

# TM158M PROTON ACER TENDL-2021 LIBRARY; T=0.K

## Principal cross sections

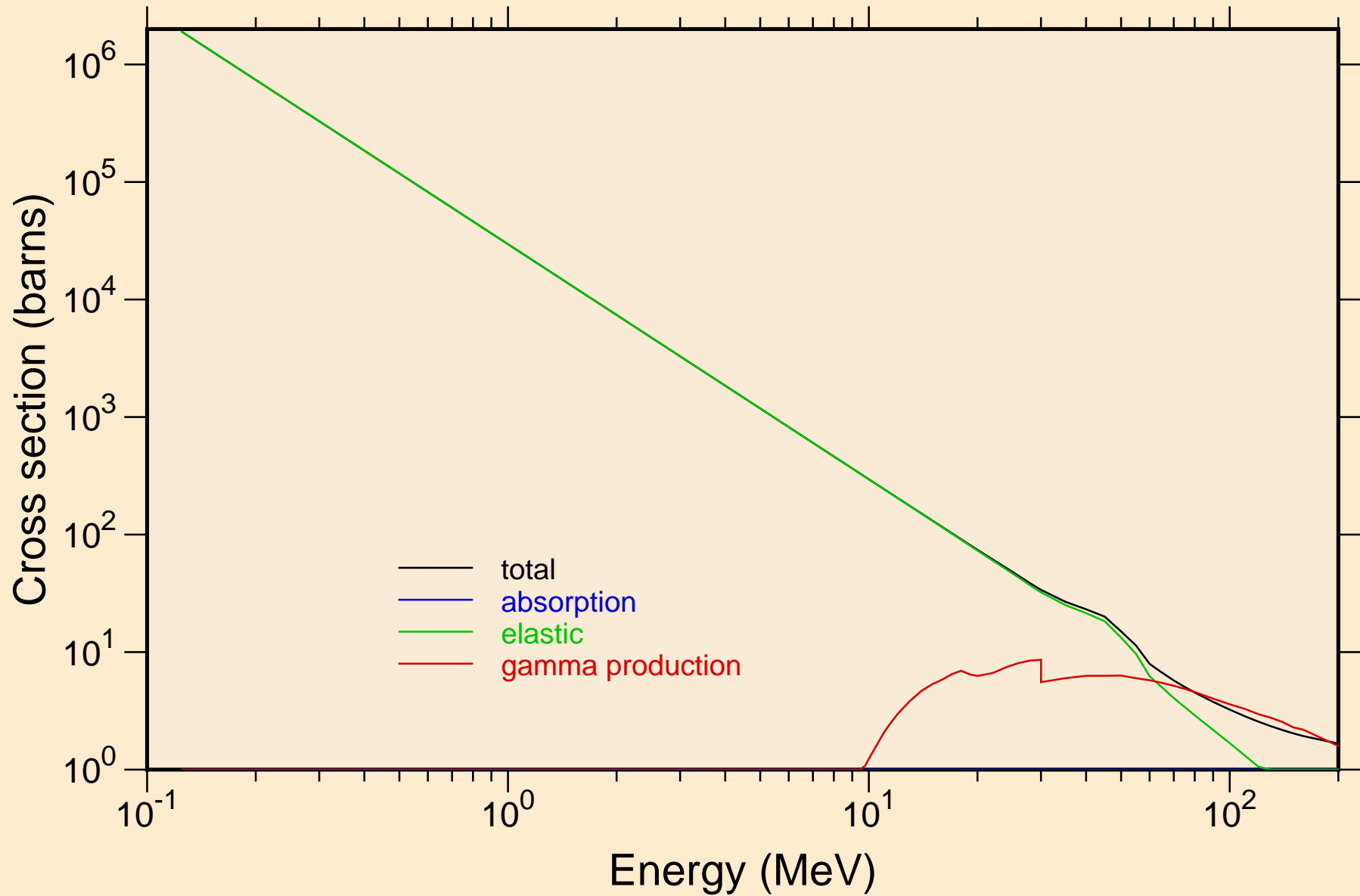

TM158M PROTON ACER TENDL-2021 LIBRARY; T=0.K  
Heating

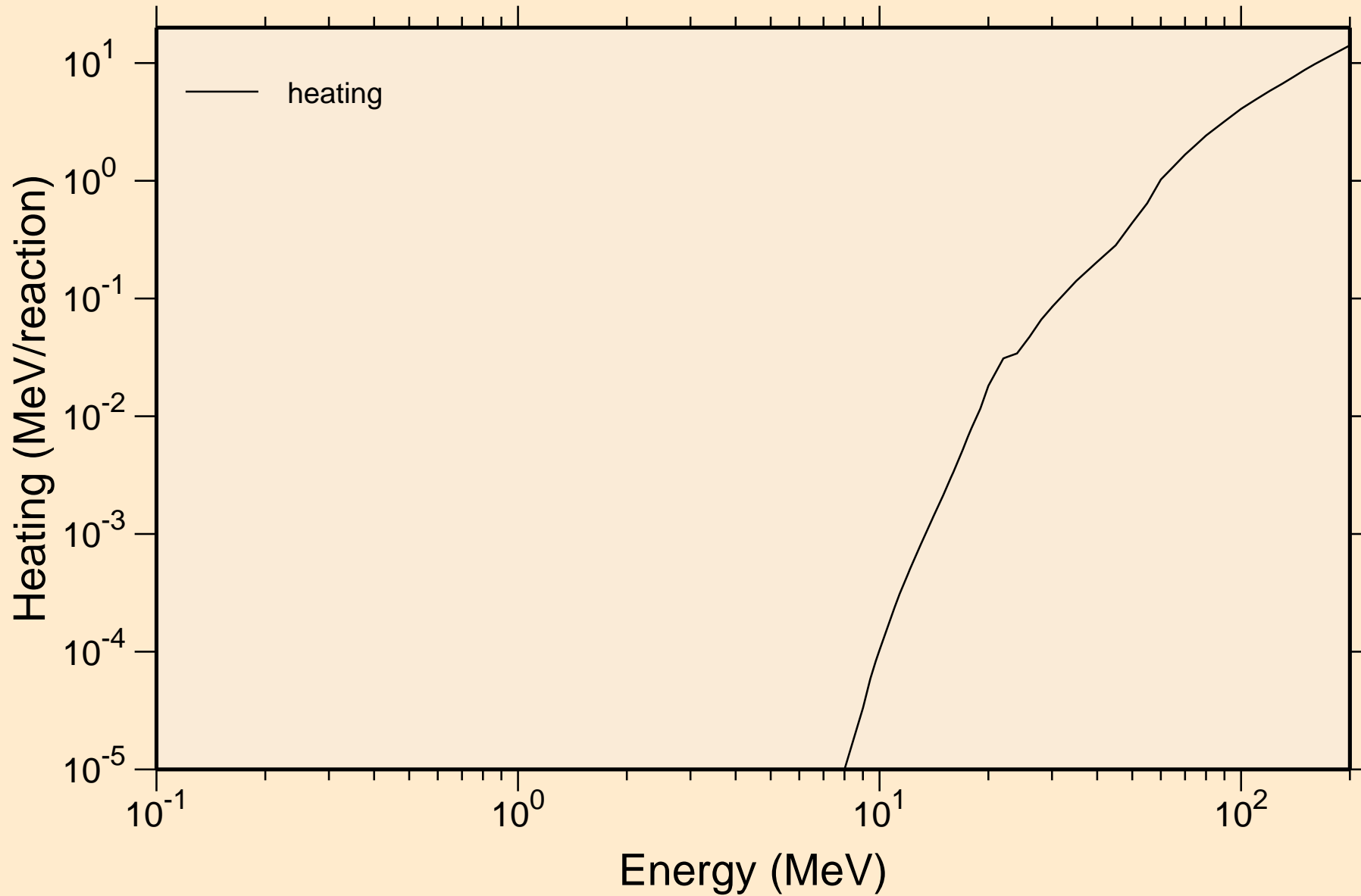

TM158M PROTON ACER TENDL-2021 LIBRARY; T=0.K  
Principal cross sections

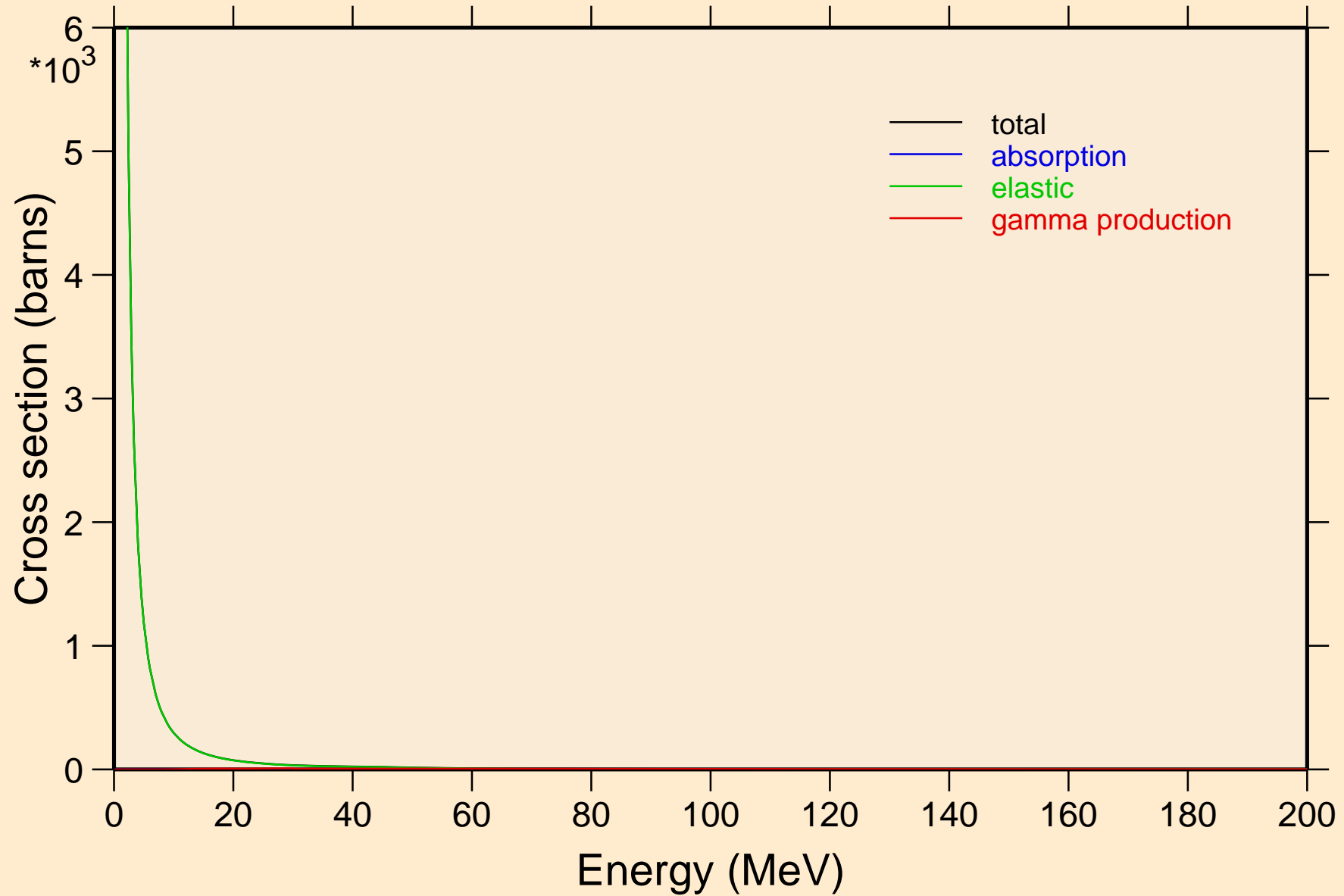

# TM158M PROTON ACER TENDL-2021 LIBRARY; T=0.K

## Heating

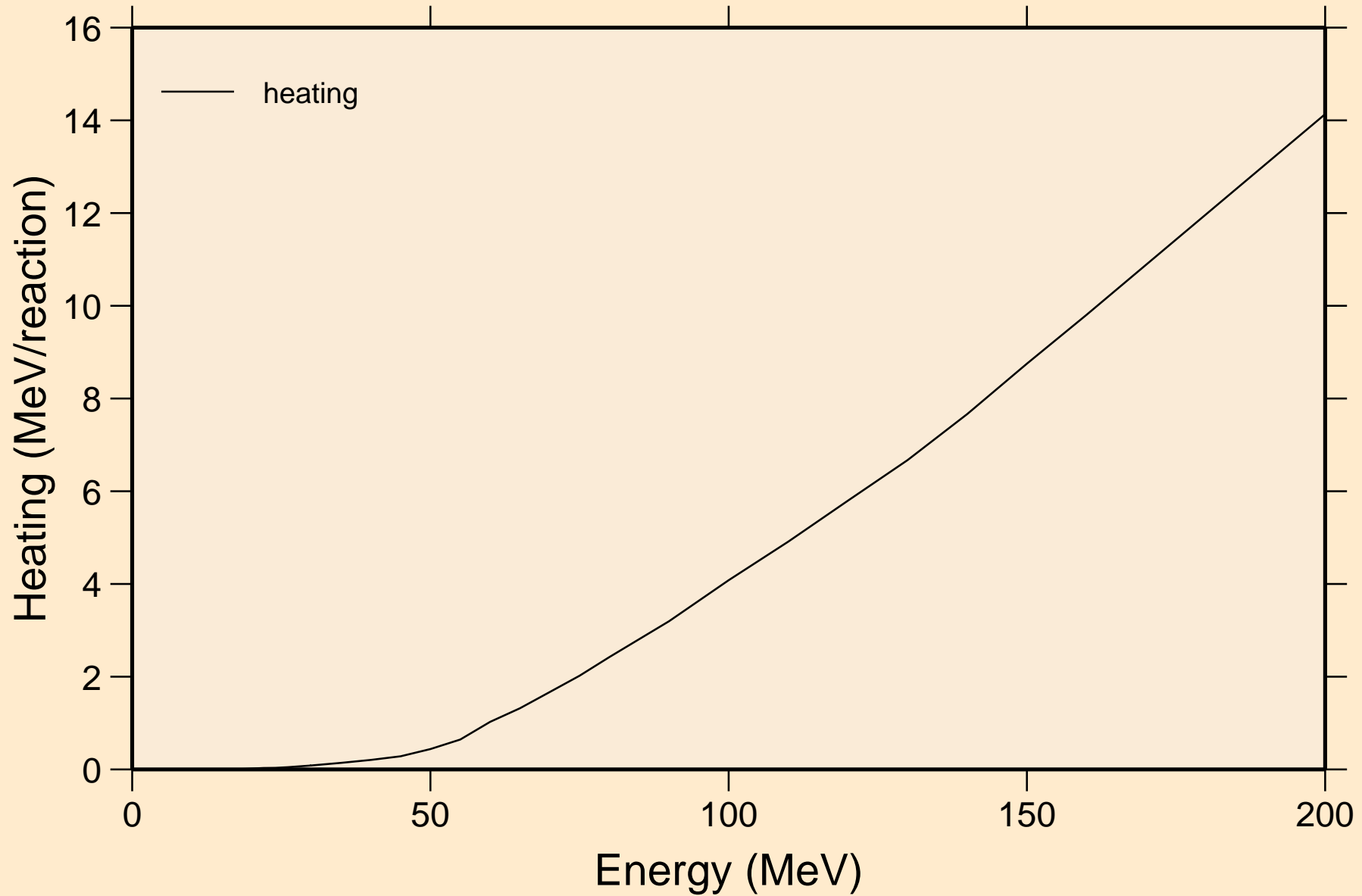

TM158M PROTON ACER TENDL-2021 LIBRARY; T=0.K  
Threshold reactions

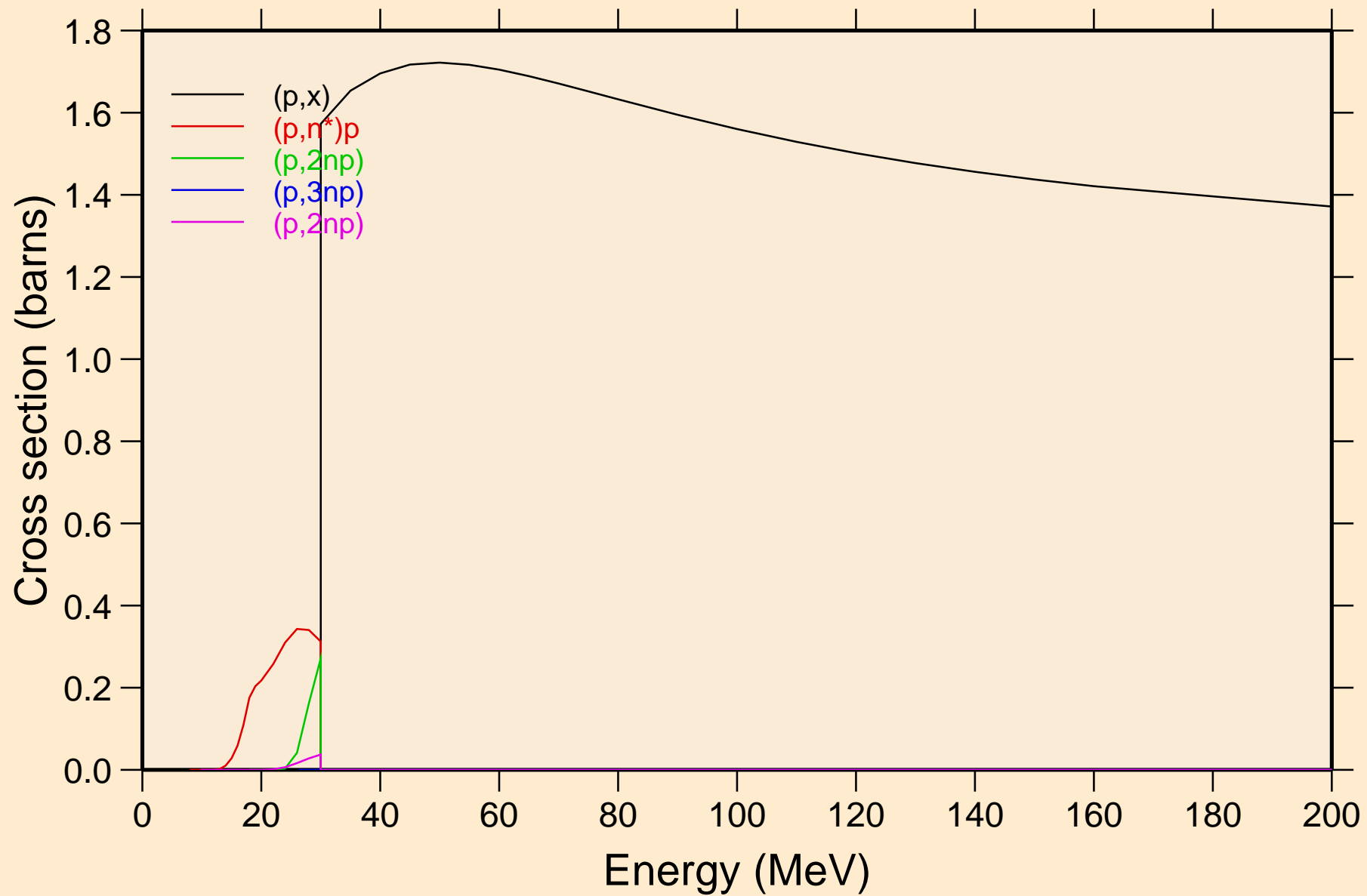

TM158M PROTON ACER TENDL-2021 LIBRARY; T=0.K  
Threshold reactions

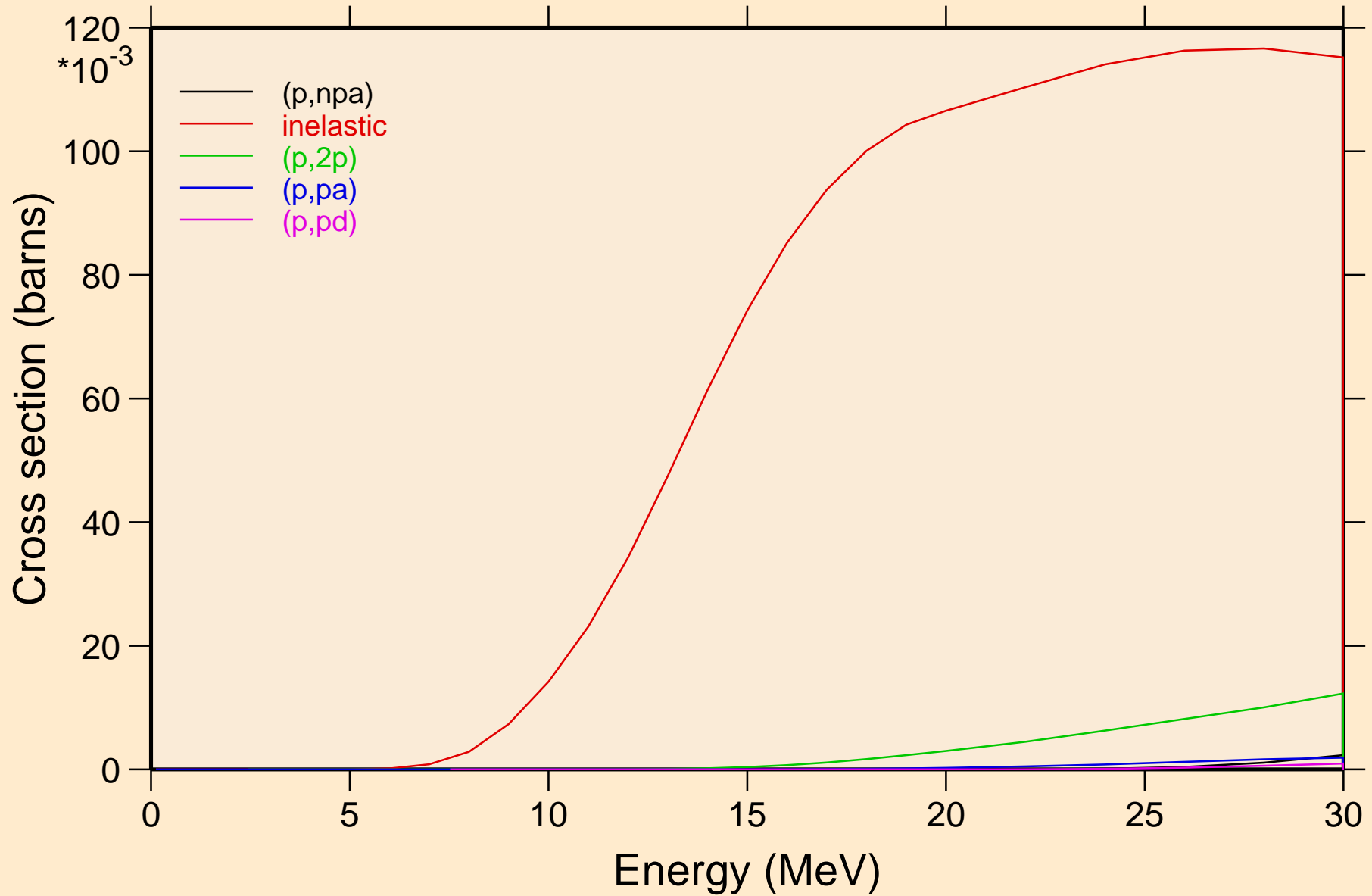

TM158M PROTON ACER TENDL-2021 LIBRARY; T=0.K  
Threshold reactions

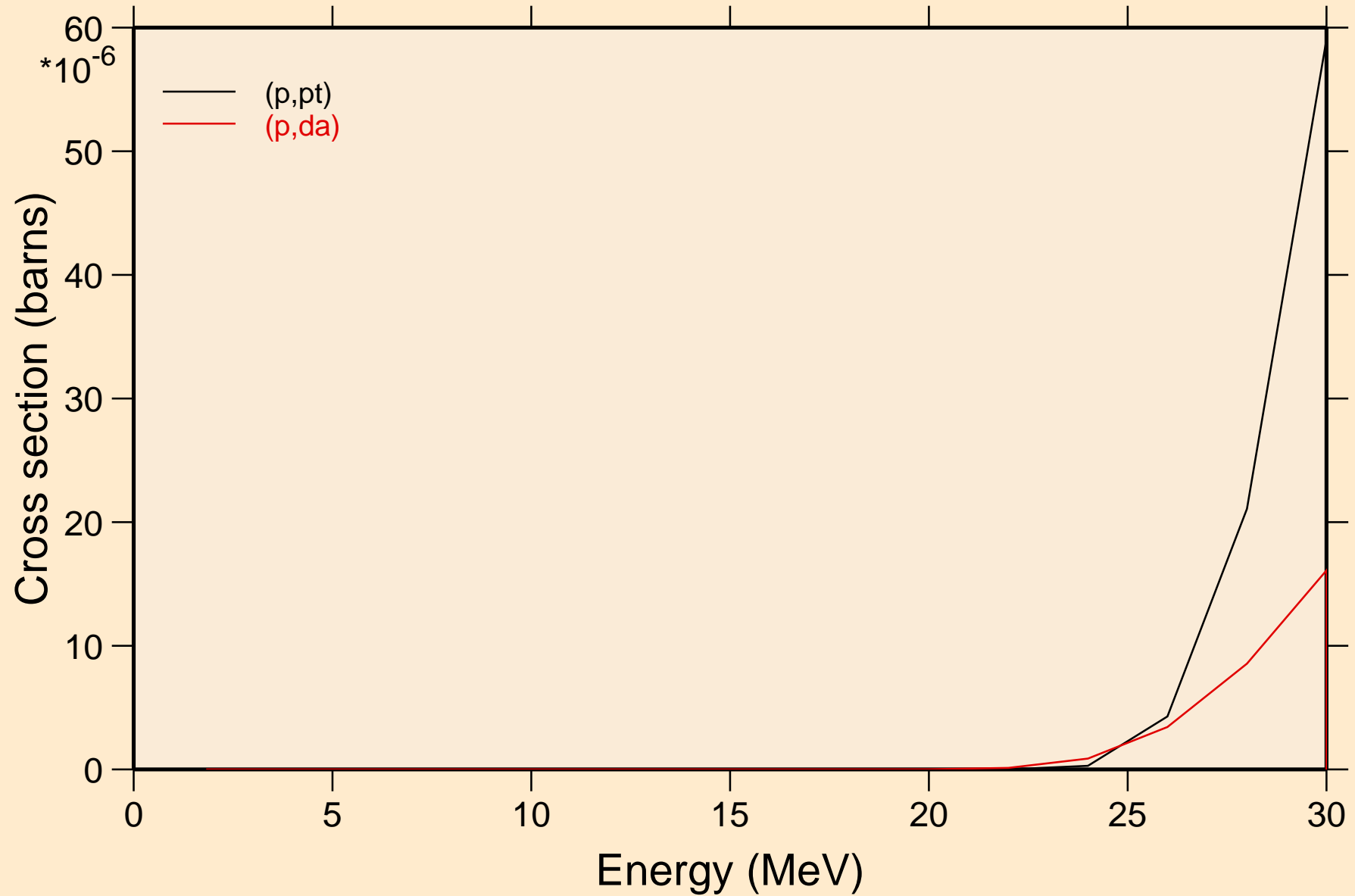

TM158M PROTON ACER TENDL-2021 LIBRARY; T=0.K  
angular distribution for elastic

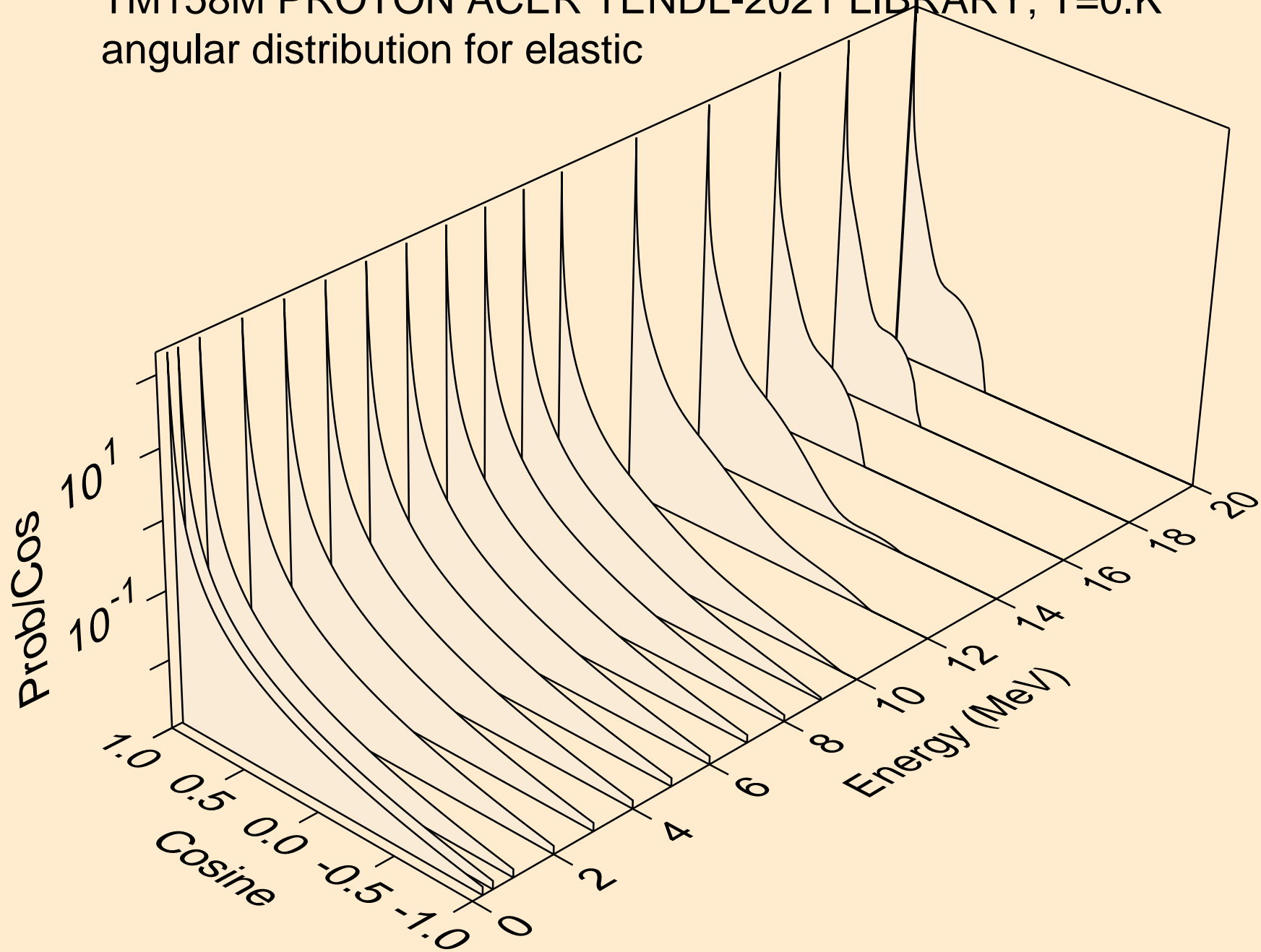



TM158M PROTON ACER TENDL-2021 LIBRARY; T=0.K  
angular distribution for elastic

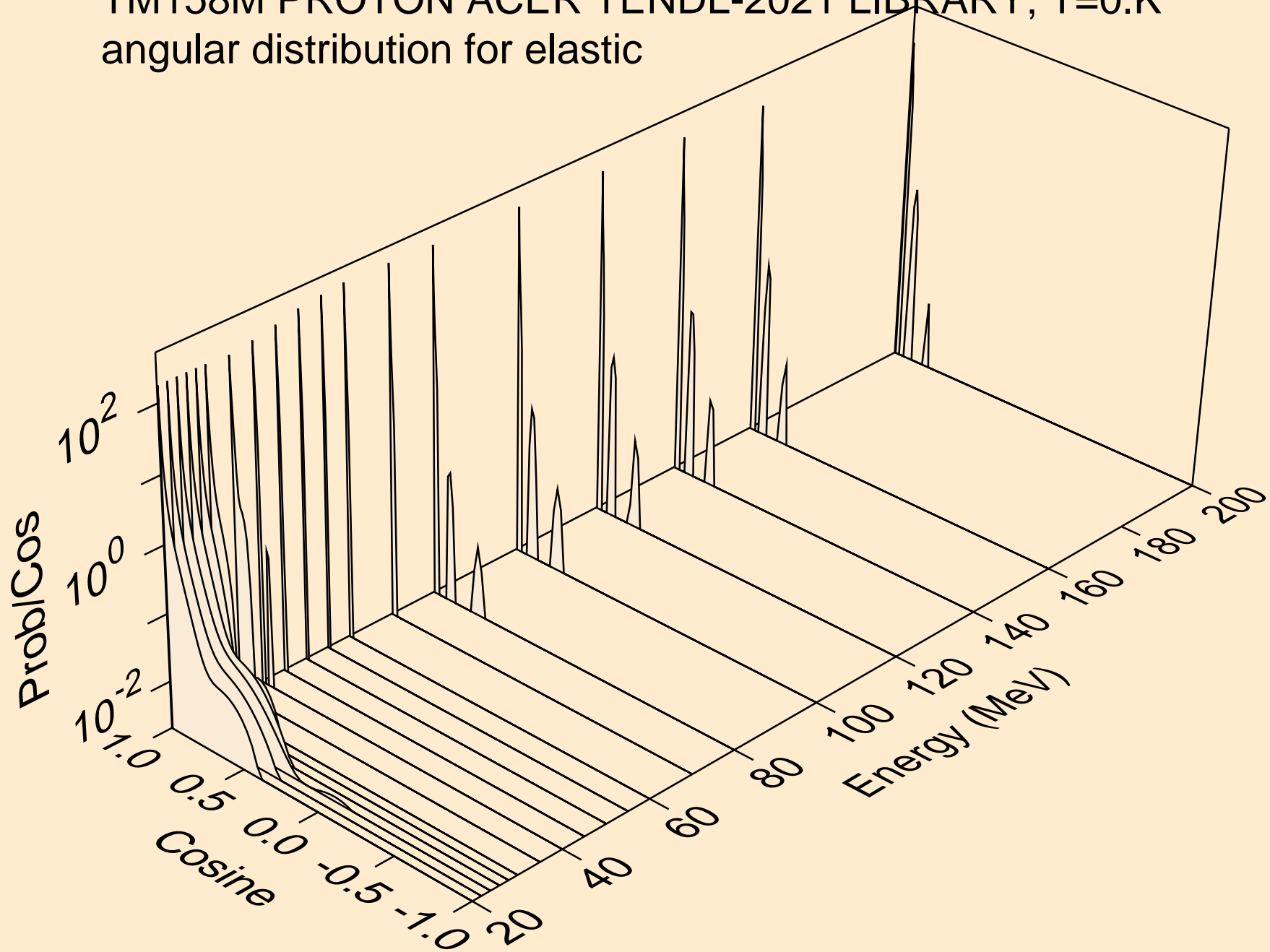

TM158M PROTON ACER TENDL-2021 LIBRARY; T=0.K  
Proton emission for (p,x)

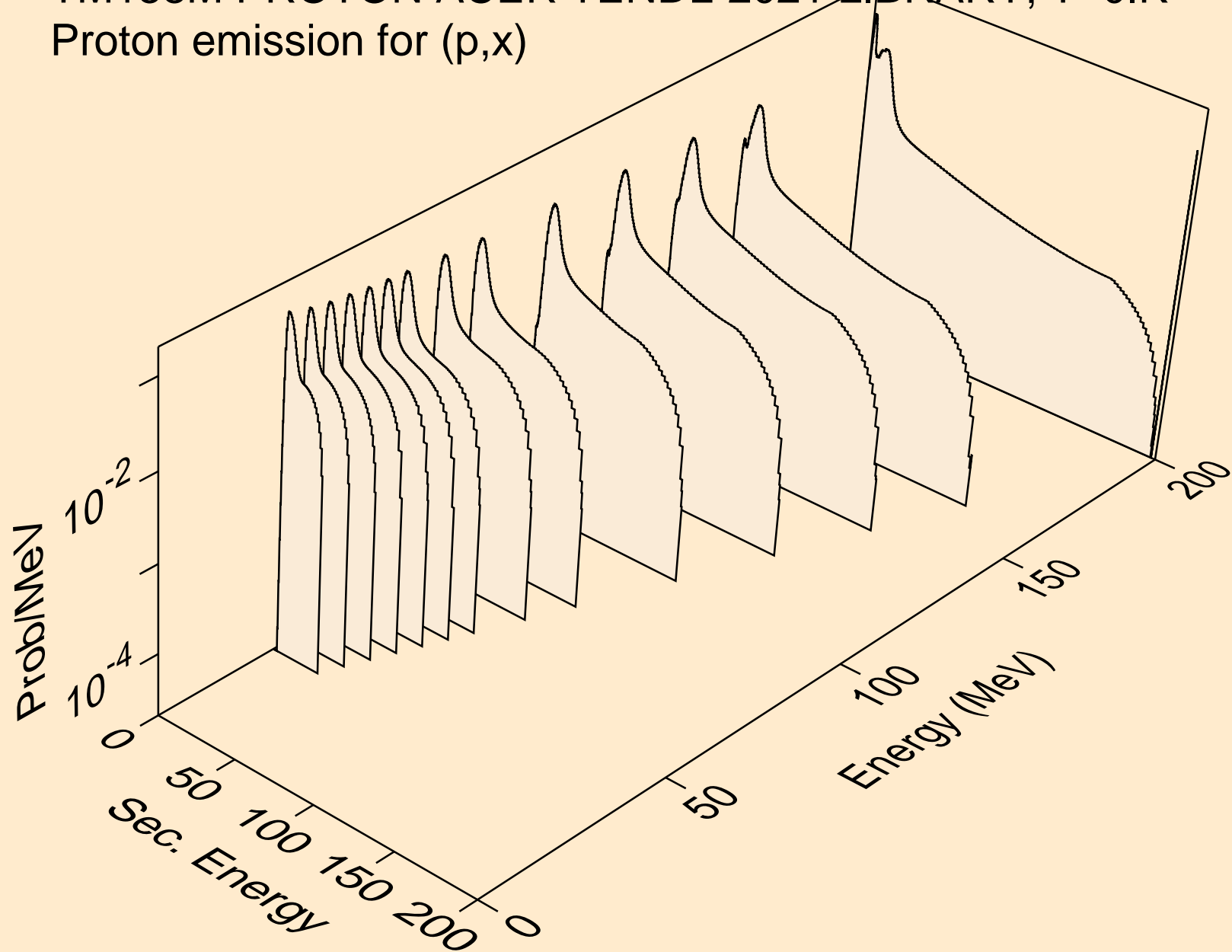

TM158M PROTON ACER TENDL-2021 LIBRARY; T=0.K  
Proton emission for (p,n\*)p

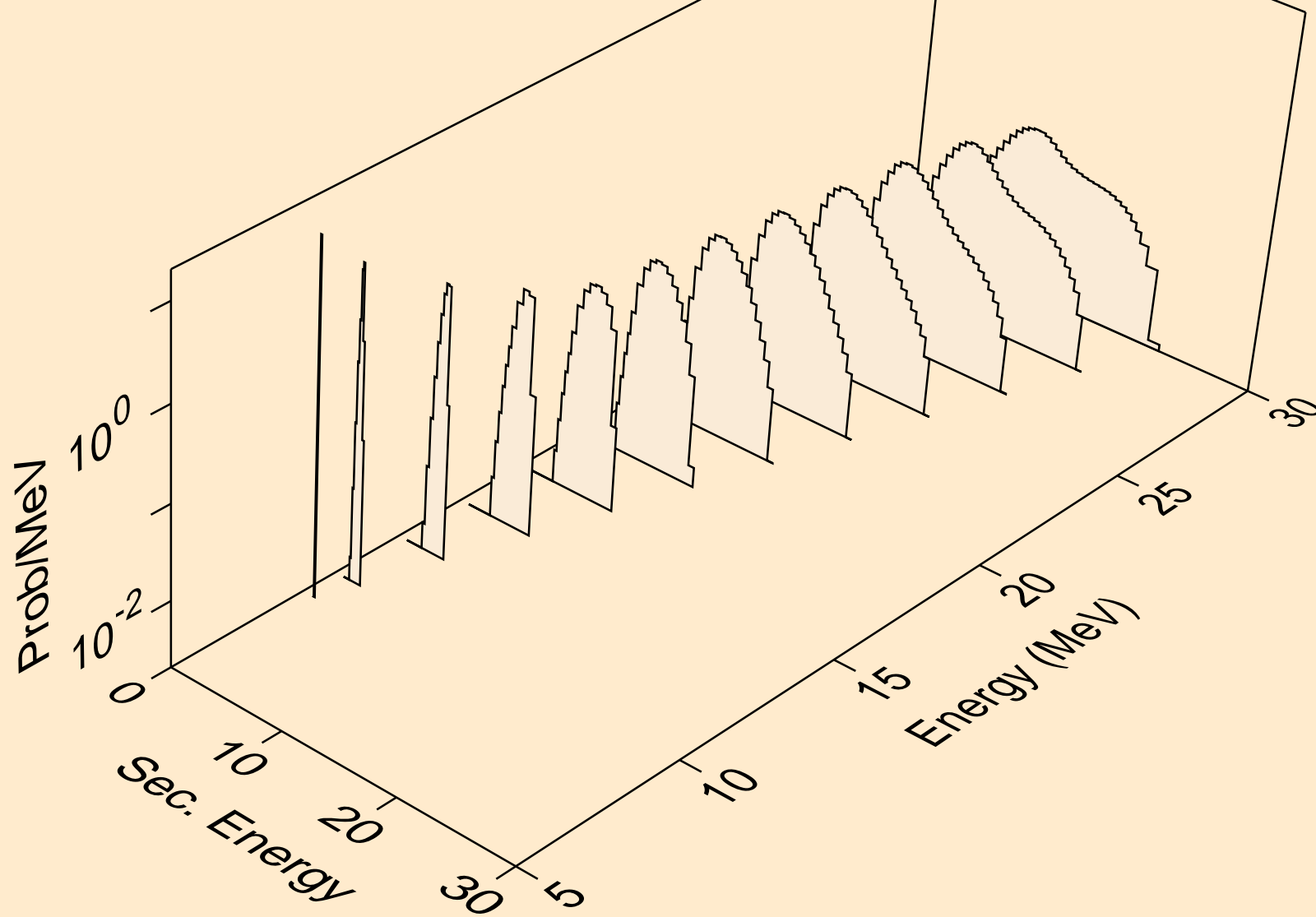

TM158M PROTON ACER TENDL-2021 LIBRARY; T=0.K  
Proton emission for (p,2np)

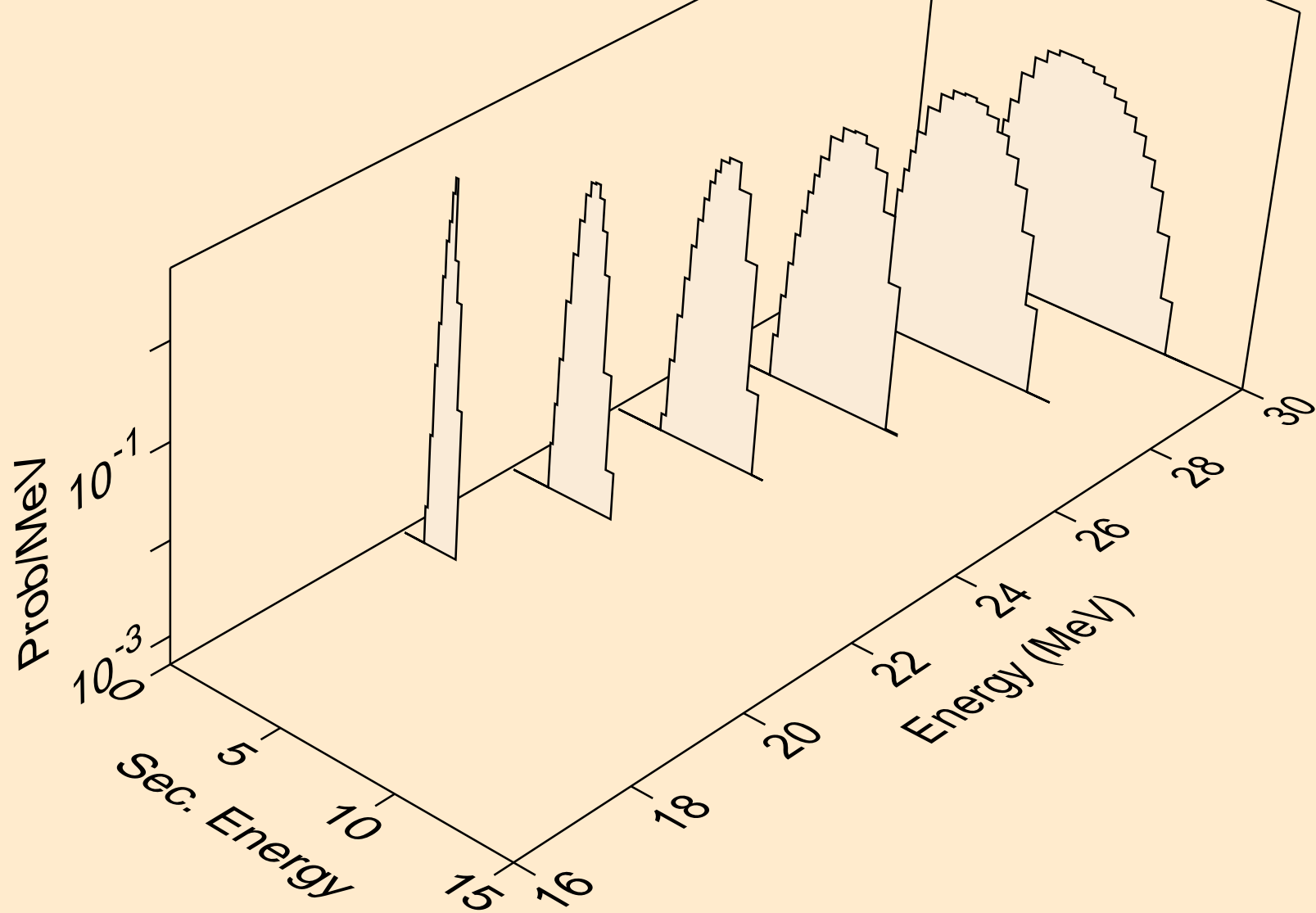

TM158M PROTON ACER TENDL-2021 LIBRARY; T=0.K  
Proton emission for (p,3np)

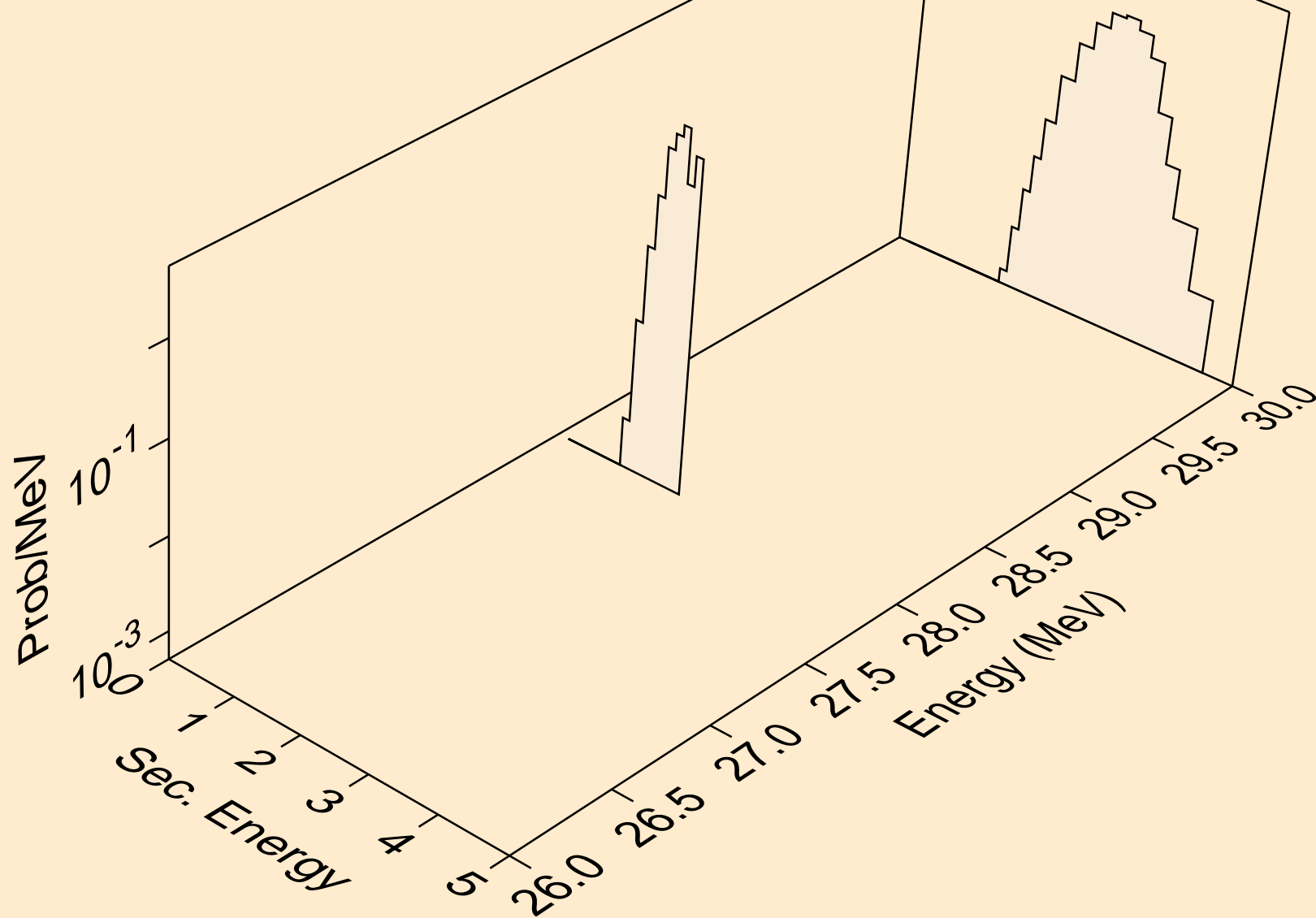

TM158M PROTON ACER TENDL-2021 LIBRARY; T=0.K  
Proton emission for (p,2np)

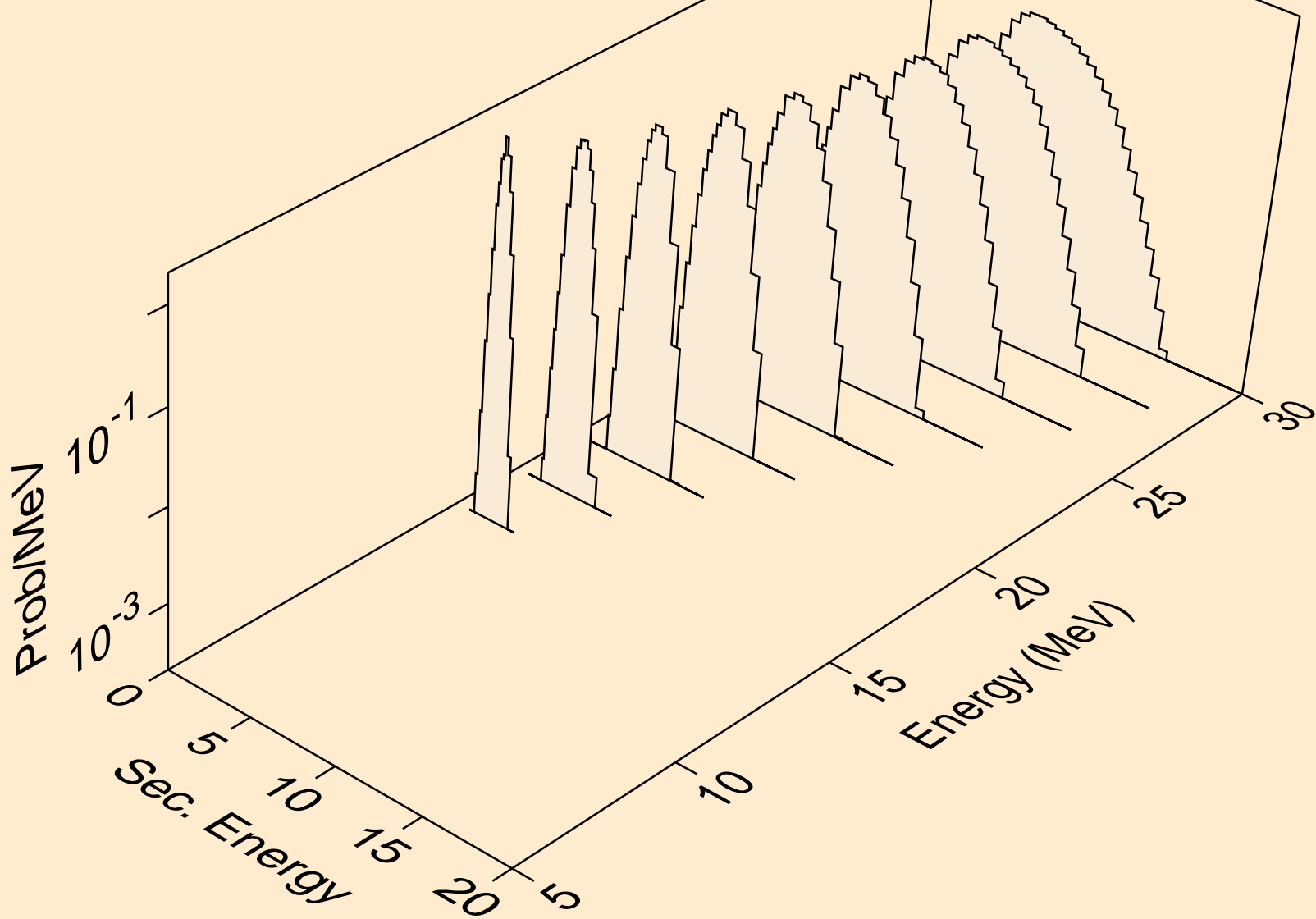

TM158M PROTON ACER TENDL-2021 LIBRARY; T=0.K  
Proton emission for (p,npa)

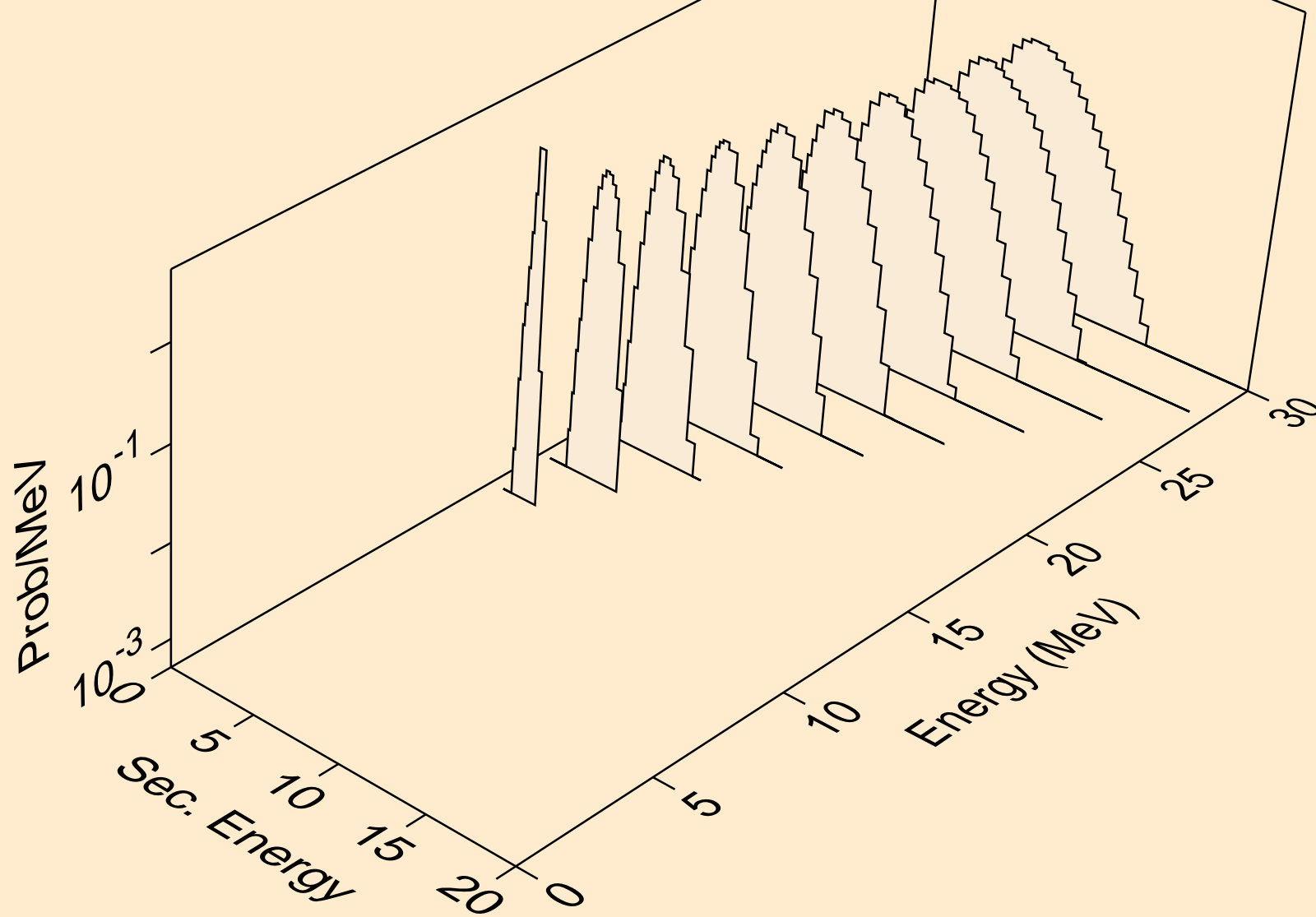

TM158M PROTON ACER TENDL-2021 LIBRARY; T=0.K  
Proton emission for inelastic

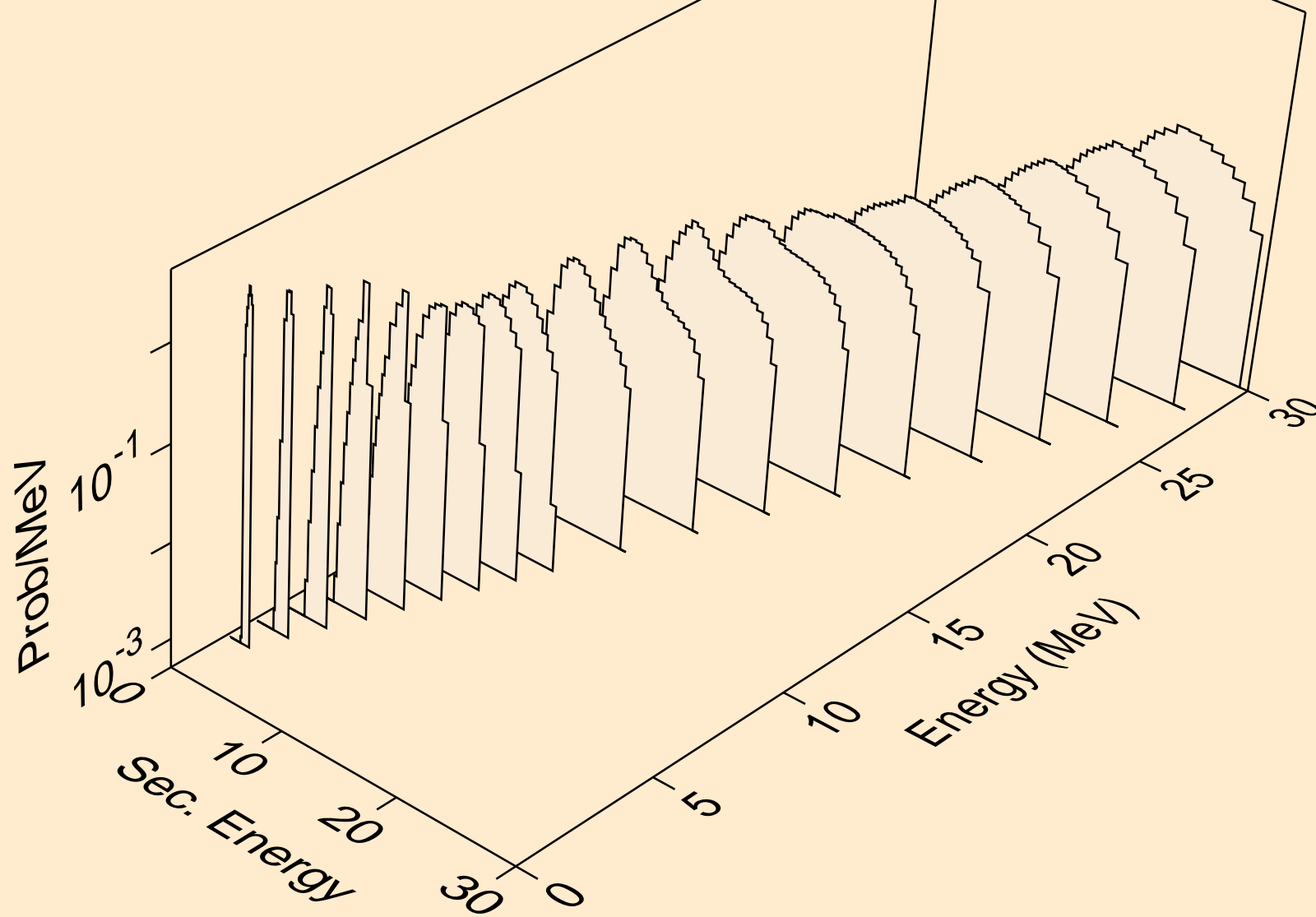



TM158M PROTON ACER TENDL-2021 LIBRARY; T=0.K  
Proton emission for (p,2p)

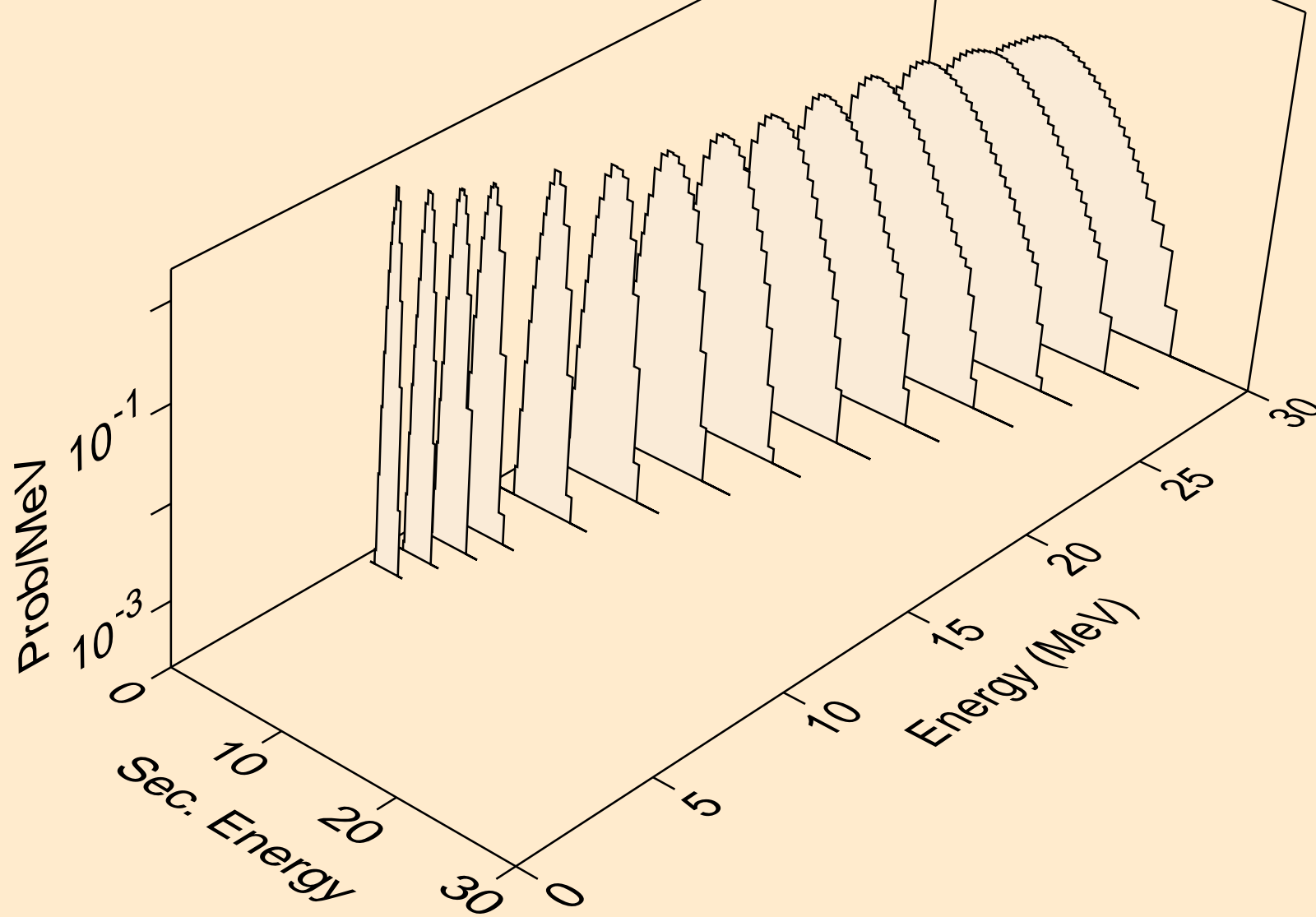

TM158M PROTON ACER TENDL-2021 LIBRARY; T=0.K  
Proton emission for (p,pa)

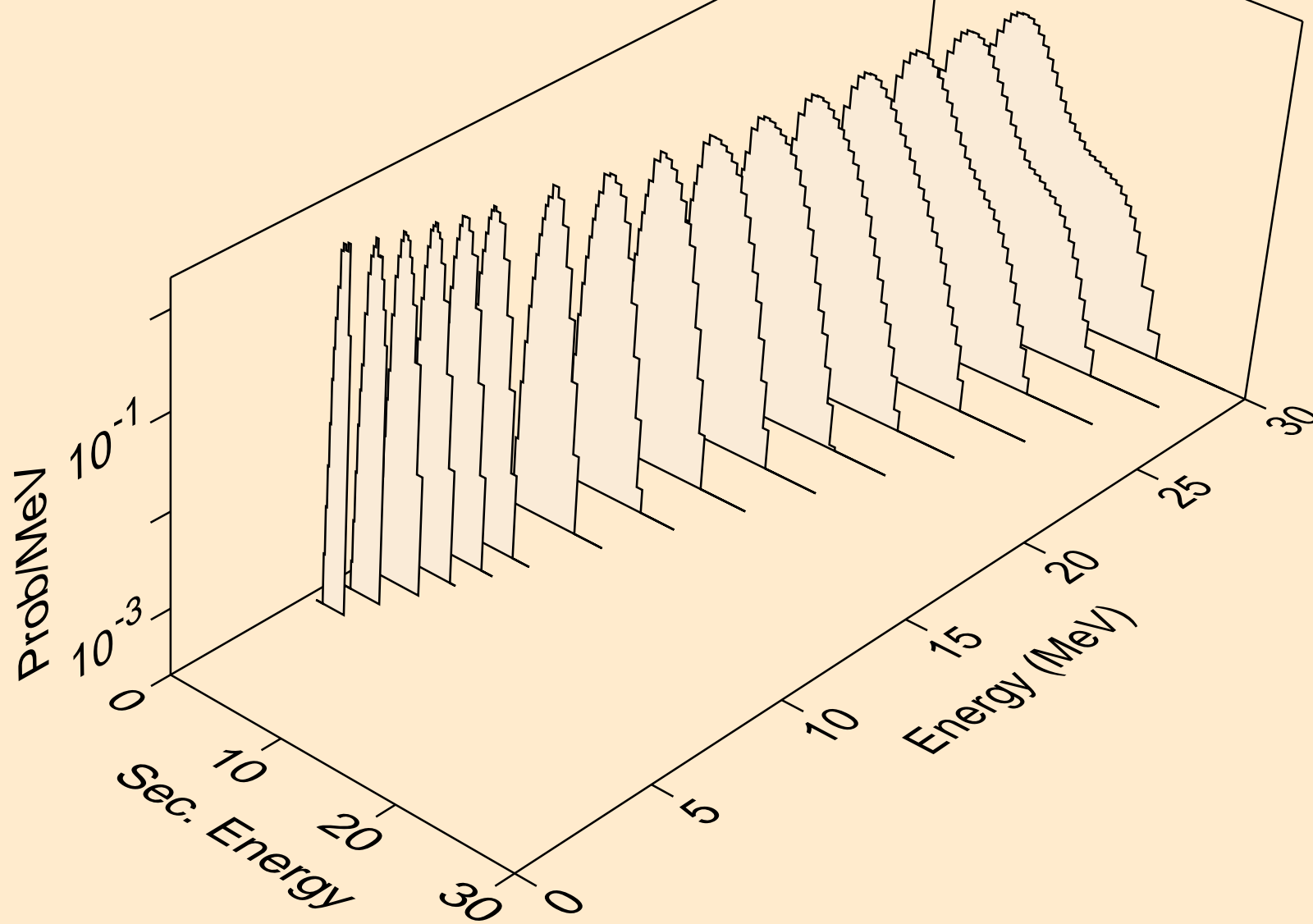

TM158M PROTON ACER TENDL-2021 LIBRARY; T=0.K  
Proton emission for (p,pd)

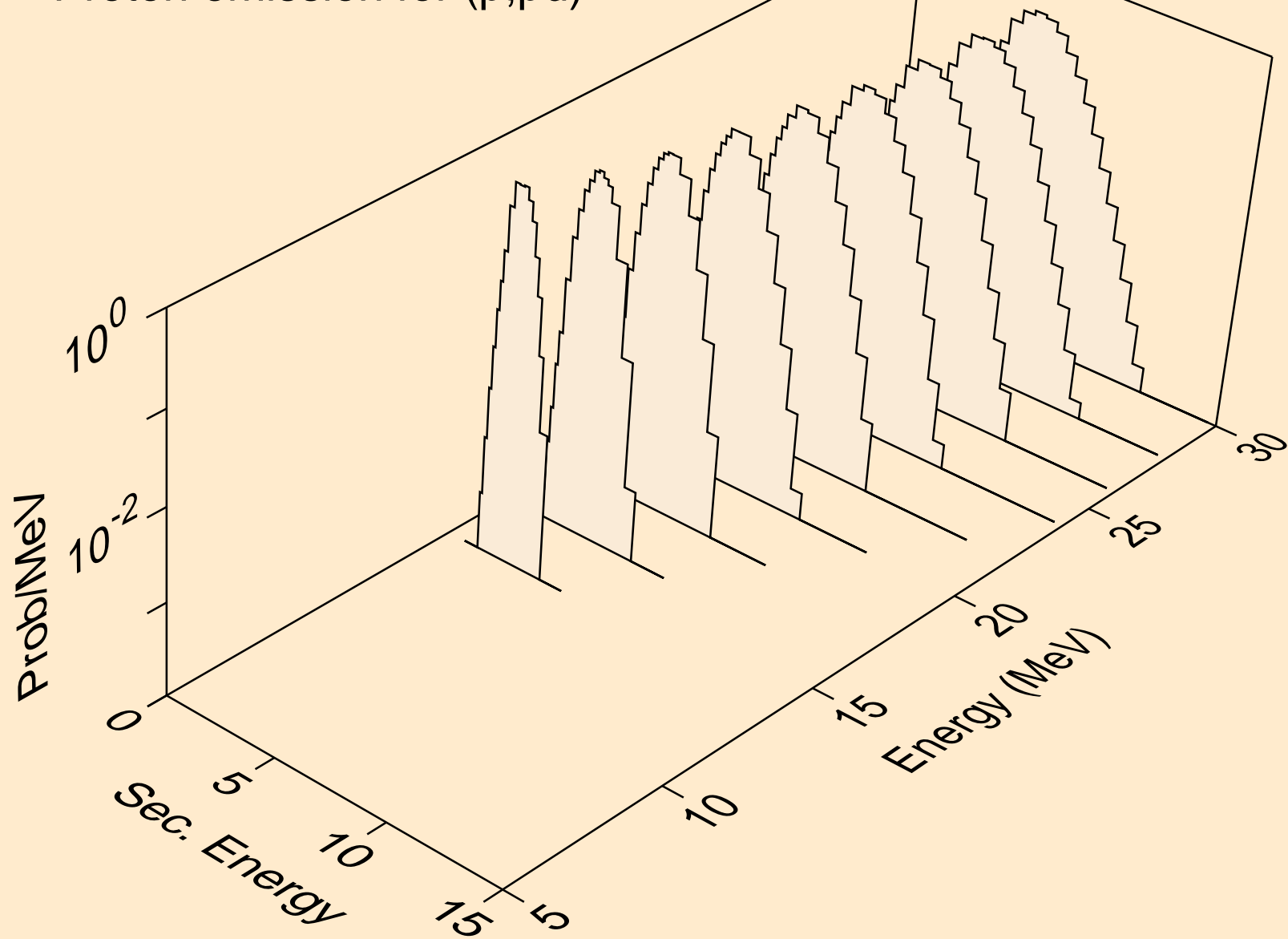

TM158M PROTON ACER TENDL-2021 LIBRARY; T=0.K  
Proton emission for (p,pt)

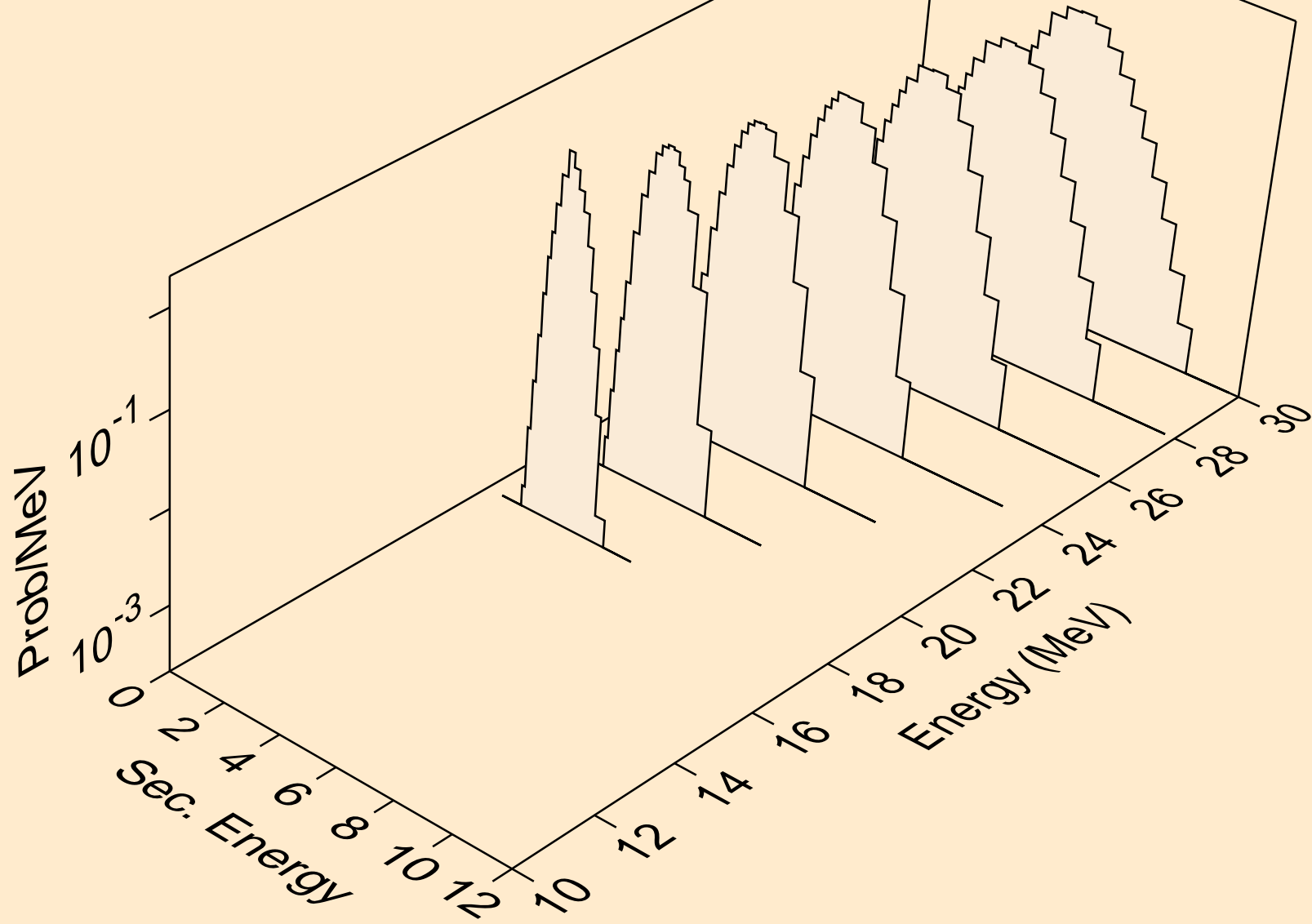

TM158M PROTON ACER TENDL-2021 LIBRARY; T=0.K  
Photon emission for (z,n)

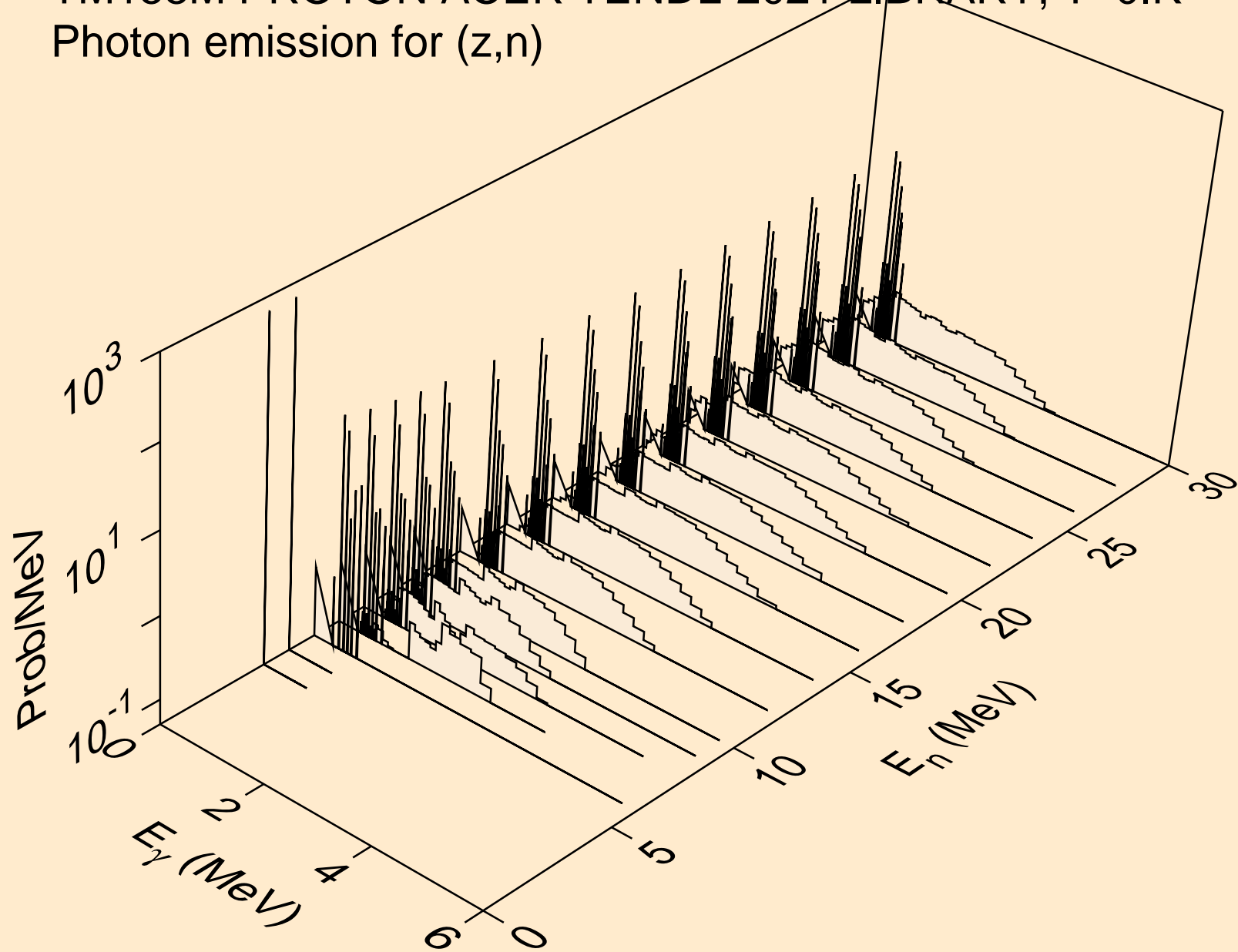

TM158M PROTON ACER TENDL-2021 LIBRARY; T=0.K  
Photon emission for (n,x)

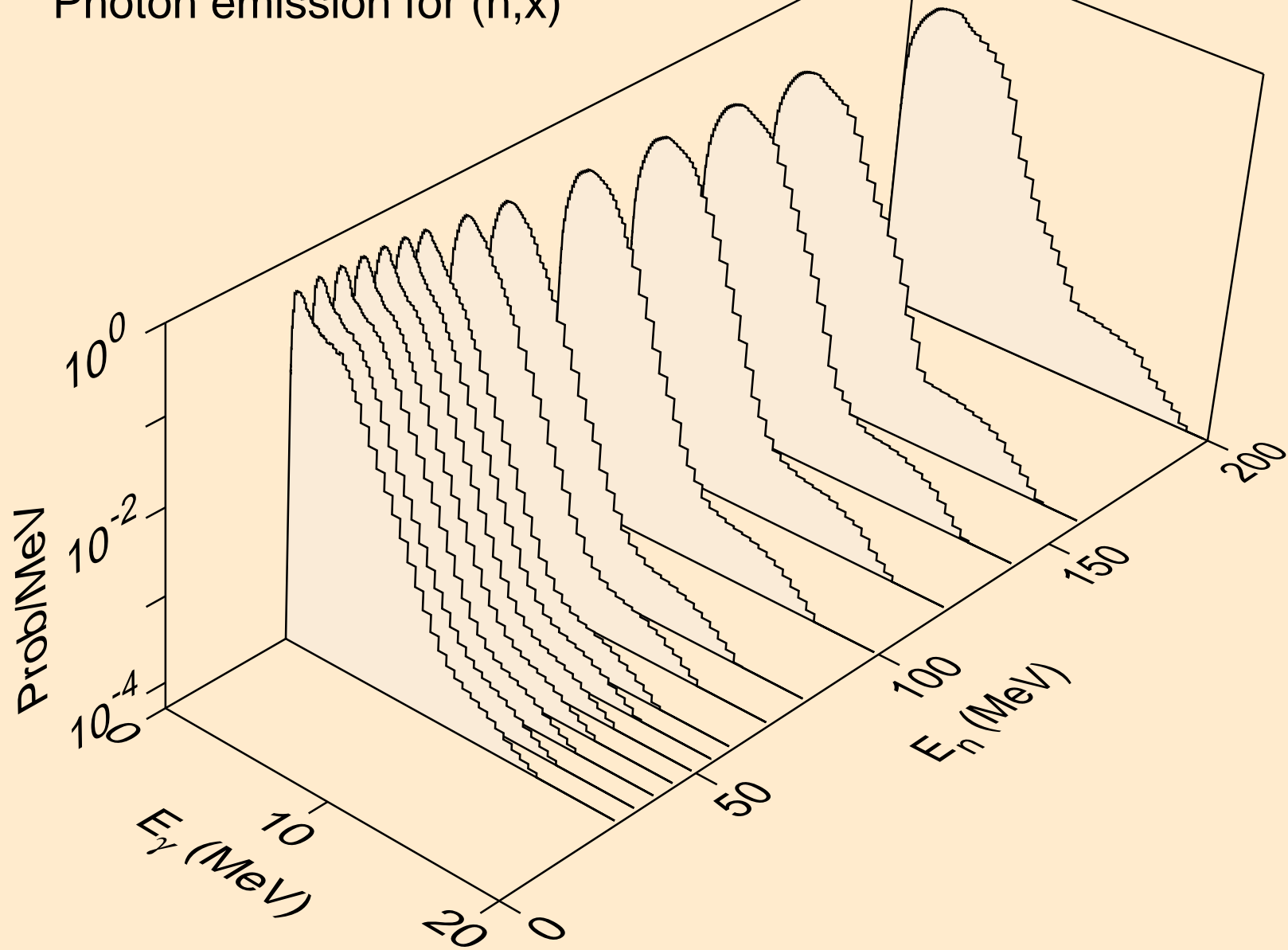

TM158M PROTON ACER TENDL-2021 LIBRARY; T=0.K  
Photon emission for (n,2nd)

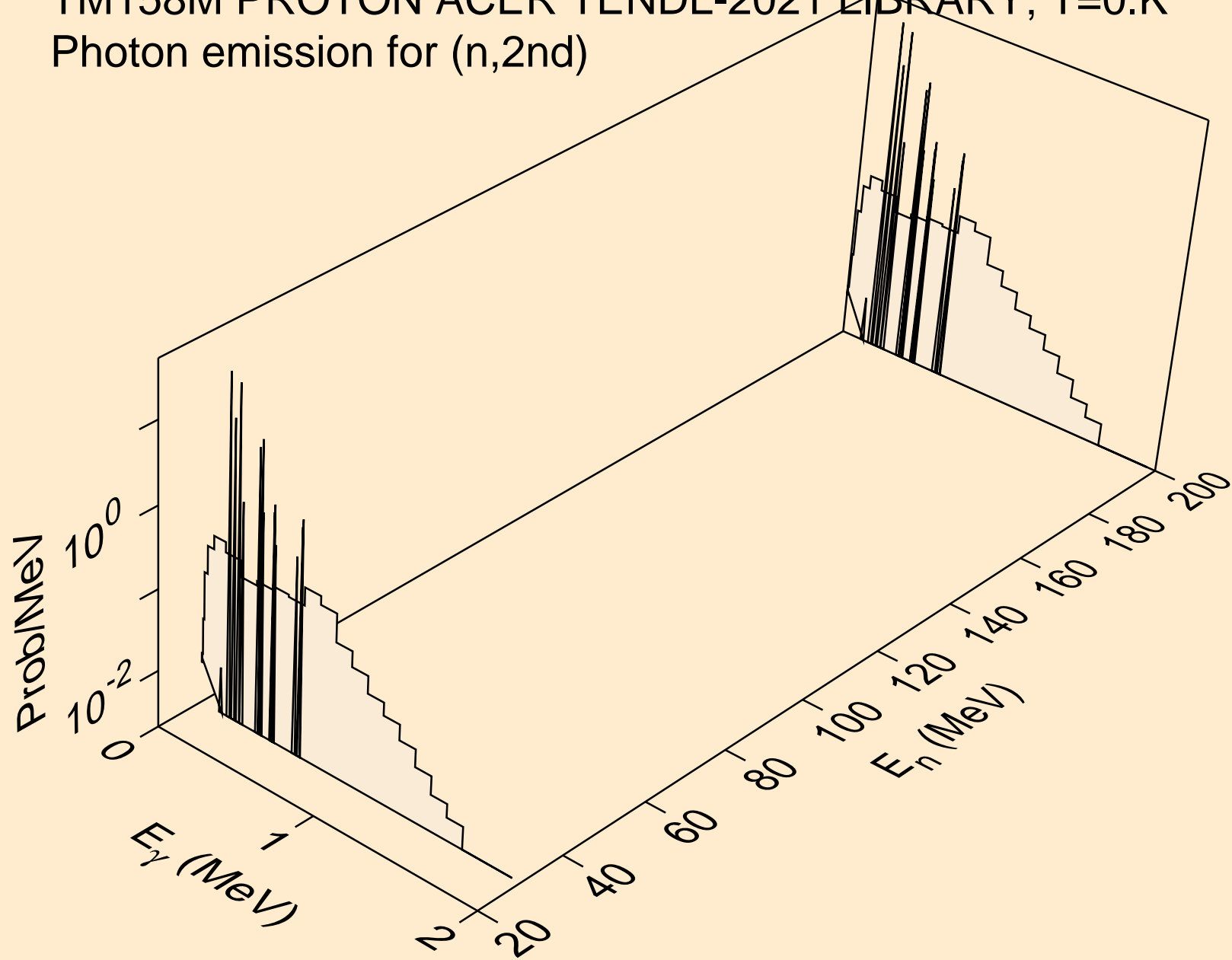

TM158M PROTON ACER TENDL-2021 LIBRARY; T=0.K  
Photon emission for (n,2n)

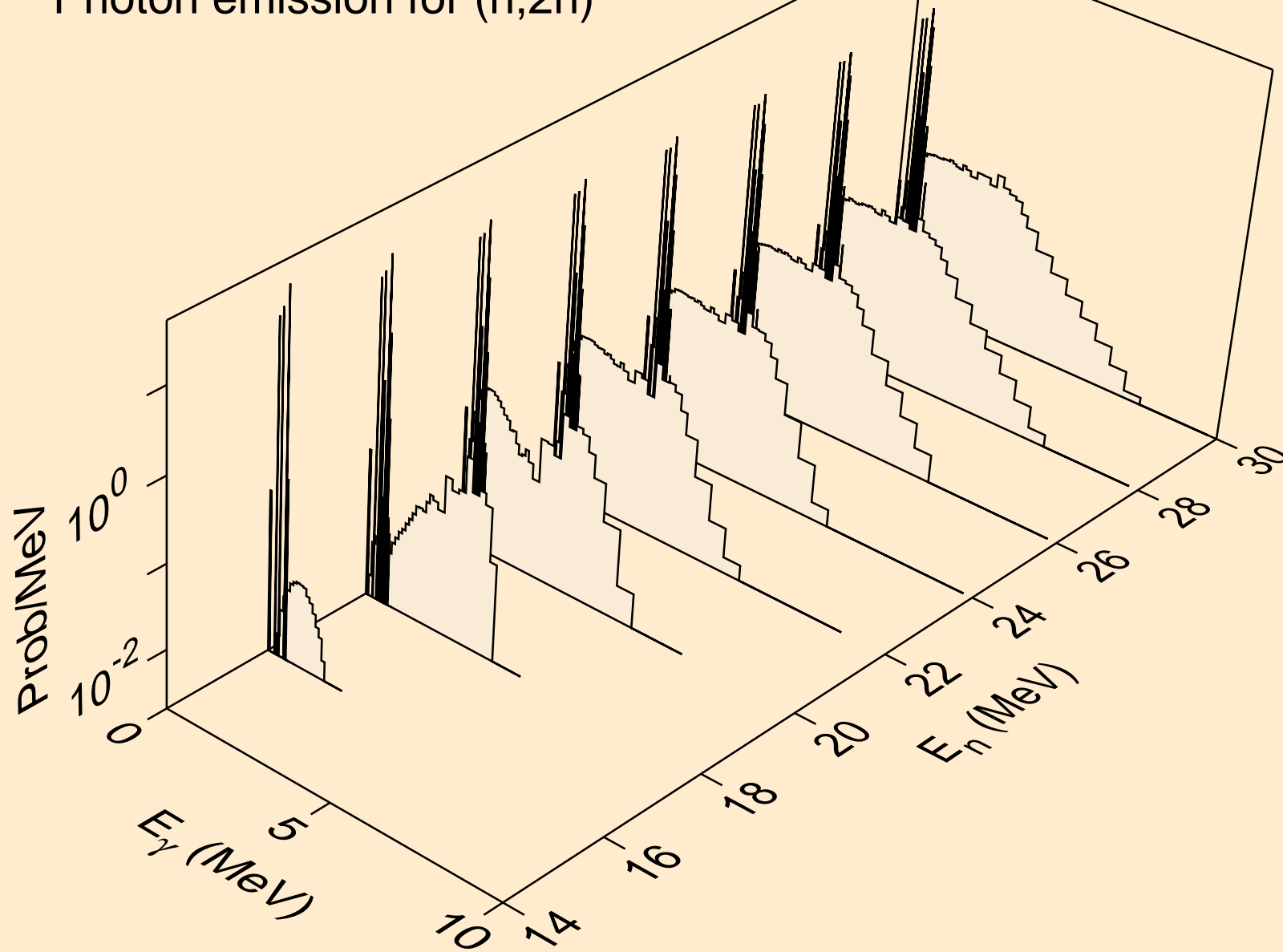



TM158M PROTON ACER TENDL-2021 LIBRARY; T=0.K  
Photon emission for (n,3n)

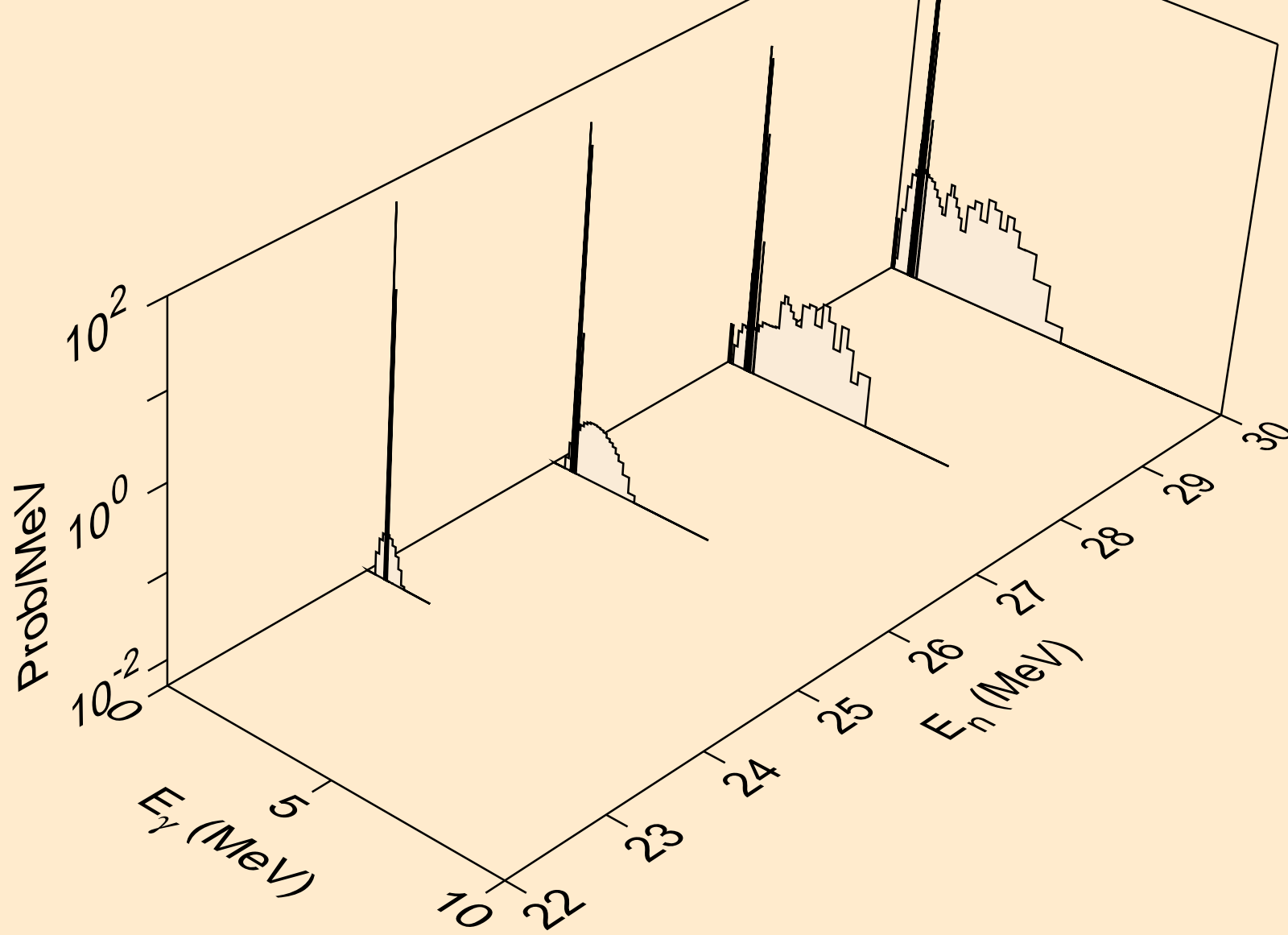

TM158M PROTON ACER TENDL-2021 LIBRARY; T=0.K  
Photon emission for (n,n\*)a

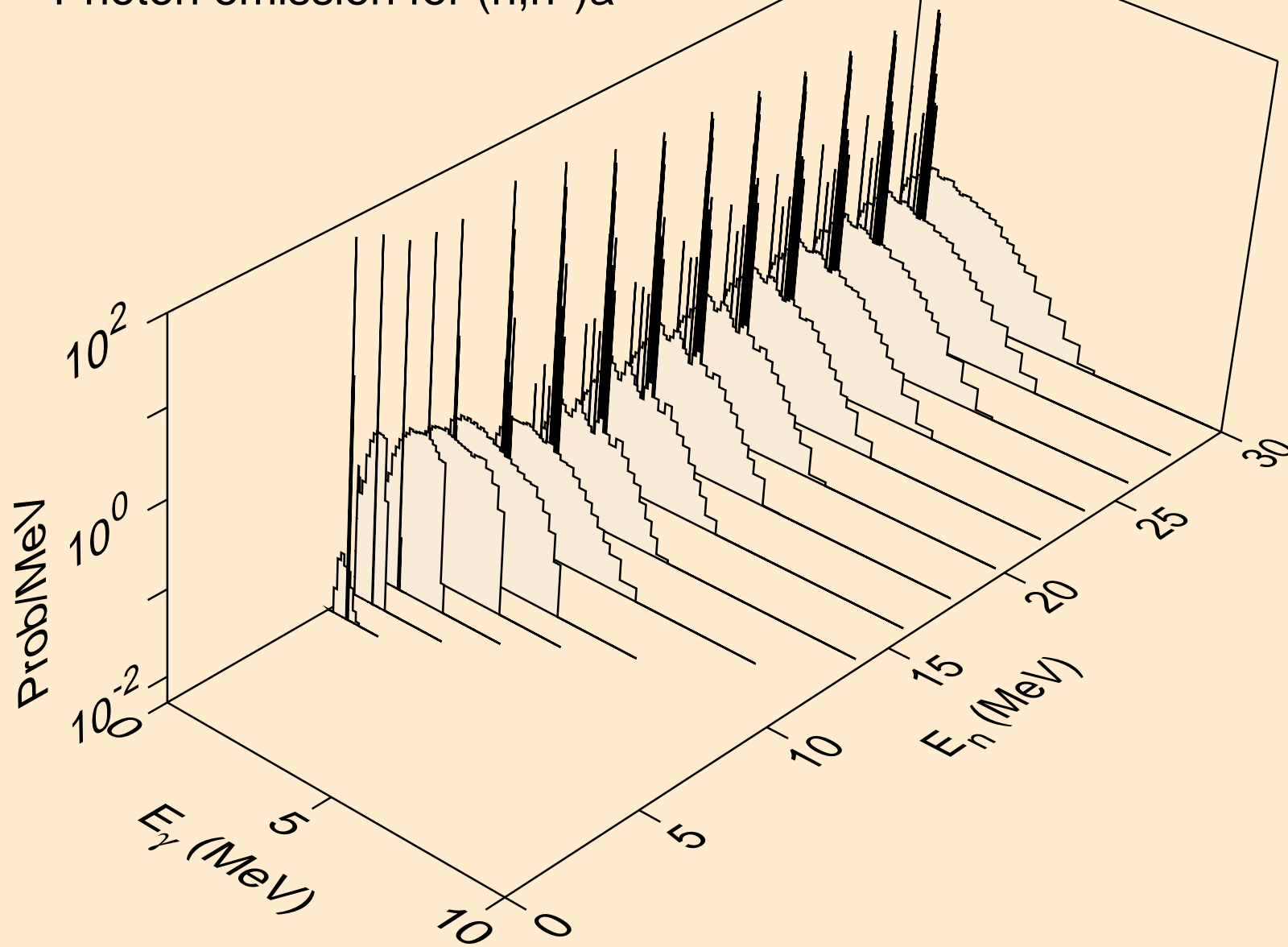

TM158M PROTON ACER TENDL-2021 LIBRARY; T=0.K  
Photon emission for (n,n\*)3a

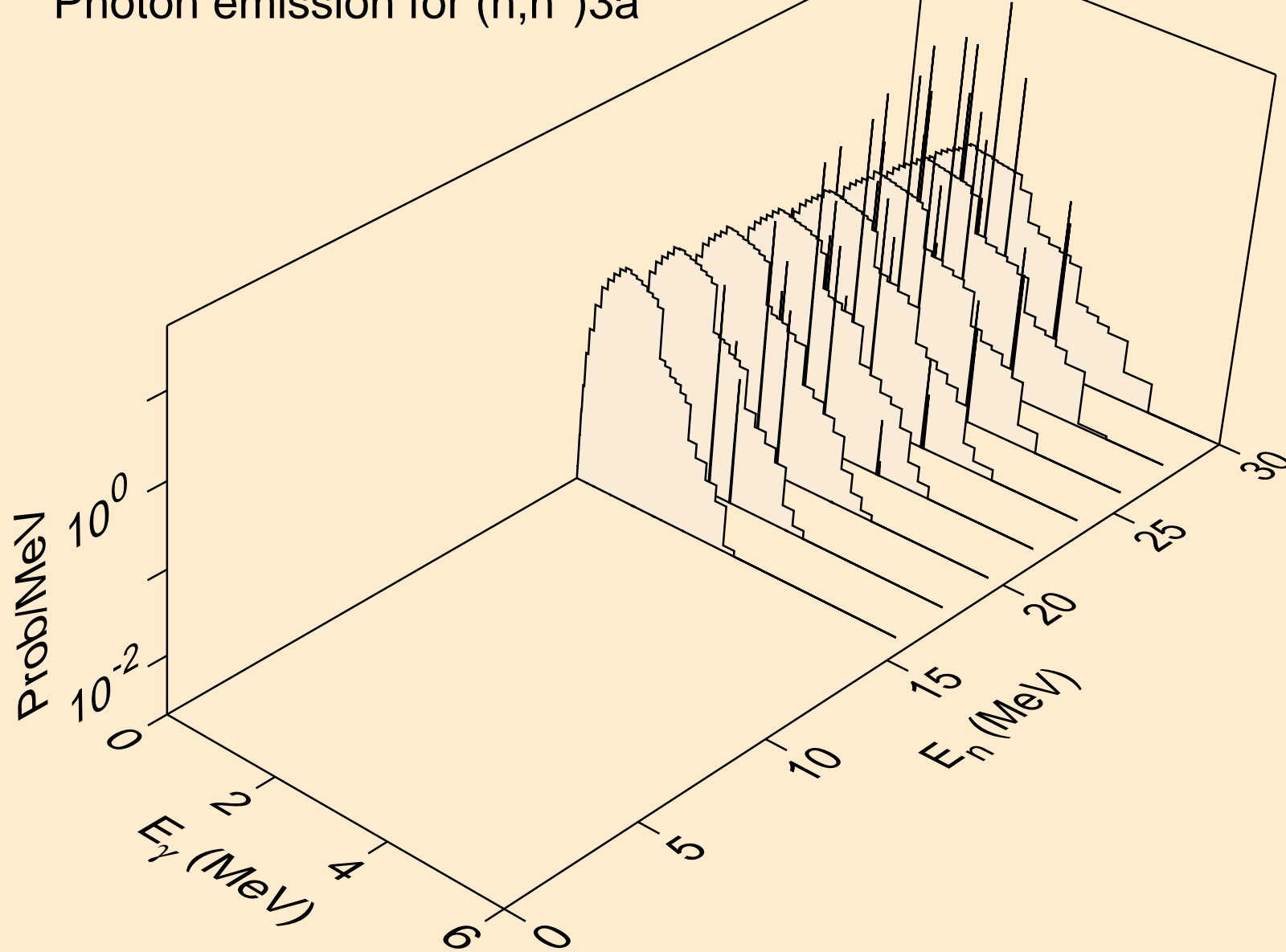

TM158M PROTON ACER TENDL-2021 LIBRARY; T=0.K  
Photon emission for (n,2n)a

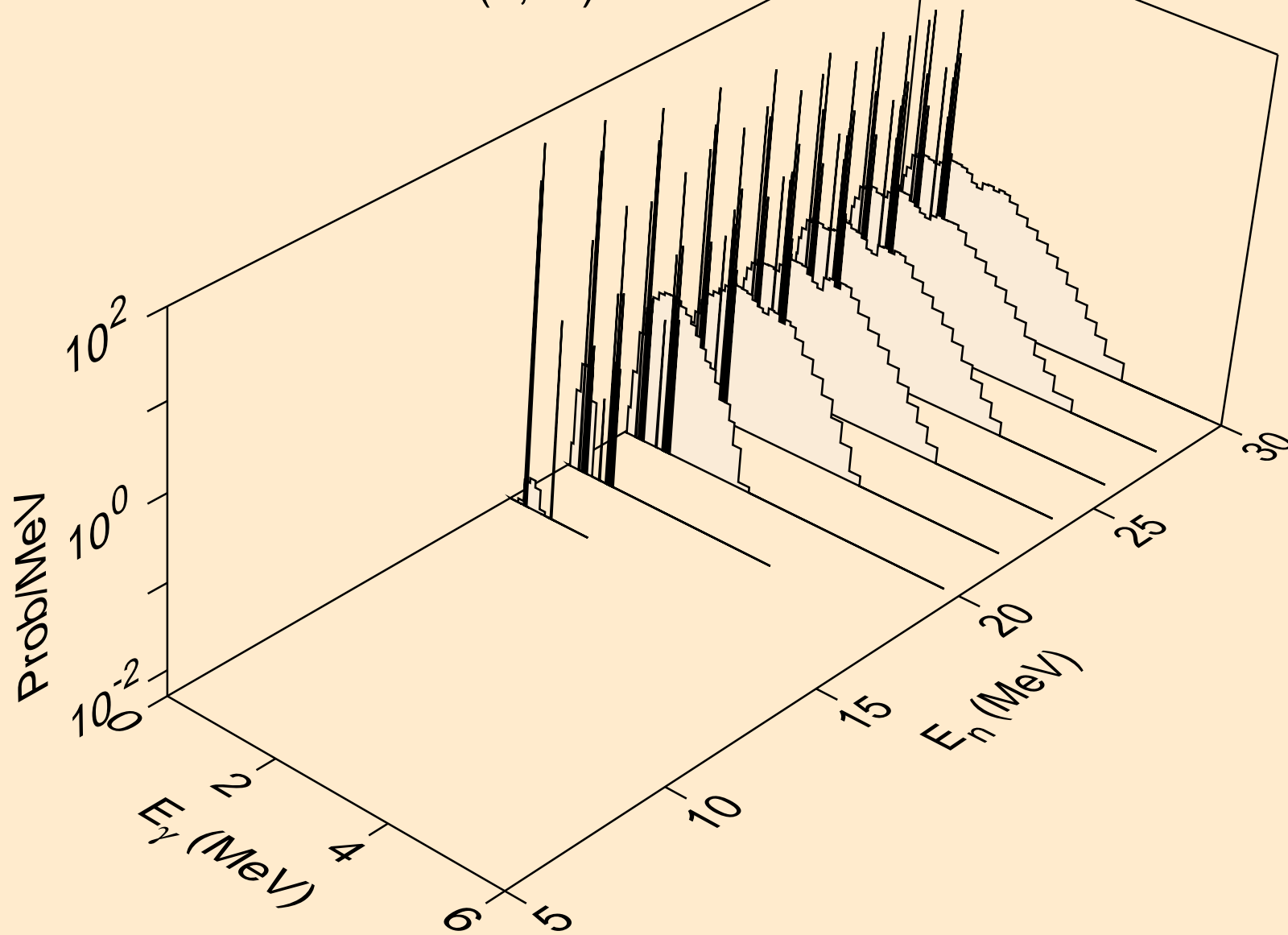

TM158M PROTON ACER TENDL-2021 LIBRARY; T=0.K  
Photon emission for (n,3n)a

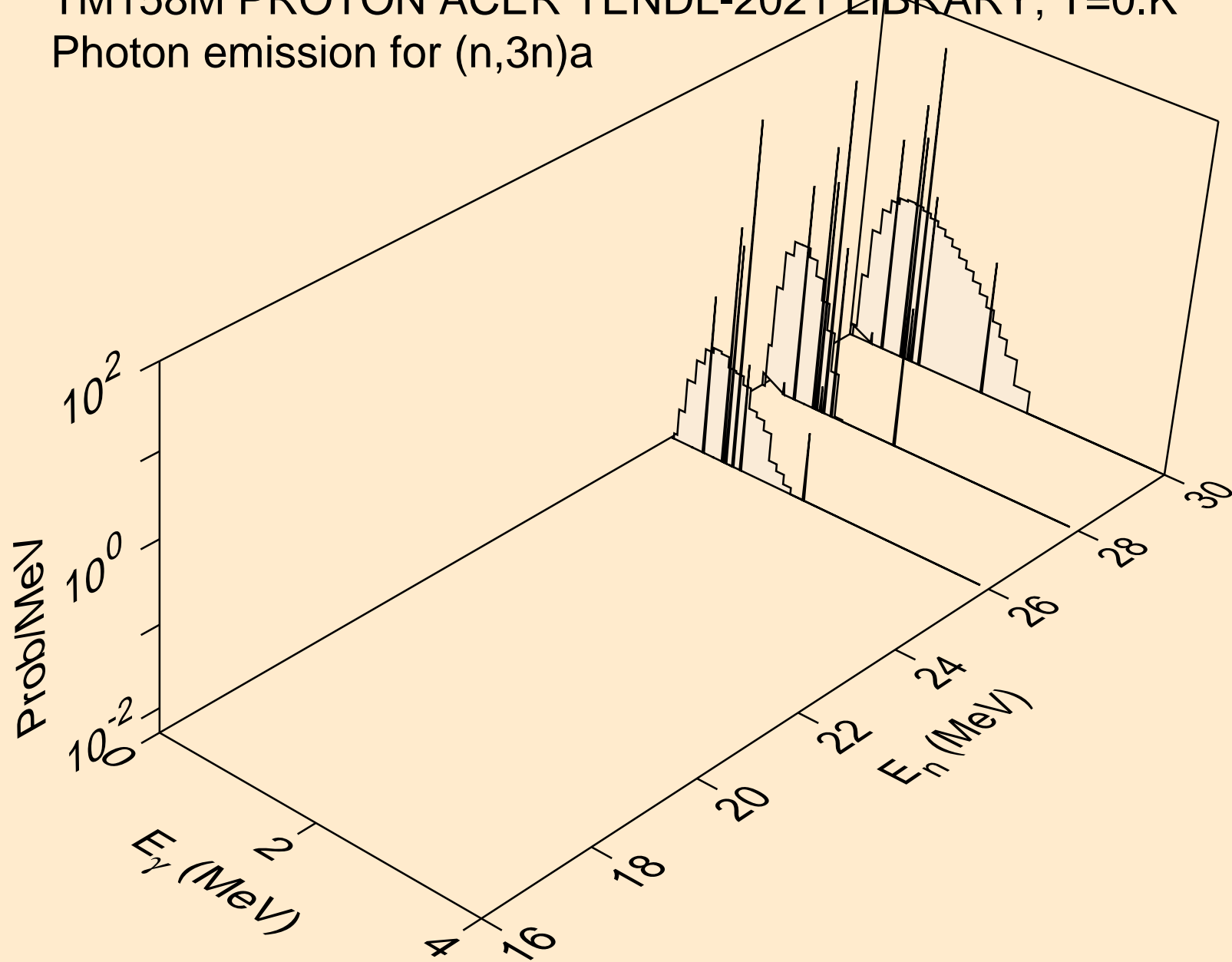

TM158M PROTON ACER TENDL-2021 LIBRARY; T=0.K  
Photon emission for (n,n\*)p

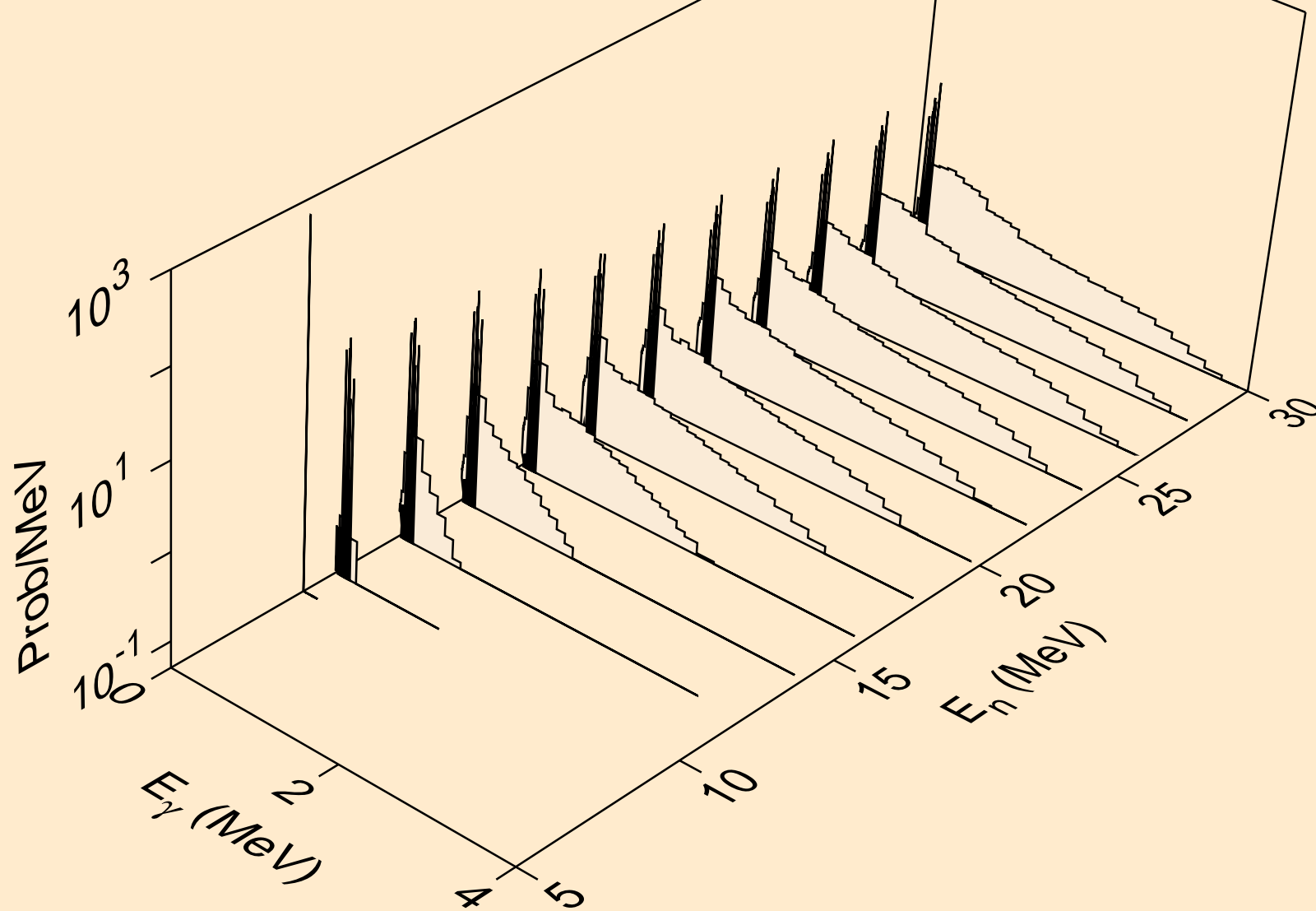

TM158M PROTON ACER TENDL-2021 LIBRARY; T=0.K  
Photon emission for (n,n\*)2a

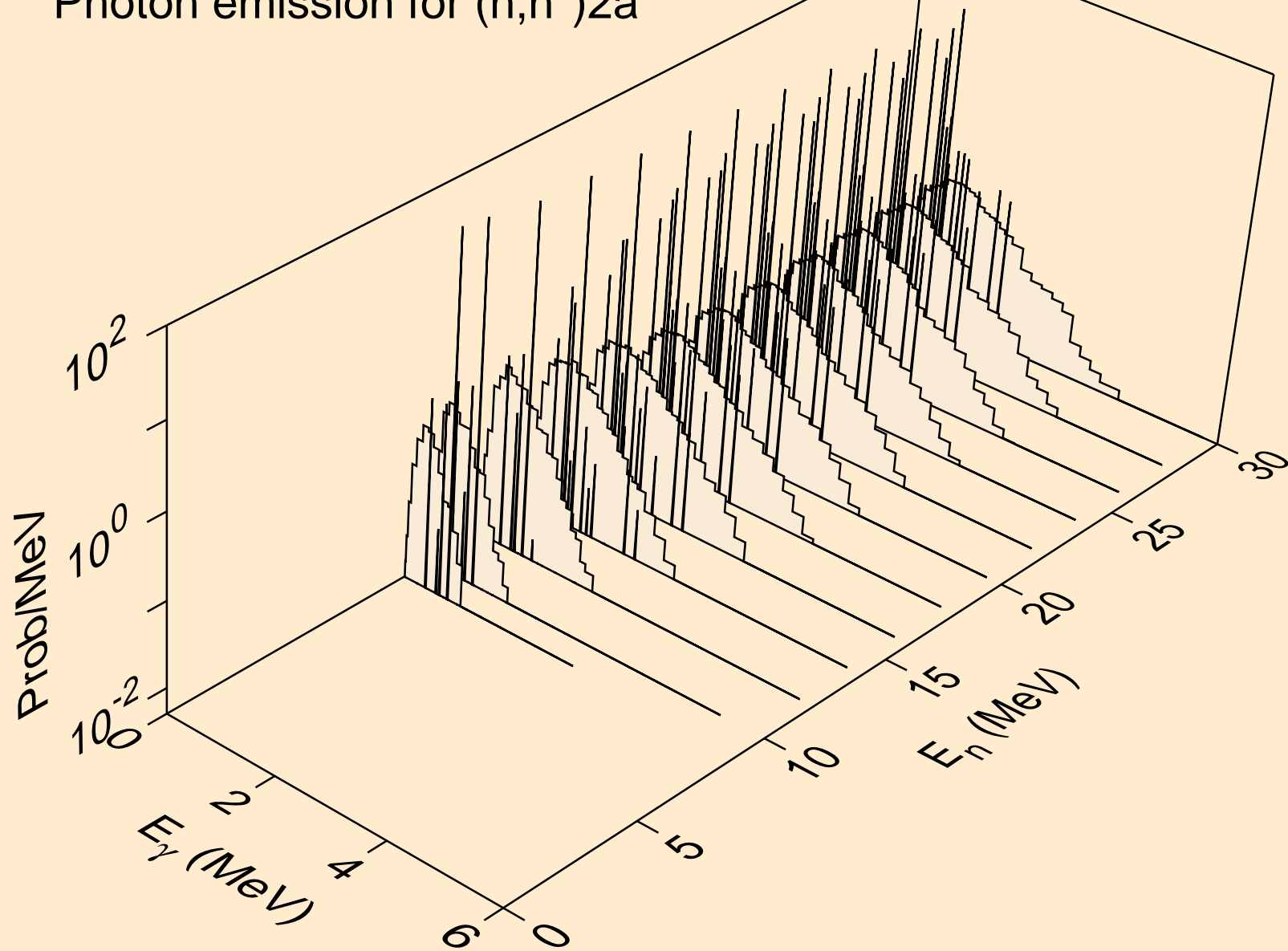

TM158M PROTON ACER TENDL-2021 LIBRARY; T=0.K  
Photon emission for (n,2n)2a

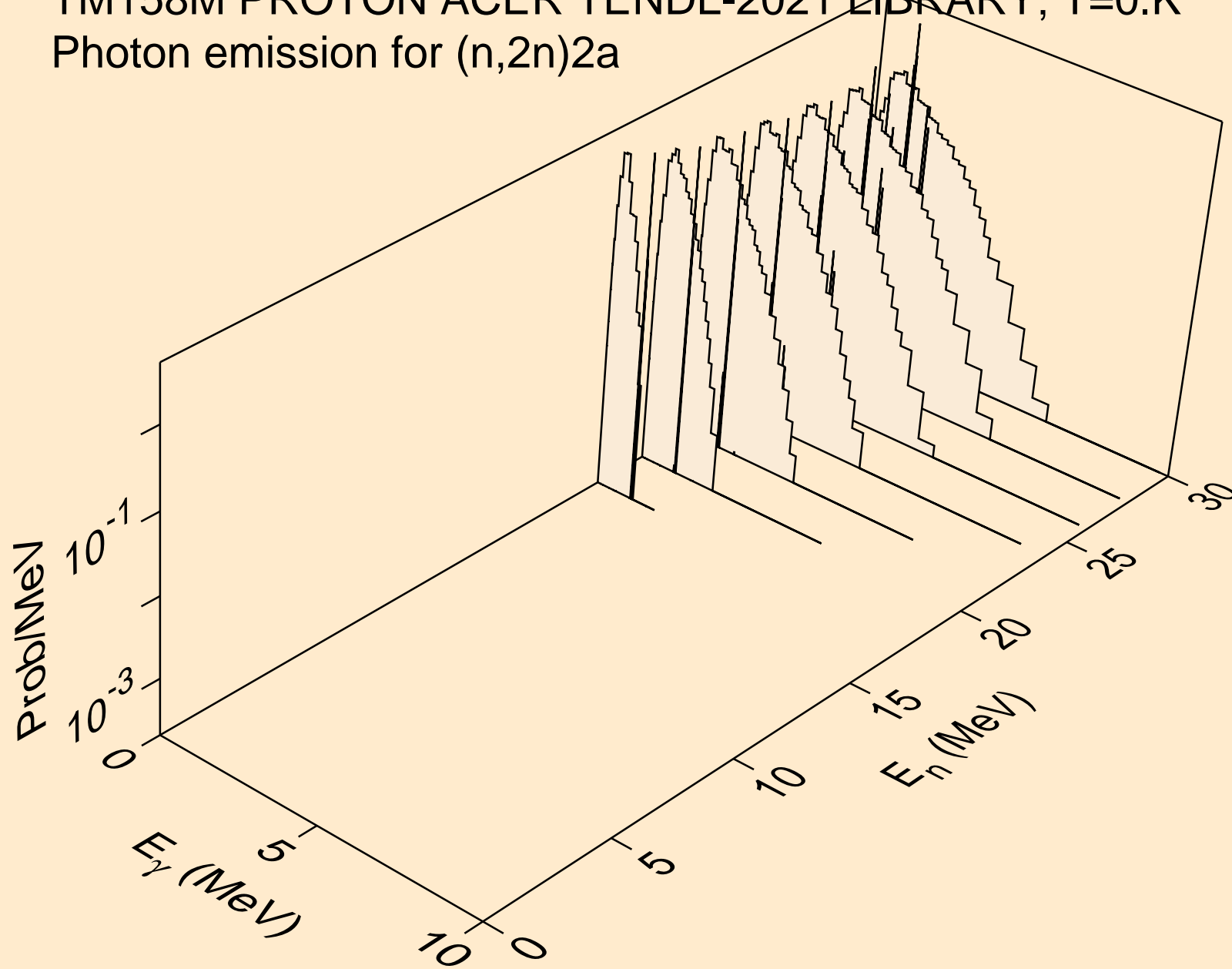



TM158M PROTON ACER TENDL-2021 LIBRARY; T=0.K  
Photon emission for (n,n\*)d

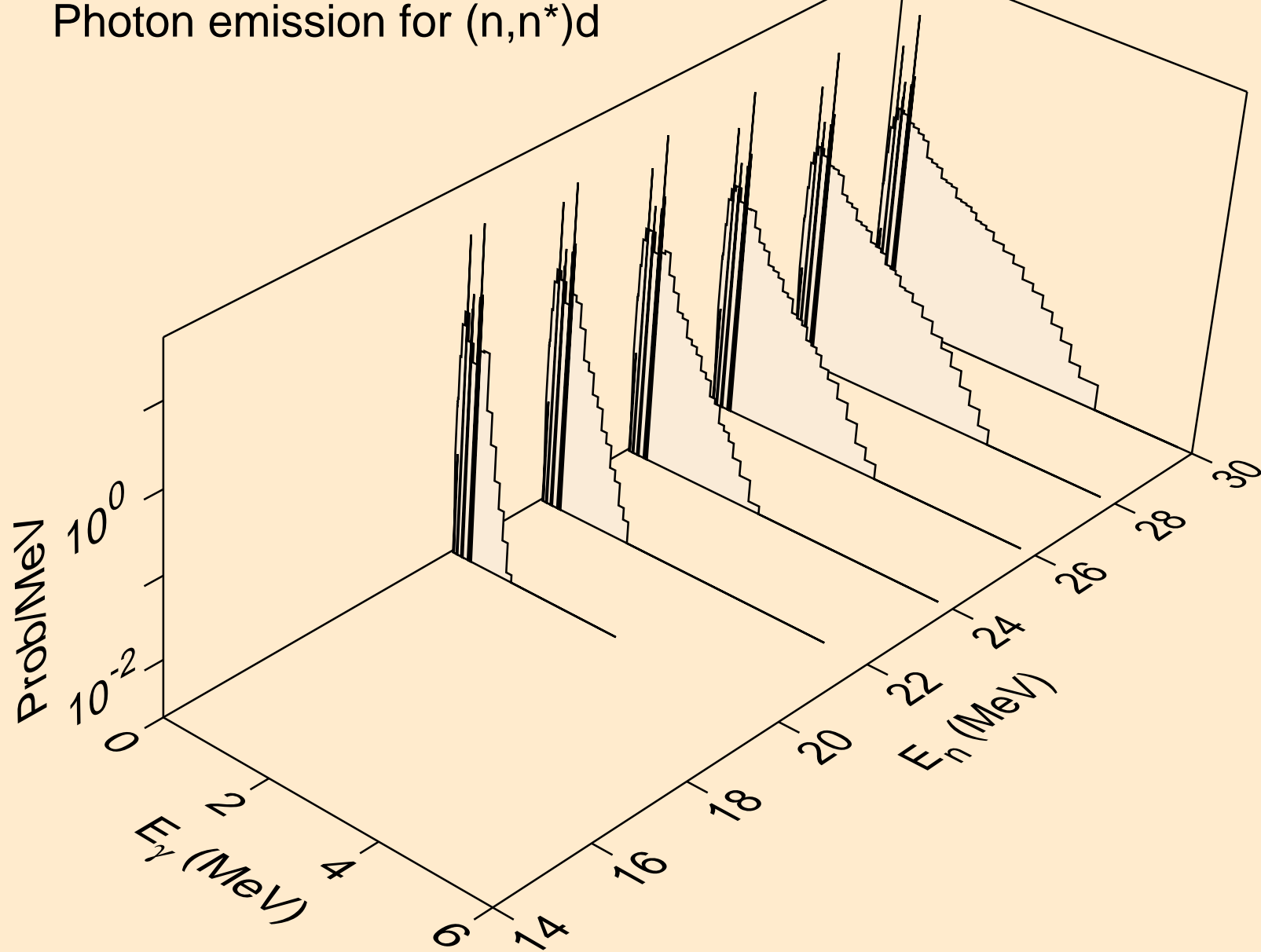

TM158M PROTON ACER TENDL-2021 LIBRARY; T=0.K  
Photon emission for (n,n\*)t

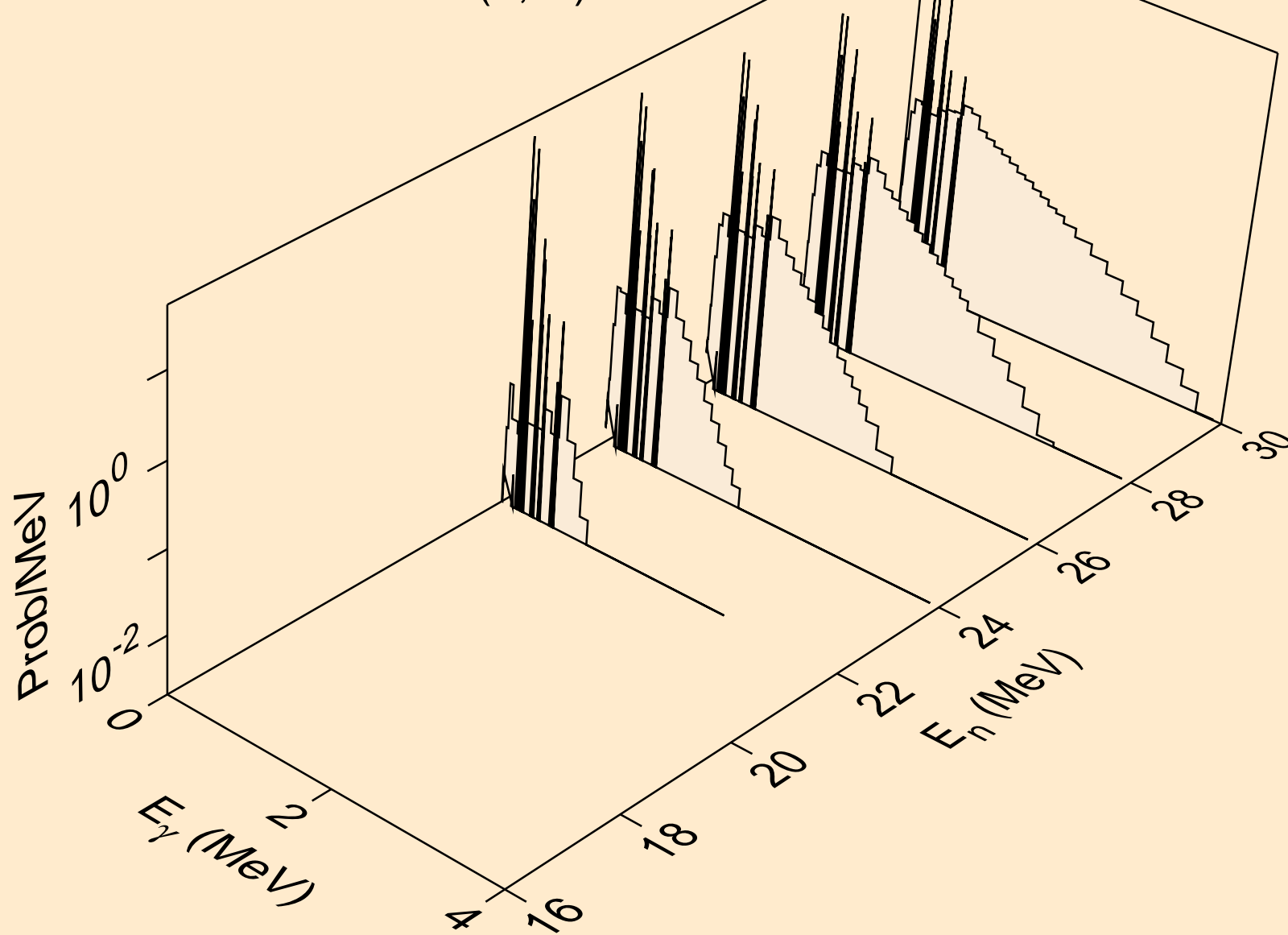

TM158M PROTON ACER TENDL-2021 LIBRARY; T=0.K  
Photon emission for (n,n\*)he3

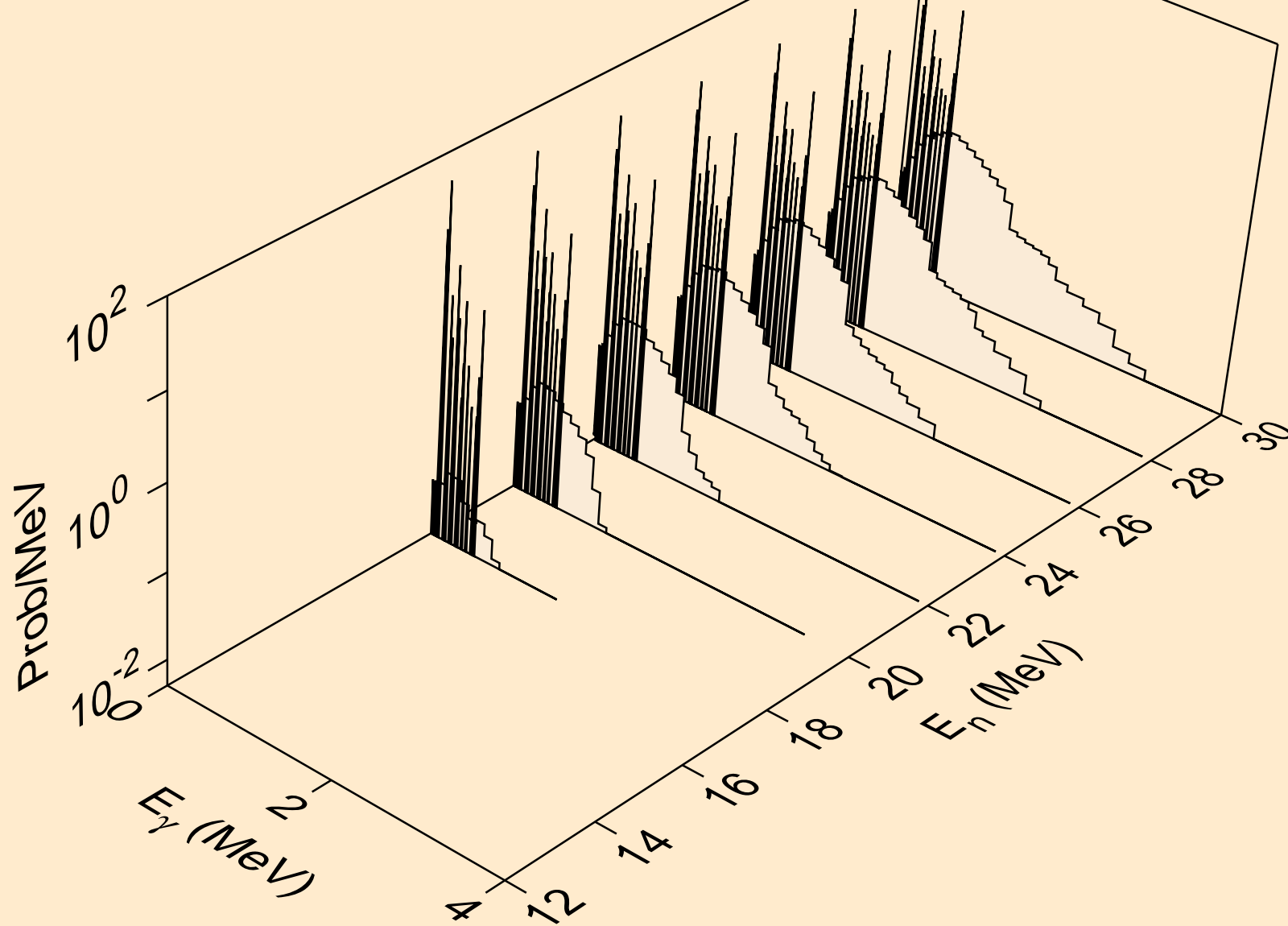

TM158M PROTON ACER TENDL-2021 LIBRARY; T=0.K  
Photon emission for (n,2np)

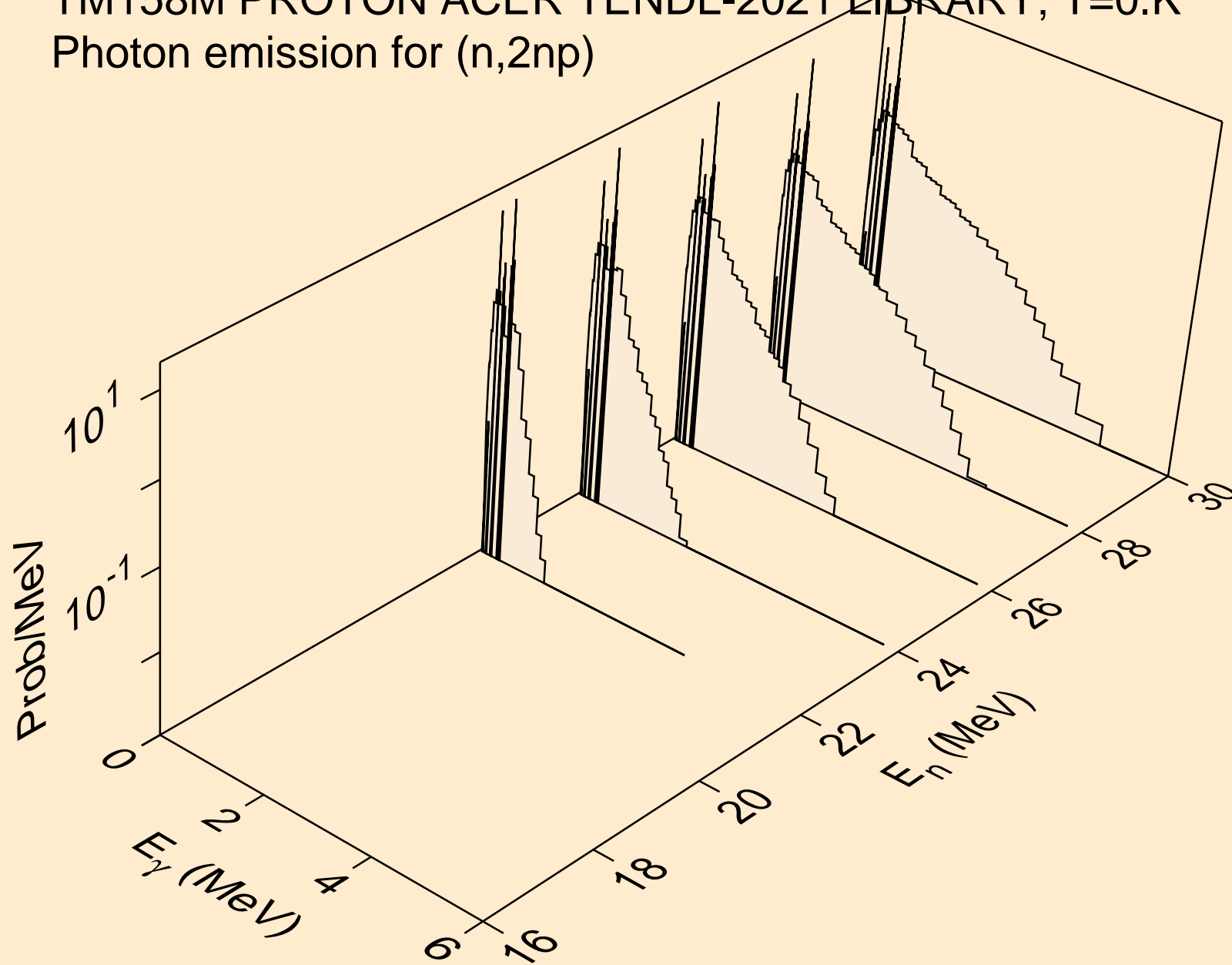

TM158M PROTON ACER TENDL-2021 LIBRARY; T=0.K  
Photon emission for (n,3np)

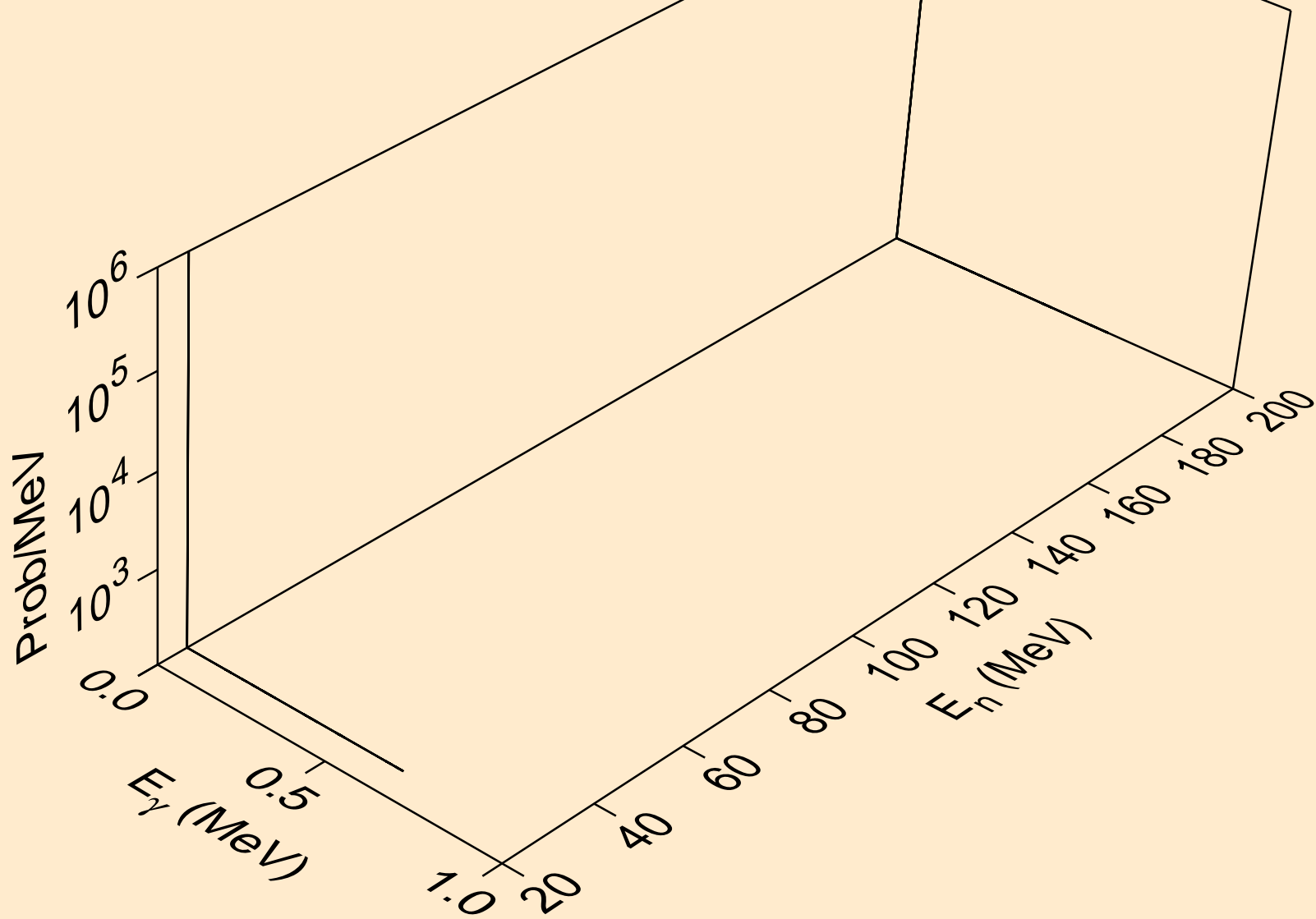

TM158M PROTON ACER TENDL-2021 LIBRARY; T=0.K  
Photon emission for (n,2np)

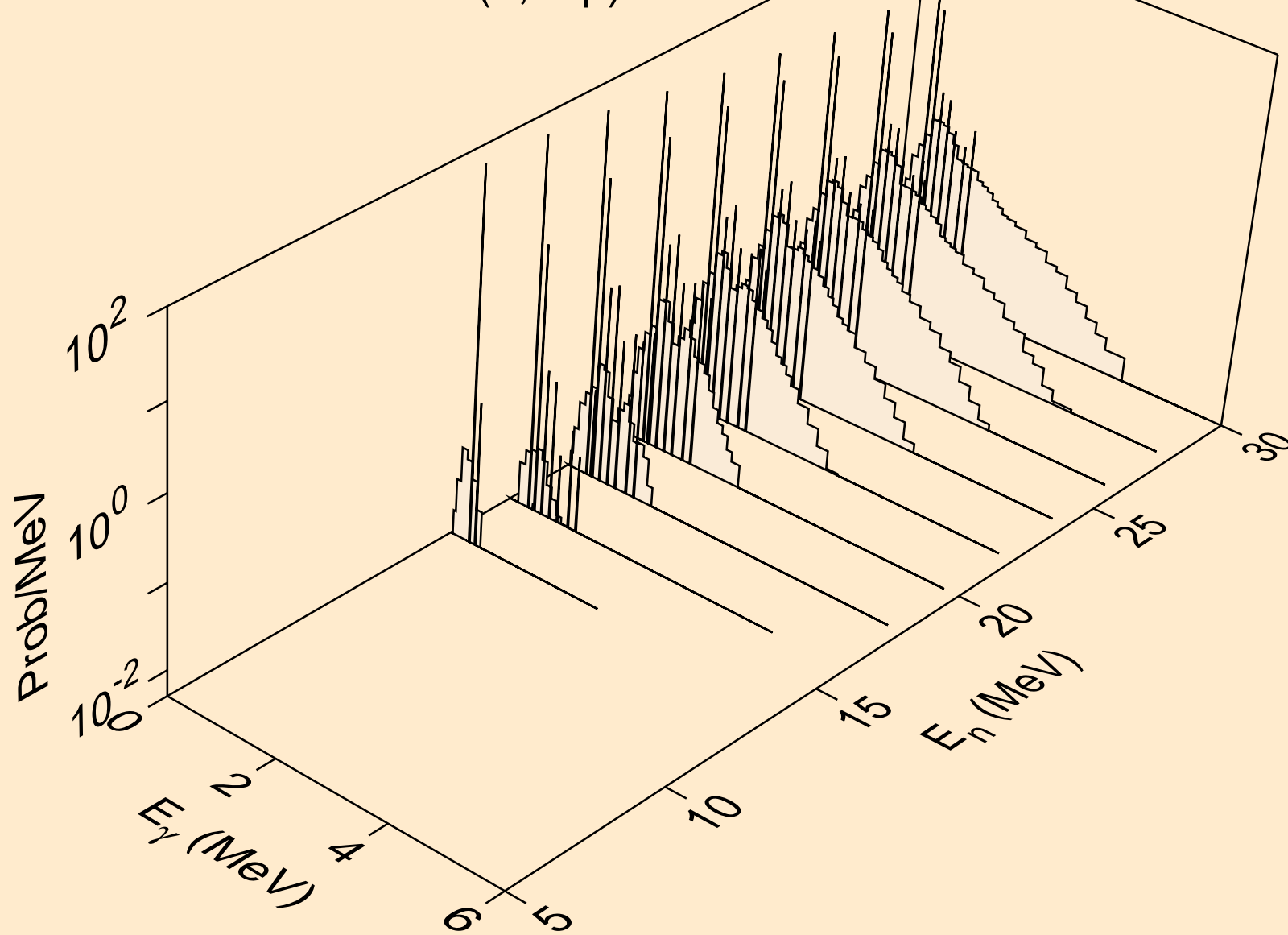

TM158M PROTON ACER TENDL-2021 LIBRARY; T=0.K  
Photon emission for (n,npa)

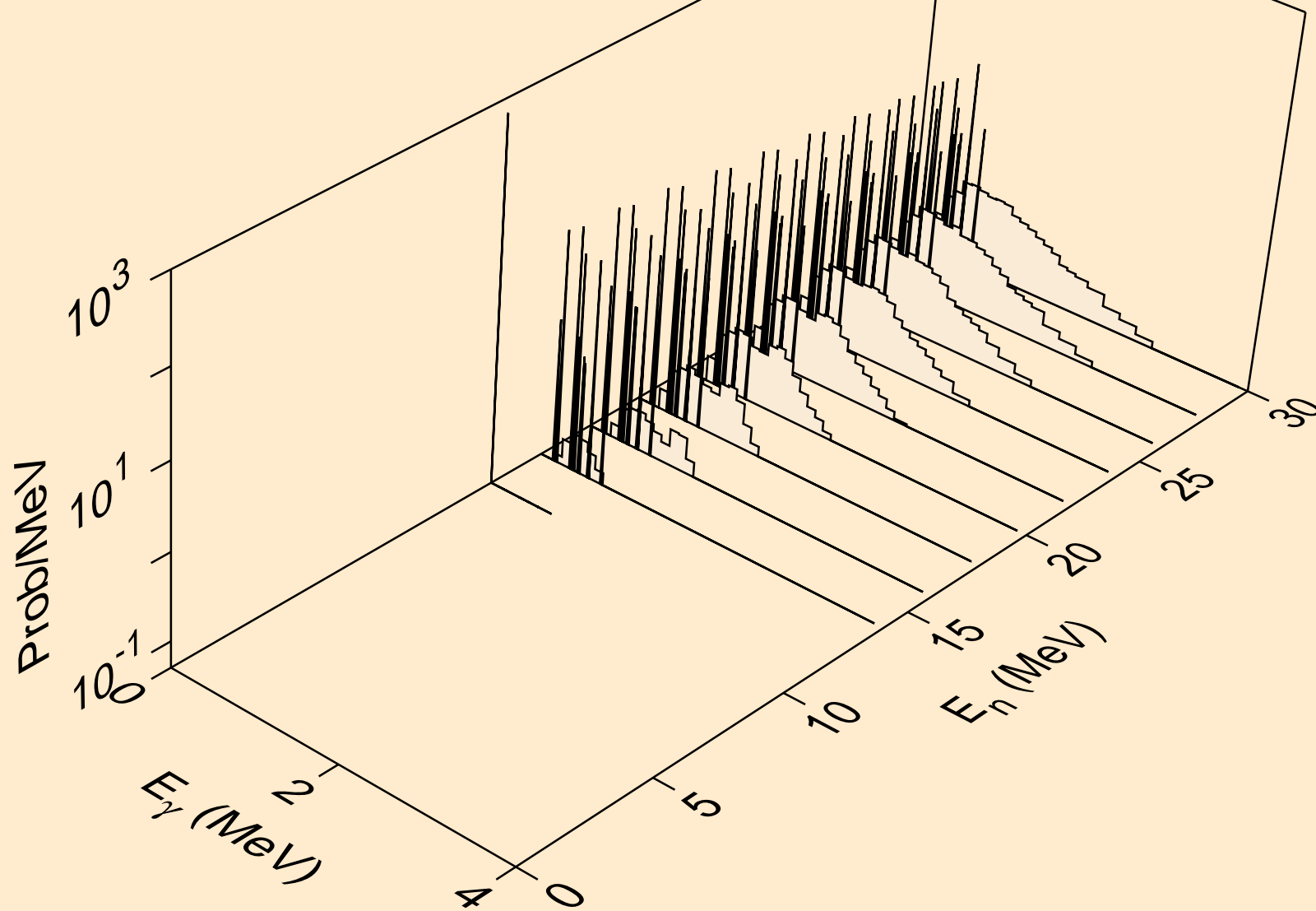

TM158M PROTON ACER TENDL-2021 LIBRARY; T=0.K  
Photon emission for (n,gma)

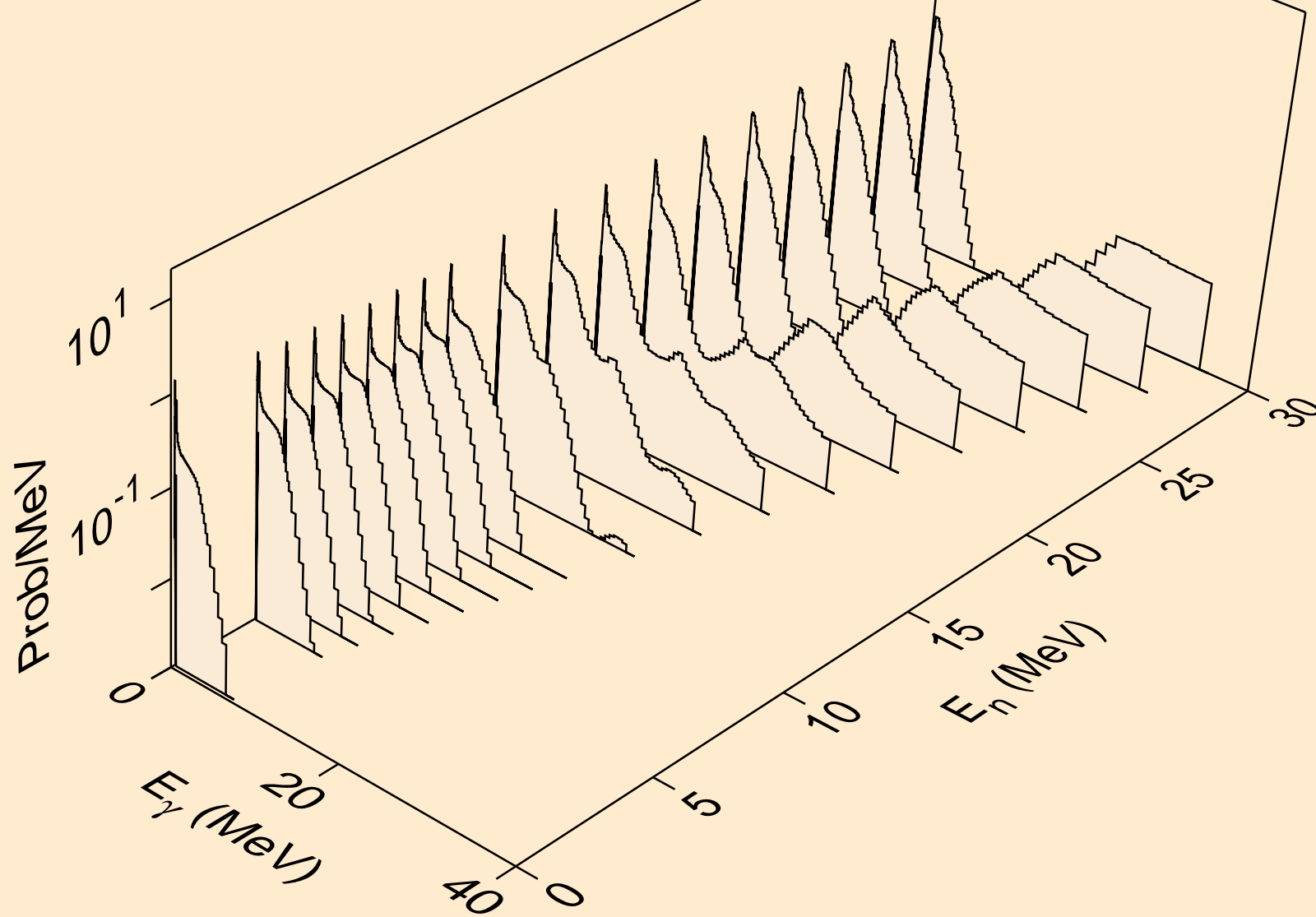



TM158M PROTON ACER TENDL-2021 LIBRARY; T=0.K  
Photon emission for inelastic

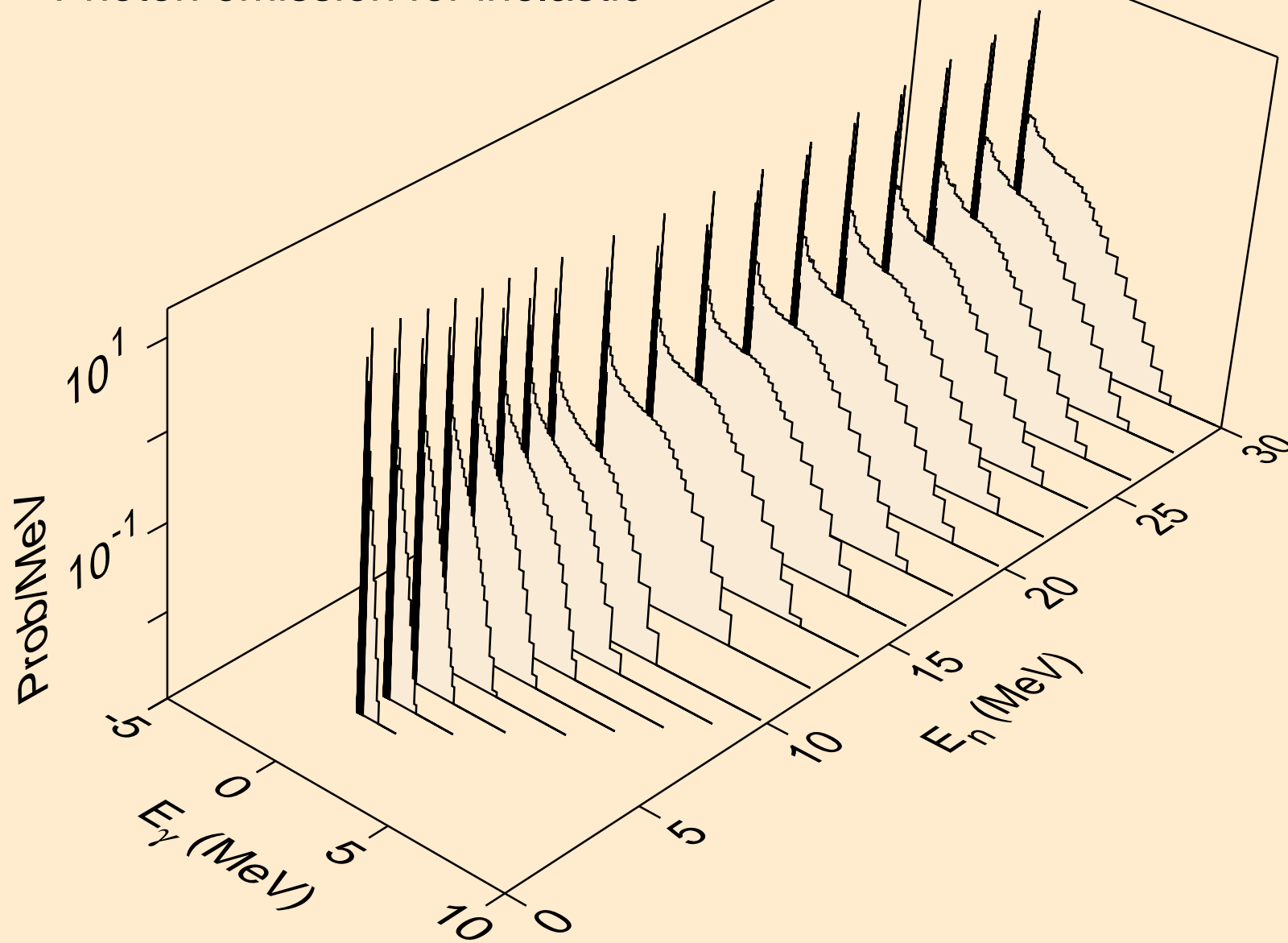

TM158M PROTON ACER TENDL-2021 LIBRARY; T=0.K  
Photon emission for (n,d)

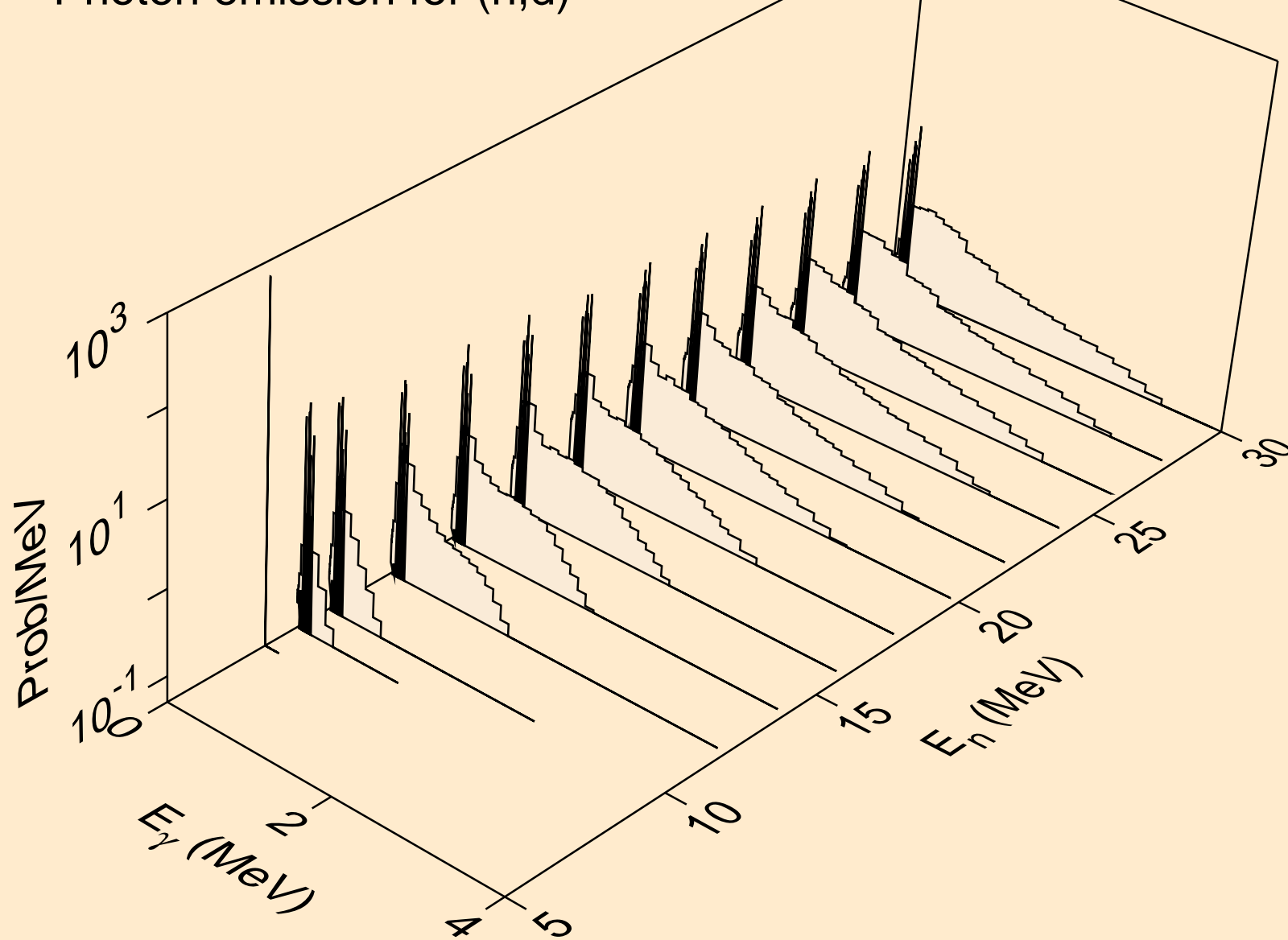

TM158M PROTON ACER TENDL-2021 LIBRARY; T=0.K  
Photon emission for (n,t)

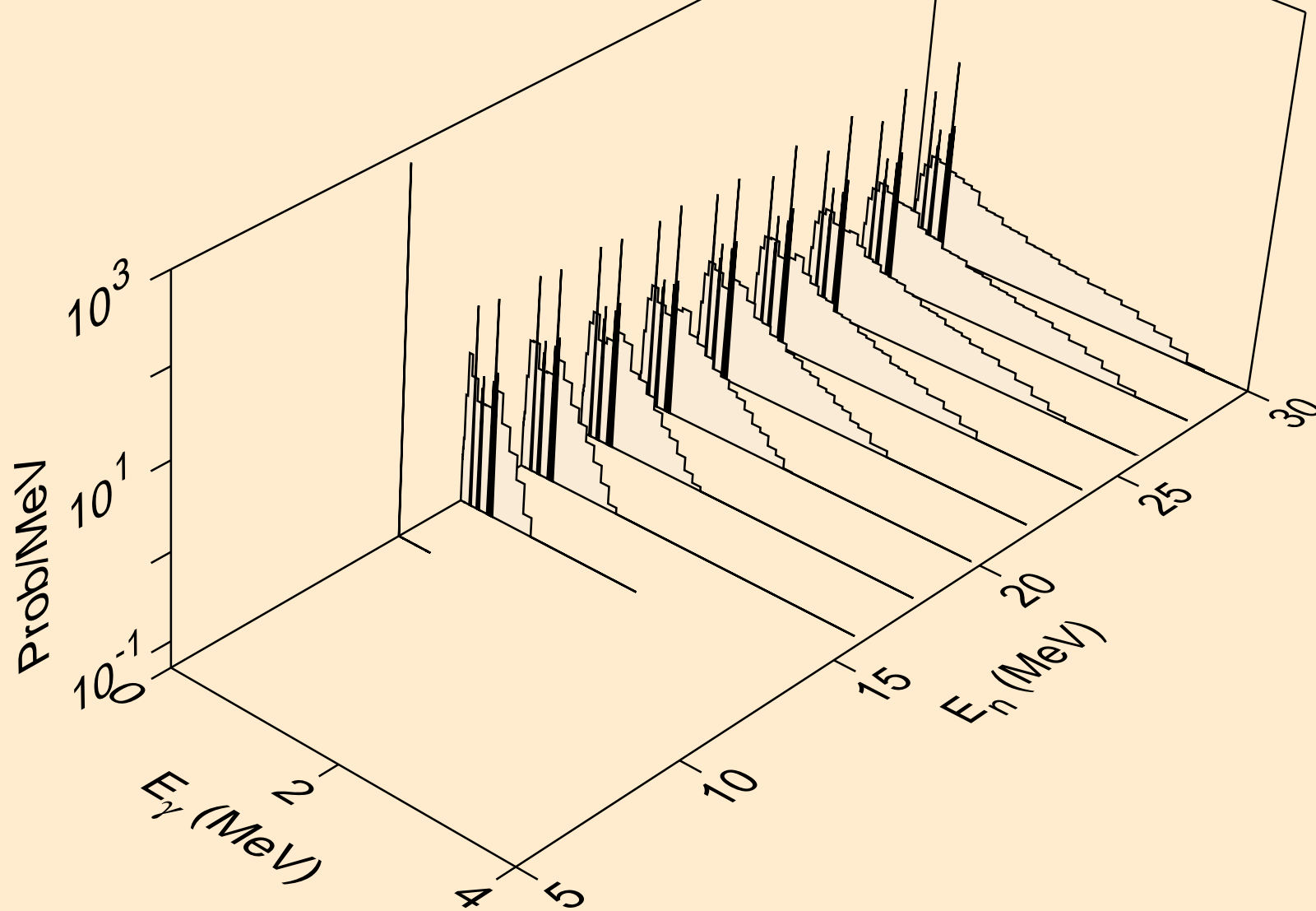

TM158M PROTON ACER TENDL-2021 LIBRARY; T=0.K  
Photon emission for (n,he3)

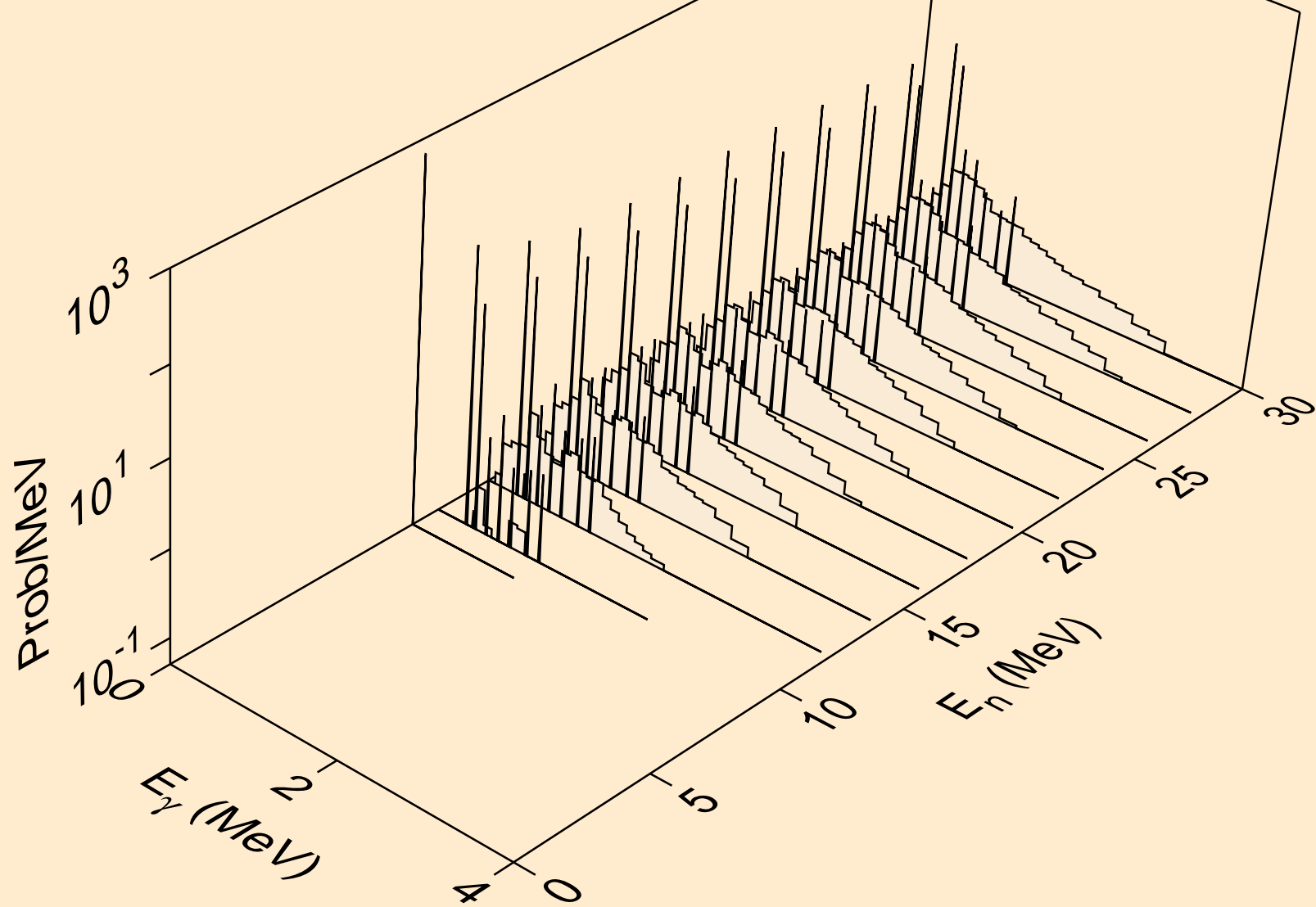

TM158M PROTON ACER TENDL-2021 LIBRARY; T=0.K  
Photon emission for (n,a)

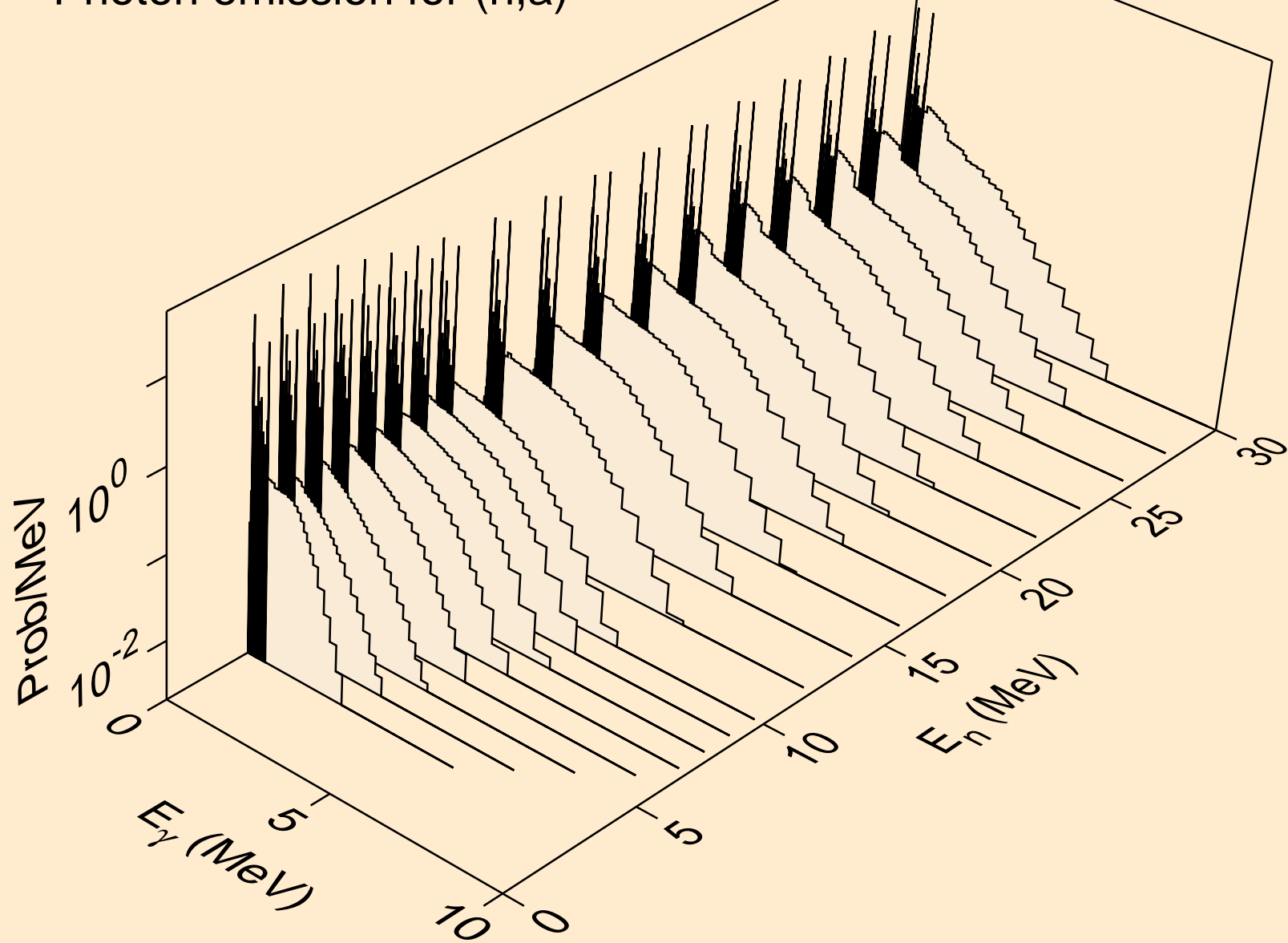

TM158M PROTON ACER TENDL-2021 LIBRARY; T=0.K  
Photon emission for (n,2a)

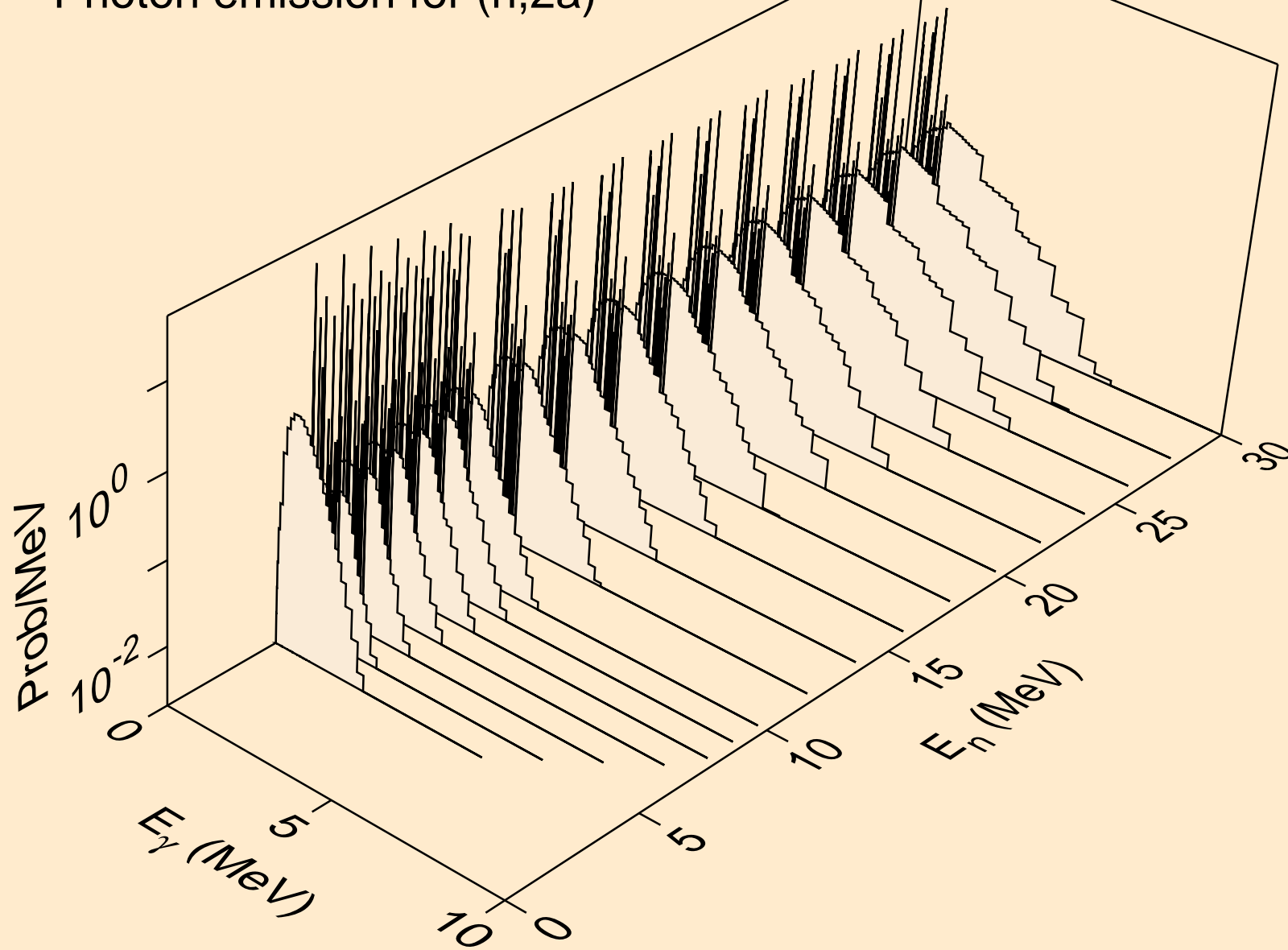

TM158M PROTON ACER TENDL-2021 LIBRARY; T=0.K  
Photon emission for (n,3a)

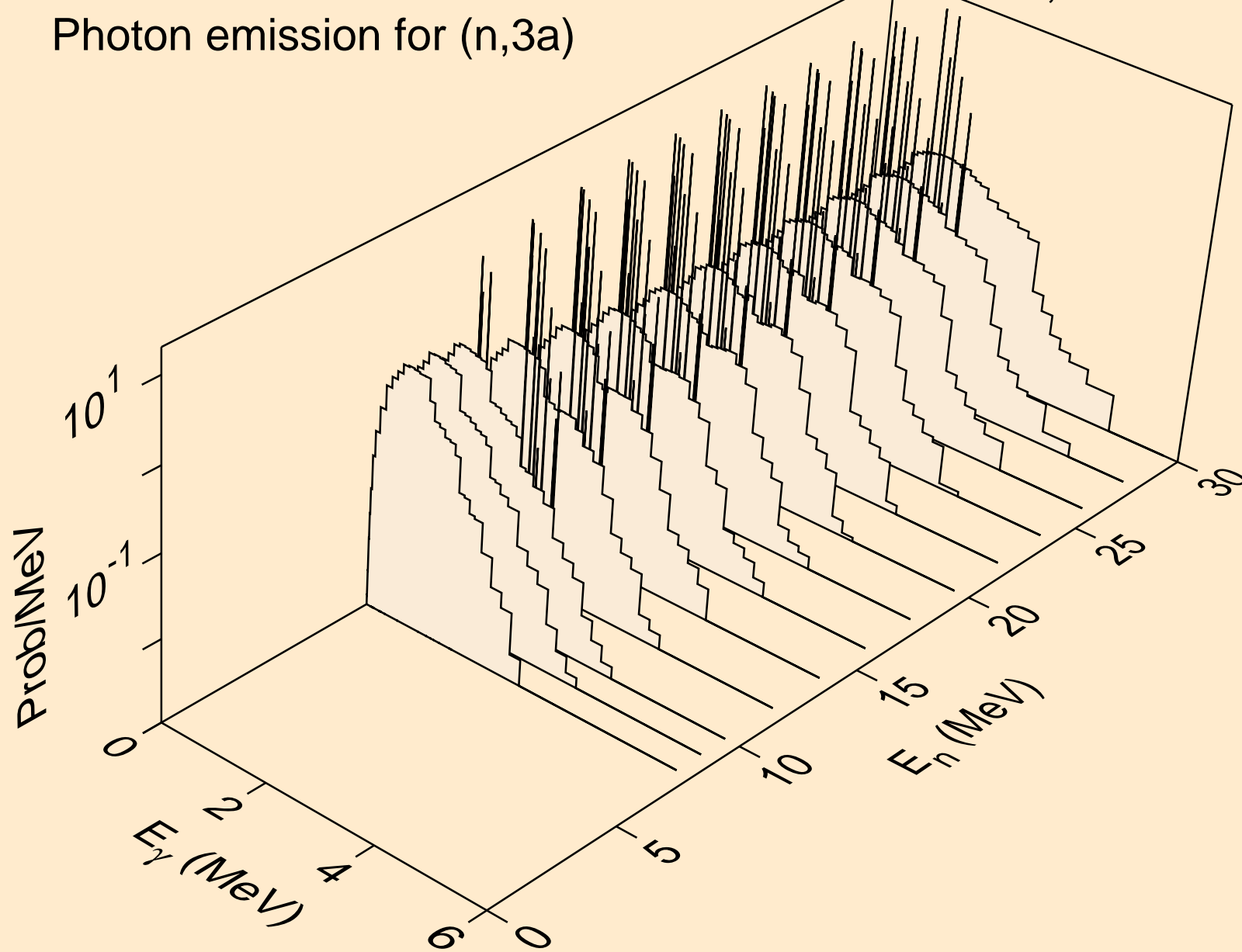

TM158M PROTON ACER TENDL-2021 LIBRARY; T=0.K  
Photon emission for (n,2p)

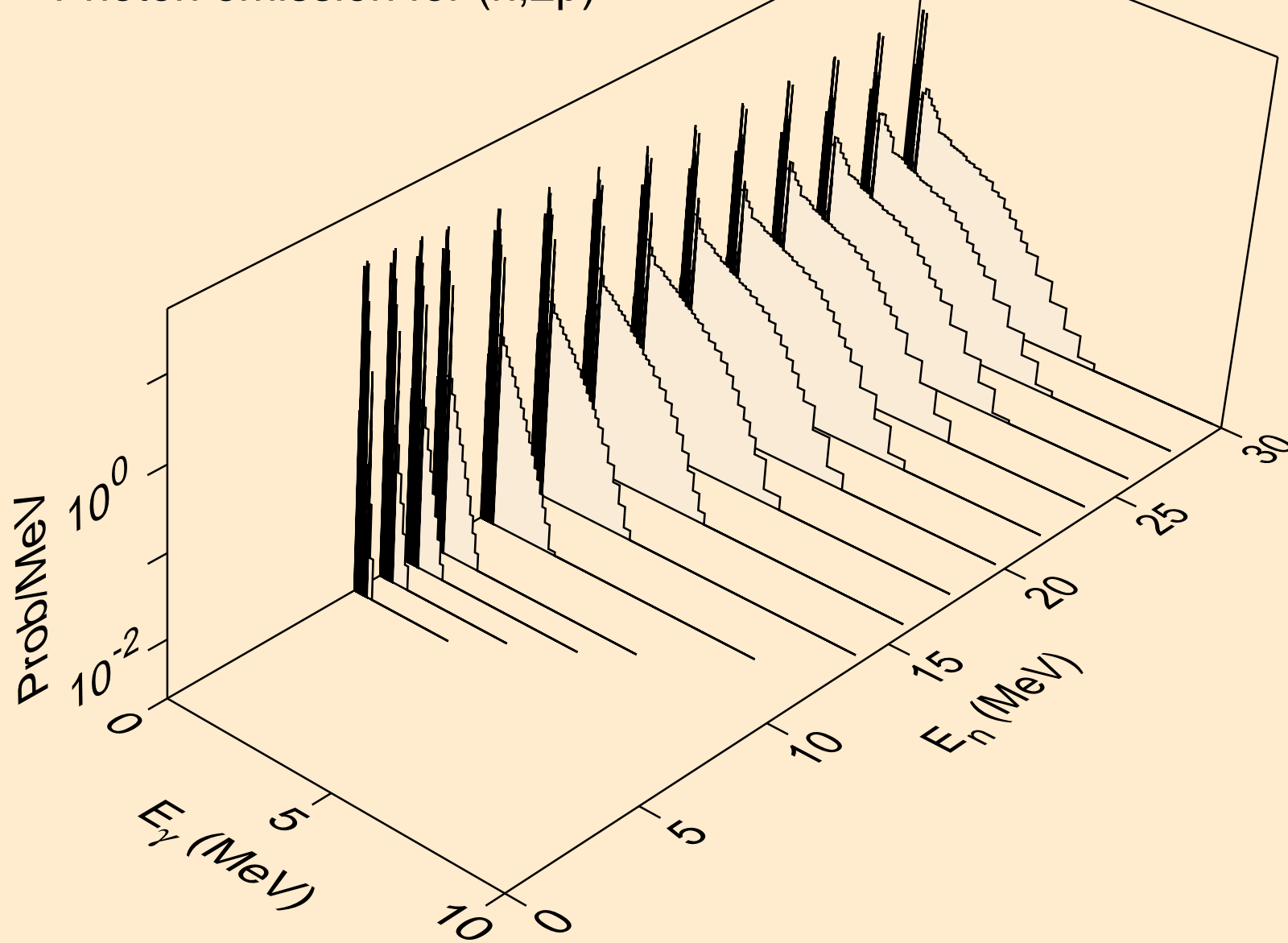



TM158M PROTON ACER TENDL-2021 LIBRARY; T=0.K  
Photon emission for (n,p)

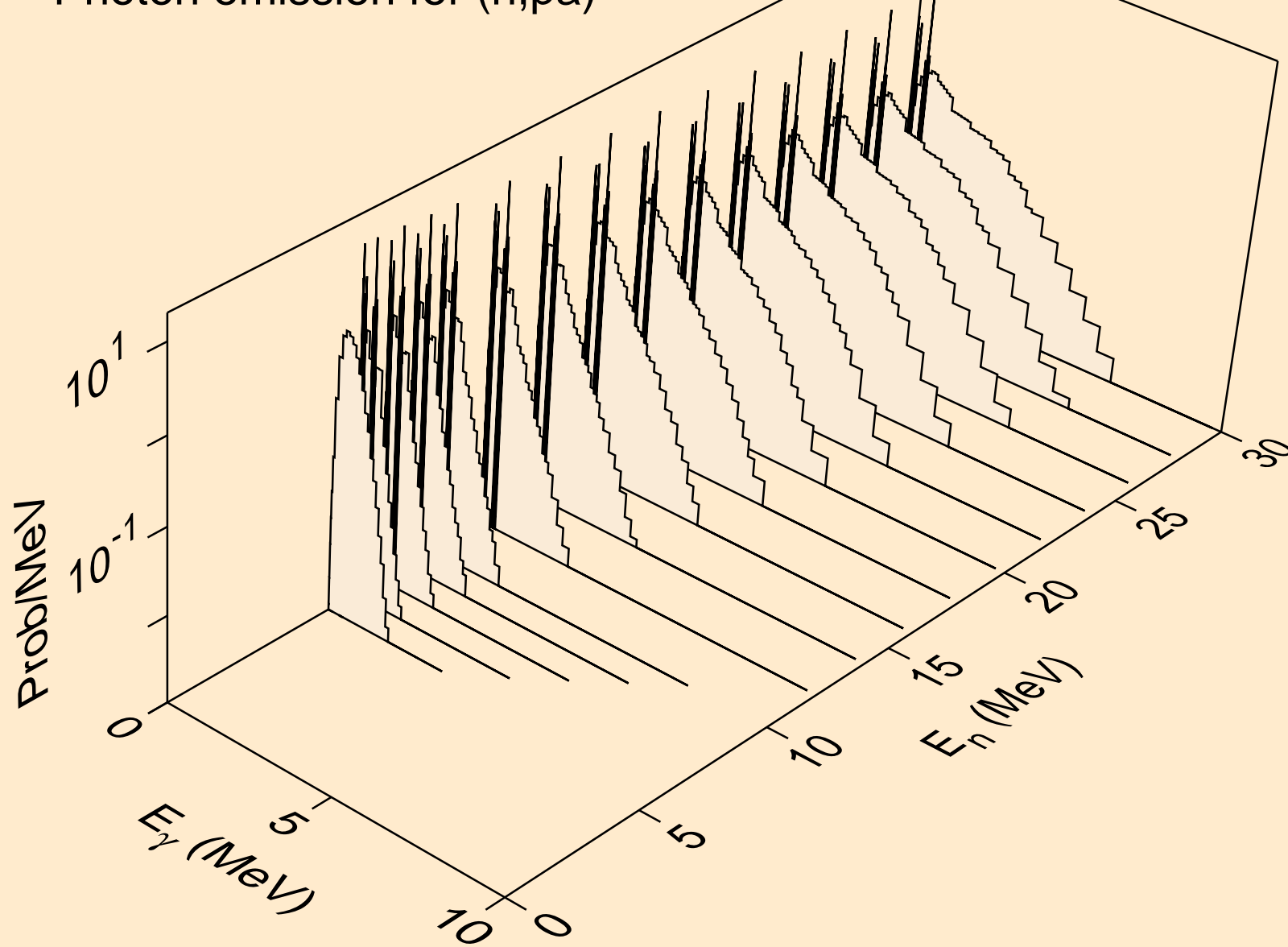

TM158M PROTON ACER TENDL-2021 LIBRARY; T=0.K  
Photon emission for (n,pd)

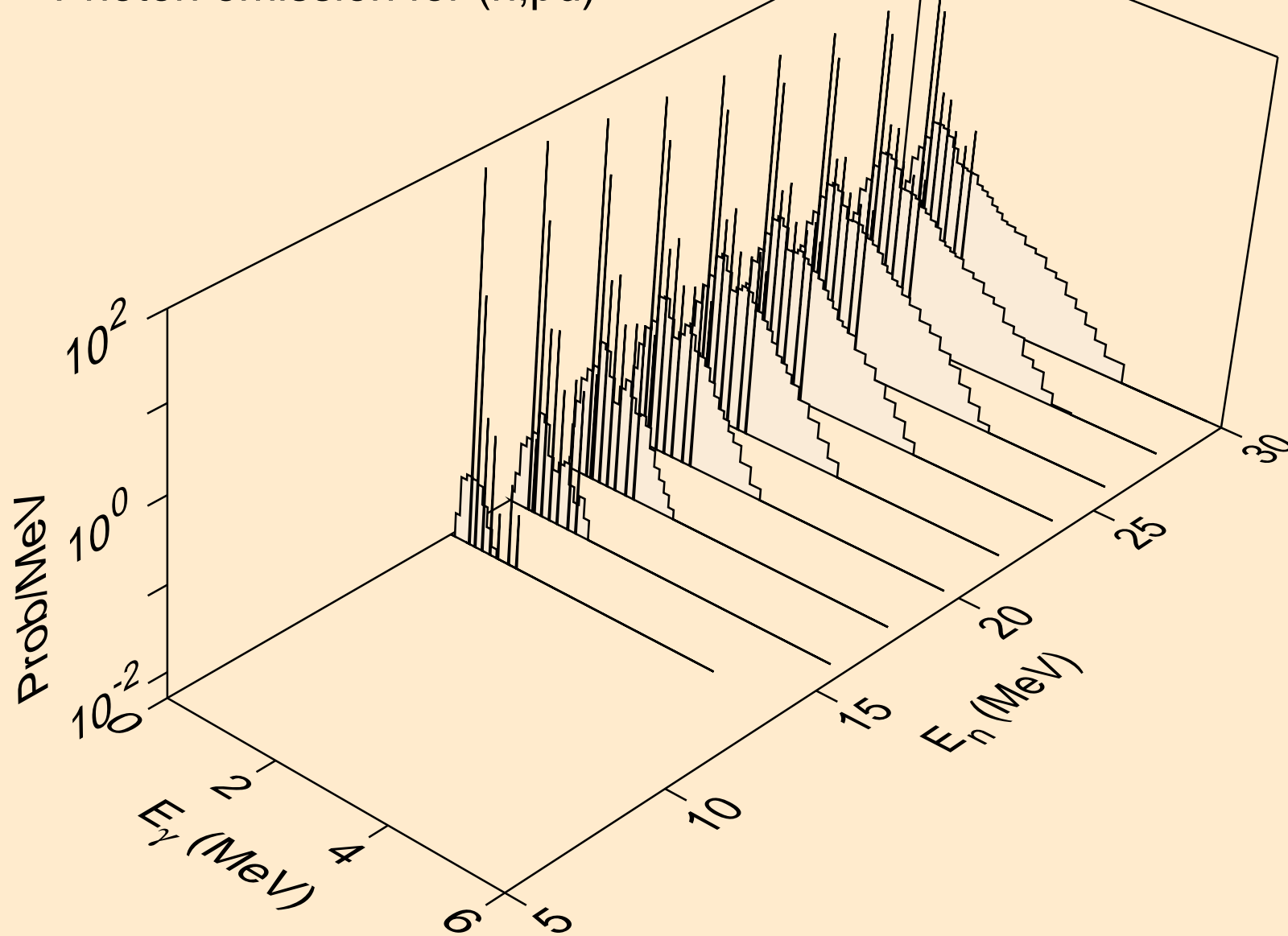

TM158M PROTON ACER TENDL-2021 LIBRARY; T=0.K  
Photon emission for (n,pt)

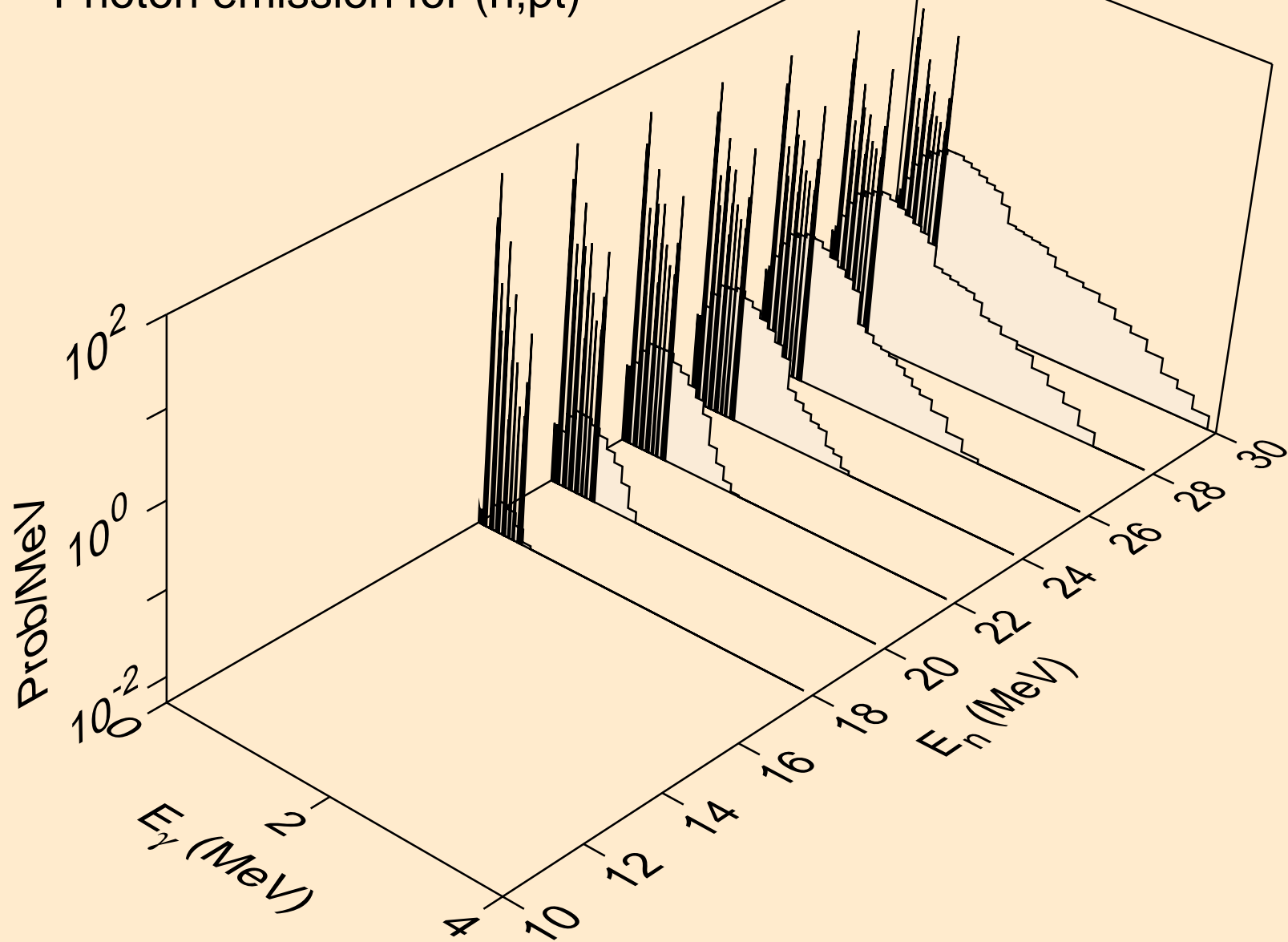

TM158M PROTON ACER TENDL-2021 LIBRARY; T=0.K  
Photon emission for (n,da)

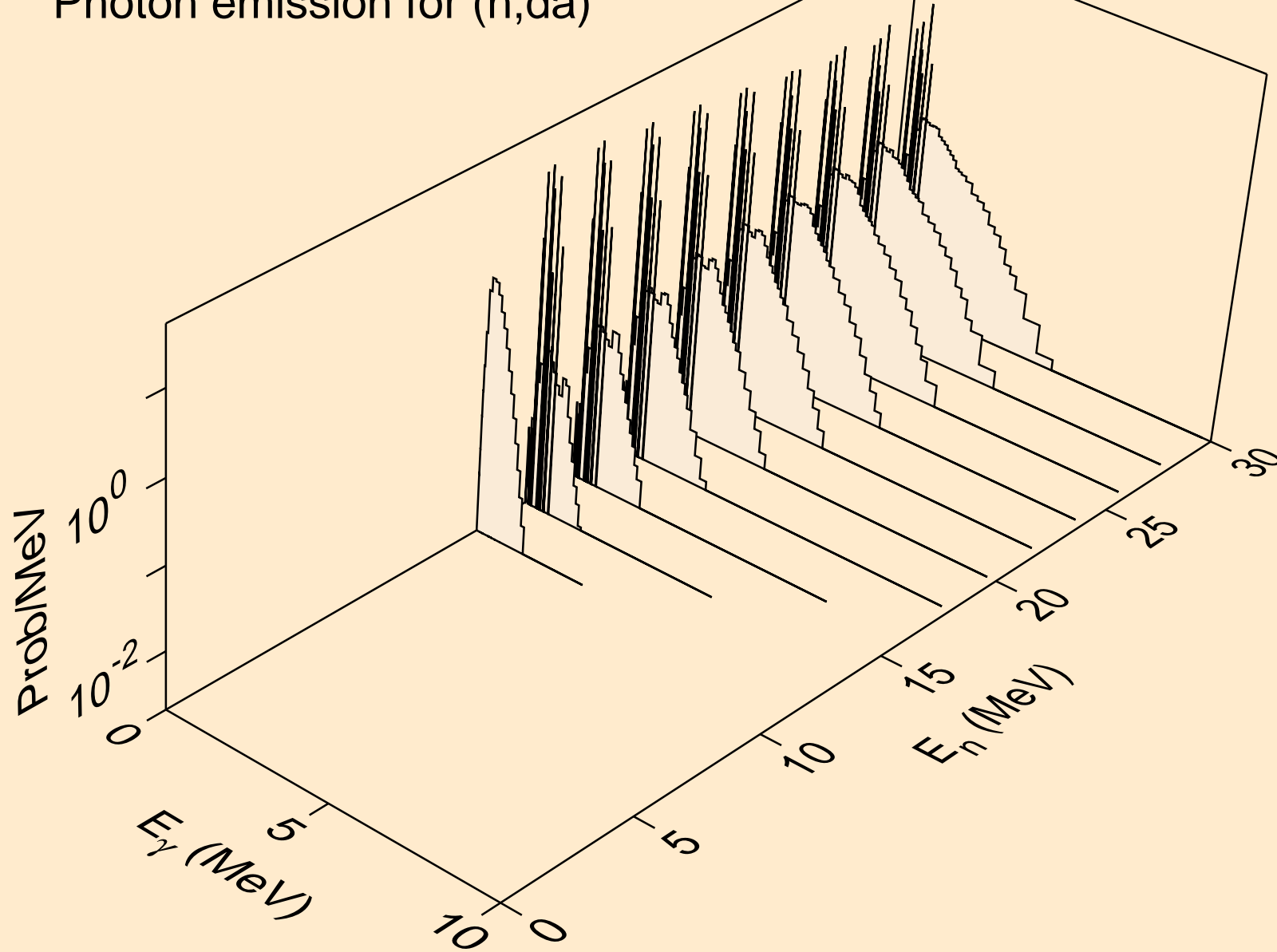

TM158M PROTON ACER TENDL-2021 LIBRARY; T=0.K  
Particle heating contributions

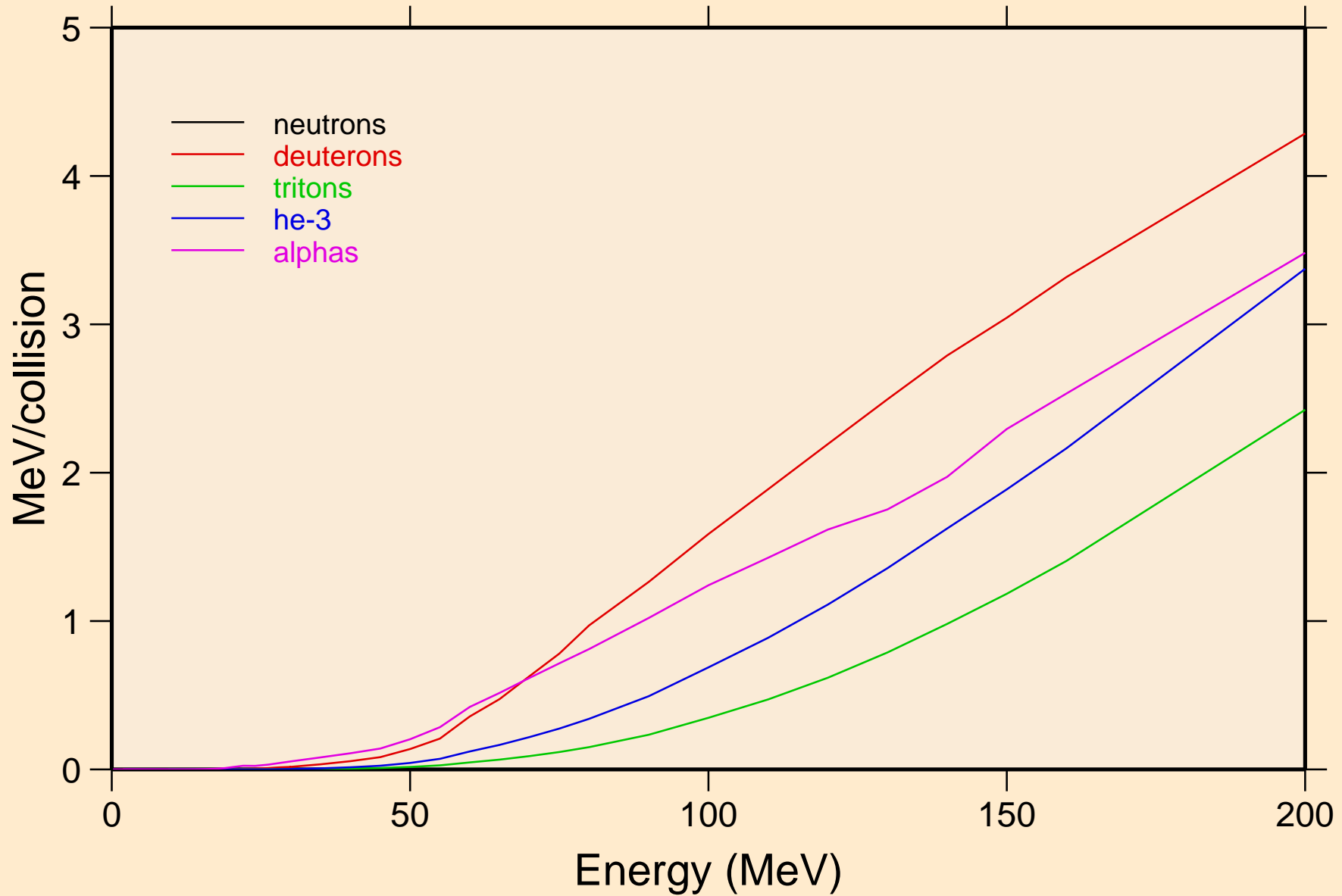

TM158M PROTON ACER TENDL-2021 LIBRARY; T=0.K  
Recoil Heating

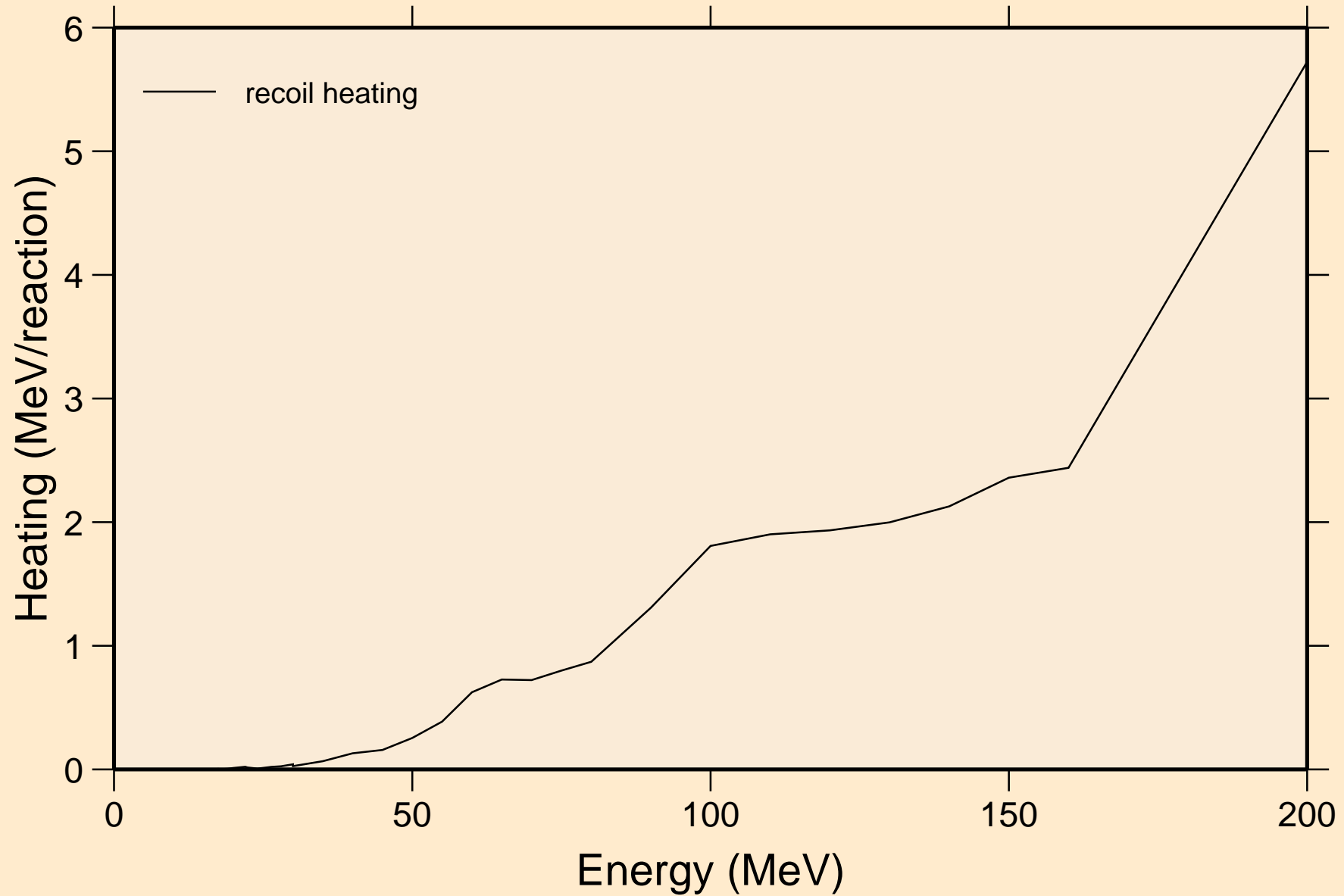

TM158M PROTON ACER TENDL-2021 LIBRARY; T=0.K  
Particle production cross sections

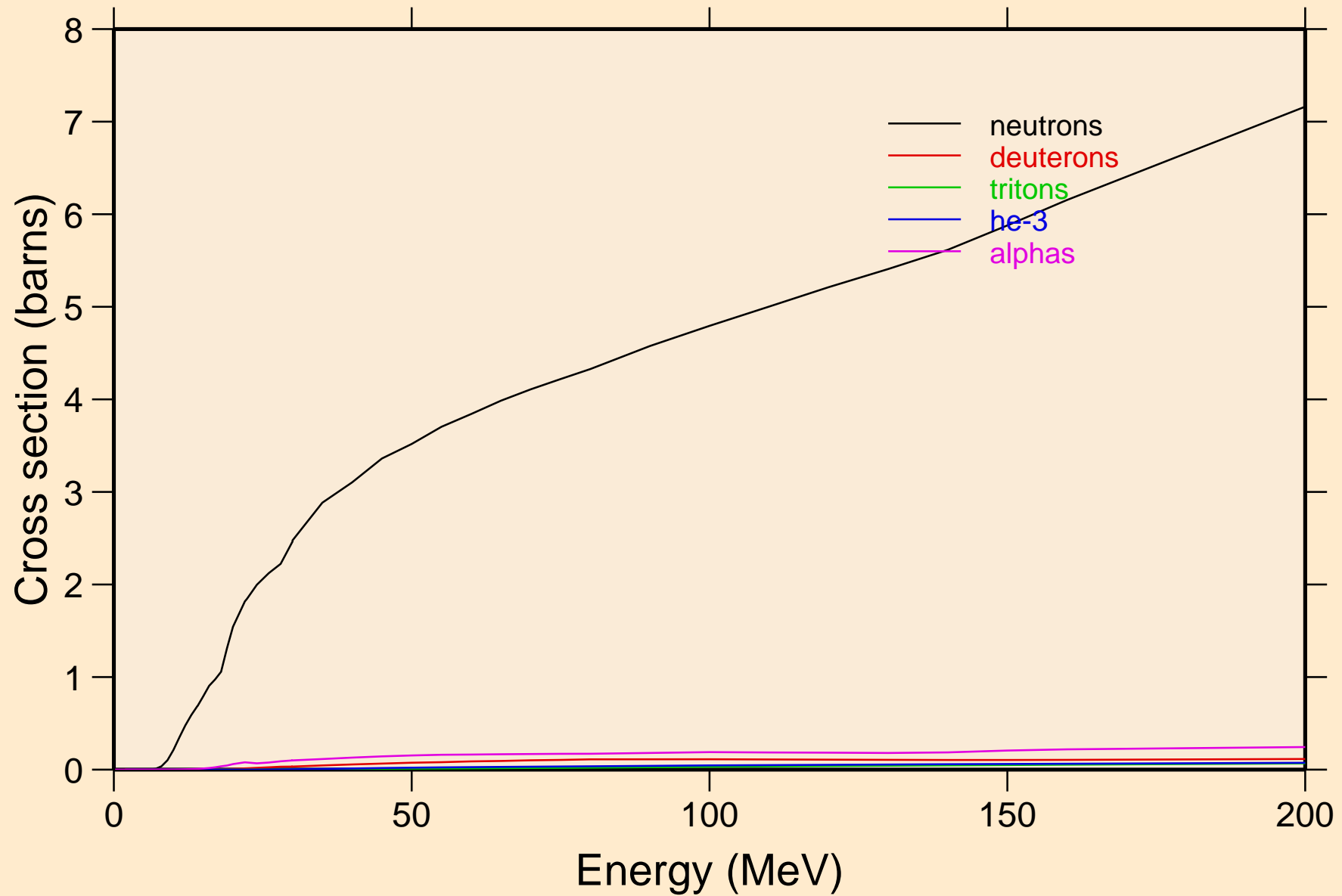

TM158M PROTON ACER TENDL-2021 LIBRARY; T=0.K  
neutrons from (p,n)

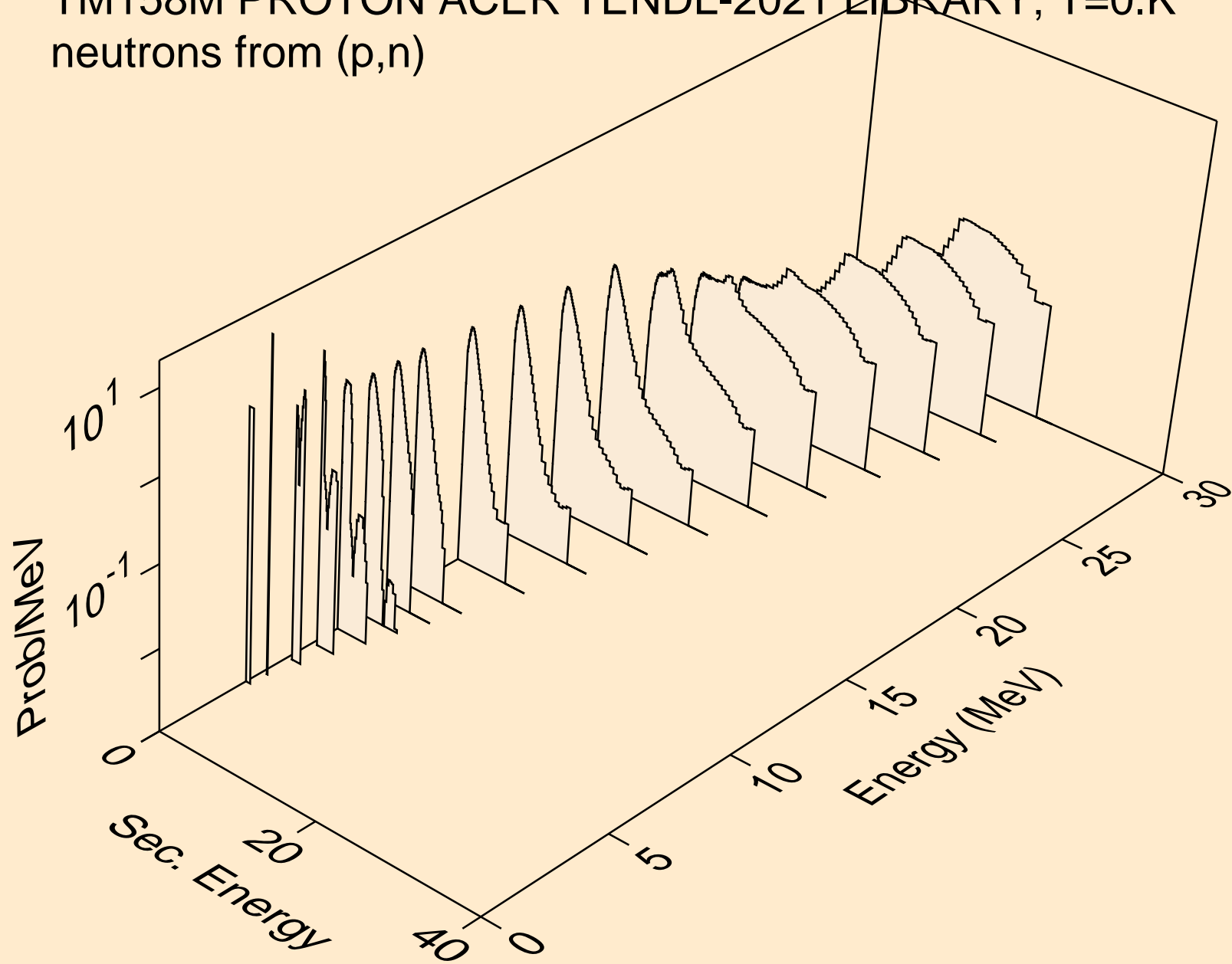



TM158M PROTON ACER TENDL-2021 LIBRARY; T=0.K  
neutrons from (p,x)

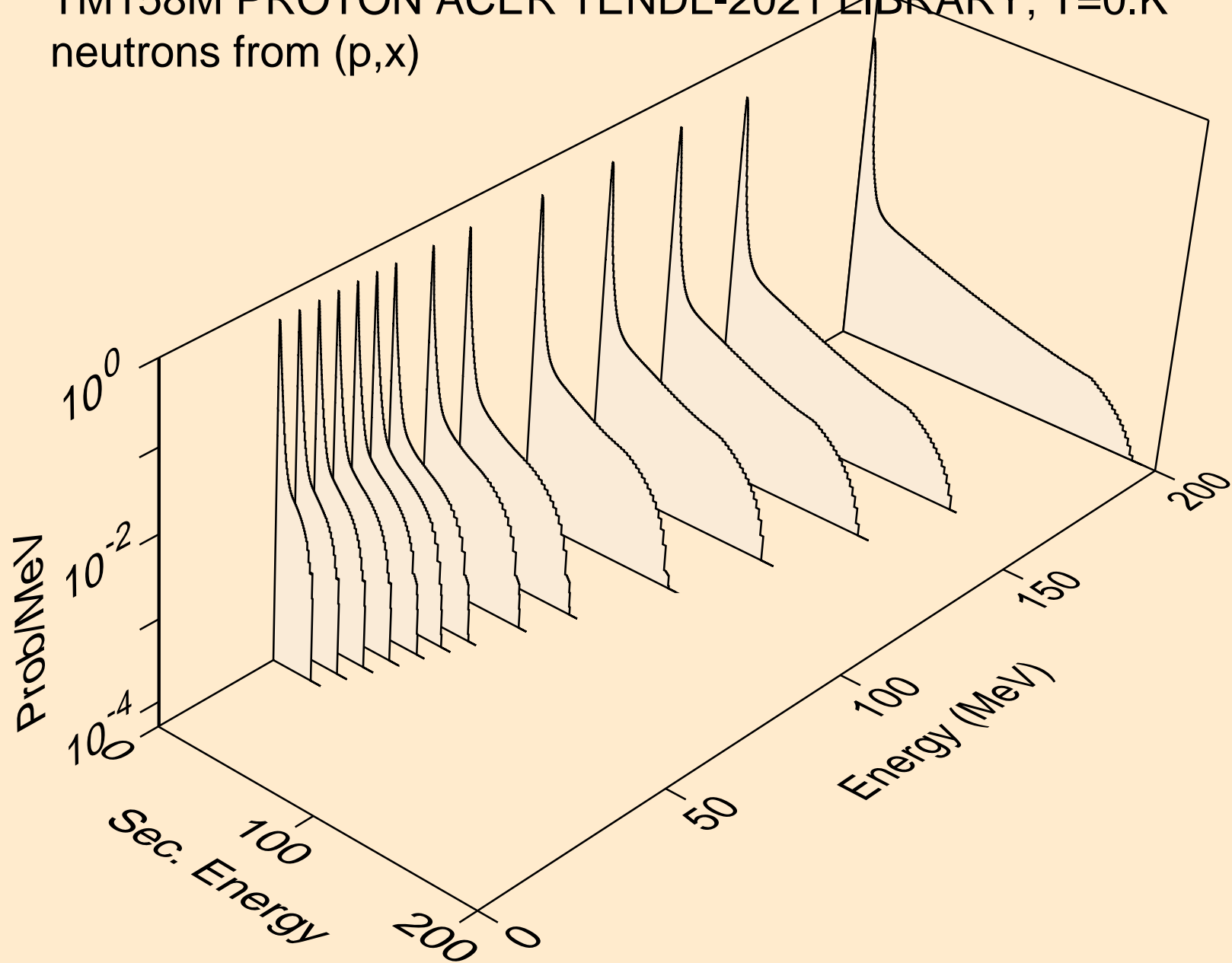

TM158M PROTON ACER TENDL-2021 LIBRARY; T=0.K  
neutrons from (p,2nd)

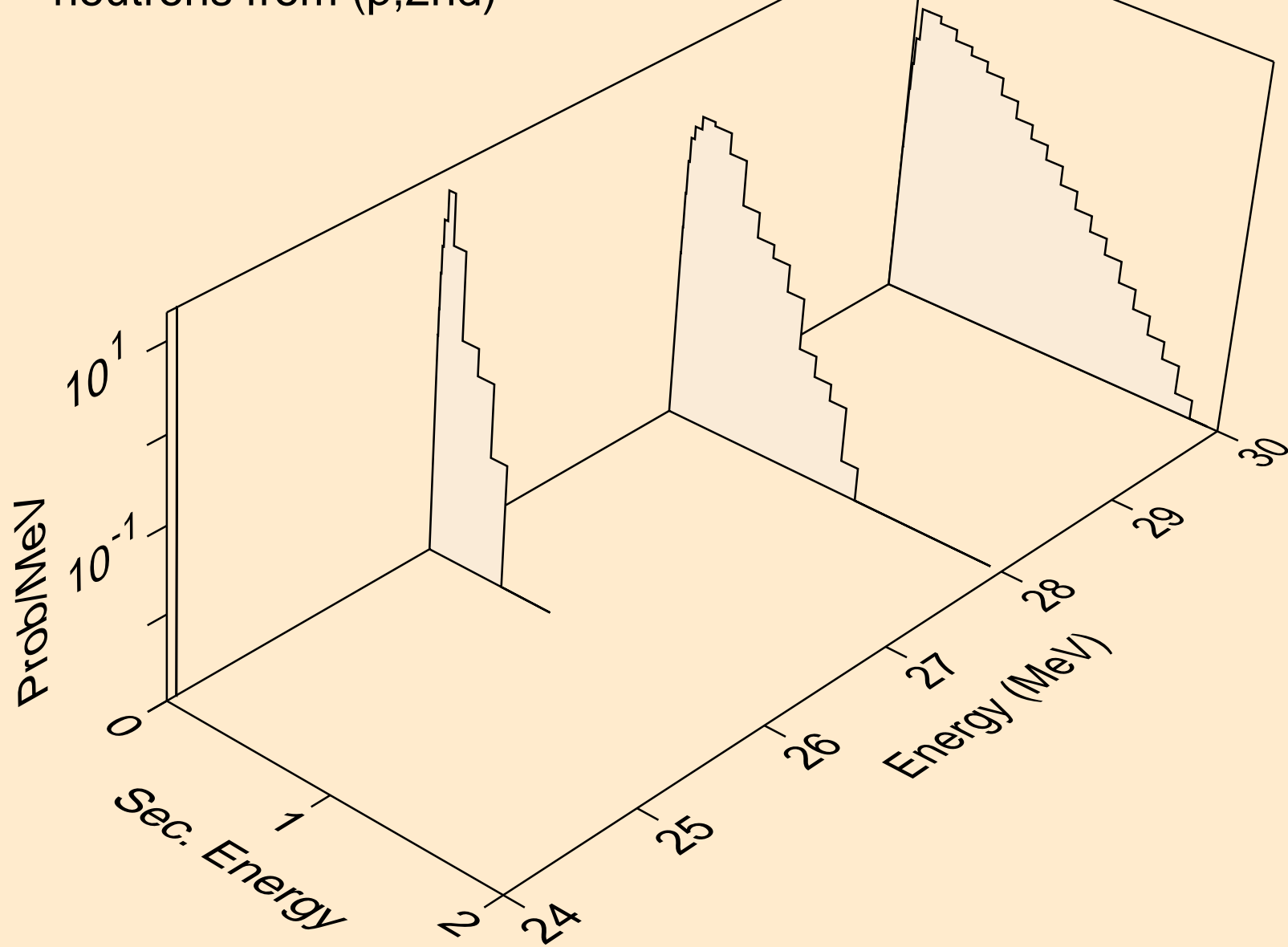

TM158M PROTON ACER TENDL-2021 LIBRARY; T=0.K  
neutrons from (p,2n)

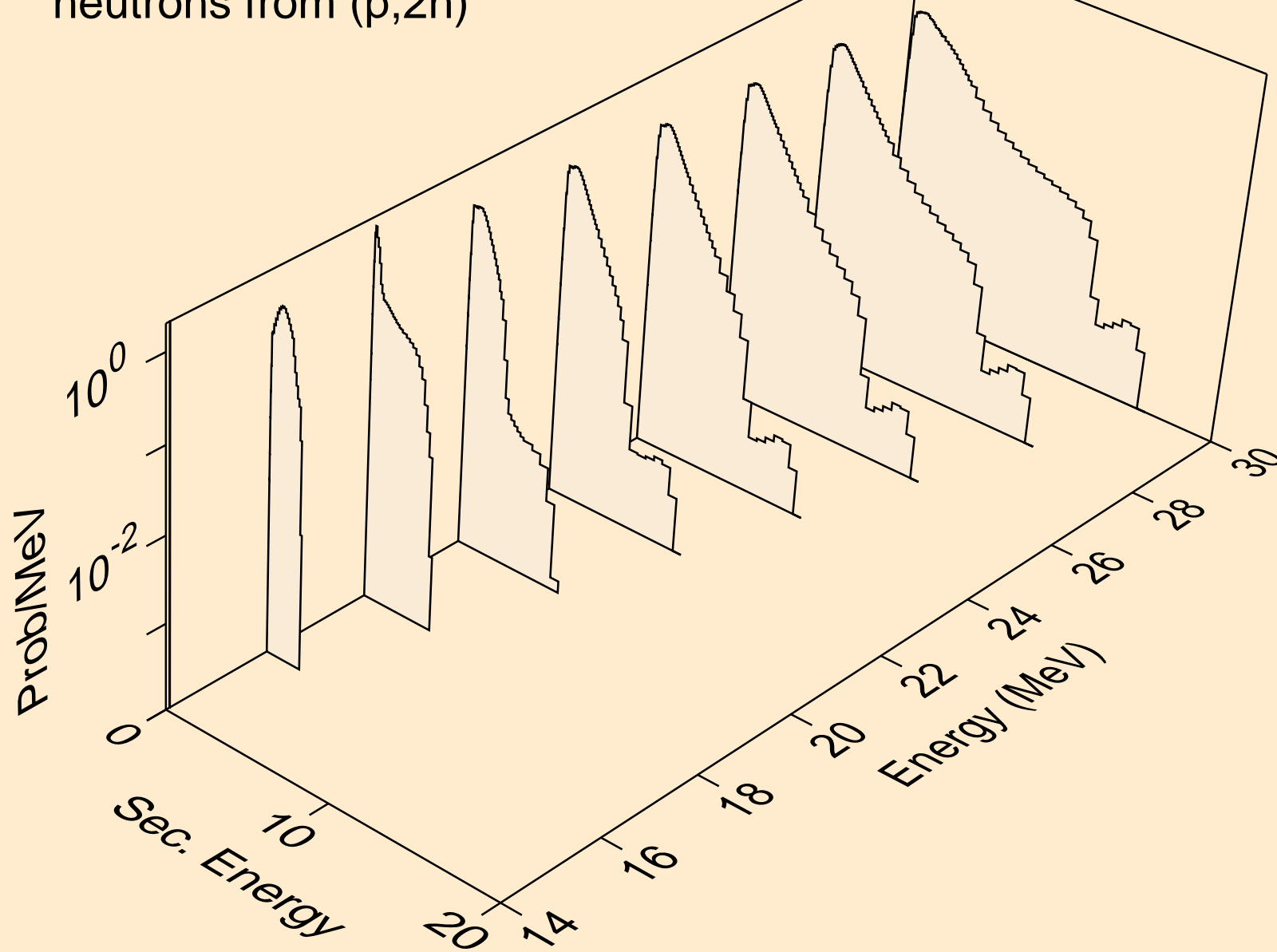

TM158M PROTON ACER TENDL-2021 LIBRARY; T=0.K  
neutrons from (p,3n)

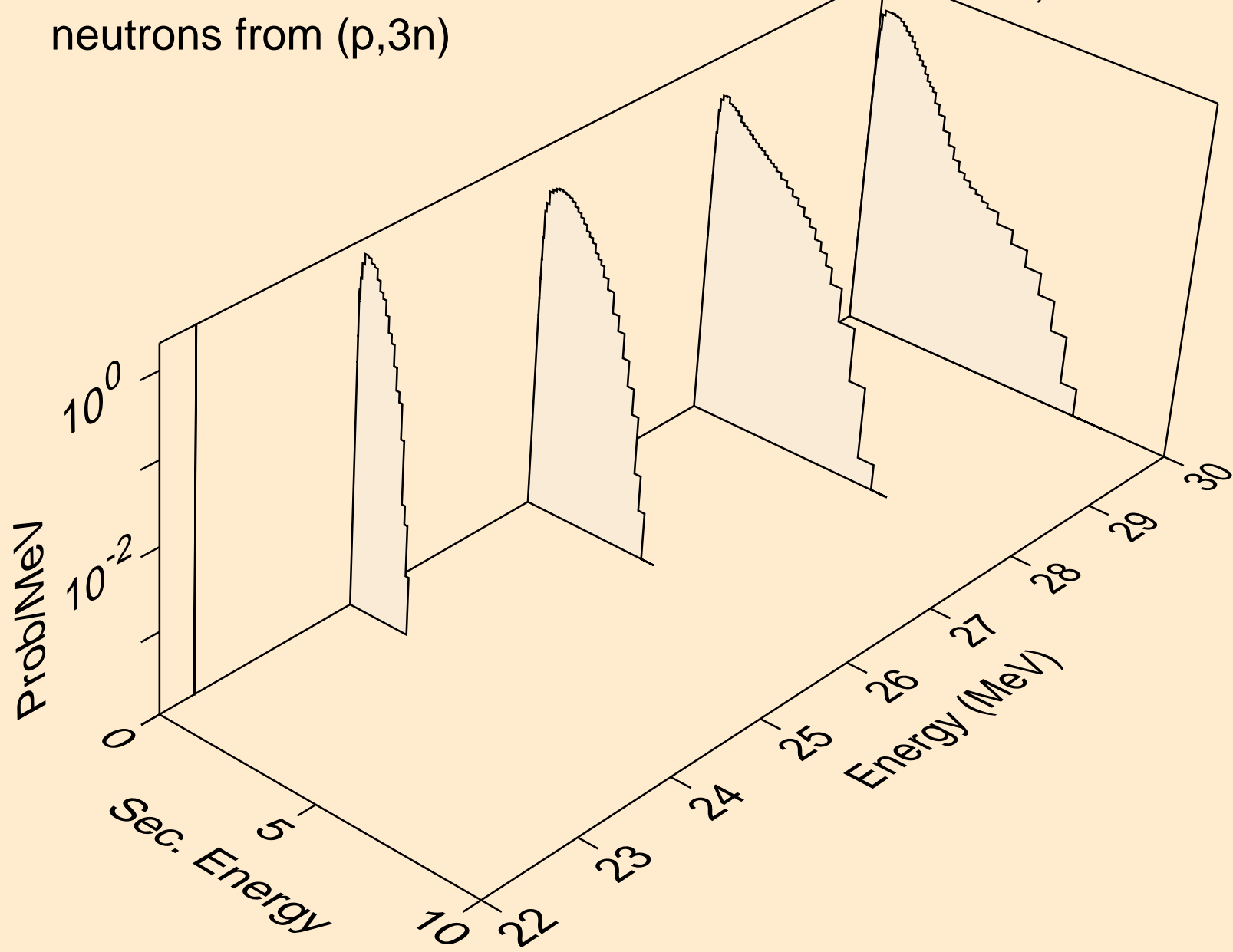

TM158M PROTON ACER TENDL-2021 LIBRARY; T=0.K  
neutrons from (p,n\*)a

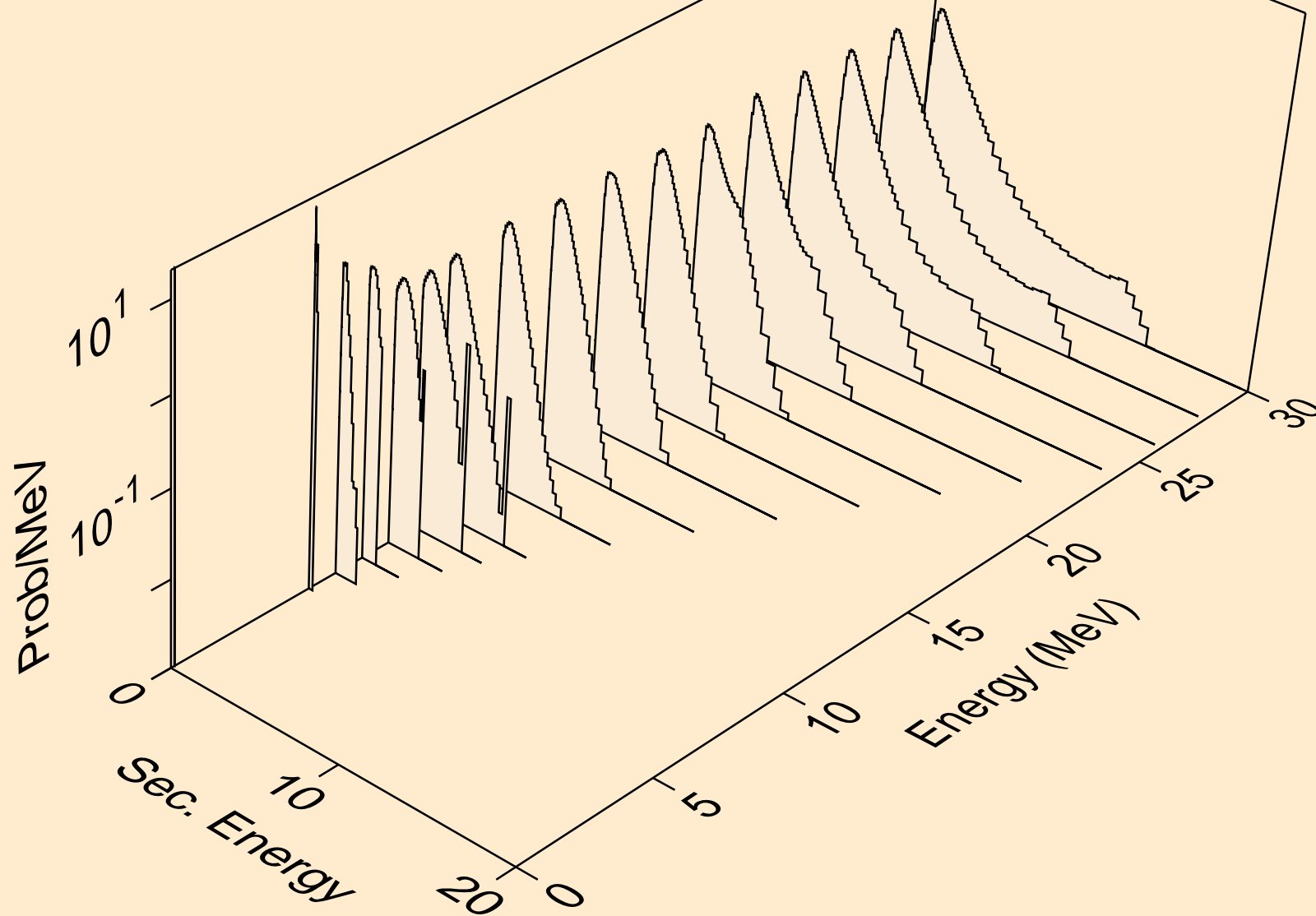

TM158M PROTON ACER TENDL-2021 LIBRARY; T=0.K  
neutrons from (p,n\*)3a

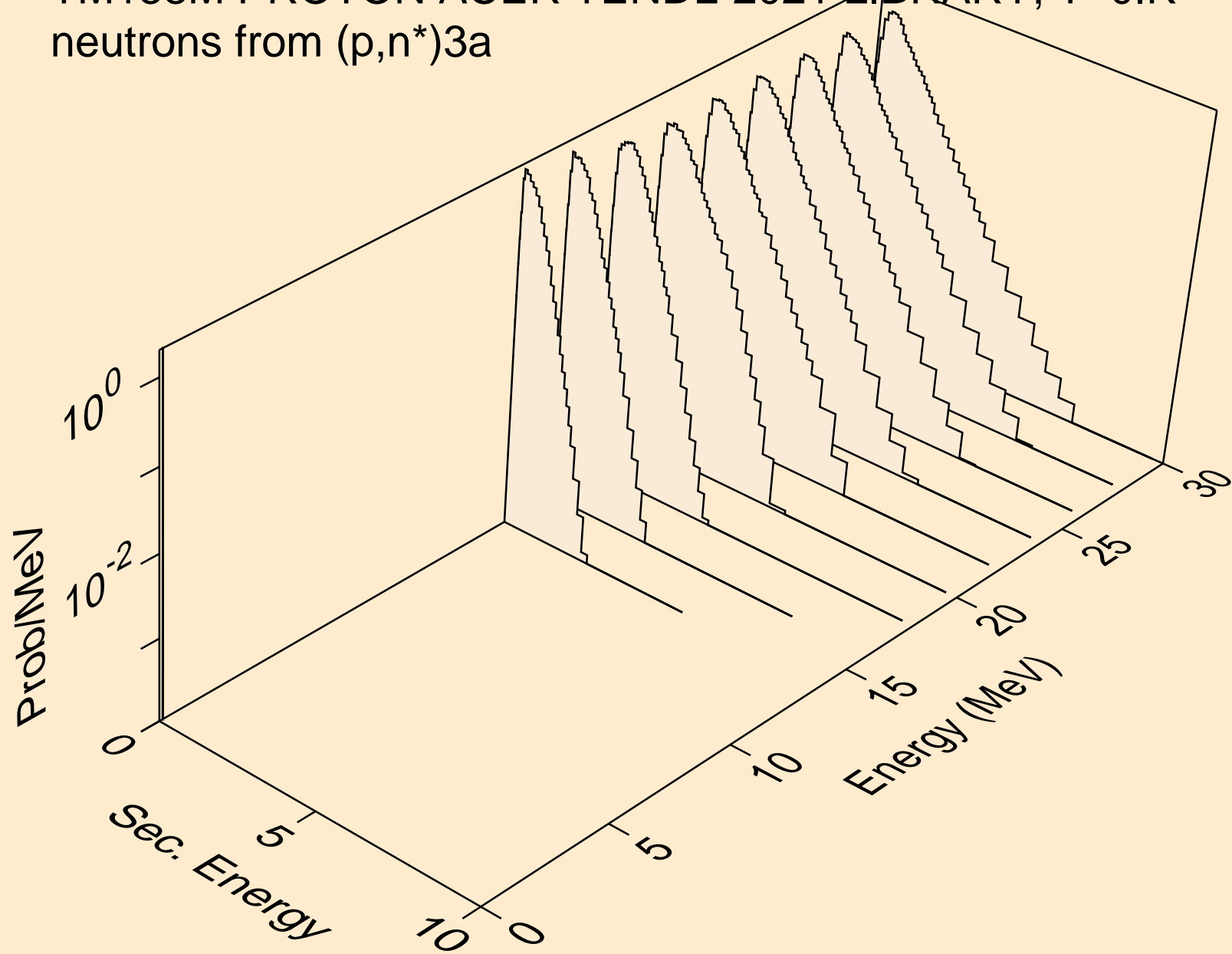

TM158M PROTON ACER TENDL-2021 LIBRARY; T=0.K  
neutrons from (p,2n)a

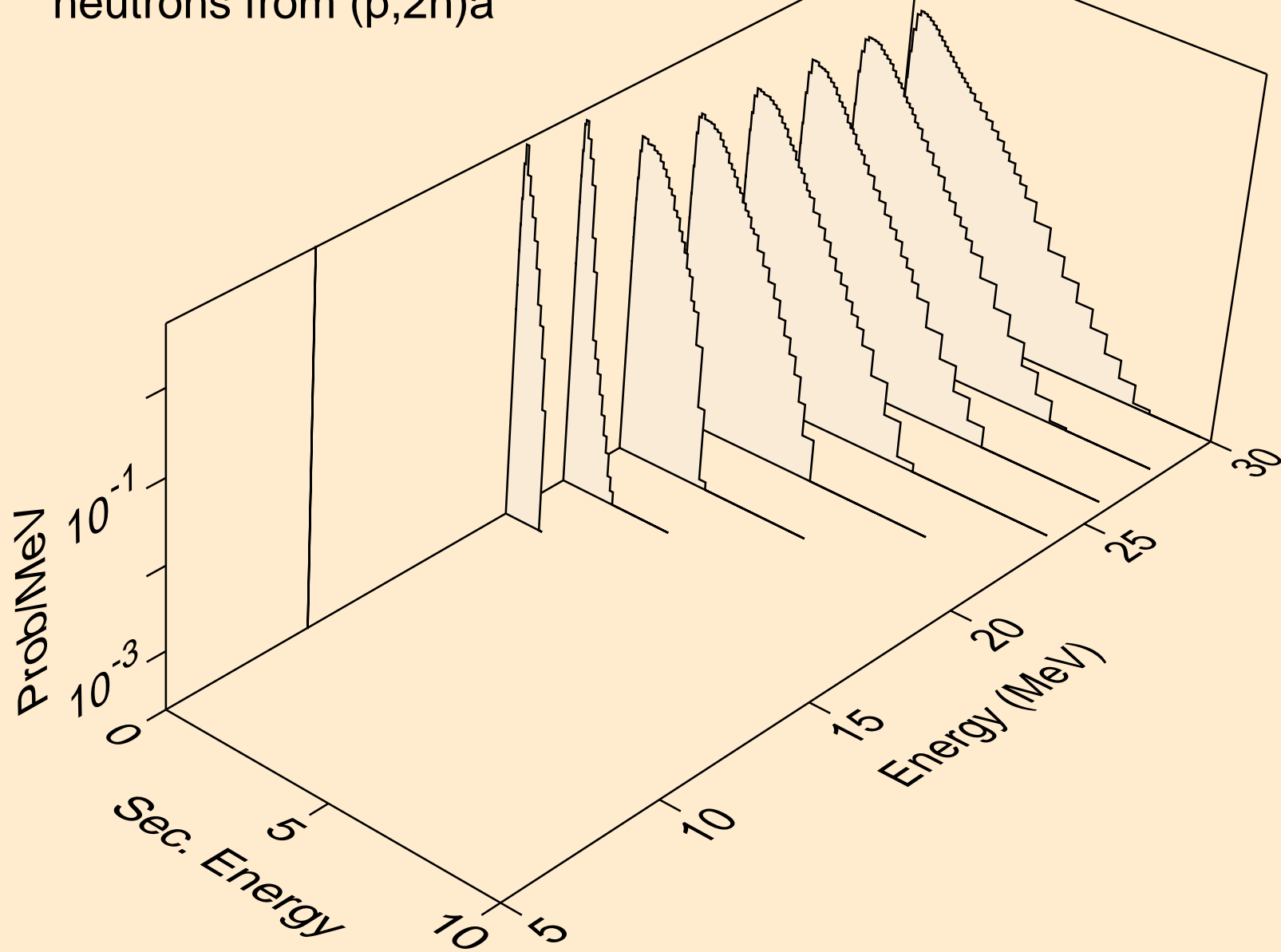

TM158M PROTON ACER TENDL-2021 LIBRARY; T=0.K  
neutrons from (p,3n)a

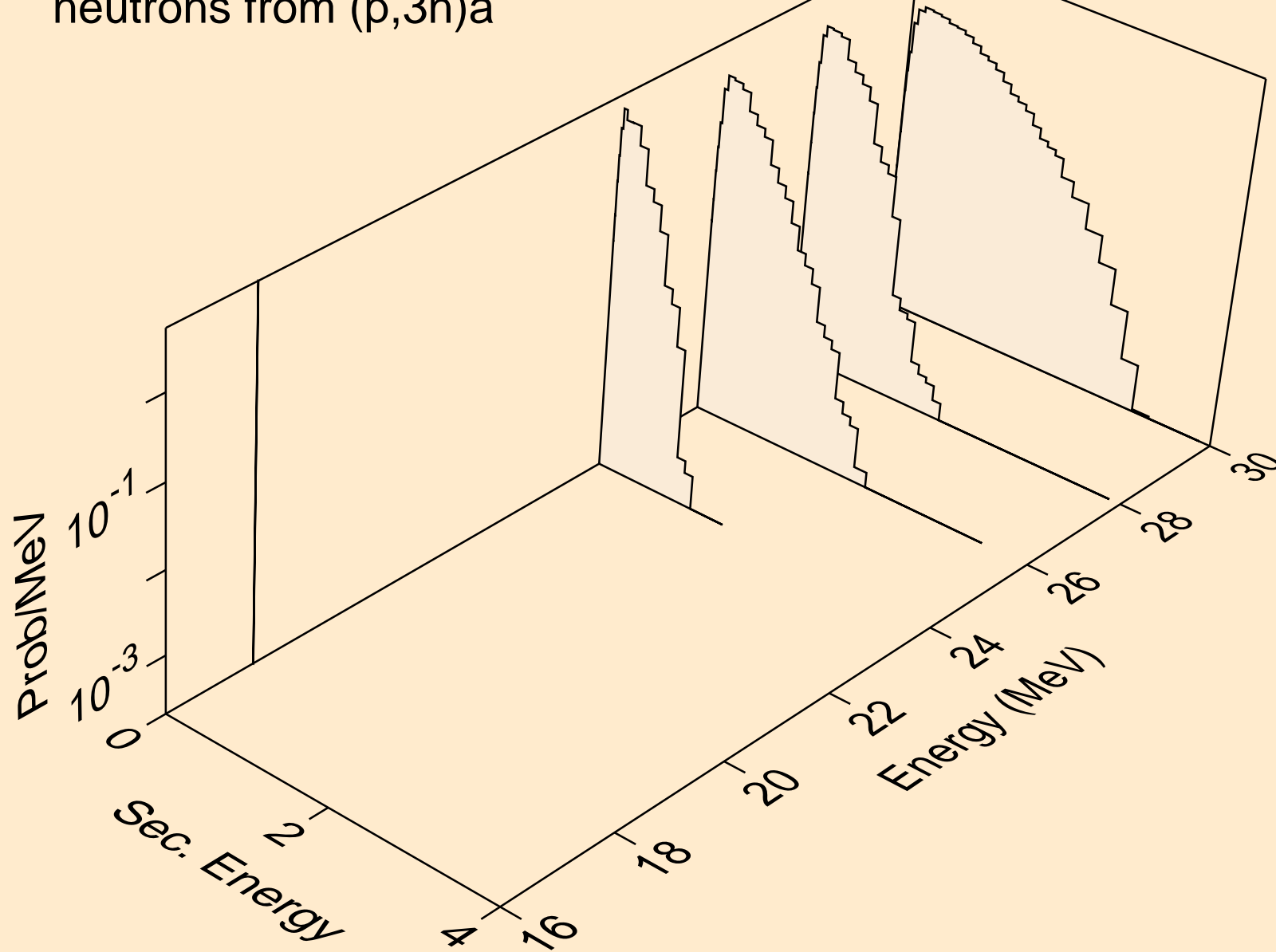



TM158M PROTON ACER TENDL-2021 LIBRARY; T=0.K  
neutrons from (p,n\*)p

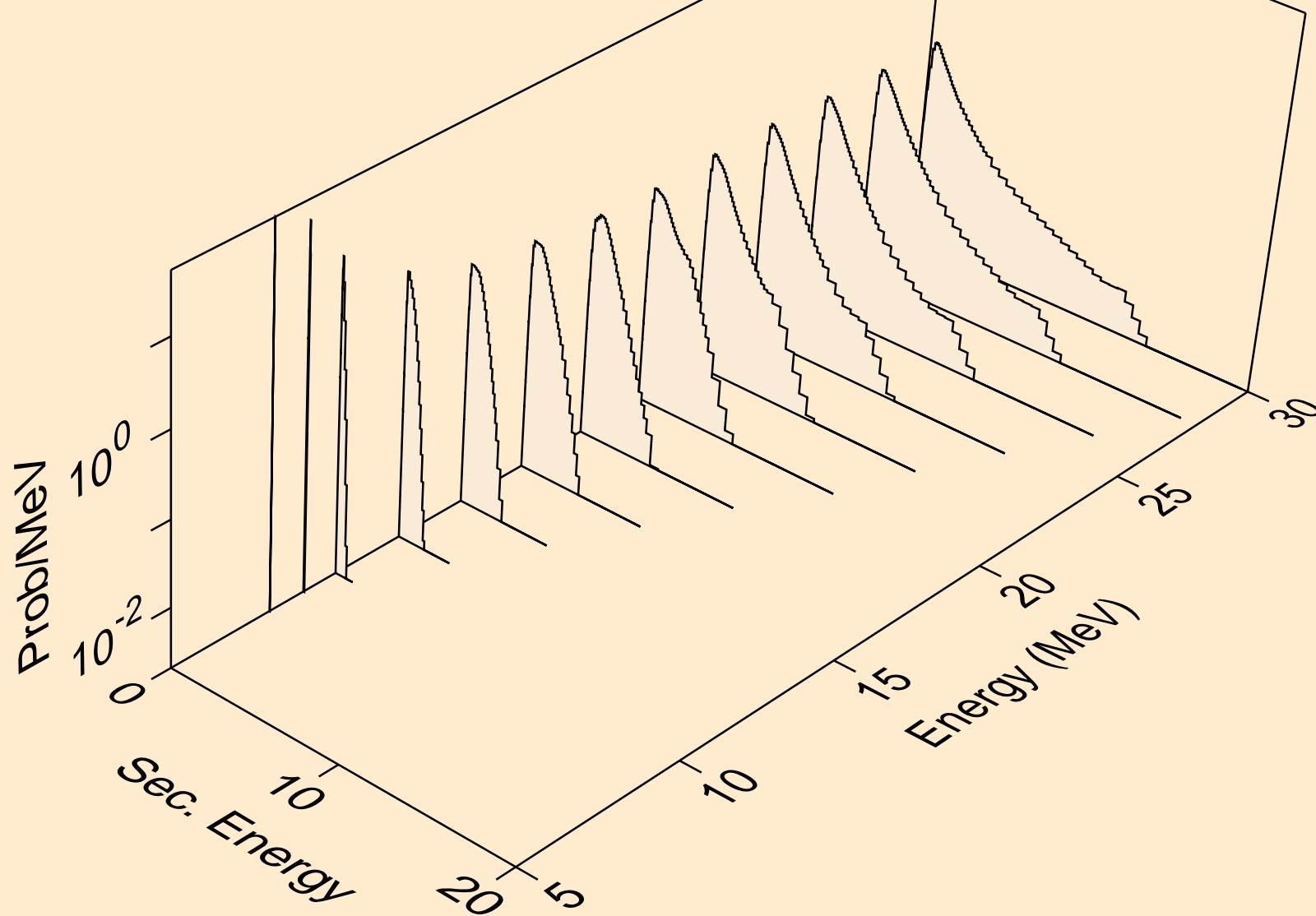

TM158M PROTON ACER TENDL-2021 LIBRARY; T=0.K  
neutrons from (p,n\*)2a

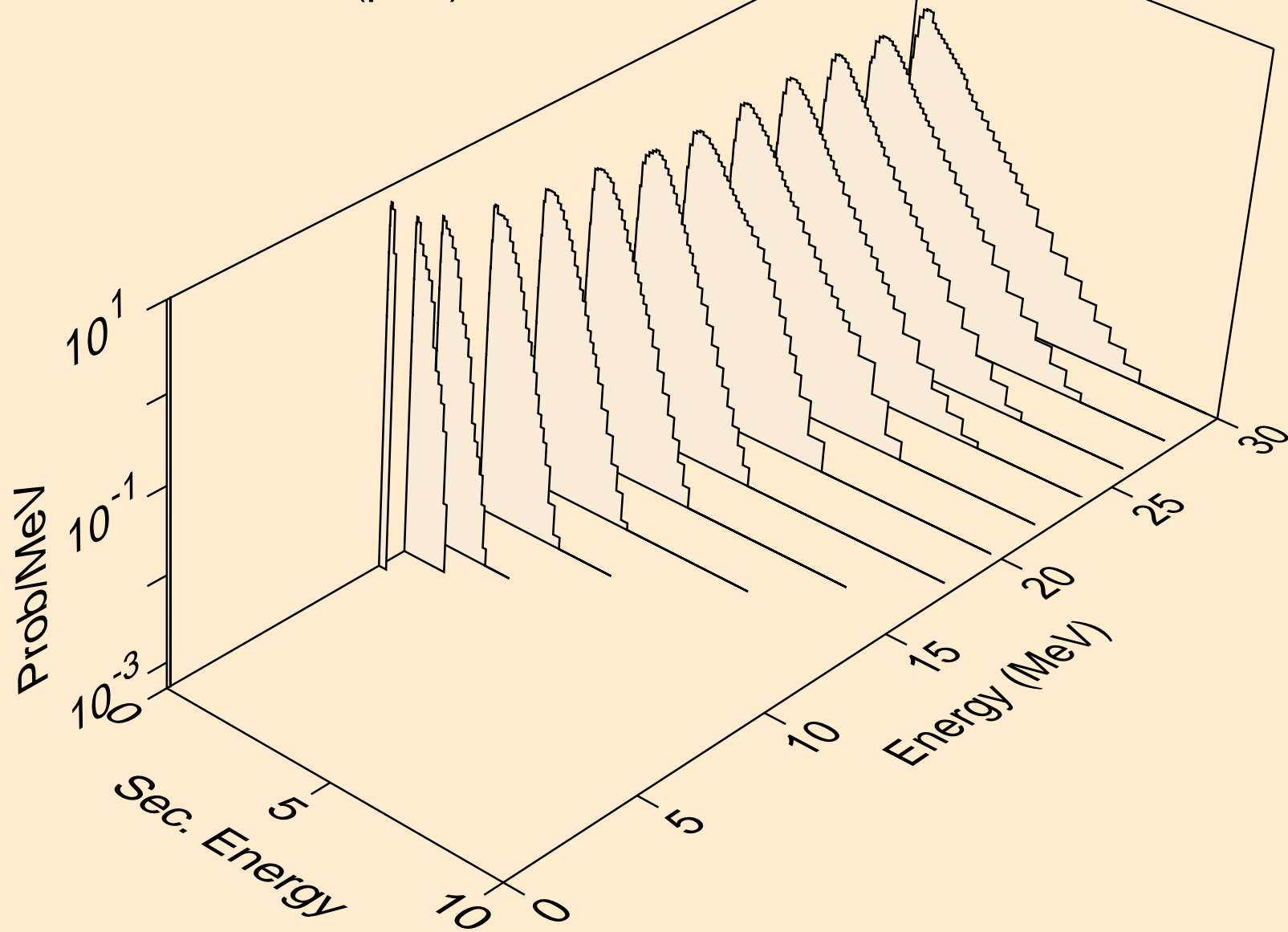

TM158M PROTON ACER TENDL-2021 LIBRARY; T=0.K  
neutrons from (p,2n)2a

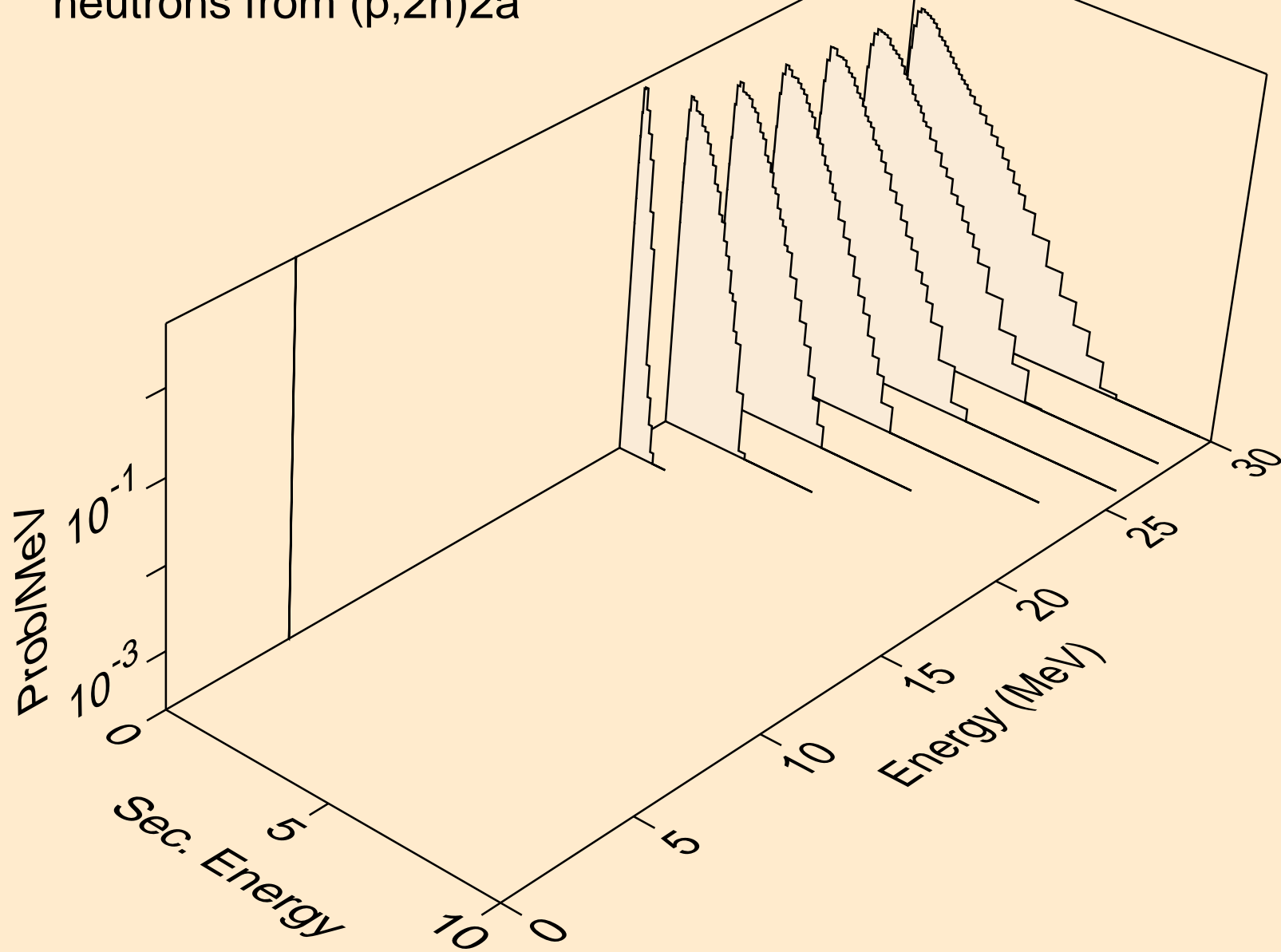

TM158M PROTON ACER TENDL-2021 LIBRARY; T=0.K  
neutrons from (p,n\*)d

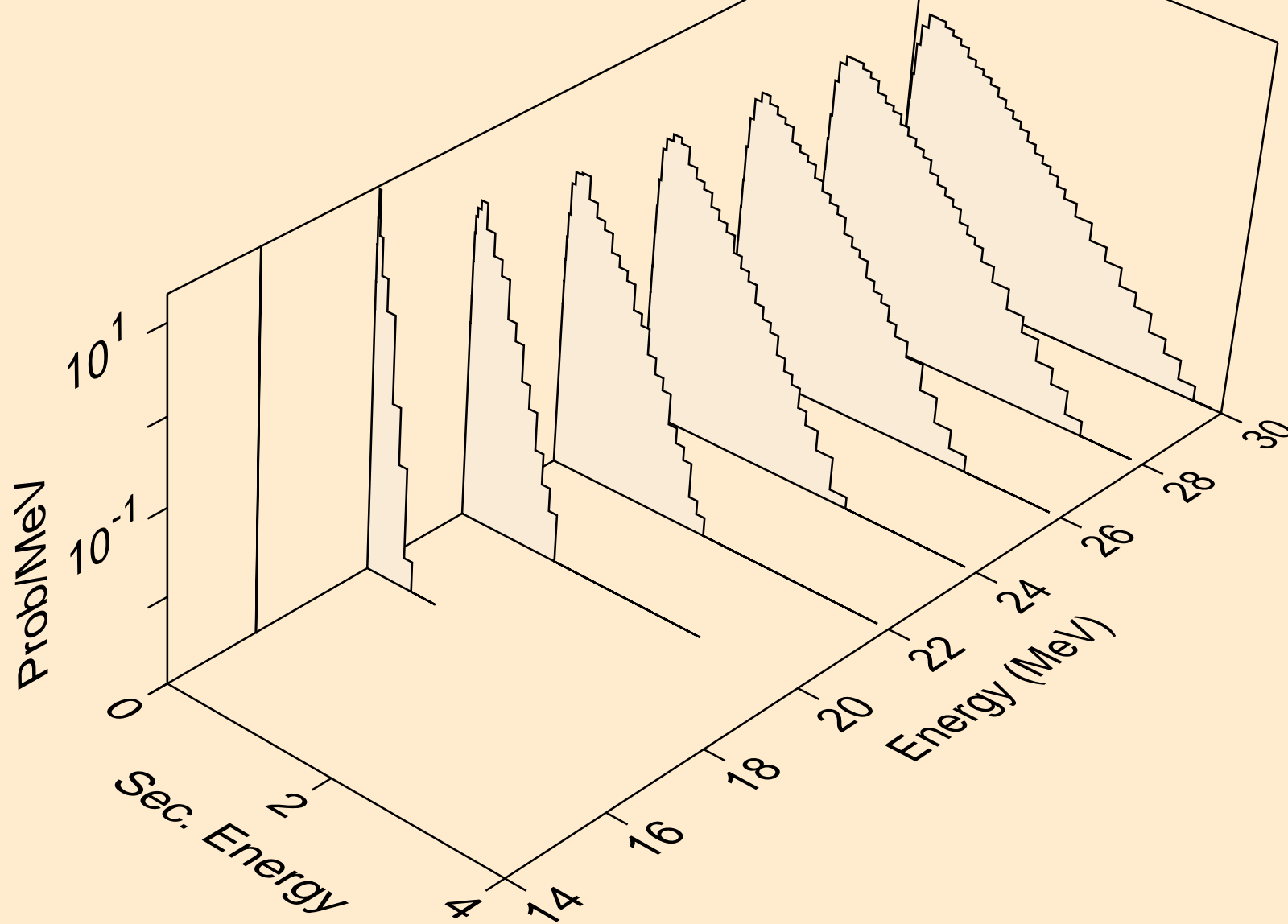

TM158M PROTON ACER TENDL-2021 LIBRARY; T=0.K  
neutrons from (p,n\*)t

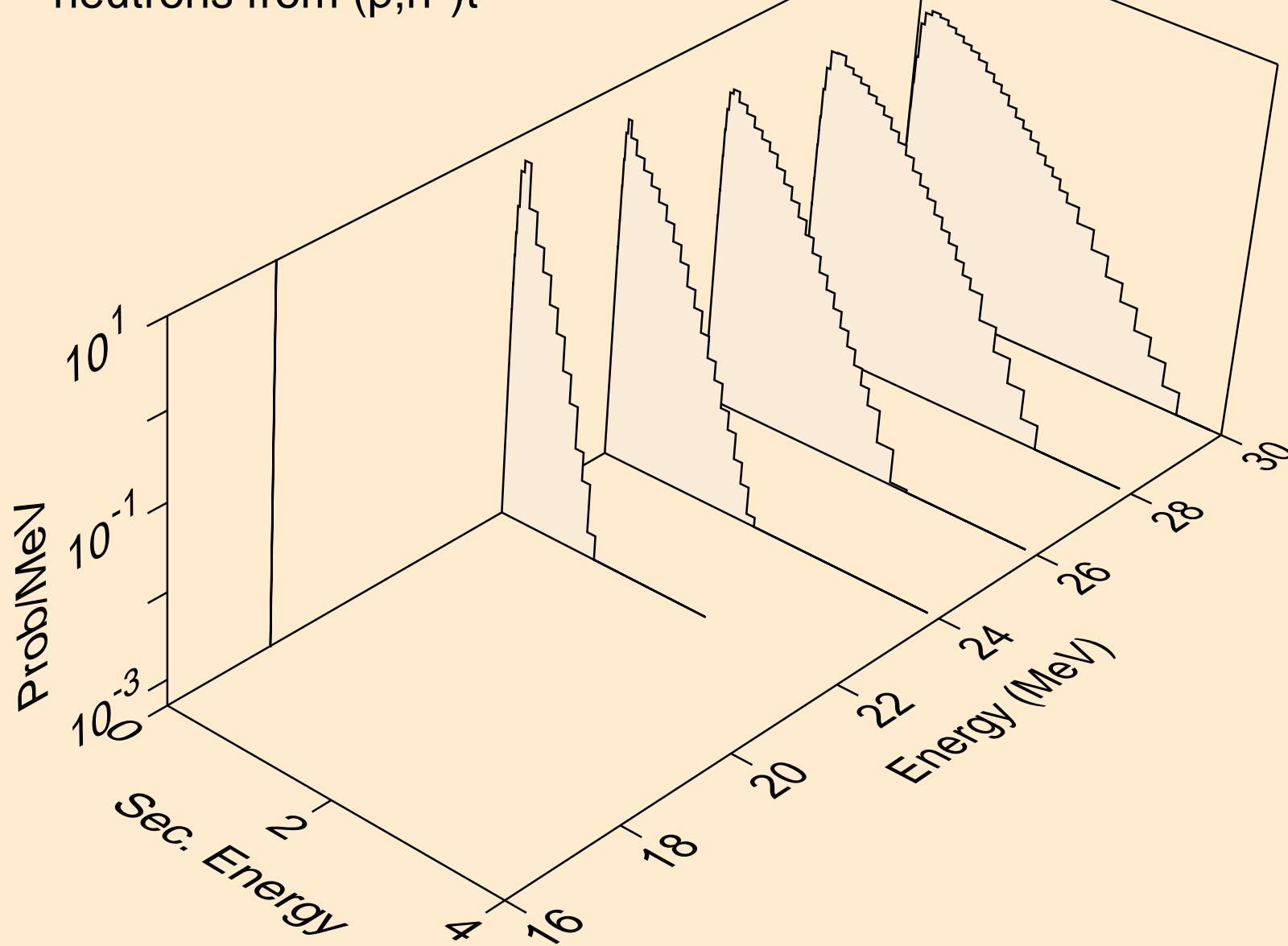

TM158M PROTON ACER TENDL-2021 LIBRARY; T=0.K  
neutrons from (p,n\*)he3

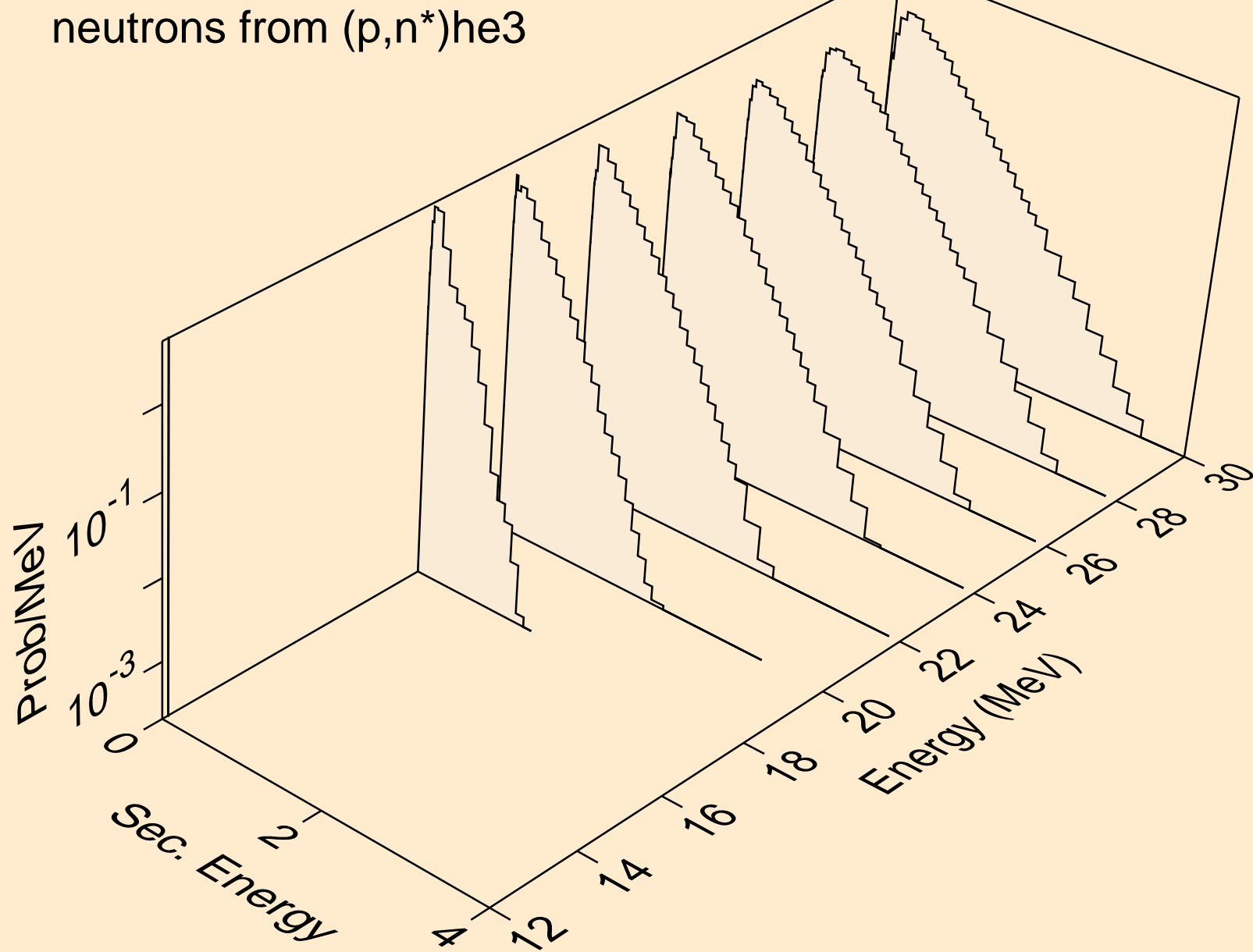

TM158M PROTON ACER TENDL-2021 LIBRARY; T=0.K  
neutrons from (p,2np)

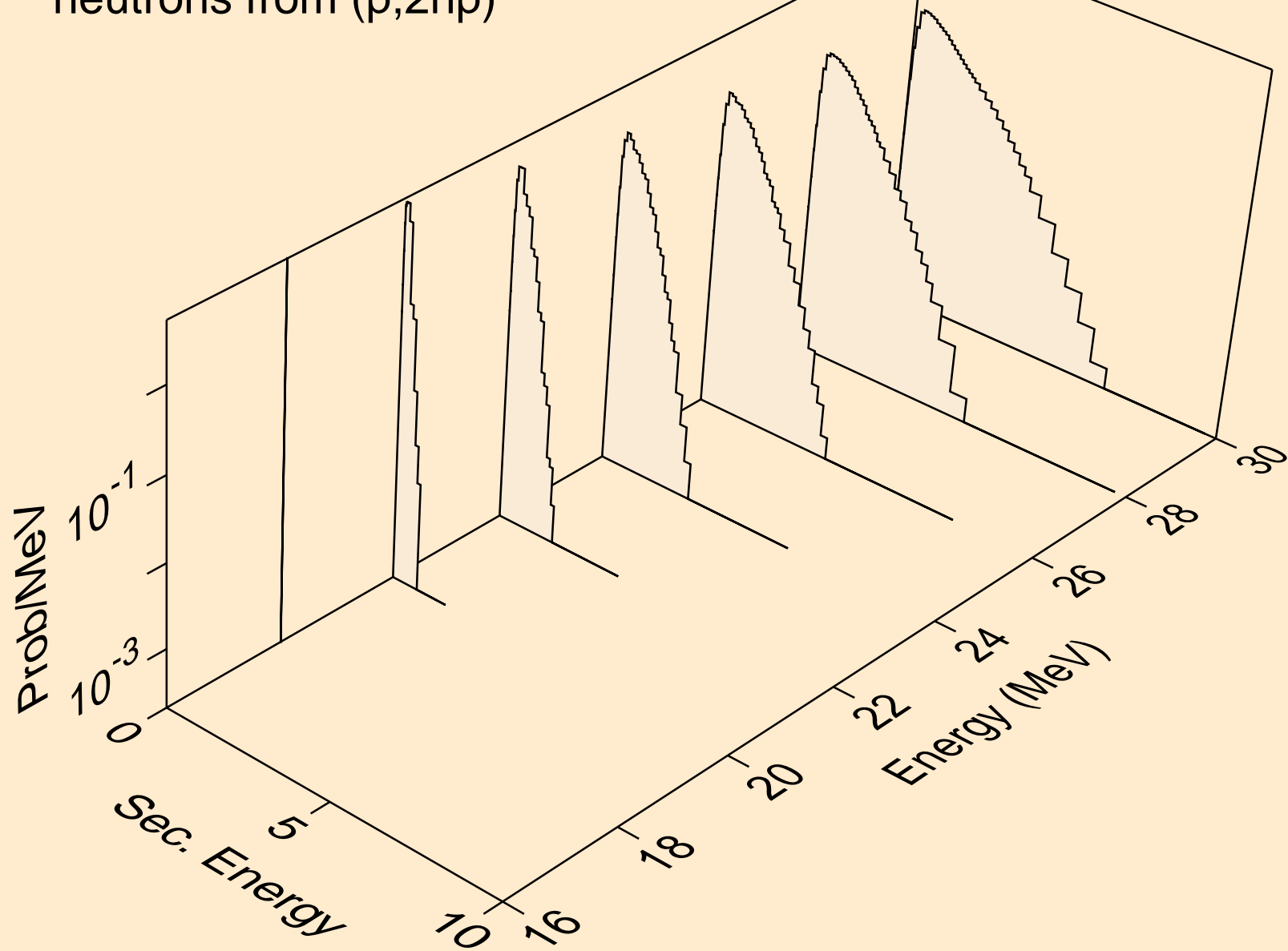

TM158M PROTON ACER TENDL-2021 LIBRARY; T=0.K  
neutrons from (p,3np)

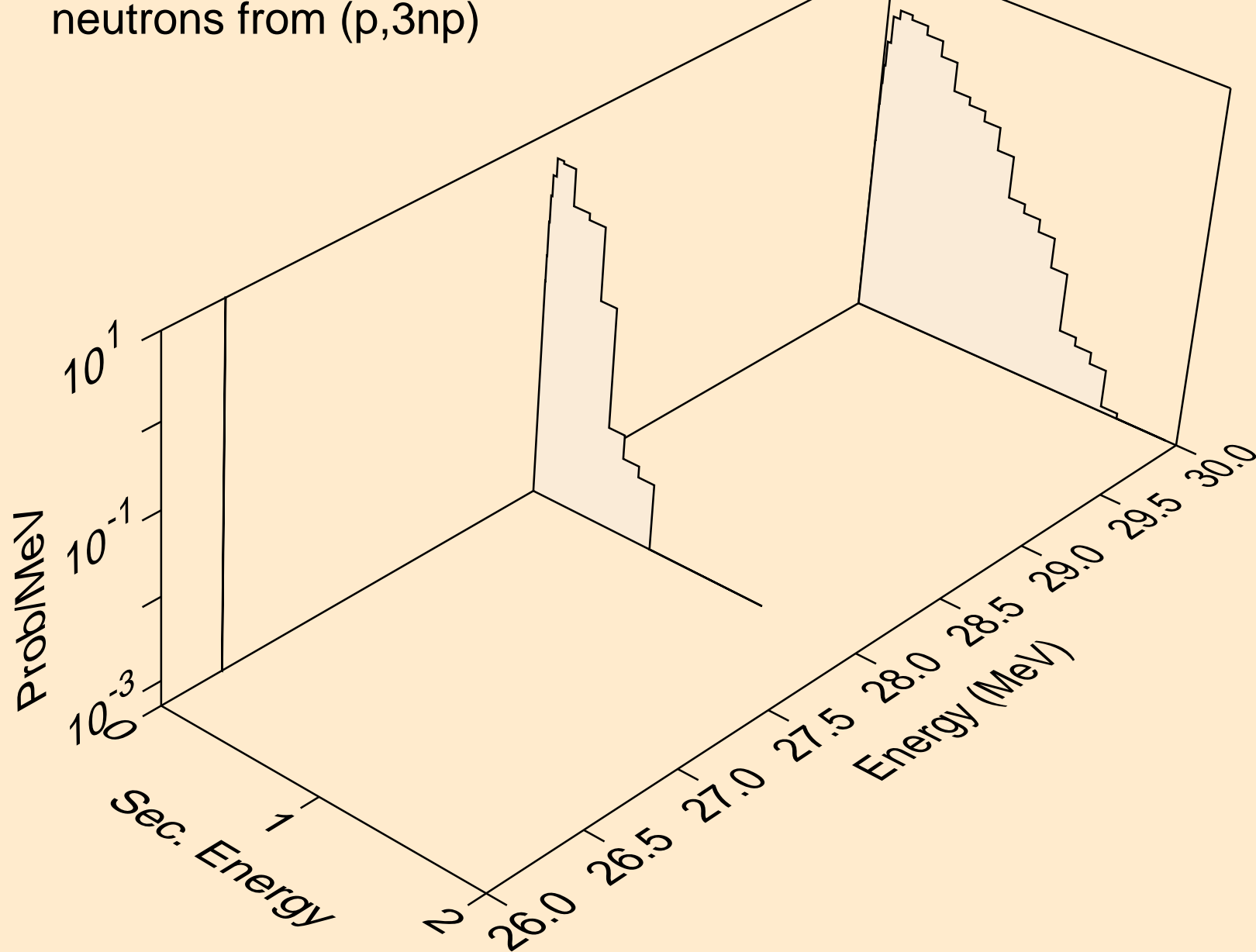



TM158M PROTON ACER TENDL-2021 LIBRARY; T=0.K  
neutrons from (p,2np)

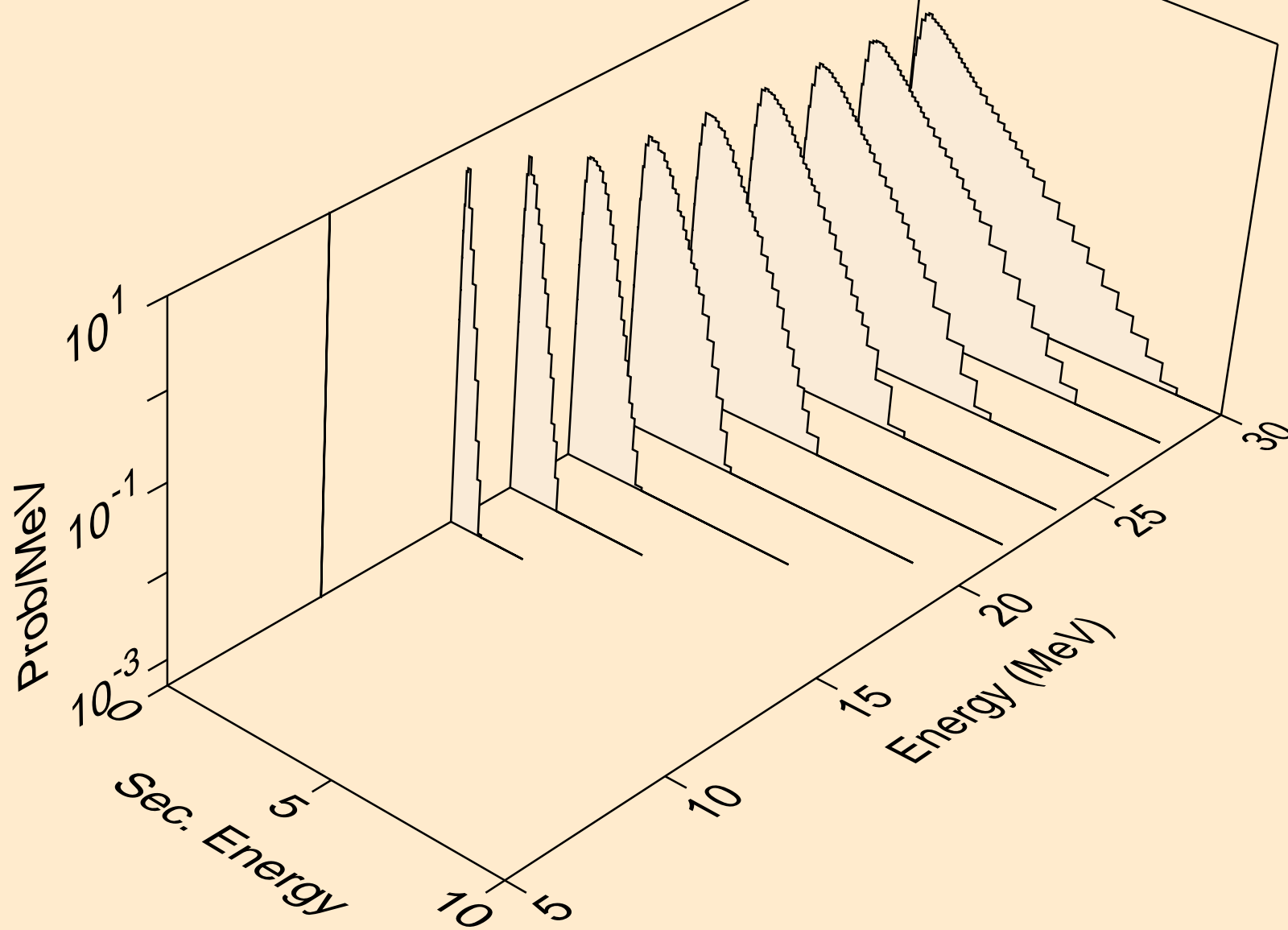

TM158M PROTON ACER TENDL-2021 LIBRARY; T=0.K  
neutrons from (p,npa)

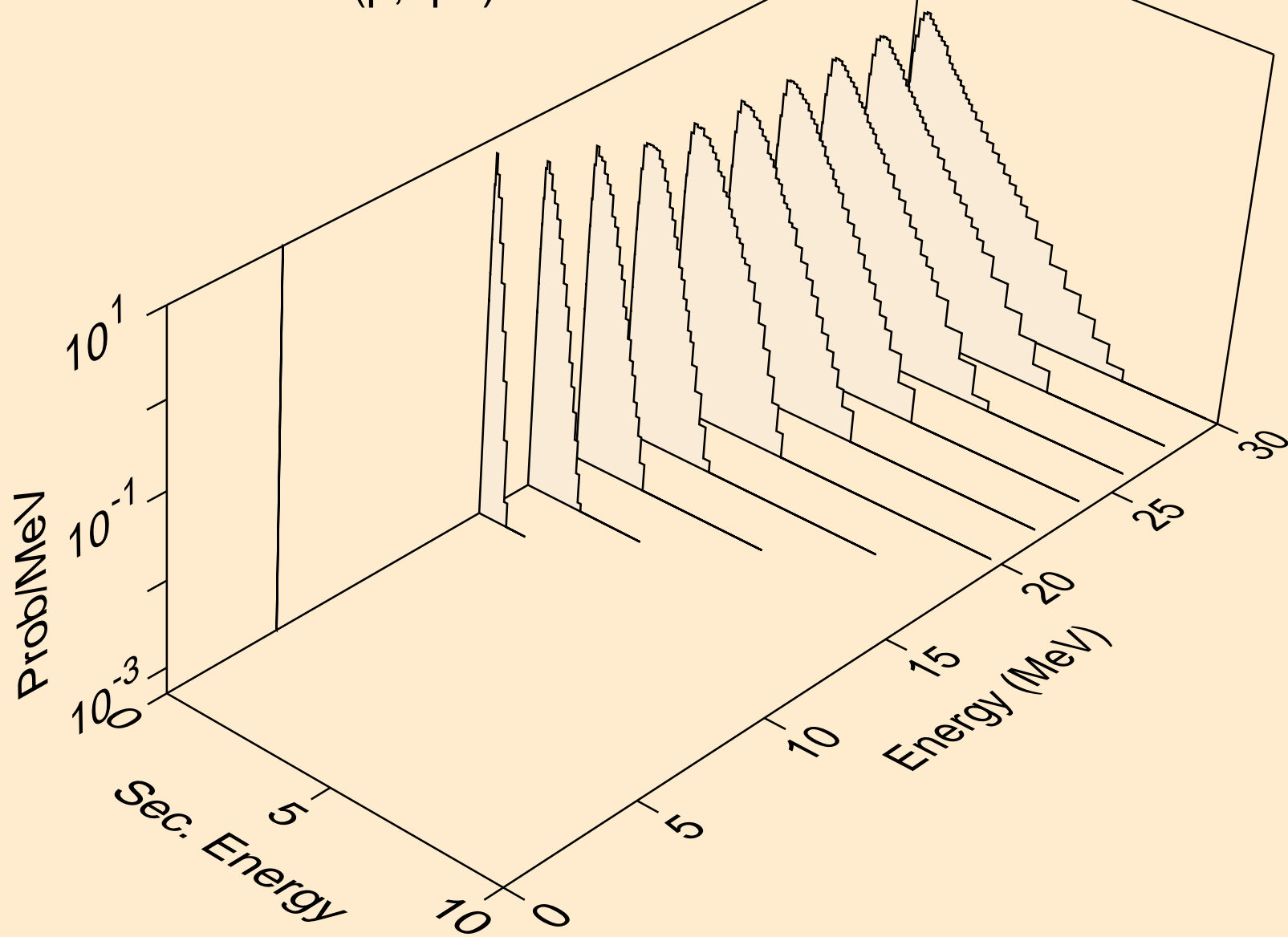

TM158M PROTON ACER TENDL-2021 LIBRARY; T=0.K  
deuterons from (p,x)

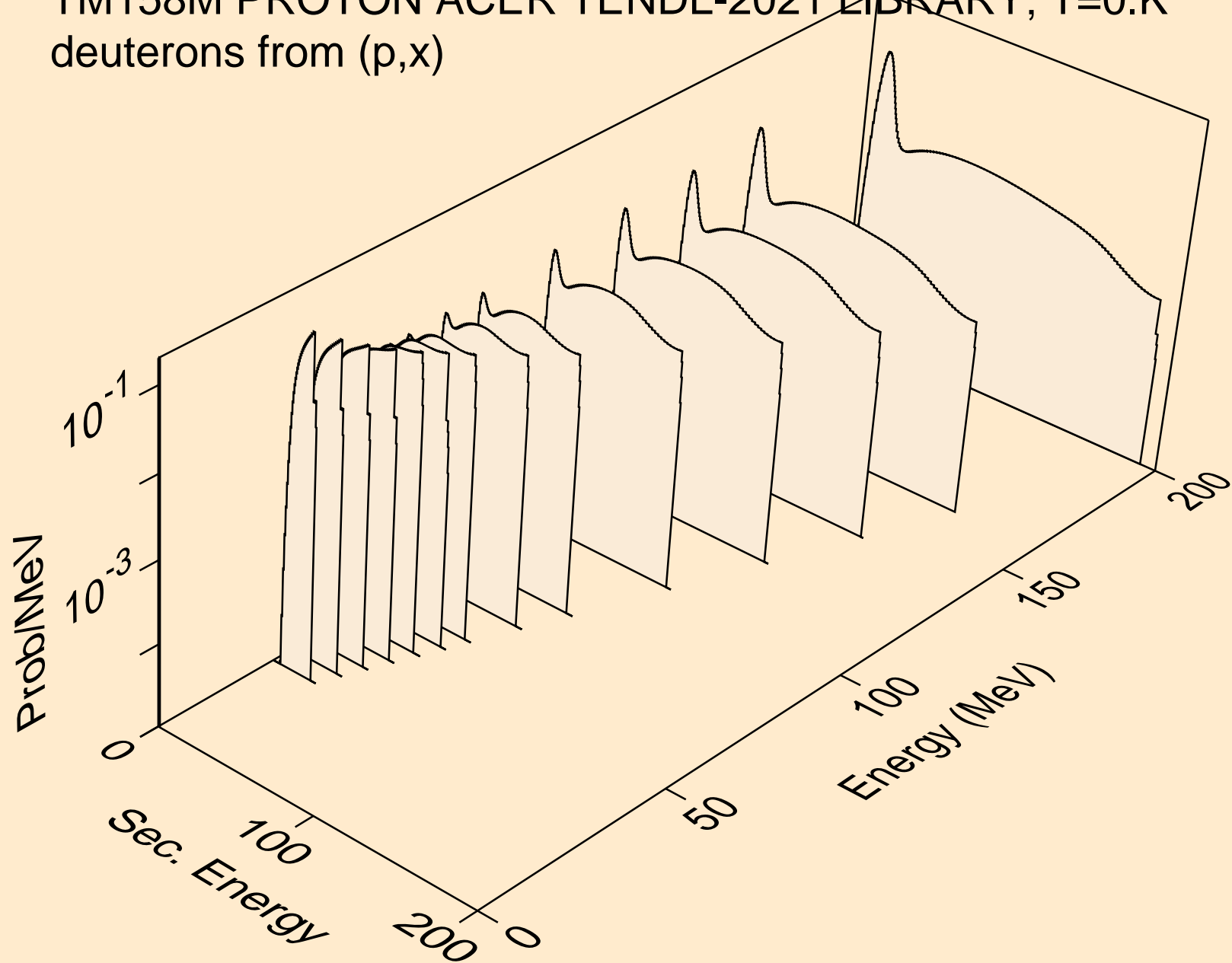

TM158M PROTON ACER TENDL-2021 LIBRARY; T=0.K  
deuterons from (p,2nd)

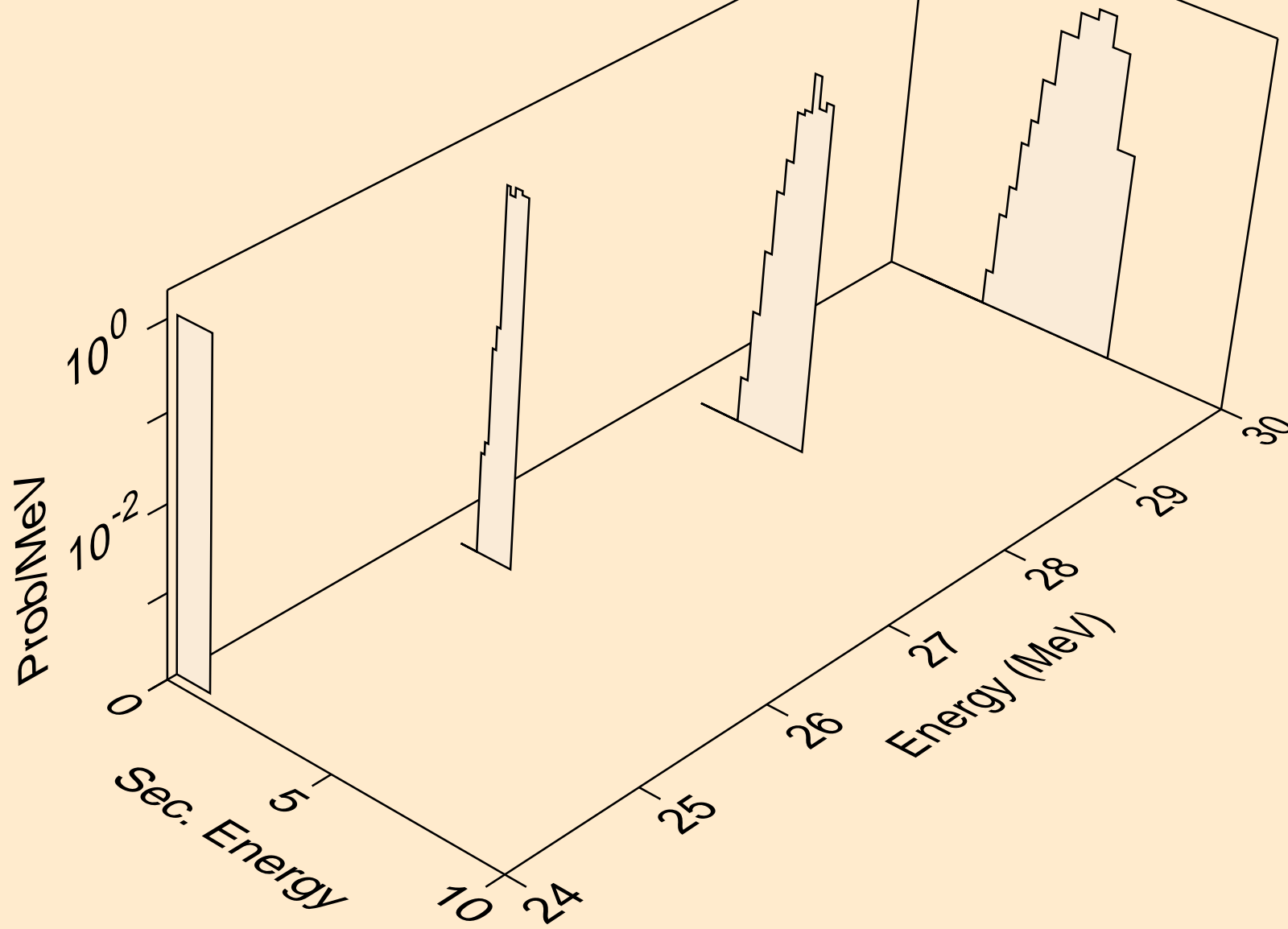

TM158M PROTON ACER TENDL-2021 LIBRARY; T=0.K  
deuterons from (p,n\*)d

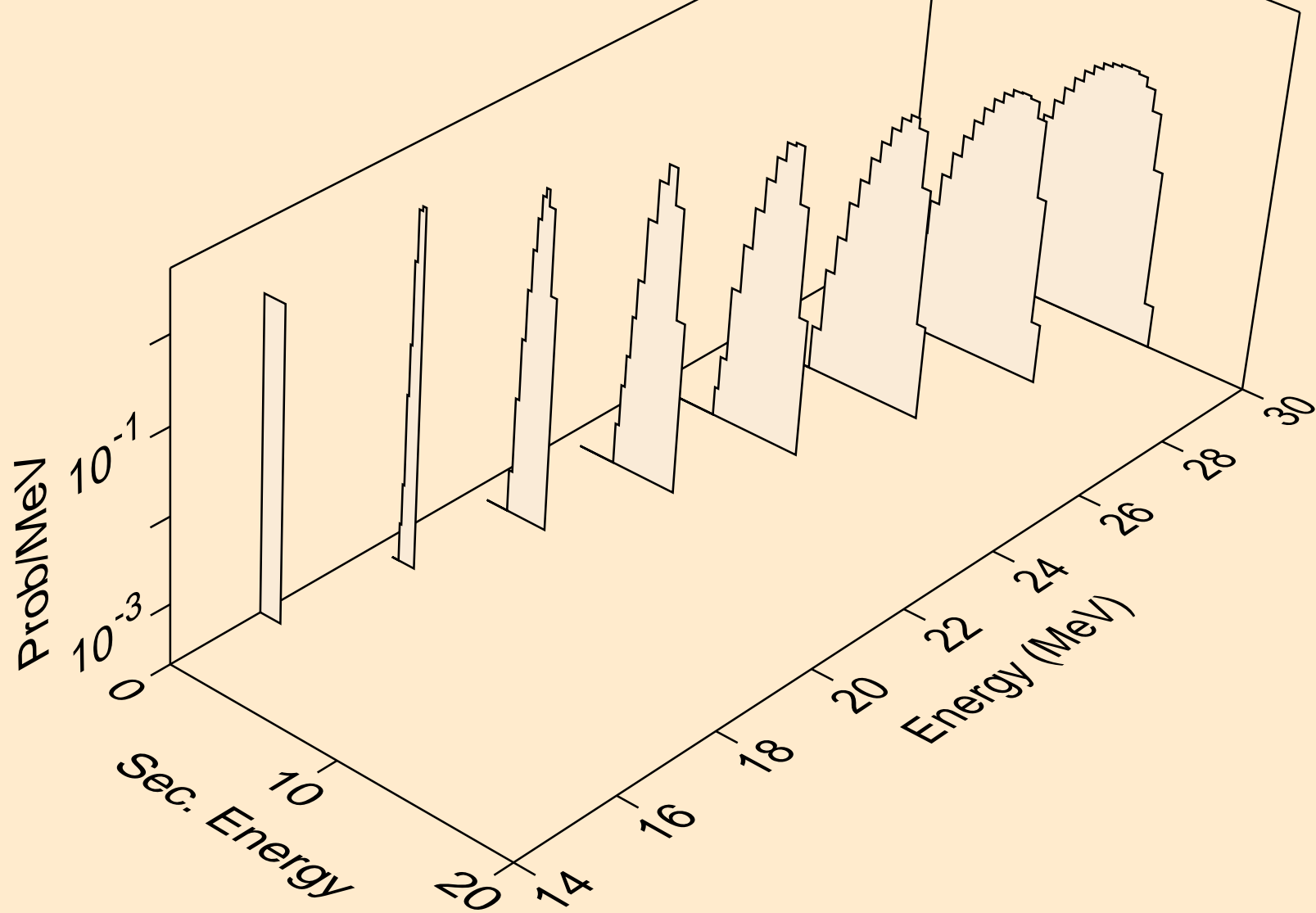

TM158M PROTON ACER TENDL-2021 LIBRARY; T=0.K  
deuterons from (p,d)

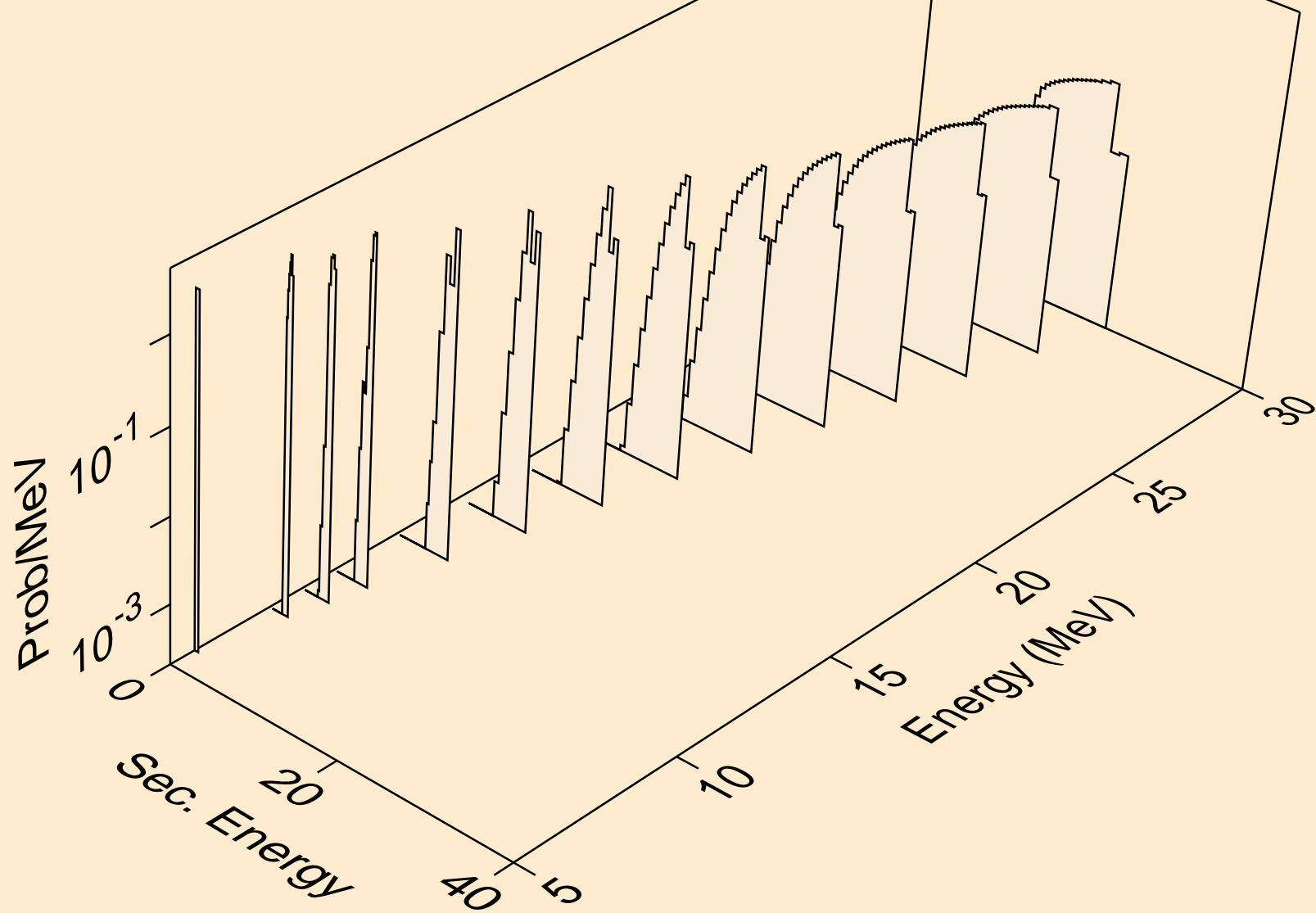

TM158M PROTON ACER TENDL-2021 LIBRARY; T=0.K  
deuterons from (p,pd)

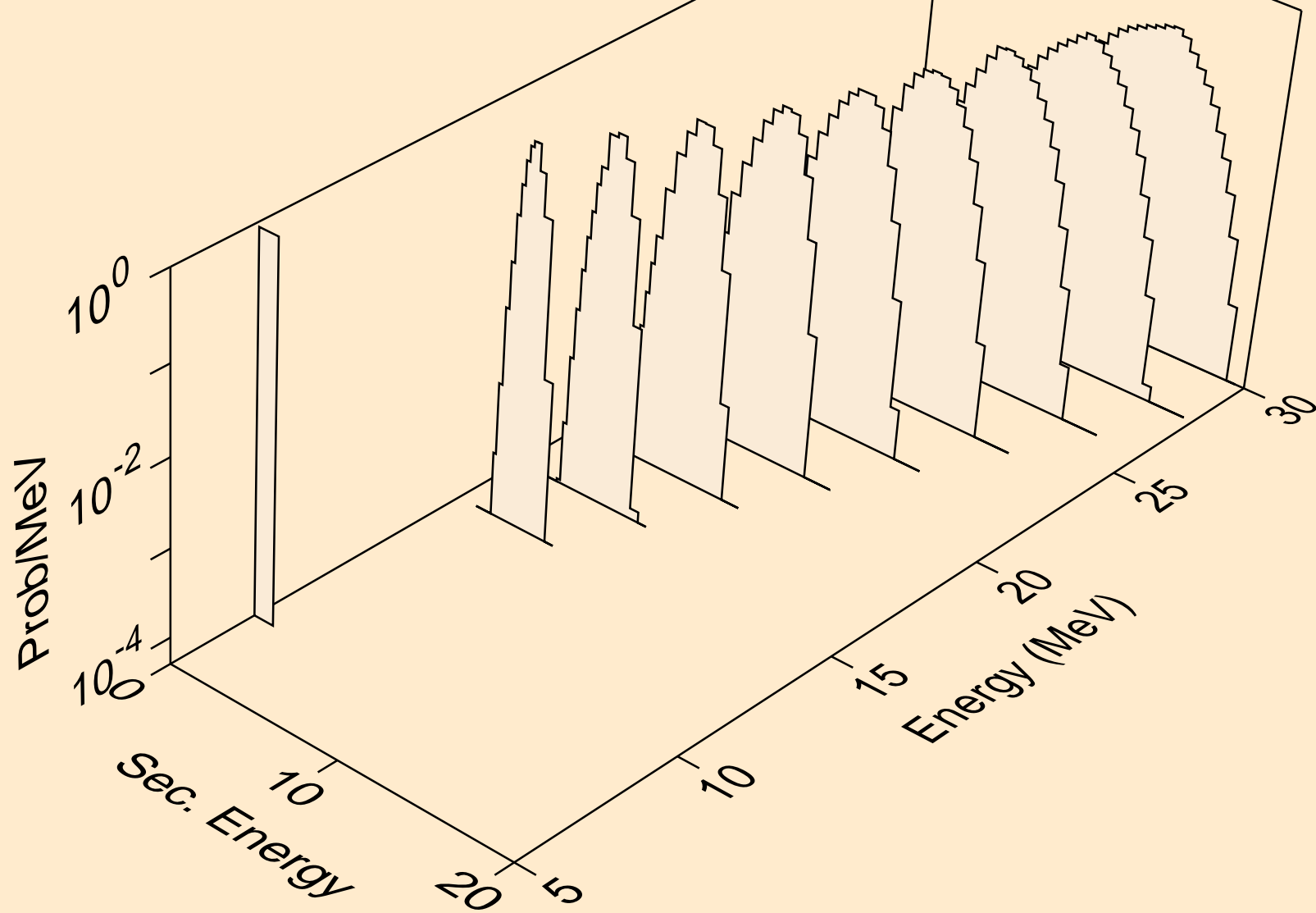

TM158M PROTON ACER TENDL-2021 LIBRARY; T=0.K  
deuterons from (p,da)

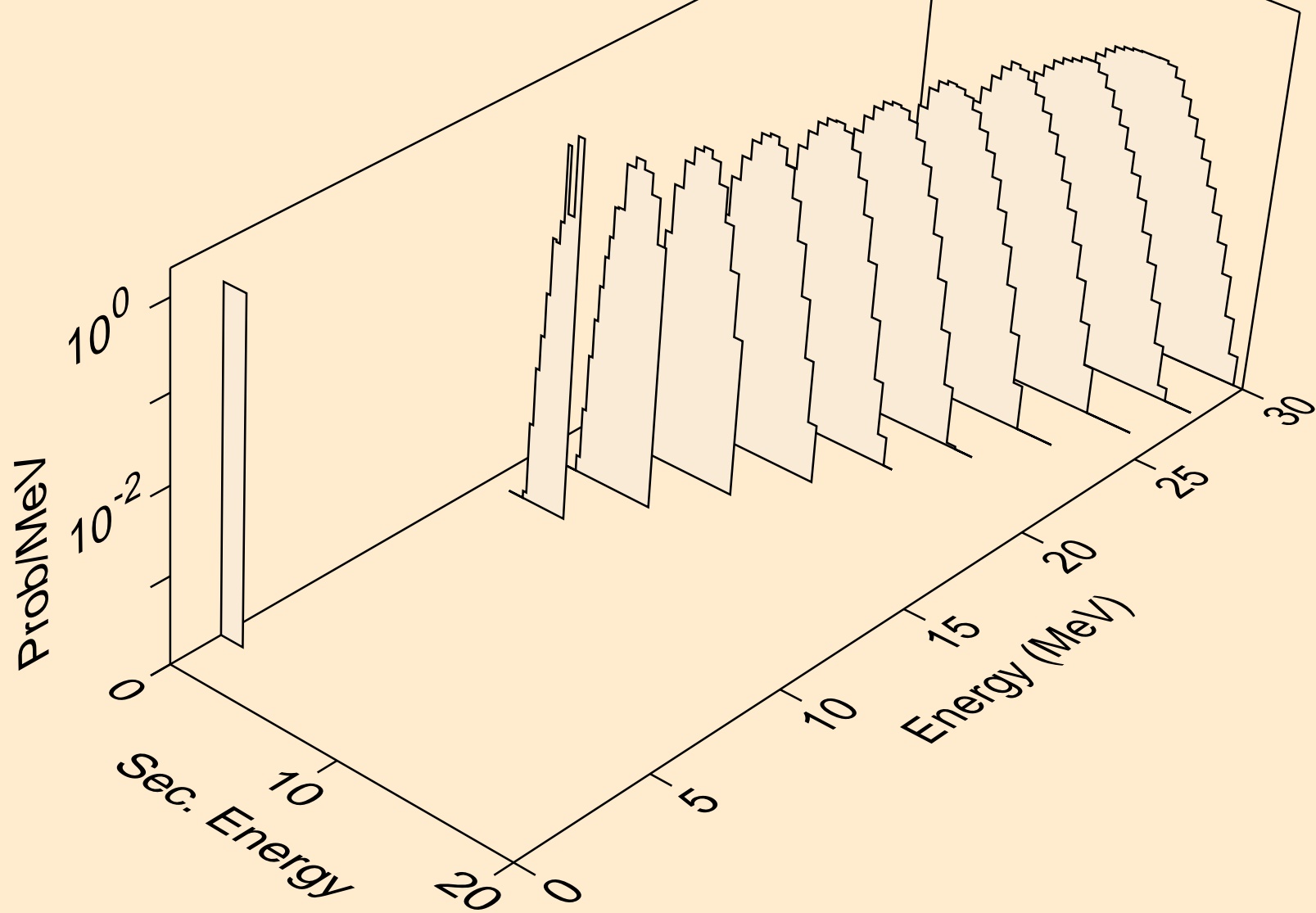



TM158M PROTON ACER TENDL-2021 LIBRARY; T=0.K  
tritons from (p,x)

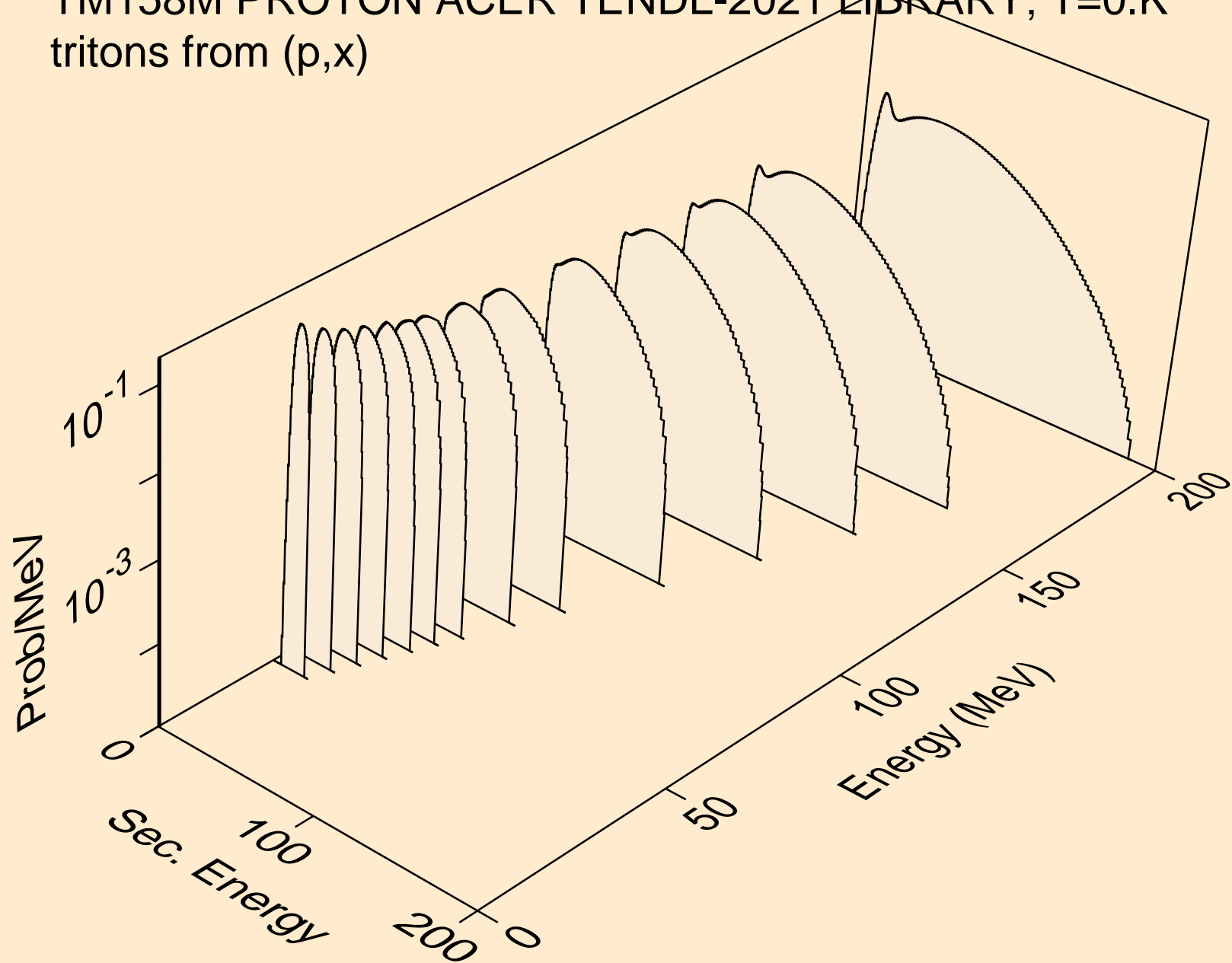

TM158M PROTON ACER TENDL-2021 LIBRARY; T=0.K  
tritons from (p,n\*)t

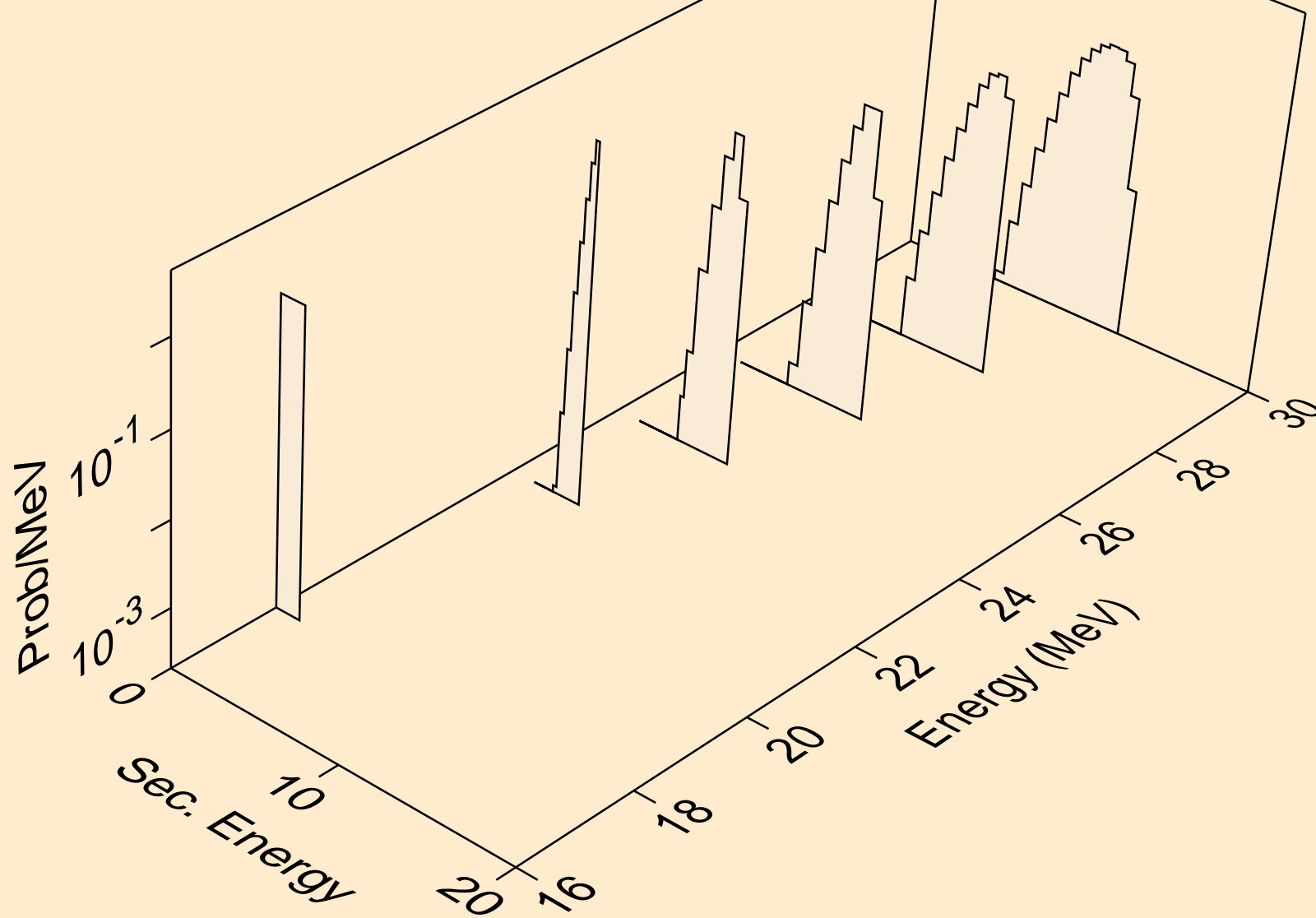

TM158M PROTON ACER TENDL-2021 LIBRARY; T=0.K  
tritons from (p,t)

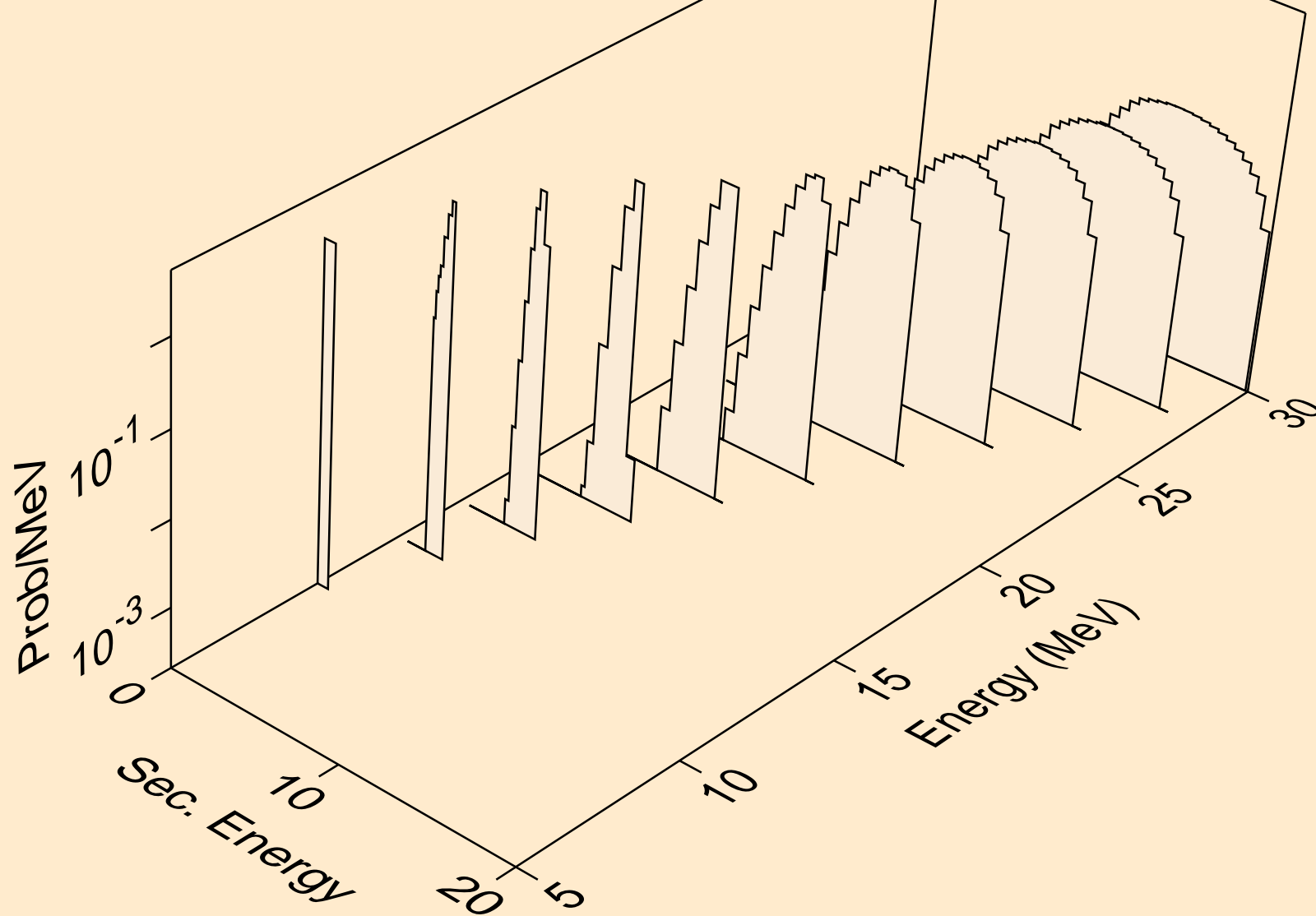

TM158M PROTON ACER TENDL-2021 LIBRARY; T=0.K  
tritons from (p,pt)

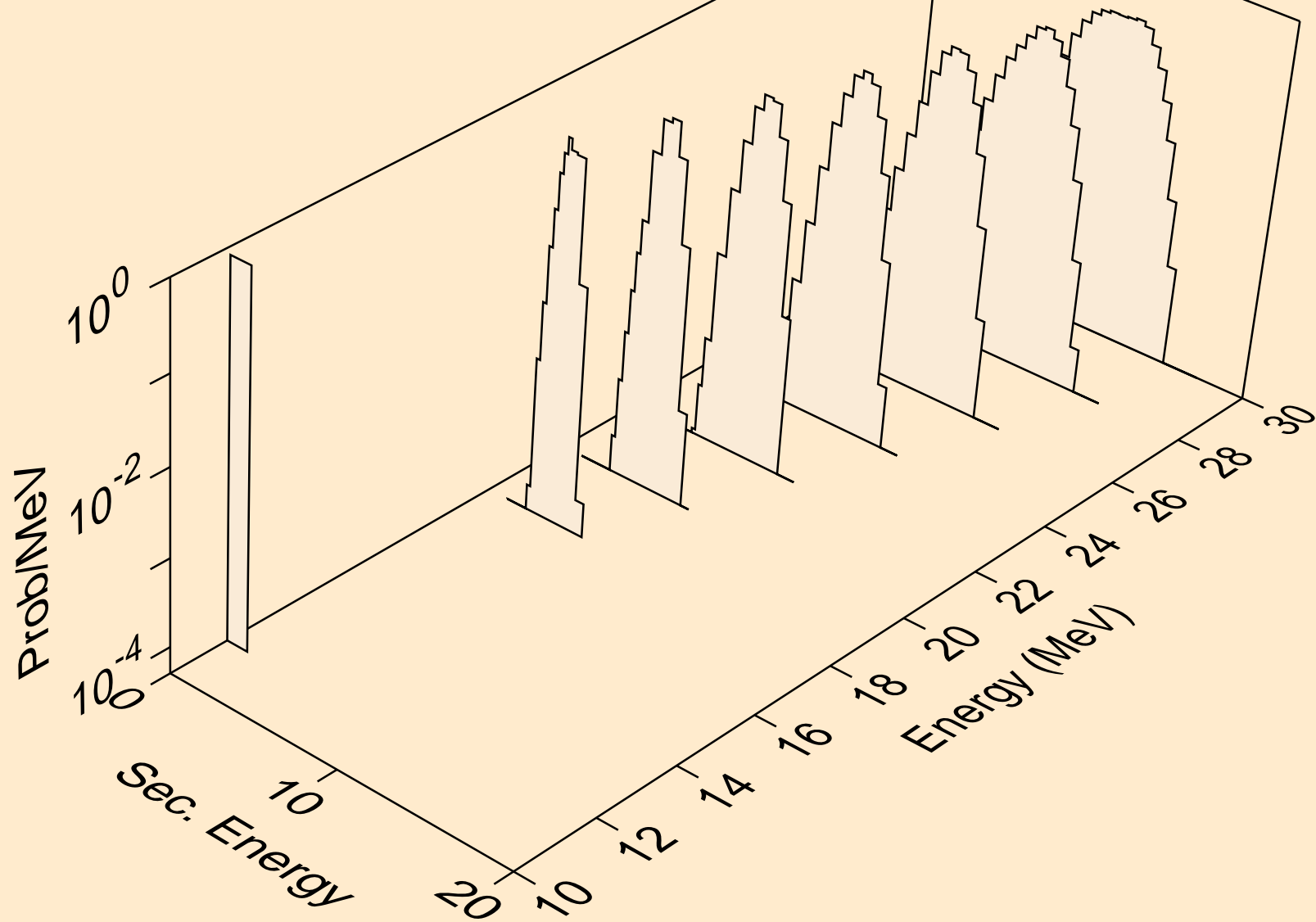

TM158M PROTON ACER TENDL-2021 LIBRARY; T=0.K  
he3s from (p,x)

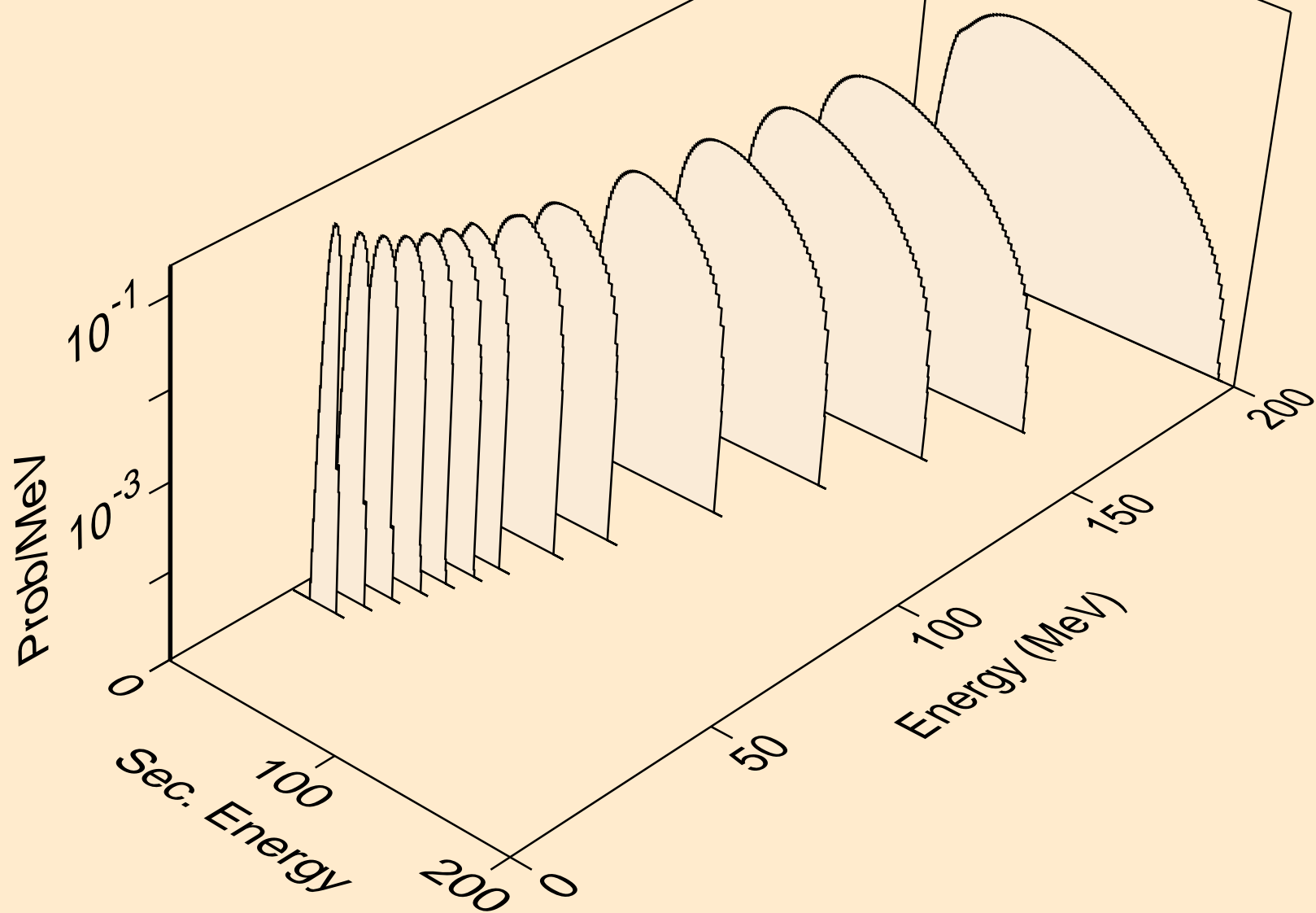

TM158M PROTON ACER TENDL-2021 LIBRARY; T=0.K  
he3s from (p,n\*)he3

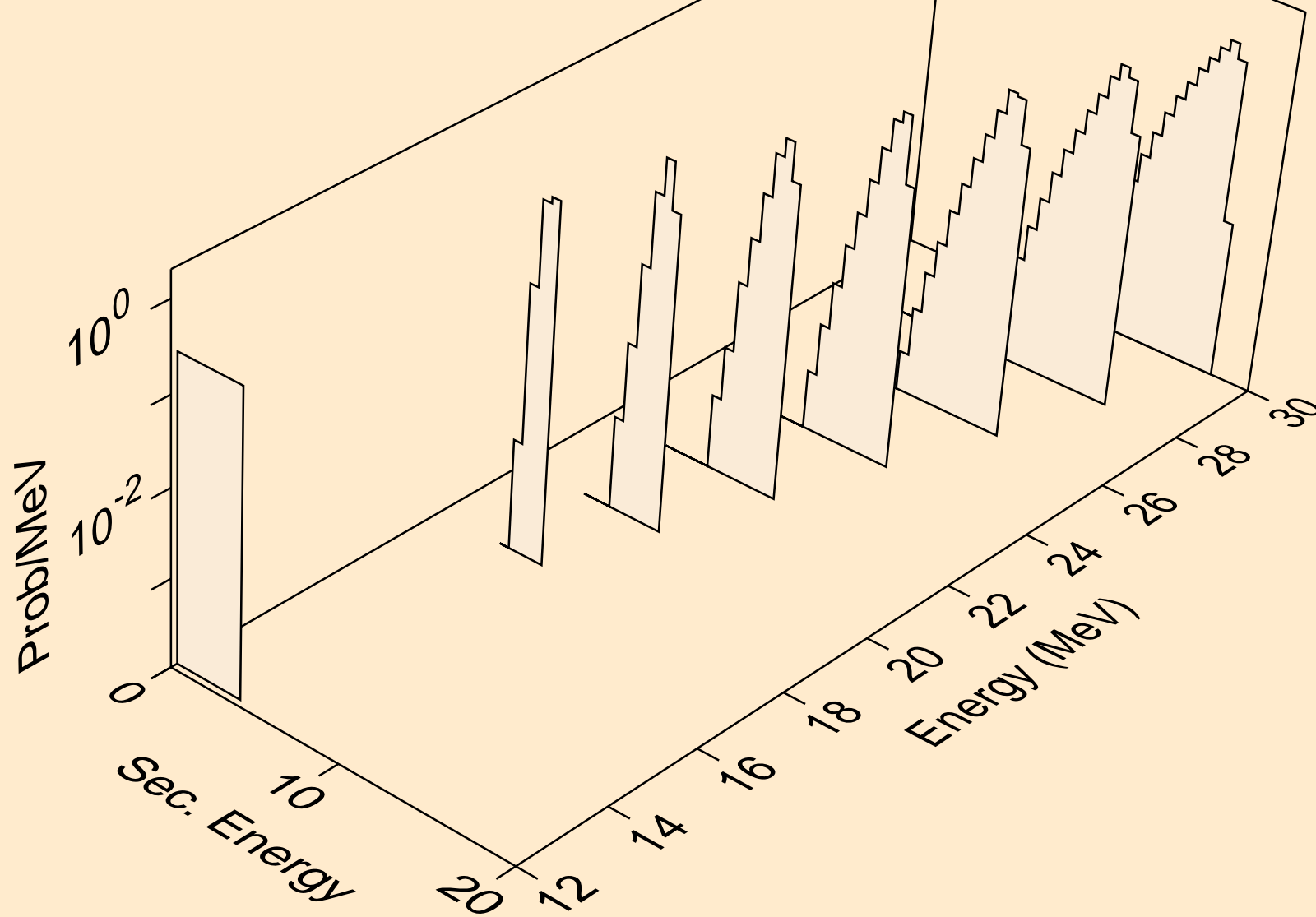

TM158M PROTON ACER TENDL-2021 LIBRARY; T=0.K  
he3s from (p,he3)

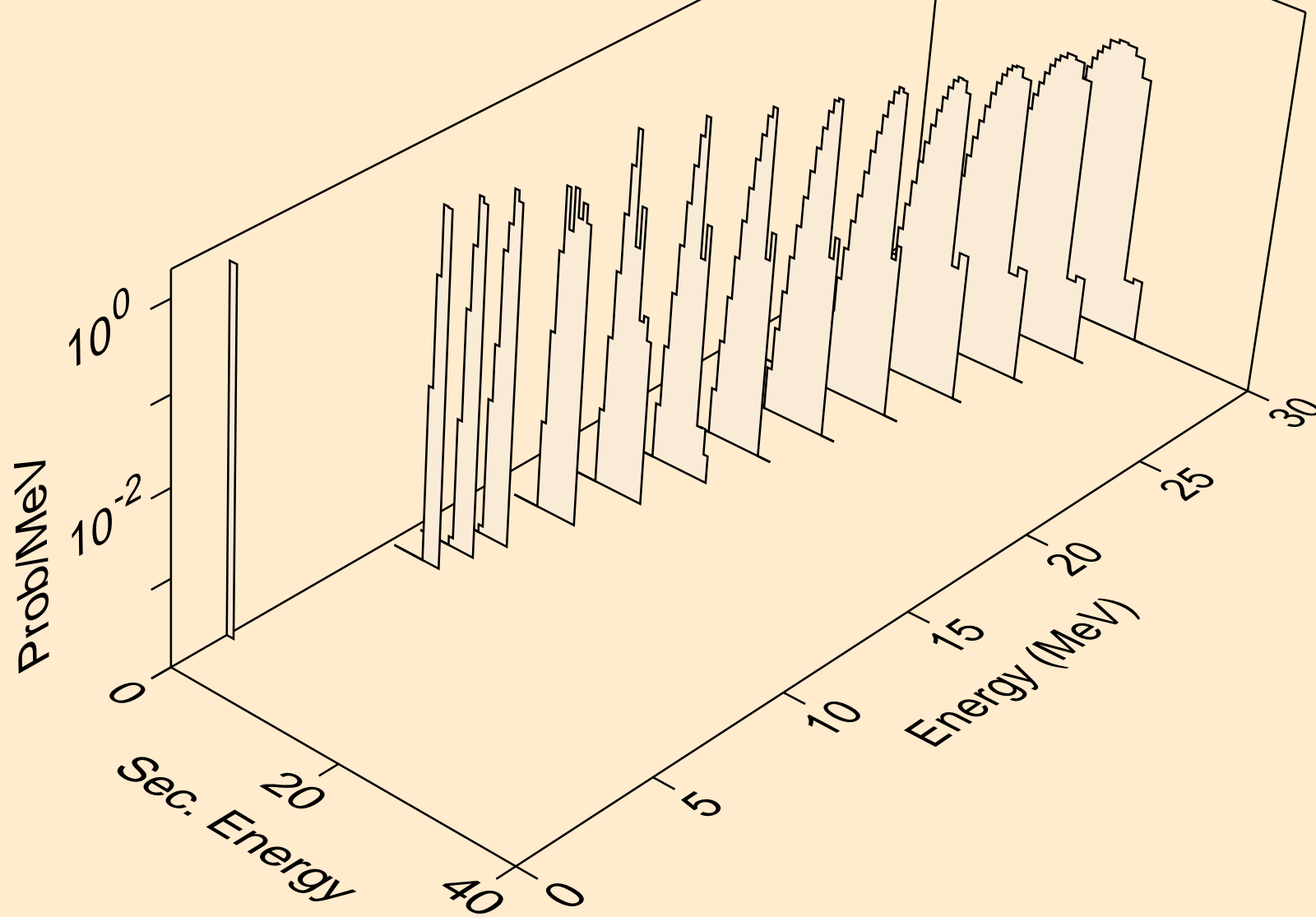

TM158M PROTON ACER TENDL-2021 LIBRARY; T=0.K  
alphas from (p,x)

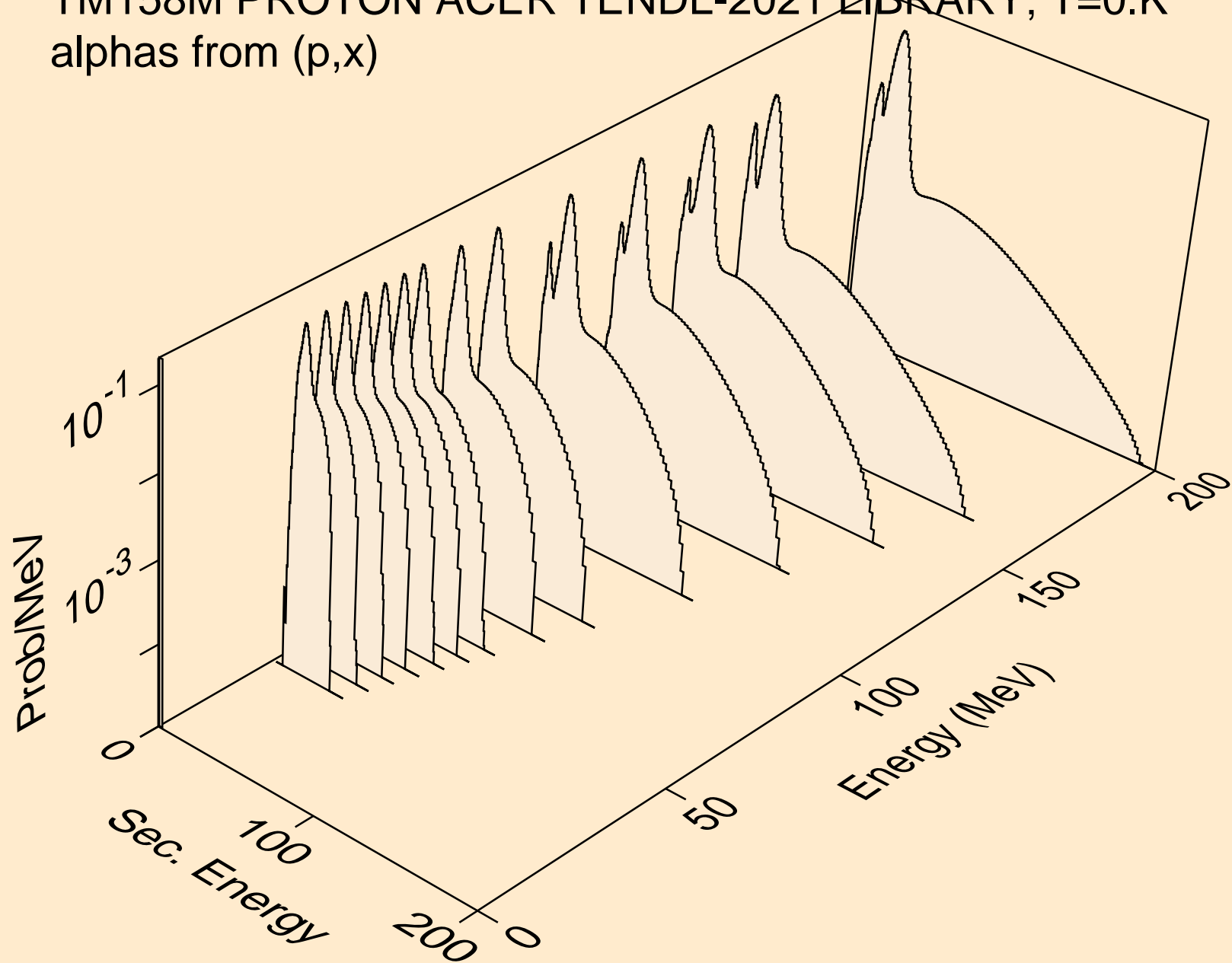



TM158M PROTON ACER TENDL-2021 LIBRARY; T=0.K  
alphas from (p,n\*)a

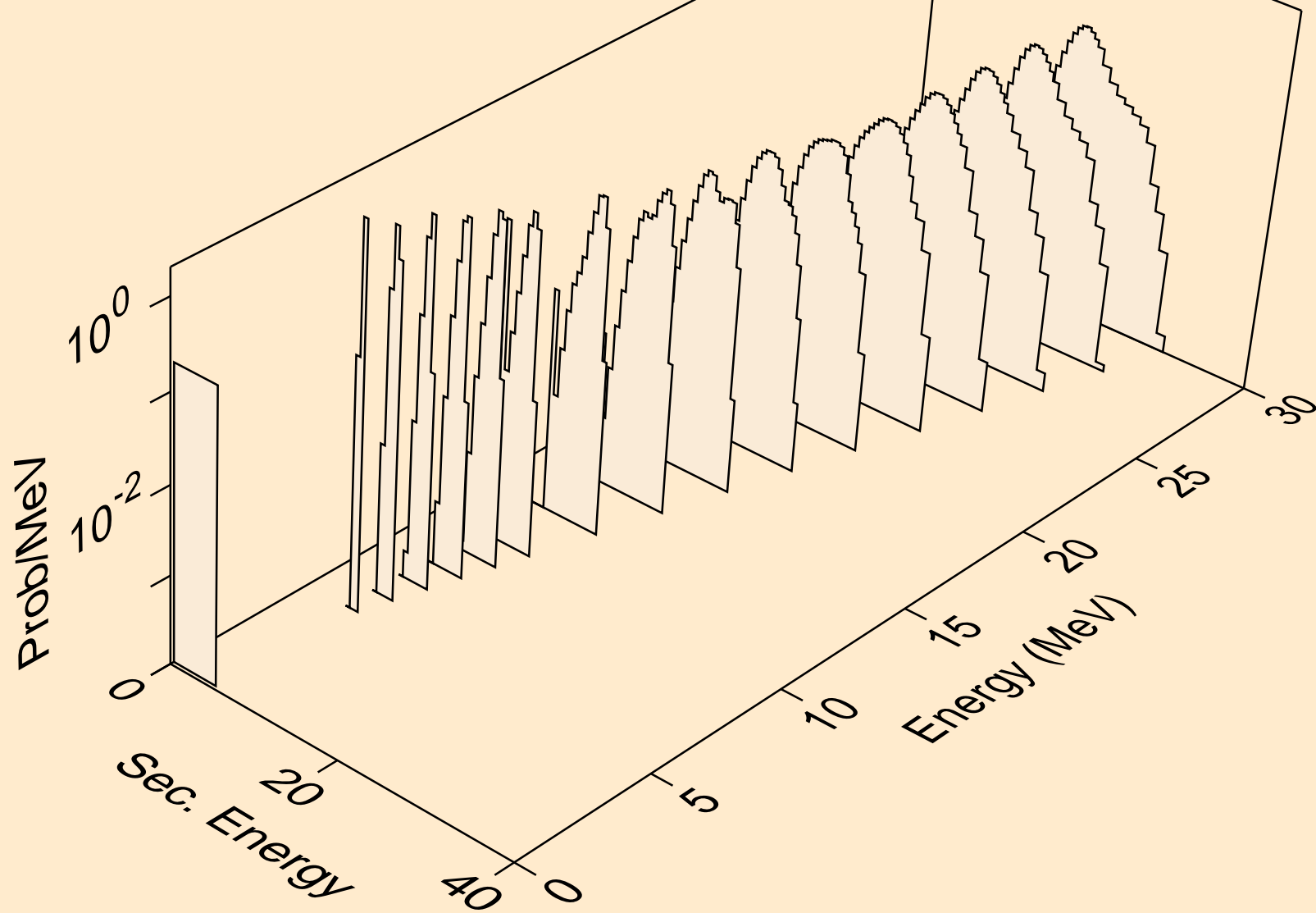

TM158M PROTON ACER TENDL-2021 LIBRARY; T=0.K  
alphas from (p,n\*)3a

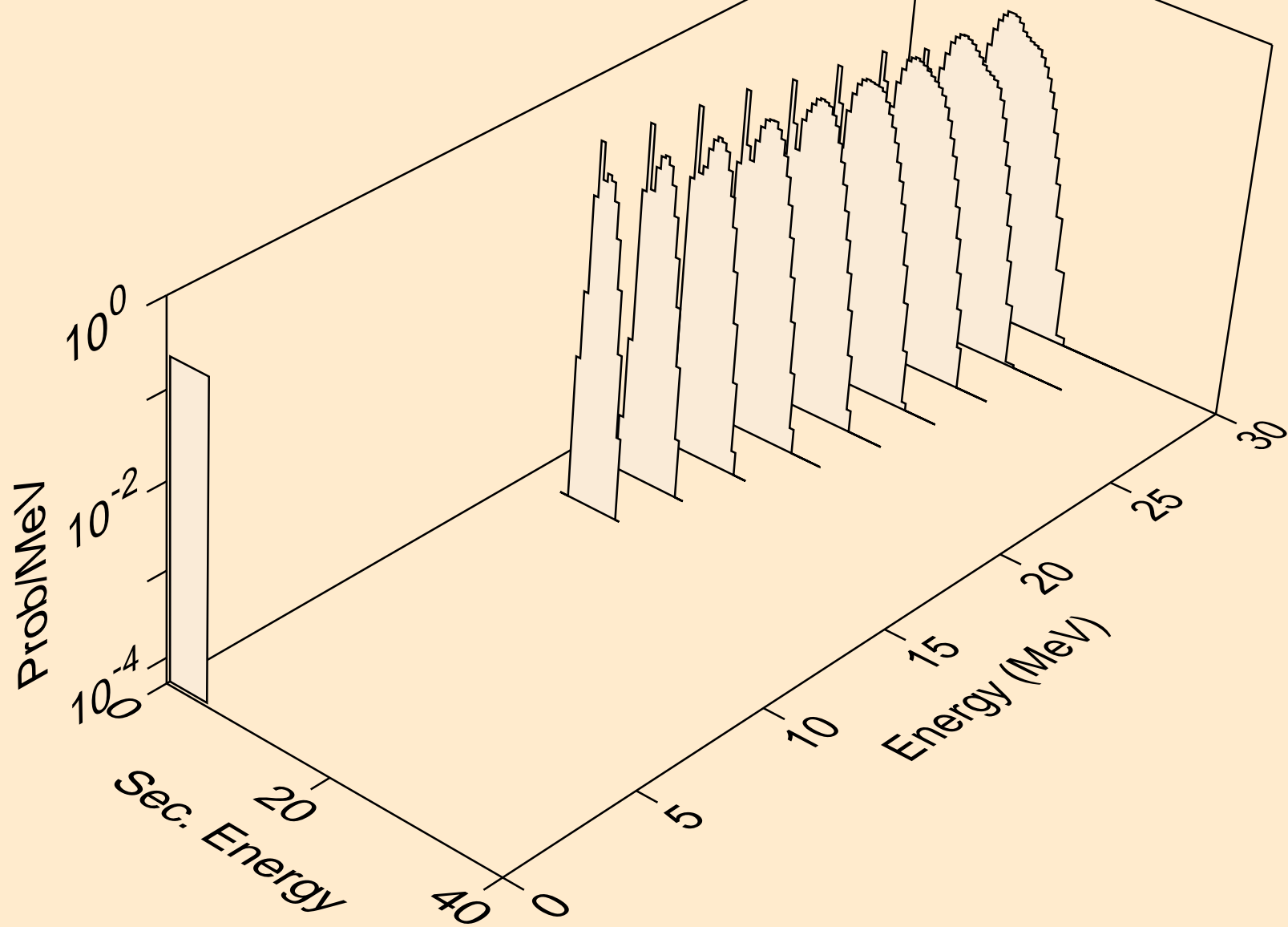

TM158M PROTON ACER TENDL-2021 LIBRARY; T=0.K  
alphas from (p,2n)a

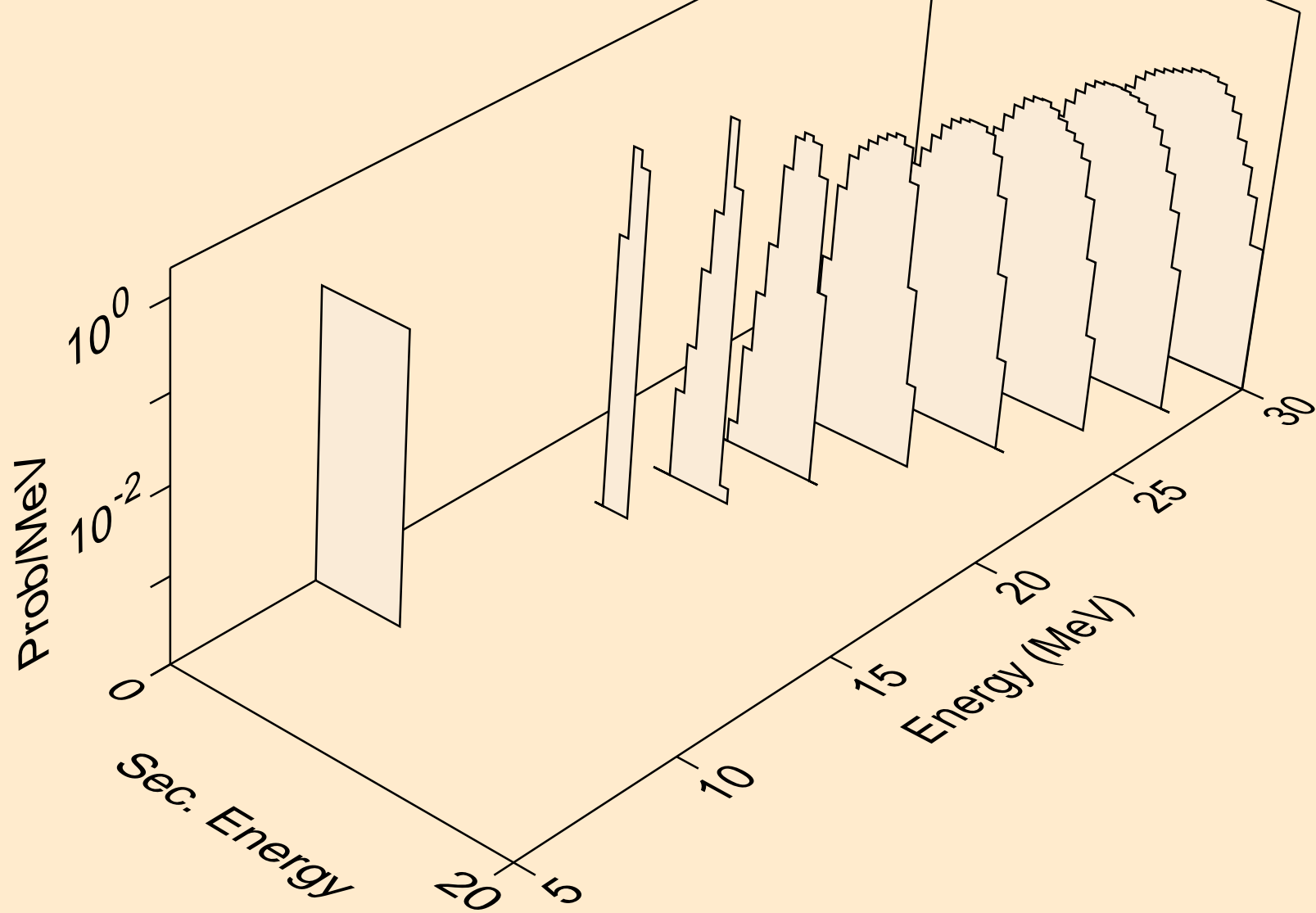

TM158M PROTON ACER TENDL-2021 LIBRARY; T=0.K  
alphas from (p,3n)a

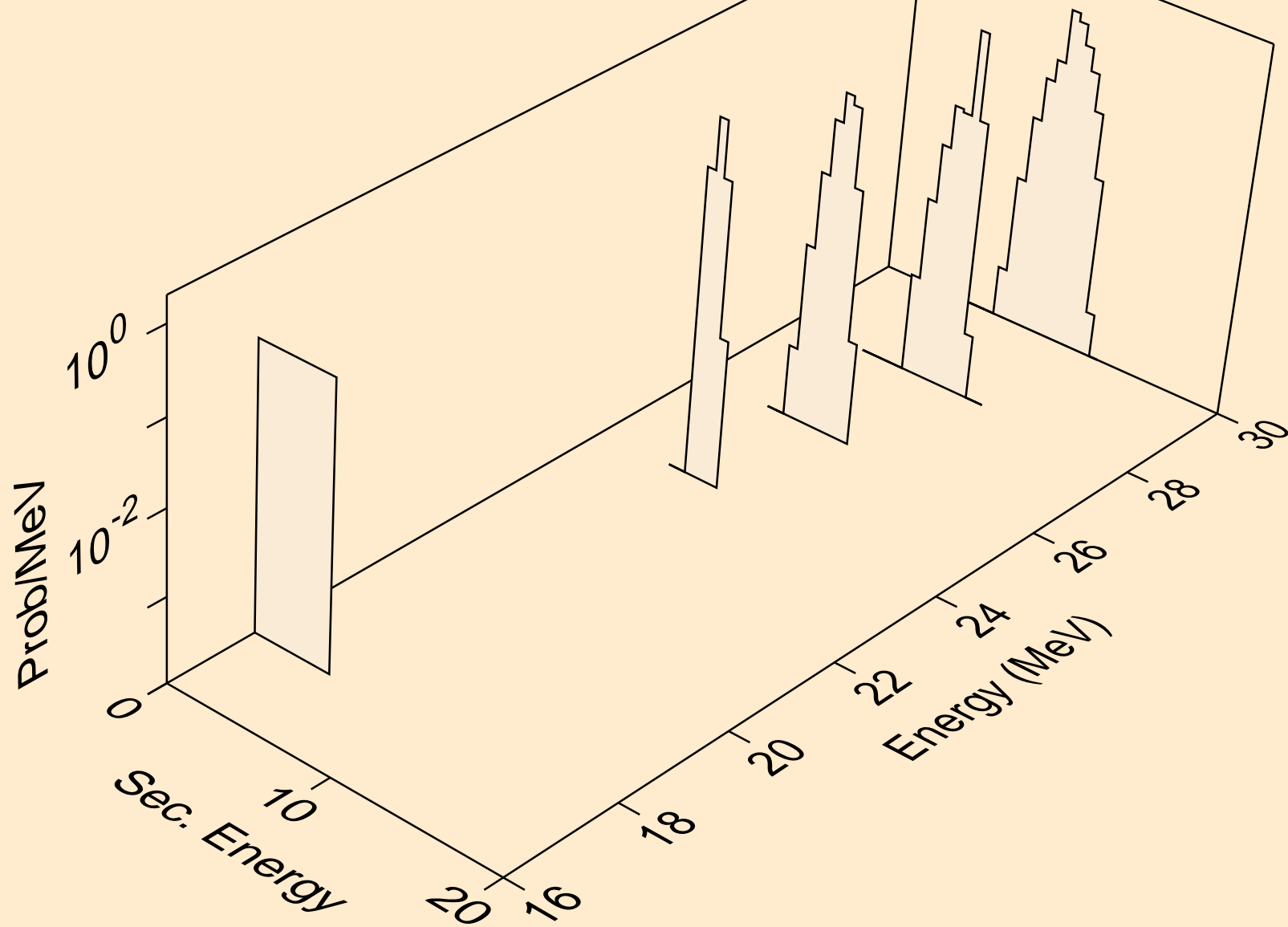

TM158M PROTON ACER TENDL-2021 LIBRARY; T=0.K  
alphas from (p,n\*)2a

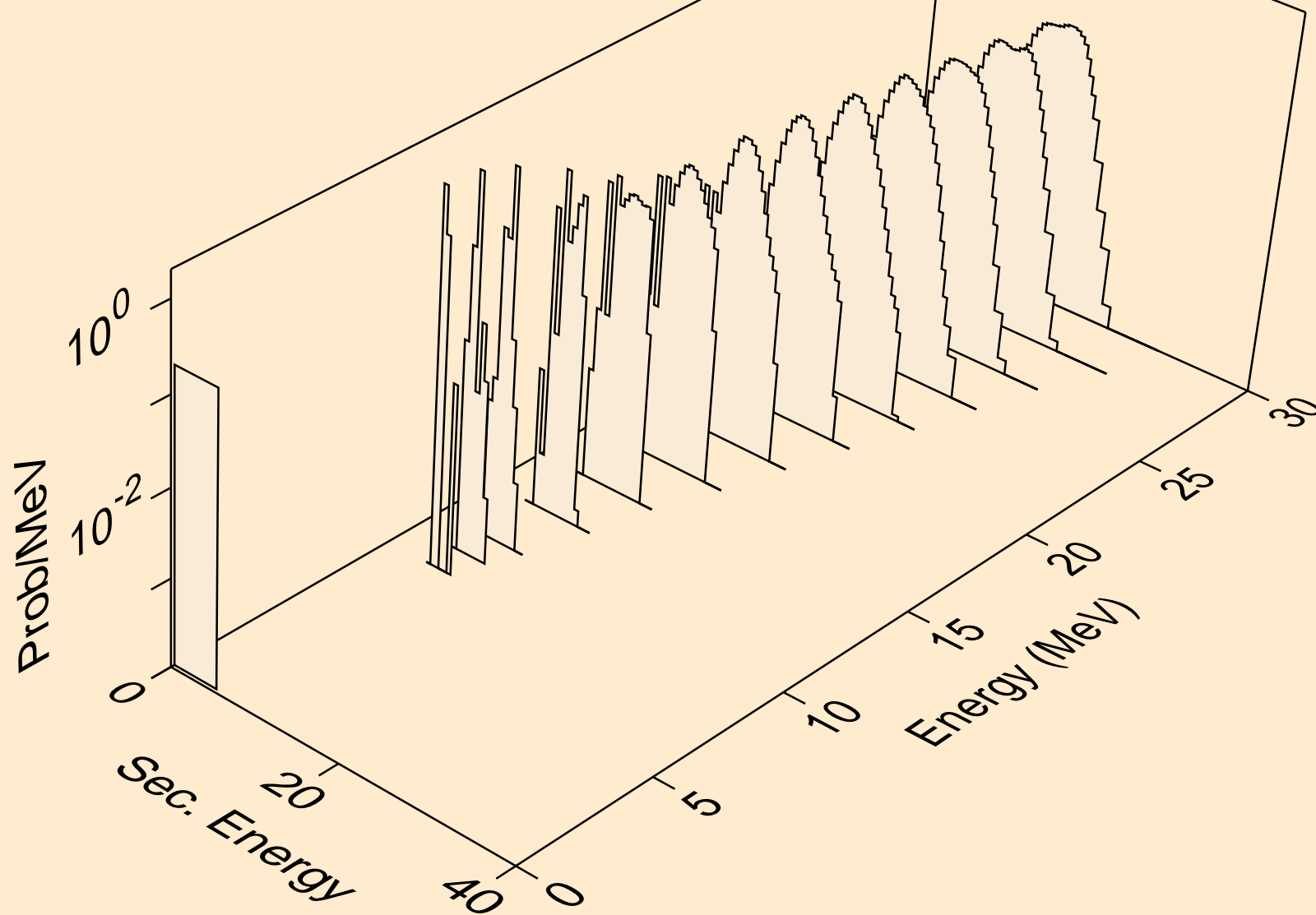

TM158M PROTON ACER TENDL-2021 LIBRARY; T=0.K  
alphas from (p,2n)2a

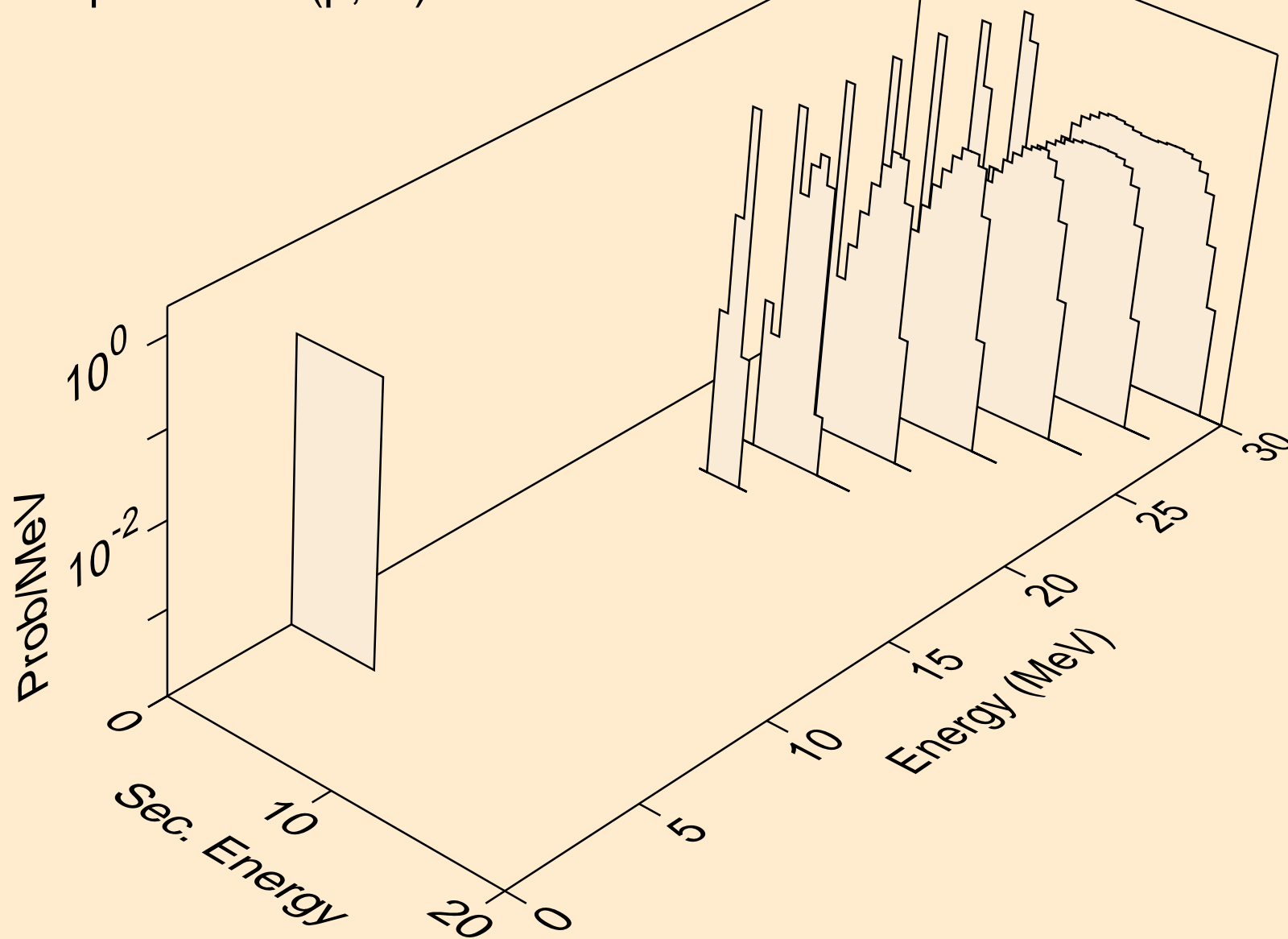

TM158M PROTON ACER TENDL-2021 LIBRARY; T=0.K  
alphas from (p,npa)

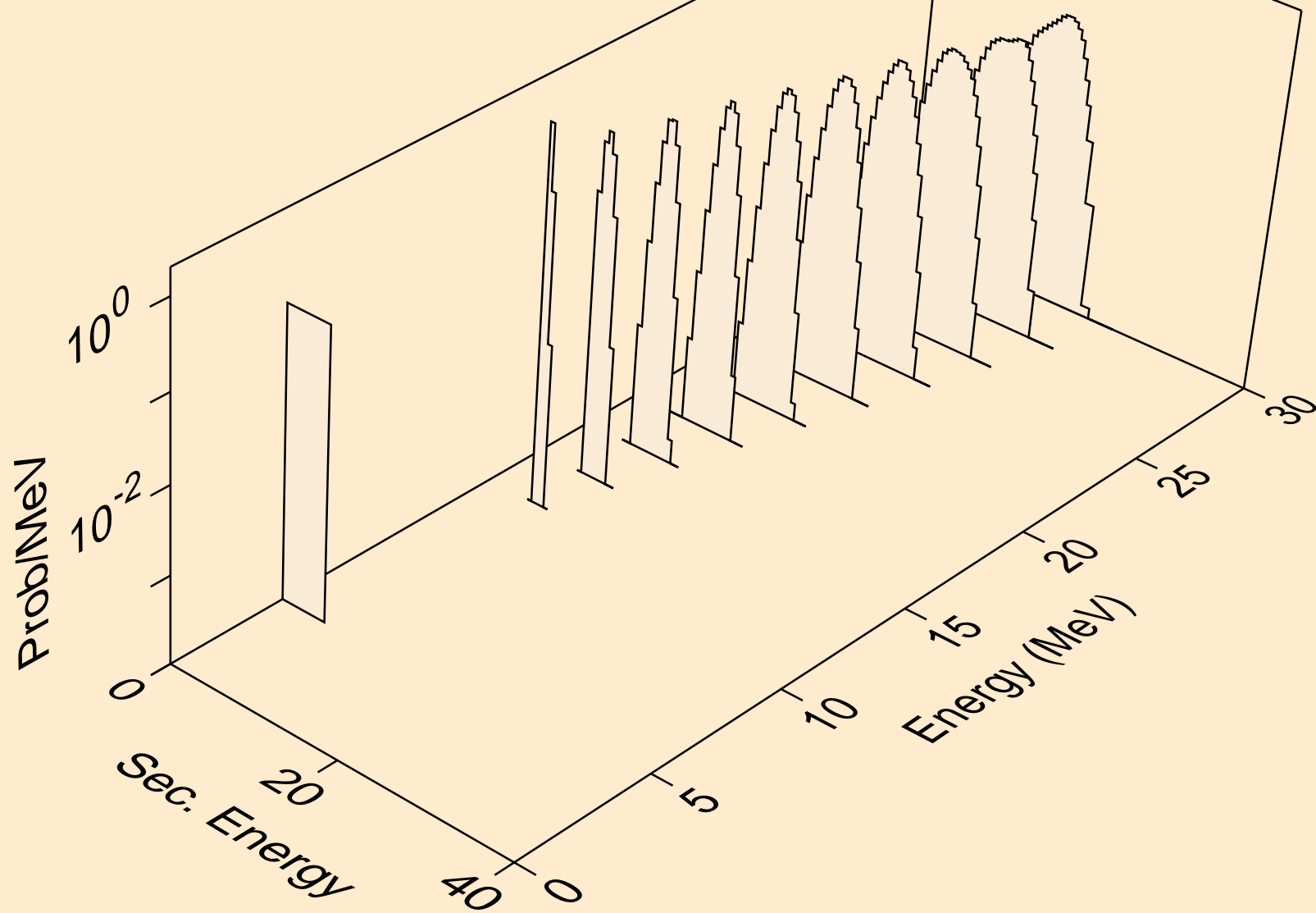

TM158M PROTON ACER TENDL-2021 LIBRARY; T=0.K  
alphas from (p,a)

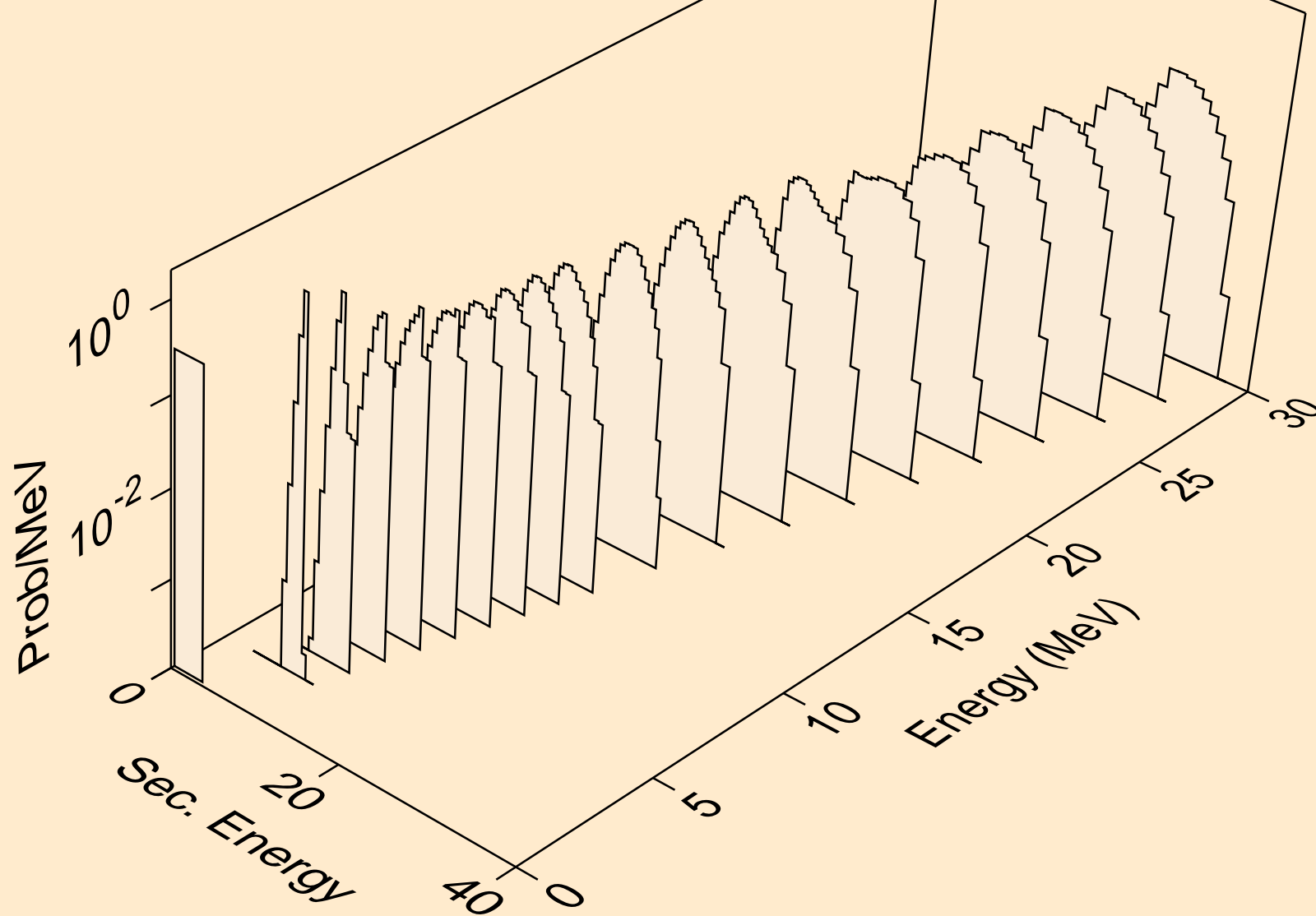



TM158M PROTON ACER TENDL-2021 LIBRARY; T=0.K  
alphas from (p,2a)

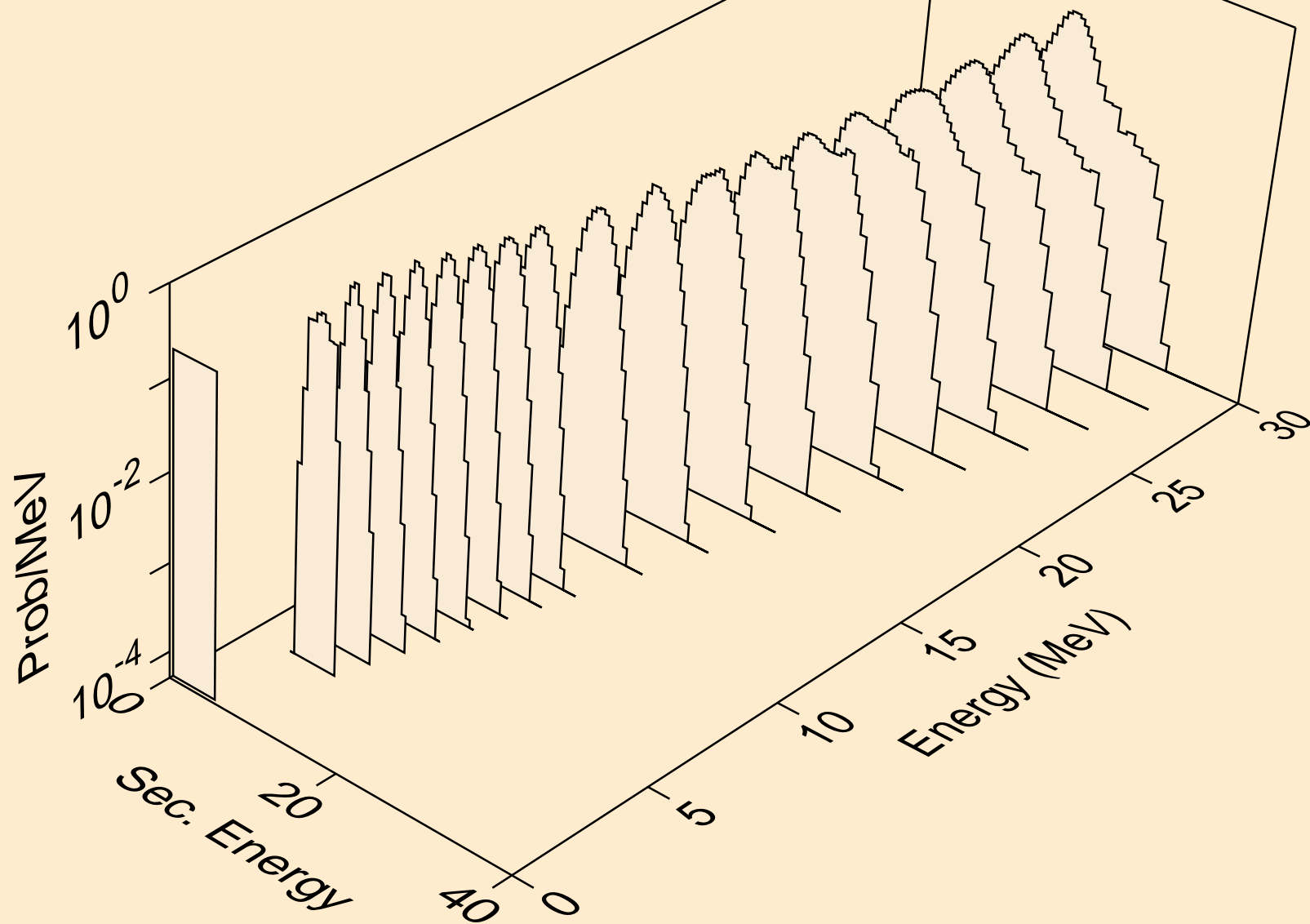

TM158M PROTON ACER TENDL-2021 LIBRARY; T=0.K  
alphas from (p,3a)

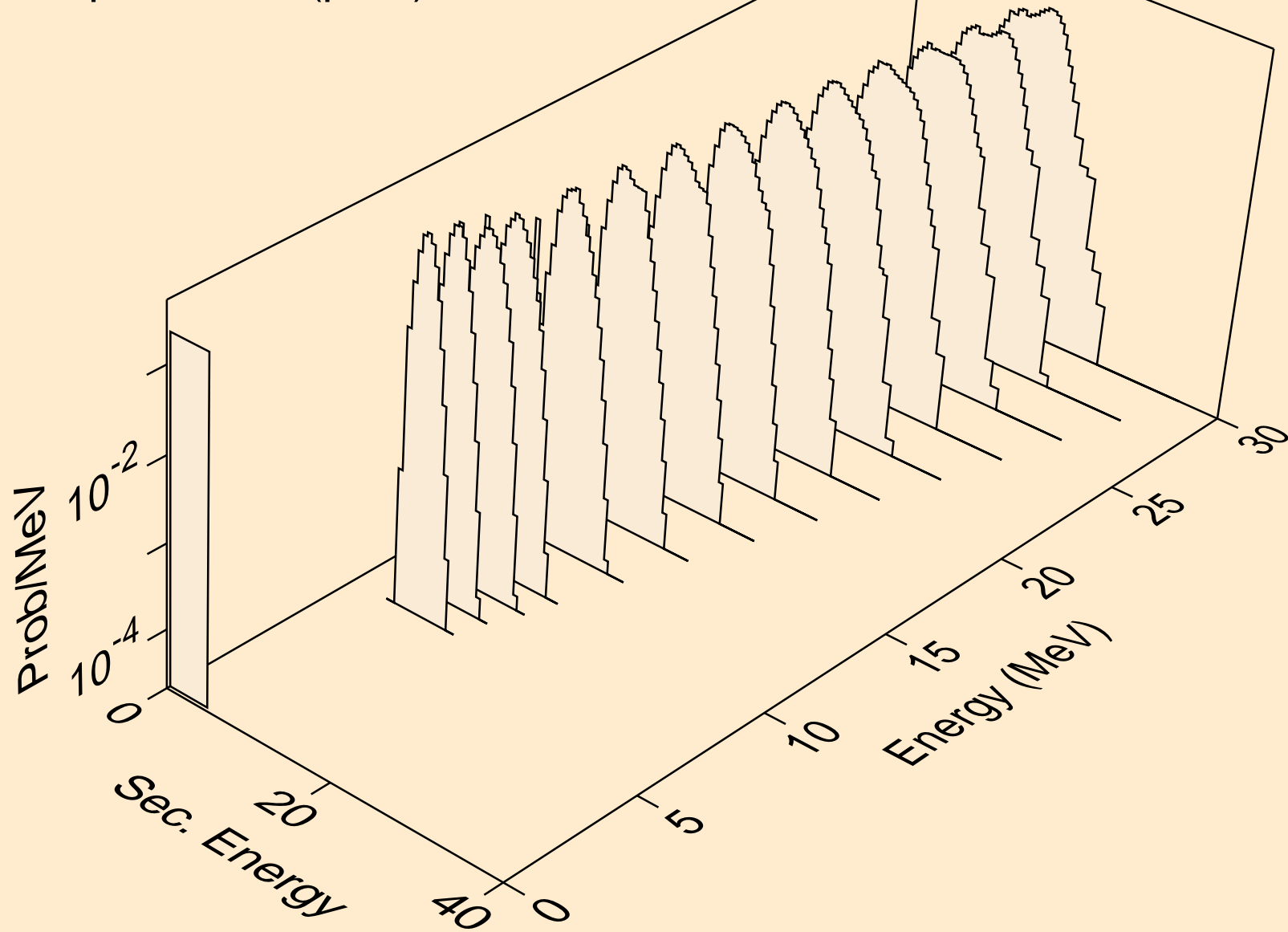

TM158M PROTON ACER TENDL-2021 LIBRARY; T=0.K  
alphas from (p,pa)

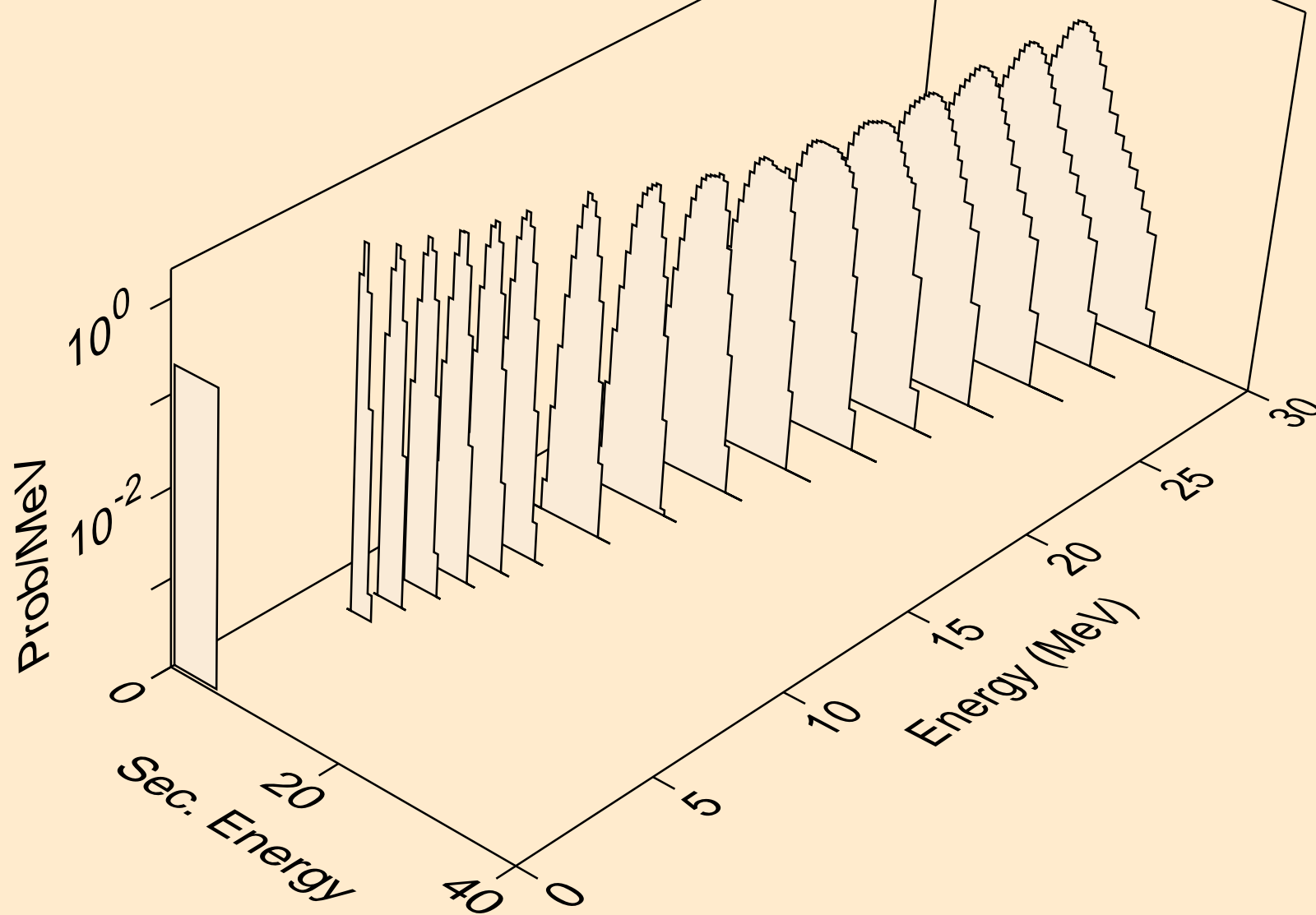

TM158M PROTON ACER TENDL-2021 LIBRARY; T=0.K  
alphas from (p,da)

