

# TM174 PROTON ACER TENDL-2021 LIBRARY; T=0.K

## Principal cross sections

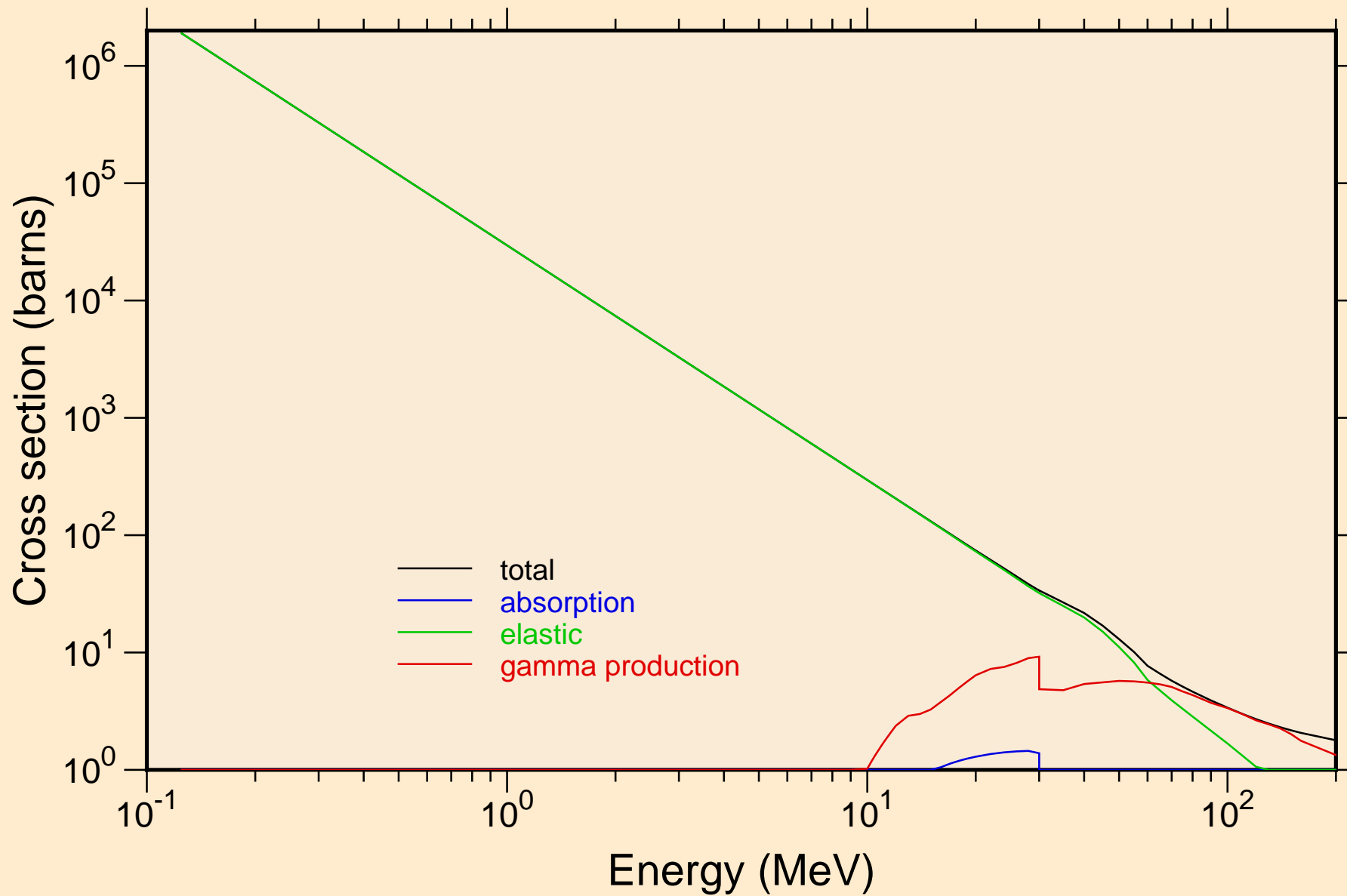

TM174 PROTON ACER TENDL-2021 LIBRARY; T=0.K  
Heating

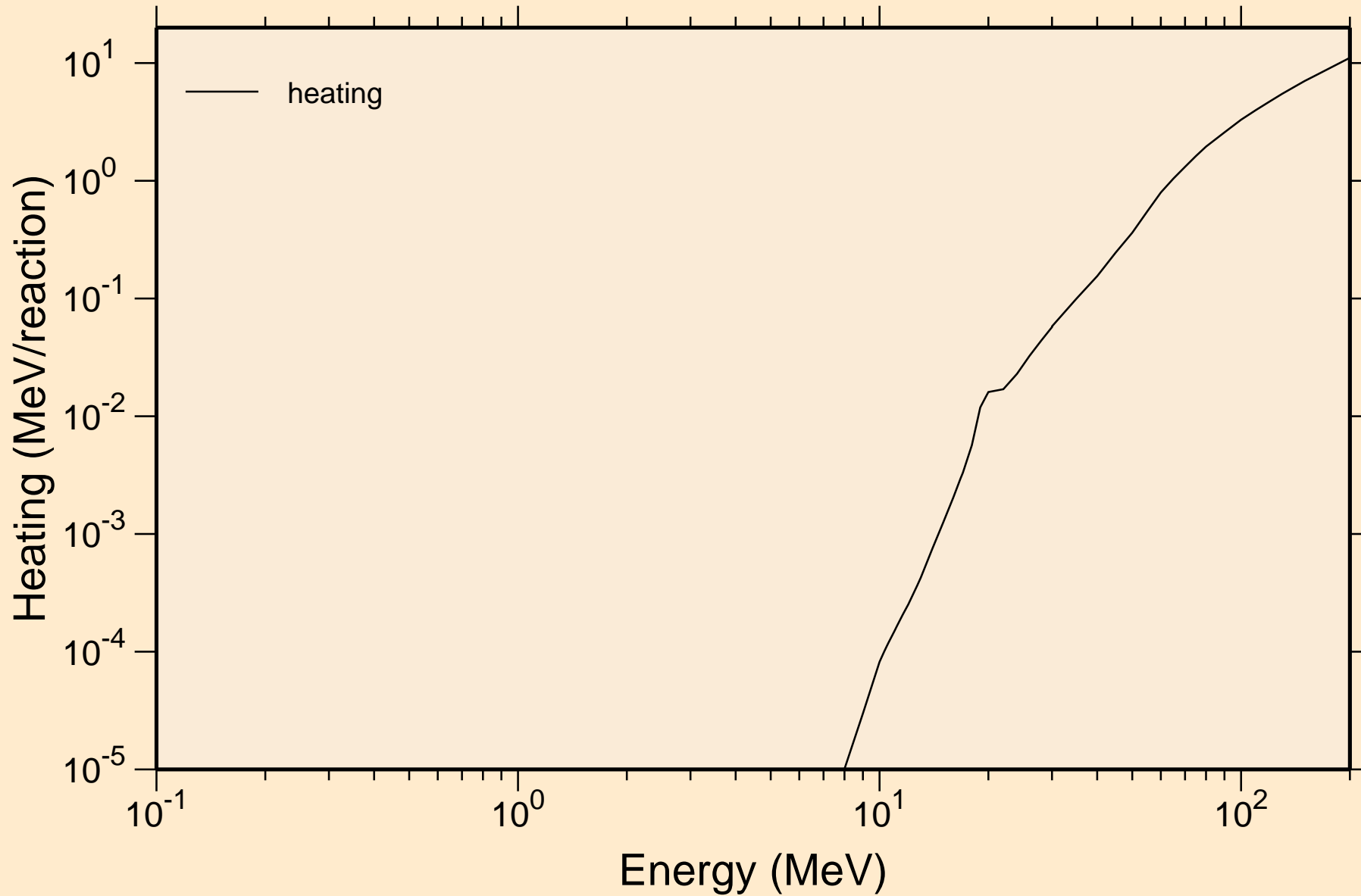

# TM174 PROTON ACER TENDL-2021 LIBRARY; T=0.K

## Principal cross sections

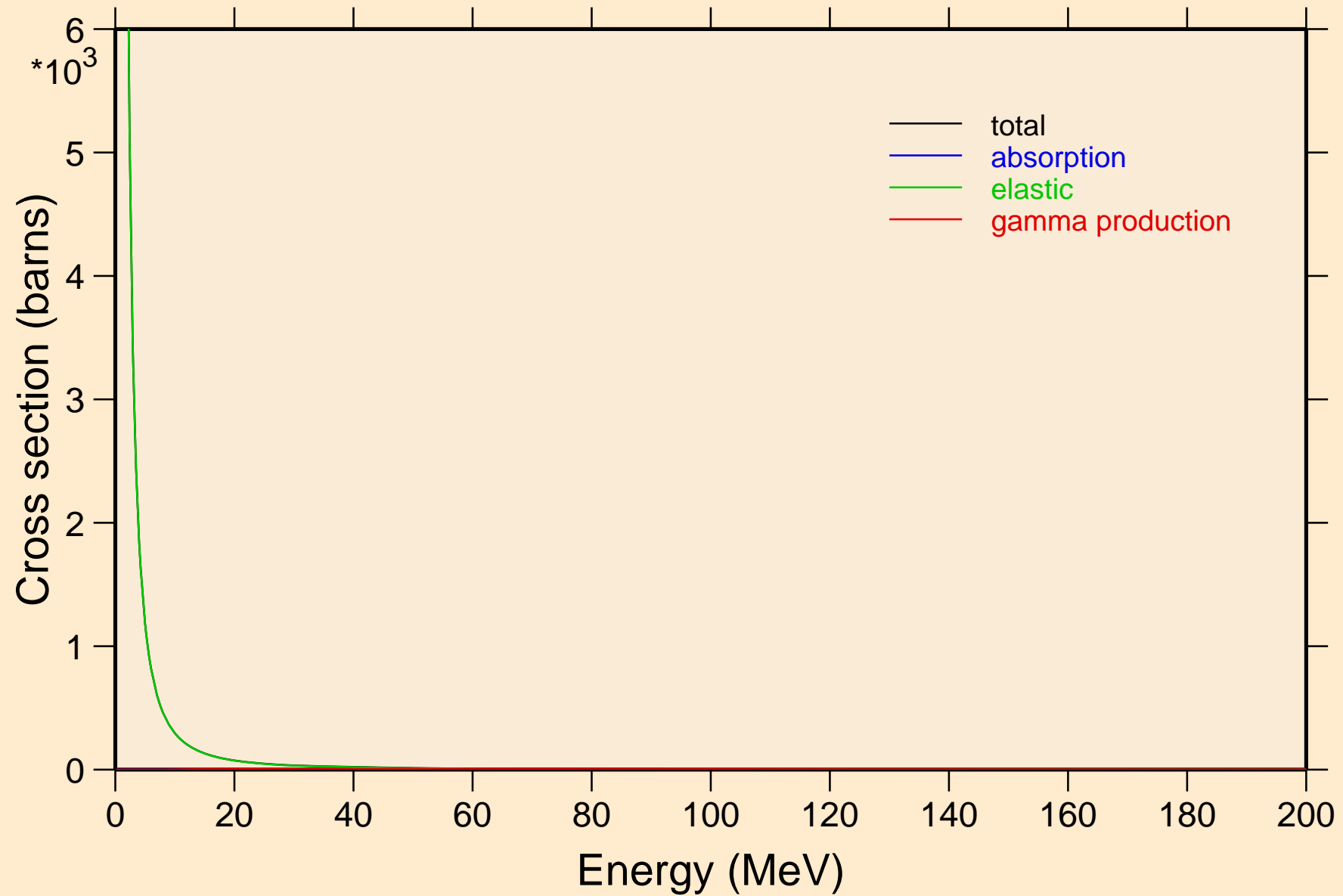

TM174 PROTON ACER TENDL-2021 LIBRARY; T=0.K

Heating

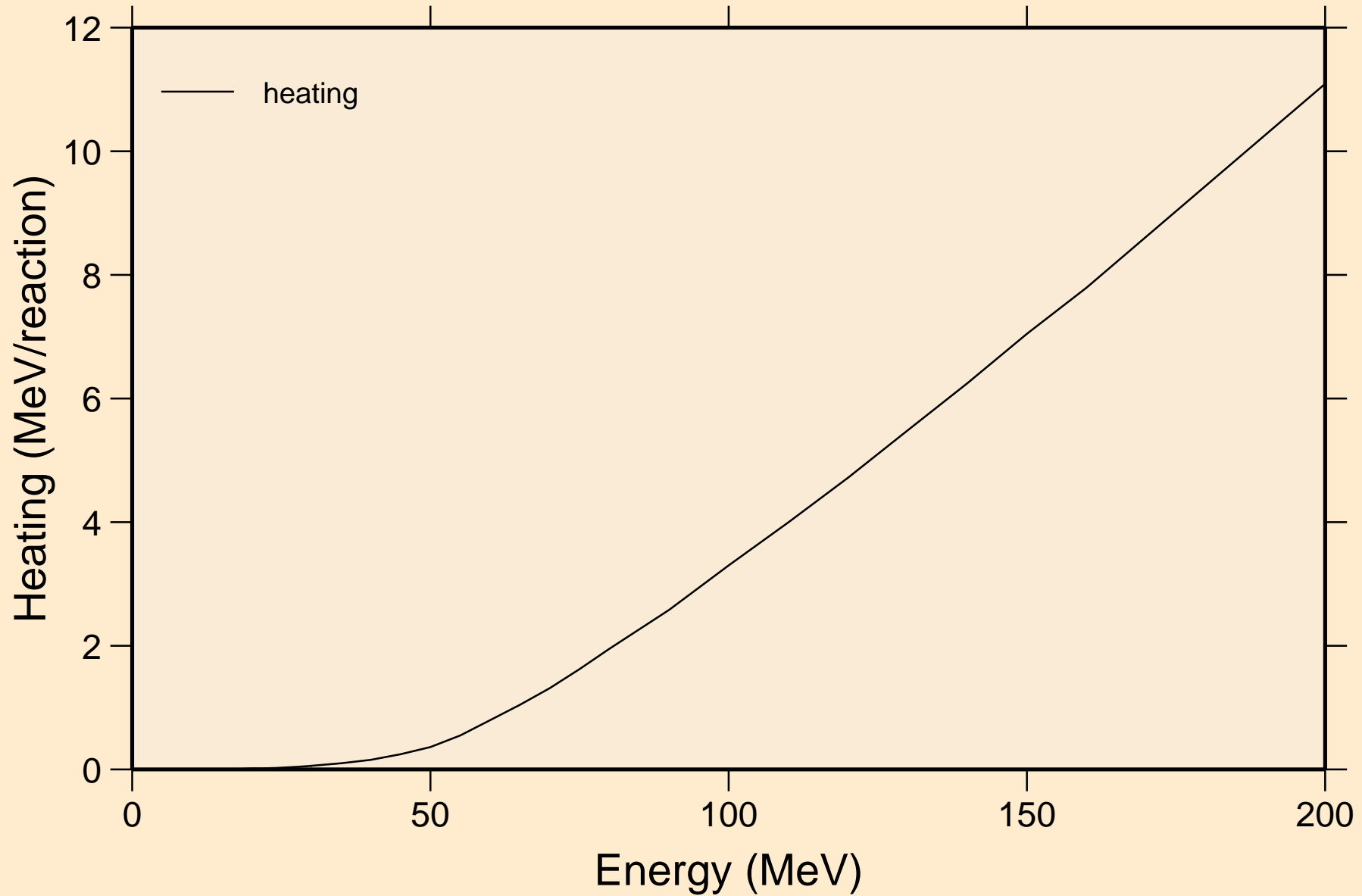

# TM174 PROTON ACER TENDL-2021 LIBRARY; T=0.K

## Threshold reactions

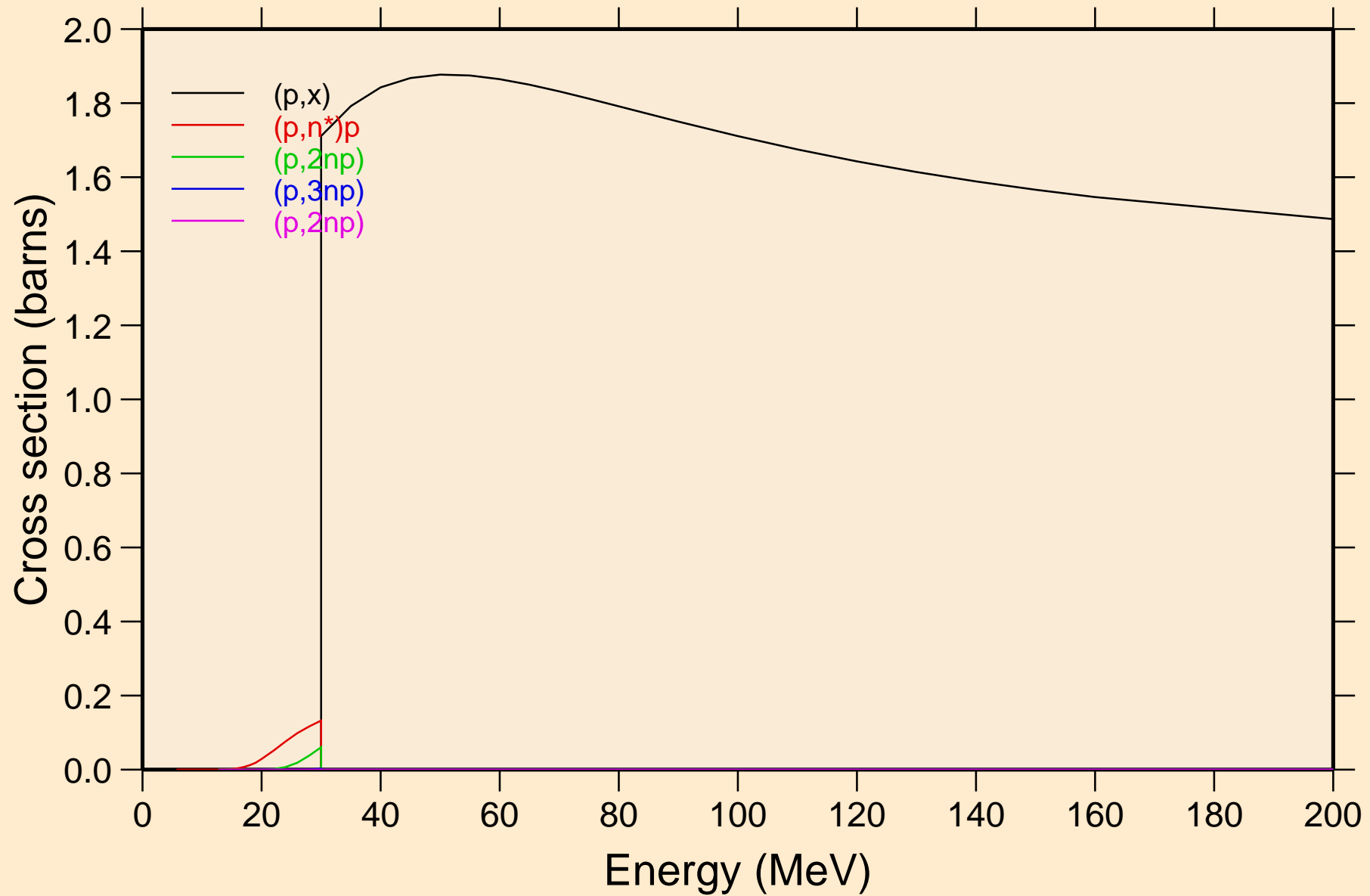

# TM174 PROTON ACER TENDL-2021 LIBRARY; T=0.K

## Threshold reactions

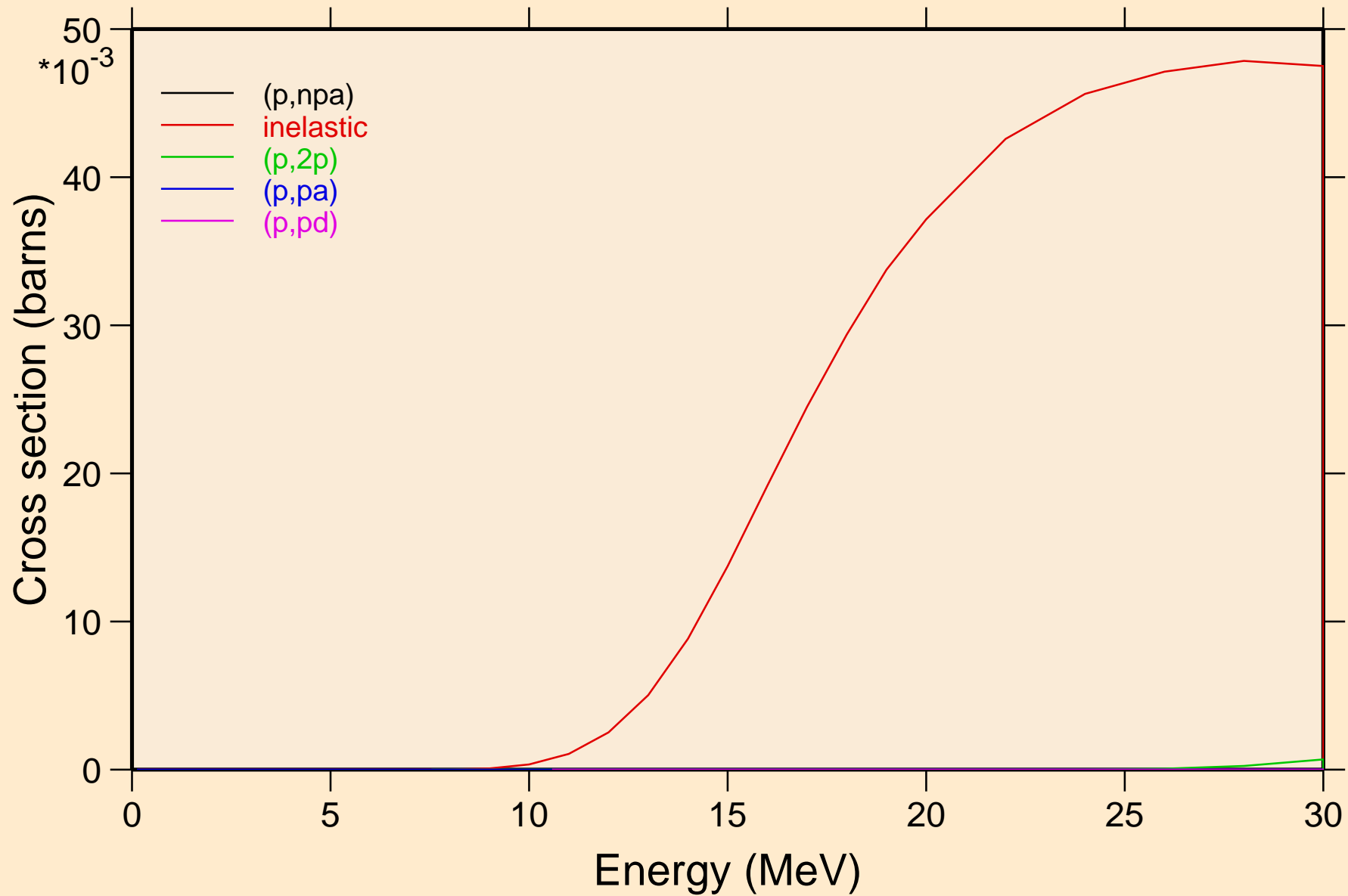

TM174 PROTON ACER TENDL-2021 LIBRARY; T=0.K  
Threshold reactions

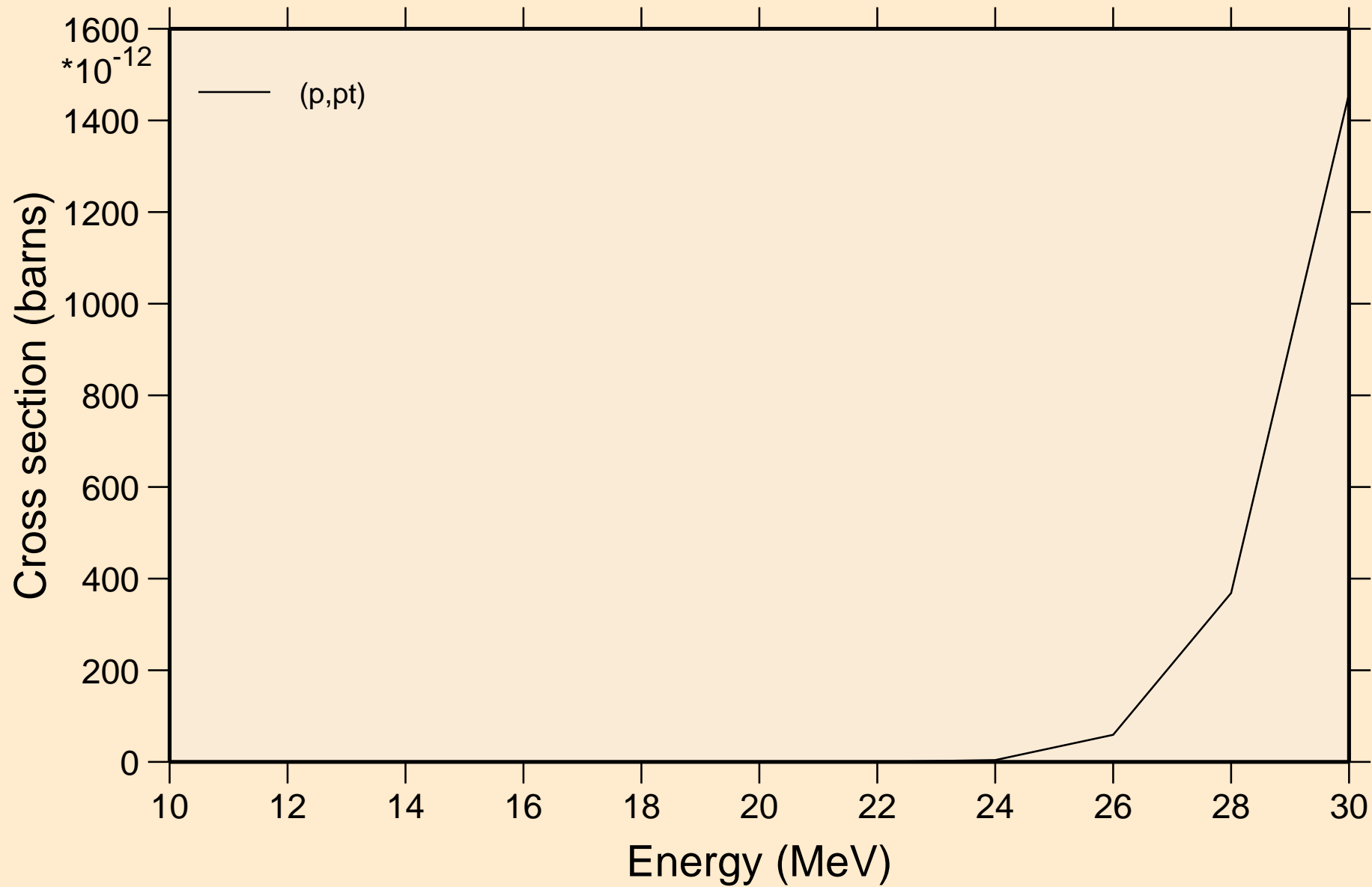

TM174 PROTON ACER TENDL-2021 LIBRARY; T=0.K  
angular distribution for elastic

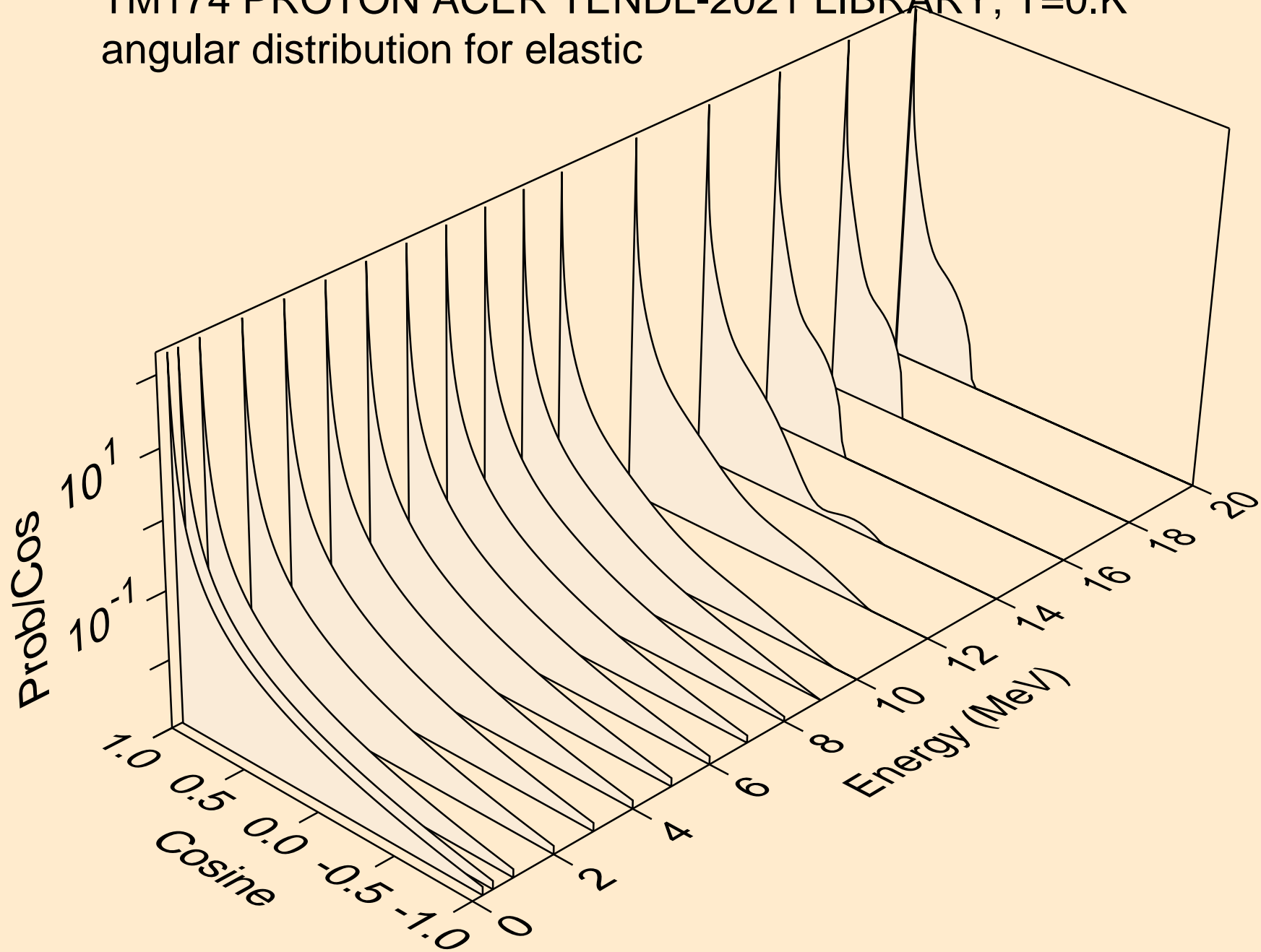



TM174 PROTON ACER TENDL-2021 LIBRARY; T=0.K  
angular distribution for elastic

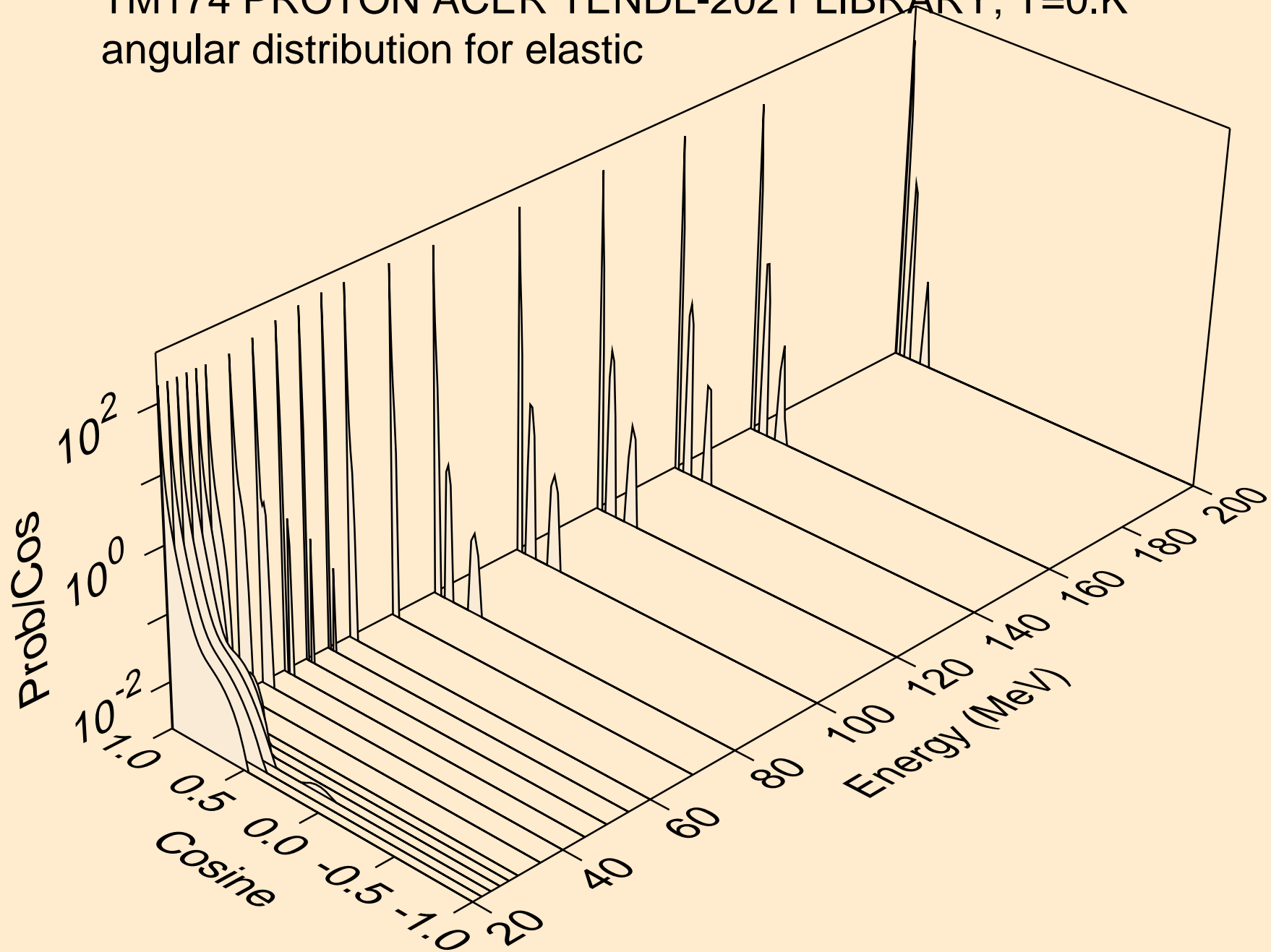

TM174 PROTON ACER TENDL-2021 LIBRARY; T=0.K  
Proton emission for (p,x)

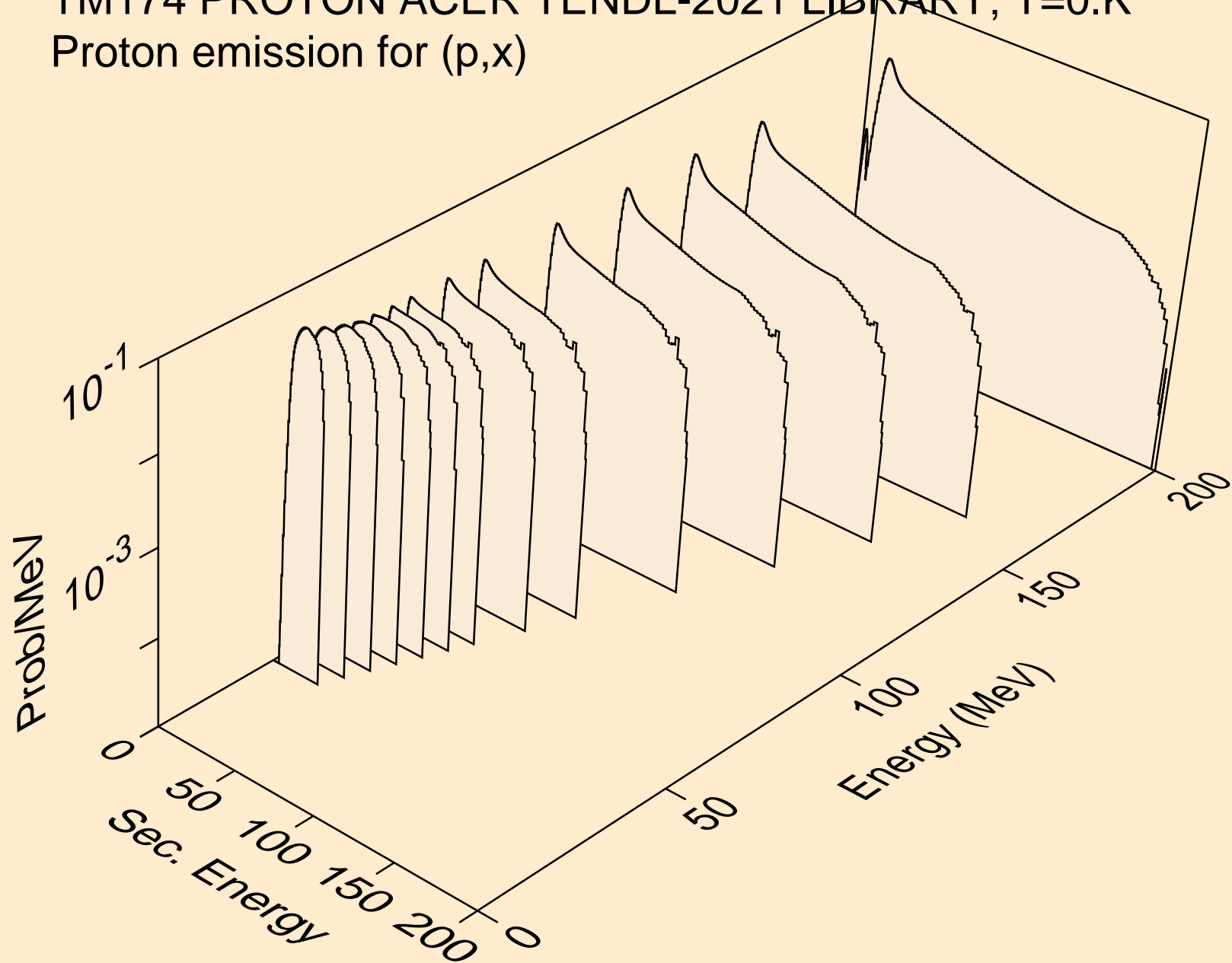

TM174 PROTON ACER TENDL-2021 LIBRARY; T=0.K  
Proton emission for (p,n\*)p

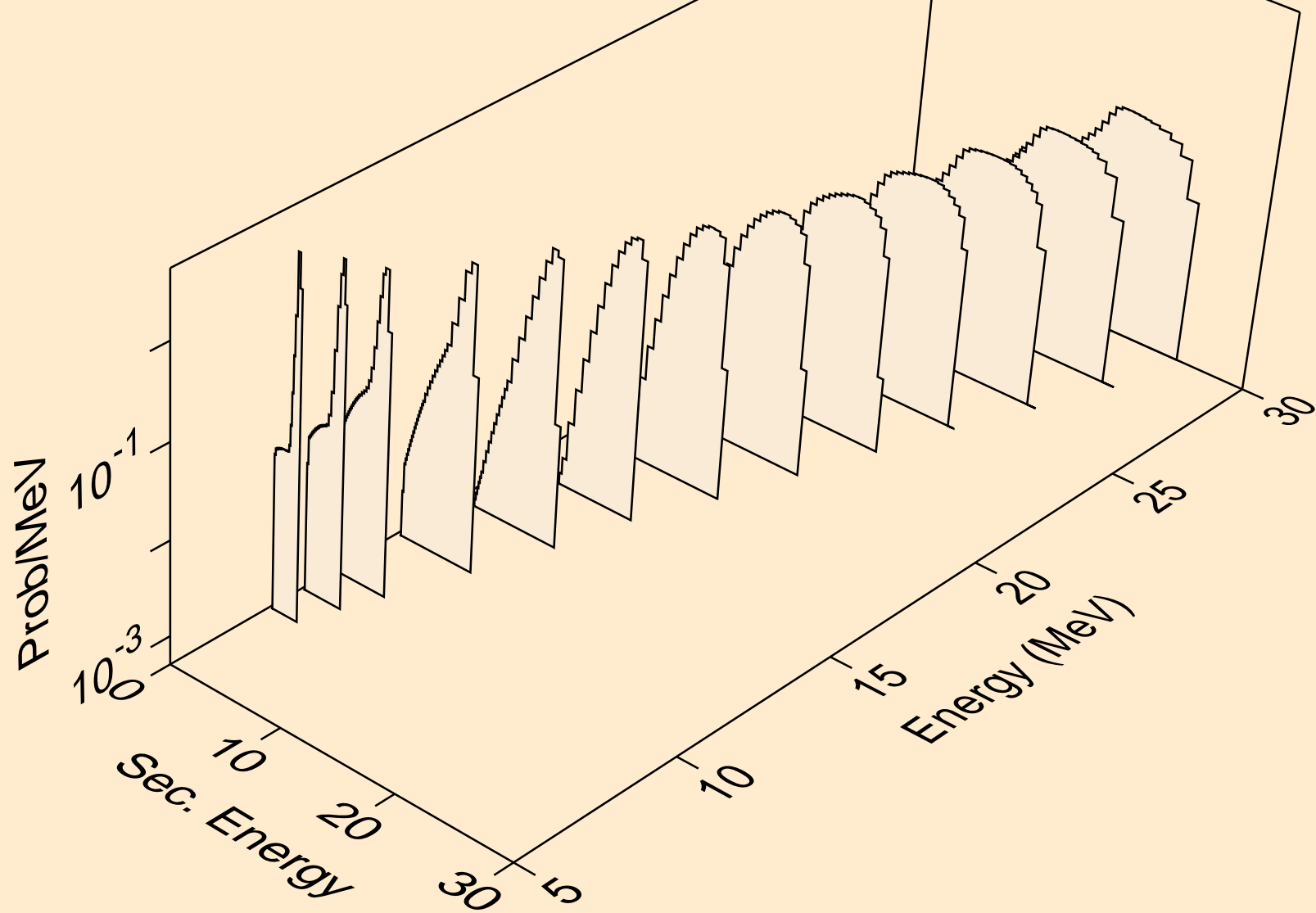

TM174 PROTON ACER TENDL-2021 LIBRARY; T=0.K  
Proton emission for (p,2np)

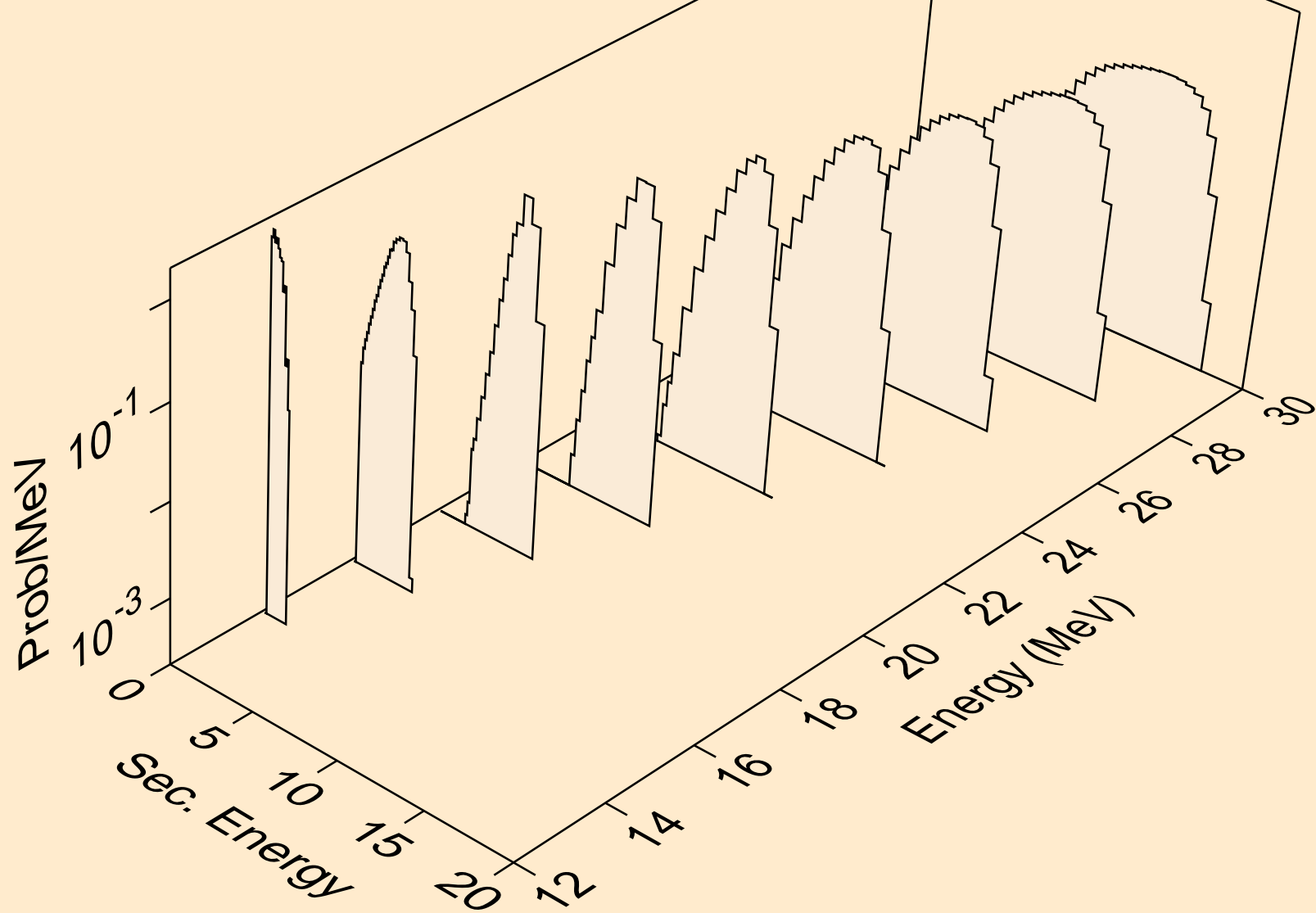

TM174 PROTON ACER TENDL-2021 LIBRARY; T=0.K  
Proton emission for (p,3np)

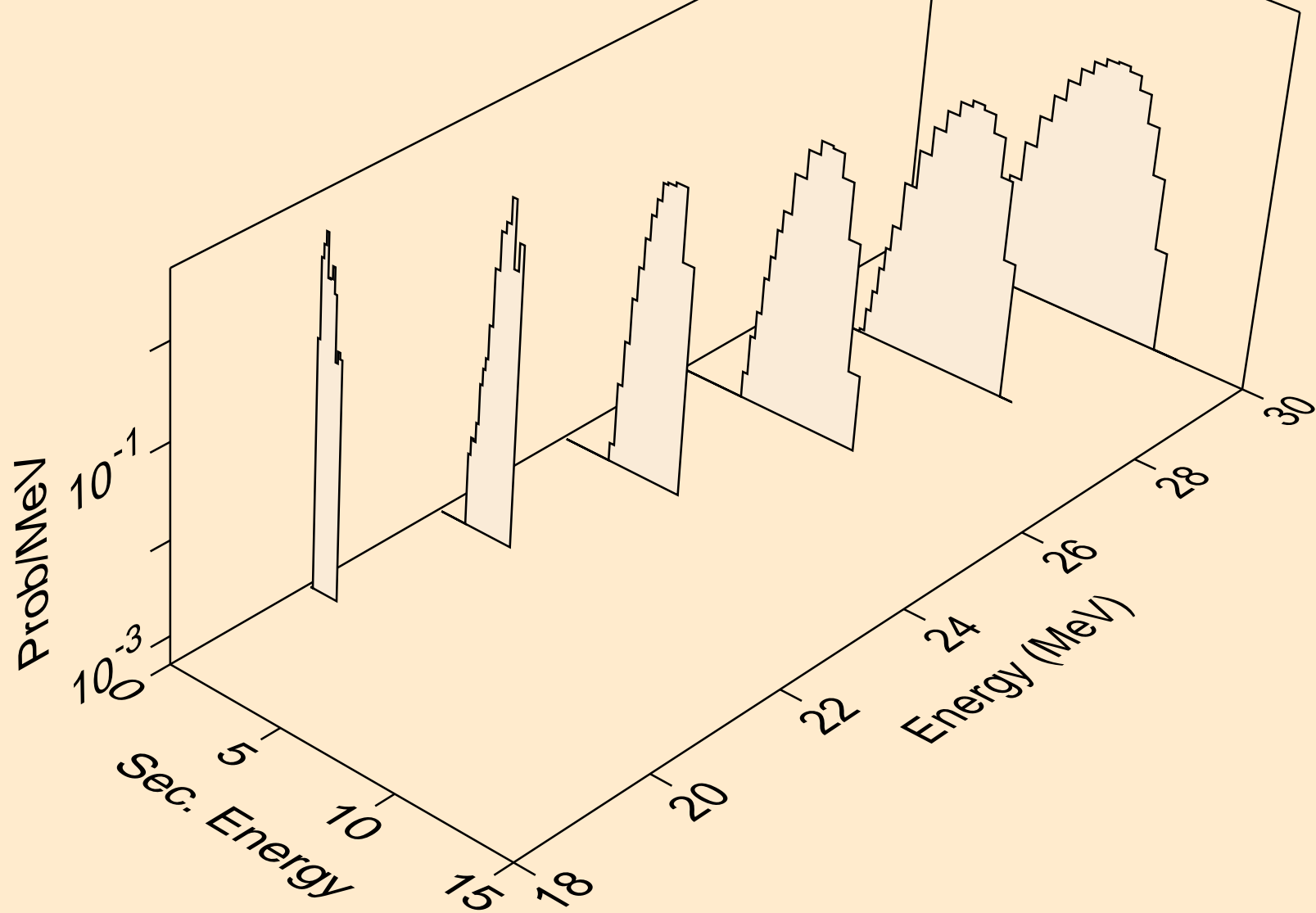

TM174 PROTON ACER TENDL-2021 LIBRARY; T=0.K  
Proton emission for (p,2np)

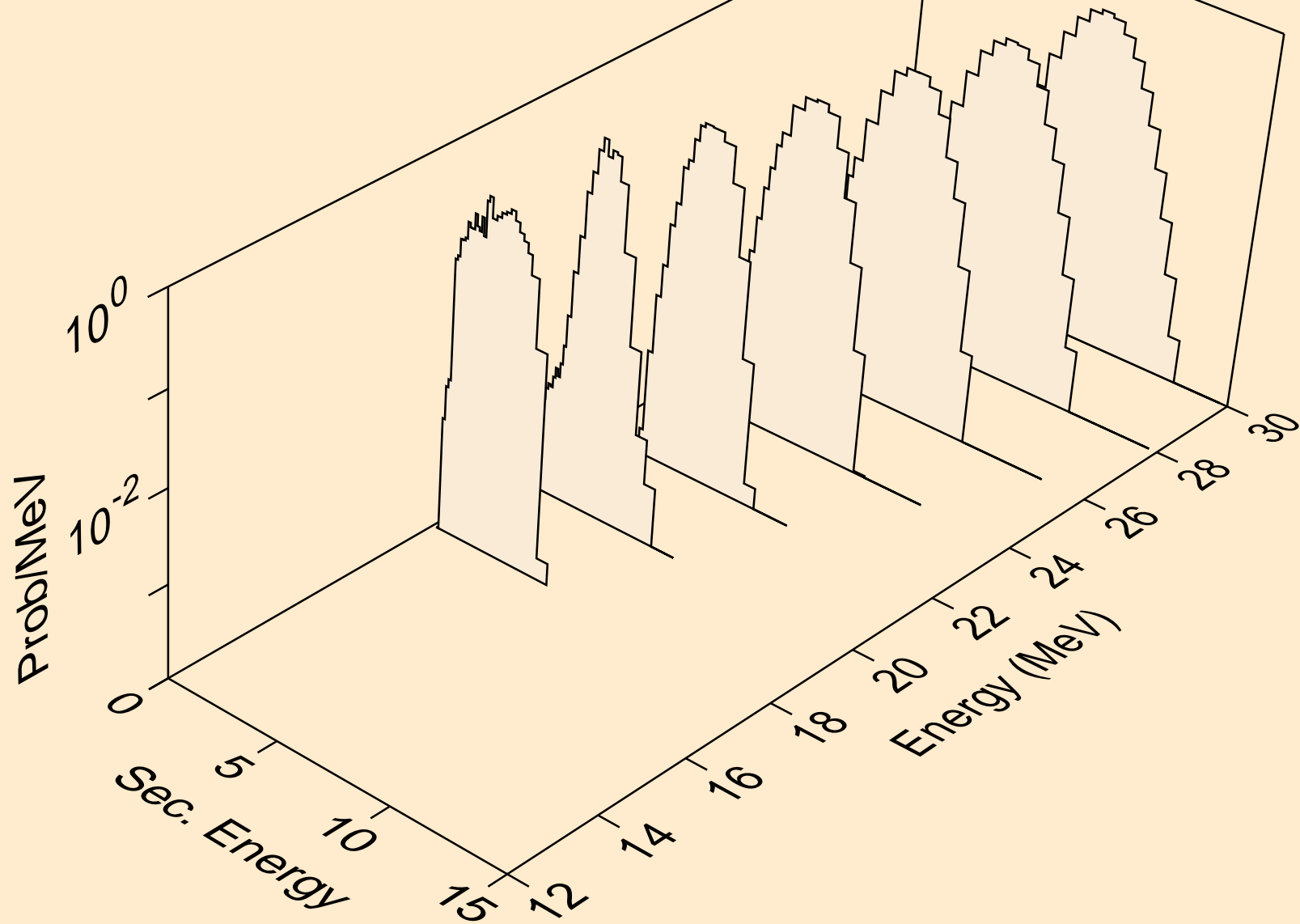

TM174 PROTON ACER TENDL-2021 LIBRARY; T=0.K  
Proton emission for (p,npa)

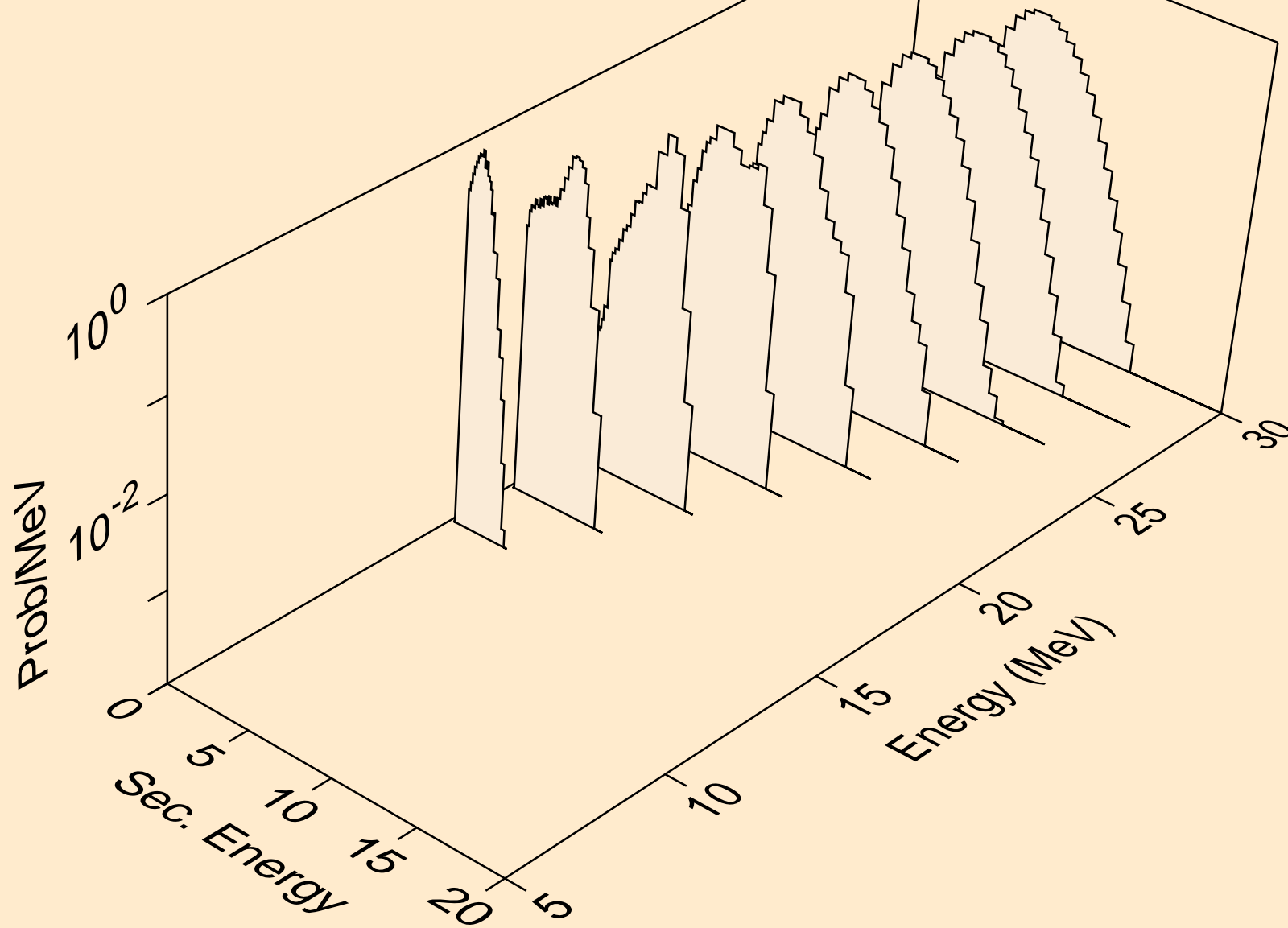

TM174 PROTON ACER TENDL-2021 LIBRARY; T=0.K  
Proton emission for inelastic

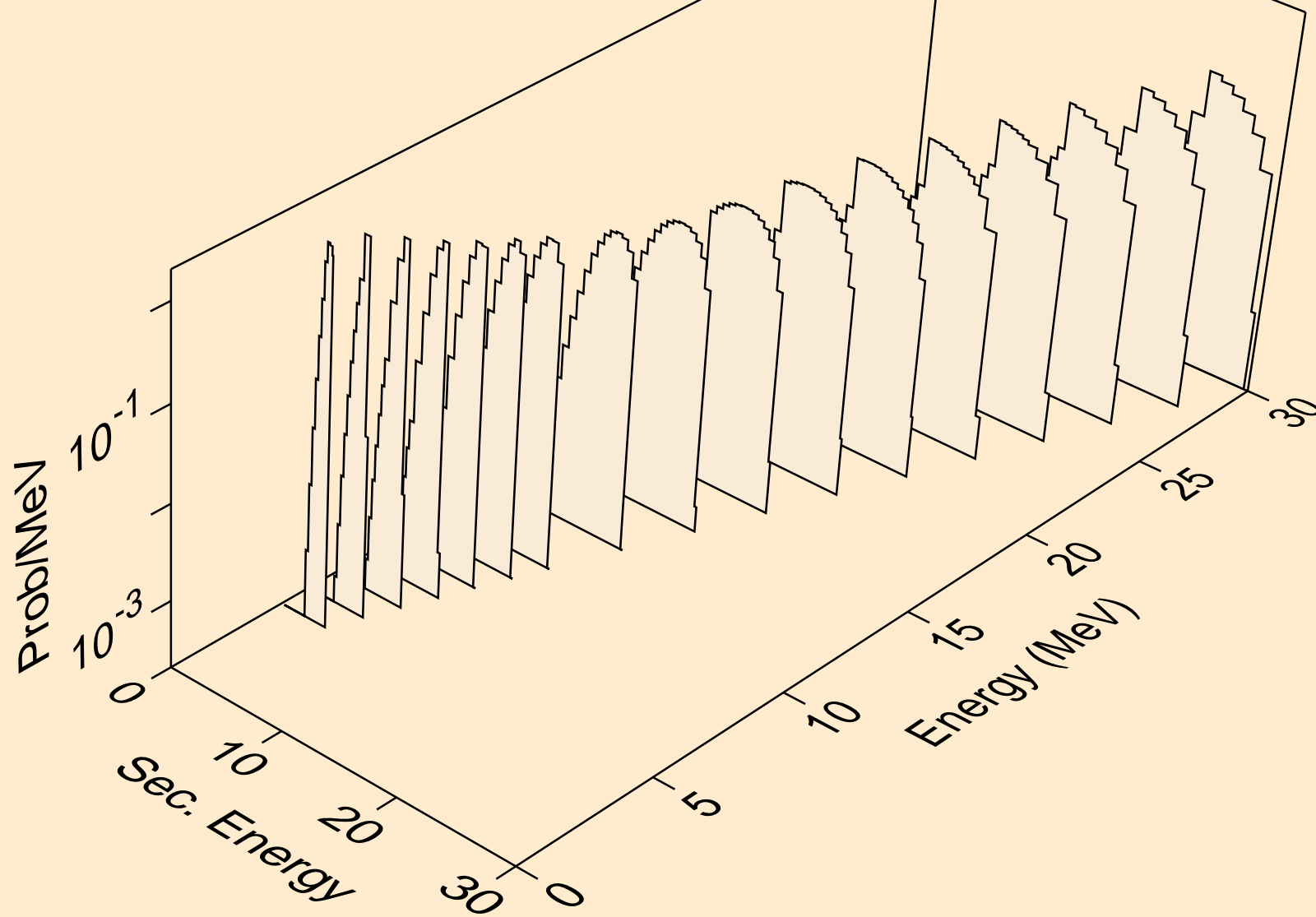



TM174 PROTON ACER TENDL-2021 LIBRARY; T=0.K  
Proton emission for (p,2p)

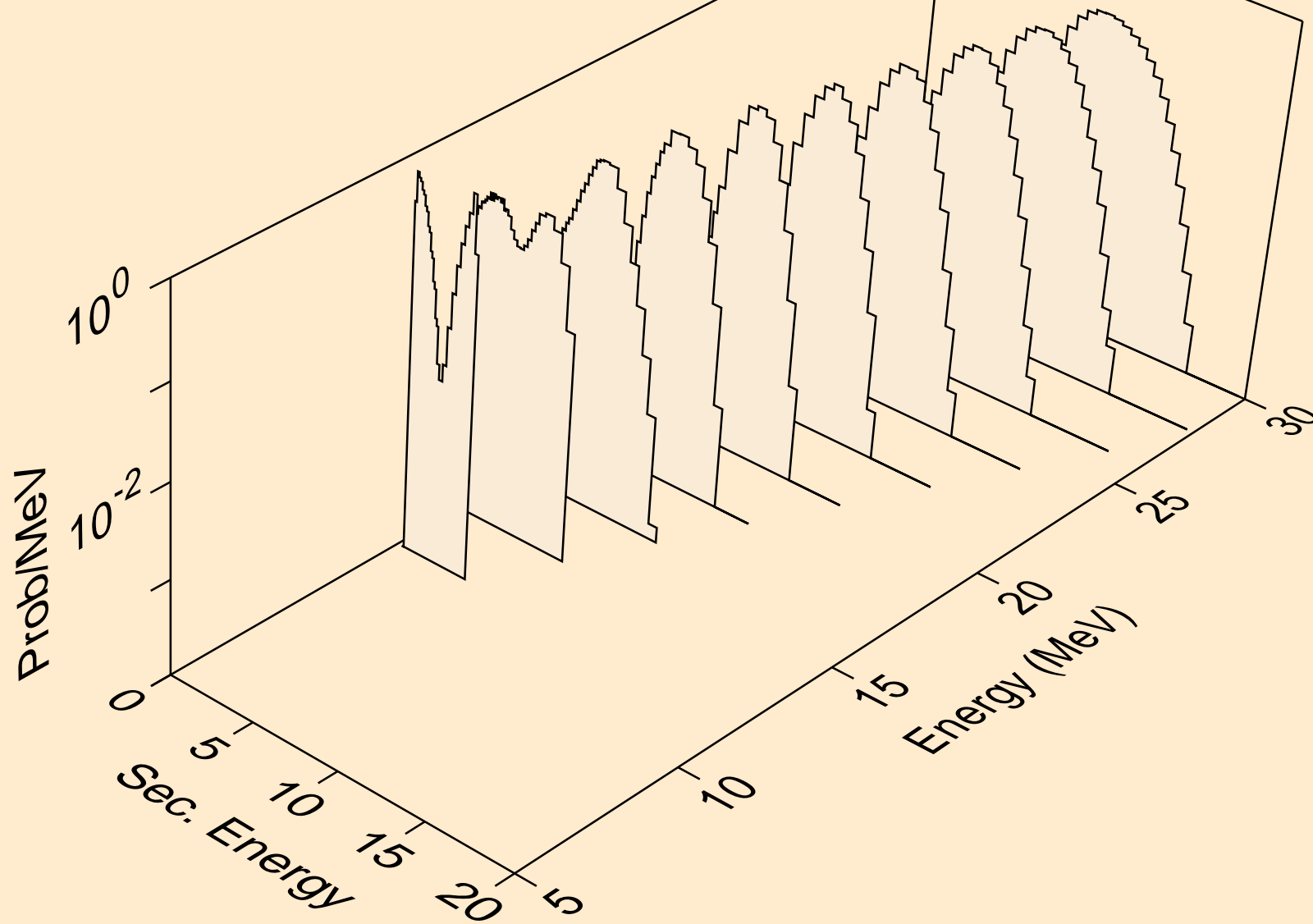

TM174 PROTON ACER TENDL-2021 LIBRARY; T=0.K  
Proton emission for (p,pa)

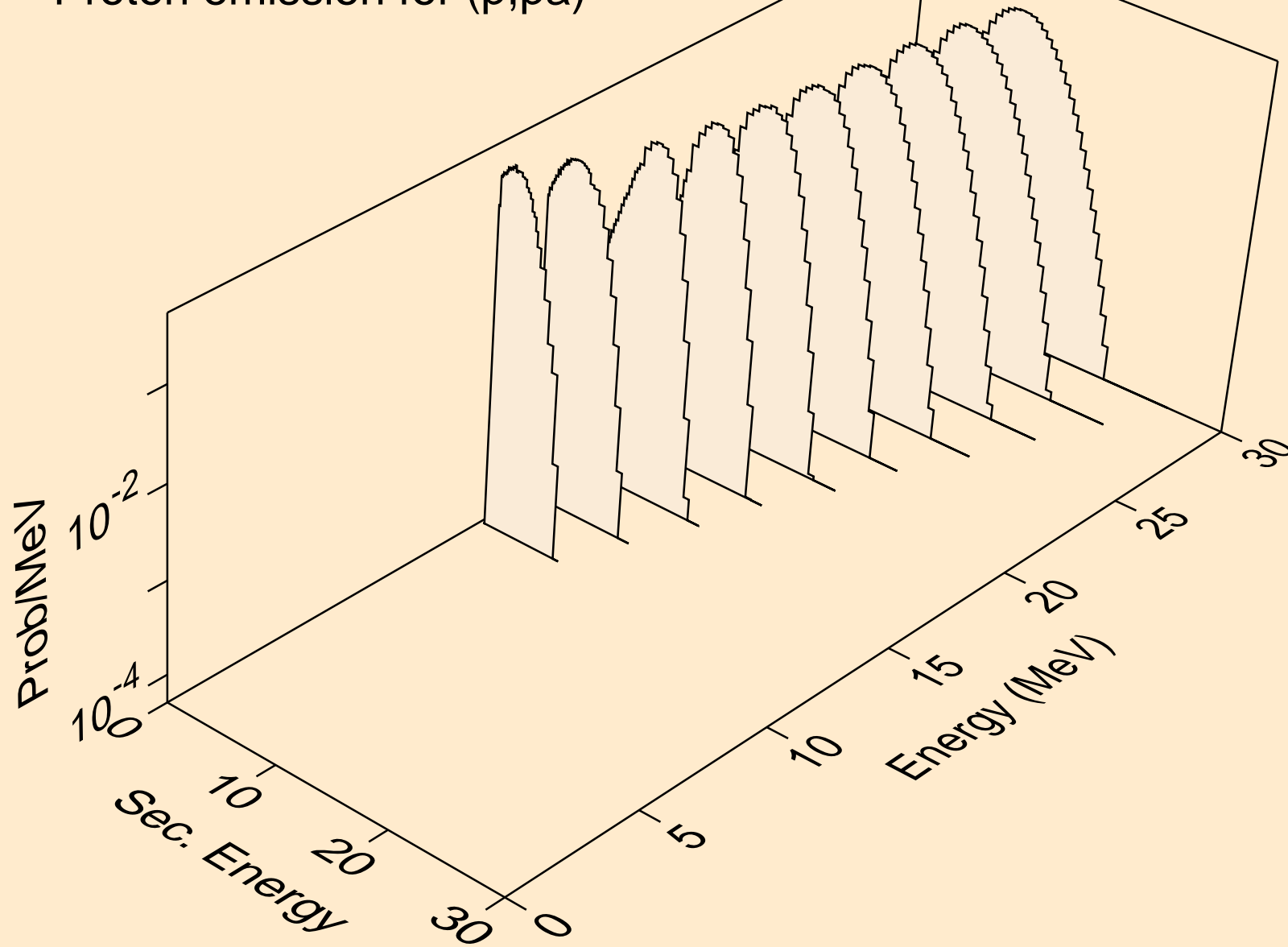

TM174 PROTON ACER TENDL-2021 LIBRARY; T=0.K  
Proton emission for (p,pd)

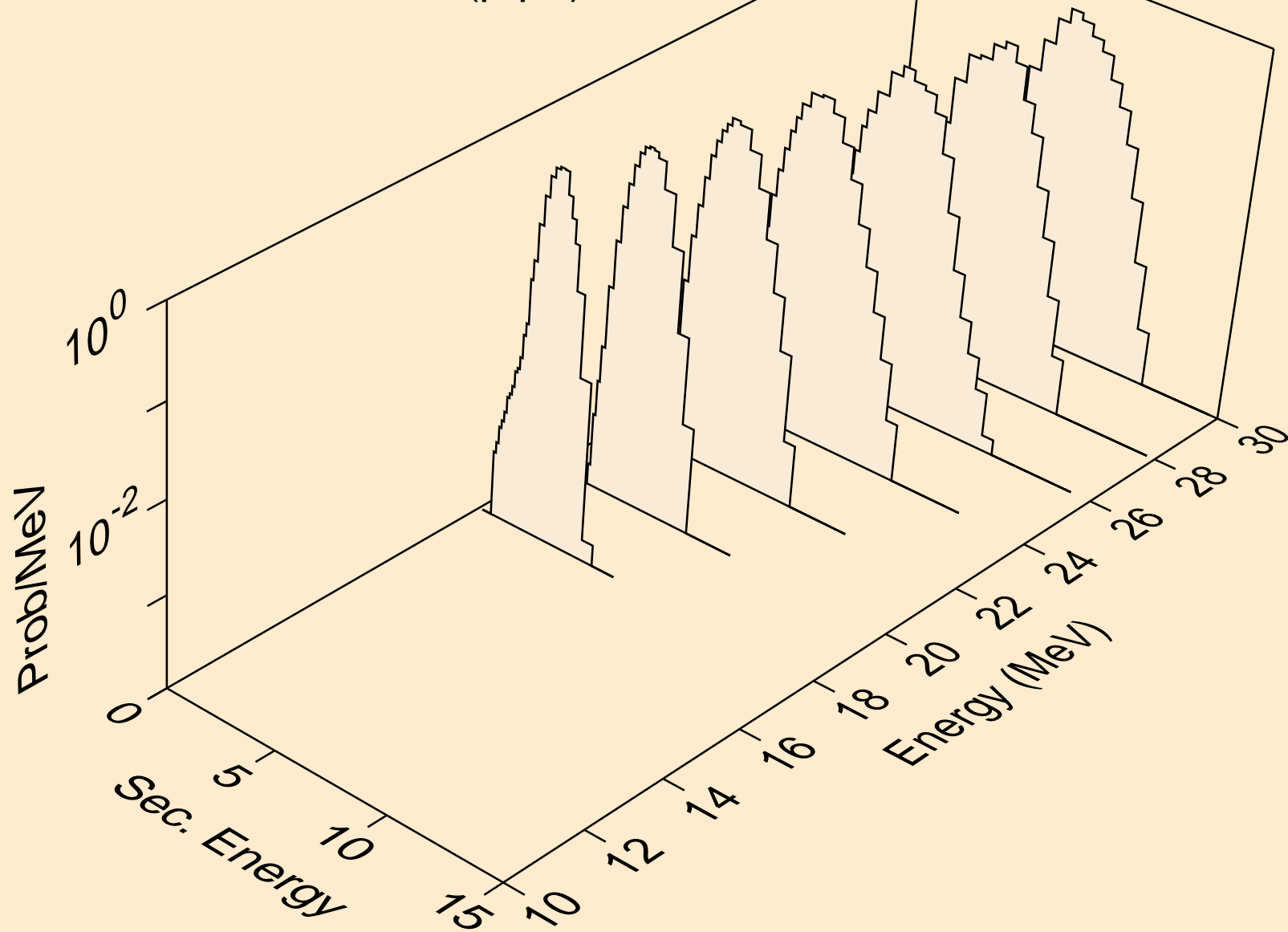

TM174 PROTON ACER TENDL-2021 LIBRARY; T=0.K  
Proton emission for (p,pt)

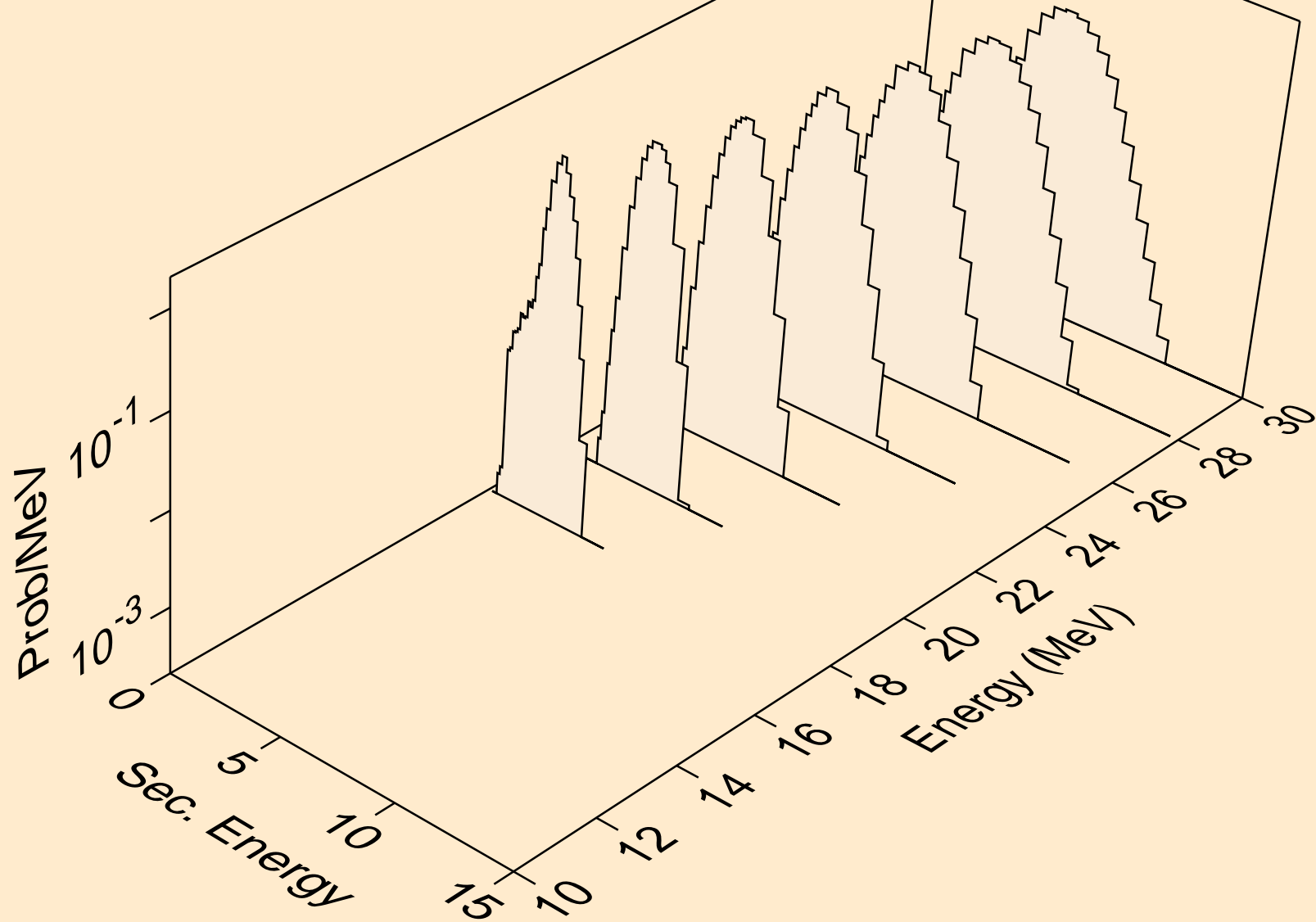

TM174 PROTON ACER TENDL-2021 LIBRARY; T=0.K  
Photon emission for (z,n)

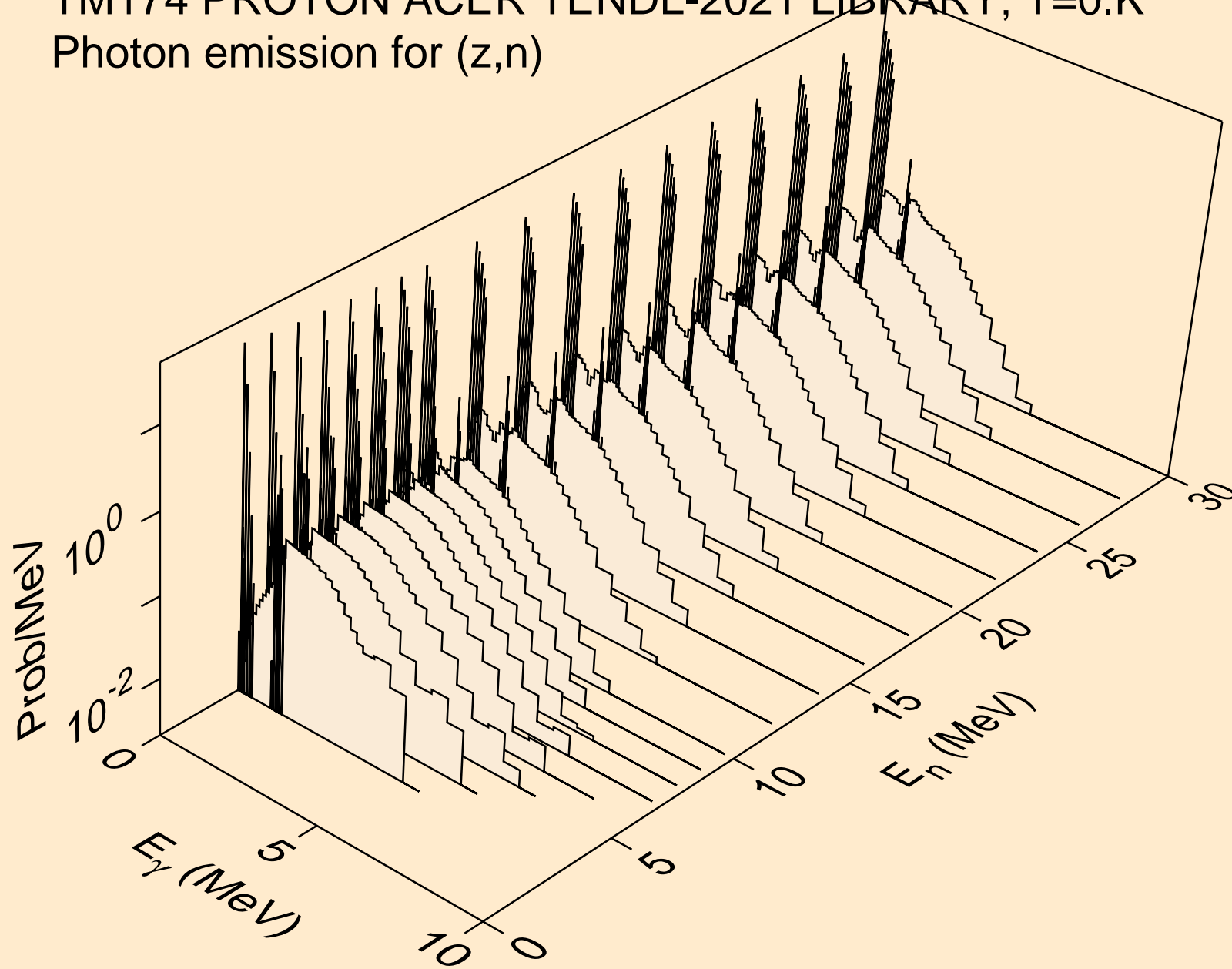

TM174 PROTON ACER TENDL-2021 LIBRARY; T=0.K  
Photon emission for (n,x)

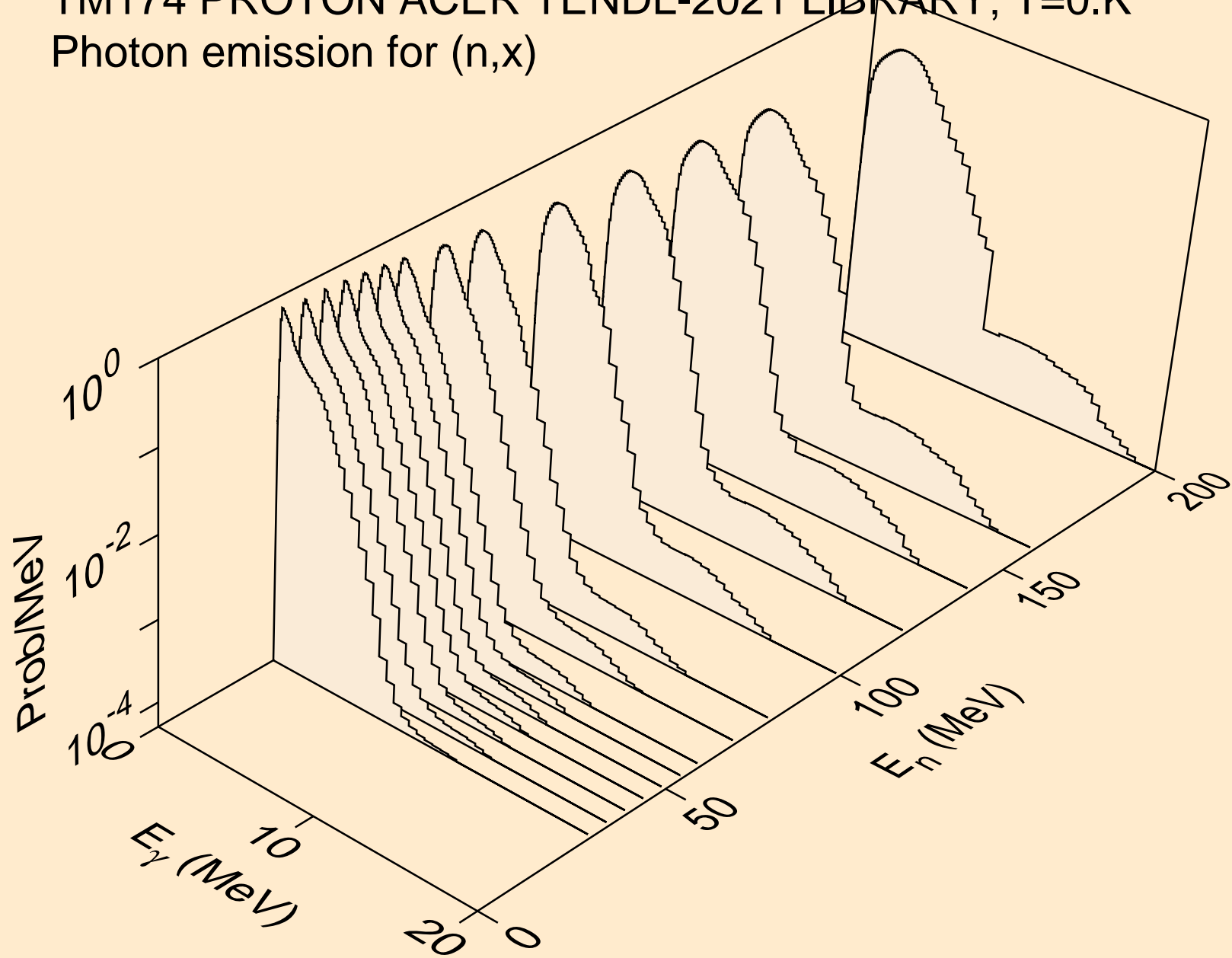

TM174 PROTON ACER TENDL-2021 LIBRARY; T=0.K  
Photon emission for (n,2nd)

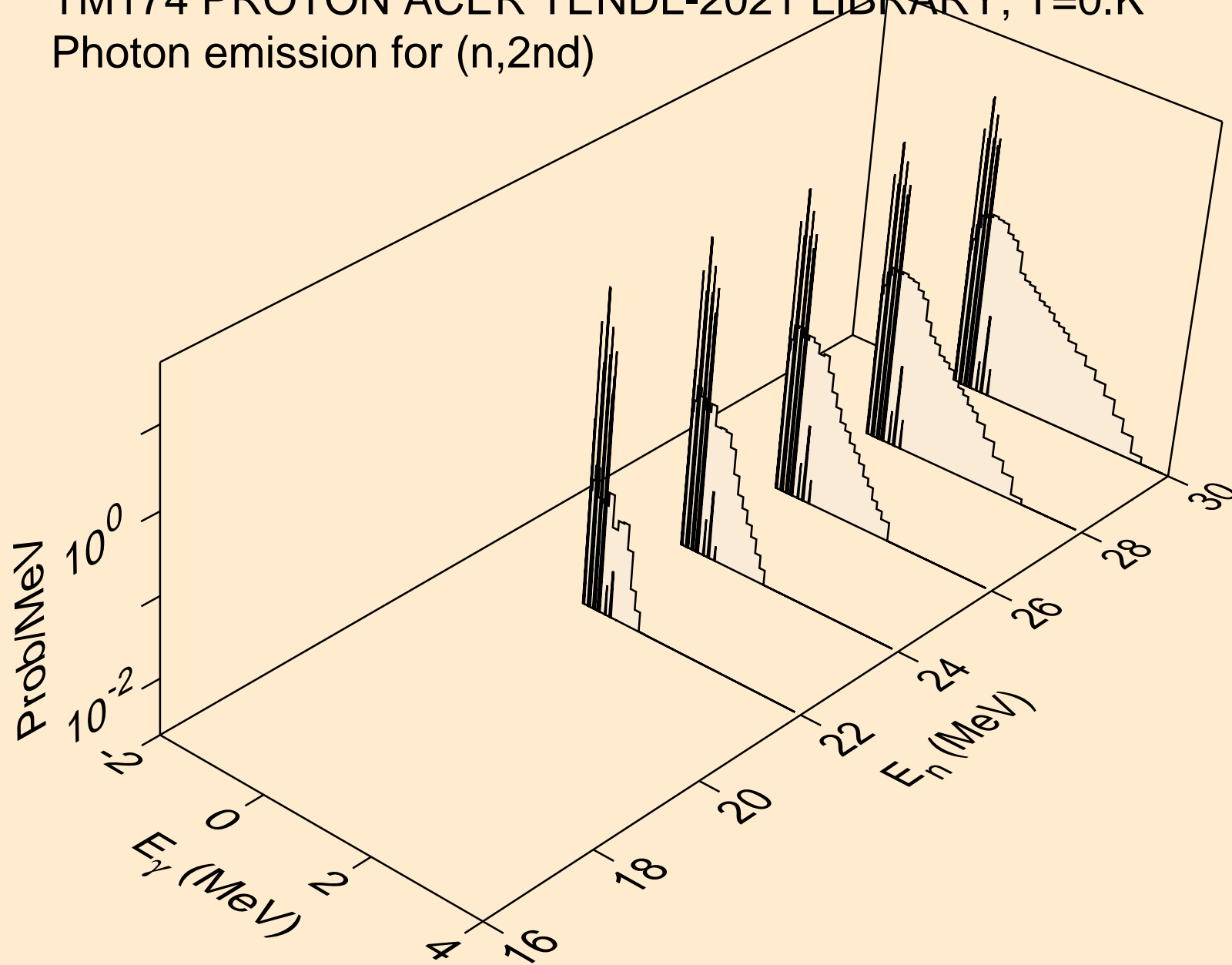

TM174 PROTON ACER TENDL-2021 LIBRARY; T=0.K  
Photon emission for (n,2n)

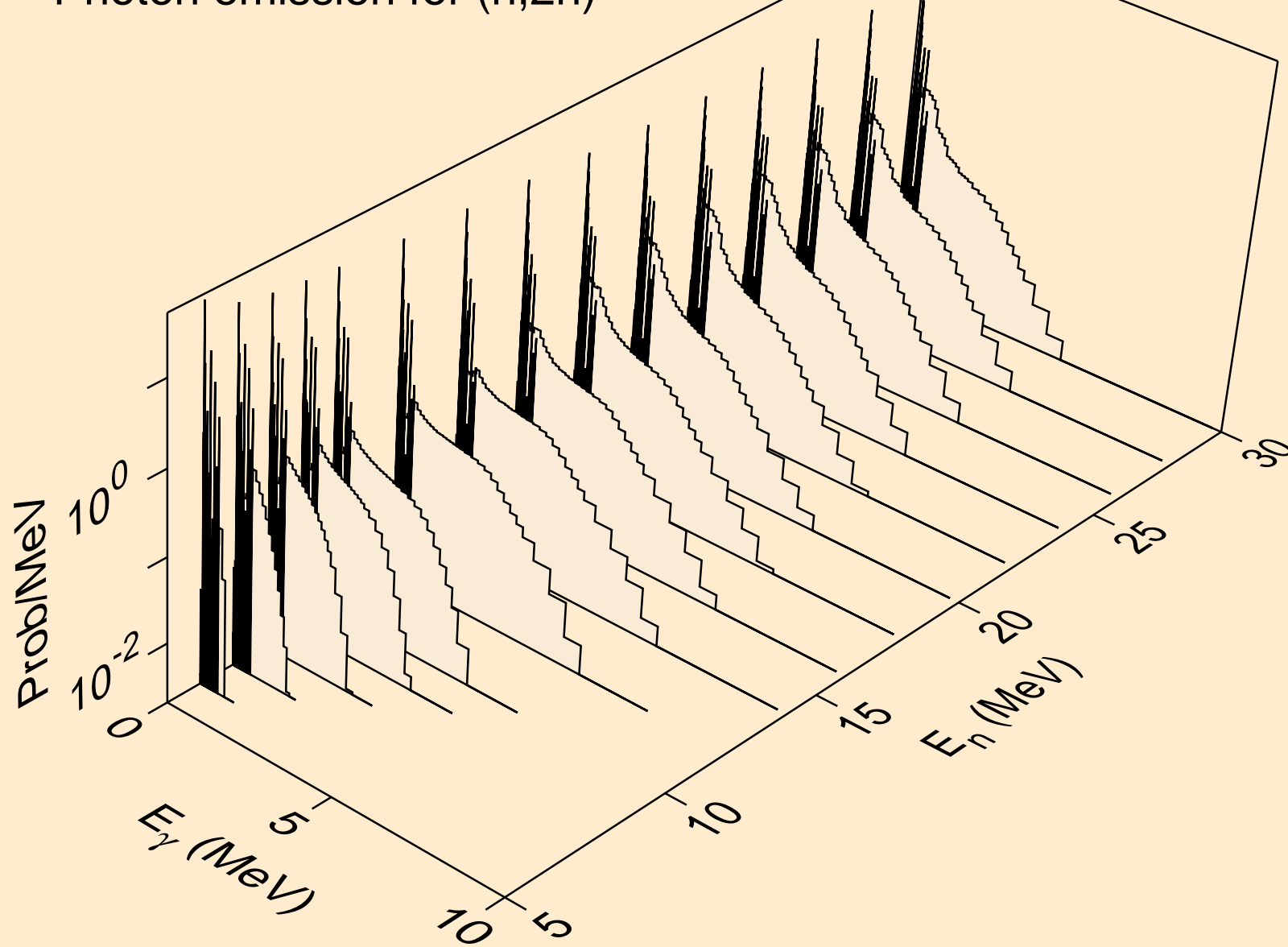



TM174 PROTON ACER TENDL-2021 LIBRARY; T=0.K  
Photon emission for (n,3n)

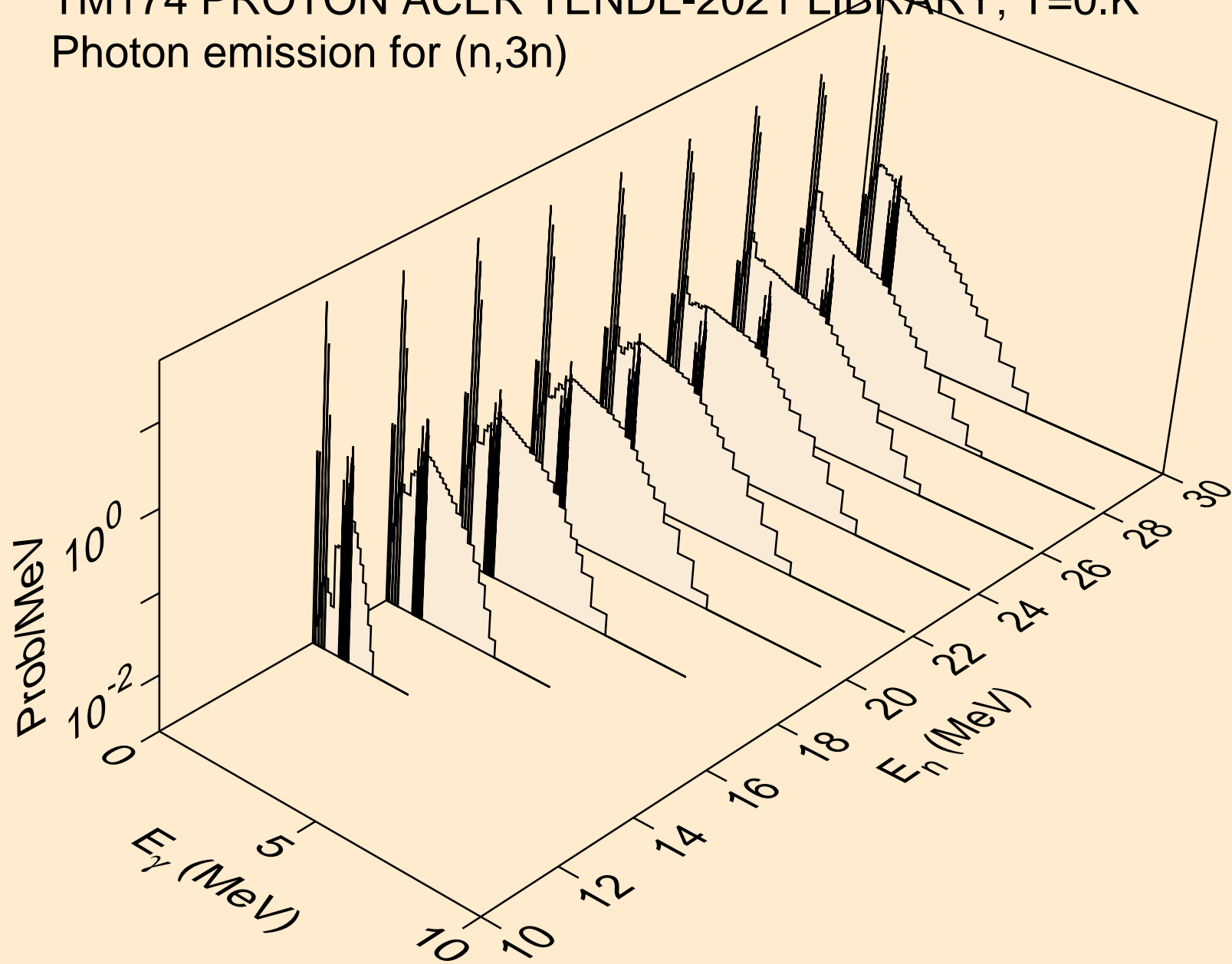

TM174 PROTON ACER TENDL-2021 LIBRARY; T=0.K  
Photon emission for (n,n\*)a

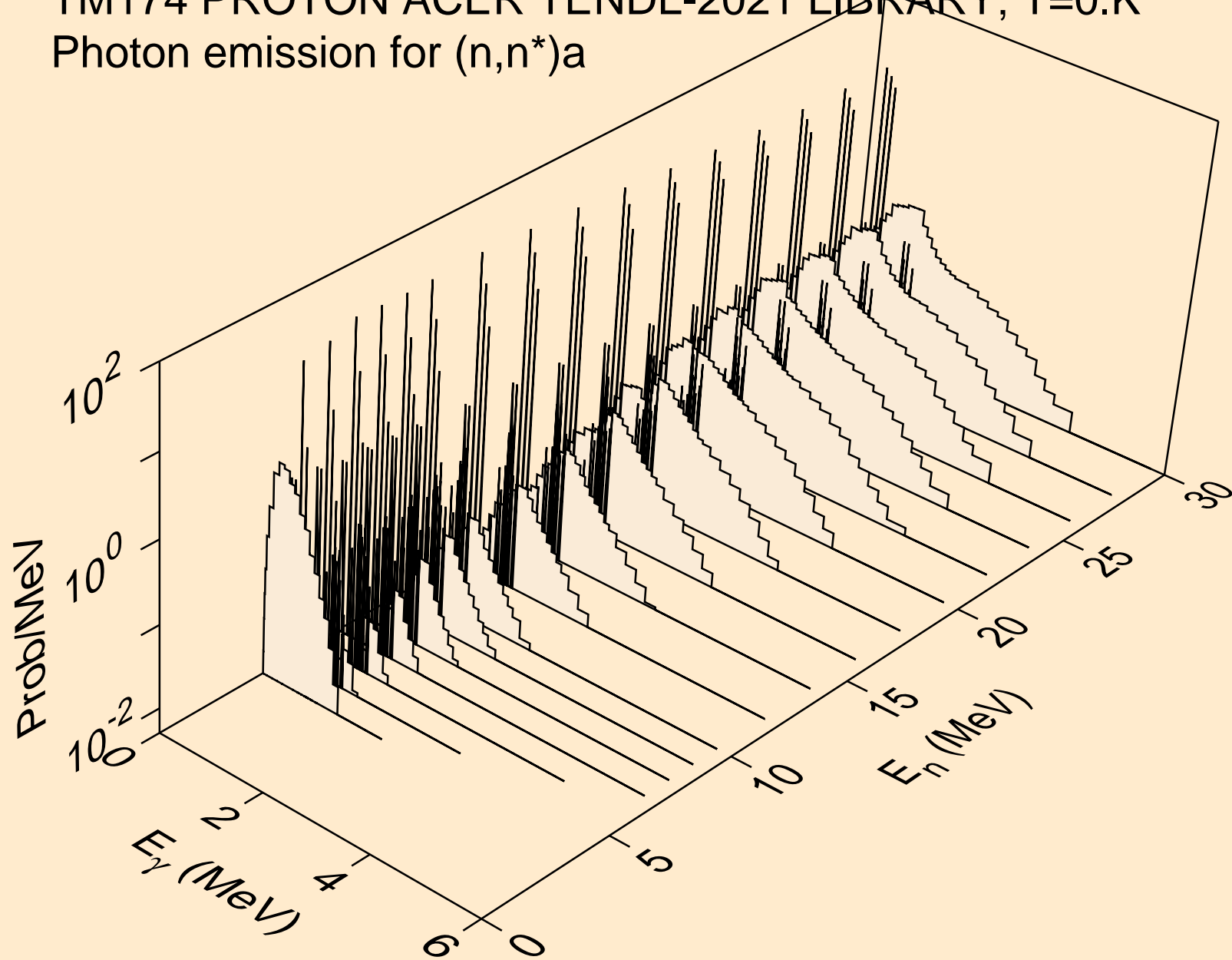

TM174 PROTON ACER TENDL-2021 LIBRARY; T=0.K  
Photon emission for (n,2n)a

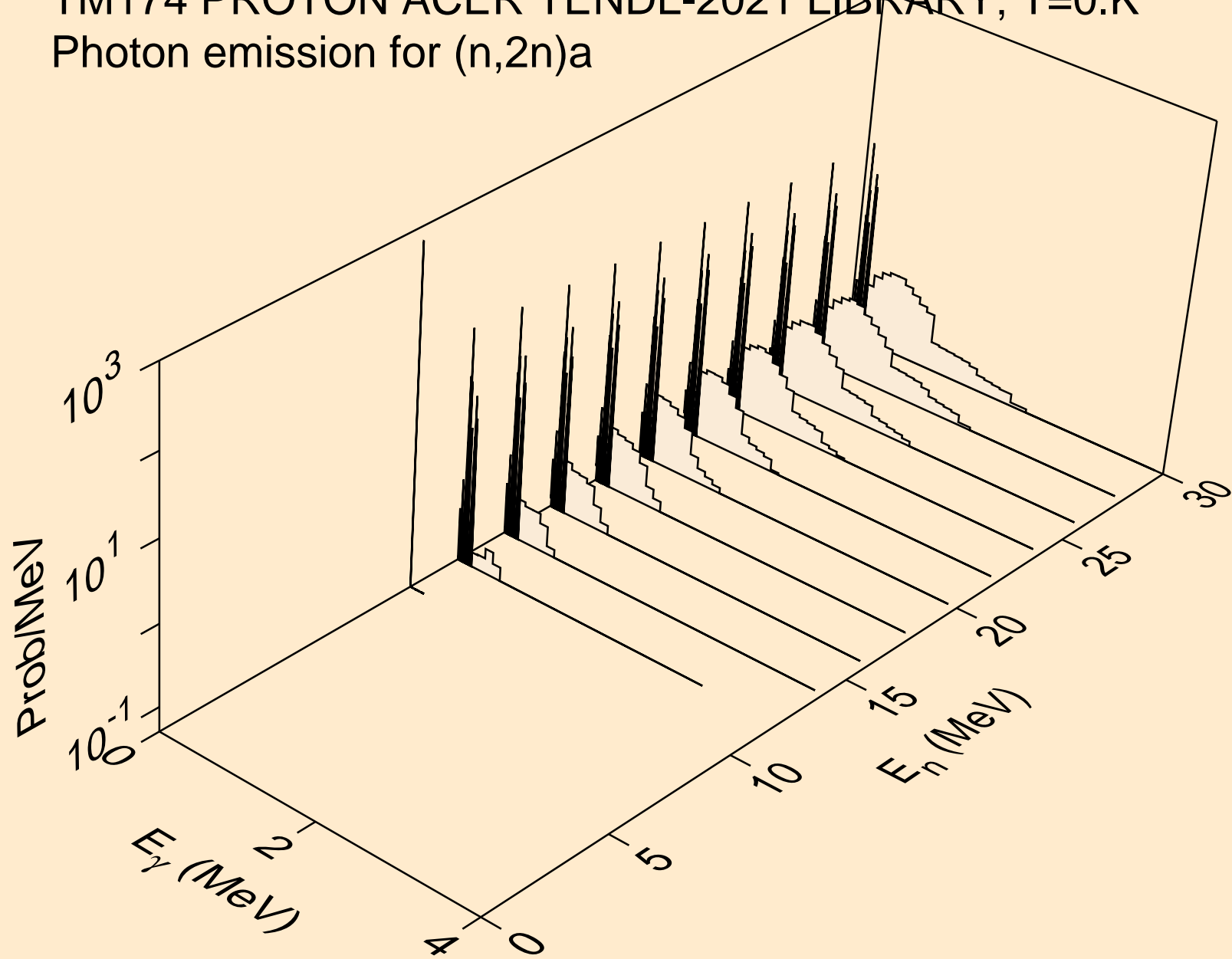

TM174 PROTON ACER TENDL-2021 LIBRARY; T=0.K  
Photon emission for (n,3n)a

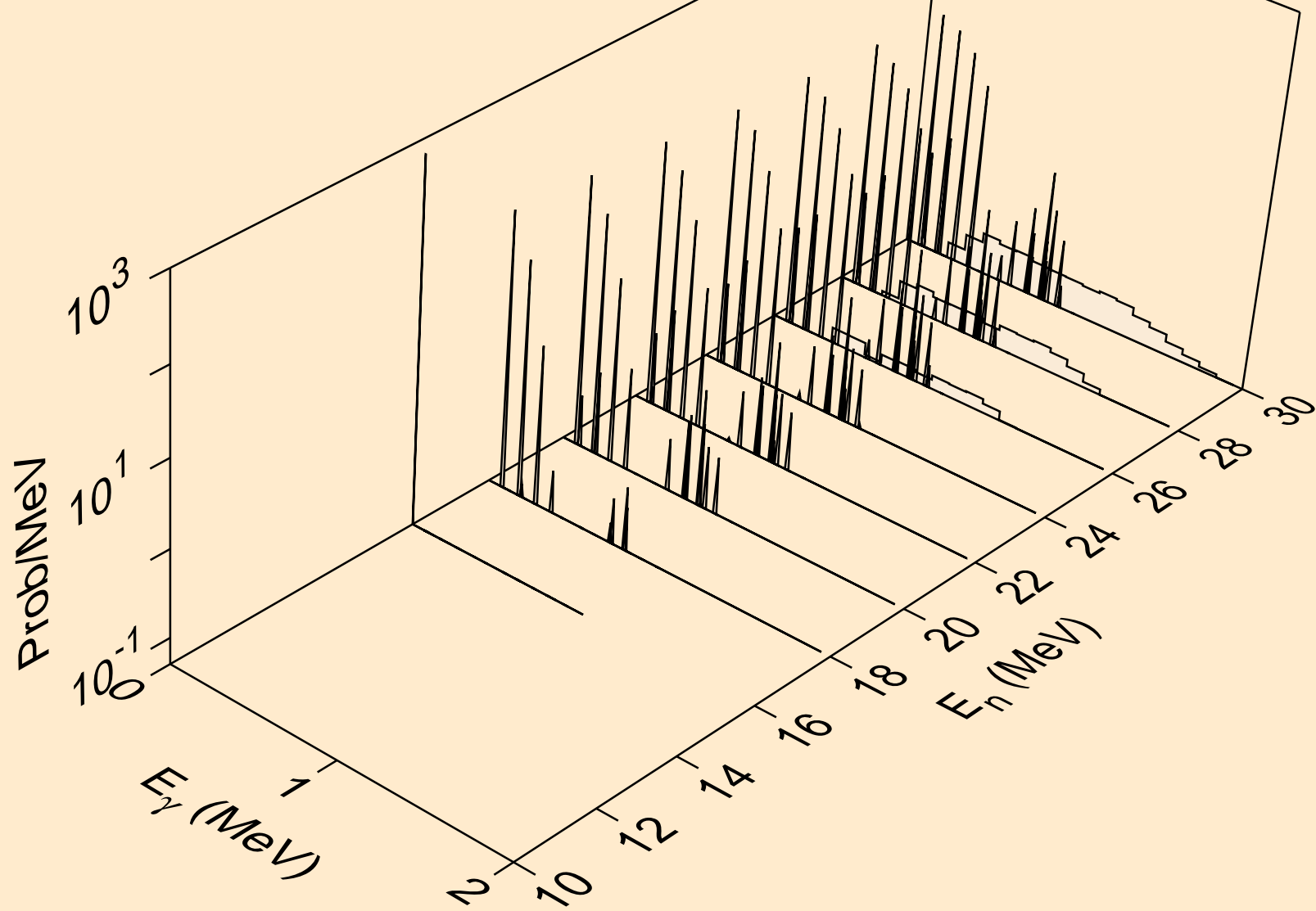

TM174 PROTON ACER TENDL-2021 LIBRARY; T=0.K  
Photon emission for (n,n\*)p

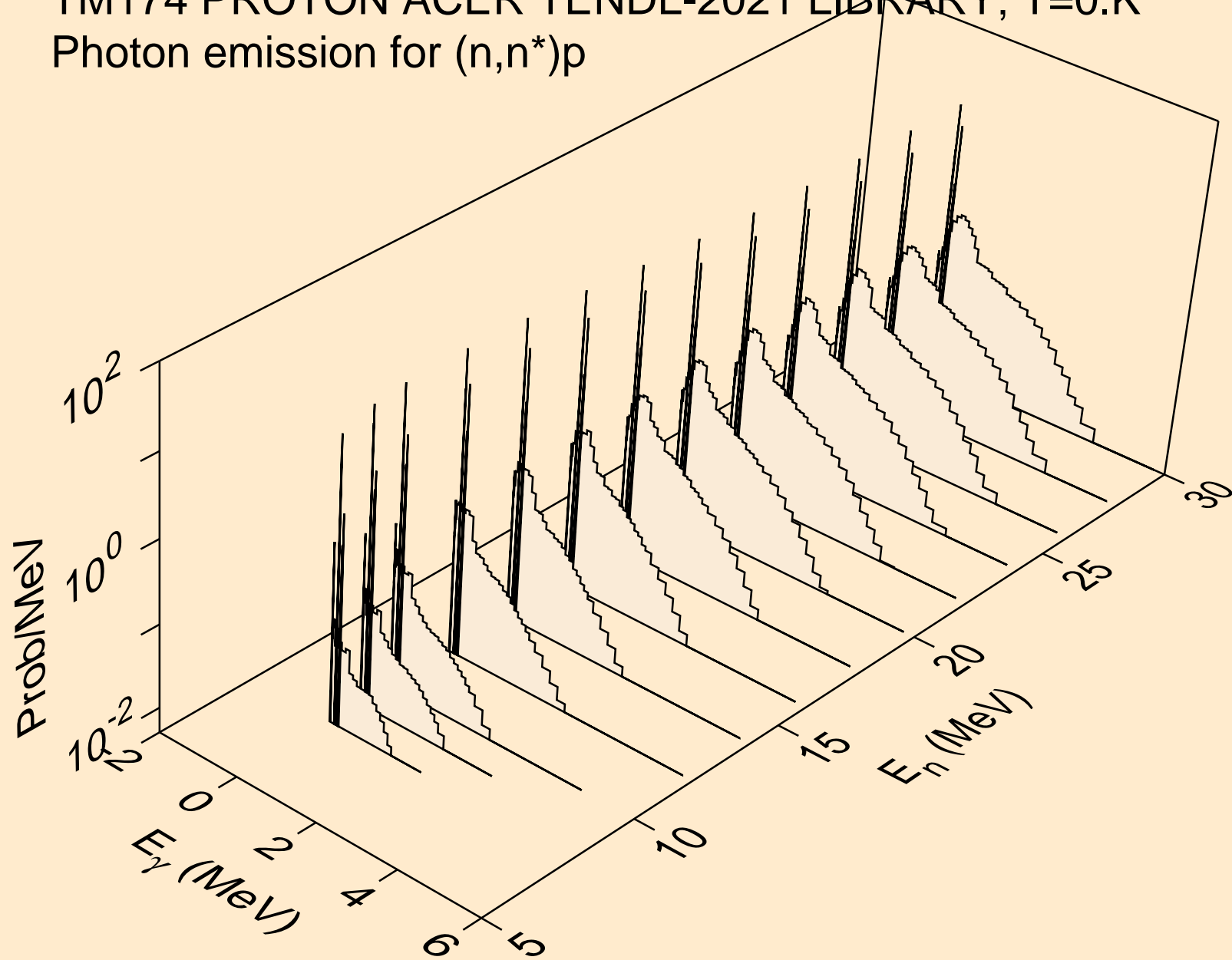

TM174 PROTON ACER TENDL-2021 LIBRARY; T=0.K  
Photon emission for (n,n\*)2a

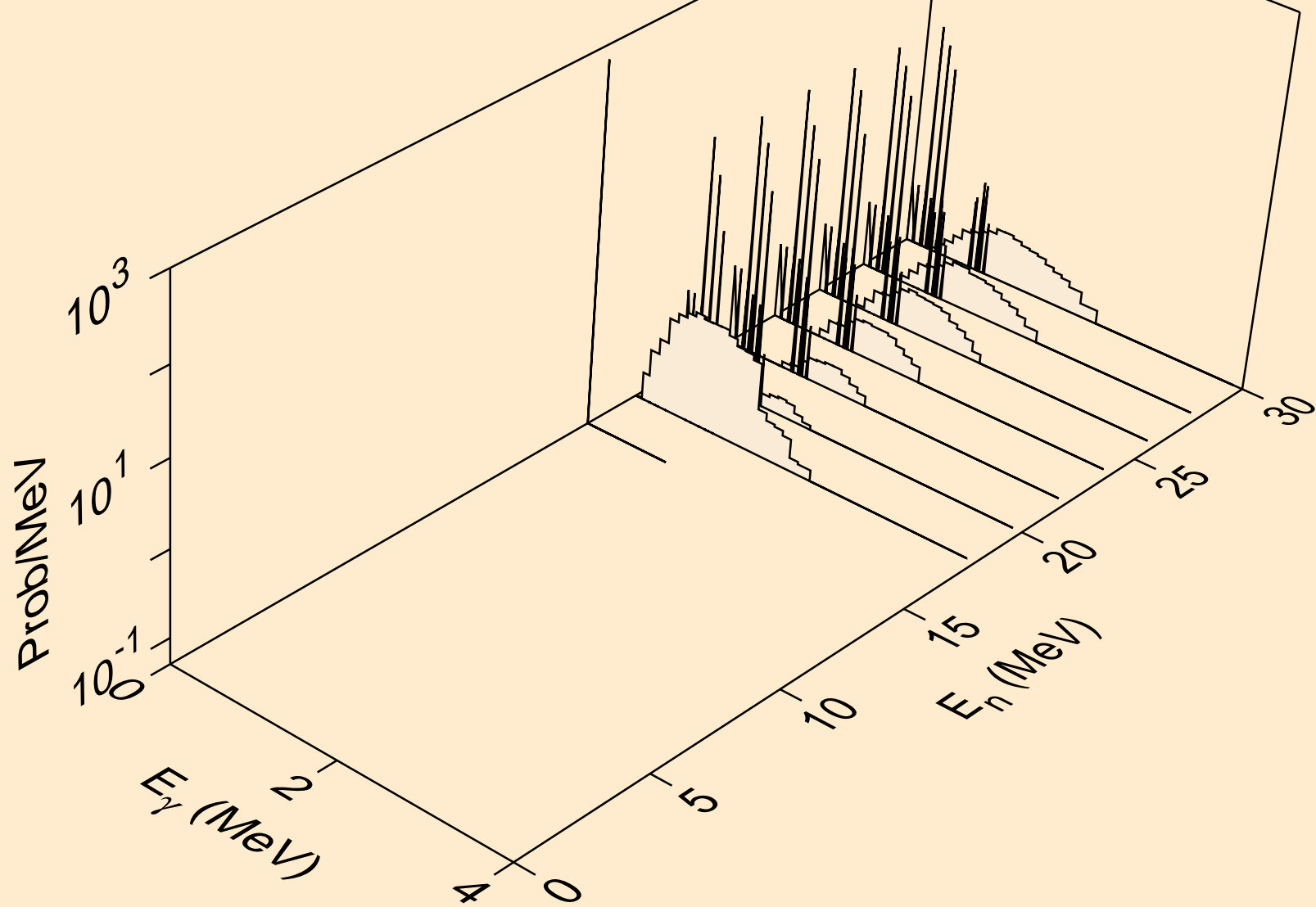

TM174 PROTON ACER TENDL-2021 LIBRARY; T=0.K  
Photon emission for (n,n\*)d

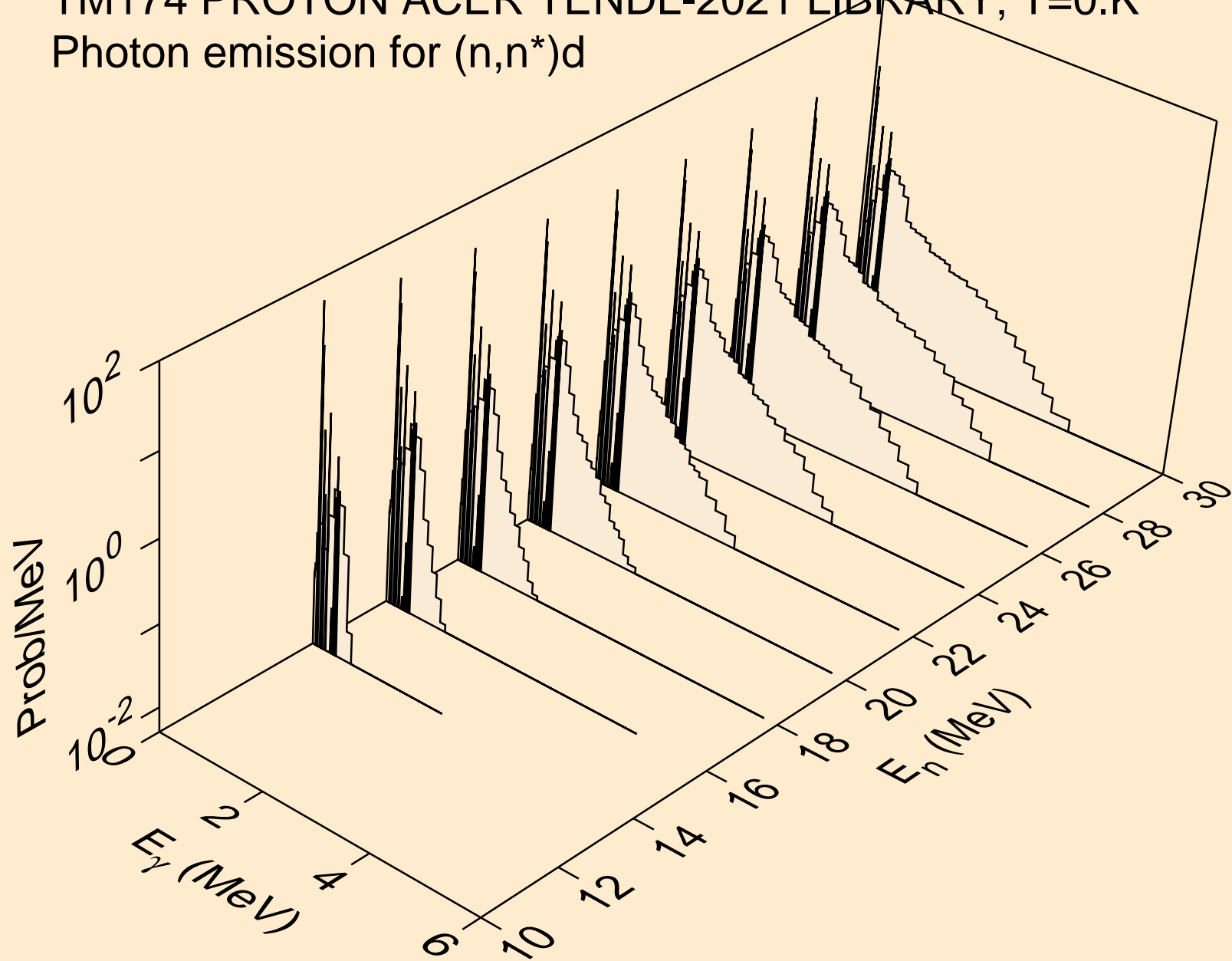

TM174 PROTON ACER TENDL-2021 LIBRARY; T=0.K  
Photon emission for (n,n\*)t

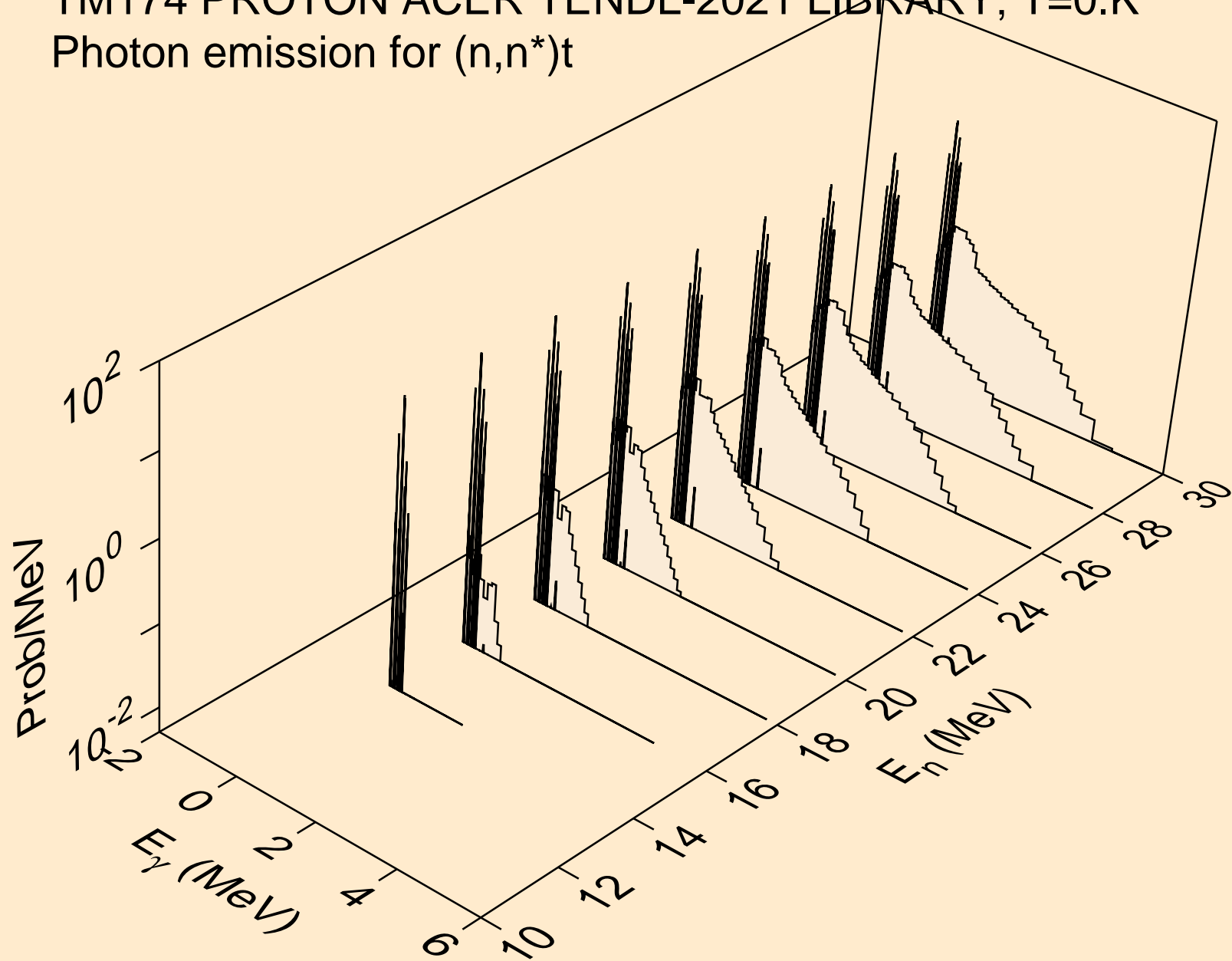



TM174 PROTON ACER TENDL-2021 LIBRARY; T=0.K  
Photon emission for (n,n\*)he3

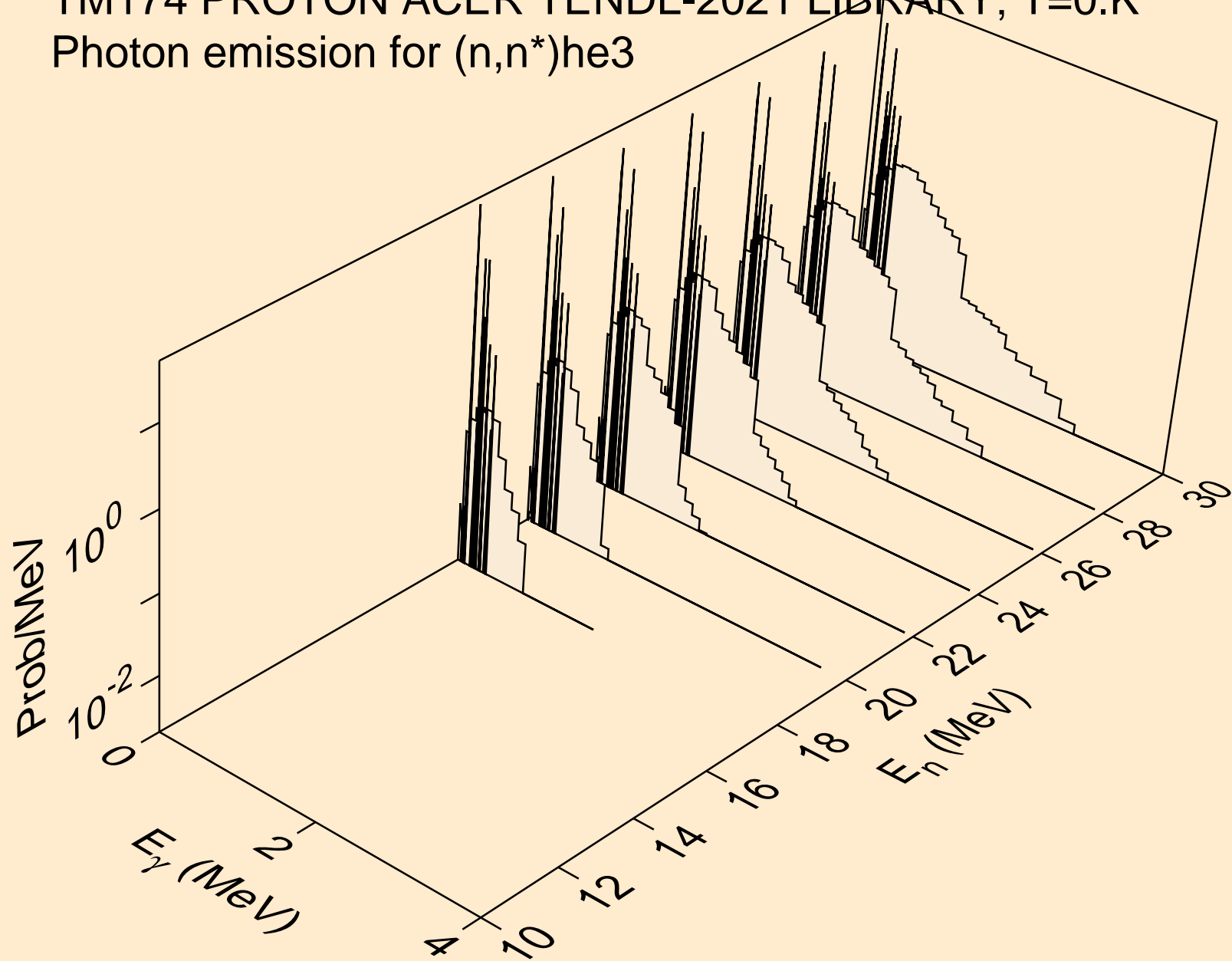

TM174 PROTON ACER TENDL-2021 LIBRARY; T=0.K  
Photon emission for (n,4n)

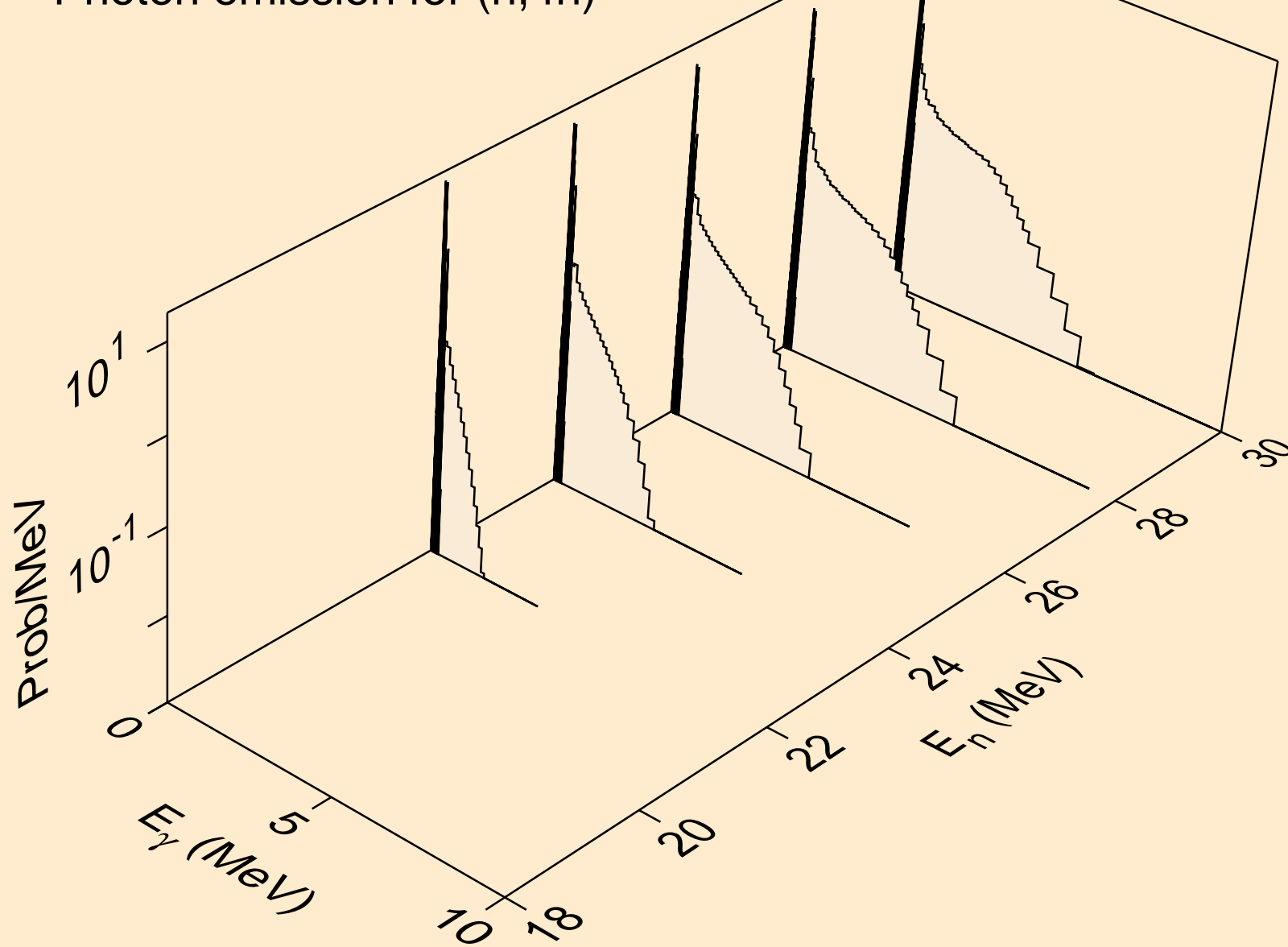

TM174 PROTON ACER TENDL-2021 LIBRARY; T=0.K  
Photon emission for (n,2np)

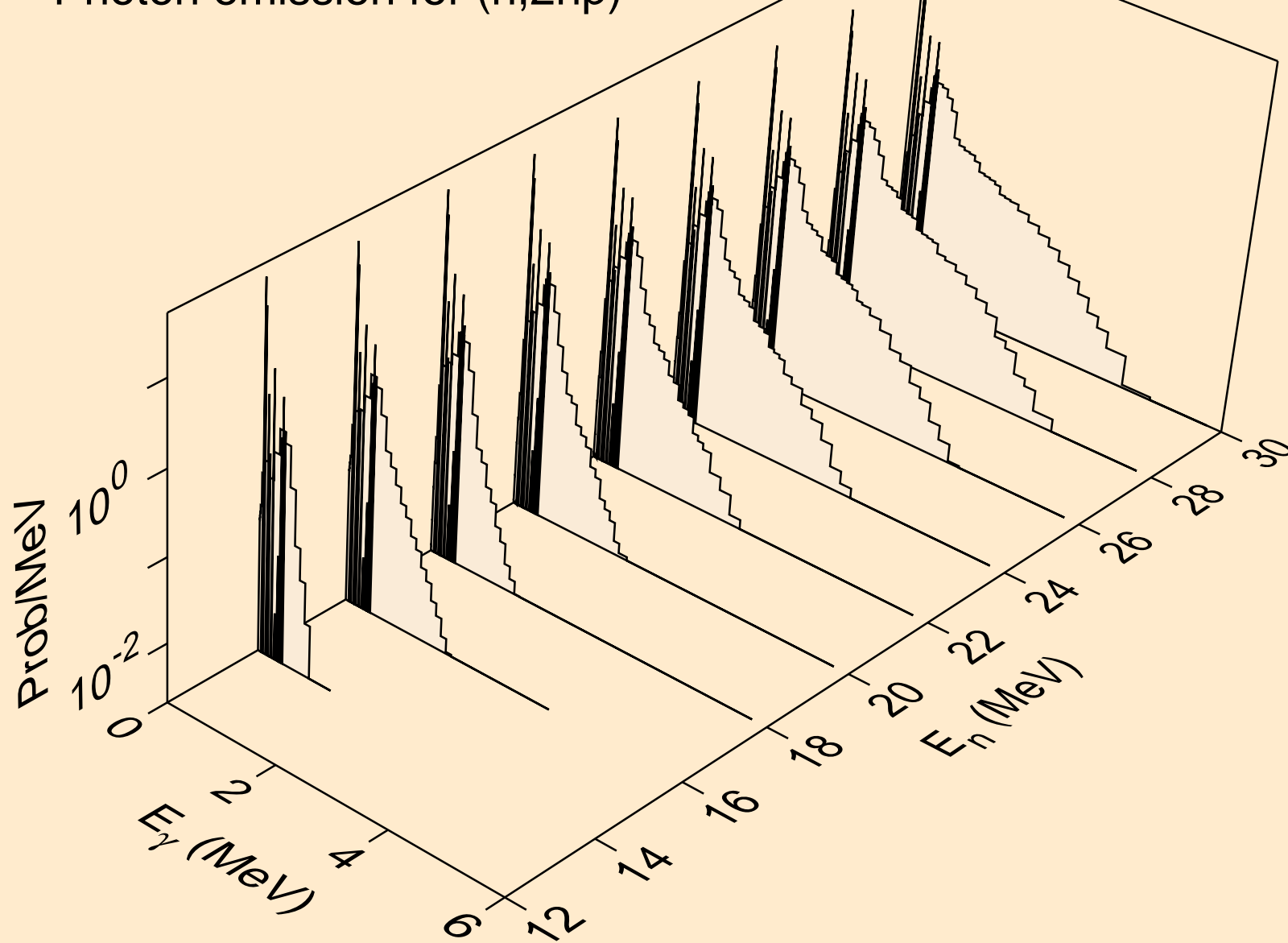

TM174 PROTON ACER TENDL-2021 LIBRARY; T=0.K  
Photon emission for (n,3np)

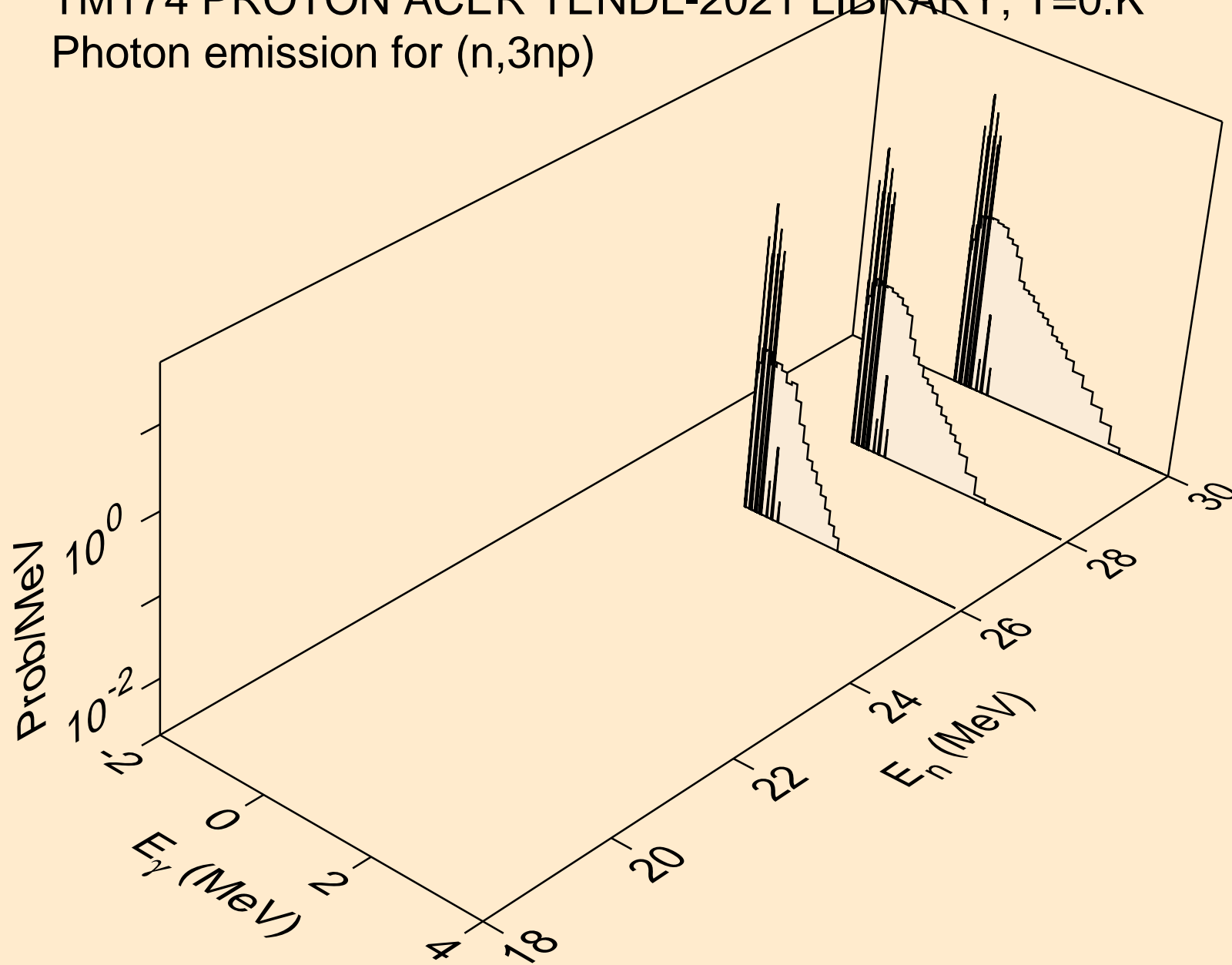

TM174 PROTON ACER TENDL-2021 LIBRARY; T=0.K  
Photon emission for (n,2np)

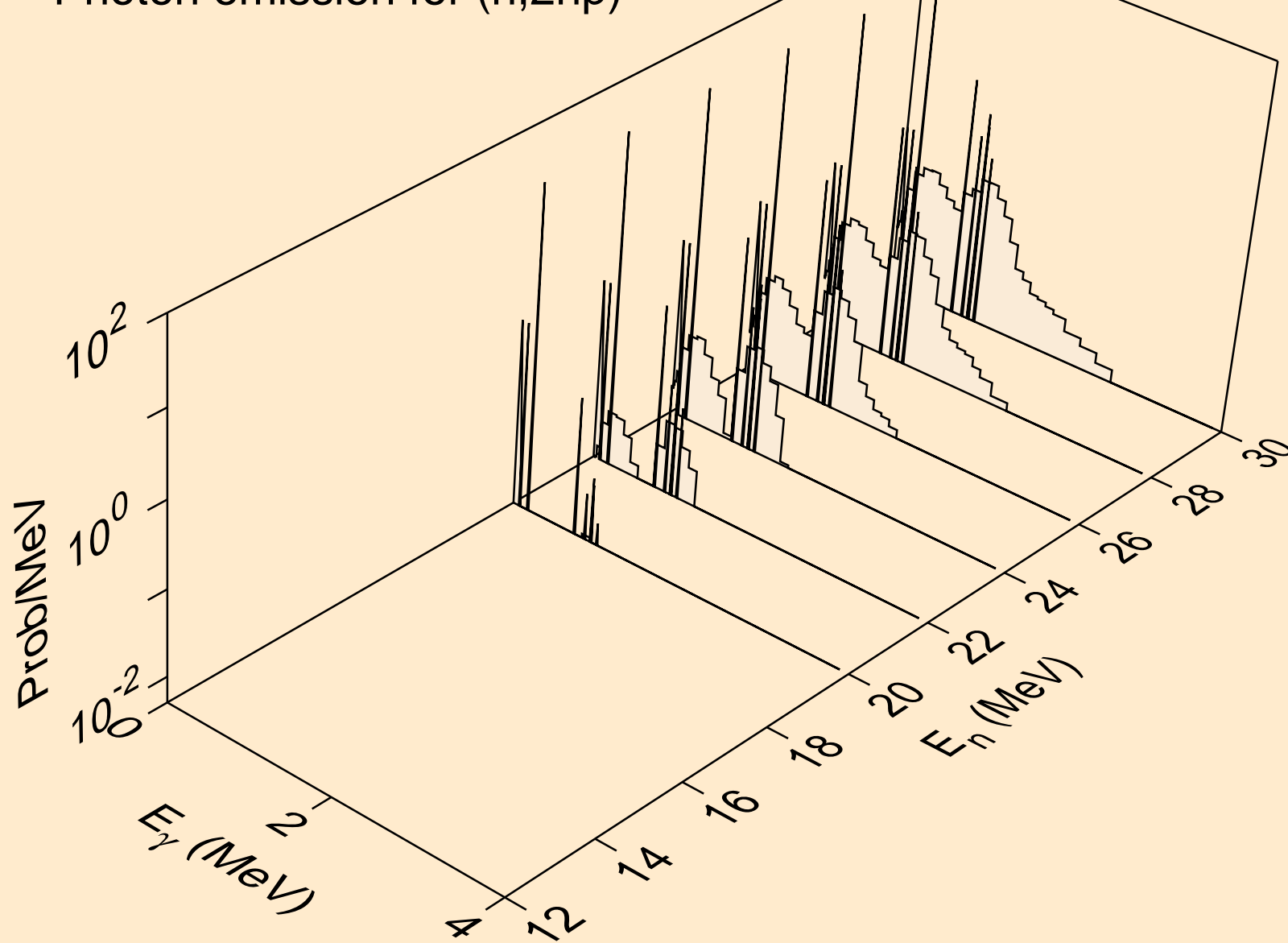

TM174 PROTON ACER TENDL-2021 LIBRARY; T=0.K  
Photon emission for (n,npa)

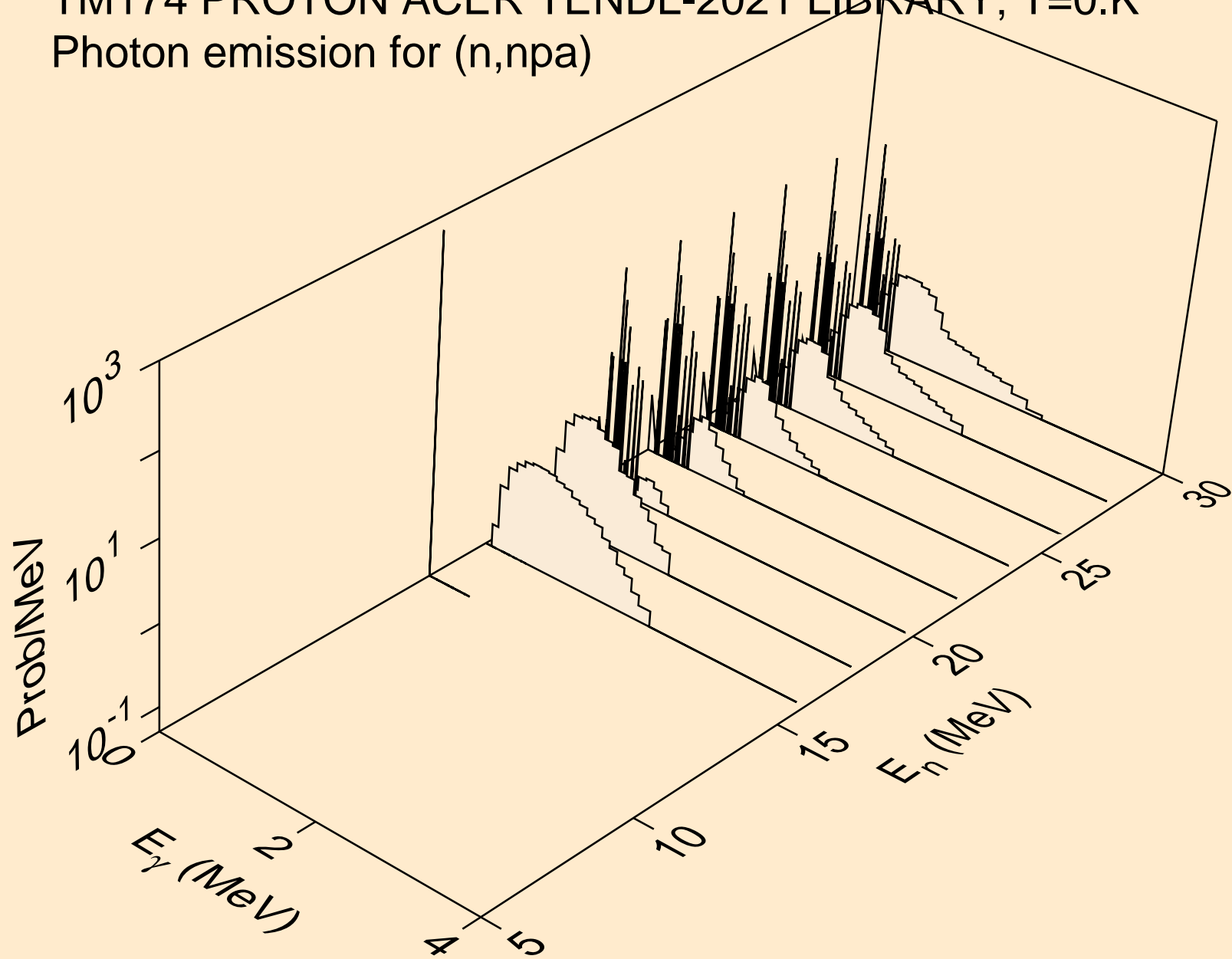

TM174 PROTON ACER TENDL-2021 LIBRARY; T=0.K  
Photon emission for (n,gma)

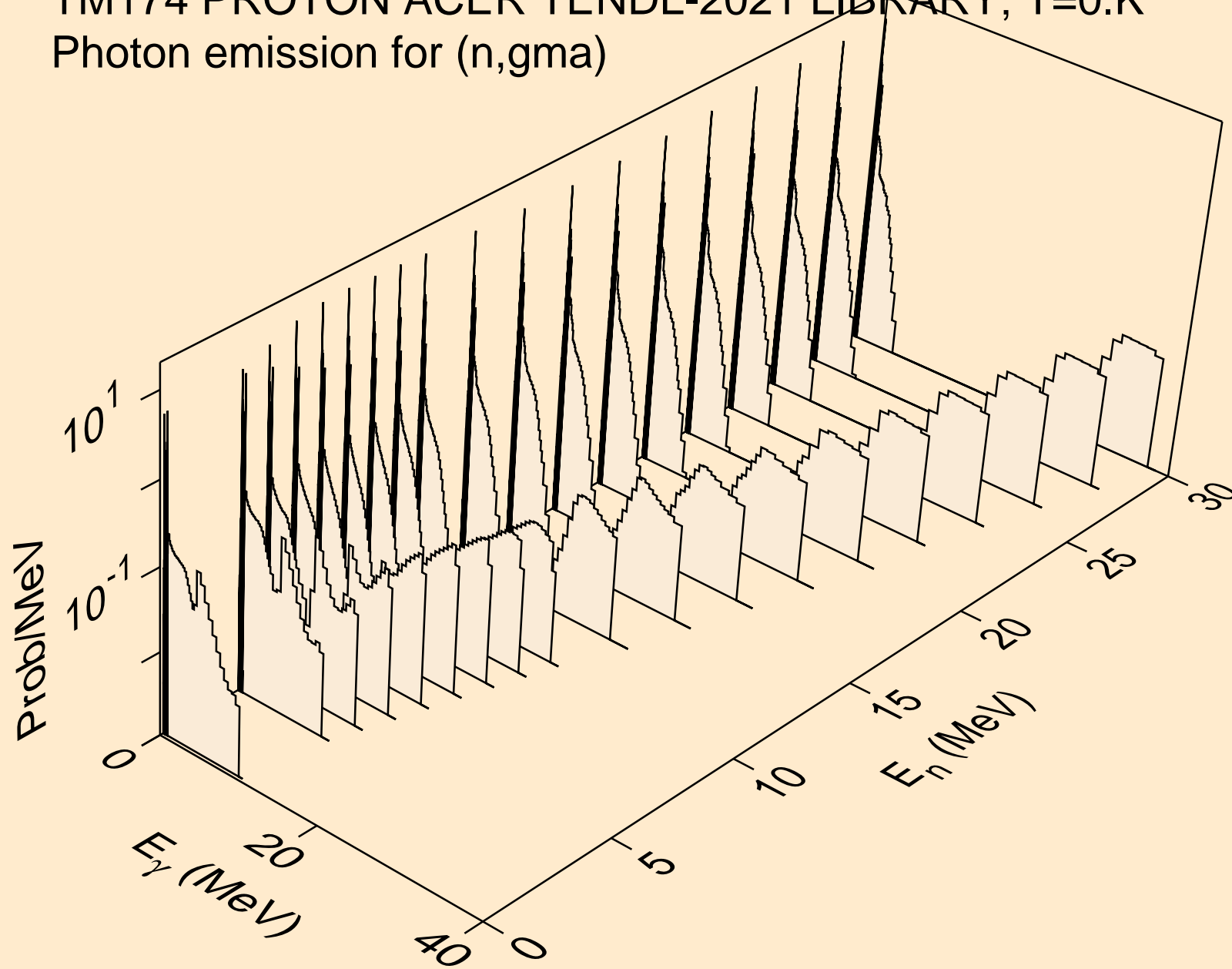

TM174 PROTON ACER TENDL-2021 LIBRARY; T=0.K  
Photon emission for inelastic

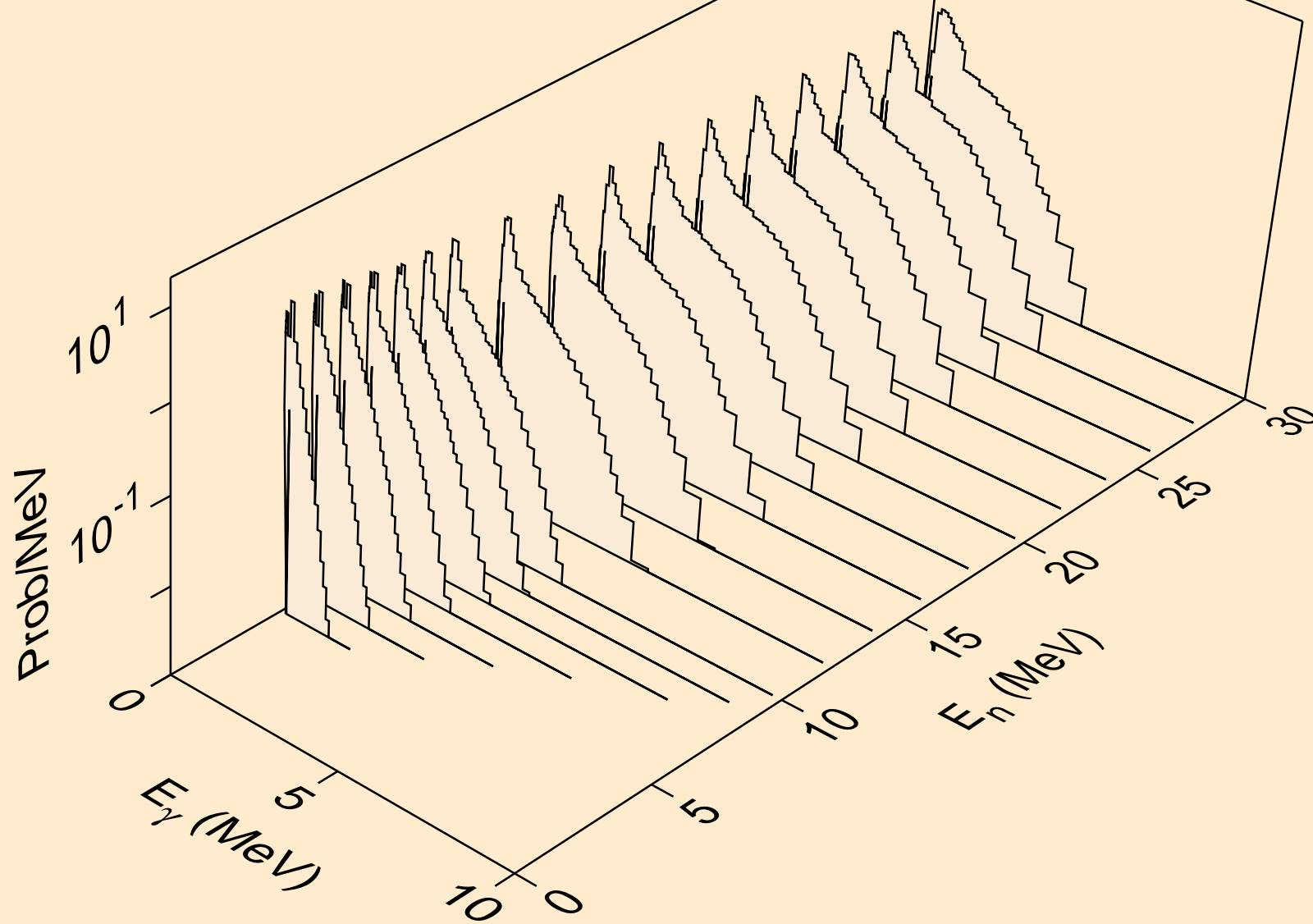



TM174 PROTON ACER TENDL-2021 LIBRARY; T=0.K  
Photon emission for (n,d)

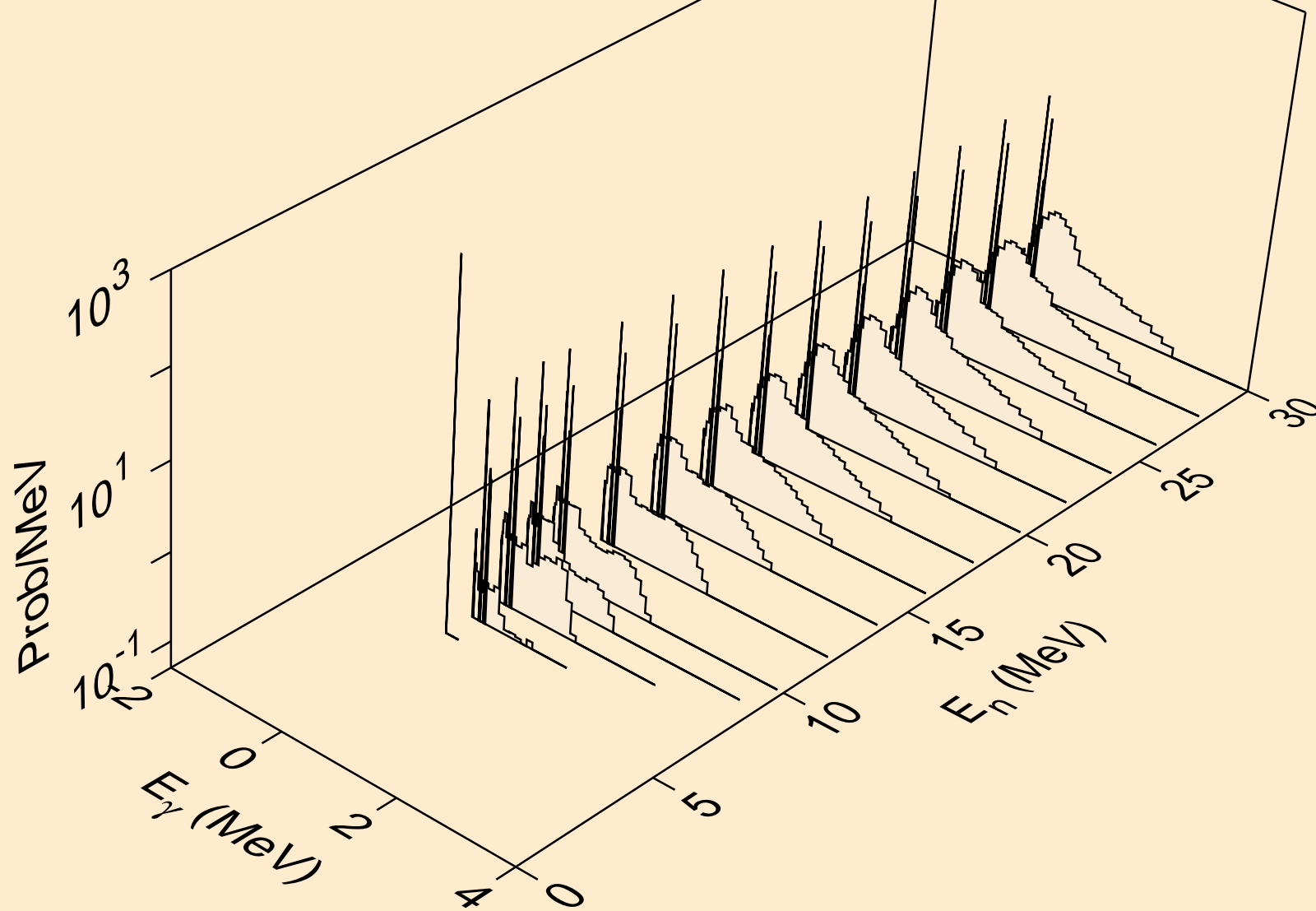

TM174 PROTON ACER TENDL-2021 LIBRARY; T=0.K  
Photon emission for (n,t)

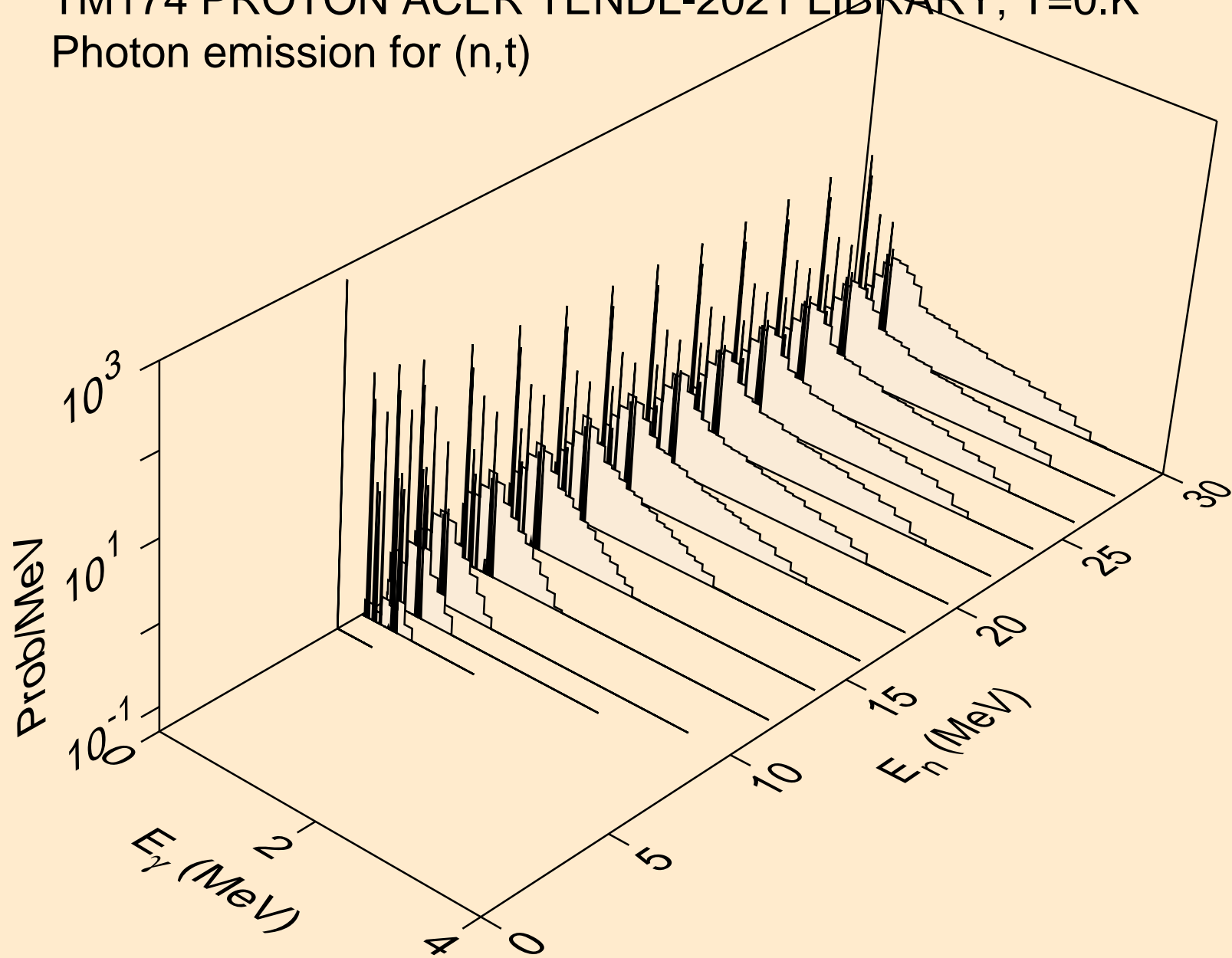

TM174 PROTON ACER TENDL-2021 LIBRARY; T=0.K  
Photon emission for (n,he3)

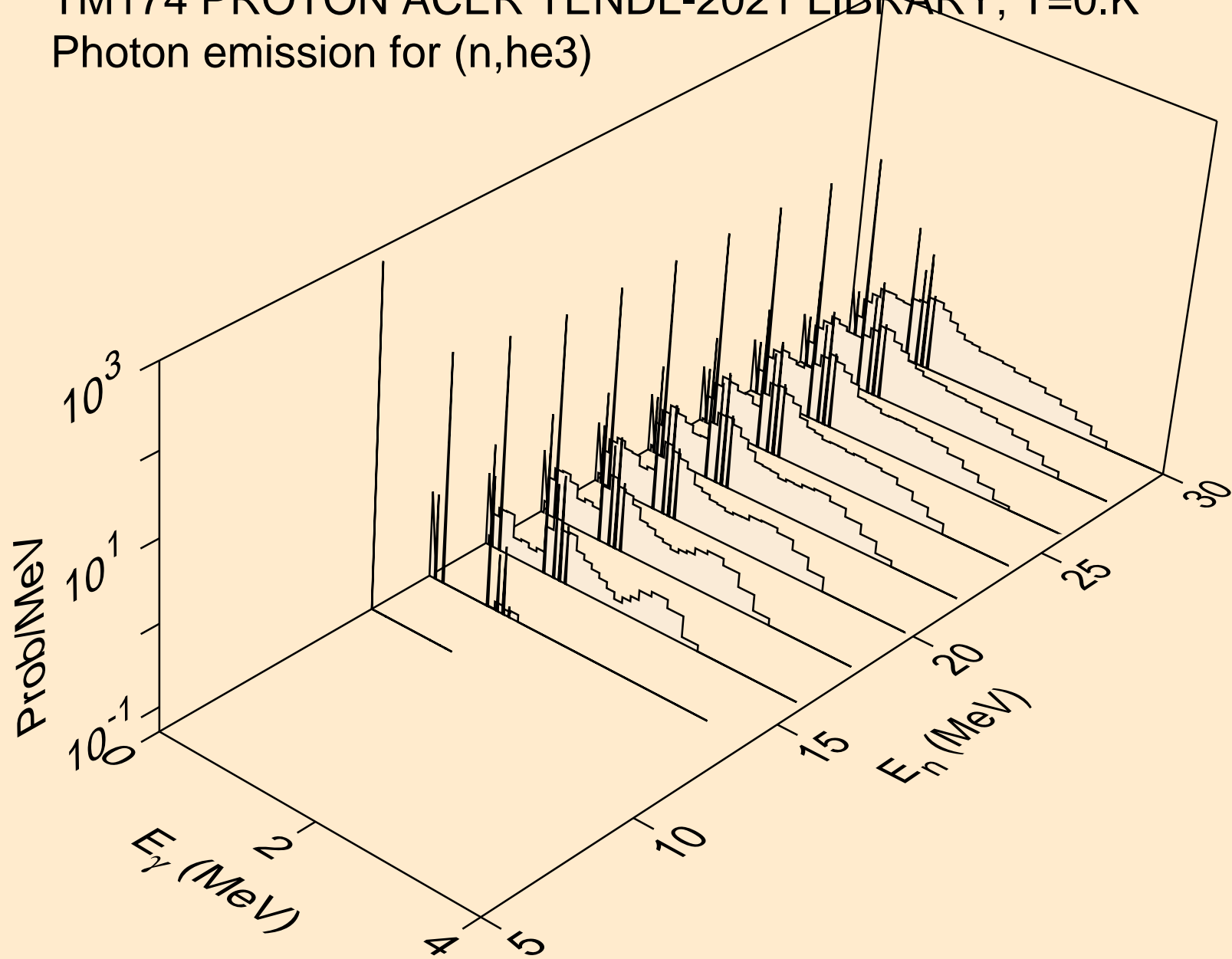

TM174 PROTON ACER TENDL-2021 LIBRARY; T=0.K  
Photon emission for (n,a)

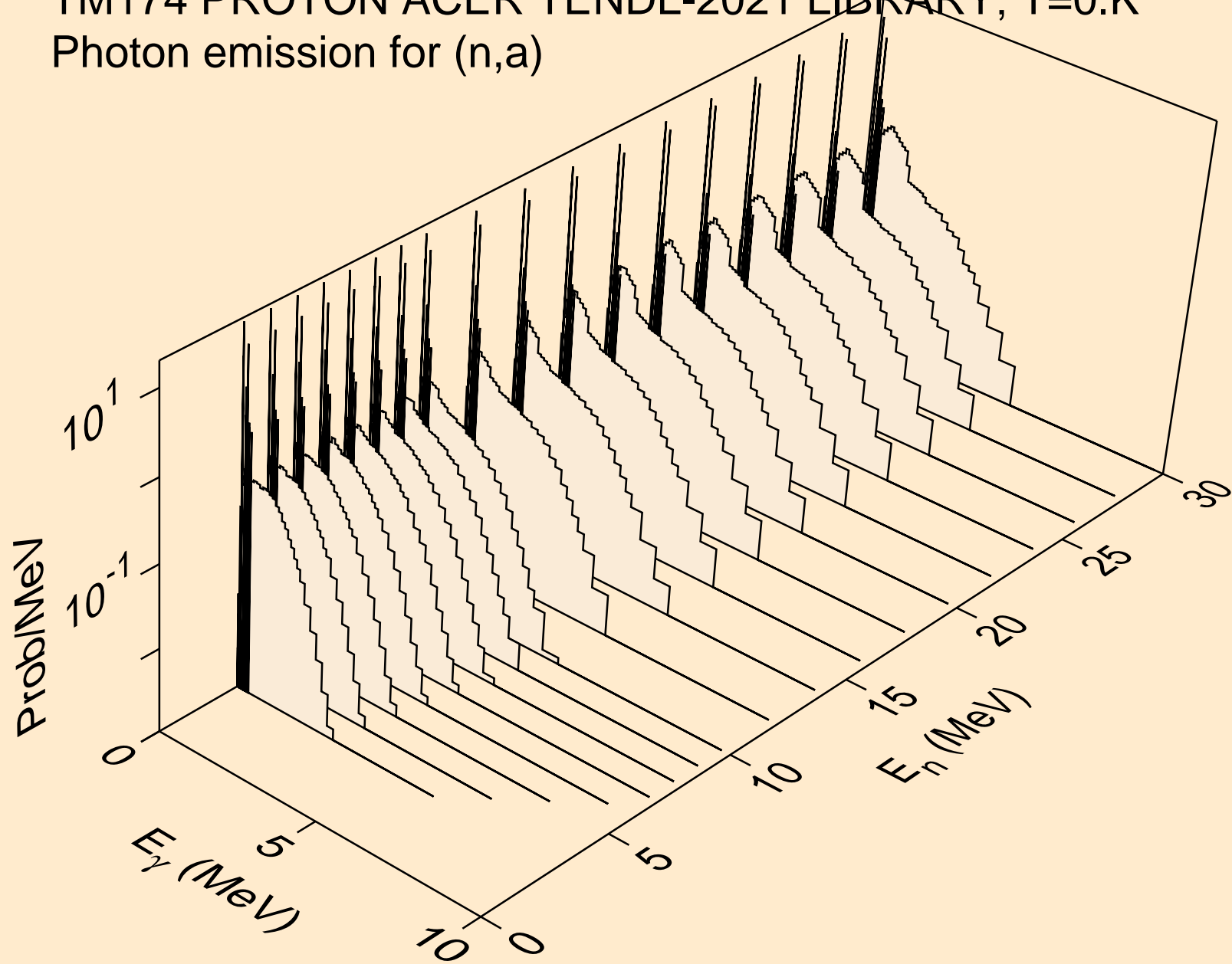

TM174 PROTON ACER TENDL-2021 LIBRARY; T=0.K  
Photon emission for (n,2a)

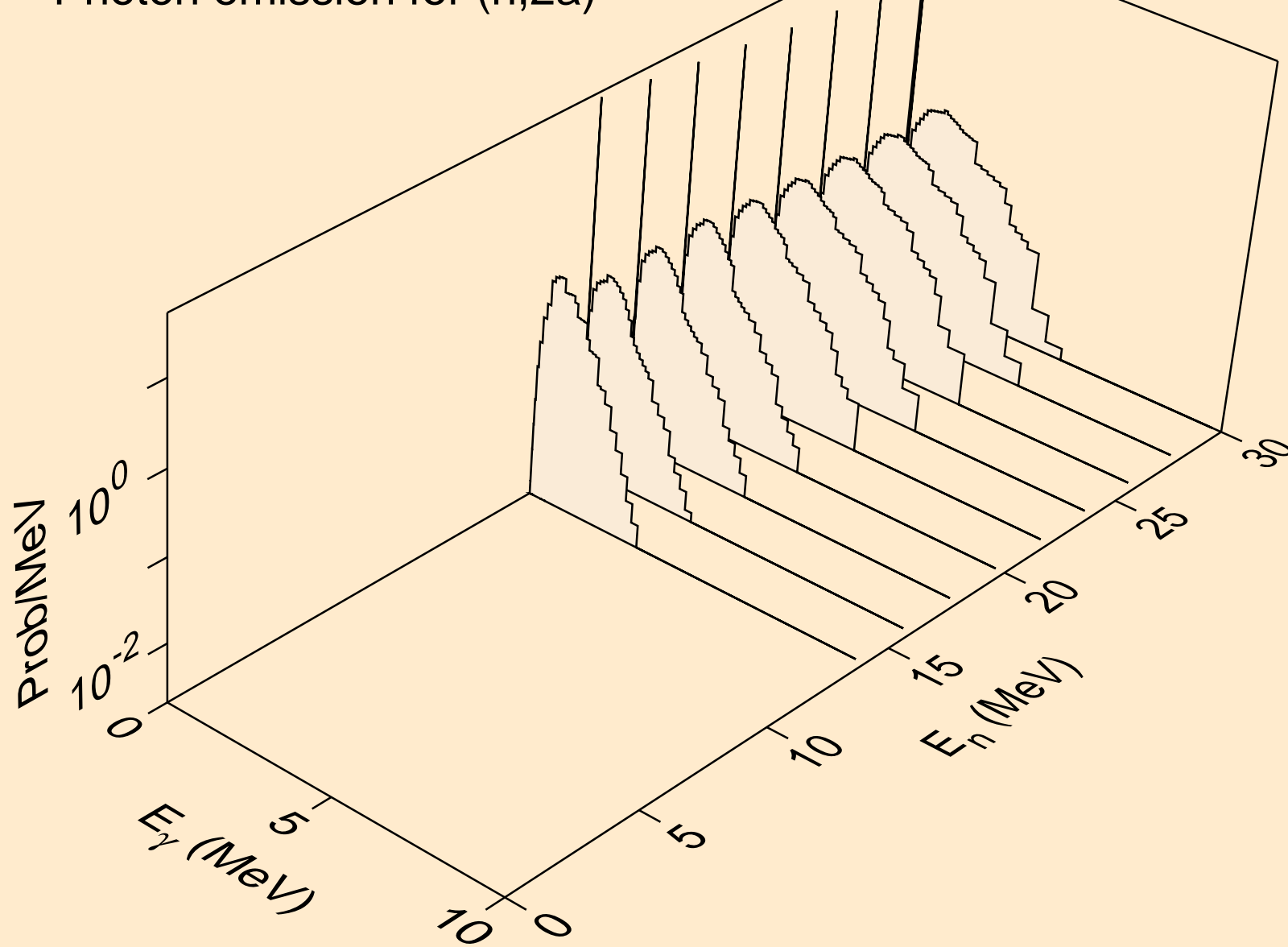

TM174 PROTON ACER TENDL-2021 LIBRARY; T=0.K  
Photon emission for (n,2p)

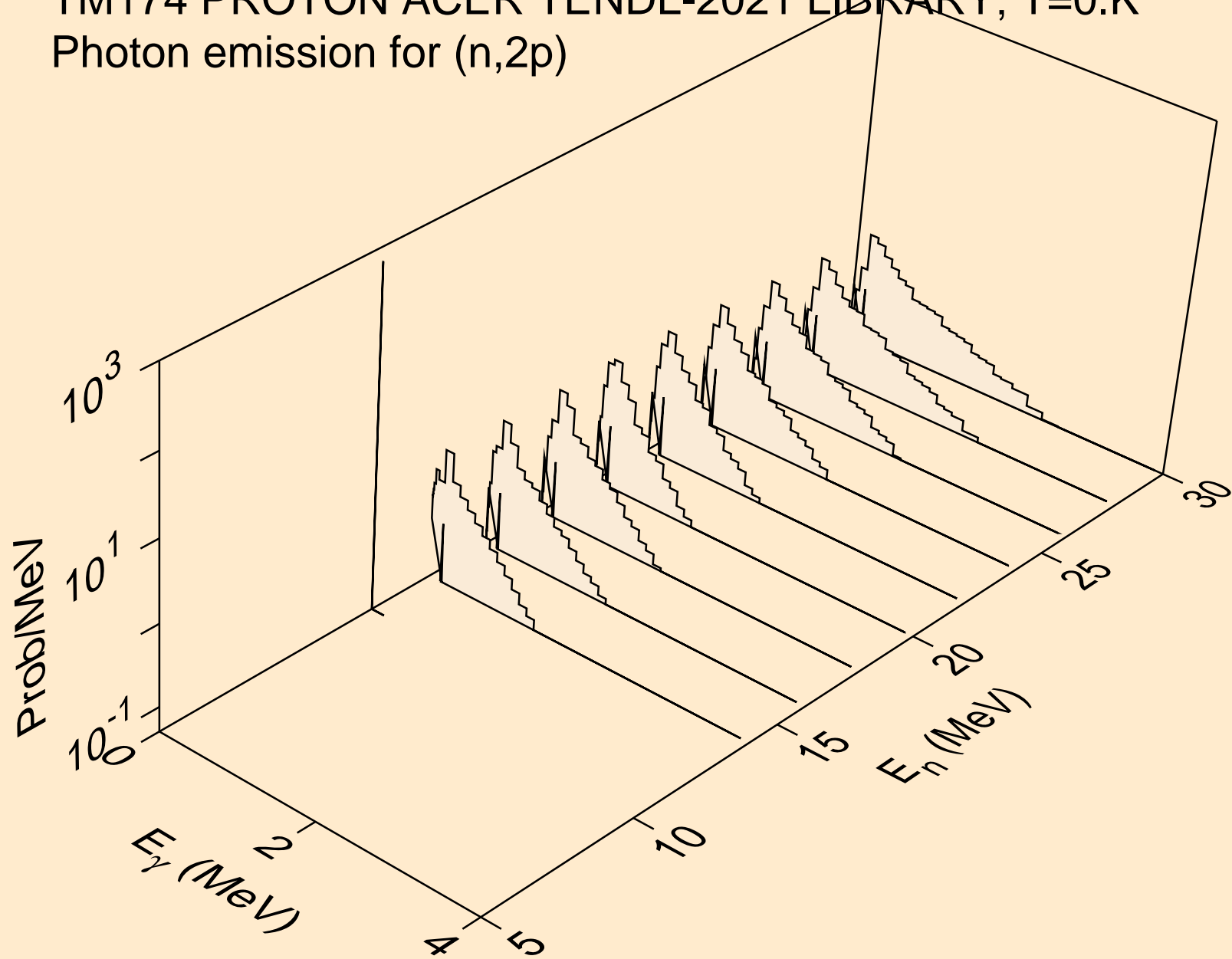

TM174 PROTON ACER TENDL-2021 LIBRARY; T=0.K  
Photon emission for (n,pa)

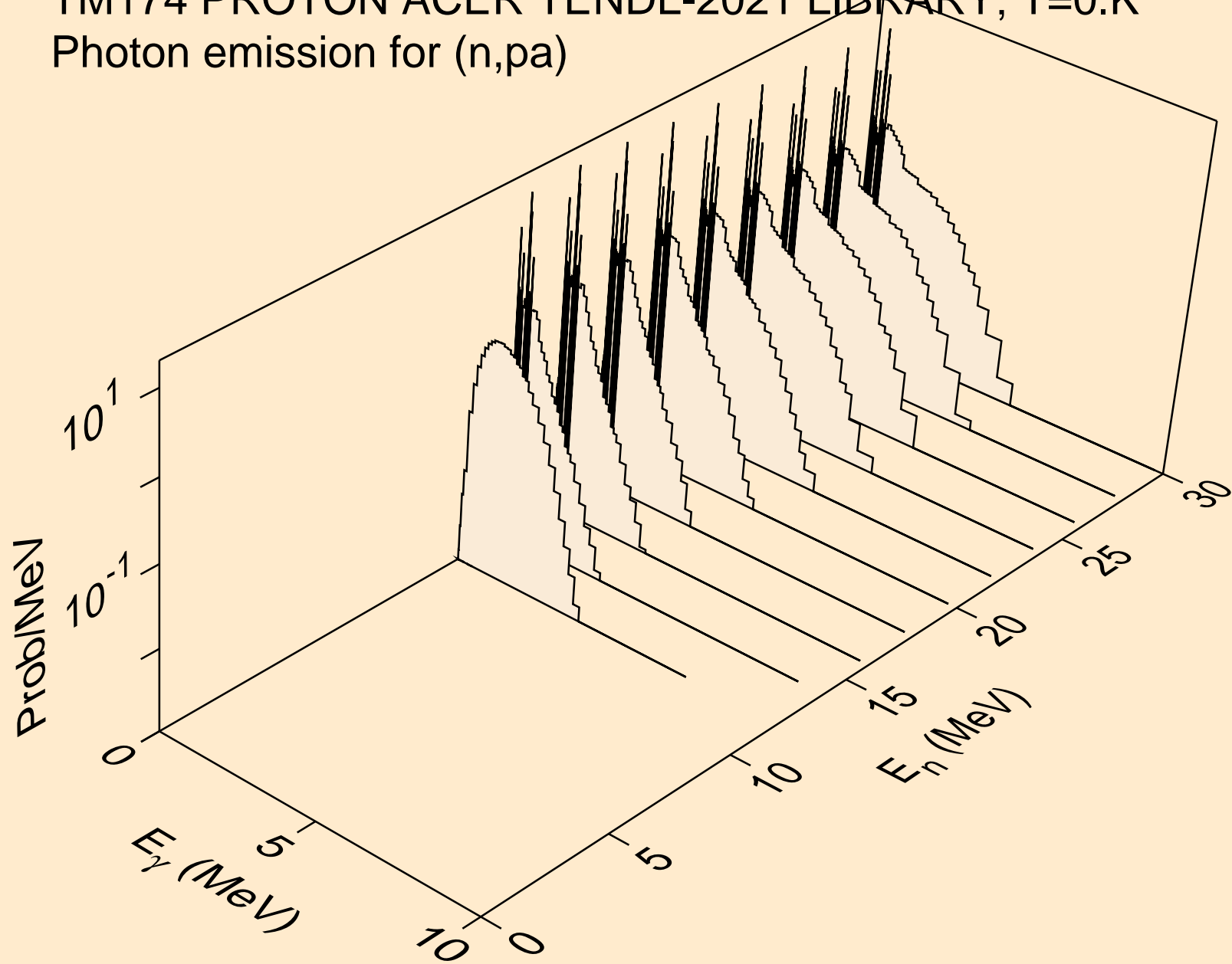

TM174 PROTON ACER TENDL-2021 LIBRARY; T=0.K  
Photon emission for (n,pd)

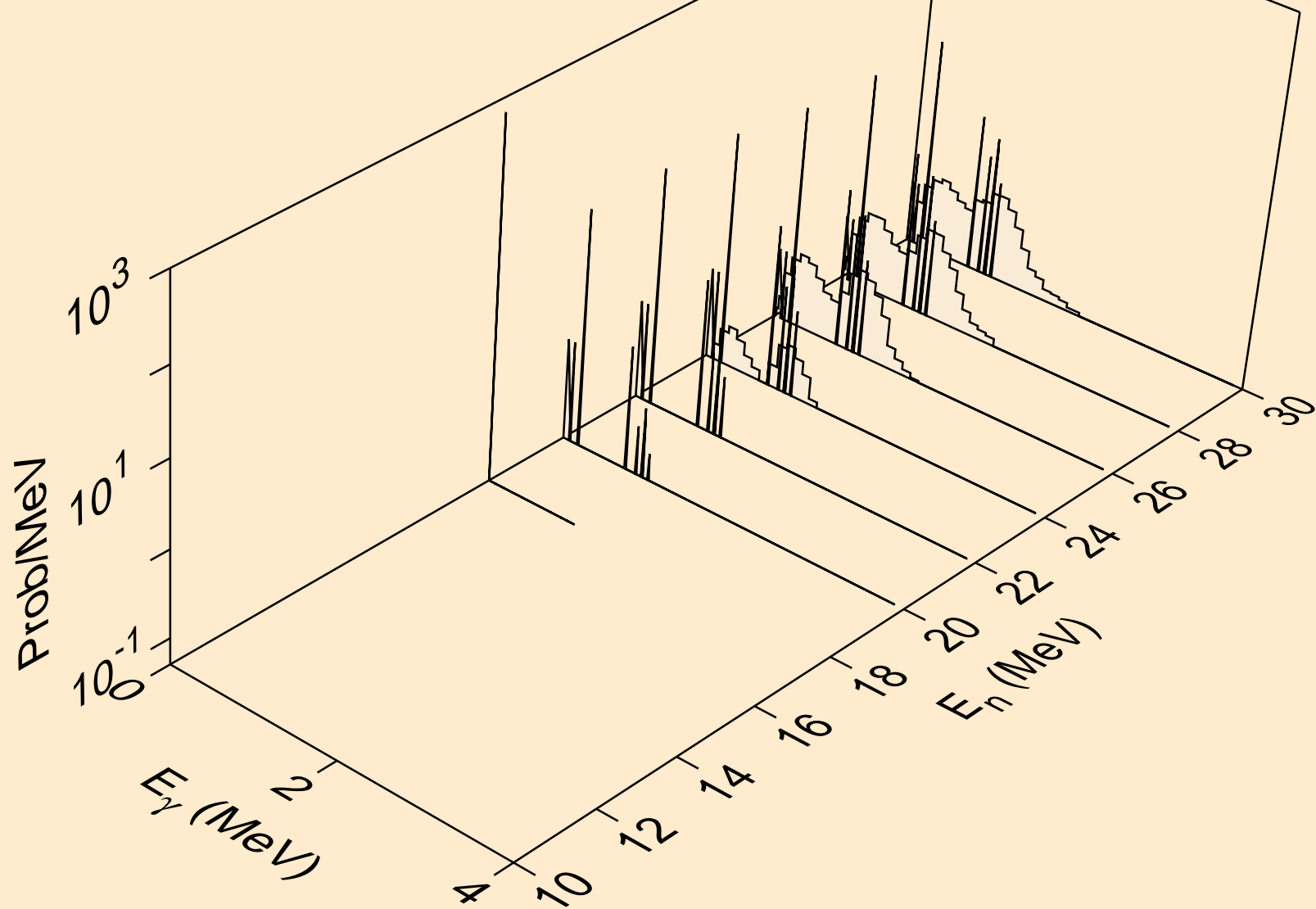



TM174 PROTON ACER TENDL-2021 LIBRARY; T=0.K  
Photon emission for (n,pt)

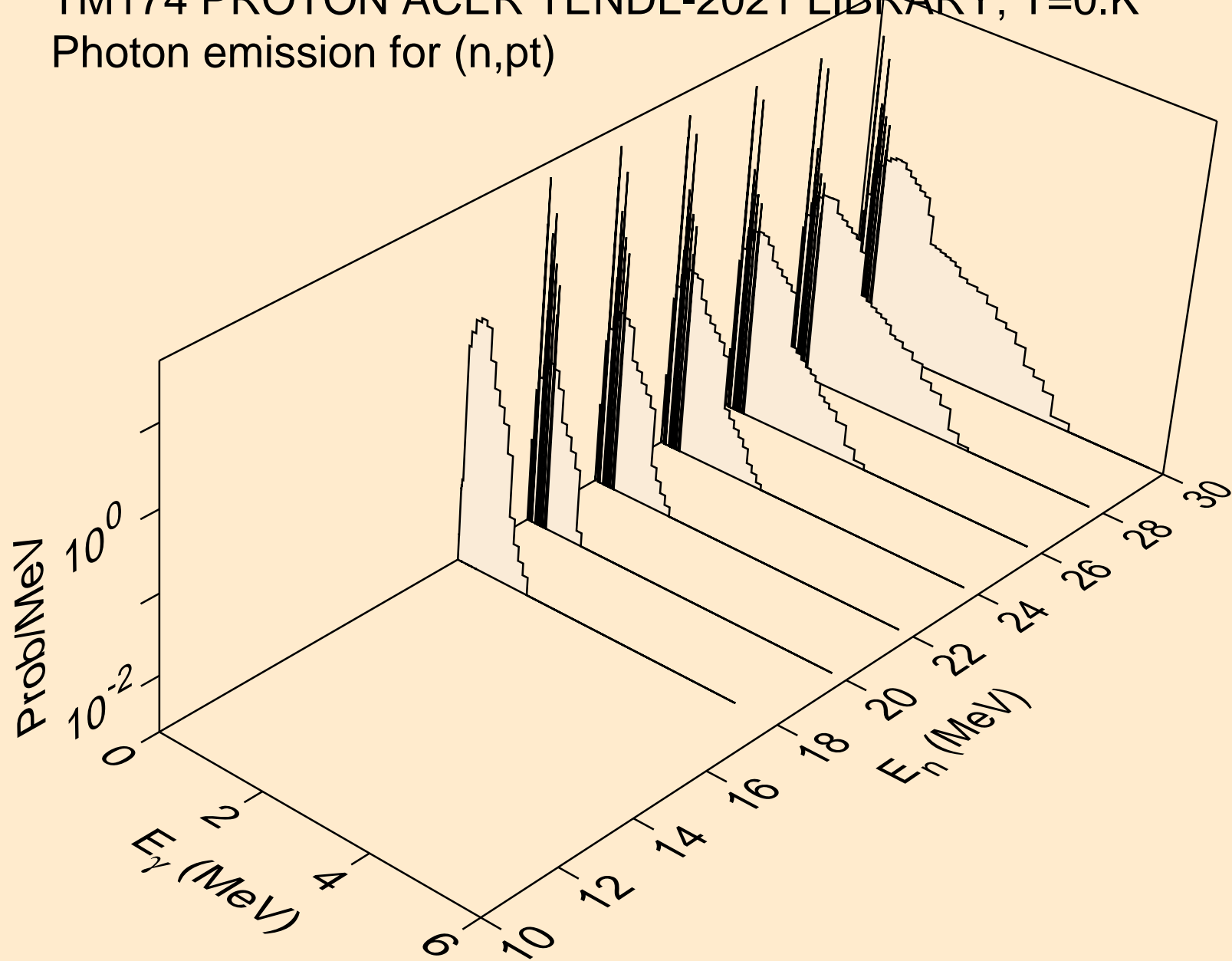

TM174 PROTON ACER TENDL-2021 LIBRARY; T=0.K  
Particle heating contributions

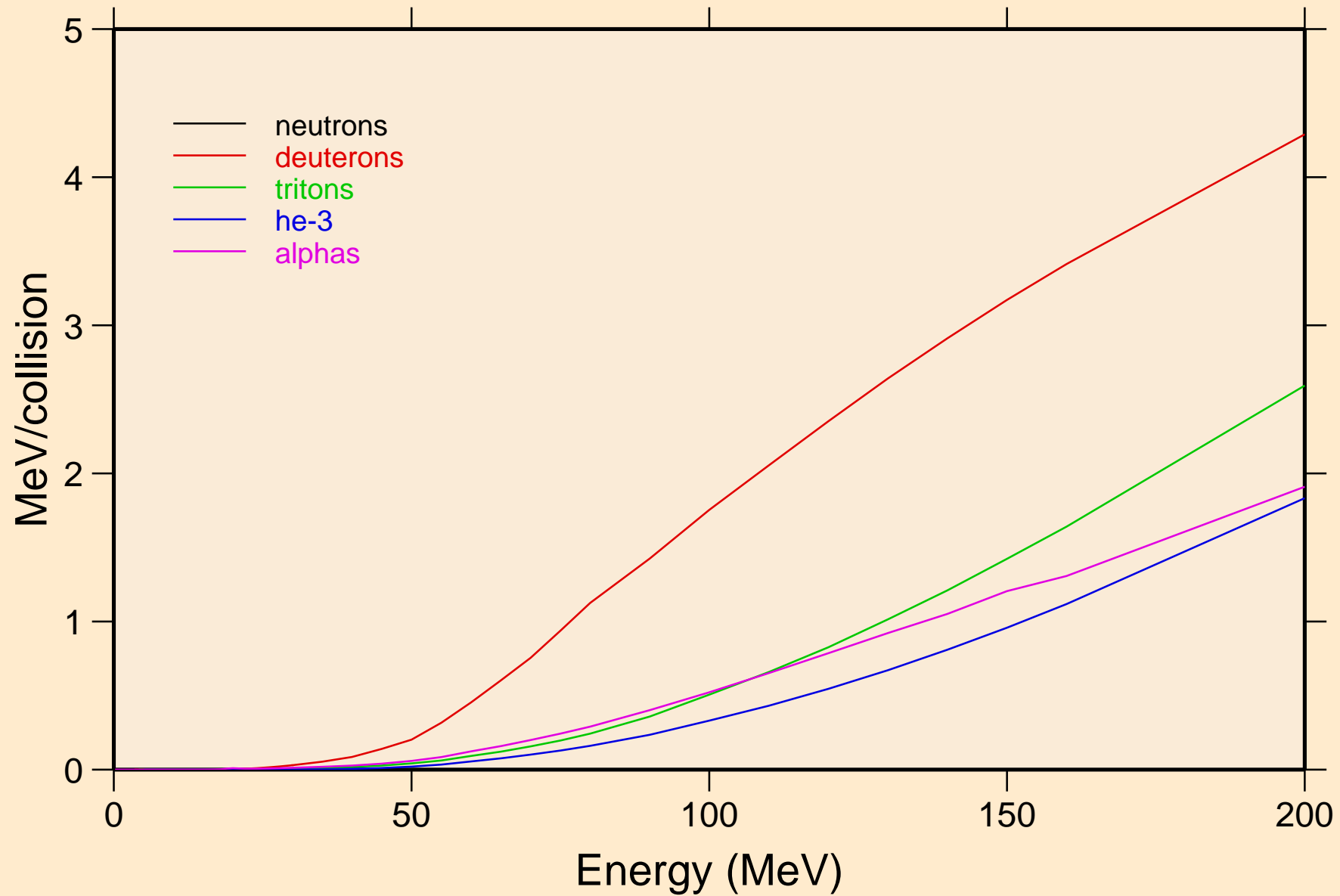

TM174 PROTON ACER TENDL-2021 LIBRARY; T=0.K  
Recoil Heating

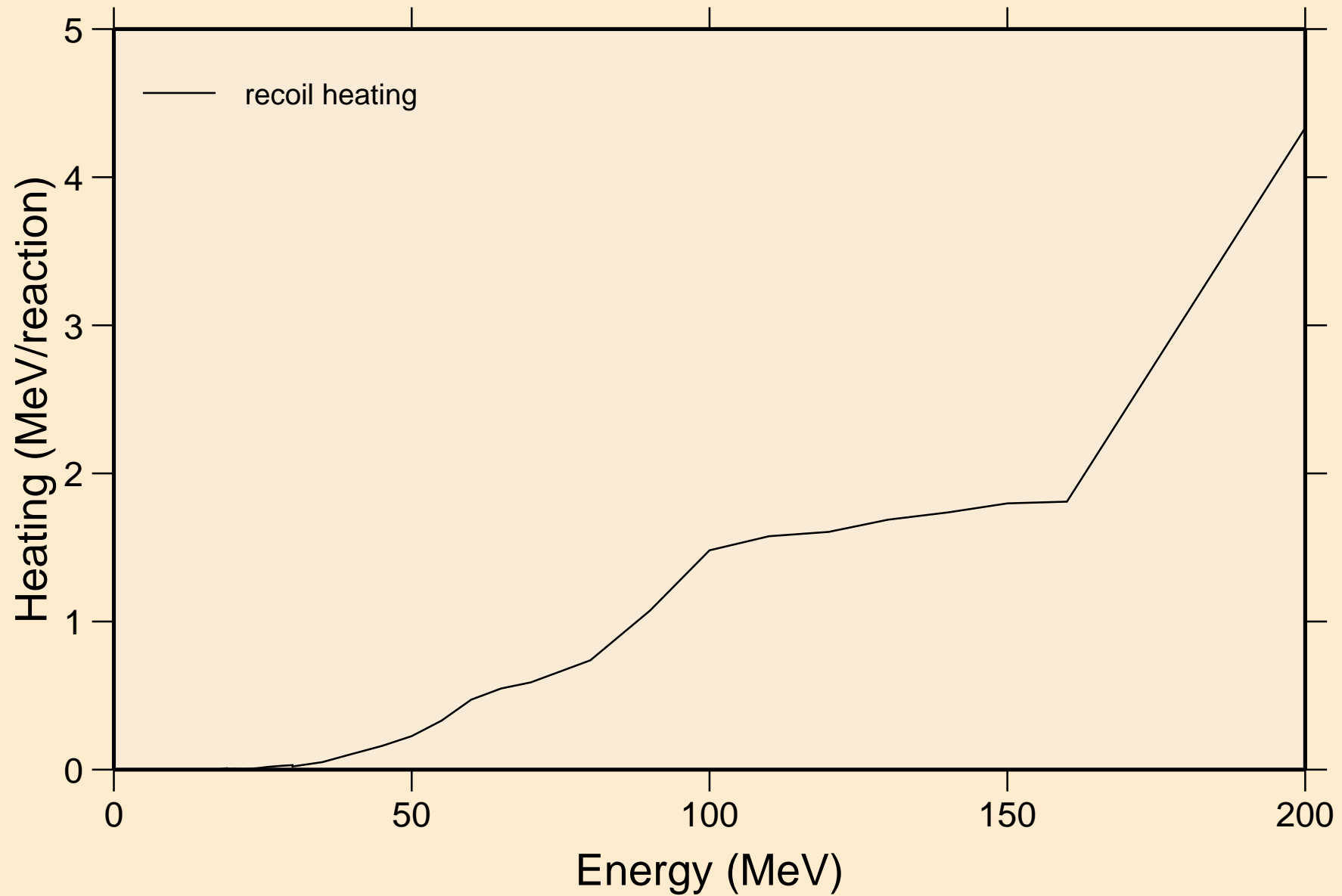

TM174 PROTON ACER TENDL-2021 LIBRARY; T=0.K  
Particle production cross sections

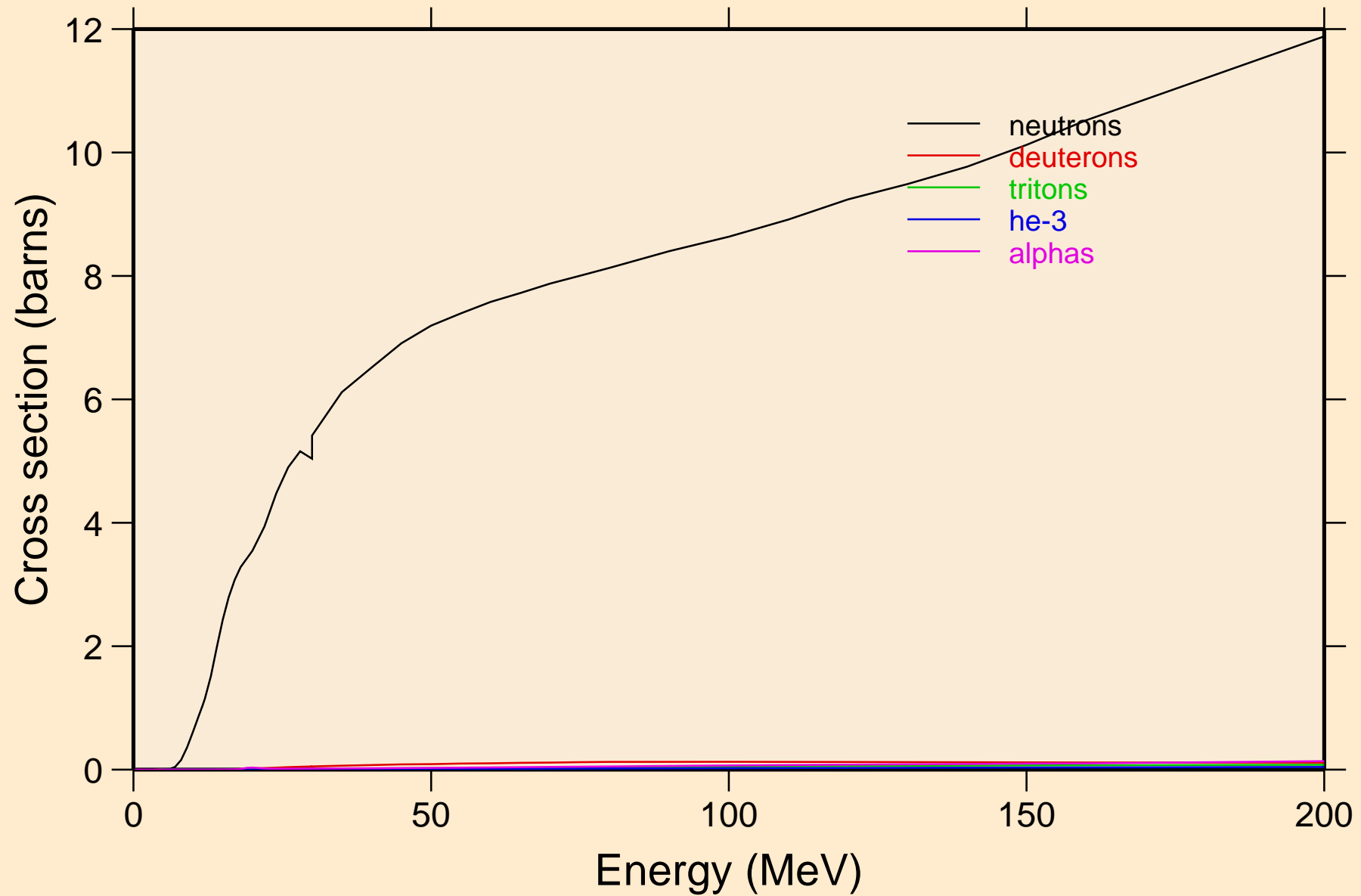

TM174 PROTON ACER TENDL-2021 LIBRARY; T=0.K  
neutrons from (p,n)

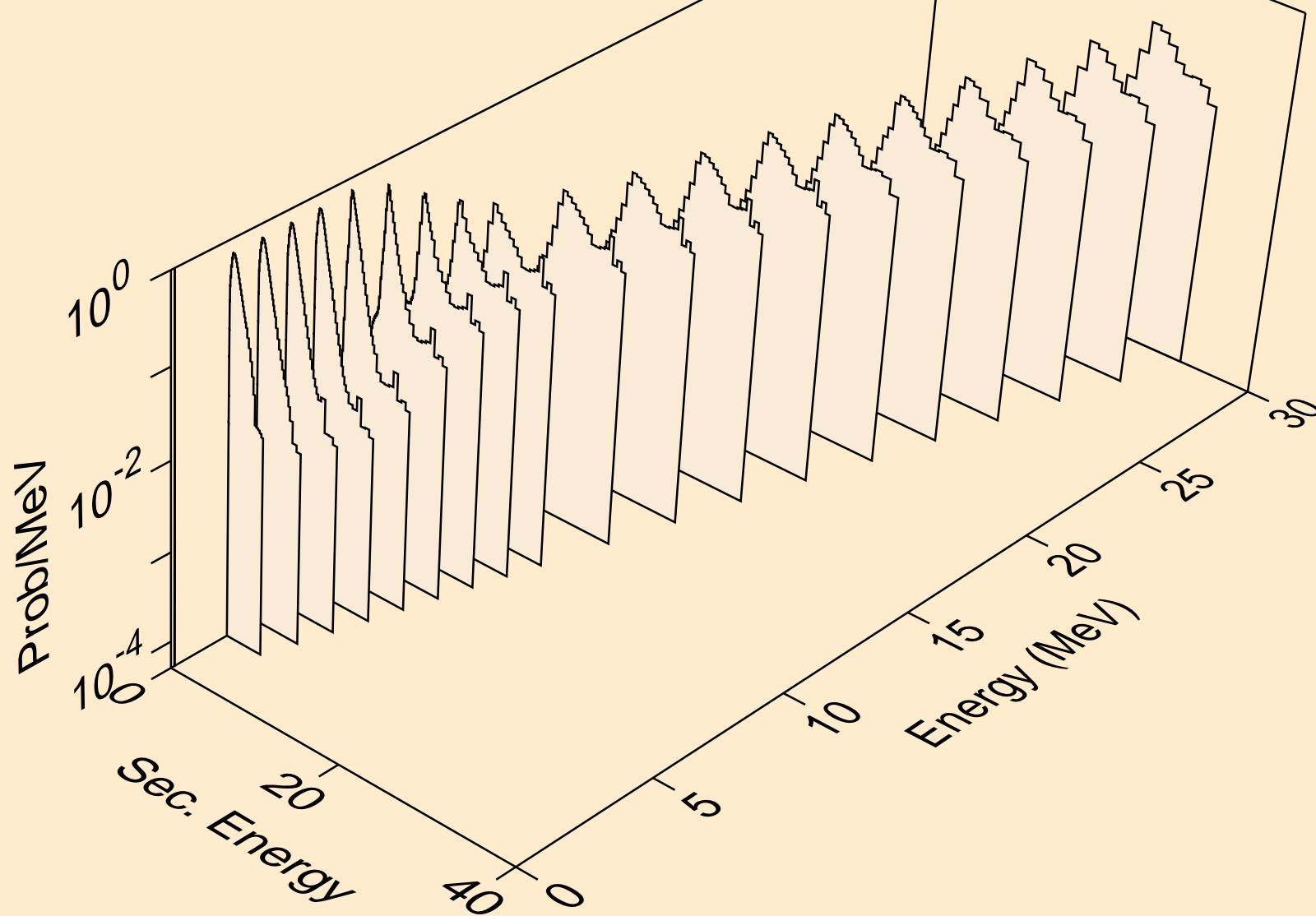

TM174 PROTON ACER TENDL-2021 LIBRARY; T=0.K  
neutrons from (p,x)

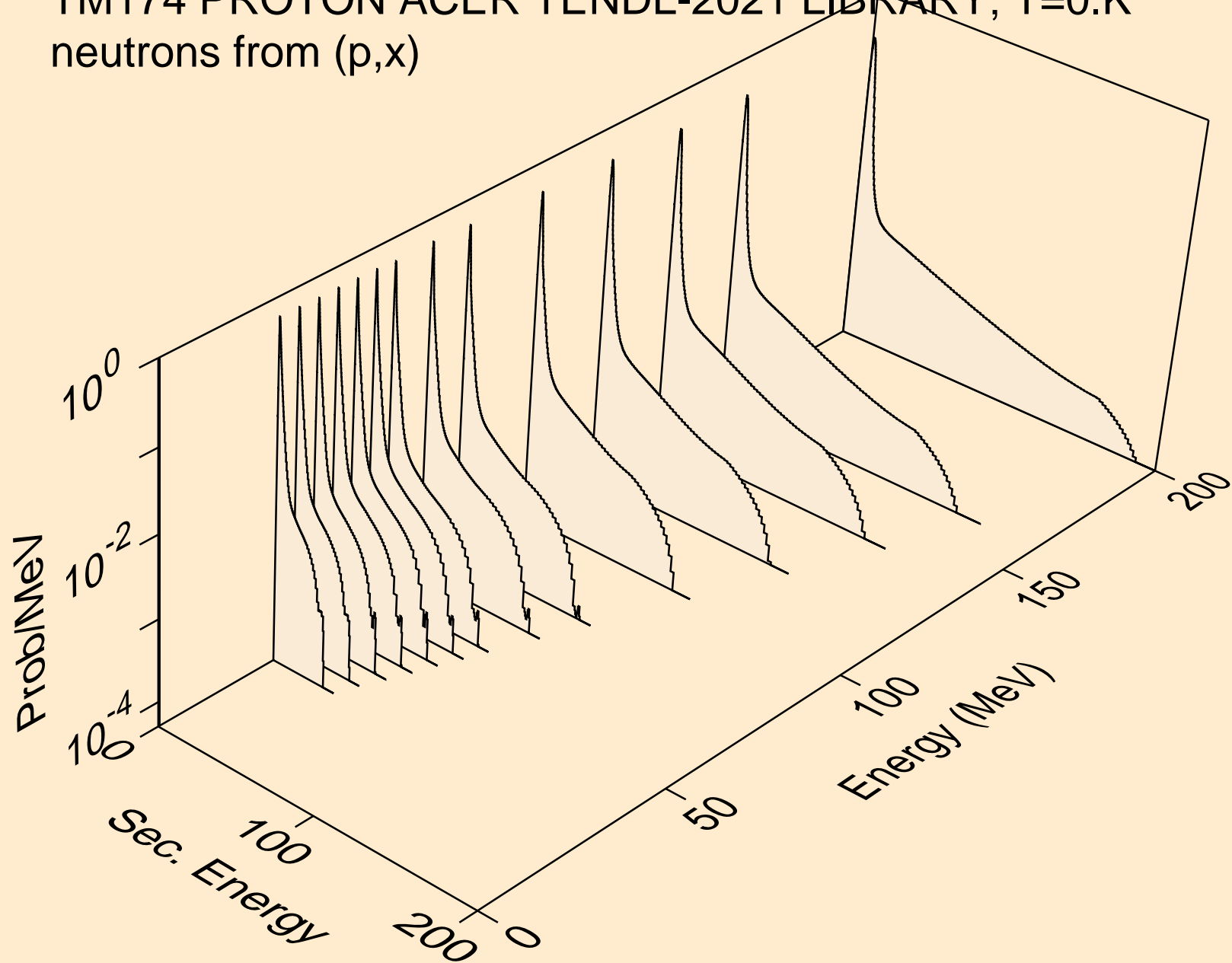

TM174 PROTON ACER TENDL-2021 LIBRARY; T=0.K  
neutrons from (p,2nd)

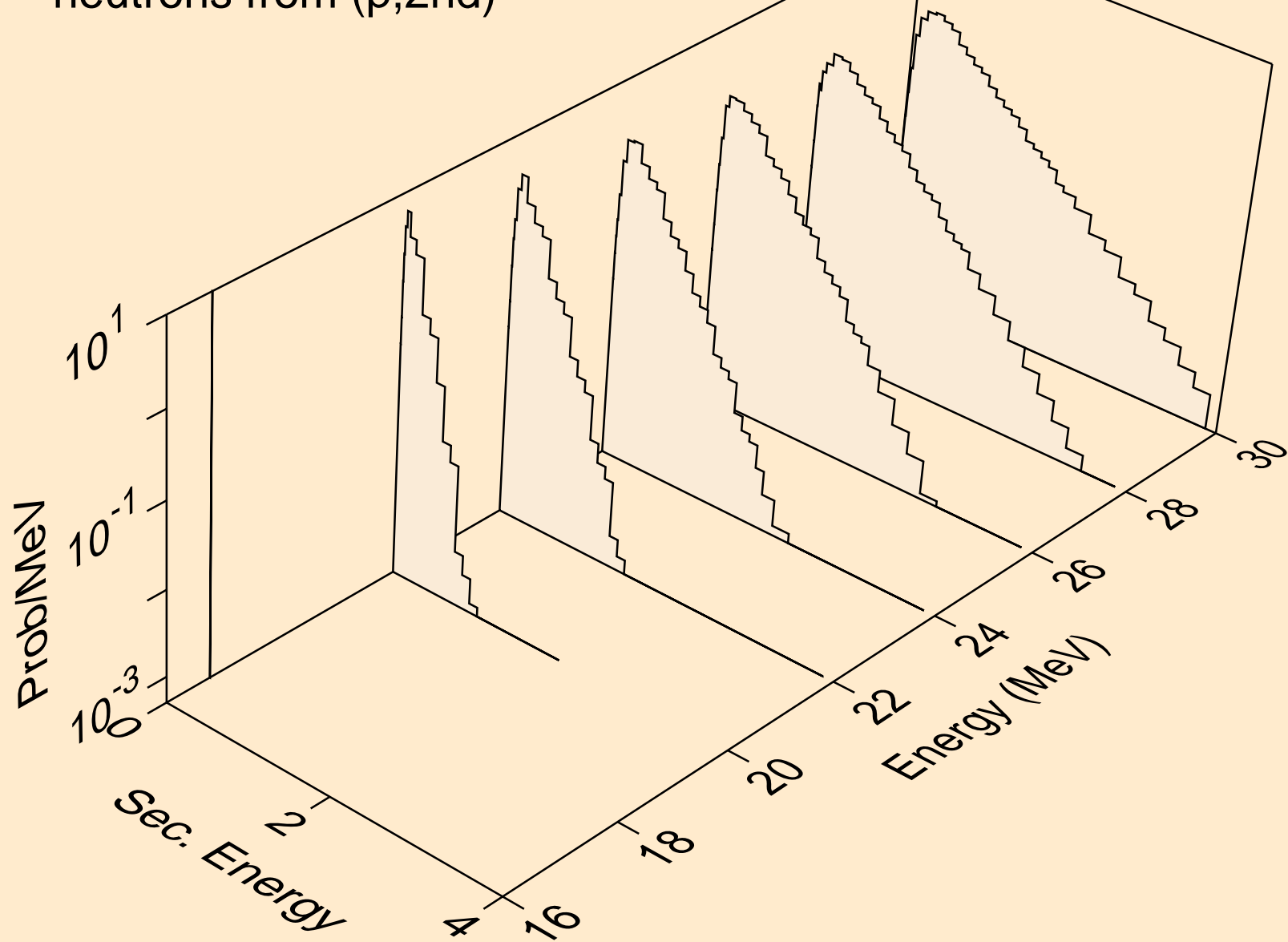

TM174 PROTON ACER TENDL-2021 LIBRARY; T=0.K  
neutrons from (p,2n)

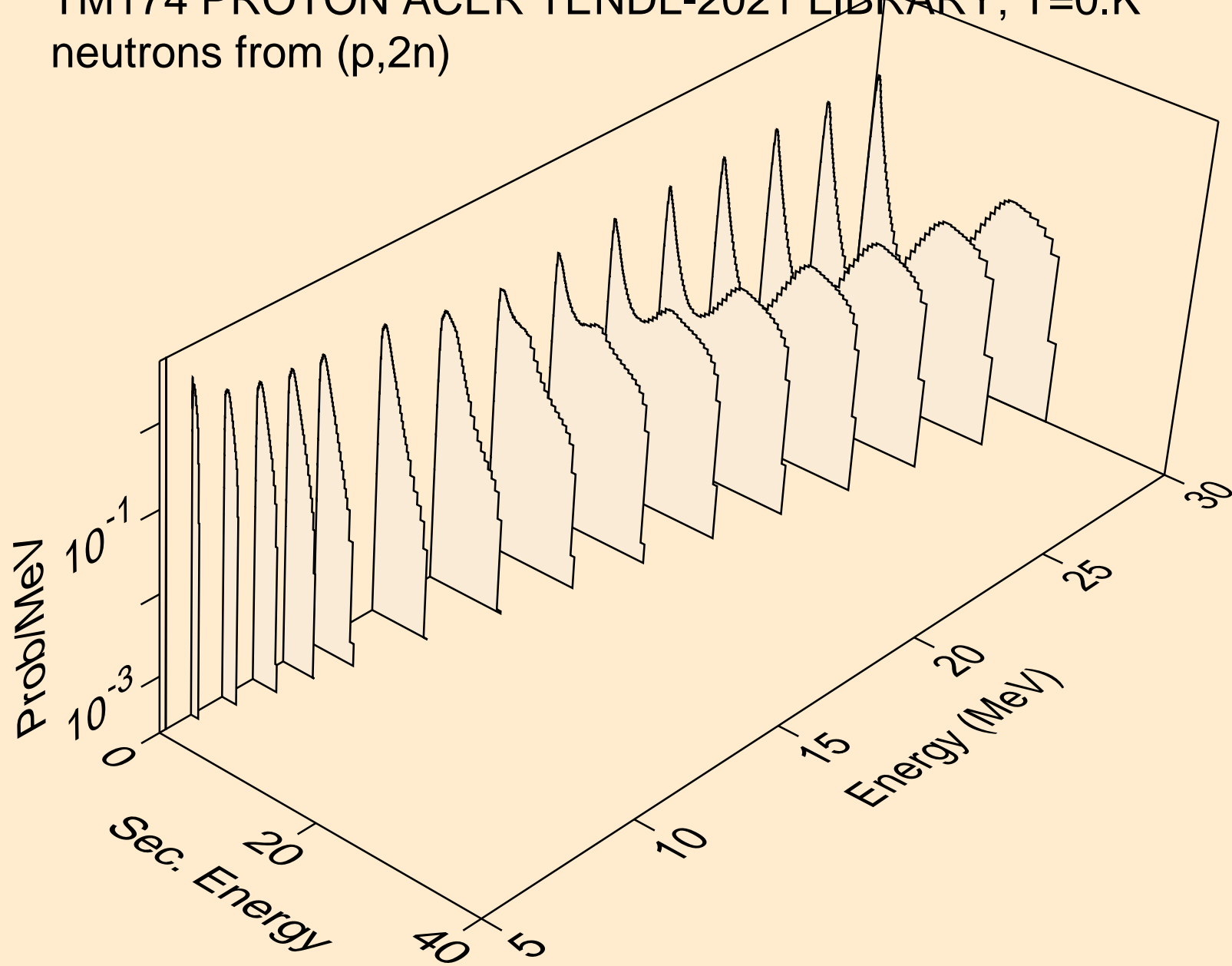



TM174 PROTON ACER TENDL-2021 LIBRARY; T=0.K  
neutrons from (p,3n)

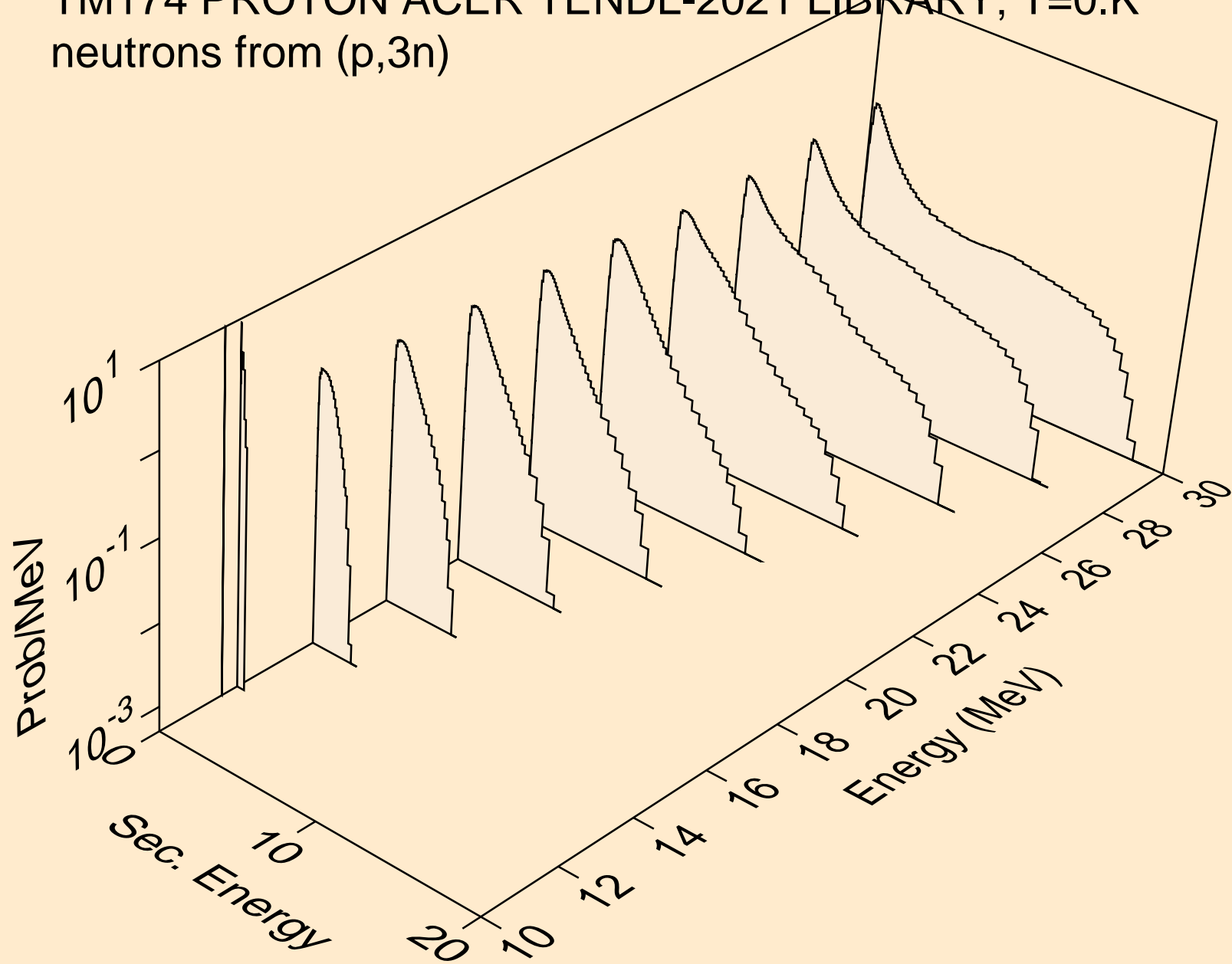

TM174 PROTON ACER TENDL-2021 LIBRARY; T=0.K  
neutrons from (p,n\*)a

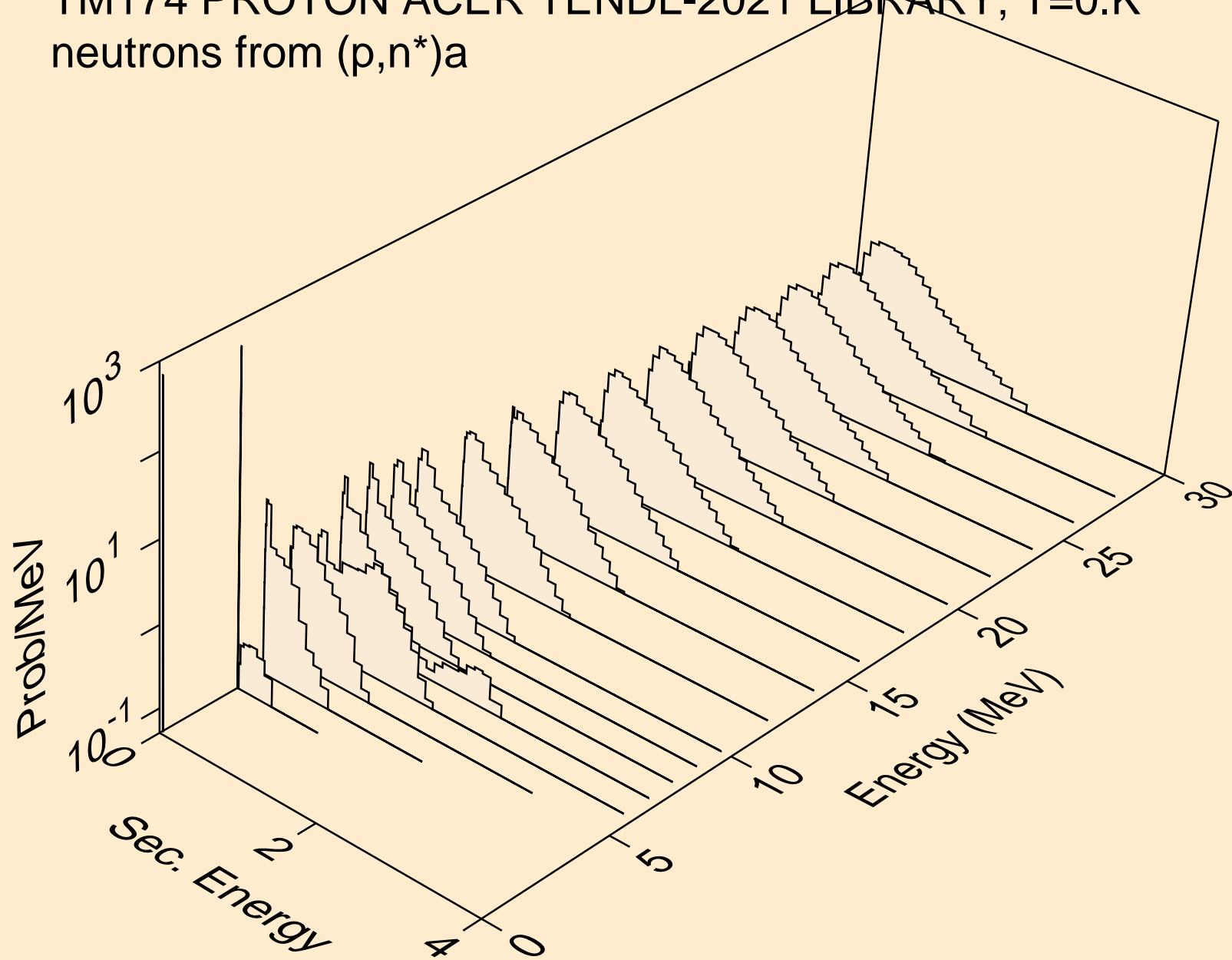

TM174 PROTON ACER TENDL-2021 LIBRARY; T=0.K  
neutrons from (p,2n)a

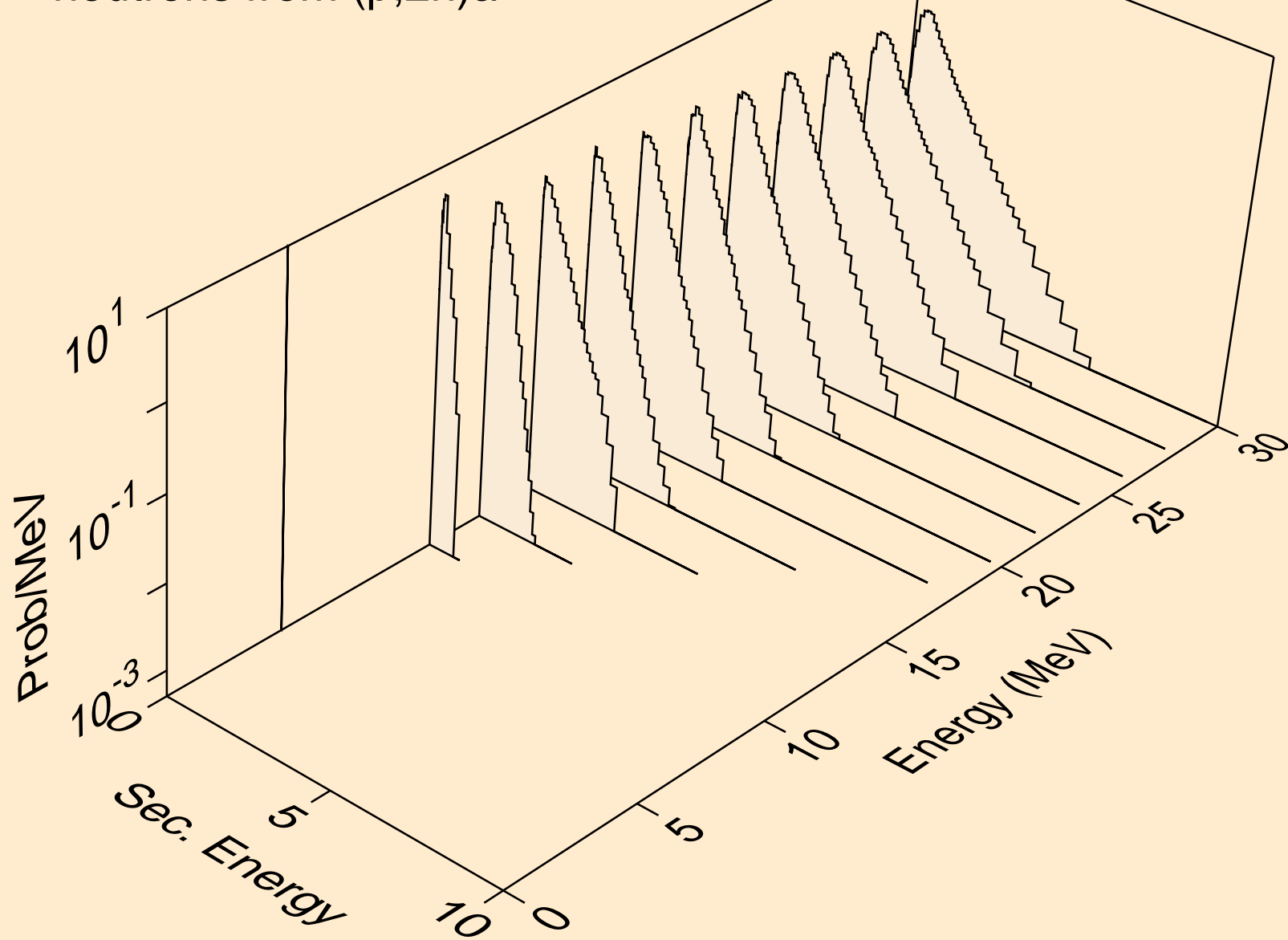

TM174 PROTON ACER TENDL-2021 LIBRARY; T=0.K  
neutrons from (p,3n)a

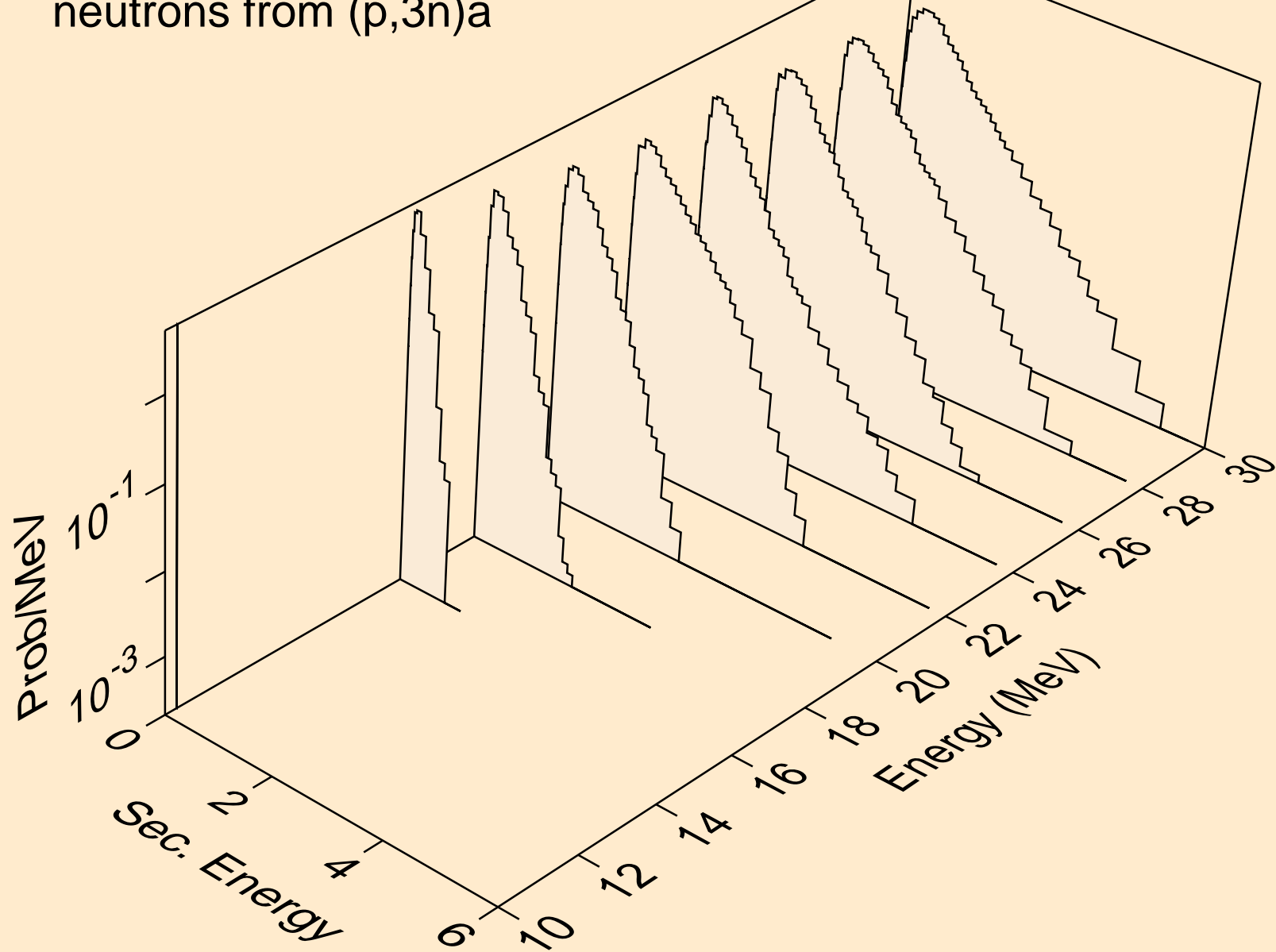

TM174 PROTON ACER TENDL-2021 LIBRARY; T=0.K  
neutrons from (p,n\*)p

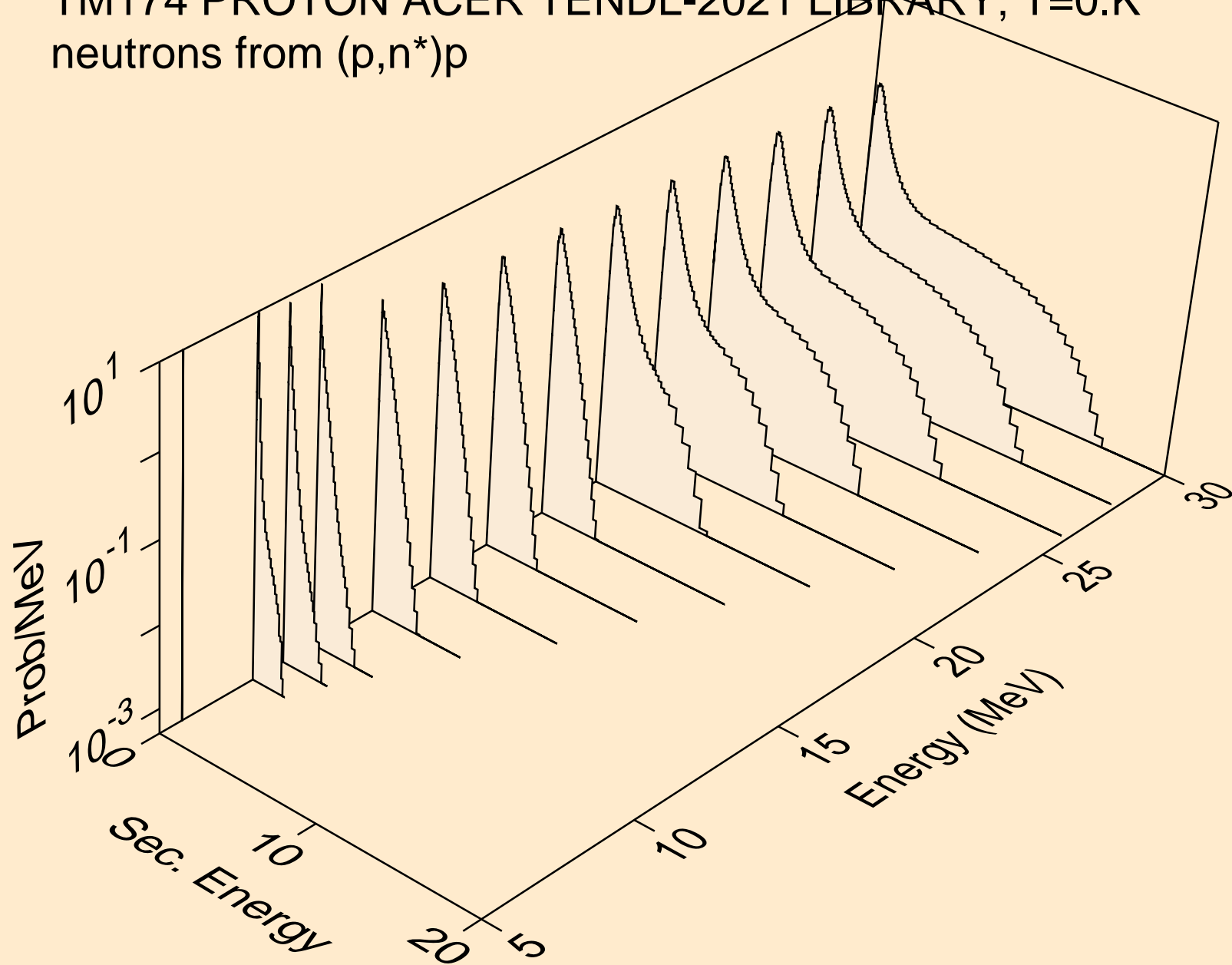

TM174 PROTON ACER TENDL-2021 LIBRARY; T=0.K  
neutrons from (p,n\*)2a

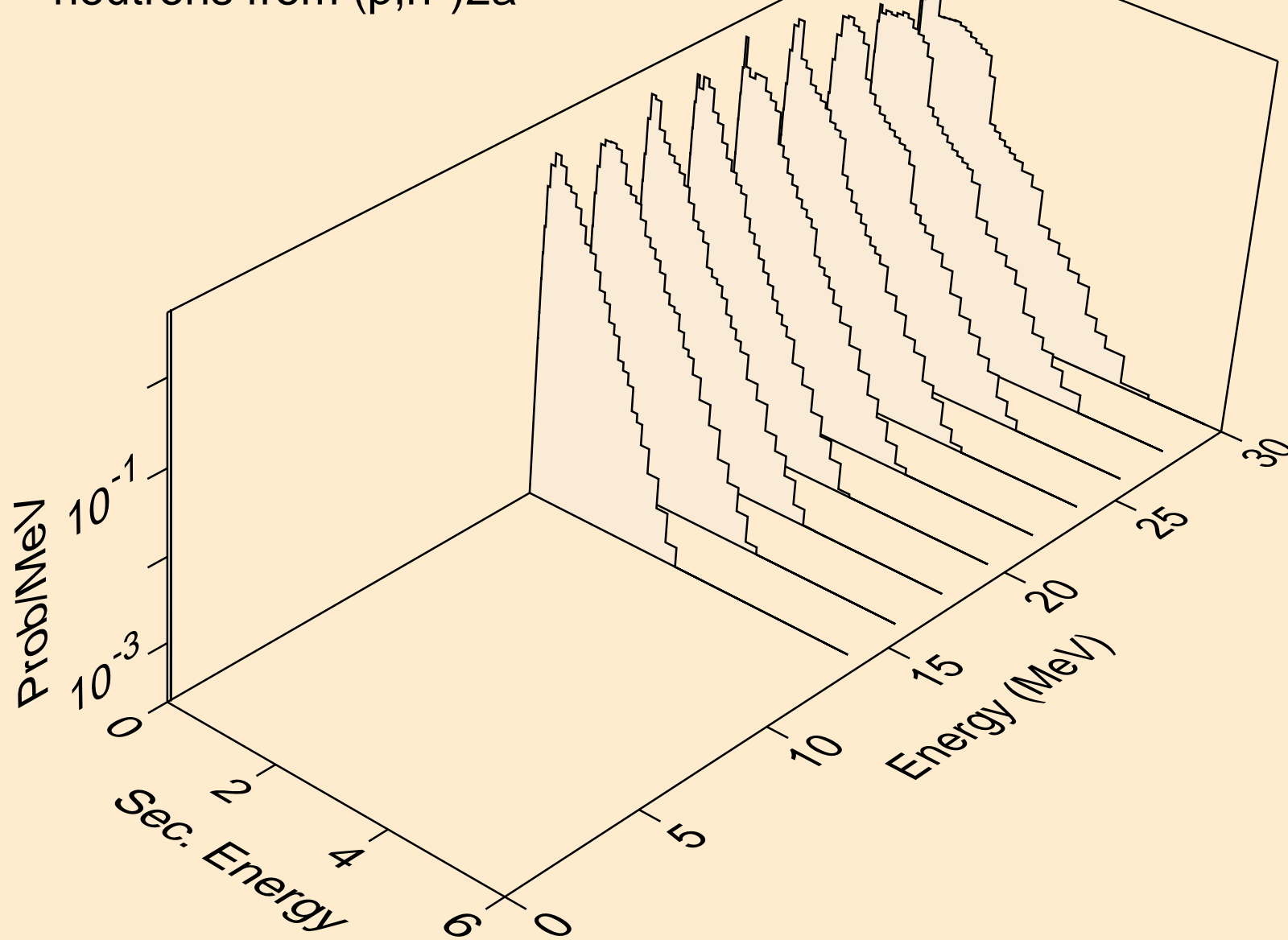

TM174 PROTON ACER TENDL-2021 LIBRARY; T=0.K  
neutrons from (p,n\*)d

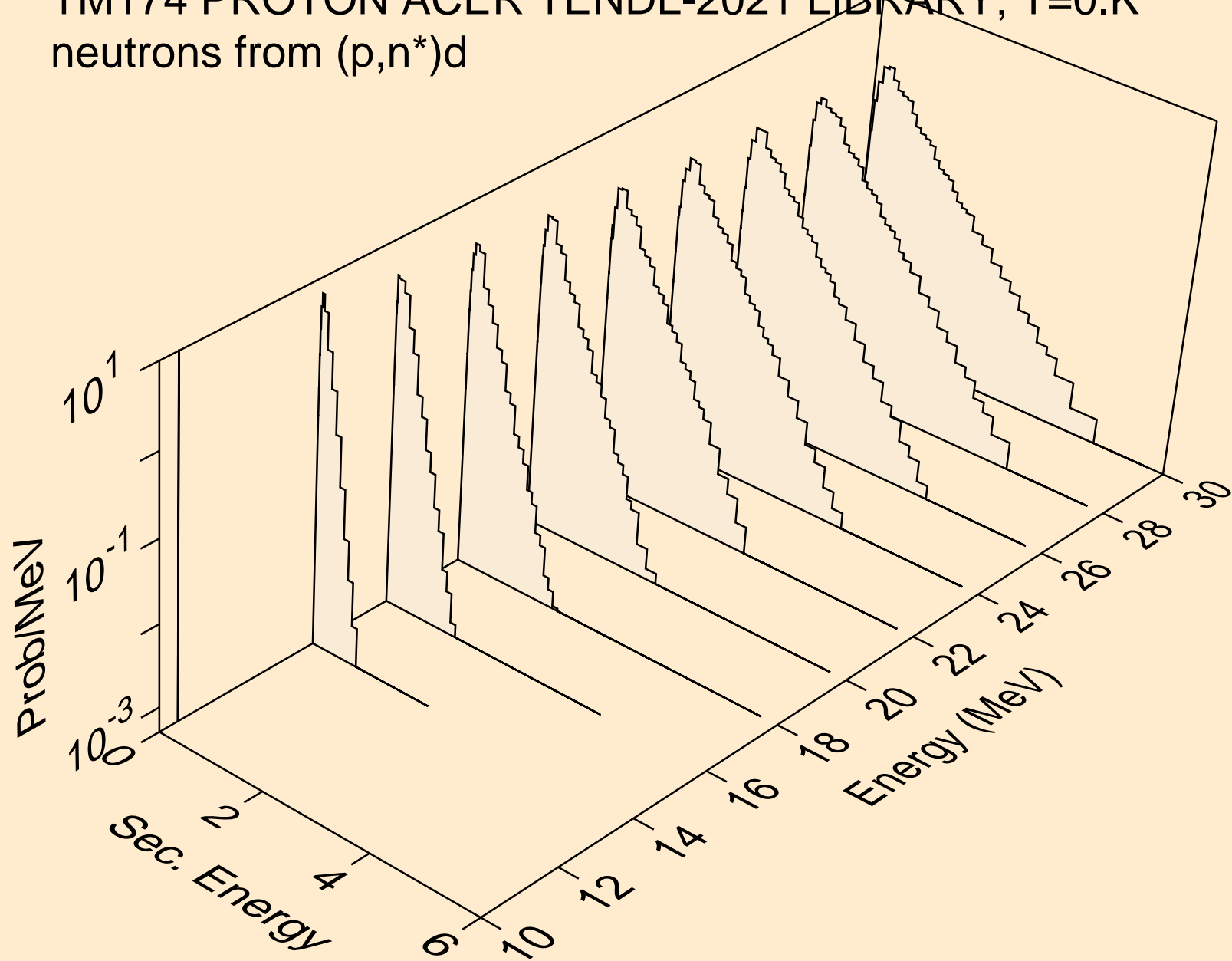

TM174 PROTON ACER TENDL-2021 LIBRARY; T=0.K  
neutrons from (p,n\*)t

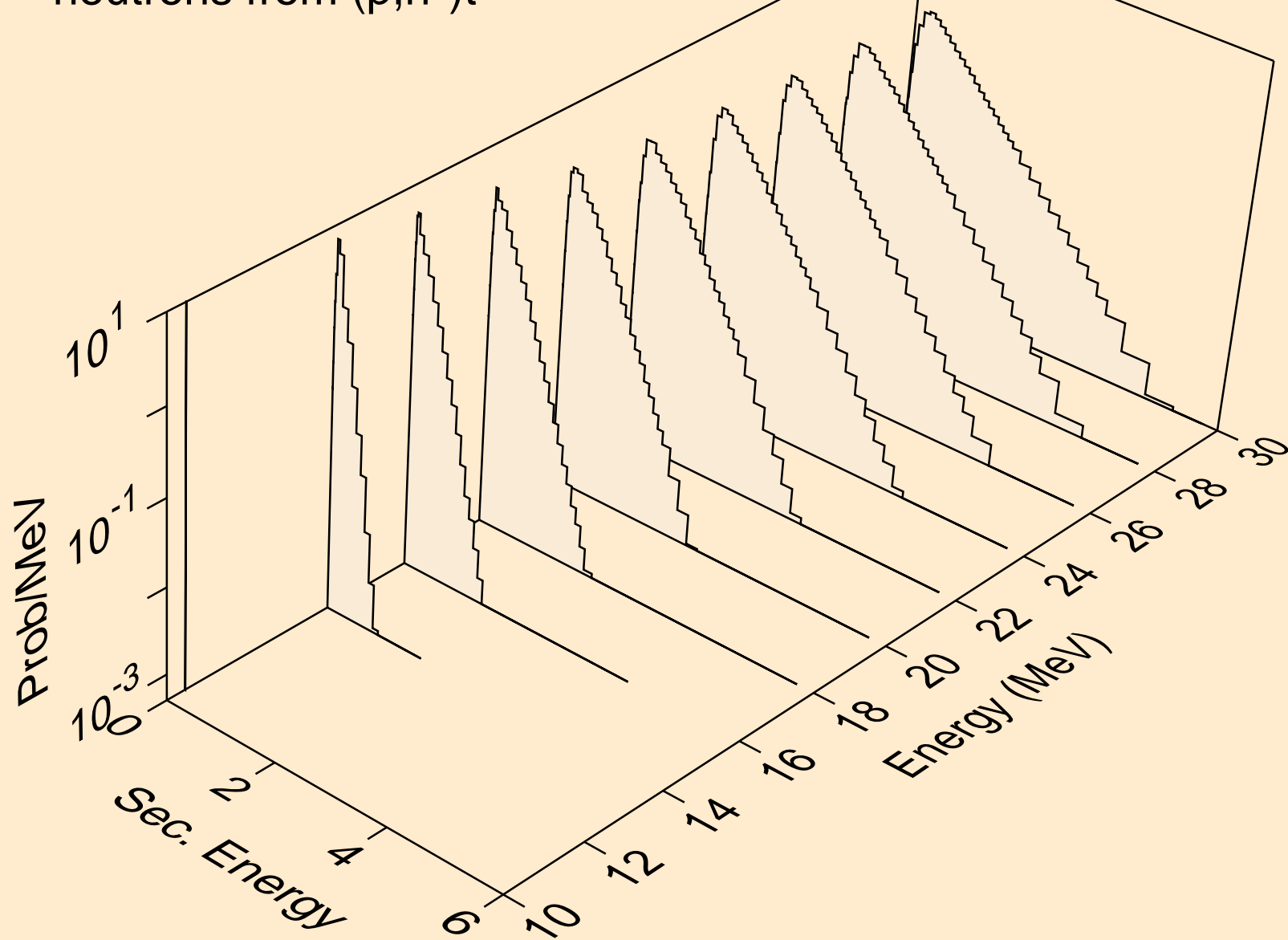



TM174 PROTON ACER TENDL-2021 LIBRARY; T=0.K  
neutrons from (p,n\*)he3

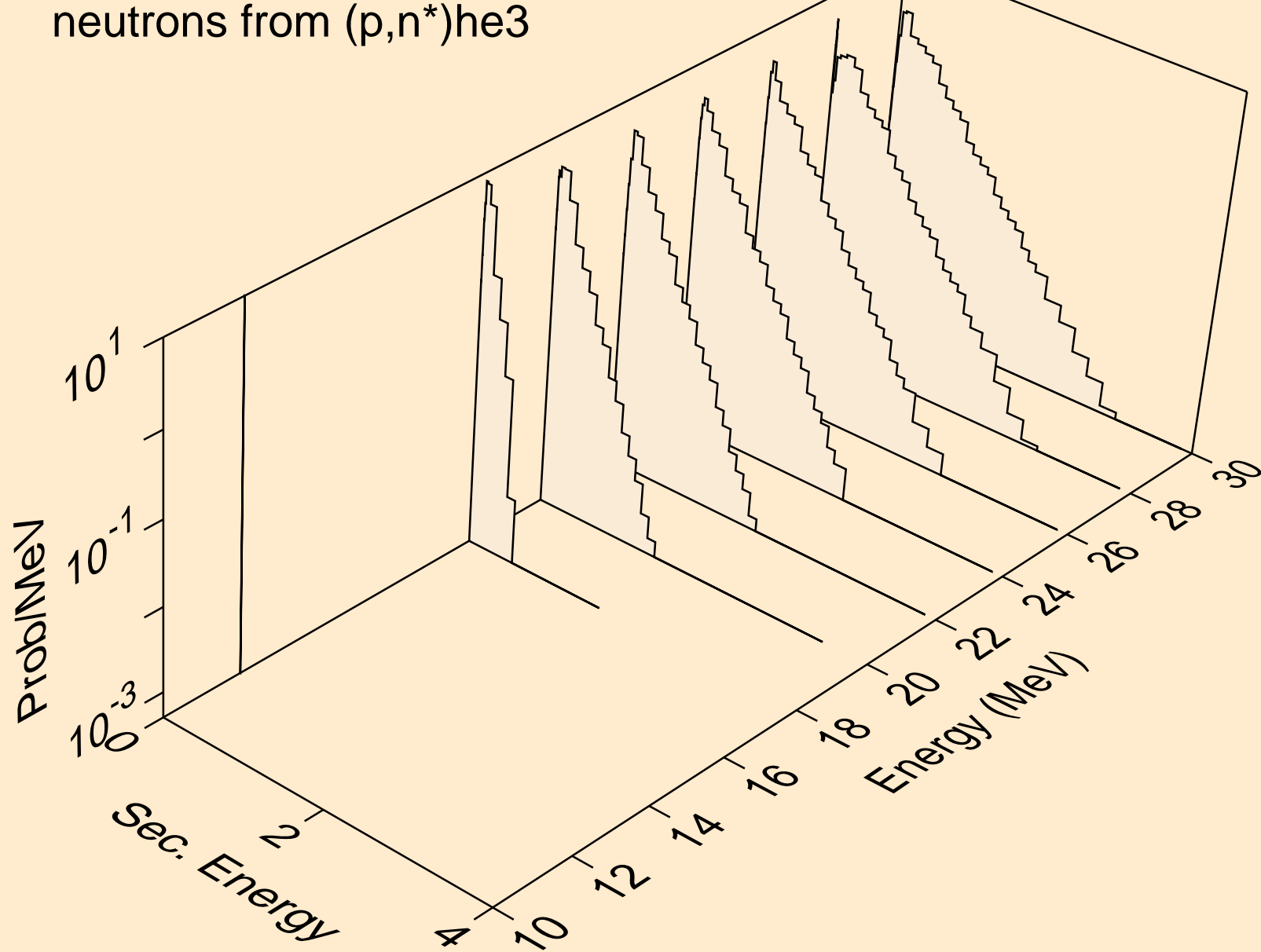

TM174 PROTON ACER TENDL-2021 LIBRARY; T=0.K  
neutrons from (p,4n)

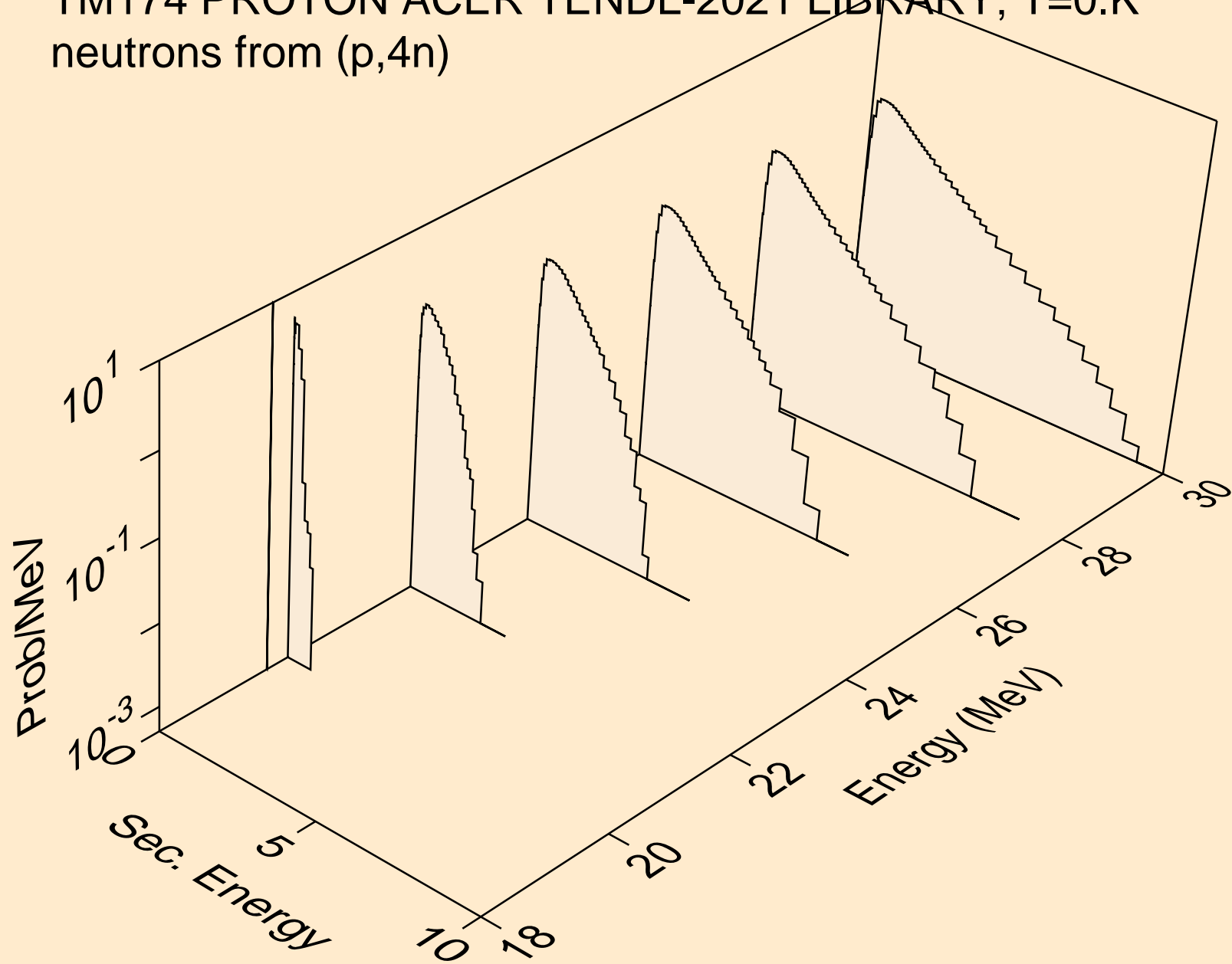

TM174 PROTON ACER TENDL-2021 LIBRARY; T=0.K  
neutrons from (p,2np)

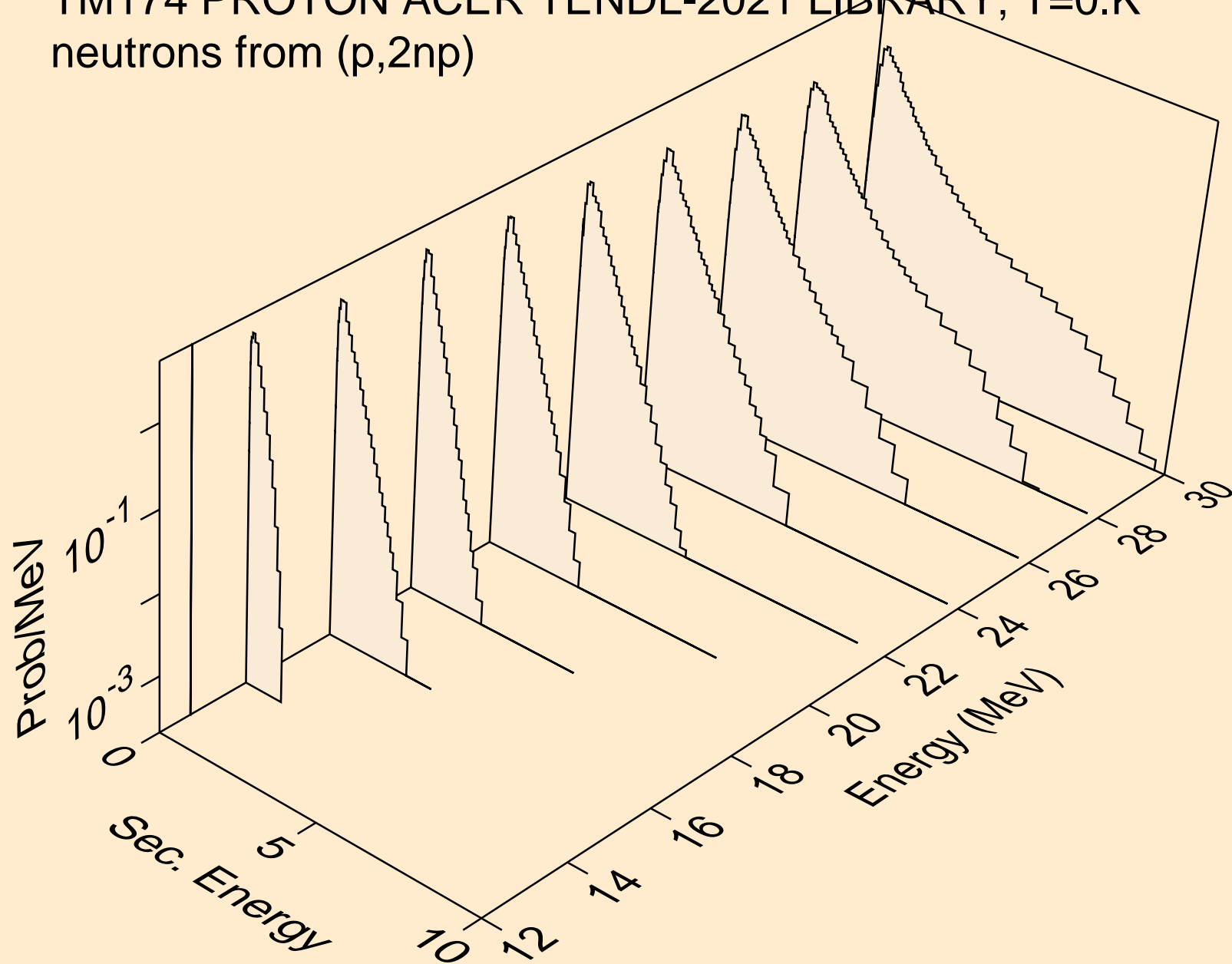

TM174 PROTON ACER TENDL-2021 LIBRARY; T=0.K  
neutrons from (p,3np)

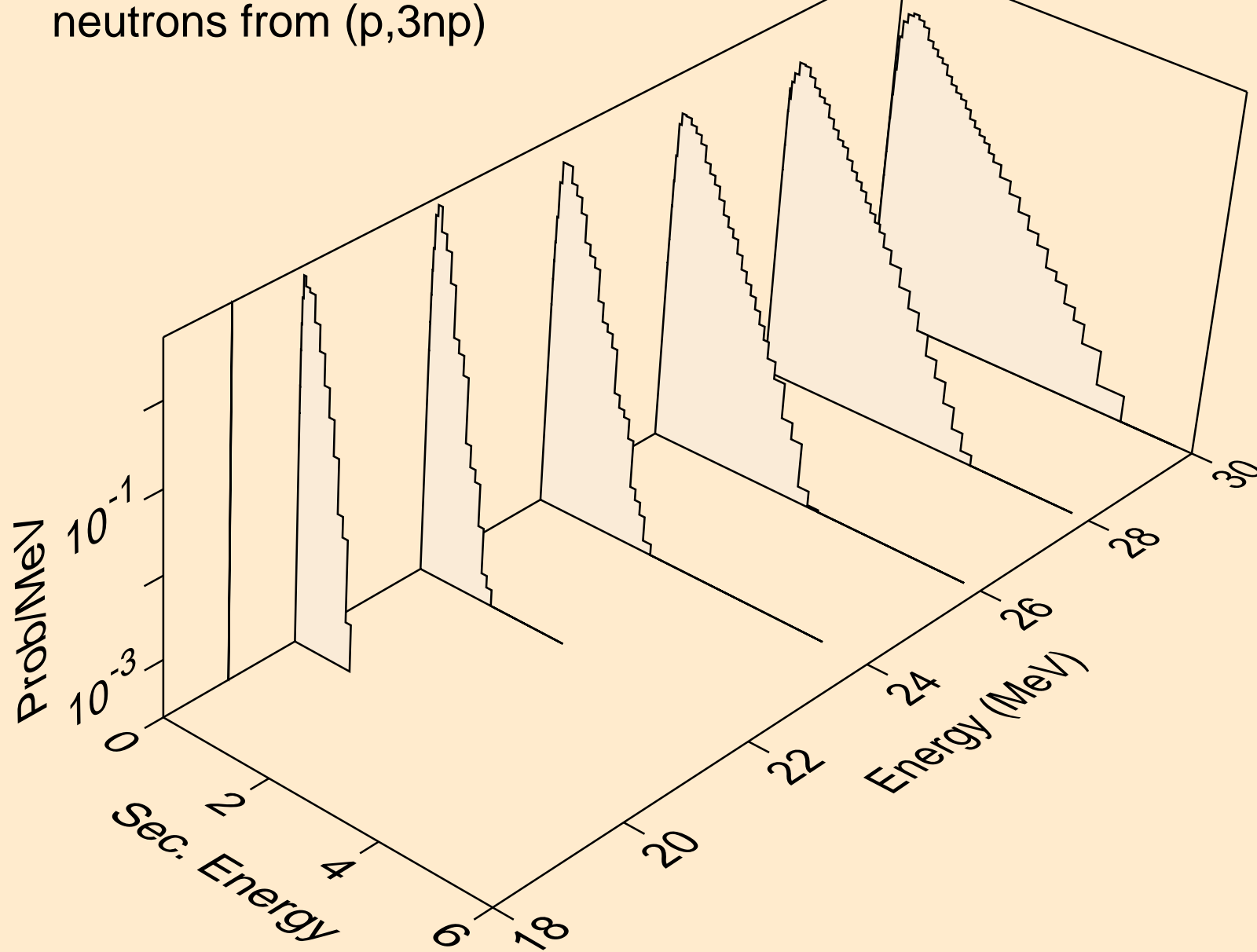

TM174 PROTON ACER TENDL-2021 LIBRARY; T=0.K  
neutrons from (p,2np)

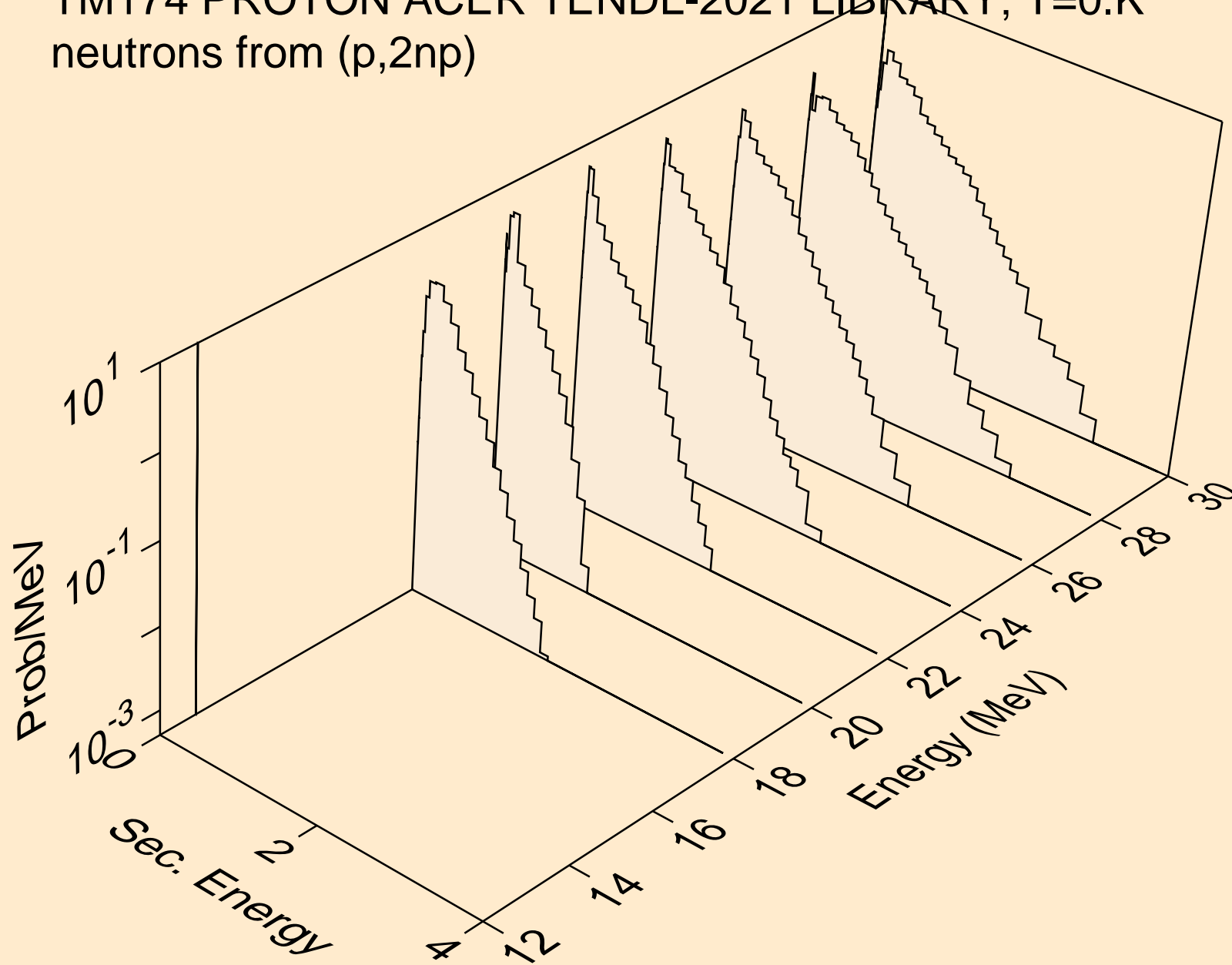

TM174 PROTON ACER TENDL-2021 LIBRARY; T=0.K  
neutrons from (p,npa)

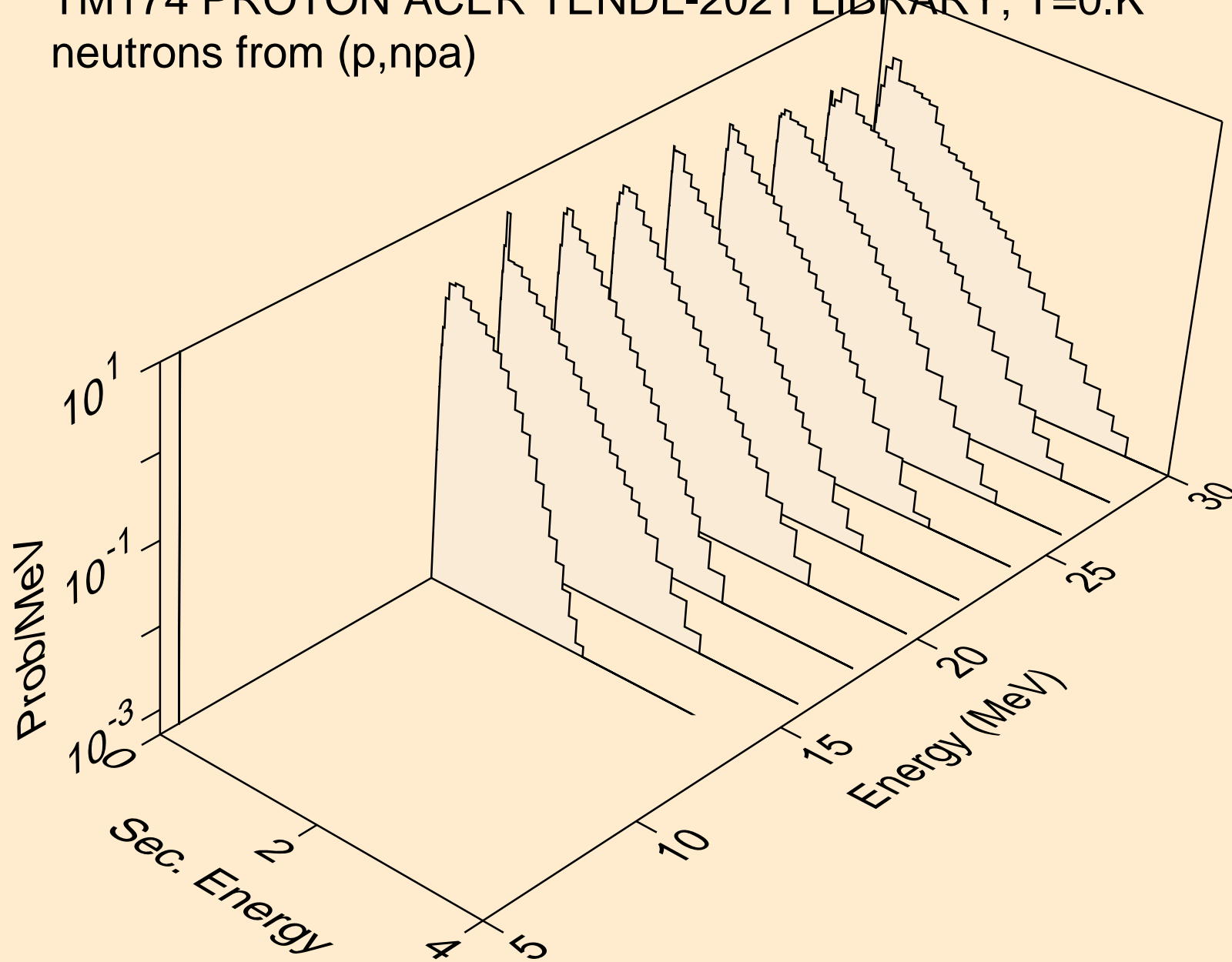

TM174 PROTON ACER TENDL-2021 LIBRARY; T=0.K  
deuterons from (p,x)

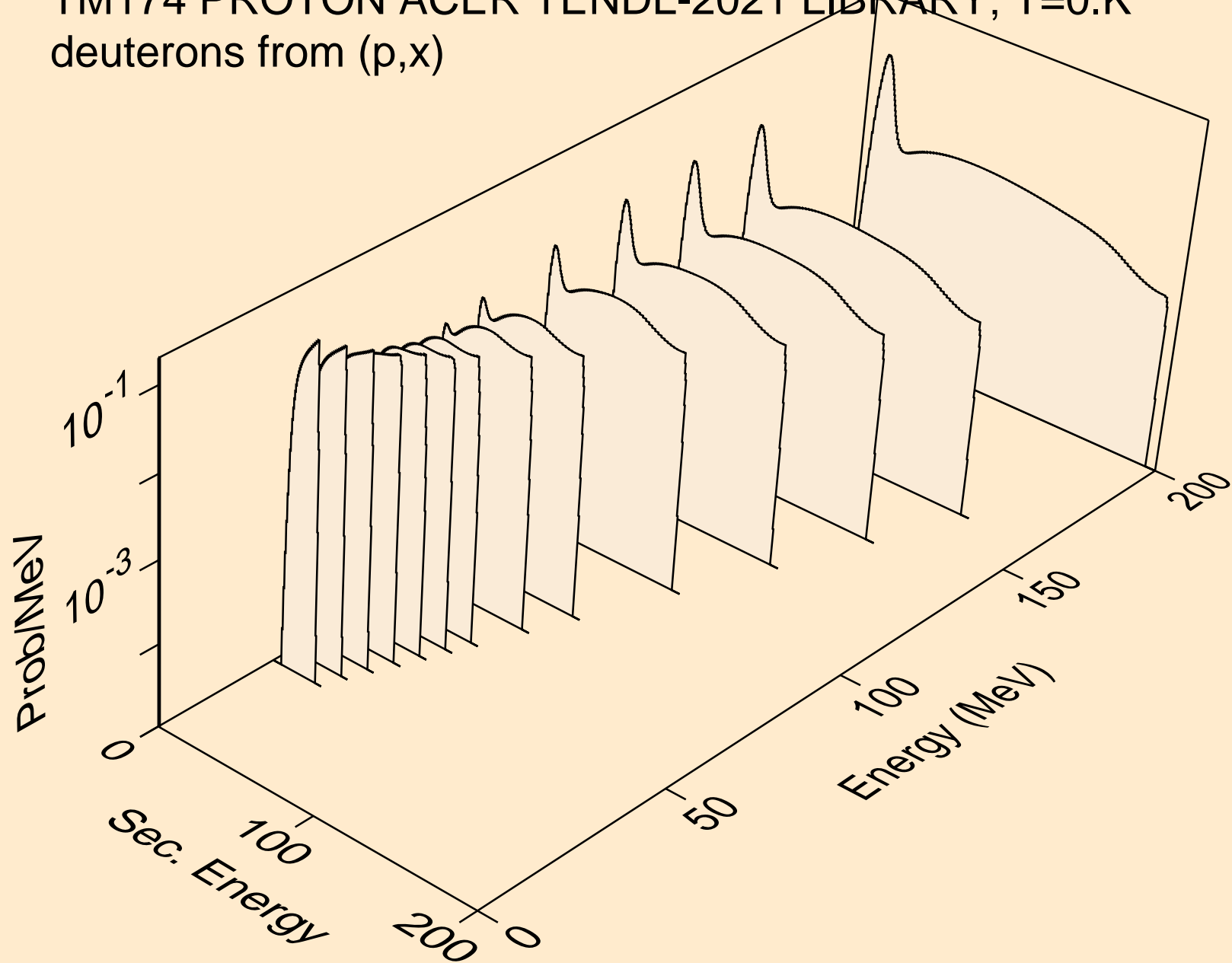

TM174 PROTON ACER TENDL-2021 LIBRARY; T=0.K  
deuterons from (p,2nd)

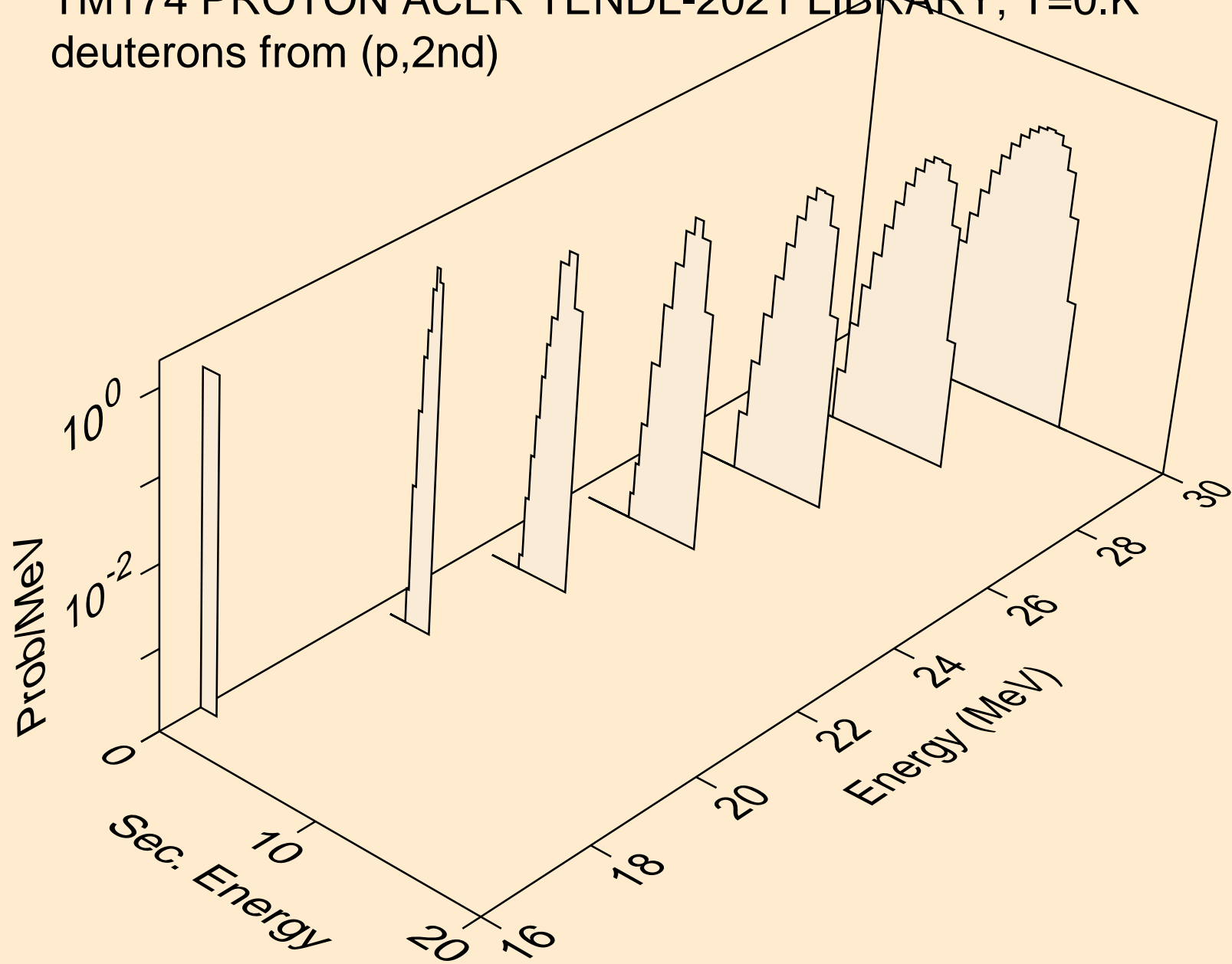



TM174 PROTON ACER TENDL-2021 LIBRARY; T=0.K  
deuterons from (p,n\*)d

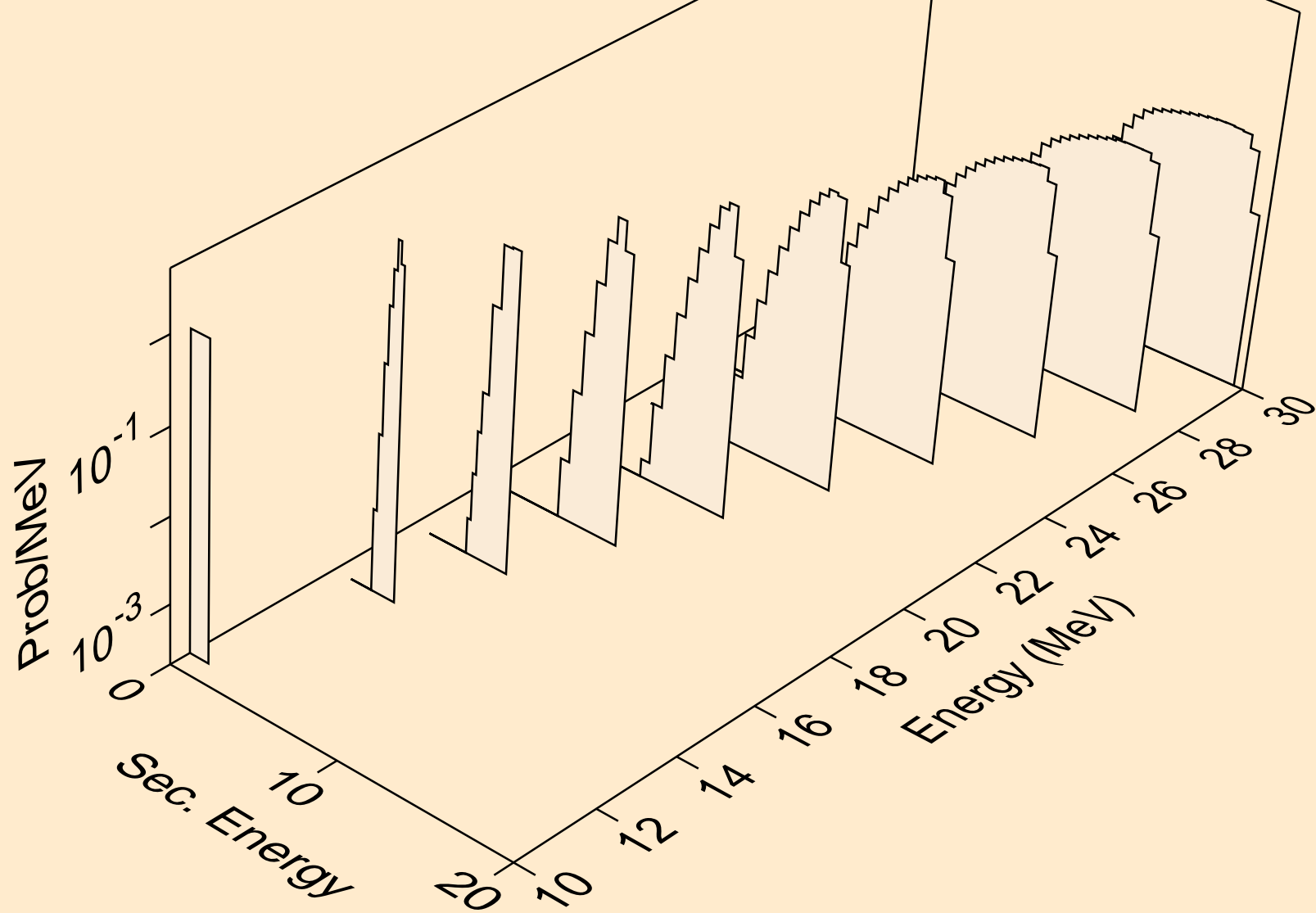

TM174 PROTON ACER TENDL-2021 LIBRARY; T=0.K  
deuterons from (p,d)

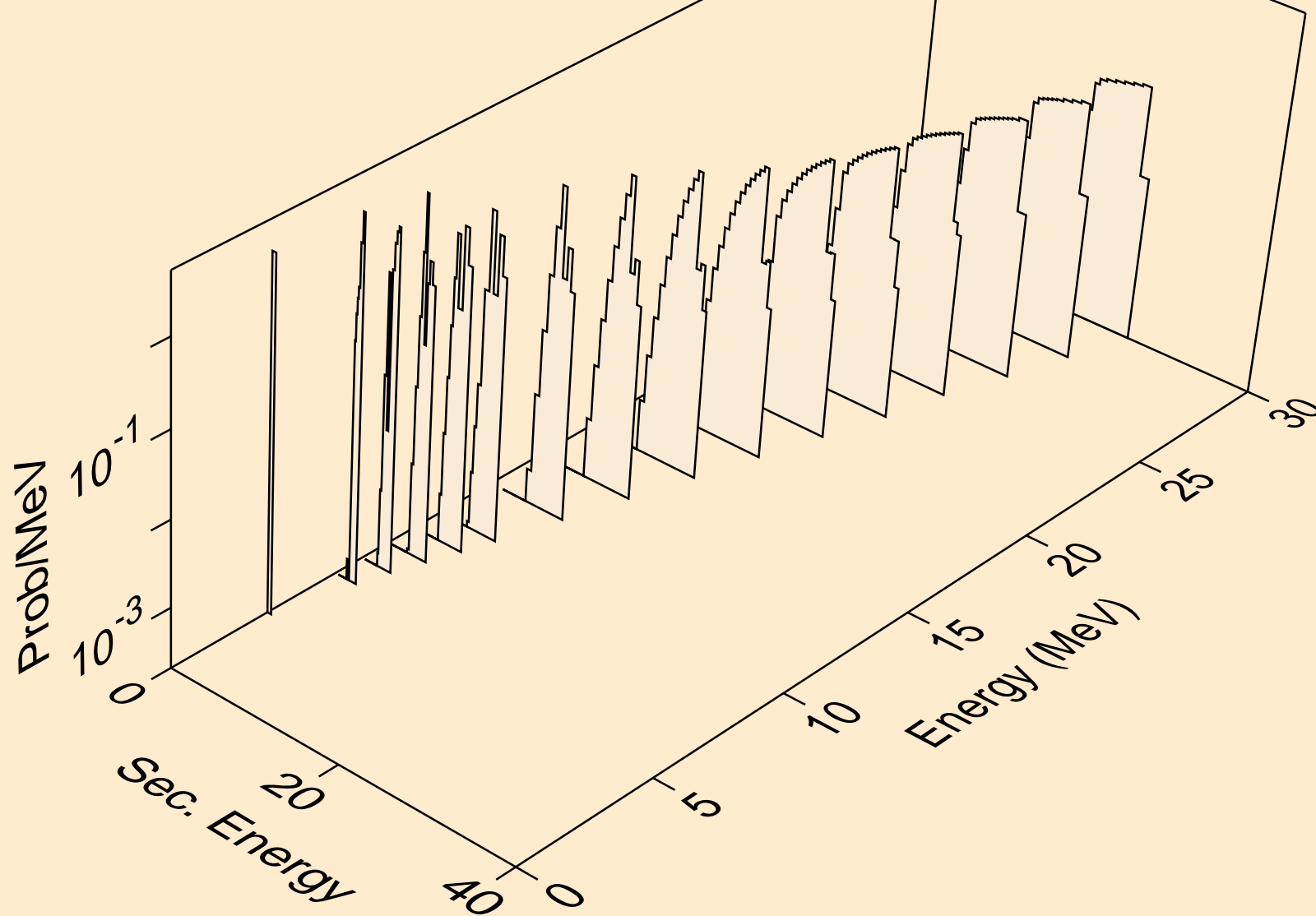

TM174 PROTON ACER TENDL-2021 LIBRARY; T=0.K  
deuterons from (p,pd)

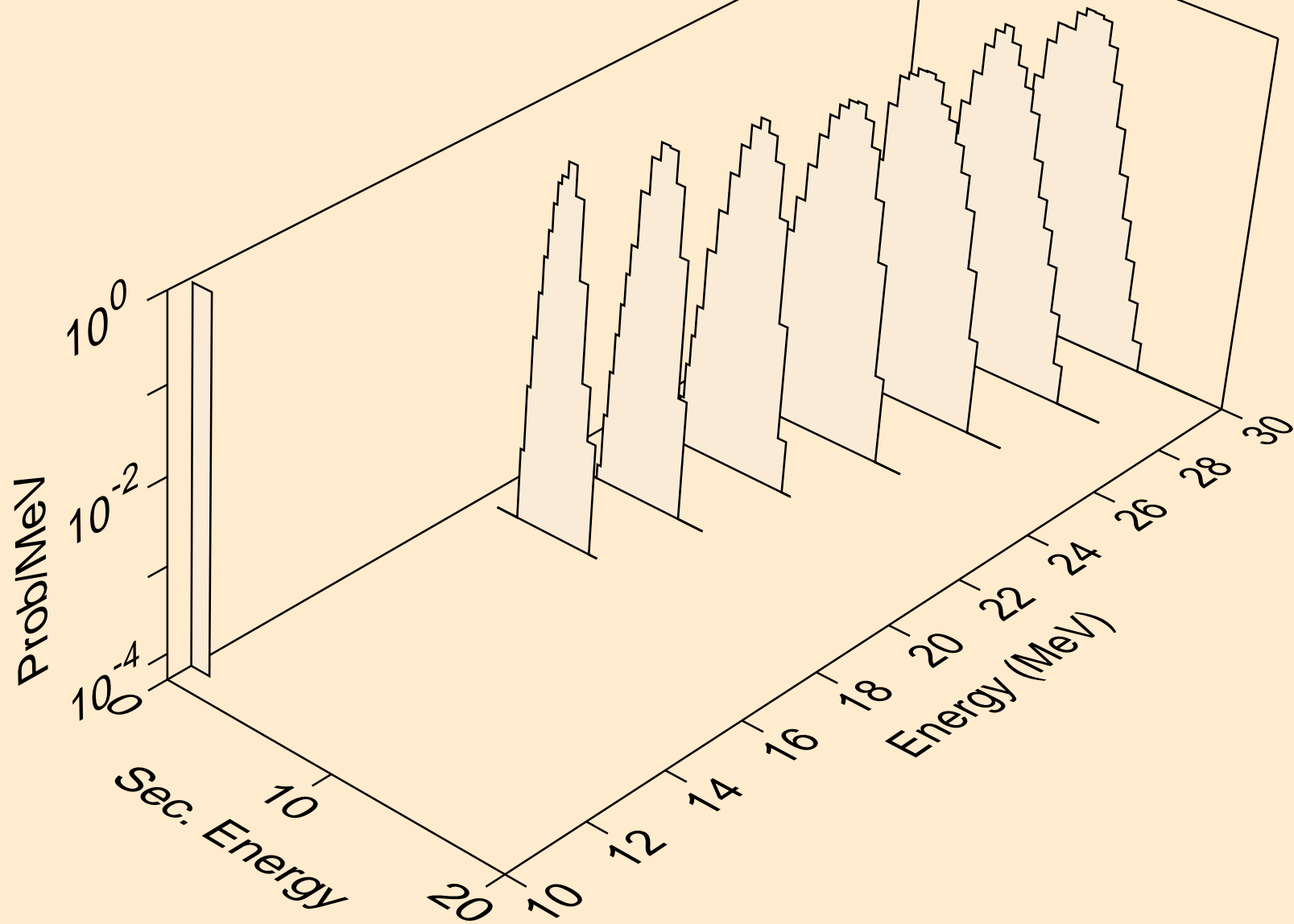

TM174 PROTON ACER TENDL-2021 LIBRARY; T=0.K  
tritons from (p,x)

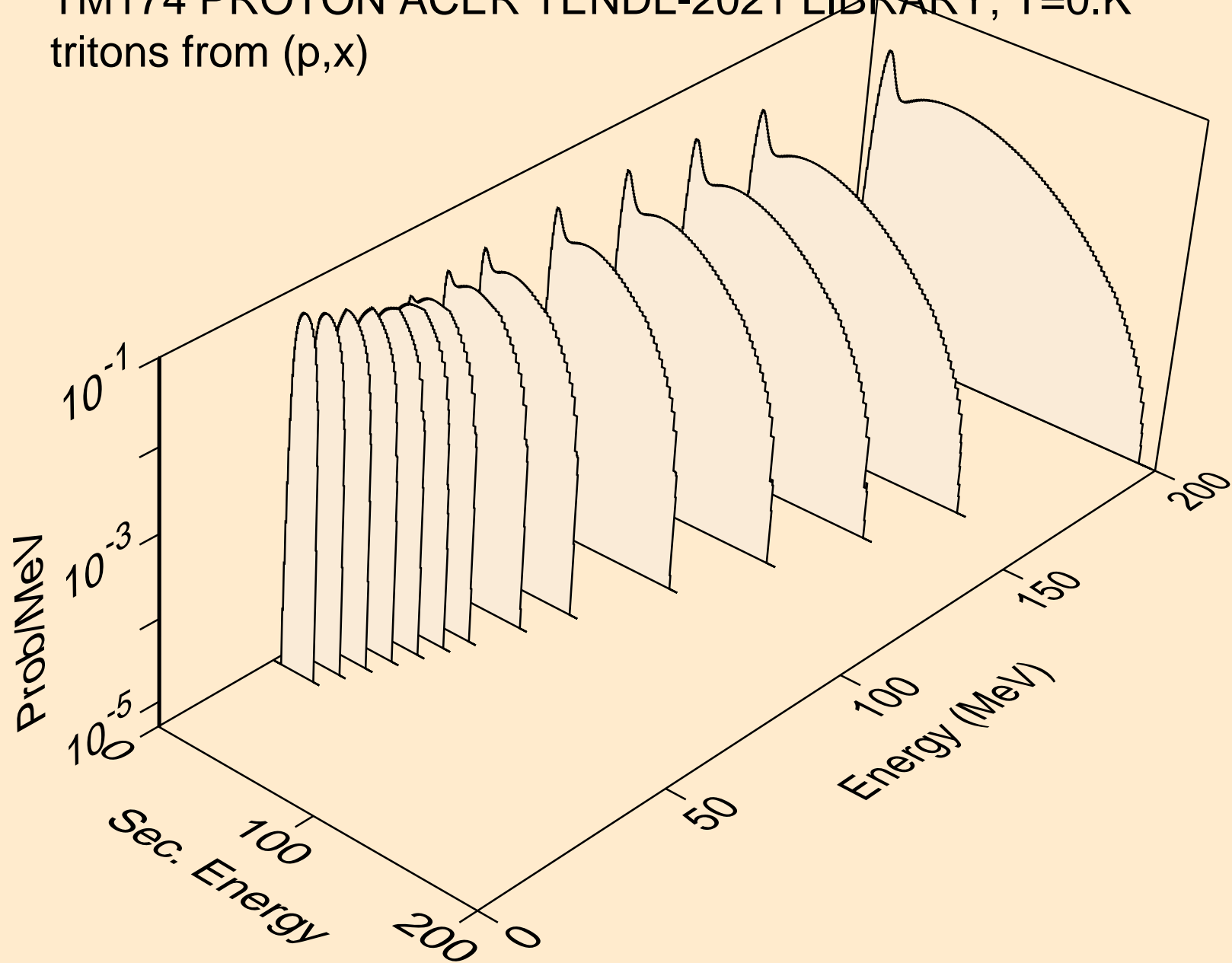

TM174 PROTON ACER TENDL-2021 LIBRARY; T=0.K  
tritons from (p,n\*)t

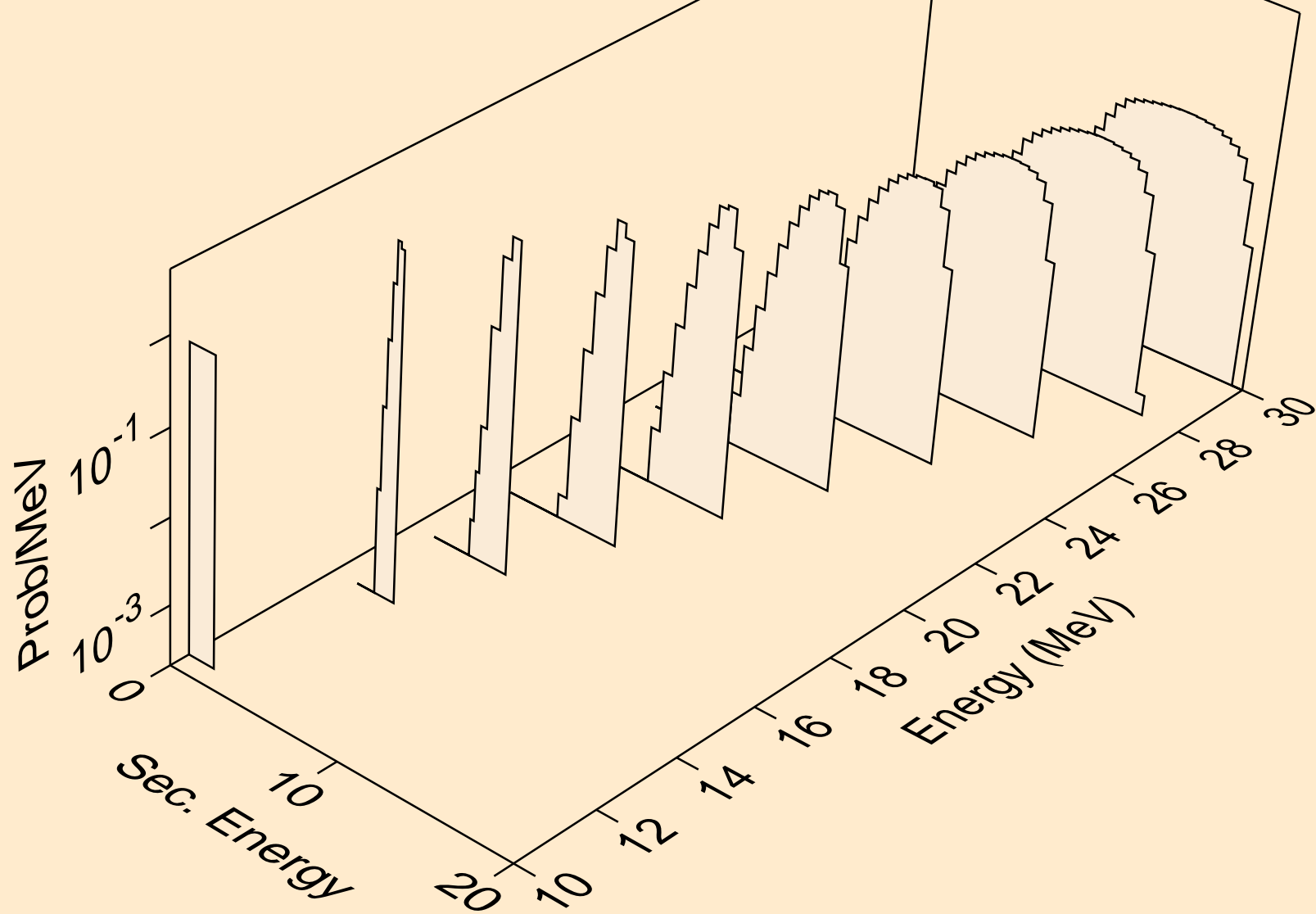

TM174 PROTON ACER TENDL-2021 LIBRARY; T=0.K  
tritons from (p,t)

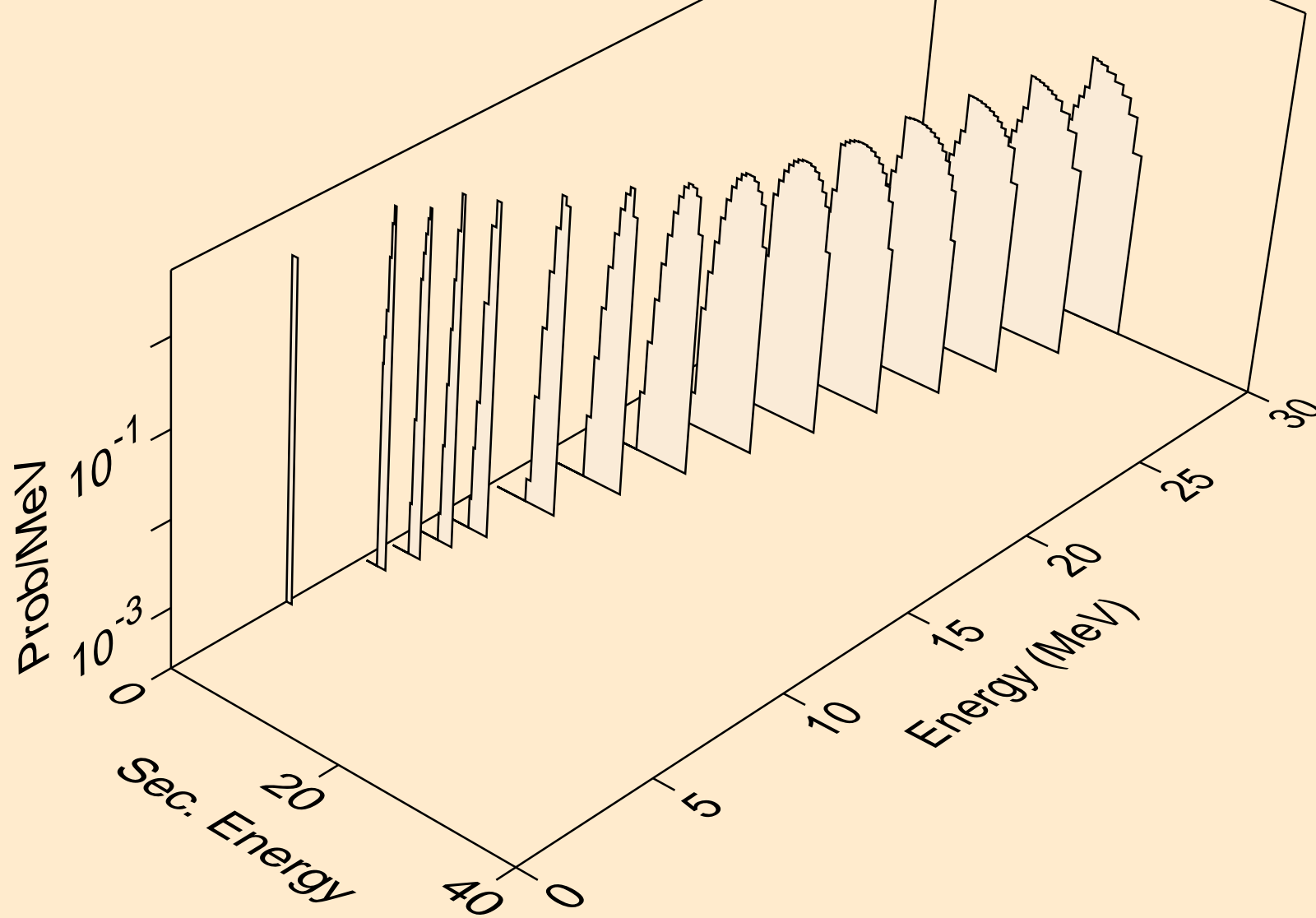

TM174 PROTON ACER TENDL-2021 LIBRARY; T=0.K  
tritons from (p,pt)

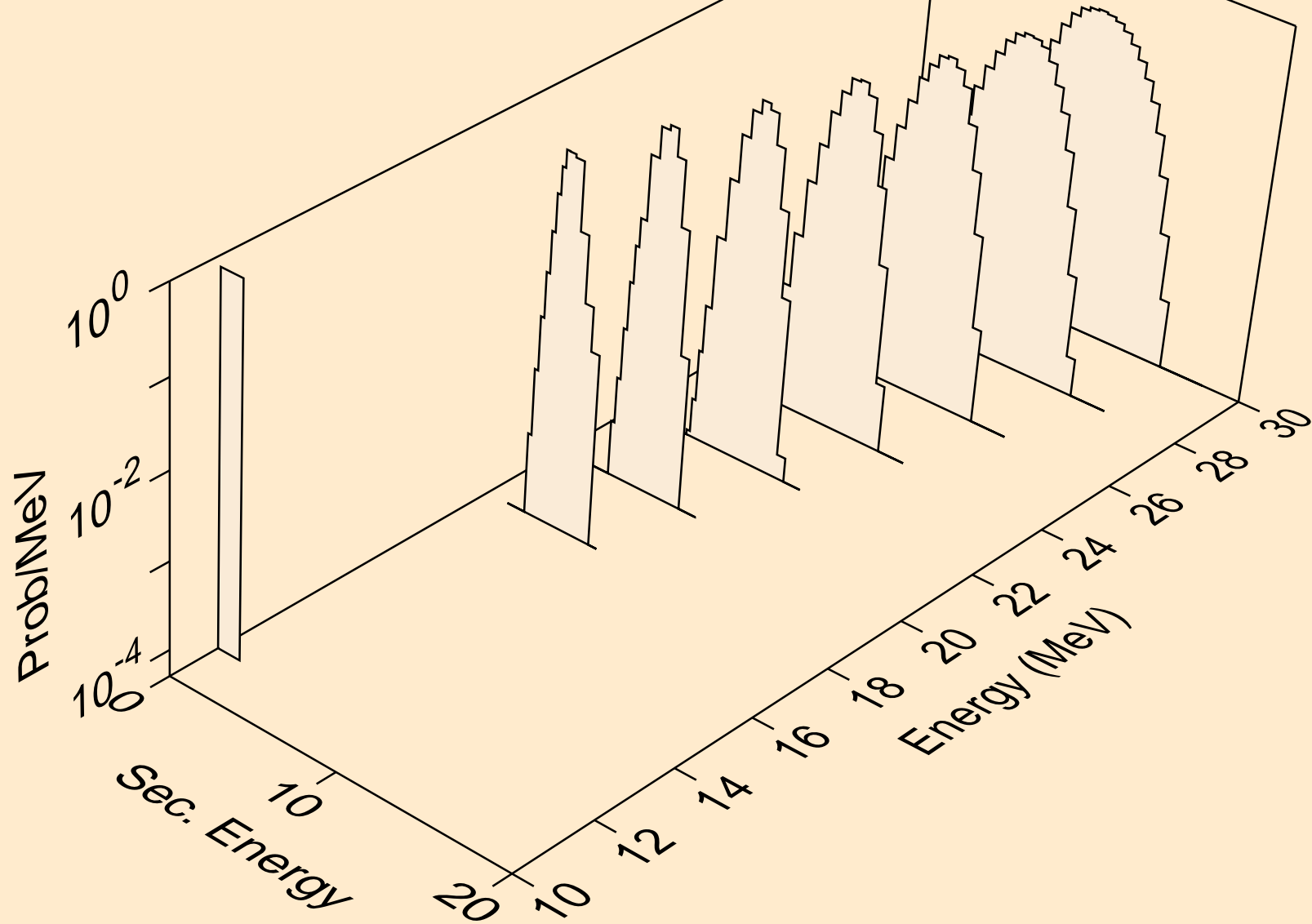

TM174 PROTON ACER TENDL-2021 LIBRARY; T=0.K  
he3s from (p,x)

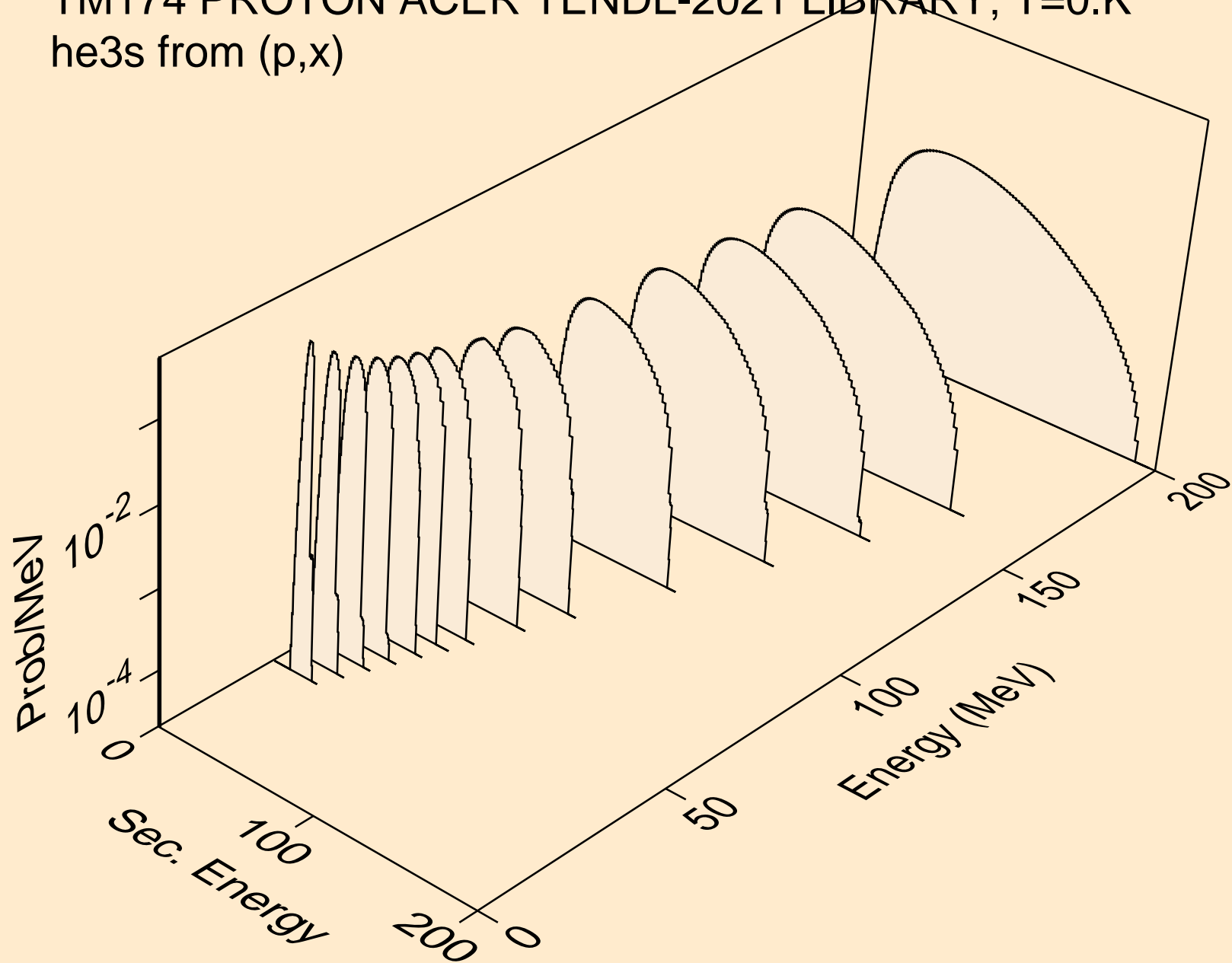



TM174 PROTON ACER TENDL-2021 LIBRARY; T=0.K  
he3s from (p,n\*)he3

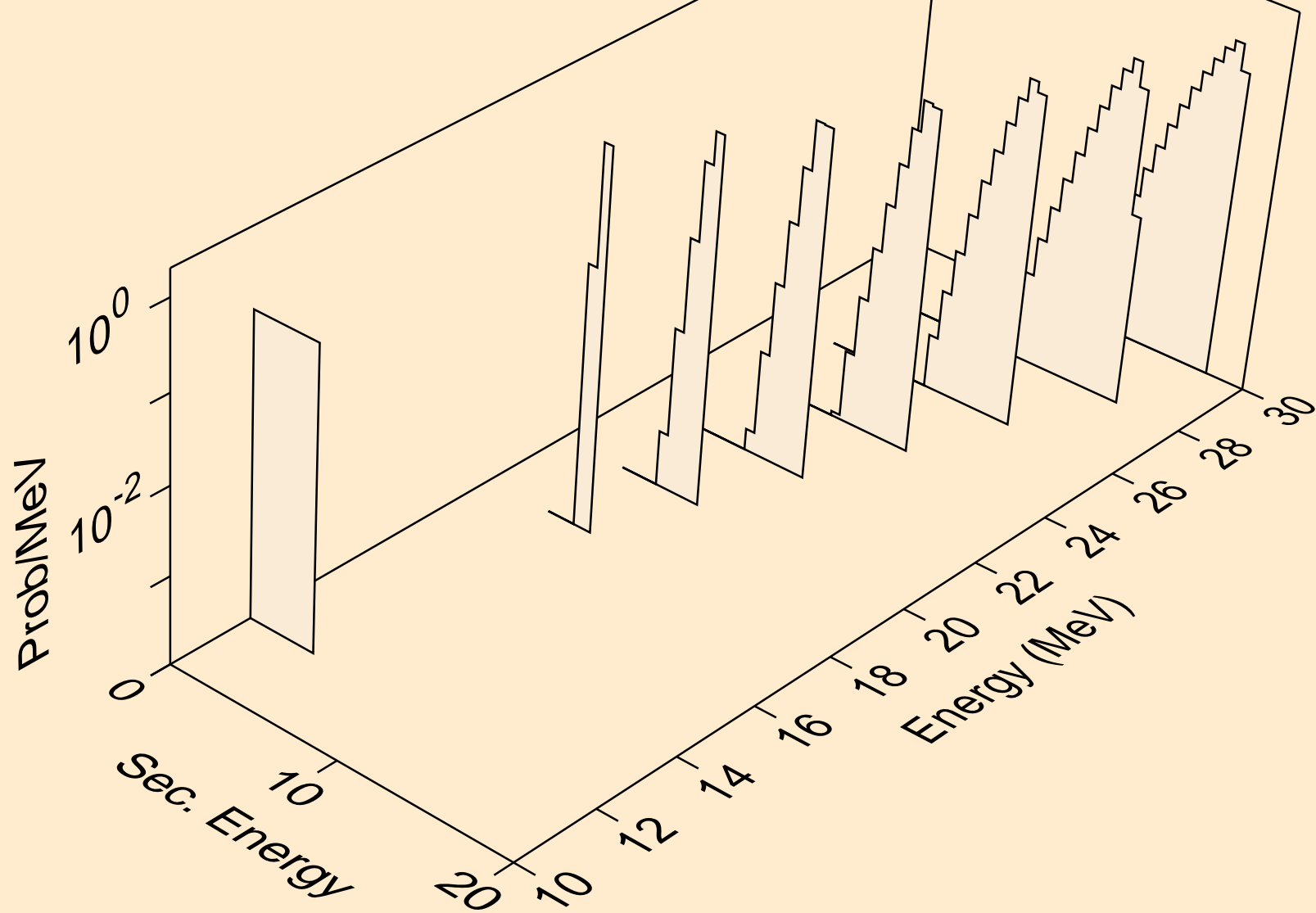

TM174 PROTON ACER TENDL-2021 LIBRARY; T=0.K  
he3s from (p,he3)

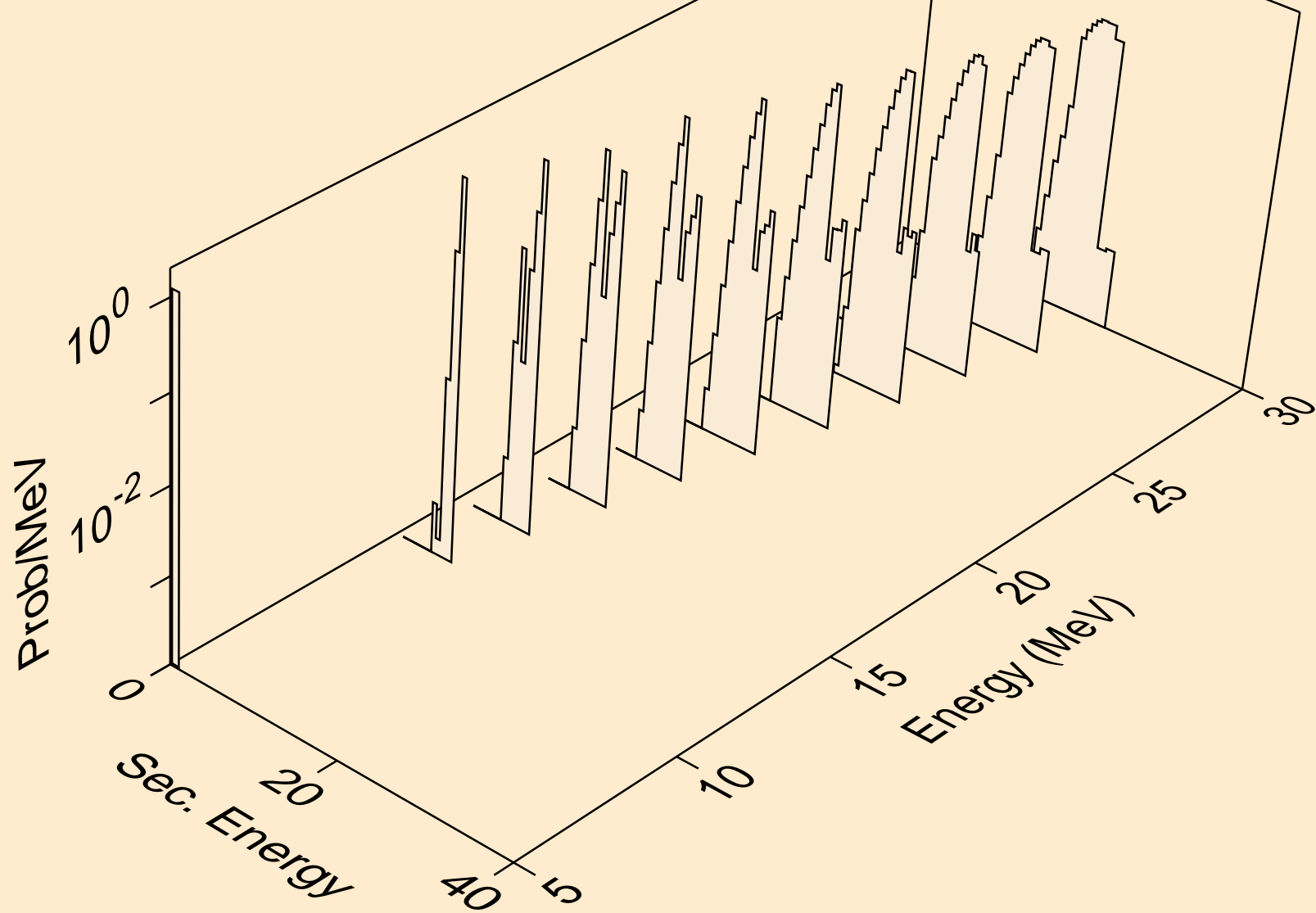

TM174 PROTON ACER TENDL-2021 LIBRARY; T=0.K  
alphas from (p,x)

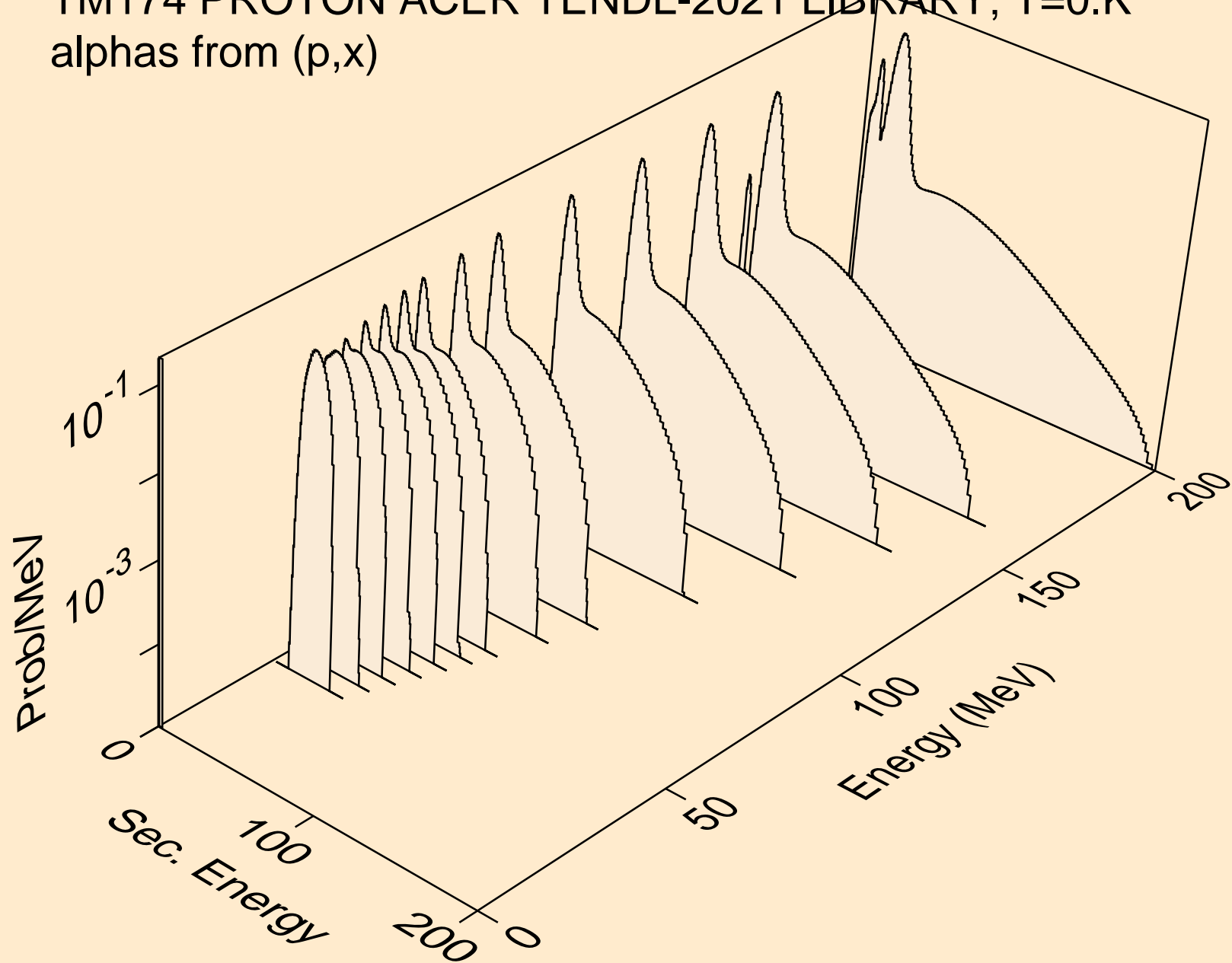

TM174 PROTON ACER TENDL-2021 LIBRARY; T=0.K  
alphas from (p,n\*)a

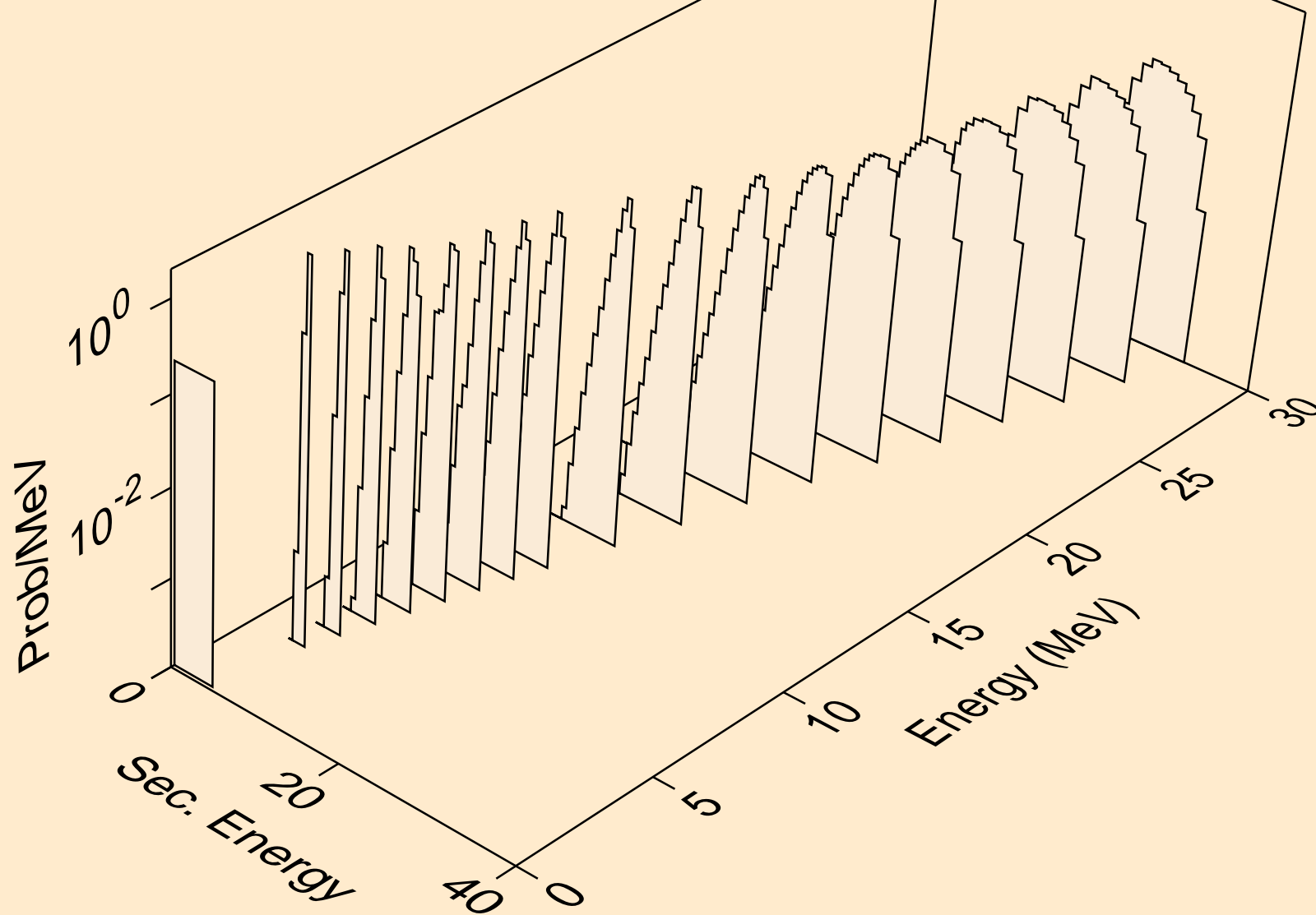

TM174 PROTON ACER TENDL-2021 LIBRARY; T=0.K  
alphas from (p,2n)a

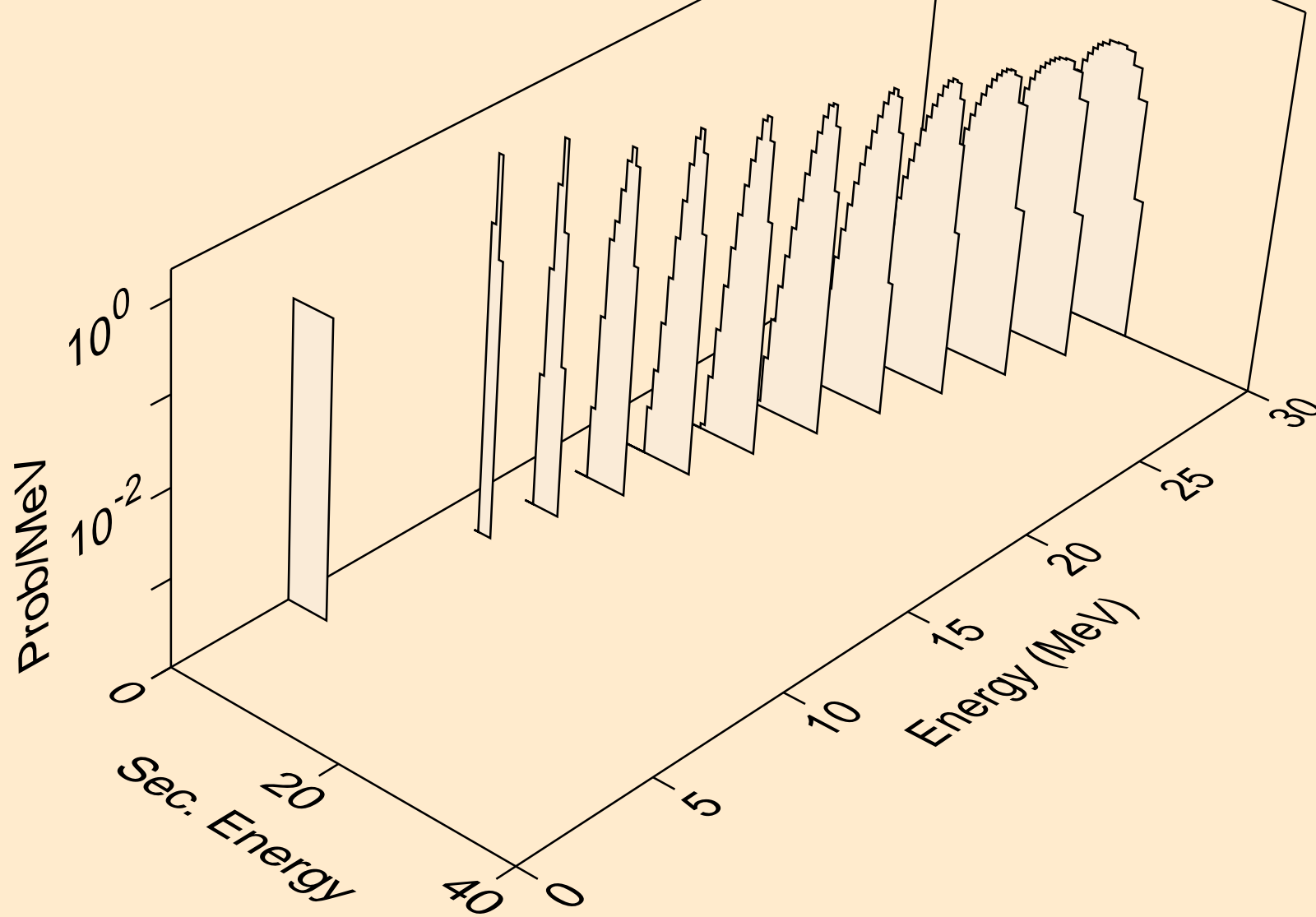

TM174 PROTON ACER TENDL-2021 LIBRARY; T=0.K  
alphas from (p,3n)a

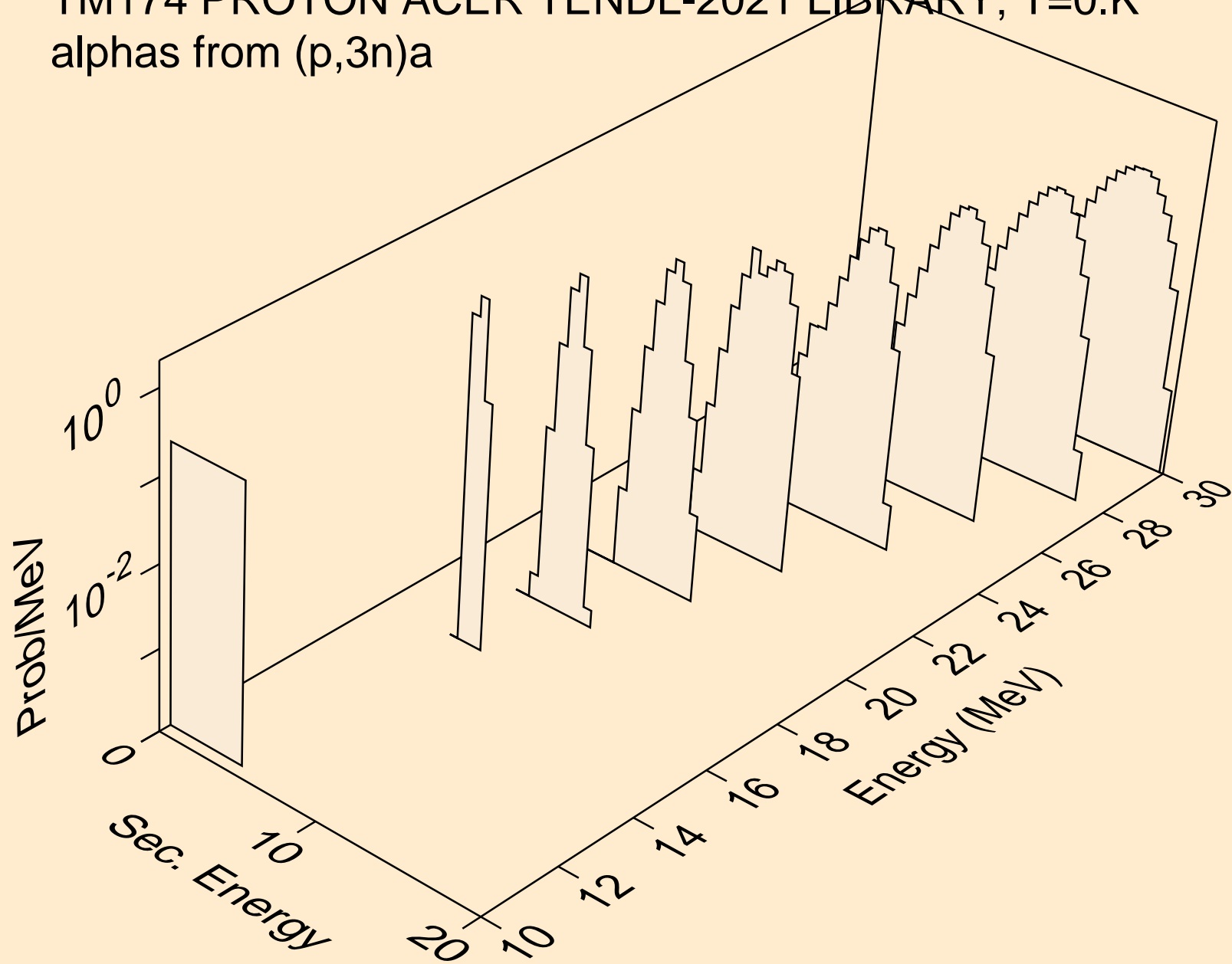

TM174 PROTON ACER TENDL-2021 LIBRARY; T=0.K  
alphas from (p,n\*)2a

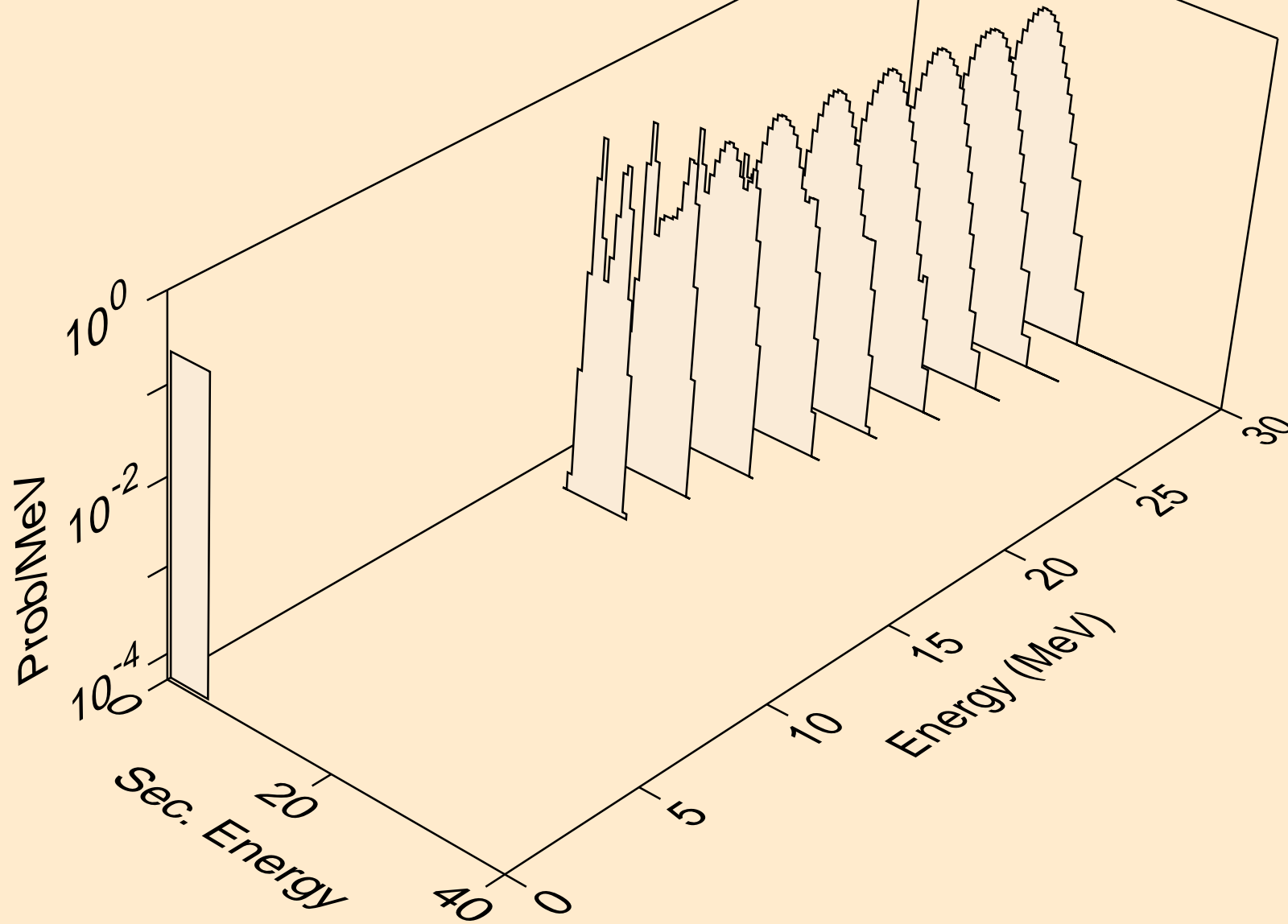

TM174 PROTON ACER TENDL-2021 LIBRARY; T=0.K  
alphas from (p,npa)

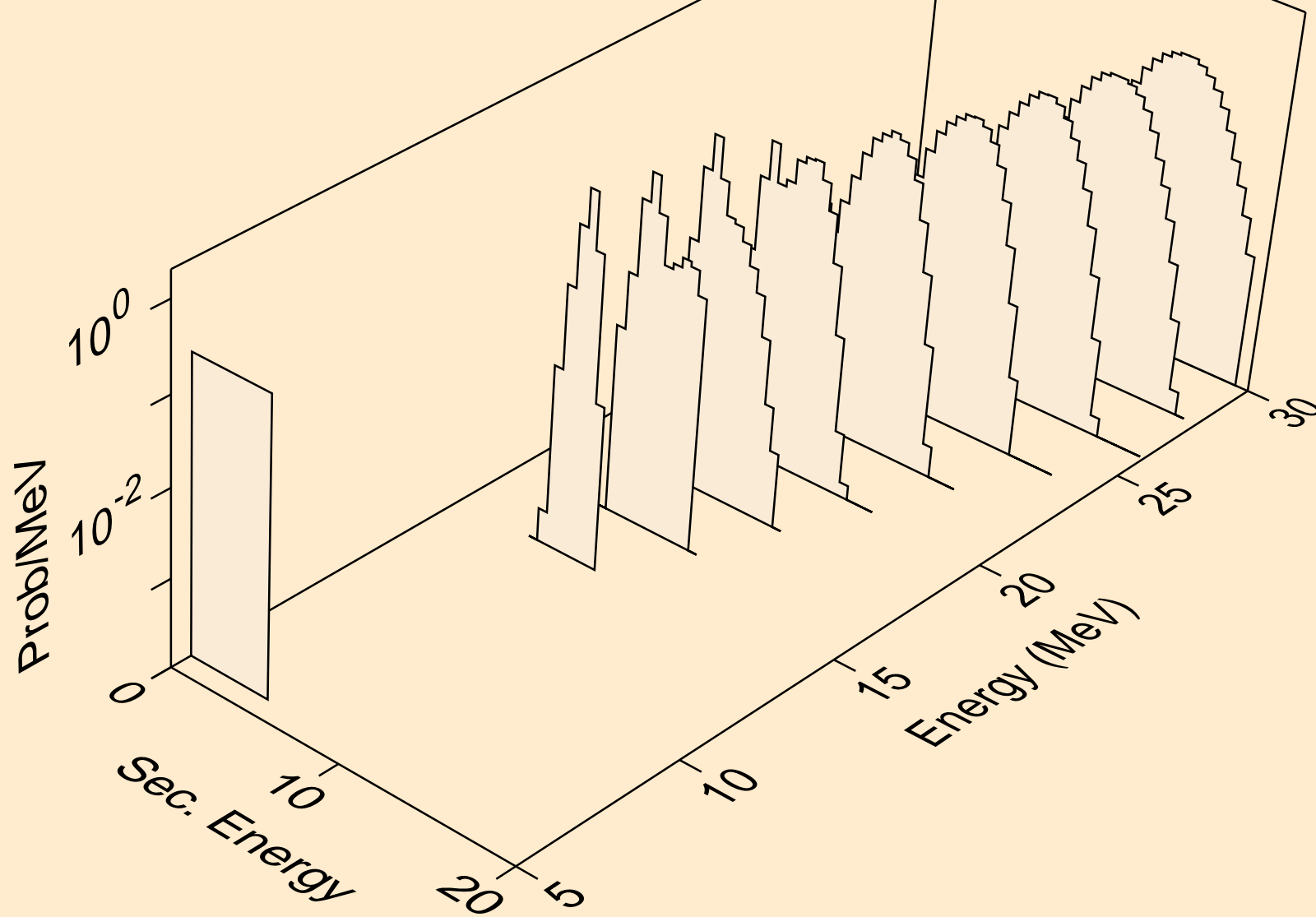



TM174 PROTON ACER TENDL-2021 LIBRARY; T=0.K  
alphas from (p,a)

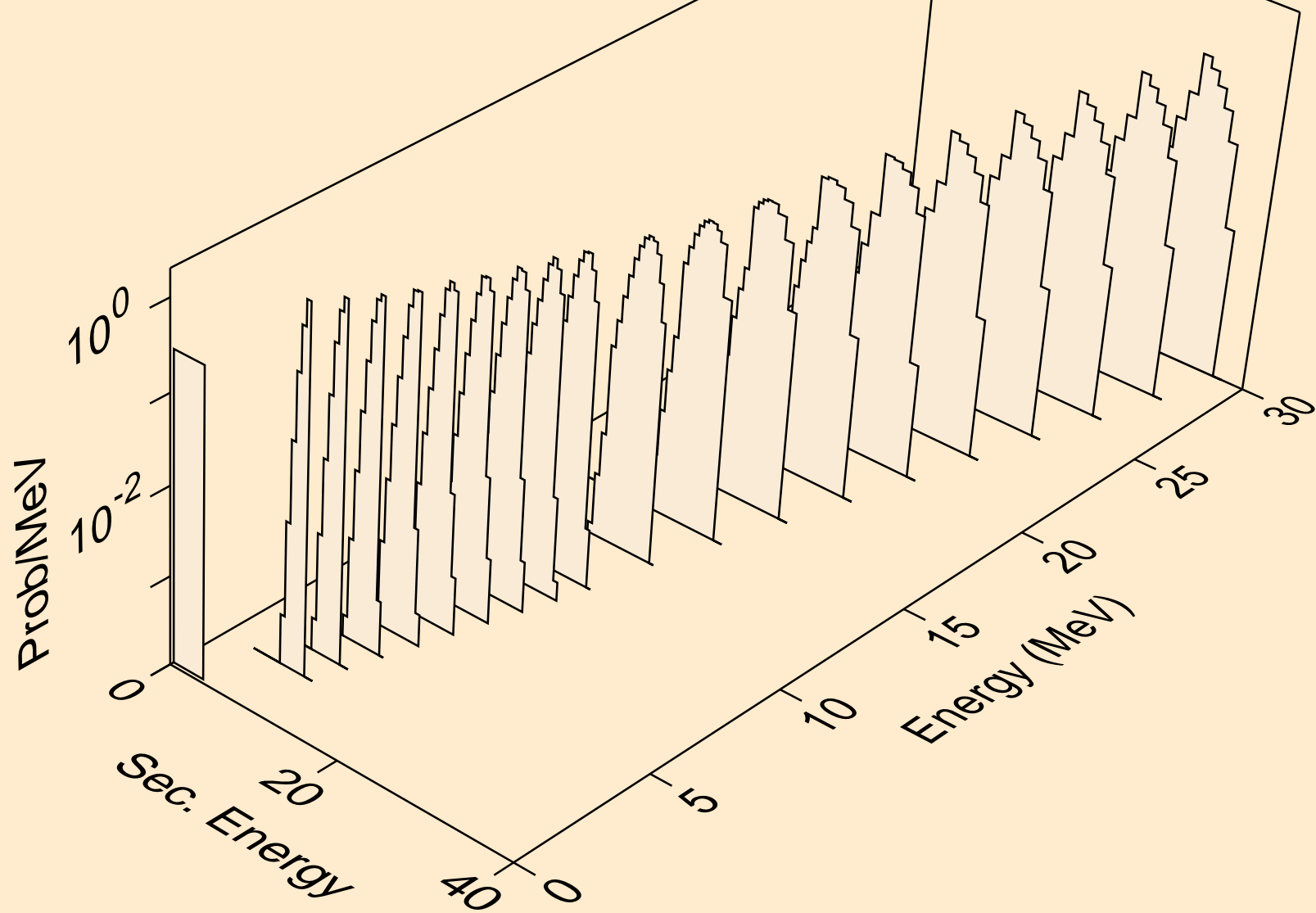

TM174 PROTON ACER TENDL-2021 LIBRARY; T=0.K  
alphas from (p,2a)

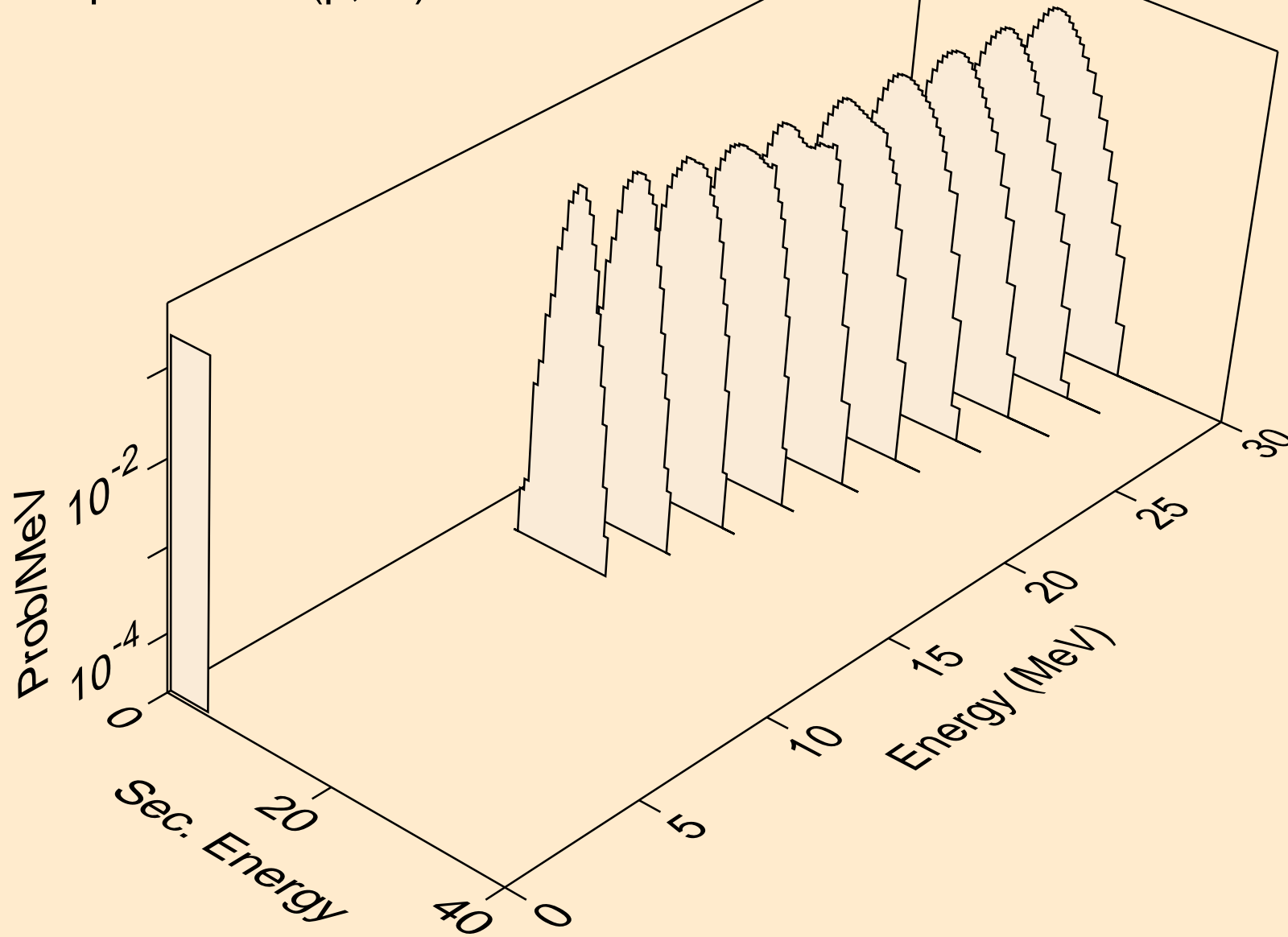

TM174 PROTON ACER TENDL-2021 LIBRARY; T=0.K  
alphas from (p,pa)

