

# U233 PROTON ACER TENDL-2021 LIBRARY; T=0.K

## Principal cross sections

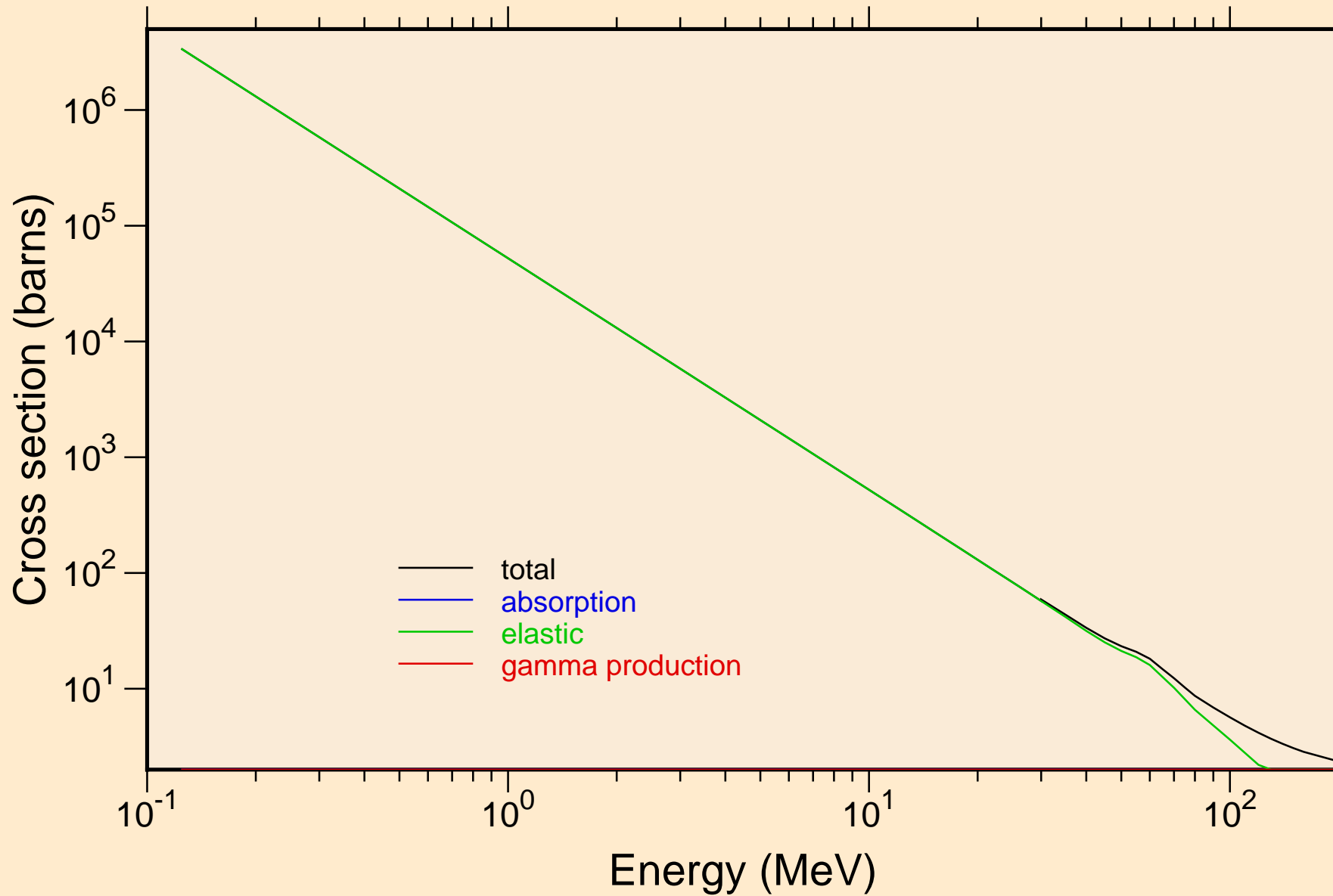

U233 PROTON ACER TENDL-2021 LIBRARY; T=0.K  
Heating

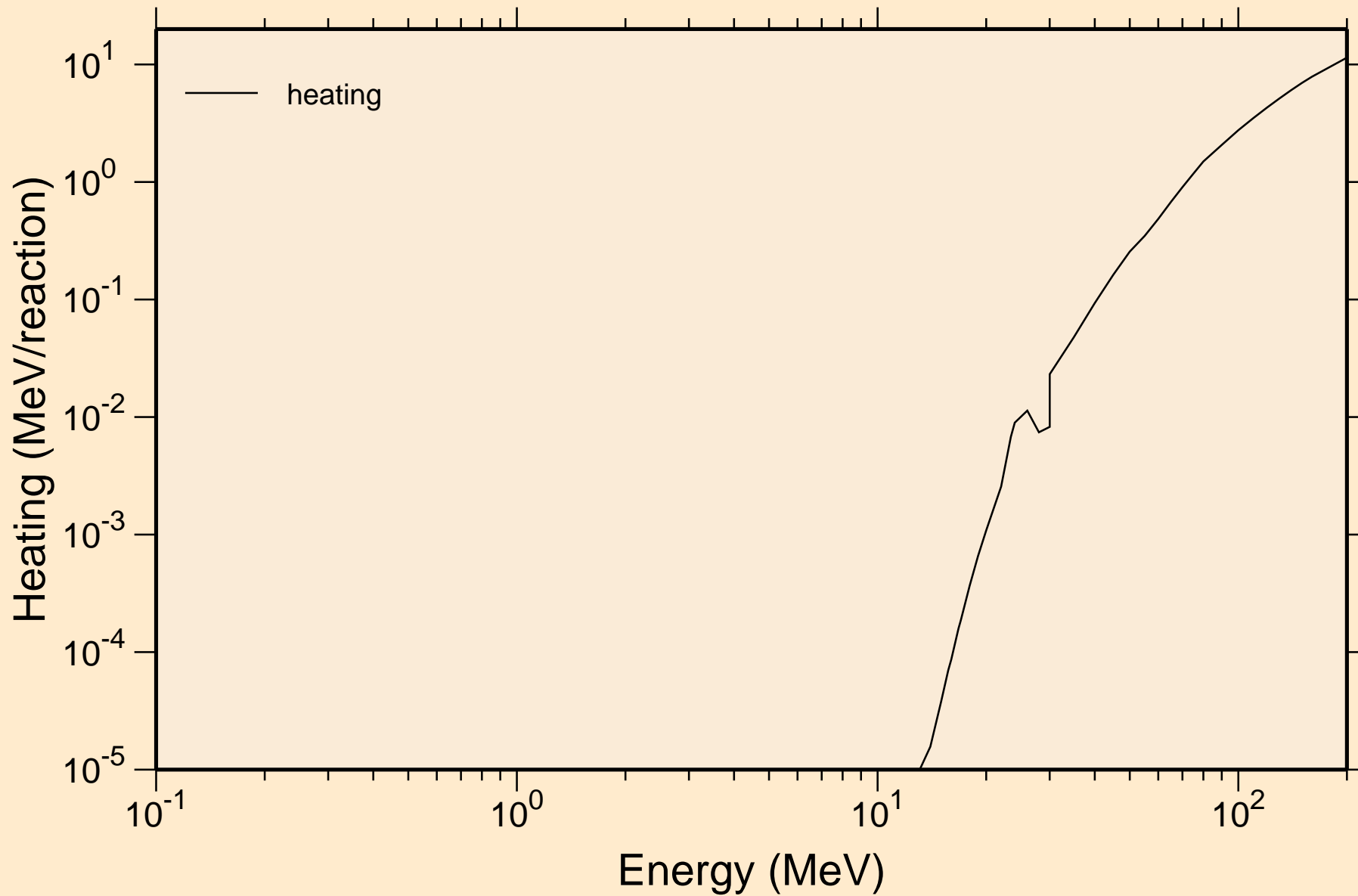

U233 PROTON ACER TENDL-2021 LIBRARY; T=0.K  
Principal cross sections

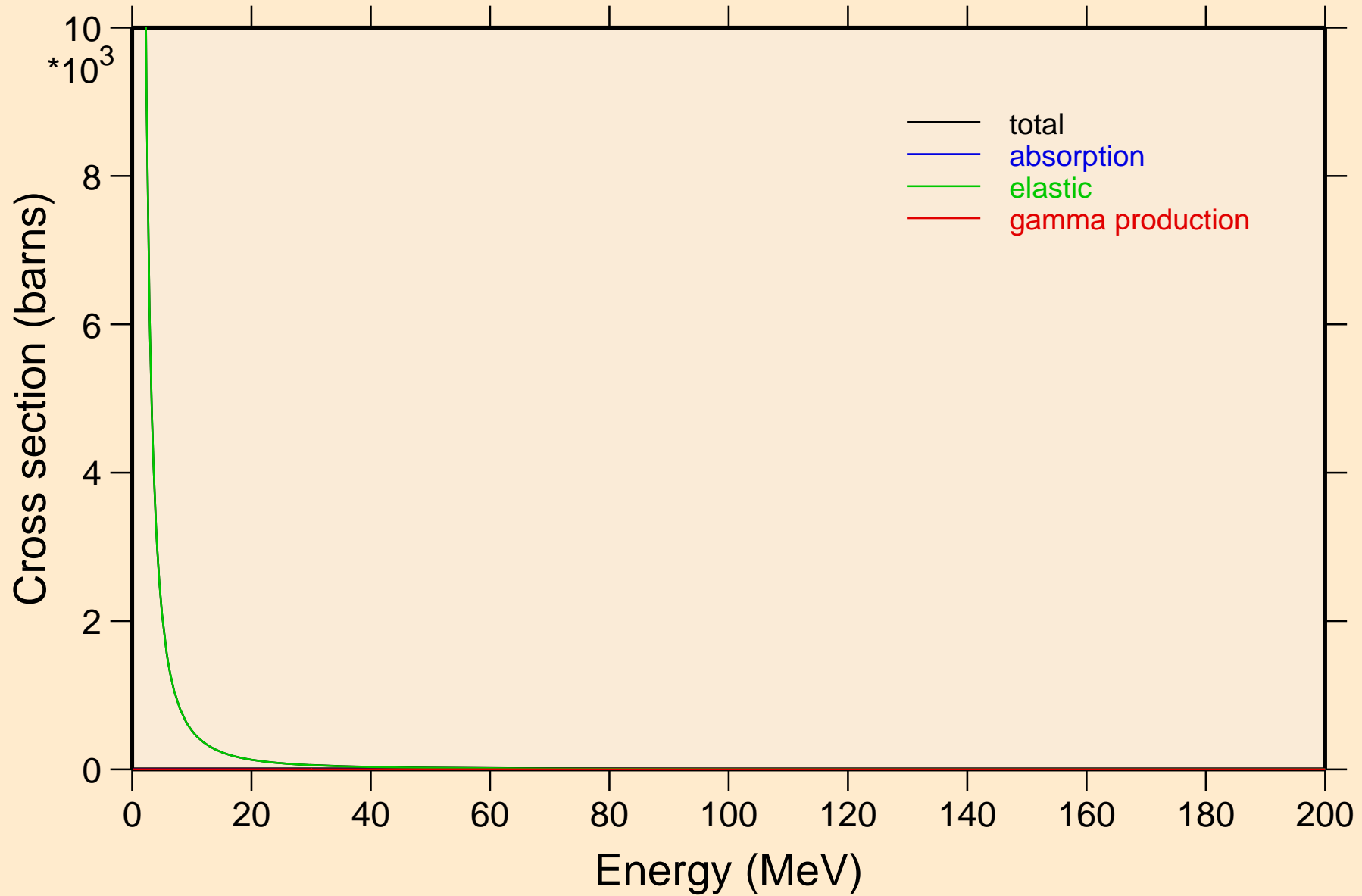

U233 PROTON ACER TENDL-2021 LIBRARY; T=0.K

Heating

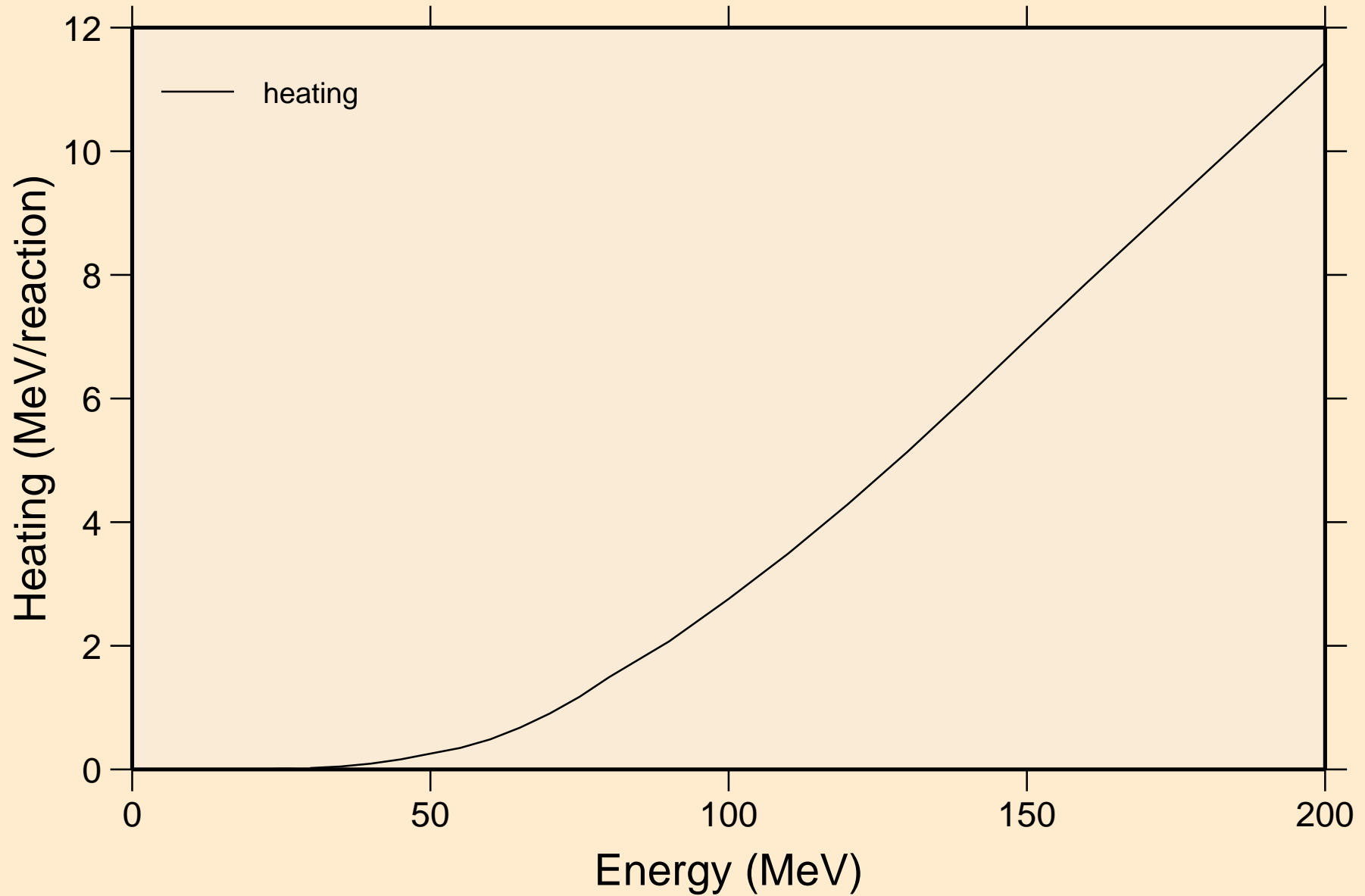

# U233 PROTON ACER TENDL-2021 LIBRARY; T=0.K

## Threshold reactions

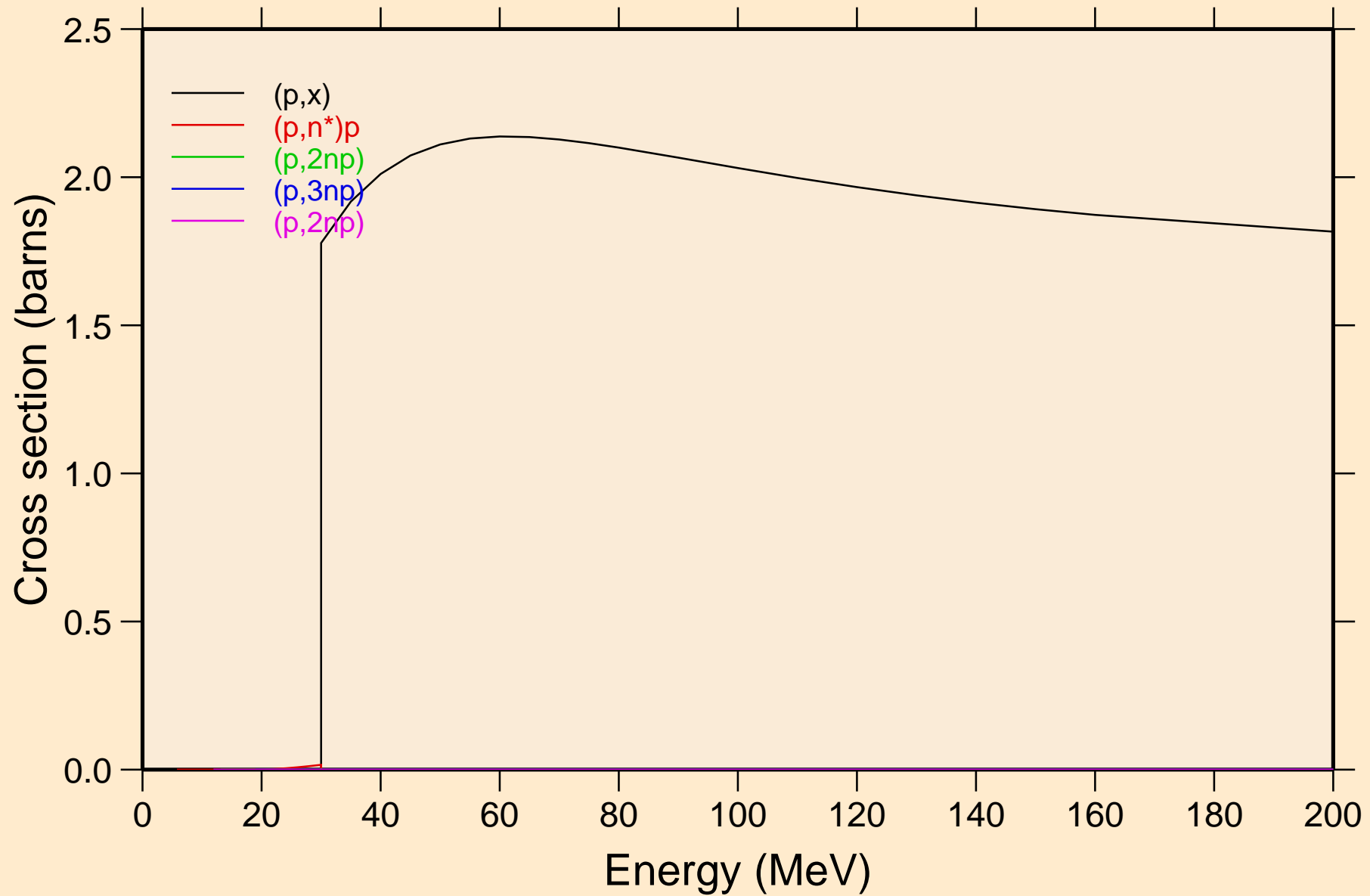

# U233 PROTON ACER TENDL-2021 LIBRARY; T=0.K

## Threshold reactions

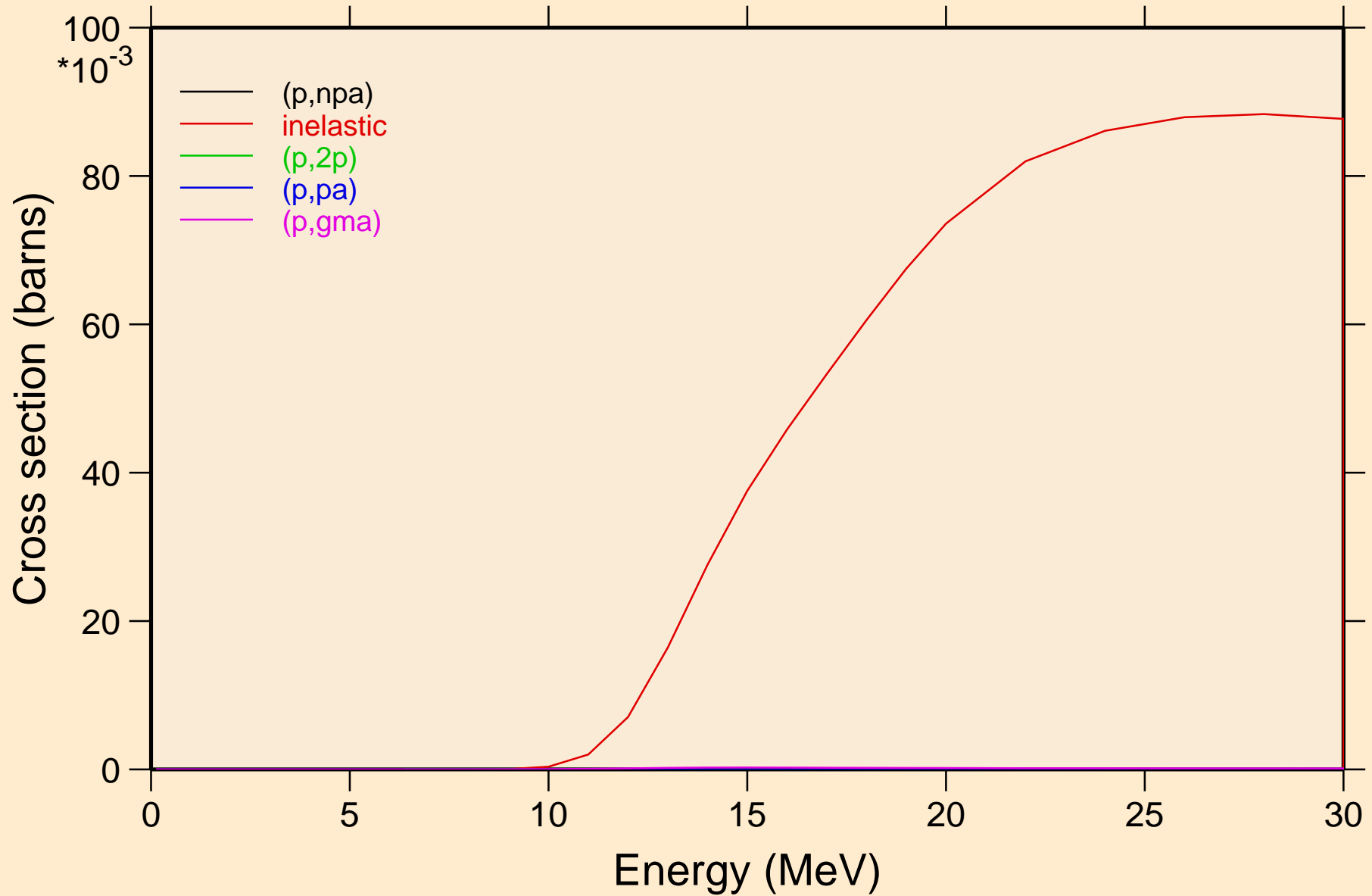

# U233 PROTON ACER TENDL-2021 LIBRARY; T=0.K

## Threshold reactions

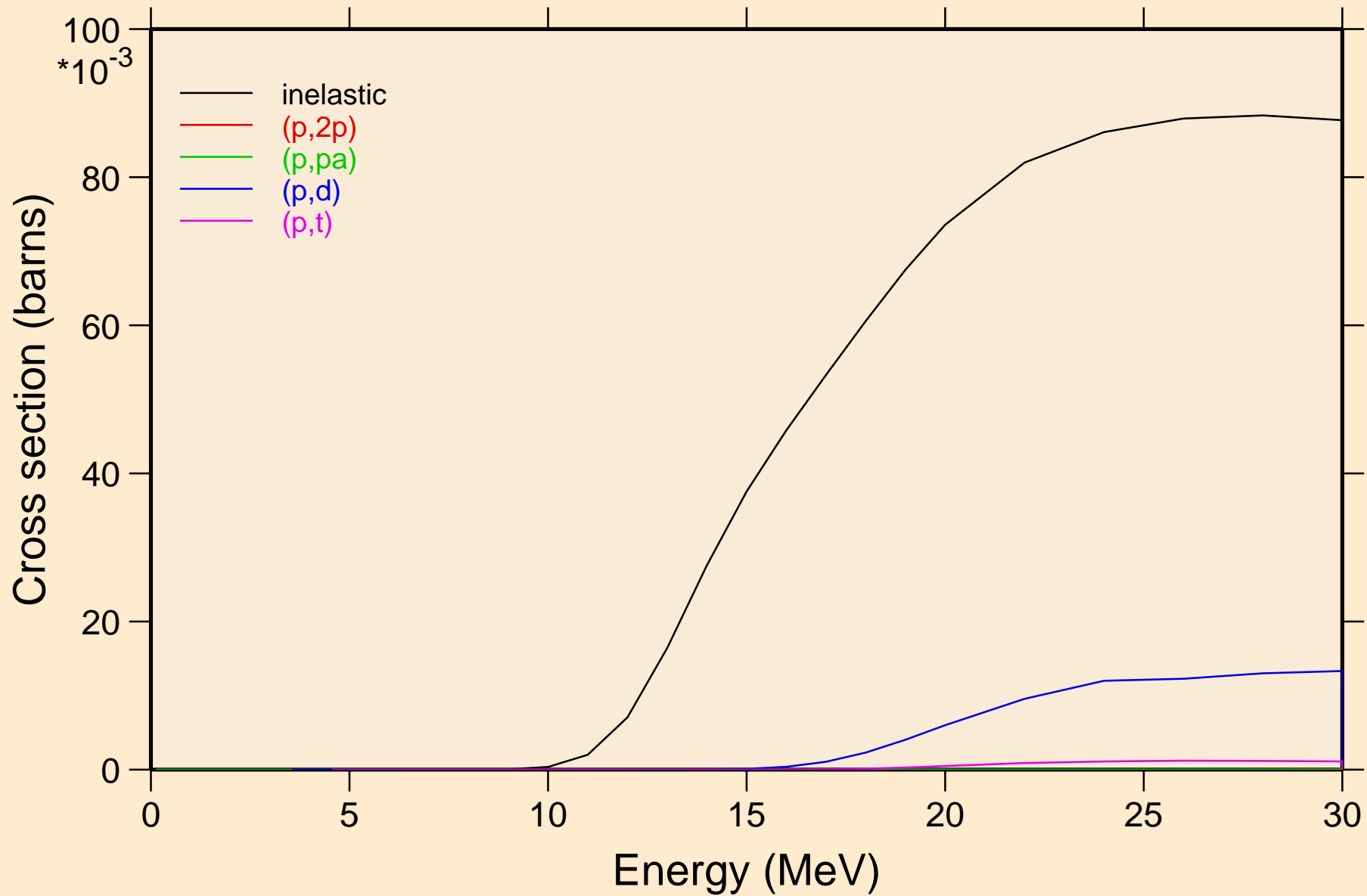

U233 PROTON ACER TENDL-2021 LIBRARY; T=0.K  
Threshold reactions

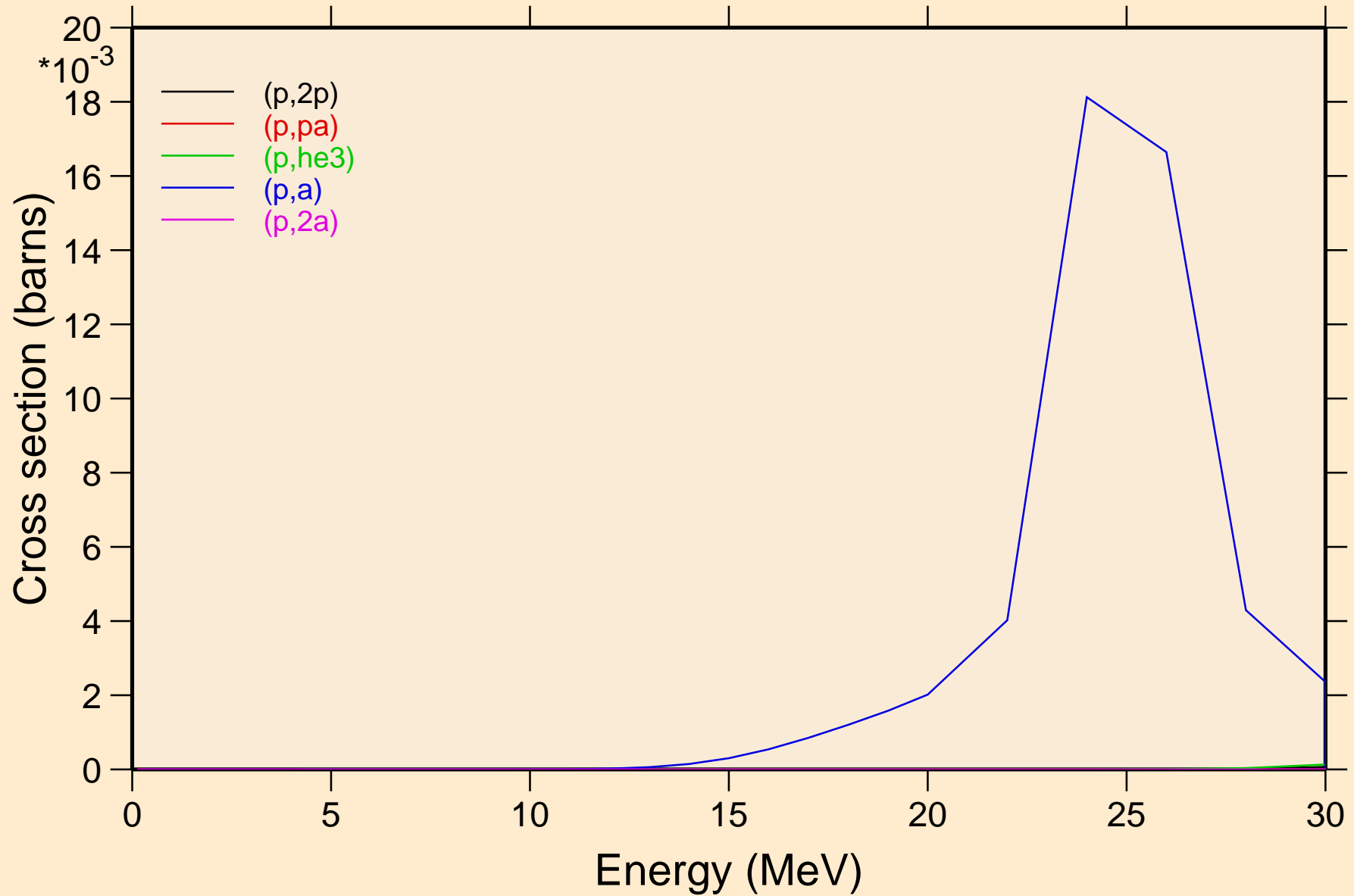



U233 PROTON ACER TENDL-2021 LIBRARY; T=0.K  
Threshold reactions

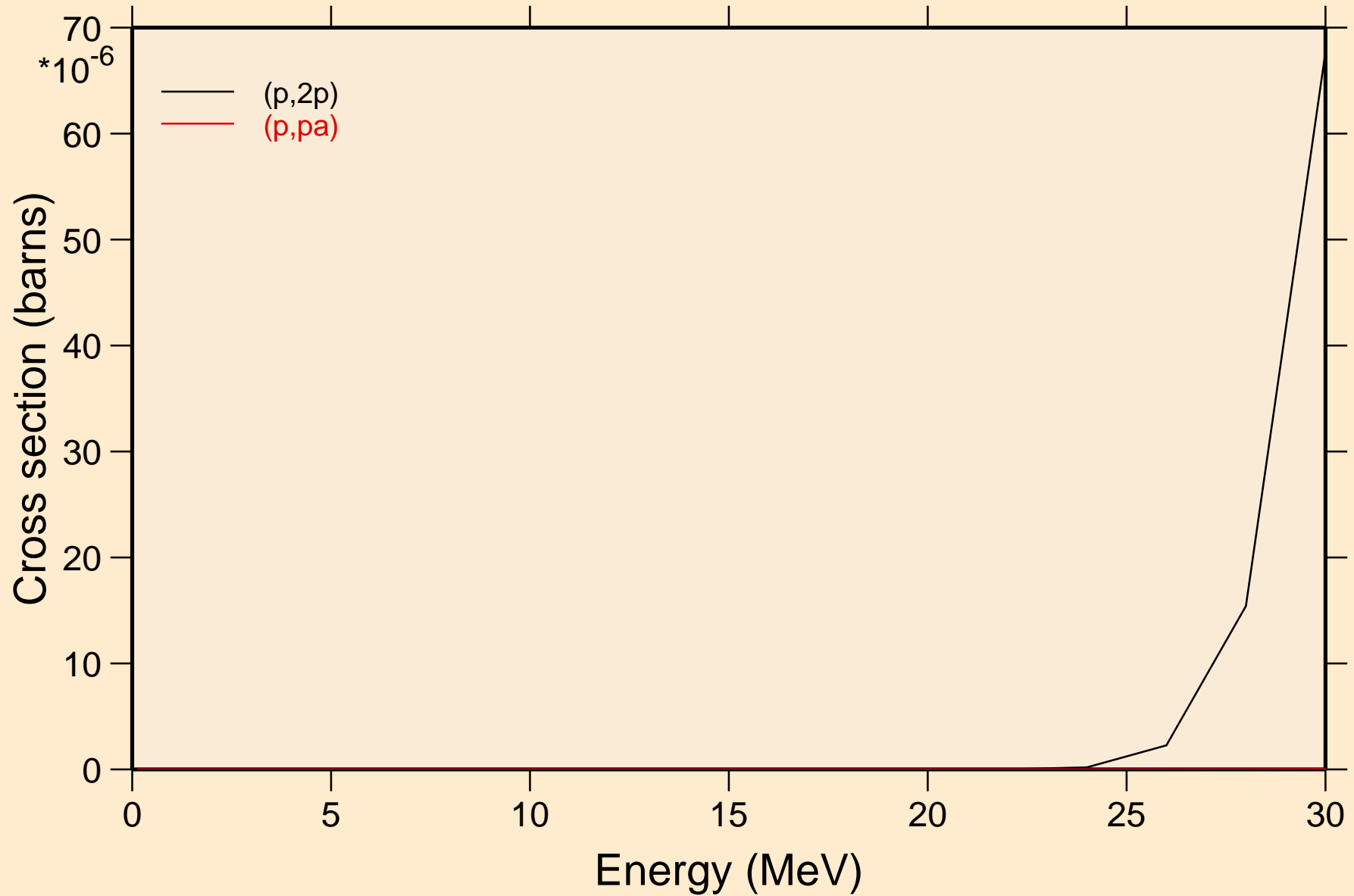

U233 PROTON ACER TENDL-2021 LIBRARY; T=0.K  
angular distribution for elastic

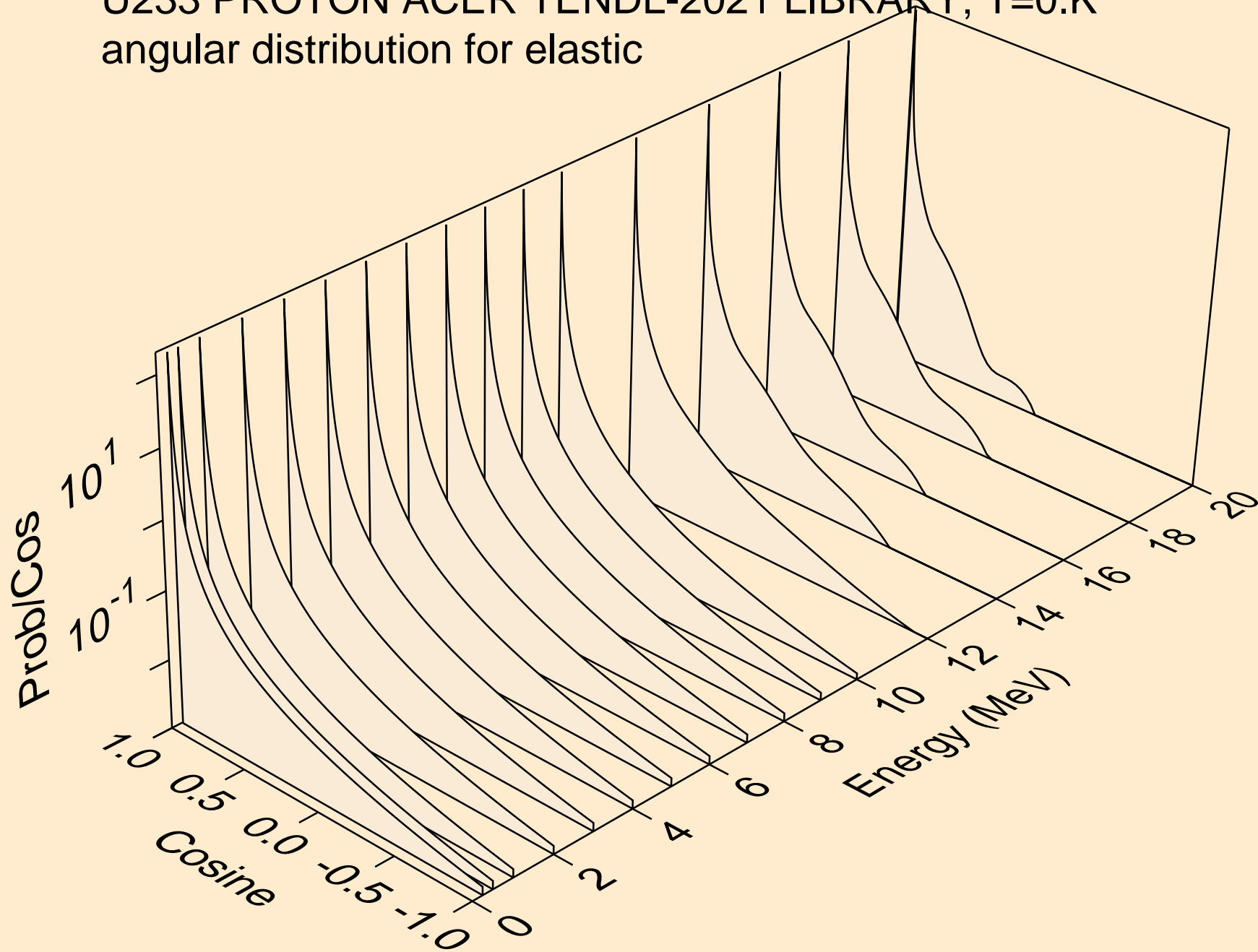

U233 PROTON ACER TENDL-2021 LIBRARY; T=0.K  
angular distribution for elastic

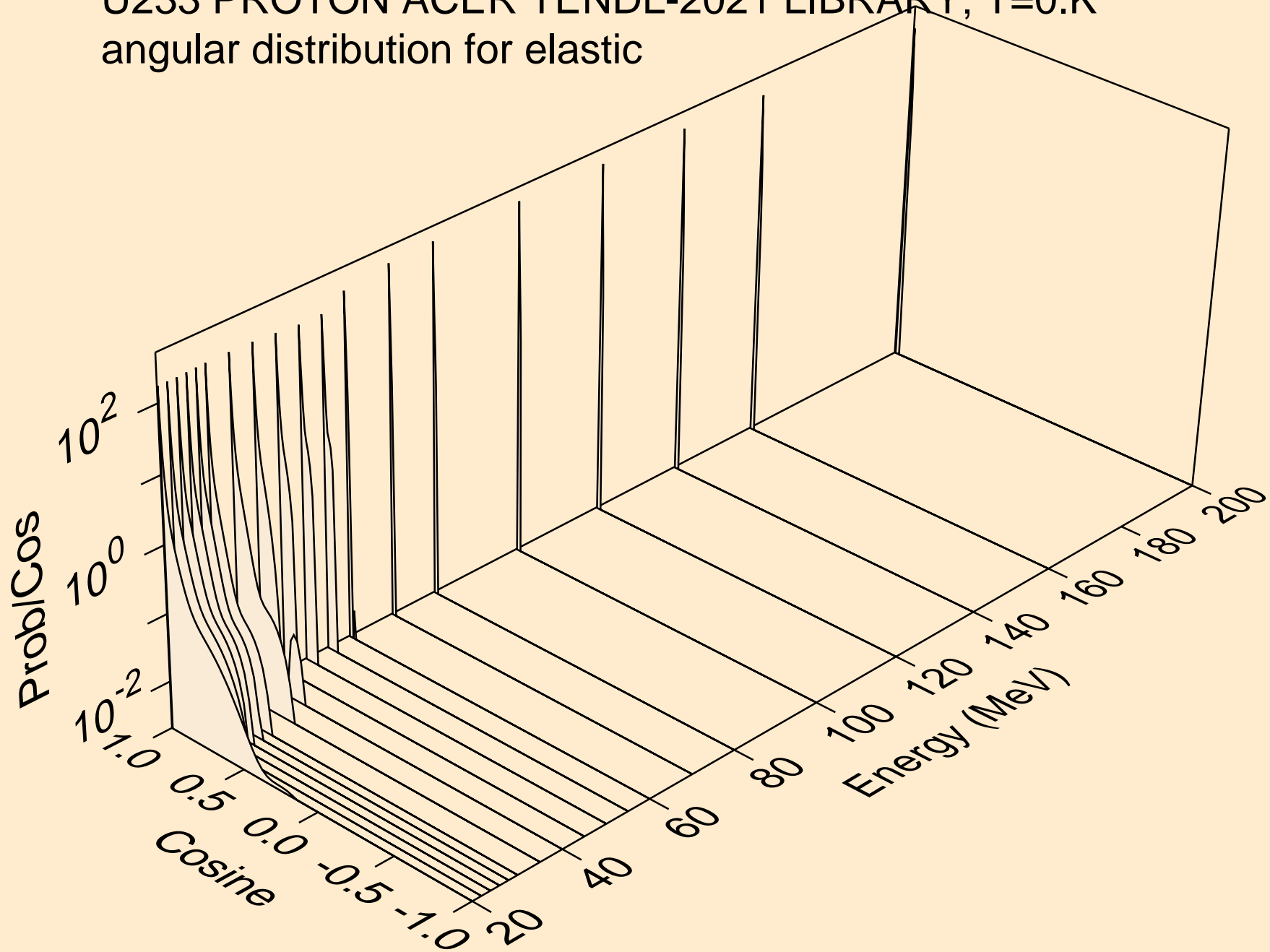

U233 PROTON ACER TENDL-2021 LIBRARY; T=0.K  
Proton emission for (p,x)

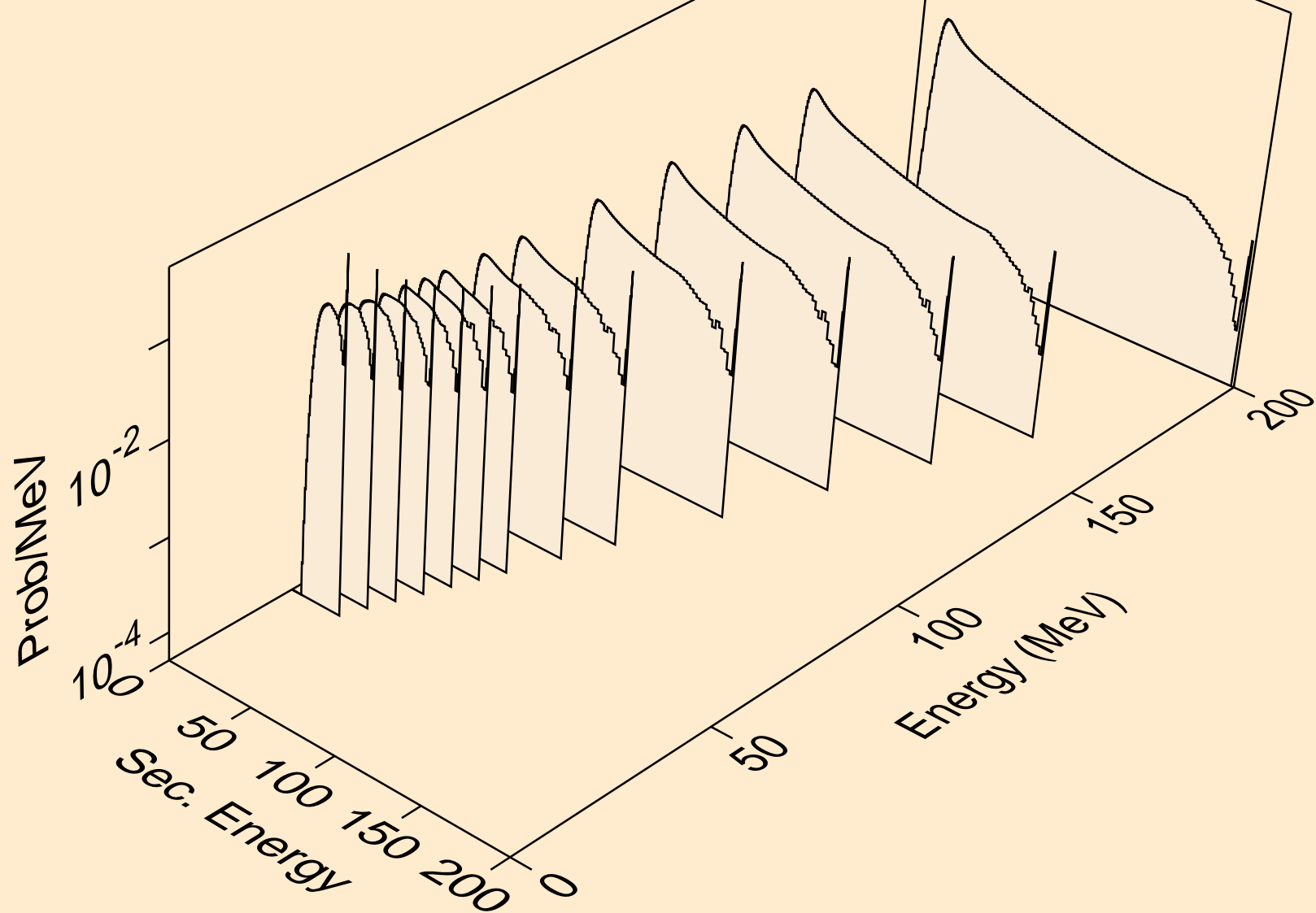

U233 PROTON ACER TENDL-2021 LIBRARY; T=0.K  
Proton emission for (p,n\*)p

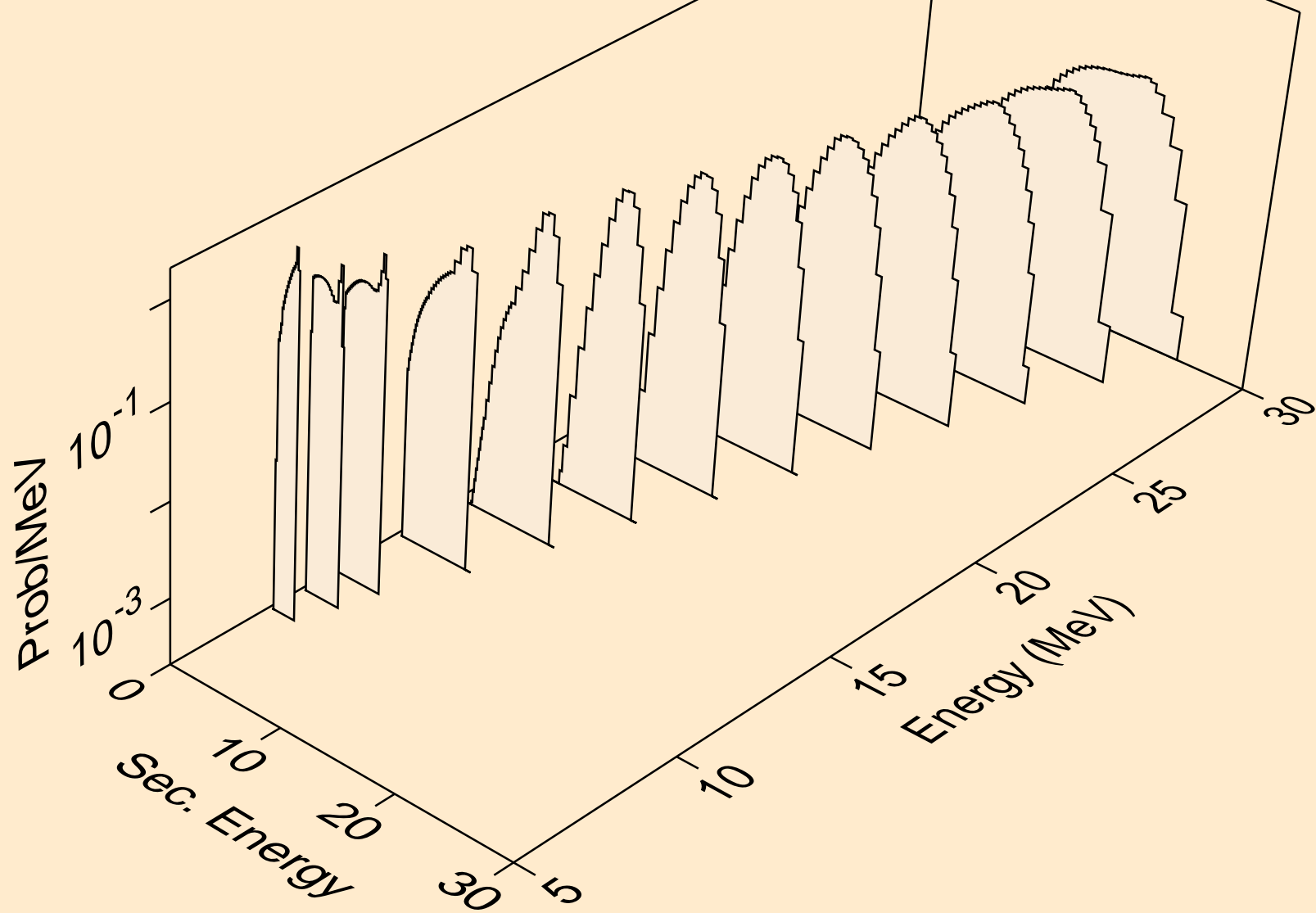

U233 PROTON ACER TENDL-2021 LIBRARY; T=0.K  
Proton emission for (p,2np)

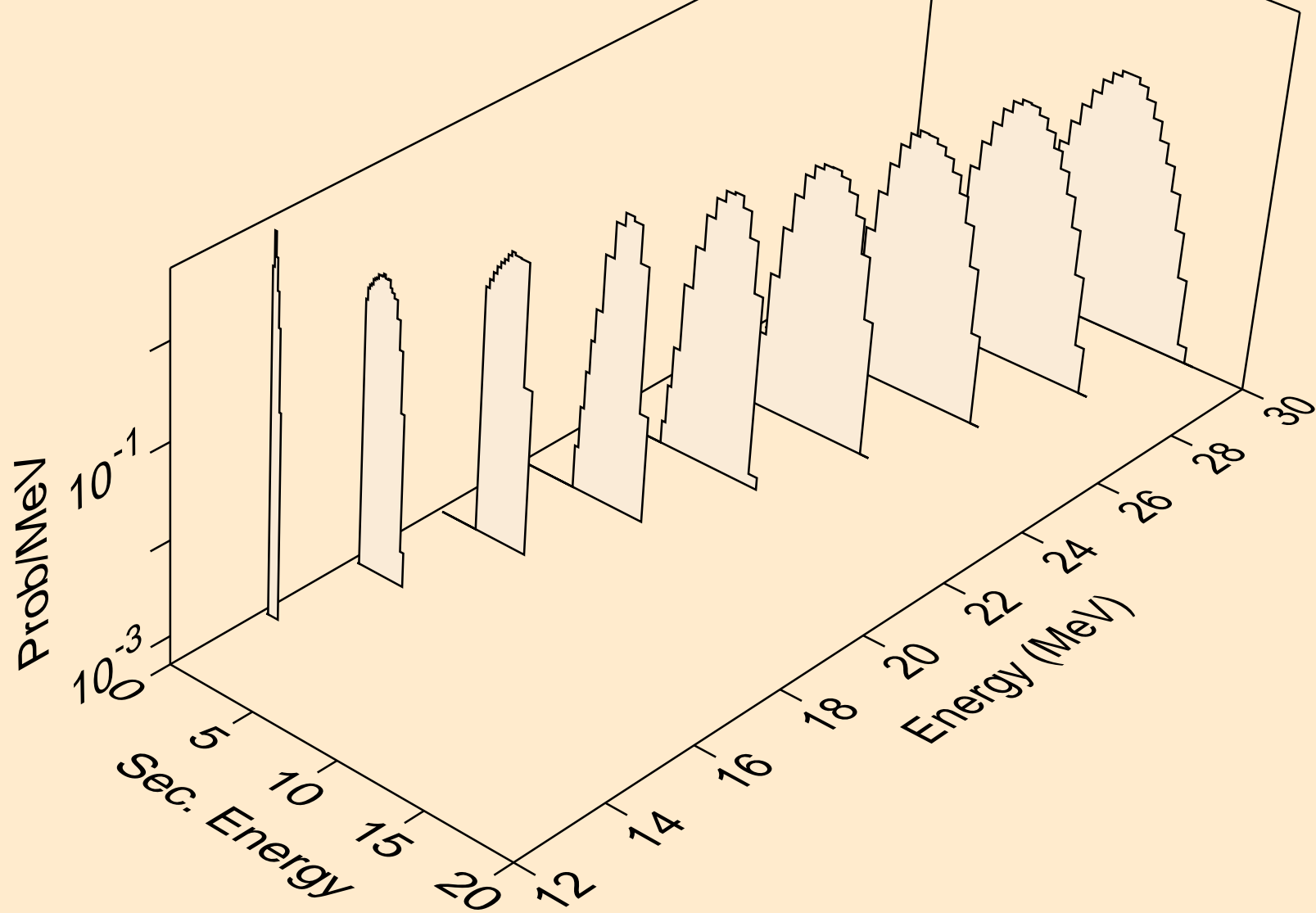

U233 PROTON ACER TENDL-2021 LIBRARY; T=0.K  
Proton emission for (p,3np)

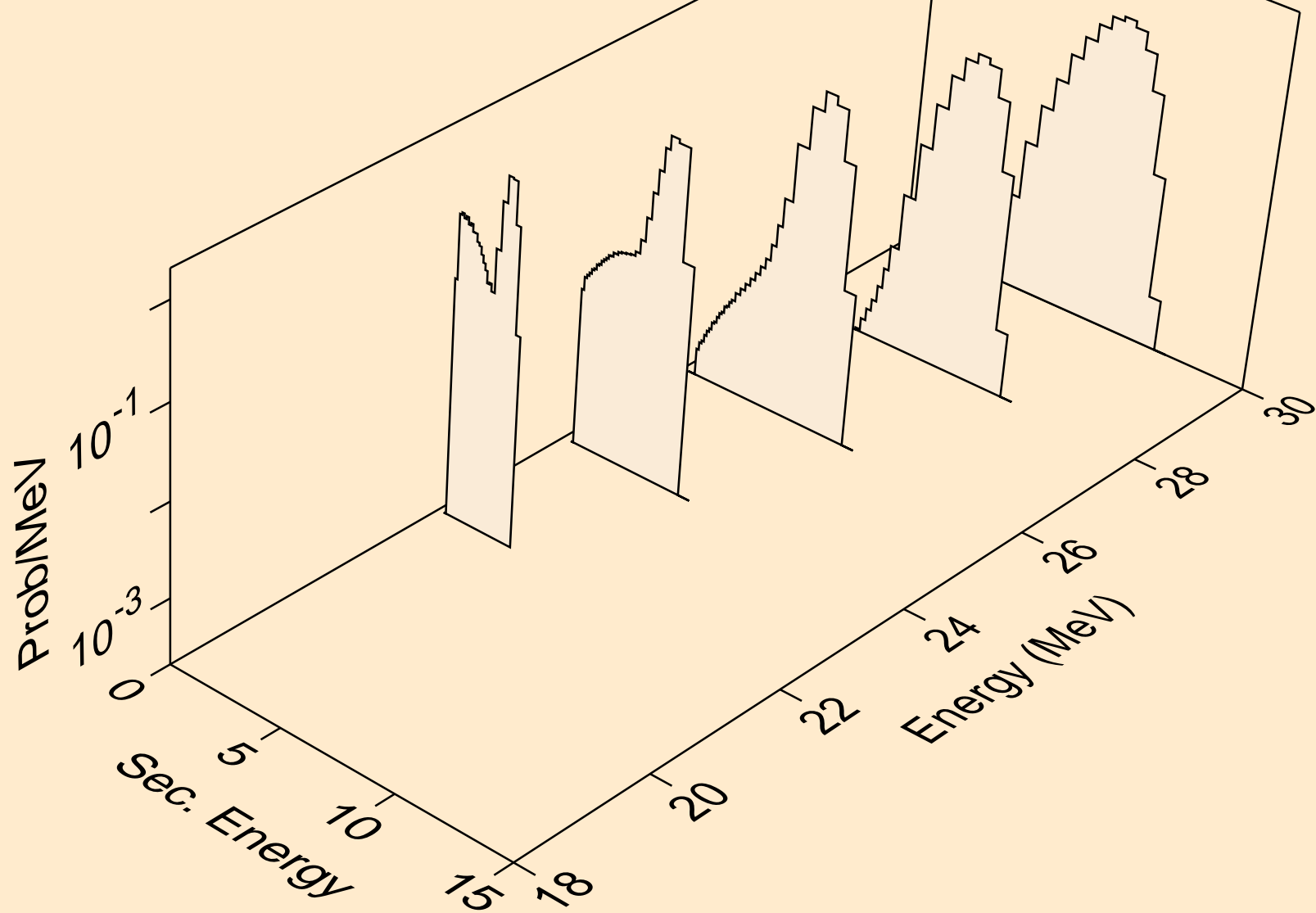

U233 PROTON ACER TENDL-2021 LIBRARY; T=0.K  
Proton emission for (p,2np)

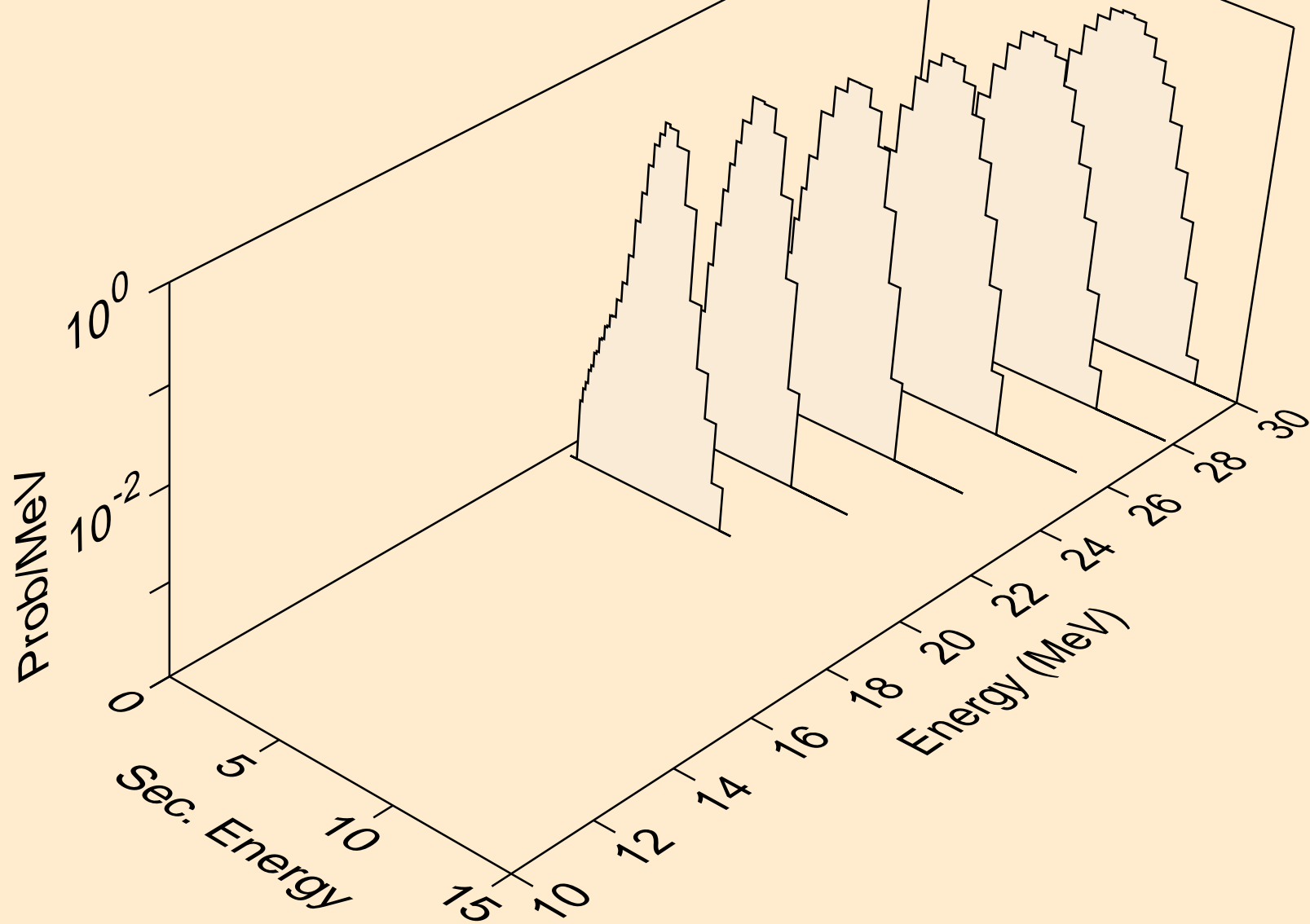



U233 PROTON ACER TENDL-2021 LIBRARY; T=0.K  
Proton emission for (p,npa)

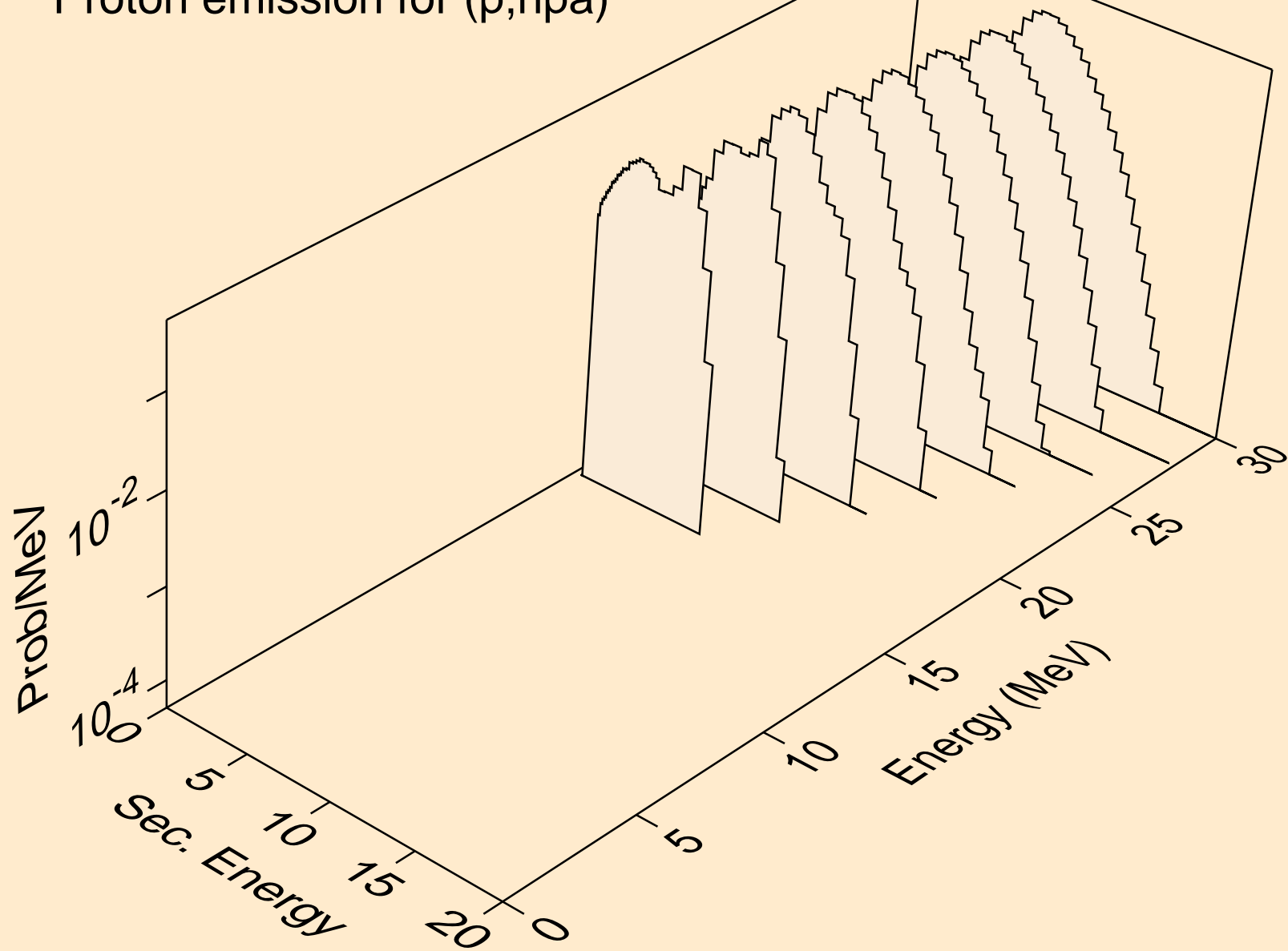

U233 PROTON ACER TENDL-2021 LIBRARY; T=0.K  
Proton emission for inelastic

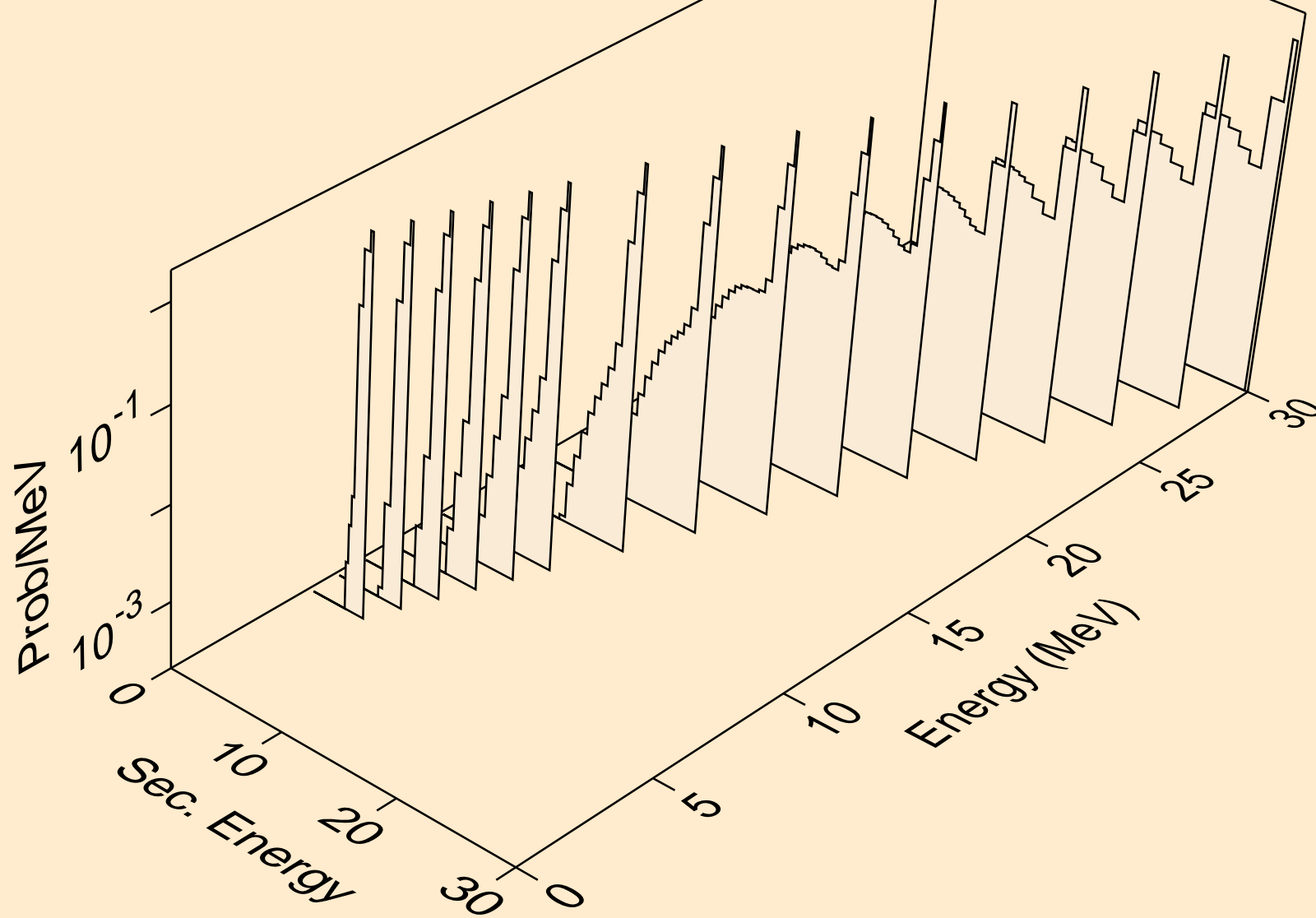

U233 PROTON ACER TENDL-2021 LIBRARY; T=0.K  
Proton emission for (p,2p)

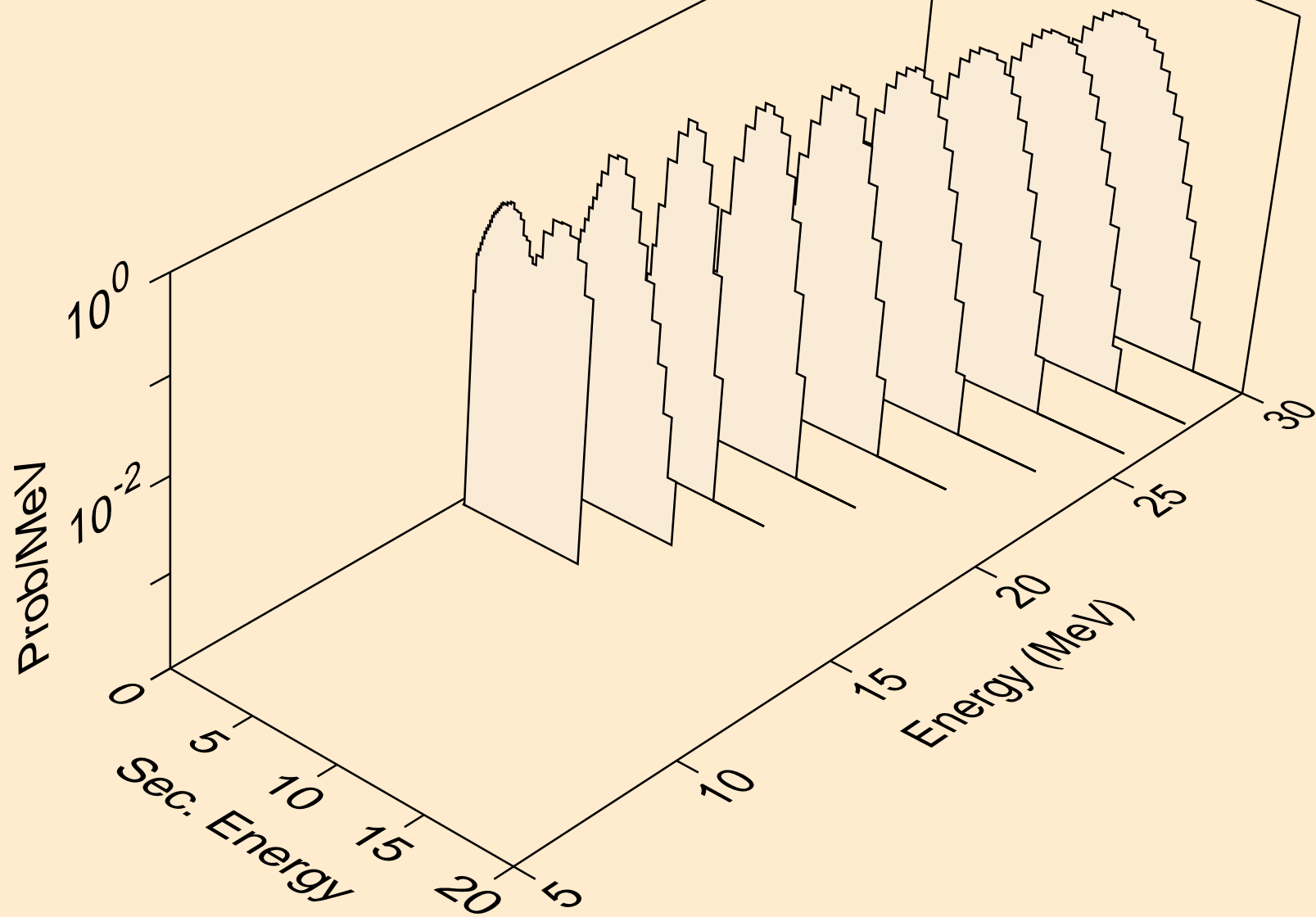

U233 PROTON ACER TENDL-2021 LIBRARY; T=0.K  
Proton emission for (p,pa)

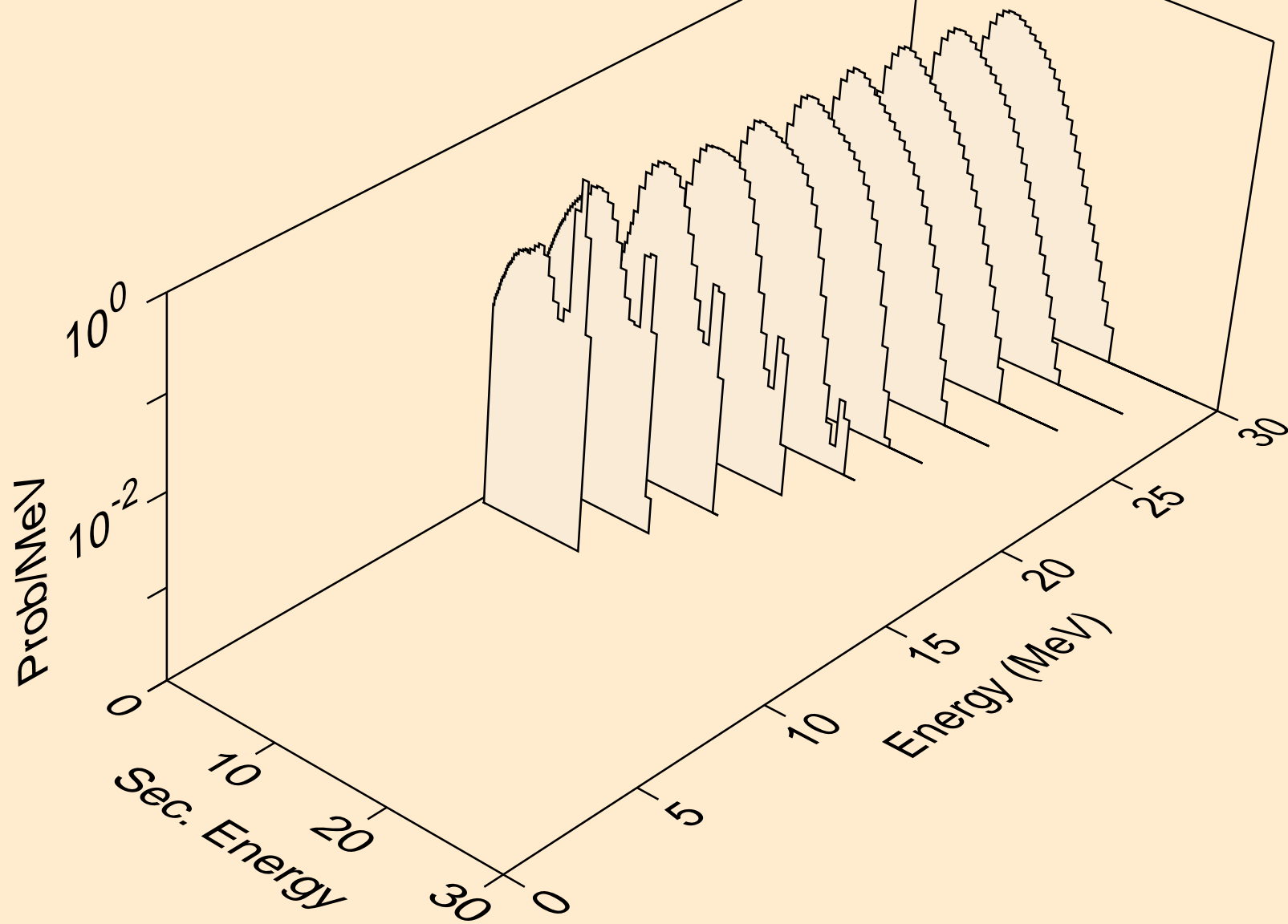

U233 PROTON ACER TENDL-2021 LIBRARY; T=0.K  
Photon emission for (z,n)

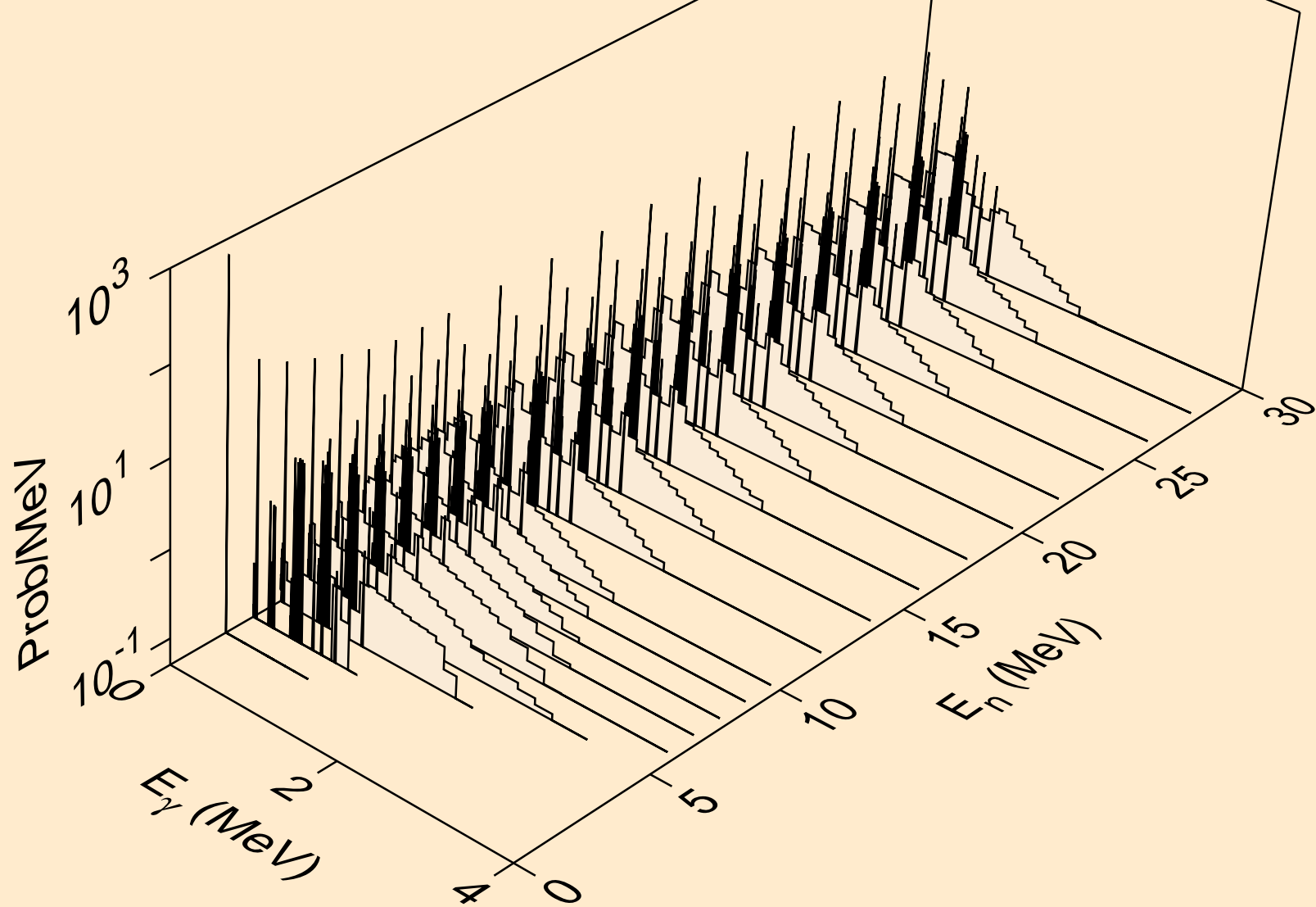

U233 PROTON ACER TENDL-2021 LIBRARY; T=0.K  
Photon emission for (n,x)

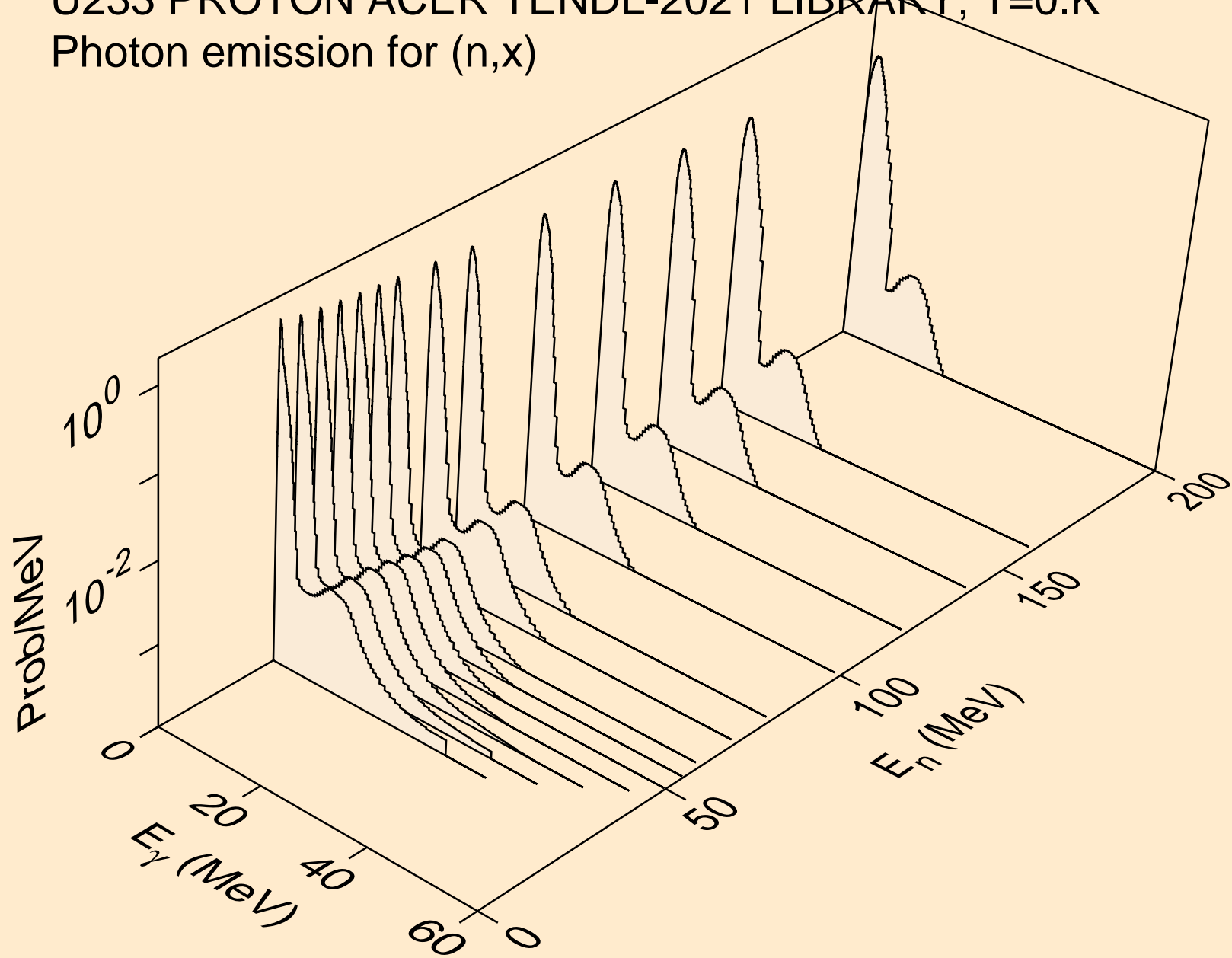

U233 PROTON ACER TENDL-2021 LIBRARY; T=0.K  
Photon emission for (n,2nd)

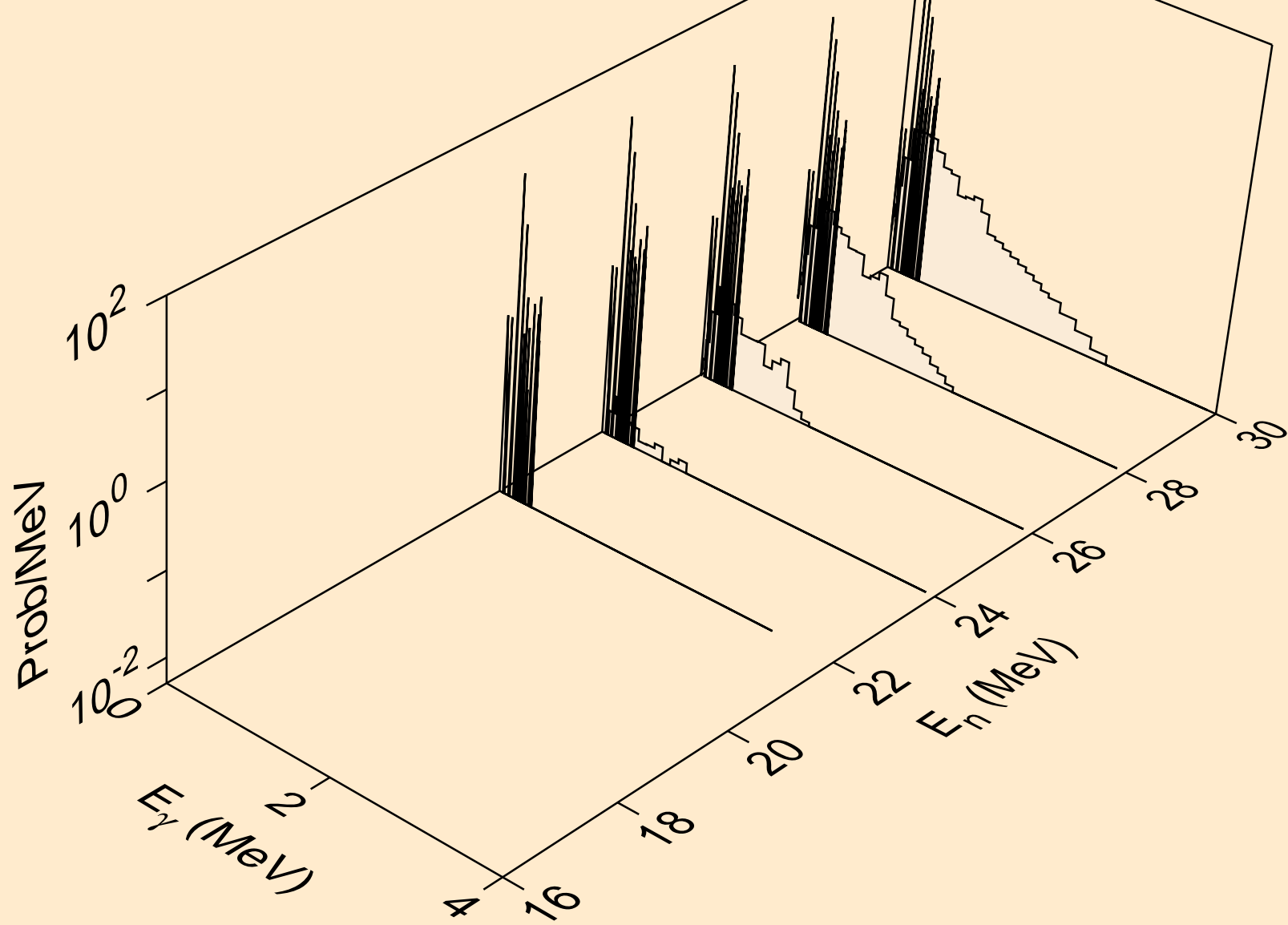

U233 PROTON ACER TENDL-2021 LIBRARY; T=0.K  
Photon emission for (n,2n)

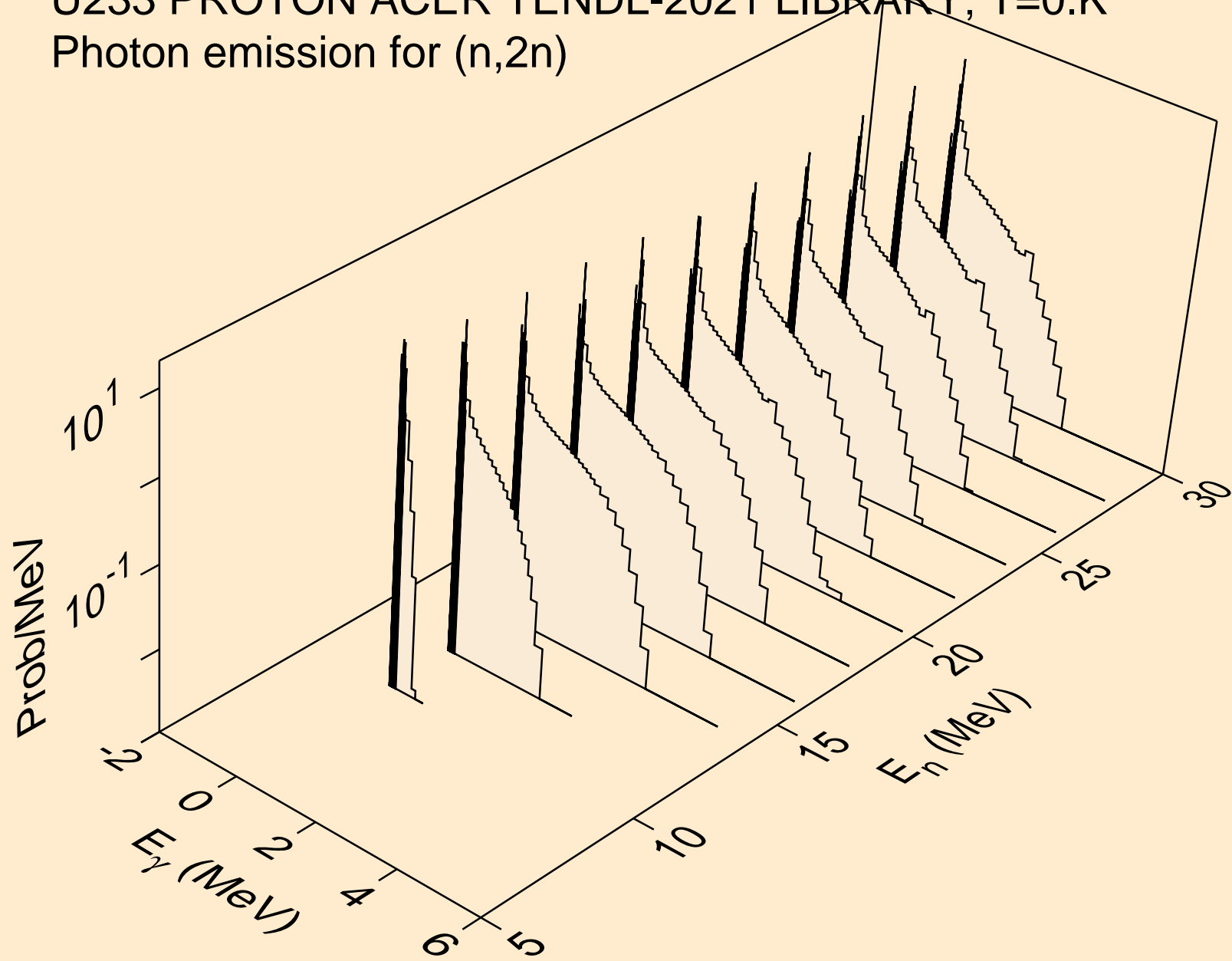



U233 PROTON ACER TENDL-2021 LIBRARY; T=0.K  
Photon emission for (n,3n)

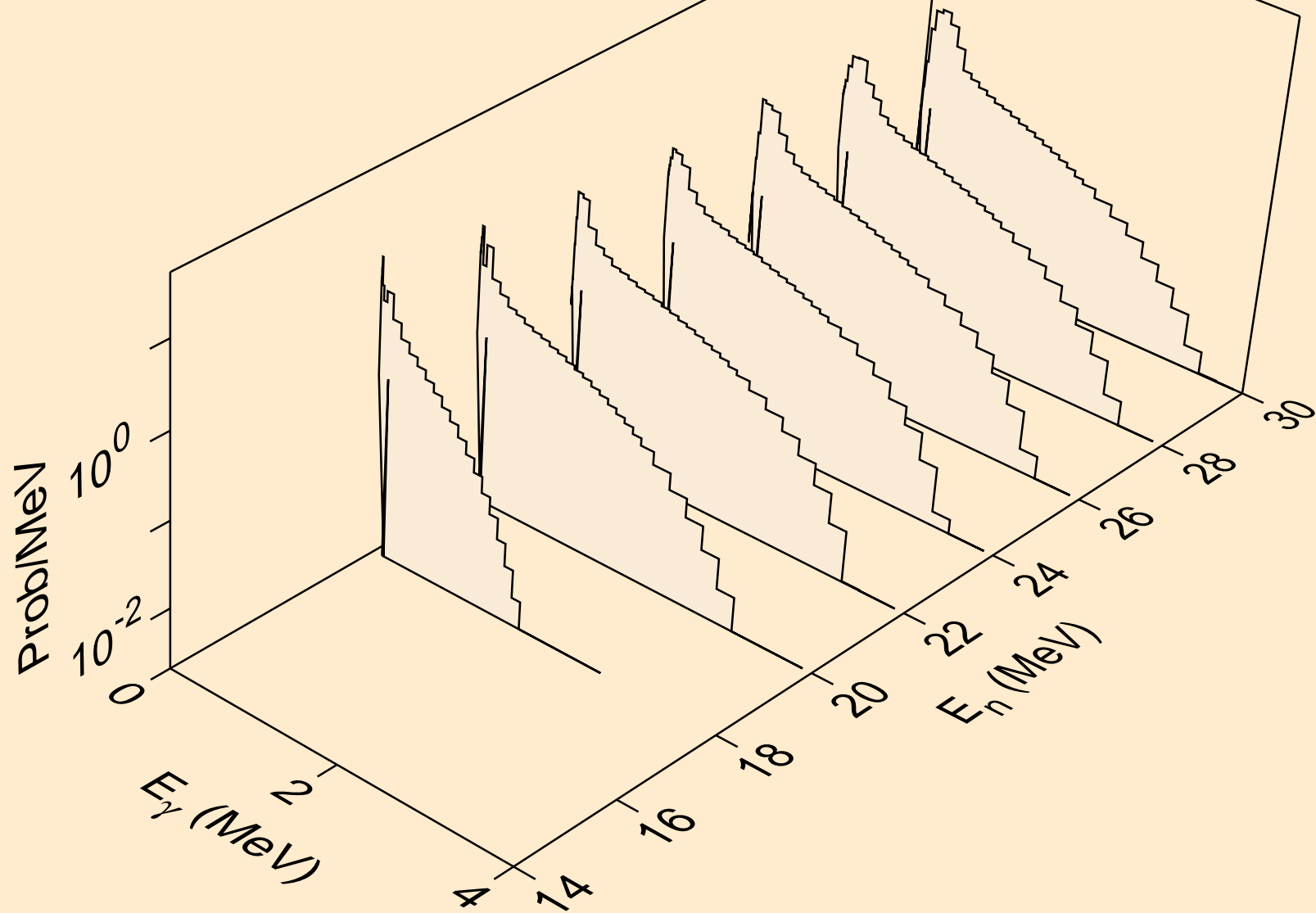

U233 PROTON ACER TENDL-2021 LIBRARY; T=0.K  
Photon emission for (n,n\*)a

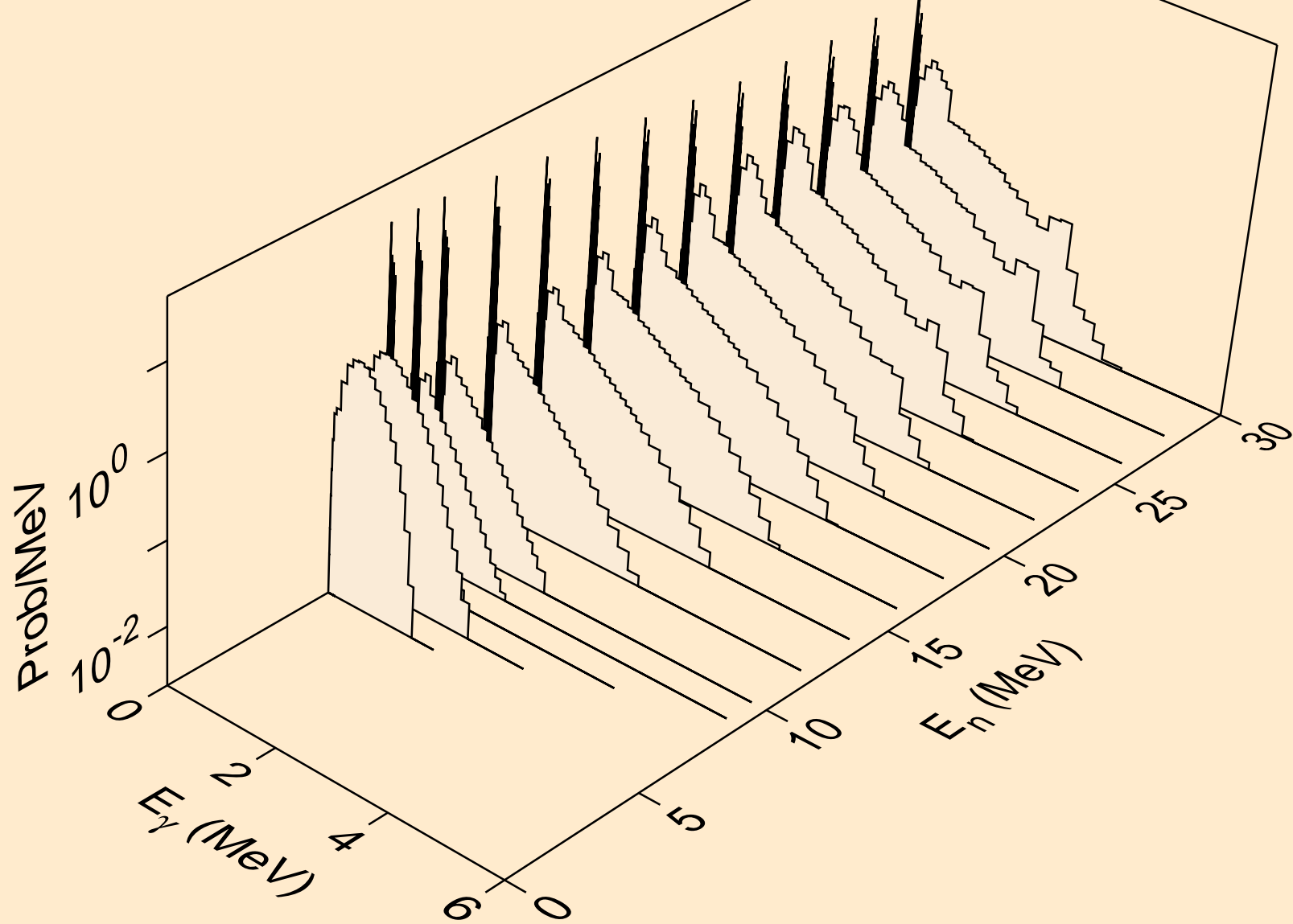

U233 PROTON ACER TENDL-2021 LIBRARY; T=0.K  
Photon emission for (n,2n) $\alpha$

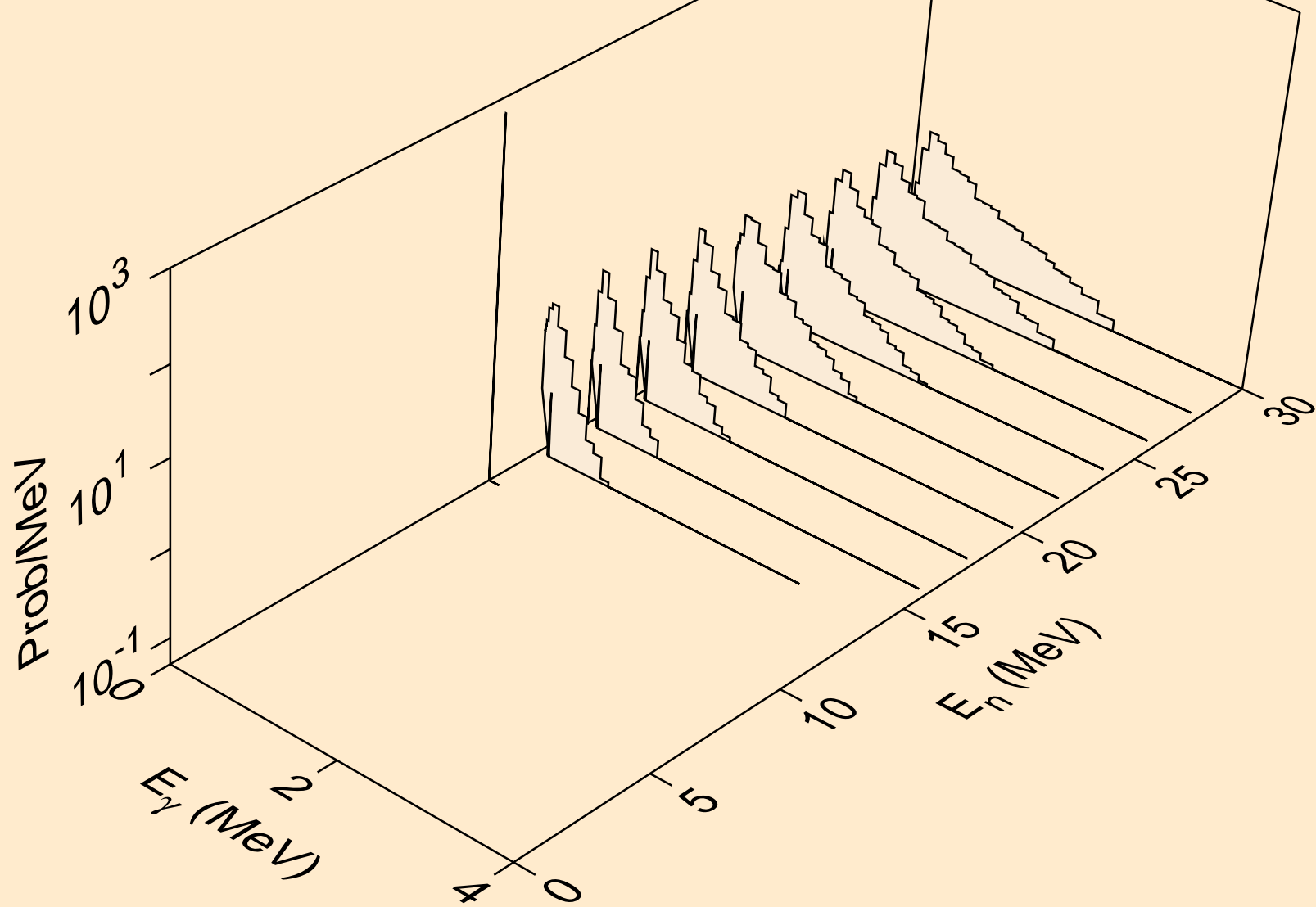

U233 PROTON ACER TENDL-2021 LIBRARY; T=0.K  
Photon emission for (n,3n)a

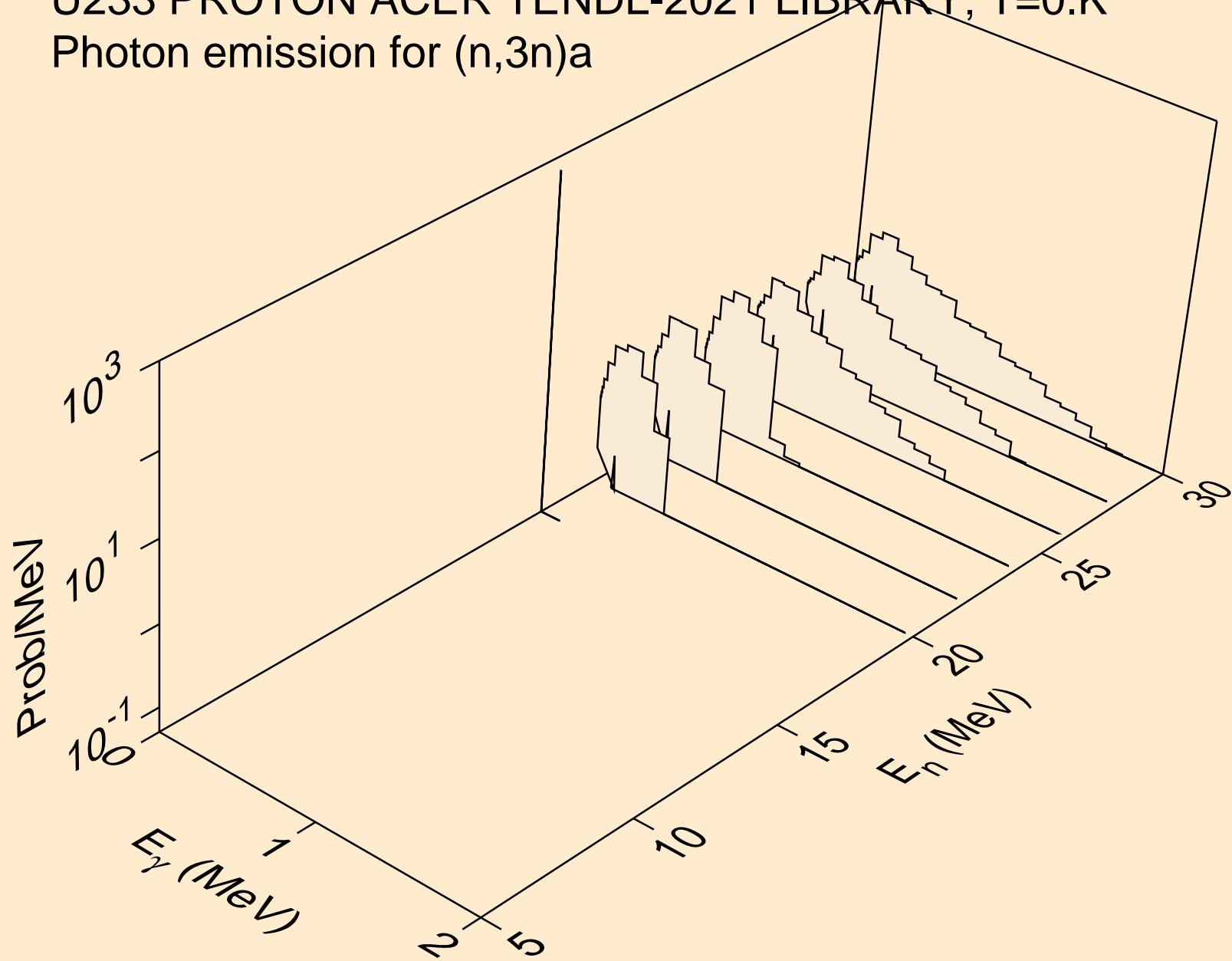

U233 PROTON ACER TENDL-2021 LIBRARY; T=0.K  
Photon emission for (n,n\*)p

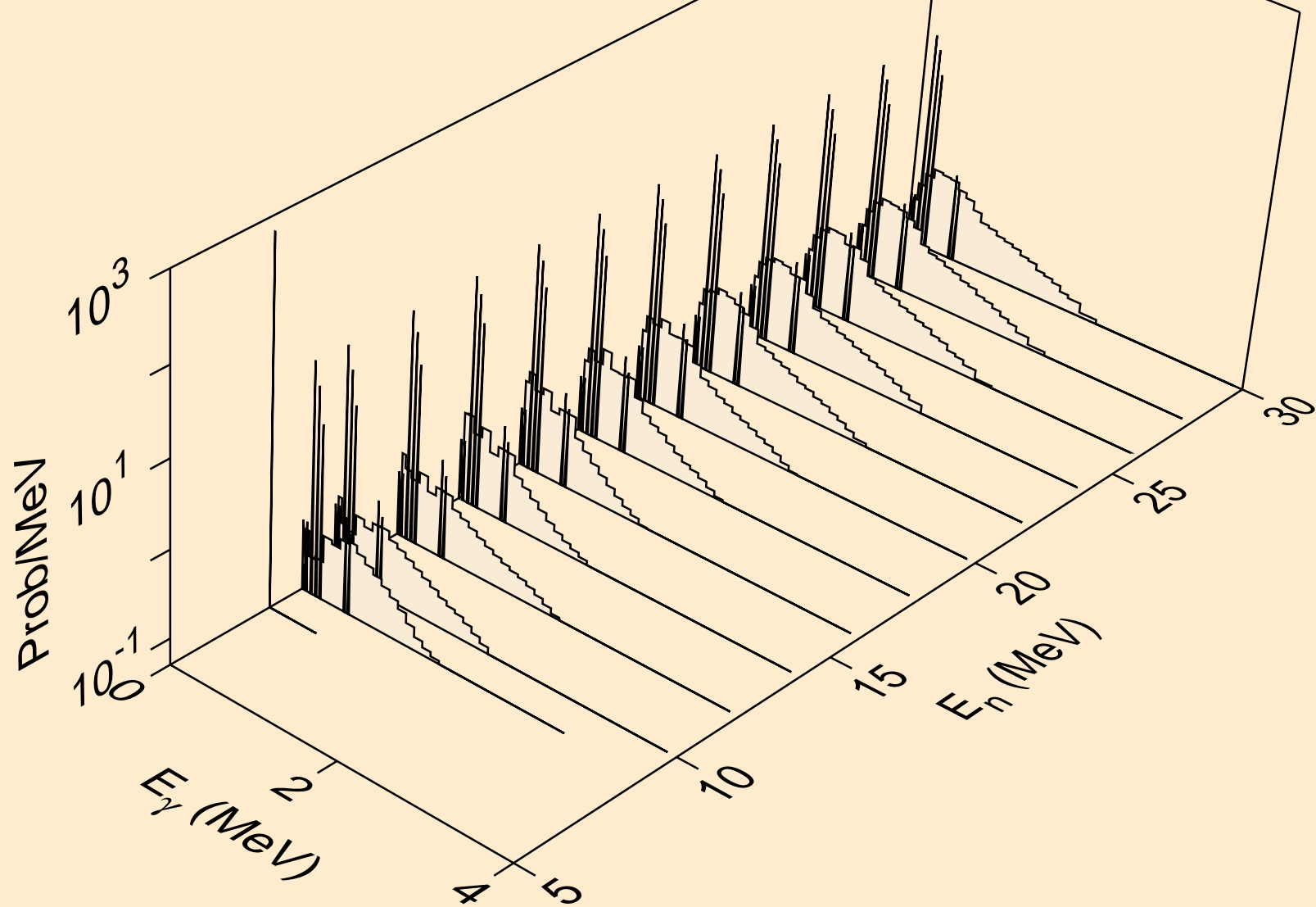

U233 PROTON ACER TENDL-2021 LIBRARY; T=0.K  
Photon emission for (n,n\*)2a

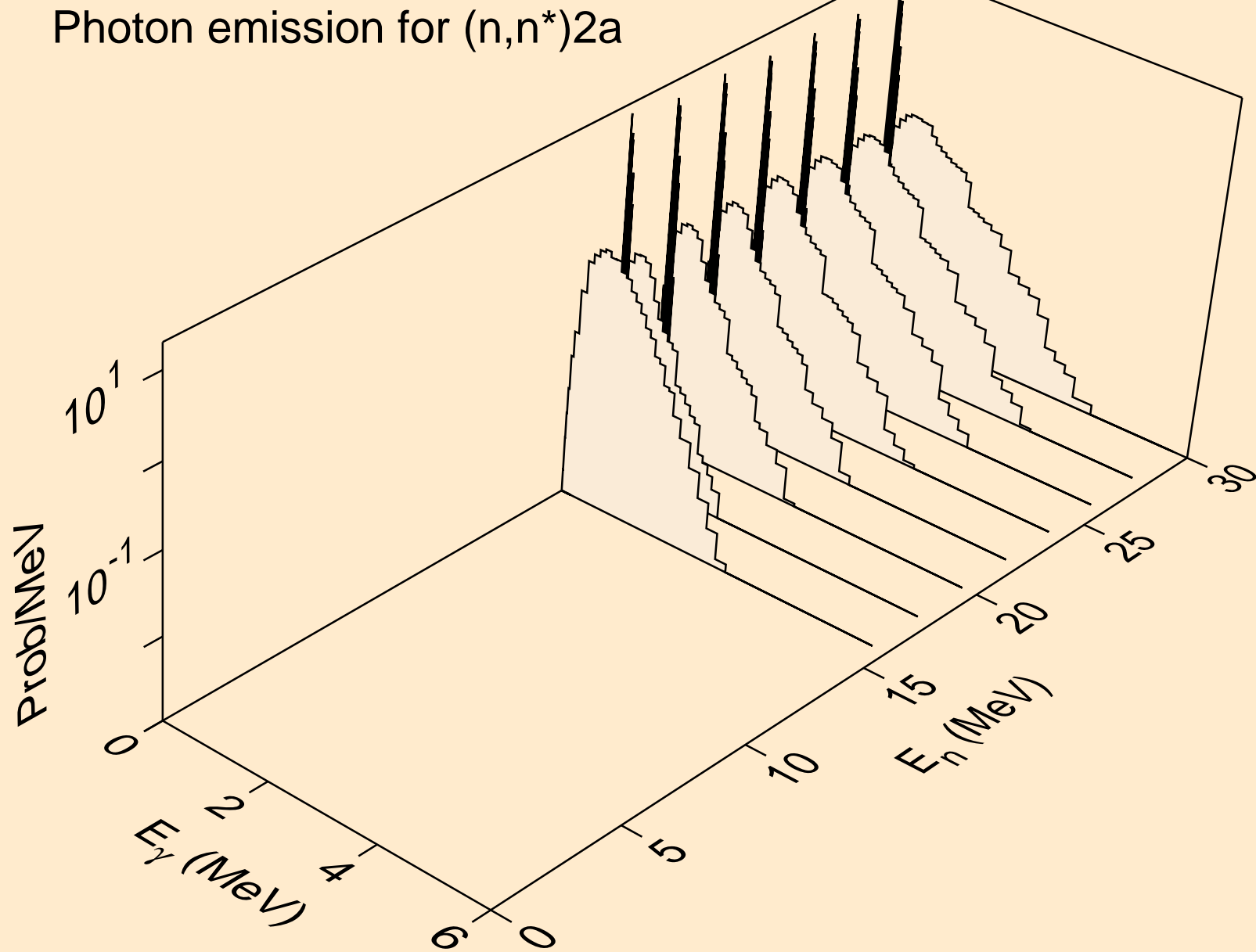

U233 PROTON ACER TENDL-2021 LIBRARY; T=0.K  
Photon emission for (n,n\*)d

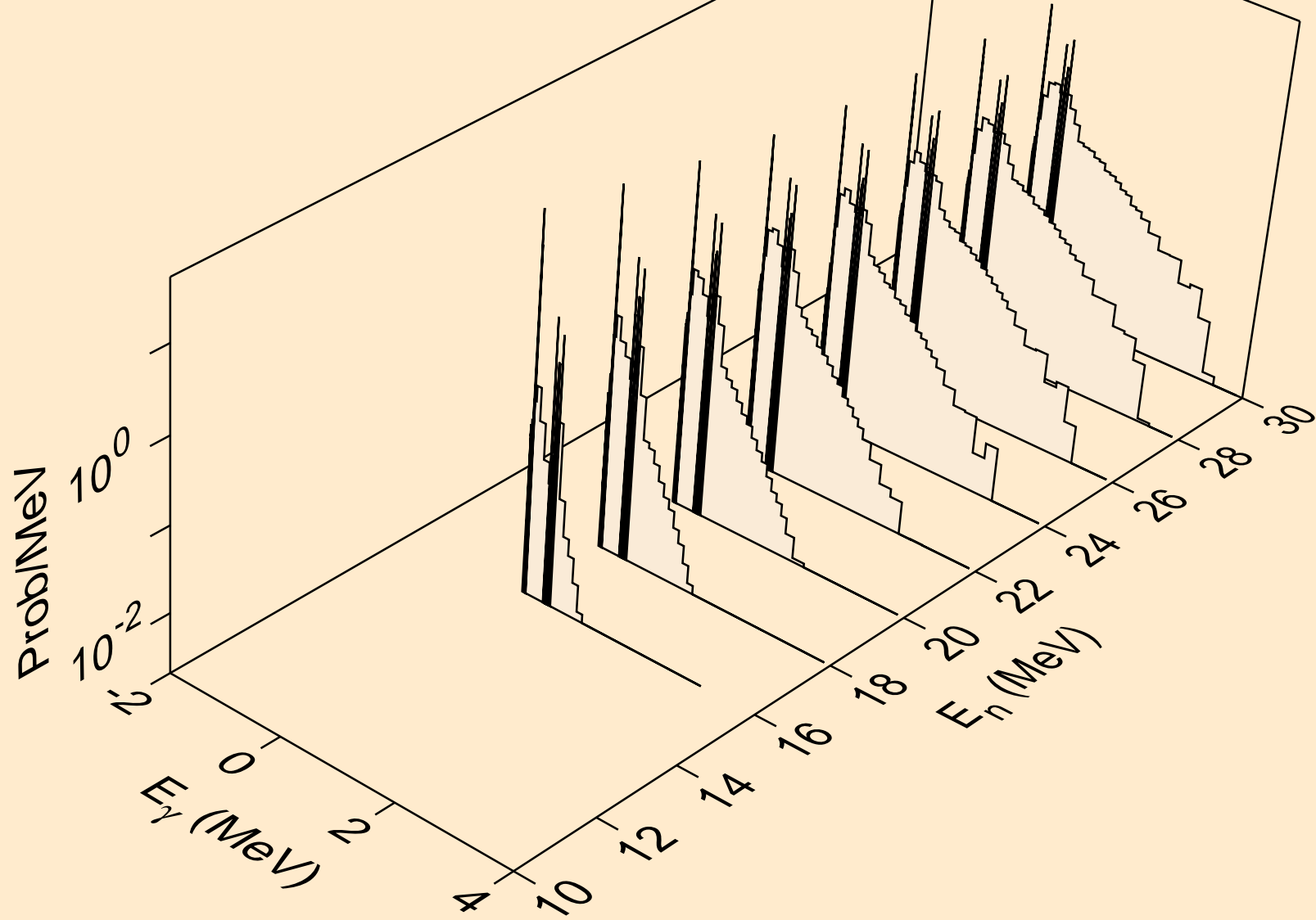

U233 PROTON ACER TENDL-2021 LIBRARY; T=0.K  
Photon emission for (n,n\*)t

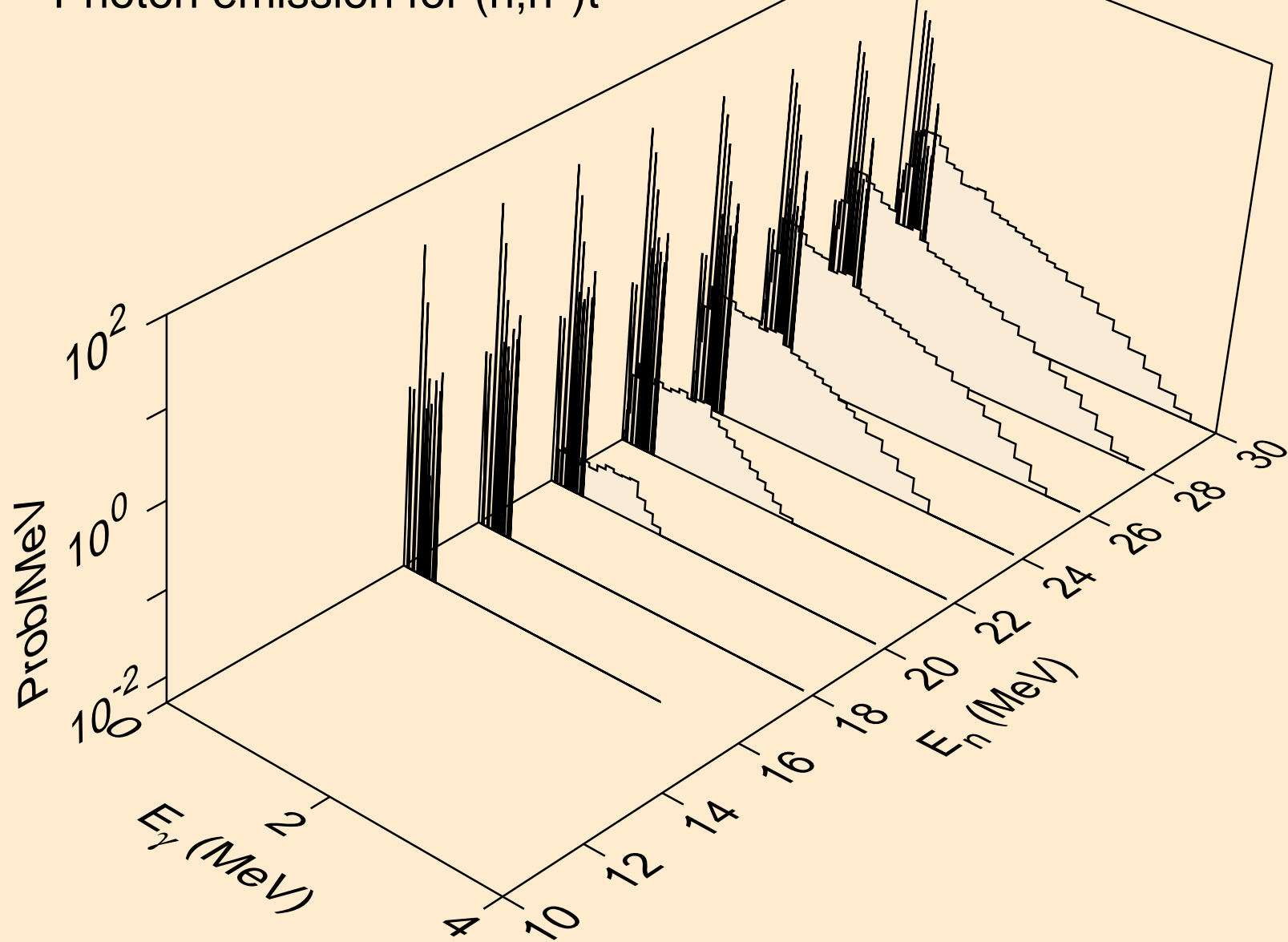



U233 PROTON ACER TENDL-2021 LIBRARY; T=0.K  
Photon emission for (n,n\*)he3

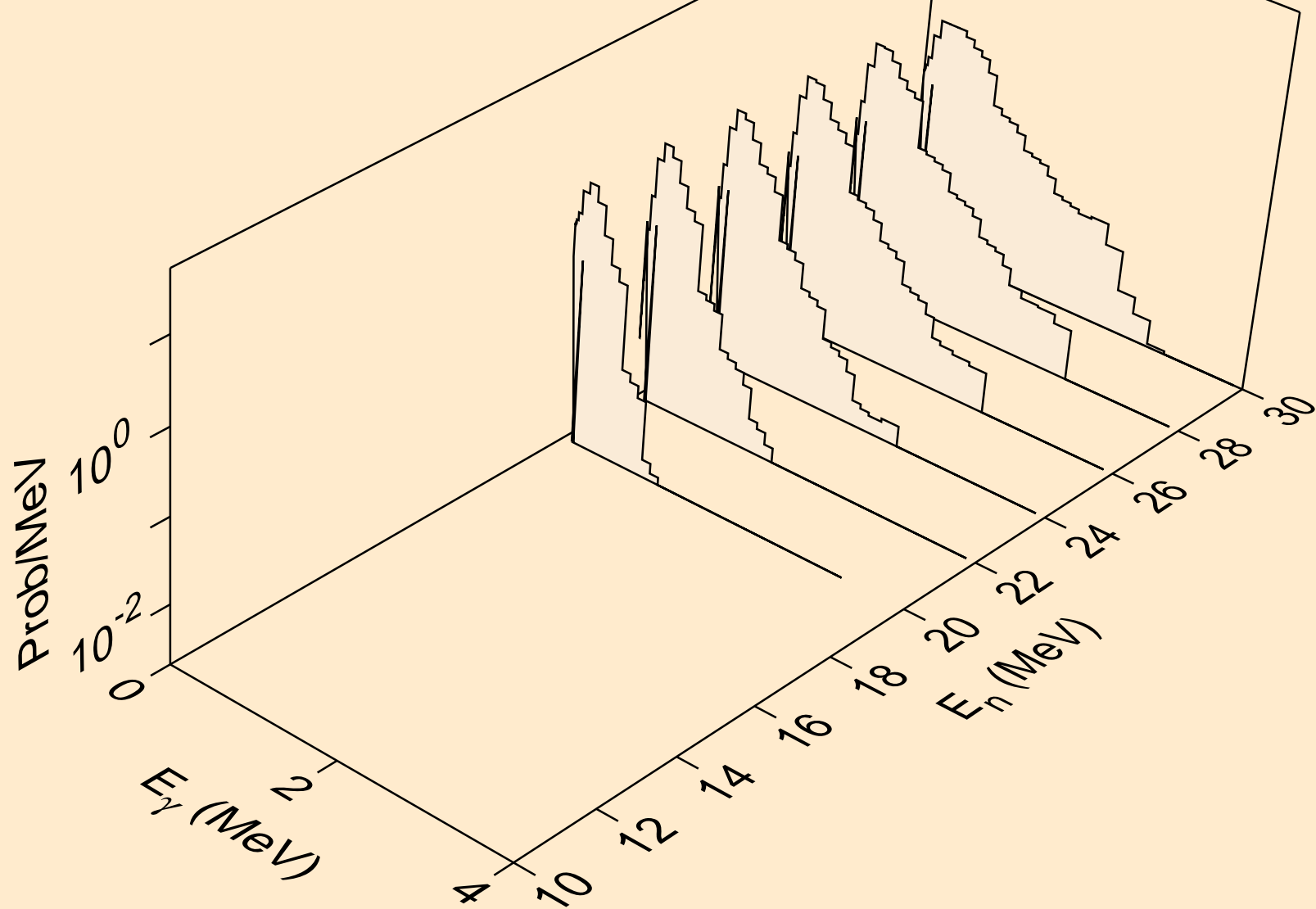

U233 PROTON ACER TENDL-2021 LIBRARY; T=0.K  
Photon emission for (n,4n)

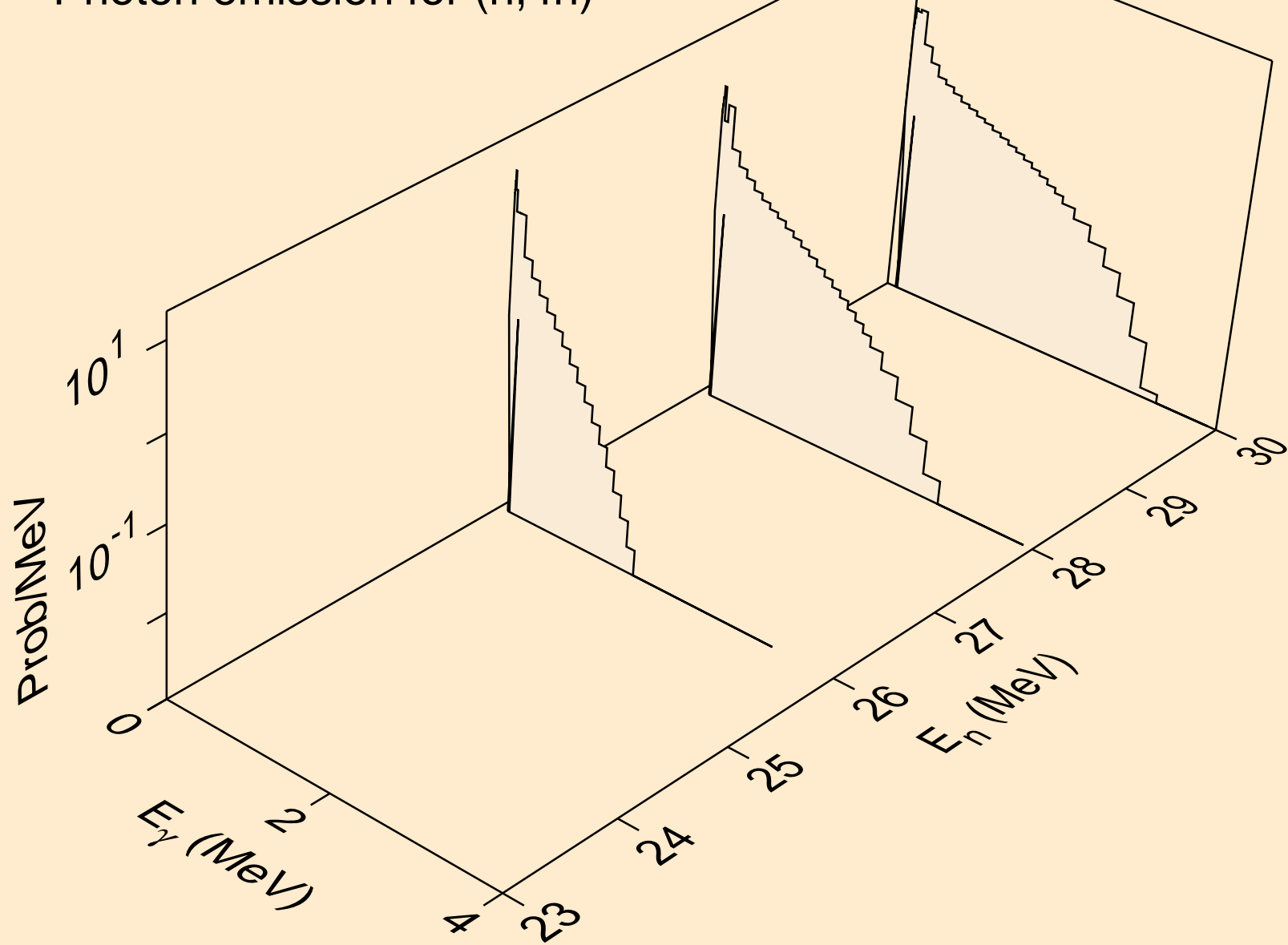

U233 PROTON ACER TENDL-2021 LIBRARY; T=0.K  
Photon emission for (n,2np)

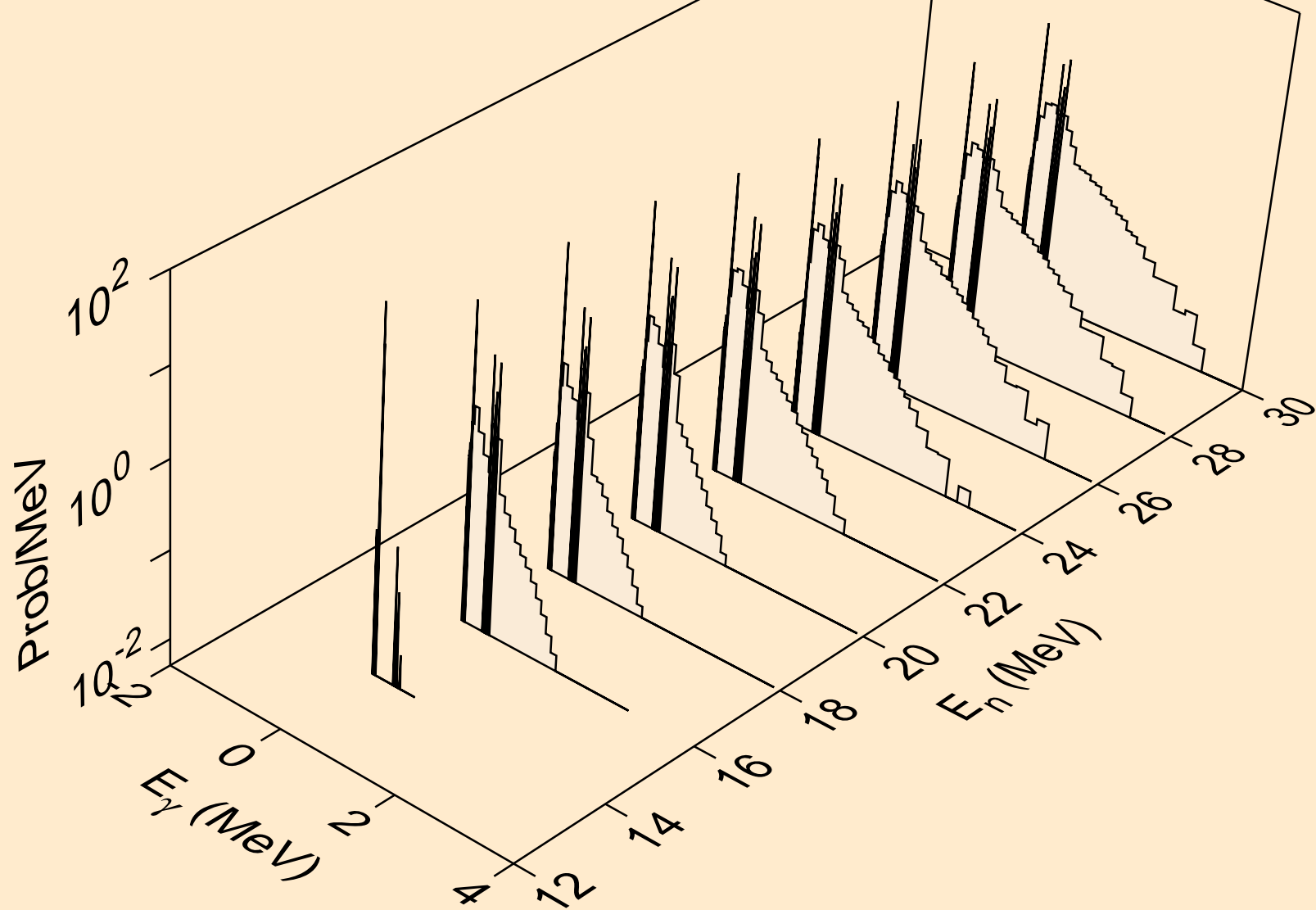

U233 PROTON ACER TENDL-2021 LIBRARY; T=0.K  
Photon emission for (n,3np)

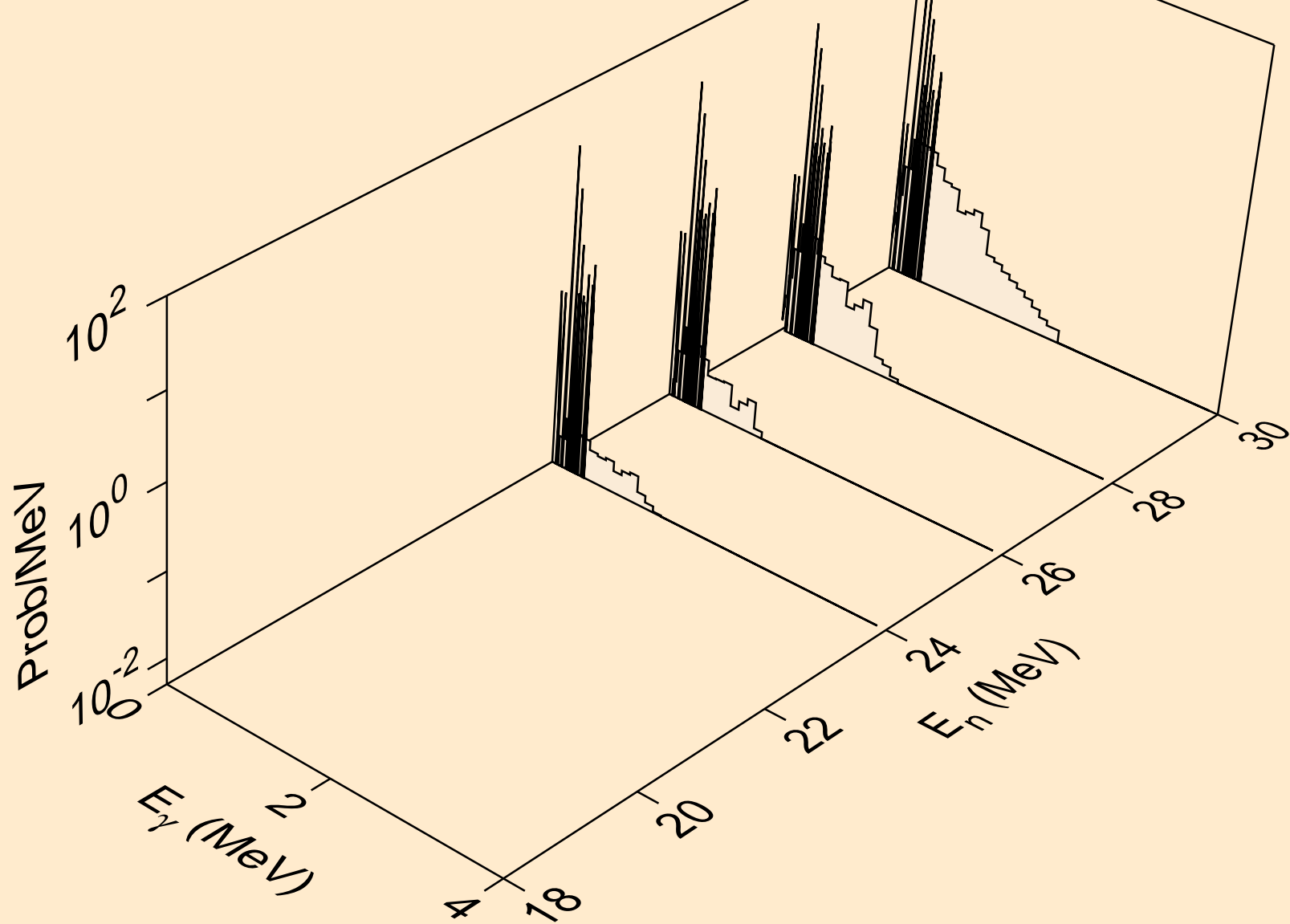

U233 PROTON ACER TENDL-2021 LIBRARY; T=0.K  
Photon emission for (n,2np)

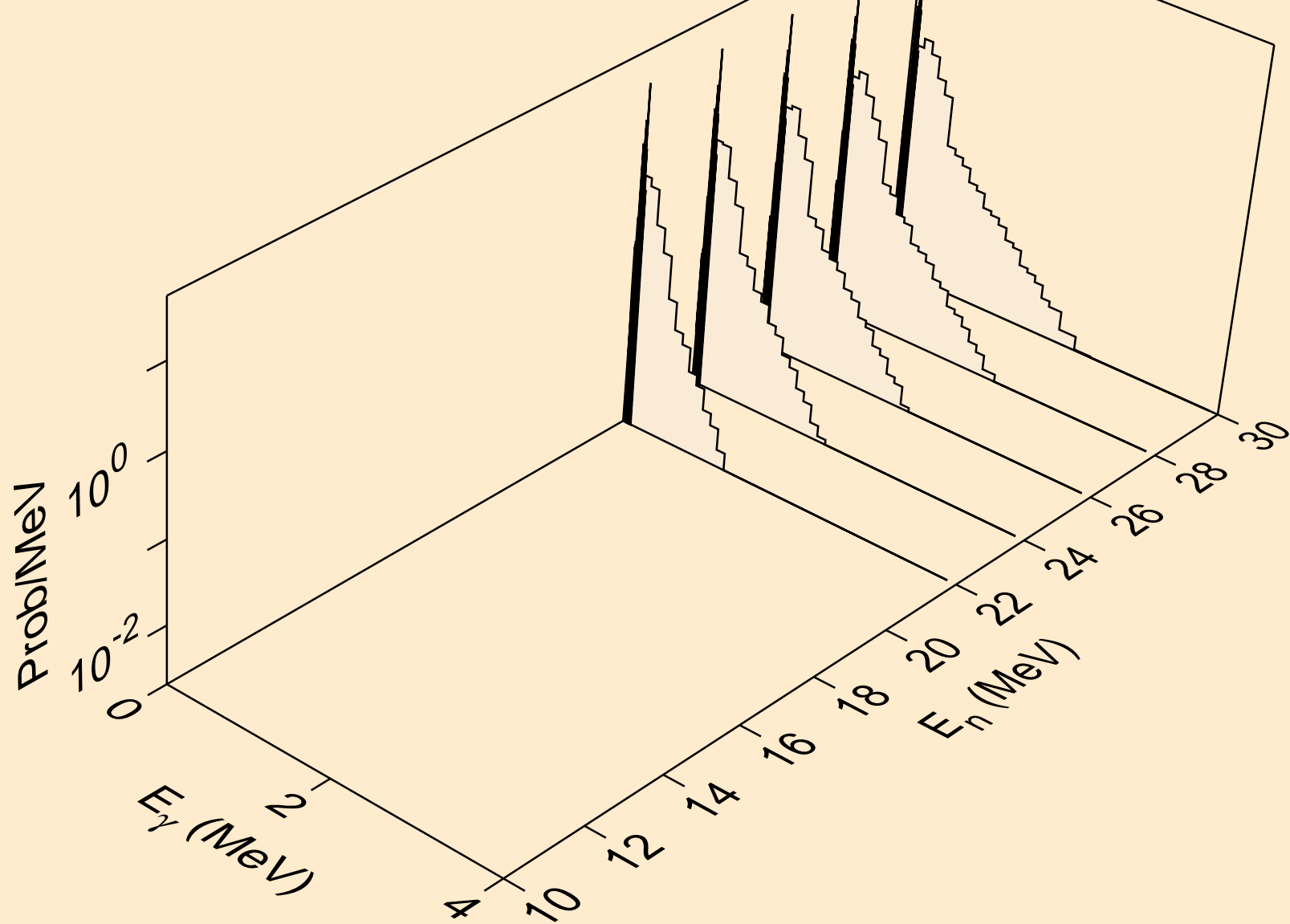

U233 PROTON ACER TENDL-2021 LIBRARY; T=0.K  
Photon emission for (n,npa)

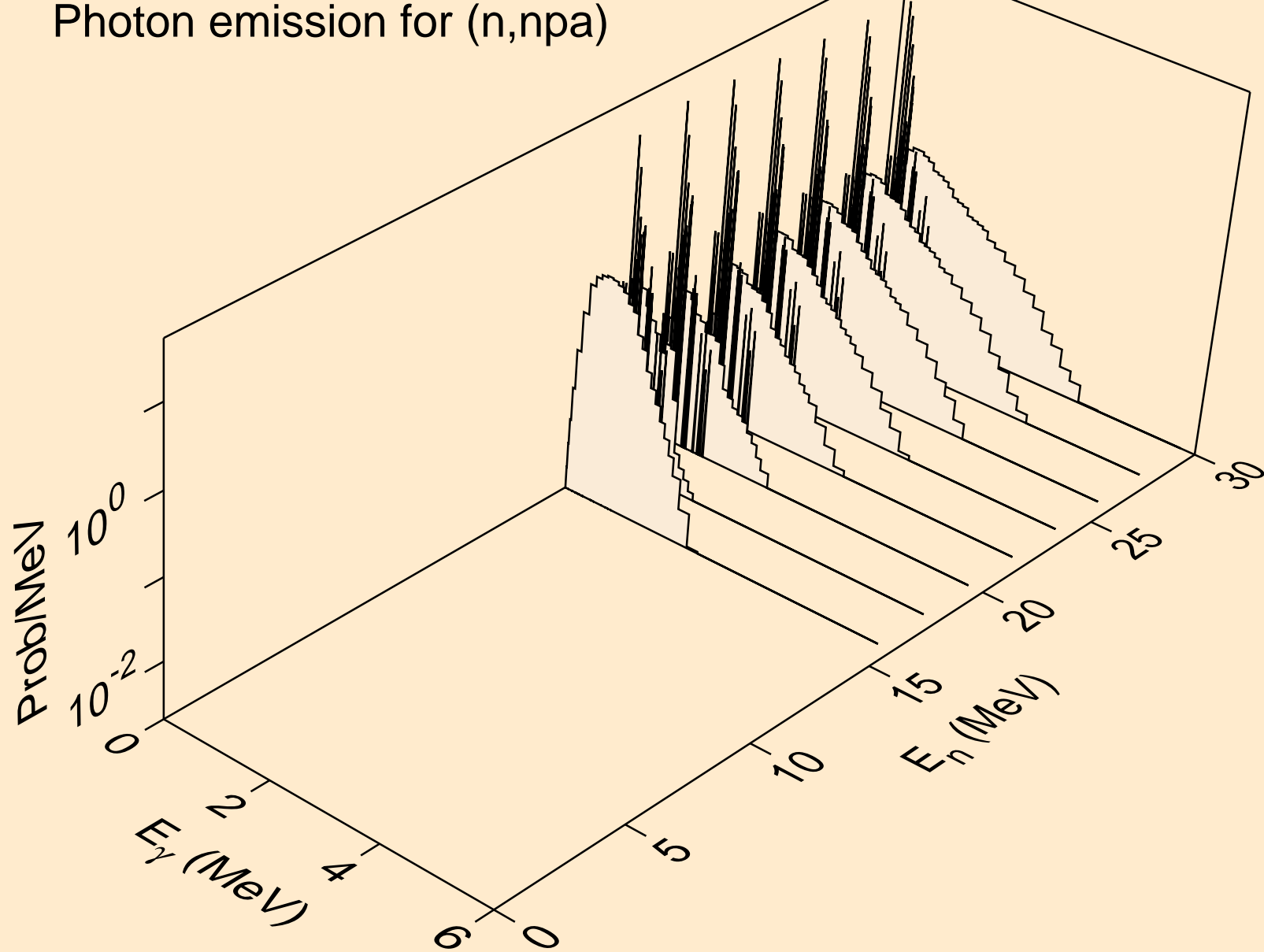

U233 PROTON ACER TENDL-2021 LIBRARY; T=0.K  
Photon emission for (n,gma)

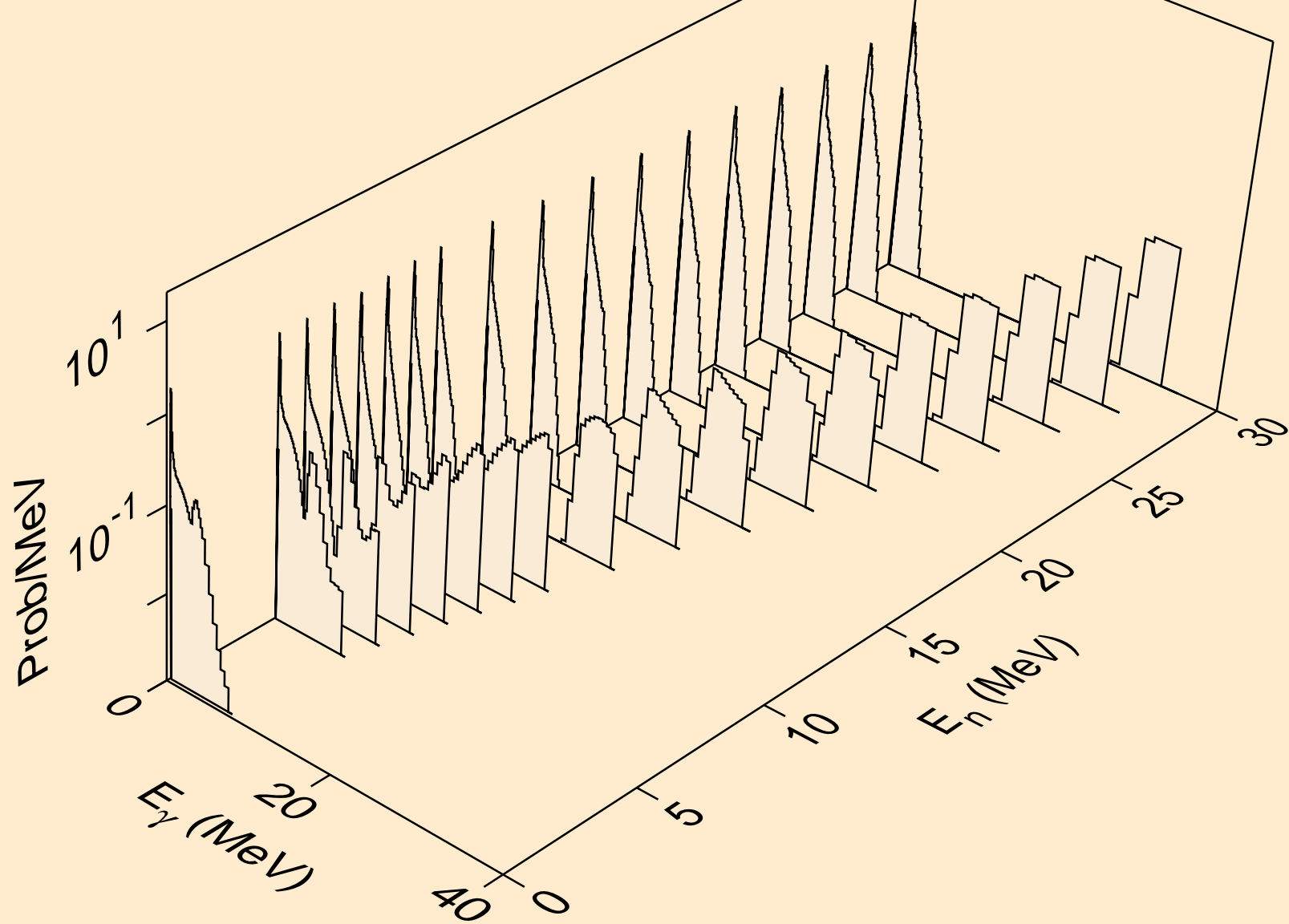

U233 PROTON ACER TENDL-2021 LIBRARY; T=0.K  
Photon emission for inelastic

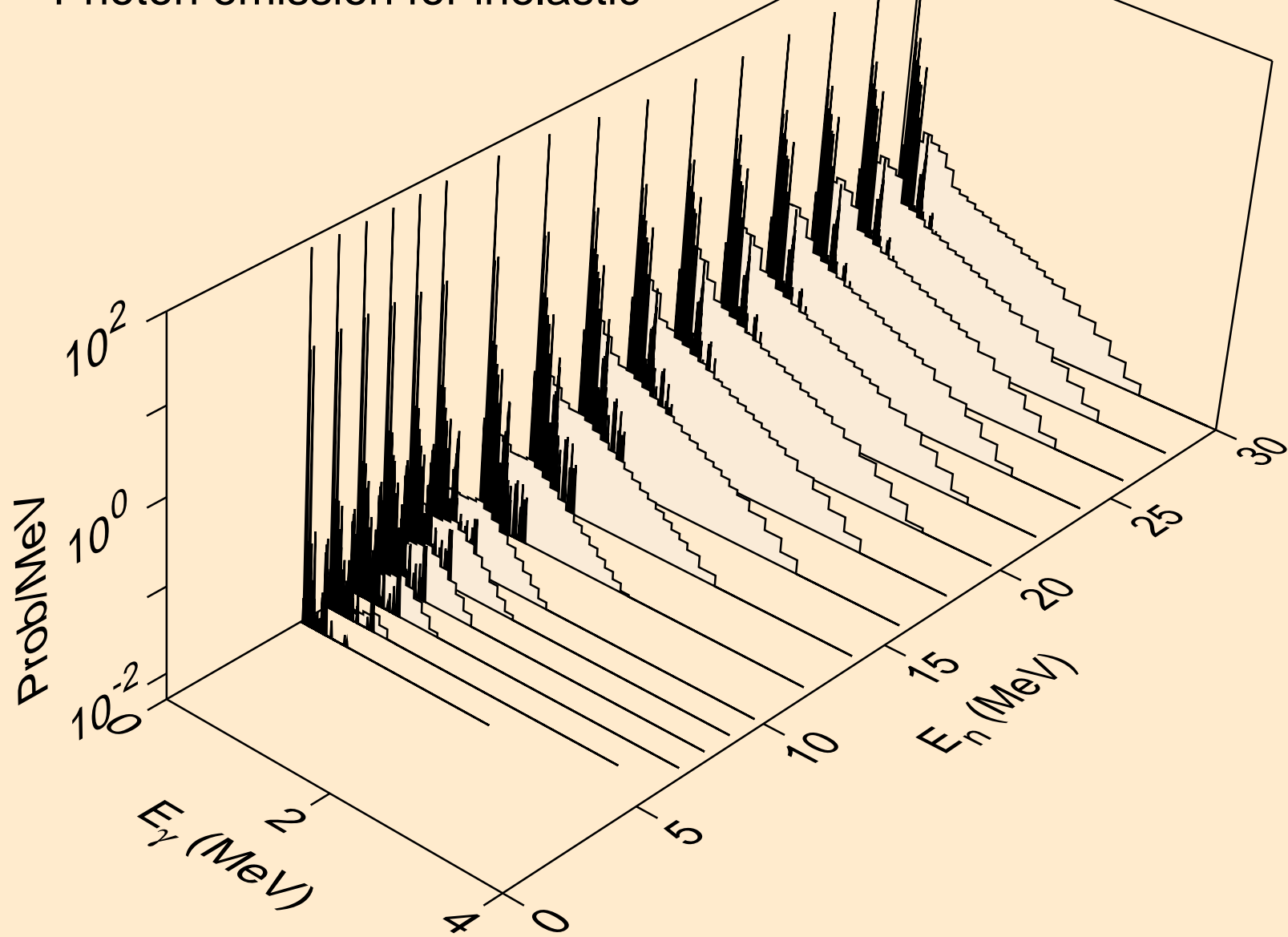



U233 PROTON ACER TENDL-2021 LIBRARY; T=0.K  
Photon emission for (n,d)

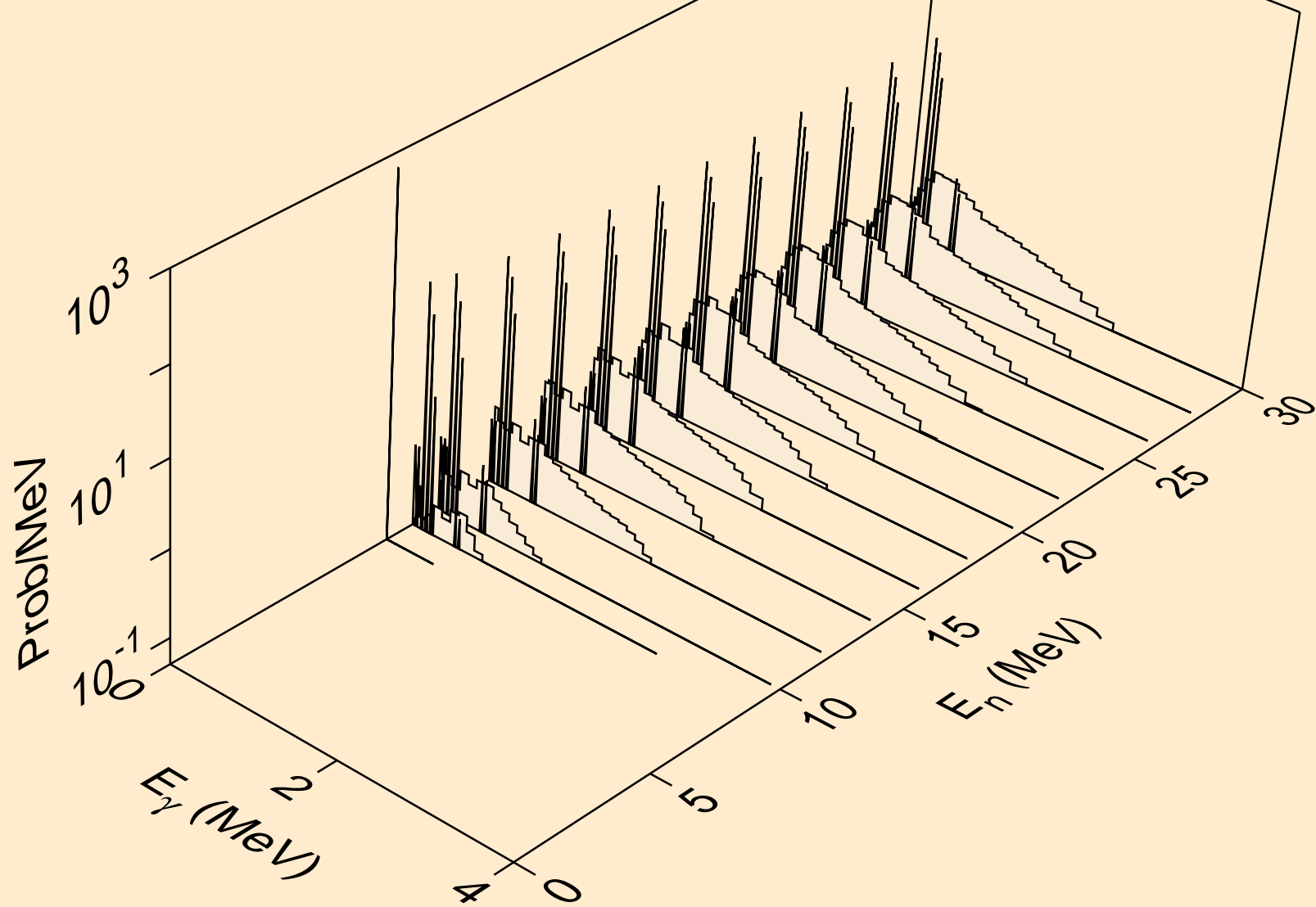

U233 PROTON ACER TENDL-2021 LIBRARY; T=0.K  
Photon emission for (n,t)

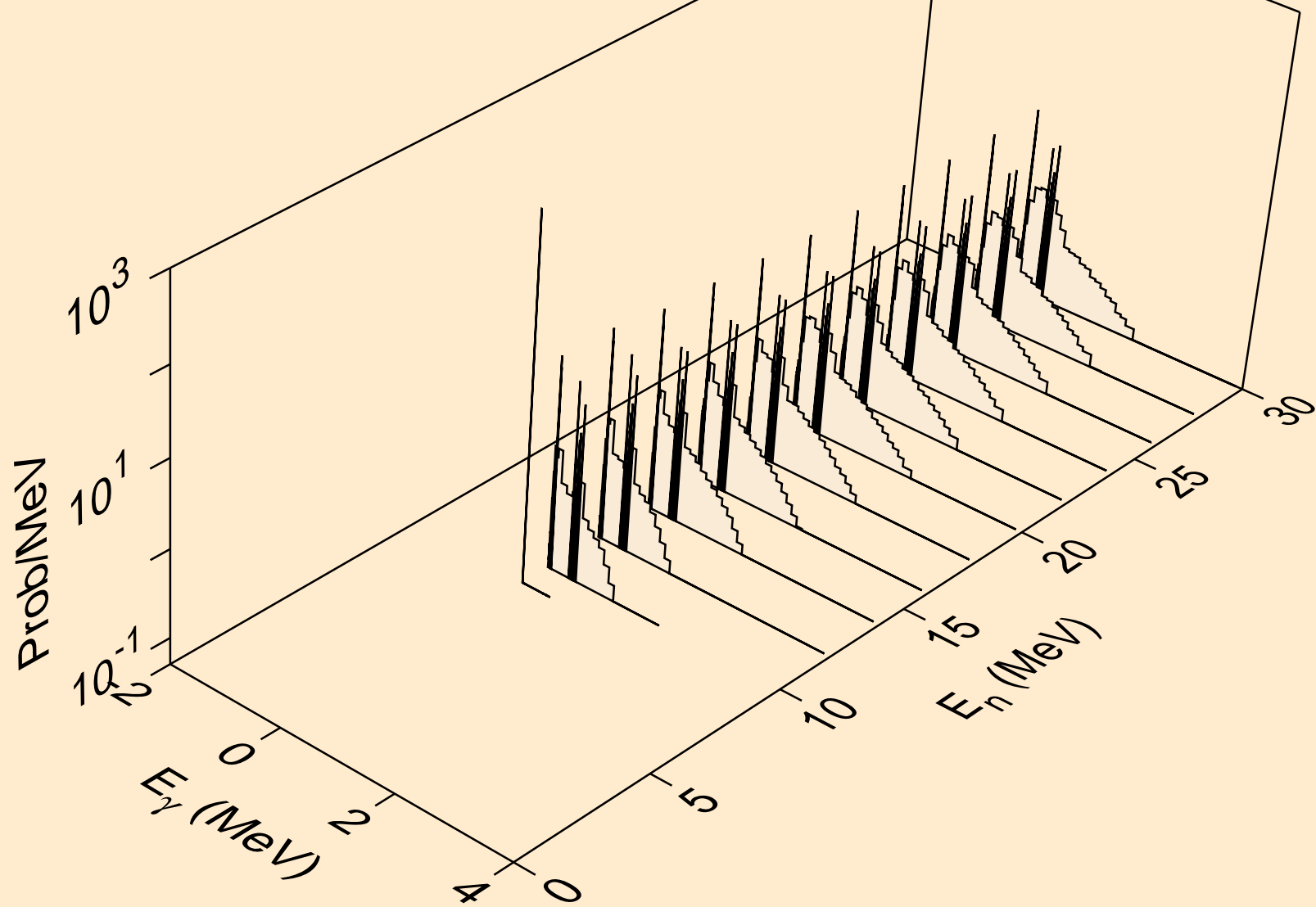

U233 PROTON ACER TENDL-2021 LIBRARY; T=0.K  
Photon emission for (n,he3)

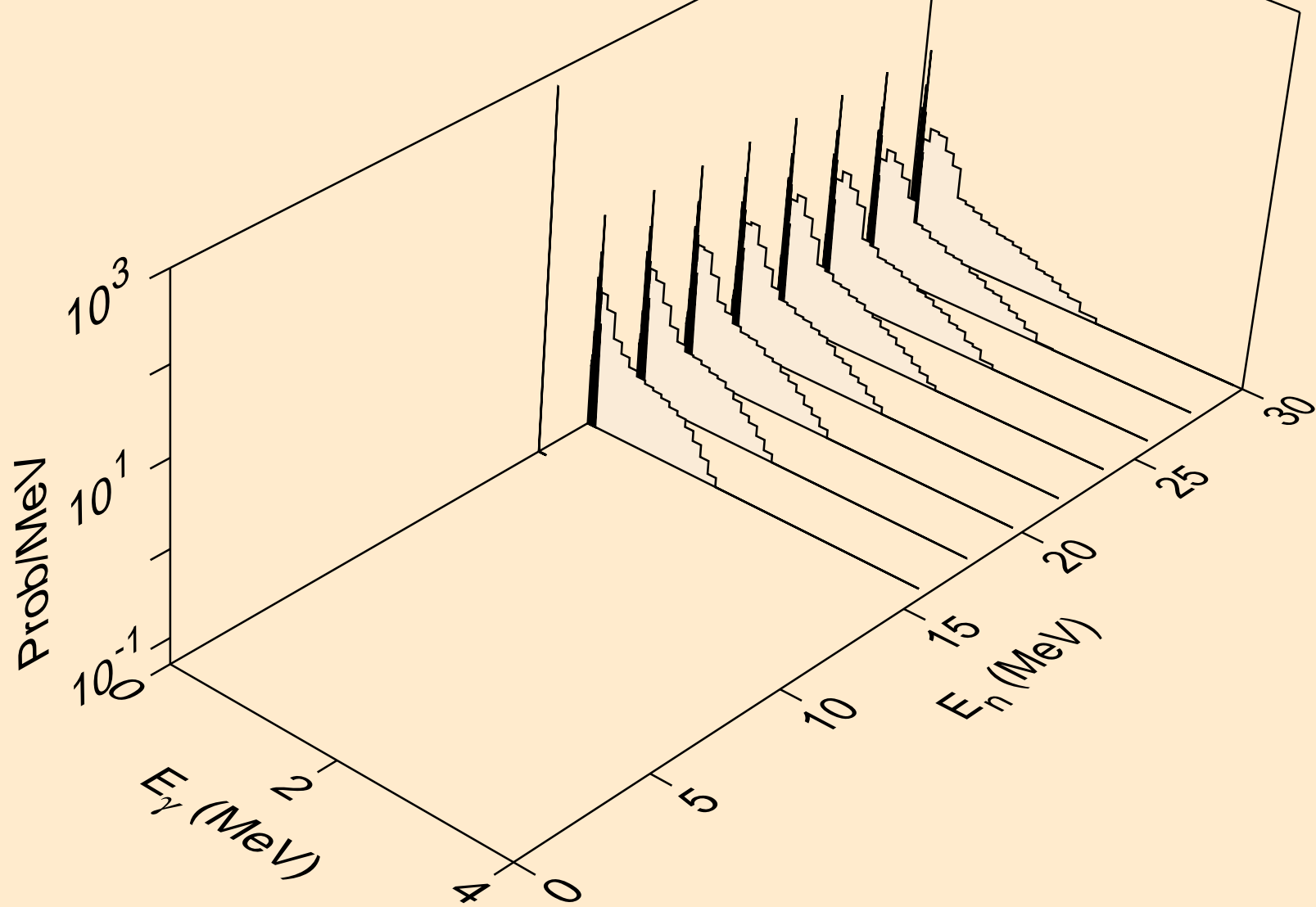

U233 PROTON ACER TENDL-2021 LIBRARY; T=0.K  
Photon emission for (n,a)

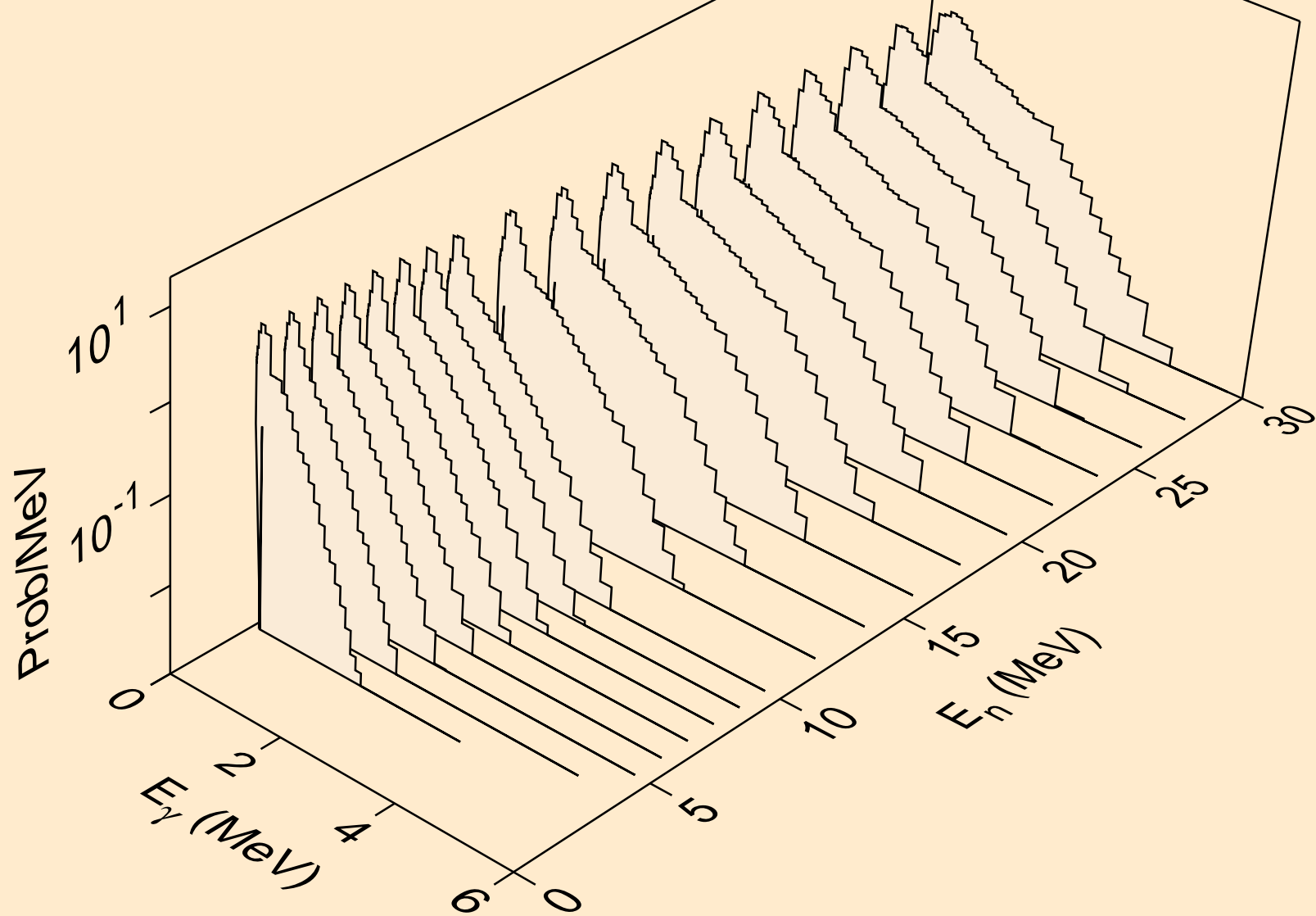

U233 PROTON ACER TENDL-2021 LIBRARY; T=0.K  
Photon emission for (n,2a)

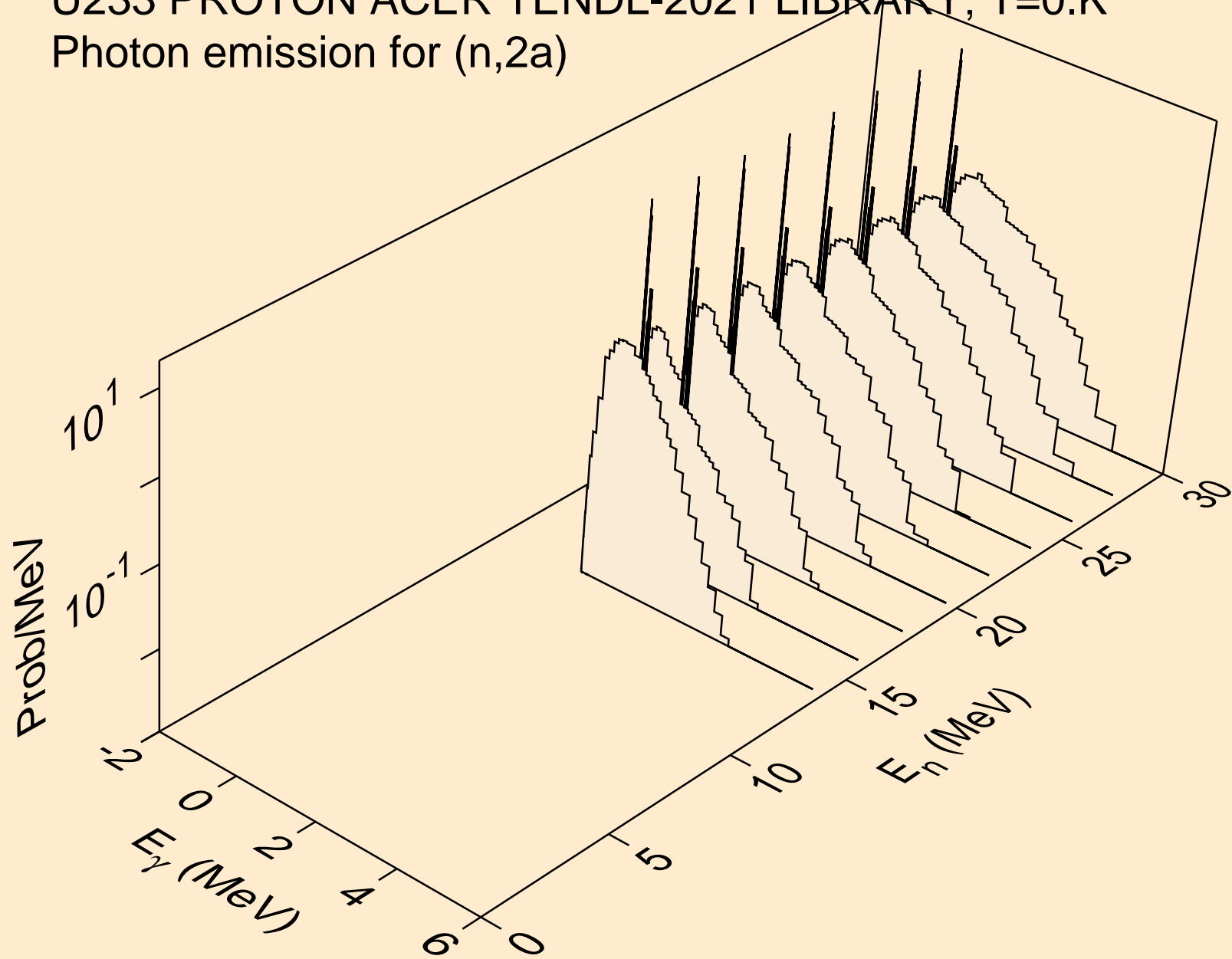

U233 PROTON ACER TENDL-2021 LIBRARY; T=0.K  
Photon emission for (n,2p)

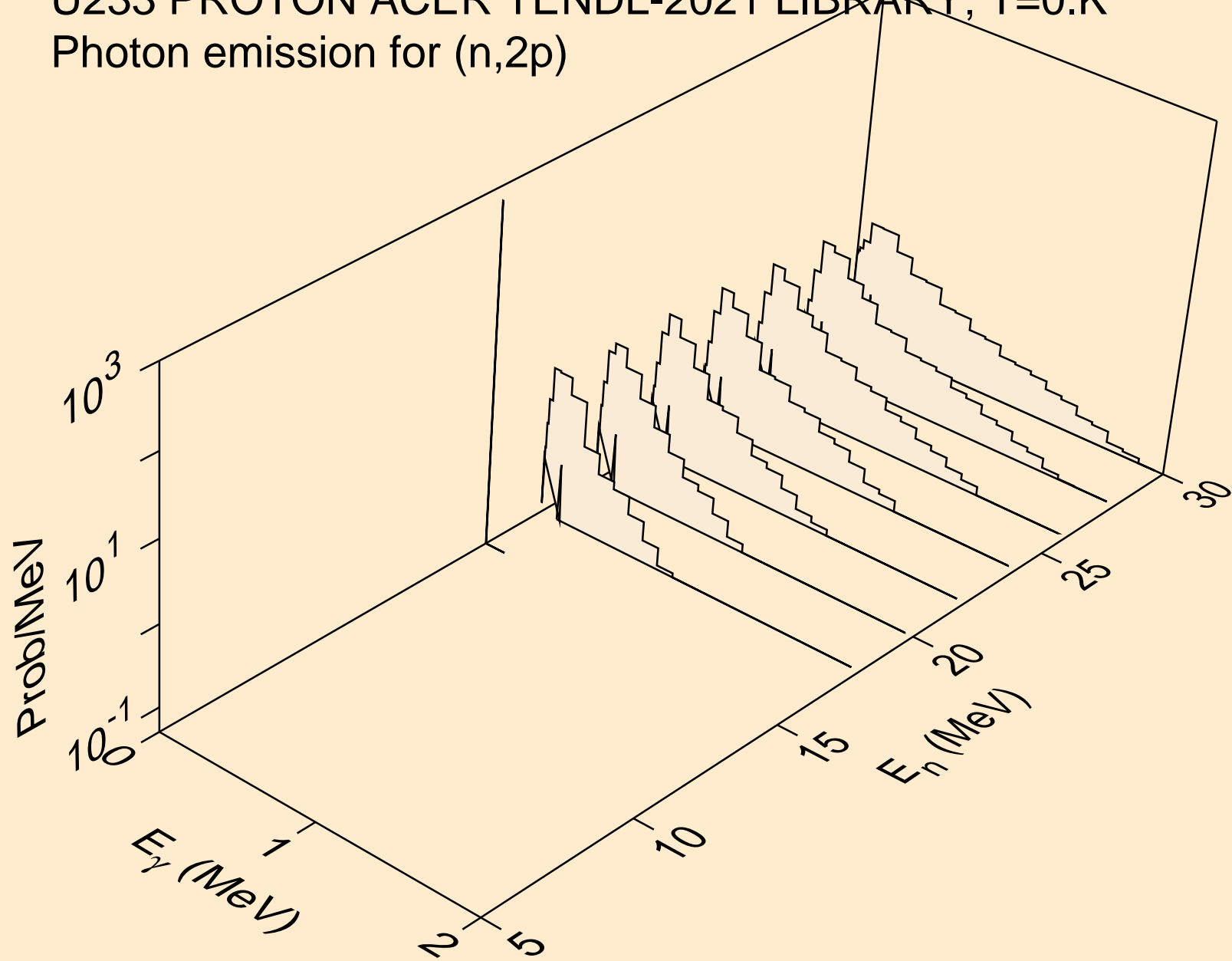

U233 PROTON ACER TENDL-2021 LIBRARY; T=0.K  
Photon emission for (n,pa)

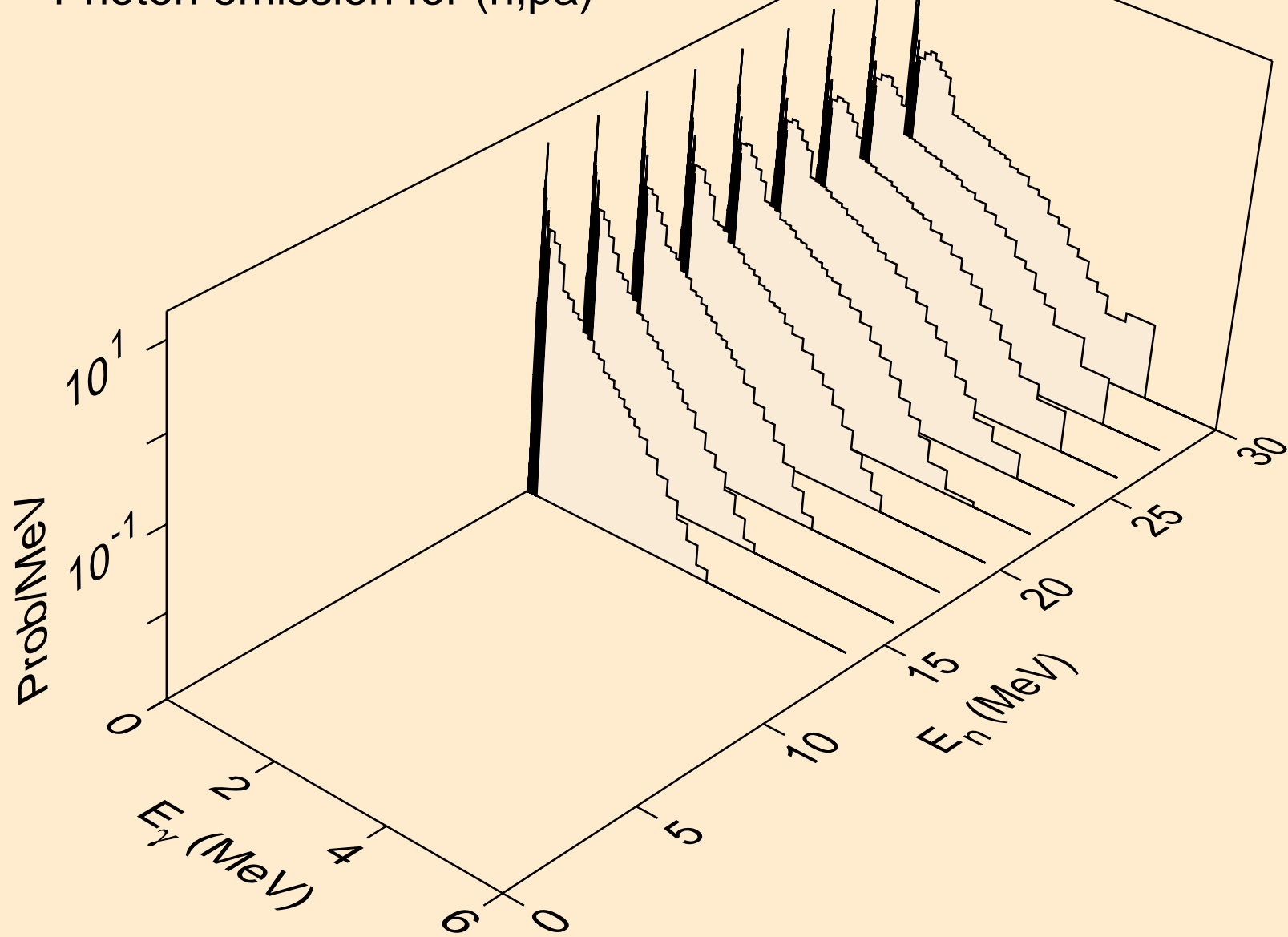

U233 PROTON ACER TENDL-2021 LIBRARY; T=0.K  
Particle heating contributions

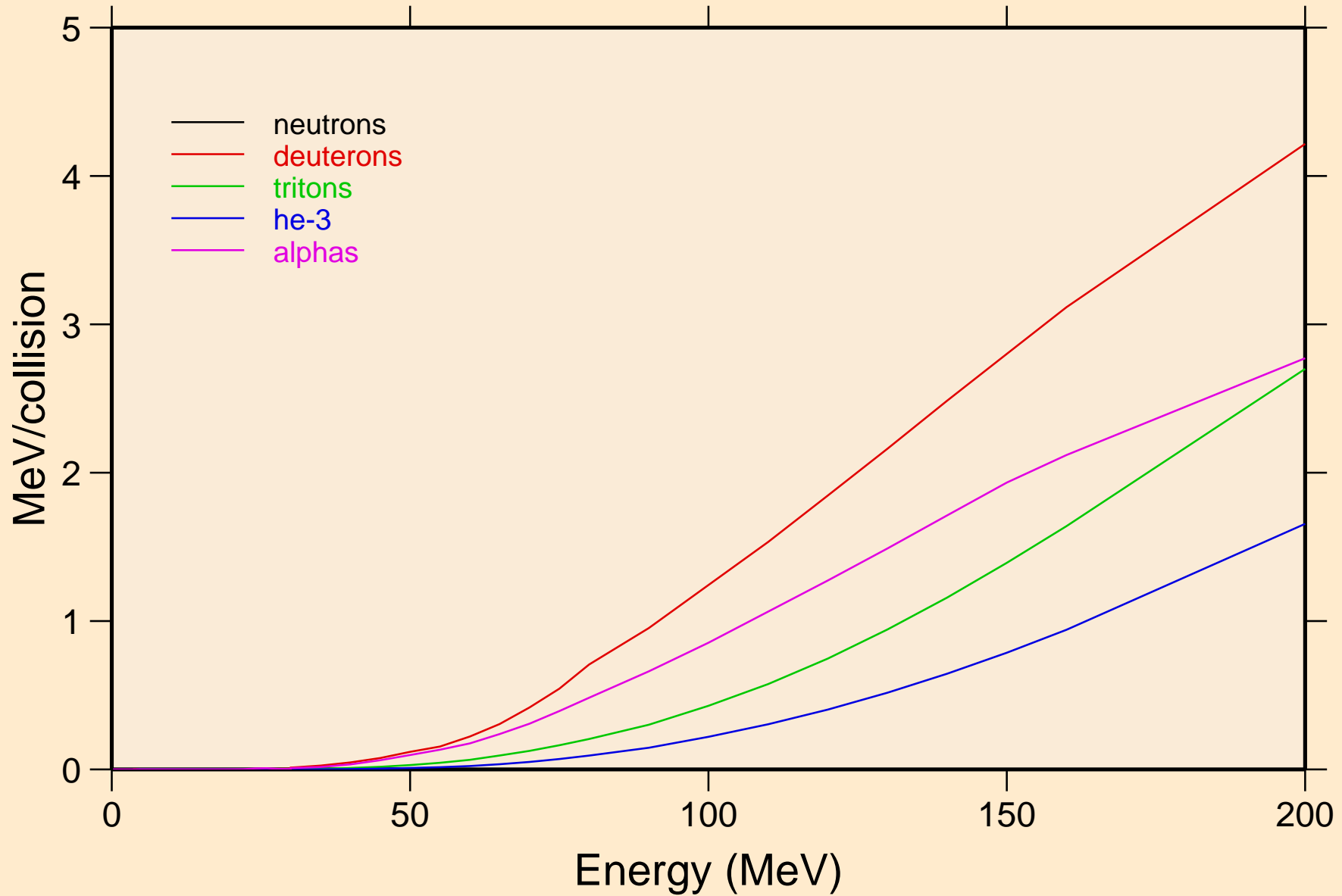



U233 PROTON ACER TENDL-2021 LIBRARY; T=0.K  
Recoil Heating

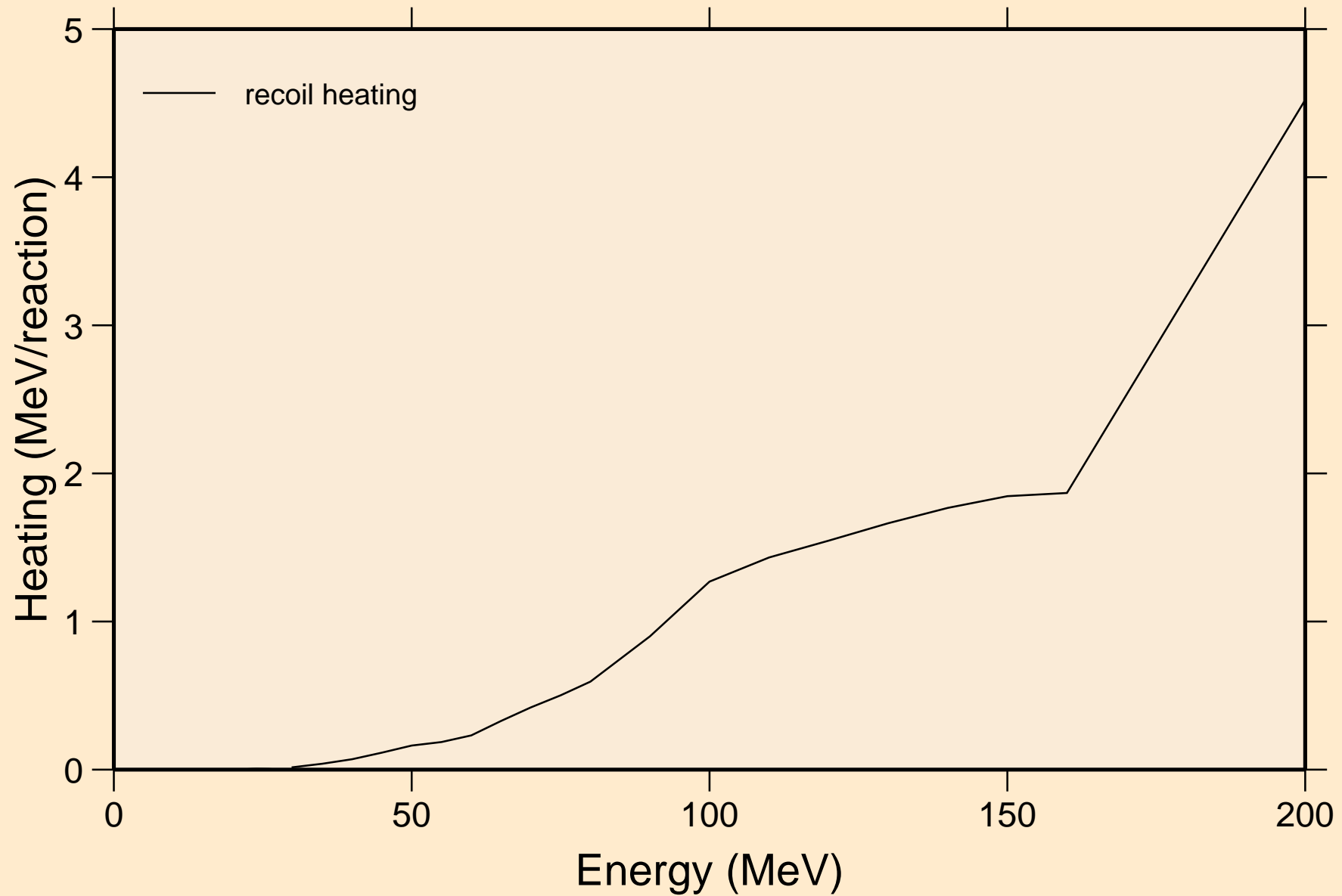

U233 PROTON ACER TENDL-2021 LIBRARY; T=0.K  
Particle production cross sections

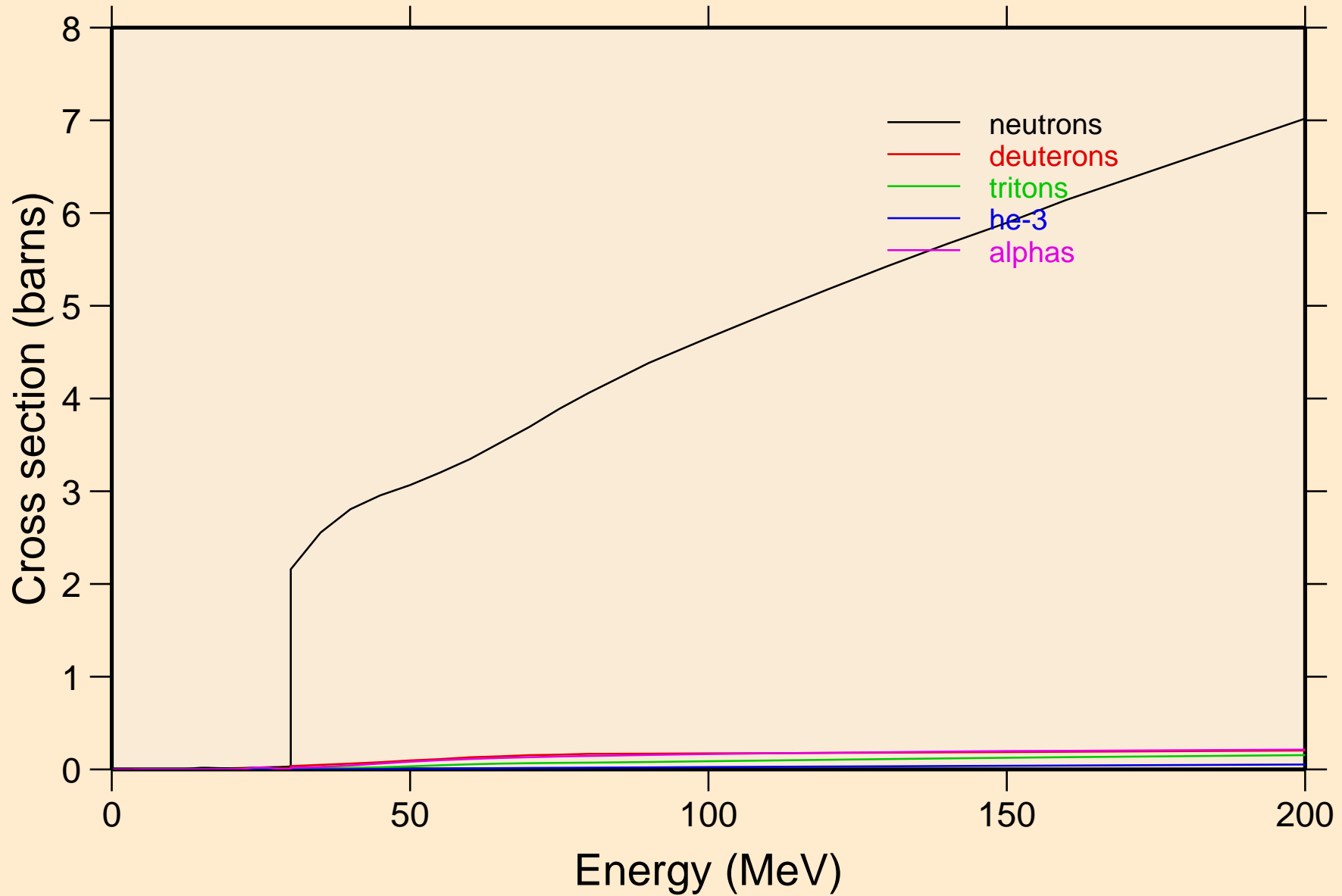

U233 PROTON ACER TENDL-2021 LIBRARY; T=0.K  
neutrons from (p,n)

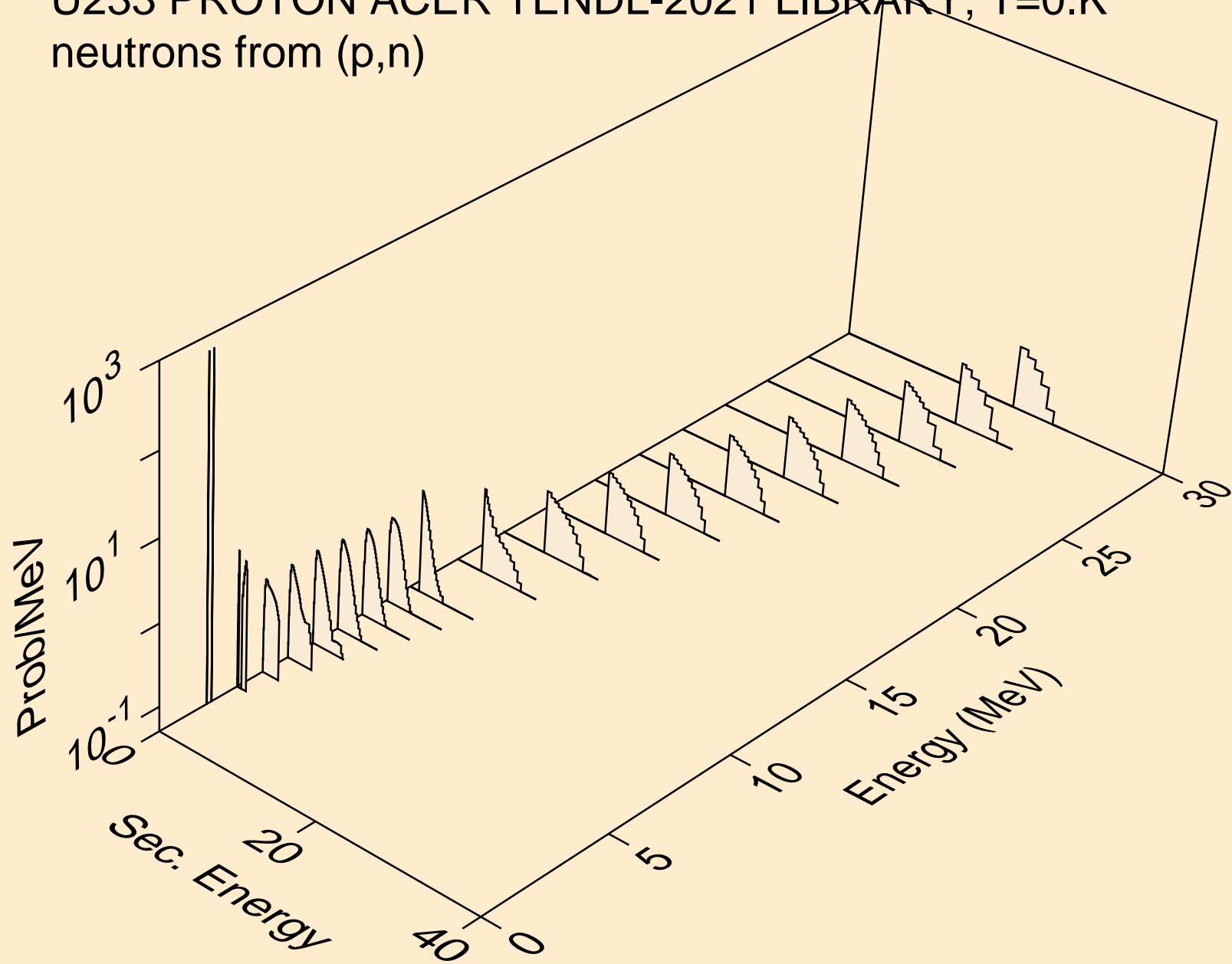

U233 PROTON ACER TENDL-2021 LIBRARY; T=0.K  
neutrons from (p,x)

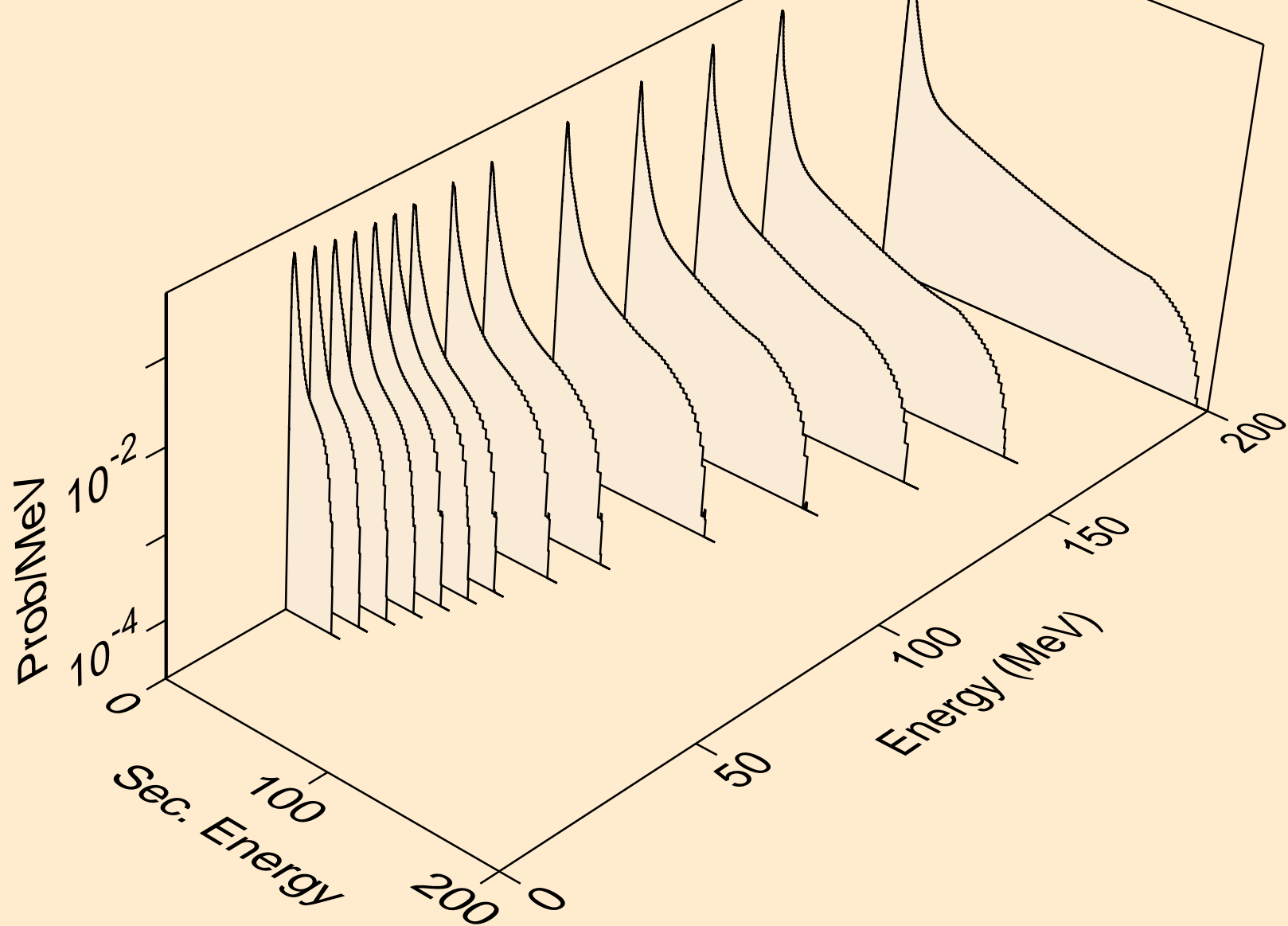

U233 PROTON ACER TENDL-2021 LIBRARY; T=0.K  
neutrons from (p,2nd)

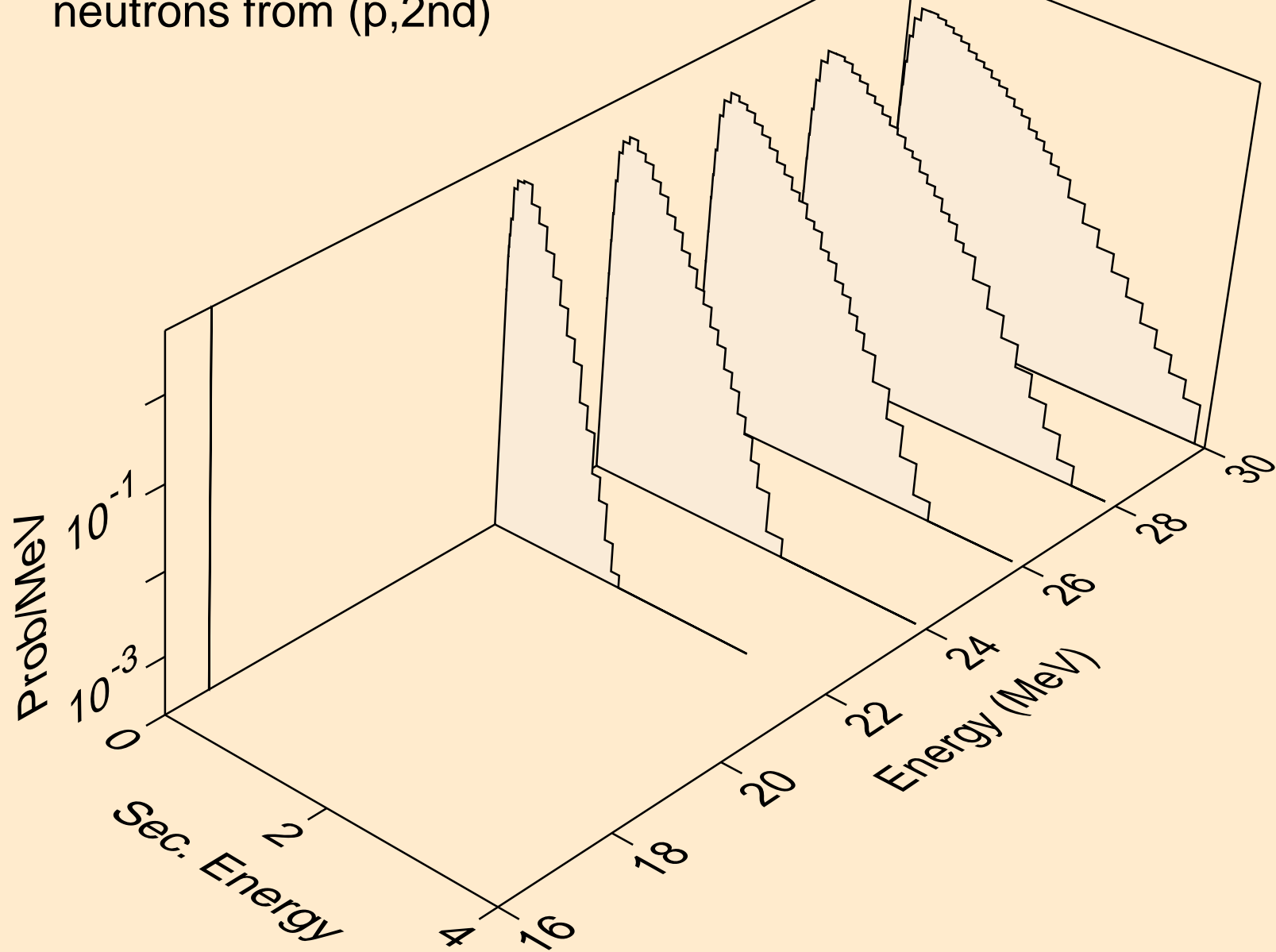

U233 PROTON ACER TENDL-2021 LIBRARY; T=0.K  
neutrons from (p,2n)

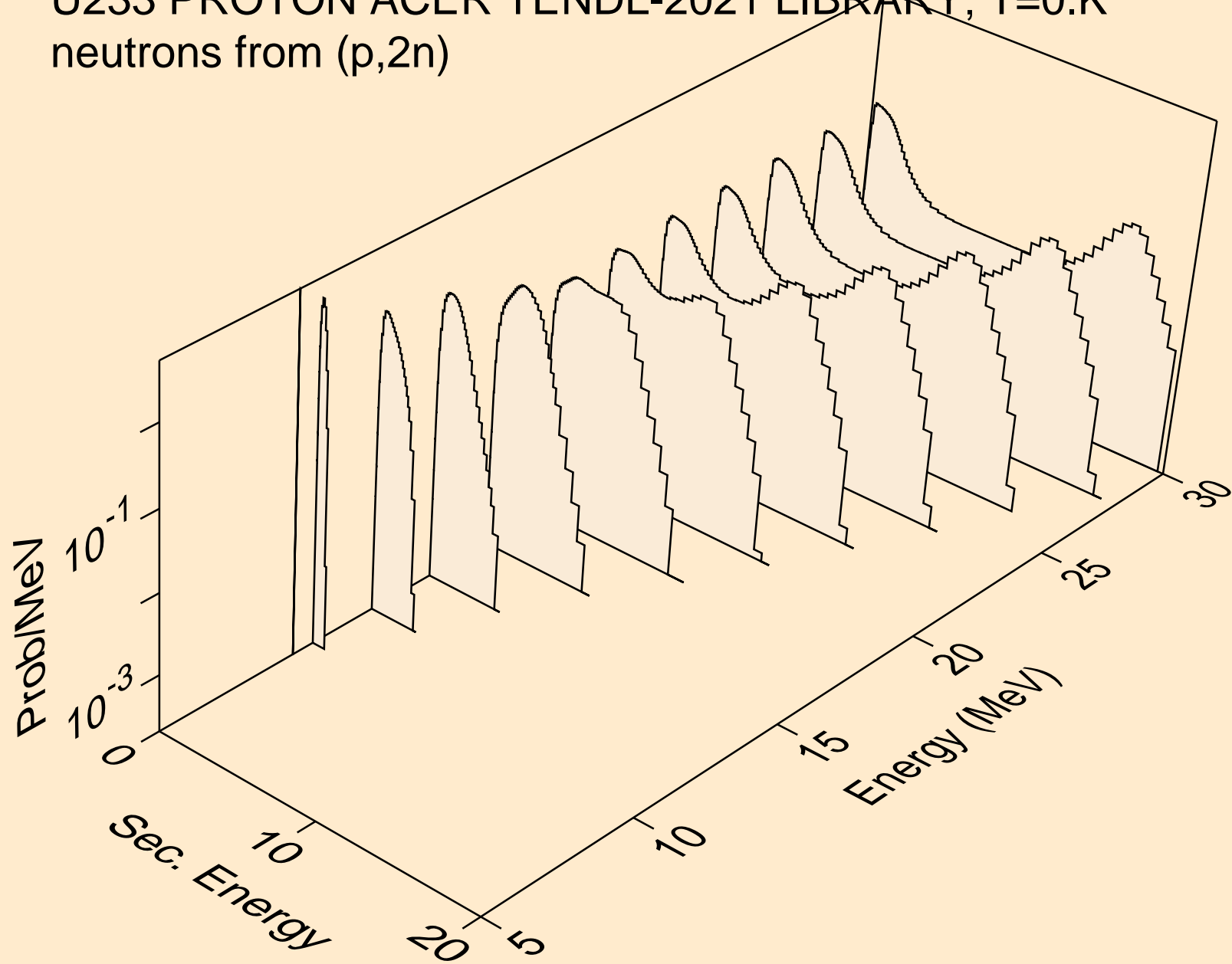

U233 PROTON ACER TENDL-2021 LIBRARY; T=0.K  
neutrons from (p,3n)

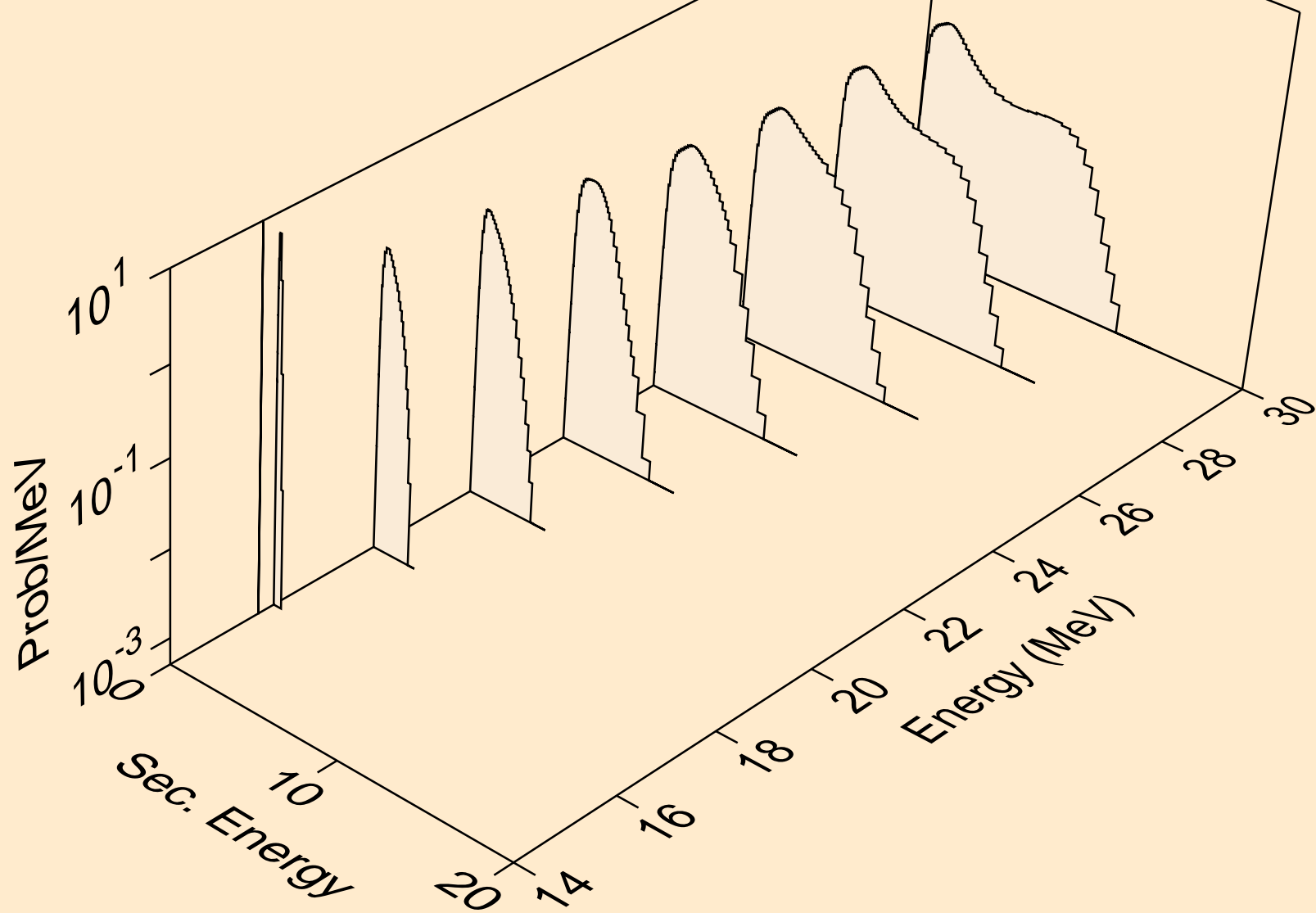

U233 PROTON ACER TENDL-2021 LIBRARY; T=0.K  
neutrons from (p,n\*)a

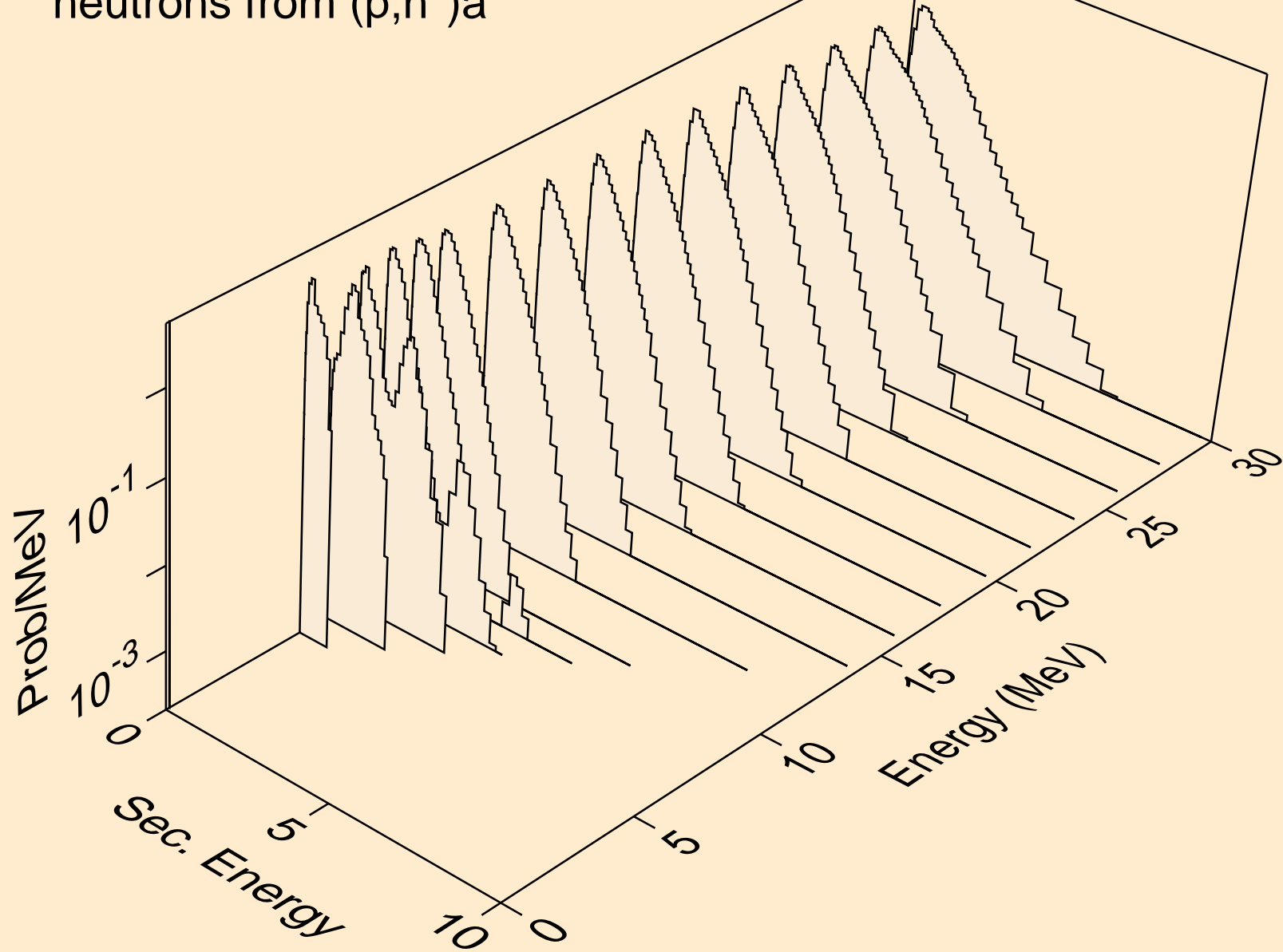



U233 PROTON ACER TENDL-2021 LIBRARY; T=0.K  
neutrons from (p,2n)a

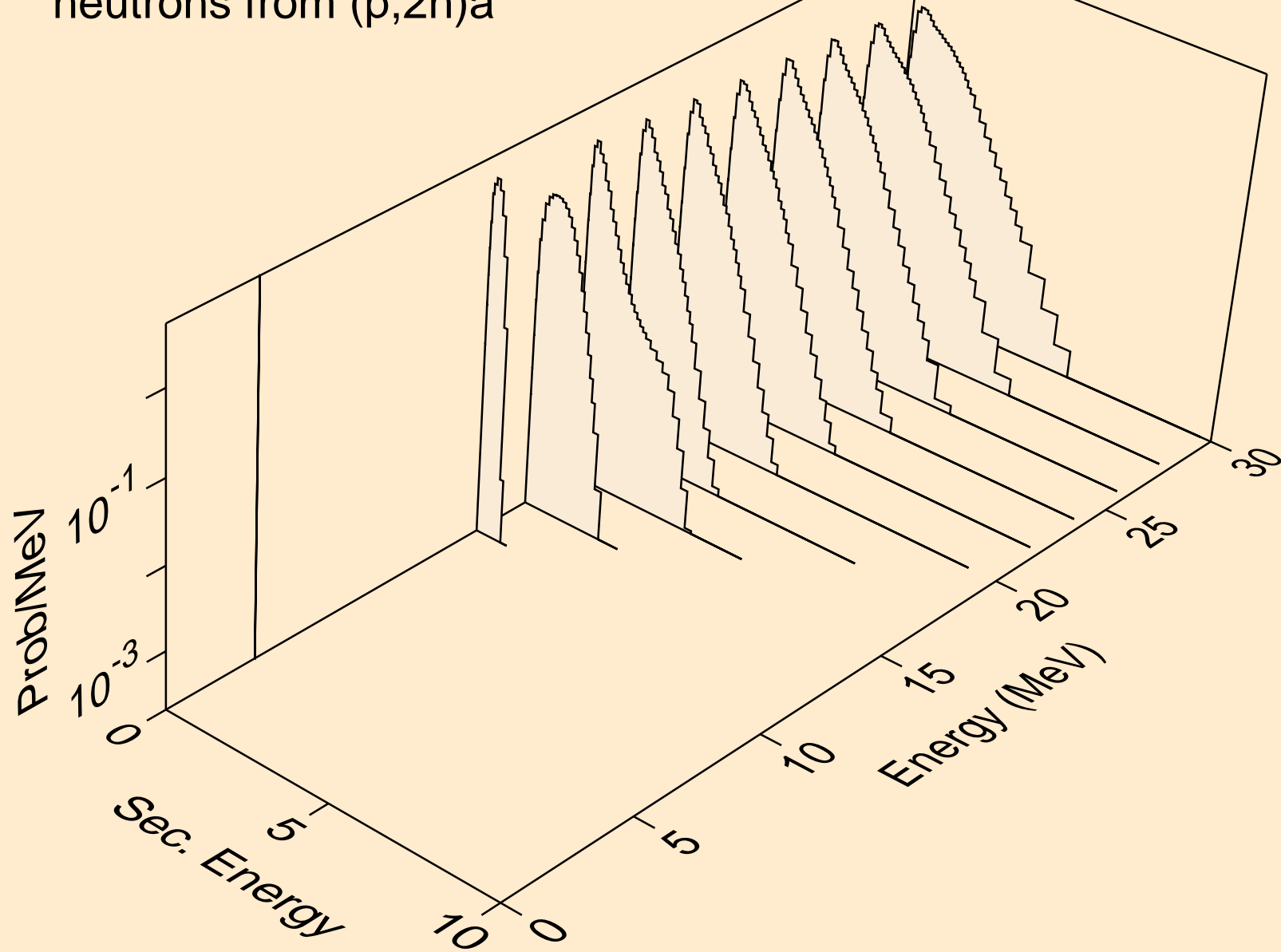

U233 PROTON ACER TENDL-2021 LIBRARY; T=0.K  
neutrons from (p,3n)a

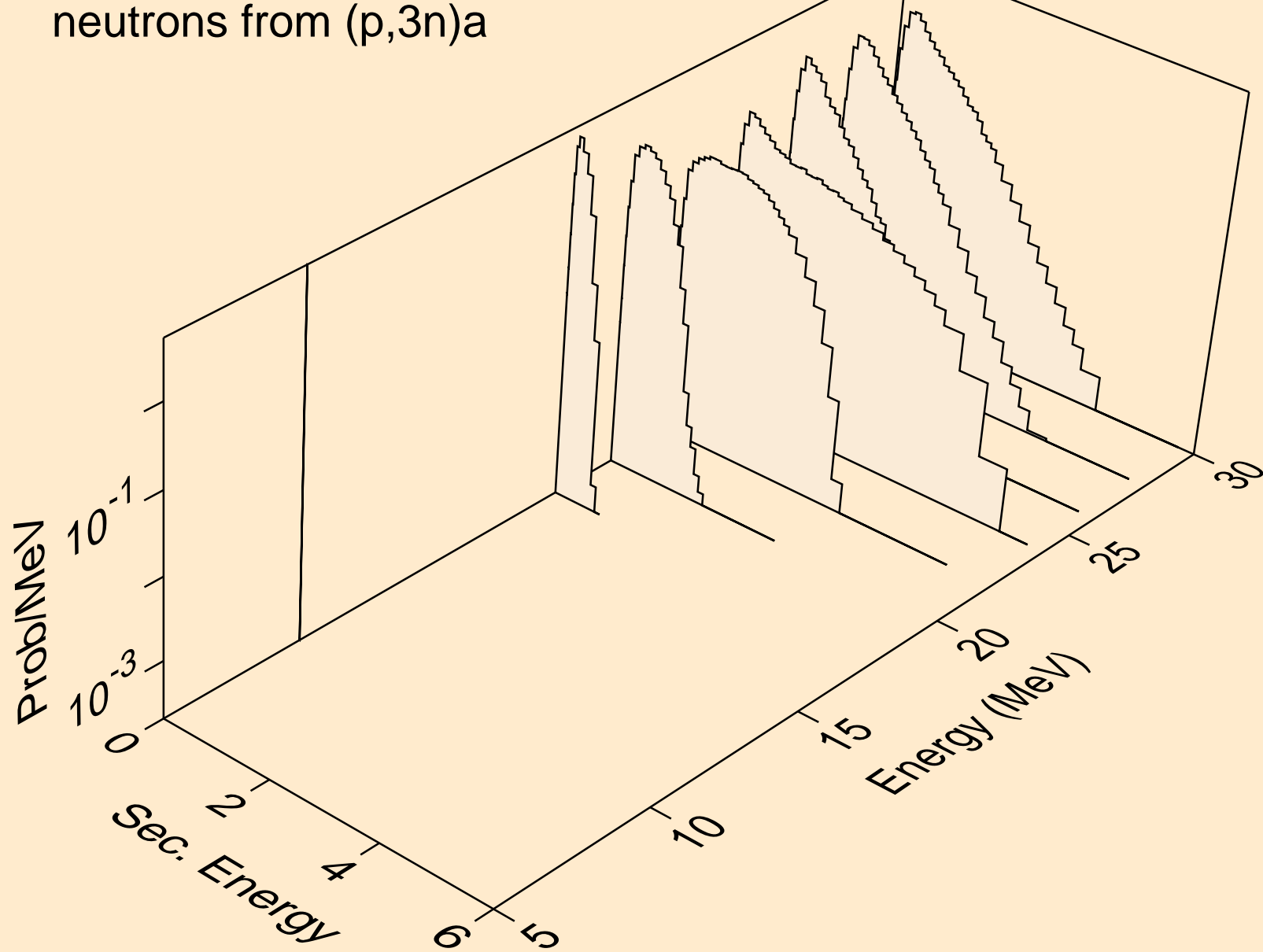

U233 PROTON ACER TENDL-2021 LIBRARY; T=0.K  
neutrons from (p,n\*)p

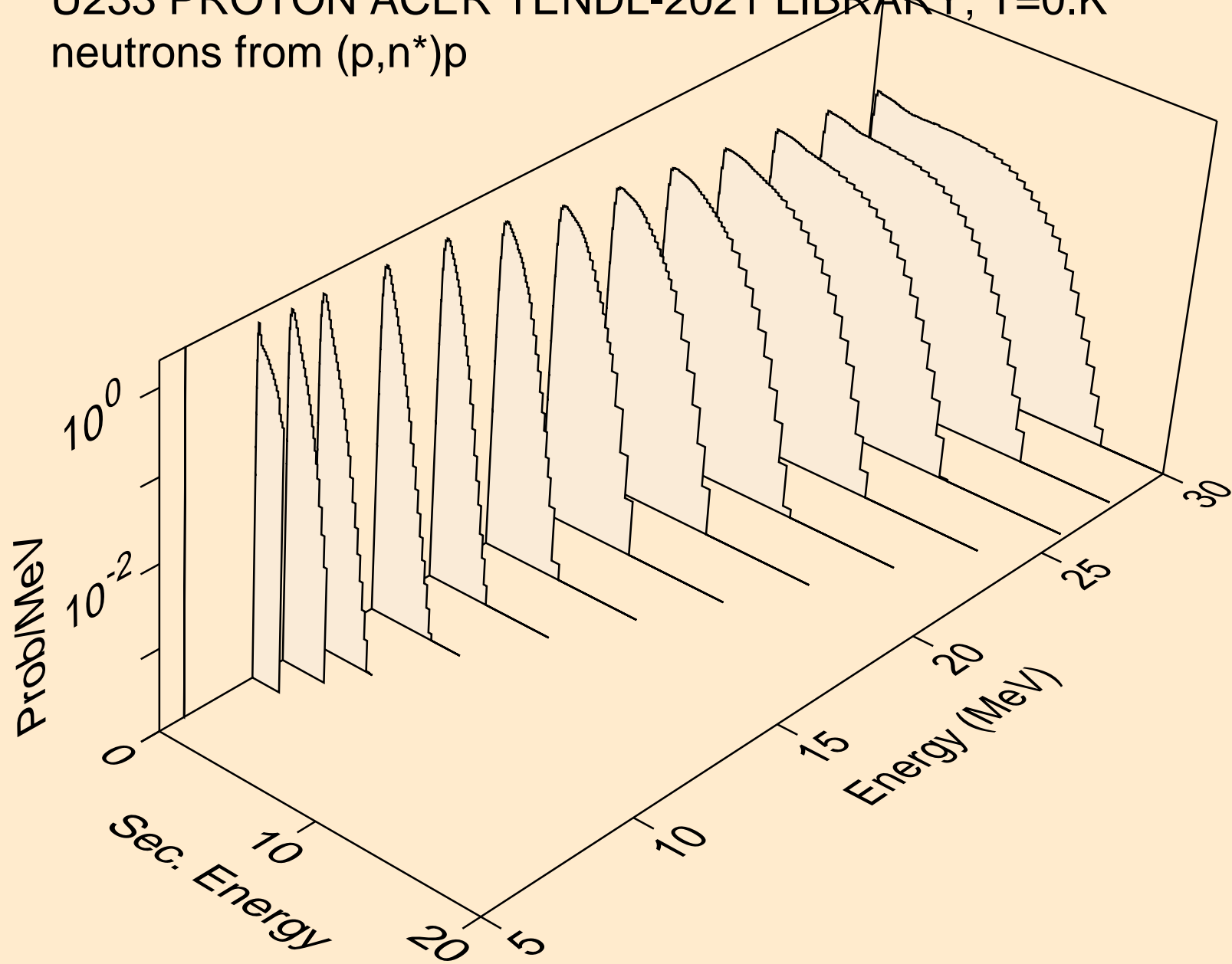

U233 PROTON ACER TENDL-2021 LIBRARY; T=0.K  
neutrons from (p,n\*)2a

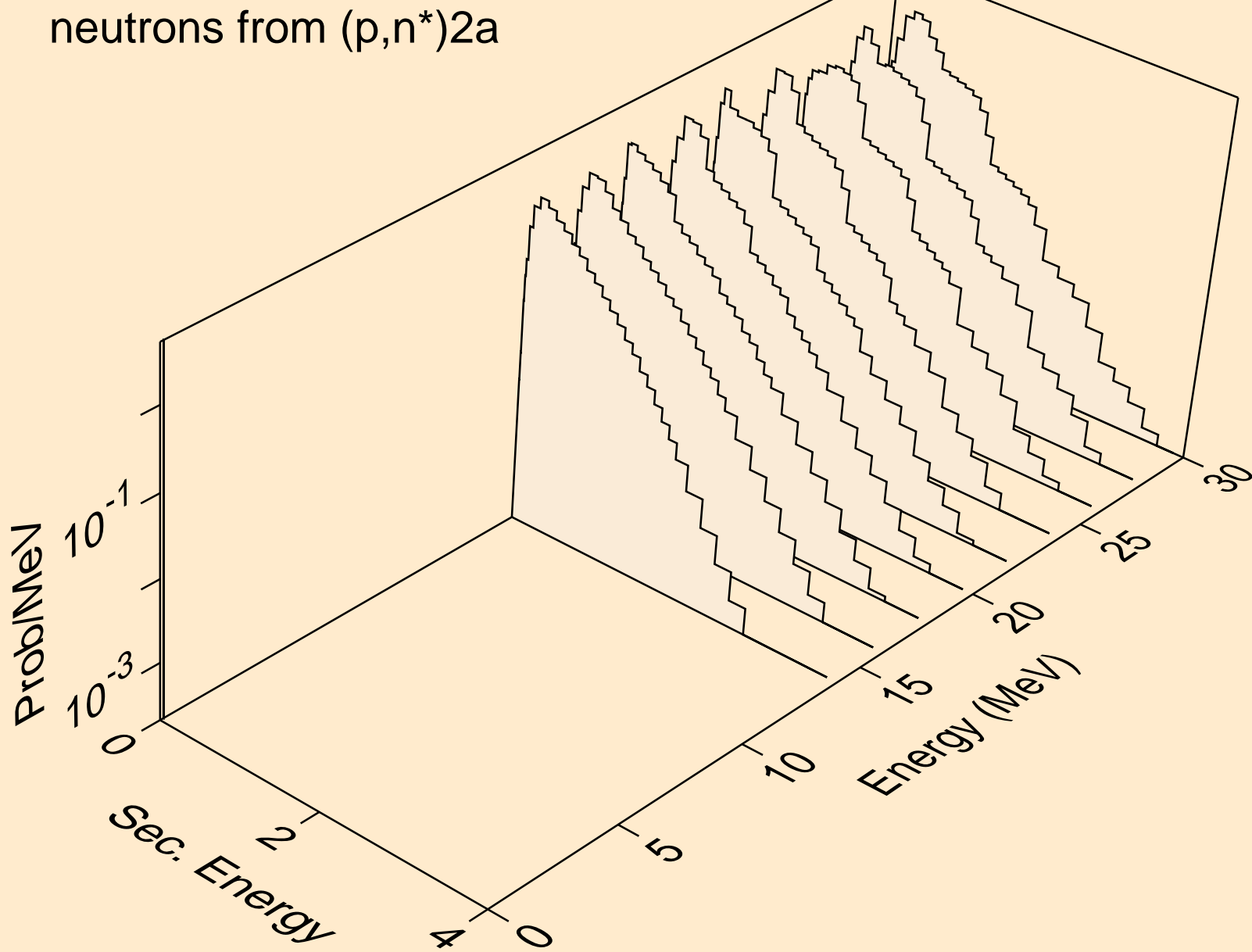

U233 PROTON ACER TENDL-2021 LIBRARY; T=0.K  
neutrons from (p,n\*)d

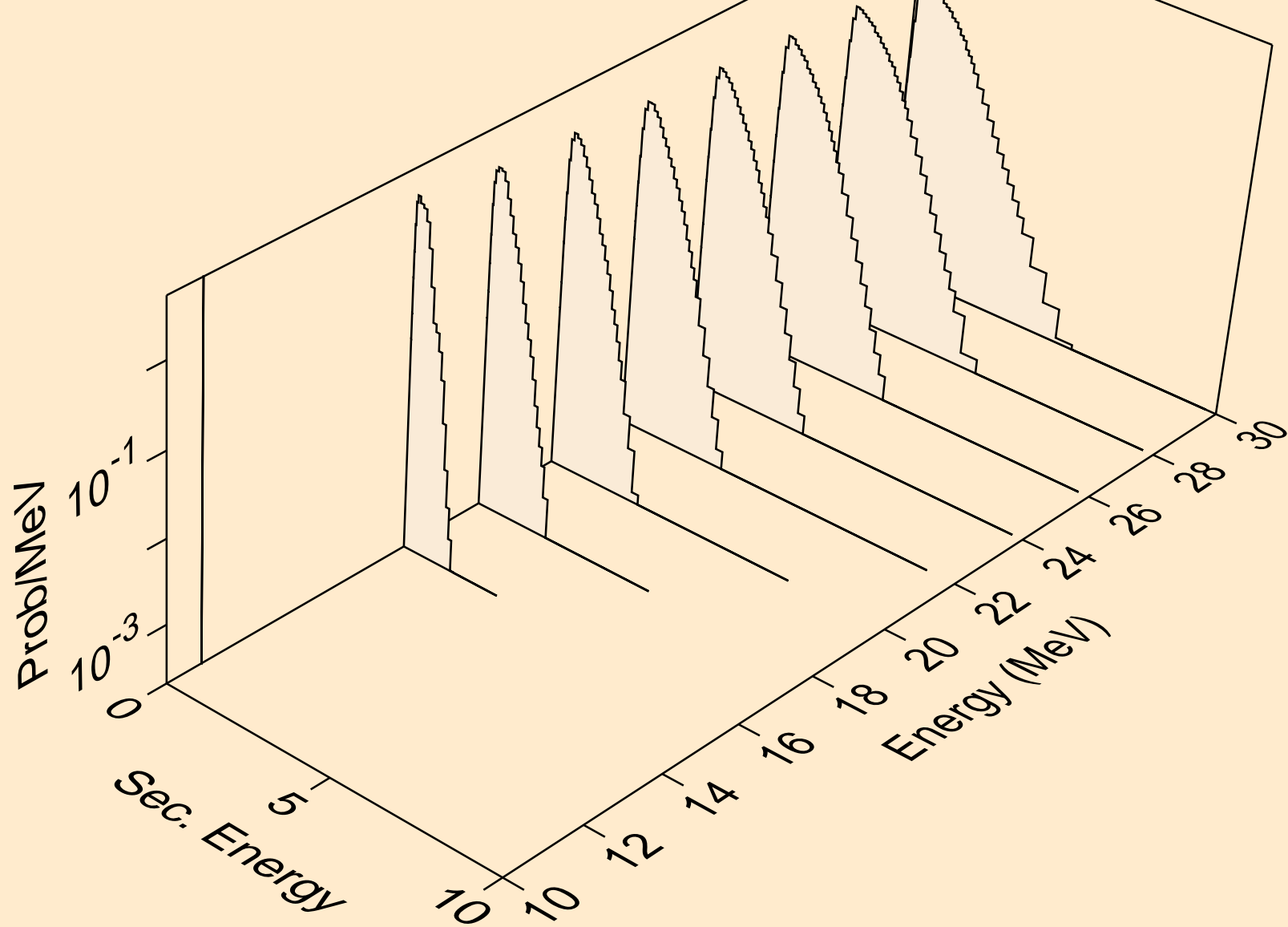

U233 PROTON ACER TENDL-2021 LIBRARY; T=0.K  
neutrons from (p,n\*)t

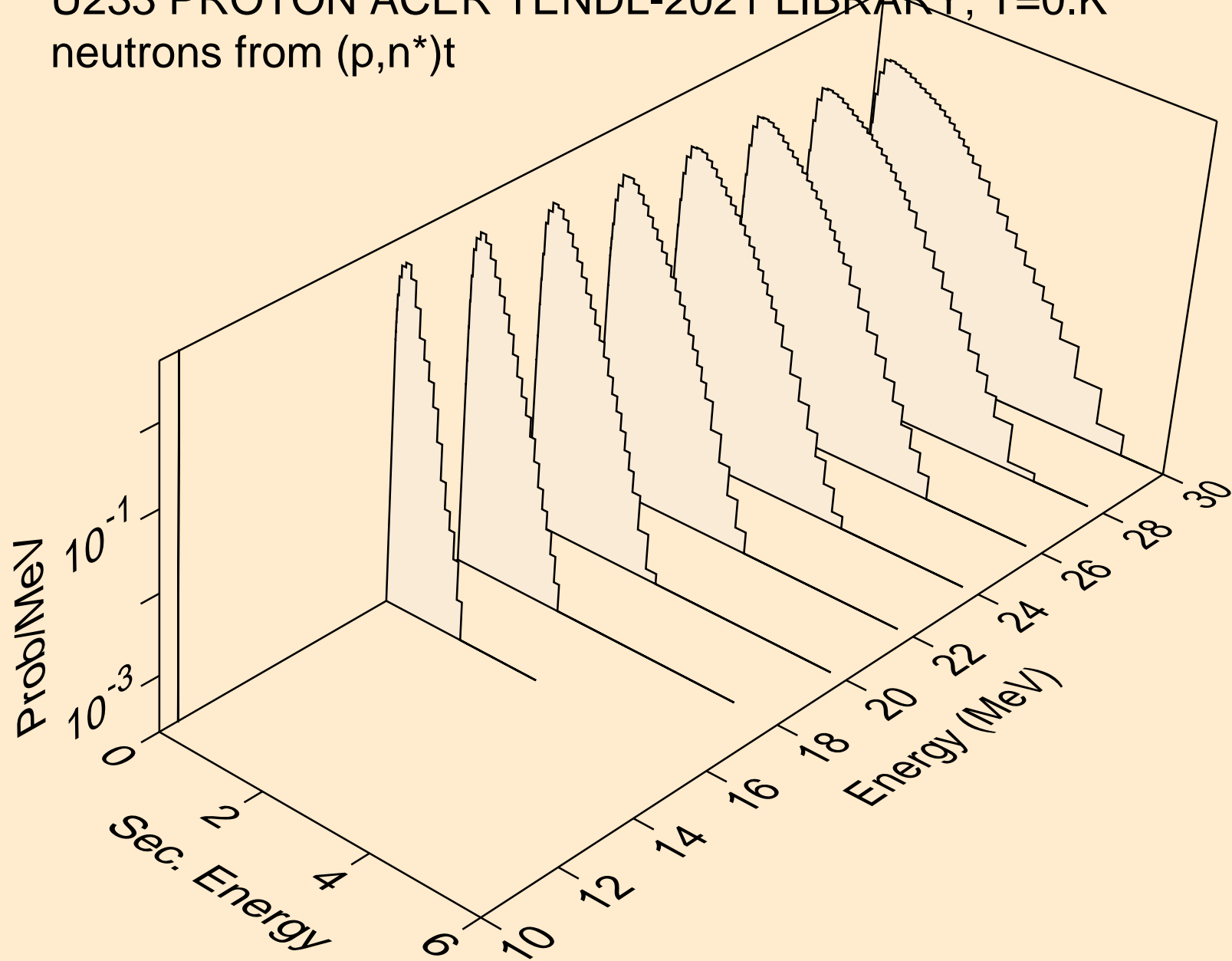

U233 PROTON ACER TENDL-2021 LIBRARY; T=0.K  
neutrons from (p,n\*)he3

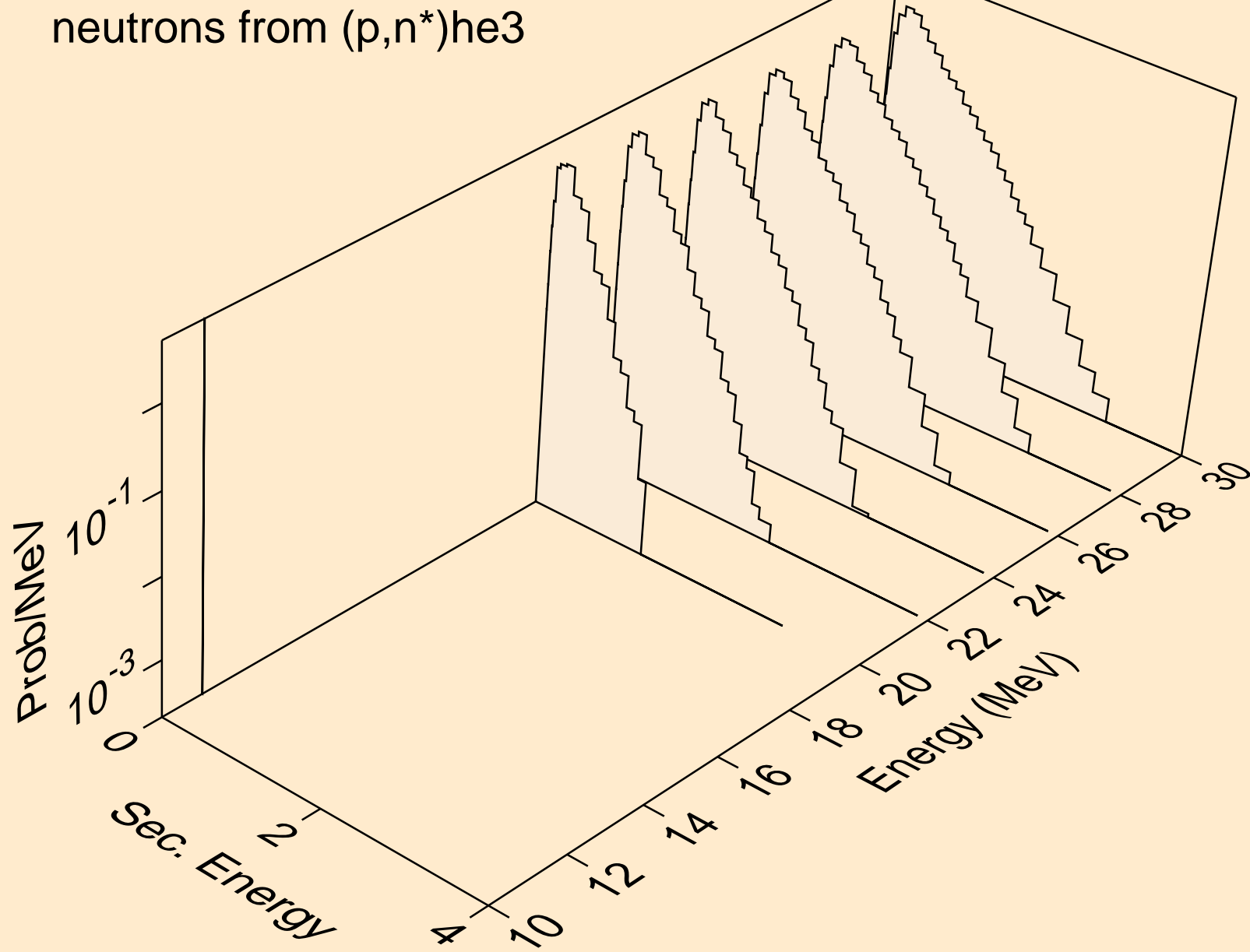

U233 PROTON ACER TENDL-2021 LIBRARY; T=0.K  
neutrons from (p,4n)

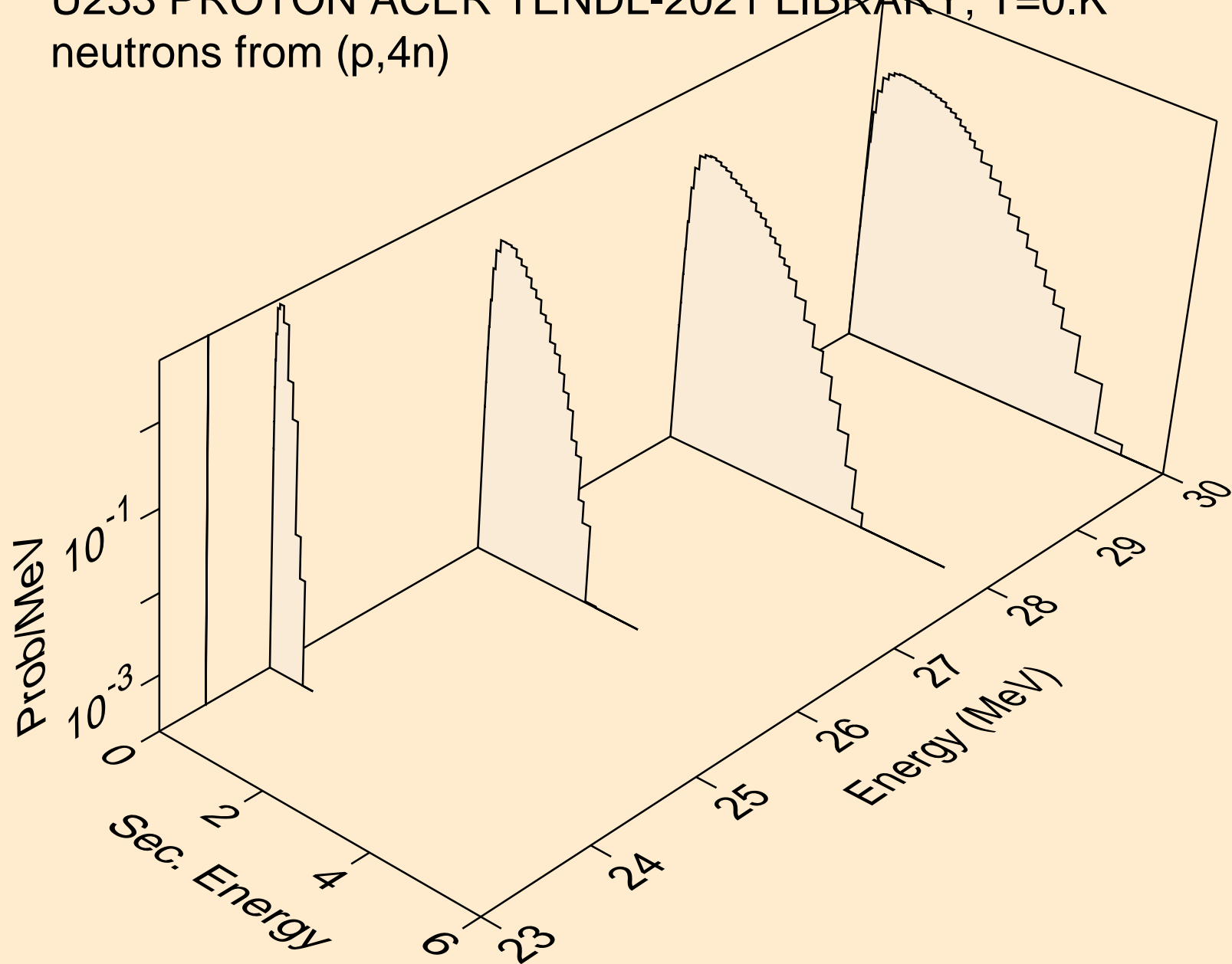



U233 PROTON ACER TENDL-2021 LIBRARY; T=0.K  
neutrons from (p,2np)

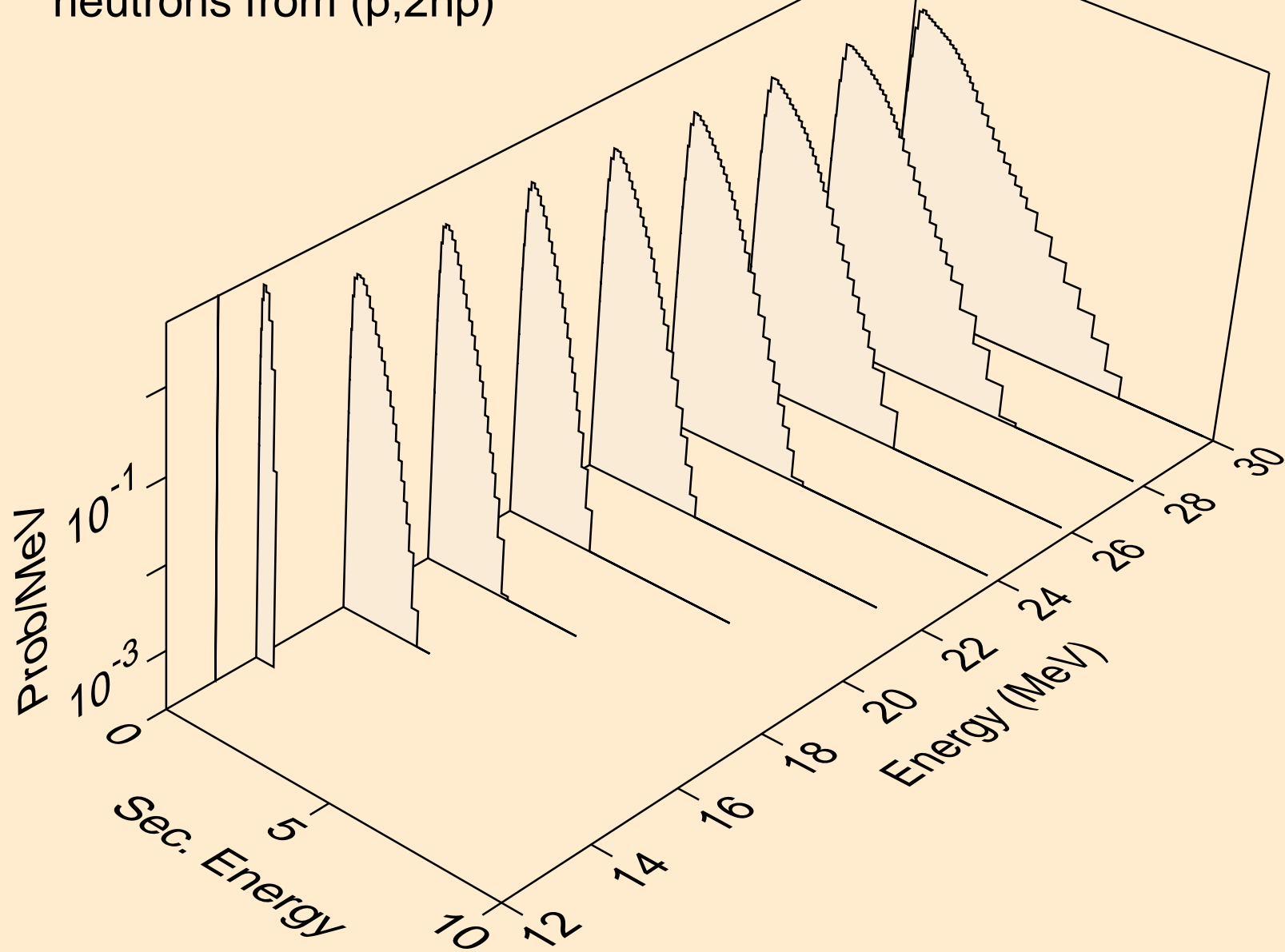

U233 PROTON ACER TENDL-2021 LIBRARY; T=0.K  
neutrons from (p,3np)

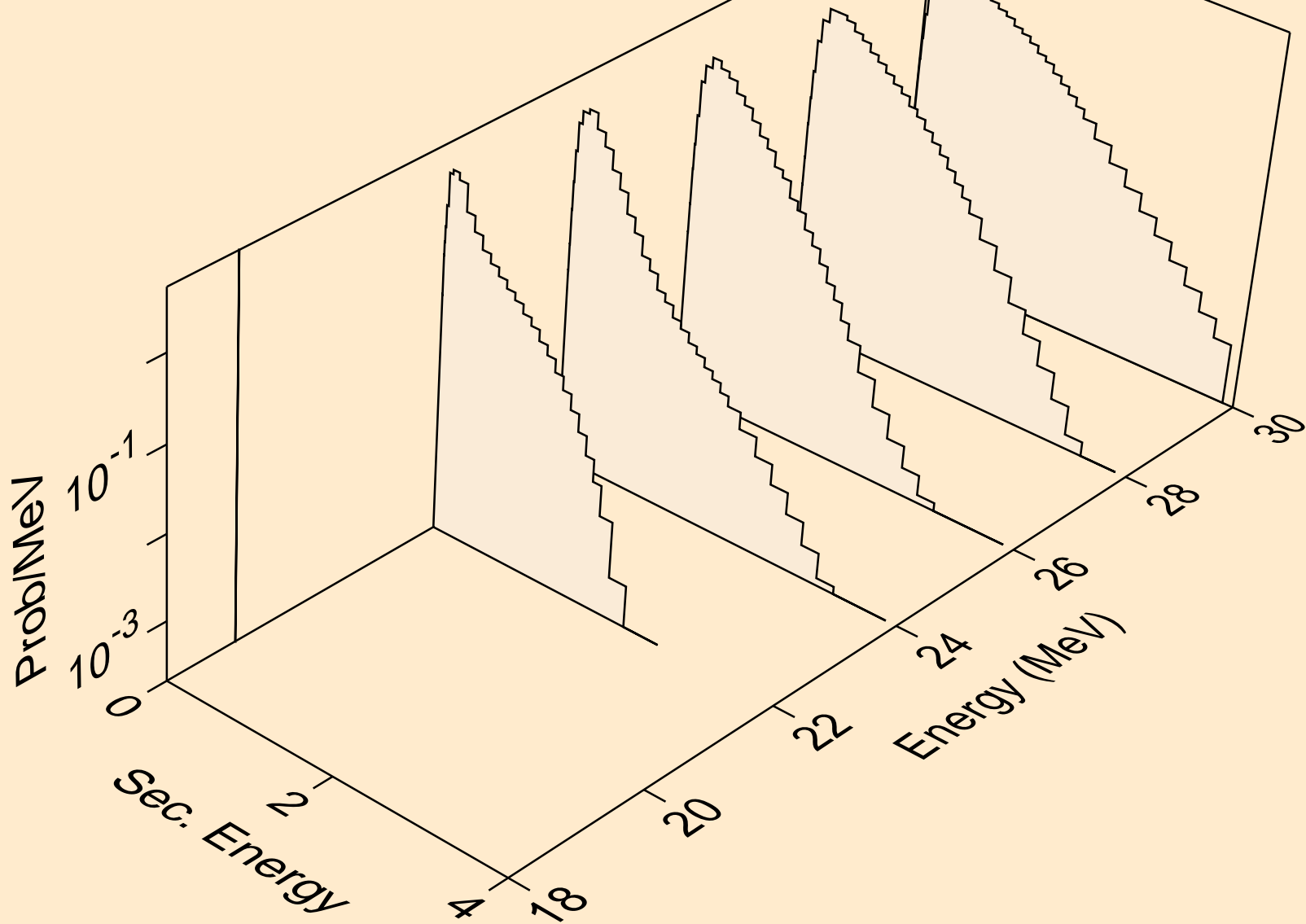

U233 PROTON ACER TENDL-2021 LIBRARY; T=0.K  
neutrons from (p,2np)

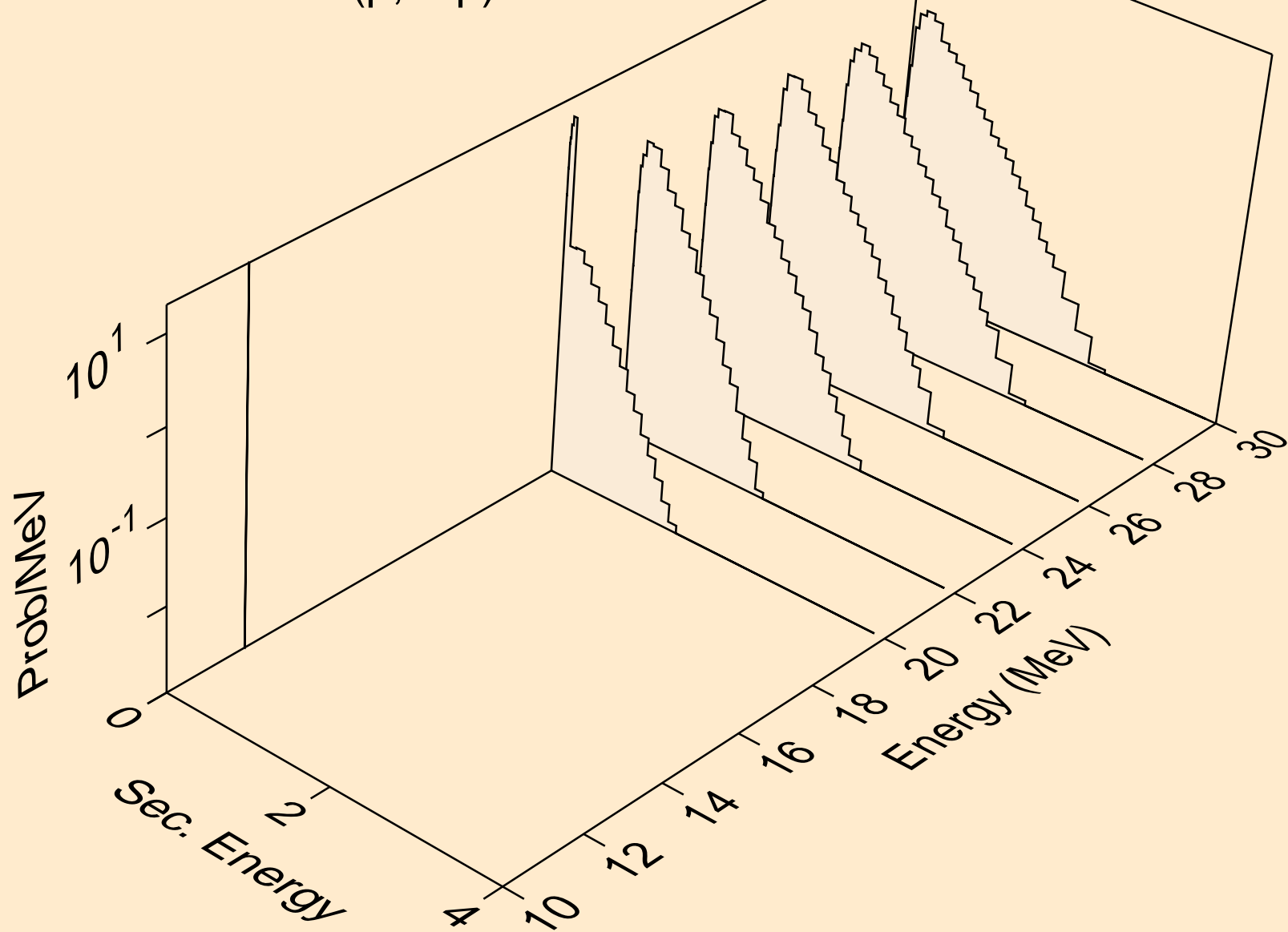

U233 PROTON ACER TENDL-2021 LIBRARY; T=0.K  
neutrons from (p,npa)

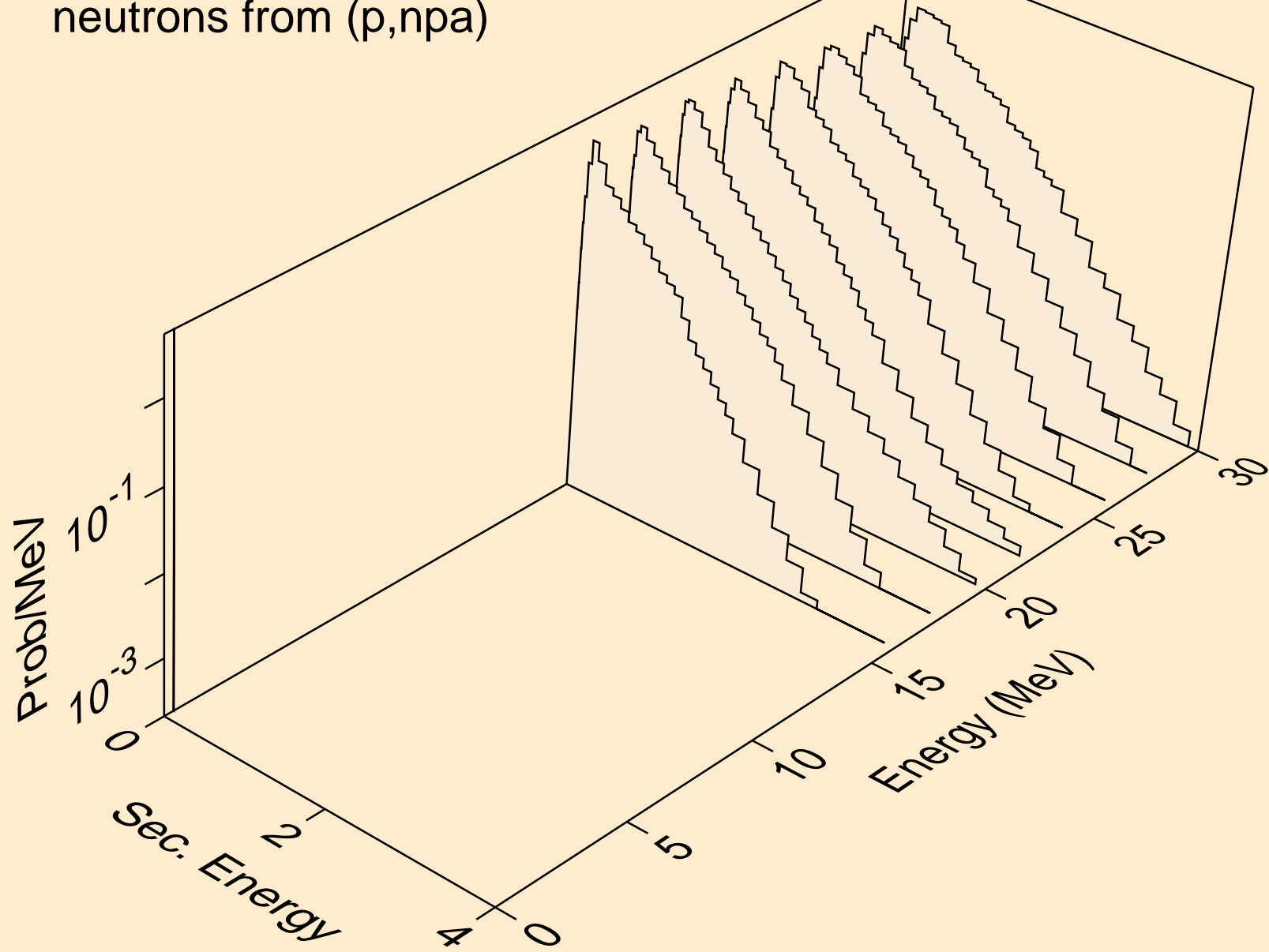

U233 PROTON ACER TENDL-2021 LIBRARY; T=0.K  
deuterons from (p,x)

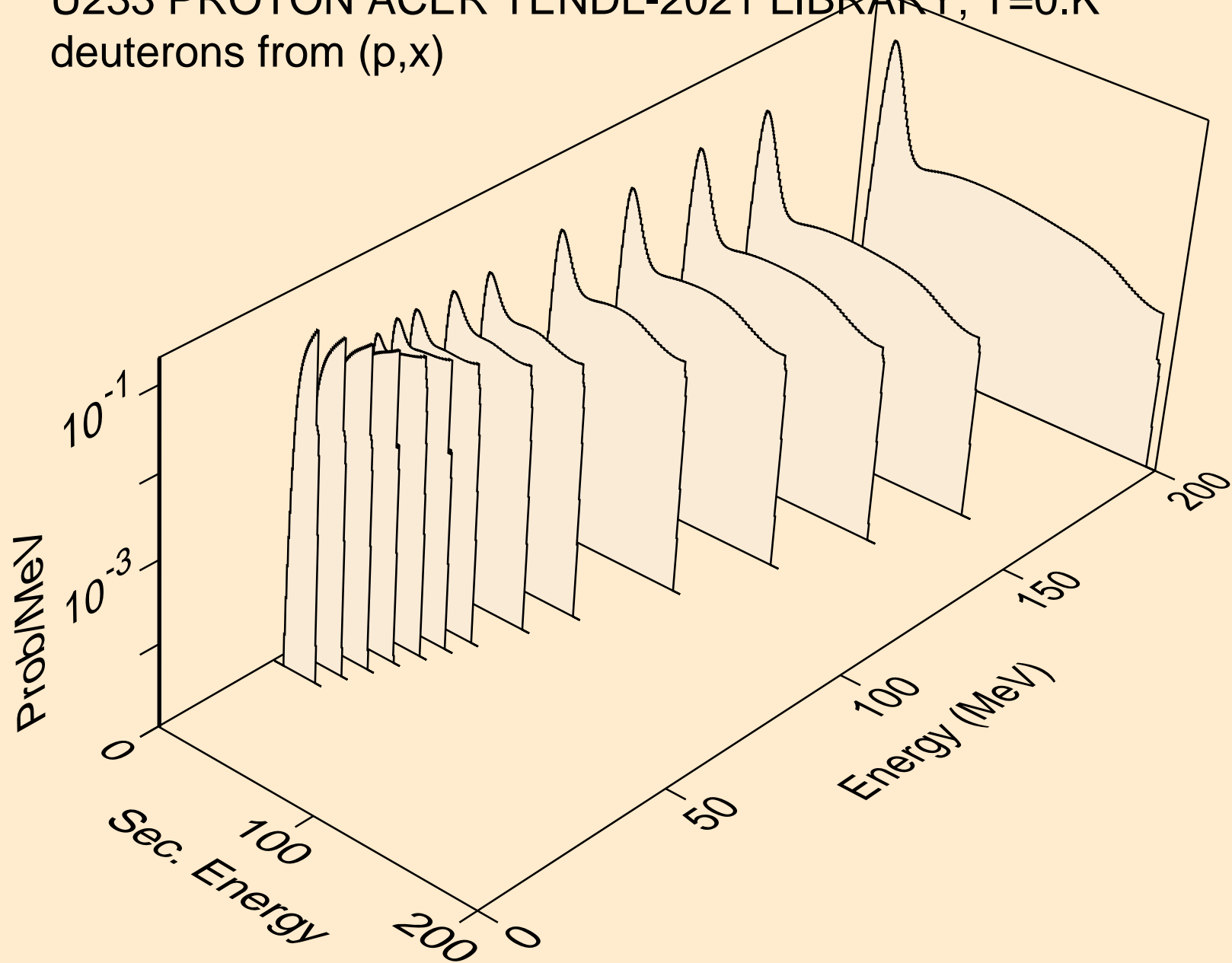

U233 PROTON ACER TENDL-2021 LIBRARY; T=0.K  
deuterons from (p,2nd)

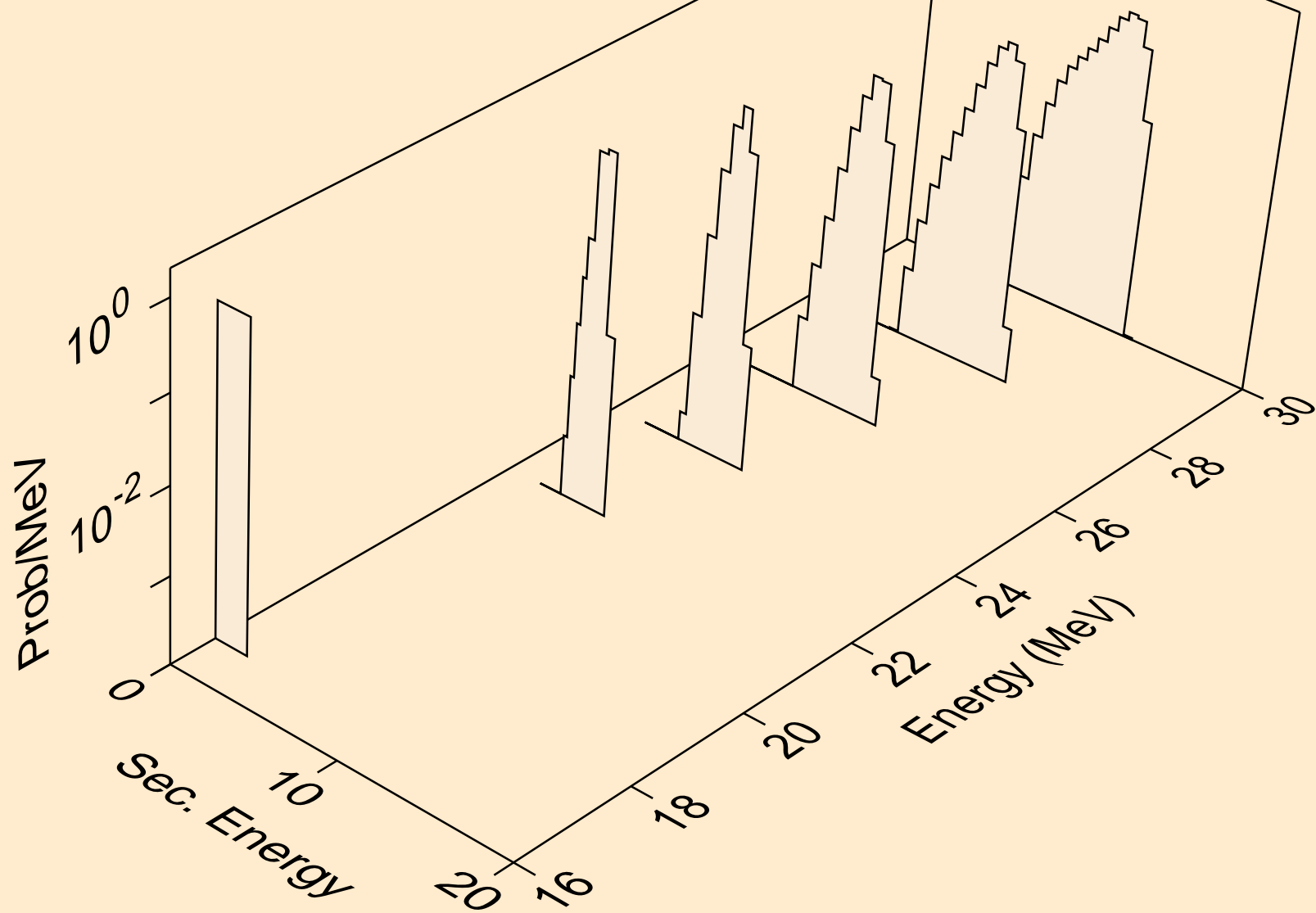

U233 PROTON ACER TENDL-2021 LIBRARY; T=0.K  
deuterons from (p,n\*)d

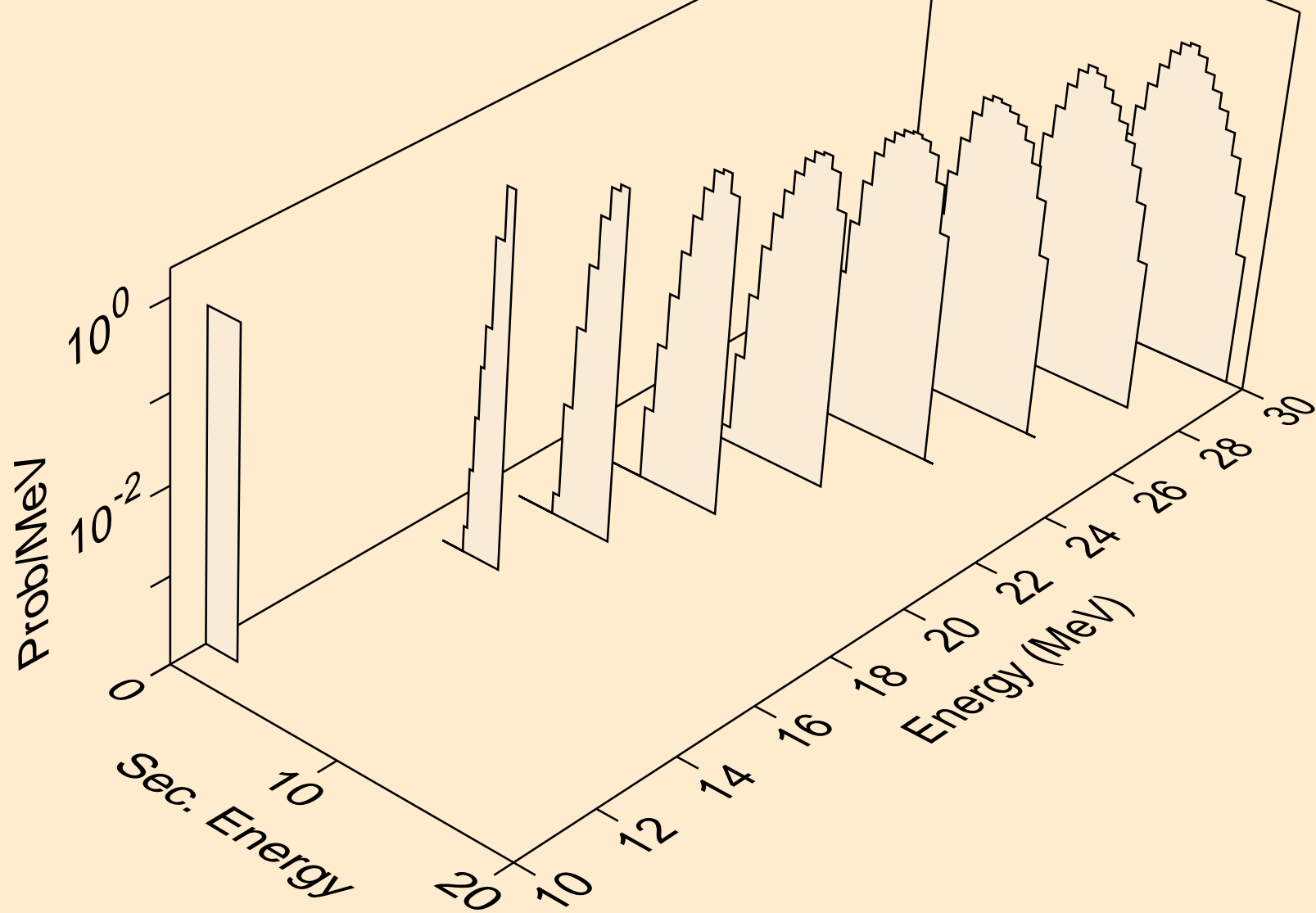

U233 PROTON ACER TENDL-2021 LIBRARY; T=0.K  
deuterons from (p,d)

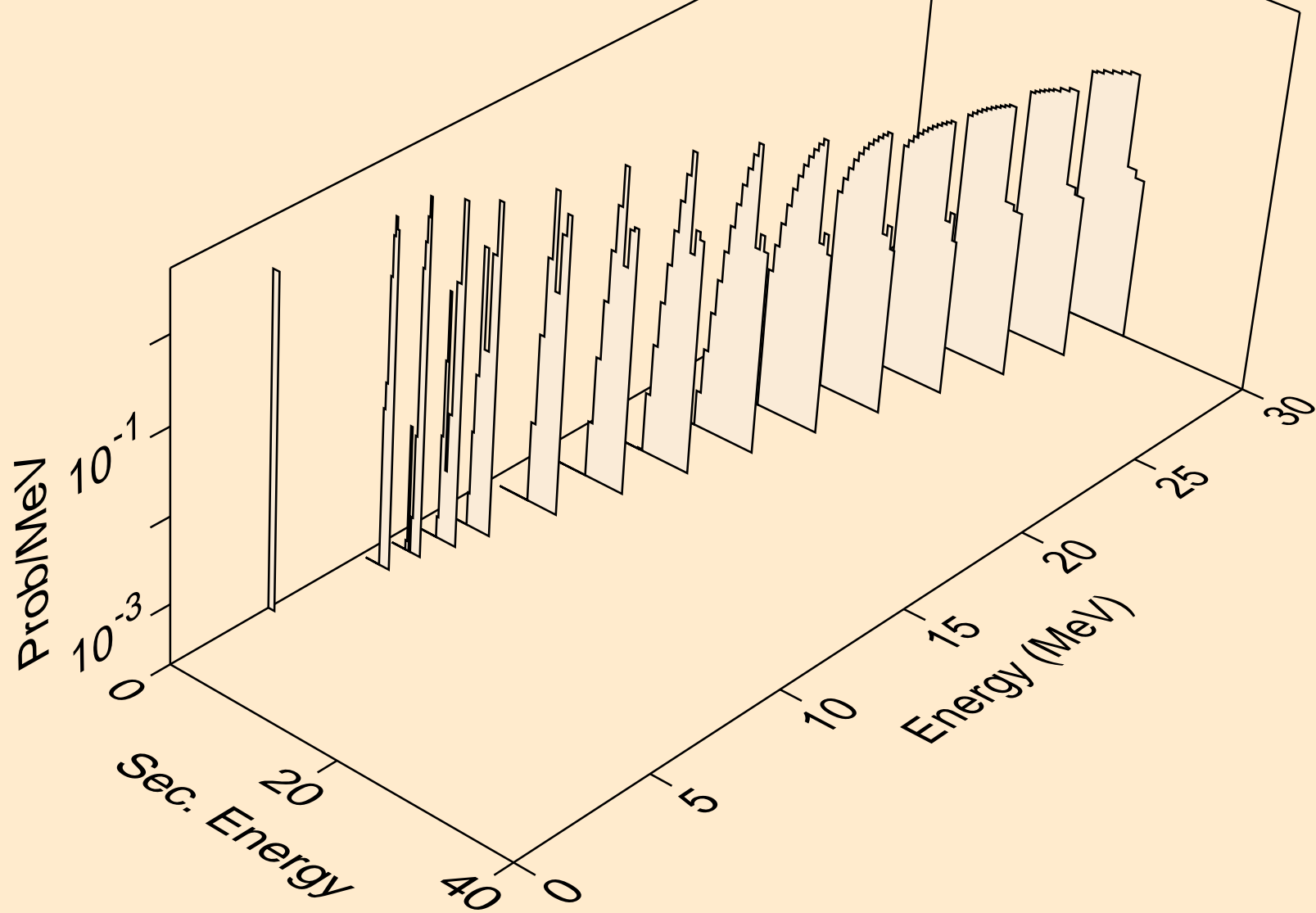



U233 PROTON ACER TENDL-2021 LIBRARY; T=0.K  
tritons from (p,x)

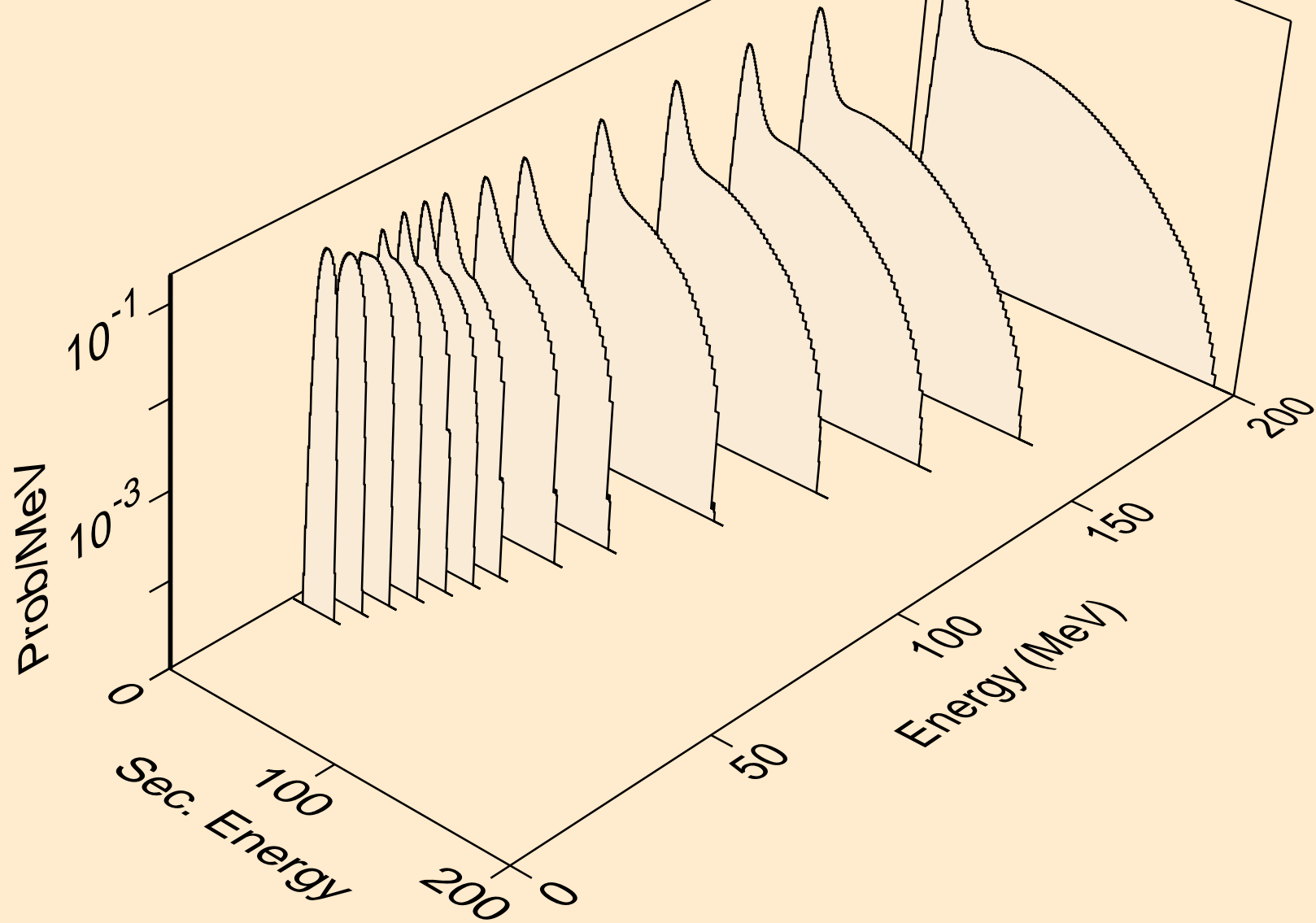

U233 PROTON ACER TENDL-2021 LIBRARY; T=0.K  
tritons from (p,n\*)t

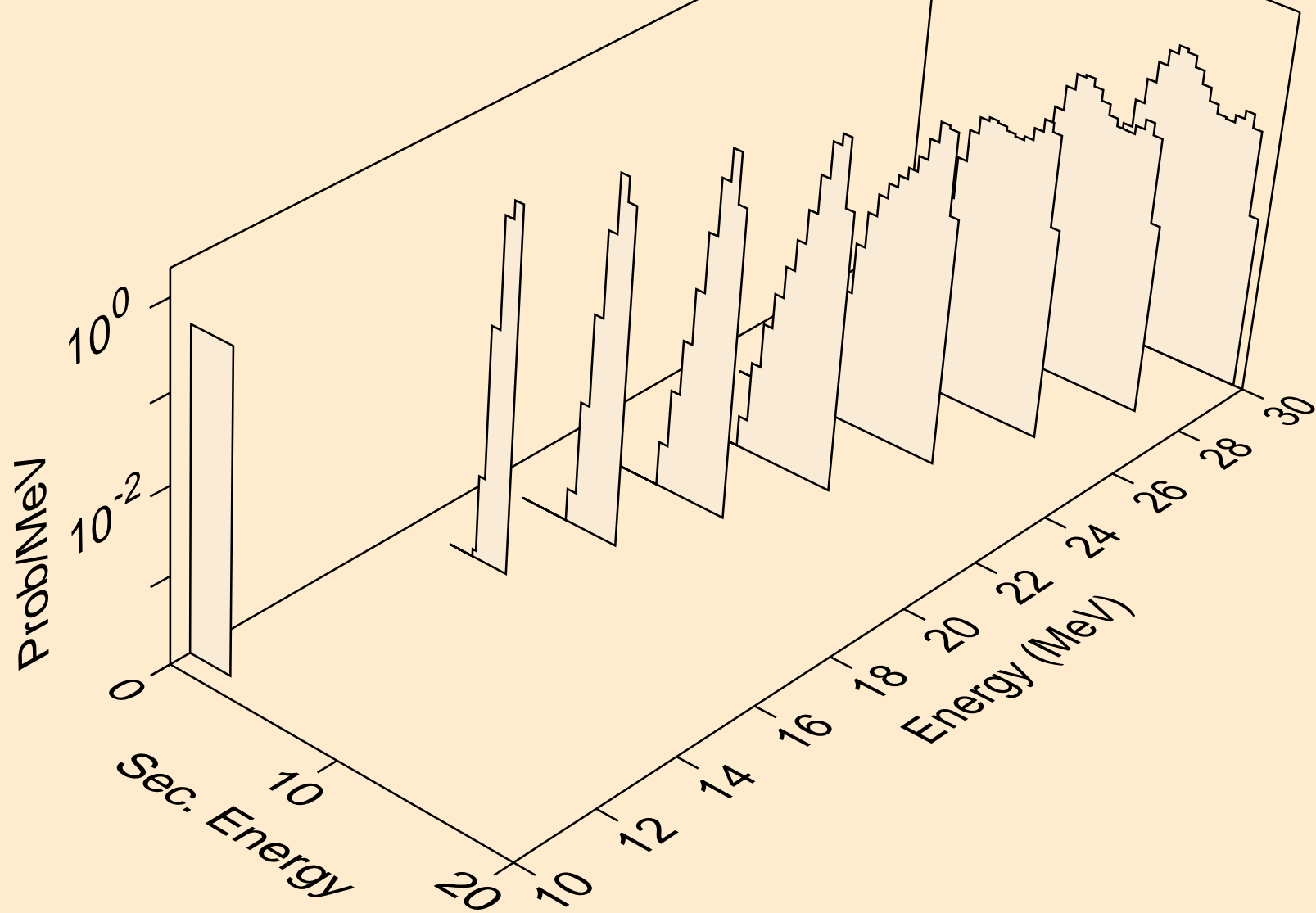

U233 PROTON ACER TENDL-2021 LIBRARY; T=0.K  
tritons from (p,t)

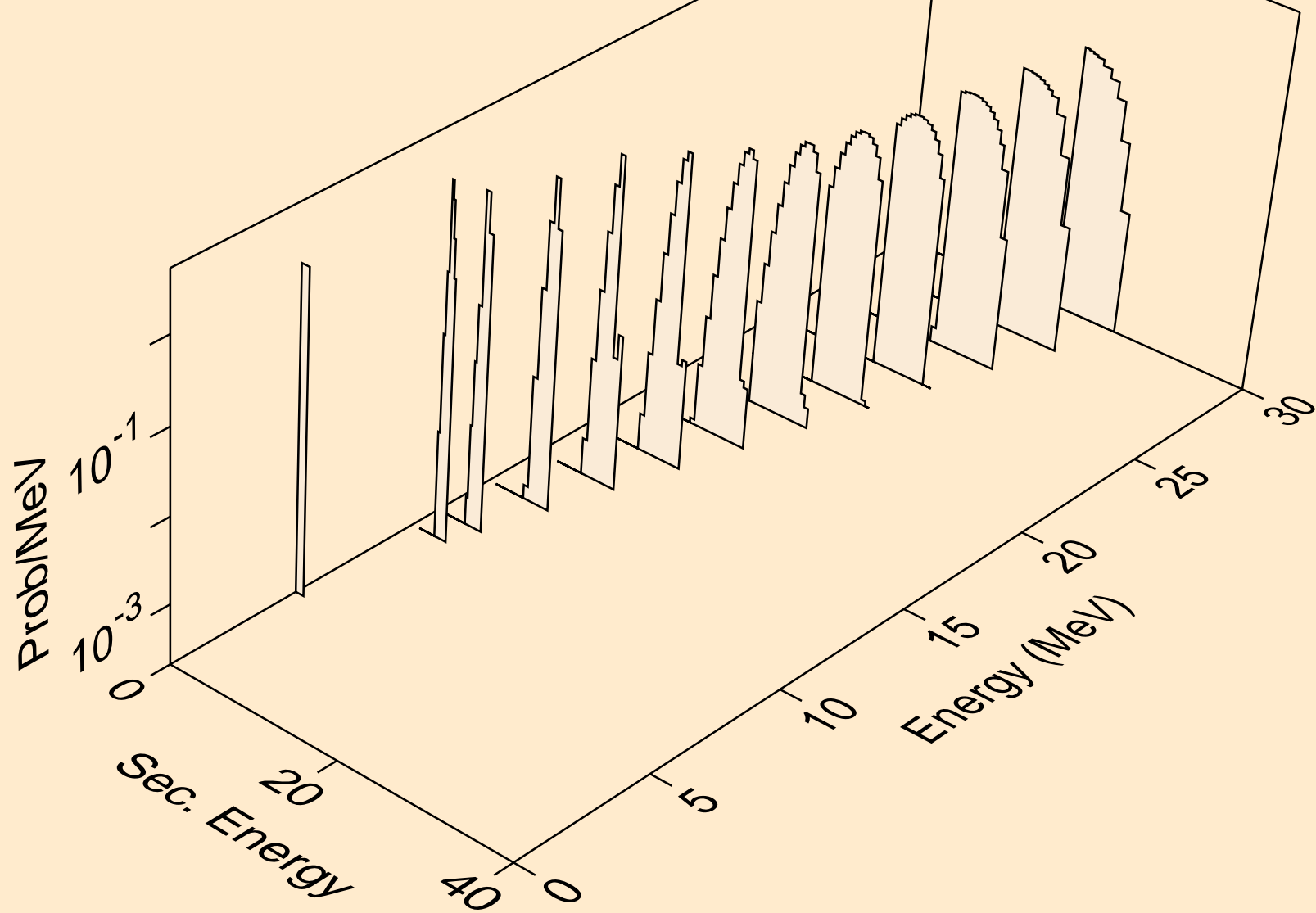

U233 PROTON ACER TENDL-2021 LIBRARY; T=0.K  
he3s from (p,x)

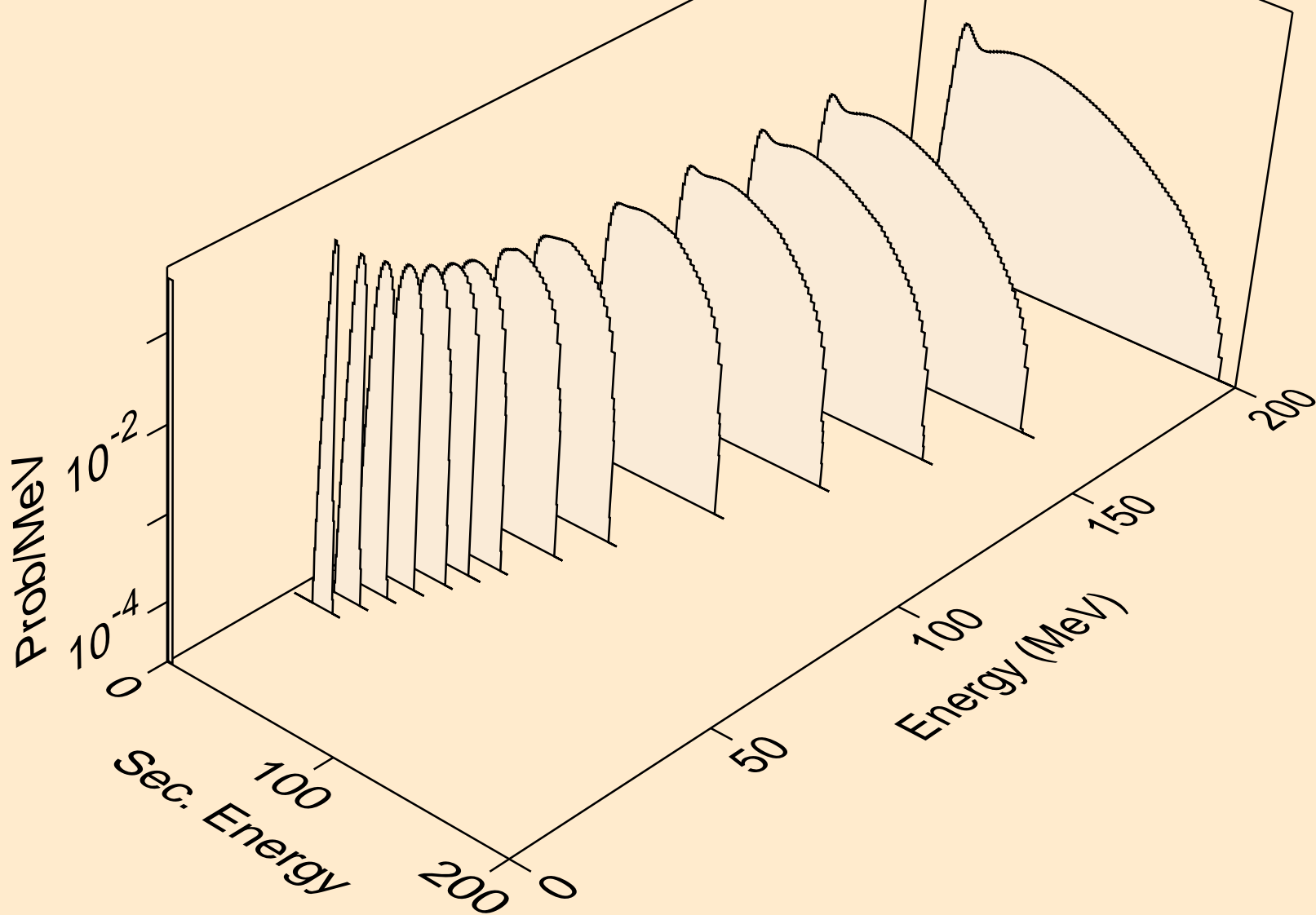

U233 PROTON ACER TENDL-2021 LIBRARY; T=0.K  
he3s from (p,n\*)he3

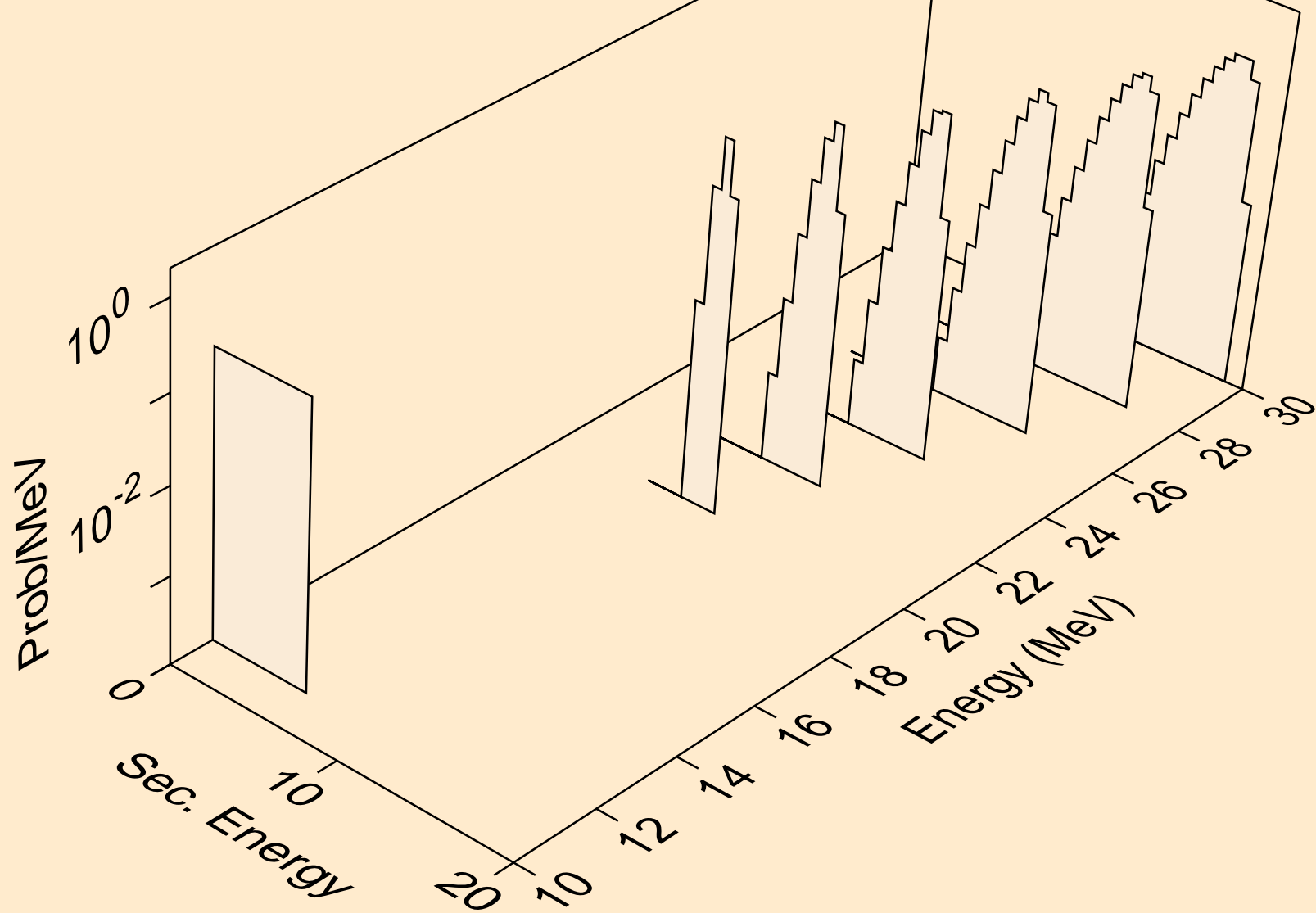

U233 PROTON ACER TENDL-2021 LIBRARY; T=0.K  
he3s from (p,he3)

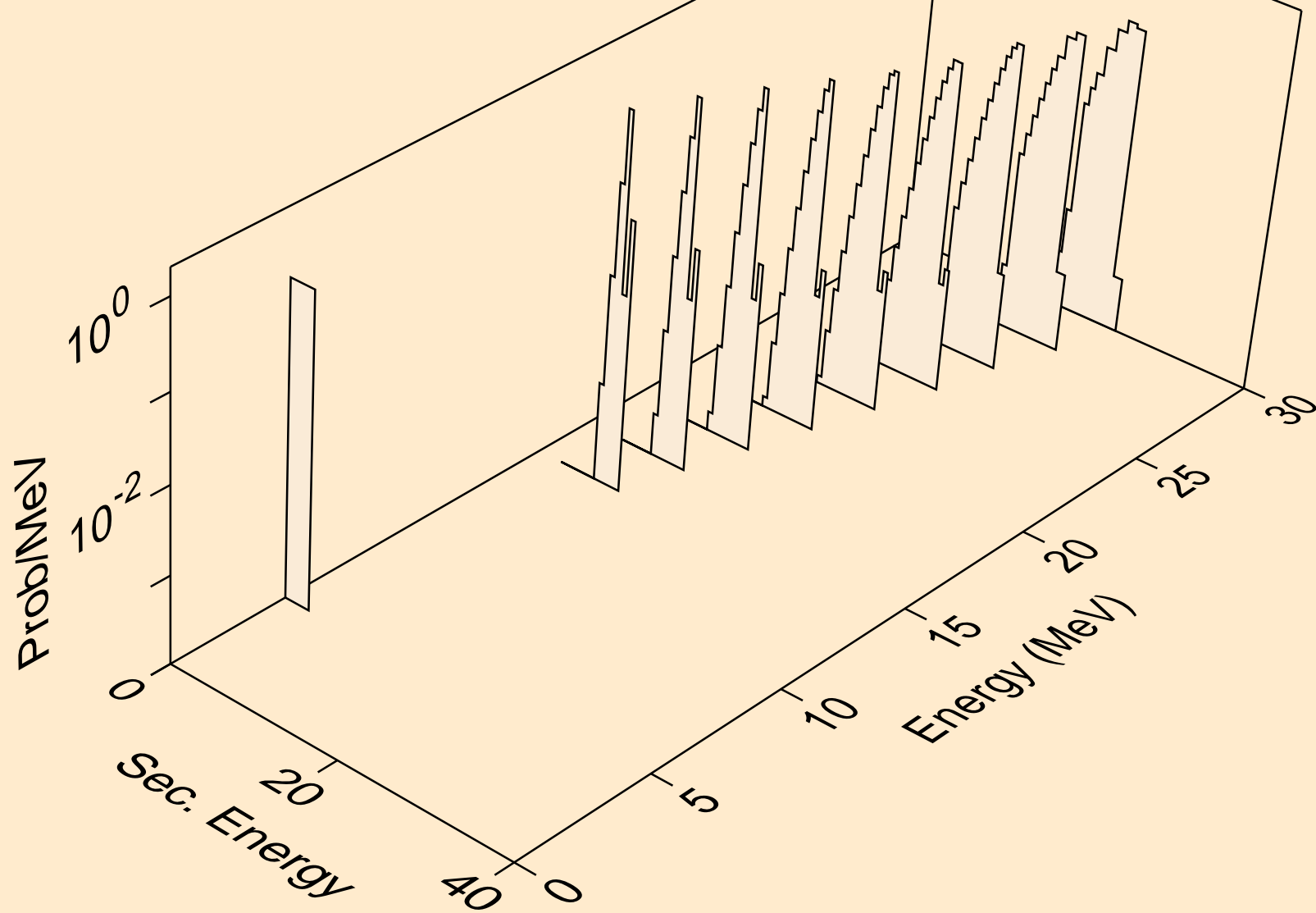

U233 PROTON ACER TENDL-2021 LIBRARY; T=0.K  
alphas from (p,x)

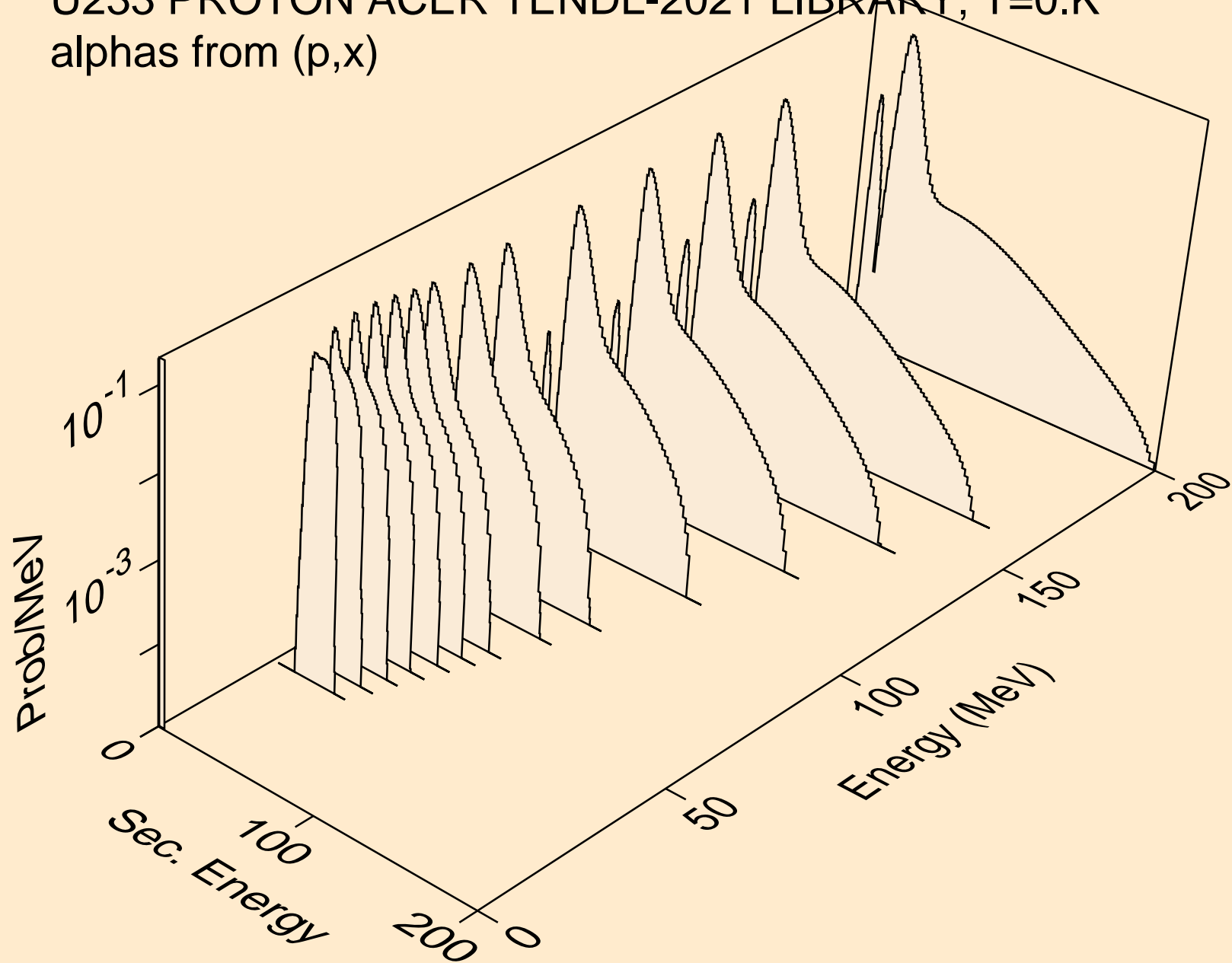

U233 PROTON ACER TENDL-2021 LIBRARY; T=0.K  
alphas from (p,n\*)a

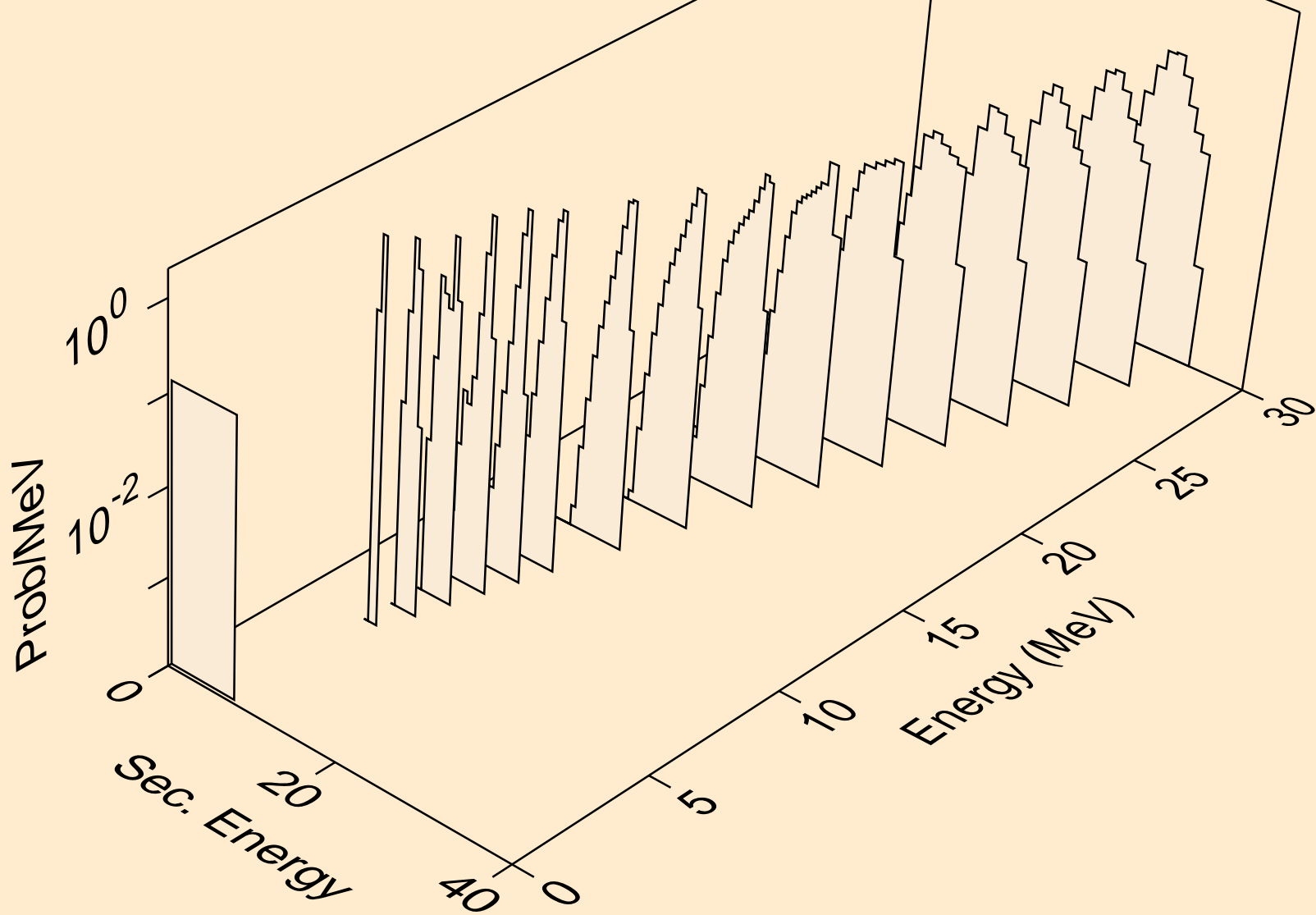



U233 PROTON ACER TENDL-2021 LIBRARY; T=0.K  
alphas from (p,2n)a

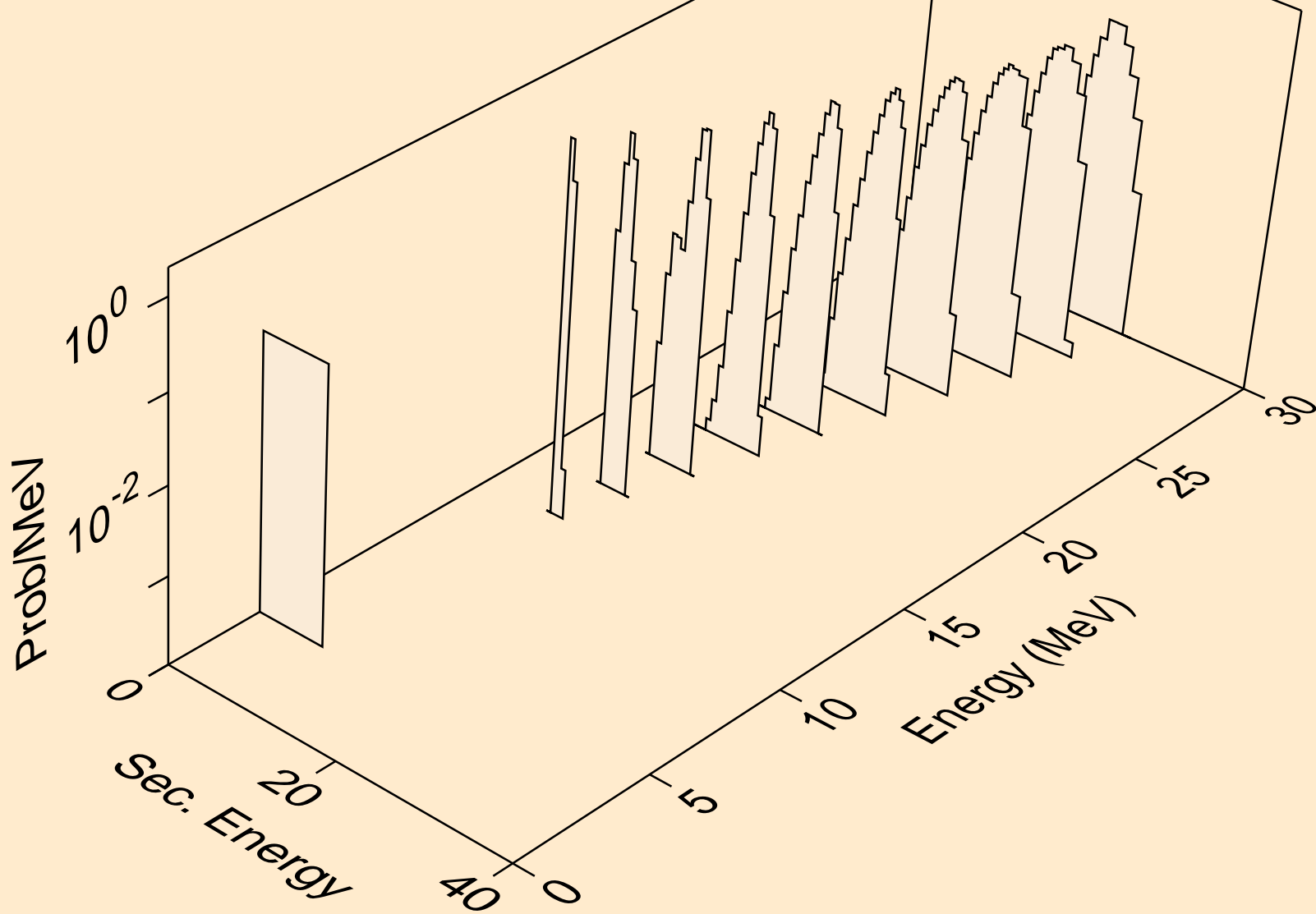

U233 PROTON ACER TENDL-2021 LIBRARY; T=0.K  
alphas from (p,3n)a

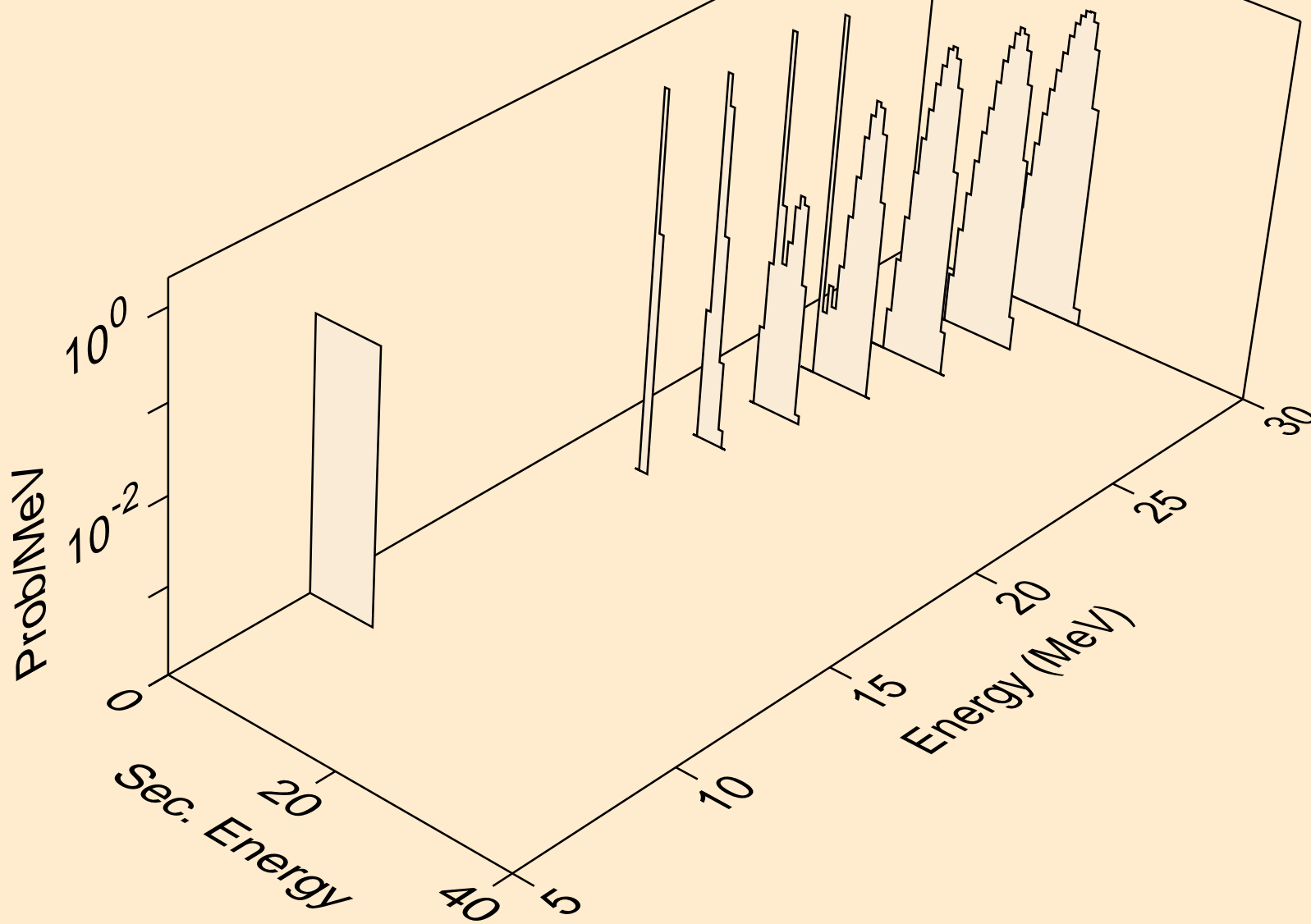

U233 PROTON ACER TENDL-2021 LIBRARY; T=0.K  
alphas from (p,n\*)2a

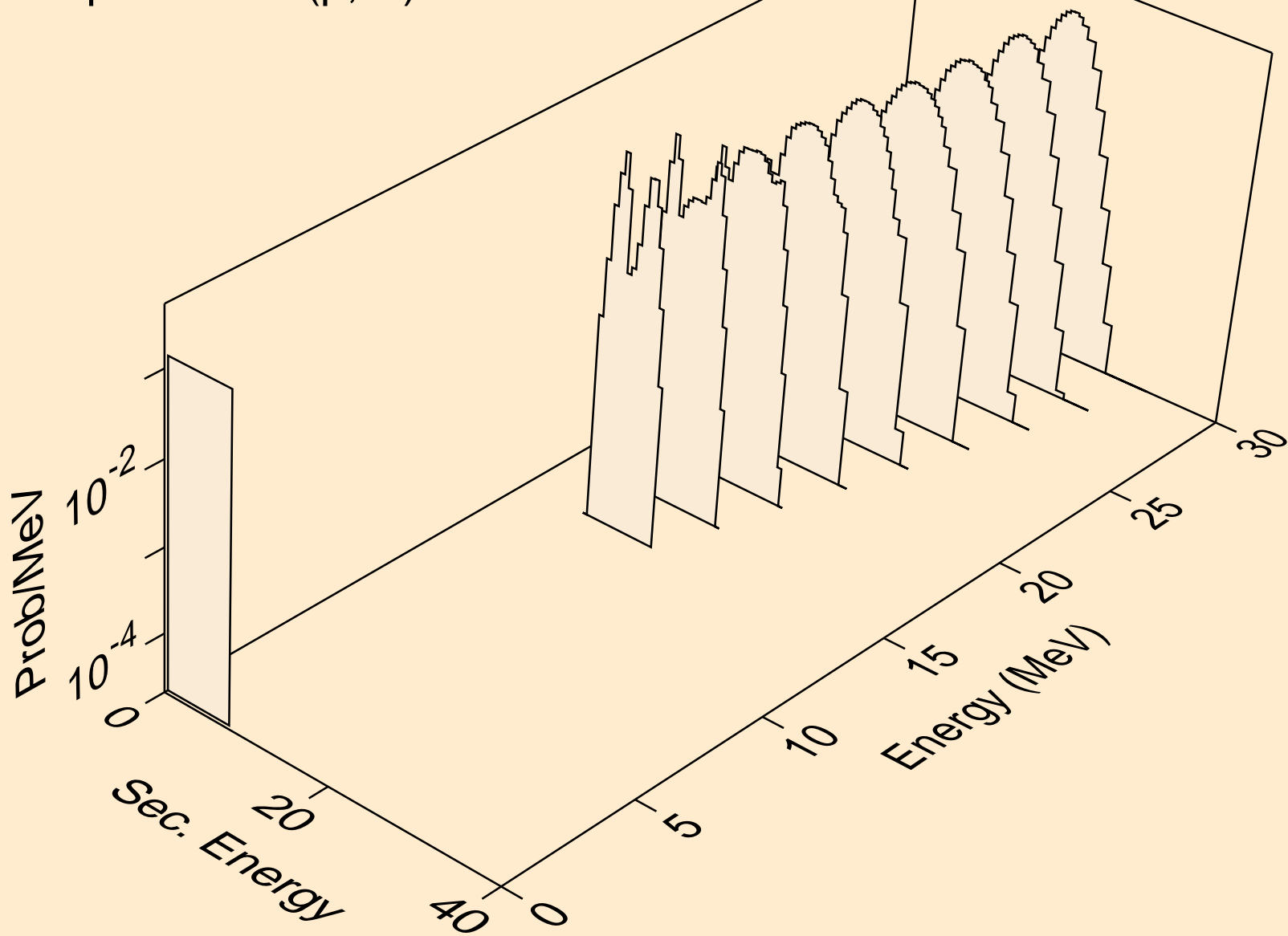

U233 PROTON ACER TENDL-2021 LIBRARY; T=0.K  
alphas from (p,npa)

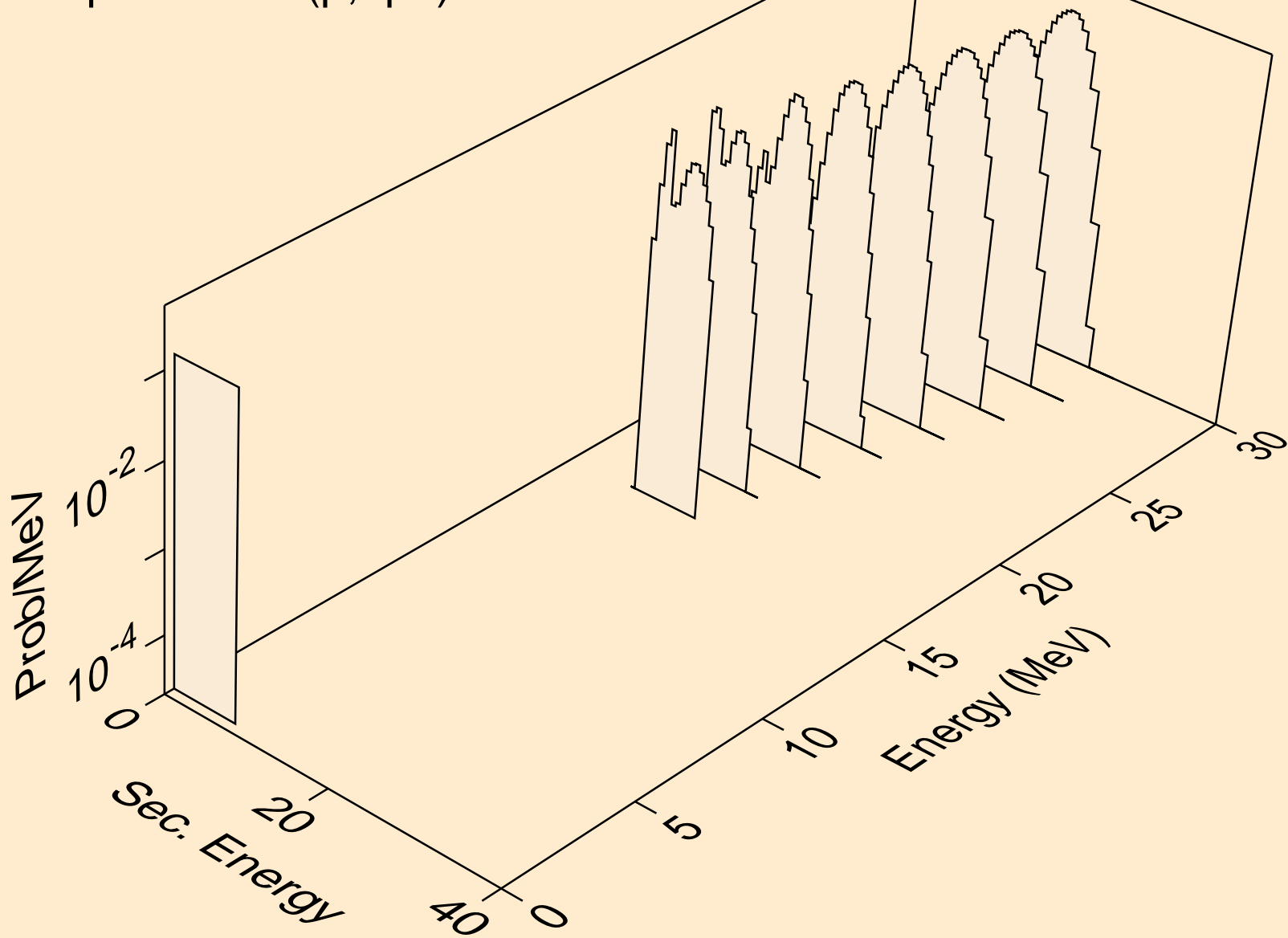

U233 PROTON ACER TENDL-2021 LIBRARY; T=0.K  
alphas from (p,a)

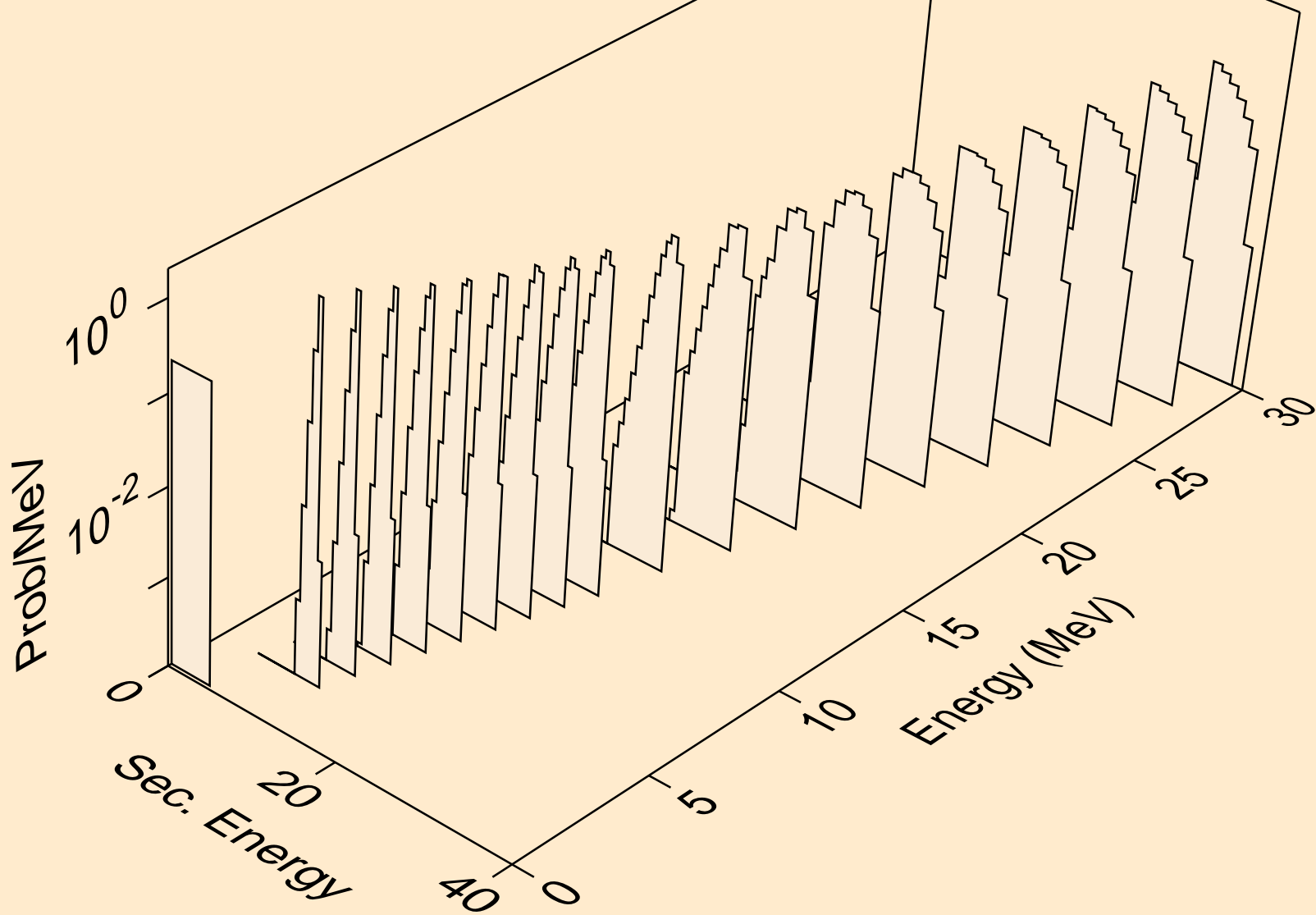

U233 PROTON ACER TENDL-2021 LIBRARY; T=0.K  
alphas from (p,2a)

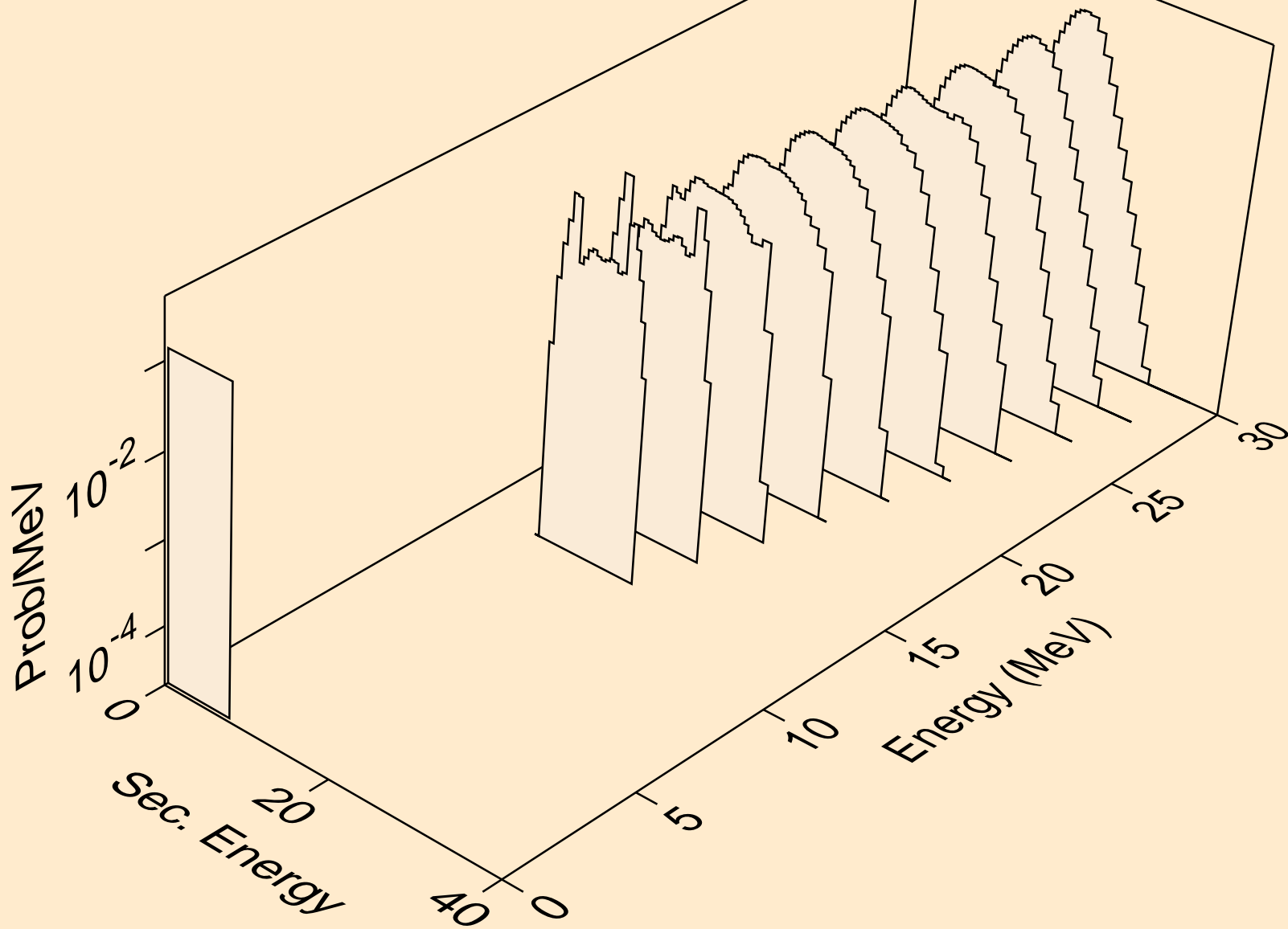

U233 PROTON ACER TENDL-2021 LIBRARY; T=0.K  
alphas from (p,pa)

