

# W193 PROTON ACER TENDL-2021 LIBRARY; T=0.K

## Principal cross sections

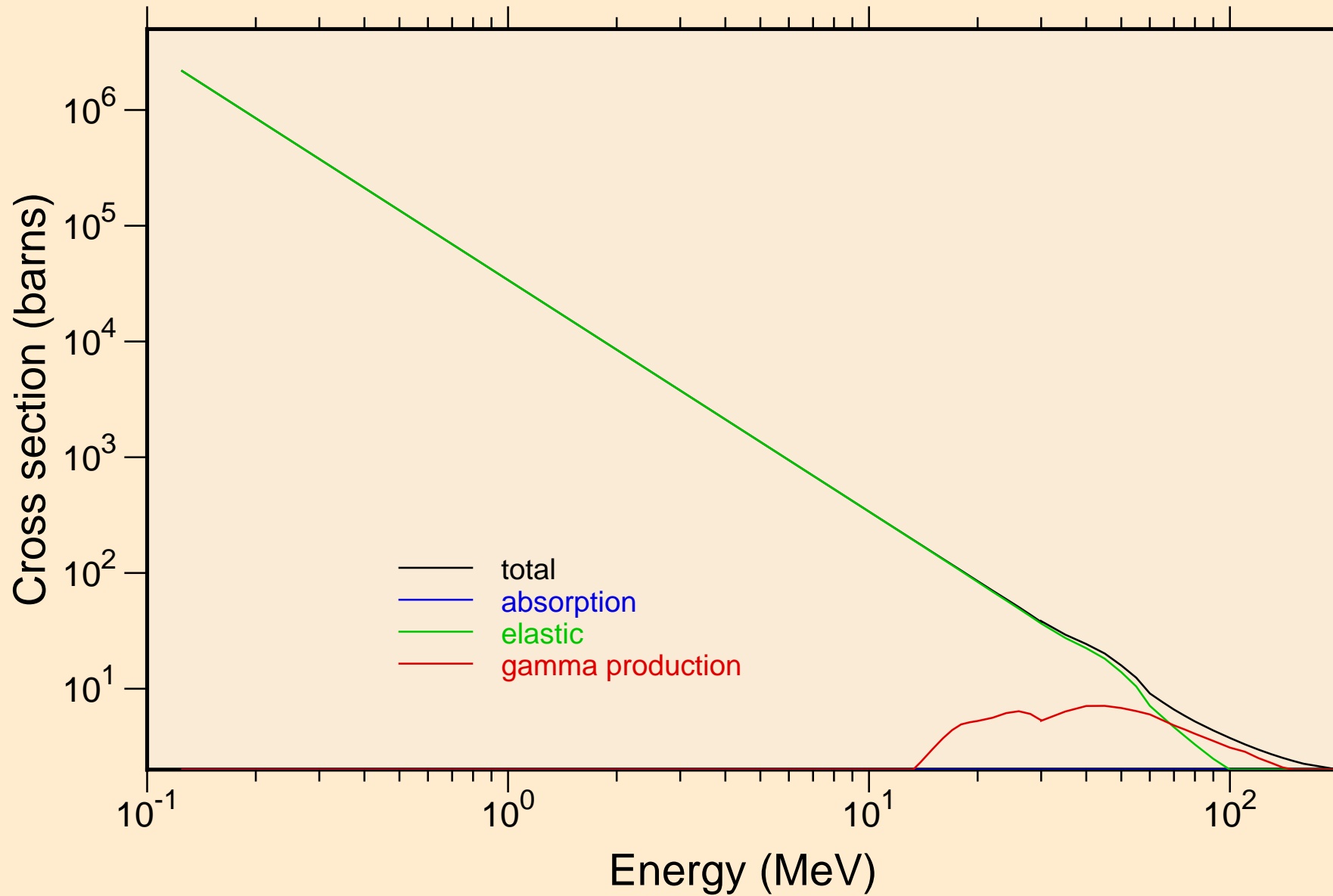

# W193 PROTON ACER TENDL-2021 LIBRARY; T=0.K

## Heating

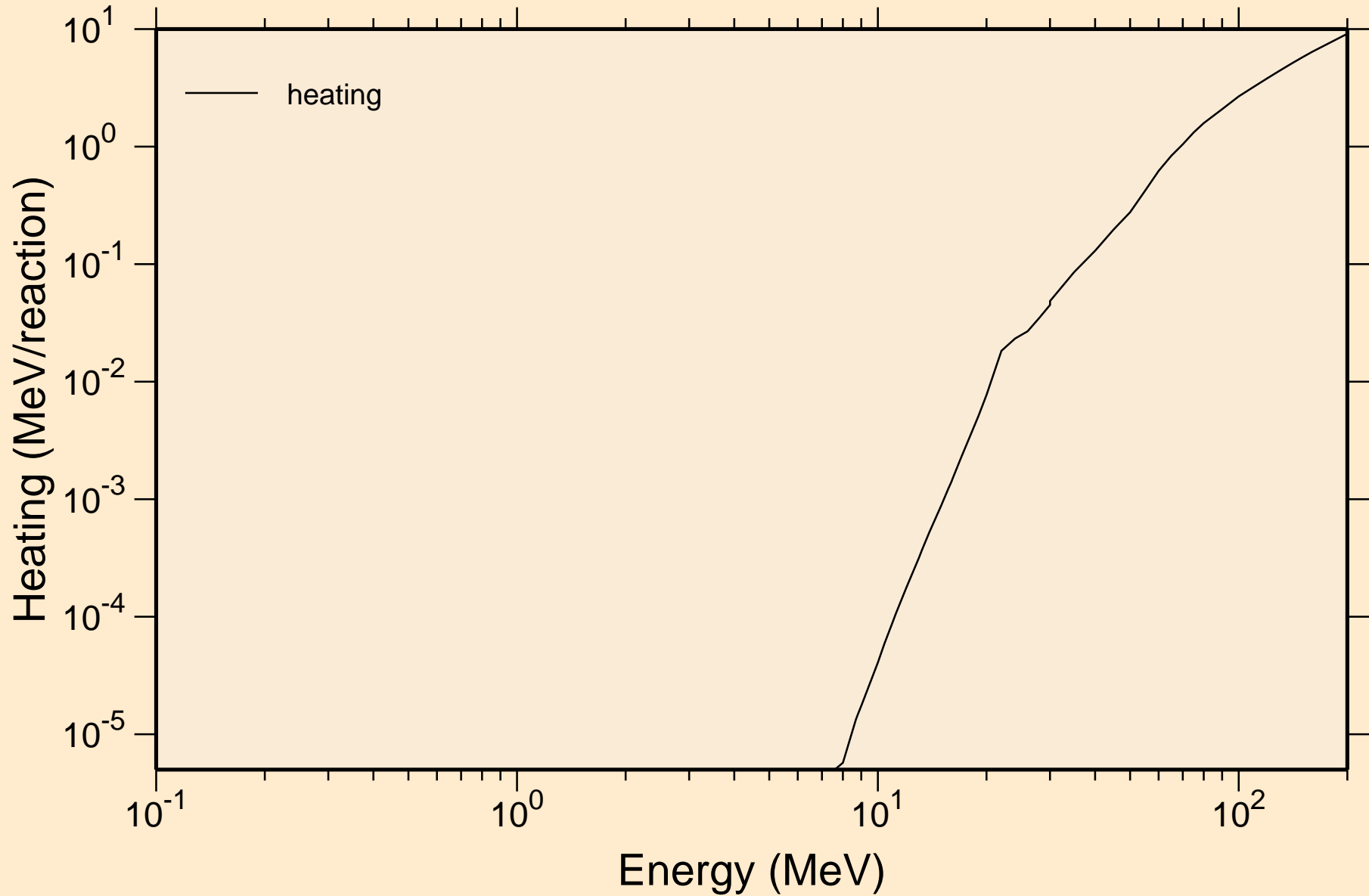

# W193 PROTON ACER TENDL-2021 LIBRARY; T=0.K

## Principal cross sections

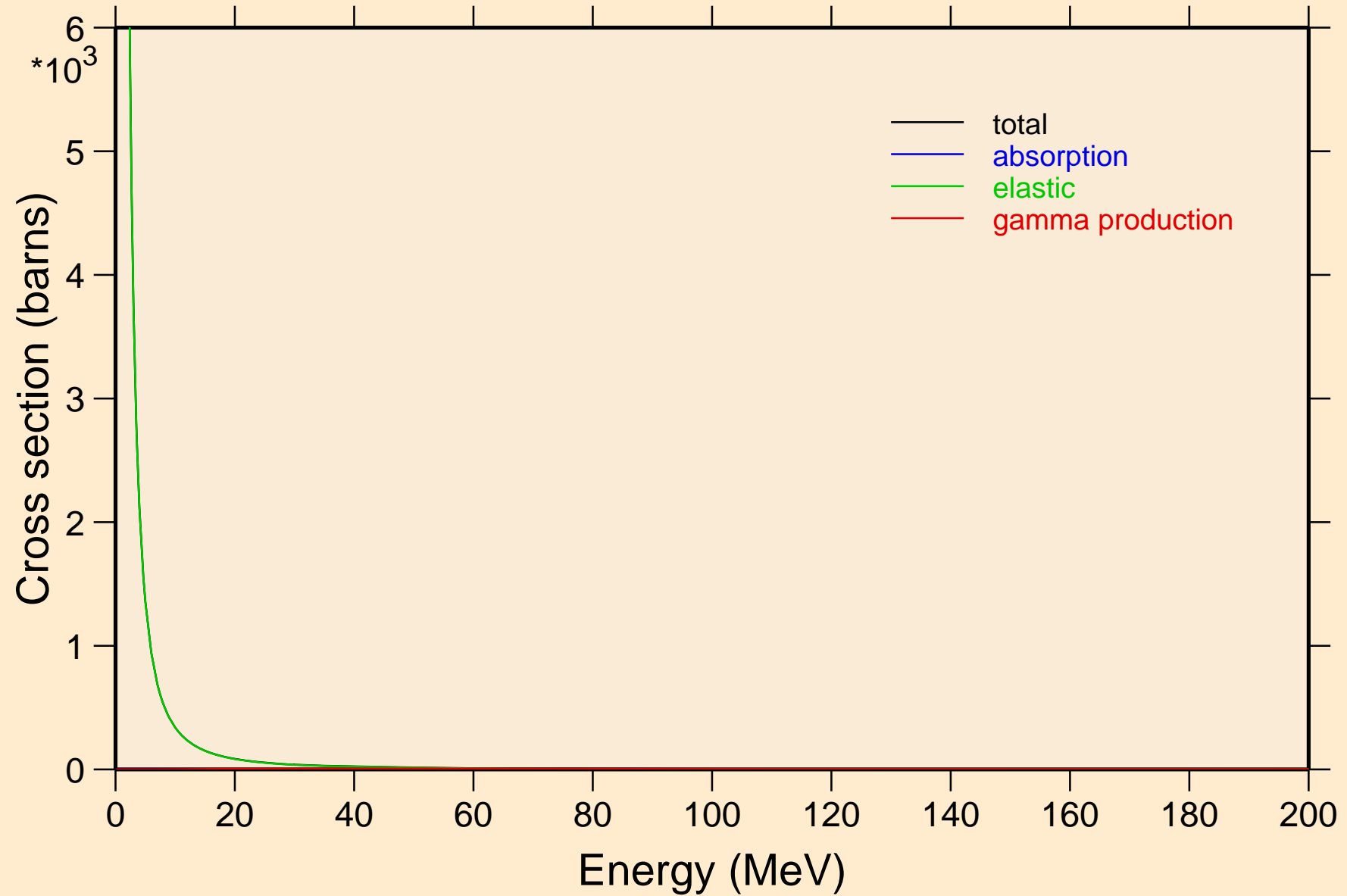

W193 PROTON ACER TENDL-2021 LIBRARY; T=0.K

Heating

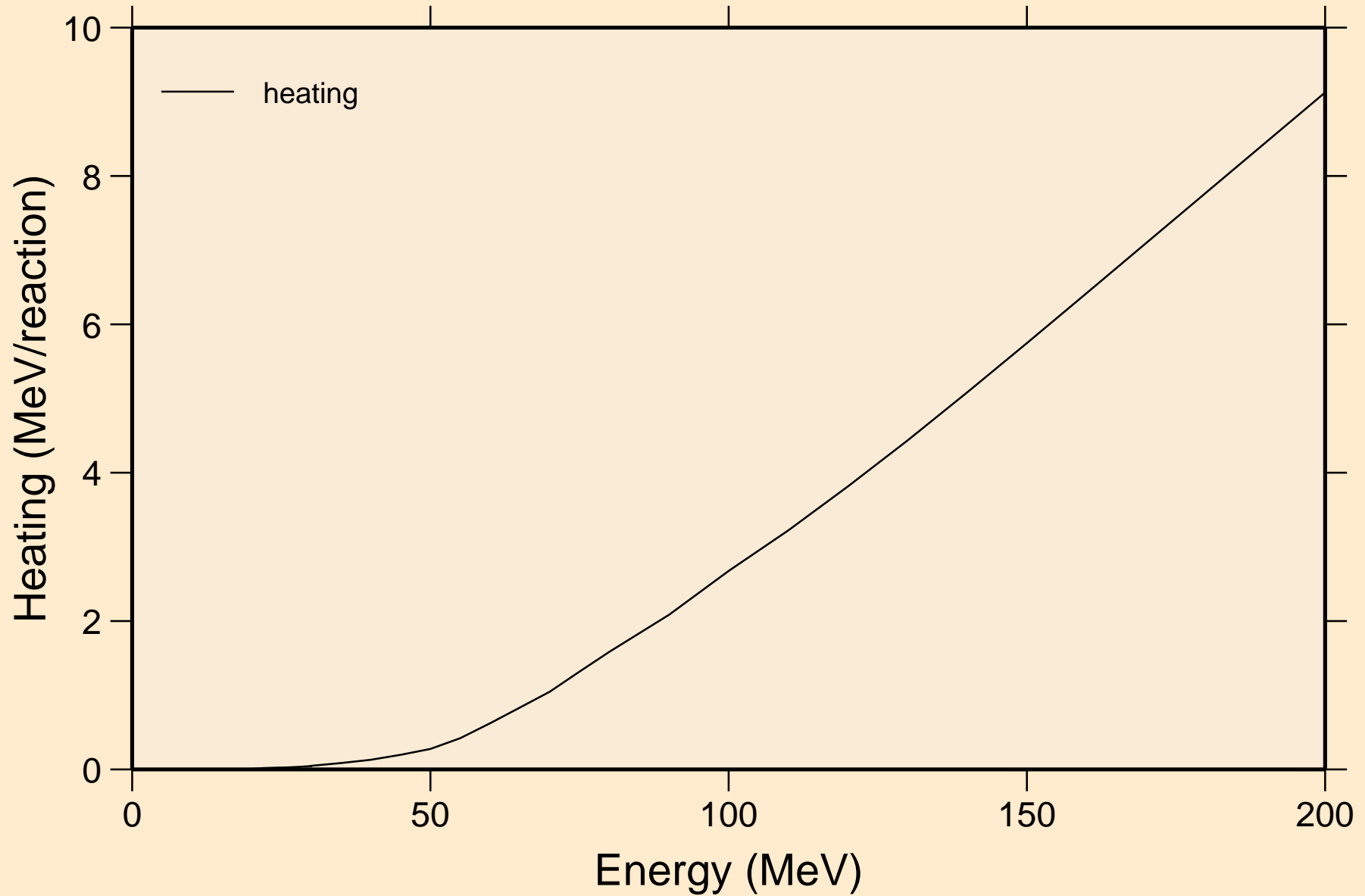

# W193 PROTON ACER TENDL-2021 LIBRARY; T=0.K

## Threshold reactions

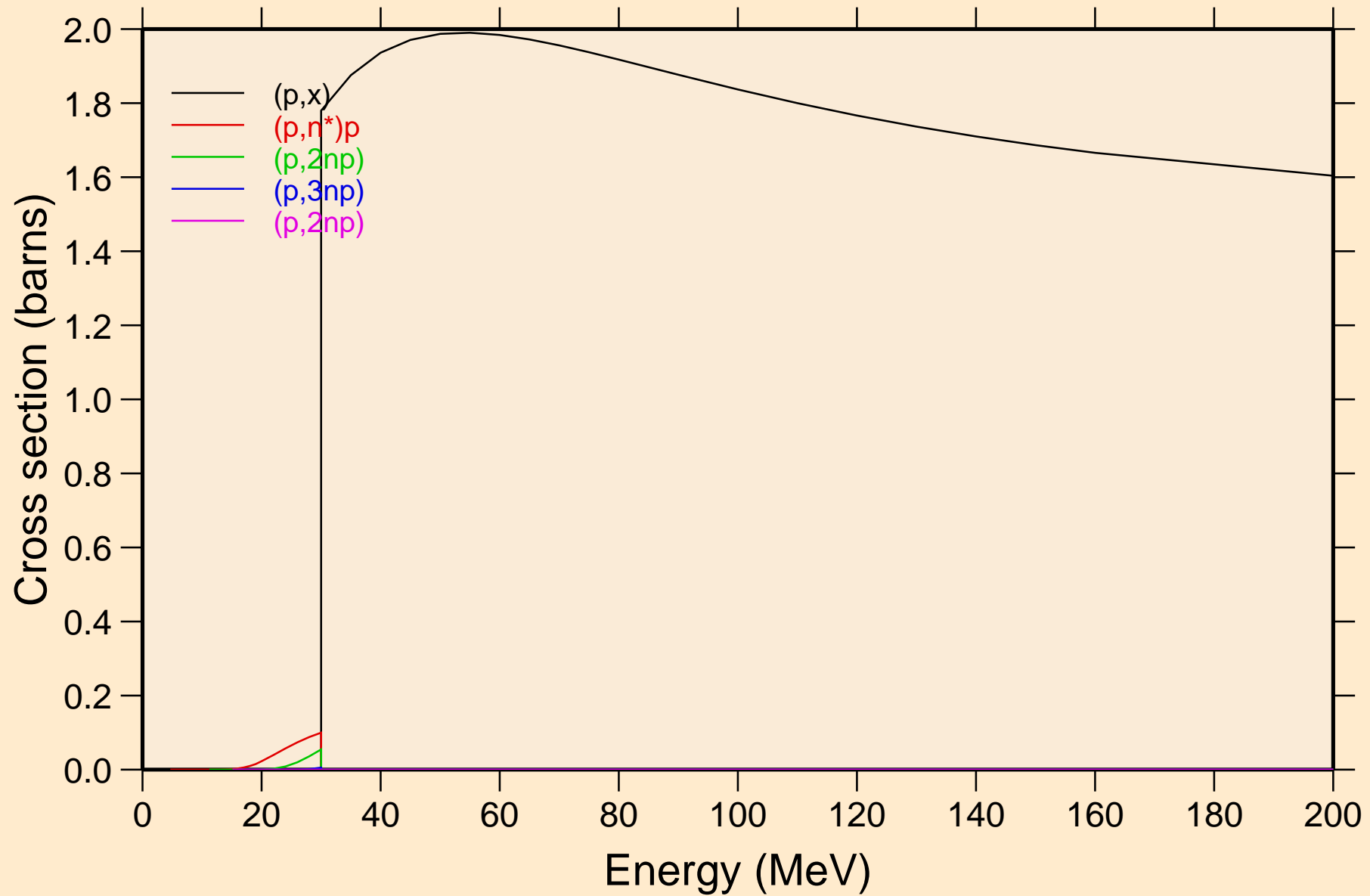

# W193 PROTON ACER TENDL-2021 LIBRARY; T=0.K

## Threshold reactions

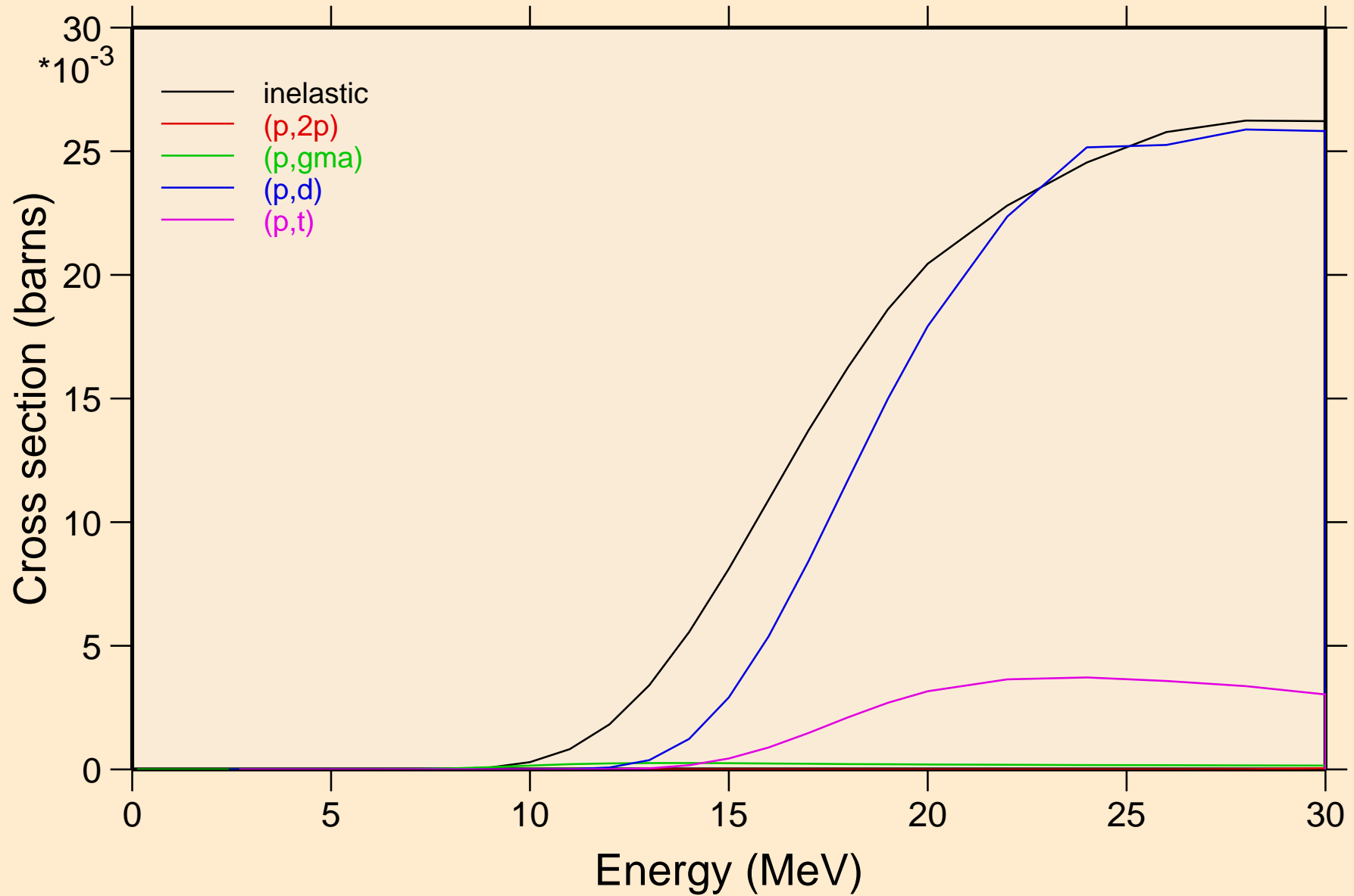

W193 PROTON ACER TENDL-2021 LIBRARY; T=0.K  
Threshold reactions

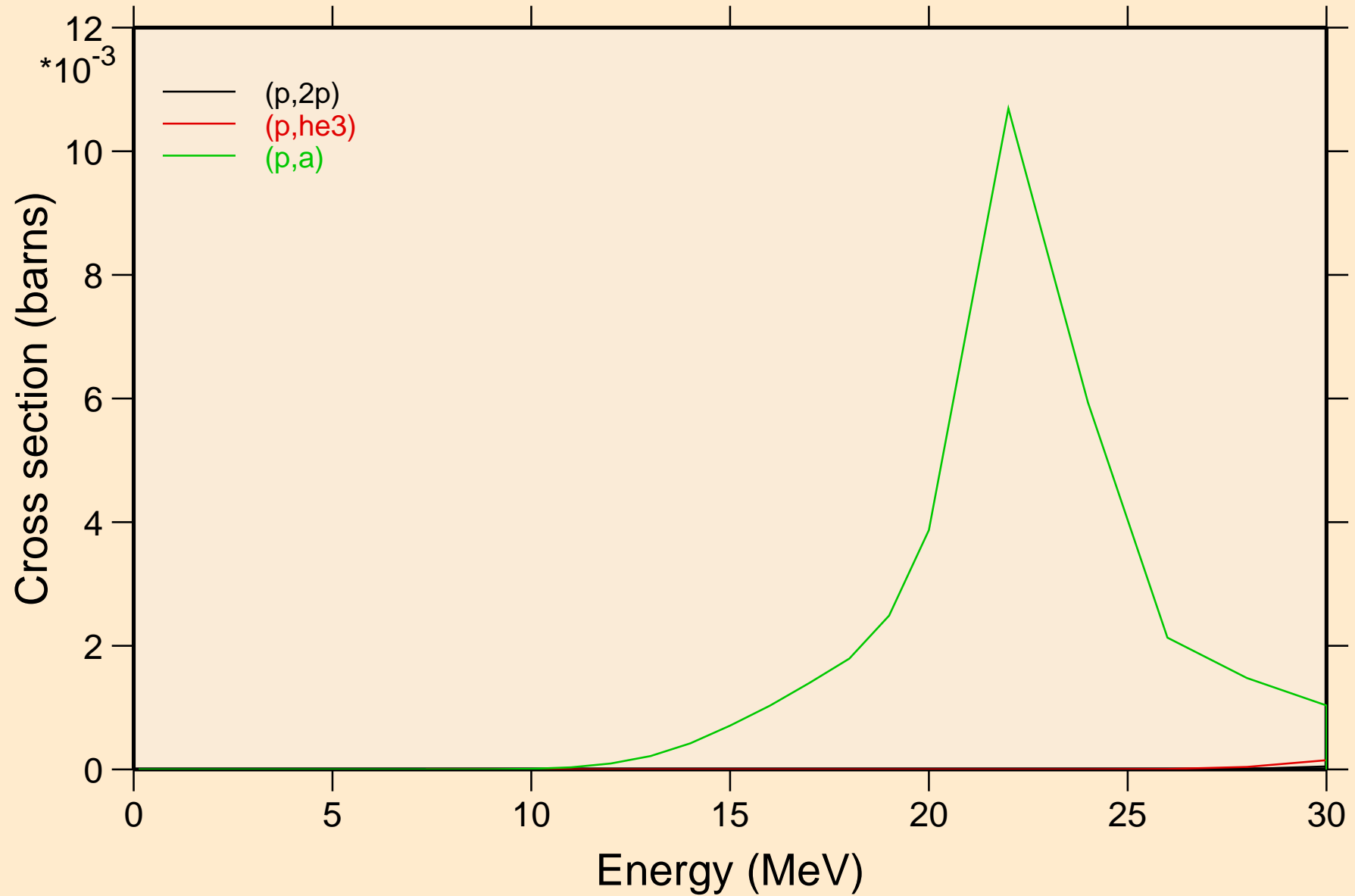

W193 PROTON ACER TENDL-2021 LIBRARY; T=0.K  
Threshold reactions

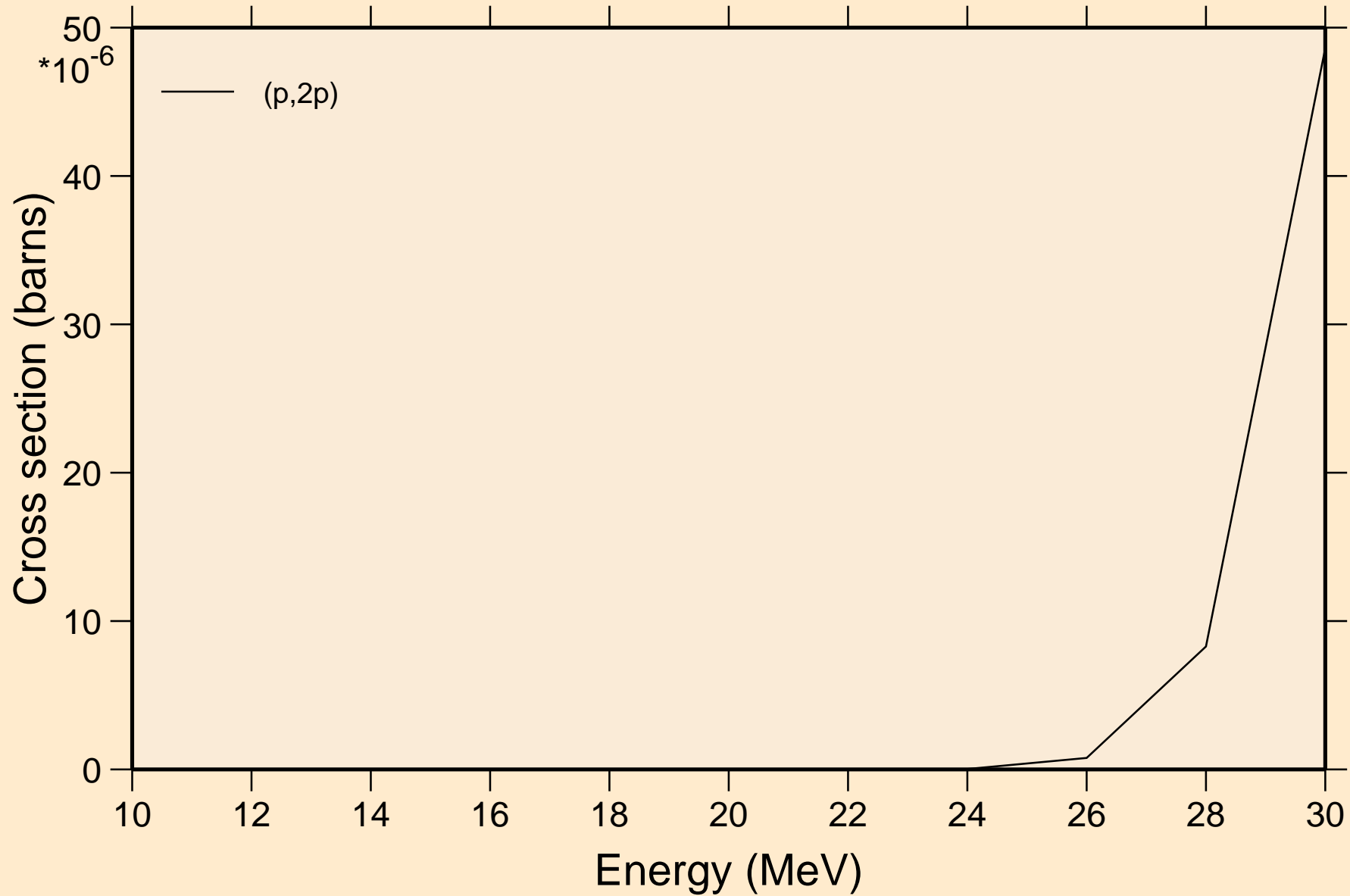



W193 PROTON ACER TENDL-2021 LIBRARY; T=0.K  
angular distribution for elastic

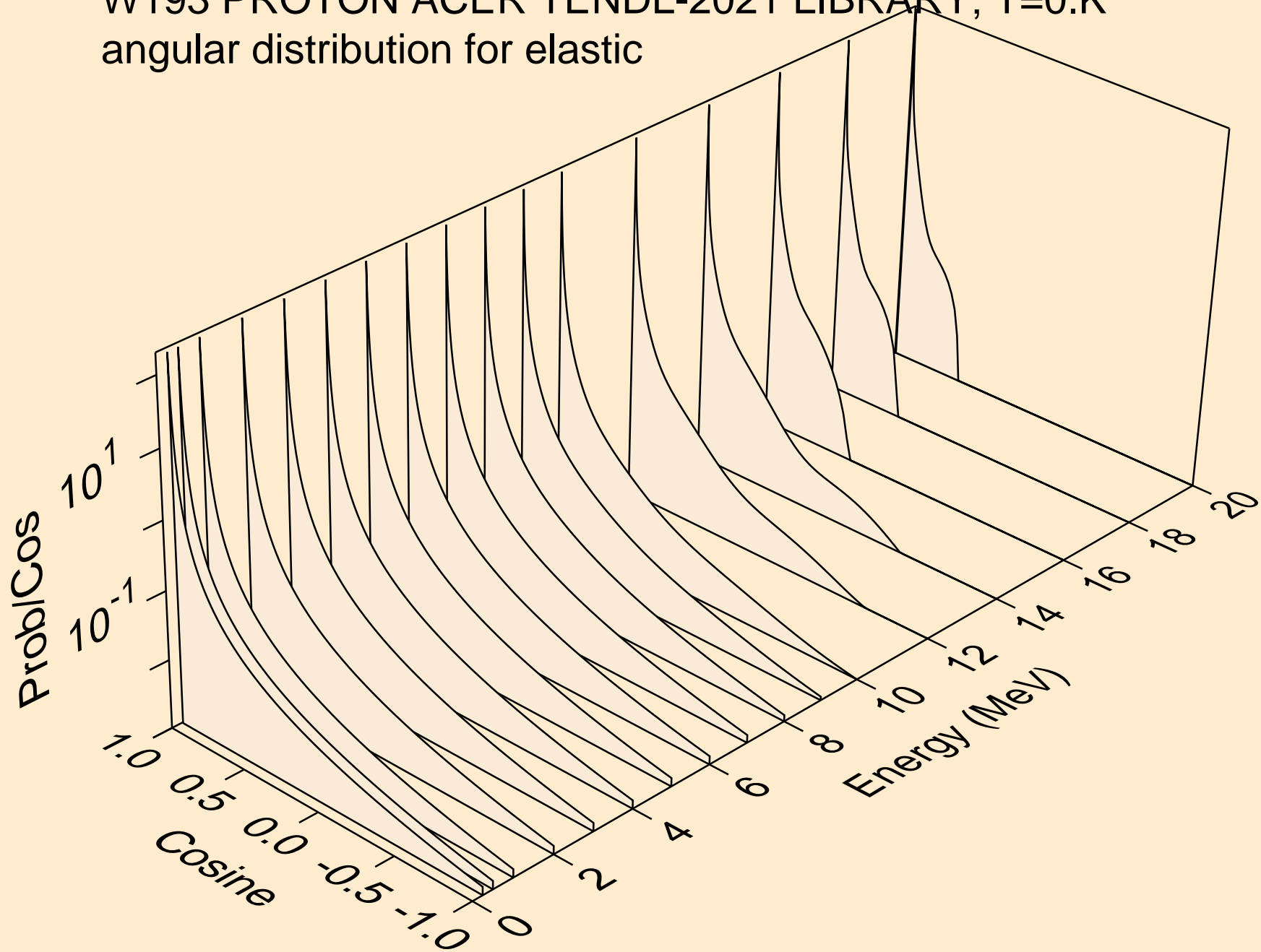

W193 PROTON ACER TENDL-2021 LIBRARY; T=0.K  
angular distribution for elastic

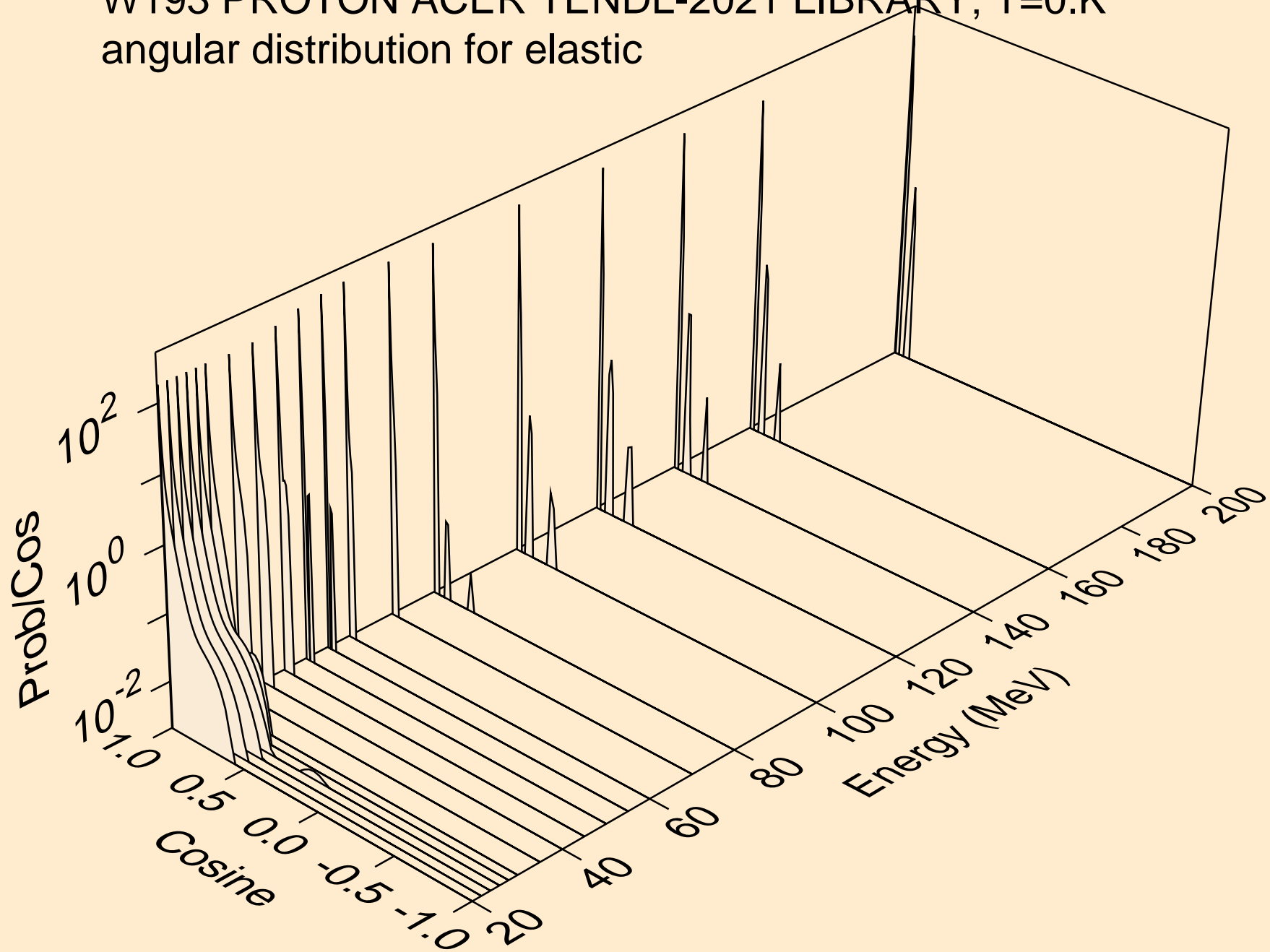

W193 PROTON ACER TENDL-2021 LIBRARY; T=0.K  
Proton emission for (p,x)

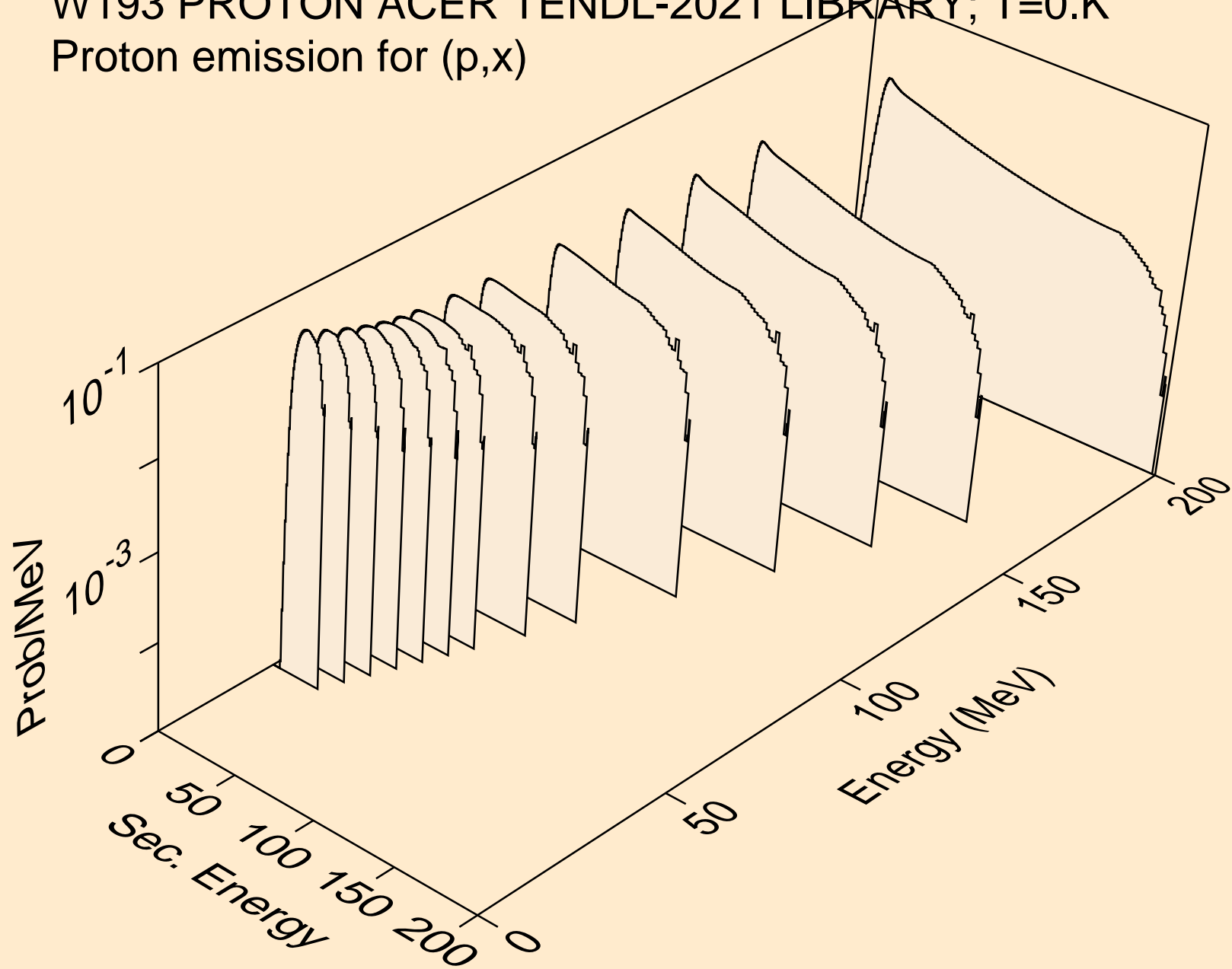

W193 PROTON ACER TENDL-2021 LIBRARY; T=0.K  
Proton emission for (p,n\*)p

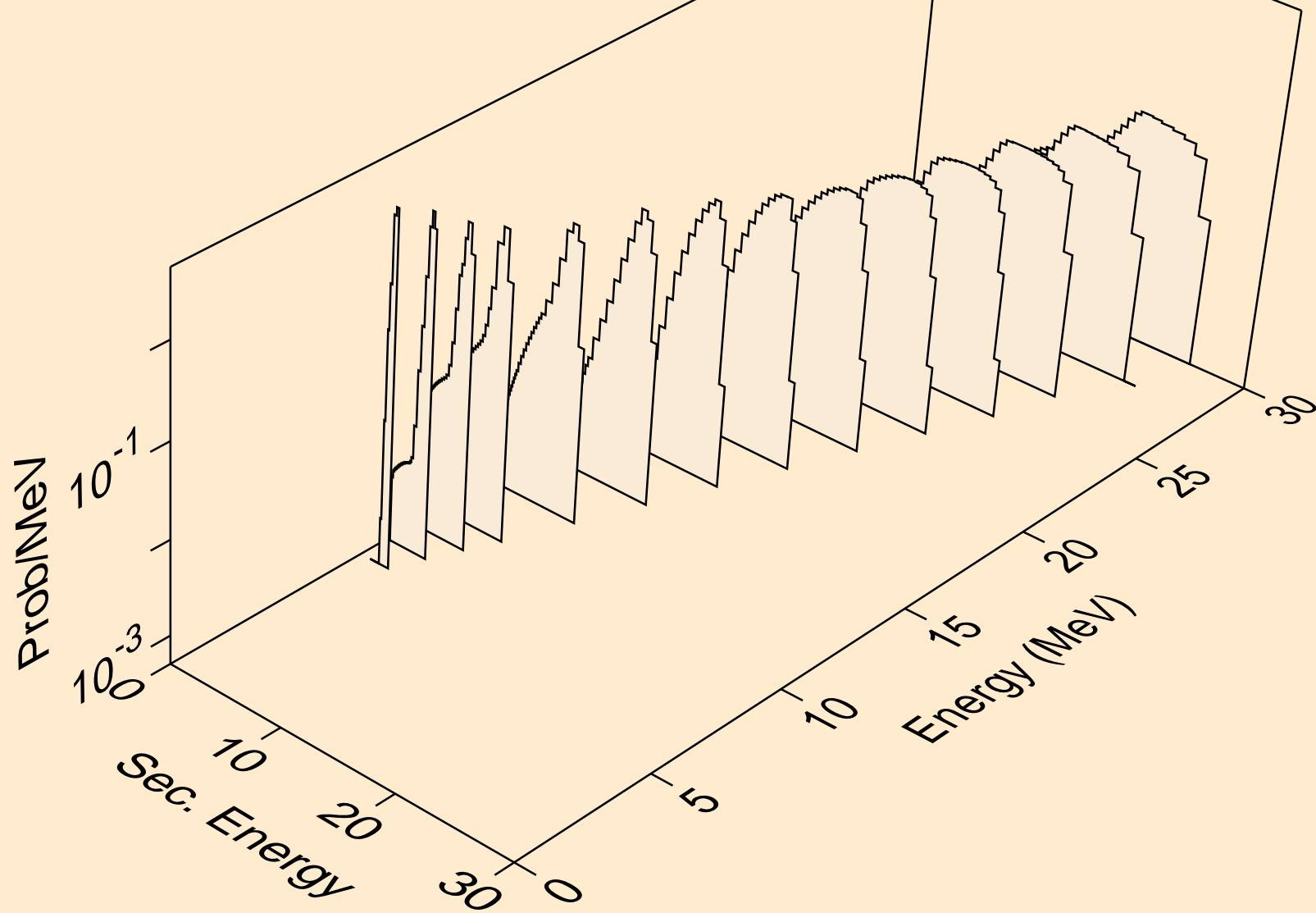

W193 PROTON ACER TENDL-2021 LIBRARY; T=0.K  
Proton emission for (p,2np)

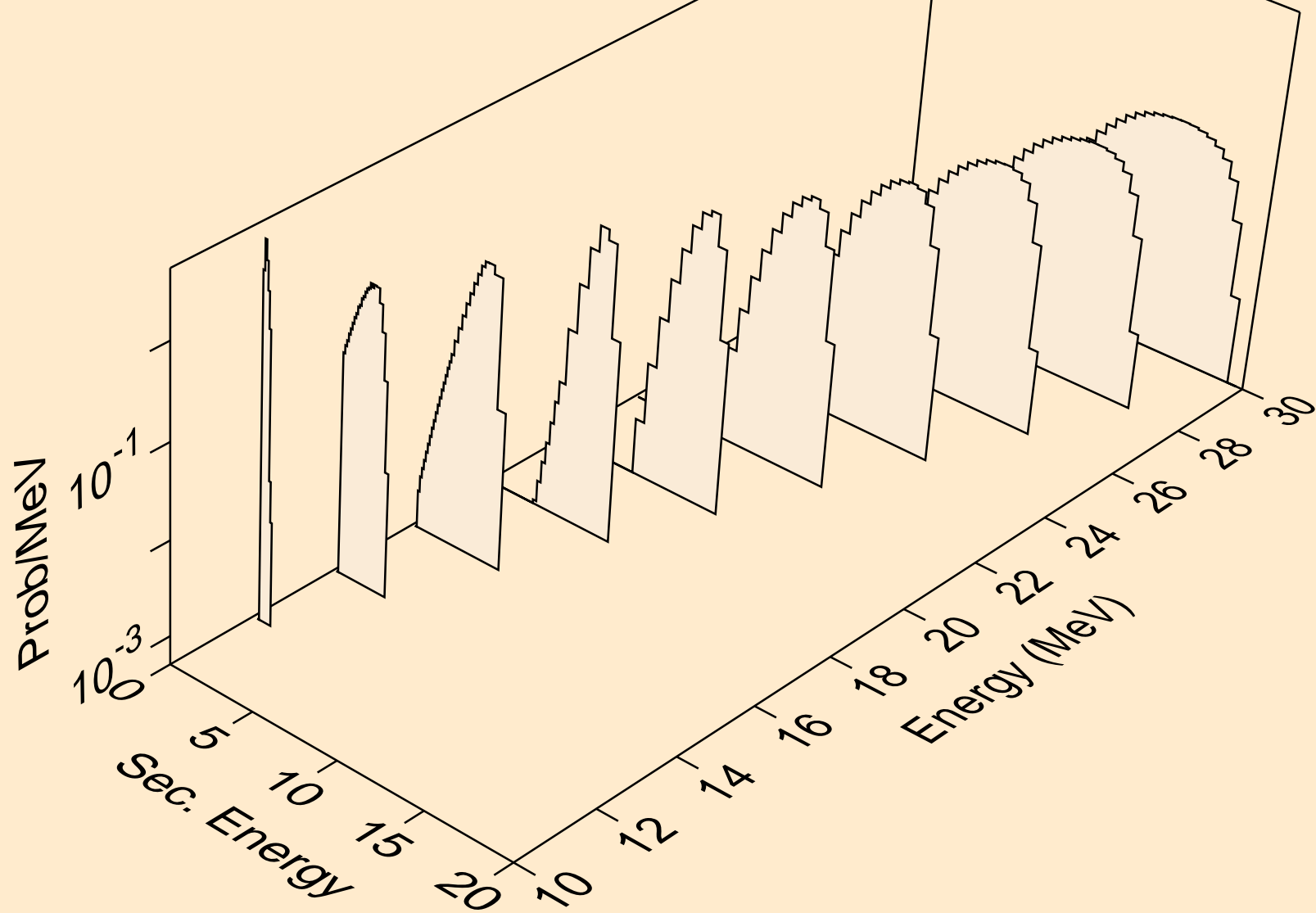

W193 PROTON ACER TENDL-2021 LIBRARY; T=0.K  
Proton emission for (p,3np)

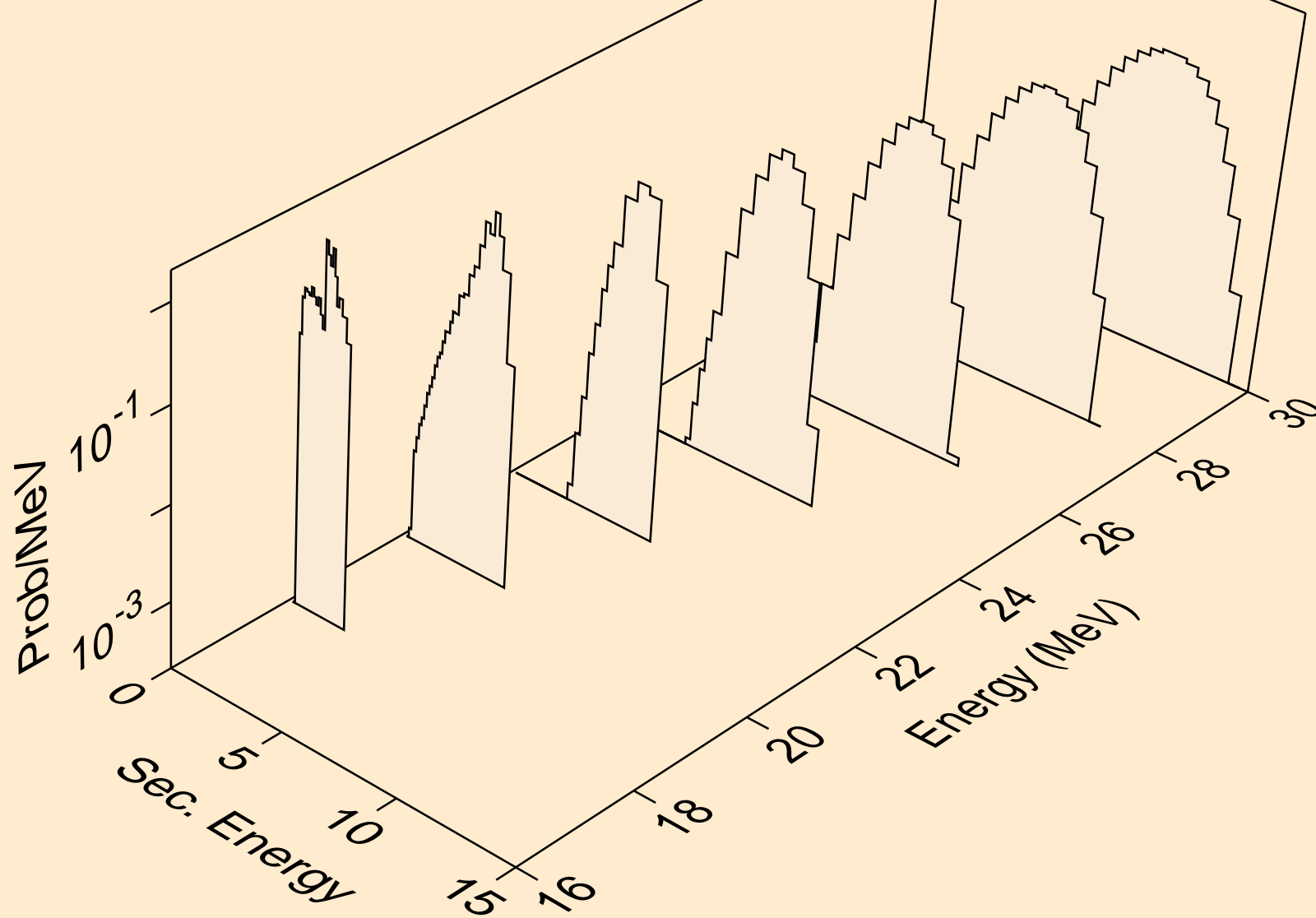

W193 PROTON ACER TENDL-2021 LIBRARY; T=0.K  
Proton emission for (p,2np)

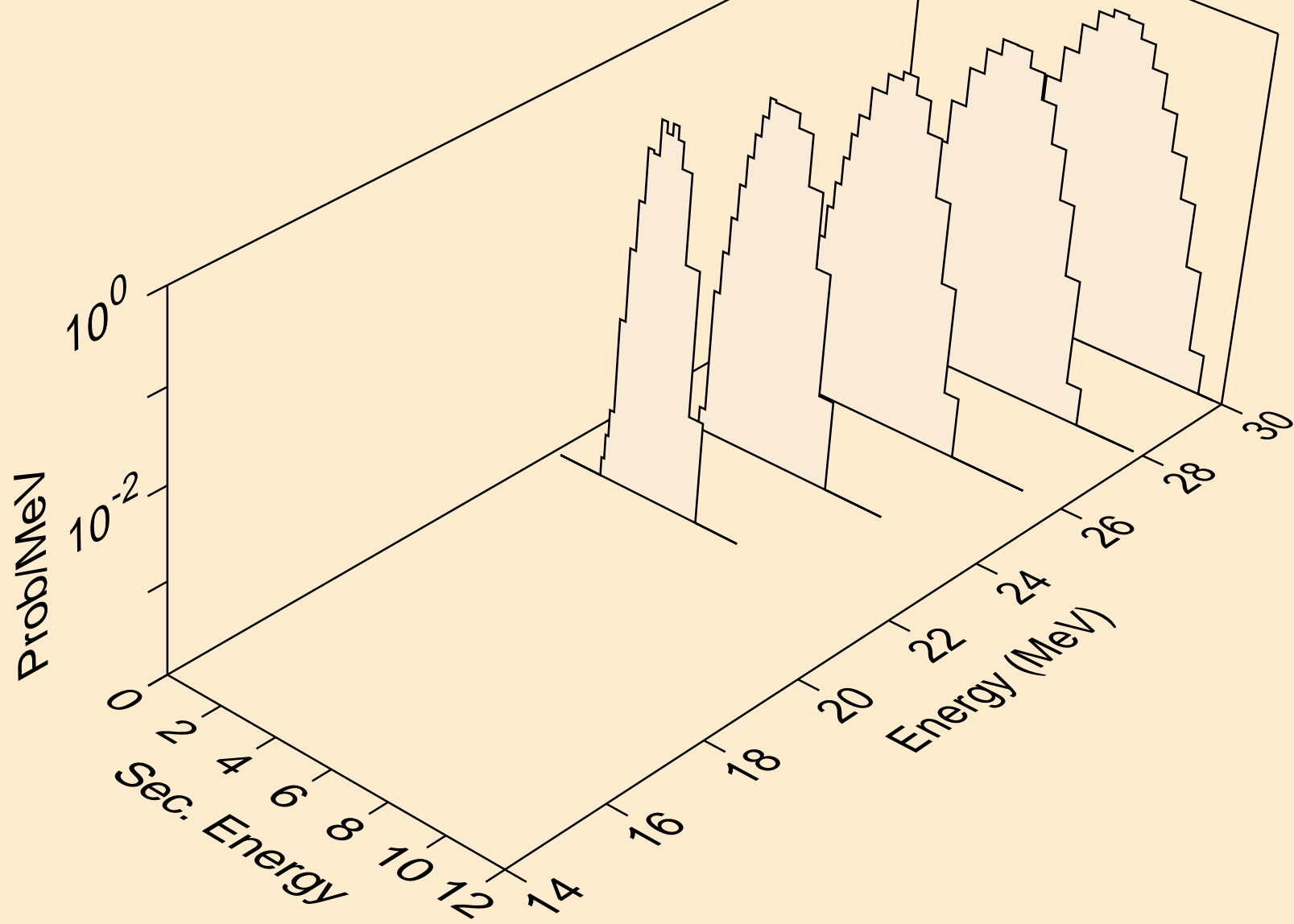

W193 PROTON ACER TENDL-2021 LIBRARY; T=0.K  
Proton emission for inelastic

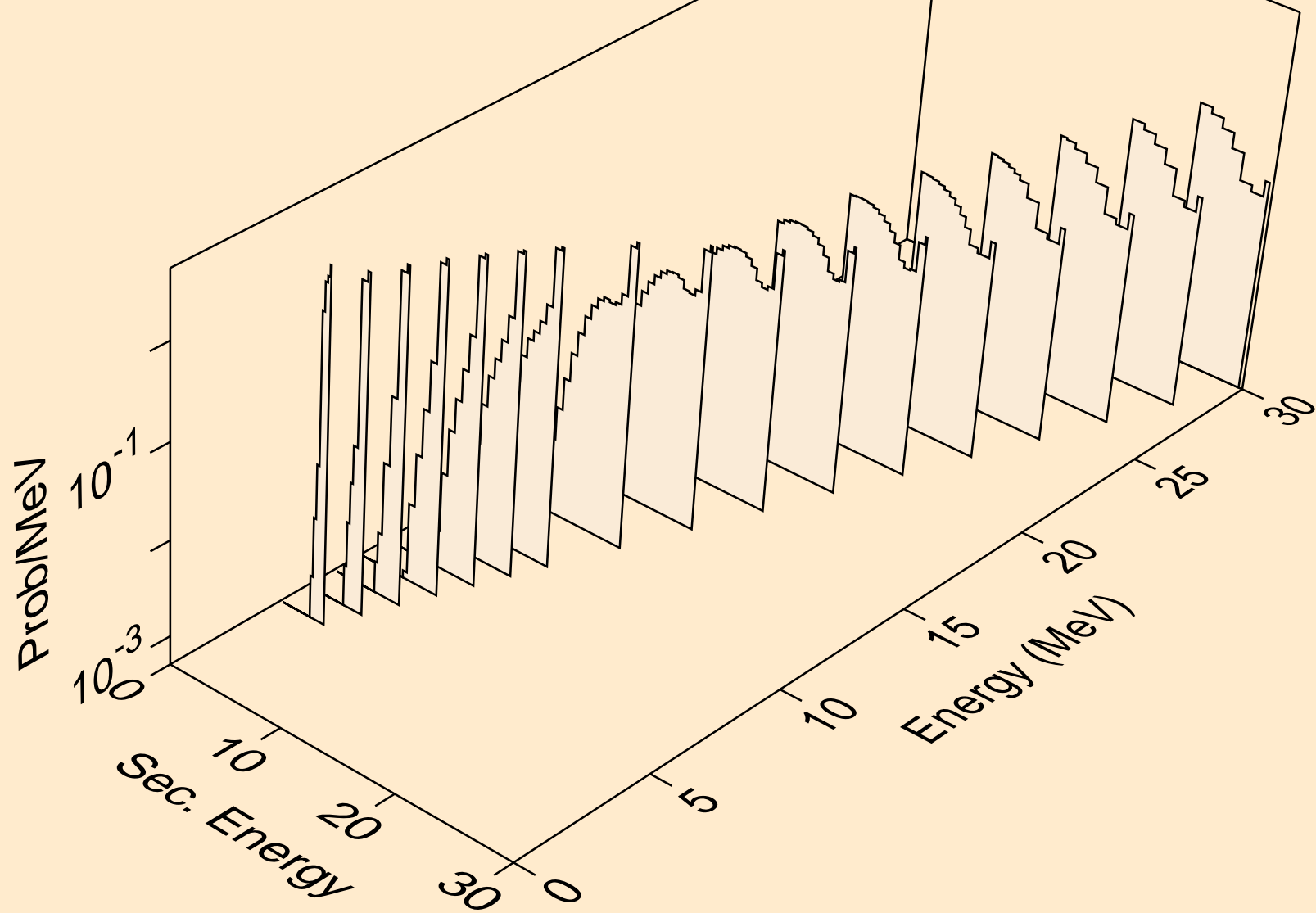



W193 PROTON ACER TENDL-2021 LIBRARY; T=0.K  
Proton emission for (p,2p)

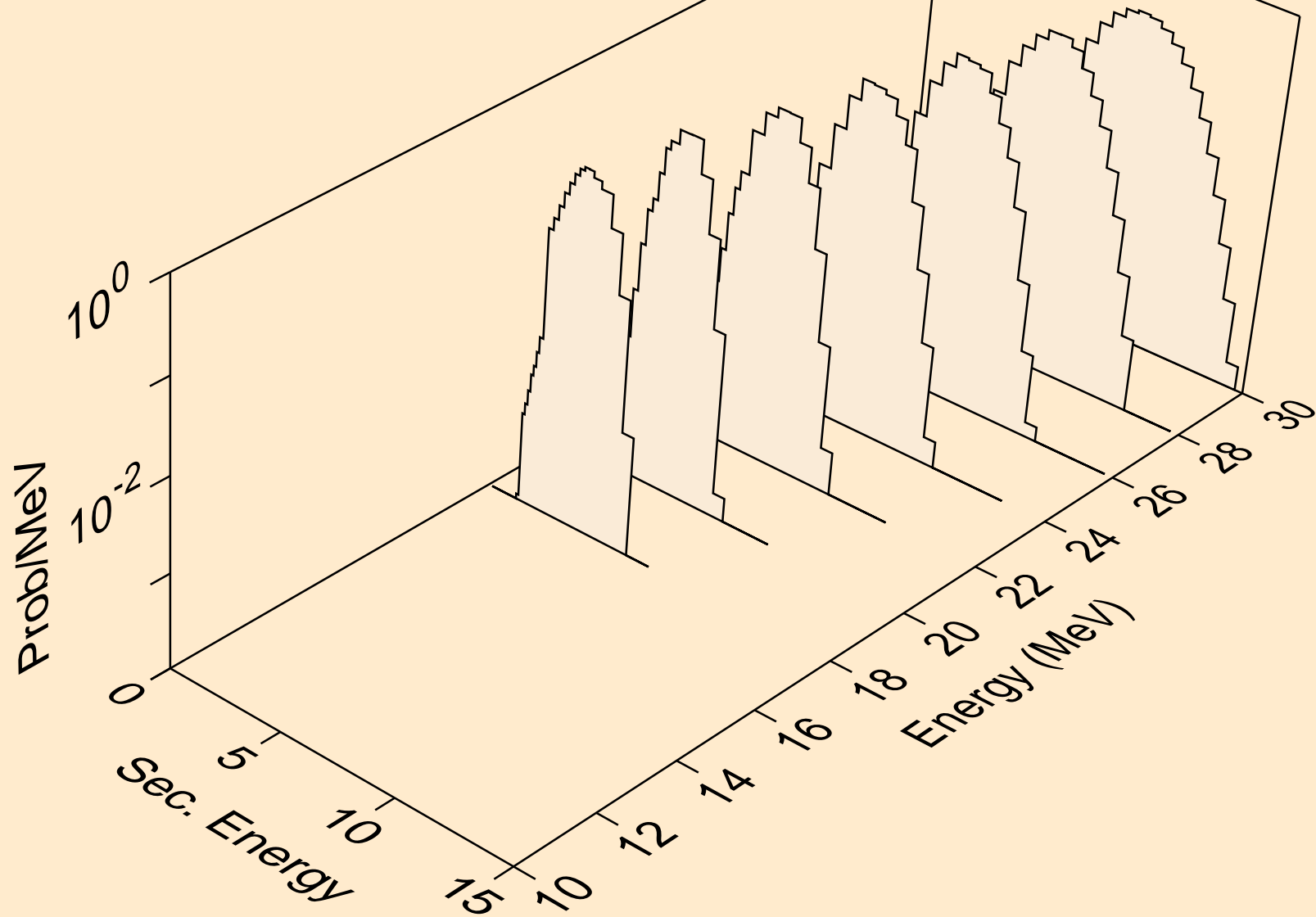

W193 PROTON ACER TENDL-2021 LIBRARY; T=0.K  
Photon emission for (z,n)

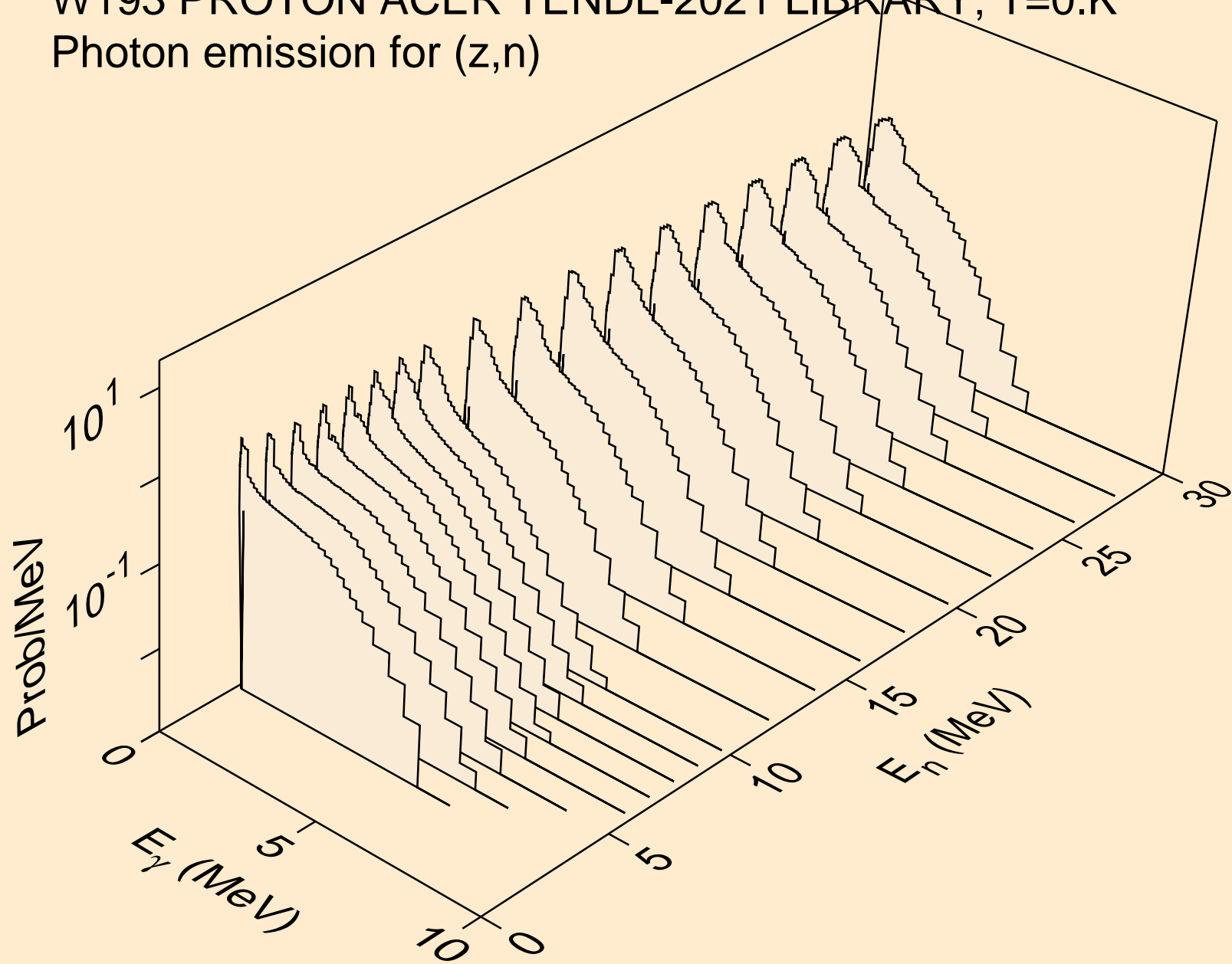

W193 PROTON ACER TENDL-2021 LIBRARY; T=0.K  
Photon emission for (n,x)

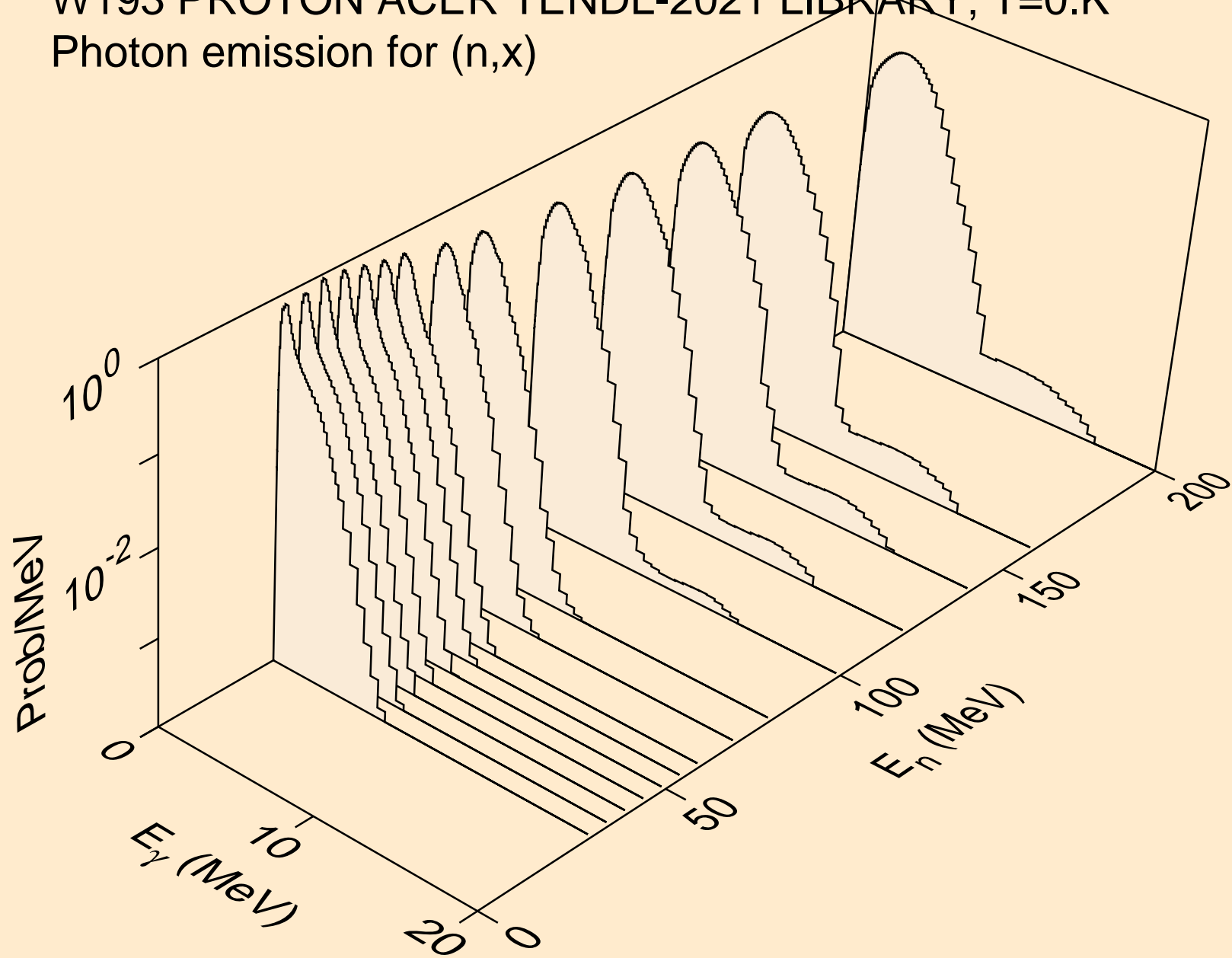

W193 PROTON ACER TENDL-2021 LIBRARY; T=0.K  
Photon emission for (n,2nd)

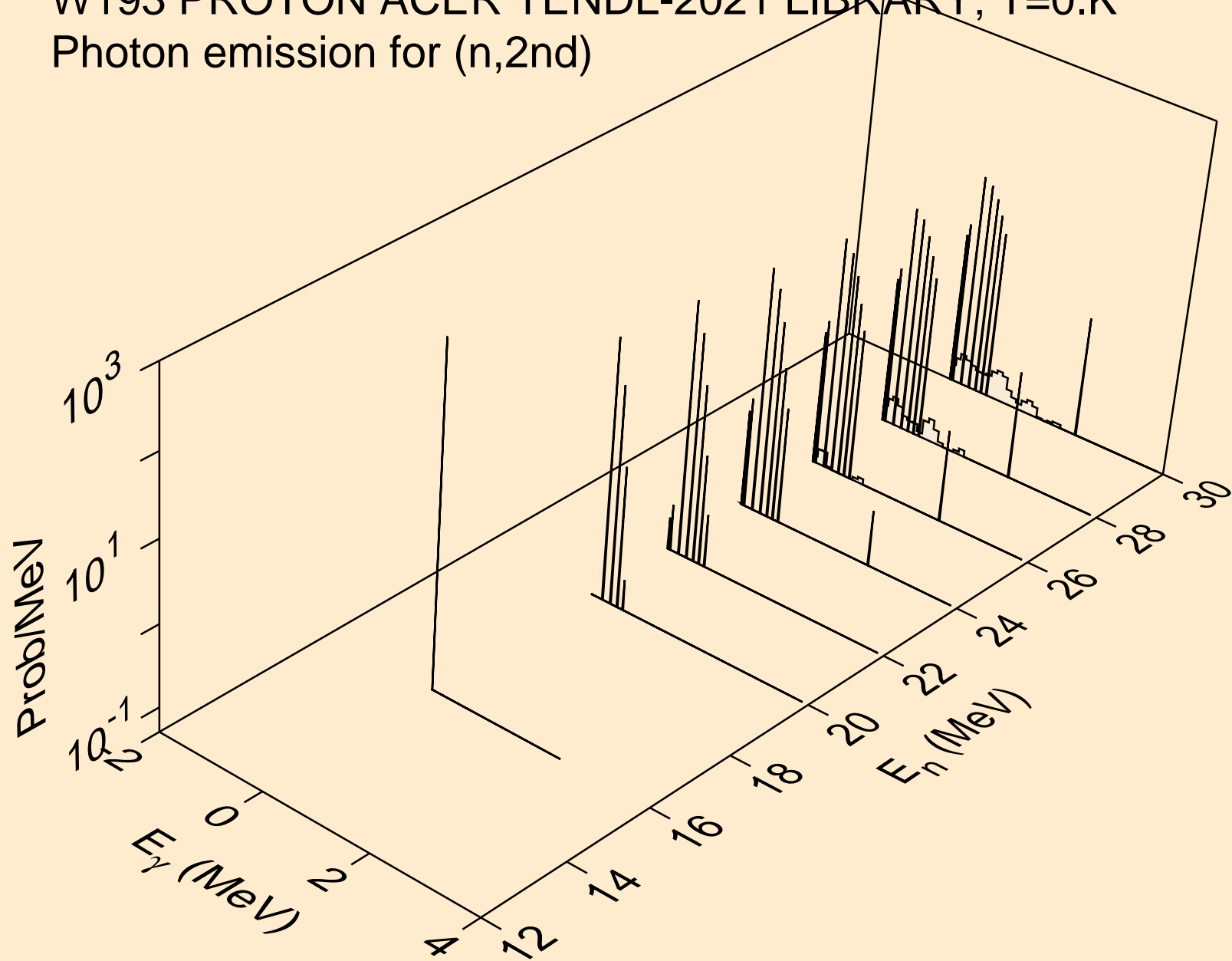

W193 PROTON ACER TENDL-2021 LIBRARY; T=0.K  
Photon emission for (n,2n)

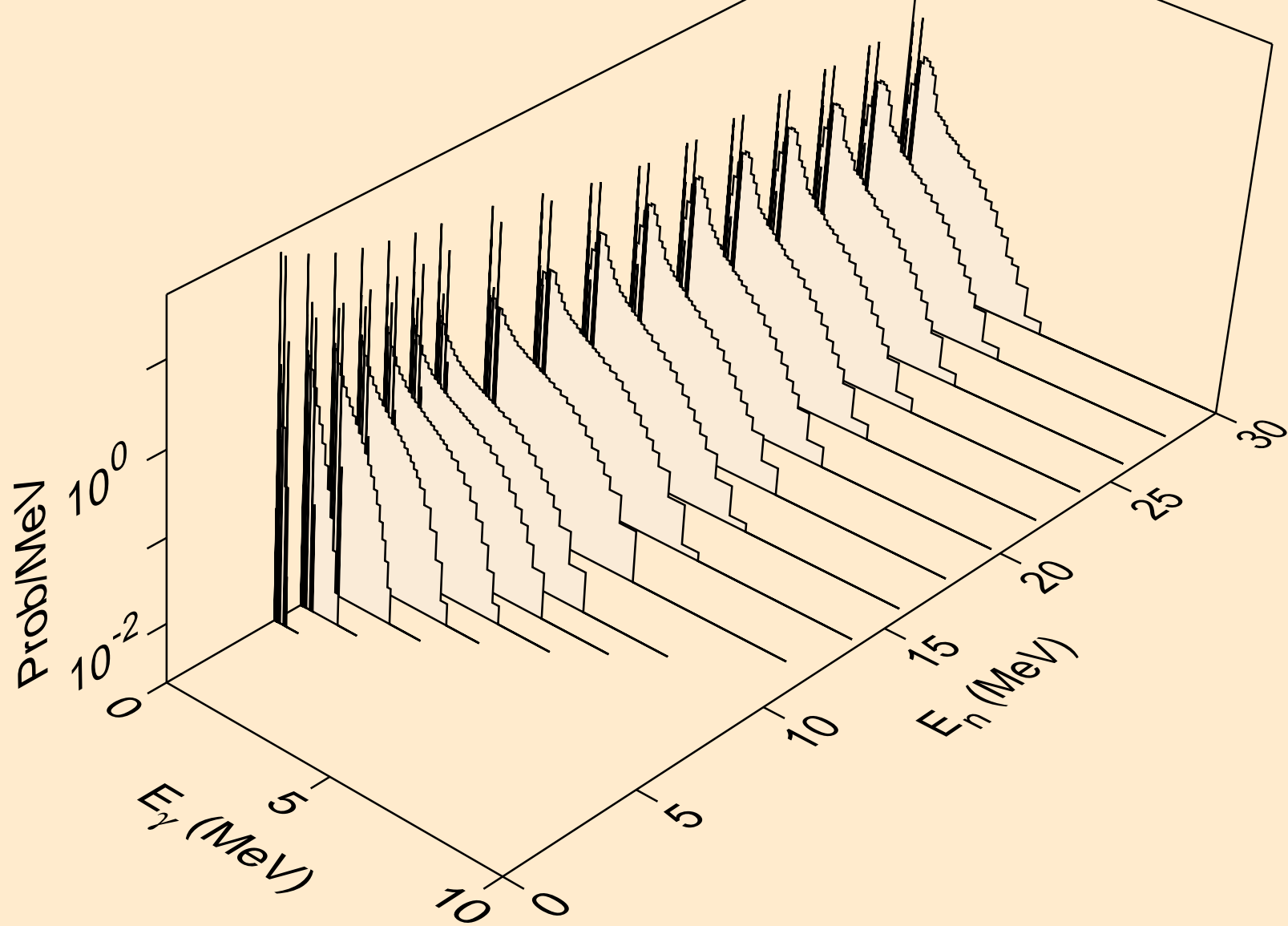

W193 PROTON ACER TENDL-2021 LIBRARY; T=0.K  
Photon emission for (n,3n)

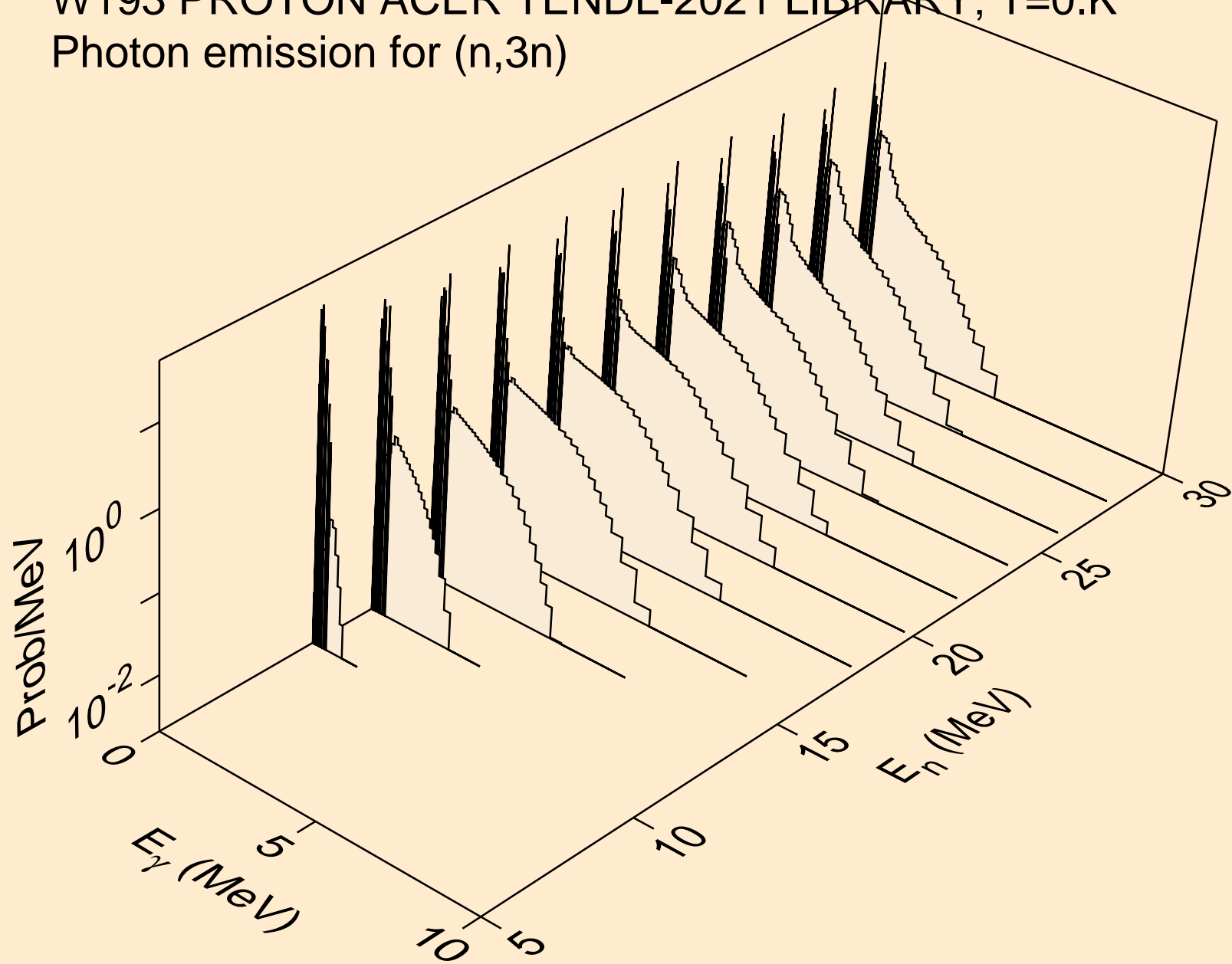

W193 PROTON ACER TENDL-2021 LIBRARY; T=0.K  
Photon emission for (n,n\*)a

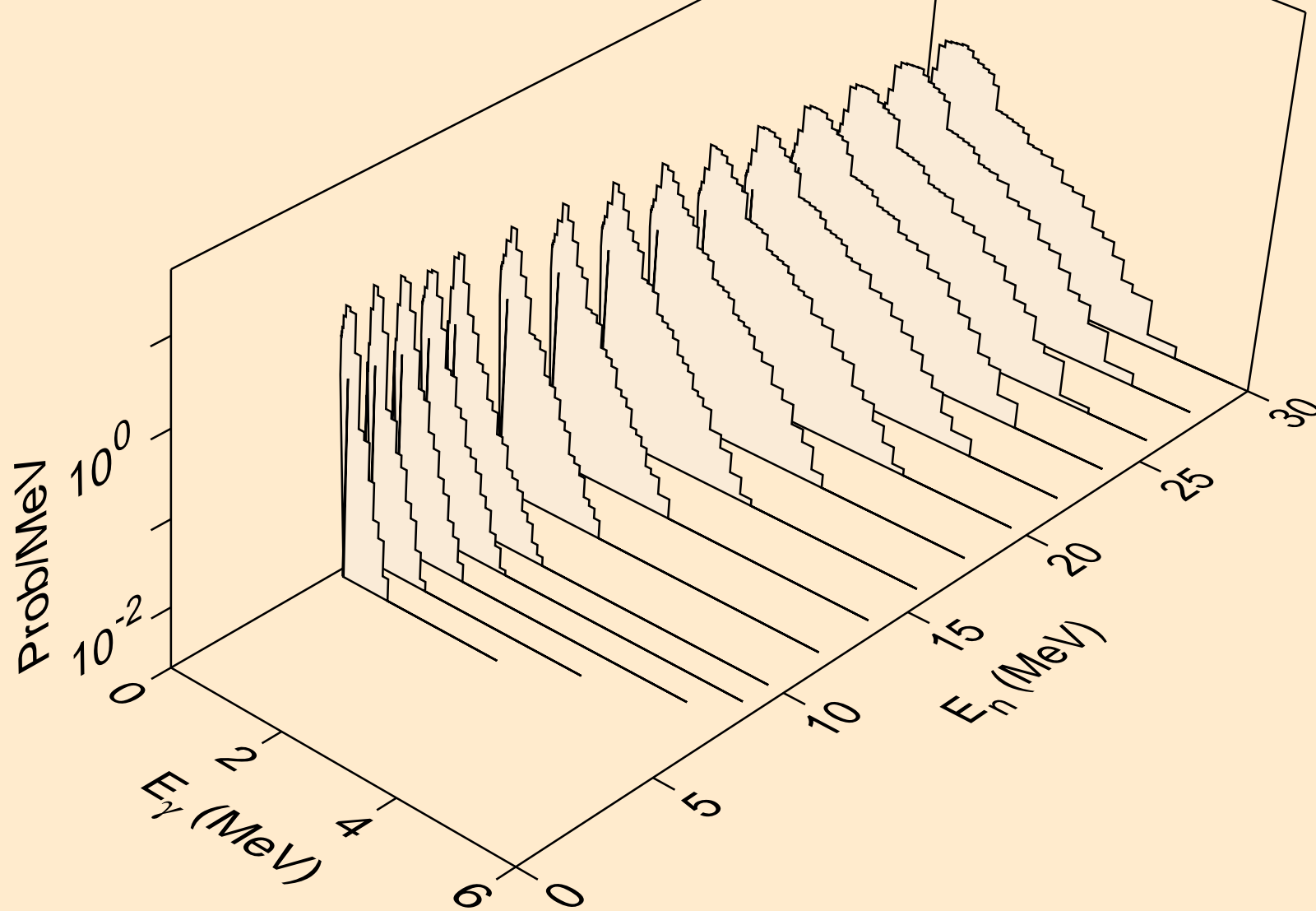

W193 PROTON ACER TENDL-2021 LIBRARY; T=0.K  
Photon emission for (n,2n) $\alpha$

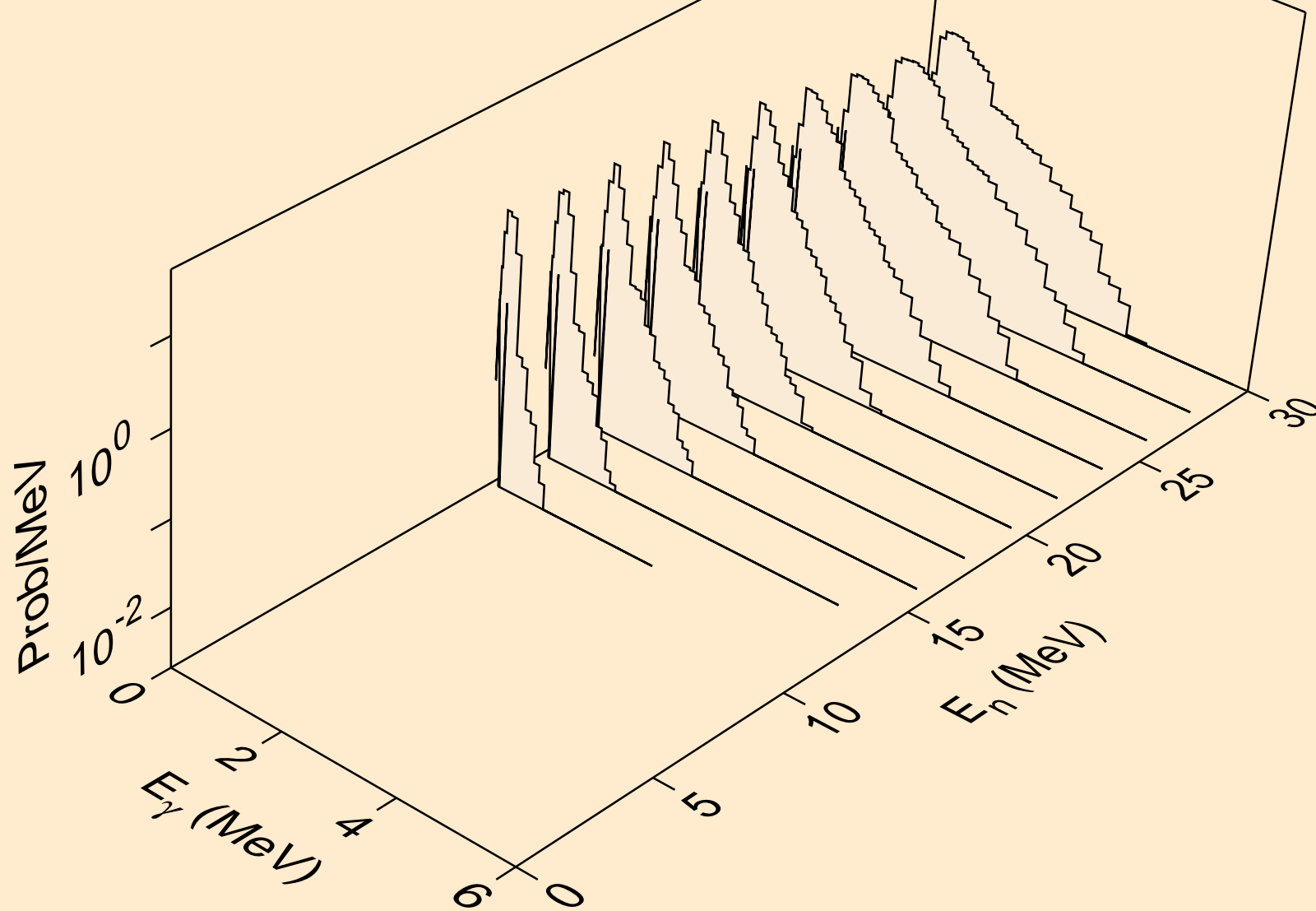



W193 PROTON ACER TENDL-2021 LIBRARY; T=0.K  
Photon emission for (n,3n)a

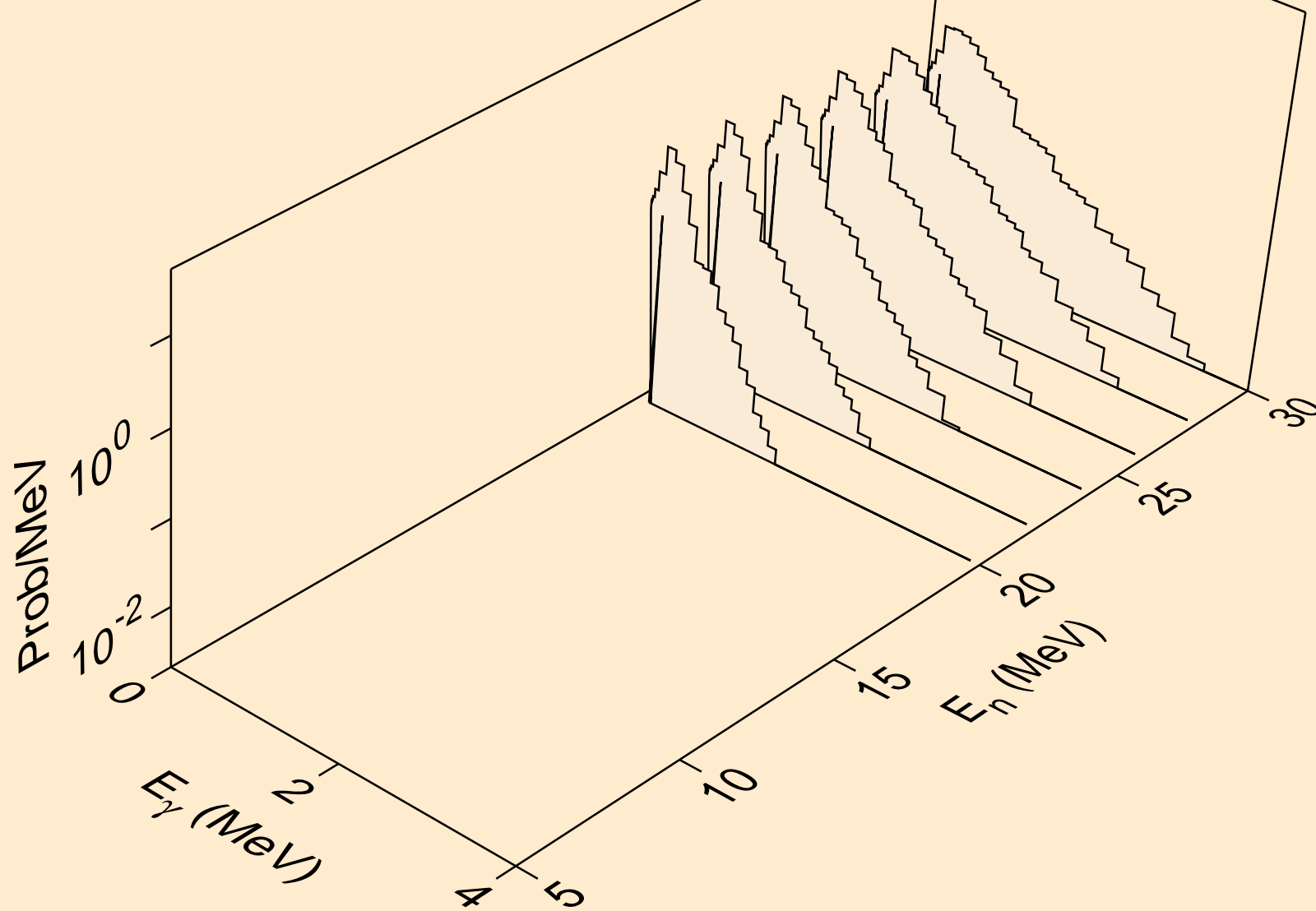

W193 PROTON ACER TENDL-2021 LIBRARY; T=0.K  
Photon emission for (n,n\*)p

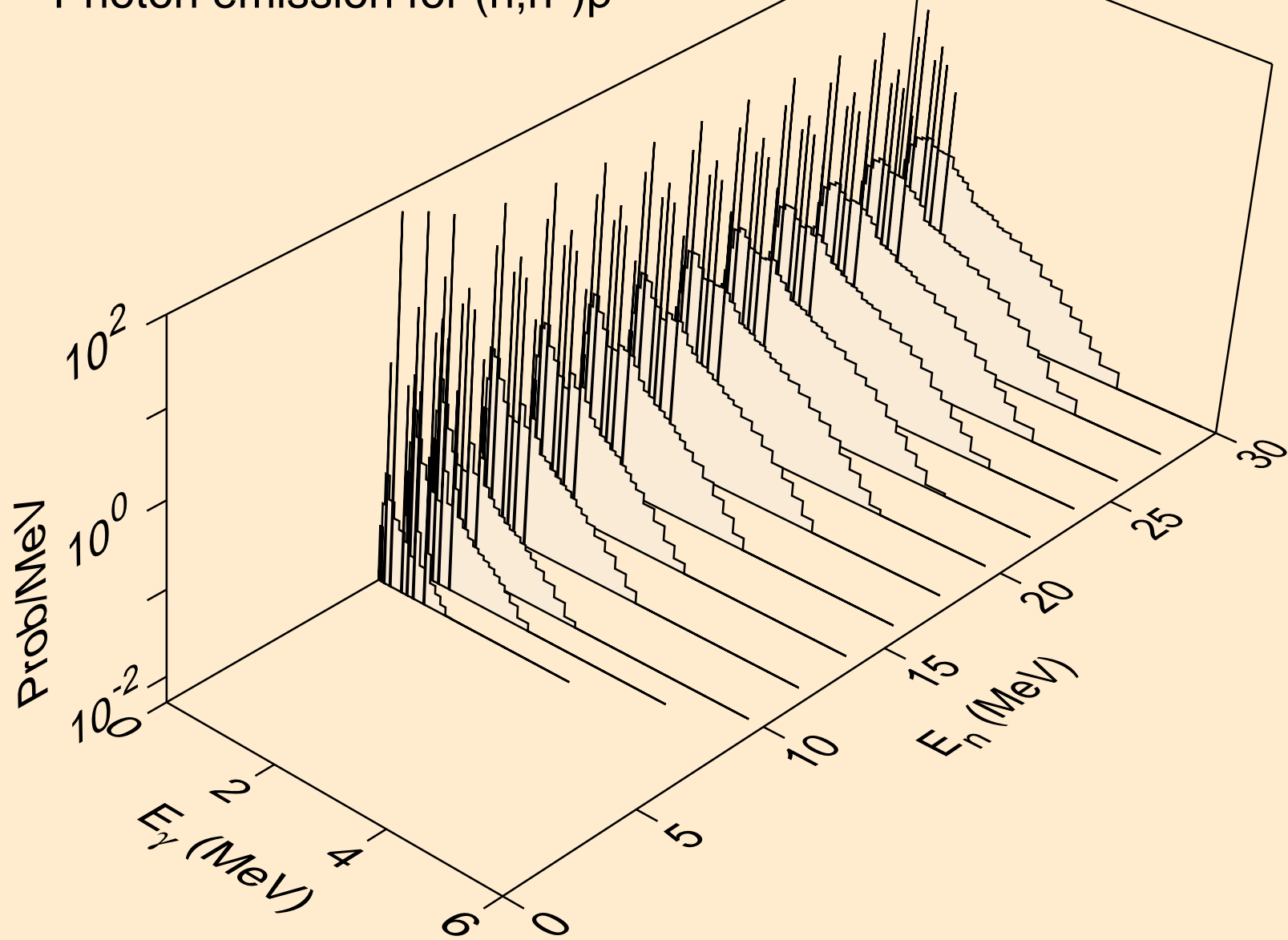

W193 PROTON ACER TENDL-2021 LIBRARY; T=0.K  
Photon emission for (n,n\*)d

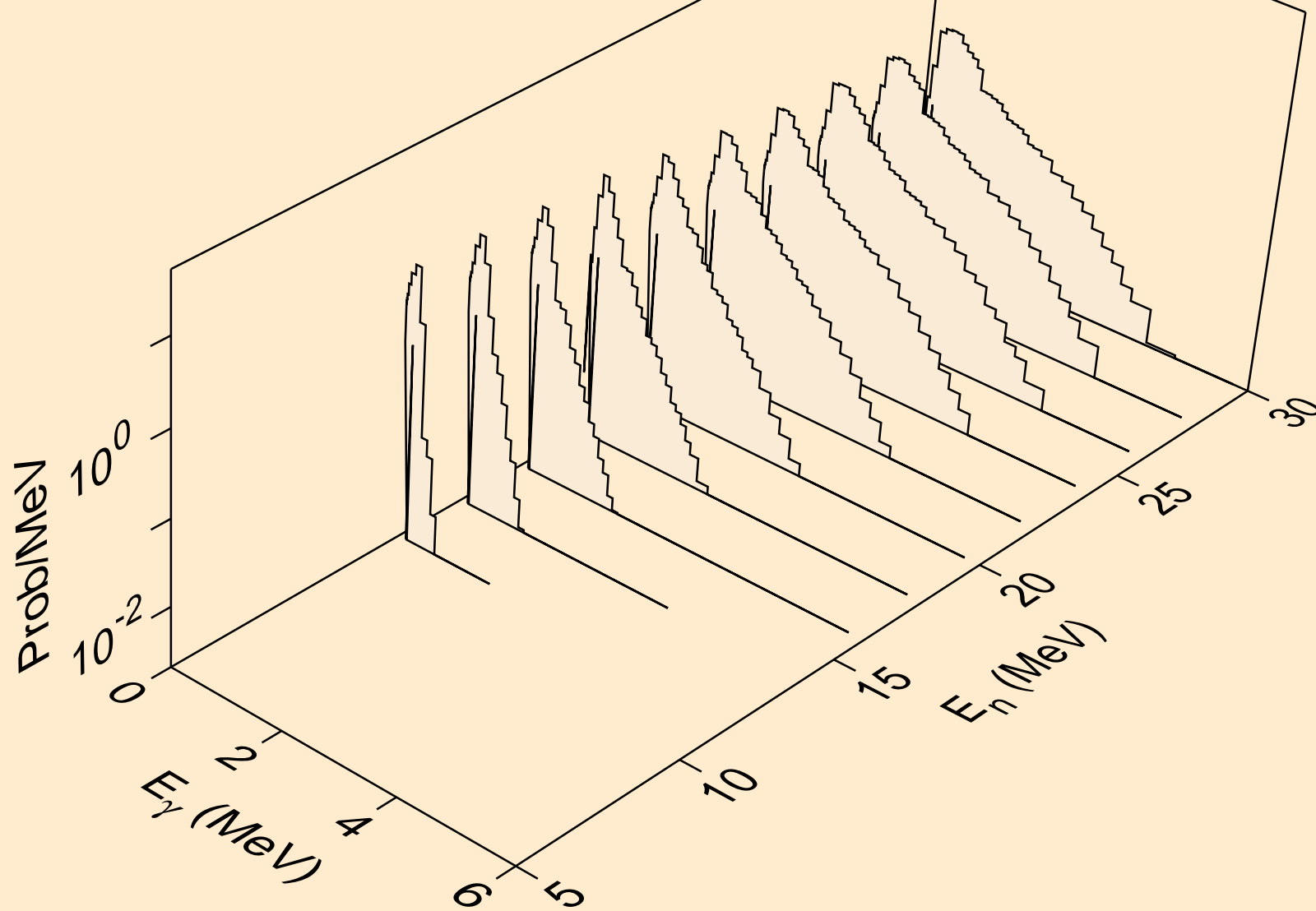

W193 PROTON ACER TENDL-2021 LIBRARY; T=0.K  
Photon emission for (n,n\*)t

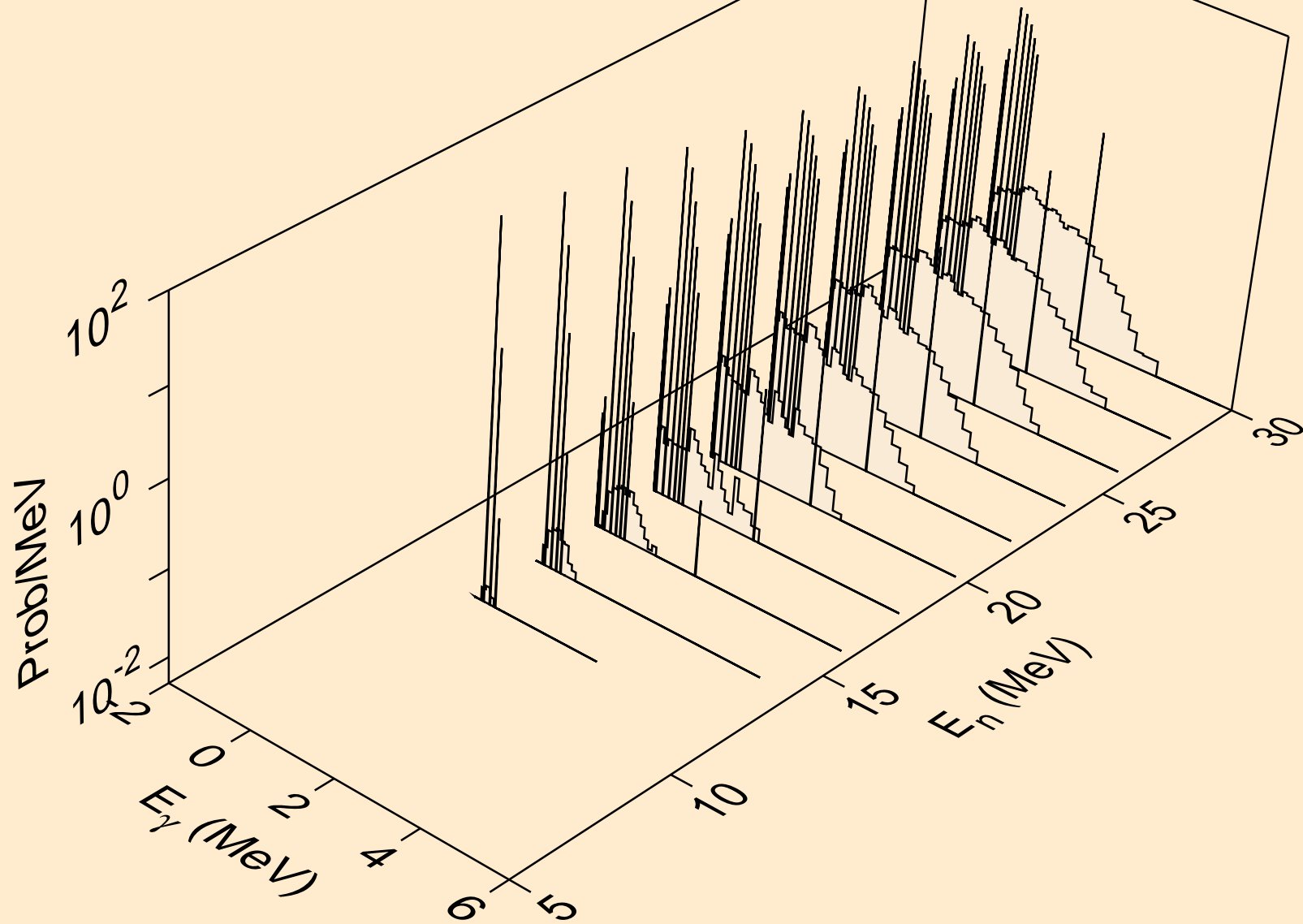

W193 PROTON ACER TENDL-2021 LIBRARY; T=0.K  
Photon emission for (n,n\*)he3

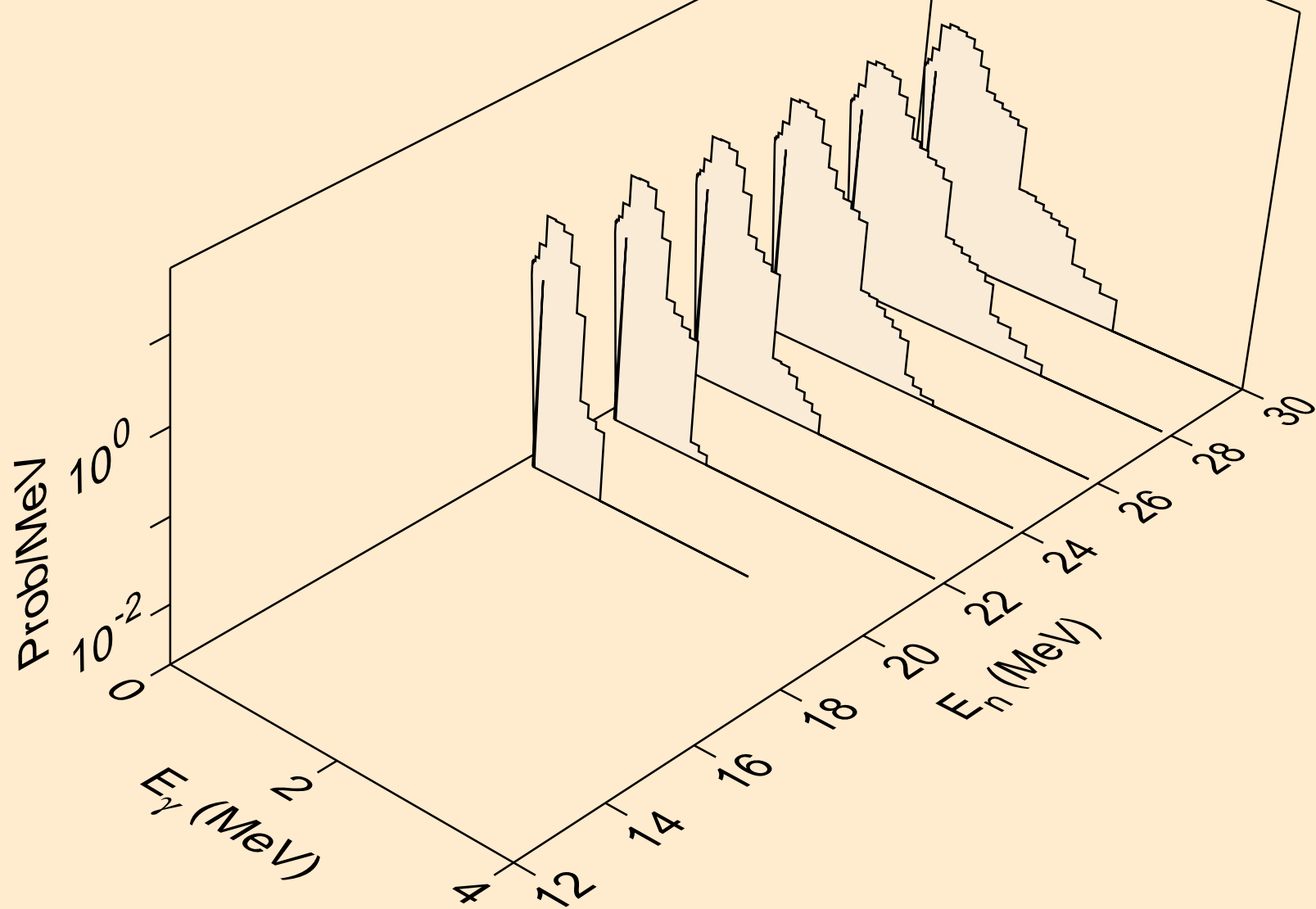

W193 PROTON ACER TENDL-2021 LIBRARY; T=0.K  
Photon emission for (n,4n)

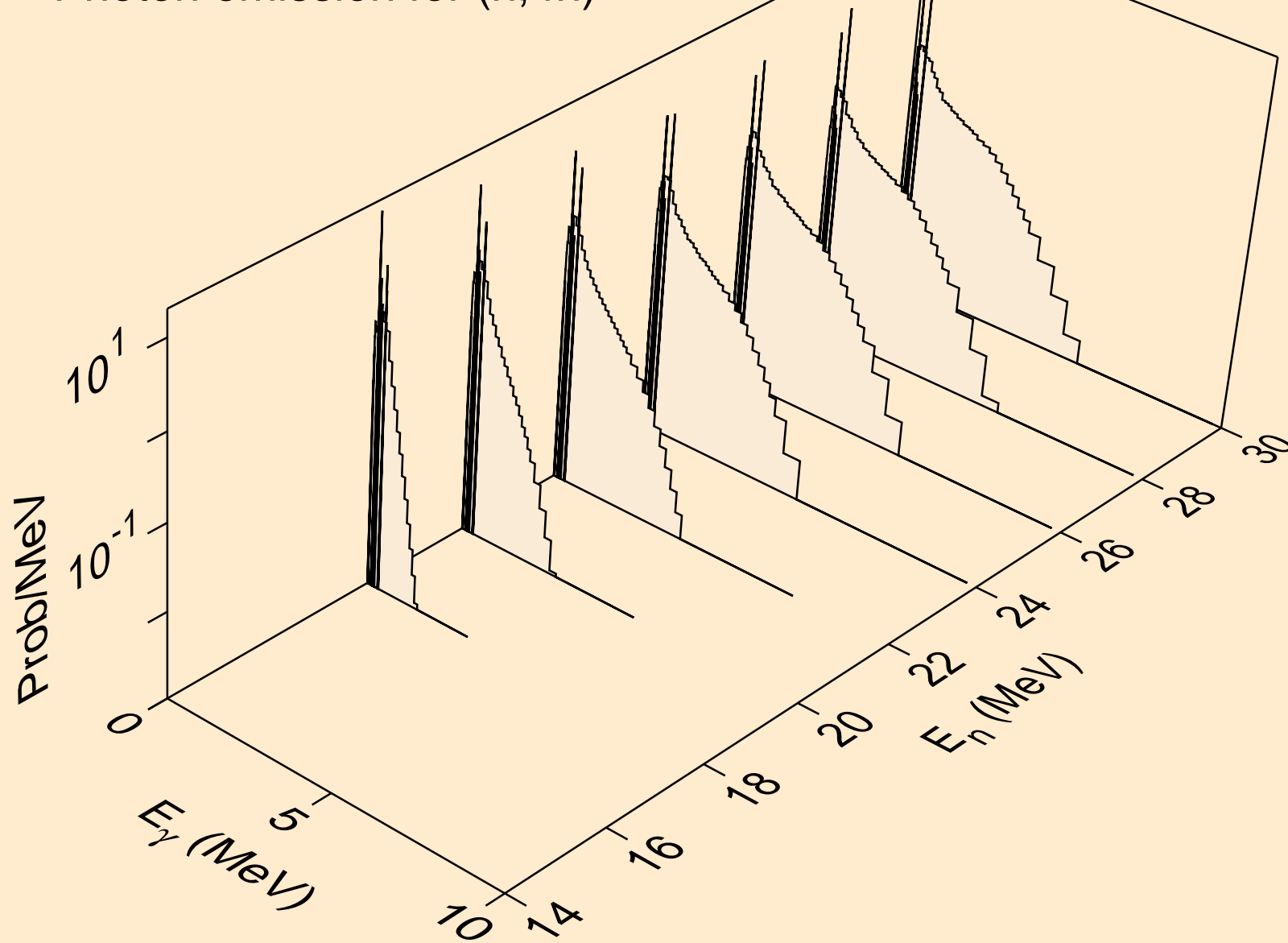

W193 PROTON ACER TENDL-2021 LIBRARY; T=0.K  
Photon emission for (n,2np)

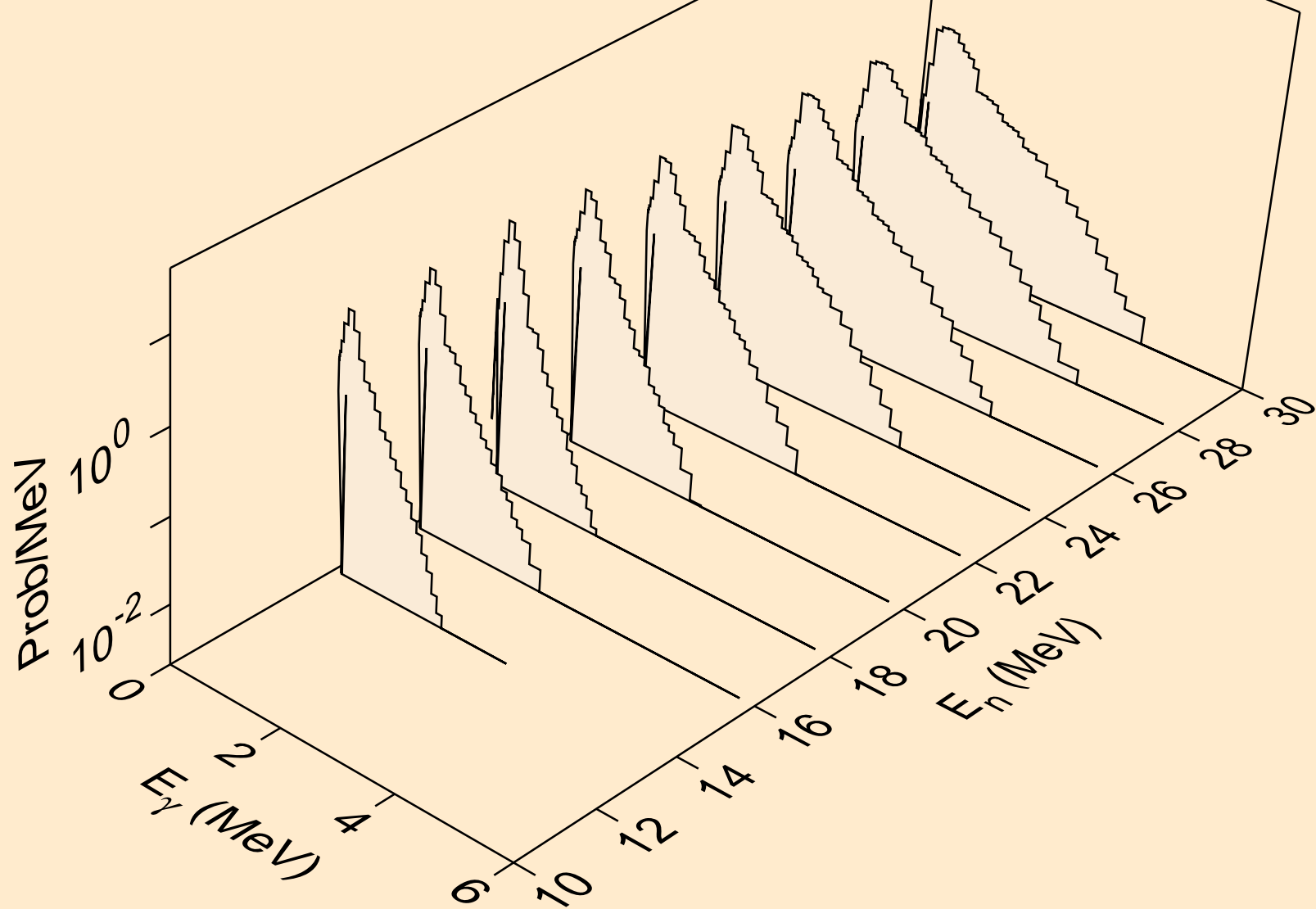

W193 PROTON ACER TENDL-2021 LIBRARY; T=0.K  
Photon emission for (n,3np)

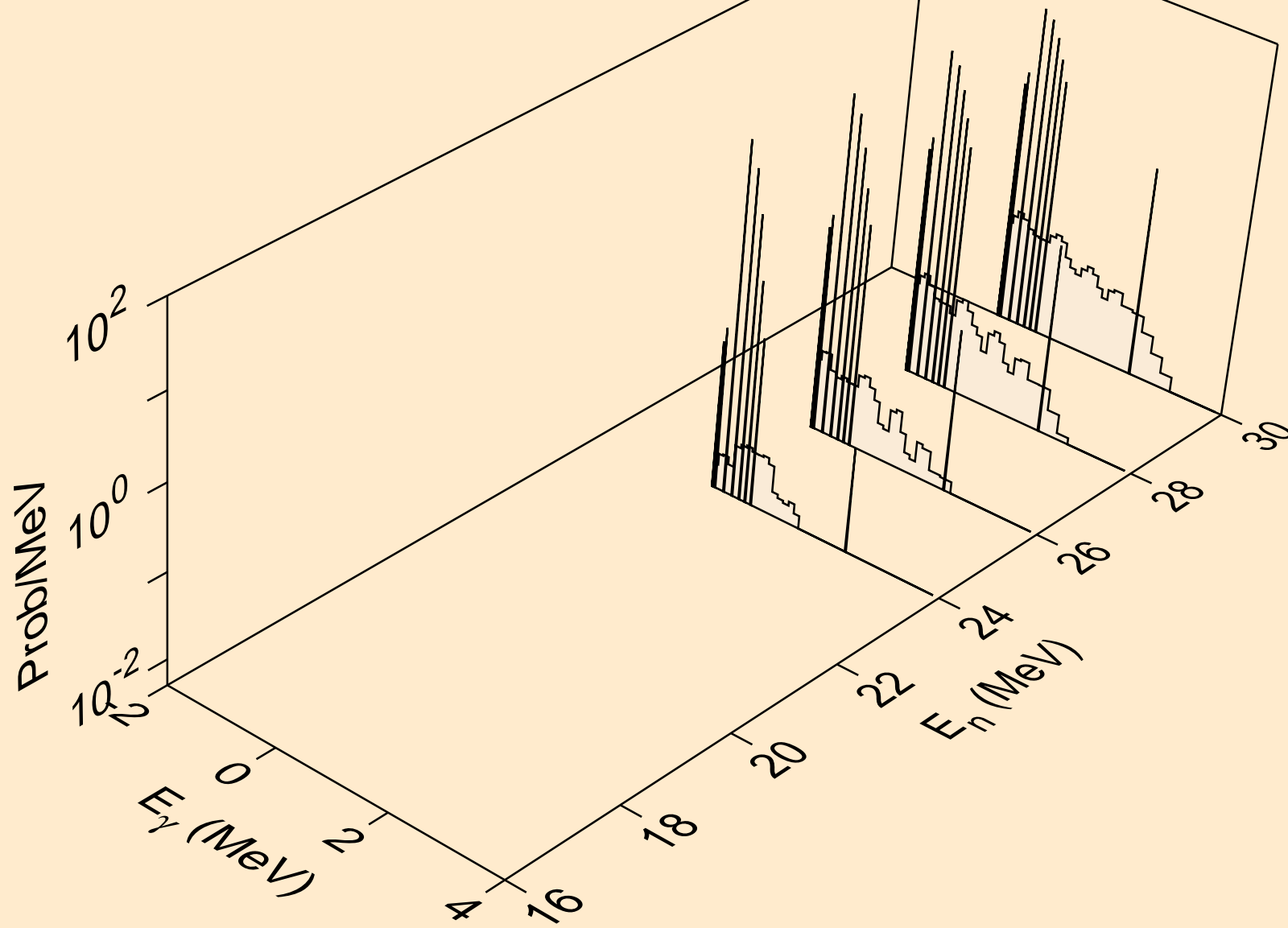



W193 PROTON ACER TENDL-2021 LIBRARY; T=0.K  
Photon emission for (n,2np)

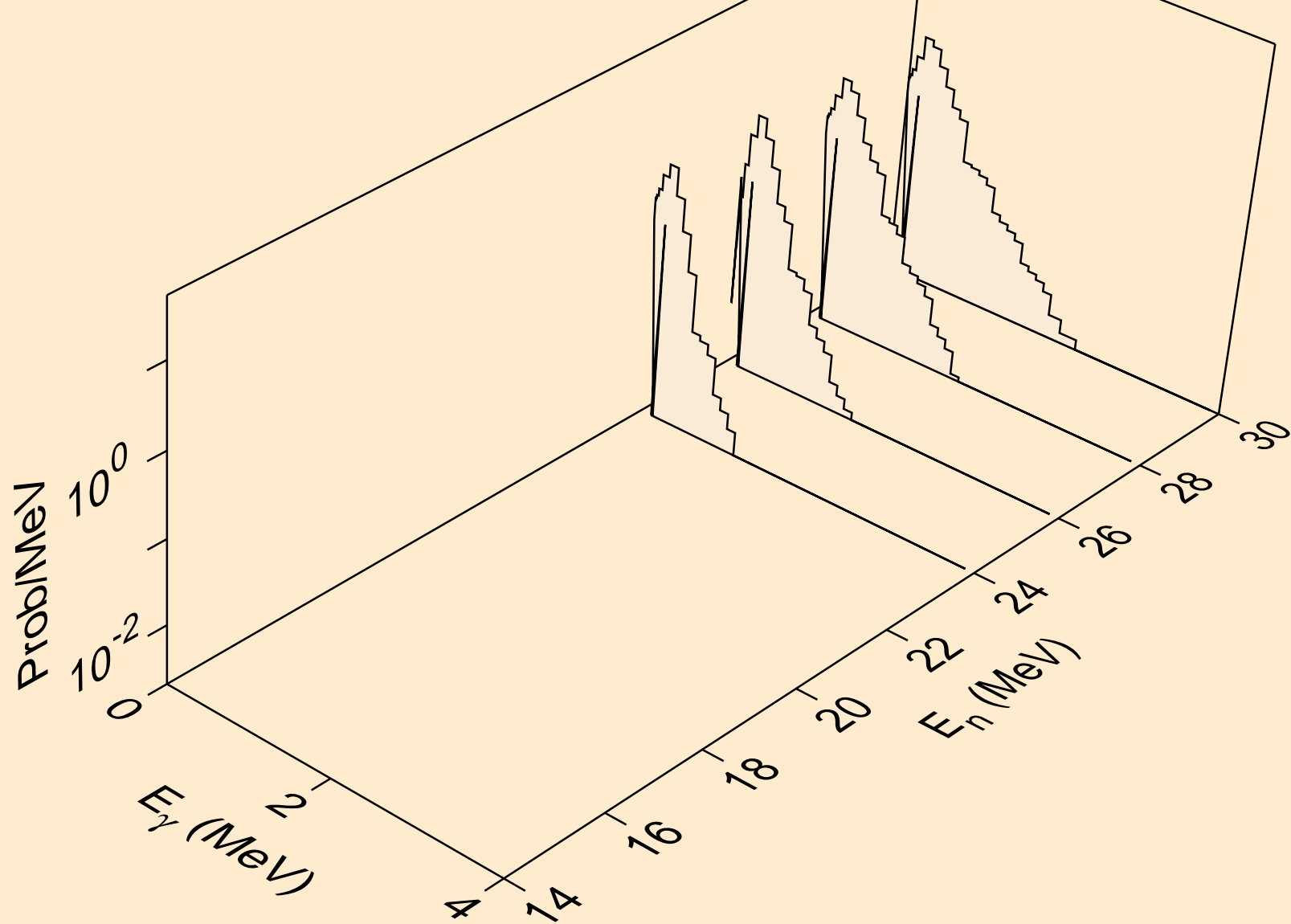

W193 PROTON ACER TENDL-2021 LIBRARY; T=0.K  
Photon emission for (n,gma)

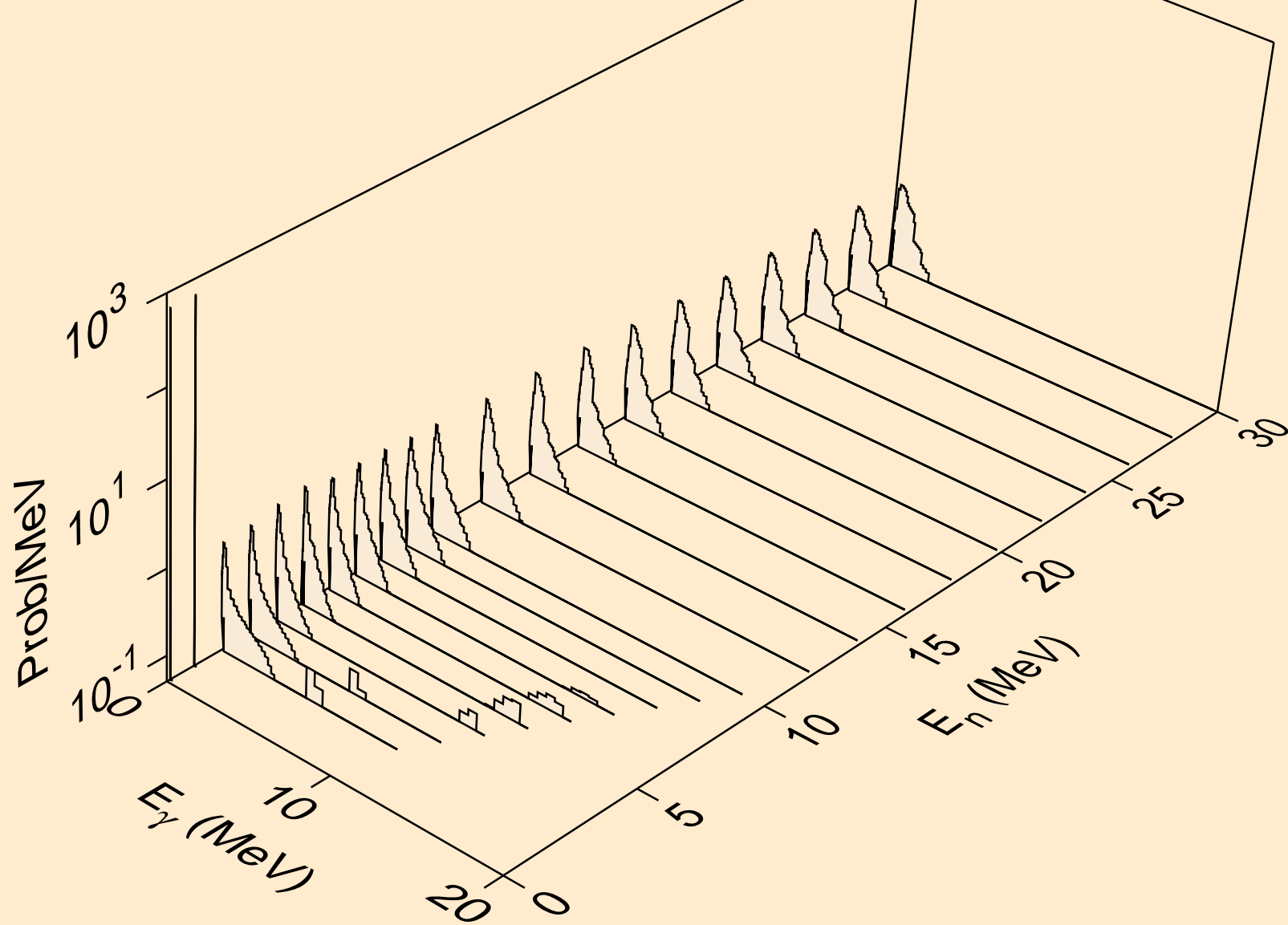

W193 PROTON ACER TENDL-2021 LIBRARY; T=0.K  
Photon emission for inelastic

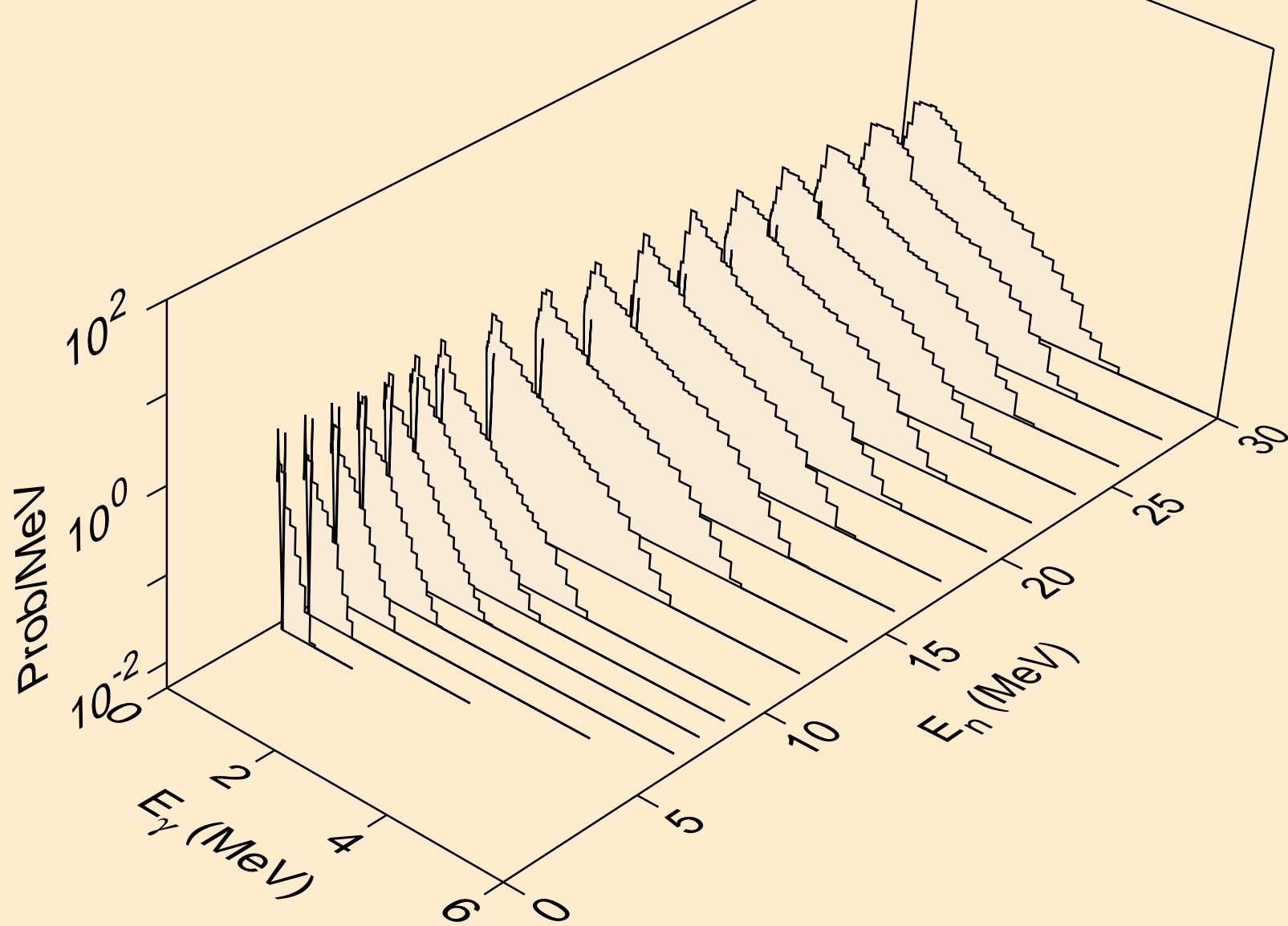

W193 PROTON ACER TENDL-2021 LIBRARY; T=0.K  
Photon emission for (n,d)

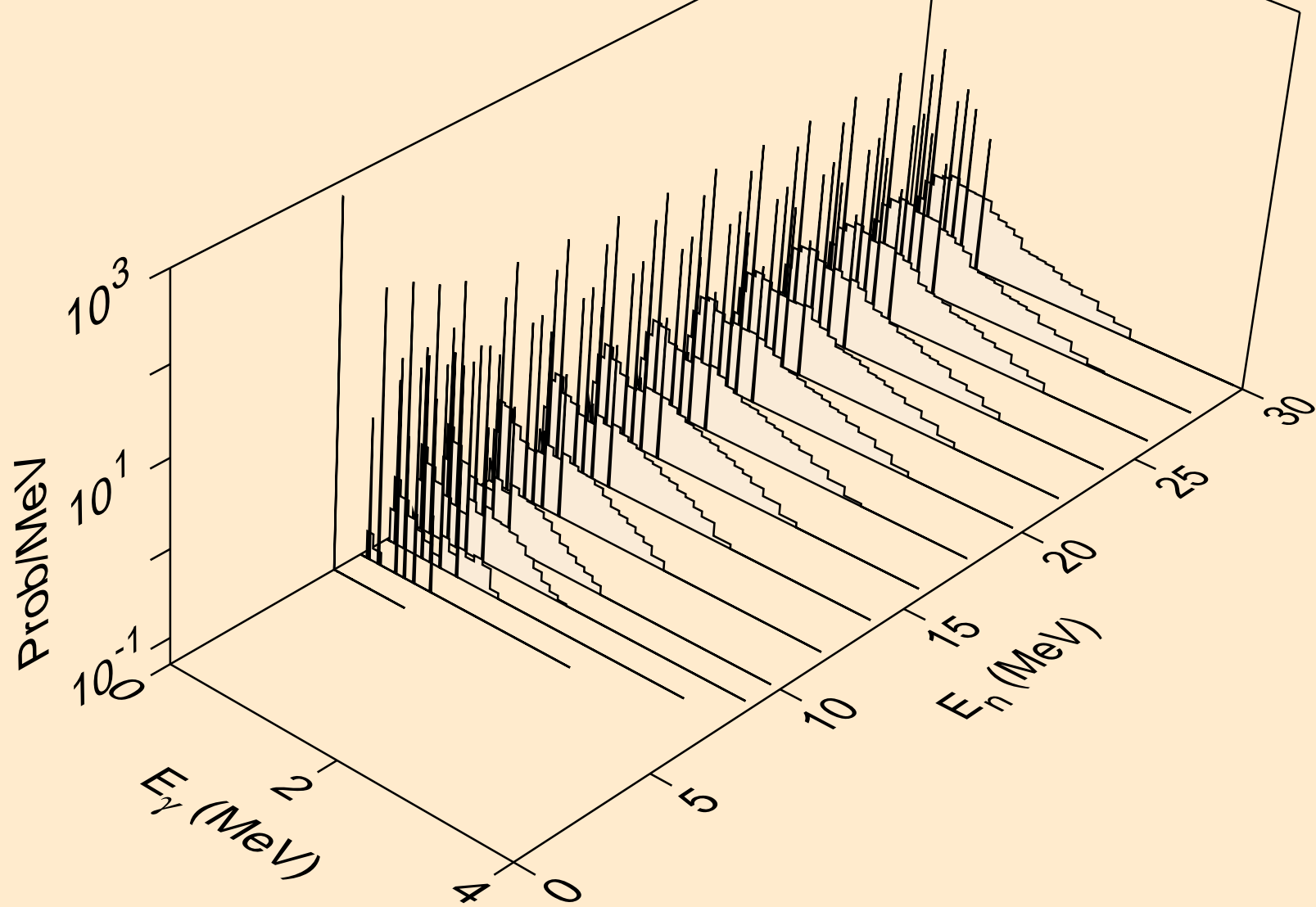

W193 PROTON ACER TENDL-2021 LIBRARY; T=0.K  
Photon emission for (n,t)

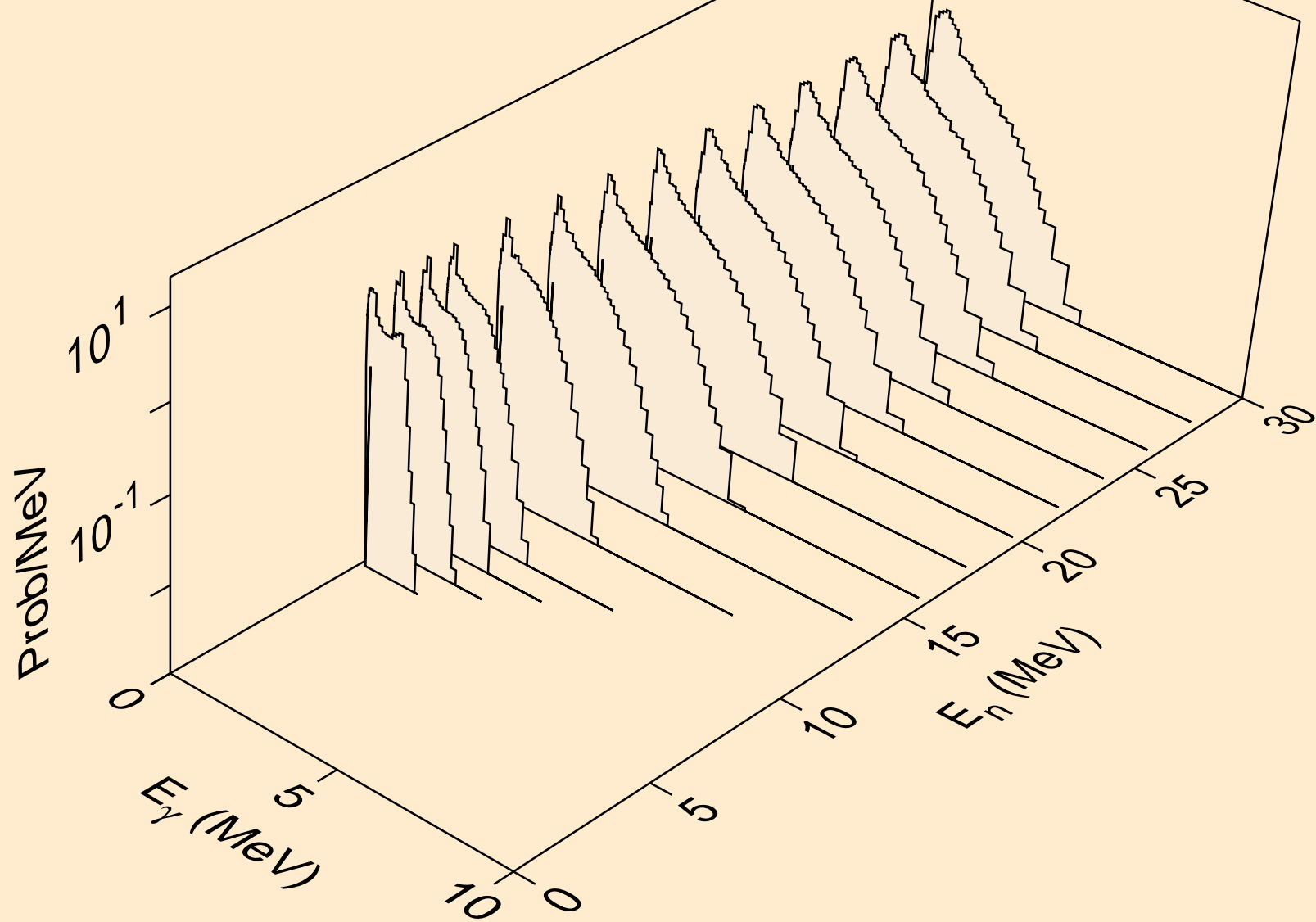

W193 PROTON ACER TENDL-2021 LIBRARY; T=0.K  
Photon emission for (n,he3)

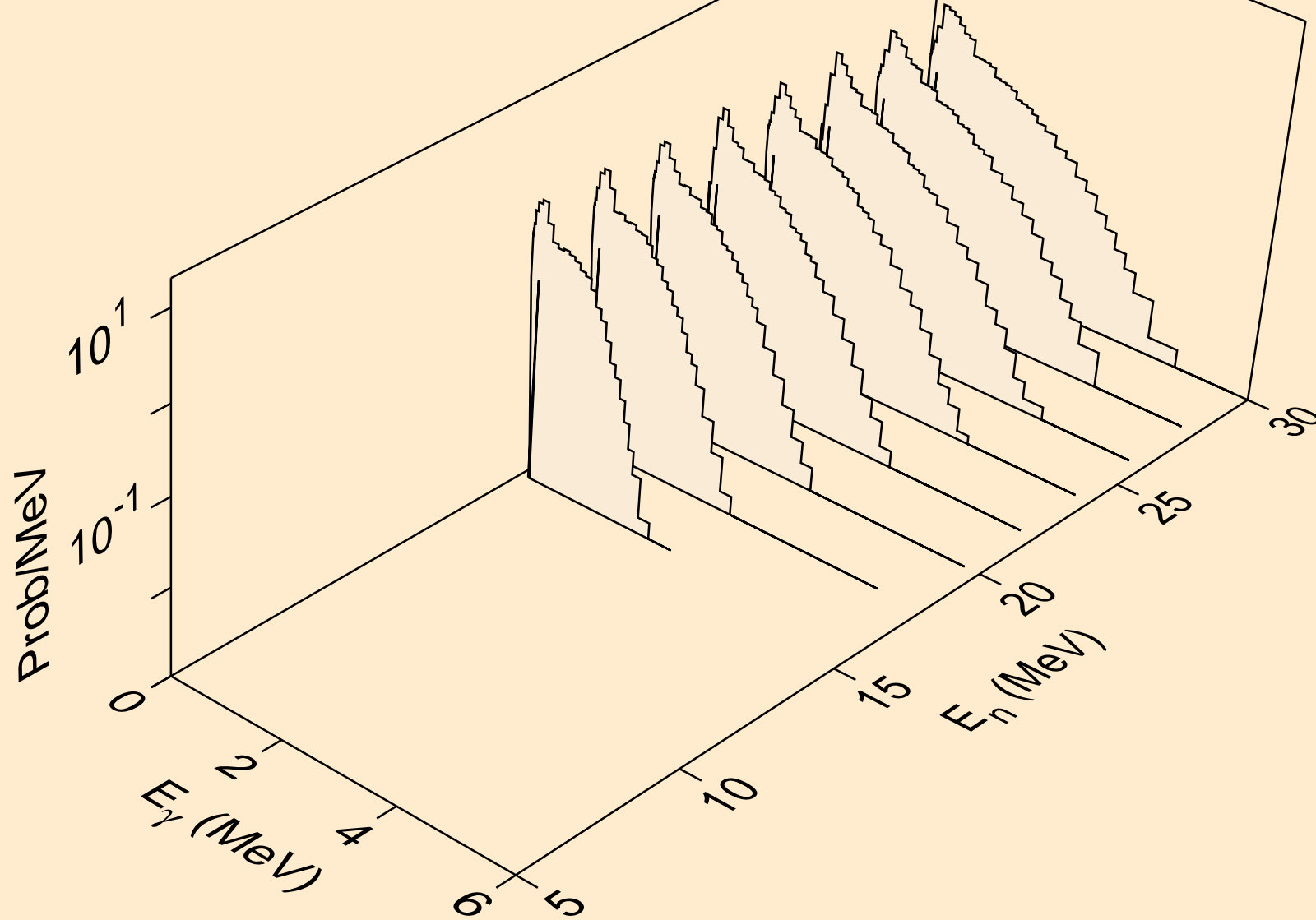

W193 PROTON ACER TENDL-2021 LIBRARY; T=0.K  
Photon emission for (n,a)

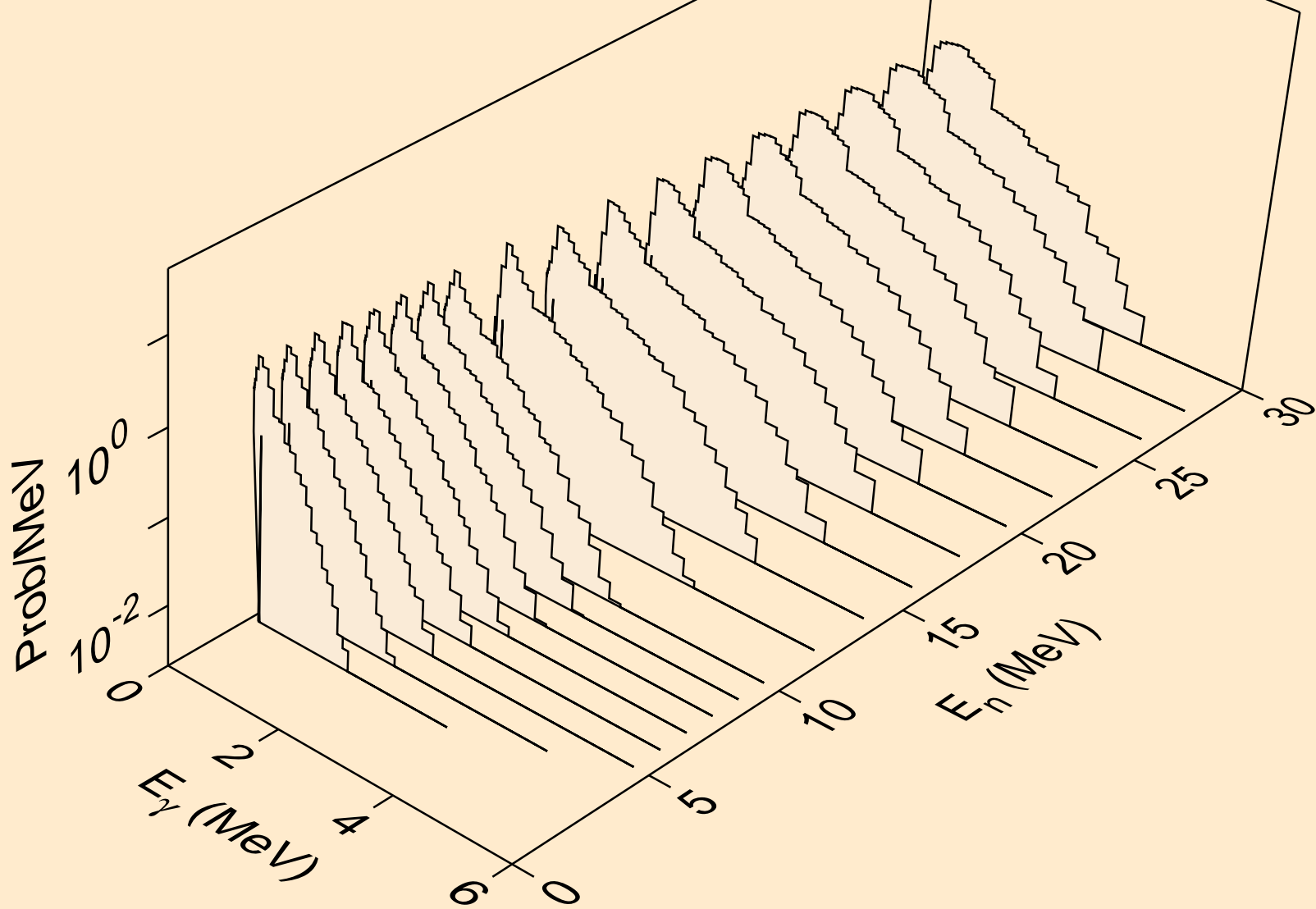

W193 PROTON ACER TENDL-2021 LIBRARY; T=0.K  
Photon emission for (n,2p)

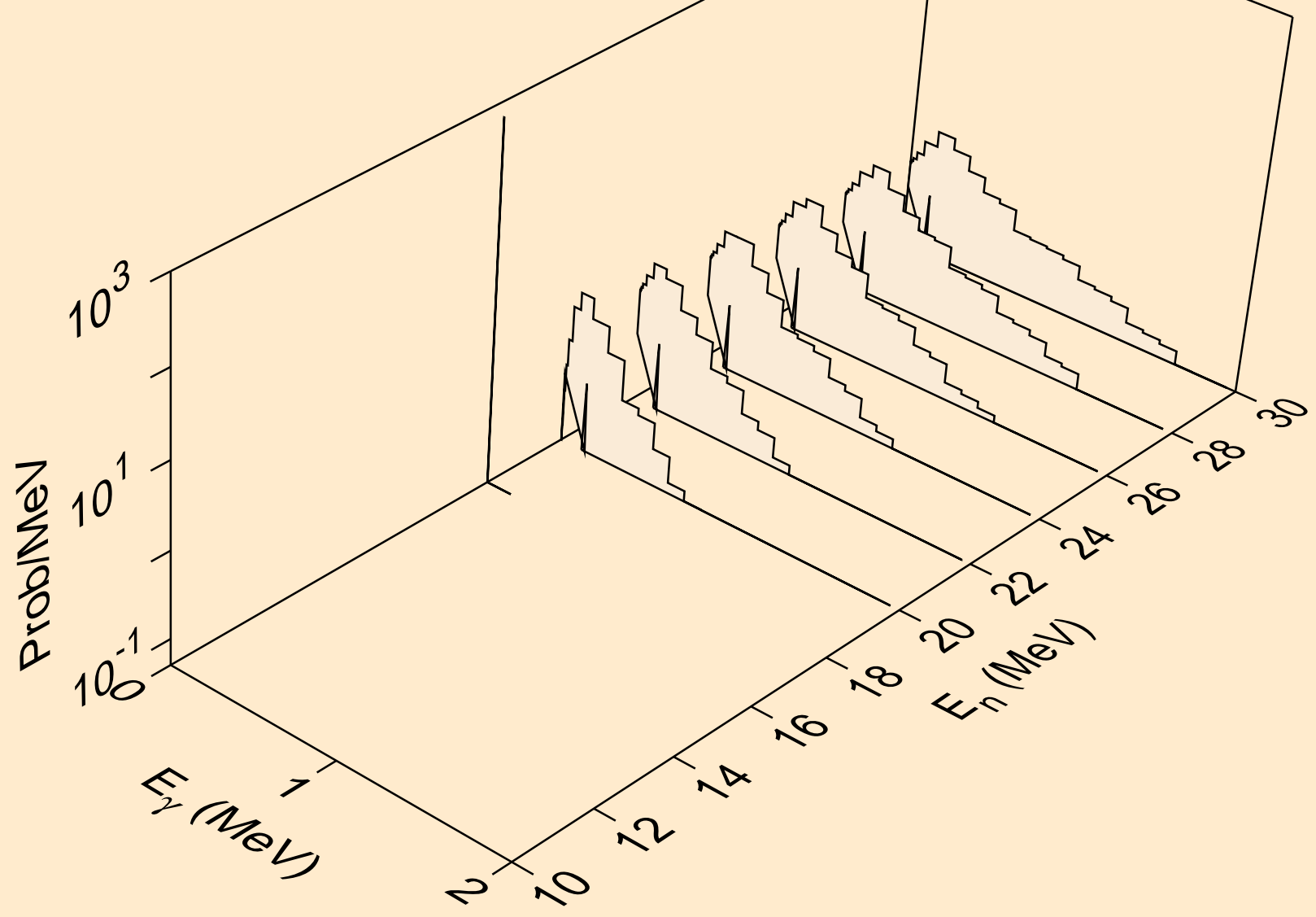



# W193 PROTON ACER TENDL-2021 LIBRARY; T=0.K

## Particle heating contributions

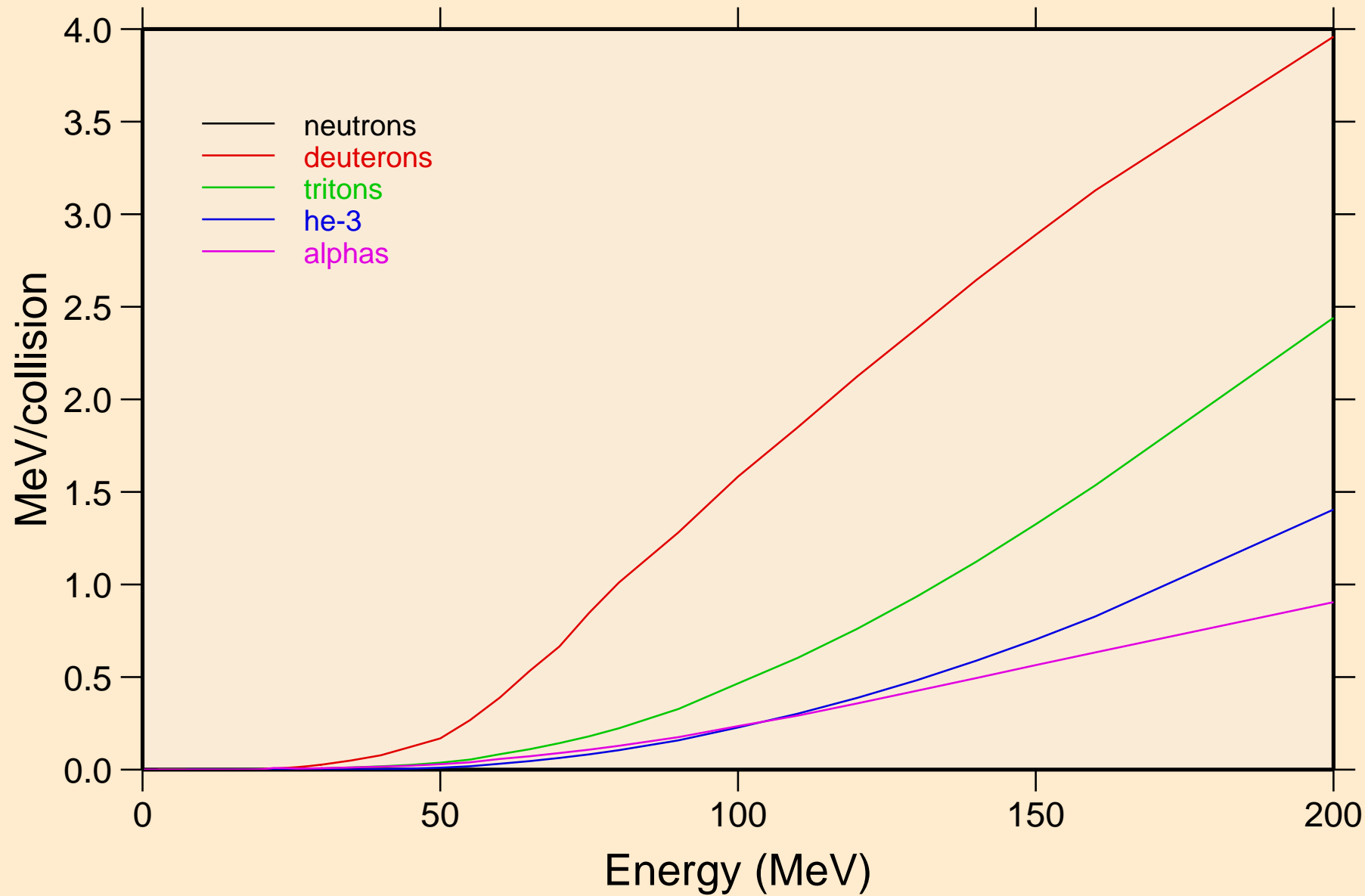

W193 PROTON ACER TENDL-2021 LIBRARY; T=0.K  
Recoil Heating

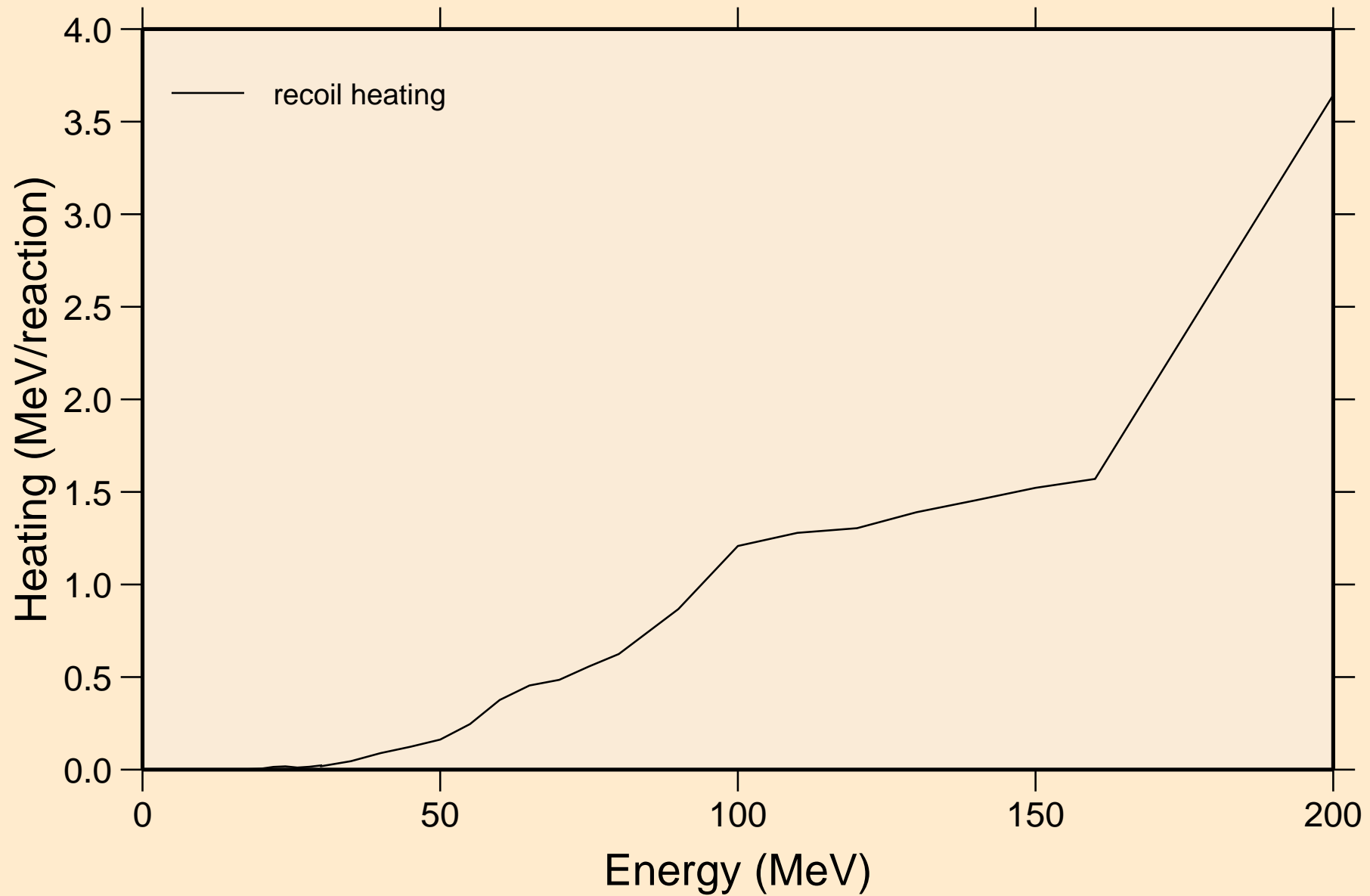

W193 PROTON ACER TENDL-2021 LIBRARY; T=0.K  
Particle production cross sections

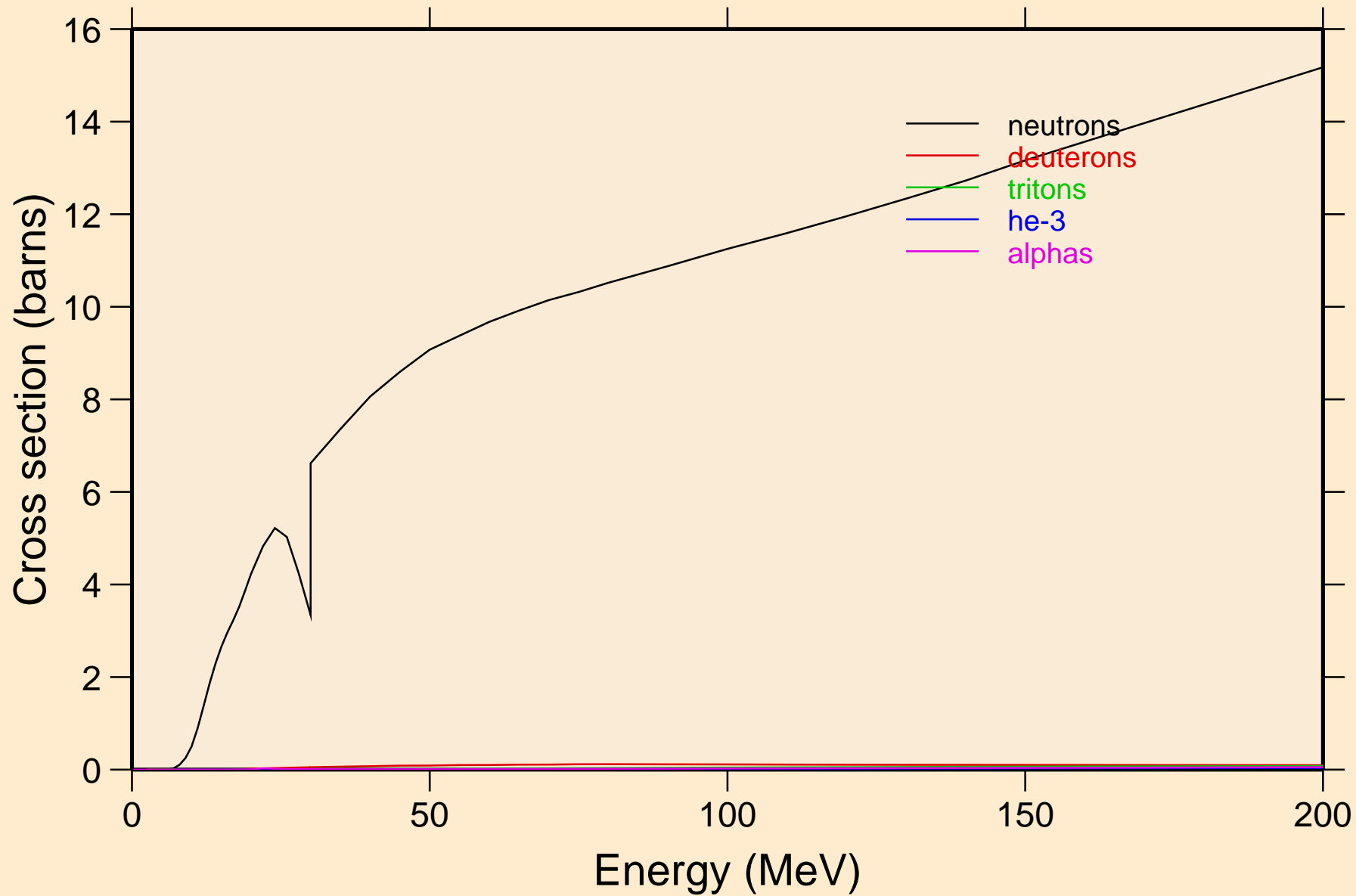

W193 PROTON ACER TENDL-2021 LIBRARY; T=0.K  
neutrons from (p,n)

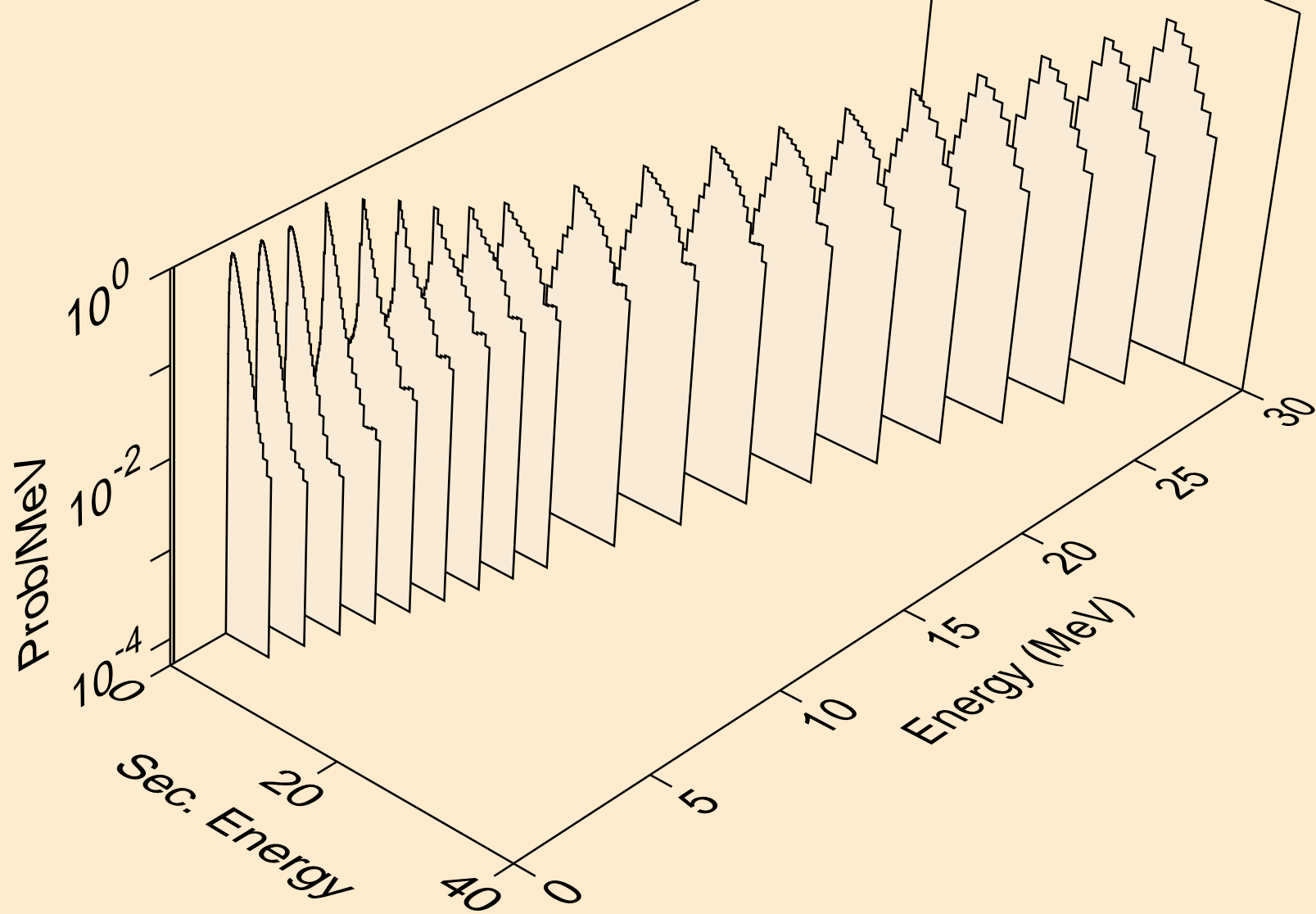

W193 PROTON ACER TENDL-2021 LIBRARY; T=0.K  
neutrons from (p,x)

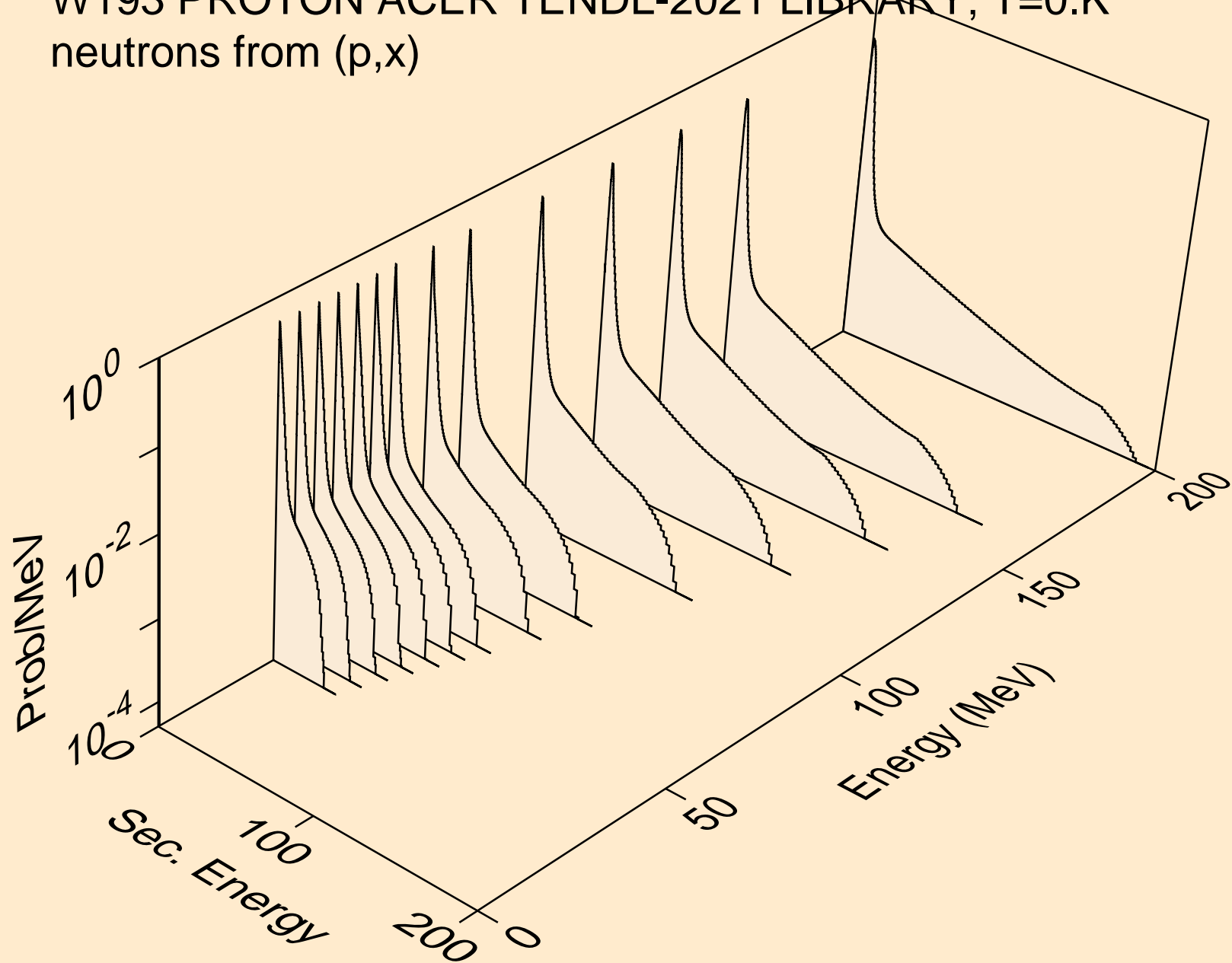

W193 PROTON ACER TENDL-2021 LIBRARY; T=0.K  
neutrons from (p,2nd)

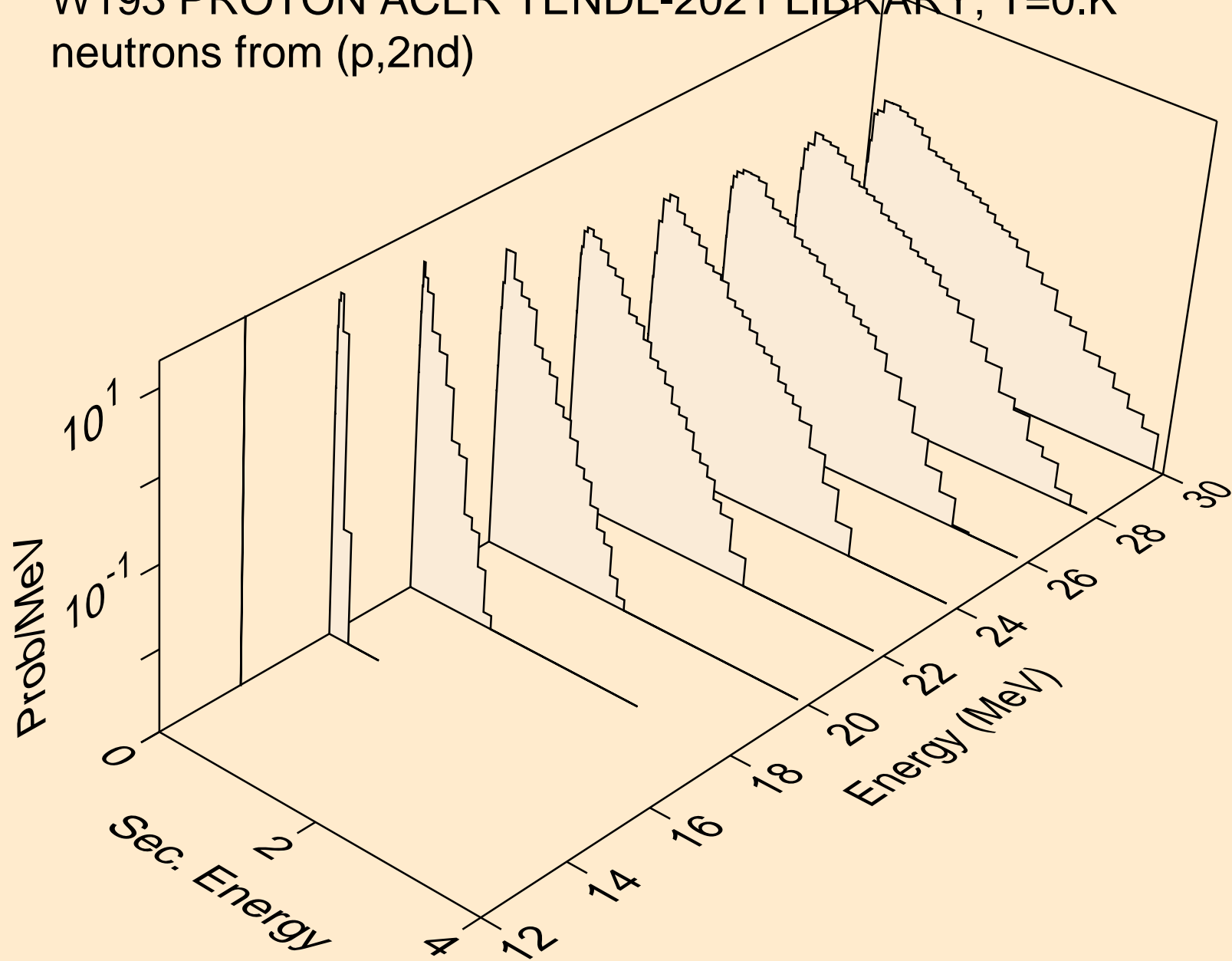

W193 PROTON ACER TENDL-2021 LIBRARY; T=0.K  
neutrons from (p,2n)

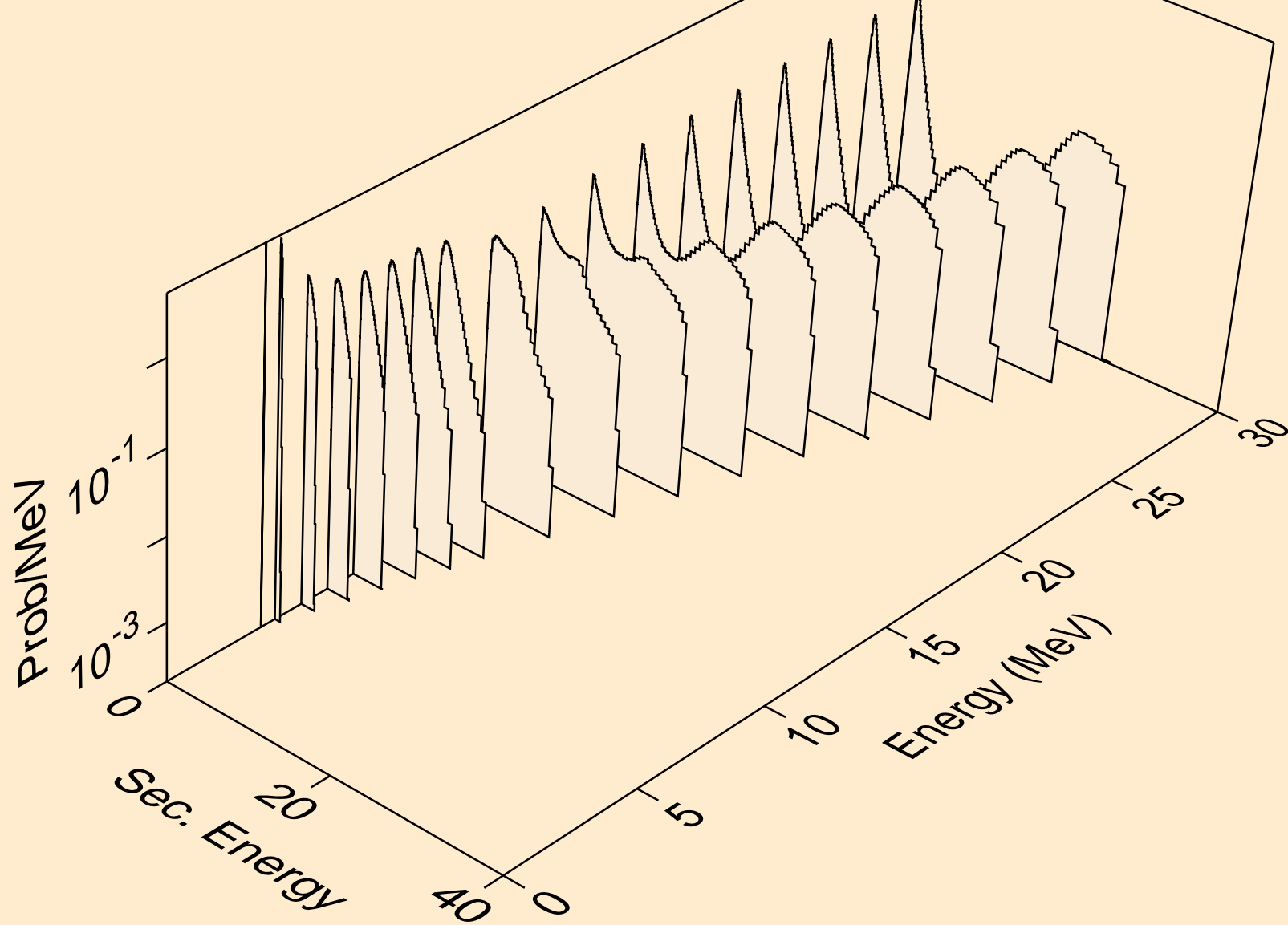

W193 PROTON ACER TENDL-2021 LIBRARY; T=0.K  
neutrons from (p,3n)

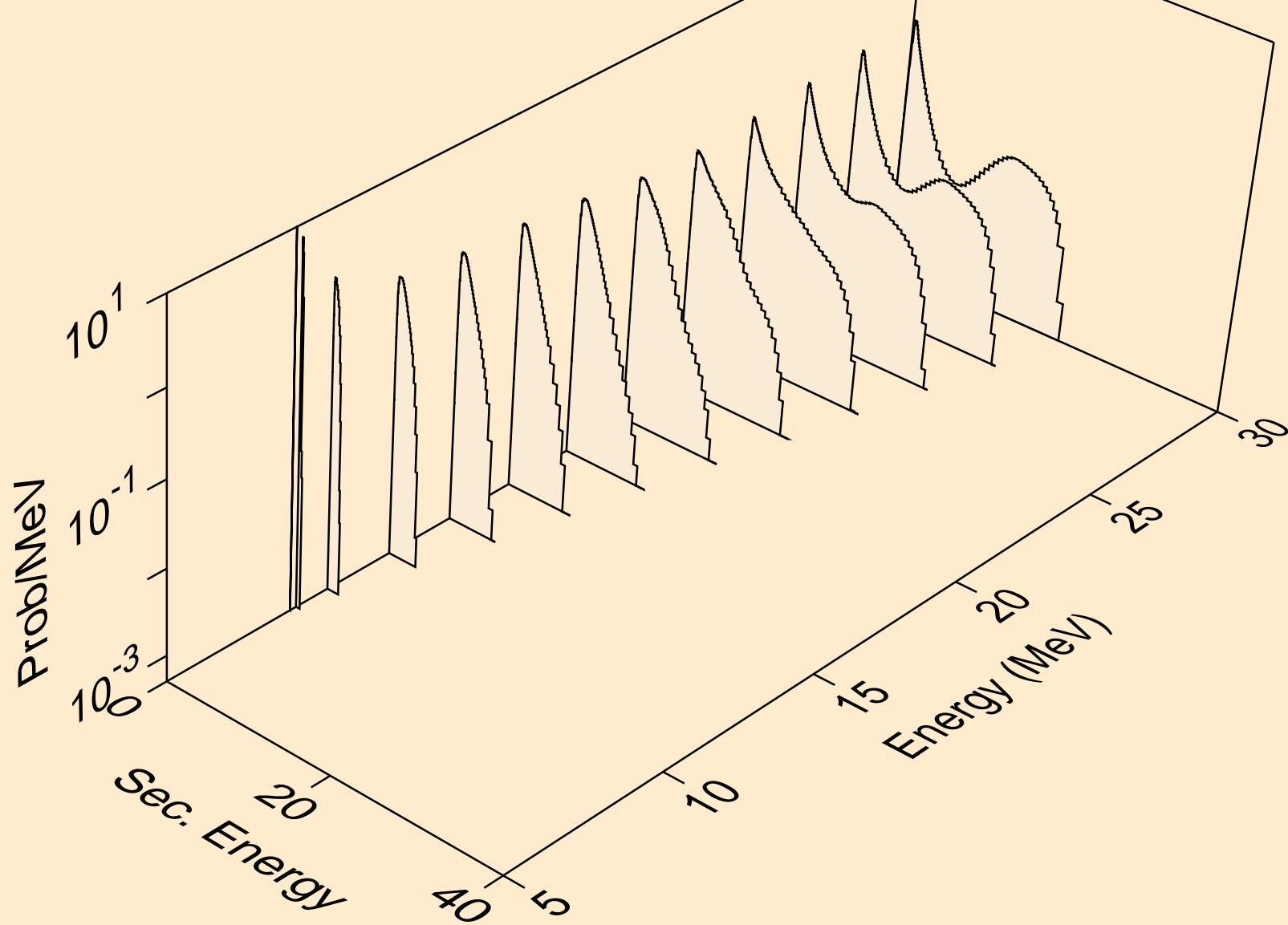



W193 PROTON ACER TENDL-2021 LIBRARY; T=0.K  
neutrons from (p,n\*)a

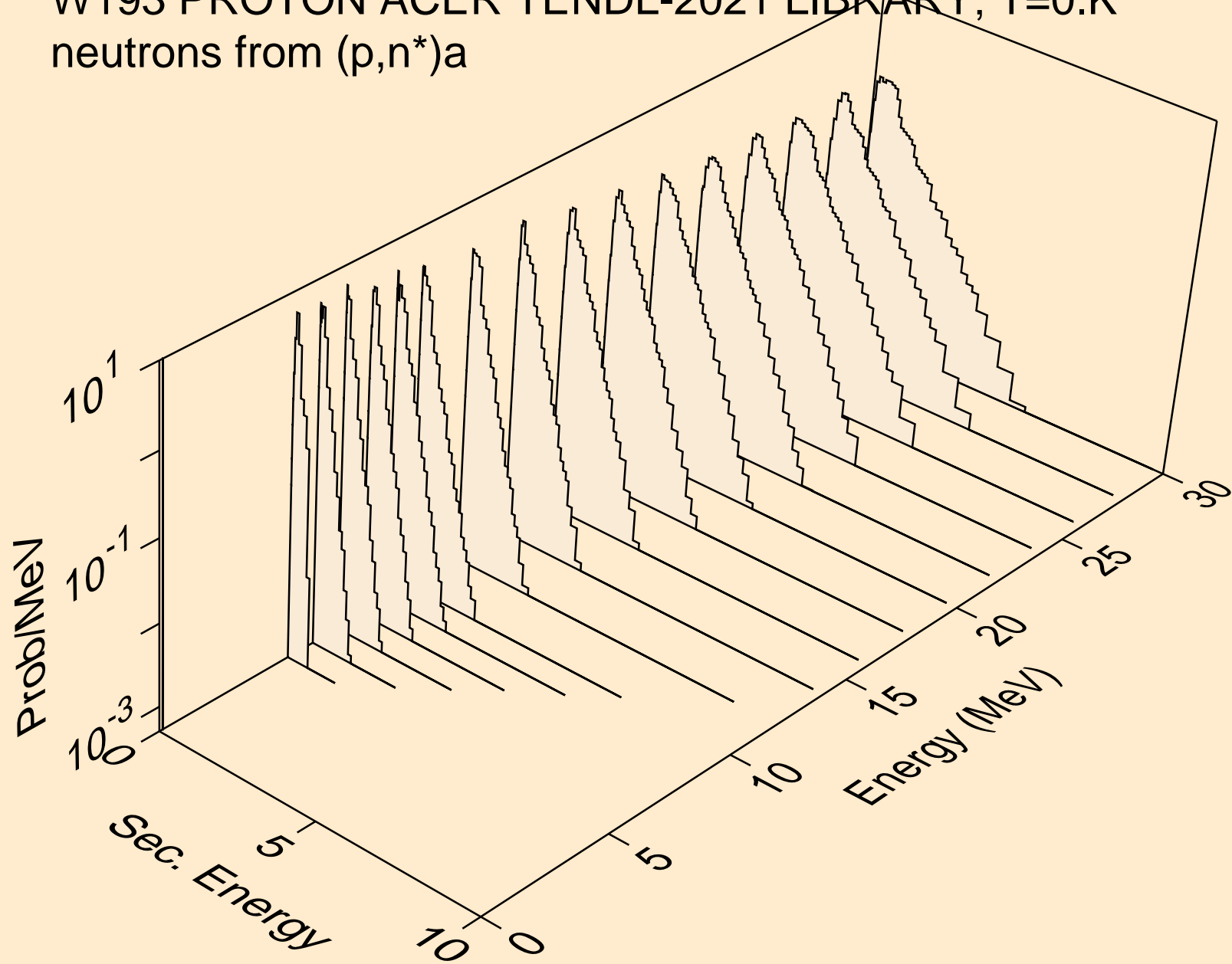

W193 PROTON ACER TENDL-2021 LIBRARY; T=0.K  
neutrons from (p,2n)a

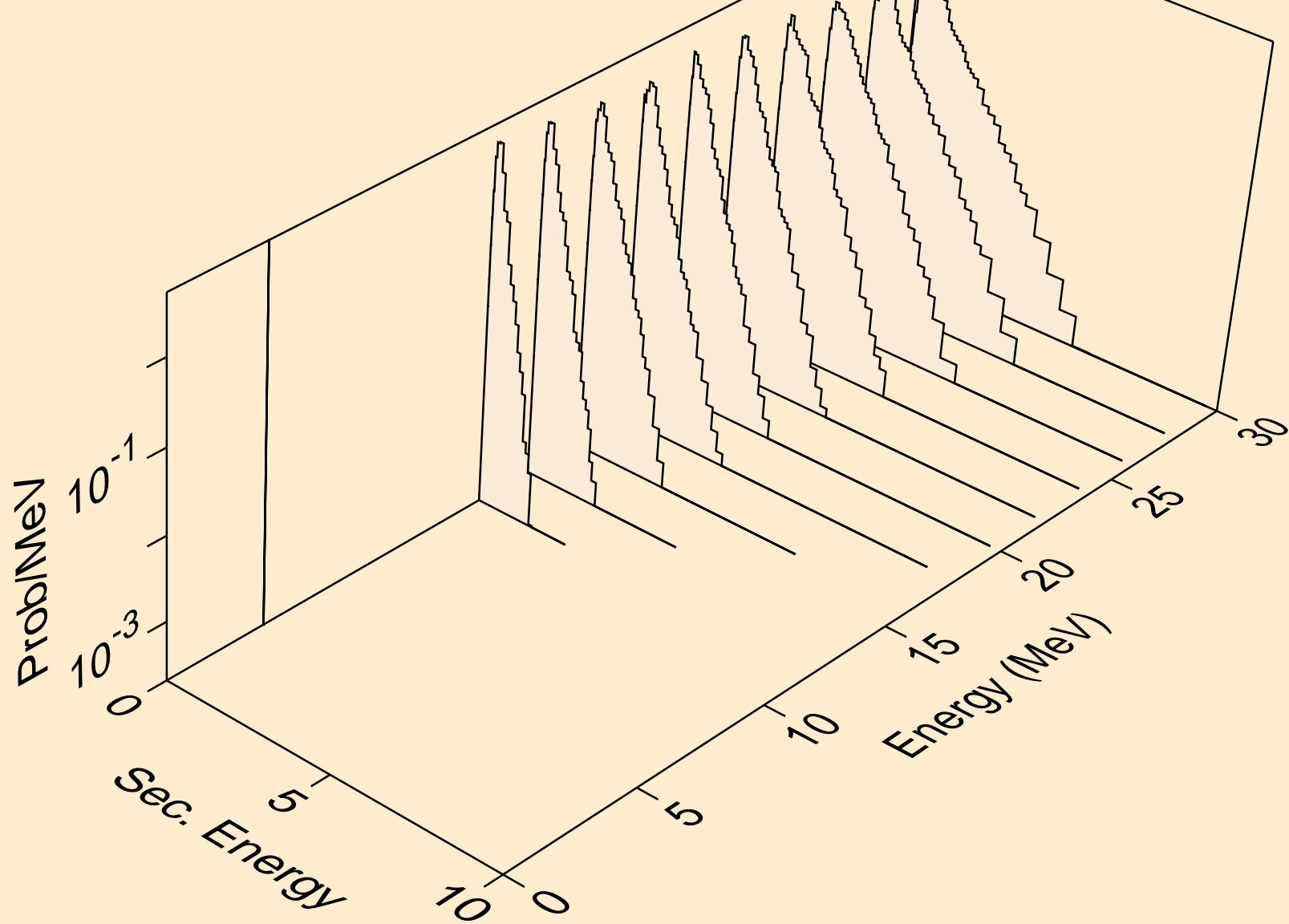

W193 PROTON ACER TENDL-2021 LIBRARY; T=0.K  
neutrons from (p,3n)a

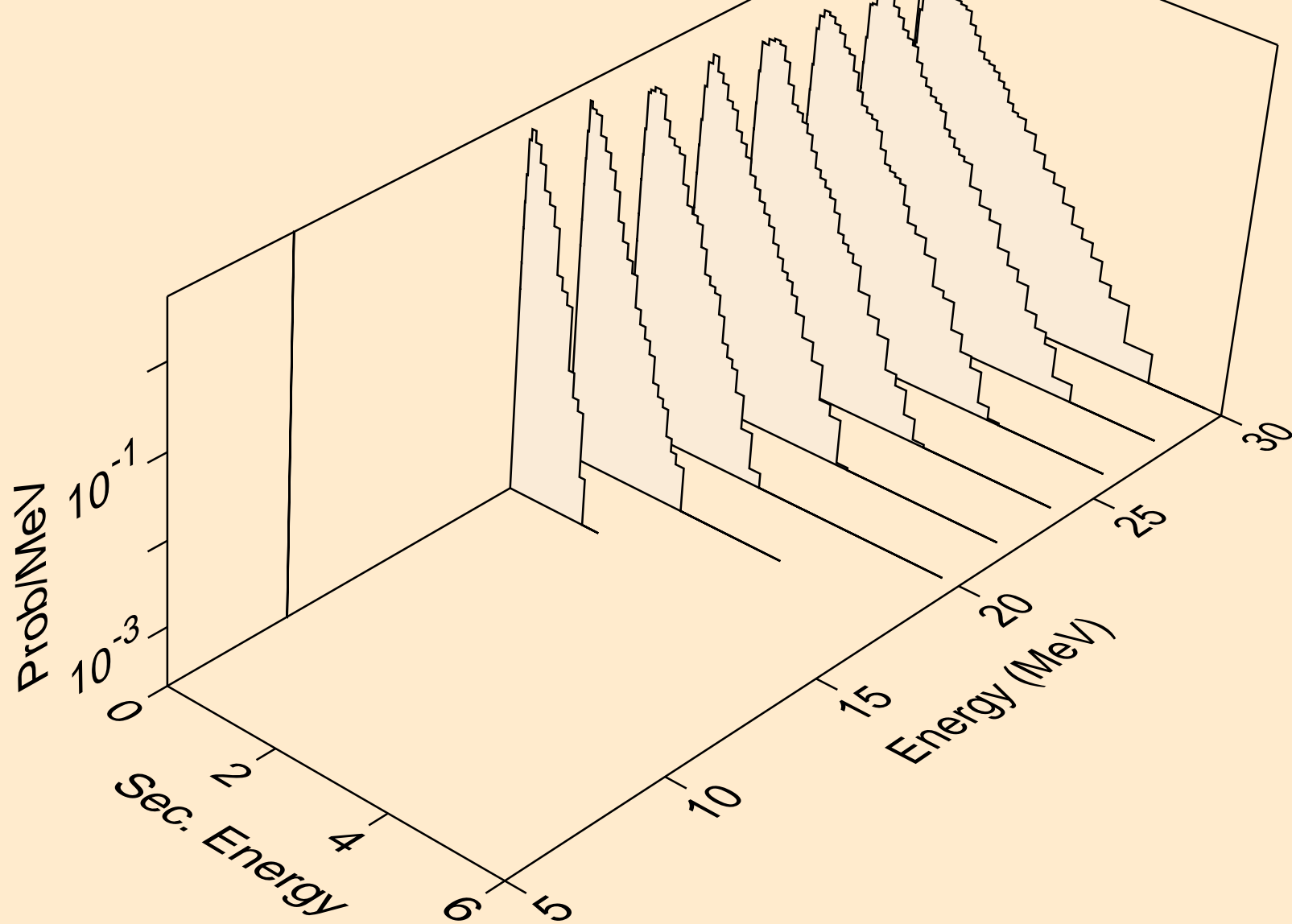

W193 PROTON ACER TENDL-2021 LIBRARY; T=0.K  
neutrons from (p,n\*)p

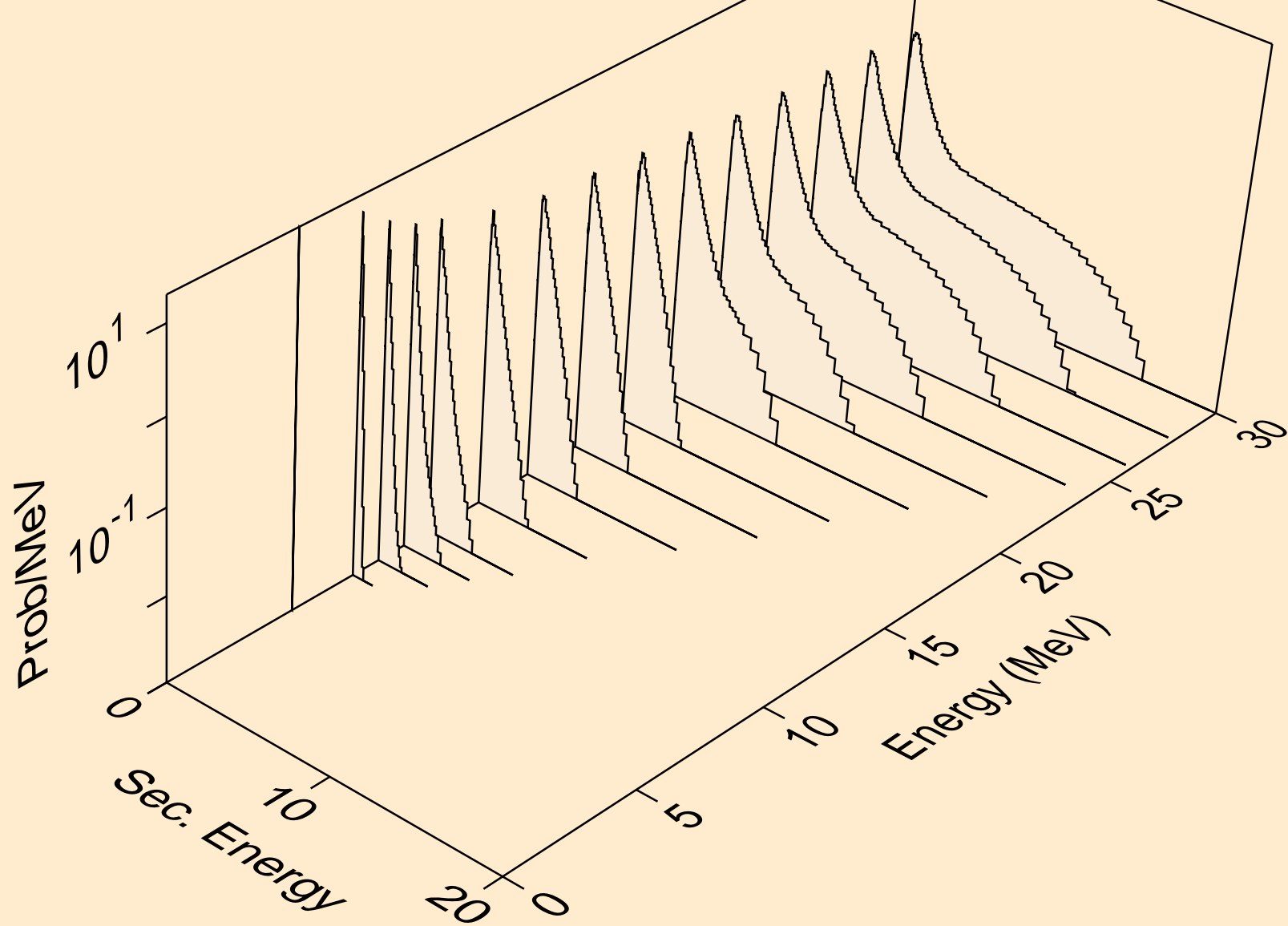

W193 PROTON ACER TENDL-2021 LIBRARY; T=0.K  
neutrons from (p,n\*)d

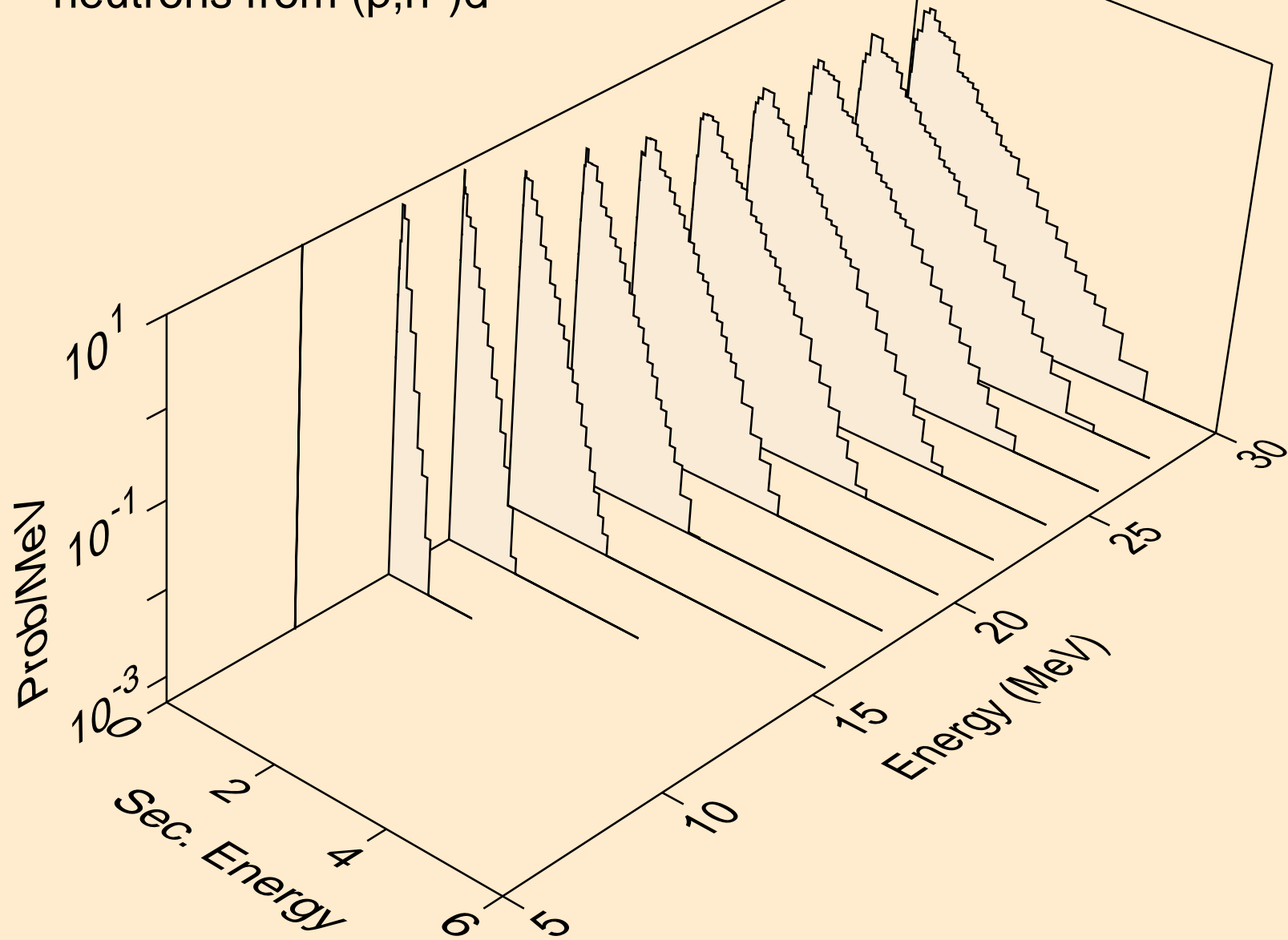

W193 PROTON ACER TENDL-2021 LIBRARY; T=0.K  
neutrons from (p,n\*)t

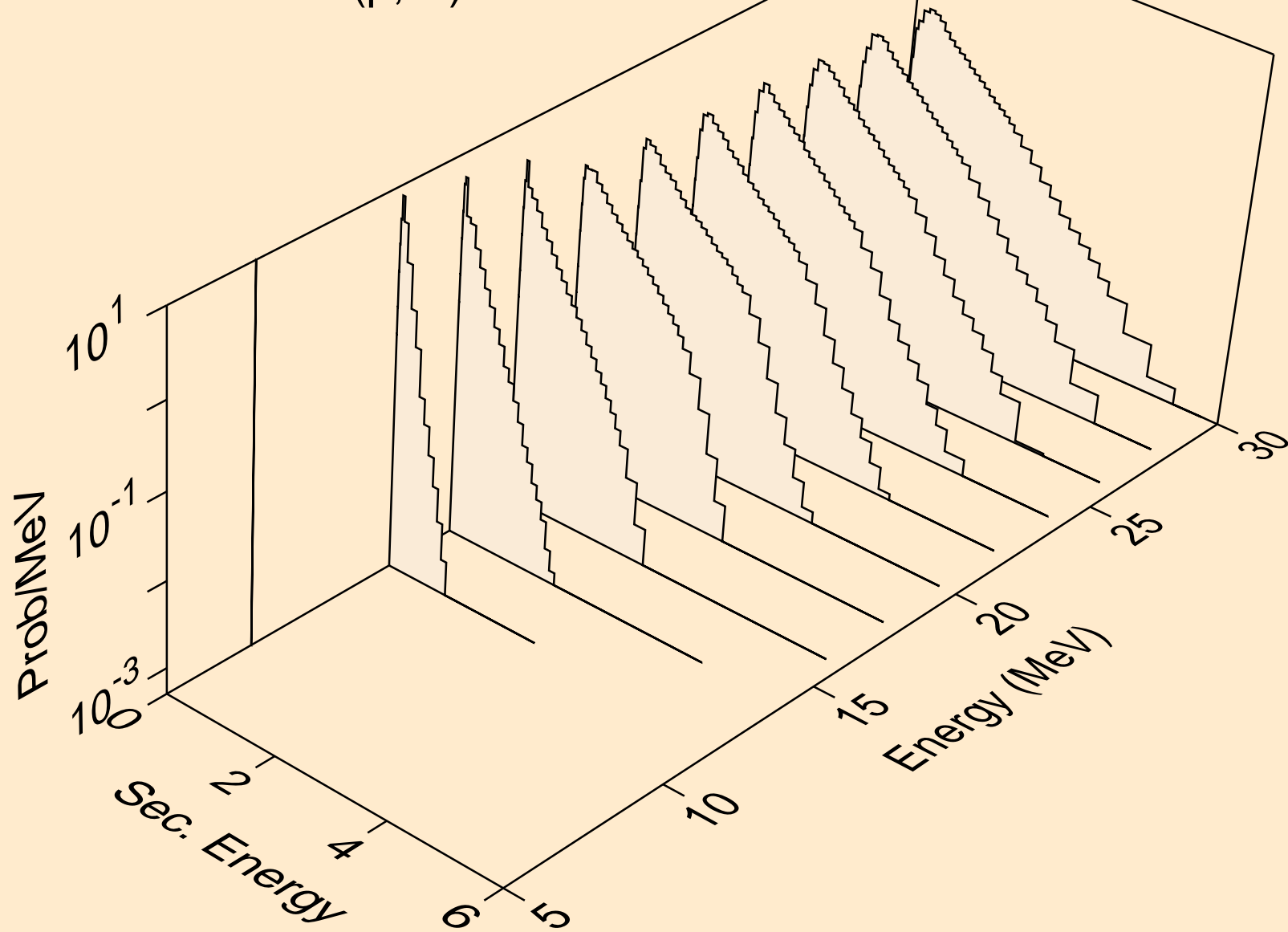

W193 PROTON ACER TENDL-2021 LIBRARY; T=0.K  
neutrons from (p,n\*)he3

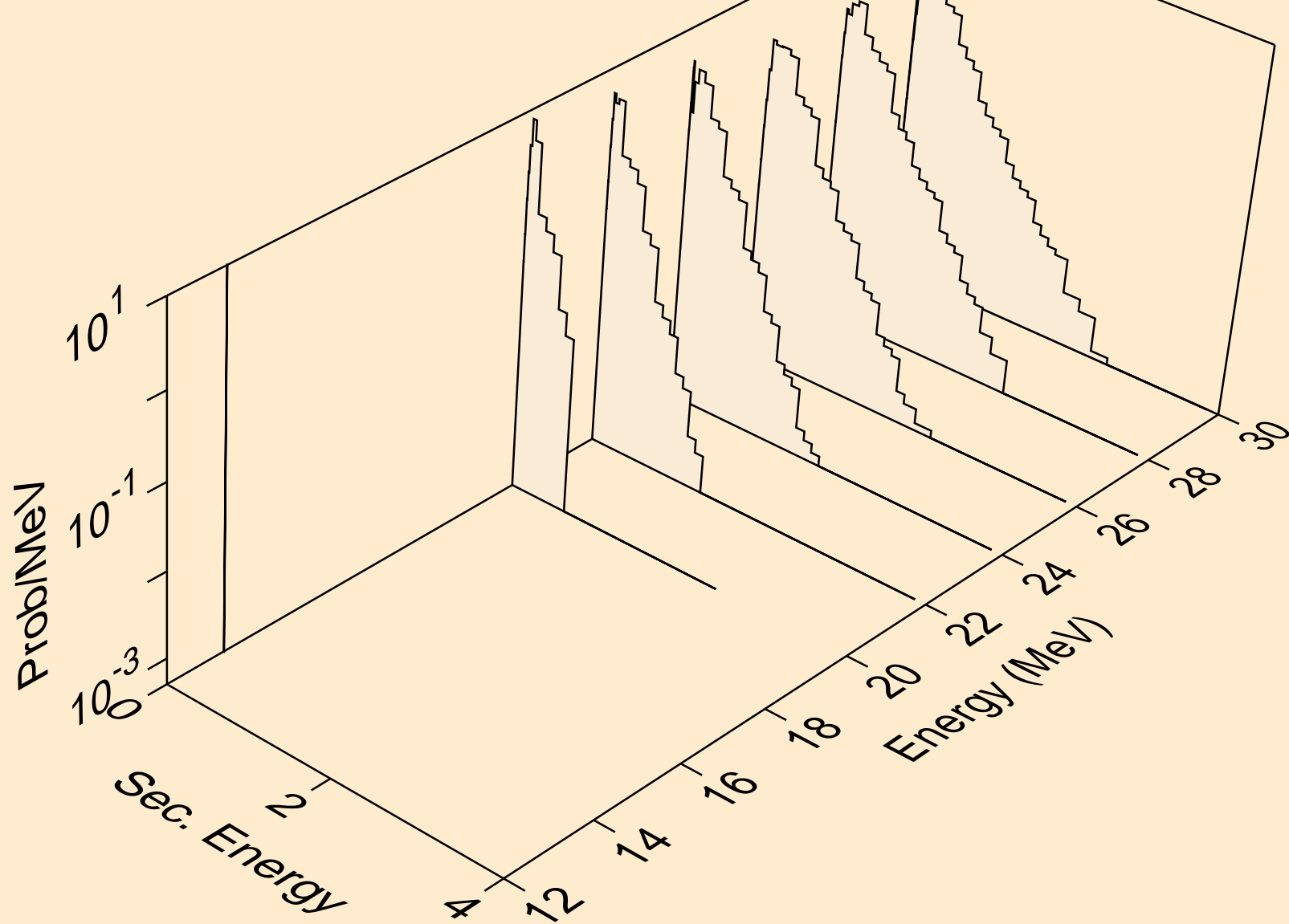

W193 PROTON ACER TENDL-2021 LIBRARY; T=0.K  
neutrons from (p,4n)

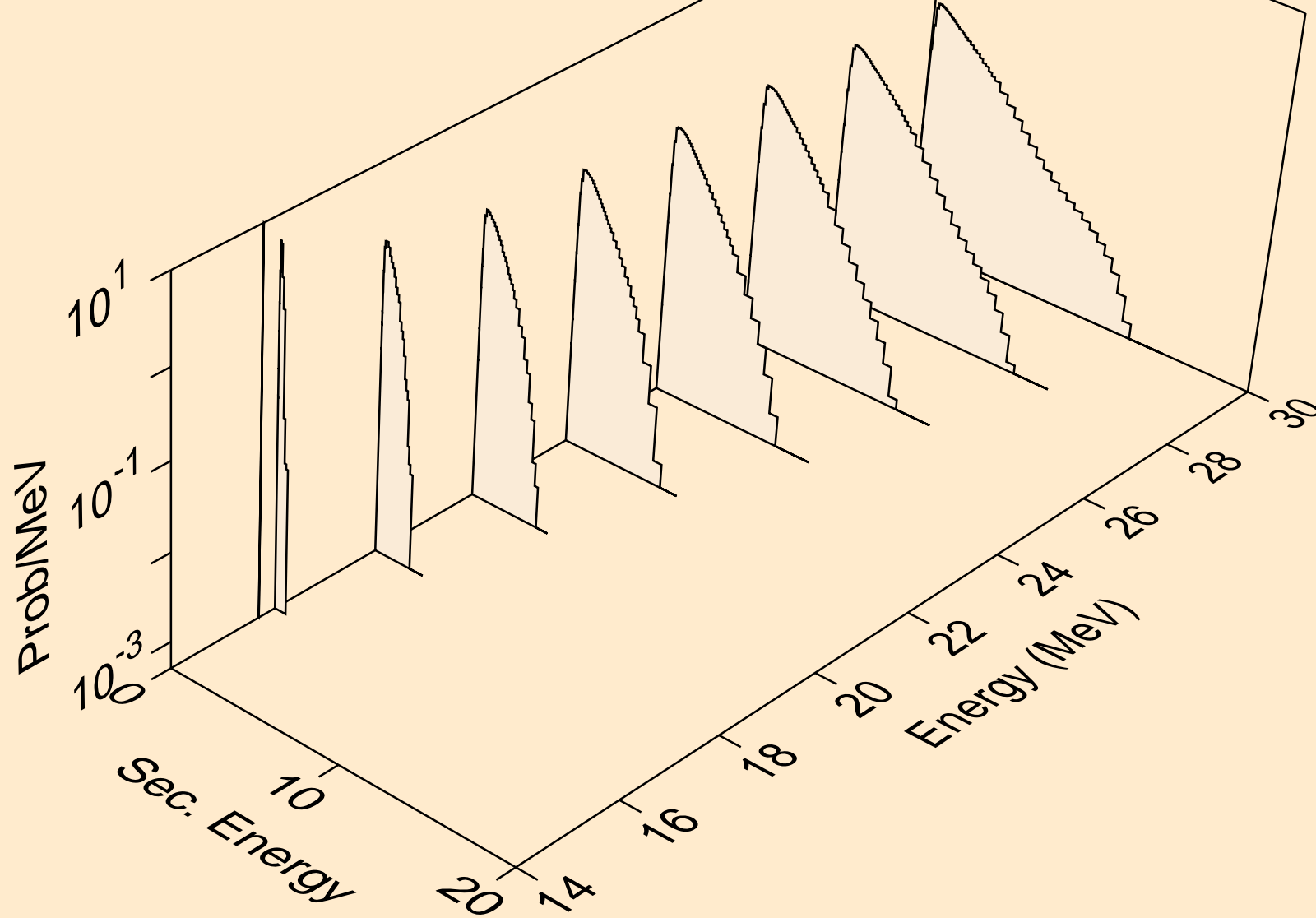



W193 PROTON ACER TENDL-2021 LIBRARY; T=0.K  
neutrons from (p,2np)

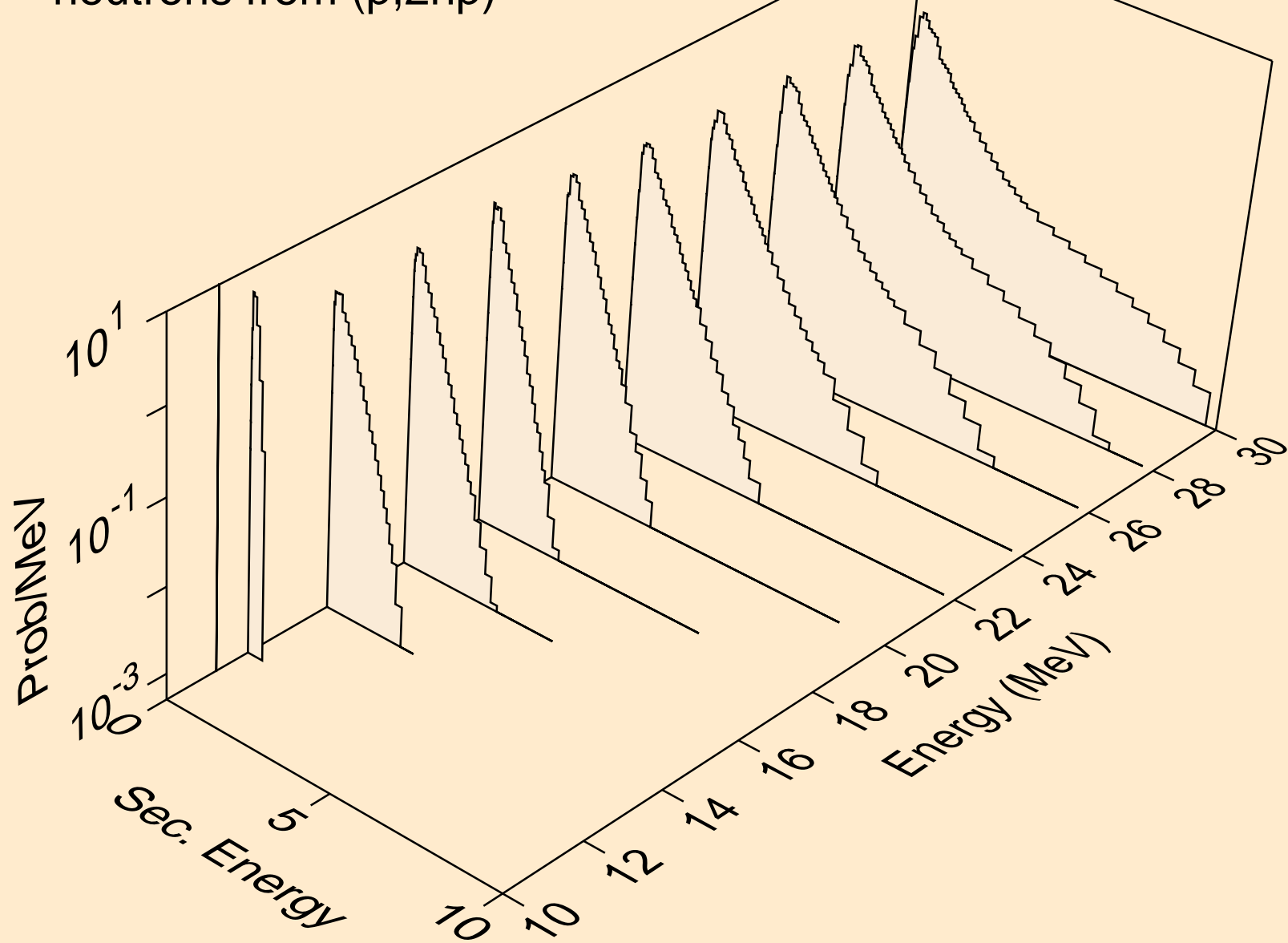

W193 PROTON ACER TENDL-2021 LIBRARY; T=0.K  
neutrons from (p,3np)

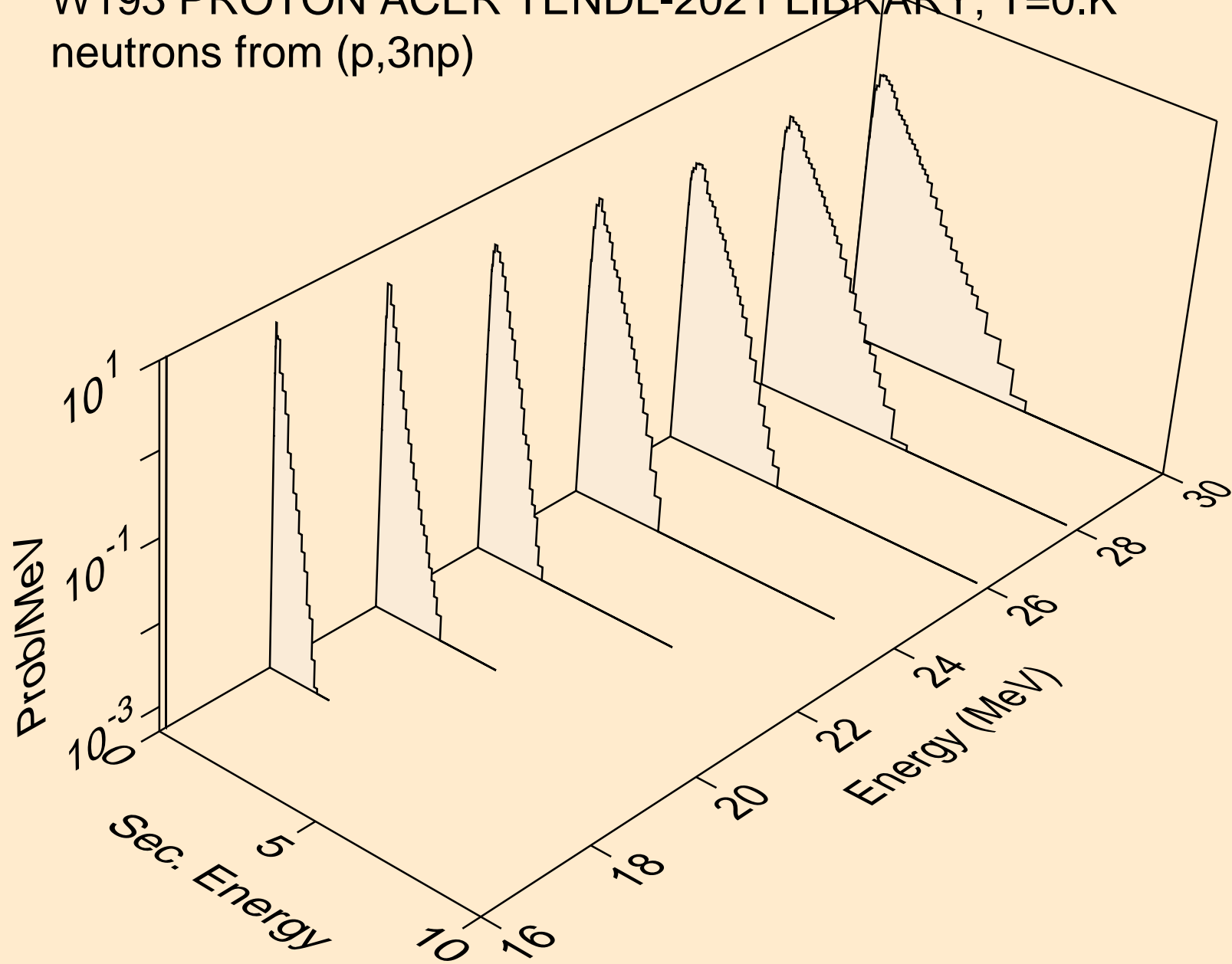

W193 PROTON ACER TENDL-2021 LIBRARY; T=0.K  
neutrons from (p,2np)

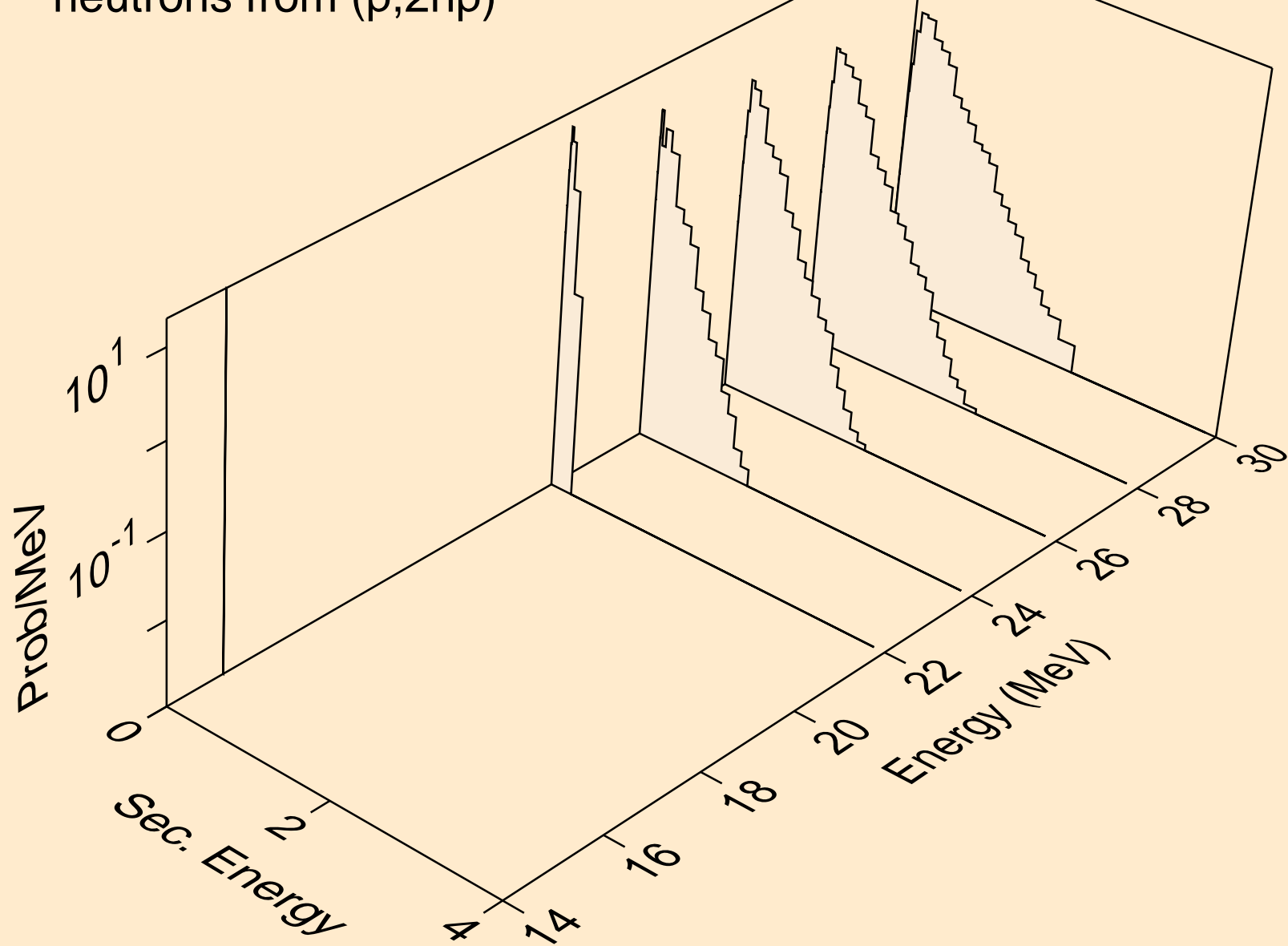

W193 PROTON ACER TENDL-2021 LIBRARY; T=0.K  
deuterons from (p,x)

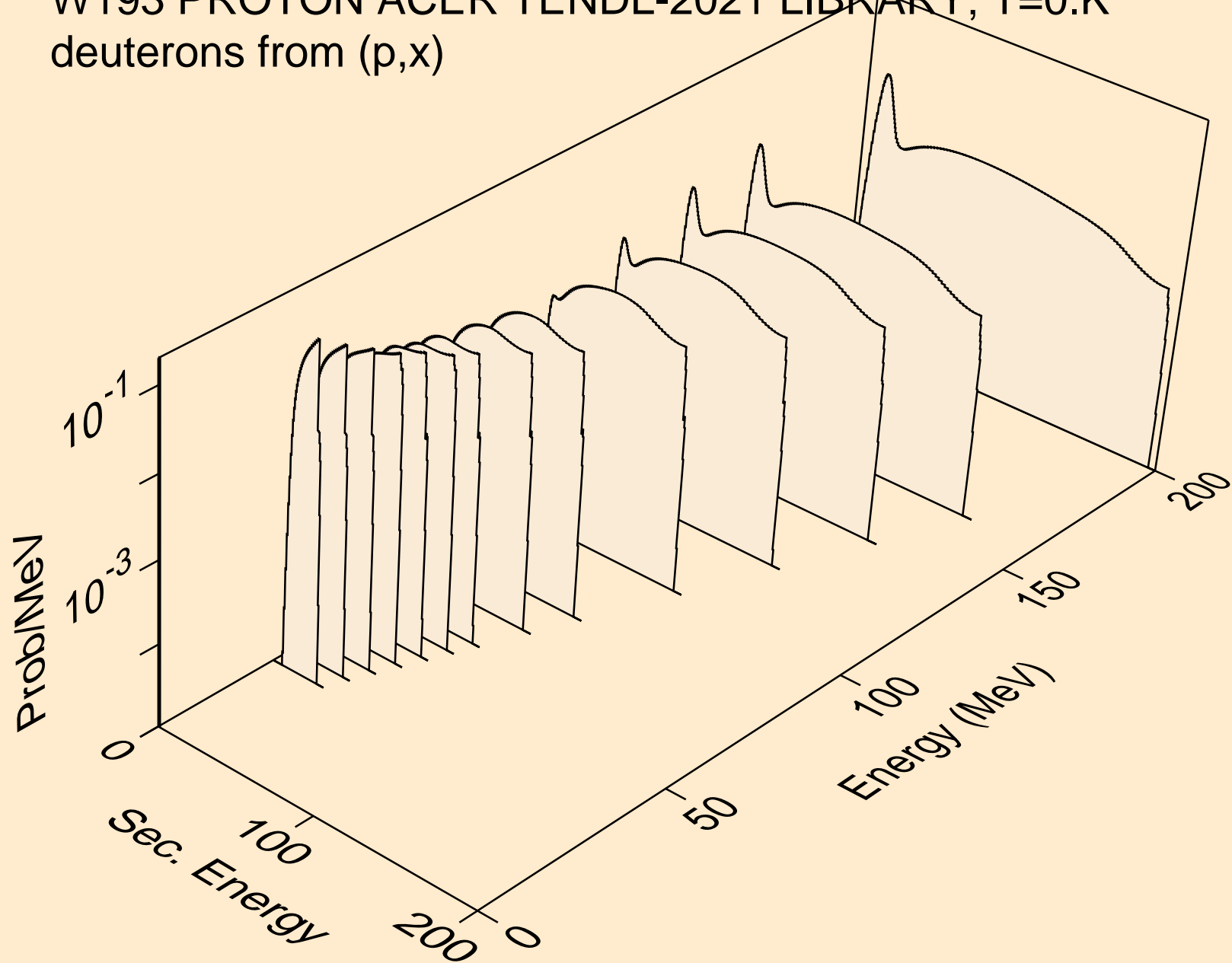

W193 PROTON ACER TENDL-2021 LIBRARY; T=0.K  
deuterons from (p,2nd)

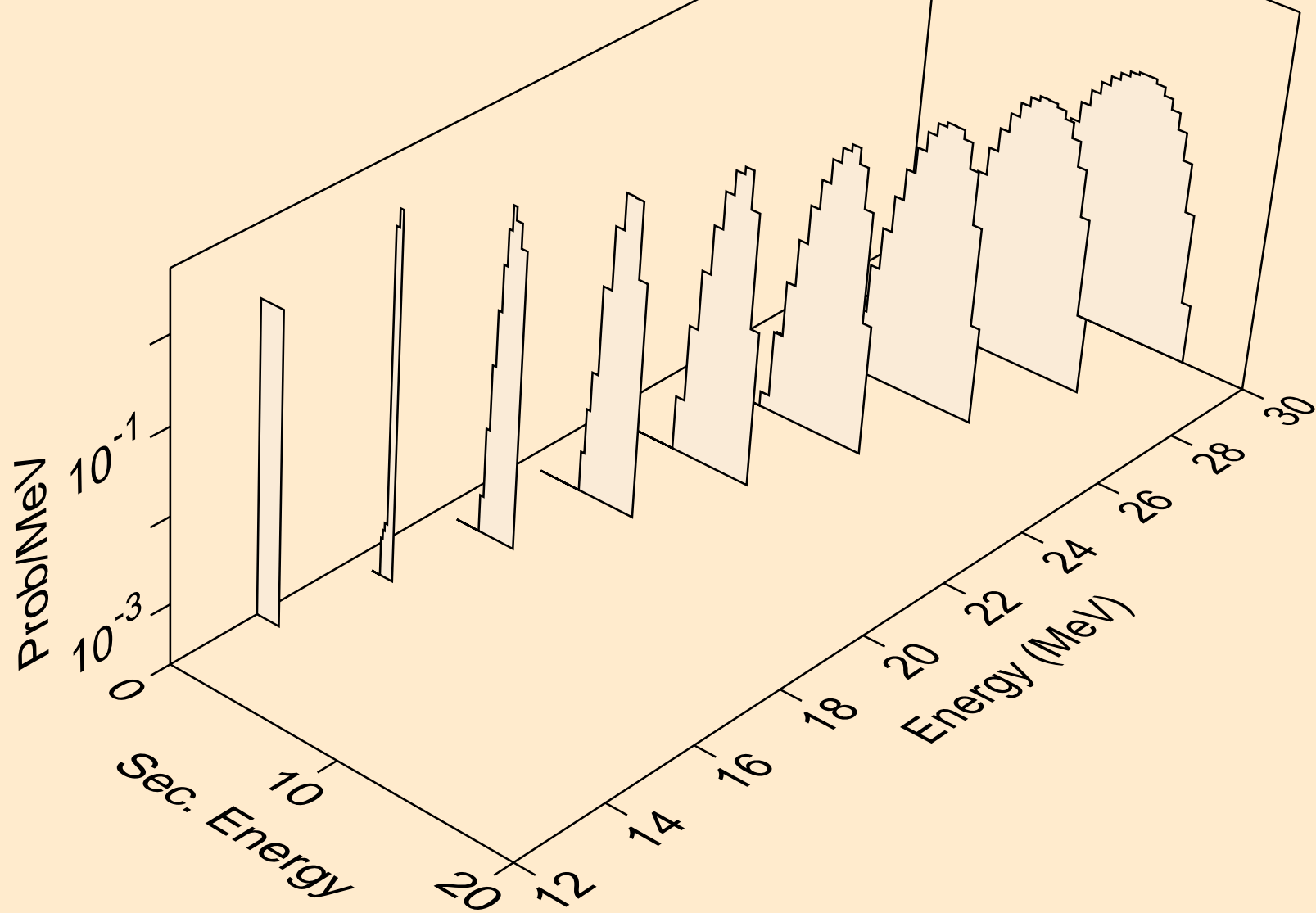

W193 PROTON ACER TENDL-2021 LIBRARY; T=0.K  
deuterons from (p,n\*)d

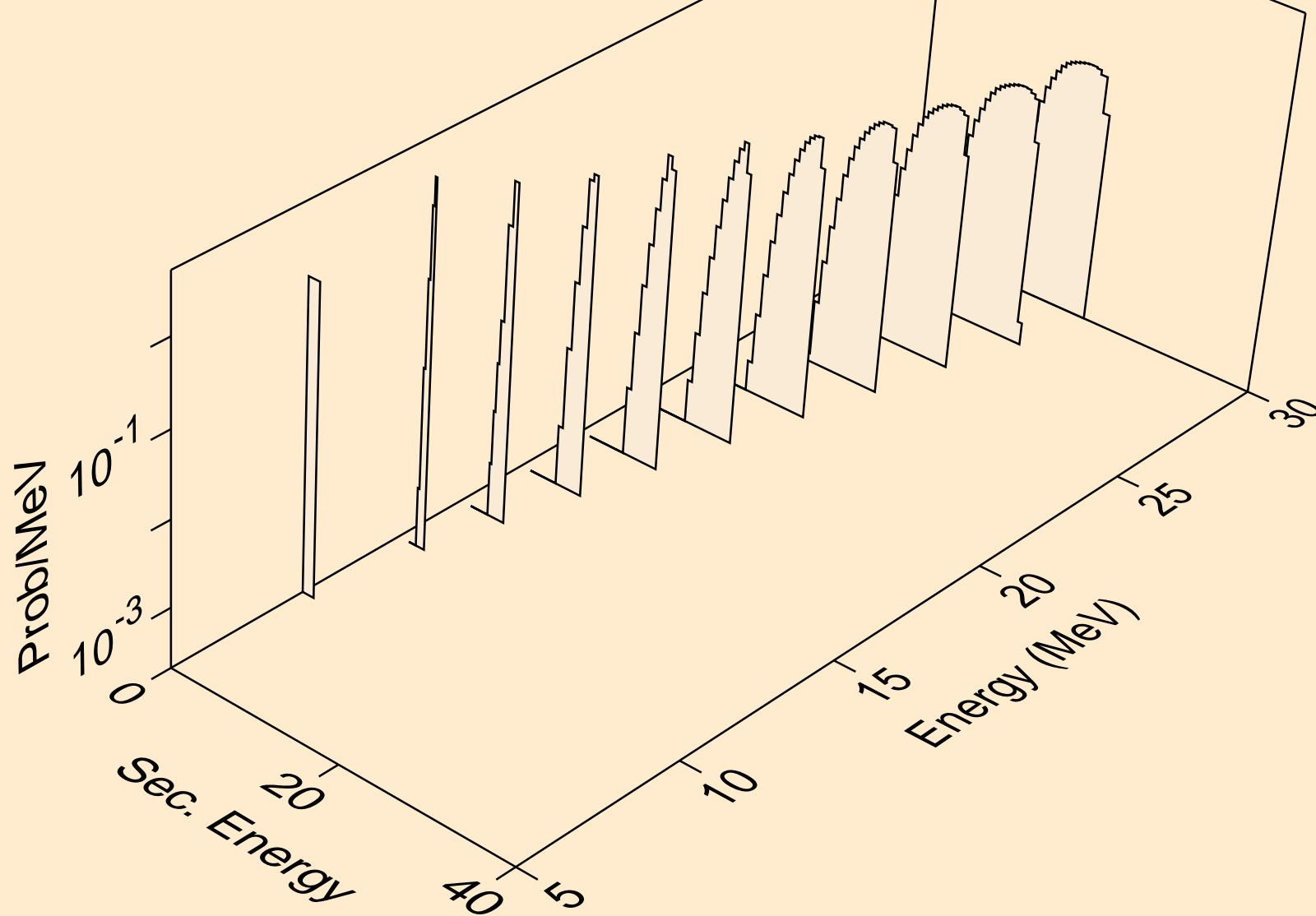

W193 PROTON ACER TENDL-2021 LIBRARY; T=0.K  
deuterons from (p,d)

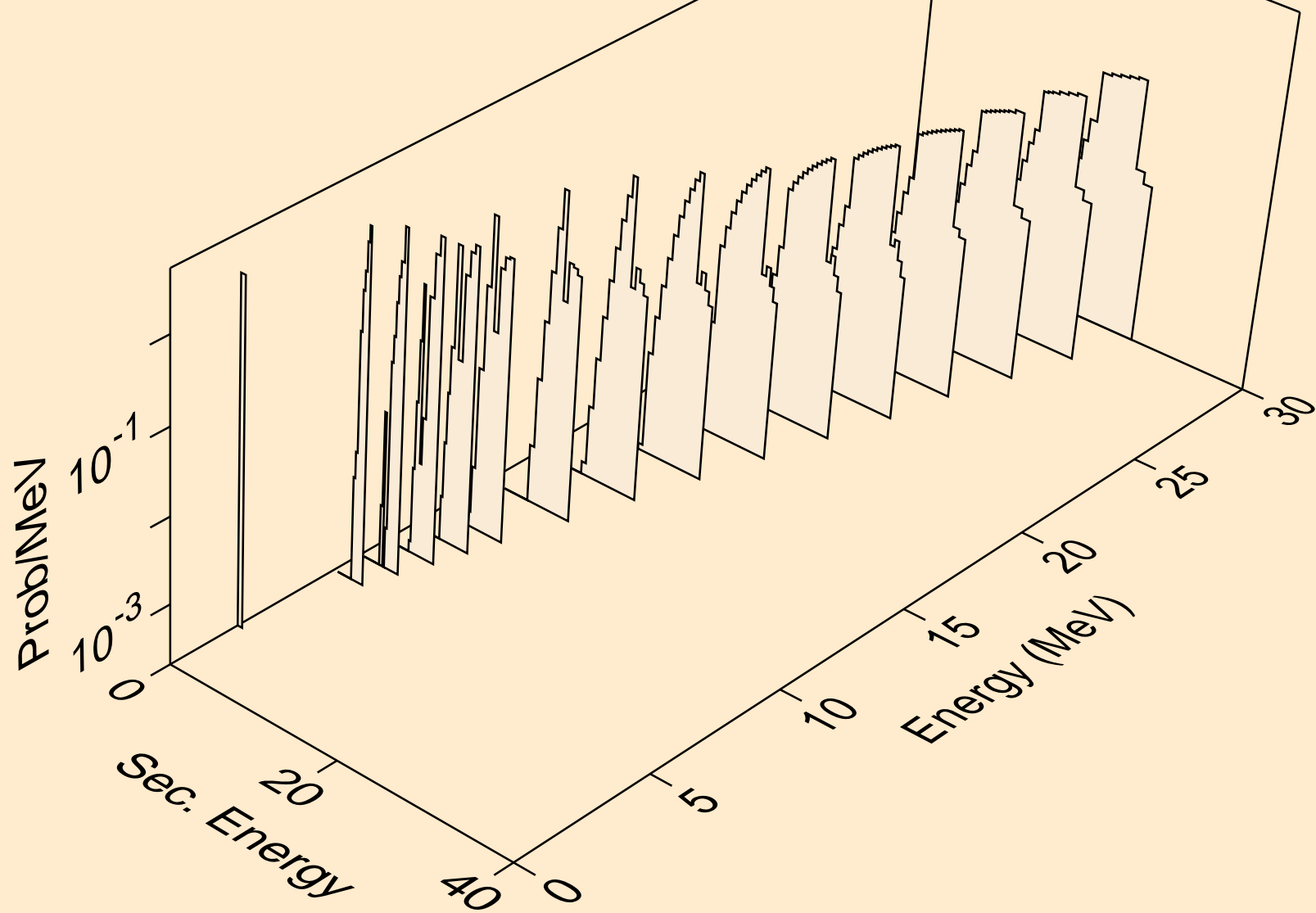

W193 PROTON ACER TENDL-2021 LIBRARY; T=0.K  
tritons from (p,x)

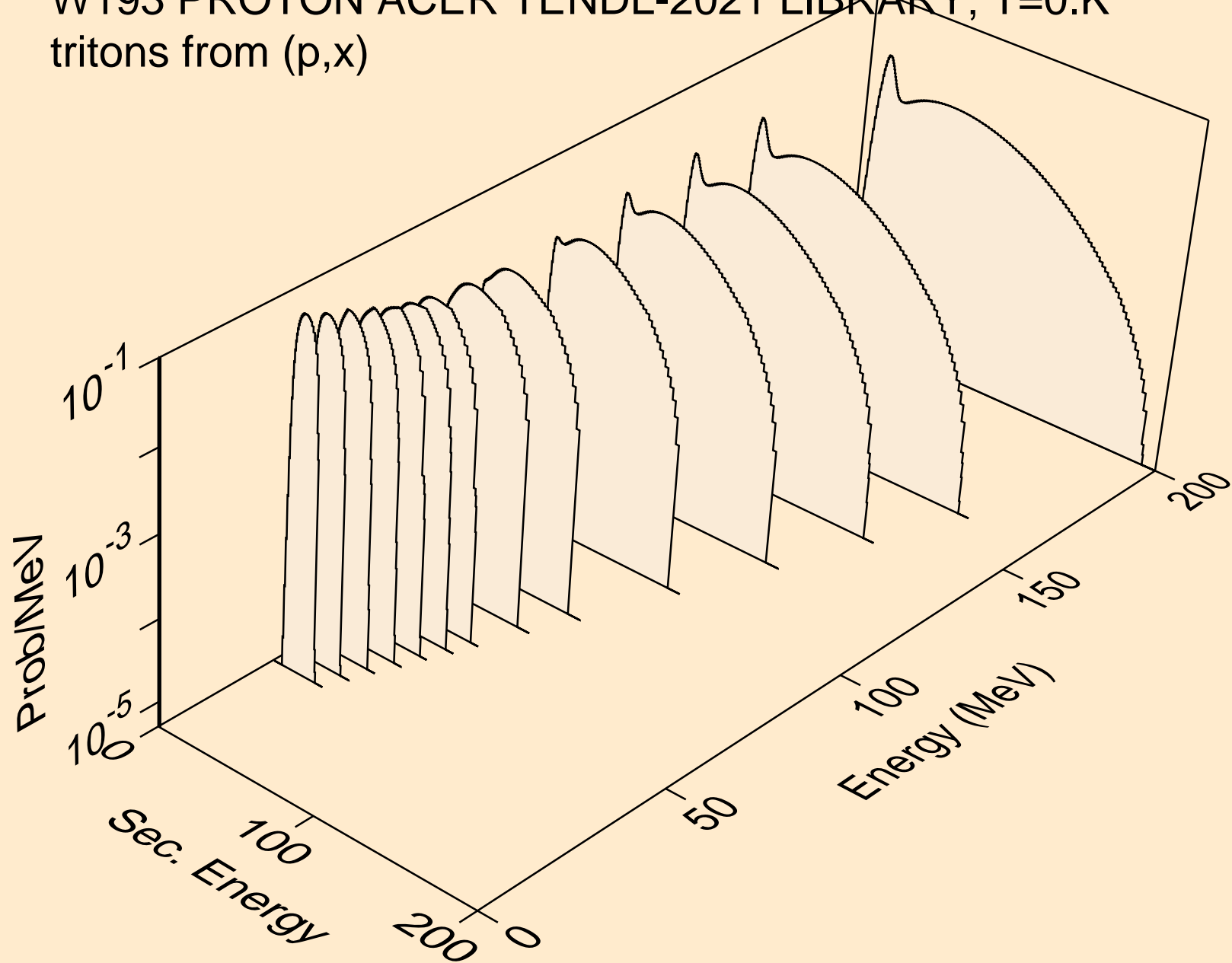



W193 PROTON ACER TENDL-2021 LIBRARY; T=0.K  
tritons from (p,n\*)t

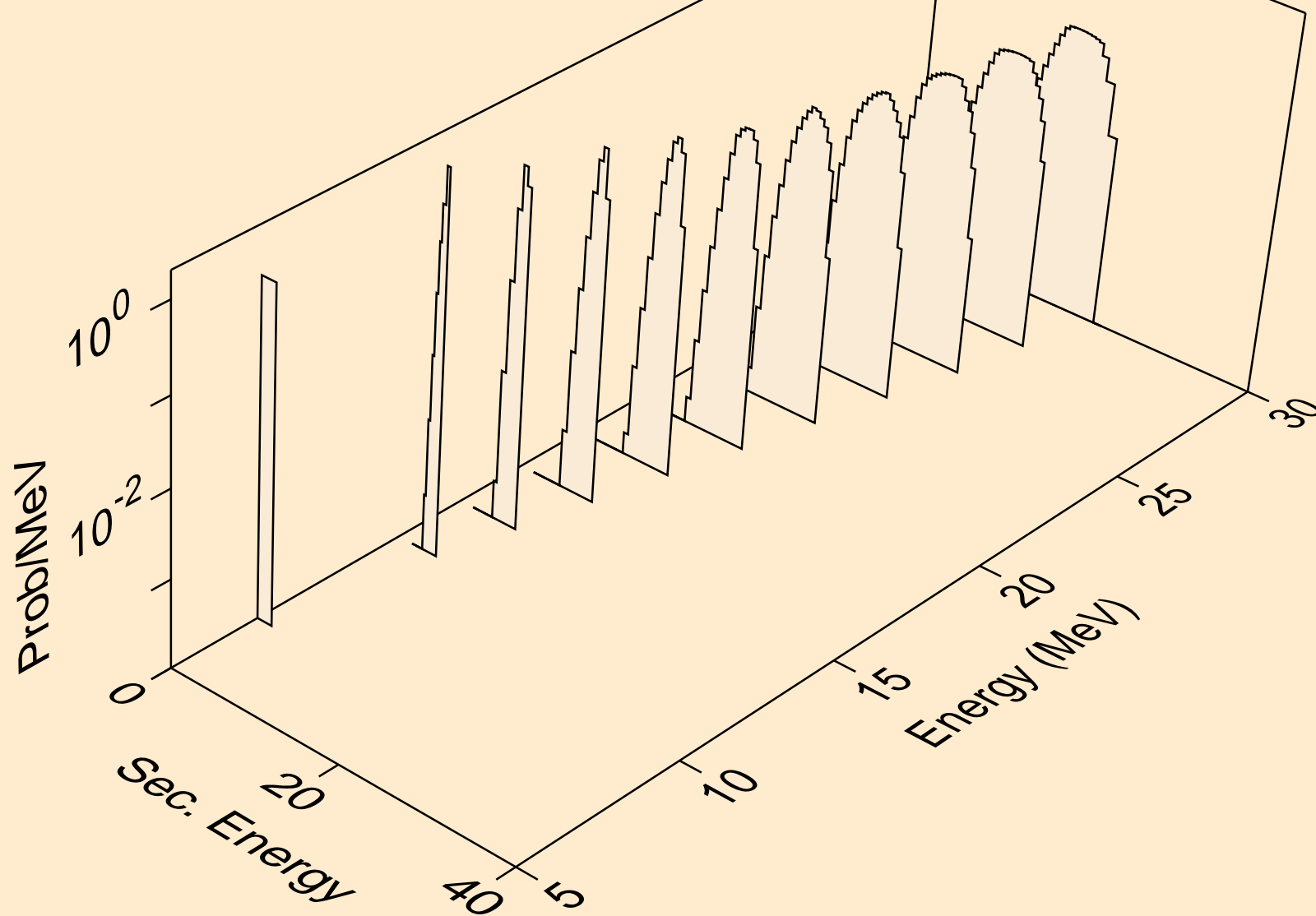

W193 PROTON ACER TENDL-2021 LIBRARY; T=0.K  
tritons from (p,t)

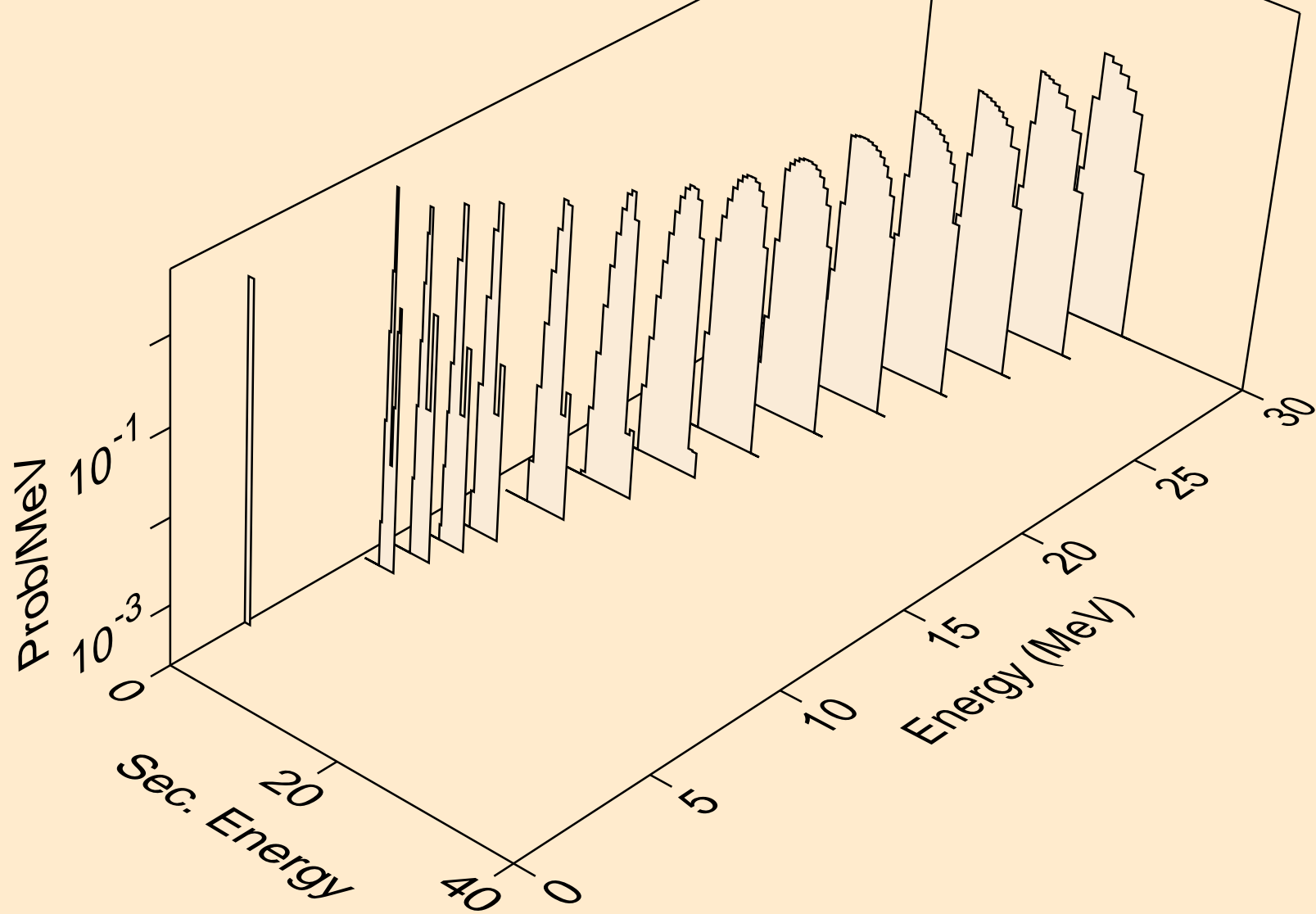

W193 PROTON ACER TENDL-2021 LIBRARY; T=0.K  
he3s from (p,x)

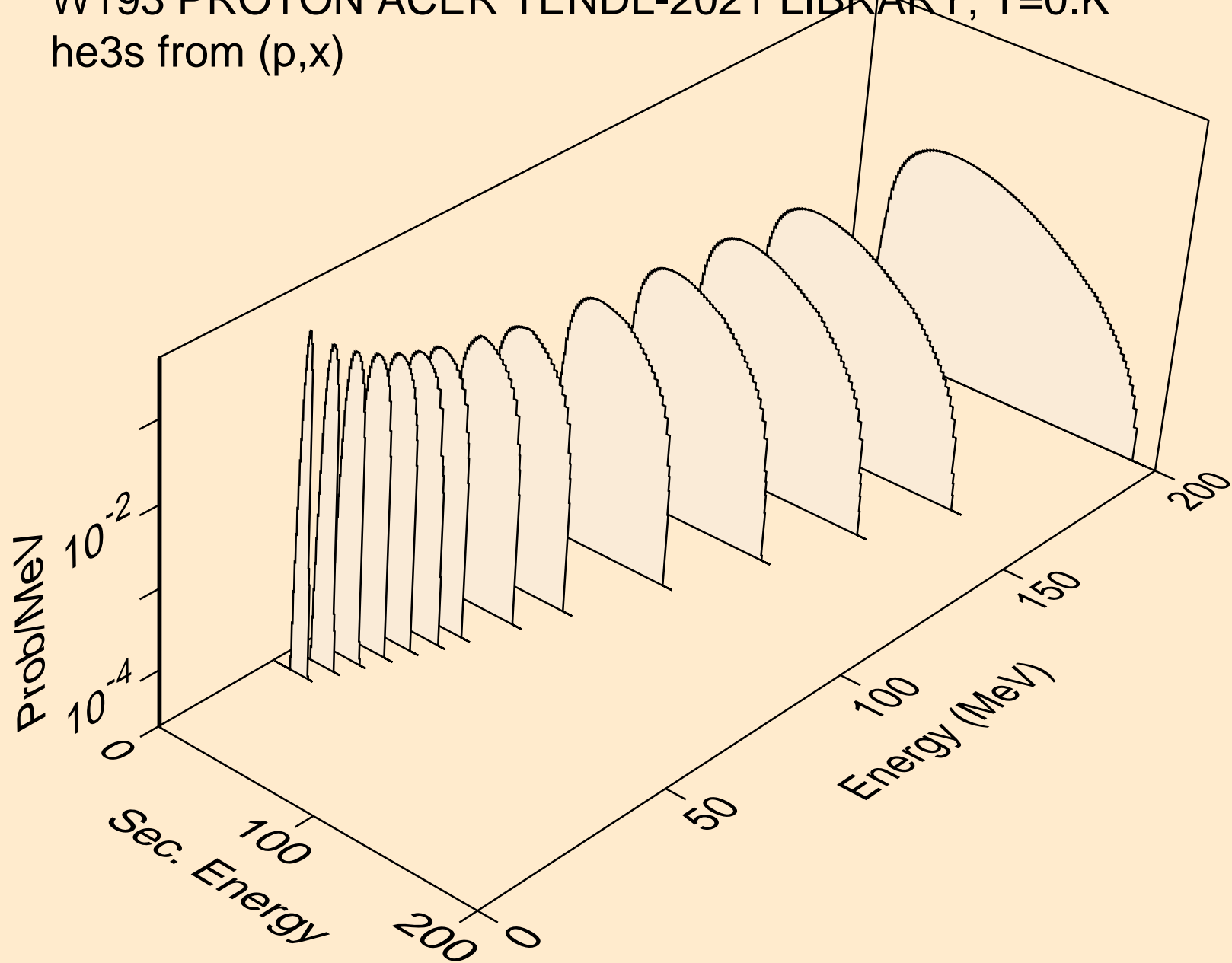

W193 PROTON ACER TENDL-2021 LIBRARY; T=0.K  
he3s from (p,n\*)he3

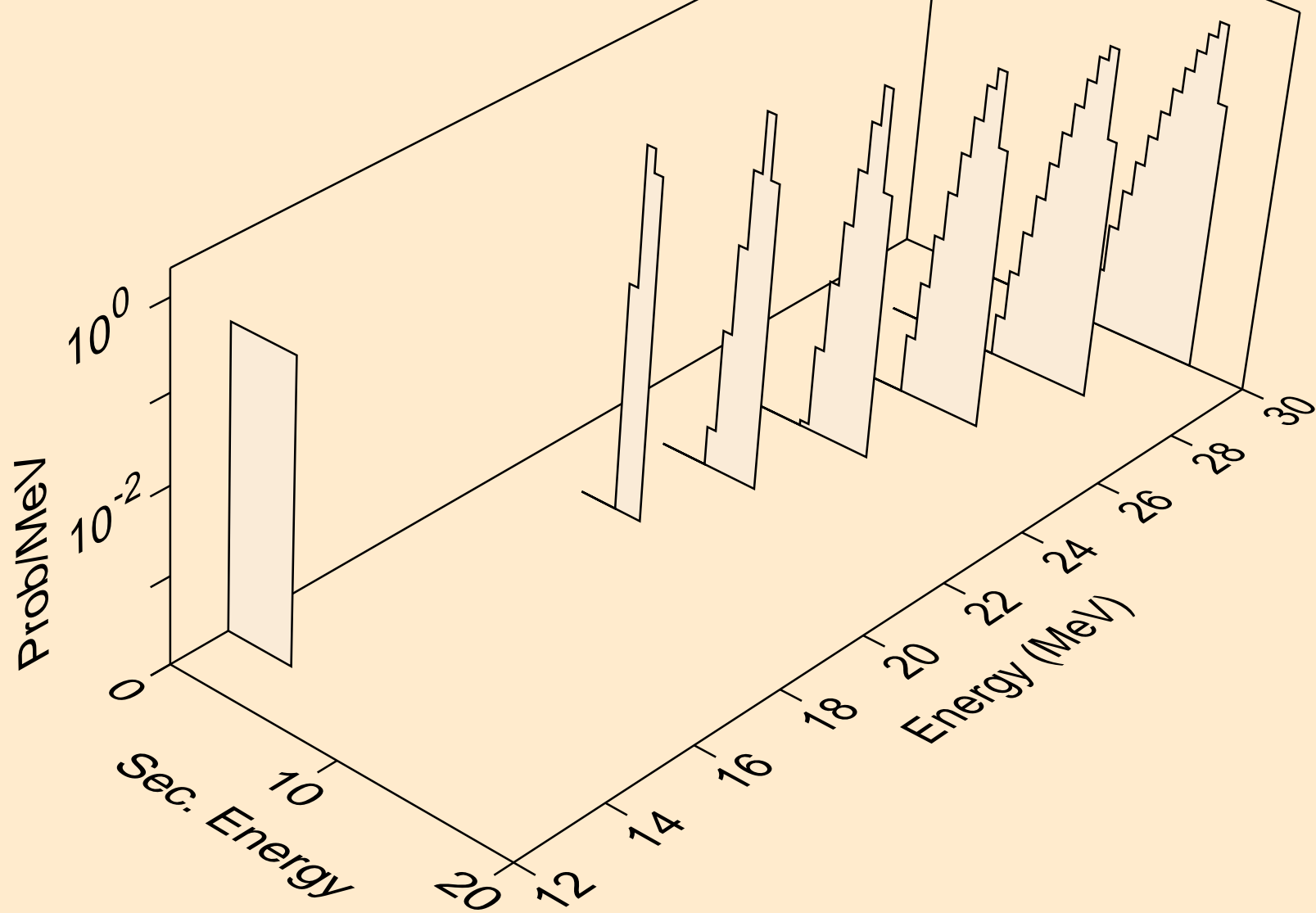

W193 PROTON ACER TENDL-2021 LIBRARY; T=0.K  
he3s from (p,he3)

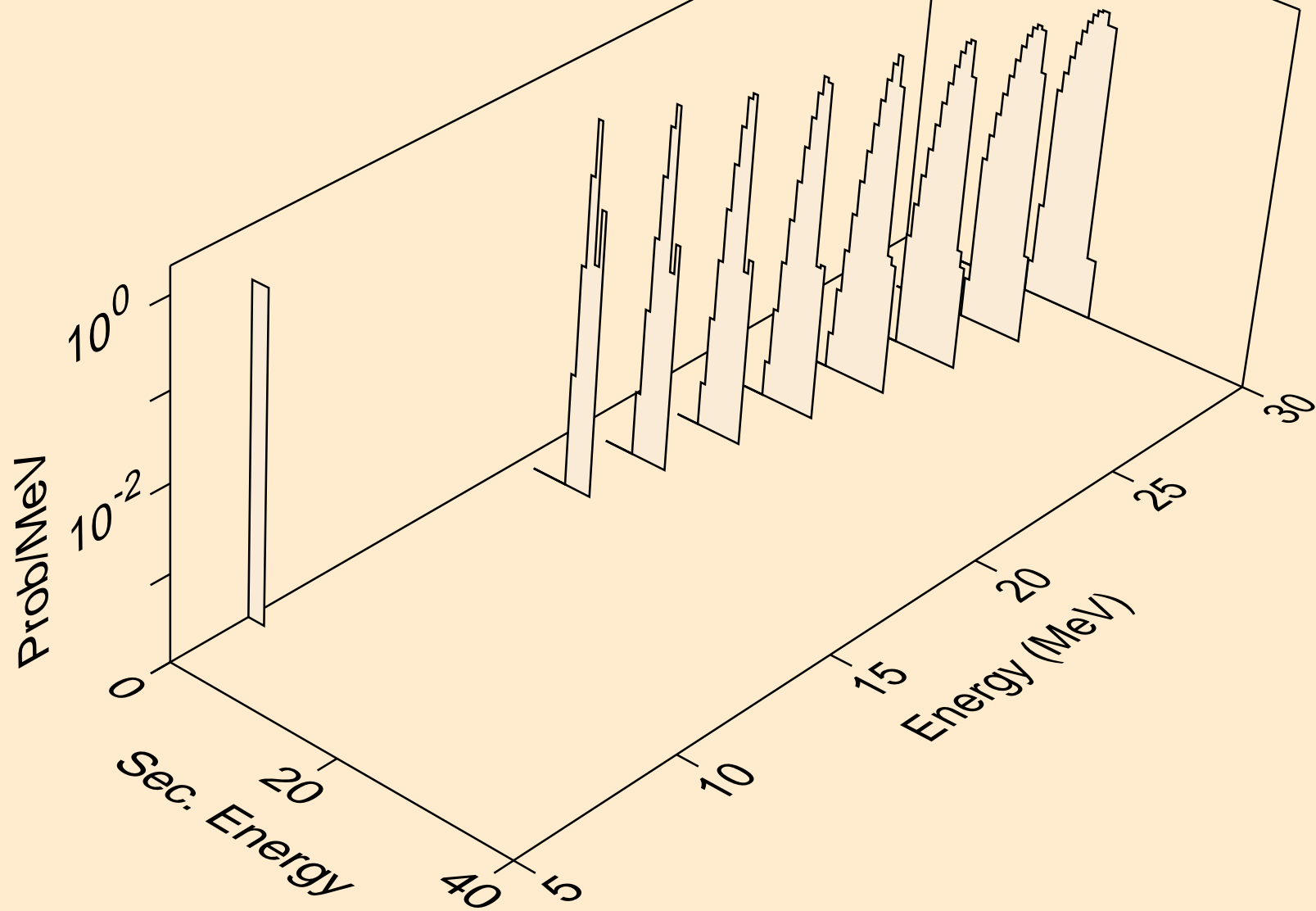

W193 PROTON ACER TENDL-2021 LIBRARY; T=0.K  
alphas from (p,x)

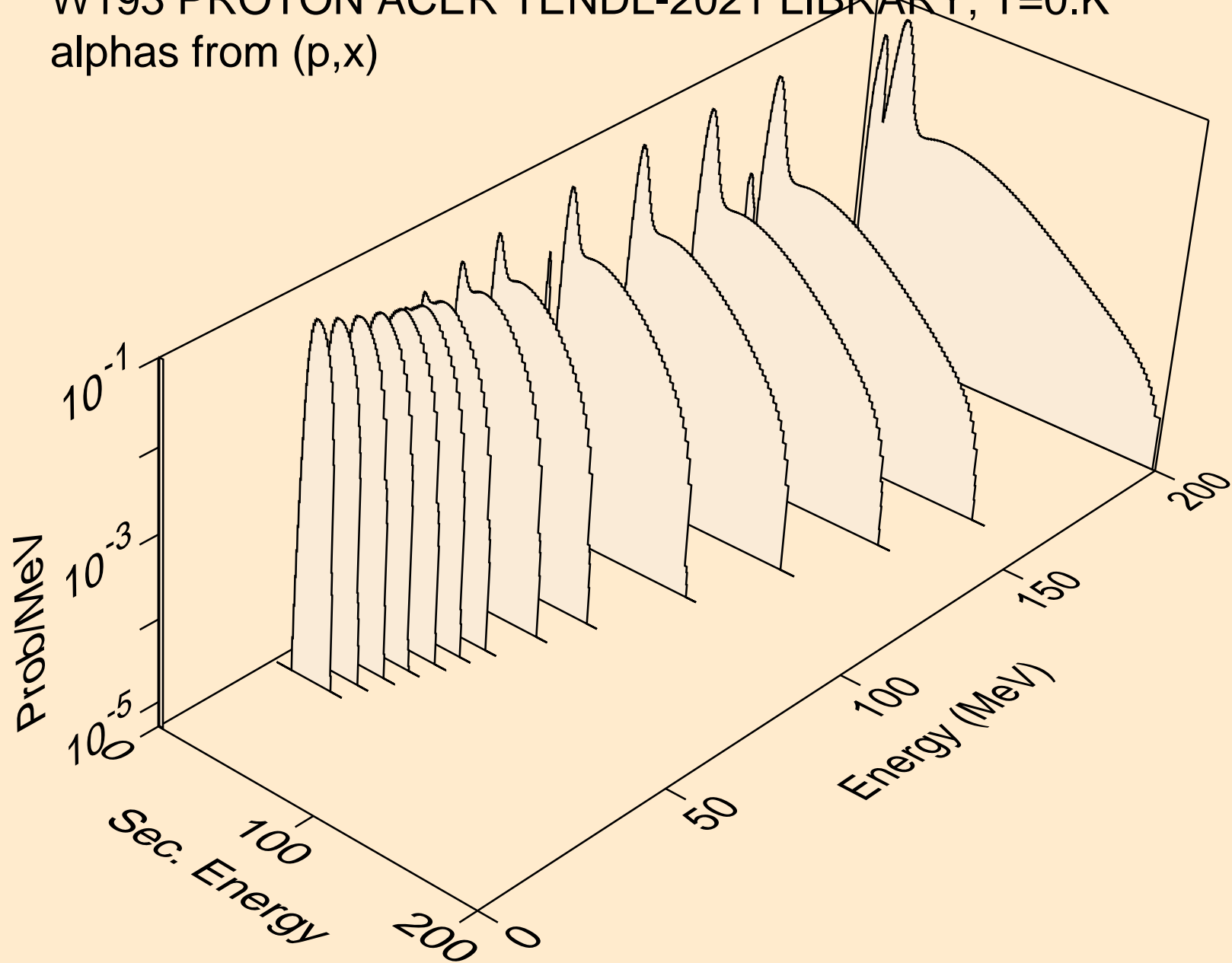

W193 PROTON ACER TENDL-2021 LIBRARY; T=0.K  
alphas from (p,n\*)a

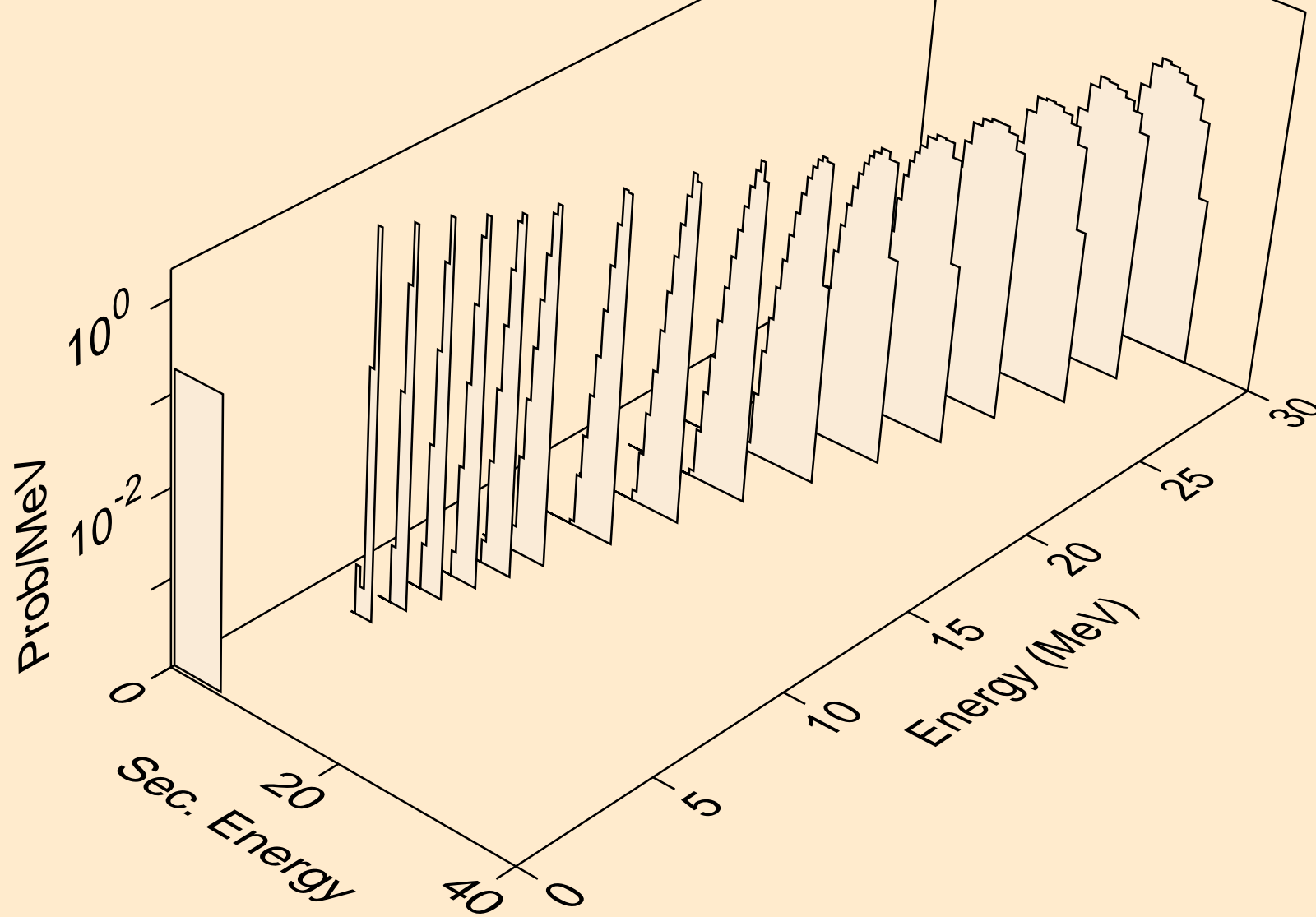

W193 PROTON ACER TENDL-2021 LIBRARY; T=0.K  
alphas from (p,2n)a

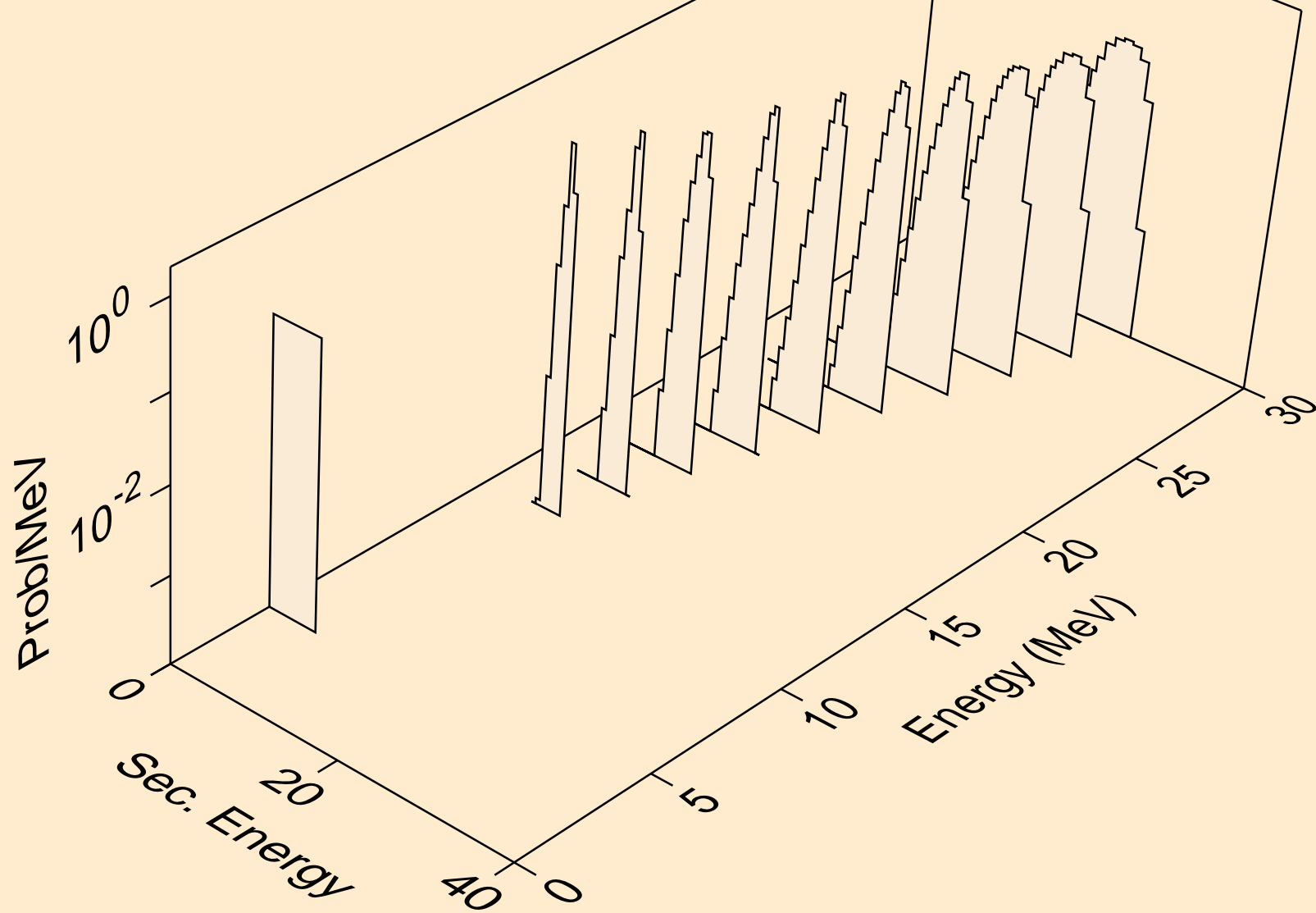



W193 PROTON ACER TENDL-2021 LIBRARY; T=0.K  
alphas from (p,3n)a

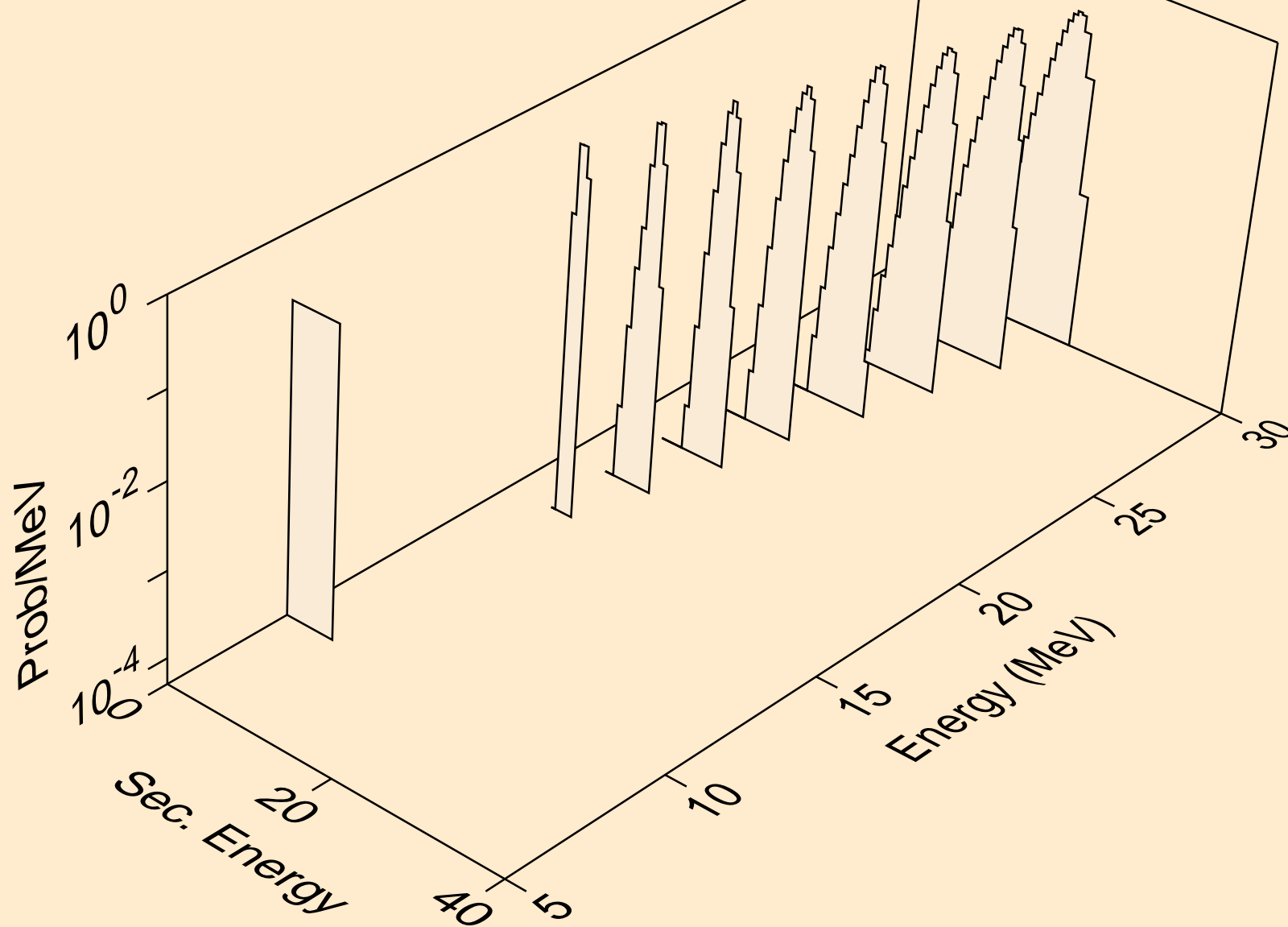

W193 PROTON ACER TENDL-2021 LIBRARY; T=0.K  
alphas from (p,a)

