

# YB153 PROTON ACER TENDL-2021 LIBRARY; T=0.K

## Principal cross sections

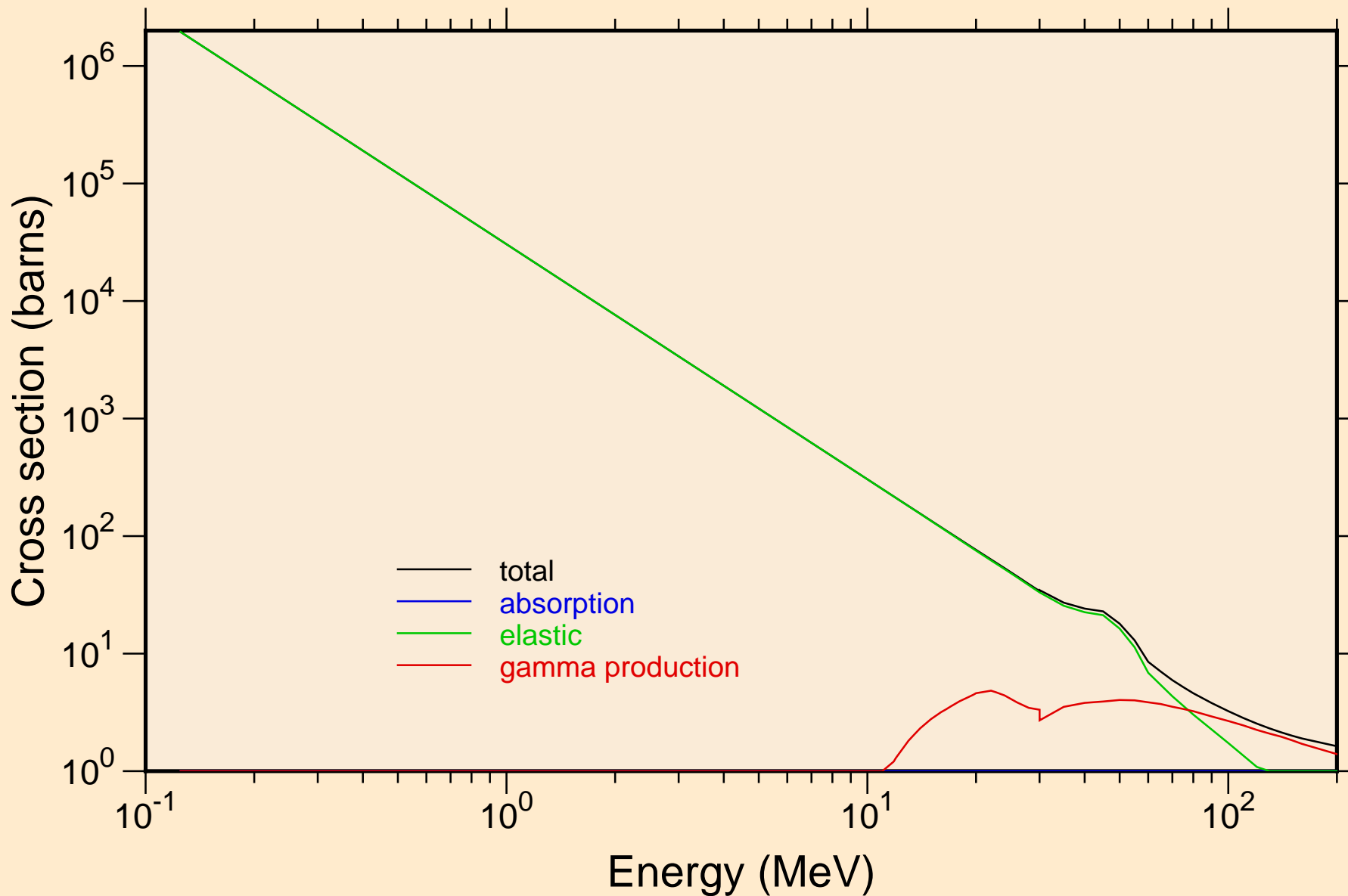

# YB153 PROTON ACER TENDL-2021 LIBRARY; T=0.K

## Heating

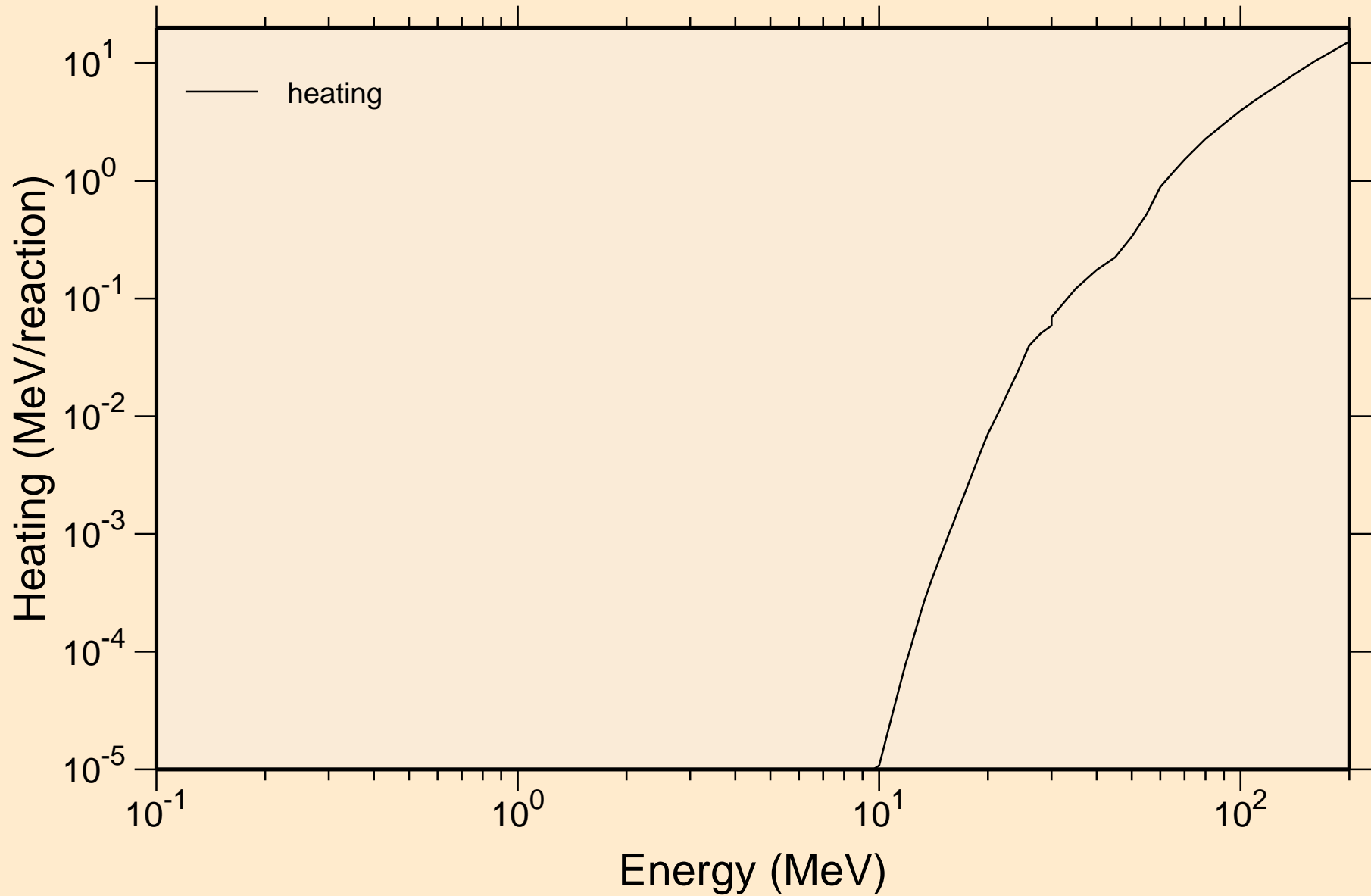

# YB153 PROTON ACER TENDL-2021 LIBRARY; T=0.K

## Principal cross sections

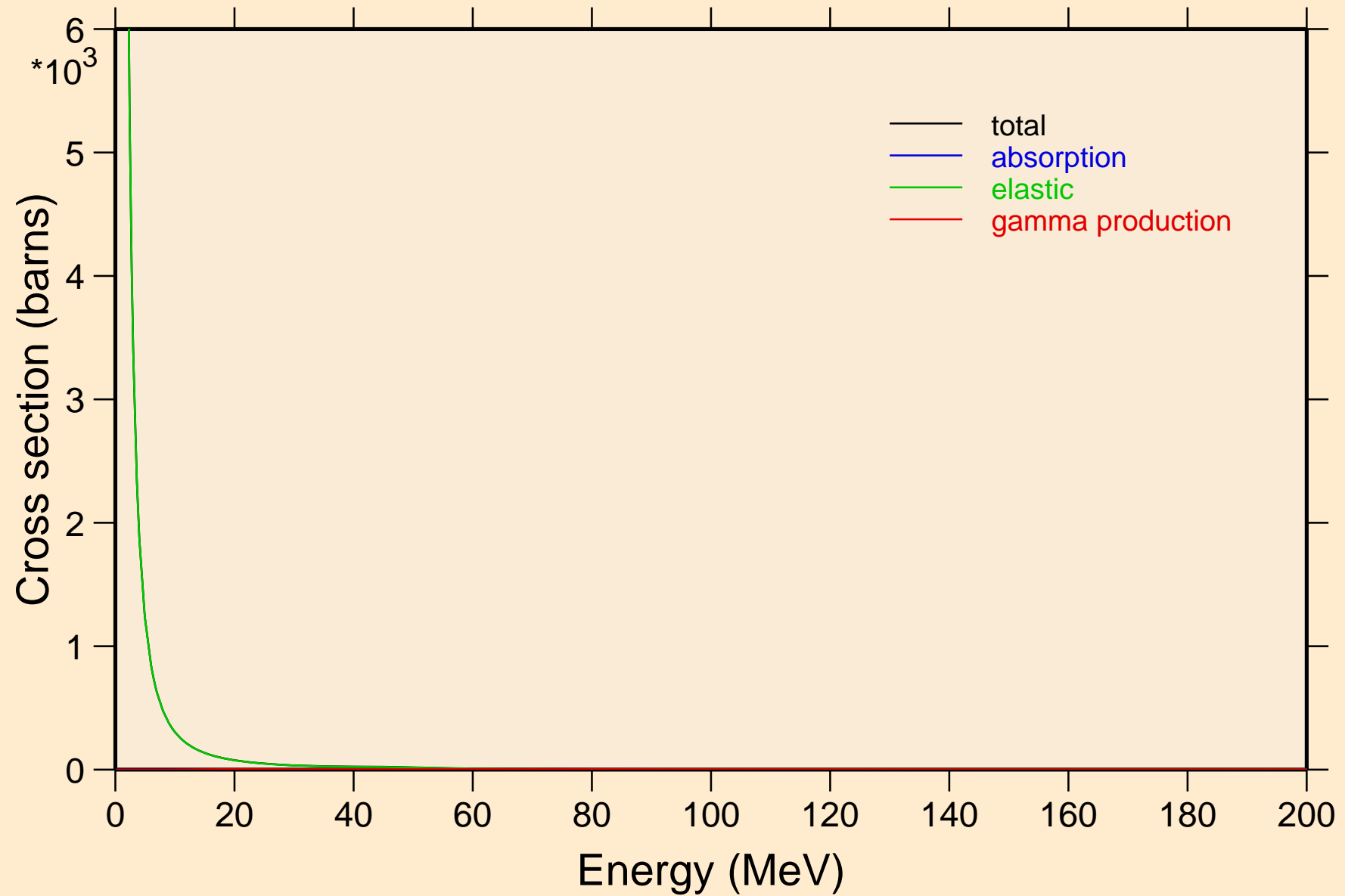

YB153 PROTON ACER TENDL-2021 LIBRARY; T=0.K

Heating

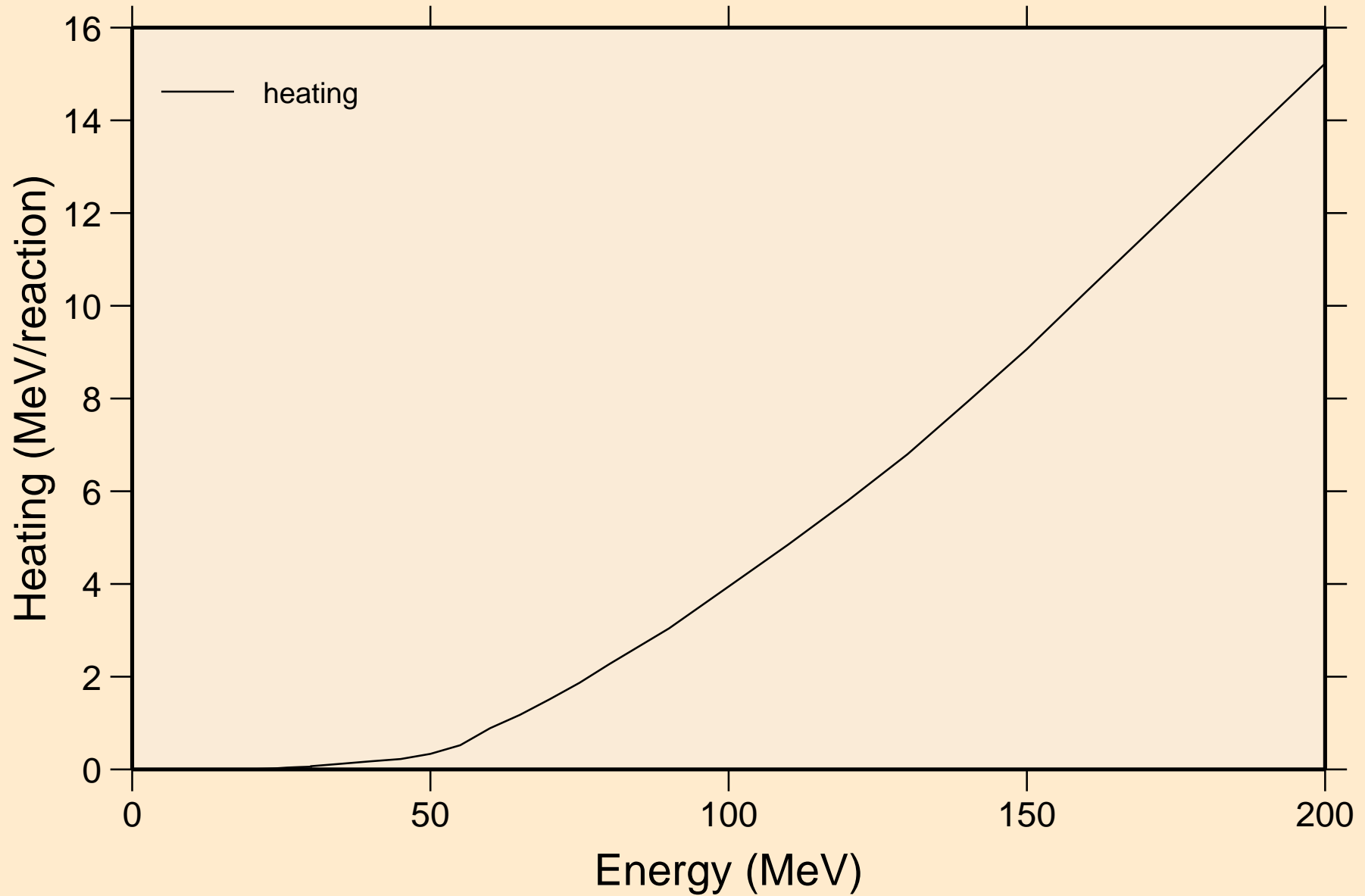

# YB153 PROTON ACER TENDL-2021 LIBRARY; T=0.K

## Threshold reactions

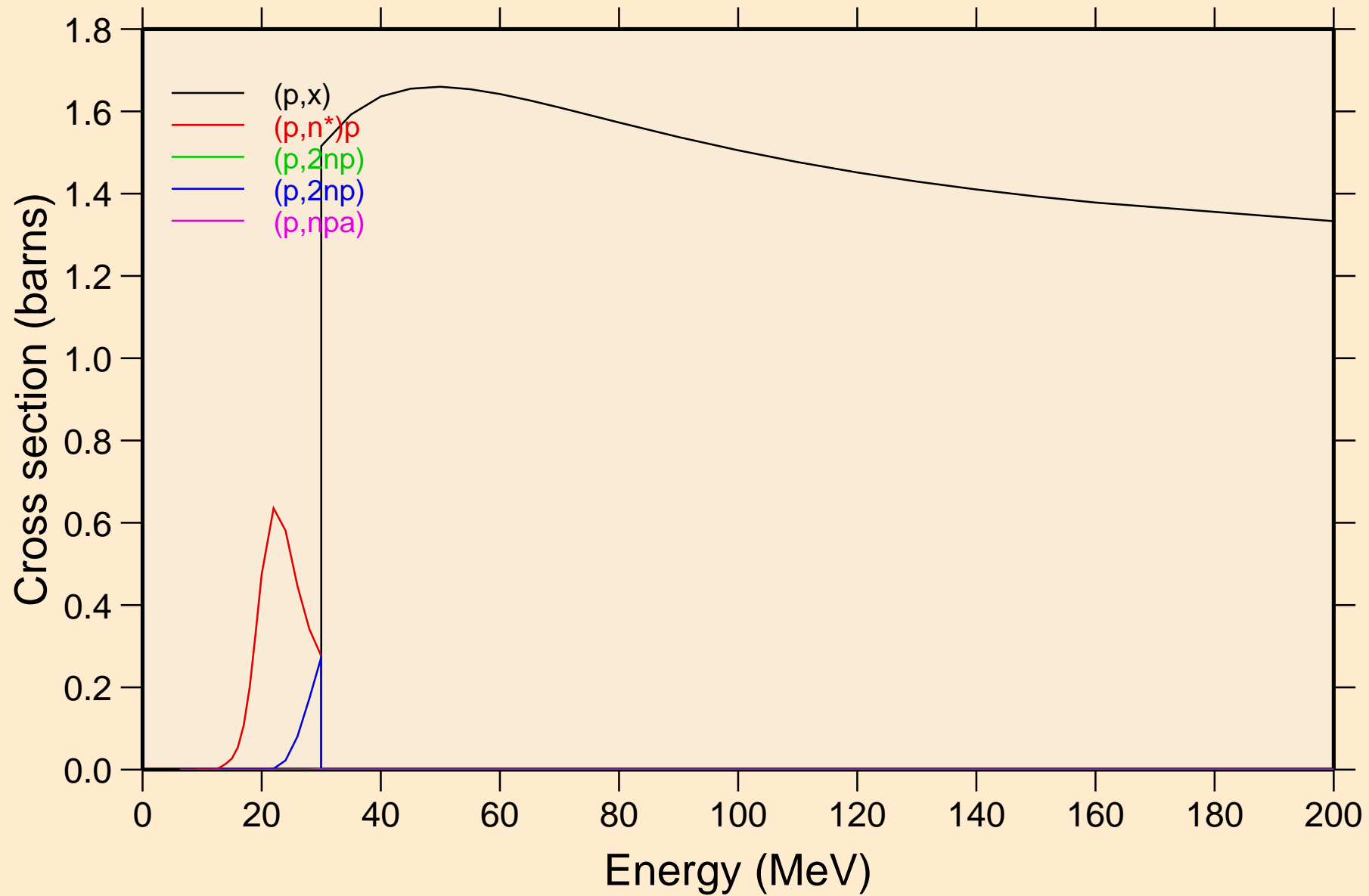

YB153 PROTON ACER TENDL-2021 LIBRARY; T=0.K  
Threshold reactions

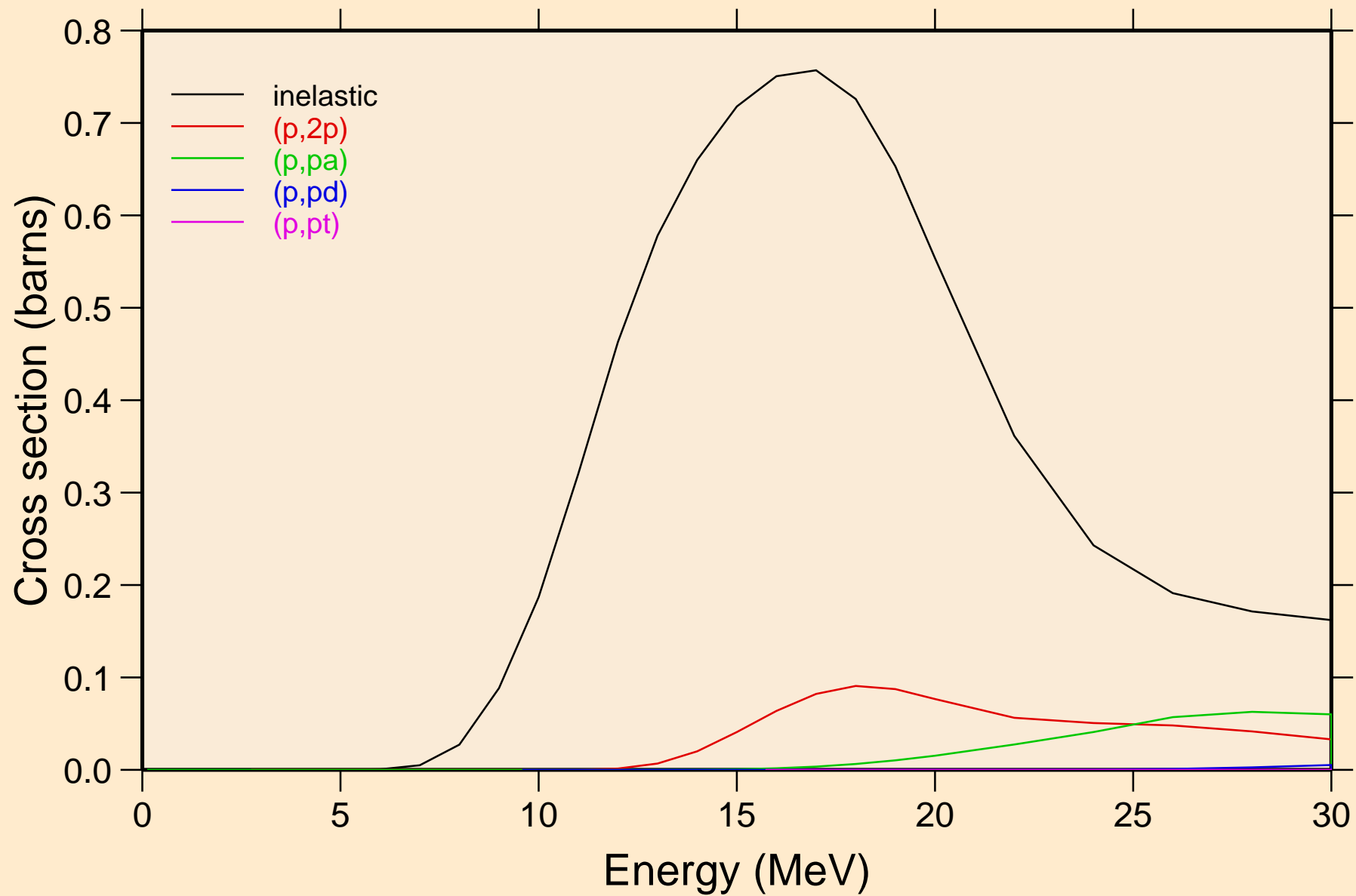

YB153 PROTON ACER TENDL-2021 LIBRARY; T=0.K  
Threshold reactions

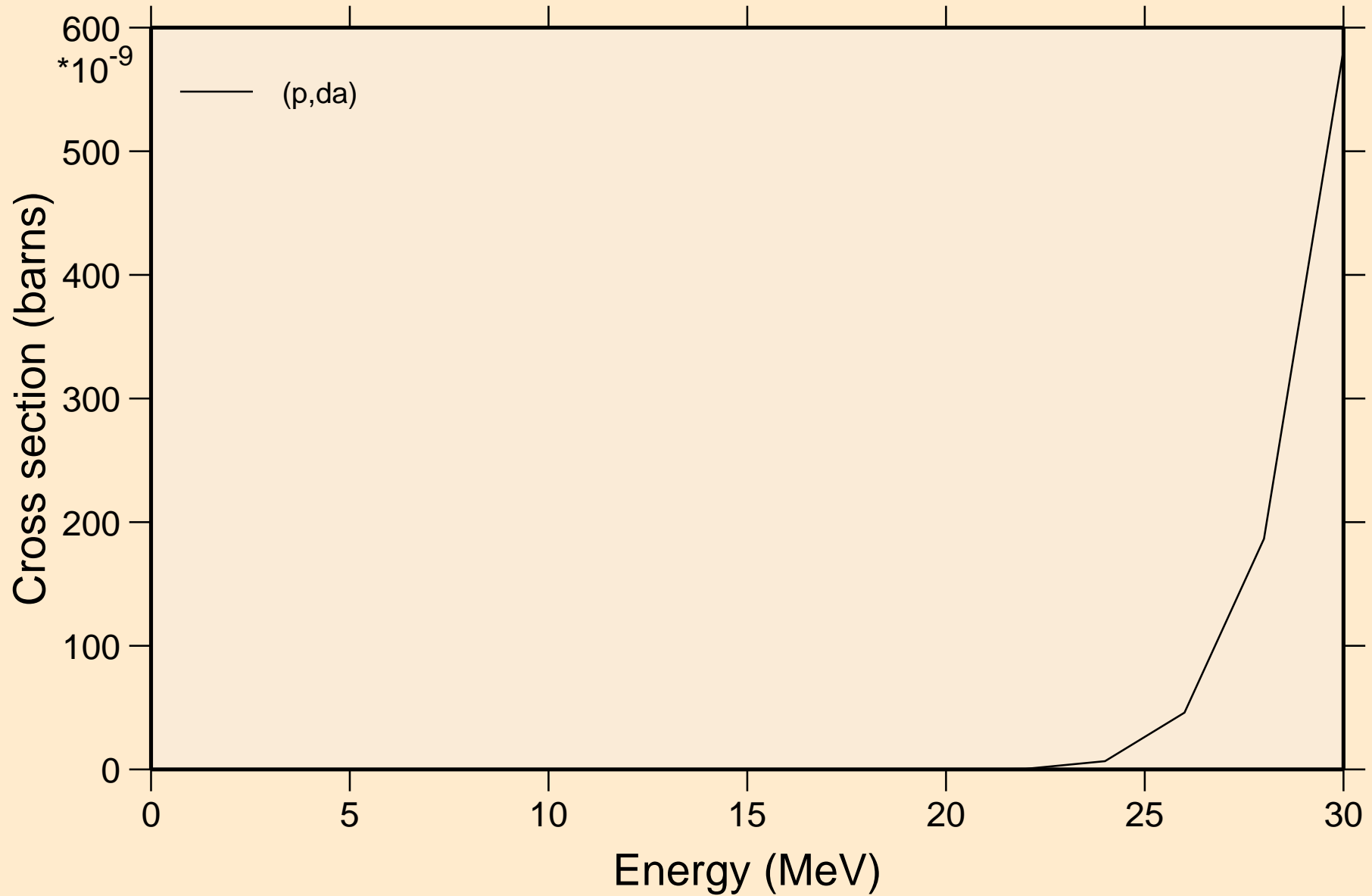

YB153 PROTON ACER TENDL-2021 LIBRARY; T=0.K  
angular distribution for elastic

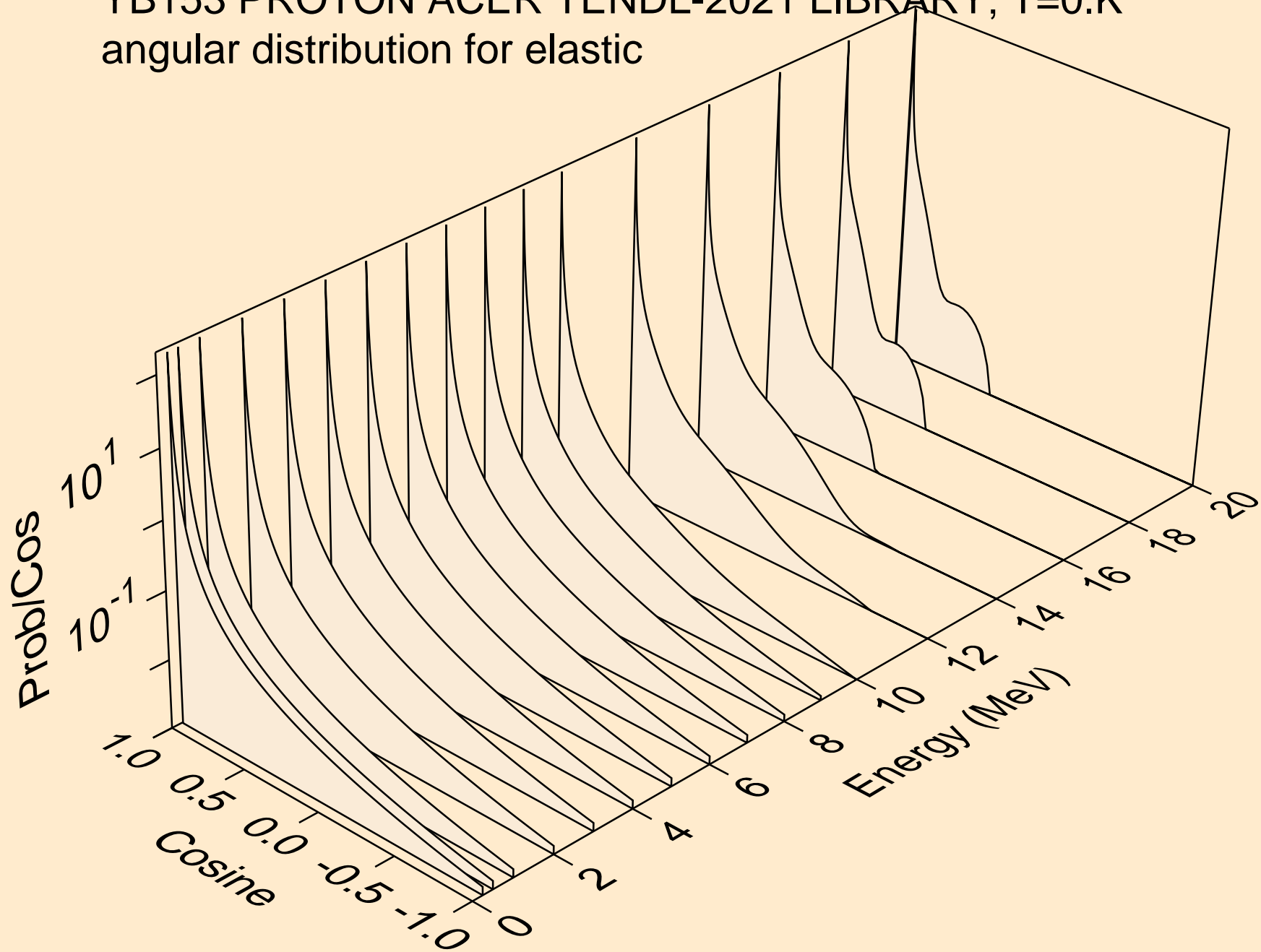



YB153 PROTON ACER TENDL-2021 LIBRARY; T=0.K  
angular distribution for elastic

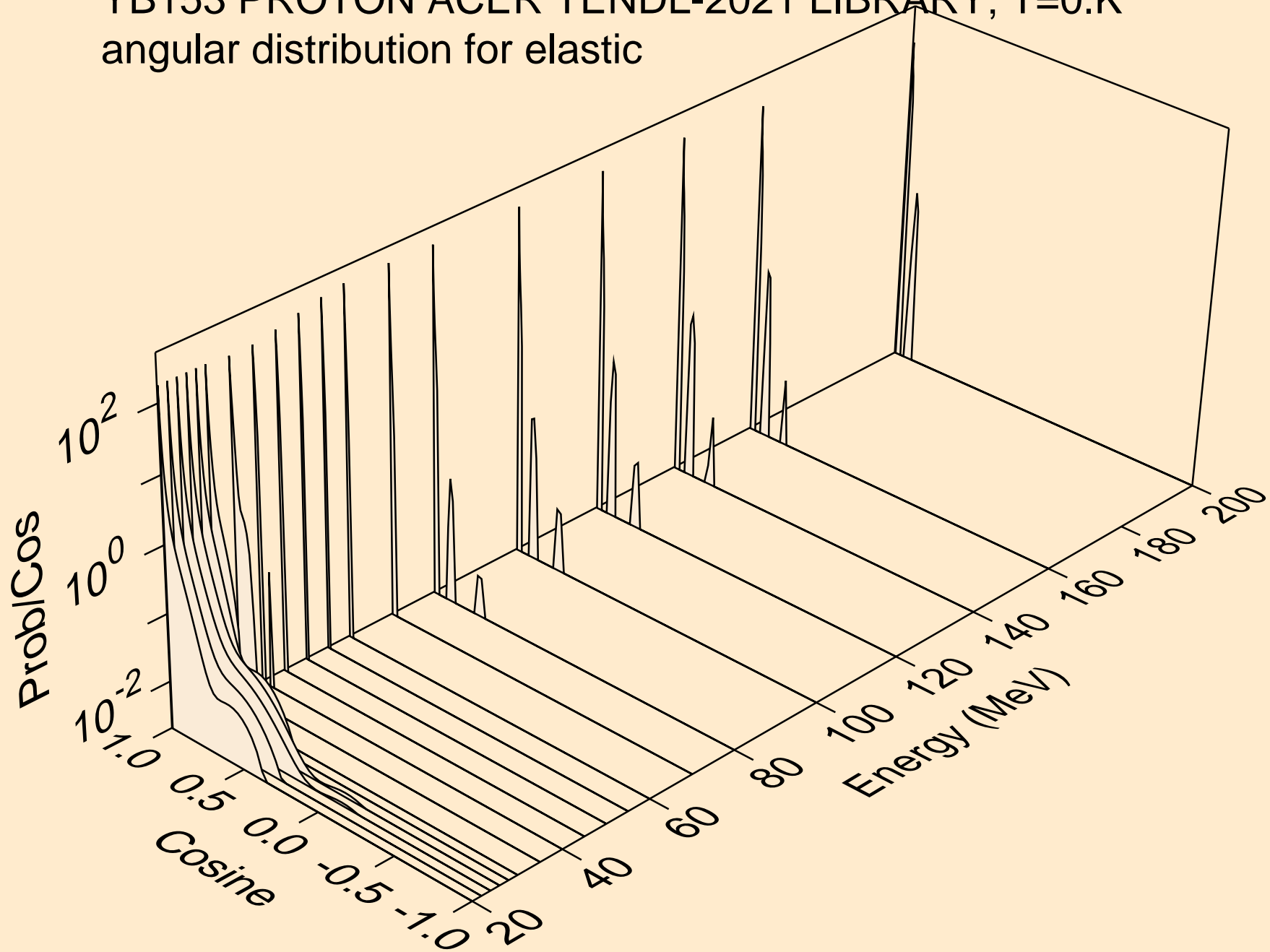

YB153 PROTON ACER TENDL-2021 LIBRARY; T=0.K  
Proton emission for (p,x)

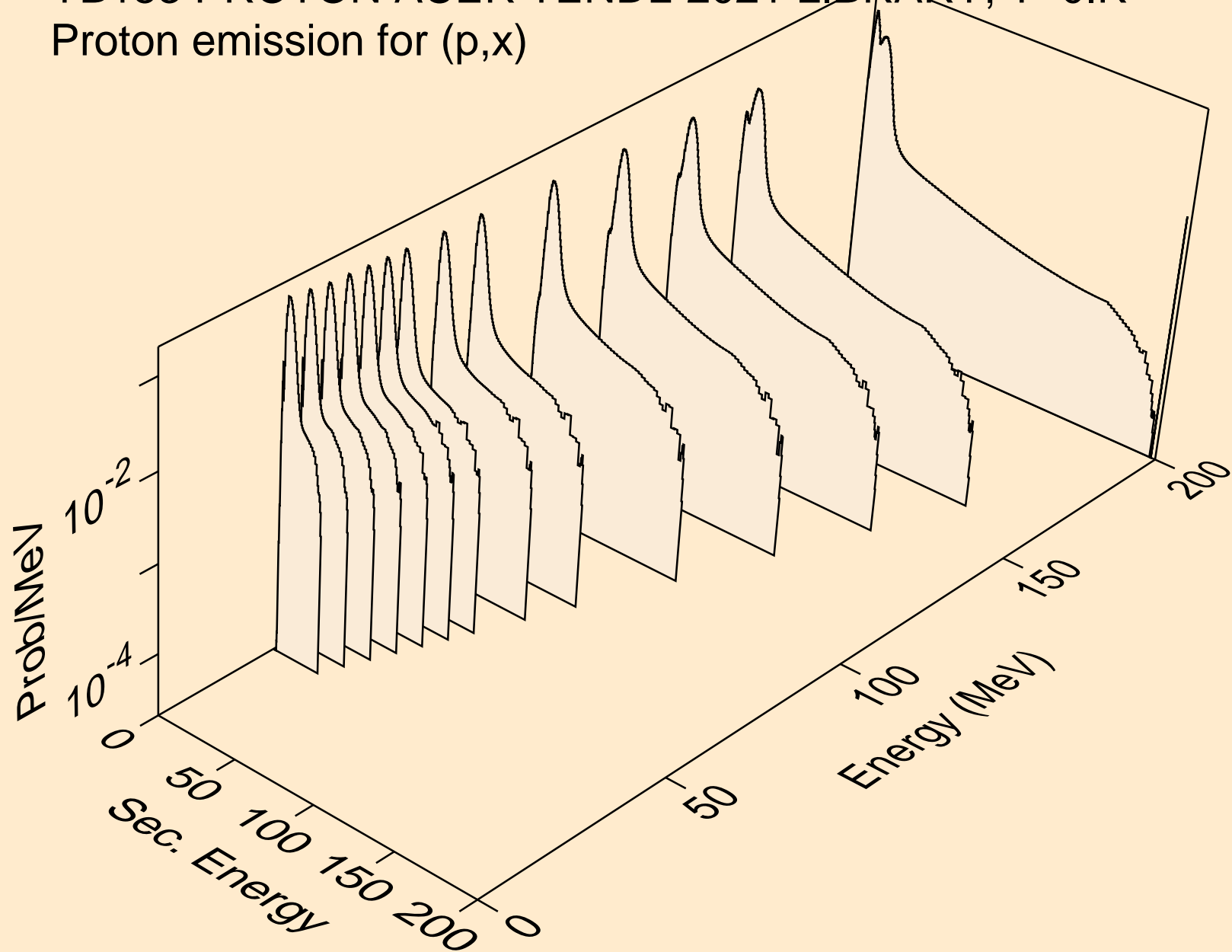

YB153 PROTON ACER TENDL-2021 LIBRARY; T=0.K  
Proton emission for (p,n\*)p

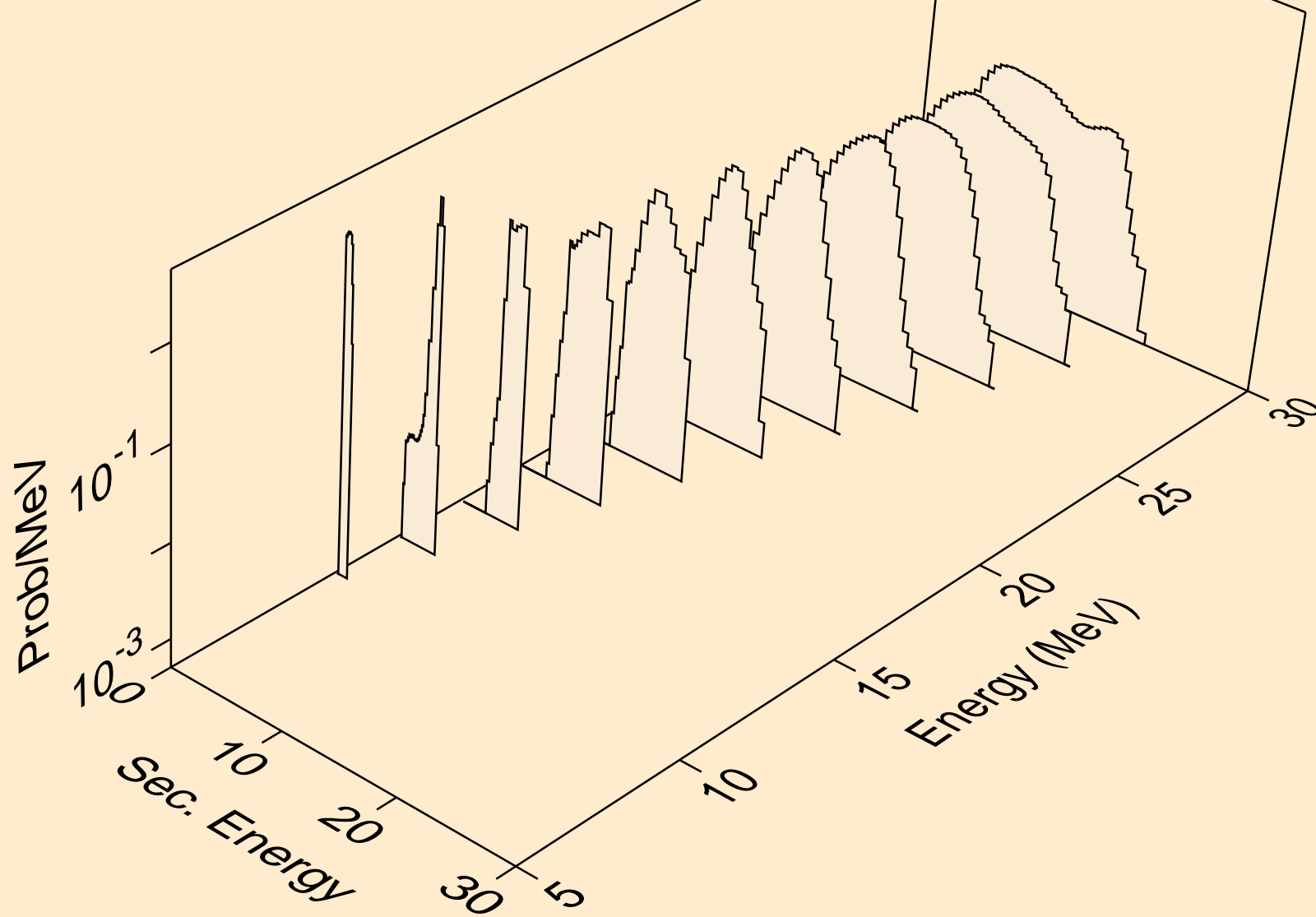

YB153 PROTON ACER TENDL-2021 LIBRARY; T=0.K  
Proton emission for (p,2np)

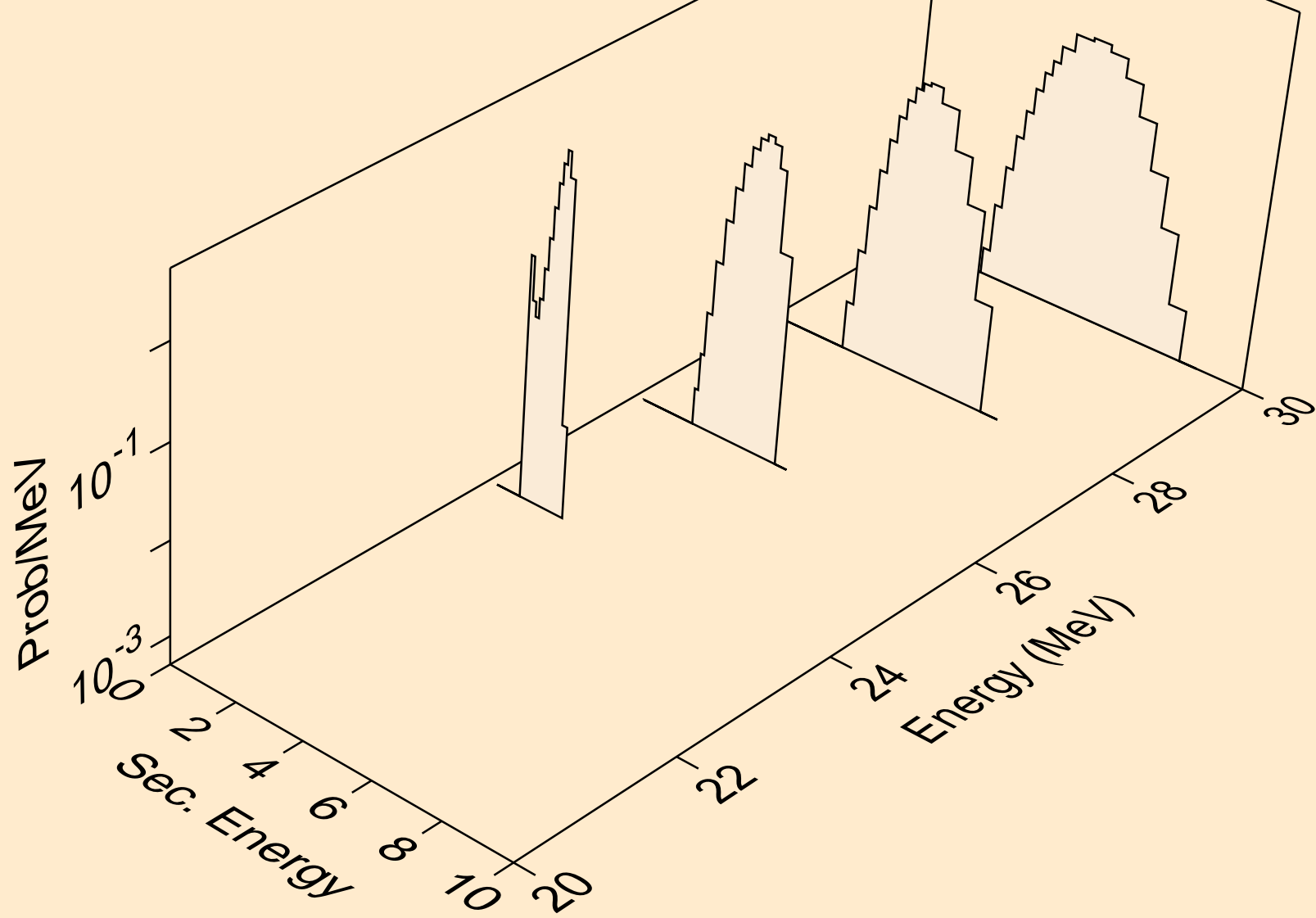

YB153 PROTON ACER TENDL-2021 LIBRARY; T=0.K  
Proton emission for (p,2np)

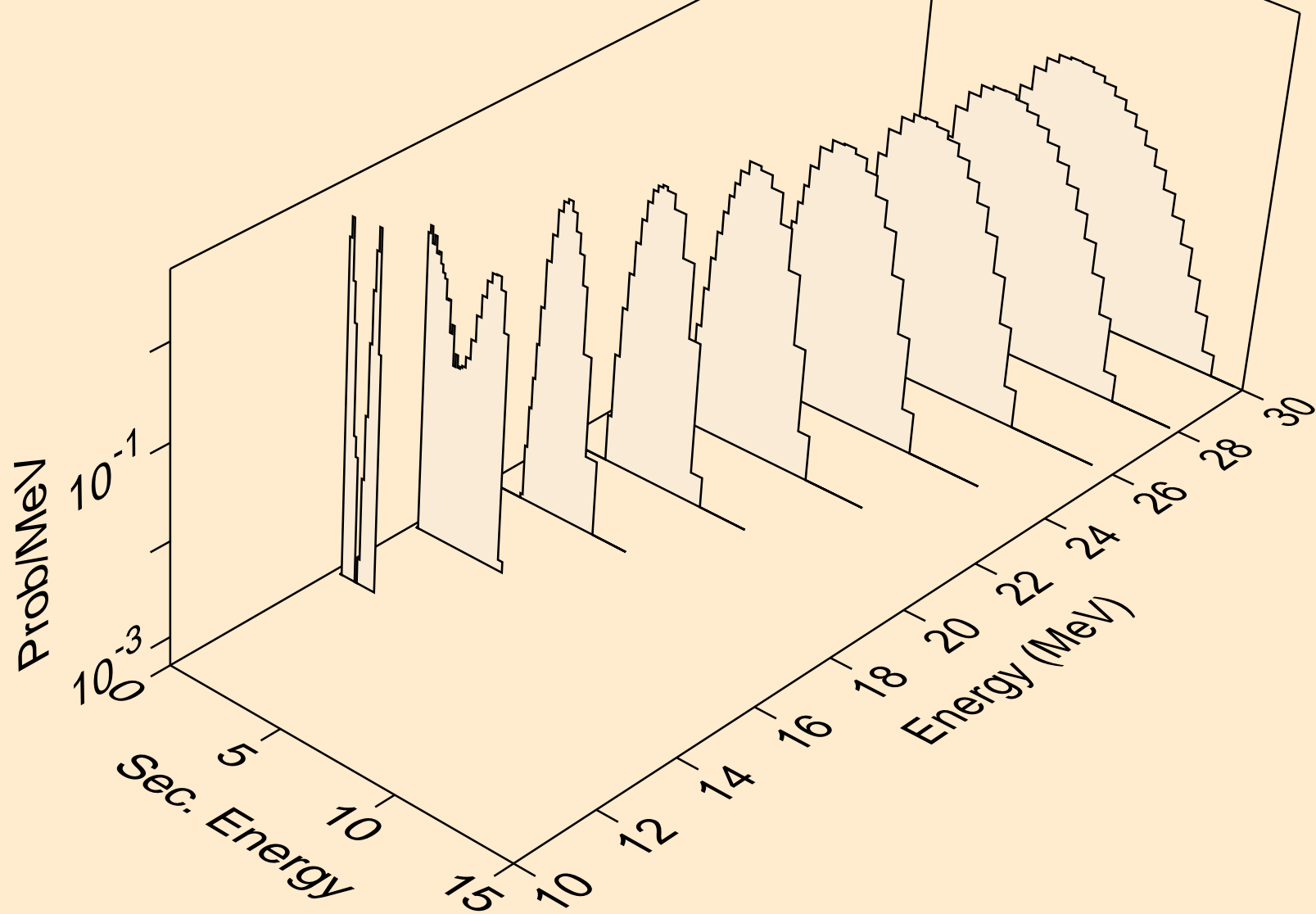

YB153 PROTON ACER TENDL-2021 LIBRARY; T=0.K  
Proton emission for (p,npa)

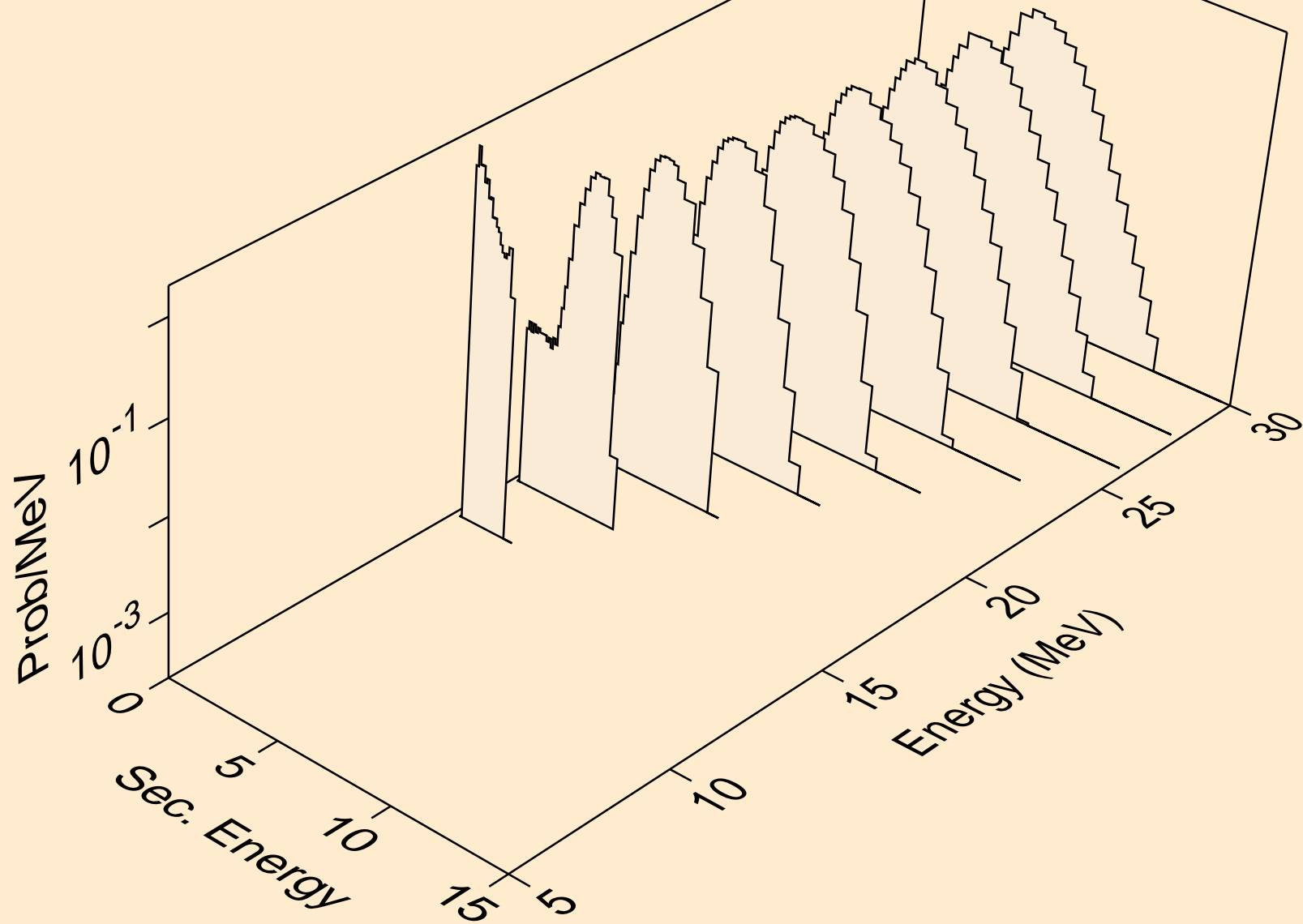

YB153 PROTON ACER TENDL-2021 LIBRARY; T=0.K  
Proton emission for inelastic

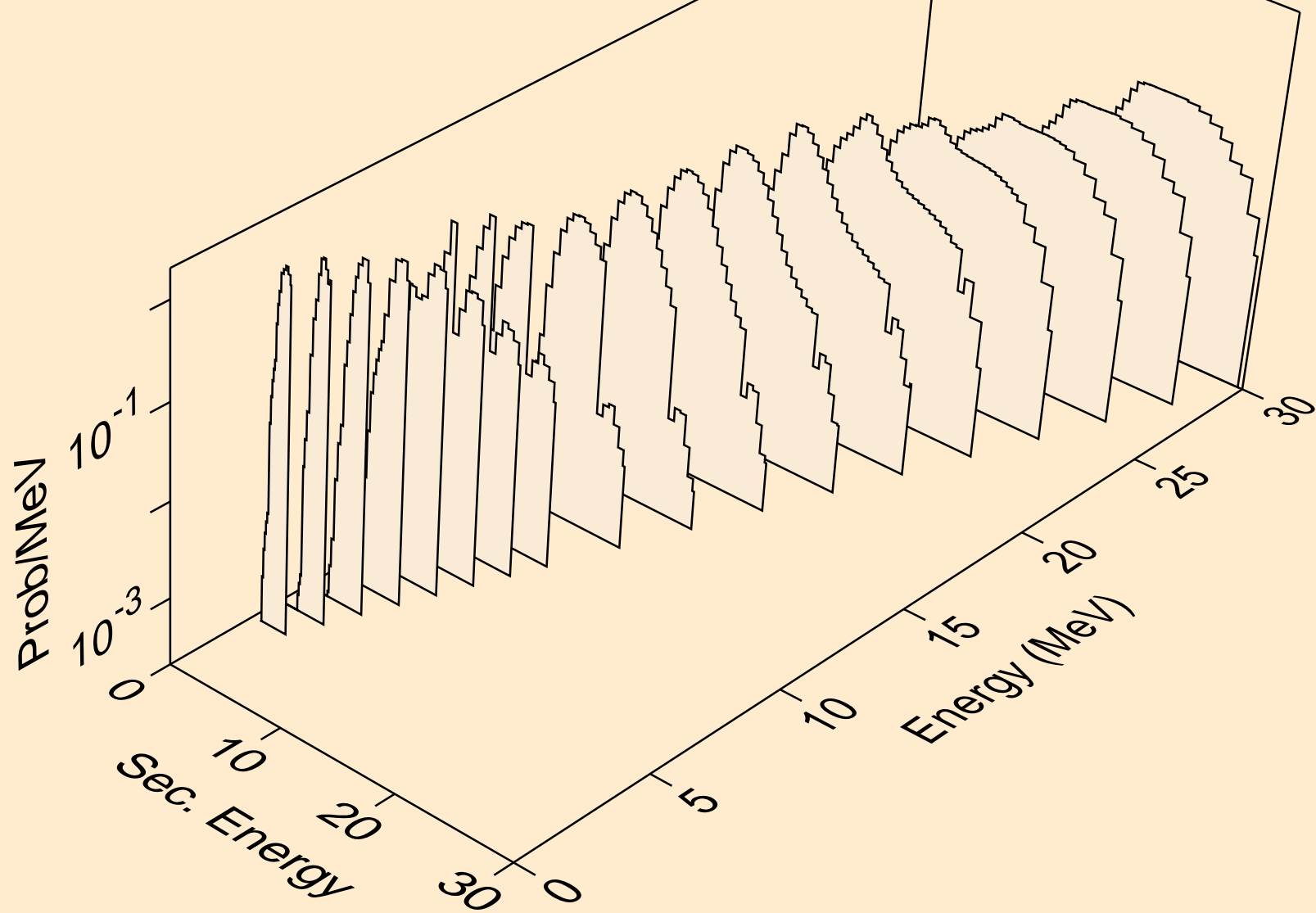

YB153 PROTON ACER TENDL-2021 LIBRARY; T=0.K  
Proton emission for (p,2p)

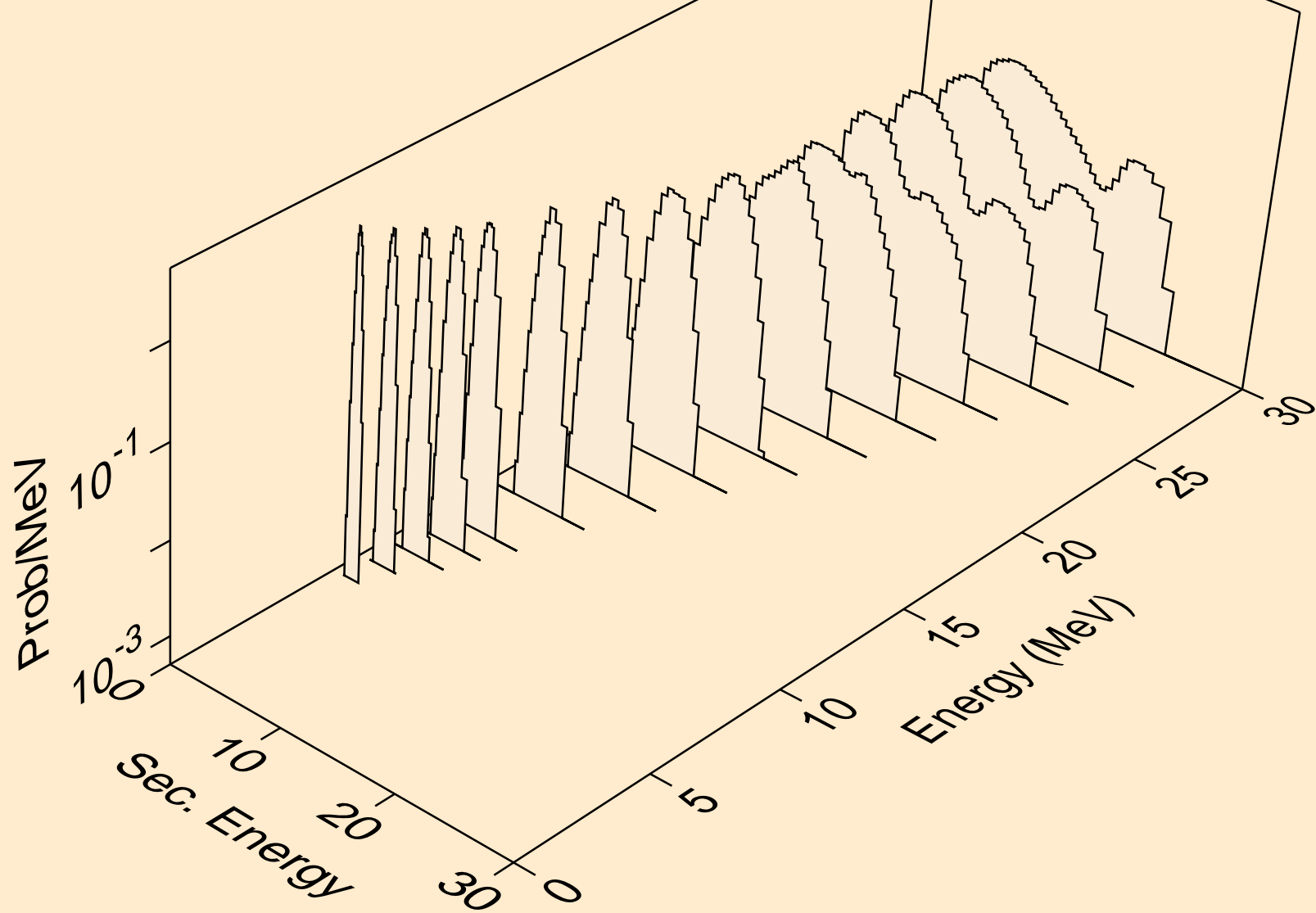



YB153 PROTON ACER TENDL-2021 LIBRARY; T=0.K  
Proton emission for (p,pa)

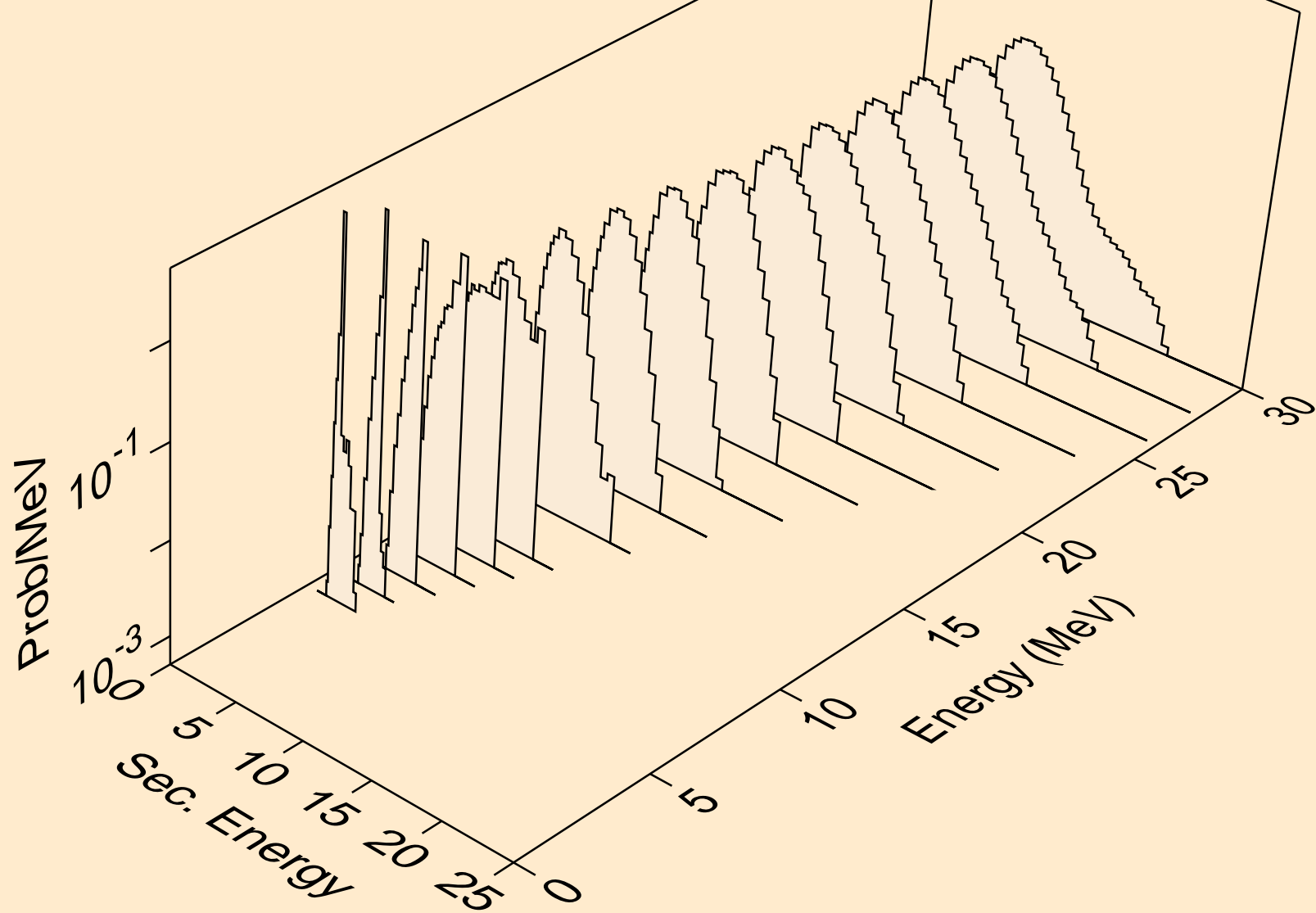

YB153 PROTON ACER TENDL-2021 LIBRARY; T=0.K  
Proton emission for (p,pd)

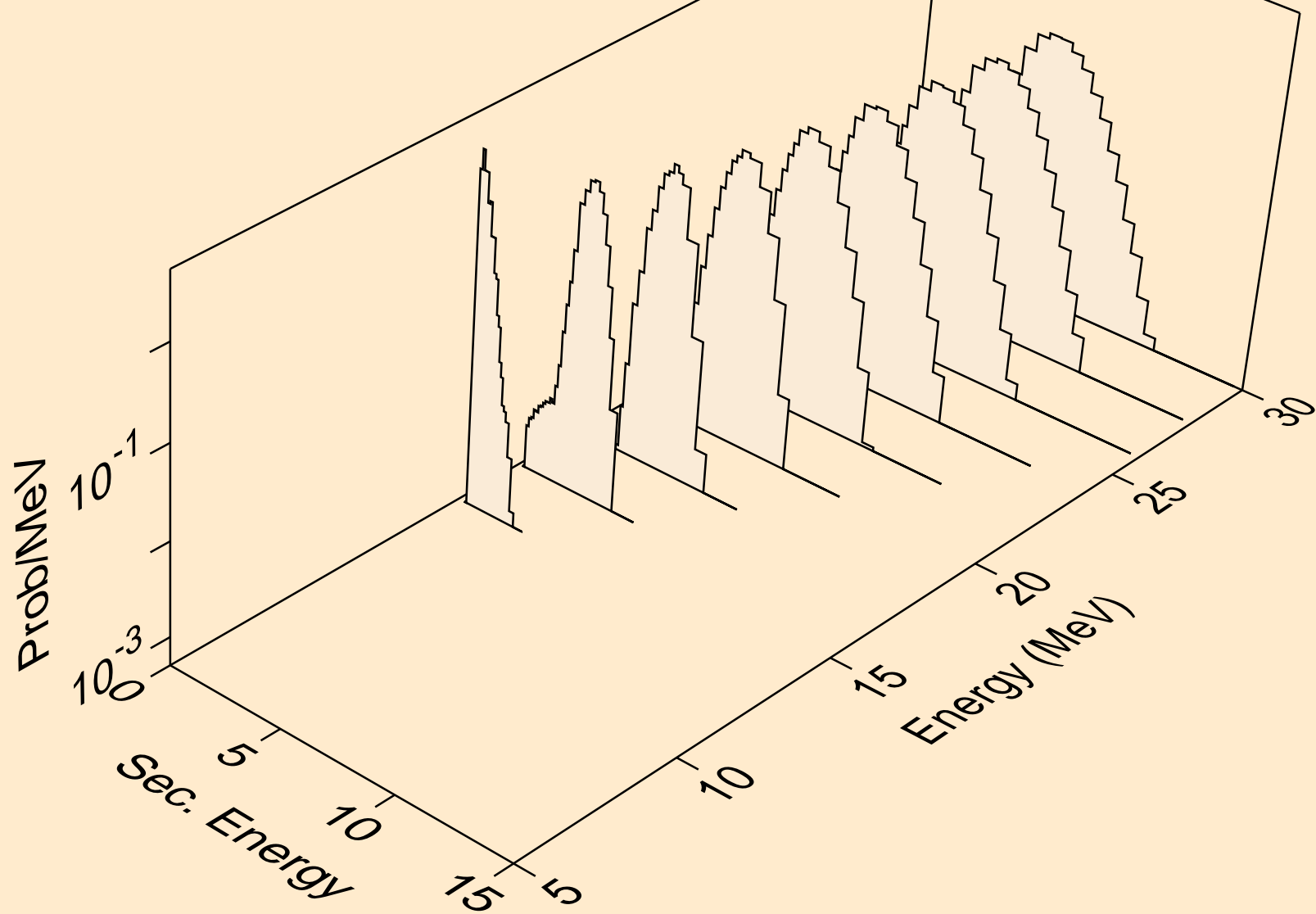

YB153 PROTON ACER TENDL-2021 LIBRARY; T=0.K  
Proton emission for (p,pt)

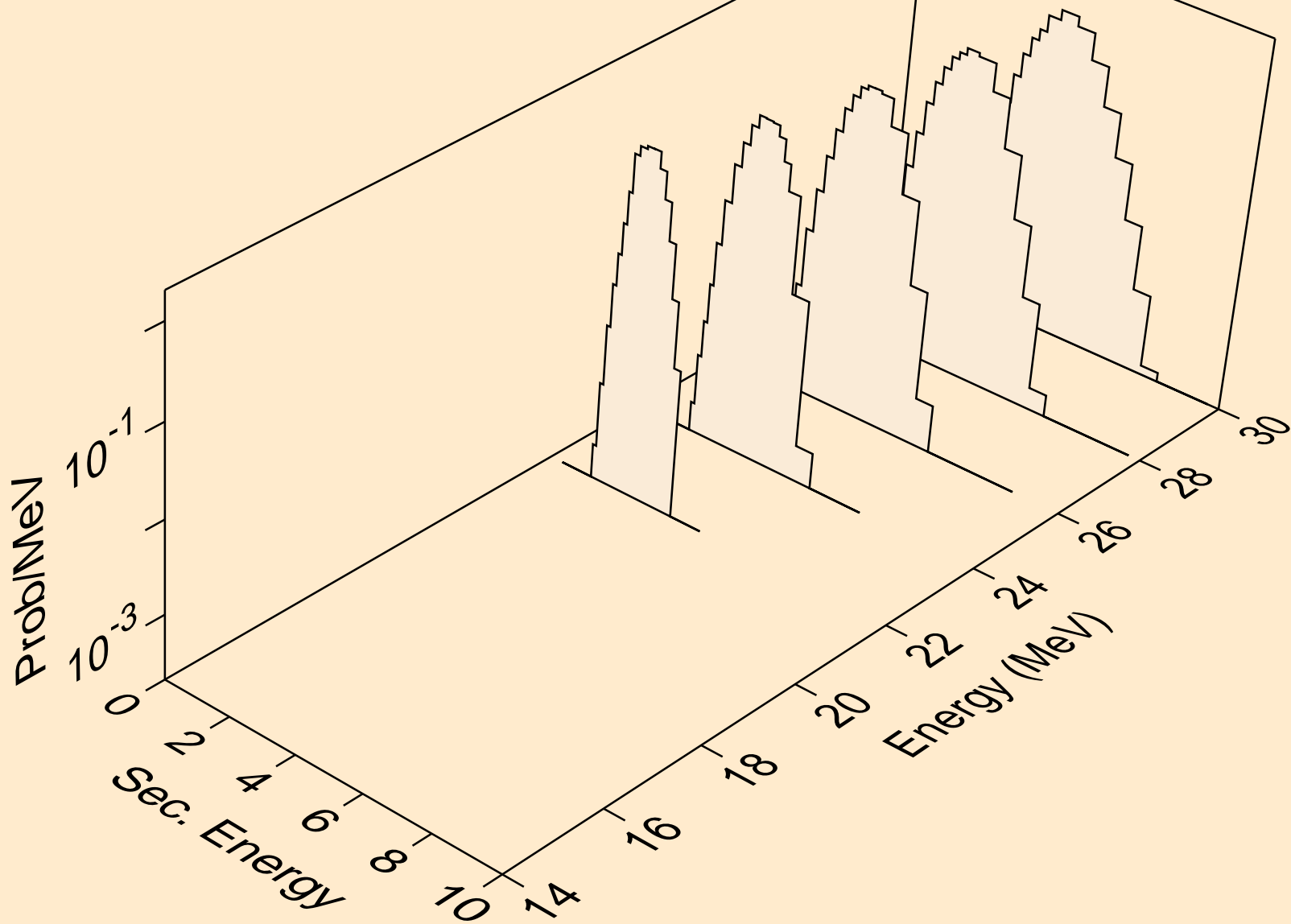

YB153 PROTON ACER TENDL-2021 LIBRARY; T=0.K  
Photon emission for (z,n)

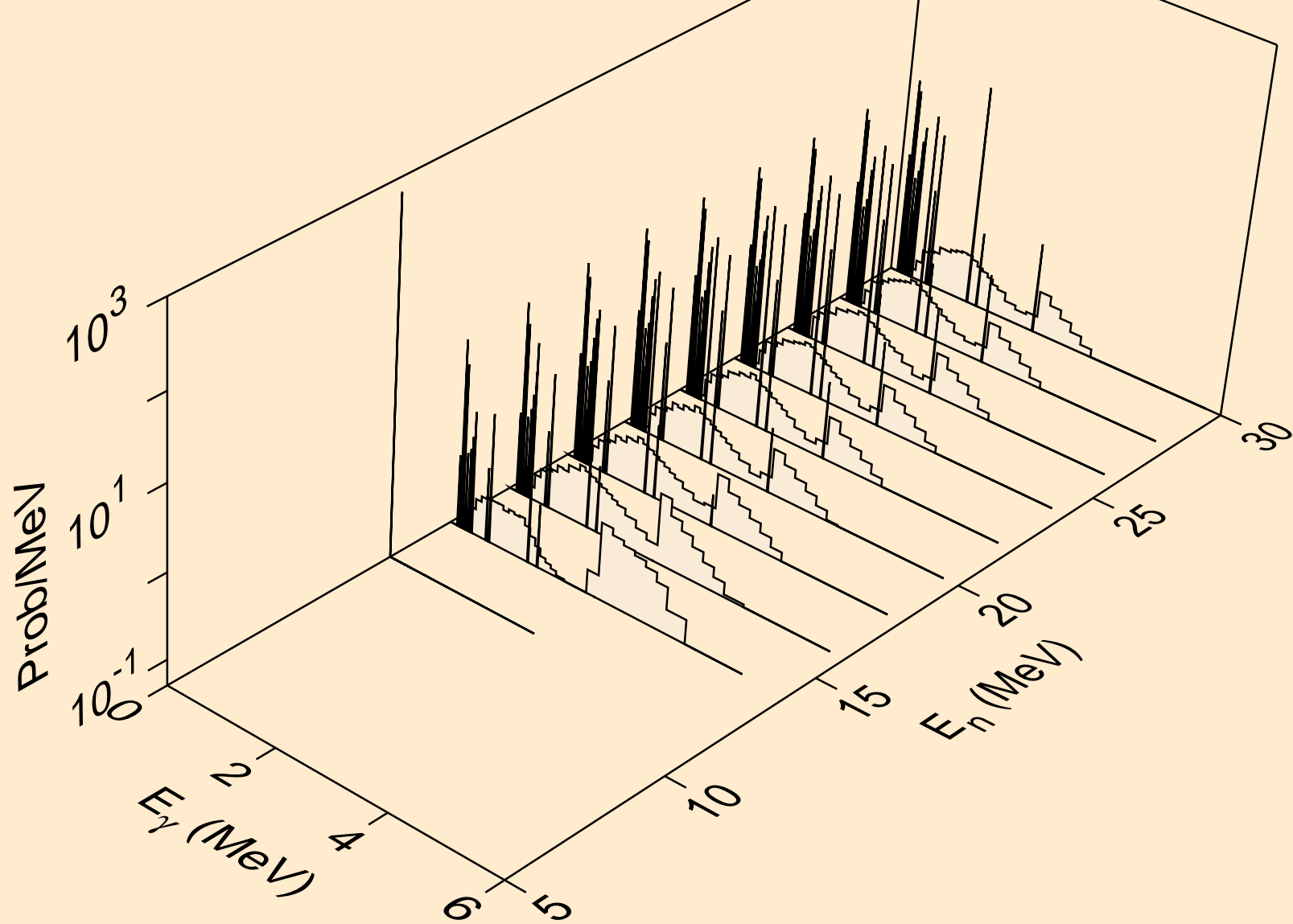

YB153 PROTON ACER TENDL-2021 LIBRARY; T=0.K  
Photon emission for (n,x)

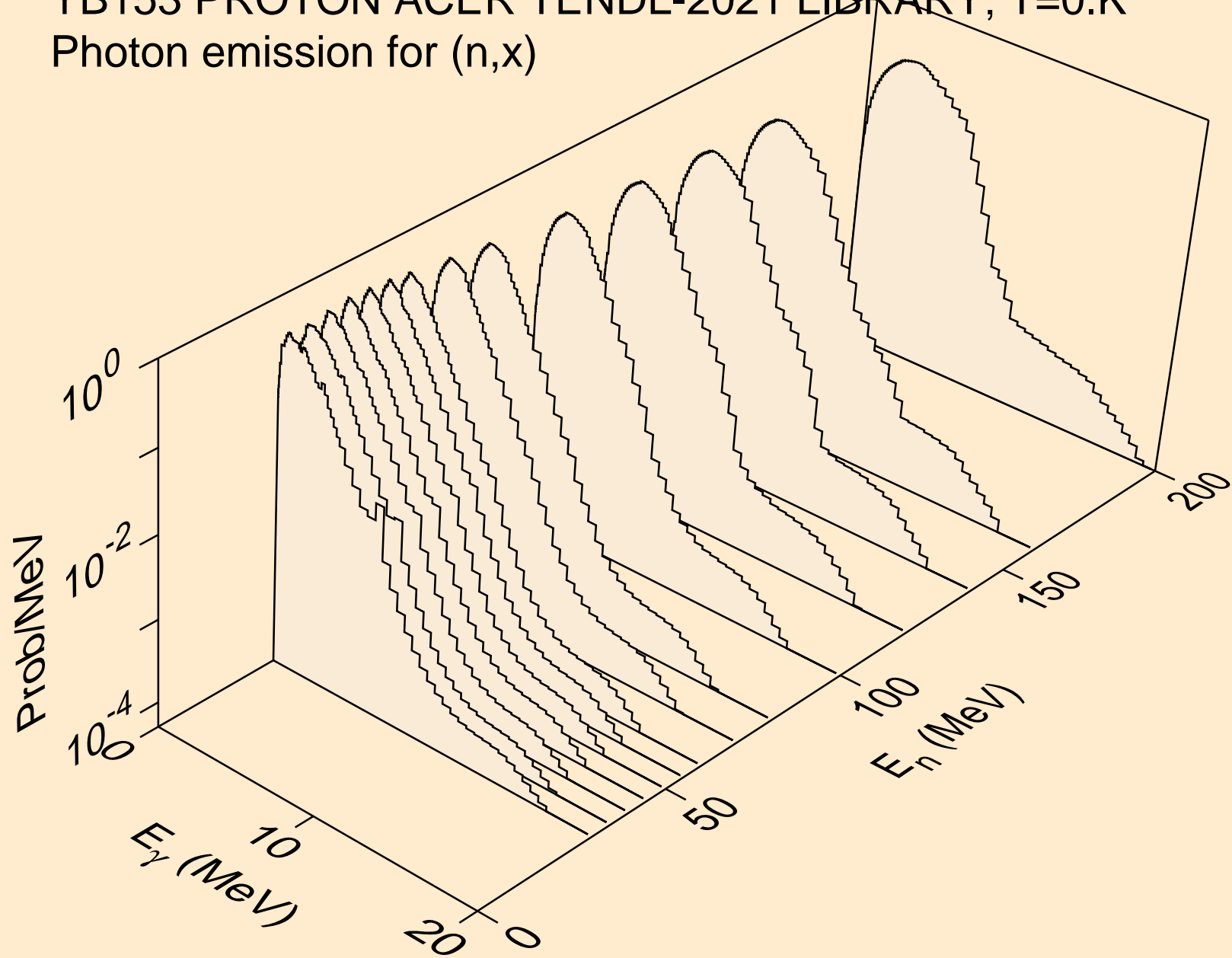

YB153 PROTON ACER TENDL-2021 LIBRARY; T=0.K  
Photon emission for (n,2n)

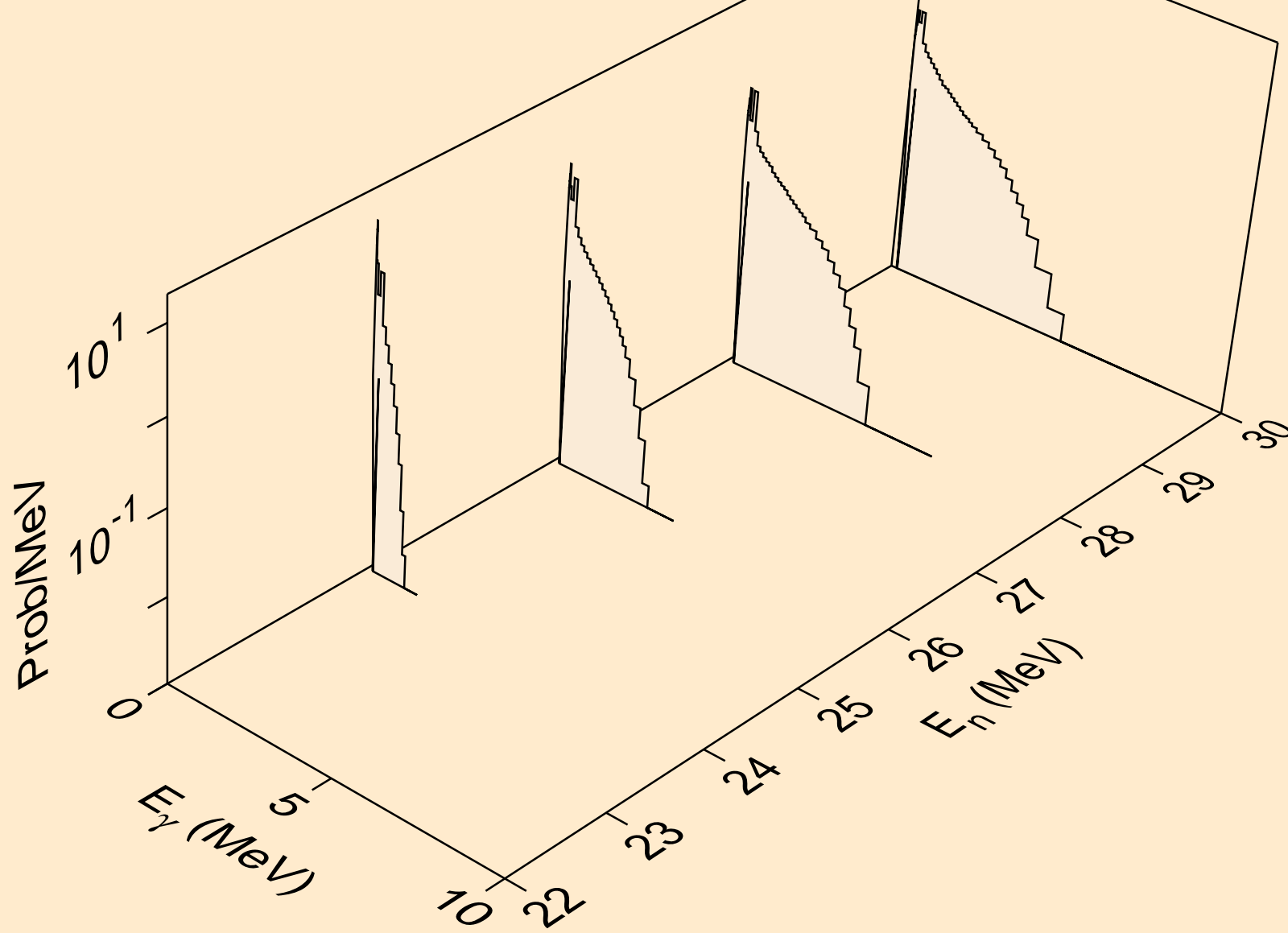

YB153 PROTON ACER TENDL-2021 LIBRARY; T=0.K  
Photon emission for (n,n\*)a

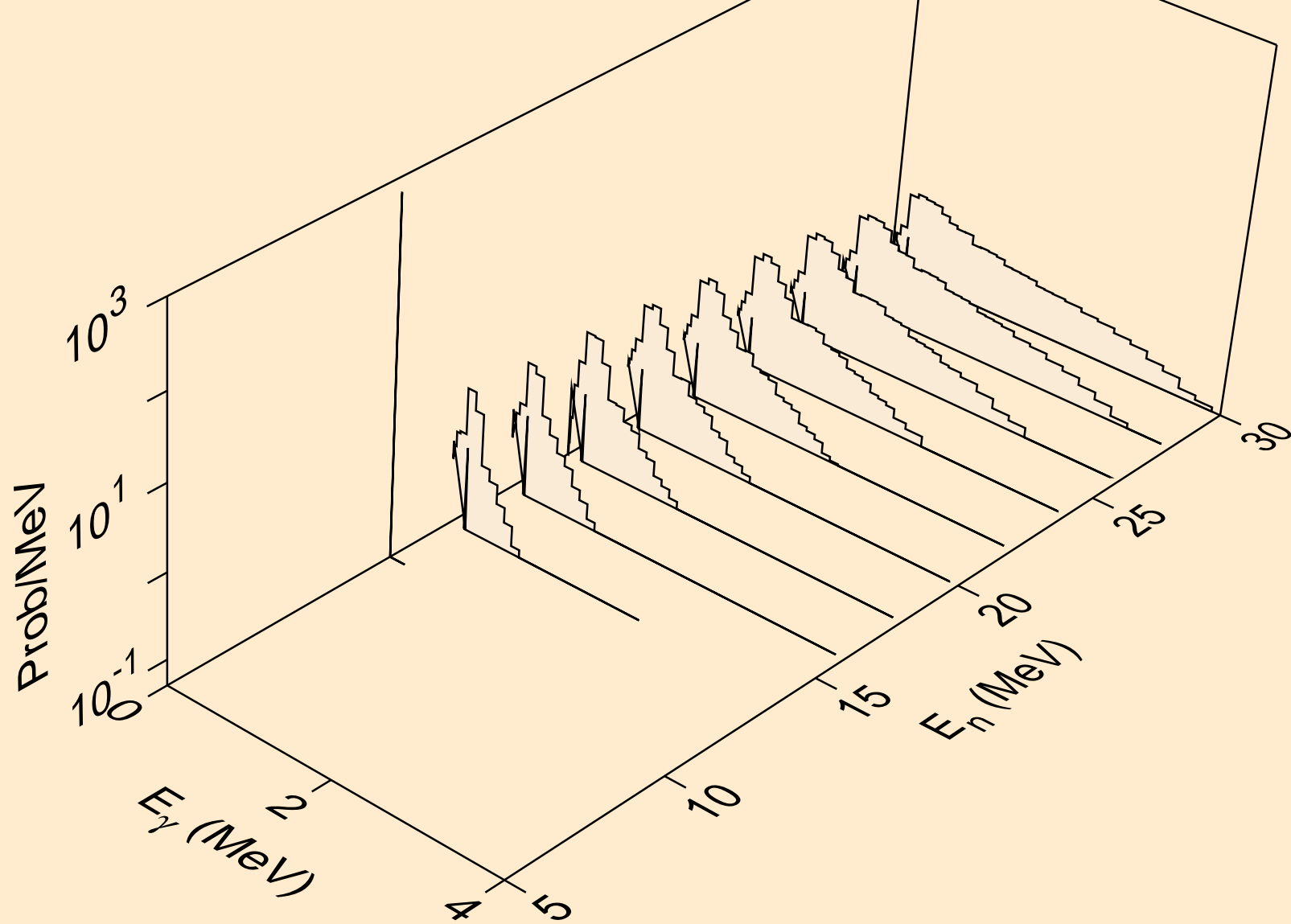

YB153 PROTON ACER TENDL-2021 LIBRARY; T=0.K  
Photon emission for (n,n\*)p

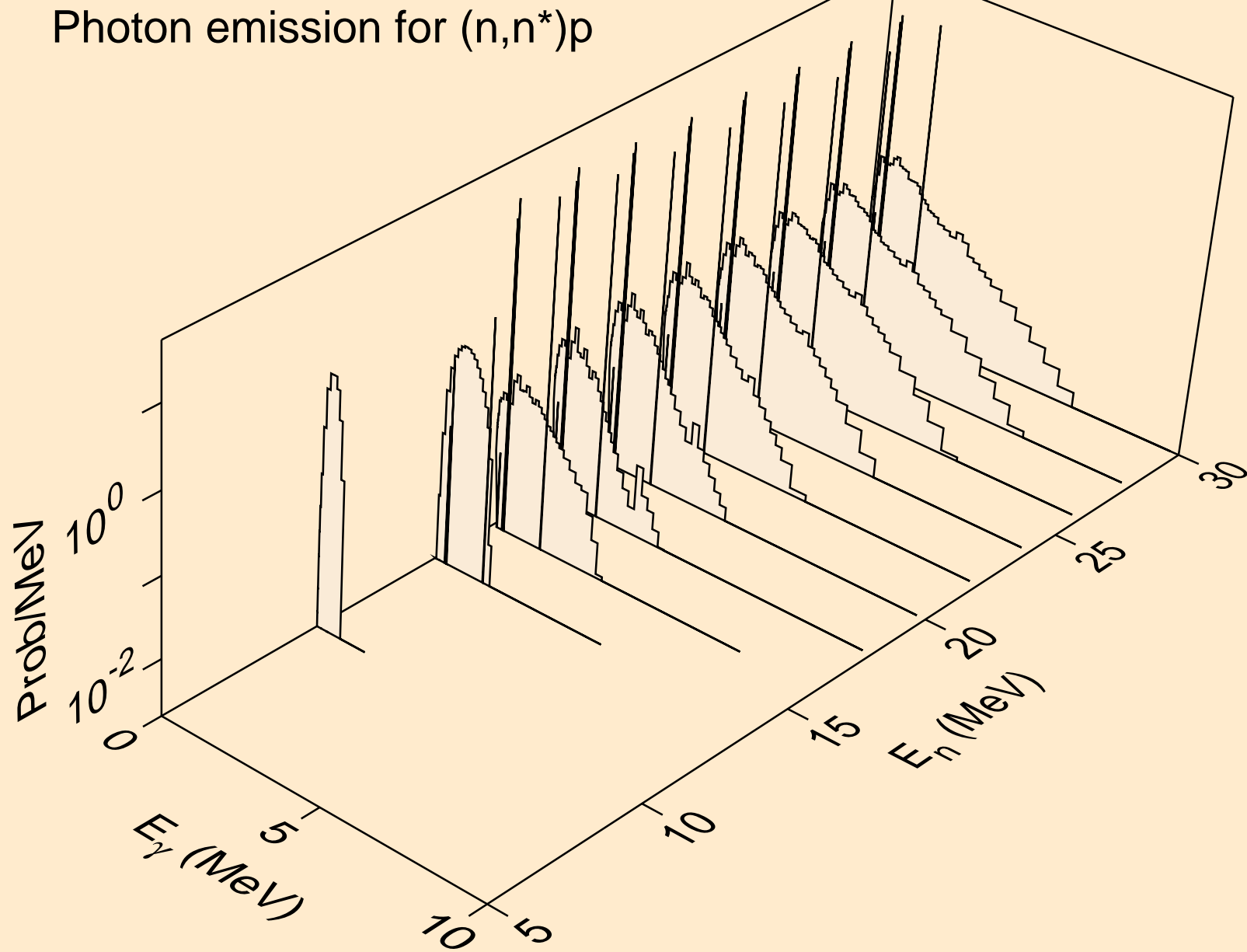



YB153 PROTON ACER TENDL-2021 LIBRARY; T=0.K  
Photon emission for (n,n\*)d

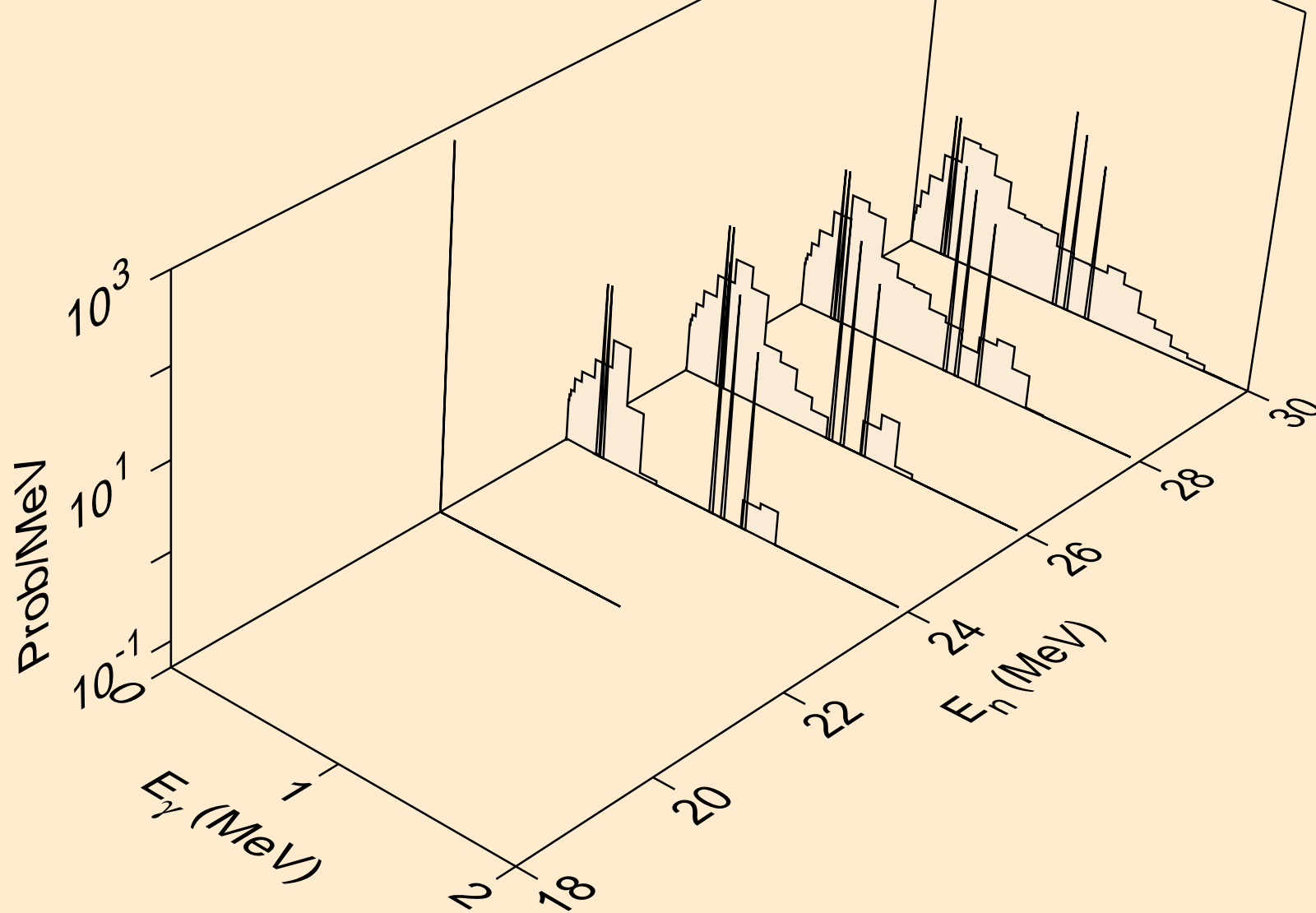

YB153 PROTON ACER TENDL-2021 LIBRARY; T=0.K  
Photon emission for (n,n\*)he3

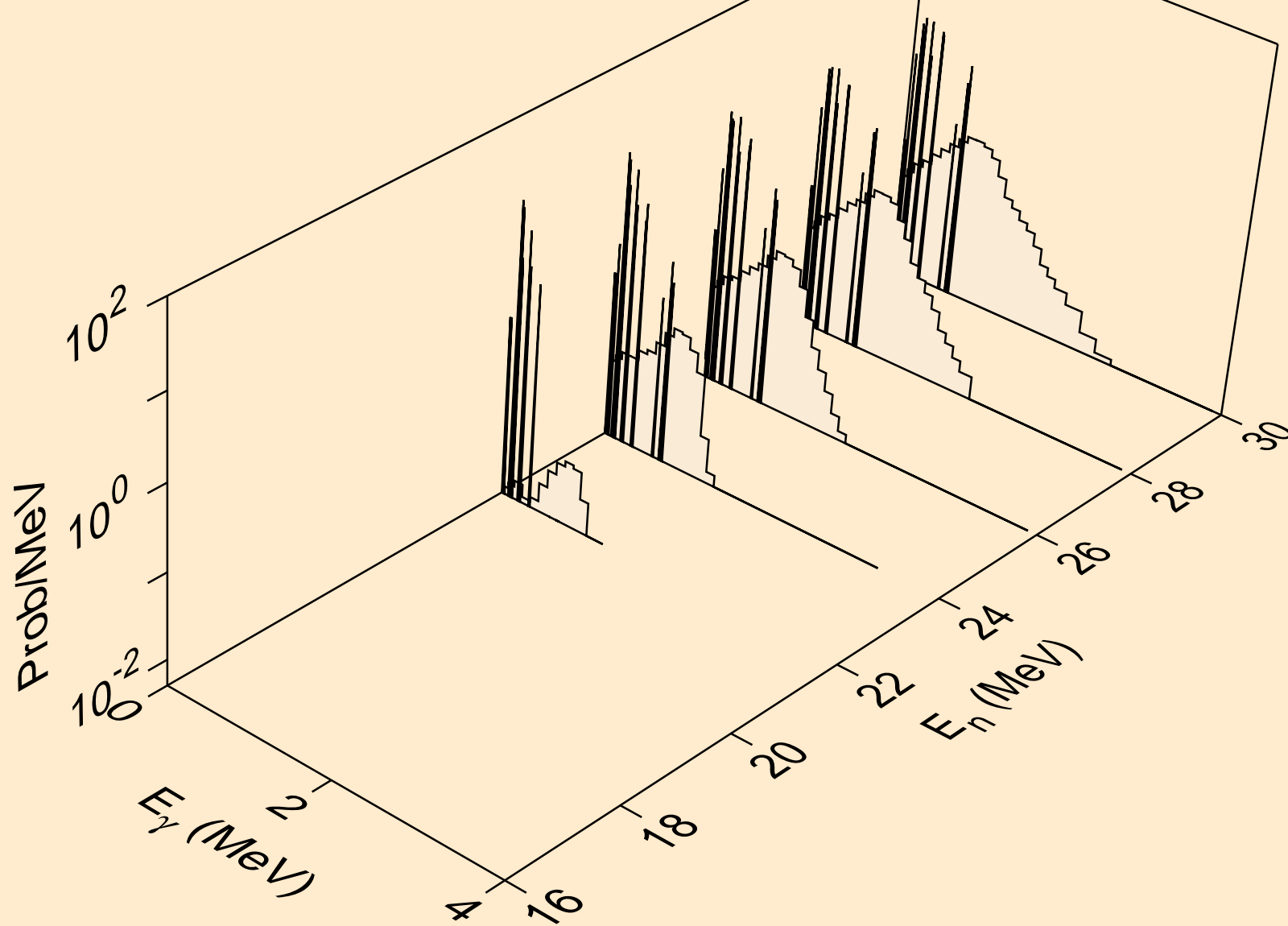

YB153 PROTON ACER TENDL-2021 LIBRARY; T=0.K  
Photon emission for (n,2np)

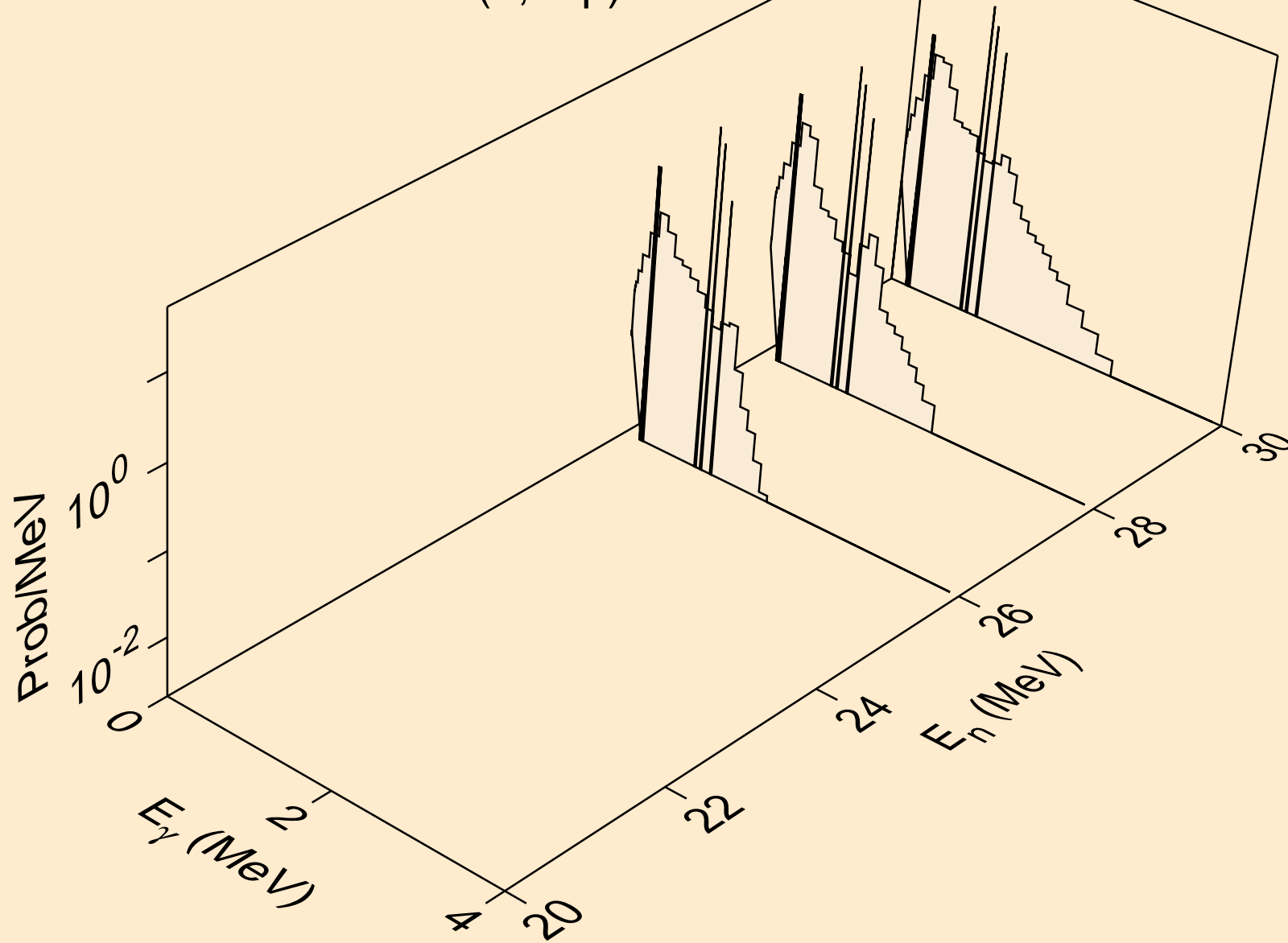

YB153 PROTON ACER TENDL-2021 LIBRARY; T=0.K  
Photon emission for (n,2np)

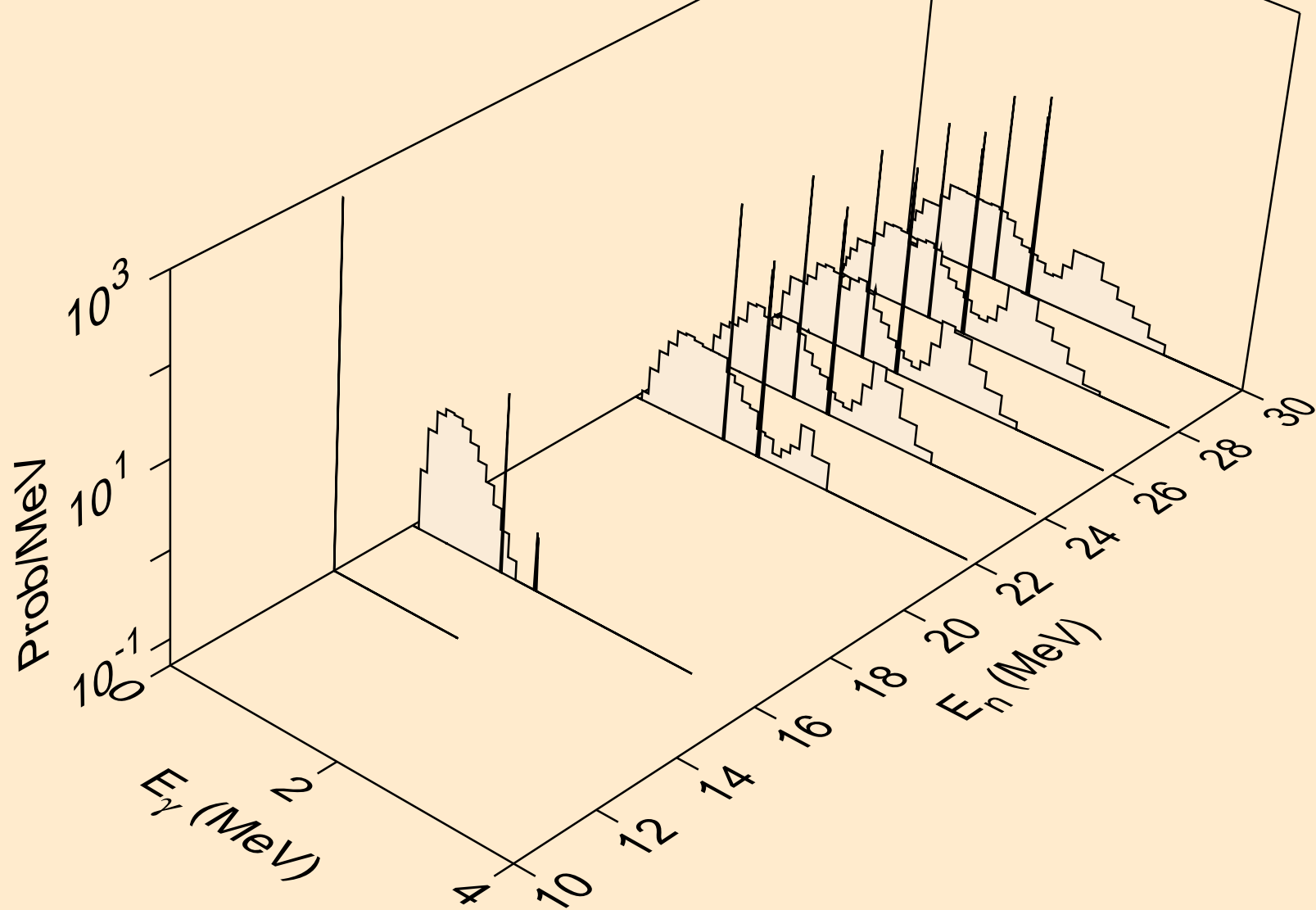

YB153 PROTON ACER TENDL-2021 LIBRARY; T=0.K  
Photon emission for (n,npa)

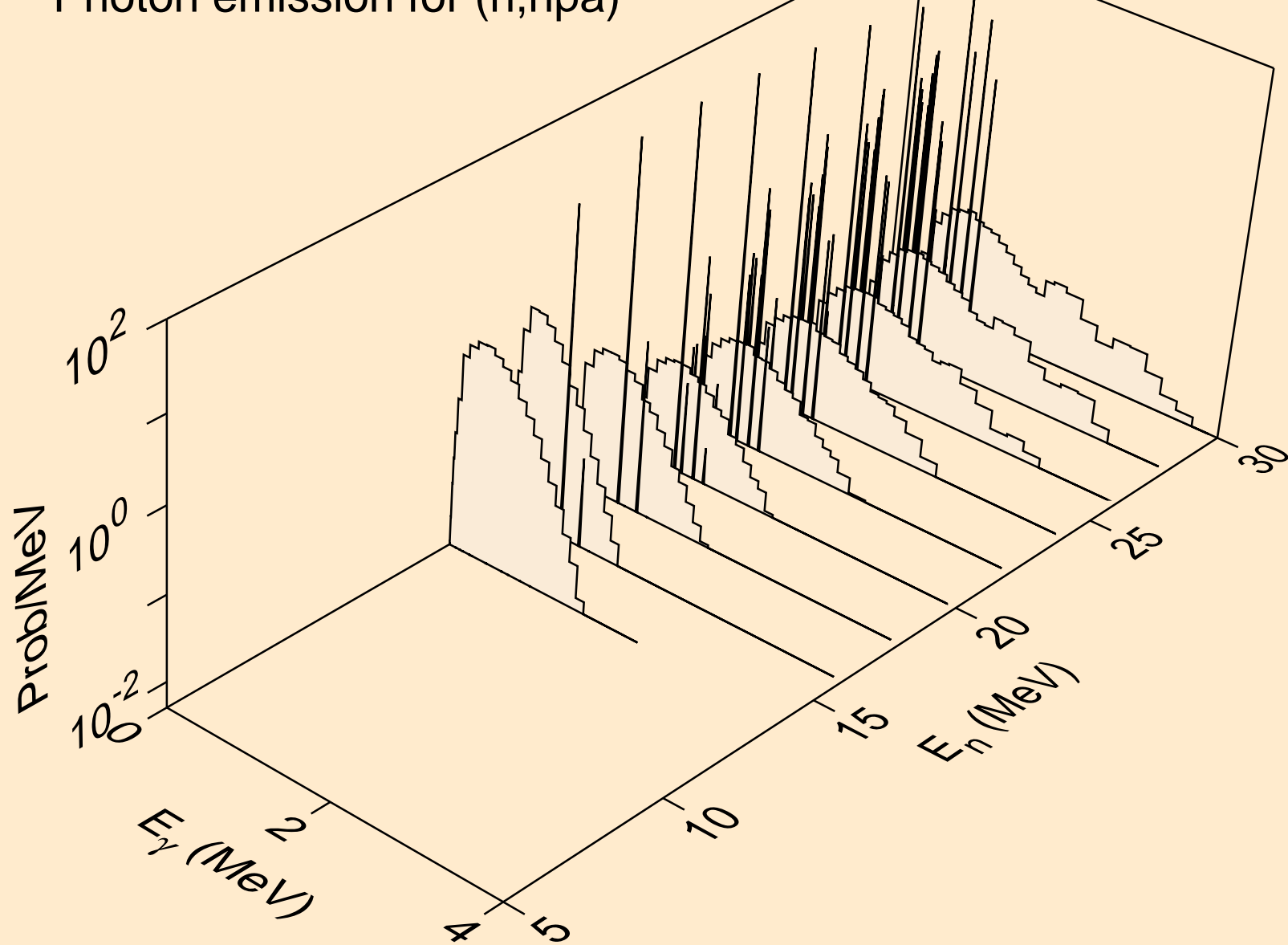

YB153 PROTON ACER TENDL-2021 LIBRARY; T=0.K  
Photon emission for (n,gma)

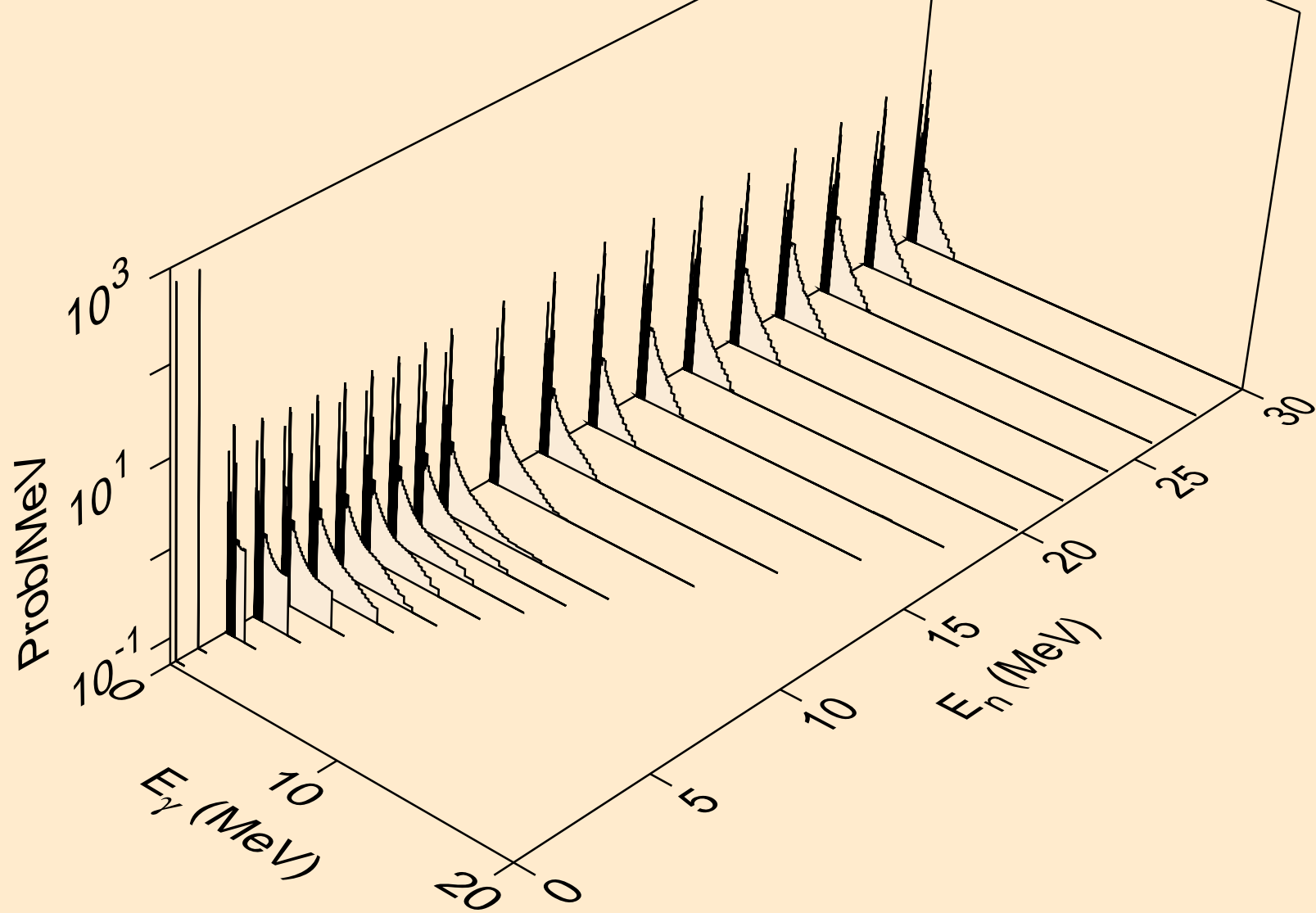

YB153 PROTON ACER TENDL-2021 LIBRARY; T=0.K  
Photon emission for inelastic

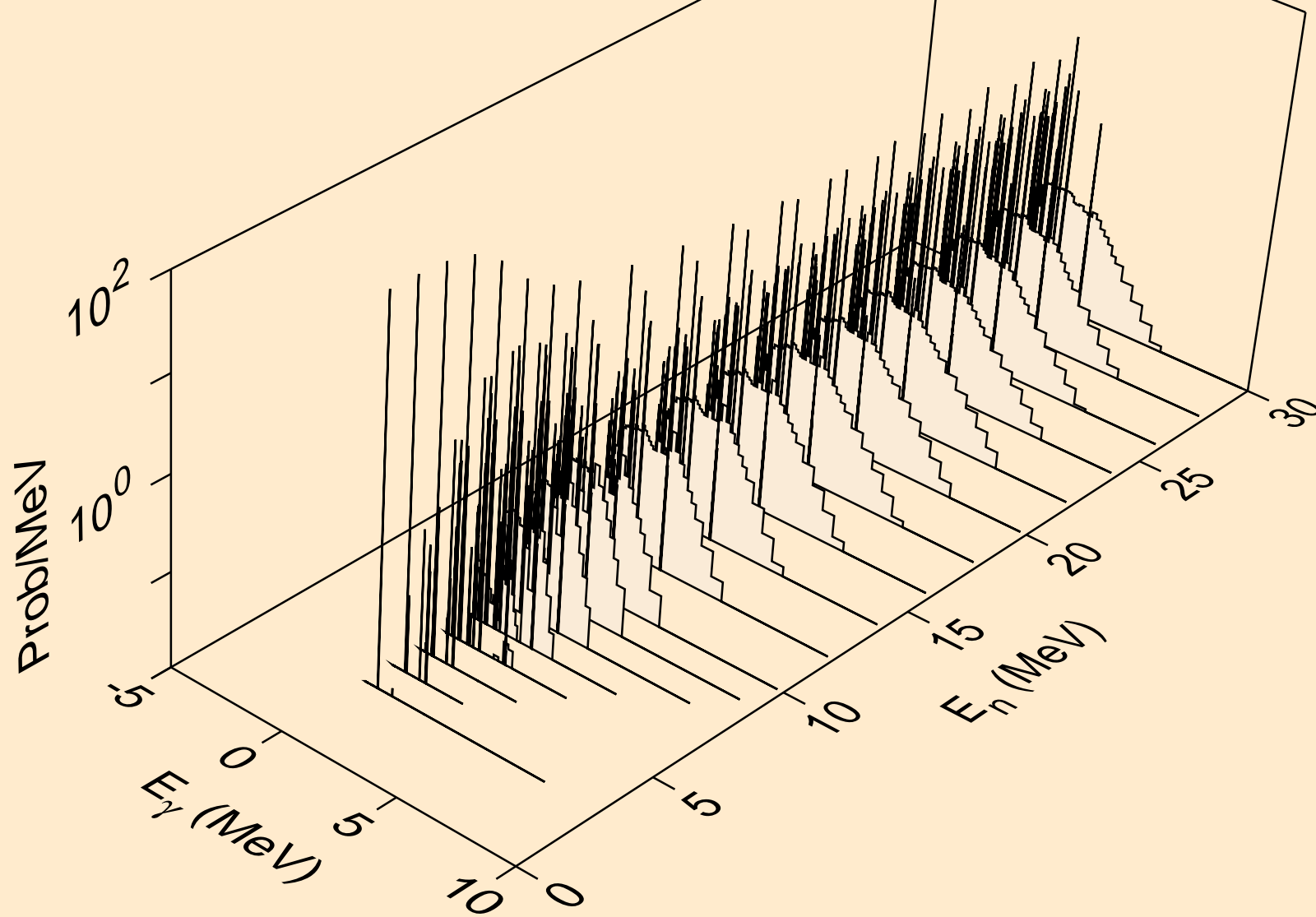

YB153 PROTON ACER TENDL-2021 LIBRARY; T=0.K  
Photon emission for (n,d)

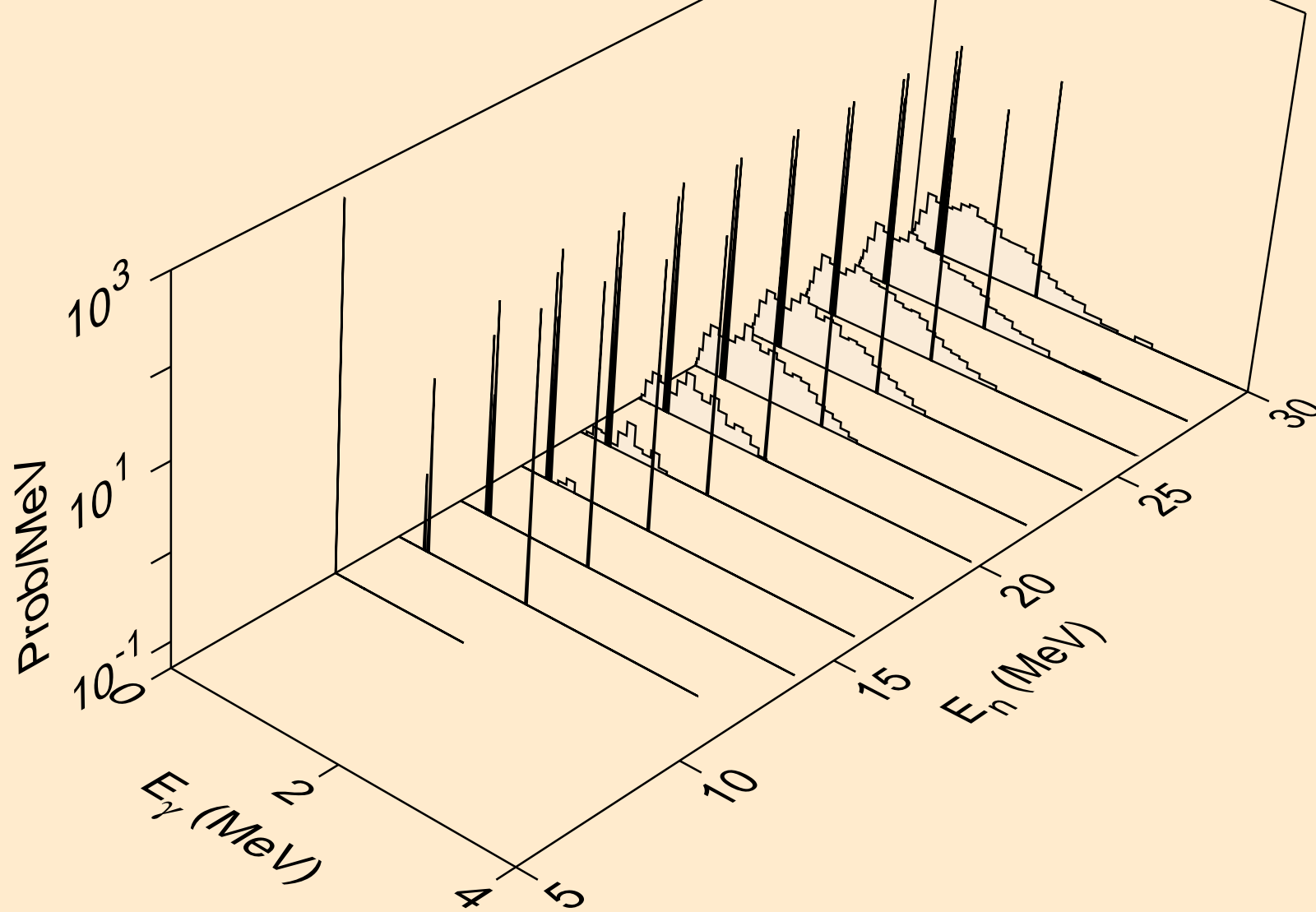



YB153 PROTON ACER TENDL-2021 LIBRARY; T=0.K  
Photon emission for (n,t)

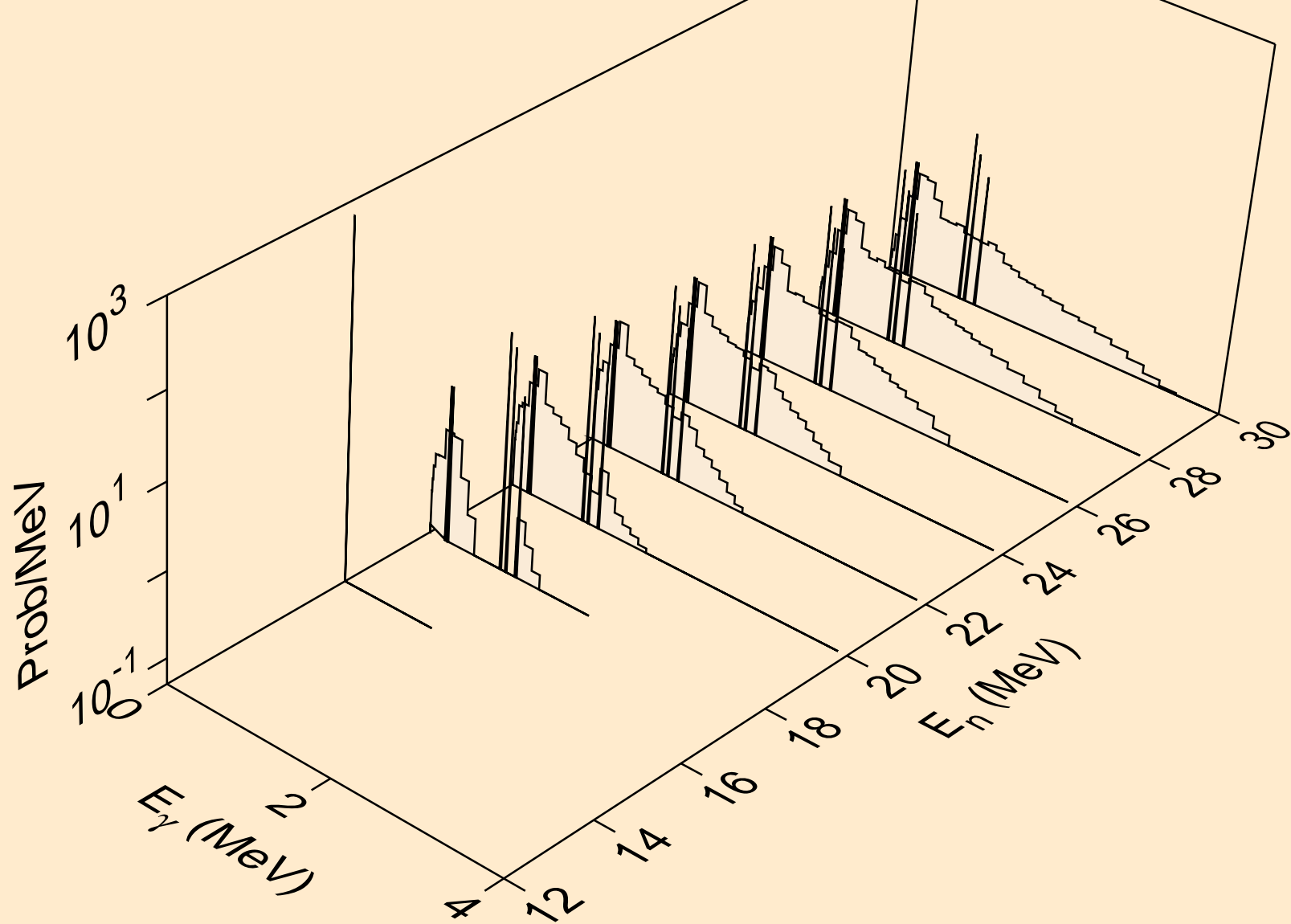

YB153 PROTON ACER TENDL-2021 LIBRARY; T=0.K  
Photon emission for (n,he3)

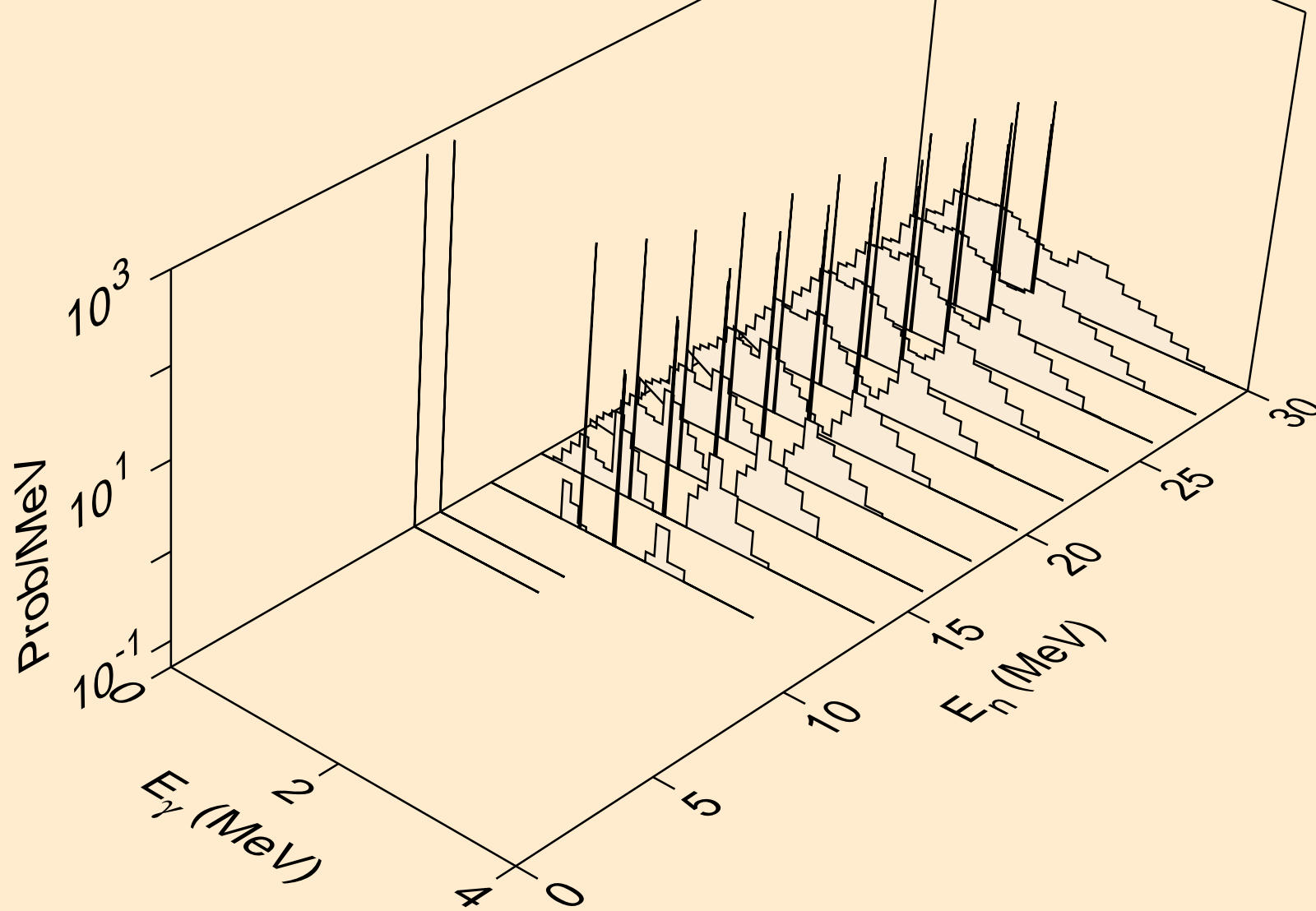

YB153 PROTON ACER TENDL-2021 LIBRARY; T=0.K  
Photon emission for (n,a)

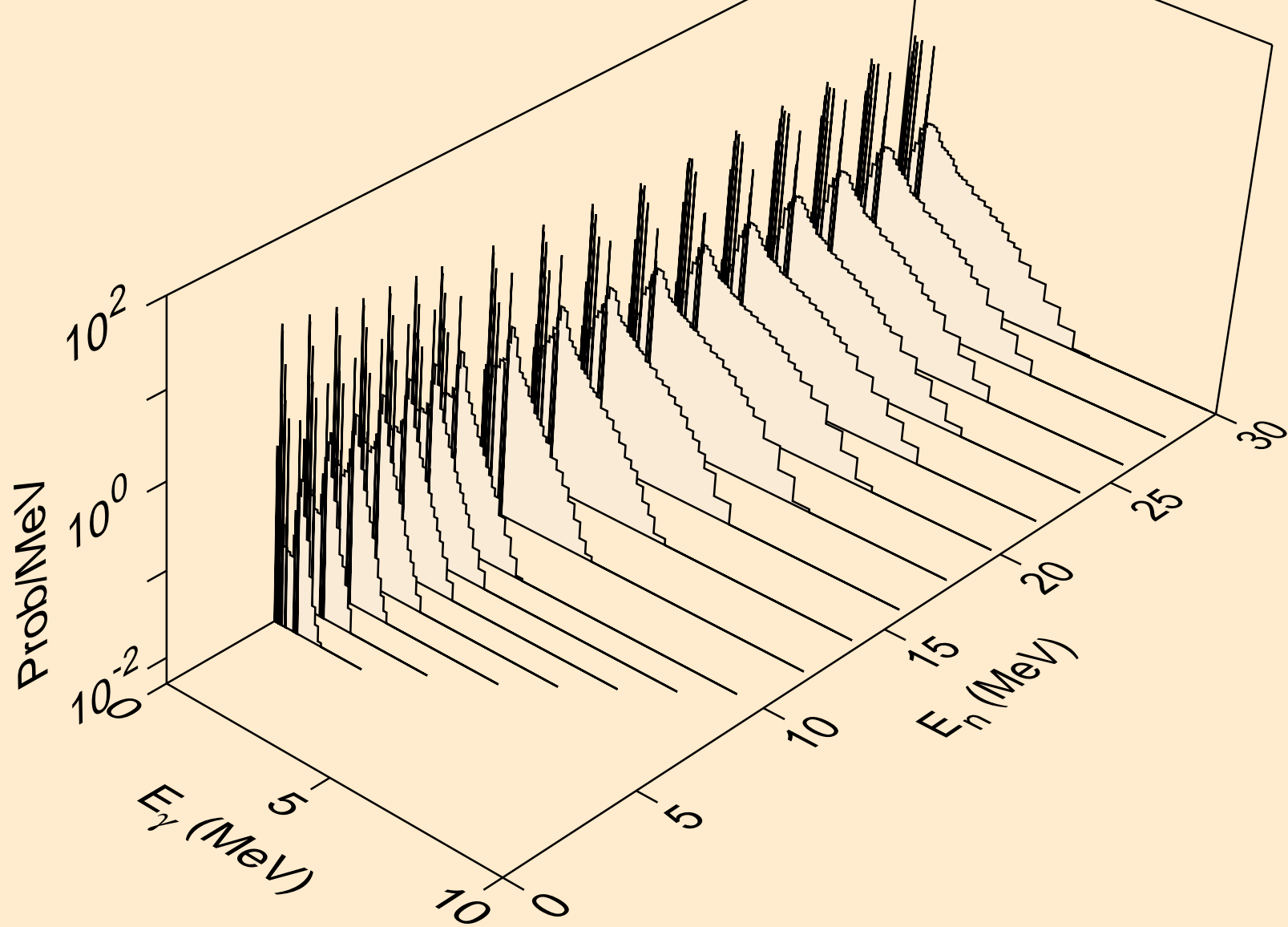

YB153 PROTON ACER TENDL-2021 LIBRARY; T=0.K  
Photon emission for (n,2a)

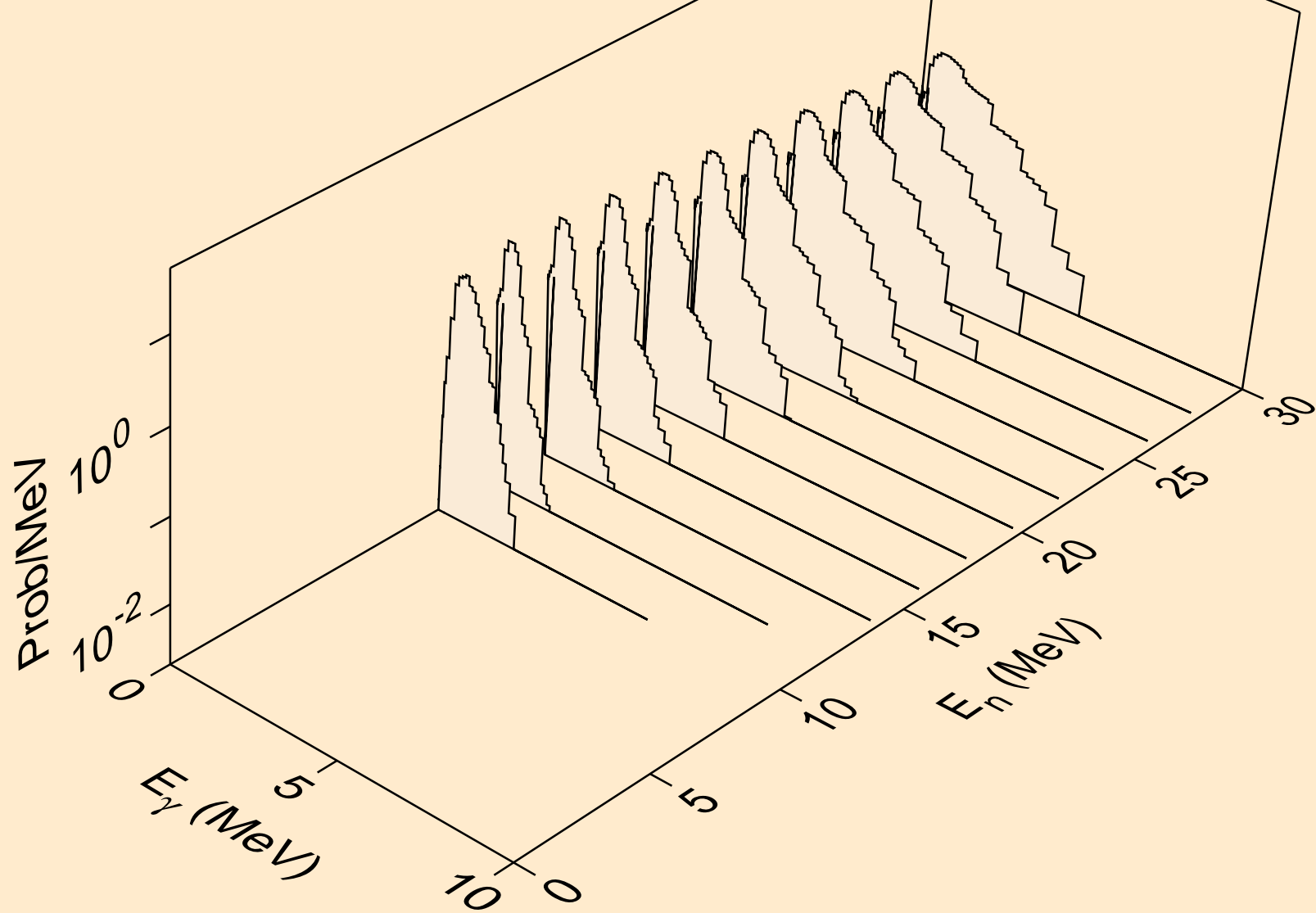

YB153 PROTON ACER TENDL-2021 LIBRARY; T=0.K  
Photon emission for (n,2p)

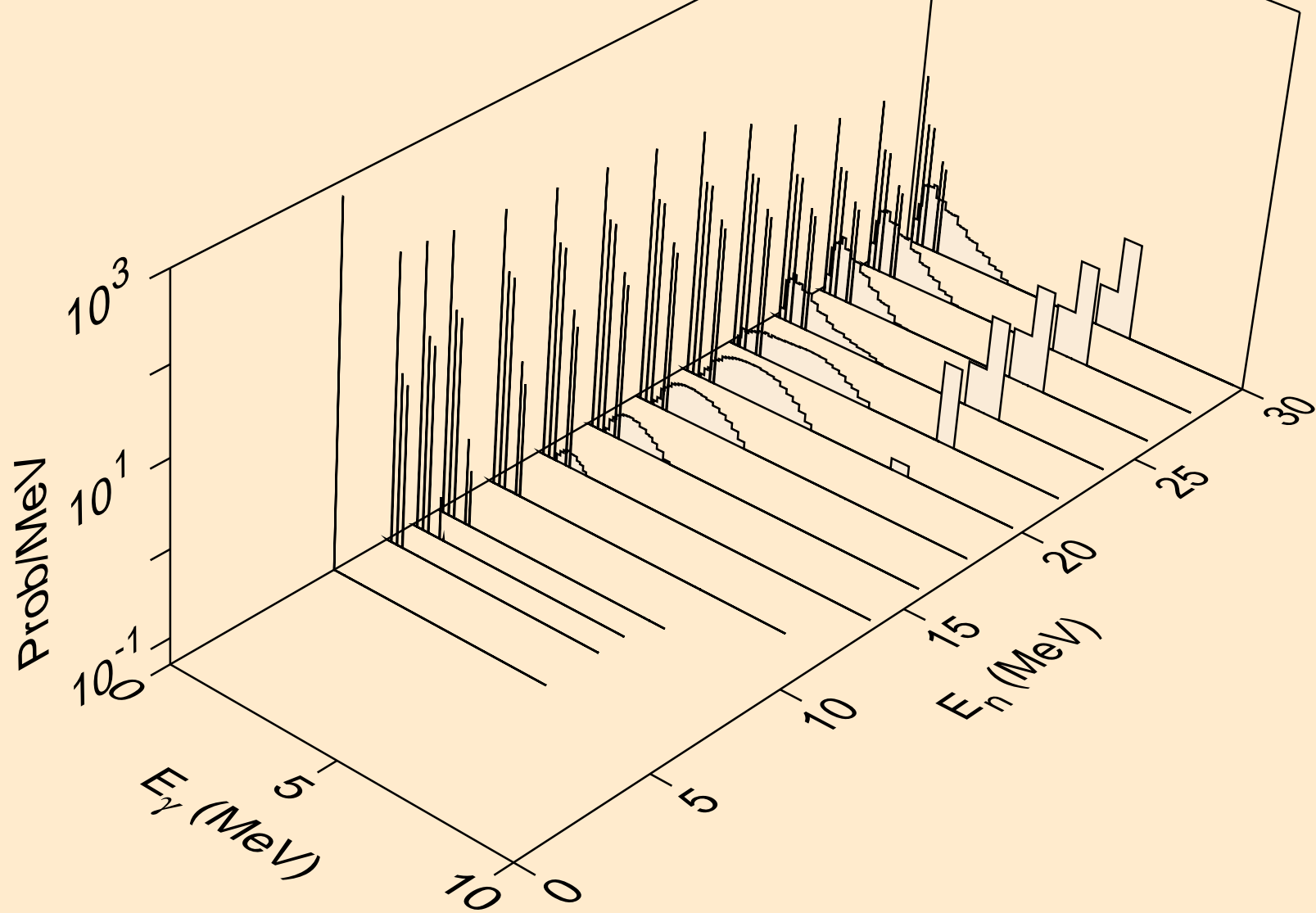

YB153 PROTON ACER TENDL-2021 LIBRARY; T=0.K  
Photon emission for (n,p)

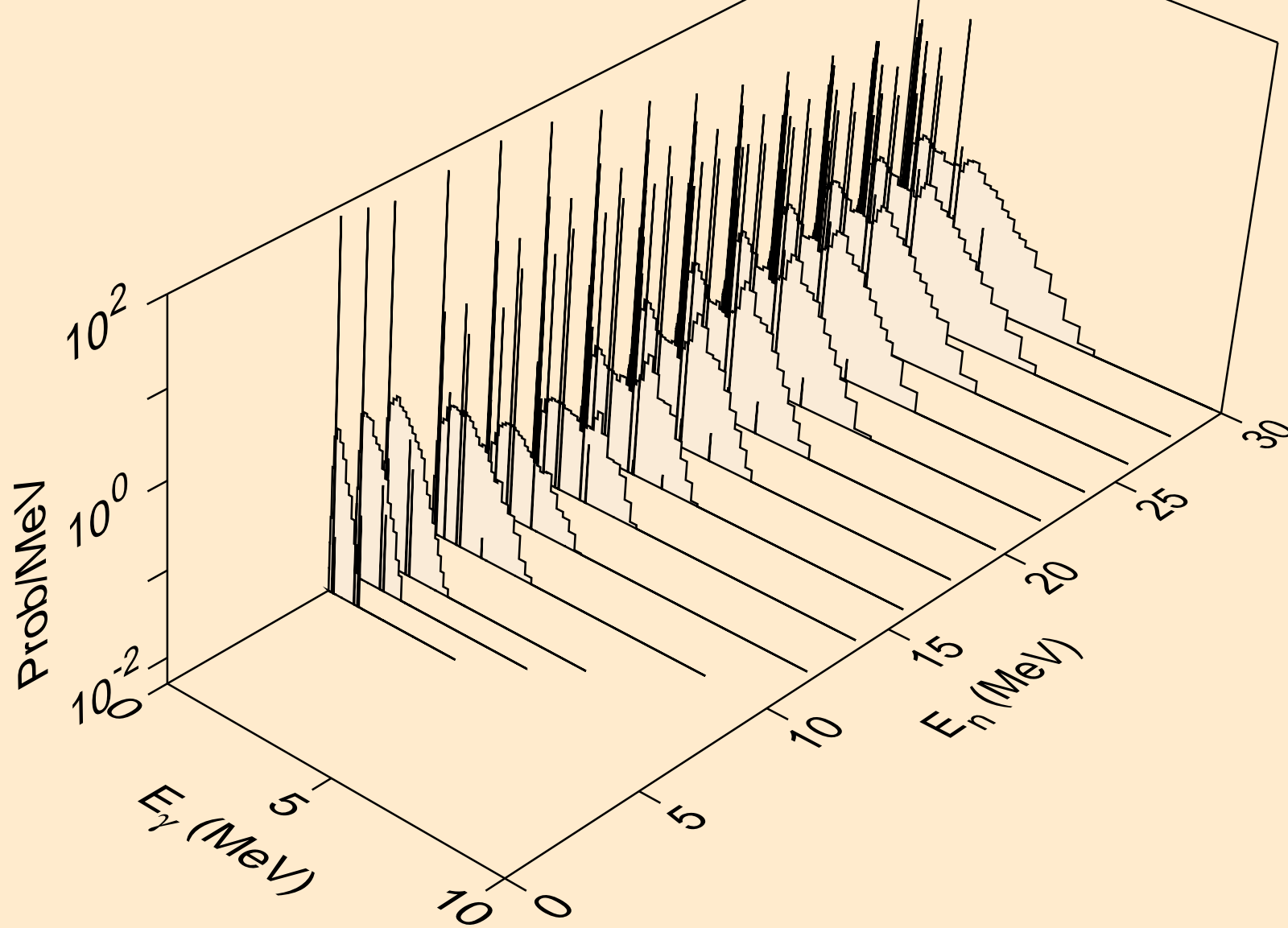

YB153 PROTON ACER TENDL-2021 LIBRARY; T=0.K  
Photon emission for (n,pd)

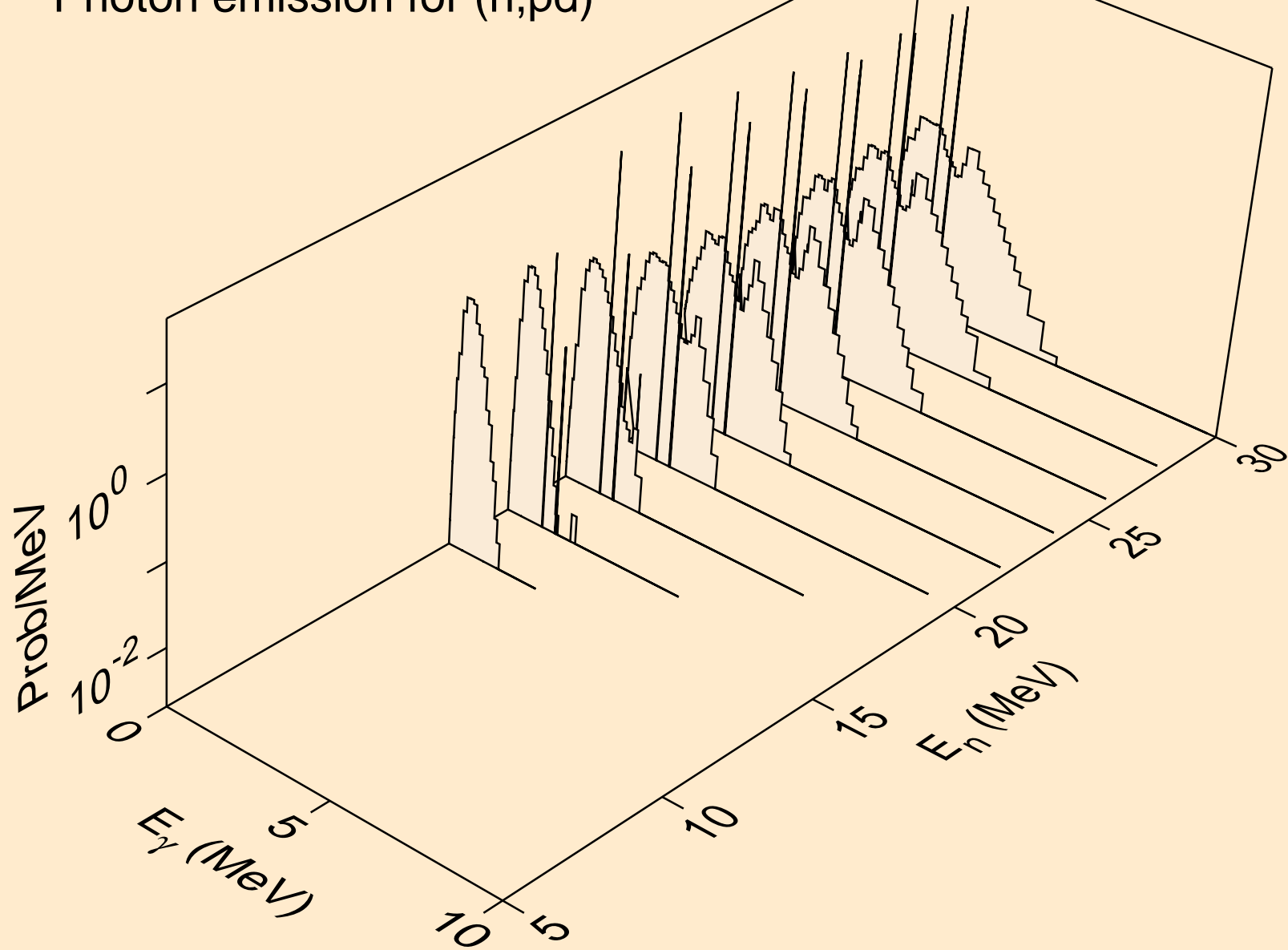

YB153 PROTON ACER TENDL-2021 LIBRARY; T=0.K  
Photon emission for (n,pt)

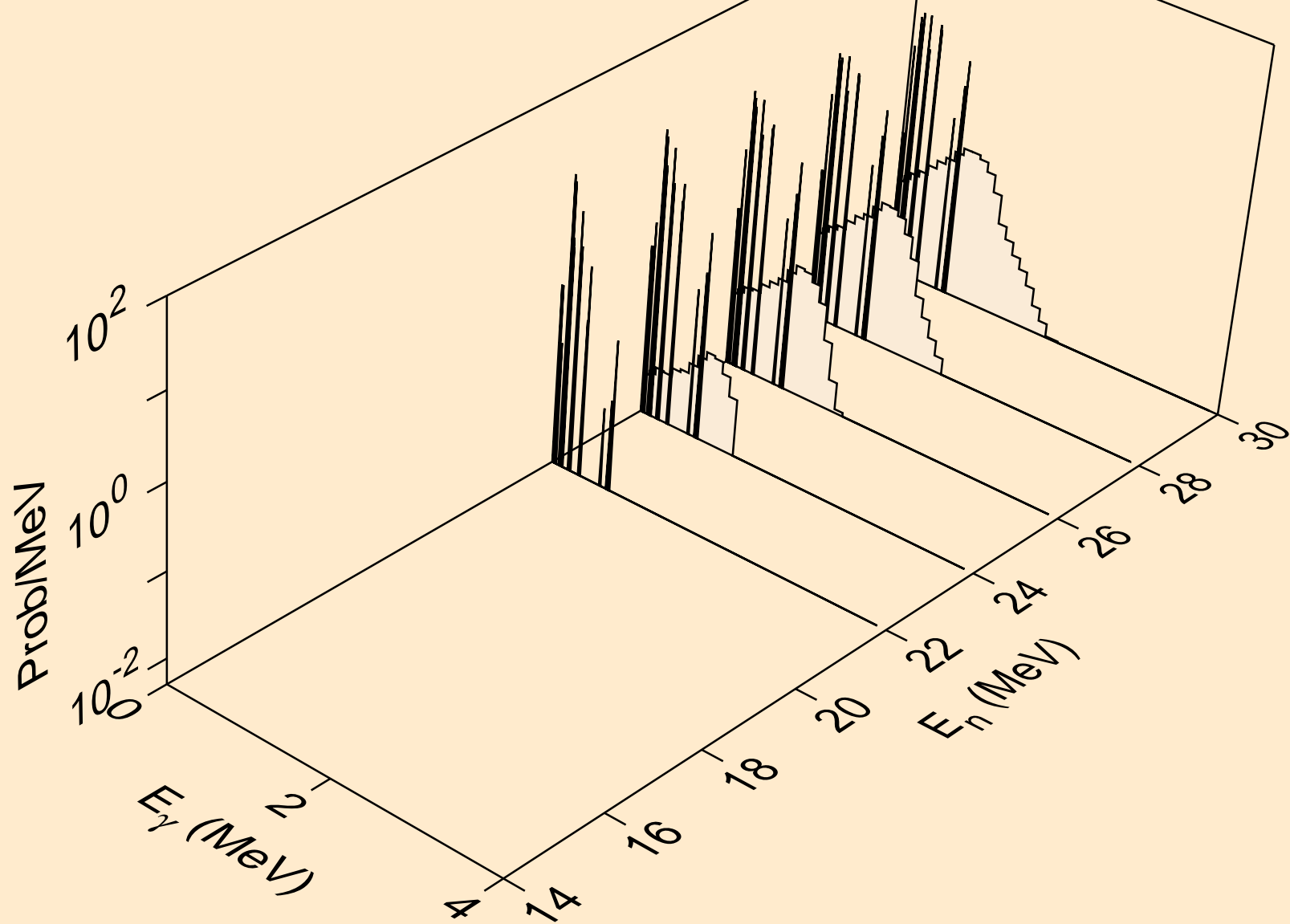



YB153 PROTON ACER TENDL-2021 LIBRARY; T=0.K  
Photon emission for (n,da)

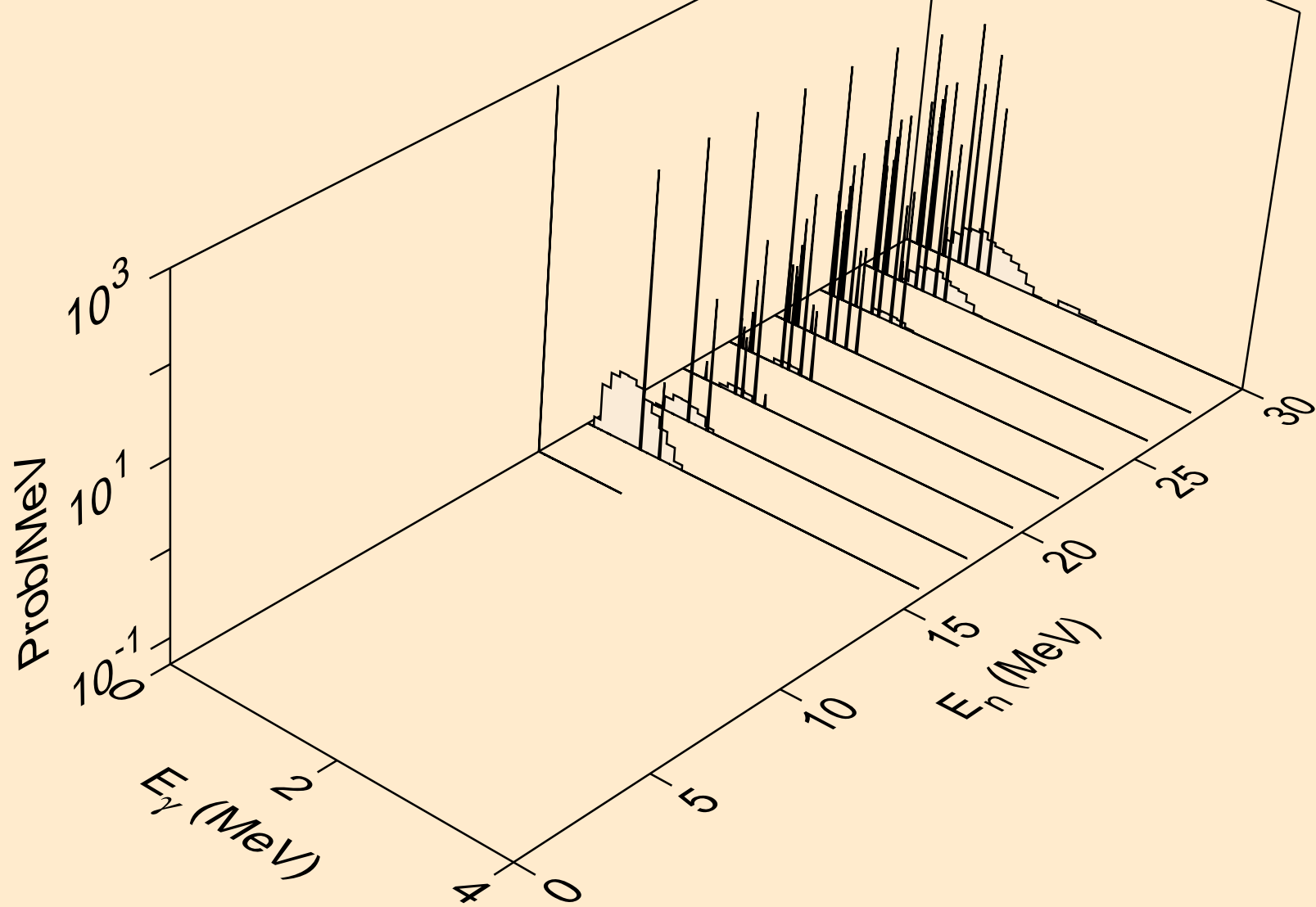

YB153 PROTON ACER TENDL-2021 LIBRARY; T=0.K  
Particle heating contributions

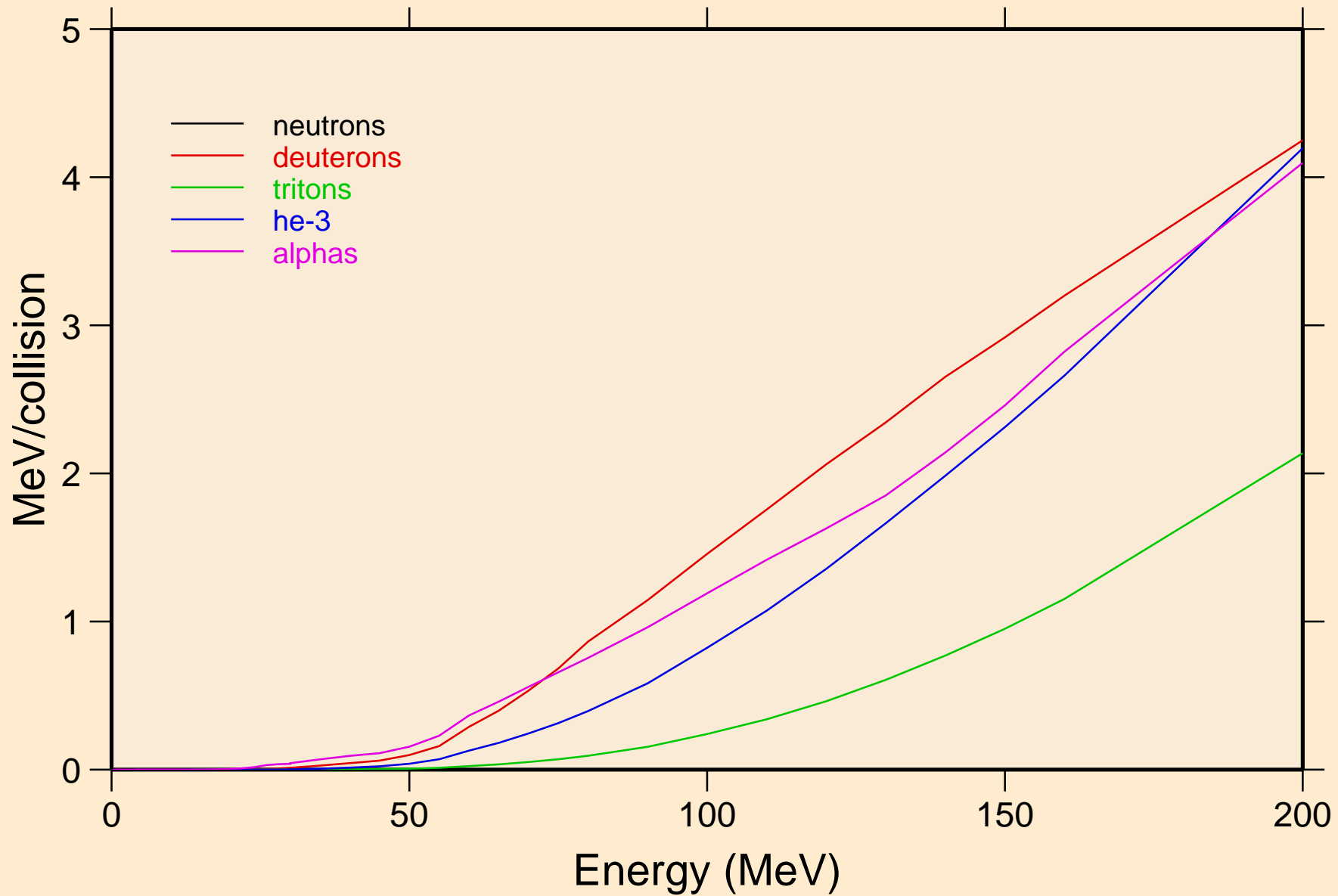

# YB153 PROTON ACER TENDL-2021 LIBRARY; T=0.K

## Recoil Heating

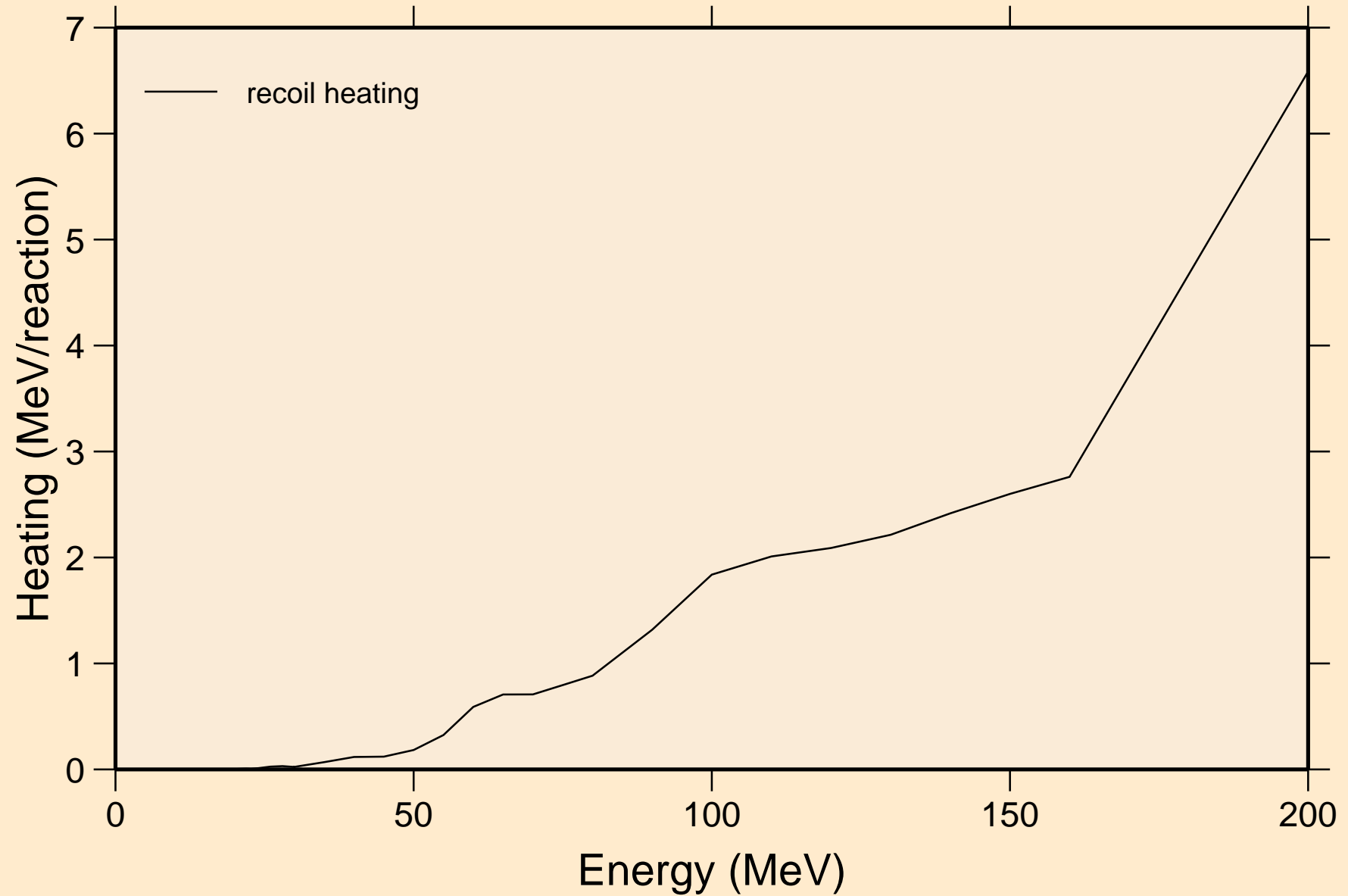

YB153 PROTON ACER TENDL-2021 LIBRARY; T=0.K  
Particle production cross sections

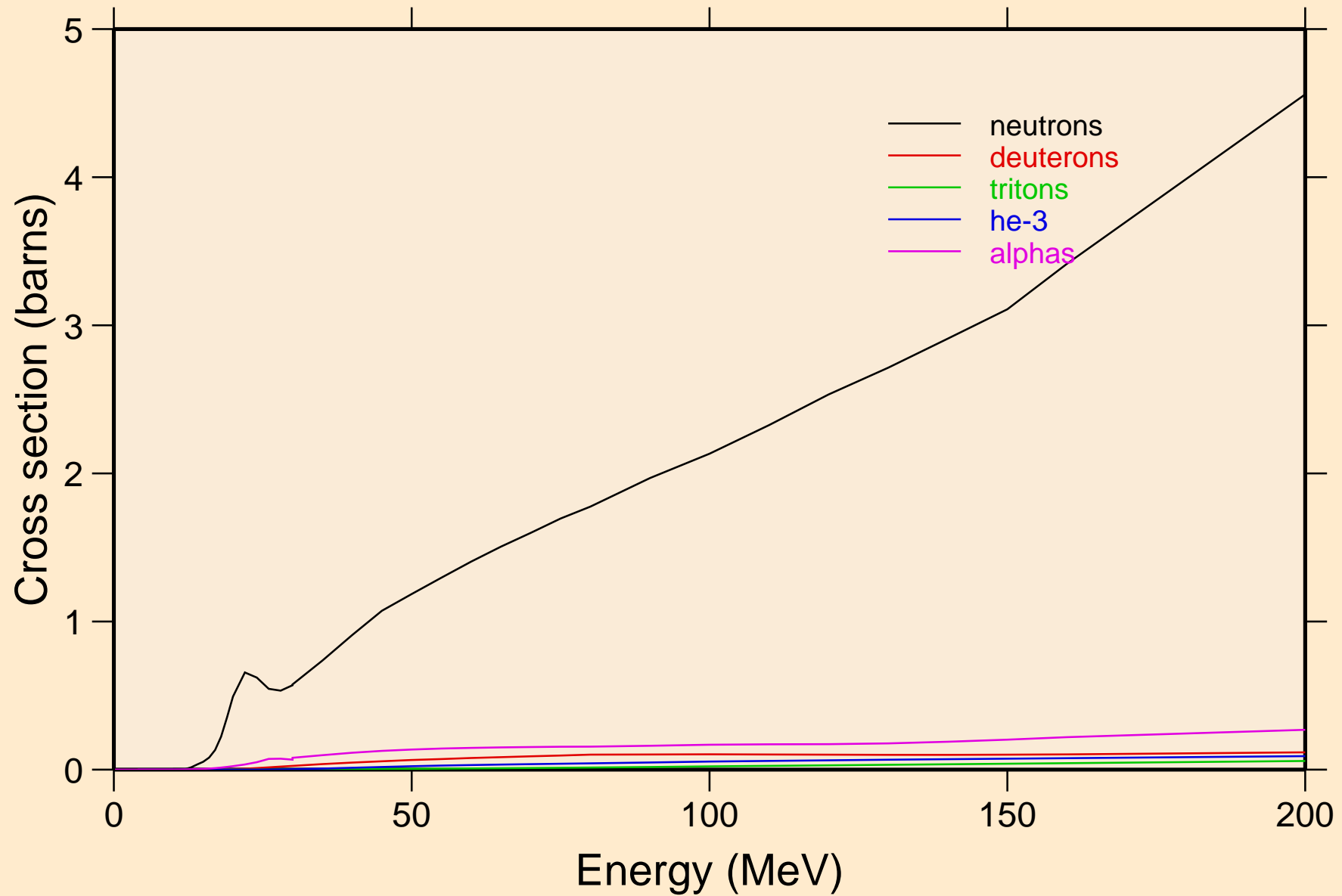

YB153 PROTON ACER TENDL-2021 LIBRARY; T=0.K  
neutrons from (p,n)

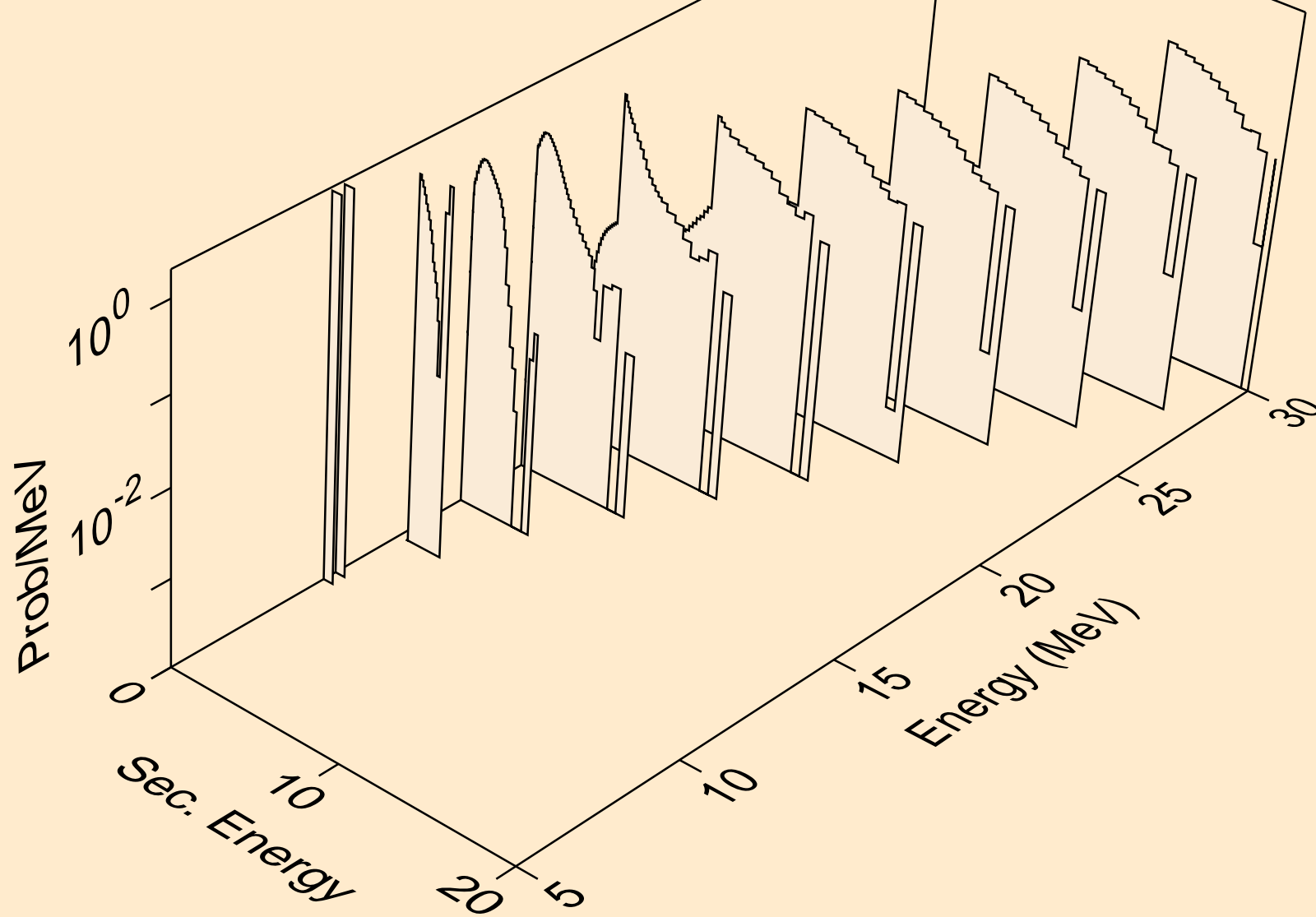

YB153 PROTON ACER TENDL-2021 LIBRARY; T=0.K  
neutrons from (p,x)

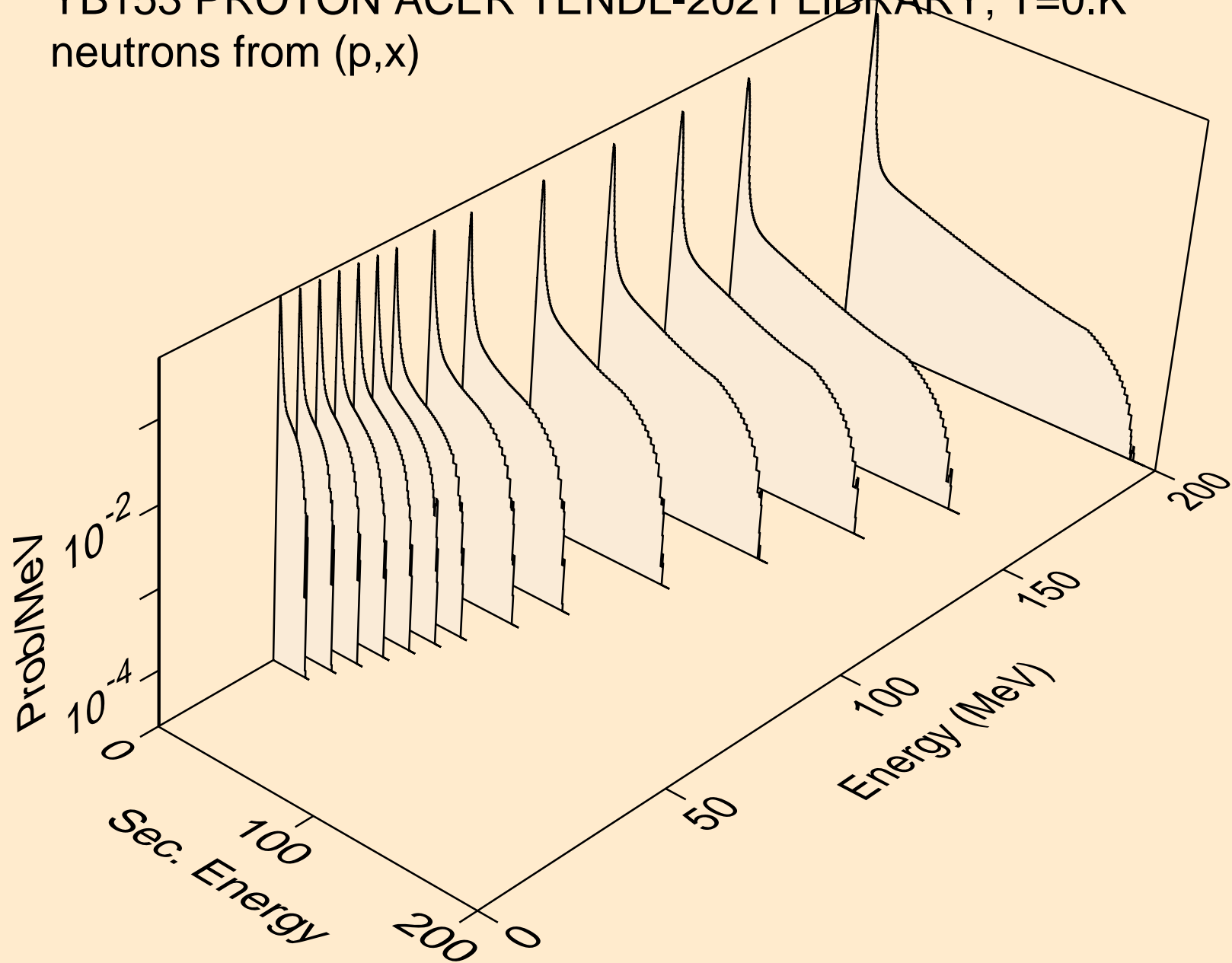

YB153 PROTON ACER TENDL-2021 LIBRARY; T=0.K  
neutrons from (p,2n)

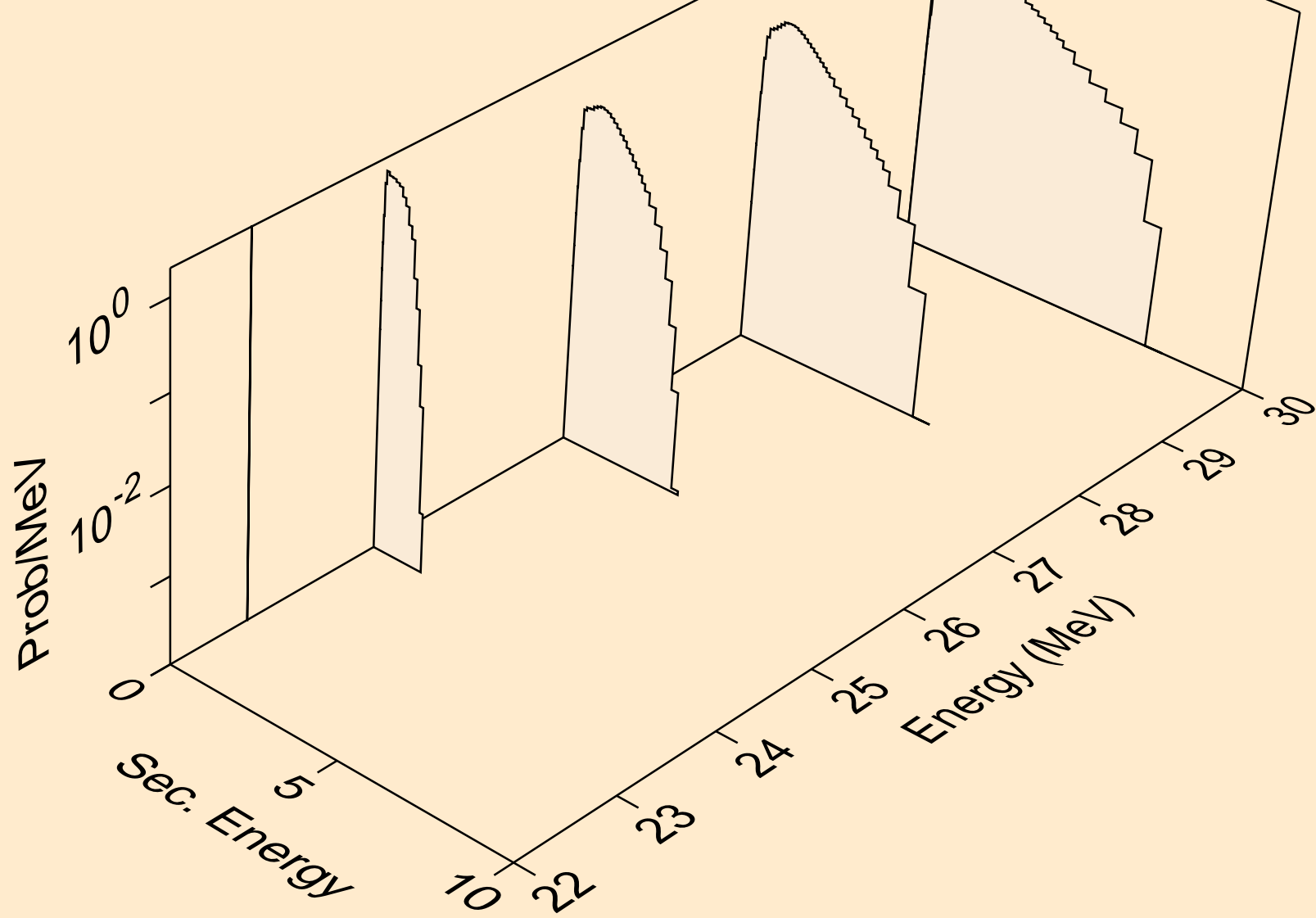

YB153 PROTON ACER TENDL-2021 LIBRARY; T=0.K  
neutrons from (p,n\*)a

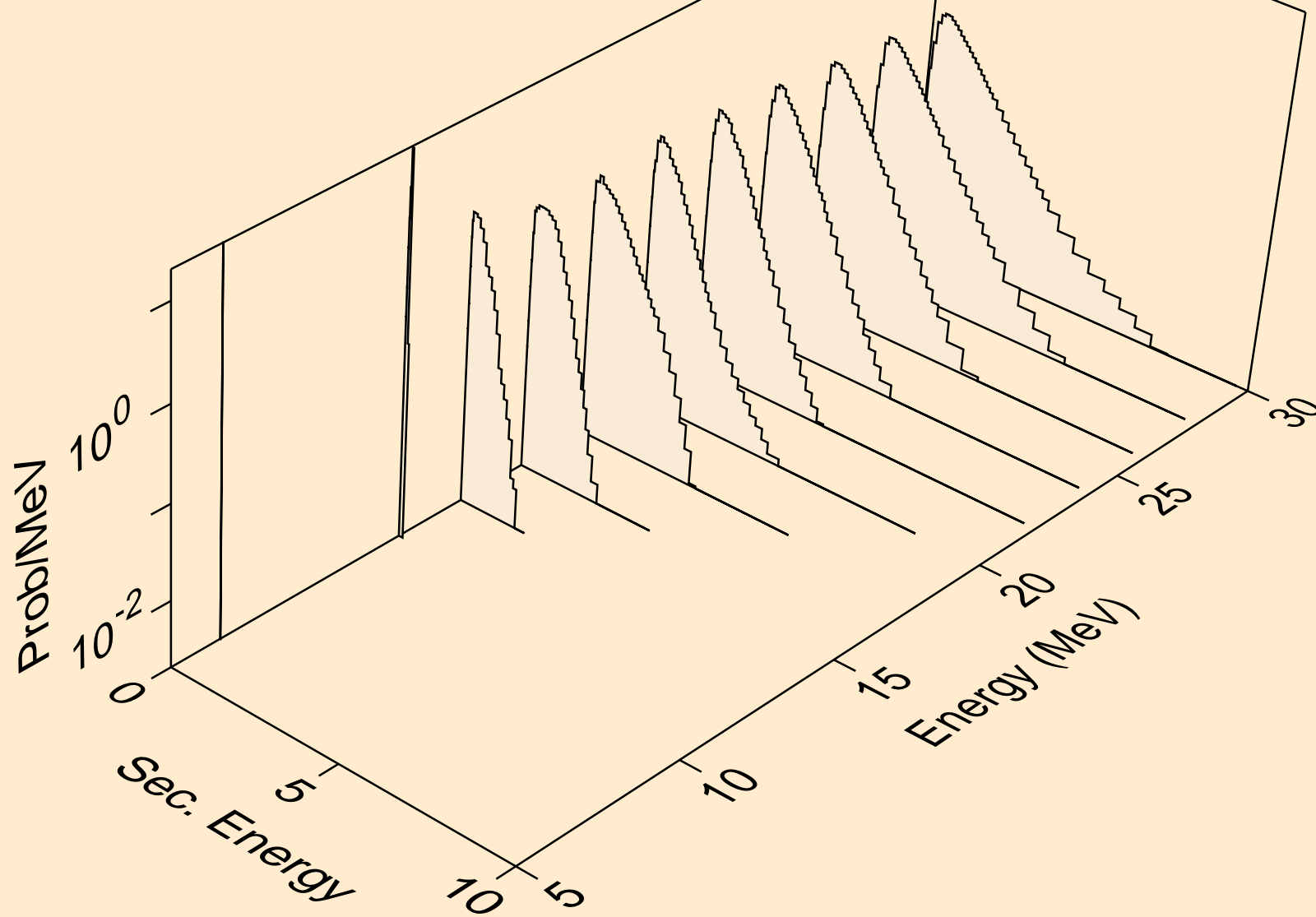



YB153 PROTON ACER TENDL-2021 LIBRARY; T=0.K  
neutrons from (p,n\*)p

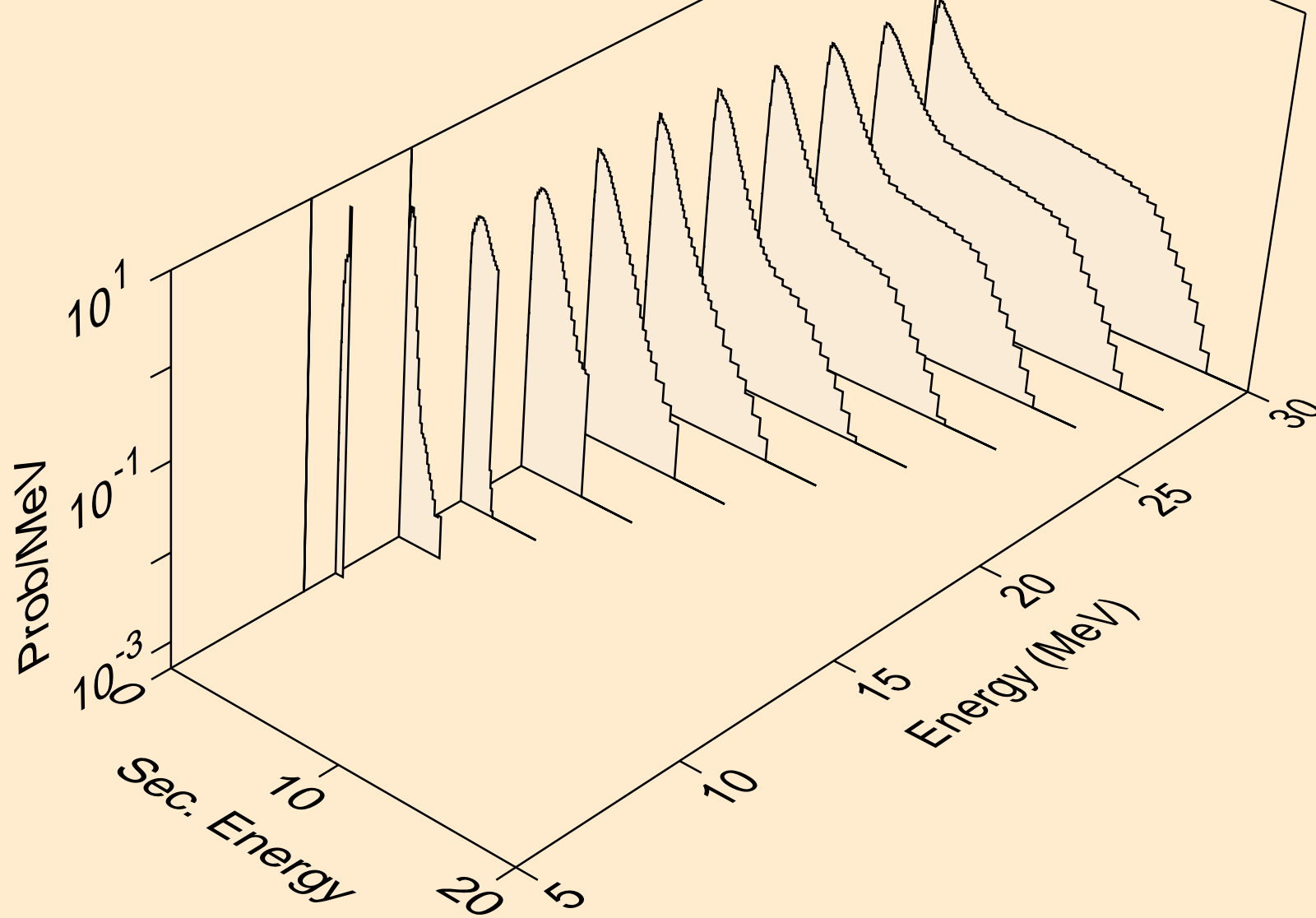

YB153 PROTON ACER TENDL-2021 LIBRARY; T=0.K  
neutrons from (p,n\*)d

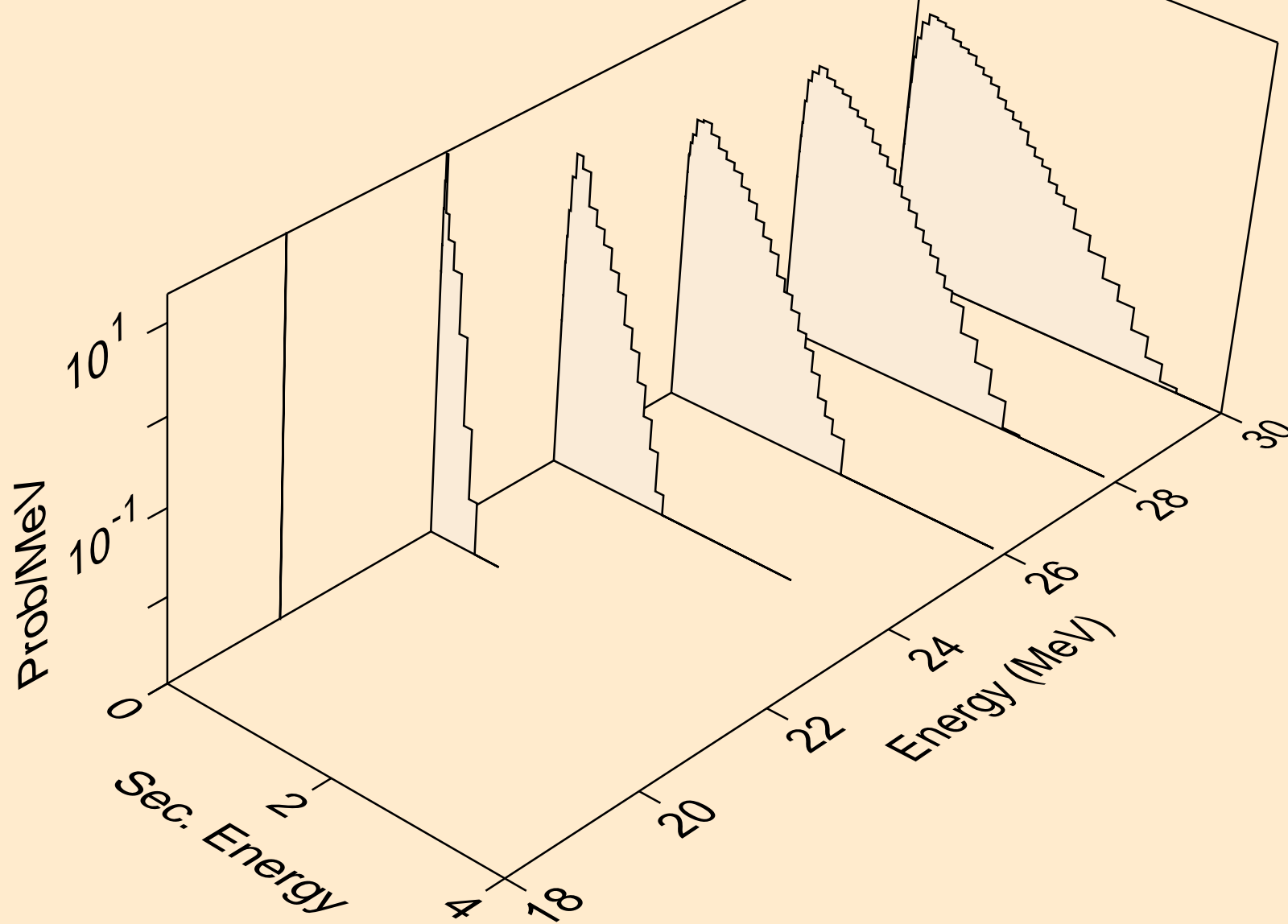

YB153 PROTON ACER TENDL-2021 LIBRARY; T=0.K  
neutrons from (p,n\*)he3

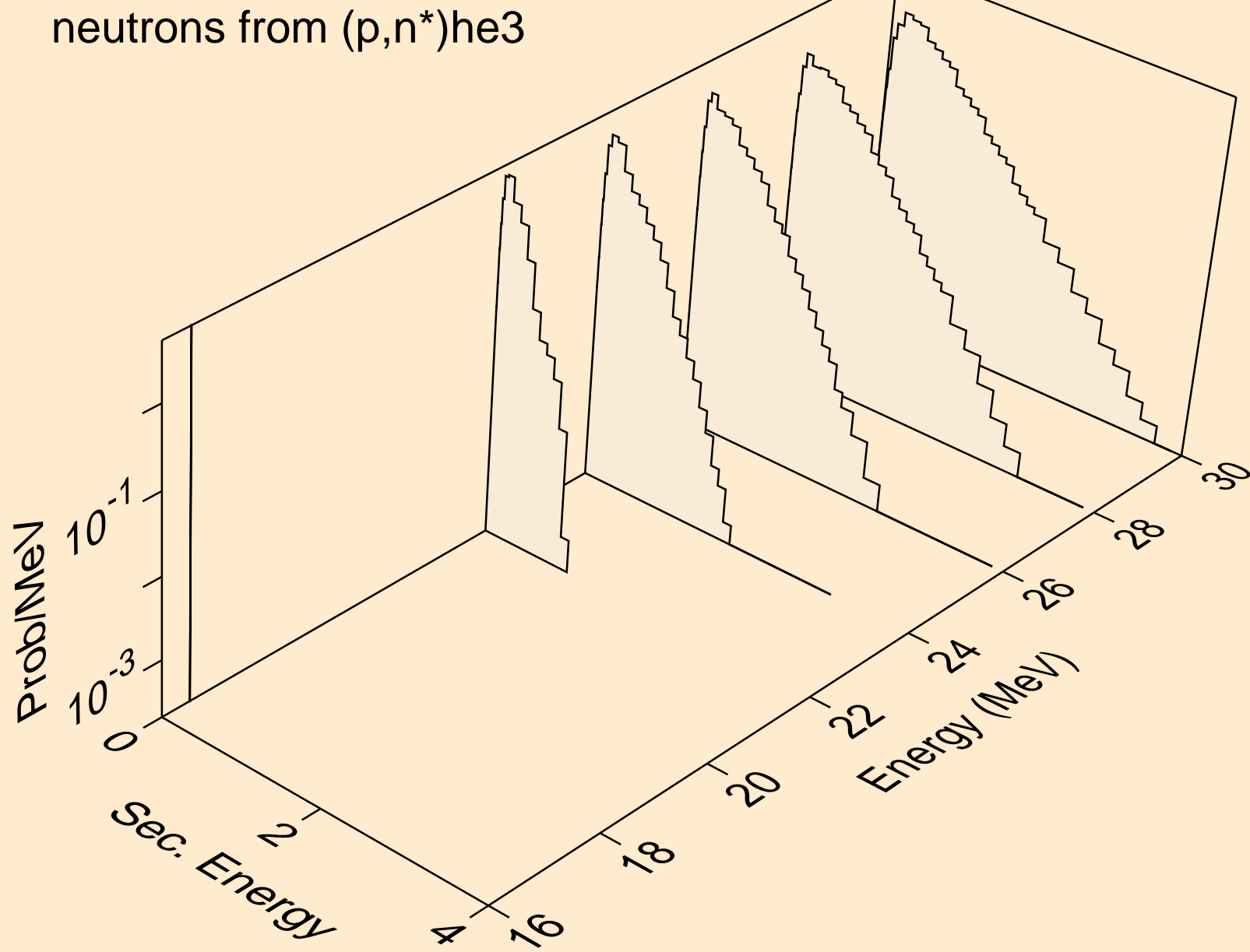

YB153 PROTON ACER TENDL-2021 LIBRARY; T=0.K  
neutrons from (p,2np)

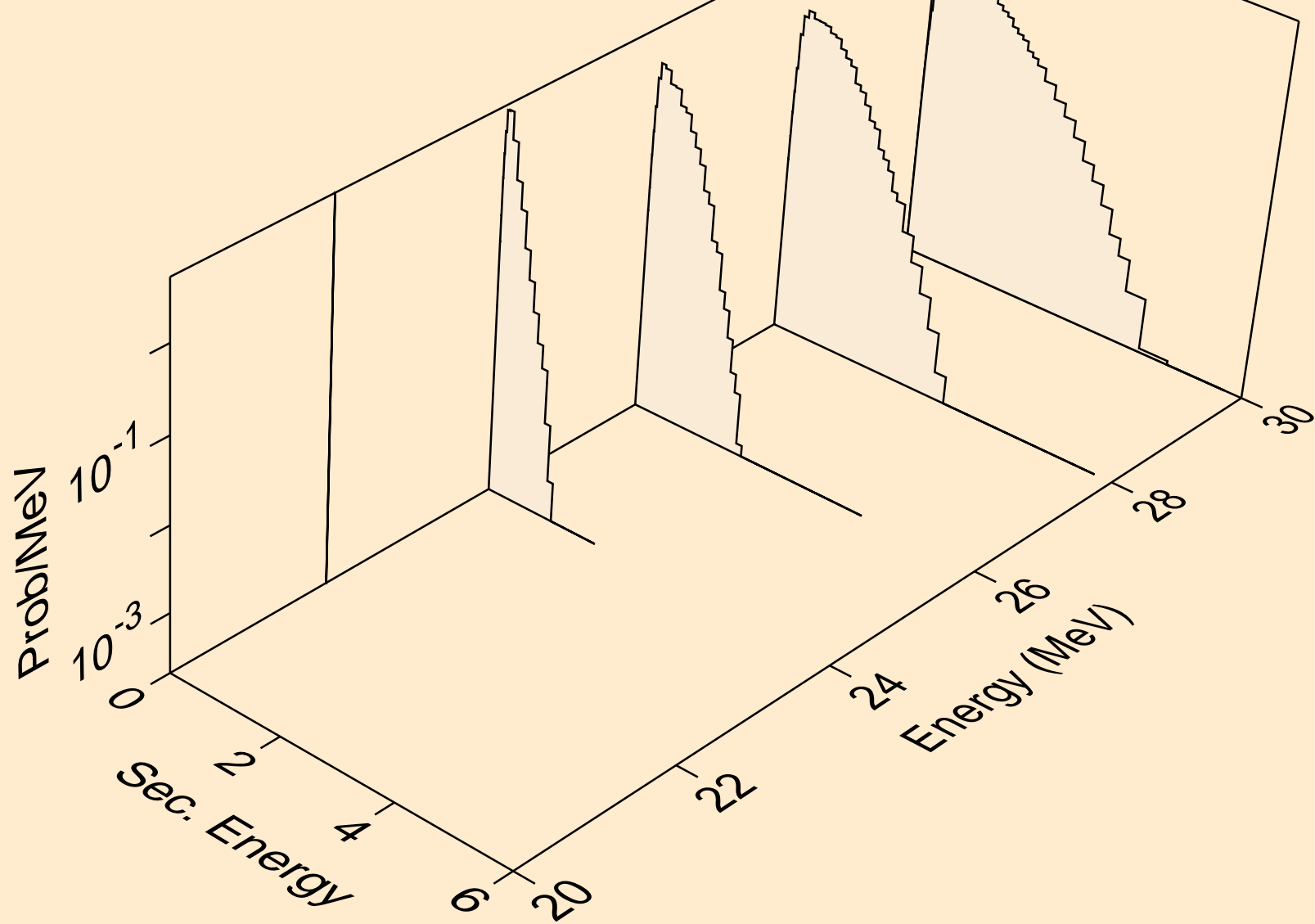

YB153 PROTON ACER TENDL-2021 LIBRARY; T=0.K  
neutrons from (p,2np)

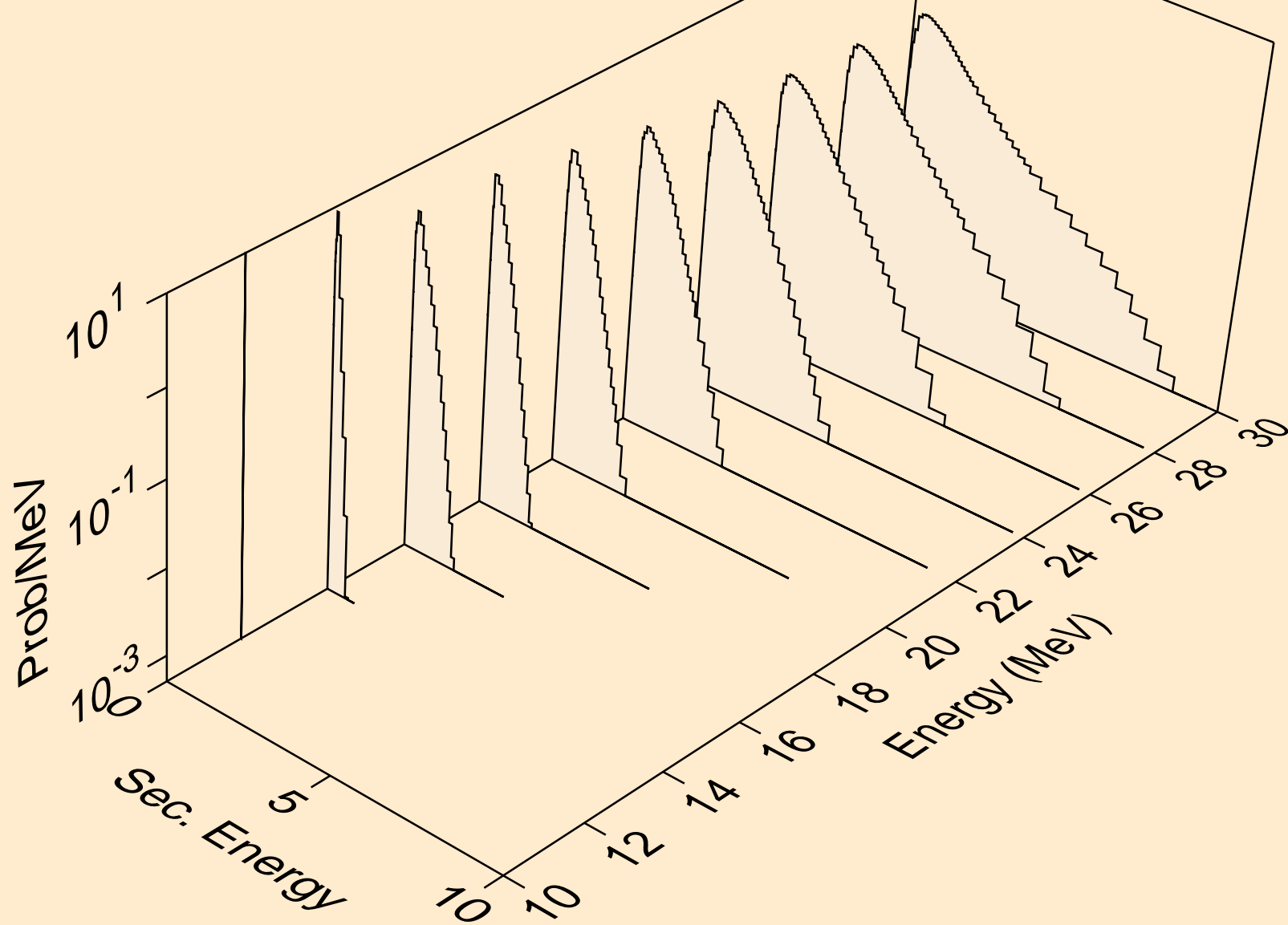

YB153 PROTON ACER TENDL-2021 LIBRARY; T=0.K  
neutrons from (p,npa)

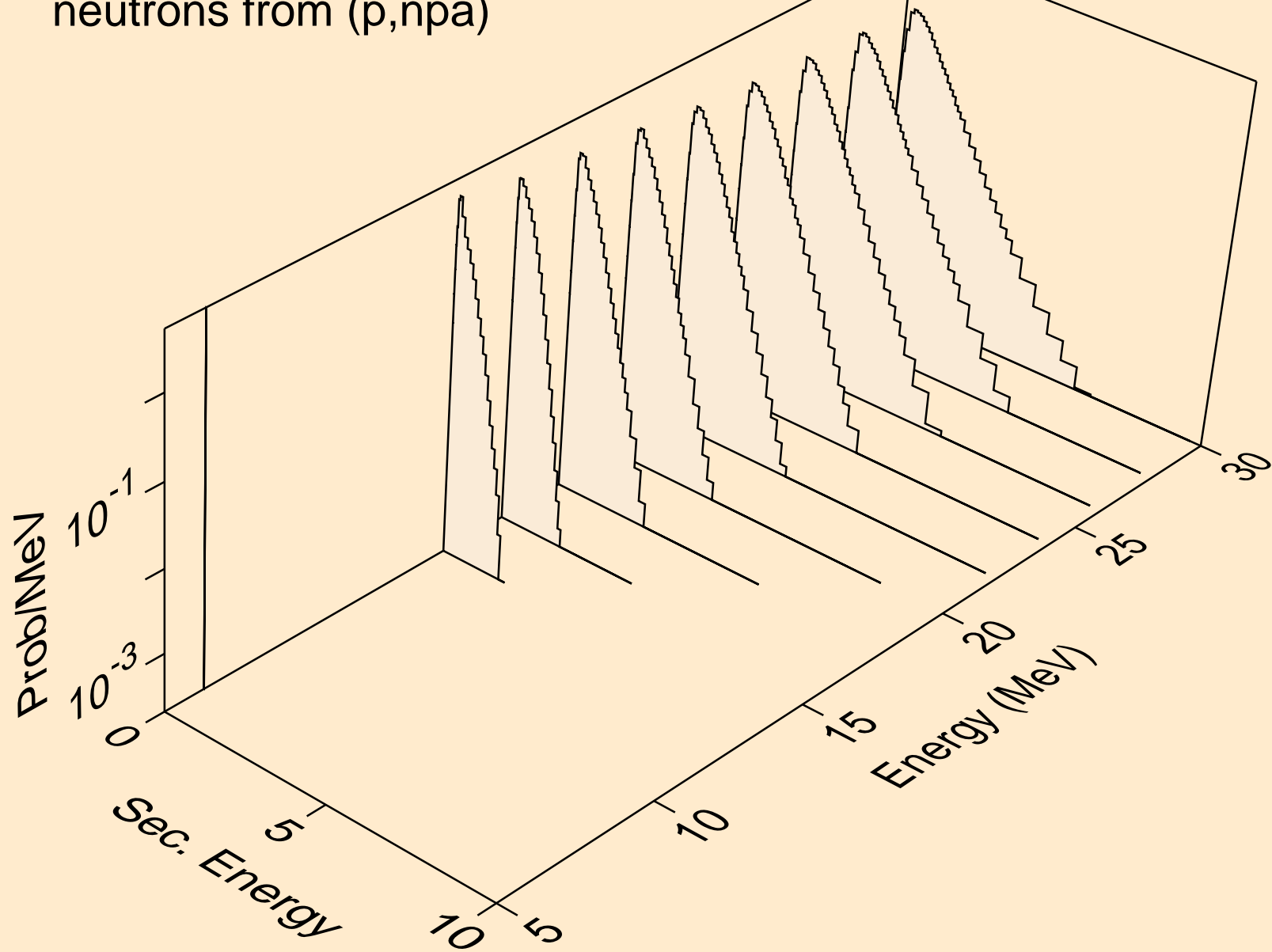

YB153 PROTON ACER TENDL-2021 LIBRARY; T=0.K  
deuterons from (p,x)

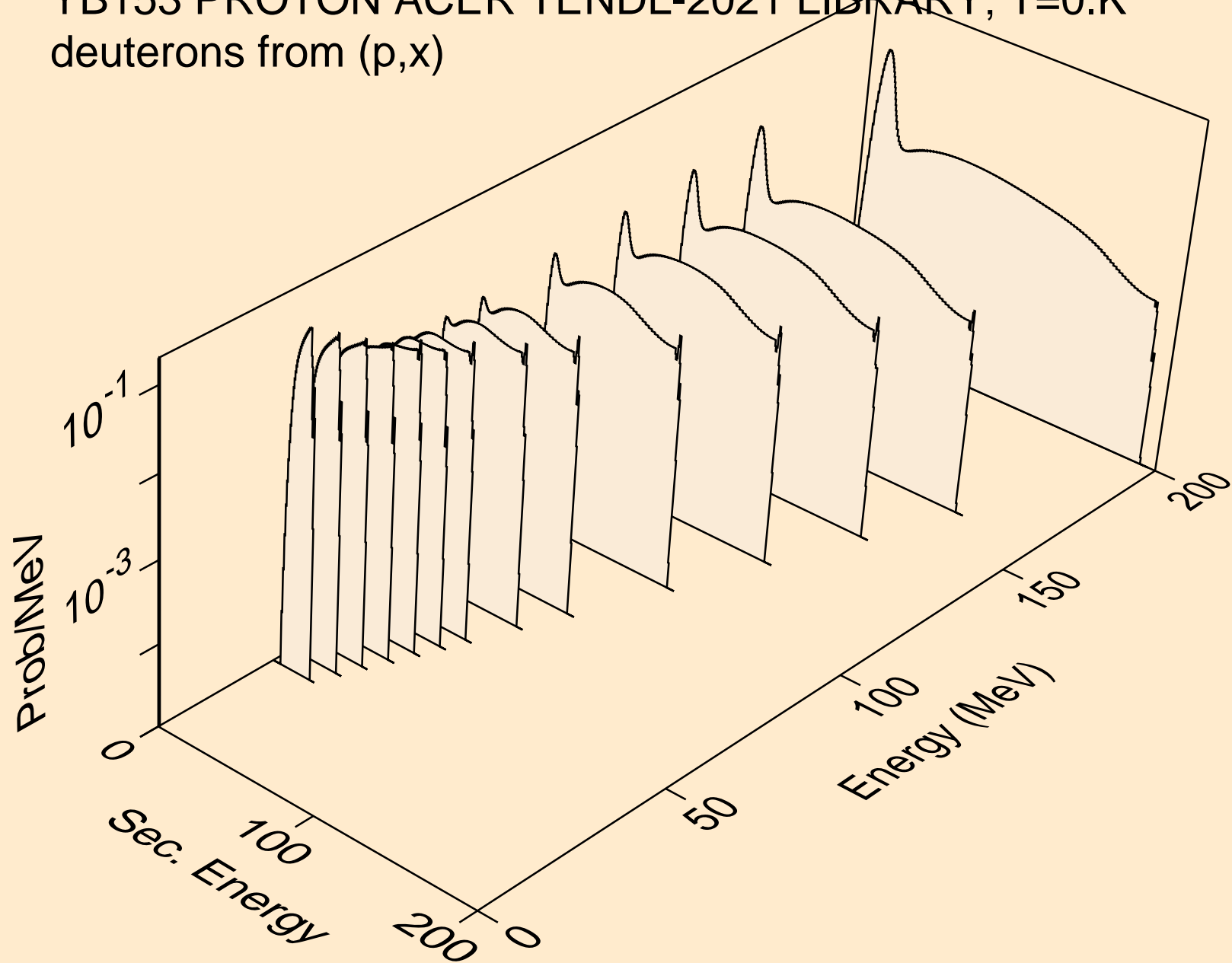

YB153 PROTON ACER TENDL-2021 LIBRARY; T=0.K  
deuterons from (p,n\*)d

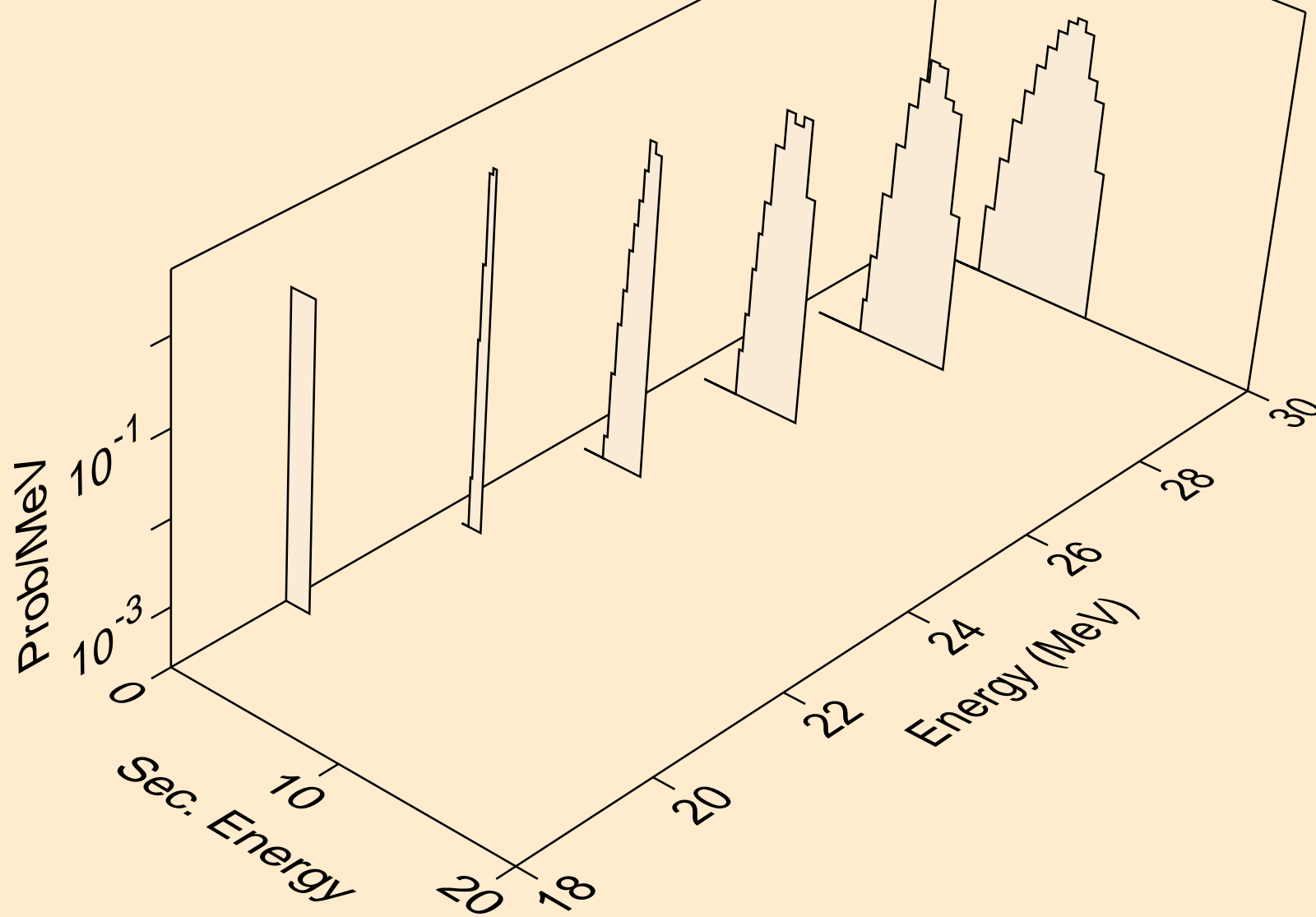



YB153 PROTON ACER TENDL-2021 LIBRARY; T=0.K  
deuterons from (p,d)

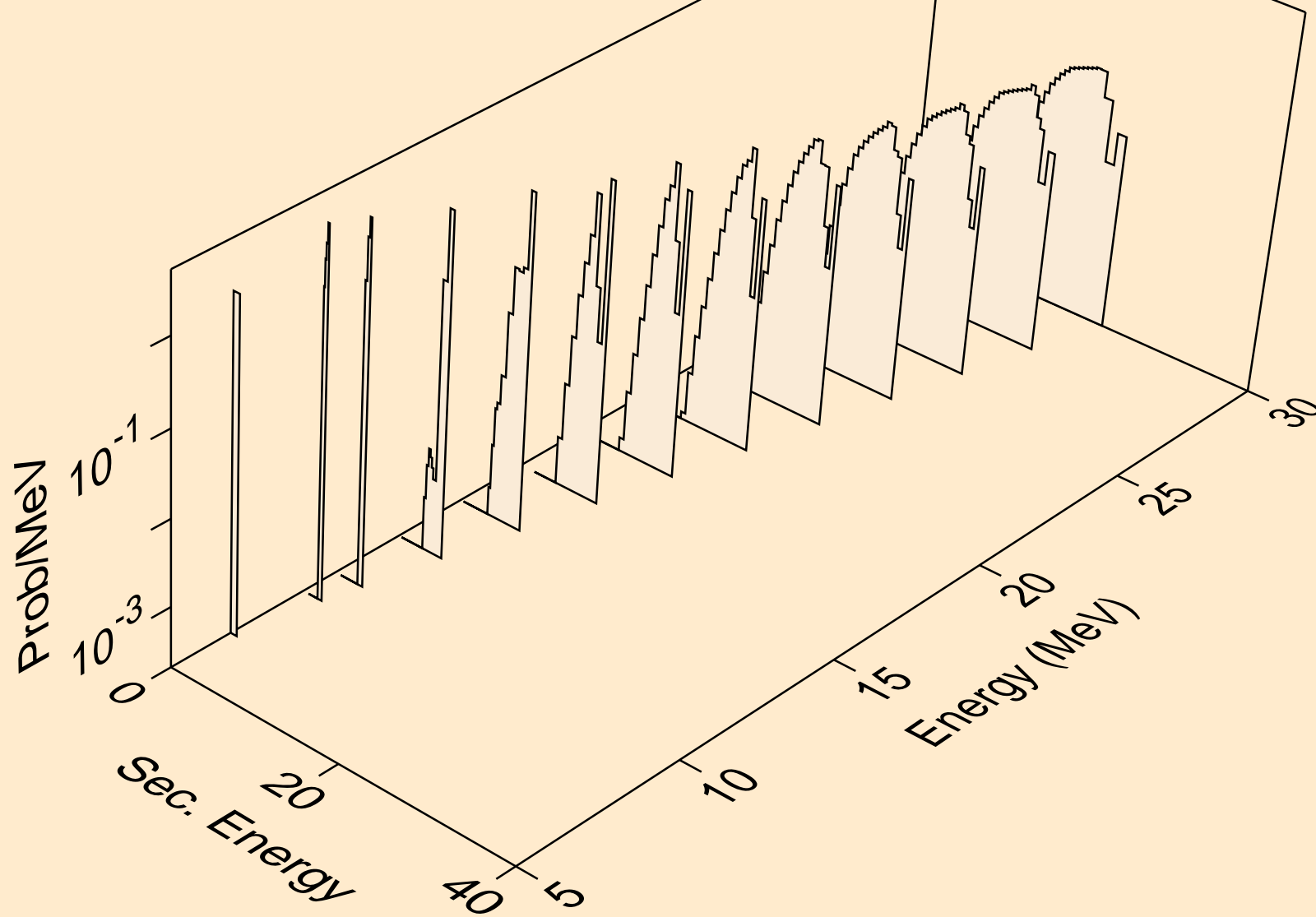

YB153 PROTON ACER TENDL-2021 LIBRARY; T=0.K  
deuterons from (p,pd)

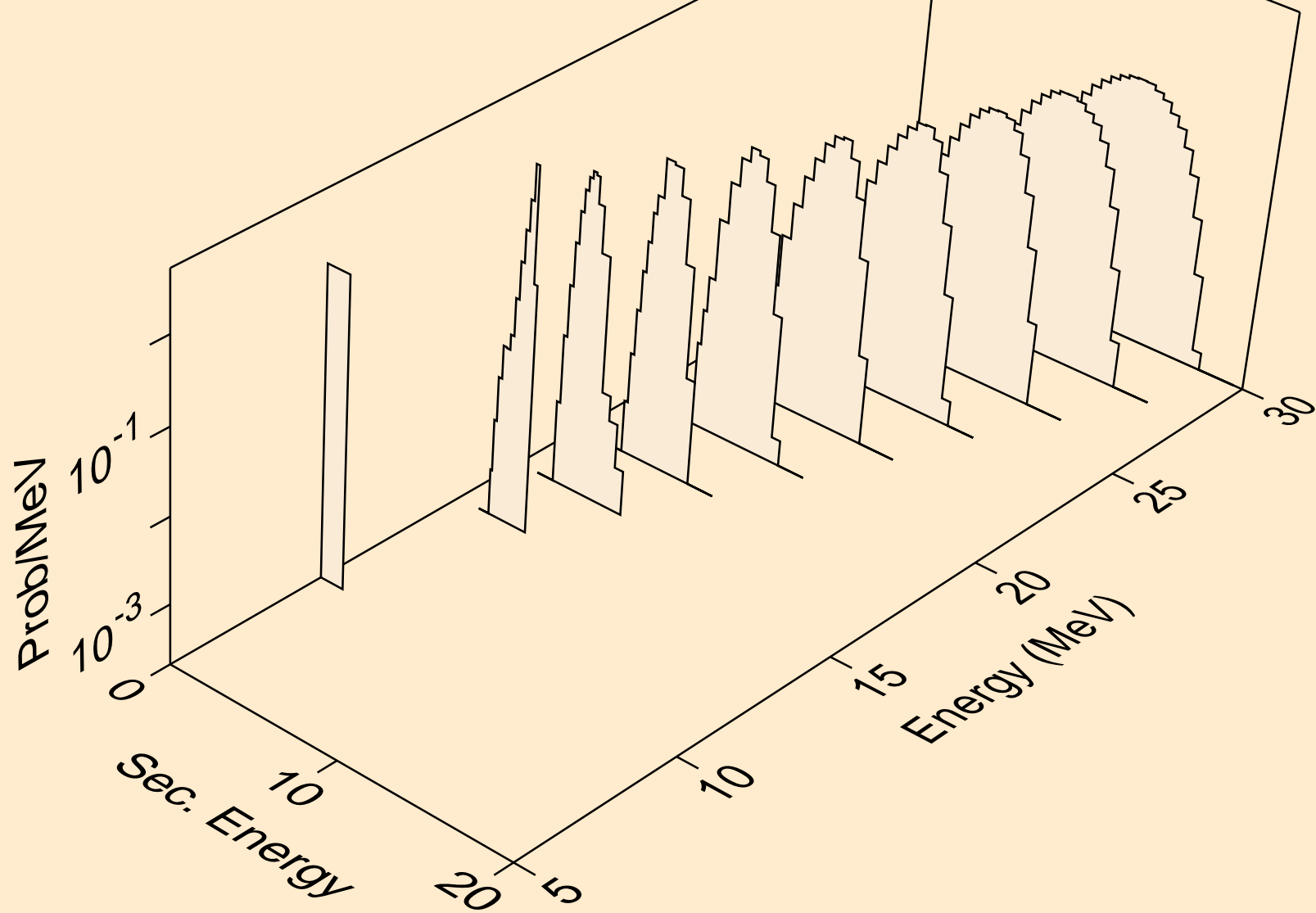

YB153 PROTON ACER TENDL-2021 LIBRARY; T=0.K  
deuterons from (p,da)

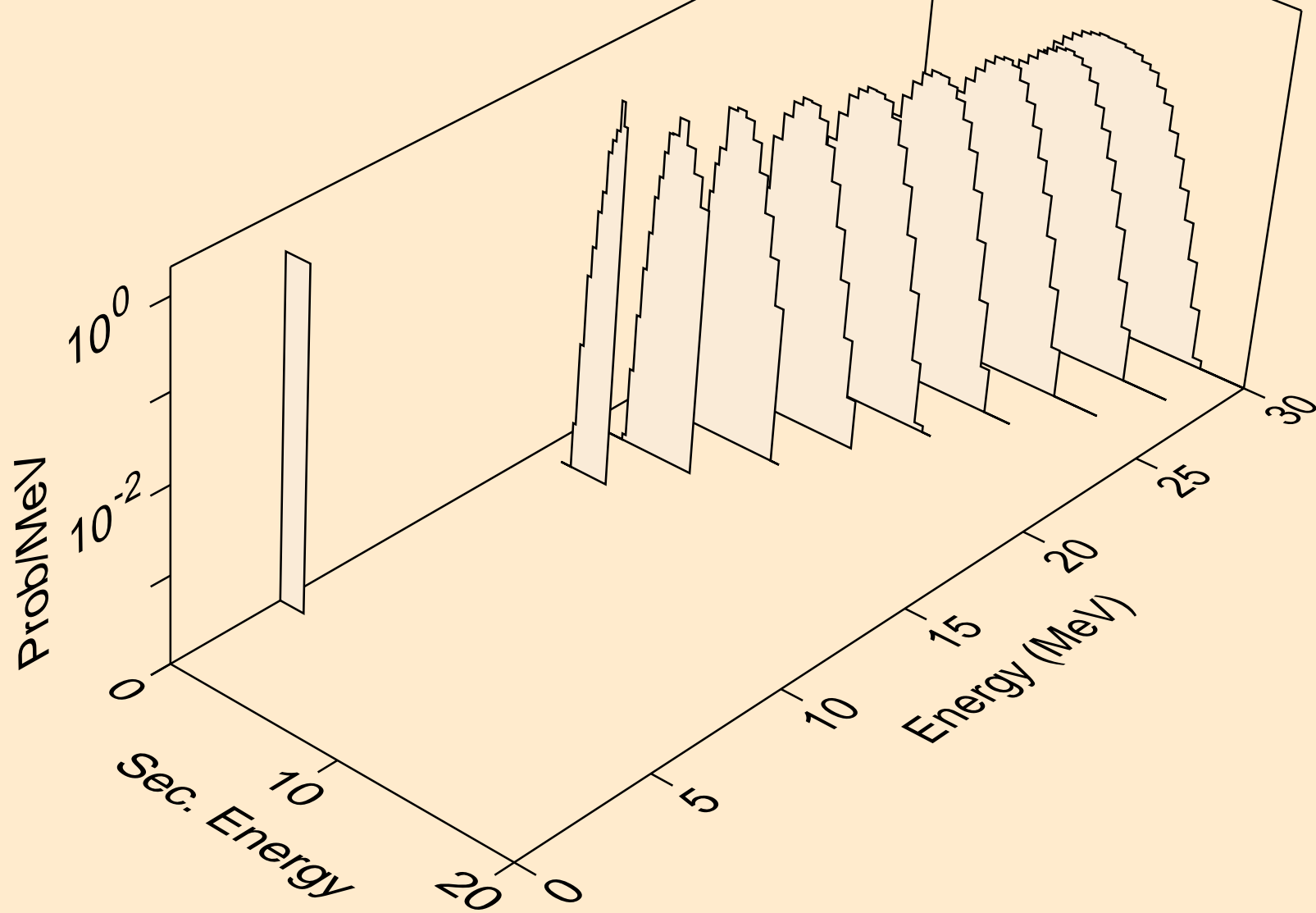

YB153 PROTON ACER TENDL-2021 LIBRARY; T=0.K  
tritons from (p,x)

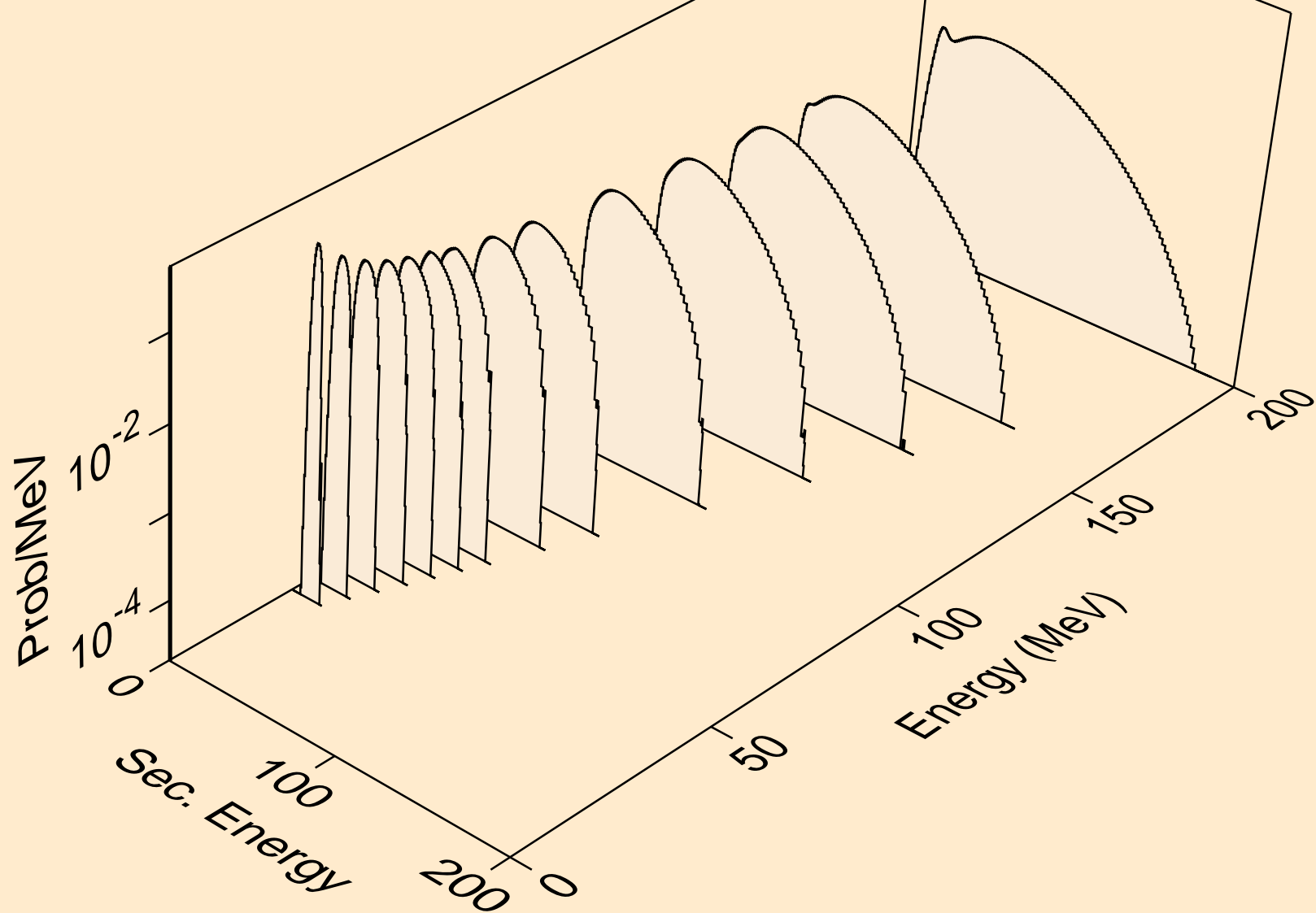

YB153 PROTON ACER TENDL-2021 LIBRARY; T=0.K  
tritons from (p,t)

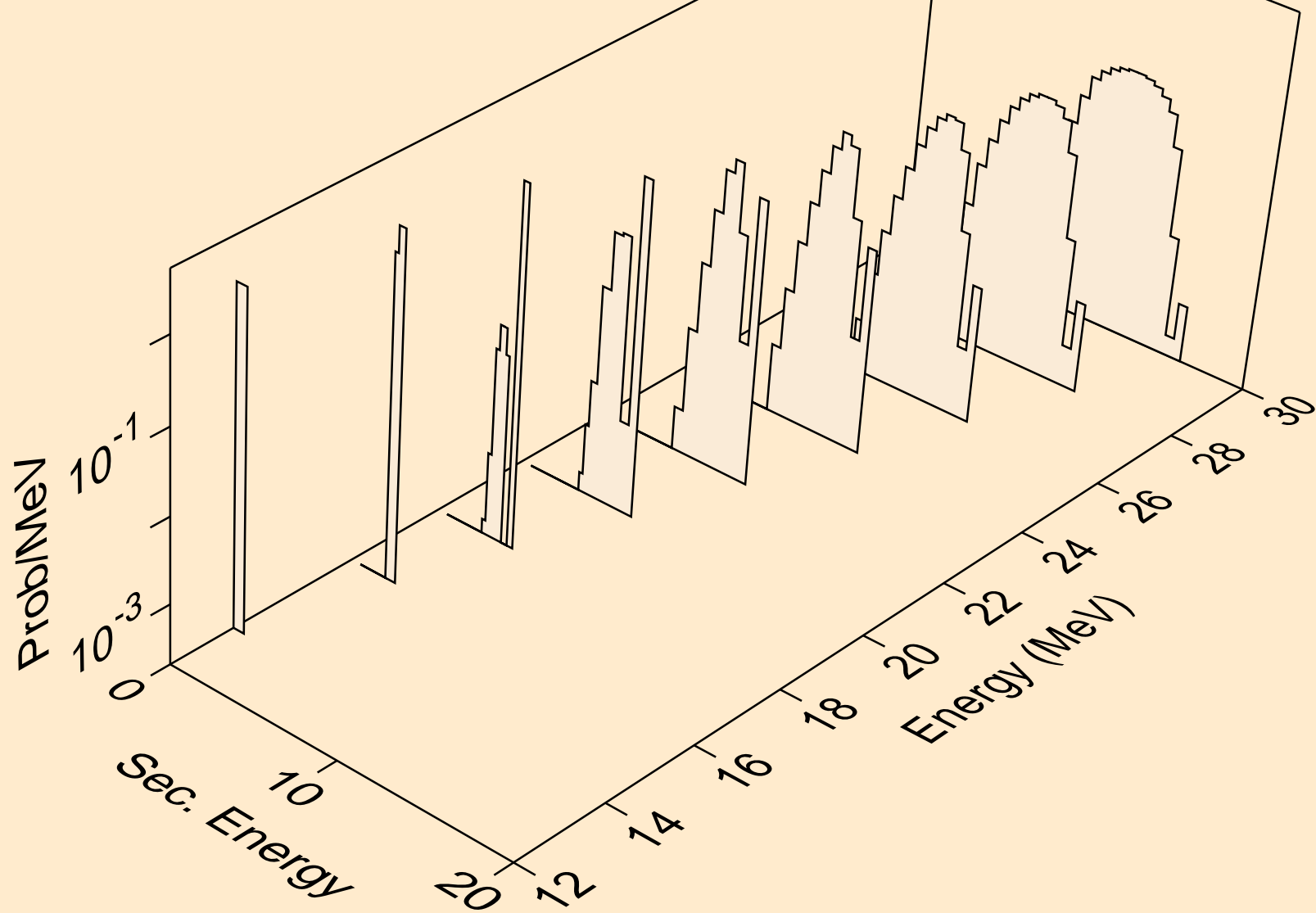

YB153 PROTON ACER TENDL-2021 LIBRARY; T=0.K  
tritons from (p,pt)

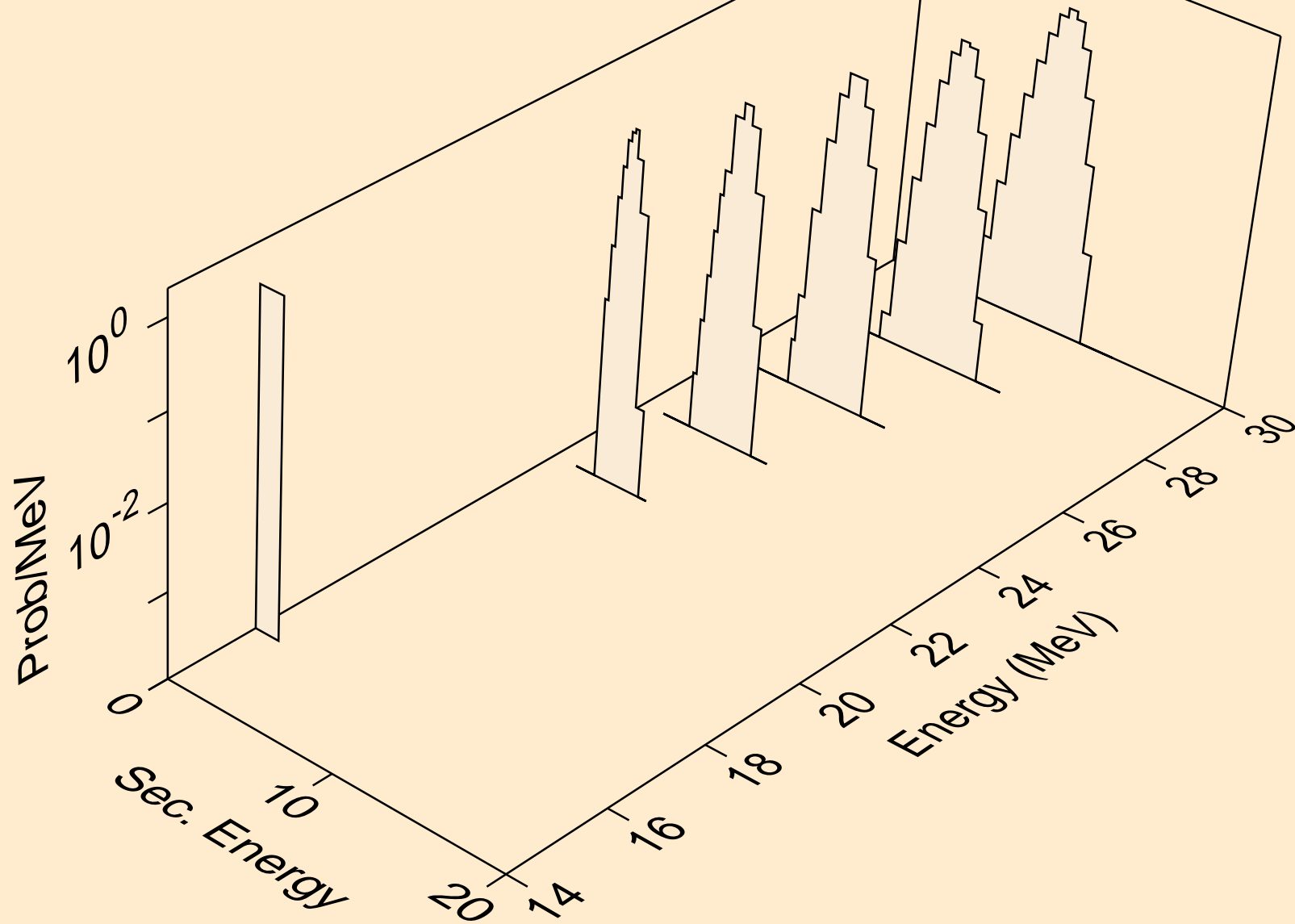

YB153 PROTON ACER TENDL-2021 LIBRARY; T=0.K  
he3s from (p,x)

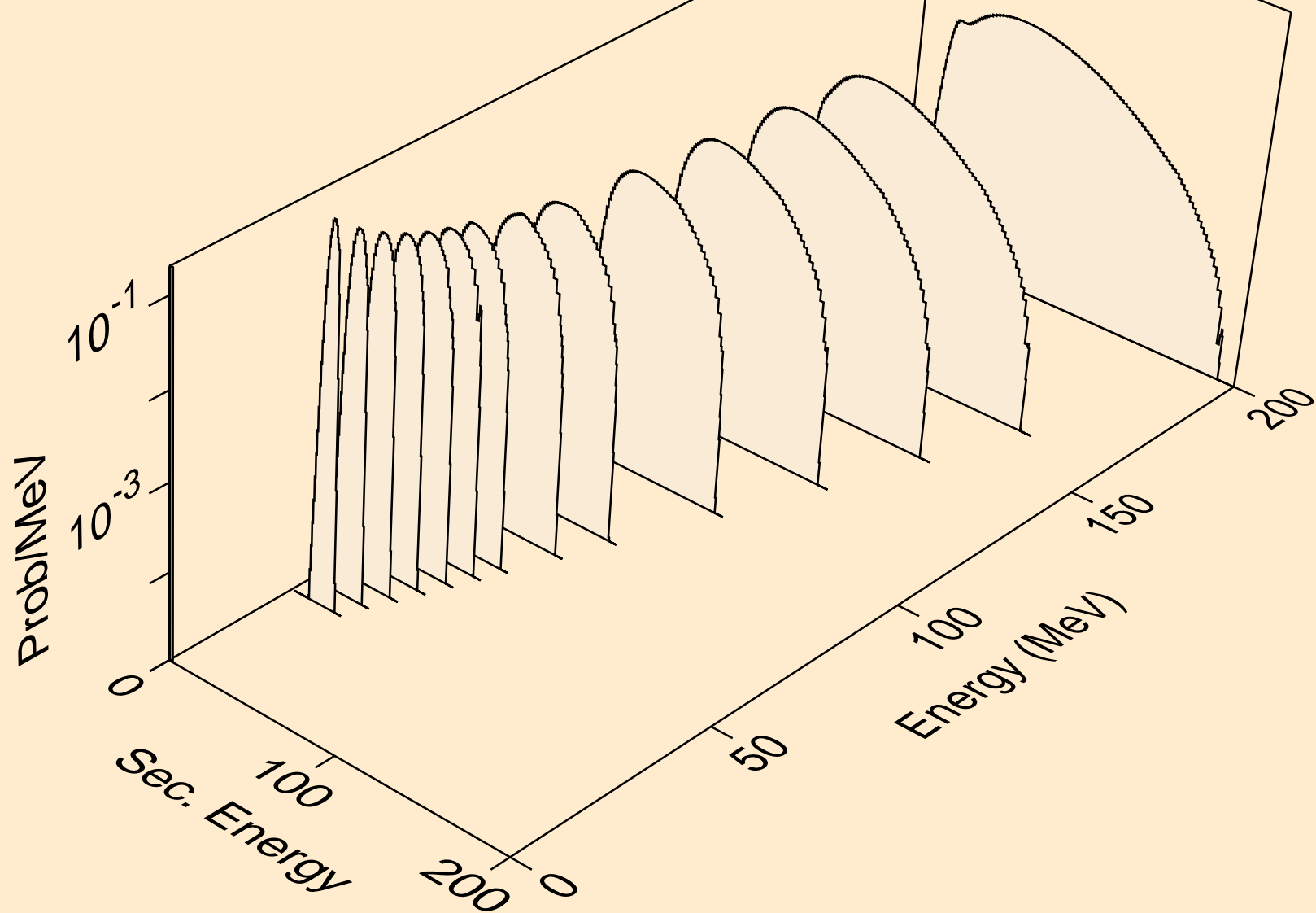

YB153 PROTON ACER TENDL-2021 LIBRARY; T=0.K  
he3s from (p,n\*)he3

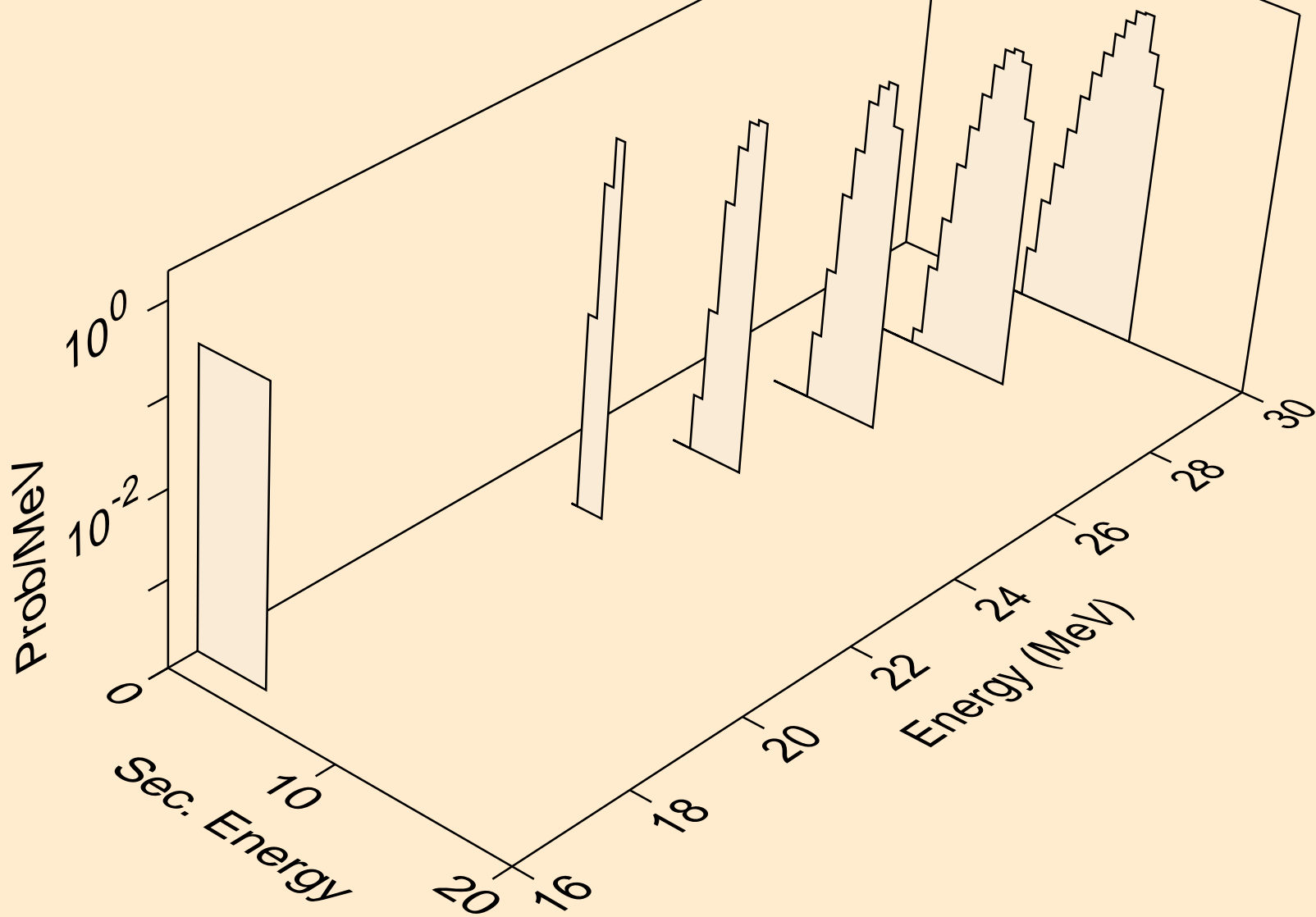



YB153 PROTON ACER TENDL-2021 LIBRARY; T=0.K  
he3s from (p,he3)

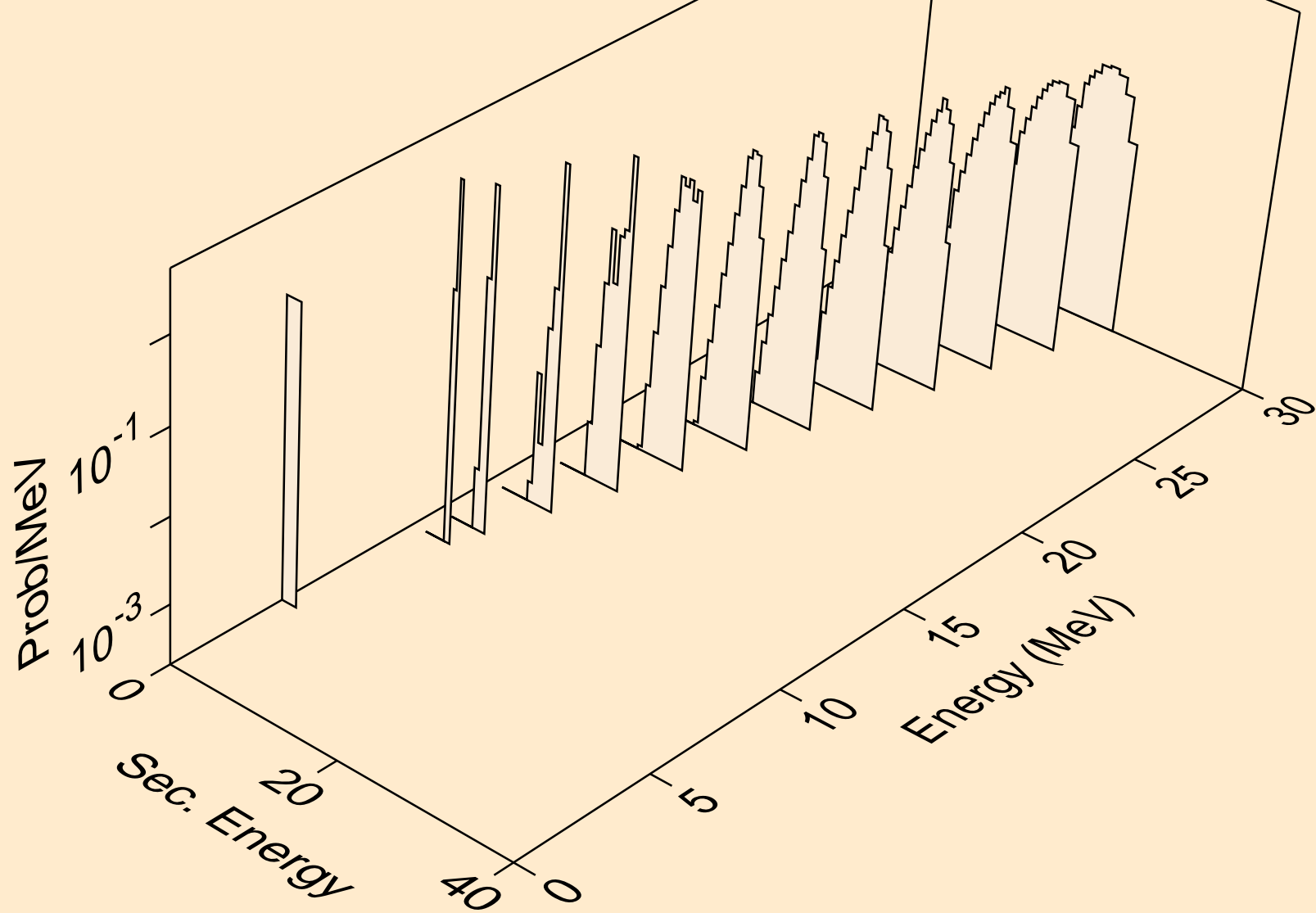

YB153 PROTON ACER TENDL-2021 LIBRARY; T=0.K  
alphas from (p,x)

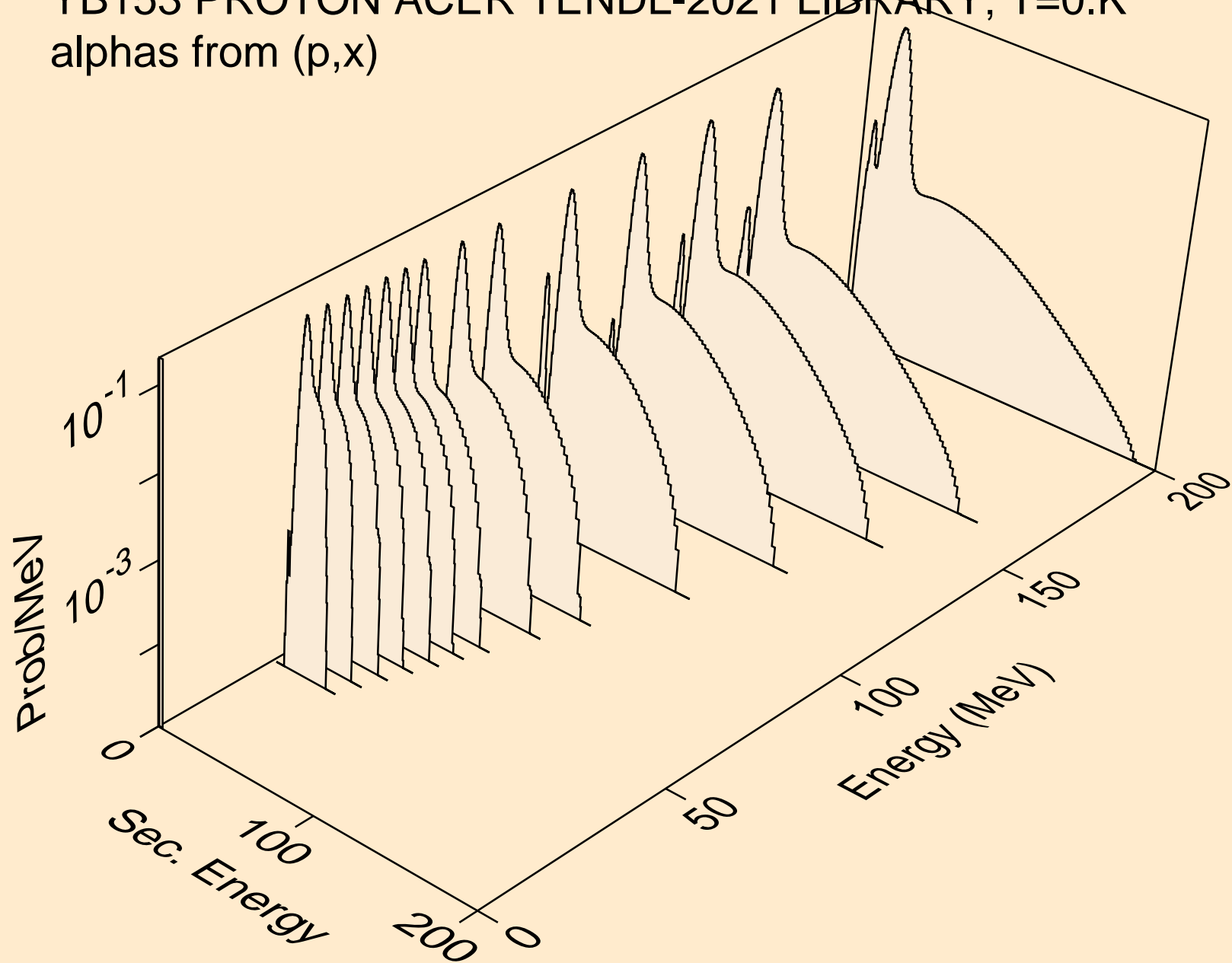

YB153 PROTON ACER TENDL-2021 LIBRARY; T=0.K  
alphas from (p,n\*)a

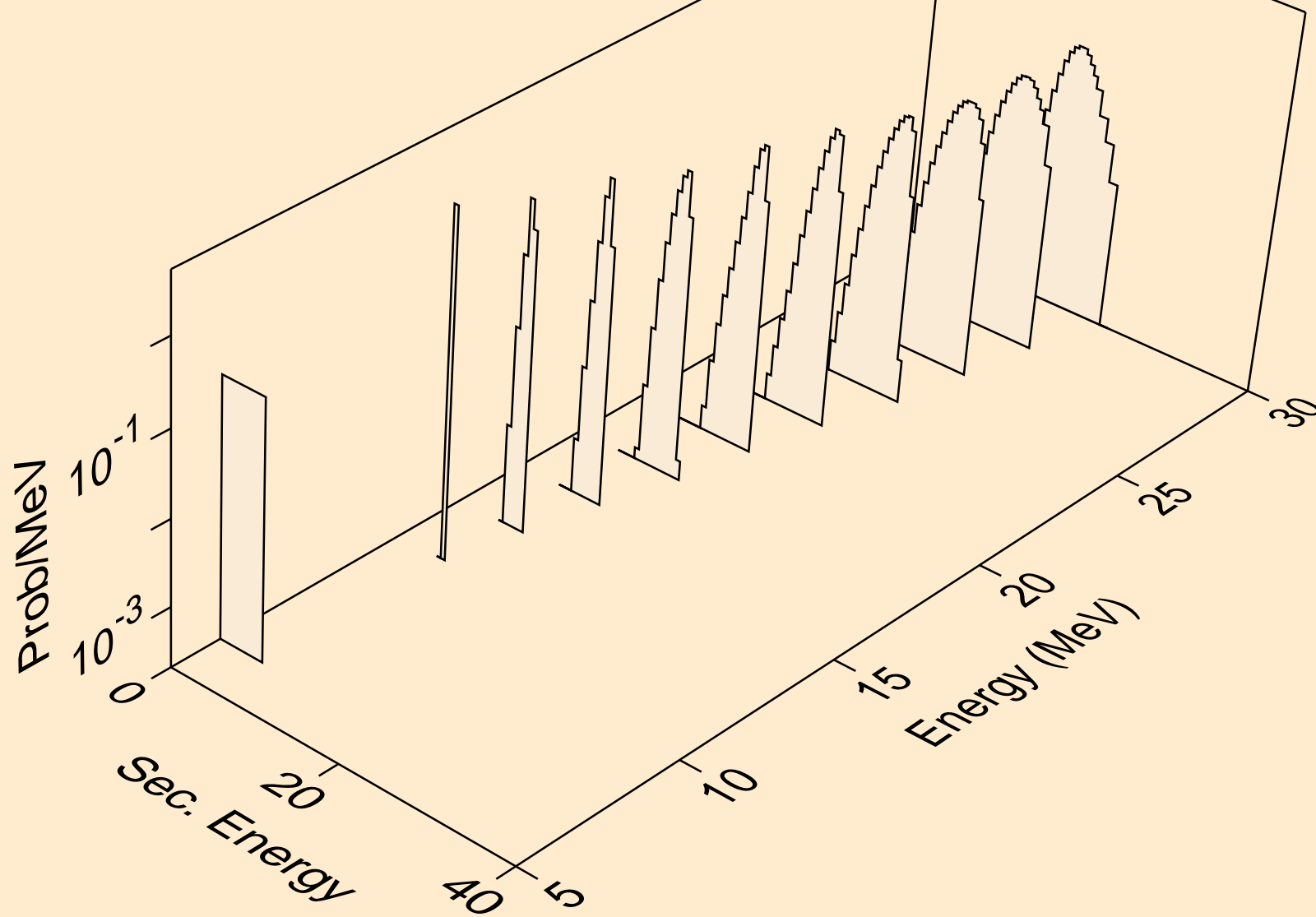

YB153 PROTON ACER TENDL-2021 LIBRARY; T=0.K  
alphas from (p,npa)

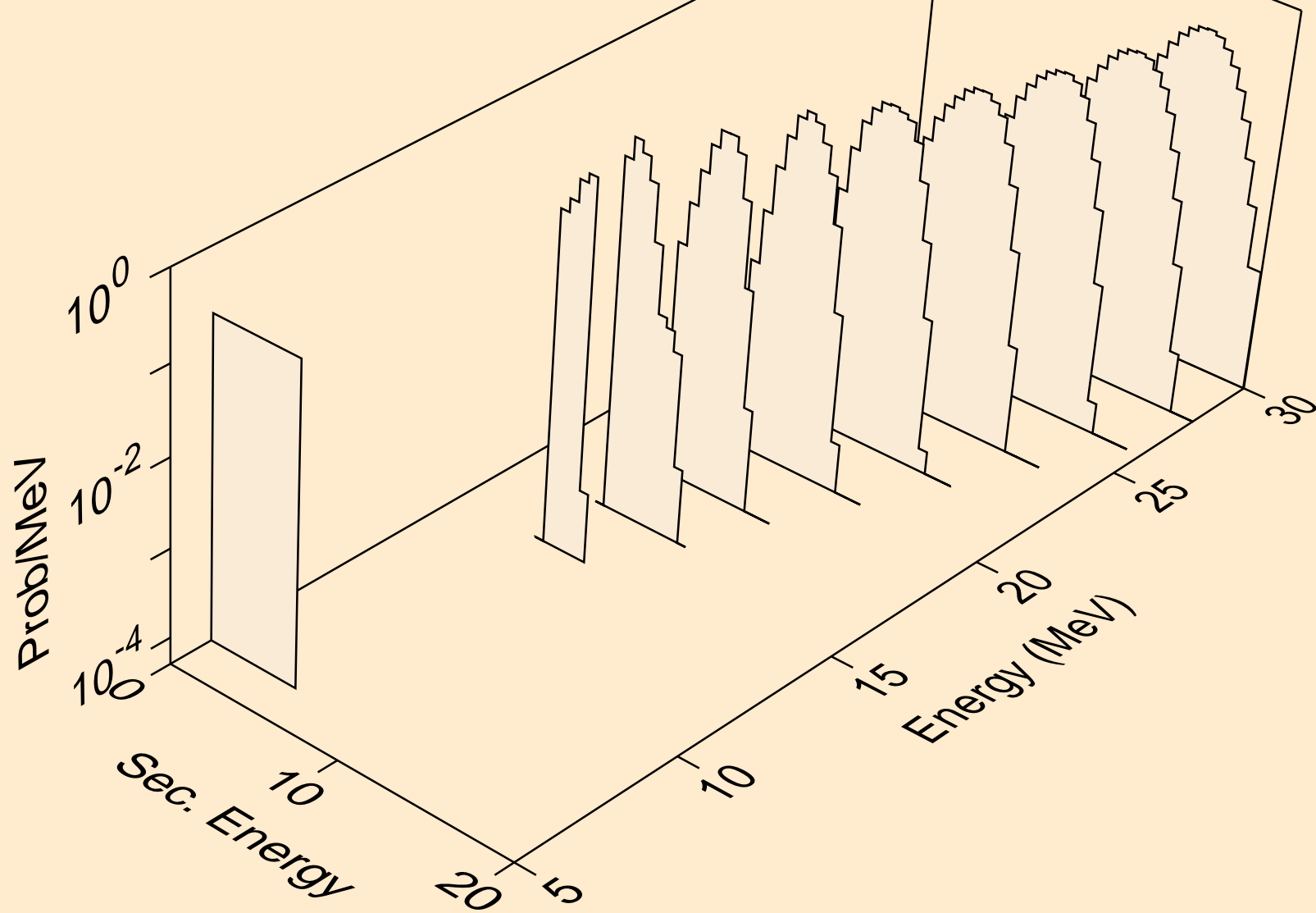

YB153 PROTON ACER TENDL-2021 LIBRARY; T=0.K  
alphas from (p,a)

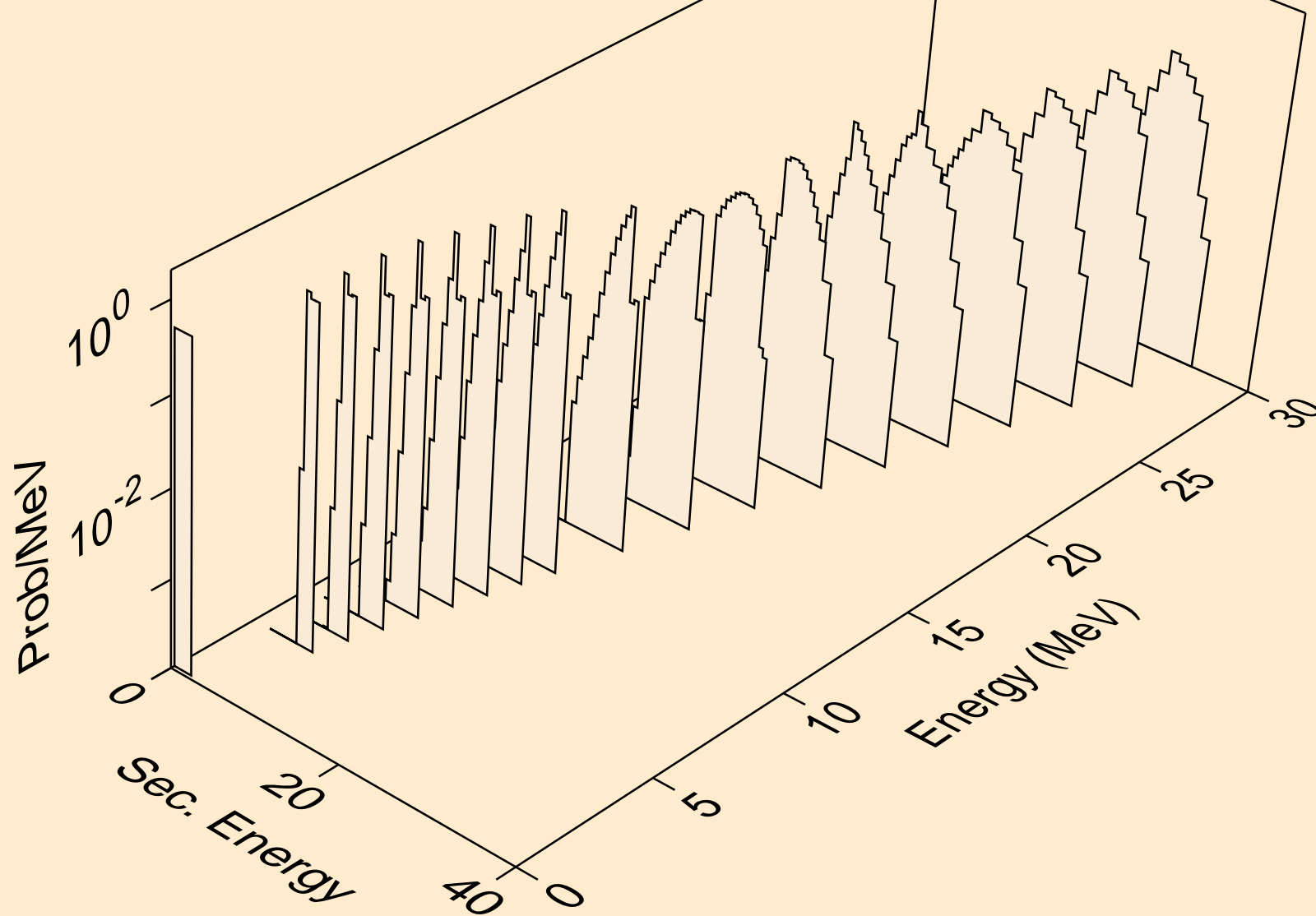

YB153 PROTON ACER TENDL-2021 LIBRARY; T=0.K  
alphas from (p,2a)

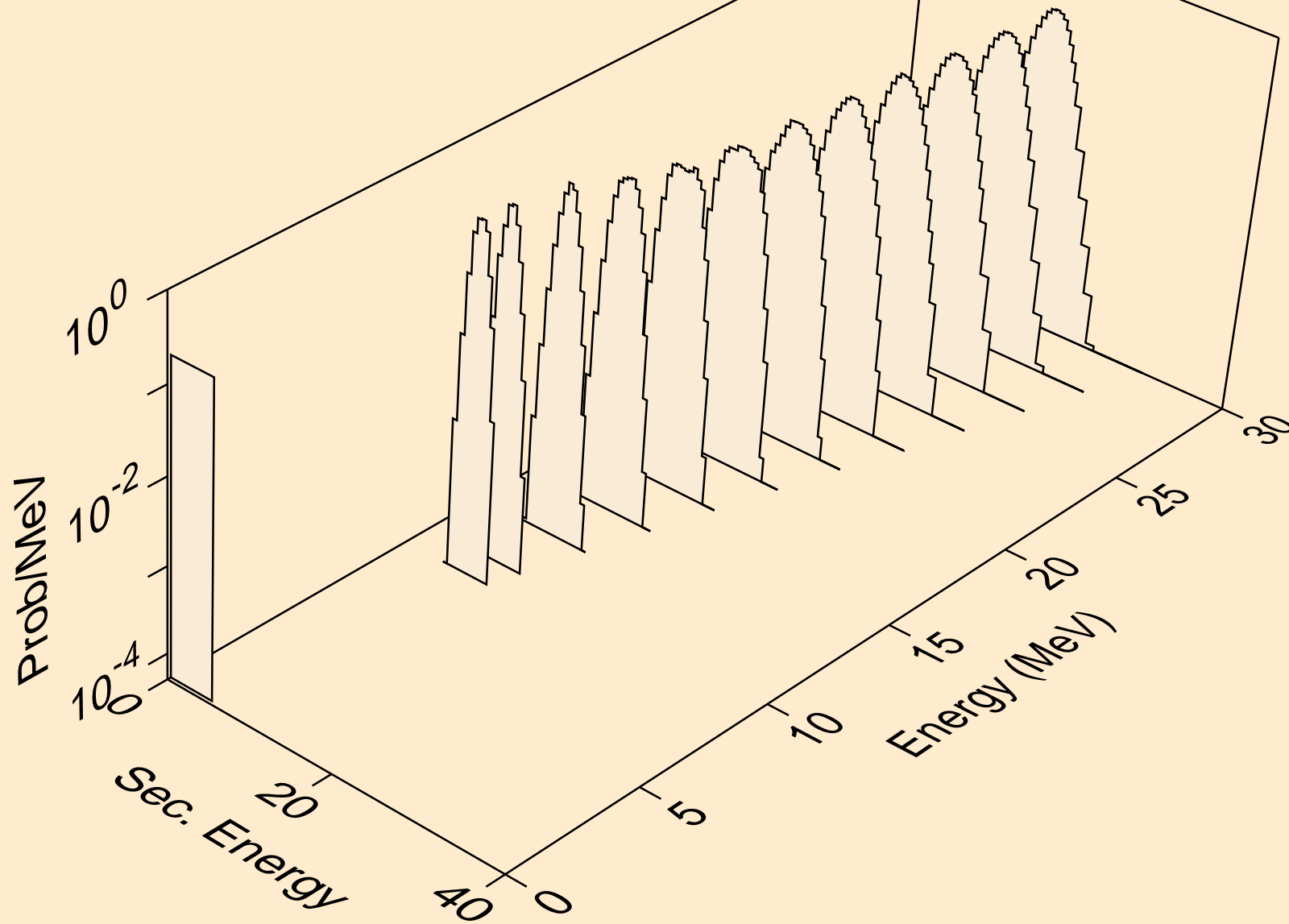

YB153 PROTON ACER TENDL-2021 LIBRARY; T=0.K  
alphas from (p,pa)

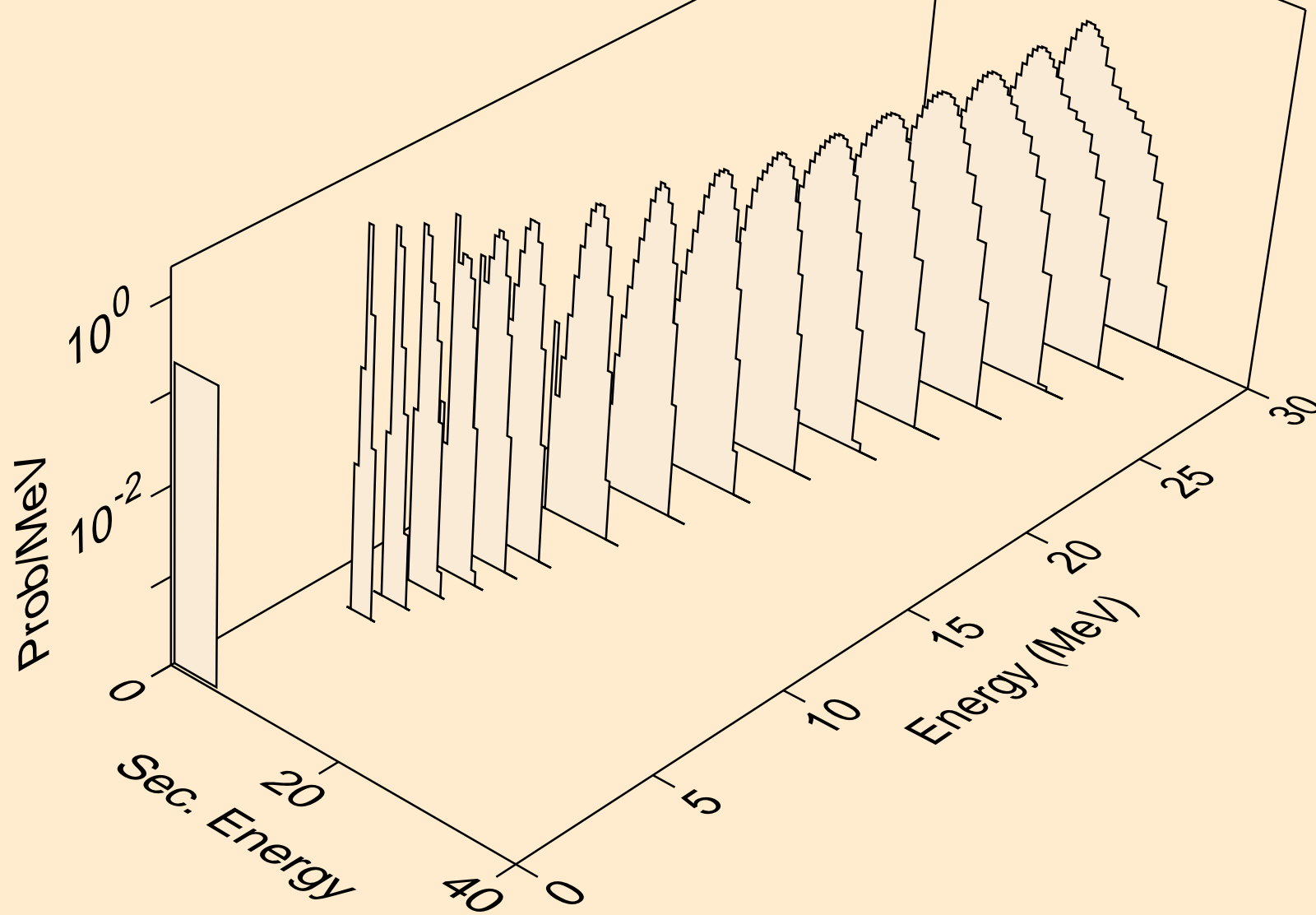

YB153 PROTON ACER TENDL-2021 LIBRARY; T=0.K  
alphas from (p,da)

