

YB177M PROTON ACER TENDL-2021 LIBRARY; T=0.K  
Principal cross sections

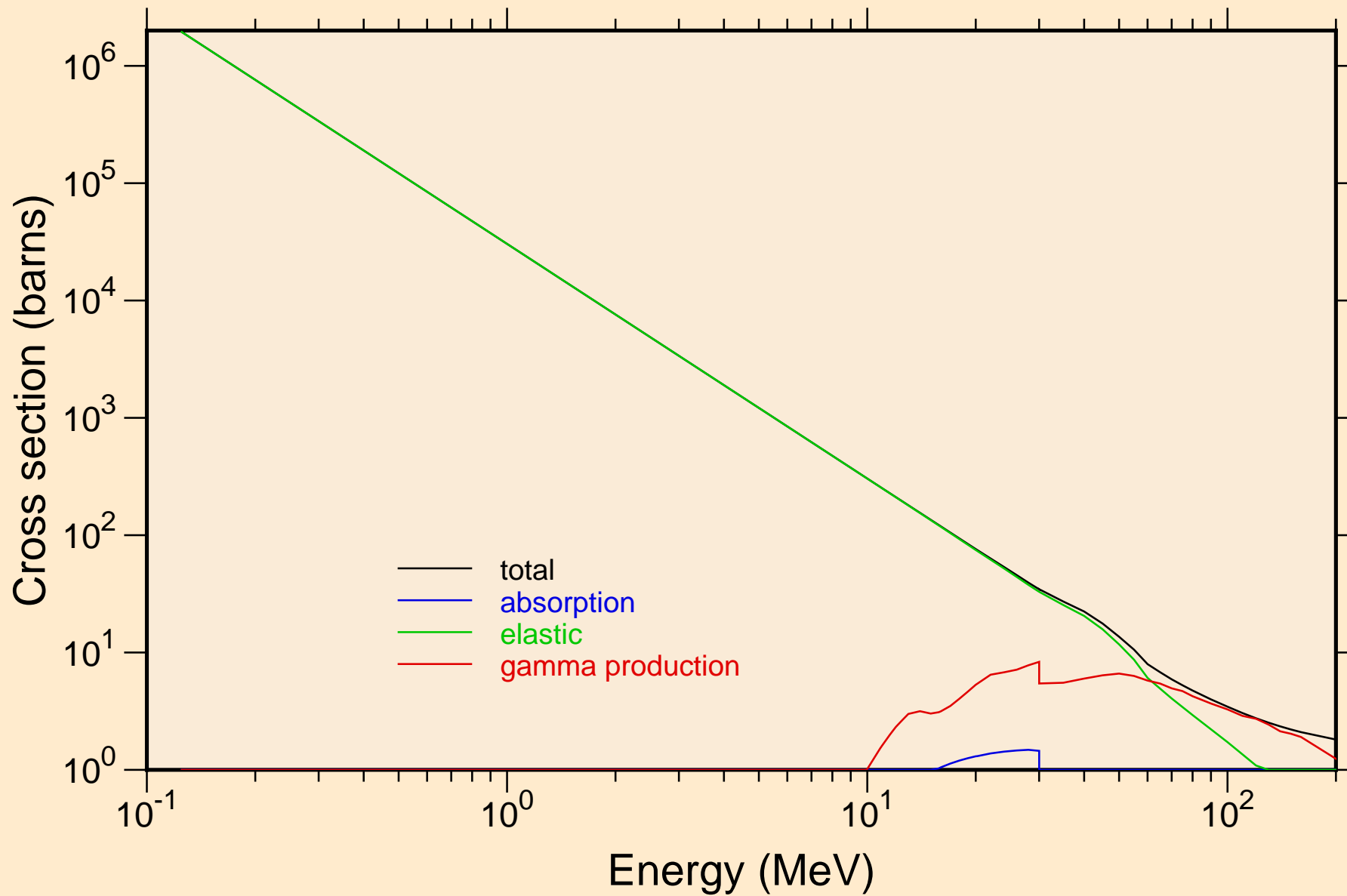

# YB177M PROTON ACER TENDL-2021 LIBRARY; T=0.K

## Heating

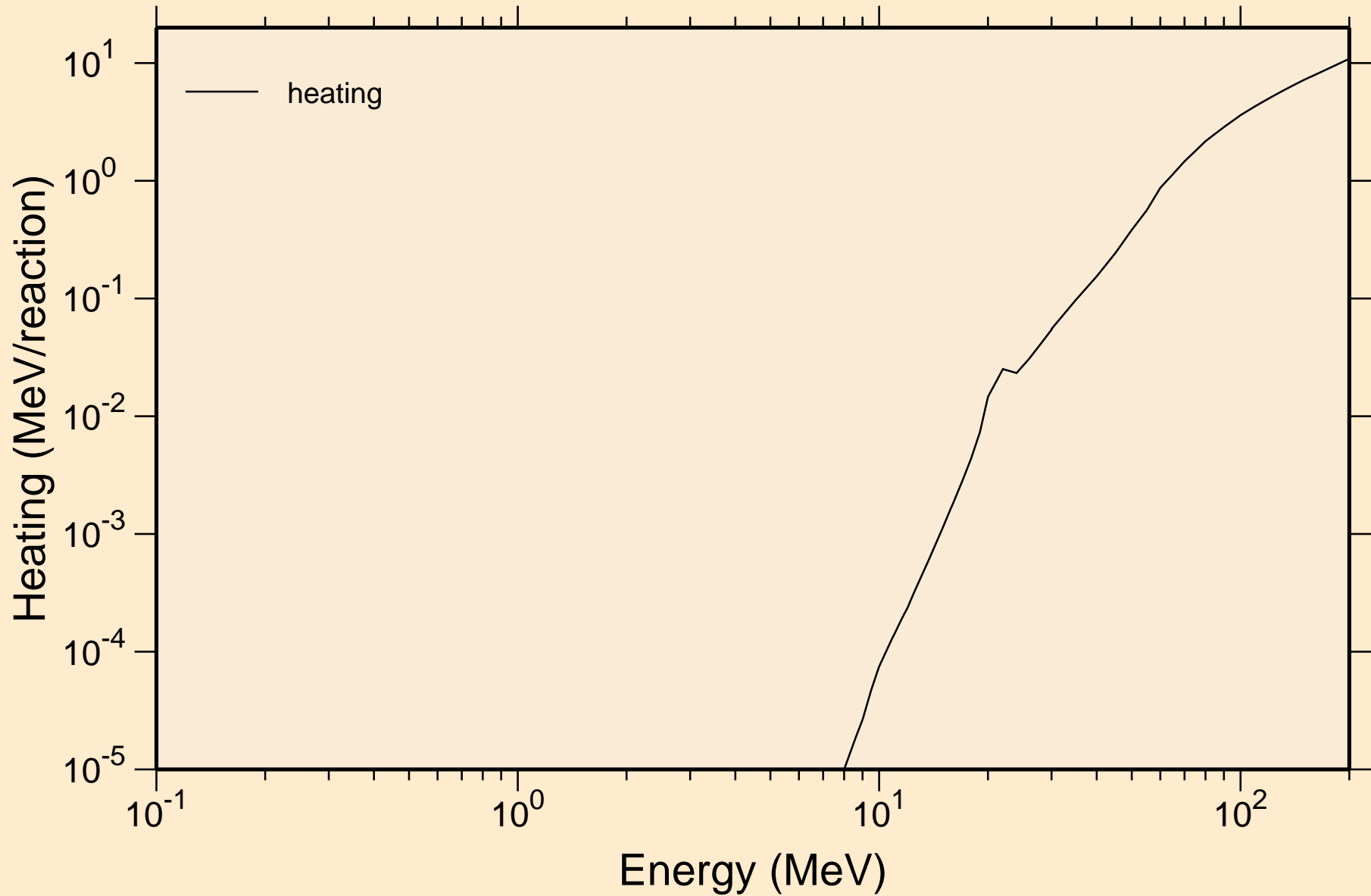

# YB177M PROTON ACER TENDL-2021 LIBRARY; T=0.K

## Principal cross sections

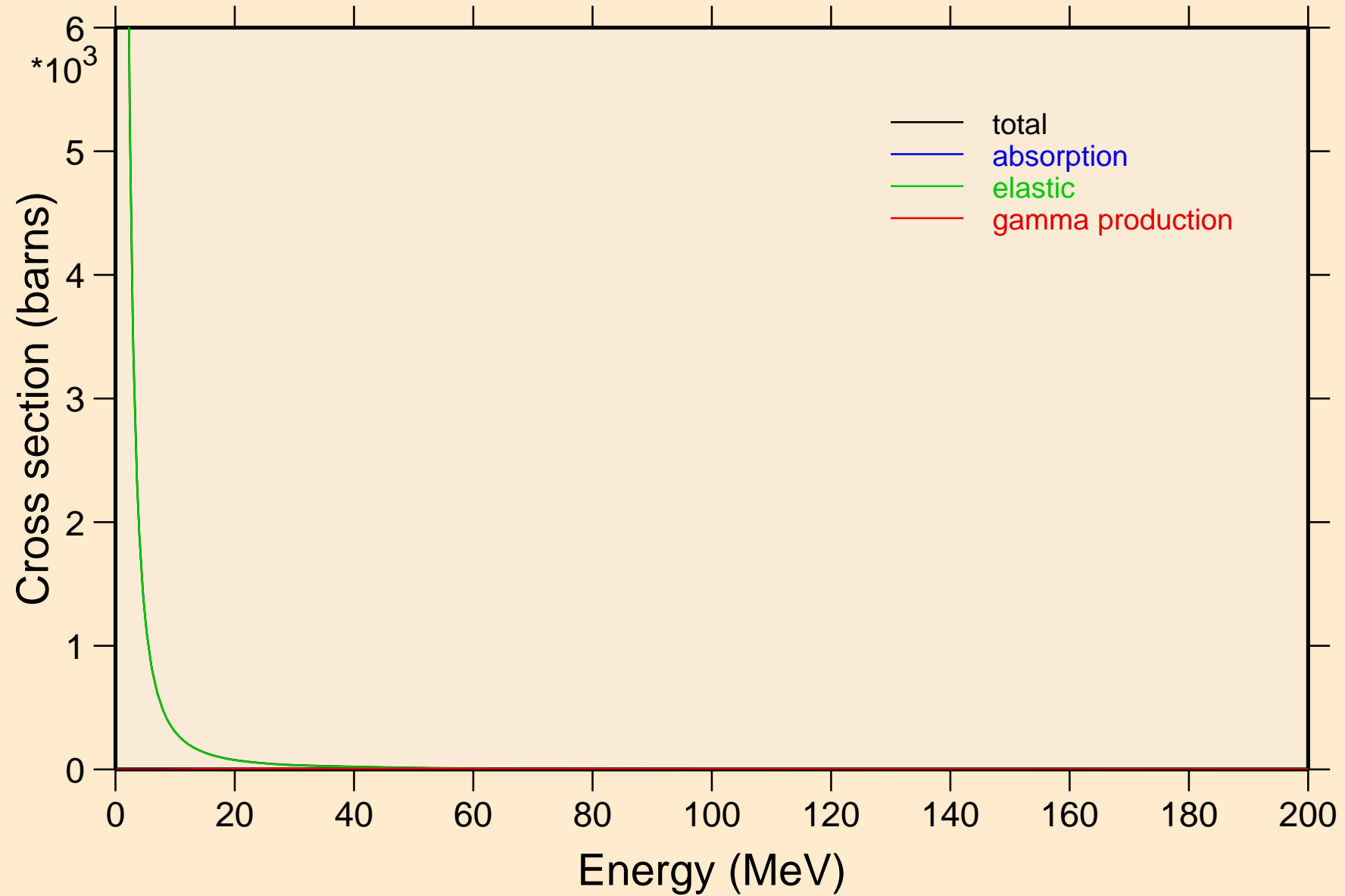

YB177M PROTON ACER TENDL-2021 LIBRARY; T=0.K

Heating

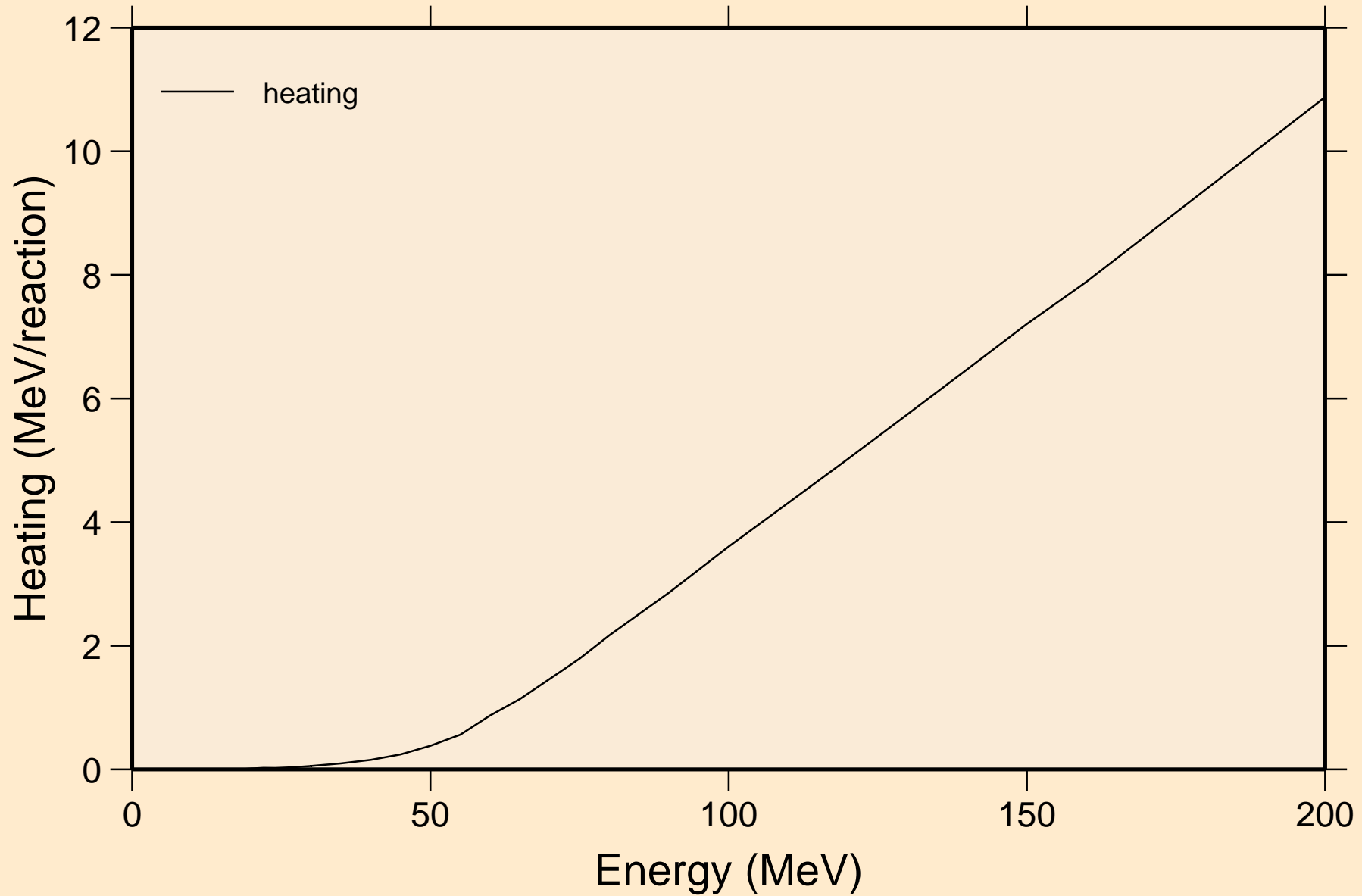

YB177M PROTON ACER TENDL-2021 LIBRARY; T=0.K  
Threshold reactions

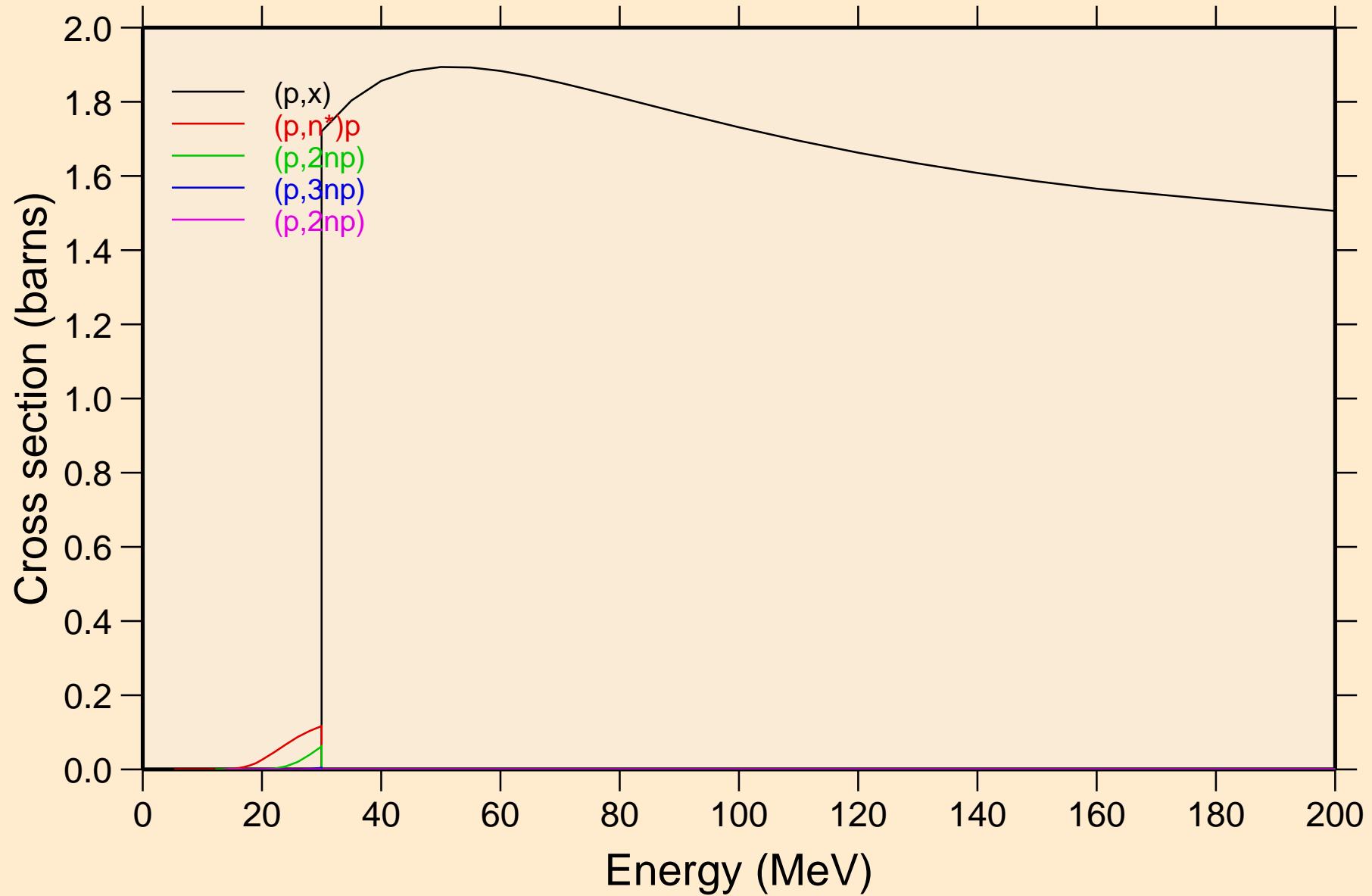

YB177M PROTON ACER TENDL-2021 LIBRARY; T=0.K  
Threshold reactions

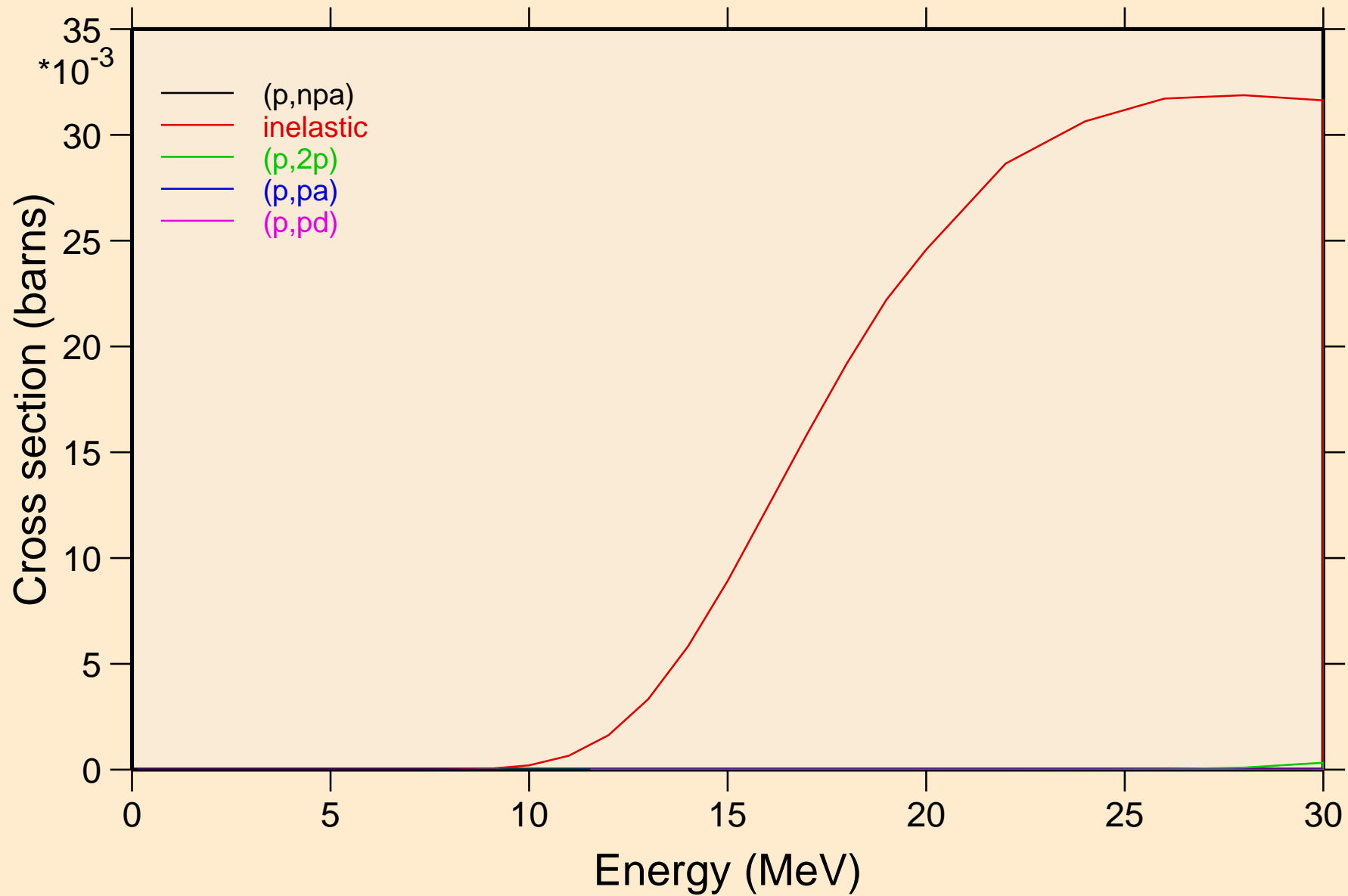

YB177M PROTON ACER TENDL-2021 LIBRARY; T=0.K  
Threshold reactions

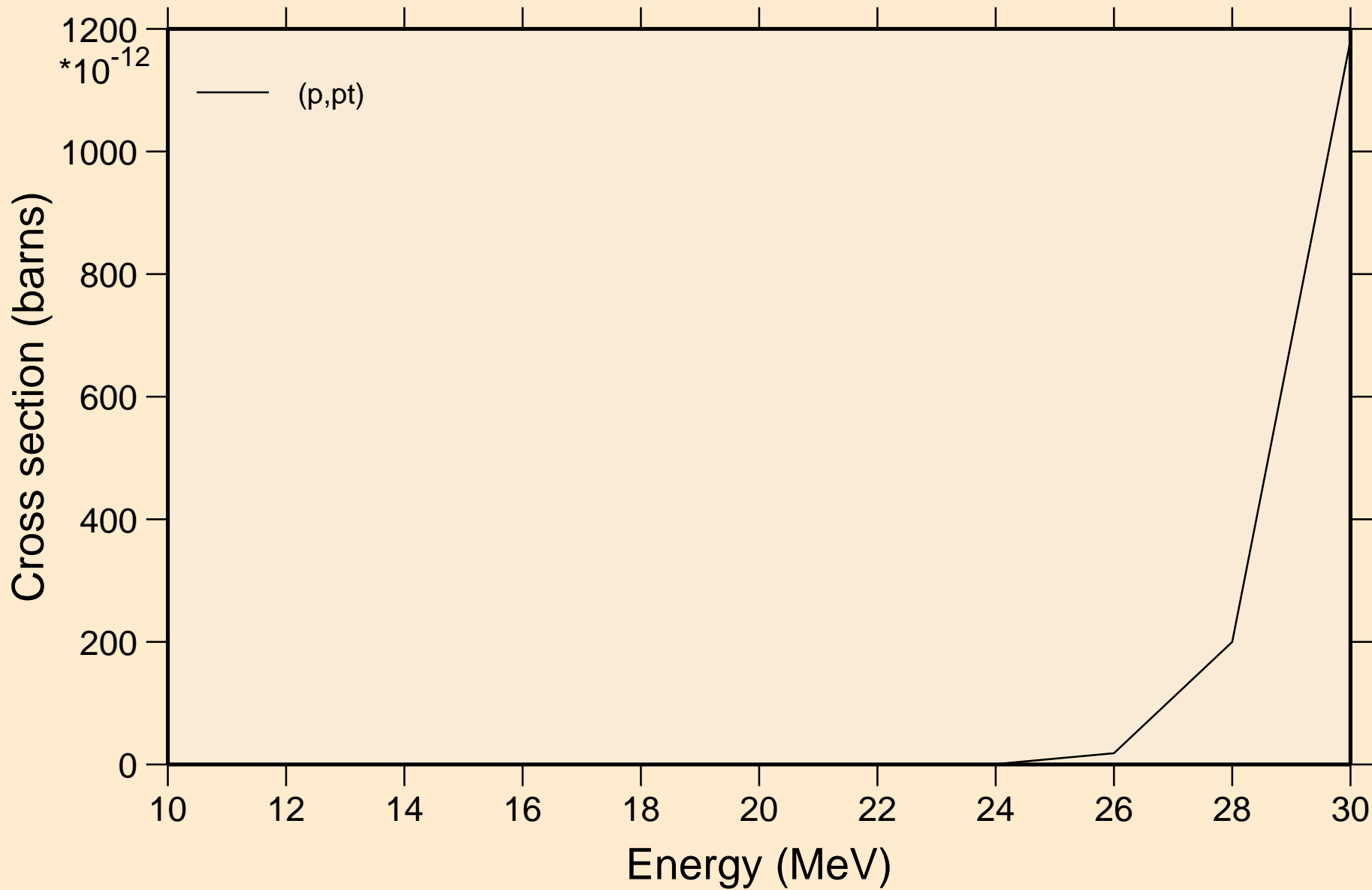

YB177M PROTON ACER TENDL-2021 LIBRARY; T=0.K  
angular distribution for elastic

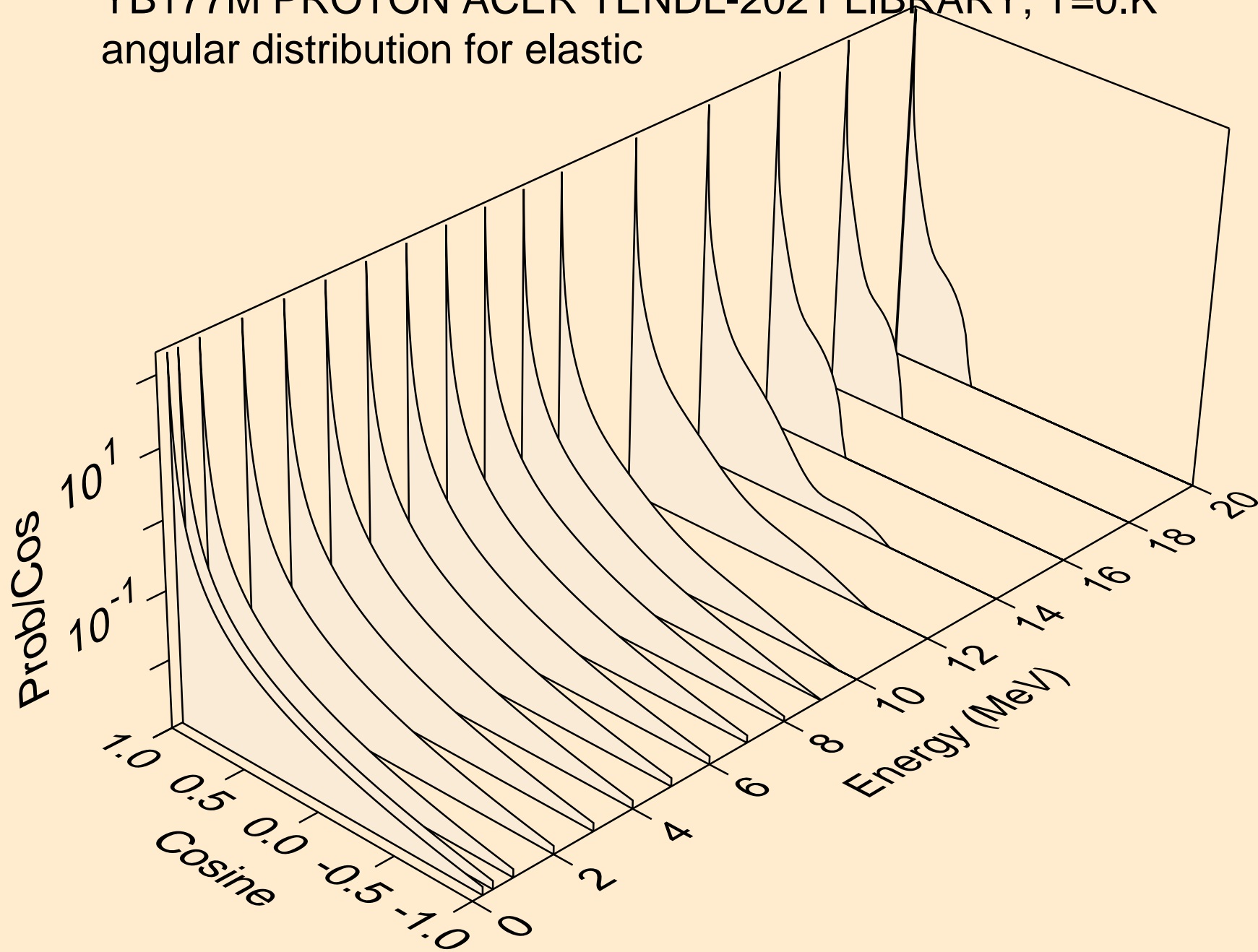



YB177M PROTON ACER TENDL-2021 LIBRARY; T=0.K  
angular distribution for elastic

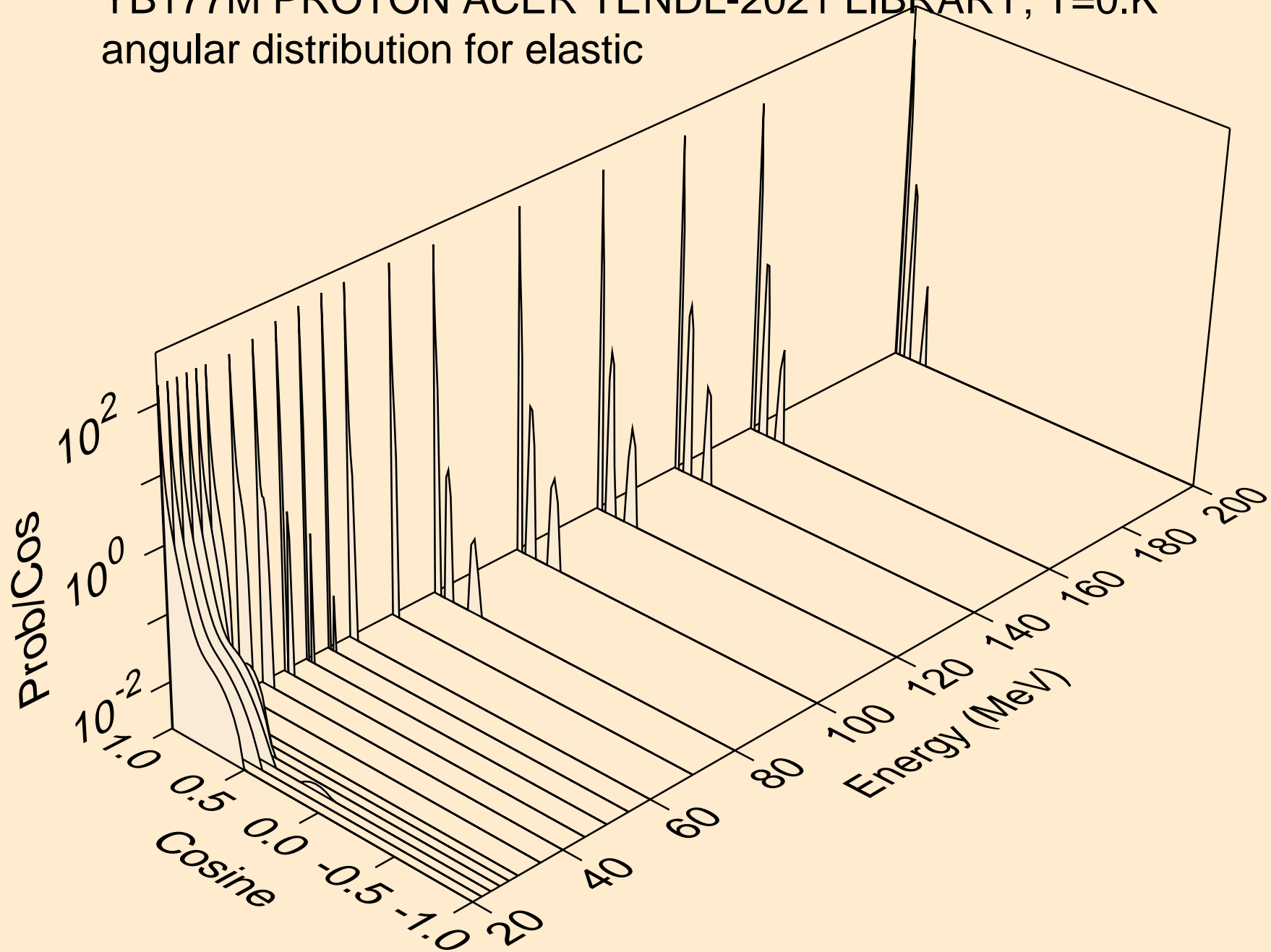

YB177M PROTON ACER TENDL-2021 LIBRARY; T=0.K  
Proton emission for (p,x)

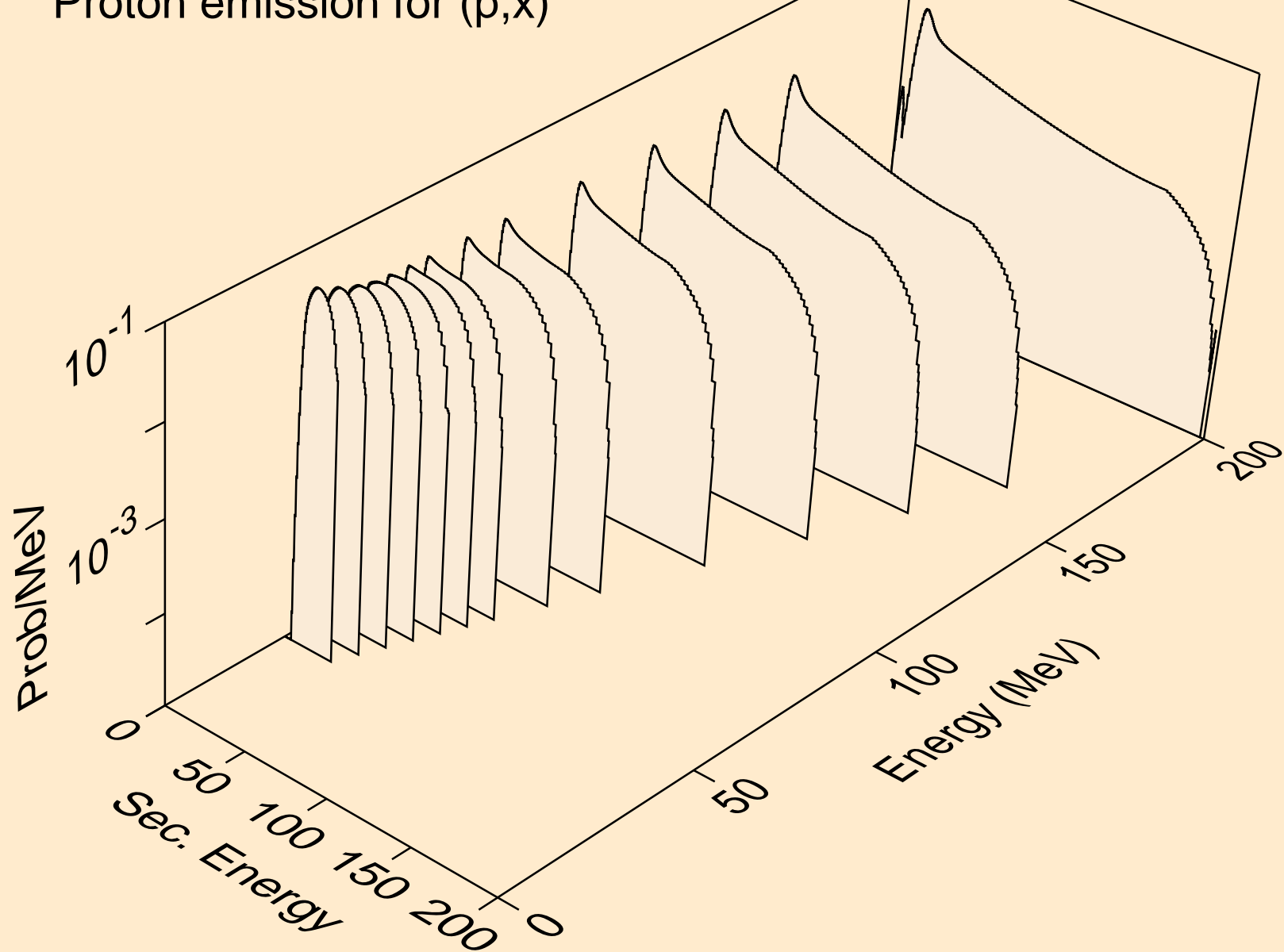

YB177M PROTON ACER TENDL-2021 LIBRARY; T=0.K  
Proton emission for (p,n\*)p

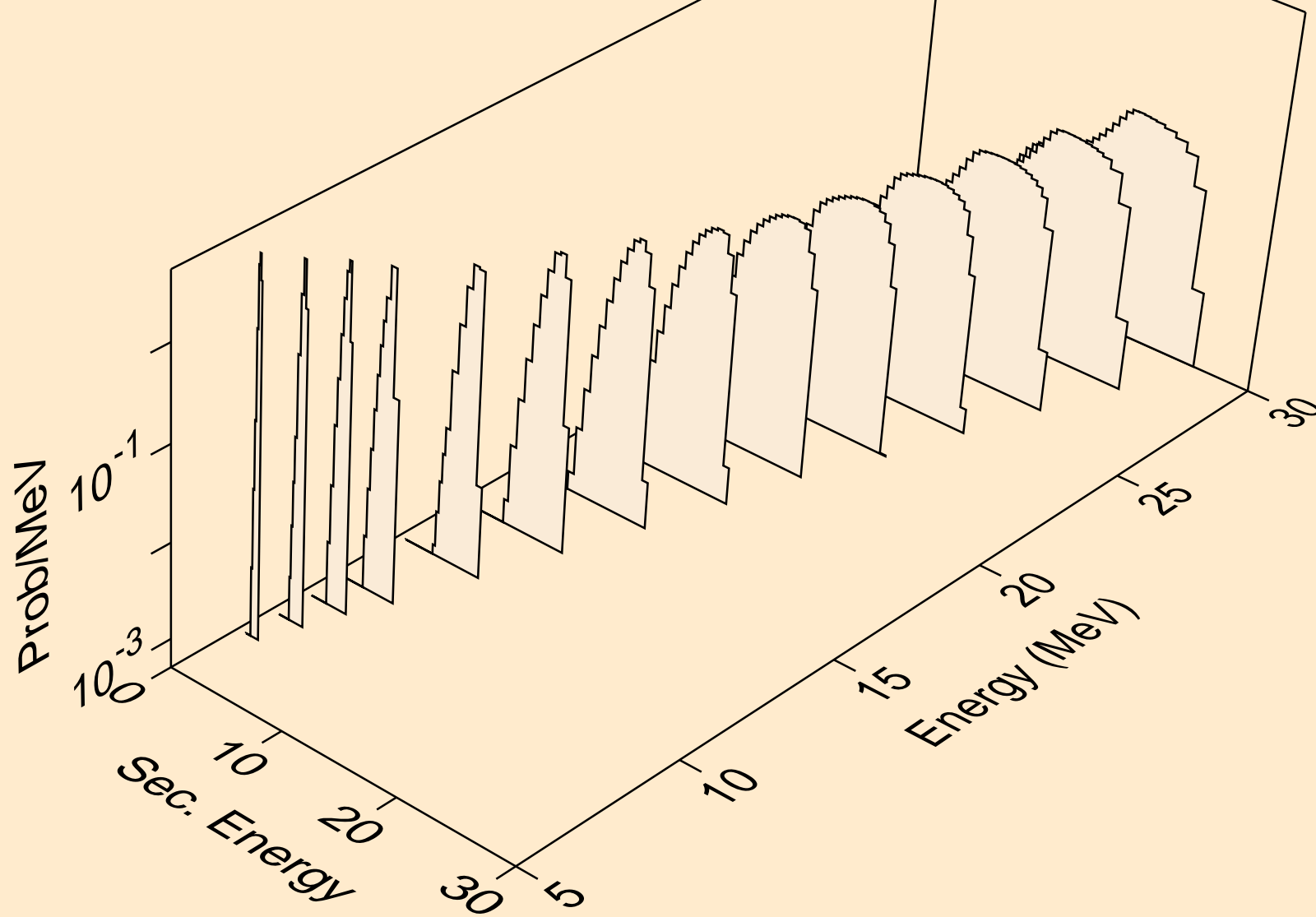

YB177M PROTON ACER TENDL-2021 LIBRARY; T=0.K  
Proton emission for (p,2np)

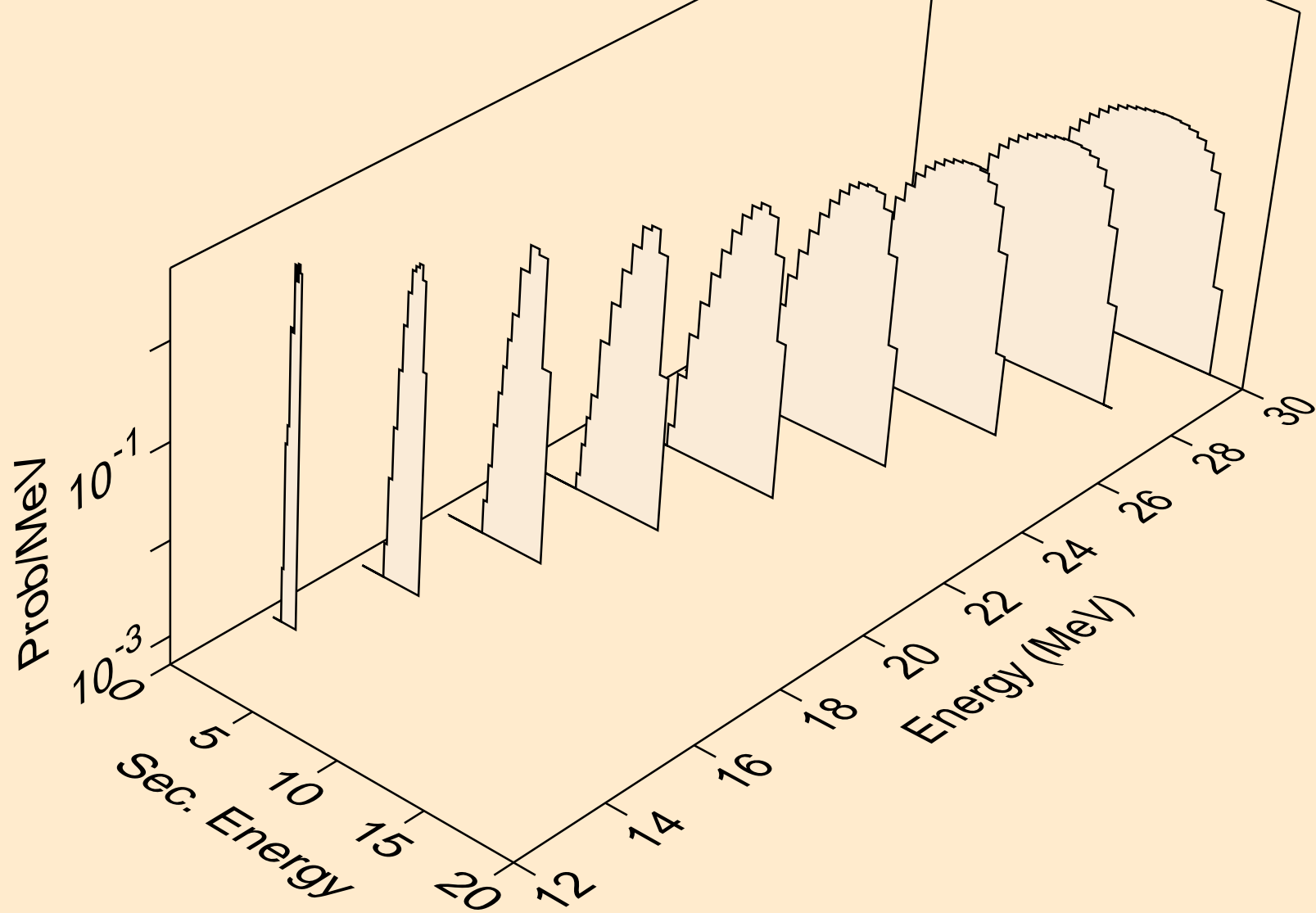

YB177M PROTON ACER TENDL-2021 LIBRARY; T=0.K  
Proton emission for (p,3np)

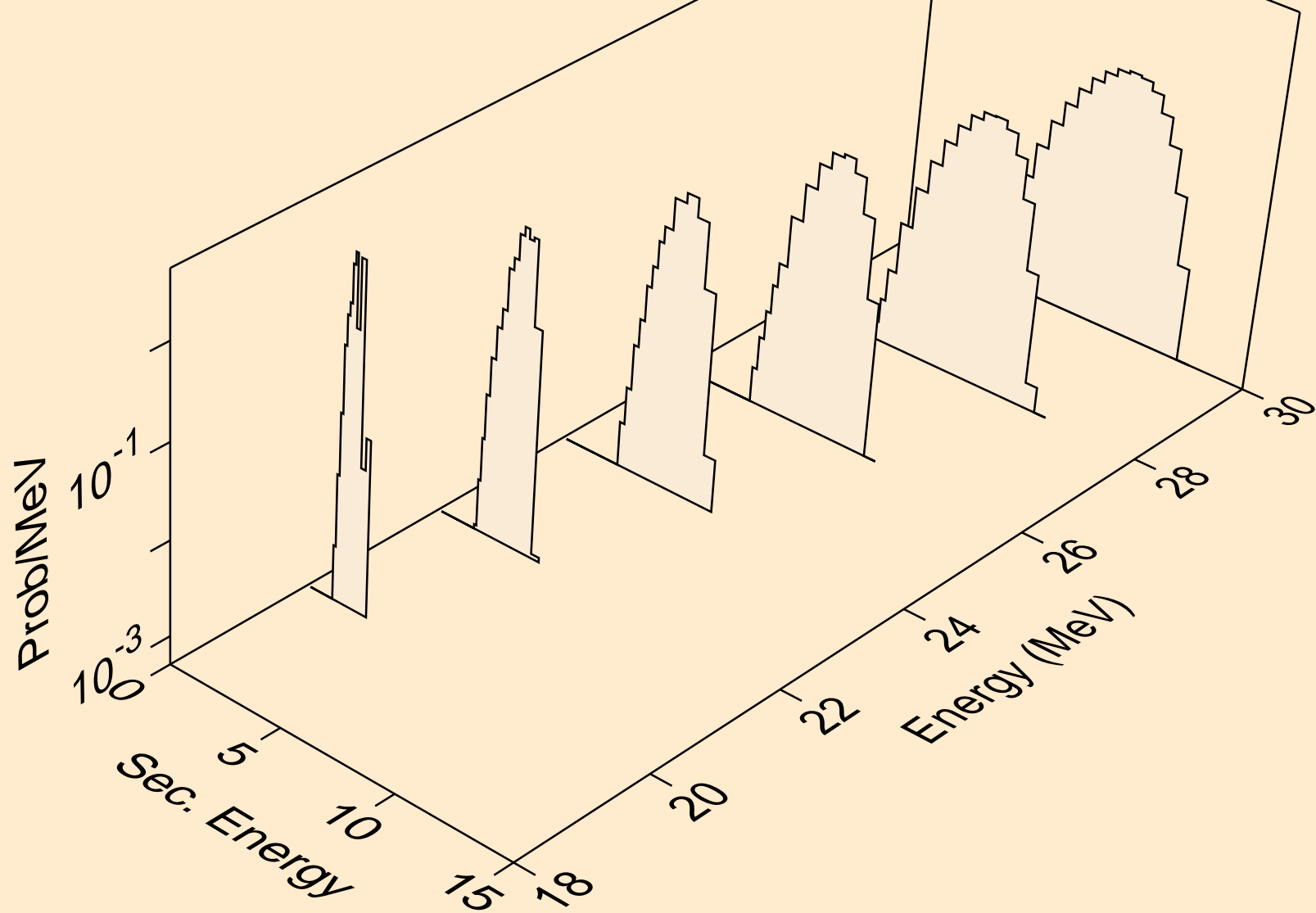

YB177M PROTON ACER TENDL-2021 LIBRARY; T=0.K  
Proton emission for (p,2np)

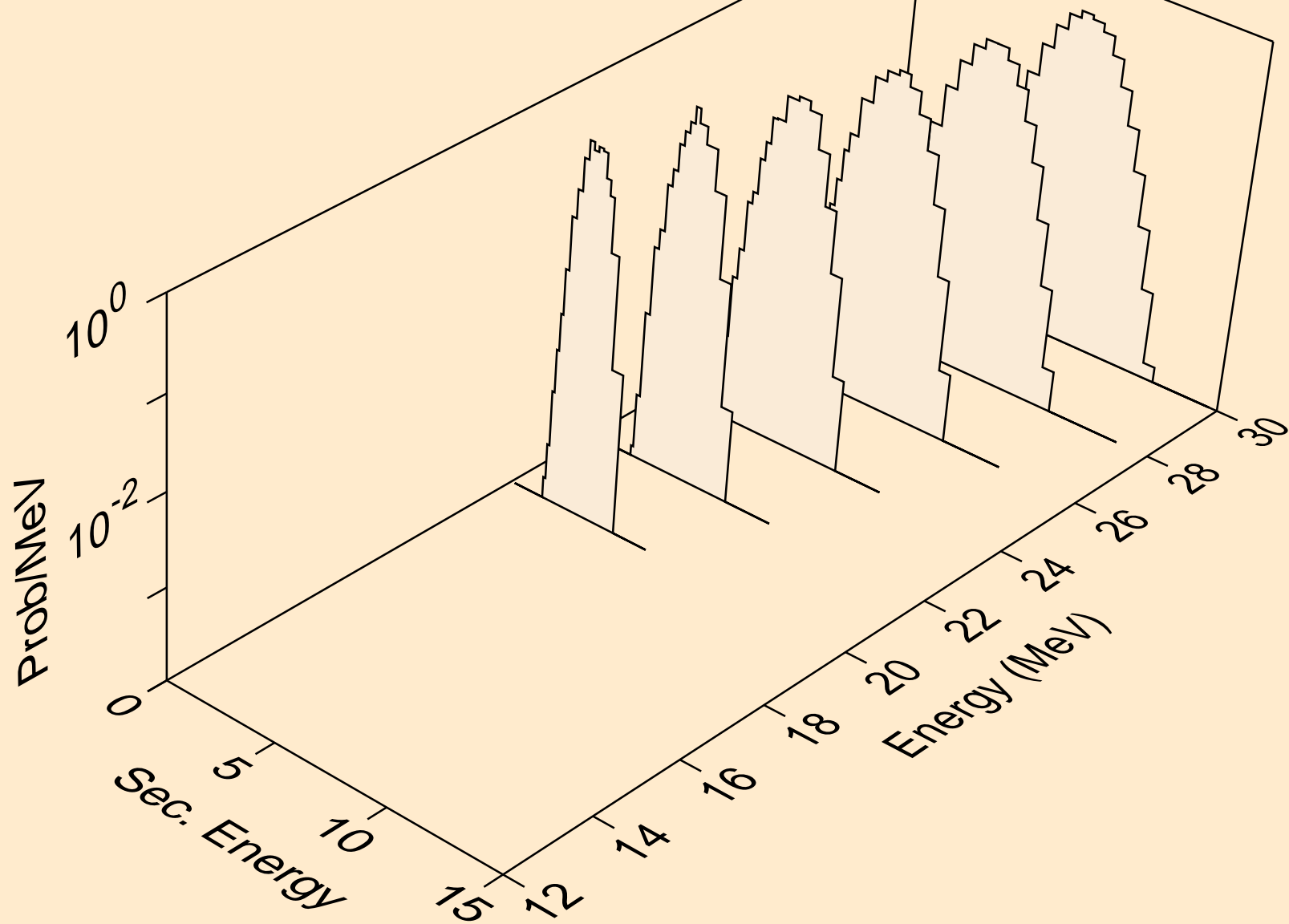

YB177M PROTON ACER TENDL-2021 LIBRARY; T=0.K  
Proton emission for (p,npa)

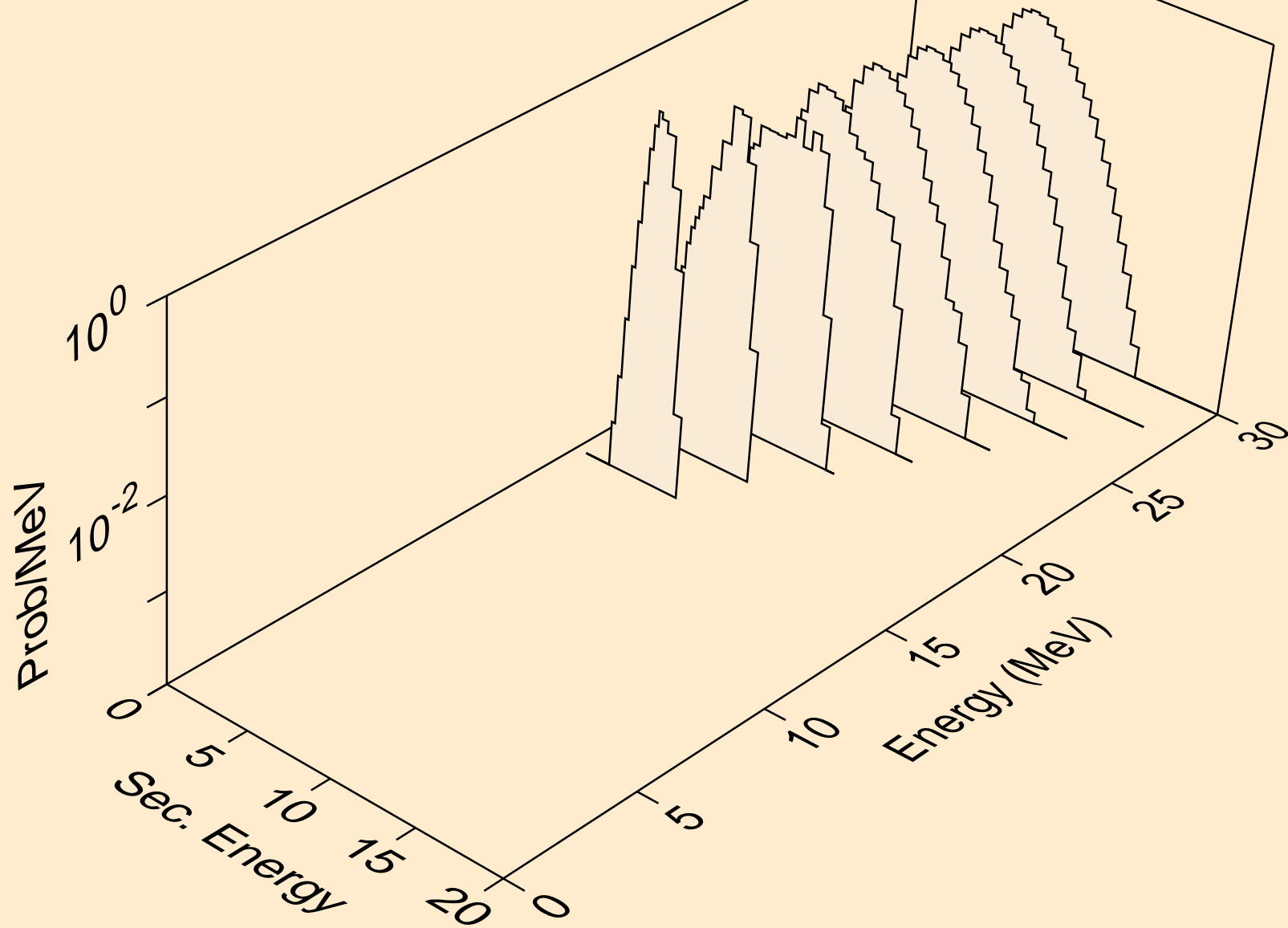

YB177M PROTON ACER TENDL-2021 LIBRARY; T=0.K  
Proton emission for inelastic

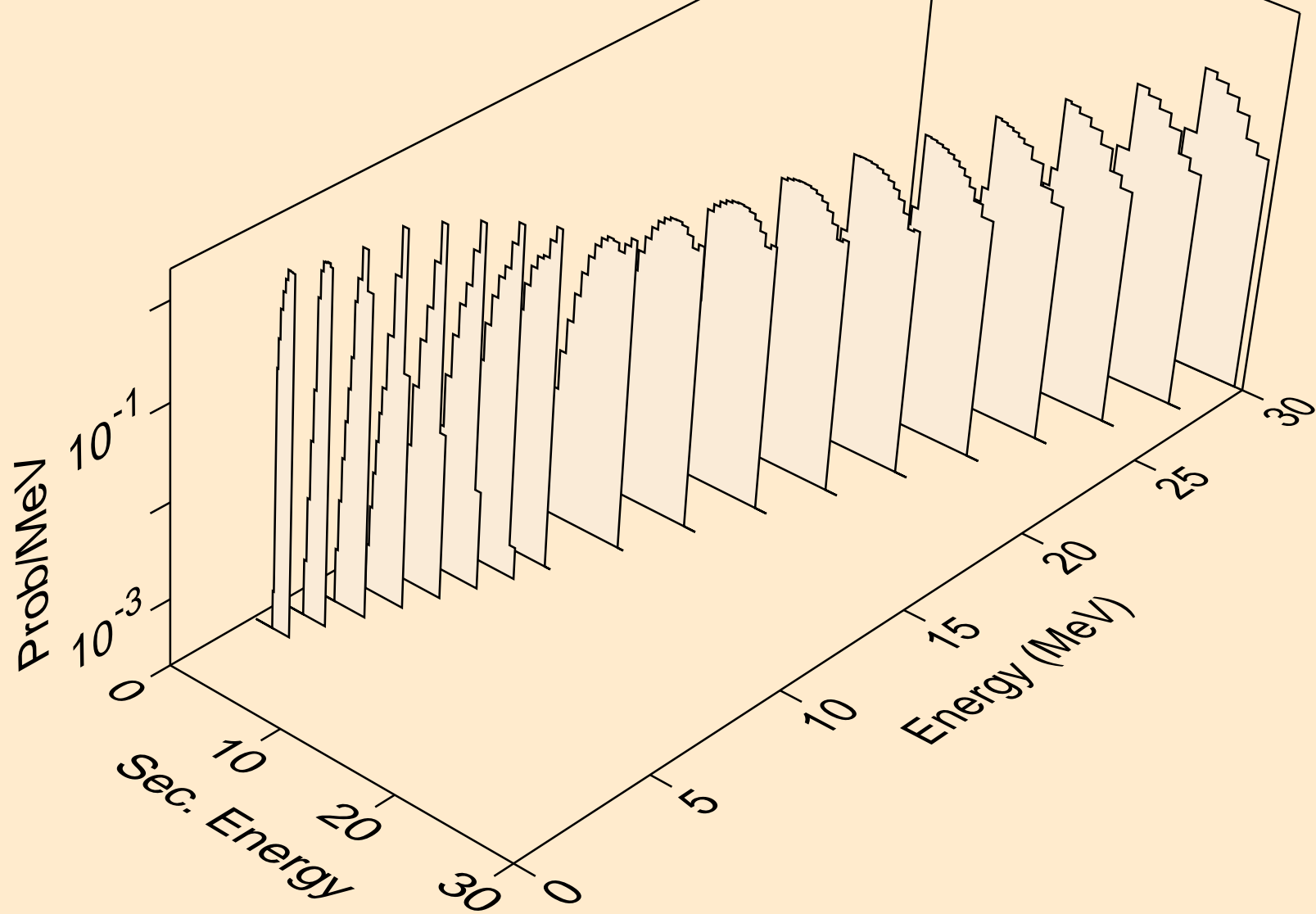



YB177M PROTON ACER TENDL-2021 LIBRARY; T=0.K  
Proton emission for (p,2p)

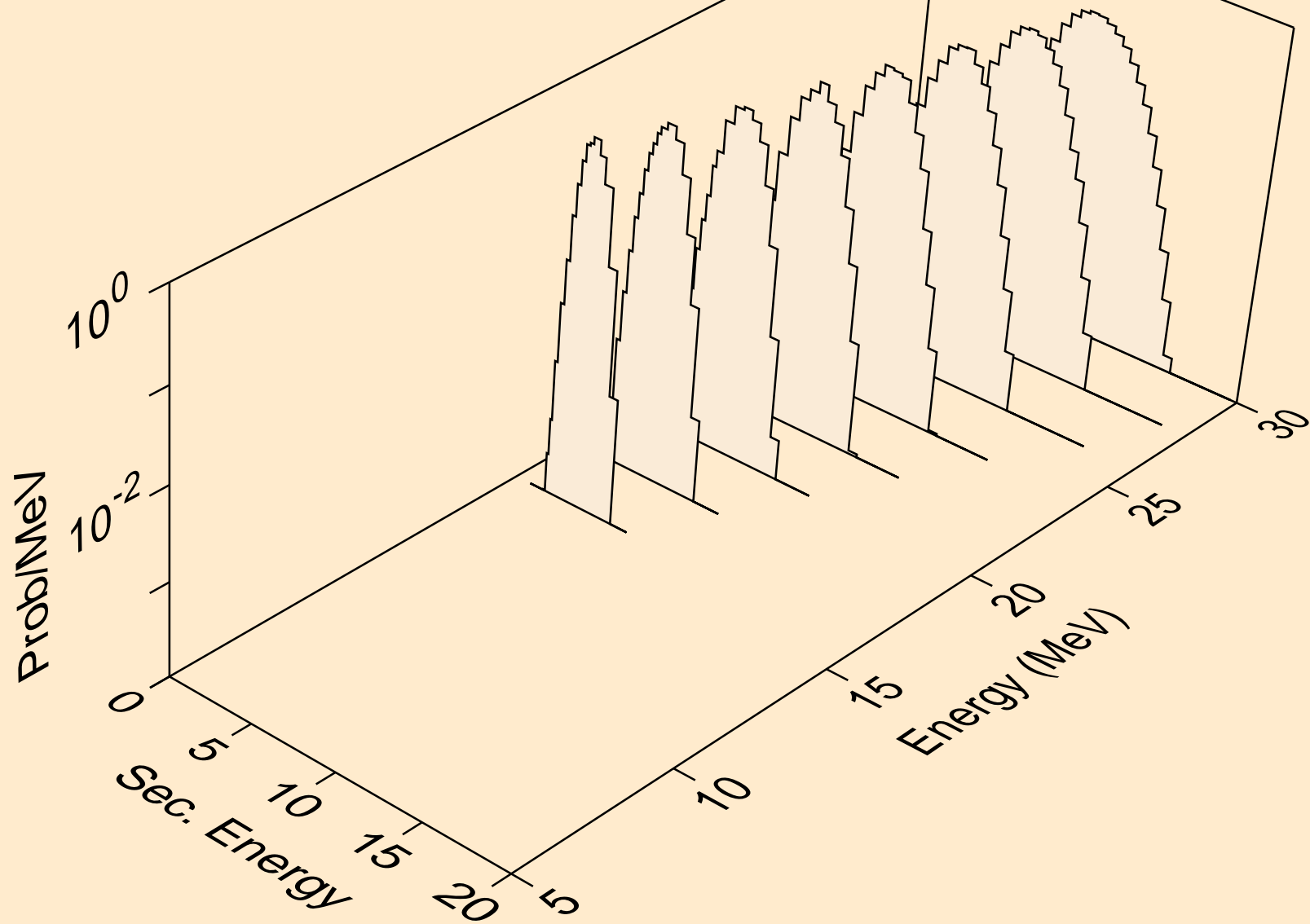

YB177M PROTON ACER TENDL-2021 LIBRARY; T=0.K  
Proton emission for (p,pa)

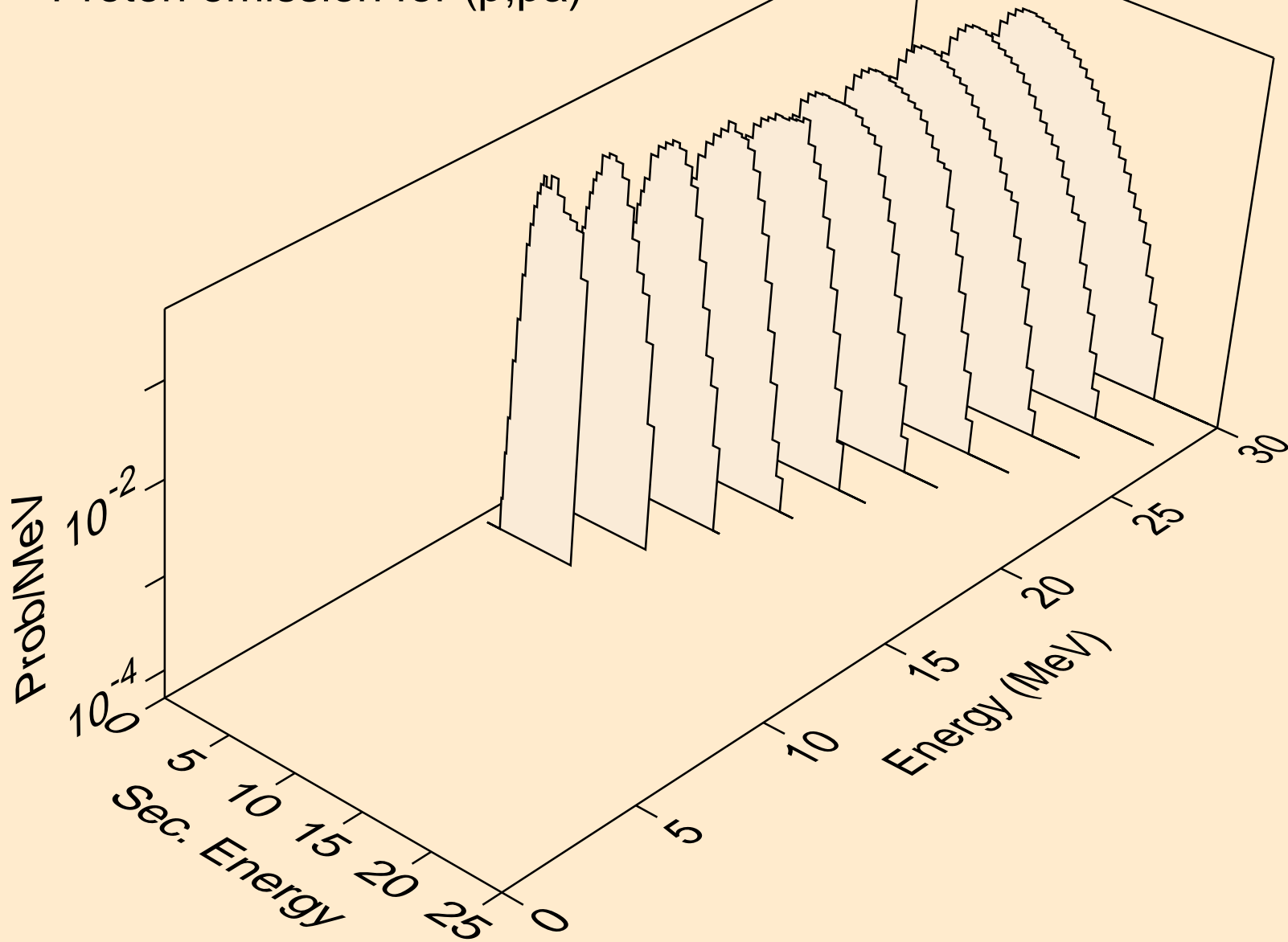

YB177M PROTON ACER TENDL-2021 LIBRARY; T=0.K  
Proton emission for (p,pd)

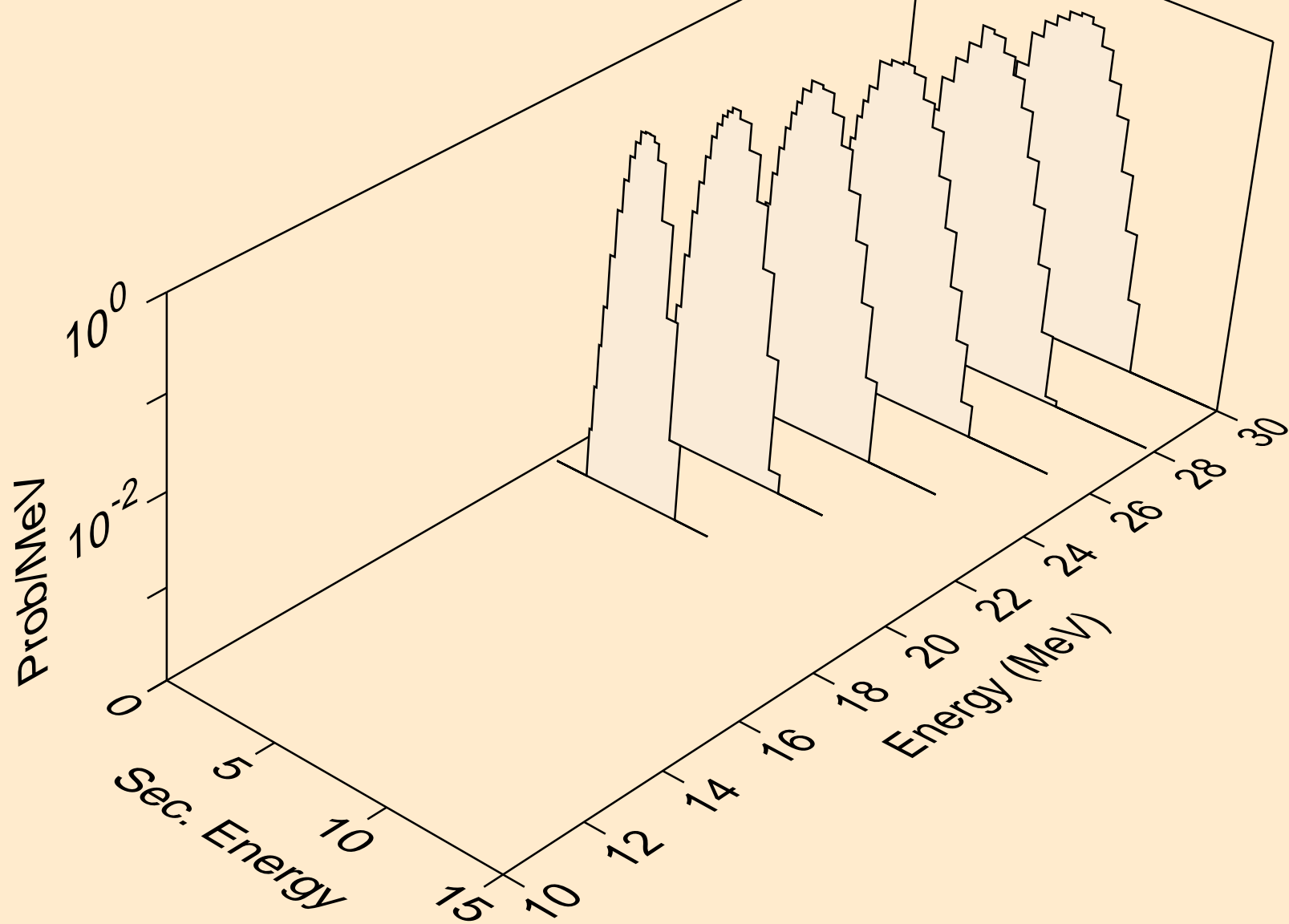

YB177M PROTON ACER TENDL-2021 LIBRARY; T=0.K  
Proton emission for (p,pt)

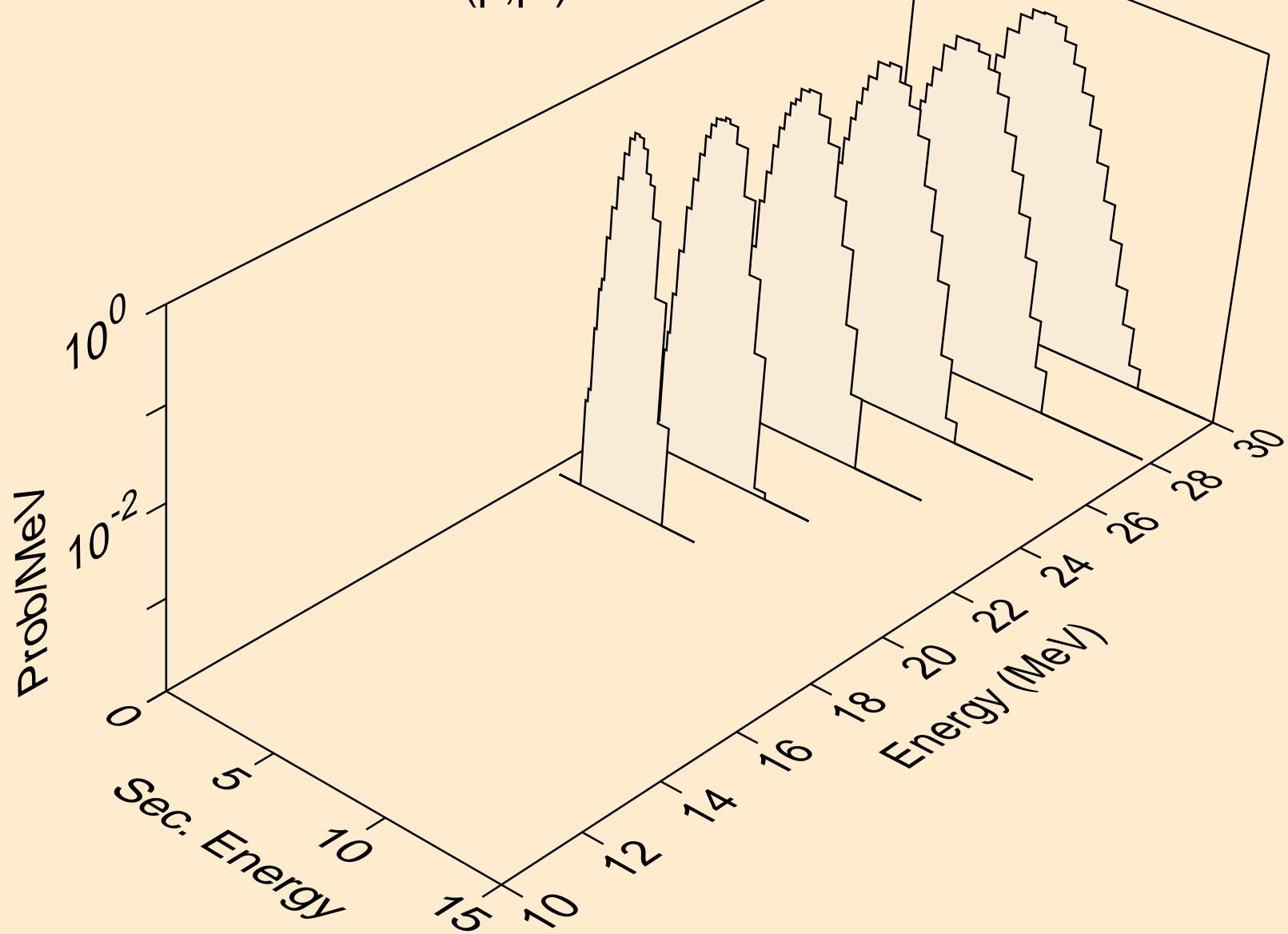

YB177M PROTON ACER TENDL-2021 LIBRARY; T=0.K  
Photon emission for (z,n)

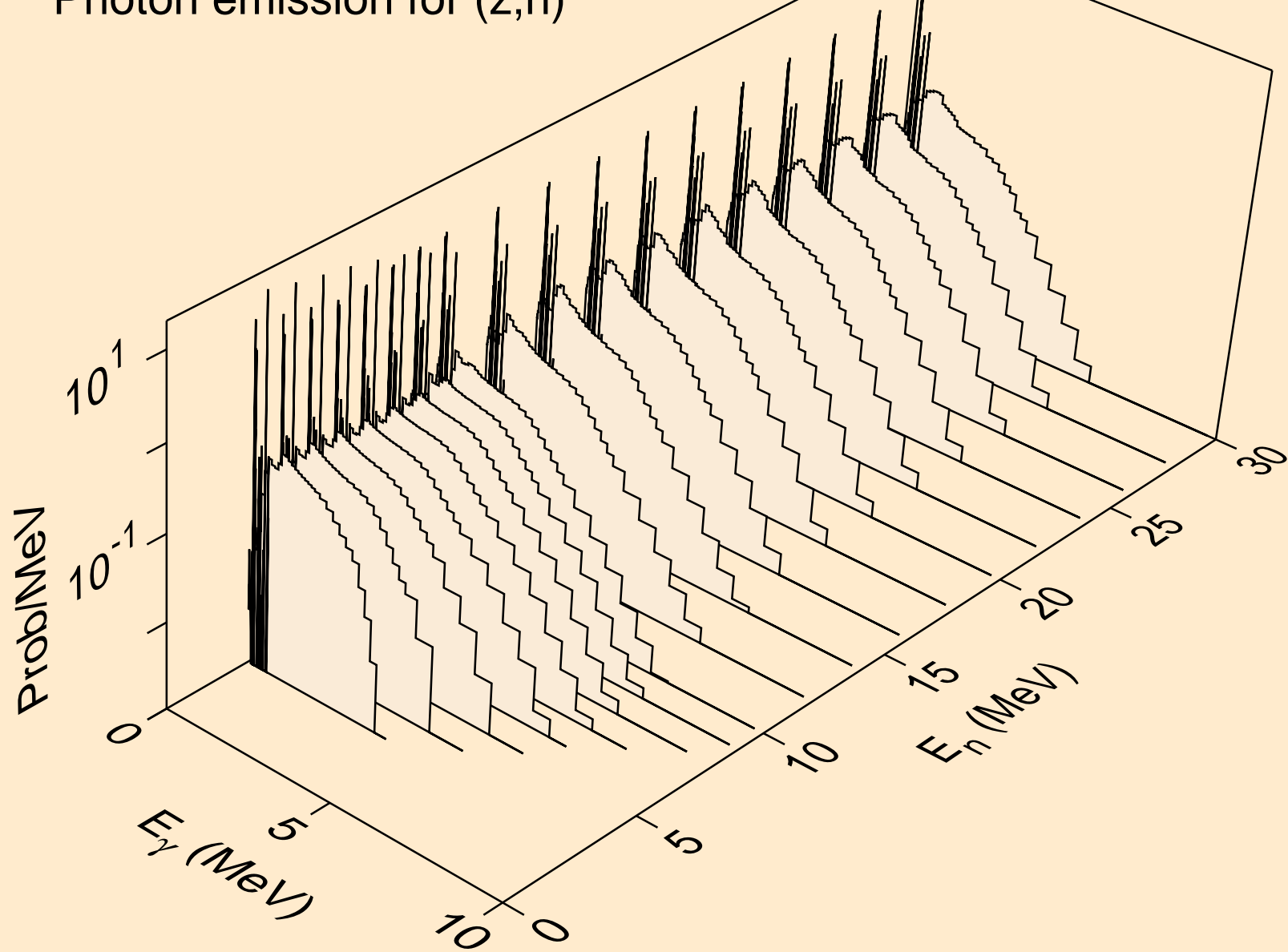

YB177M PROTON ACER TENDL-2021 LIBRARY; T=0.K  
Photon emission for (n,x)

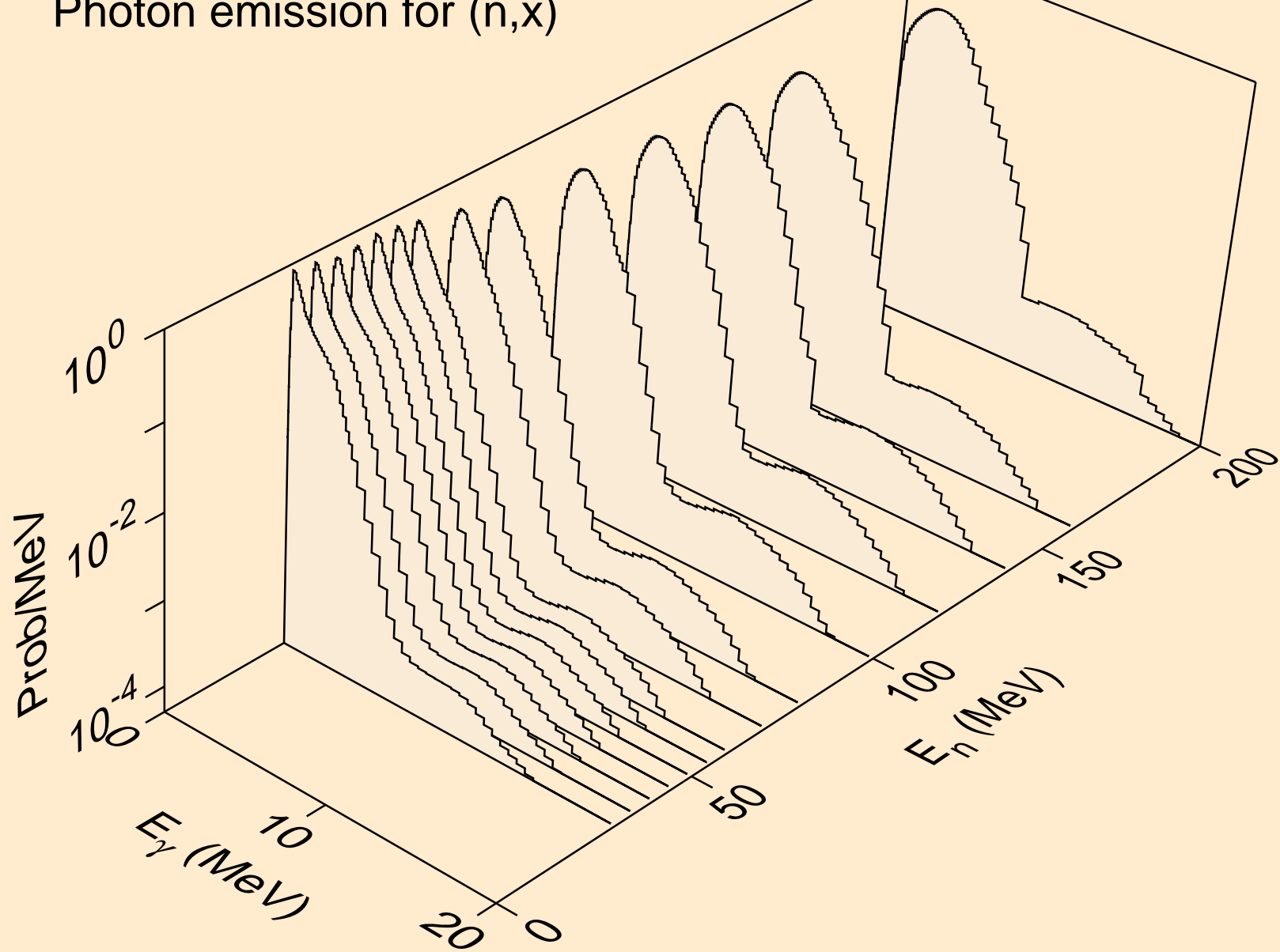

YB177M PROTON ACER TENDL-2021 LIBRARY; T=0.K  
Photon emission for (n,2nd)

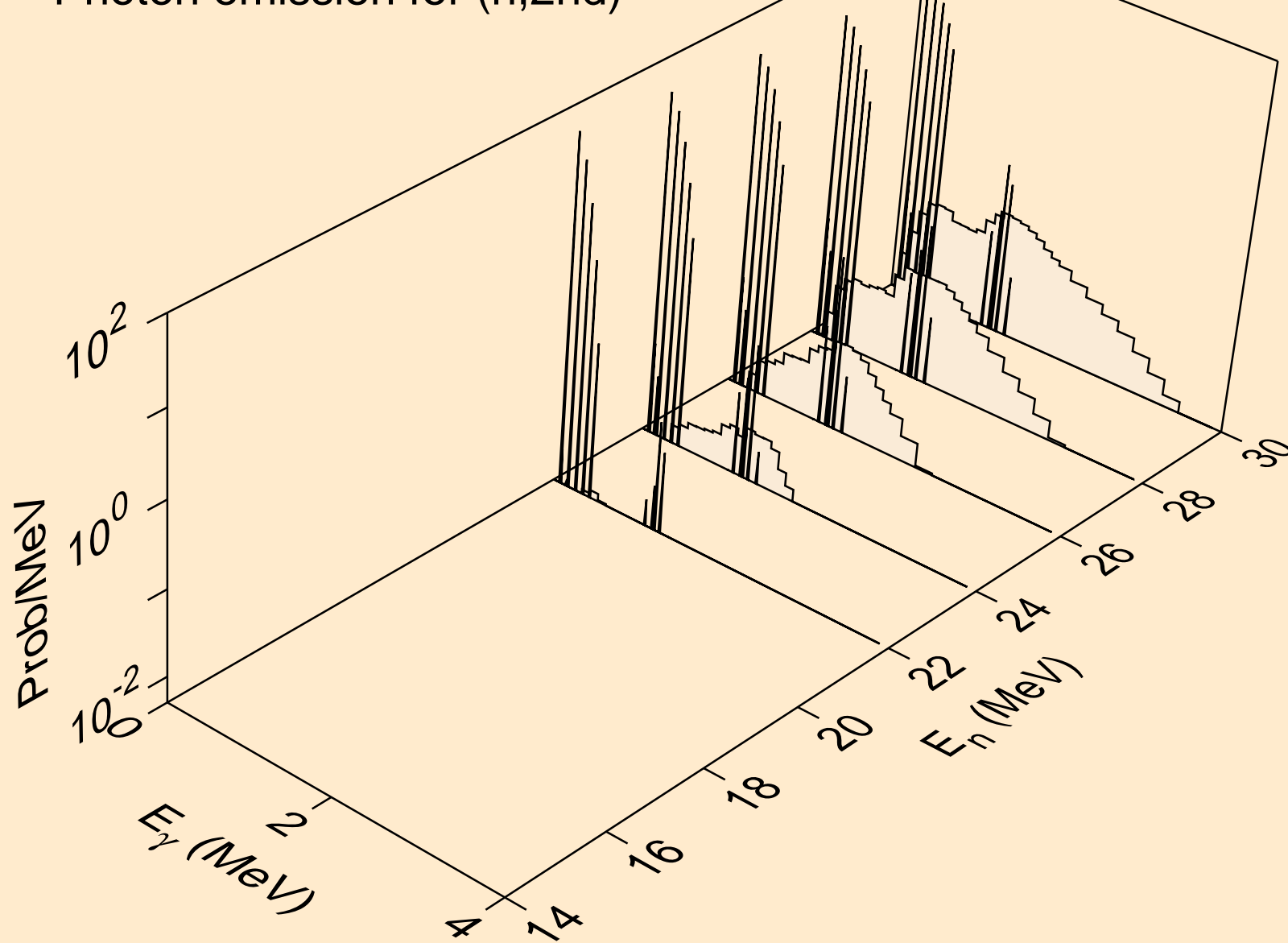

YB177M PROTON ACER TENDL-2021 LIBRARY; T=0.K  
Photon emission for (n,2n)

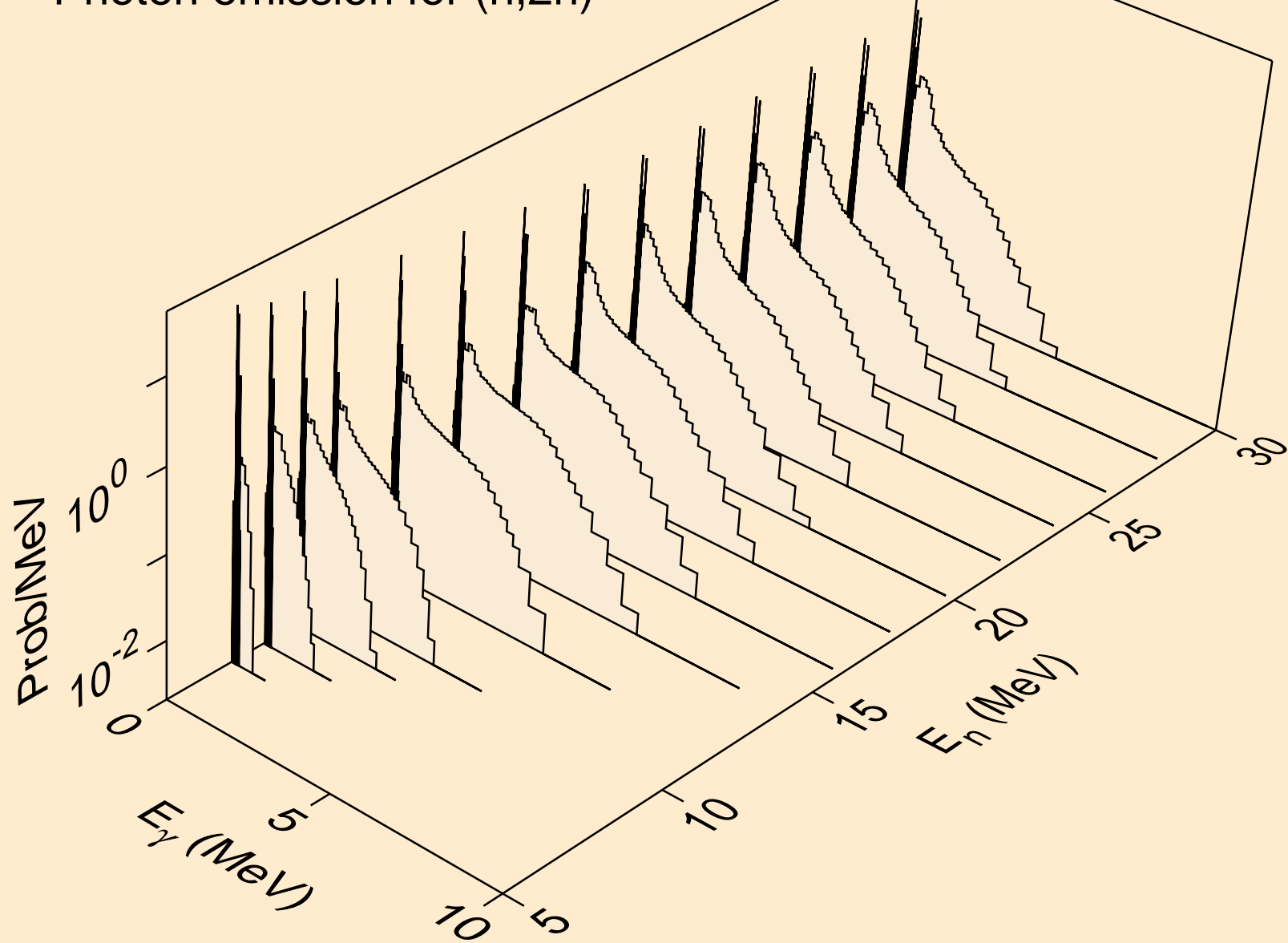



YB177M PROTON ACER TENDL-2021 LIBRARY; T=0.K  
Photon emission for (n,3n)

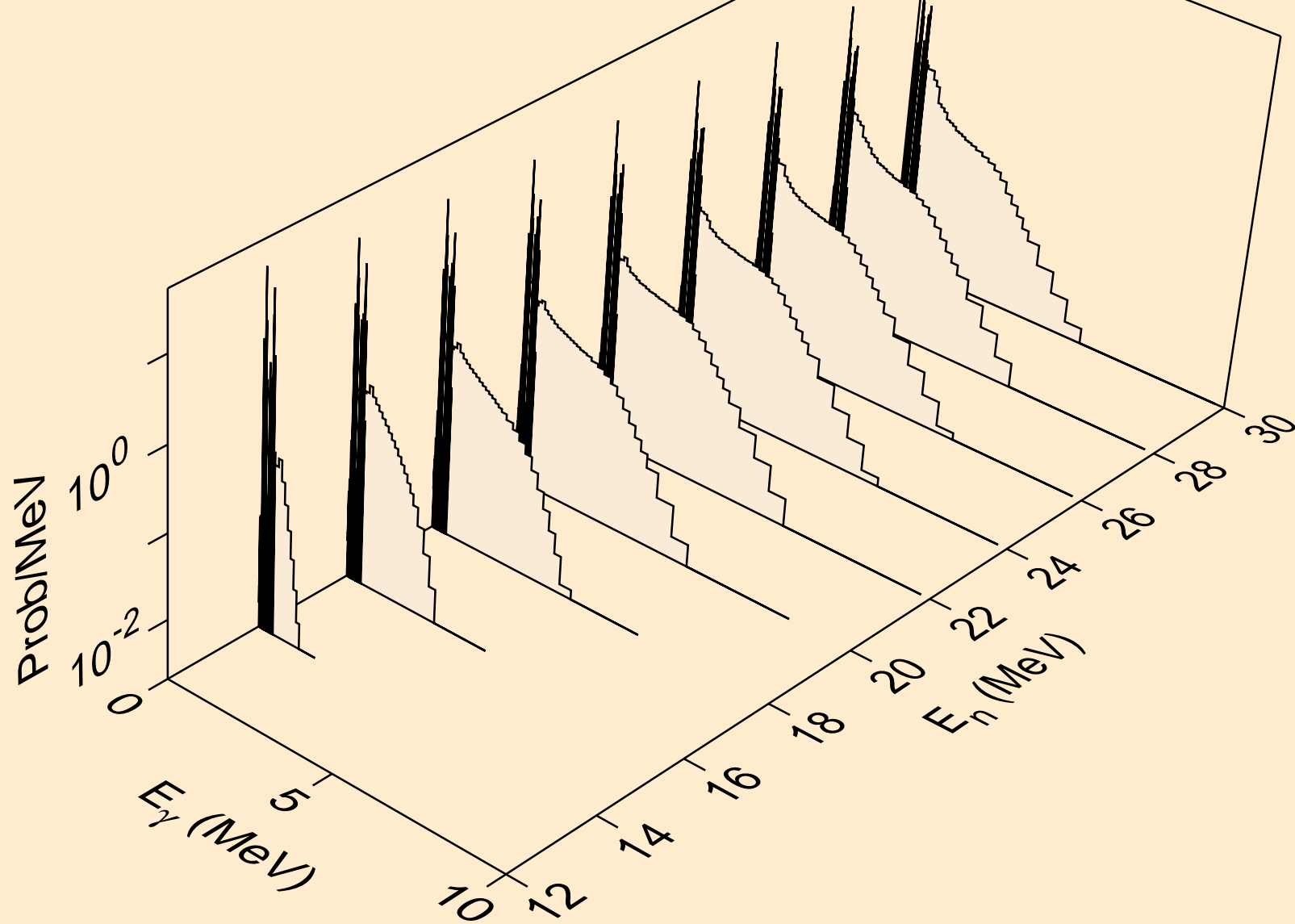

YB177M PROTON ACER TENDL-2021 LIBRARY; T=0.K  
Photon emission for (n,n\*)a

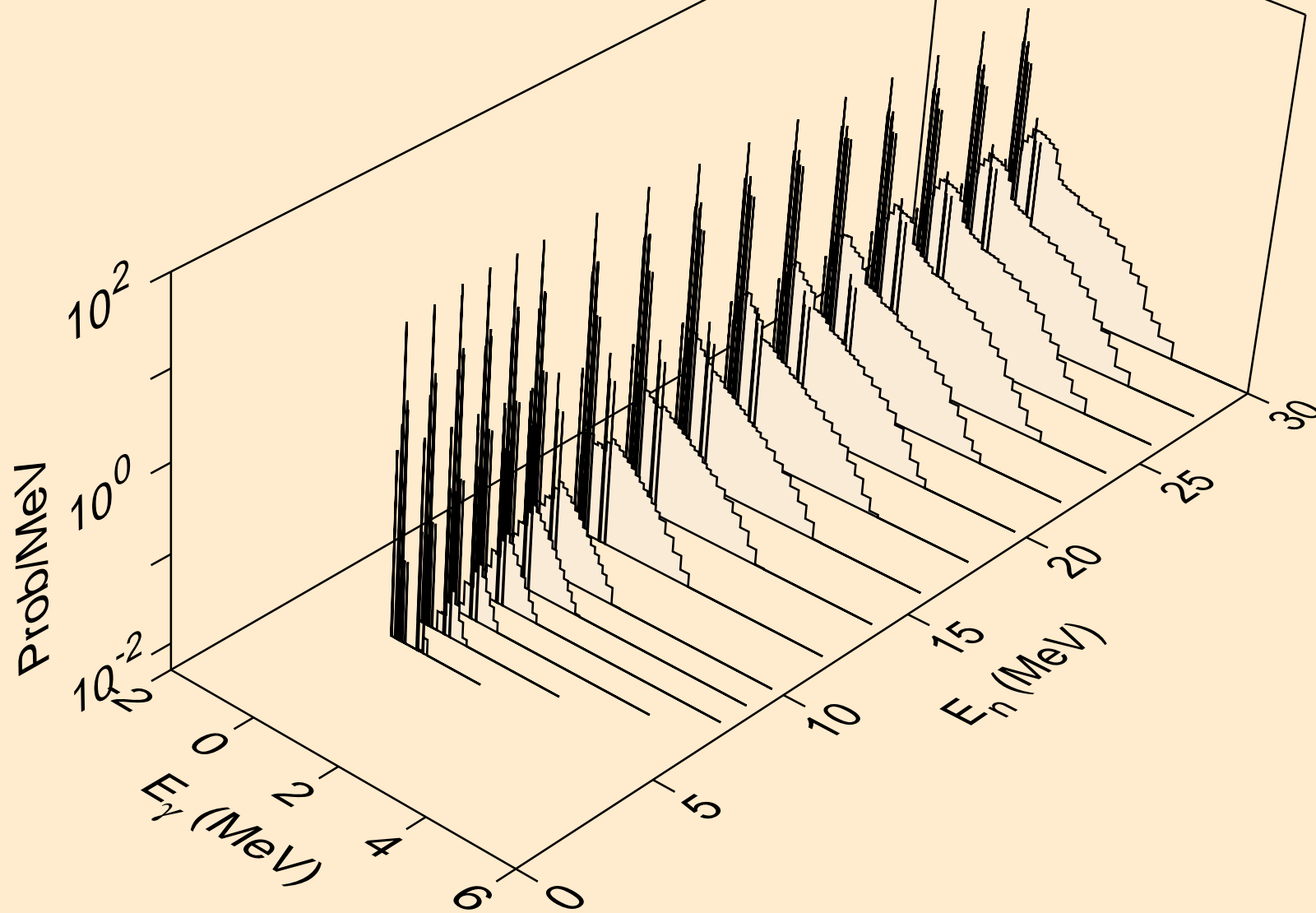

YB177M PROTON ACER TENDL-2021 LIBRARY; T=0.K  
Photon emission for (n,2n)a

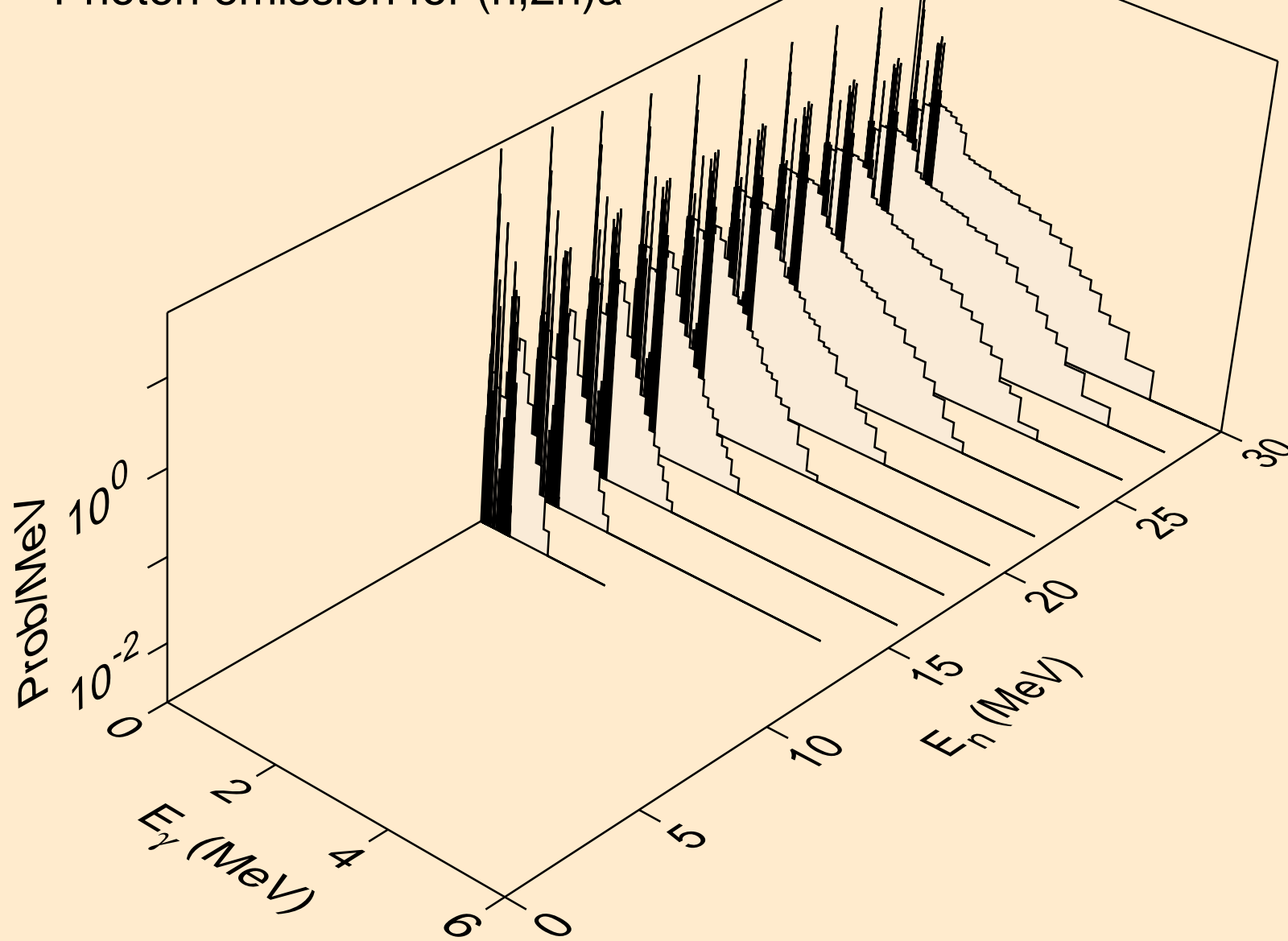

YB177M PROTON ACER TENDL-2021 LIBRARY; T=0.K  
Photon emission for (n,3n)a

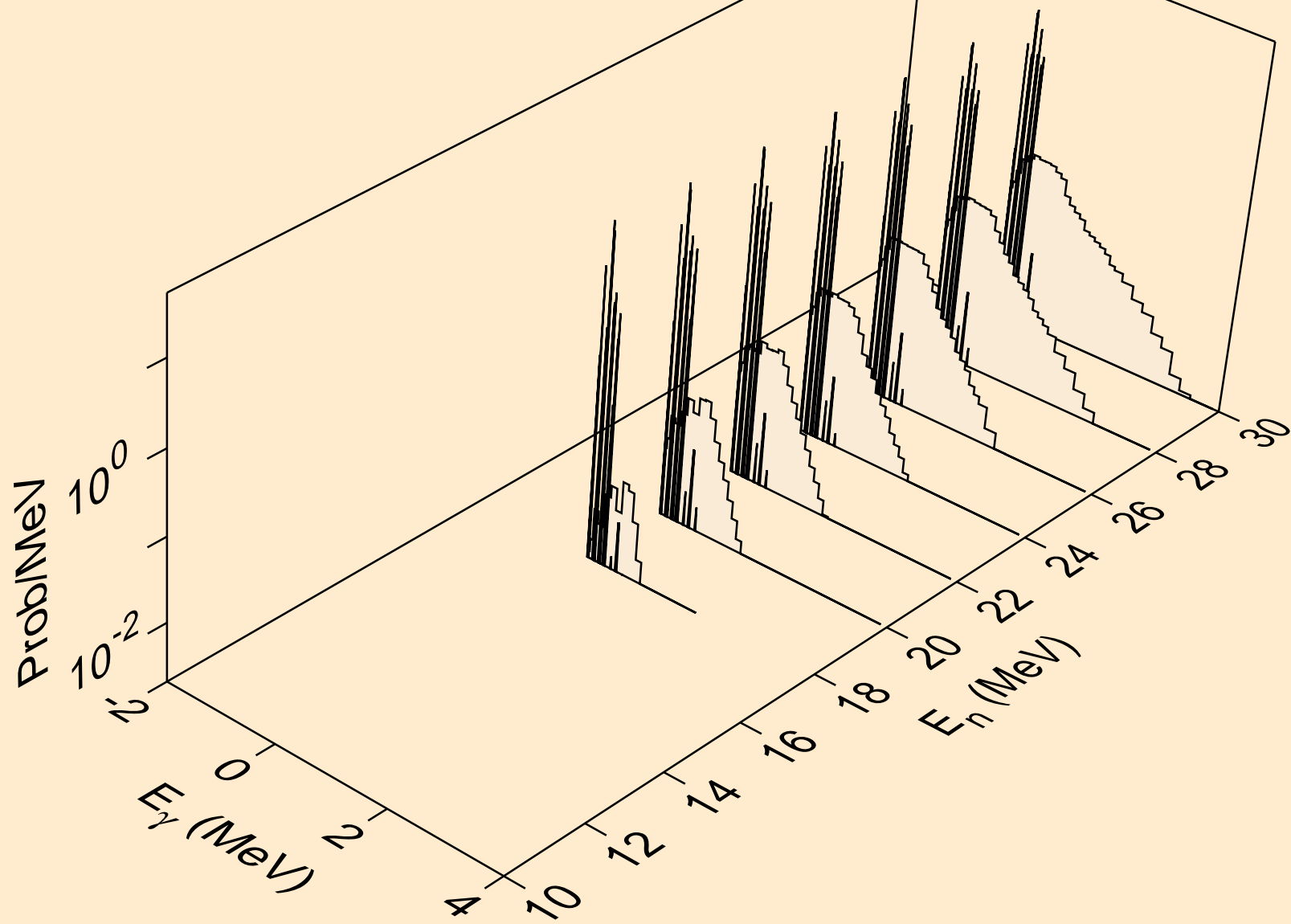

YB177M PROTON ACER TENDL-2021 LIBRARY; T=0.K  
Photon emission for (n,n\*)p

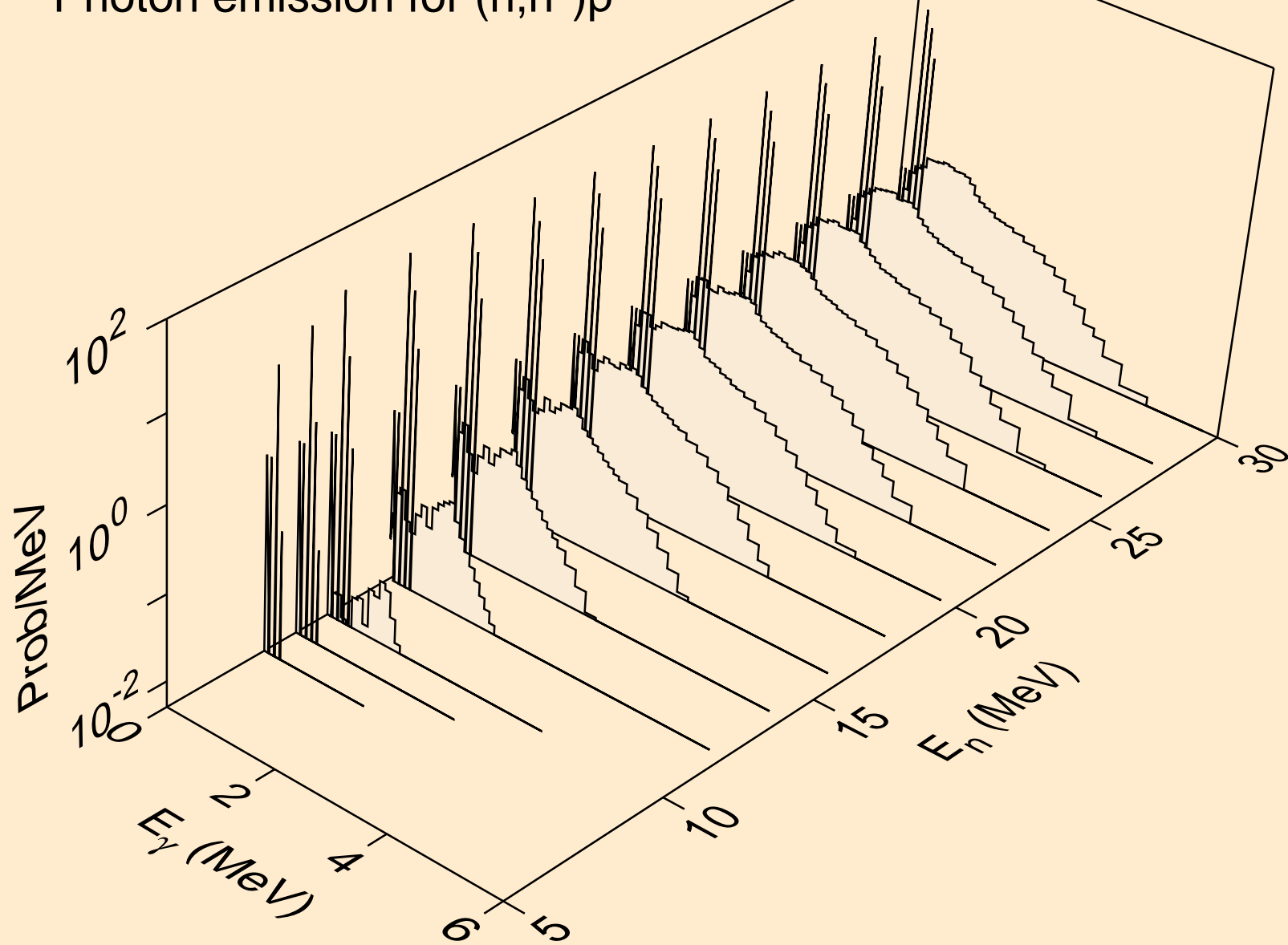

YB177M PROTON ACER TENDL-2021 LIBRARY; T=0.K  
Photon emission for (n,n\*)2a

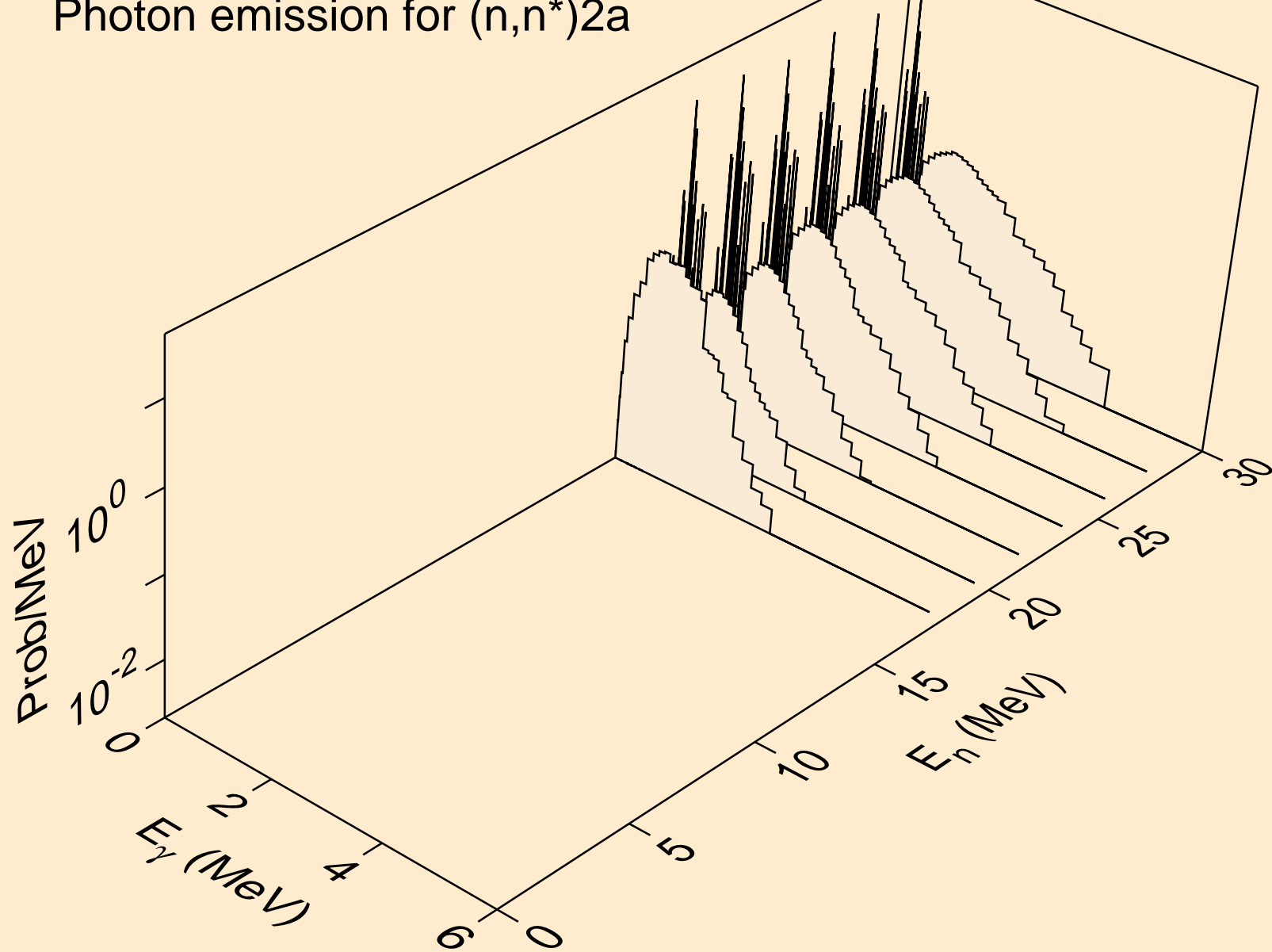

YB177M PROTON ACER TENDL-2021 LIBRARY; T=0.K  
Photon emission for (n,n\*)d

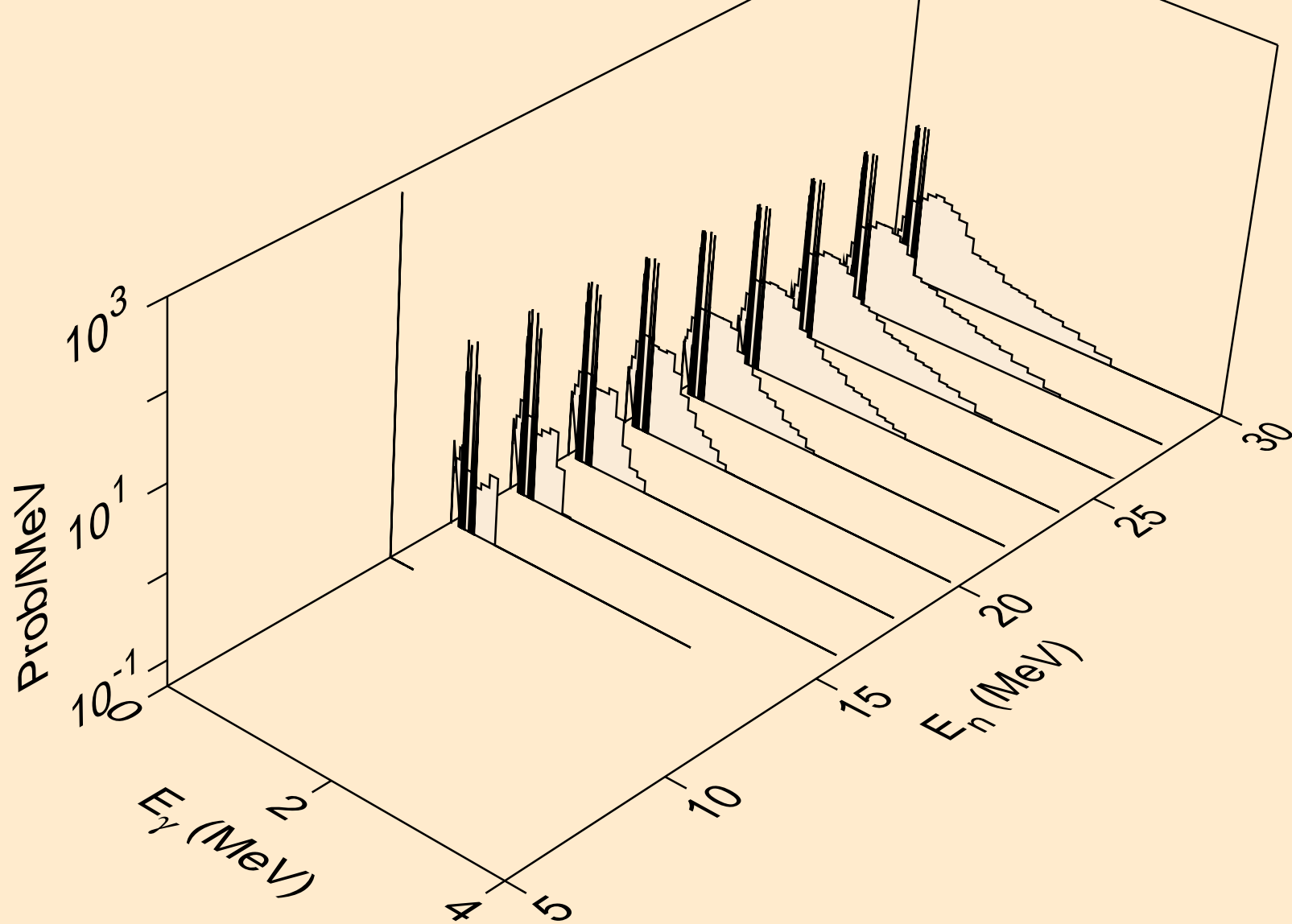

YB177M PROTON ACER TENDL-2021 LIBRARY; T=0.K  
Photon emission for (n,n\*)t

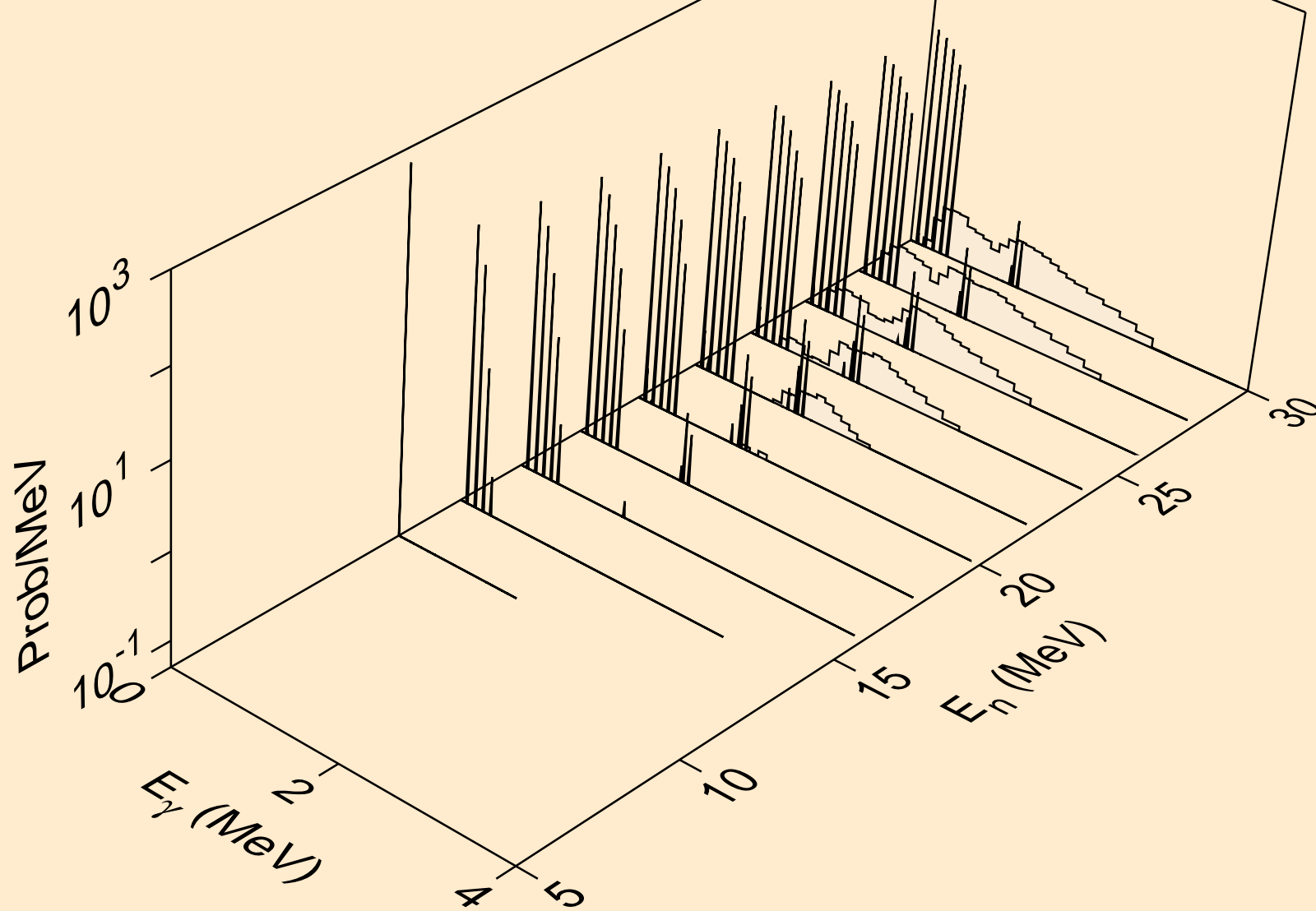



YB177M PROTON ACER TENDL-2021 LIBRARY; T=0.K  
Photon emission for (n,n\*)he3

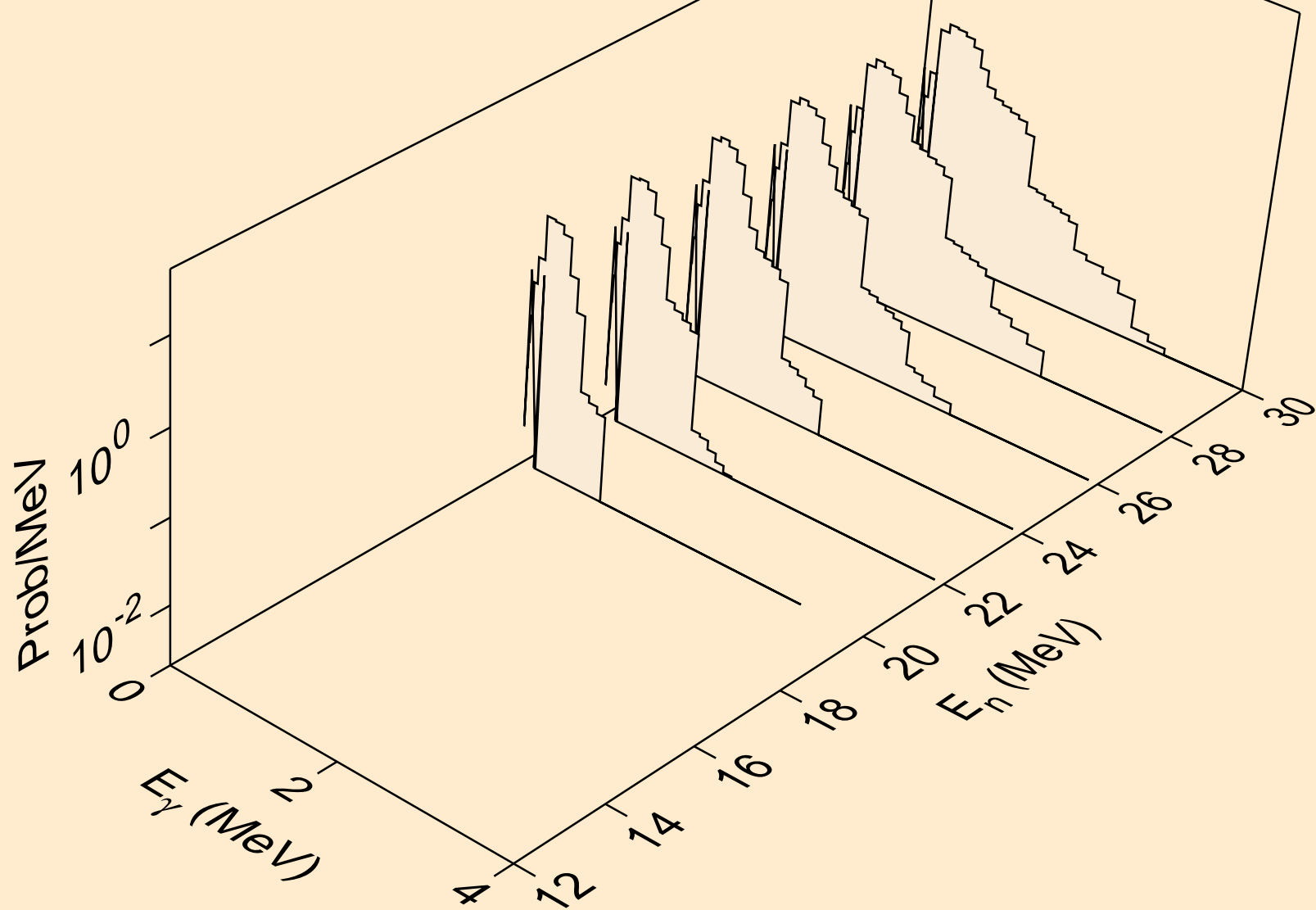

YB177M PROTON ACER TENDL-2021 LIBRARY; T=0.K  
Photon emission for (n,4n)

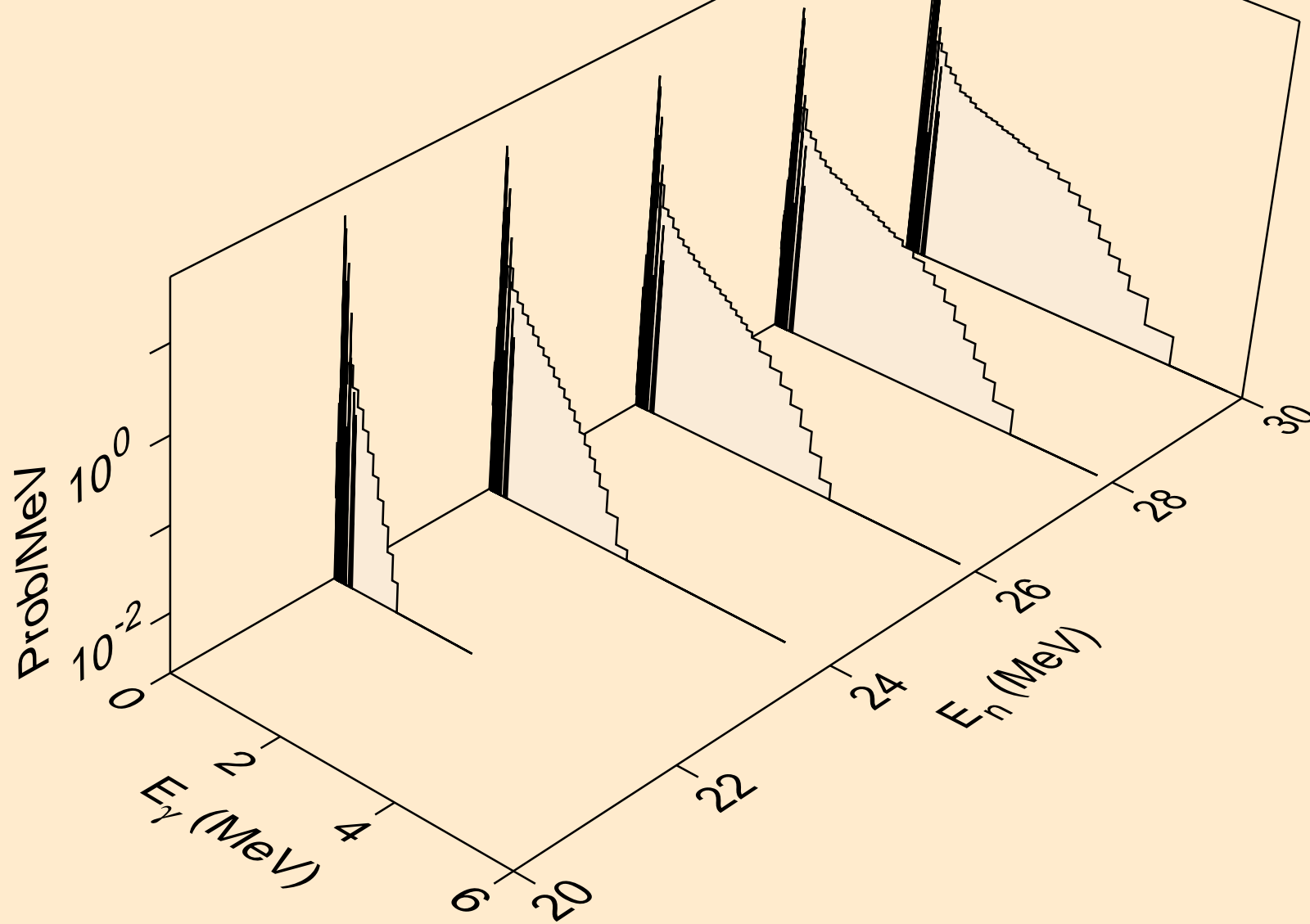

YB177M PROTON ACER TENDL-2021 LIBRARY; T=0.K  
Photon emission for (n,2np)

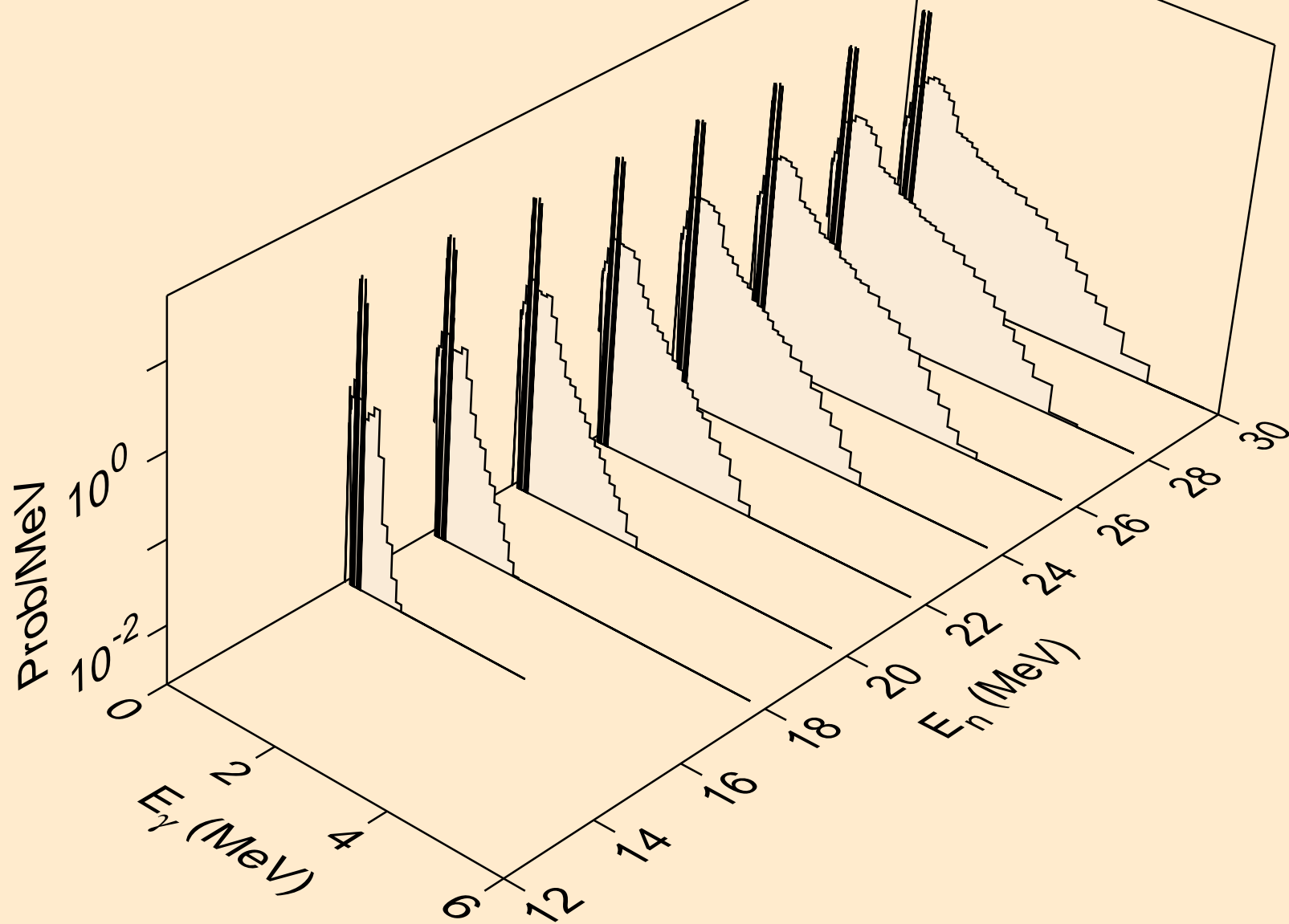

YB177M PROTON ACER TENDL-2021 LIBRARY; T=0.K  
Photon emission for (n,3np)

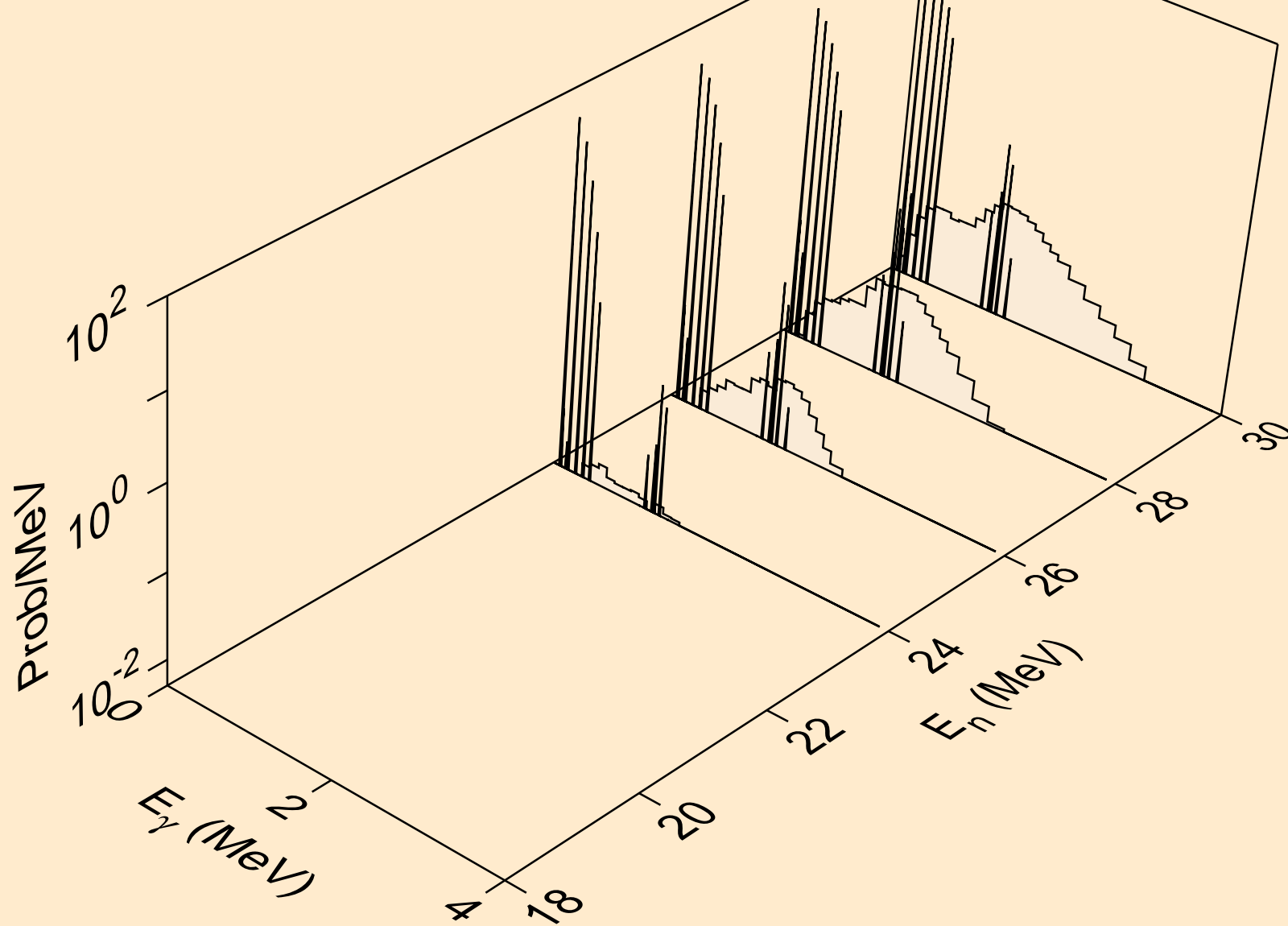

YB177M PROTON ACER TENDL-2021 LIBRARY; T=0.K  
Photon emission for (n,2np)

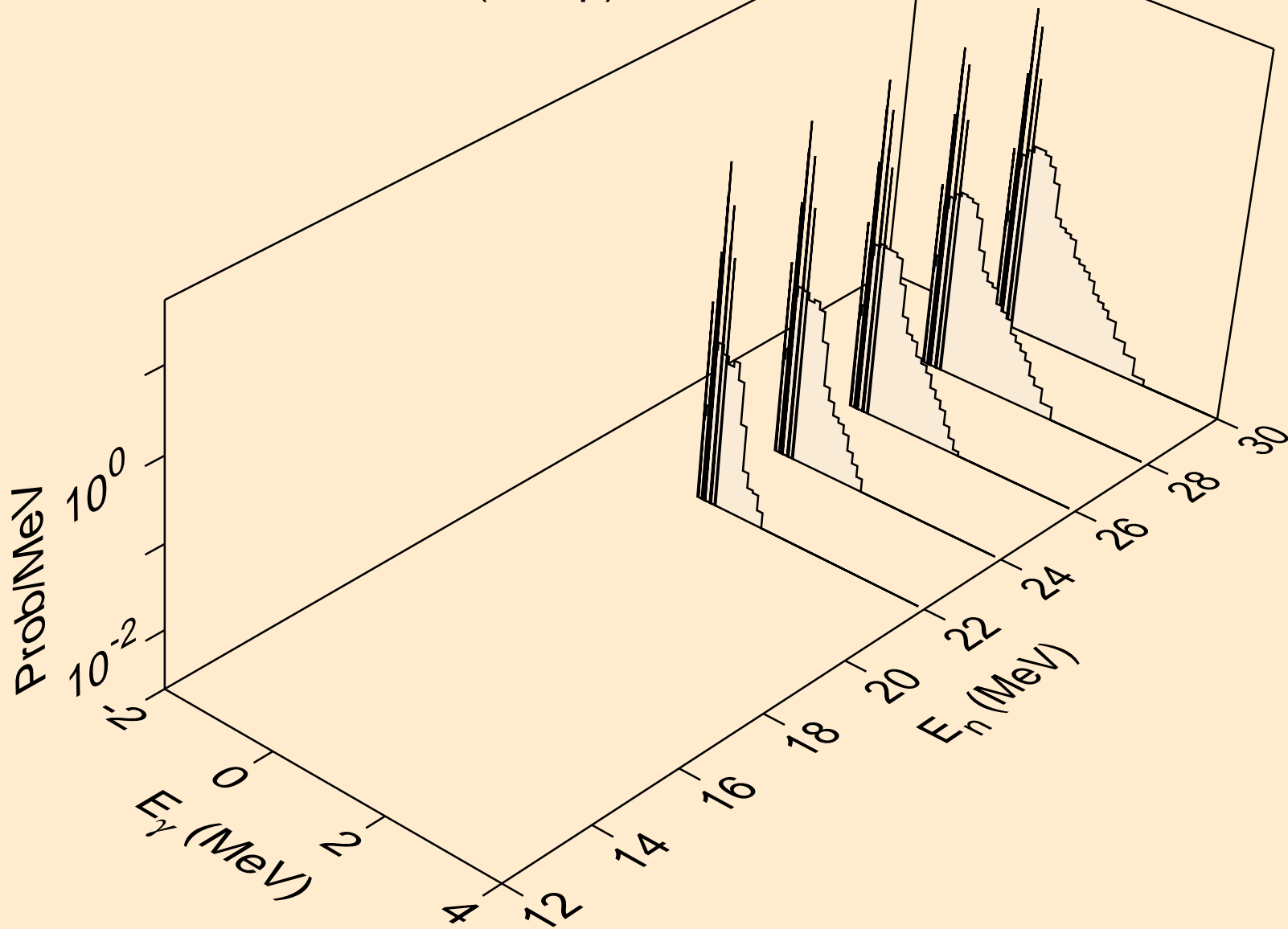

YB177M PROTON ACER TENDL-2021 LIBRARY; T=0.K  
Photon emission for (n,npa)

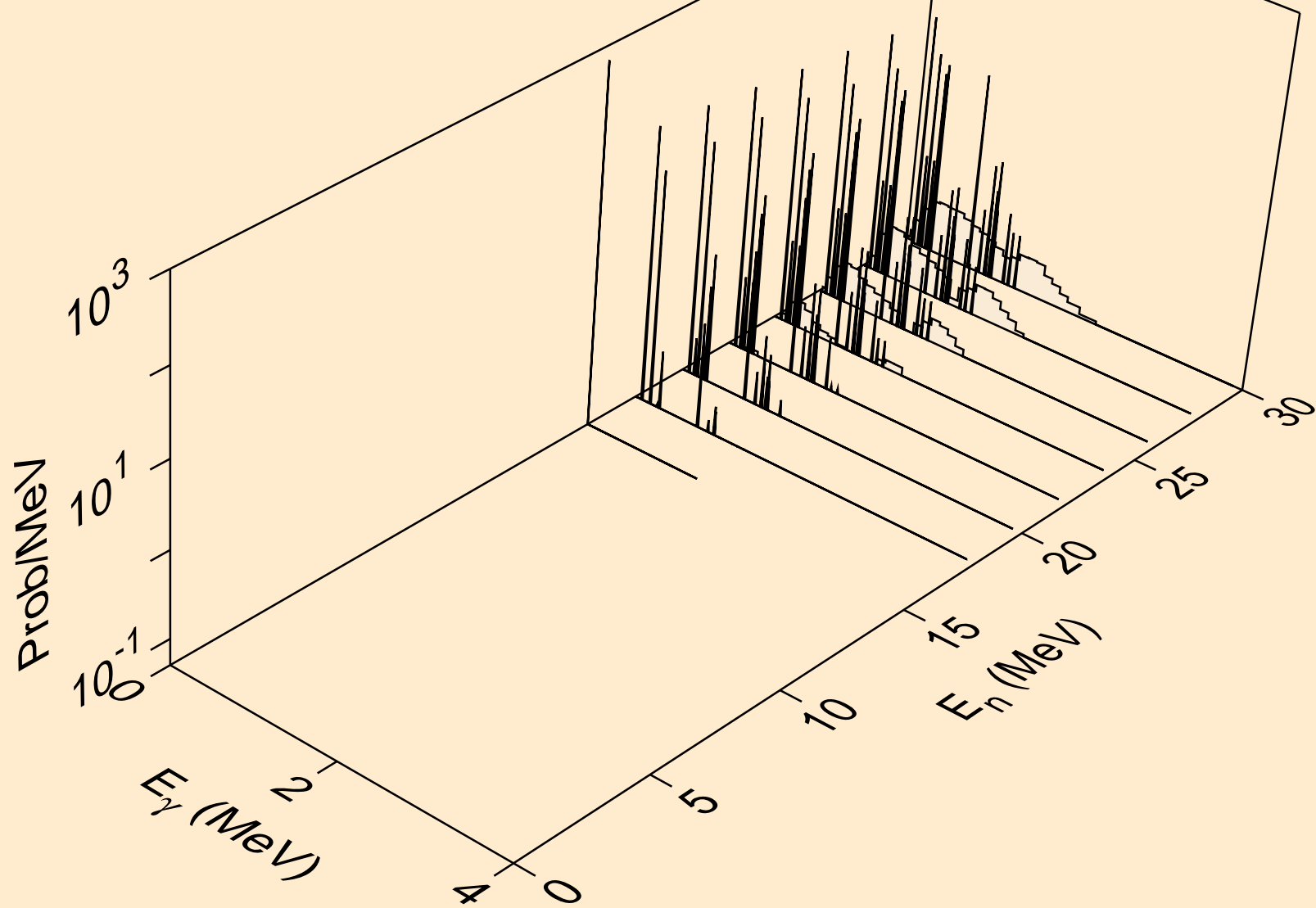

YB177M PROTON ACER TENDL-2021 LIBRARY; T=0.K  
Photon emission for (n,gma)

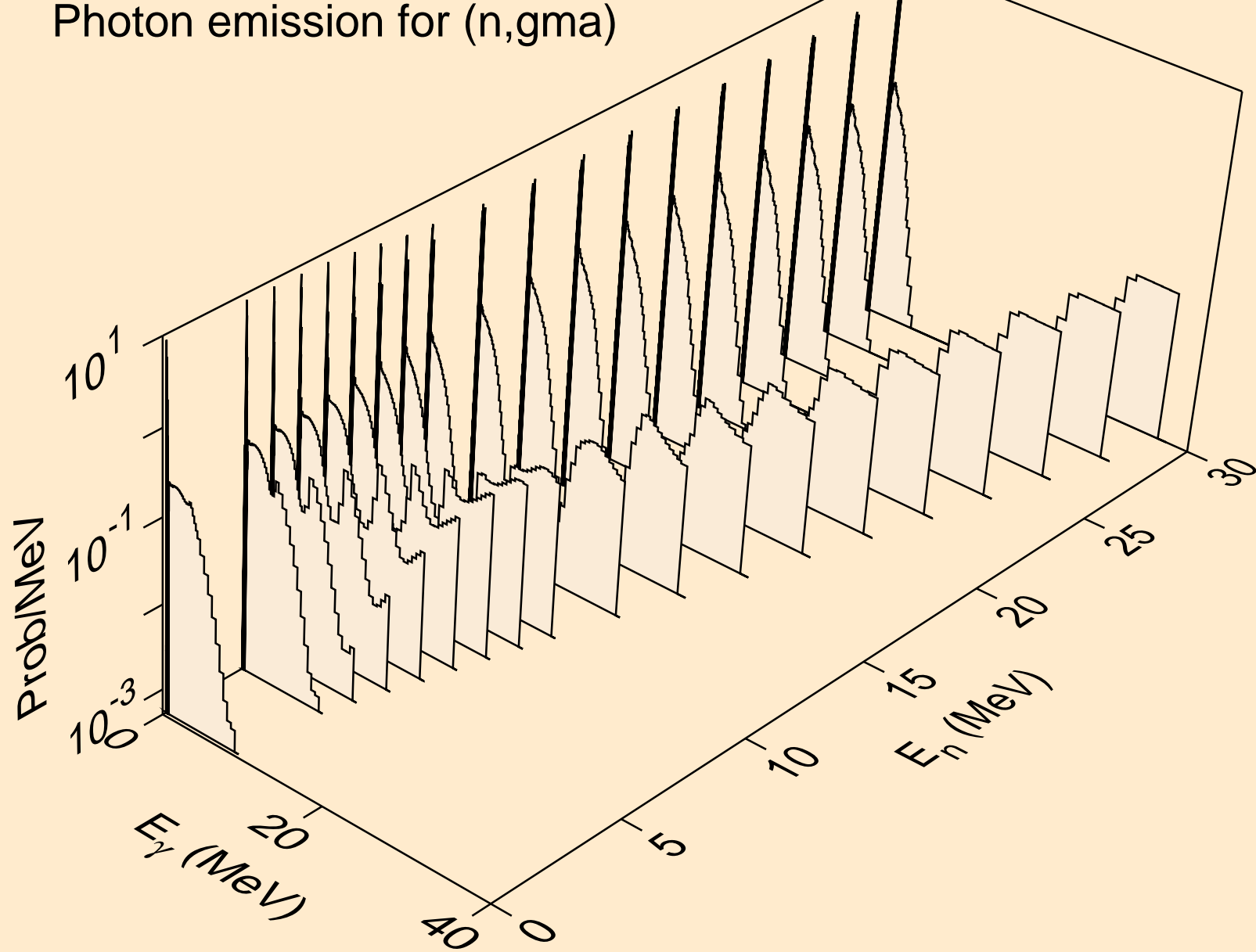

YB177M PROTON ACER TENDL-2021 LIBRARY; T=0.K  
Photon emission for inelastic

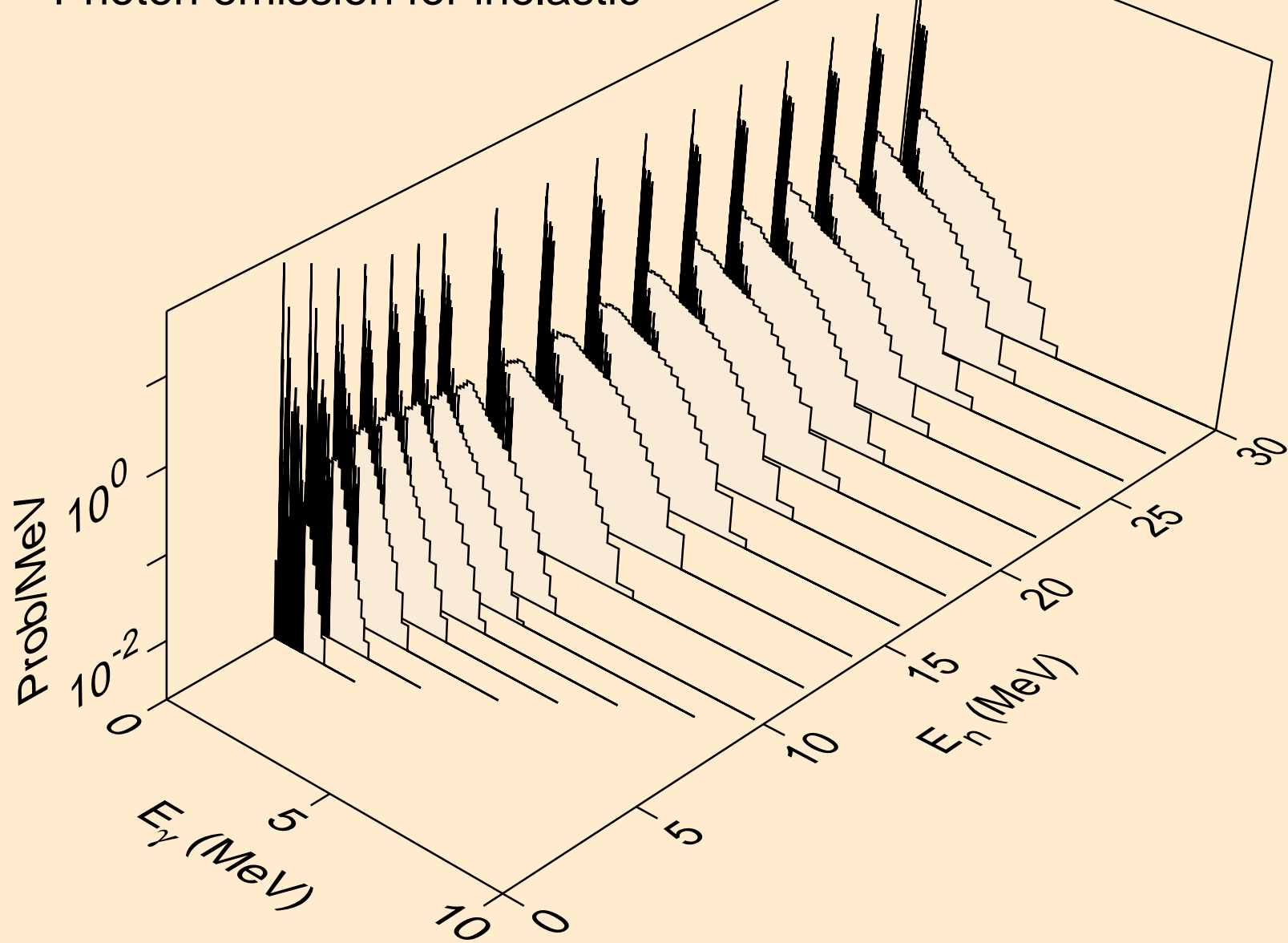



YB177M PROTON ACER TENDL-2021 LIBRARY; T=0.K  
Photon emission for (n,d)

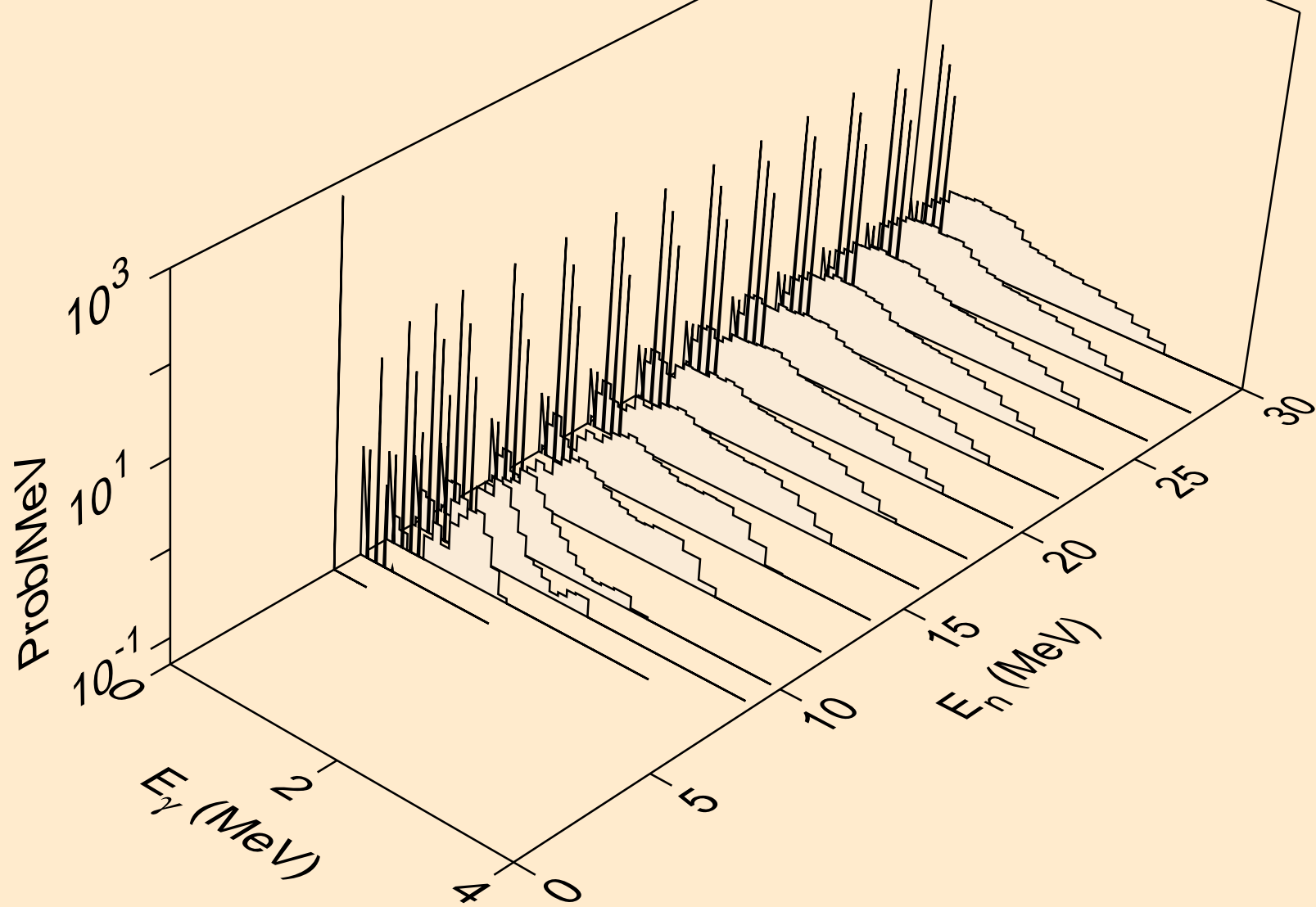

YB177M PROTON ACER TENDL-2021 LIBRARY; T=0.K  
Photon emission for (n,t)

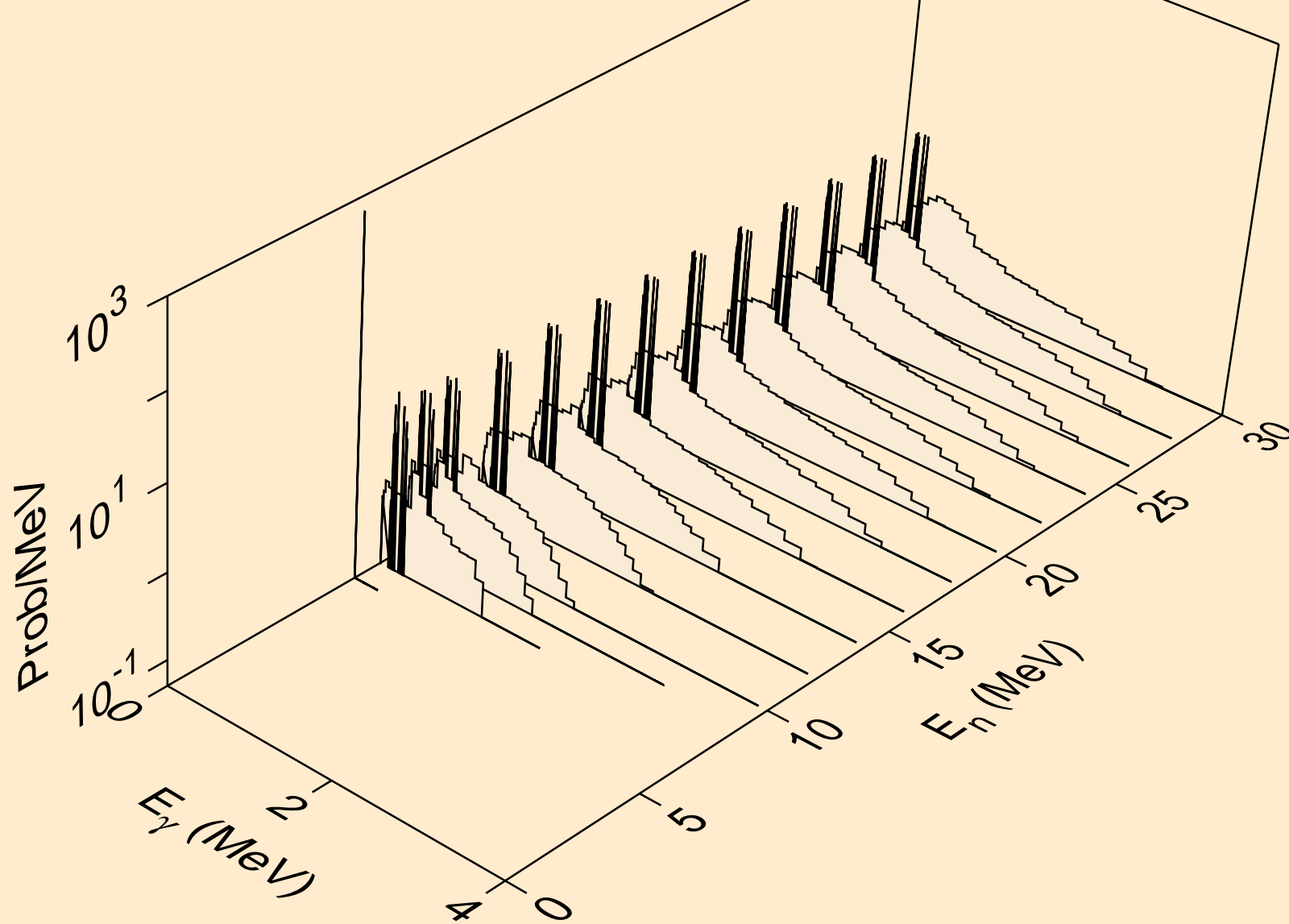

YB177M PROTON ACER TENDL-2021 LIBRARY; T=0.K  
Photon emission for (n,he3)

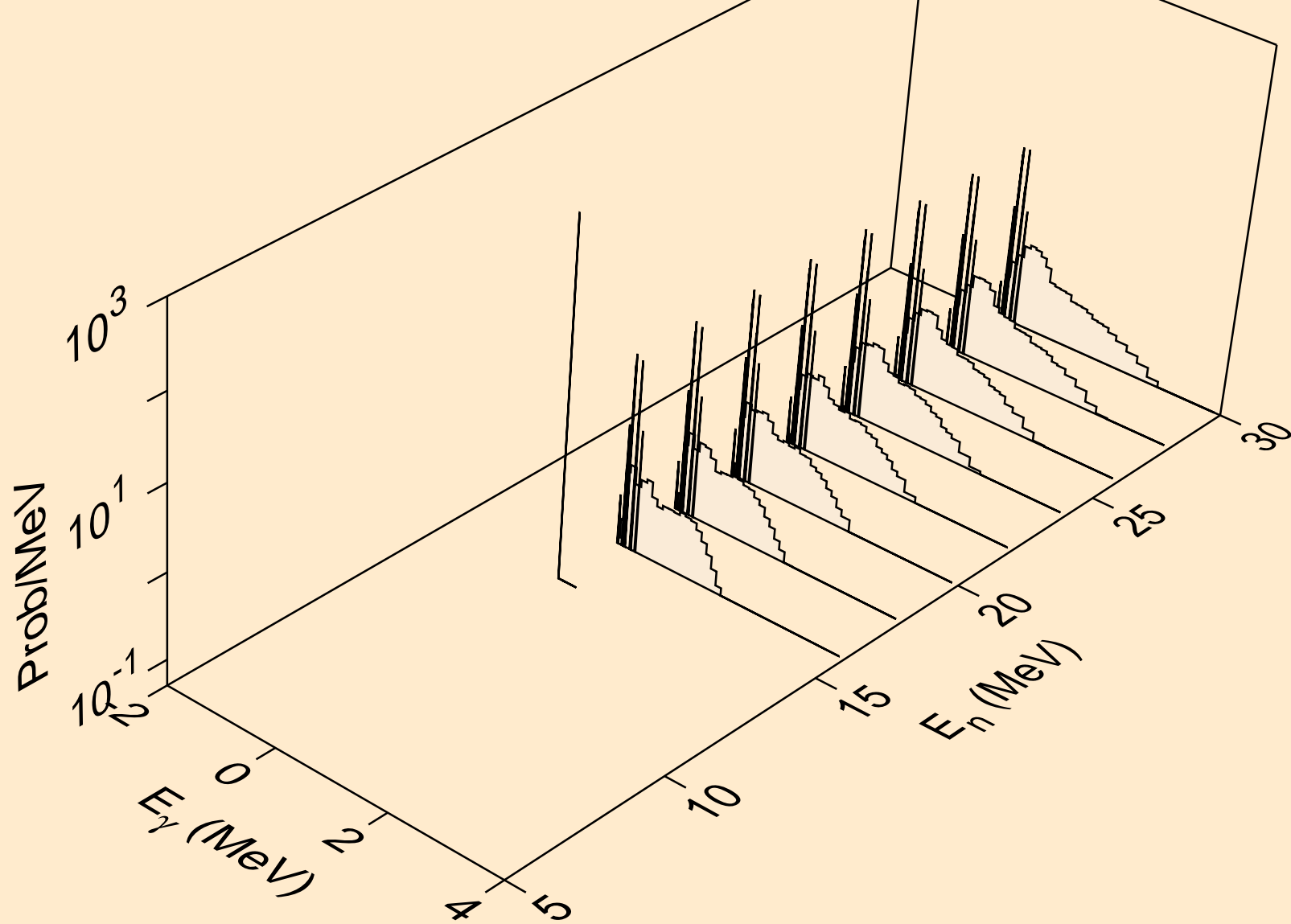

YB177M PROTON ACER TENDL-2021 LIBRARY; T=0.K  
Photon emission for (n,a)

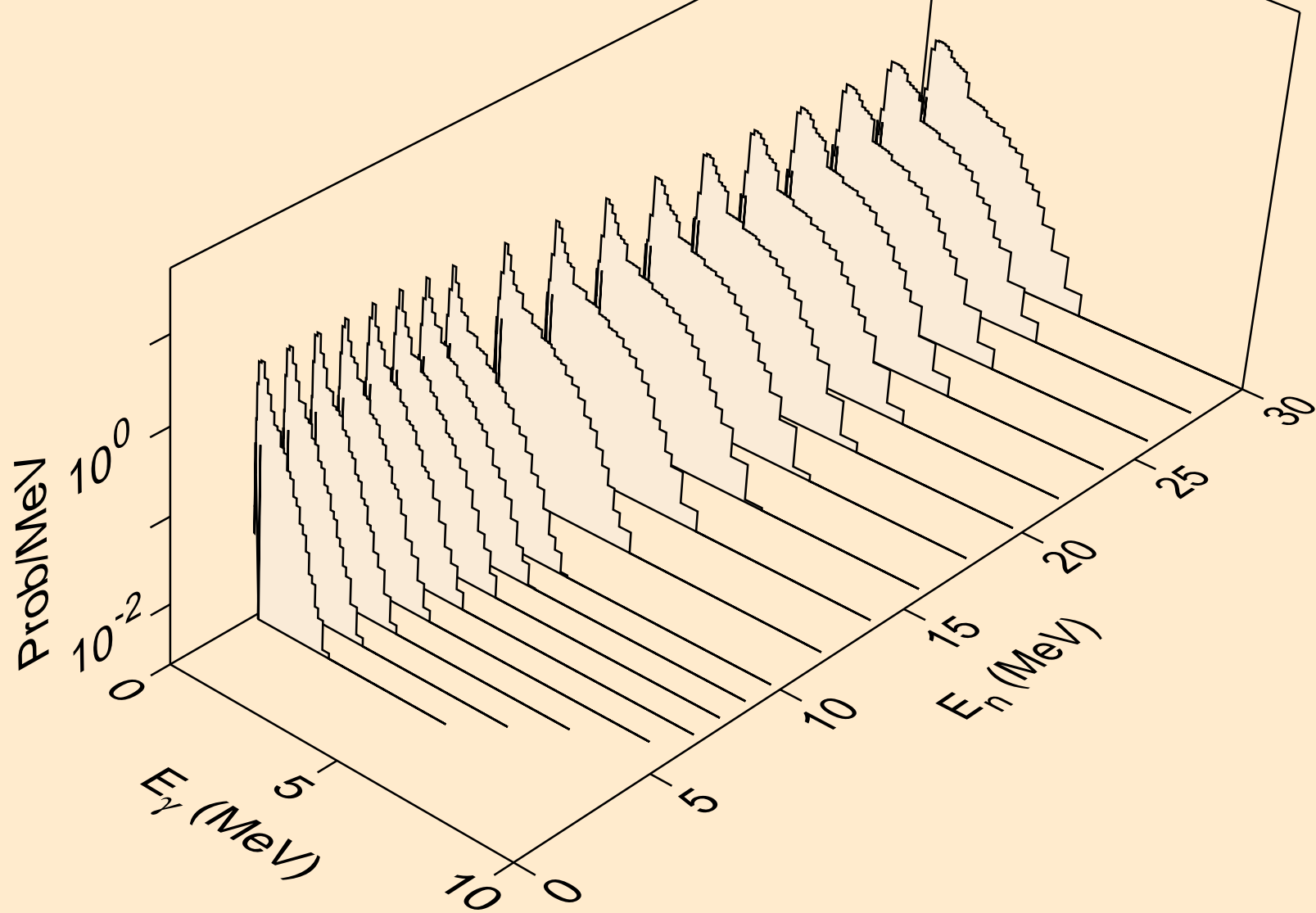

YB177M PROTON ACER TENDL-2021 LIBRARY; T=0.K  
Photon emission for (n,2a)

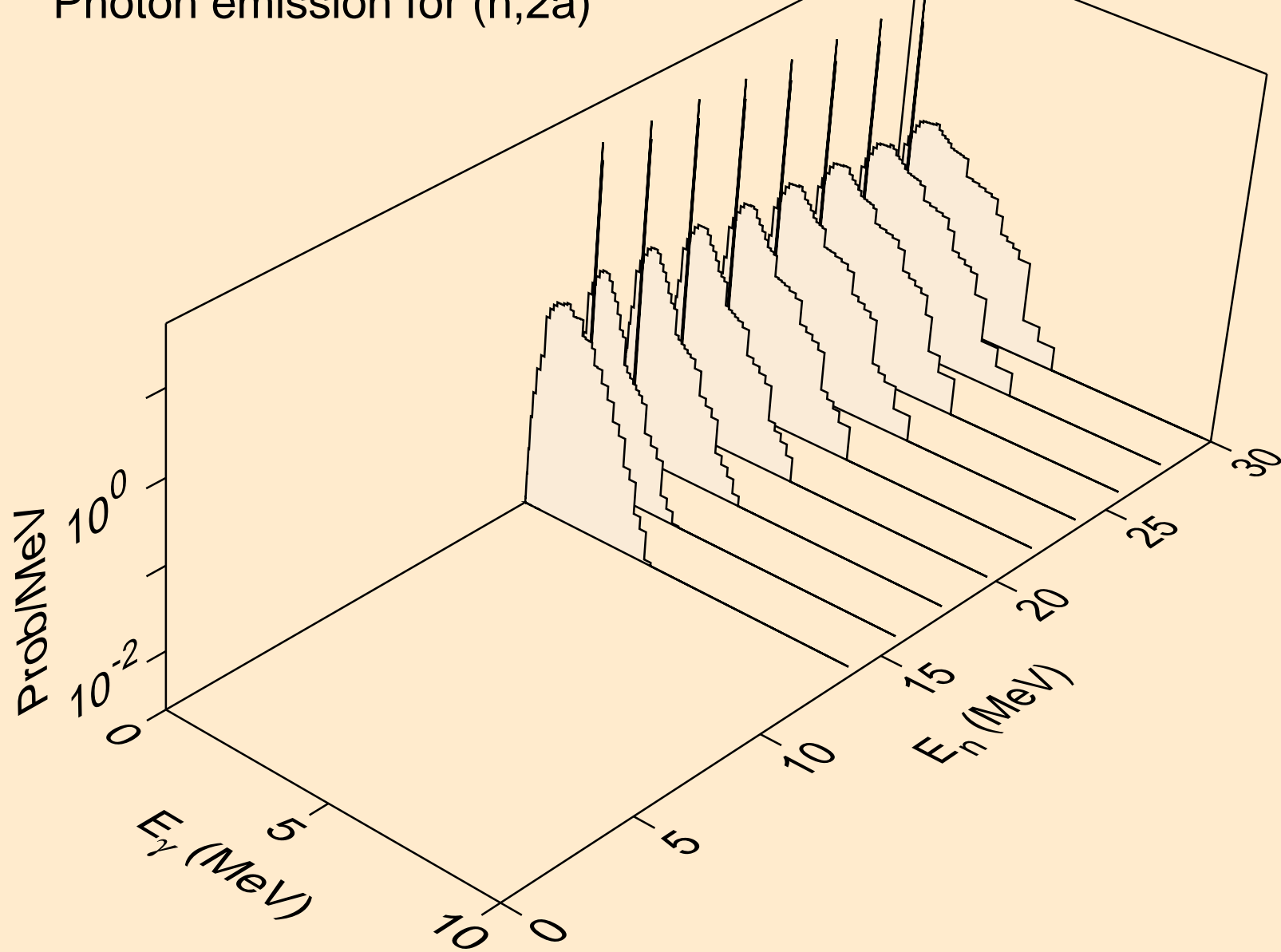

YB177M PROTON ACER TENDL-2021 LIBRARY; T=0.K  
Photon emission for (n,2p)

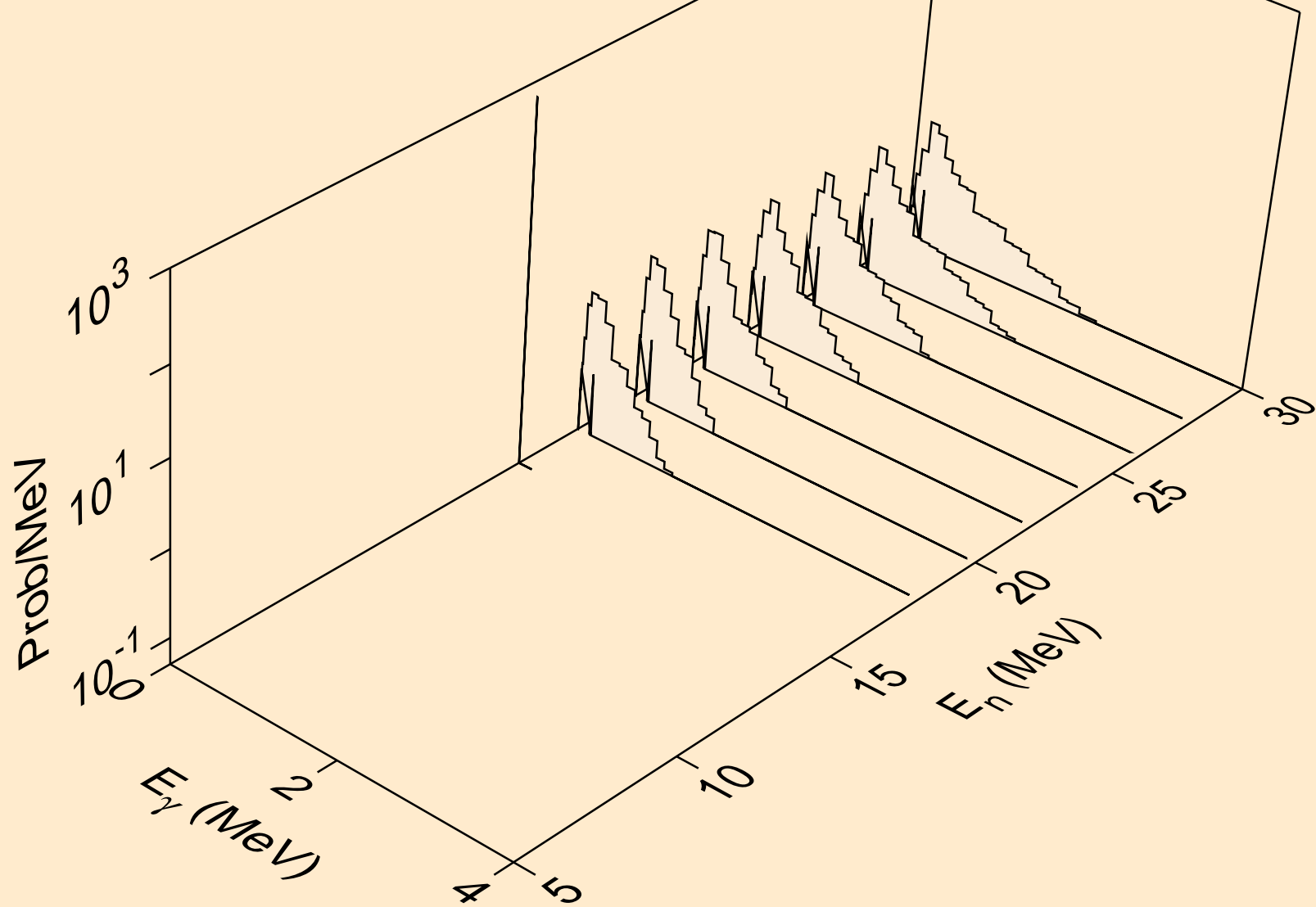

YB177M PROTON ACER TENDL-2021 LIBRARY; T=0.K  
Photon emission for (n,pa)

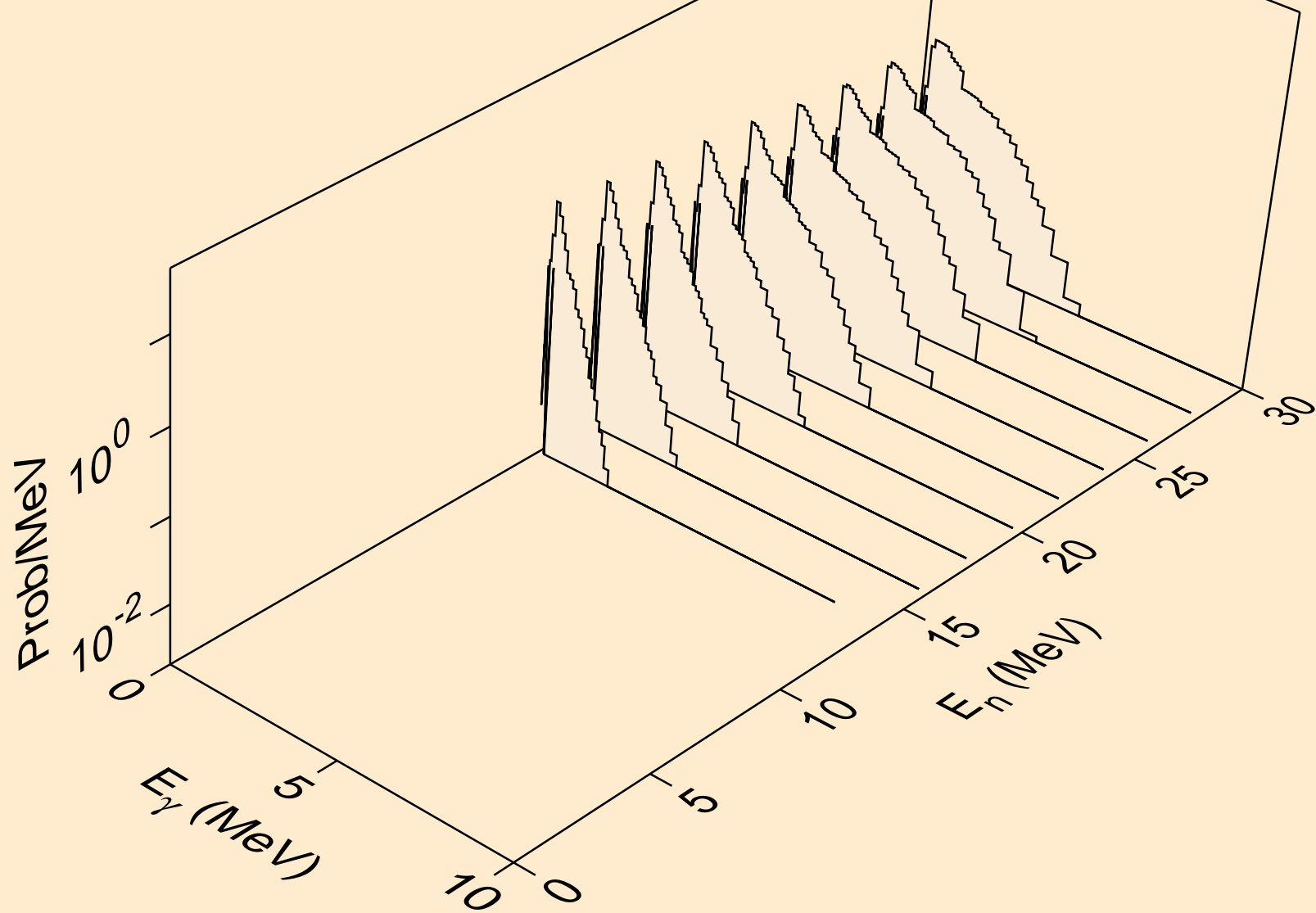

YB177M PROTON ACER TENDL-2021 LIBRARY; T=0.K  
Photon emission for (n,pd)

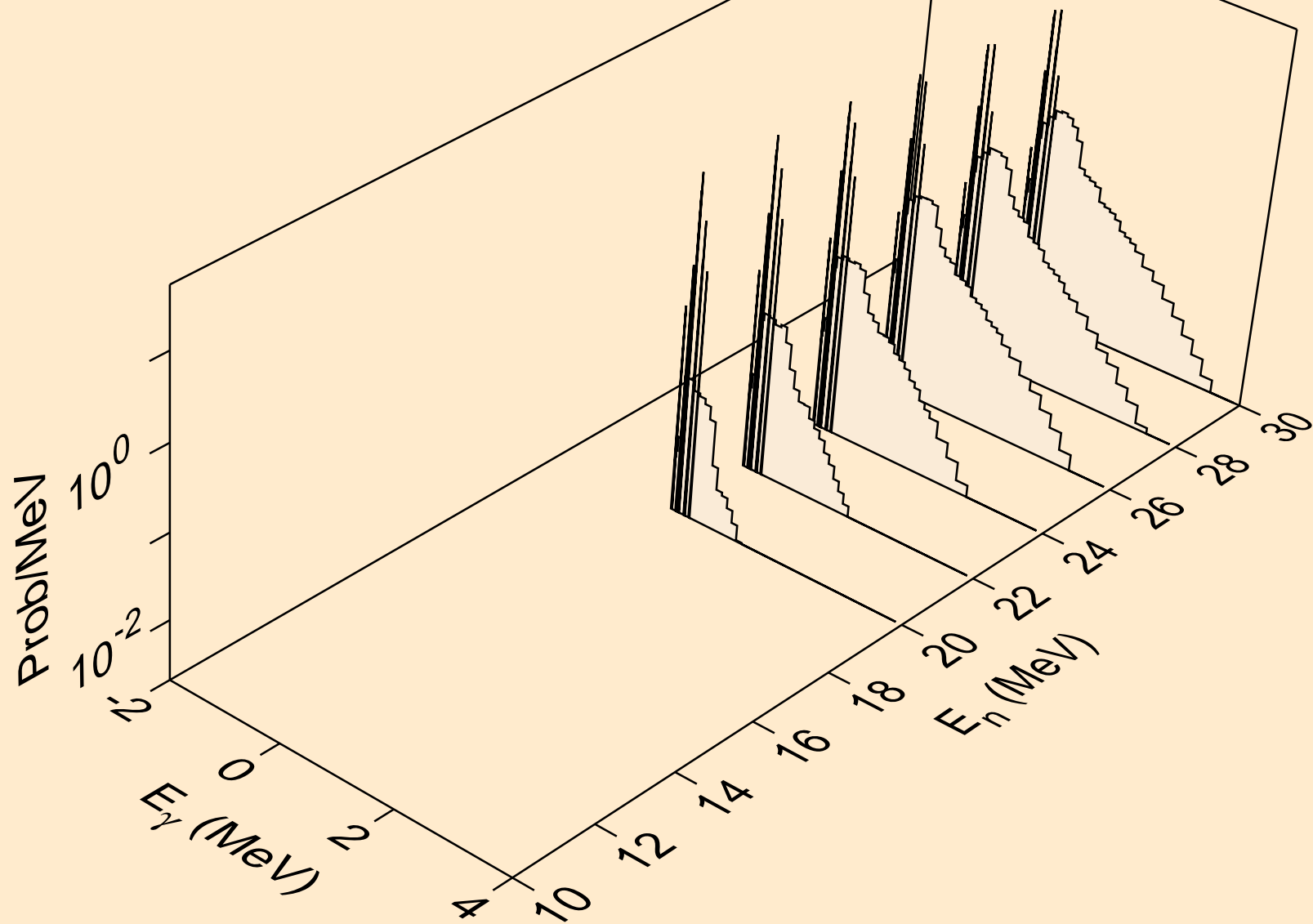



YB177M PROTON ACER TENDL-2021 LIBRARY; T=0.K  
Photon emission for (n,pt)

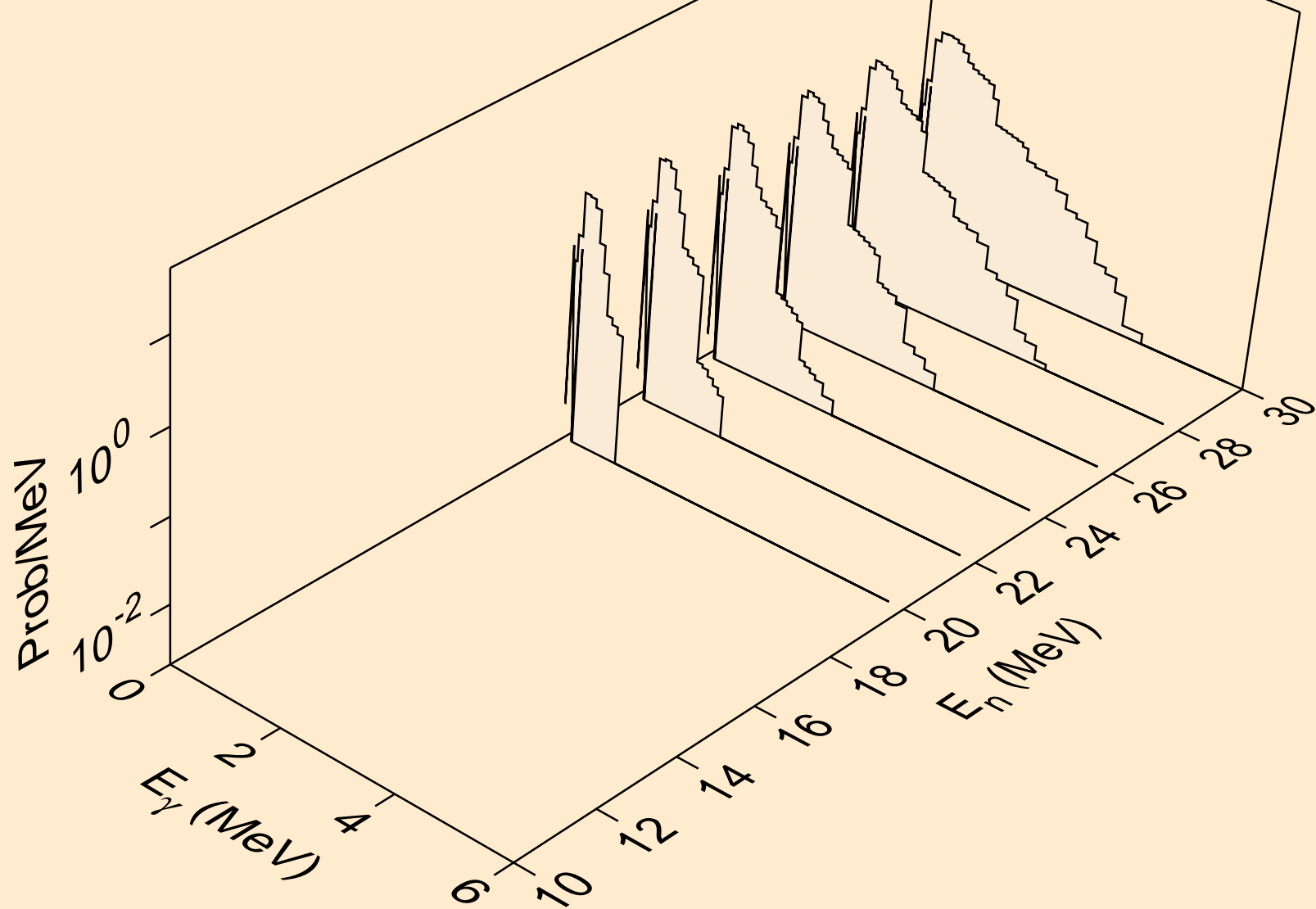

YB177M PROTON ACER TENDL-2021 LIBRARY; T=0.K  
Particle heating contributions

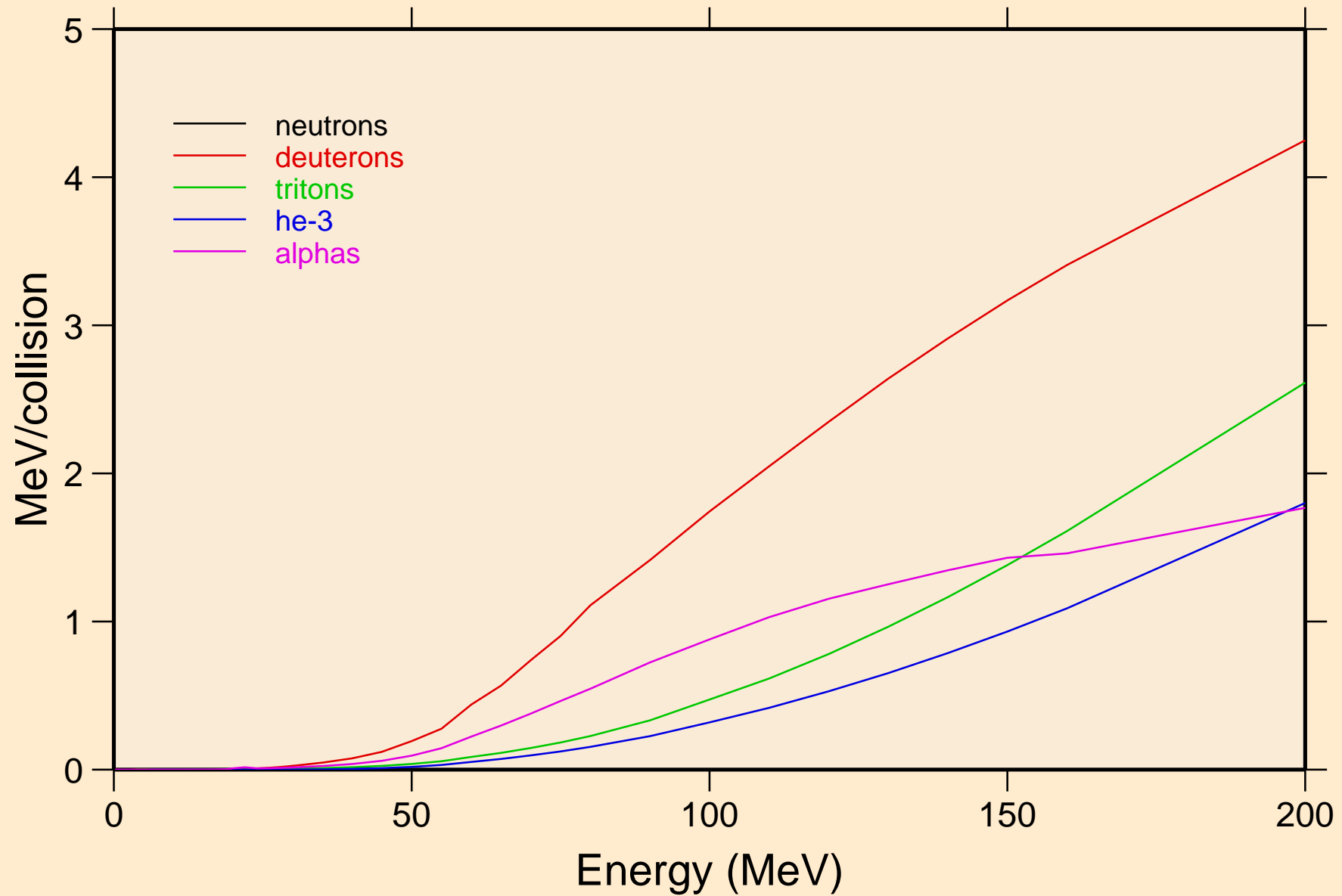

YB177M PROTON ACER TENDL-2021 LIBRARY; T=0.K  
Recoil Heating

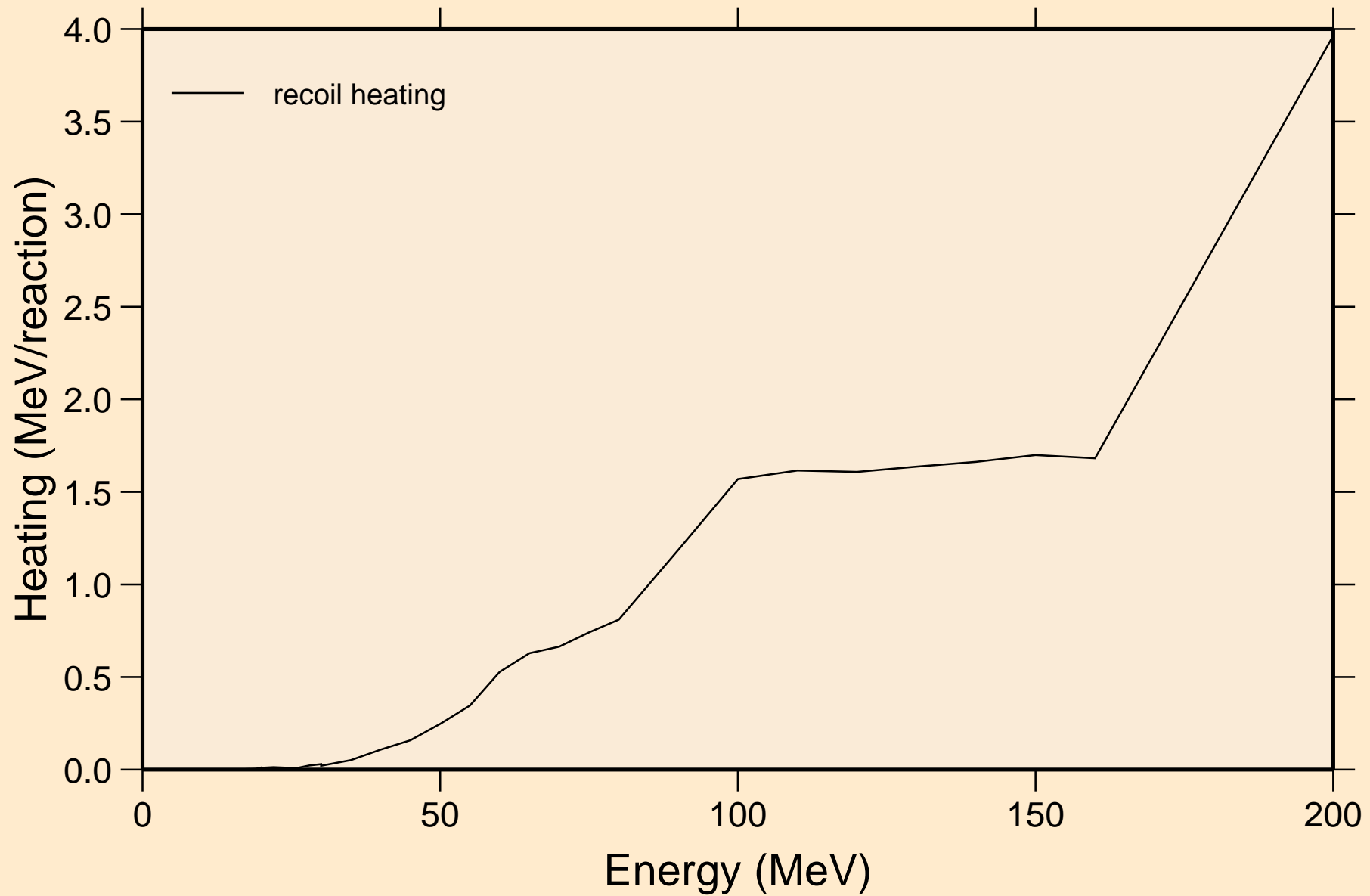

YB177M PROTON ACER TENDL-2021 LIBRARY; T=0.K  
Particle production cross sections

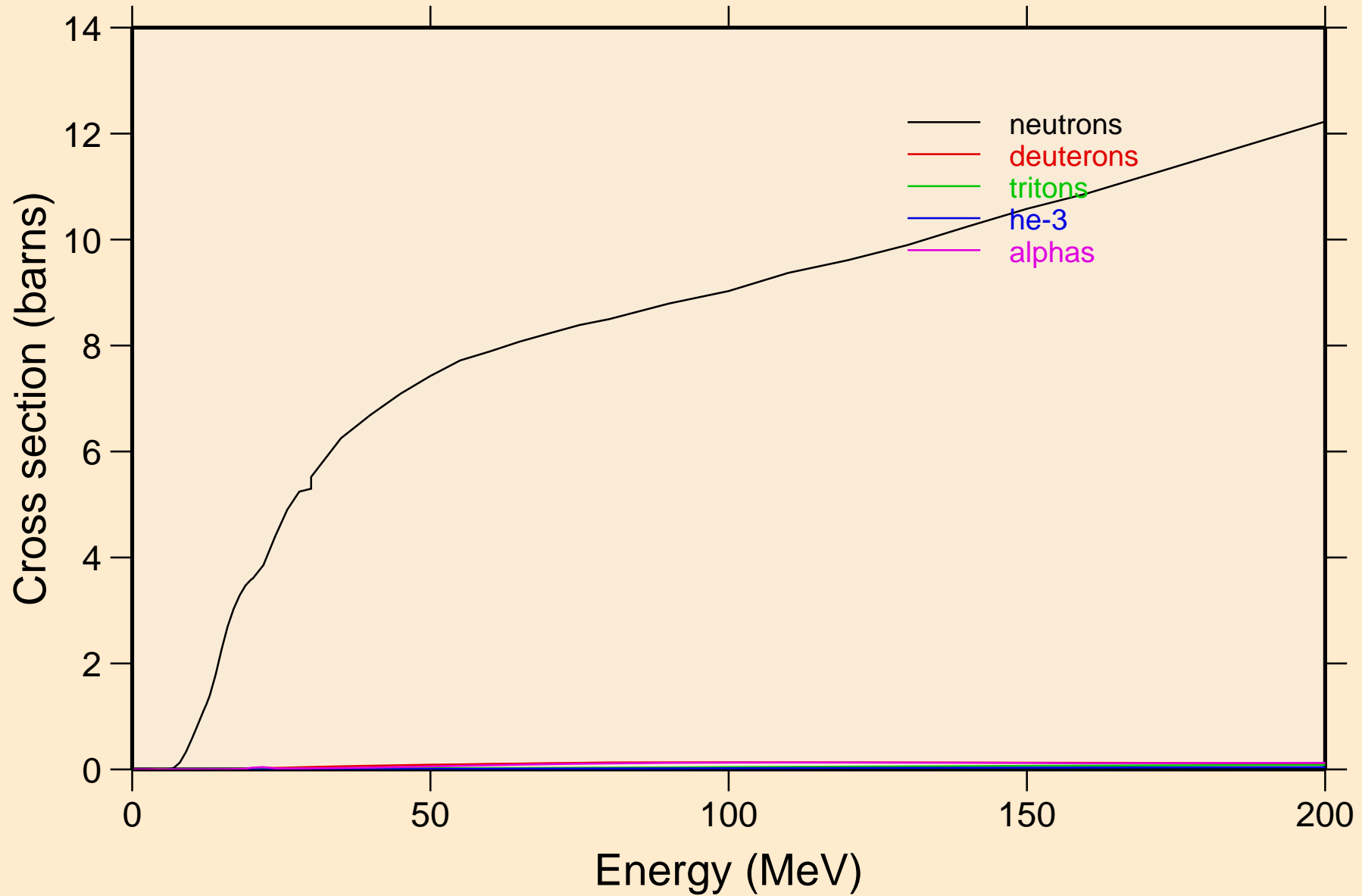

YB177M PROTON ACER TENDL-2021 LIBRARY; T=0.K  
neutrons from (p,n)

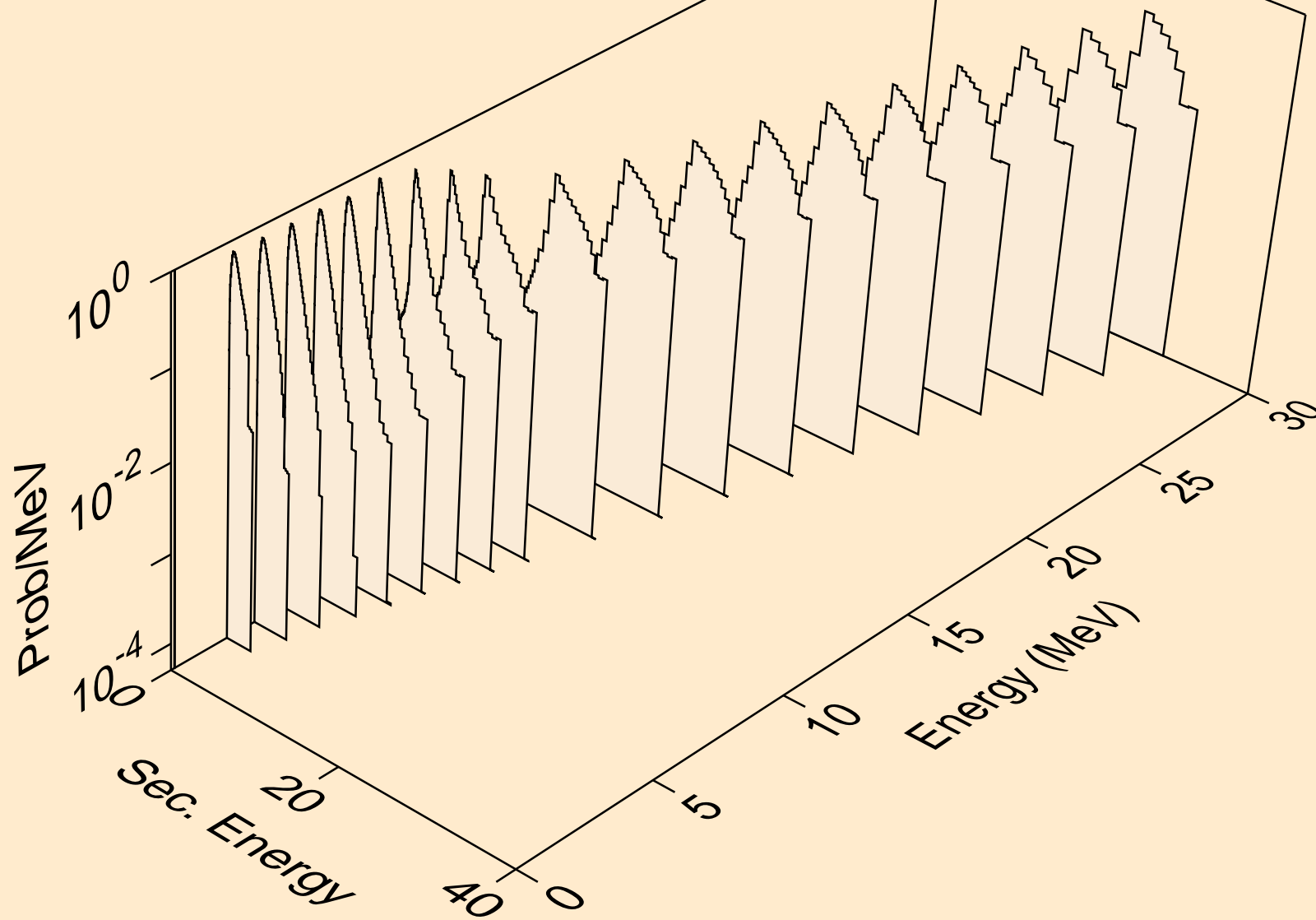

YB177M PROTON ACER TENDL-2021 LIBRARY; T=0.K  
neutrons from (p,x)

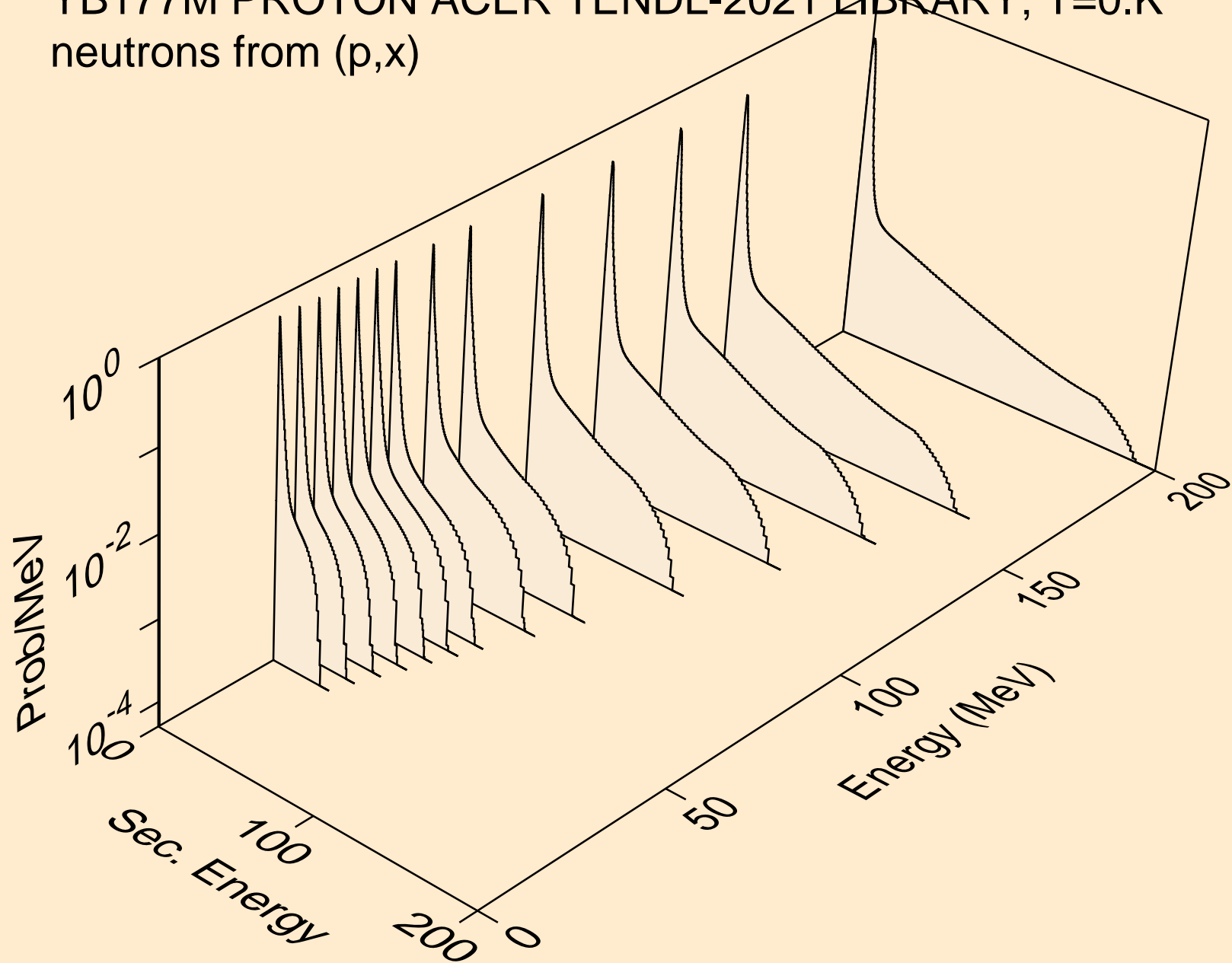

YB177M PROTON ACER TENDL-2021 LIBRARY; T=0.K  
neutrons from (p,2nd)

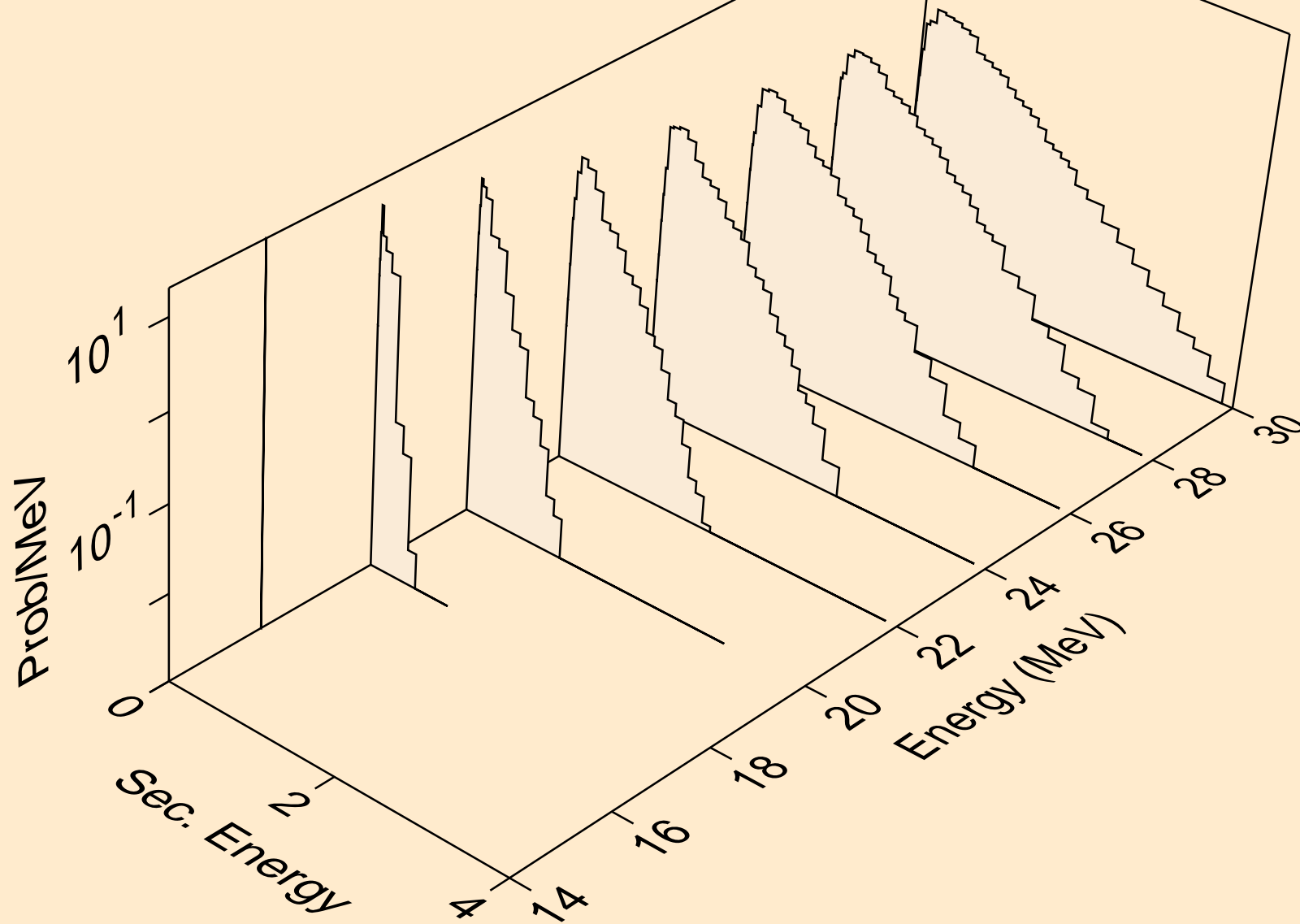

YB177M PROTON ACER TENDL-2021 LIBRARY; T=0.K  
neutrons from (p,2n)

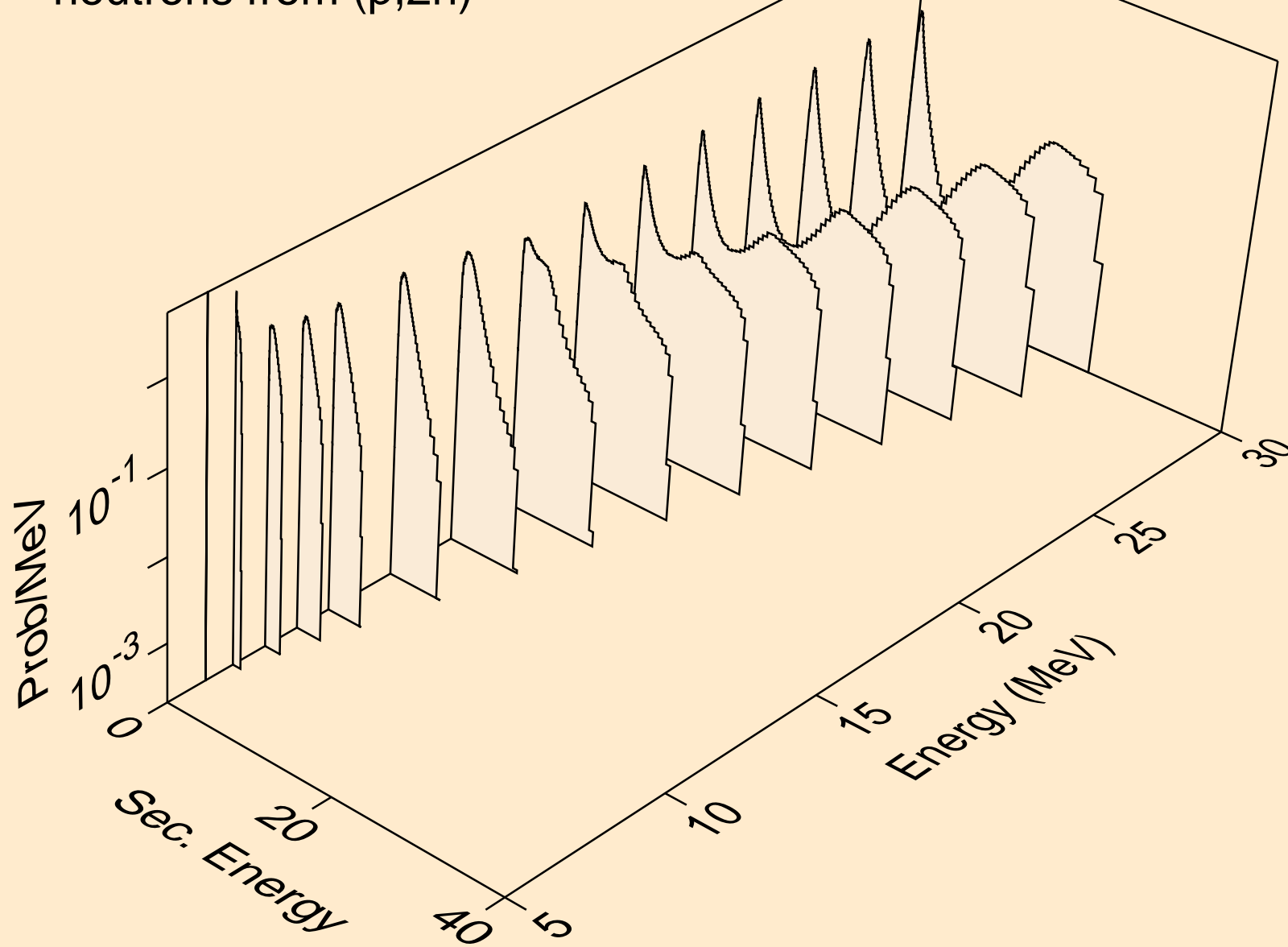



YB177M PROTON ACER TENDL-2021 LIBRARY; T=0.K  
neutrons from (p,3n)

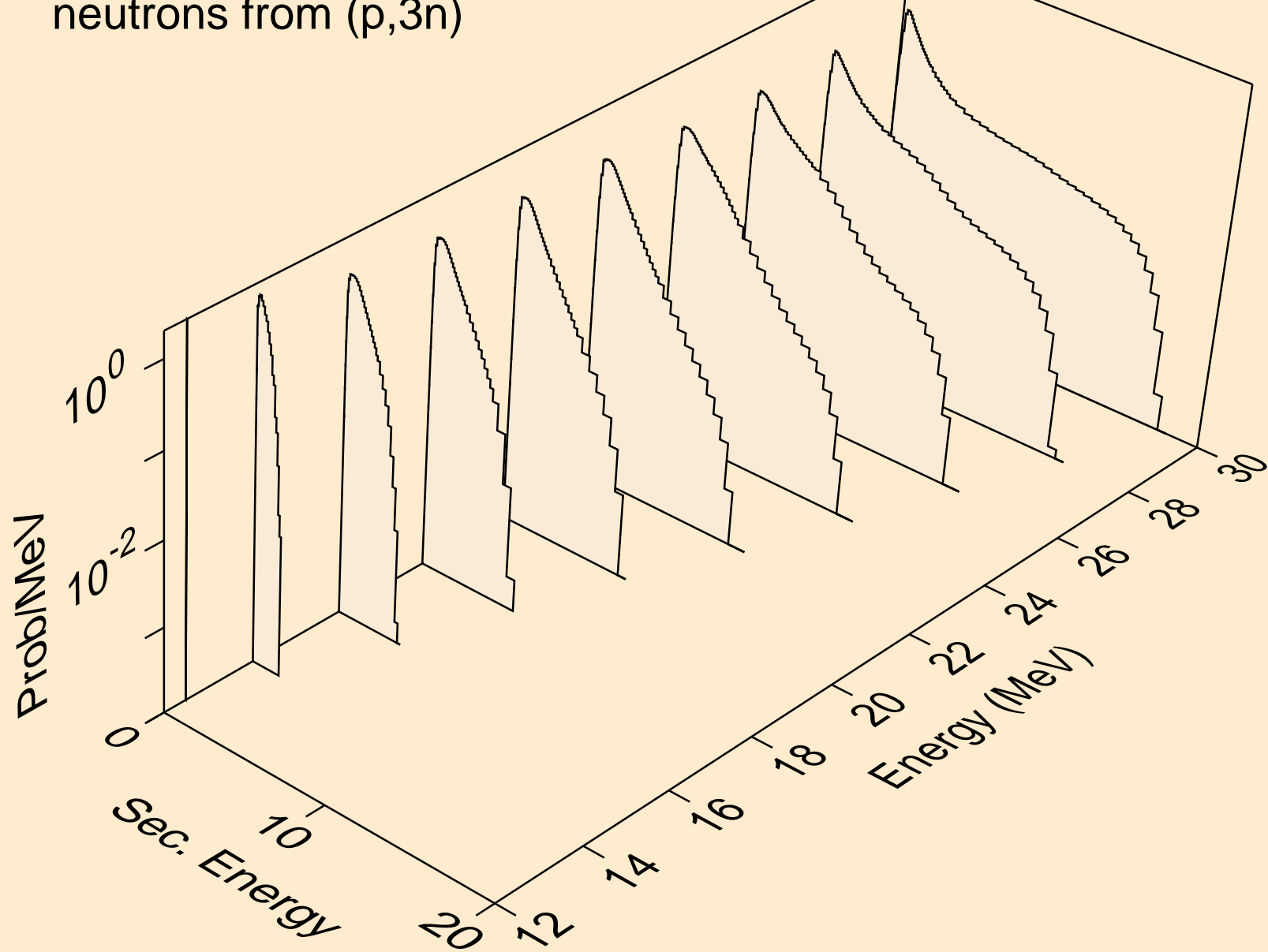

YB177M PROTON ACER TENDL-2021 LIBRARY; T=0.K  
neutrons from (p,n\*)a

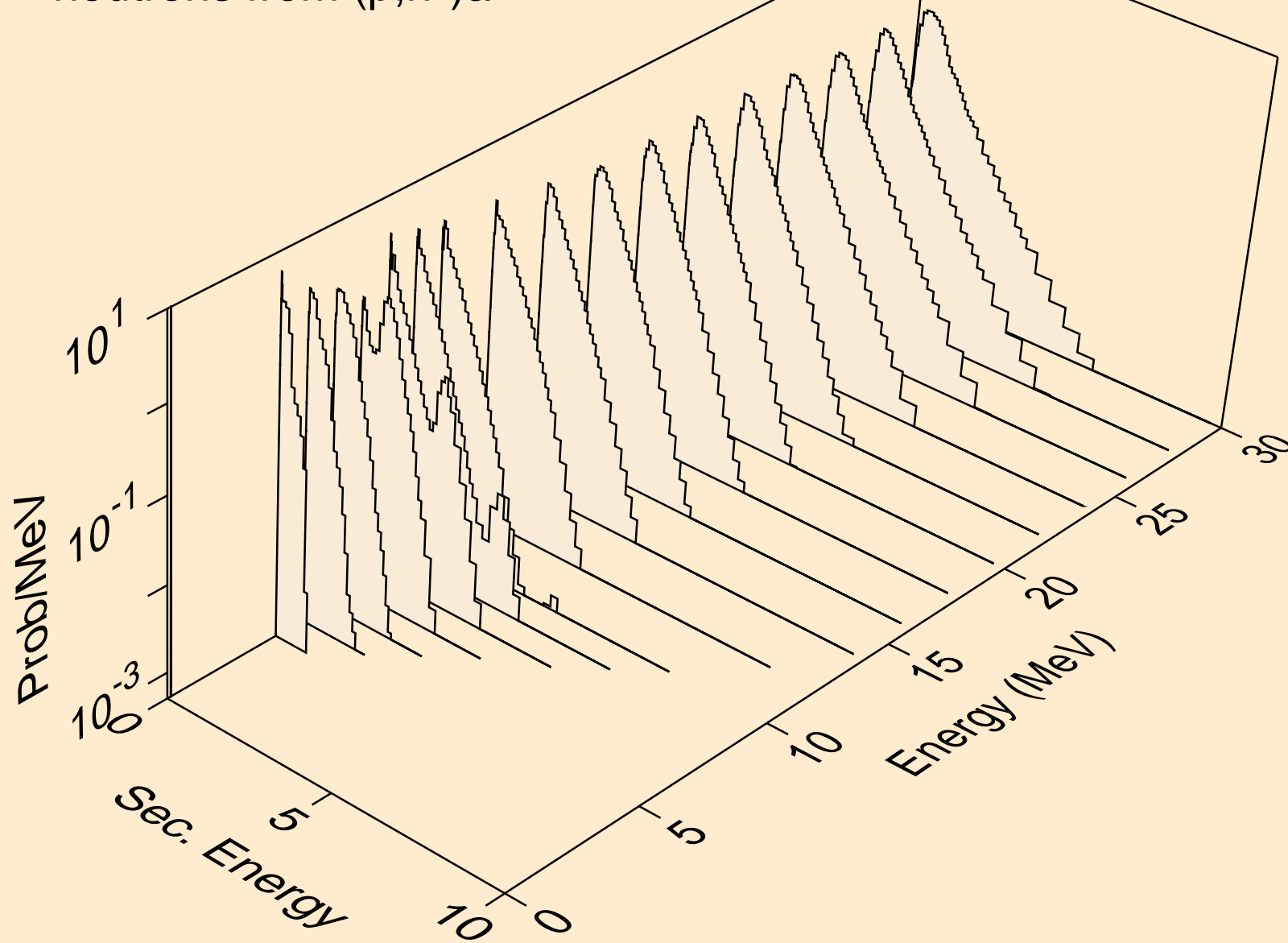

YB177M PROTON ACER TENDL-2021 LIBRARY; T=0.K  
neutrons from (p,2n)a

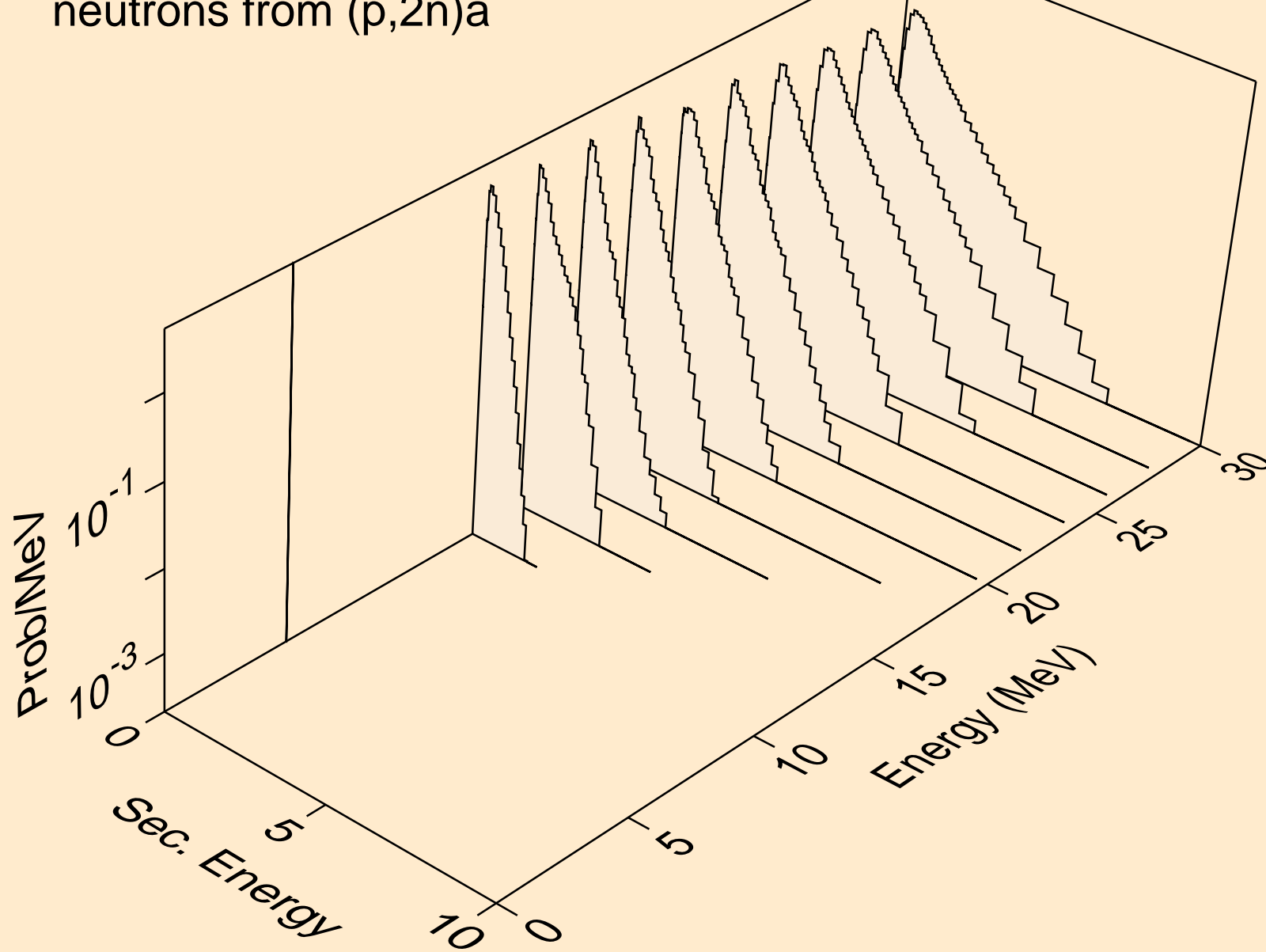

YB177M PROTON ACER TENDL-2021 LIBRARY; T=0.K  
neutrons from (p,3n)a

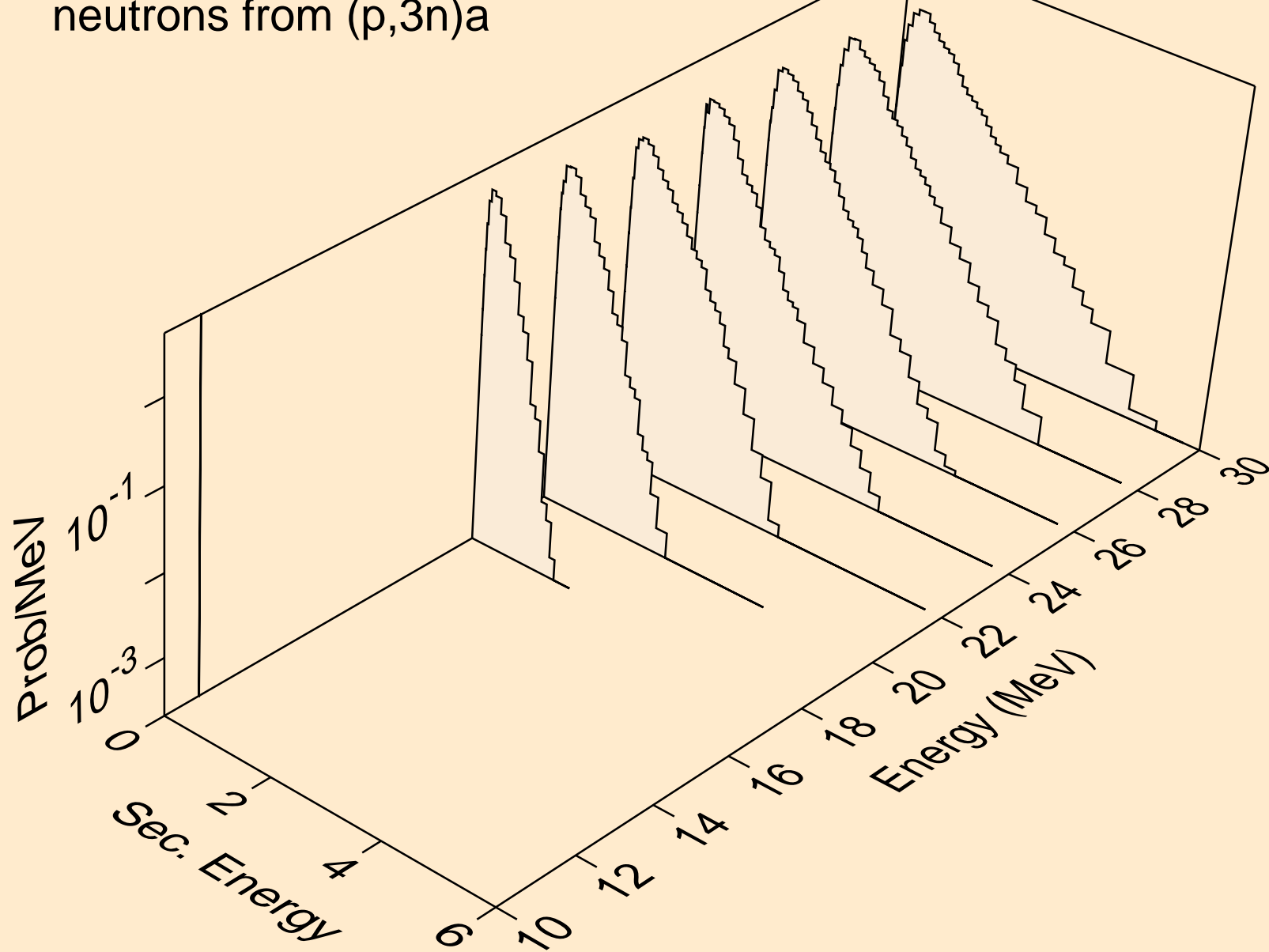

YB177M PROTON ACER TENDL-2021 LIBRARY; T=0.K  
neutrons from (p,n\*)p

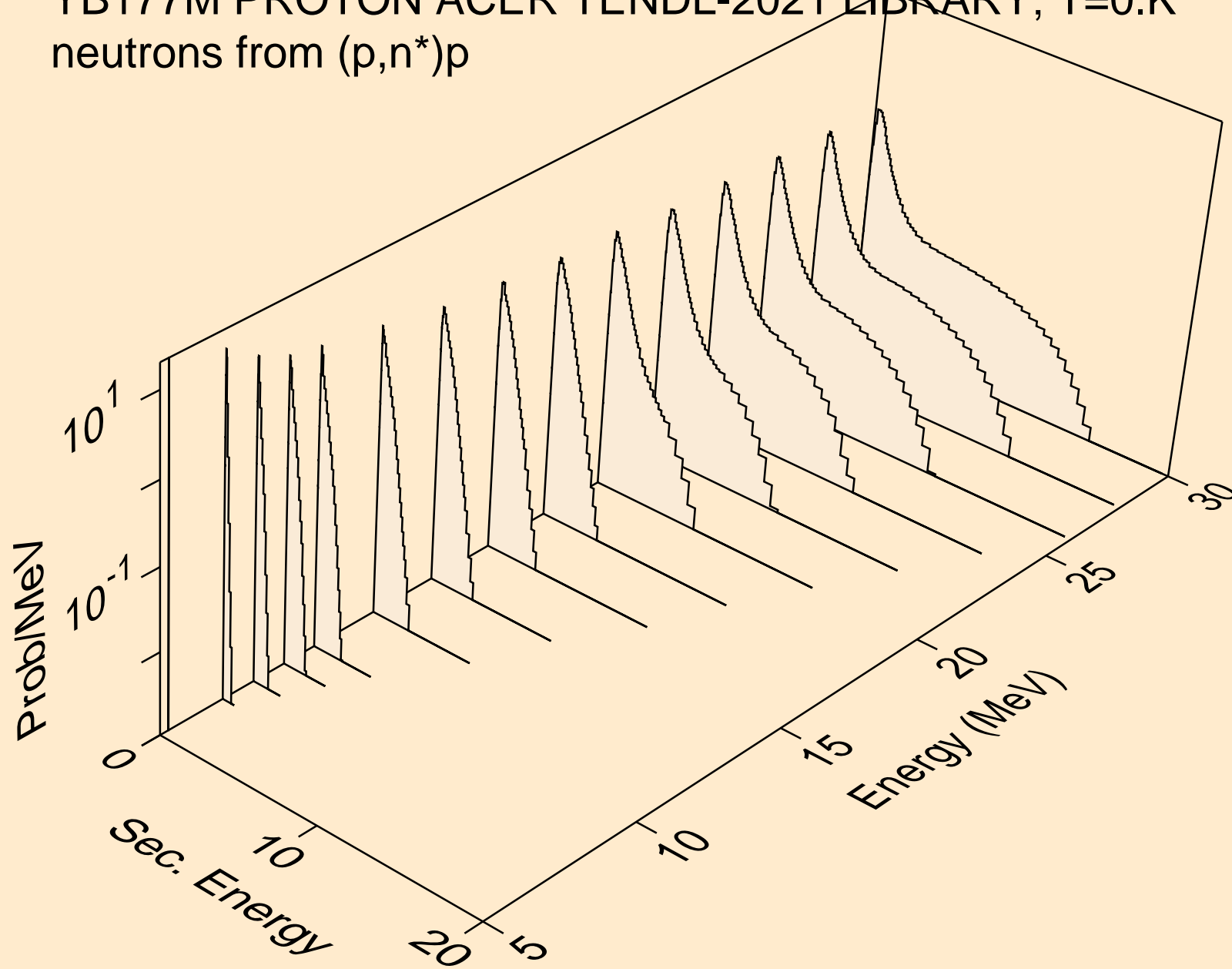

YB177M PROTON ACER TENDL-2021 LIBRARY; T=0.K  
neutrons from (p,n\*)2a

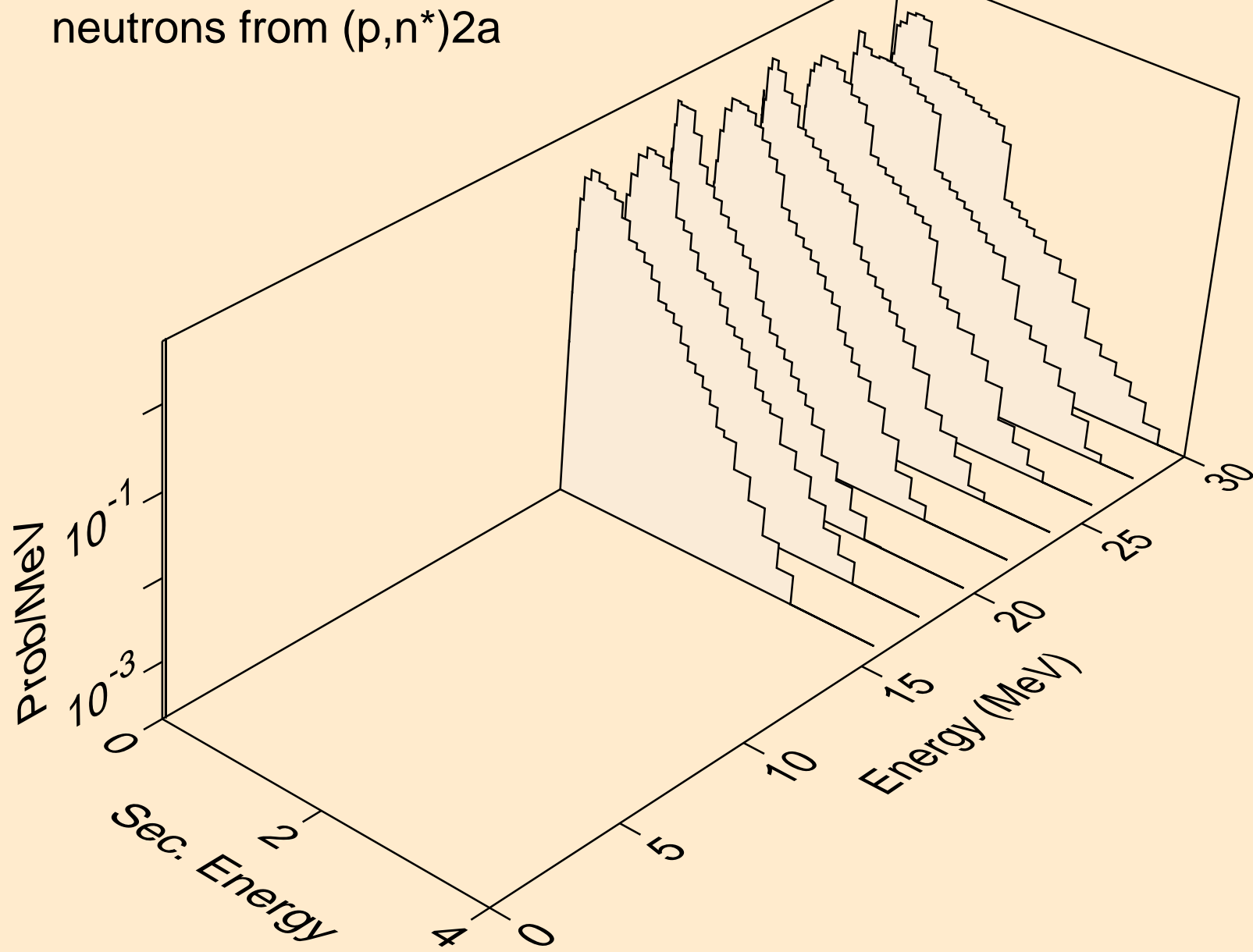

YB177M PROTON ACER TENDL-2021 LIBRARY; T=0.K  
neutrons from (p,n\*)d

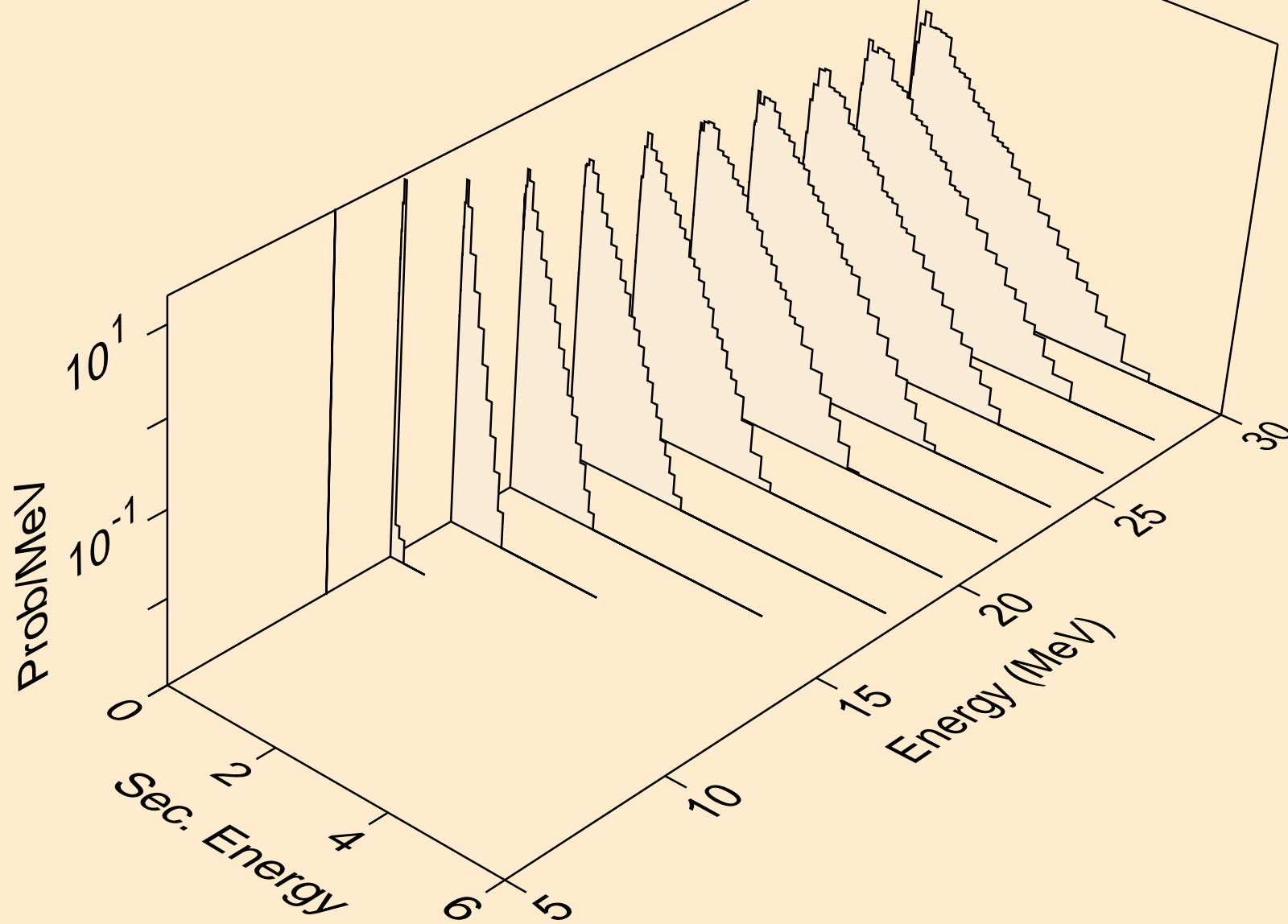

YB177M PROTON ACER TENDL-2021 LIBRARY; T=0.K  
neutrons from (p,n\*)t

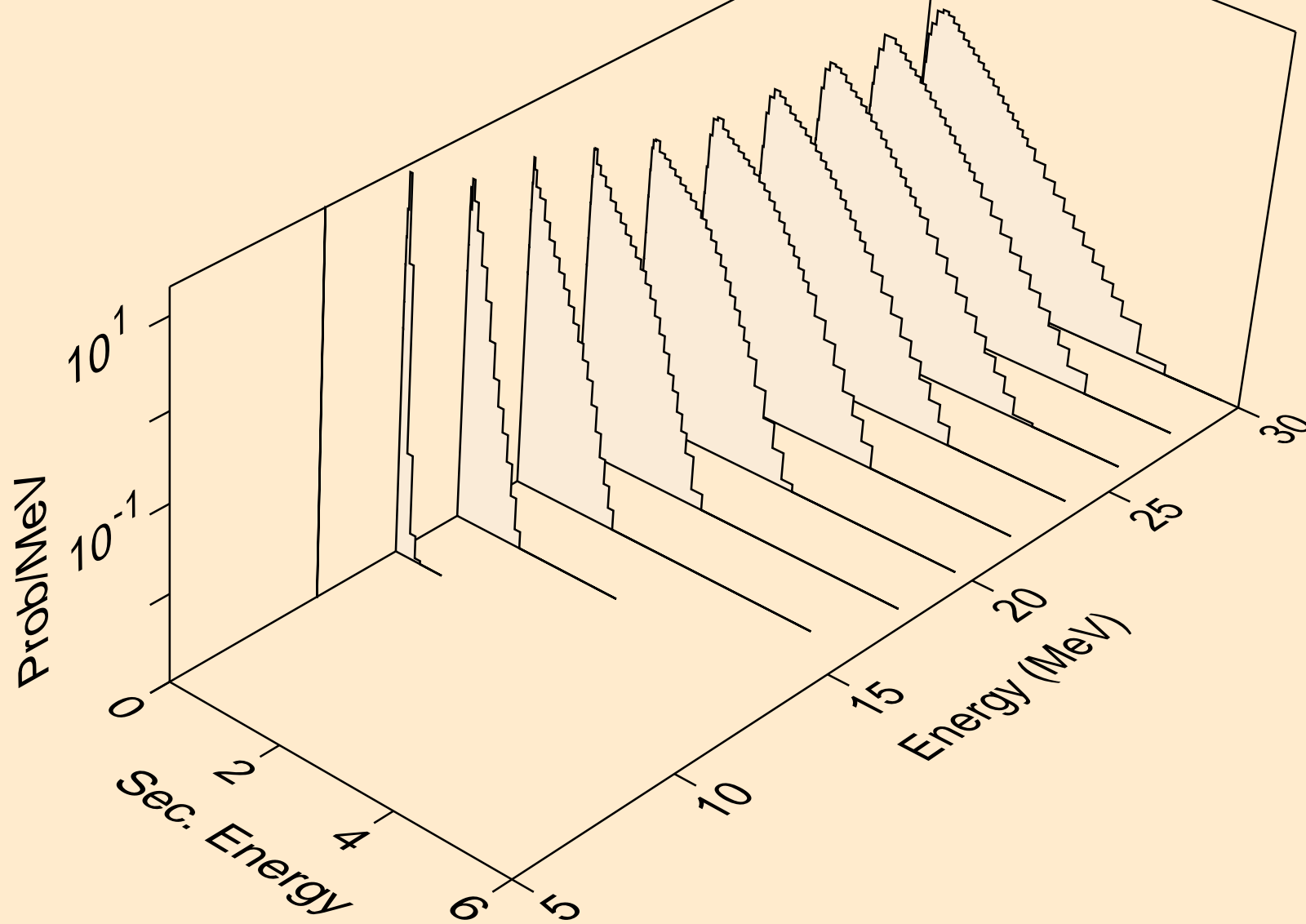



YB177M PROTON ACER TENDL-2021 LIBRARY; T=0.K  
neutrons from (p,n\*)he3

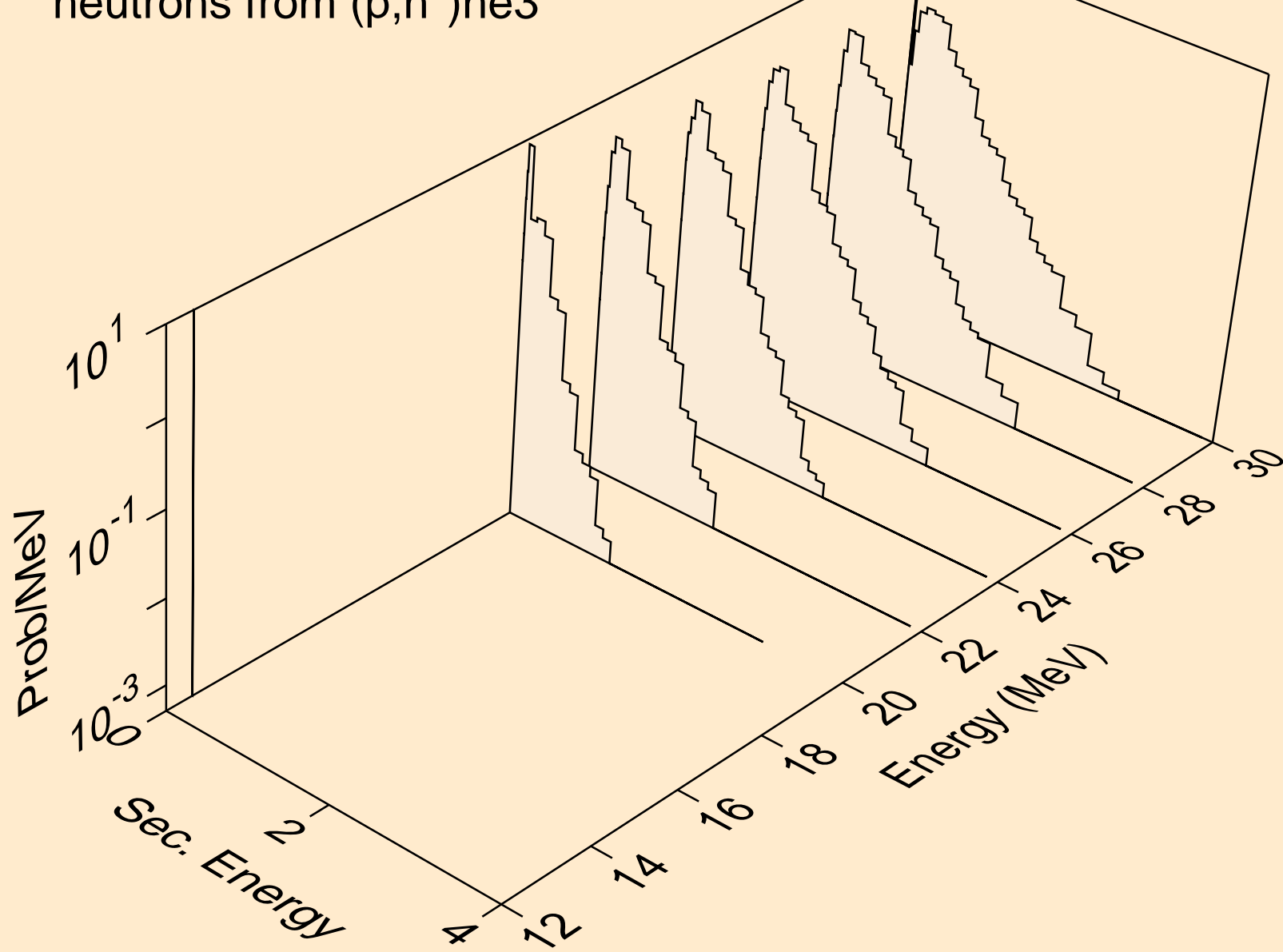

YB177M PROTON ACER TENDL-2021 LIBRARY; T=0.K  
neutrons from (p,4n)

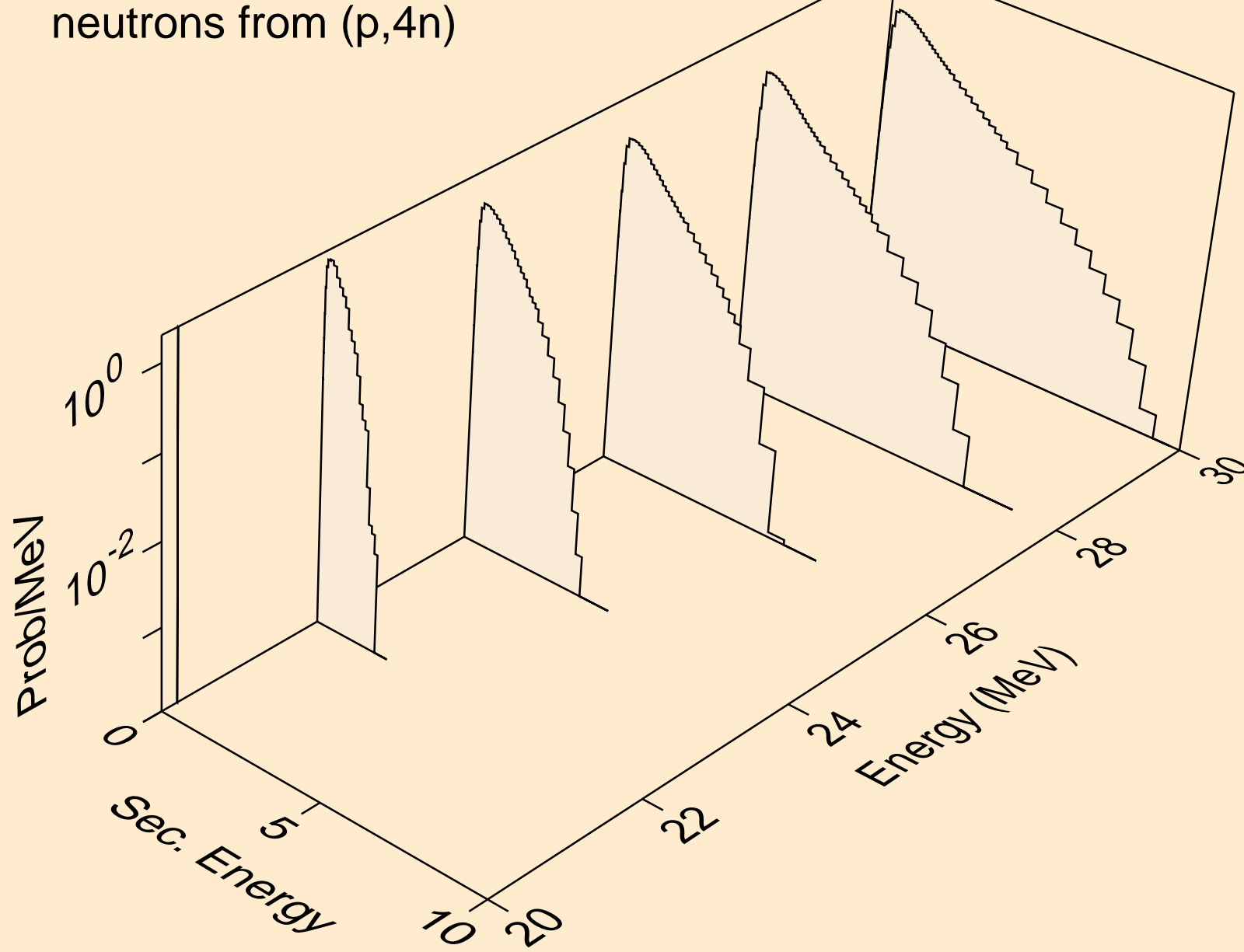

YB177M PROTON ACER TENDL-2021 LIBRARY; T=0.K  
neutrons from (p,2np)

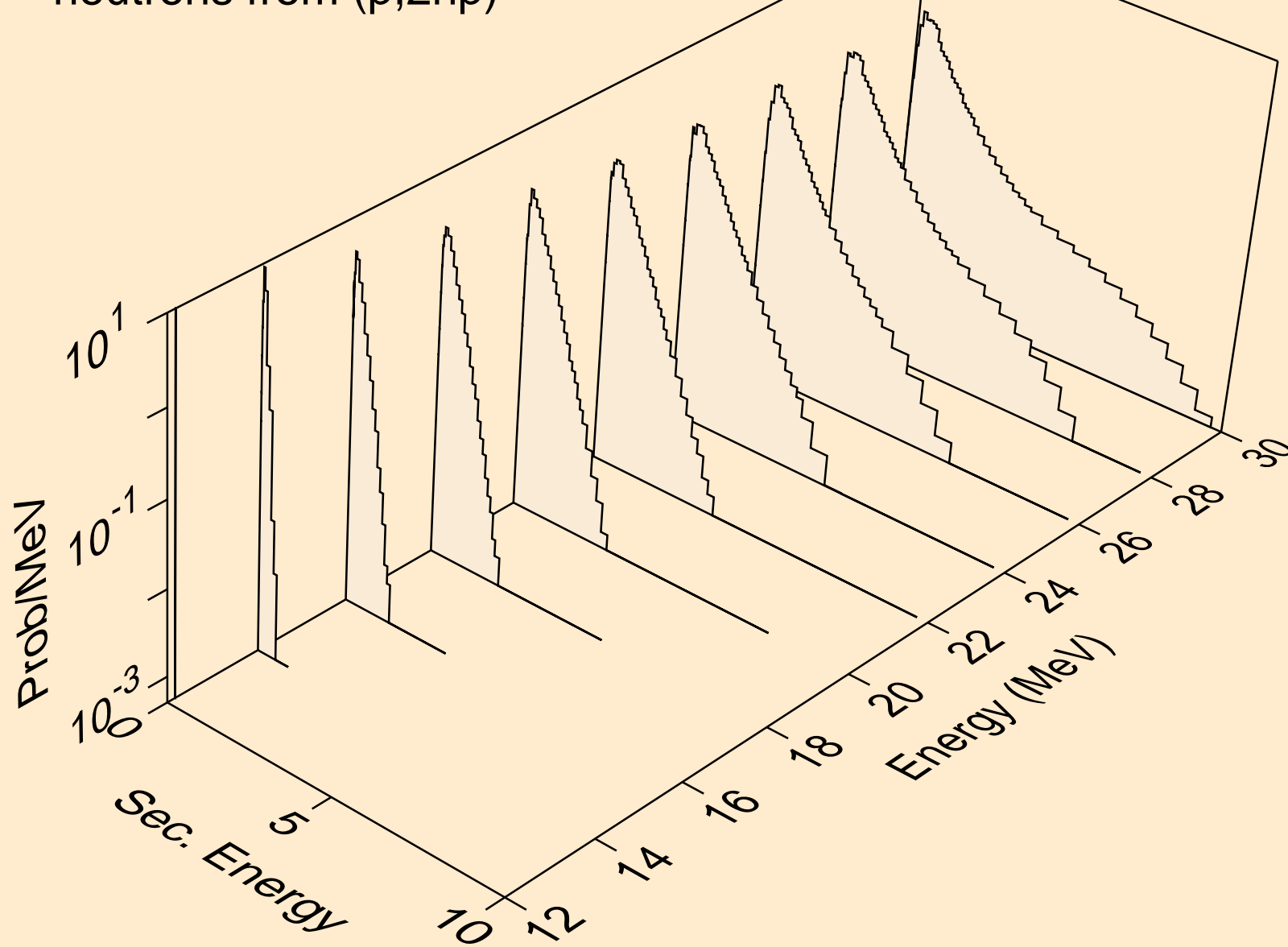

YB177M PROTON ACER TENDL-2021 LIBRARY; T=0.K  
neutrons from (p,3np)

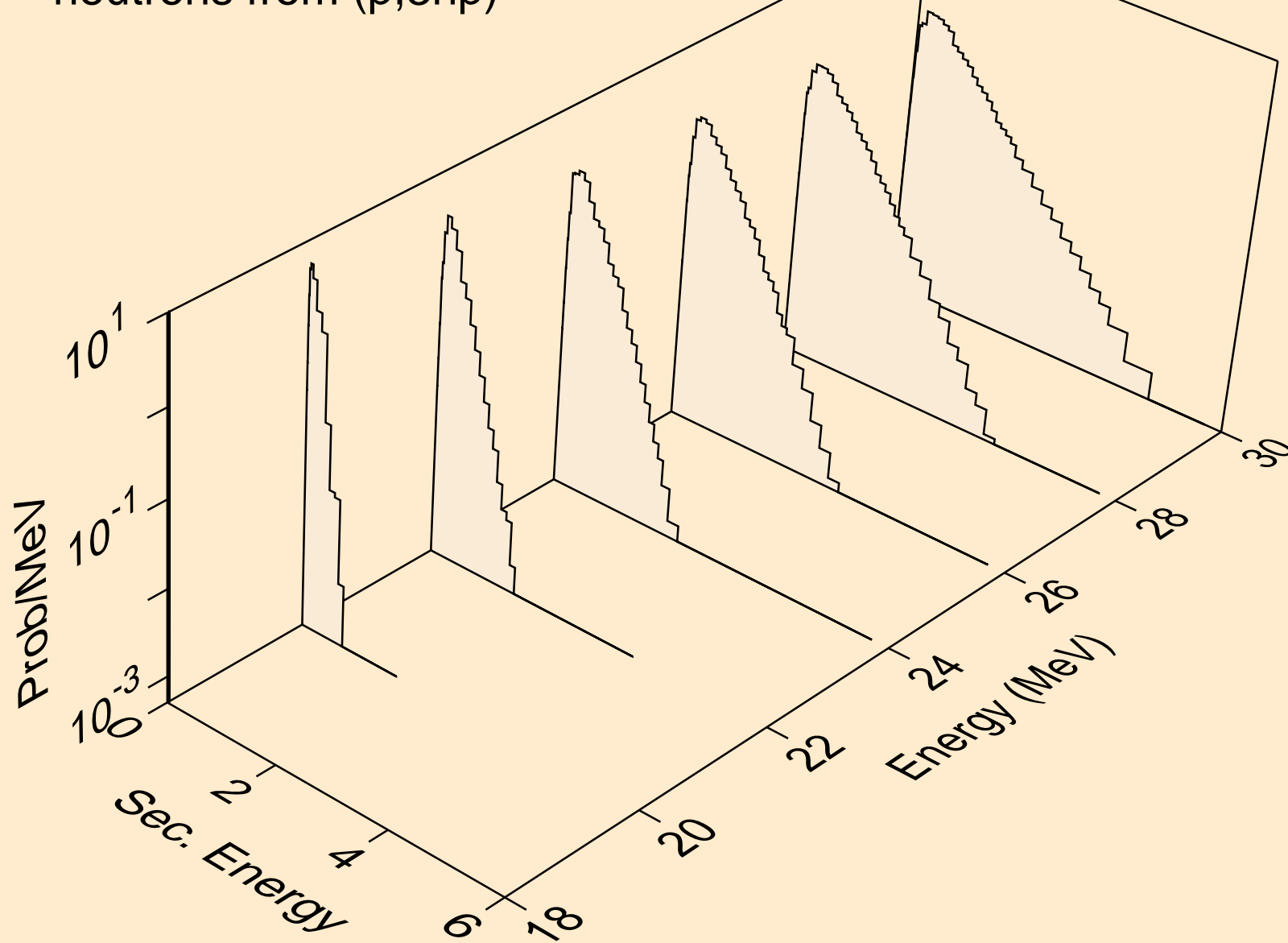

YB177M PROTON ACER TENDL-2021 LIBRARY; T=0.K  
neutrons from (p,2np)

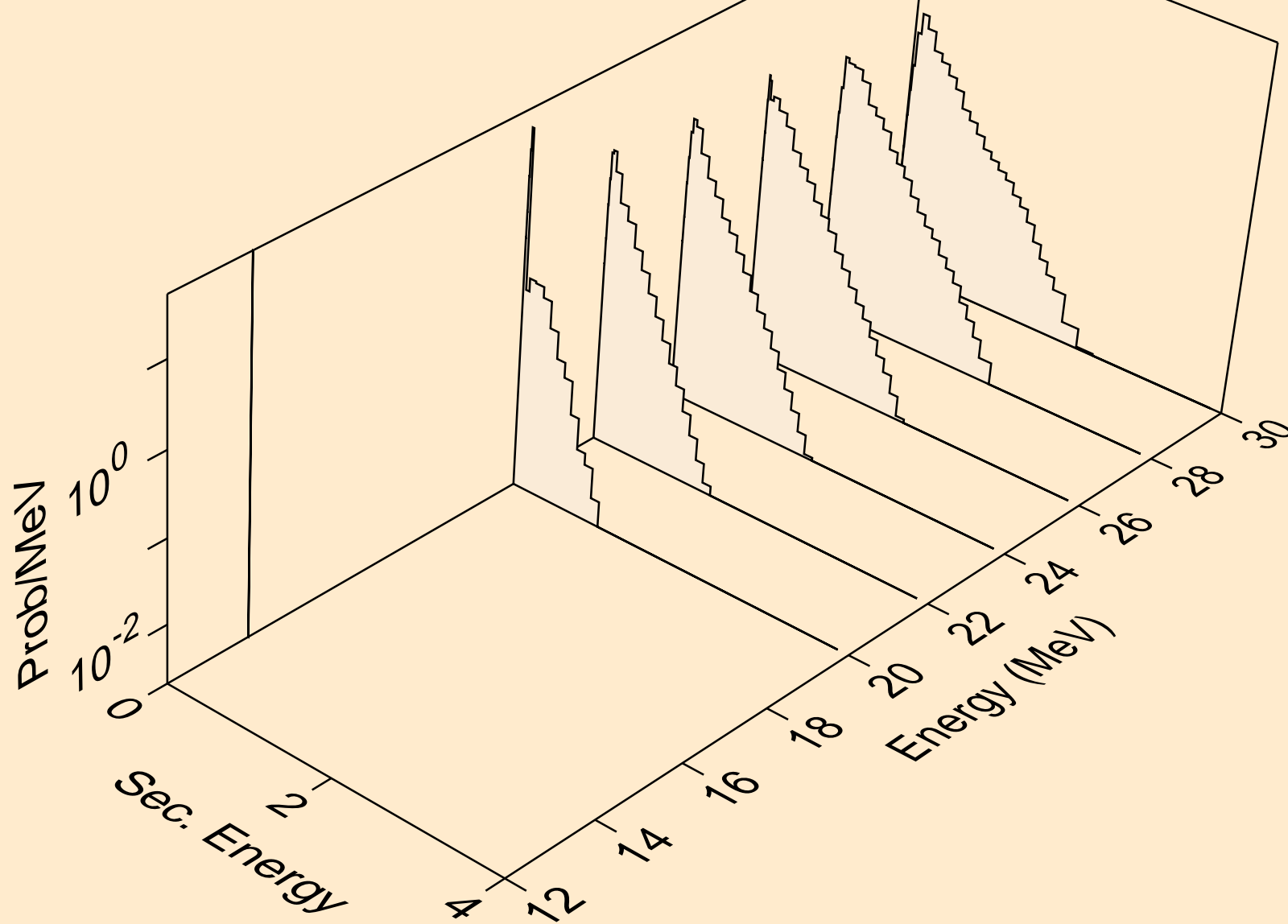

YB177M PROTON ACER TENDL-2021 LIBRARY; T=0.K  
neutrons from (p,npa)

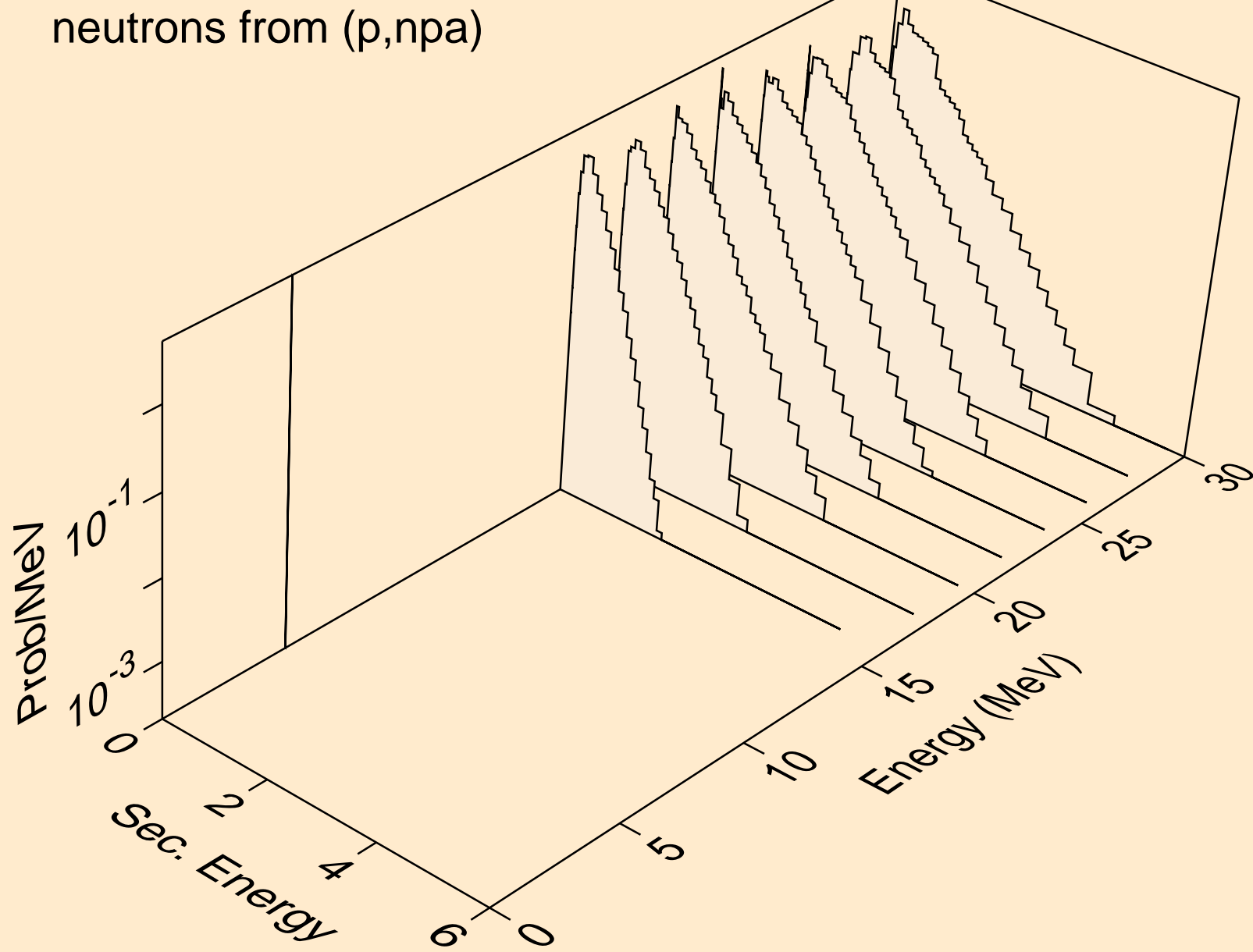

YB177M PROTON ACER TENDL-2021 LIBRARY; T=0.K  
deuterons from (p,x)

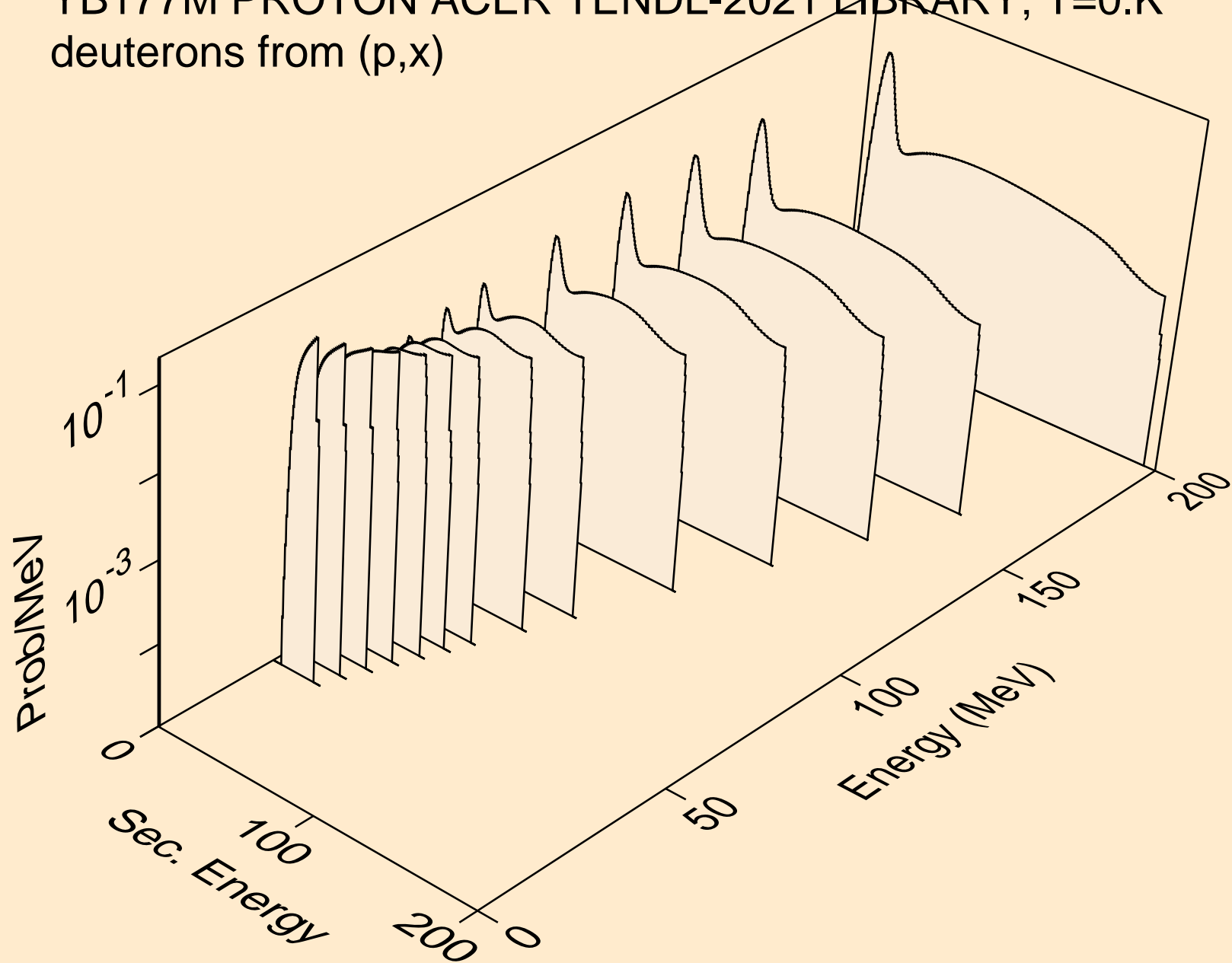

YB177M PROTON ACER TENDL-2021 LIBRARY; T=0.K  
deuterons from (p,2nd)

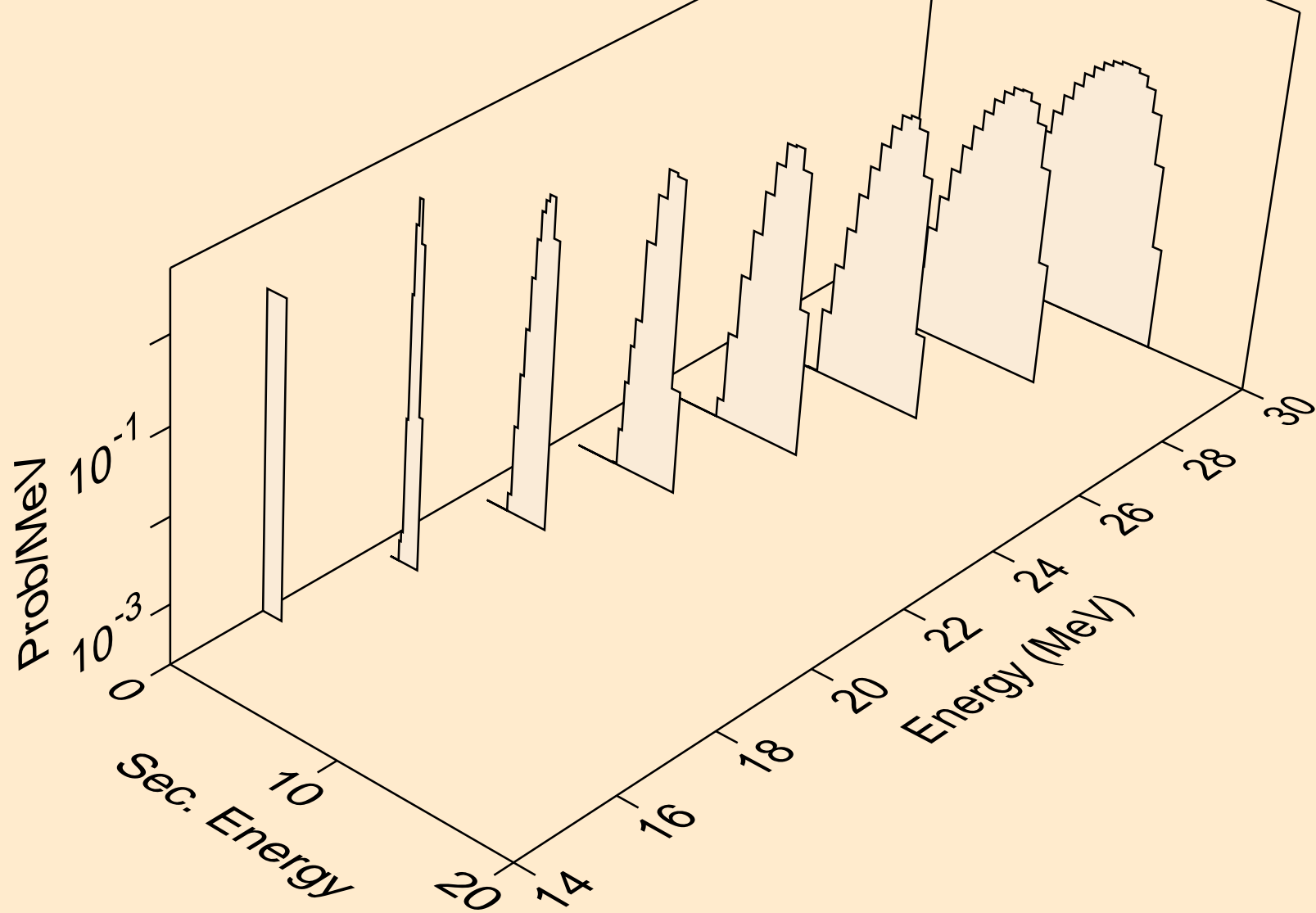



YB177M PROTON ACER TENDL-2021 LIBRARY; T=0.K  
deuterons from (p,n\*)d

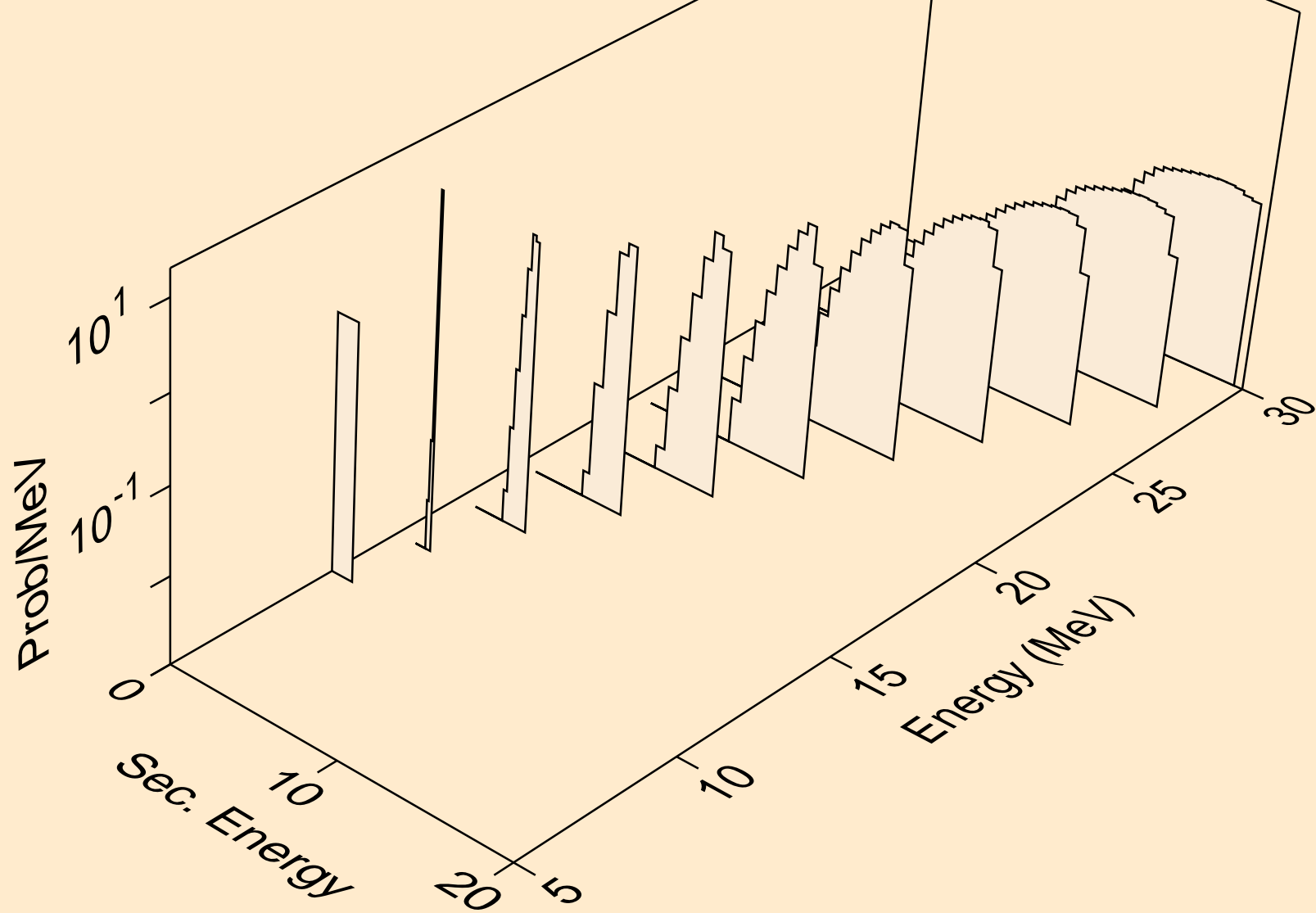

YB177M PROTON ACER TENDL-2021 LIBRARY; T=0.K  
deuterons from (p,d)

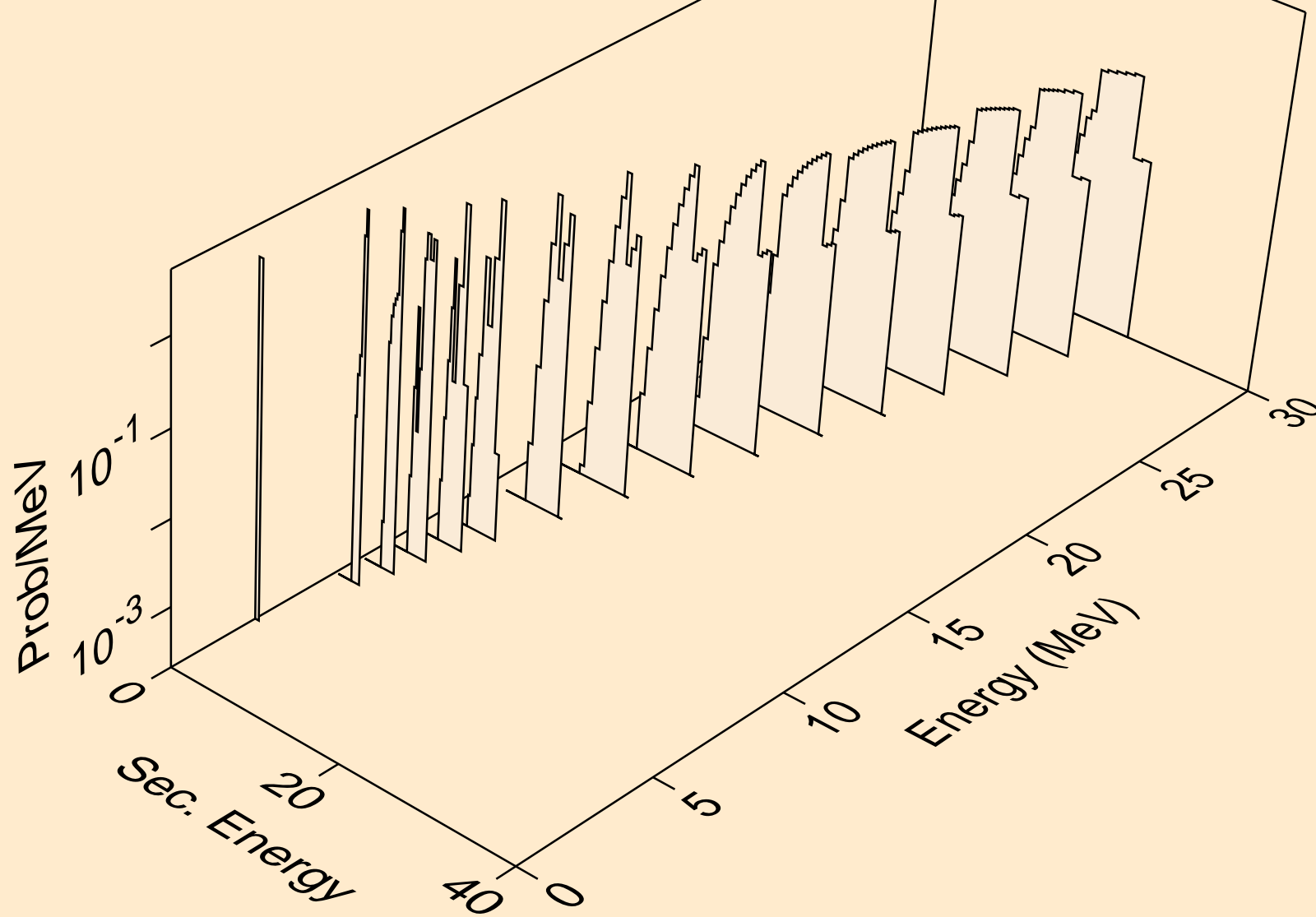

YB177M PROTON ACER TENDL-2021 LIBRARY; T=0.K  
deuterons from (p,pd)

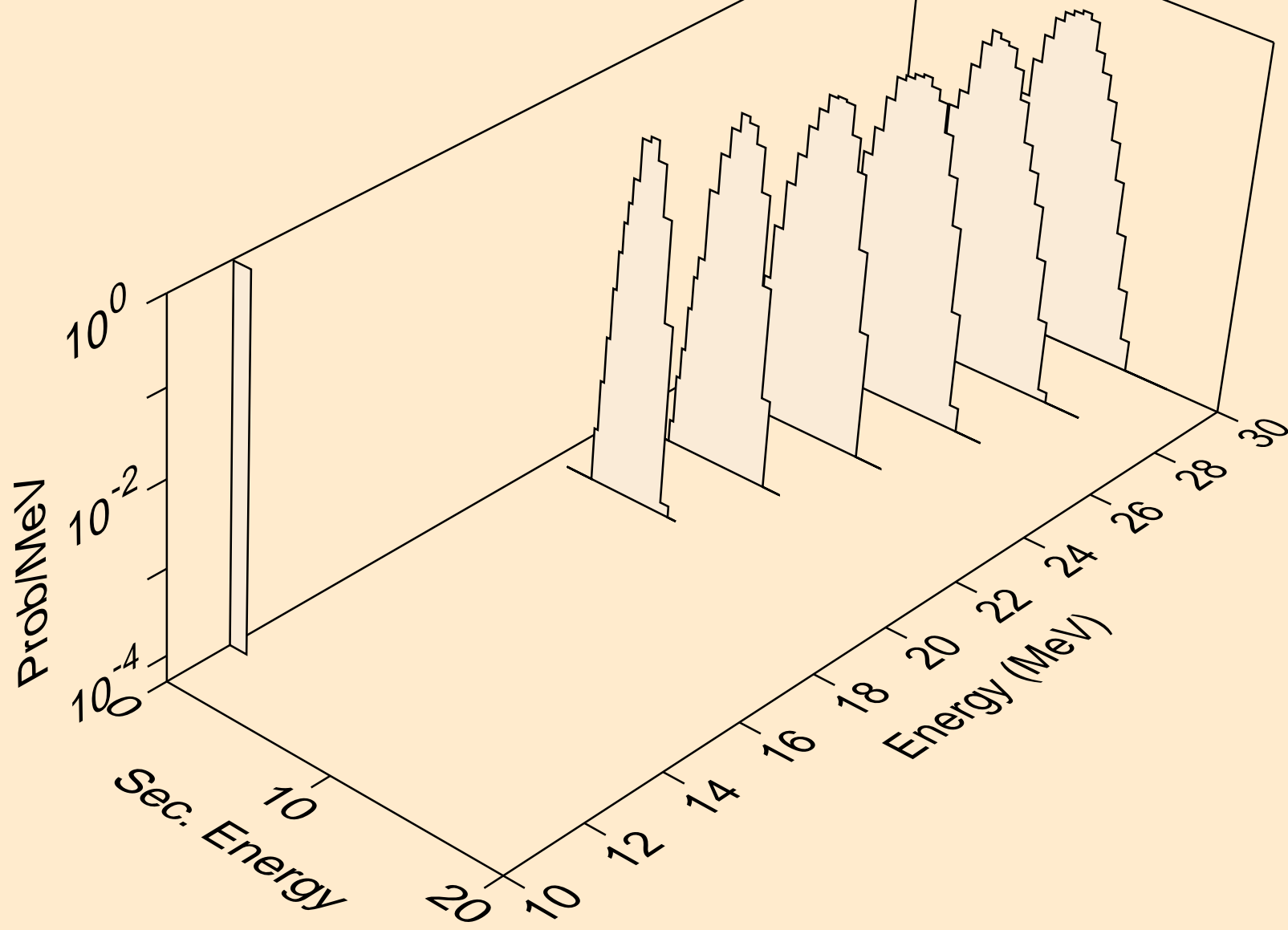

YB177M PROTON ACER TENDL-2021 LIBRARY; T=0.K  
tritons from (p,x)

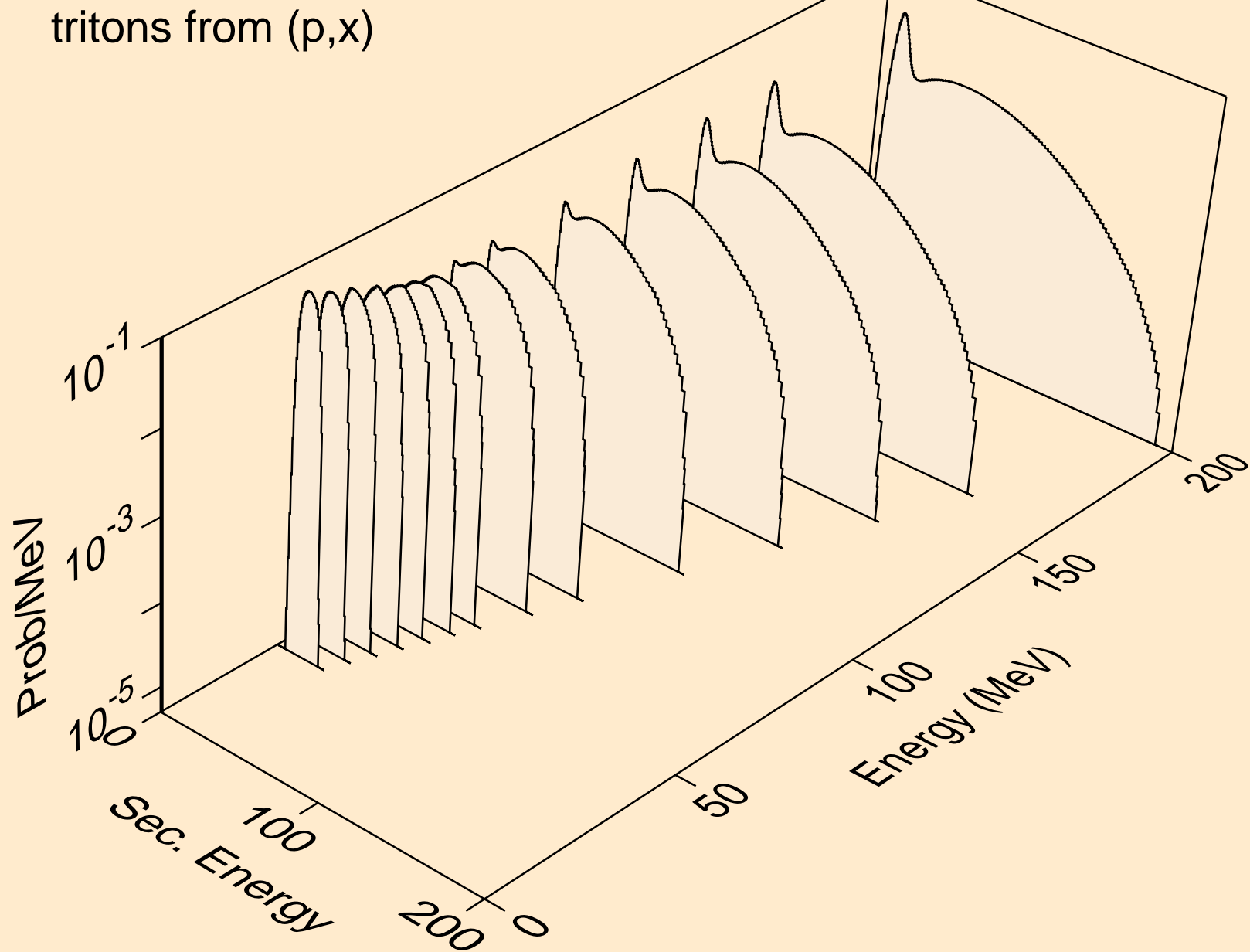

YB177M PROTON ACER TENDL-2021 LIBRARY; T=0.K  
tritons from (p,n\*)t

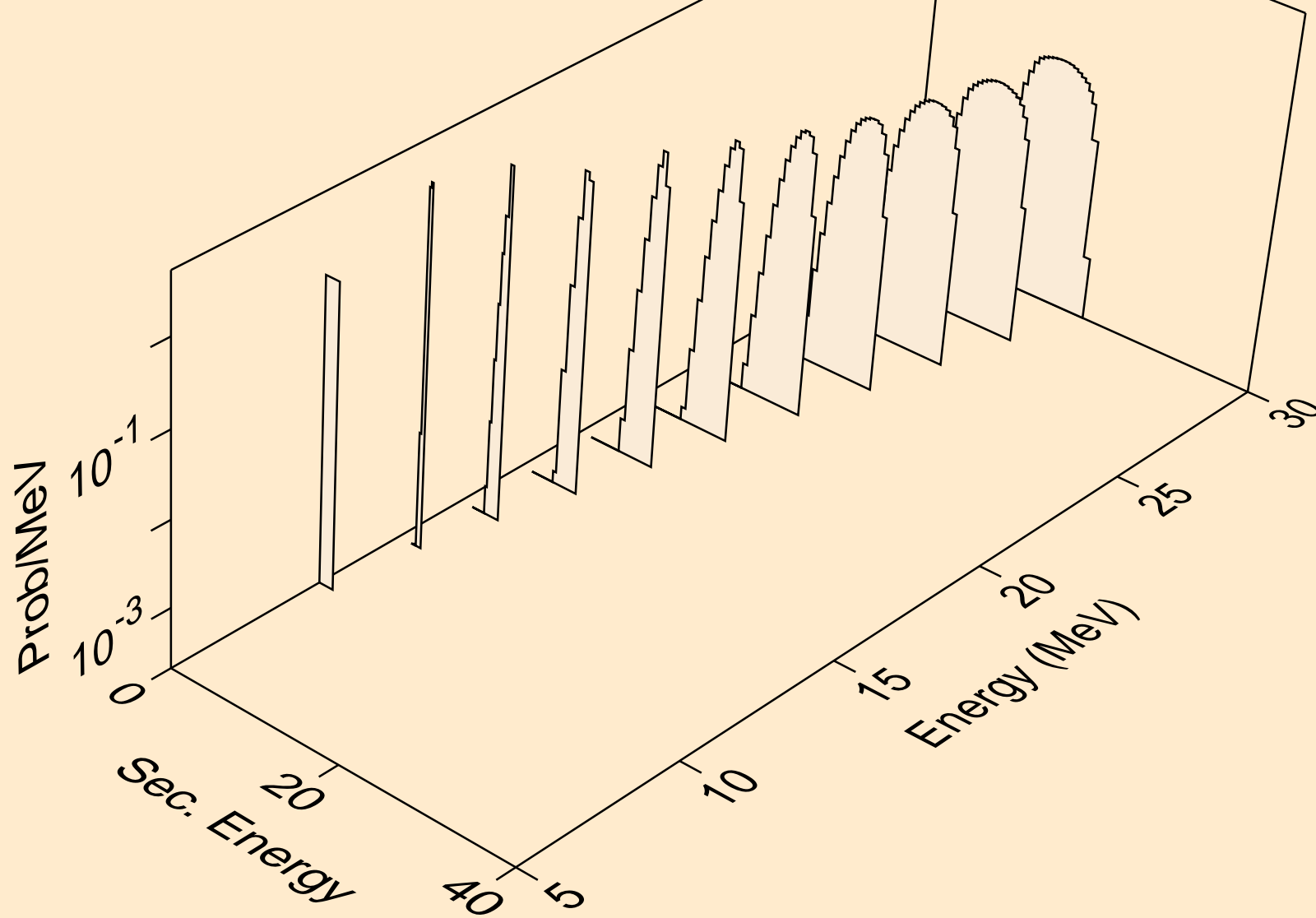

YB177M PROTON ACER TENDL-2021 LIBRARY; T=0.K  
tritons from (p,t)

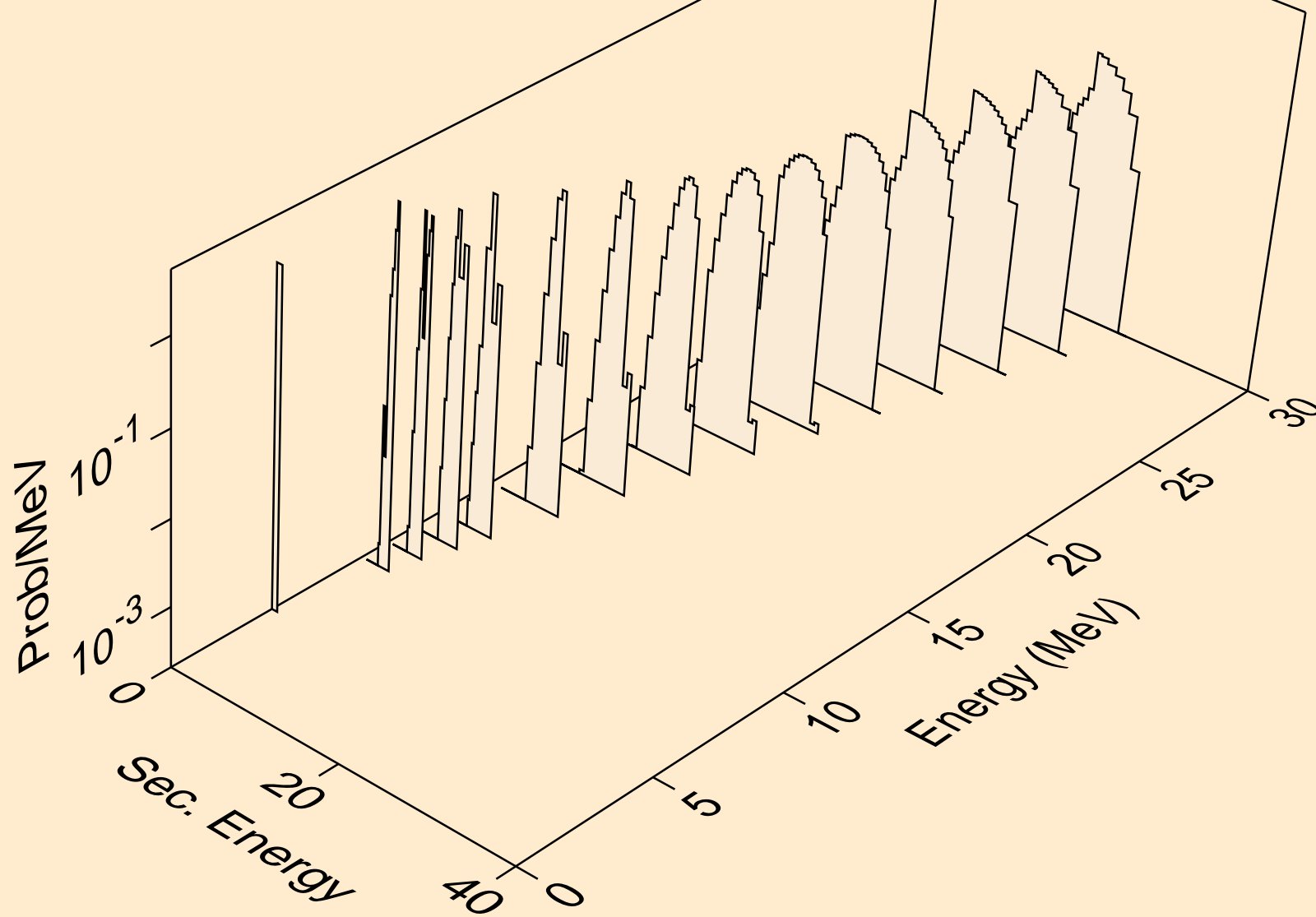

YB177M PROTON ACER TENDL-2021 LIBRARY; T=0.K  
tritons from (p,pt)

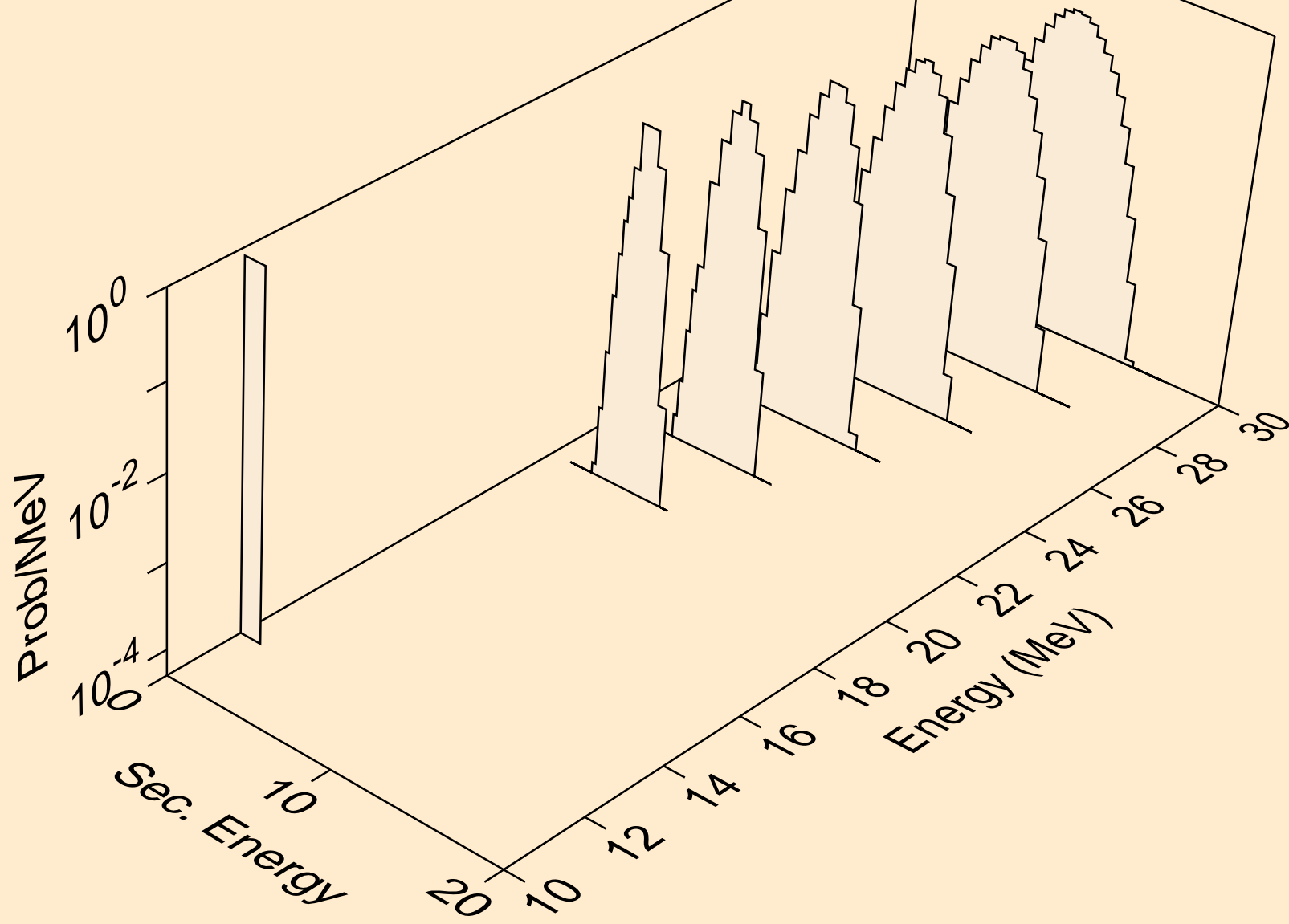

YB177M PROTON ACER TENDL-2021 LIBRARY; T=0.K  
he3s from (p,x)

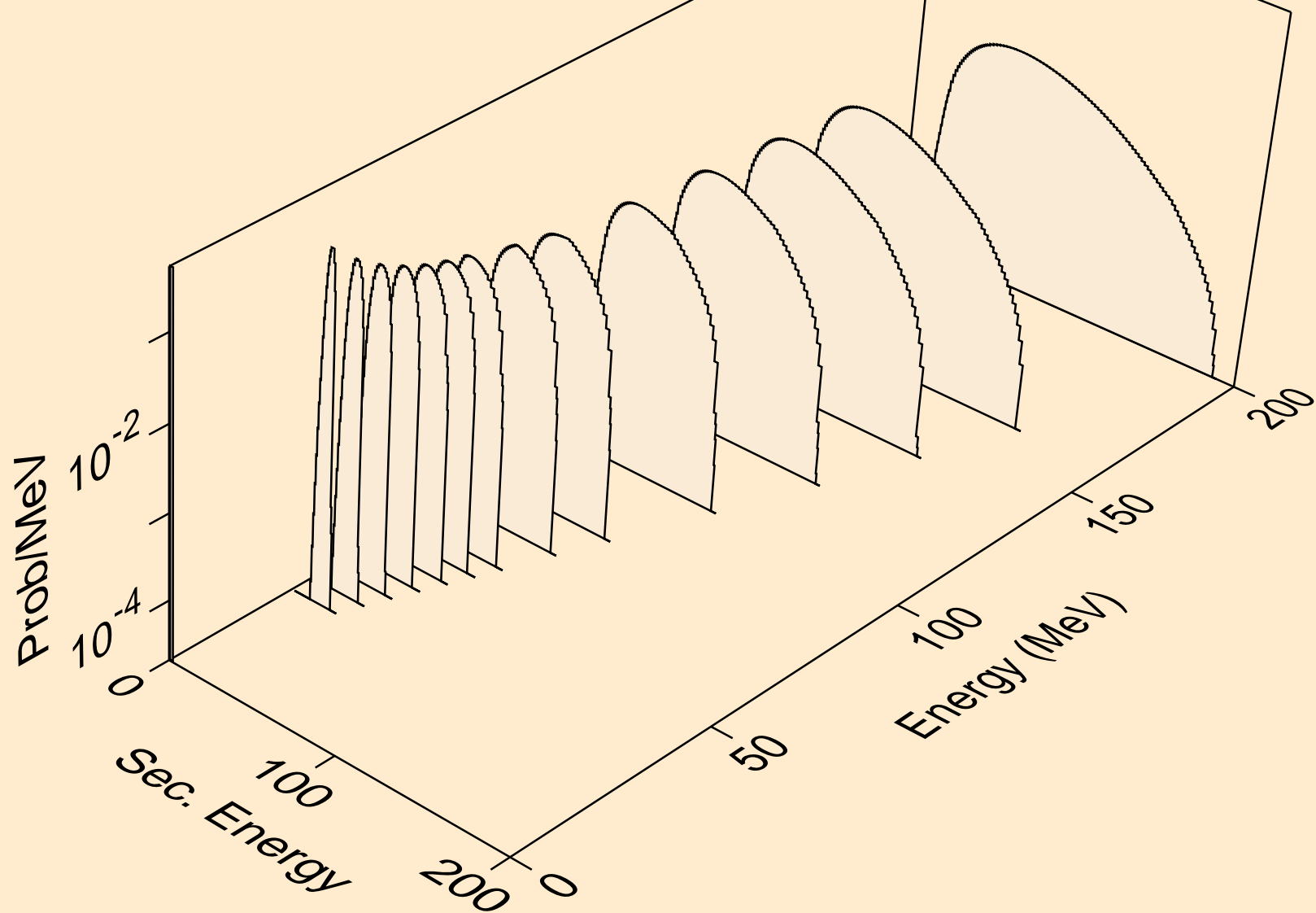



YB177M PROTON ACER TENDL-2021 LIBRARY; T=0.K  
he3s from (p,n\*)he3

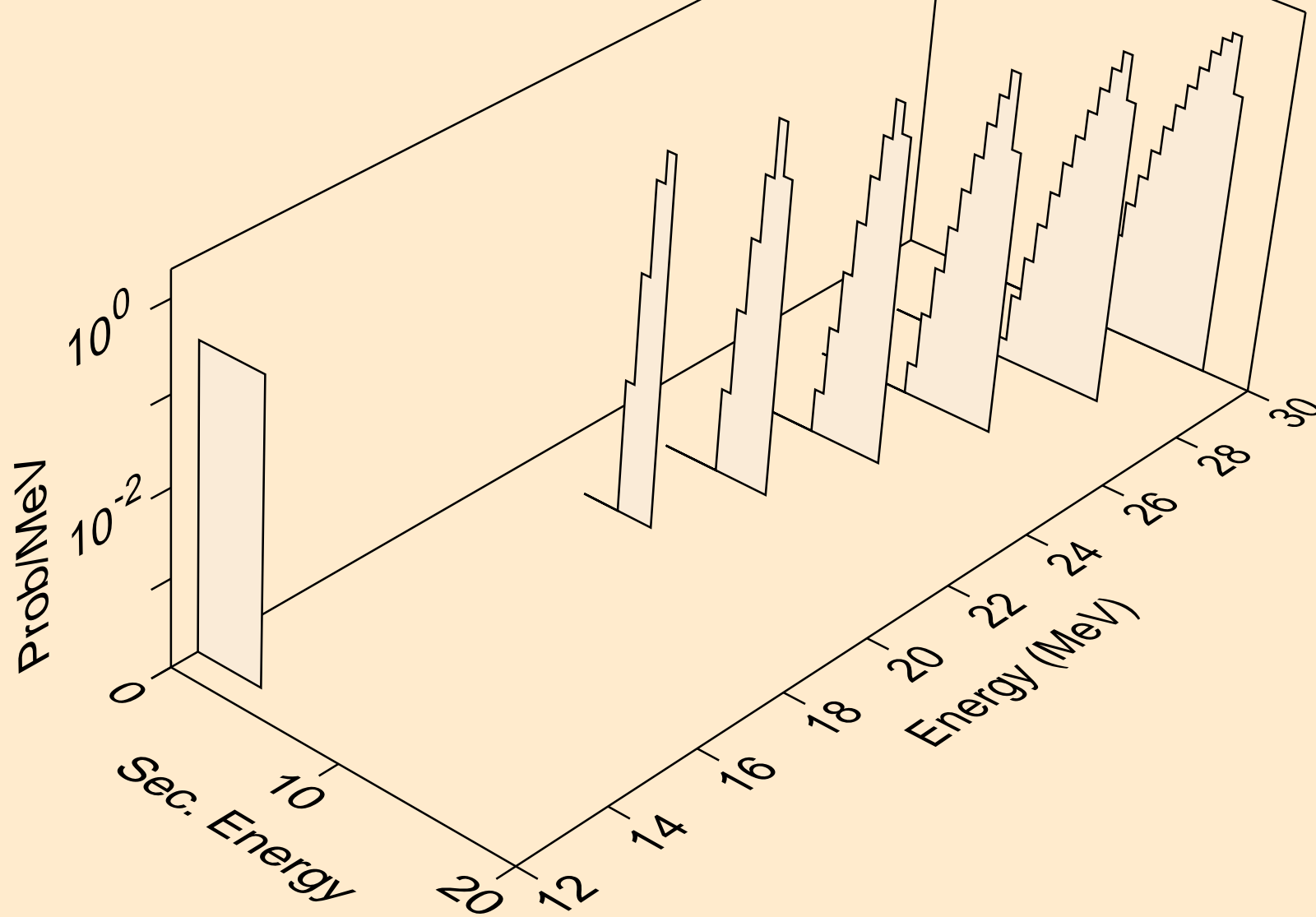

YB177M PROTON ACER TENDL-2021 LIBRARY; T=0.K  
he3s from (p,he3)

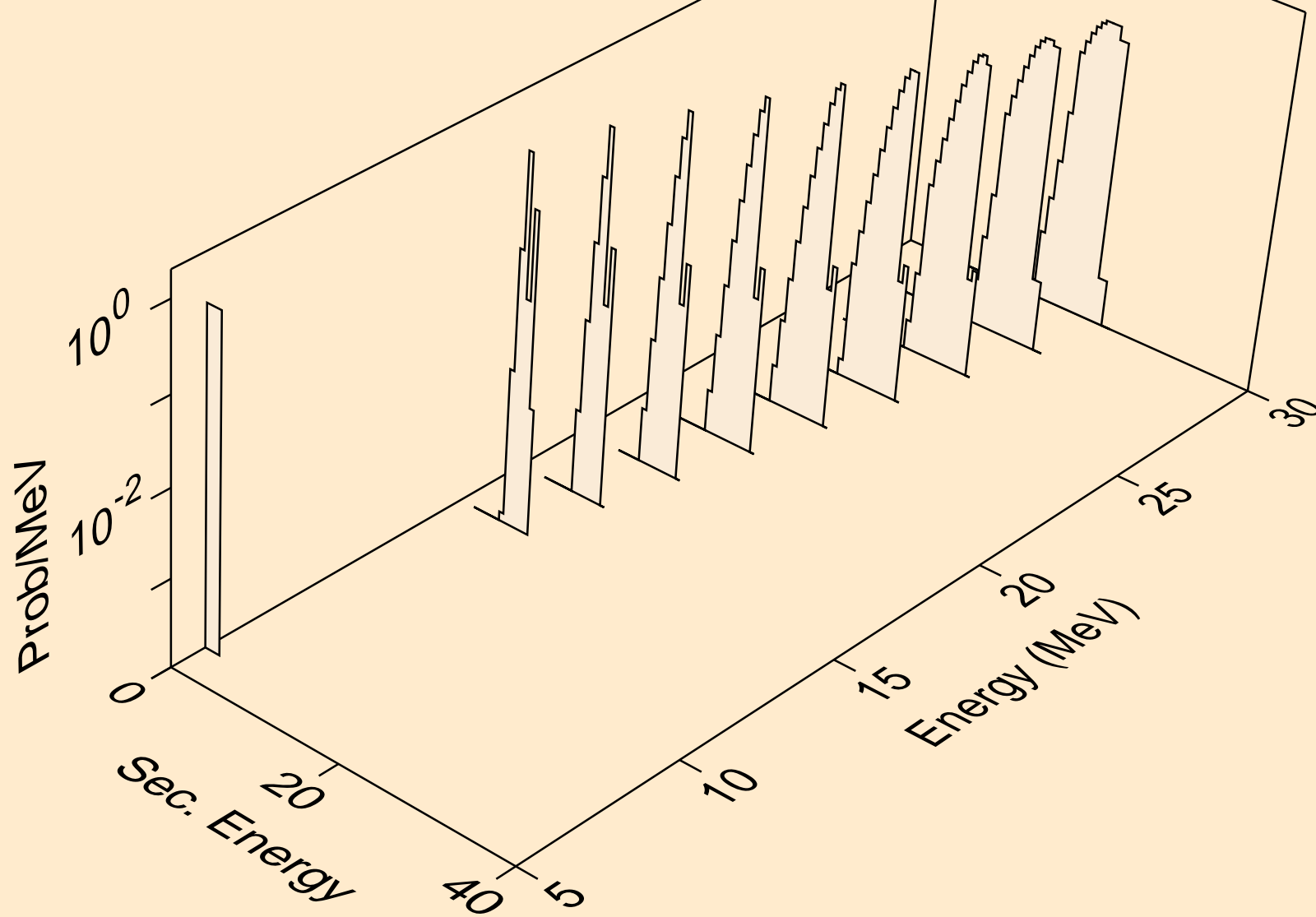

YB177M PROTON ACER TENDL-2021 LIBRARY; T=0.K  
alphas from (p,x)

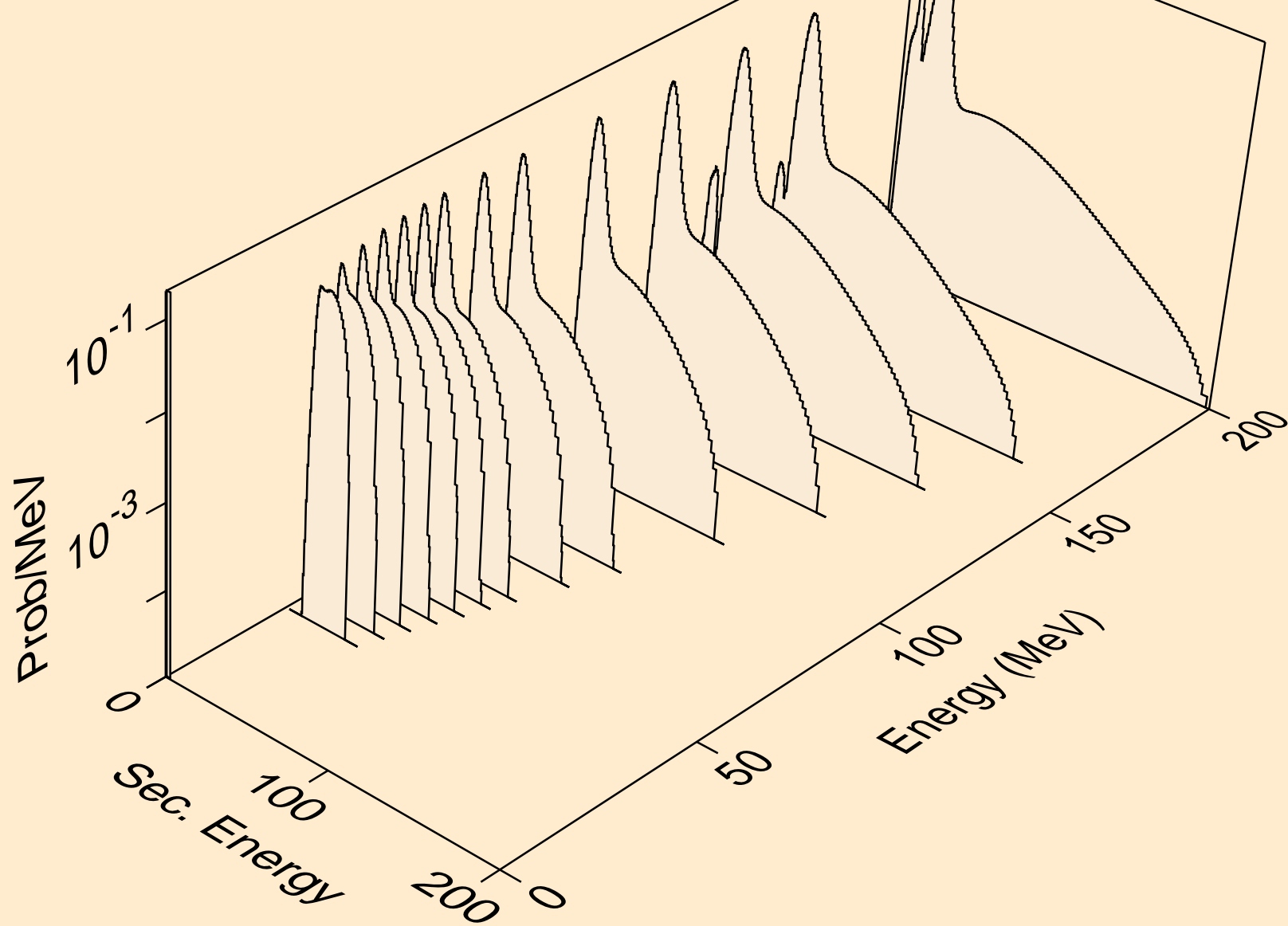

YB177M PROTON ACER TENDL-2021 LIBRARY; T=0.K  
alphas from (p,n\*)a

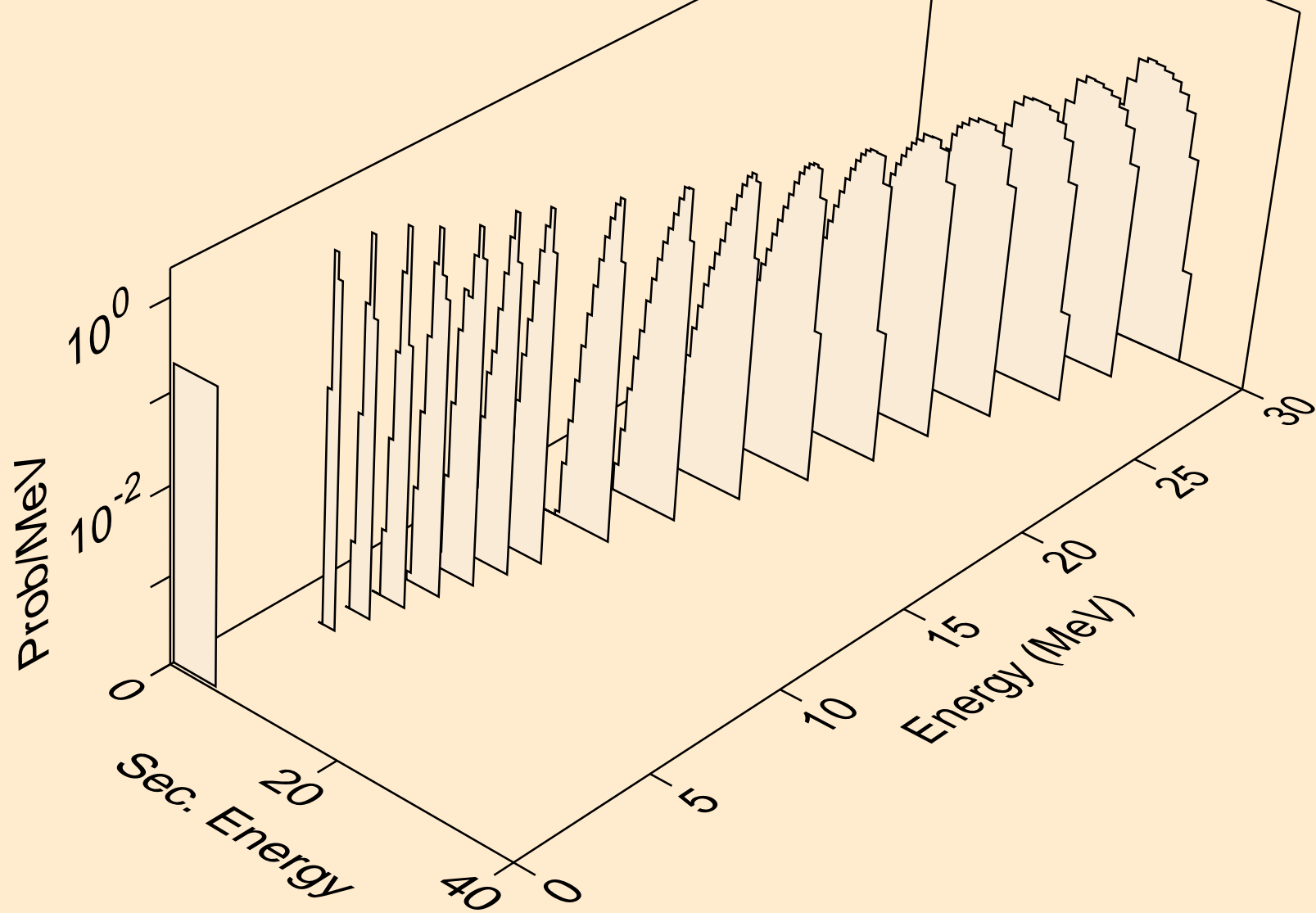

YB177M PROTON ACER TENDL-2021 LIBRARY; T=0.K  
alphas from (p,2n)a

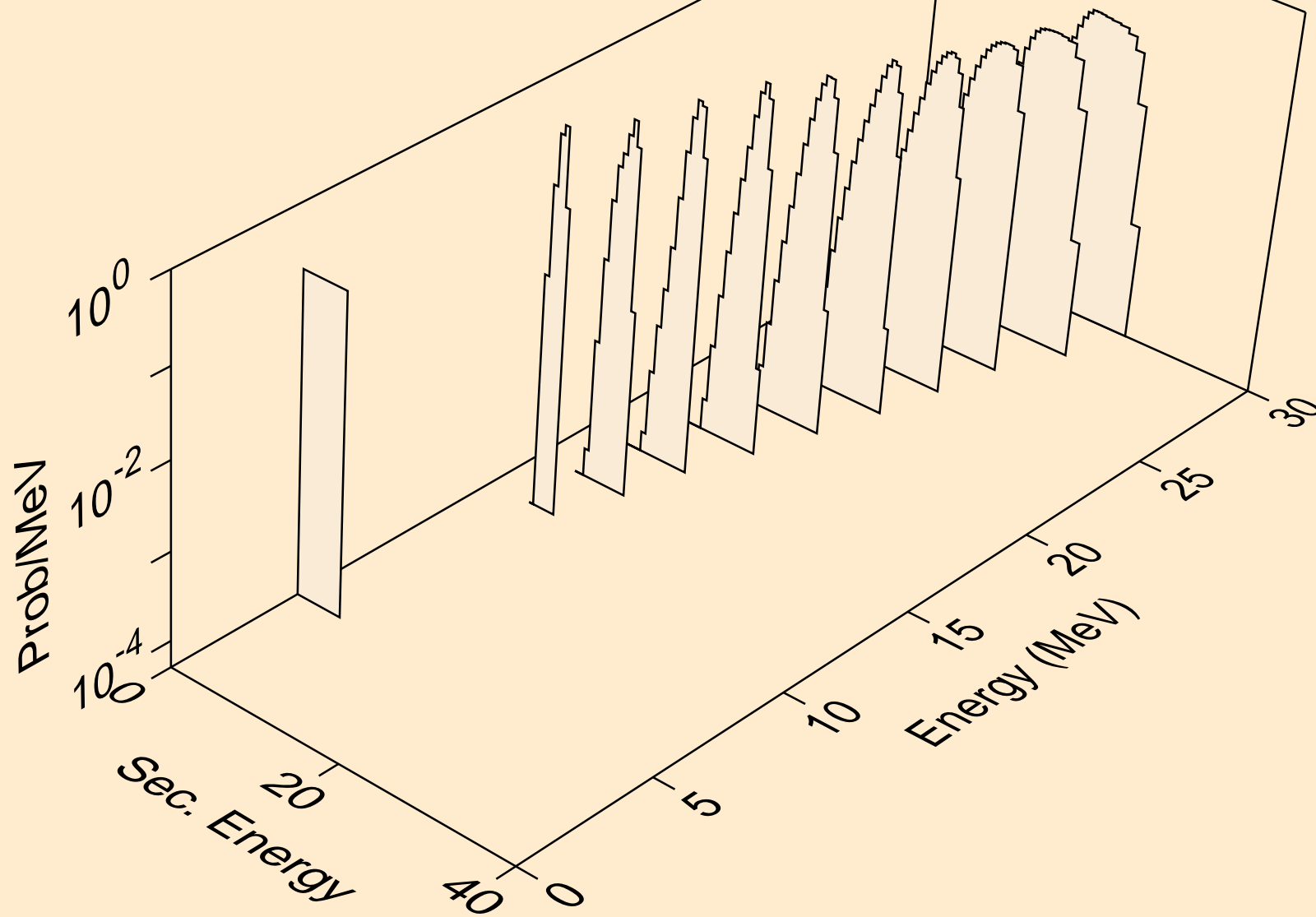

YB177M PROTON ACER TENDL-2021 LIBRARY; T=0.K  
alphas from (p,3n)a

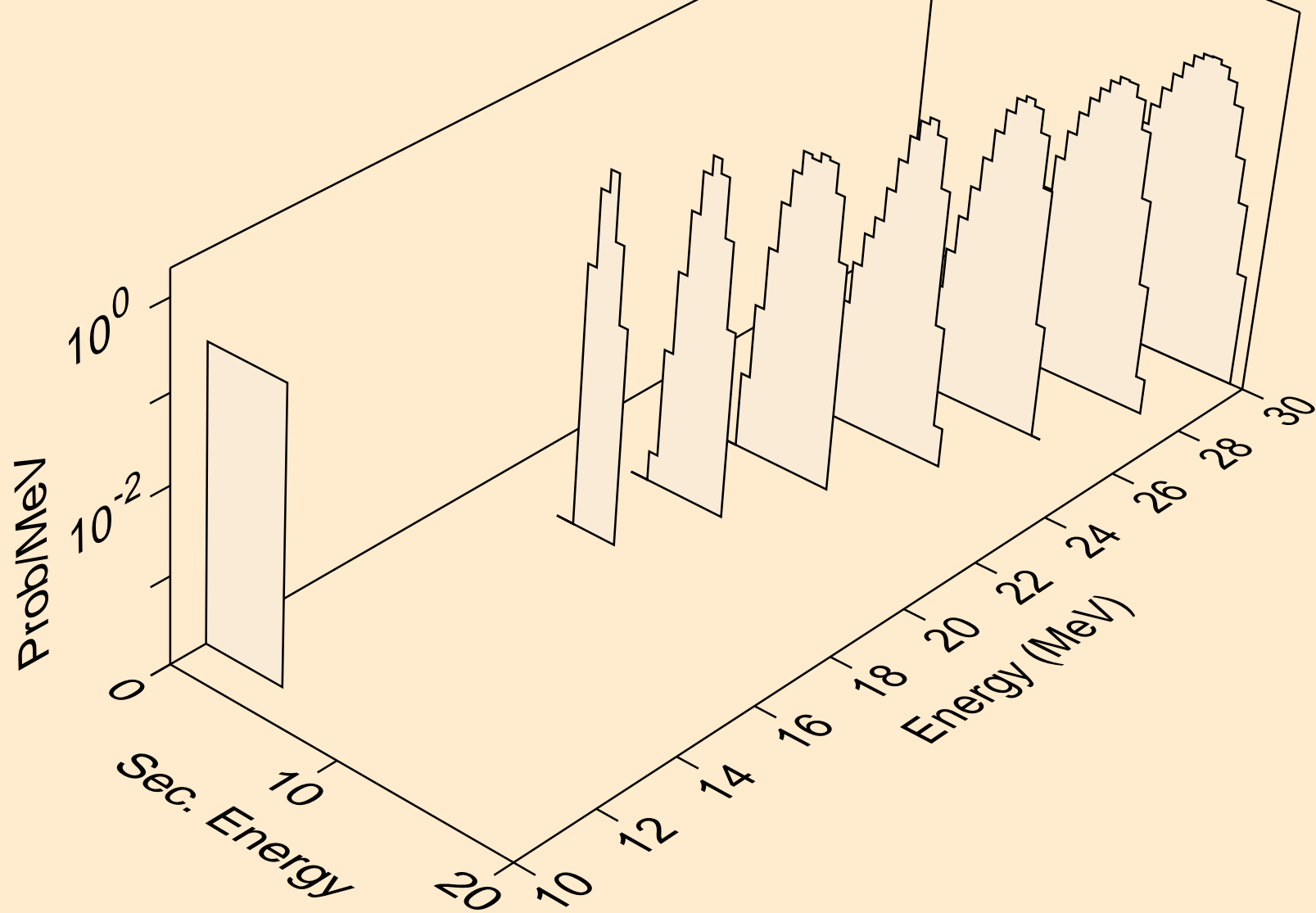

YB177M PROTON ACER TENDL-2021 LIBRARY; T=0.K  
alphas from (p,n\*)2a

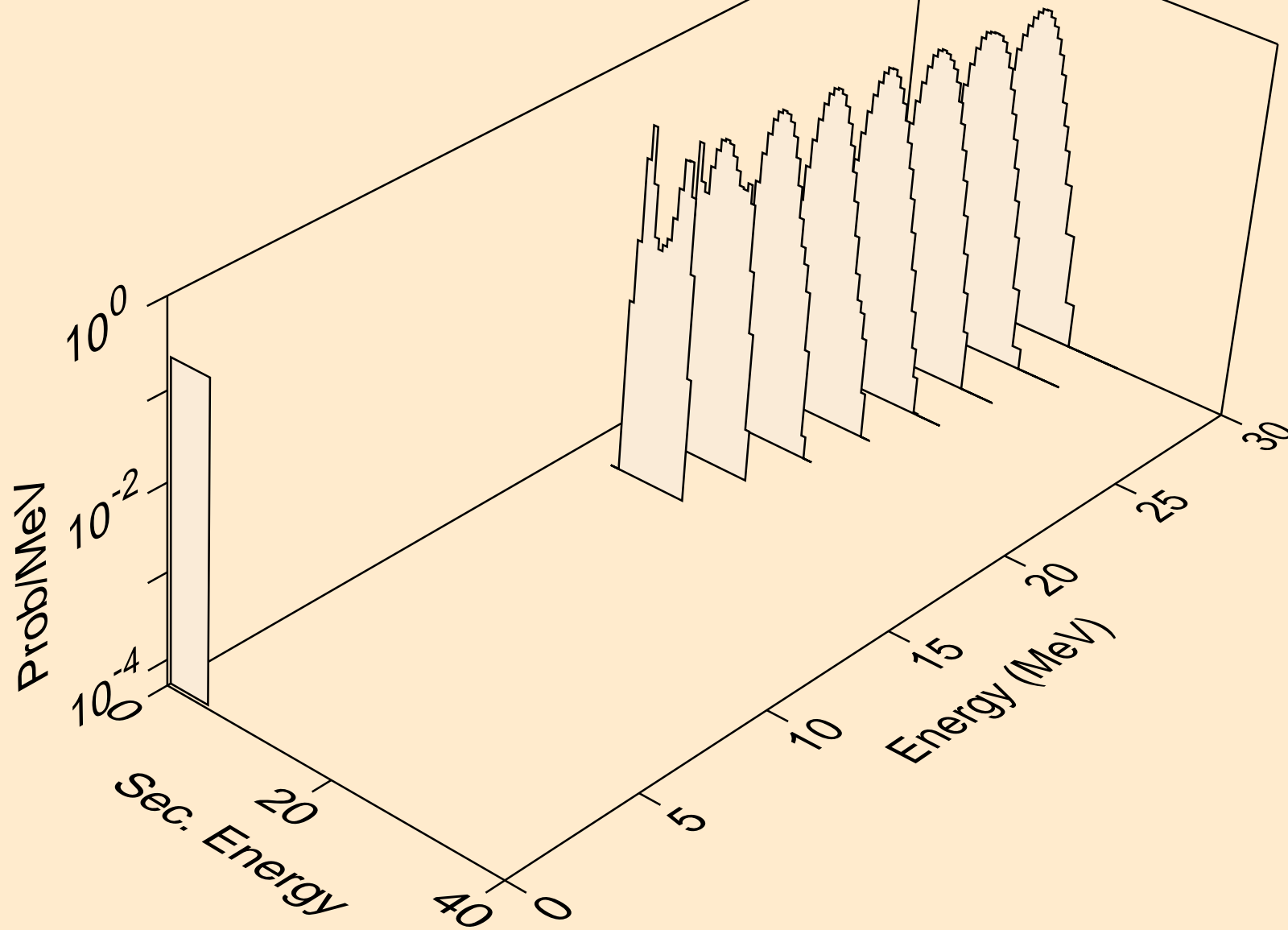

YB177M PROTON ACER TENDL-2021 LIBRARY; T=0.K  
alphas from (p,npa)

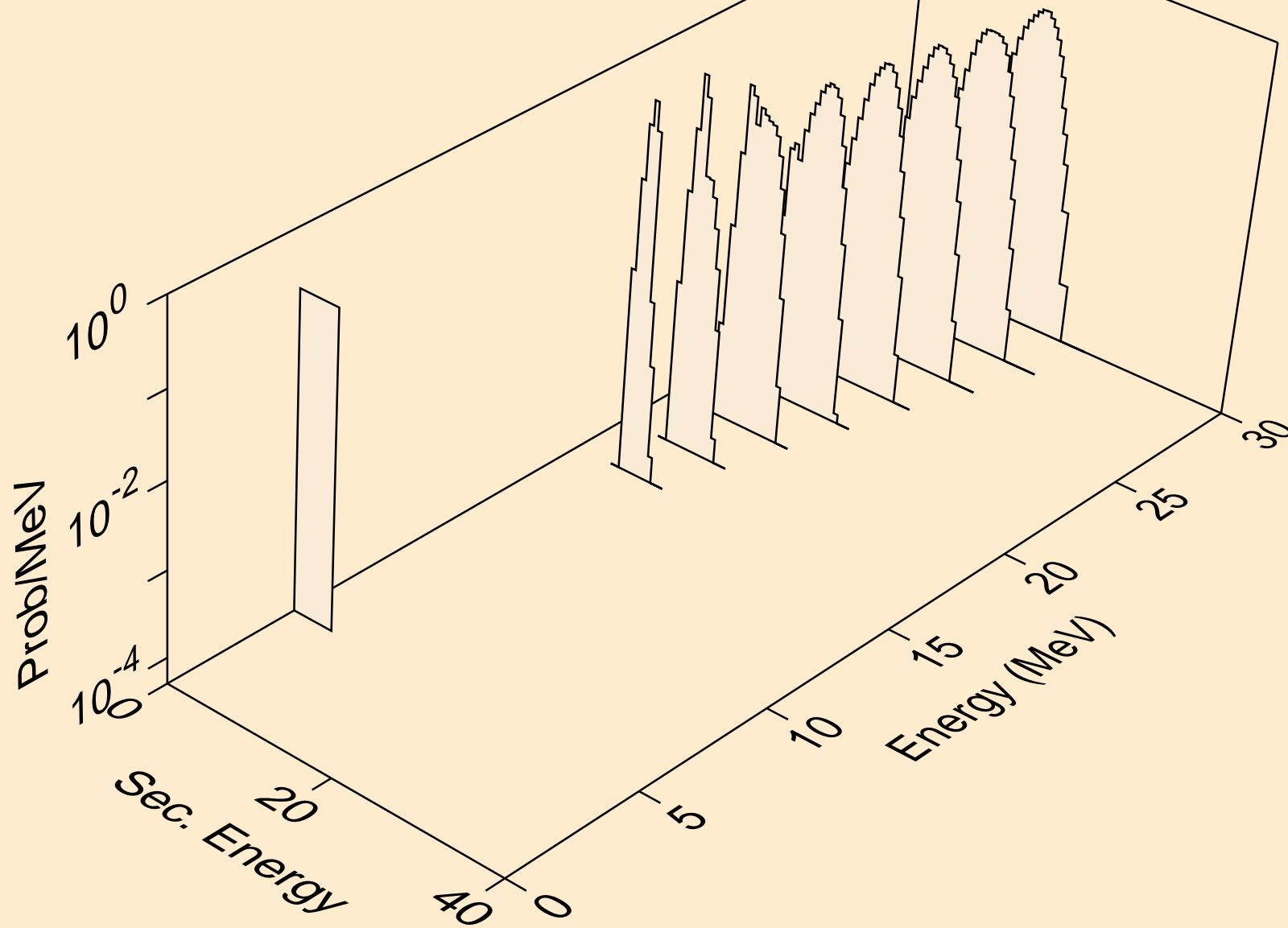



YB177M PROTON ACER TENDL-2021 LIBRARY; T=0.K  
alphas from (p,a)

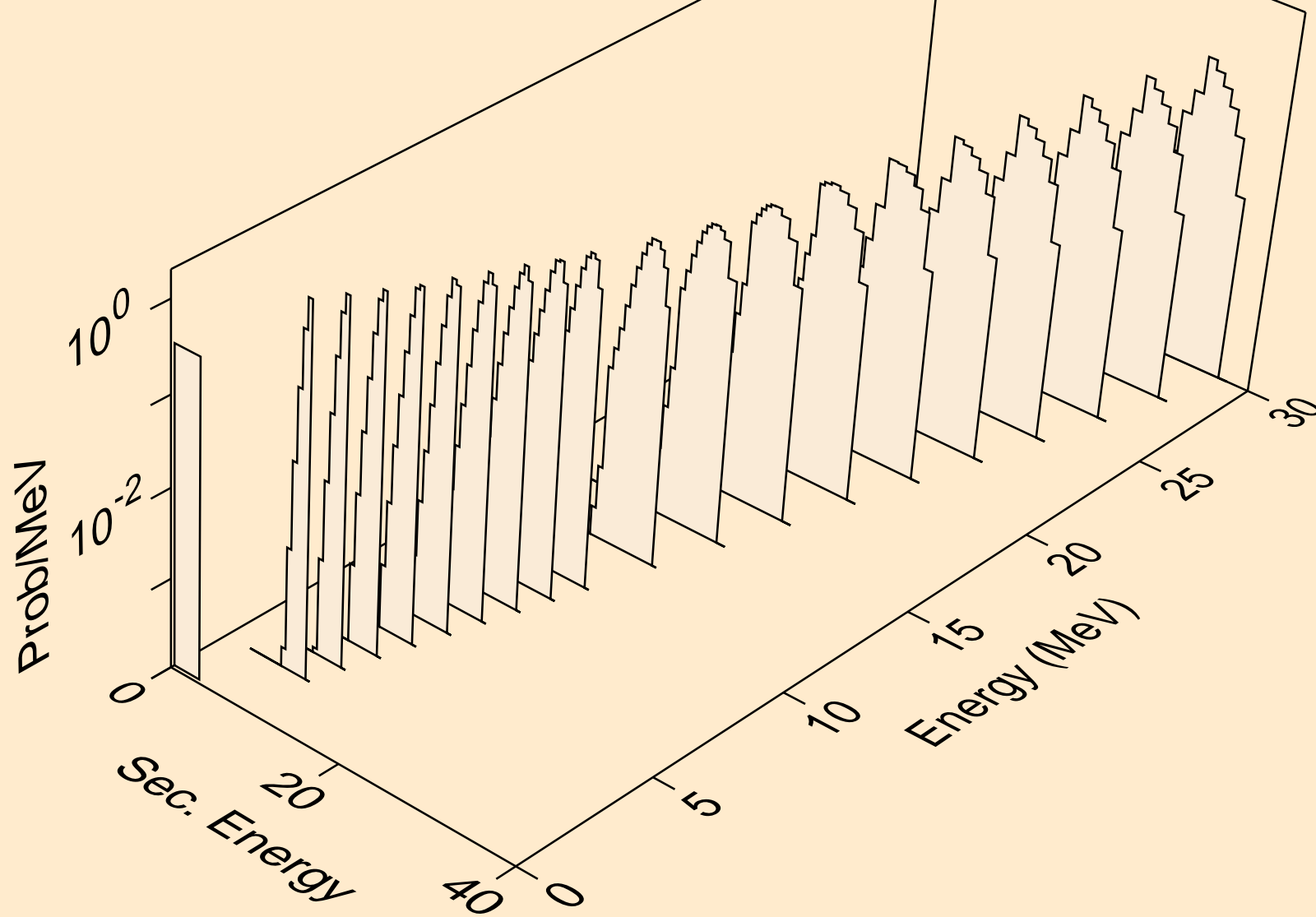

YB177M PROTON ACER TENDL-2021 LIBRARY; T=0.K  
alphas from (p,2a)

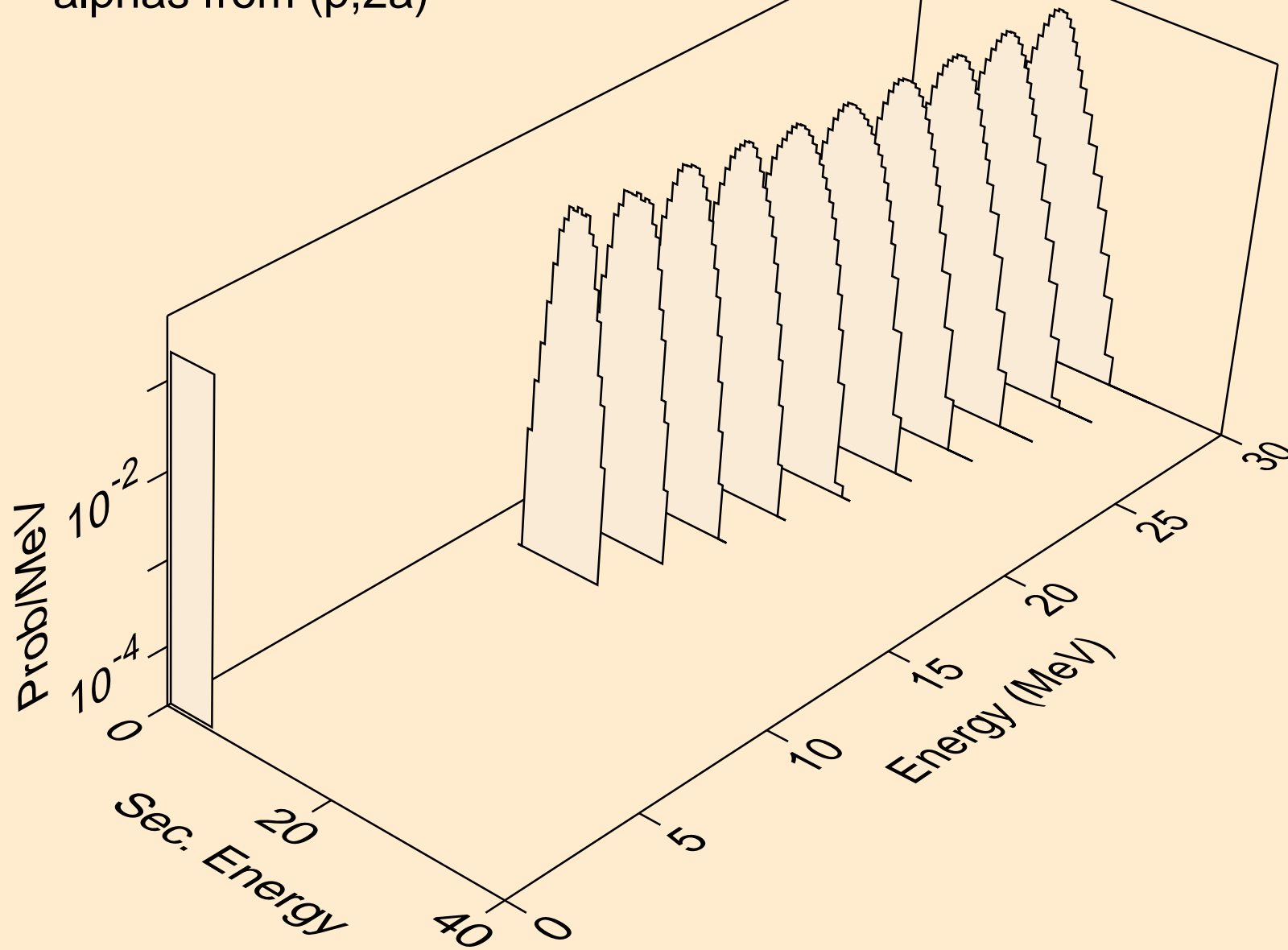

YB177M PROTON ACER TENDL-2021 LIBRARY; T=0.K  
alphas from (p,pa)

