

AC237 TRITON ACER TENDL-2021 LIBRARY; T=0.K  
Principal cross sections

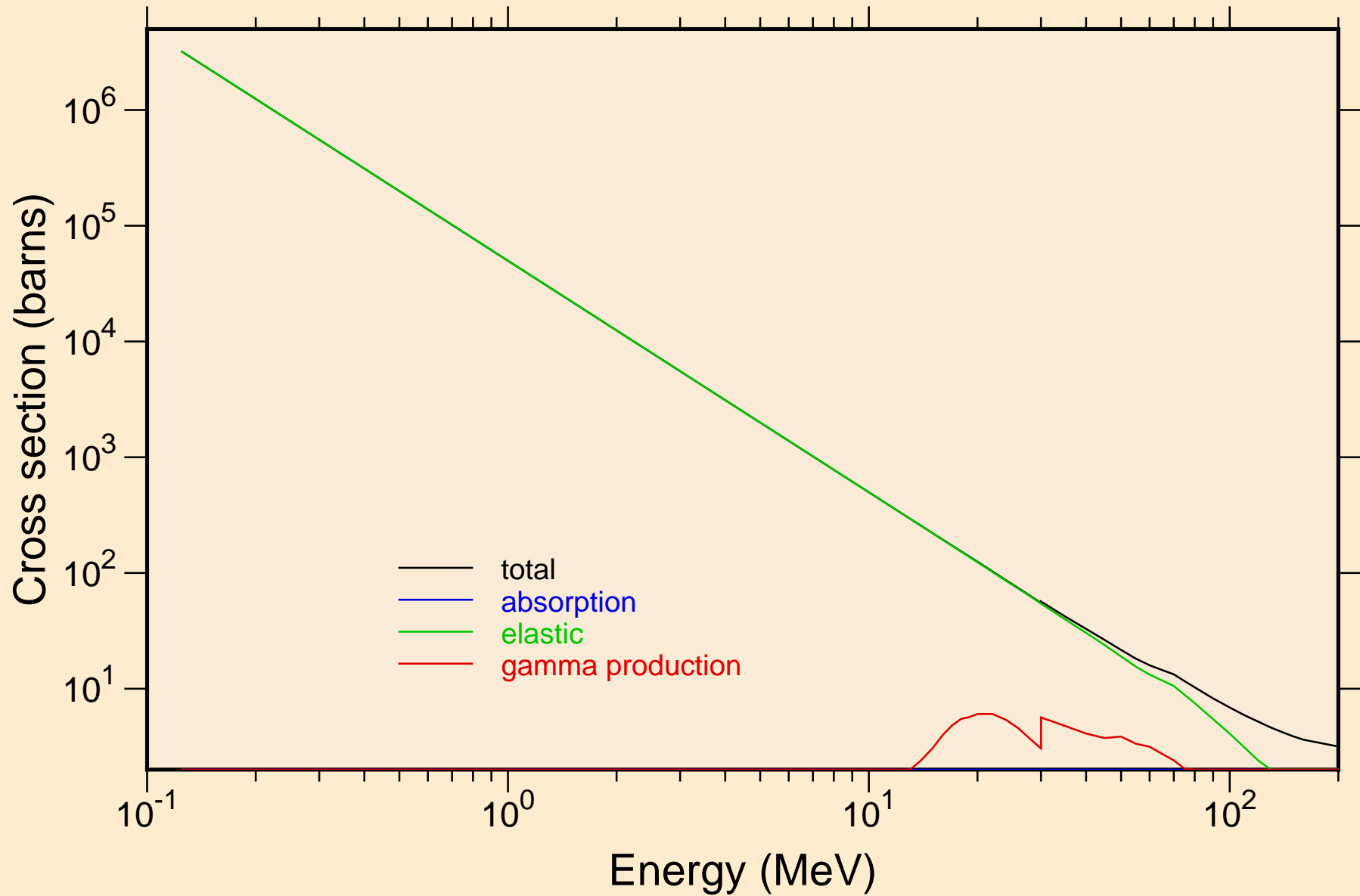

AC237 TRITON ACER TENDL-2021 LIBRARY; T=0.K

Heating

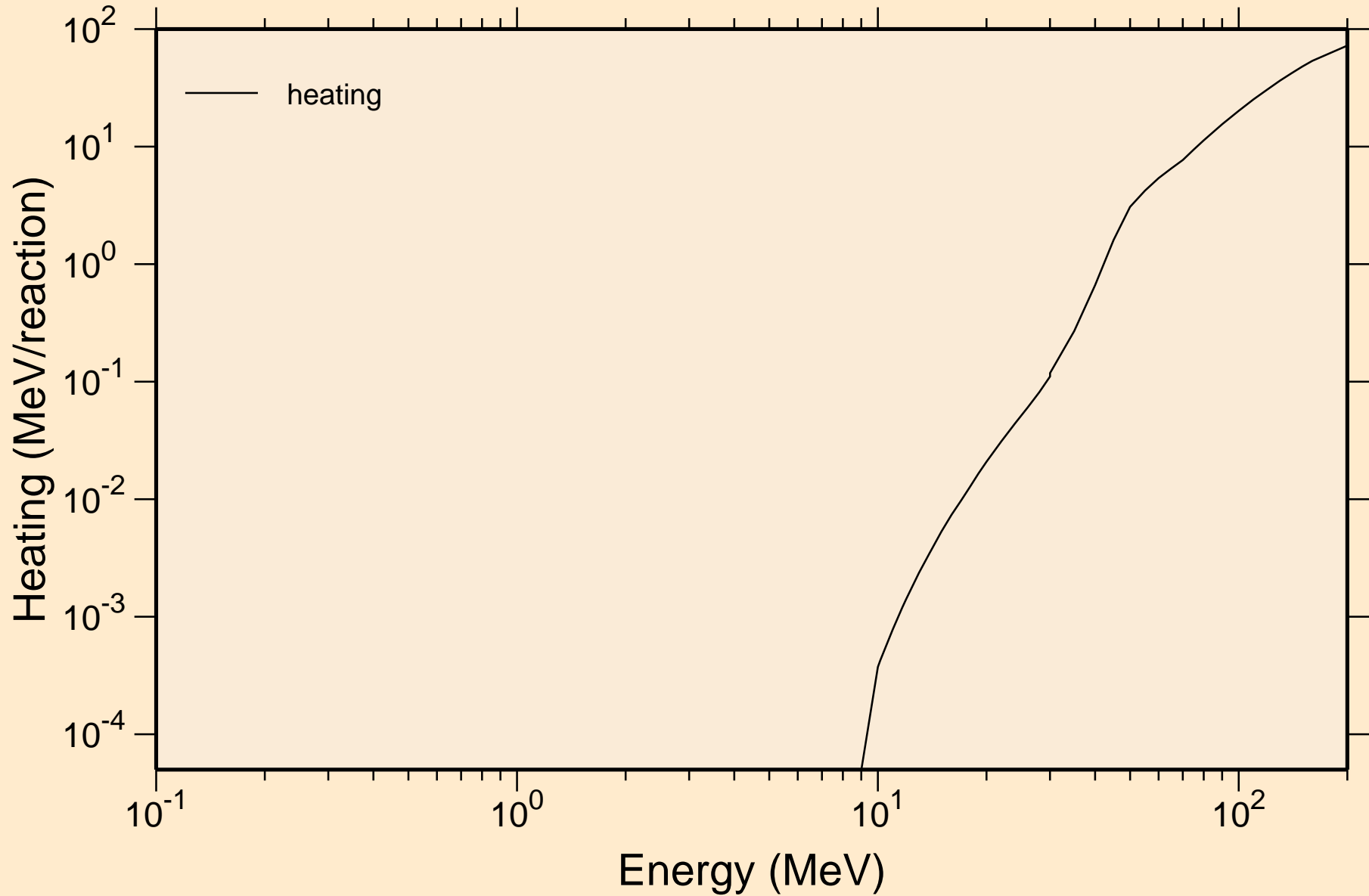

# AC237 TRITON ACER TENDL-2021 LIBRARY; T=0.K

## Principal cross sections

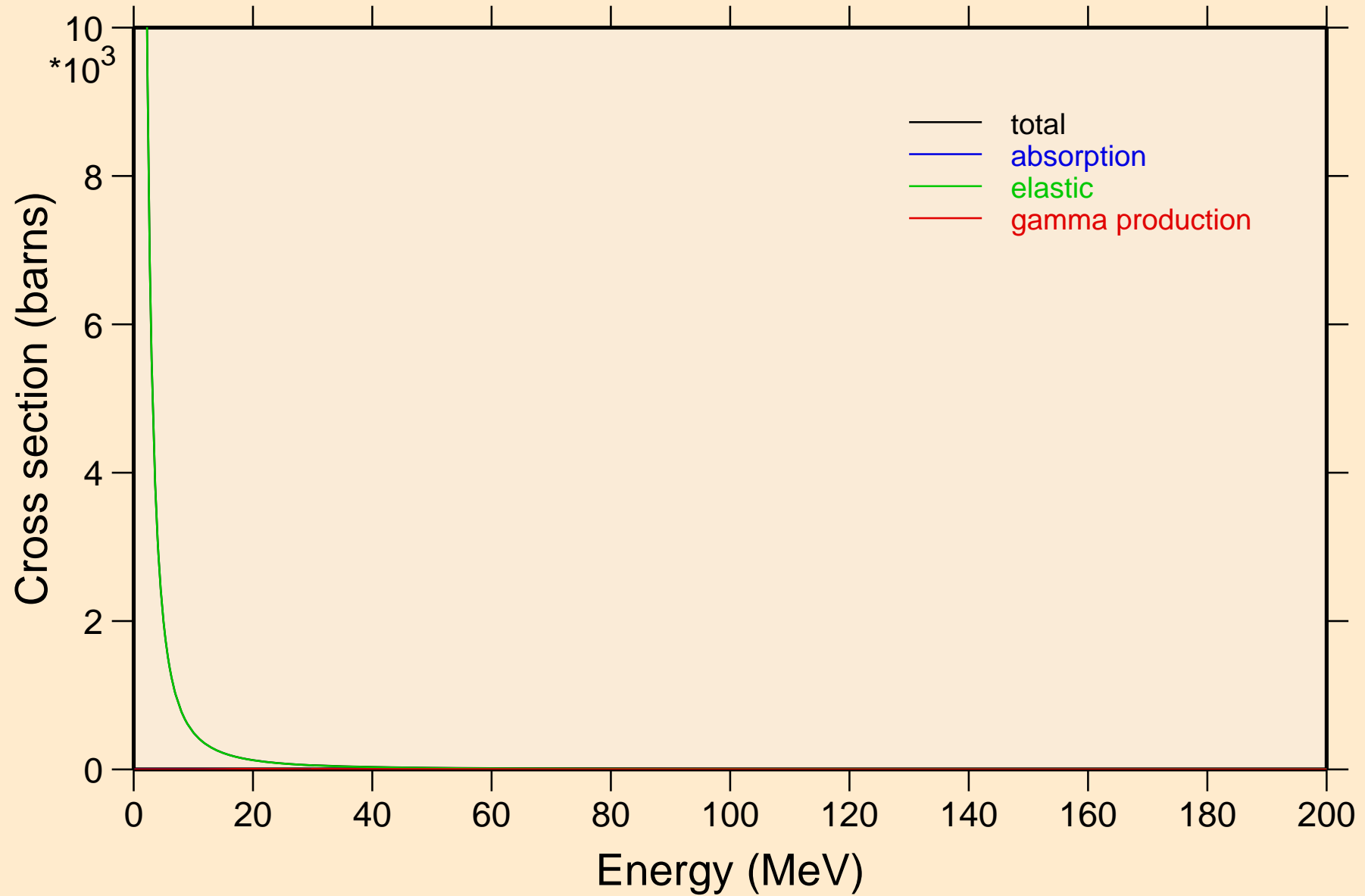

AC237 TRITON ACER TENDL-2021 LIBRARY; T=0.K

Heating

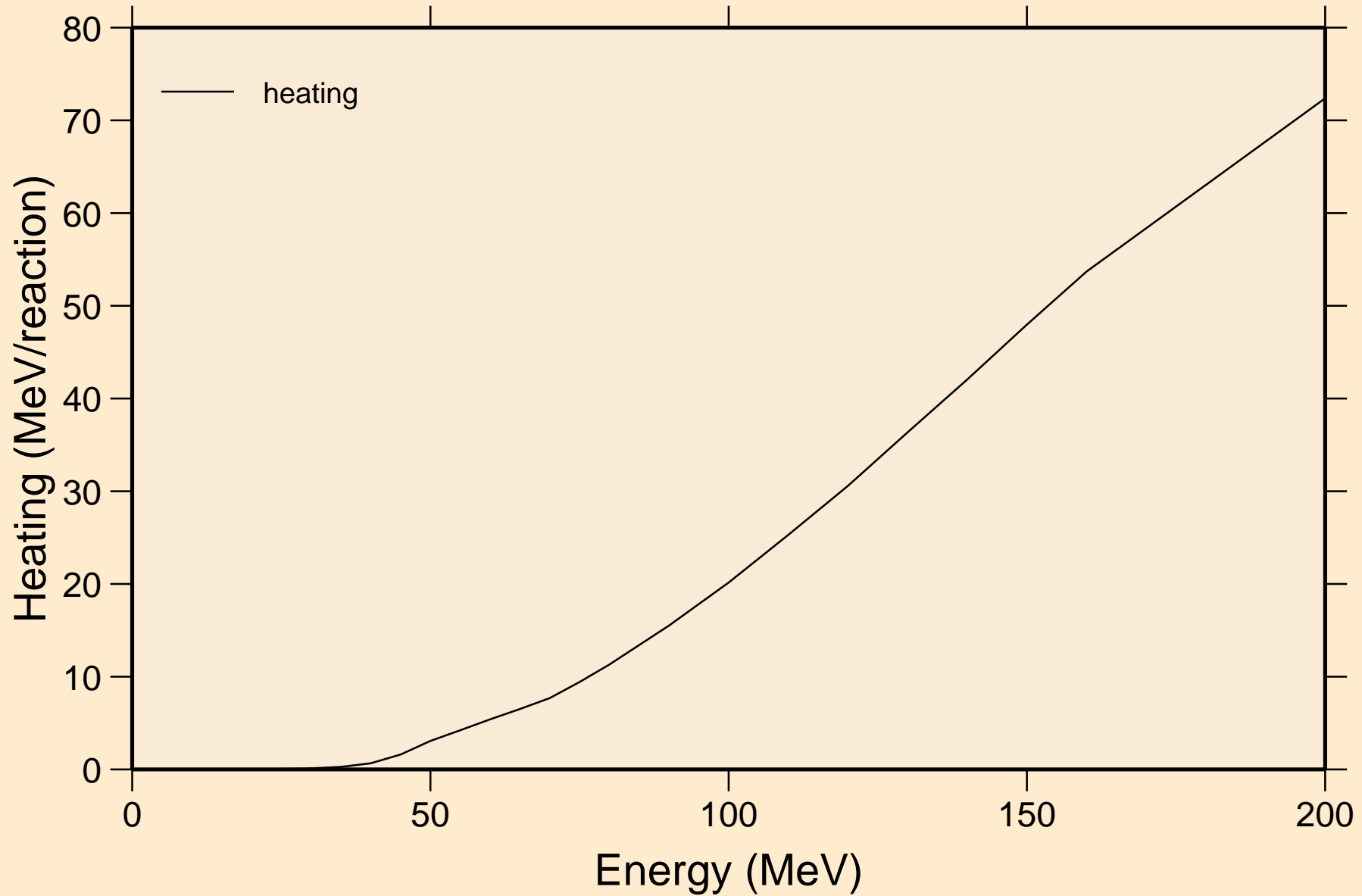

AC237 TRITON ACER TENDL-2021 LIBRARY; T=0.K  
Threshold reactions

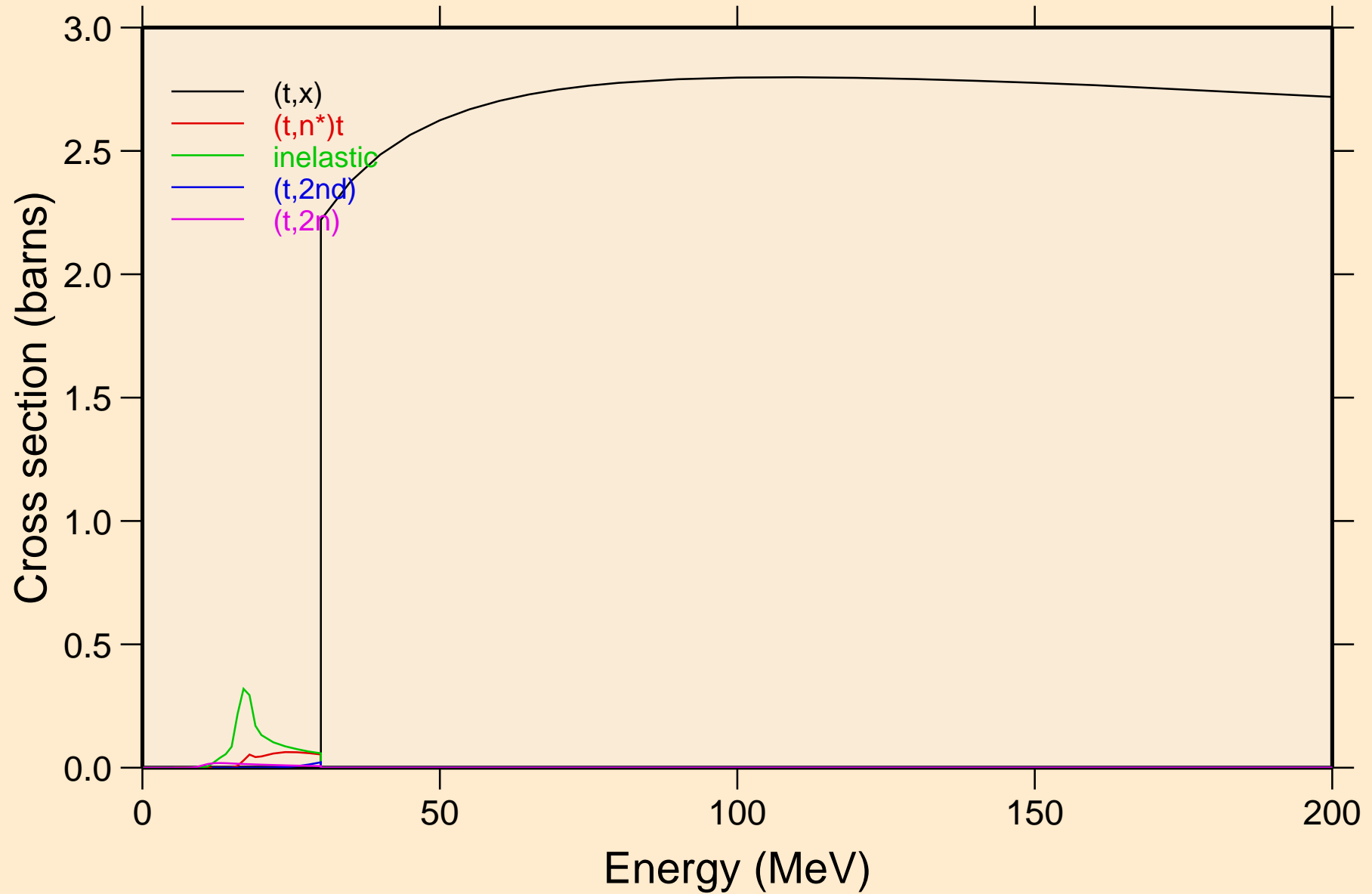

AC237 TRITON ACER TENDL-2021 LIBRARY; T=0.K  
Threshold reactions

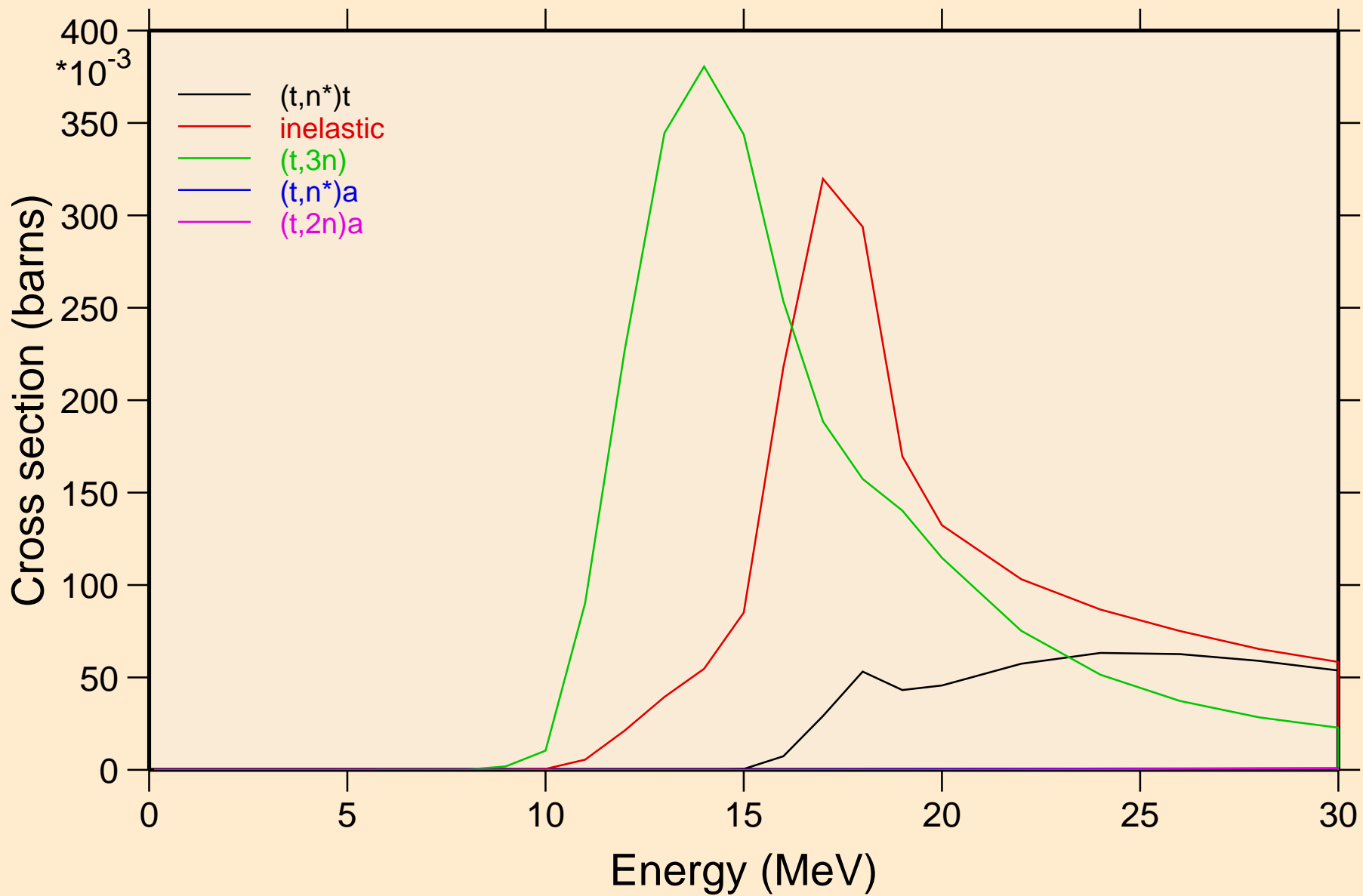

AC237 TRITON ACER TENDL-2021 LIBRARY; T=0.K  
Threshold reactions

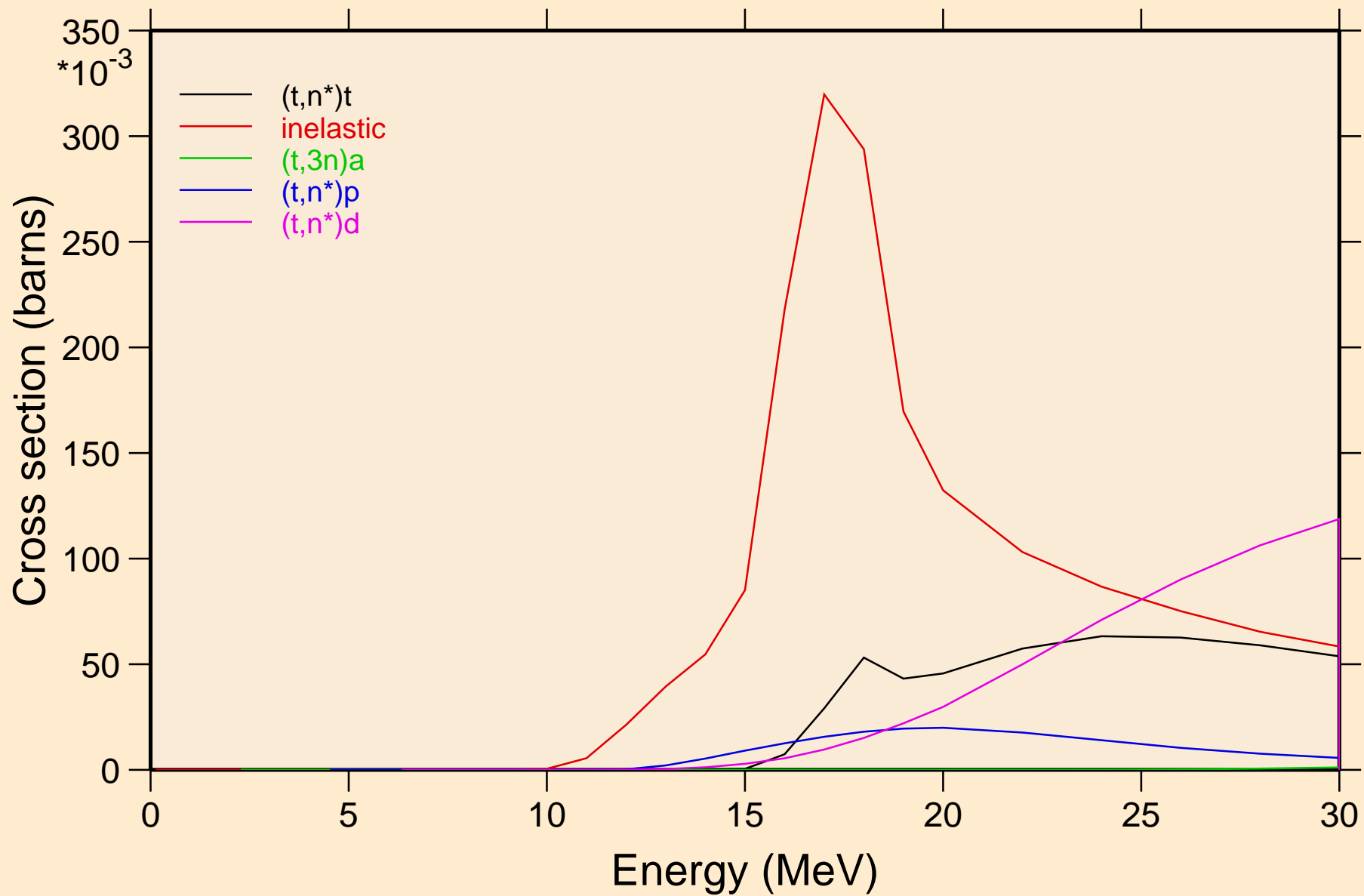

AC237 TRITON ACER TENDL-2021 LIBRARY; T=0.K  
Threshold reactions

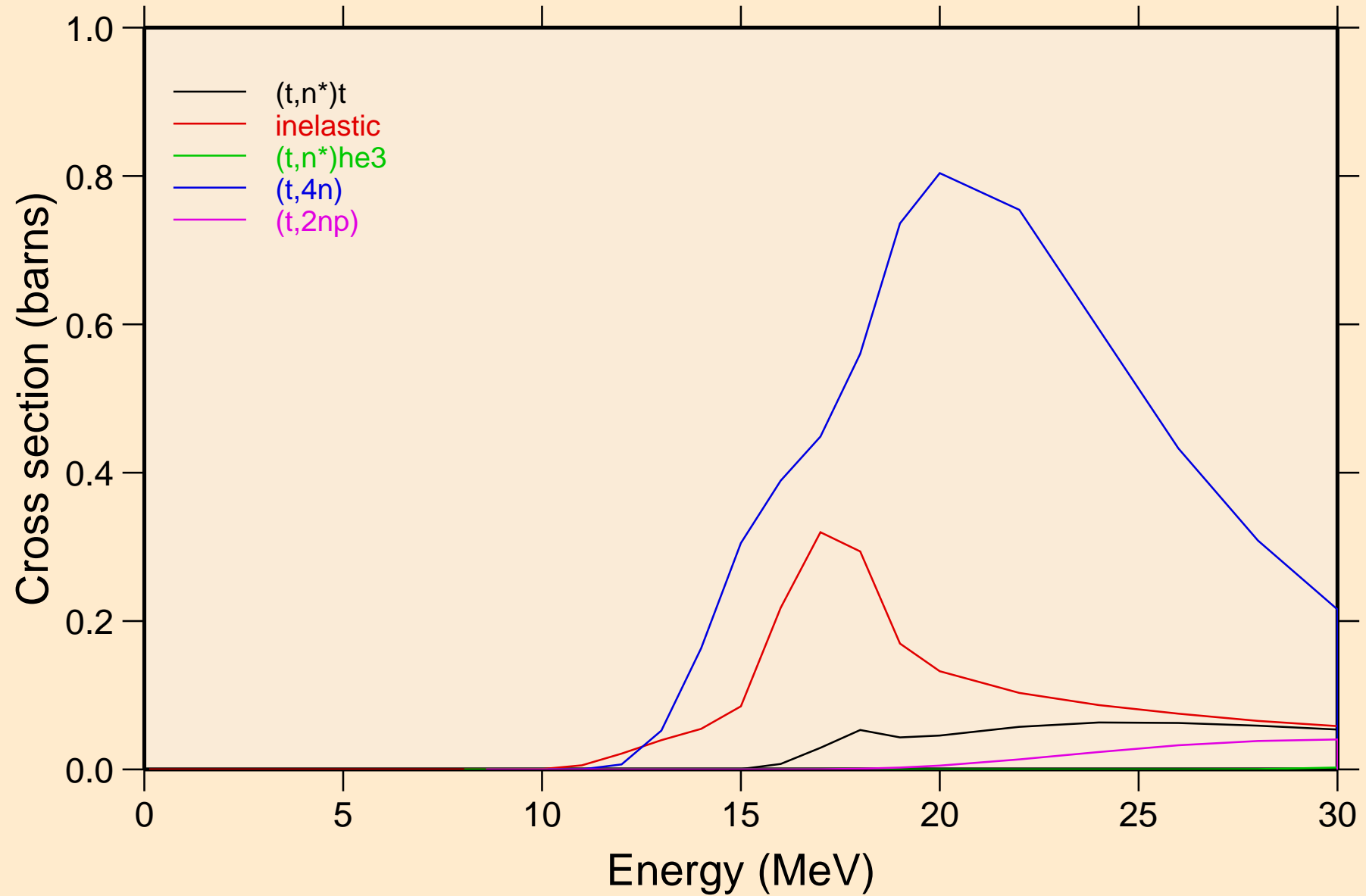



AC237 TRITON ACER TENDL-2021 LIBRARY; T=0.K  
Threshold reactions

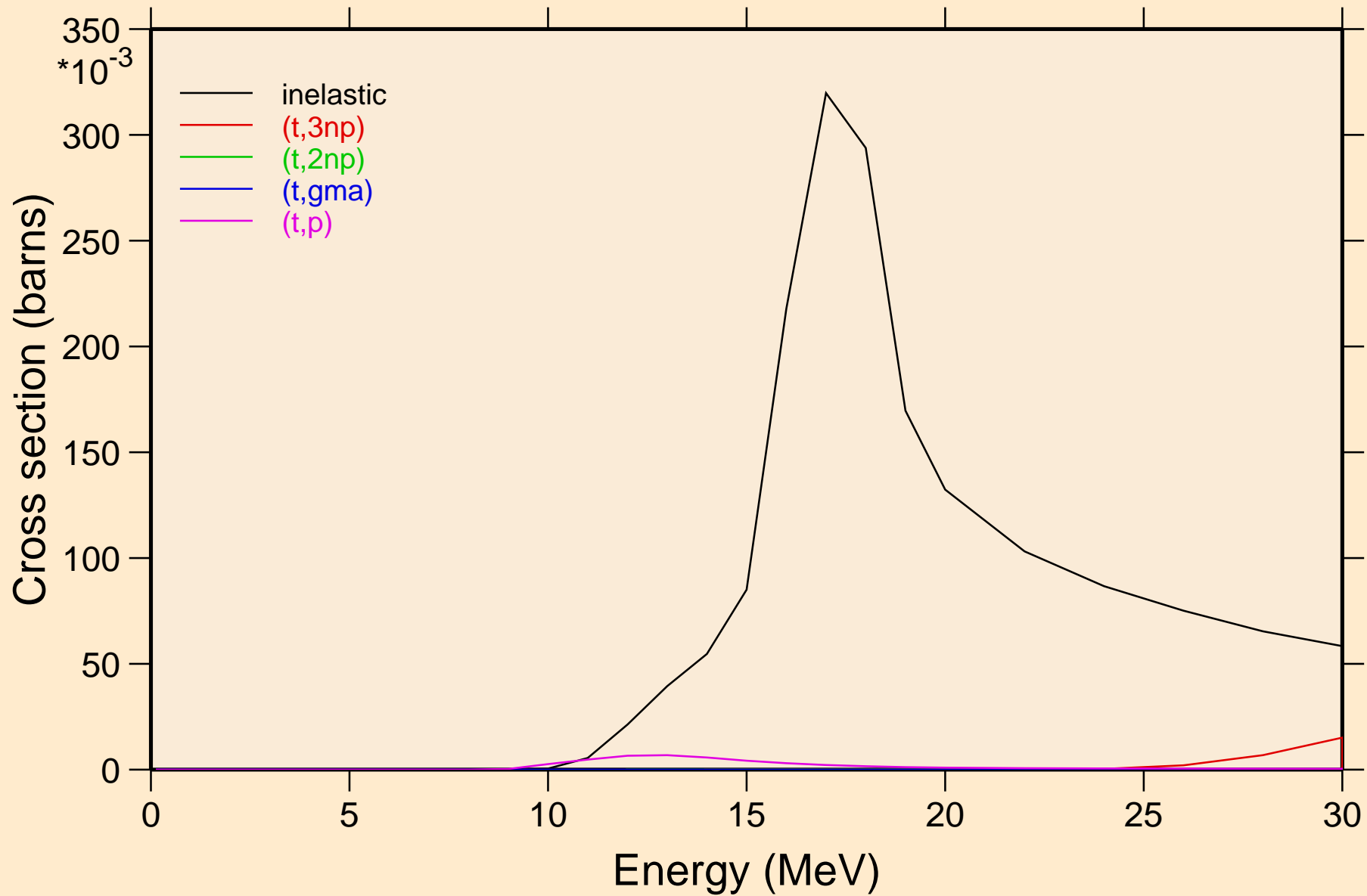

AC237 TRITON ACER TENDL-2021 LIBRARY; T=0.K  
Threshold reactions

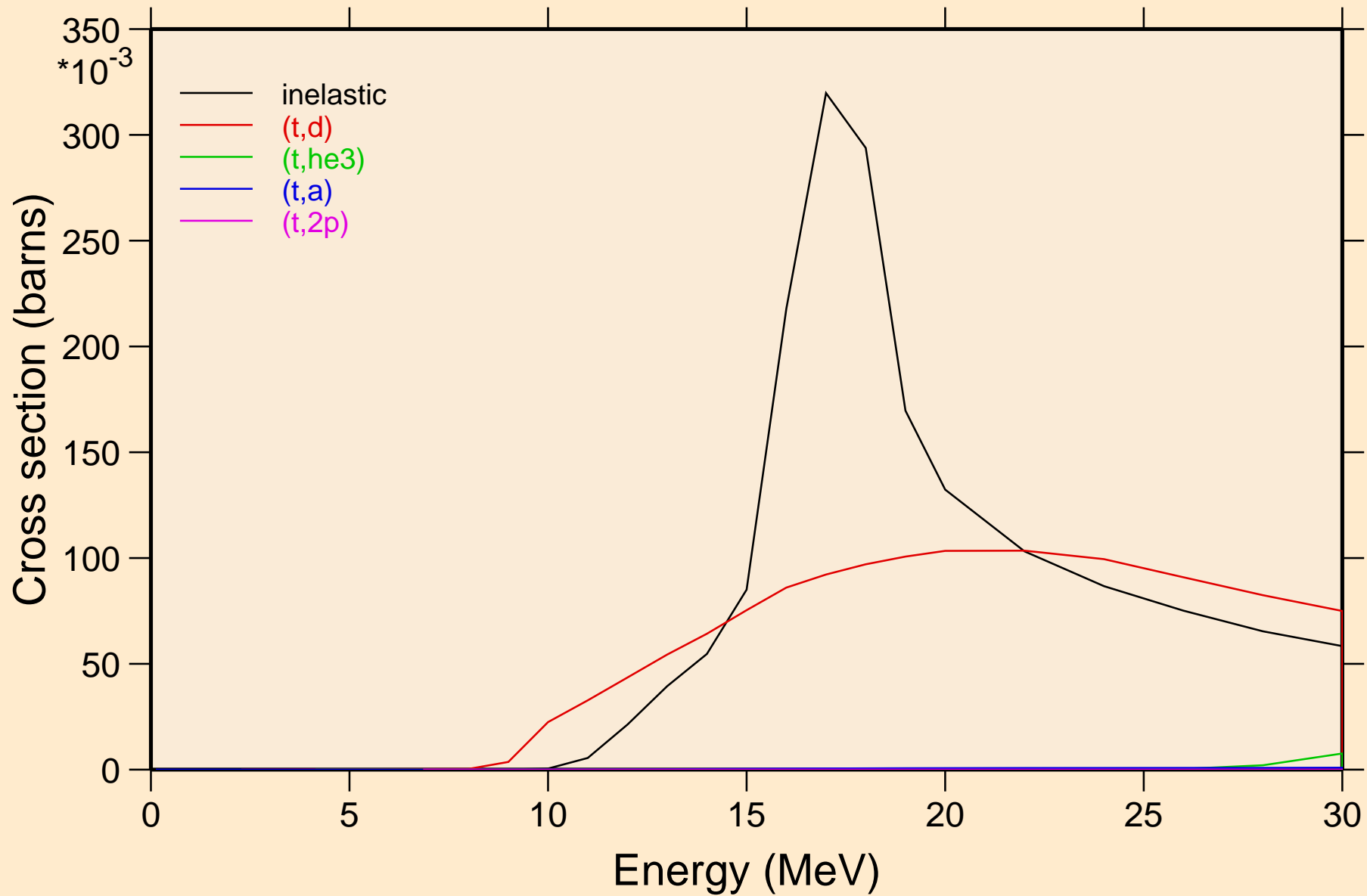

AC237 TRITON ACER TENDL-2021 LIBRARY; T=0.K  
angular distribution for elastic

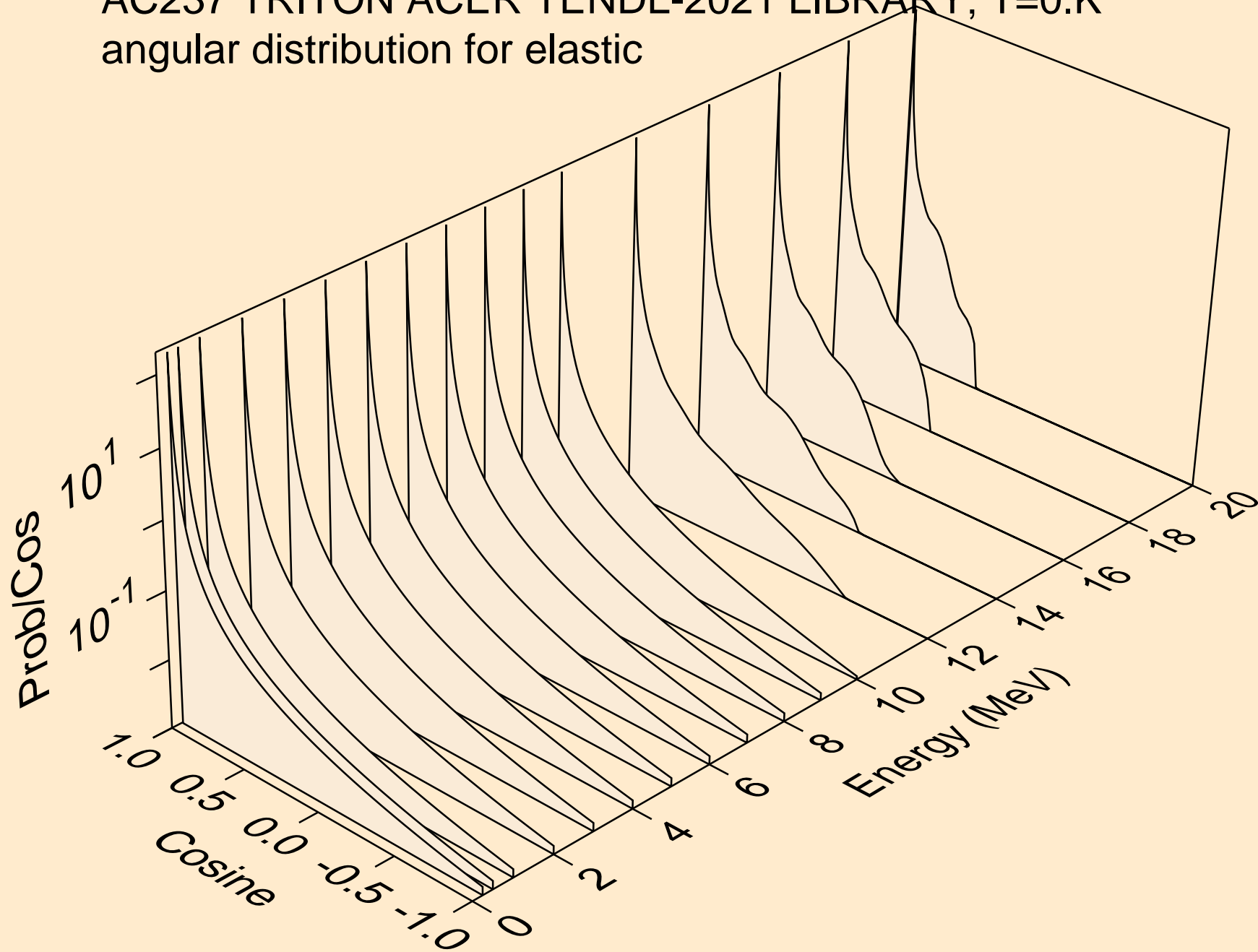

AC237 TRITON ACER TENDL-2021 LIBRARY; T=0.K  
angular distribution for elastic

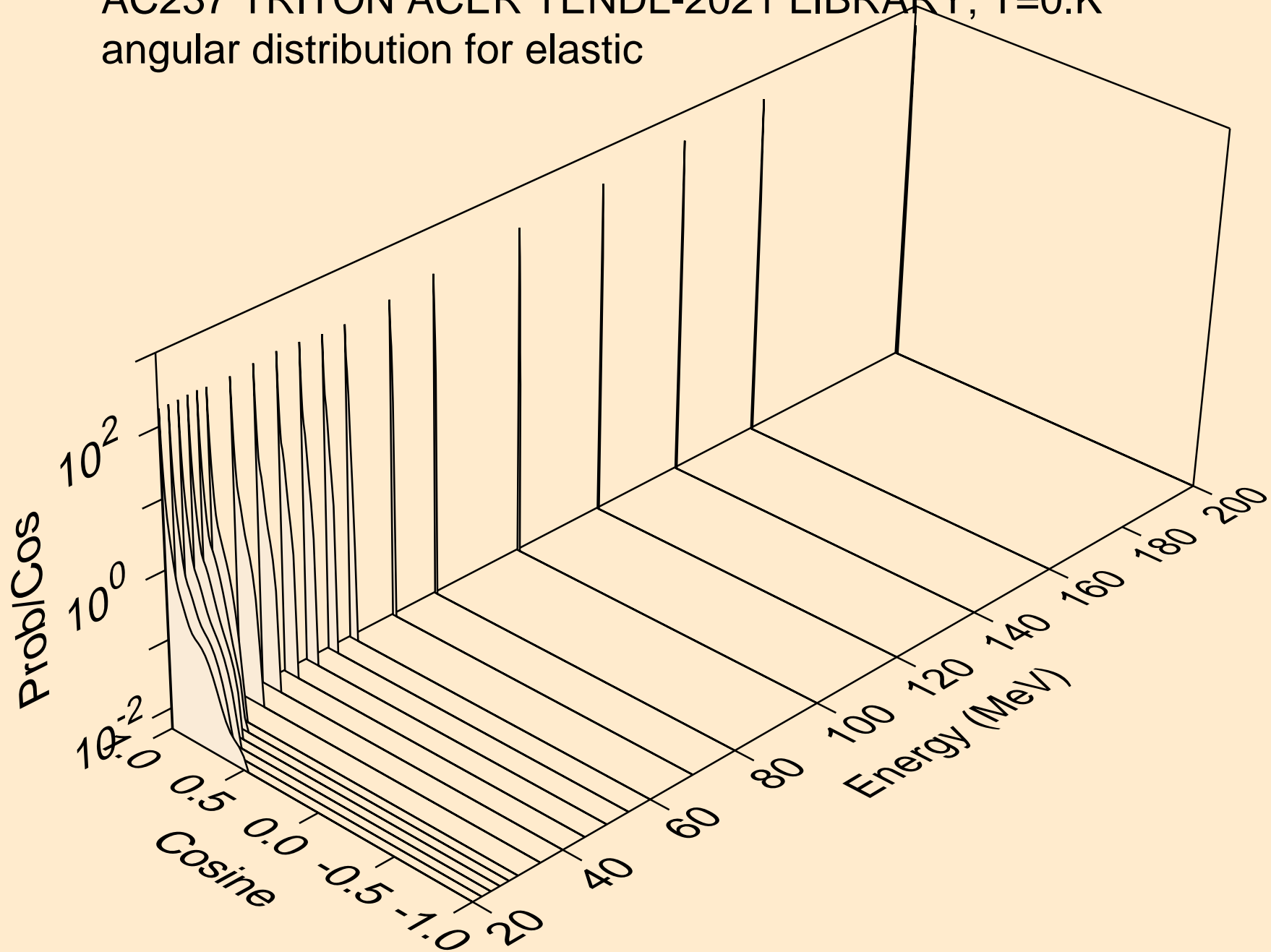

AC237 TRITON ACER TENDL-2021 LIBRARY; T=0.K  
Triton emission for (t,x)

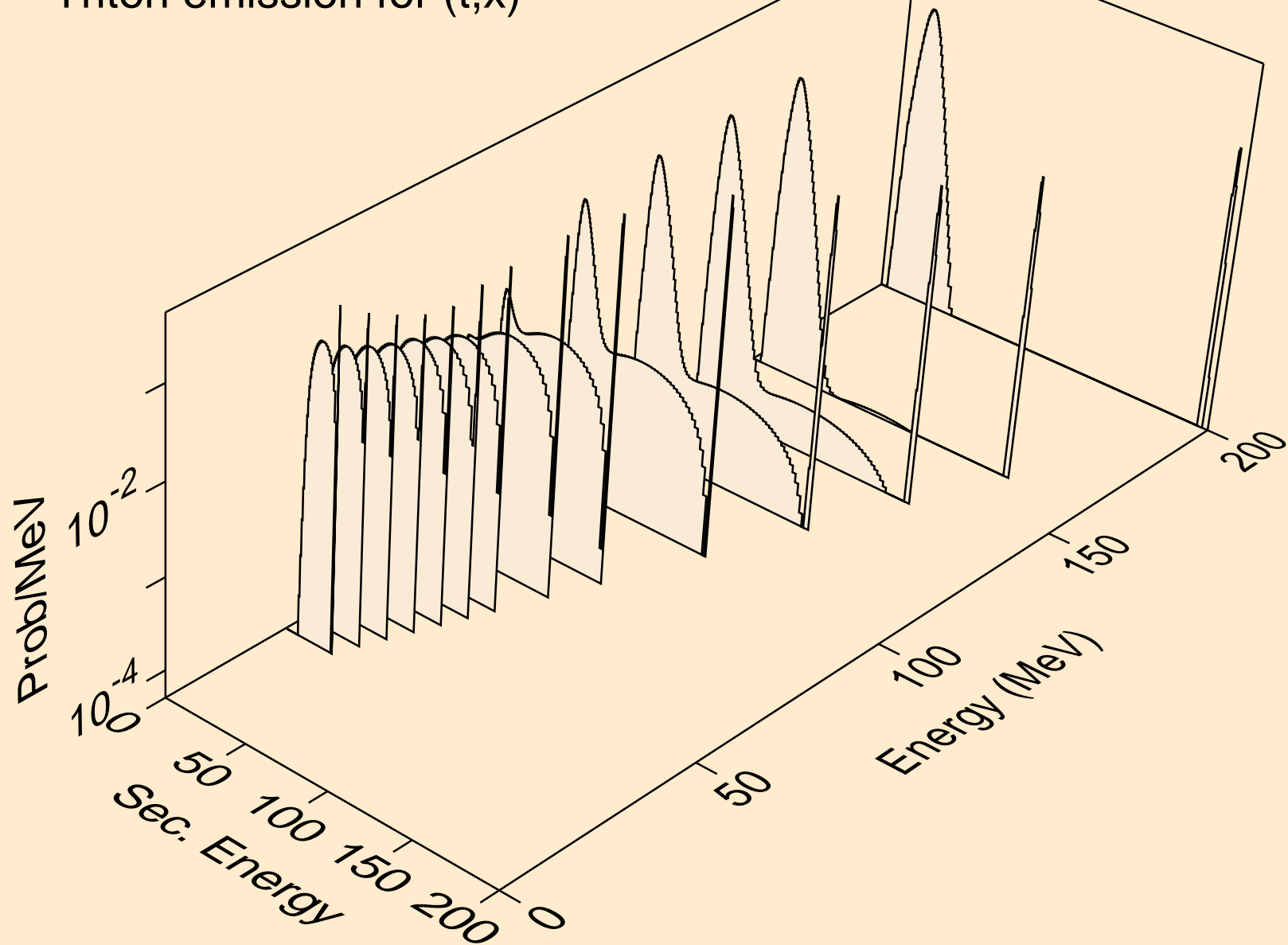

AC237 TRITON ACER TENDL-2021 LIBRARY; T=0.K  
Triton emission for (t,n\*)t

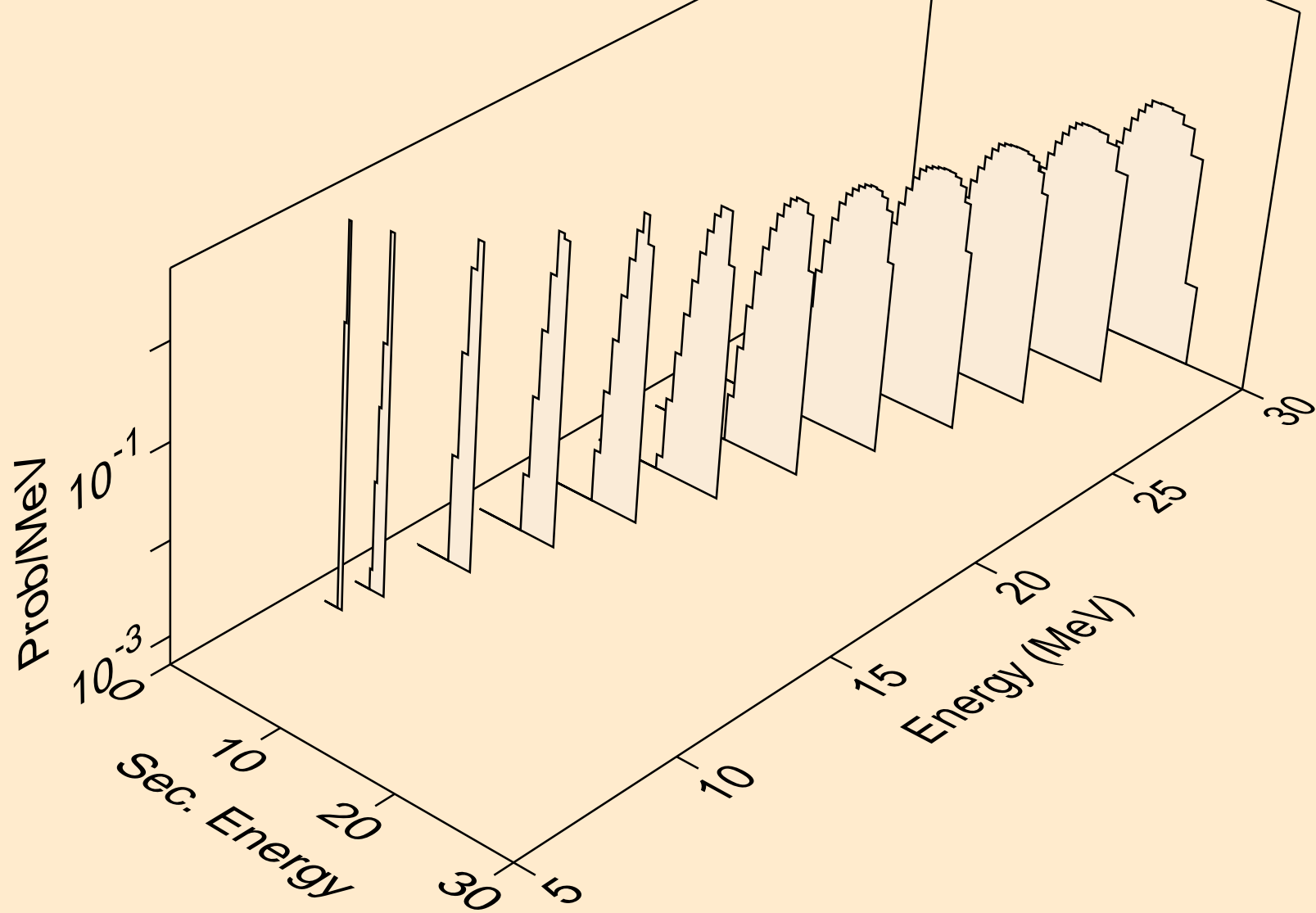

AC237 TRITON ACER TENDL-2021 LIBRARY; T=0.K  
Triton emission for inelastic

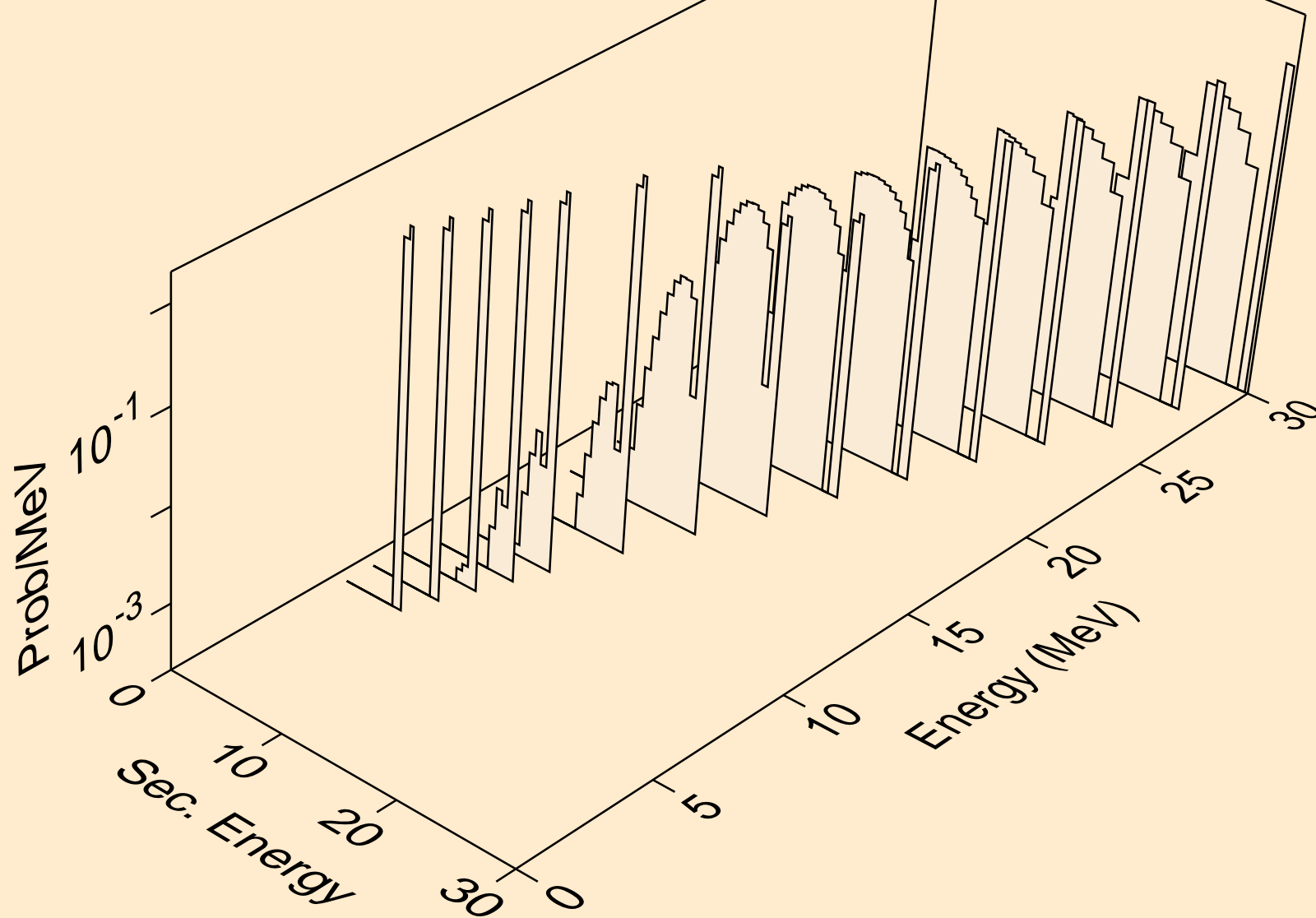

AC237 TRITON ACER TENDL-2021 LIBRARY; T=0.K  
Photon emission for (z,n)

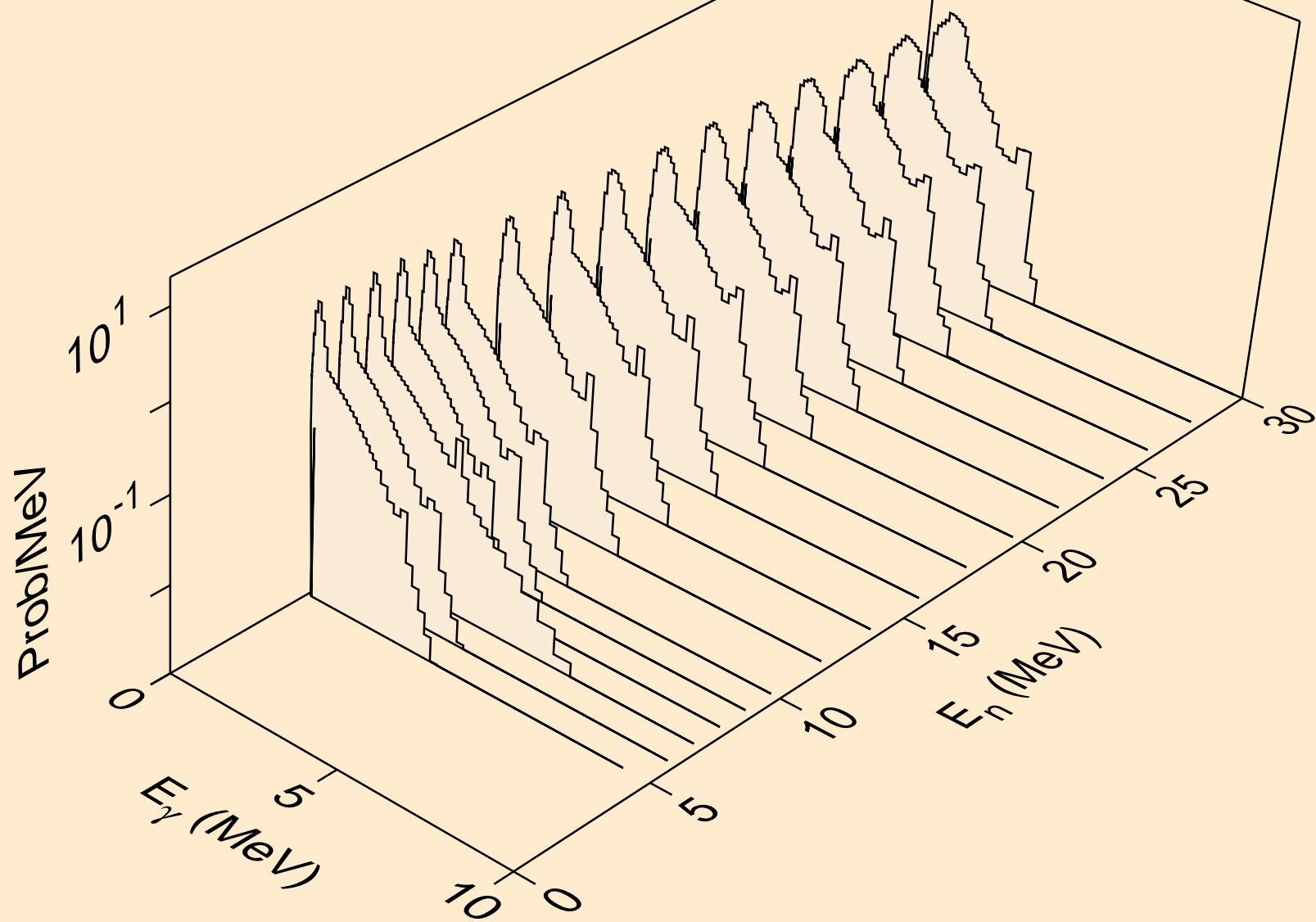



AC237 TRITON ACER TENDL-2021 LIBRARY; T=0.K  
Photon emission for (n,x)

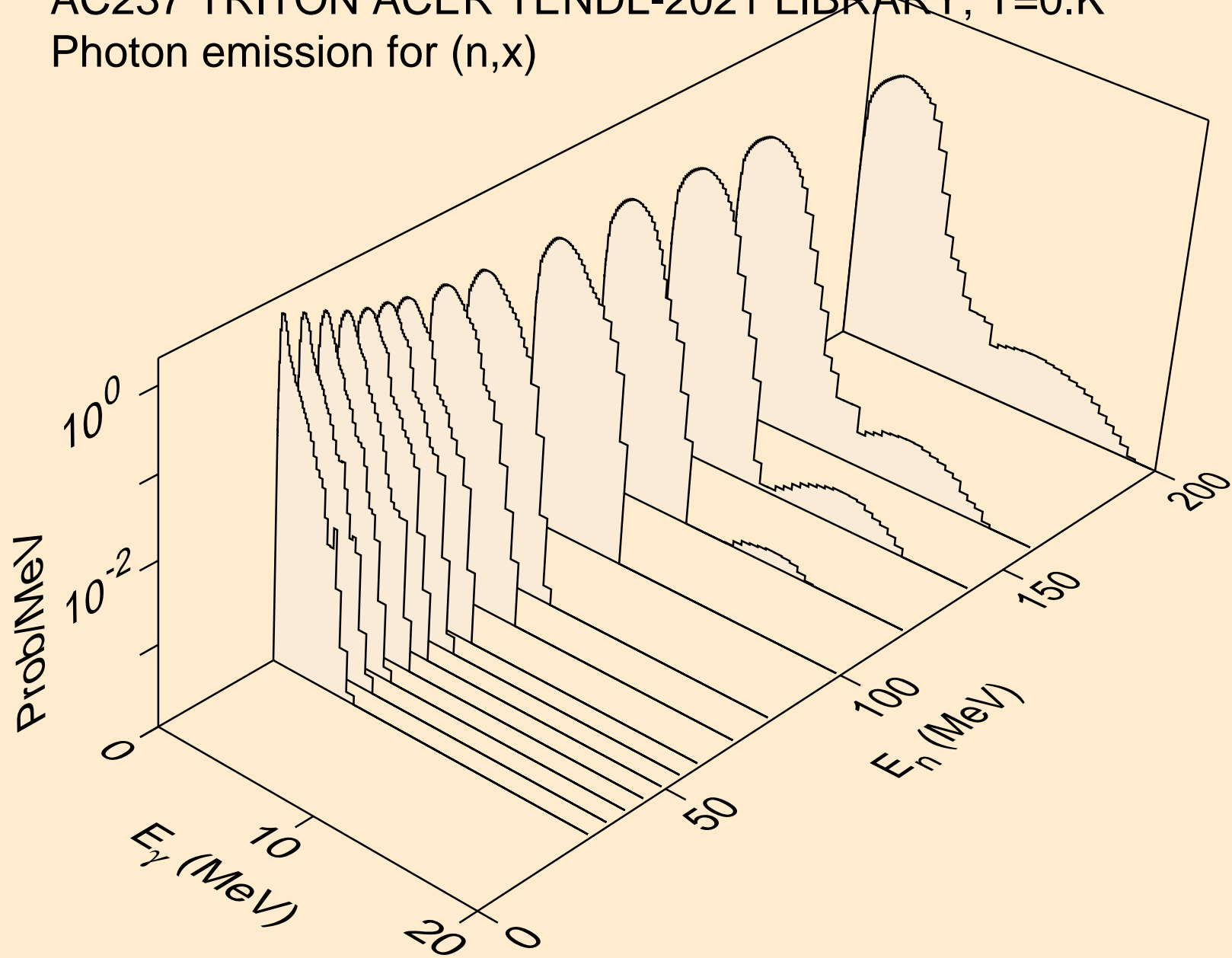

AC237 TRITON ACER TENDL-2021 LIBRARY; T=0.K  
Photon emission for (n,2nd)

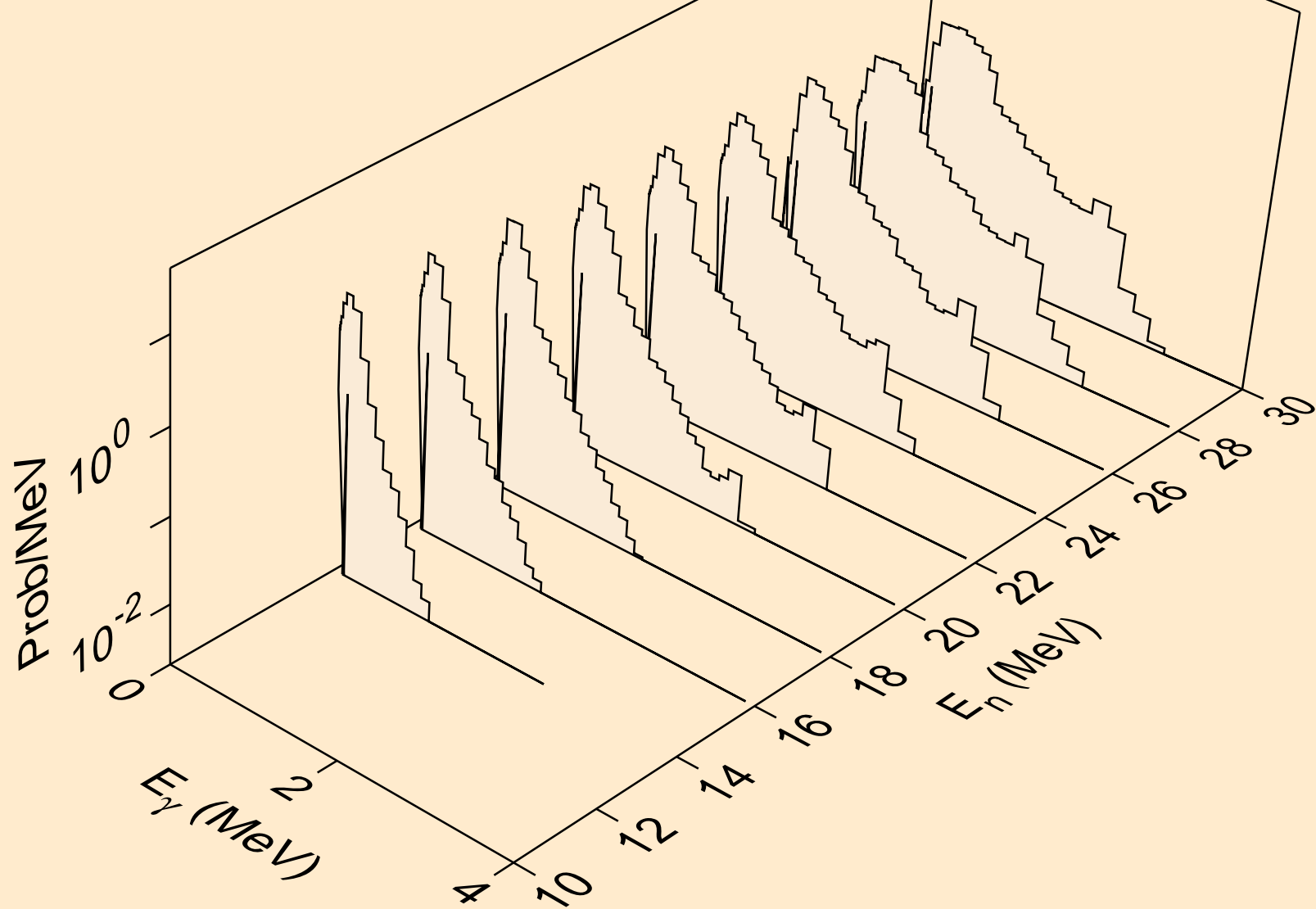

AC237 TRITON ACER TENDL-2021 LIBRARY; T=0.K  
Photon emission for (n,2n)

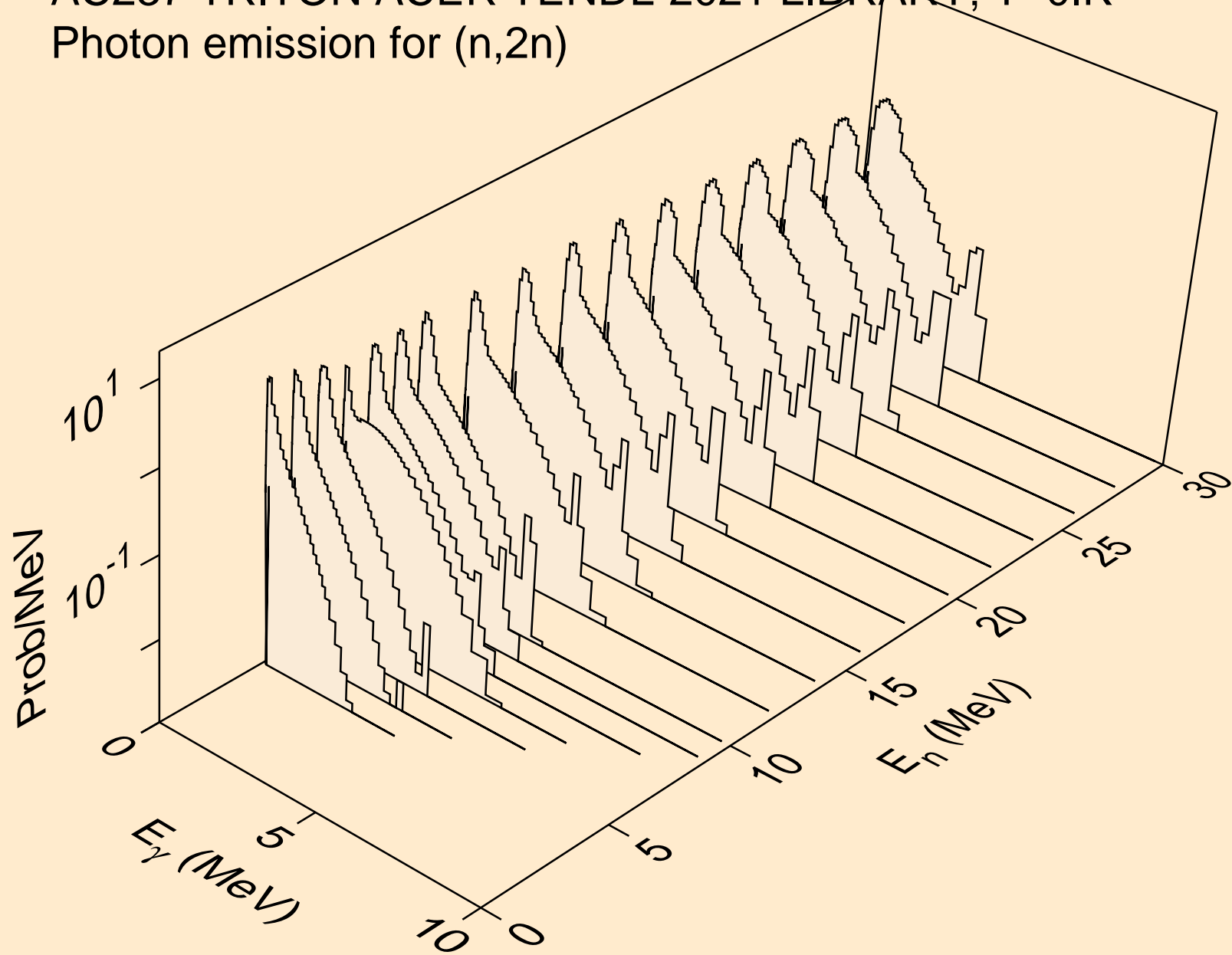

AC237 TRITON ACER TENDL-2021 LIBRARY; T=0.K  
Photon emission for (n,3n)

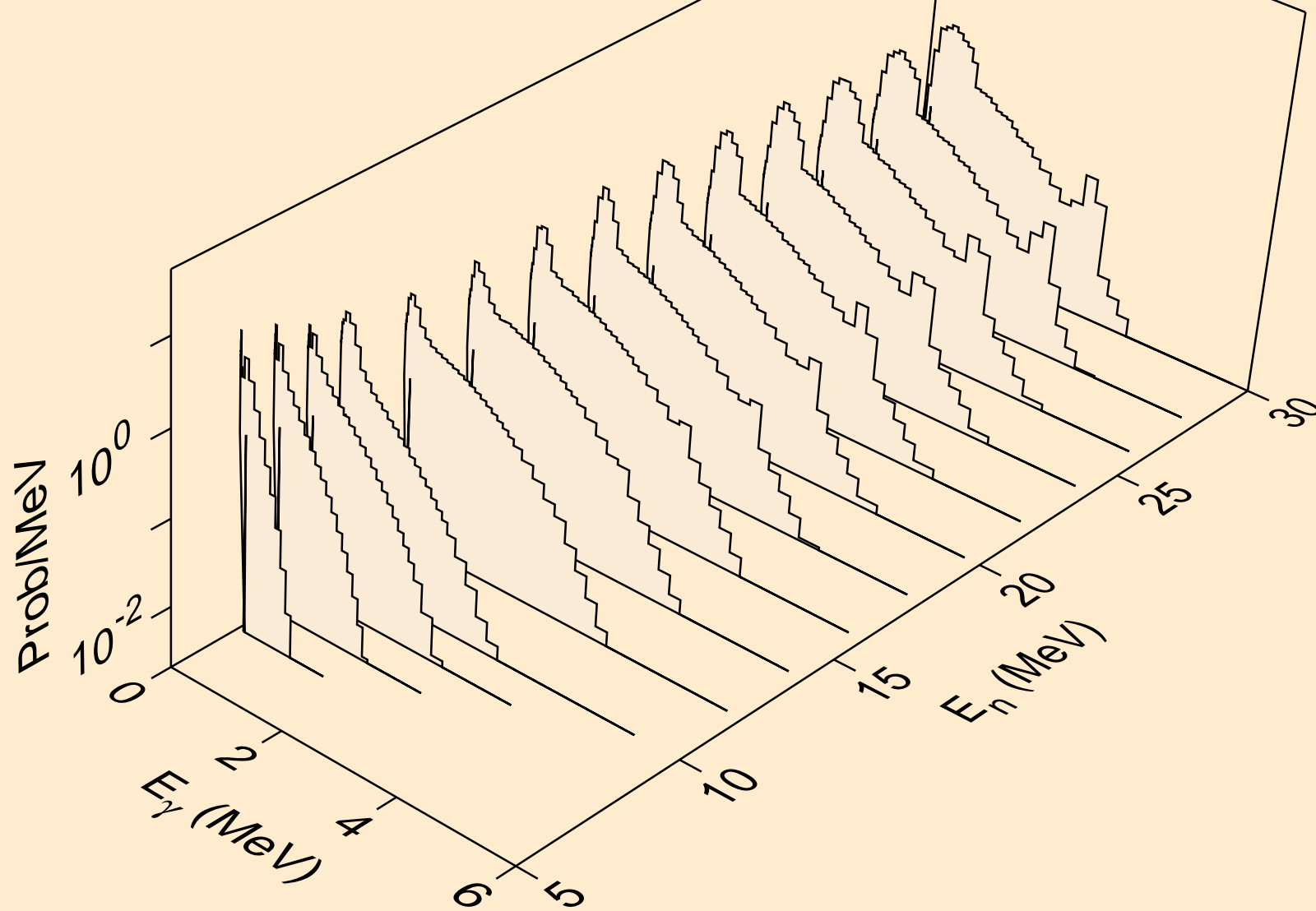

AC237 TRITON ACER TENDL-2021 LIBRARY; T=0.K  
Photon emission for (n,n\*)a

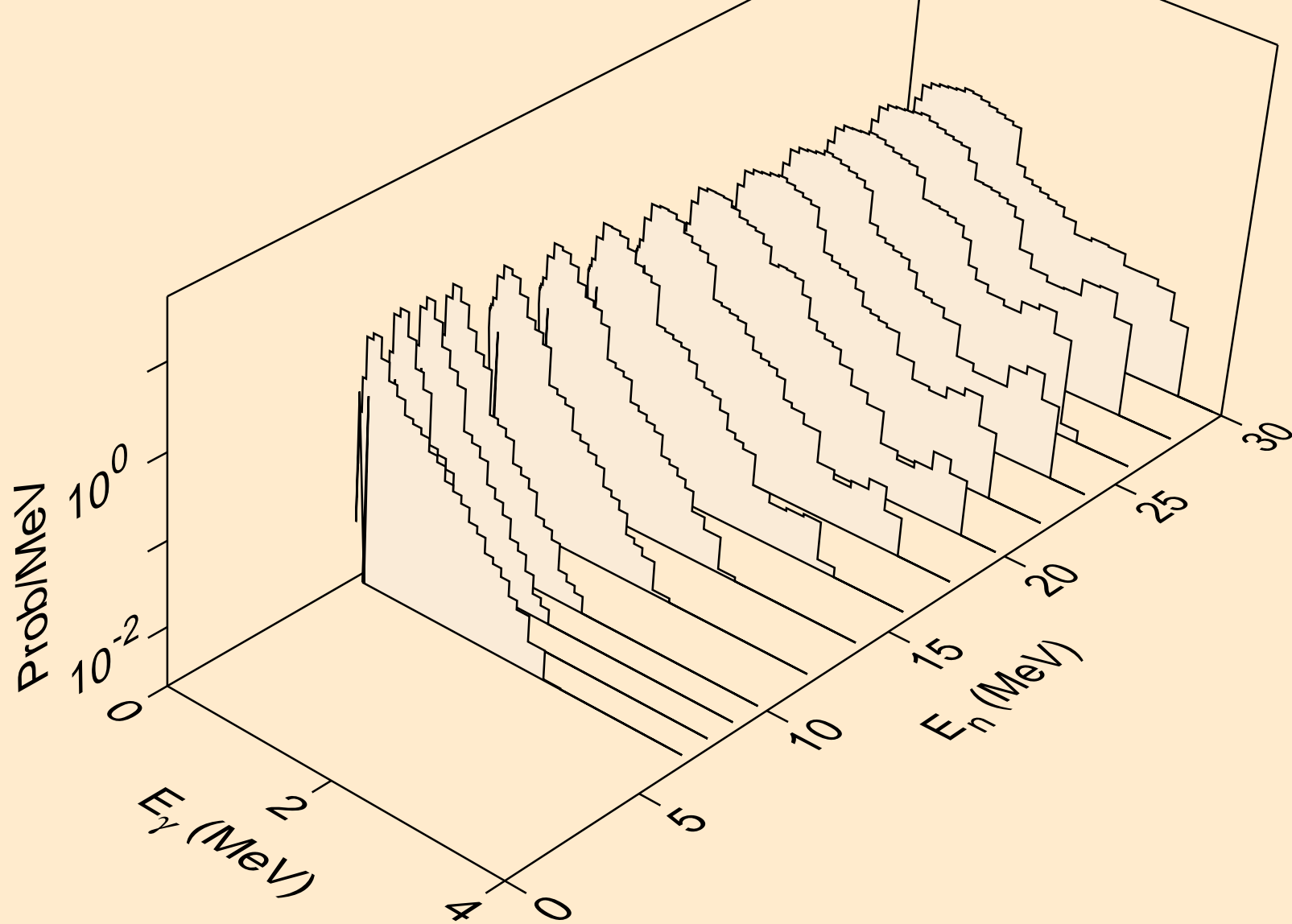

AC237 TRITON ACER TENDL-2021 LIBRARY; T=0.K  
Photon emission for (n,2n)a

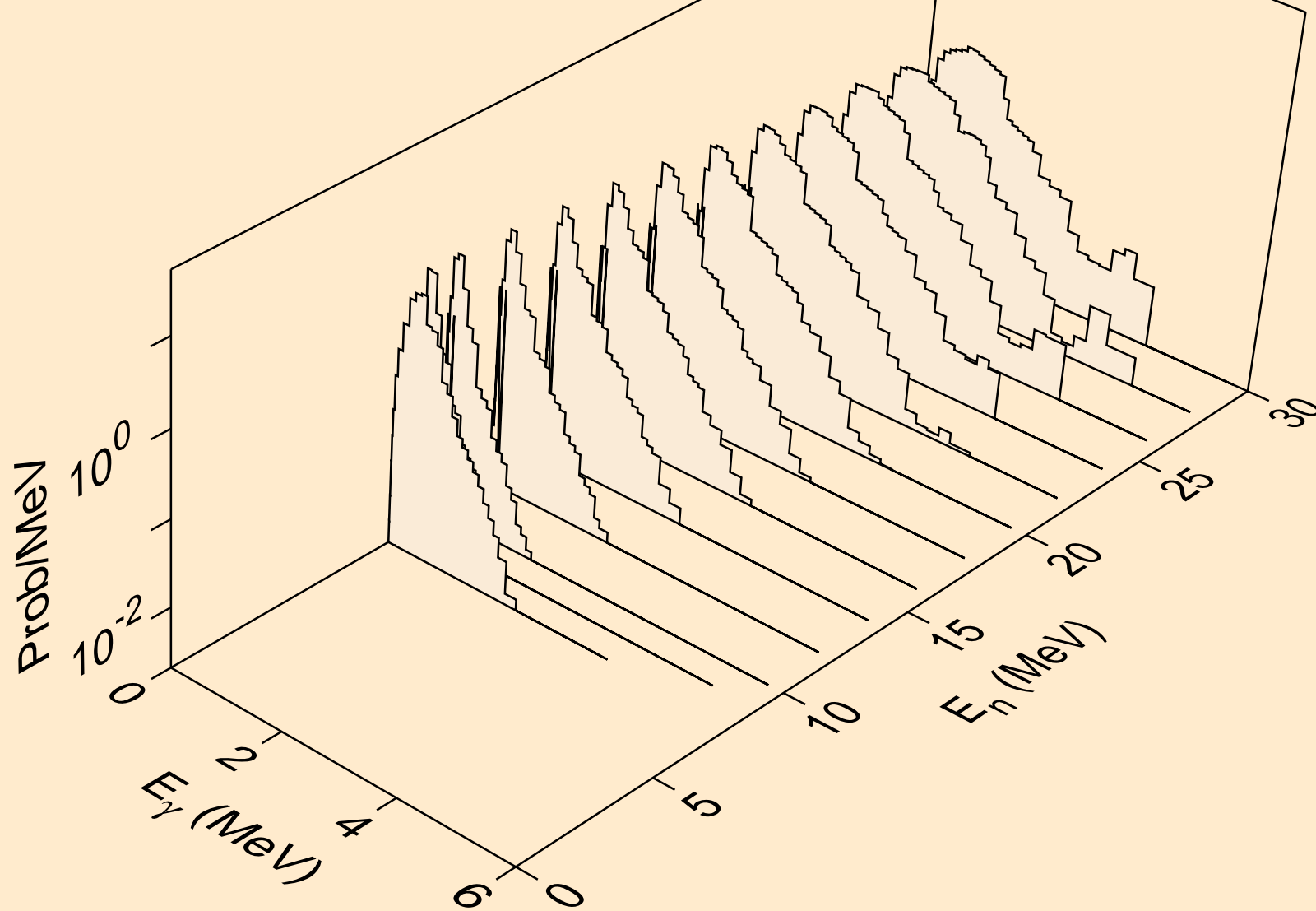

AC237 TRITON ACER TENDL-2021 LIBRARY; T=0.K  
Photon emission for (n,3n)a

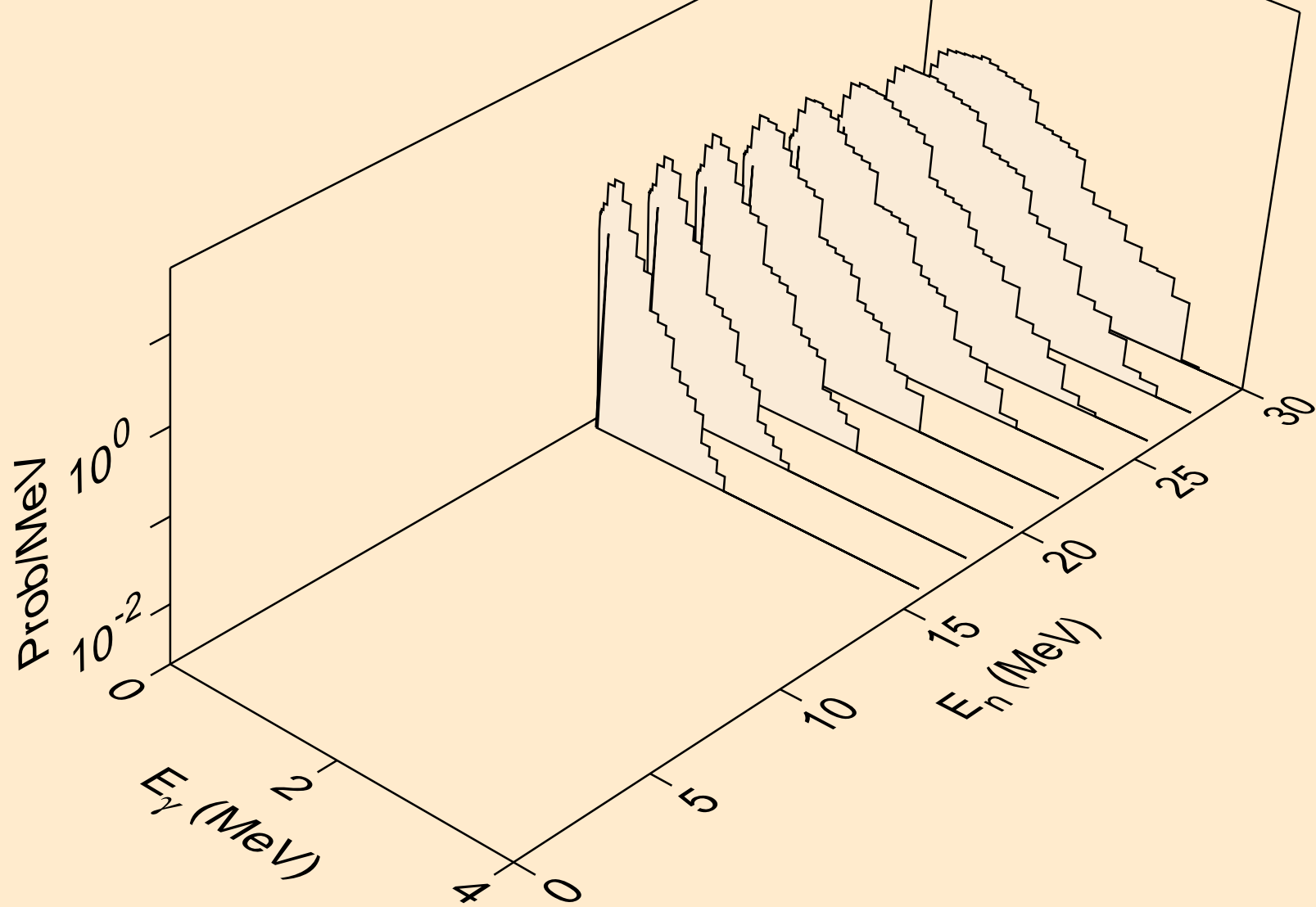

AC237 TRITON ACER TENDL-2021 LIBRARY; T=0.K  
Photon emission for (n,n\*)p

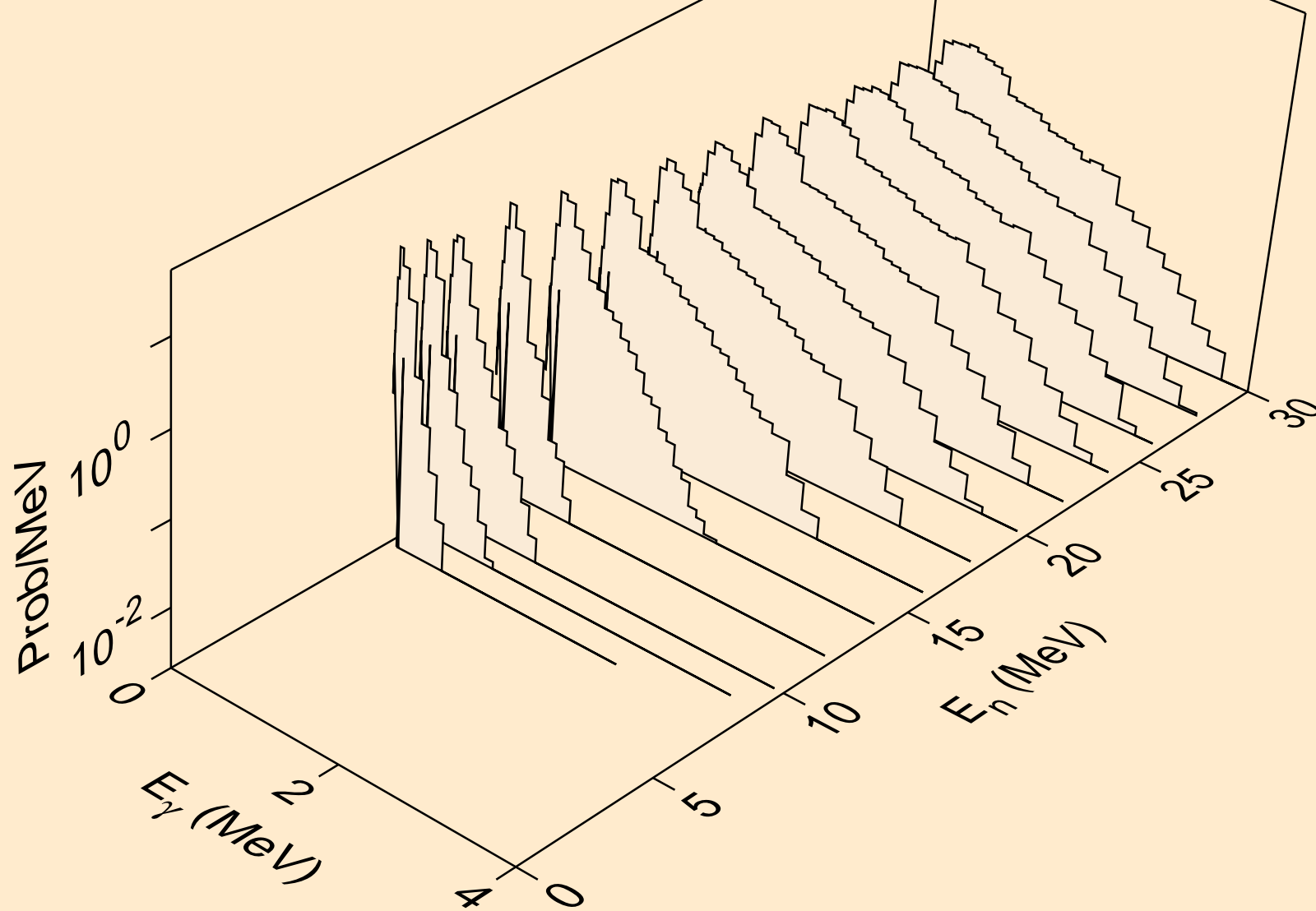



AC237 TRITON ACER TENDL-2021 LIBRARY; T=0.K  
Photon emission for (n,n\*)d

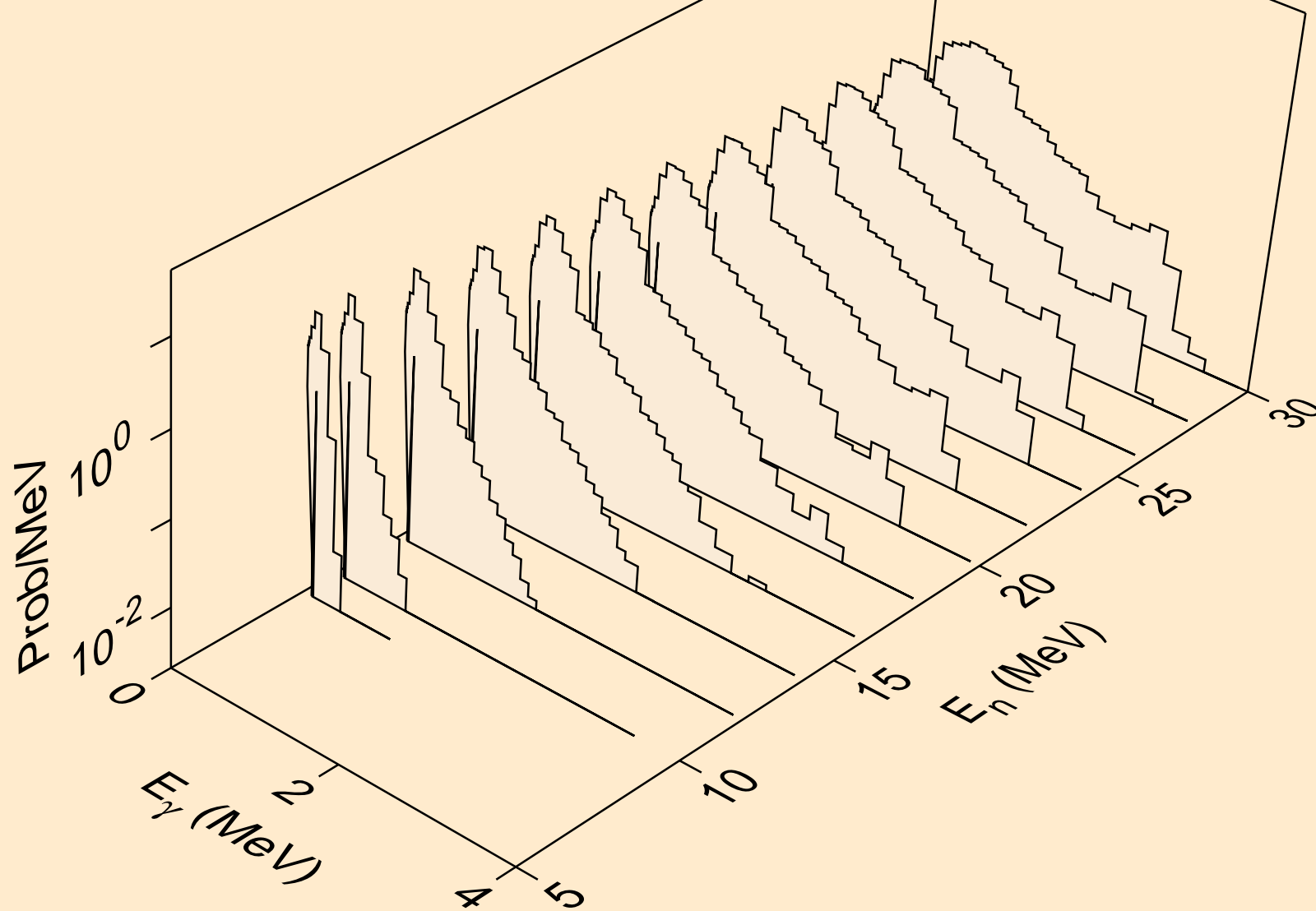

AC237 TRITON ACER TENDL-2021 LIBRARY; T=0.K  
Photon emission for (n,n\*)t

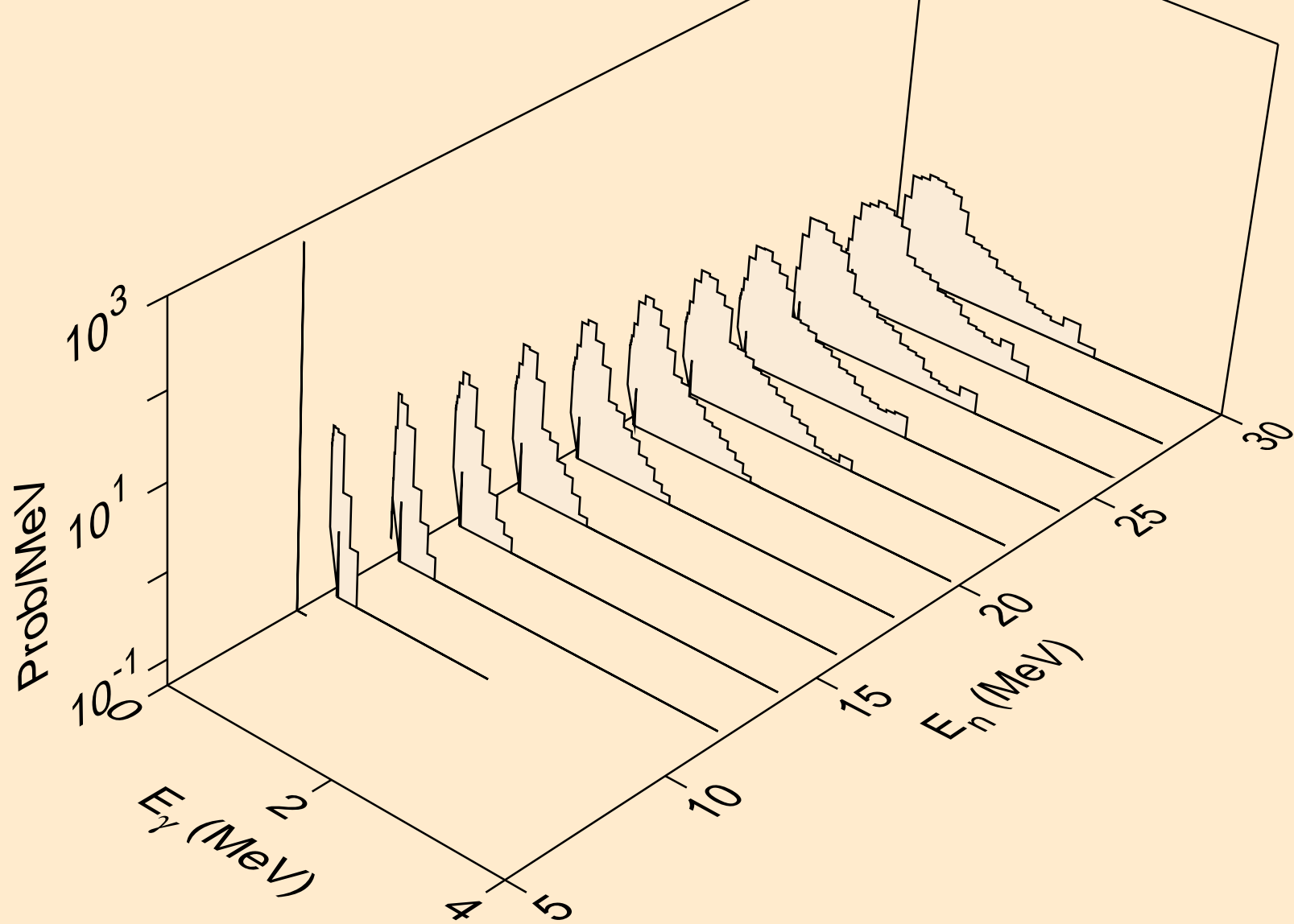

AC237 TRITON ACER TENDL-2021 LIBRARY; T=0.K  
Photon emission for (n,n\*)he3

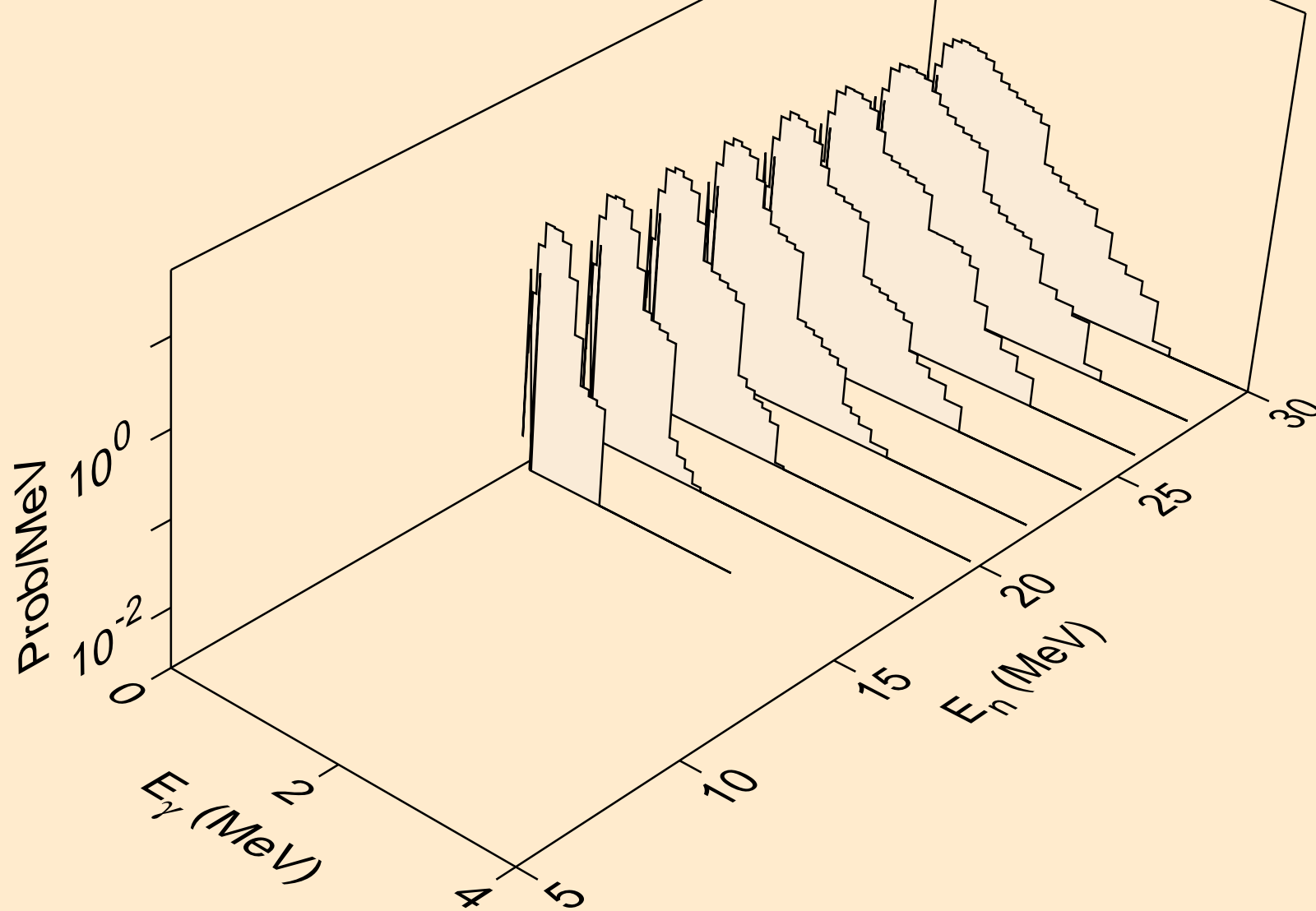

AC237 TRITON ACER TENDL-2021 LIBRARY; T=0.K  
Photon emission for (n,4n)

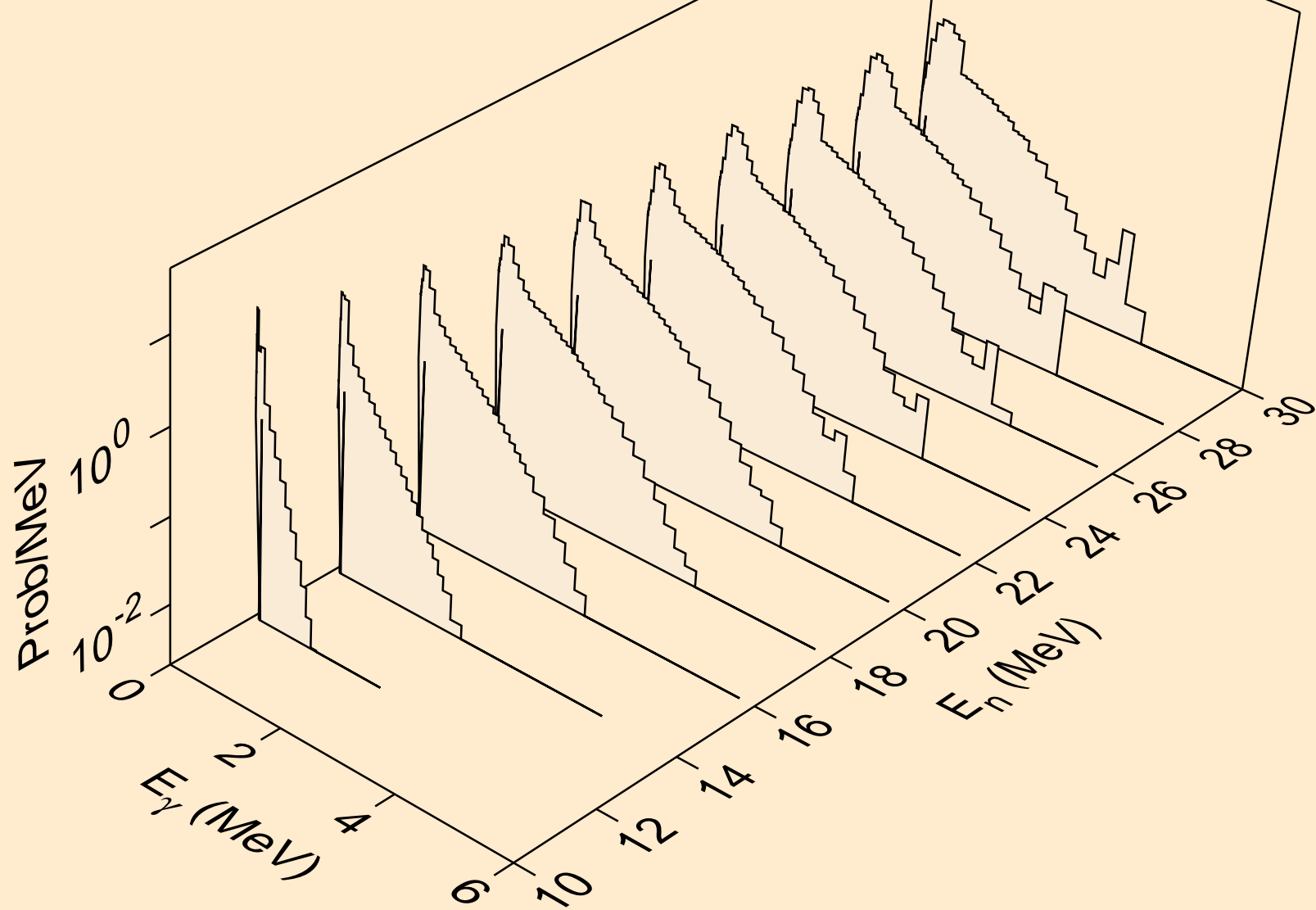

AC237 TRITON ACER TENDL-2021 LIBRARY; T=0.K  
Photon emission for (n,2np)

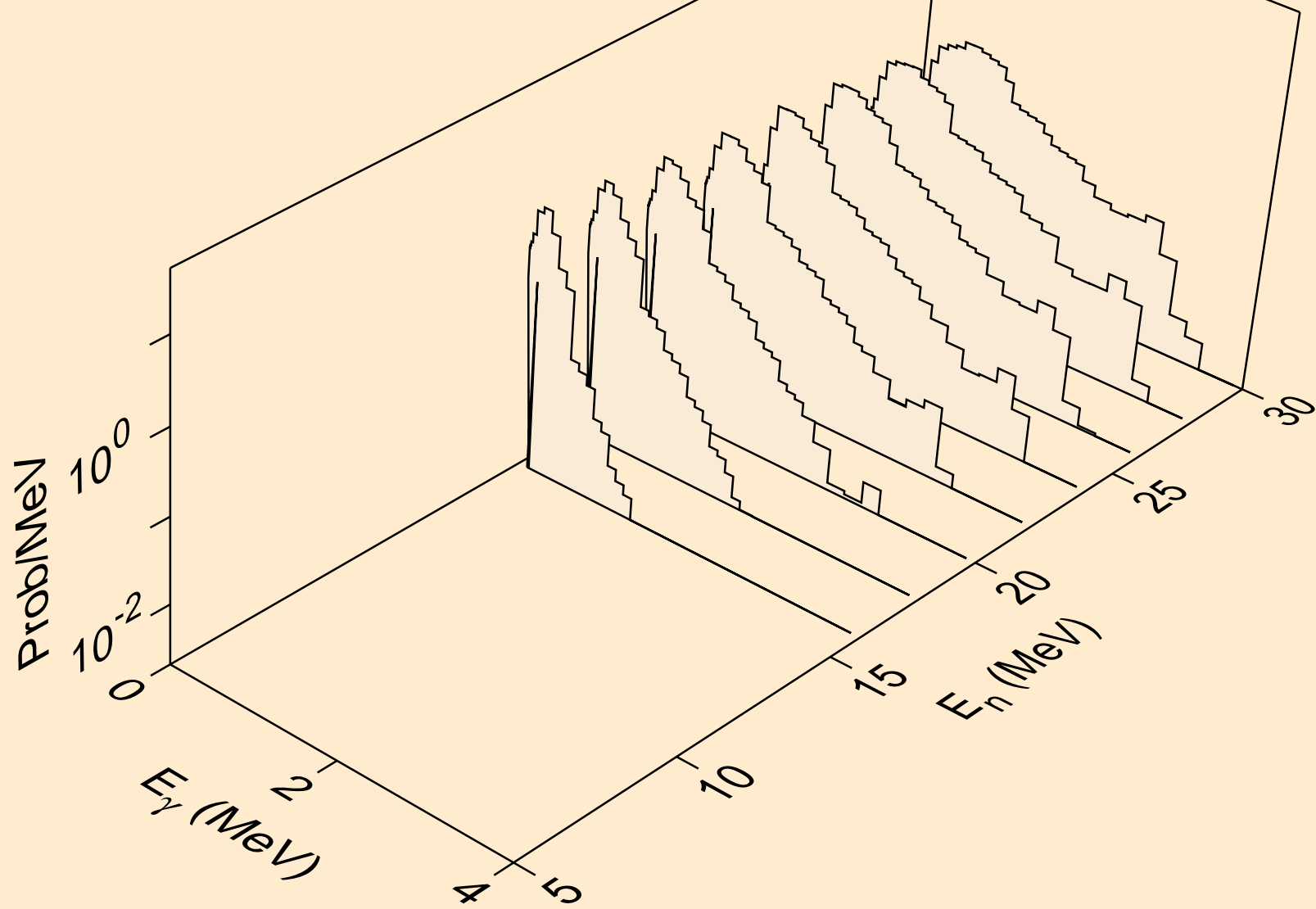

AC237 TRITON ACER TENDL-2021 LIBRARY; T=0.K  
Photon emission for (n,3np)

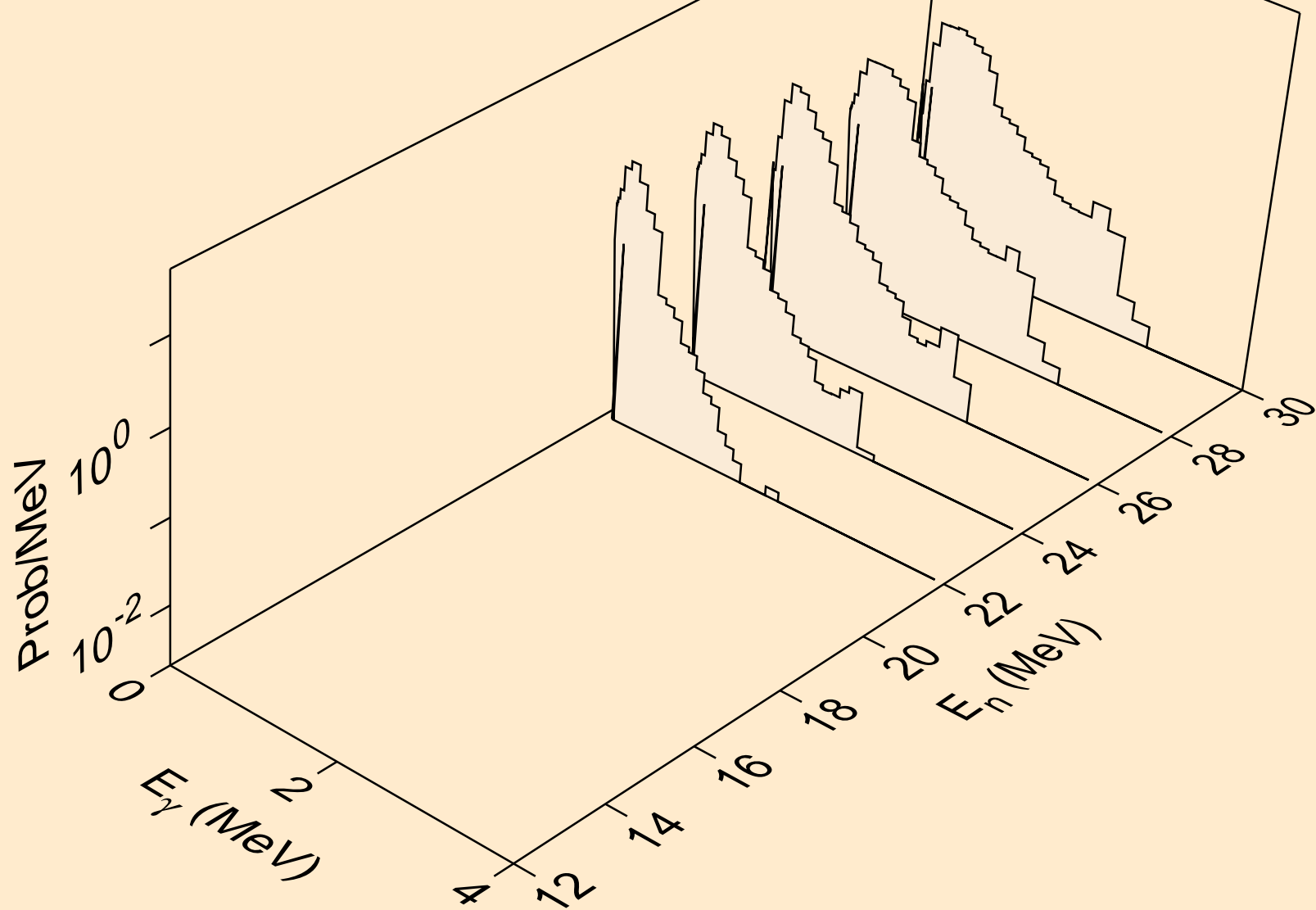

AC237 TRITON ACER TENDL-2021 LIBRARY; T=0.K  
Photon emission for (n,2np)

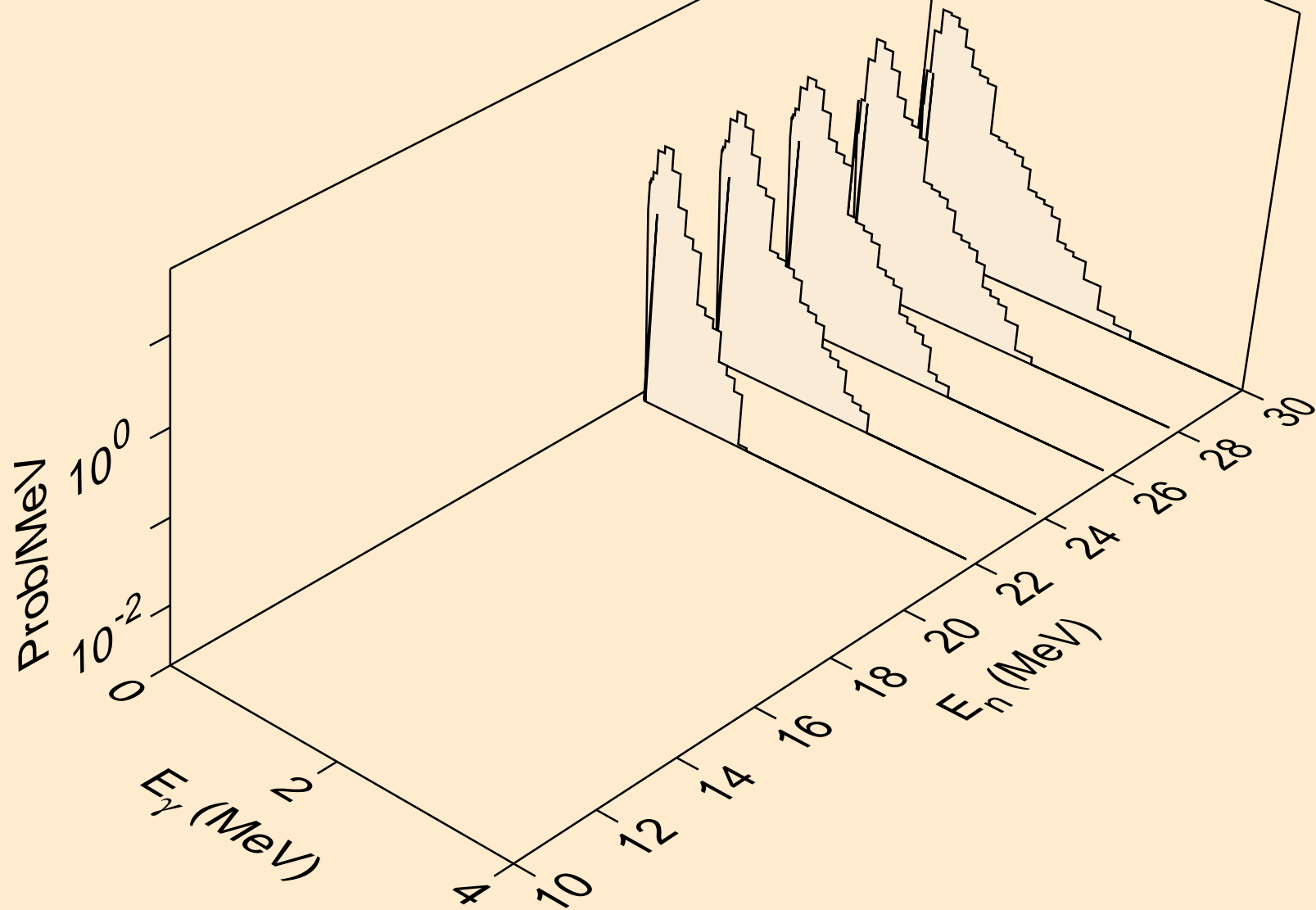

AC237 TRITON ACER TENDL-2021 LIBRARY; T=0.K  
Photon emission for (n,gma)

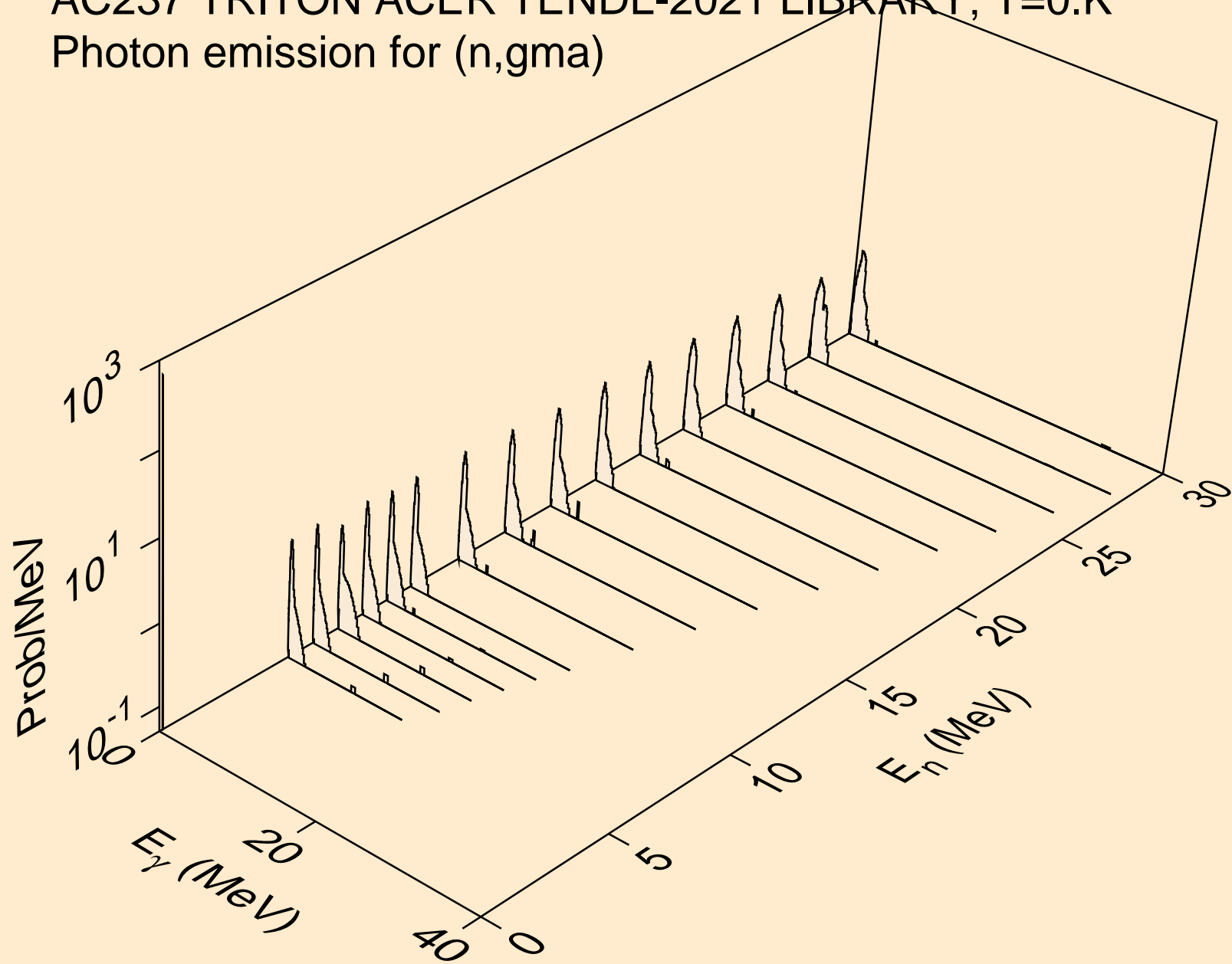



AC237 TRITON ACER TENDL-2021 LIBRARY; T=0.K  
Photon emission for (n,p)

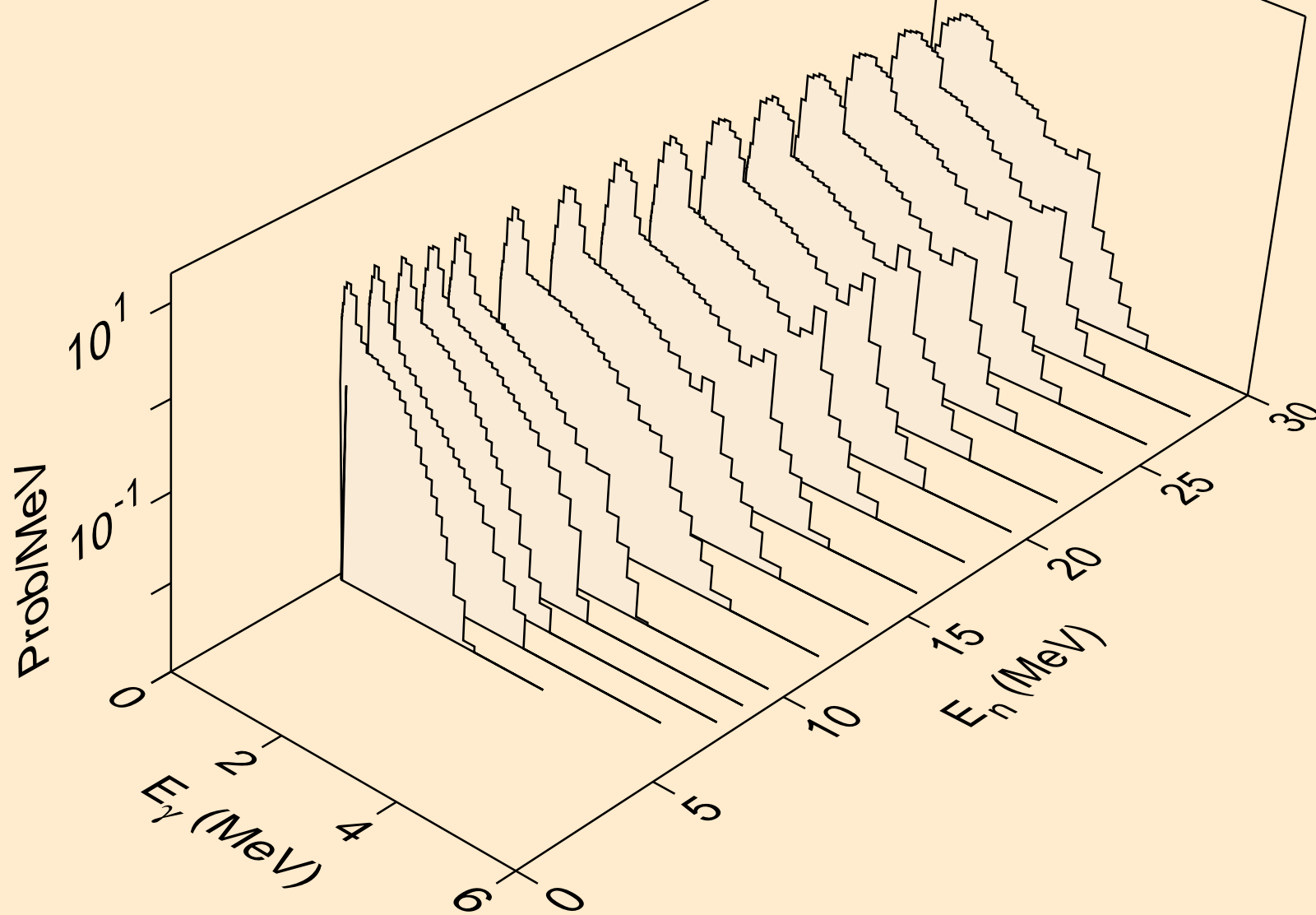

AC237 TRITON ACER TENDL-2021 LIBRARY; T=0.K  
Photon emission for (n,d)

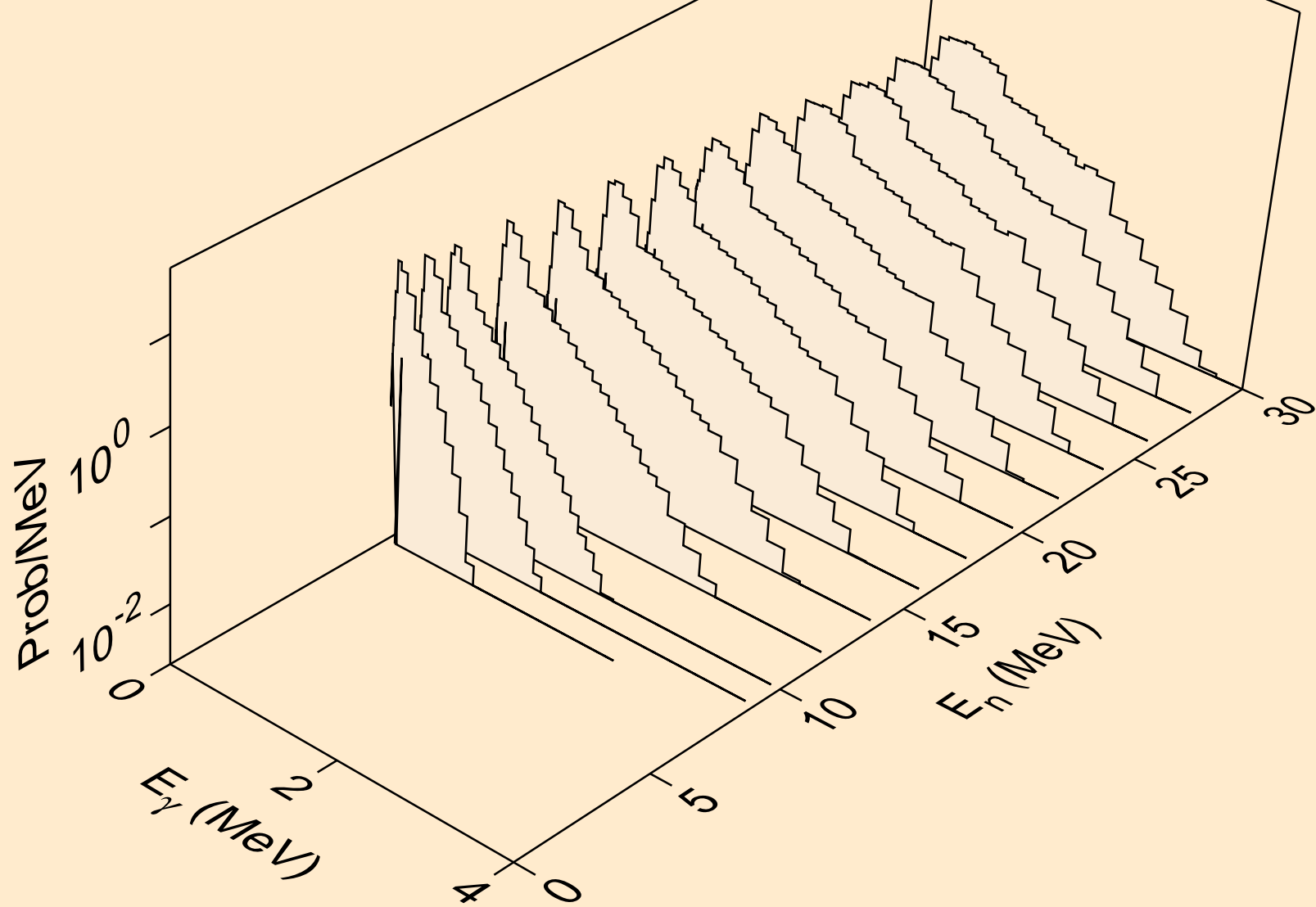

AC237 TRITON ACER TENDL-2021 LIBRARY; T=0.K  
Photon emission for inelastic

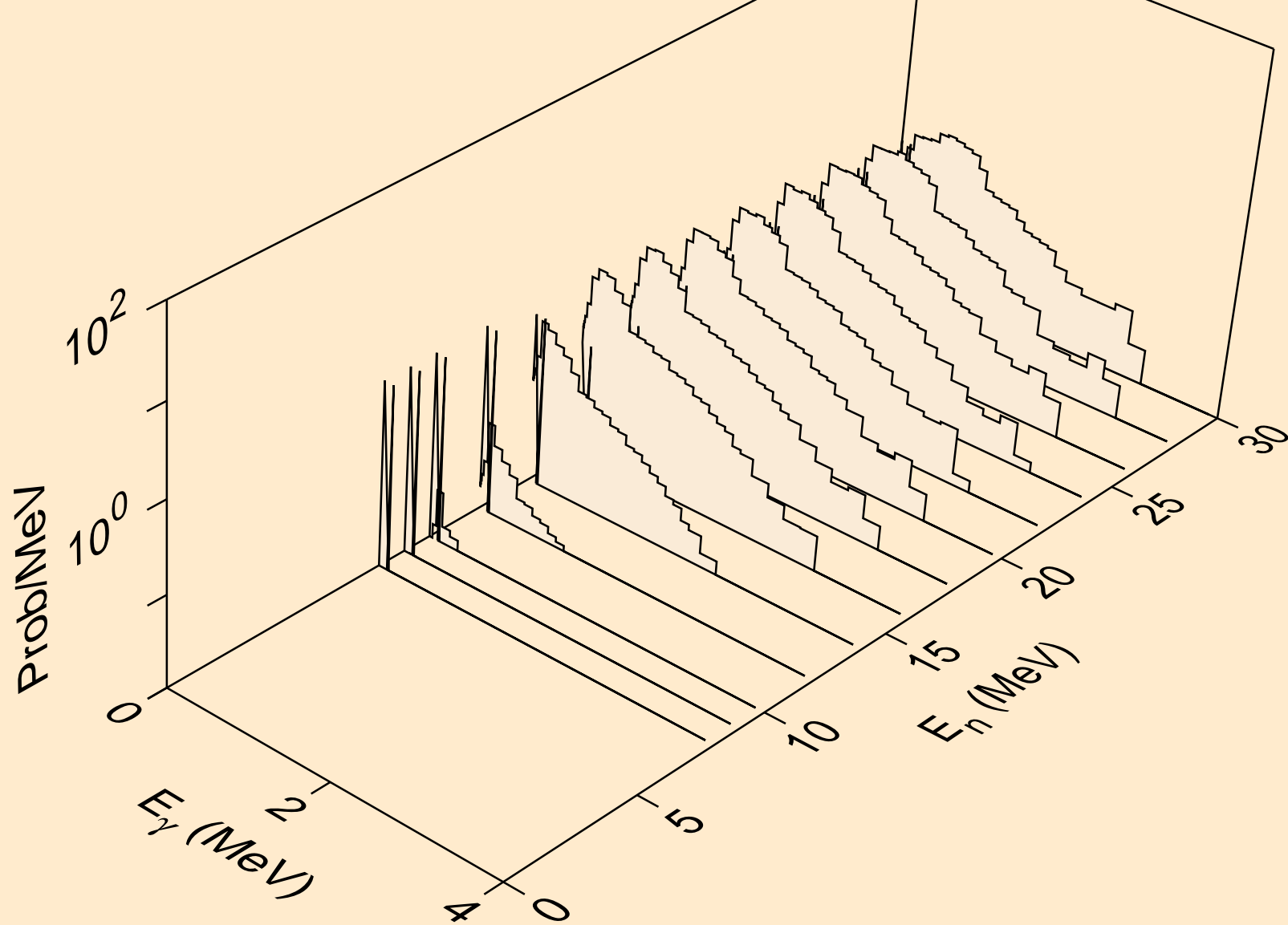

AC237 TRITON ACER TENDL-2021 LIBRARY; T=0.K  
Photon emission for (n,he3)

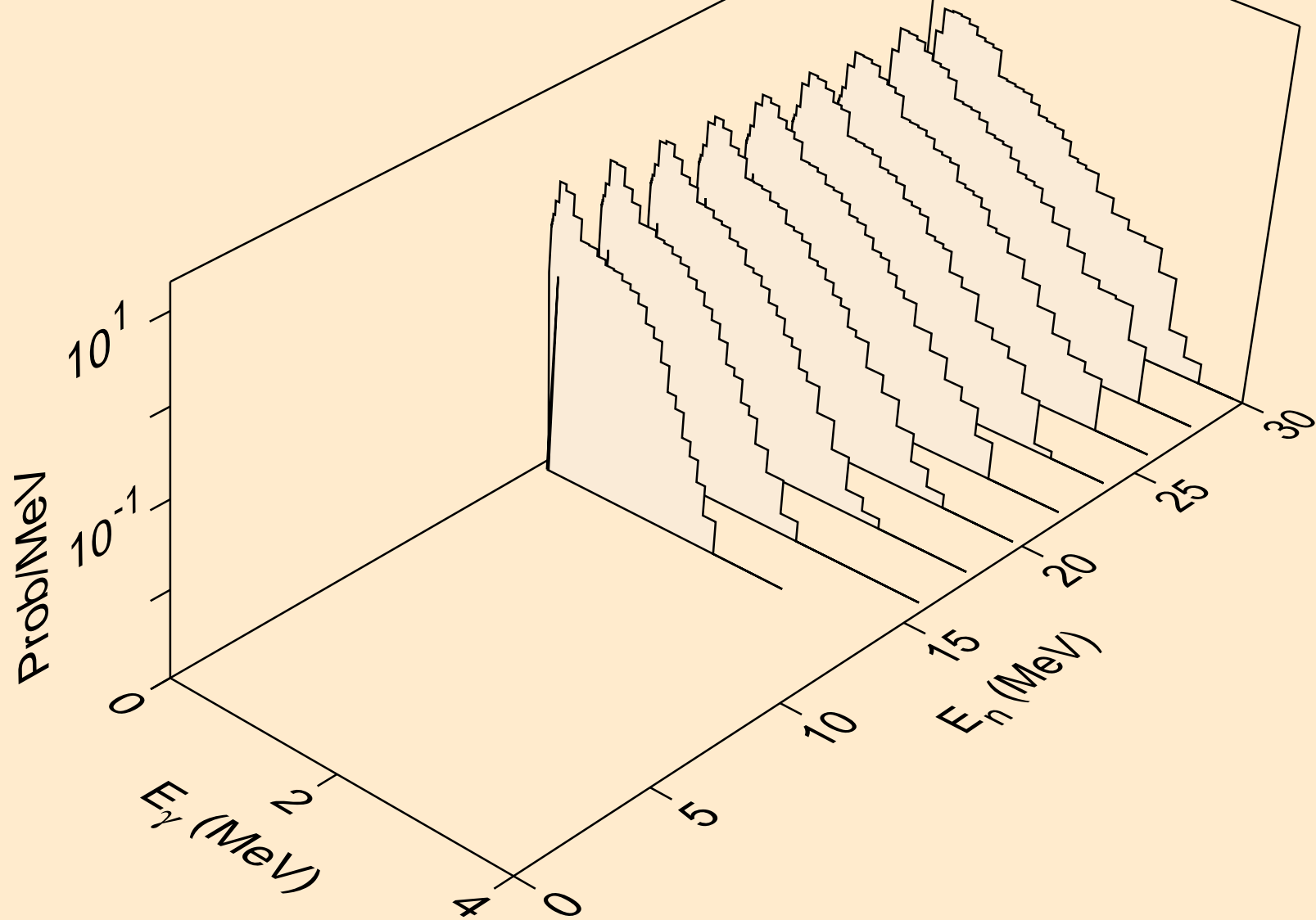

AC237 TRITON ACER TENDL-2021 LIBRARY; T=0.K  
Photon emission for (n,a)

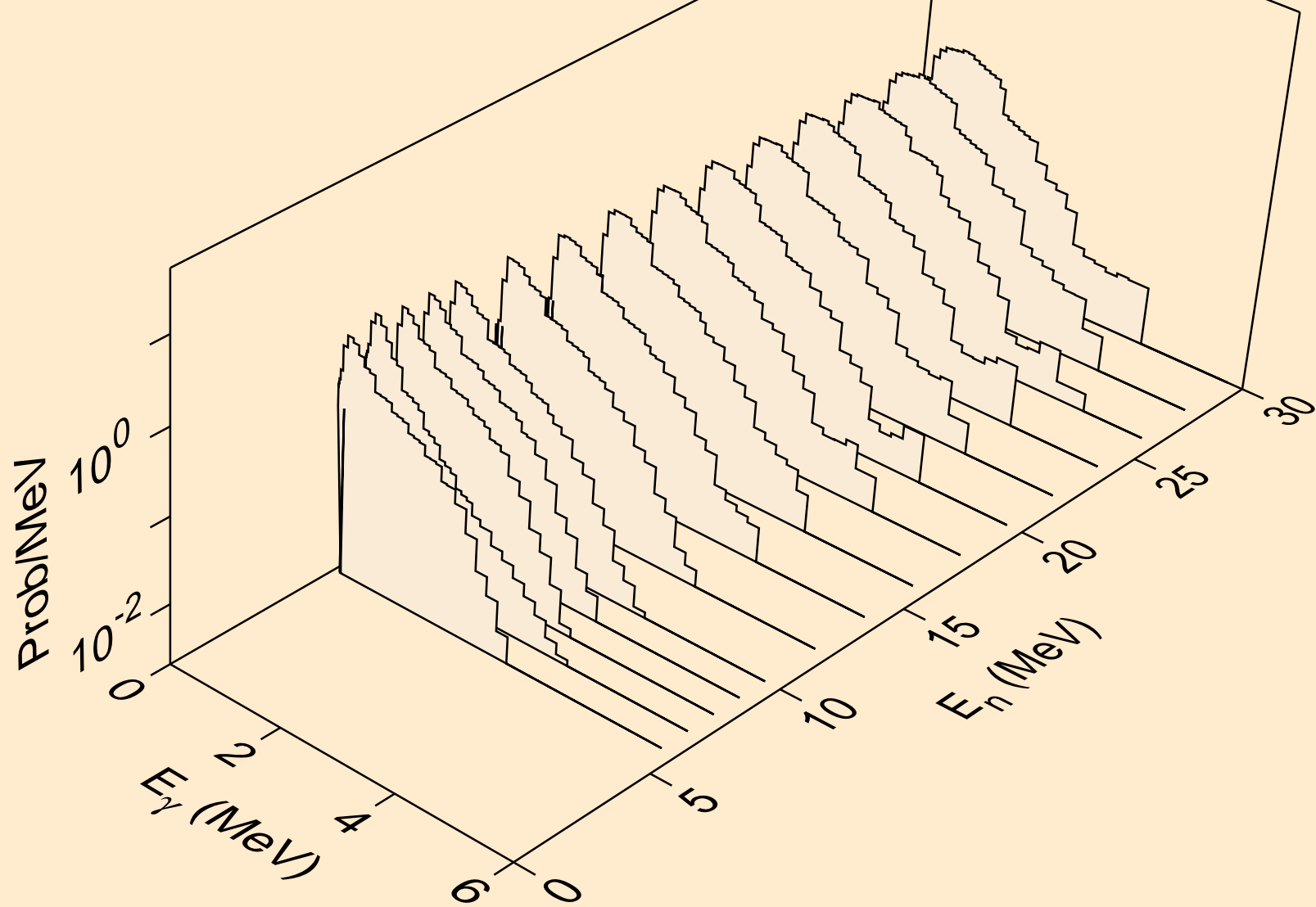

AC237 TRITON ACER TENDL-2021 LIBRARY; T=0.K  
Photon emission for (n,2p)

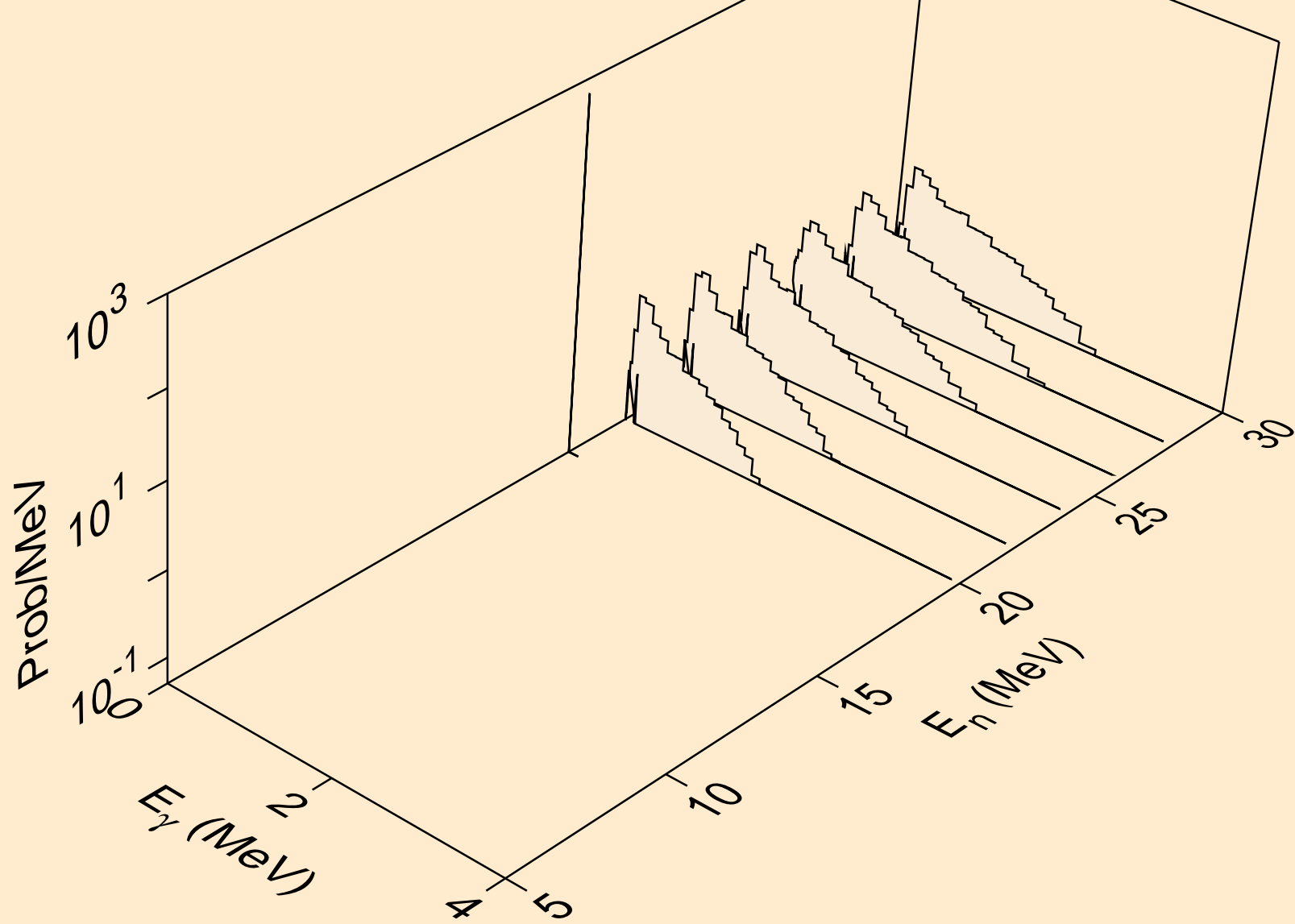

AC237 TRITON ACER TENDL-2021 LIBRARY; T=0.K  
Particle heating contributions

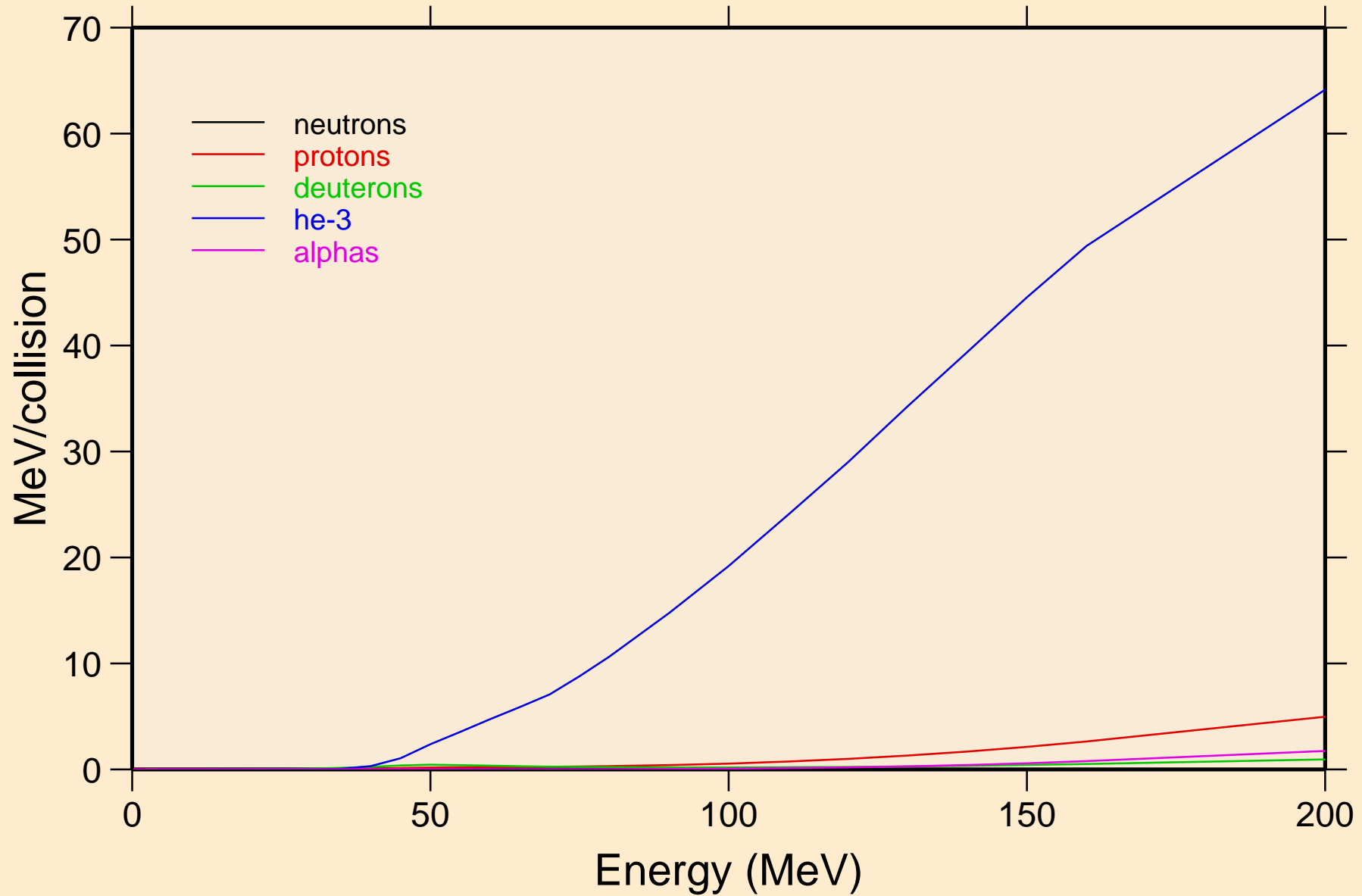

AC237 TRITON ACER TENDL-2021 LIBRARY; T=0.K  
Recoil Heating

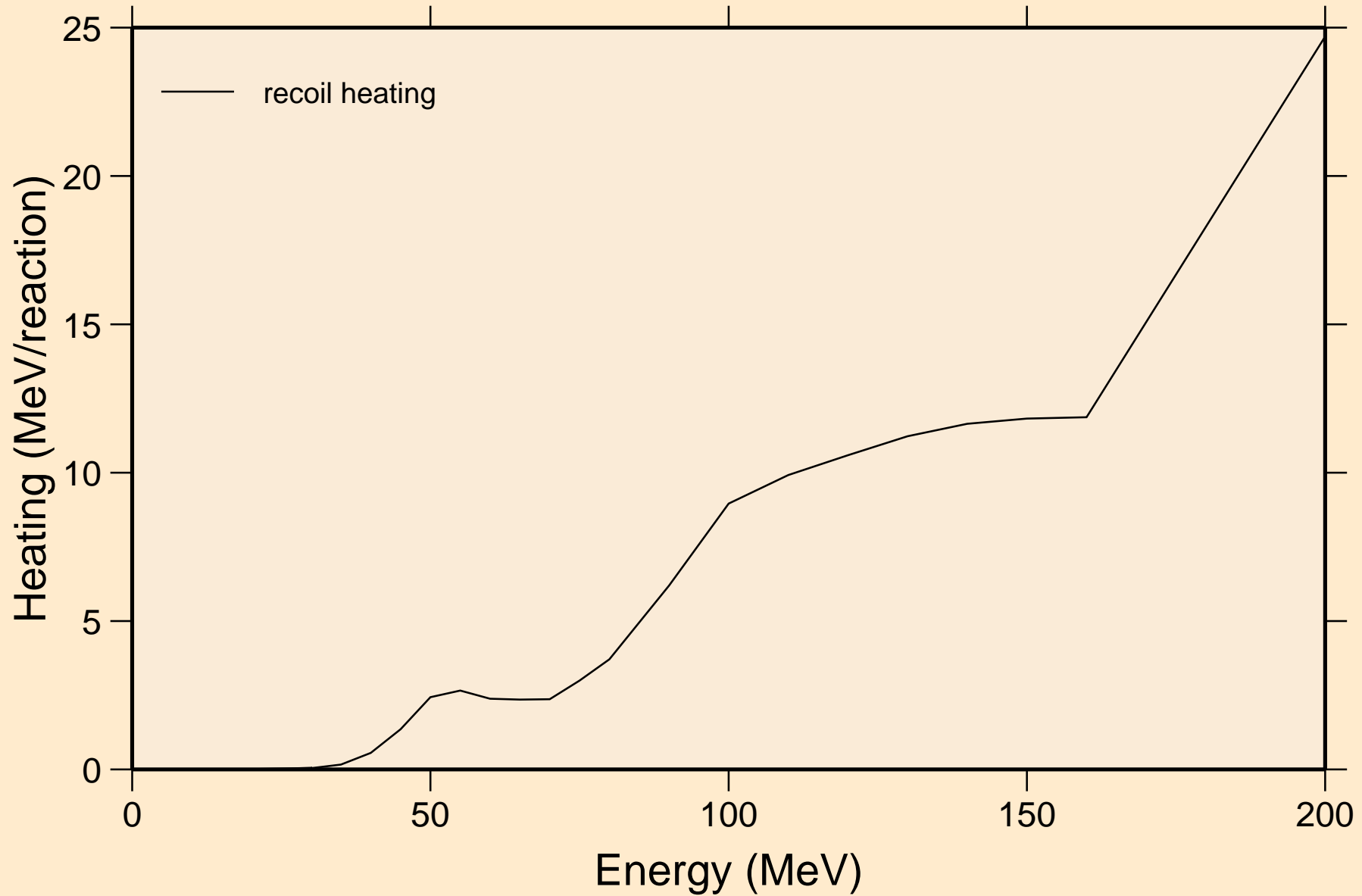



AC237 TRITON ACER TENDL-2021 LIBRARY; T=0.K  
Particle production cross sections

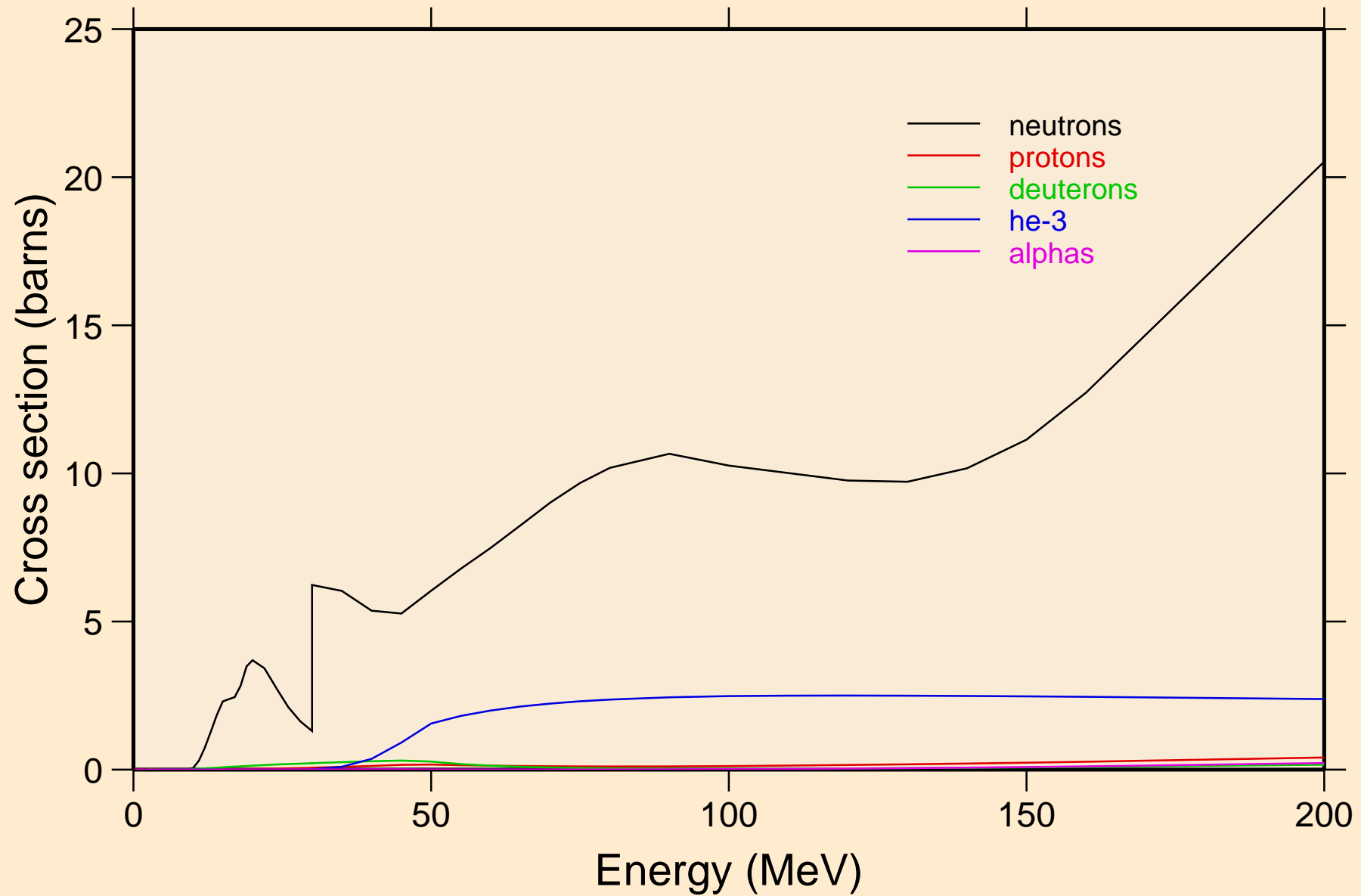

AC237 TRITON ACER TENDL-2021 LIBRARY; T=0.K  
neutrons from (t,n)

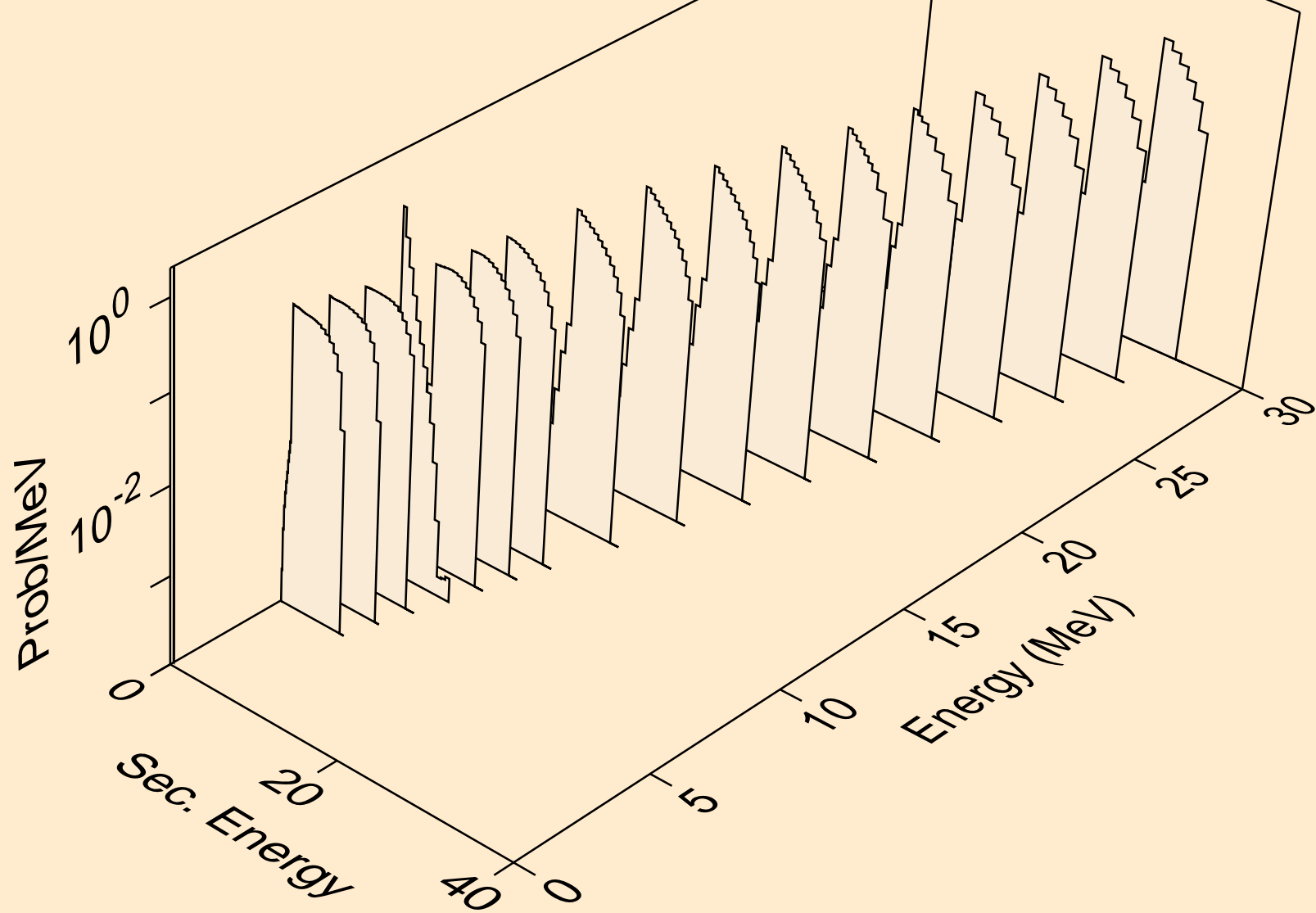

AC237 TRITON ACER TENDL-2021 LIBRARY; T=0.K  
neutrons from (t,x)

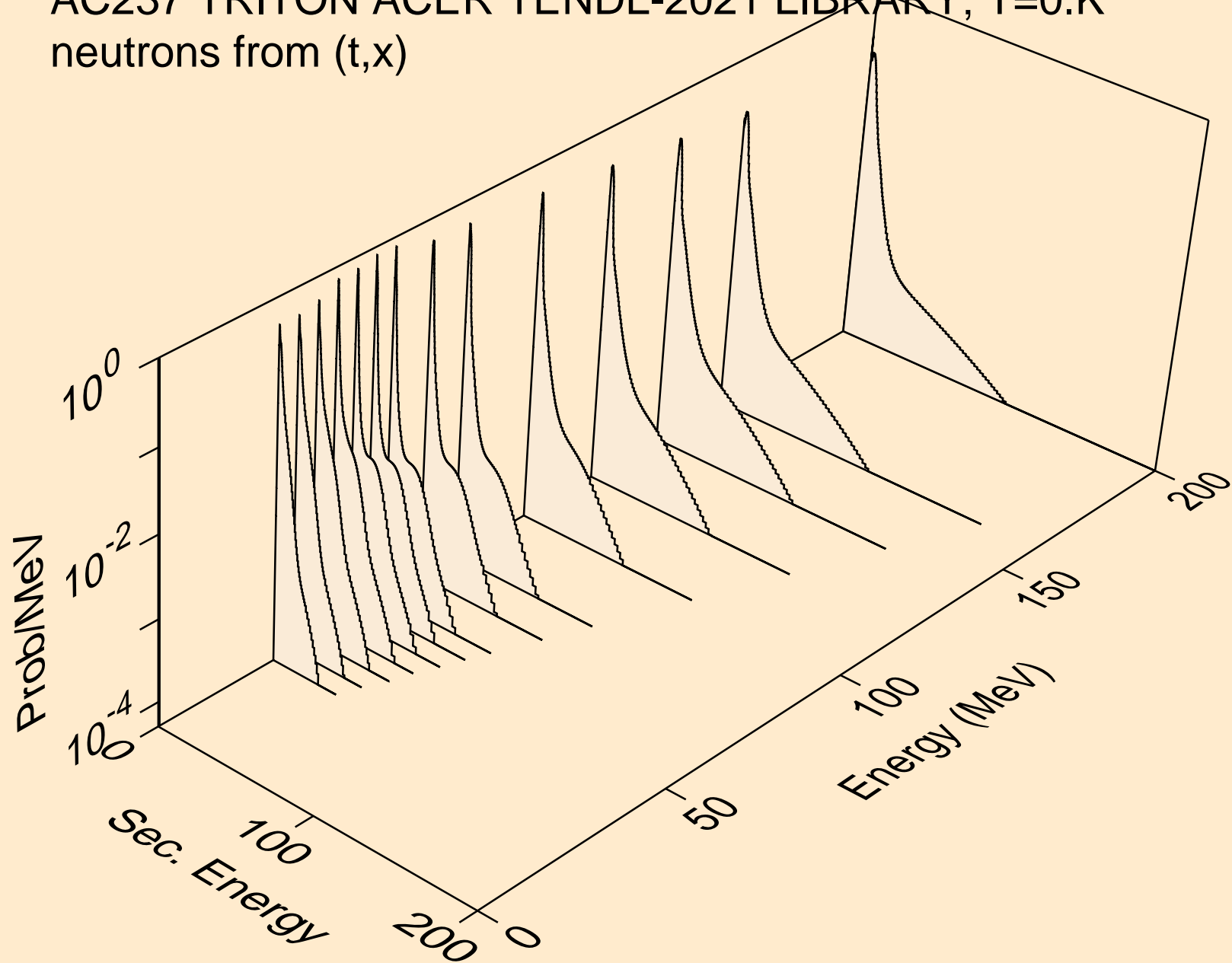

AC237 TRITON ACER TENDL-2021 LIBRARY; T=0.K  
neutrons from (t,2nd)

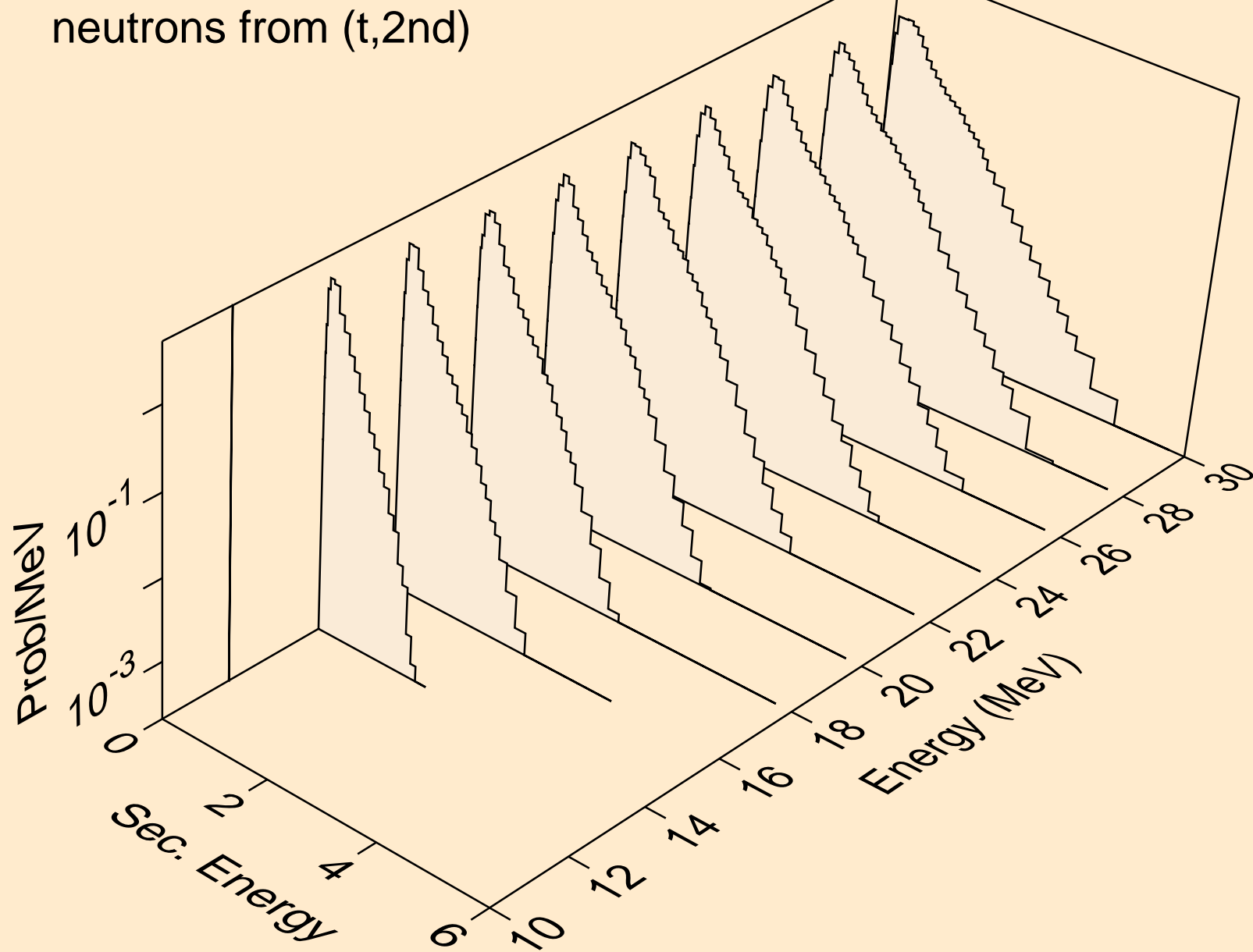

AC237 TRITON ACER TENDL-2021 LIBRARY; T=0.K  
neutrons from (t,2n)

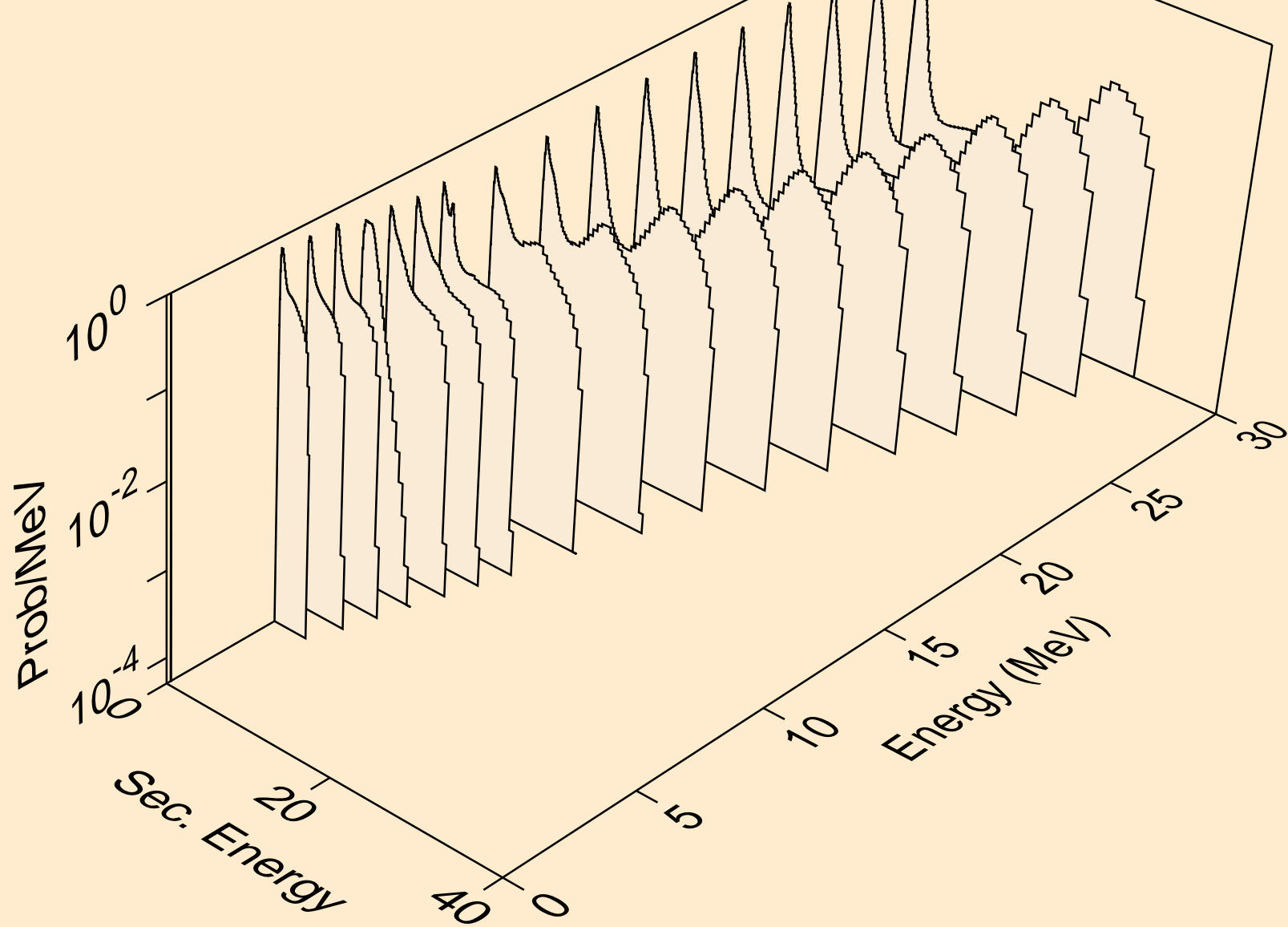

AC237 TRITON ACER TENDL-2021 LIBRARY; T=0.K  
neutrons from (t,3n)

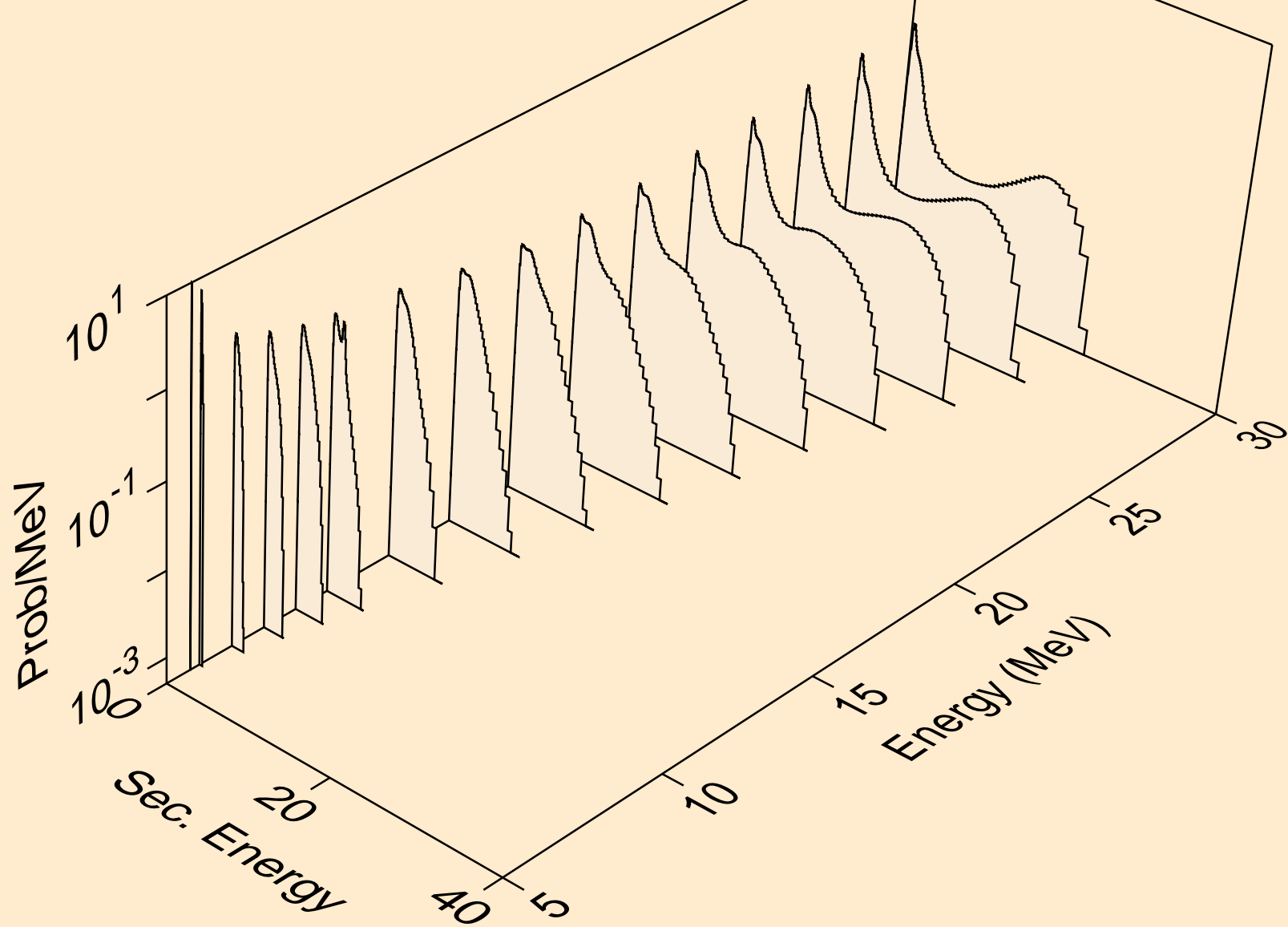

AC237 TRITON ACER TENDL-2021 LIBRARY; T=0.K  
neutrons from (t,n\*)a

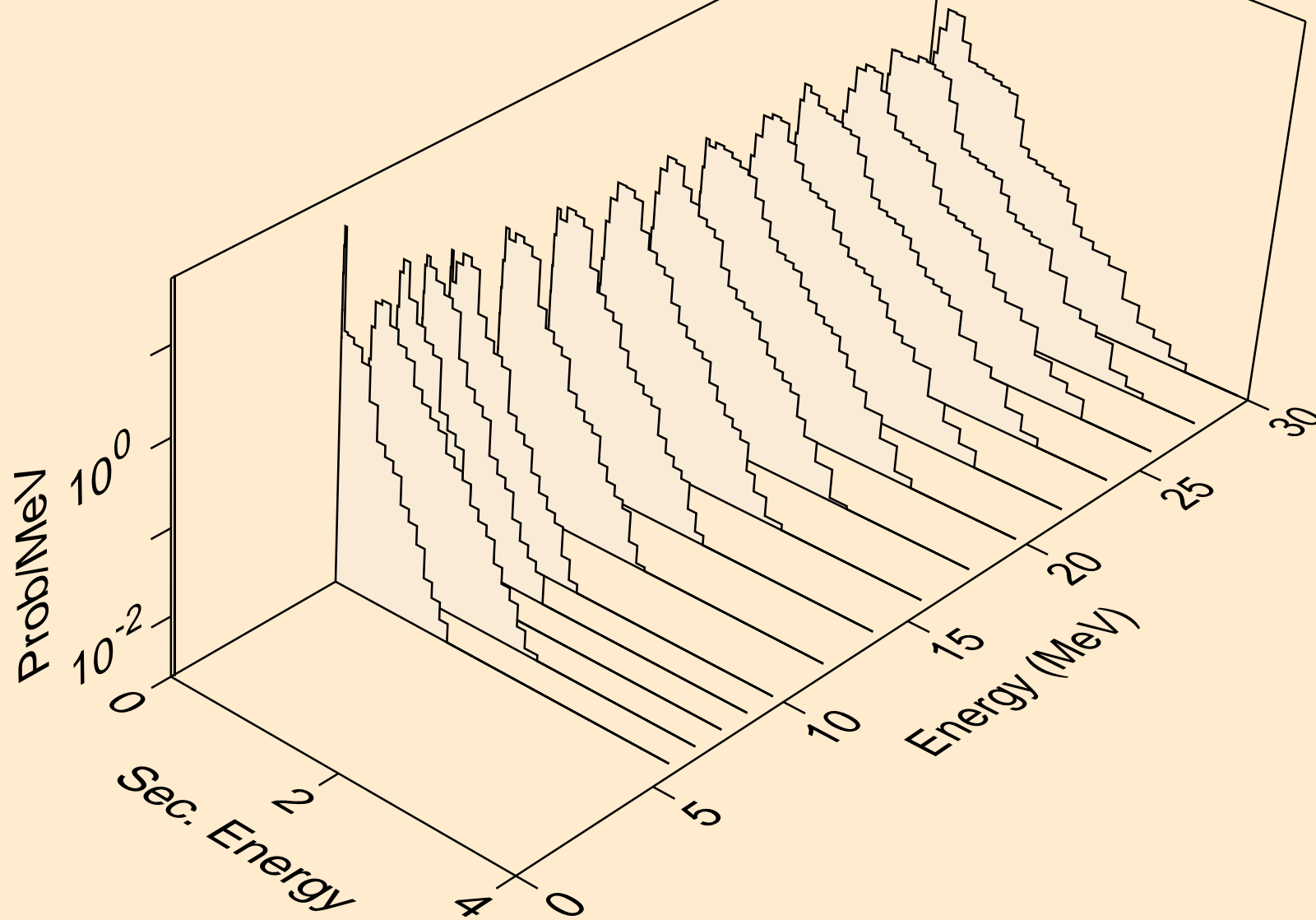

AC237 TRITON ACER TENDL-2021 LIBRARY; T=0.K  
neutrons from (t,2n)a

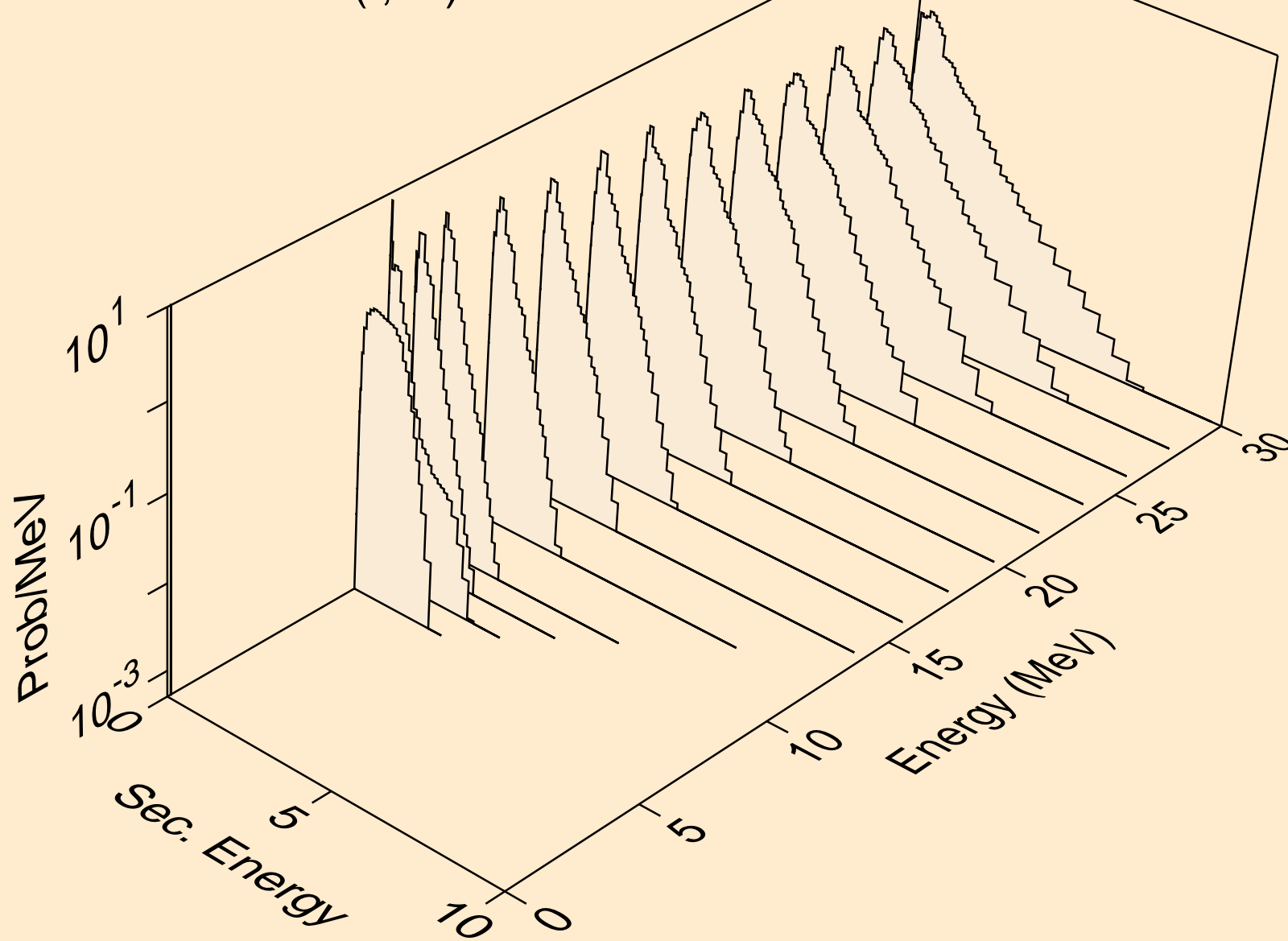



AC237 TRITON ACER TENDL-2021 LIBRARY; T=0.K  
neutrons from (t,3n)a

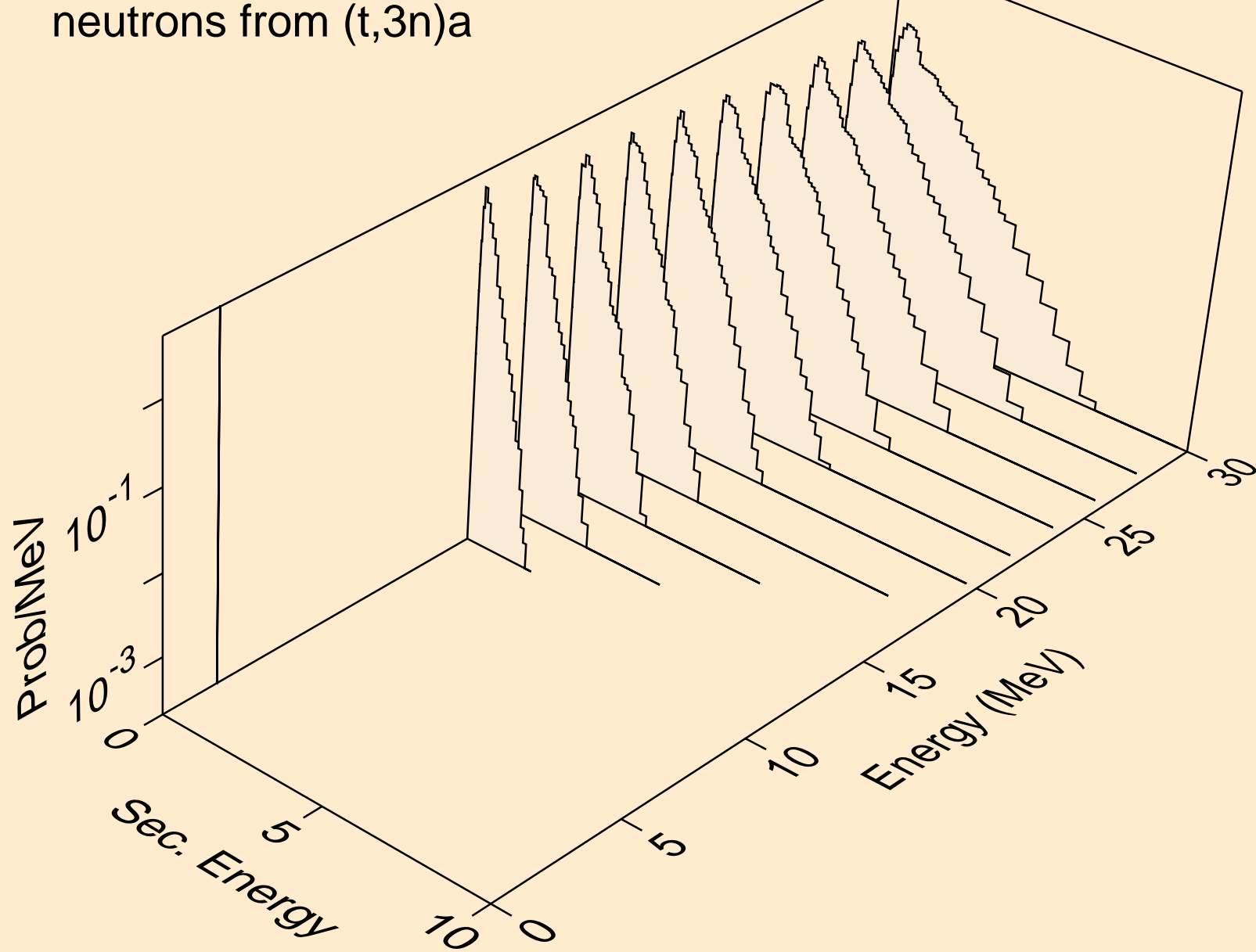

AC237 TRITON ACER TENDL-2021 LIBRARY; T=0.K  
neutrons from (t,n\*)p

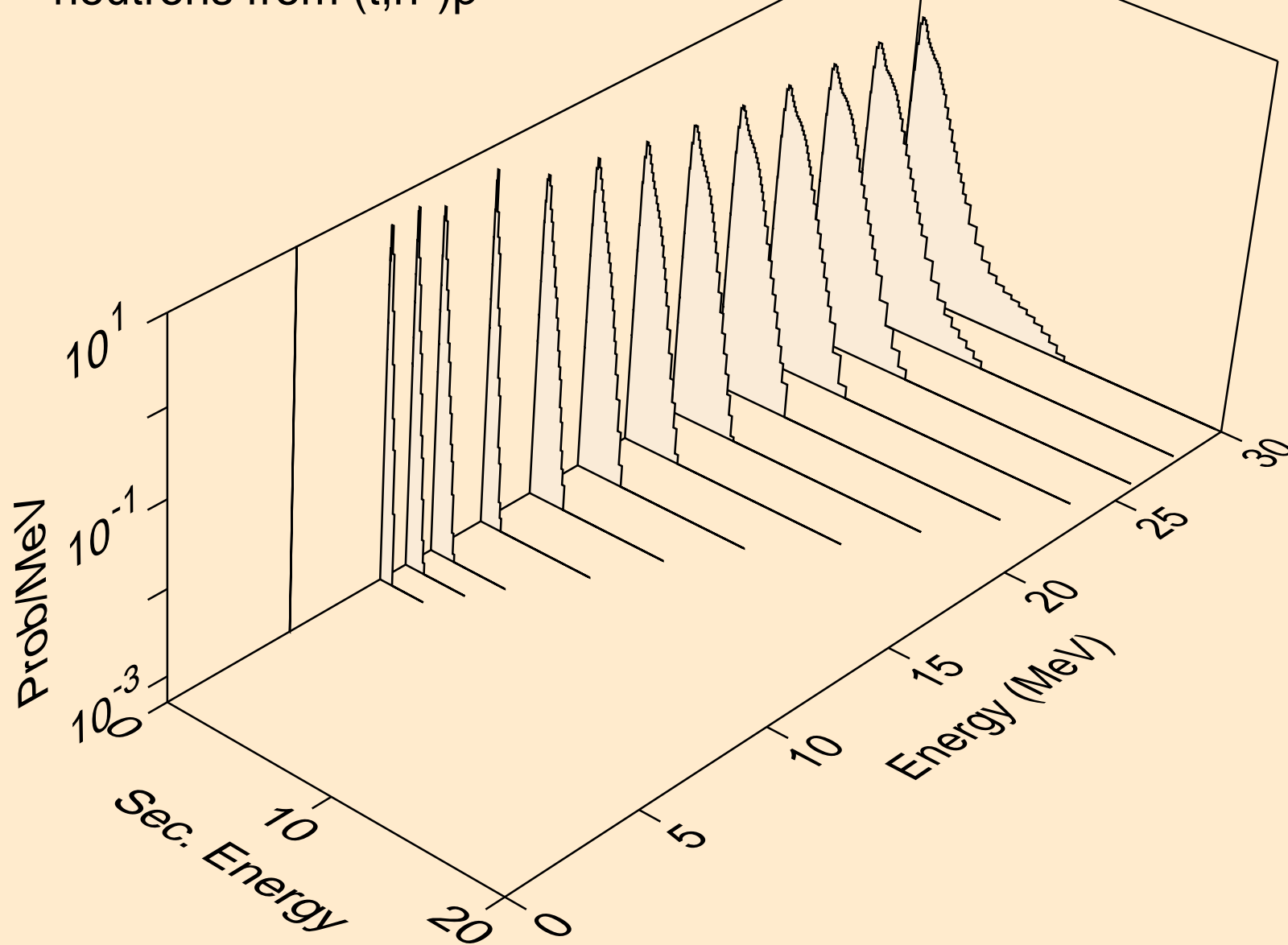

AC237 TRITON ACER TENDL-2021 LIBRARY; T=0.K  
neutrons from (t,n\*)d

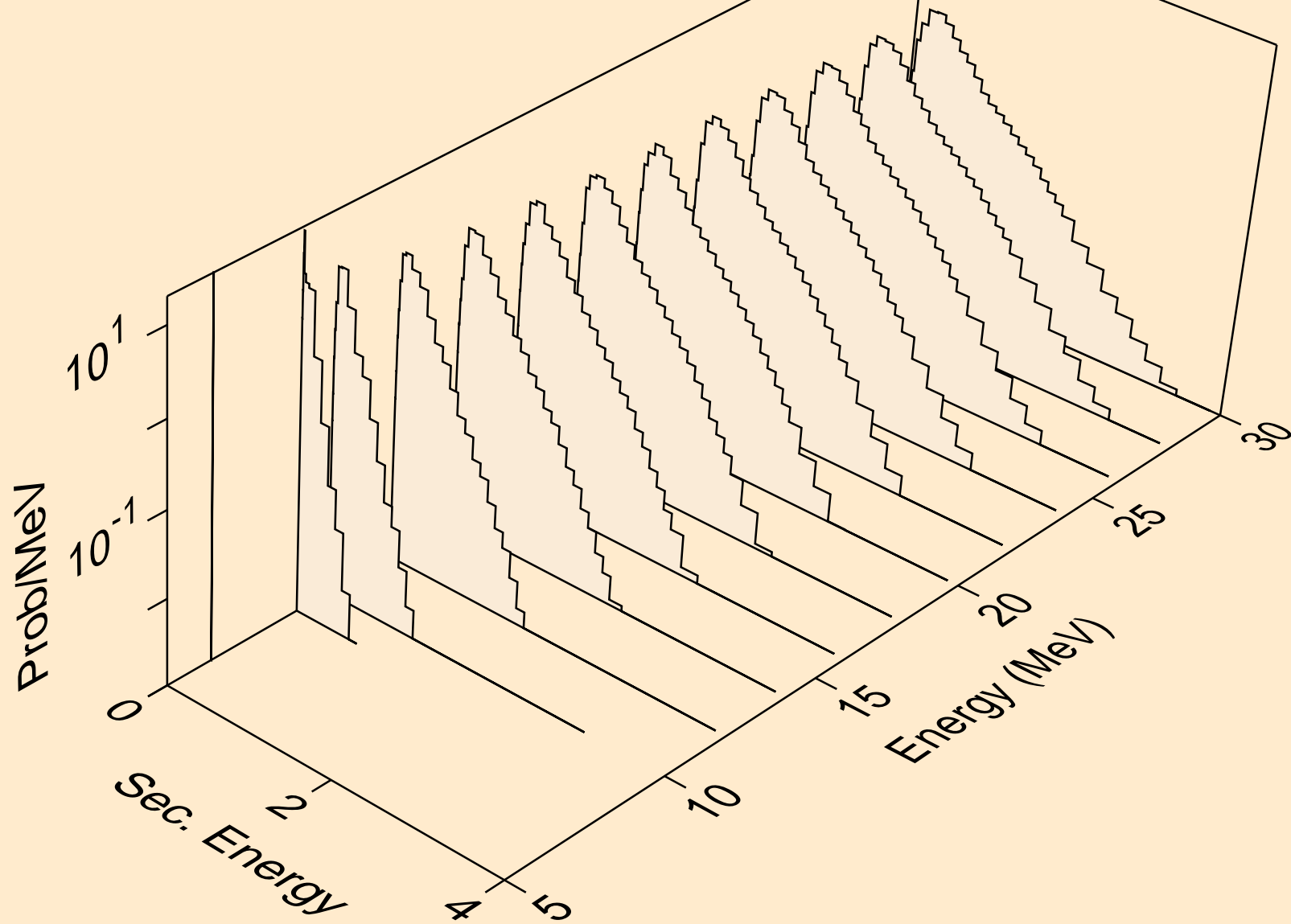

AC237 TRITON ACER TENDL-2021 LIBRARY; T=0.K  
neutrons from (t,n\*)t

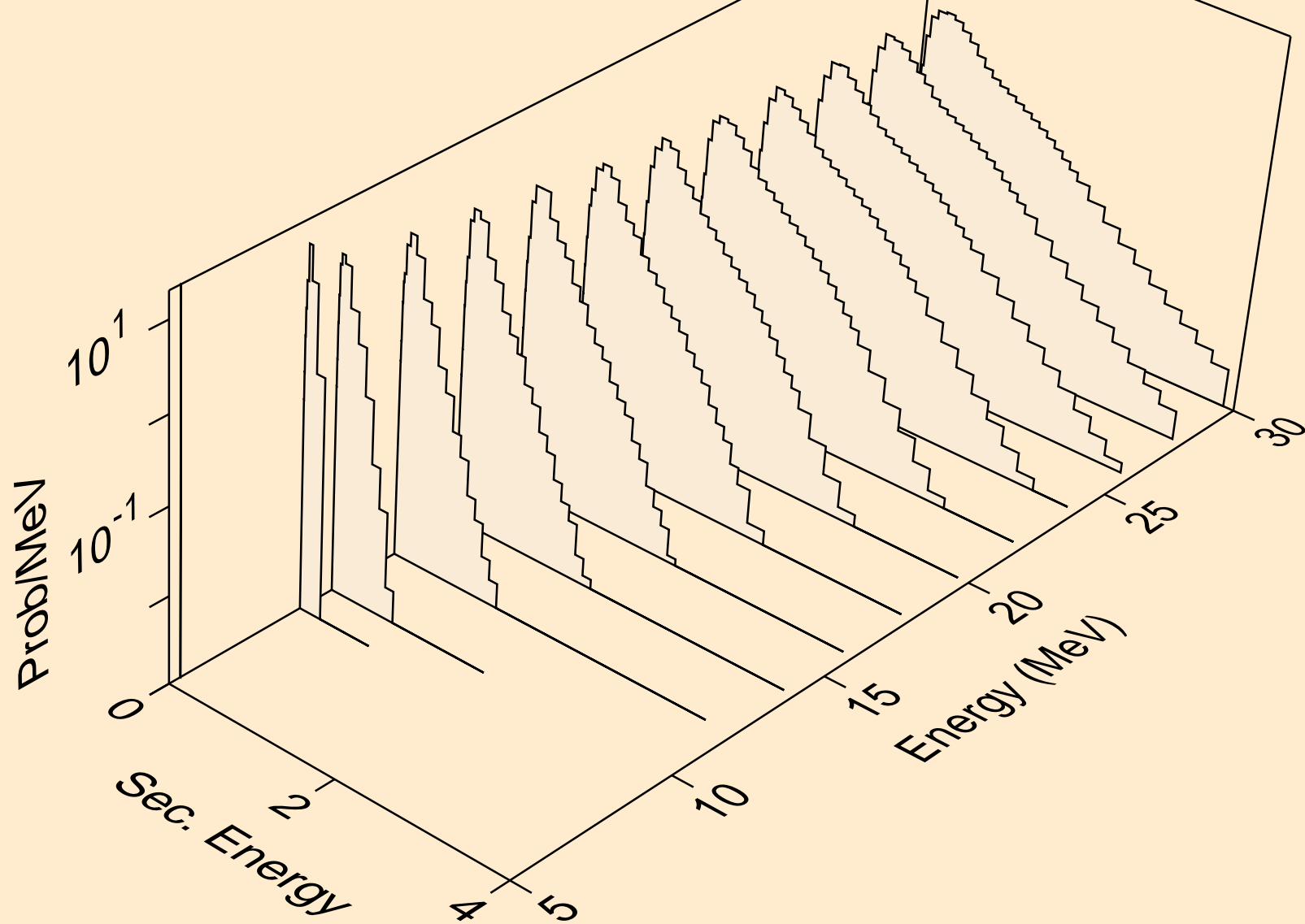

AC237 TRITON ACER TENDL-2021 LIBRARY; T=0.K  
neutrons from (t,n\*)he3

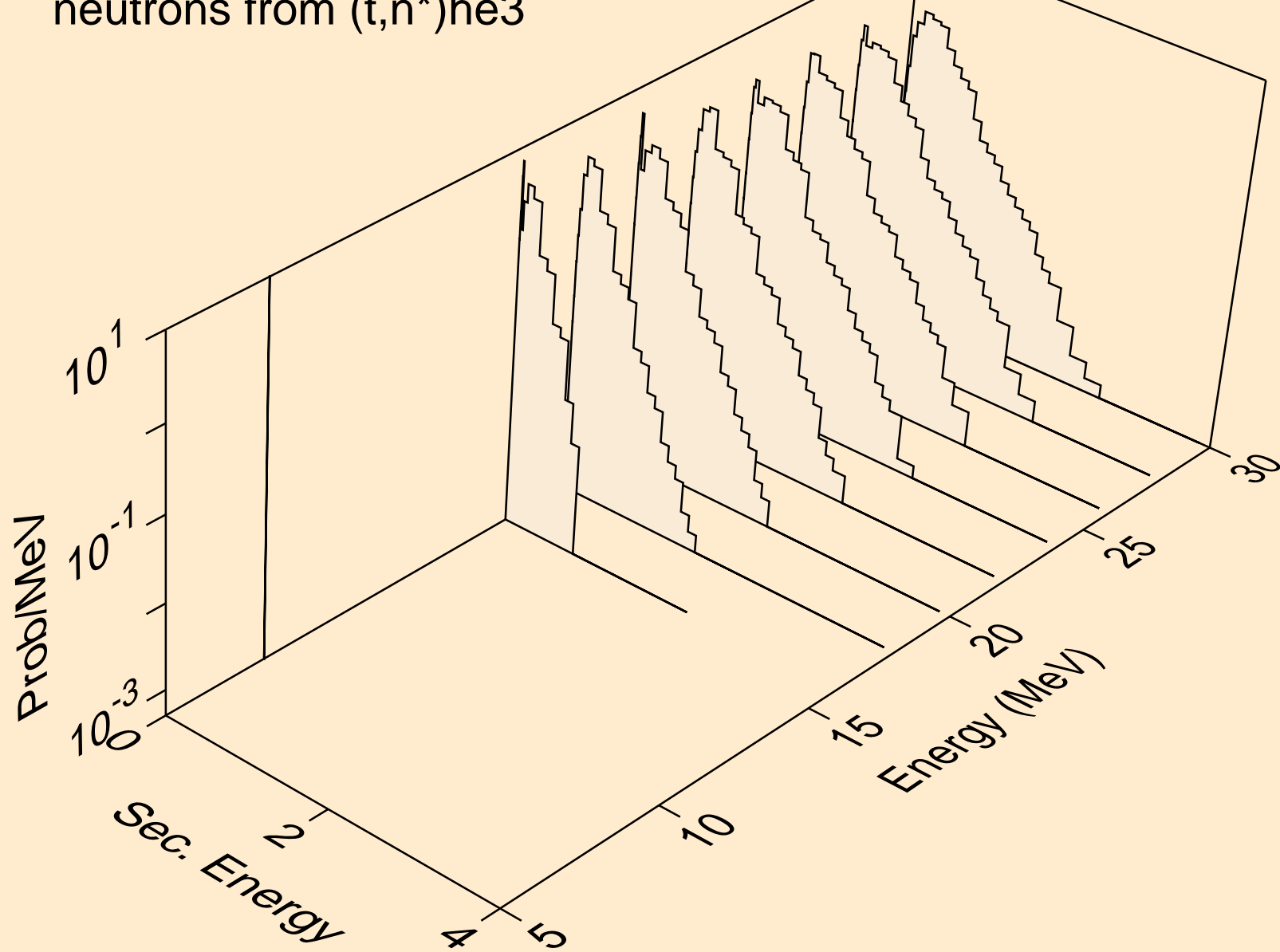

AC237 TRITON ACER TENDL-2021 LIBRARY; T=0.K  
neutrons from (t,4n)

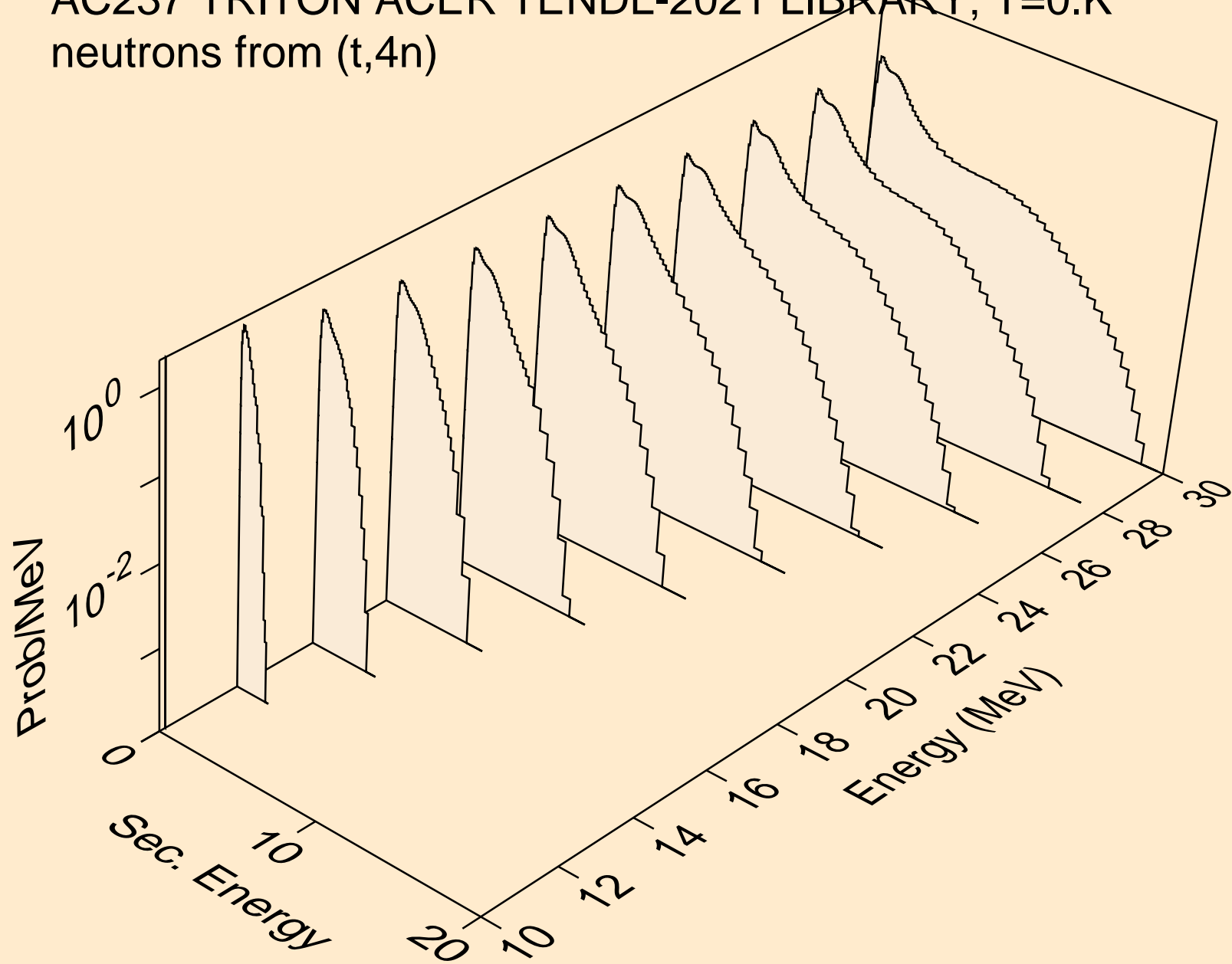

AC237 TRITON ACER TENDL-2021 LIBRARY; T=0.K  
neutrons from (t,2np)

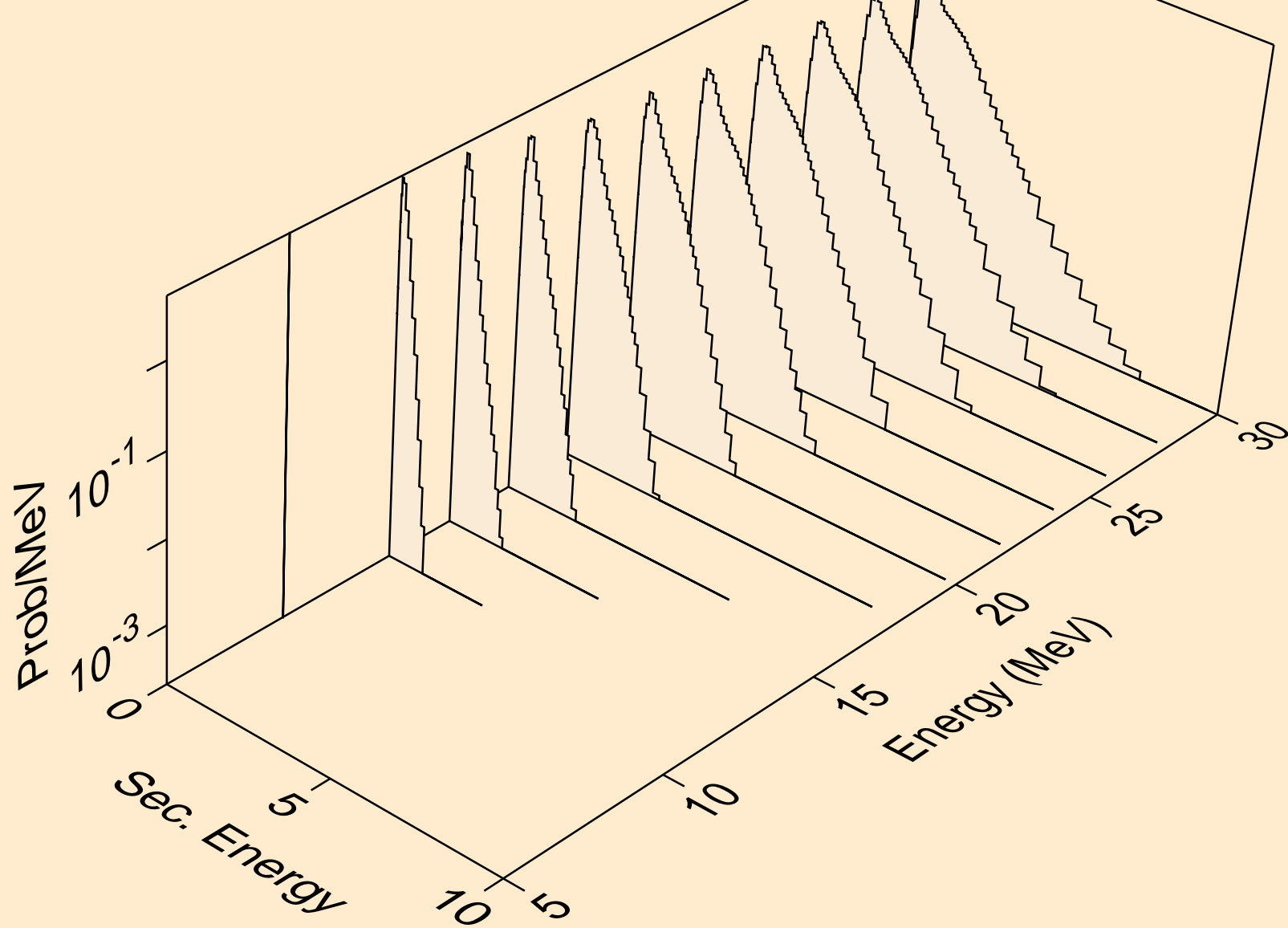

AC237 TRITON ACER TENDL-2021 LIBRARY; T=0.K  
neutrons from (t,3np)

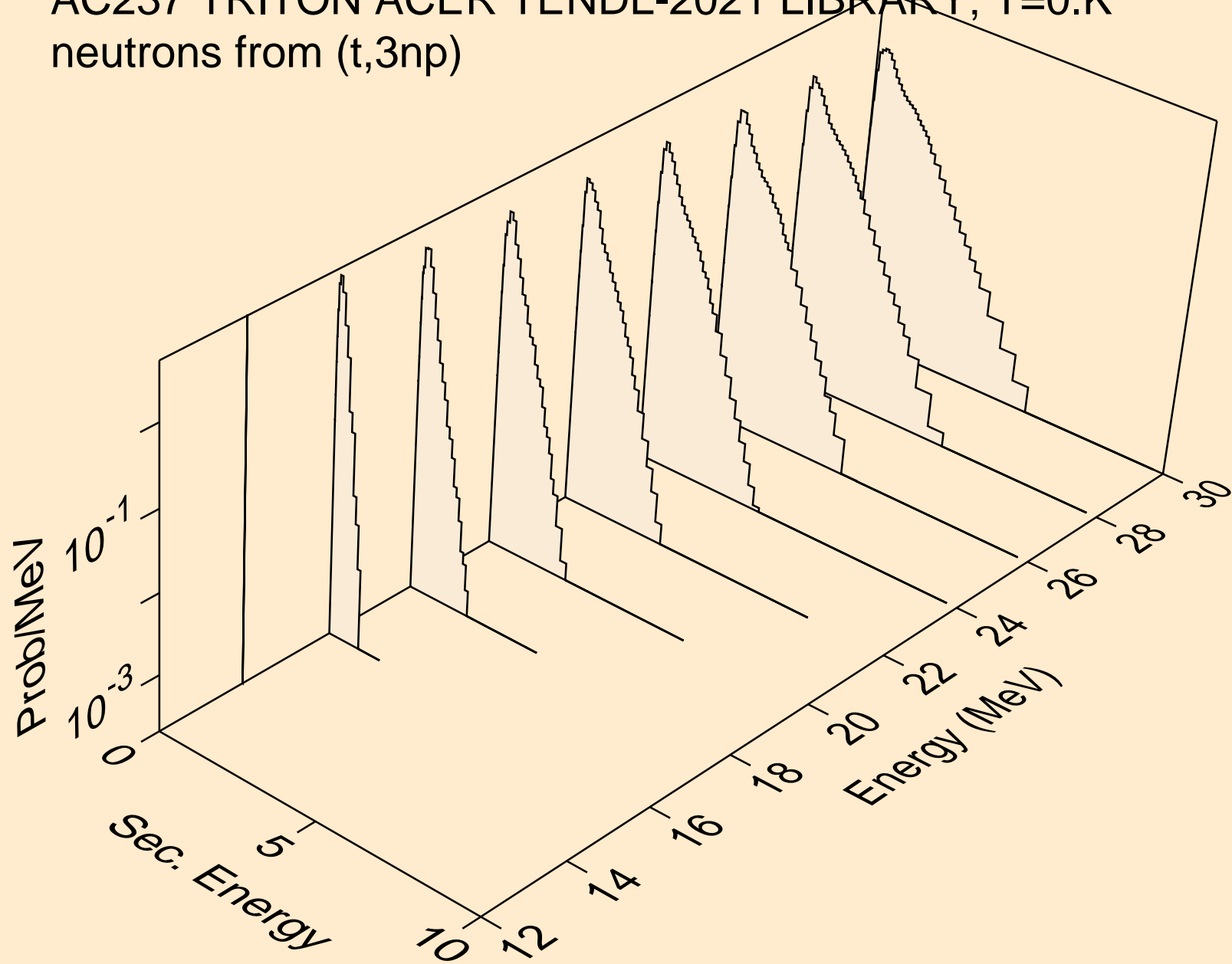



AC237 TRITON ACER TENDL-2021 LIBRARY; T=0.K  
neutrons from (t,2np)

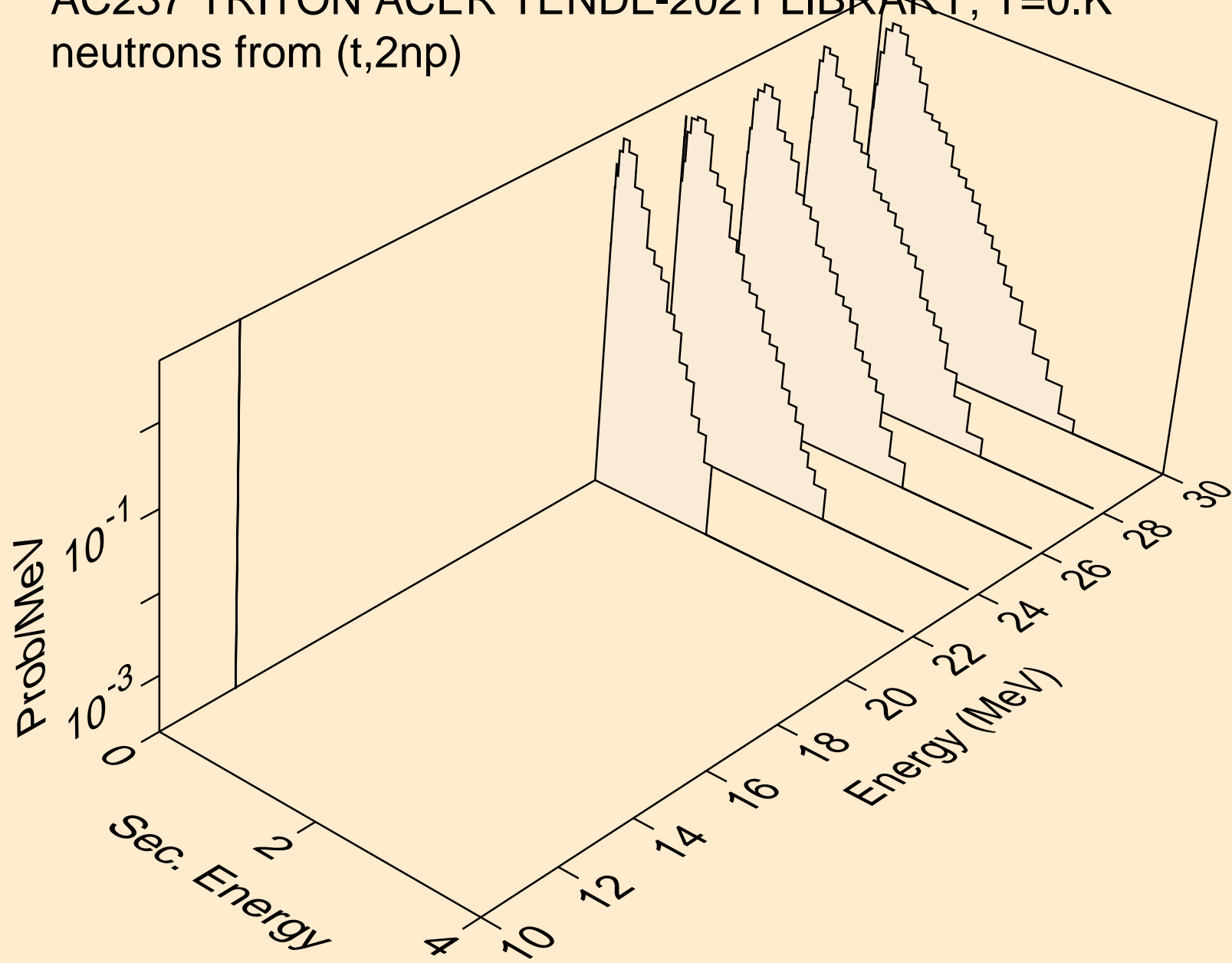

AC237 TRITON ACER TENDL-2021 LIBRARY; T=0.K  
protons from (t,x)

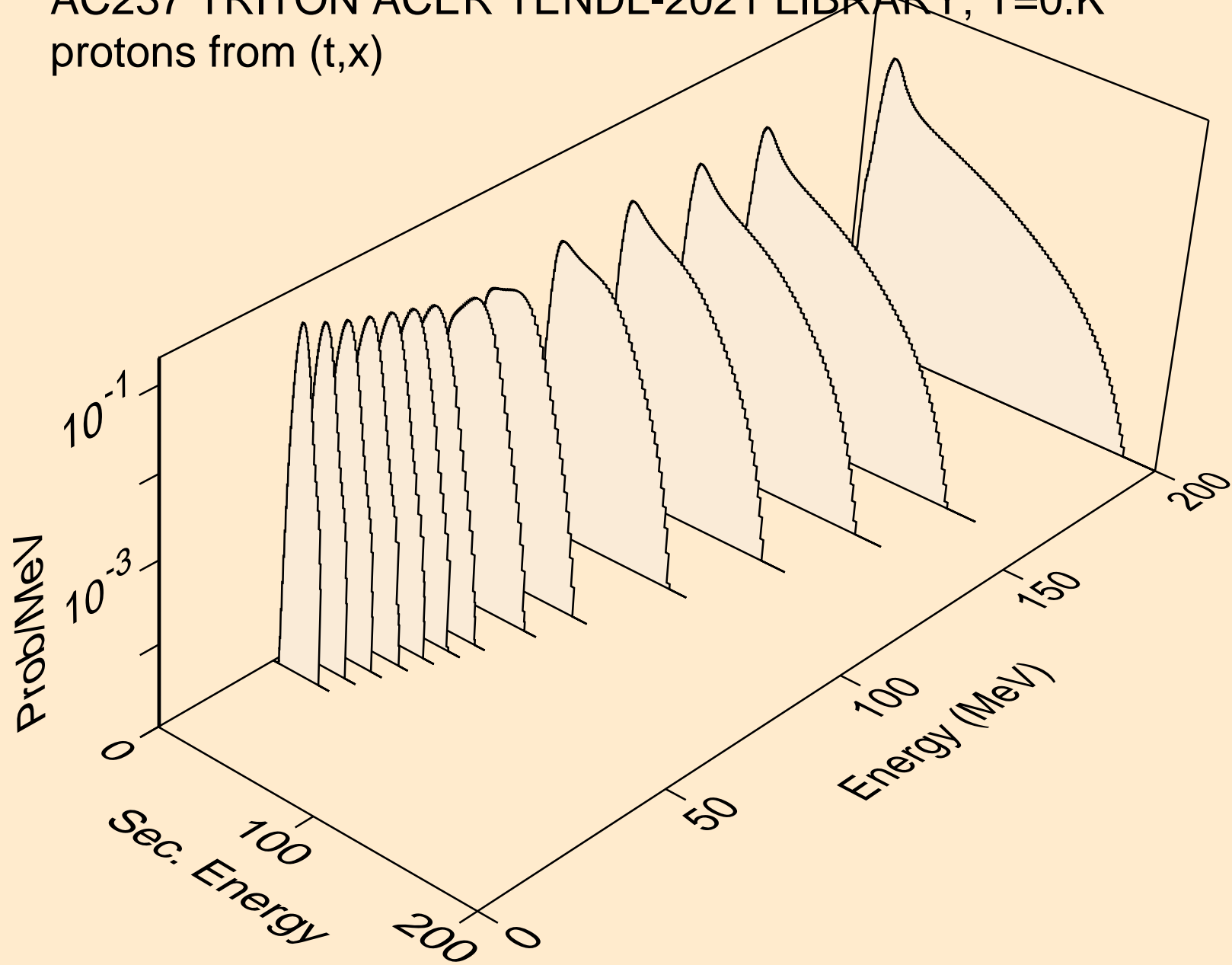

AC237 TRITON ACER TENDL-2021 LIBRARY; T=0.K  
protons from (t,n\*)p

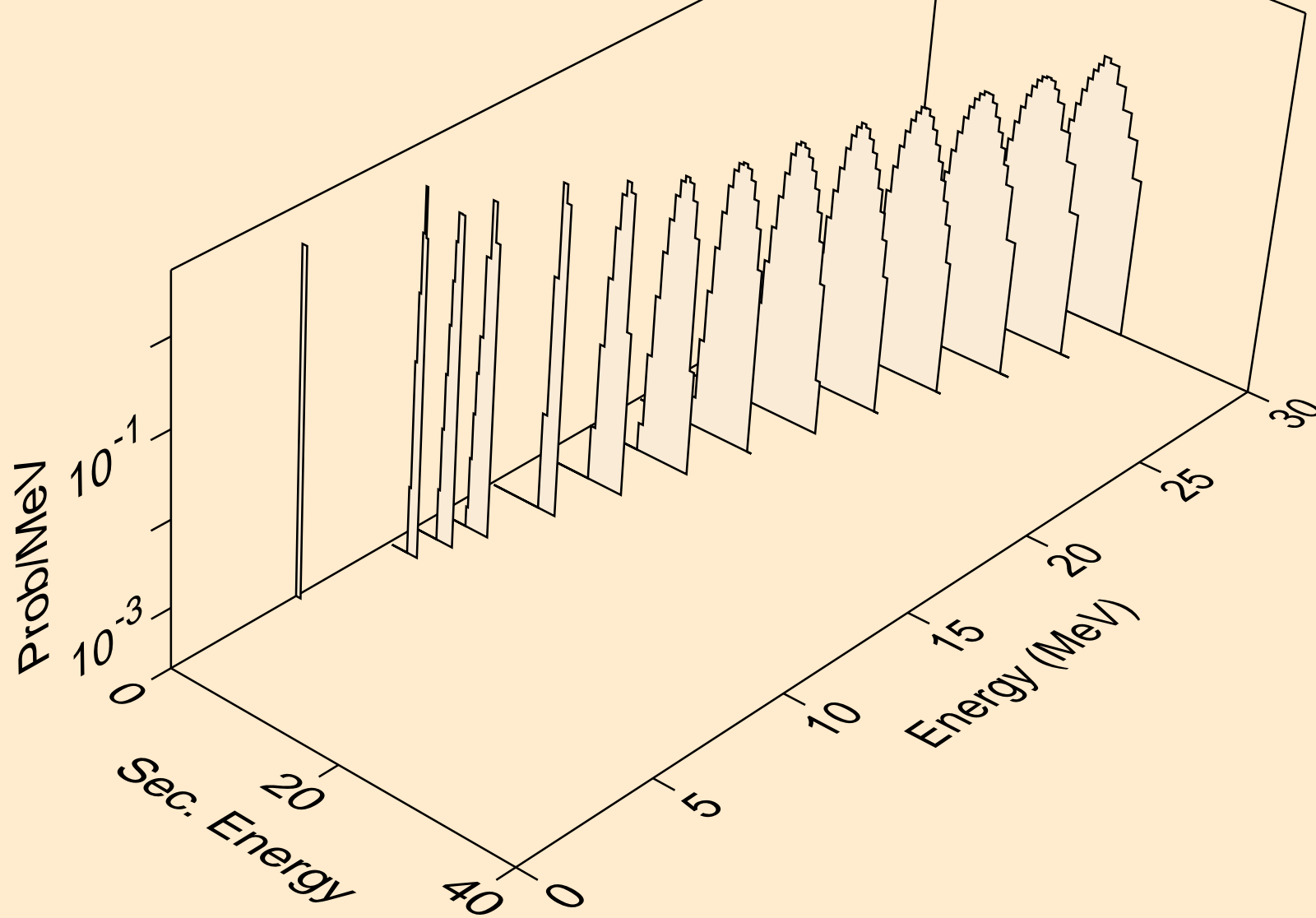

AC237 TRITON ACER TENDL-2021 LIBRARY; T=0.K  
protons from (t,2np)

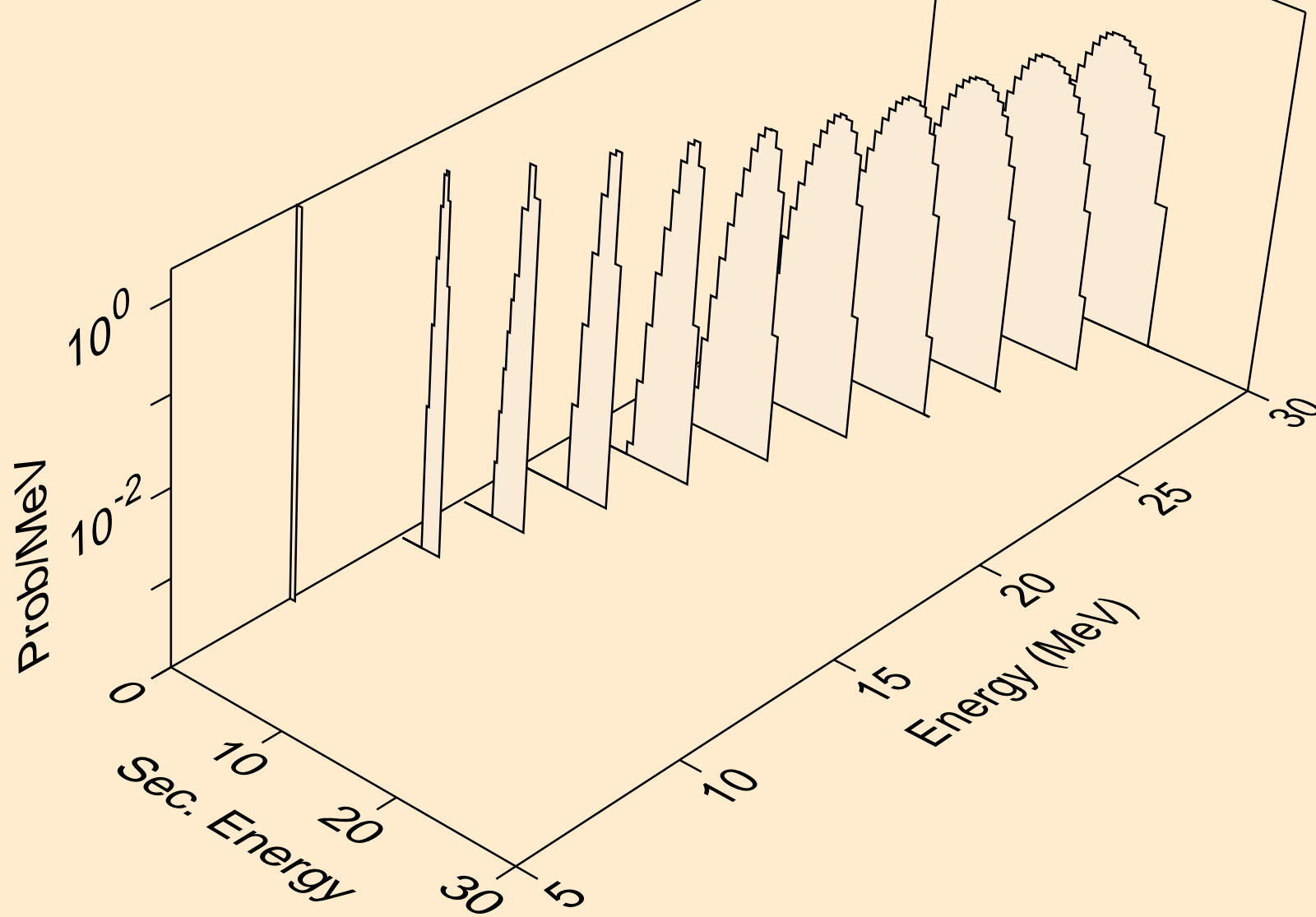

AC237 TRITON ACER TENDL-2021 LIBRARY; T=0.K  
protons from (t,3np)

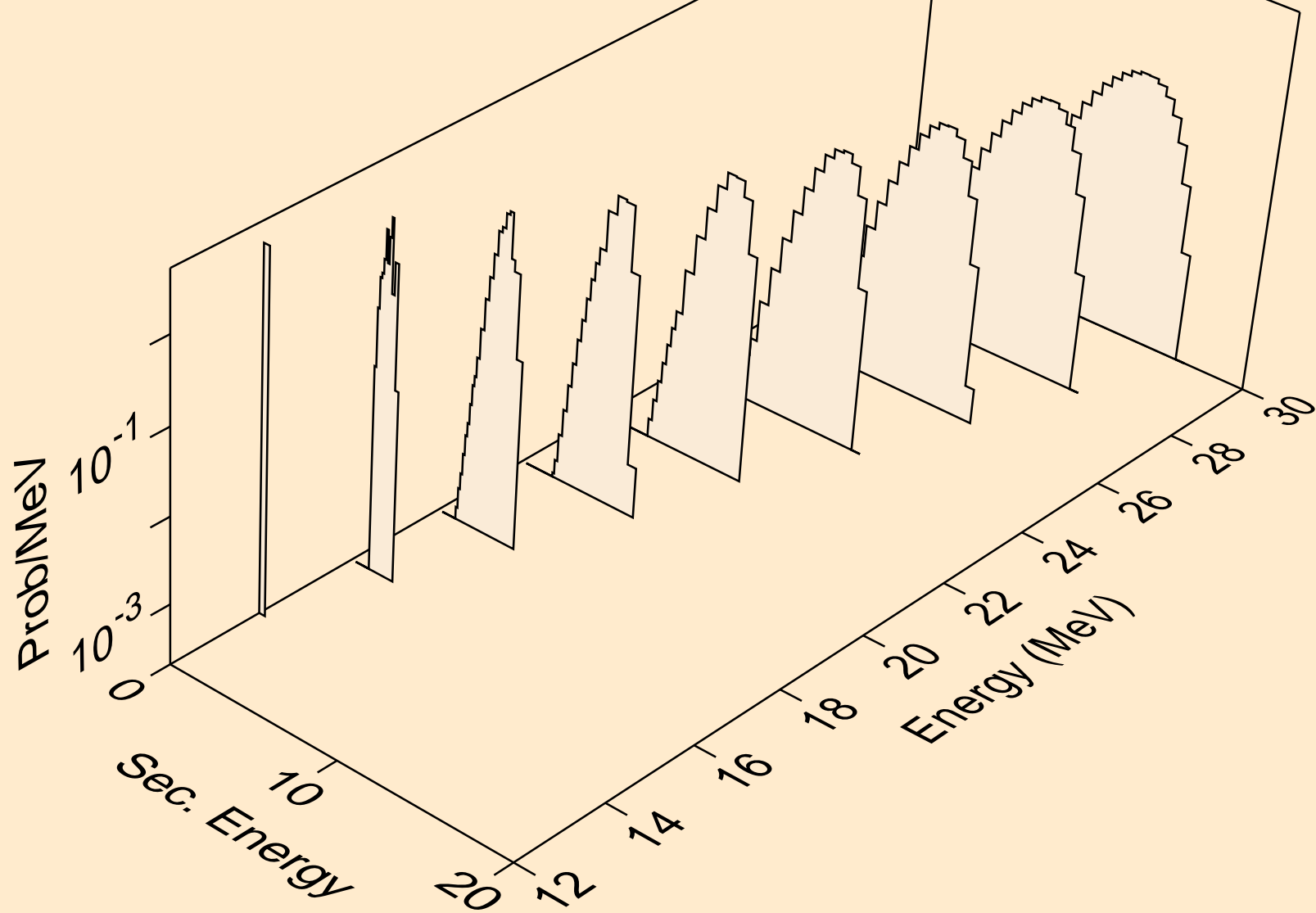

AC237 TRITON ACER TENDL-2021 LIBRARY; T=0.K  
protons from (t,2np)

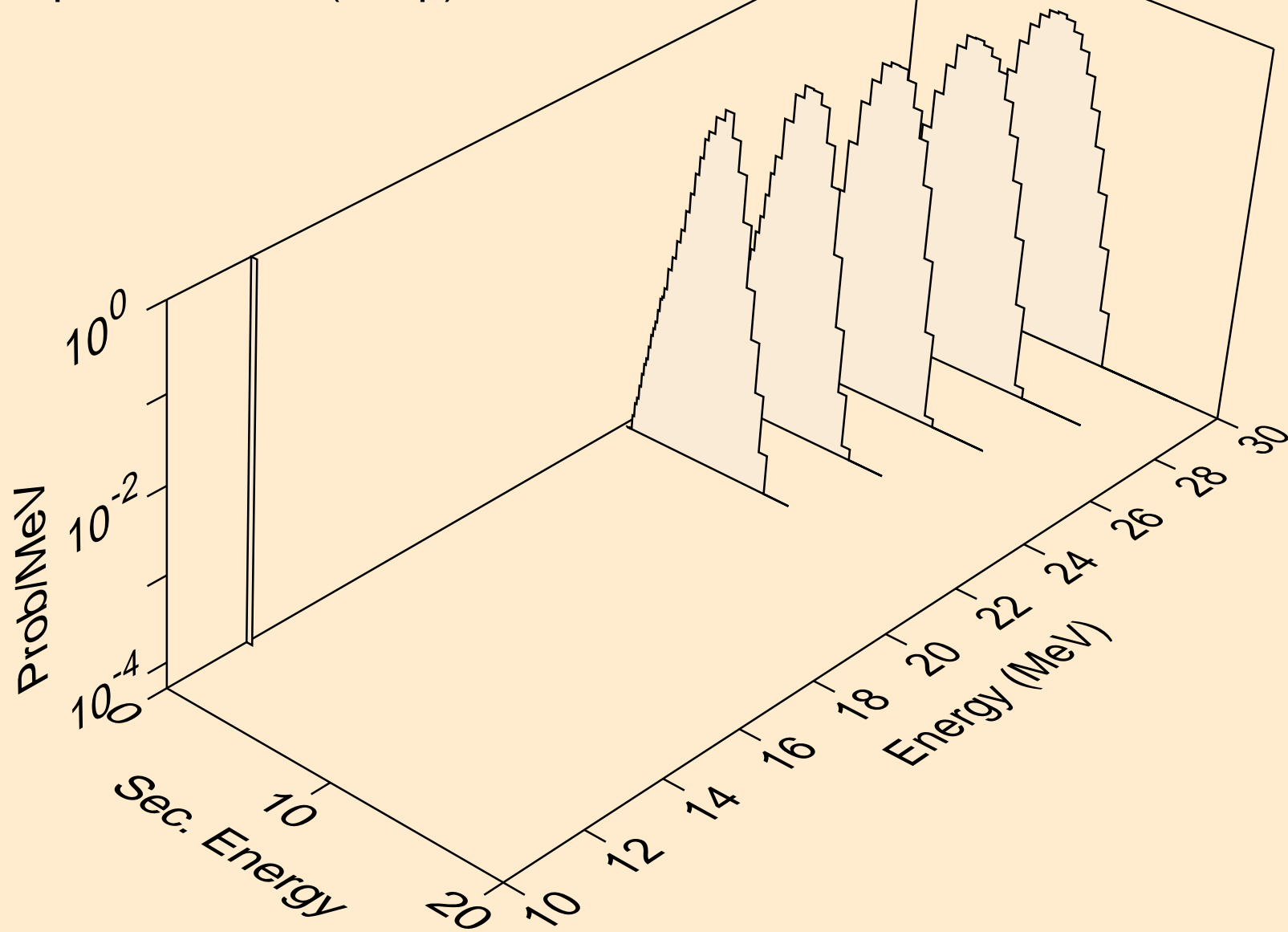

AC237 TRITON ACER TENDL-2021 LIBRARY; T=0.K  
protons from (t,p)

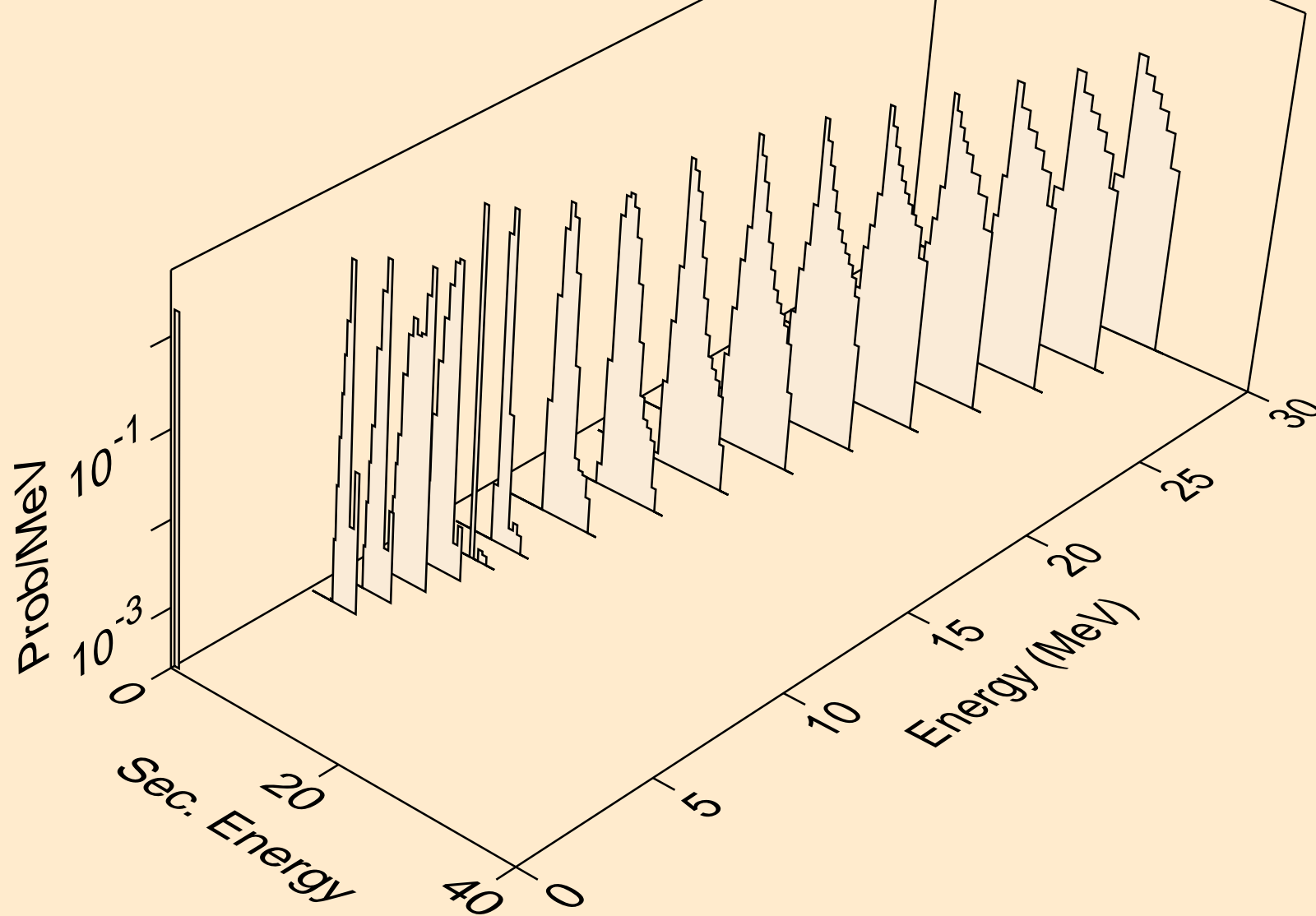

AC237 TRITON ACER TENDL-2021 LIBRARY; T=0.K  
protons from (t,2p)

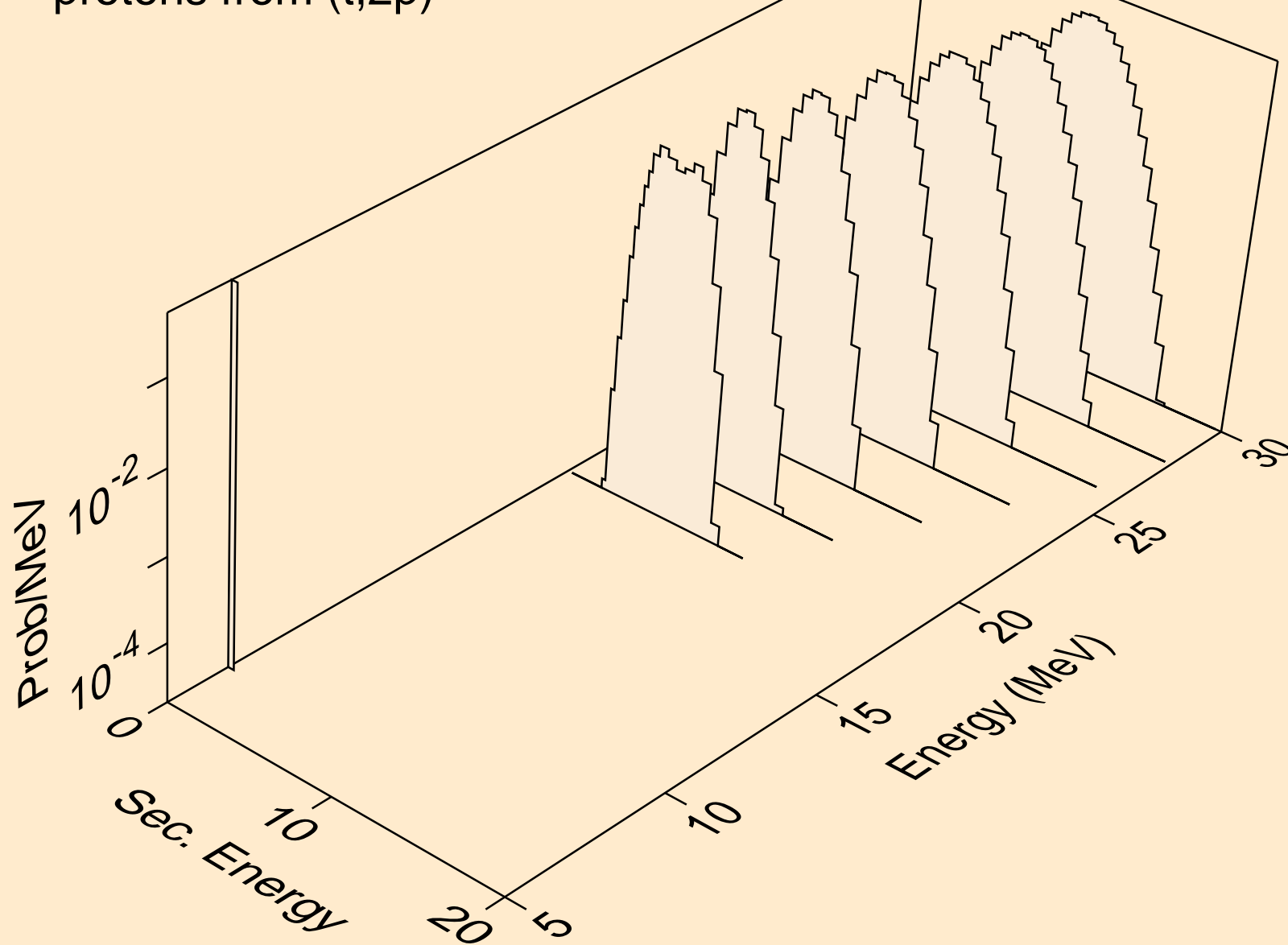



AC237 TRITON ACER TENDL-2021 LIBRARY; T=0.K  
deuterons from (t,x)

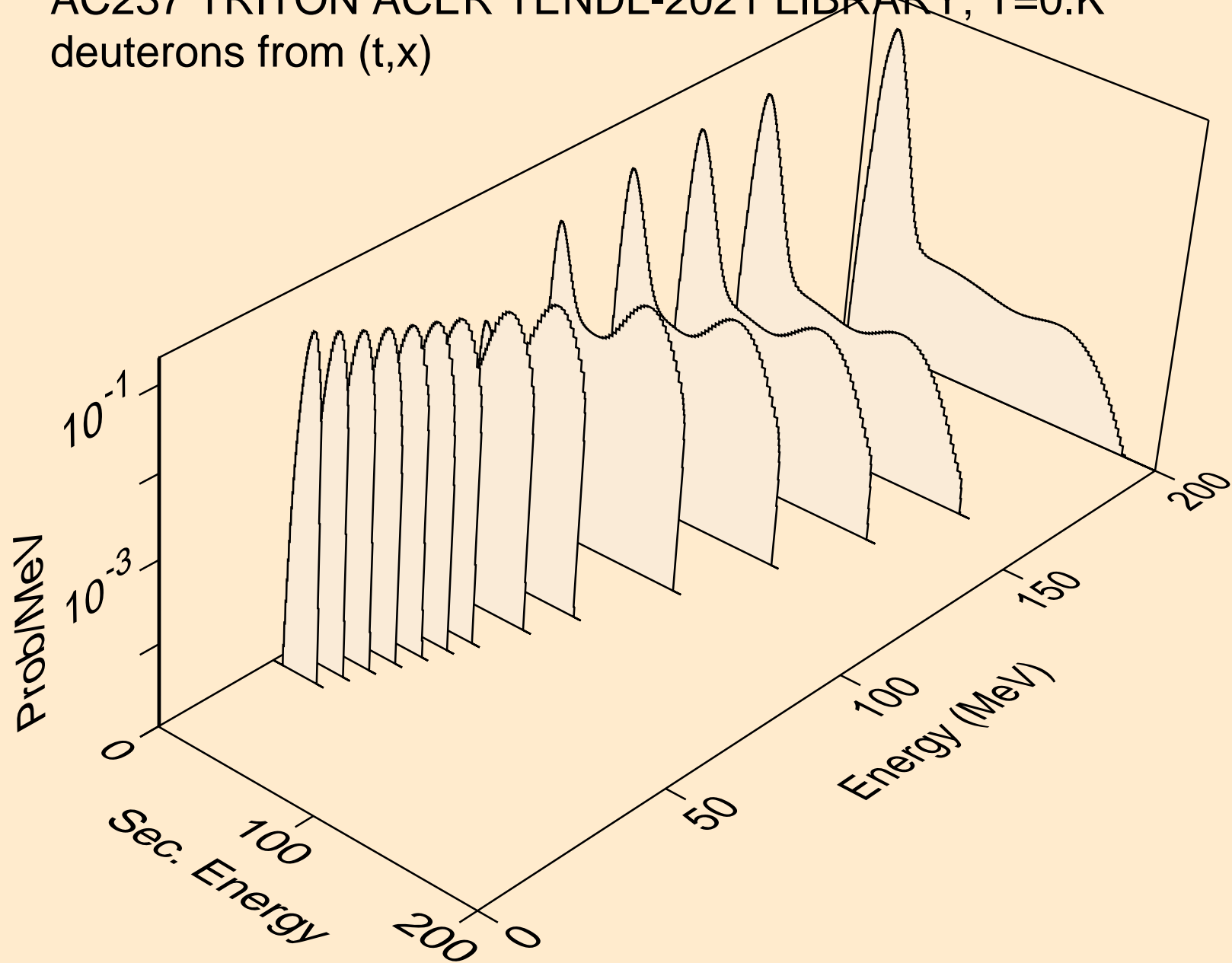

AC237 TRITON ACER TENDL-2021 LIBRARY; T=0.K  
deuterons from (t,2nd)

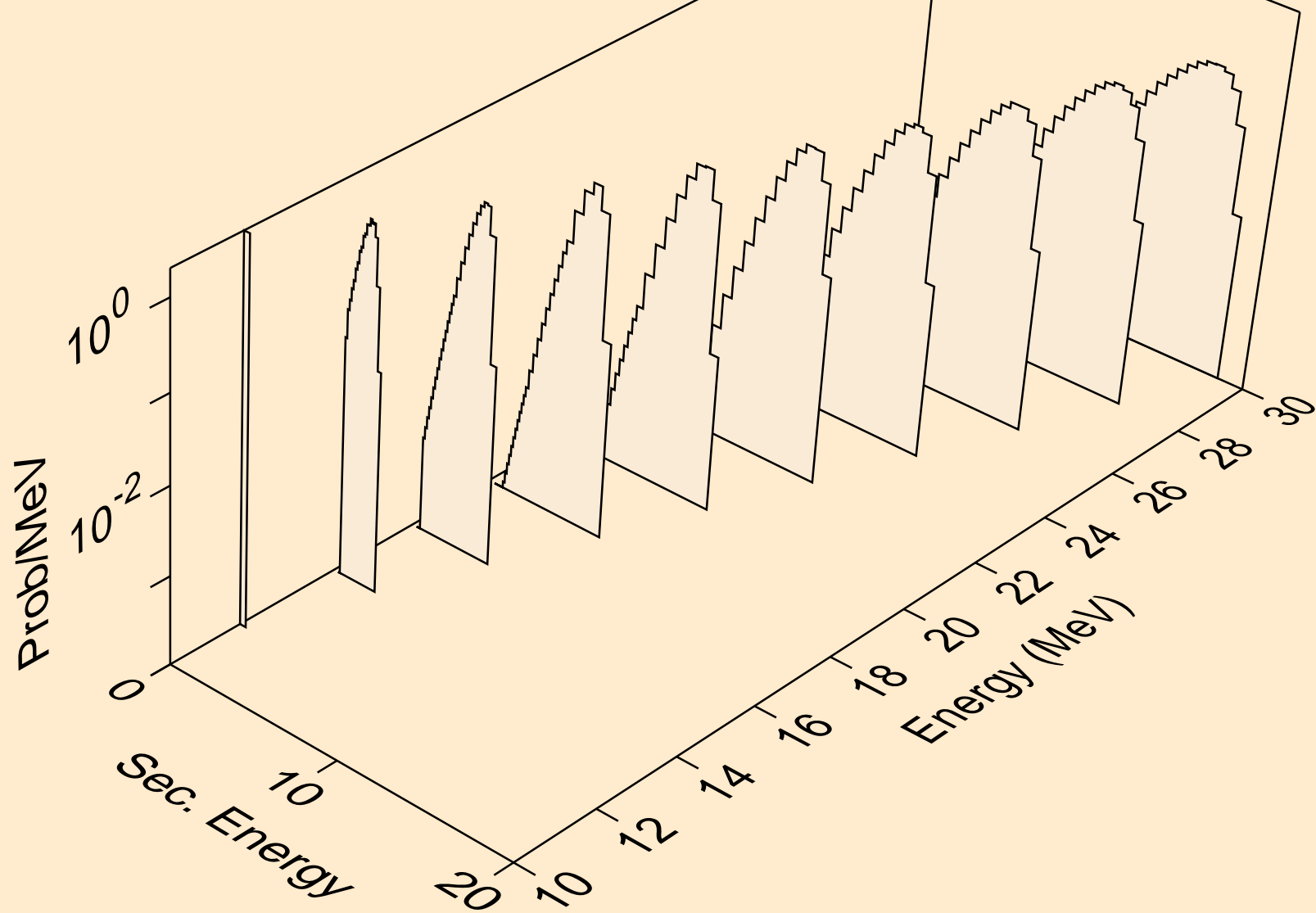

AC237 TRITON ACER TENDL-2021 LIBRARY; T=0.K  
deuterons from (t,n\*)d

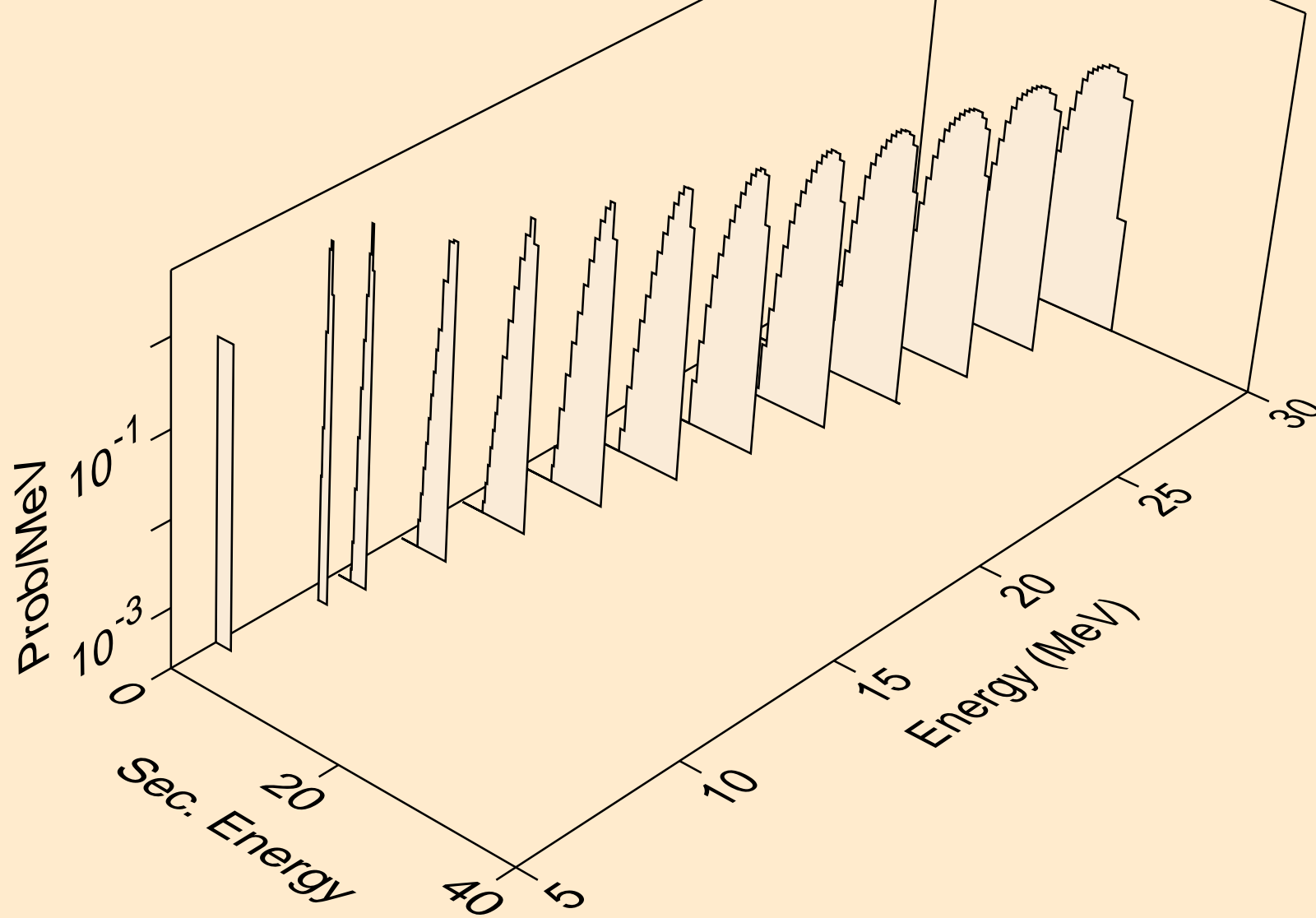

AC237 TRITON ACER TENDL-2021 LIBRARY; T=0.K  
deuterons from (t,d)

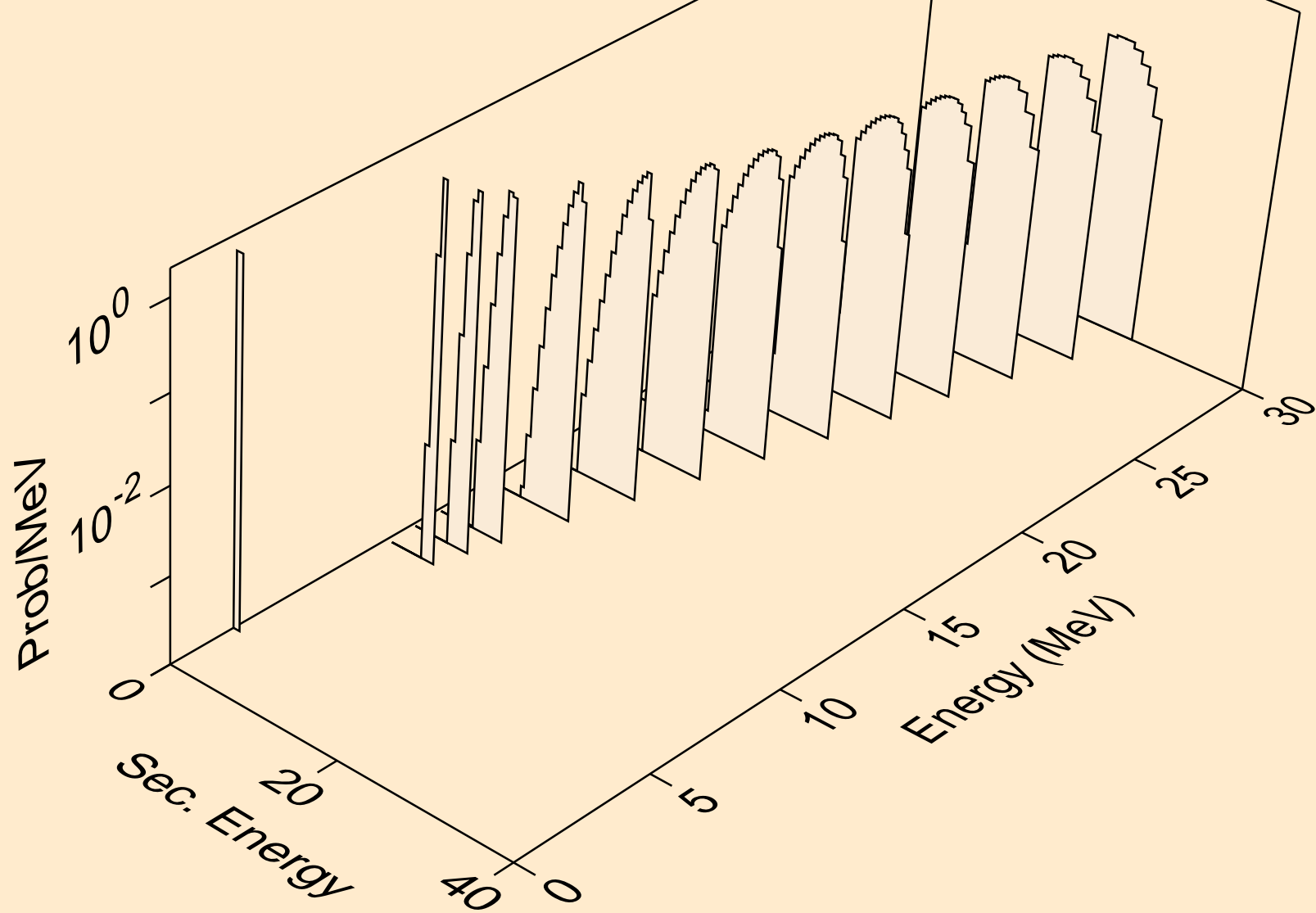

AC237 TRITON ACER TENDL-2021 LIBRARY; T=0.K  
he3s from (t,x)

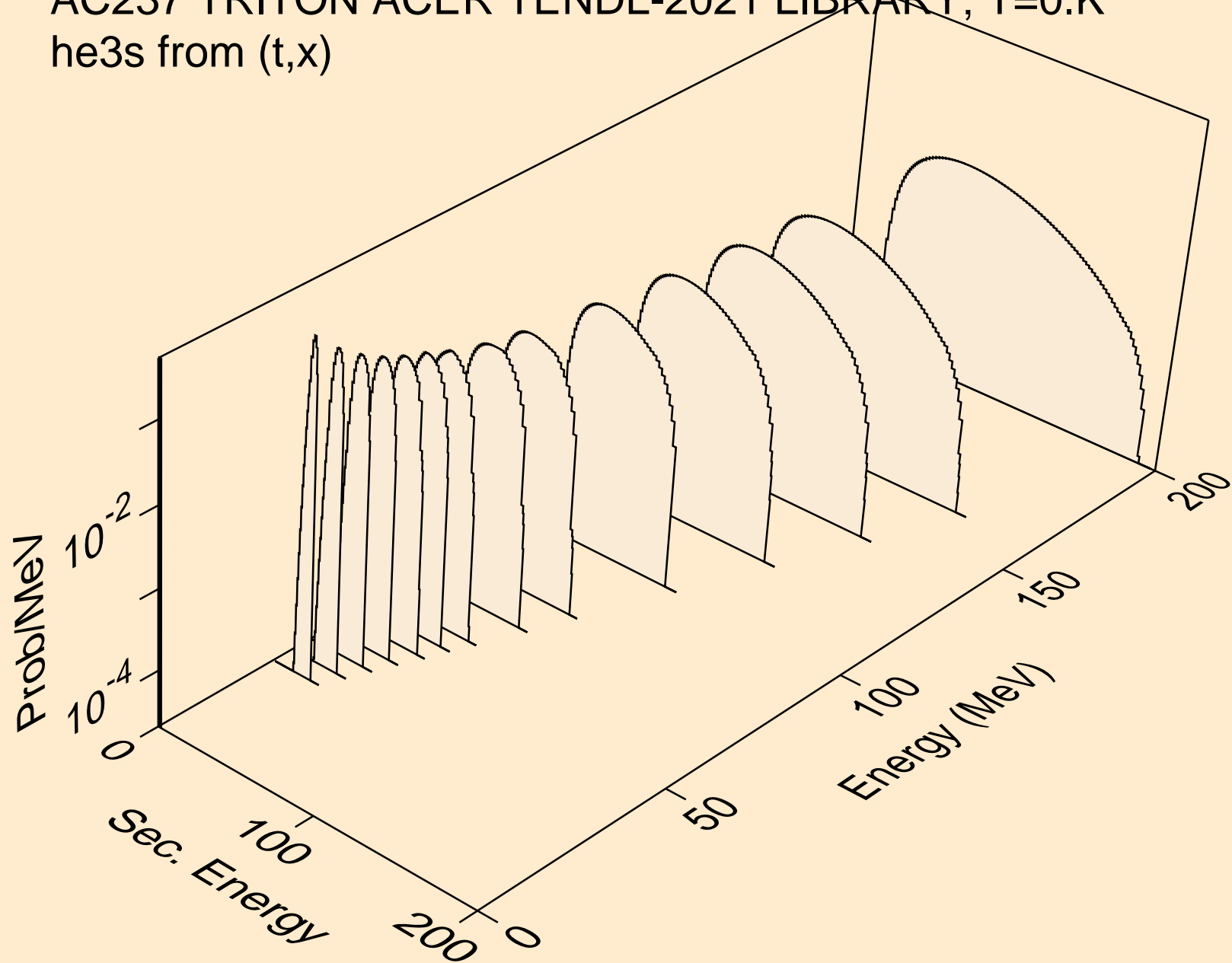

AC237 TRITON ACER TENDL-2021 LIBRARY; T=0.K  
he3s from (t,n\*)he3

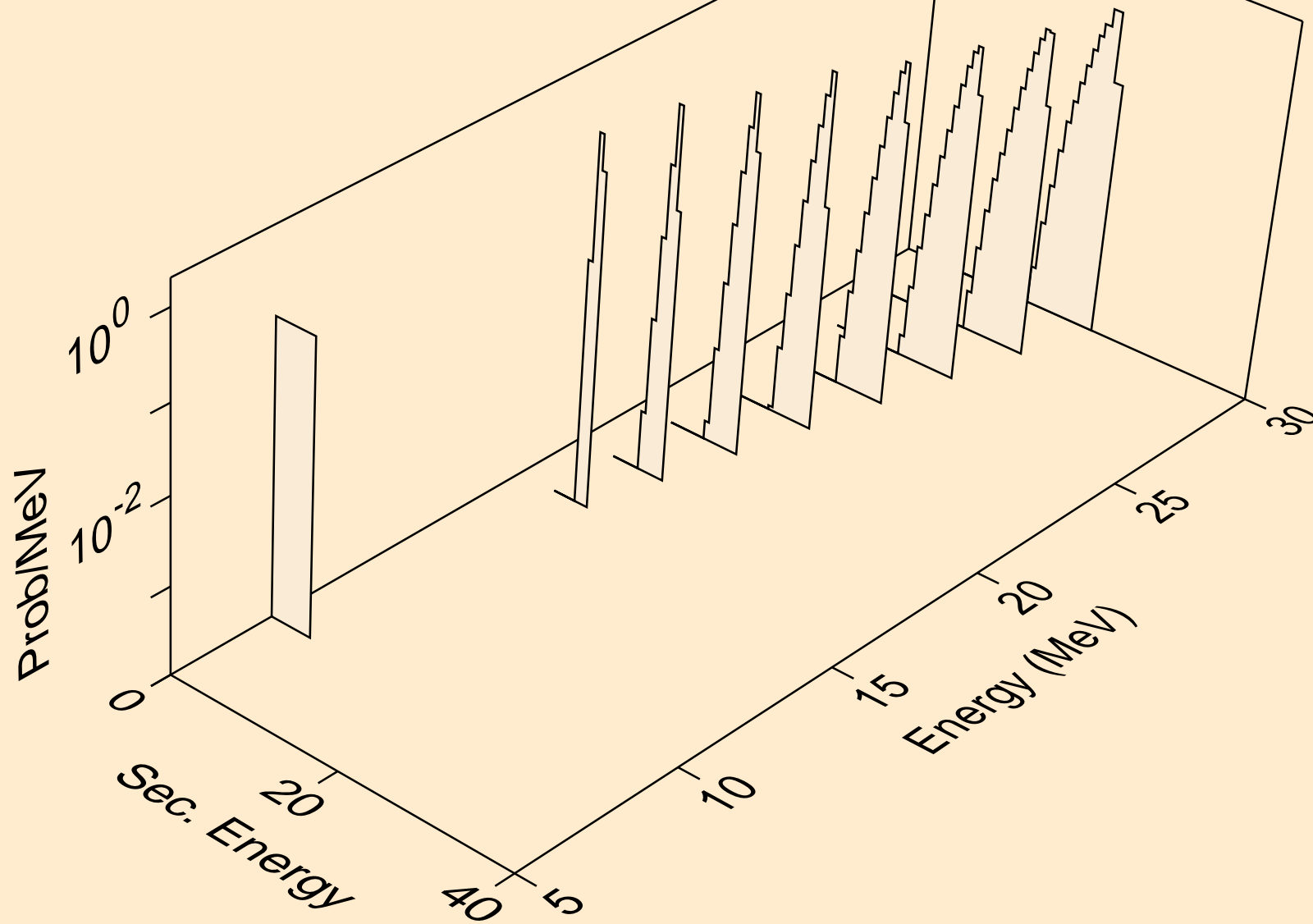

AC237 TRITON ACER TENDL-2021 LIBRARY; T=0.K  
he3s from (t,he3)

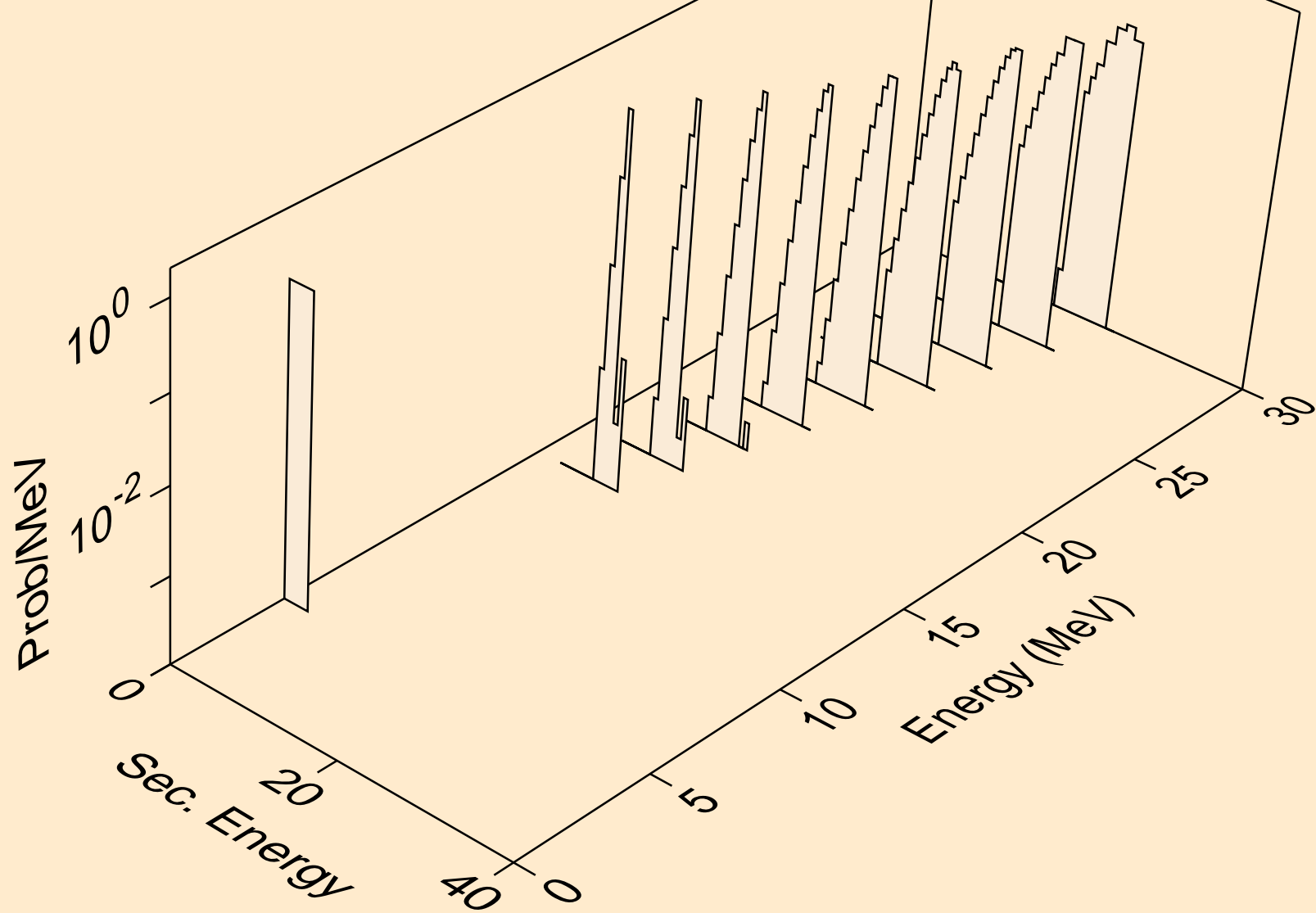

AC237 TRITON ACER TENDL-2021 LIBRARY; T=0.K  
alphas from (t,x)

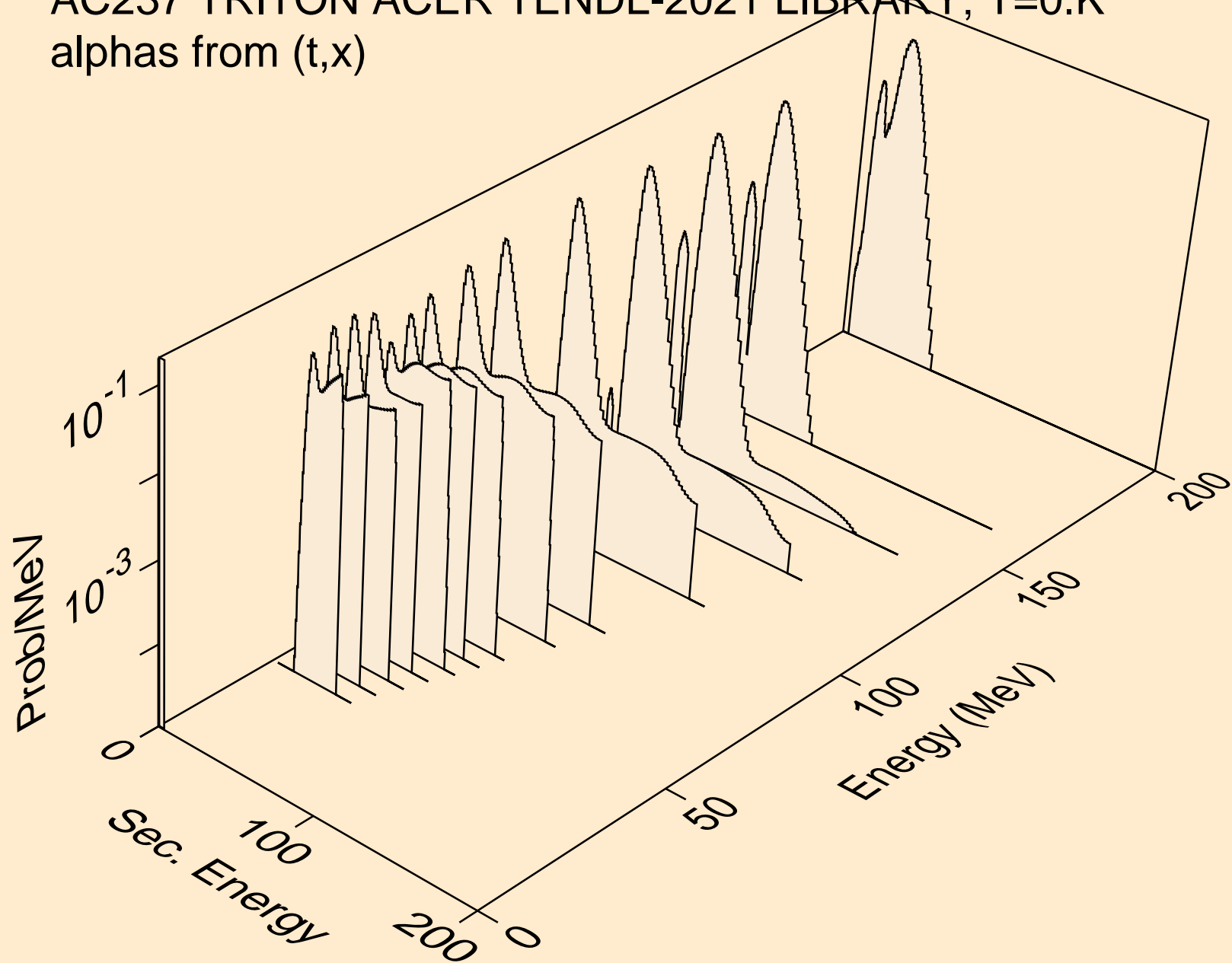



AC237 TRITON ACER TENDL-2021 LIBRARY; T=0.K  
alphas from (t,n\*)a

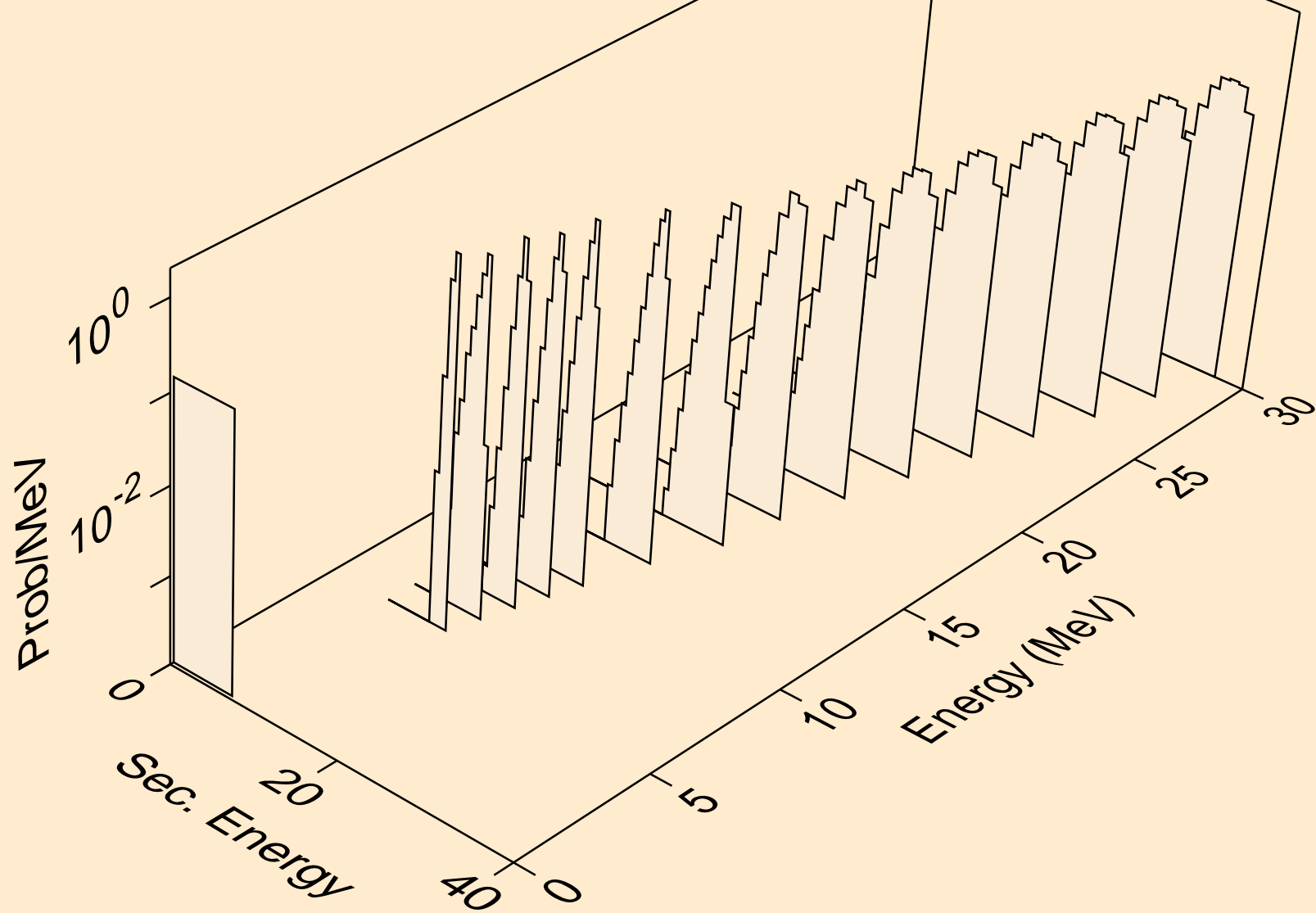

AC237 TRITON ACER TENDL-2021 LIBRARY; T=0.K  
alphas from (t,2n)a

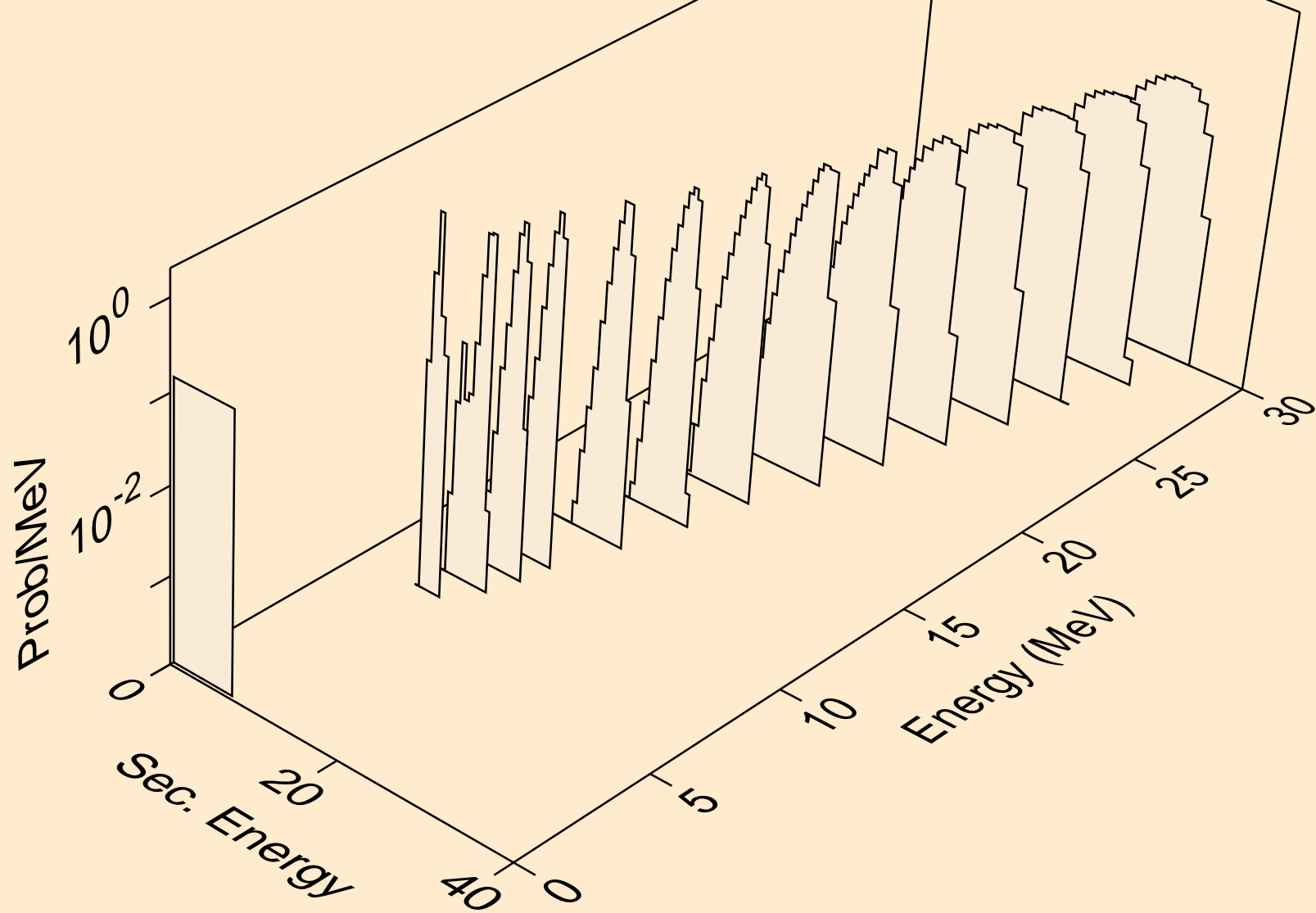

AC237 TRITON ACER TENDL-2021 LIBRARY; T=0.K  
alphas from (t,3n)a

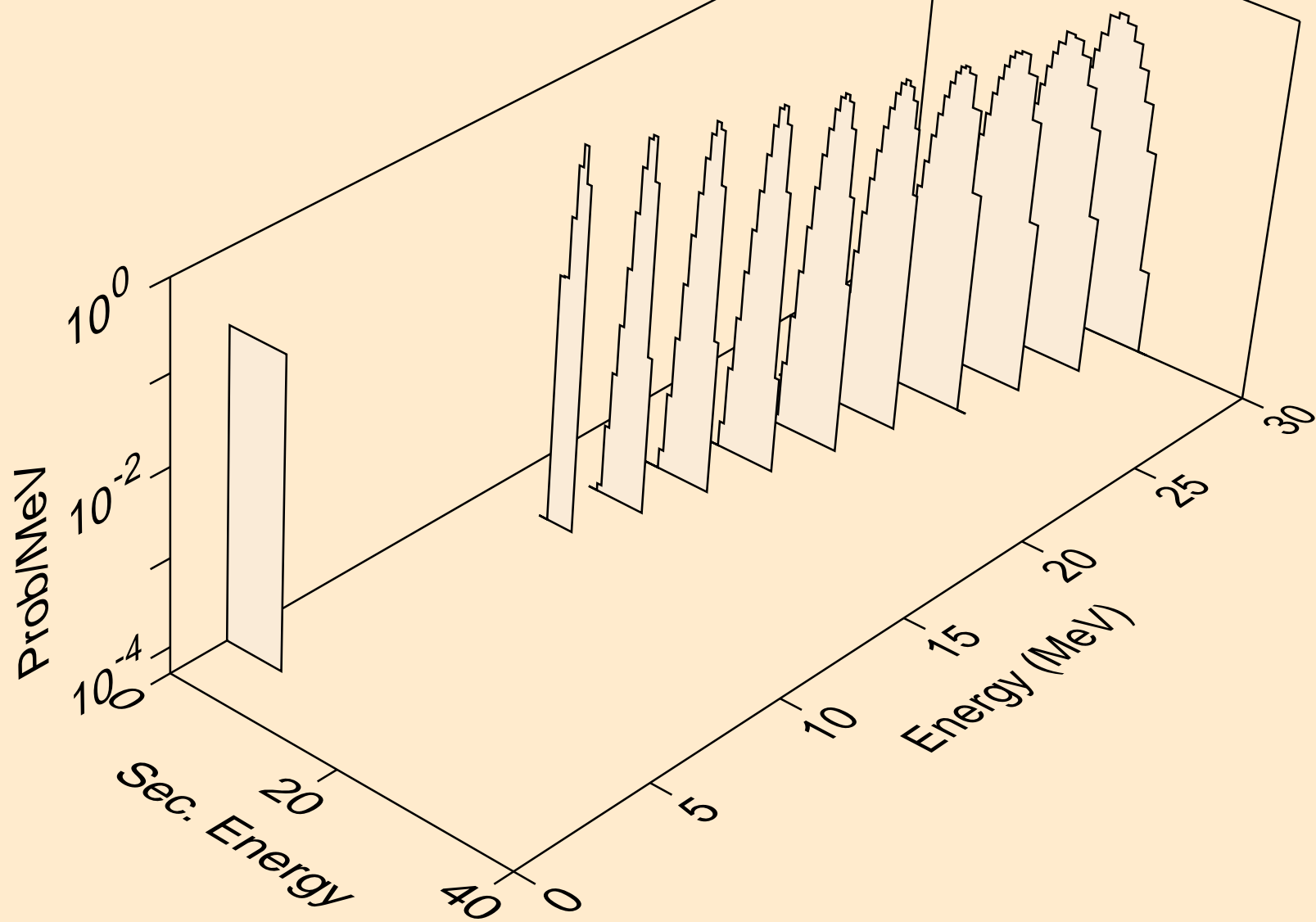

AC237 TRITON ACER TENDL-2021 LIBRARY; T=0.K  
alphas from (t,a)

