

AM246M TRITON ACER TENDL-2021 LIBRARY; T=0.K  
Principal cross sections

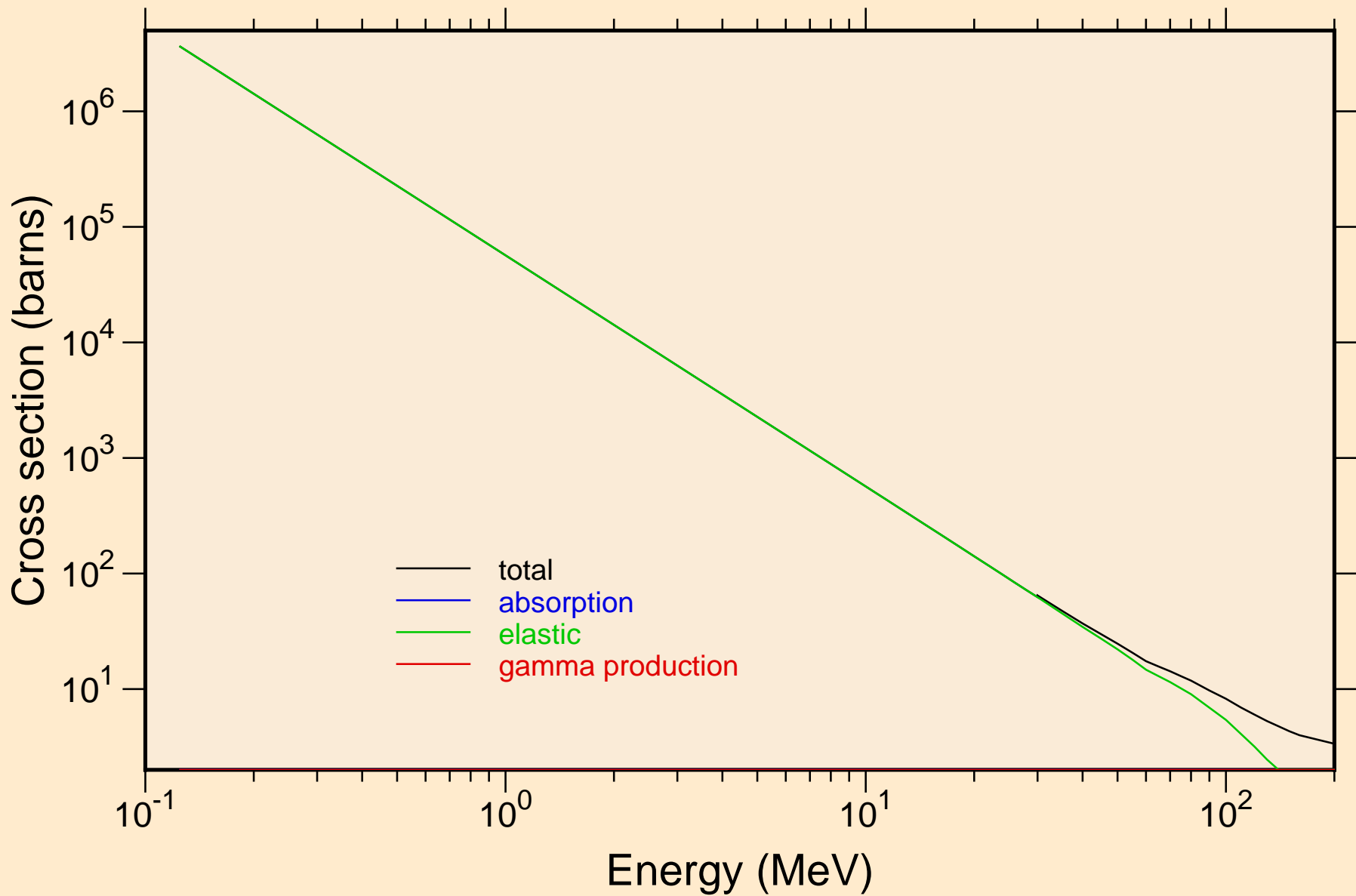

AM246M TRITON ACER TENDL-2021 LIBRARY; T=0.K

Heating

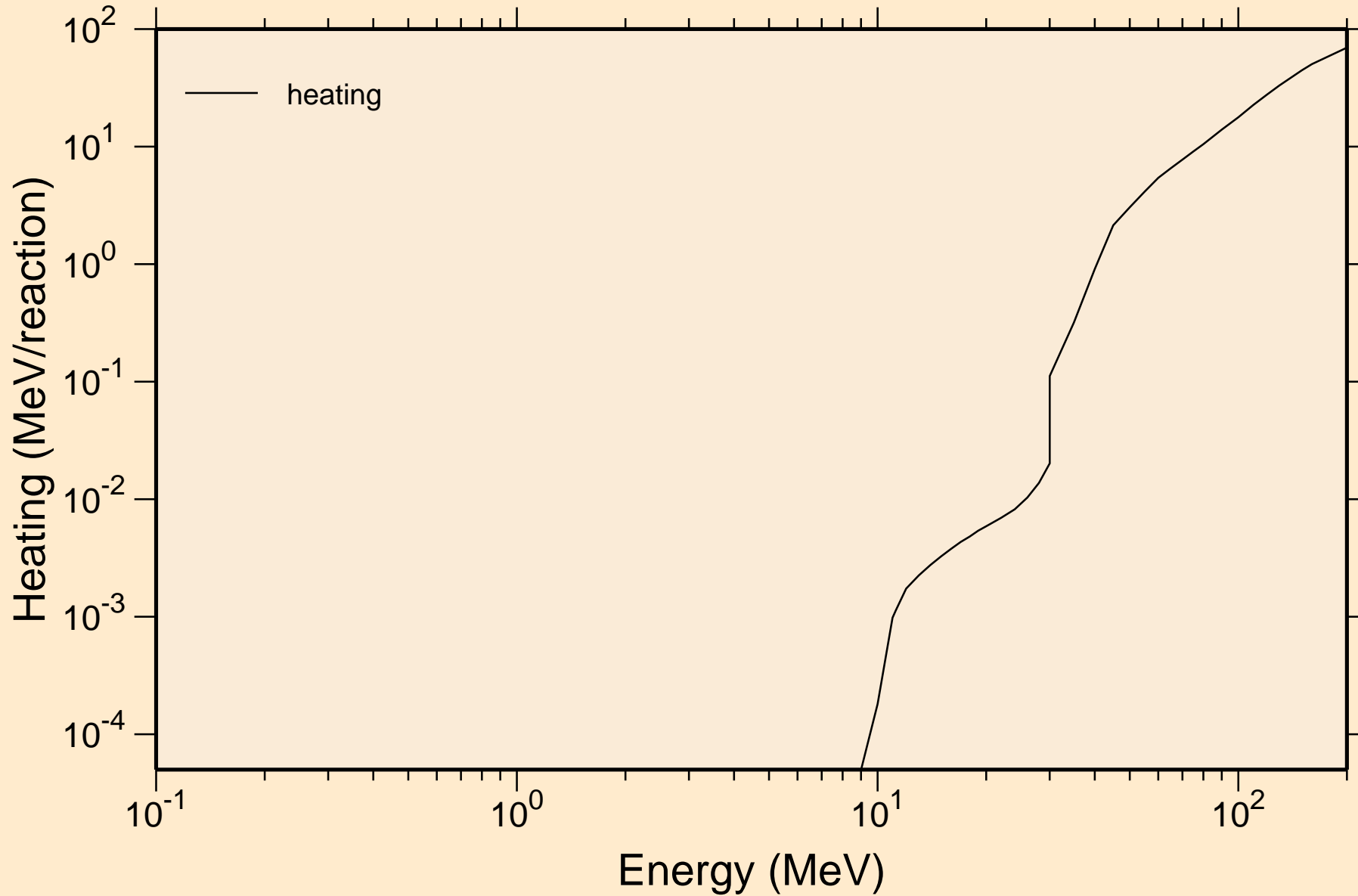

# AM246M TRITON ACER TENDL-2021 LIBRARY; T=0.K

## Principal cross sections

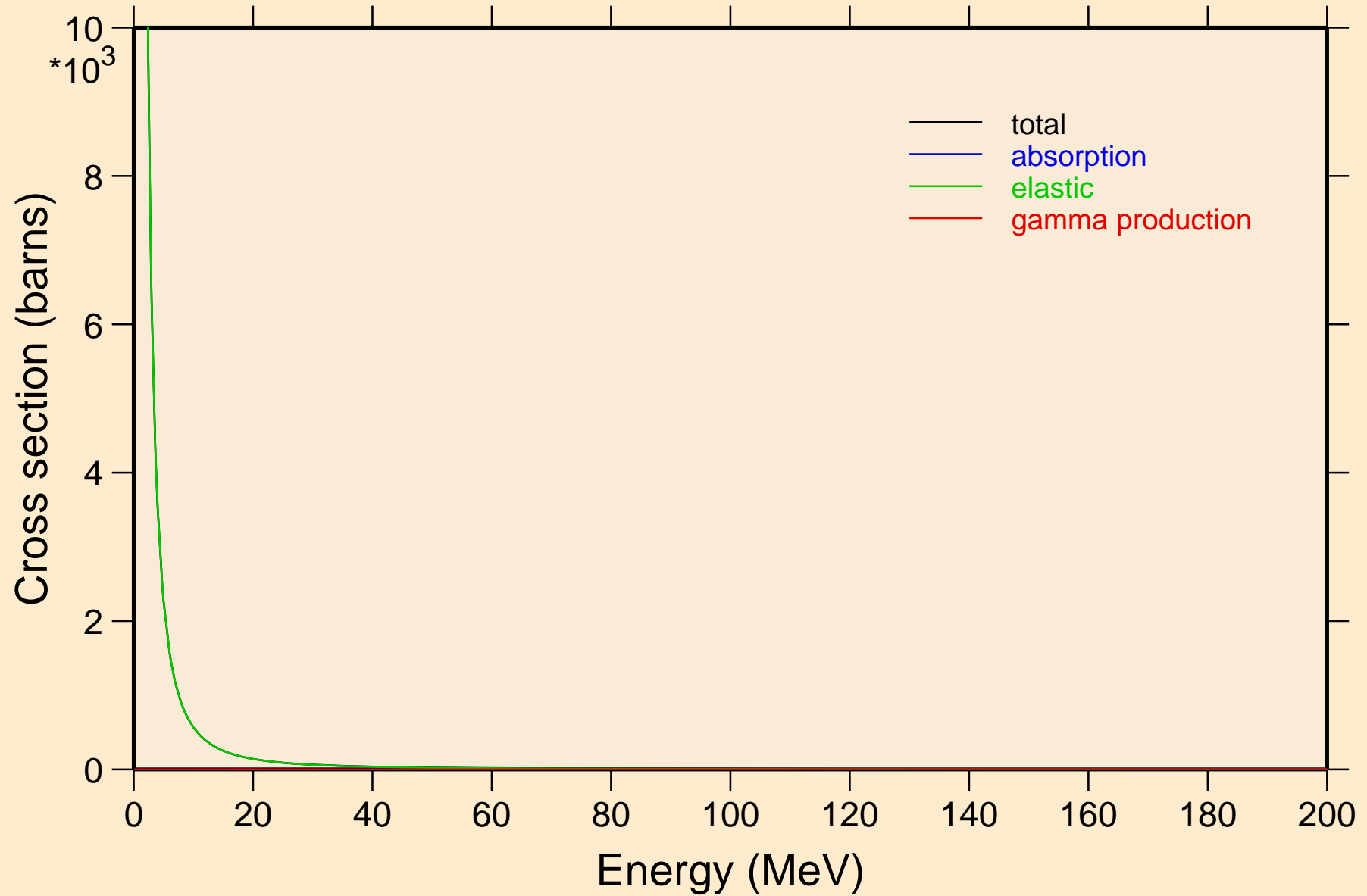

AM246M TRITON ACER TENDL-2021 LIBRARY; T=0.K

Heating

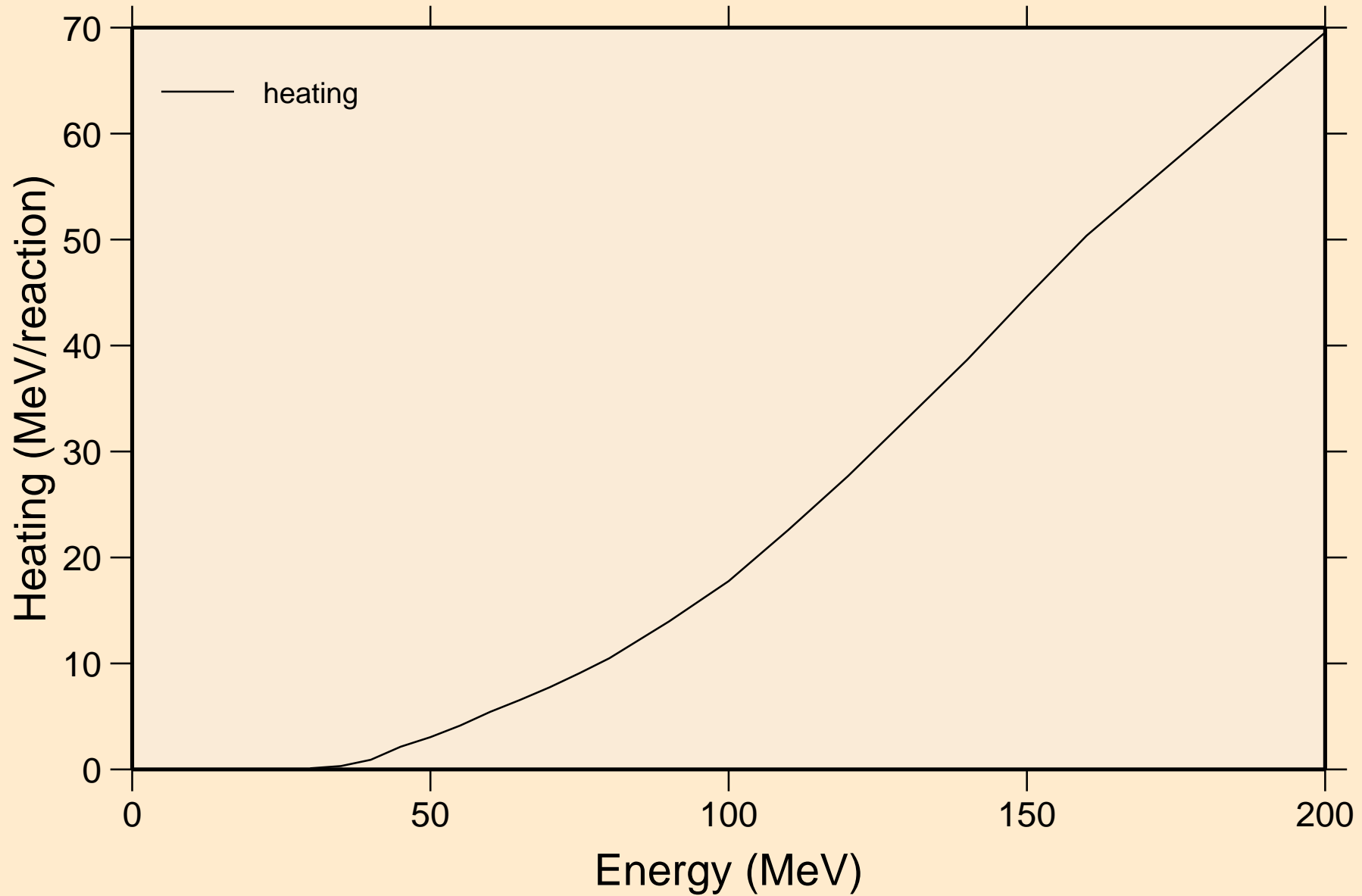

AM246M TRITON ACER TENDL-2021 LIBRARY; T=0.K  
Threshold reactions

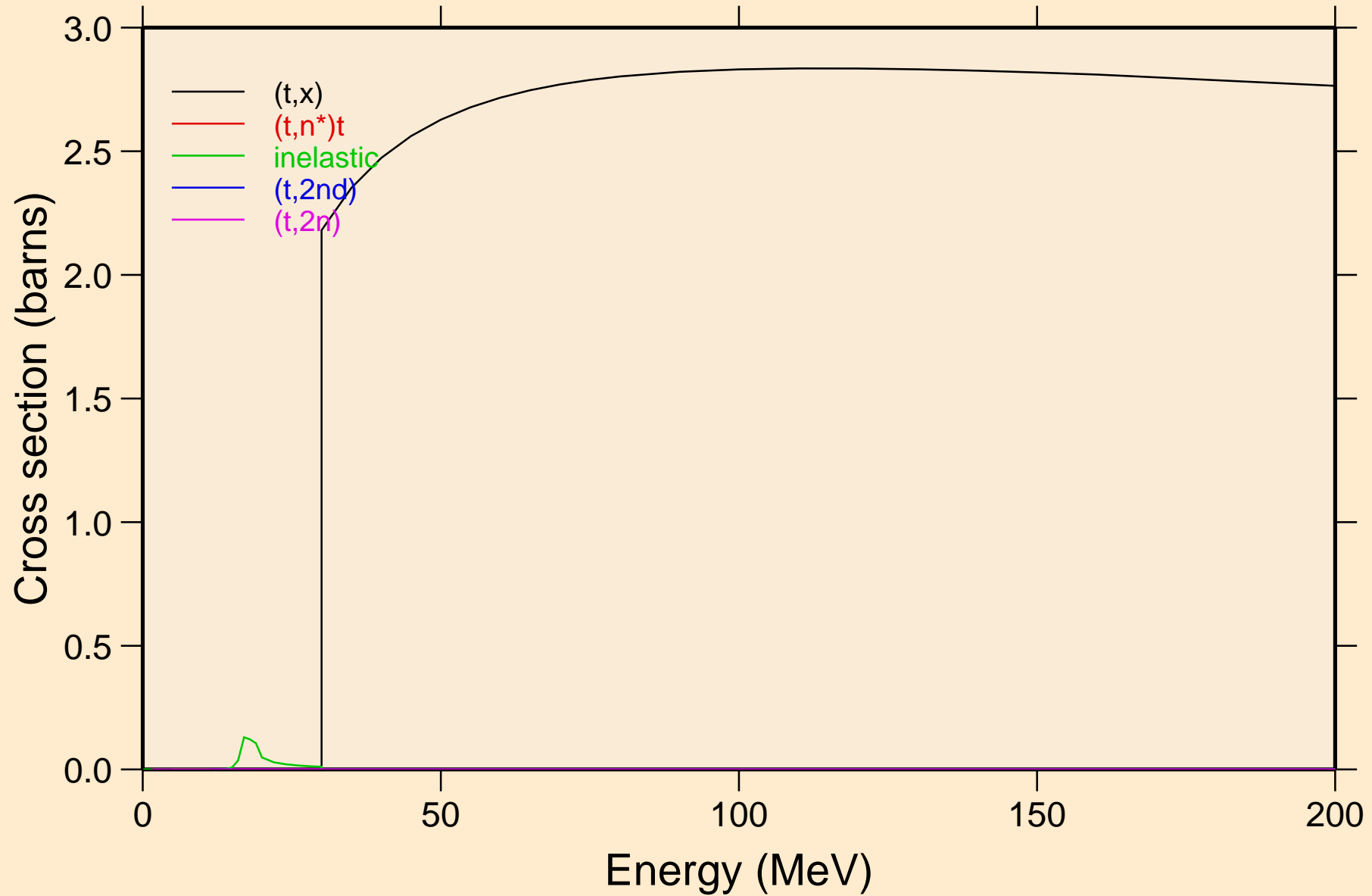

AM246M TRITON ACER TENDL-2021 LIBRARY; T=0.K  
Threshold reactions

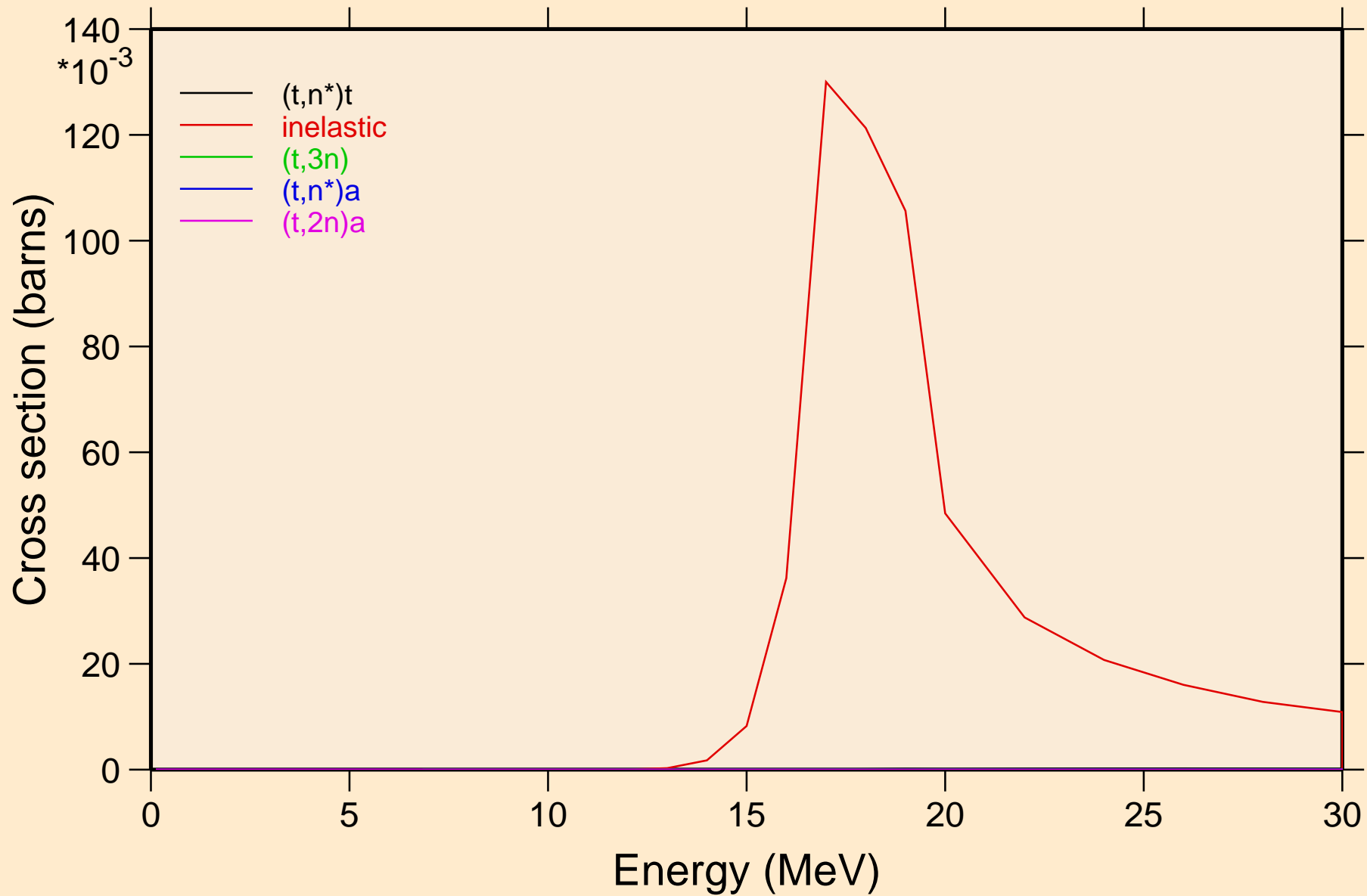

AM246M TRITON ACER TENDL-2021 LIBRARY; T=0.K  
Threshold reactions

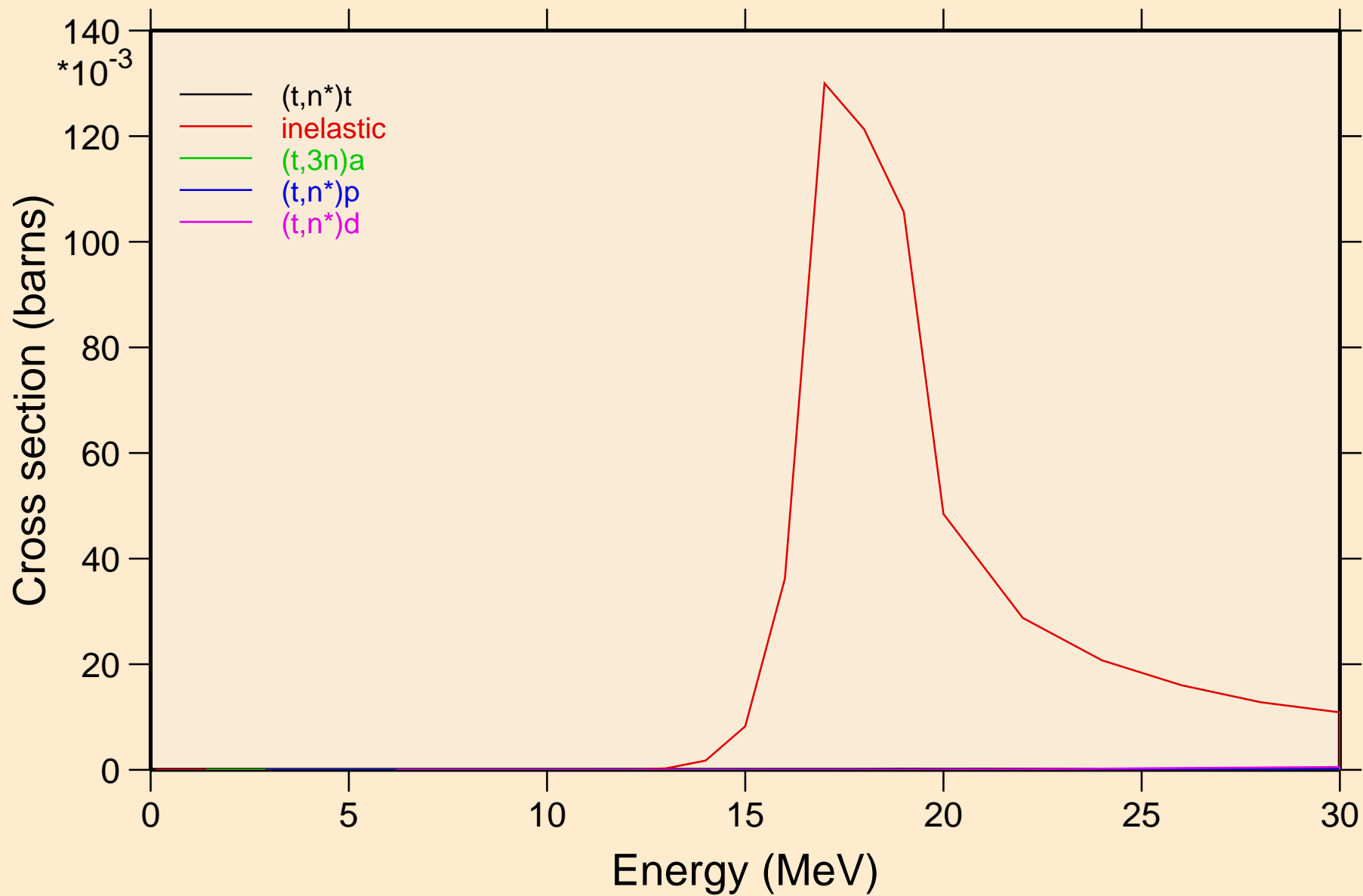

AM246M TRITON ACER TENDL-2021 LIBRARY; T=0.K  
Threshold reactions

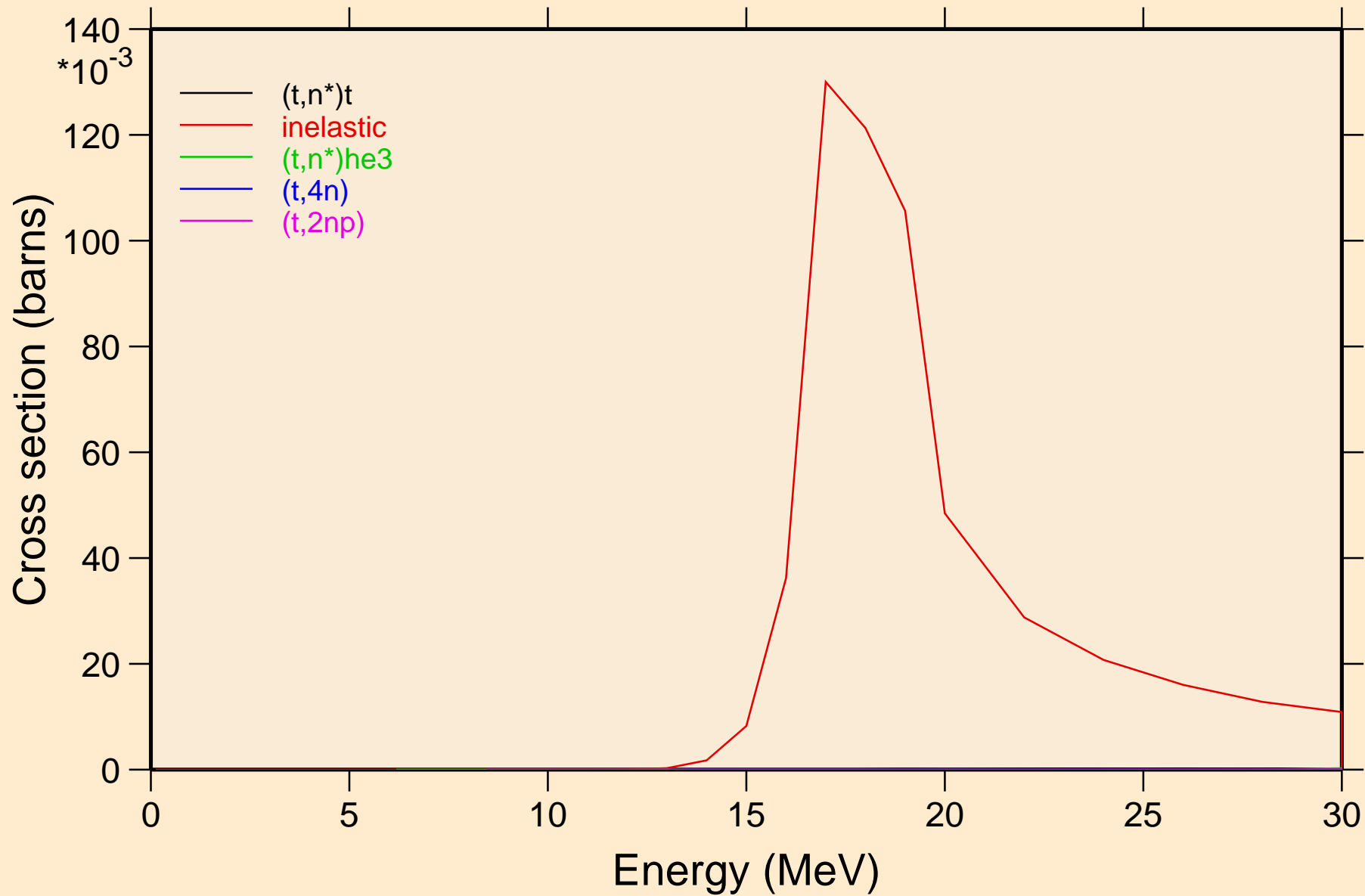



AM246M TRITON ACER TENDL-2021 LIBRARY; T=0.K  
Threshold reactions

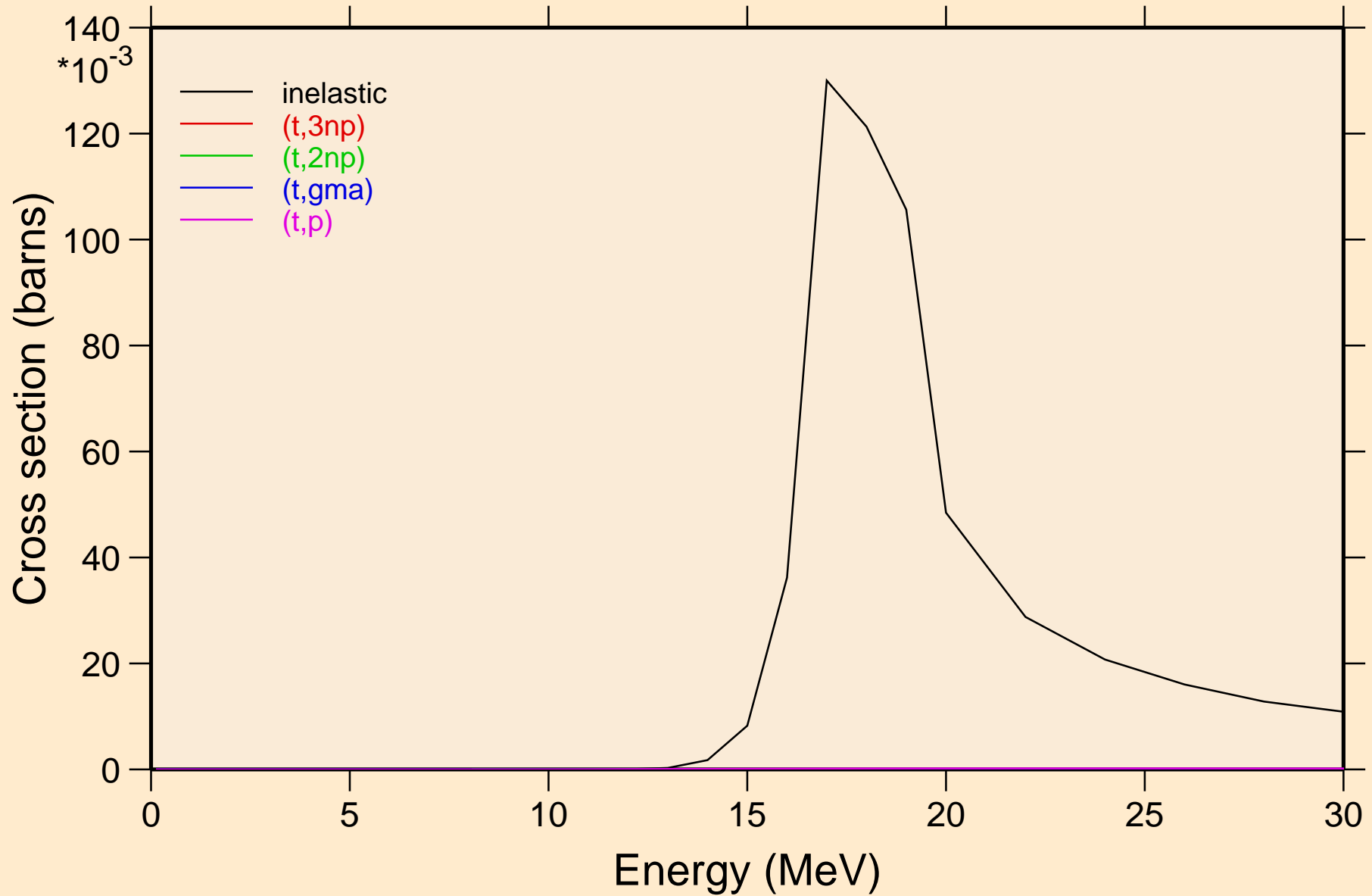

AM246M TRITON ACER TENDL-2021 LIBRARY; T=0.K  
Threshold reactions

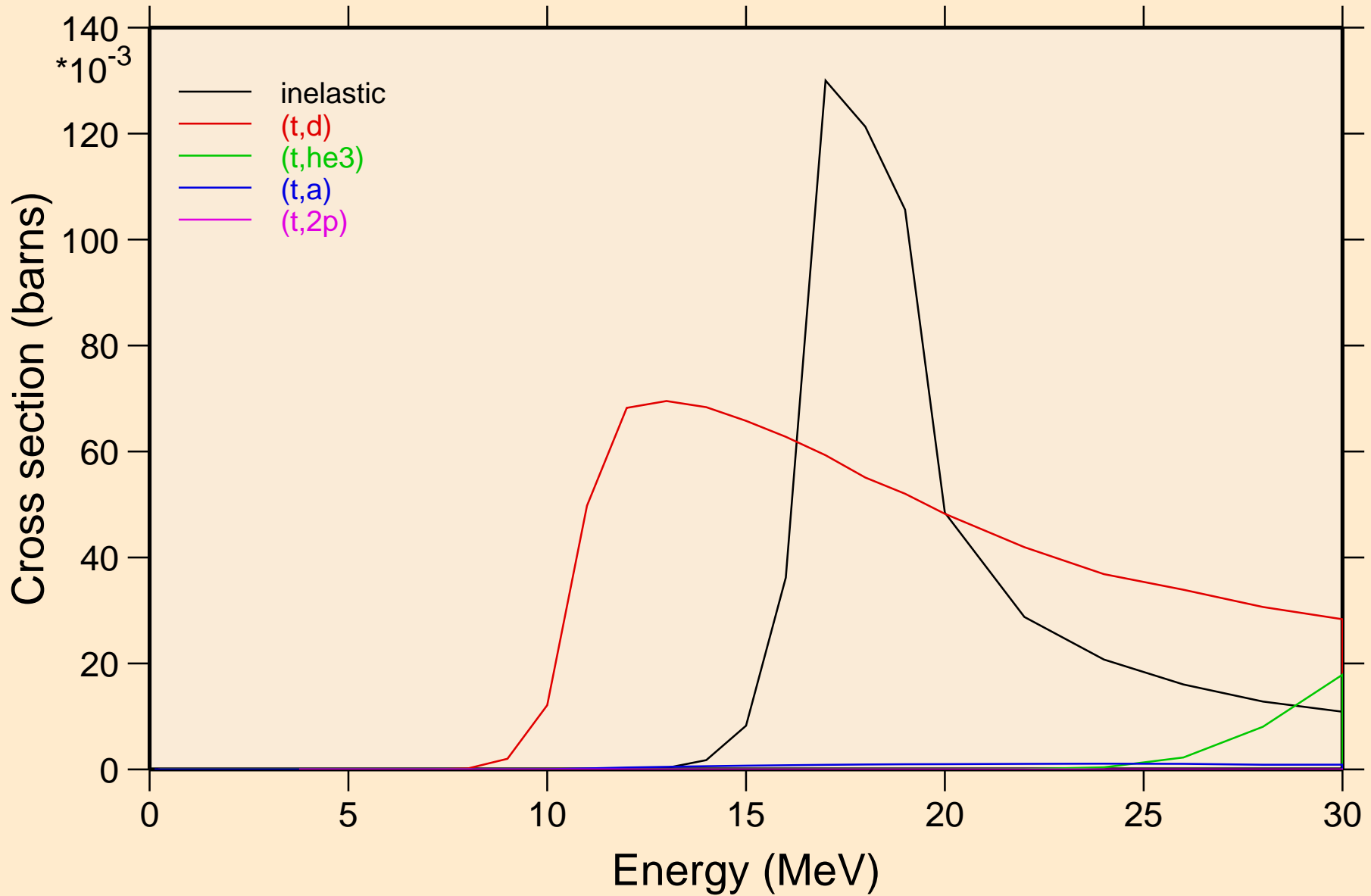

AM246M TRITON ACER TENDL-2021 LIBRARY; T=0.K  
angular distribution for elastic

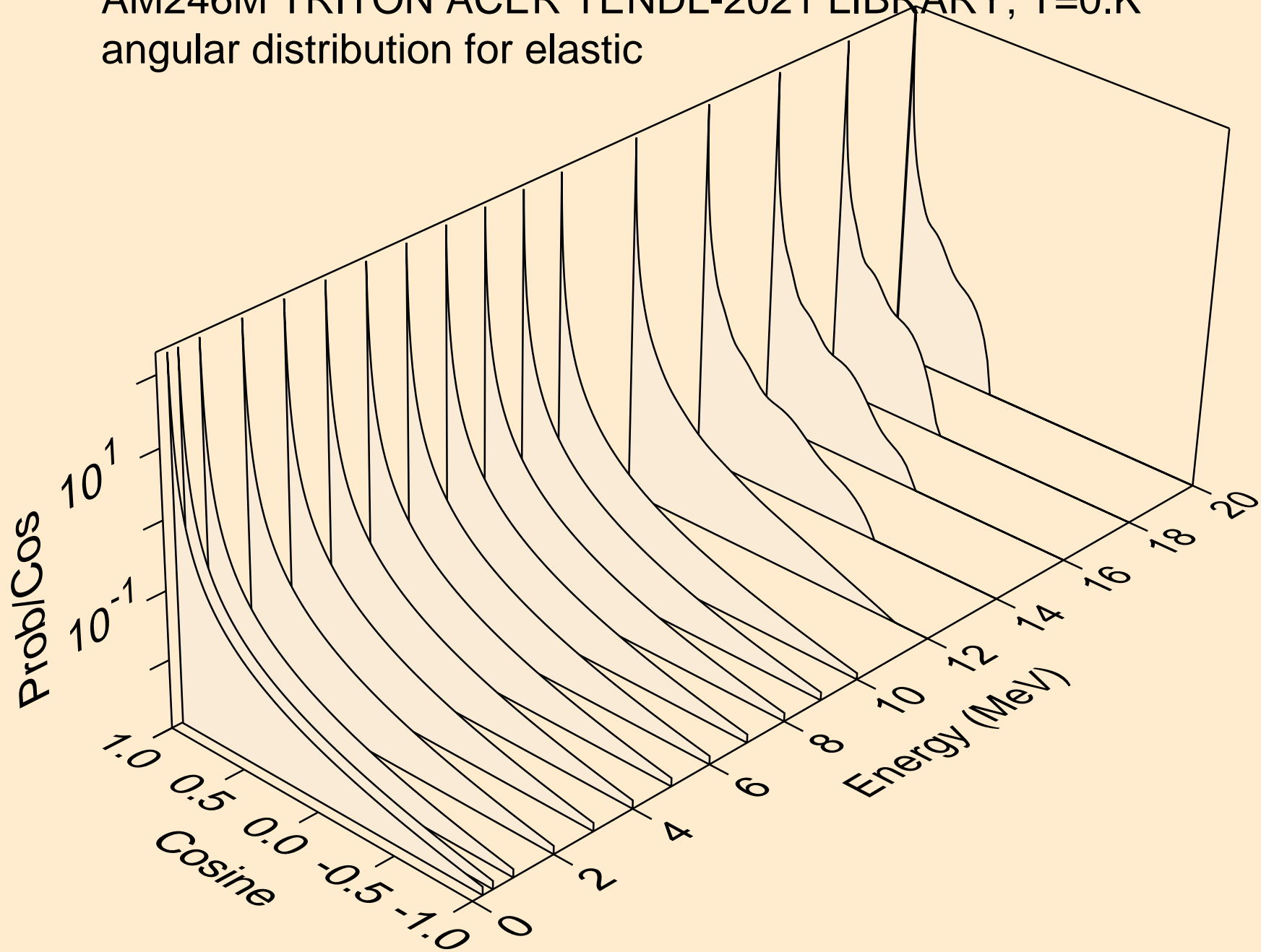

AM246M TRITON ACER TENDL-2021 LIBRARY; T=0.K  
angular distribution for elastic

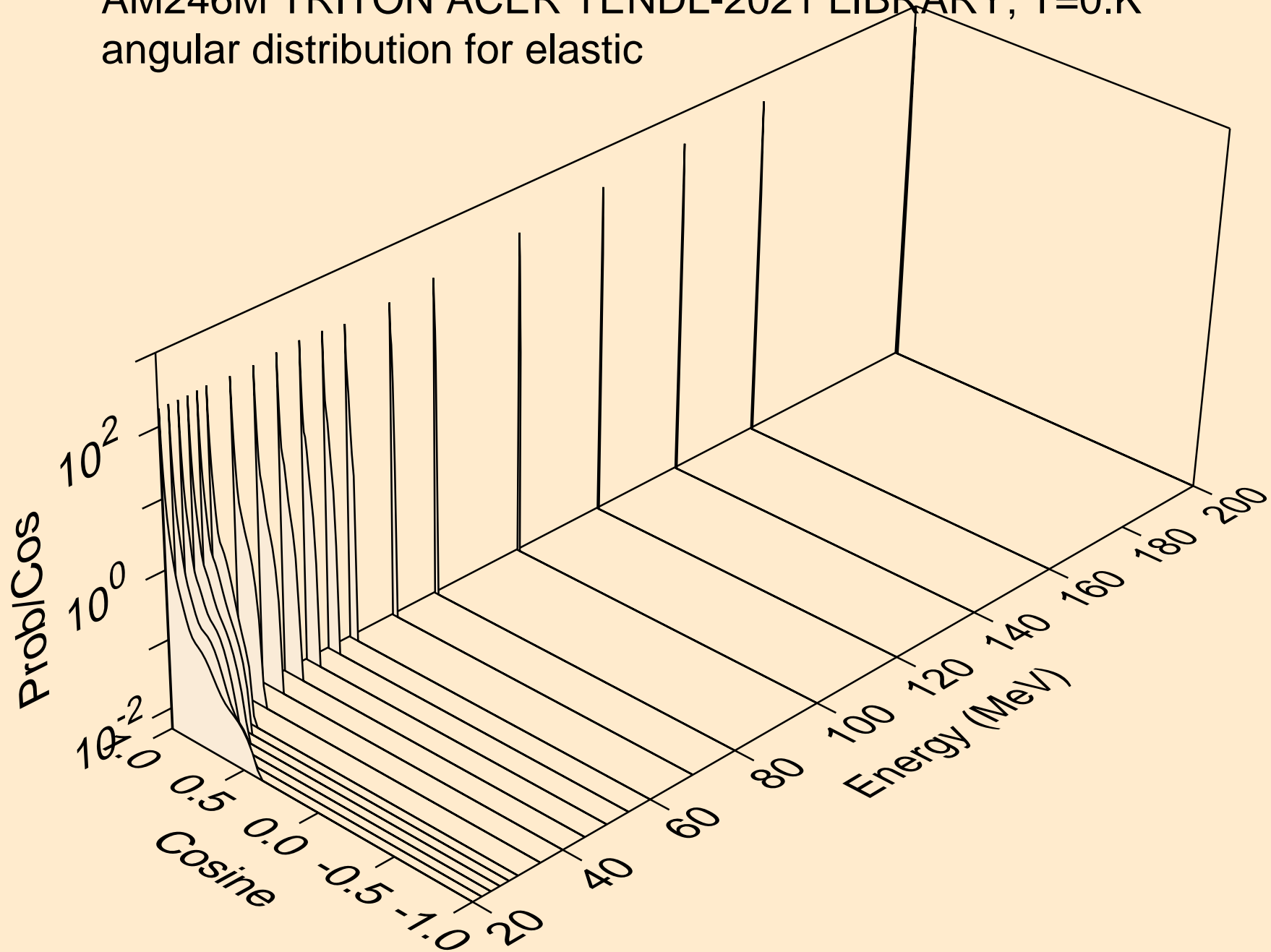

AM246M TRITON ACER TENDL-2021 LIBRARY; T=0.K  
Triton emission for (t,x)

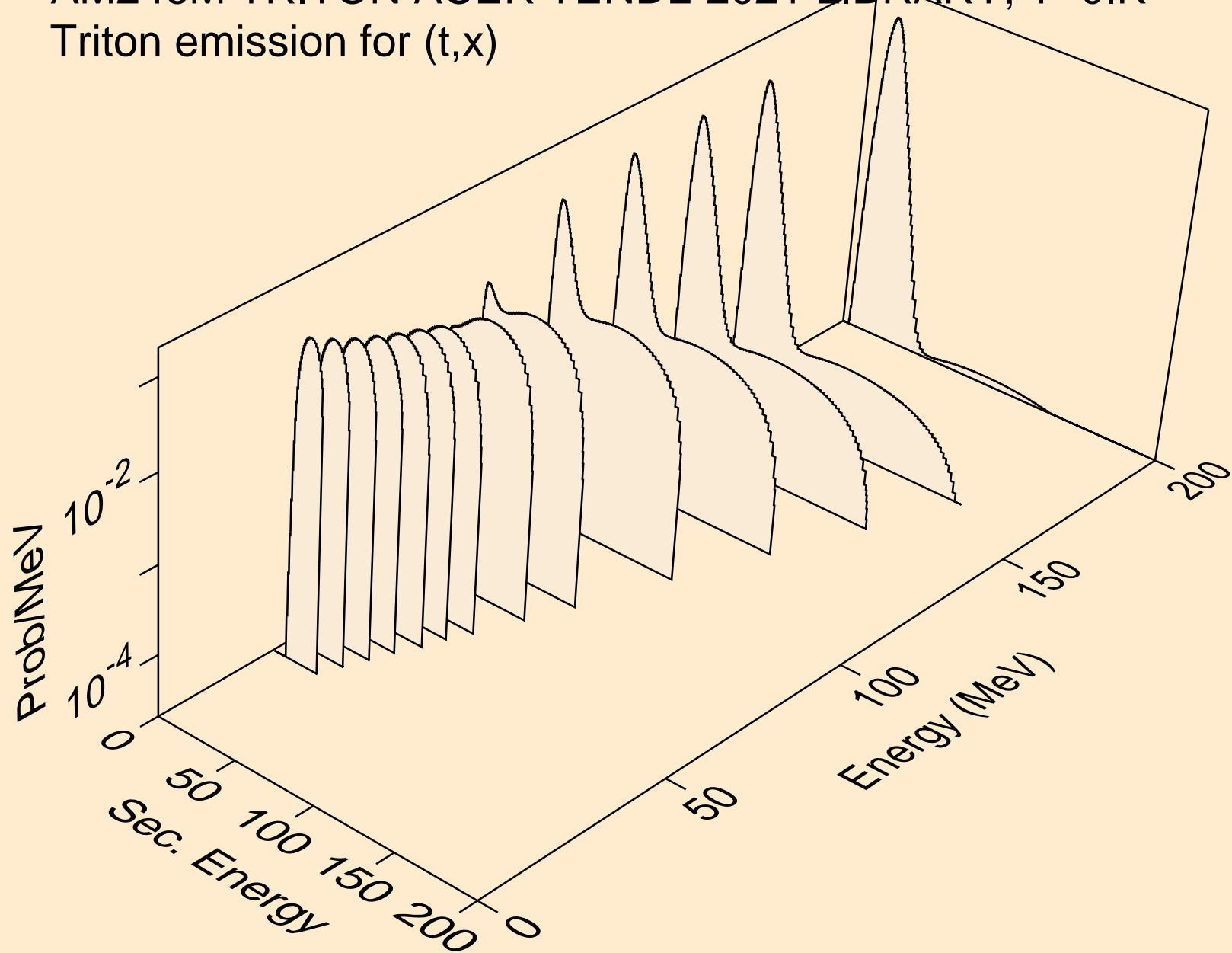

AM246M TRITON ACER TENDL-2021 LIBRARY; T=0.K  
Triton emission for (t,n\*)t

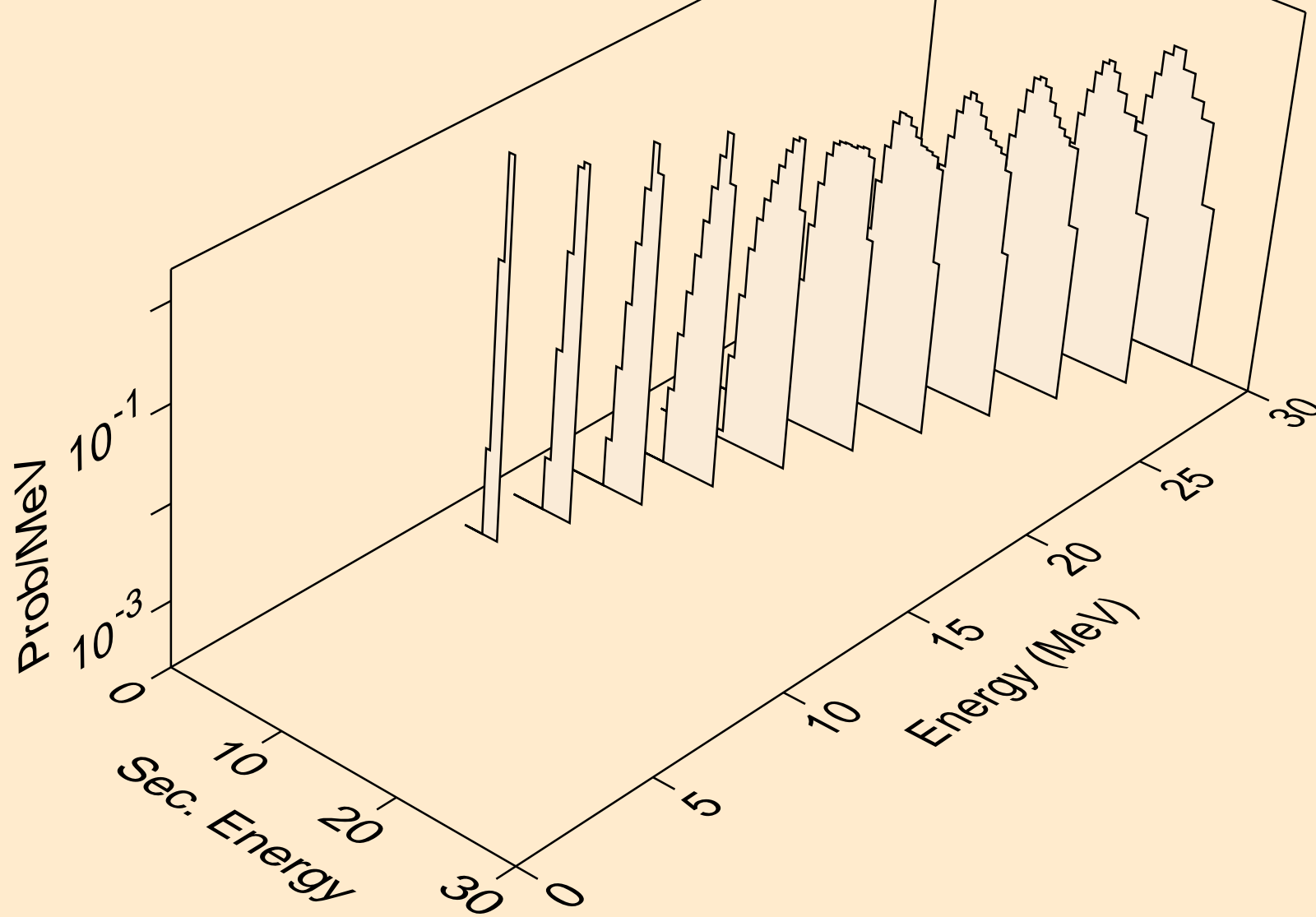

AM246M TRITON ACER TENDL-2021 LIBRARY; T=0.K  
Triton emission for inelastic

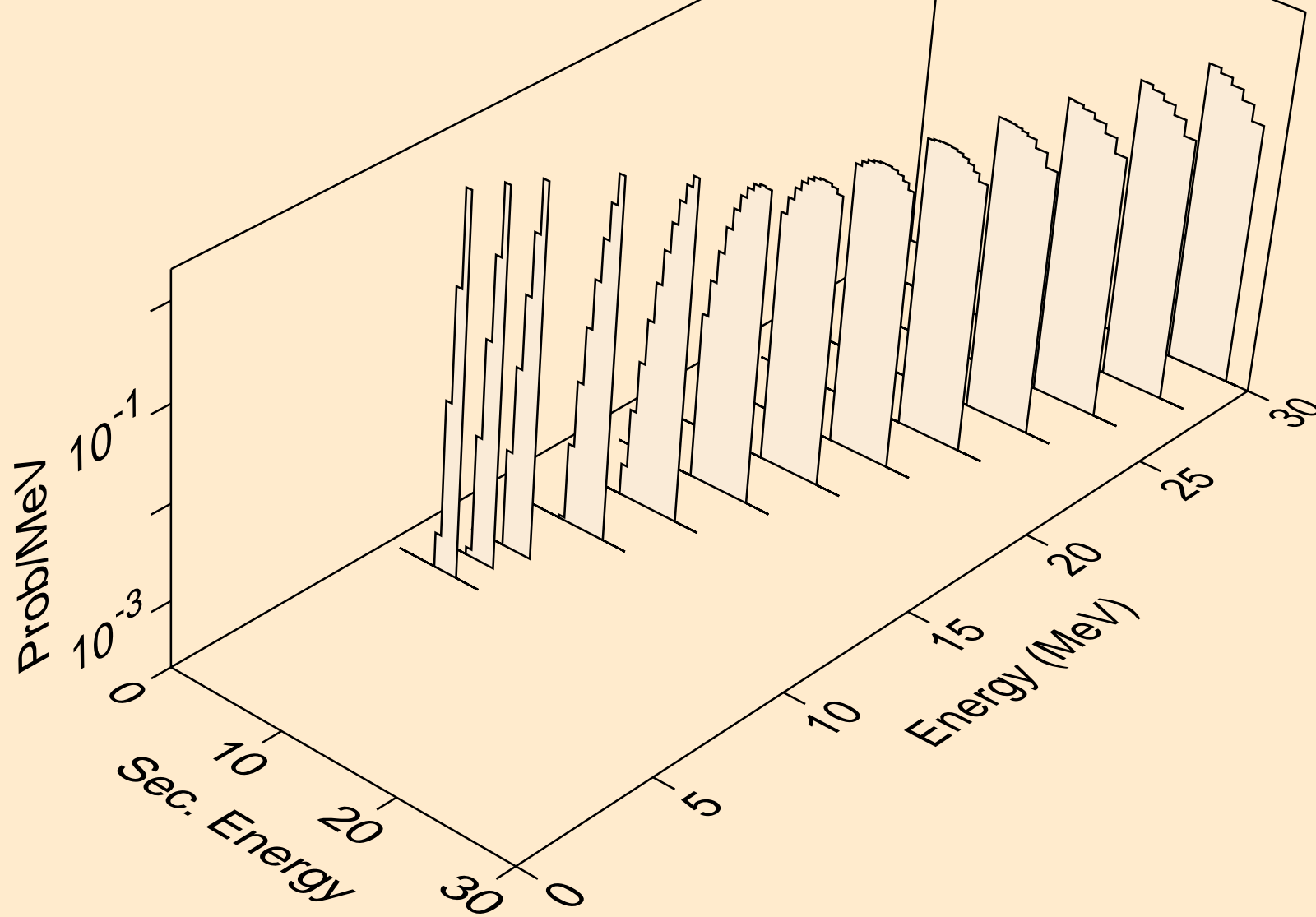

AM246M TRITON ACER TENDL-2021 LIBRARY; T=0.K  
Photon emission for (z,n)

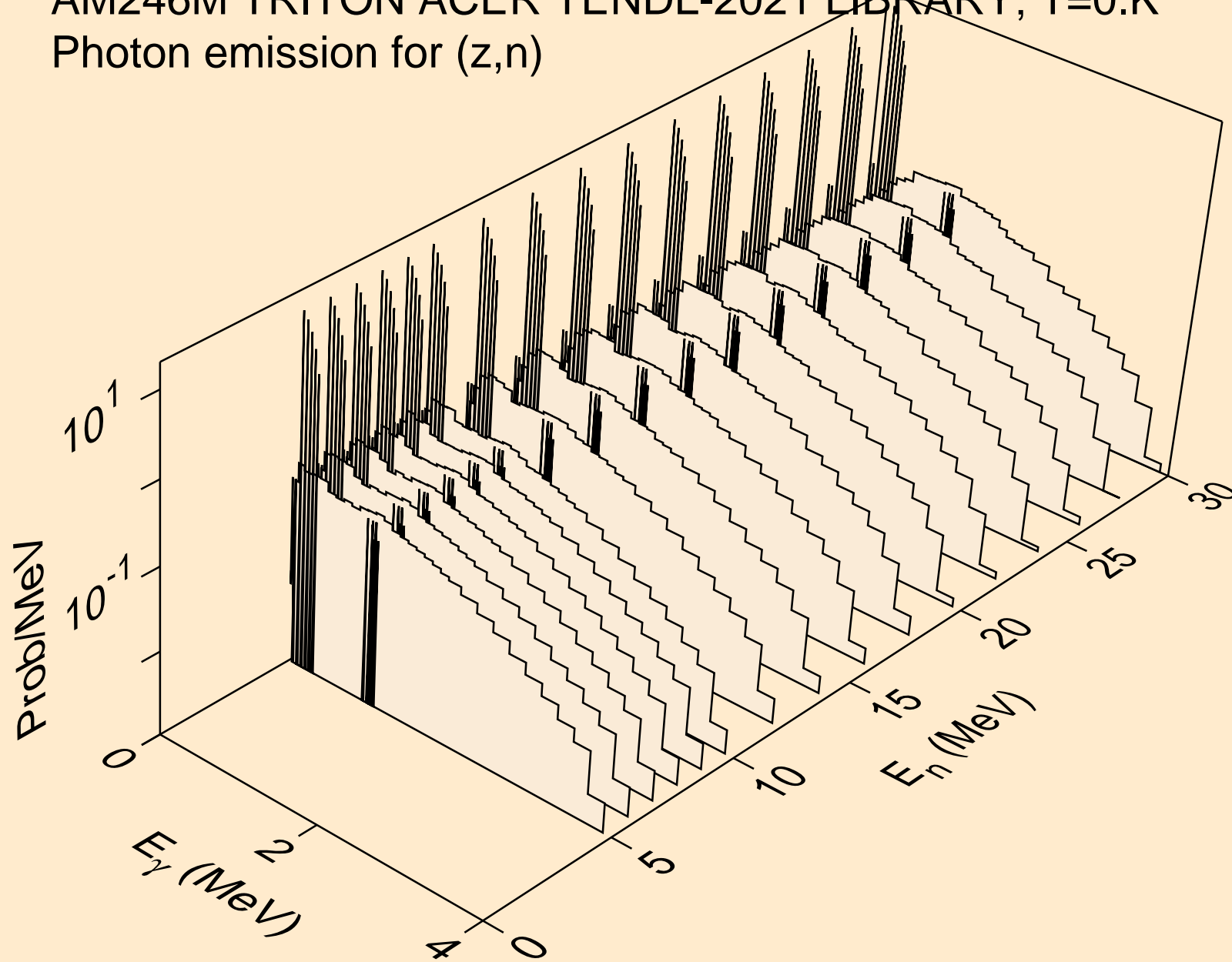



AM246M TRITON ACER TENDL-2021 LIBRARY; T=0.K  
Photon emission for (n,x)

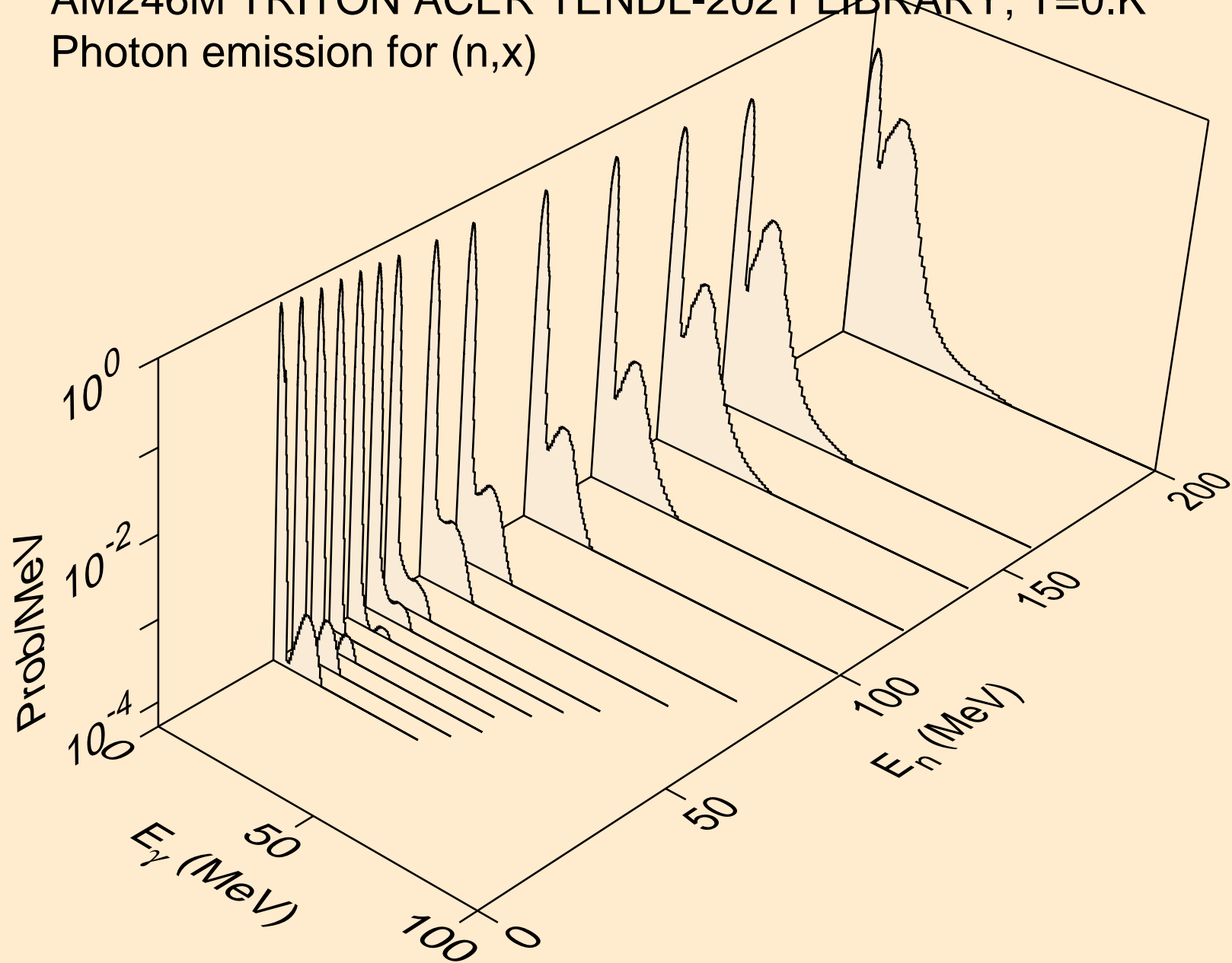

AM246M TRITON ACER TENDL-2021 LIBRARY; T=0.K  
Photon emission for (n,2nd)

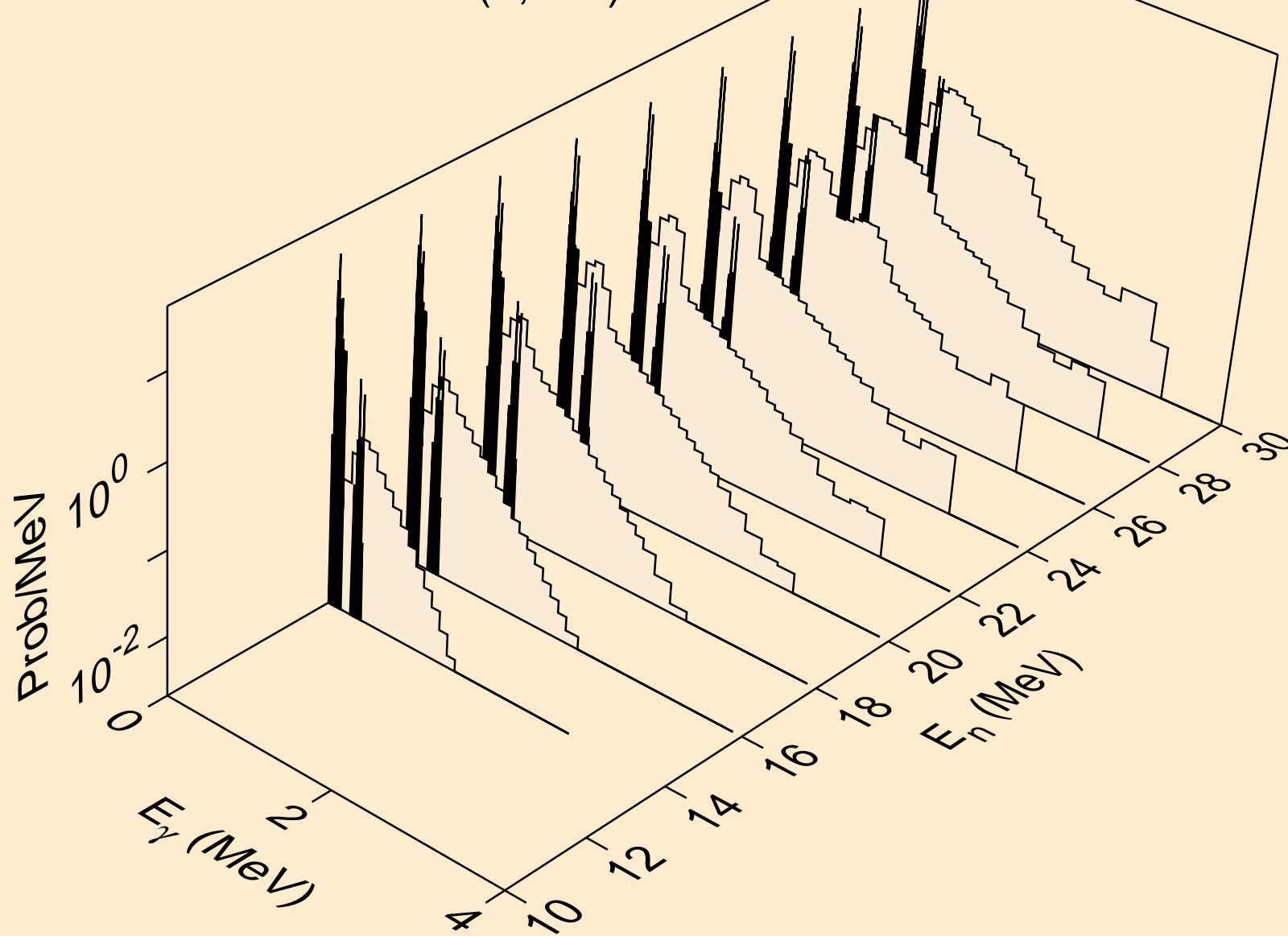

AM246M TRITON ACER TENDL-2021 LIBRARY; T=0.K  
Photon emission for (n,2n)

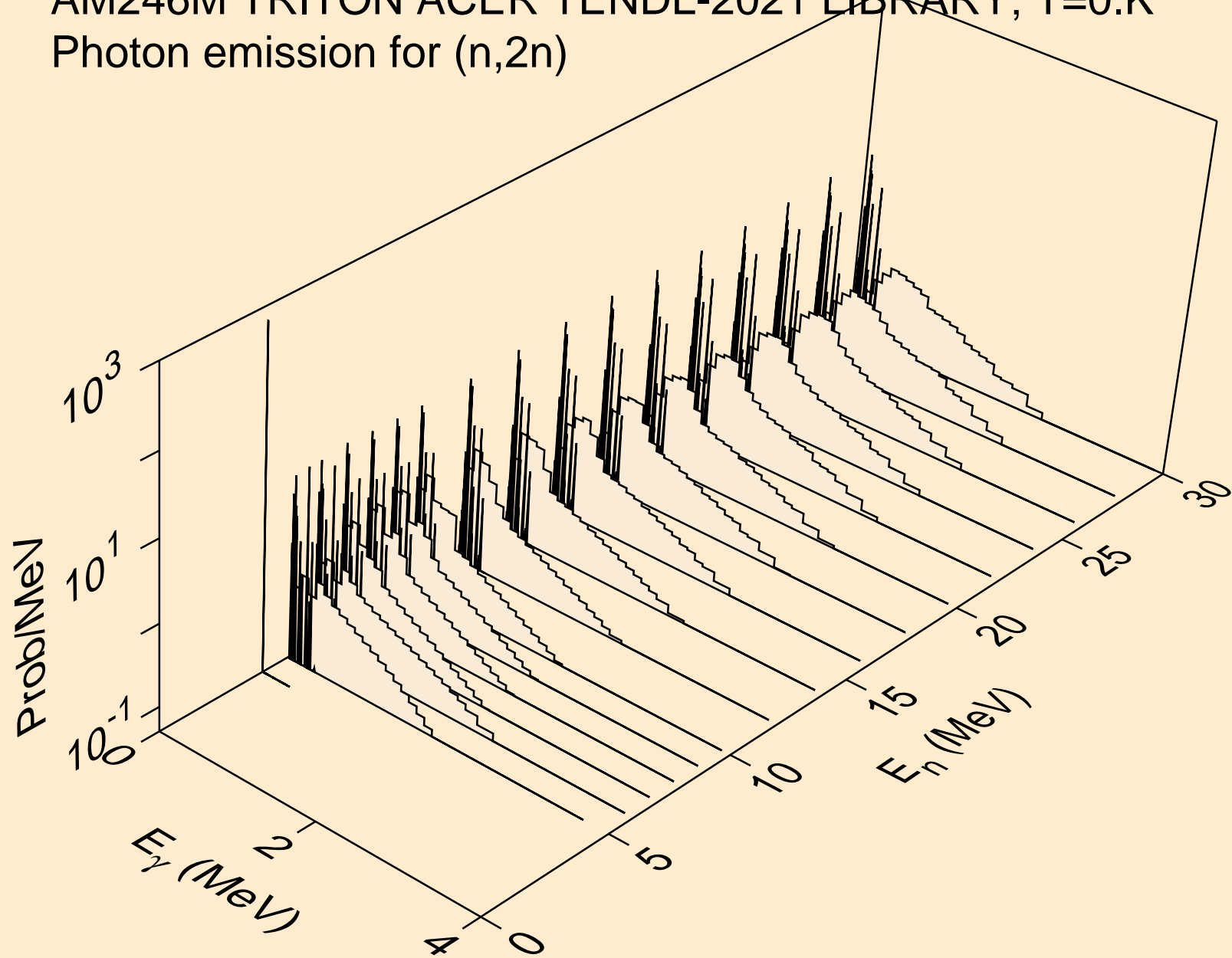

AM246M TRITON ACER TENDL-2021 LIBRARY; T=0.K  
Photon emission for (n,3n)

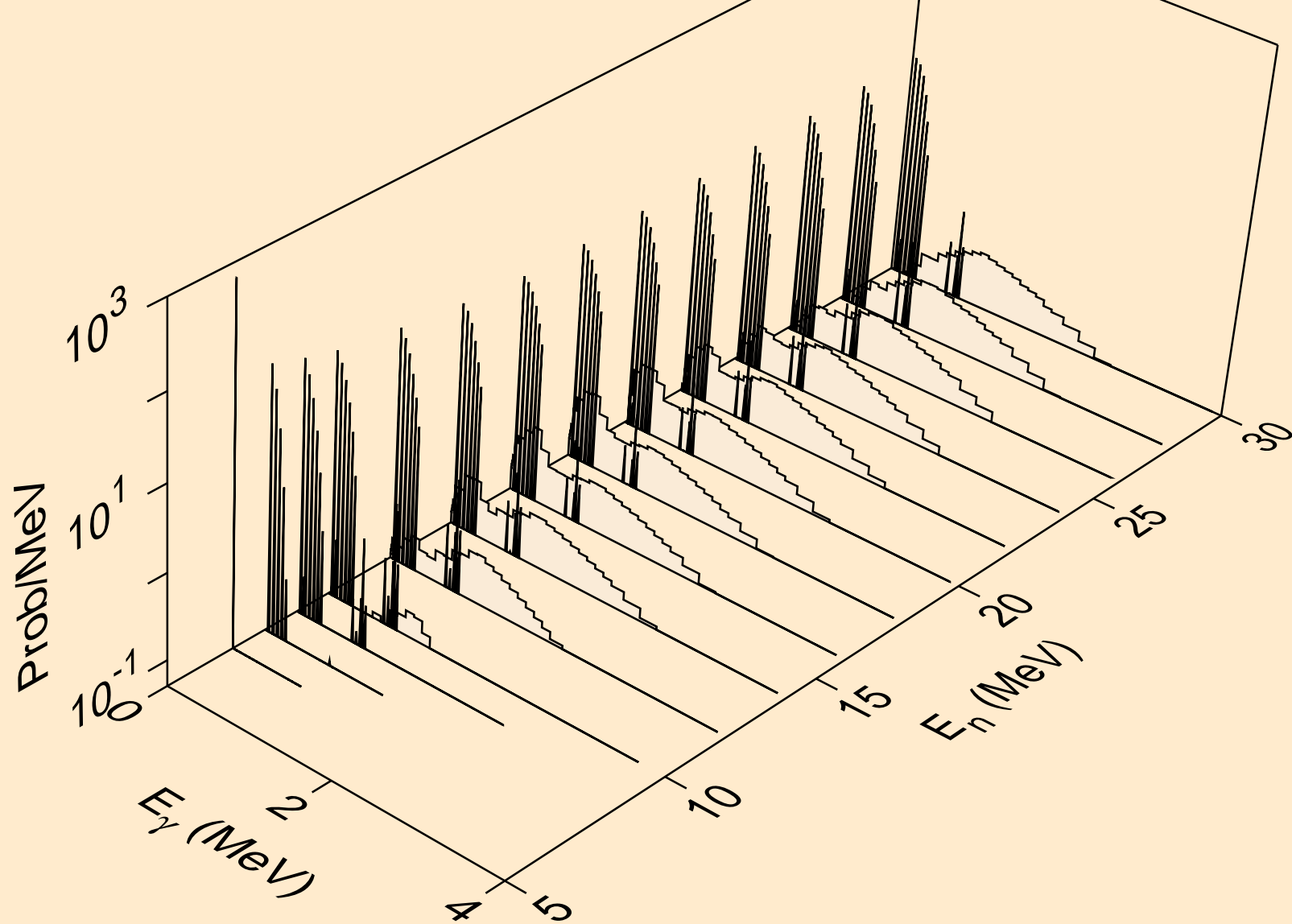

AM246M TRITON ACER TENDL-2021 LIBRARY; T=0.K  
Photon emission for (n,n\*)a

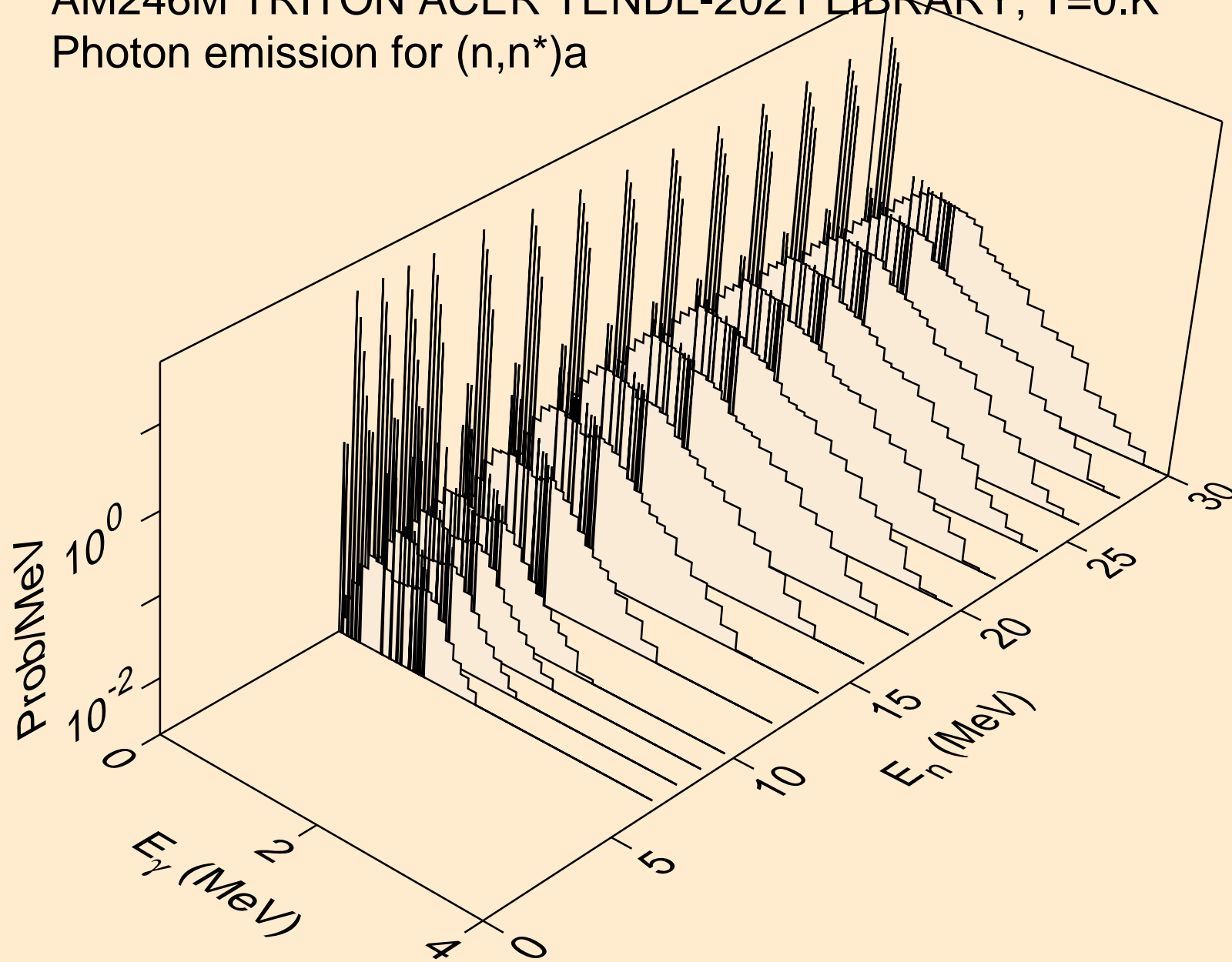

AM246M TRITON ACER TENDL-2021 LIBRARY; T=0.K  
Photon emission for (n,2n)a

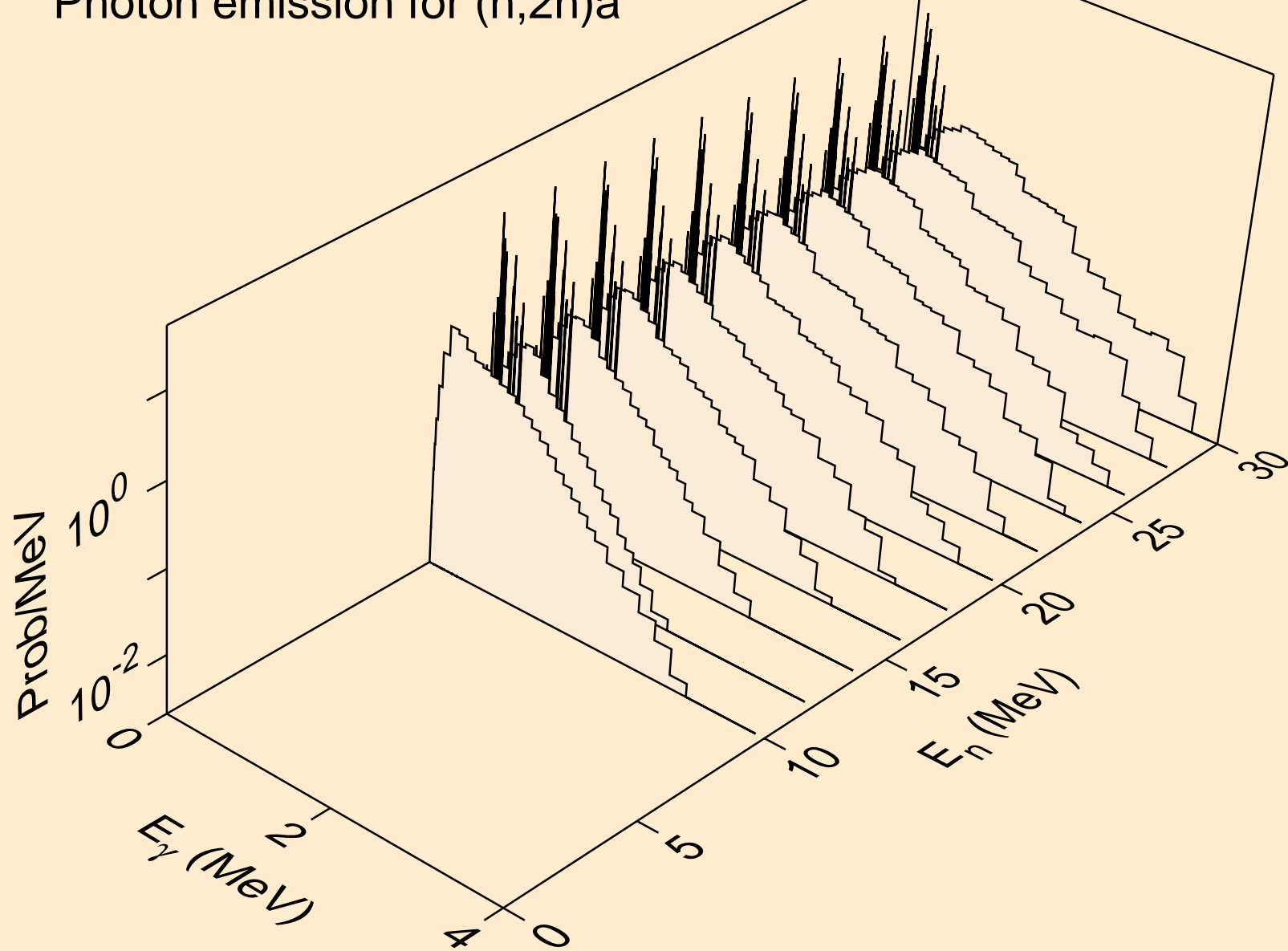

AM246M TRITON ACER TENDL-2021 LIBRARY; T=0.K  
Photon emission for (n,3n)a

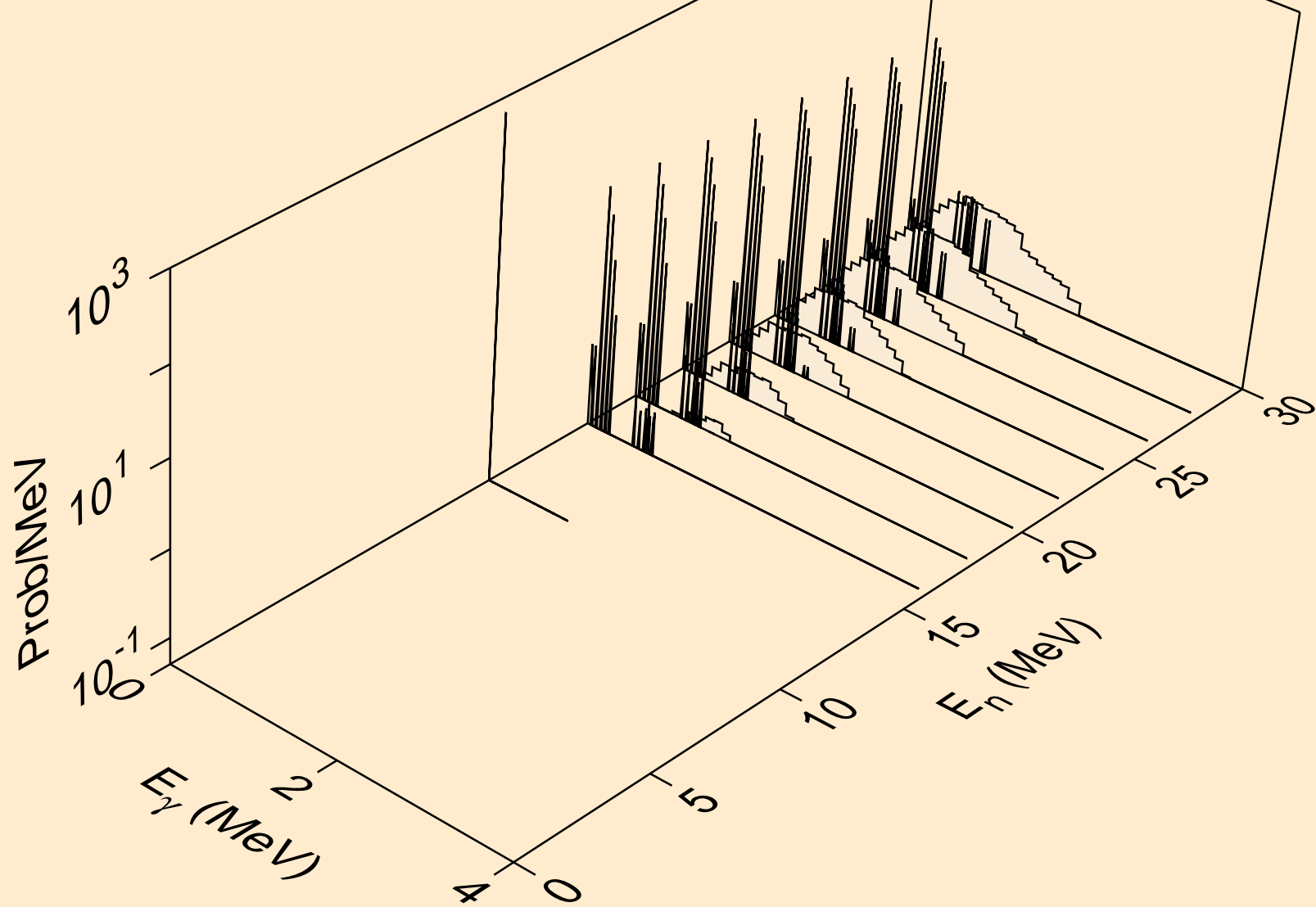

AM246M TRITON ACER TENDL-2021 LIBRARY; T=0.K  
Photon emission for (n,n\*)p

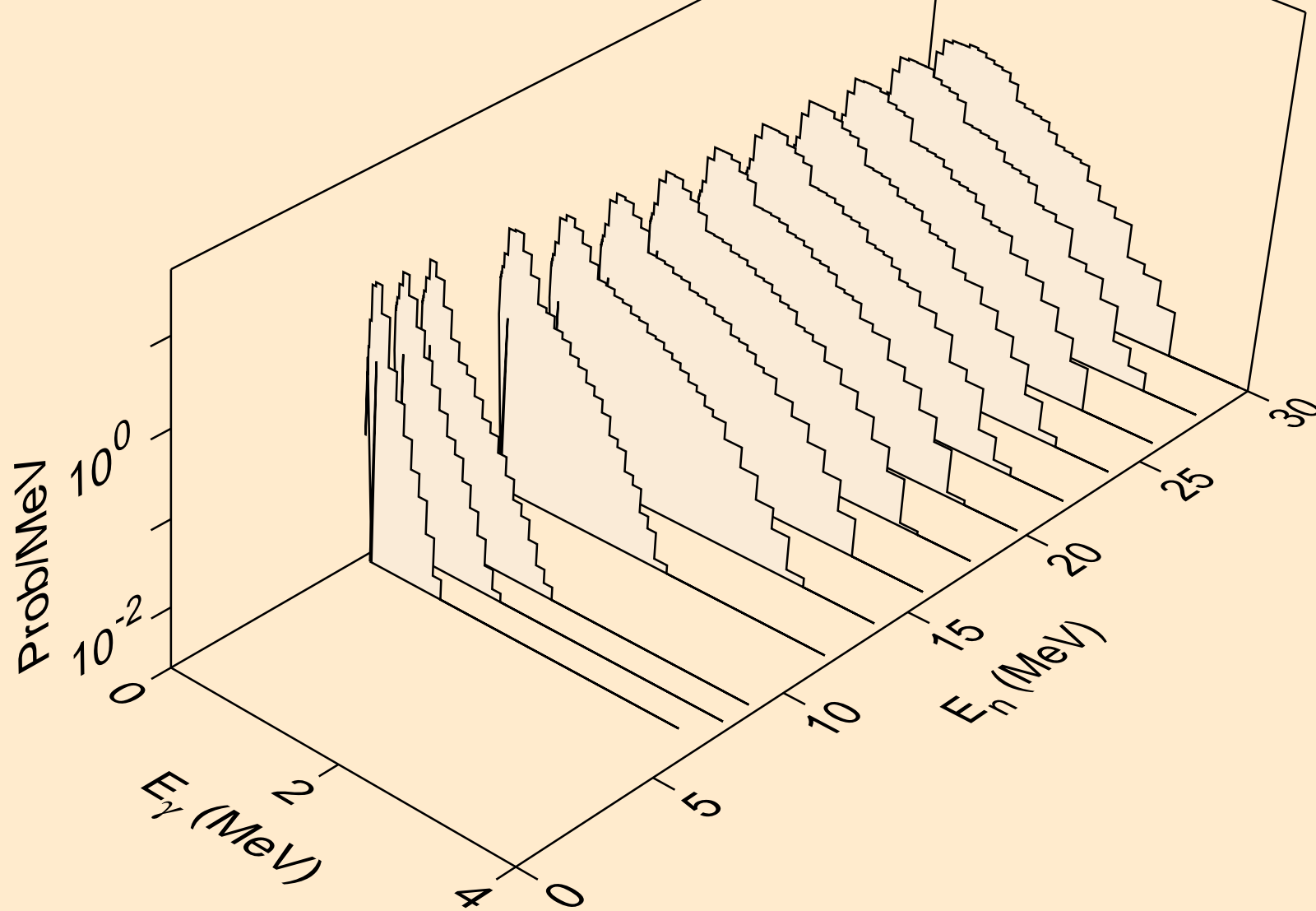



AM246M TRITON ACER TENDL-2021 LIBRARY; T=0.K  
Photon emission for (n,n\*)d

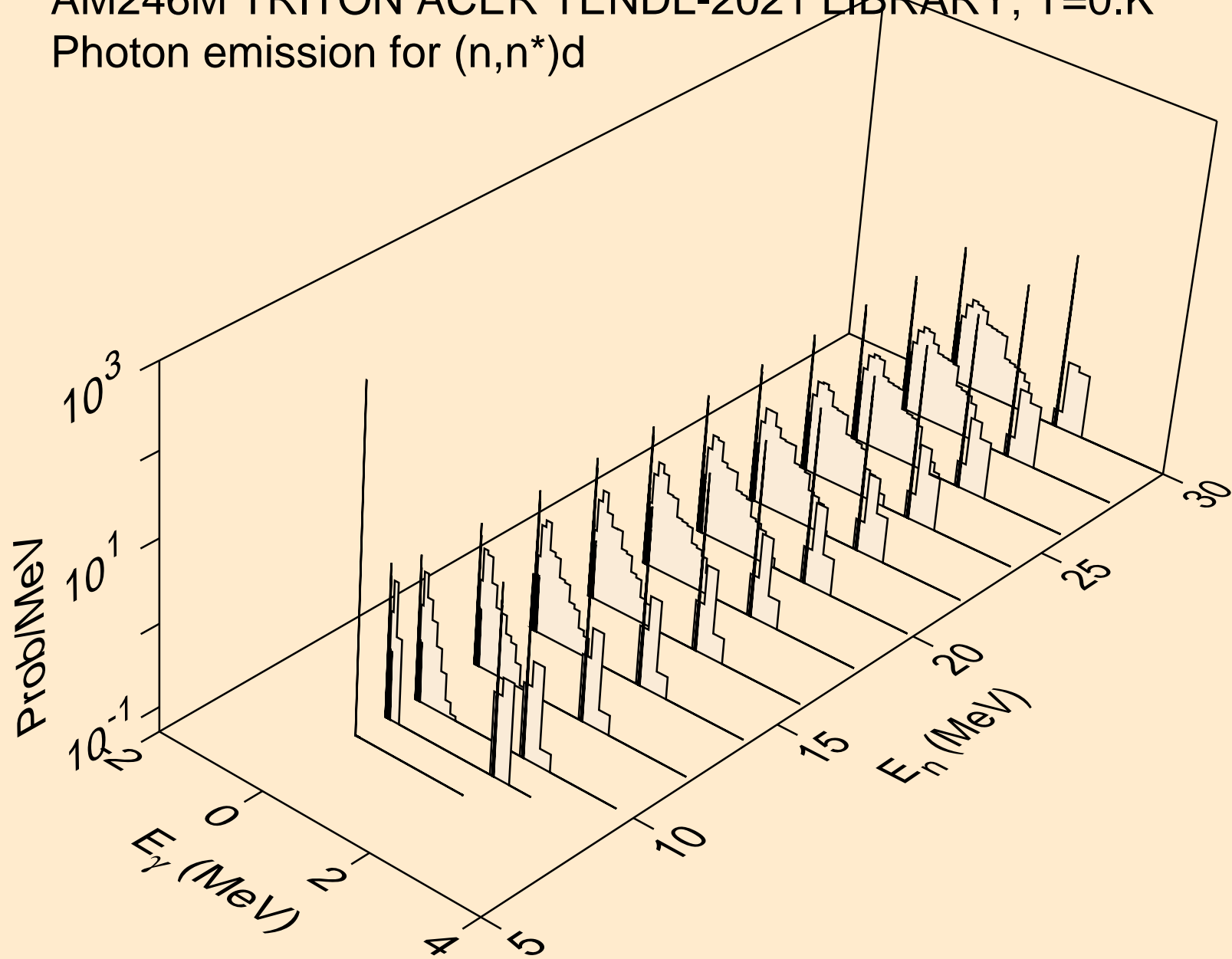

AM246M TRITON ACER TENDL-2021 LIBRARY; T=0.K  
Photon emission for (n,n\*)t

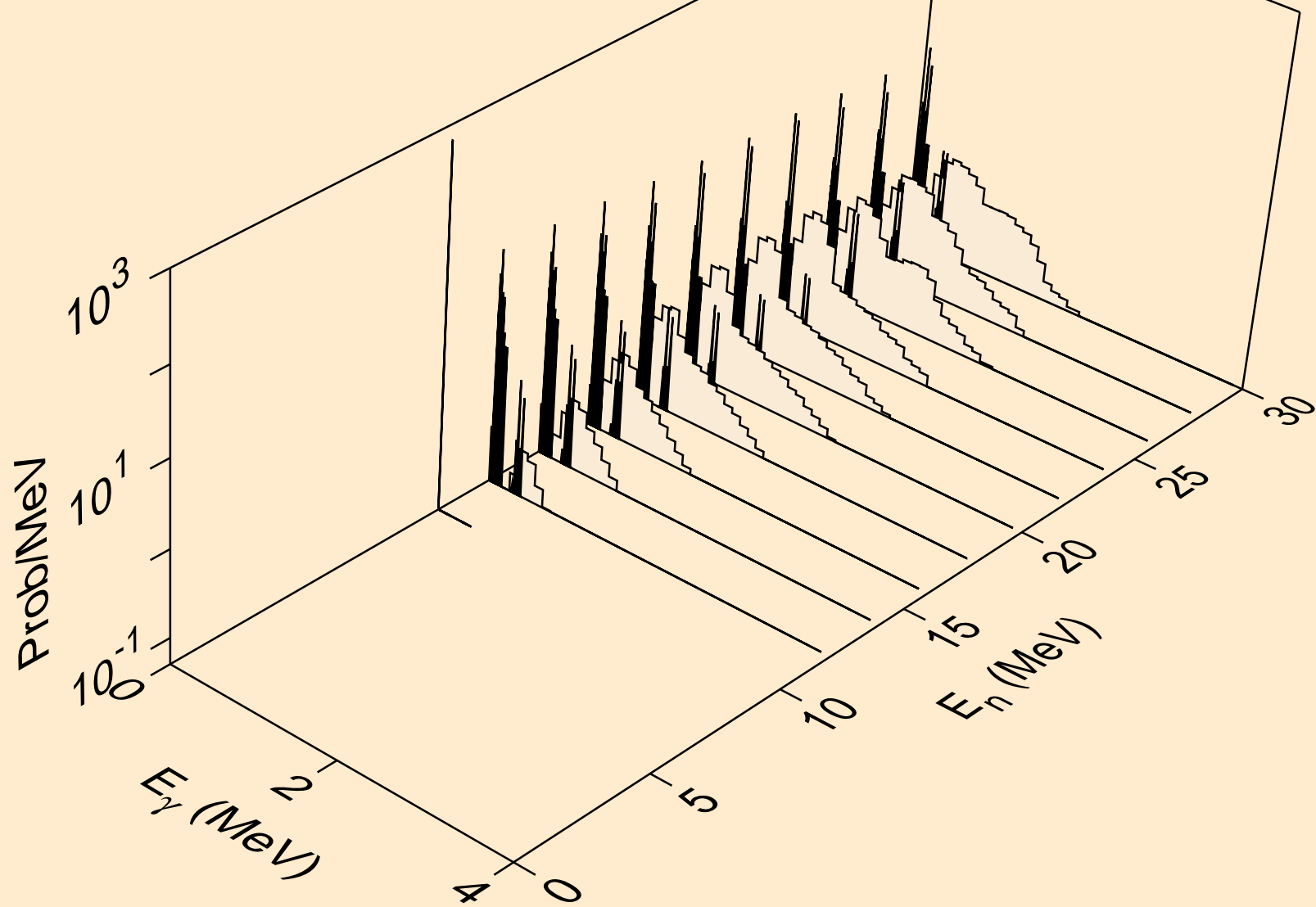

AM246M TRITON ACER TENDL-2021 LIBRARY; T=0.K  
Photon emission for (n,n\*)he3

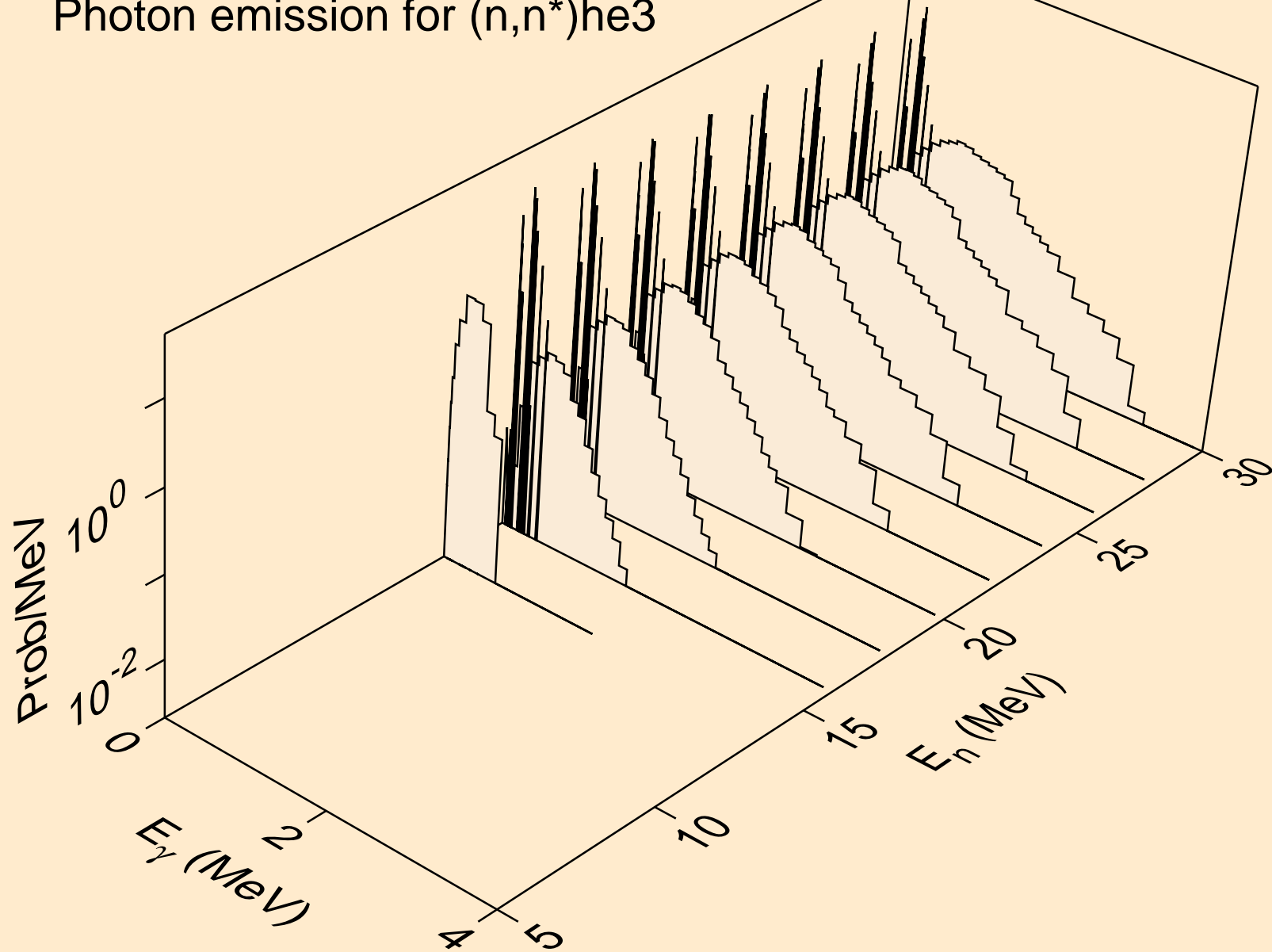

AM246M TRITON ACER TENDL-2021 LIBRARY; T=0.K  
Photon emission for (n,4n)

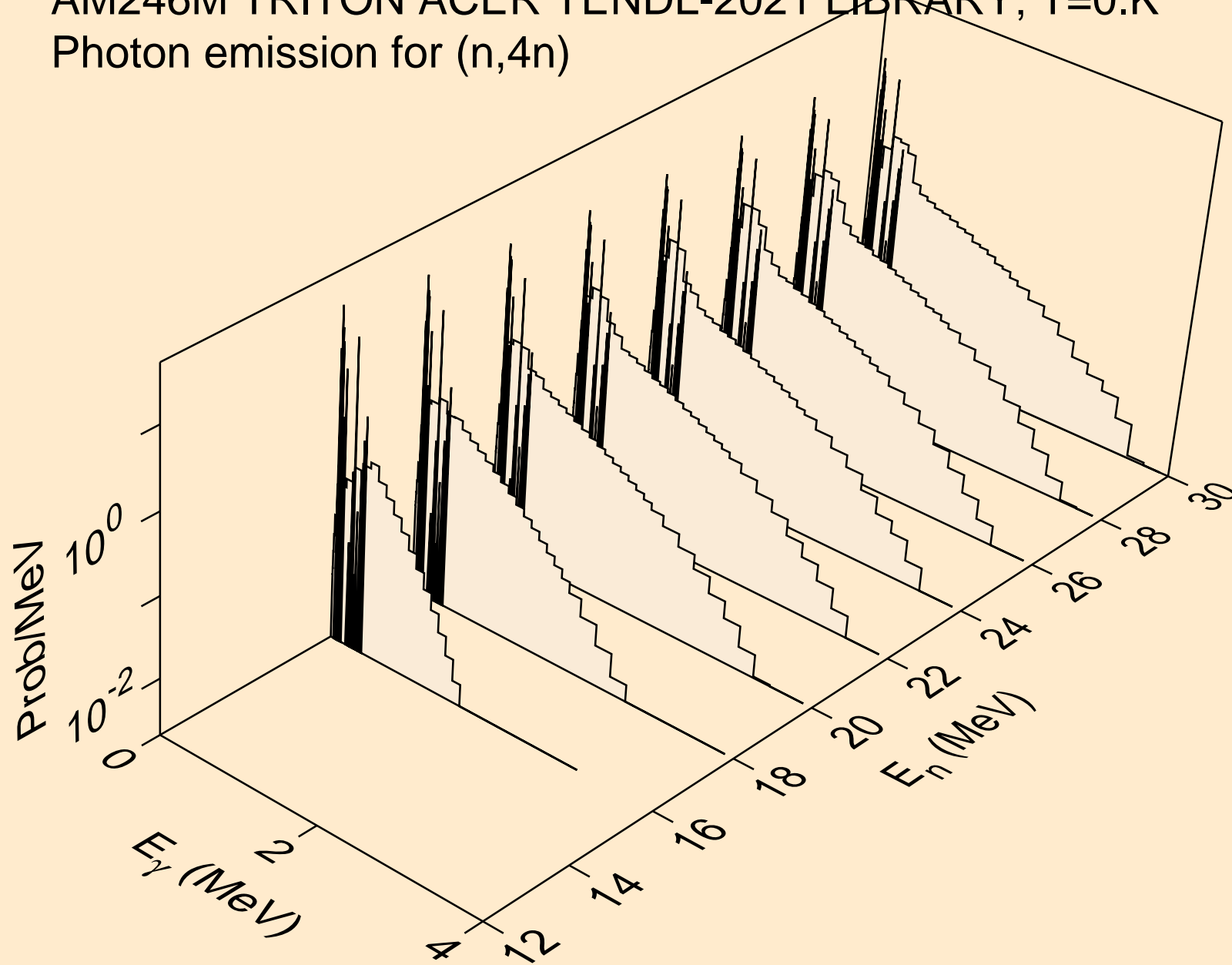

AM246M TRITON ACER TENDL-2021 LIBRARY; T=0.K  
Photon emission for (n,2np)

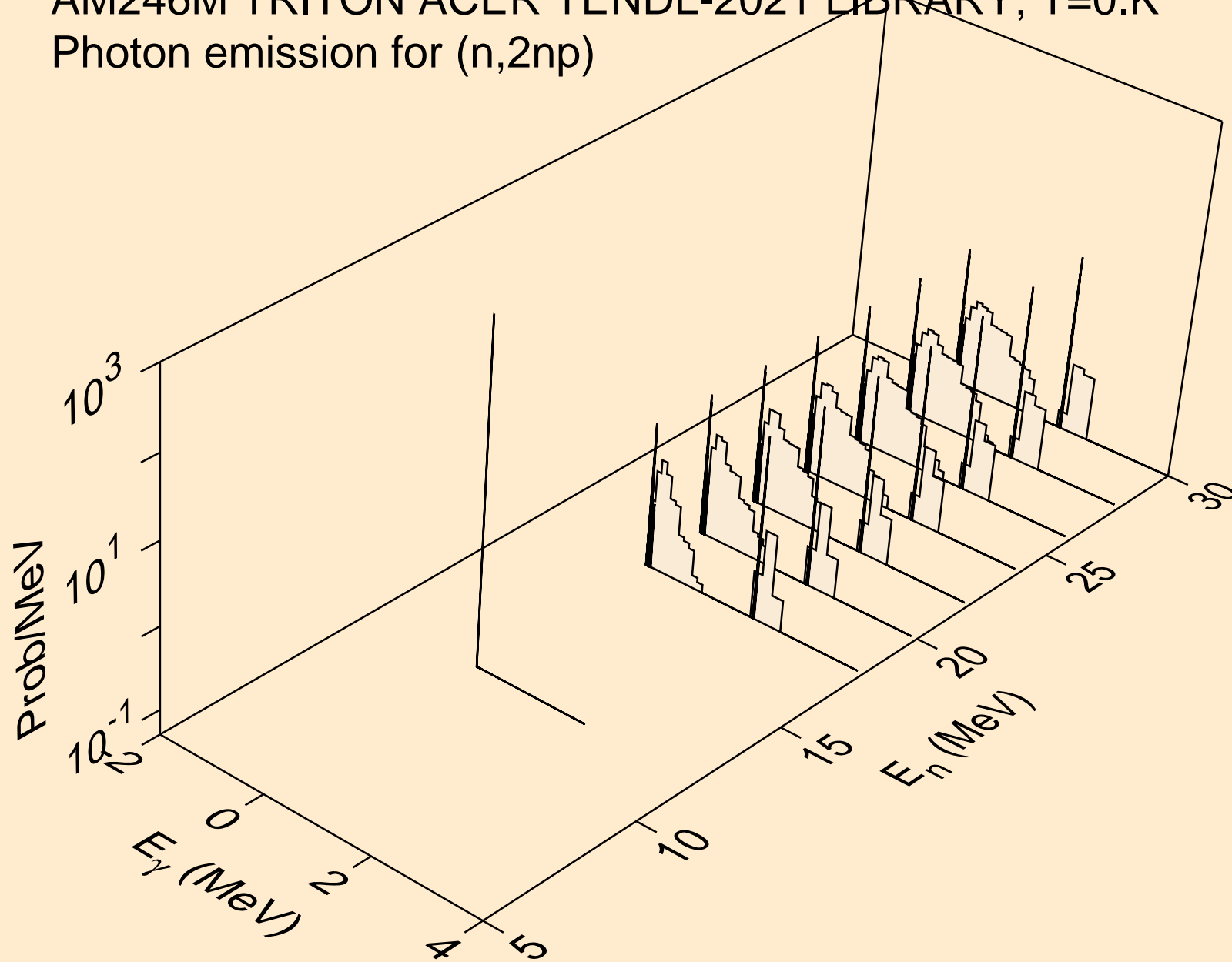

AM246M TRITON ACER TENDL-2021 LIBRARY; T=0.K  
Photon emission for (n,3np)

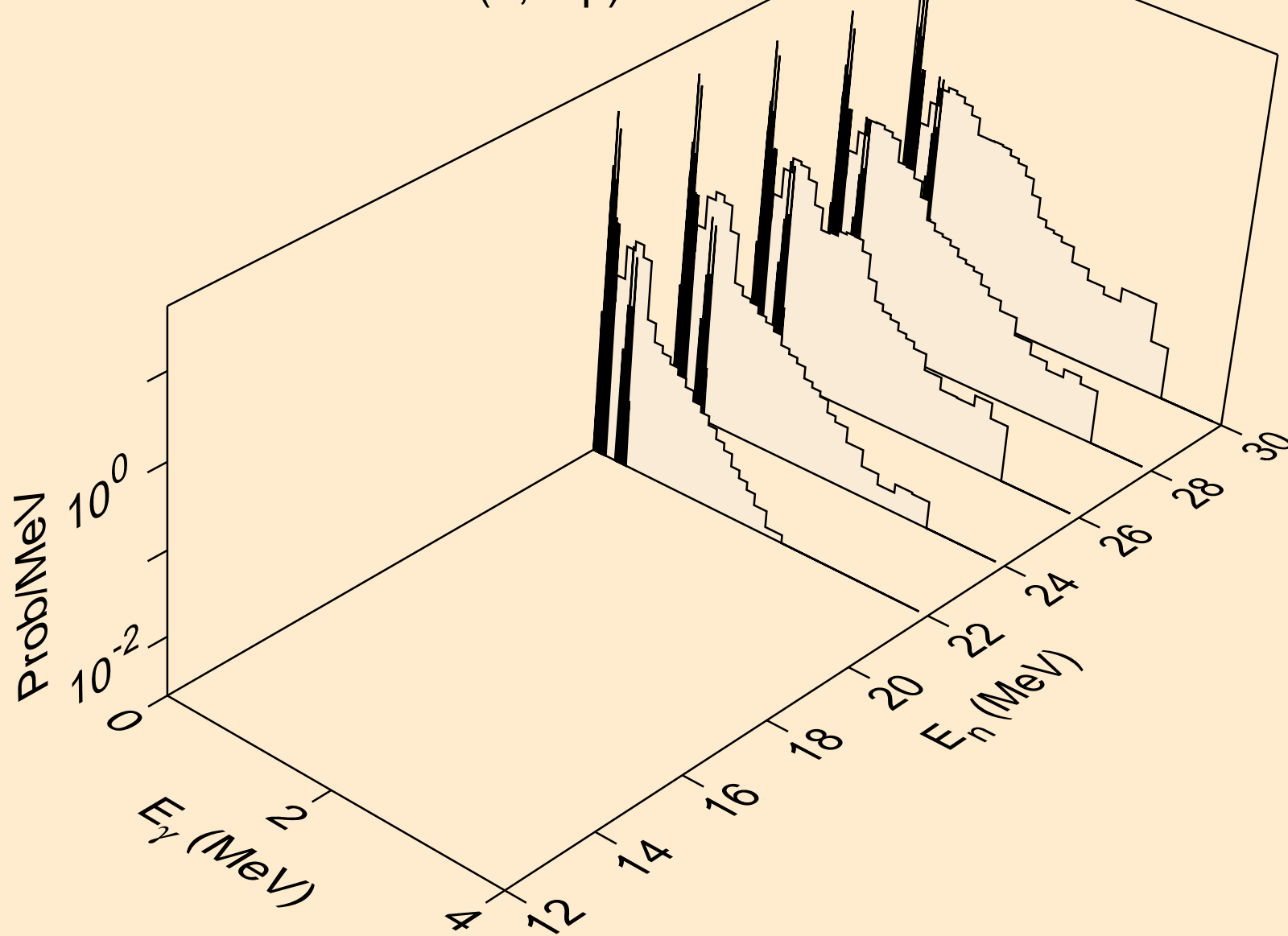

AM246M TRITON ACER TENDL-2021 LIBRARY; T=0.K  
Photon emission for (n,2np)

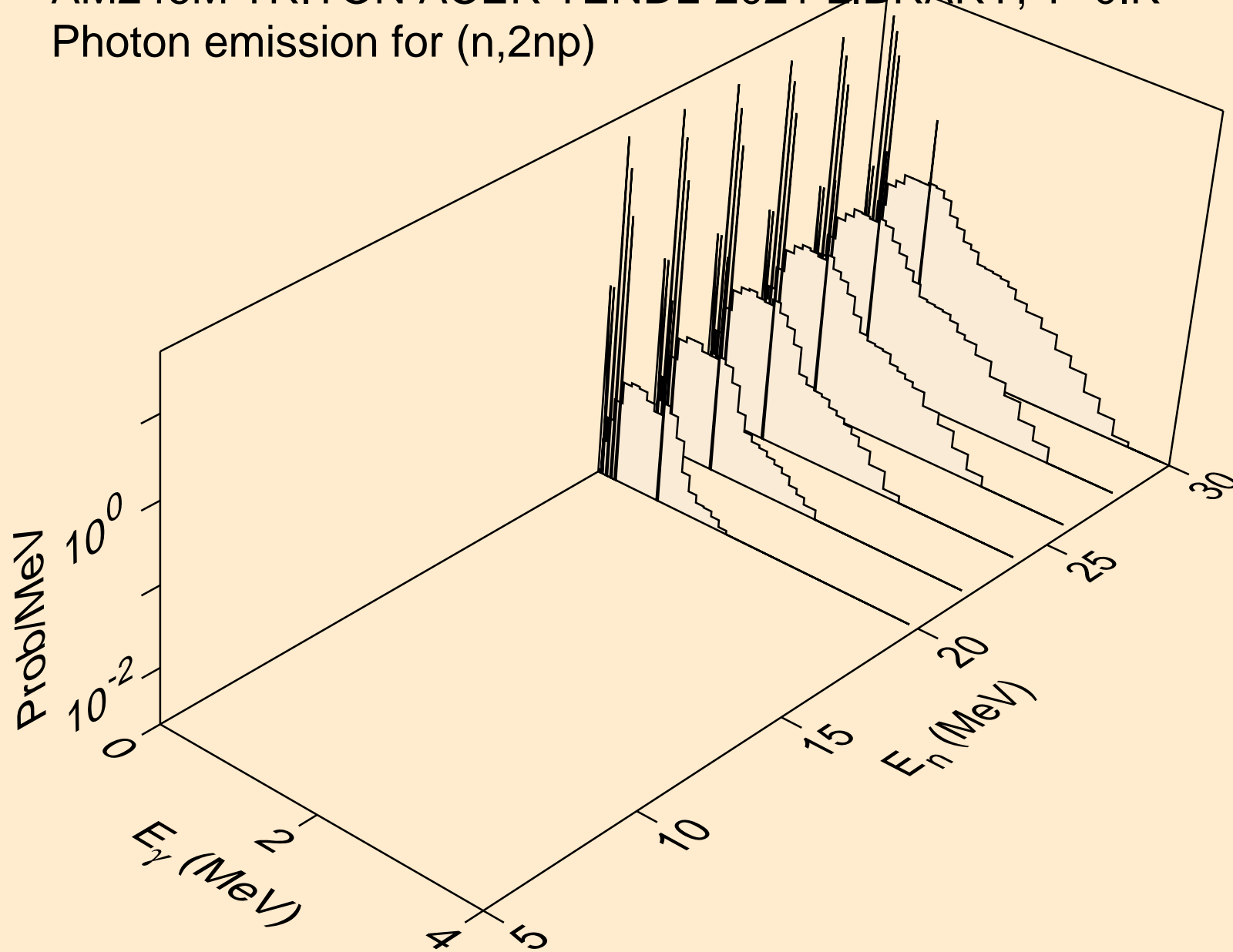

AM246M TRITON ACER TENDL-2021 LIBRARY; T=0.K  
Photon emission for (n,gma)

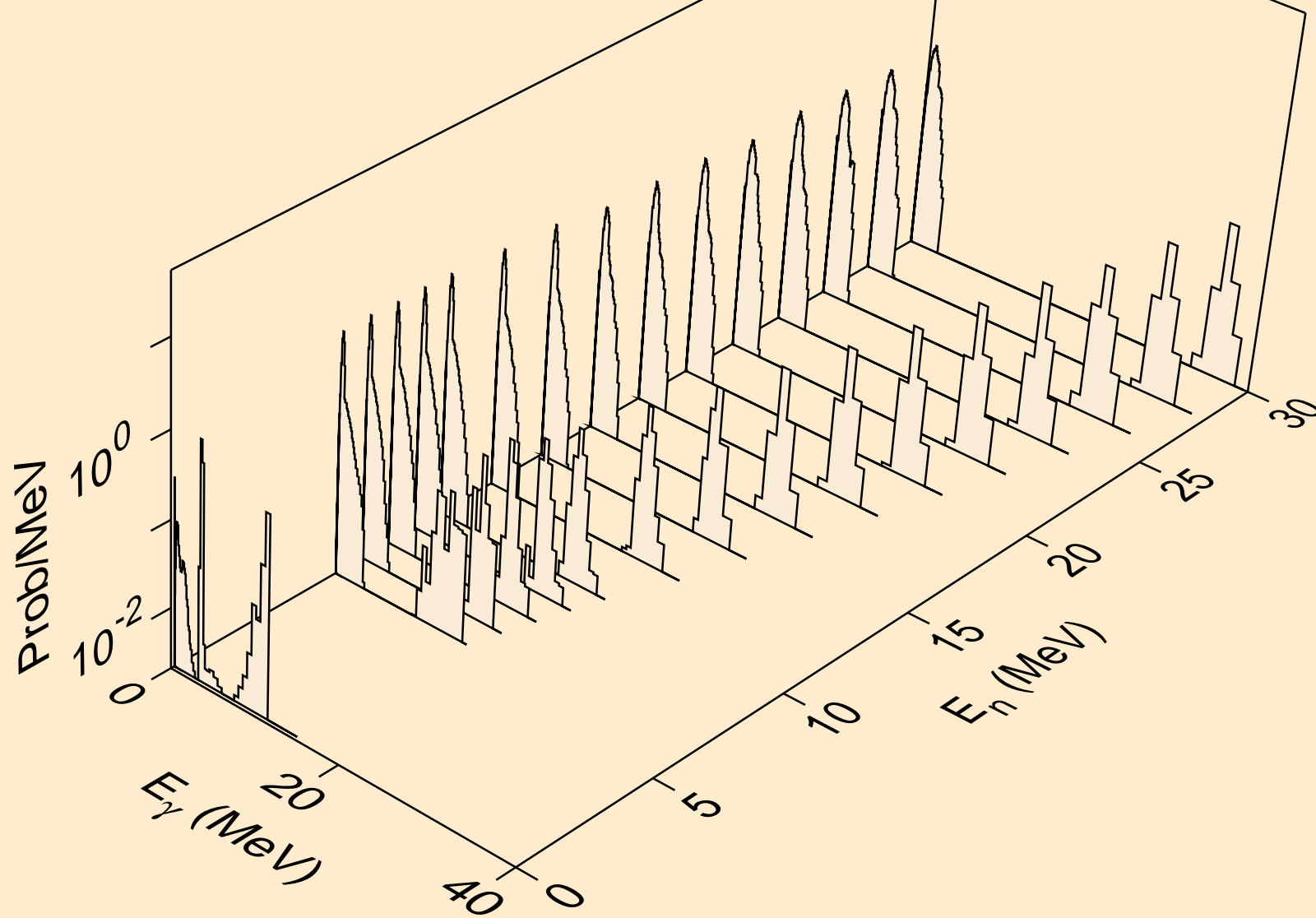



AM246M TRITON ACER TENDL-2021 LIBRARY; T=0.K  
Photon emission for (n,p)

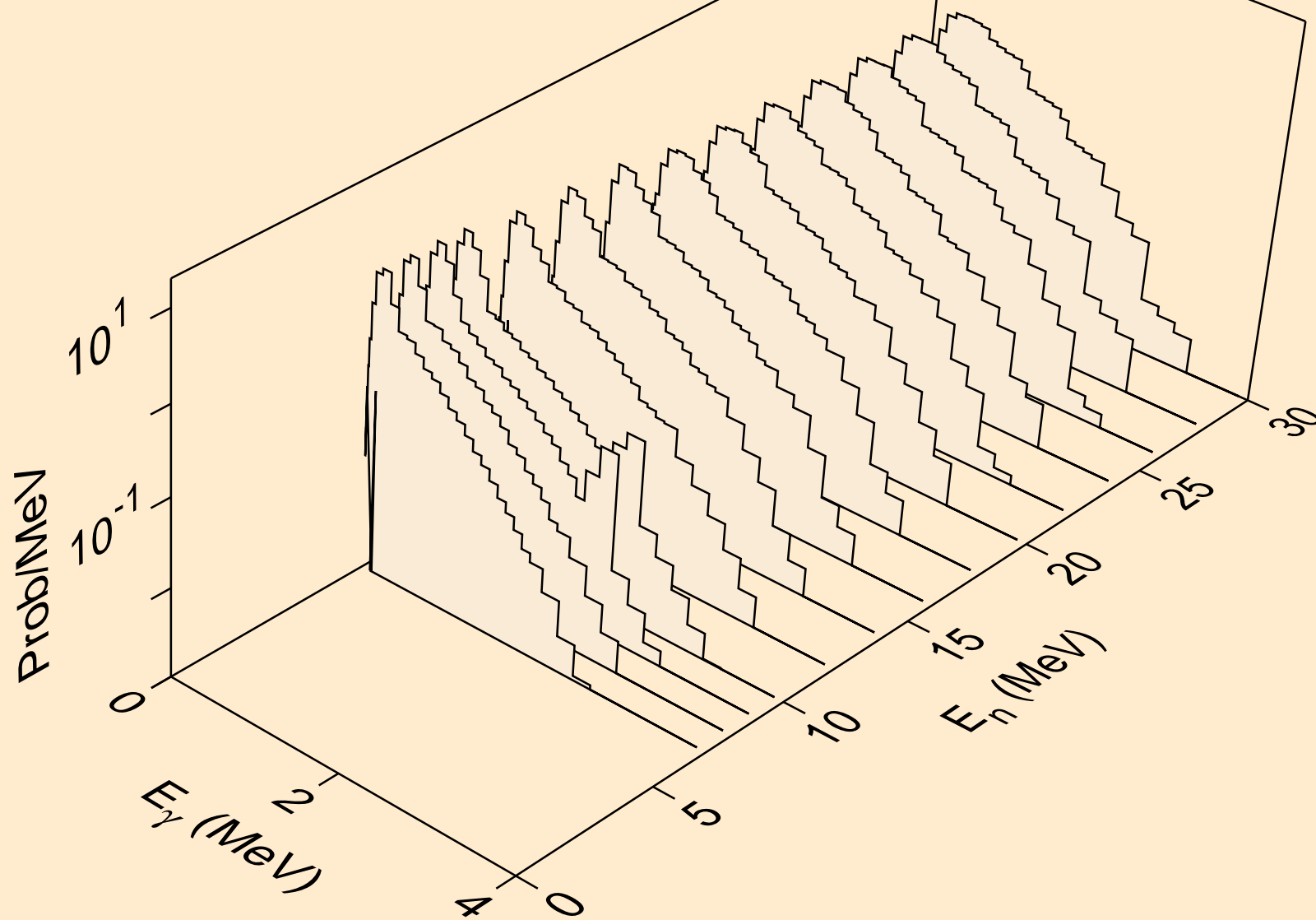

AM246M TRITON ACER TENDL-2021 LIBRARY; T=0.K  
Photon emission for (n,d)

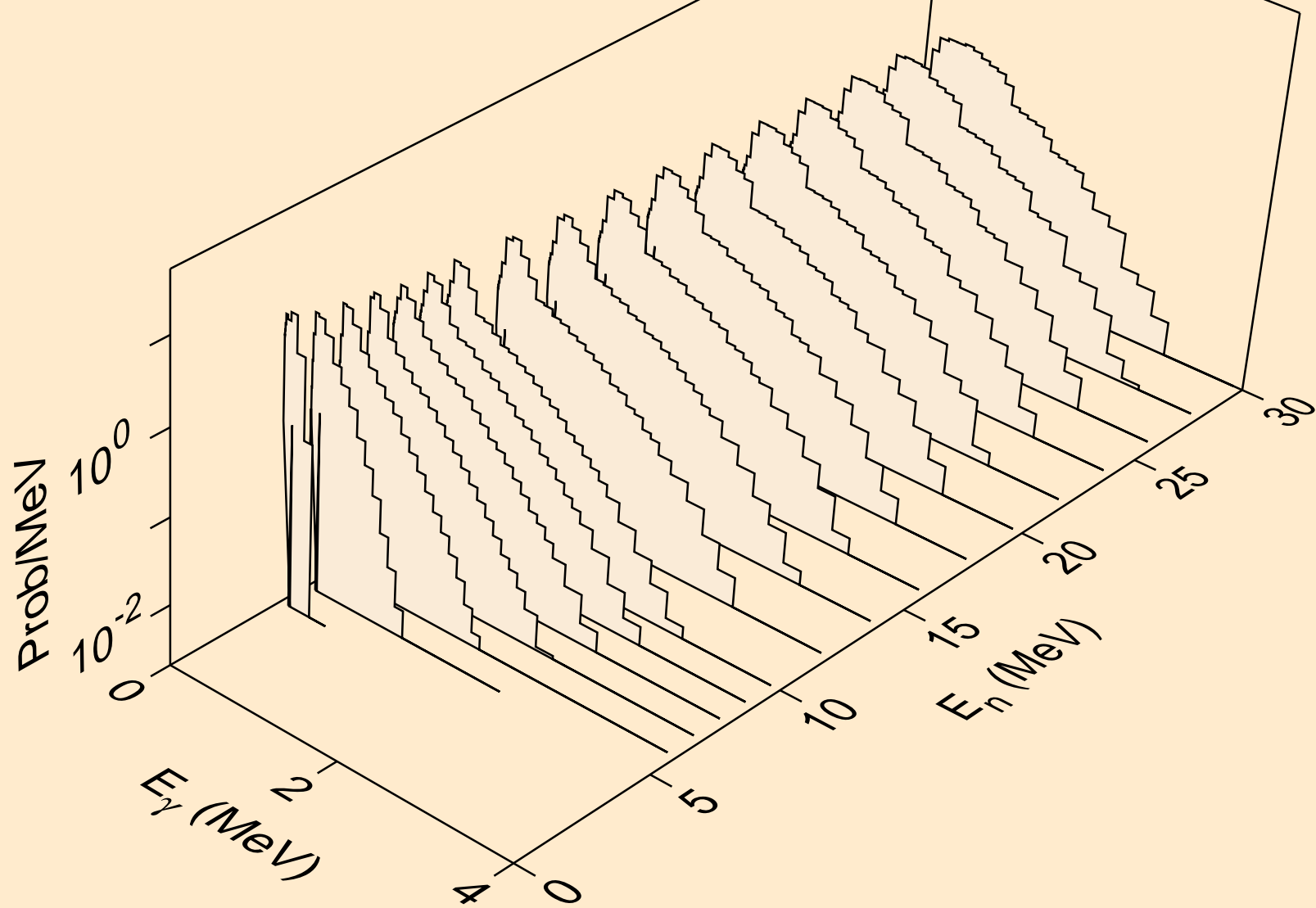

AM246M TRITON ACER TENDL-2021 LIBRARY; T=0.K  
Photon emission for inelastic

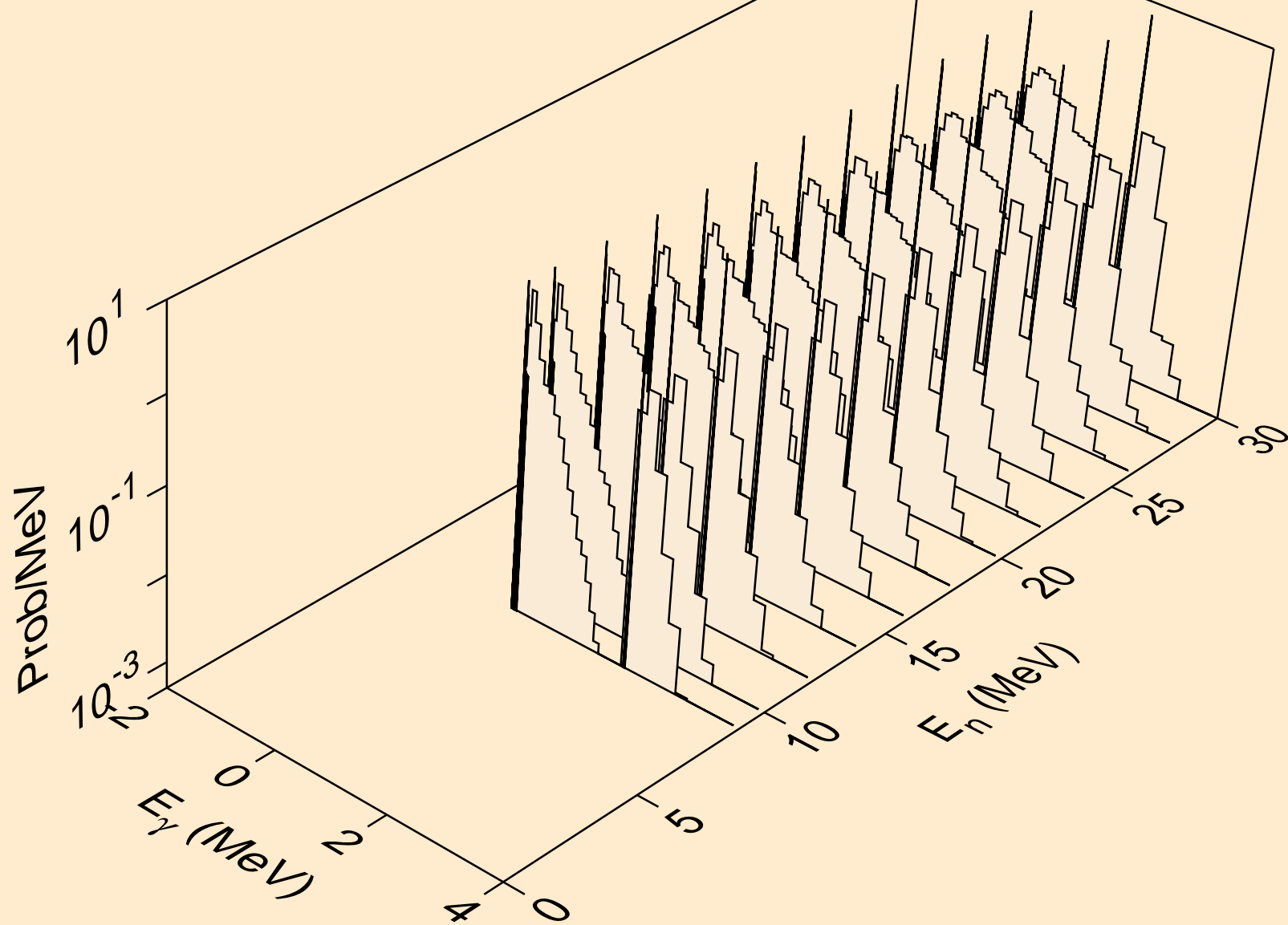

AM246M TRITON ACER TENDL-2021 LIBRARY; T=0.K  
Photon emission for (n,he3)

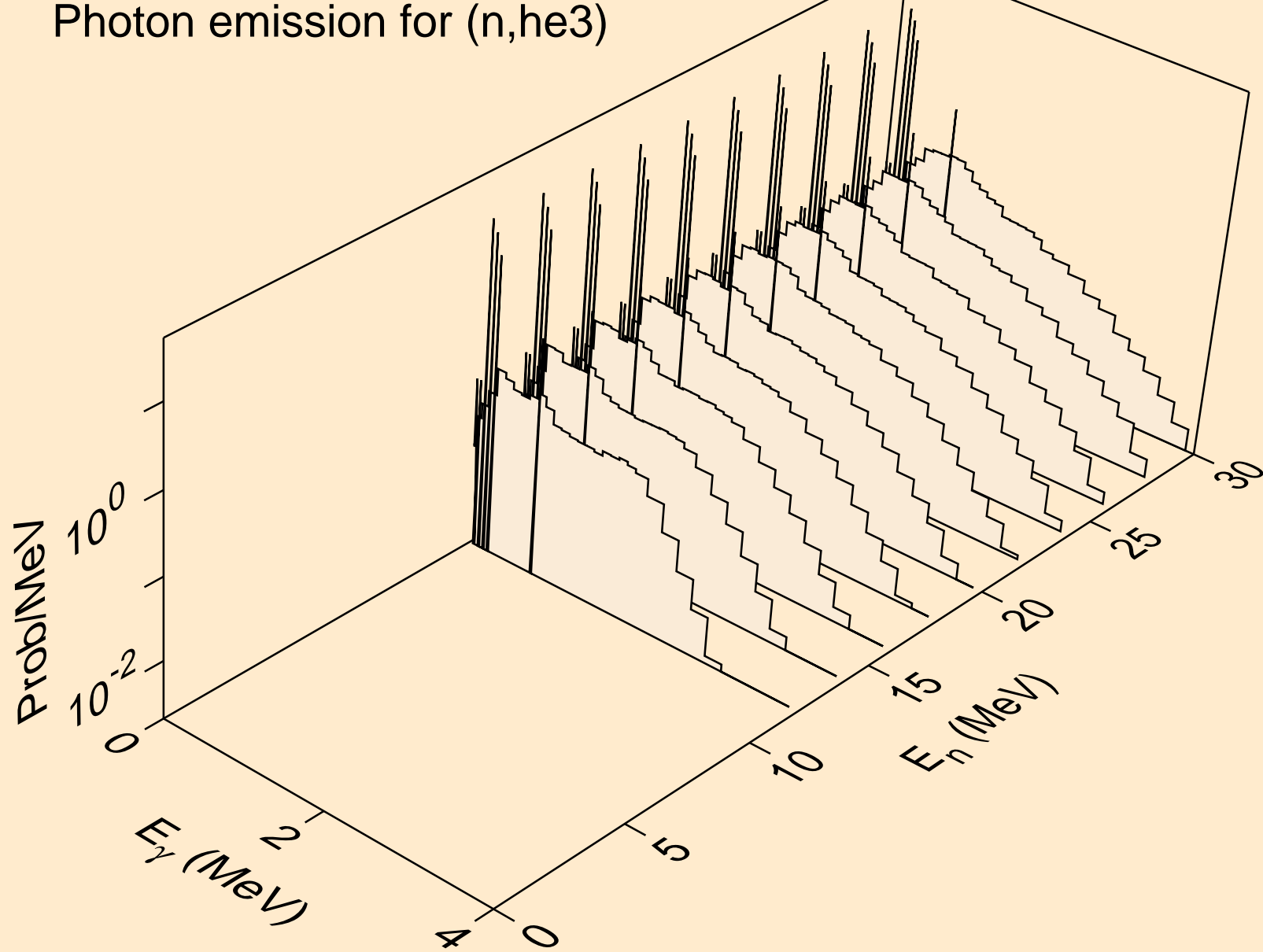

AM246M TRITON ACER TENDL-2021 LIBRARY; T=0.K  
Photon emission for (n,a)

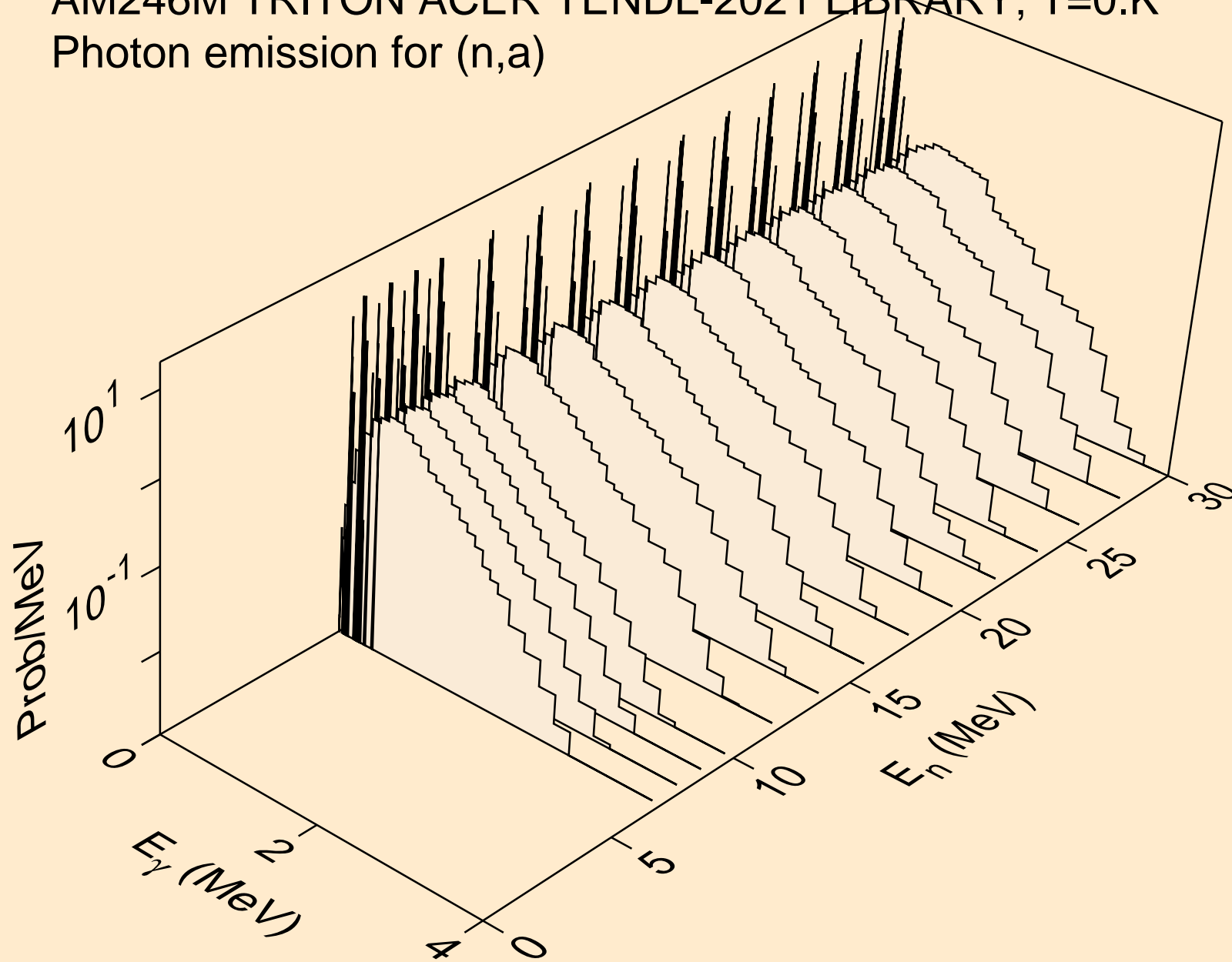

AM246M TRITON ACER TENDL-2021 LIBRARY; T=0.K  
Photon emission for (n,2p)

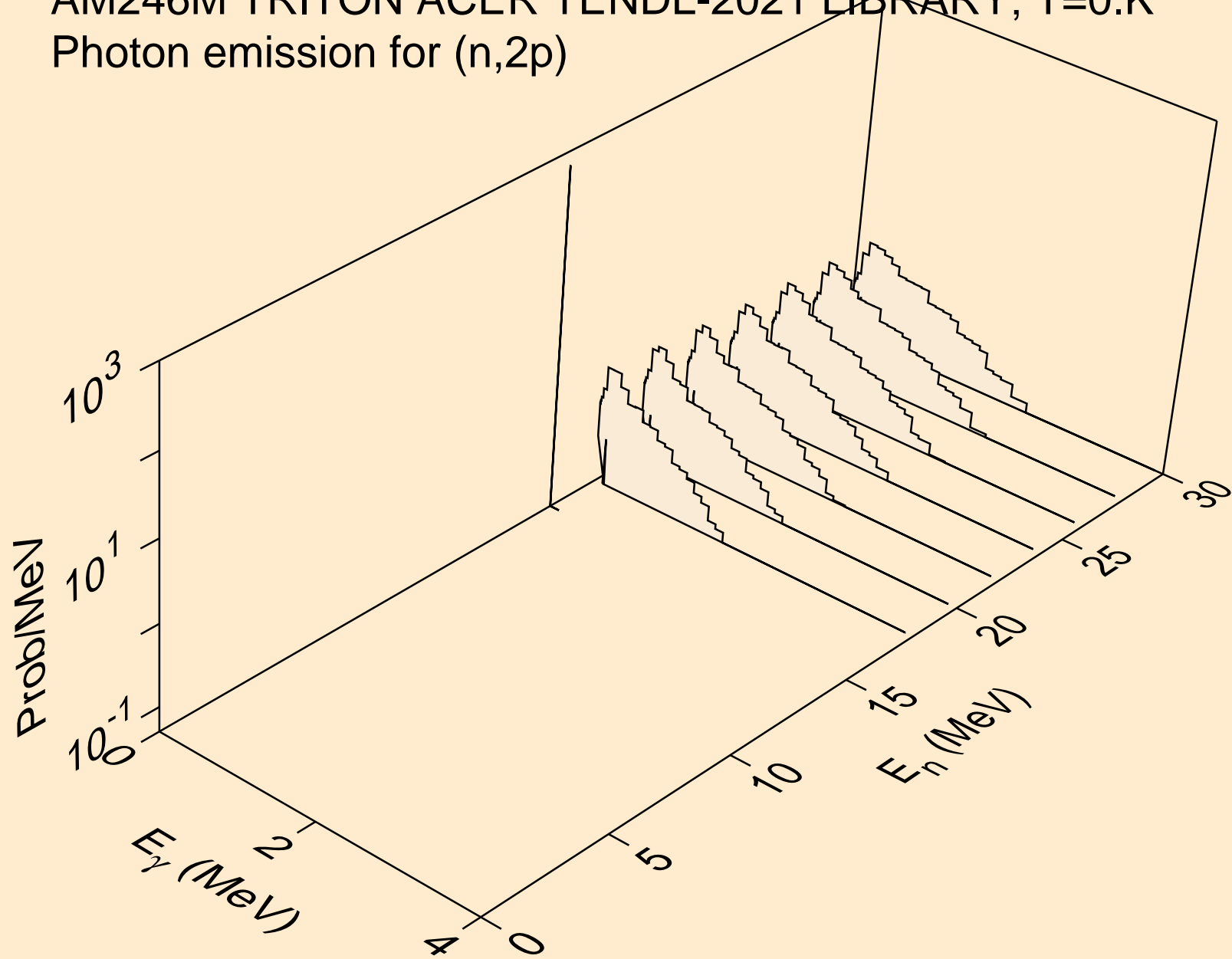

AM246M TRITON ACER TENDL-2021 LIBRARY; T=0.K  
Particle heating contributions

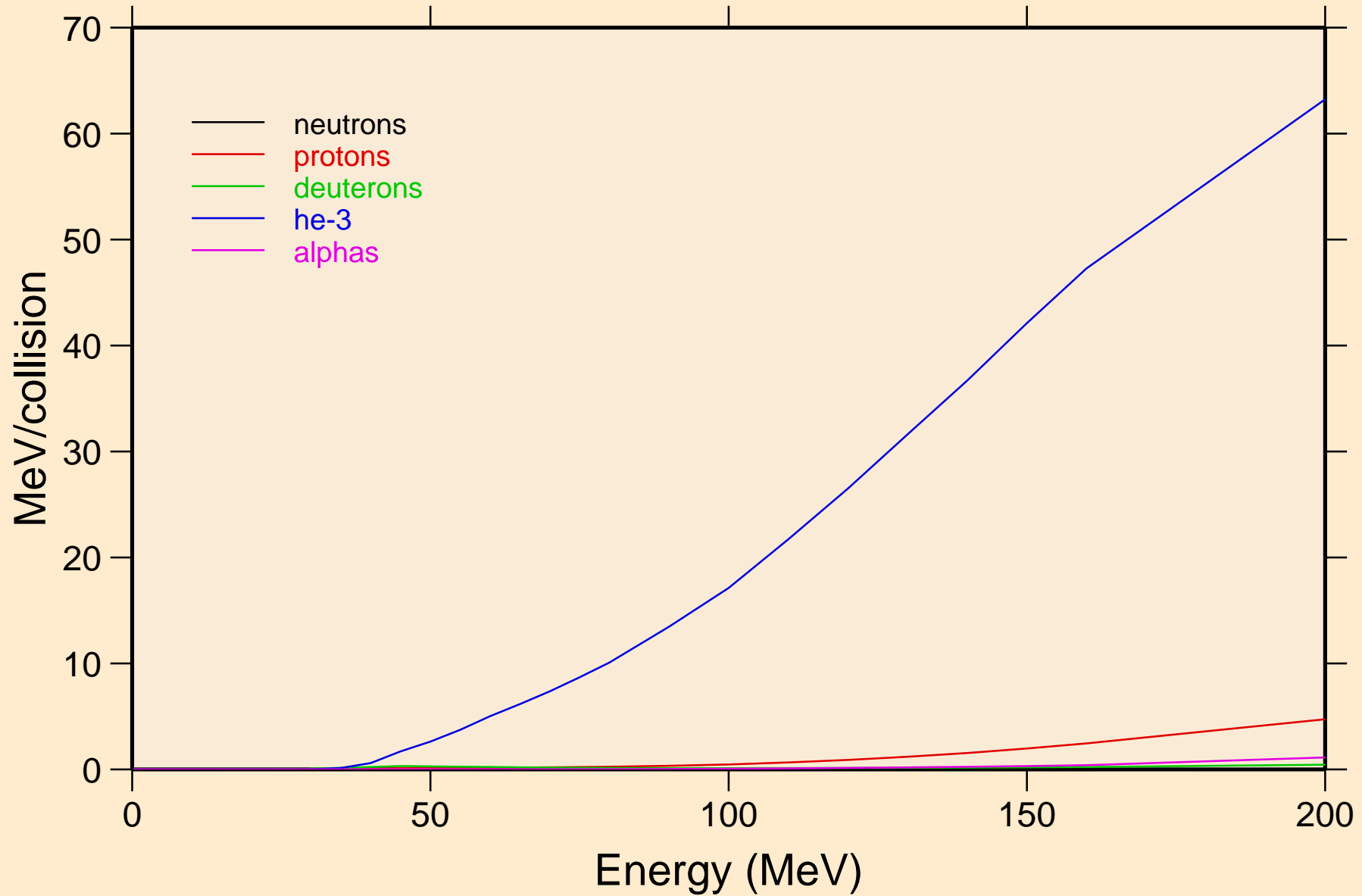

AM246M TRITON ACER TENDL-2021 LIBRARY; T=0.K  
Recoil Heating

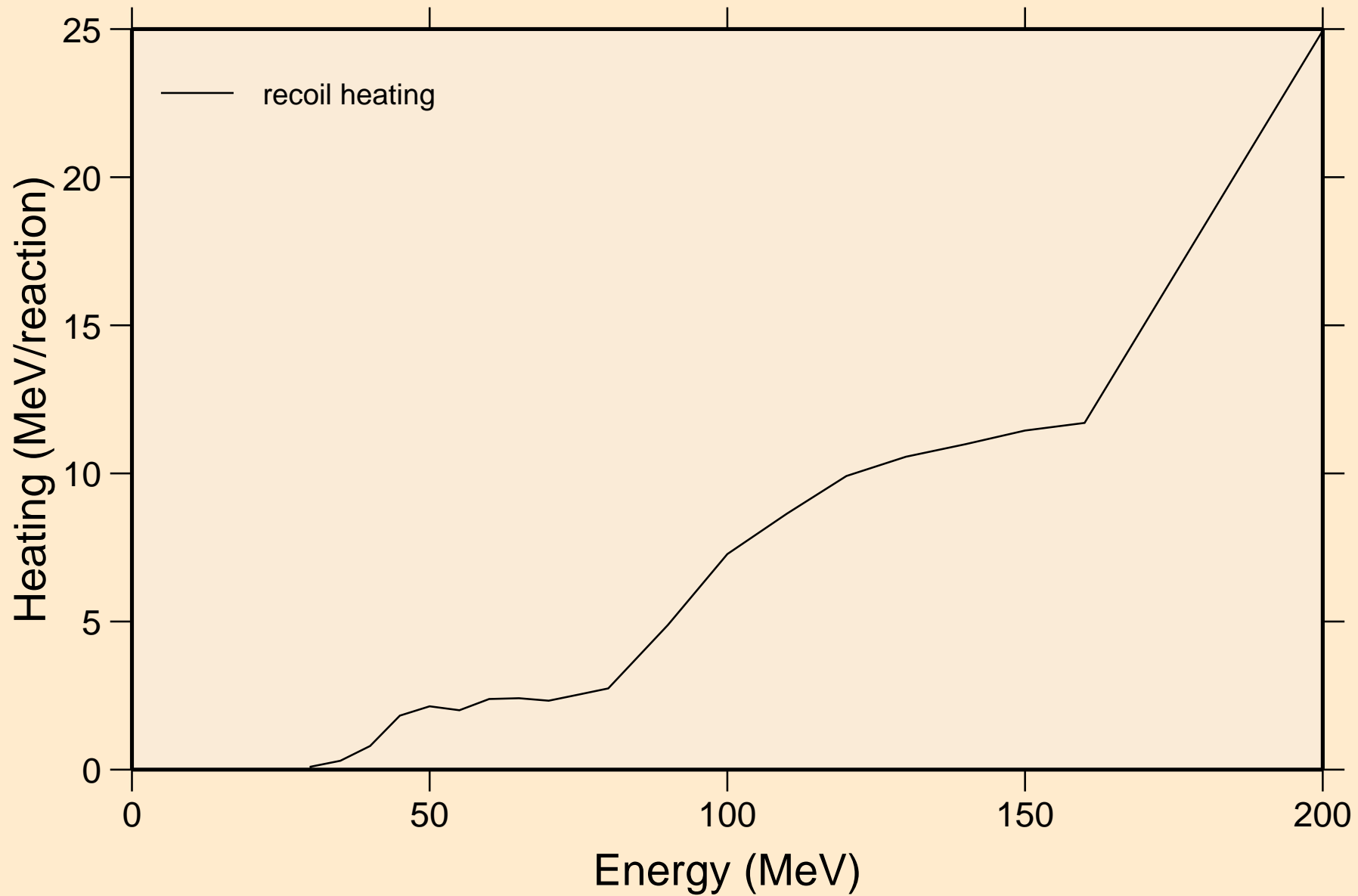



AM246M TRITON ACER TENDL-2021 LIBRARY; T=0.K  
Particle production cross sections

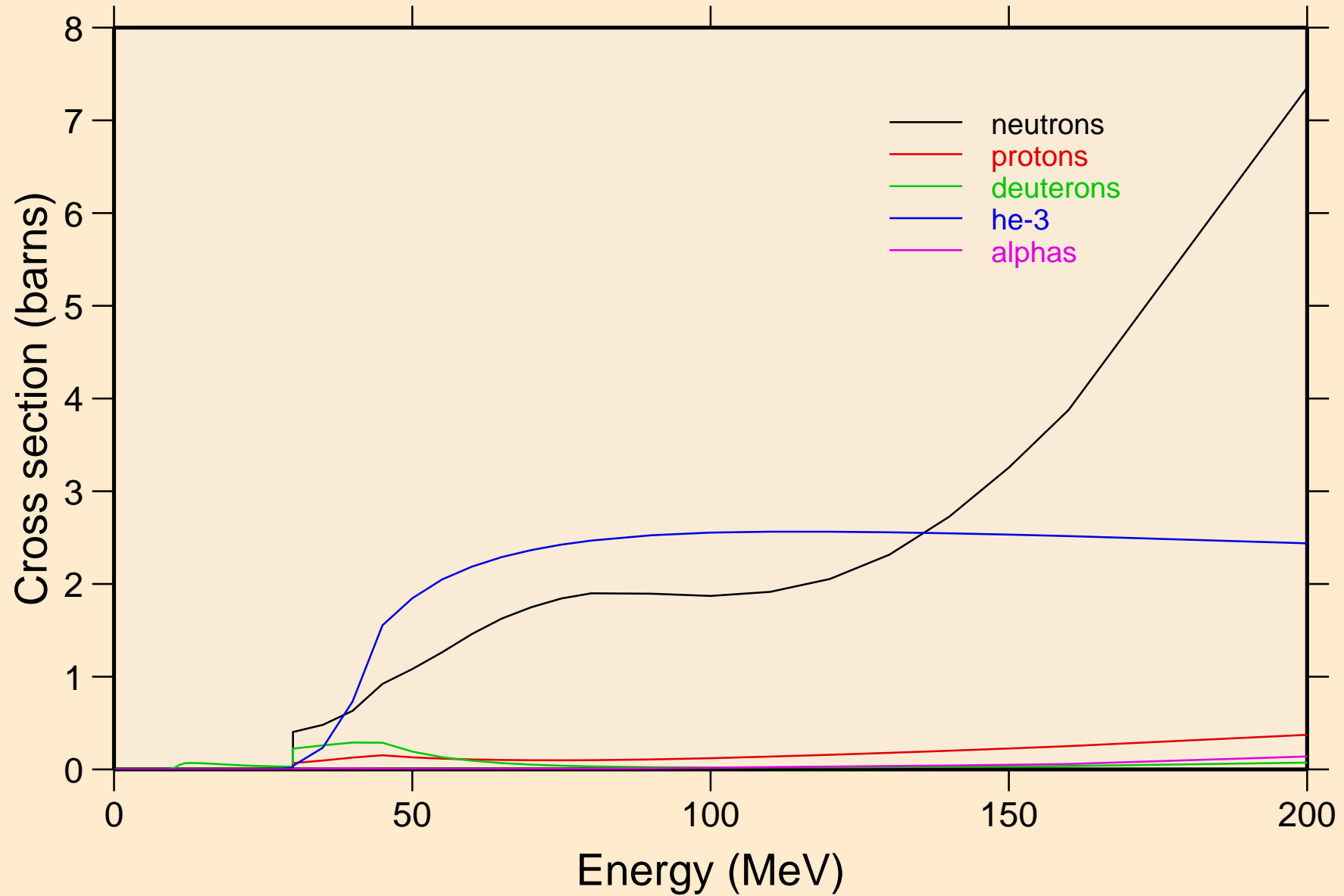

AM246M TRITON ACER TENDL-2021 LIBRARY; T=0.K  
neutrons from (t,n)

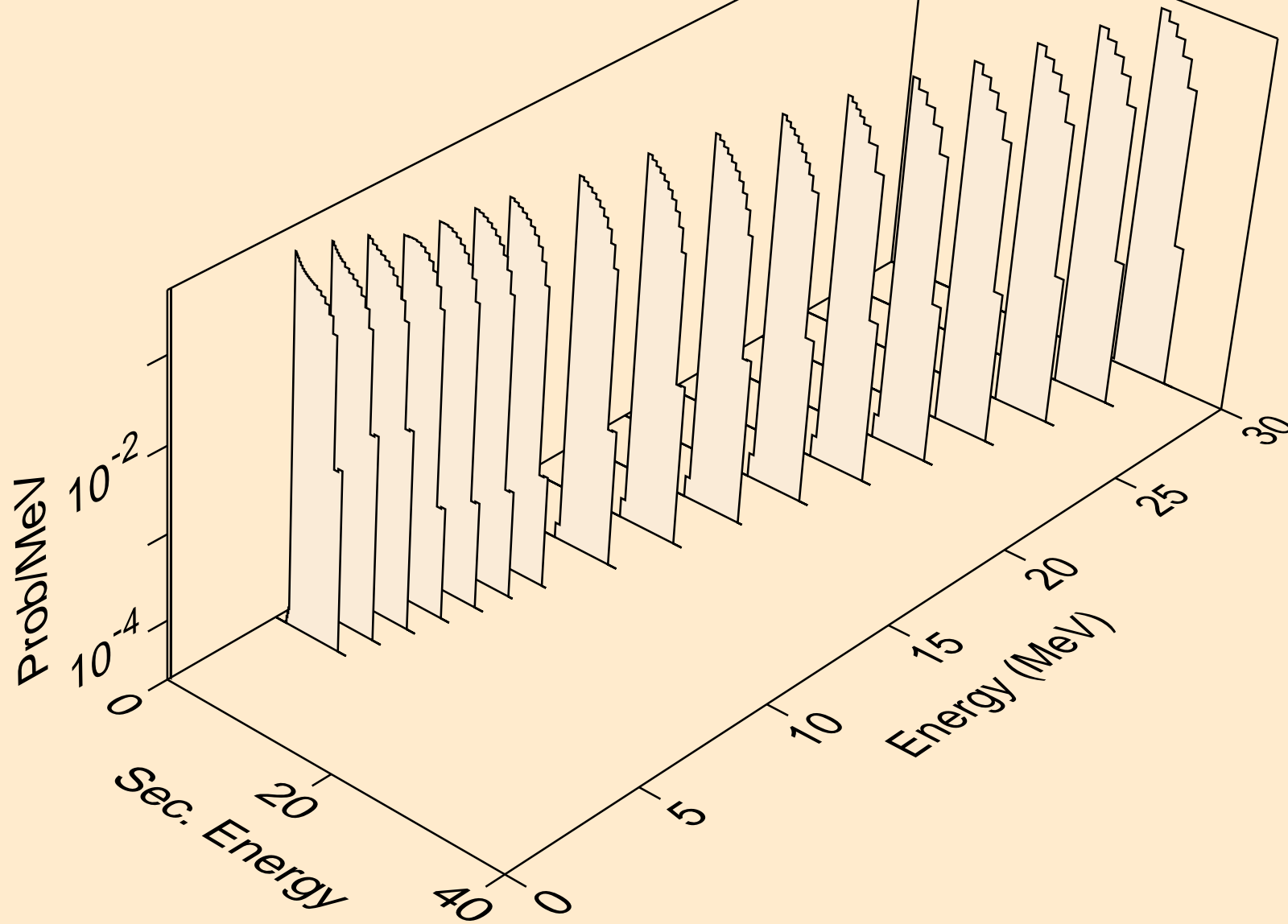

AM246M TRITON ACER TENDL-2021 LIBRARY; T=0.K  
neutrons from (t,x)

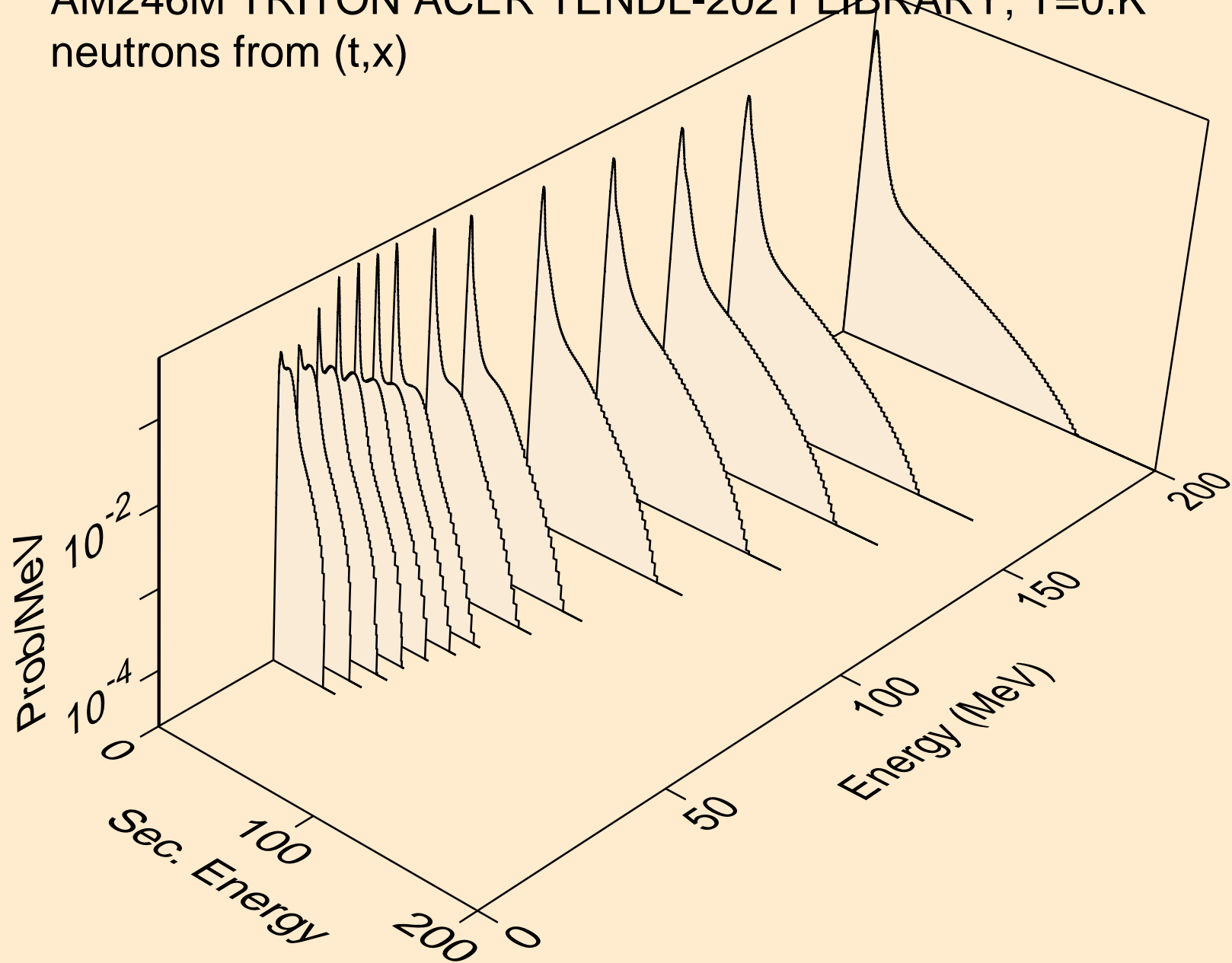

AM246M TRITON ACER TENDL-2021 LIBRARY; T=0.K  
neutrons from (t,2nd)

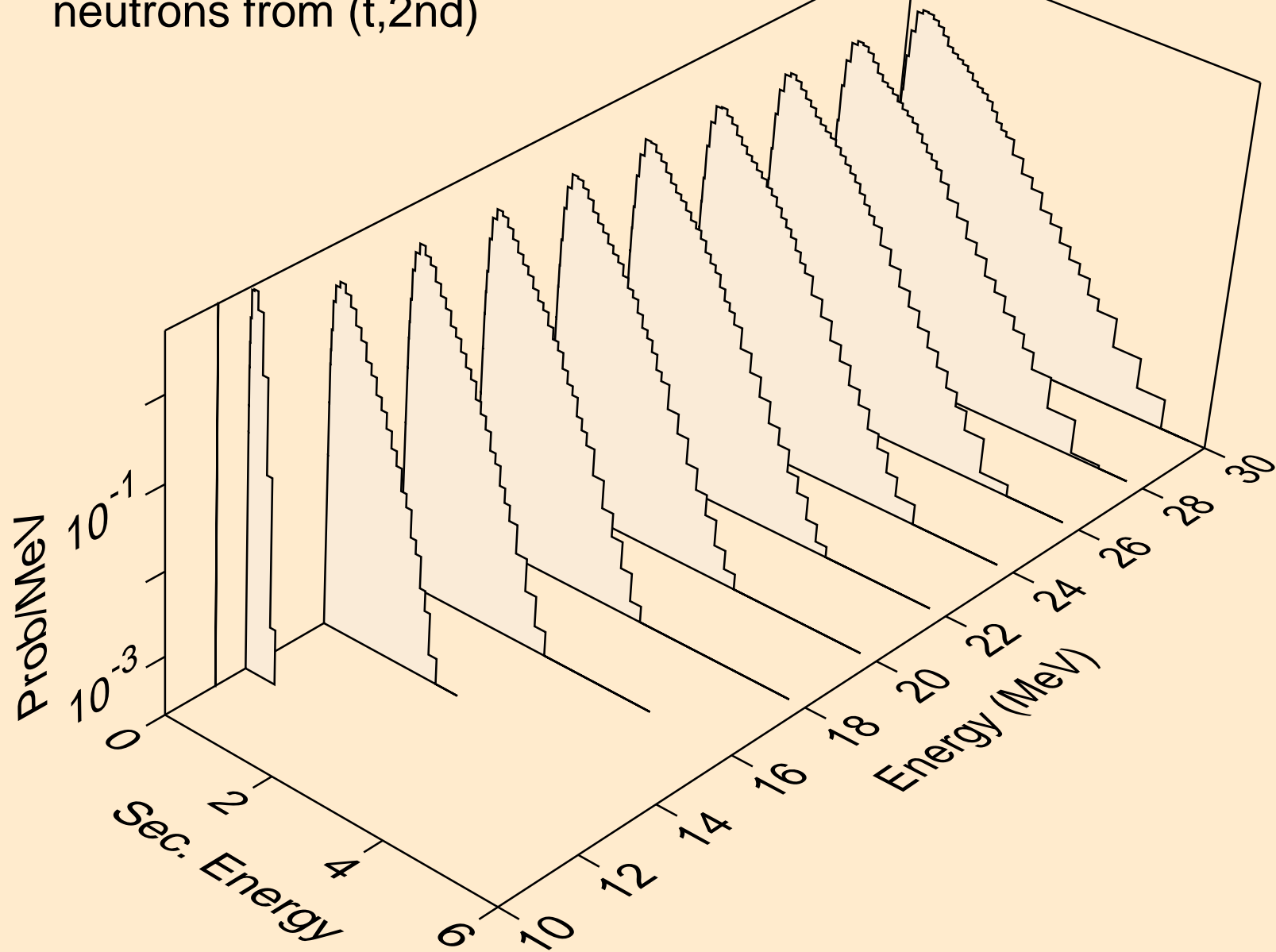

AM246M TRITON ACER TENDL-2021 LIBRARY; T=0.K  
neutrons from (t,2n)

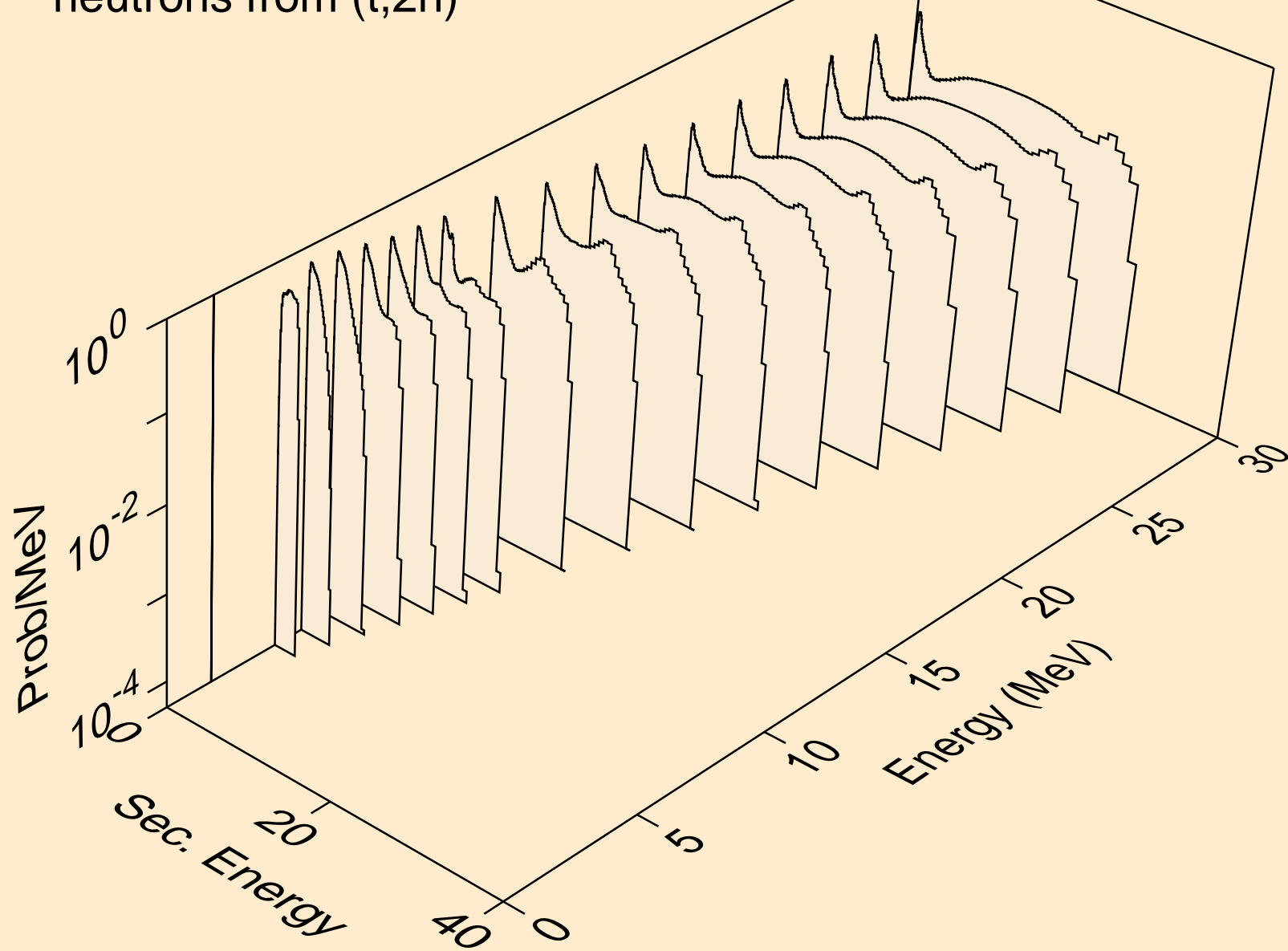

AM246M TRITON ACER TENDL-2021 LIBRARY; T=0.K  
neutrons from (t,3n)

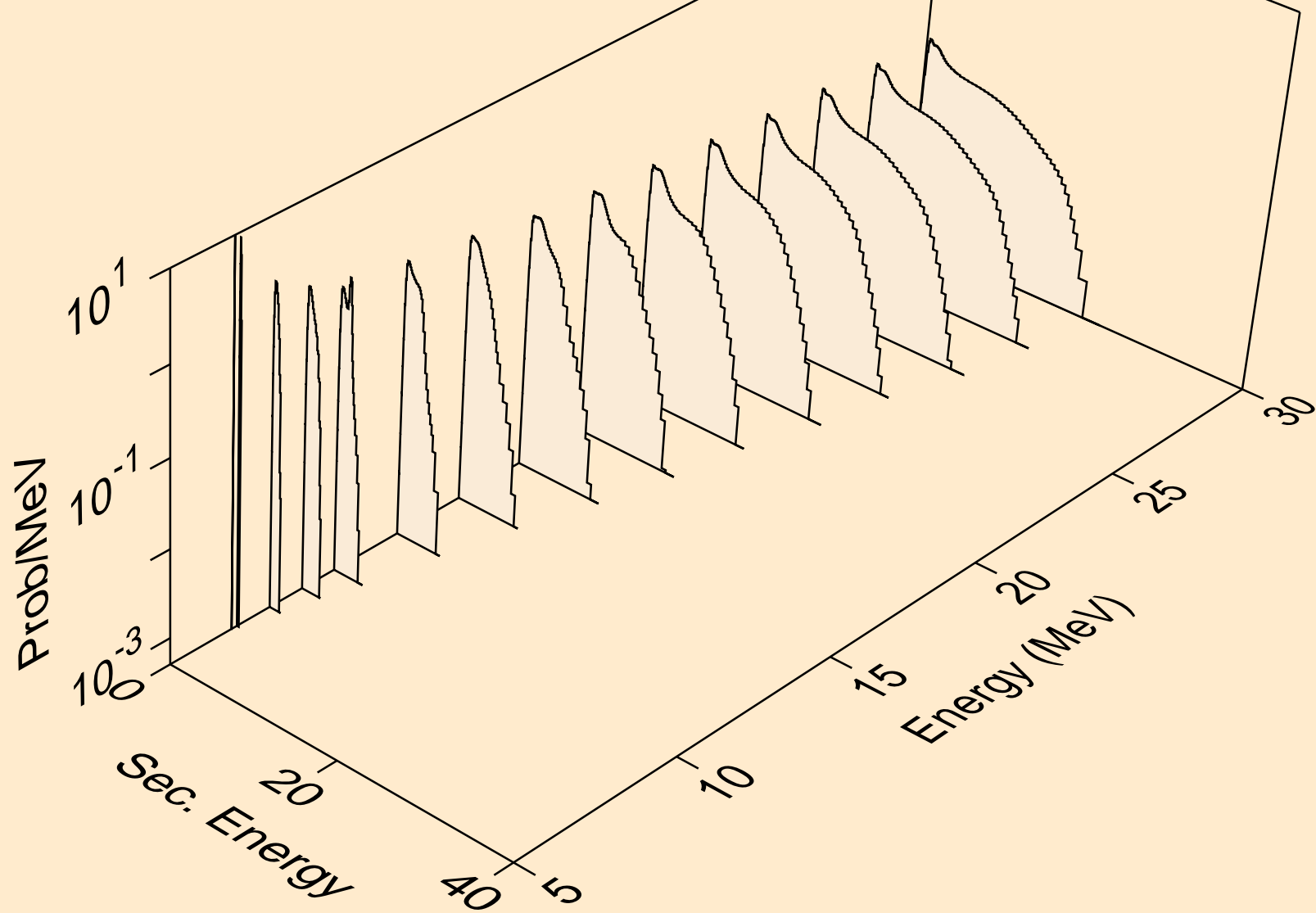

AM246M TRITON ACER TENDL-2021 LIBRARY; T=0.K  
neutrons from (t,n\*)a

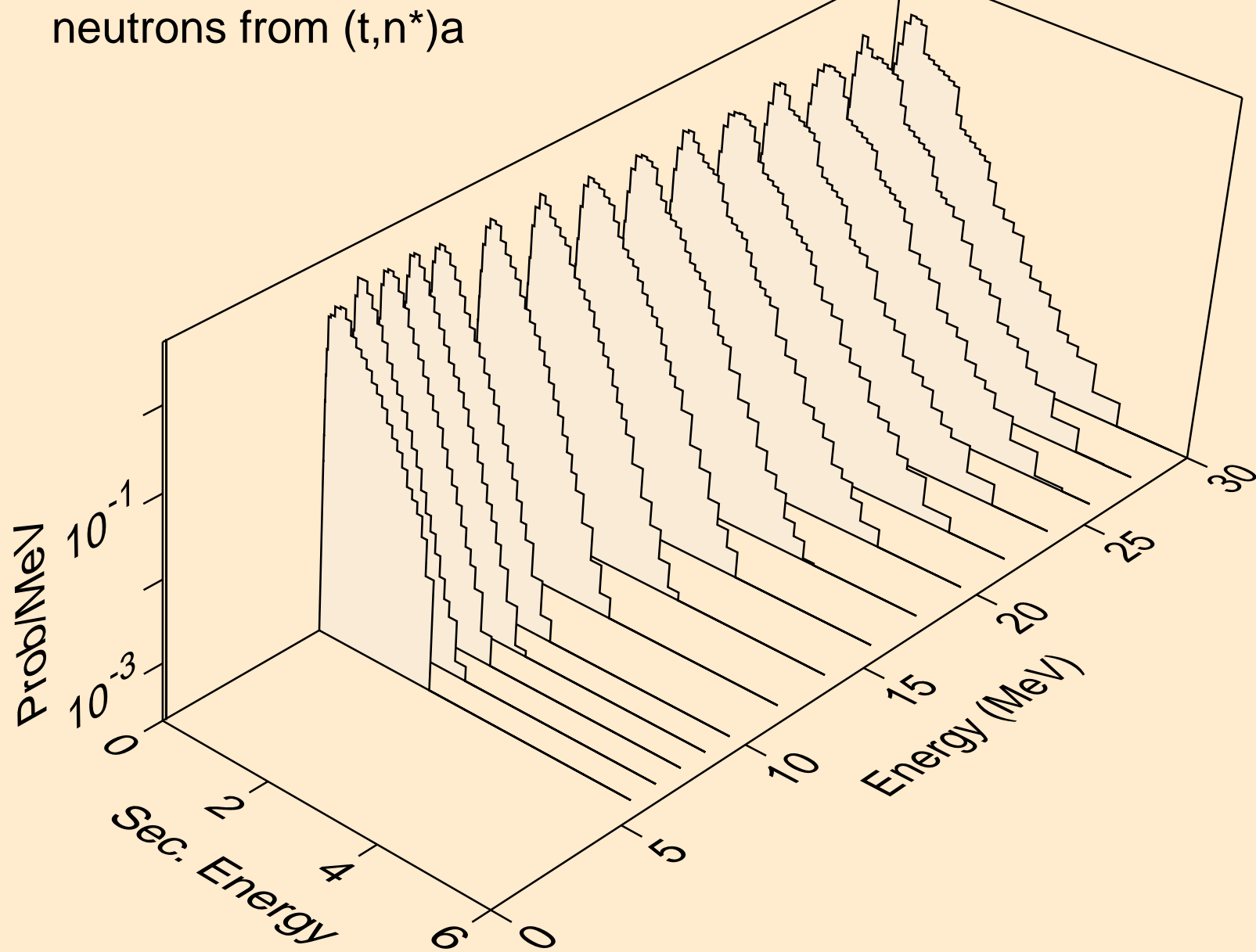

AM246M TRITON ACER TENDL-2021 LIBRARY; T=0.K  
neutrons from (t,2n)a

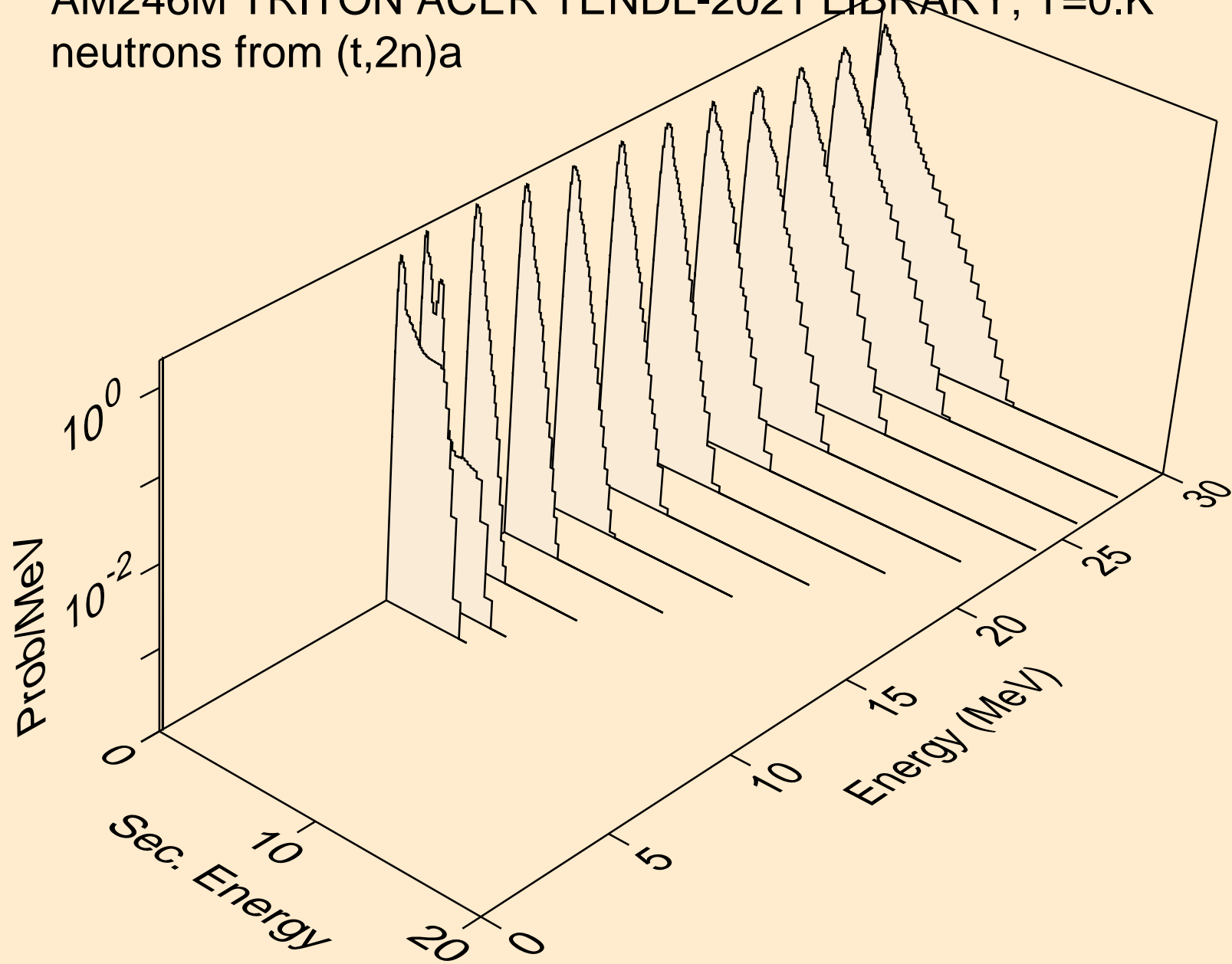



AM246M TRITON ACER TENDL-2021 LIBRARY; T=0.K  
neutrons from (t,3n)a

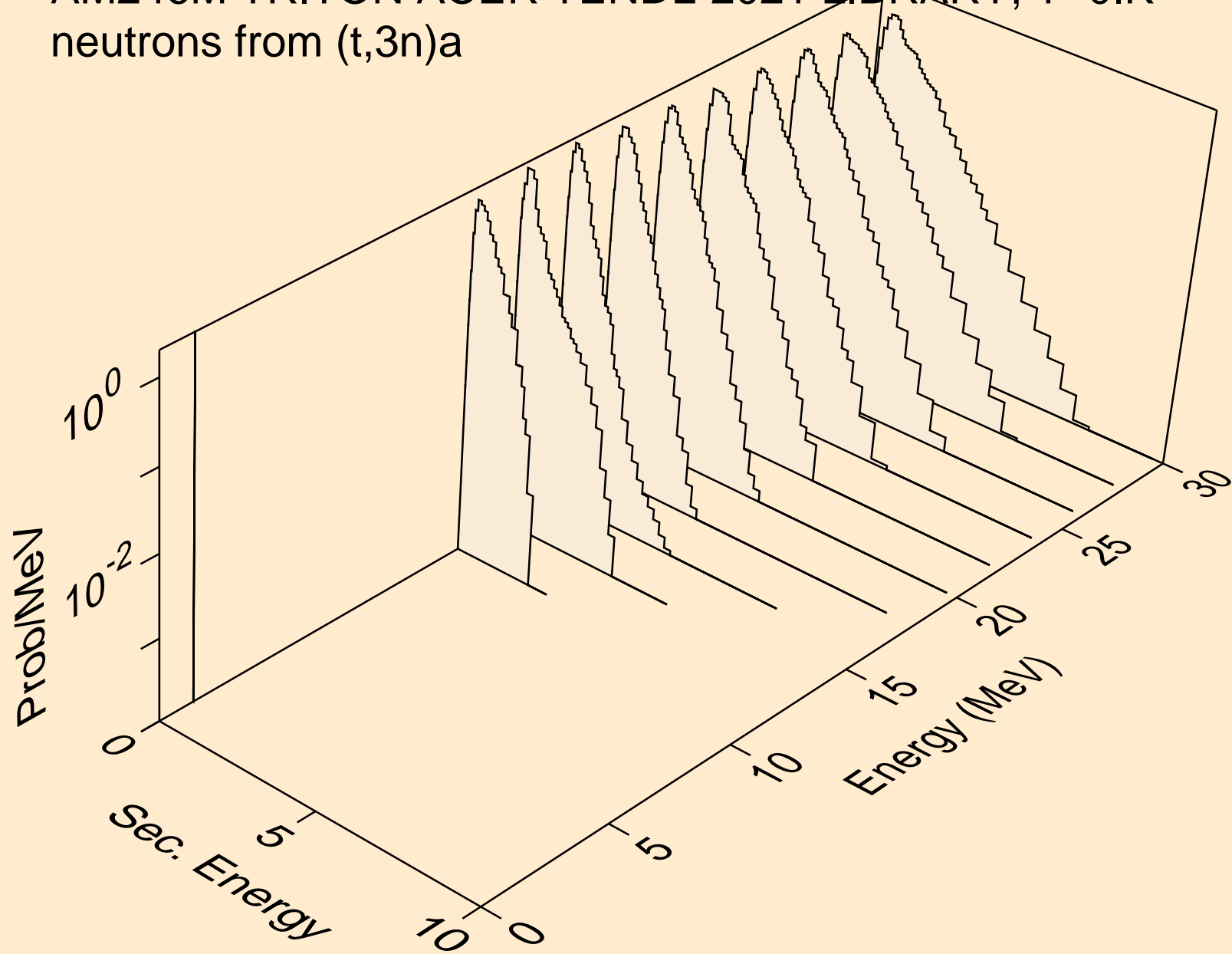

AM246M TRITON ACER TENDL-2021 LIBRARY; T=0.K  
neutrons from (t,n\*)p

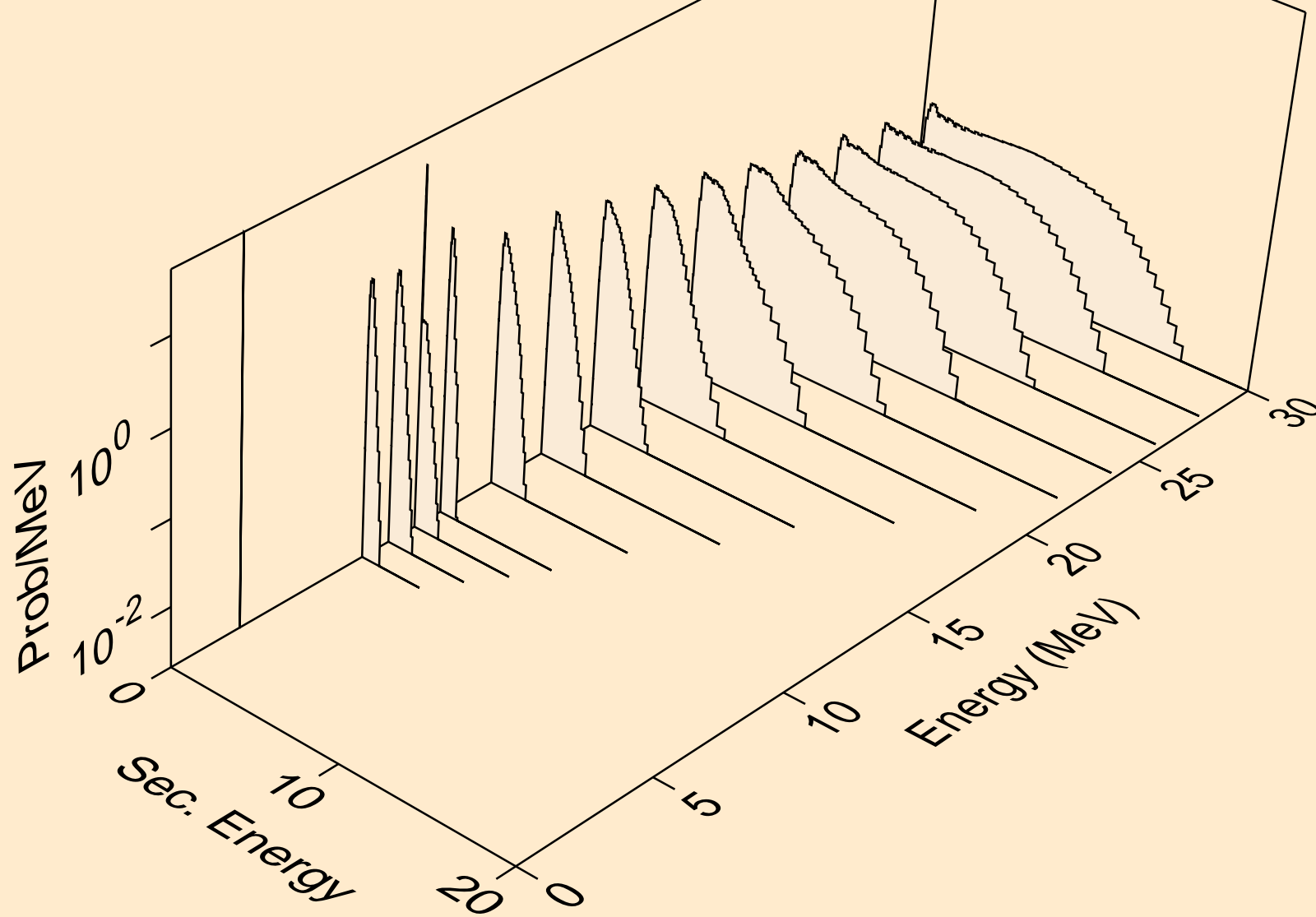

AM246M TRITON ACER TENDL-2021 LIBRARY; T=0.K  
neutrons from (t,n\*)d

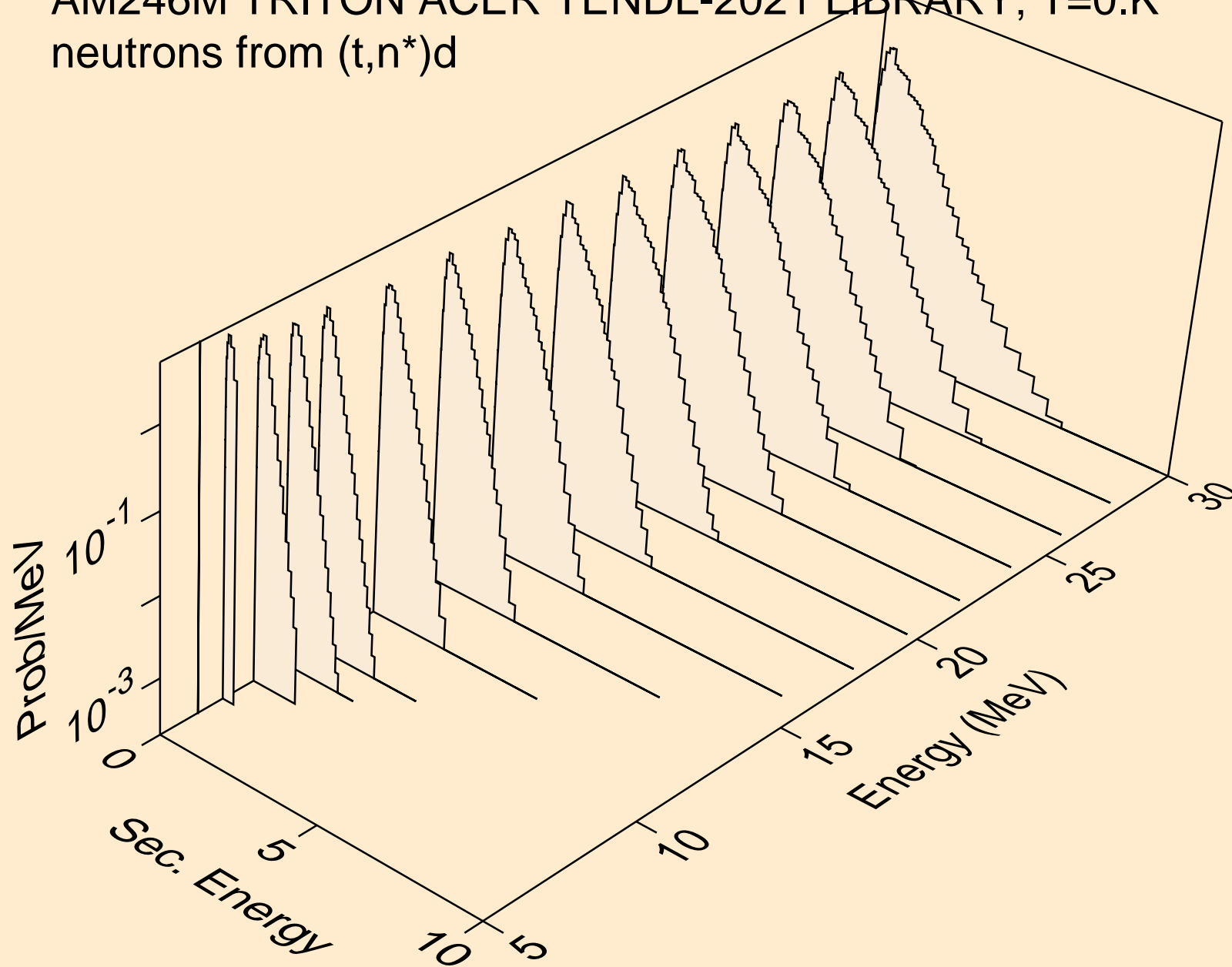

AM246M TRITON ACER TENDL-2021 LIBRARY; T=0.K  
neutrons from (t,n\*)t

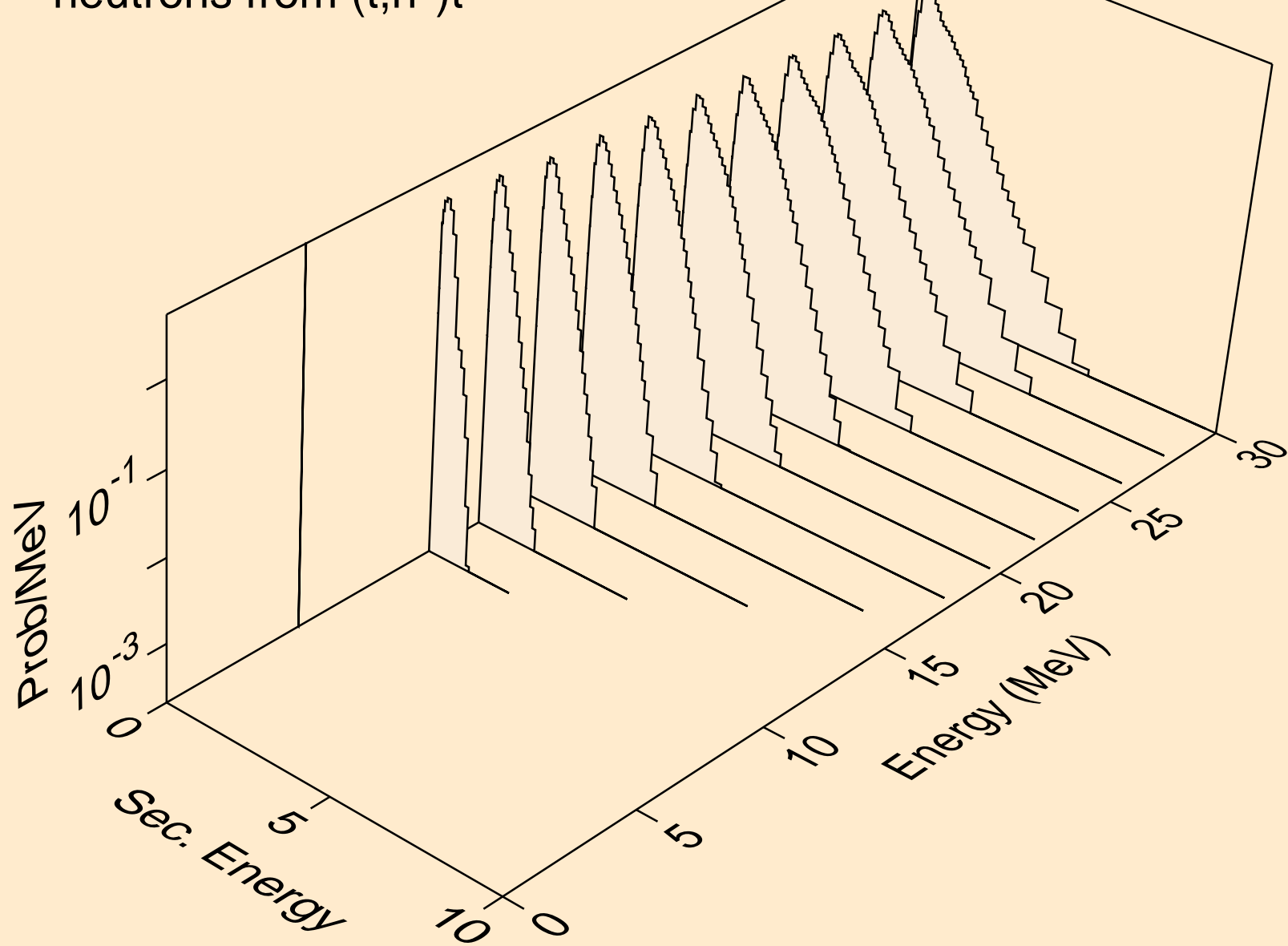

AM246M TRITON ACER TENDL-2021 LIBRARY; T=0.K  
neutrons from (t,n\*)he3

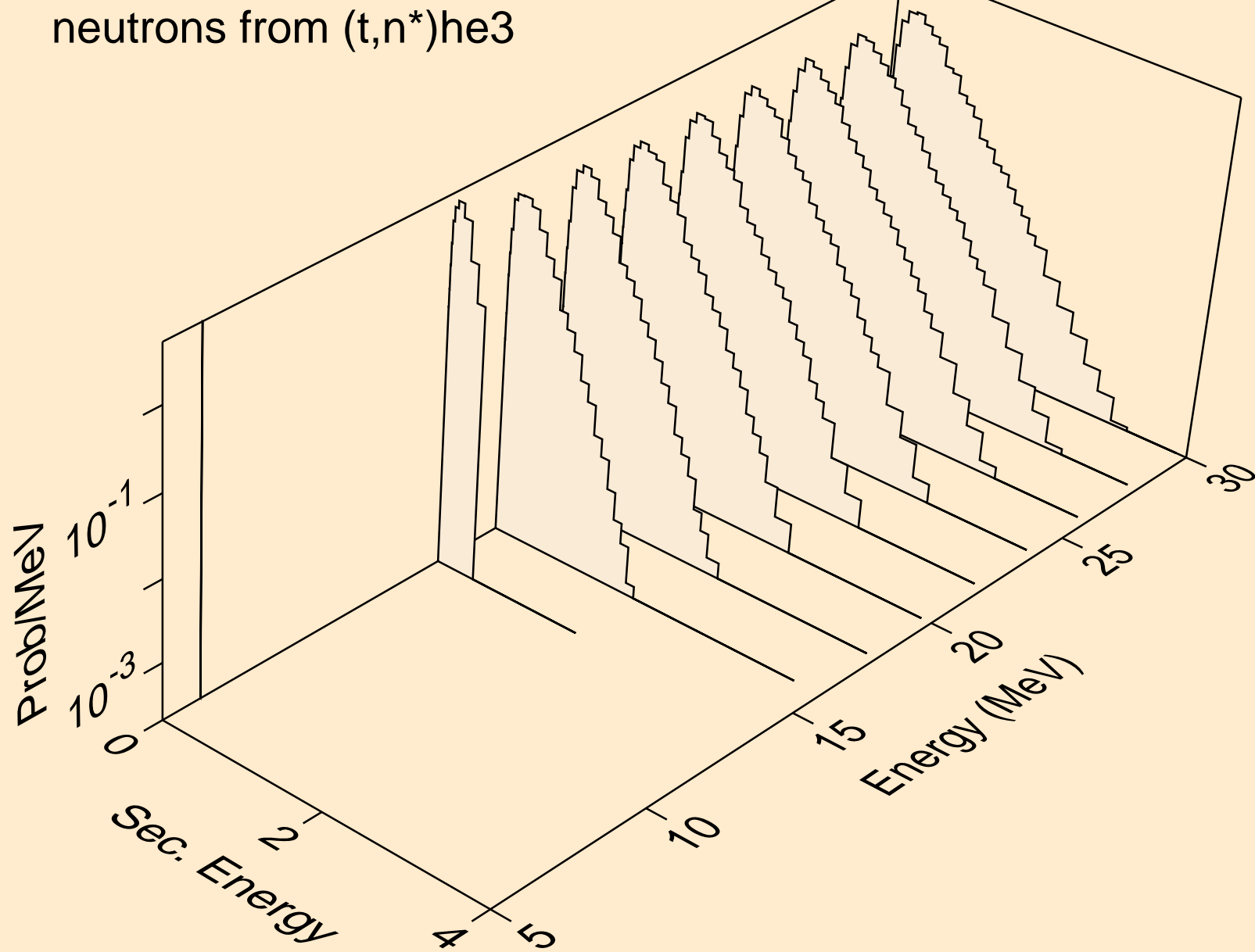

AM246M TRITON ACER TENDL-2021 LIBRARY; T=0.K  
neutrons from (t,4n)

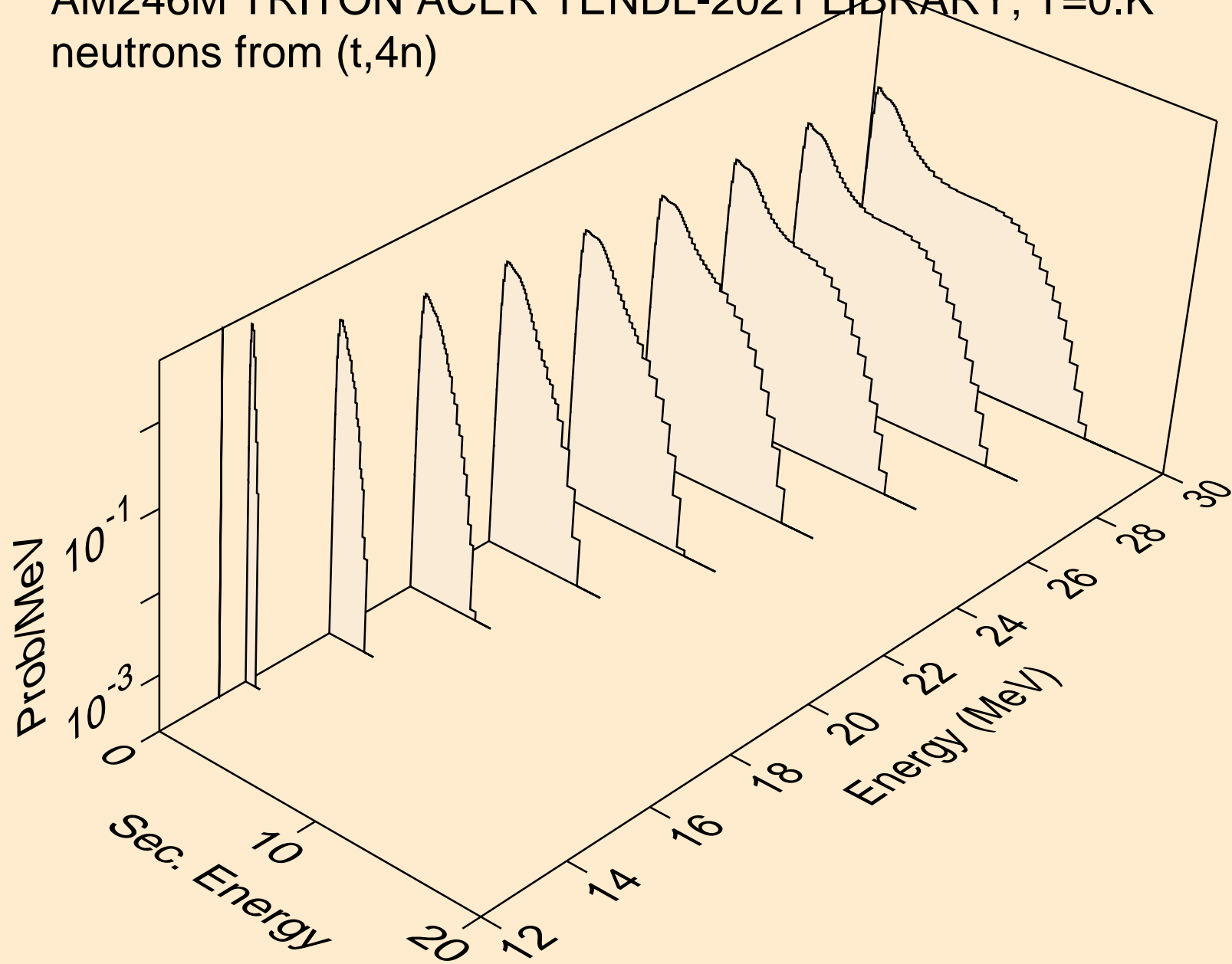

AM246M TRITON ACER TENDL-2021 LIBRARY; T=0.K  
neutrons from (t,2np)

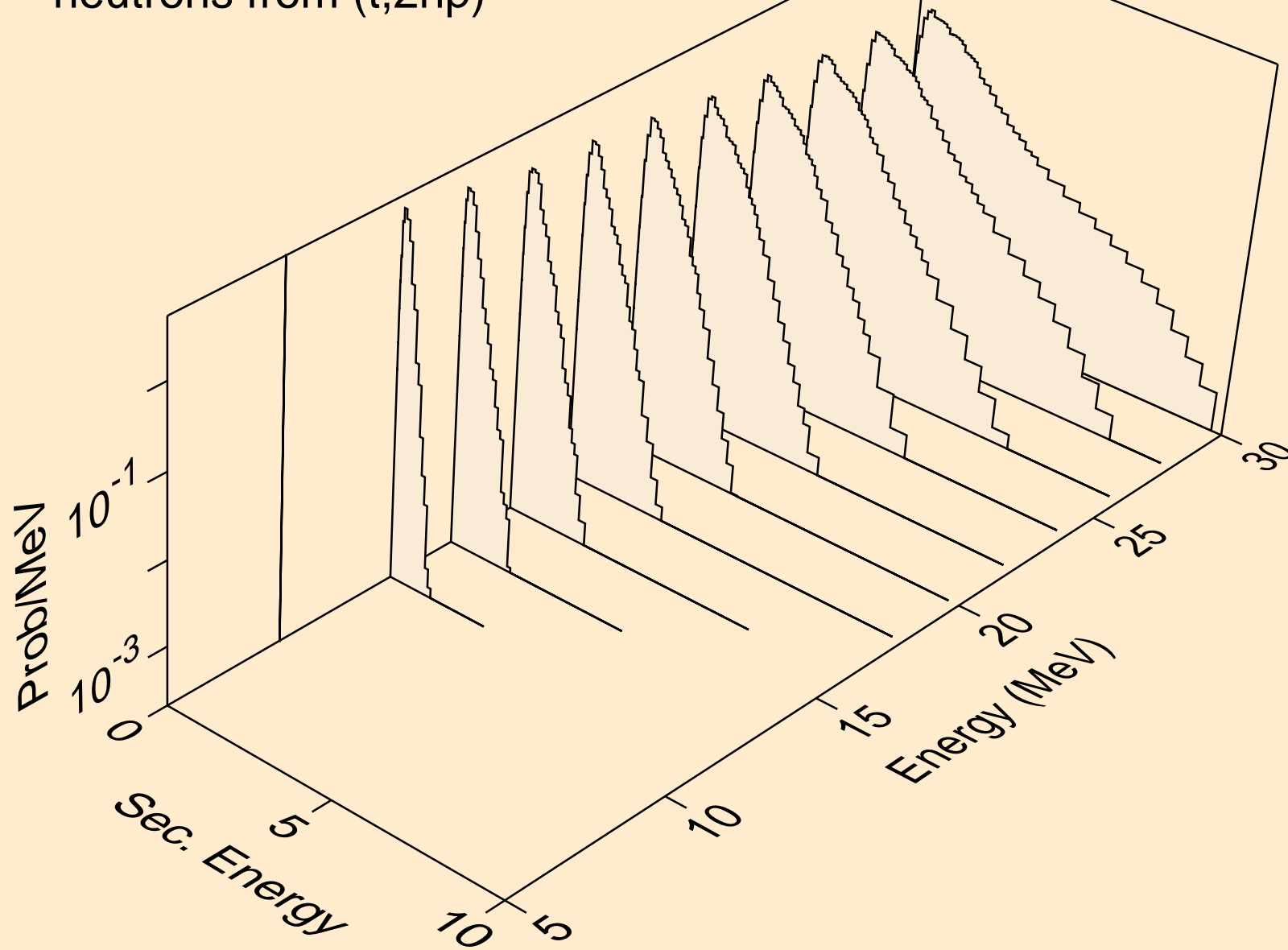

AM246M TRITON ACER TENDL-2021 LIBRARY; T=0.K  
neutrons from (t,3np)

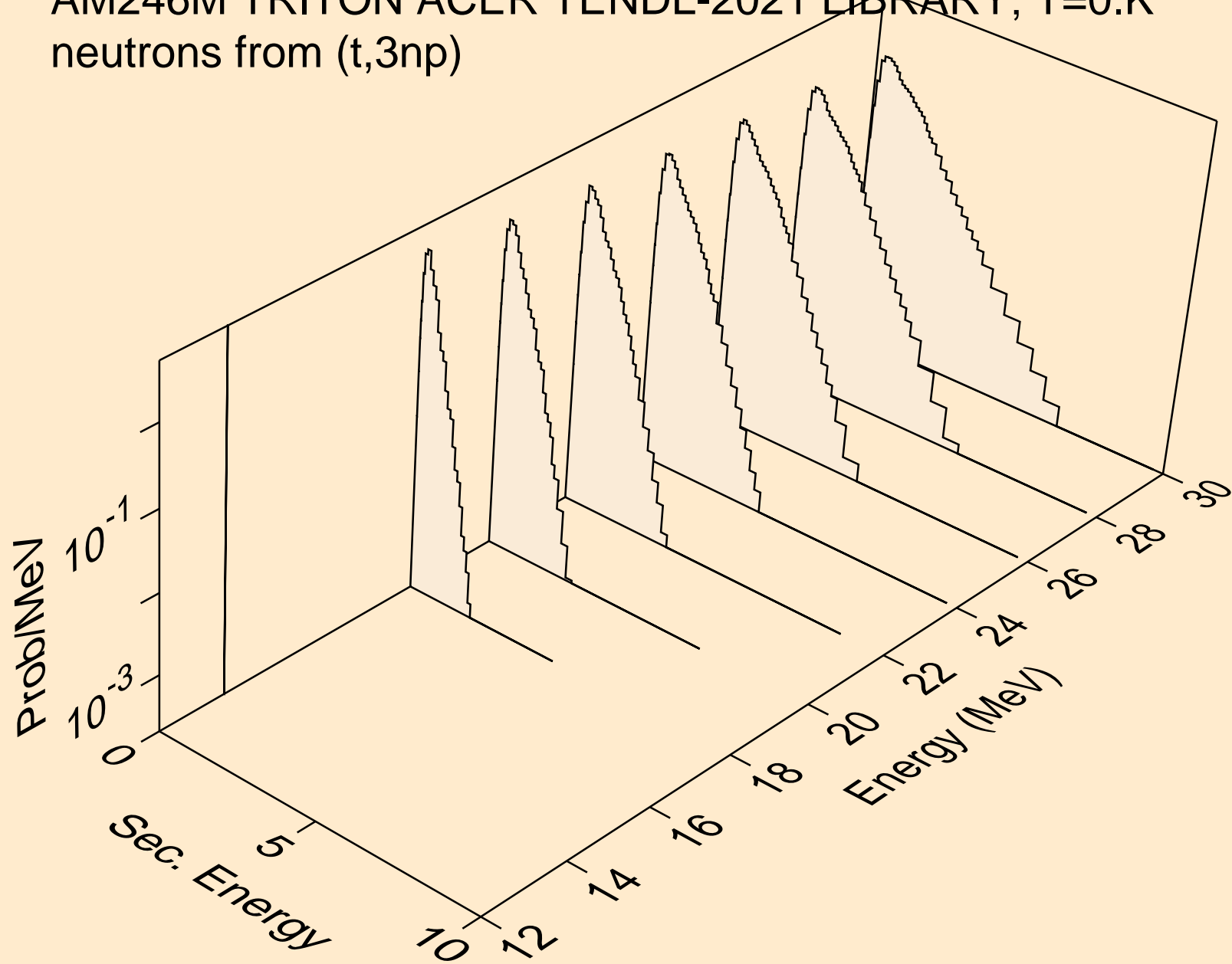



AM246M TRITON ACER TENDL-2021 LIBRARY; T=0.K  
neutrons from (t,2np)

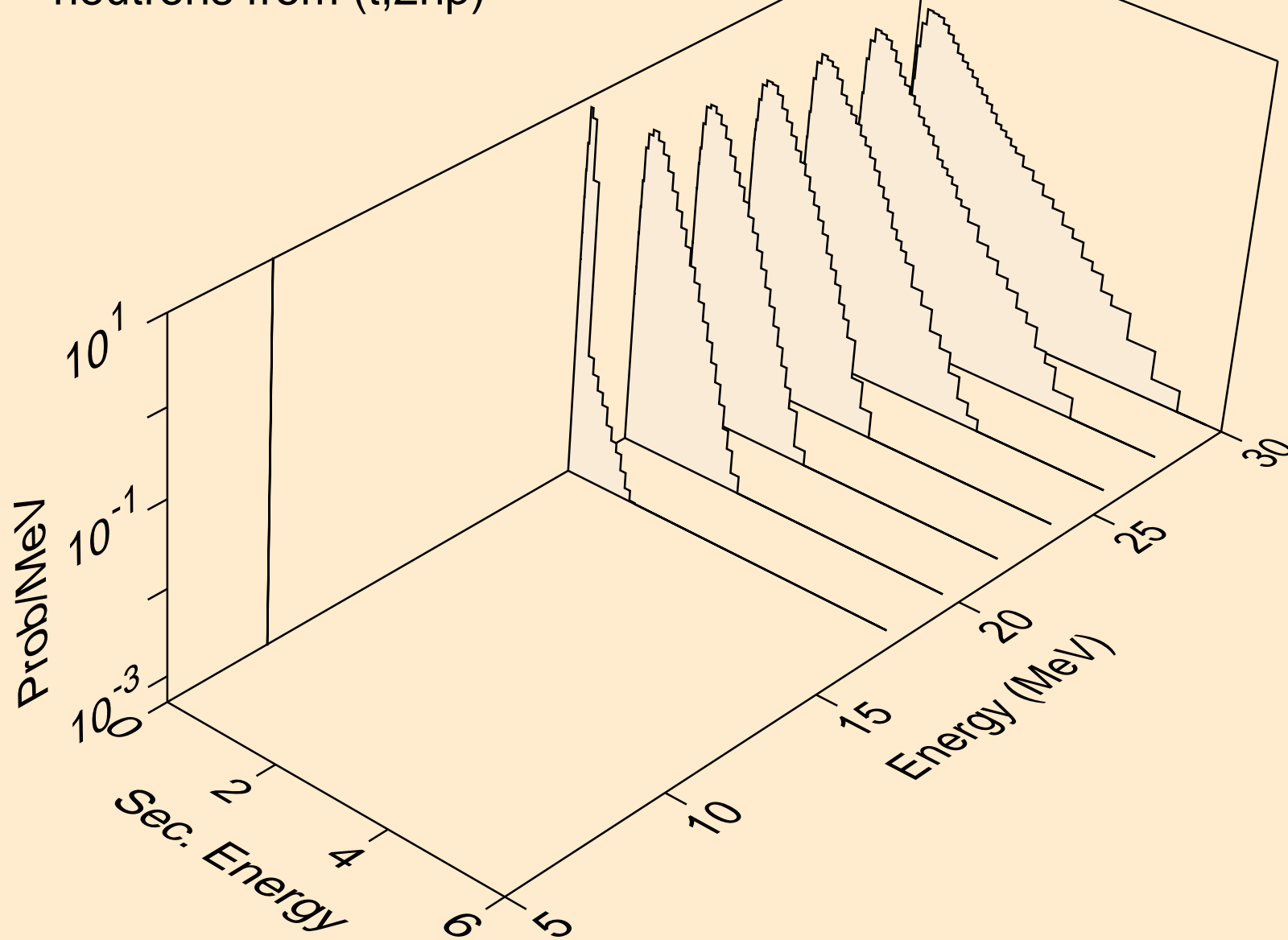

AM246M TRITON ACER TENDL-2021 LIBRARY; T=0.K  
protons from (t,x)

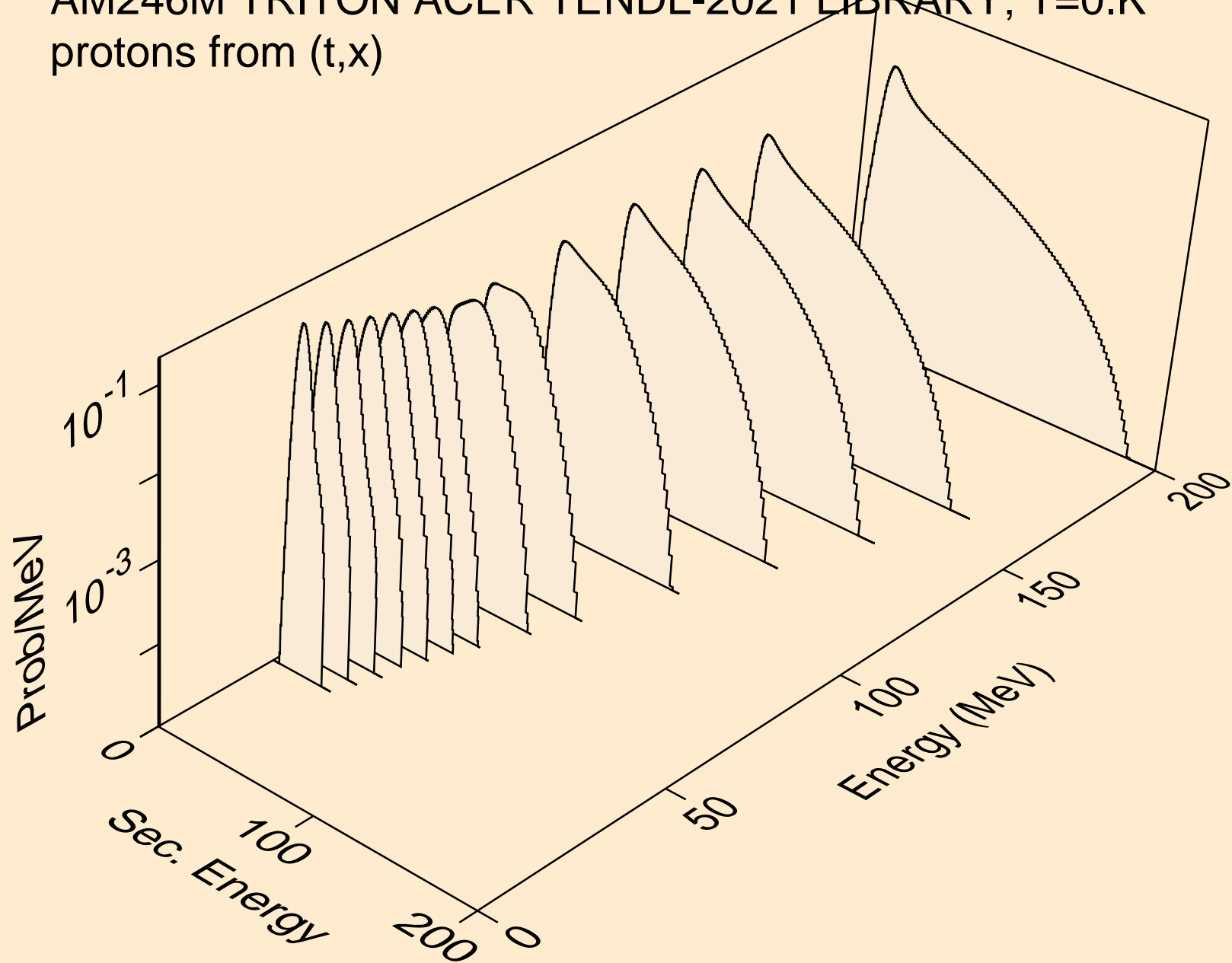

AM246M TRITON ACER TENDL-2021 LIBRARY; T=0.K  
protons from (t,n\*)p

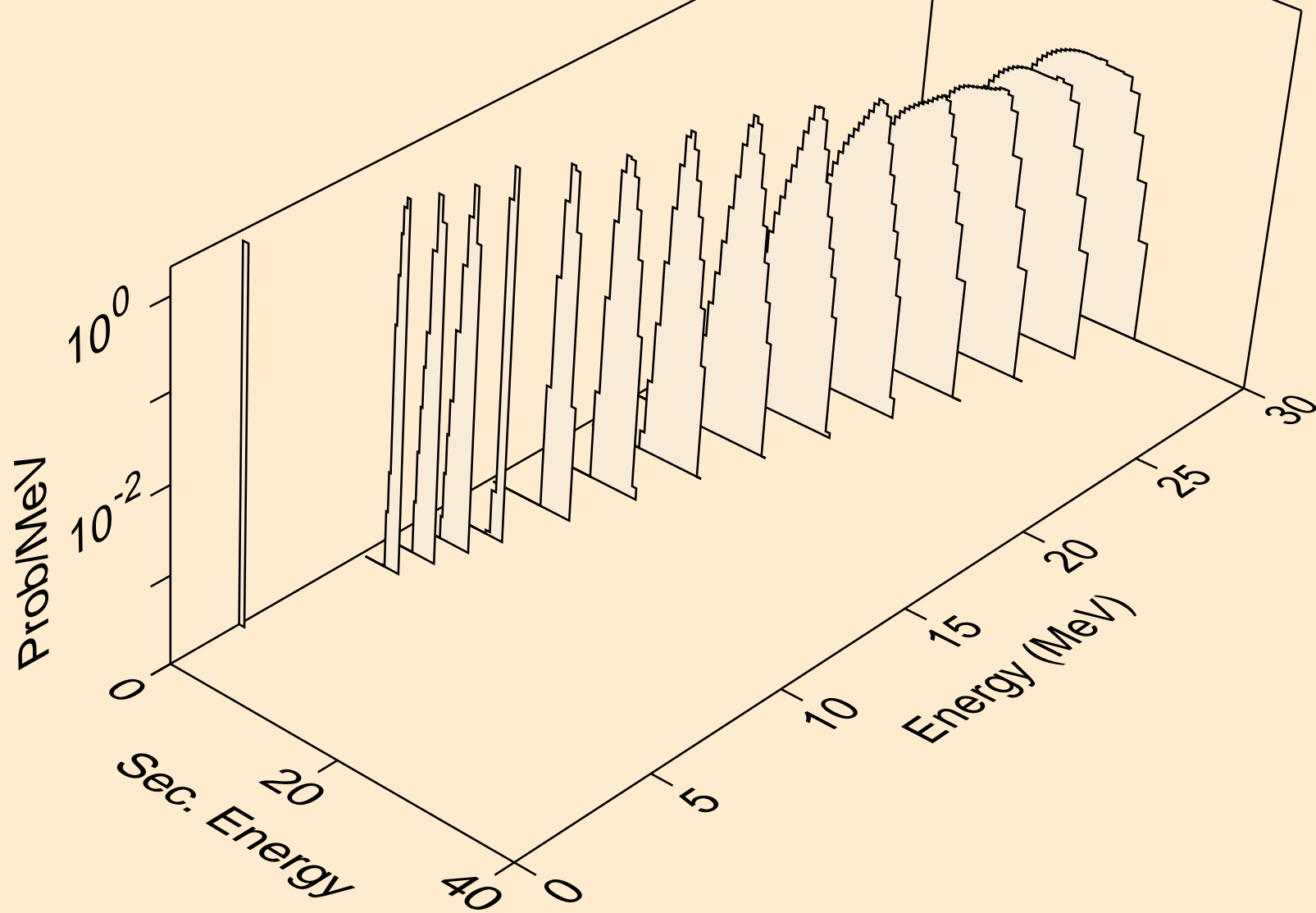

AM246M TRITON ACER TENDL-2021 LIBRARY; T=0.K  
protons from (t,2np)

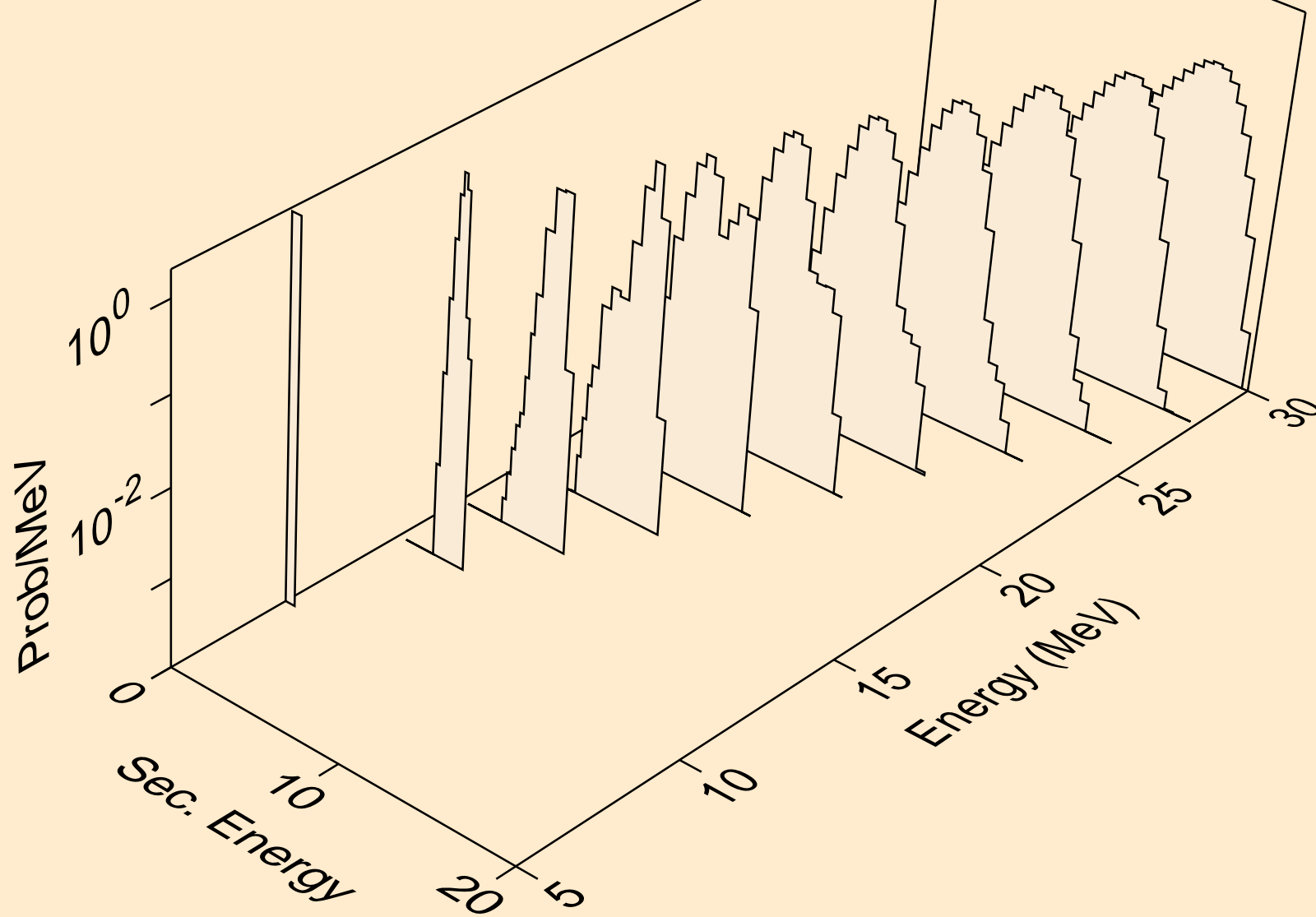

AM246M TRITON ACER TENDL-2021 LIBRARY; T=0.K  
protons from (t,3np)

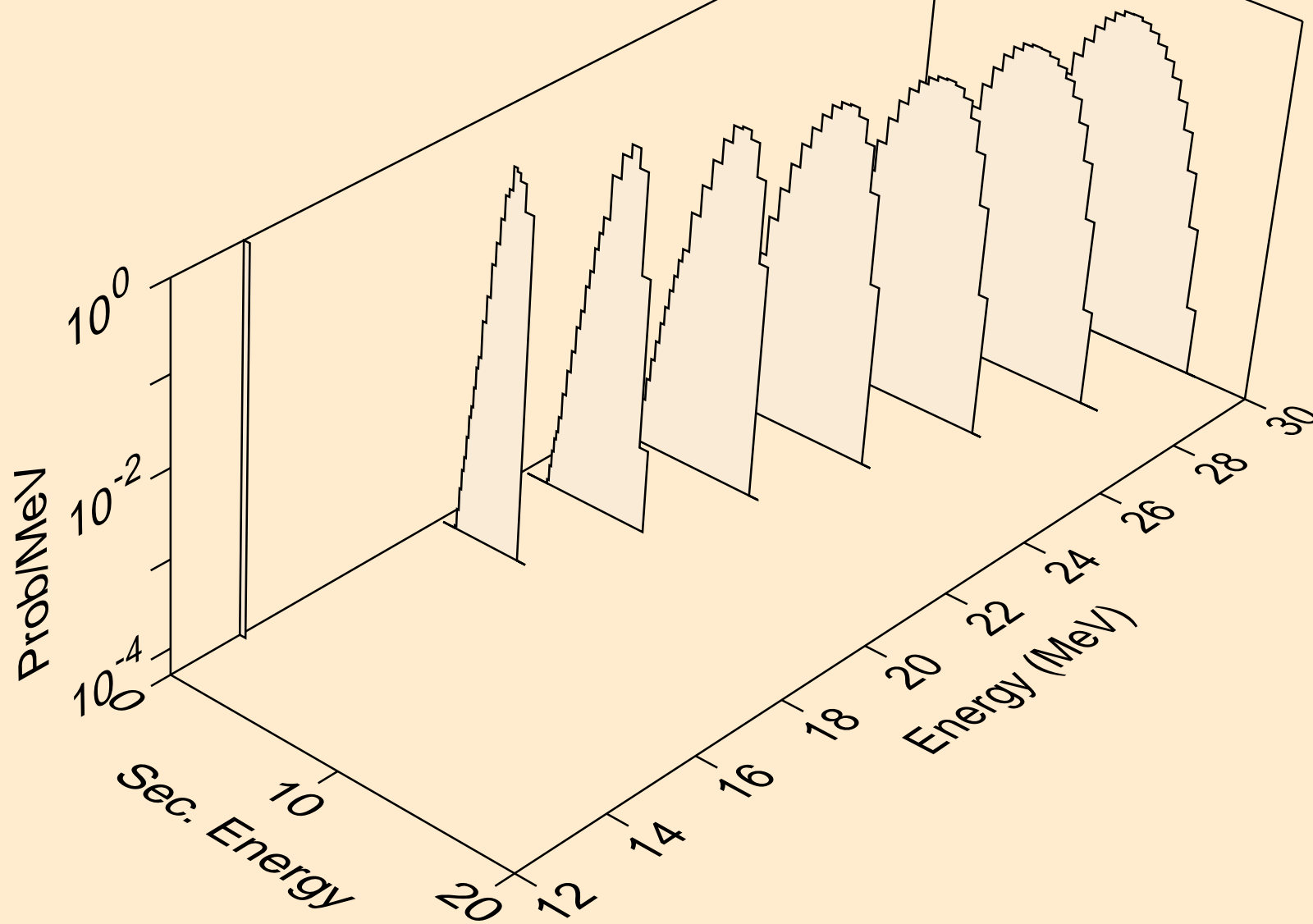

AM246M TRITON ACER TENDL-2021 LIBRARY; T=0.K  
protons from (t,2np)

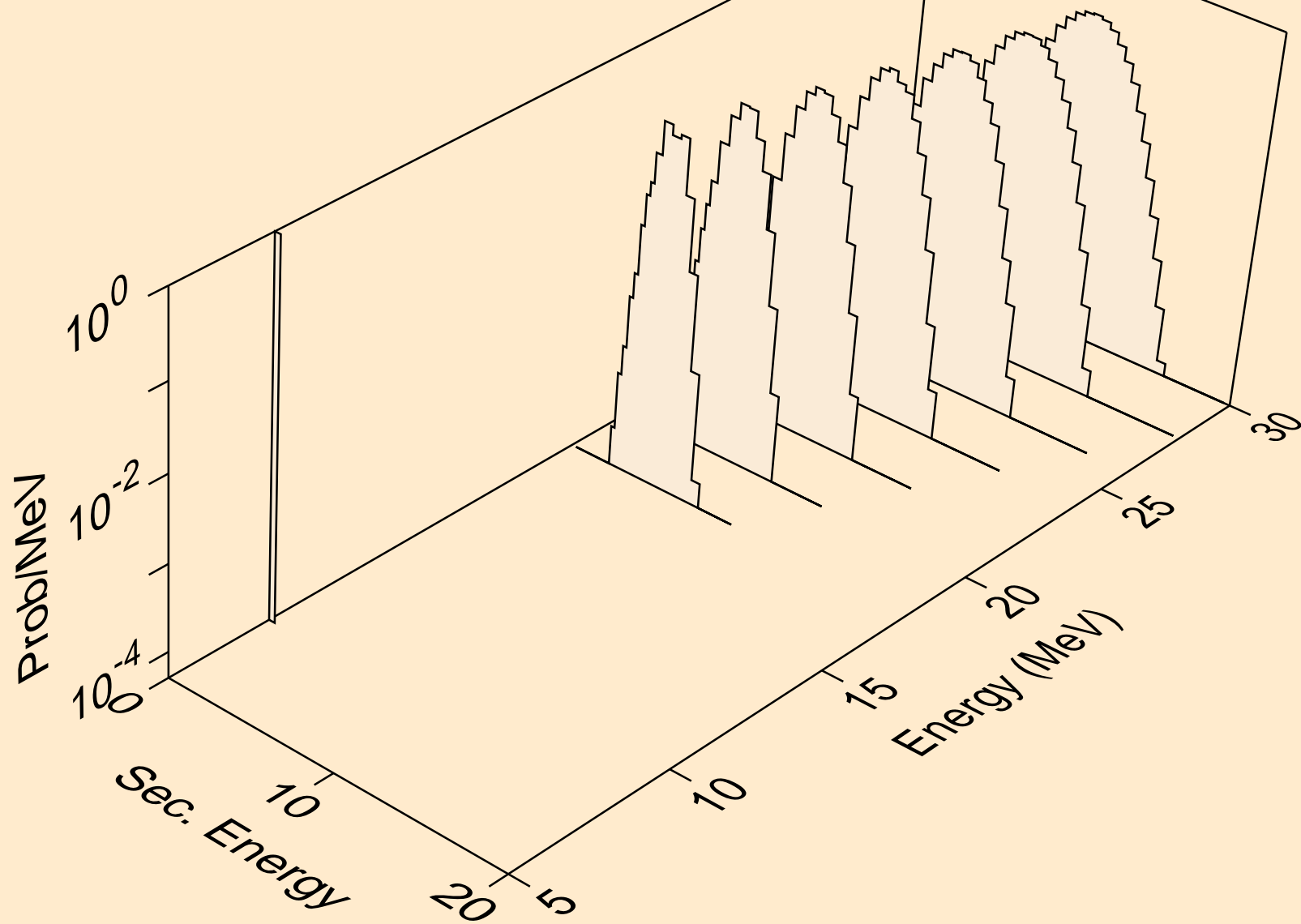

AM246M TRITON ACER TENDL-2021 LIBRARY; T=0.K  
protons from (t,p)

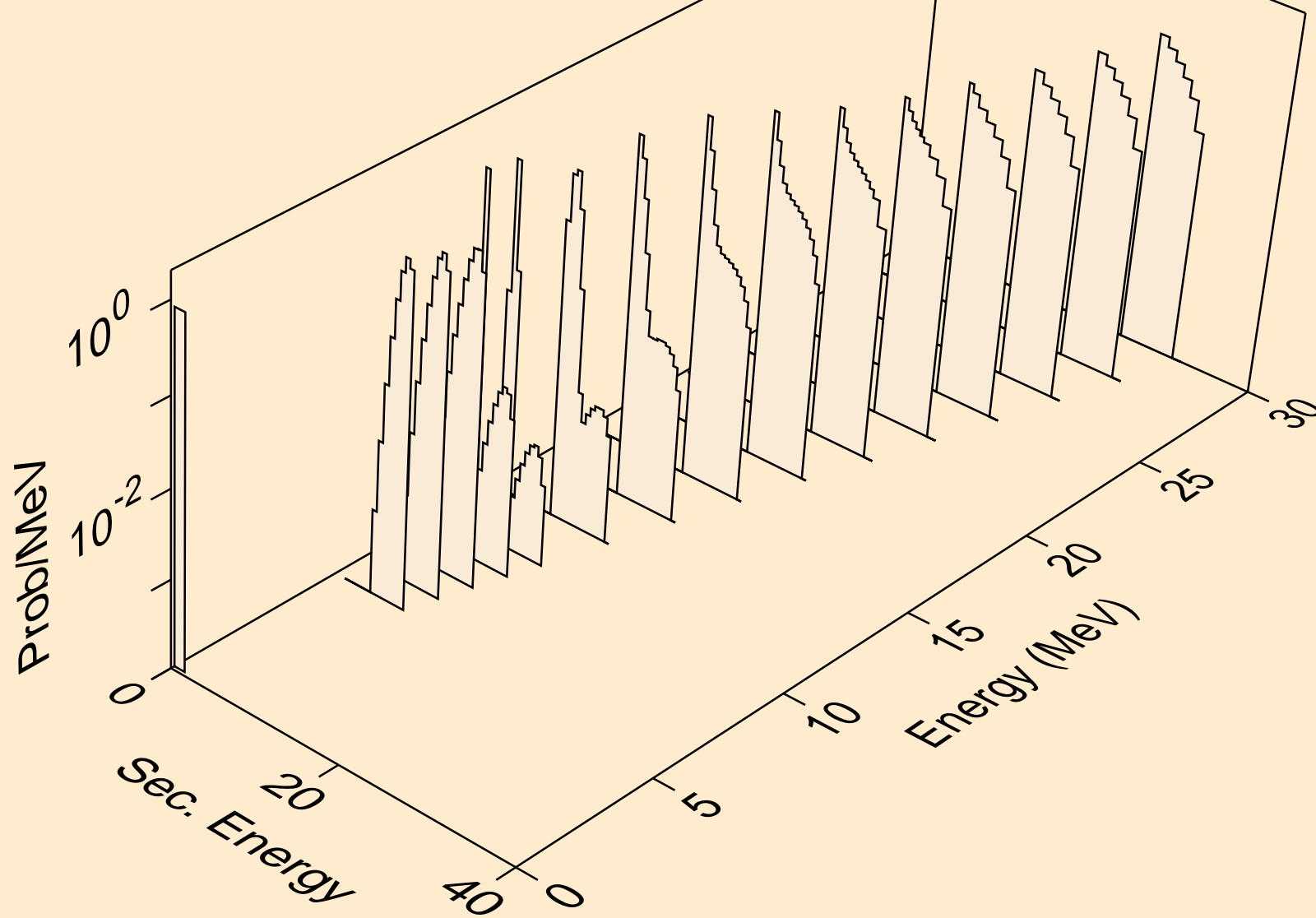

AM246M TRITON ACER TENDL-2021 LIBRARY; T=0.K  
protons from (t,2p)

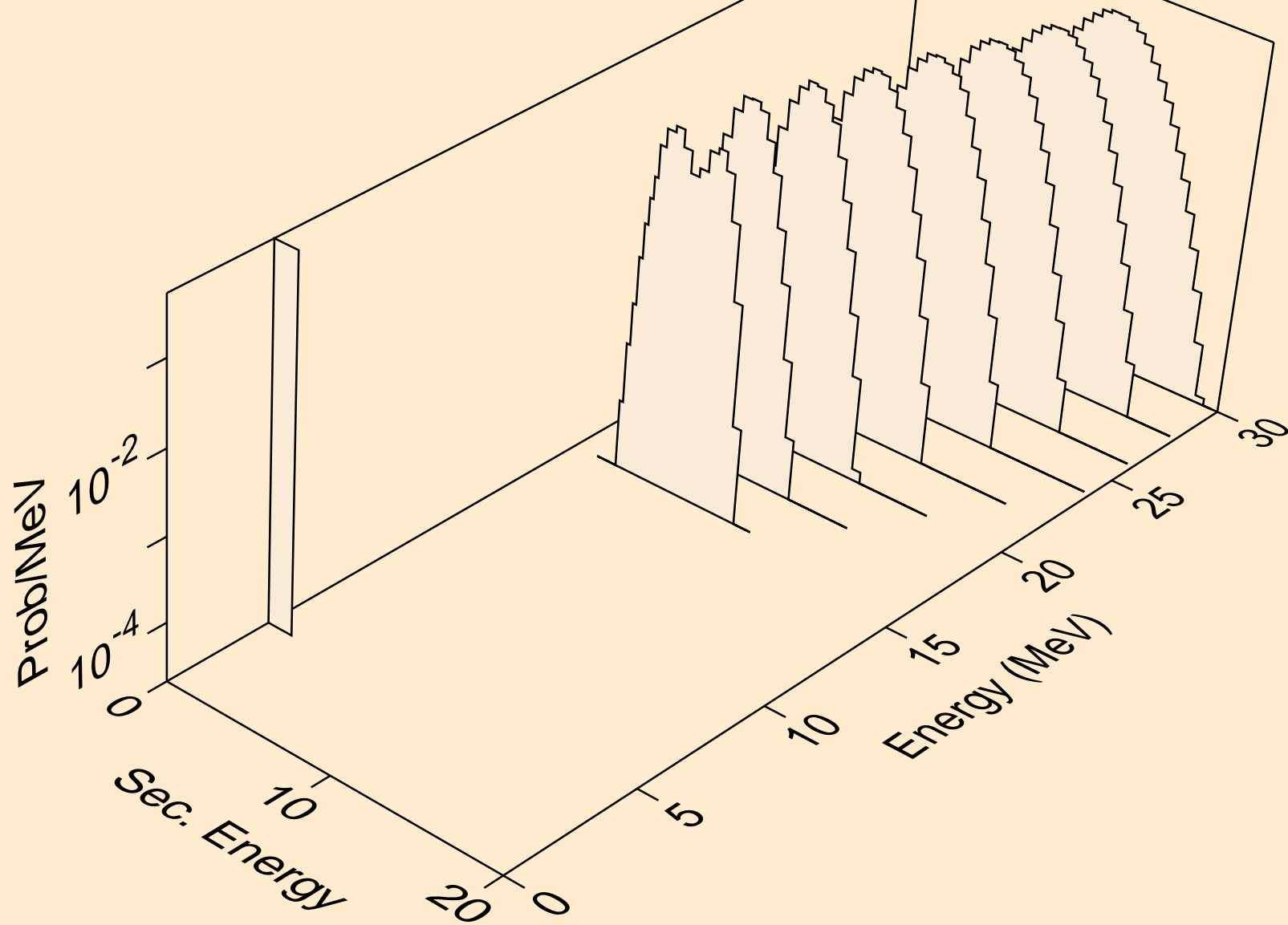



AM246M TRITON ACER TENDL-2021 LIBRARY; T=0.K  
deuterons from (t,x)

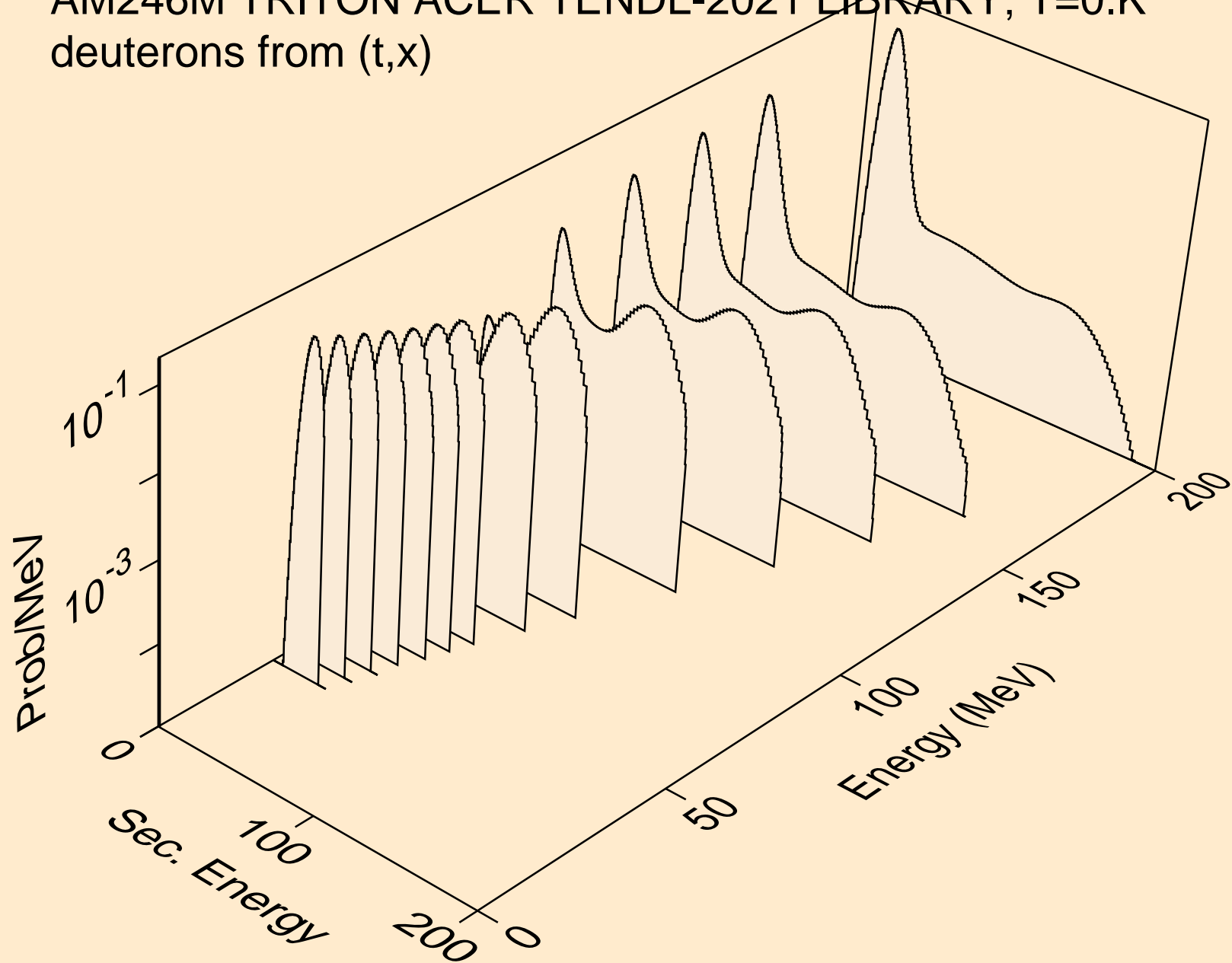

AM246M TRITON ACER TENDL-2021 LIBRARY; T=0.K  
deuterons from (t,2nd)

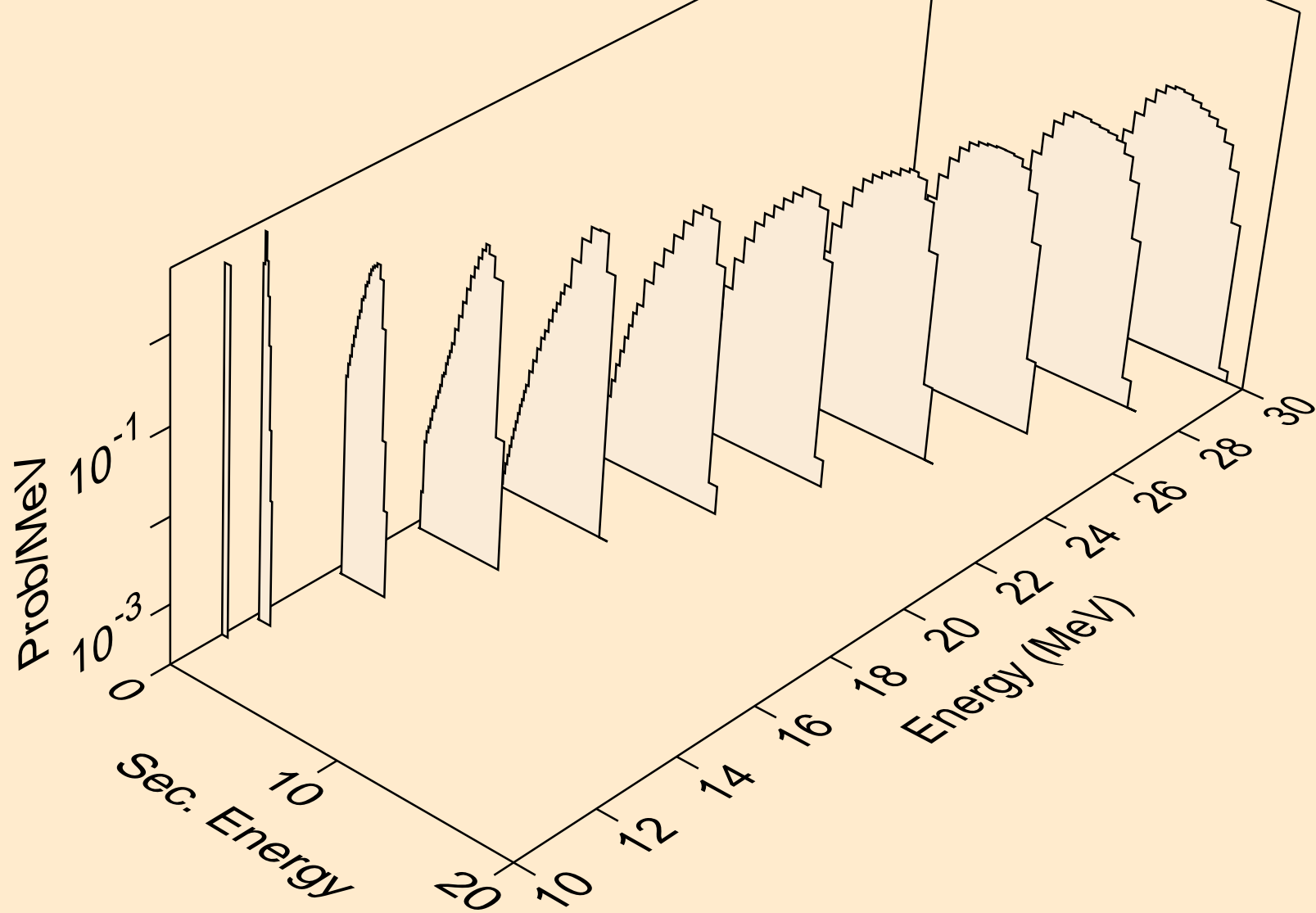

AM246M TRITON ACER TENDL-2021 LIBRARY; T=0.K  
deuterons from (t,n\*)d

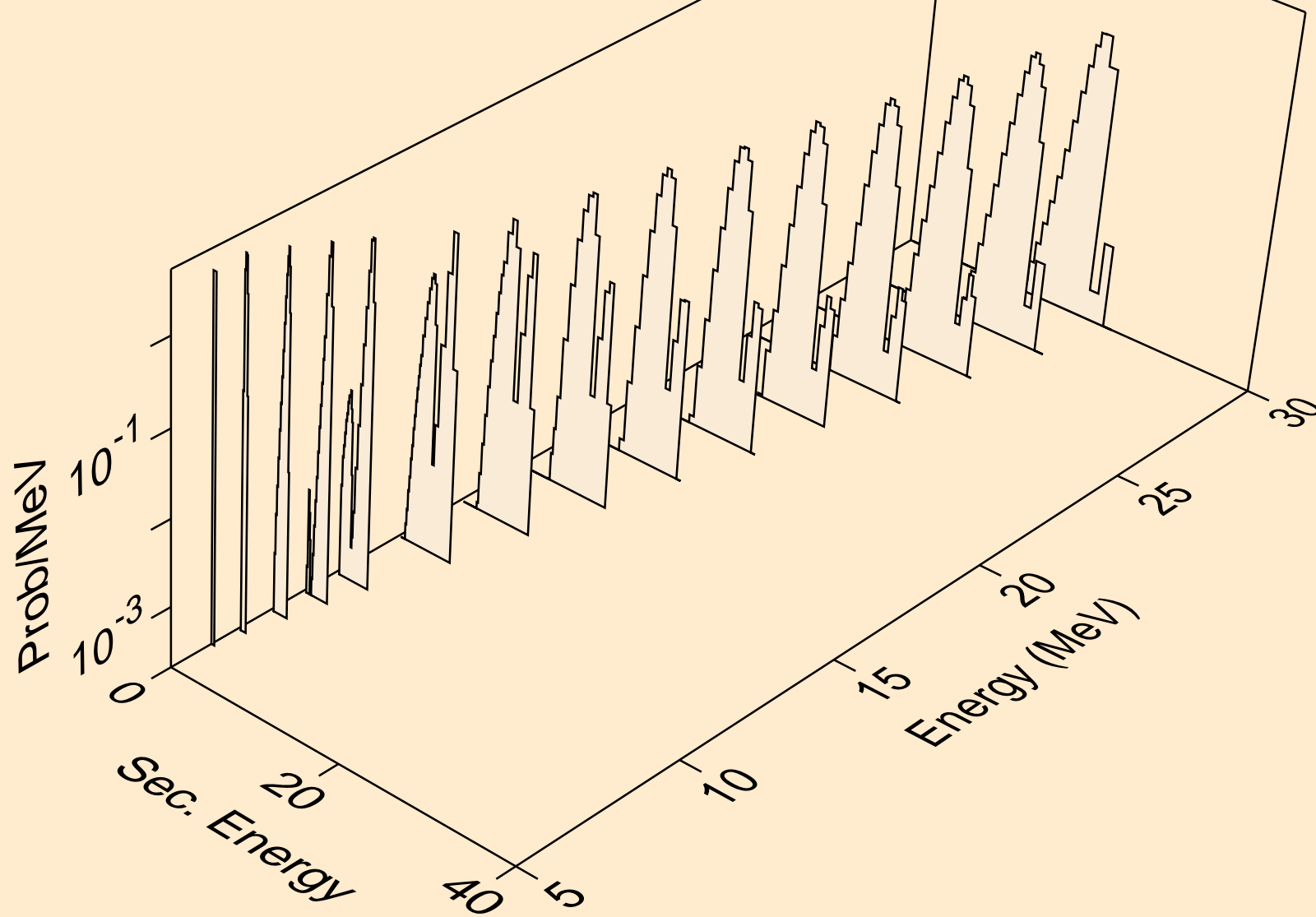

AM246M TRITON ACER TENDL-2021 LIBRARY; T=0.K  
deuterons from (t,d)

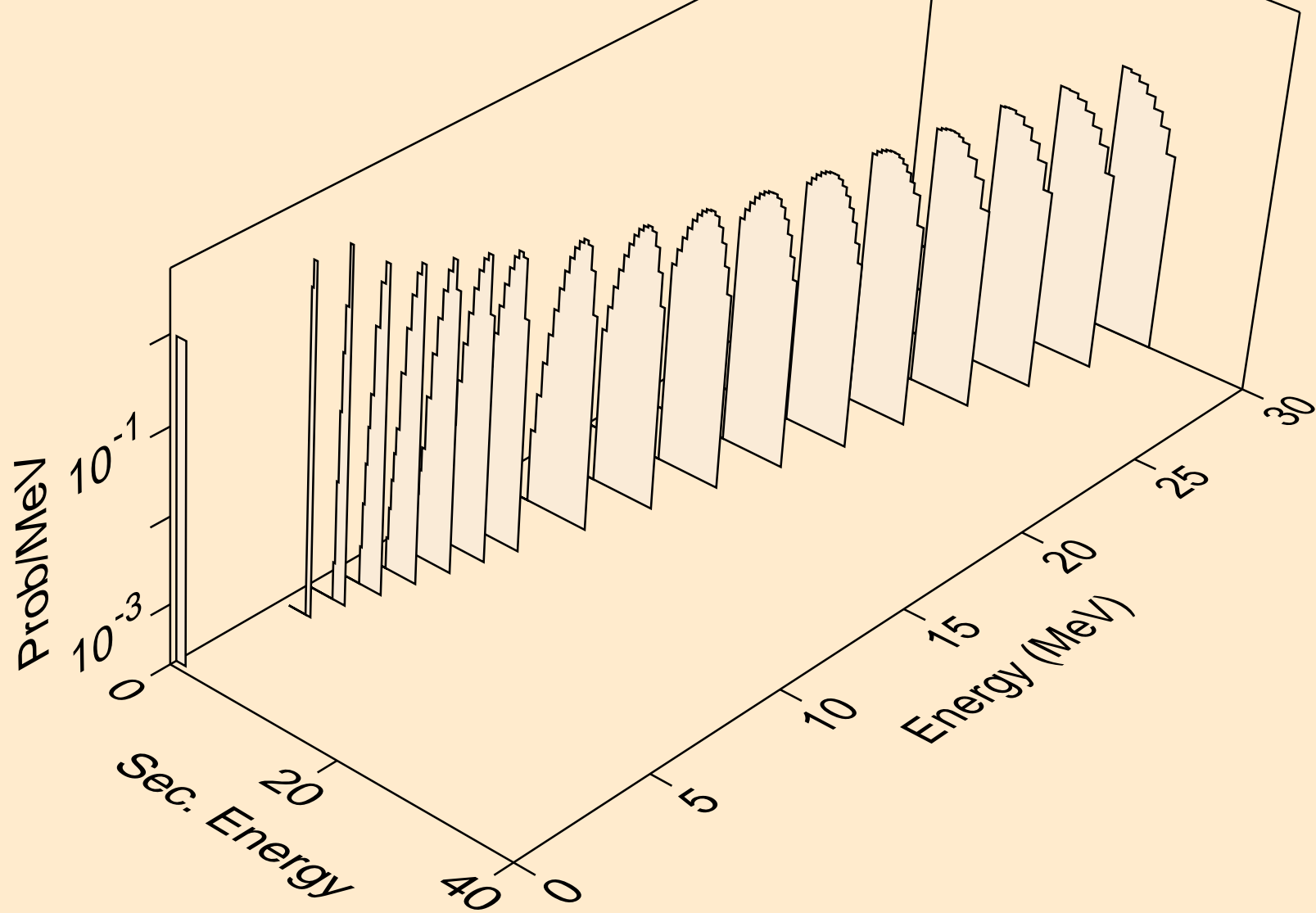

AM246M TRITON ACER TENDL-2021 LIBRARY; T=0.K  
he3s from (t,x)

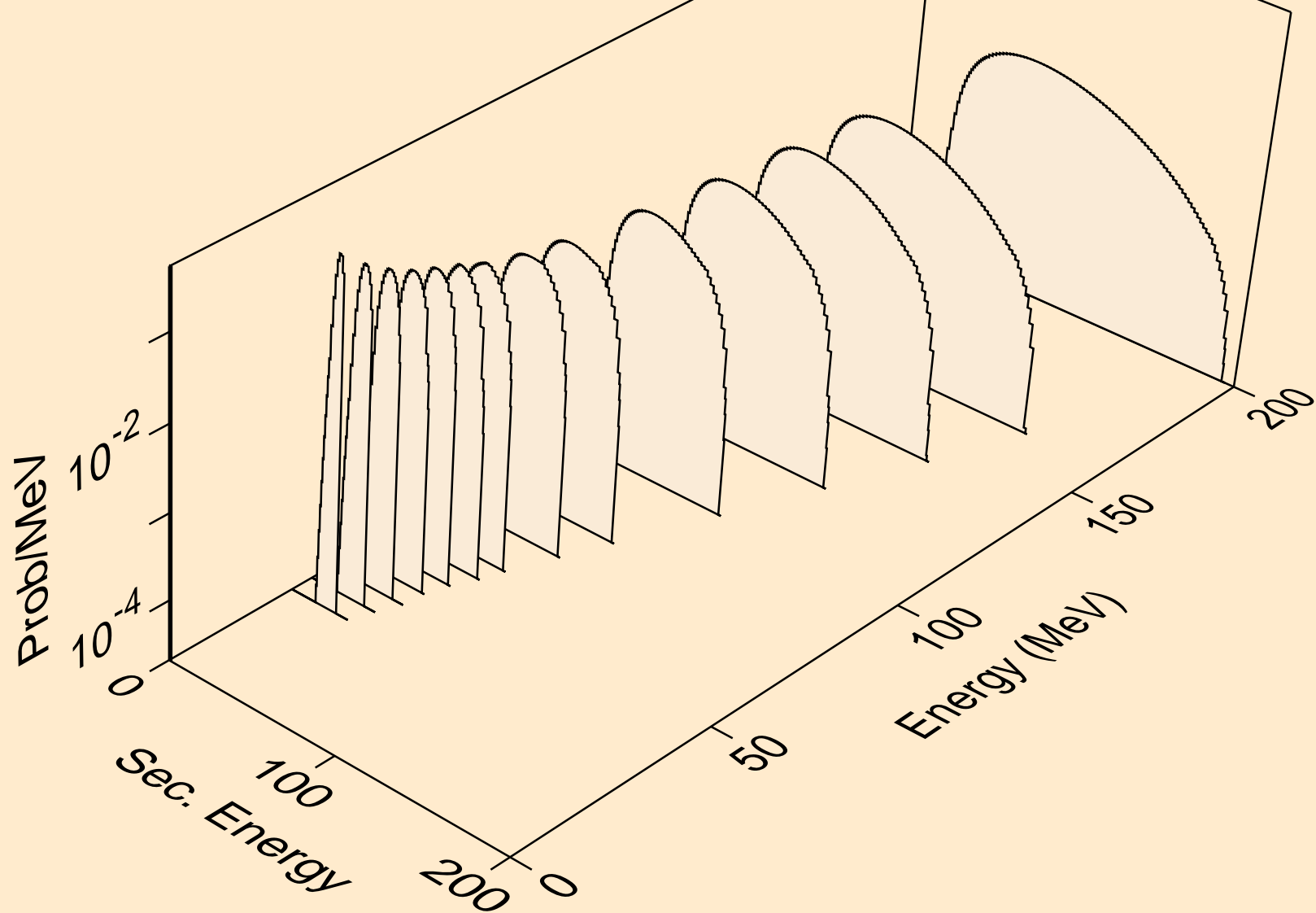

AM246M TRITON ACER TENDL-2021 LIBRARY; T=0.K  
he3s from (t,n\*)he3

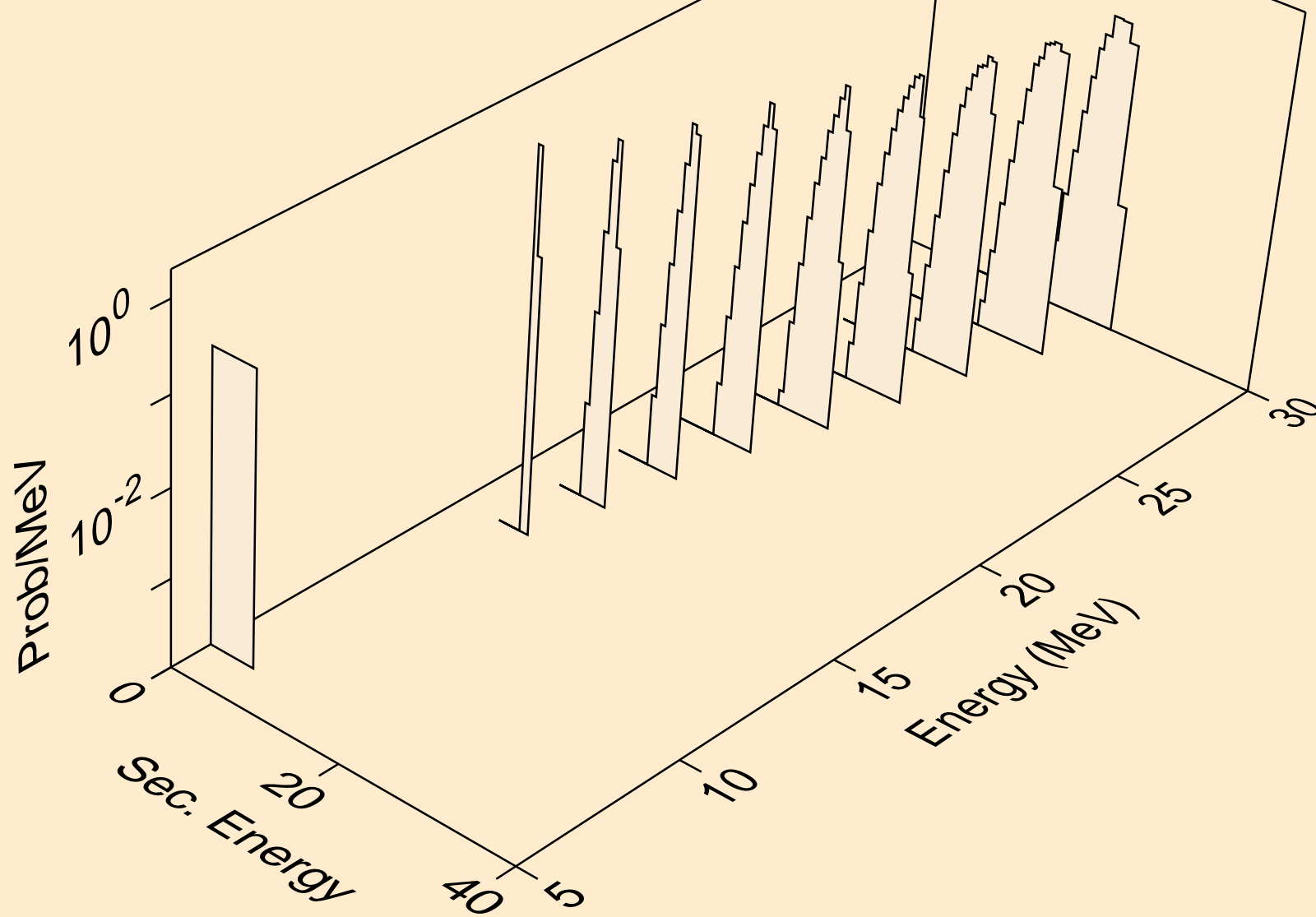

AM246M TRITON ACER TENDL-2021 LIBRARY; T=0.K  
he3s from (t,he3)

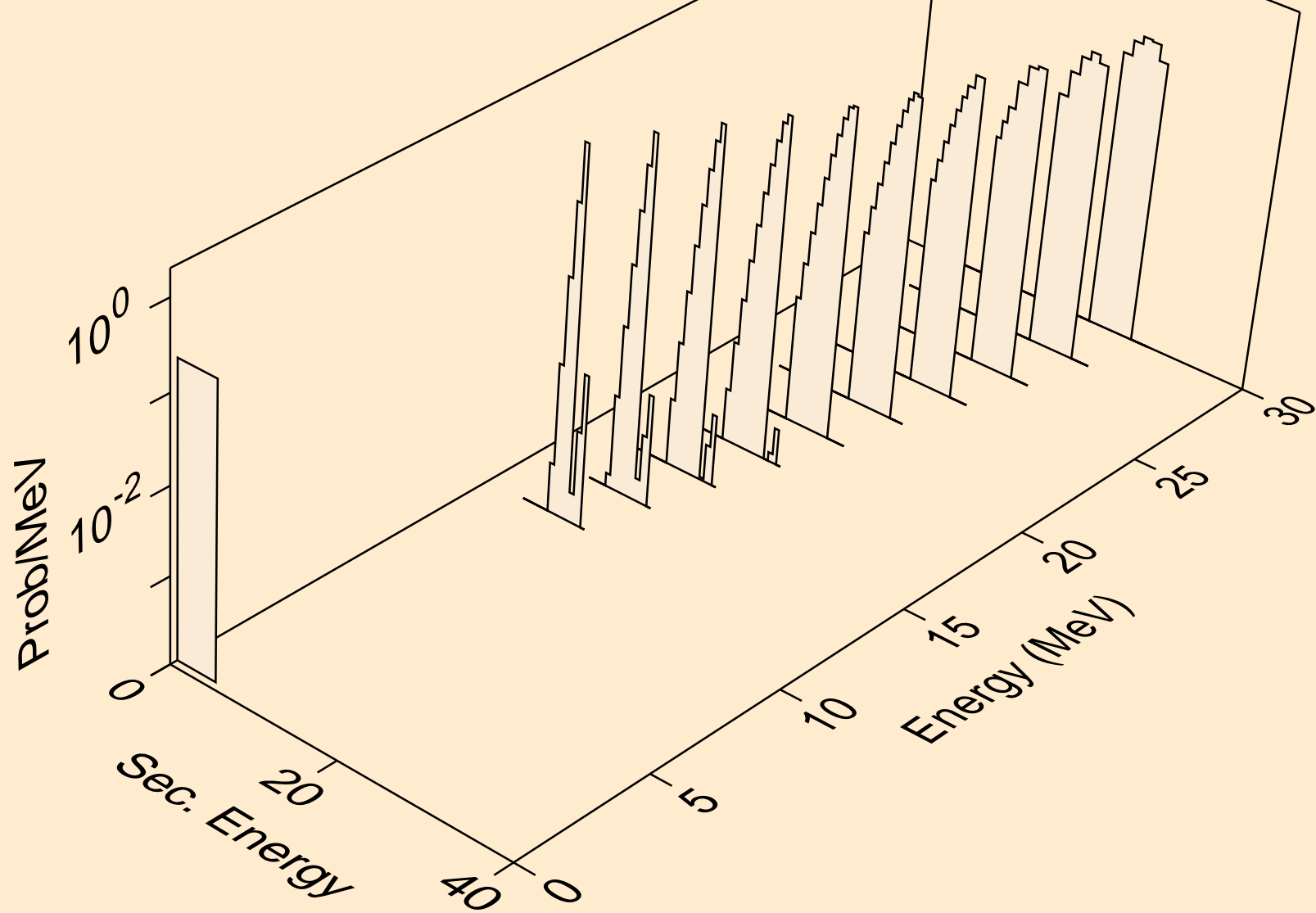

AM246M TRITON ACER TENDL-2021 LIBRARY; T=0.K  
alphas from (t,x)

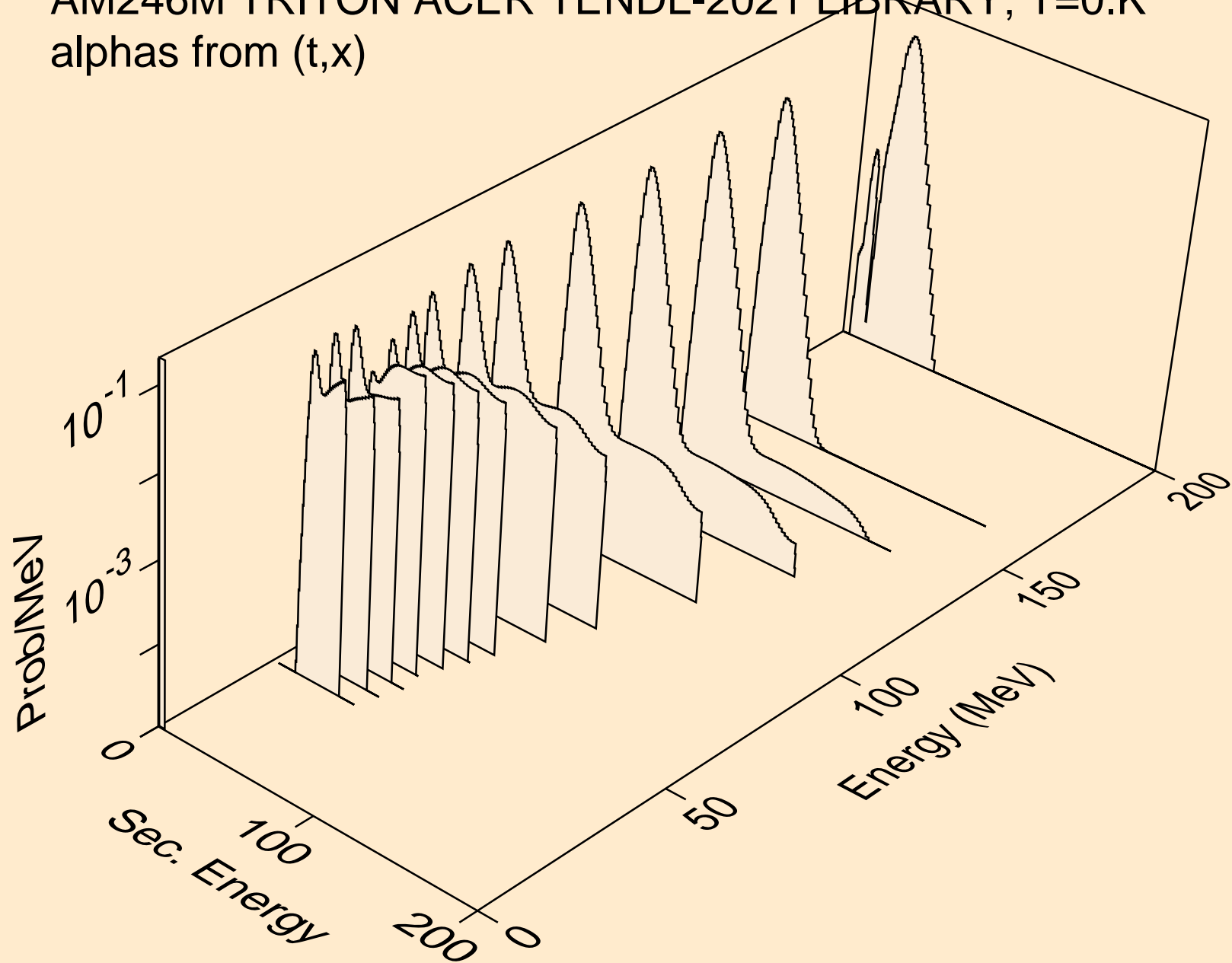



AM246M TRITON ACER TENDL-2021 LIBRARY; T=0.K  
alphas from (t,n\*)a

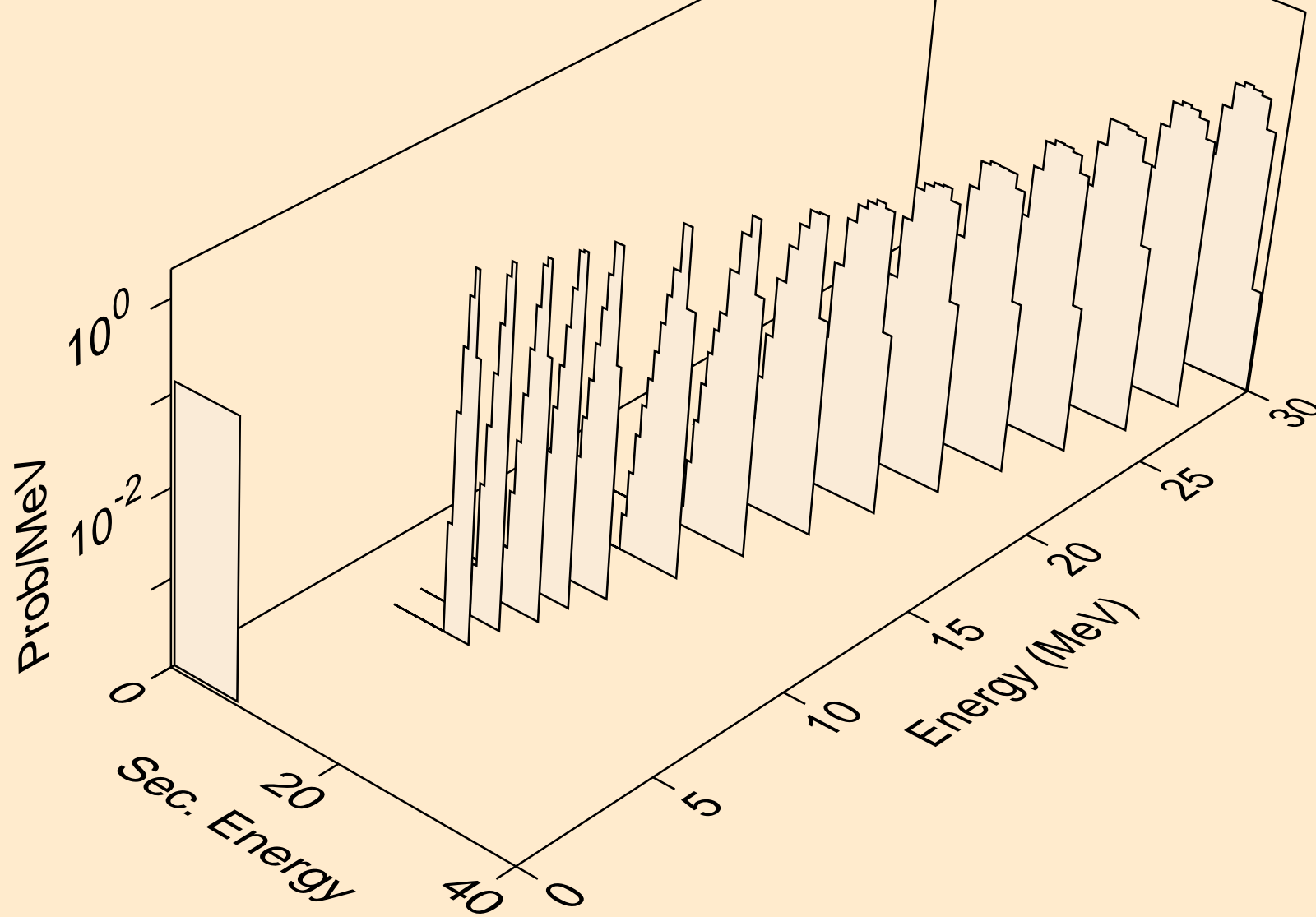

AM246M TRITON ACER TENDL-2021 LIBRARY; T=0.K  
alphas from (t,2n)a

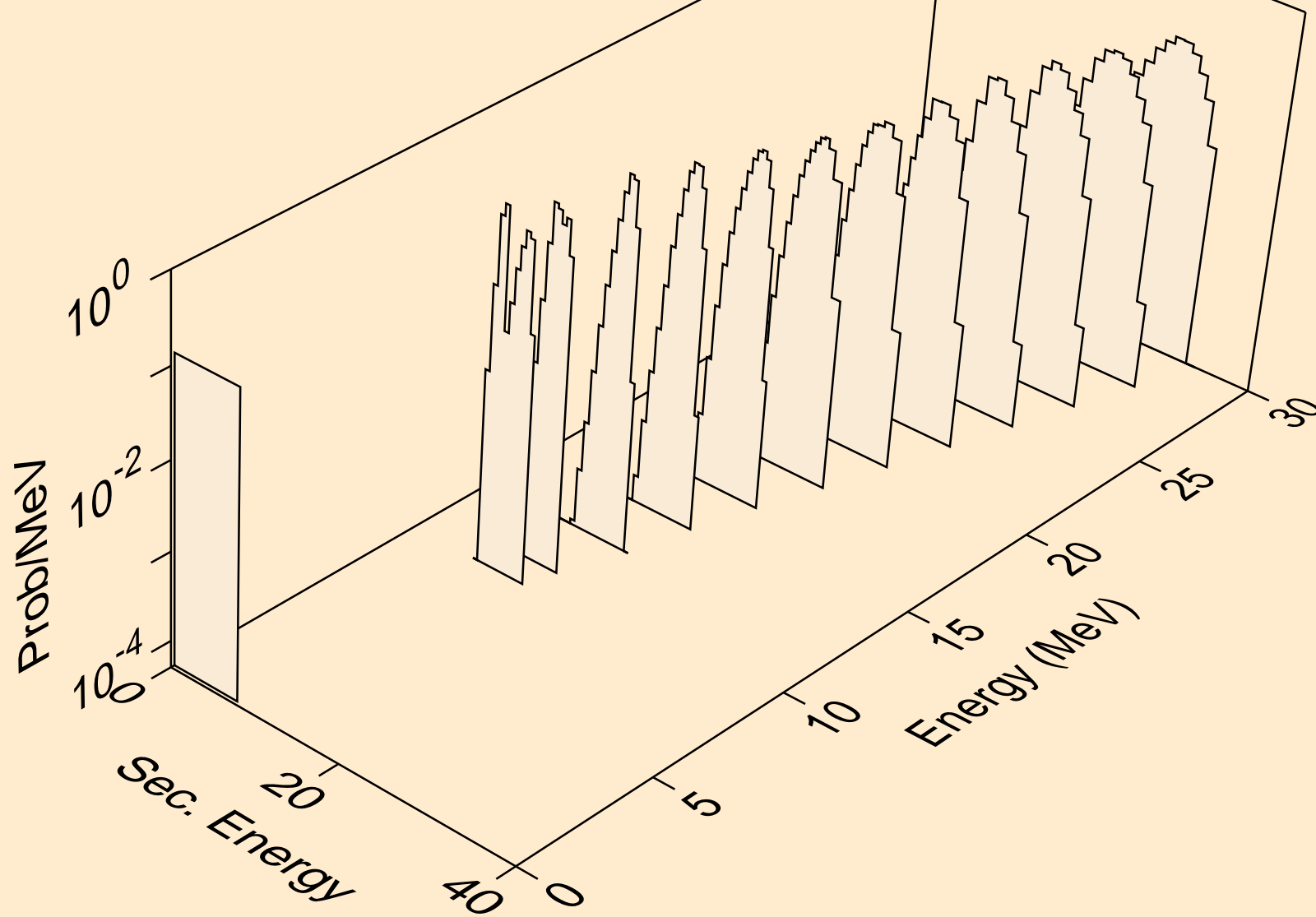

AM246M TRITON ACER TENDL-2021 LIBRARY; T=0.K  
alphas from (t,3n)a

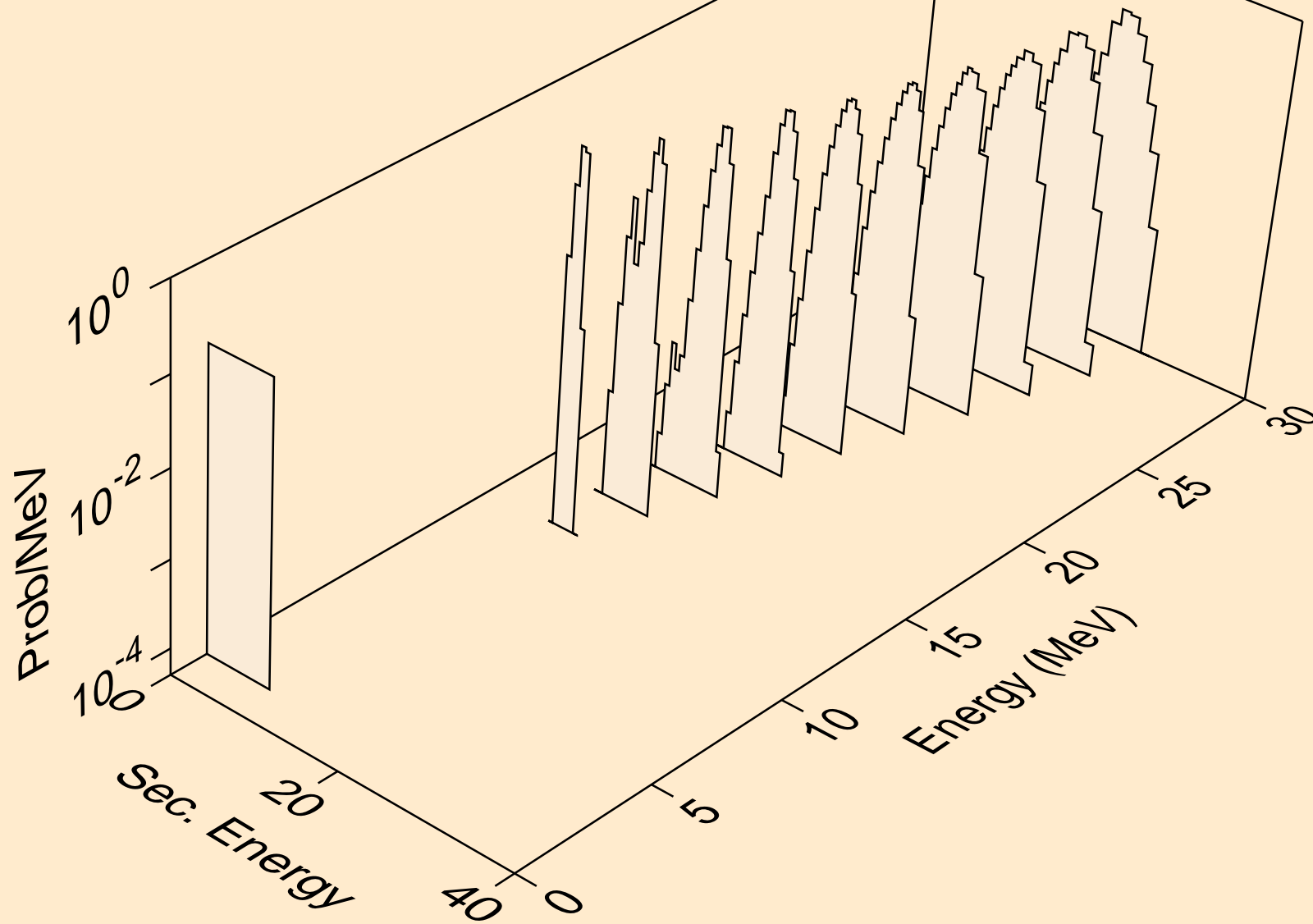

AM246M TRITON ACER TENDL-2021 LIBRARY; T=0.K  
alphas from (t,a)

