

AT222 TRITON ACER TENDL-2021 LIBRARY; T=0.K  
Principal cross sections

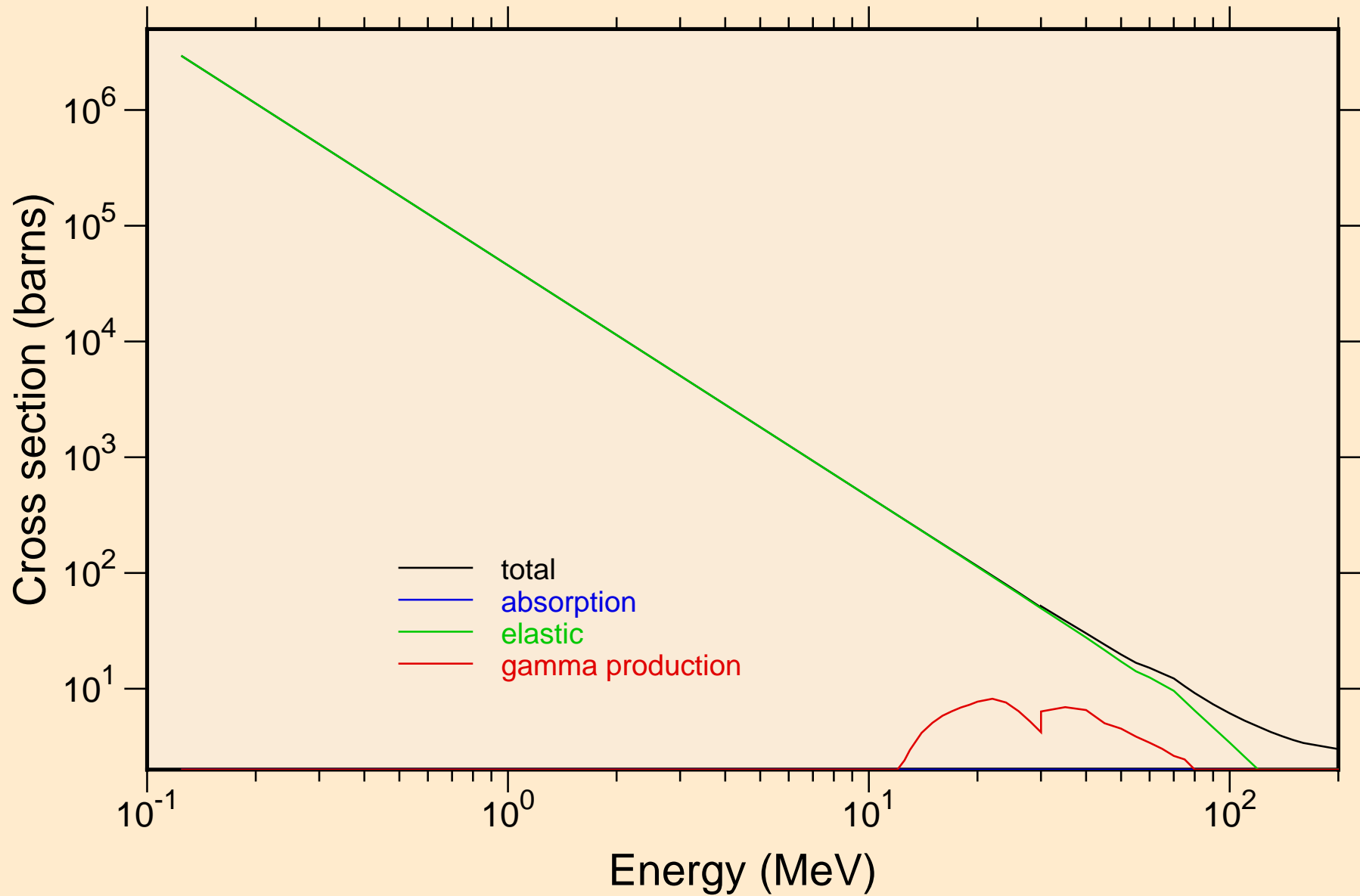

AT222 TRITON ACER TENDL-2021 LIBRARY; T=0.K

Heating

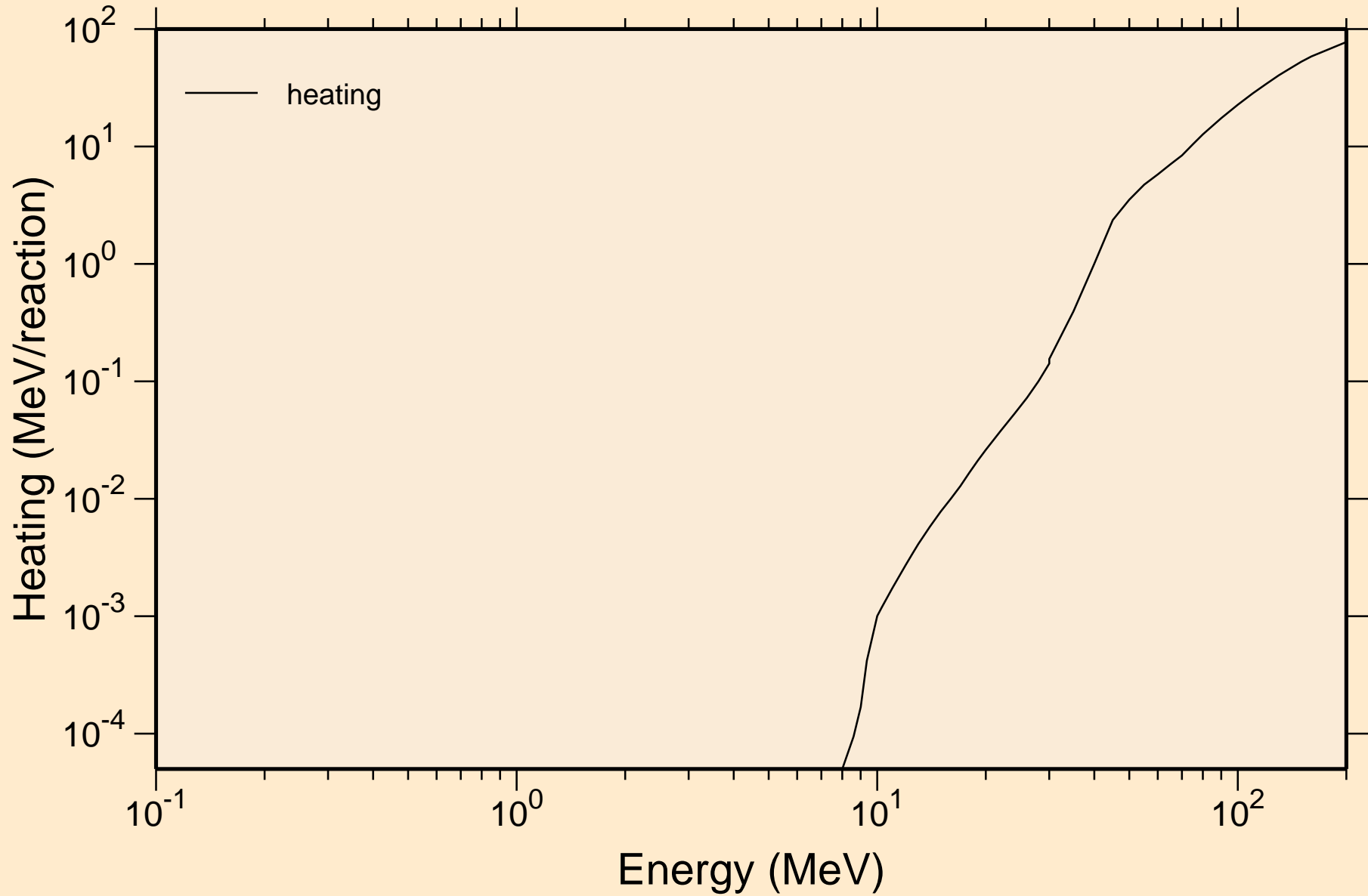

# AT222 TRITON ACER TENDL-2021 LIBRARY; T=0.K

## Principal cross sections

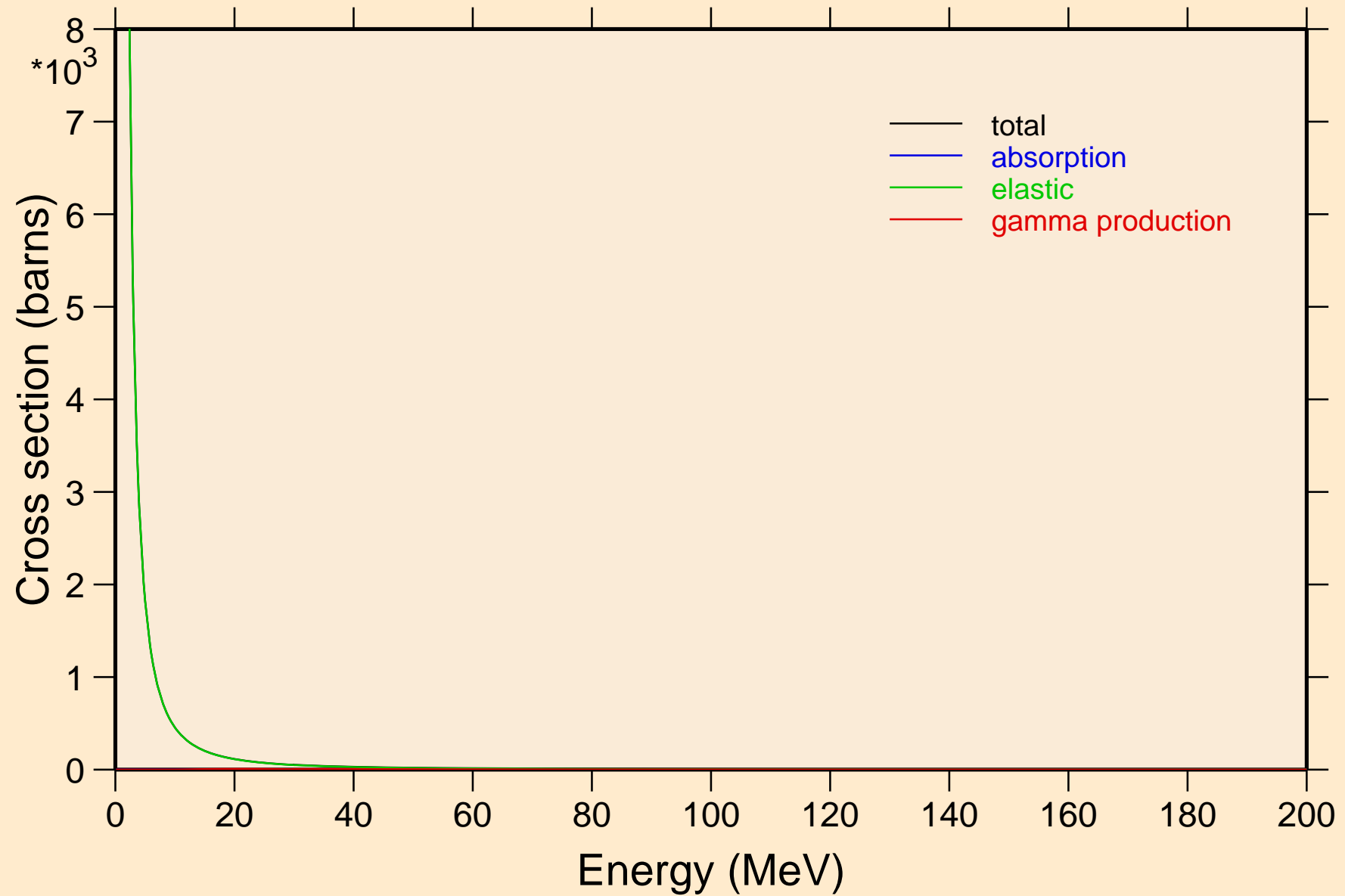

AT222 TRITON ACER TENDL-2021 LIBRARY; T=0.K

Heating

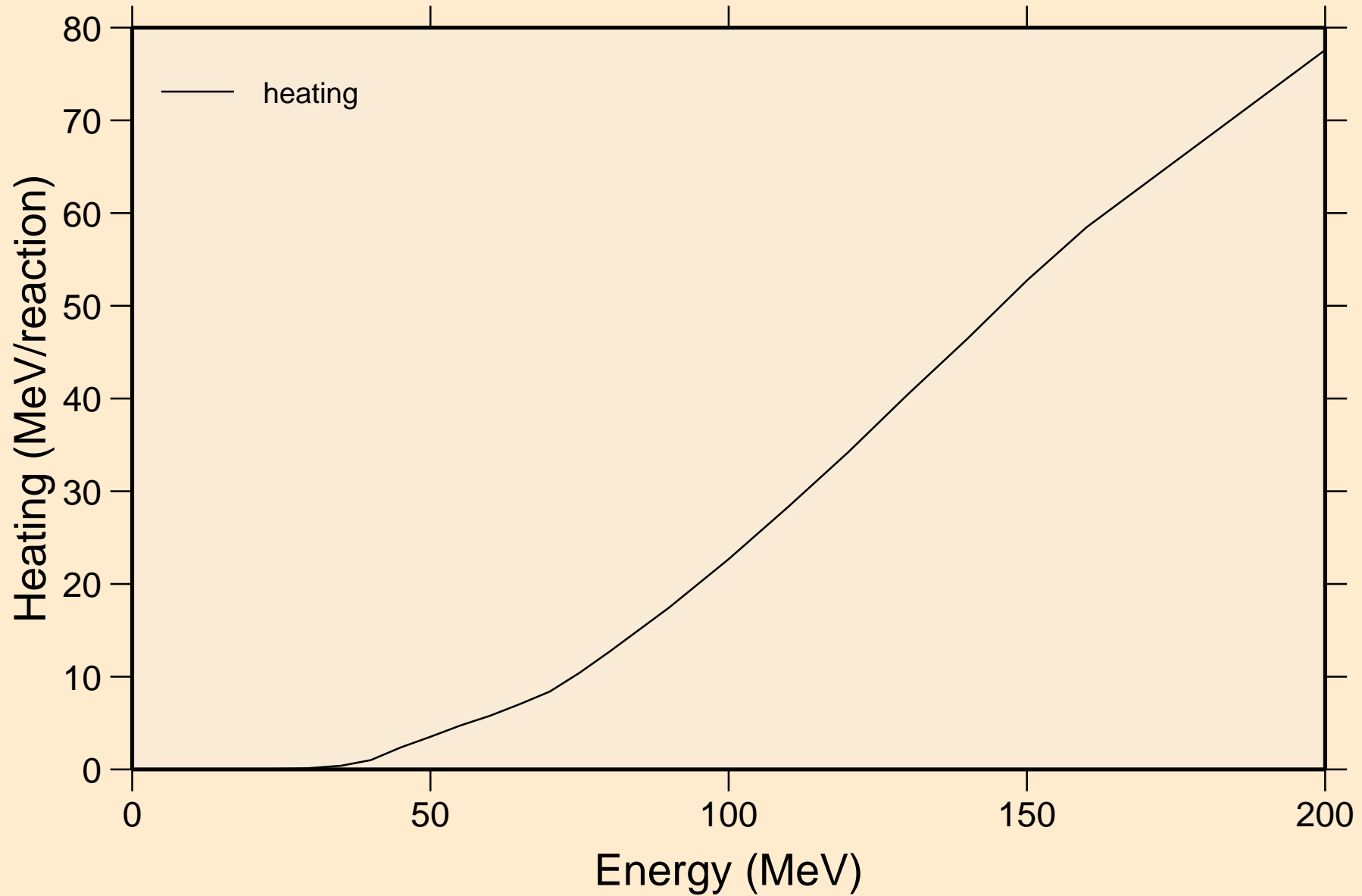

AT222 TRITON ACER TENDL-2021 LIBRARY; T=0.K  
Threshold reactions

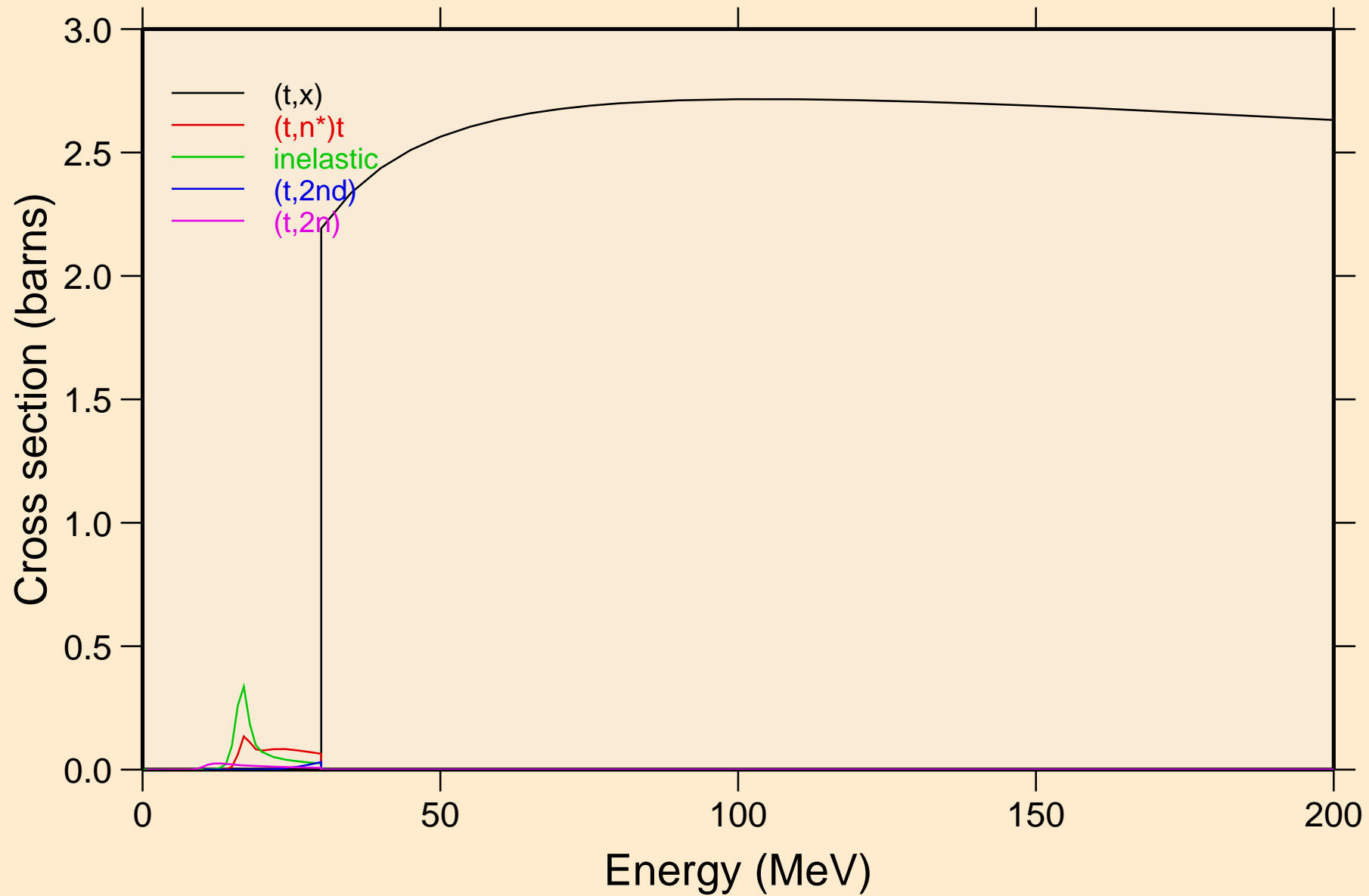

AT222 TRITON ACER TENDL-2021 LIBRARY; T=0.K  
Threshold reactions

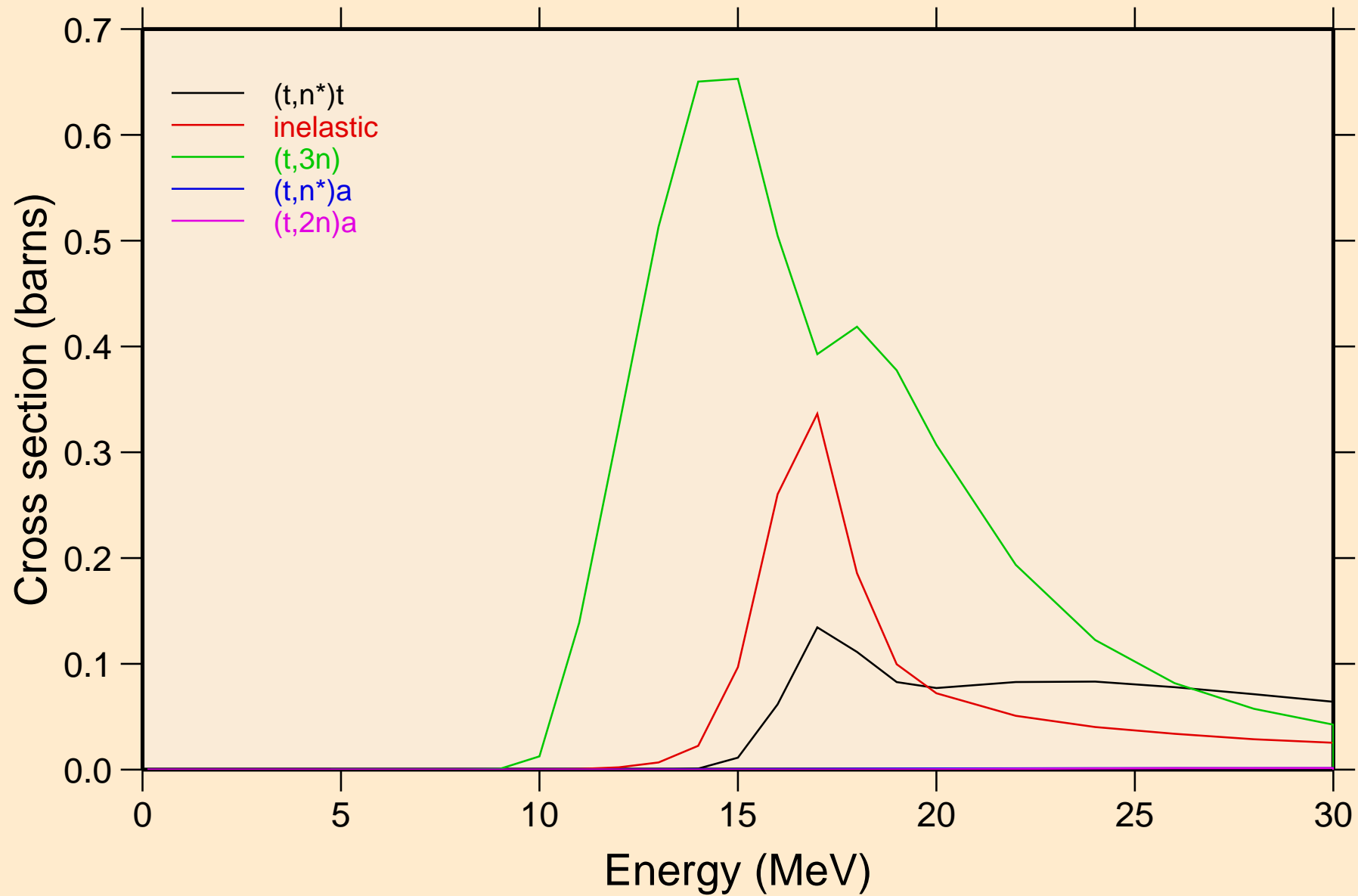

AT222 TRITON ACER TENDL-2021 LIBRARY; T=0.K  
Threshold reactions

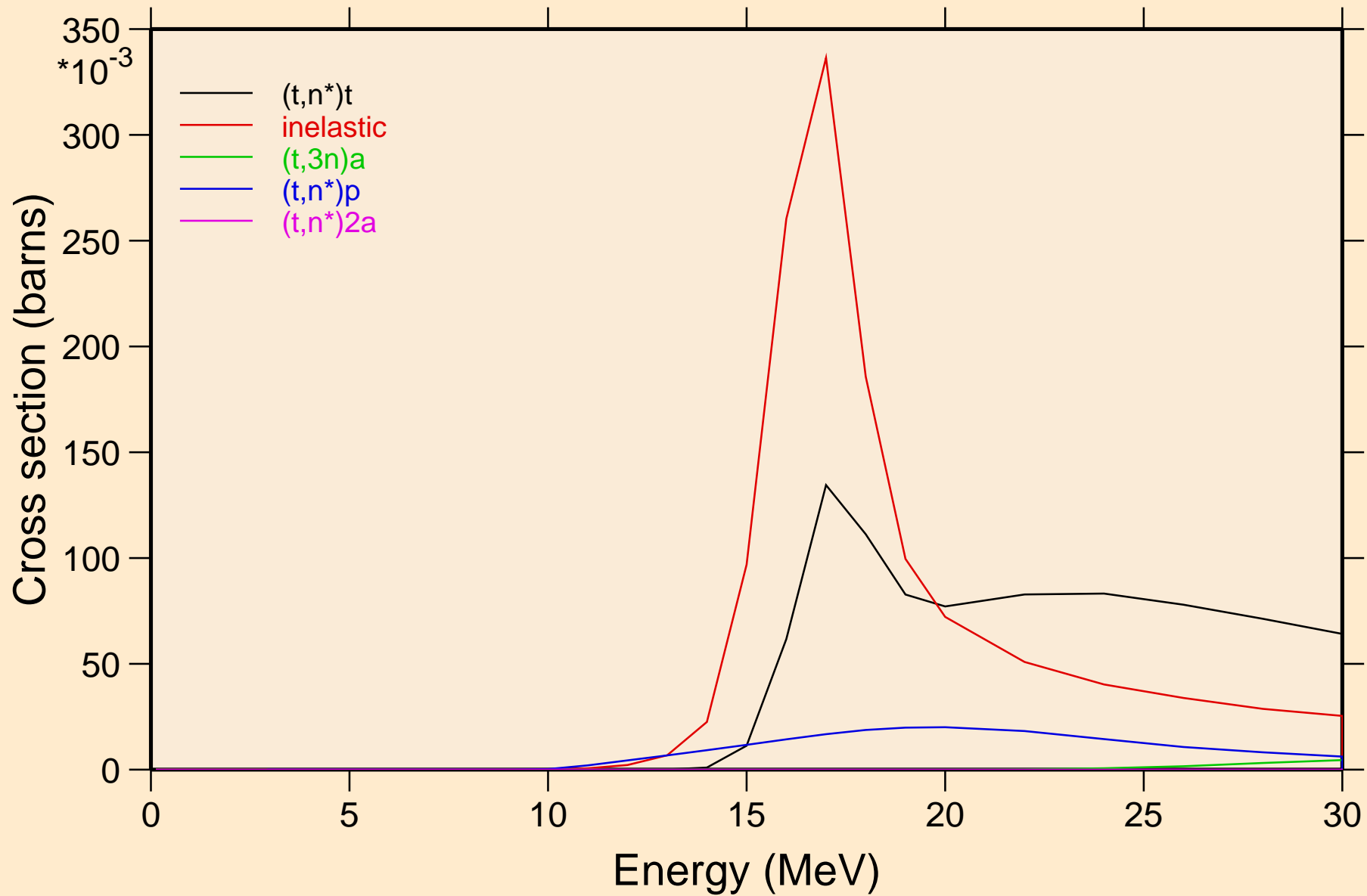

AT222 TRITON ACER TENDL-2021 LIBRARY; T=0.K  
Threshold reactions

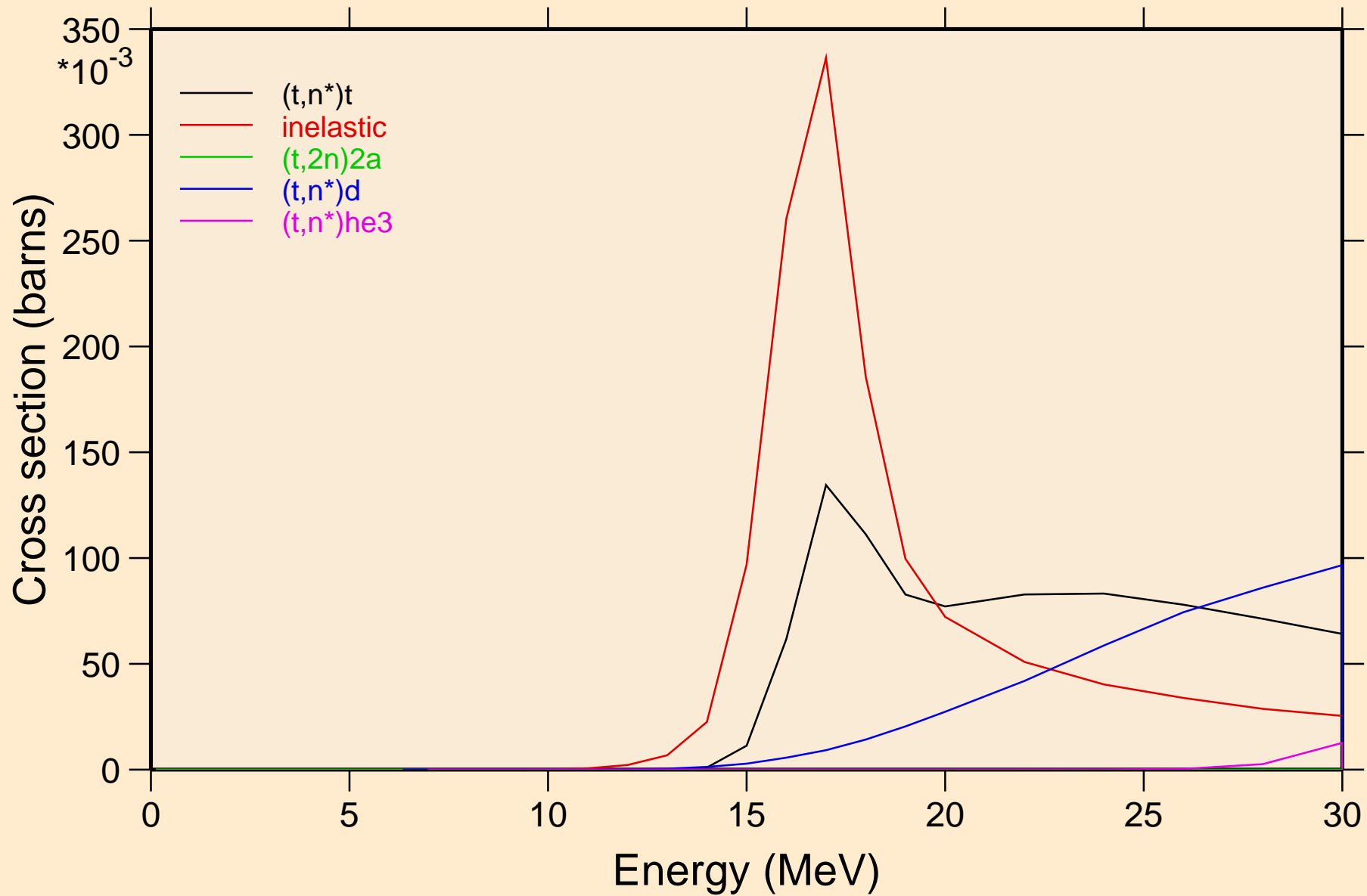



AT222 TRITON ACER TENDL-2021 LIBRARY; T=0.K  
Threshold reactions

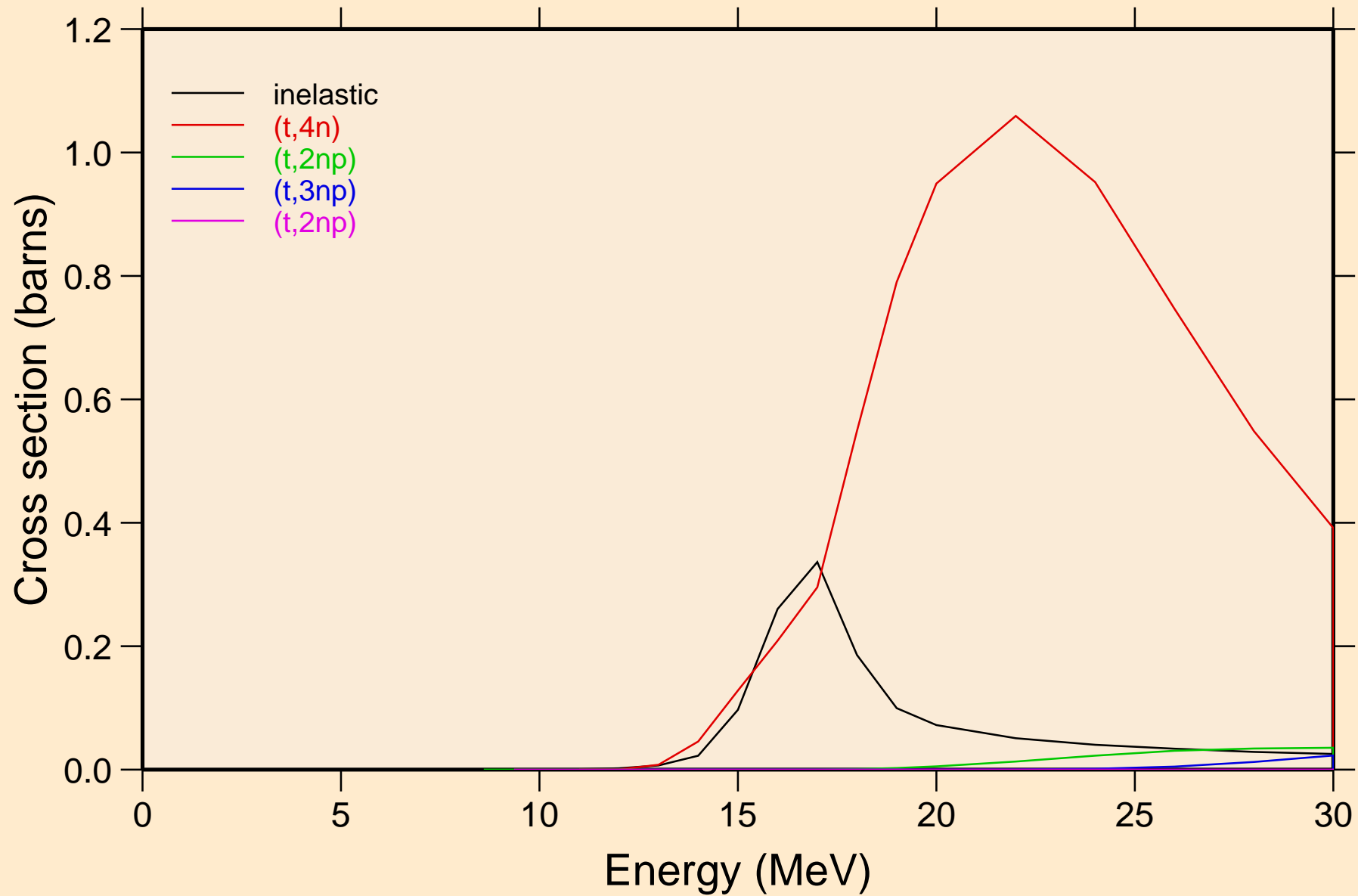

AT222 TRITON ACER TENDL-2021 LIBRARY; T=0.K  
Threshold reactions

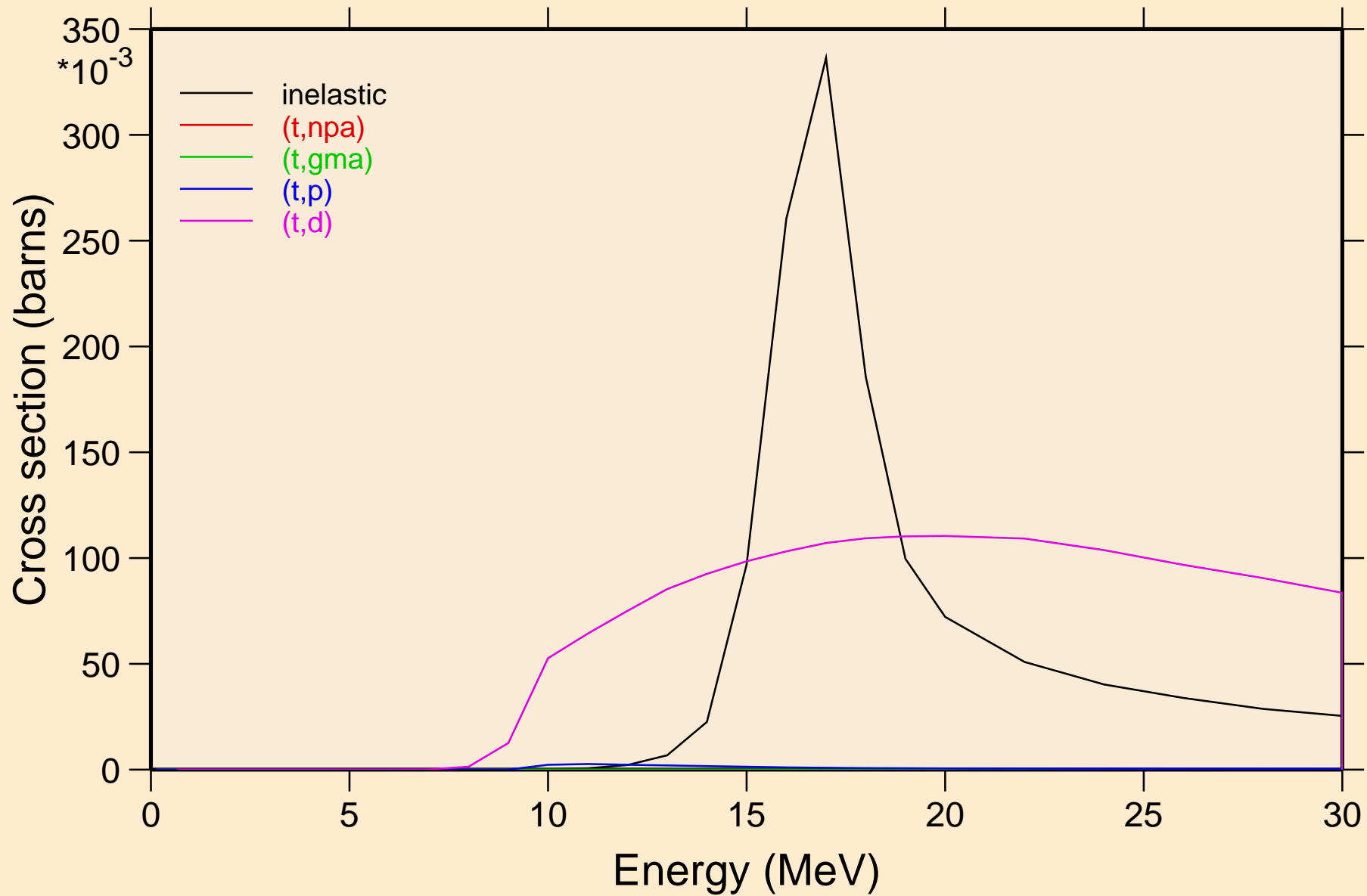

AT222 TRITON ACER TENDL-2021 LIBRARY; T=0.K  
Threshold reactions

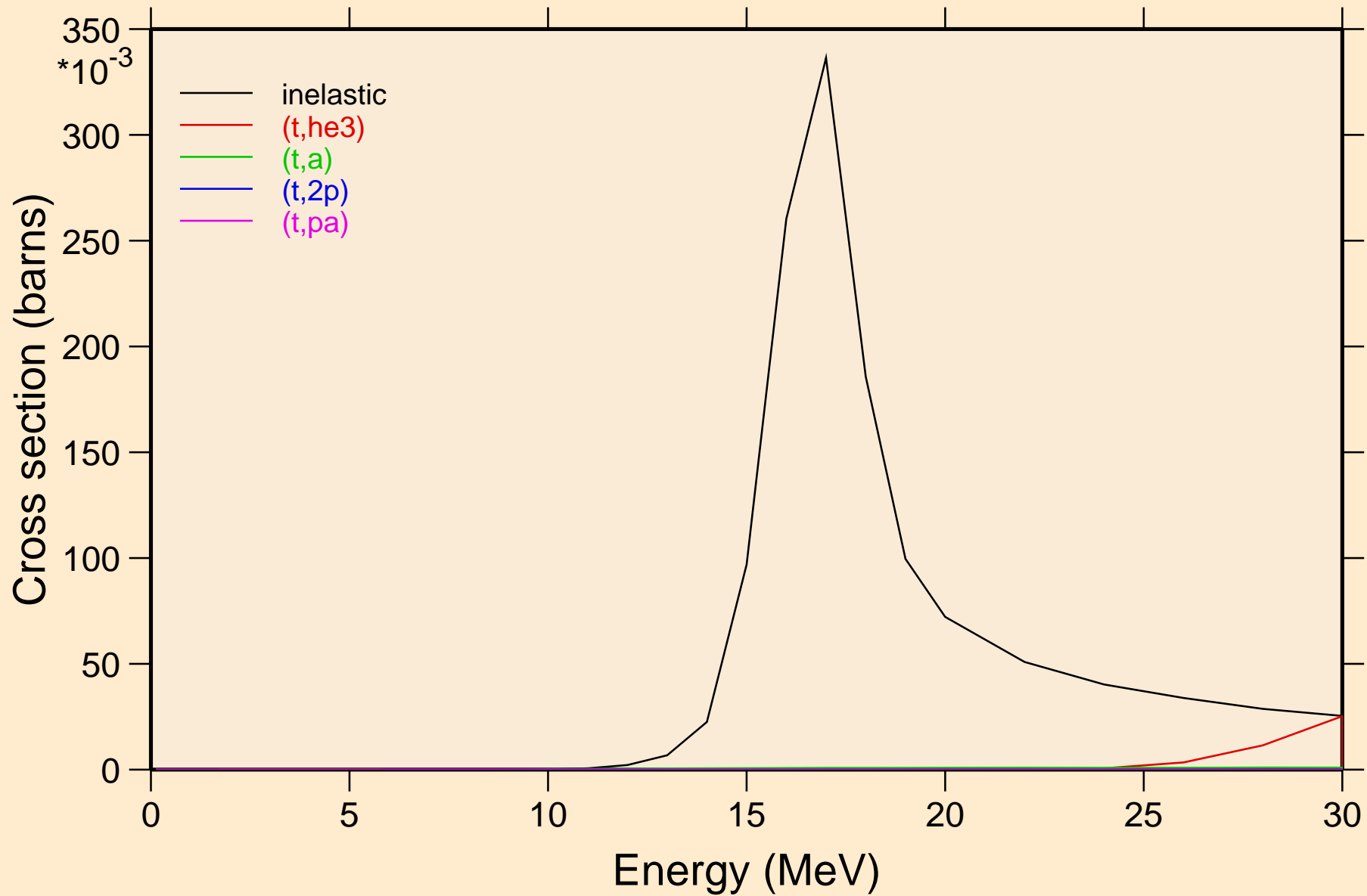

AT222 TRITON ACER TENDL-2021 LIBRARY; T=0.K  
Threshold reactions

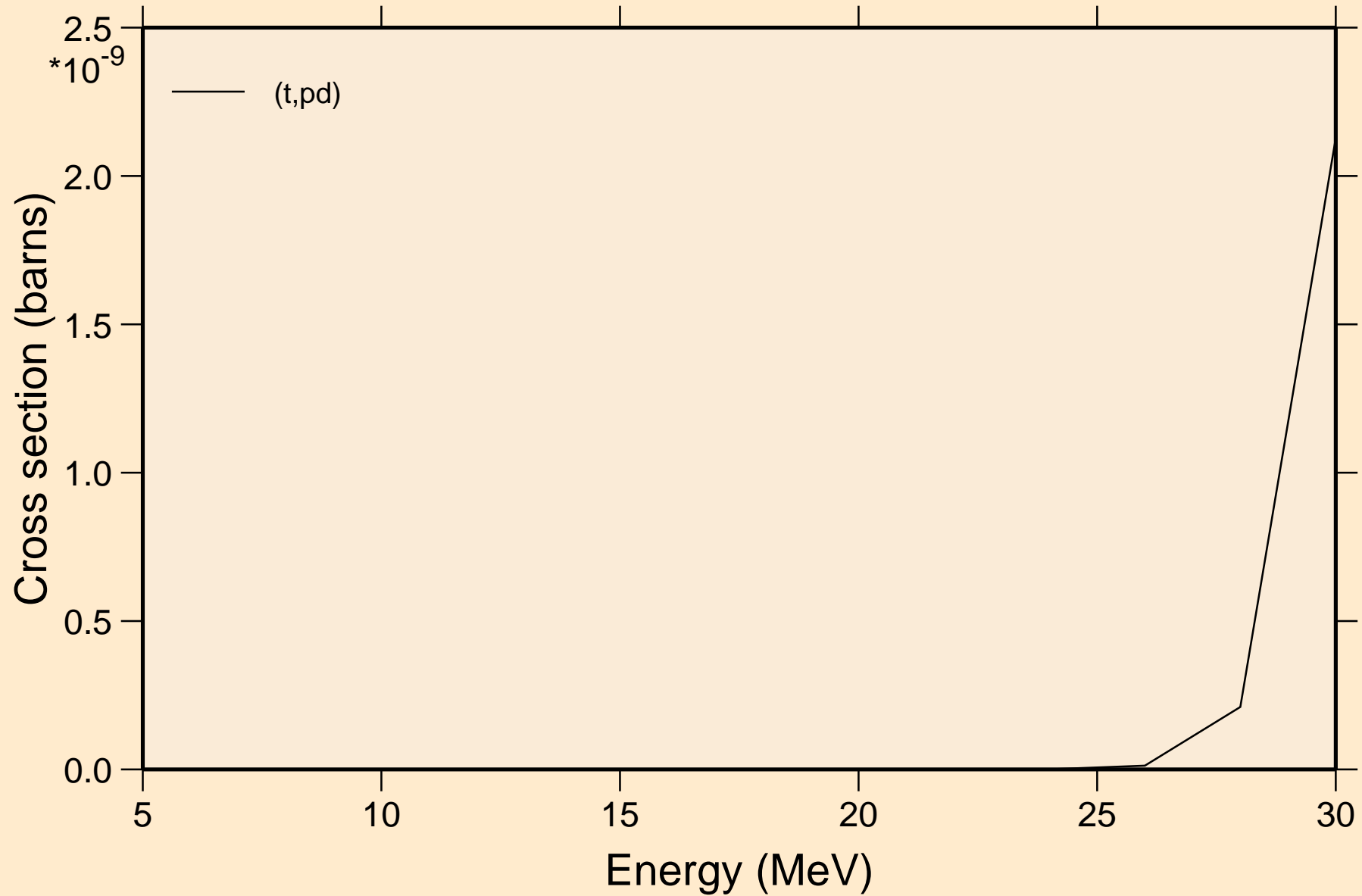

AT222 TRITON ACER TENDL-2021 LIBRARY; T=0.K  
angular distribution for elastic

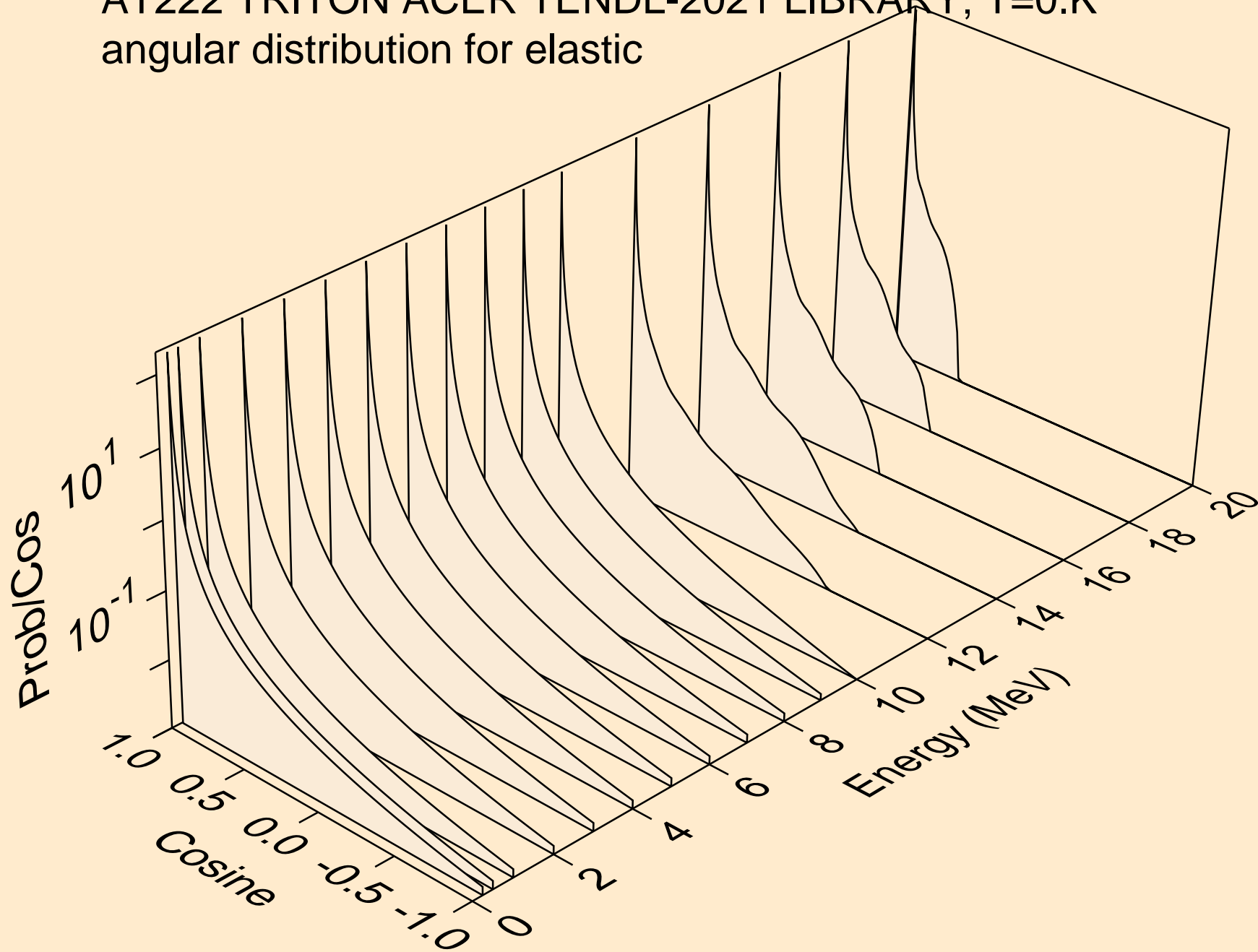

AT222 TRITON ACER TENDL-2021 LIBRARY; T=0.K  
angular distribution for elastic

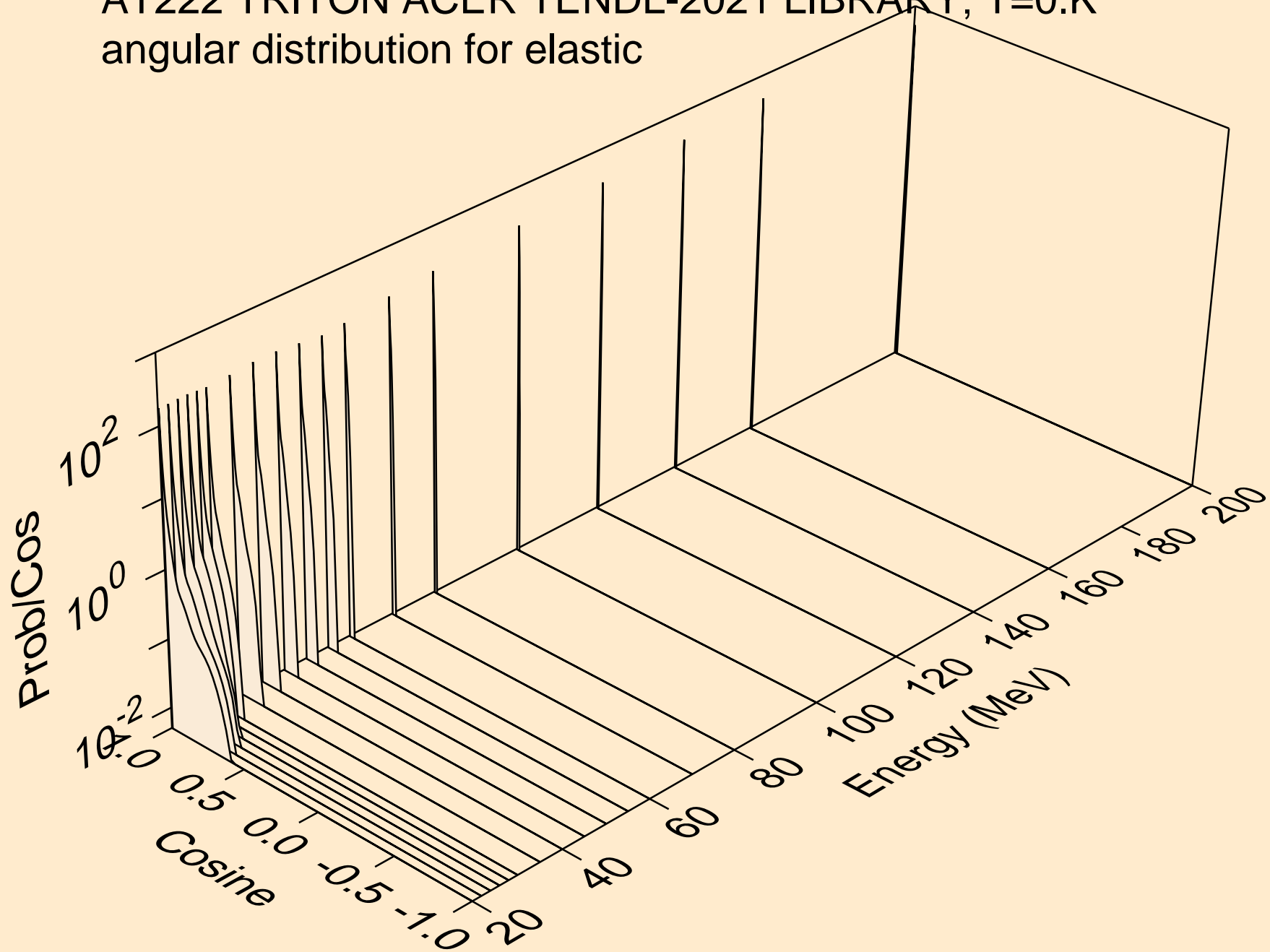

AT222 TRITON ACER TENDL-2021 LIBRARY; T=0.K  
Triton emission for (t,x)

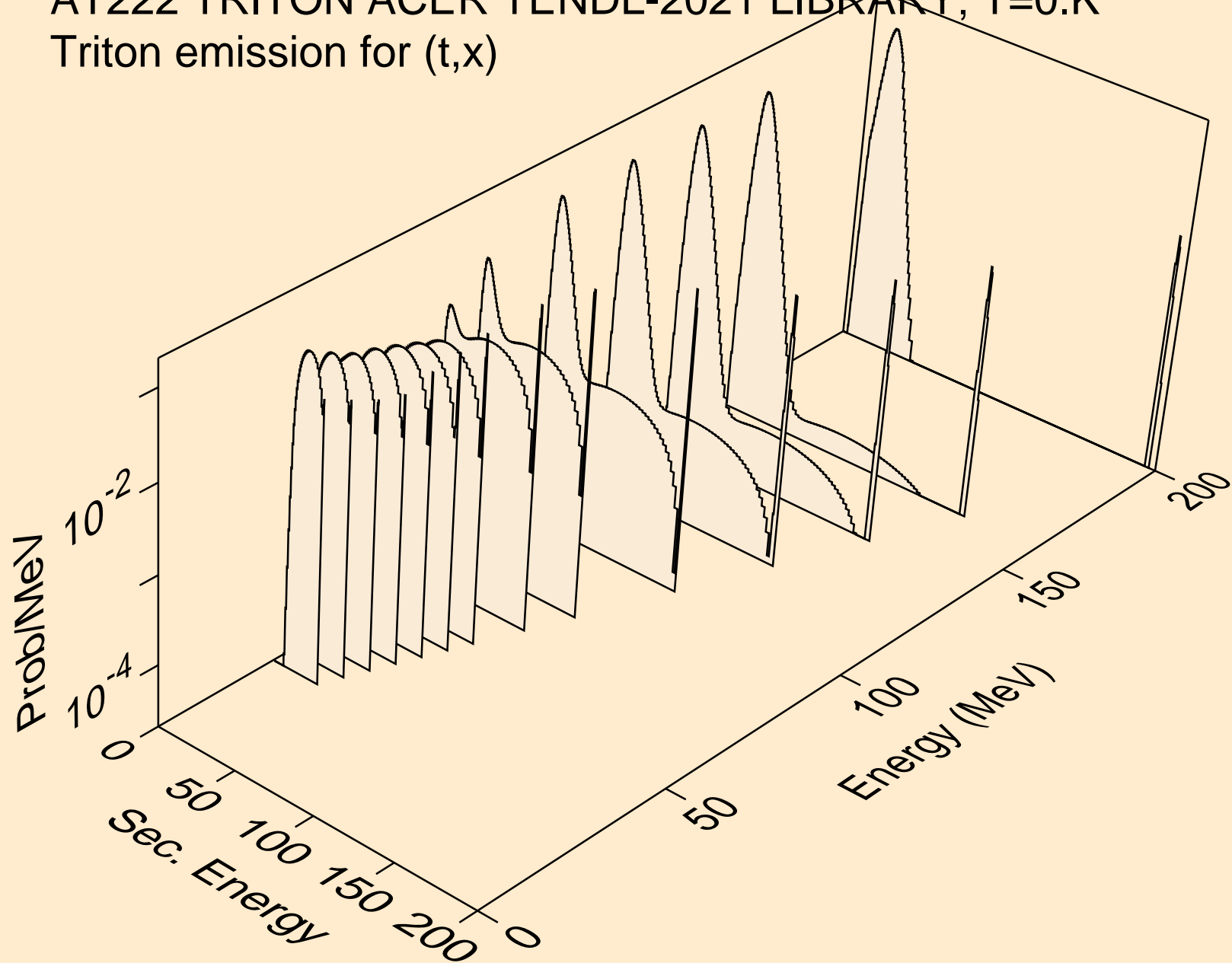

AT222 TRITON ACER TENDL-2021 LIBRARY; T=0.K  
Triton emission for (t,n\*)t

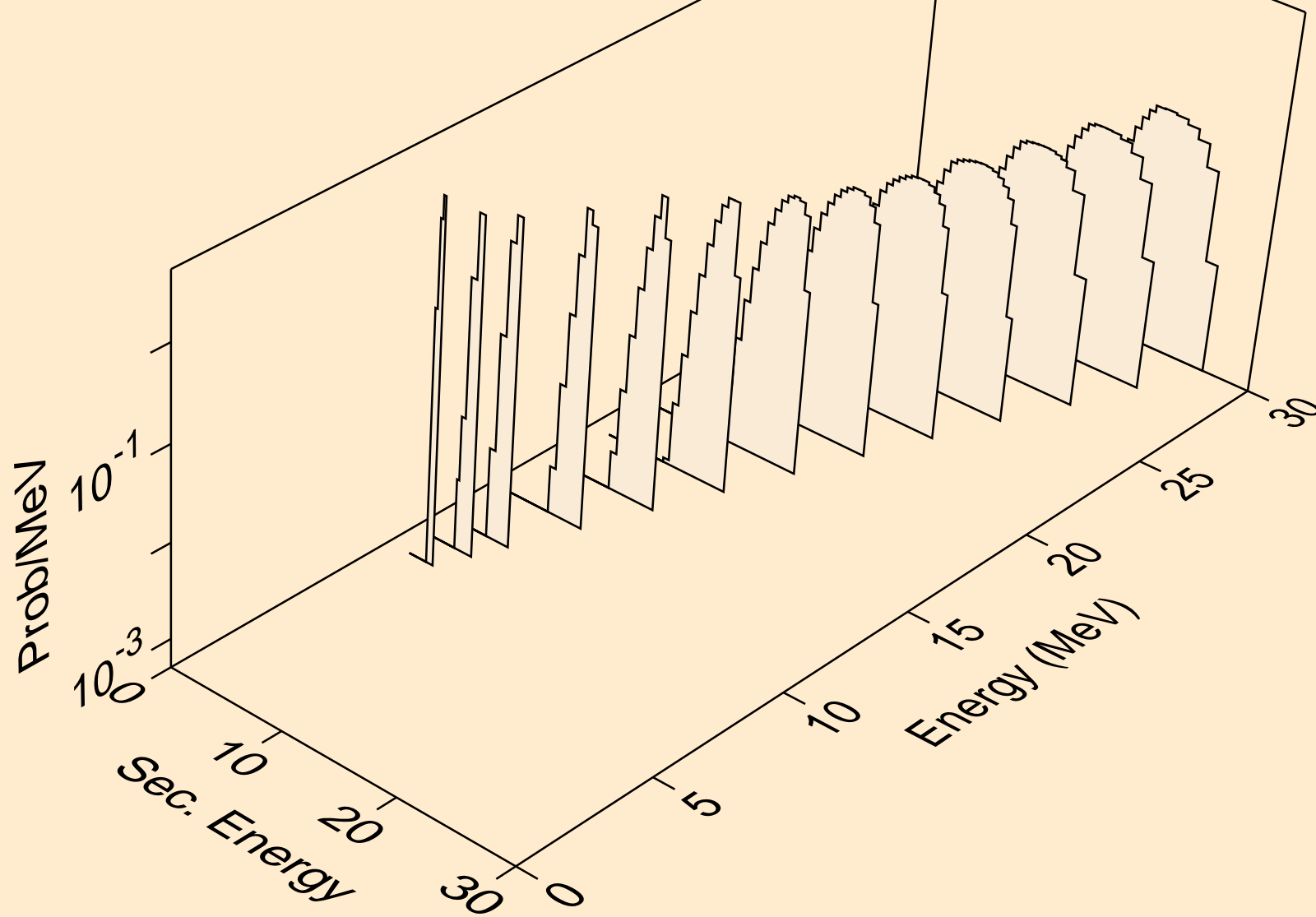



AT222 TRITON ACER TENDL-2021 LIBRARY; T=0.K  
Triton emission for inelastic

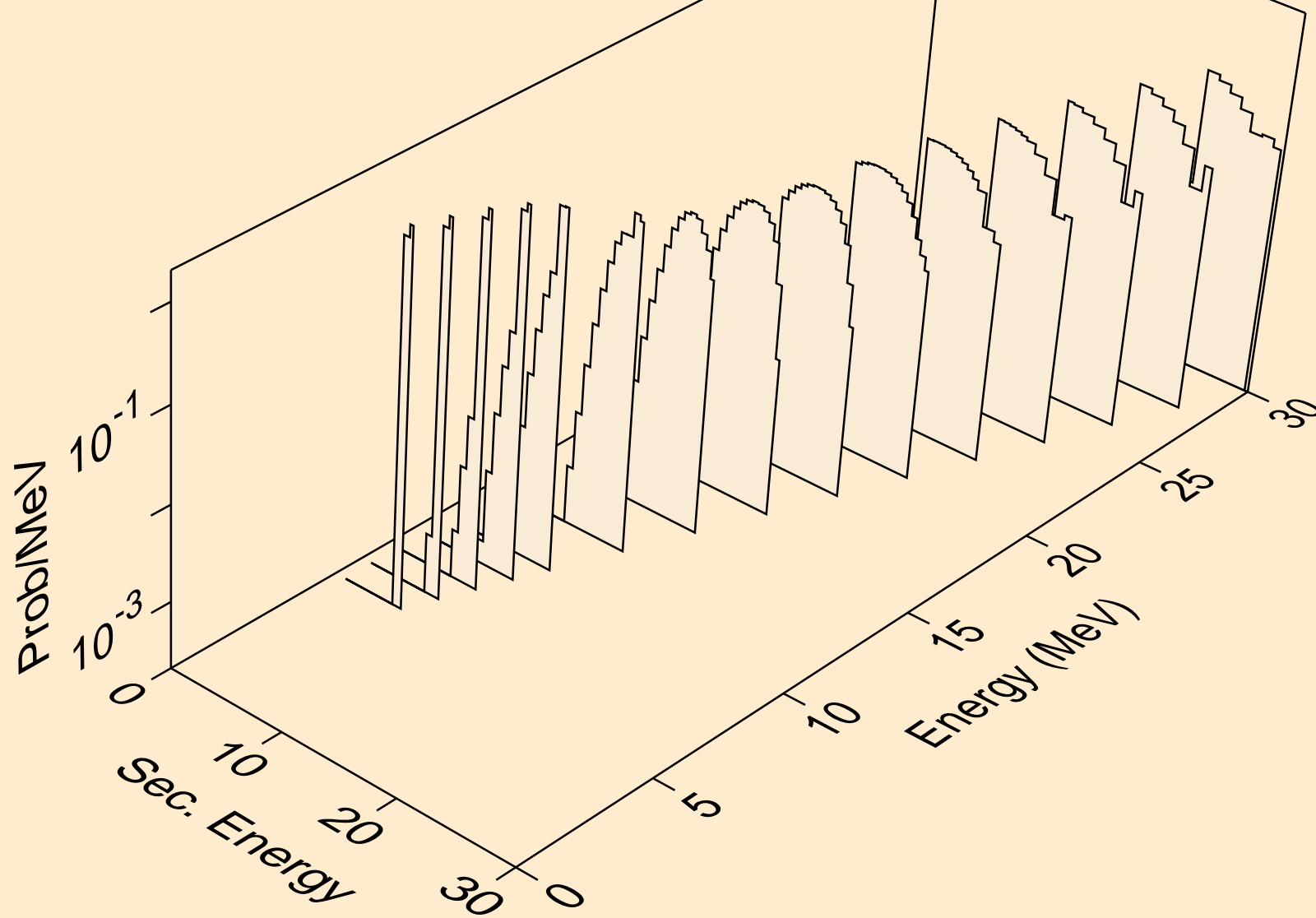

AT222 TRITON ACER TENDL-2021 LIBRARY; T=0.K  
Photon emission for (z,n)

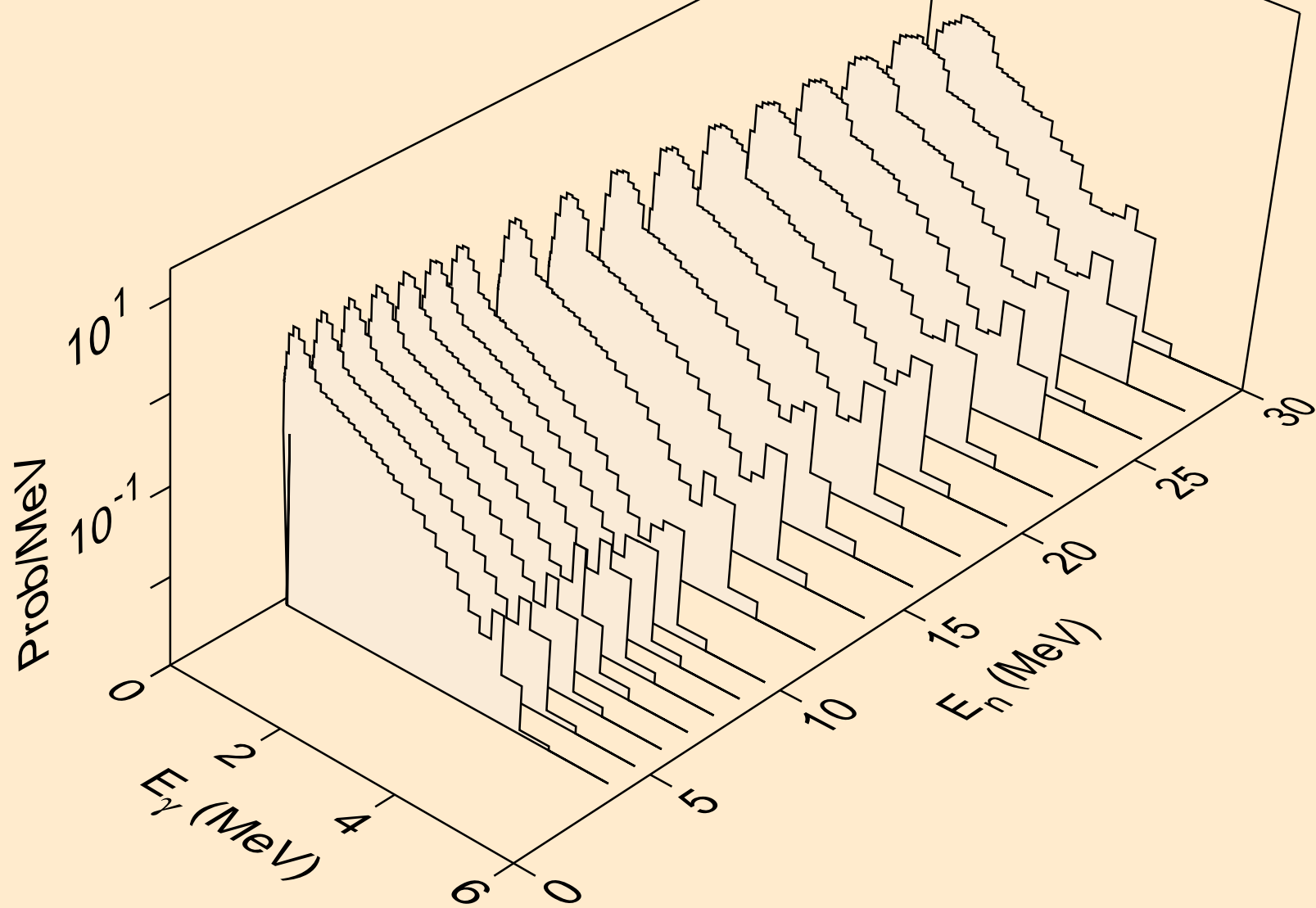

AT222 TRITON ACER TENDL-2021 LIBRARY; T=0.K  
Photon emission for (n,x)

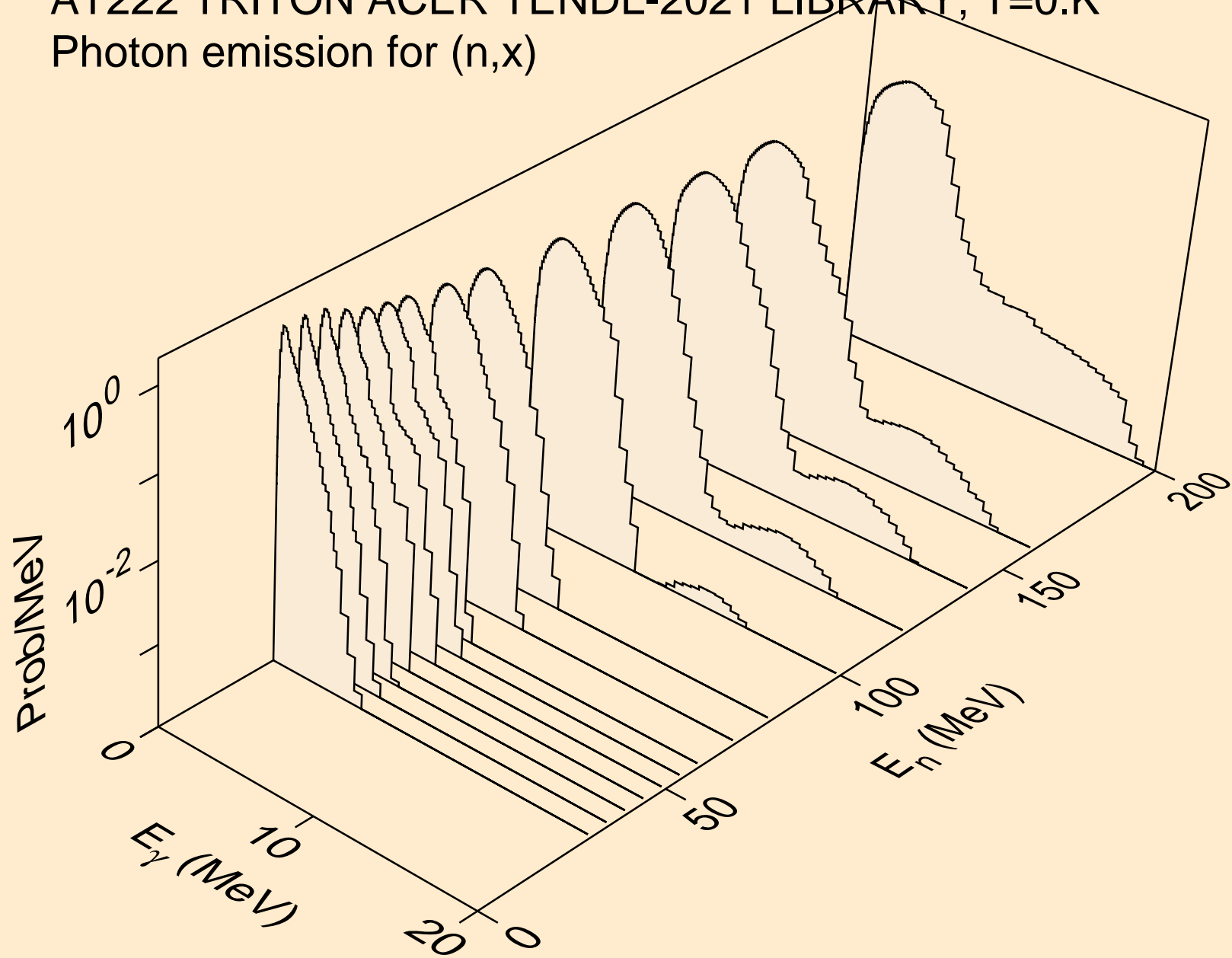

AT222 TRITON ACER TENDL-2021 LIBRARY; T=0.K  
Photon emission for (n,2nd)

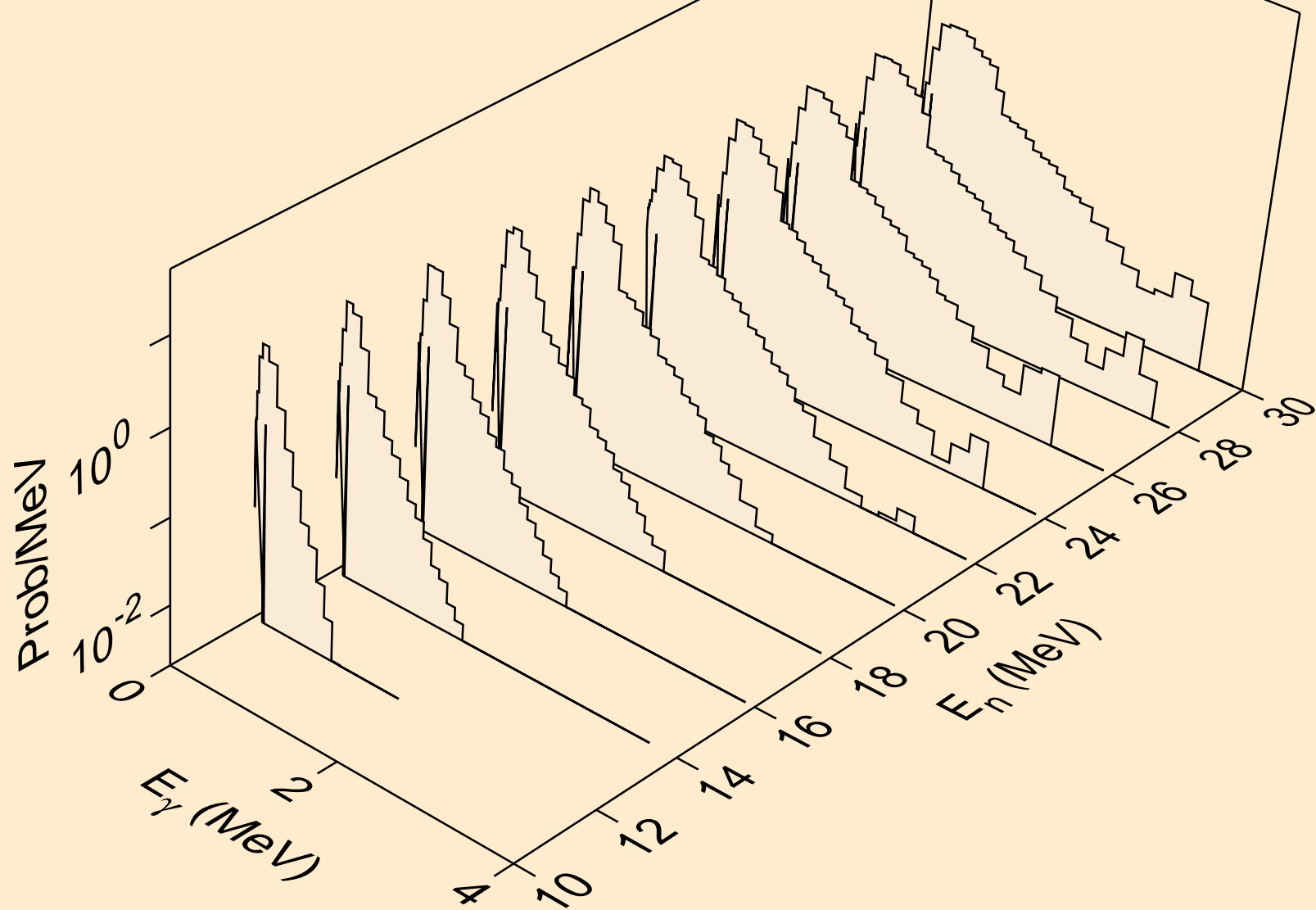

AT222 TRITON ACER TENDL-2021 LIBRARY; T=0.K  
Photon emission for (n,2n)

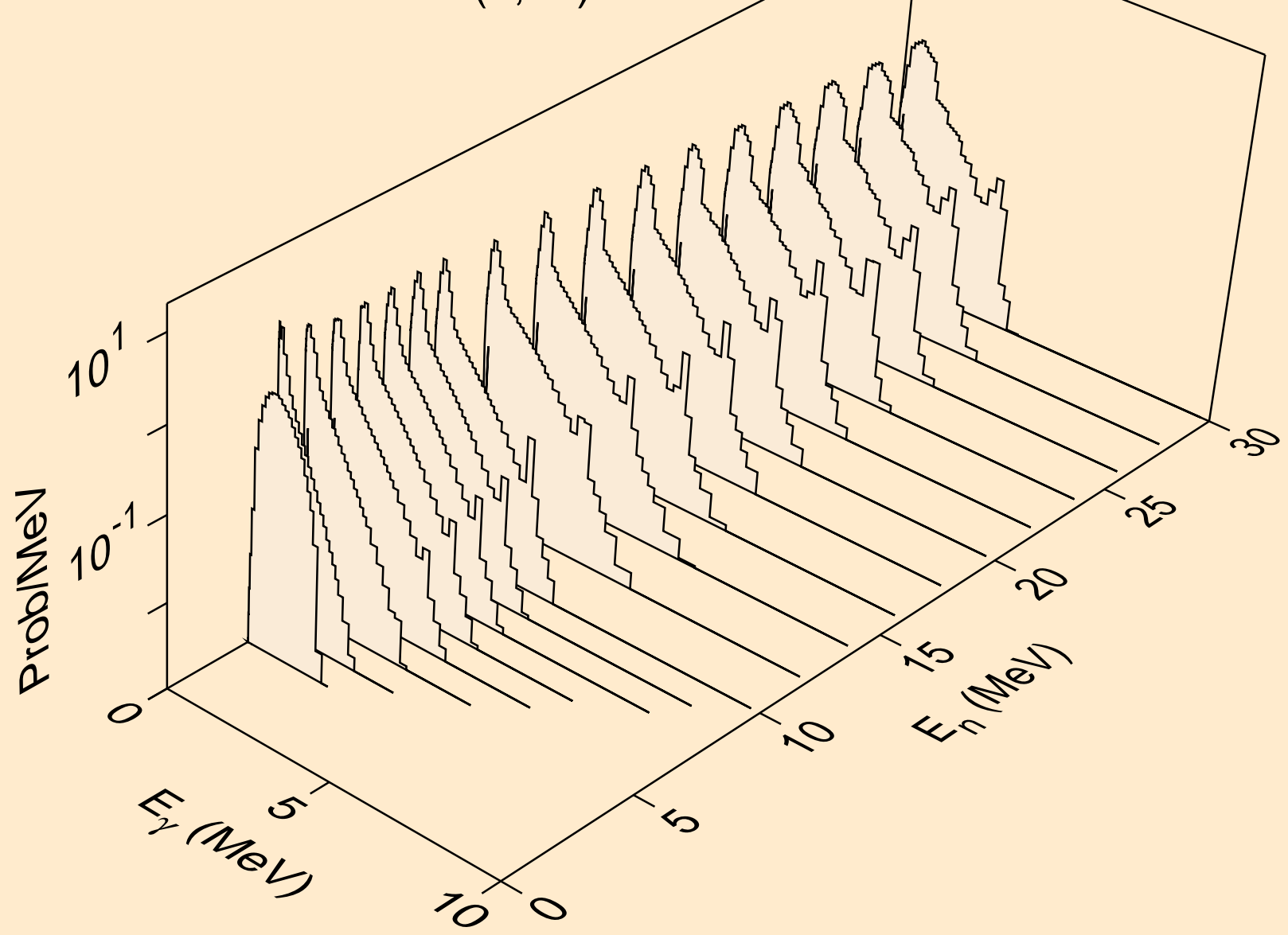

AT222 TRITON ACER TENDL-2021 LIBRARY; T=0.K  
Photon emission for (n,3n)

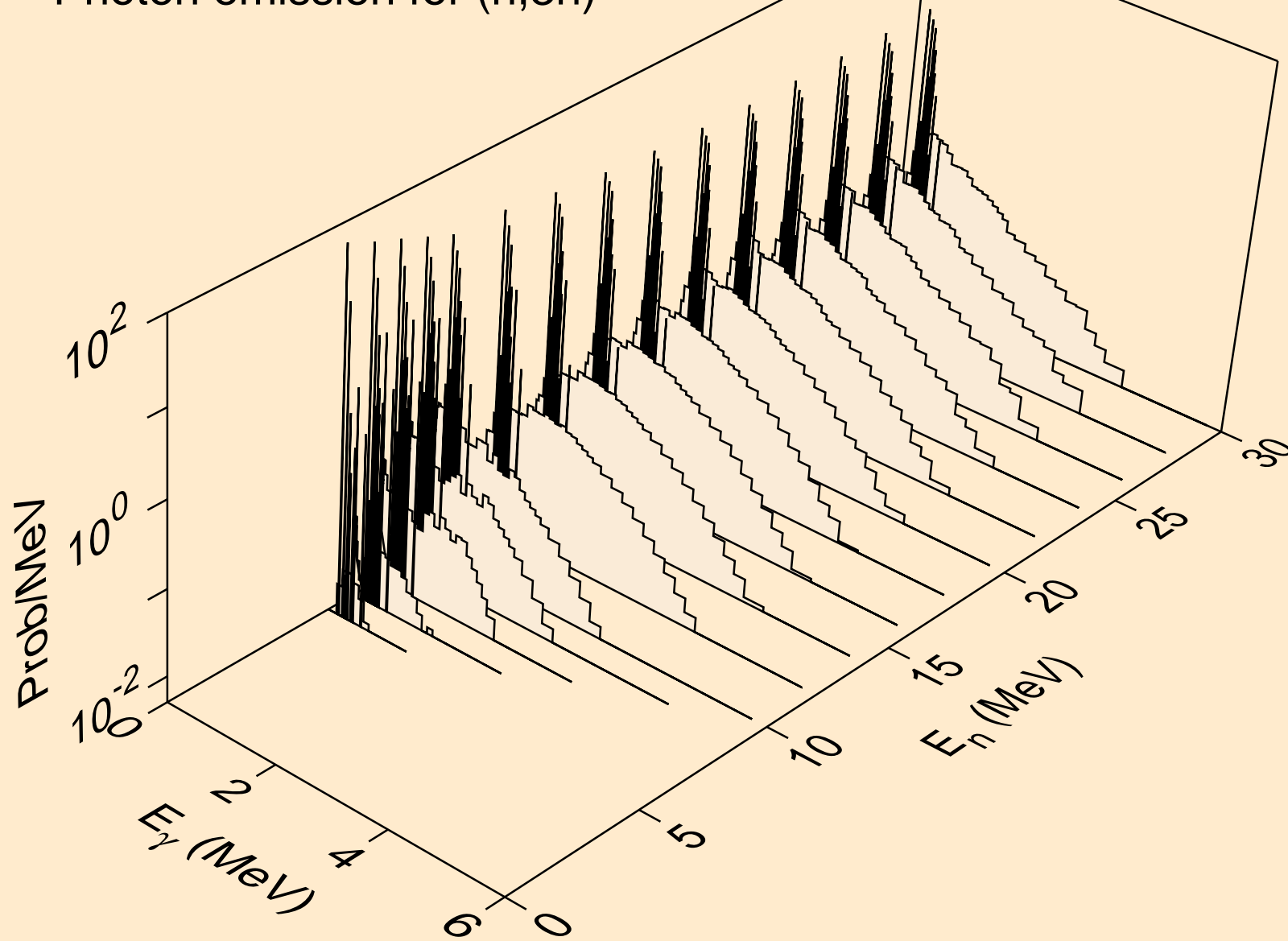

AT222 TRITON ACER TENDL-2021 LIBRARY; T=0.K  
Photon emission for (n,n\*)a

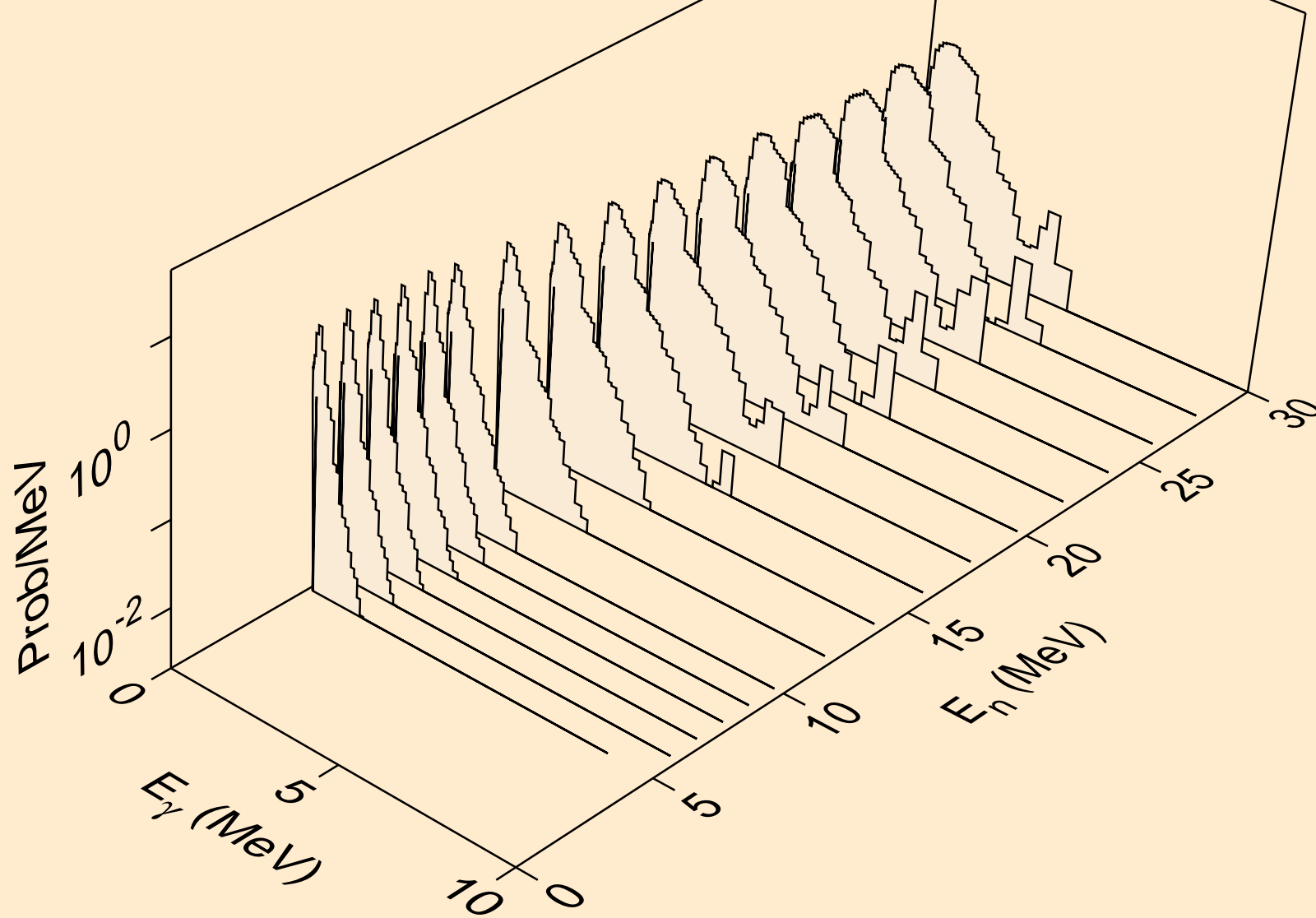

AT222 TRITON ACER TENDL-2021 LIBRARY; T=0.K  
Photon emission for (n,2n)a

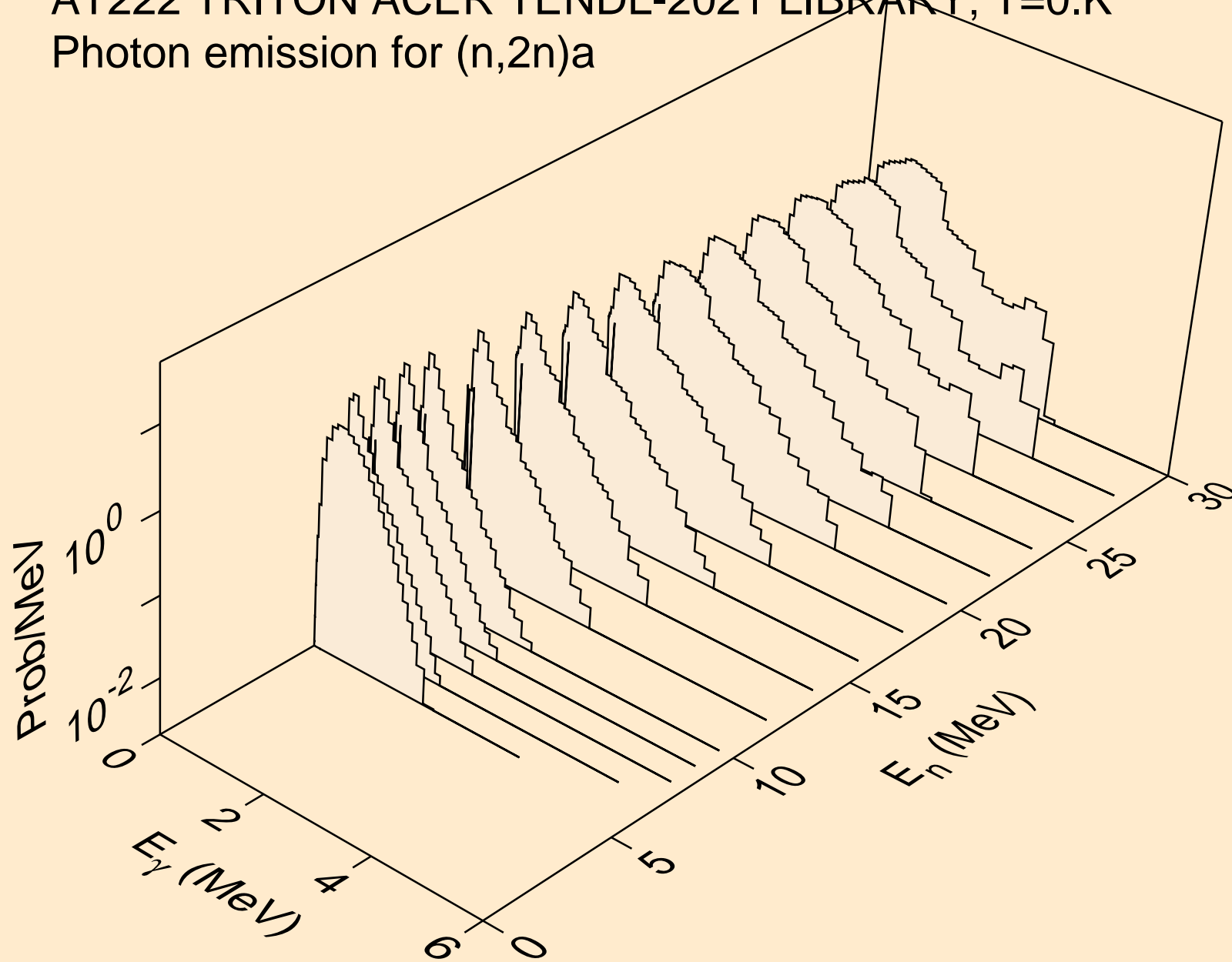



AT222 TRITON ACER TENDL-2021 LIBRARY; T=0.K  
Photon emission for (n,3n)a

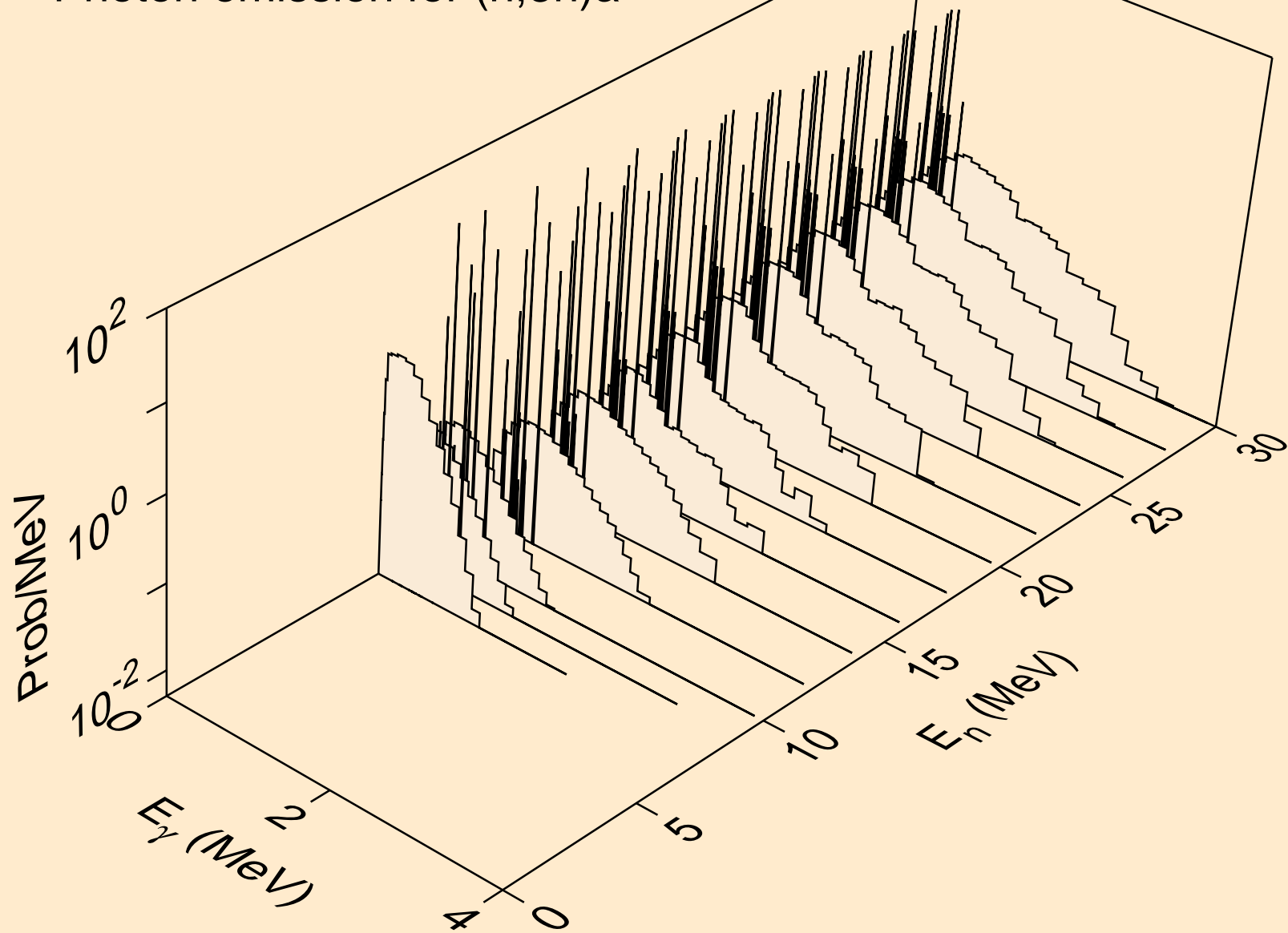

AT222 TRITON ACER TENDL-2021 LIBRARY; T=0.K  
Photon emission for (n,n\*)p

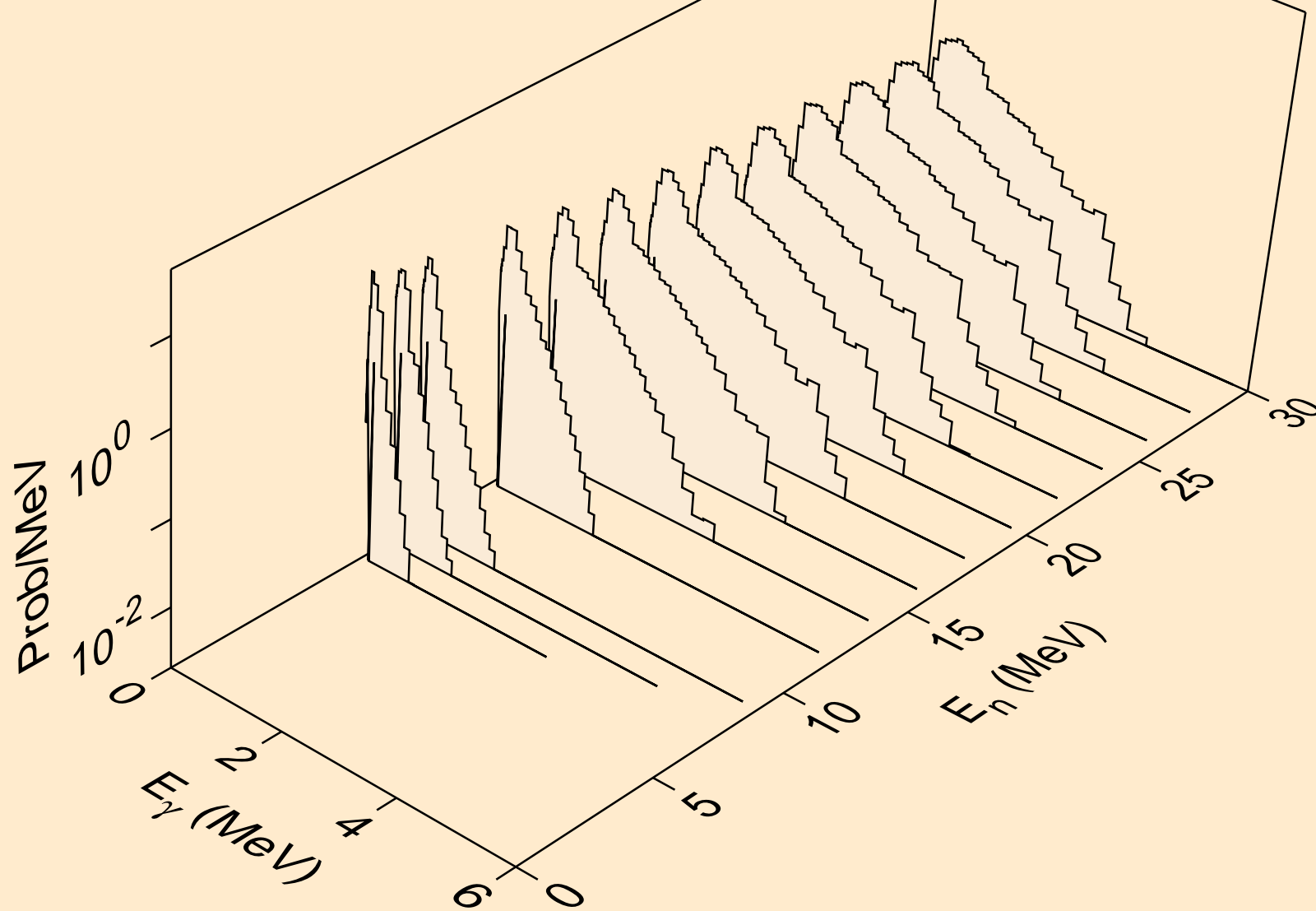

AT222 TRITON ACER TENDL-2021 LIBRARY; T=0.K  
Photon emission for (n,n\*)2a

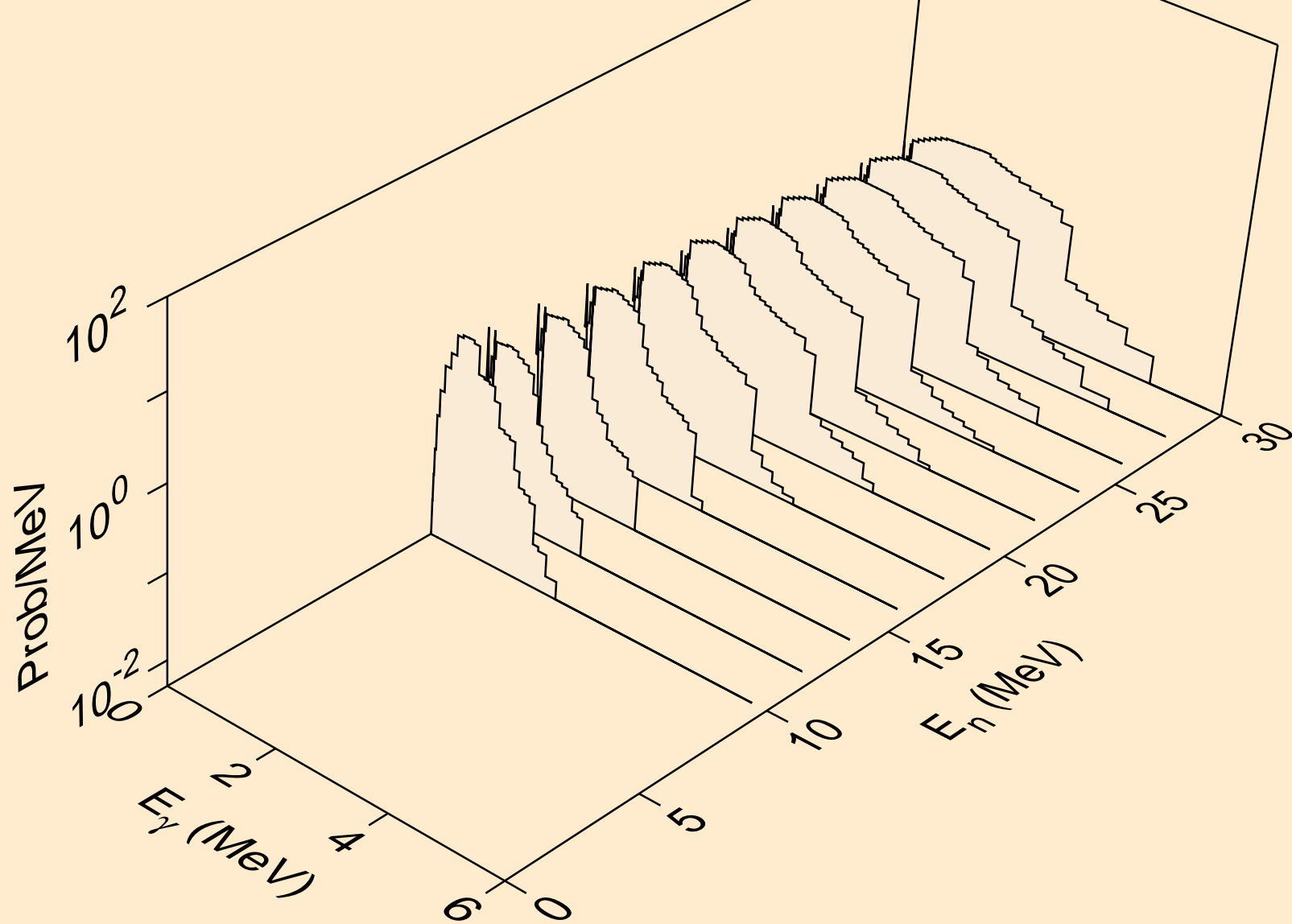

AT222 TRITON ACER TENDL-2021 LIBRARY; T=0.K  
Photon emission for (n,2n)2a

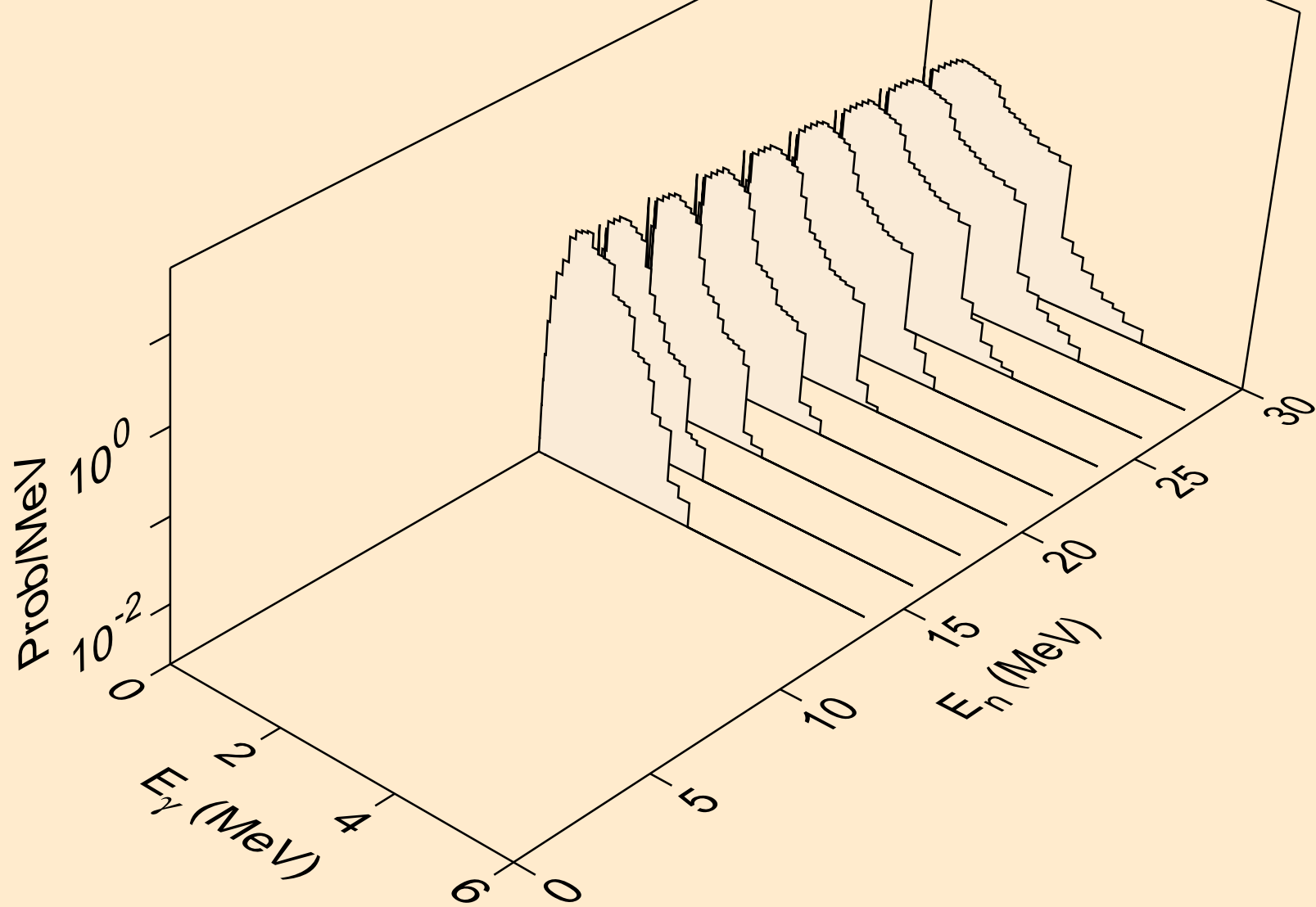

AT222 TRITON ACER TENDL-2021 LIBRARY; T=0.K  
Photon emission for (n,n\*)d

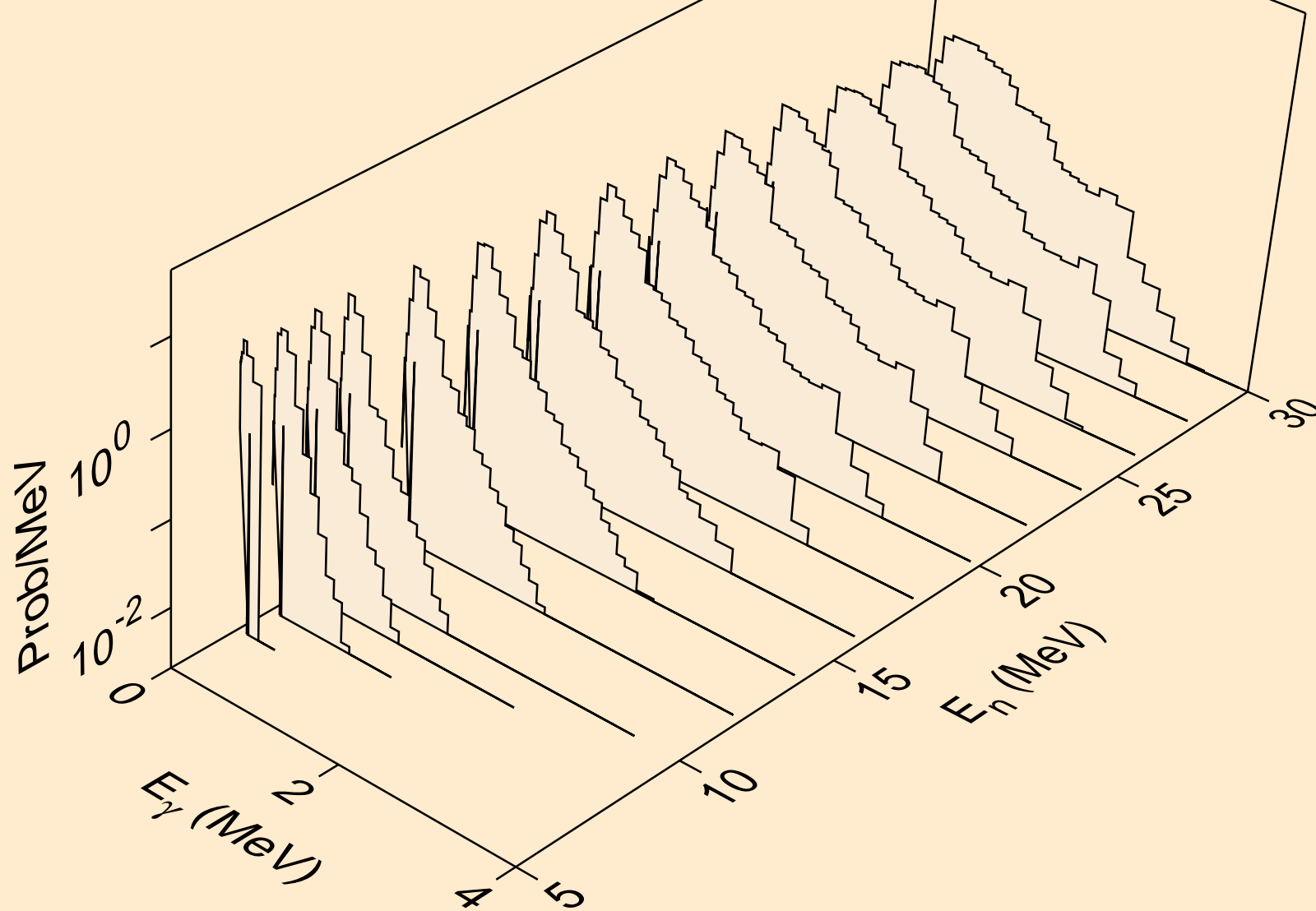

AT222 TRITON ACER TENDL-2021 LIBRARY; T=0.K  
Photon emission for (n,n\*)t

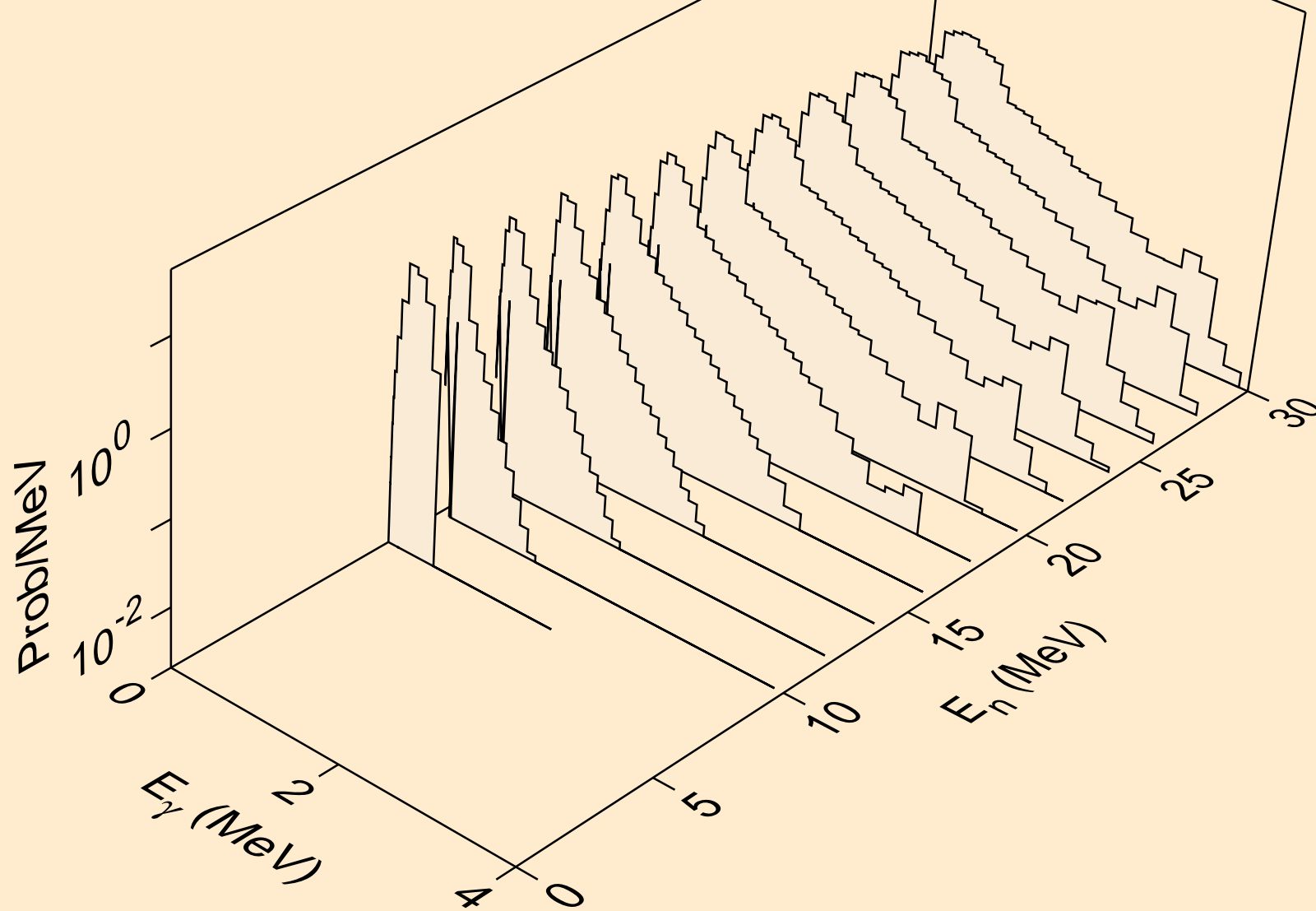

AT222 TRITON ACER TENDL-2021 LIBRARY; T=0.K  
Photon emission for (n,n\*)he3

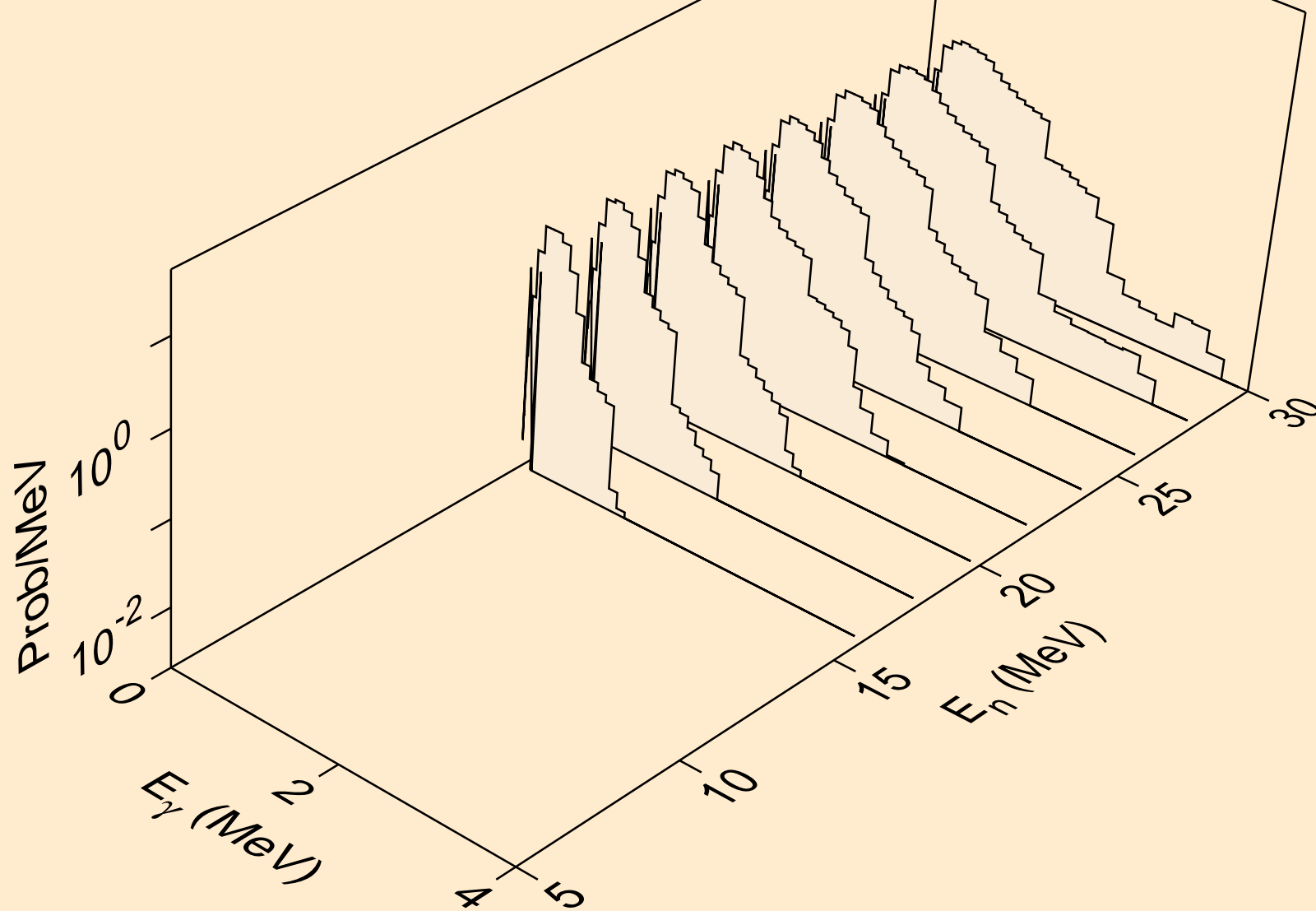

AT222 TRITON ACER TENDL-2021 LIBRARY; T=0.K  
Photon emission for (n,4n)

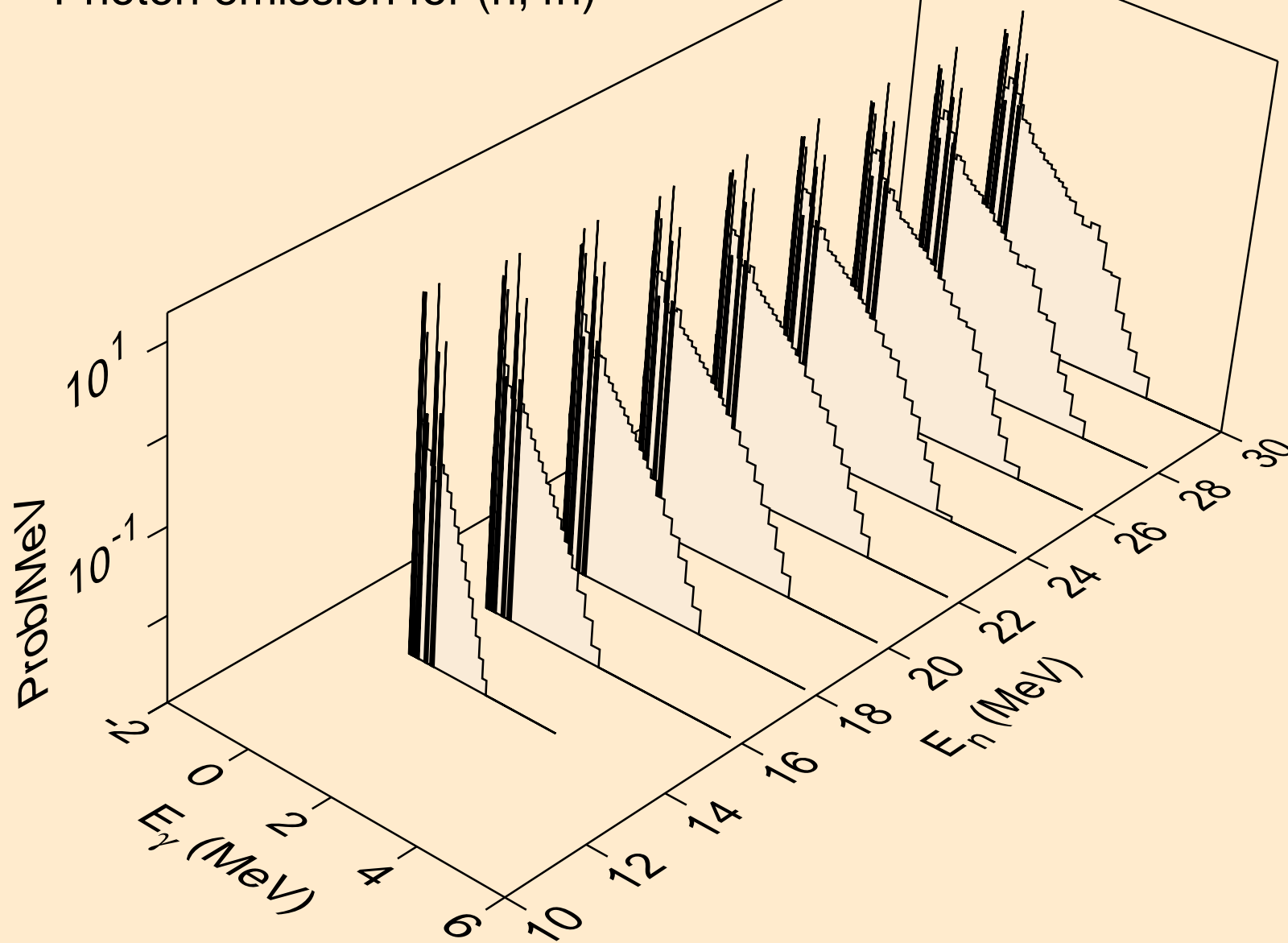



AT222 TRITON ACER TENDL-2021 LIBRARY; T=0.K  
Photon emission for (n,2np)

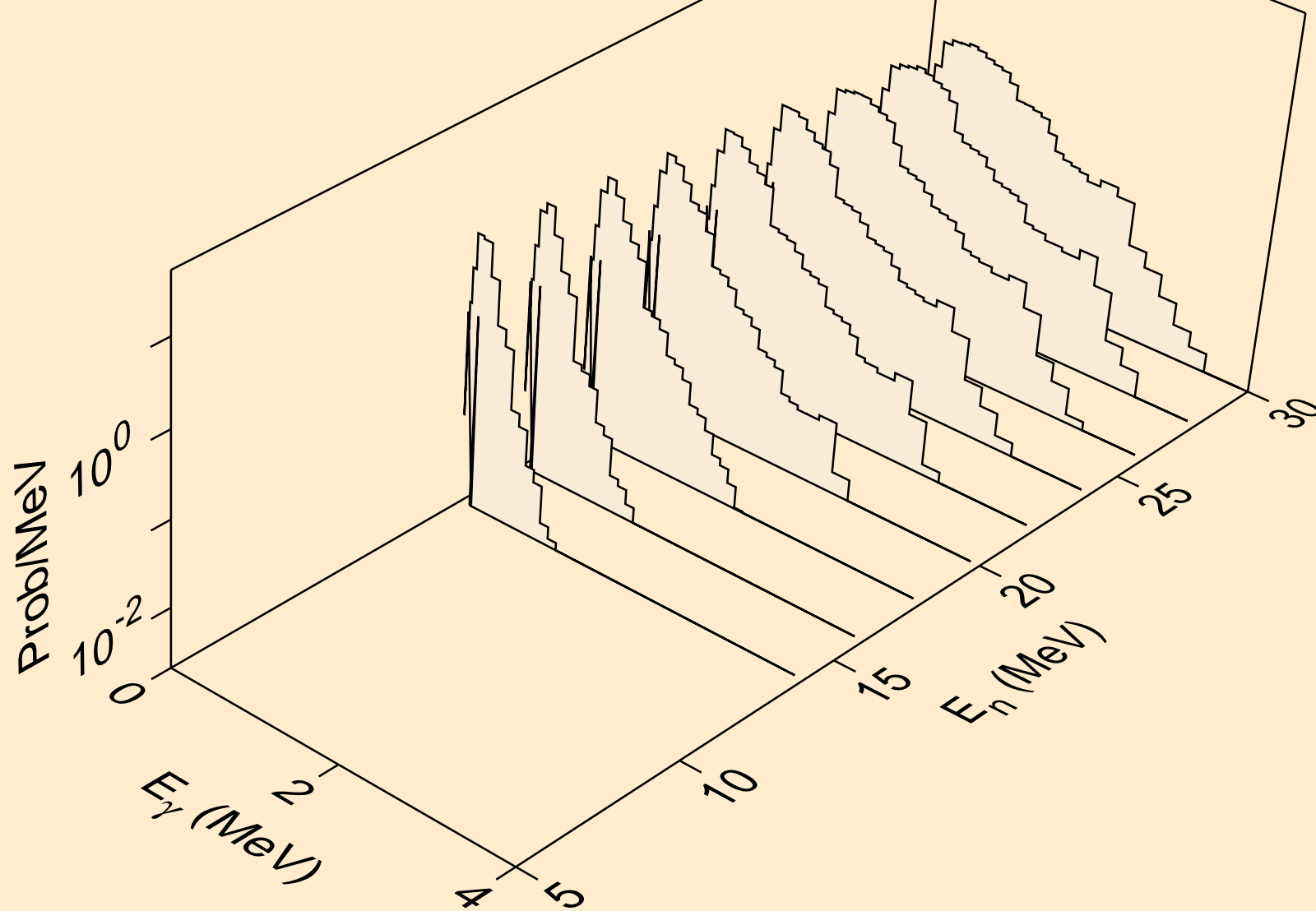

AT222 TRITON ACER TENDL-2021 LIBRARY; T=0.K  
Photon emission for (n,3np)

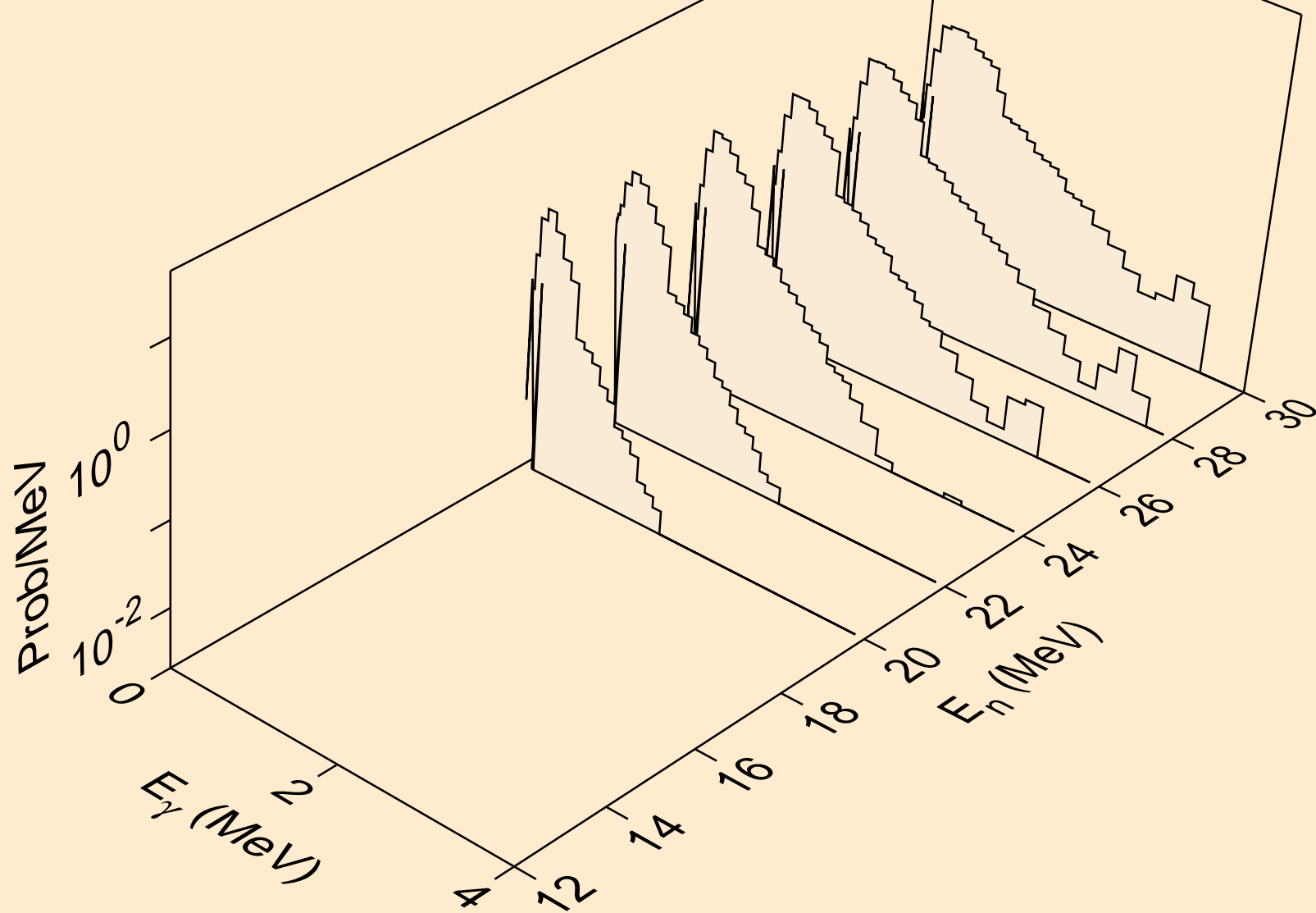

AT222 TRITON ACER TENDL-2021 LIBRARY; T=0.K  
Photon emission for (n,2np)

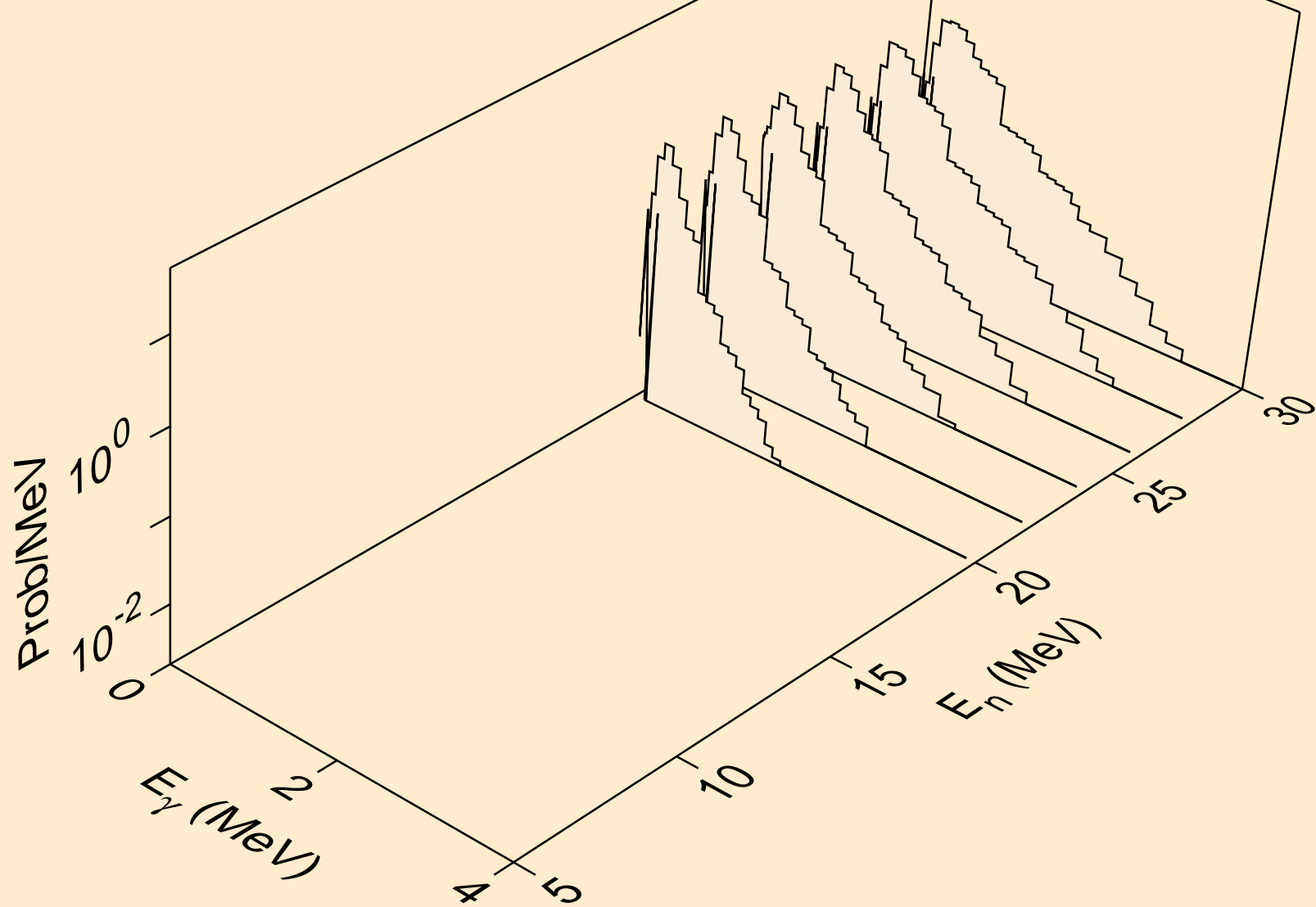

AT222 TRITON ACER TENDL-2021 LIBRARY; T=0.K  
Photon emission for (n,npa)

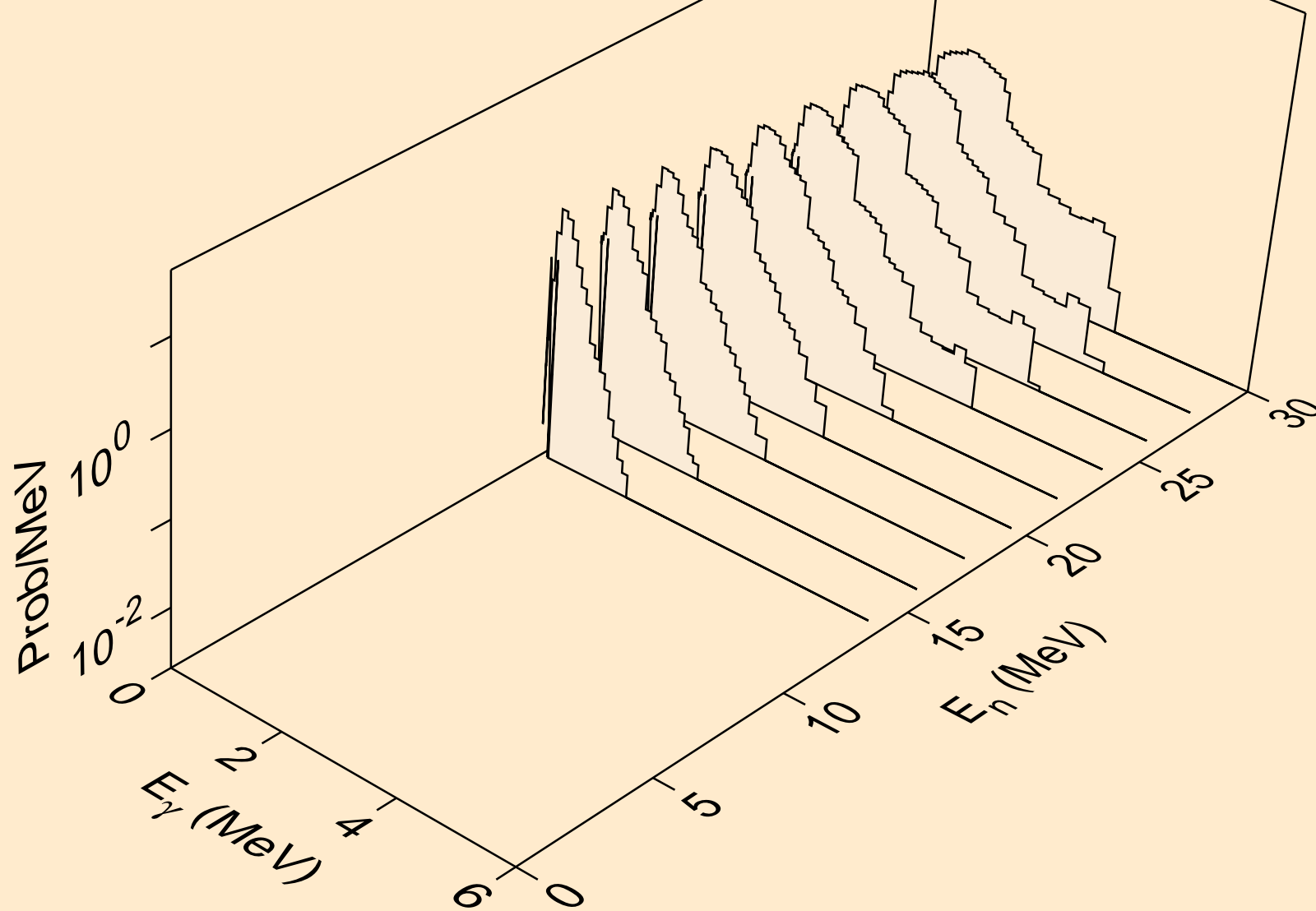

AT222 TRITON ACER TENDL-2021 LIBRARY; T=0.K  
Photon emission for (n,gma)

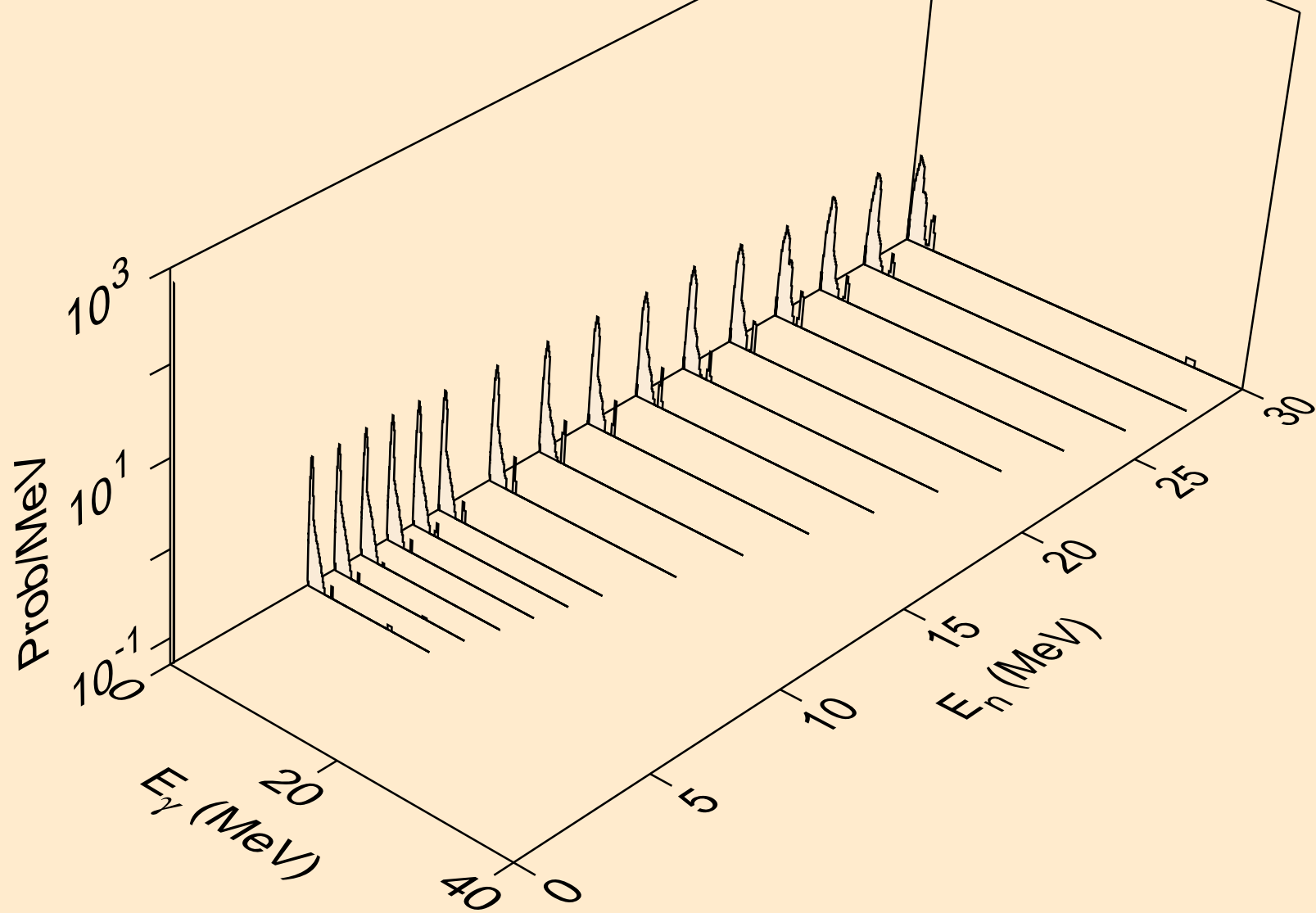

AT222 TRITON ACER TENDL-2021 LIBRARY; T=0.K  
Photon emission for (n,p)

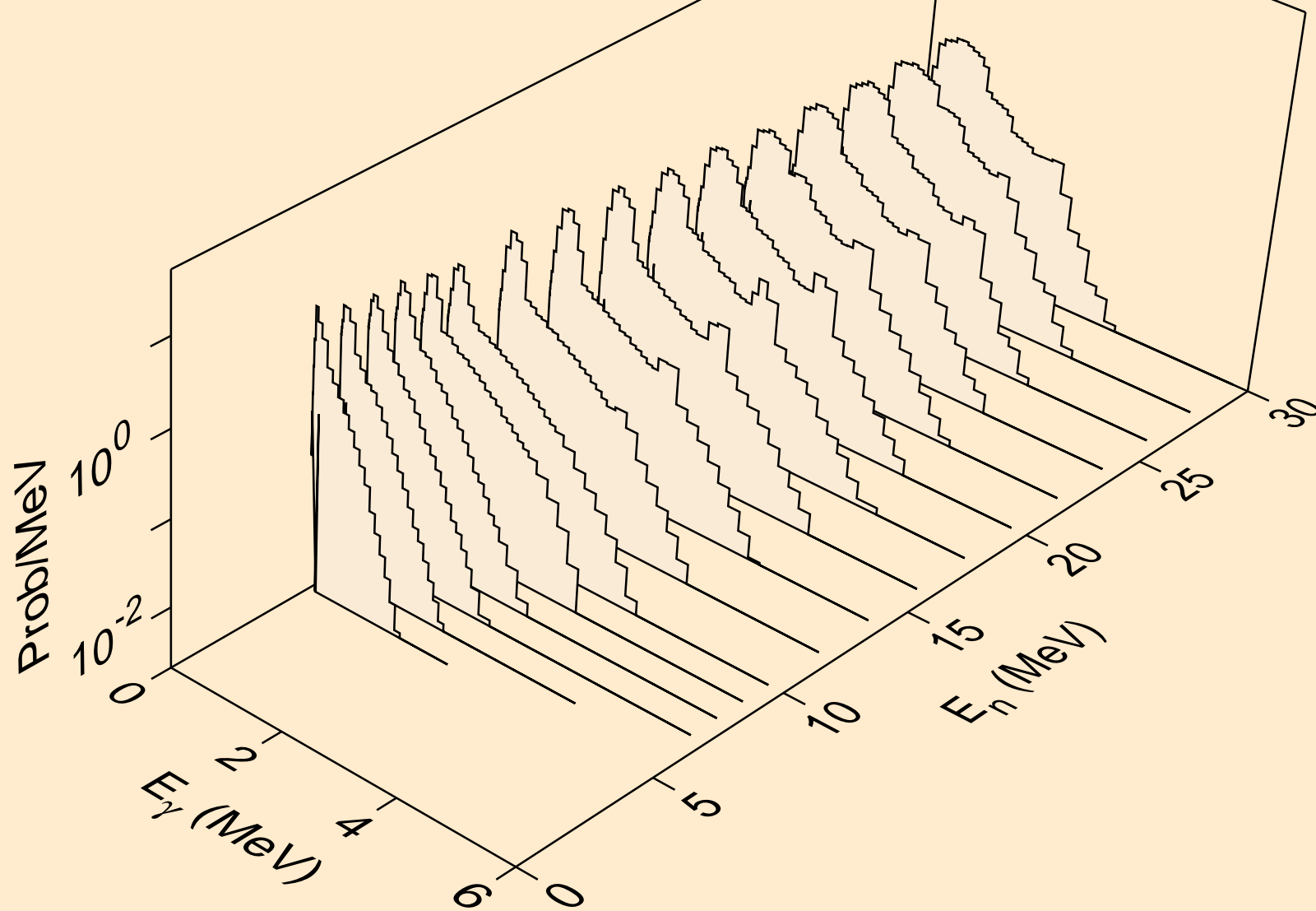

AT222 TRITON ACER TENDL-2021 LIBRARY; T=0.K  
Photon emission for (n,d)

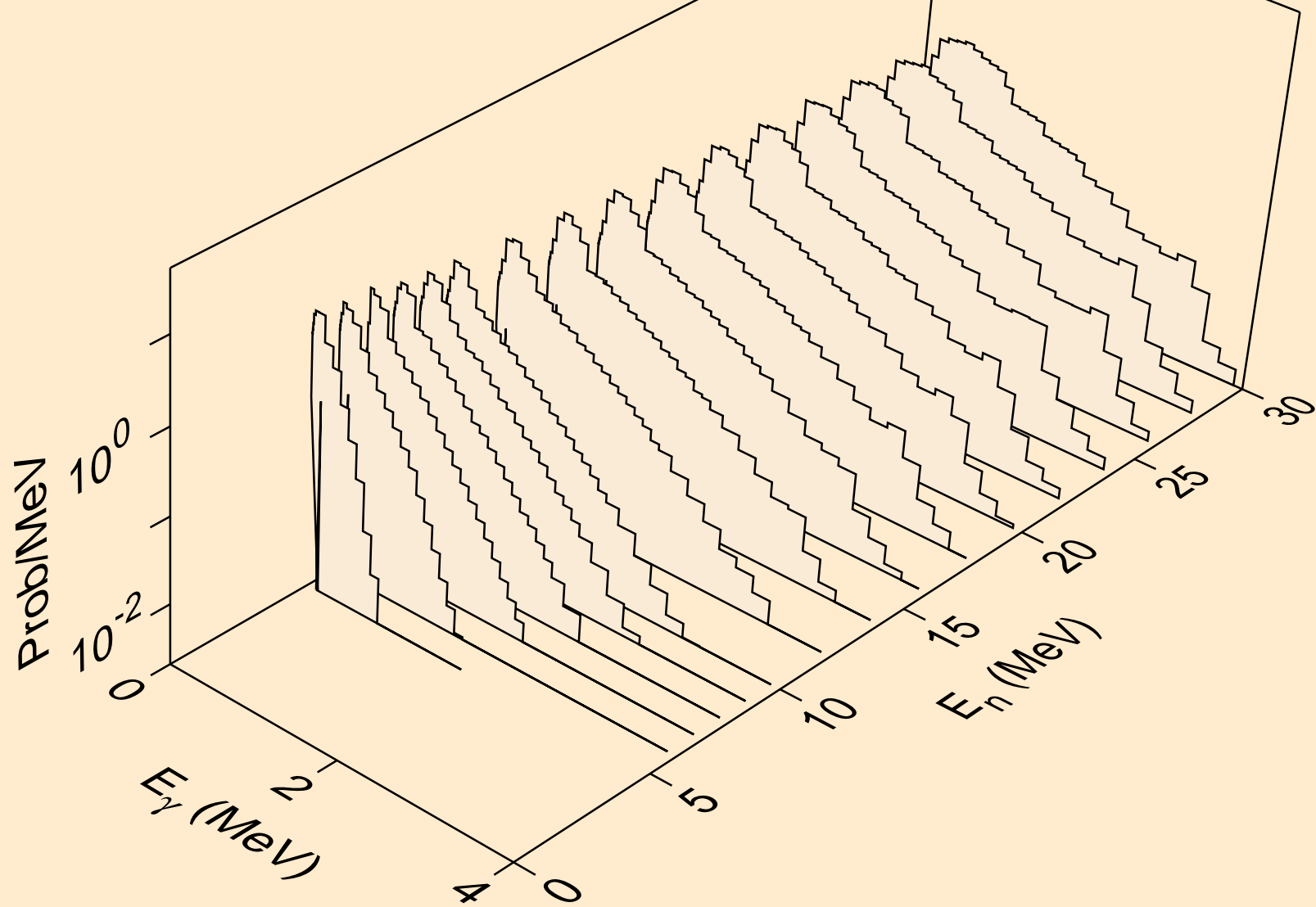

AT222 TRITON ACER TENDL-2021 LIBRARY; T=0.K  
Photon emission for inelastic

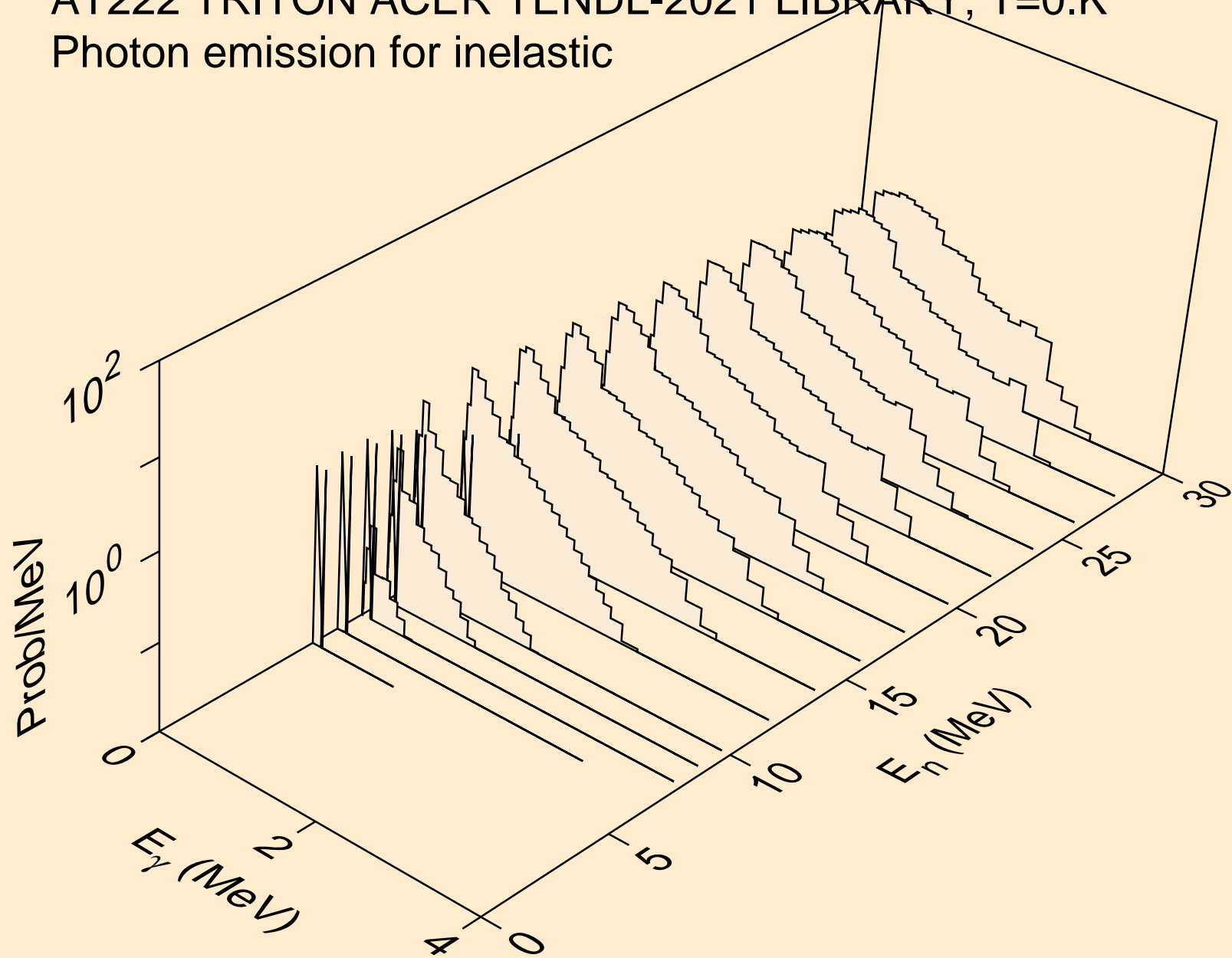



AT222 TRITON ACER TENDL-2021 LIBRARY; T=0.K  
Photon emission for (n,he3)

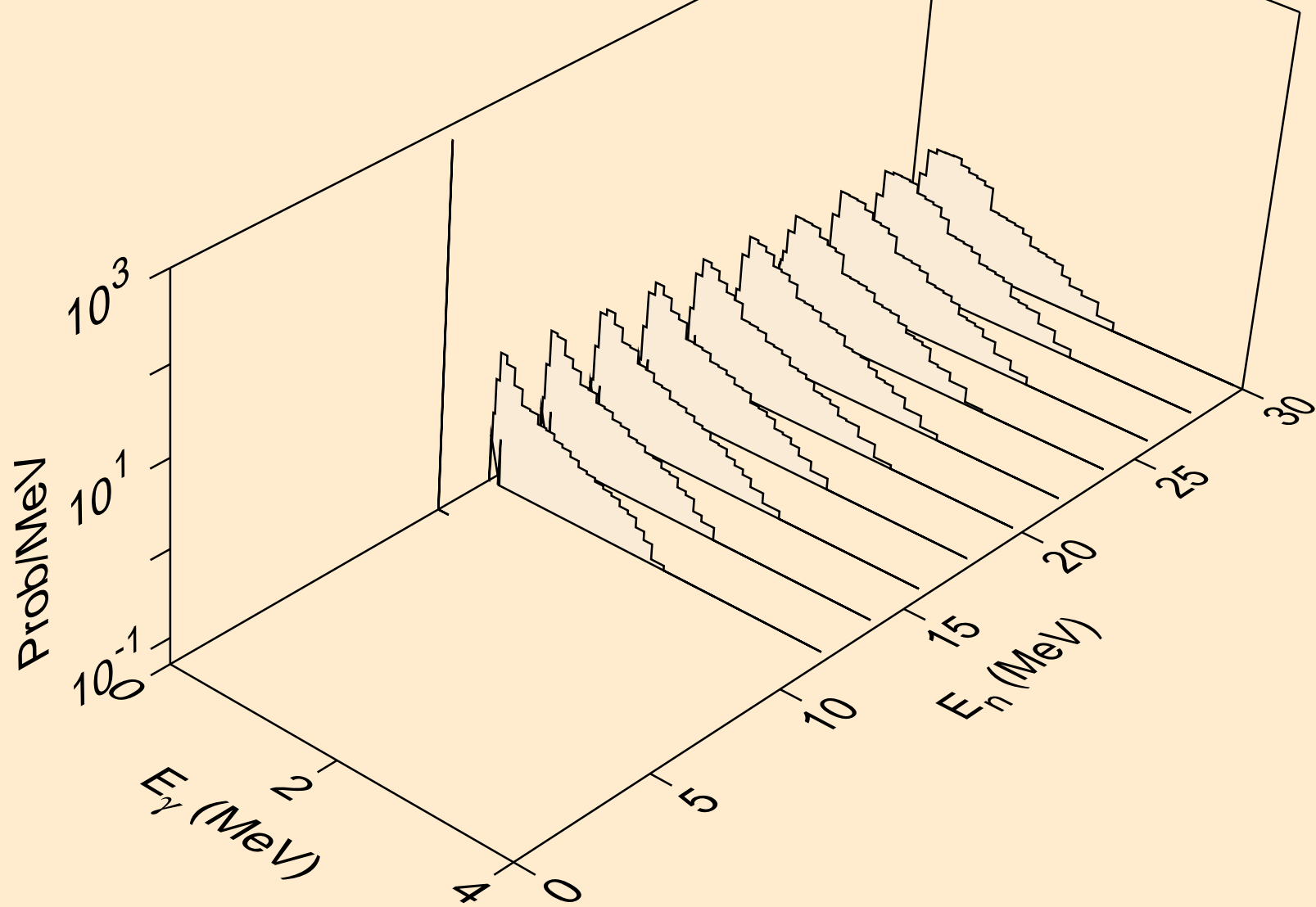

AT222 TRITON ACER TENDL-2021 LIBRARY; T=0.K  
Photon emission for (n,a)

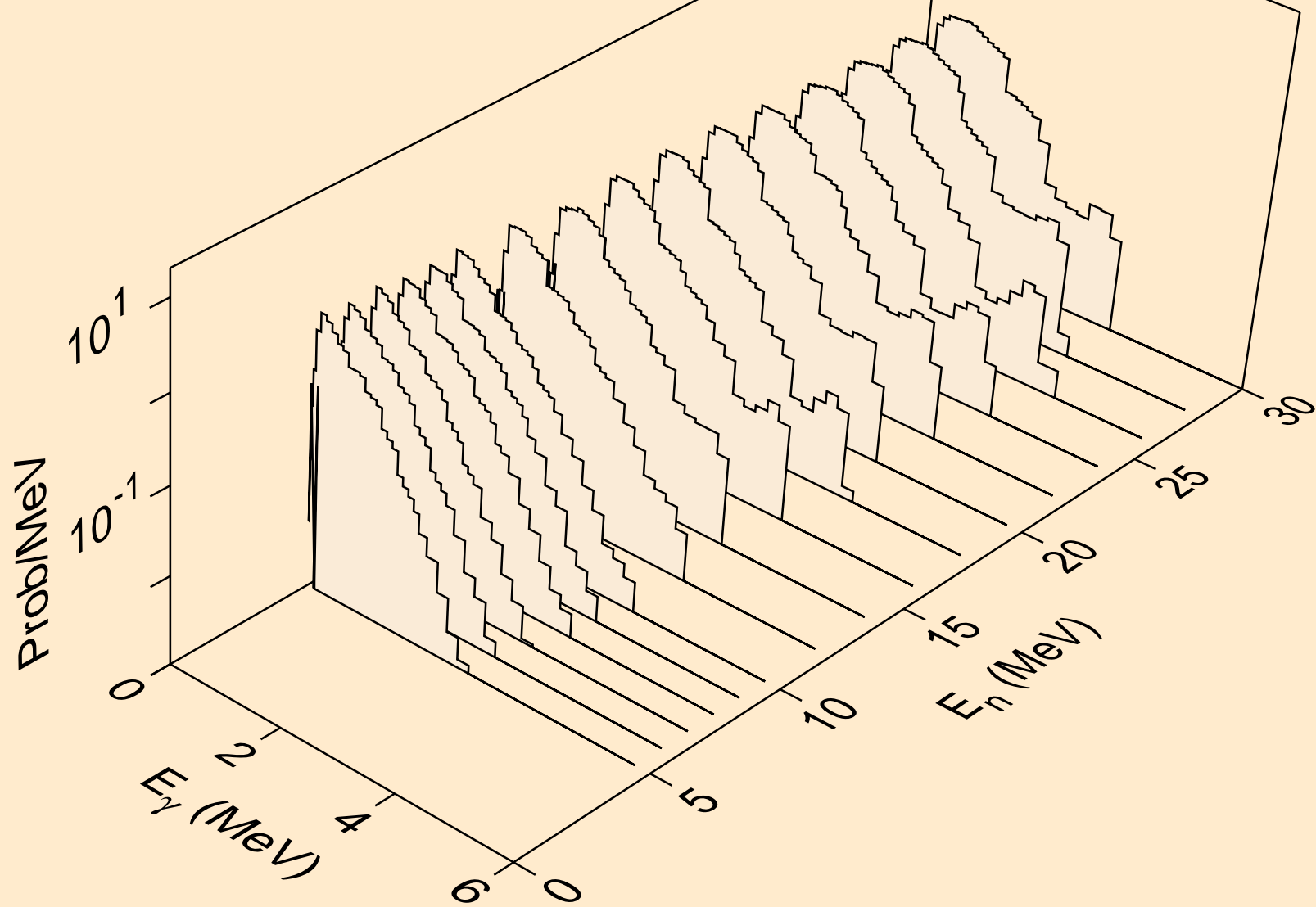

AT222 TRITON ACER TENDL-2021 LIBRARY; T=0.K  
Photon emission for (n,2p)

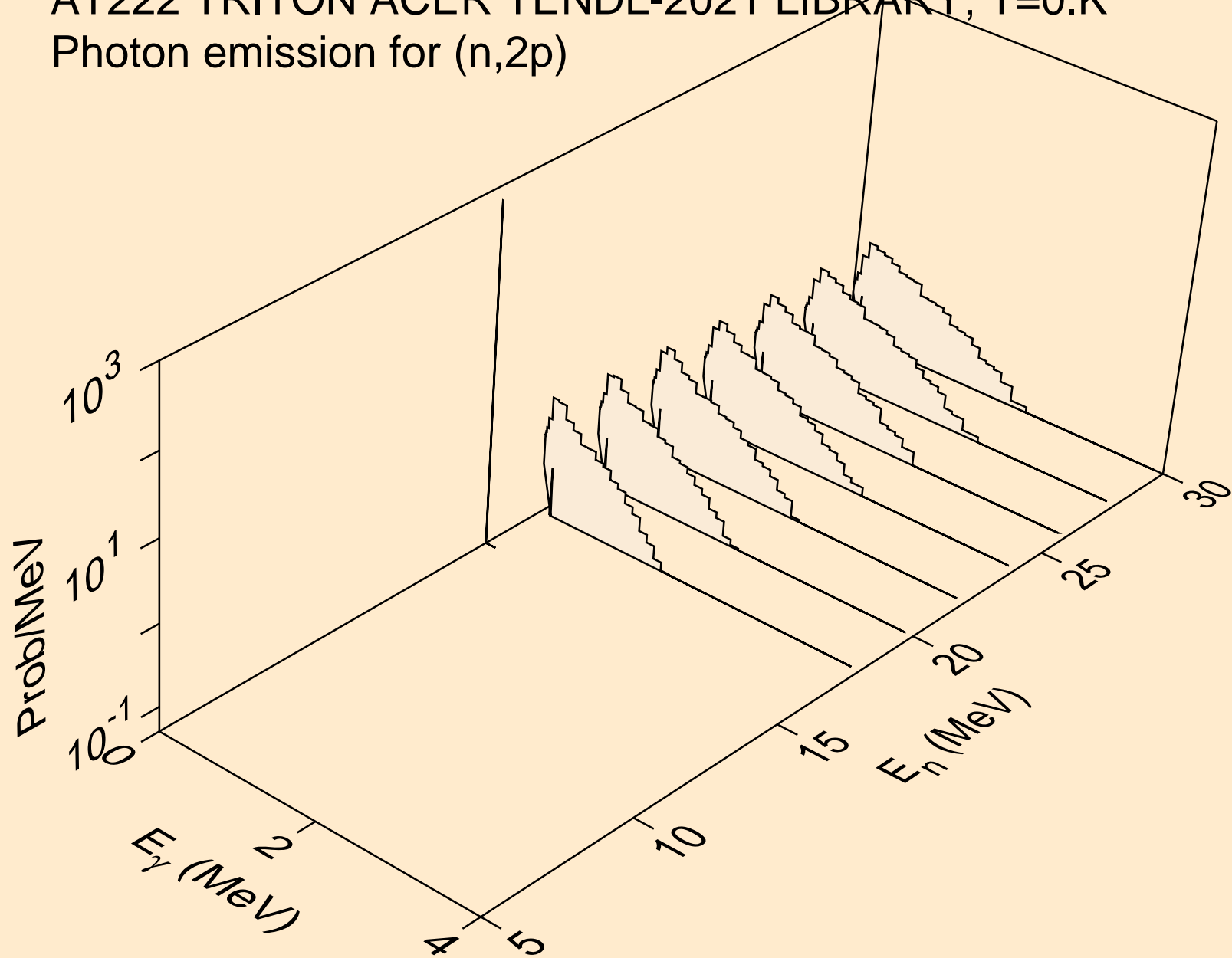

AT222 TRITON ACER TENDL-2021 LIBRARY; T=0.K  
Photon emission for (n,pa)

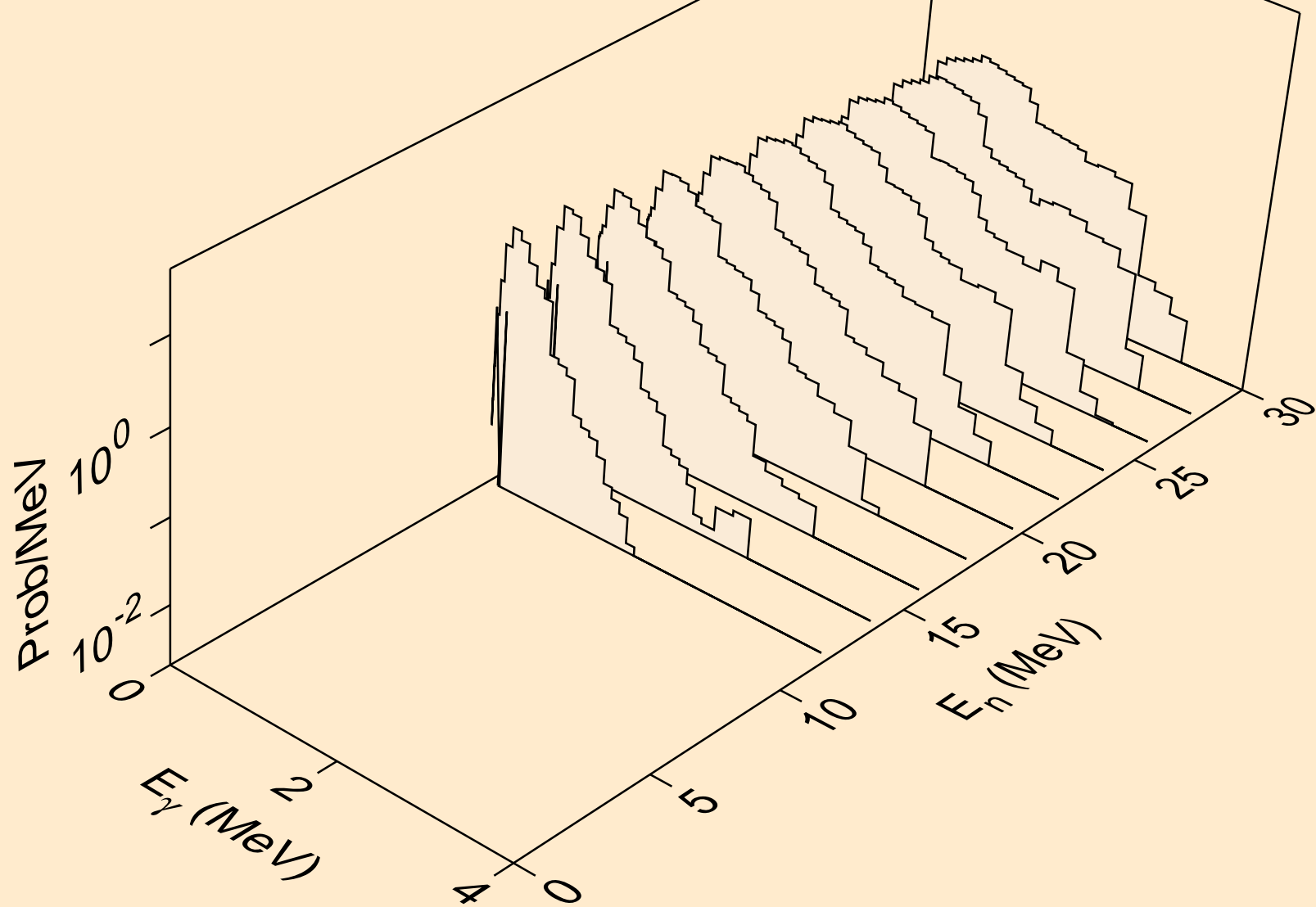

AT222 TRITON ACER TENDL-2021 LIBRARY; T=0.K  
Photon emission for (n,pd)

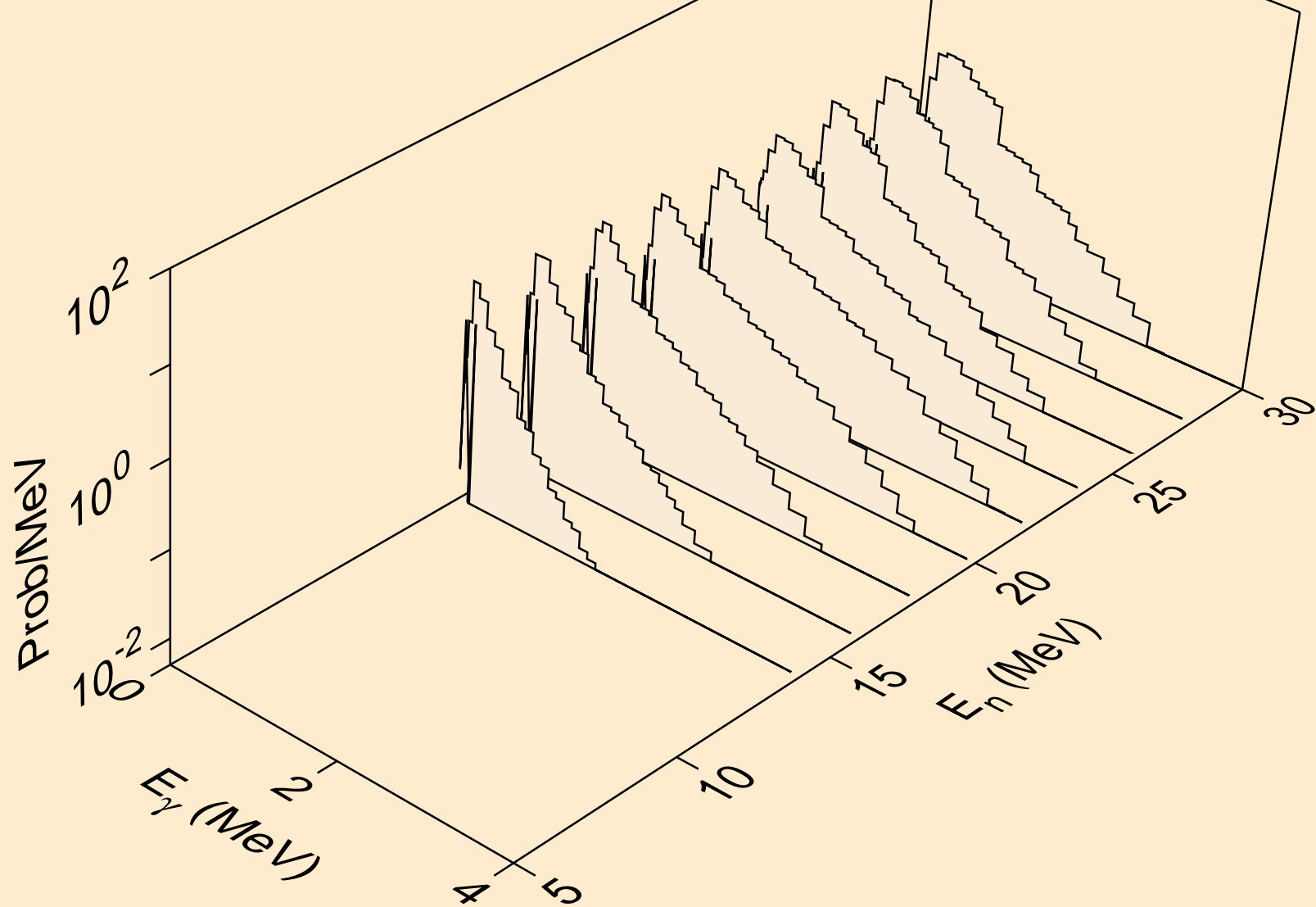

AT222 TRITON ACER TENDL-2021 LIBRARY; T=0.K  
Particle heating contributions

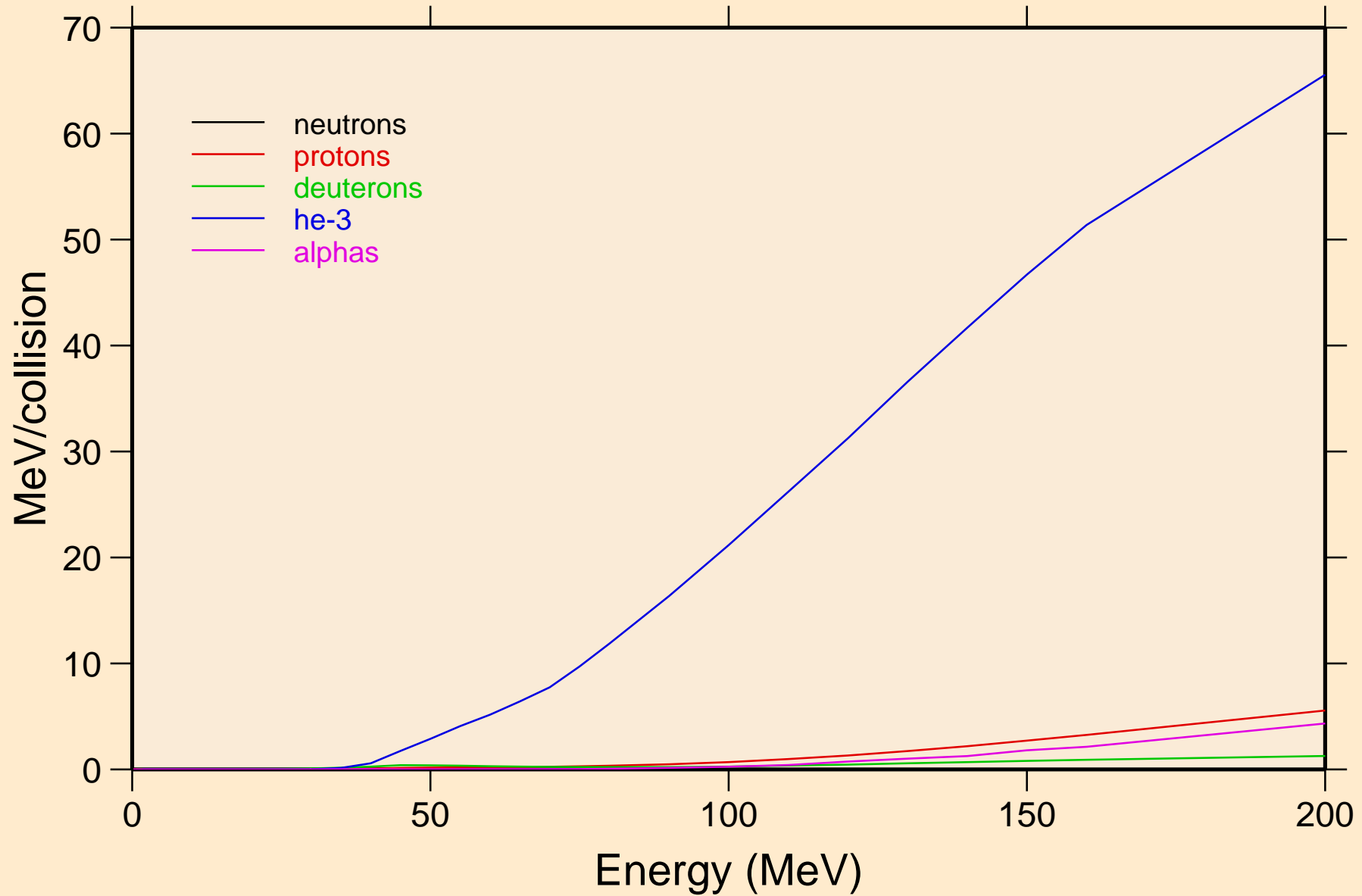

AT222 TRITON ACER TENDL-2021 LIBRARY; T=0.K  
Recoil Heating

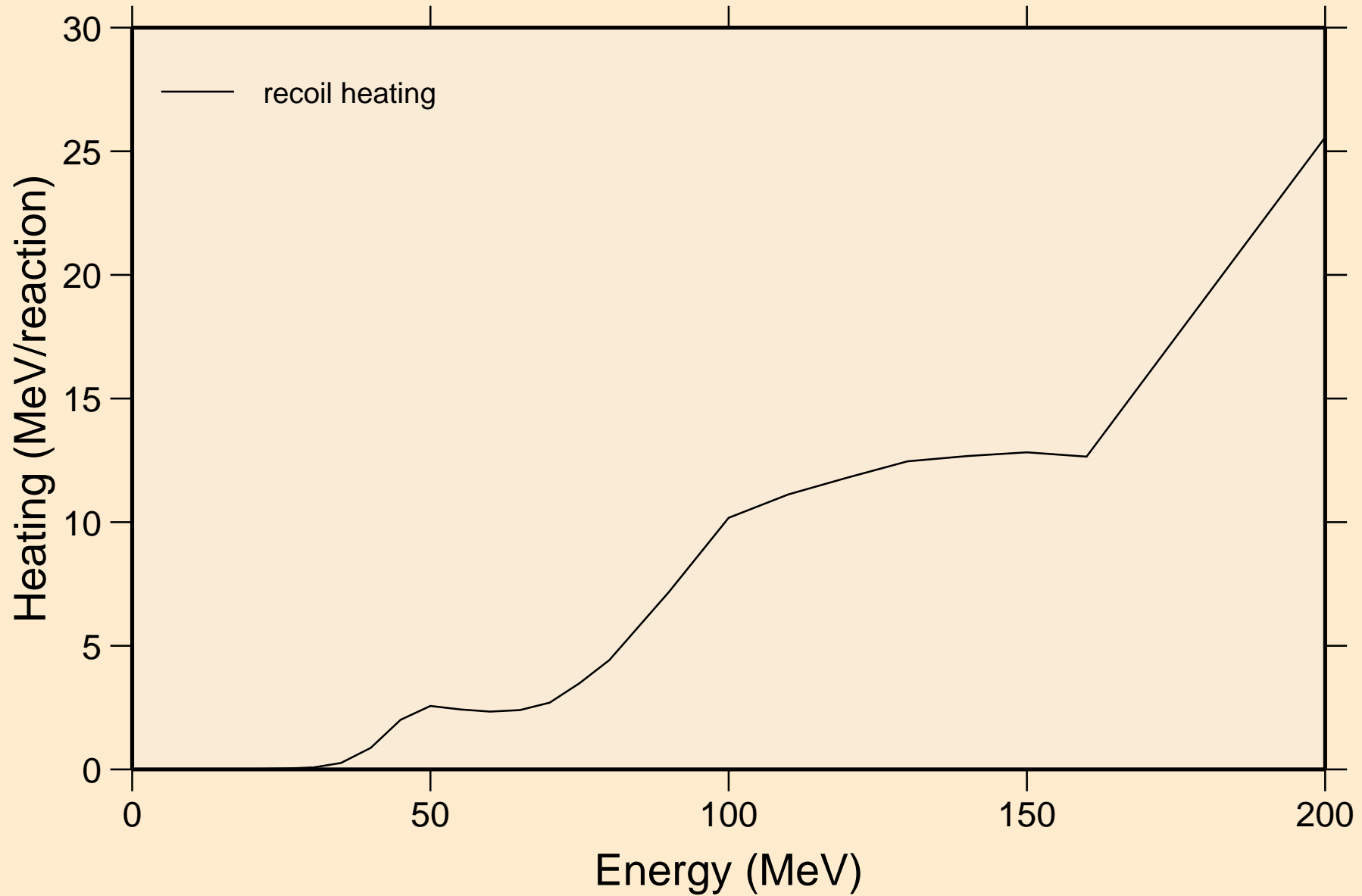

AT222 TRITON ACER TENDL-2021 LIBRARY; T=0.K  
Particle production cross sections

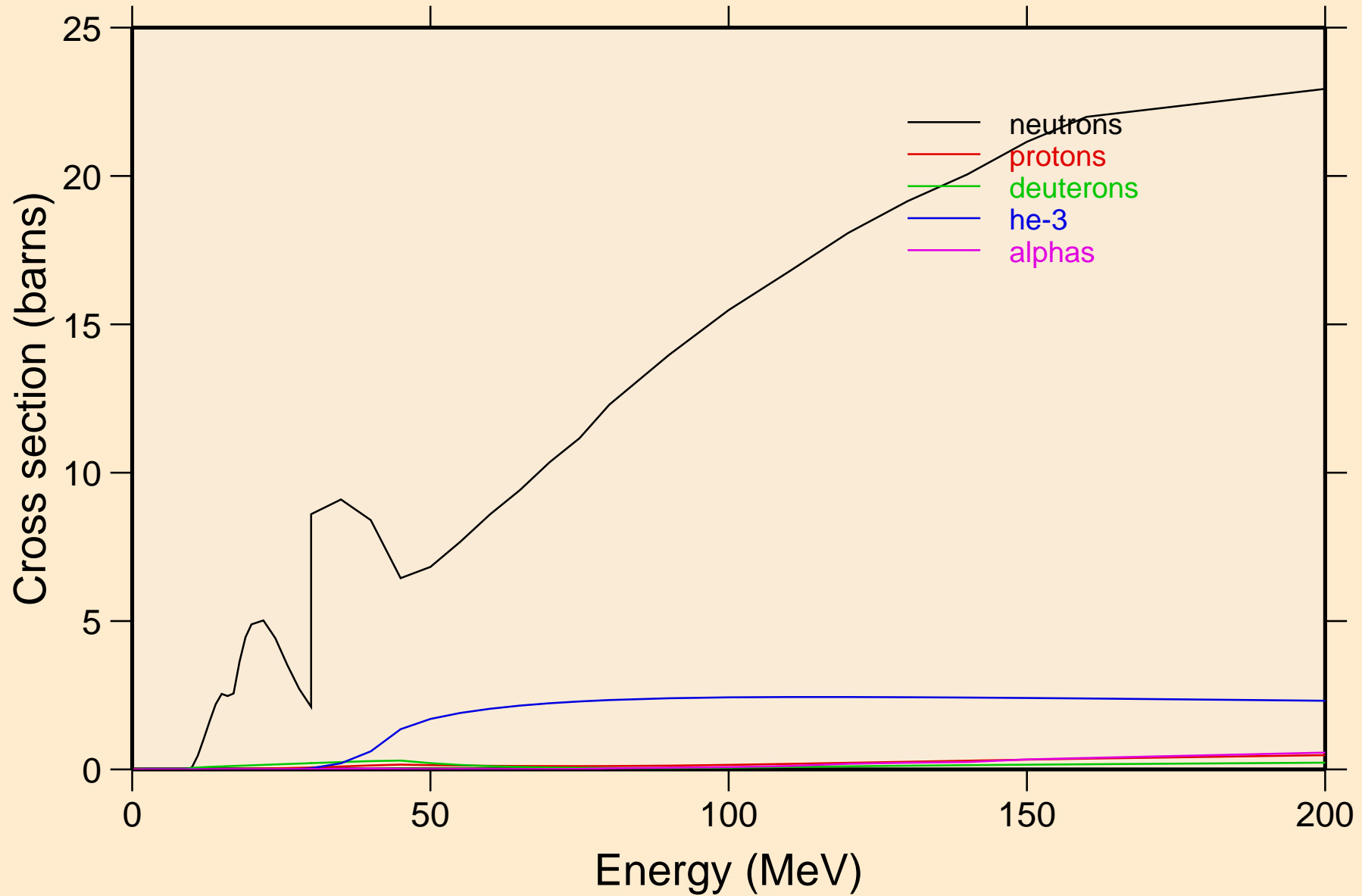



AT222 TRITON ACER TENDL-2021 LIBRARY; T=0.K  
neutrons from (t,n)

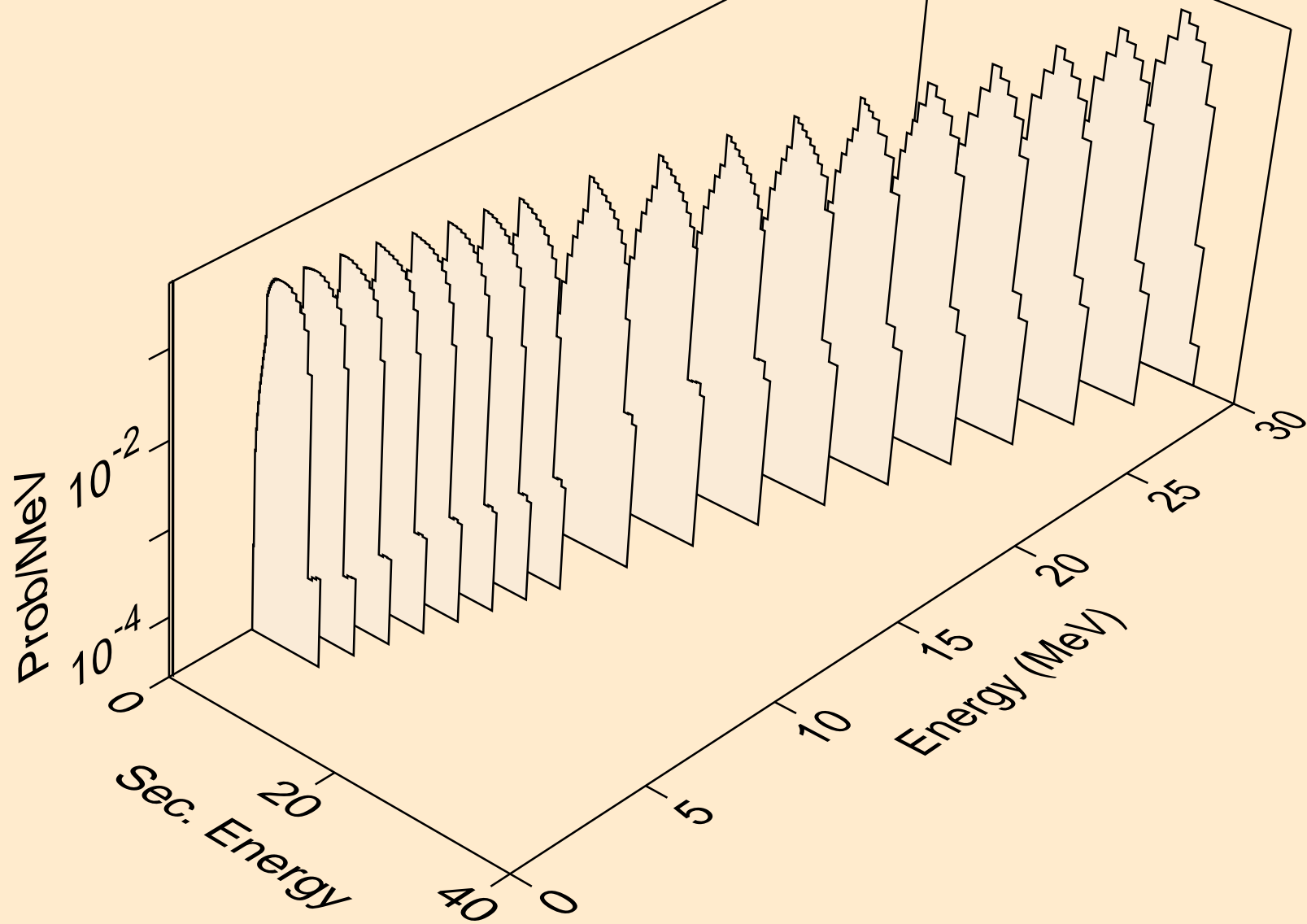

AT222 TRITON ACER TENDL-2021 LIBRARY; T=0.K  
neutrons from (t,x)

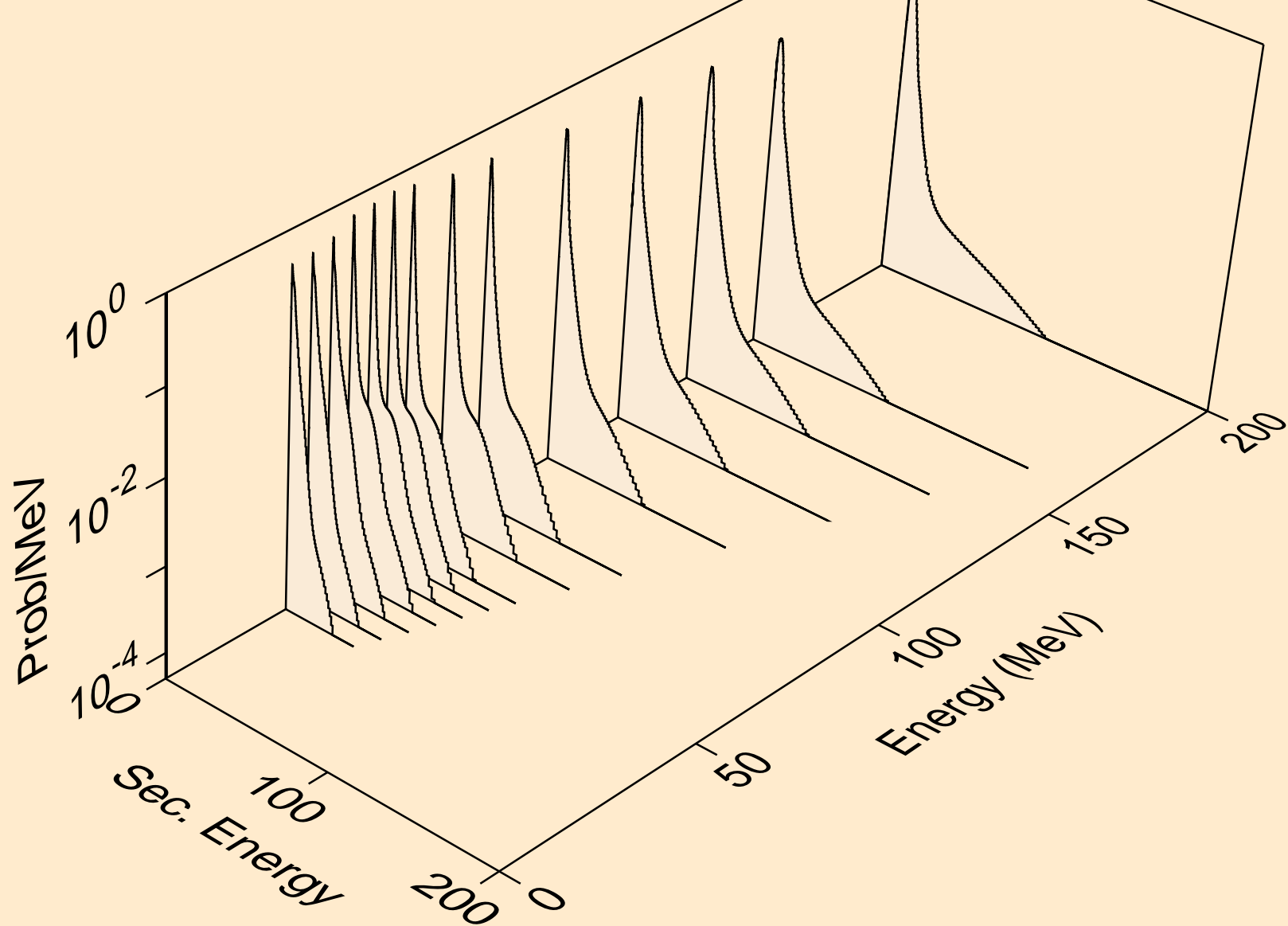

AT222 TRITON ACER TENDL-2021 LIBRARY; T=0.K  
neutrons from (t,2nd)

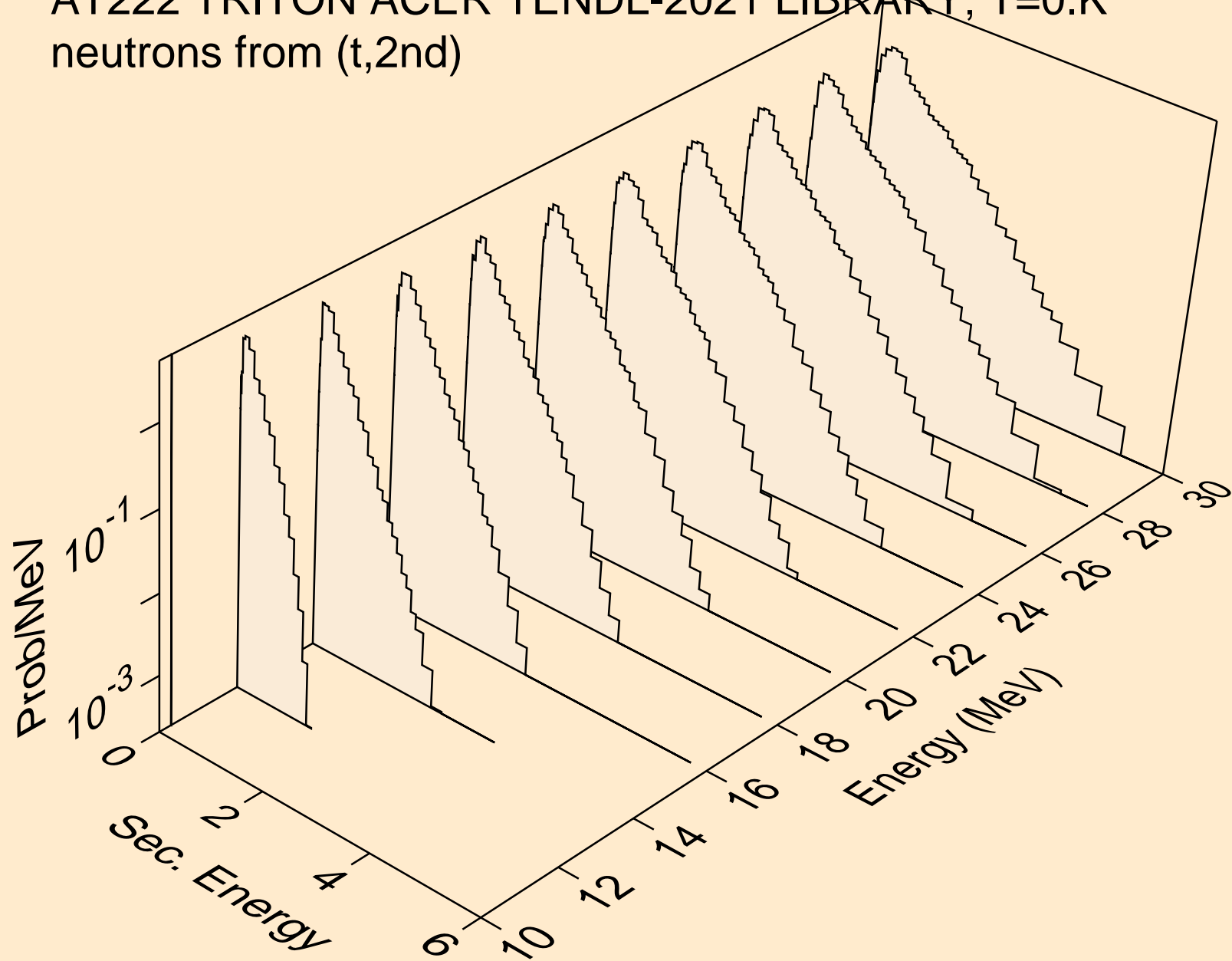

AT222 TRITON ACER TENDL-2021 LIBRARY; T=0.K  
neutrons from (t,2n)

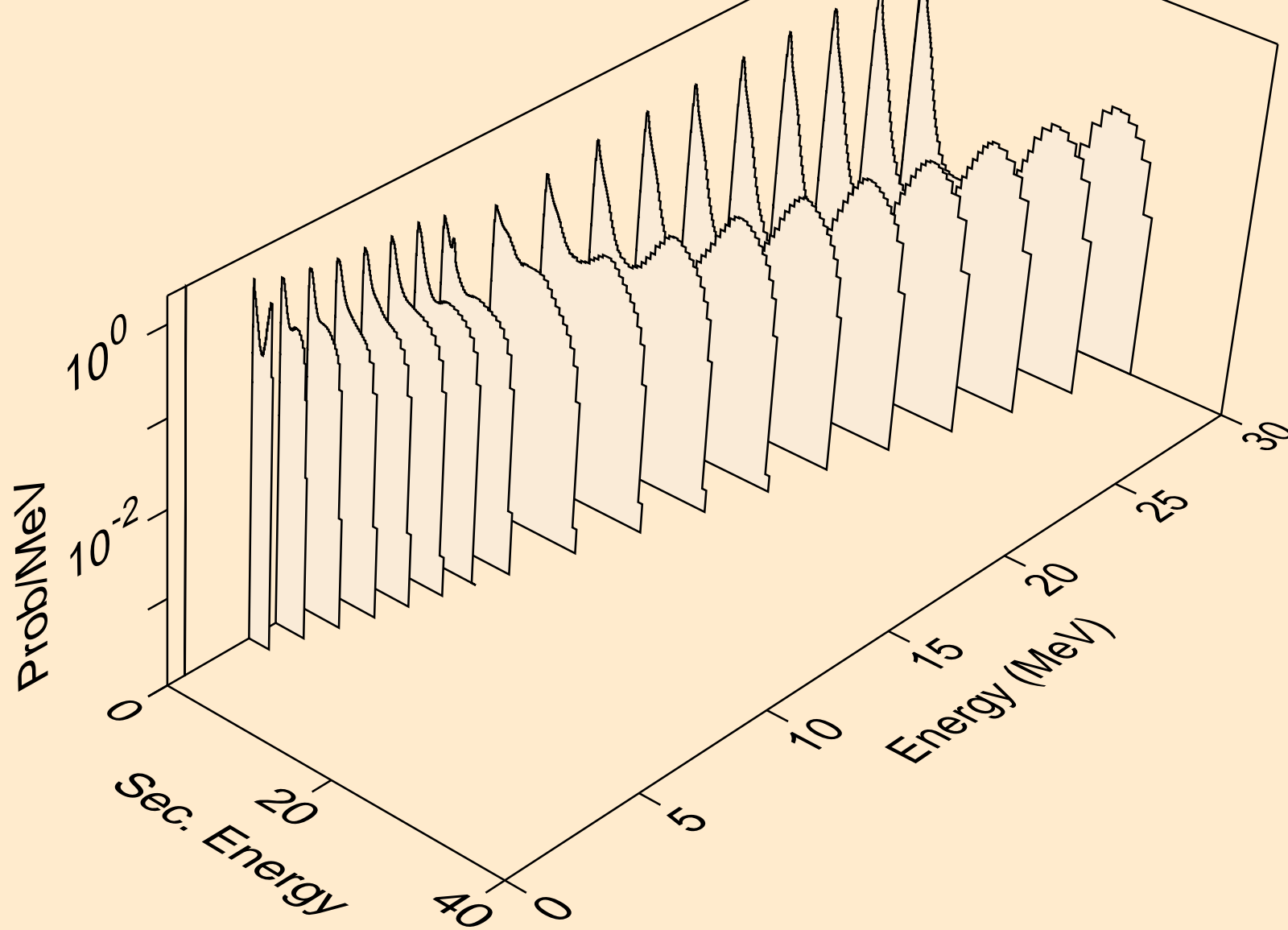

AT222 TRITON ACER TENDL-2021 LIBRARY; T=0.K  
neutrons from (t,3n)

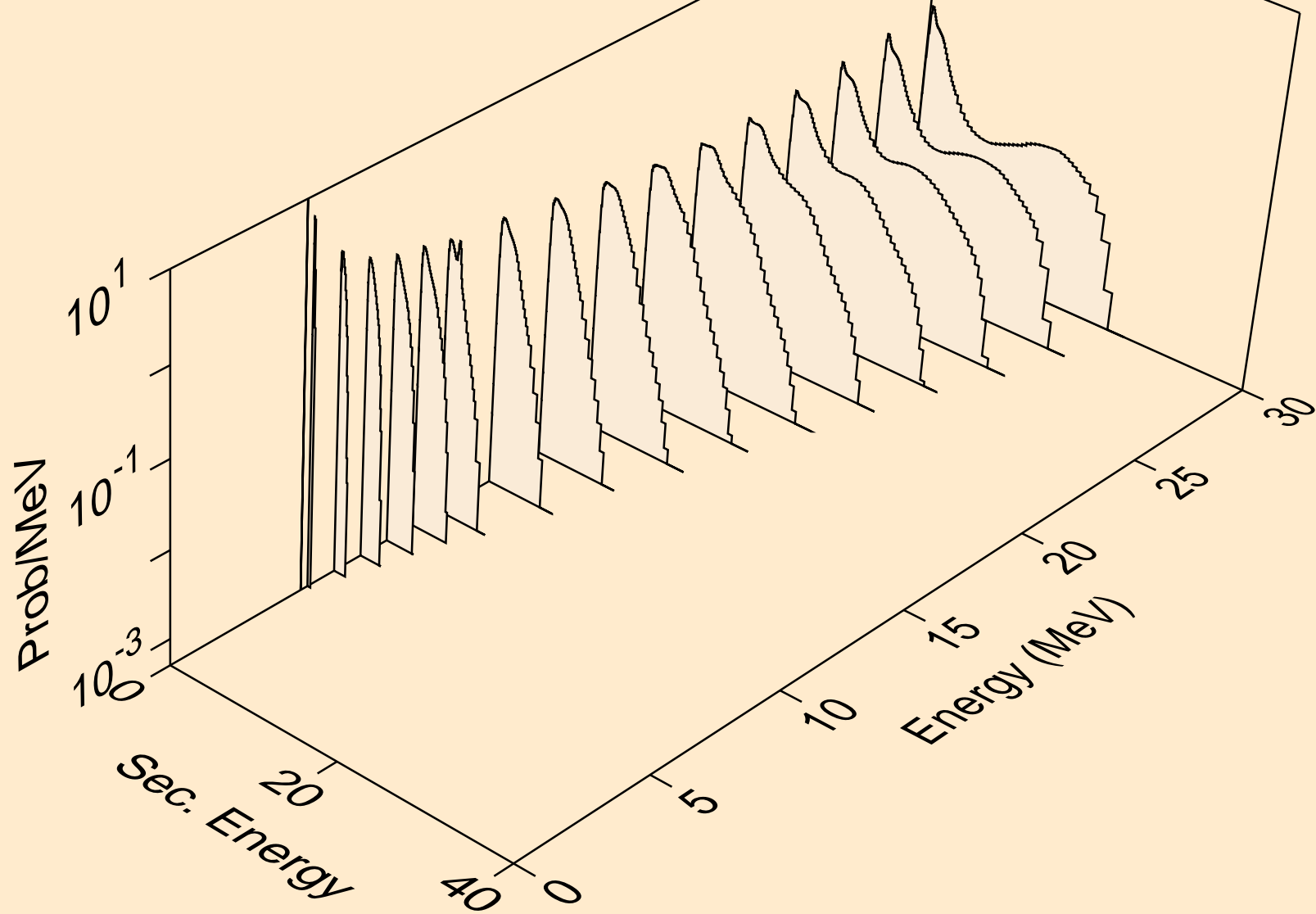

AT222 TRITON ACER TENDL-2021 LIBRARY; T=0.K  
neutrons from (t,n\*)a

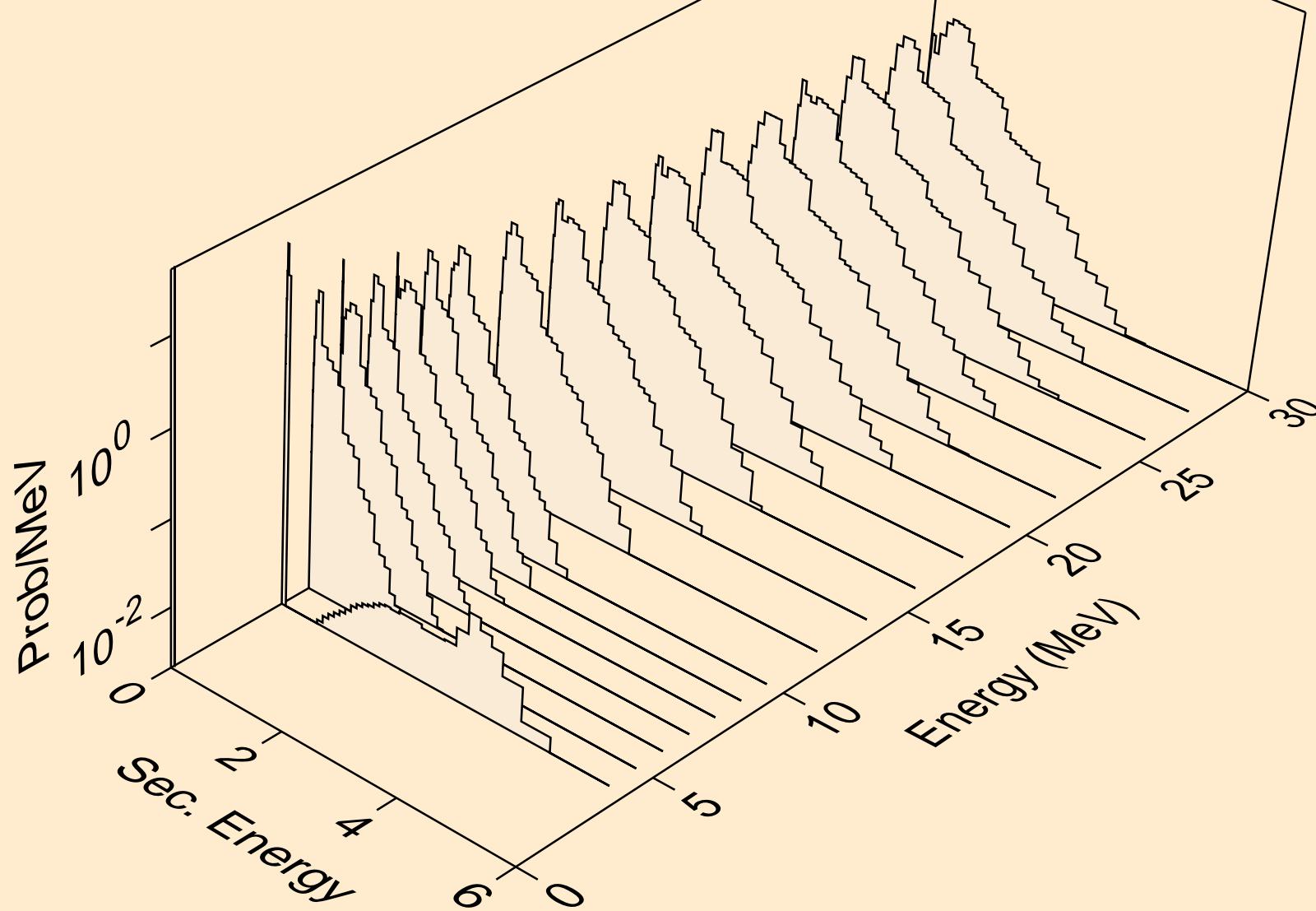

AT222 TRITON ACER TENDL-2021 LIBRARY; T=0.K  
neutrons from (t,2n)a

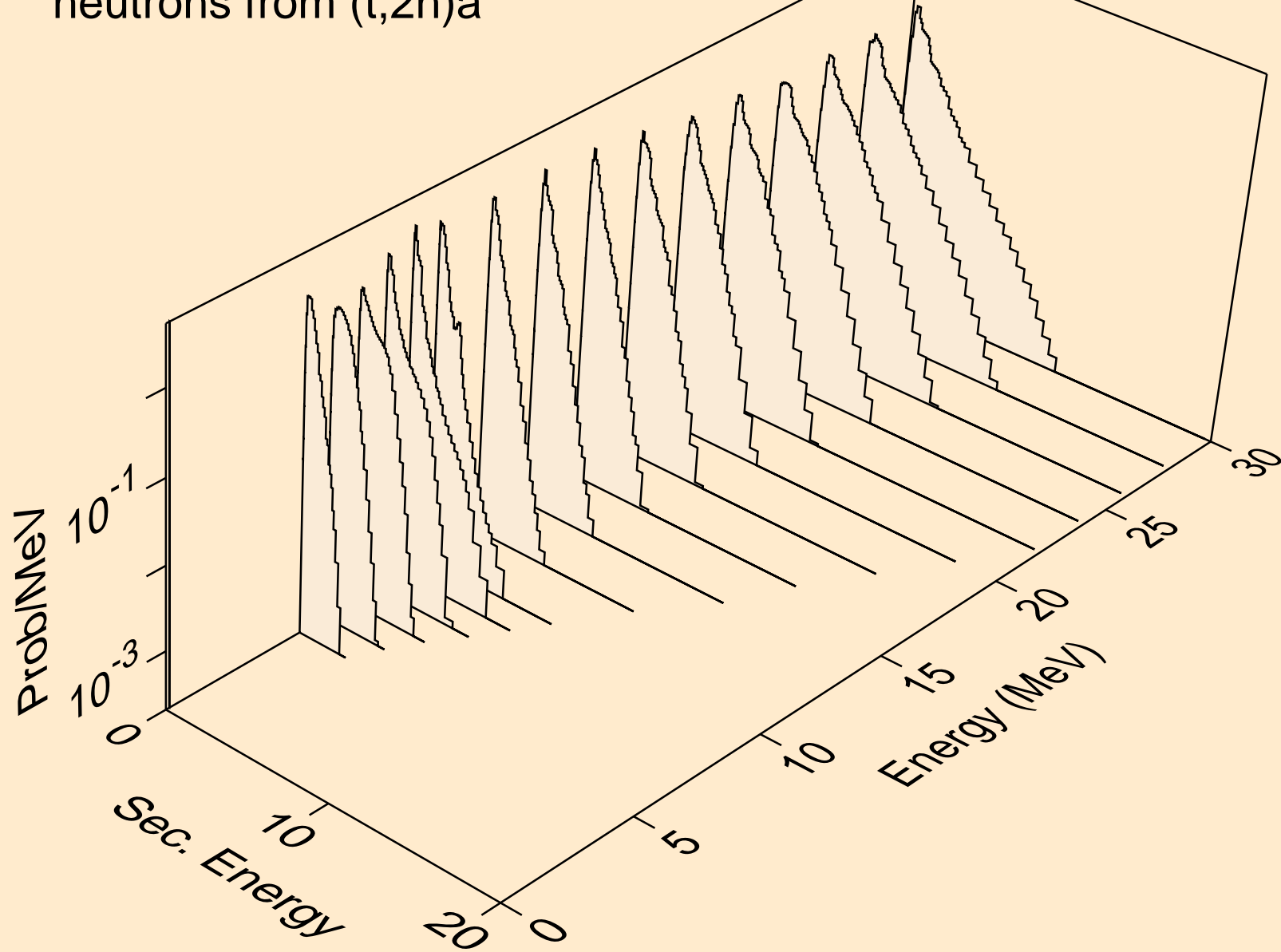

AT222 TRITON ACER TENDL-2021 LIBRARY; T=0.K  
neutrons from (t,3n)a

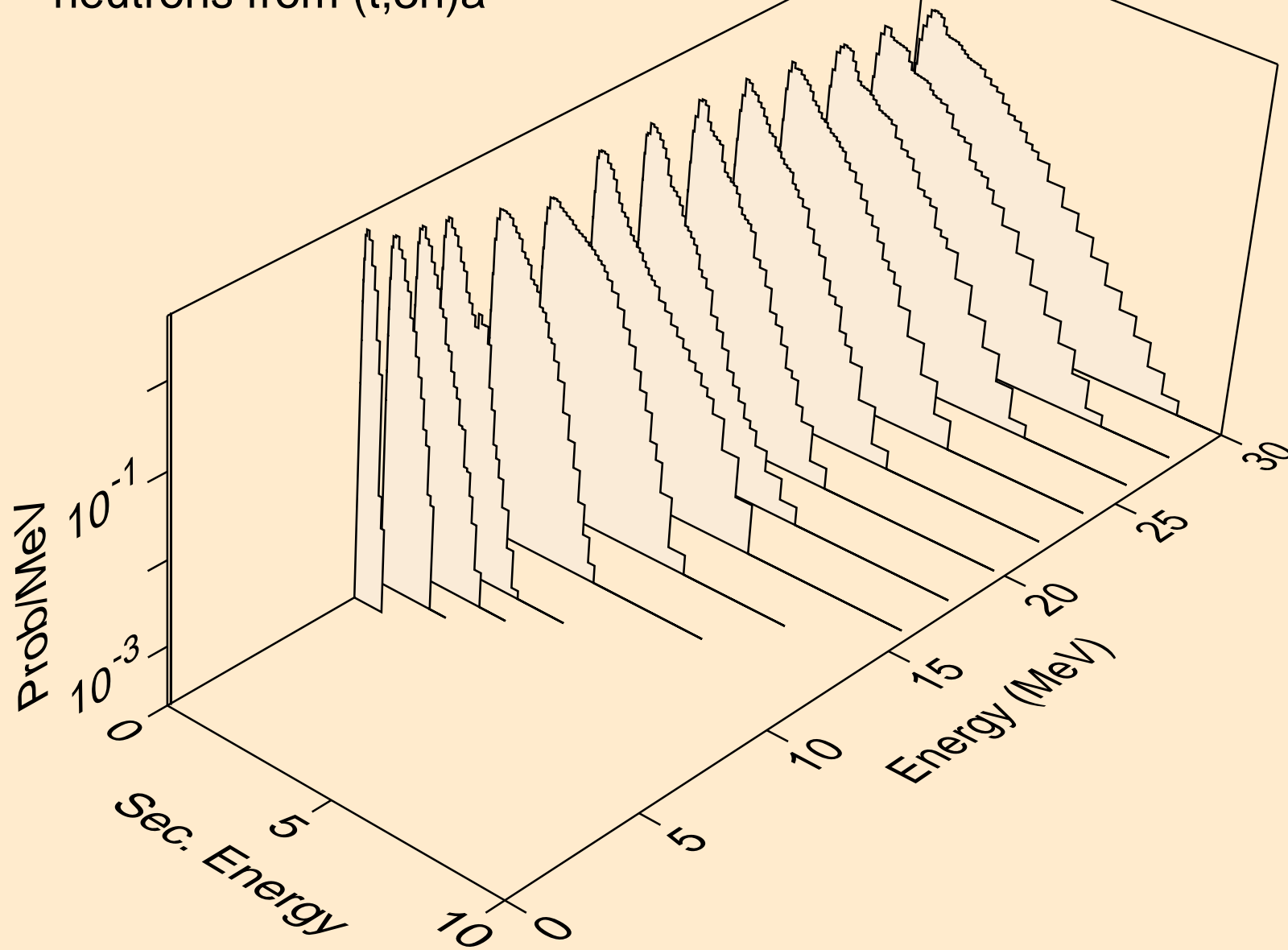



AT222 TRITON ACER TENDL-2021 LIBRARY; T=0.K  
neutrons from (t,n\*)p

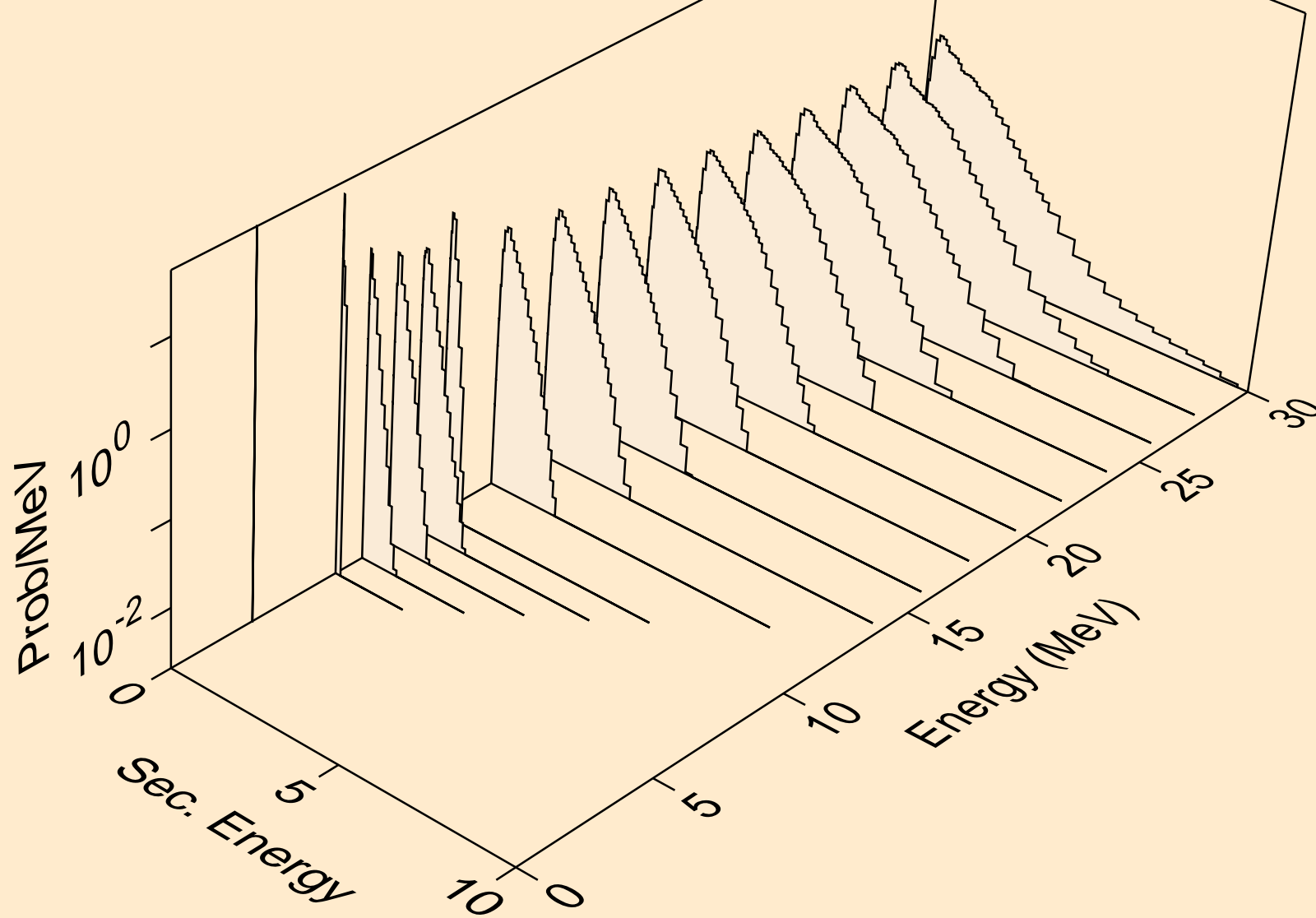

AT222 TRITON ACER TENDL-2021 LIBRARY; T=0.K  
neutrons from (t,n\*)2a

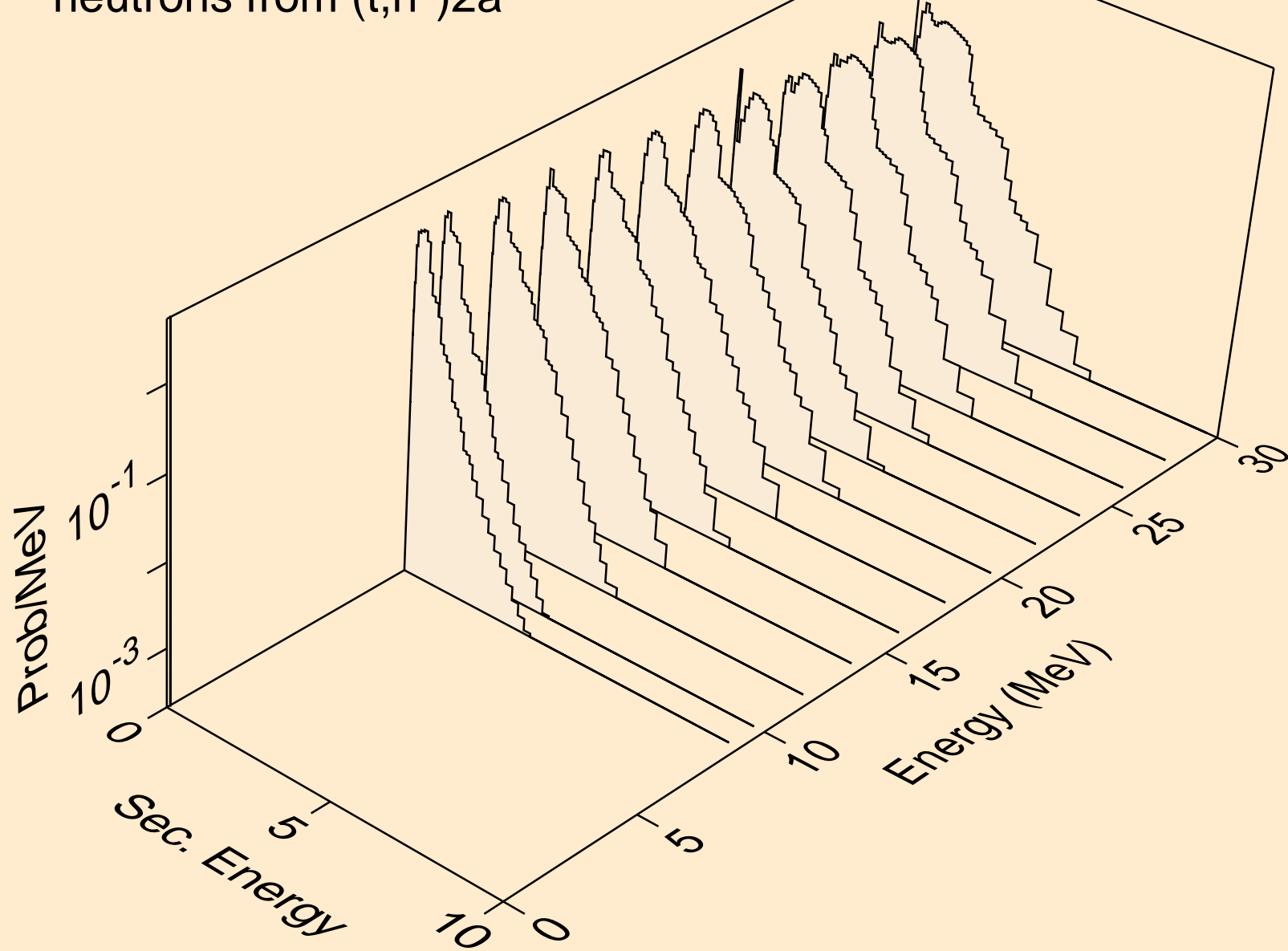

AT222 TRITON ACER TENDL-2021 LIBRARY; T=0.K  
neutrons from (t,2n)2a

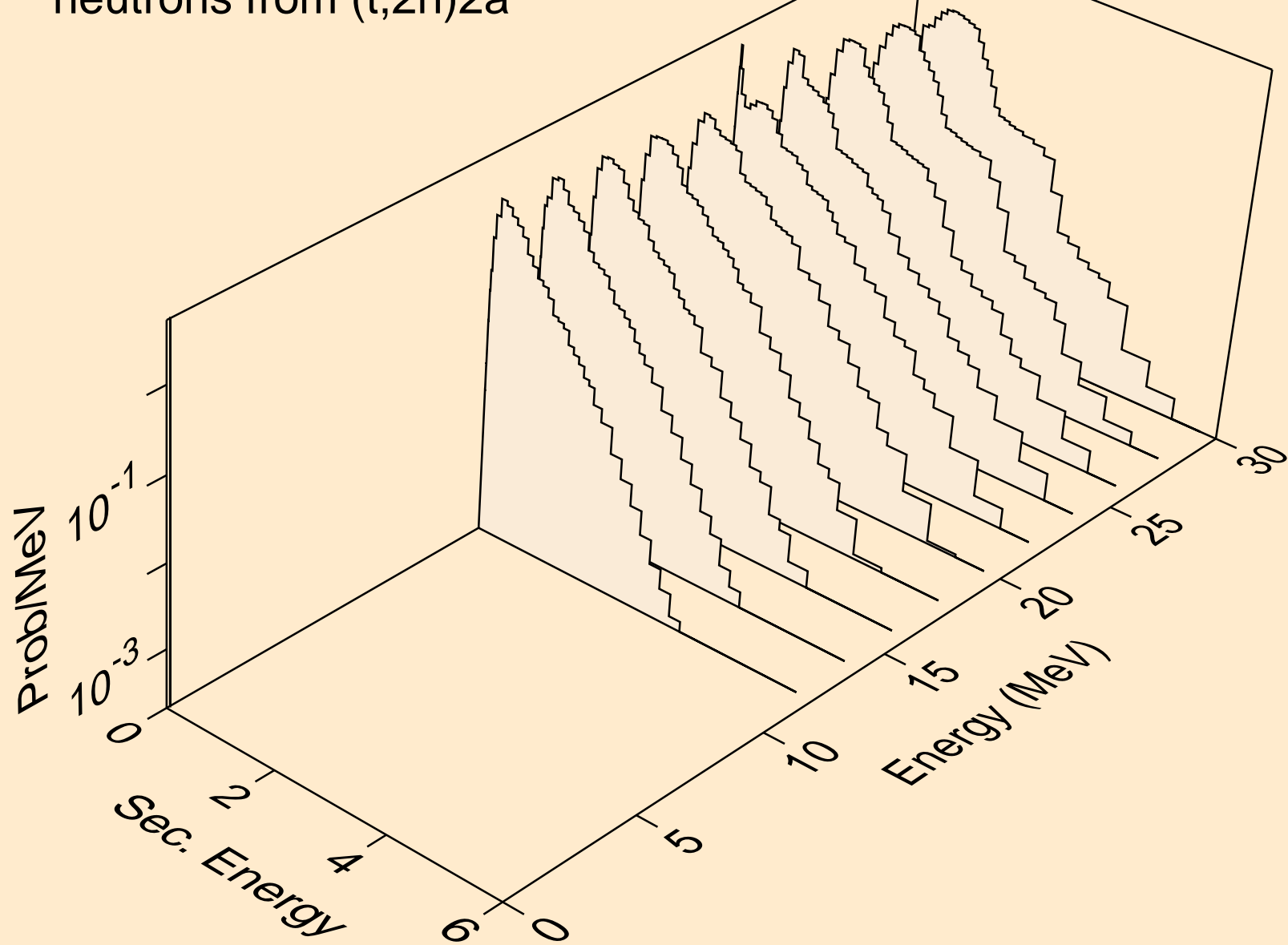

AT222 TRITON ACER TENDL-2021 LIBRARY; T=0.K  
neutrons from (t,n\*)d

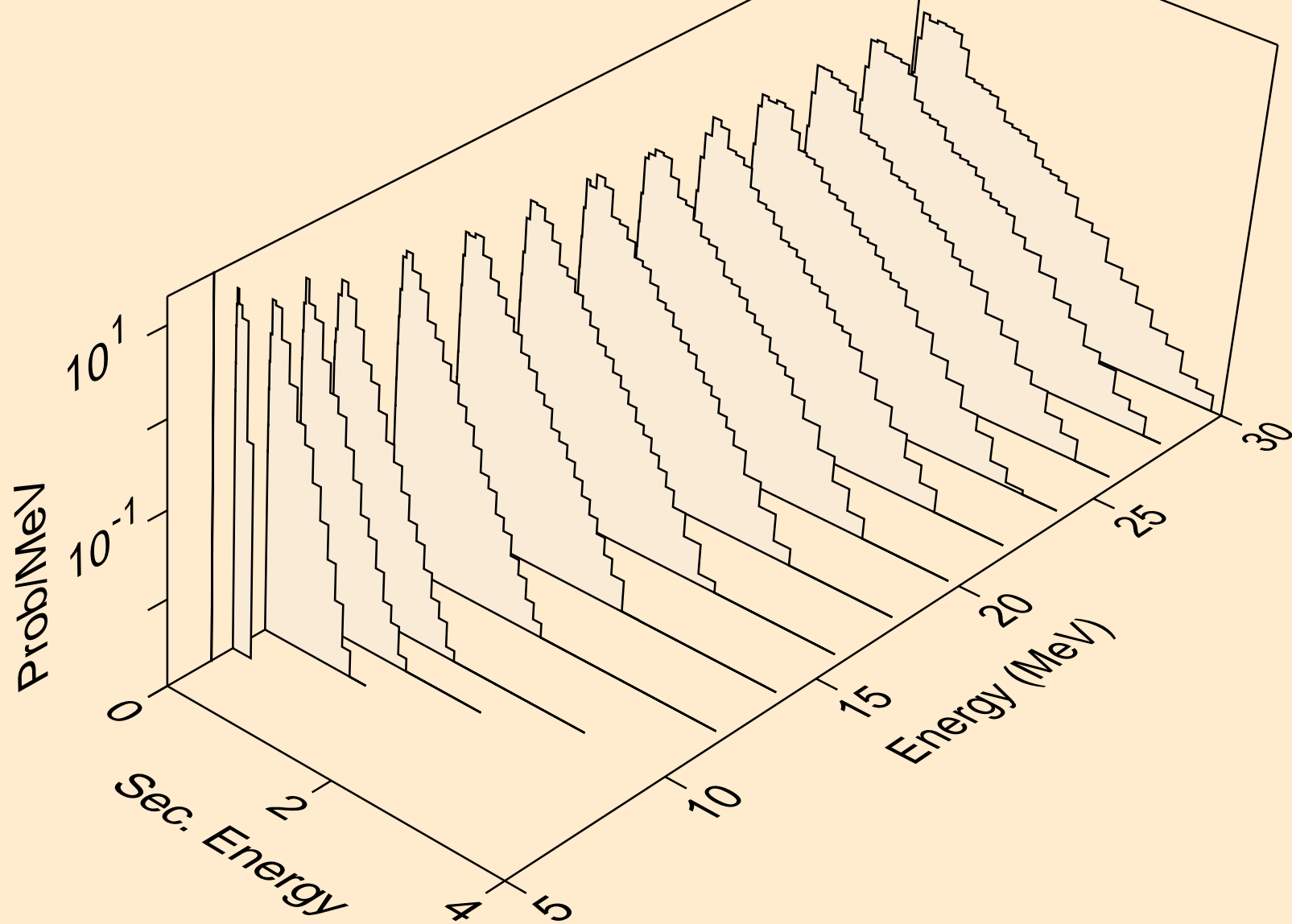

AT222 TRITON ACER TENDL-2021 LIBRARY; T=0.K  
neutrons from (t,n\*)t

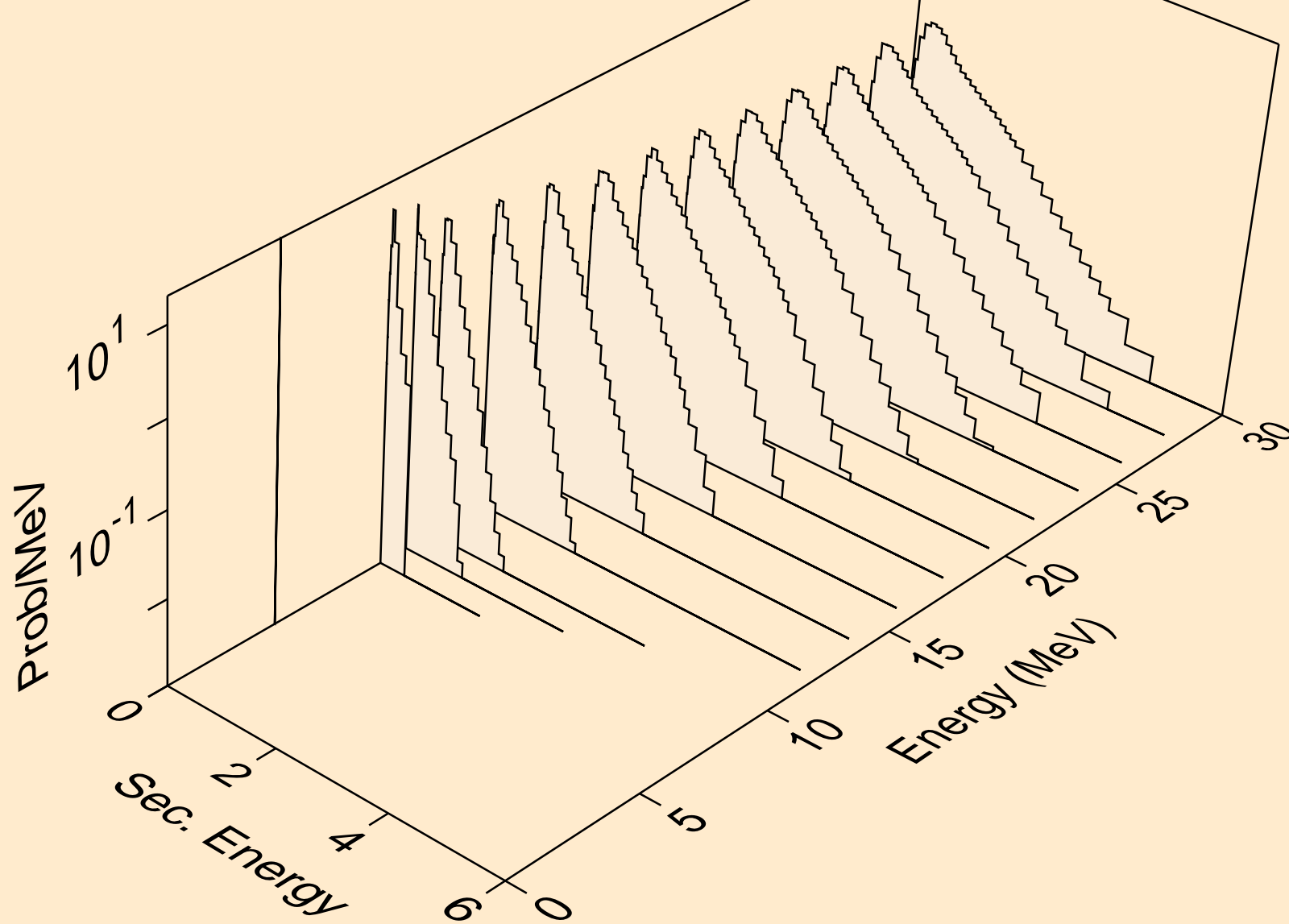

AT222 TRITON ACER TENDL-2021 LIBRARY; T=0.K  
neutrons from (t,n\*)he3

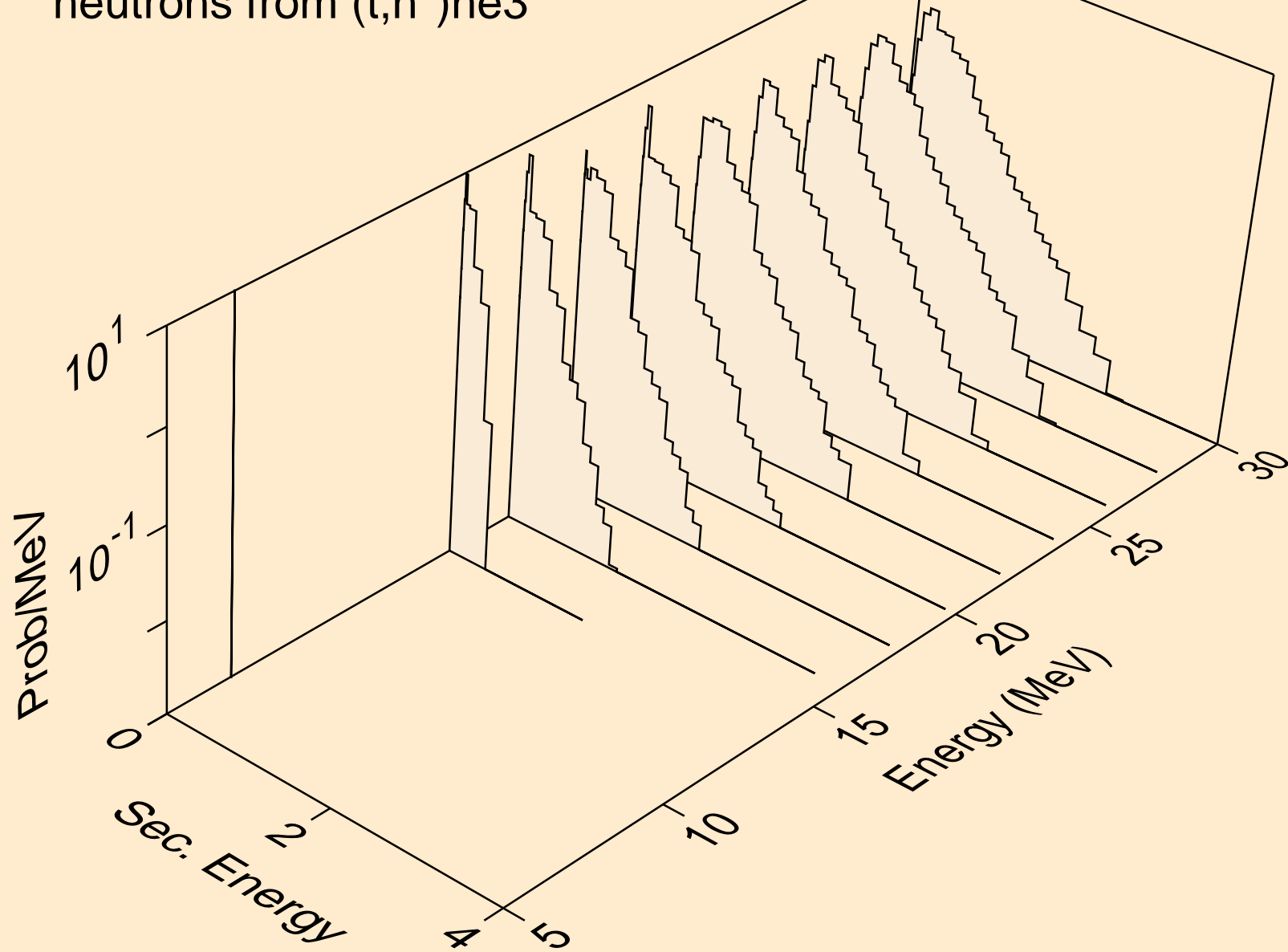

AT222 TRITON ACER TENDL-2021 LIBRARY; T=0.K  
neutrons from (t,4n)

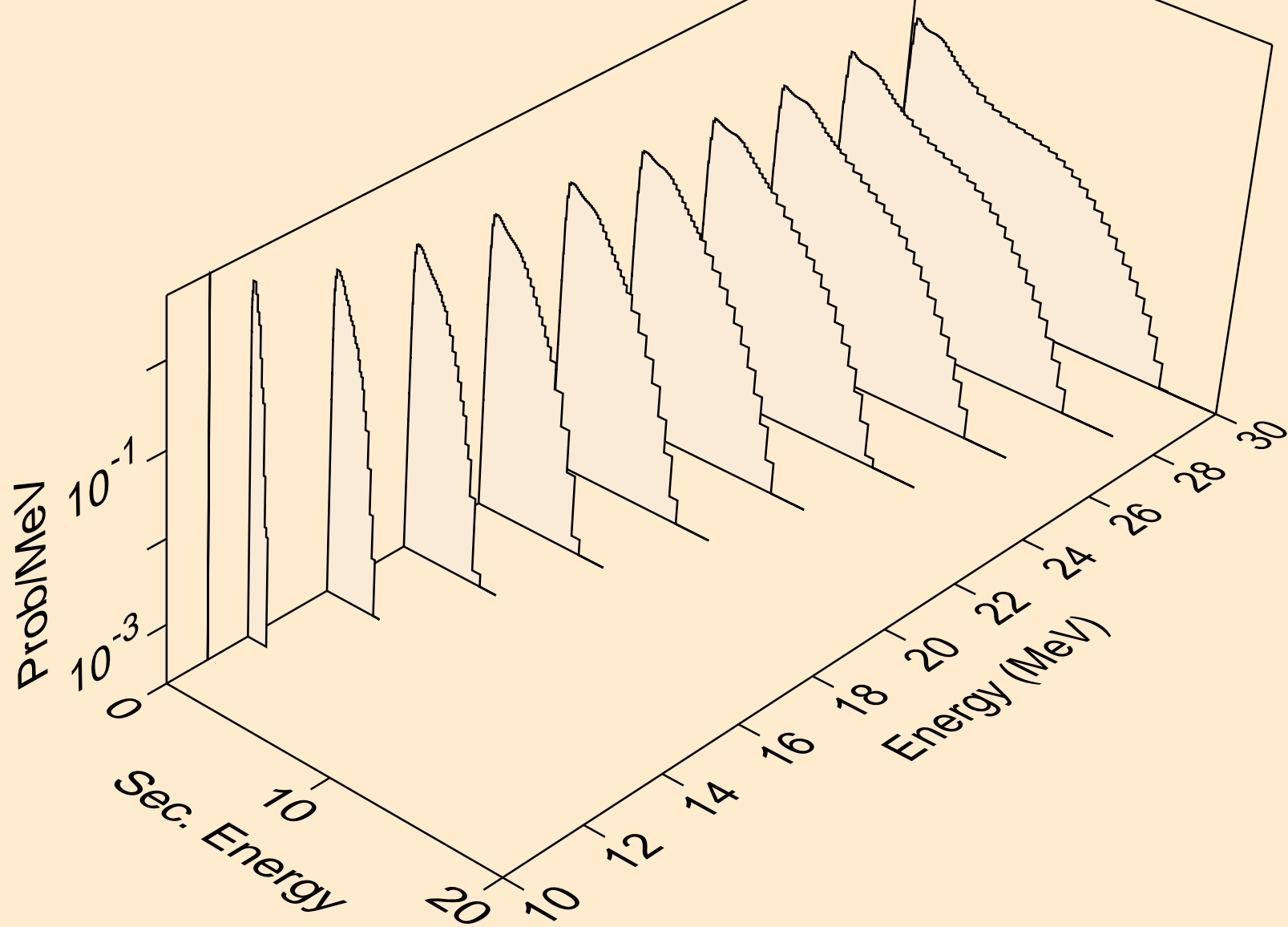

AT222 TRITON ACER TENDL-2021 LIBRARY; T=0.K  
neutrons from (t,2np)

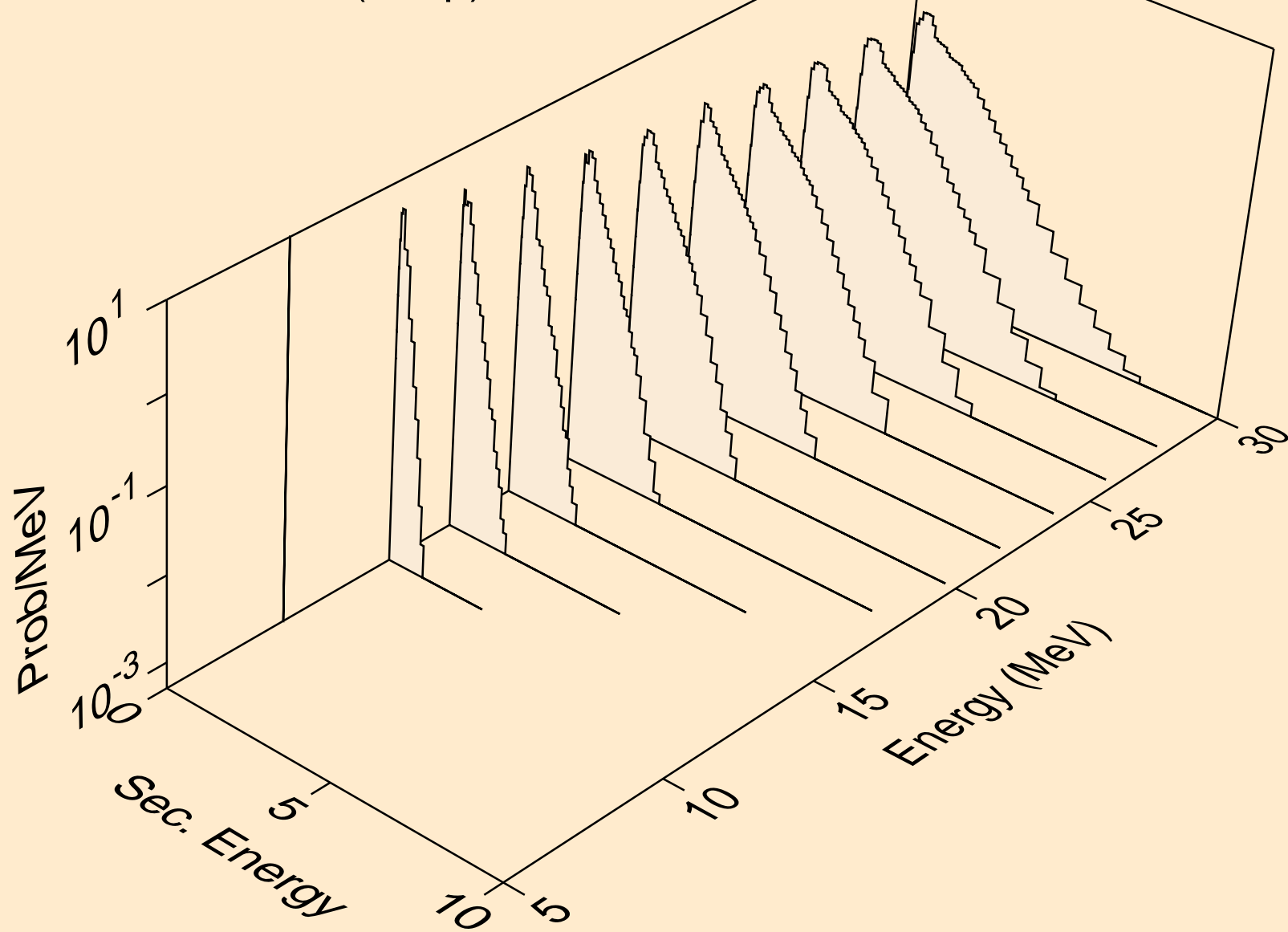



AT222 TRITON ACER TENDL-2021 LIBRARY; T=0.K  
neutrons from (t,3np)

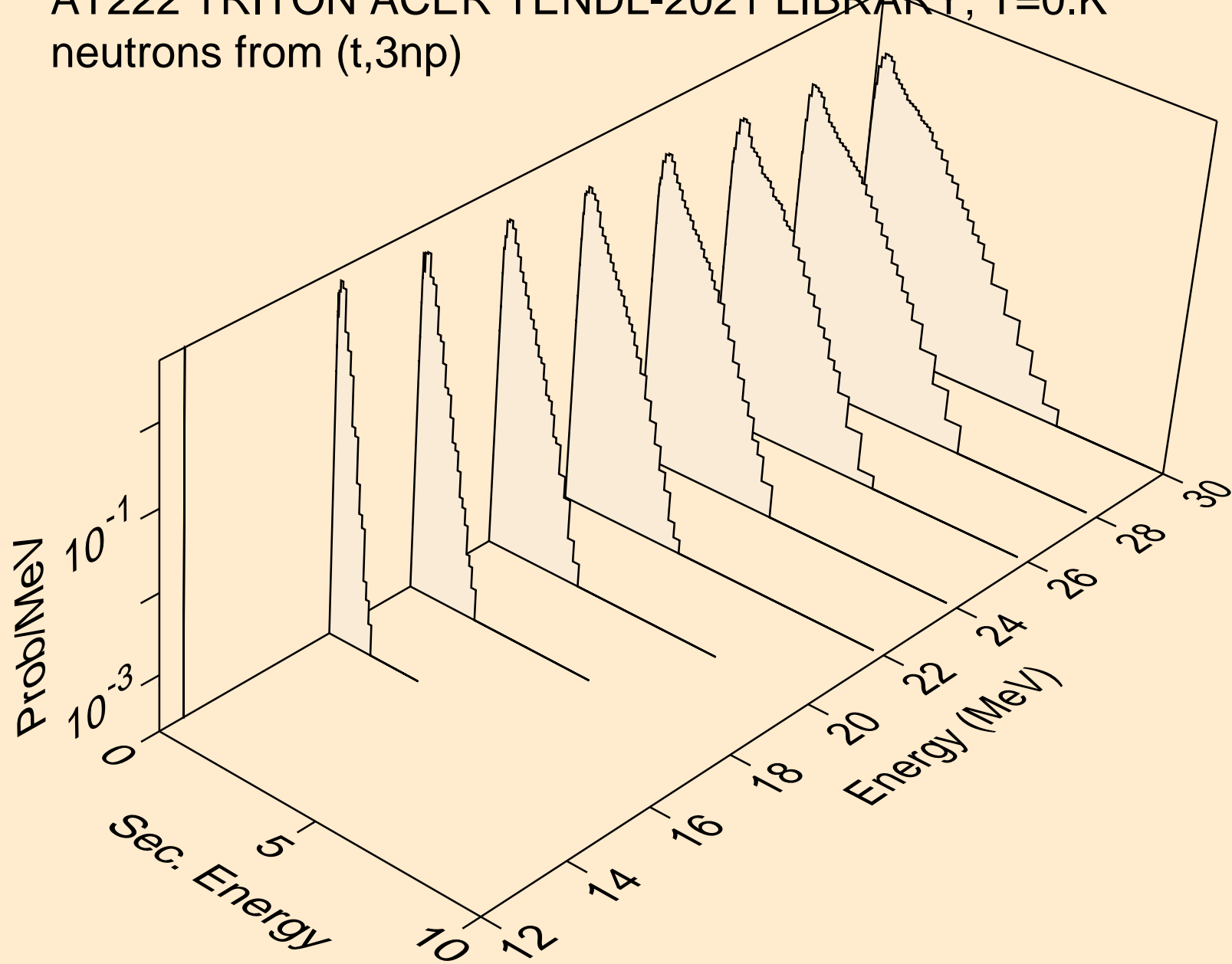

AT222 TRITON ACER TENDL-2021 LIBRARY; T=0.K  
neutrons from (t,2np)

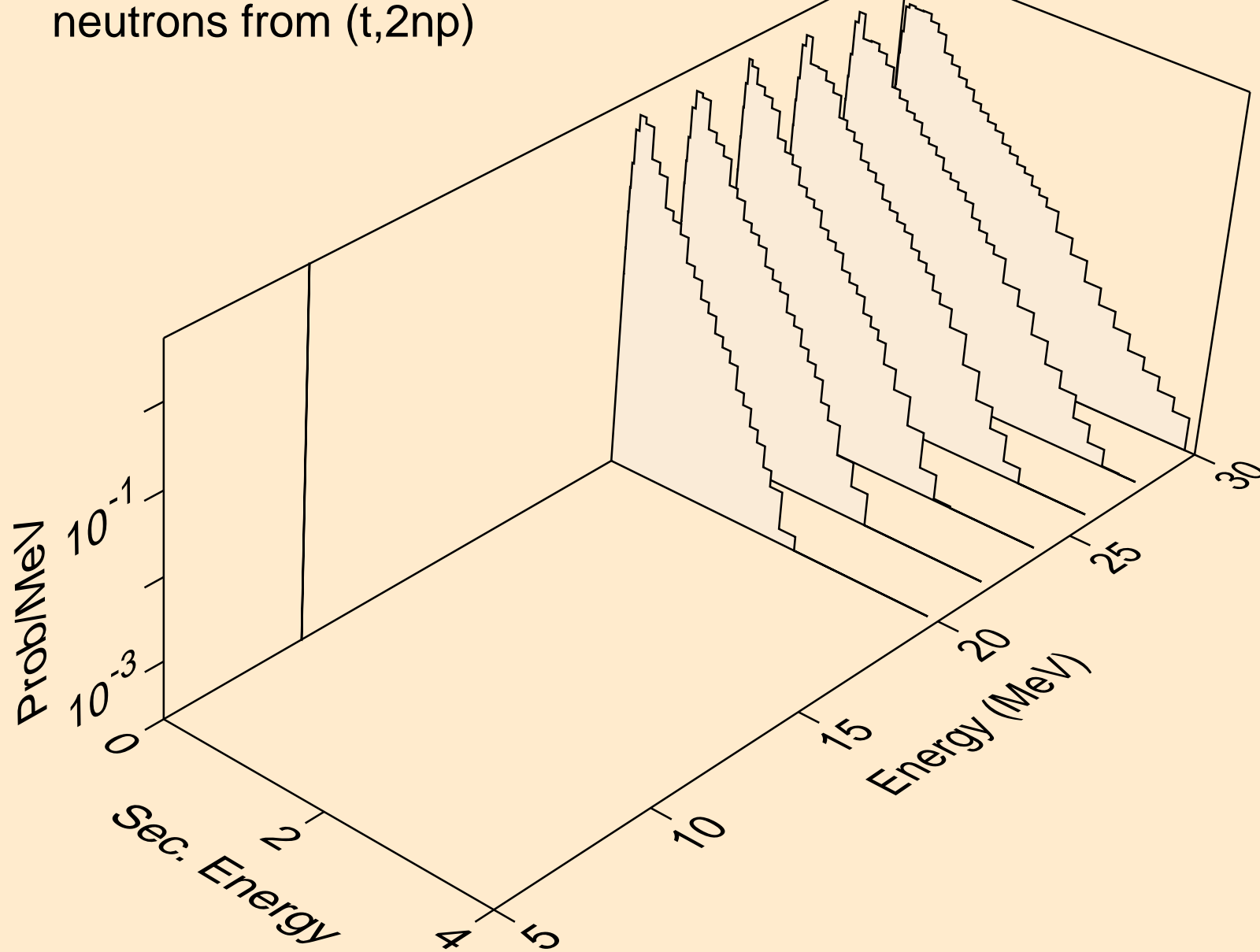

AT222 TRITON ACER TENDL-2021 LIBRARY; T=0.K  
neutrons from (t,npa)

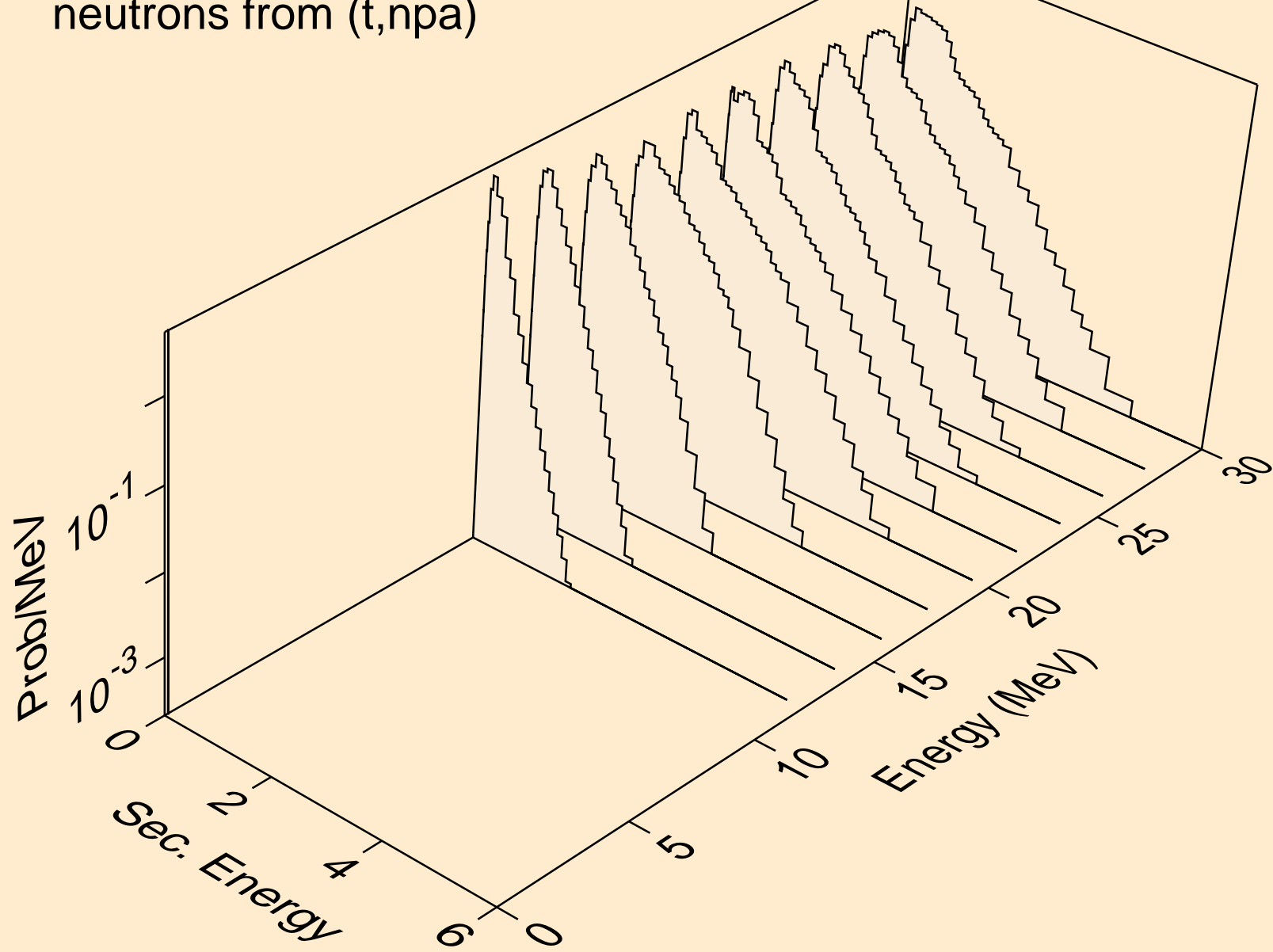

AT222 TRITON ACER TENDL-2021 LIBRARY; T=0.K  
protons from (t,x)

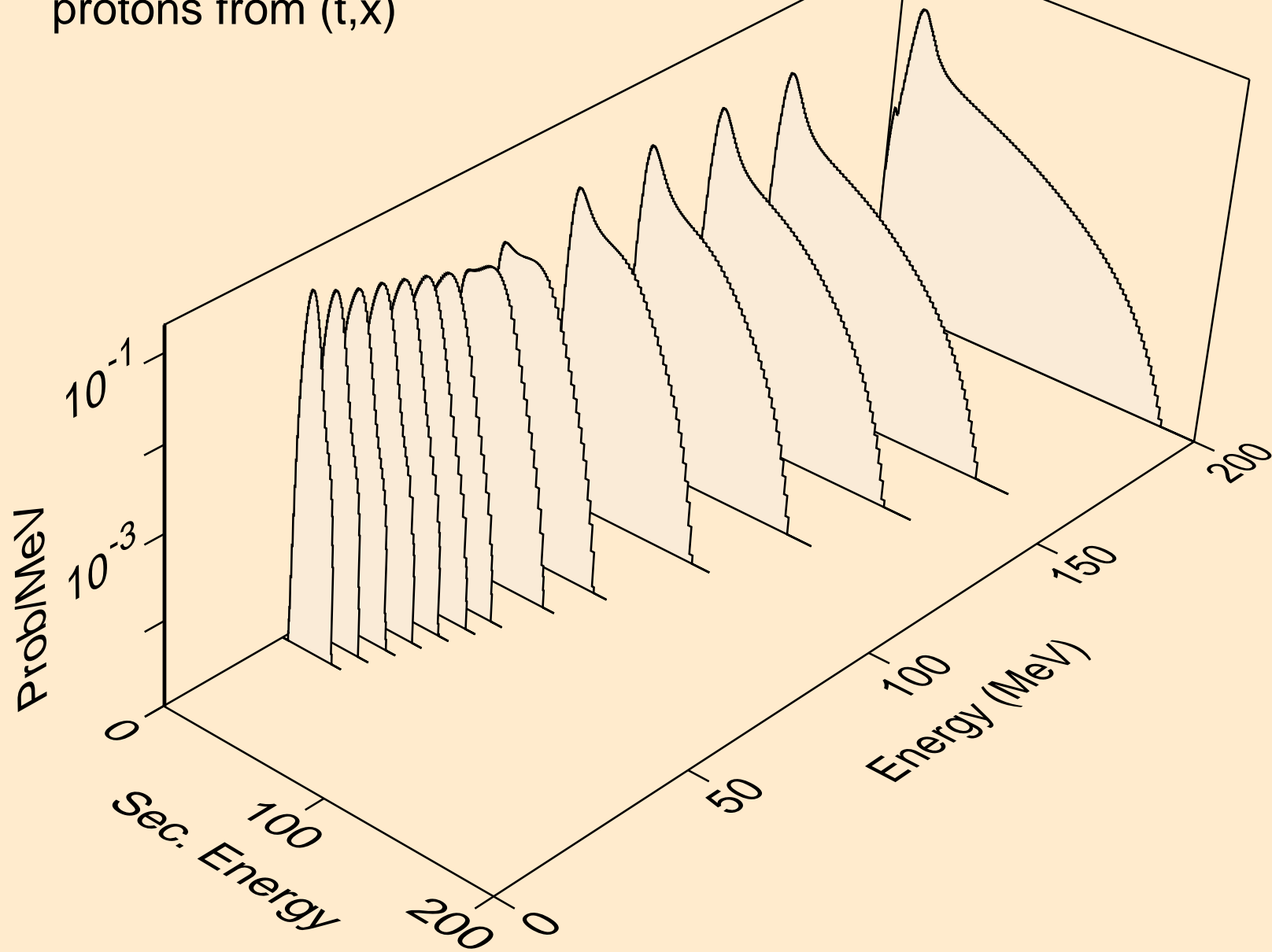

AT222 TRITON ACER TENDL-2021 LIBRARY; T=0.K  
protons from (t,n\*)p

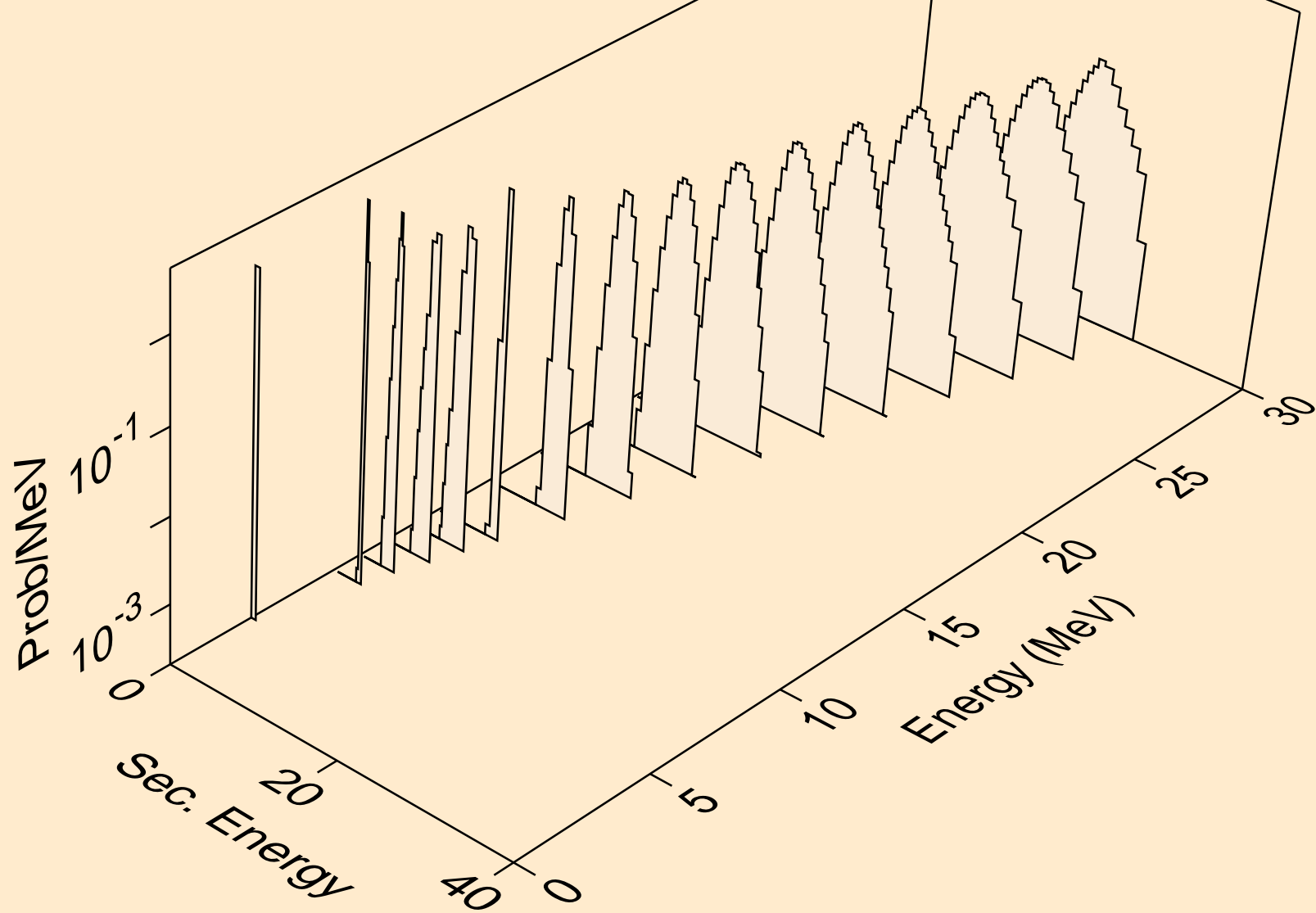

AT222 TRITON ACER TENDL-2021 LIBRARY; T=0.K  
protons from (t,2np)

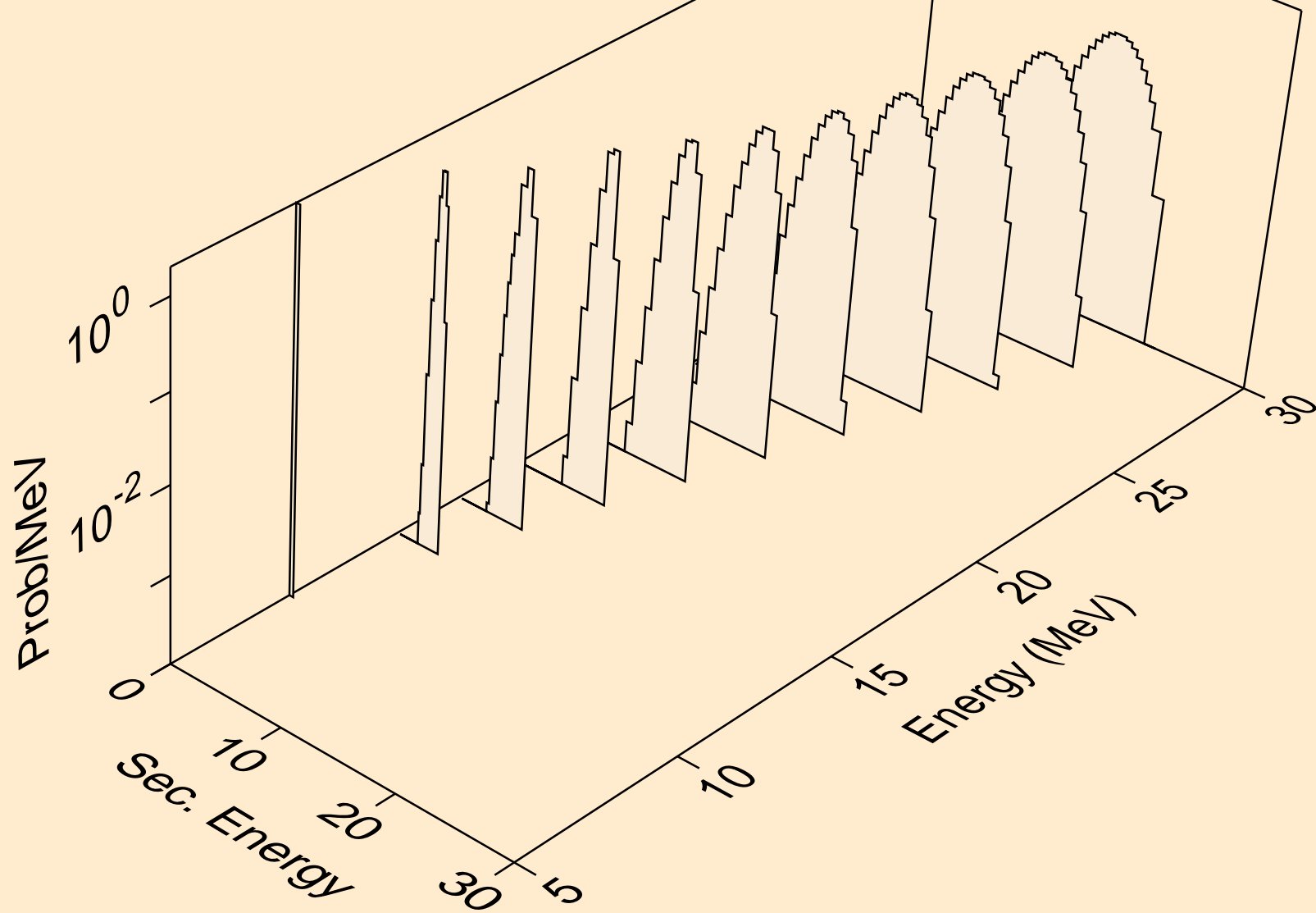

AT222 TRITON ACER TENDL-2021 LIBRARY; T=0.K  
protons from (t,3np)

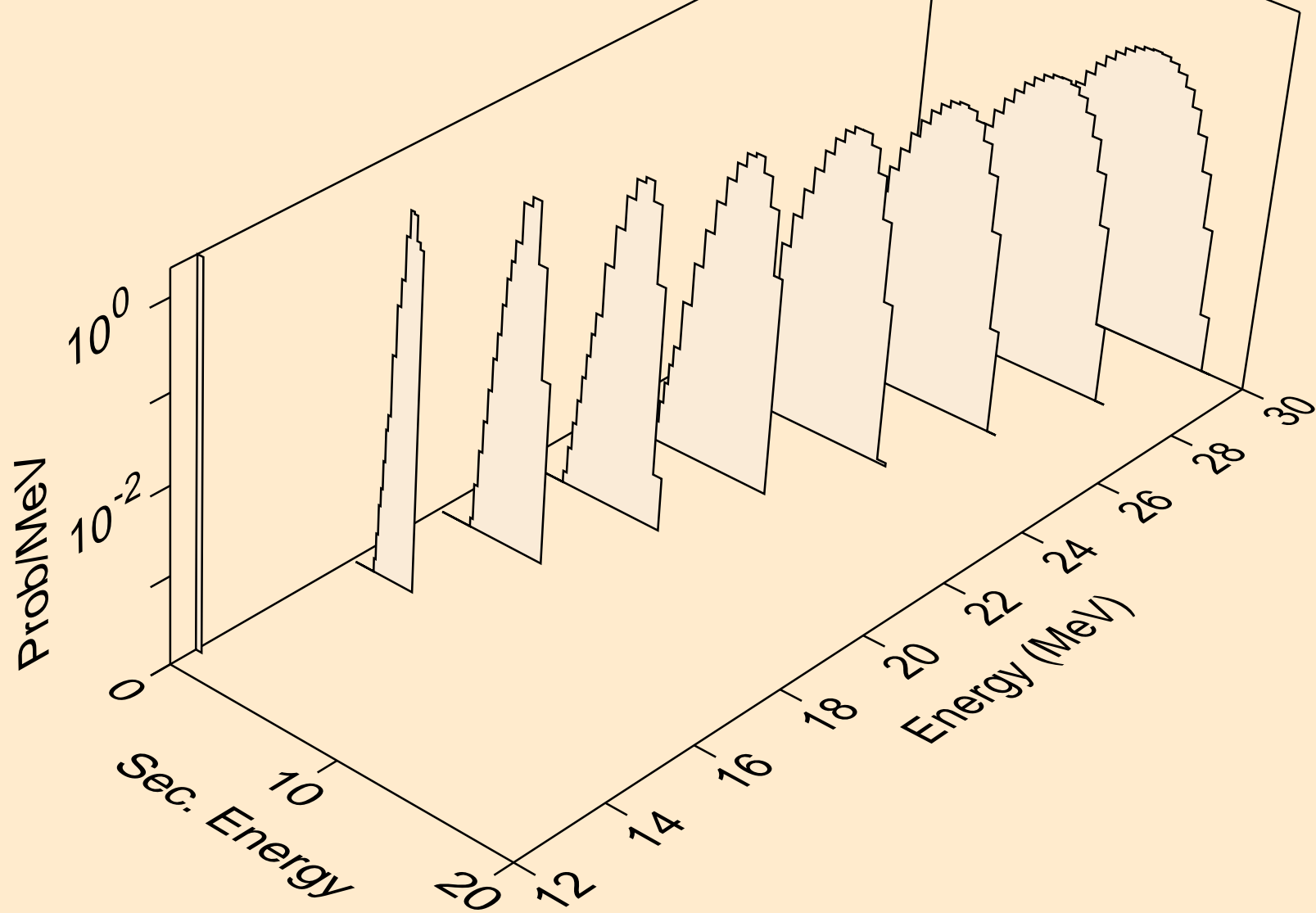

AT222 TRITON ACER TENDL-2021 LIBRARY; T=0.K  
protons from (t,2np)

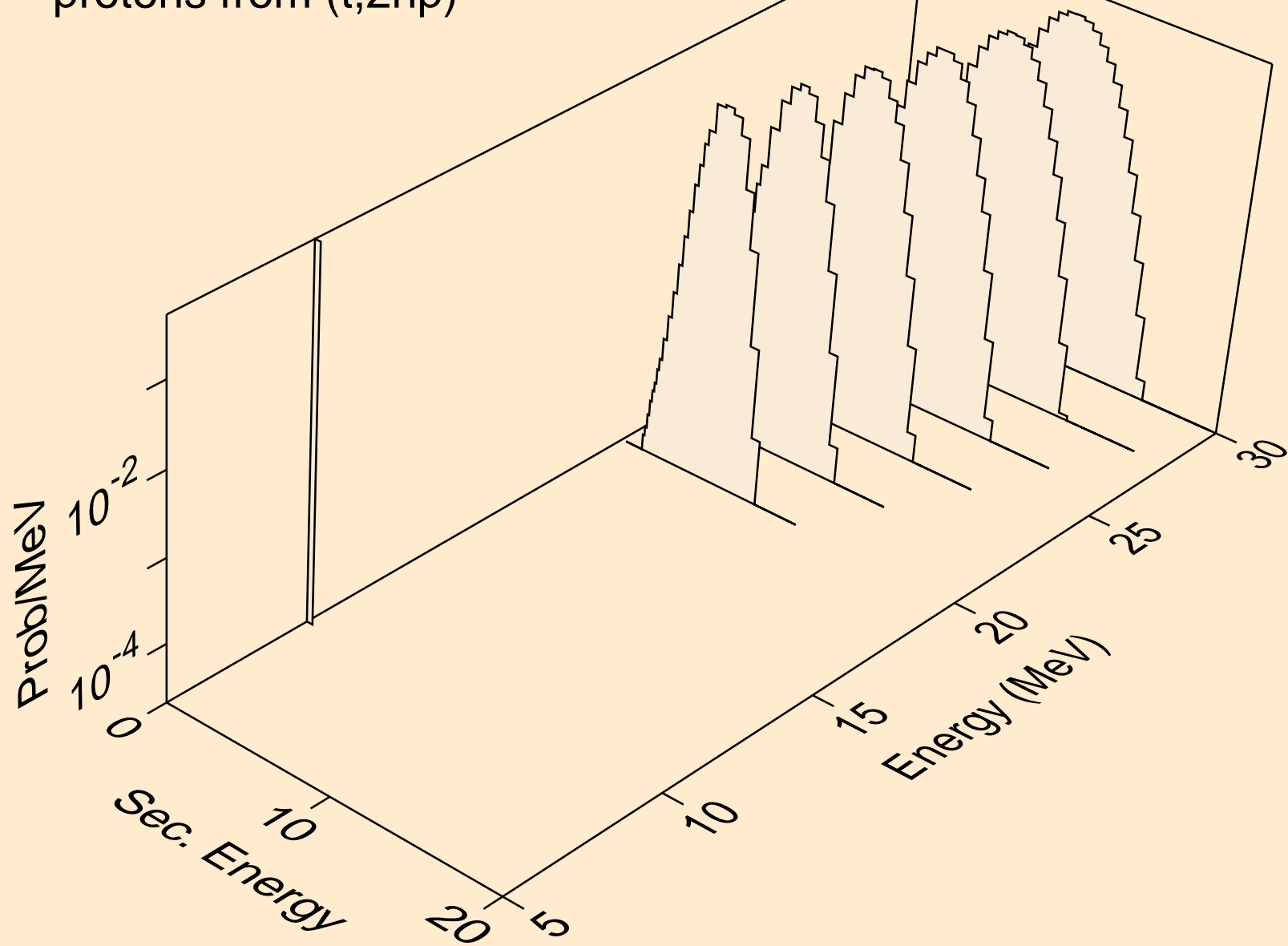



AT222 TRITON ACER TENDL-2021 LIBRARY; T=0.K  
protons from (t,npa)

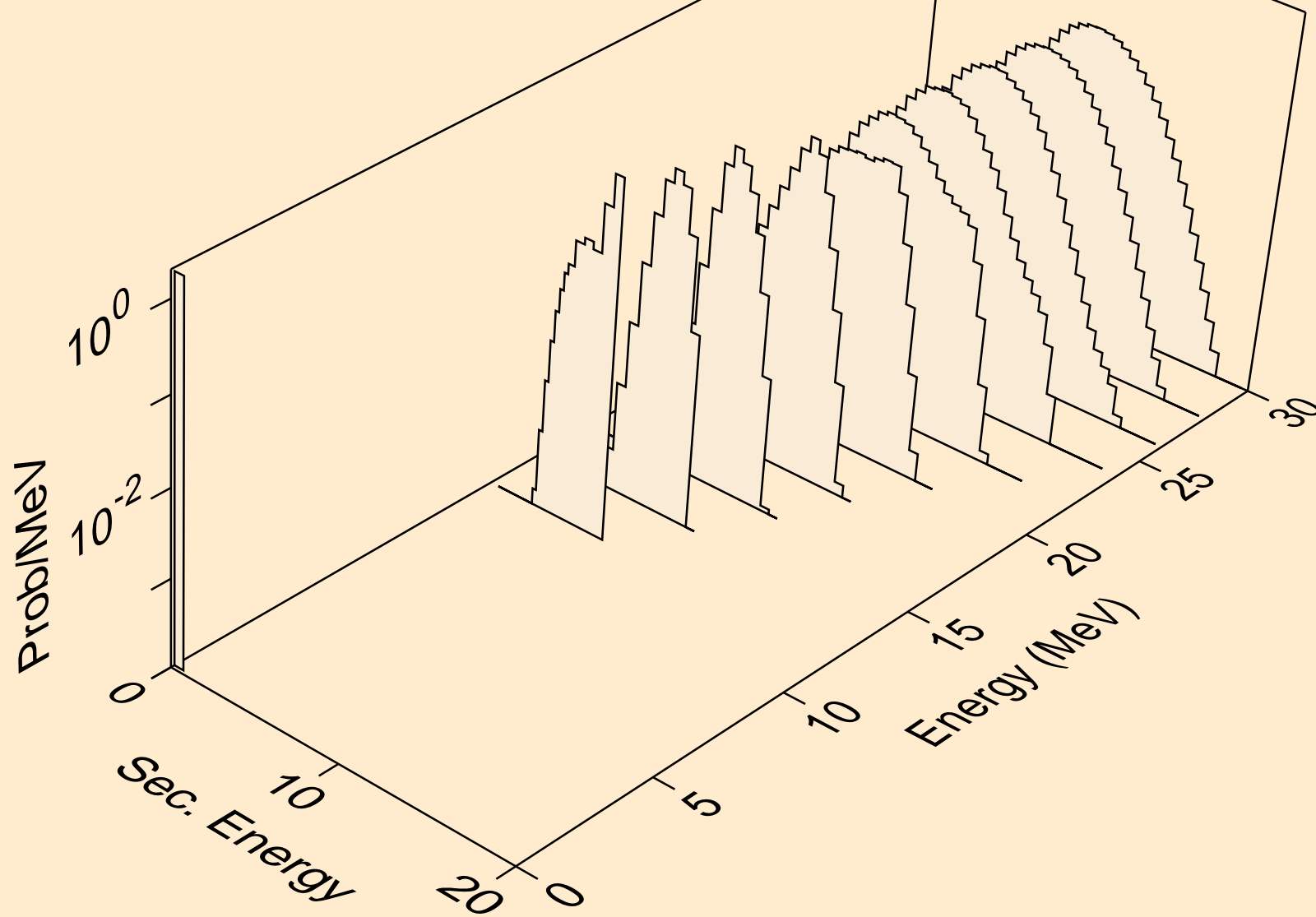

AT222 TRITON ACER TENDL-2021 LIBRARY; T=0.K  
protons from (t,p)

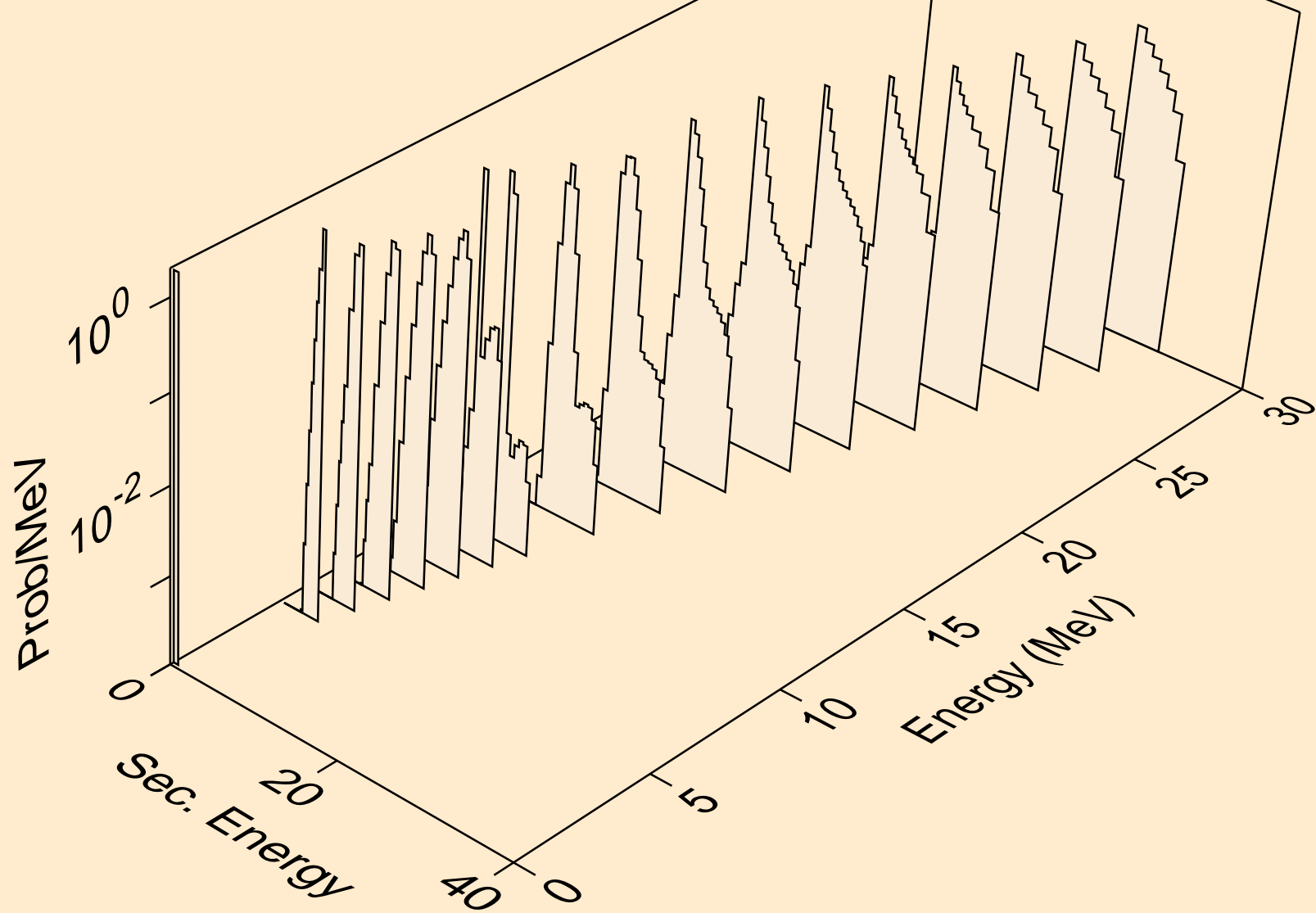

AT222 TRITON ACER TENDL-2021 LIBRARY; T=0.K  
protons from (t,2p)

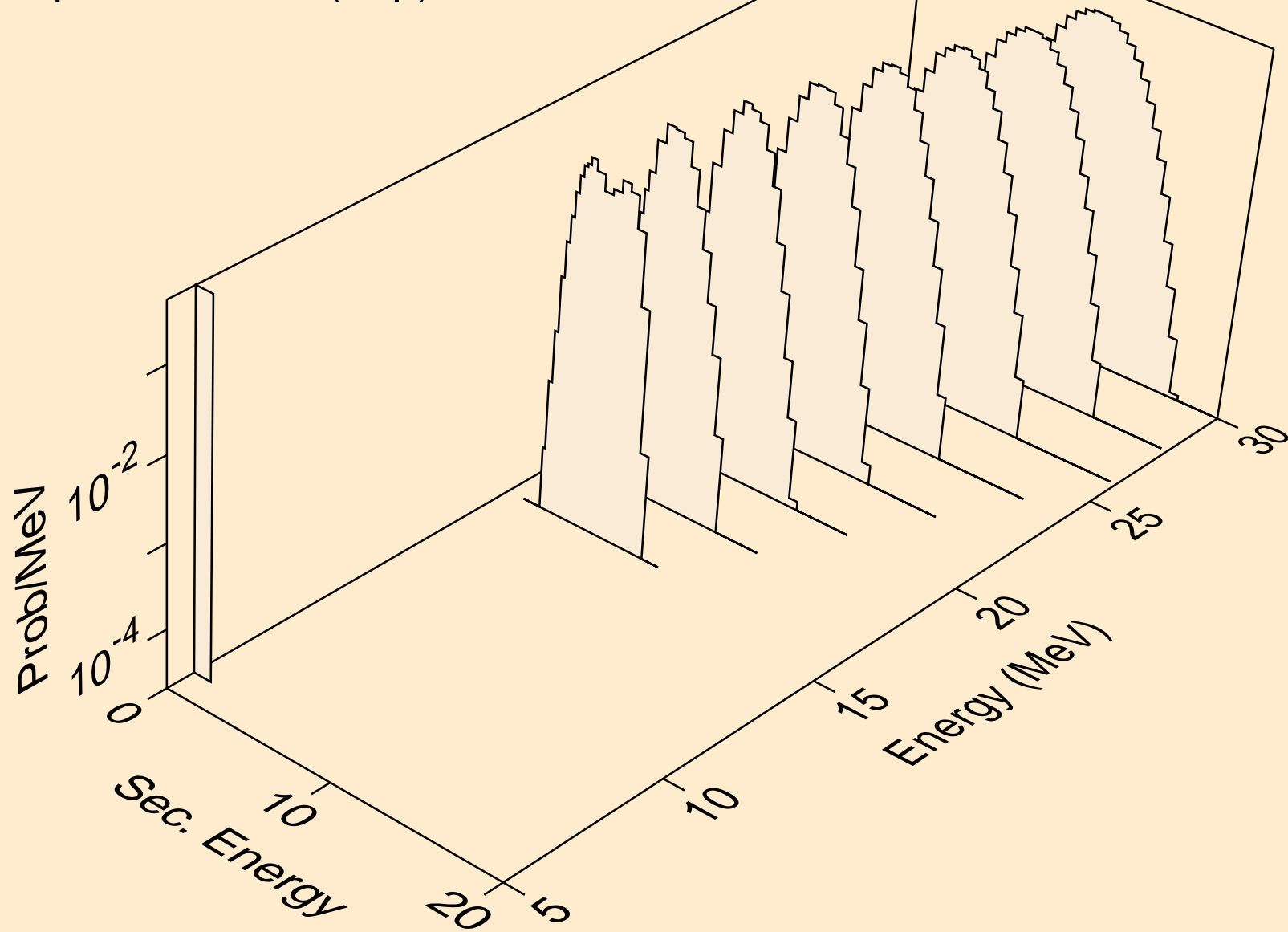

AT222 TRITON ACER TENDL-2021 LIBRARY; T=0.K  
protons from (t,pa)

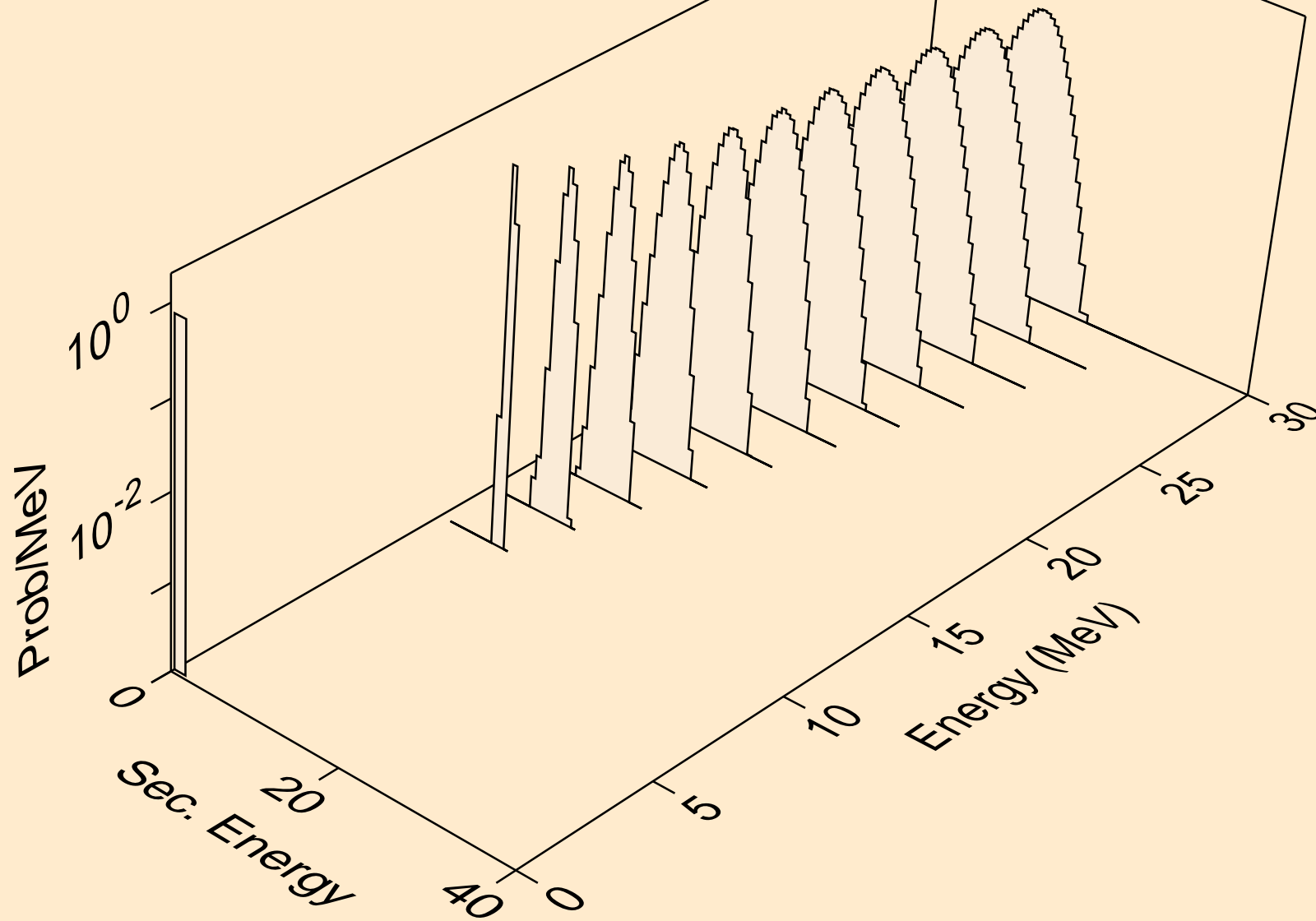

AT222 TRITON ACER TENDL-2021 LIBRARY; T=0.K  
protons from (t,pd)

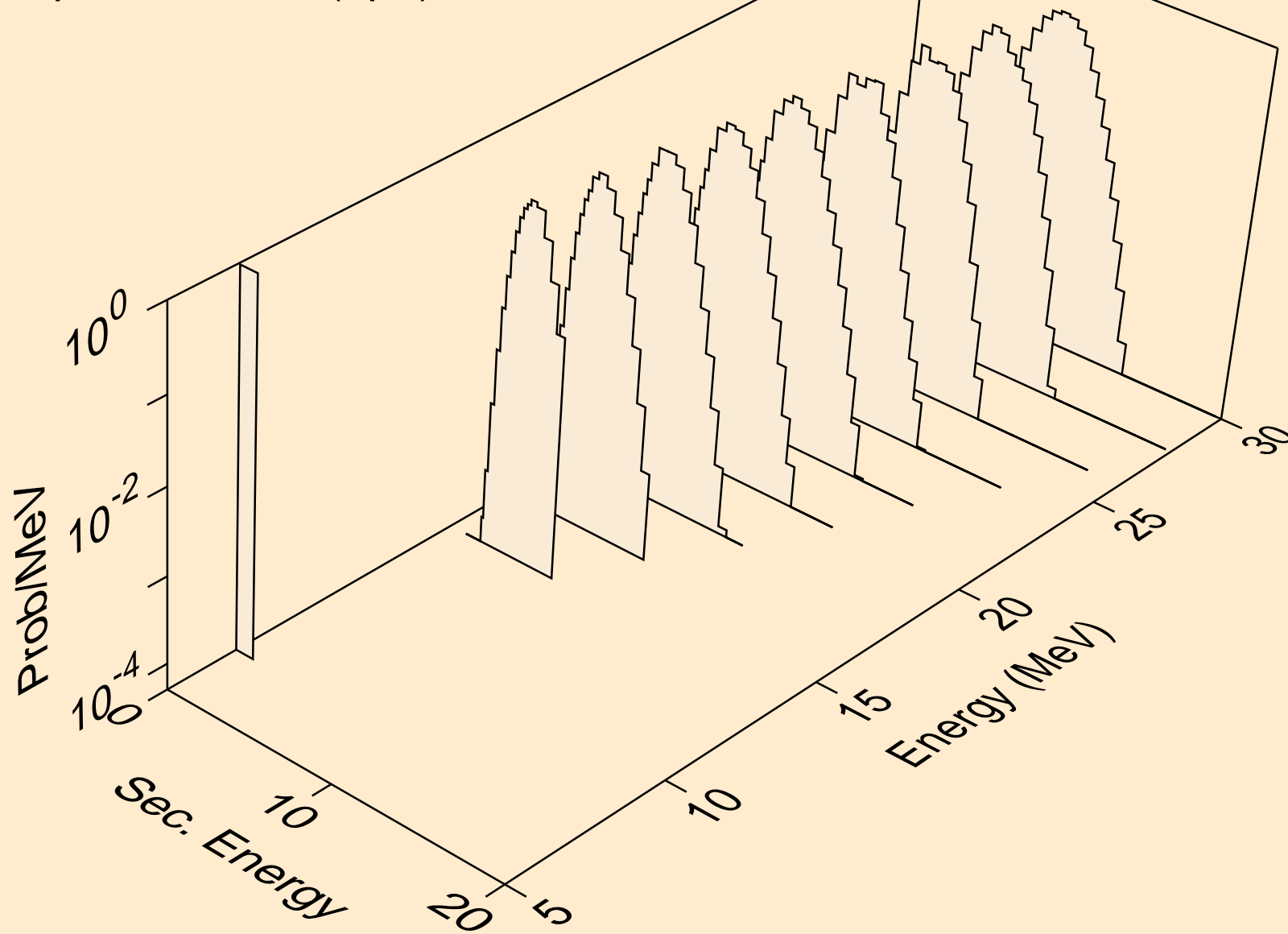

AT222 TRITON ACER TENDL-2021 LIBRARY; T=0.K  
deuterons from (t,x)

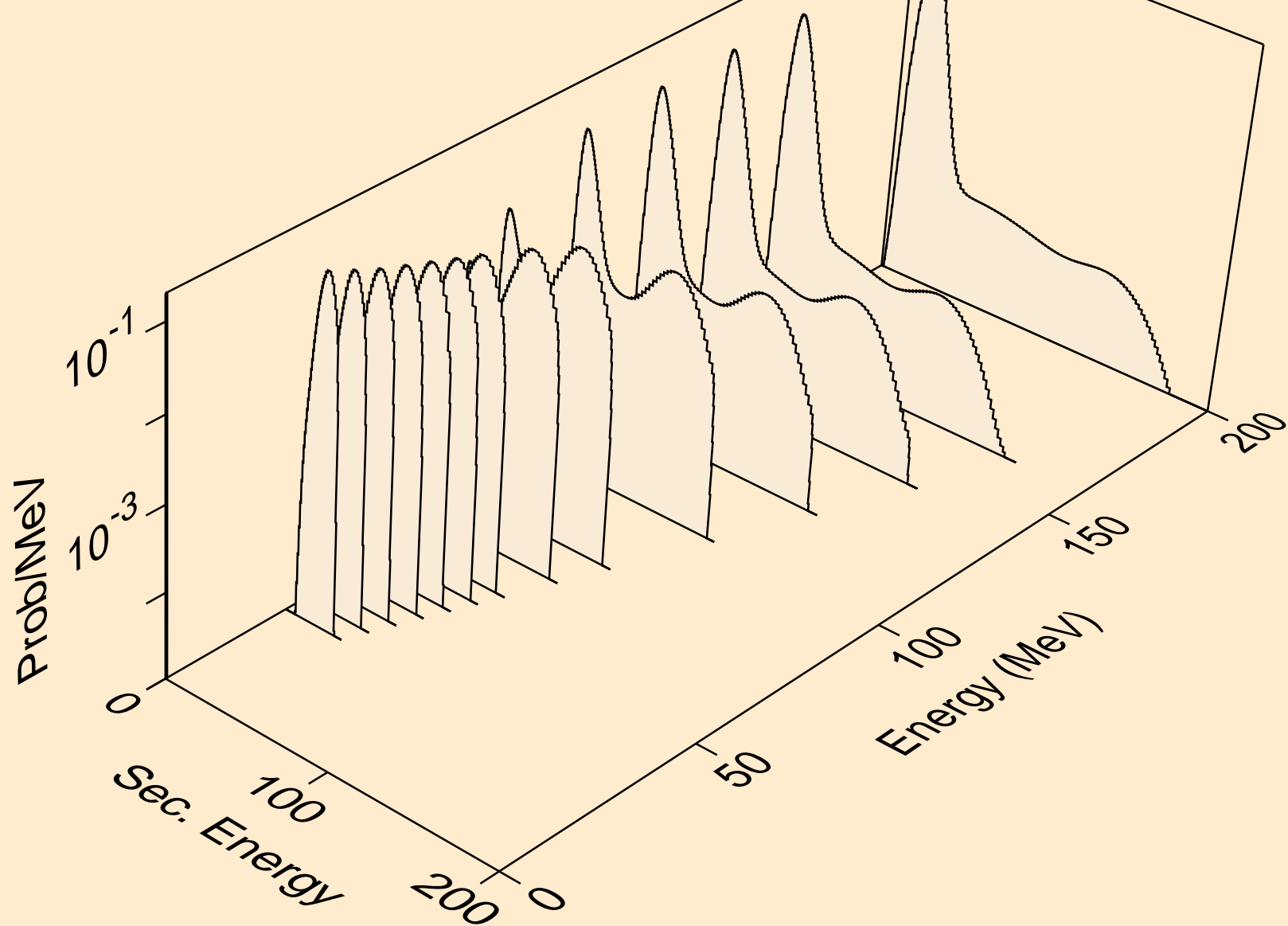

AT222 TRITON ACER TENDL-2021 LIBRARY; T=0.K  
deuterons from (t,2nd)

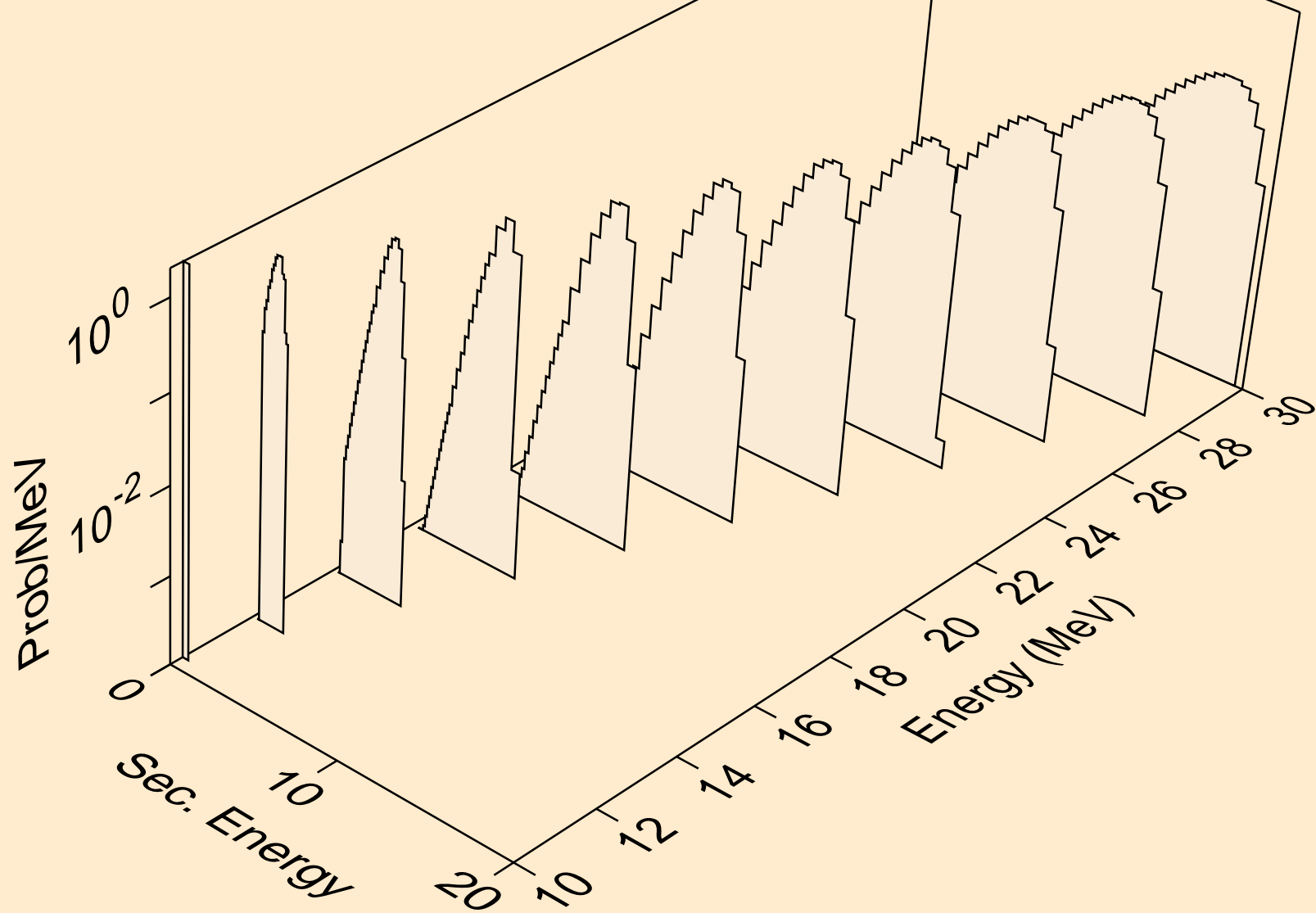

AT222 TRITON ACER TENDL-2021 LIBRARY; T=0.K  
deuterons from (t,n\*)d

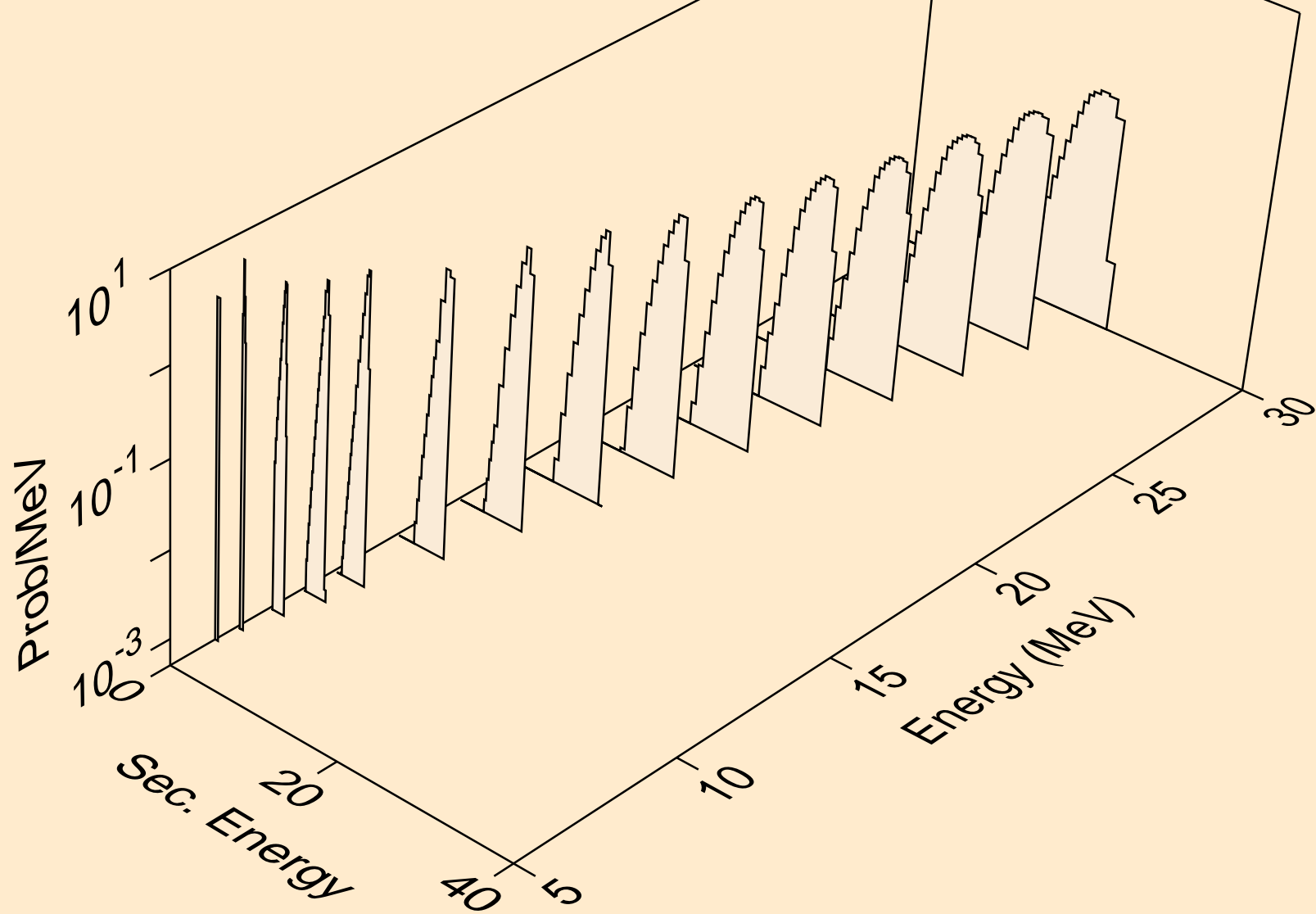



AT222 TRITON ACER TENDL-2021 LIBRARY; T=0.K  
deuterons from (t,d)

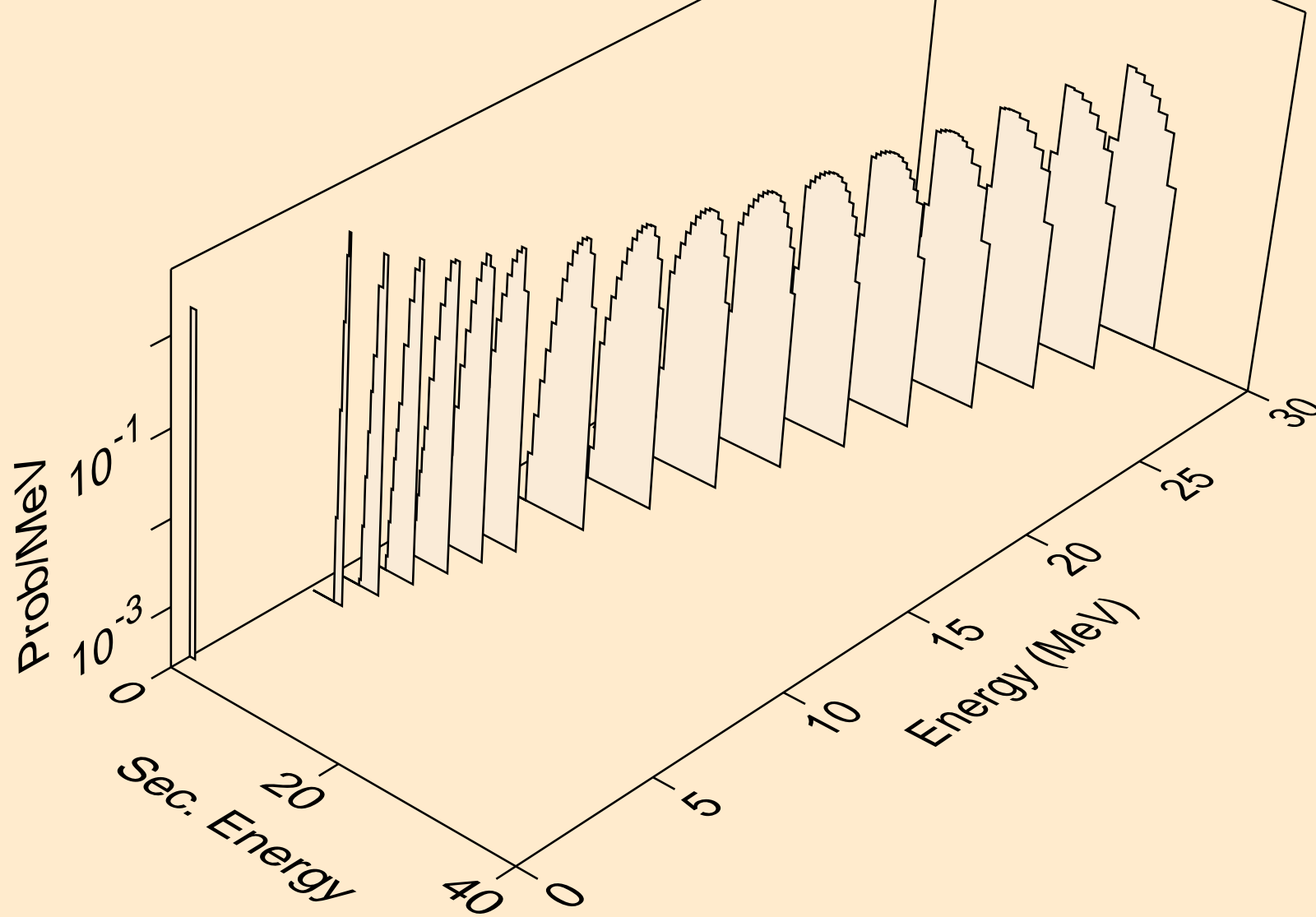

AT222 TRITON ACER TENDL-2021 LIBRARY; T=0.K  
deuterons from (t,pd)

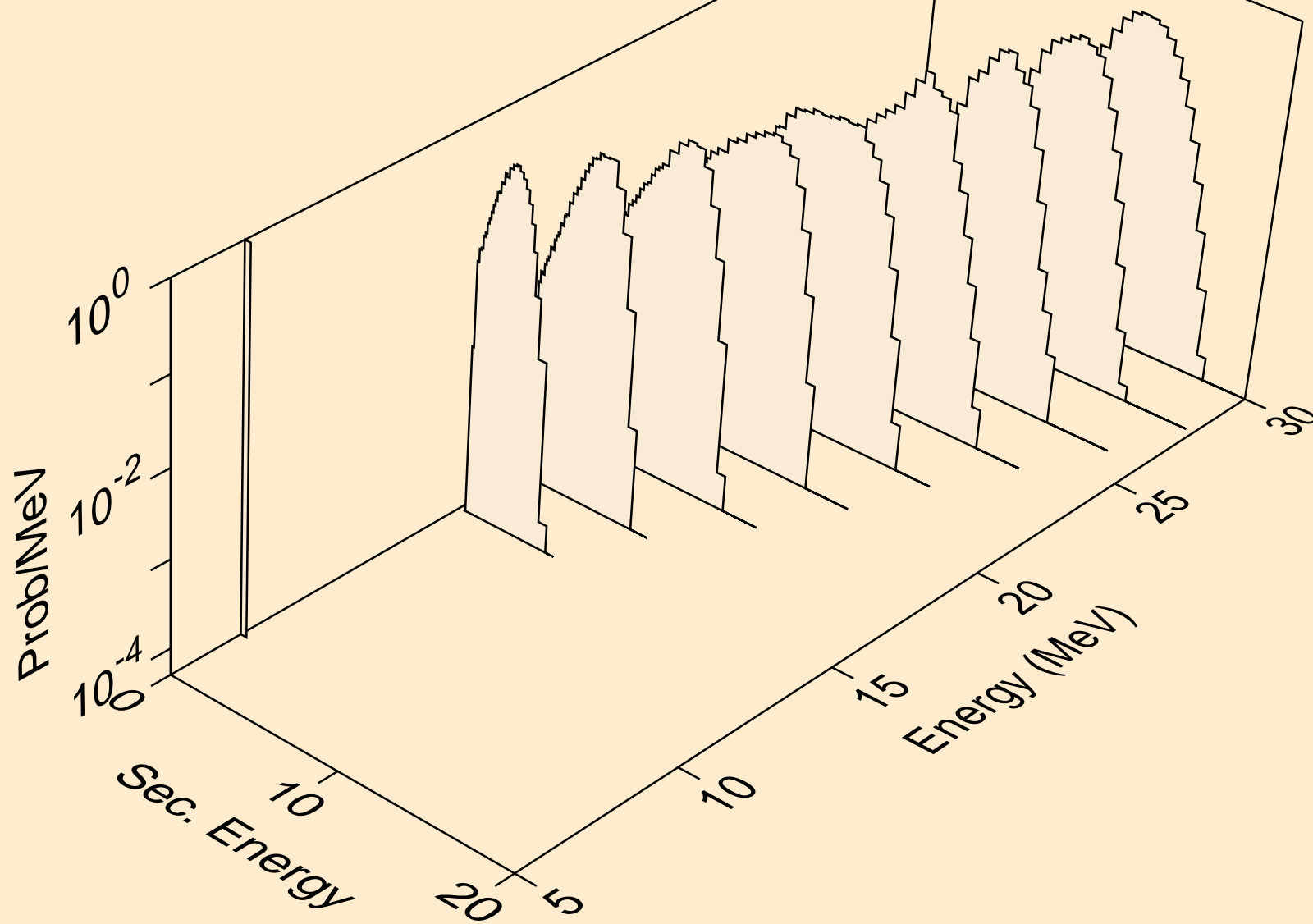

AT222 TRITON ACER TENDL-2021 LIBRARY; T=0.K  
he3s from (t,x)

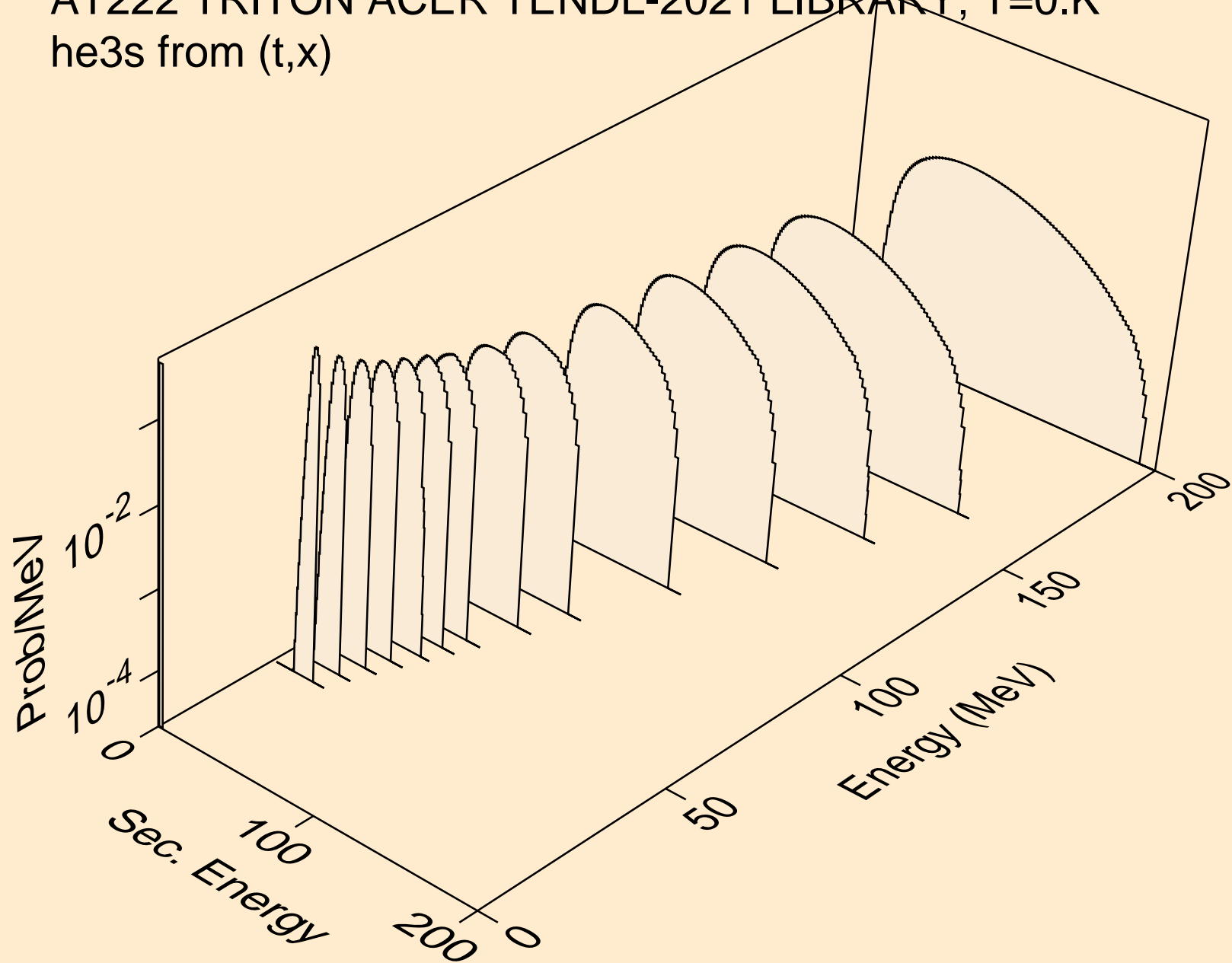

AT222 TRITON ACER TENDL-2021 LIBRARY; T=0.K  
he3s from (t,n\*)he3

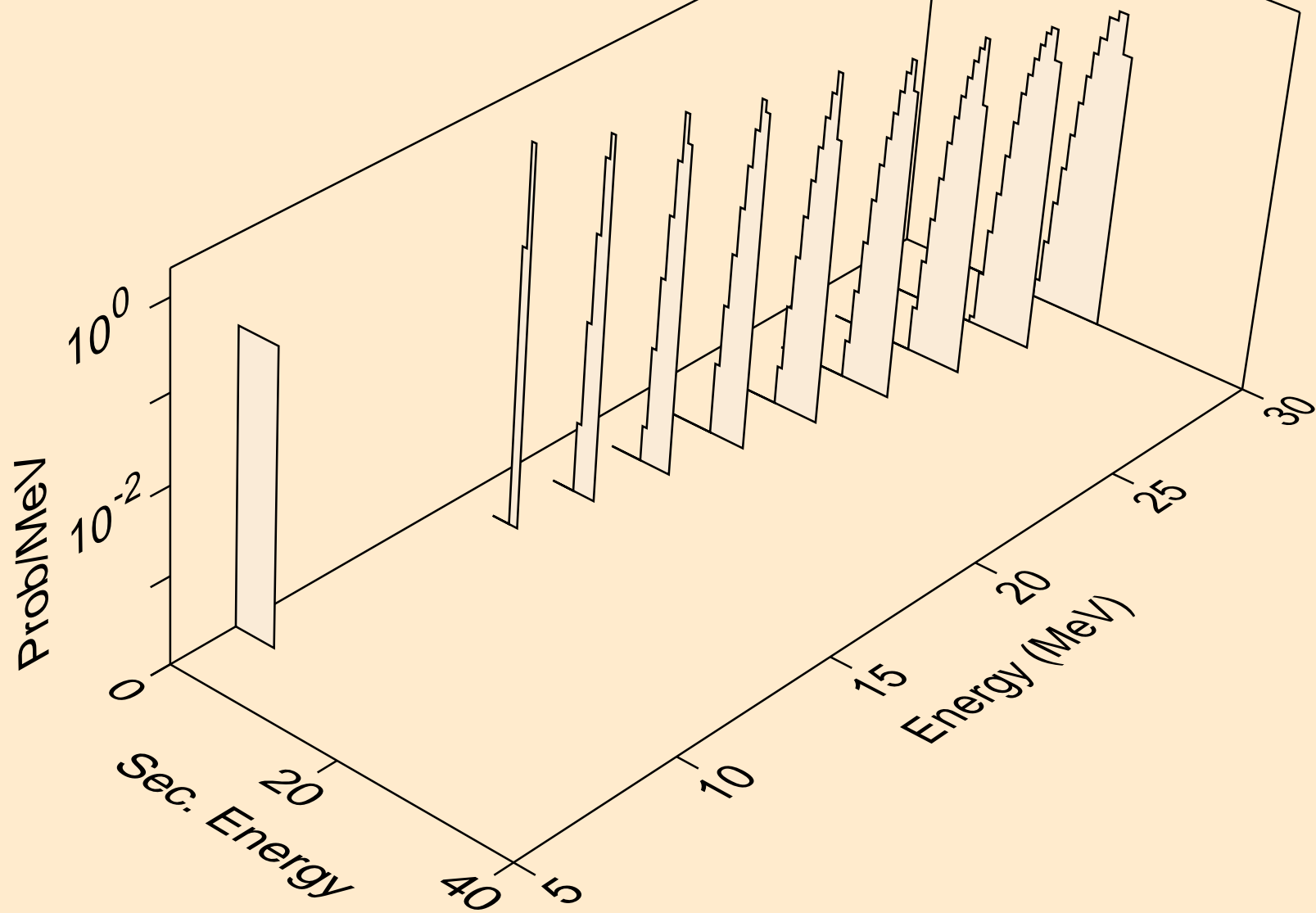

AT222 TRITON ACER TENDL-2021 LIBRARY; T=0.K  
he3s from (t,he3)

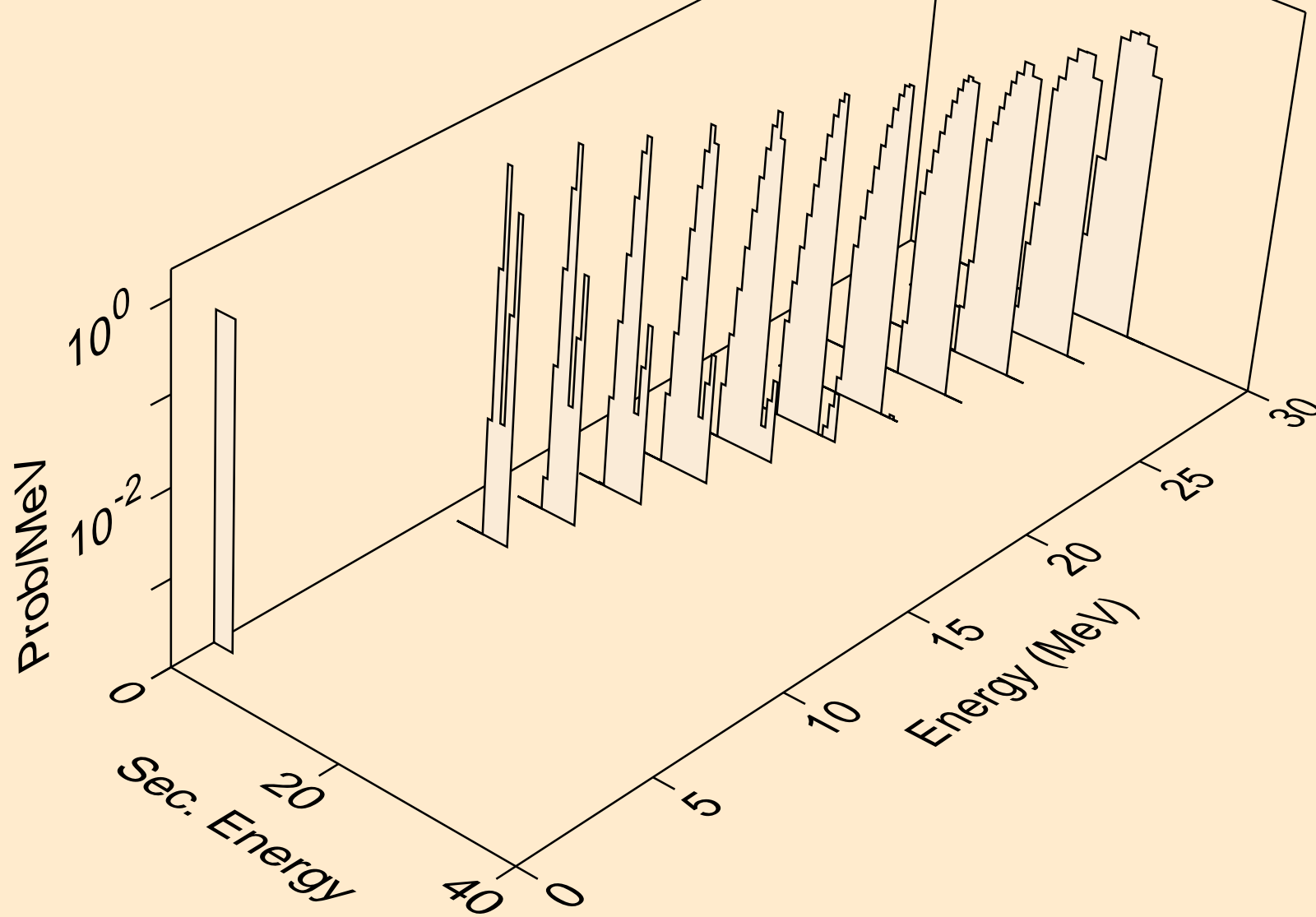

AT222 TRITON ACER TENDL-2021 LIBRARY; T=0.K  
alphas from (t,x)

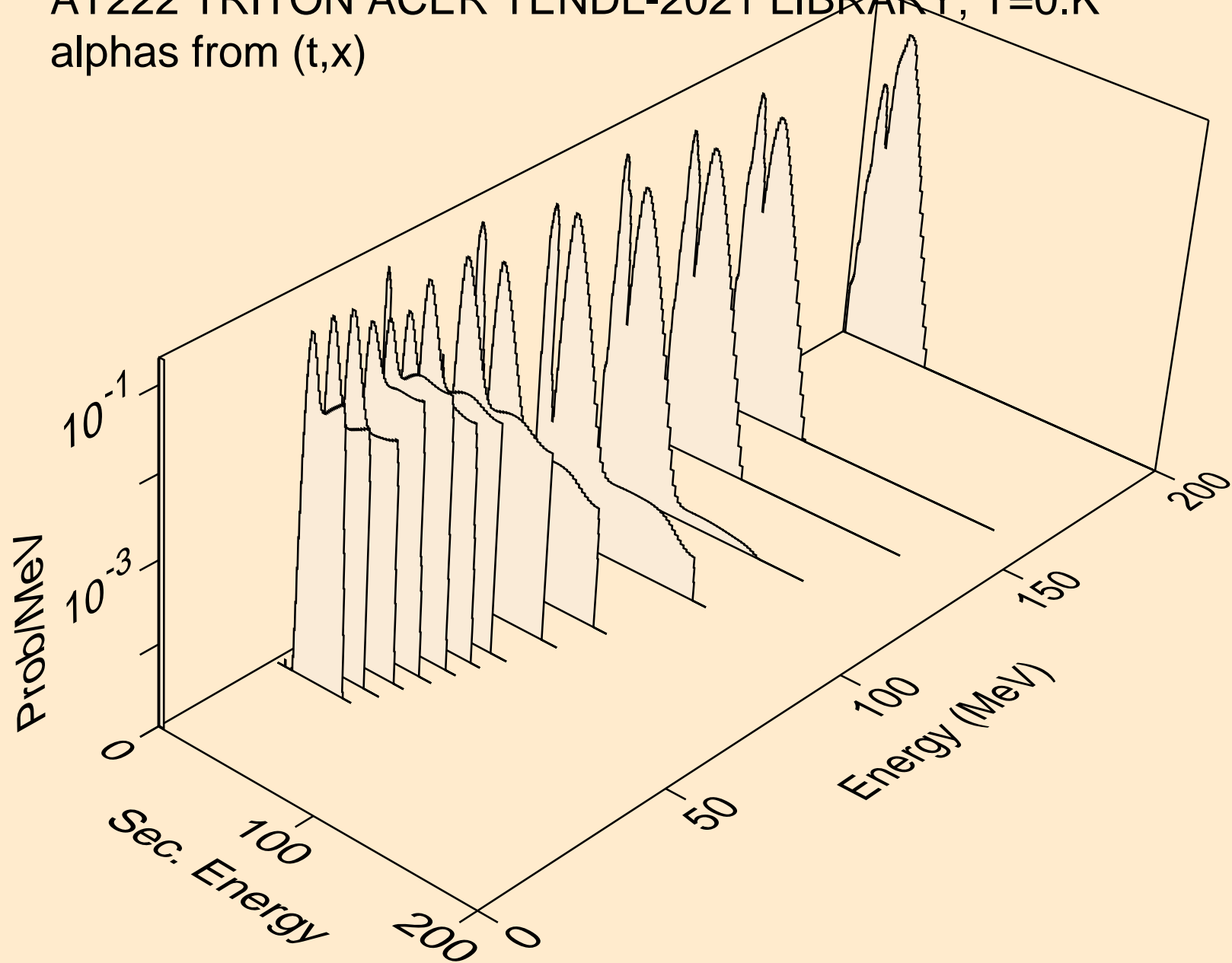

AT222 TRITON ACER TENDL-2021 LIBRARY; T=0.K  
alphas from (t,n\*)a

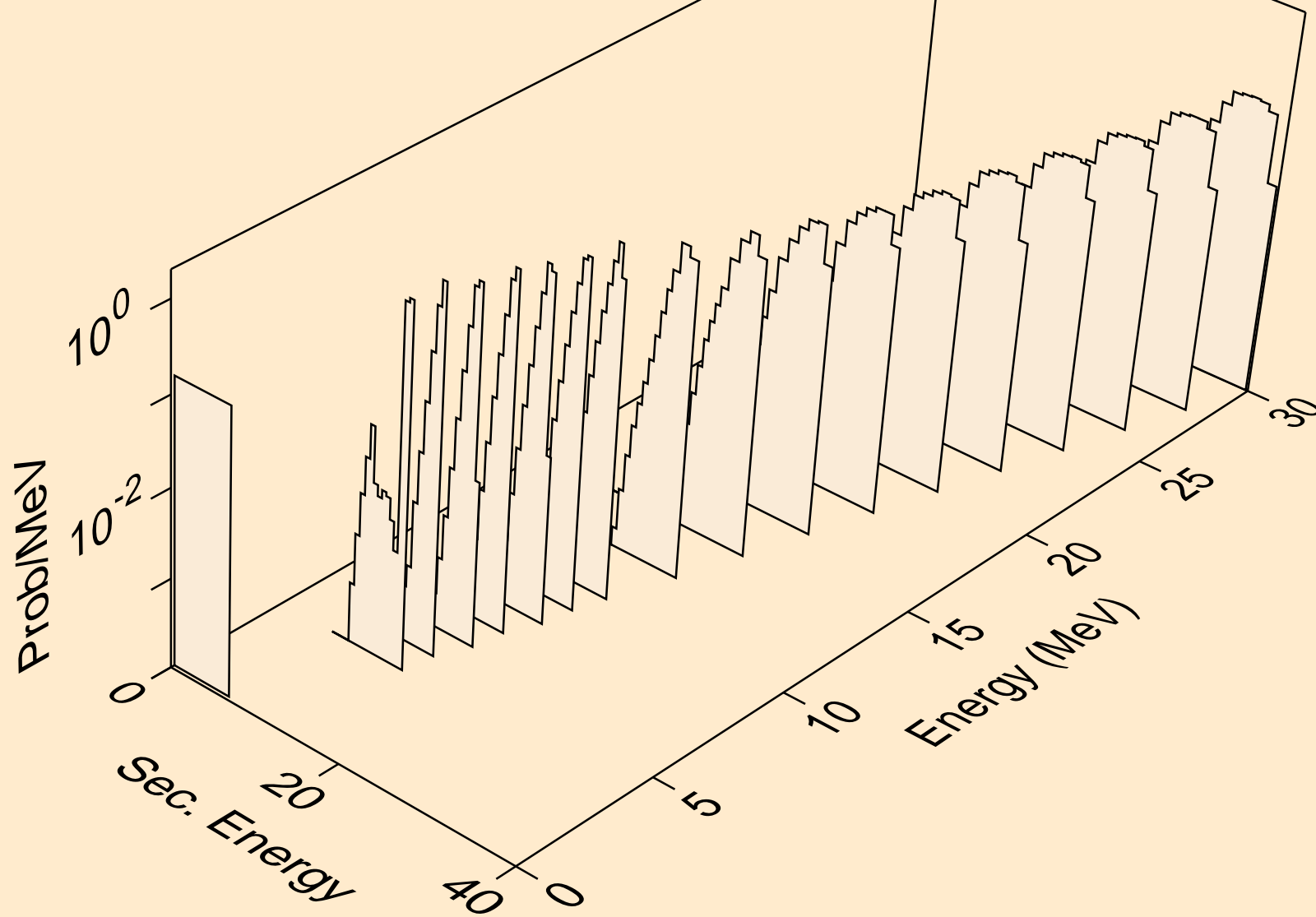

AT222 TRITON ACER TENDL-2021 LIBRARY; T=0.K  
alphas from (t,2n)a

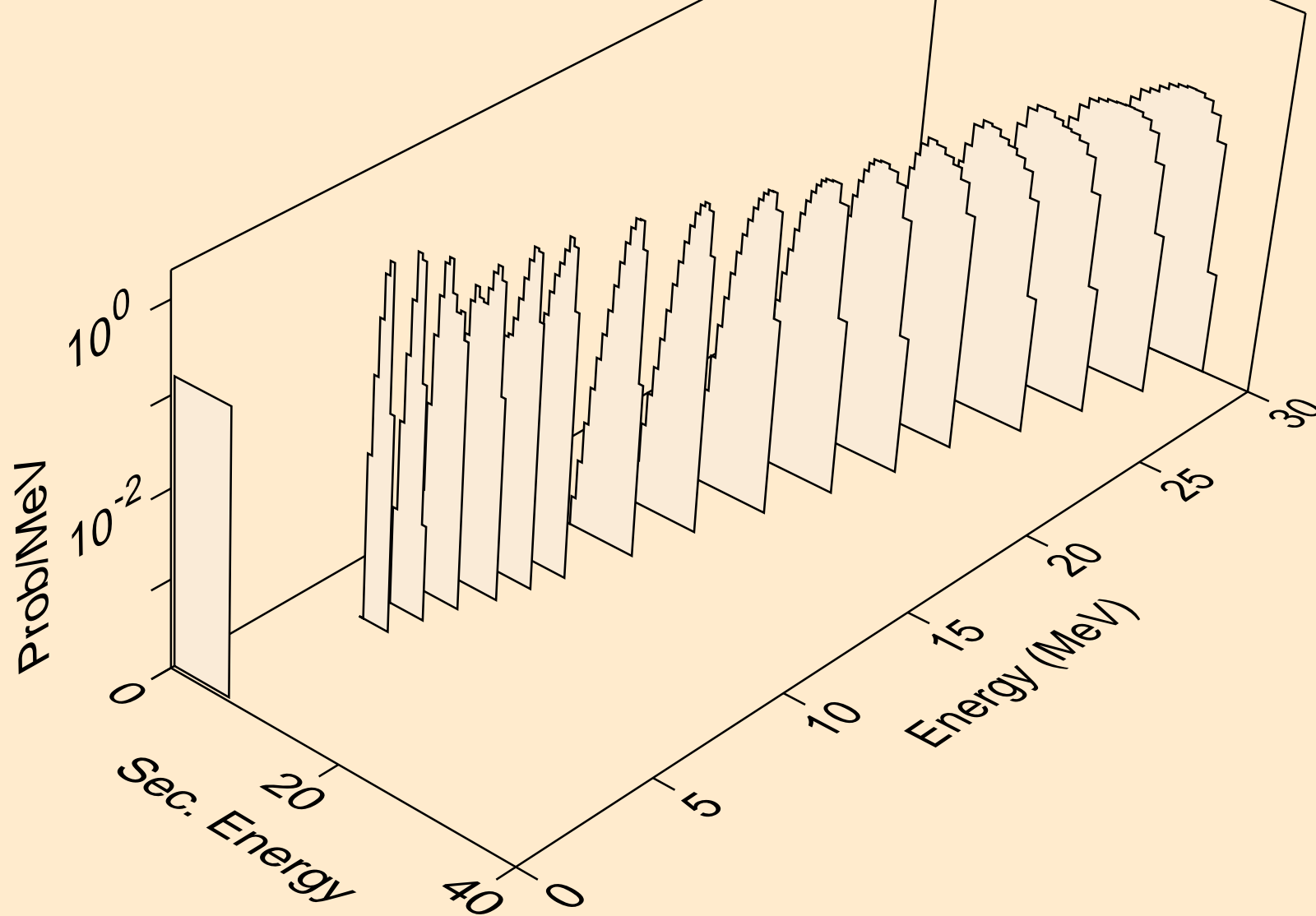



AT222 TRITON ACER TENDL-2021 LIBRARY; T=0.K  
alphas from (t,3n)a

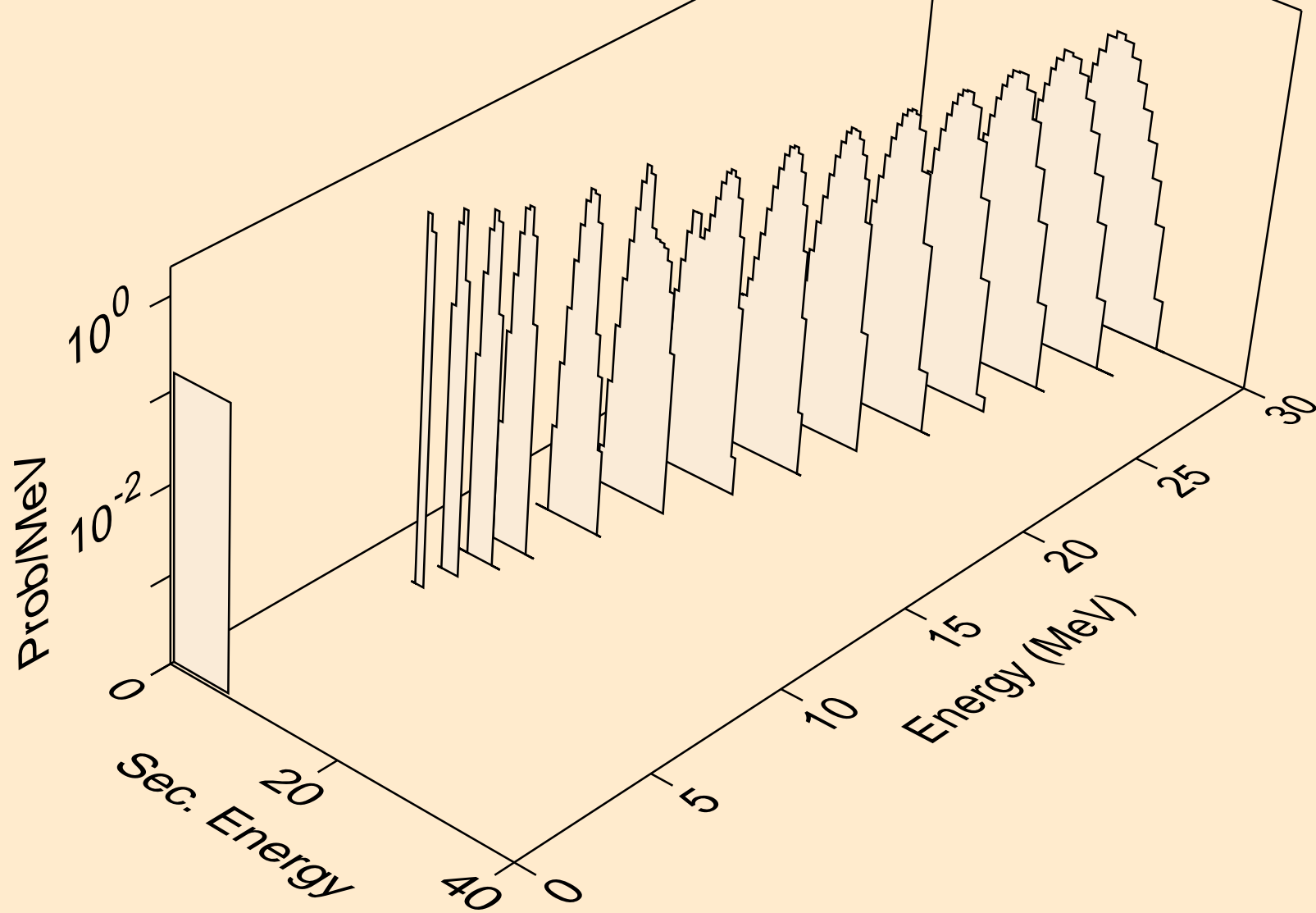

AT222 TRITON ACER TENDL-2021 LIBRARY; T=0.K  
alphas from (t,n\*)2a

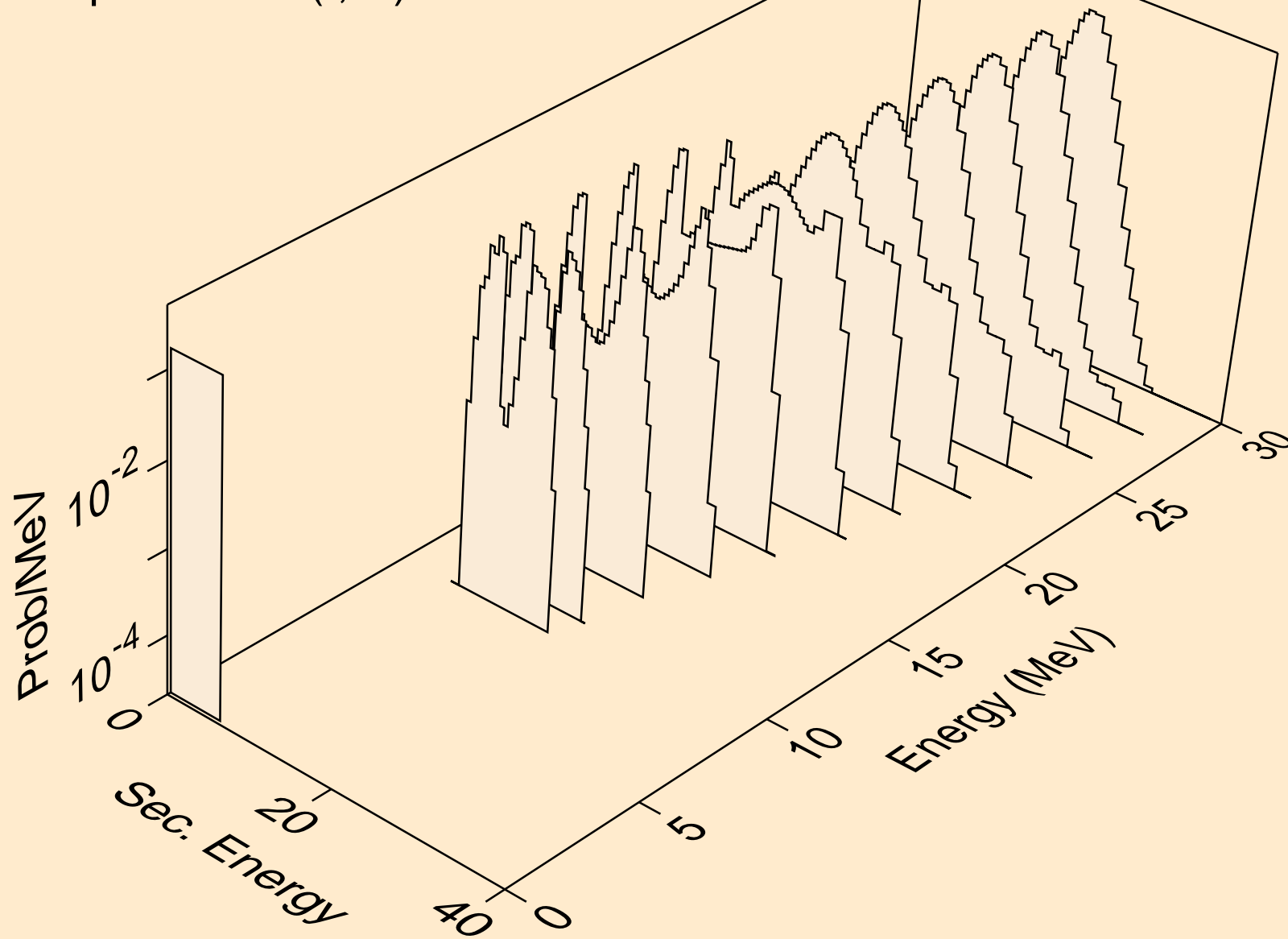

AT222 TRITON ACER TENDL-2021 LIBRARY; T=0.K  
alphas from (t,2n)2a

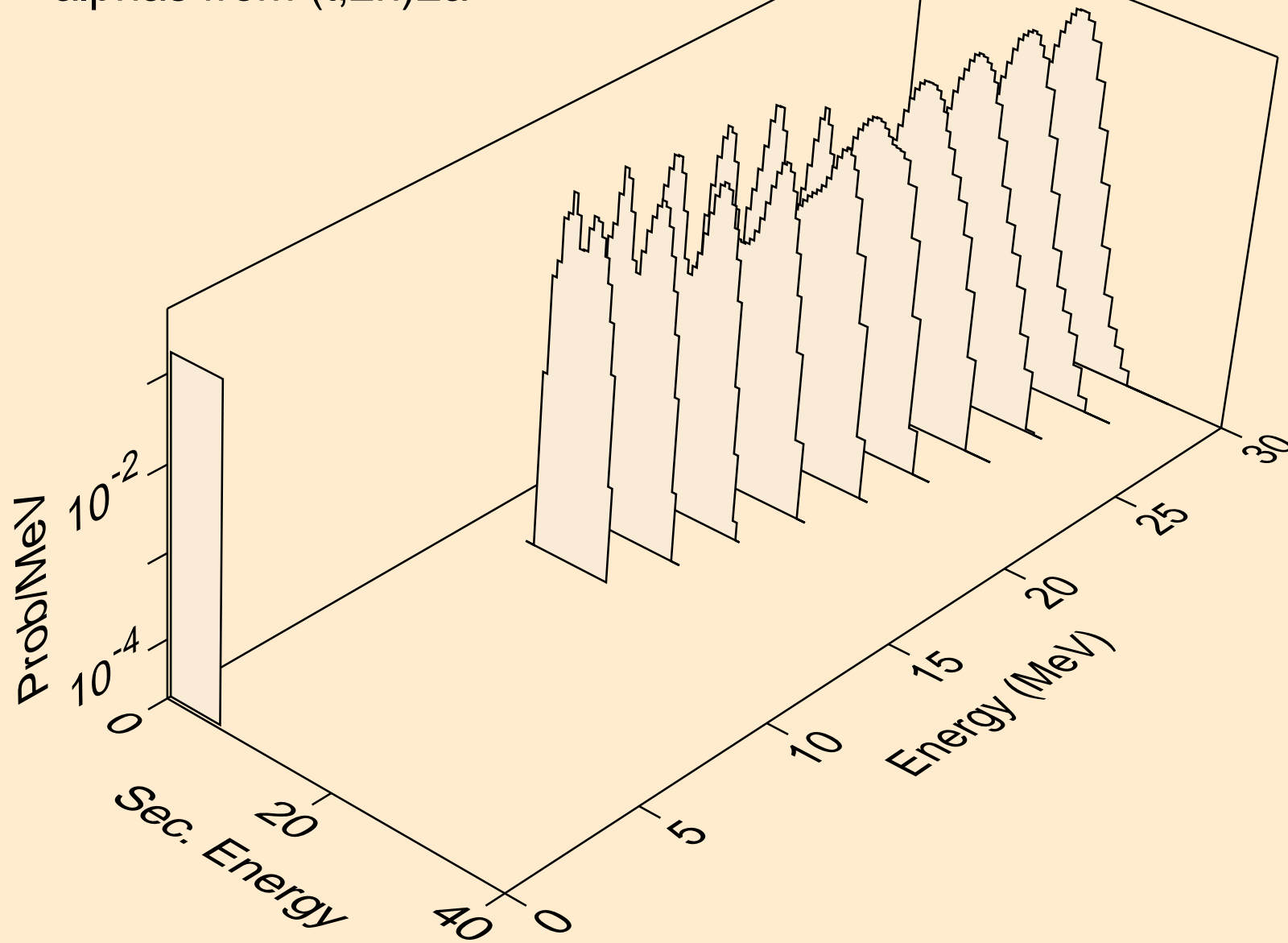

AT222 TRITON ACER TENDL-2021 LIBRARY; T=0.K  
alphas from (t,npa)

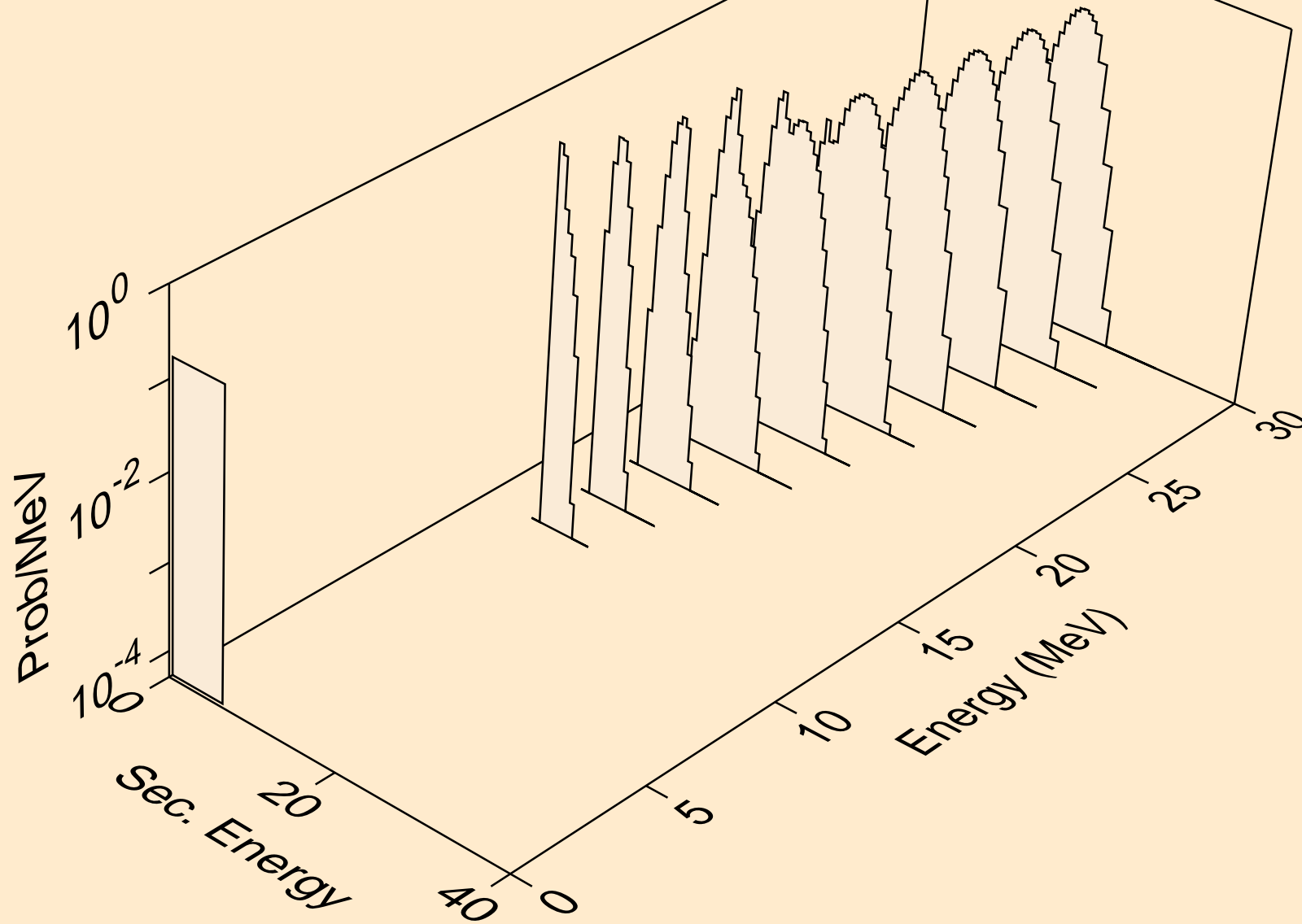

AT222 TRITON ACER TENDL-2021 LIBRARY; T=0.K  
alphas from (t,a)

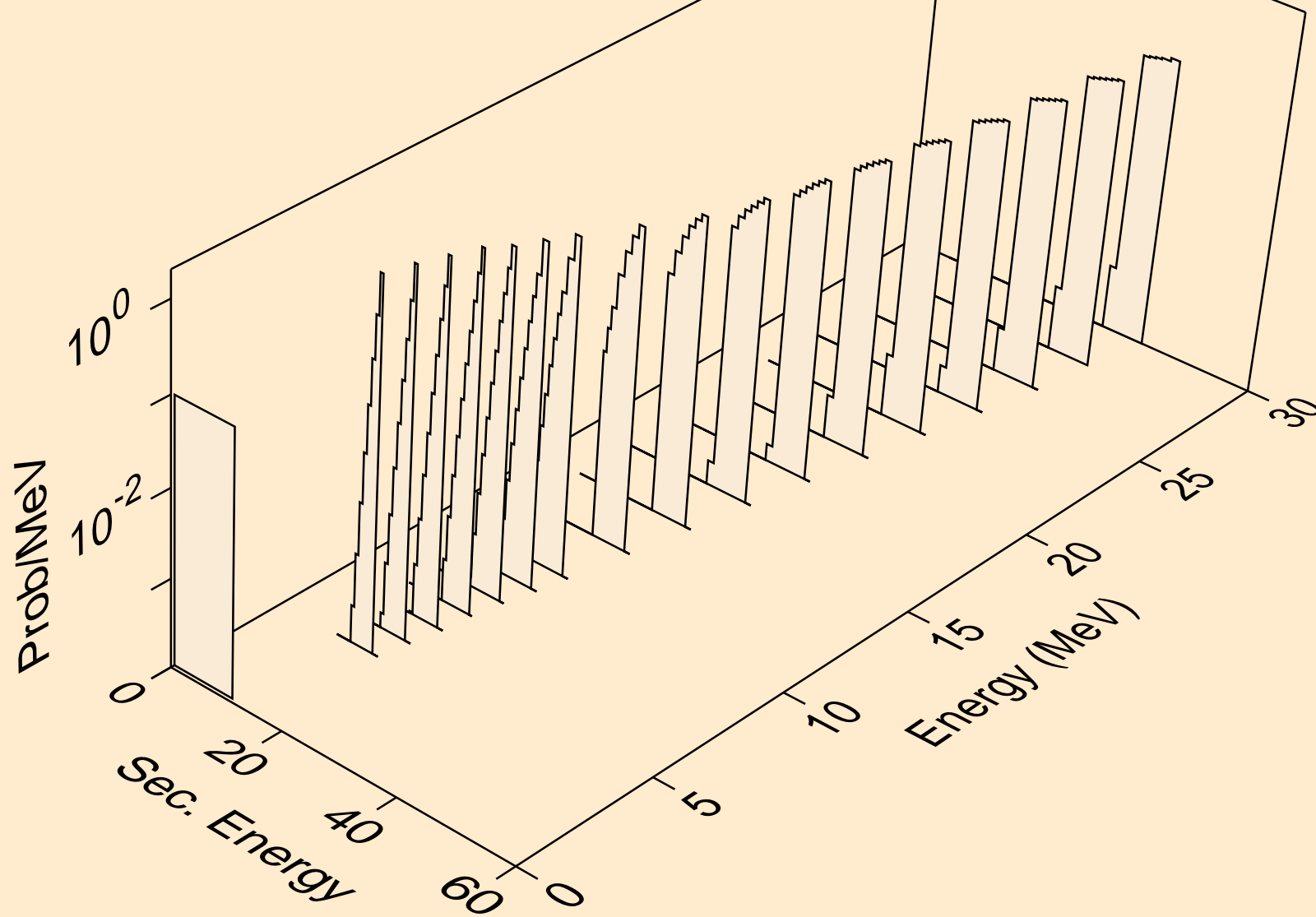

AT222 TRITON ACER TENDL-2021 LIBRARY; T=0.K  
alphas from (t,pa)

