

BA135 TRITON ACER TENDL-2021 LIBRARY; T=0.K  
Principal cross sections

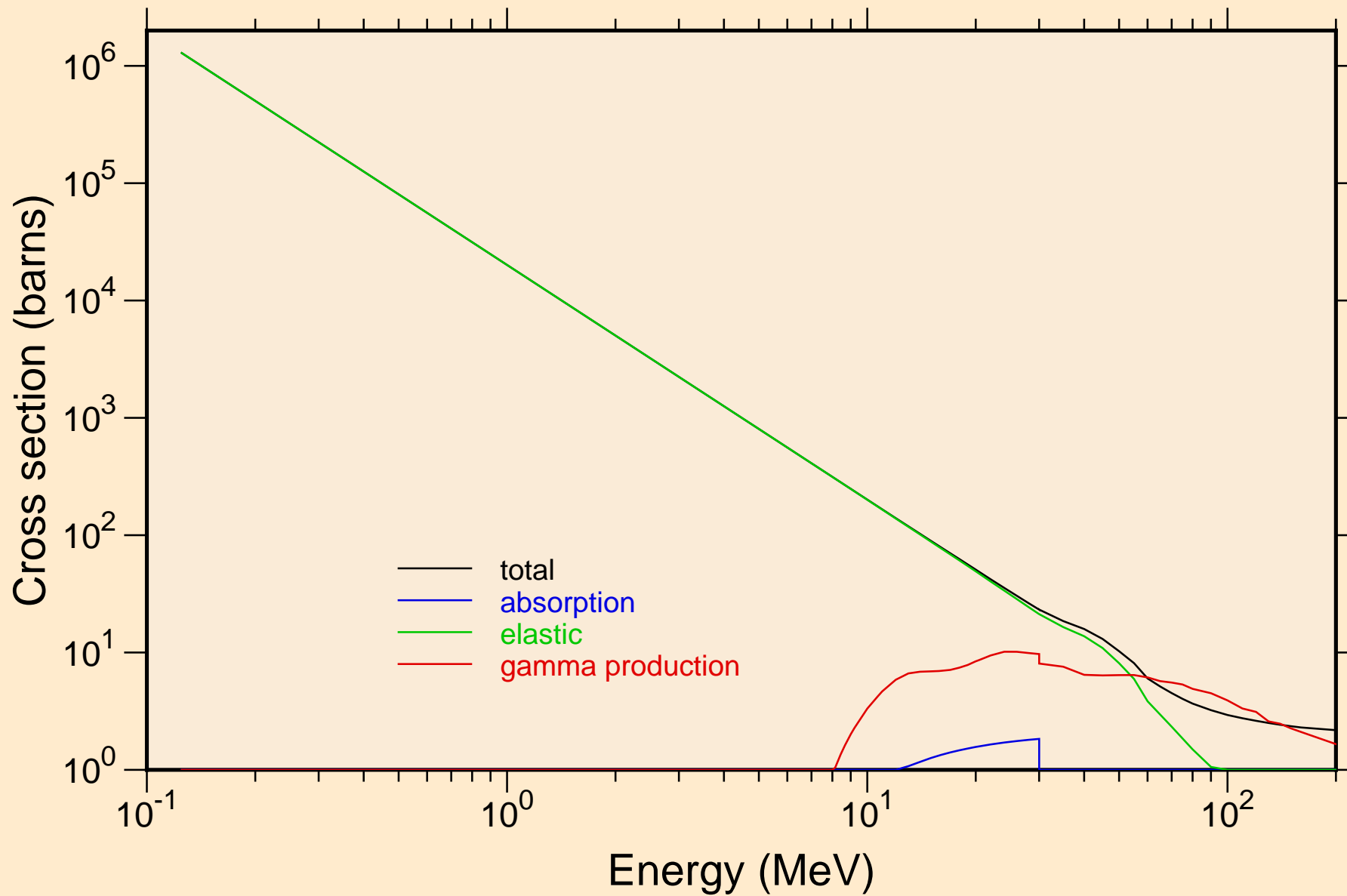

BA135 TRITON ACER TENDL-2021 LIBRARY; T=0.K

Heating

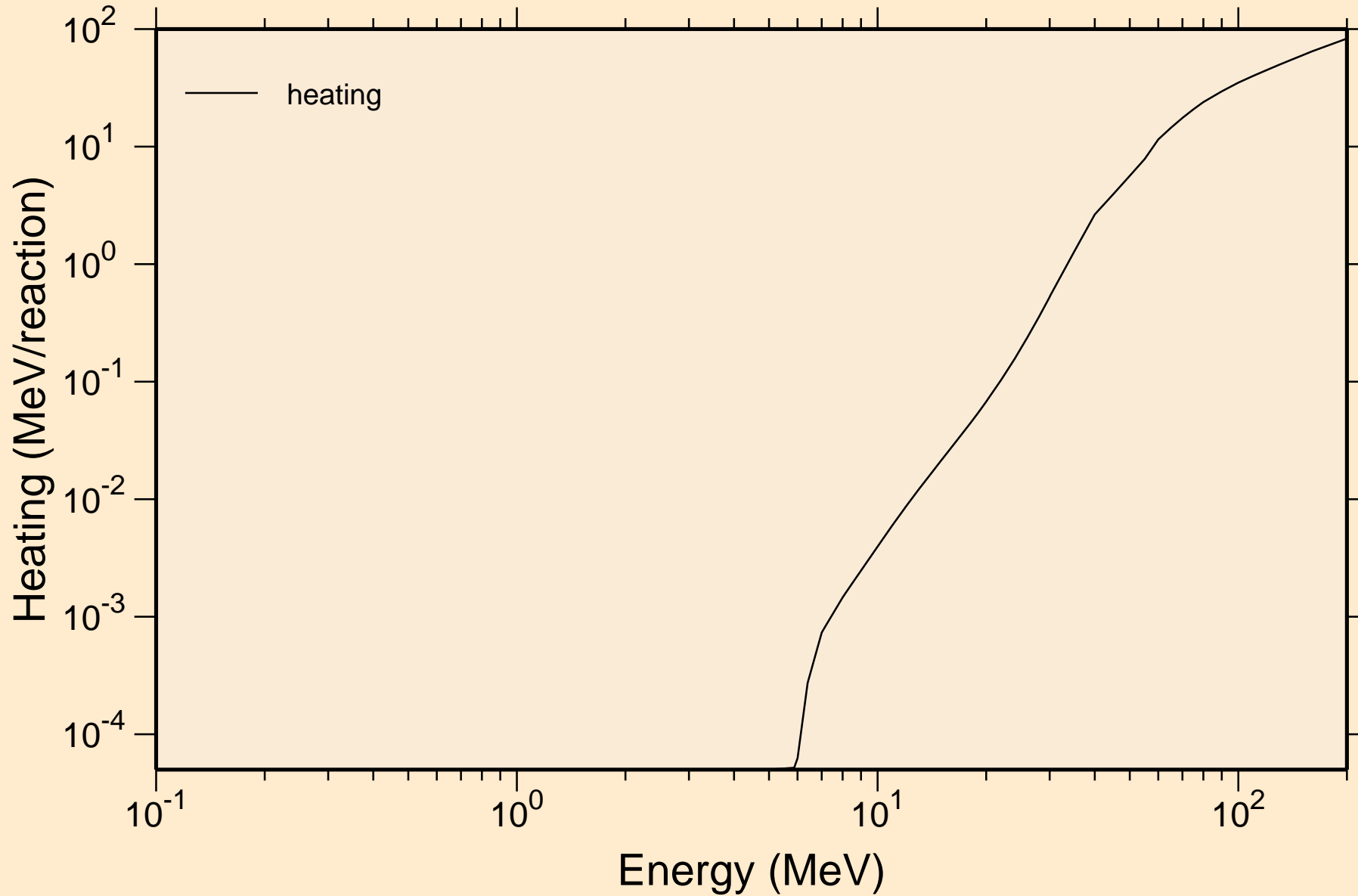

# BA135 TRITON ACER TENDL-2021 LIBRARY; T=0.K

## Principal cross sections

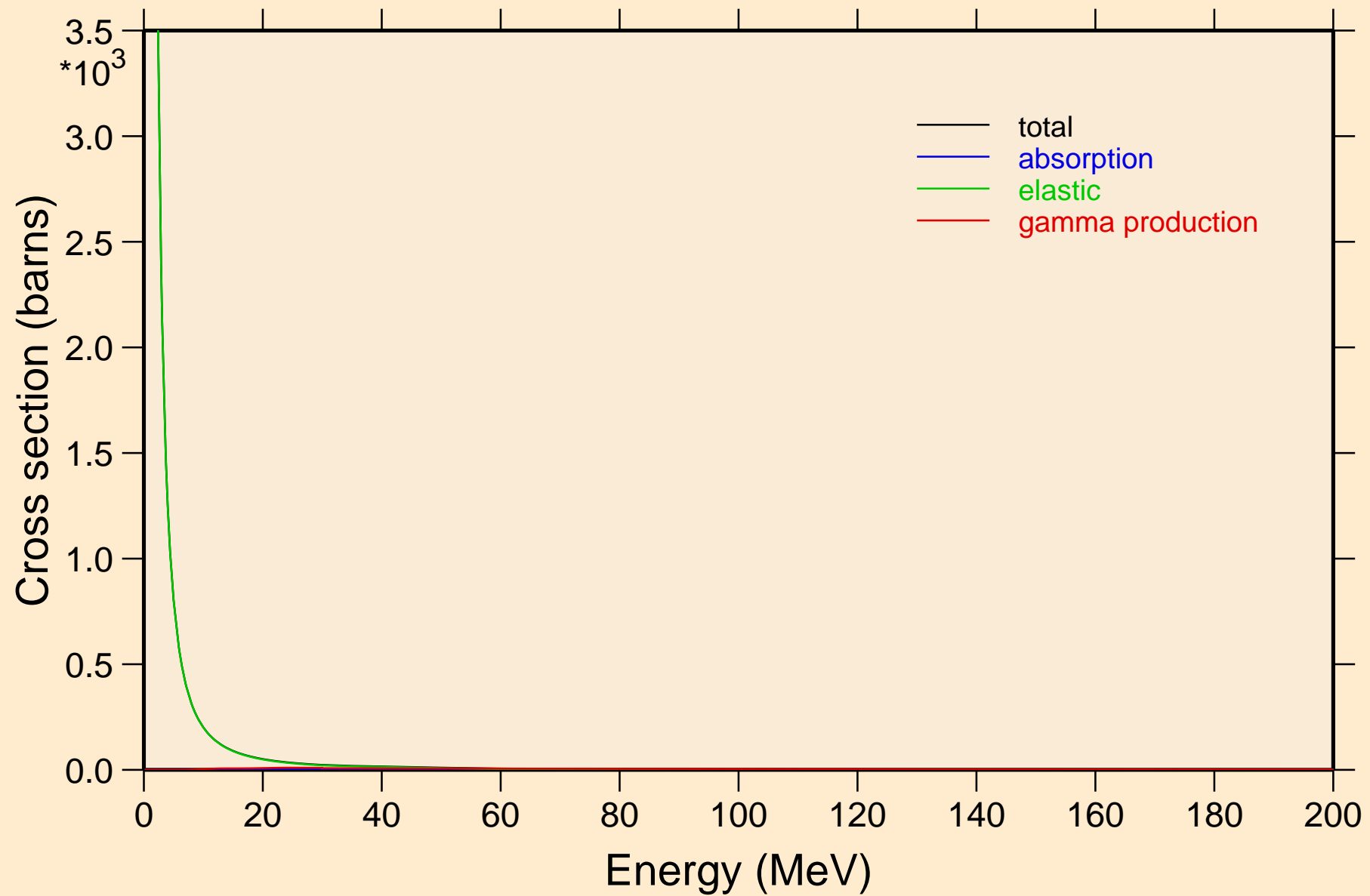

BA135 TRITON ACER TENDL-2021 LIBRARY; T=0.K

Heating

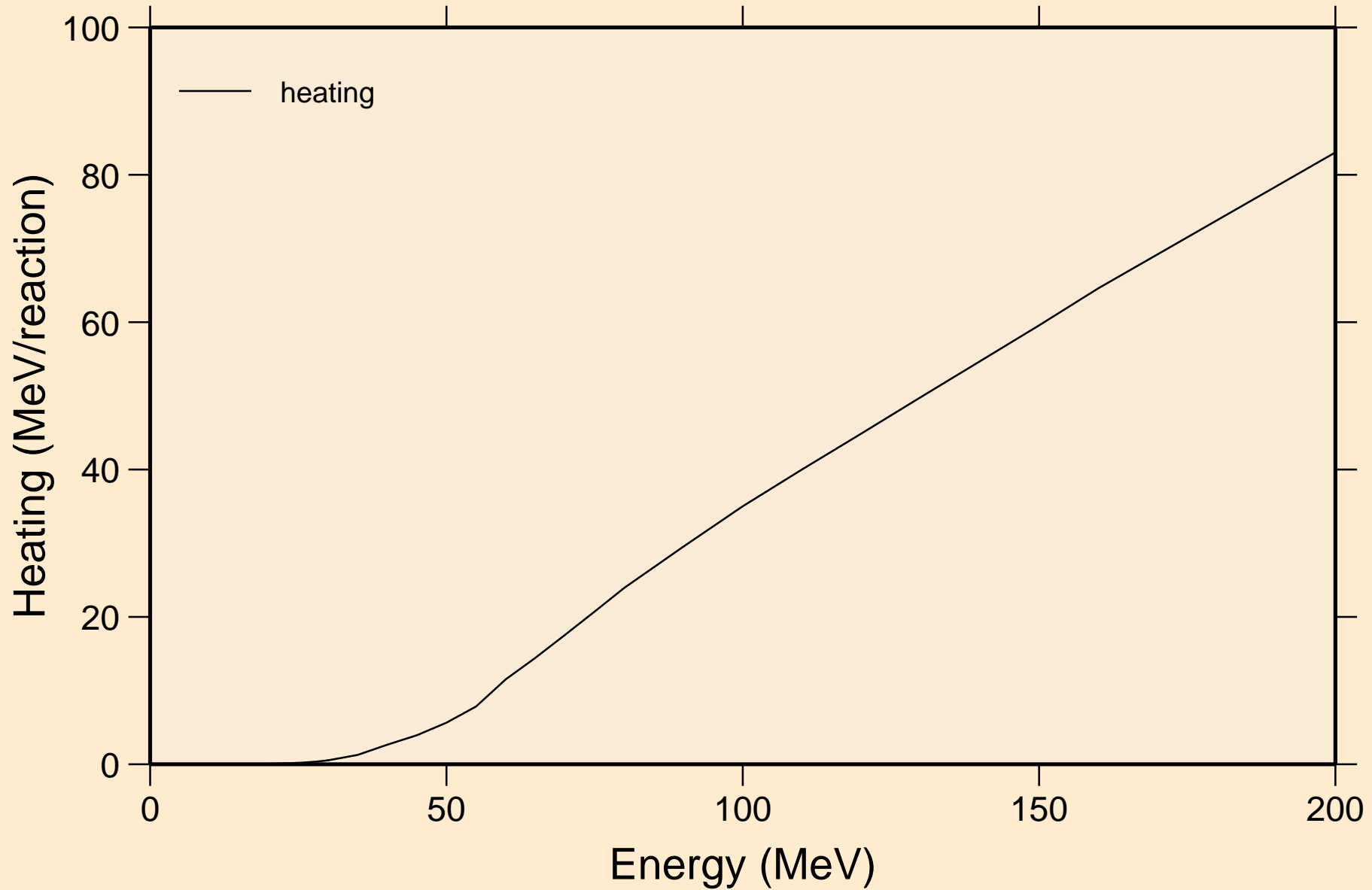

BA135 TRITON ACER TENDL-2021 LIBRARY; T=0.K  
Threshold reactions

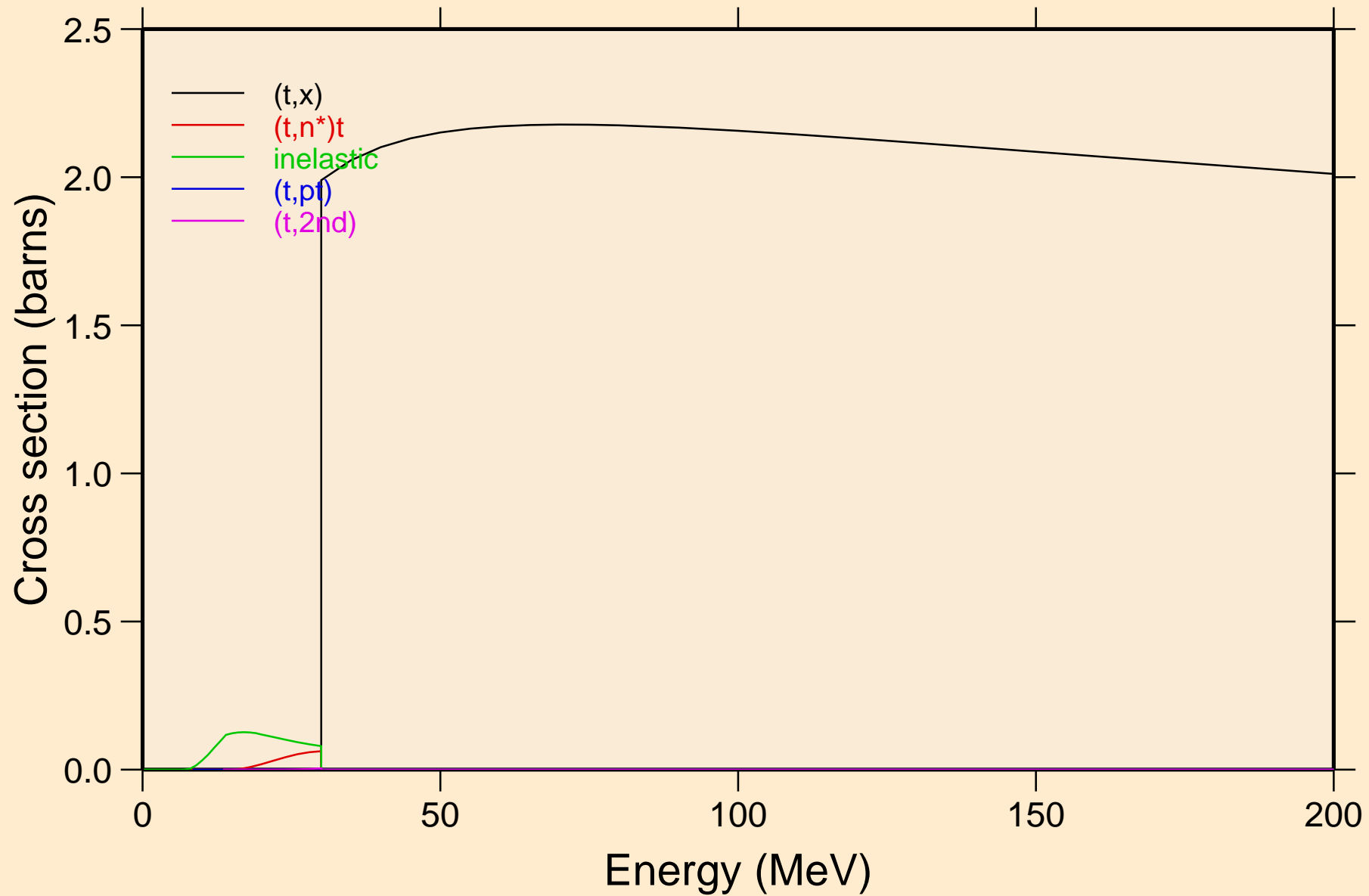

BA135 TRITON ACER TENDL-2021 LIBRARY; T=0.K  
Threshold reactions

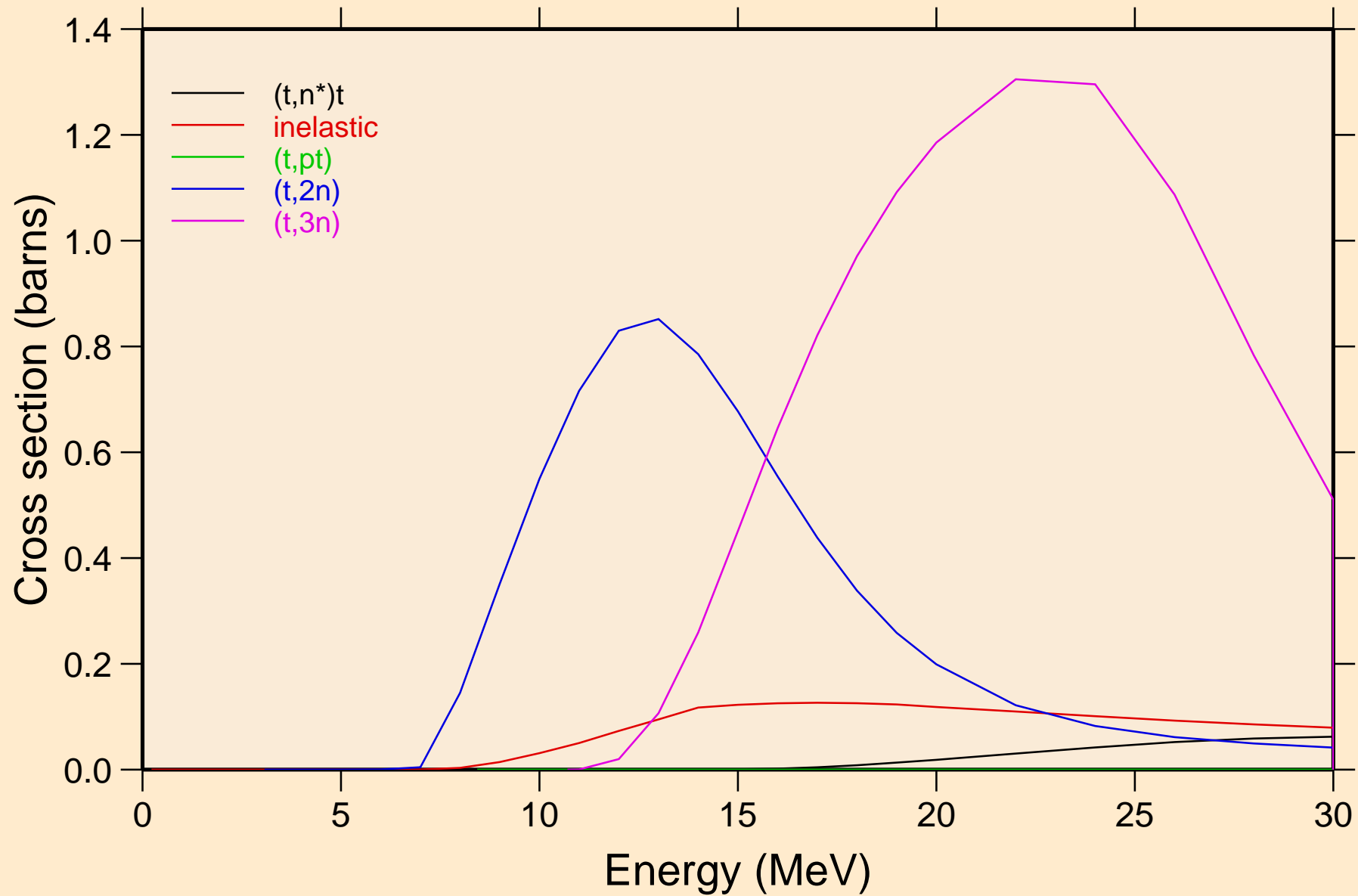

BA135 TRITON ACER TENDL-2021 LIBRARY; T=0.K  
Threshold reactions

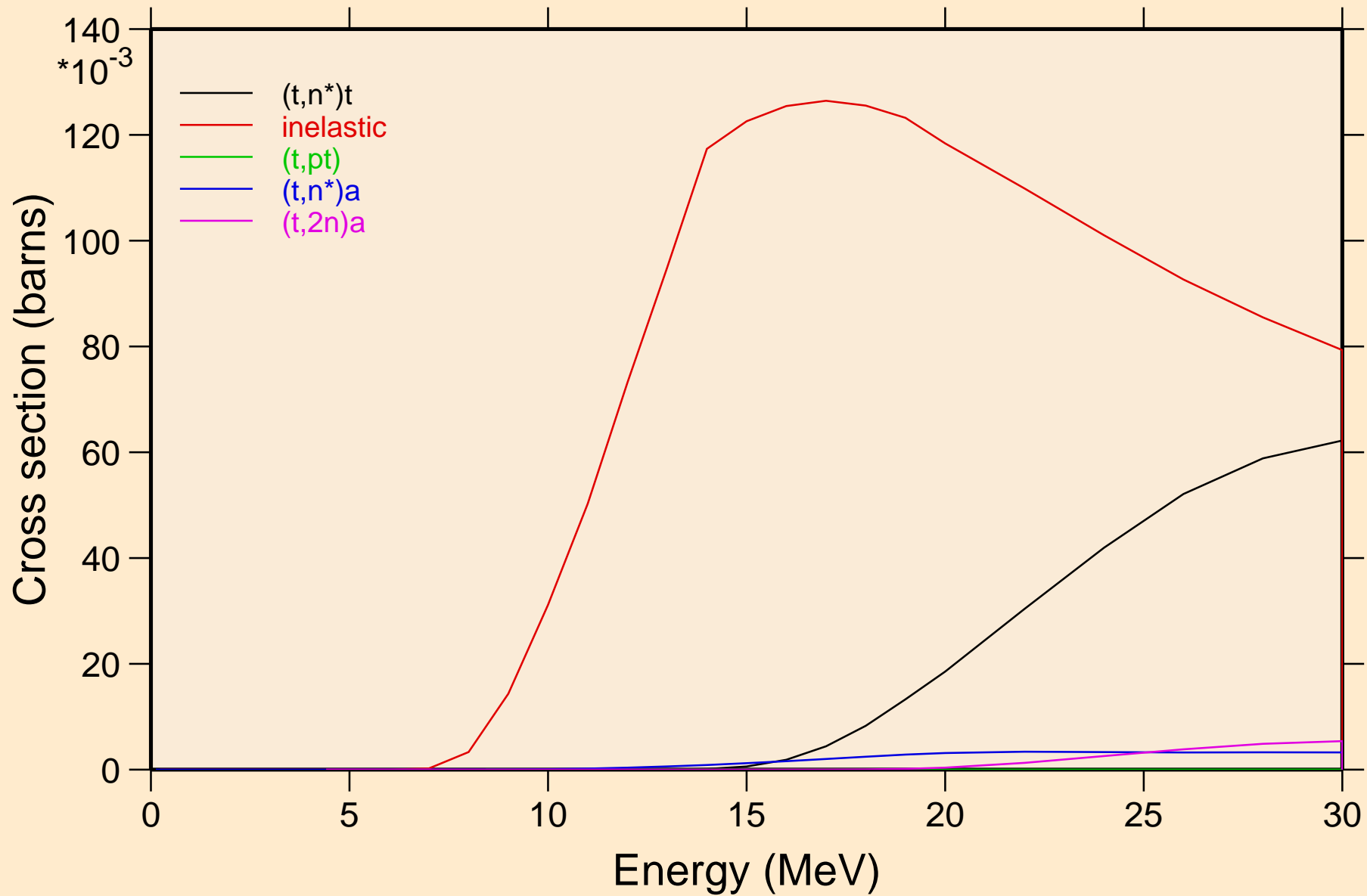

BA135 TRITON ACER TENDL-2021 LIBRARY; T=0.K  
Threshold reactions

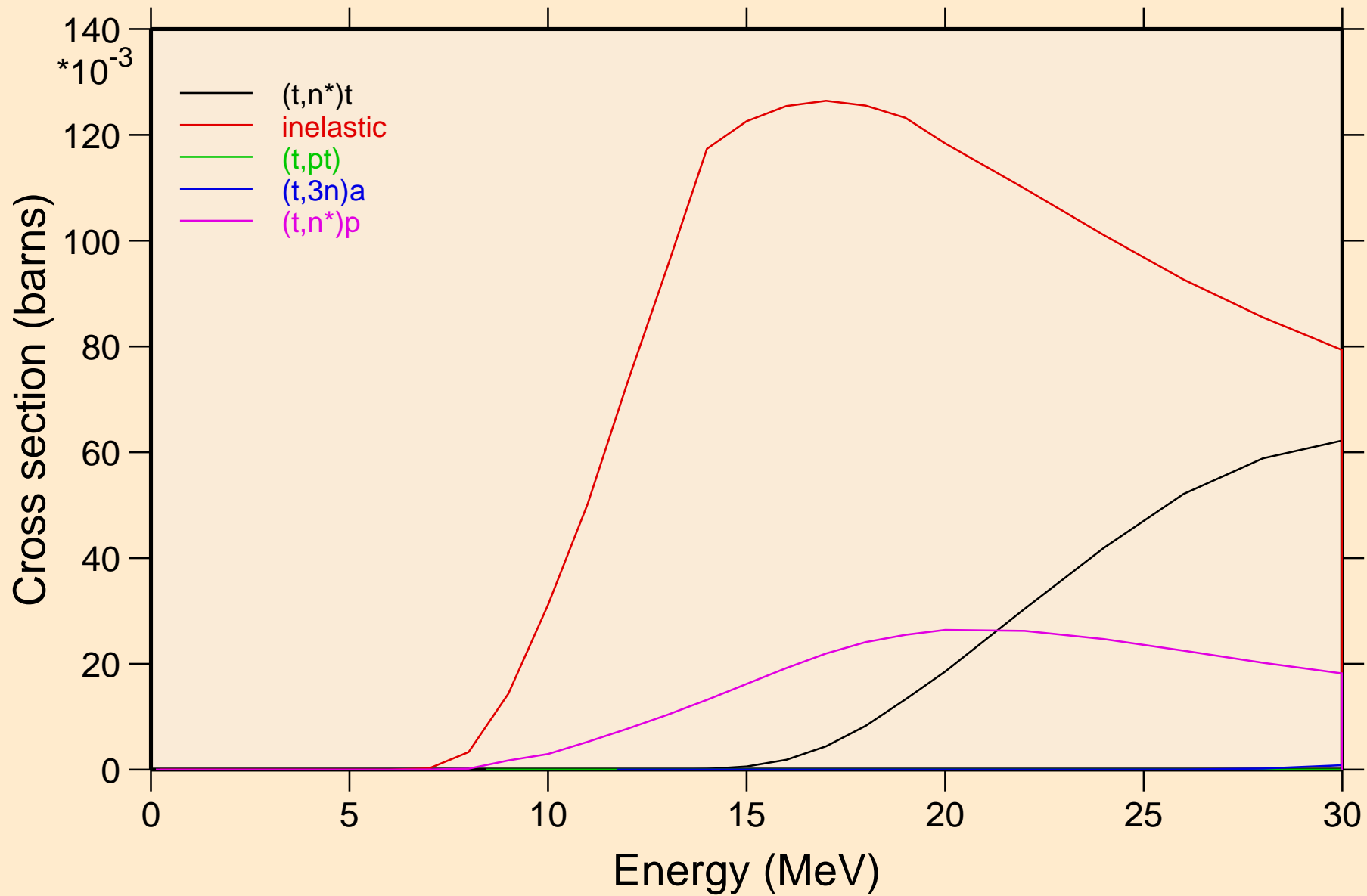



BA135 TRITON ACER TENDL-2021 LIBRARY; T=0.K  
Threshold reactions

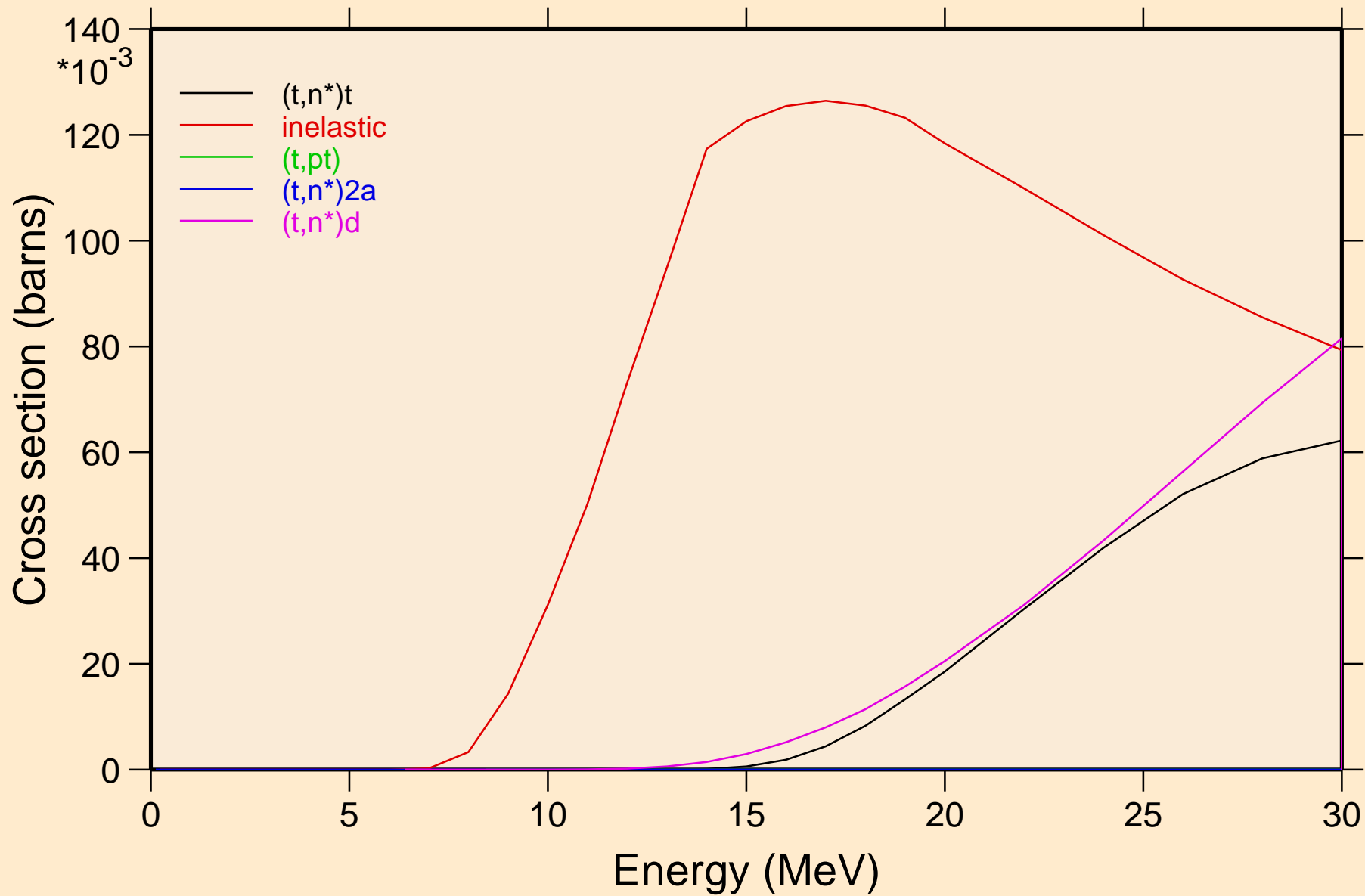

BA135 TRITON ACER TENDL-2021 LIBRARY; T=0.K  
Threshold reactions

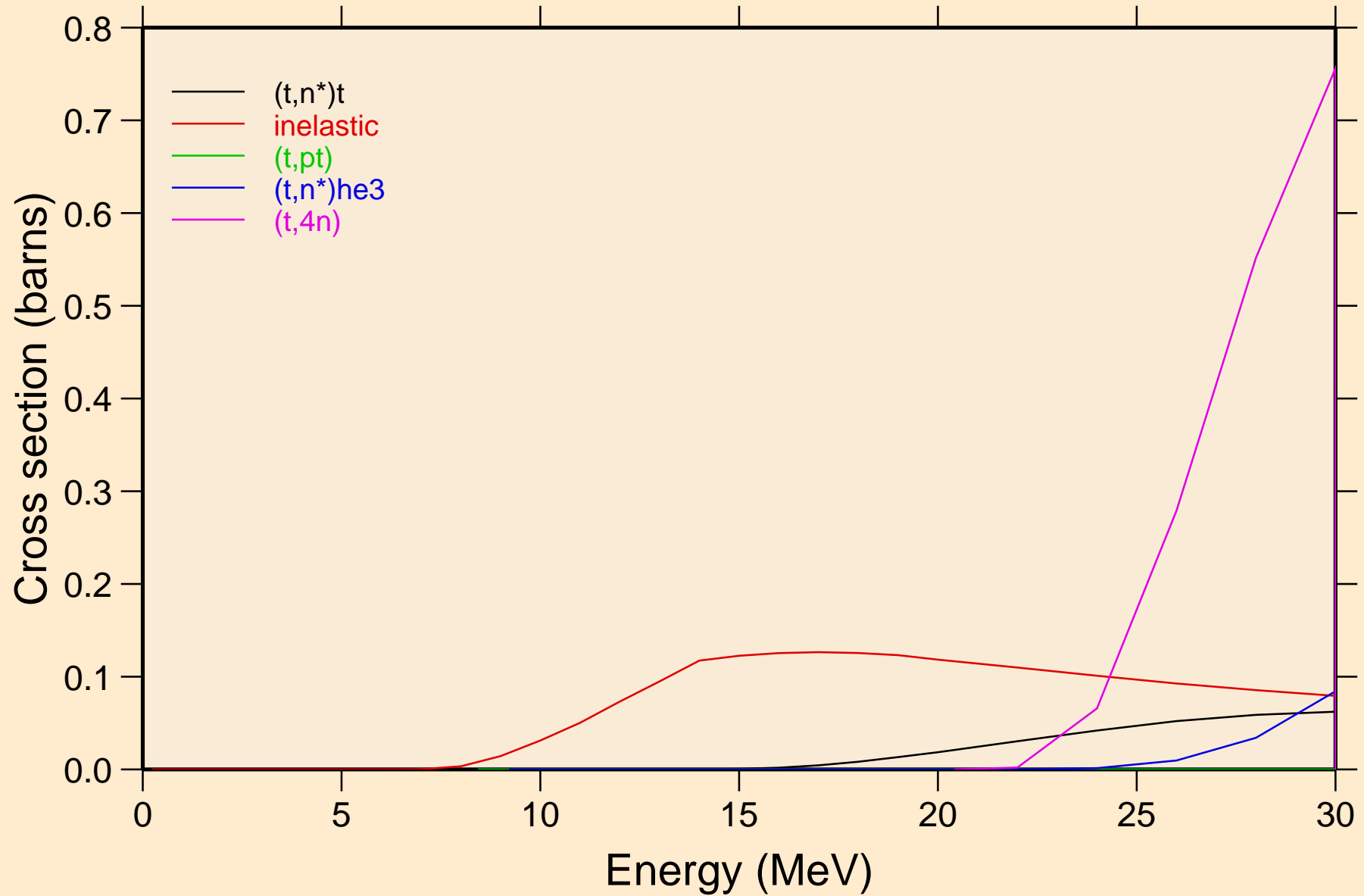

BA135 TRITON ACER TENDL-2021 LIBRARY; T=0.K  
Threshold reactions

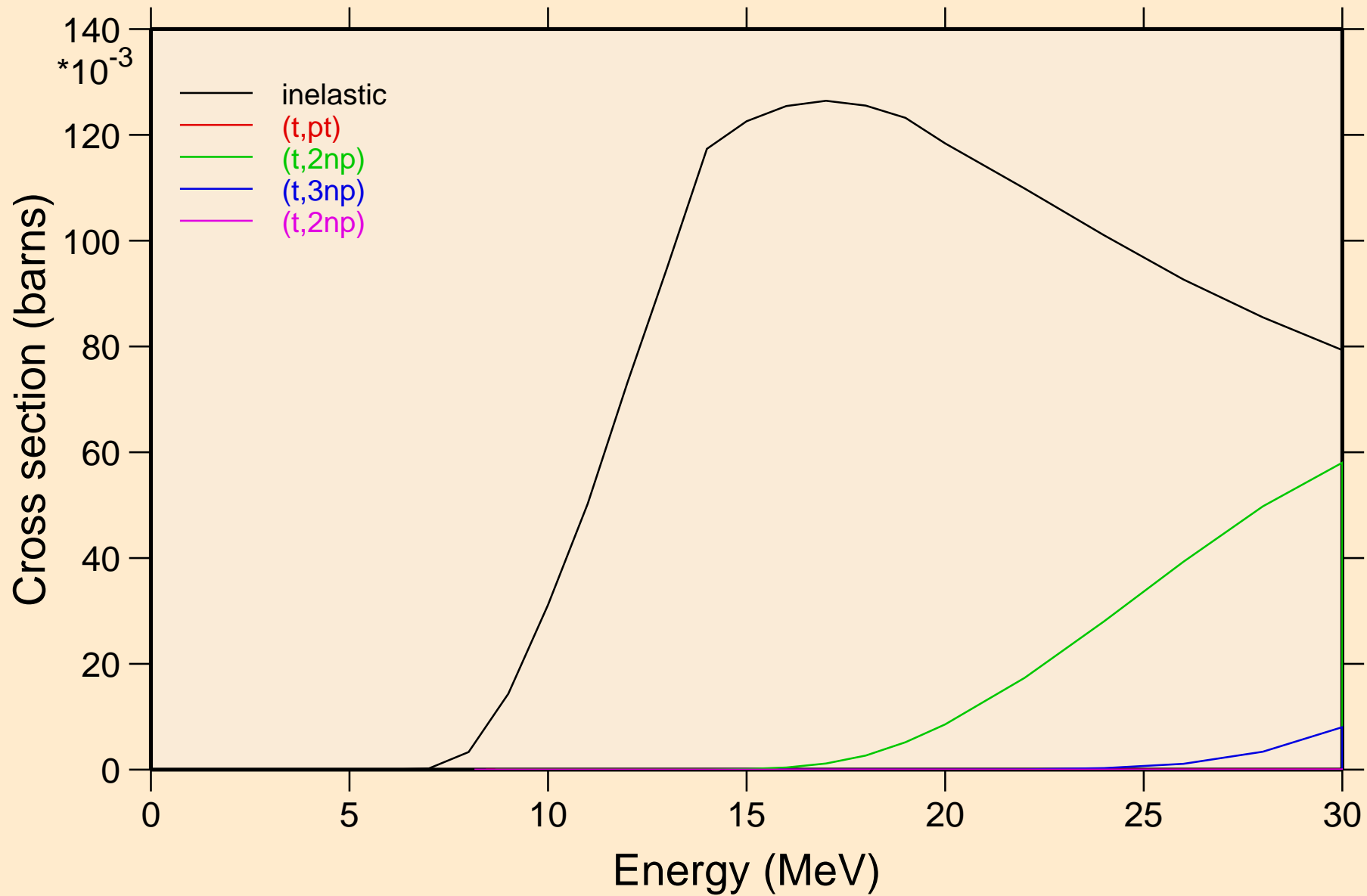

BA135 TRITON ACER TENDL-2021 LIBRARY; T=0.K  
Threshold reactions

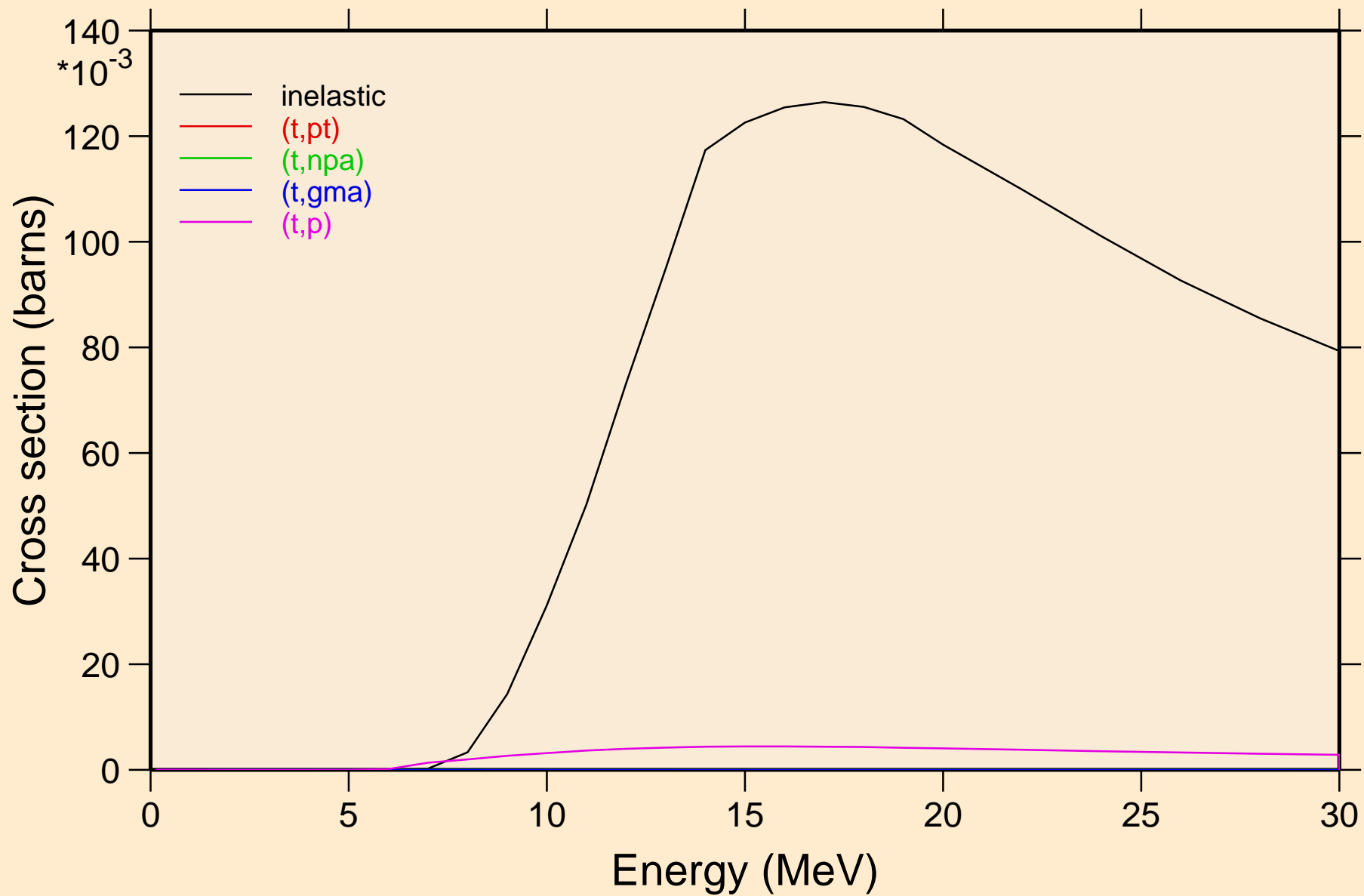

BA135 TRITON ACER TENDL-2021 LIBRARY; T=0.K  
Threshold reactions

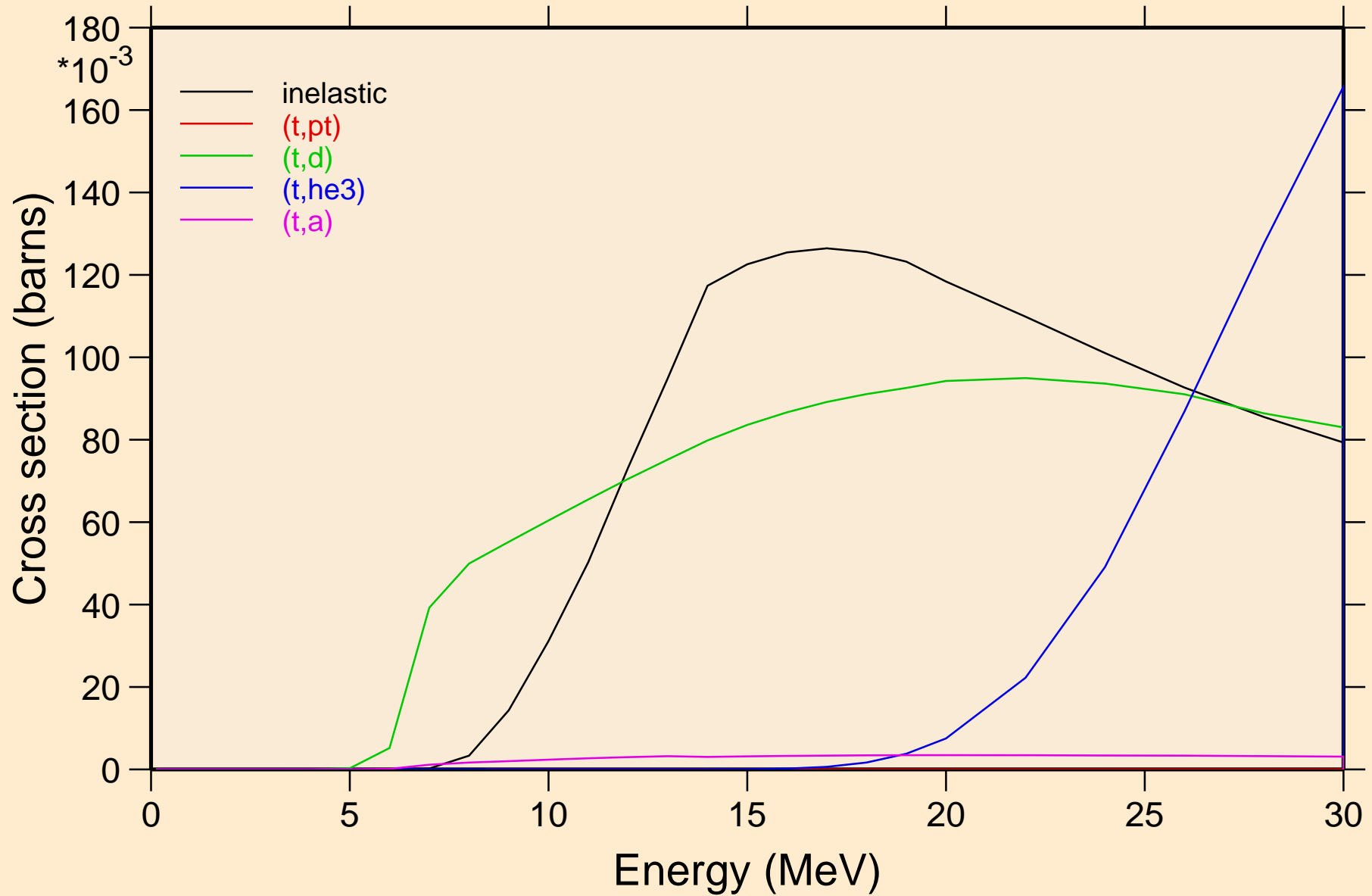

BA135 TRITON ACER TENDL-2021 LIBRARY; T=0.K  
Threshold reactions

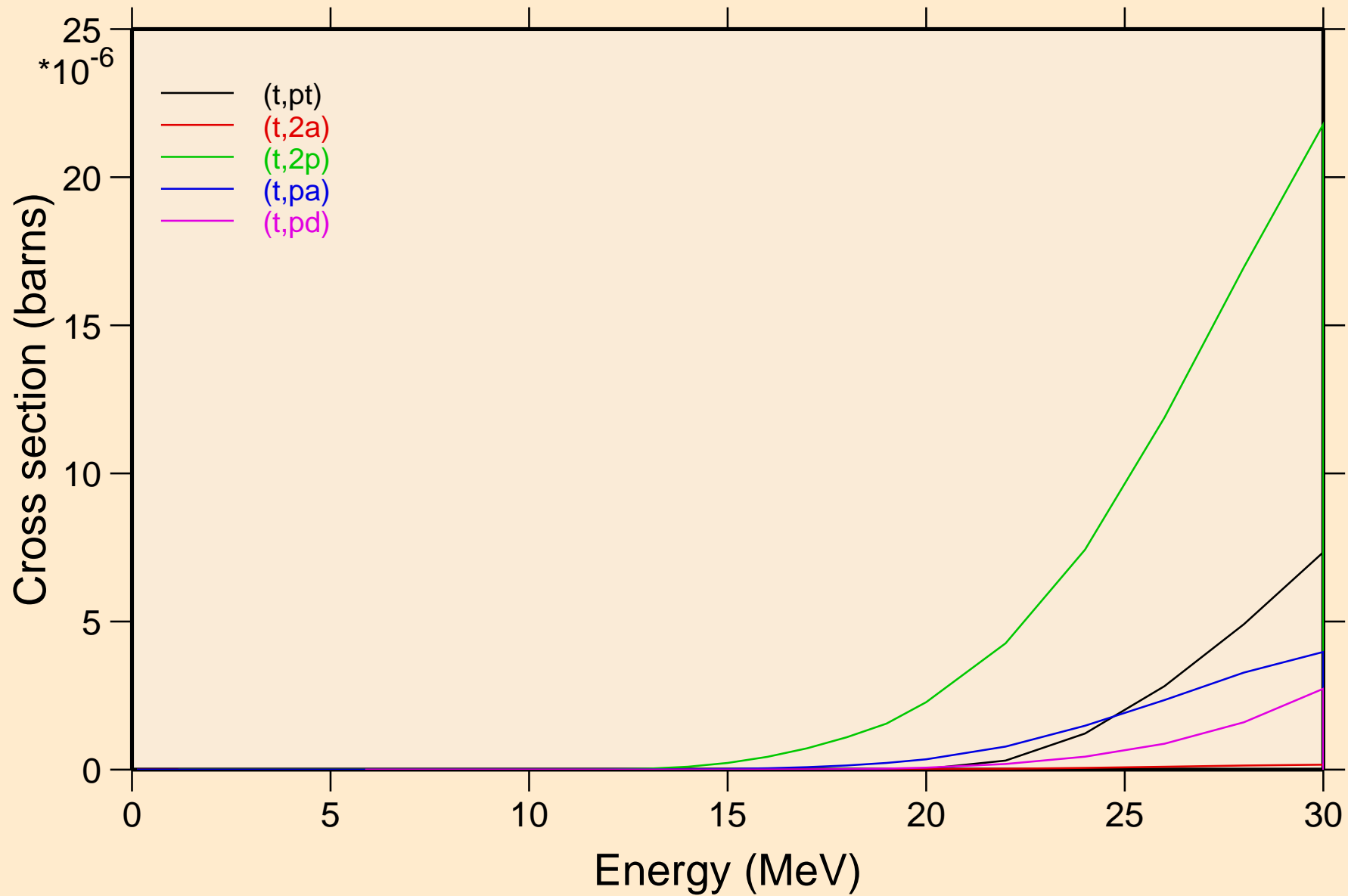

BA135 TRITON ACER TENDL-2021 LIBRARY; T=0.K  
Threshold reactions

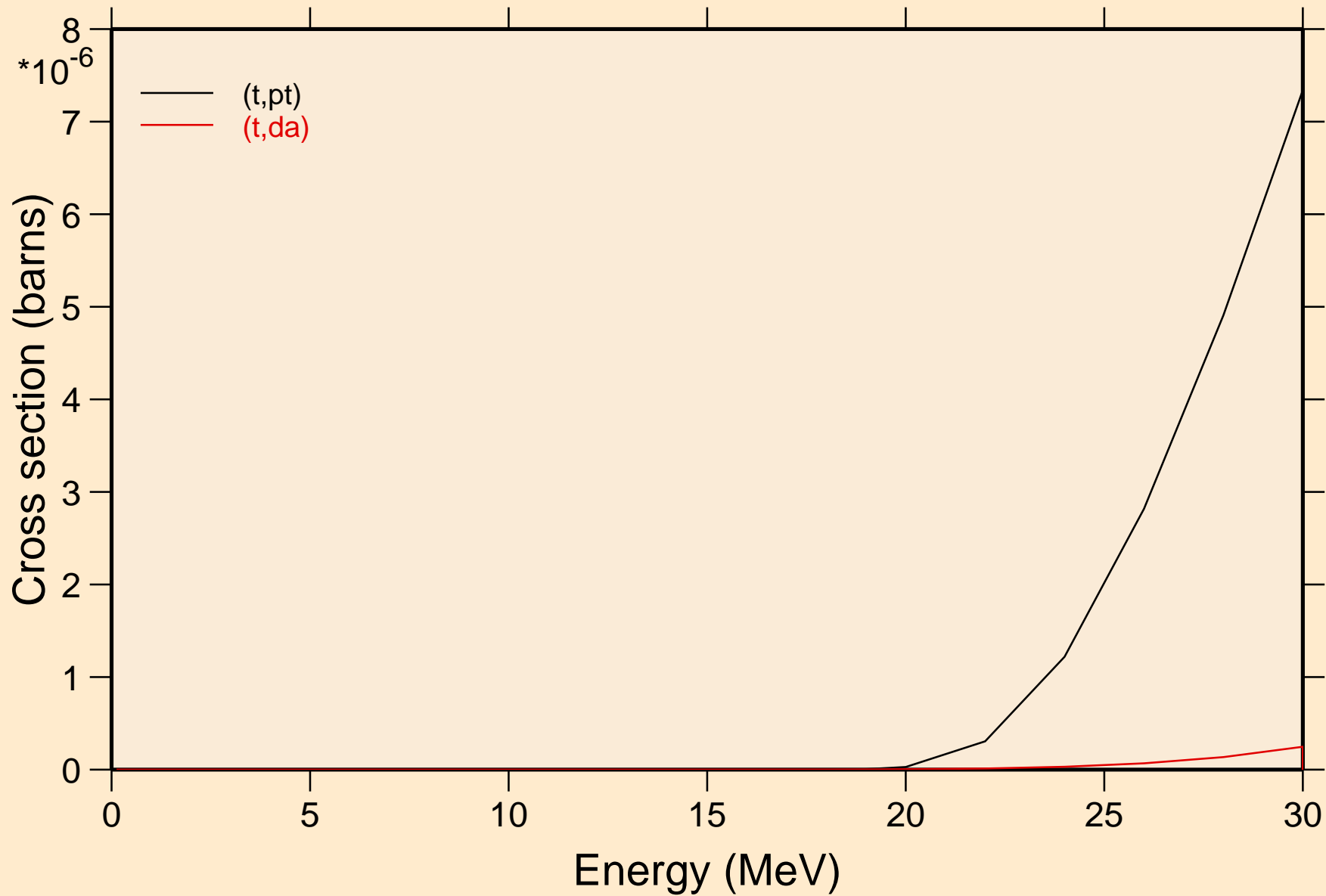

BA135 TRITON ACER TENDL-2021 LIBRARY; T=0.K  
angular distribution for elastic

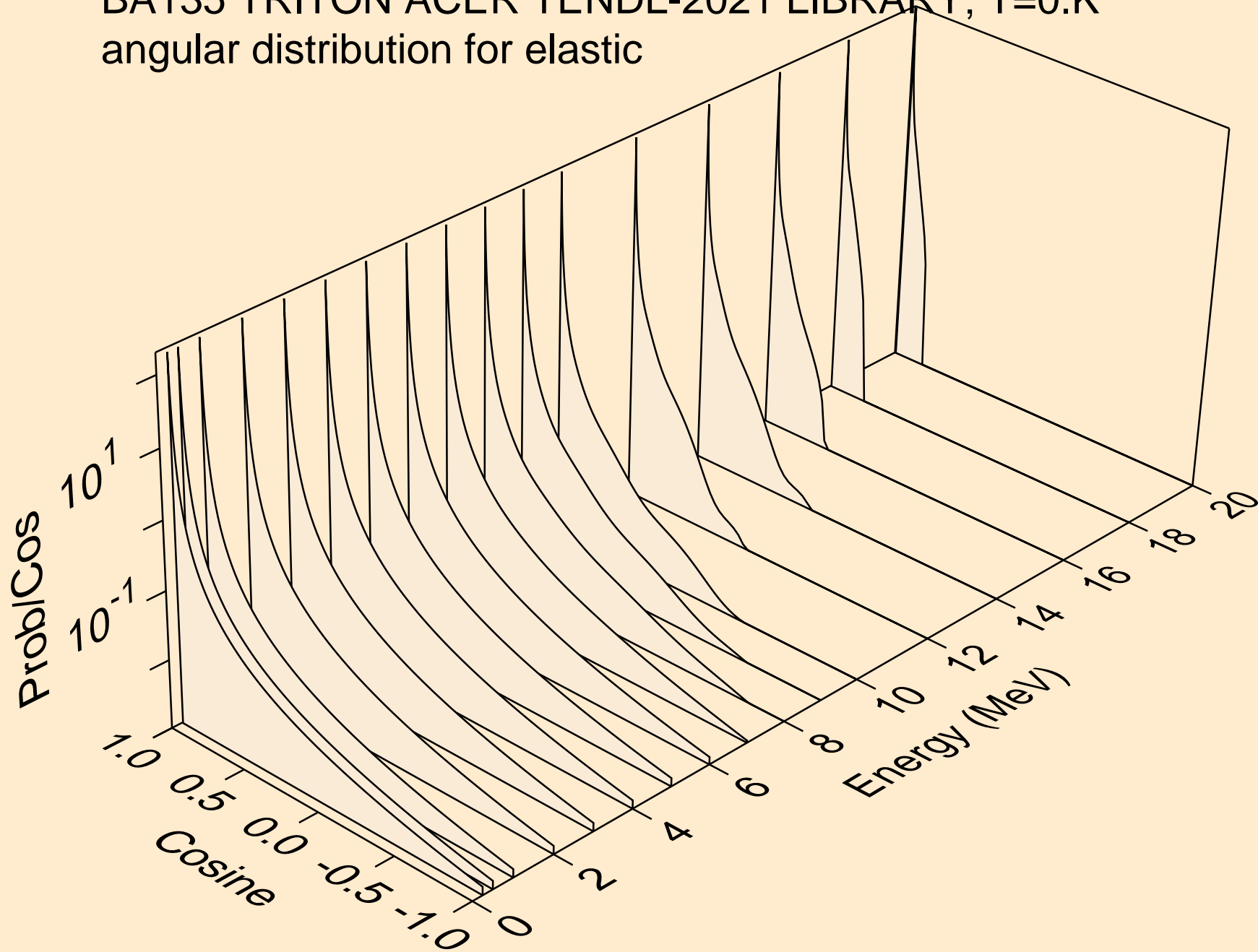



BA135 TRITON ACER TENDL-2021 LIBRARY; T=0.K  
angular distribution for elastic

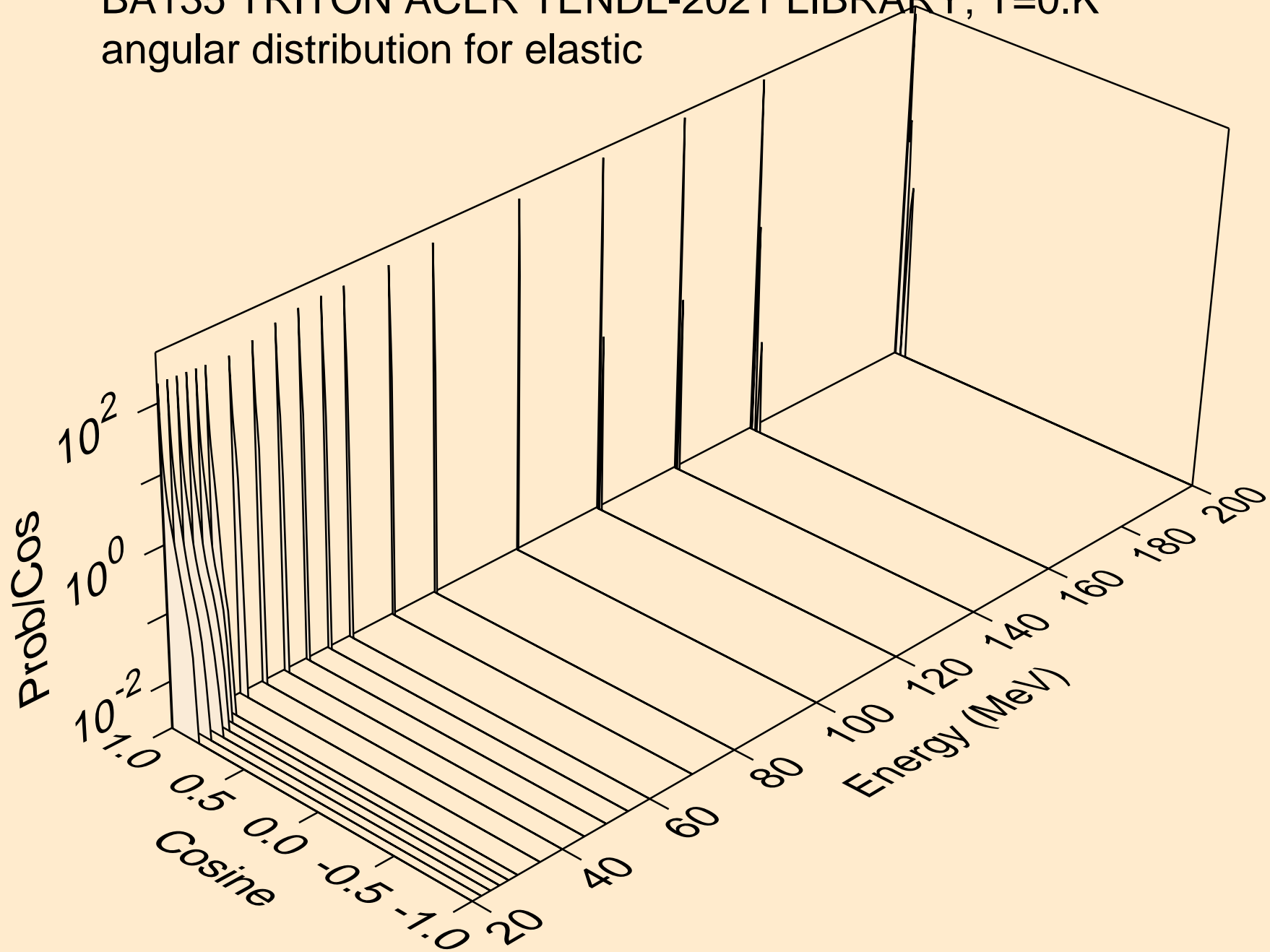

BA135 TRITON ACER TENDL-2021 LIBRARY; T=0.K  
Triton emission for (t,x)

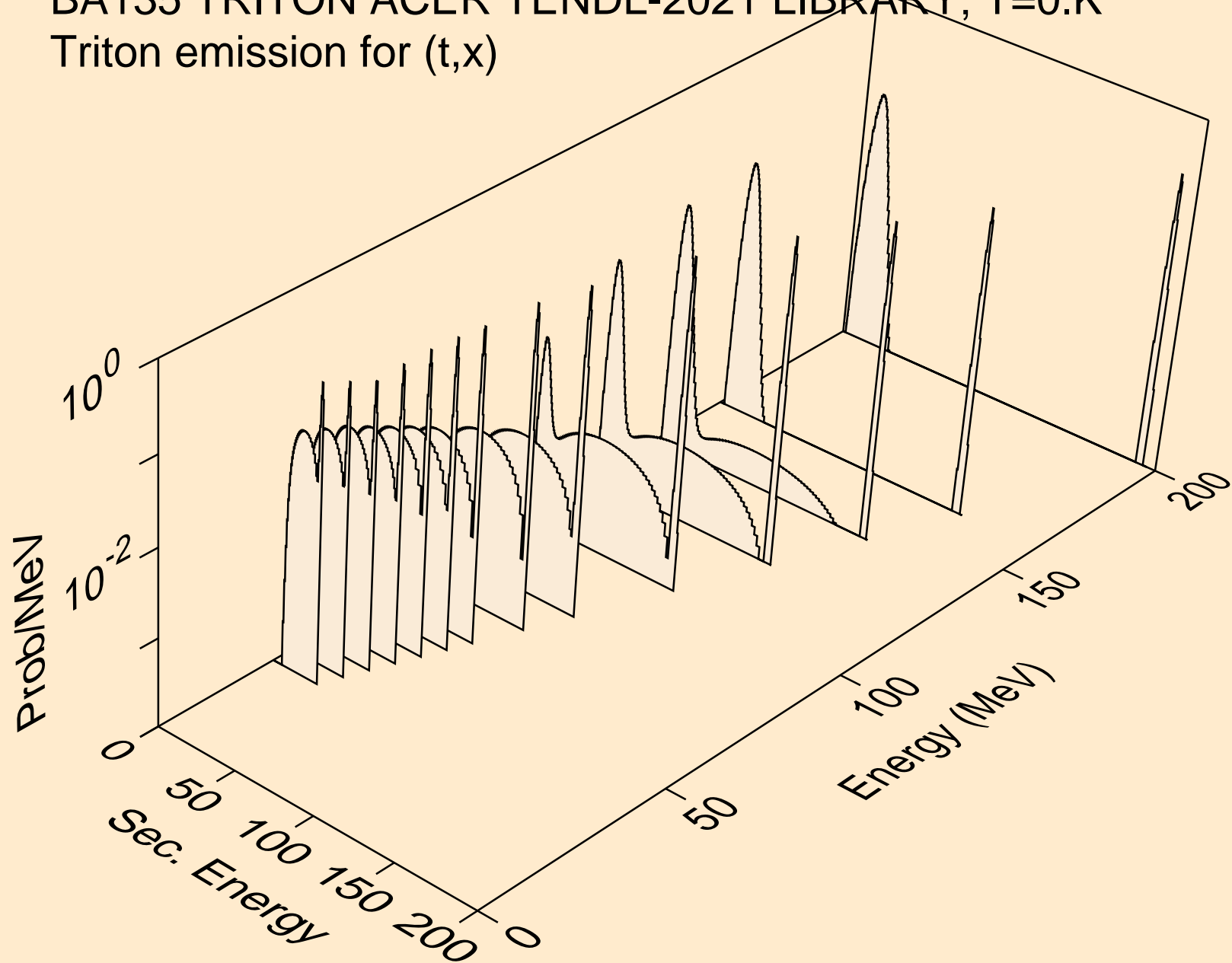

BA135 TRITON ACER TENDL-2021 LIBRARY; T=0.K  
Triton emission for (t,n\*)t

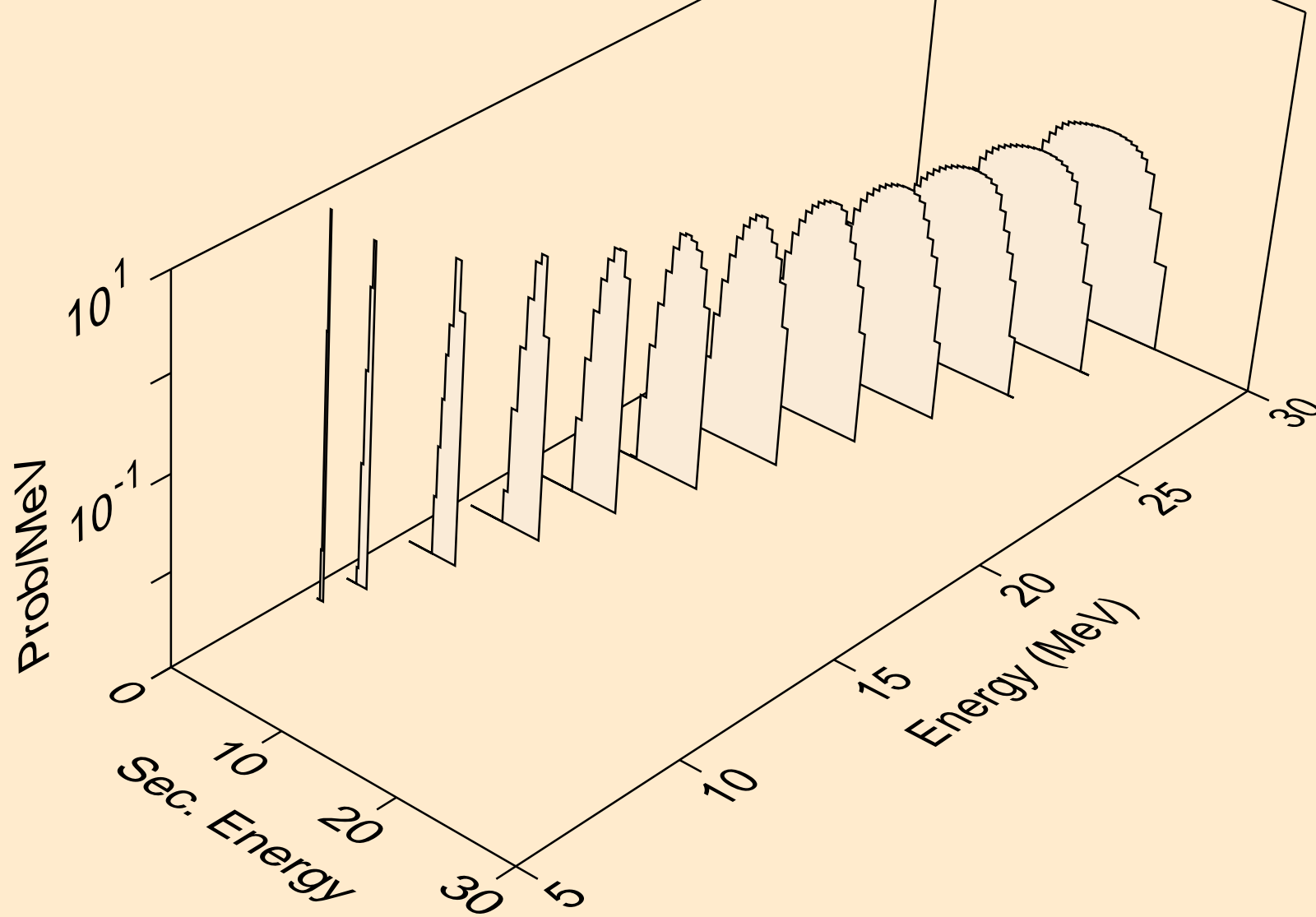

BA135 TRITON ACER TENDL-2021 LIBRARY; T=0.K  
Triton emission for inelastic

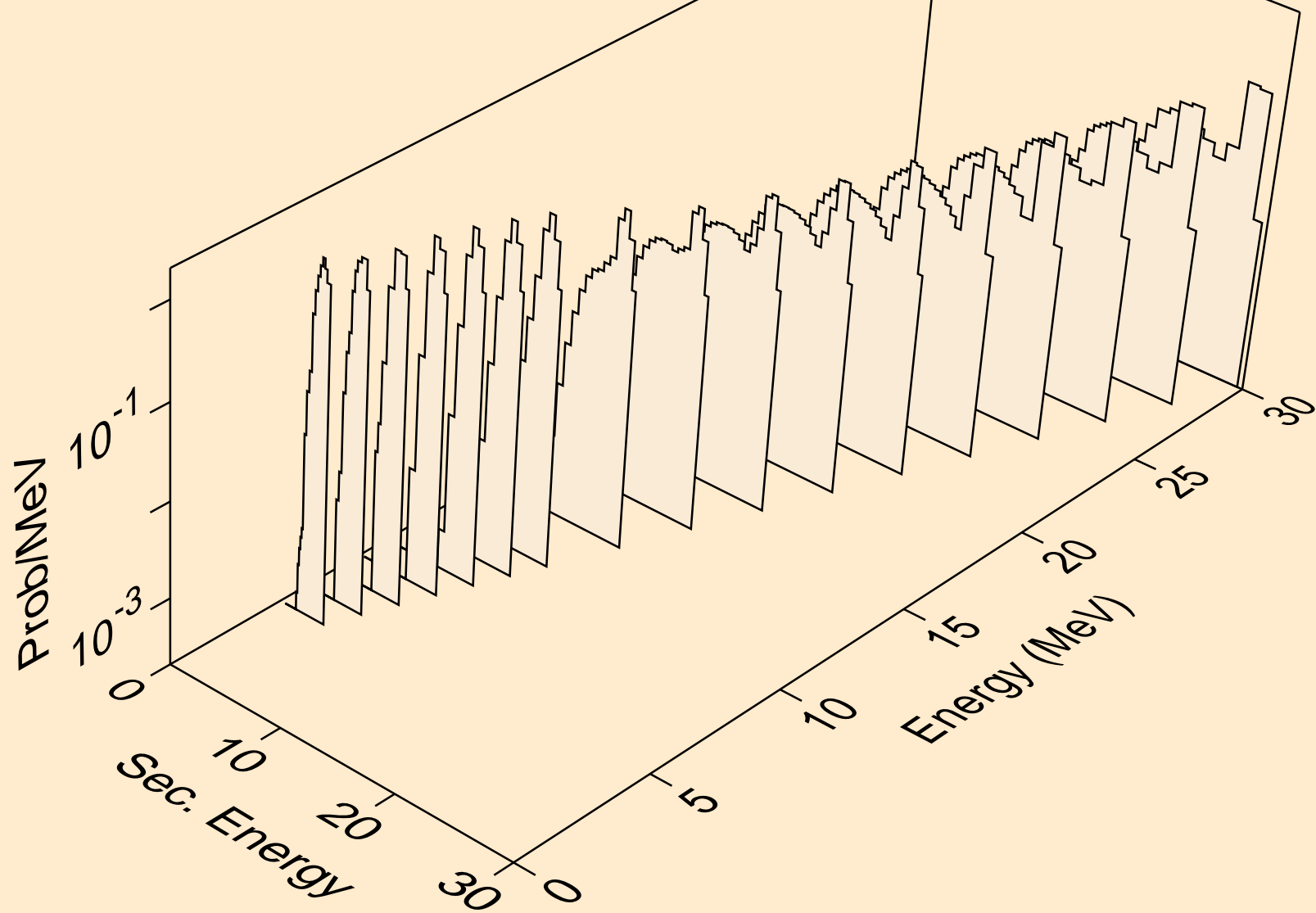

BA135 TRITON ACER TENDL-2021 LIBRARY; T=0.K  
Triton emission for (t,pt)

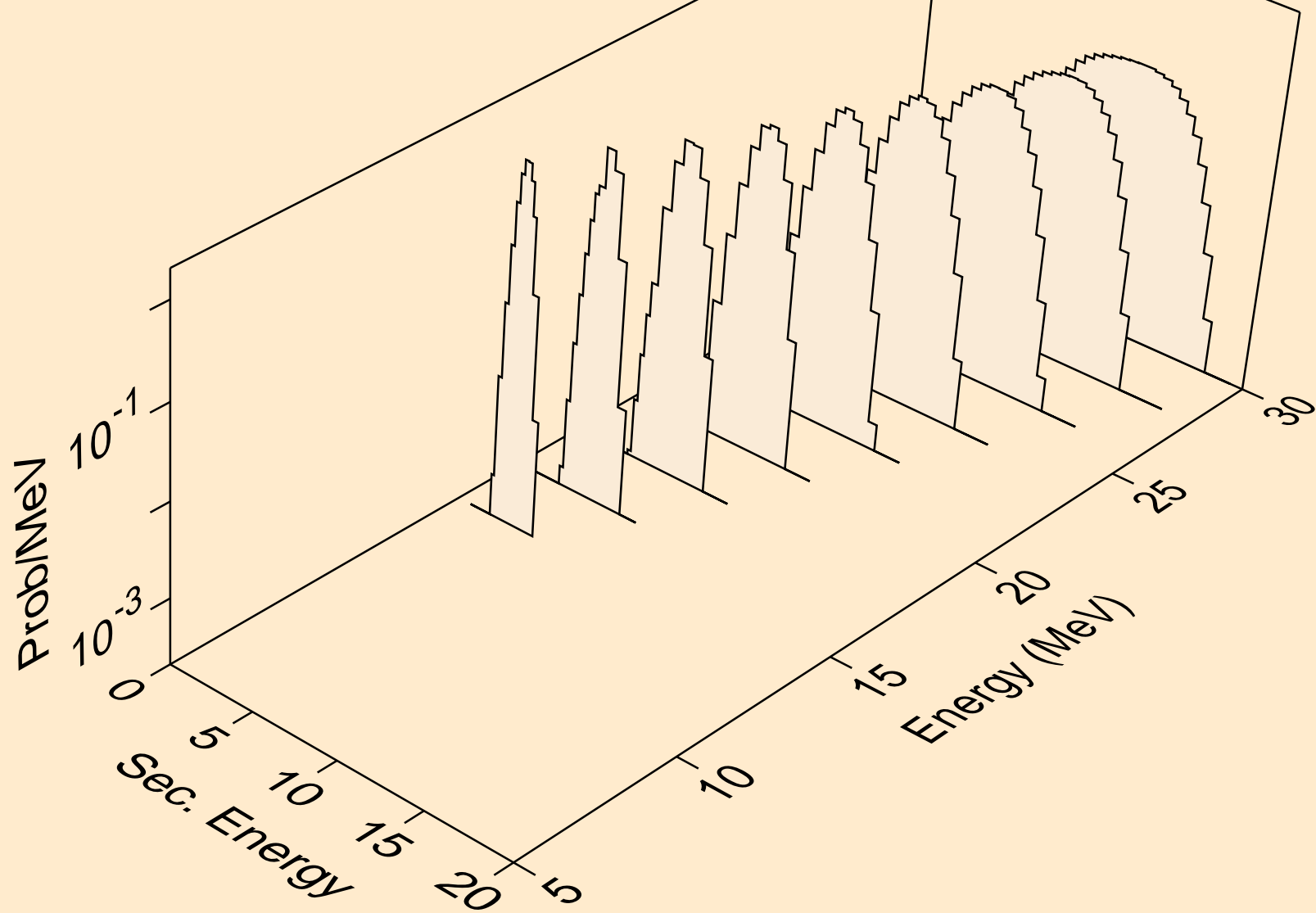

BA135 TRITON ACER TENDL-2021 LIBRARY; T=0.K  
Photon emission for (z,n)

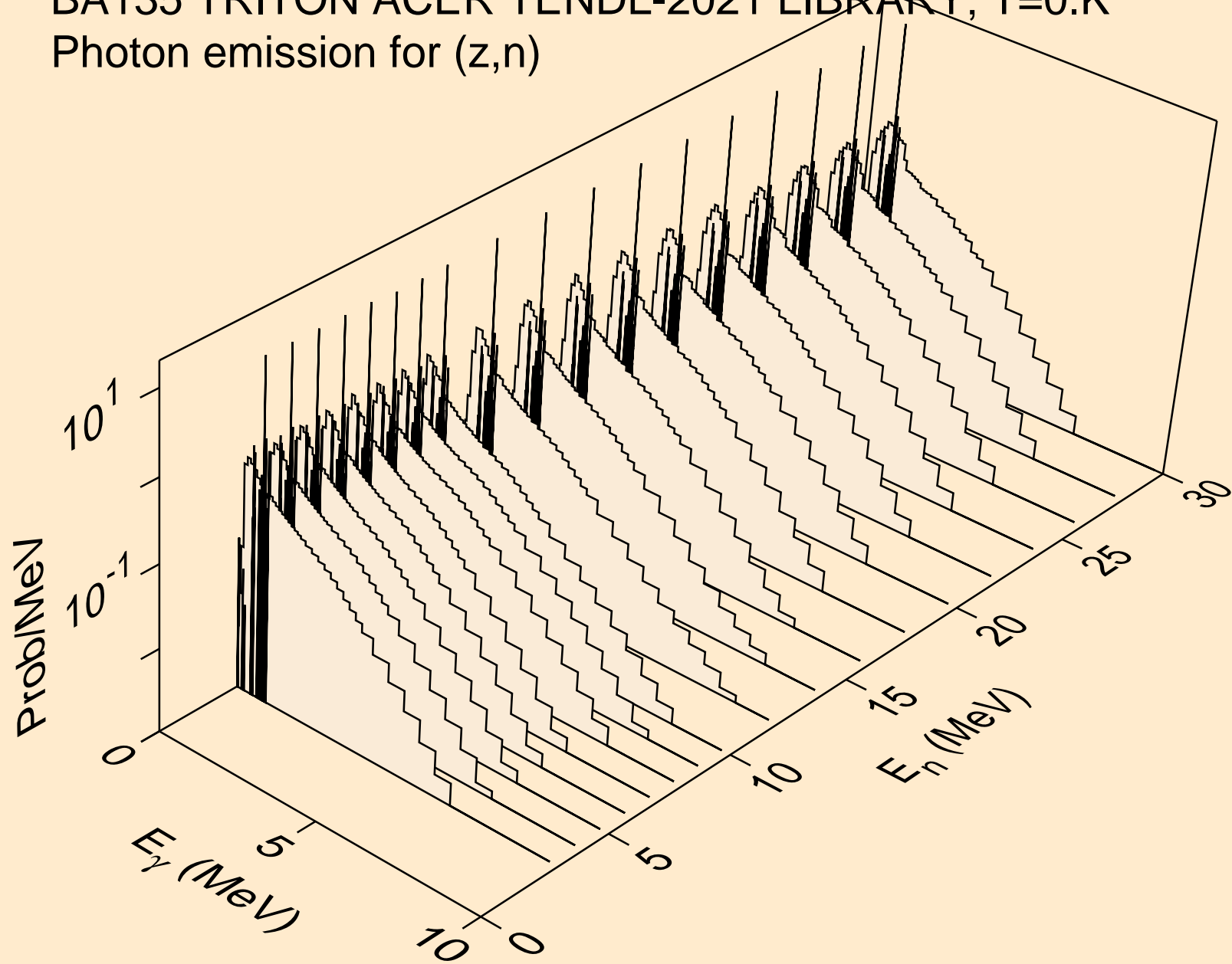

BA135 TRITON ACER TENDL-2021 LIBRARY; T=0.K  
Photon emission for (n,x)

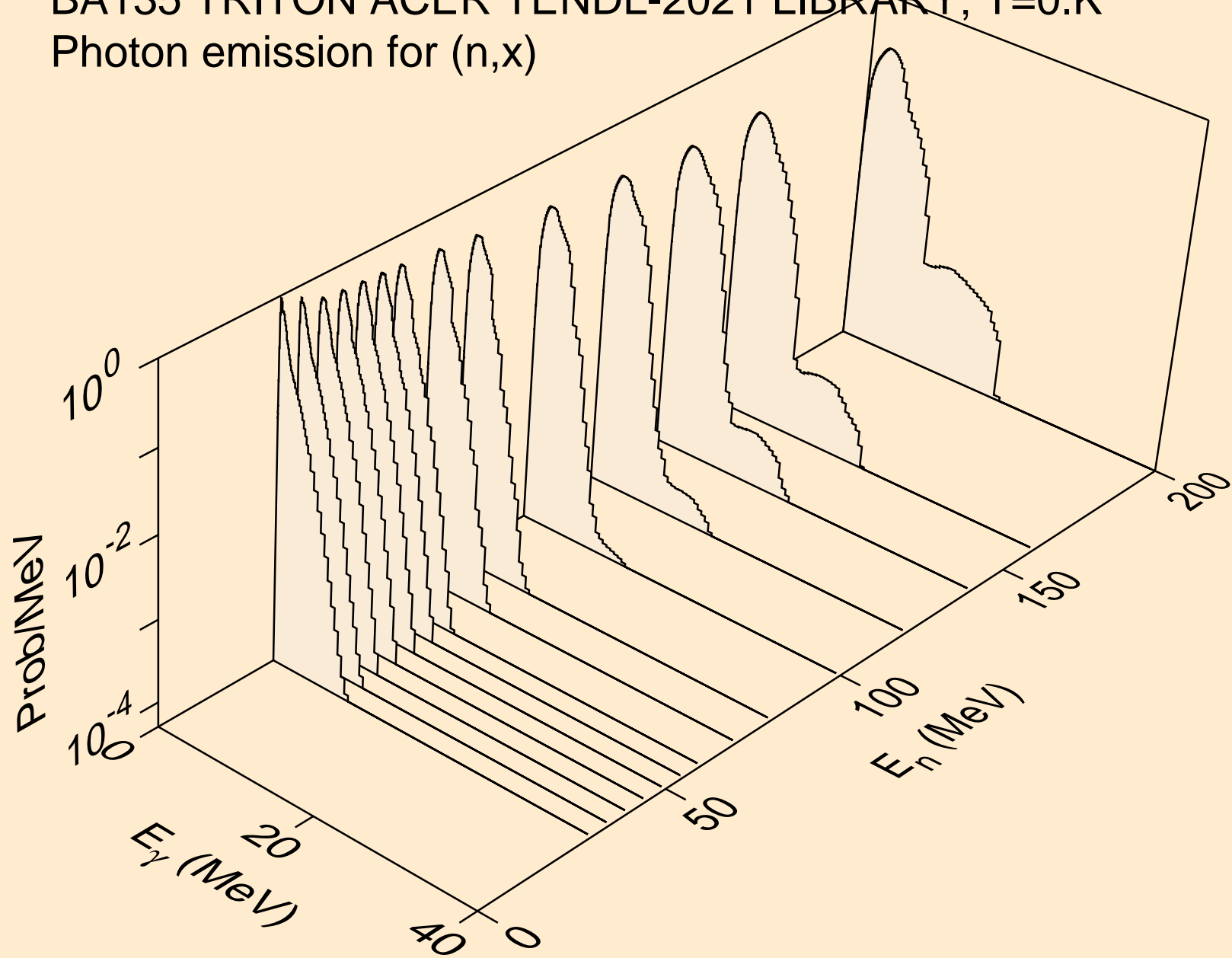

BA135 TRITON ACER TENDL-2021 LIBRARY; T=0.K  
Photon emission for (n,2nd)

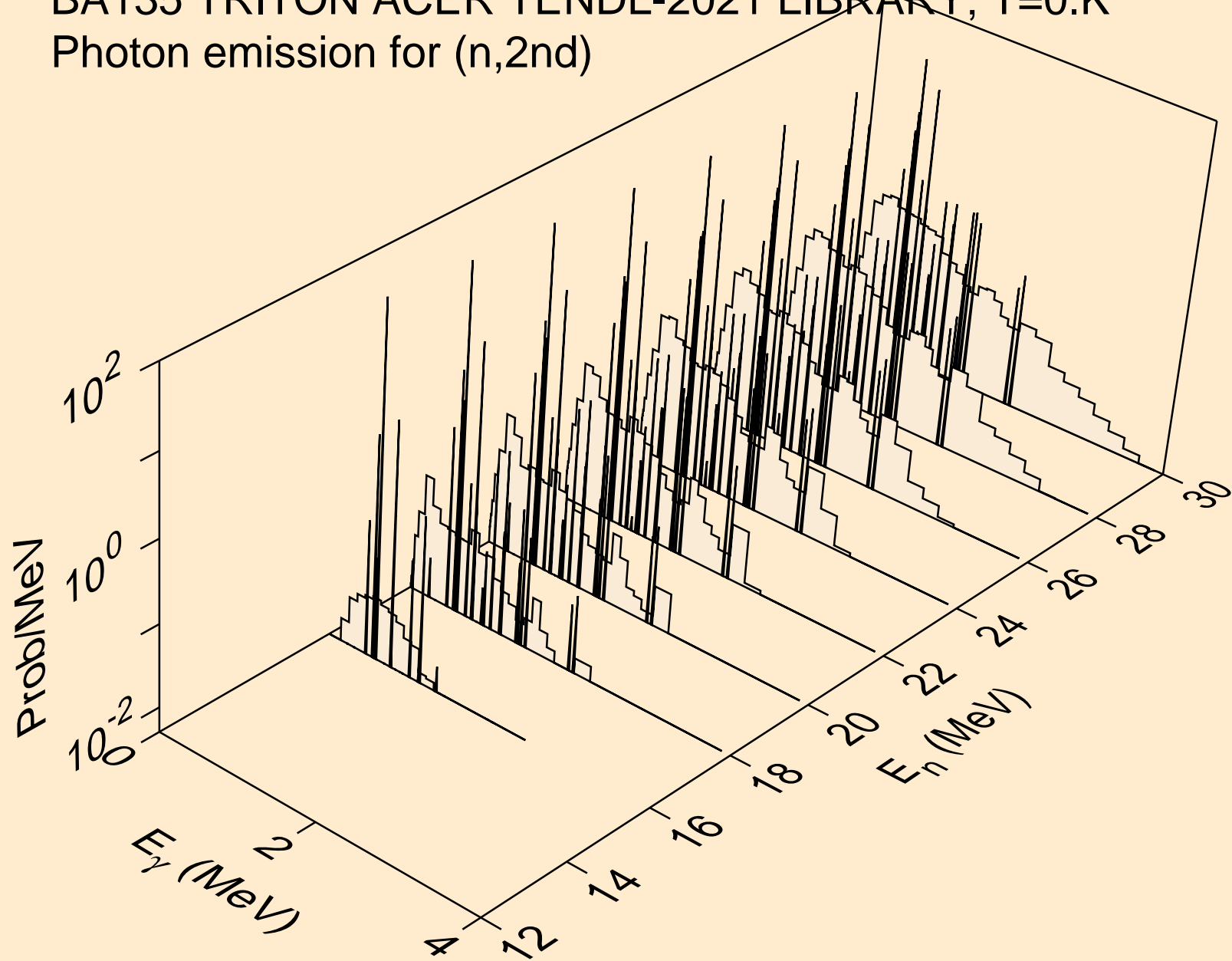



BA135 TRITON ACER TENDL-2021 LIBRARY; T=0.K  
Photon emission for (n,2n)

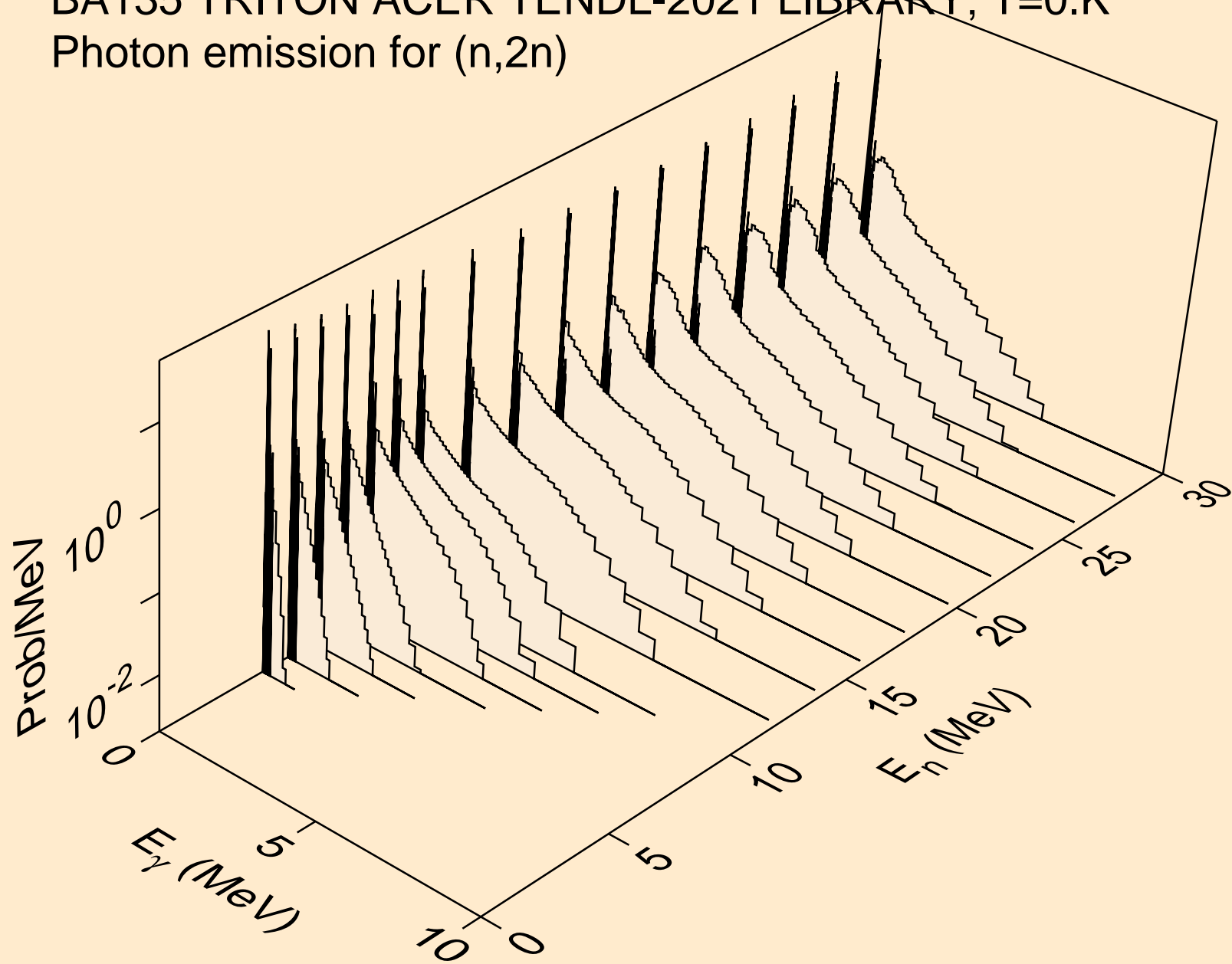

BA135 TRITON ACER TENDL-2021 LIBRARY; T=0.K  
Photon emission for (n,3n)

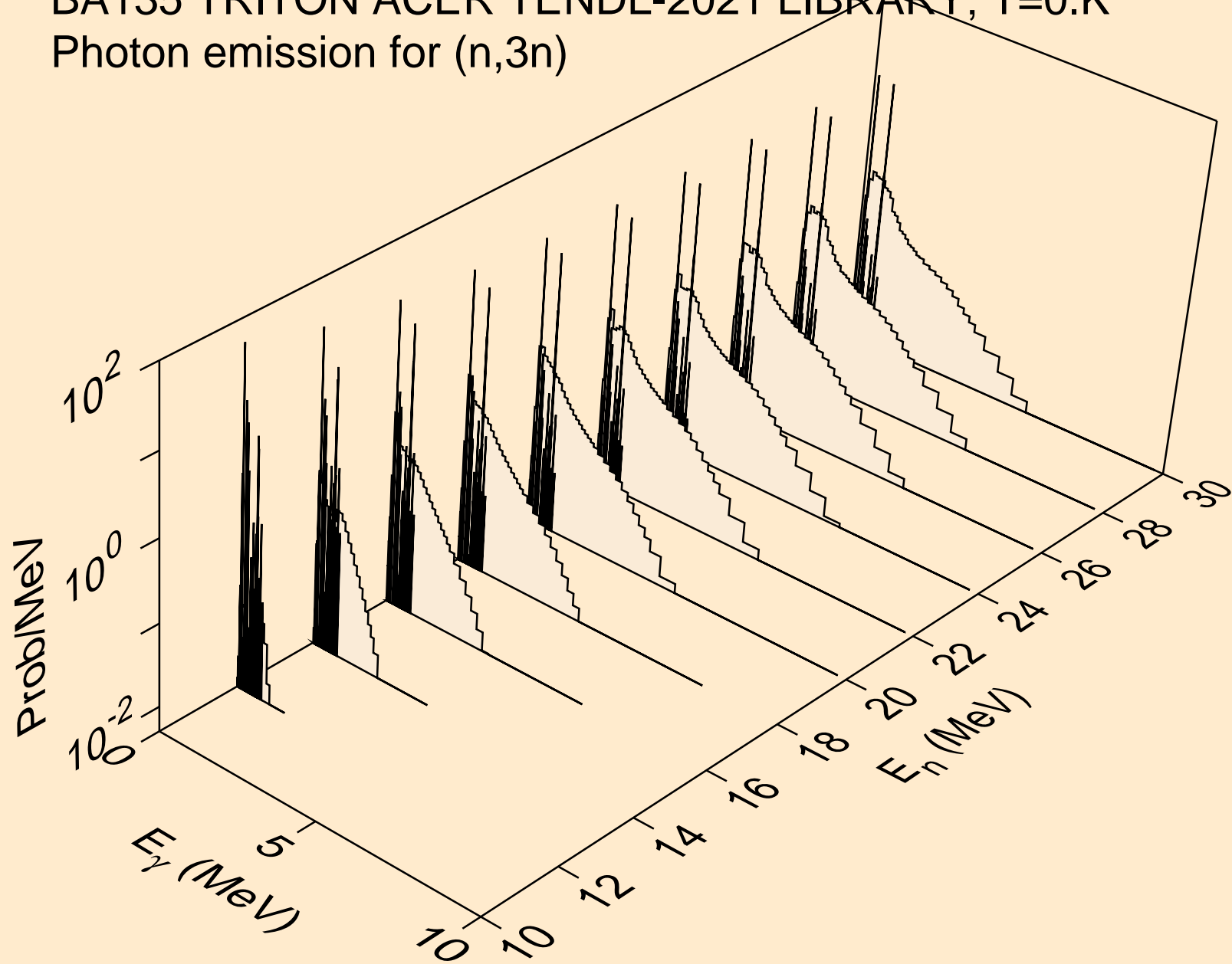

BA135 TRITON ACER TENDL-2021 LIBRARY; T=0.K  
Photon emission for (n,n\*)a

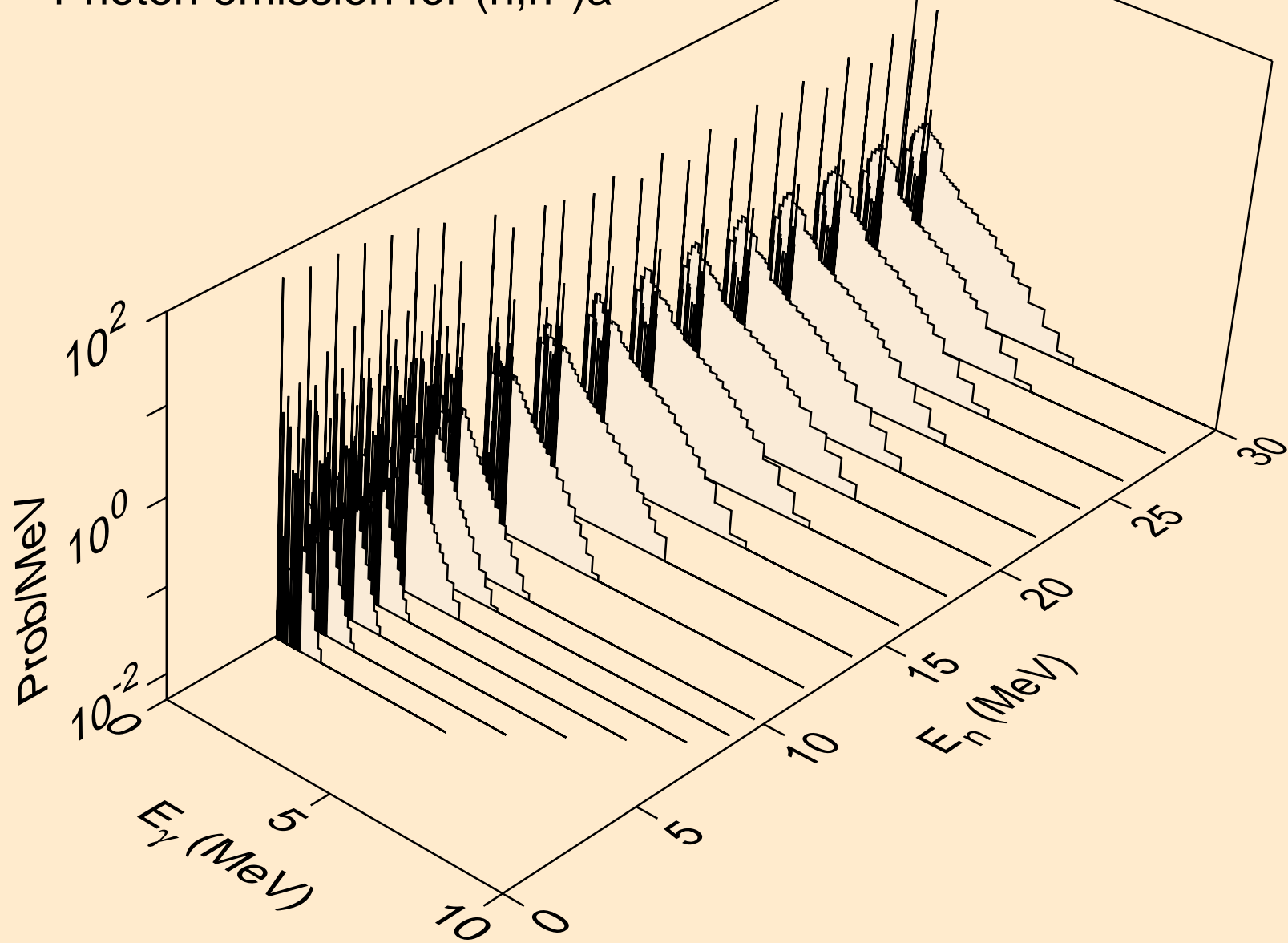

BA135 TRITON ACER TENDL-2021 LIBRARY; T=0.K  
Photon emission for (n,2n)a

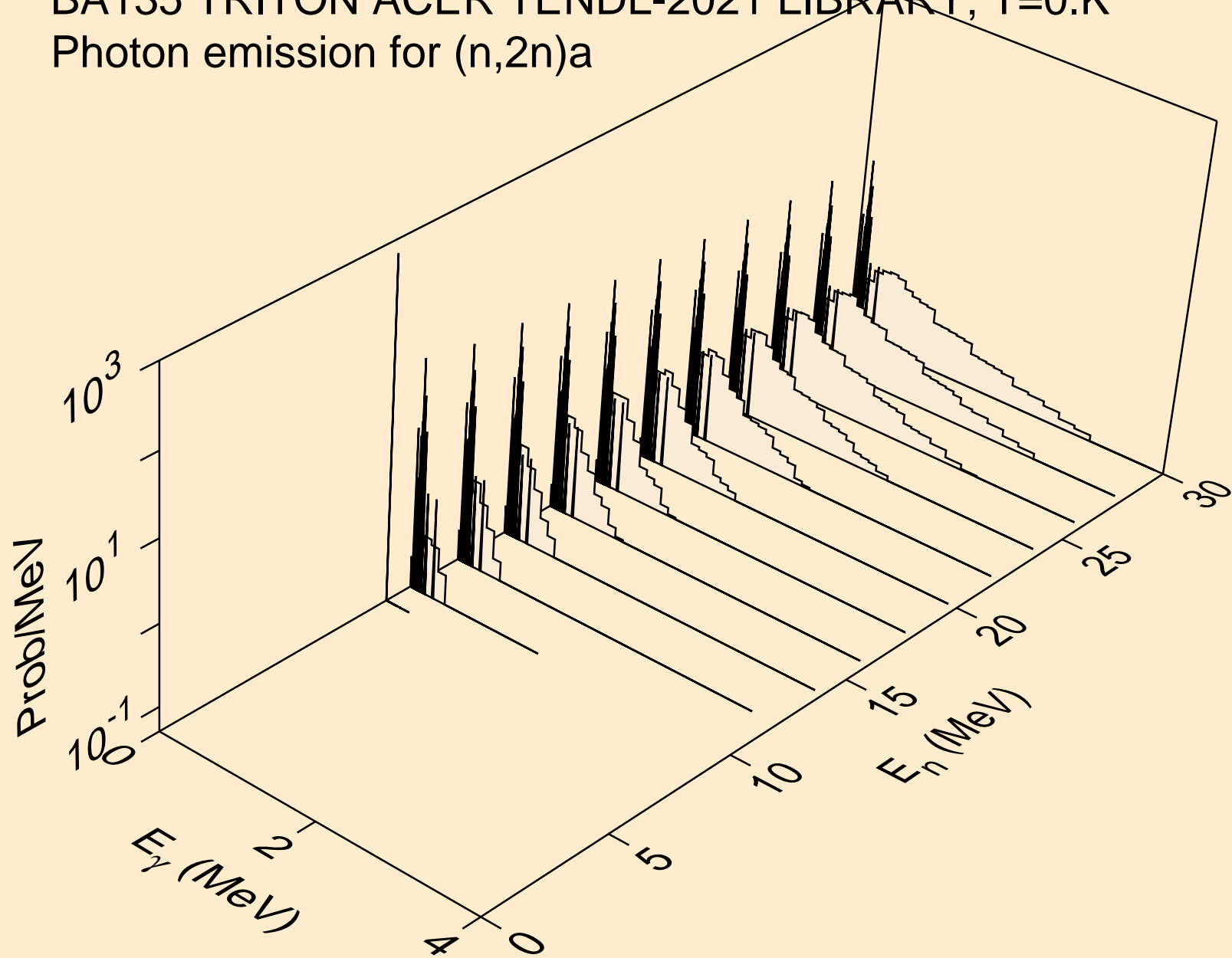

BA135 TRITON ACER TENDL-2021 LIBRARY; T=0.K  
Photon emission for (n,3n)a

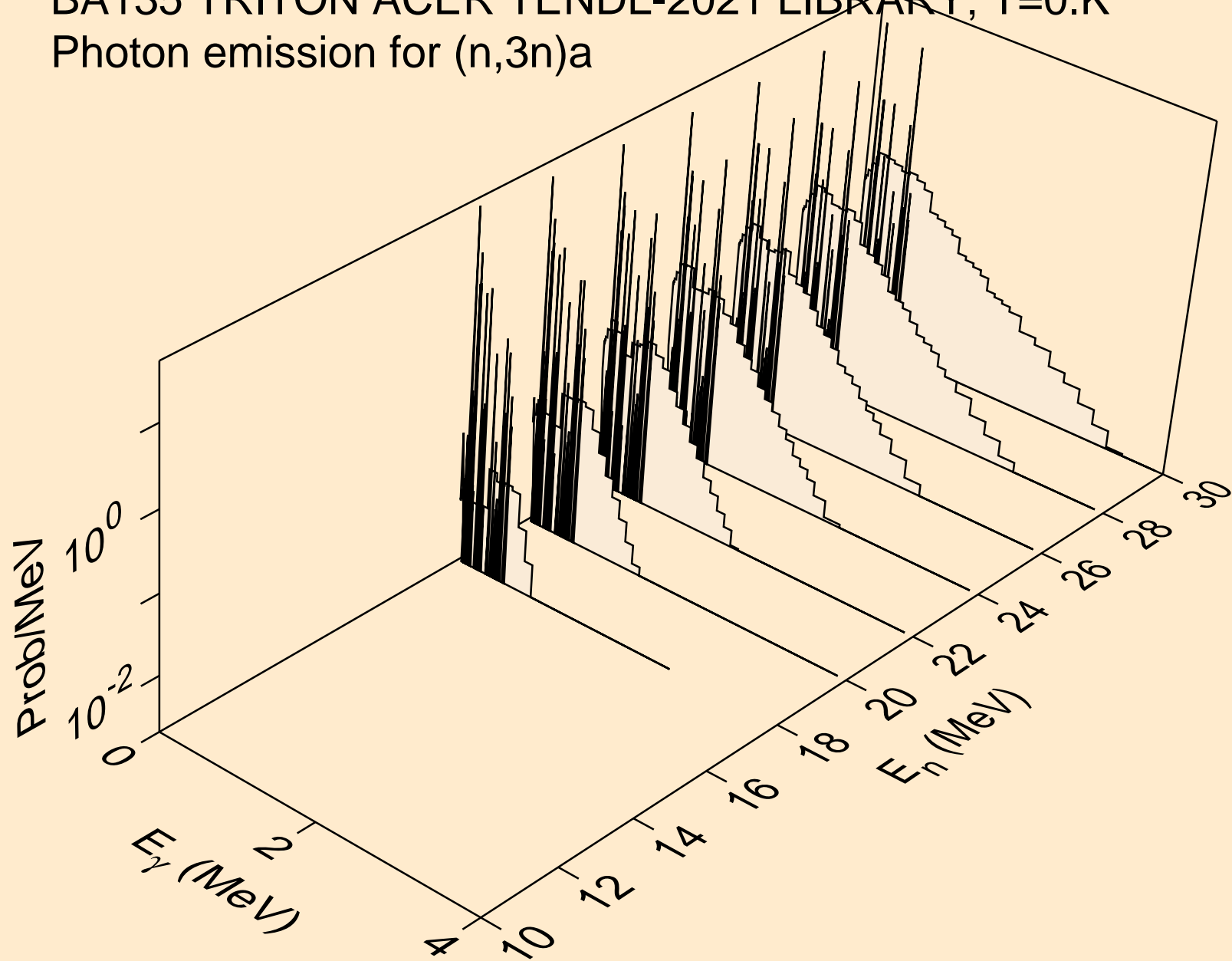

BA135 TRITON ACER TENDL-2021 LIBRARY; T=0.K  
Photon emission for (n,n\*)p

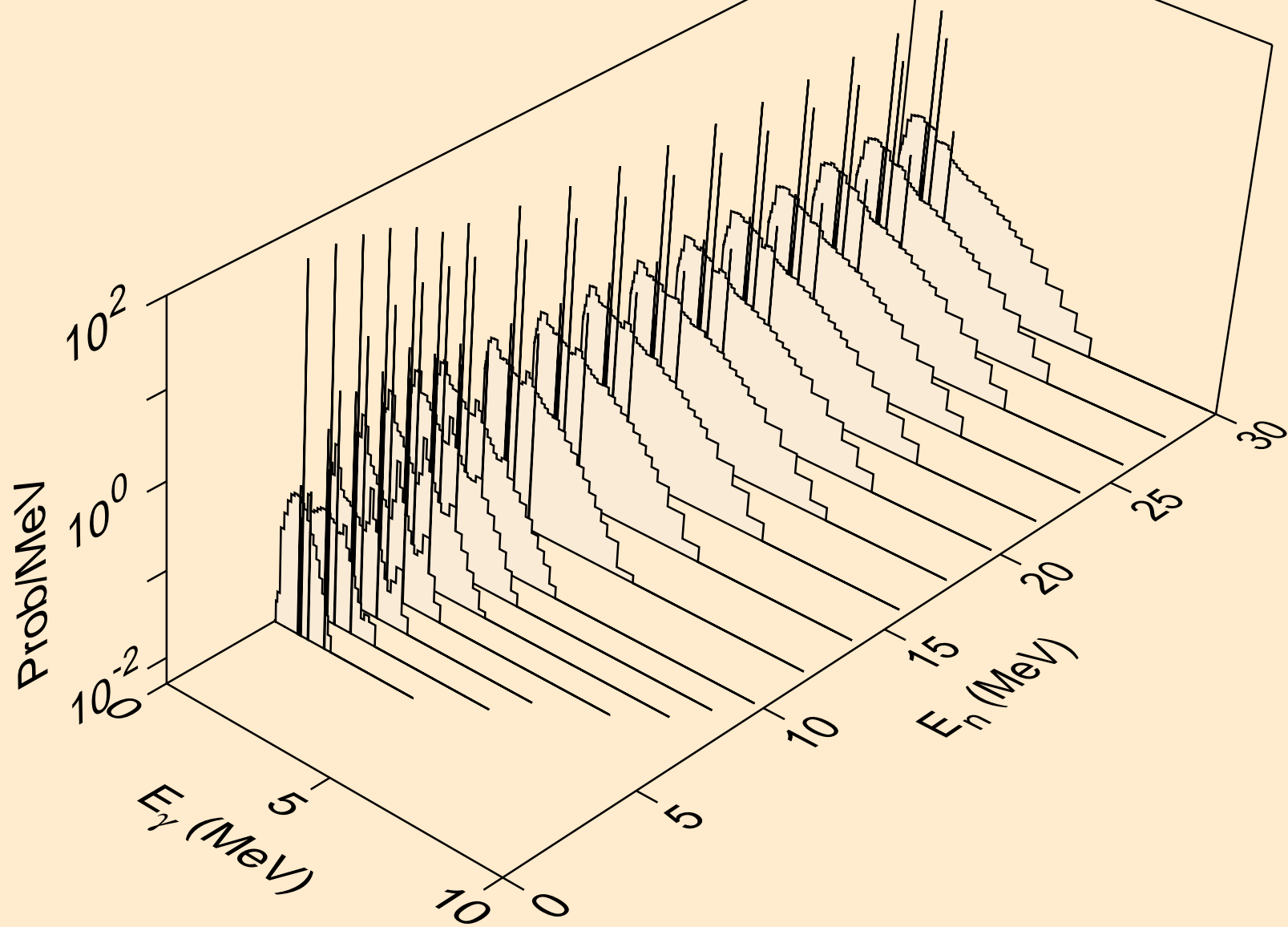

BA135 TRITON ACER TENDL-2021 LIBRARY; T=0.K  
Photon emission for (n,n\*)2a

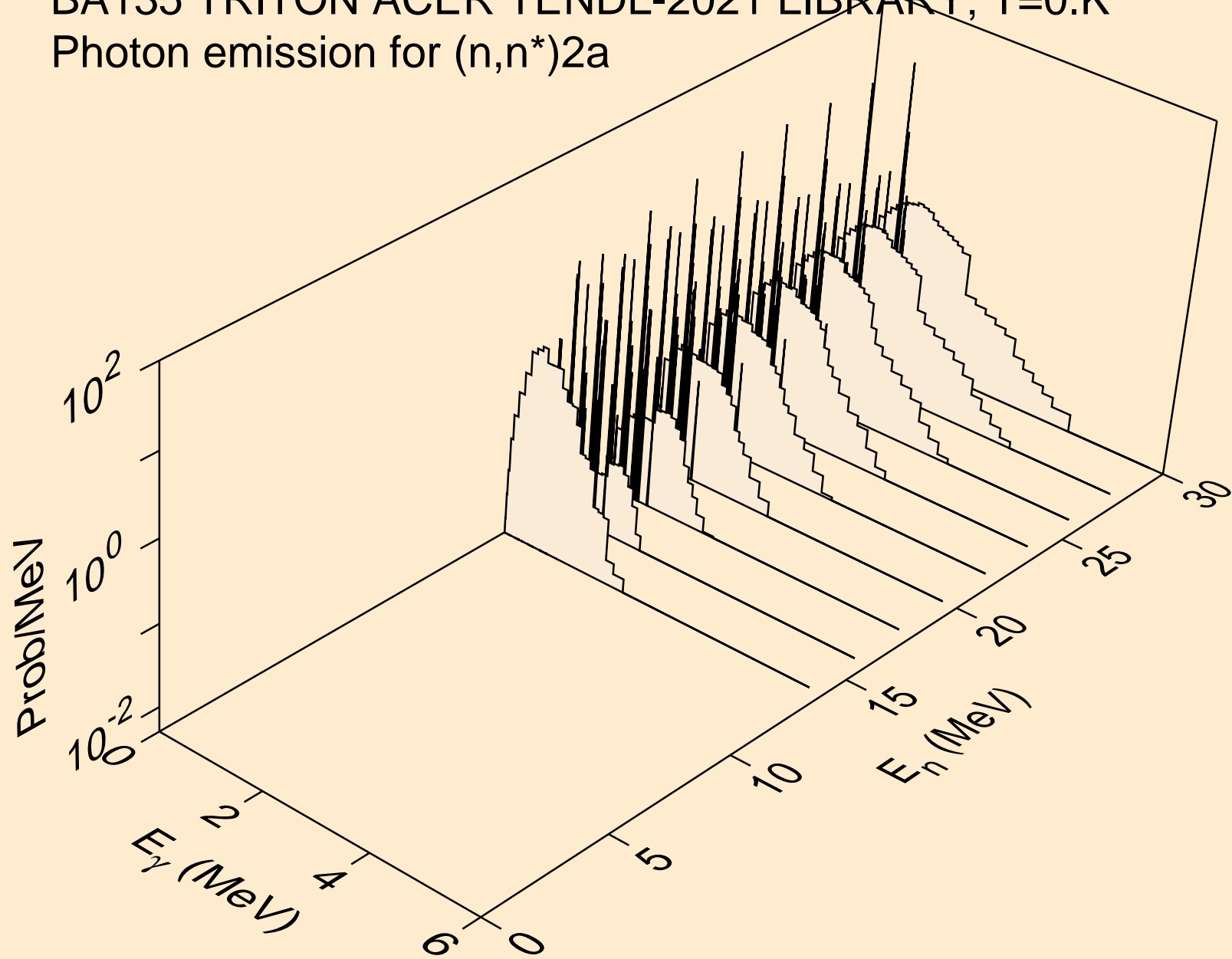

BA135 TRITON ACER TENDL-2021 LIBRARY; T=0.K  
Photon emission for (n,n\*)d

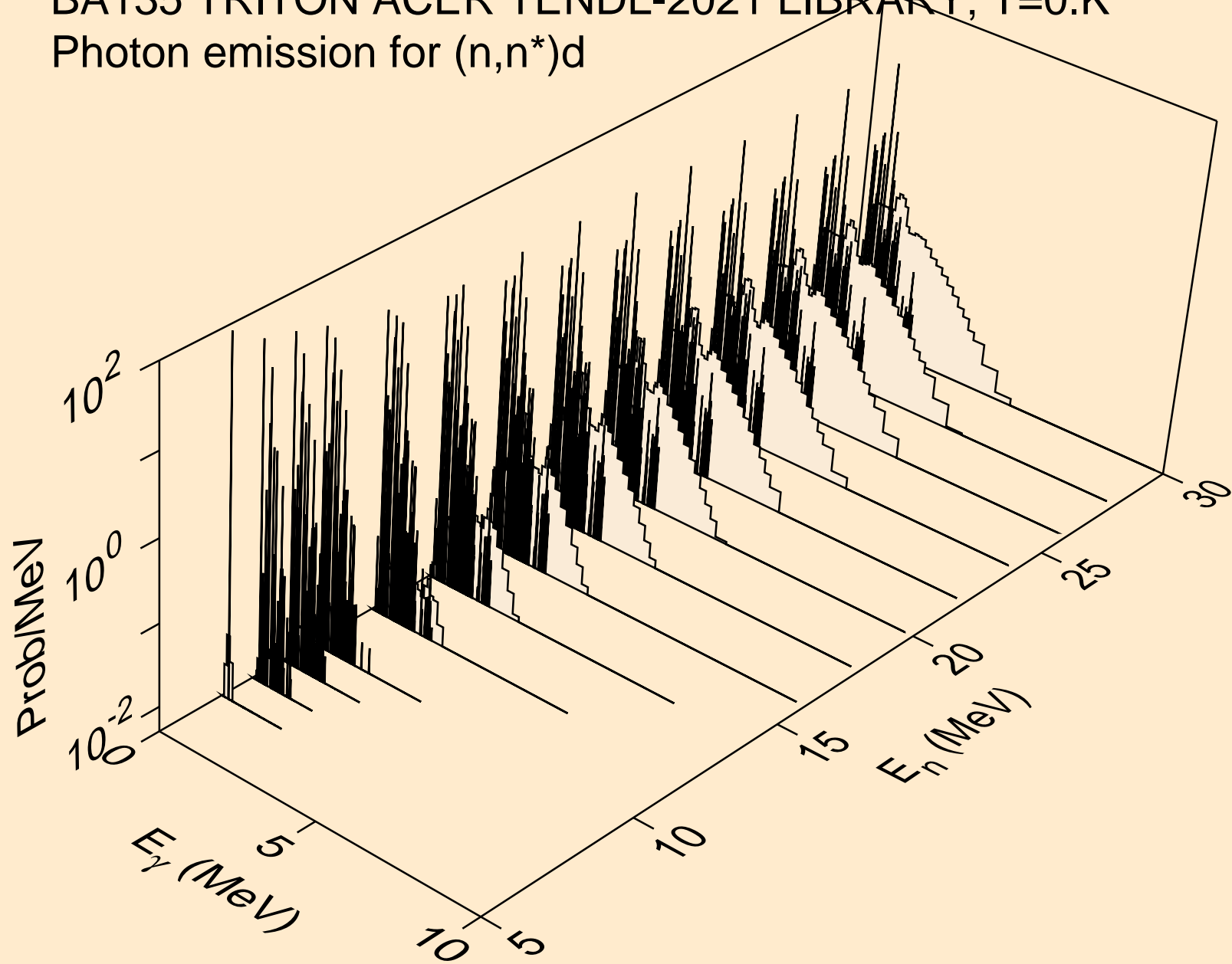



BA135 TRITON ACER TENDL-2021 LIBRARY; T=0.K  
Photon emission for (n,n\*)t

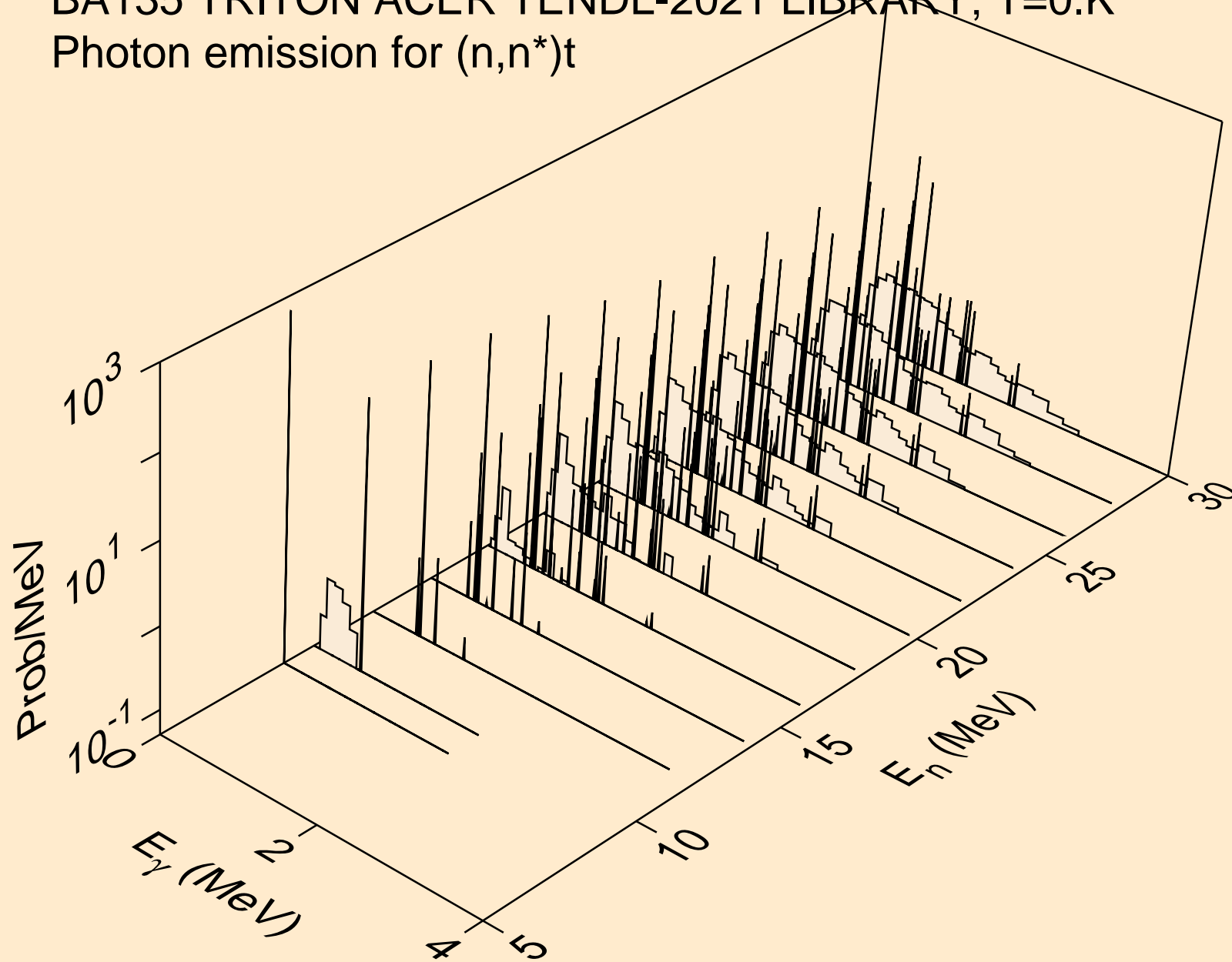

BA135 TRITON ACER TENDL-2021 LIBRARY; T=0.K  
Photon emission for (n,n\*)he3

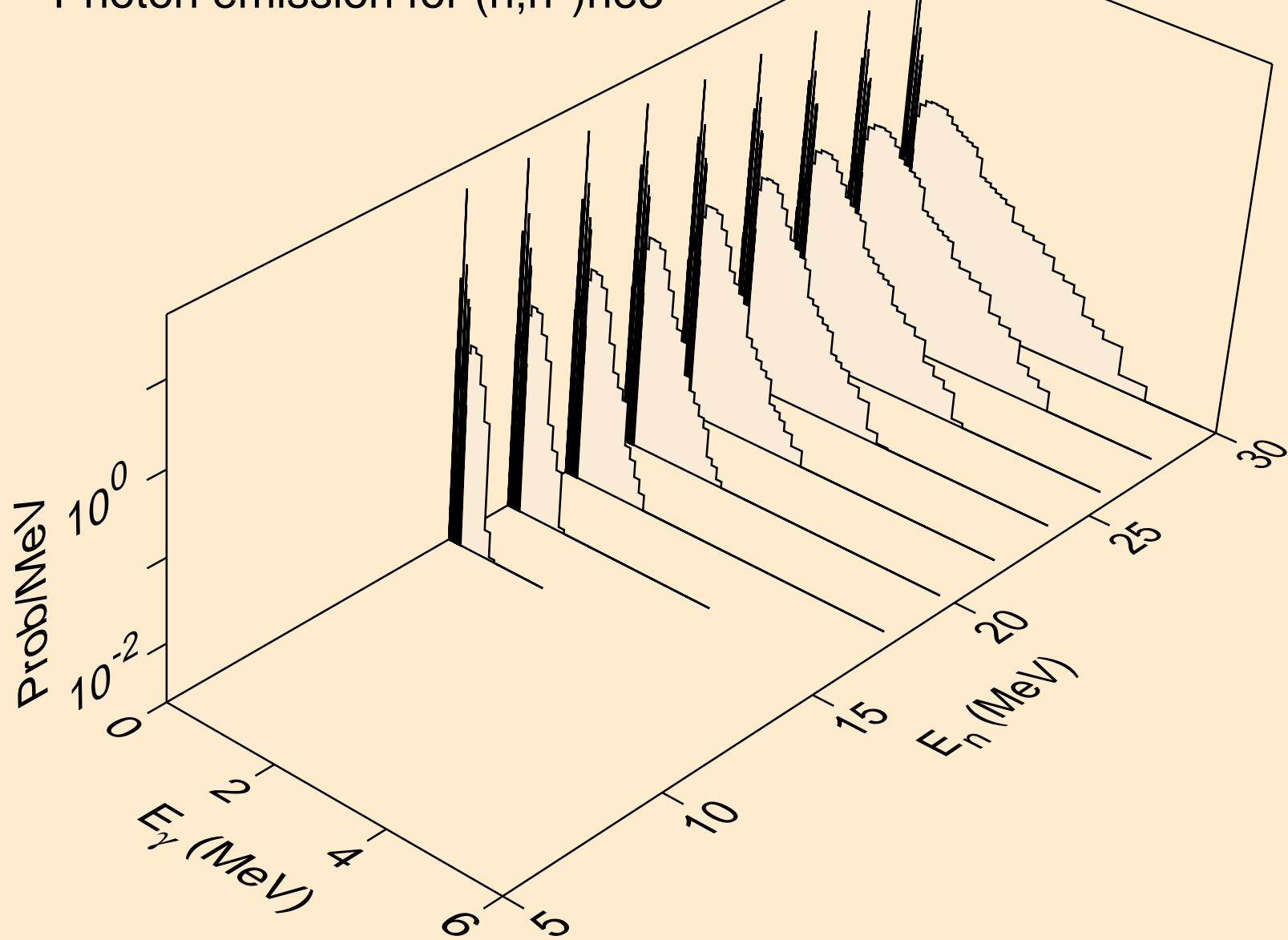

BA135 TRITON ACER TENDL-2021 LIBRARY; T=0.K  
Photon emission for (n,4n)

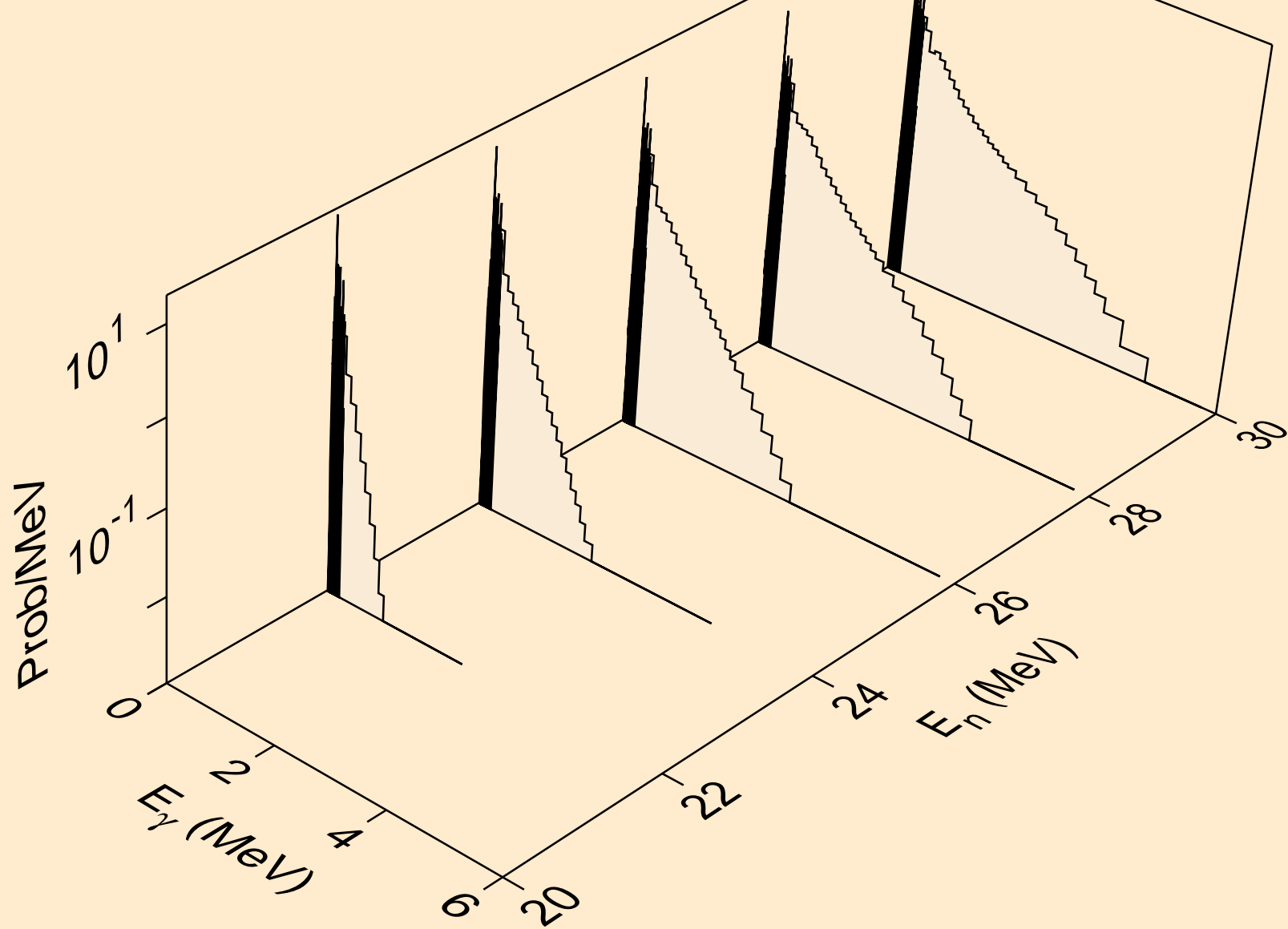

BA135 TRITON ACER TENDL-2021 LIBRARY; T=0.K  
Photon emission for (n,2np)

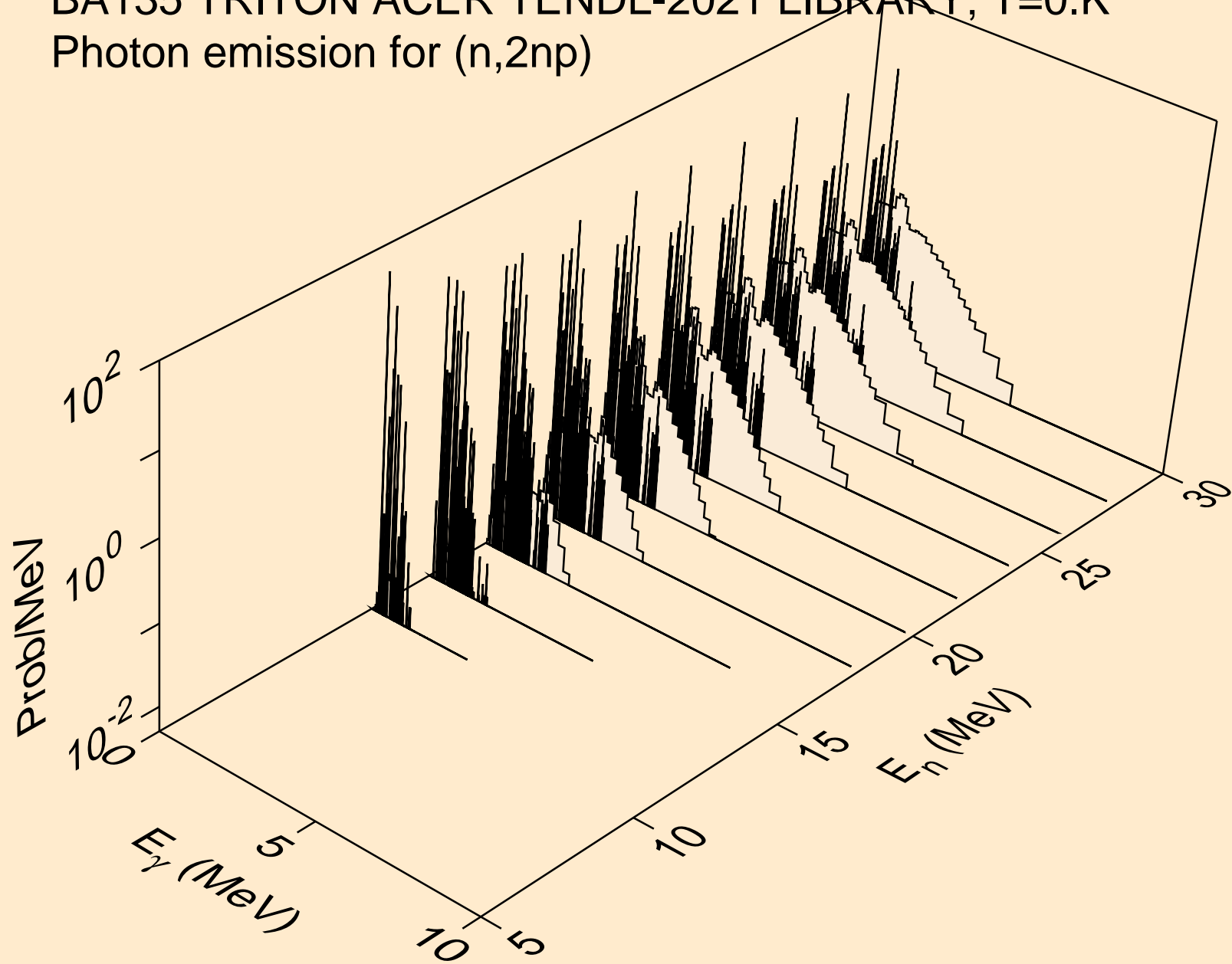

BA135 TRITON ACER TENDL-2021 LIBRARY; T=0.K  
Photon emission for (n,3np)

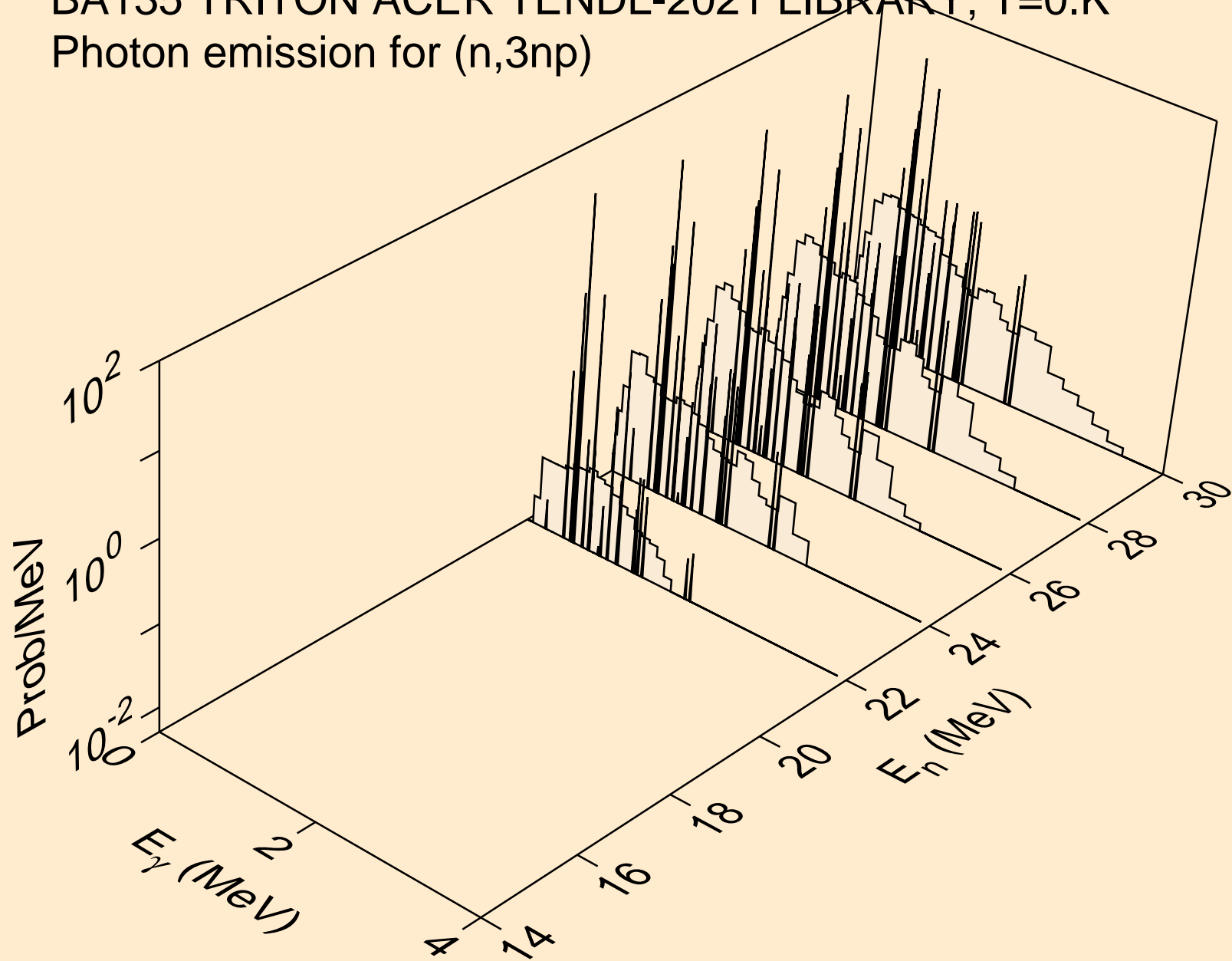

BA135 TRITON ACER TENDL-2021 LIBRARY; T=0.K  
Photon emission for (n,2np)

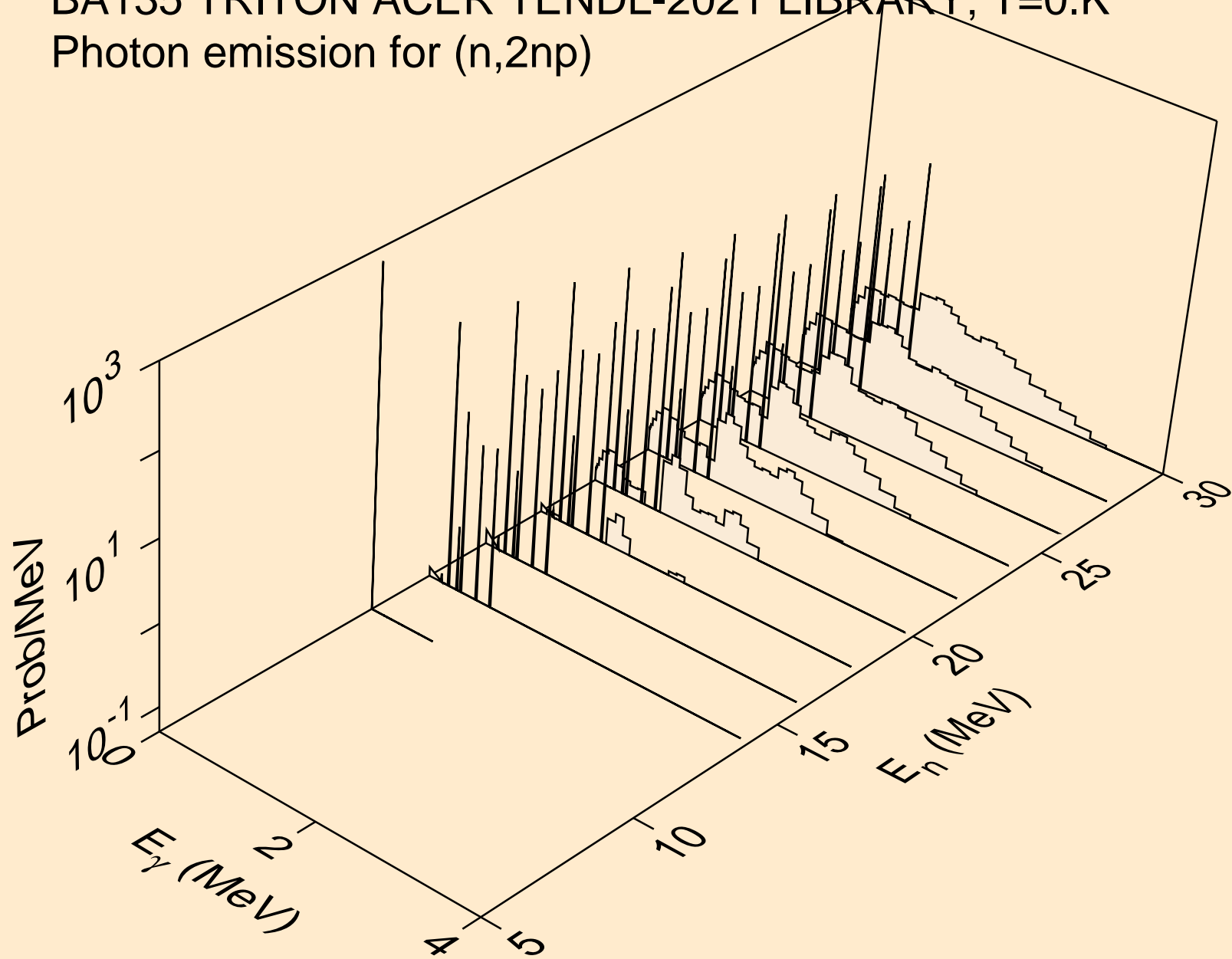

BA135 TRITON ACER TENDL-2021 LIBRARY; T=0.K  
Photon emission for (n,npa)

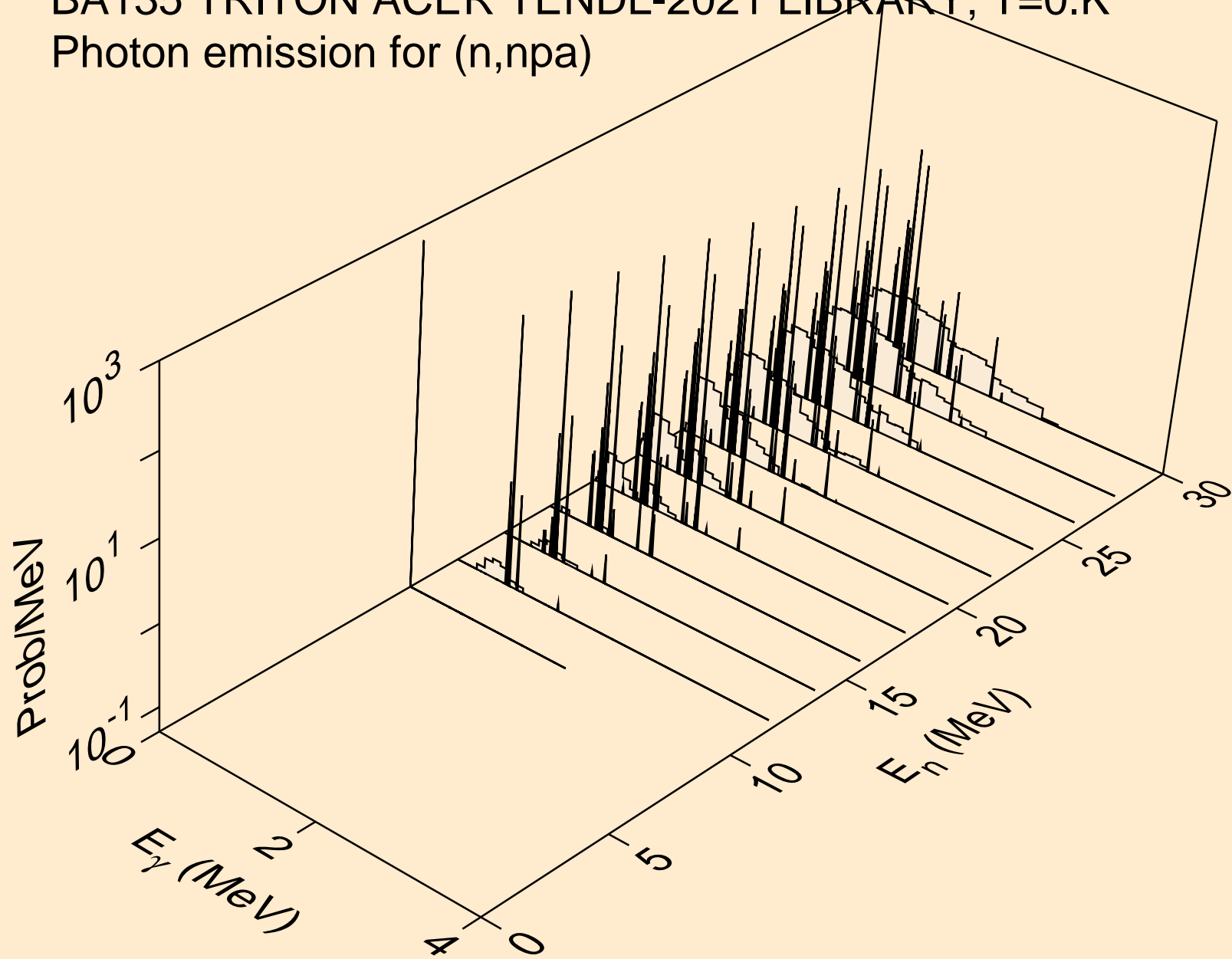

BA135 TRITON ACER TENDL-2021 LIBRARY; T=0.K  
Photon emission for (n,gma)

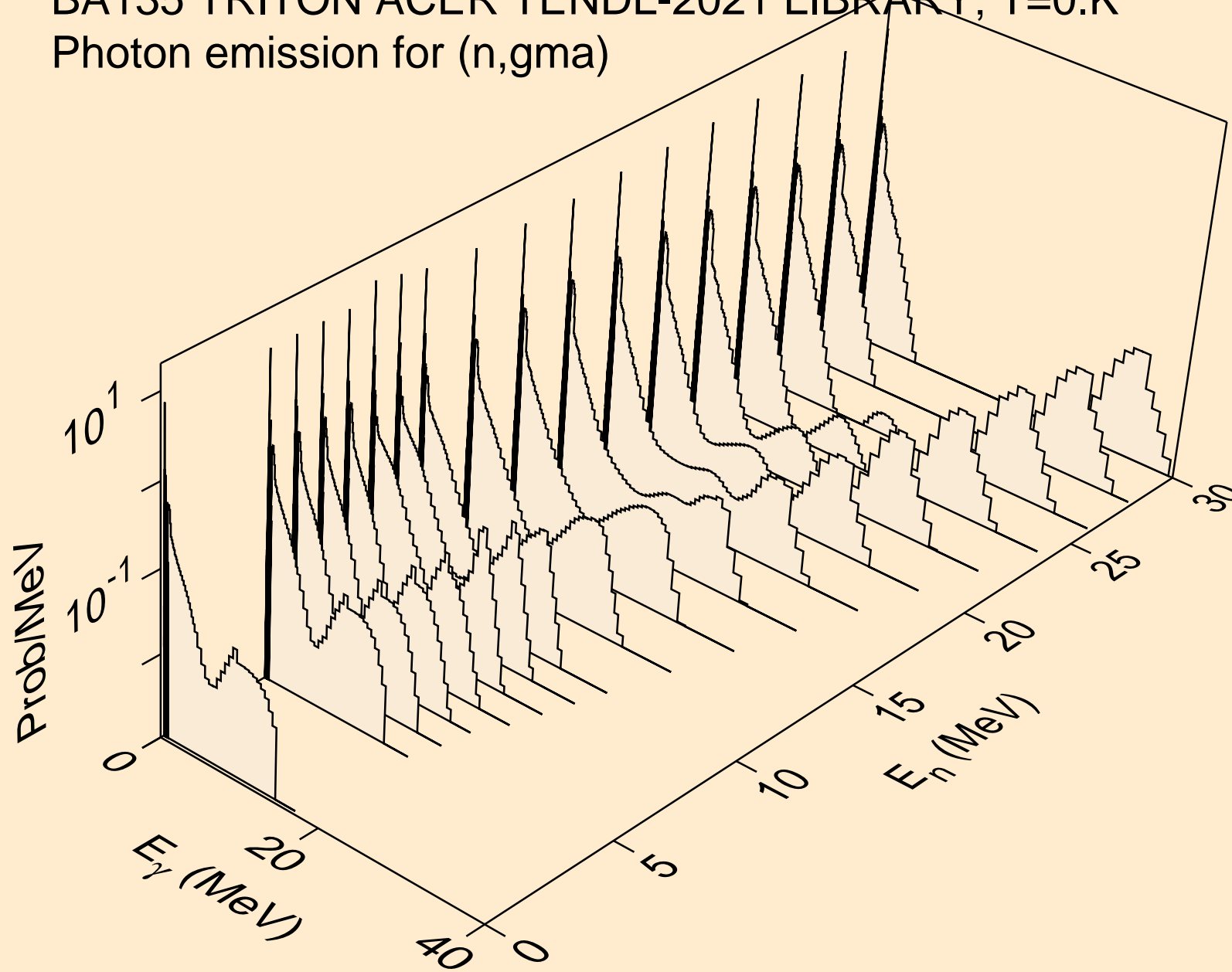



BA135 TRITON ACER TENDL-2021 LIBRARY; T=0.K  
Photon emission for (n,p)

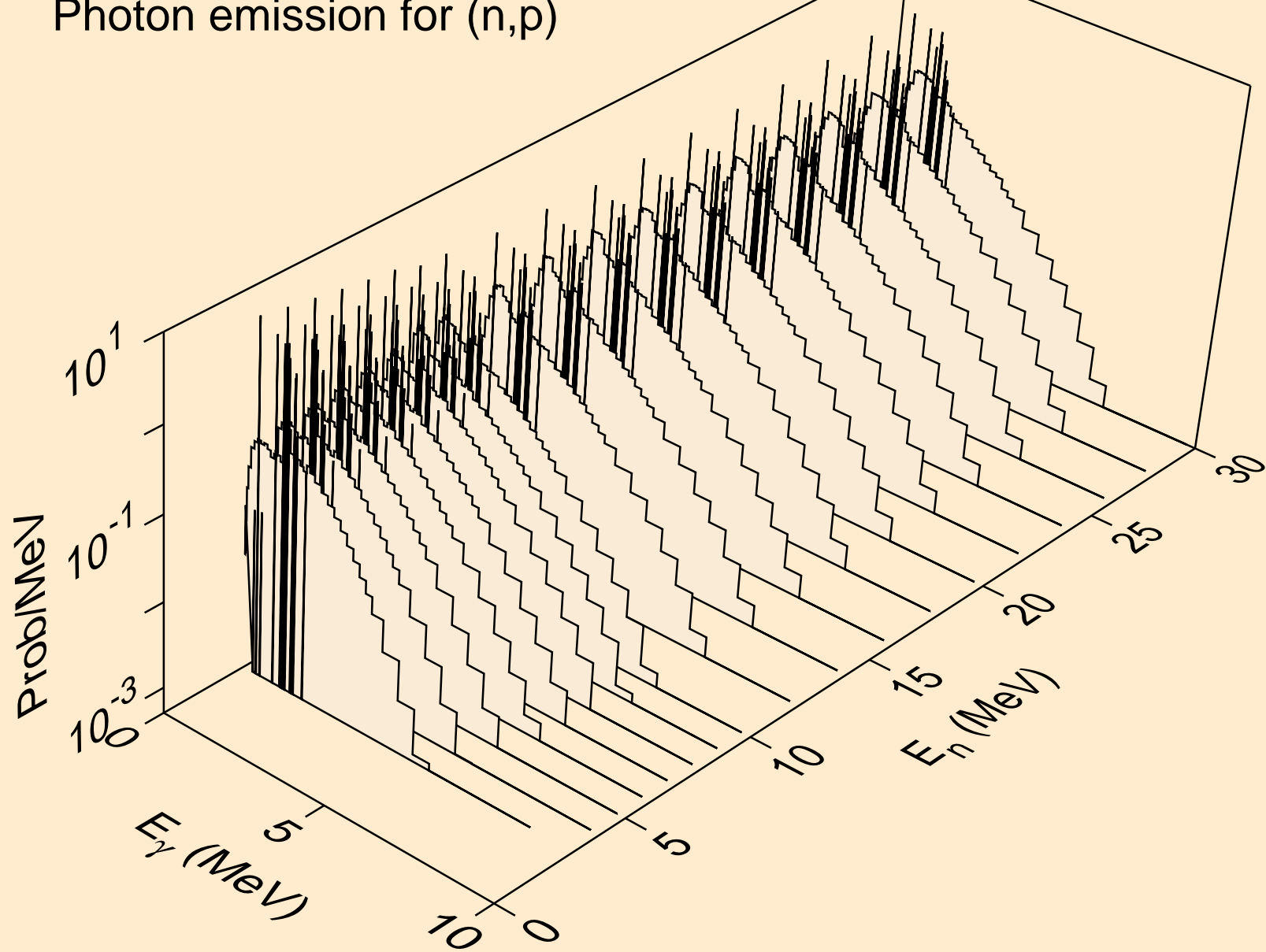

BA135 TRITON ACER TENDL-2021 LIBRARY; T=0.K  
Photon emission for (n,d)

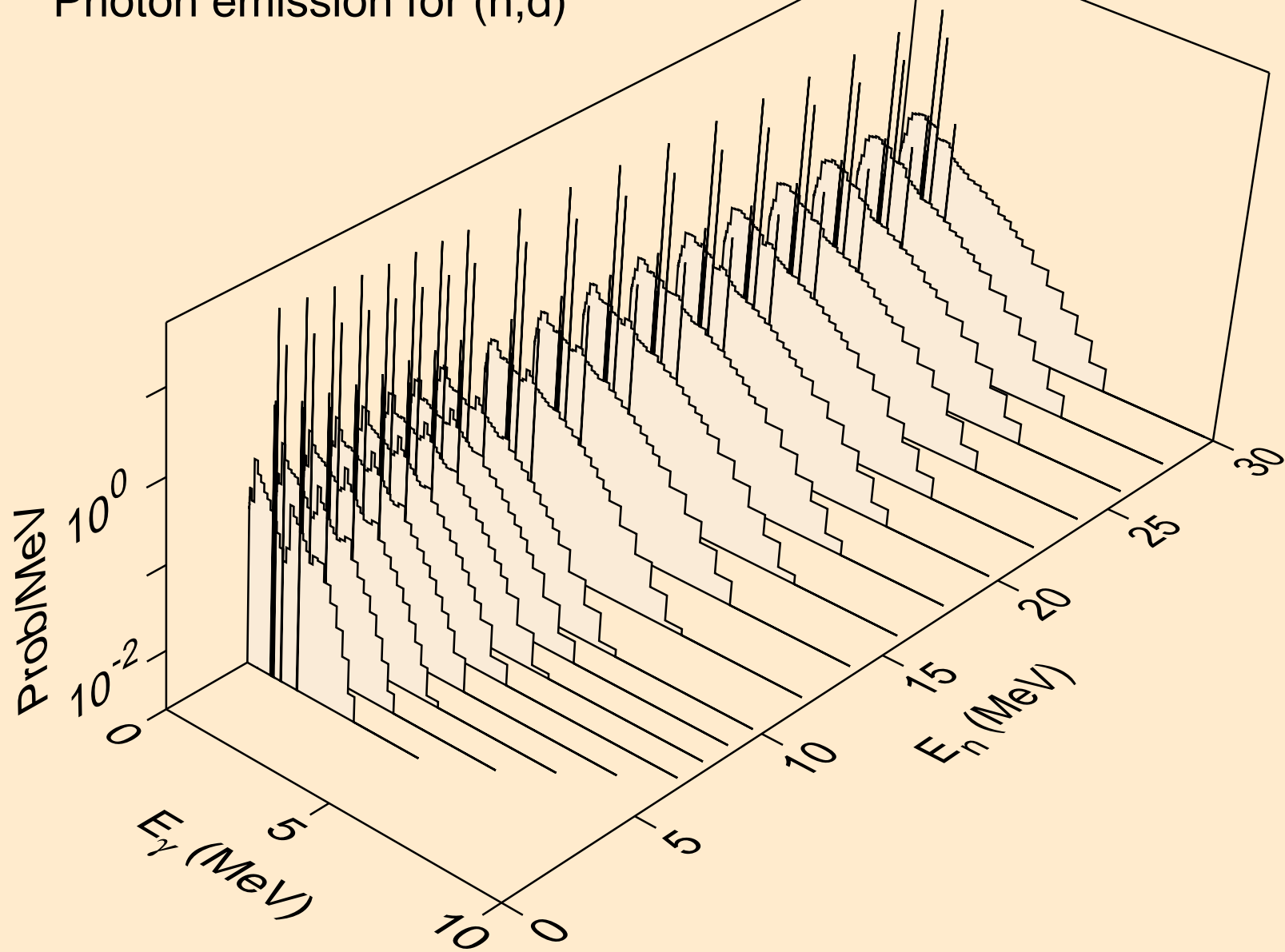

BA135 TRITON ACER TENDL-2021 LIBRARY; T=0.K  
Photon emission for inelastic

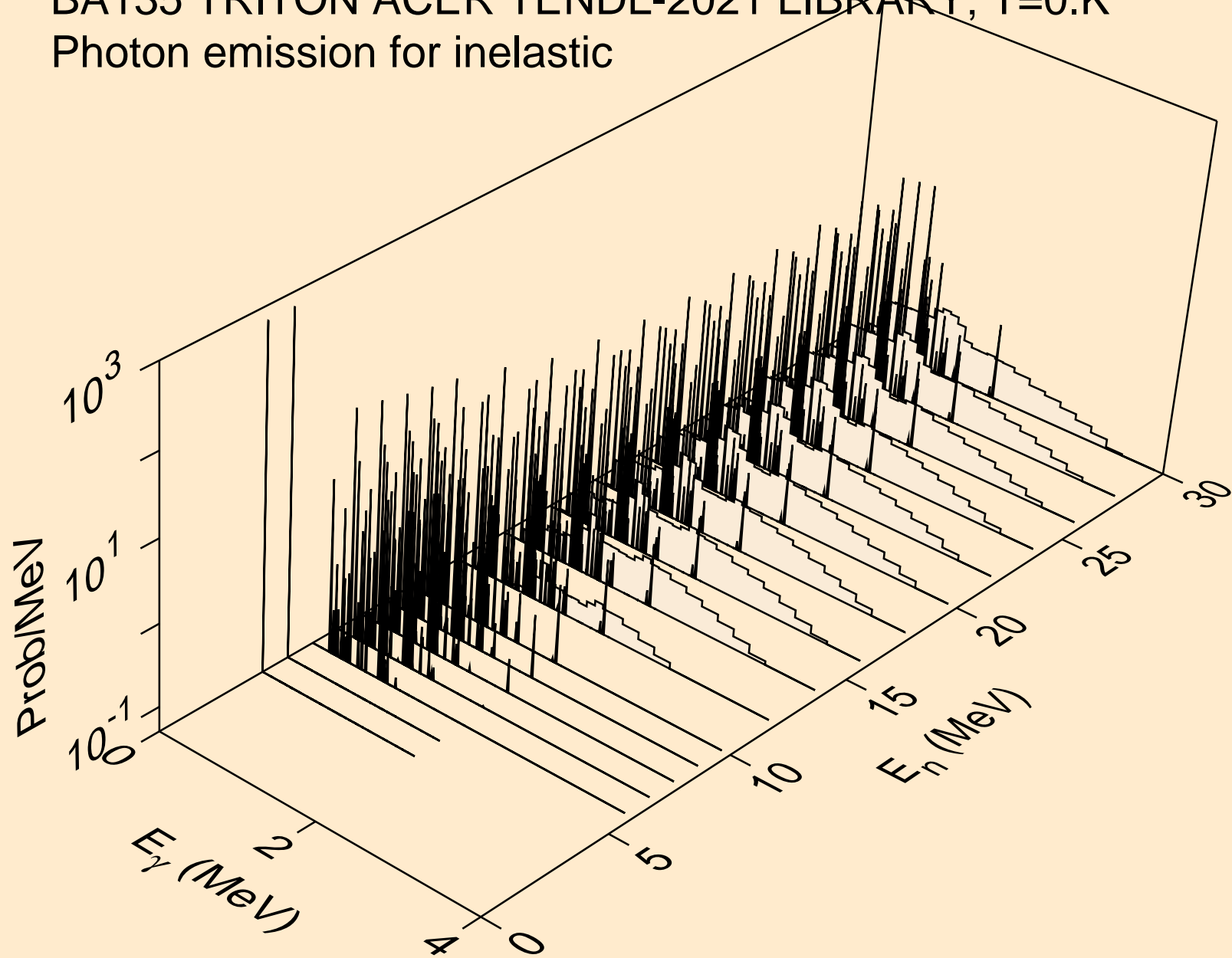

BA135 TRITON ACER TENDL-2021 LIBRARY; T=0.K  
Photon emission for (n,he3)

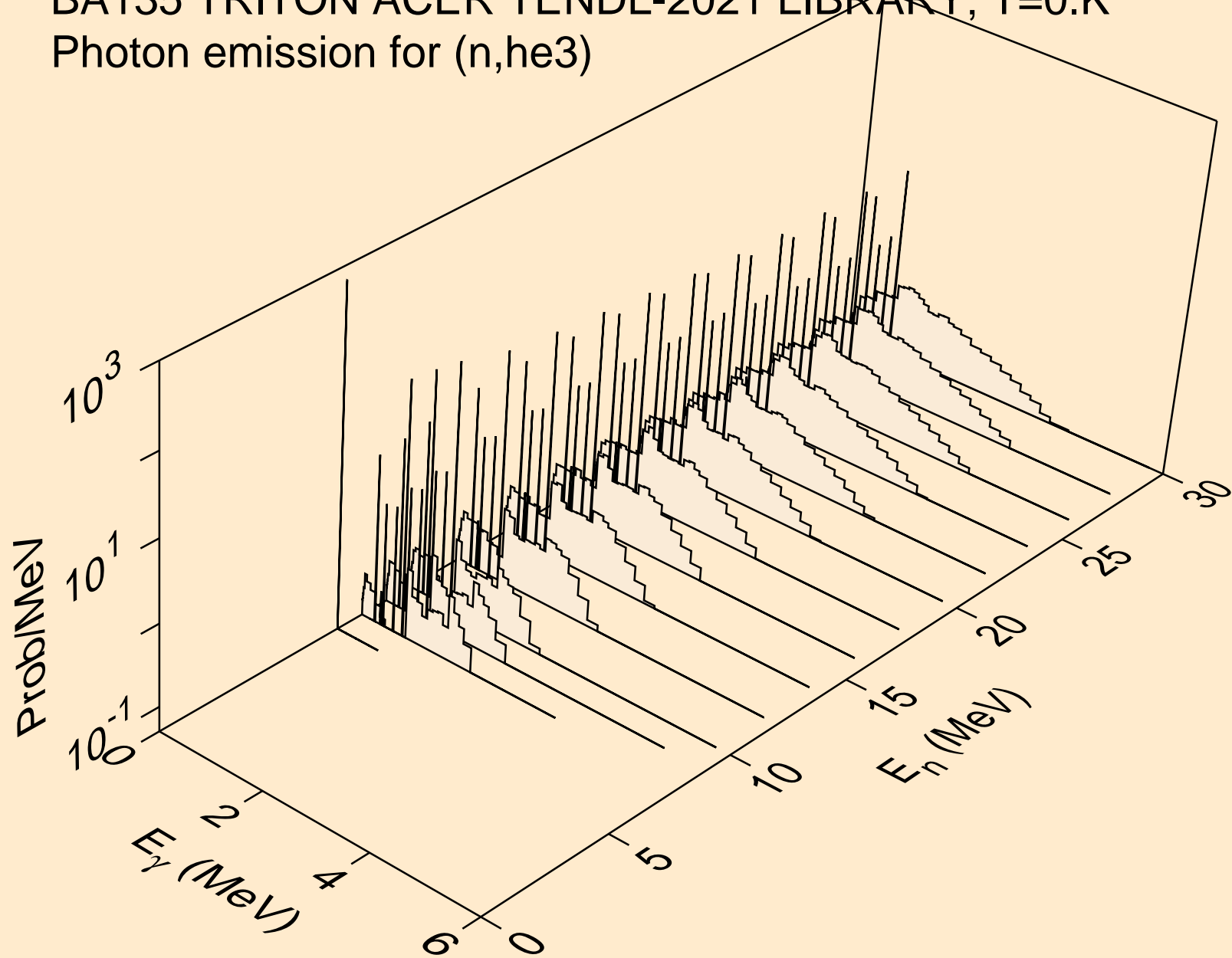

BA135 TRITON ACER TENDL-2021 LIBRARY; T=0.K  
Photon emission for (n,a)

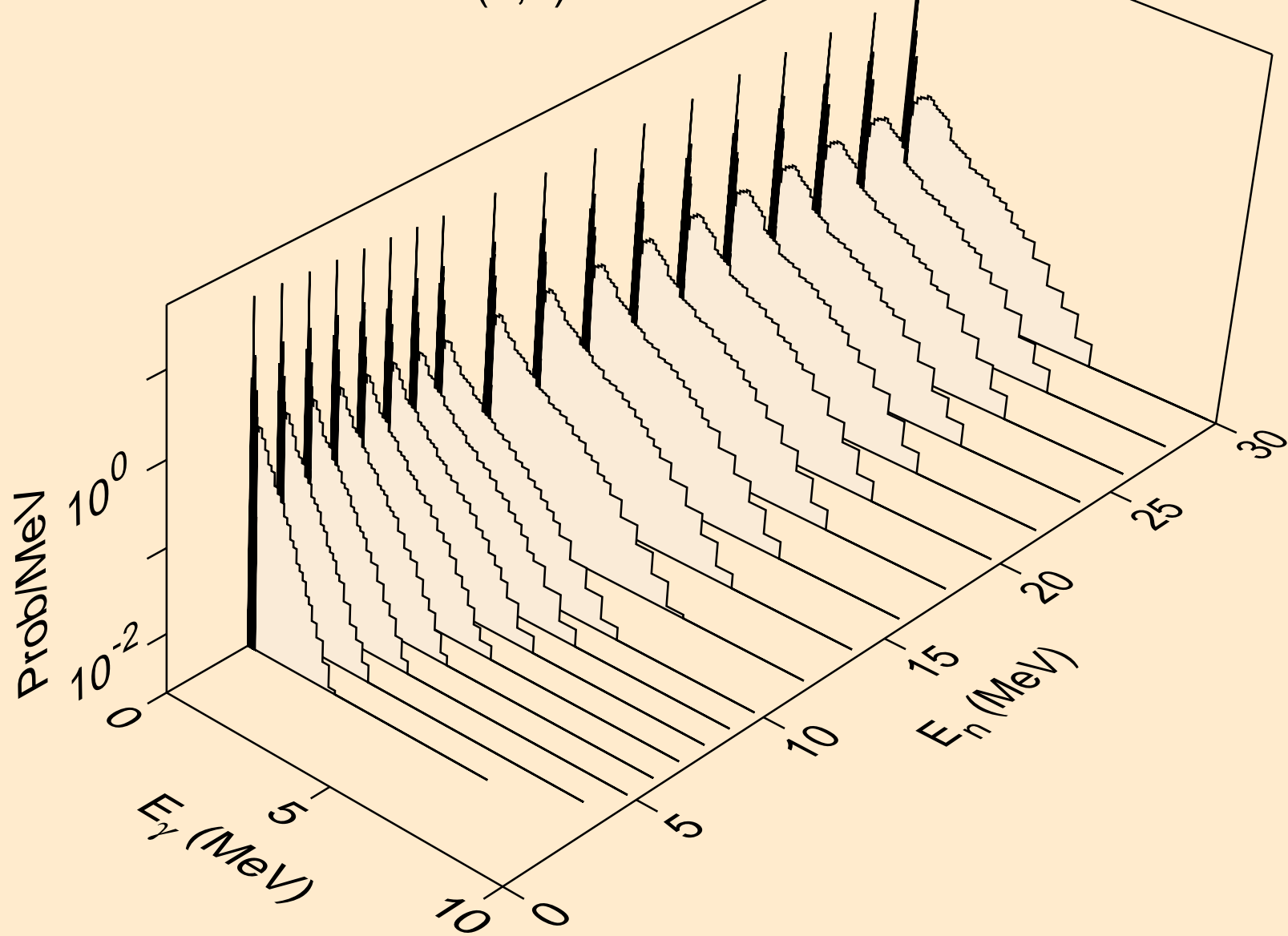

BA135 TRITON ACER TENDL-2021 LIBRARY; T=0.K  
Photon emission for (n,2a)

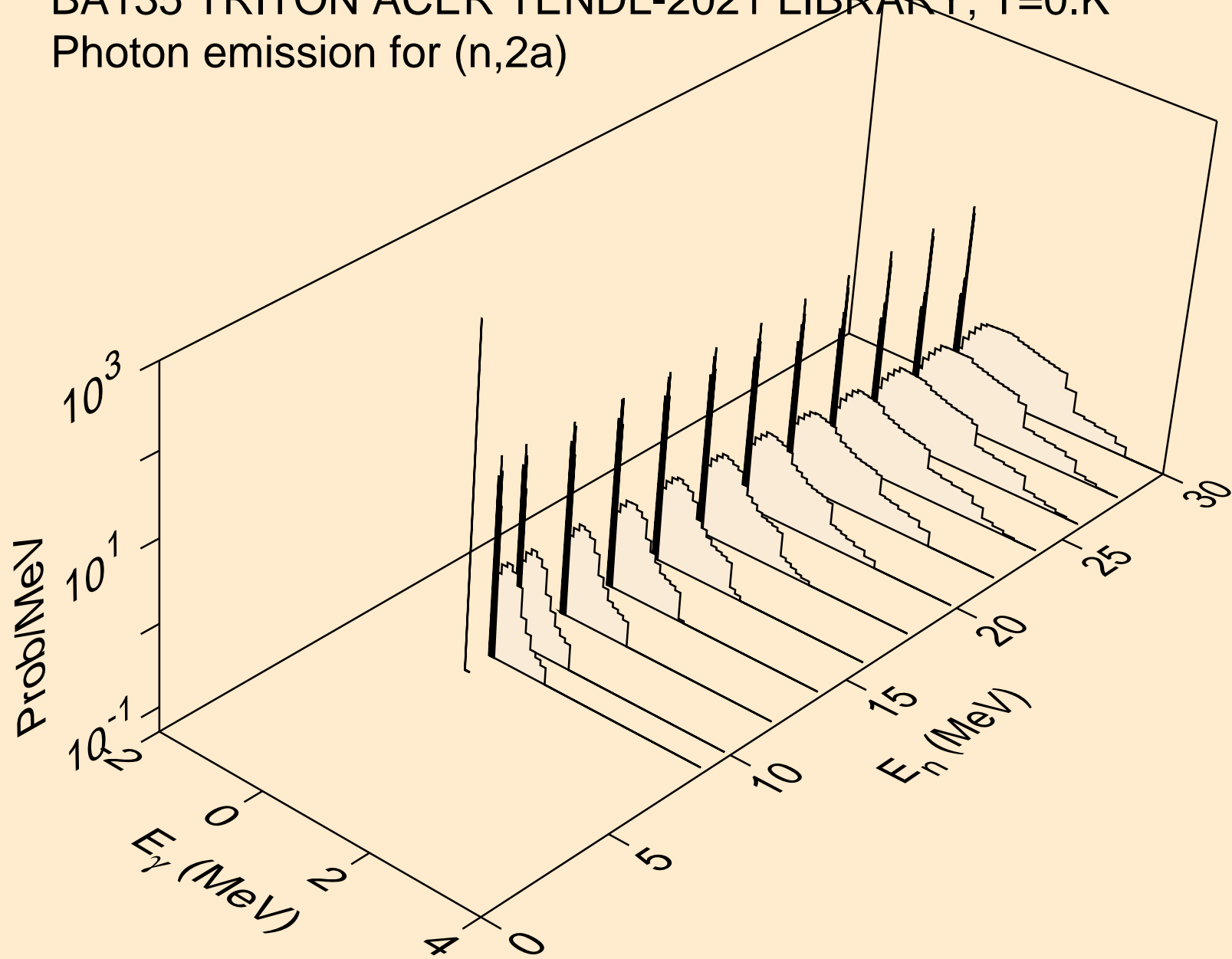

BA135 TRITON ACER TENDL-2021 LIBRARY; T=0.K  
Photon emission for (n,2p)

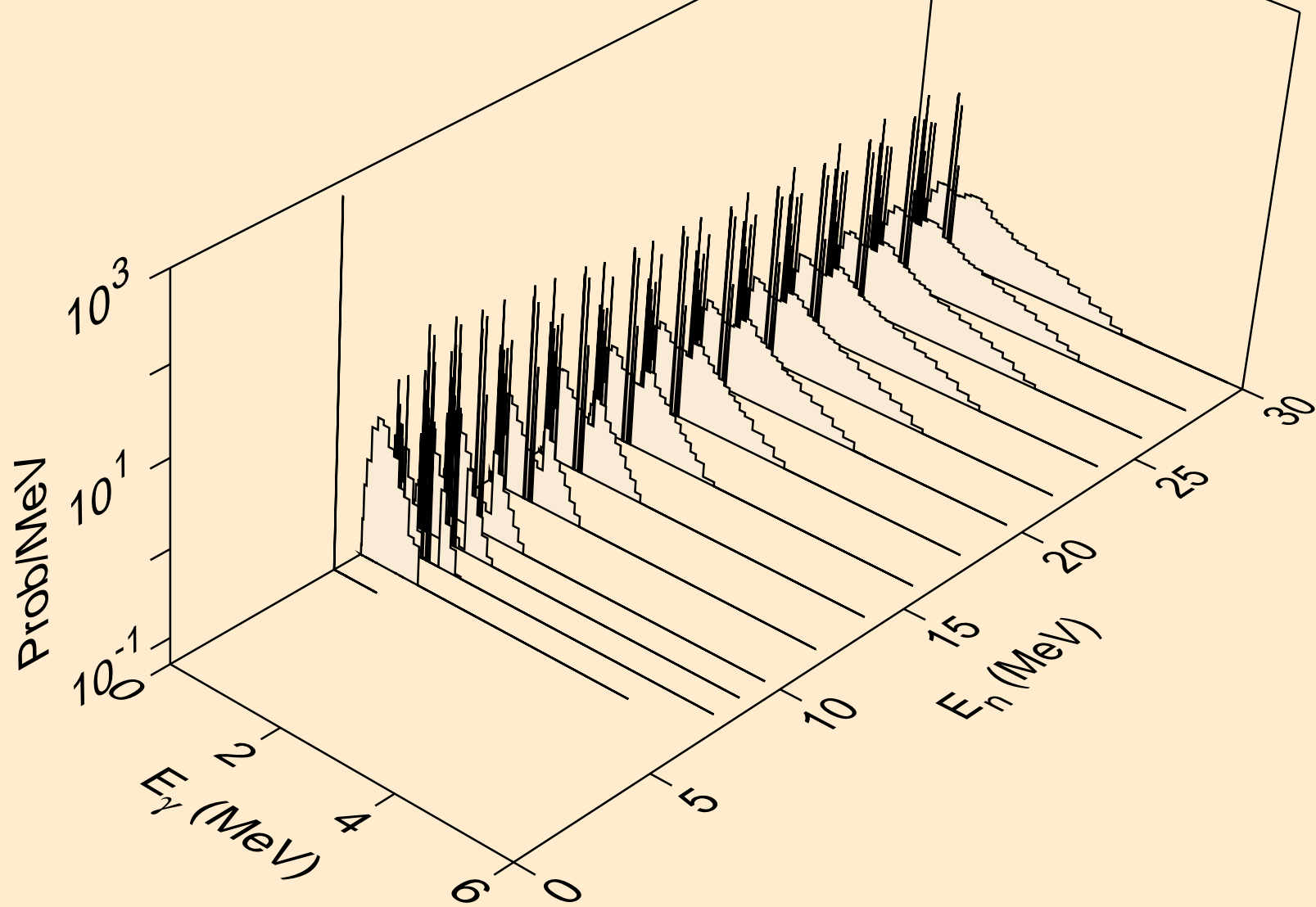

BA135 TRITON ACER TENDL-2021 LIBRARY; T=0.K  
Photon emission for (n,pa)

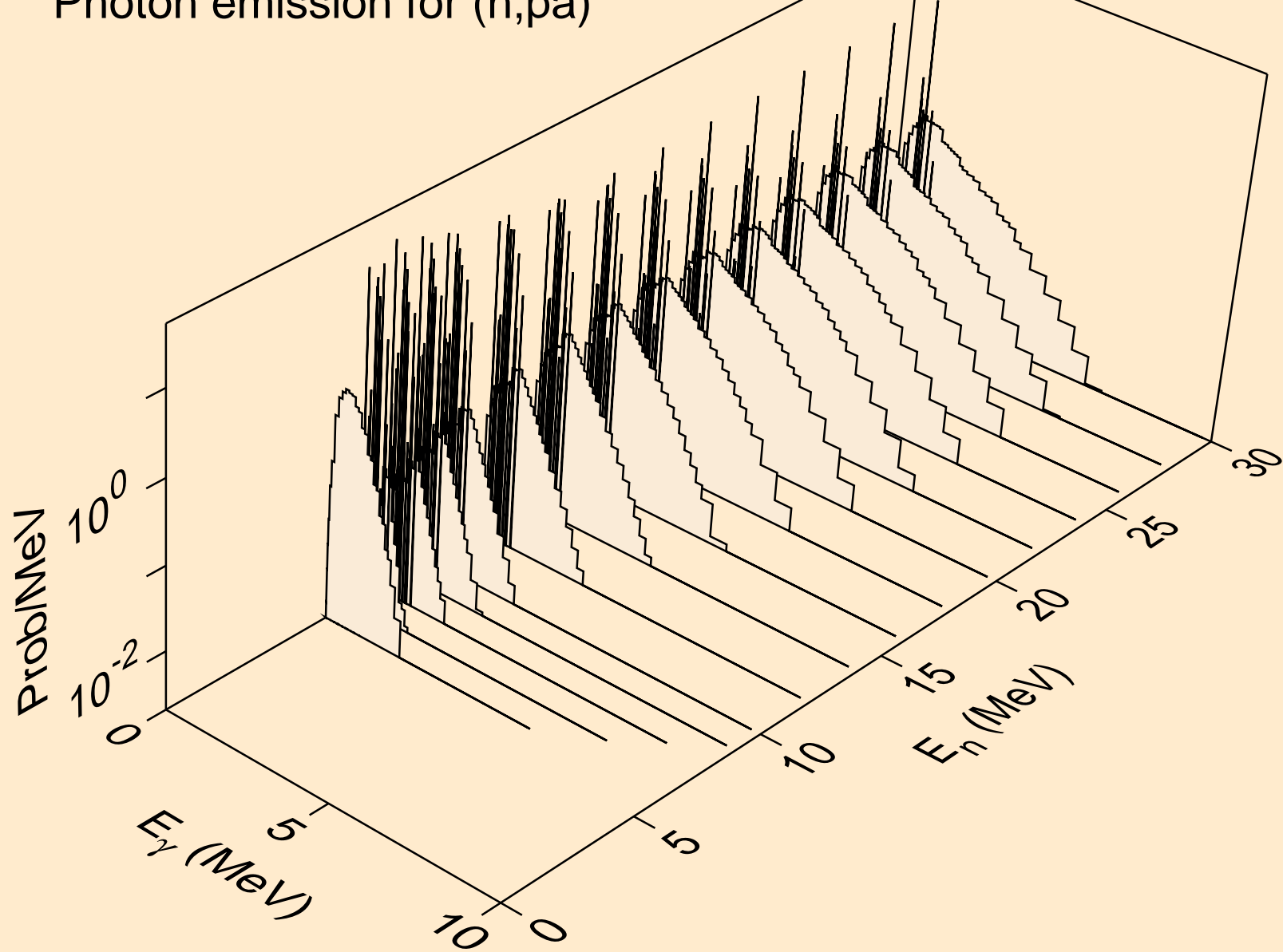



BA135 TRITON ACER TENDL-2021 LIBRARY; T=0.K  
Photon emission for (n,pd)

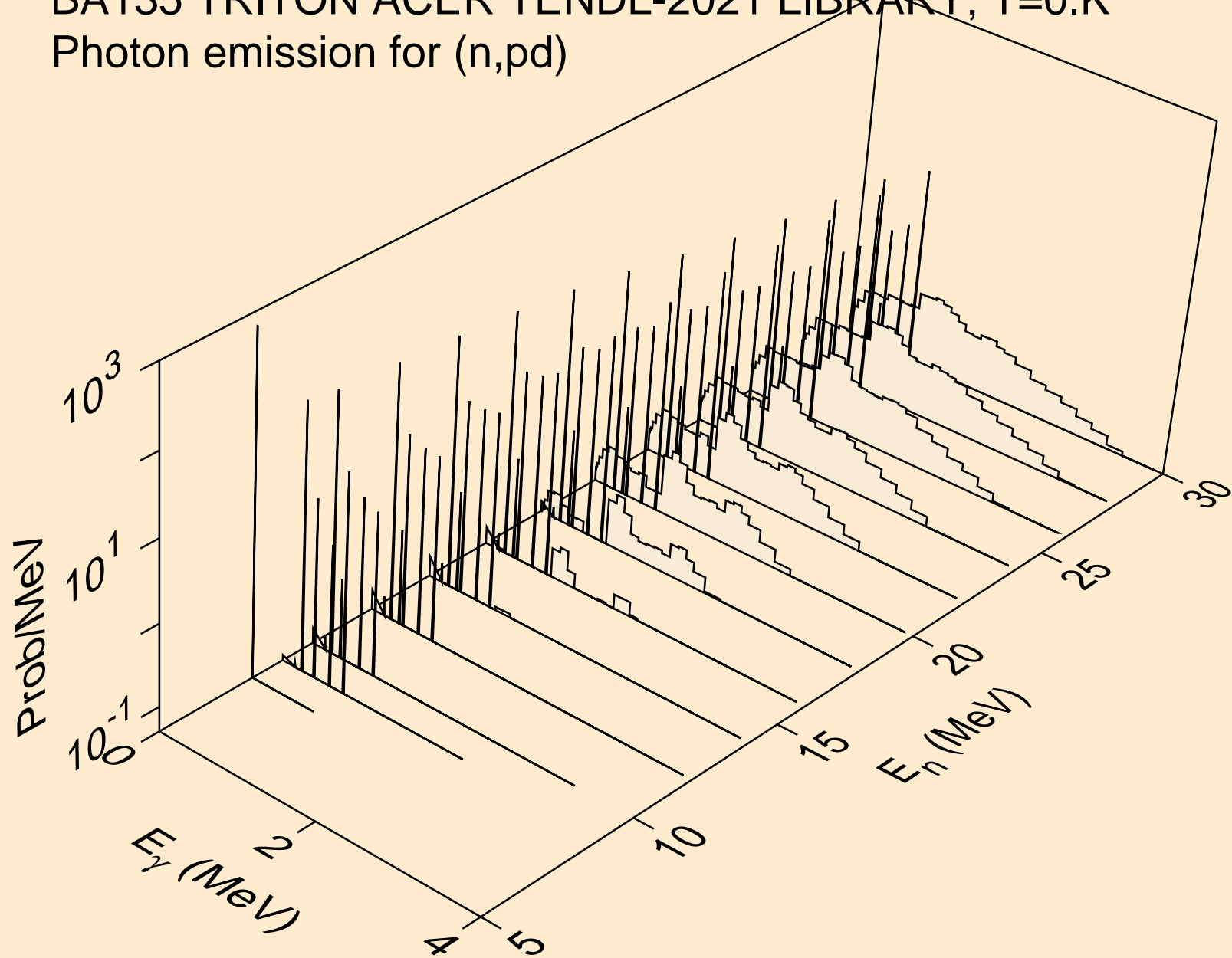

BA135 TRITON ACER TENDL-2021 LIBRARY; T=0.K  
Photon emission for (n,pt)

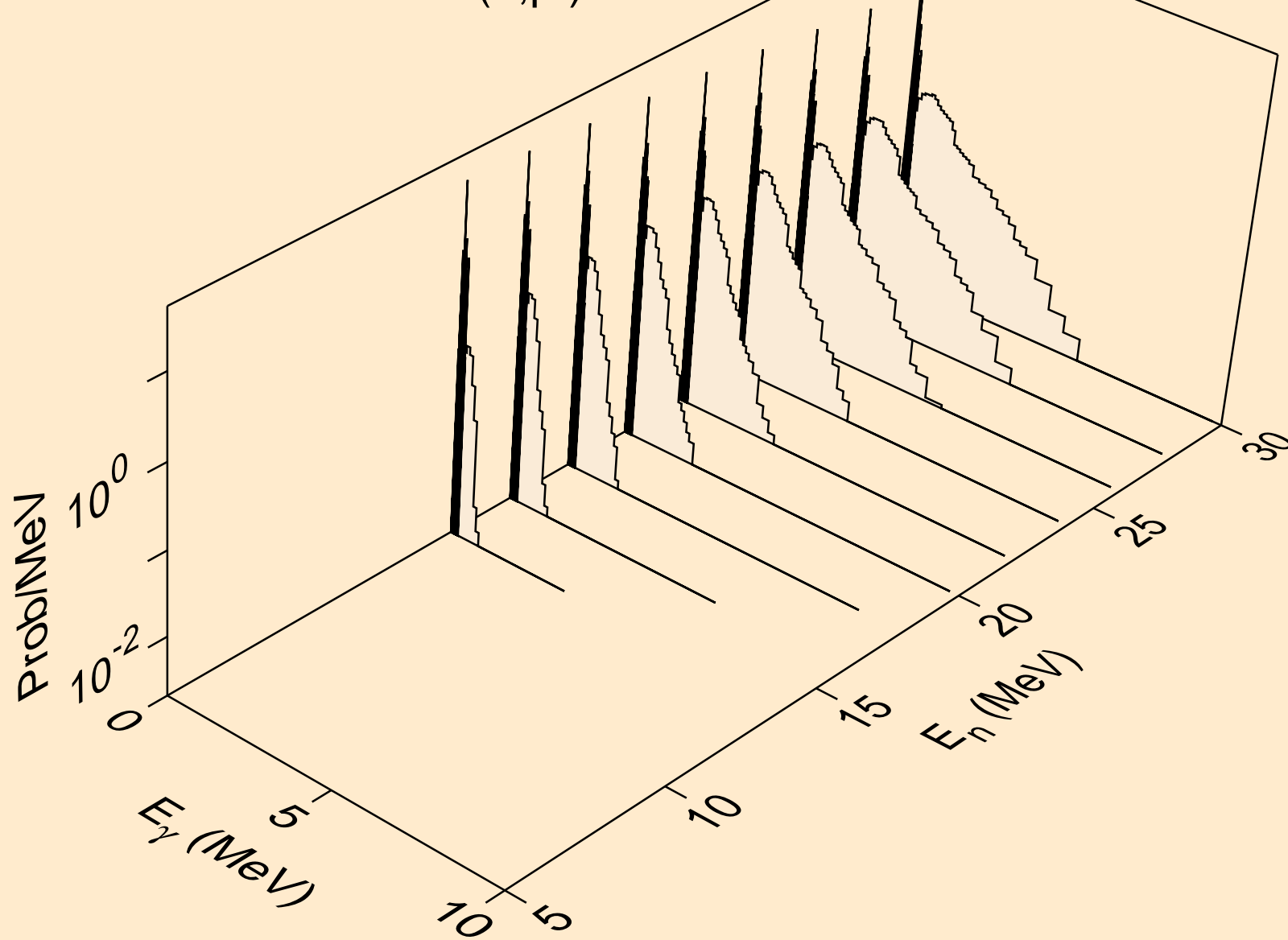

BA135 TRITON ACER TENDL-2021 LIBRARY; T=0.K  
Photon emission for (n,da)

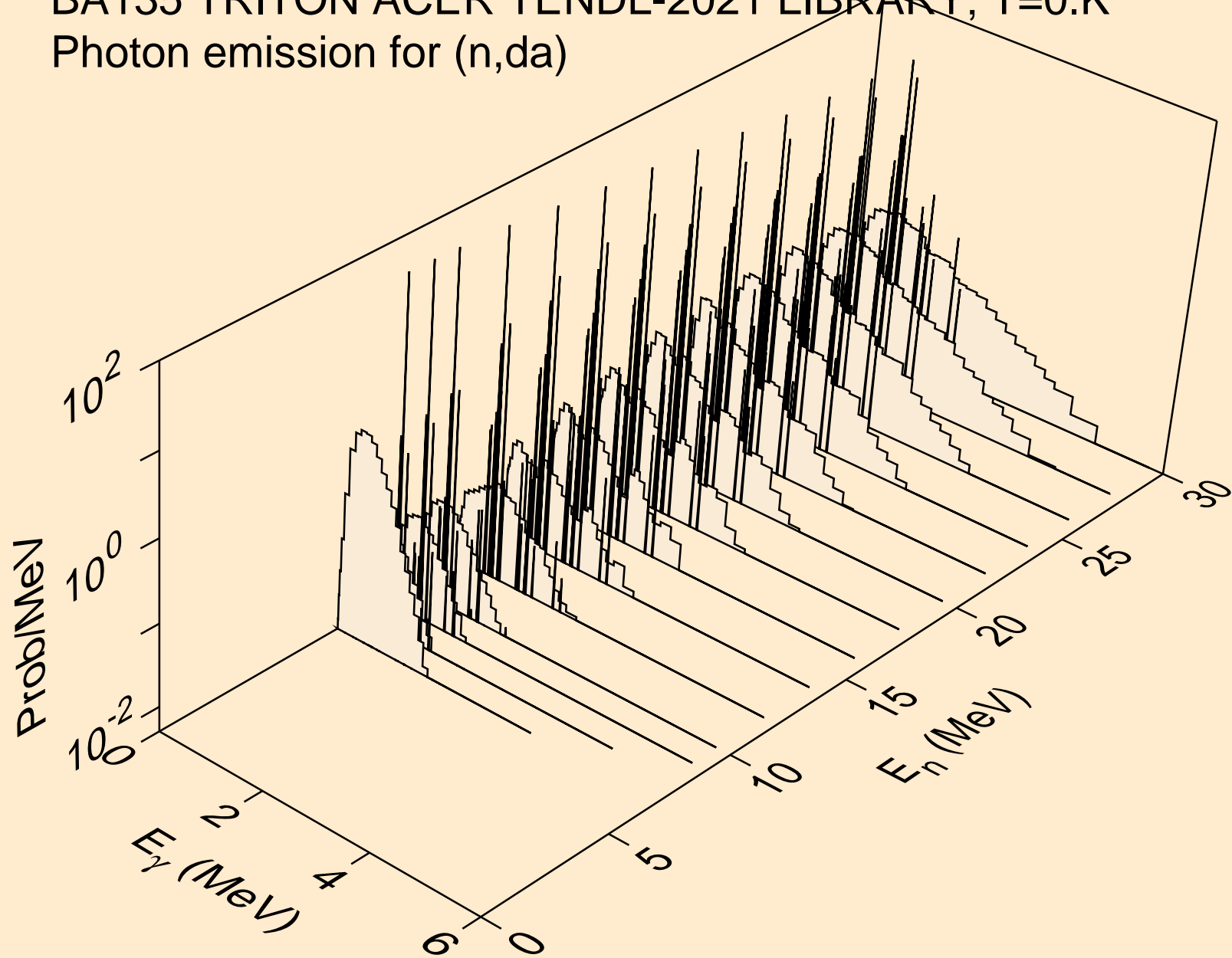

BA135 TRITON ACER TENDL-2021 LIBRARY; T=0.K  
Particle heating contributions

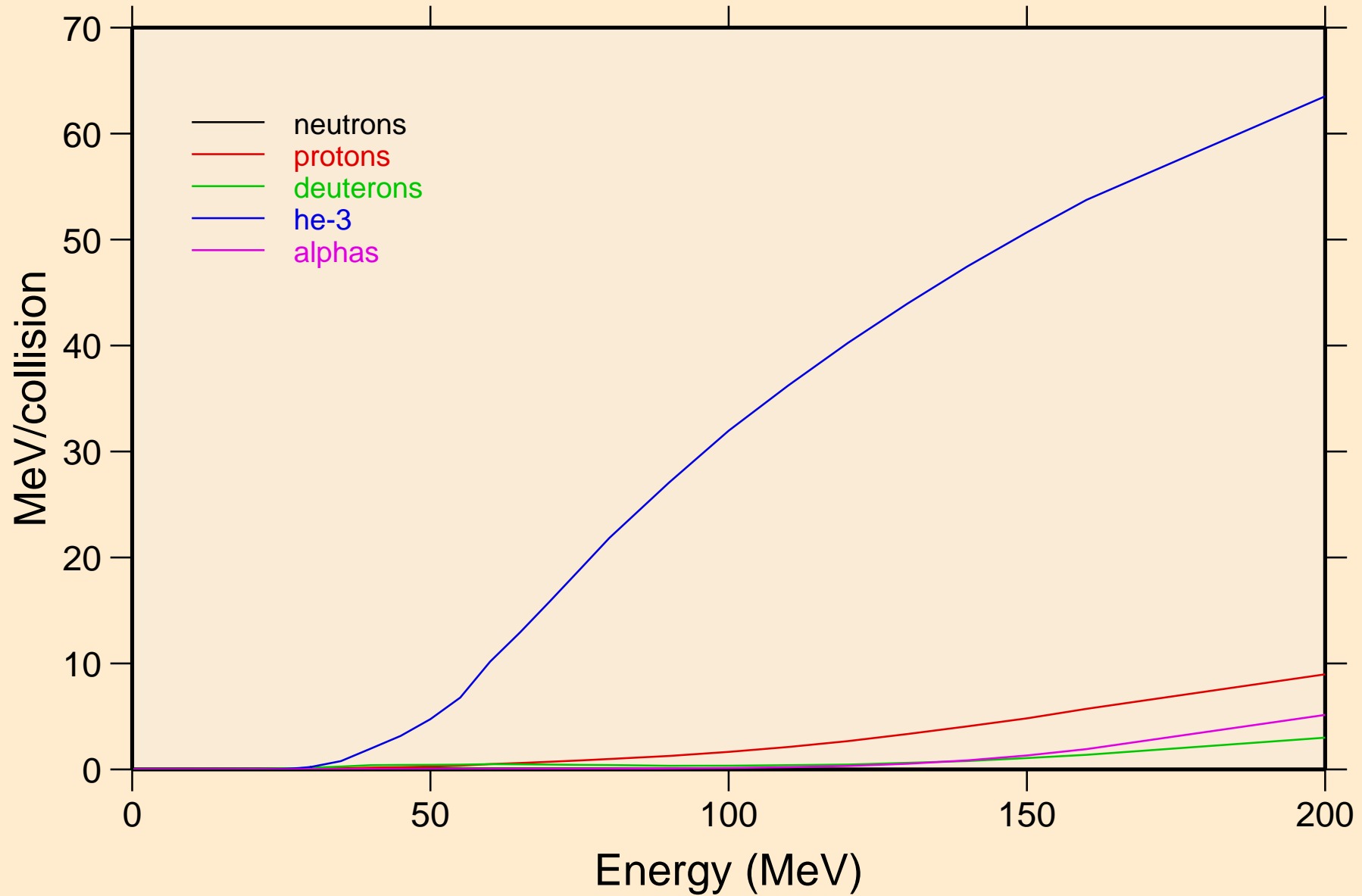

BA135 TRITON ACER TENDL-2021 LIBRARY; T=0.K  
Recoil Heating

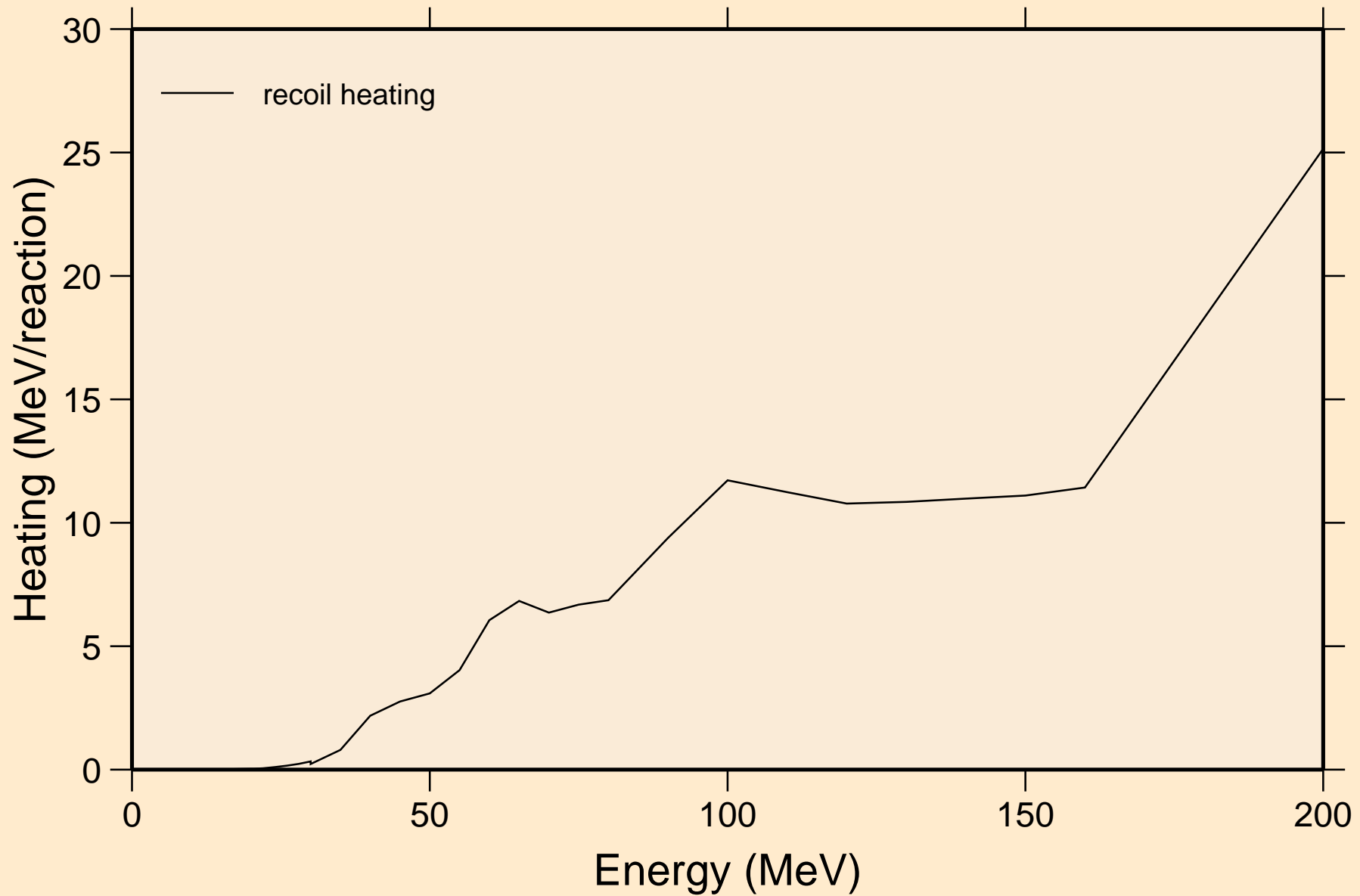

BA135 TRITON ACER TENDL-2021 LIBRARY; T=0.K  
Particle production cross sections

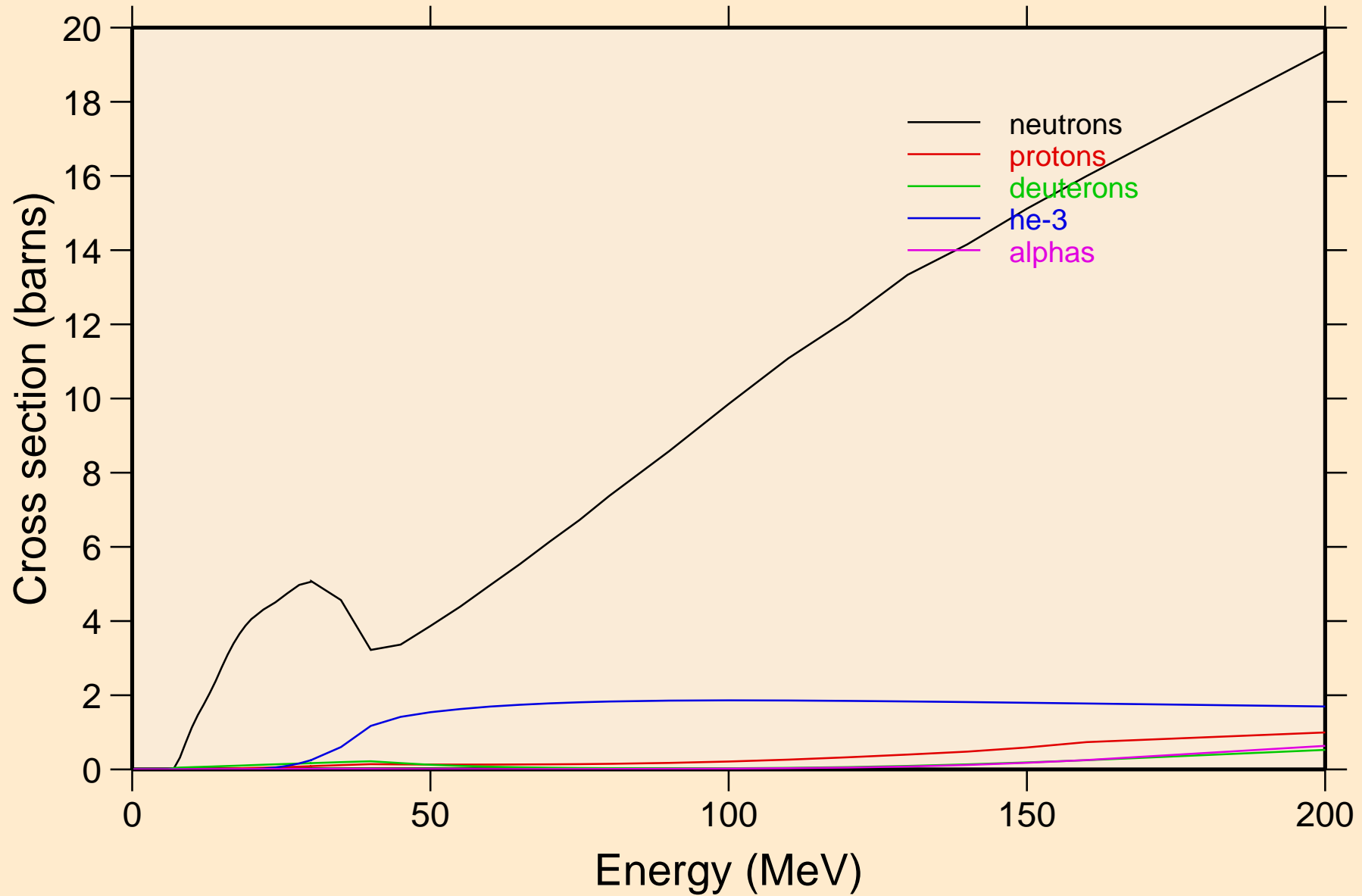

BA135 TRITON ACER TENDL-2021 LIBRARY; T=0.K  
neutrons from (t,n)

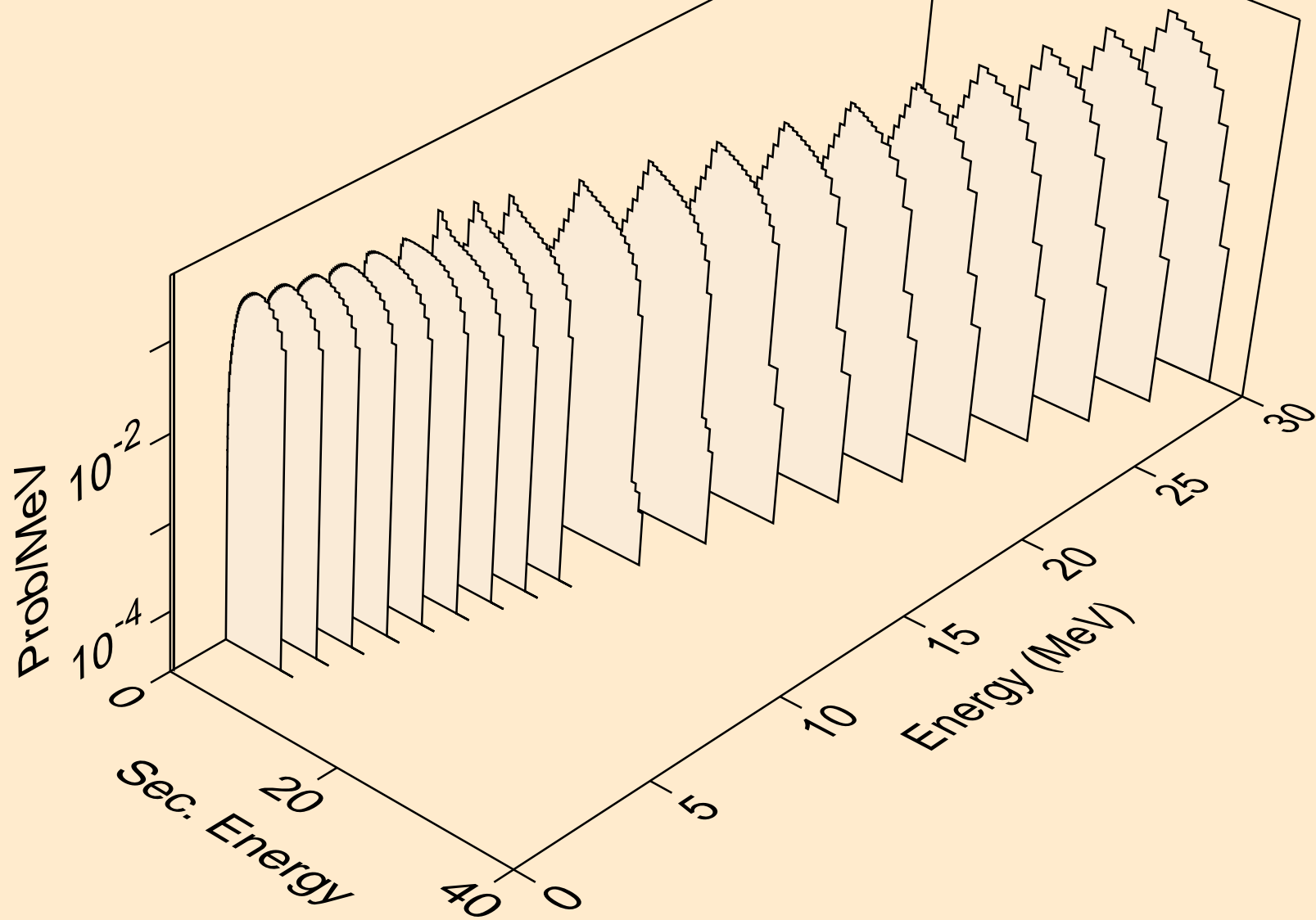

BA135 TRITON ACER TENDL-2021 LIBRARY; T=0.K  
neutrons from (t,x)

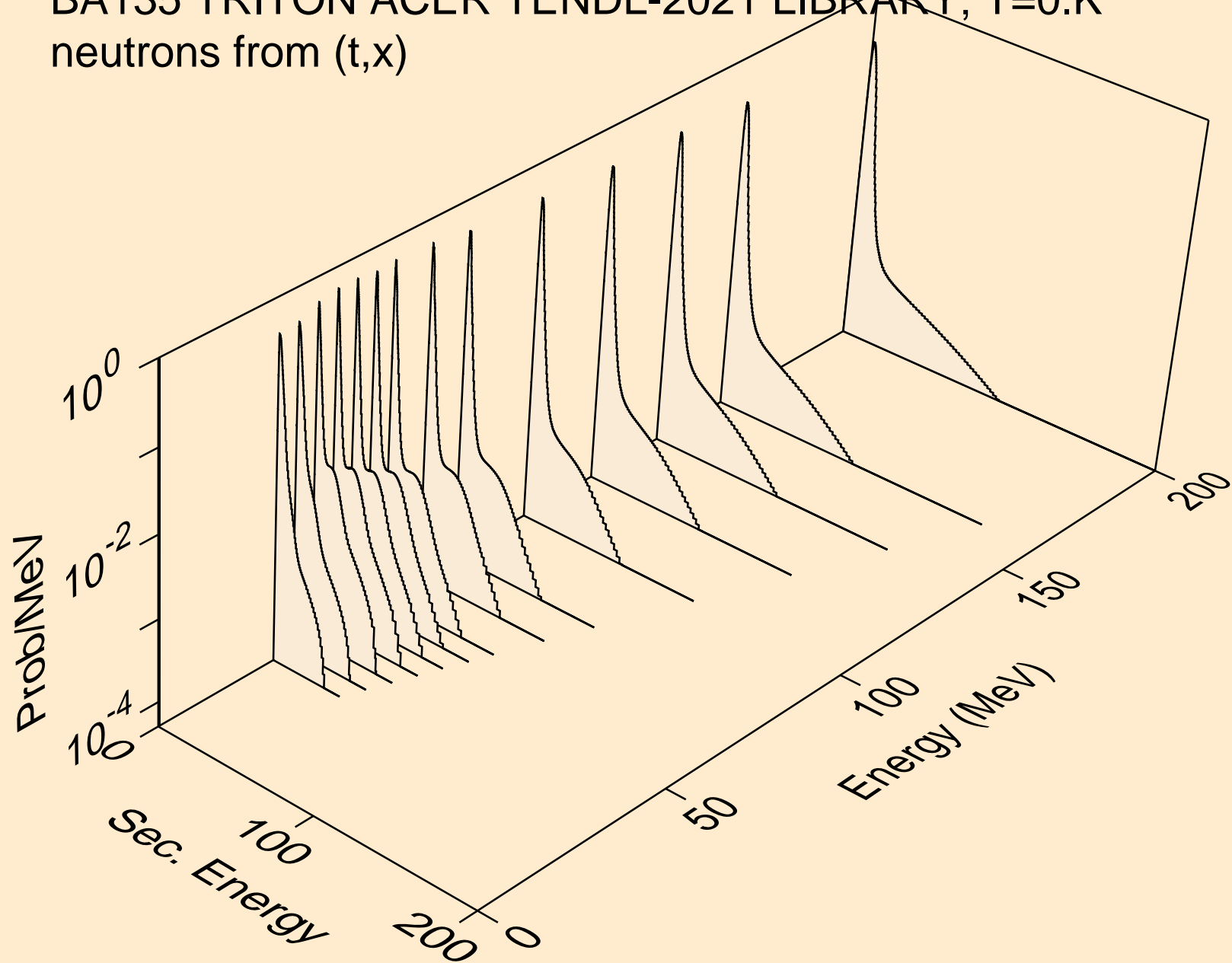



BA135 TRITON ACER TENDL-2021 LIBRARY; T=0.K  
neutrons from (t,2nd)

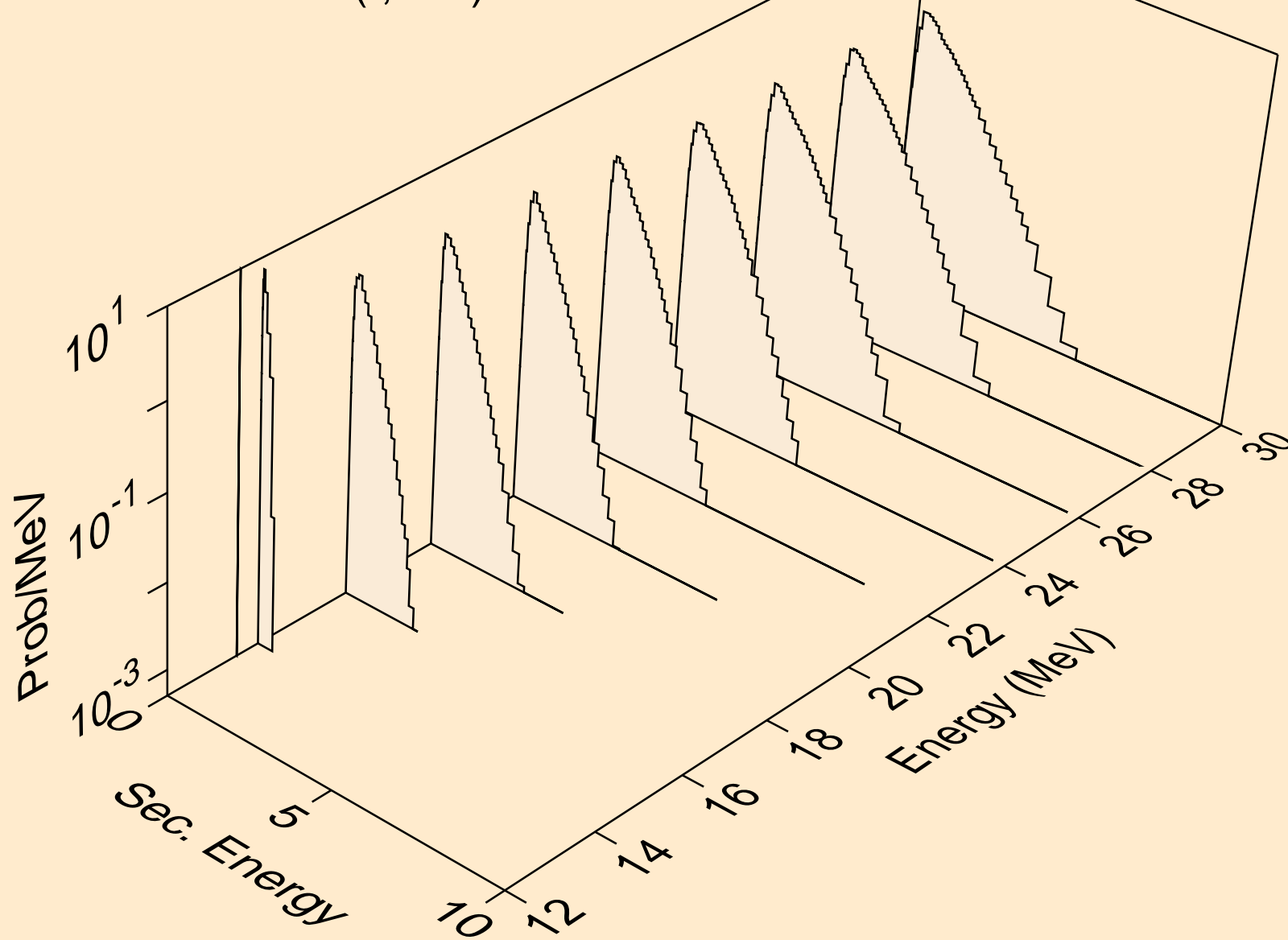

BA135 TRITON ACER TENDL-2021 LIBRARY; T=0.K  
neutrons from (t,2n)

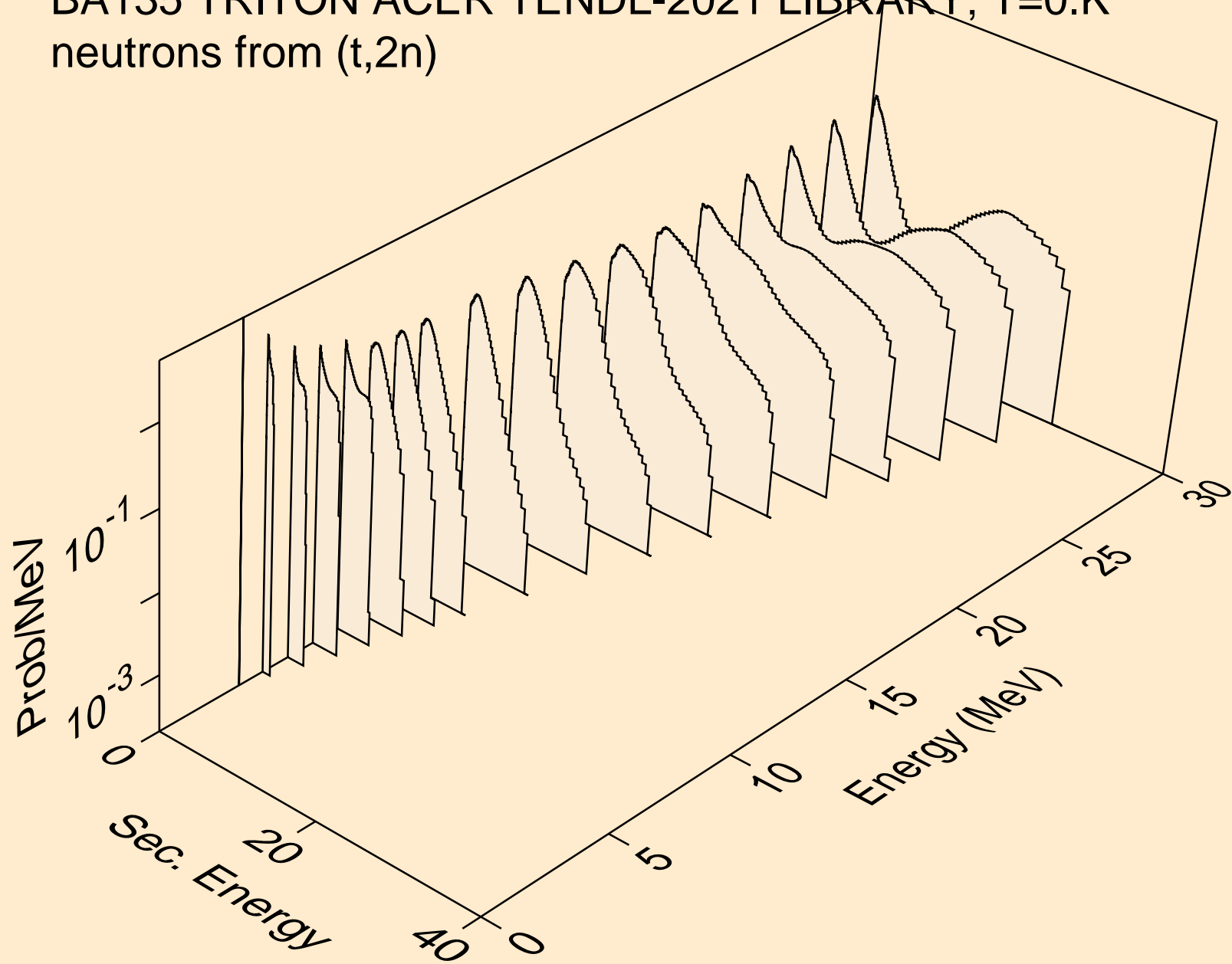

BA135 TRITON ACER TENDL-2021 LIBRARY; T=0.K  
neutrons from (t,3n)

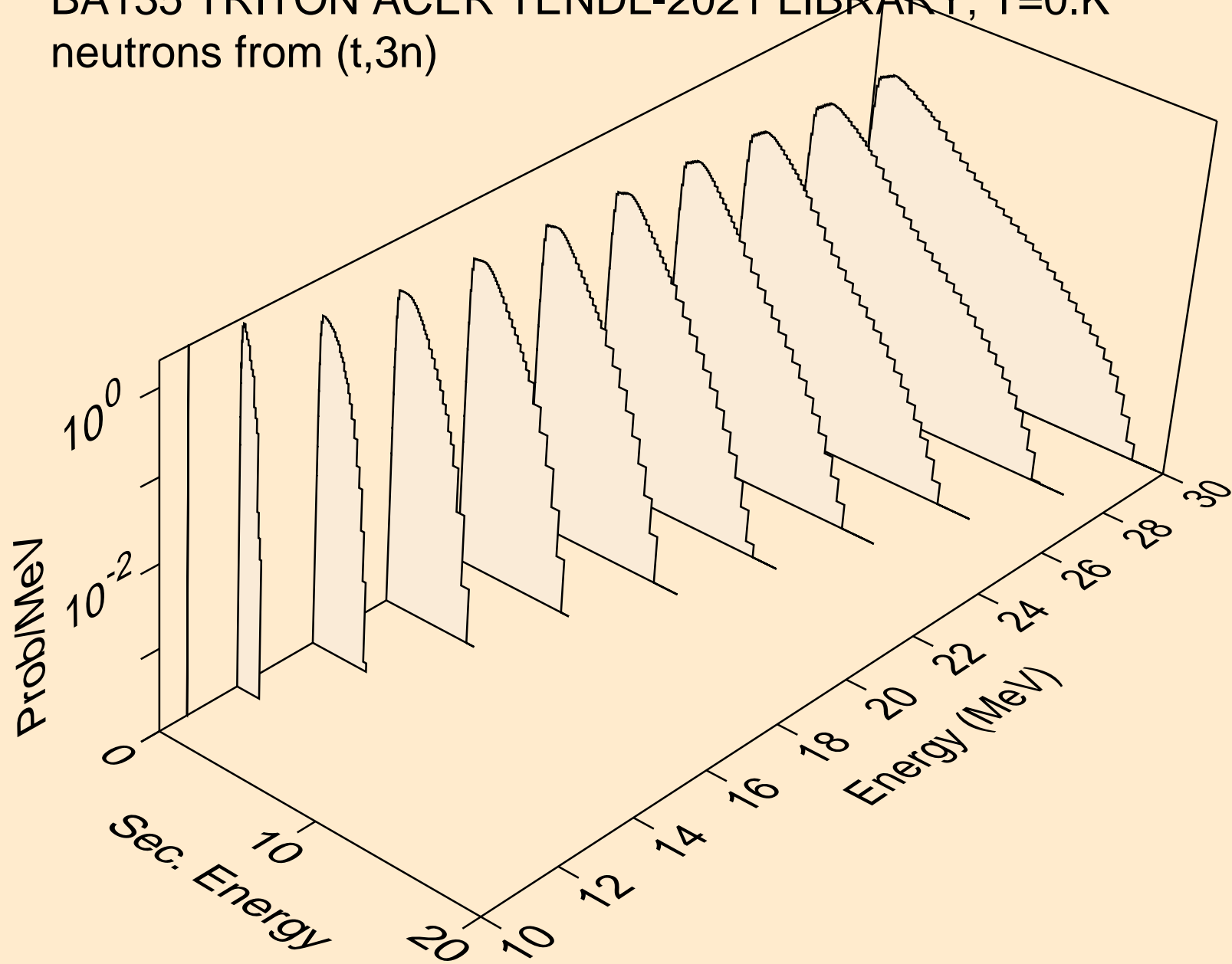

BA135 TRITON ACER TENDL-2021 LIBRARY; T=0.K  
neutrons from (t,n\*)a

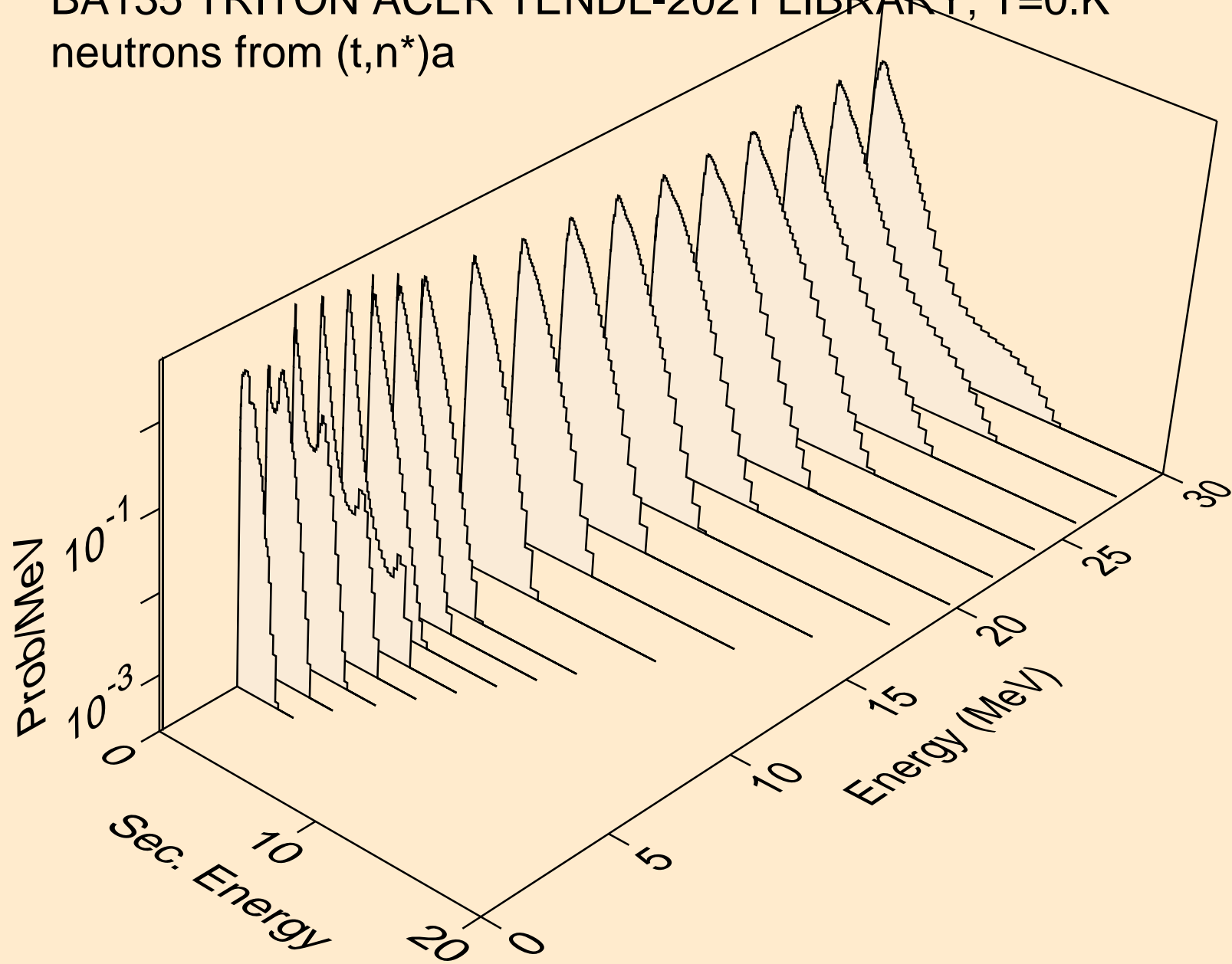

BA135 TRITON ACER TENDL-2021 LIBRARY; T=0.K  
neutrons from (t,2n)a

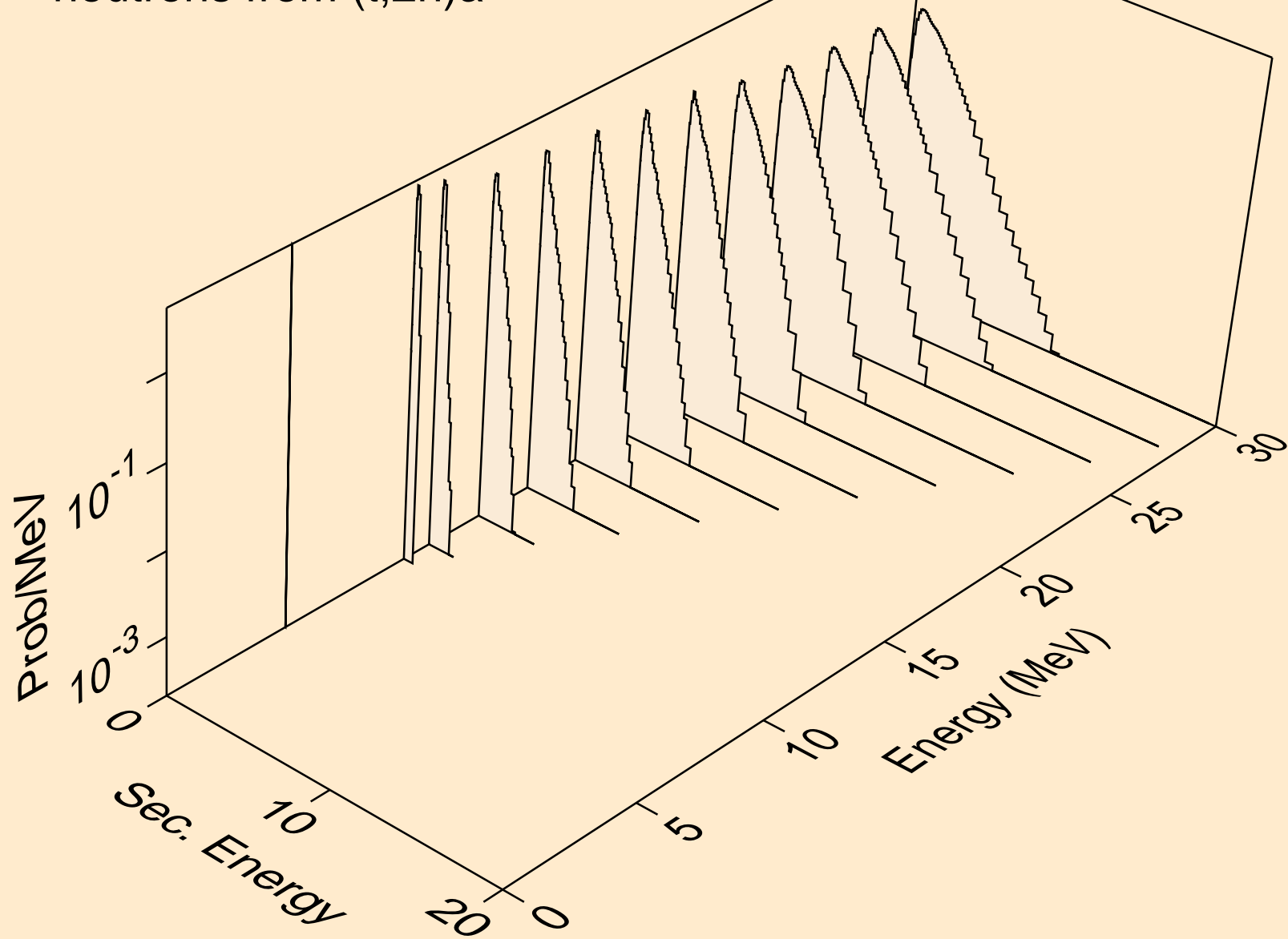

BA135 TRITON ACER TENDL-2021 LIBRARY; T=0.K  
neutrons from (t,3n)a

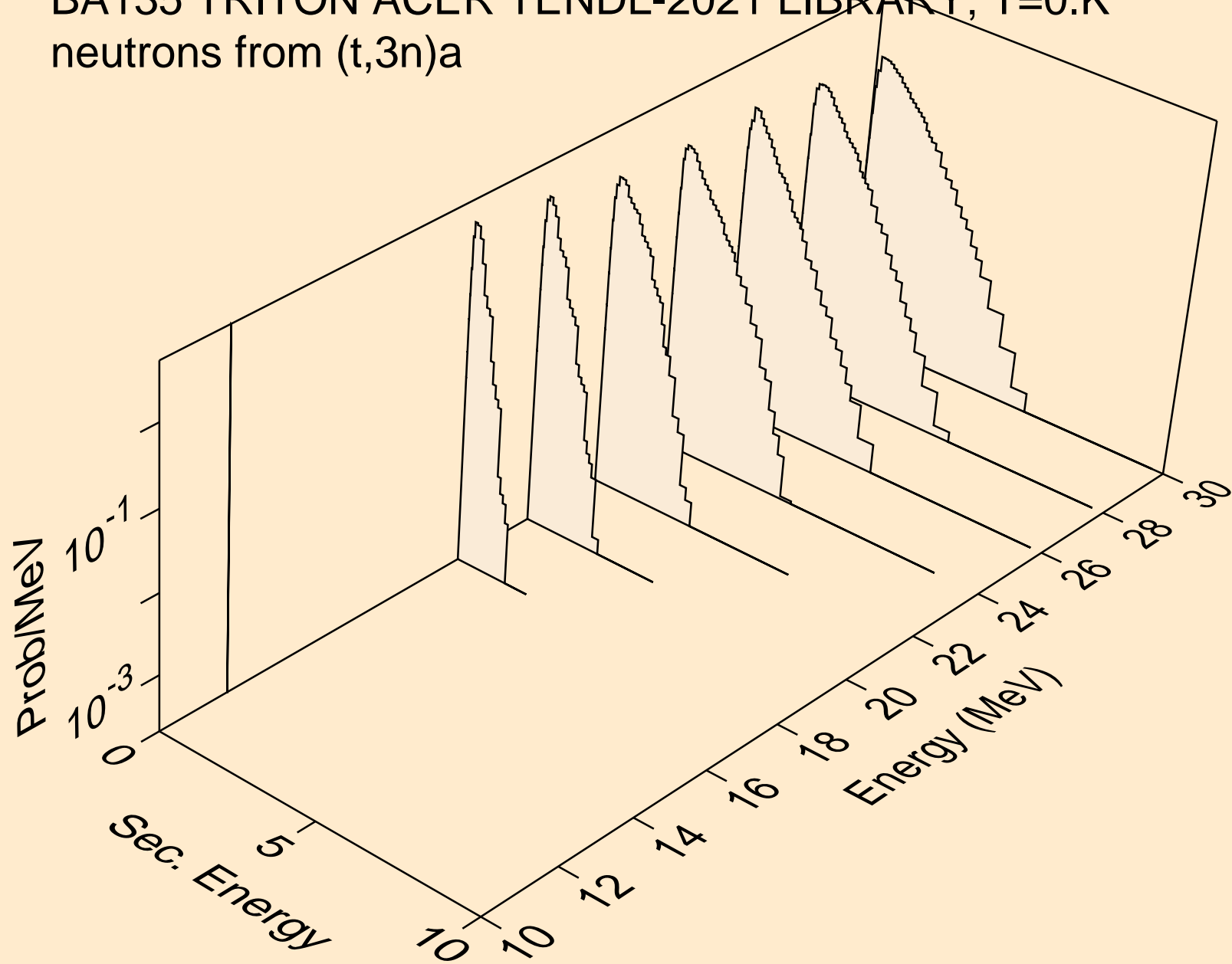

BA135 TRITON ACER TENDL-2021 LIBRARY; T=0.K  
neutrons from (t,n\*)p

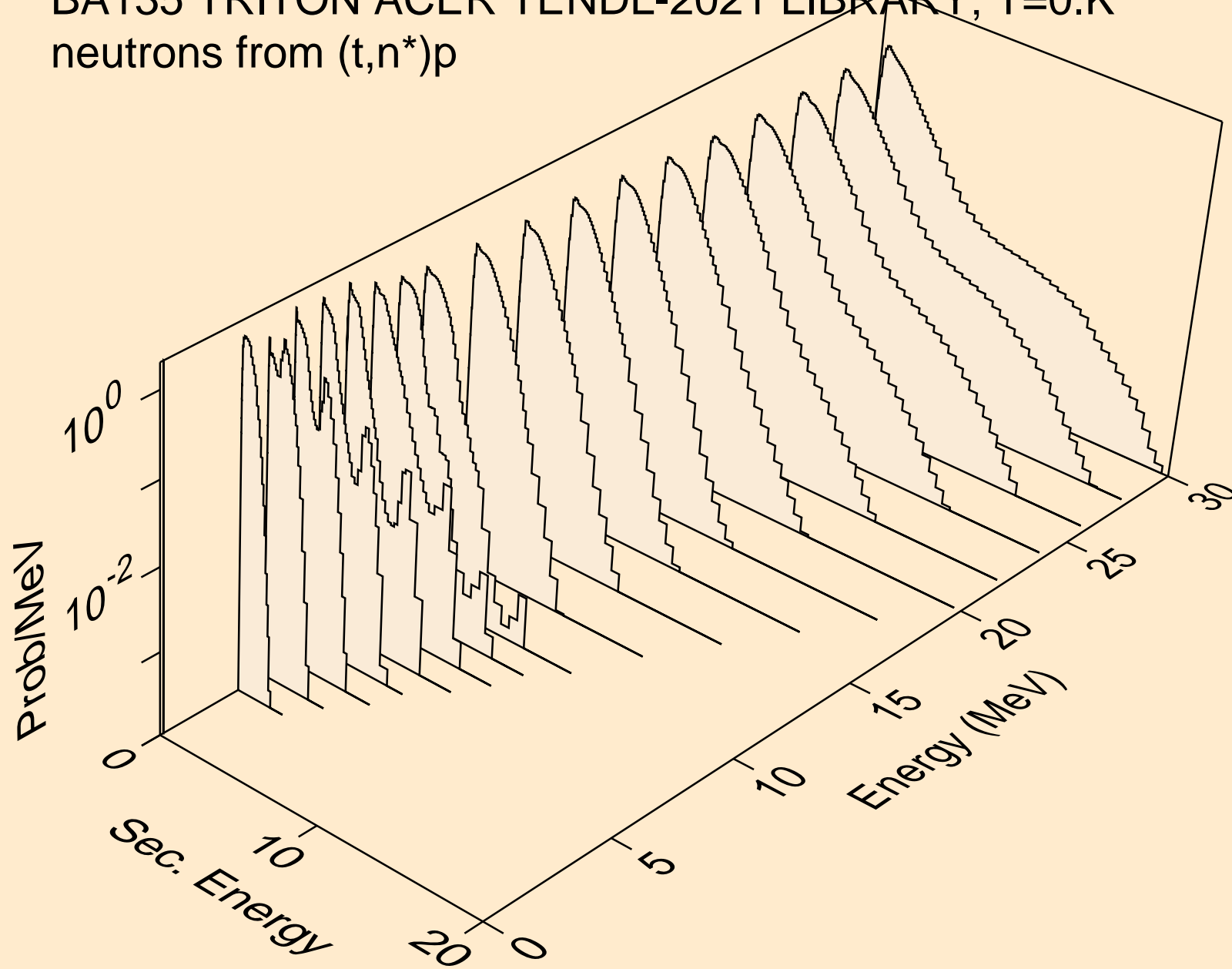

BA135 TRITON ACER TENDL-2021 LIBRARY; T=0.K  
neutrons from (t,n\*)2a

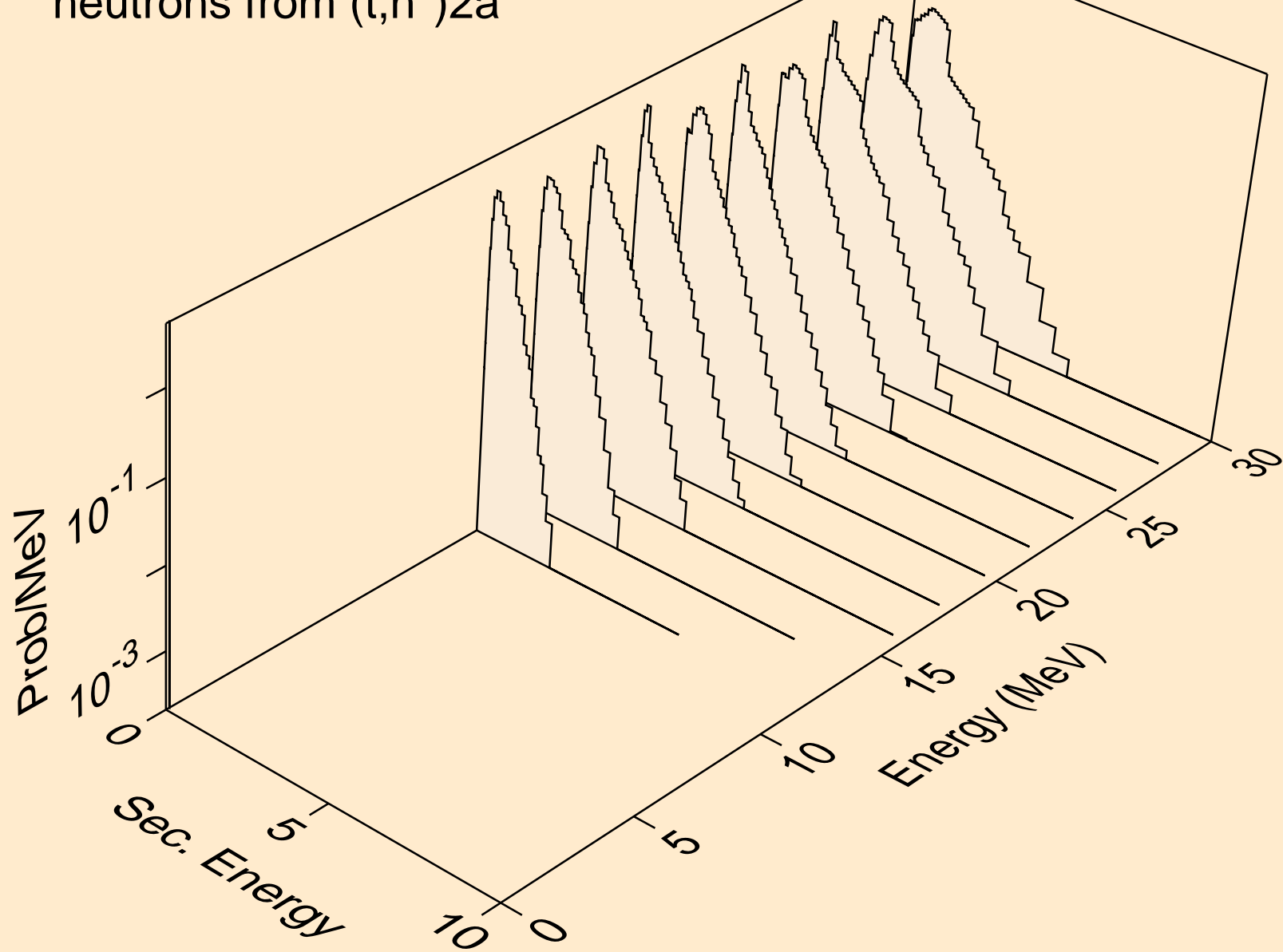



BA135 TRITON ACER TENDL-2021 LIBRARY; T=0.K  
neutrons from (t,n\*)d

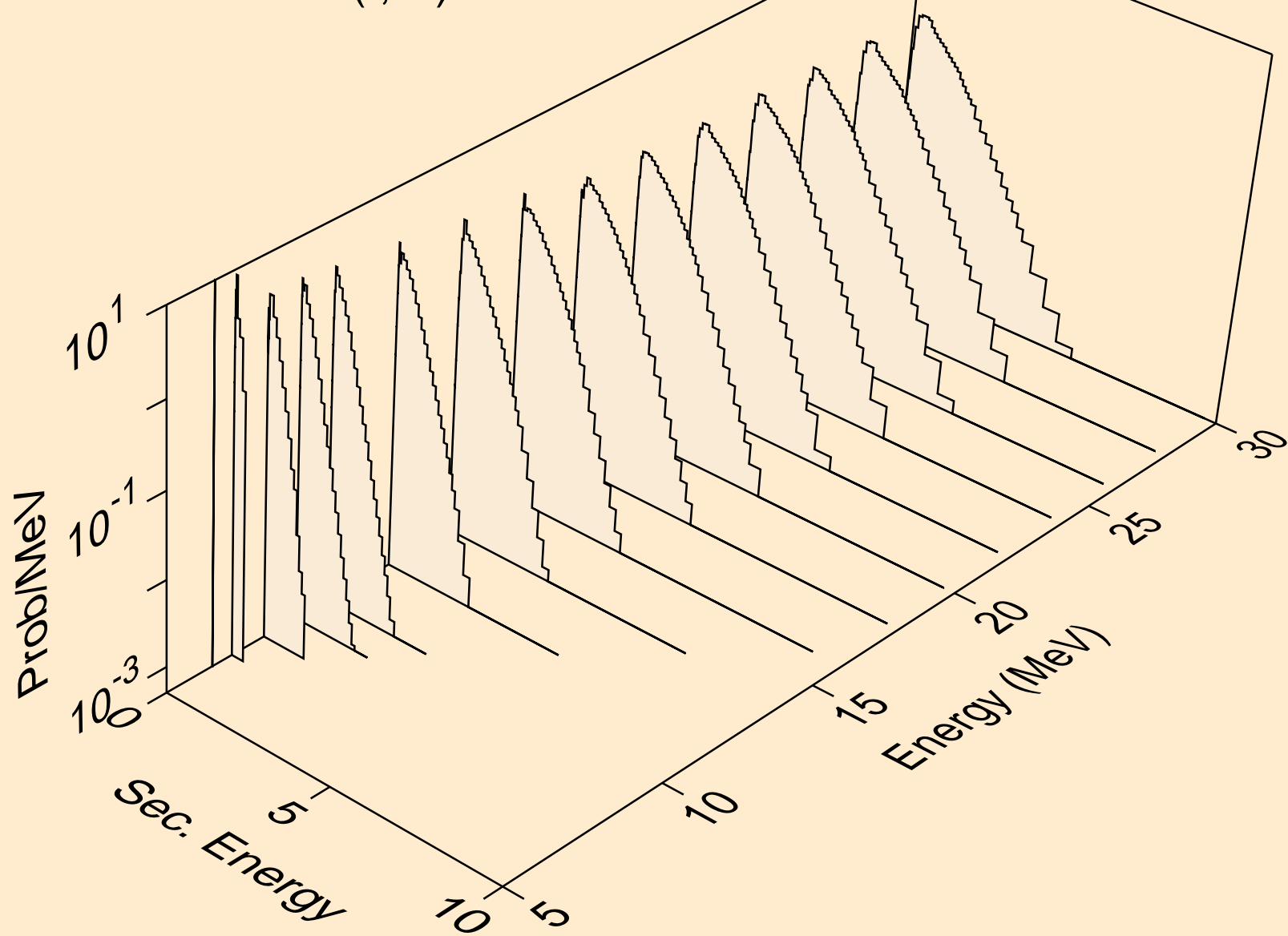

BA135 TRITON ACER TENDL-2021 LIBRARY; T=0.K  
neutrons from (t,n\*)t

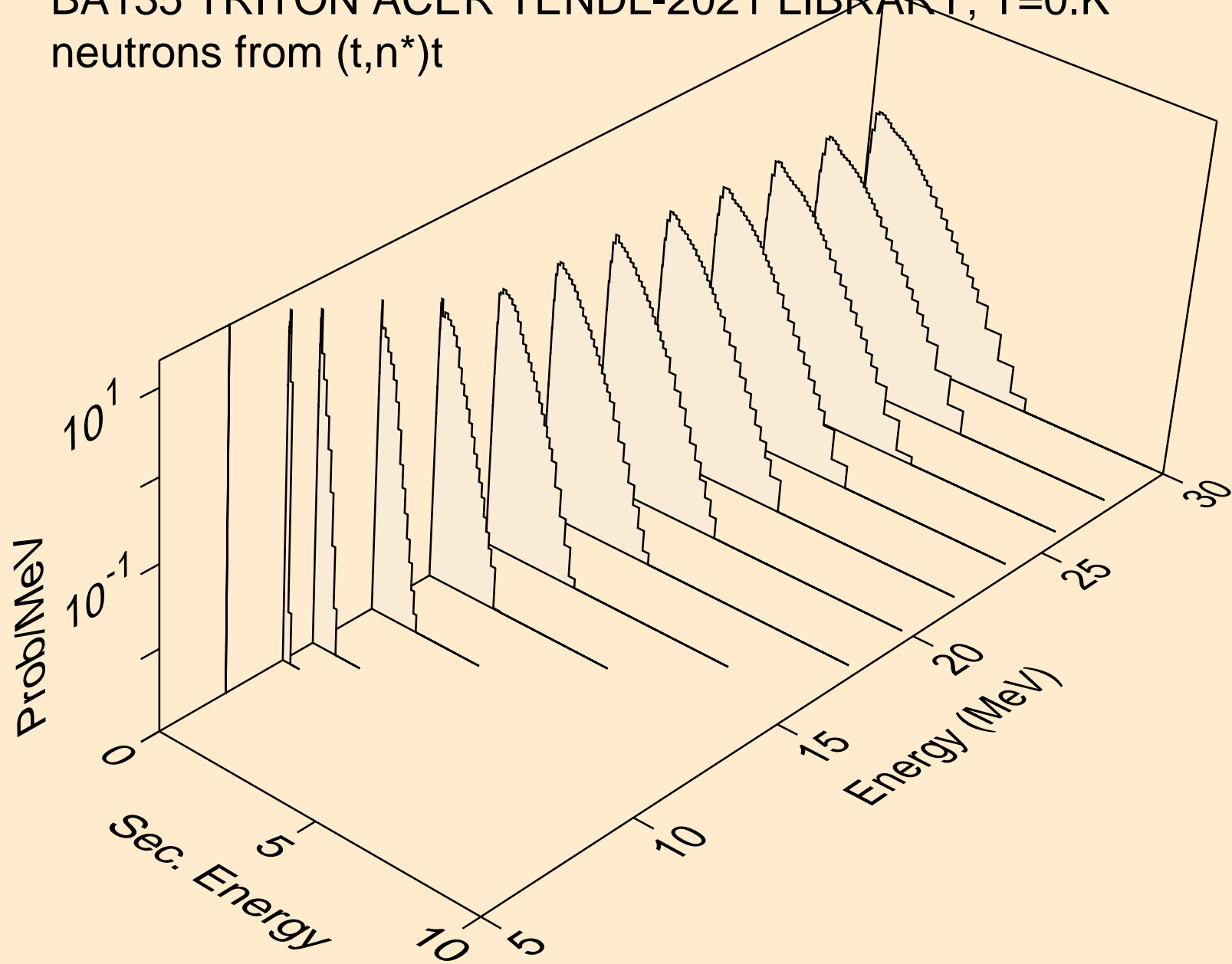

BA135 TRITON ACER TENDL-2021 LIBRARY; T=0.K  
neutrons from (t,n\*)he3

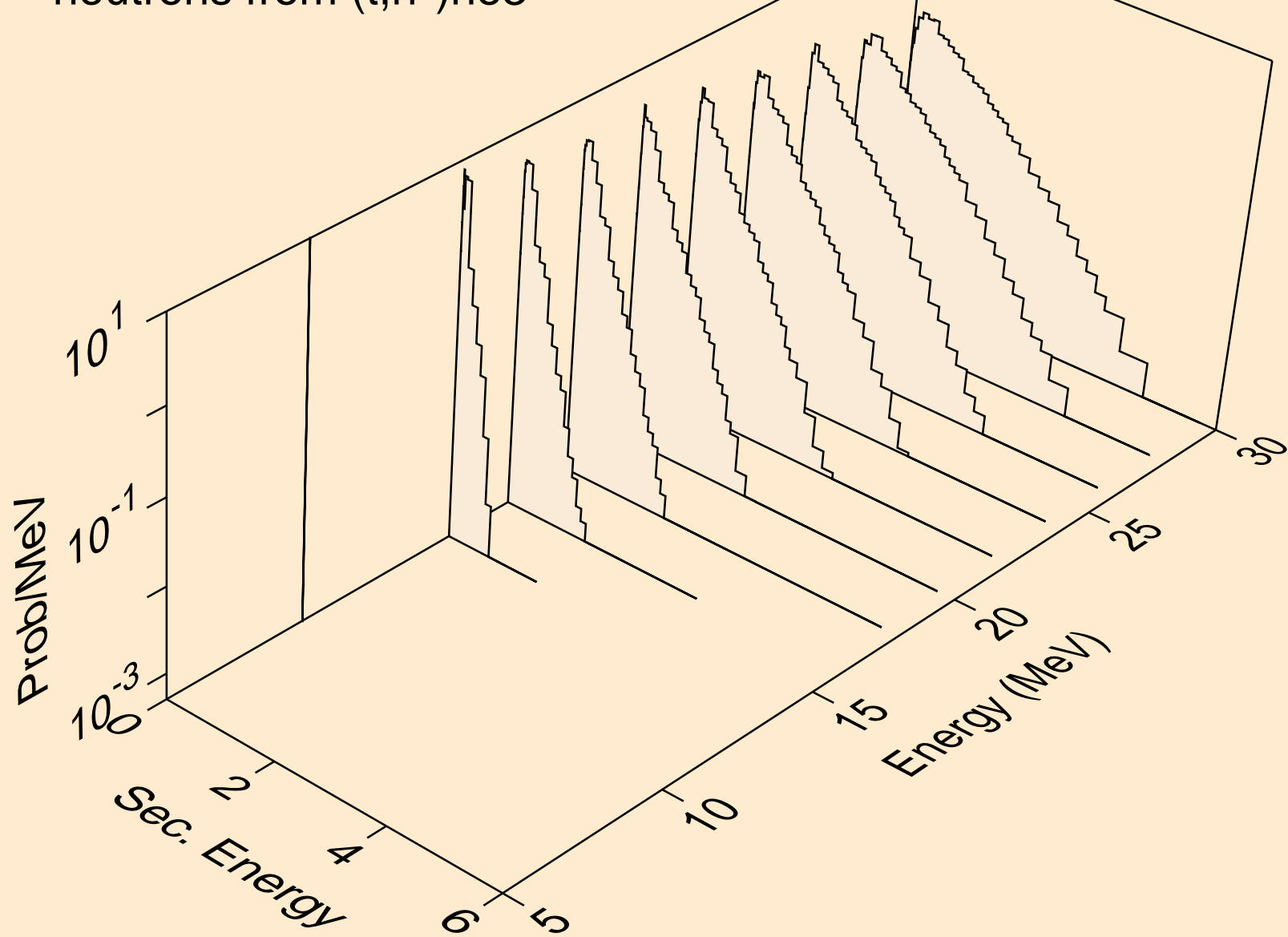

BA135 TRITON ACER TENDL-2021 LIBRARY; T=0.K  
neutrons from (t,4n)

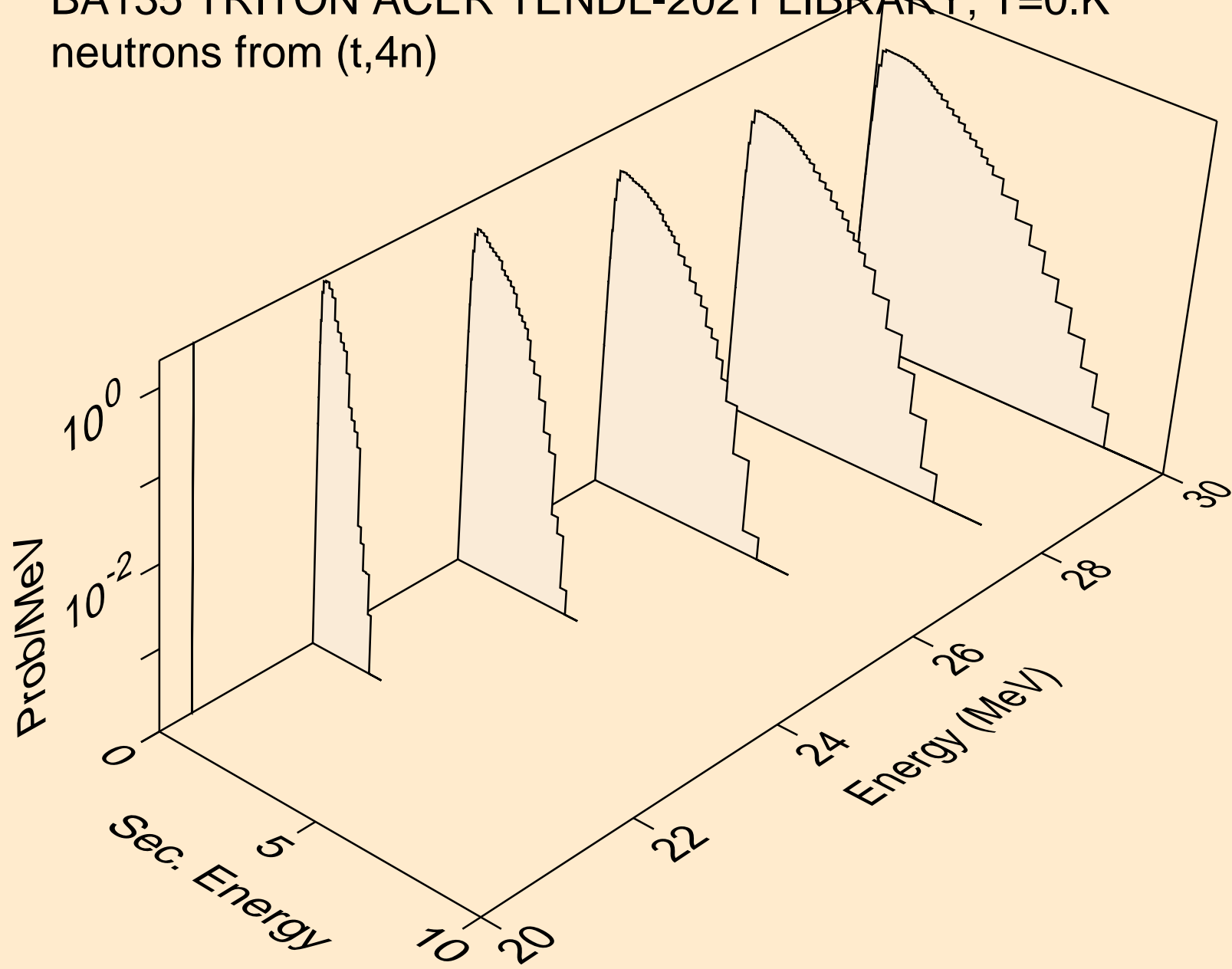

BA135 TRITON ACER TENDL-2021 LIBRARY; T=0.K  
neutrons from (t,2np)

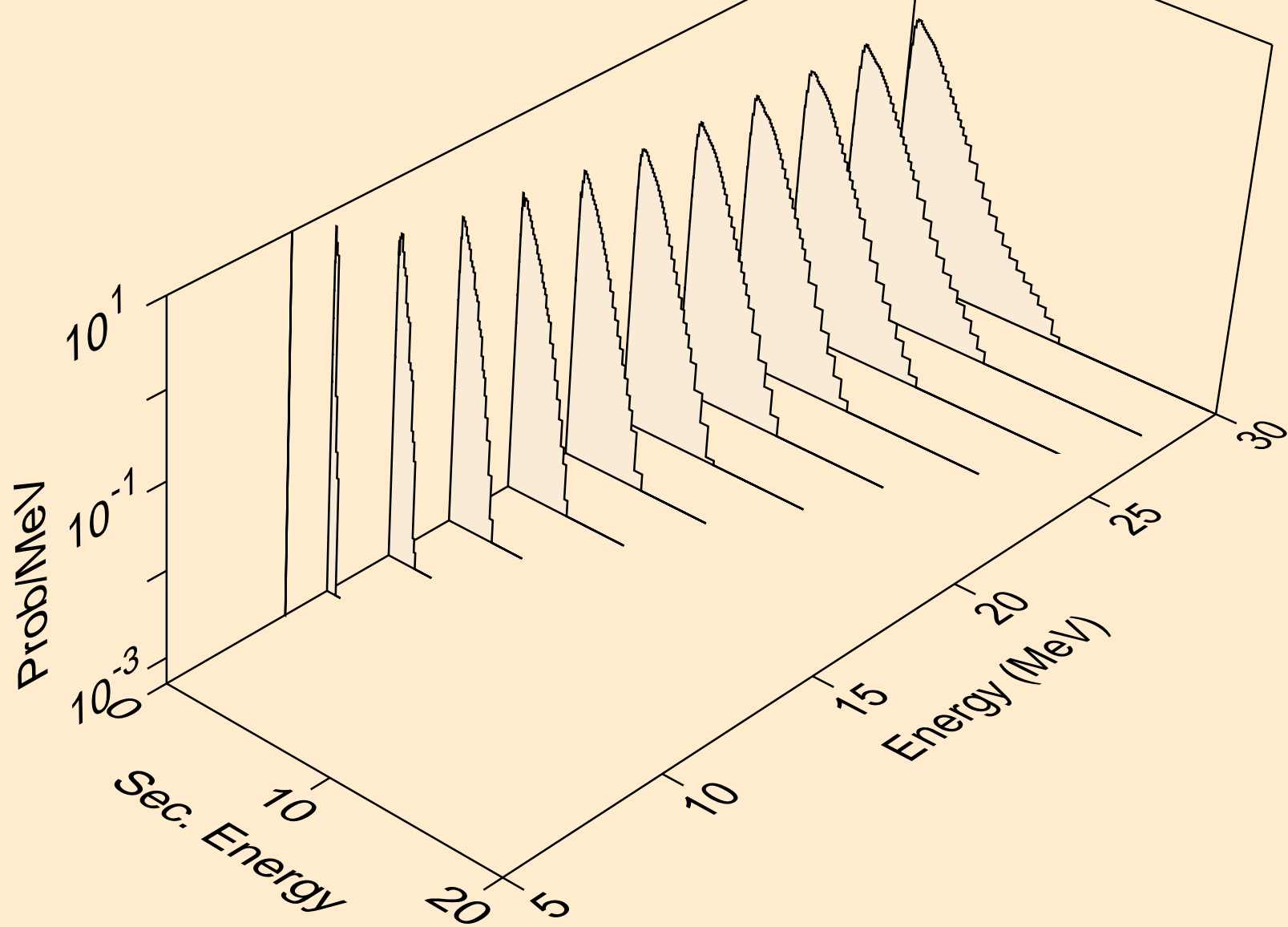

BA135 TRITON ACER TENDL-2021 LIBRARY; T=0.K  
neutrons from (t,3np)

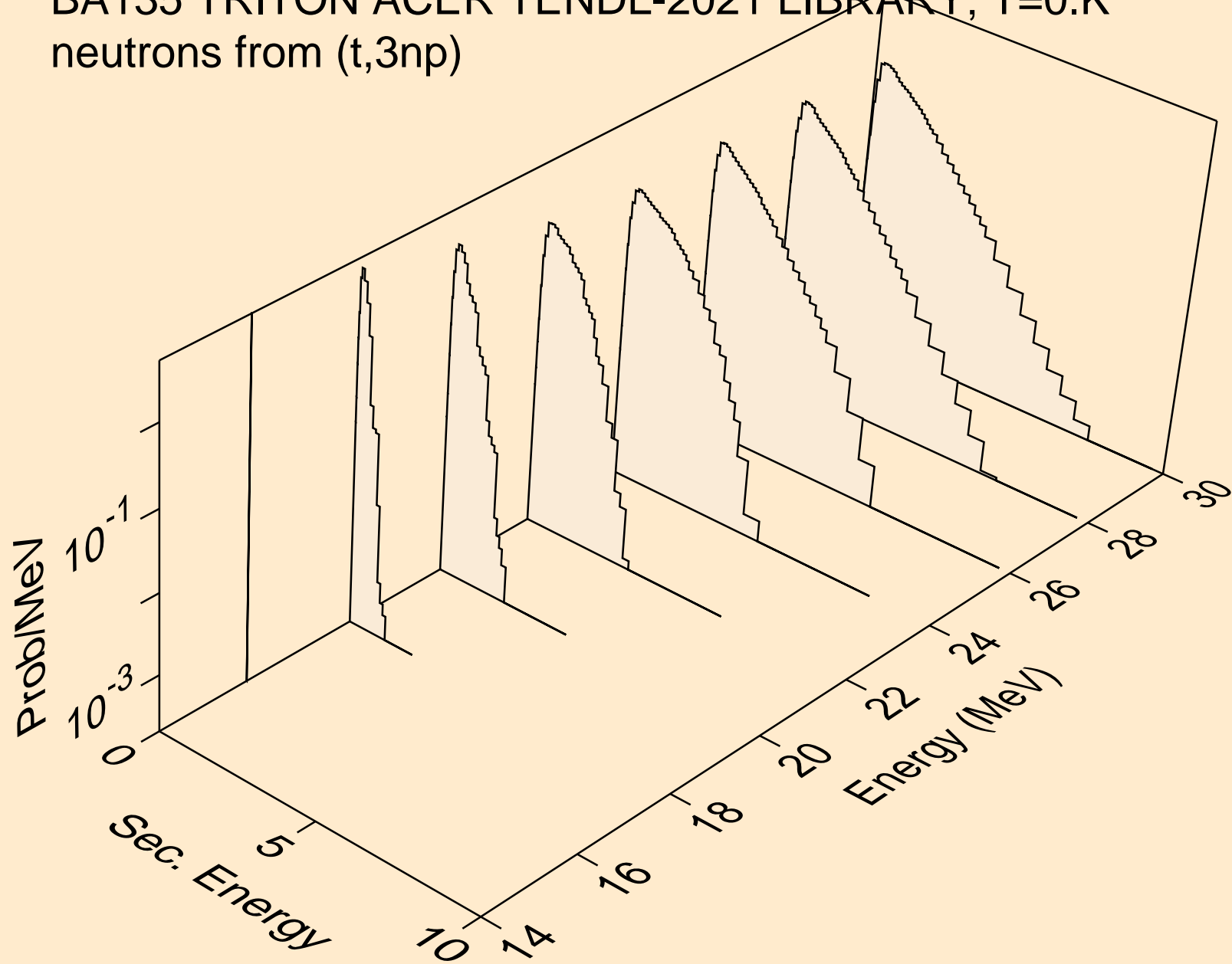

BA135 TRITON ACER TENDL-2021 LIBRARY; T=0.K  
neutrons from (t,2np)

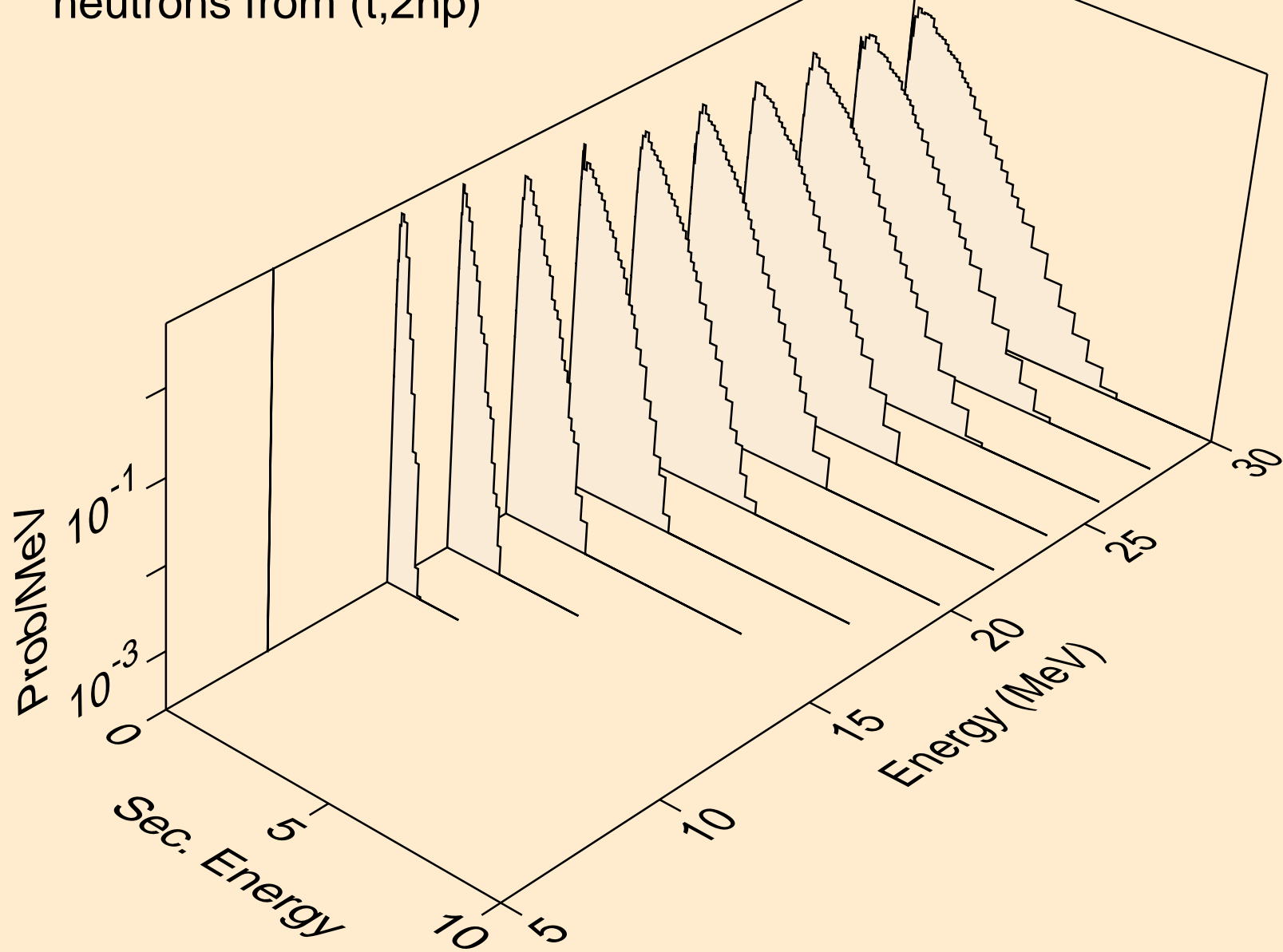

BA135 TRITON ACER TENDL-2021 LIBRARY; T=0.K  
neutrons from (t,npa)

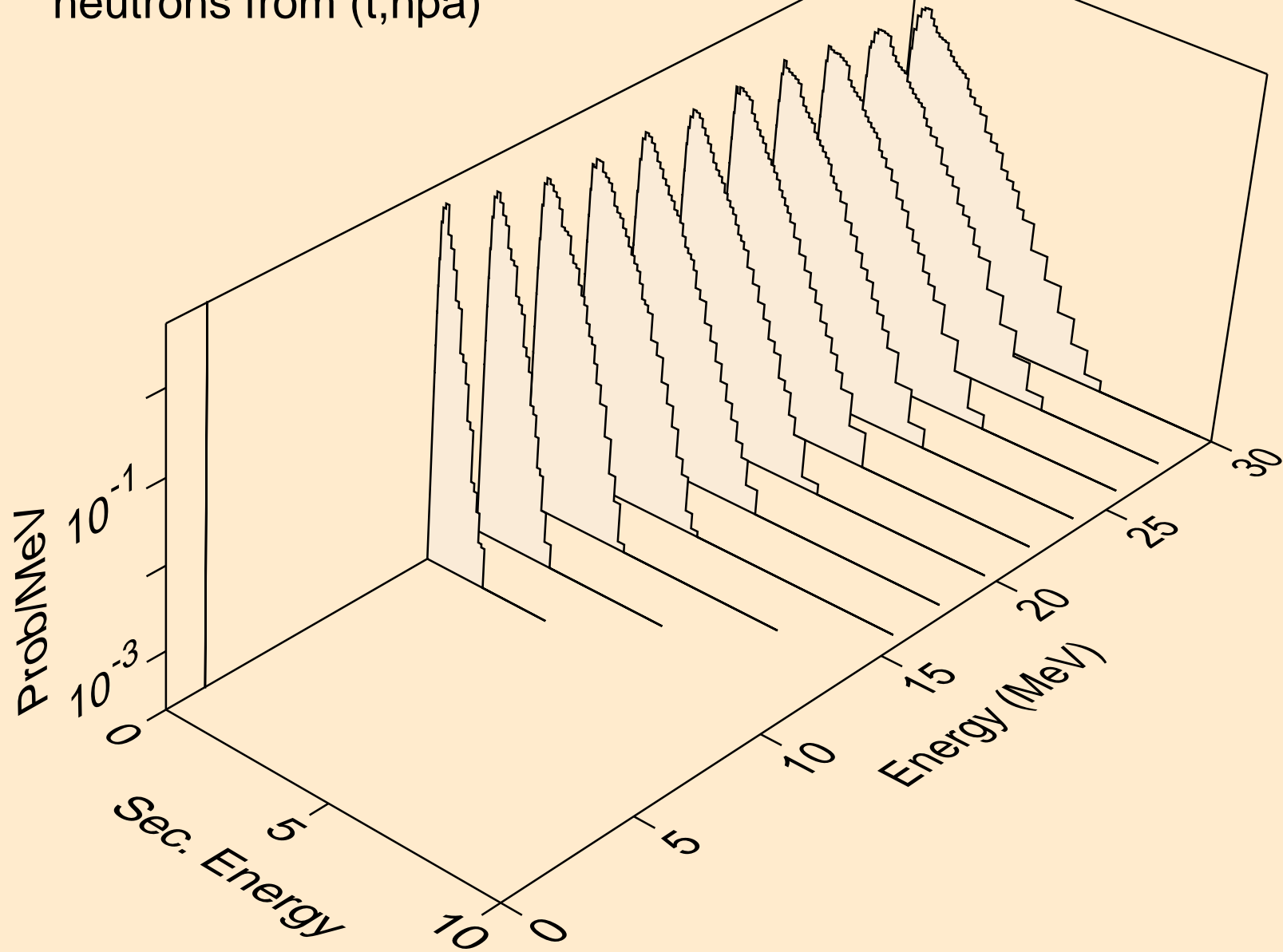



BA135 TRITON ACER TENDL-2021 LIBRARY; T=0.K  
protons from (t,x)

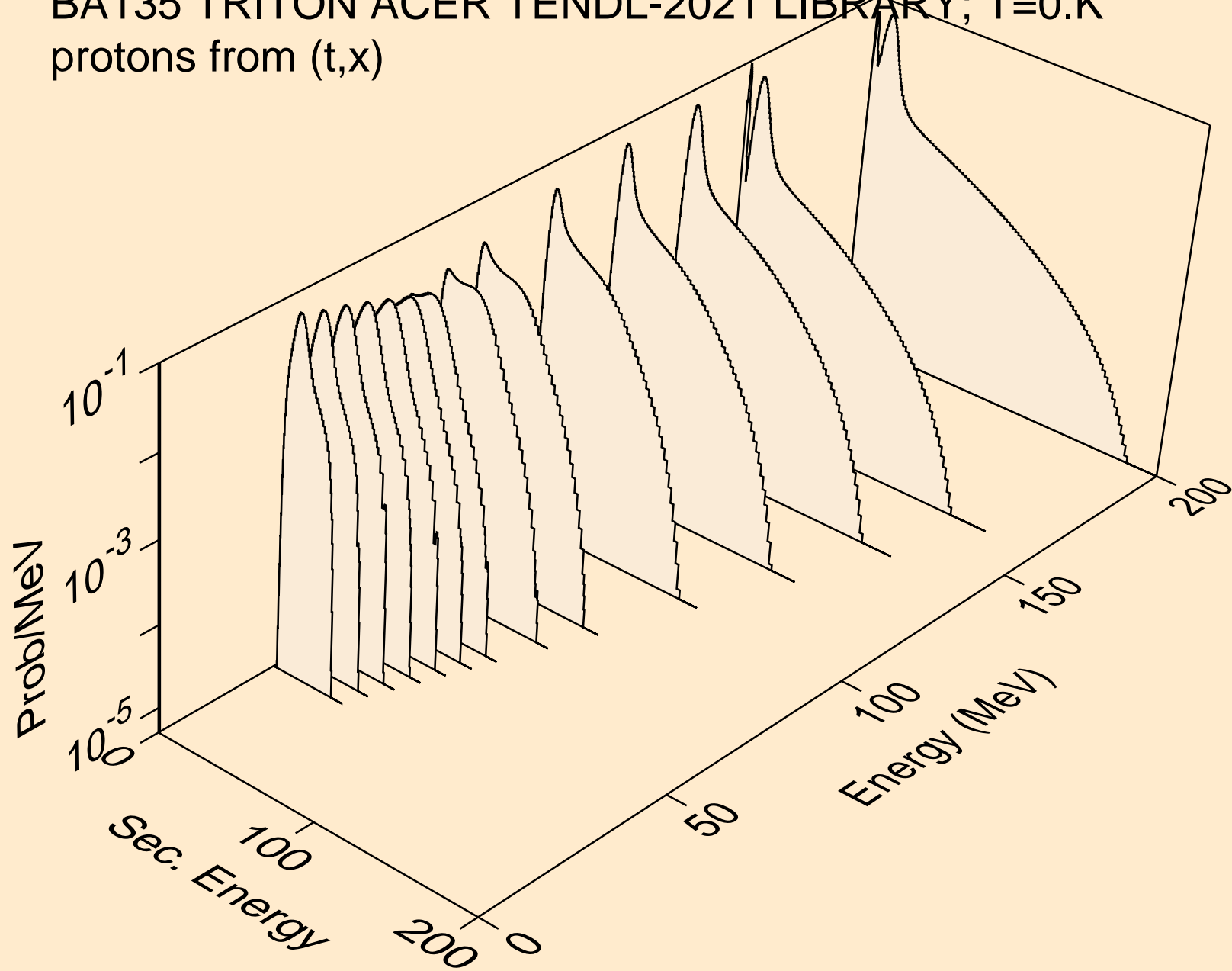

BA135 TRITON ACER TENDL-2021 LIBRARY; T=0.K  
protons from (t,n\*)p

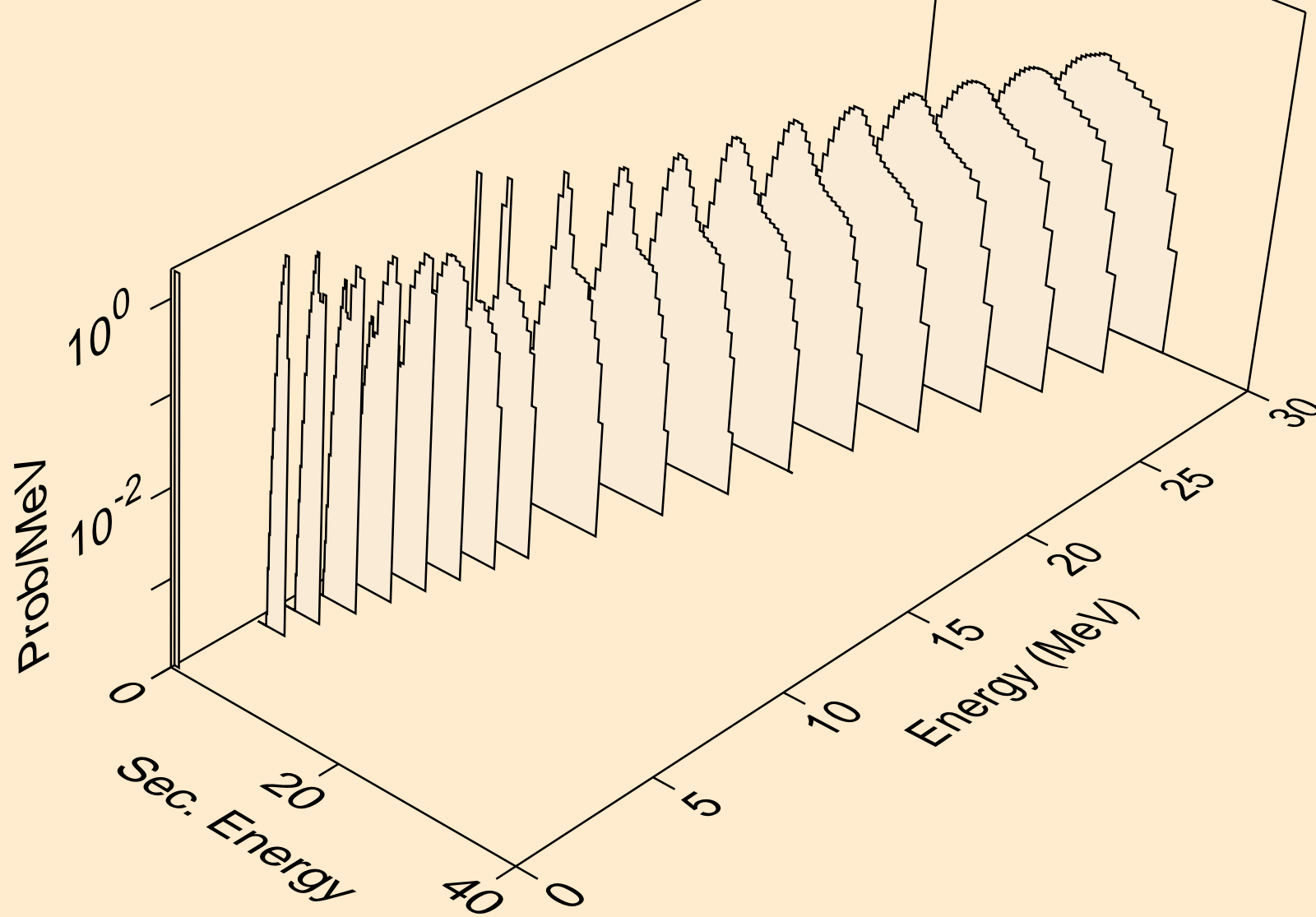

BA135 TRITON ACER TENDL-2021 LIBRARY; T=0.K  
protons from (t,2np)

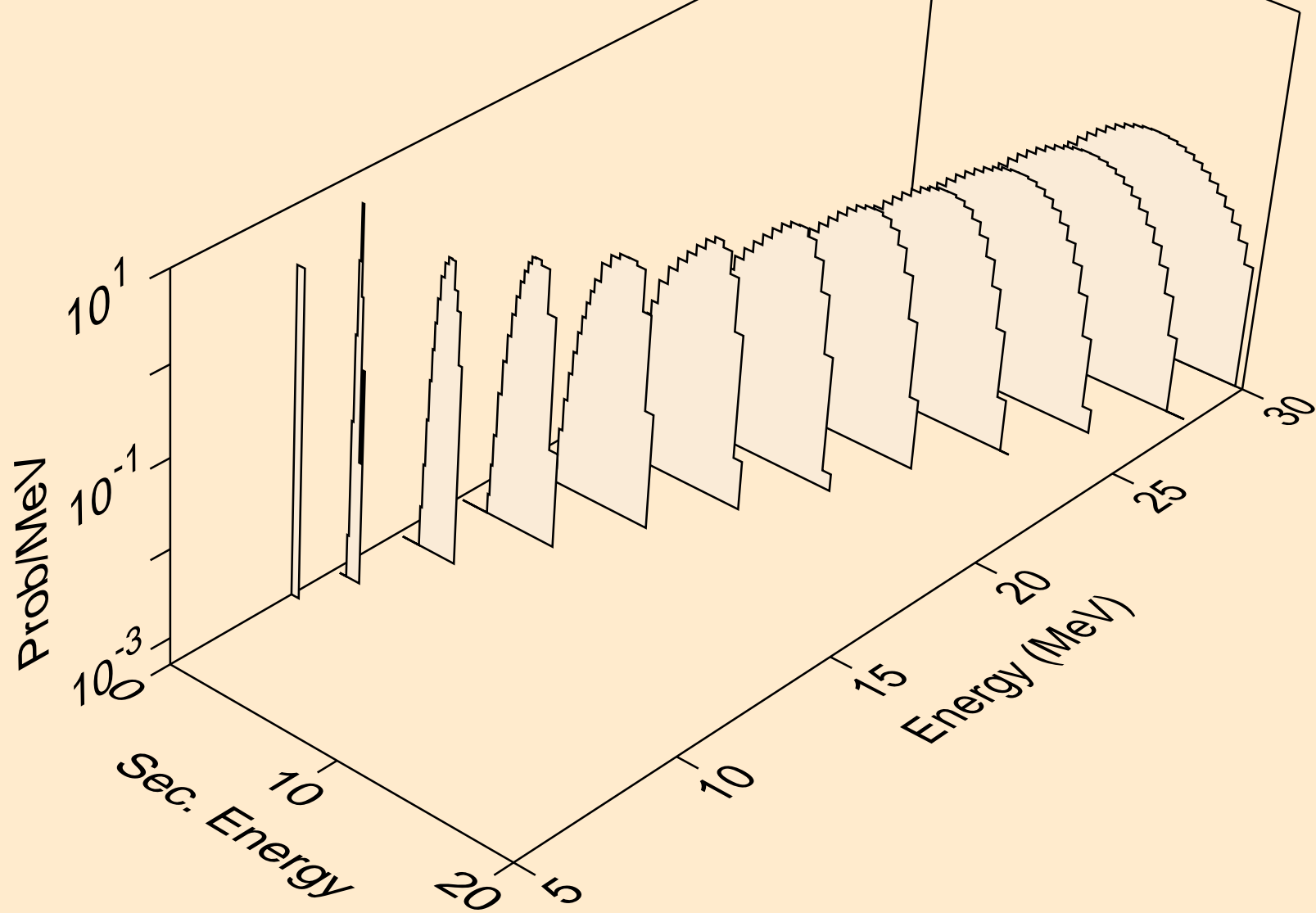

BA135 TRITON ACER TENDL-2021 LIBRARY; T=0.K  
protons from (t,3np)

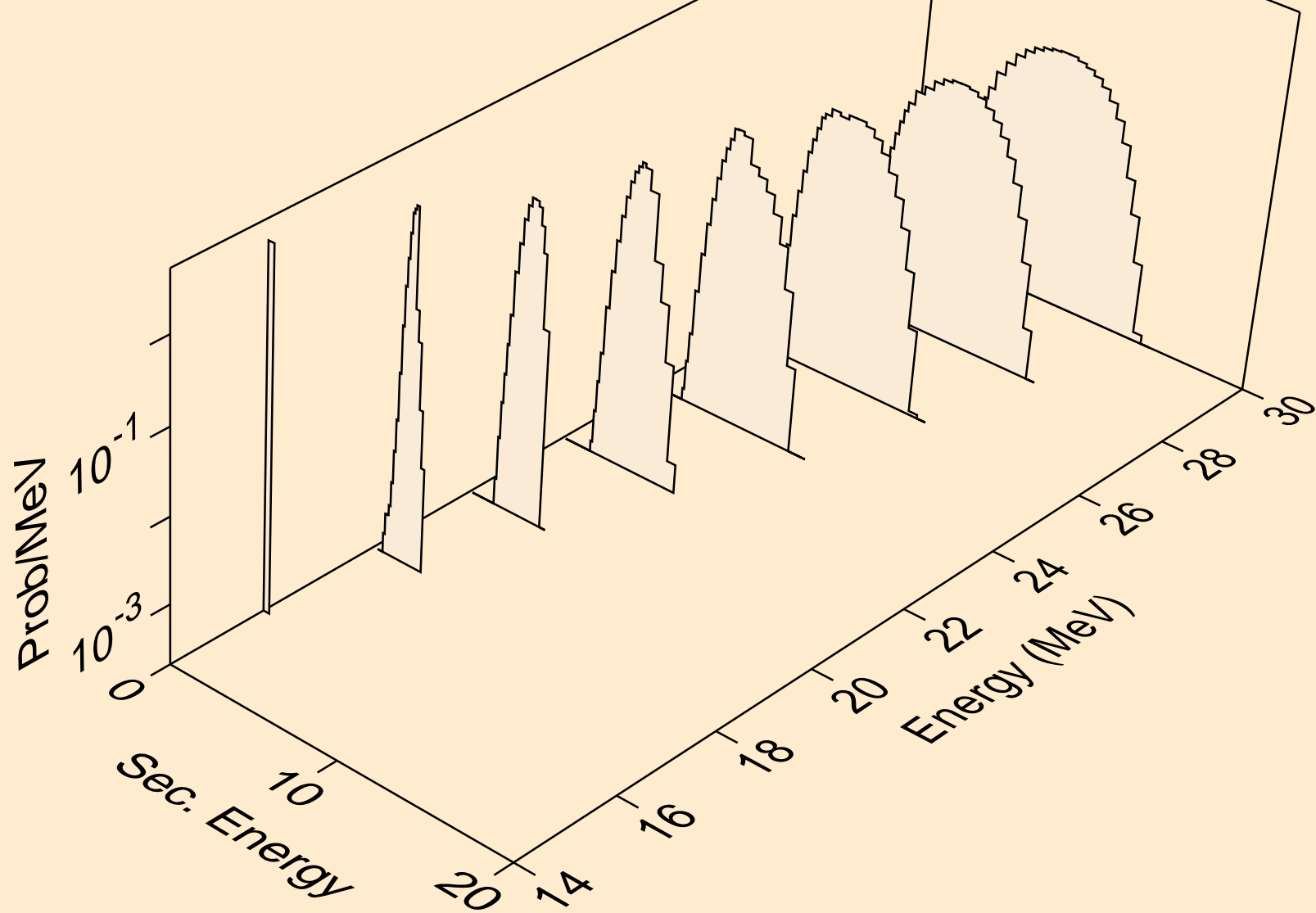

BA135 TRITON ACER TENDL-2021 LIBRARY; T=0.K  
protons from (t,2np)

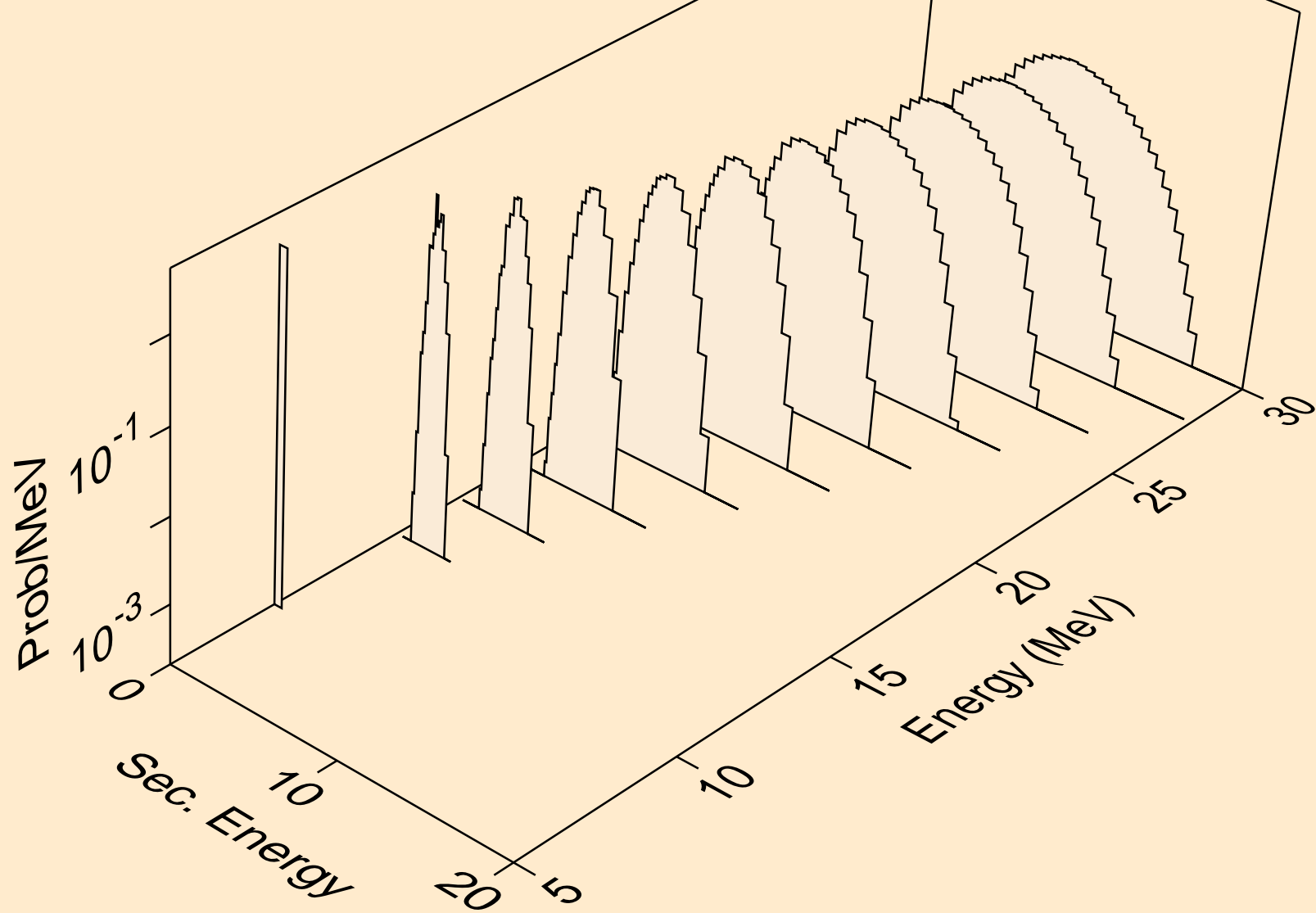

BA135 TRITON ACER TENDL-2021 LIBRARY; T=0.K  
protons from (t,npa)

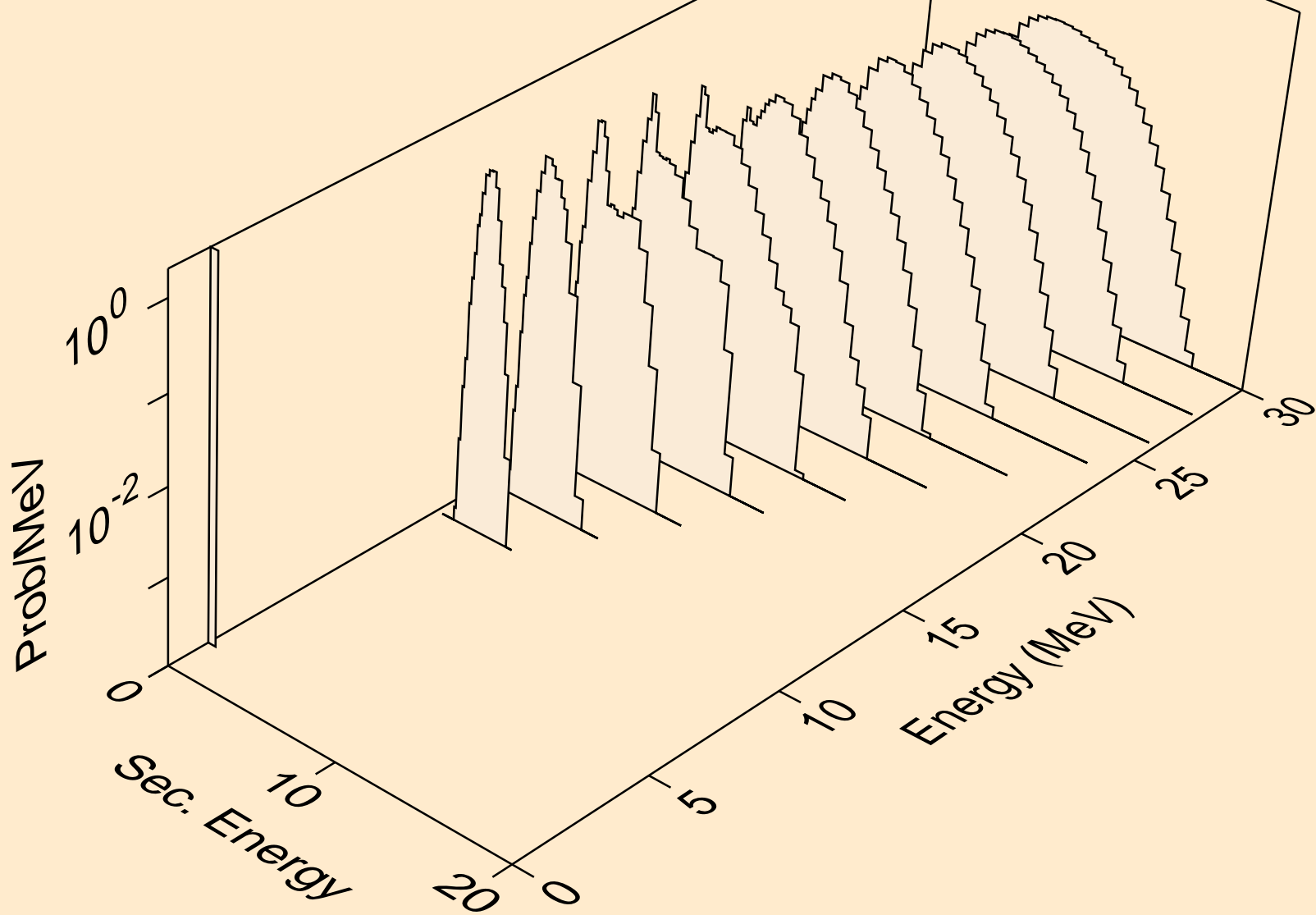

BA135 TRITON ACER TENDL-2021 LIBRARY; T=0.K  
protons from (t,p)

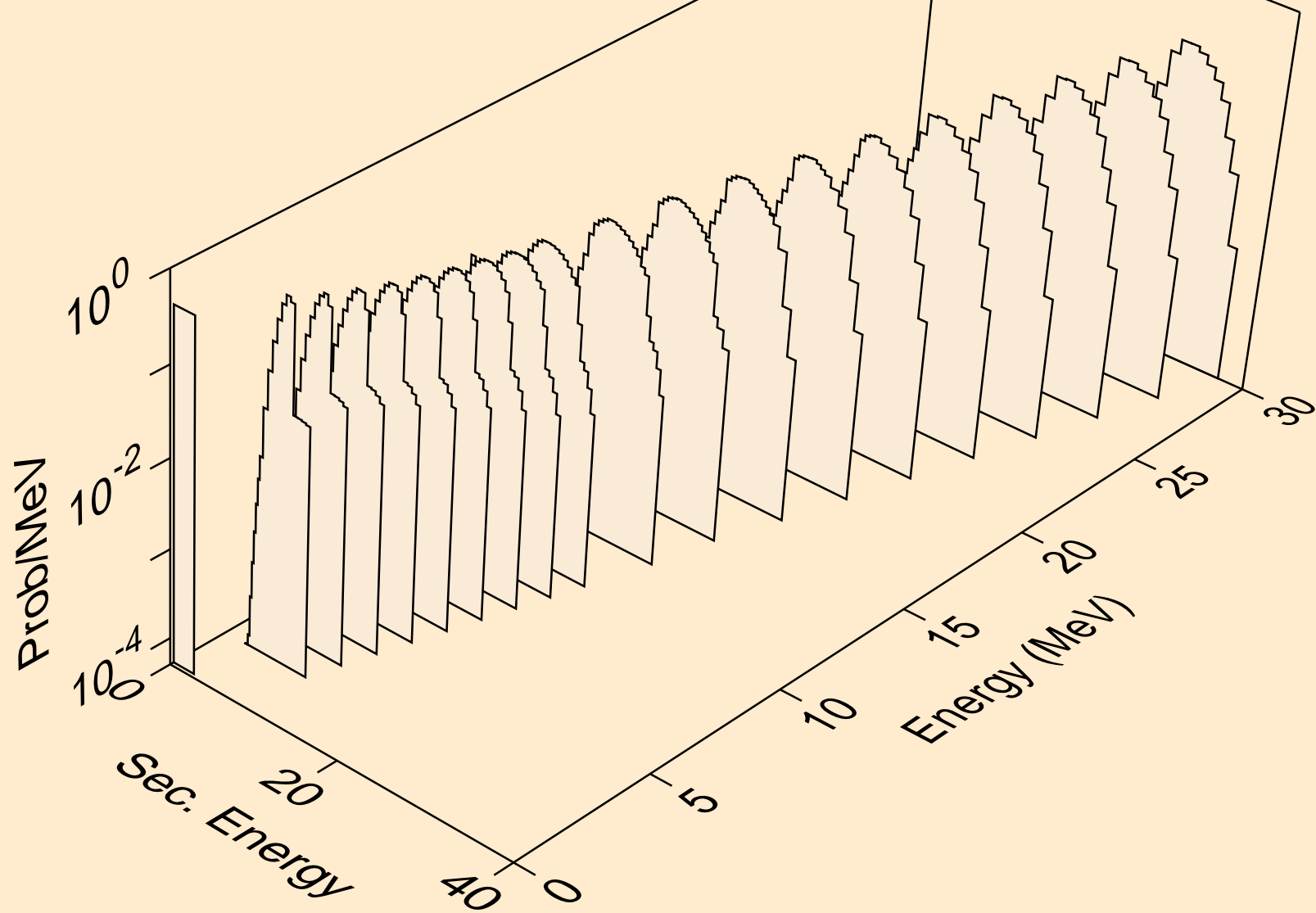

BA135 TRITON ACER TENDL-2021 LIBRARY; T=0.K  
protons from (t,2p)

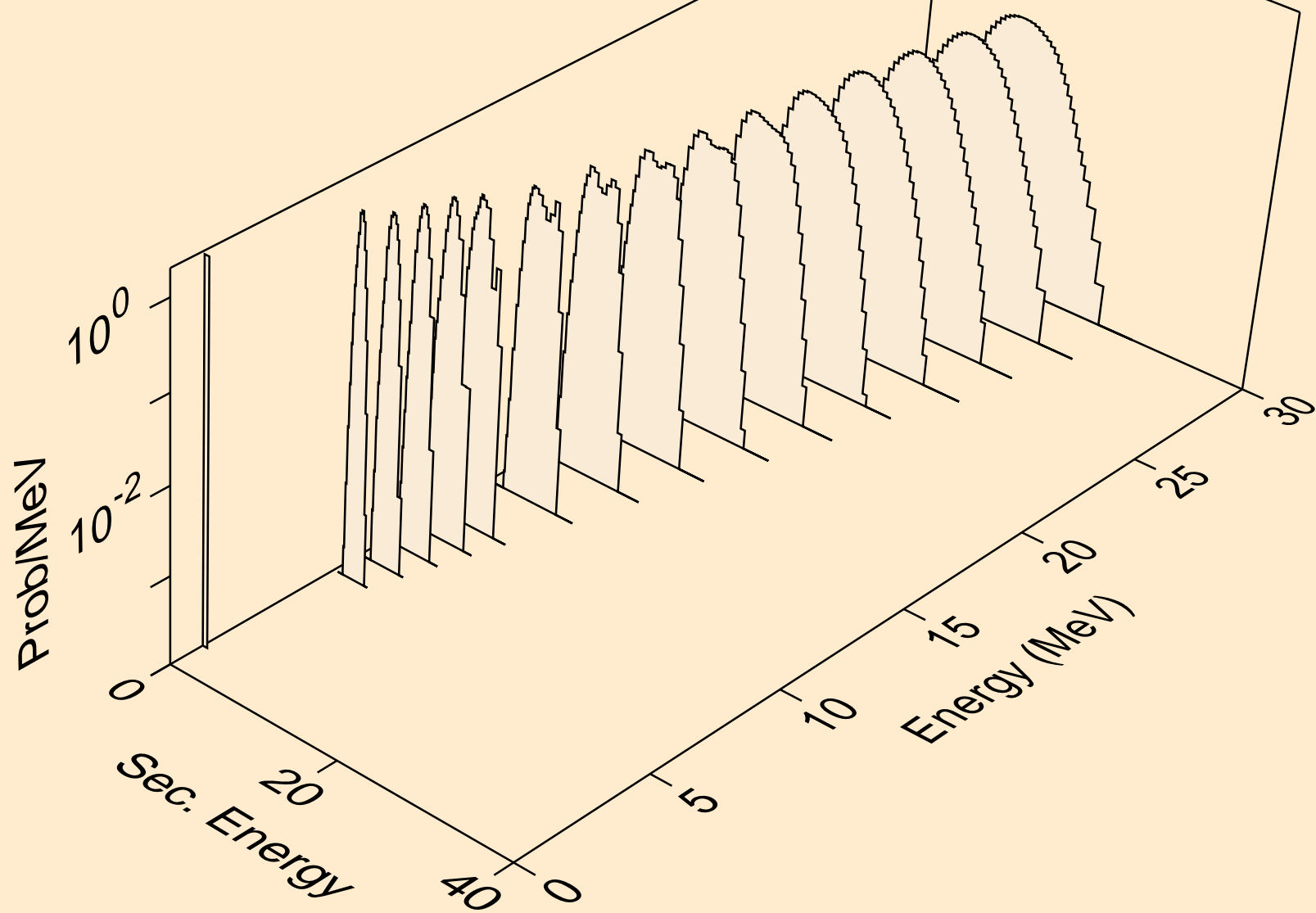



BA135 TRITON ACER TENDL-2021 LIBRARY; T=0.K  
protons from (t,pa)

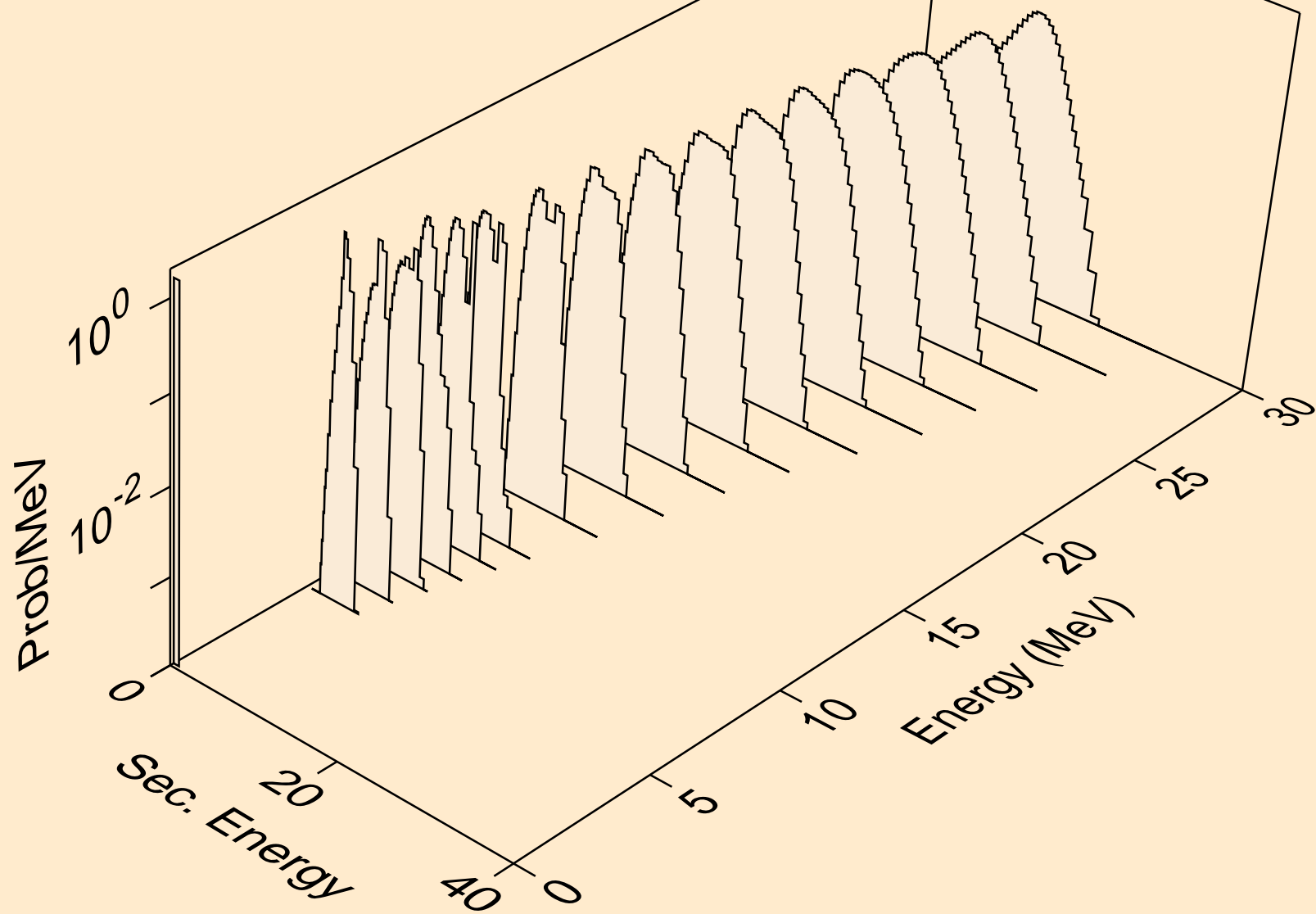

BA135 TRITON ACER TENDL-2021 LIBRARY; T=0.K  
protons from (t,pd)

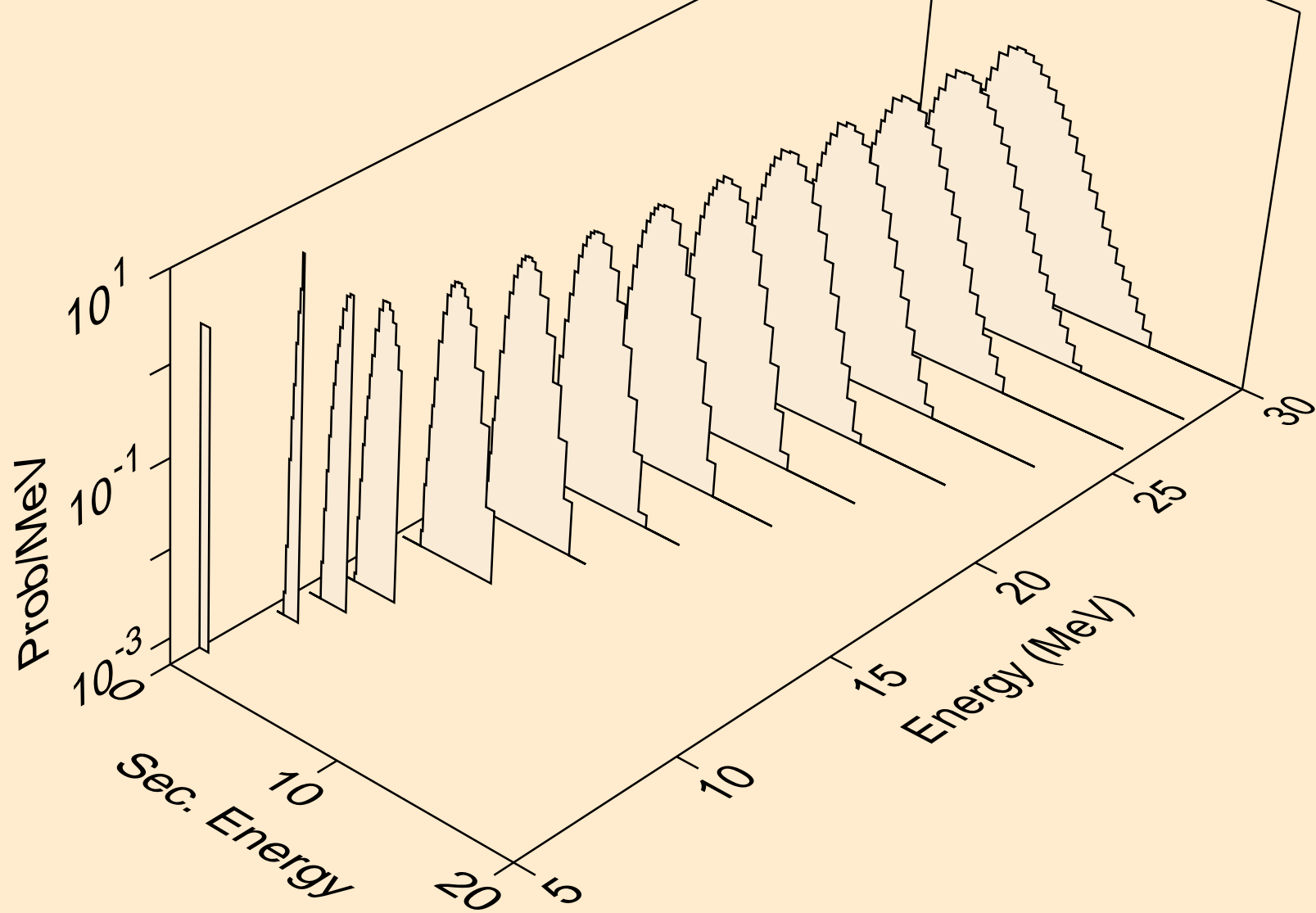

BA135 TRITON ACER TENDL-2021 LIBRARY; T=0.K  
protons from (t,pt)

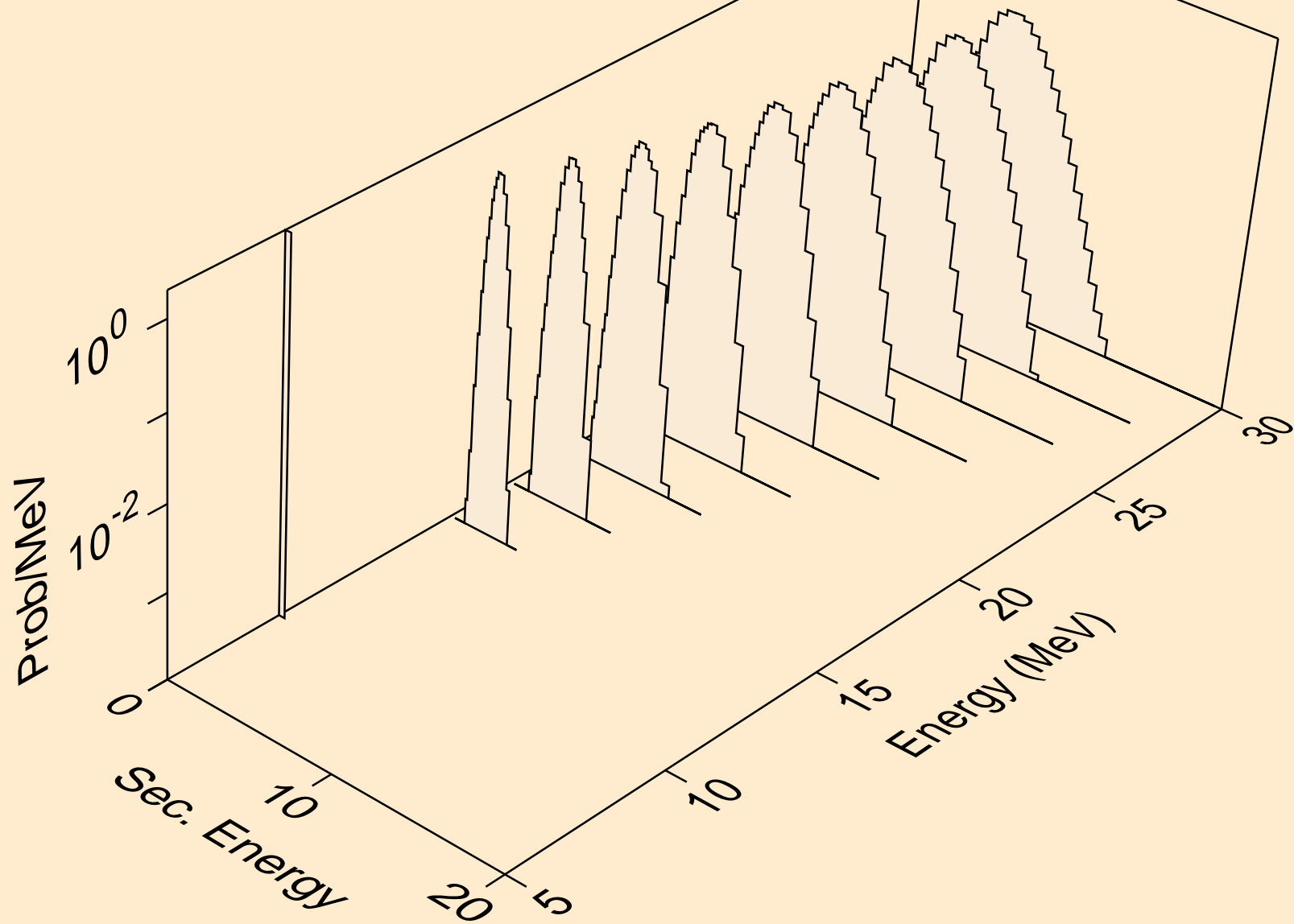

BA135 TRITON ACER TENDL-2021 LIBRARY; T=0.K  
deuterons from (t,x)

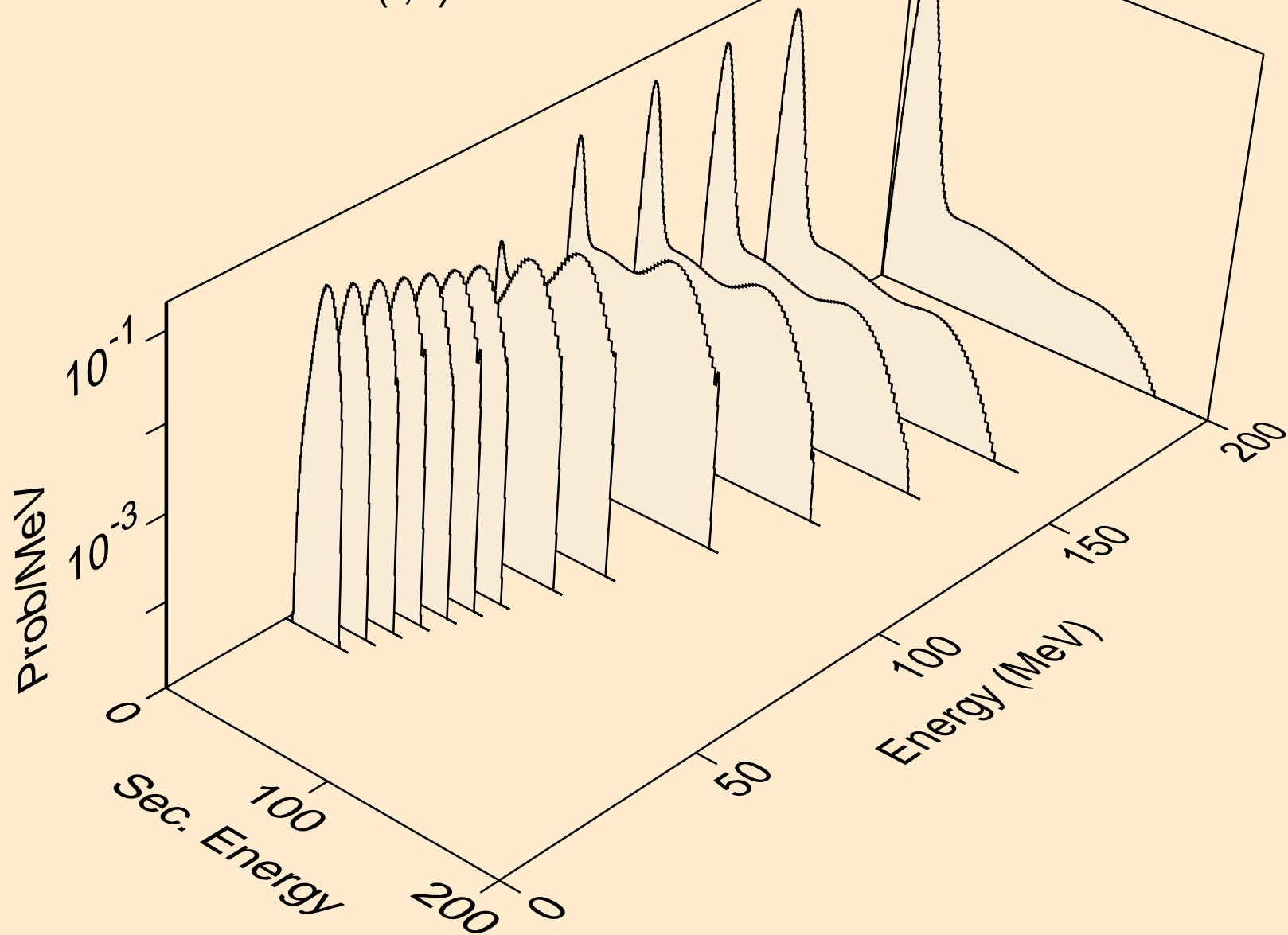

BA135 TRITON ACER TENDL-2021 LIBRARY; T=0.K  
deuterons from (t,2nd)

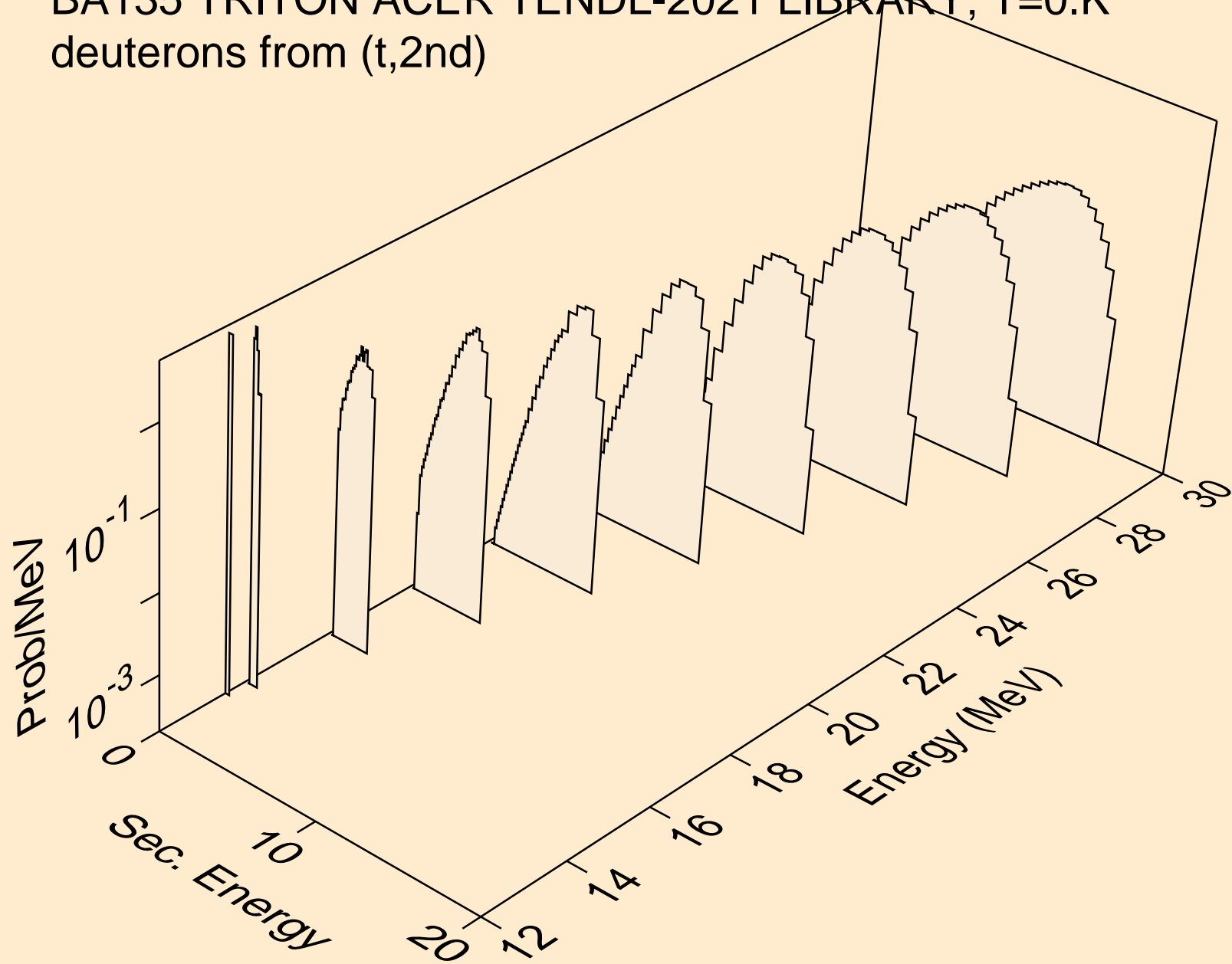

BA135 TRITON ACER TENDL-2021 LIBRARY; T=0.K  
deuterons from (t,n\*)d

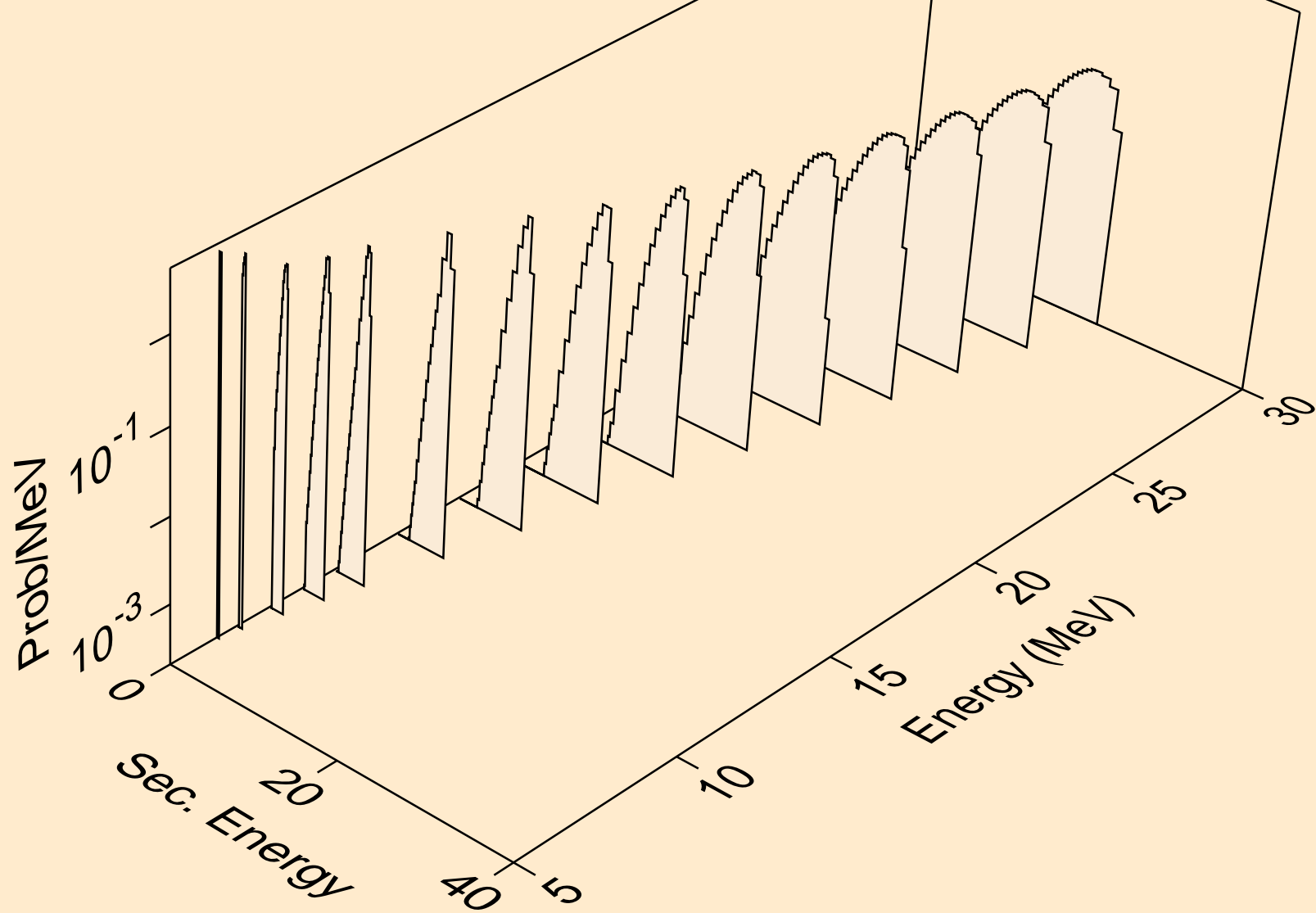

BA135 TRITON ACER TENDL-2021 LIBRARY; T=0.K  
deuterons from (t,d)

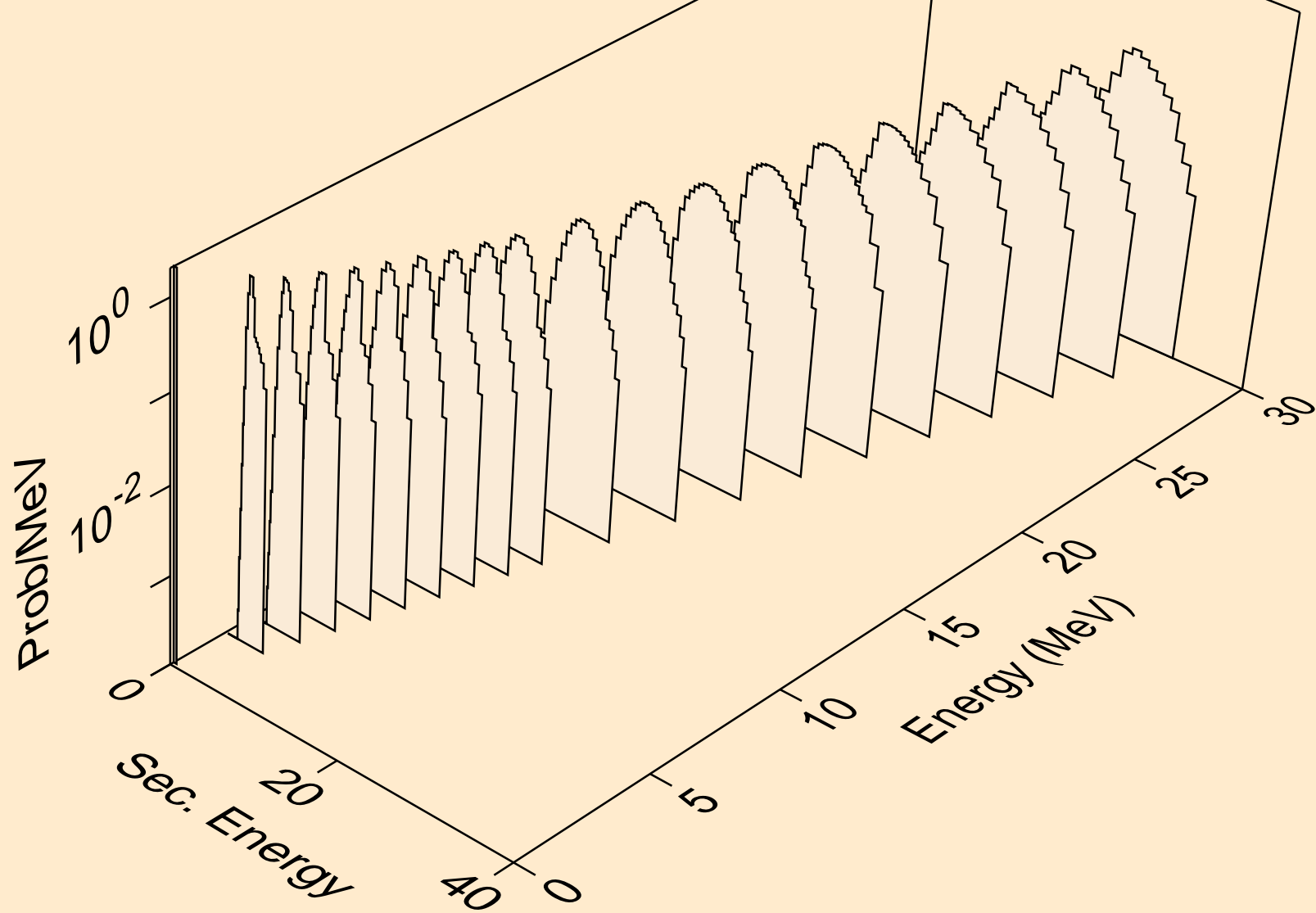

BA135 TRITON ACER TENDL-2021 LIBRARY; T=0.K  
deuterons from (t,pd)

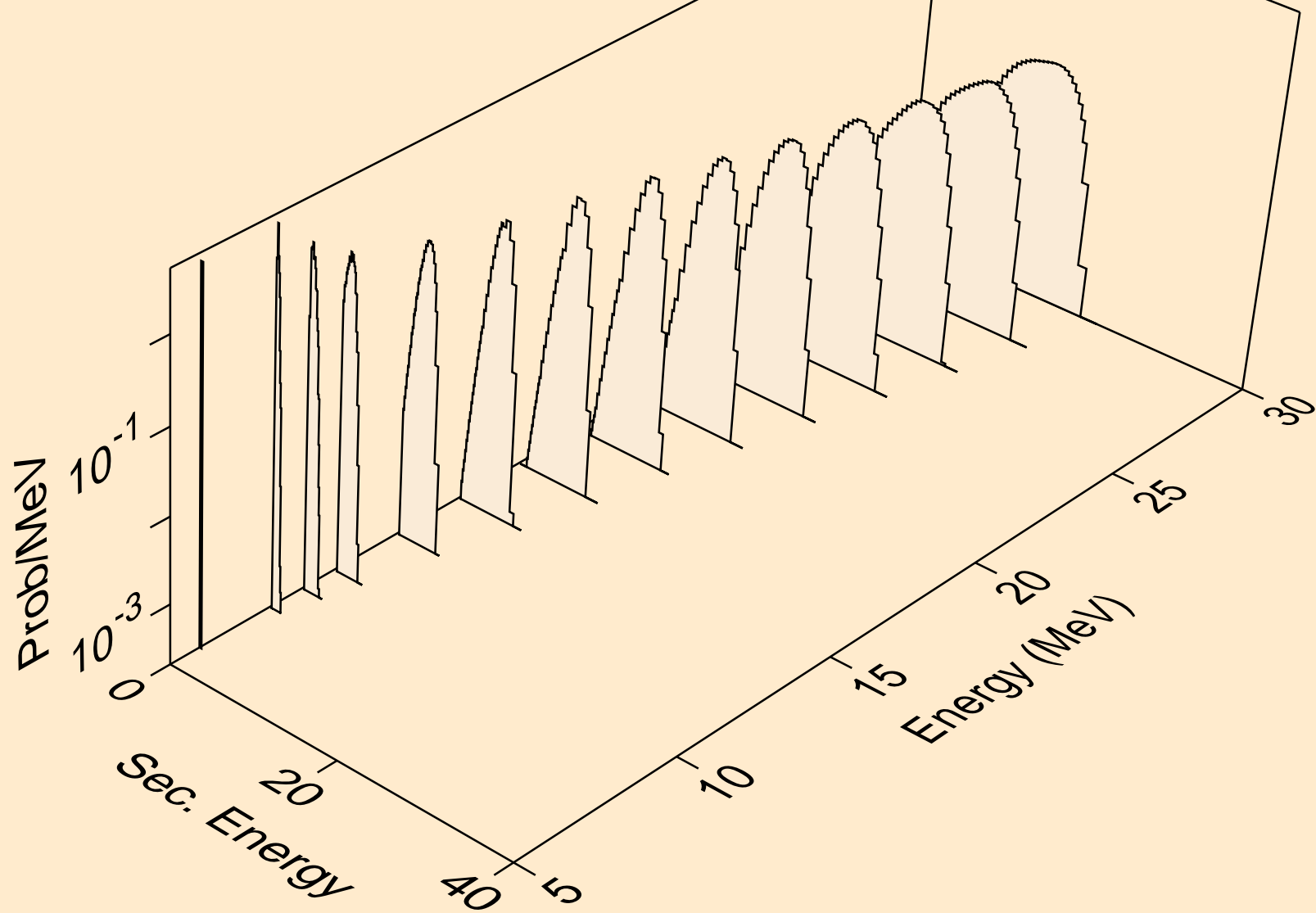



BA135 TRITON ACER TENDL-2021 LIBRARY; T=0.K  
deuterons from (t,da)

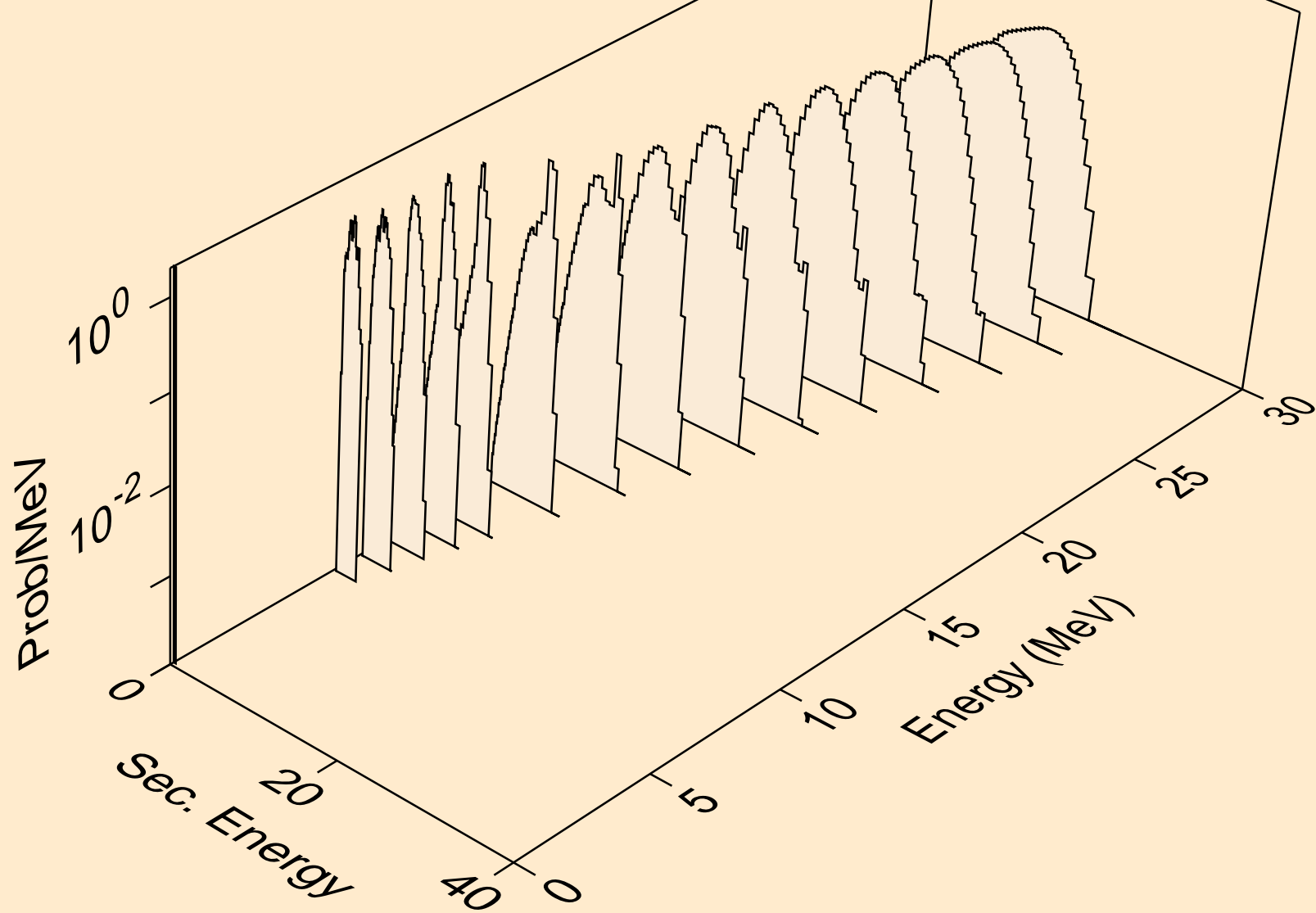

BA135 TRITON ACER TENDL-2021 LIBRARY; T=0.K  
he3s from (t,x)

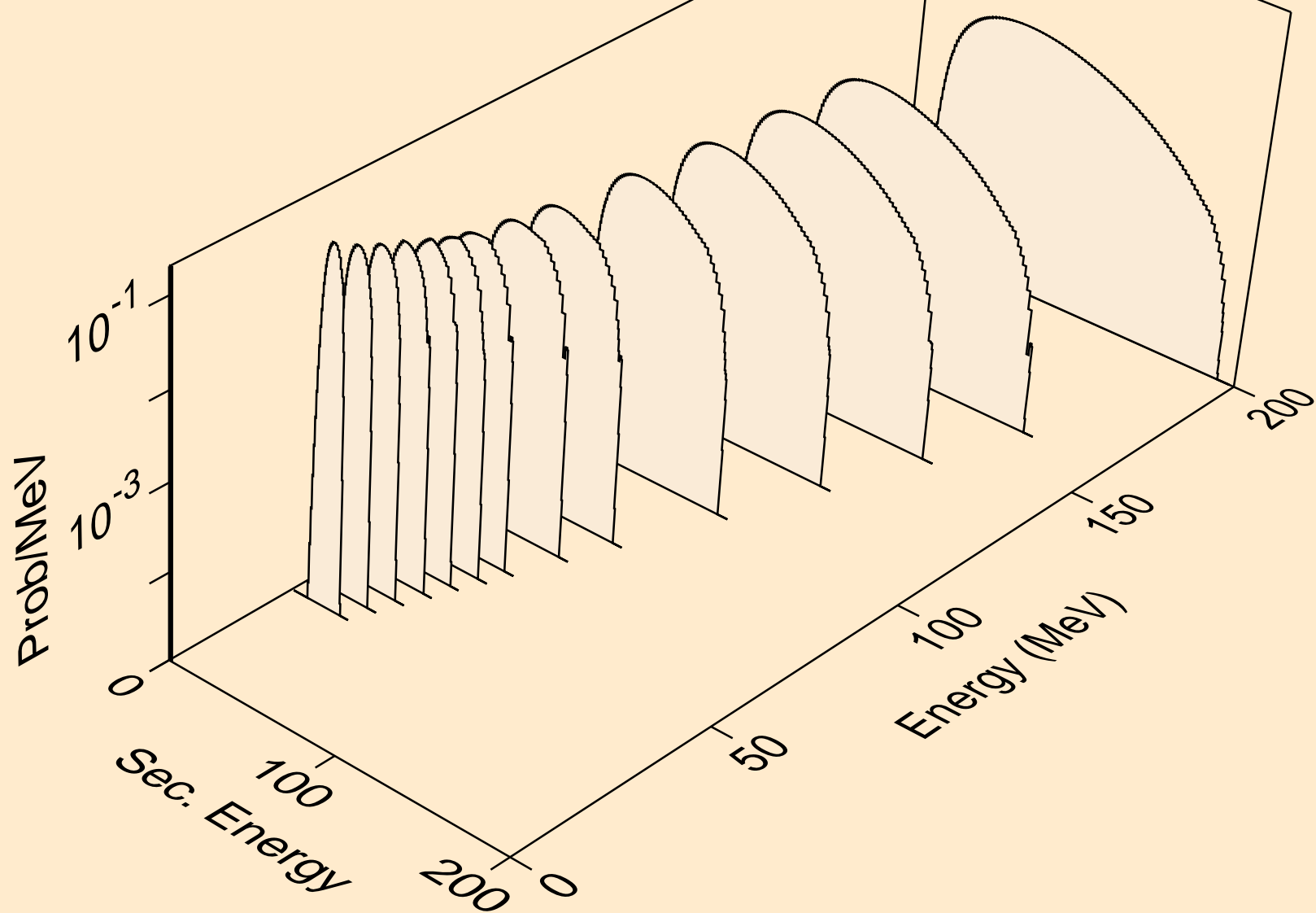

BA135 TRITON ACER TENDL-2021 LIBRARY; T=0.K  
he3s from (t,n\*)he3

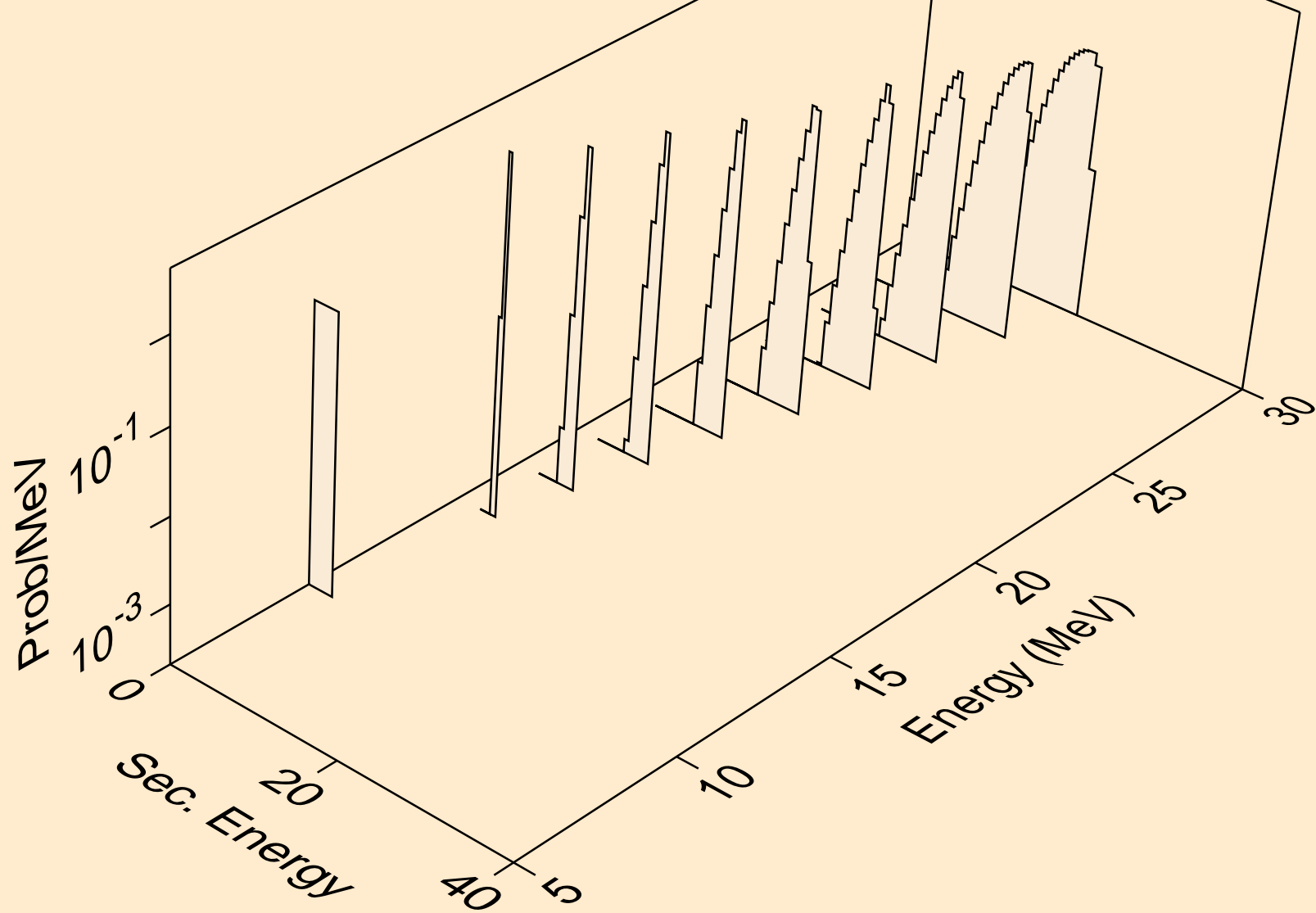

BA135 TRITON ACER TENDL-2021 LIBRARY; T=0.K  
he3s from (t,he3)

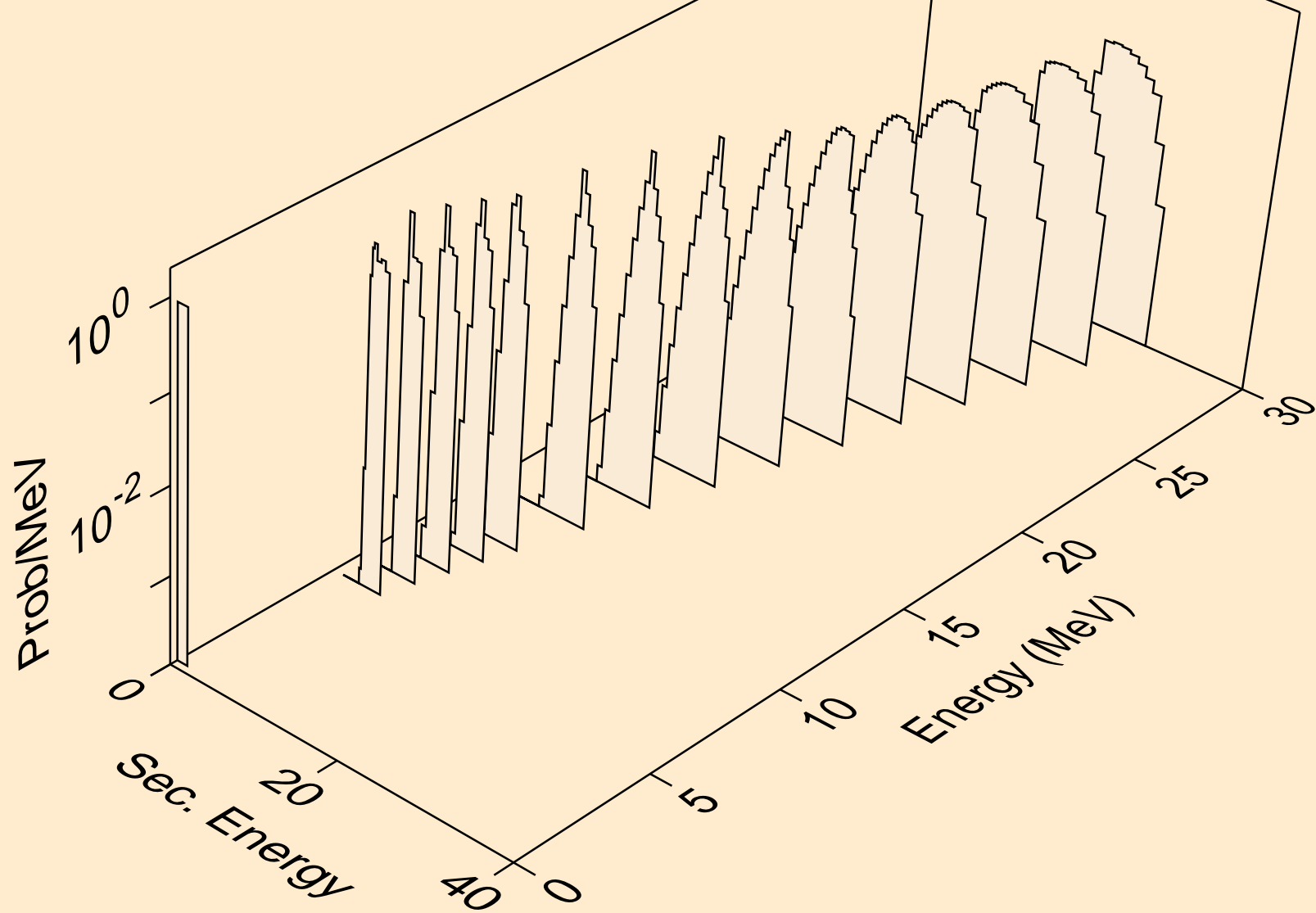

BA135 TRITON ACER TENDL-2021 LIBRARY; T=0.K  
alphas from (t,x)

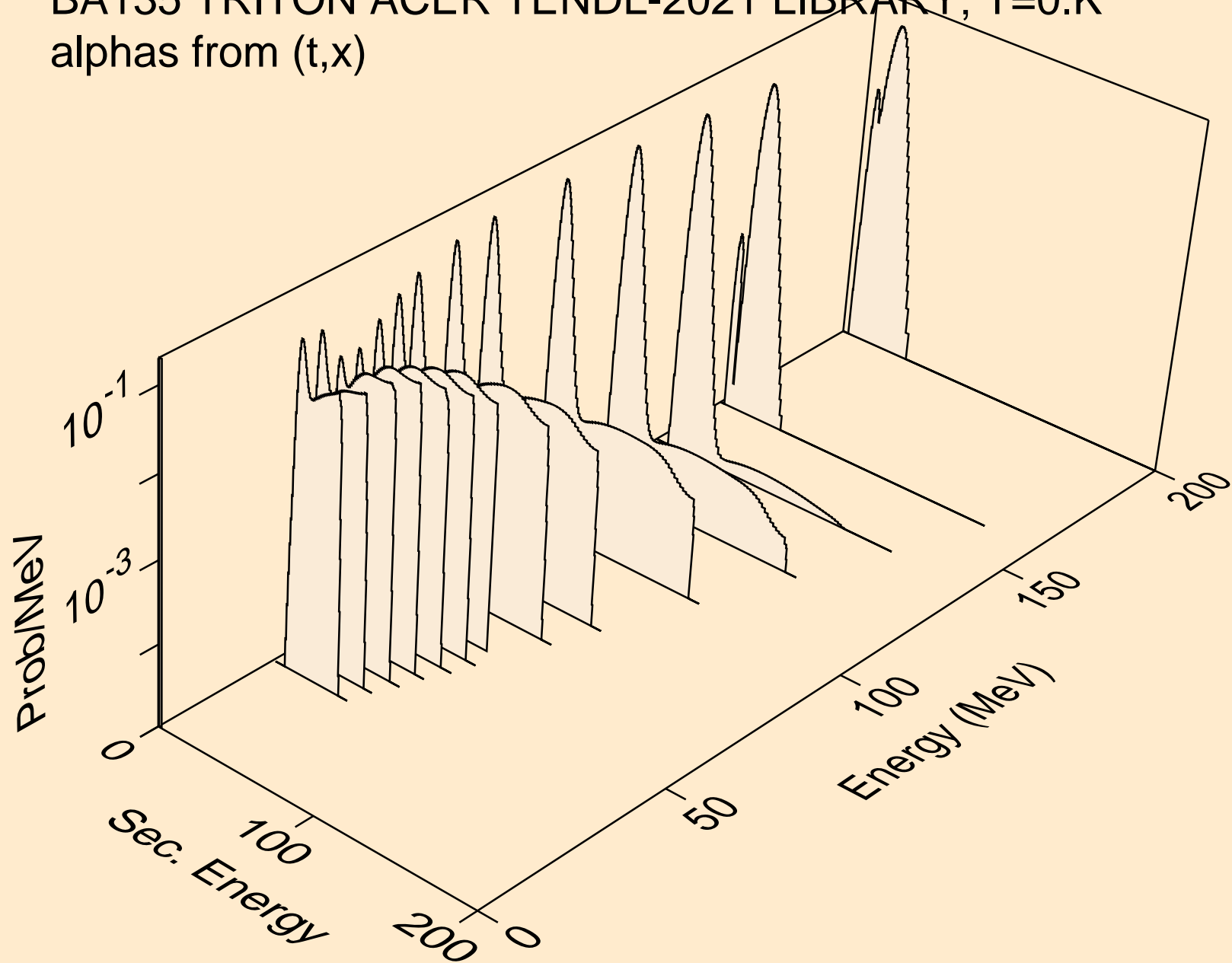

BA135 TRITON ACER TENDL-2021 LIBRARY; T=0.K  
alphas from (t,n\*)a

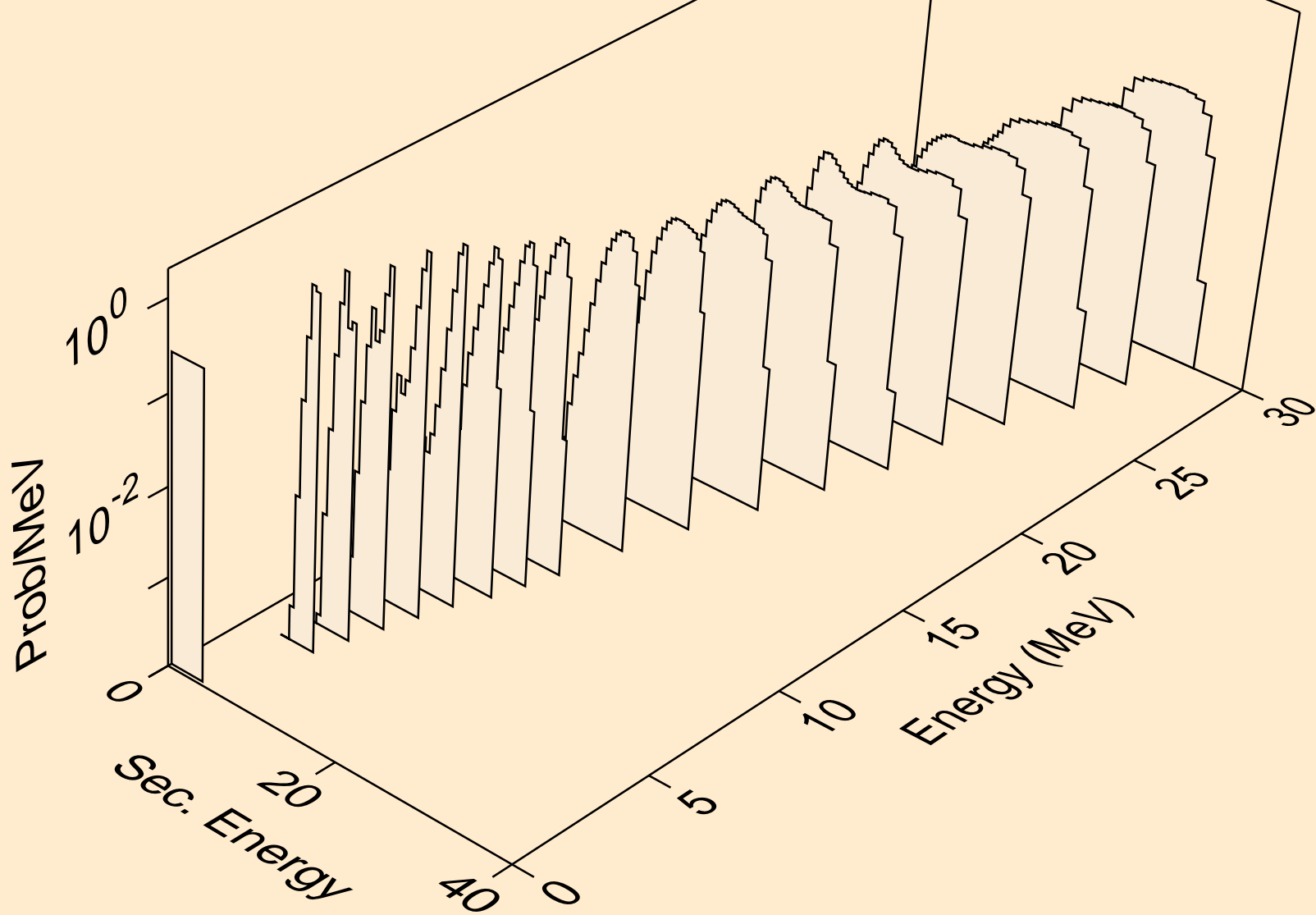

BA135 TRITON ACER TENDL-2021 LIBRARY; T=0.K  
alphas from (t,2n)a

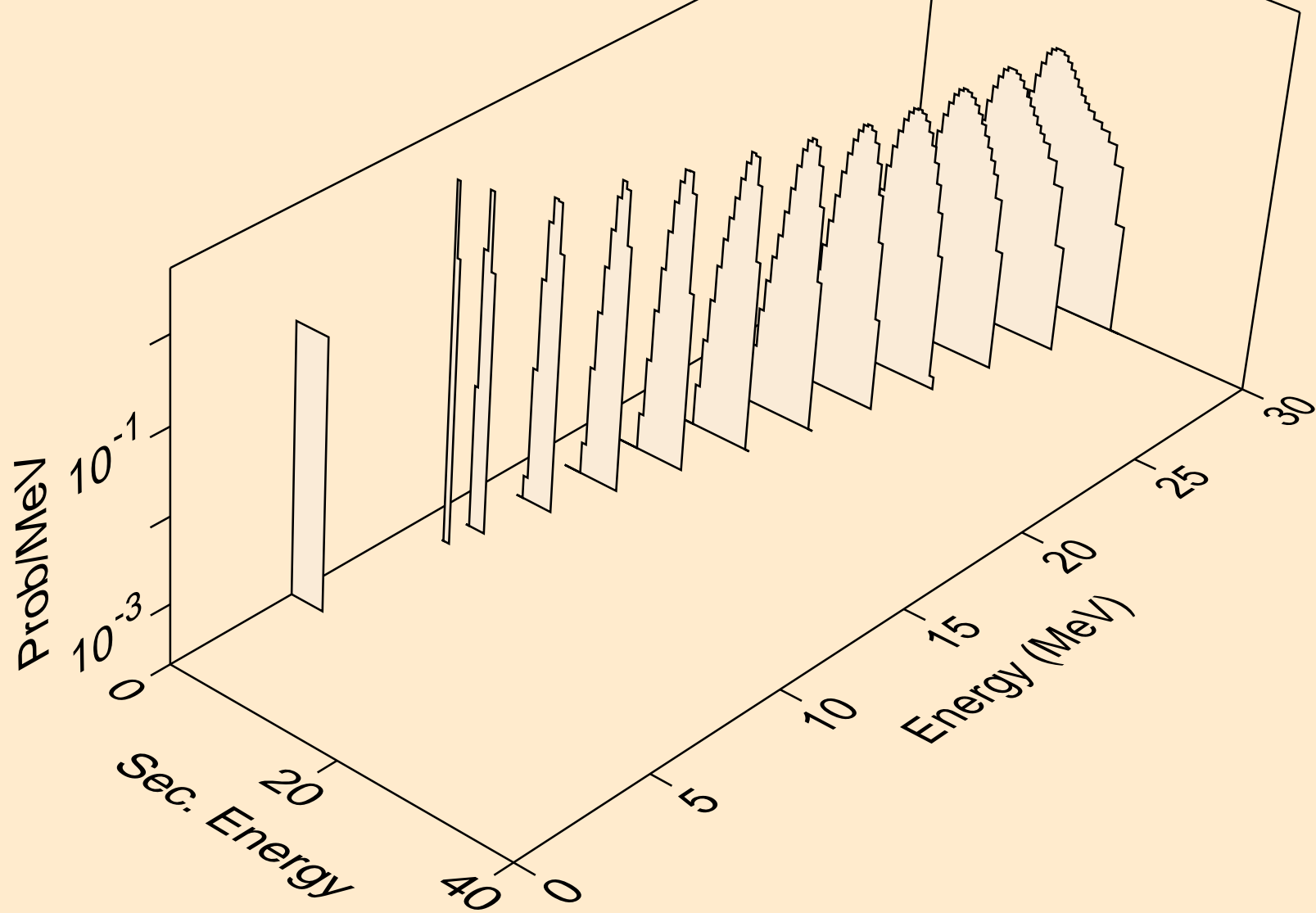

BA135 TRITON ACER TENDL-2021 LIBRARY; T=0.K  
alphas from (t,3n)a

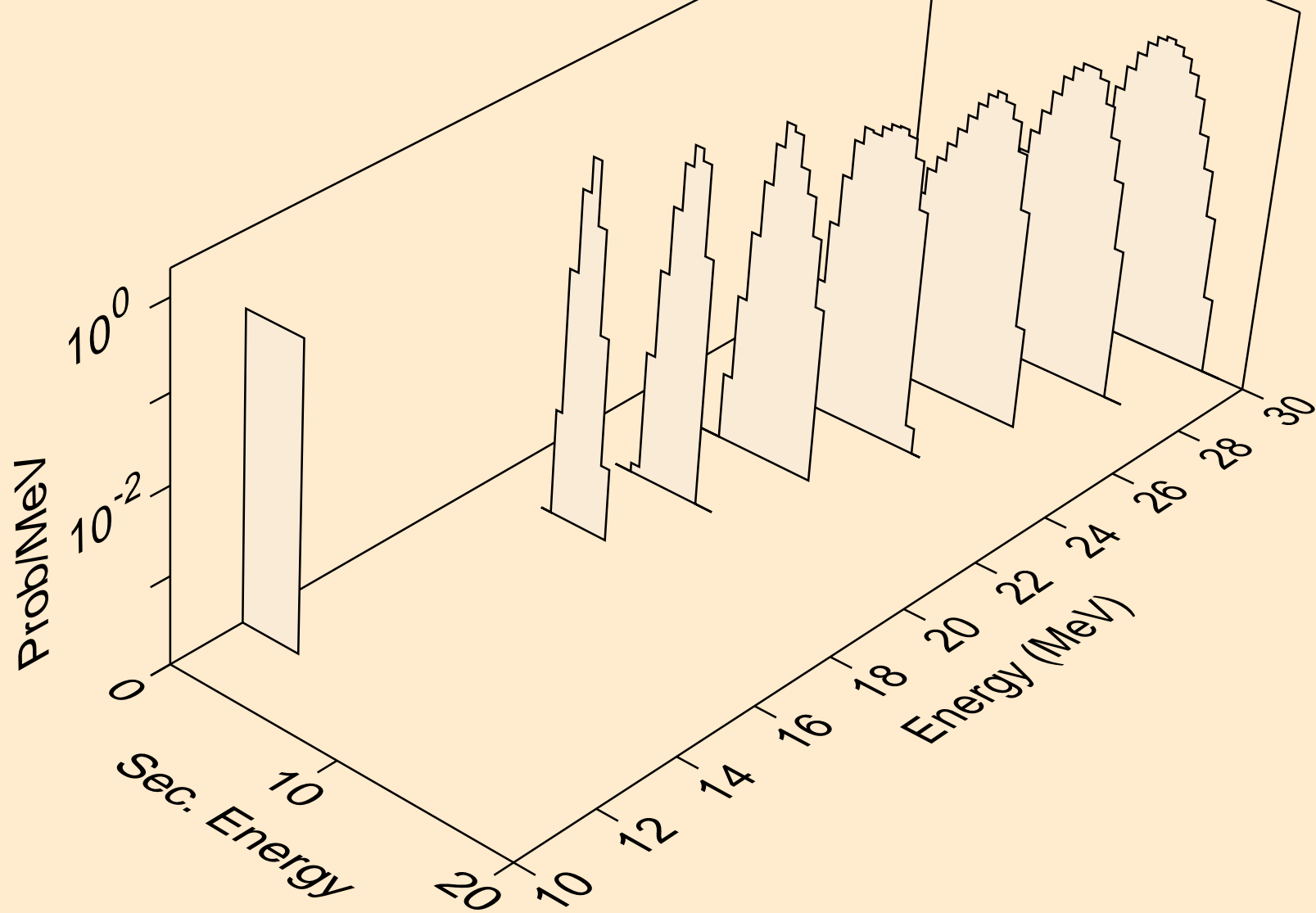



BA135 TRITON ACER TENDL-2021 LIBRARY; T=0.K  
alphas from (t,n\*)2a

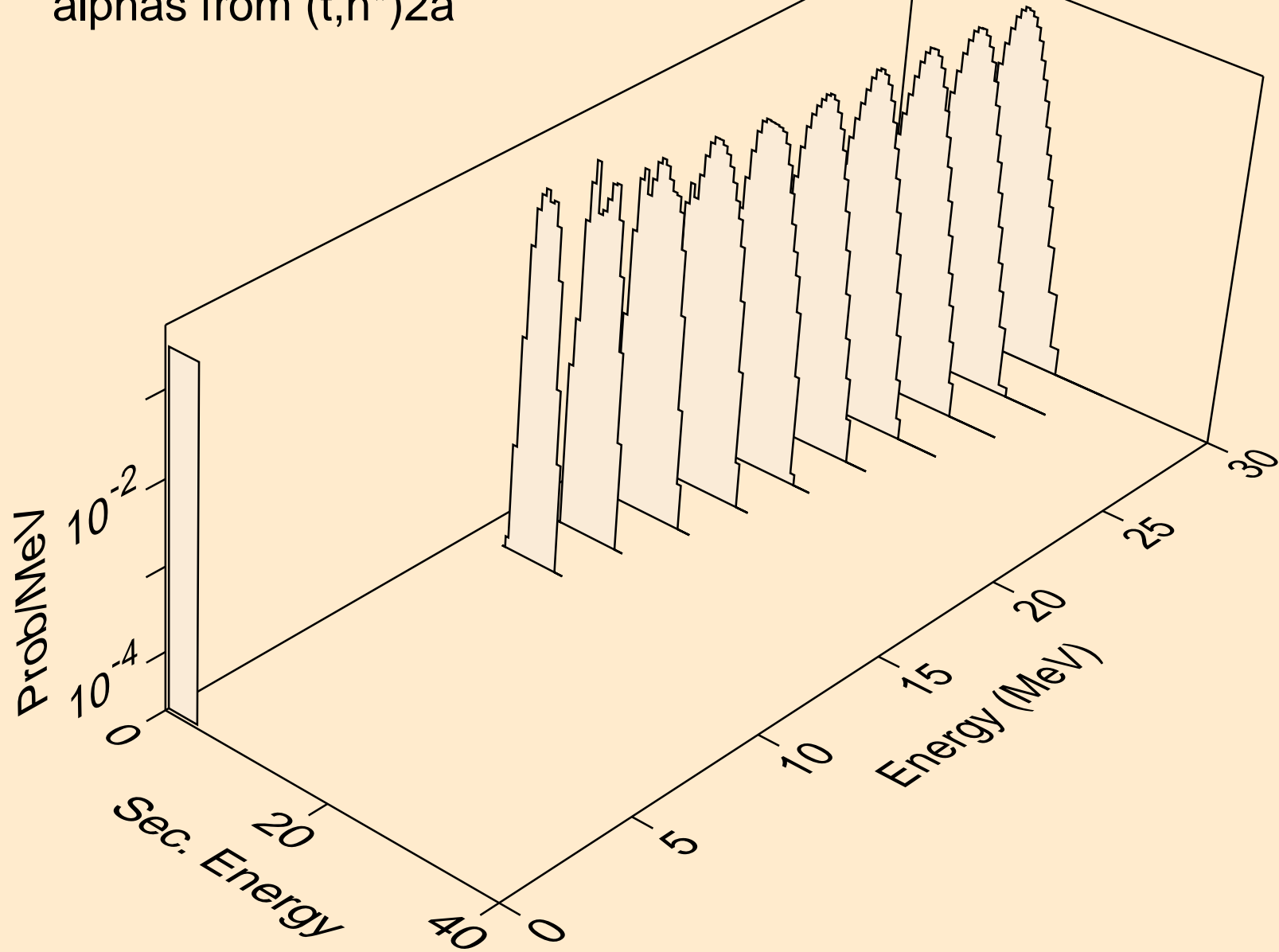

BA135 TRITON ACER TENDL-2021 LIBRARY; T=0.K  
alphas from (t,npa)

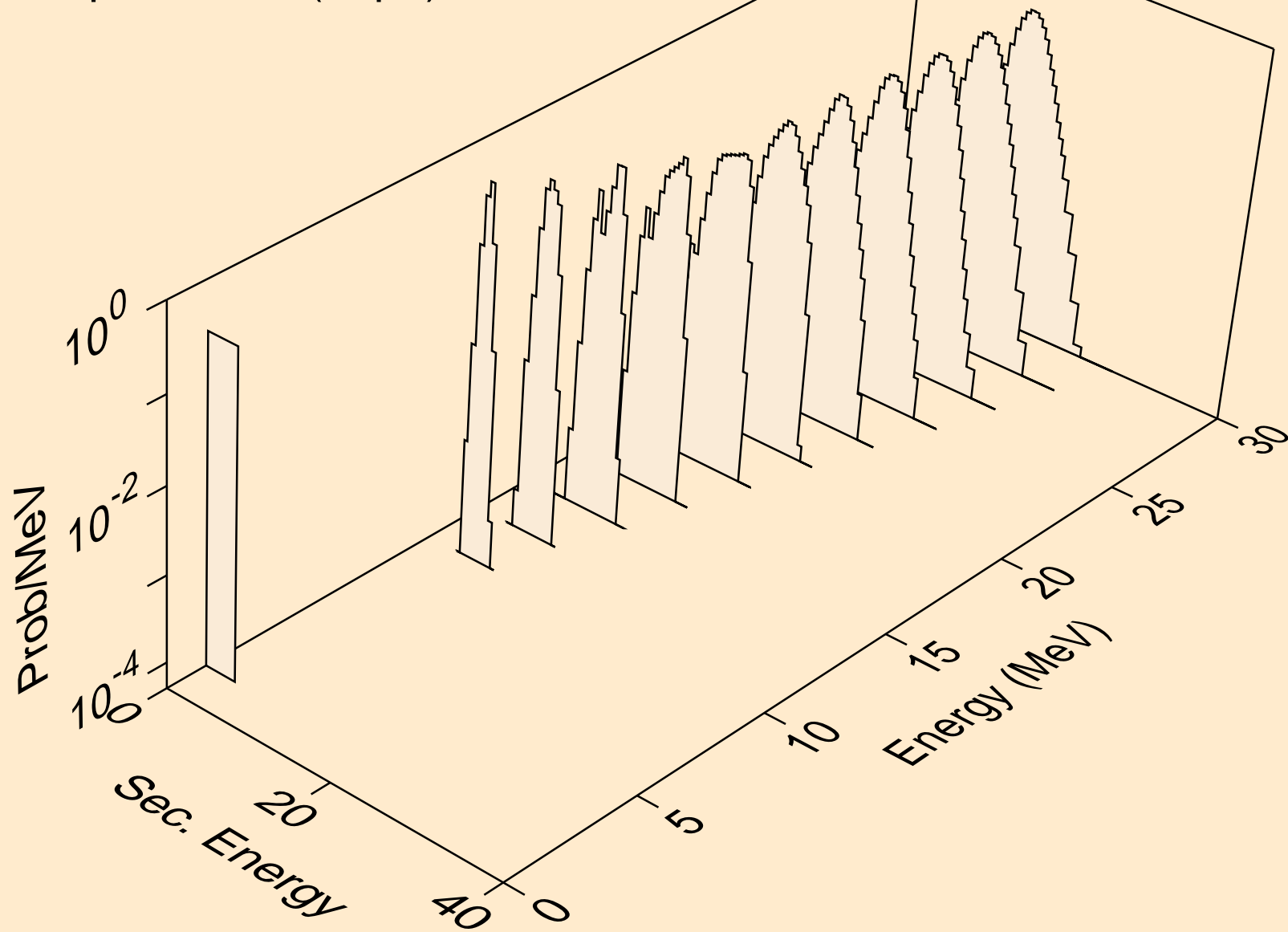

BA135 TRITON ACER TENDL-2021 LIBRARY; T=0.K  
alphas from (t,a)

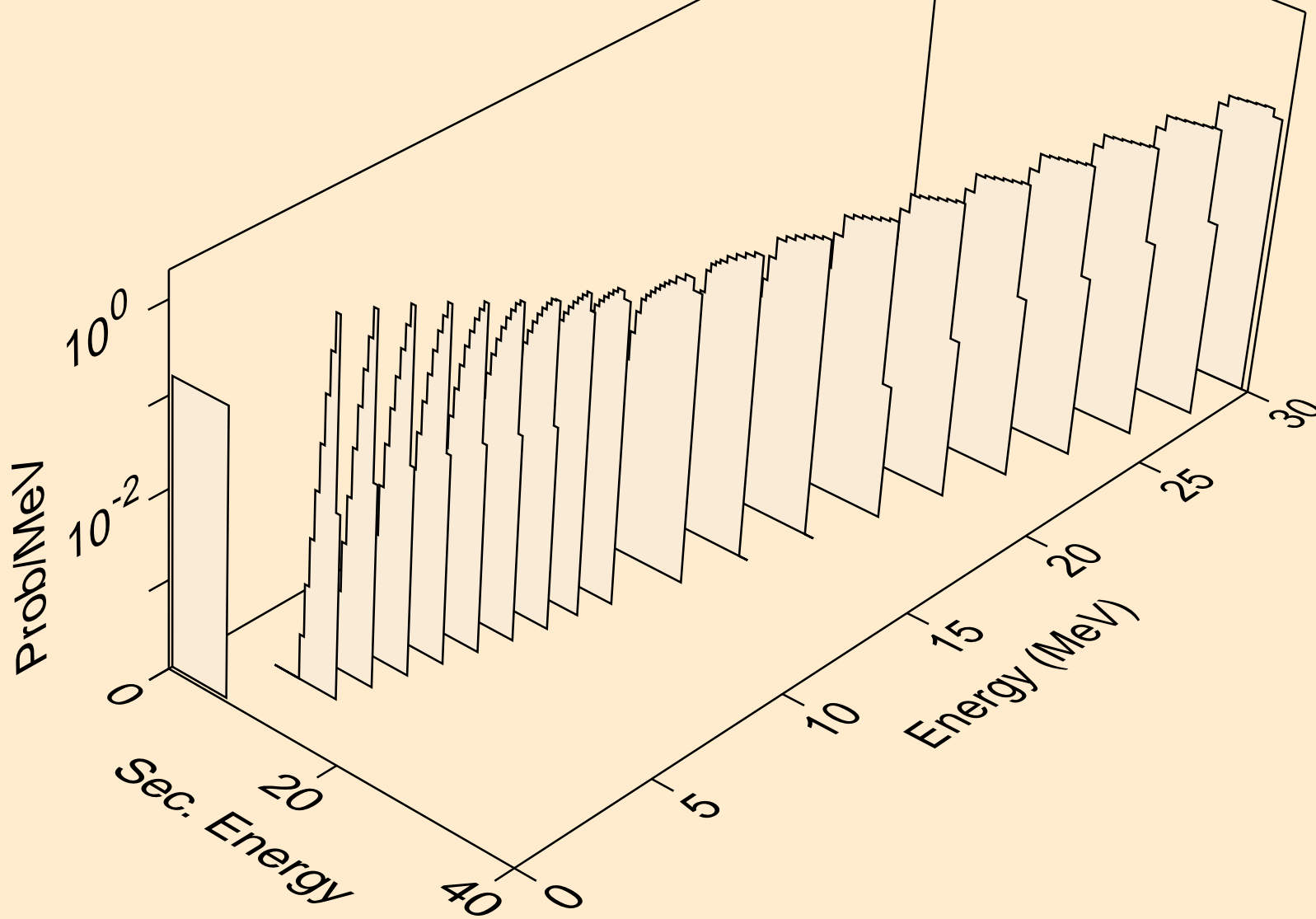

BA135 TRITON ACER TENDL-2021 LIBRARY; T=0.K  
alphas from (t,2a)

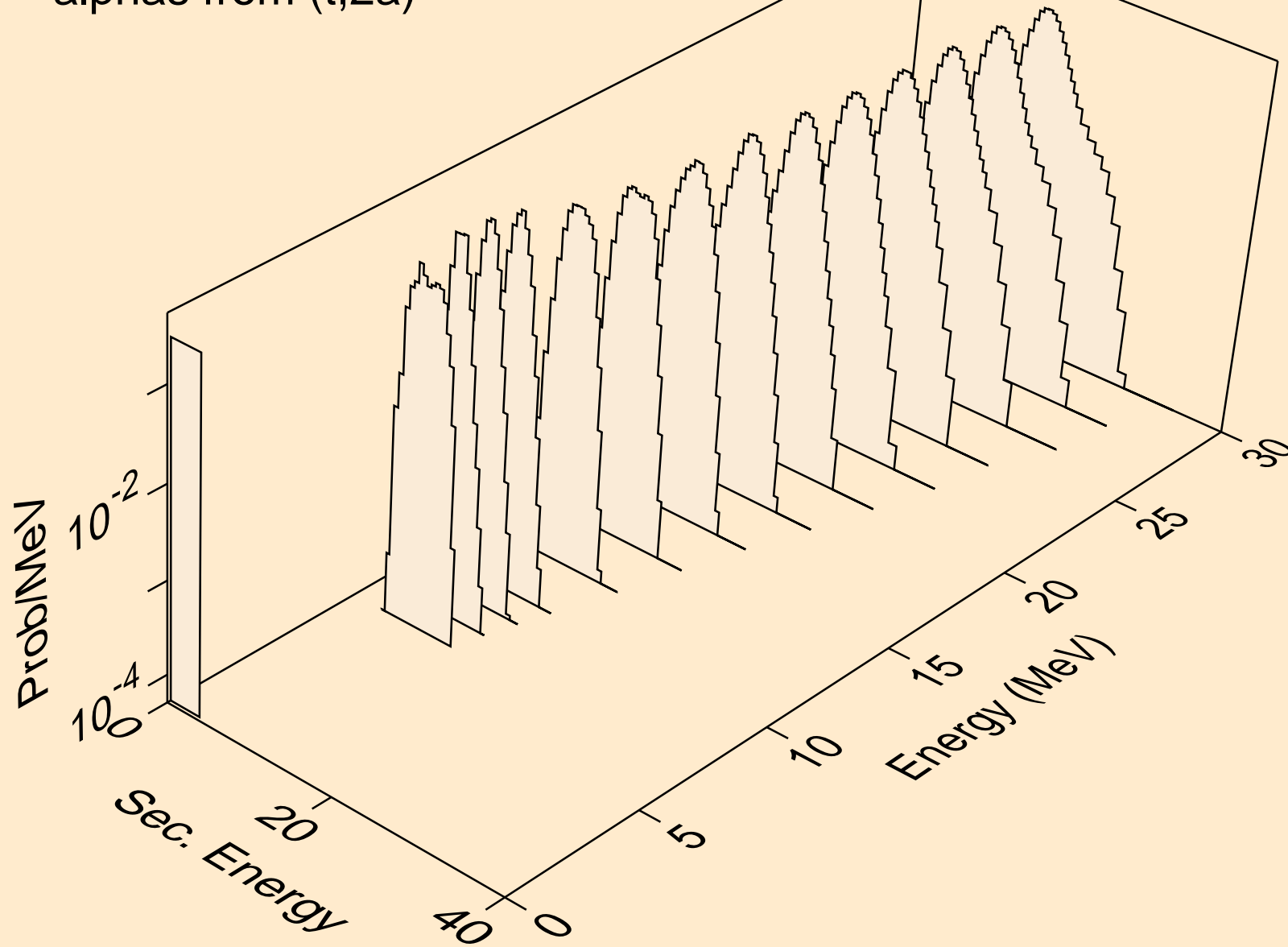

BA135 TRITON ACER TENDL-2021 LIBRARY; T=0.K  
alphas from (t,pa)

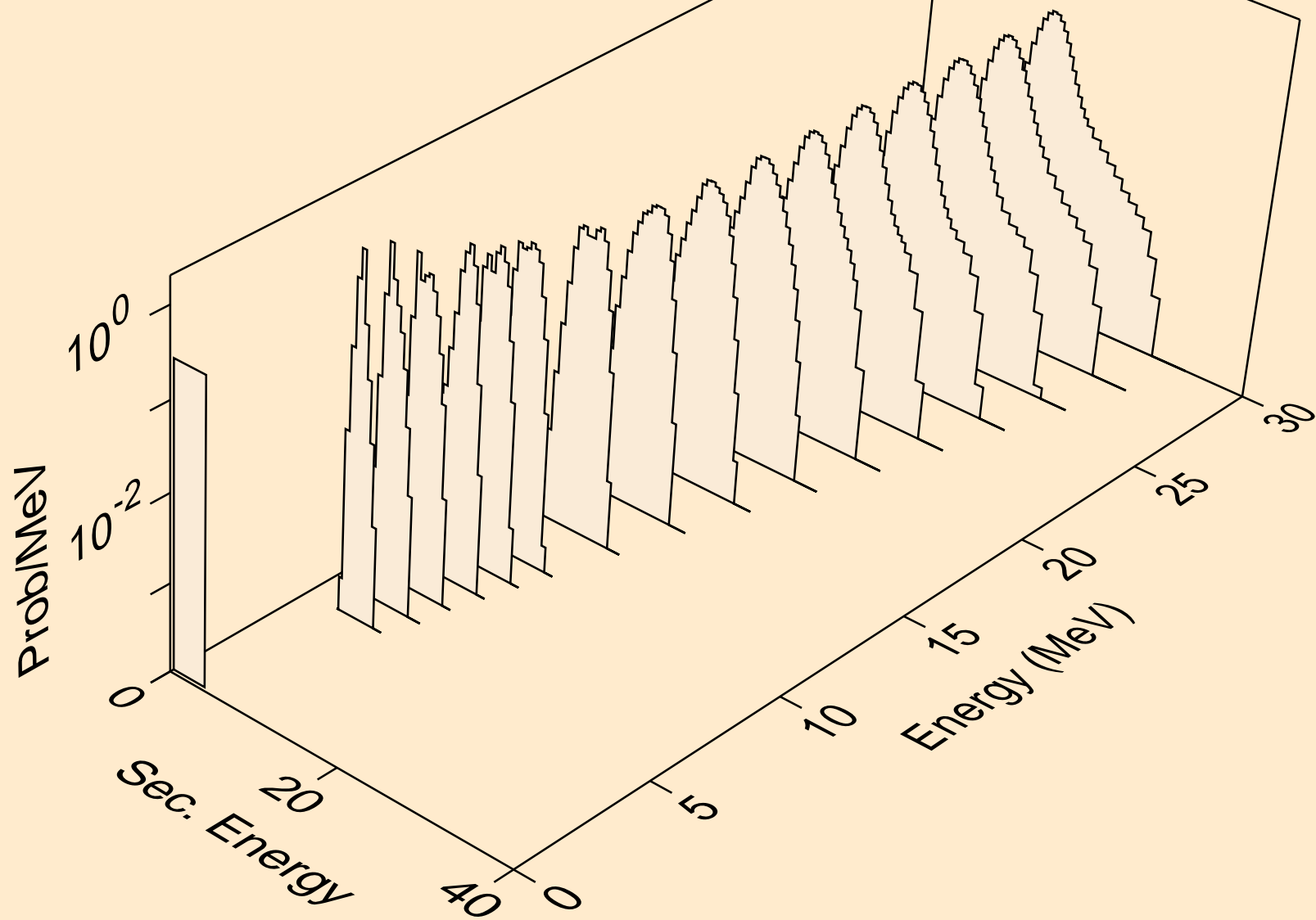

BA135 TRITON ACER TENDL-2021 LIBRARY; T=0.K  
alphas from (t,da)

