

BA136 TRITON ACER TENDL-2021 LIBRARY; T=0.K
Principal cross sections

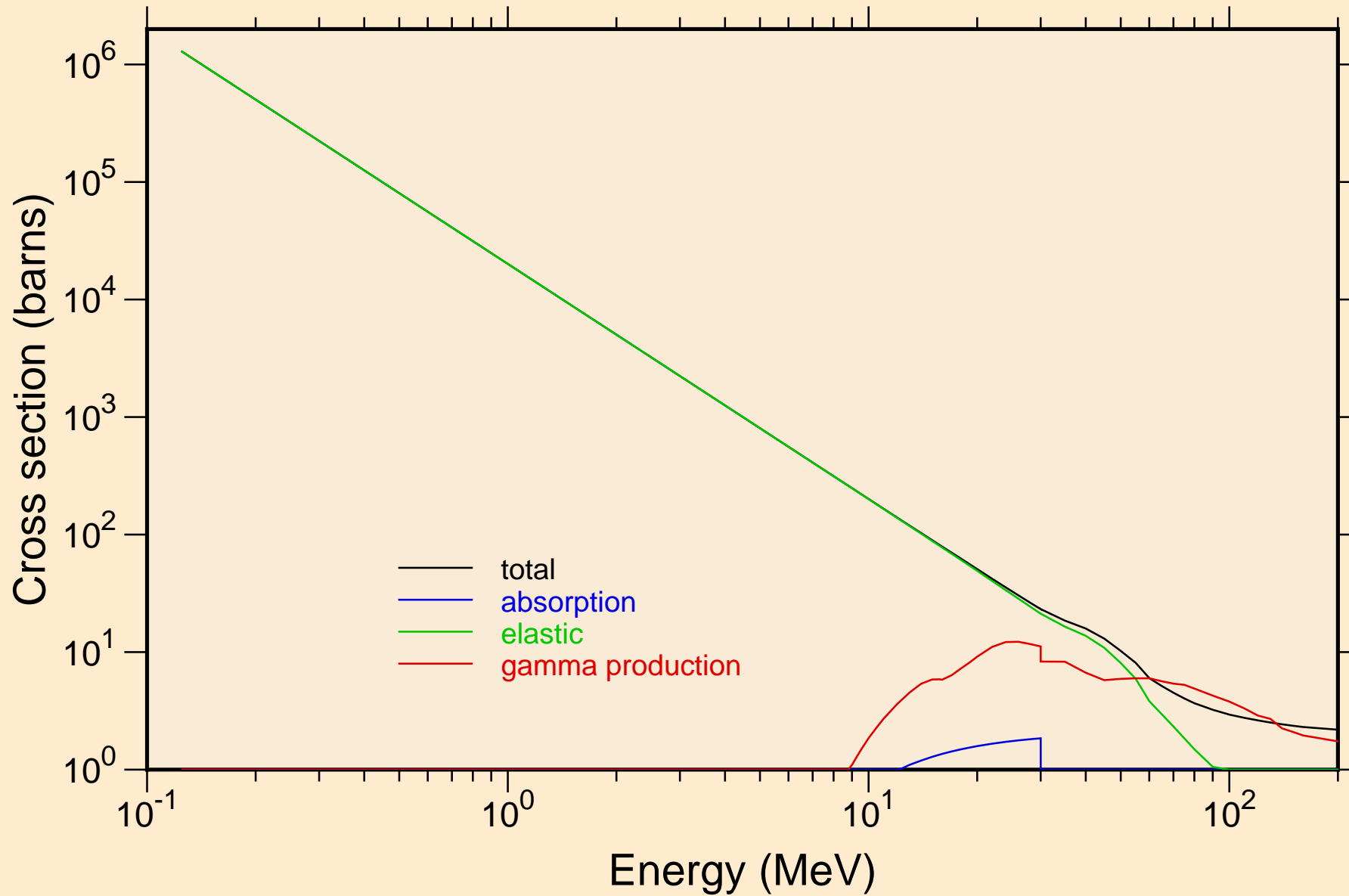

BA136 TRITON ACER TENDL-2021 LIBRARY; T=0.K

Heating

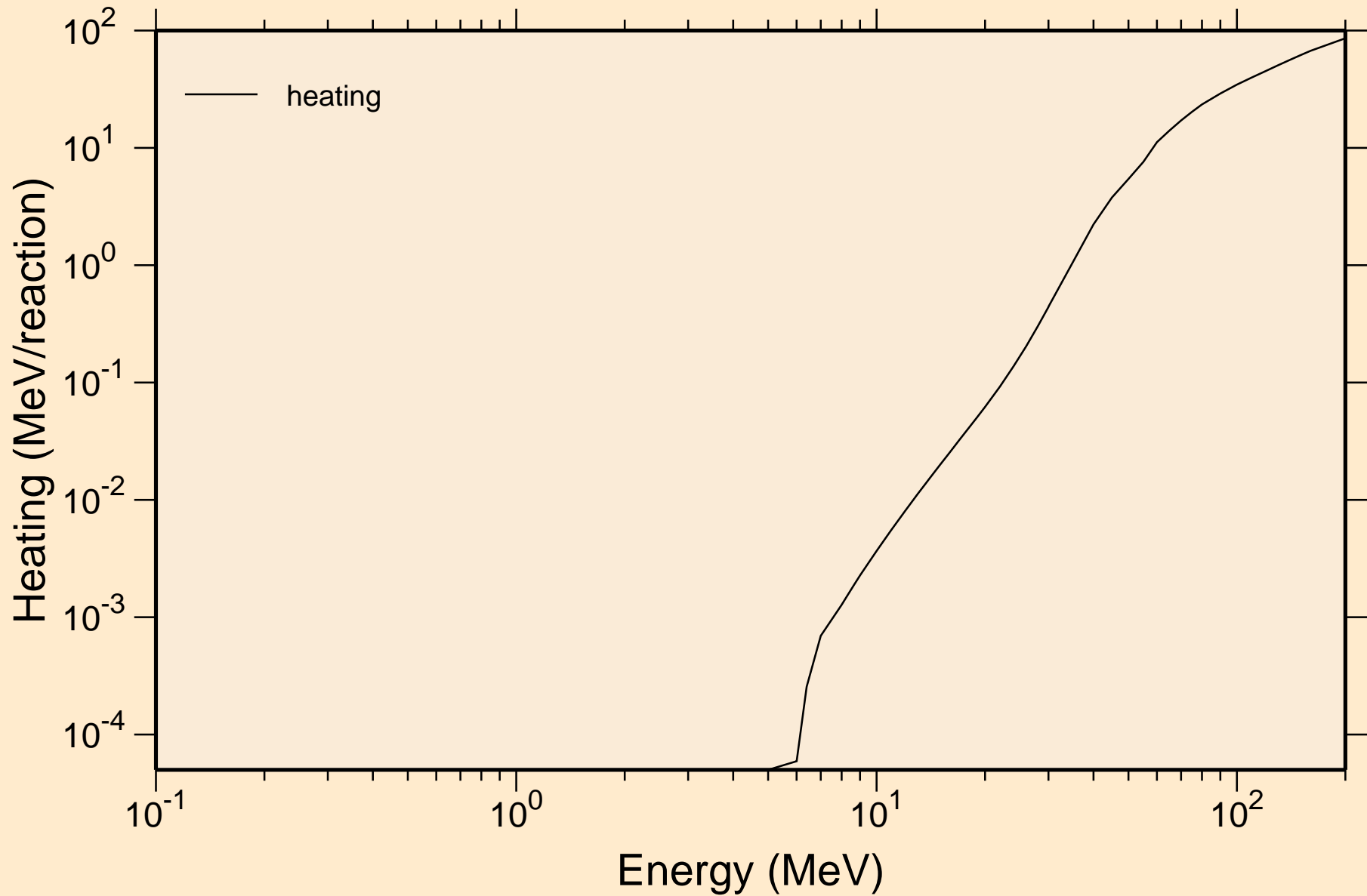

BA136 TRITON ACER TENDL-2021 LIBRARY; T=0.K

Principal cross sections

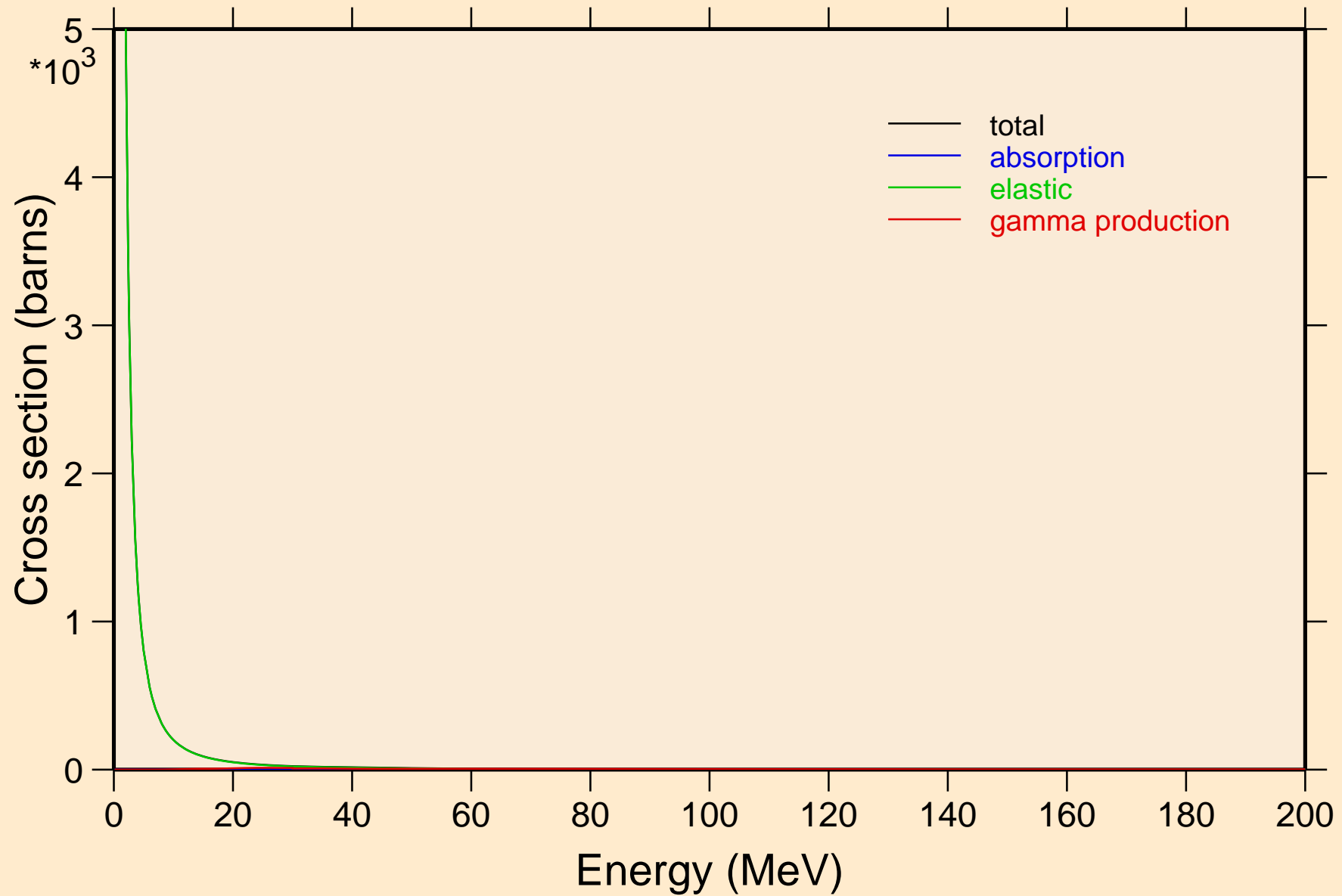

BA136 TRITON ACER TENDL-2021 LIBRARY; T=0.K

Heating

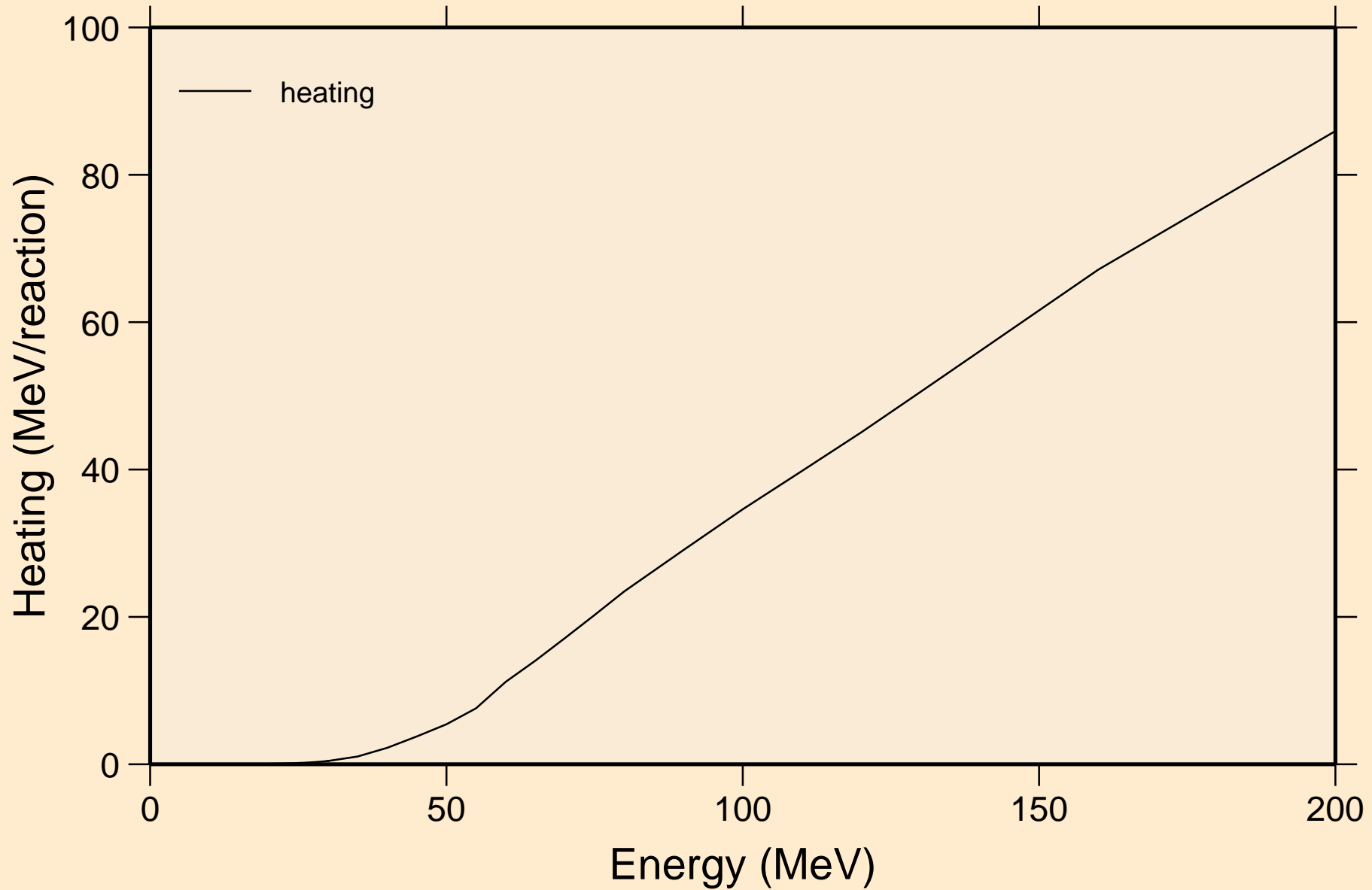

BA136 TRITON ACER TENDL-2021 LIBRARY; T=0.K
Threshold reactions

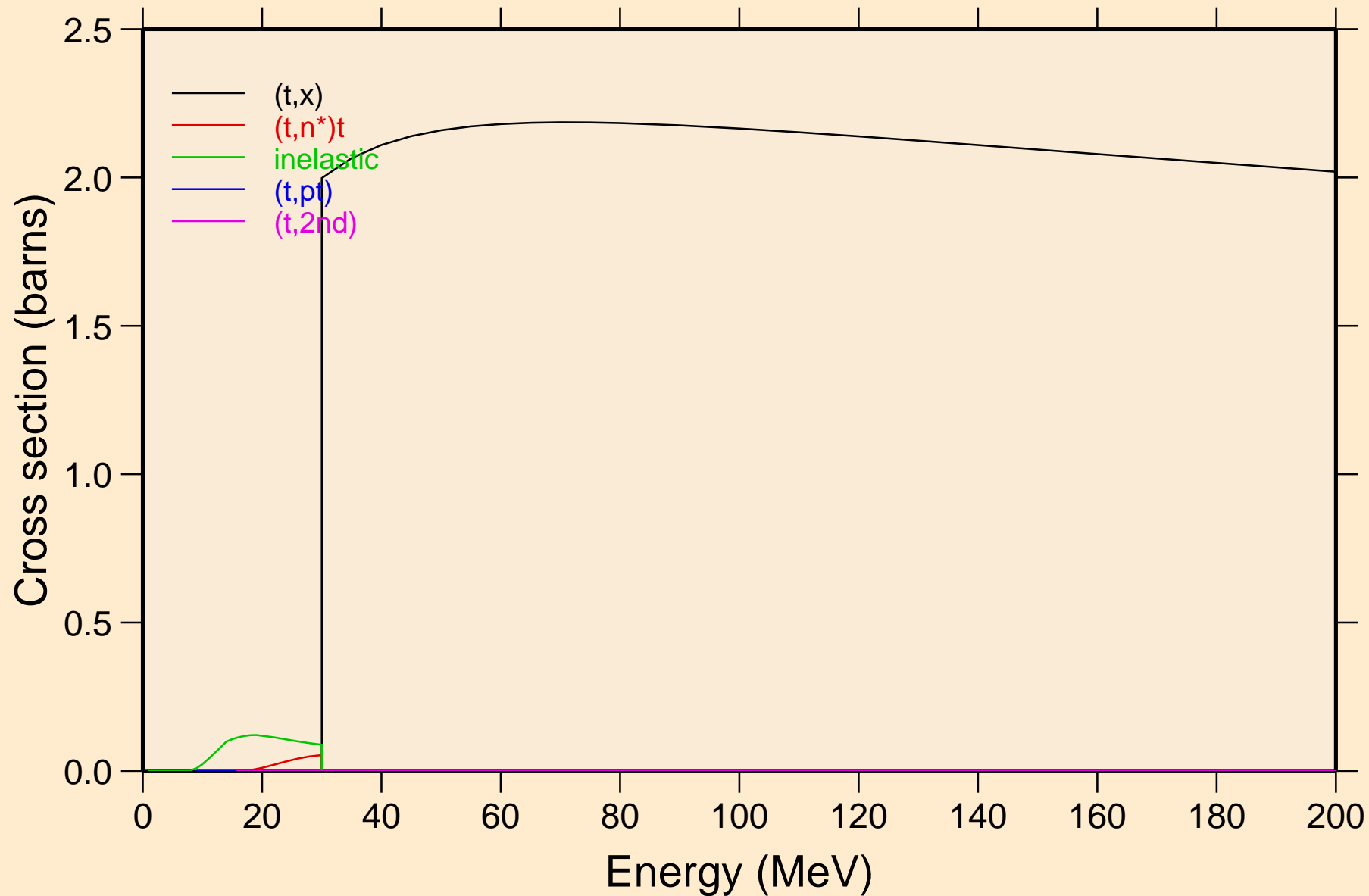

BA136 TRITON ACER TENDL-2021 LIBRARY; T=0.K
Threshold reactions

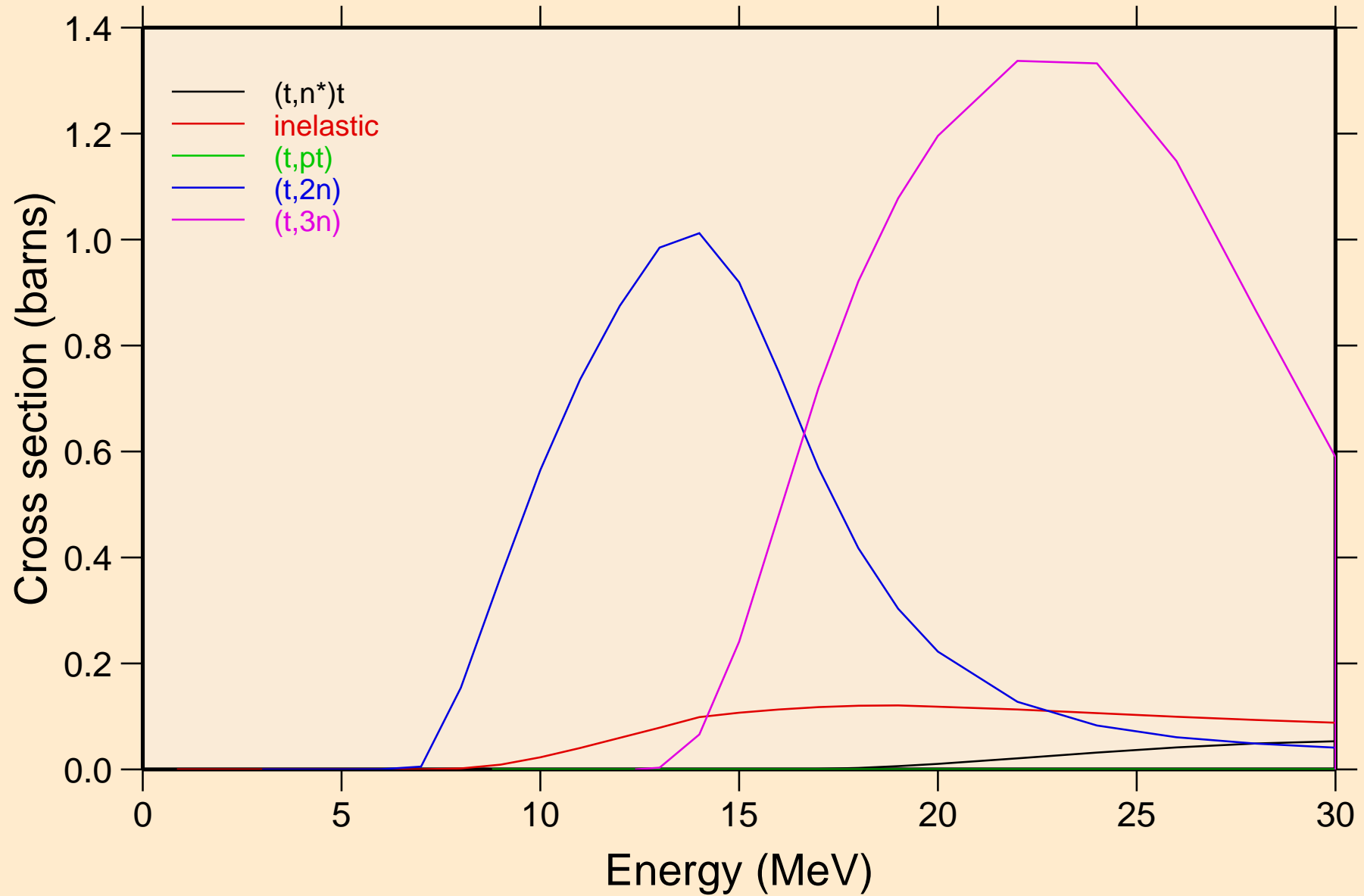

BA136 TRITON ACER TENDL-2021 LIBRARY; T=0.K
Threshold reactions

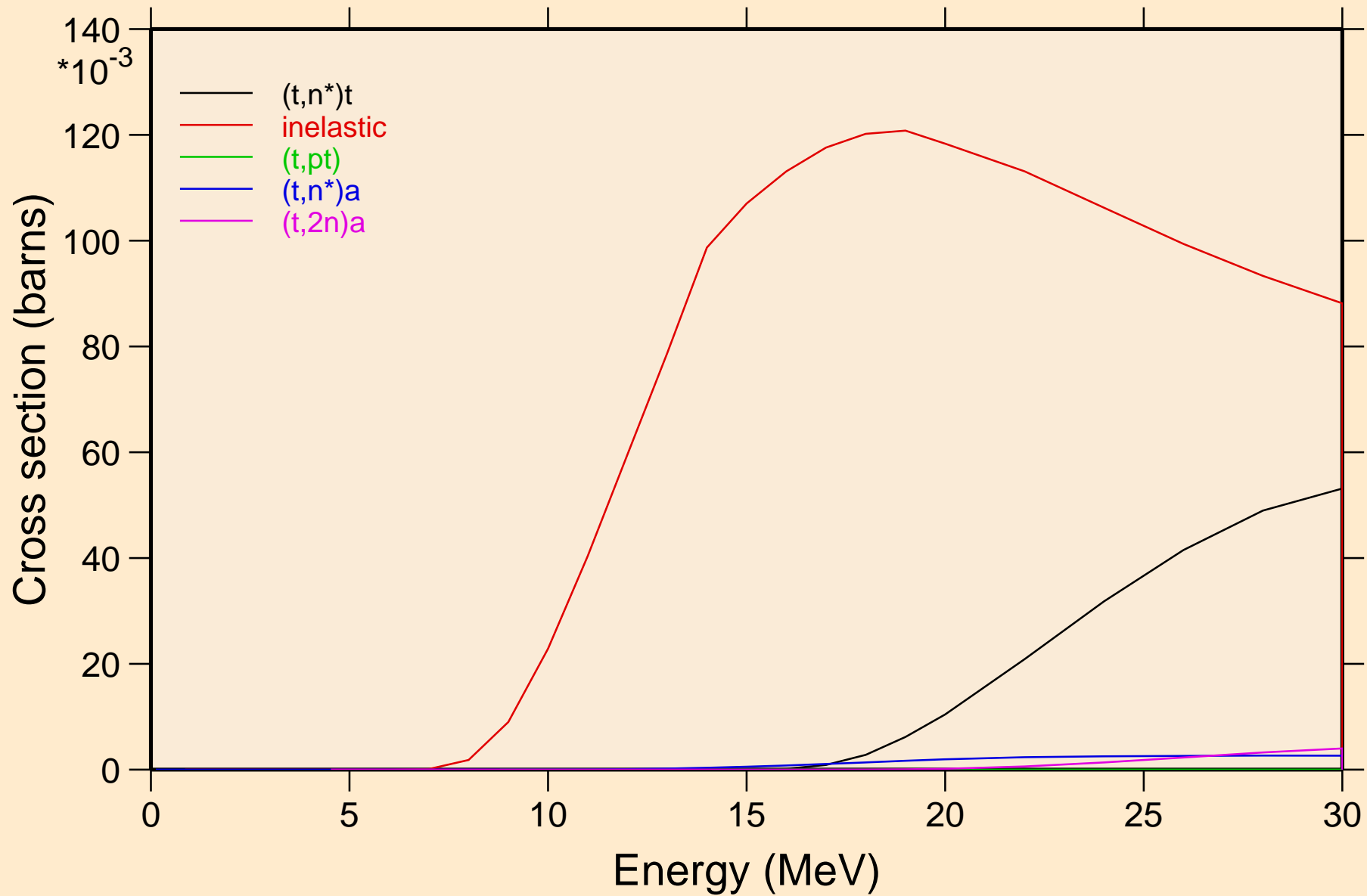

BA136 TRITON ACER TENDL-2021 LIBRARY; T=0.K
Threshold reactions

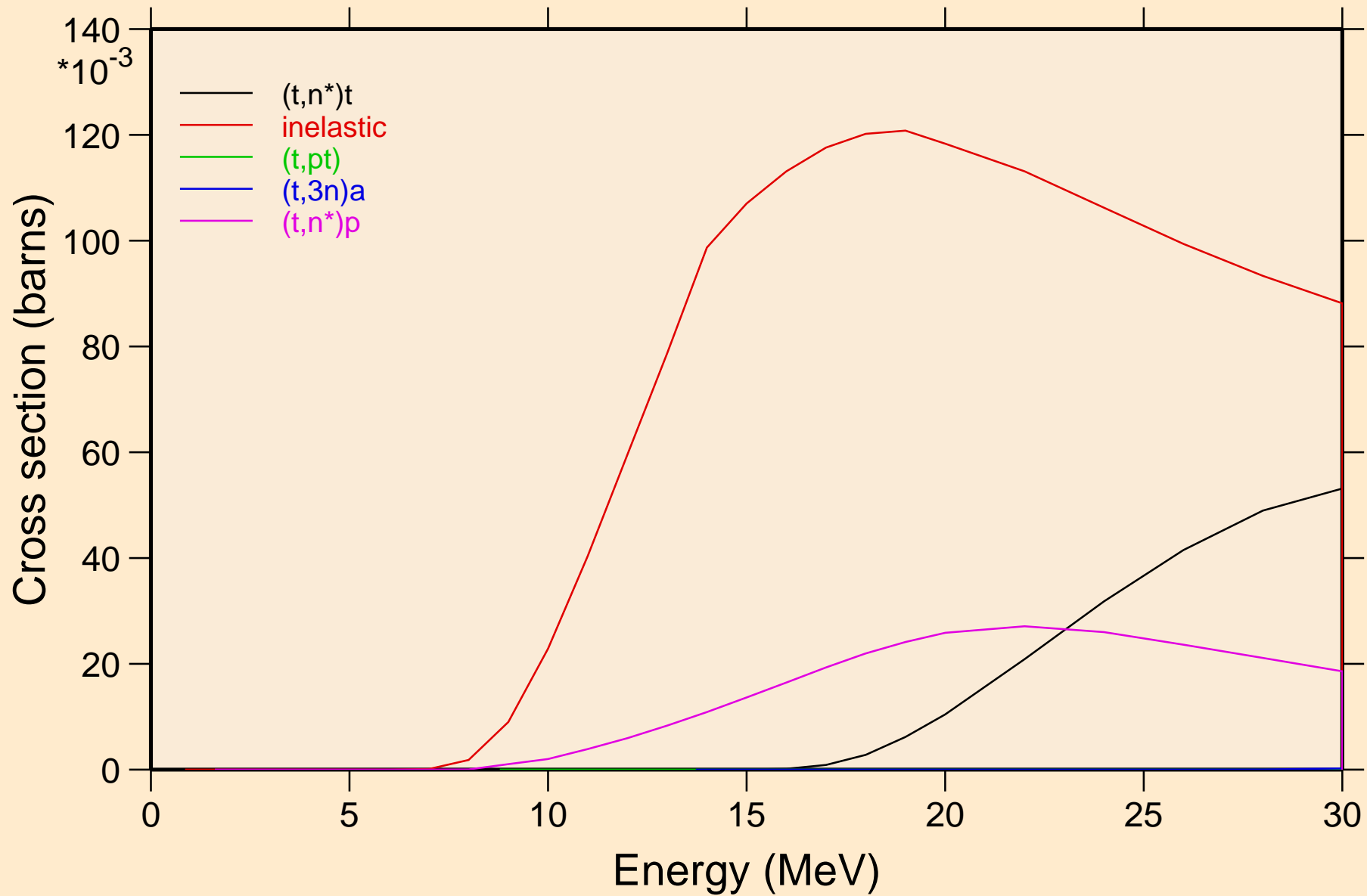

BA136 TRITON ACER TENDL-2021 LIBRARY; T=0.K
Threshold reactions

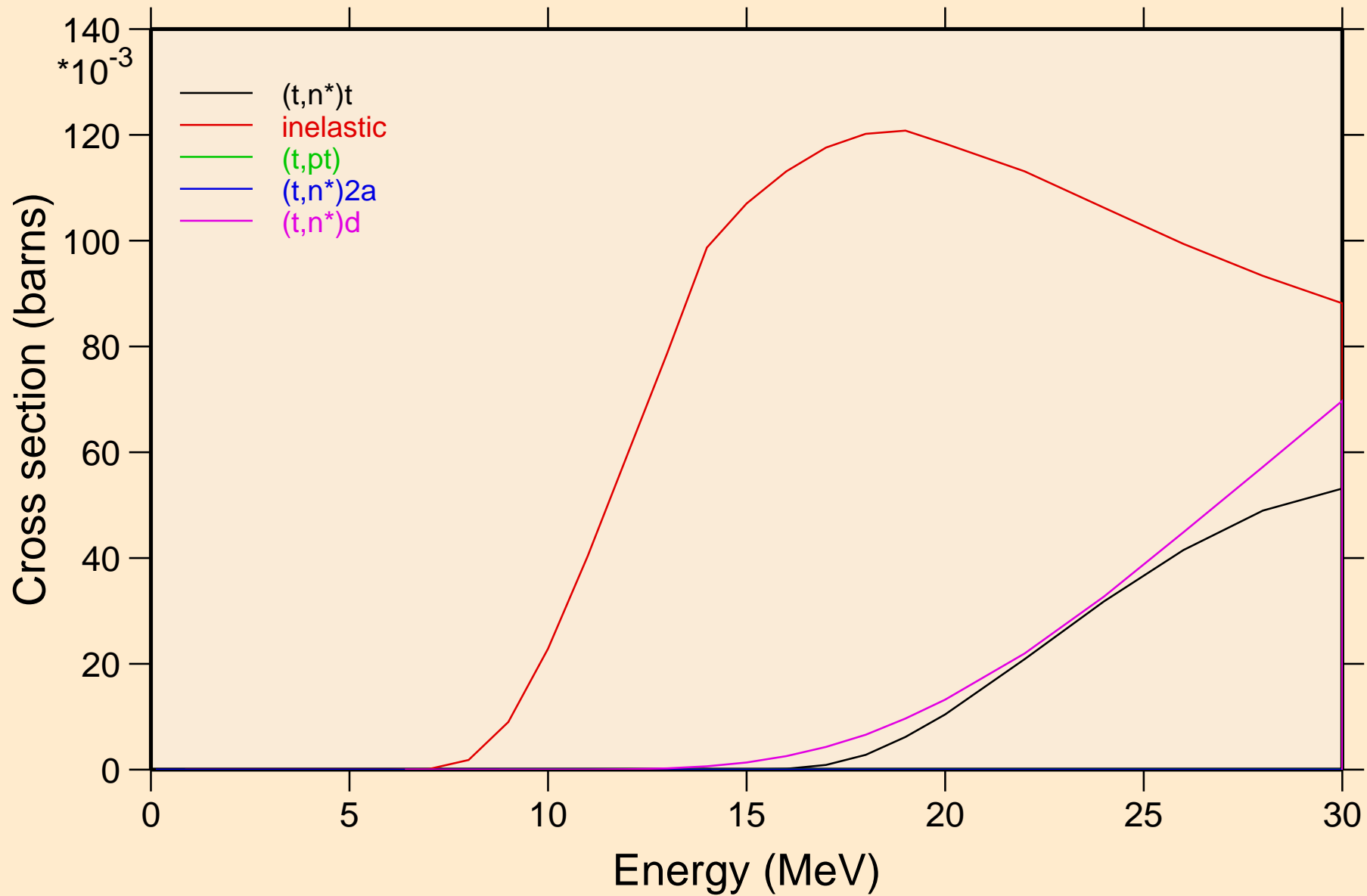

BA136 TRITON ACER TENDL-2021 LIBRARY; T=0.K
Threshold reactions

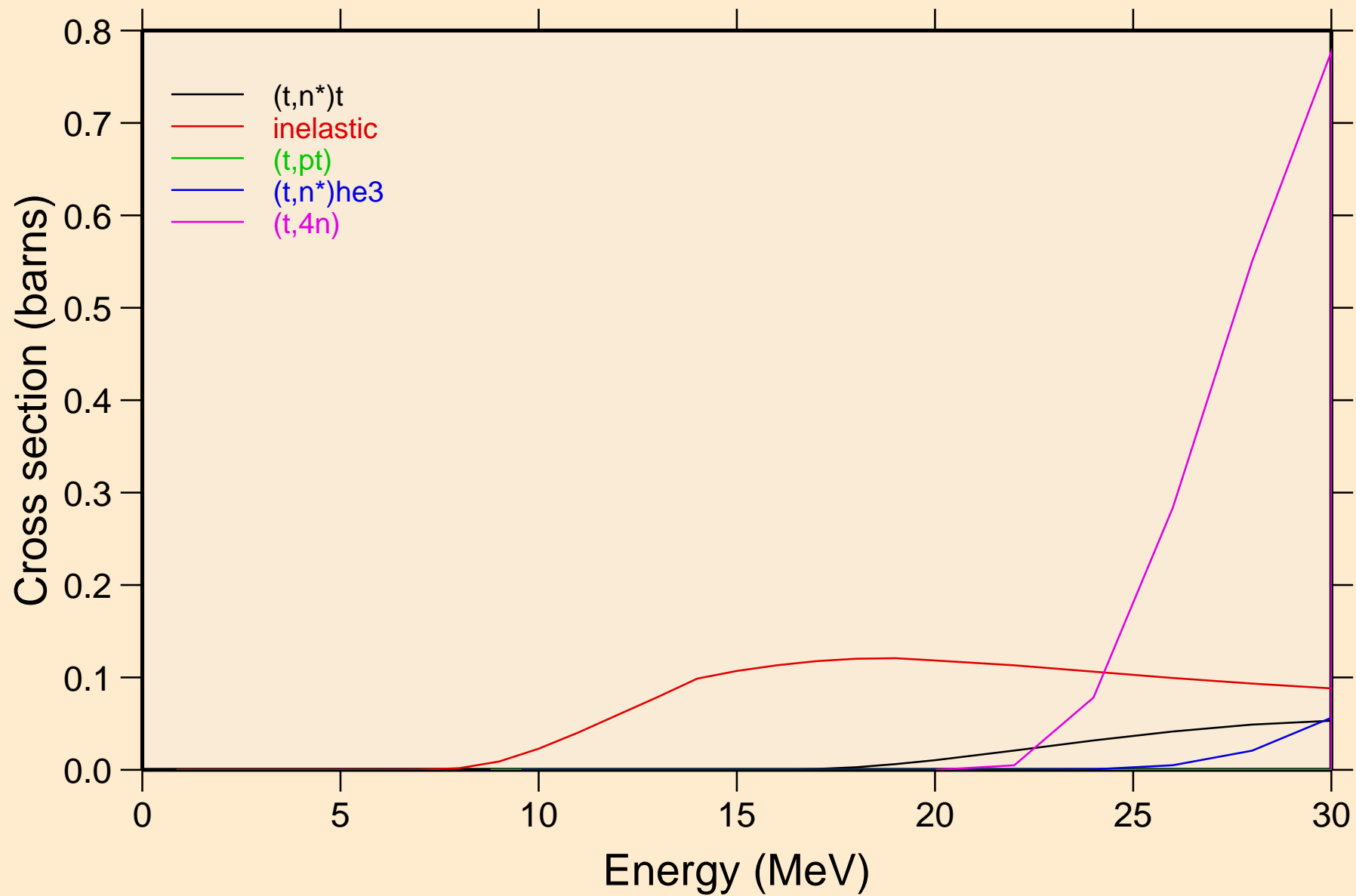

BA136 TRITON ACER TENDL-2021 LIBRARY; T=0.K
Threshold reactions

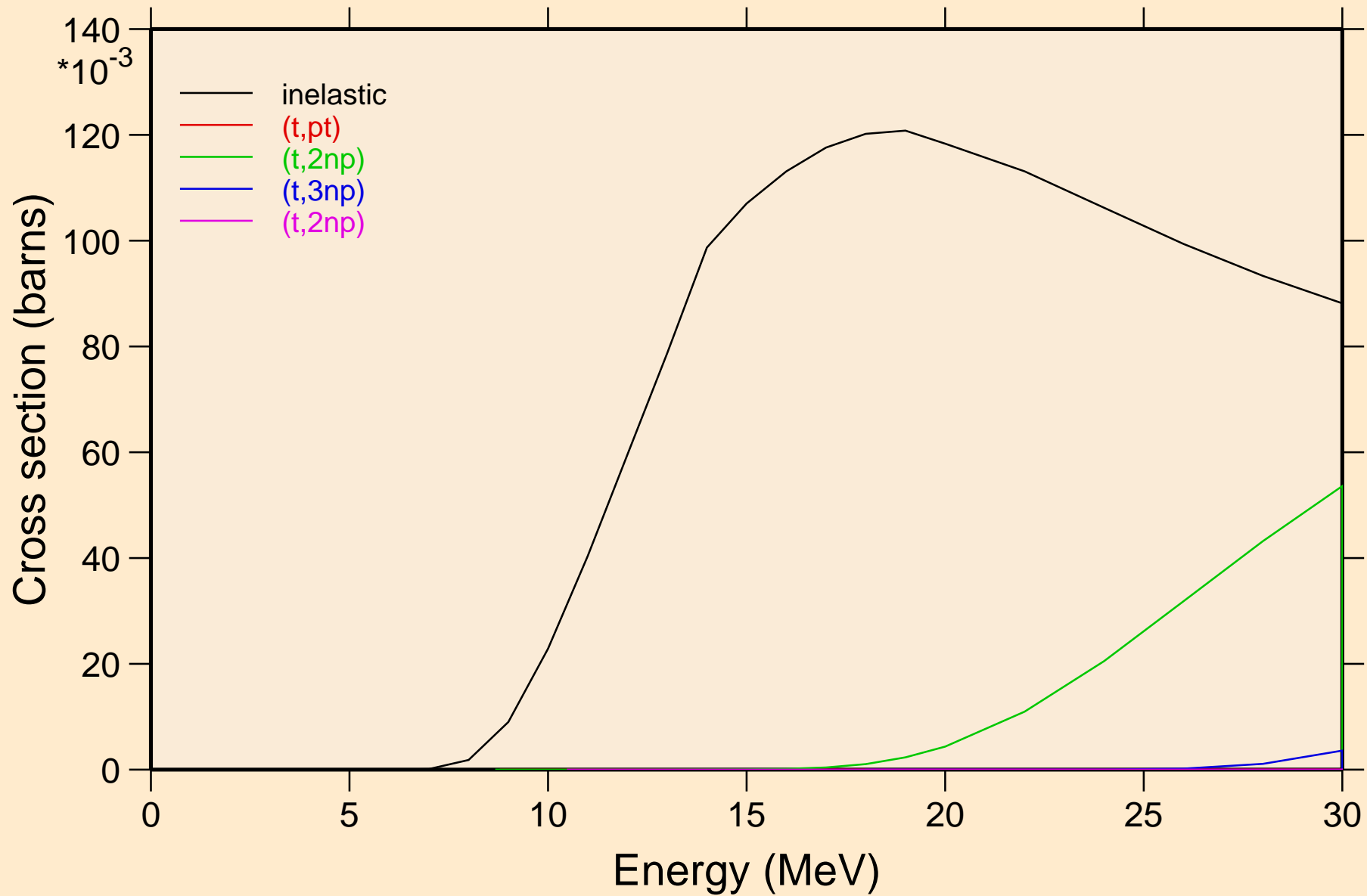

BA136 TRITON ACER TENDL-2021 LIBRARY; T=0.K
Threshold reactions

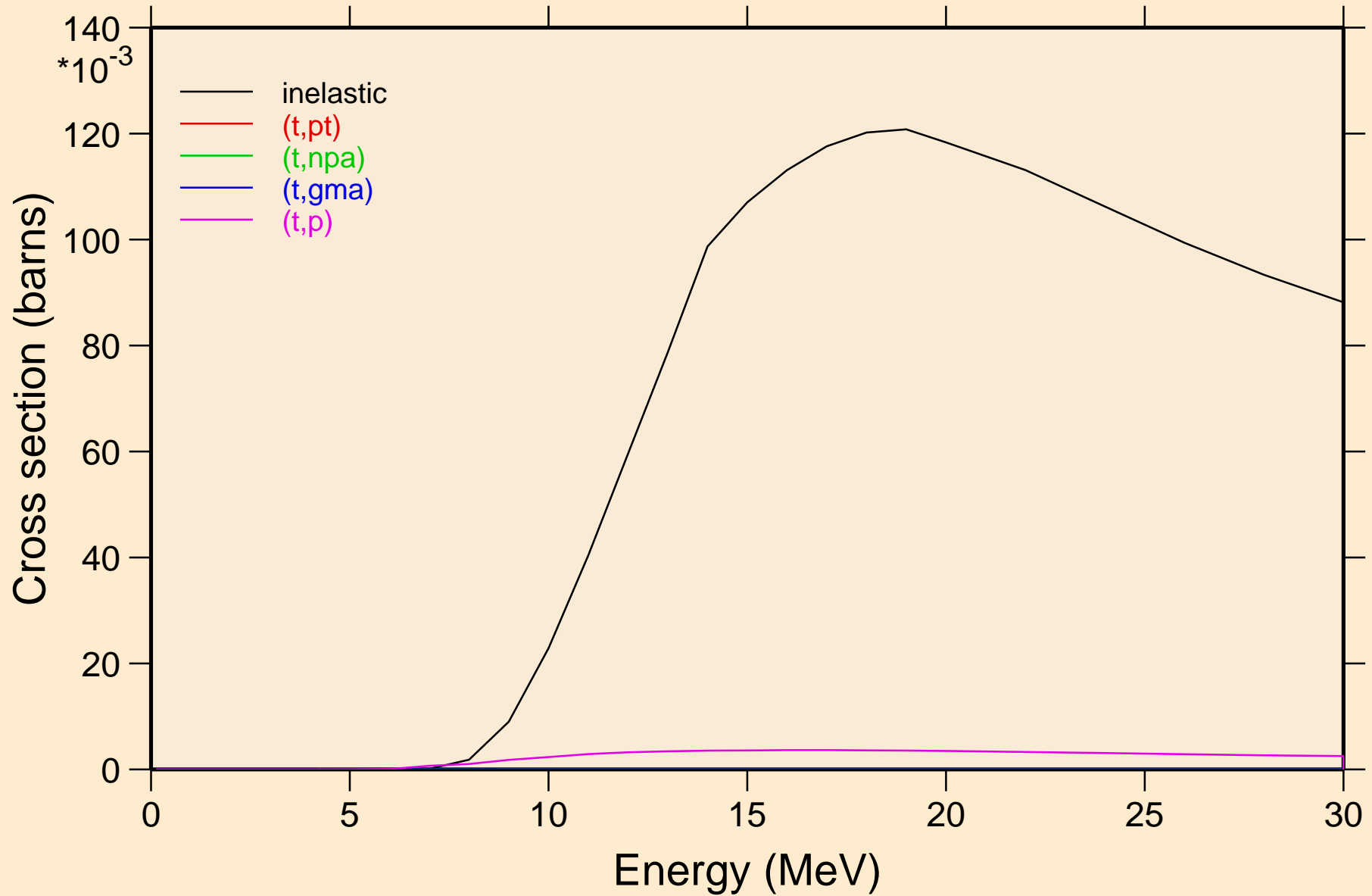

BA136 TRITON ACER TENDL-2021 LIBRARY; T=0.K
Threshold reactions

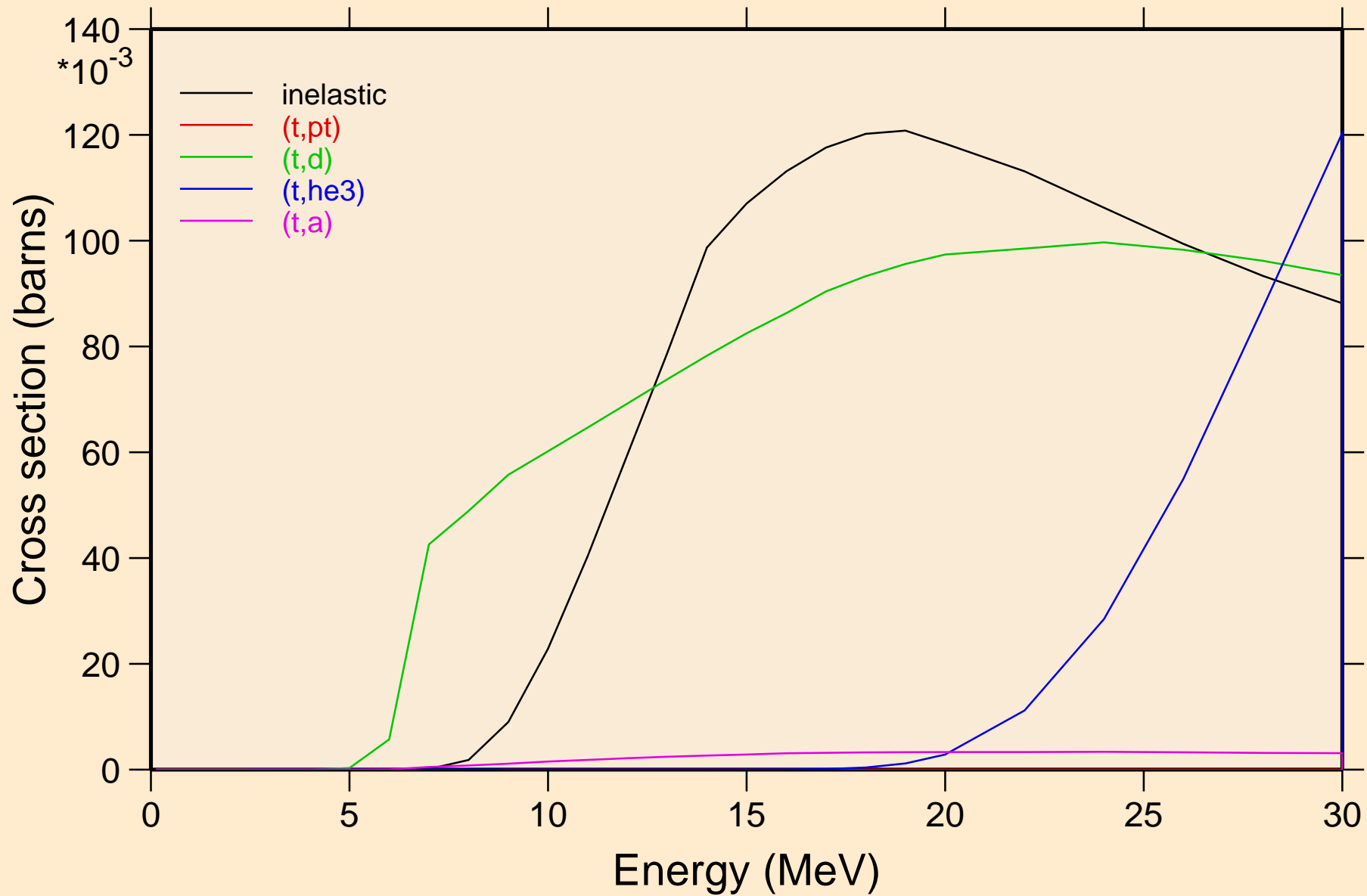

BA136 TRITON ACER TENDL-2021 LIBRARY; T=0.K
Threshold reactions

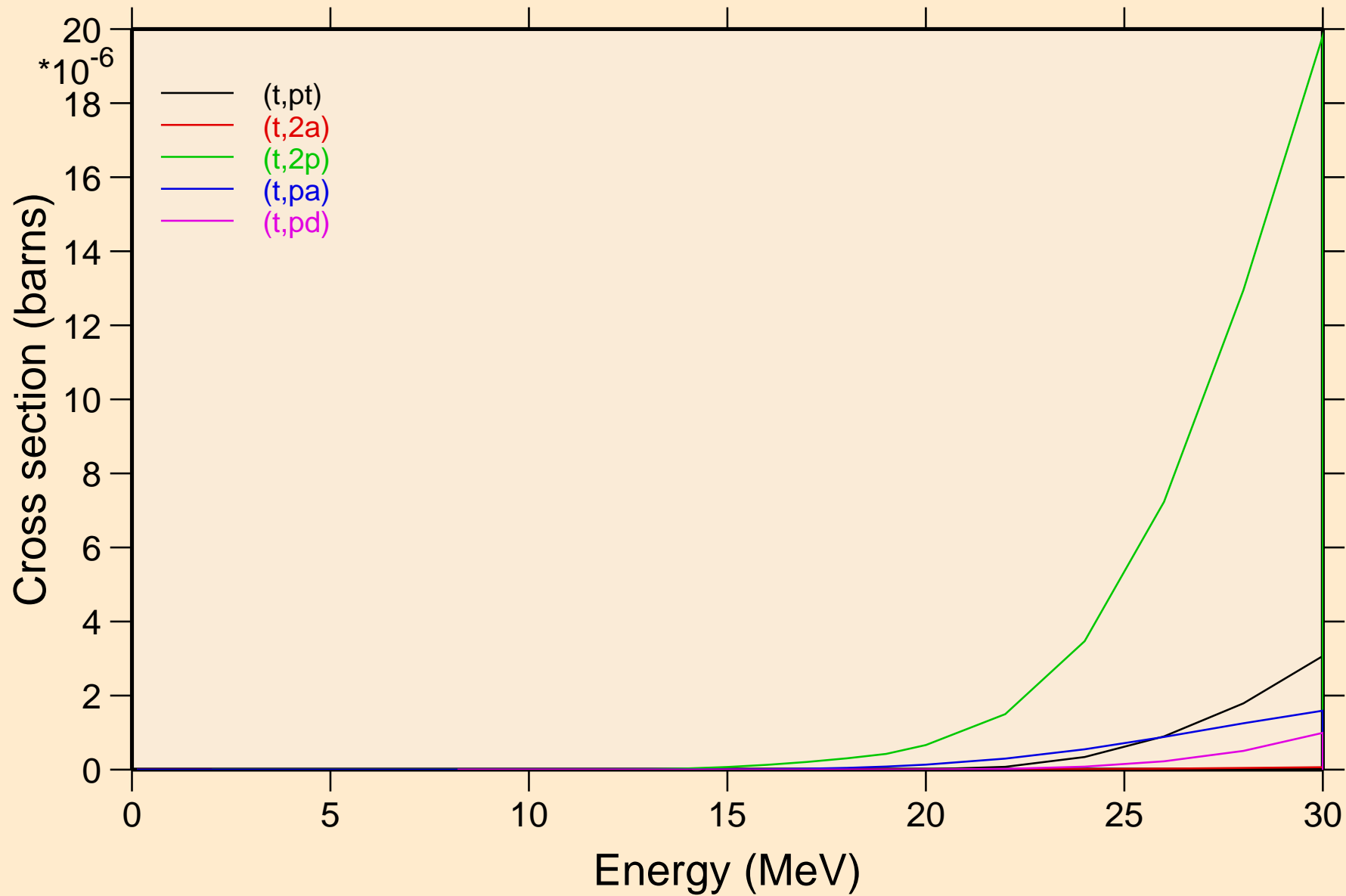

BA136 TRITON ACER TENDL-2021 LIBRARY; T=0.K
Threshold reactions

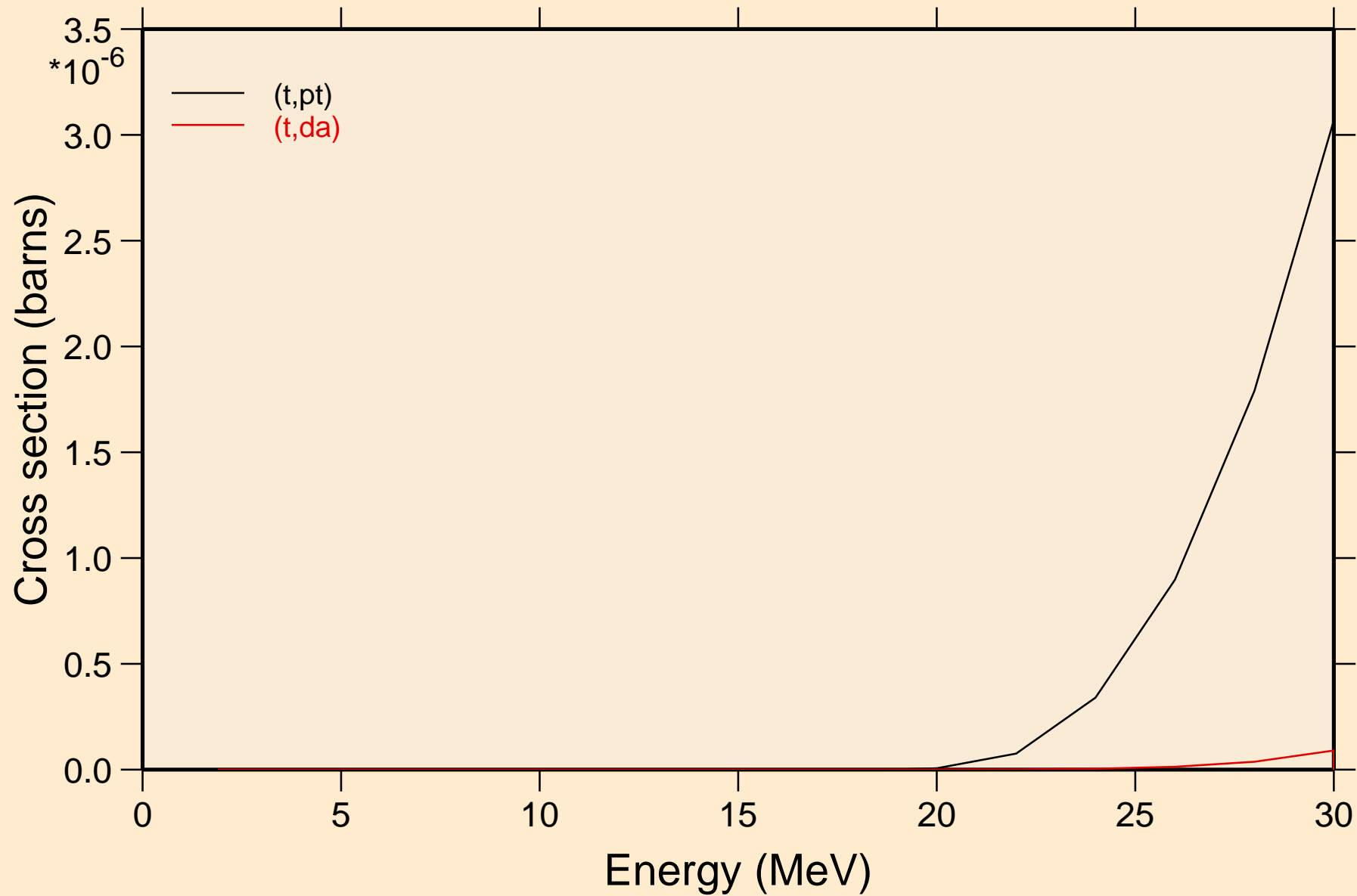

BA136 TRITON ACER TENDL-2021 LIBRARY; T=0.K
angular distribution for elastic

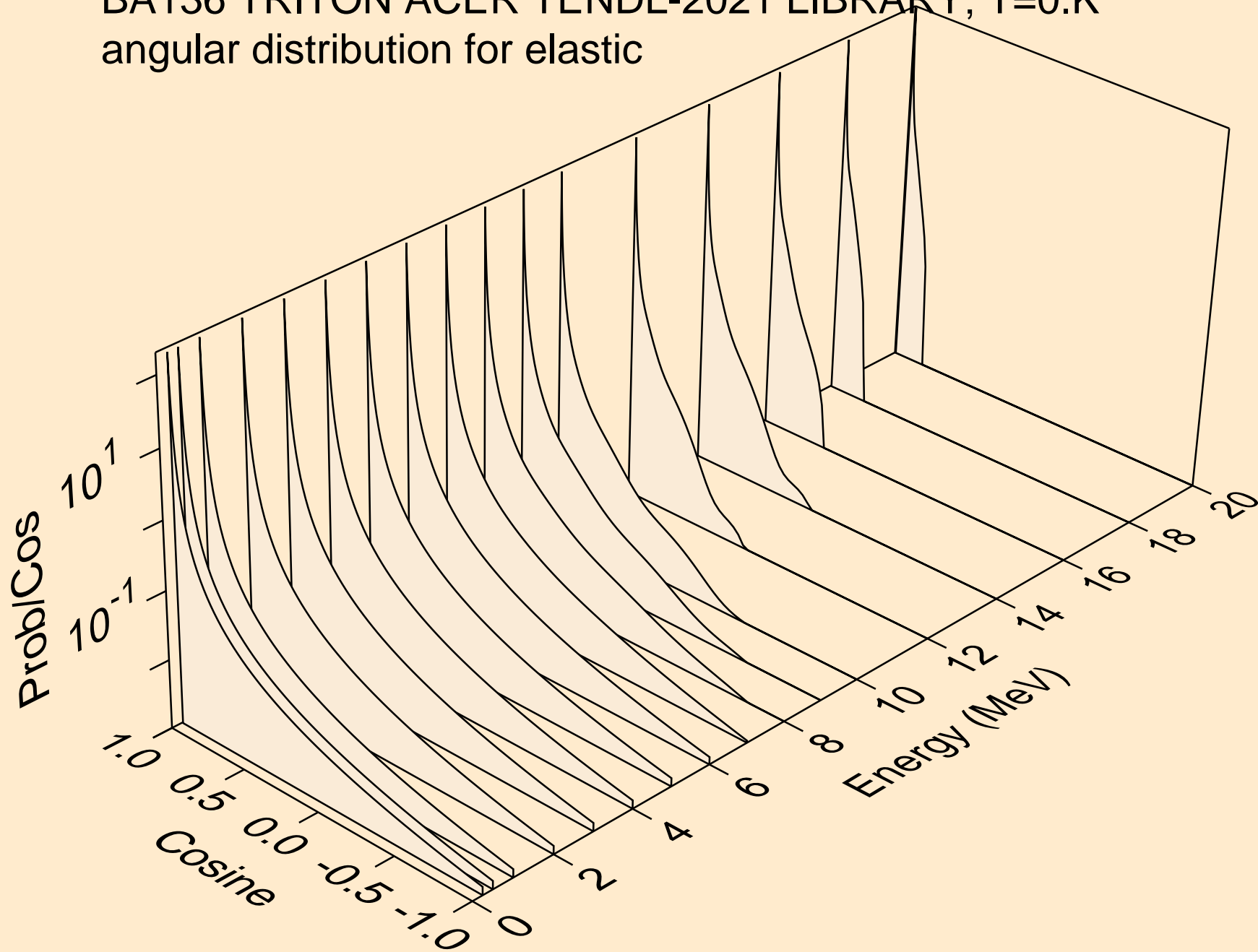

BA136 TRITON ACER TENDL-2021 LIBRARY; T=0.K
angular distribution for elastic

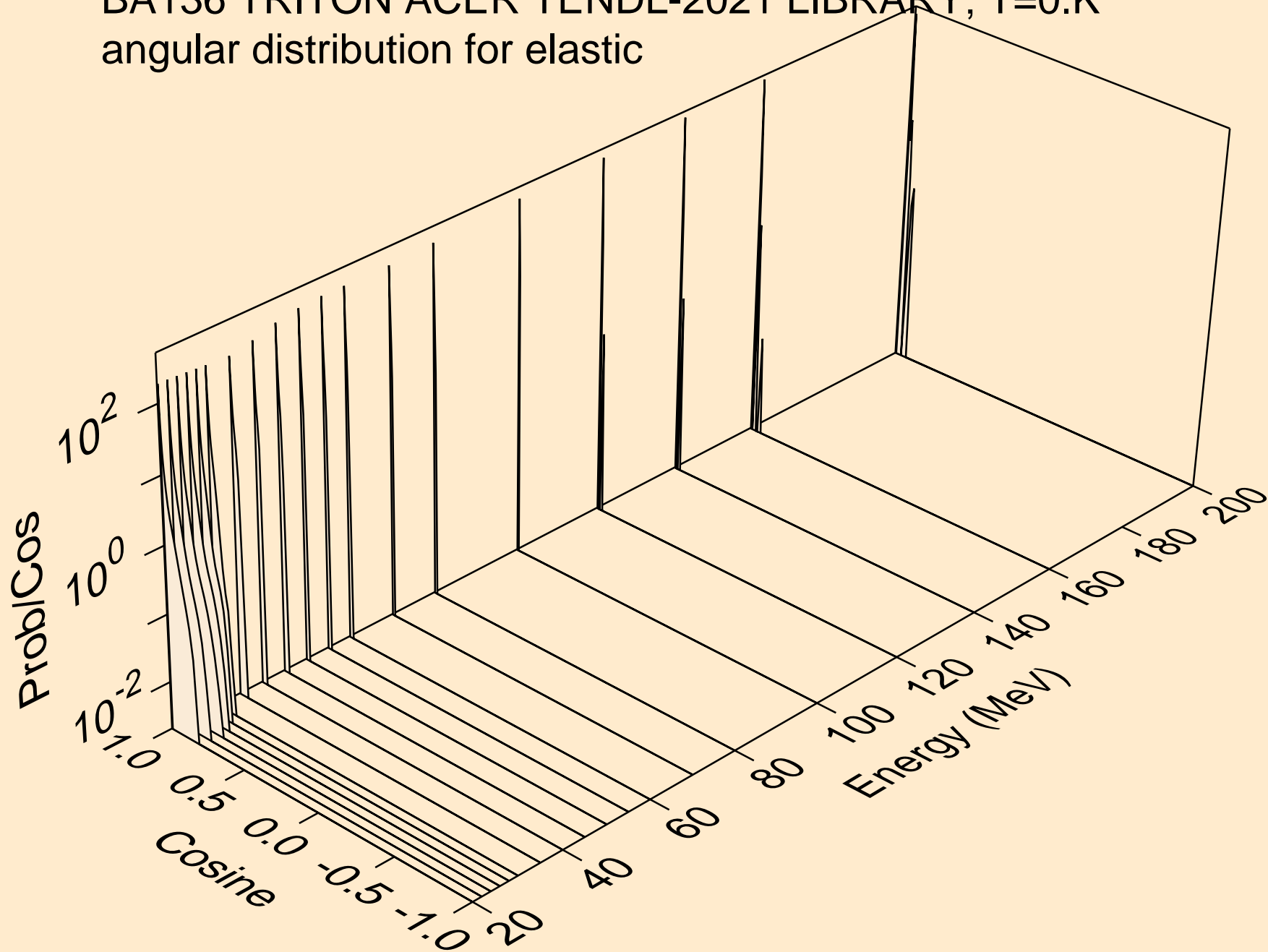

BA136 TRITON ACER TENDL-2021 LIBRARY; T=0.K
Triton emission for (t,x)

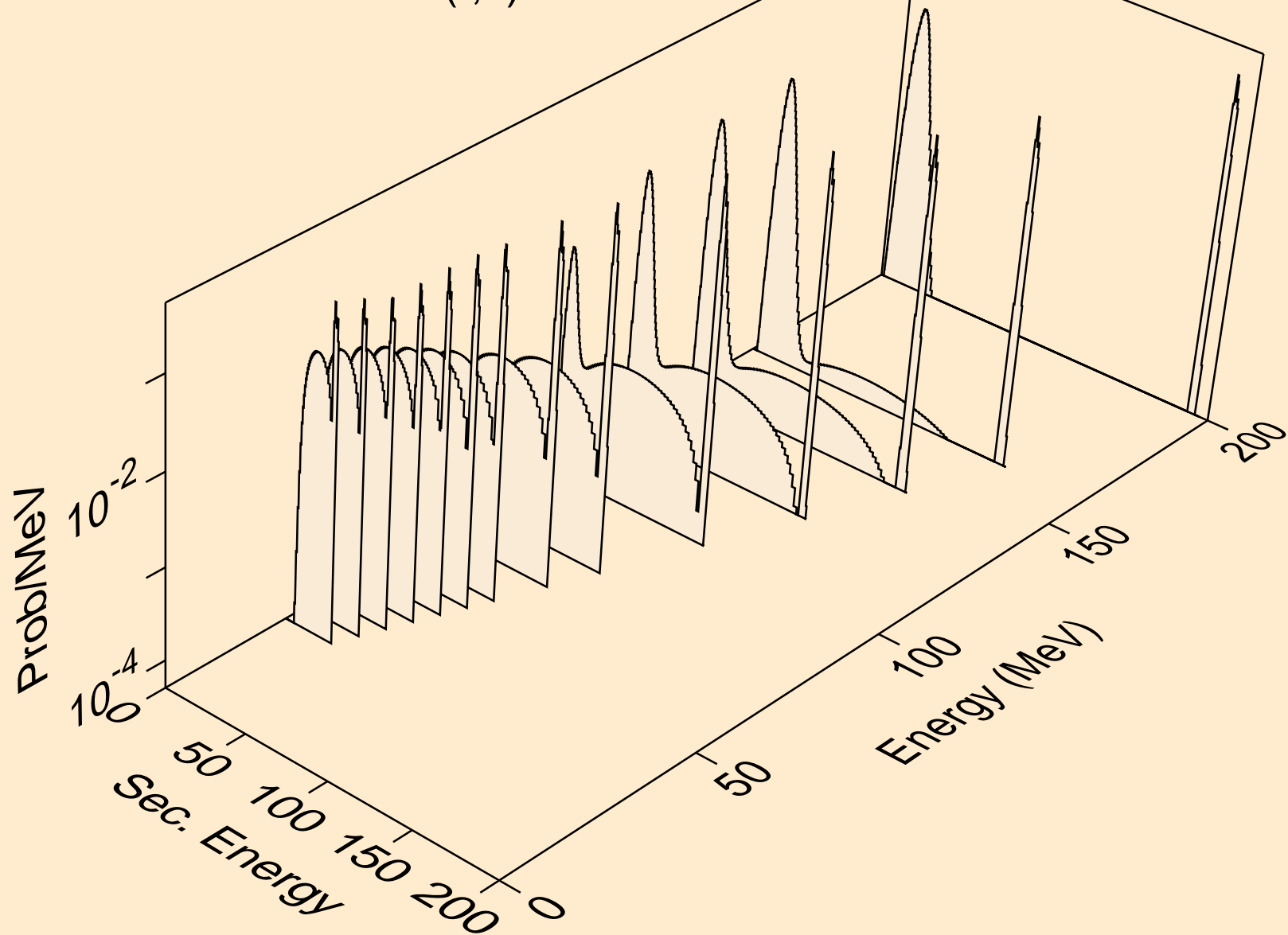

BA136 TRITON ACER TENDL-2021 LIBRARY; T=0.K
Triton emission for (t,n*)t

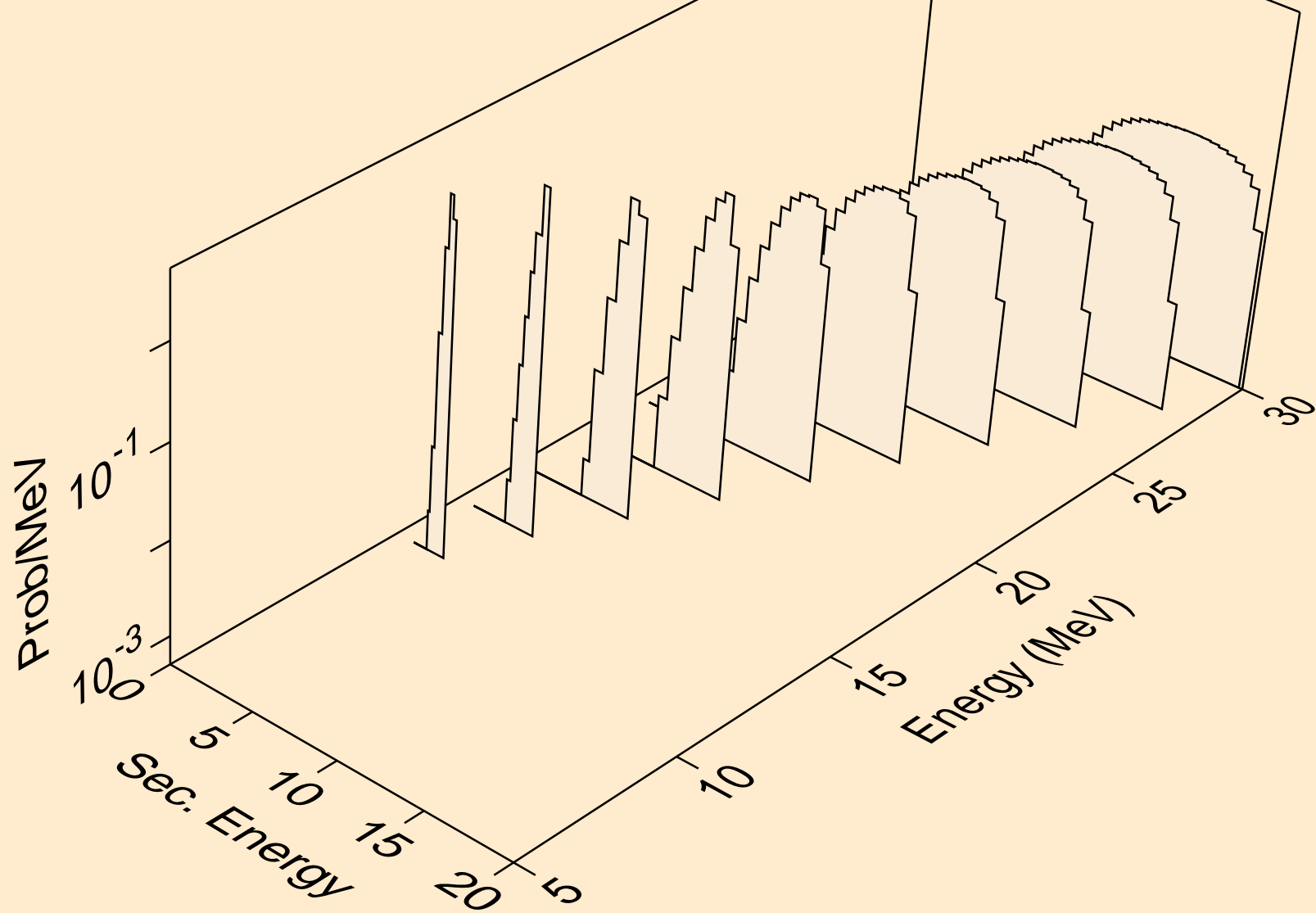

BA136 TRITON ACER TENDL-2021 LIBRARY; T=0.K
Triton emission for inelastic

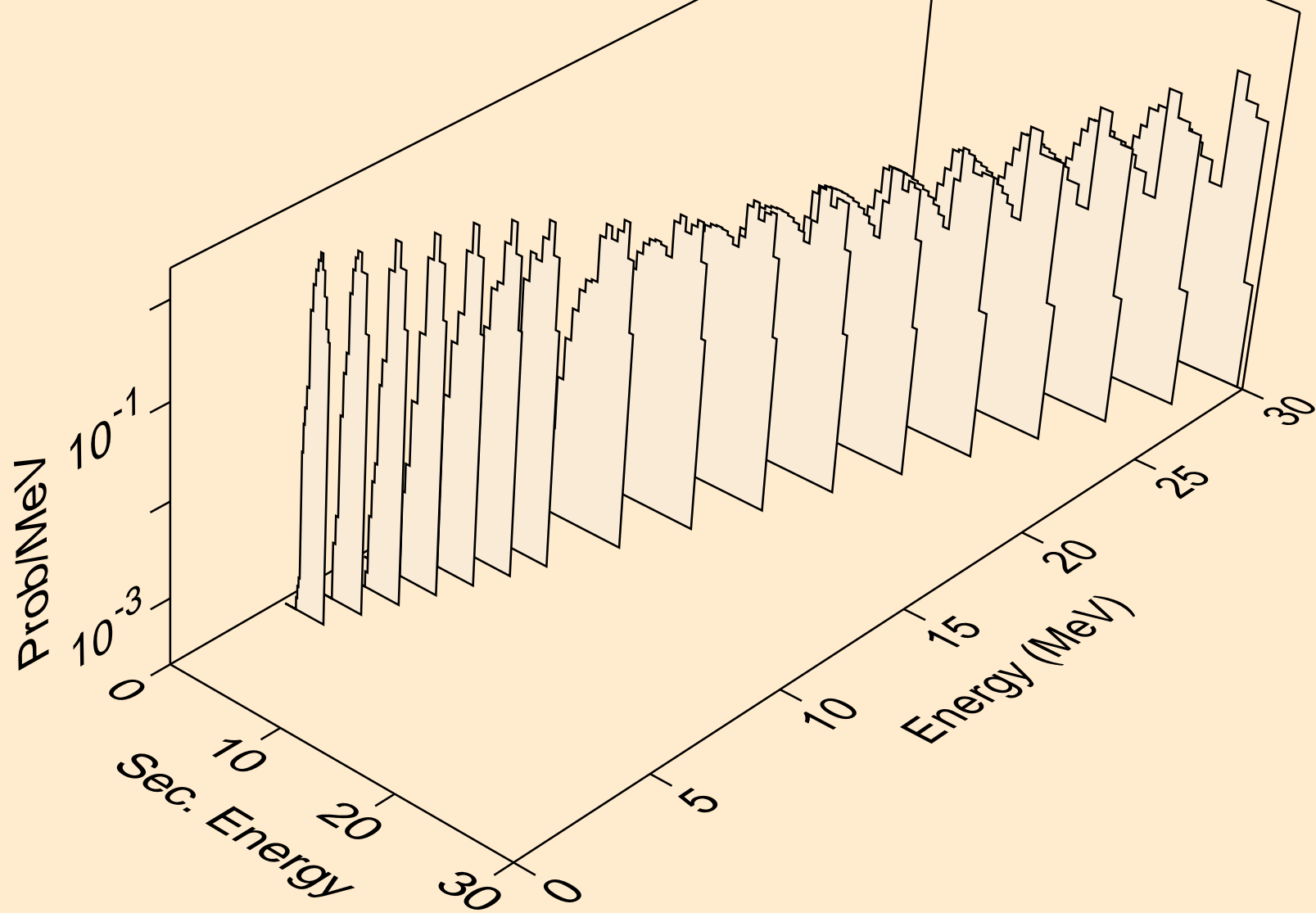

BA136 TRITON ACER TENDL-2021 LIBRARY; T=0.K
Triton emission for (t,pt)

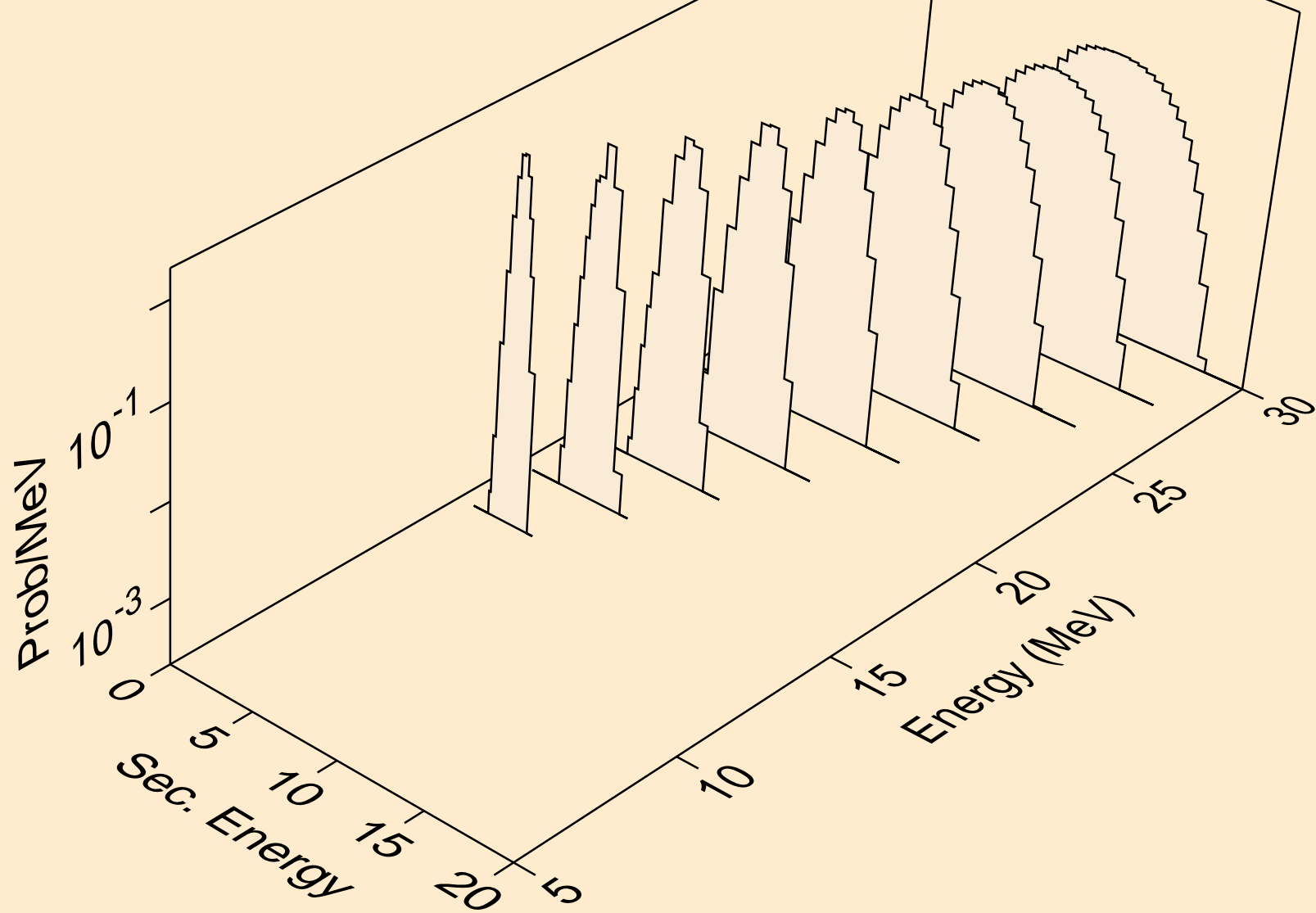

BA136 TRITON ACER TENDL-2021 LIBRARY; T=0.K
Photon emission for (z,n)

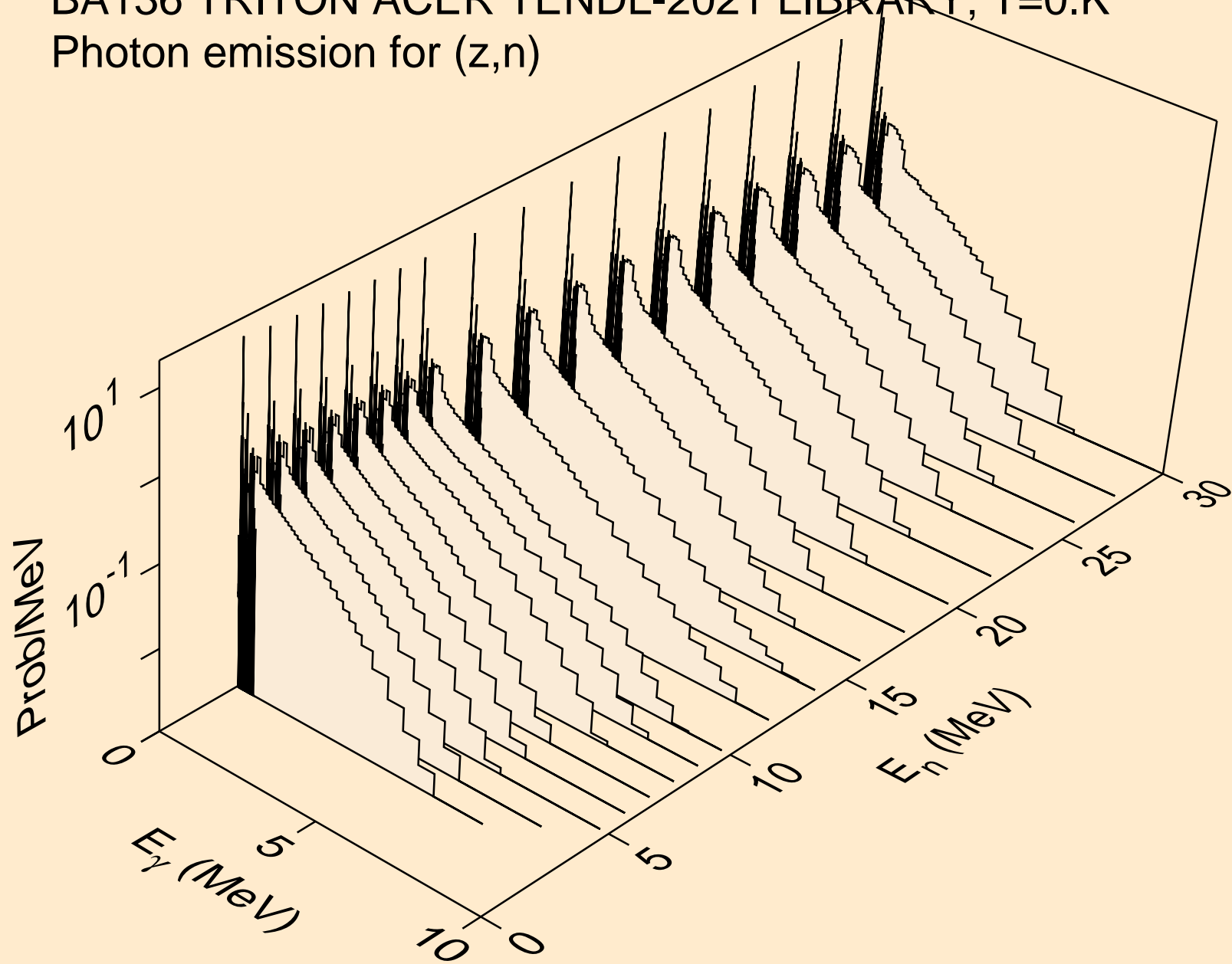

BA136 TRITON ACER TENDL-2021 LIBRARY; T=0.K
Photon emission for (n,x)

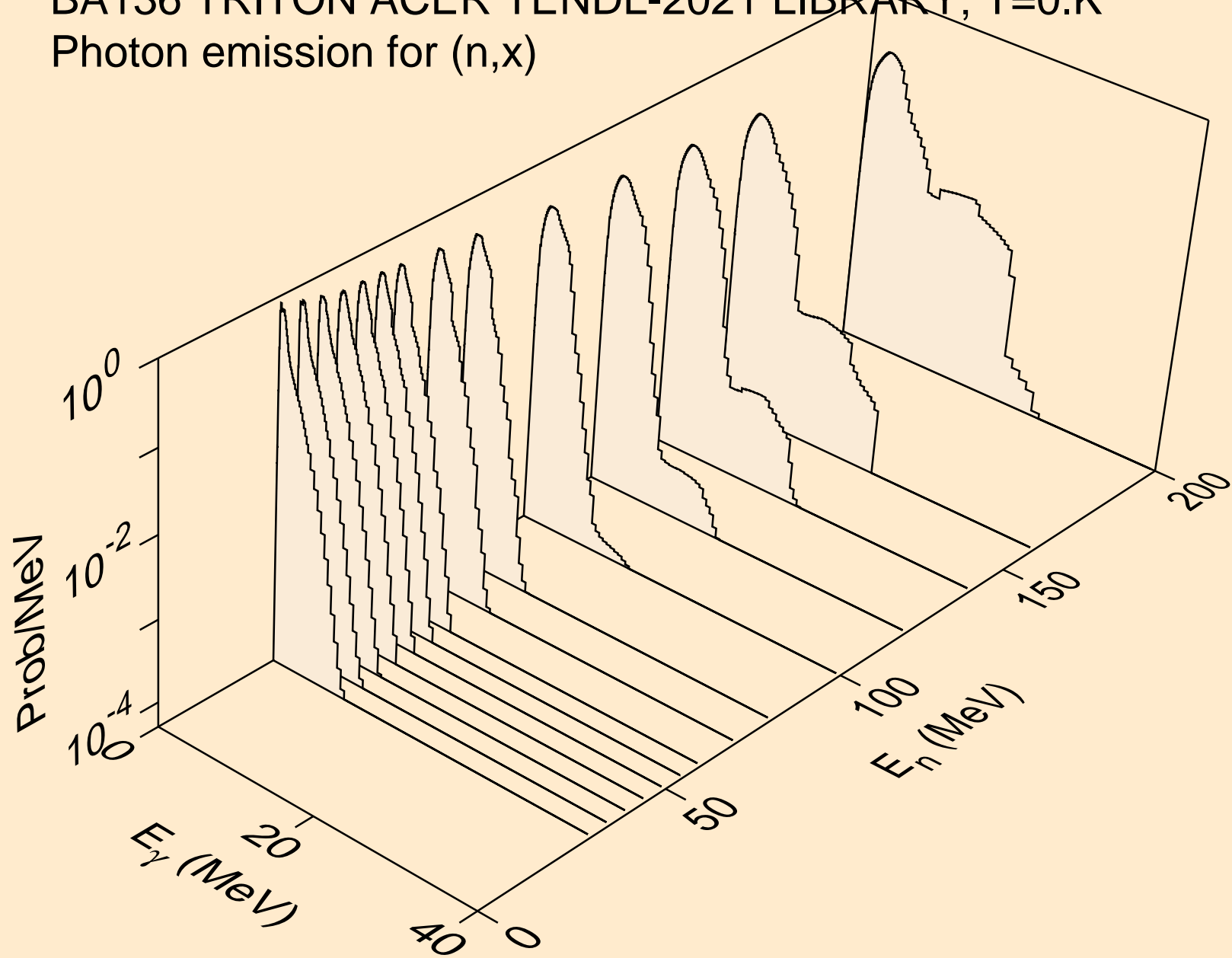

BA136 TRITON ACER TENDL-2021 LIBRARY; T=0.K
Photon emission for (n,2nd)

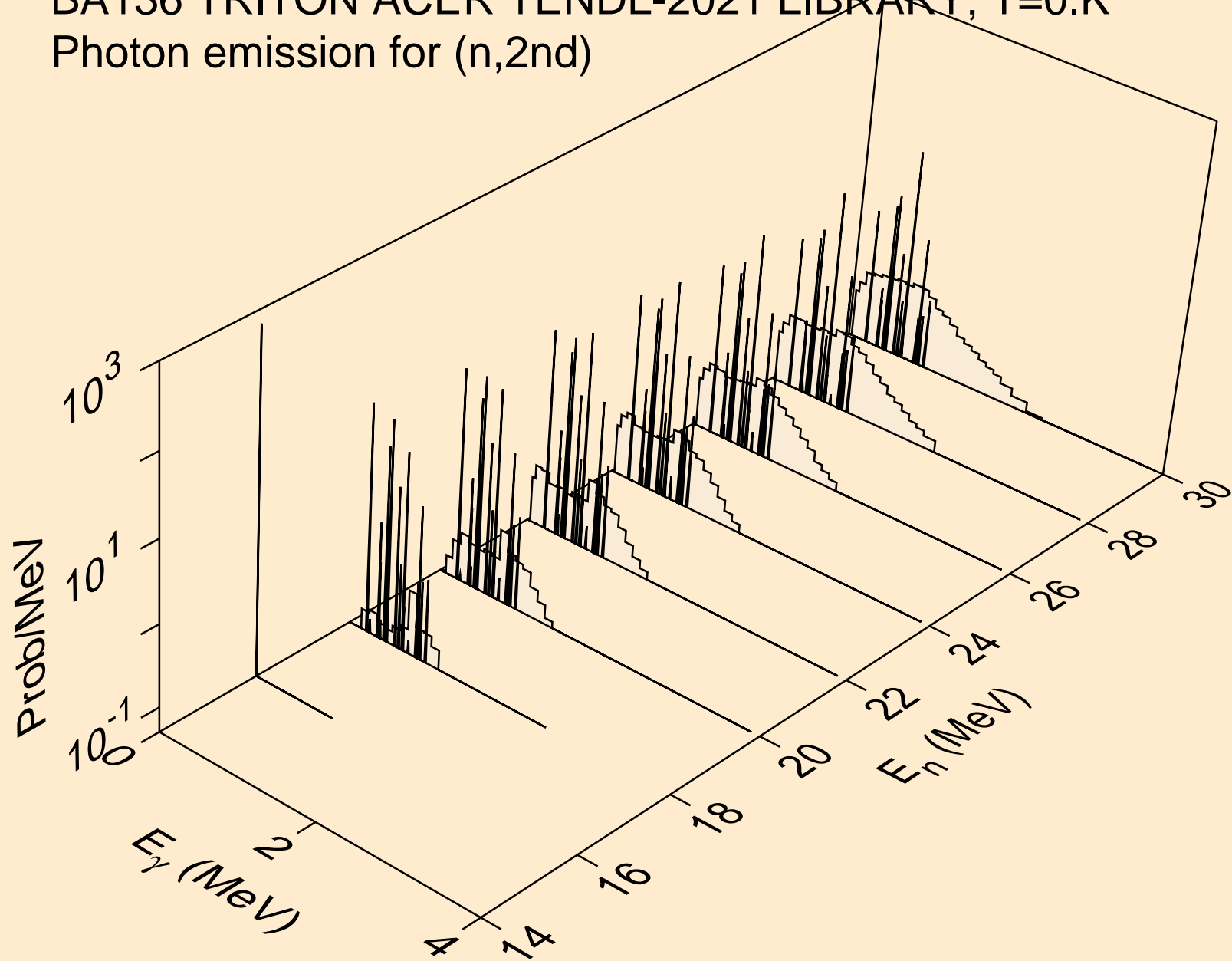

BA136 TRITON ACER TENDL-2021 LIBRARY; T=0.K
Photon emission for (n,2n)

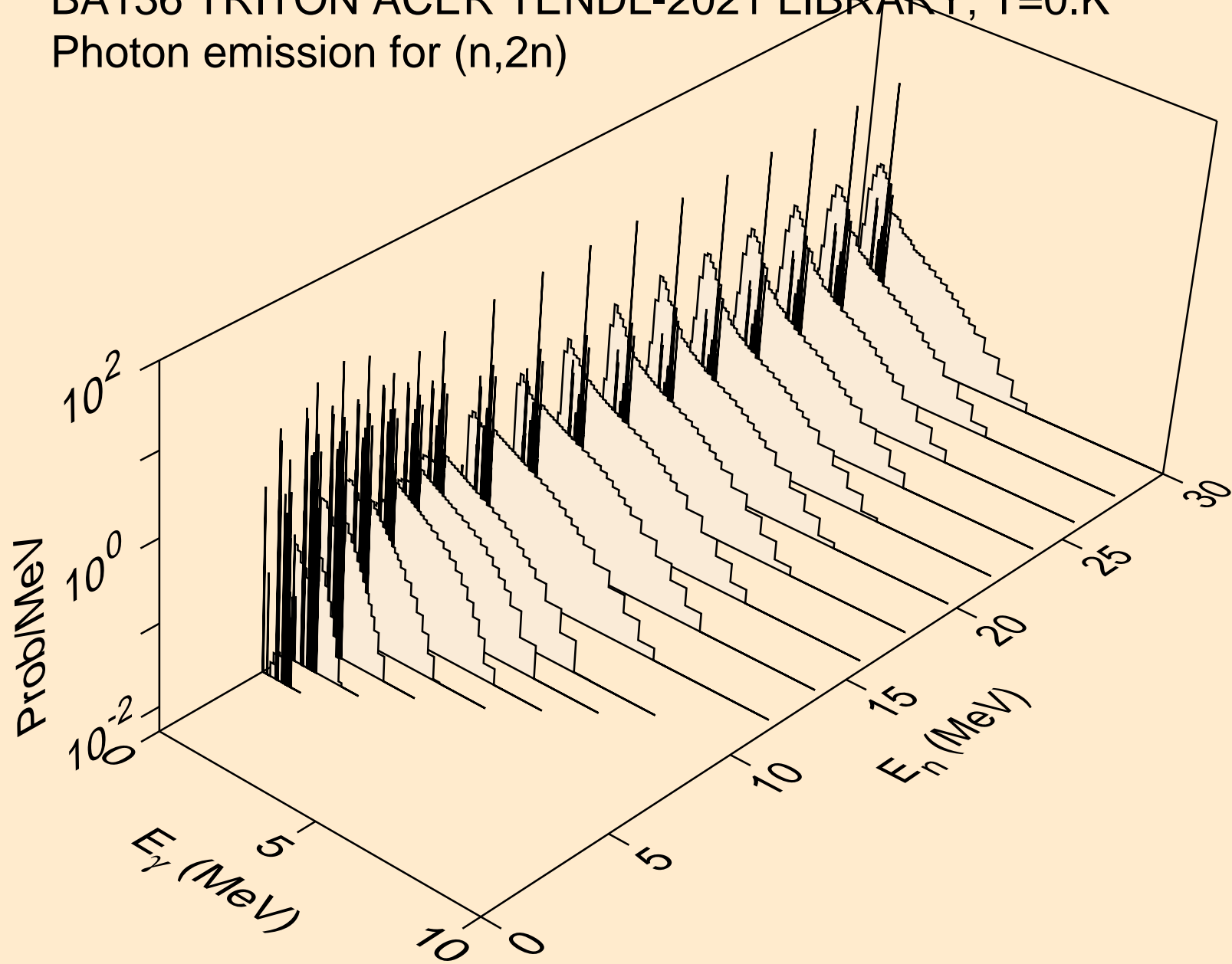

BA136 TRITON ACER TENDL-2021 LIBRARY; T=0.K
Photon emission for (n,3n)

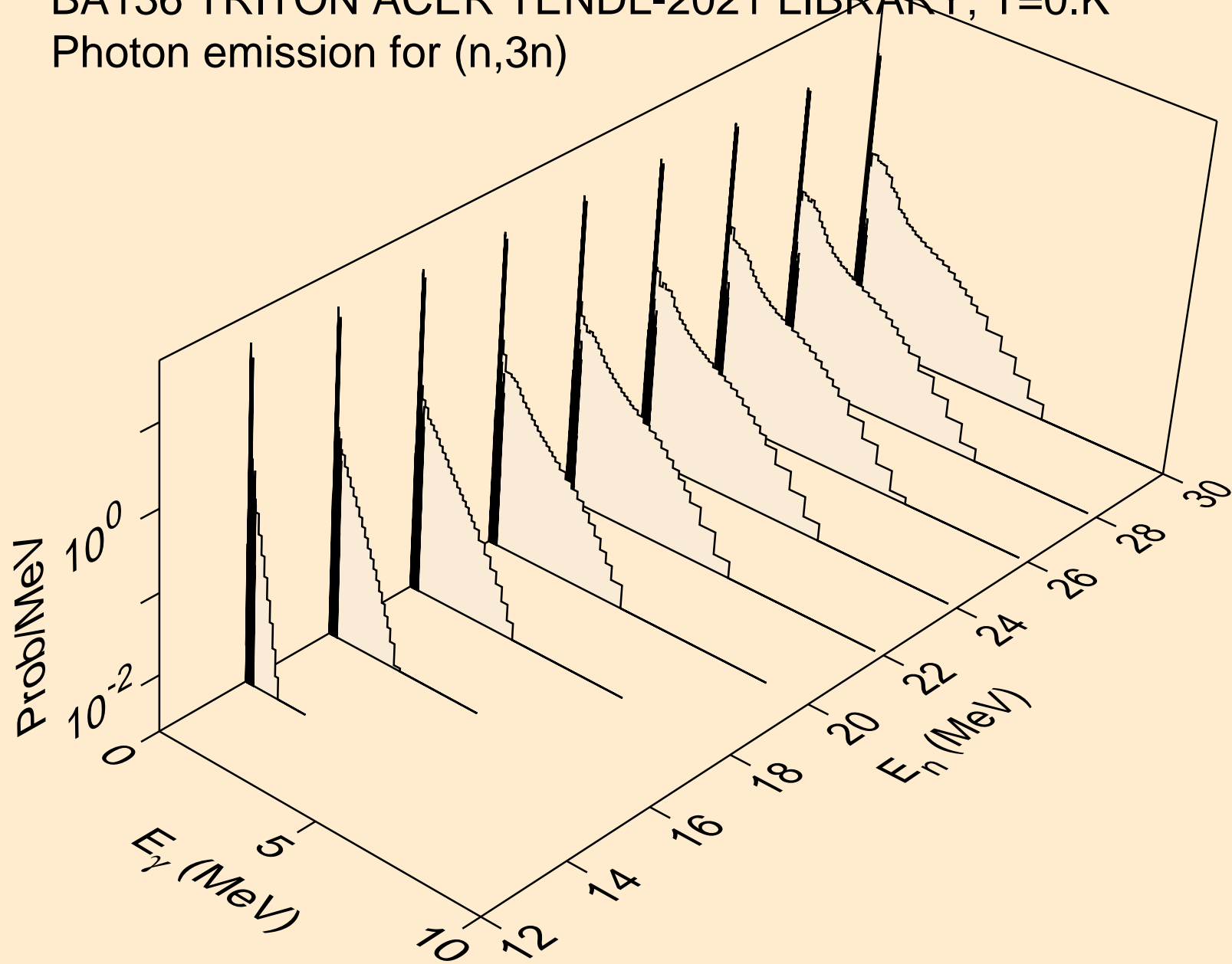

BA136 TRITON ACER TENDL-2021 LIBRARY; T=0.K
Photon emission for (n,n*)a

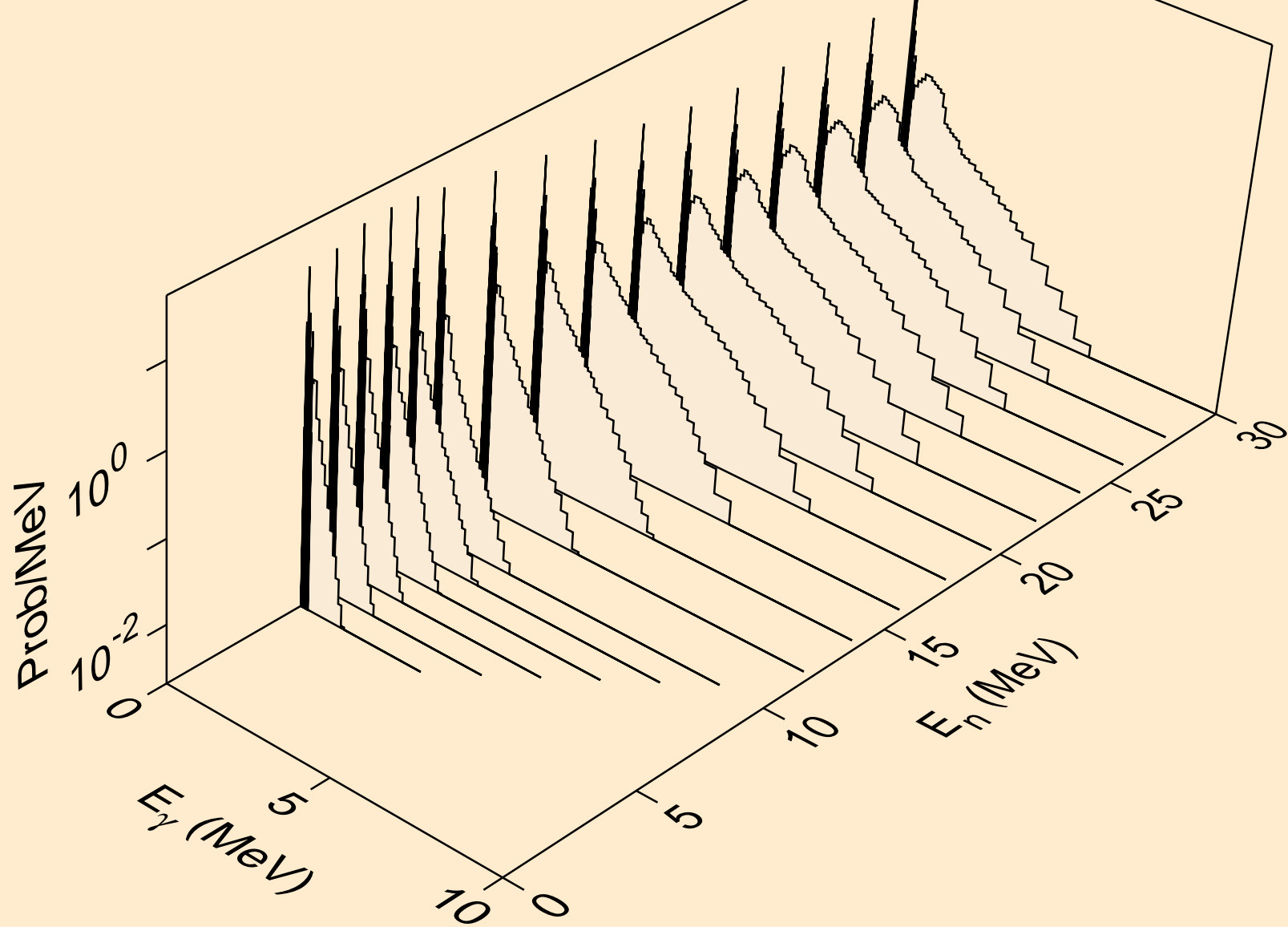

BA136 TRITON ACER TENDL-2021 LIBRARY; T=0.K
Photon emission for (n,2n)a

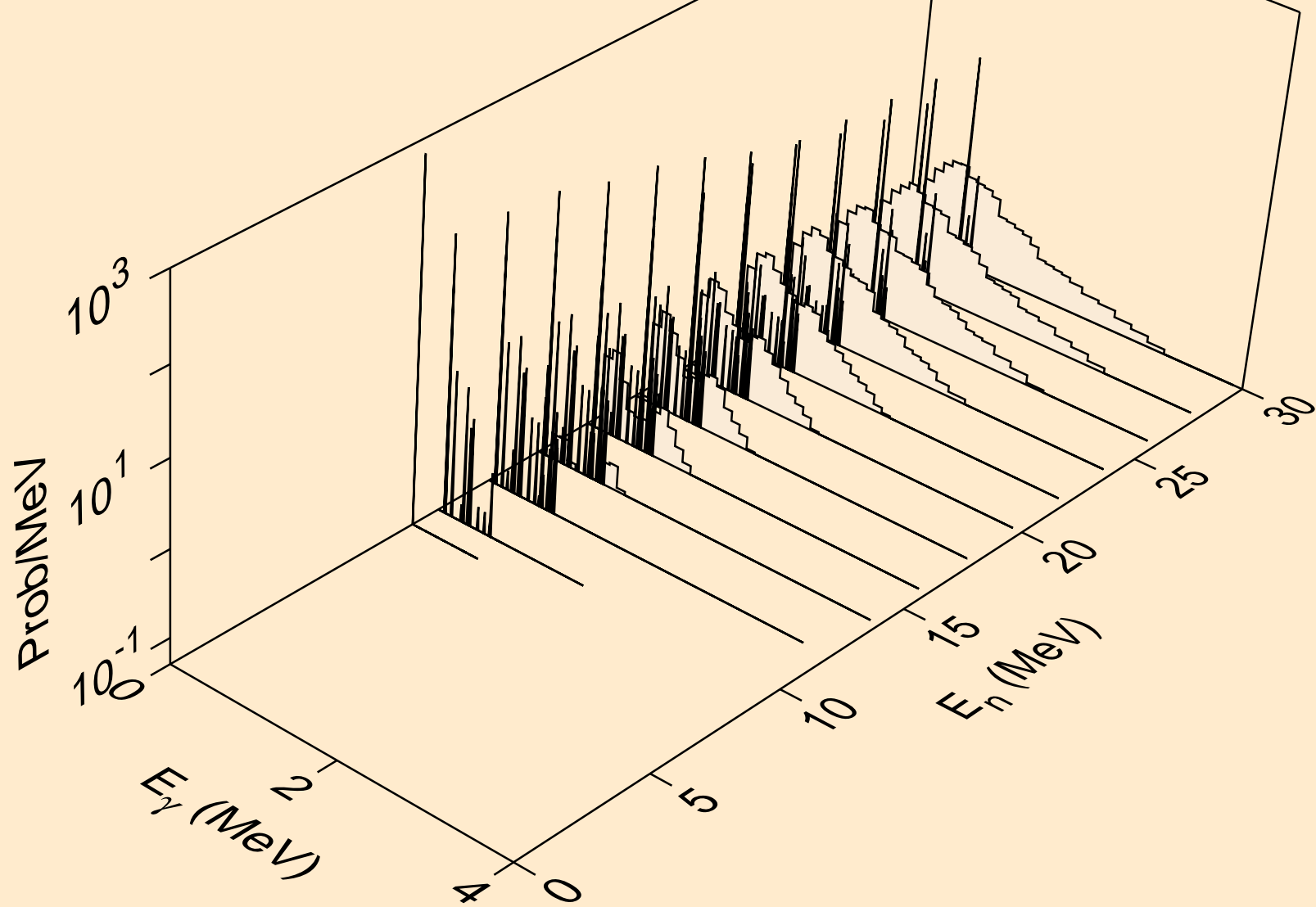

BA136 TRITON ACER TENDL-2021 LIBRARY; T=0.K
Photon emission for (n,3n)a

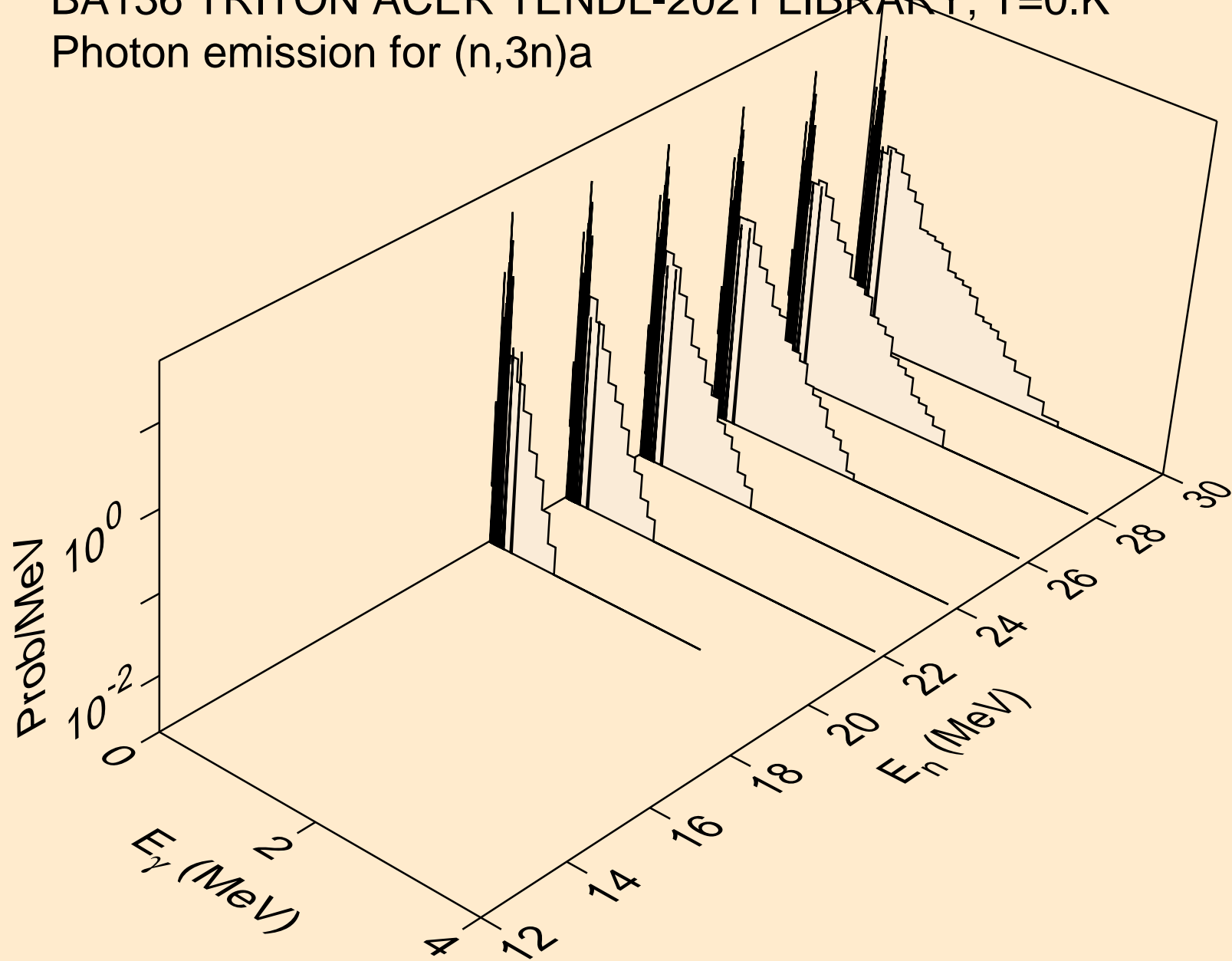

BA136 TRITON ACER TENDL-2021 LIBRARY; T=0.K
Photon emission for (n,n*)p

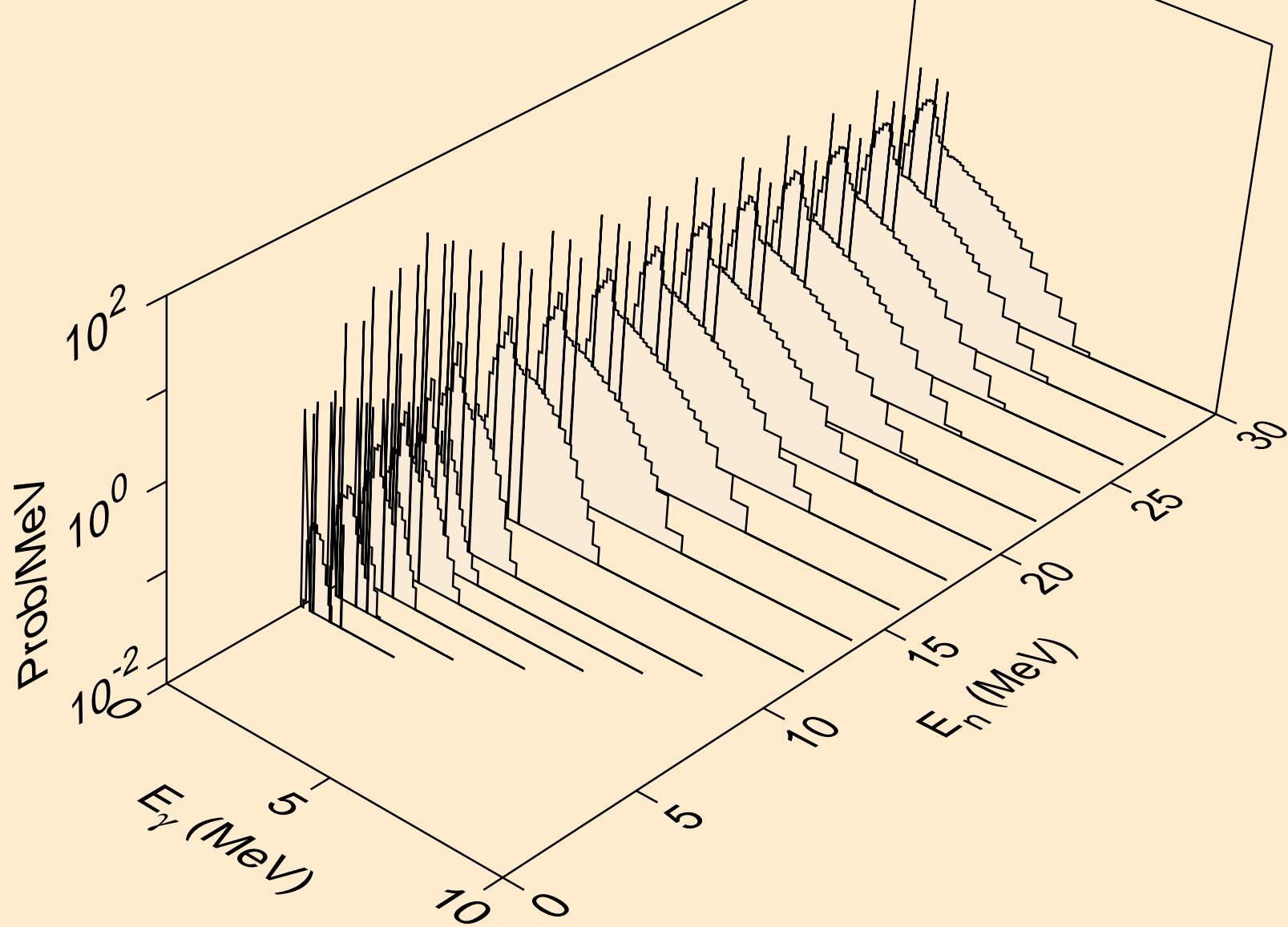

BA136 TRITON ACER TENDL-2021 LIBRARY; T=0.K
Photon emission for (n,n*)2a

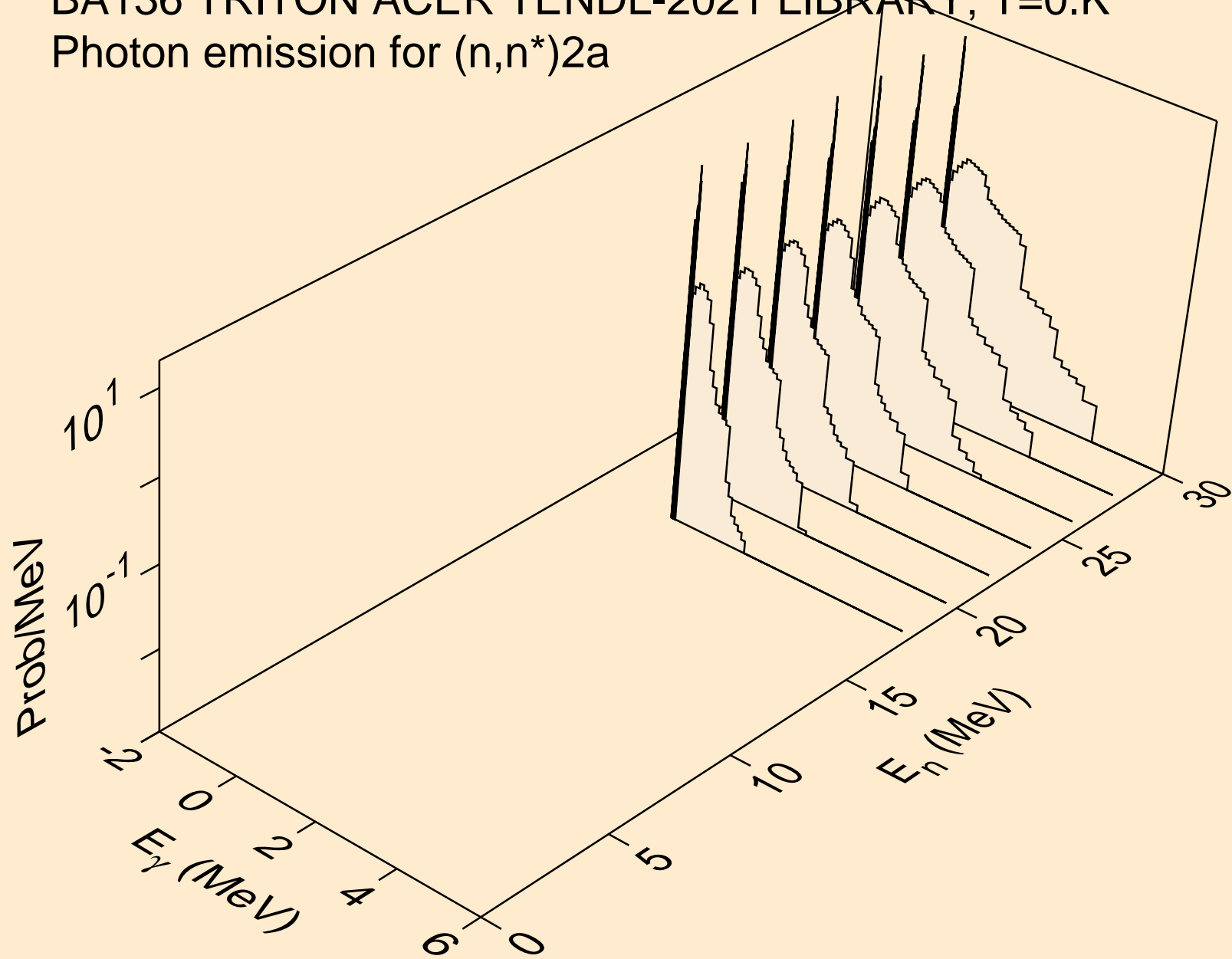

BA136 TRITON ACER TENDL-2021 LIBRARY; T=0.K
Photon emission for (n,n*)d

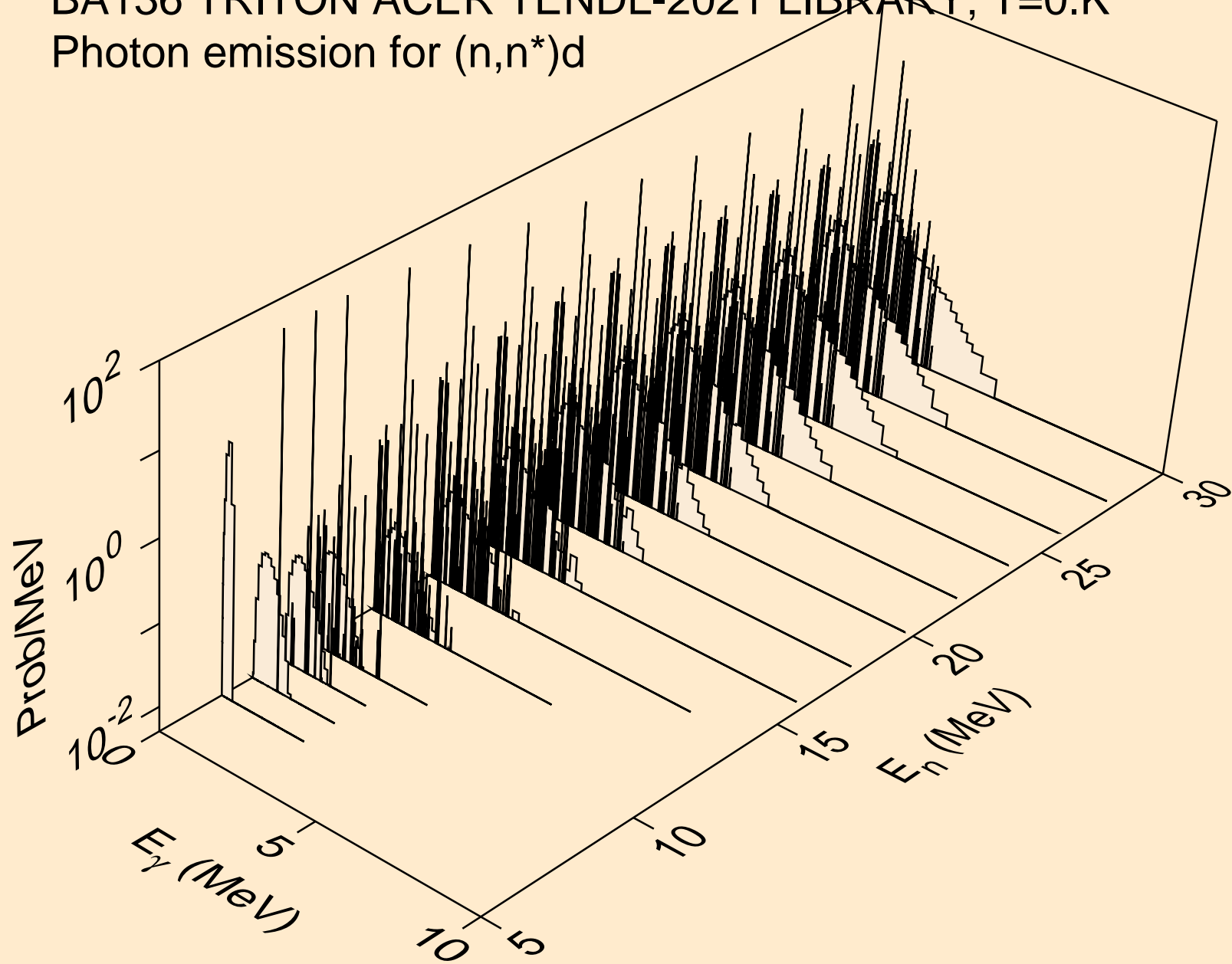

BA136 TRITON ACER TENDL-2021 LIBRARY; T=0.K
Photon emission for (n,n*)t

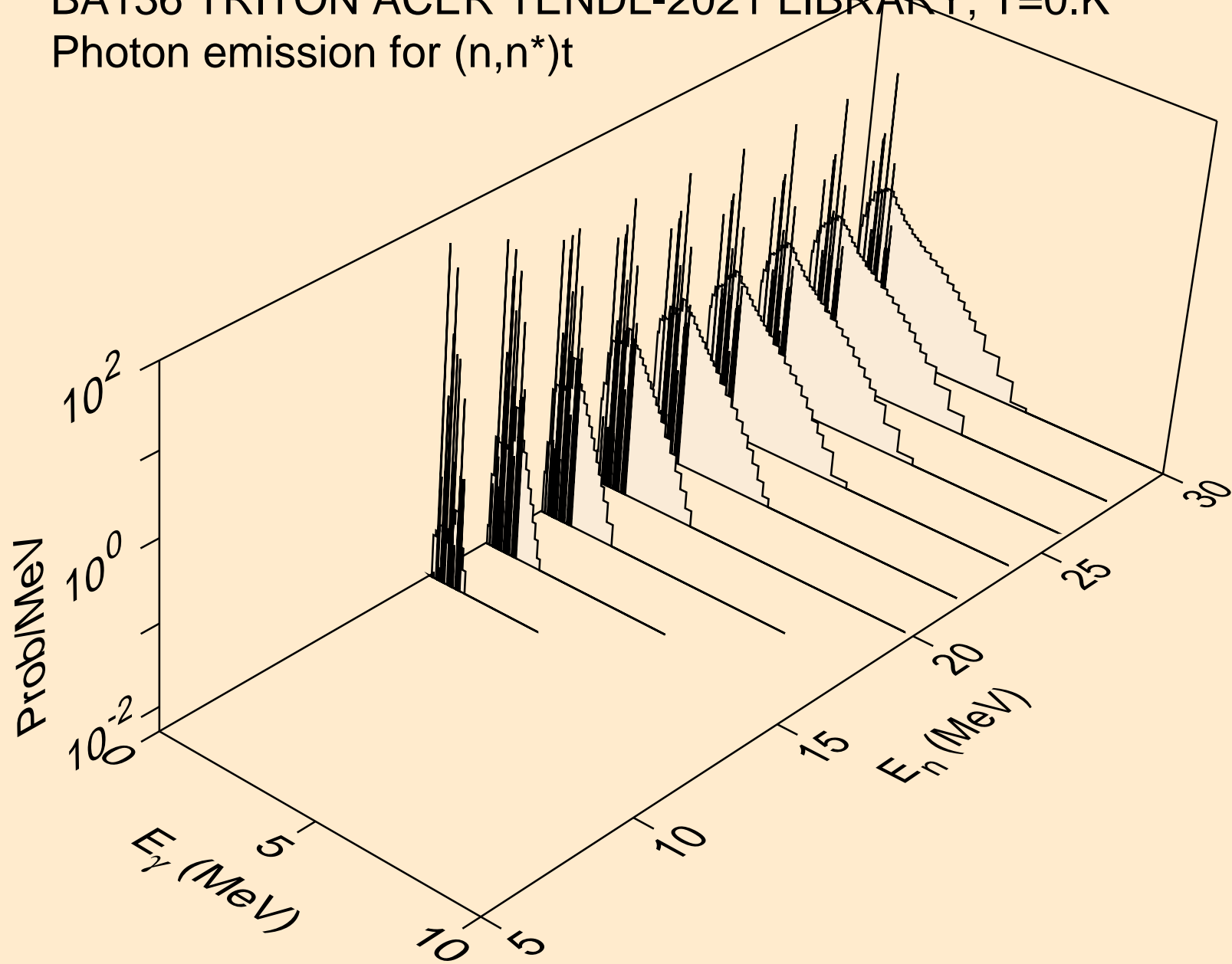

BA136 TRITON ACER TENDL-2021 LIBRARY; T=0.K
Photon emission for (n,n*)he3

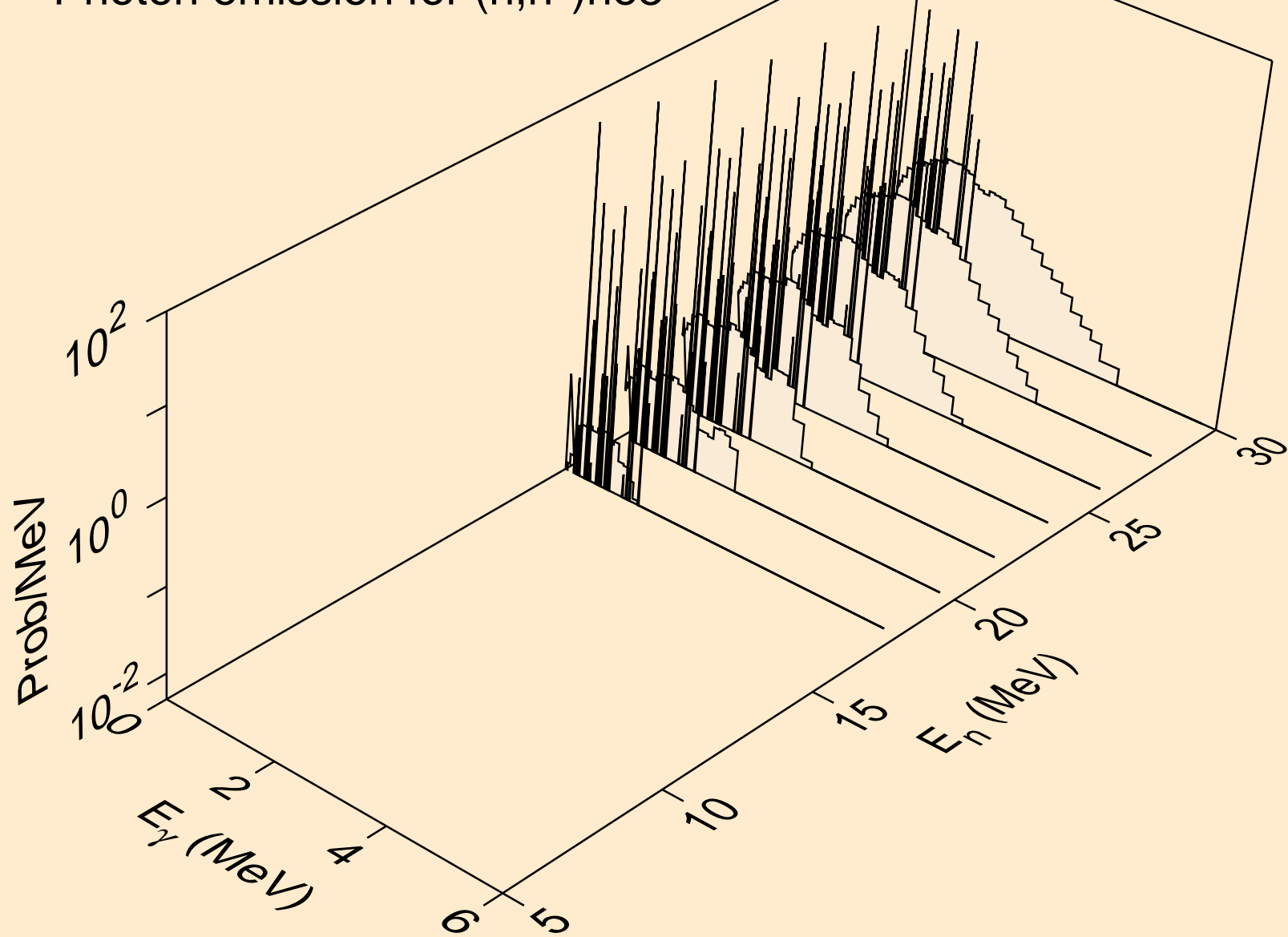

BA136 TRITON ACER TENDL-2021 LIBRARY; T=0.K
Photon emission for (n,4n)

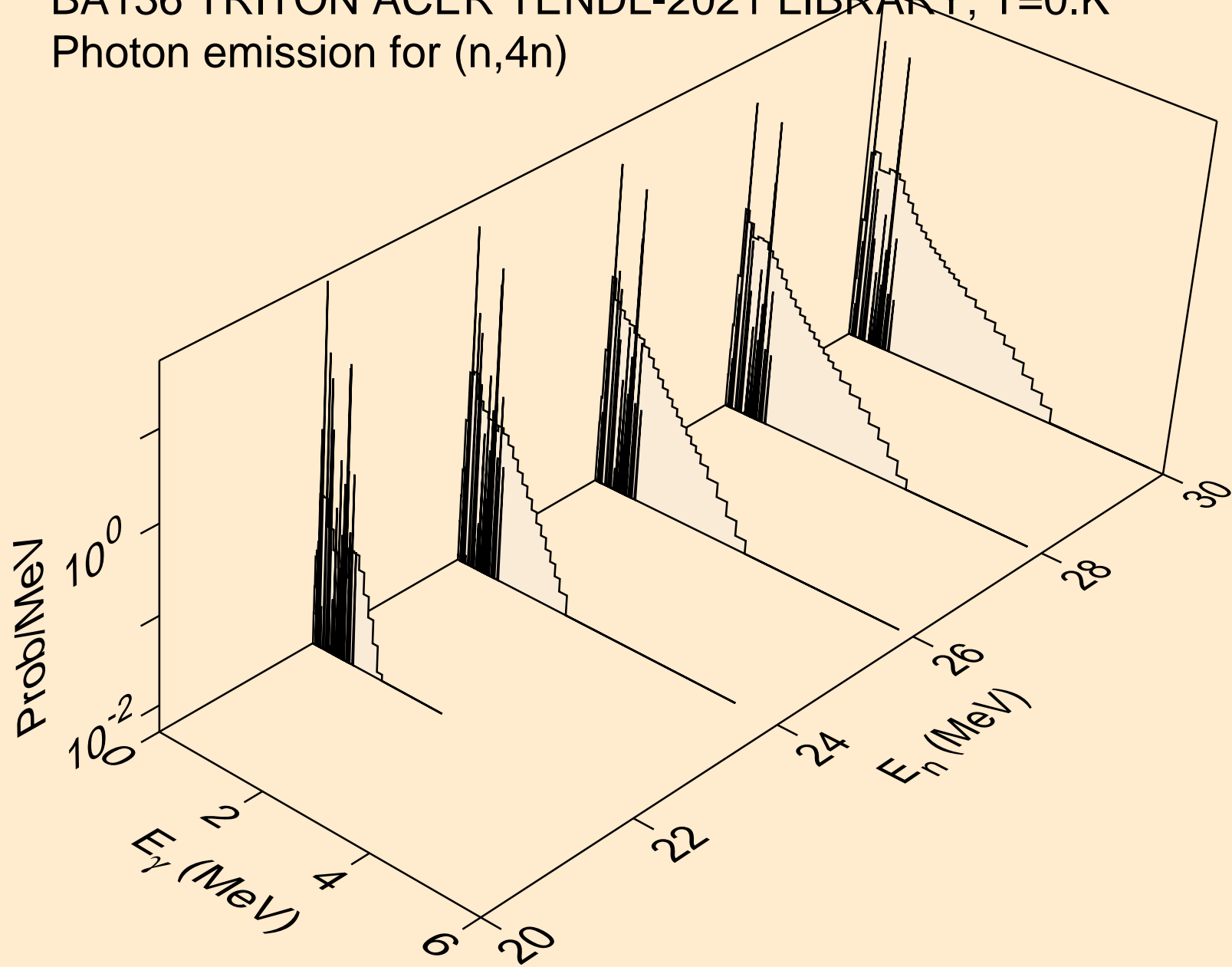

BA136 TRITON ACER TENDL-2021 LIBRARY; T=0.K
Photon emission for (n,2np)

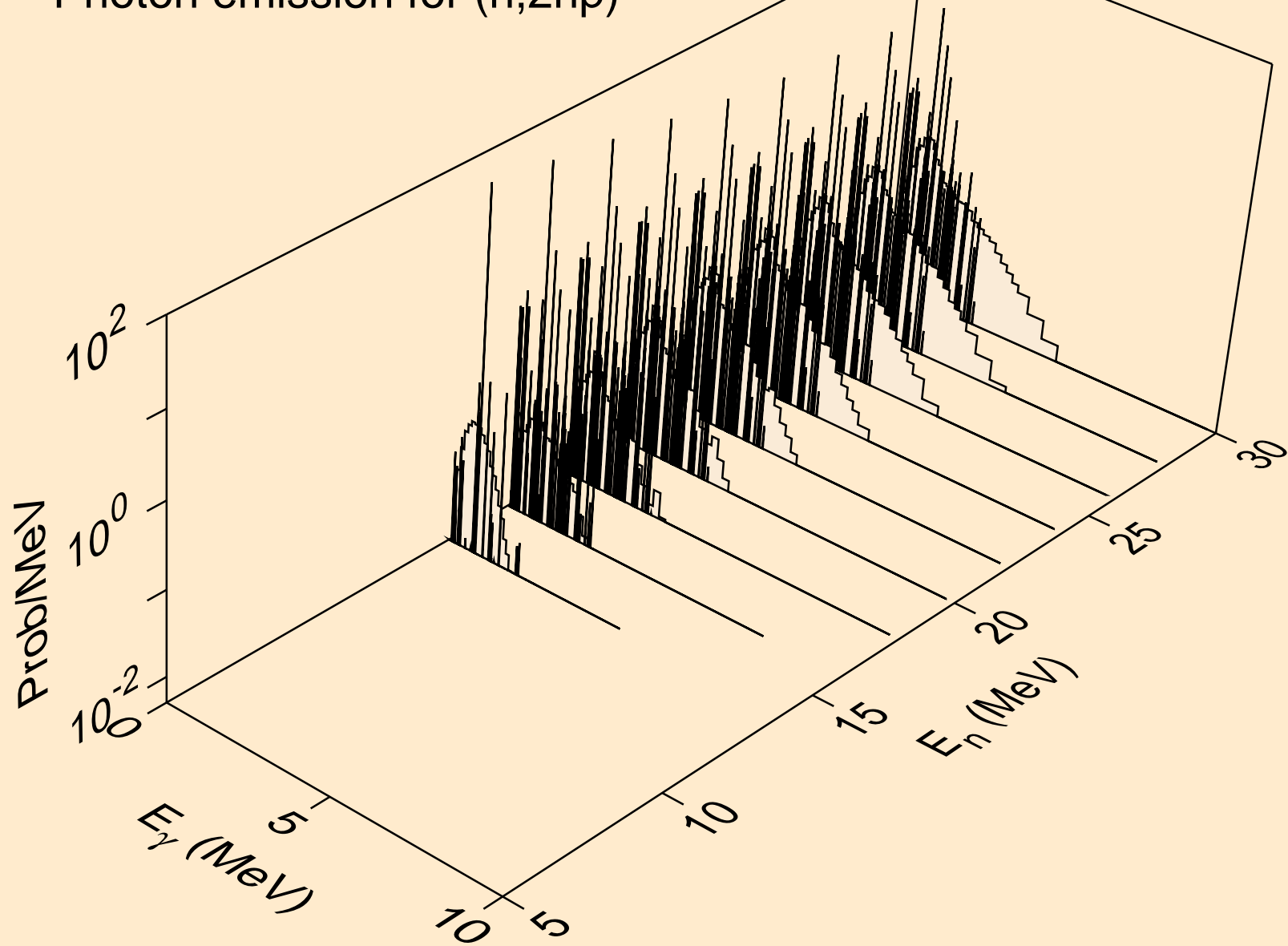

BA136 TRITON ACER TENDL-2021 LIBRARY; T=0.K
Photon emission for (n,3np)

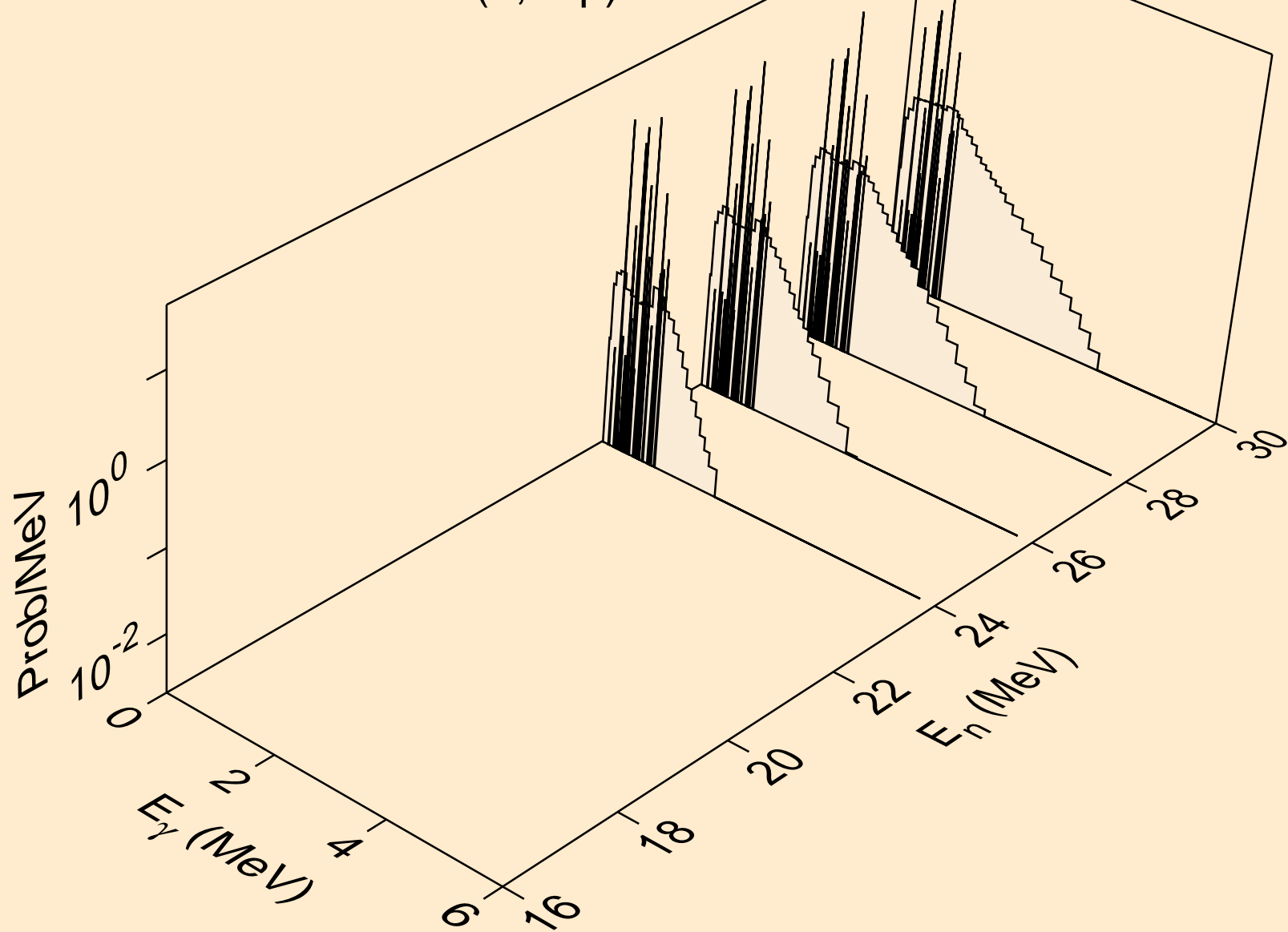

BA136 TRITON ACER TENDL-2021 LIBRARY; T=0.K
Photon emission for (n,2np)

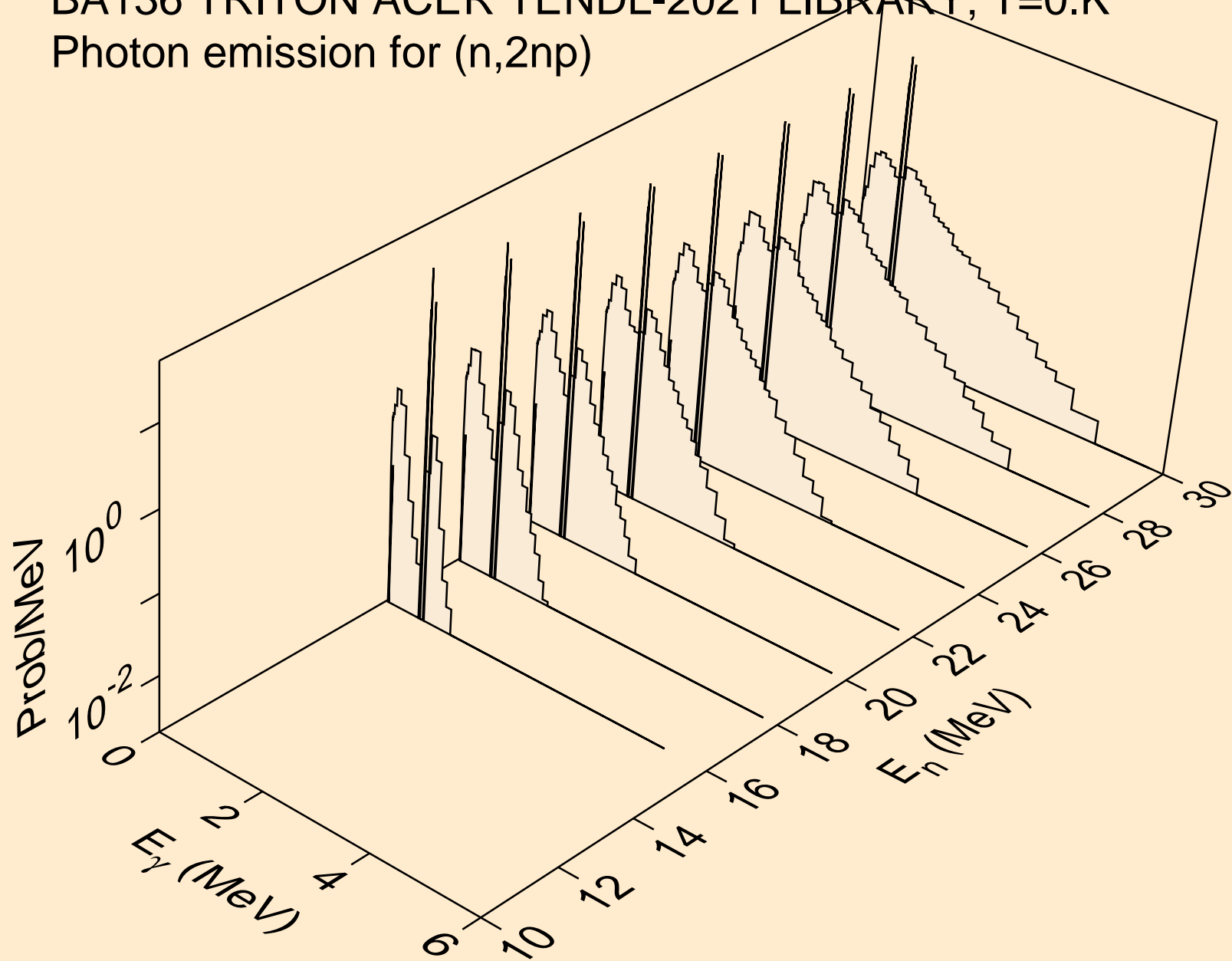

BA136 TRITON ACER TENDL-2021 LIBRARY; T=0.K
Photon emission for (n,npa)

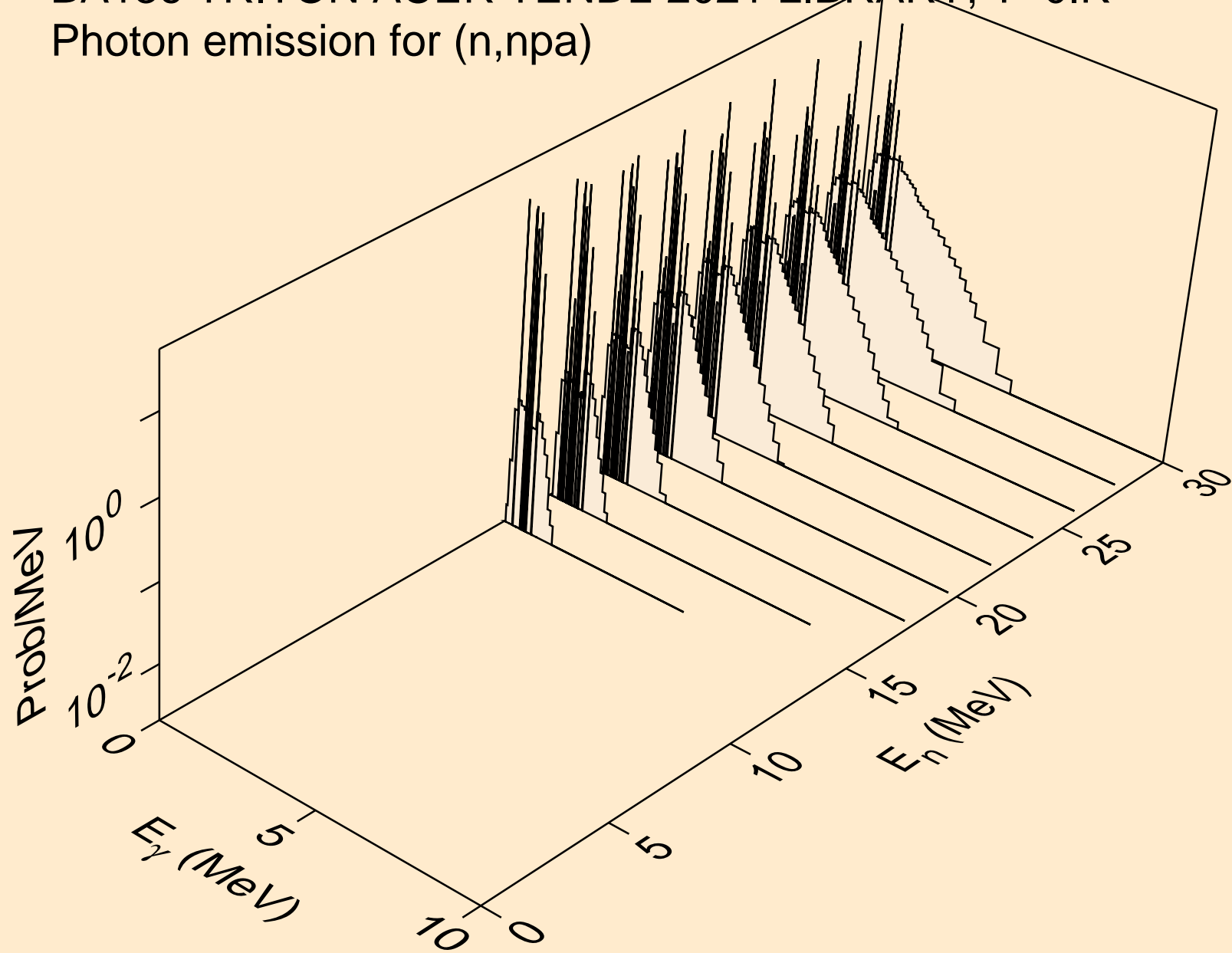

BA136 TRITON ACER TENDL-2021 LIBRARY; T=0.K
Photon emission for (n,gma)

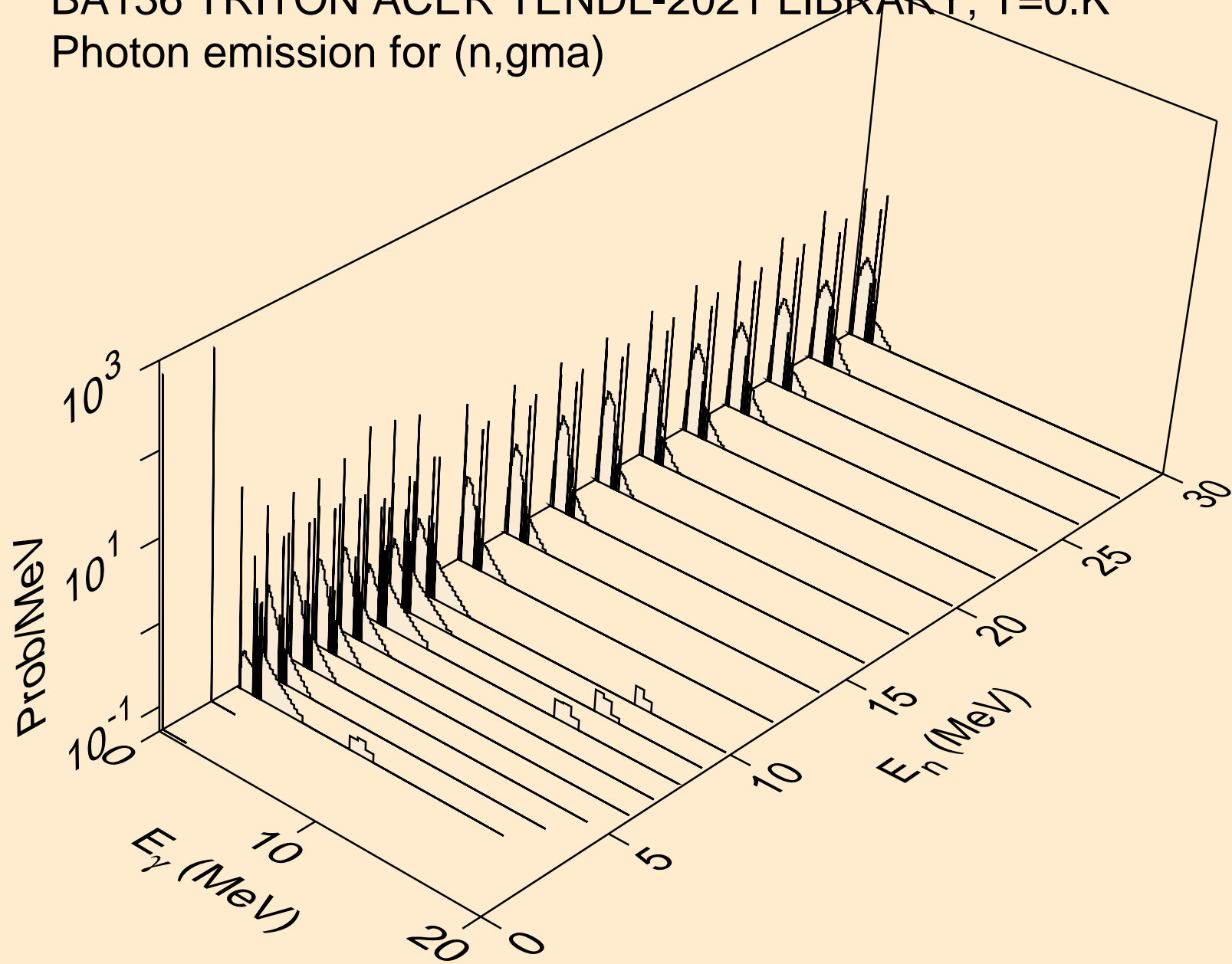

BA136 TRITON ACER TENDL-2021 LIBRARY; T=0.K
Photon emission for (n,p)

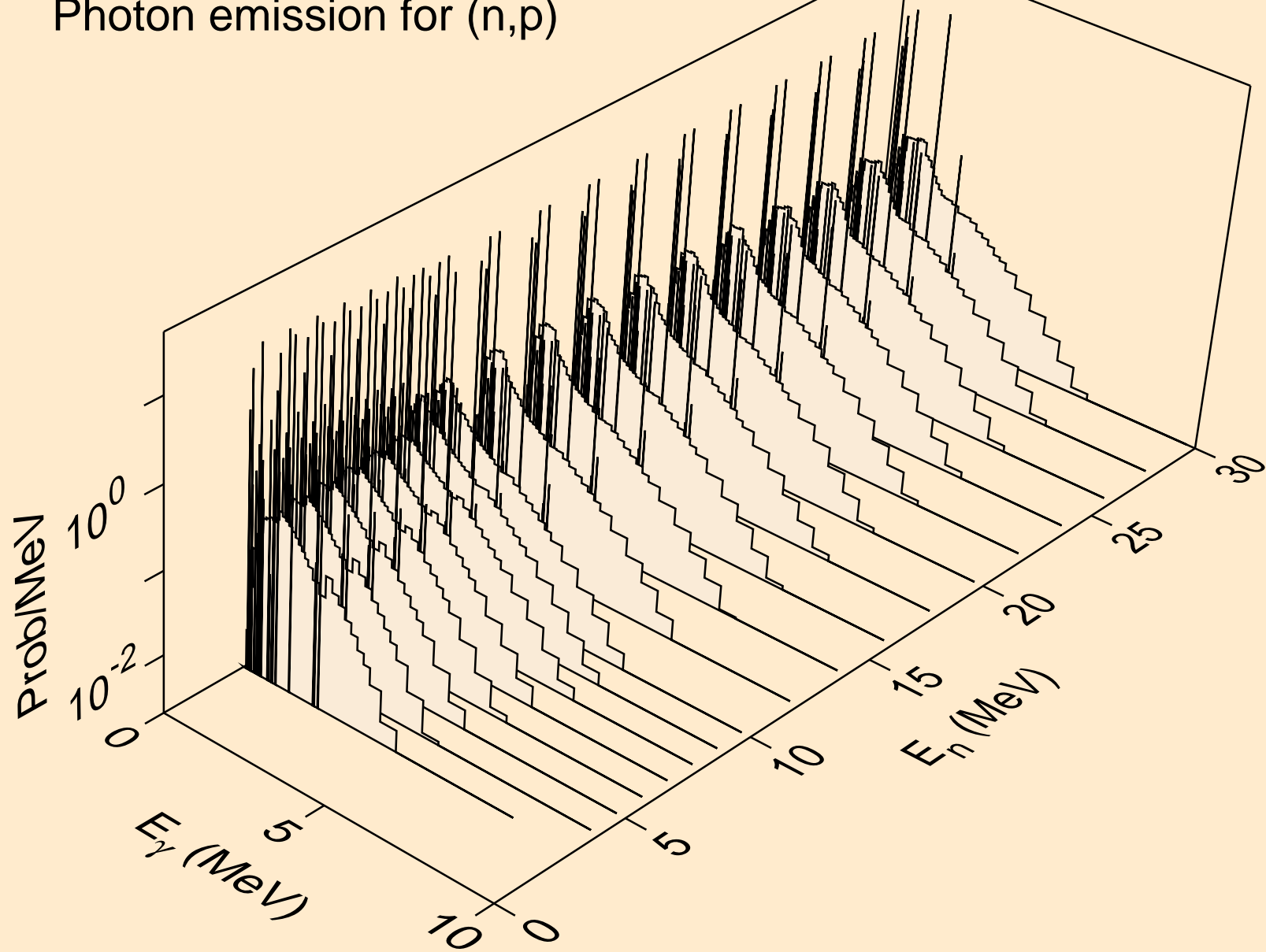

BA136 TRITON ACER TENDL-2021 LIBRARY; T=0.K
Photon emission for (n,d)

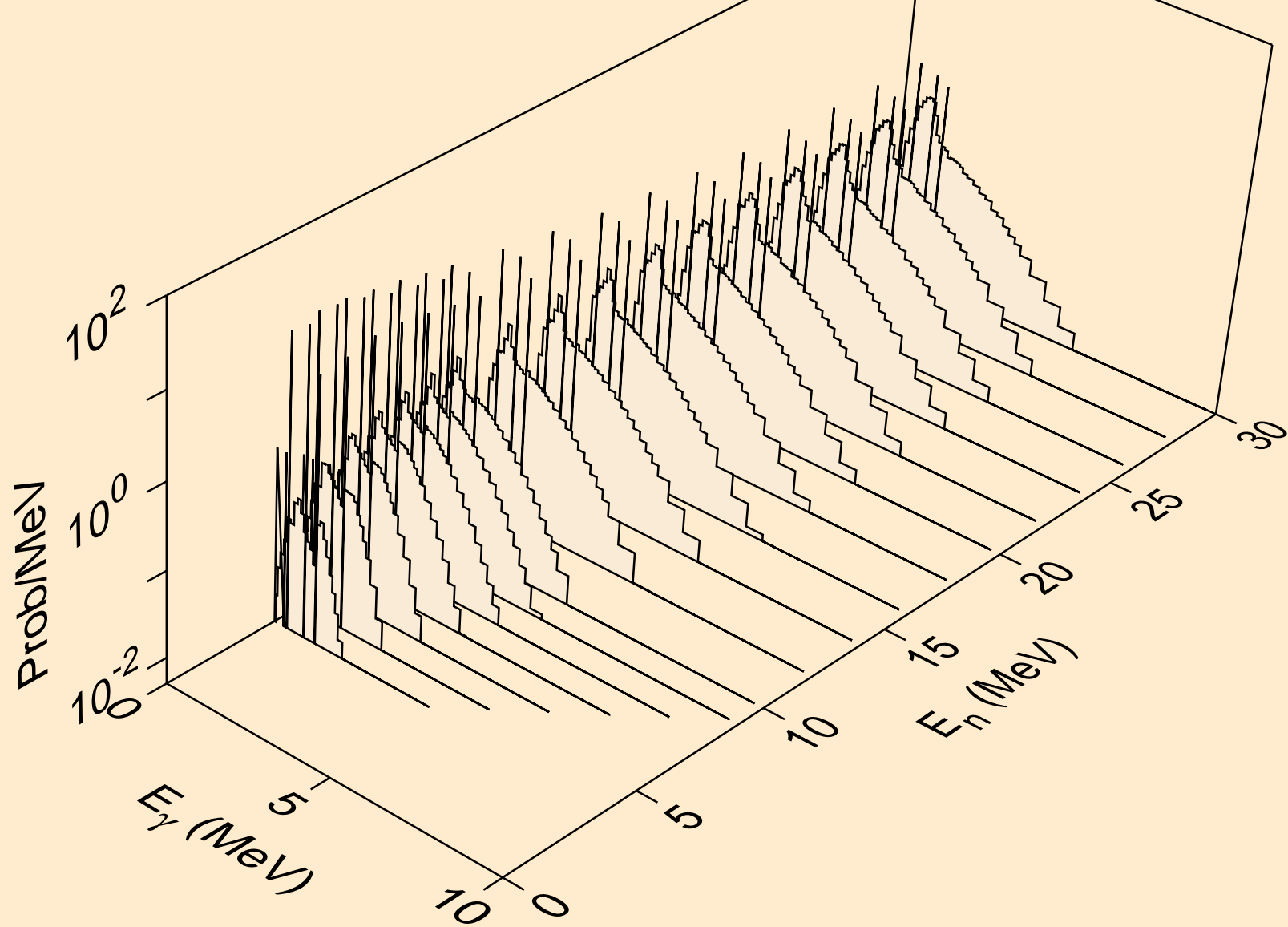

BA136 TRITON ACER TENDL-2021 LIBRARY; T=0.K
Photon emission for inelastic

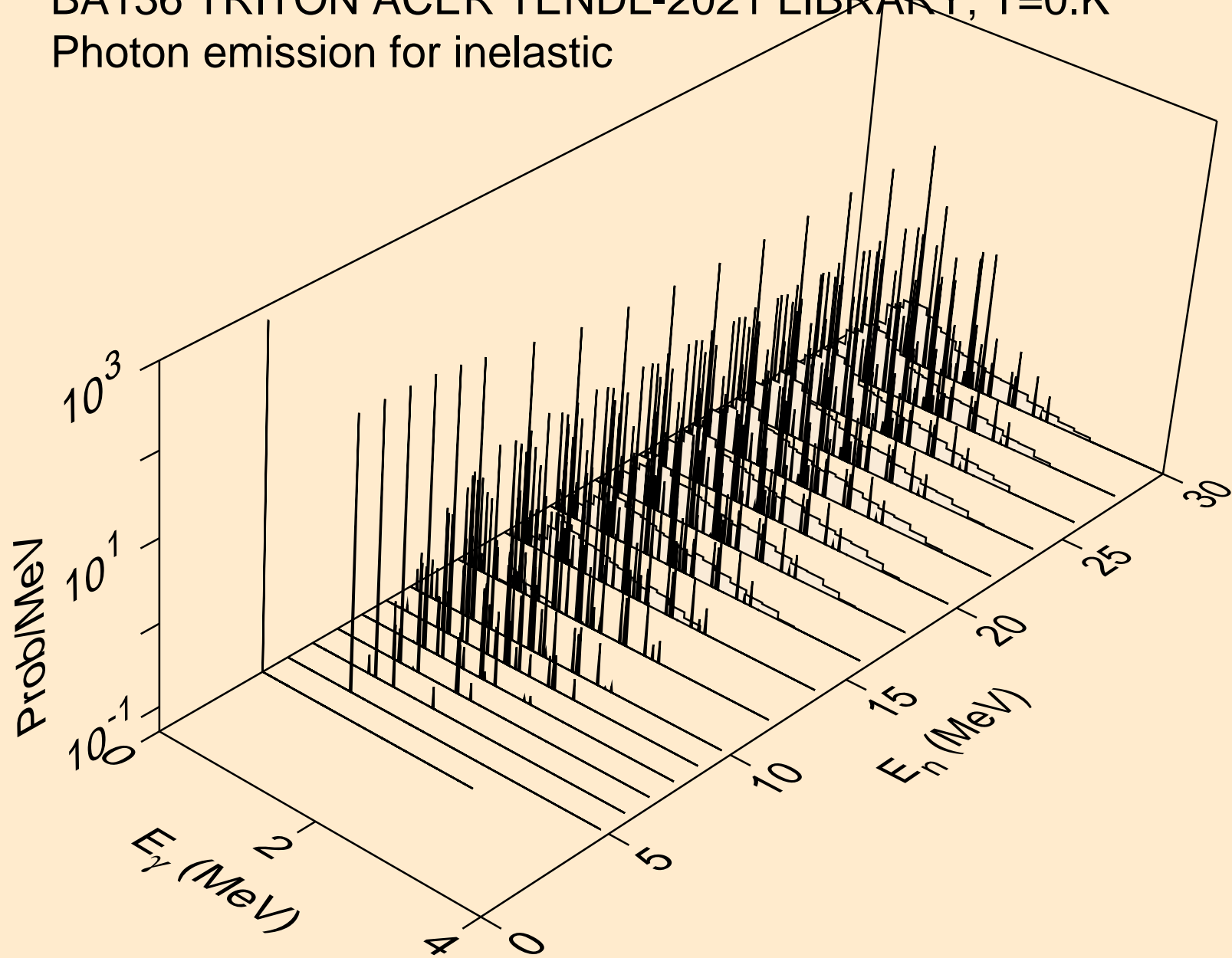

BA136 TRITON ACER TENDL-2021 LIBRARY; T=0.K
Photon emission for (n,he3)

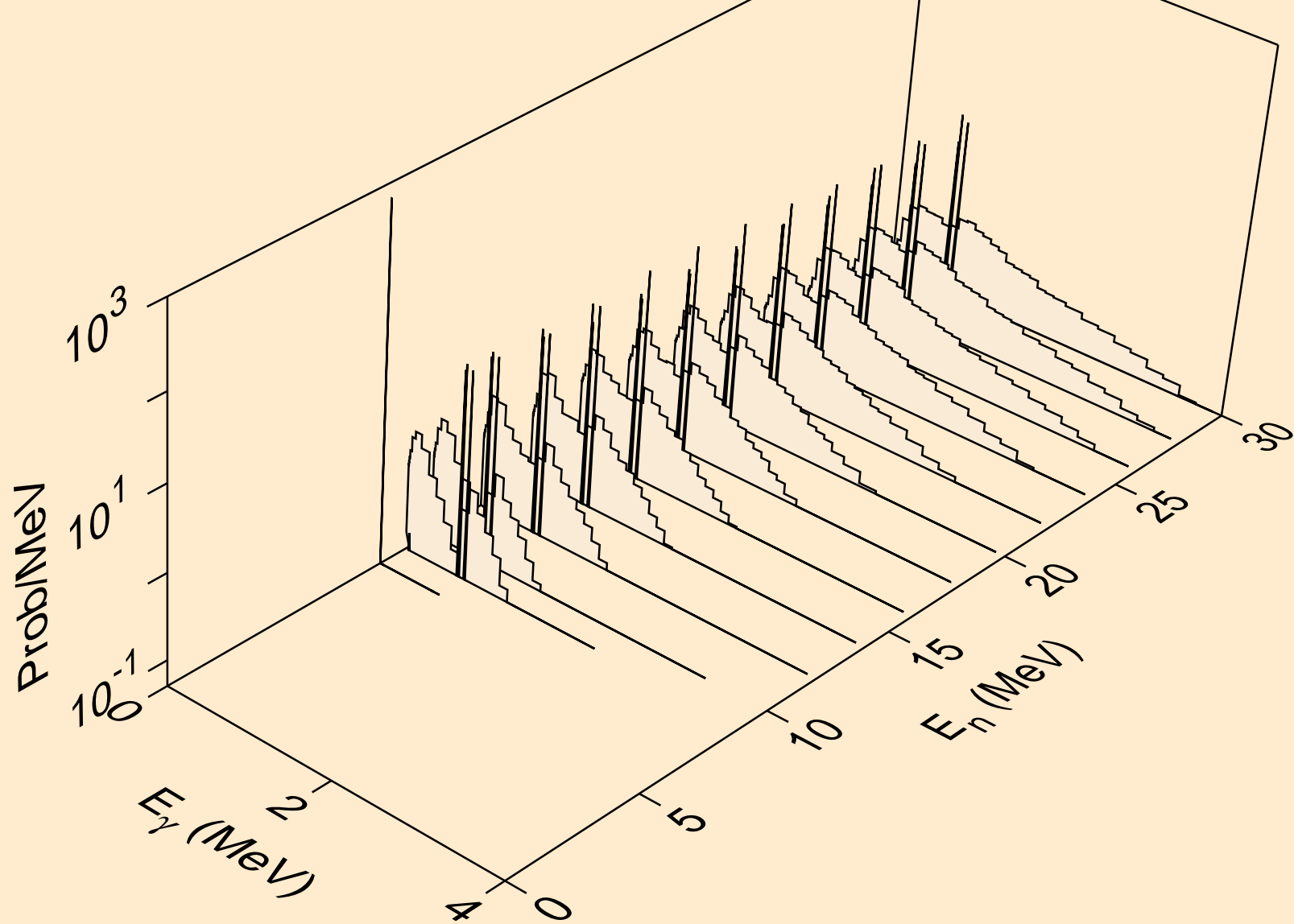

BA136 TRITON ACER TENDL-2021 LIBRARY; T=0.K
Photon emission for (n,a)

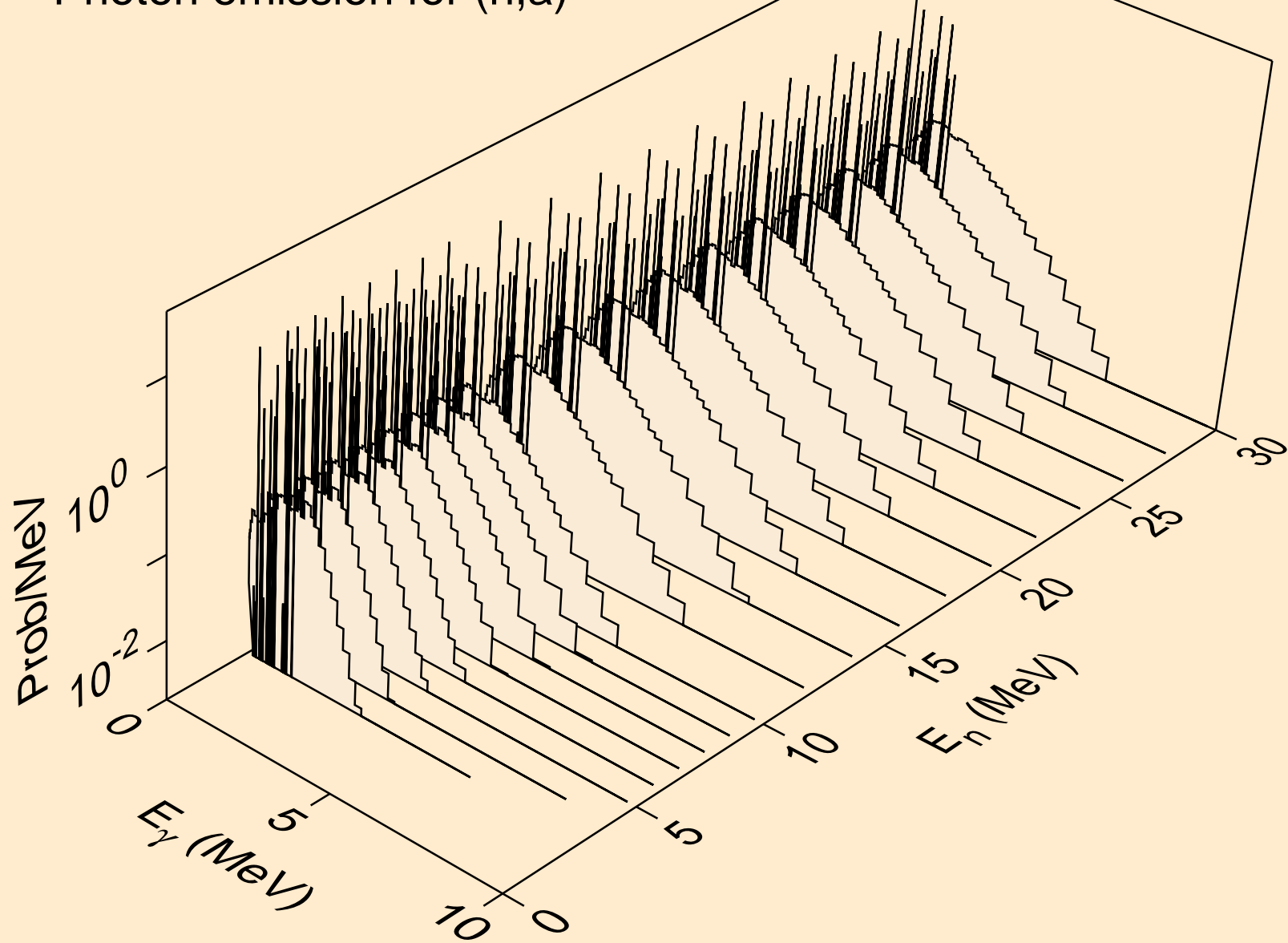

BA136 TRITON ACER TENDL-2021 LIBRARY; T=0.K
Photon emission for (n,2a)

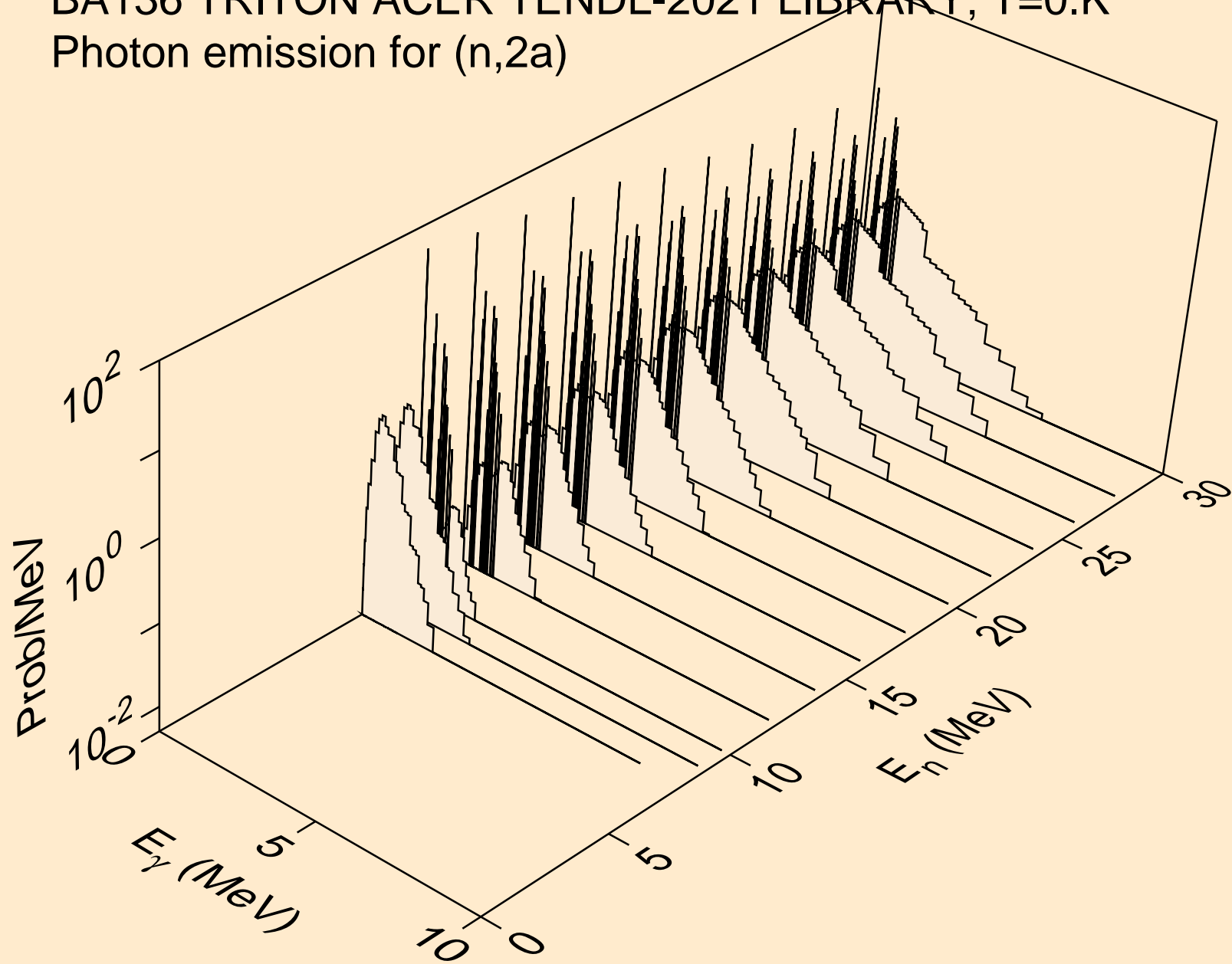

BA136 TRITON ACER TENDL-2021 LIBRARY; T=0.K
Photon emission for (n,2p)

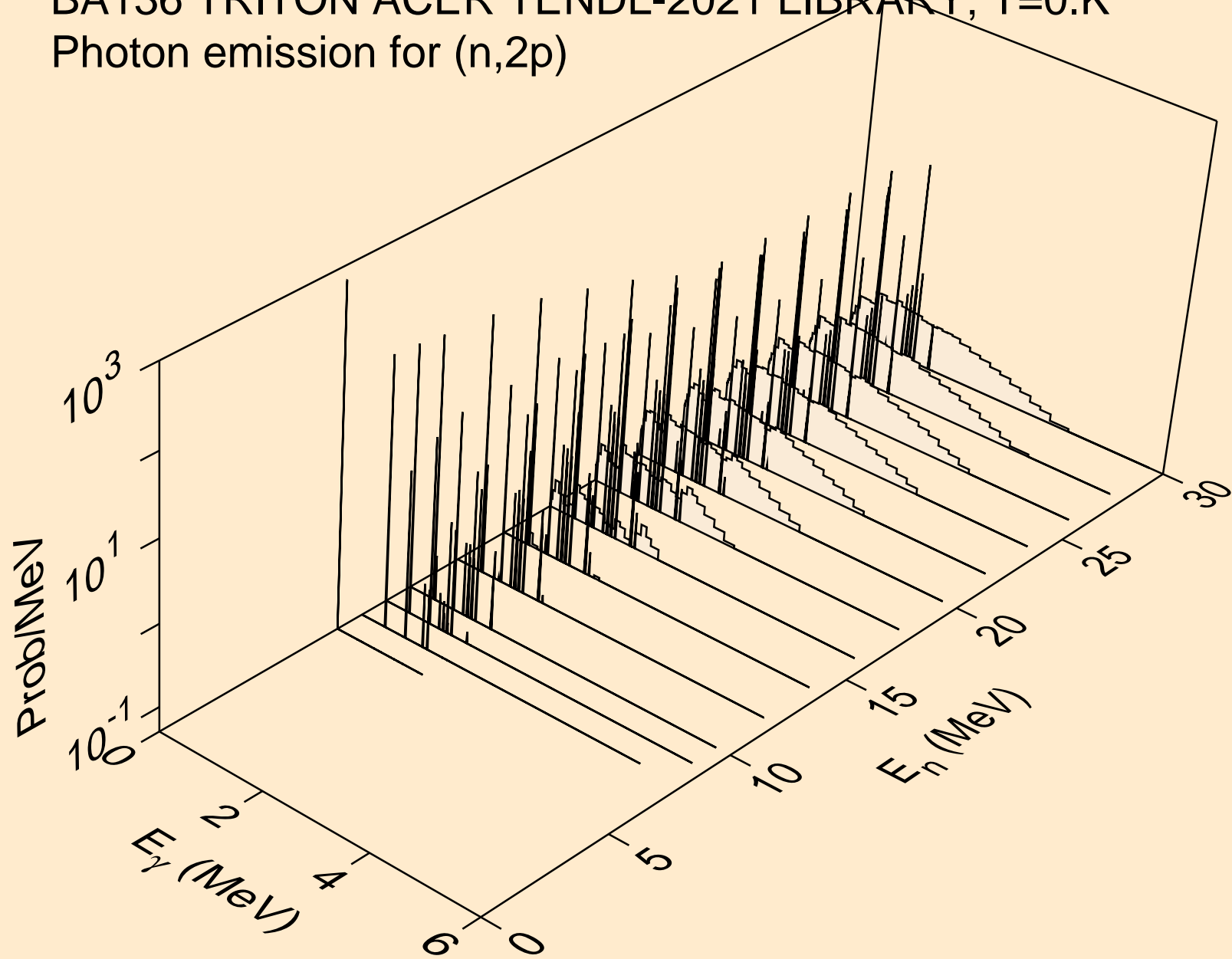

BA136 TRITON ACER TENDL-2021 LIBRARY; T=0.K
Photon emission for (n,pa)

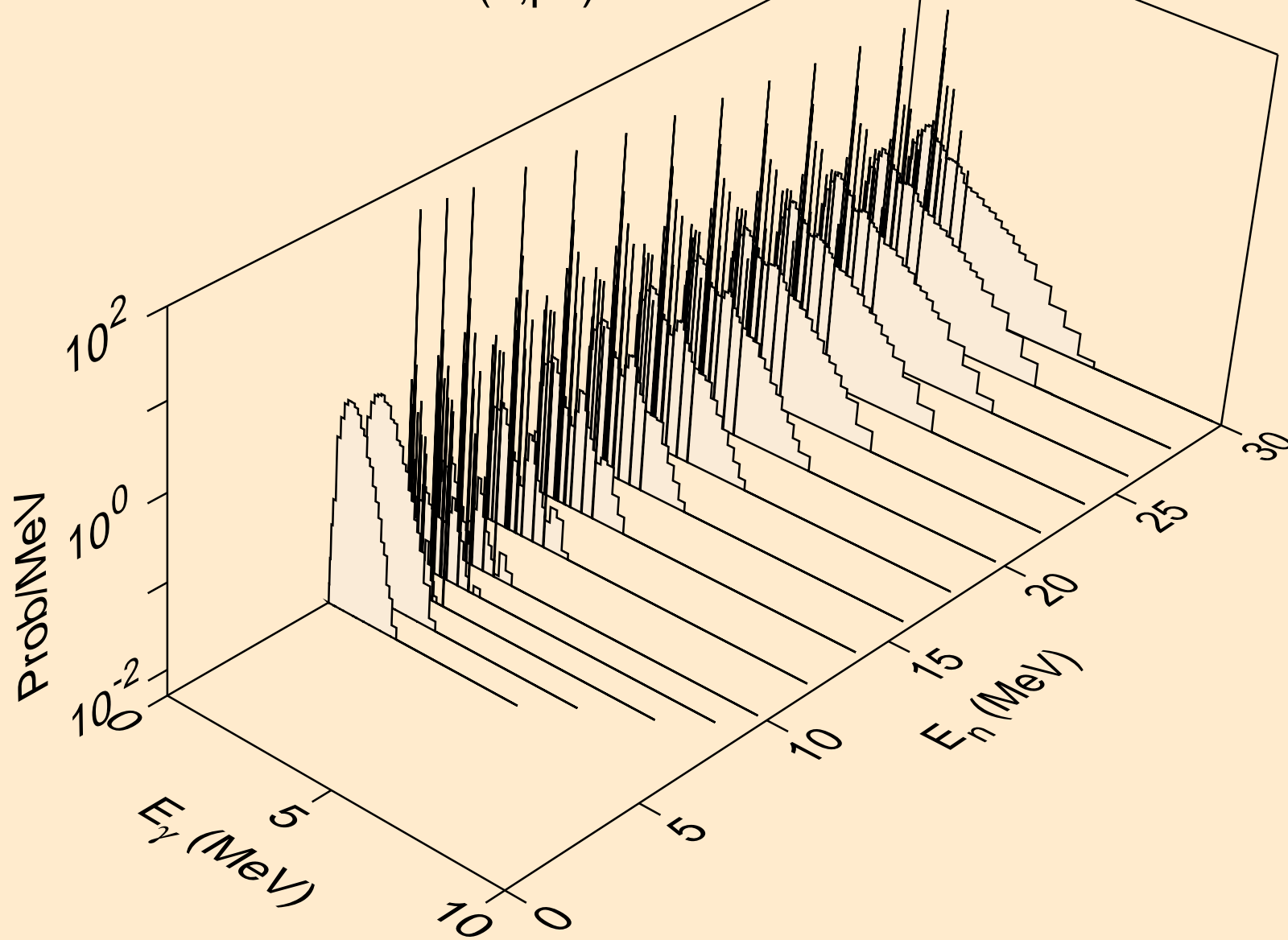

BA136 TRITON ACER TENDL-2021 LIBRARY; T=0.K
Photon emission for (n,pd)

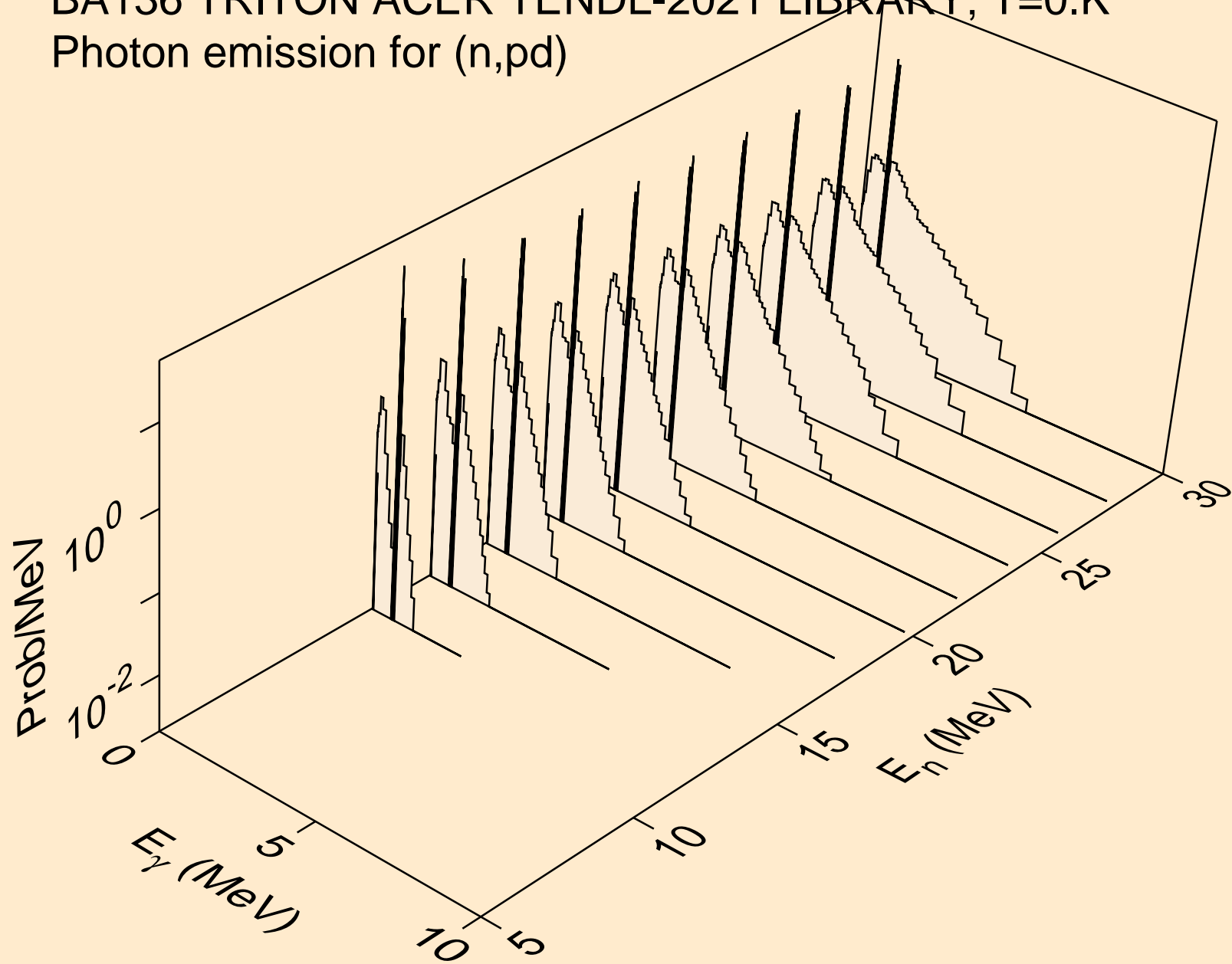

BA136 TRITON ACER TENDL-2021 LIBRARY; T=0.K
Photon emission for (n,pt)

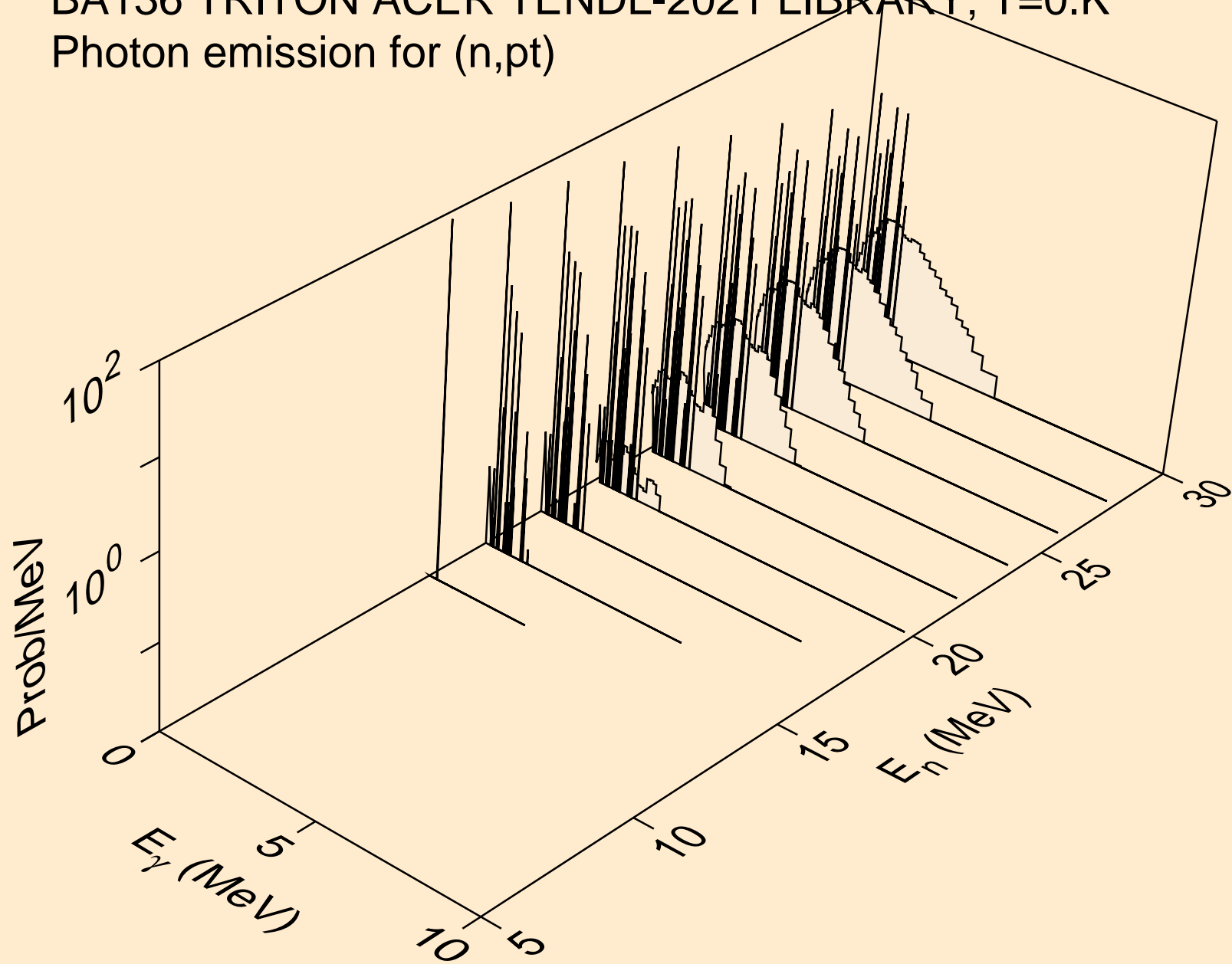

BA136 TRITON ACER TENDL-2021 LIBRARY; T=0.K
Photon emission for (n,da)

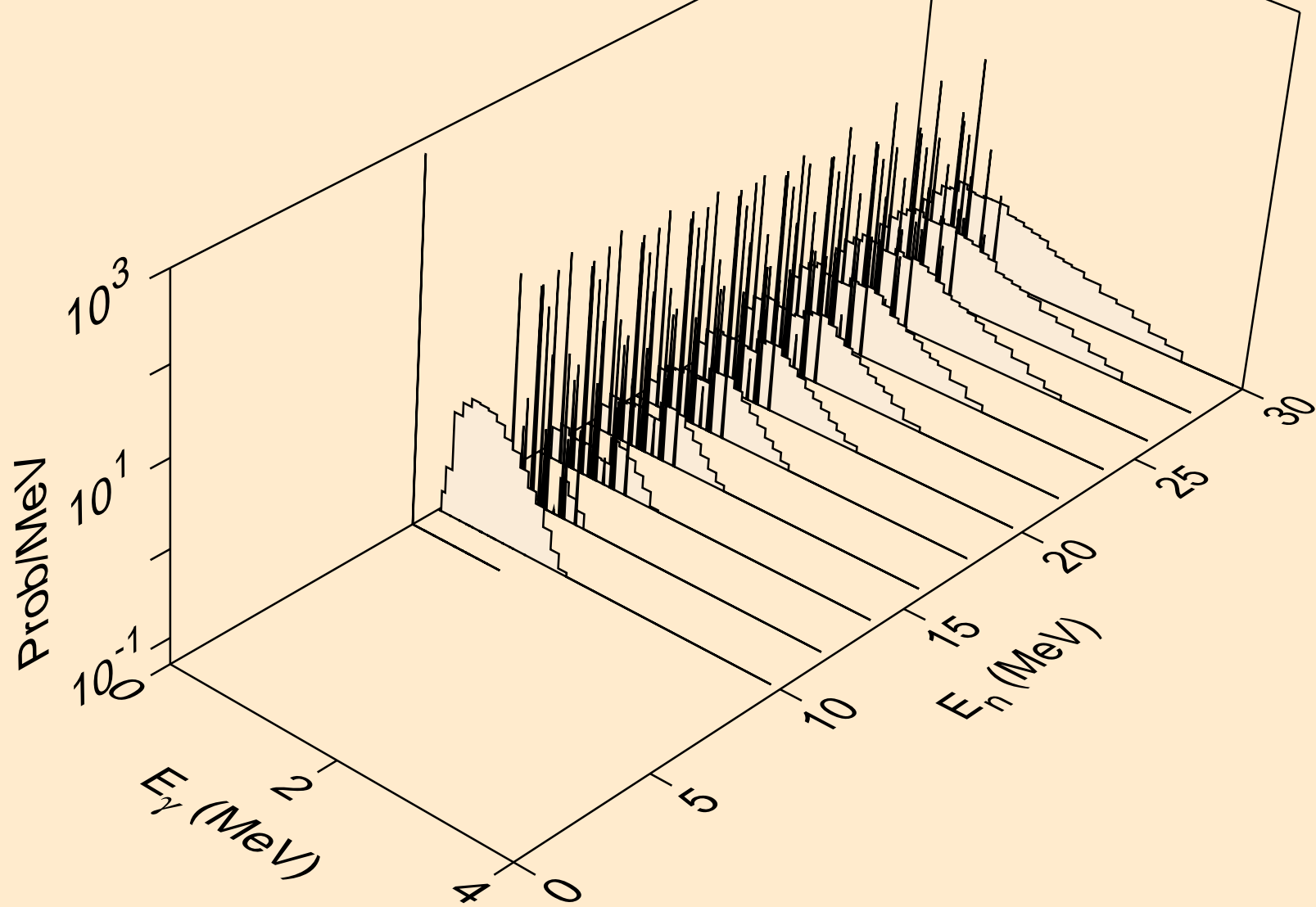

BA136 TRITON ACER TENDL-2021 LIBRARY; T=0.K
Particle heating contributions

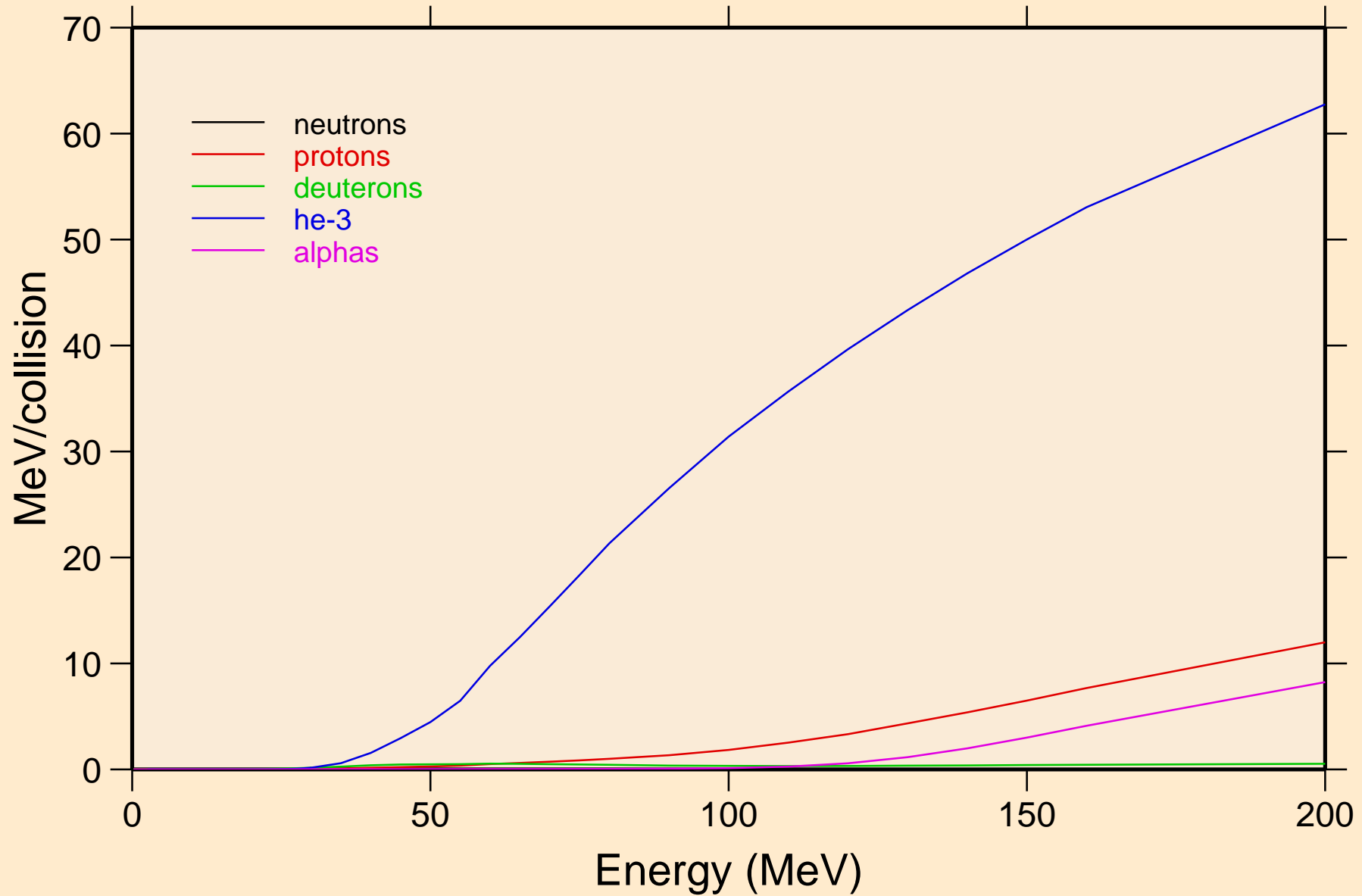

BA136 TRITON ACER TENDL-2021 LIBRARY; T=0.K
Recoil Heating

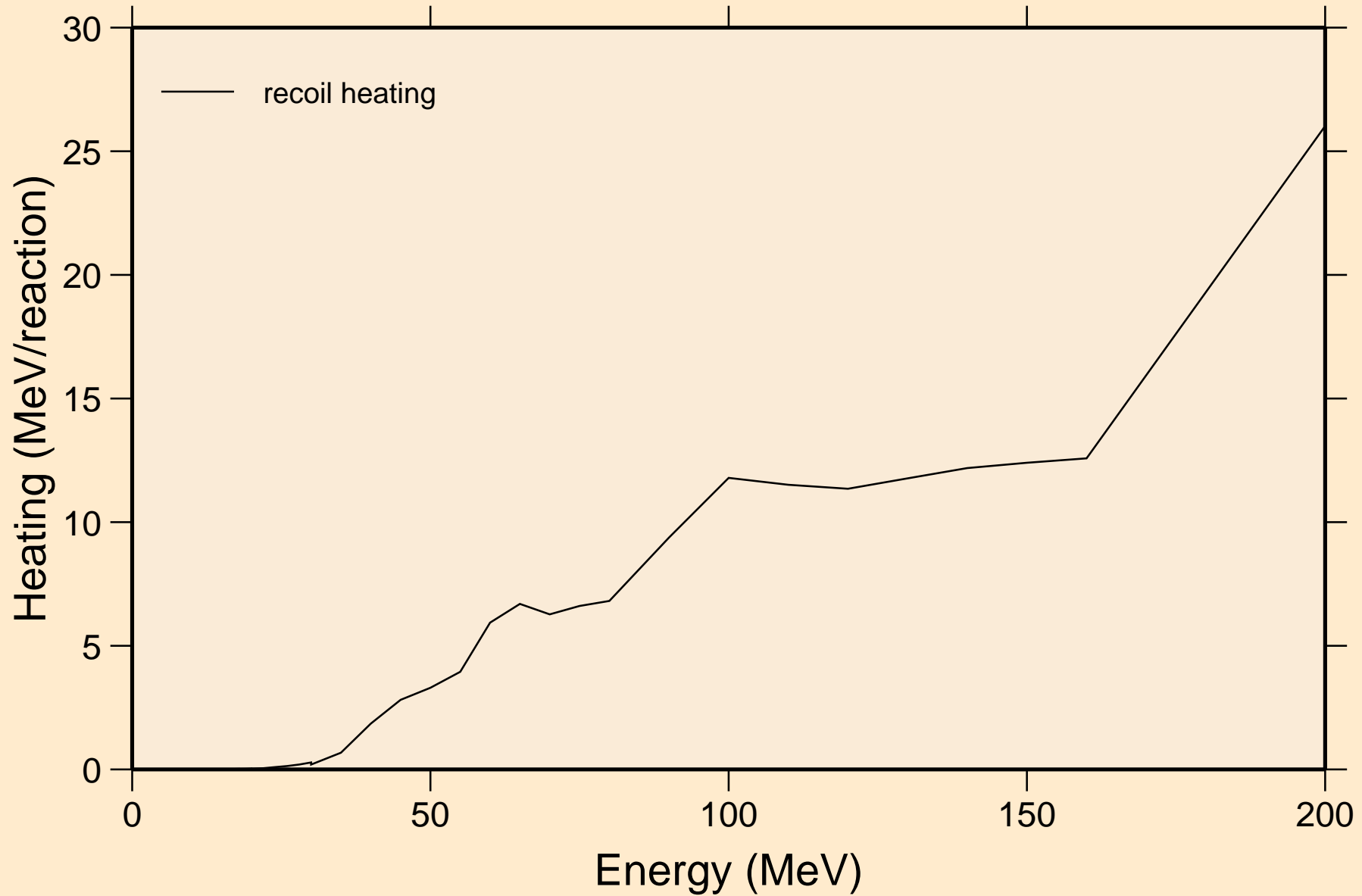

BA136 TRITON ACER TENDL-2021 LIBRARY; T=0.K
Particle production cross sections

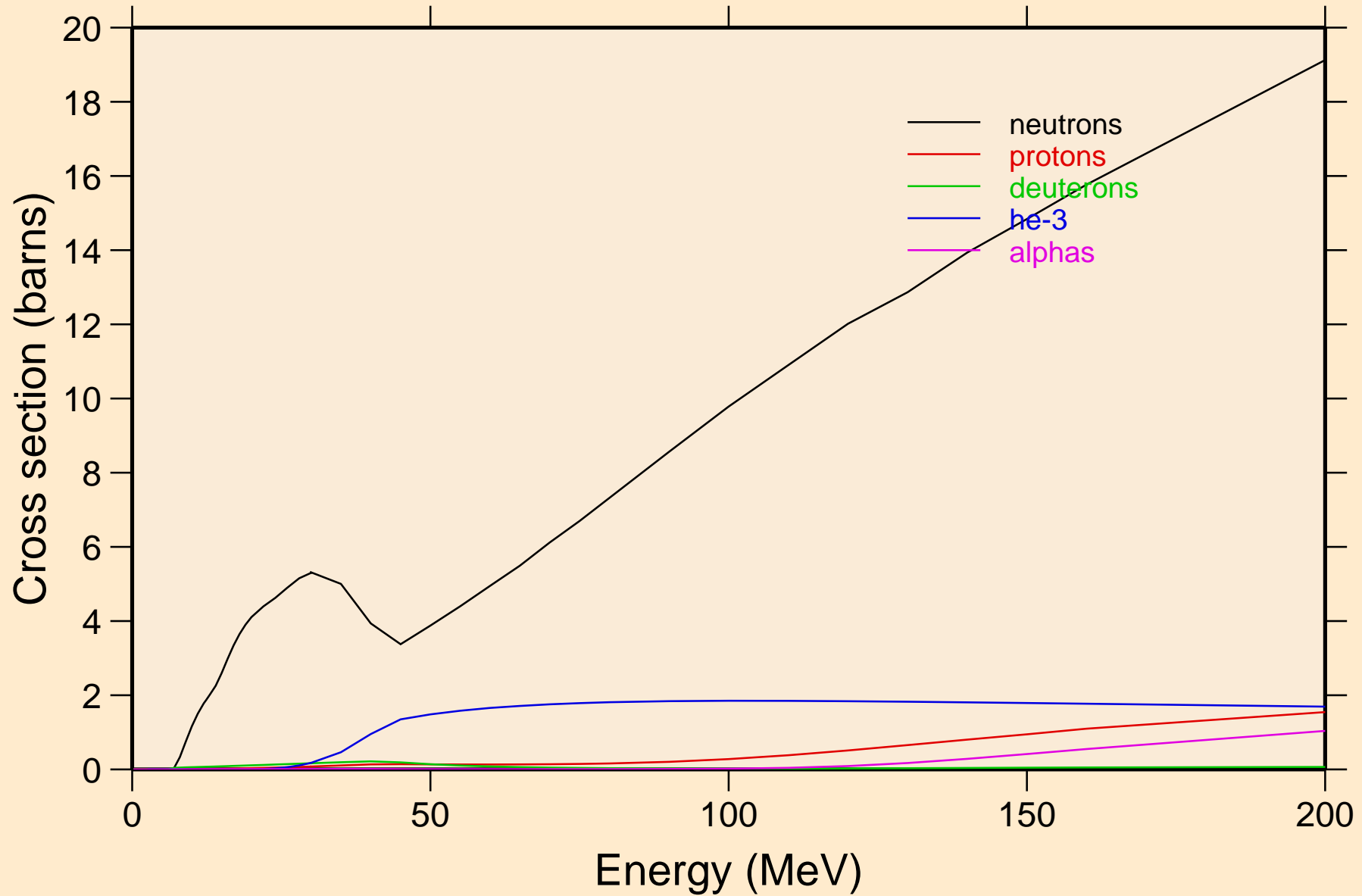

BA136 TRITON ACER TENDL-2021 LIBRARY; T=0.K
neutrons from (t,n)

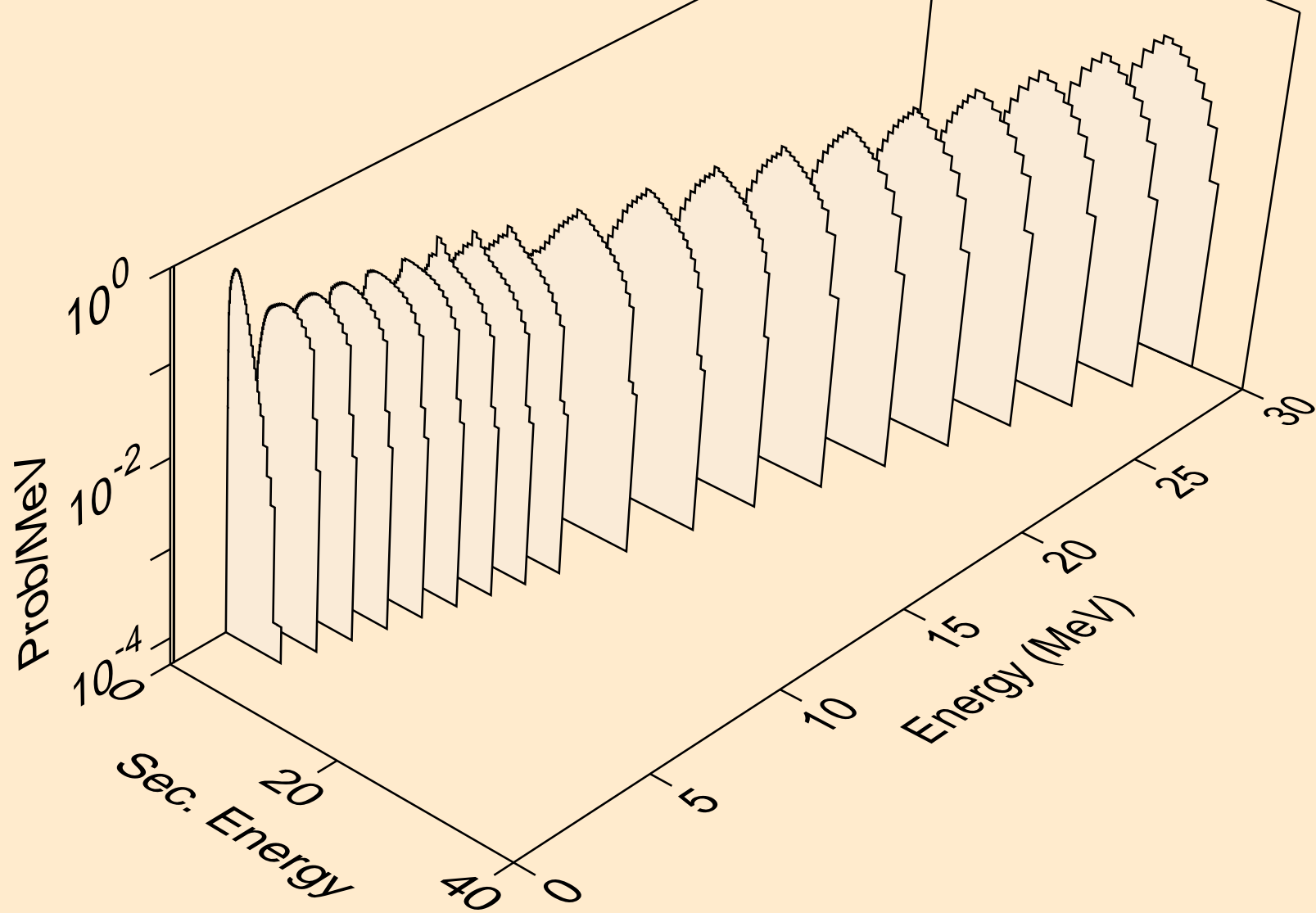

BA136 TRITON ACER TENDL-2021 LIBRARY; T=0.K
neutrons from (t,x)

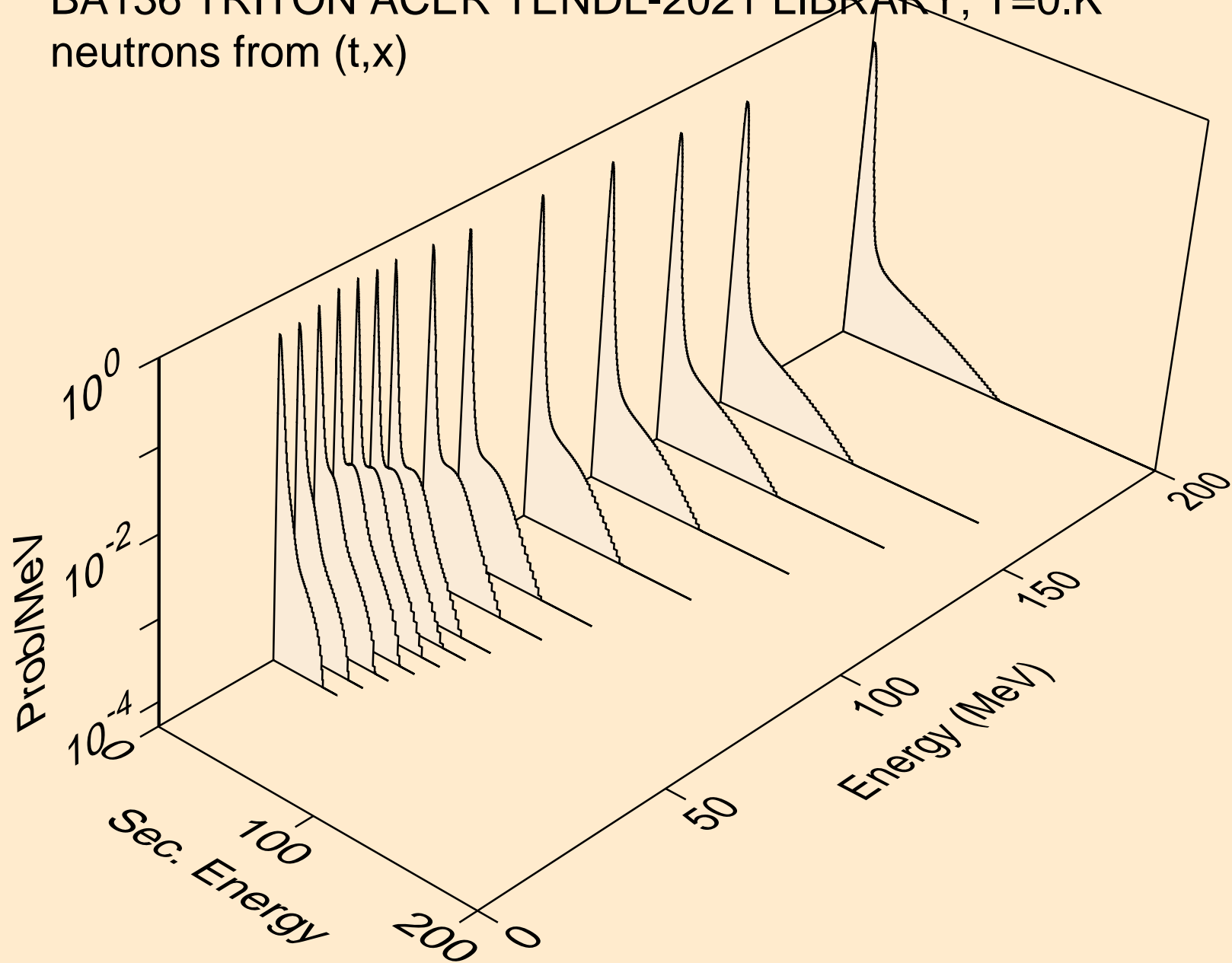

BA136 TRITON ACER TENDL-2021 LIBRARY; T=0.K
neutrons from (t,2nd)

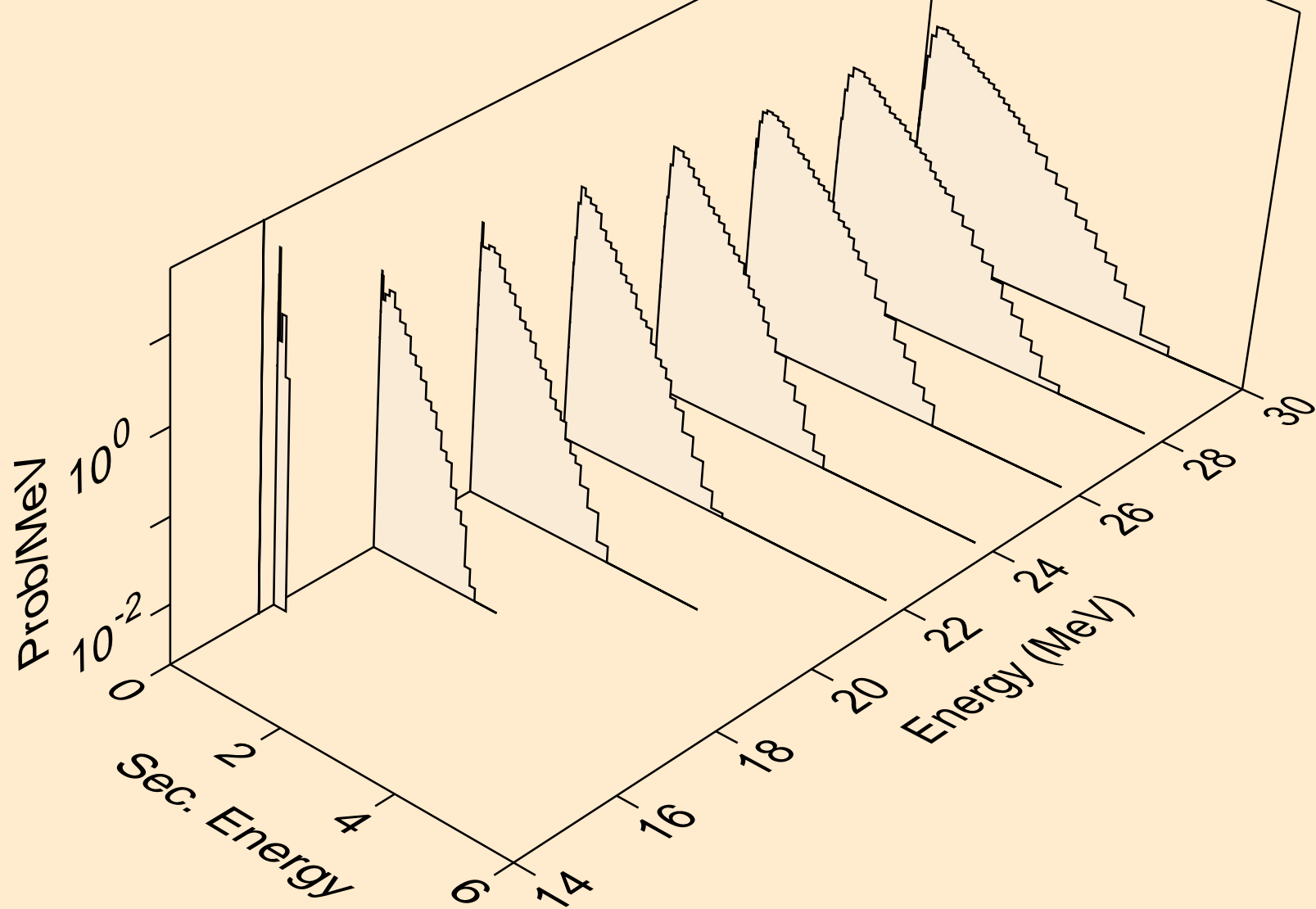

BA136 TRITON ACER TENDL-2021 LIBRARY; T=0.K
neutrons from (t,2n)

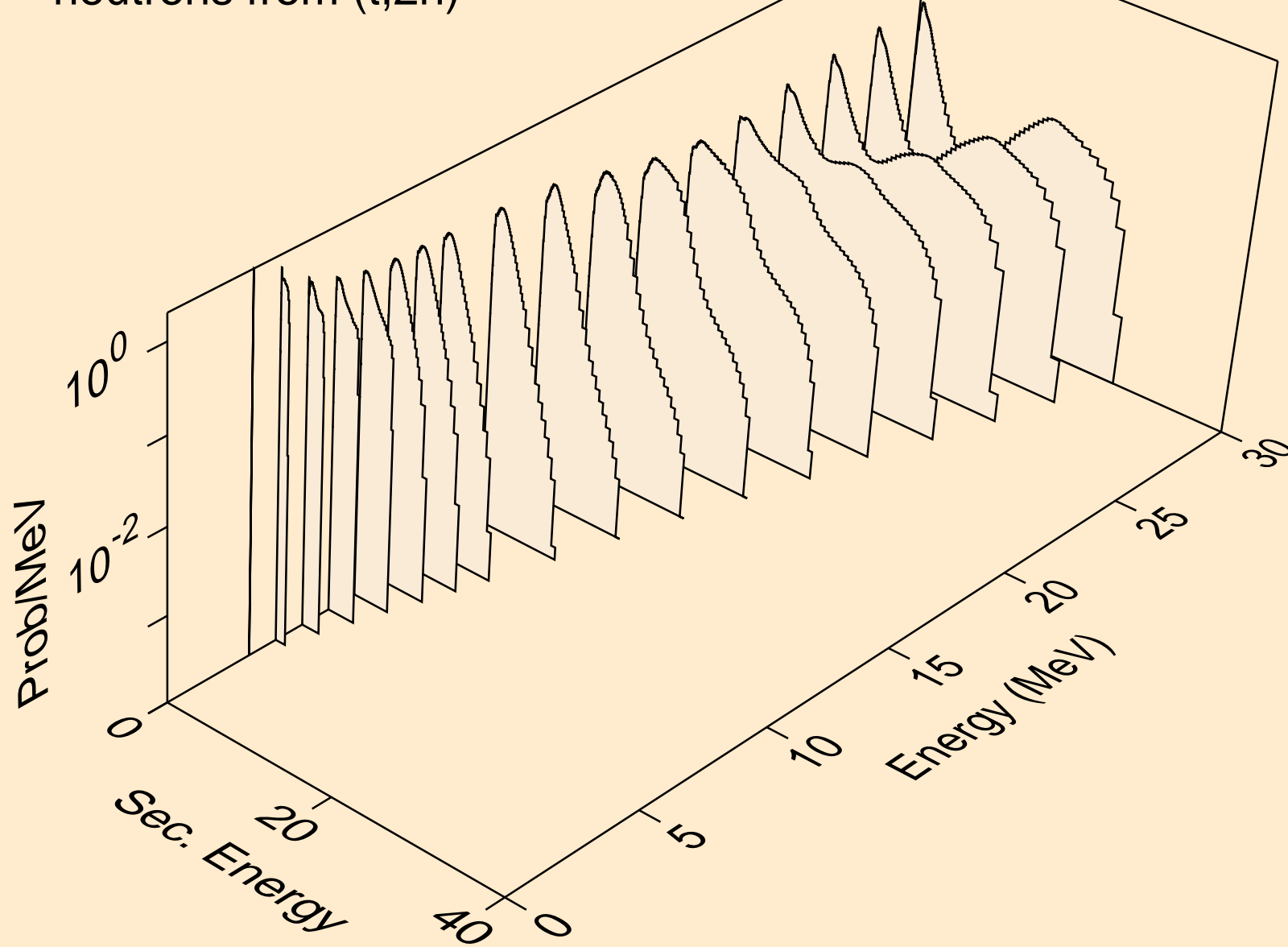

BA136 TRITON ACER TENDL-2021 LIBRARY; T=0.K
neutrons from (t,3n)

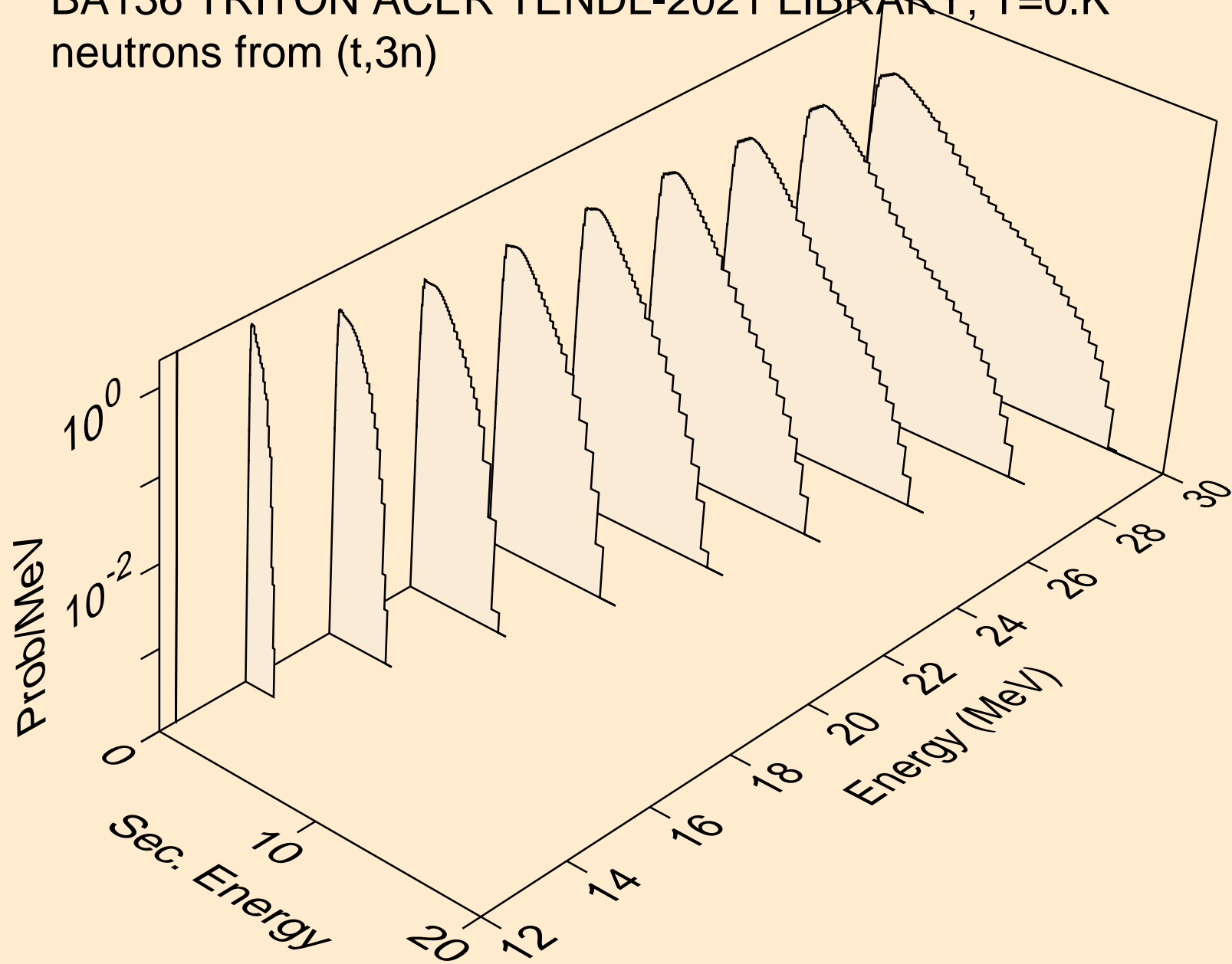

BA136 TRITON ACER TENDL-2021 LIBRARY; T=0.K
neutrons from (t,n*)a

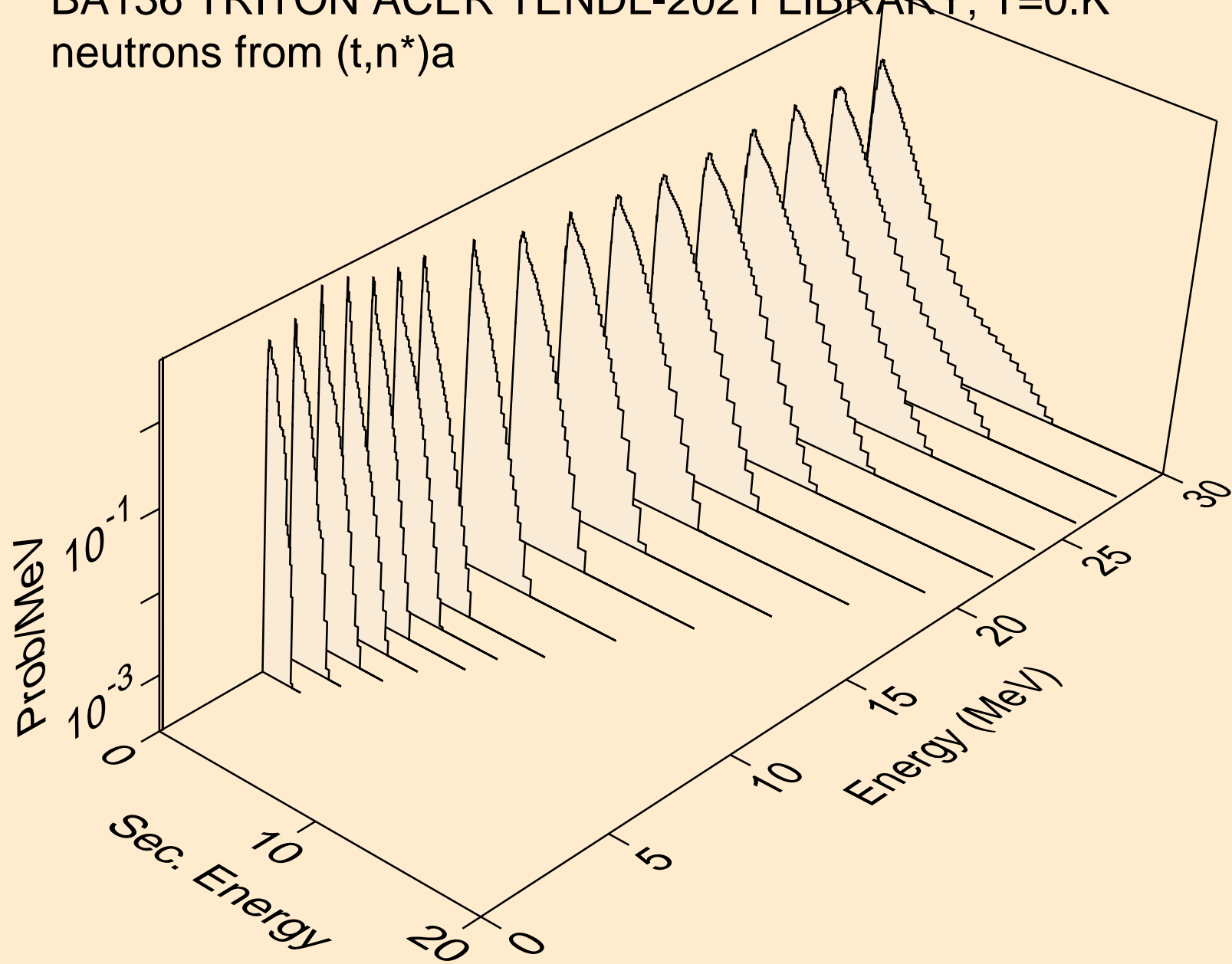

BA136 TRITON ACER TENDL-2021 LIBRARY; T=0.K
neutrons from (t,2n)a

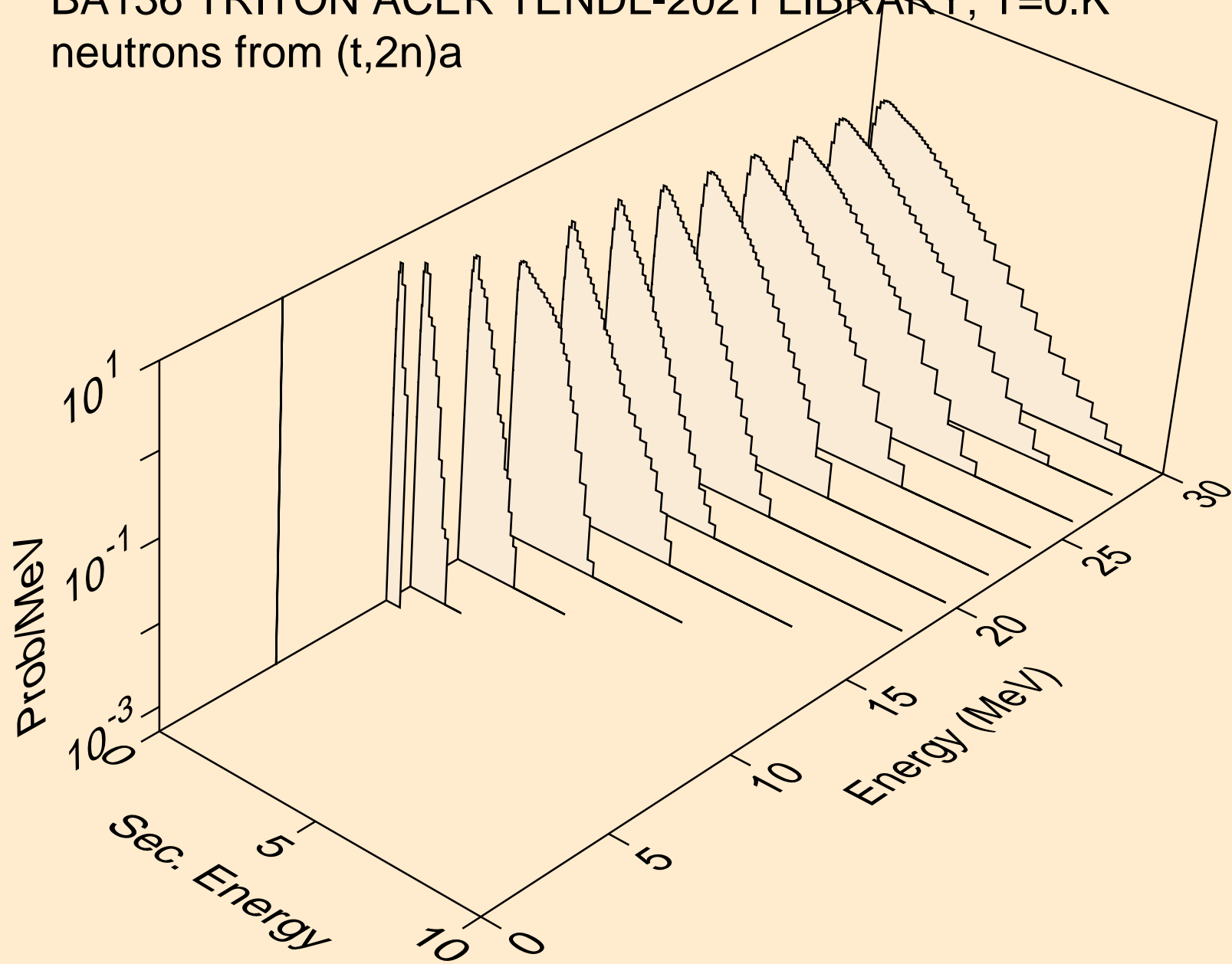

BA136 TRITON ACER TENDL-2021 LIBRARY; T=0.K
neutrons from (t,3n)a

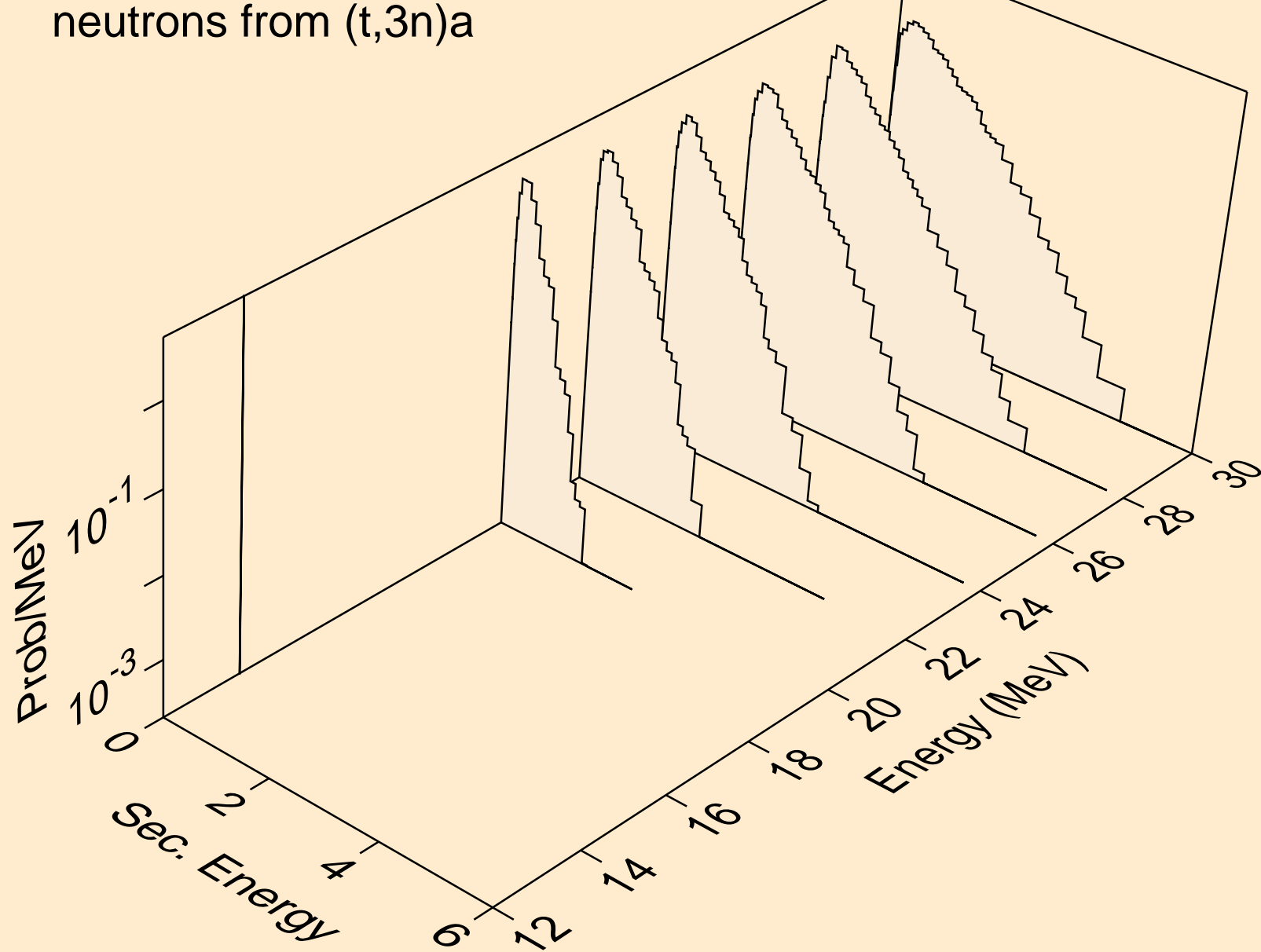

BA136 TRITON ACER TENDL-2021 LIBRARY; T=0.K
neutrons from (t,n*)p

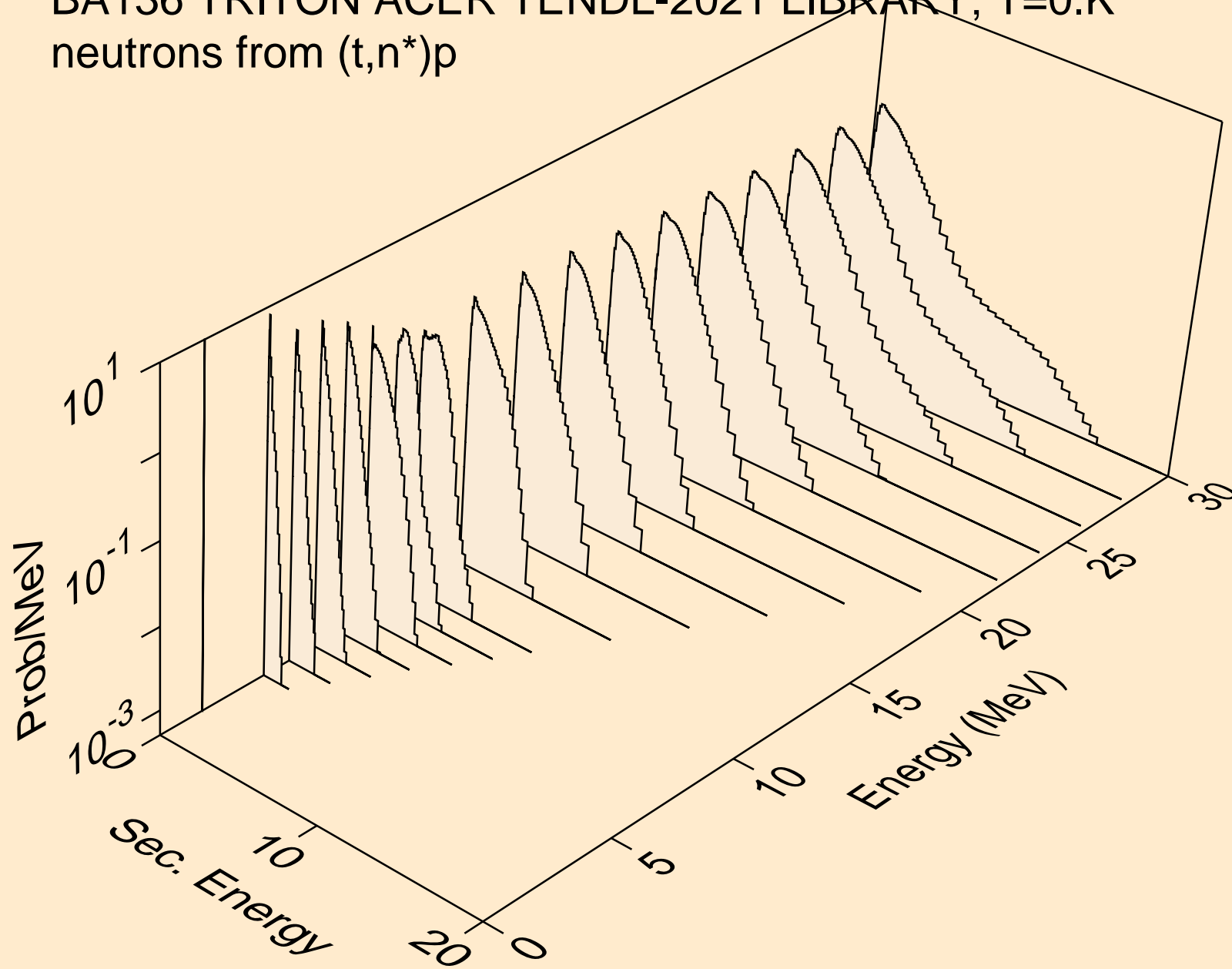

BA136 TRITON ACER TENDL-2021 LIBRARY; T=0.K
neutrons from (t,n*)2a

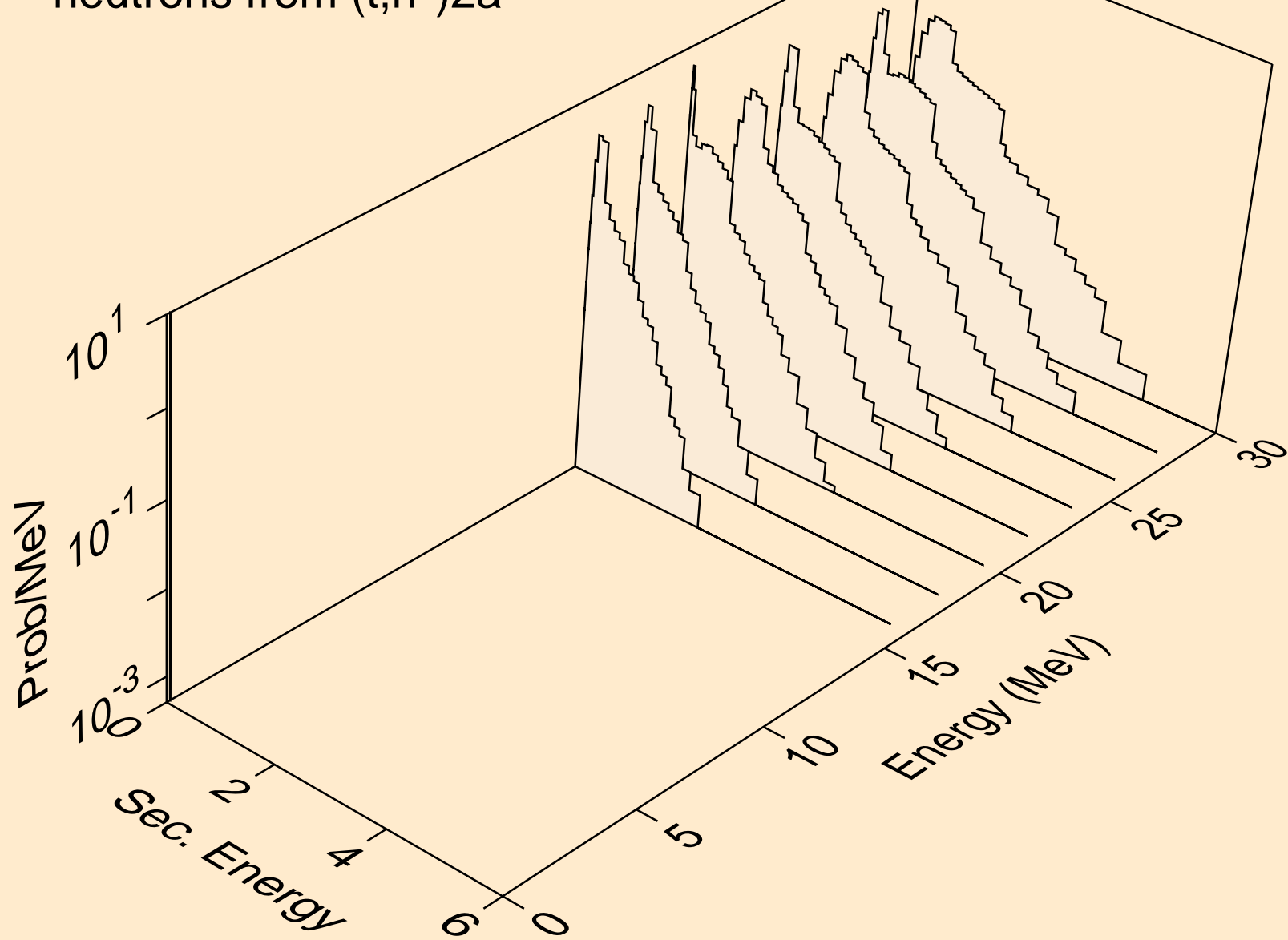

BA136 TRITON ACER TENDL-2021 LIBRARY; T=0.K
neutrons from (t,n*)d

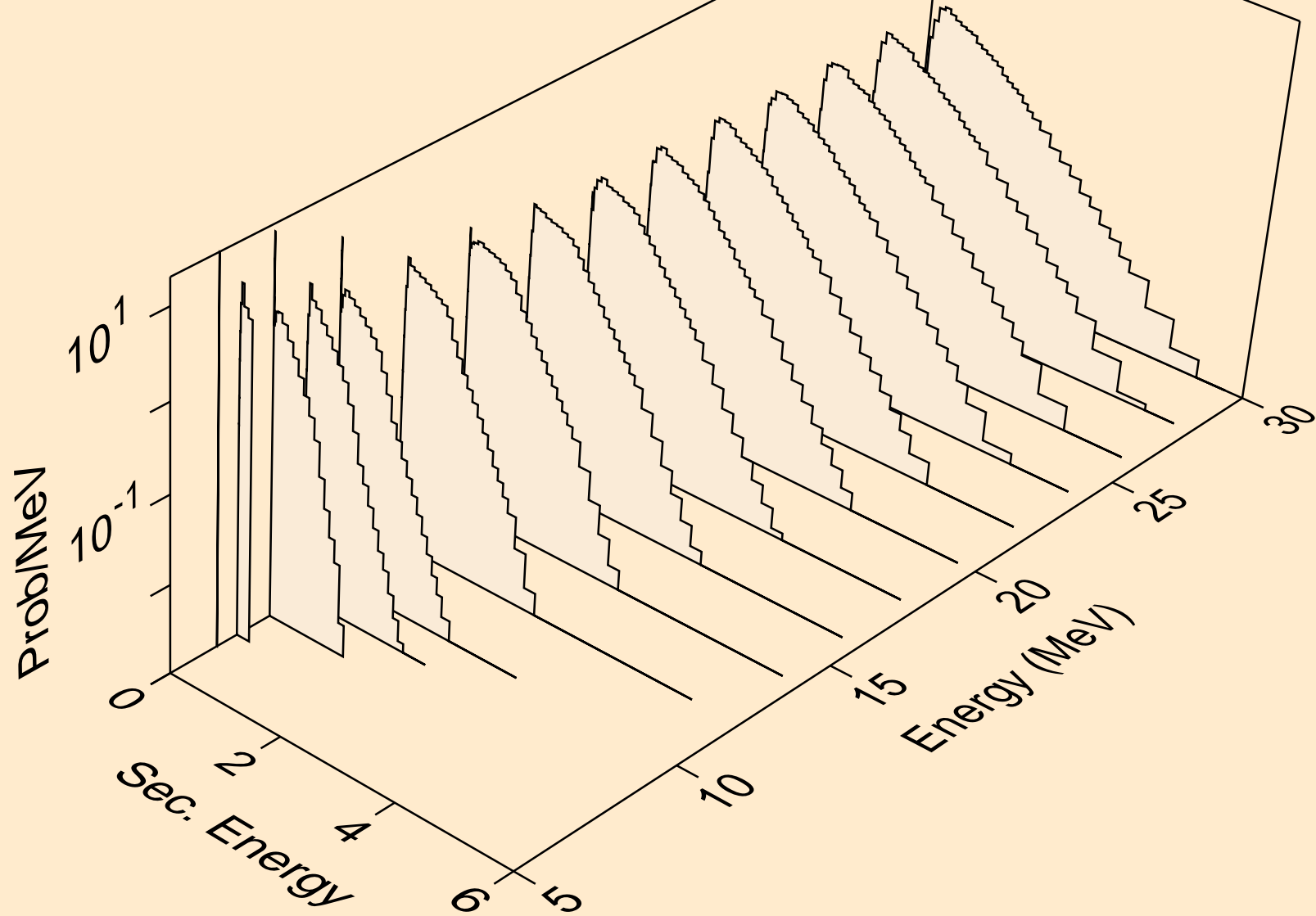

BA136 TRITON ACER TENDL-2021 LIBRARY; T=0.K
neutrons from (t,n*)t

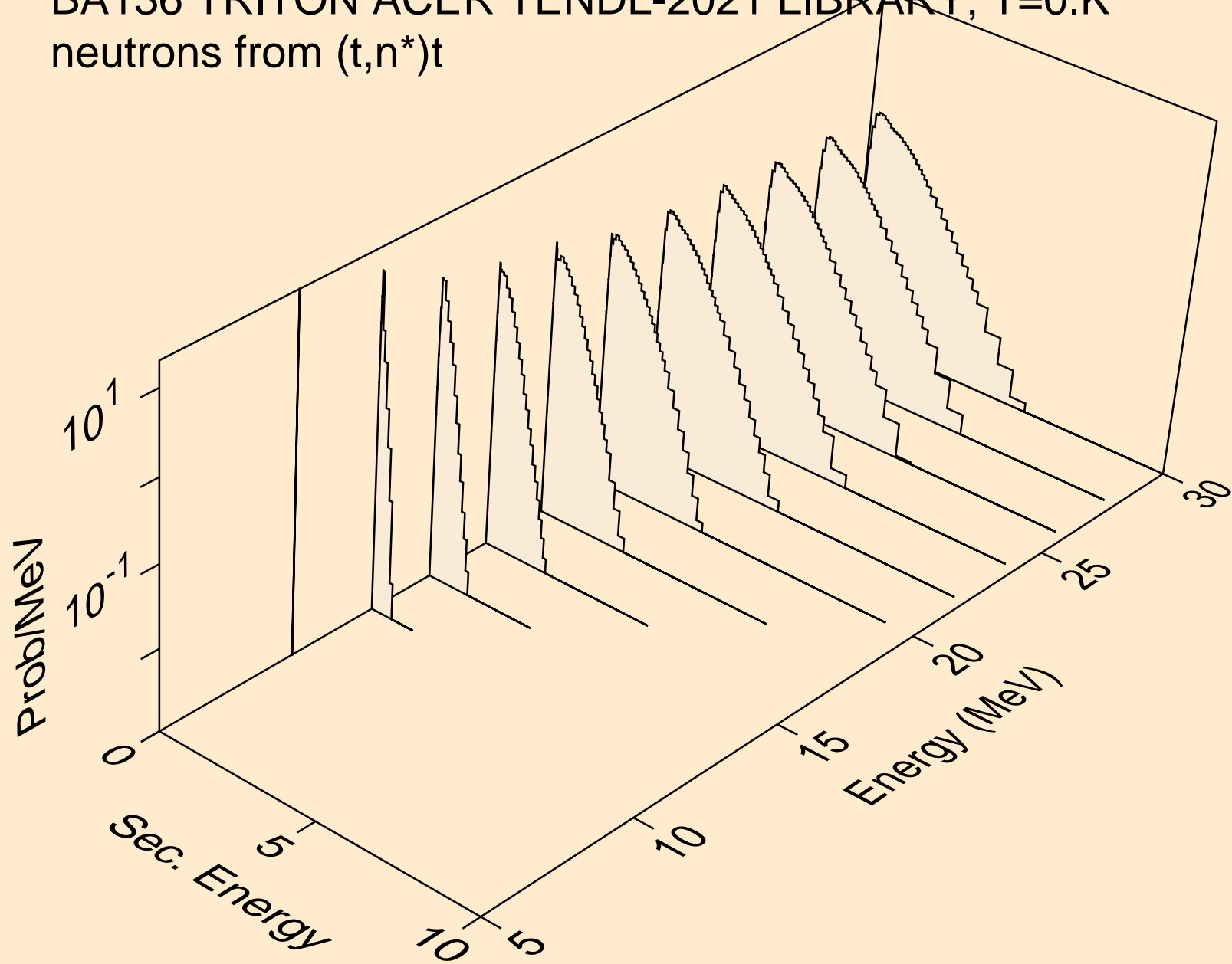

BA136 TRITON ACER TENDL-2021 LIBRARY; T=0.K
neutrons from (t,n*)he3

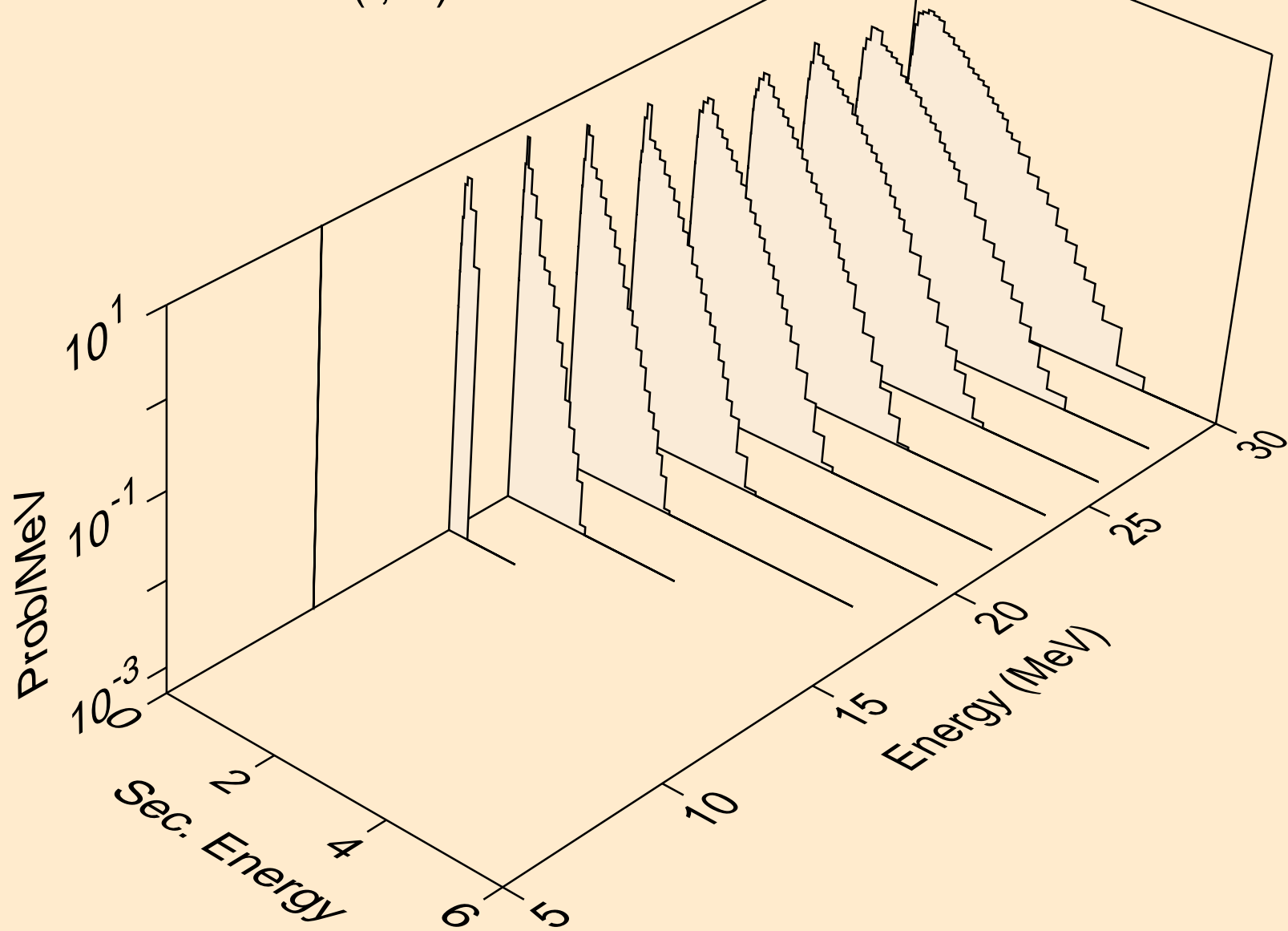

BA136 TRITON ACER TENDL-2021 LIBRARY; T=0.K
neutrons from (t,4n)

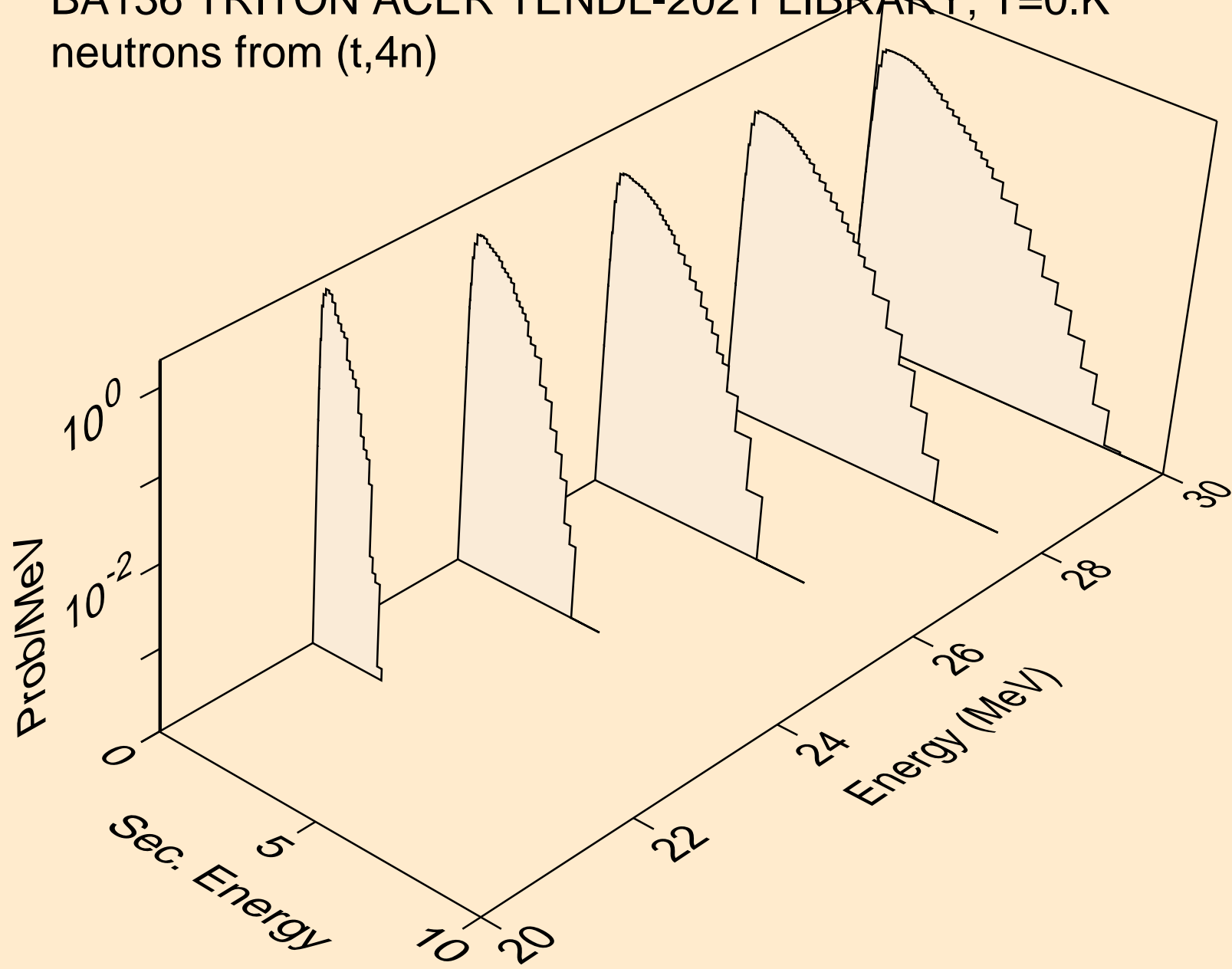

BA136 TRITON ACER TENDL-2021 LIBRARY; T=0.K
neutrons from (t,2np)

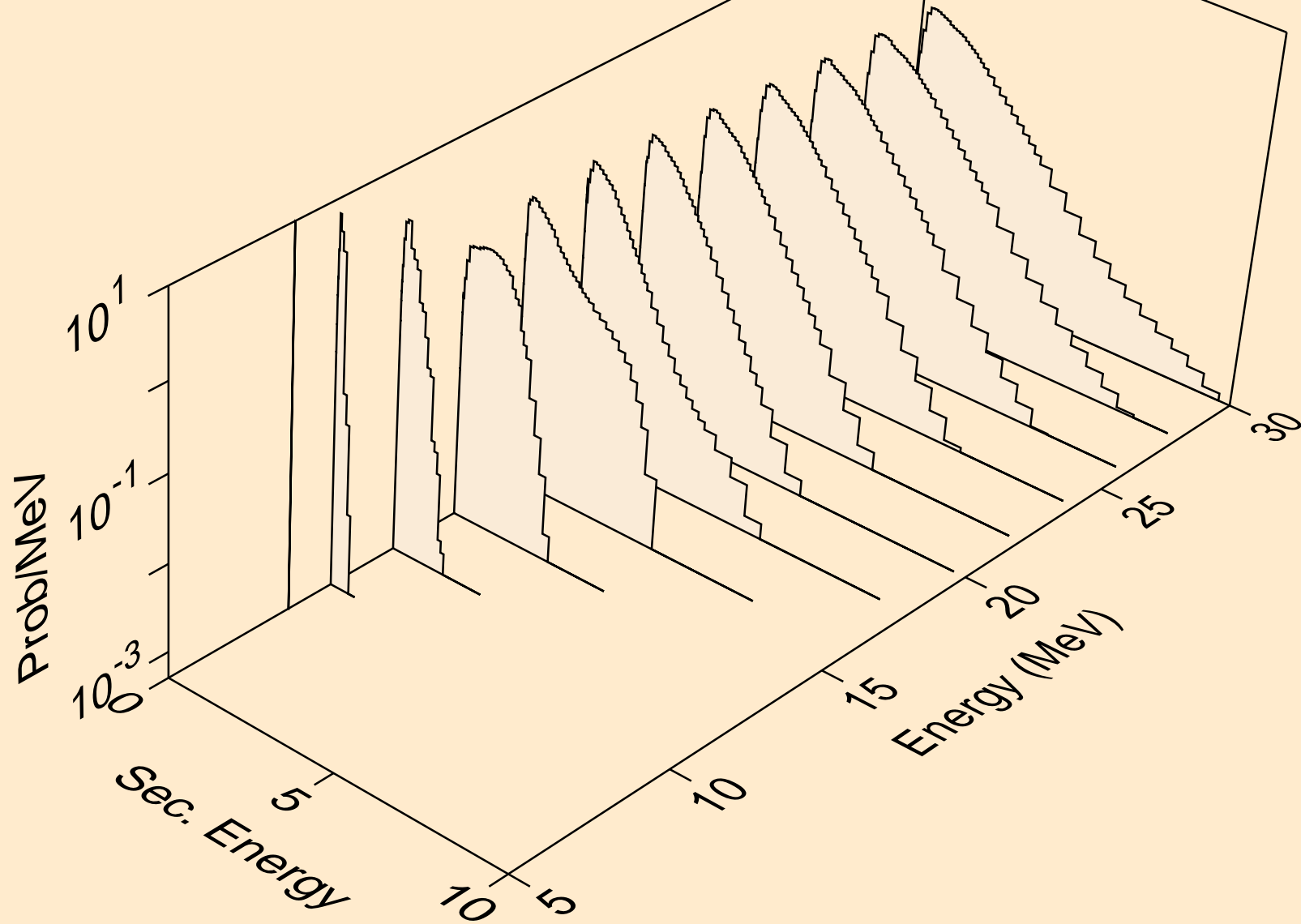

BA136 TRITON ACER TENDL-2021 LIBRARY; T=0.K
neutrons from (t,3np)

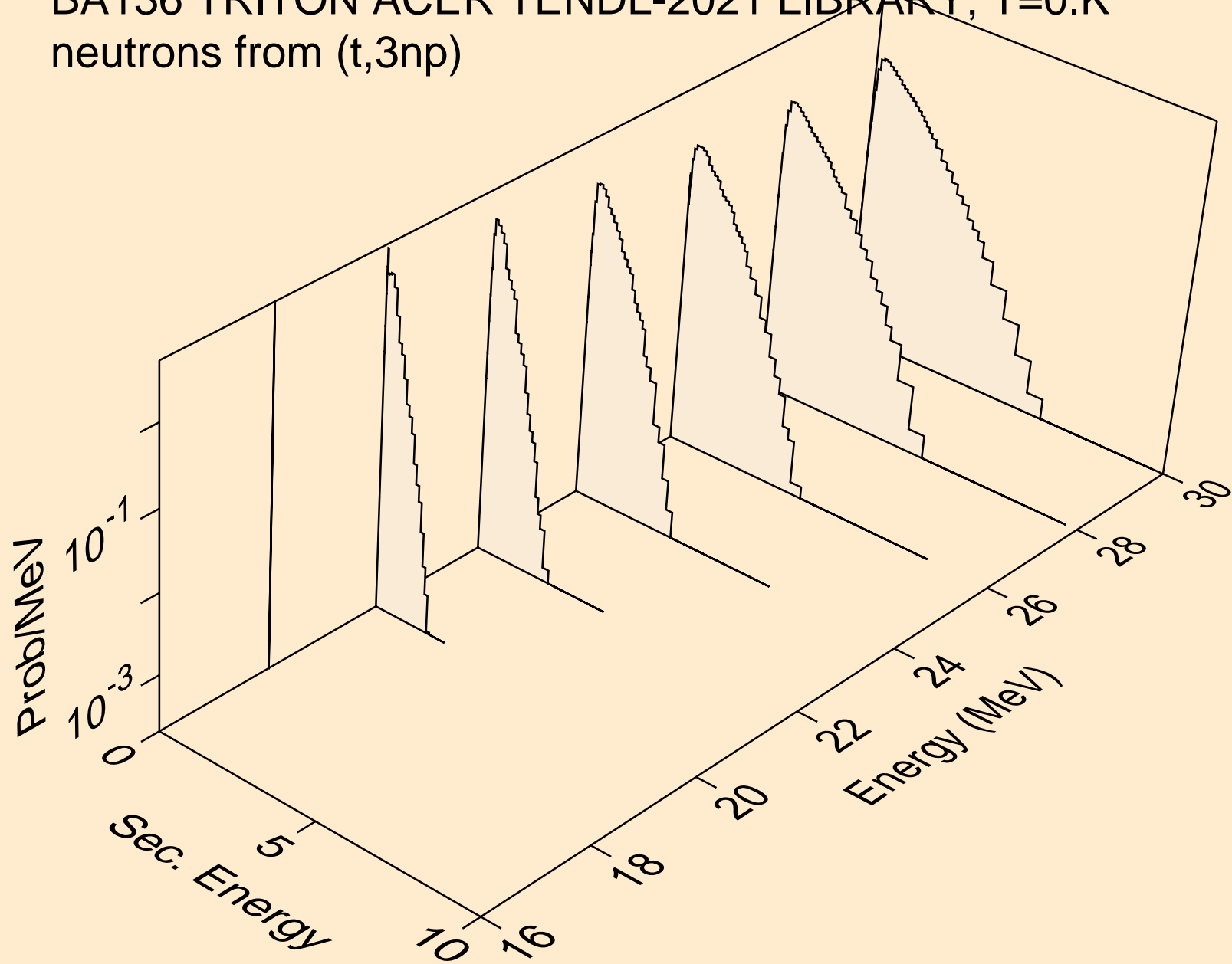

BA136 TRITON ACER TENDL-2021 LIBRARY; T=0.K
neutrons from (t,2np)

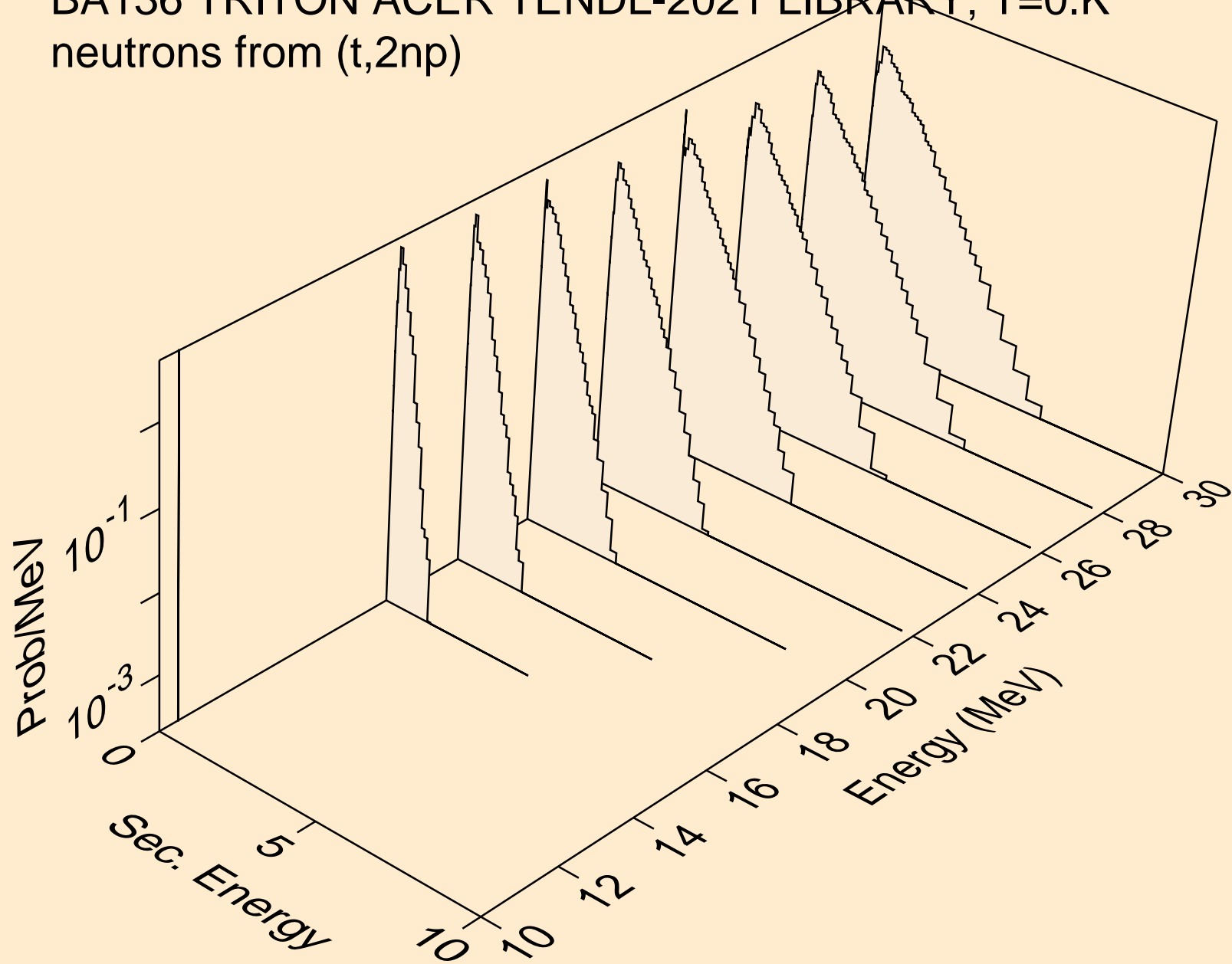

BA136 TRITON ACER TENDL-2021 LIBRARY; T=0.K
neutrons from (t,npa)

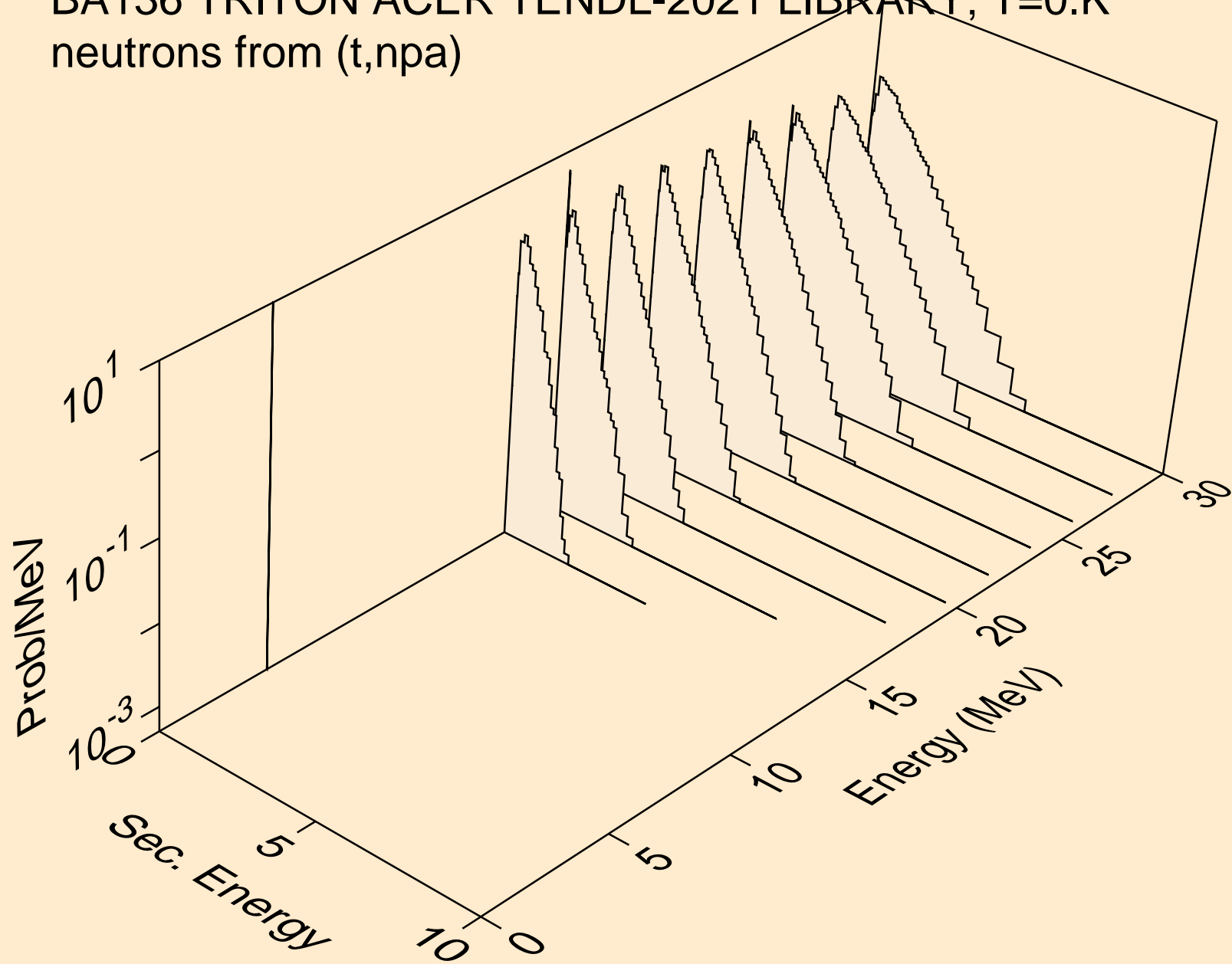

BA136 TRITON ACER TENDL-2021 LIBRARY; T=0.K
protons from (t,x)

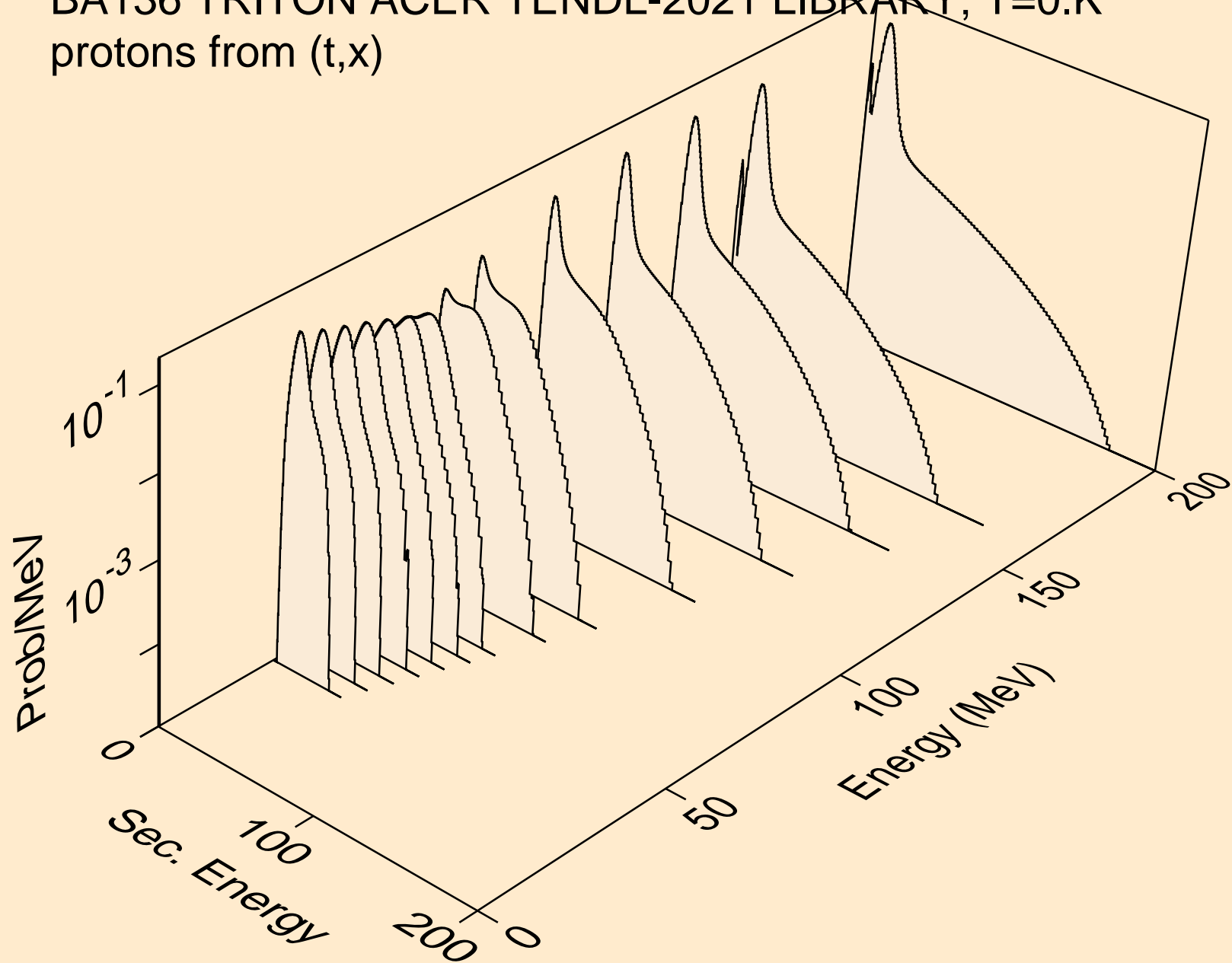

BA136 TRITON ACER TENDL-2021 LIBRARY; T=0.K
protons from (t,n*)p

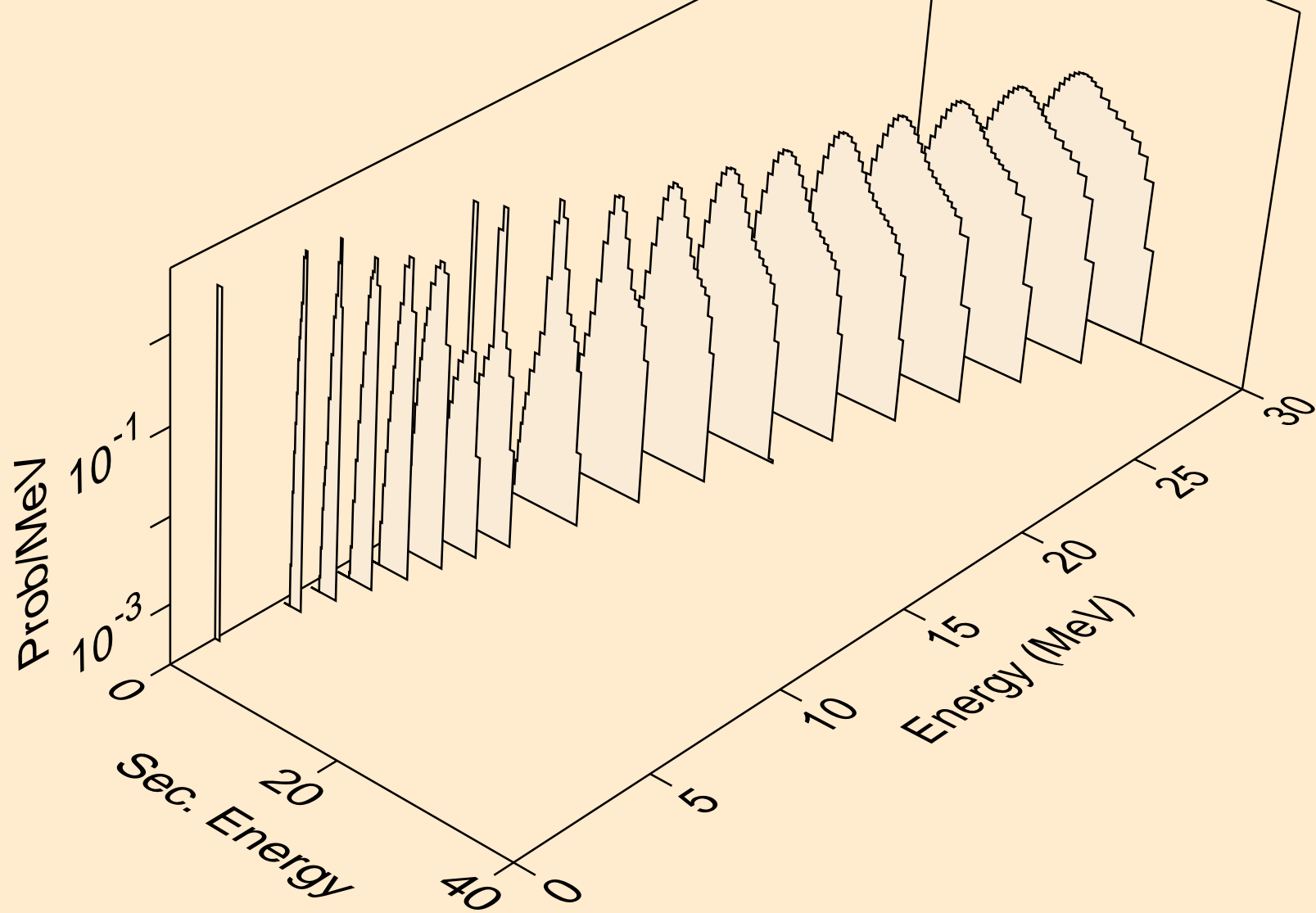

BA136 TRITON ACER TENDL-2021 LIBRARY; T=0.K
protons from (t,2np)

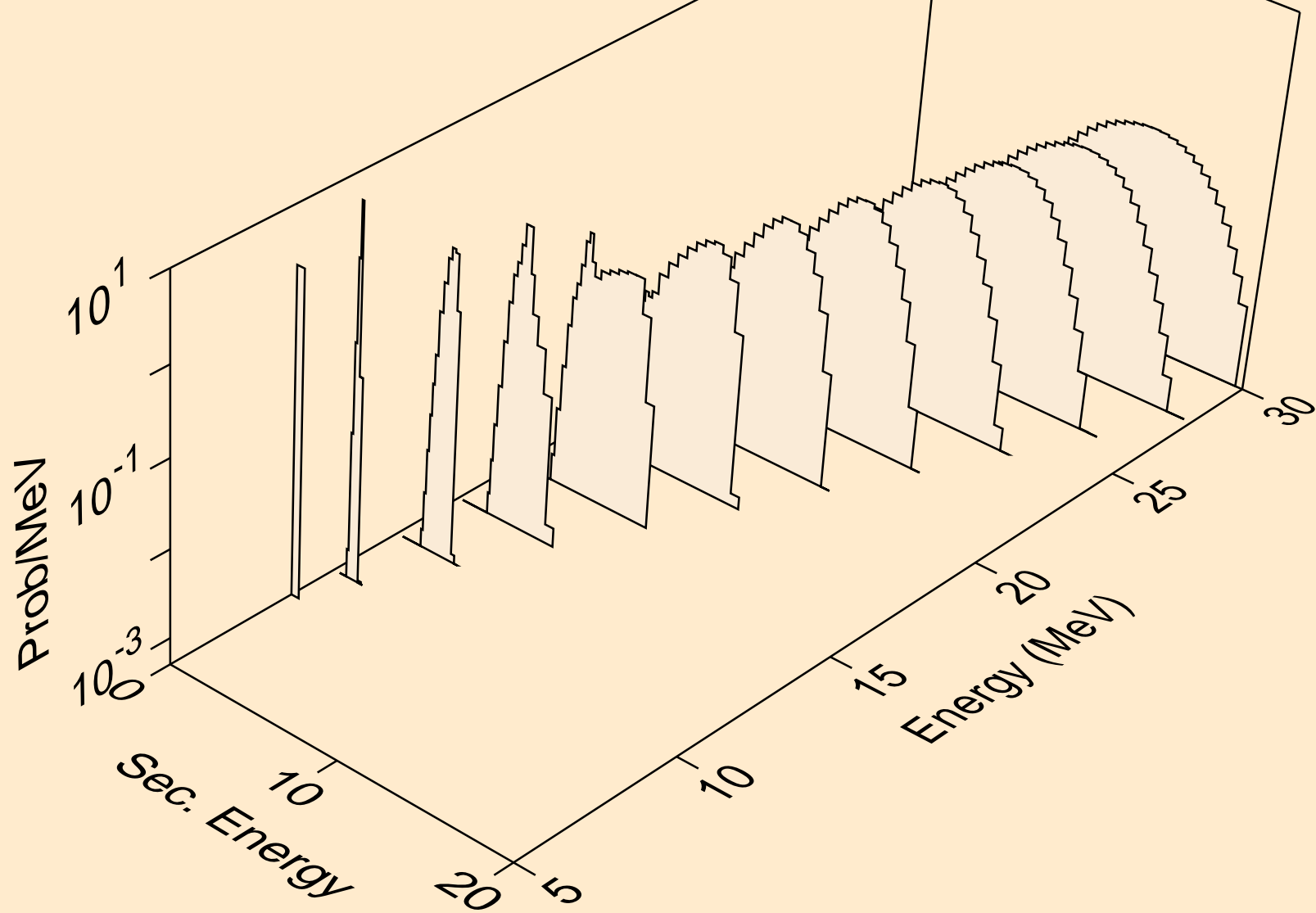

BA136 TRITON ACER TENDL-2021 LIBRARY; T=0.K
protons from (t,3np)

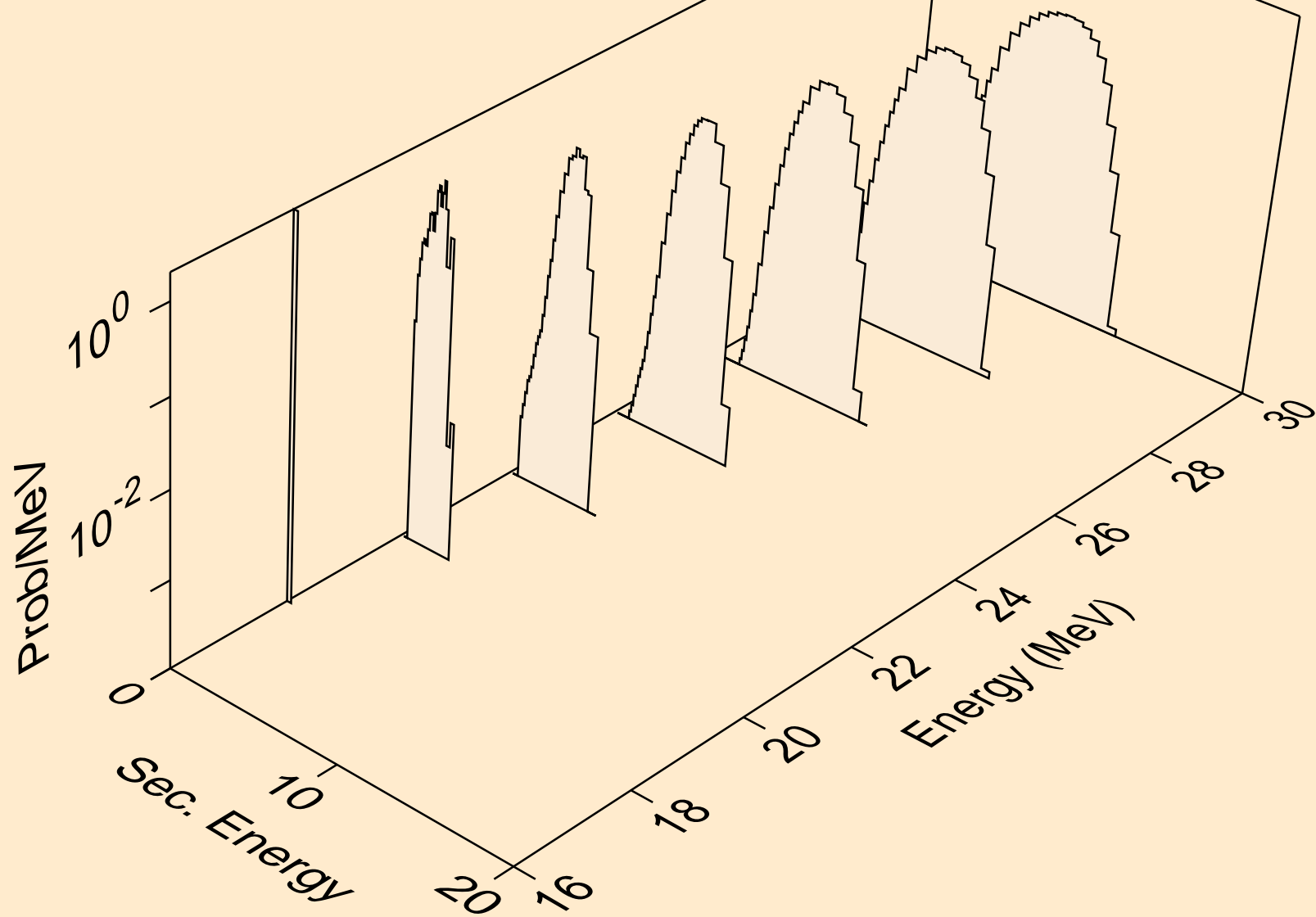

BA136 TRITON ACER TENDL-2021 LIBRARY; T=0.K
protons from (t,2np)

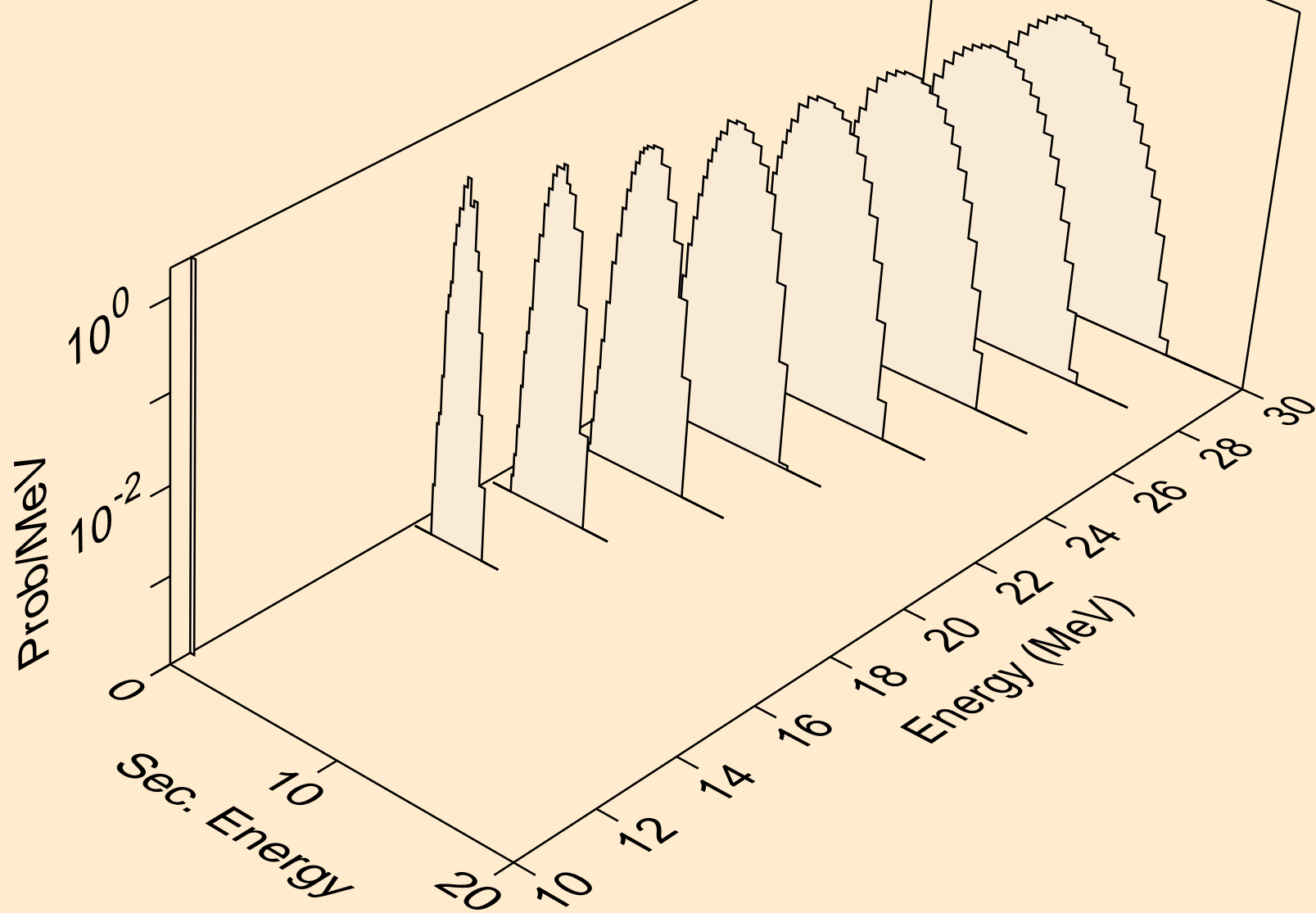

BA136 TRITON ACER TENDL-2021 LIBRARY; T=0.K
protons from (t,npa)

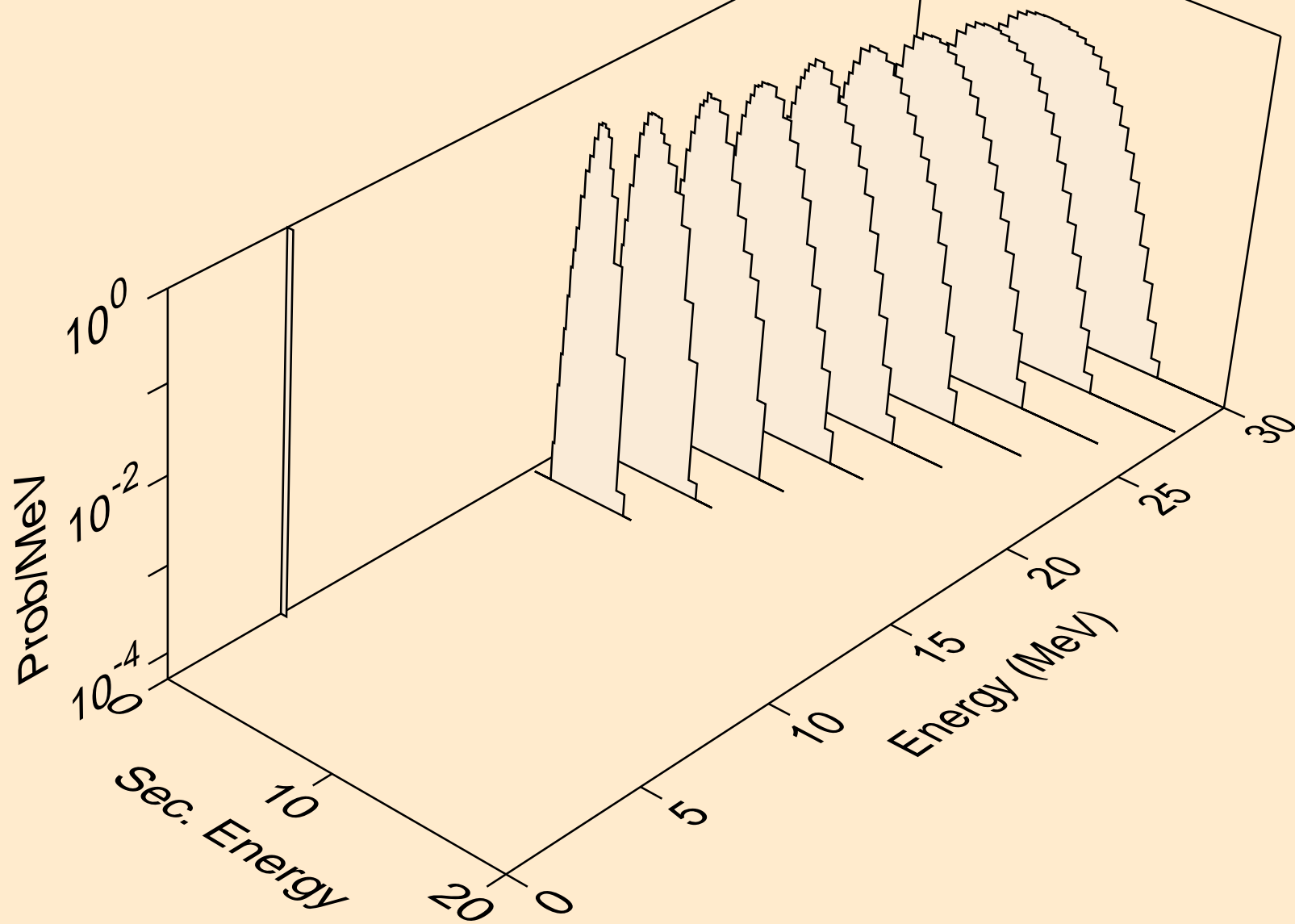

BA136 TRITON ACER TENDL-2021 LIBRARY; T=0.K
protons from (t,p)

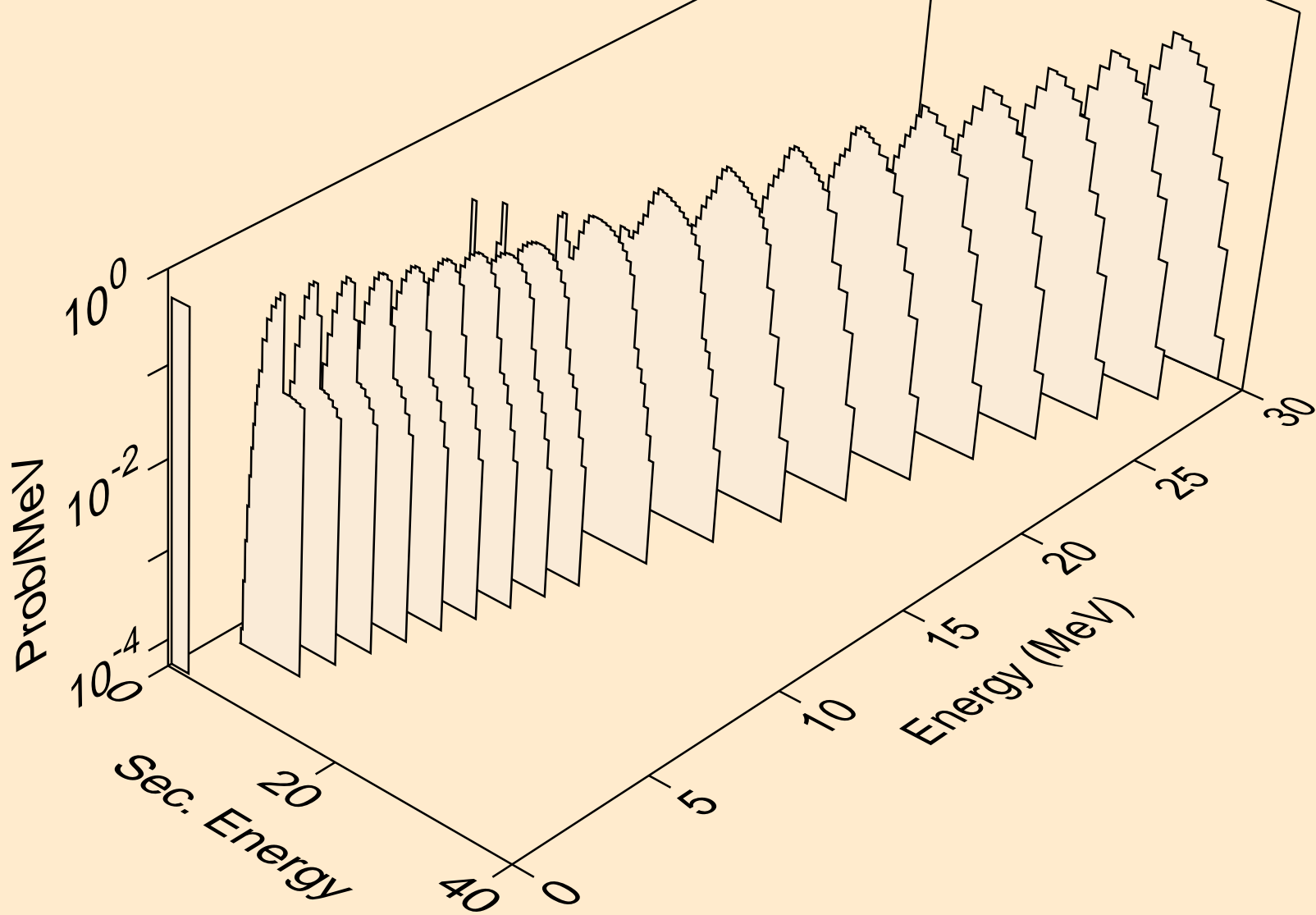

BA136 TRITON ACER TENDL-2021 LIBRARY; T=0.K
protons from (t,2p)

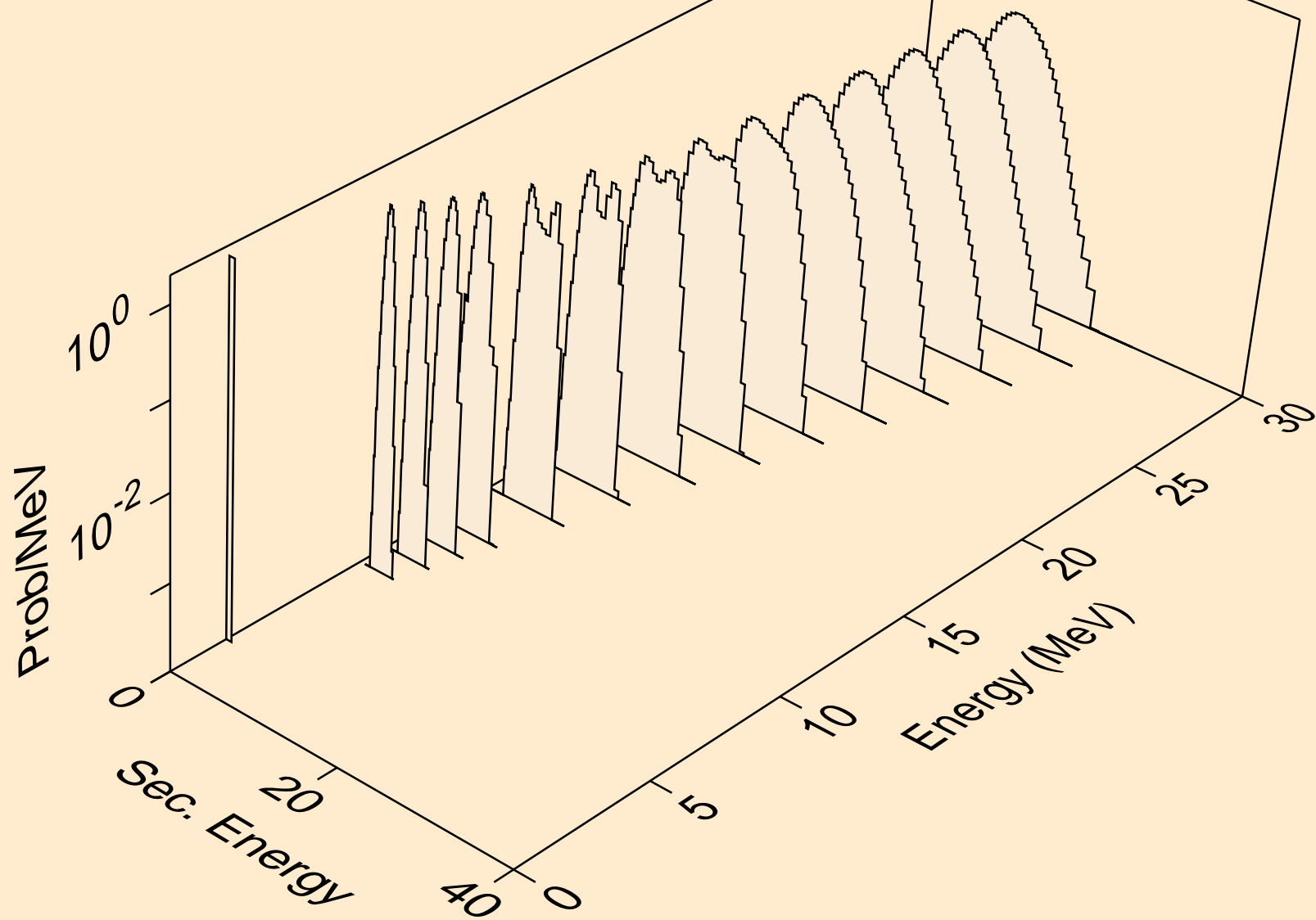

BA136 TRITON ACER TENDL-2021 LIBRARY; T=0.K
protons from (t,pa)

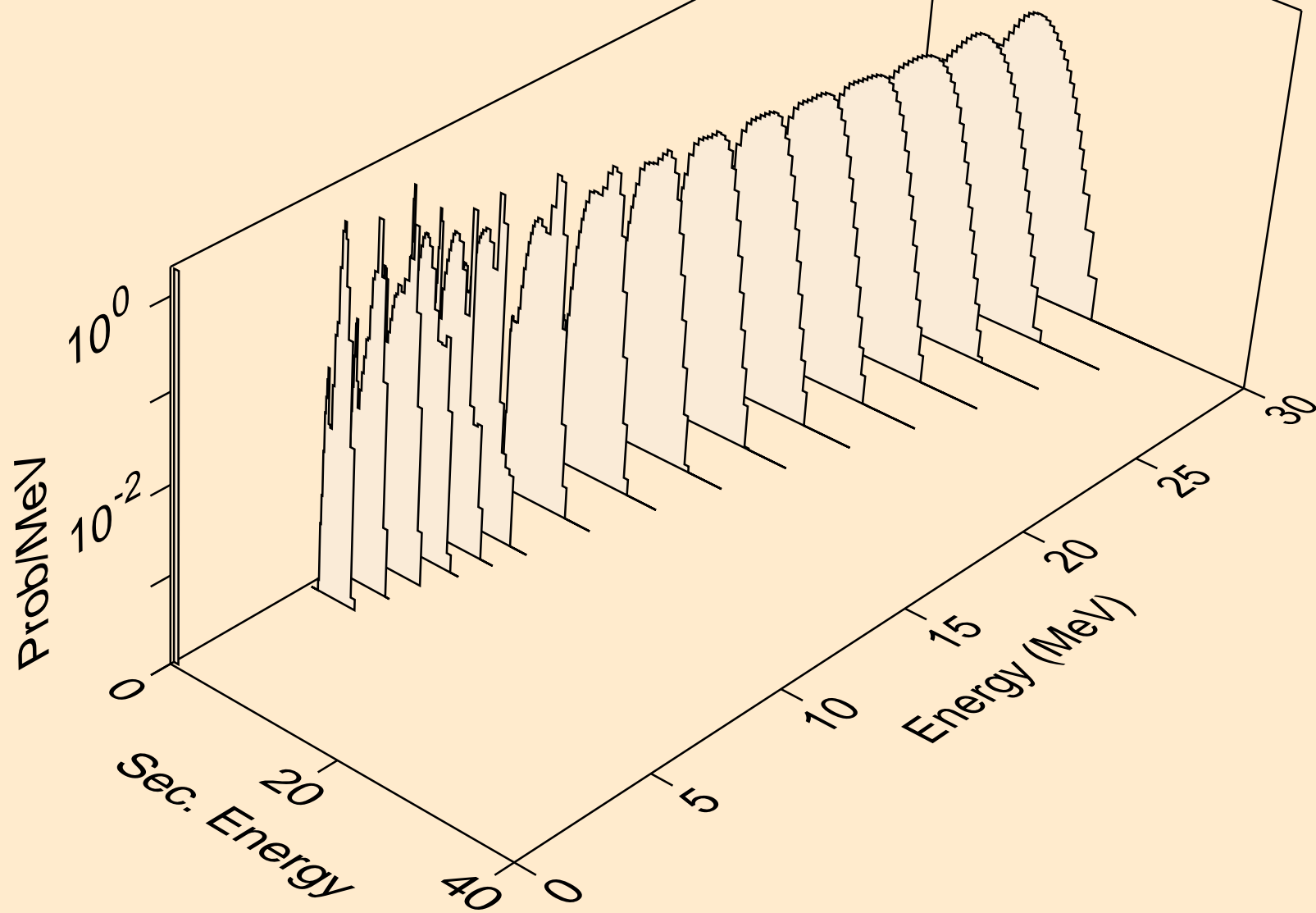

BA136 TRITON ACER TENDL-2021 LIBRARY; T=0.K
protons from (t,pd)

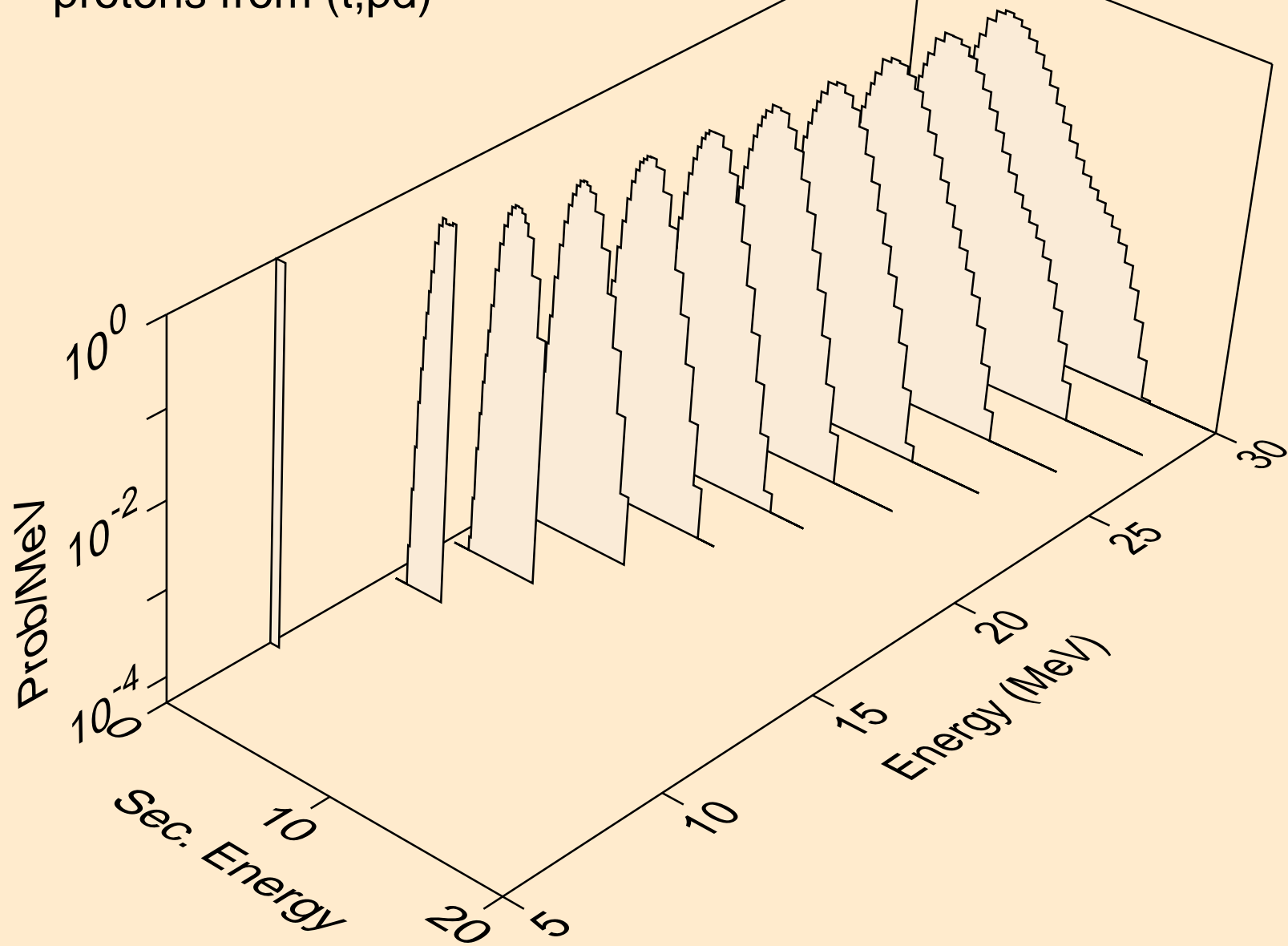

BA136 TRITON ACER TENDL-2021 LIBRARY; T=0.K
protons from (t,pt)

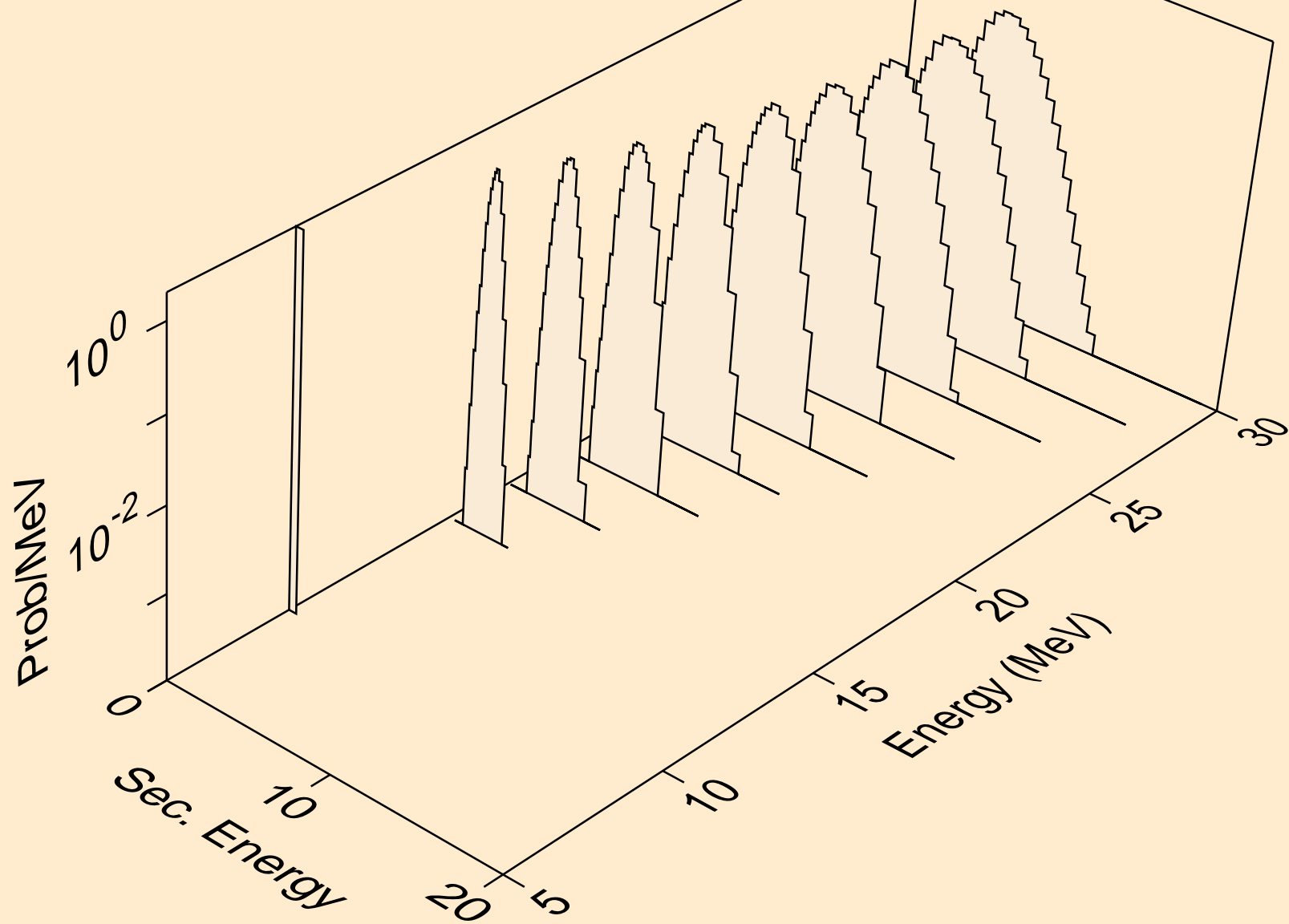

BA136 TRITON ACER TENDL-2021 LIBRARY; T=0.K
deuterons from (t,x)

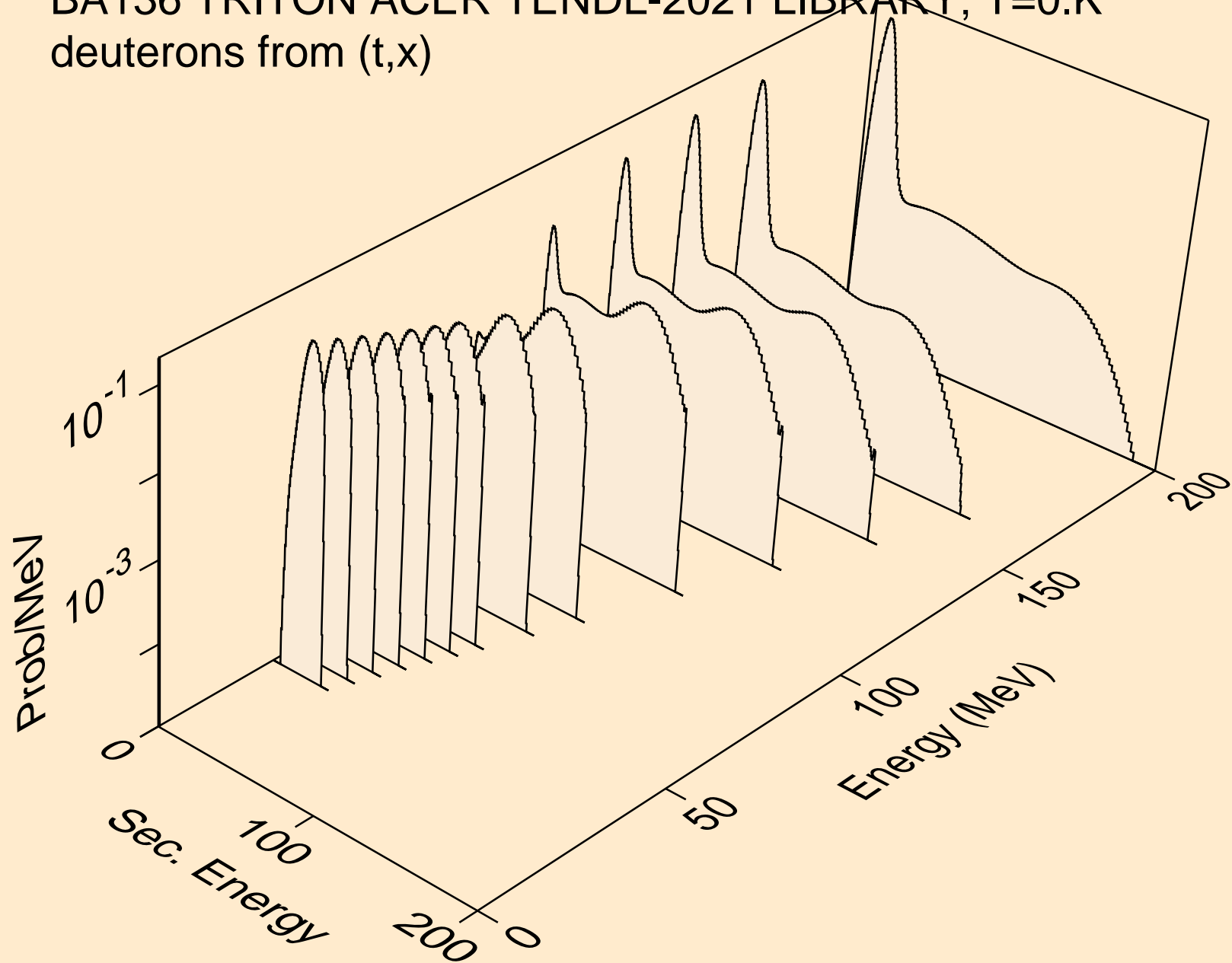

BA136 TRITON ACER TENDL-2021 LIBRARY; T=0.K
deuterons from (t,2nd)

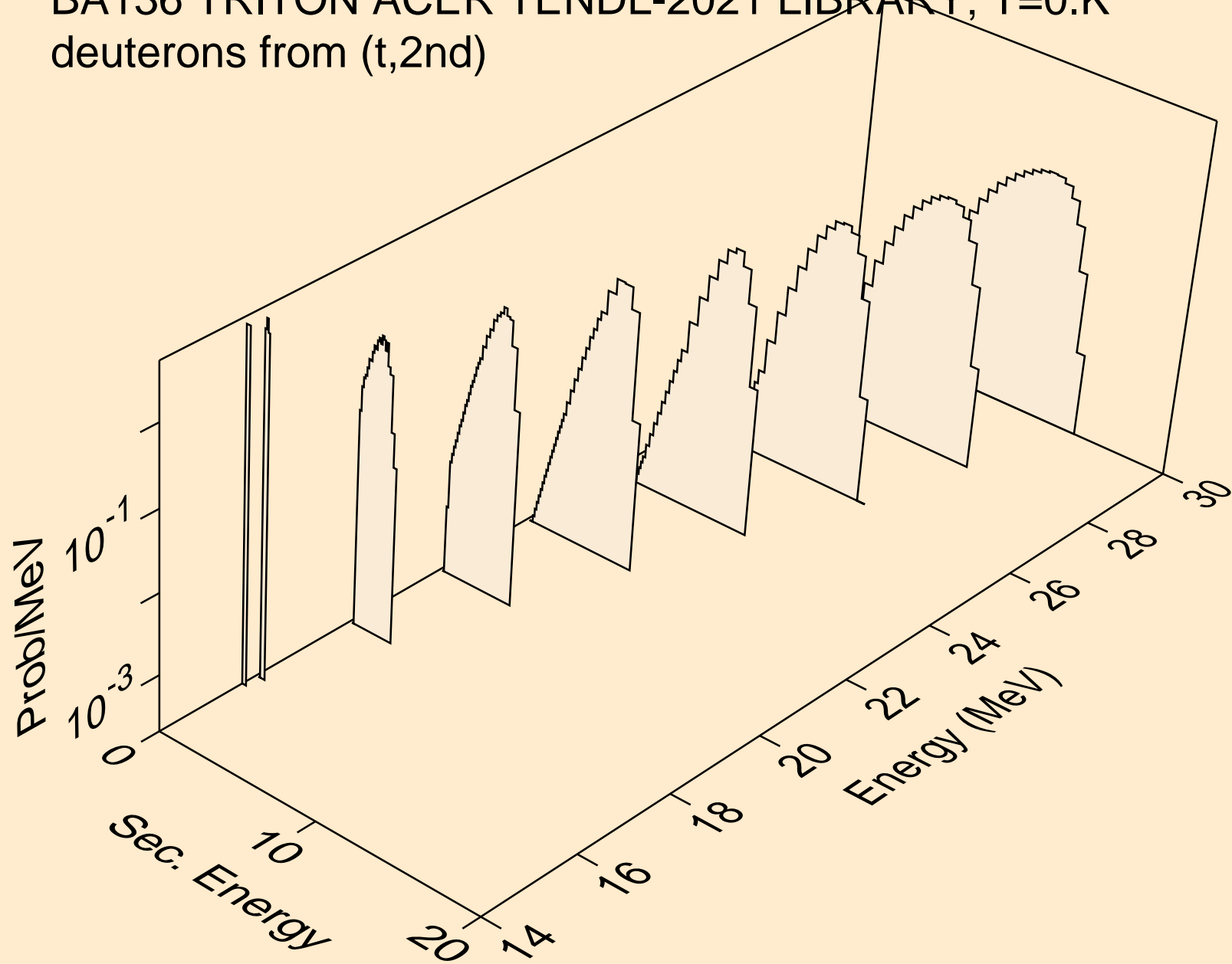

BA136 TRITON ACER TENDL-2021 LIBRARY; T=0.K
deuterons from (t,n*)d

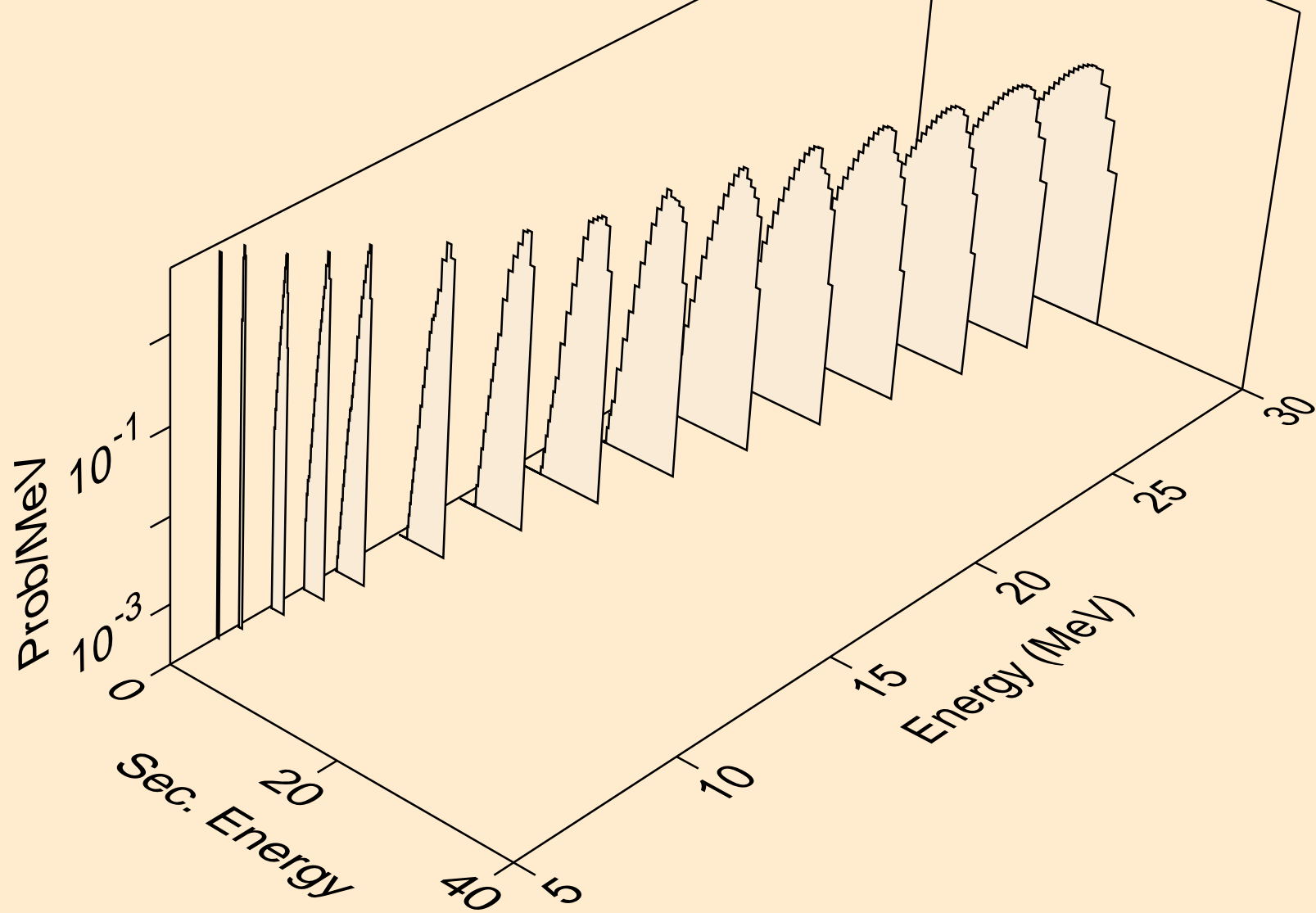

BA136 TRITON ACER TENDL-2021 LIBRARY; T=0.K
deuterons from (t,d)

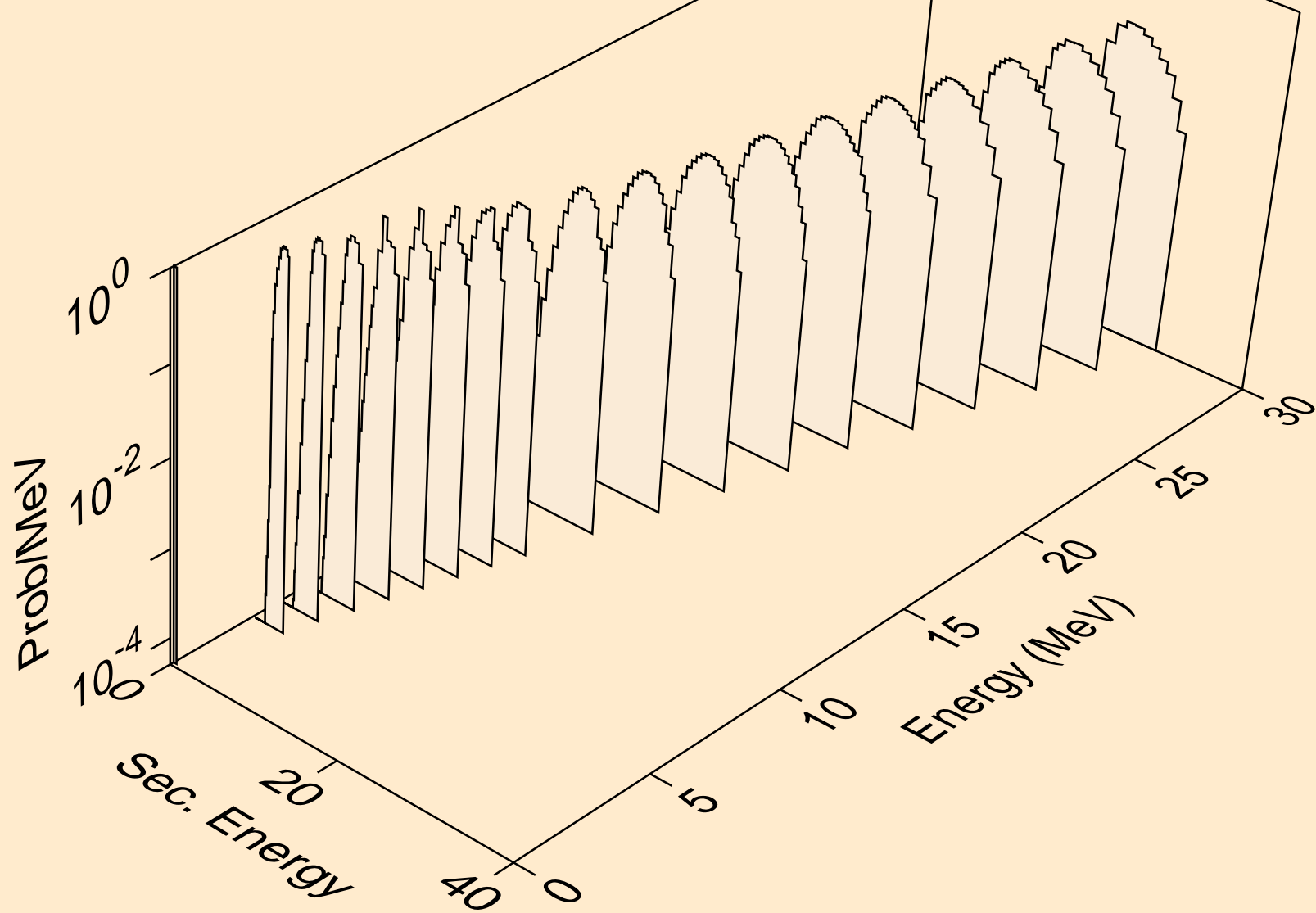

BA136 TRITON ACER TENDL-2021 LIBRARY; T=0.K
deuterons from (t,pd)

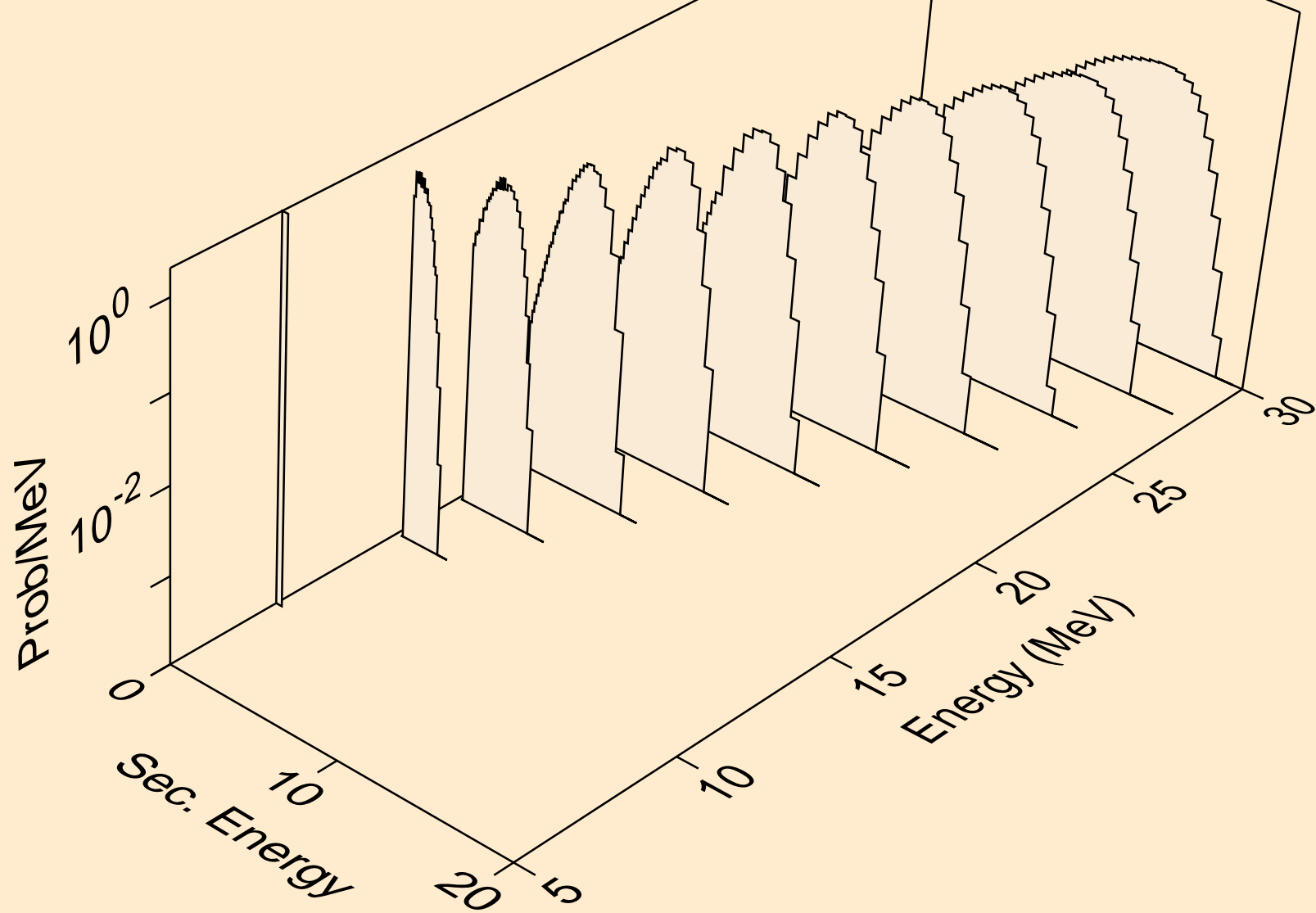

BA136 TRITON ACER TENDL-2021 LIBRARY; T=0.K
deuterons from (t,da)

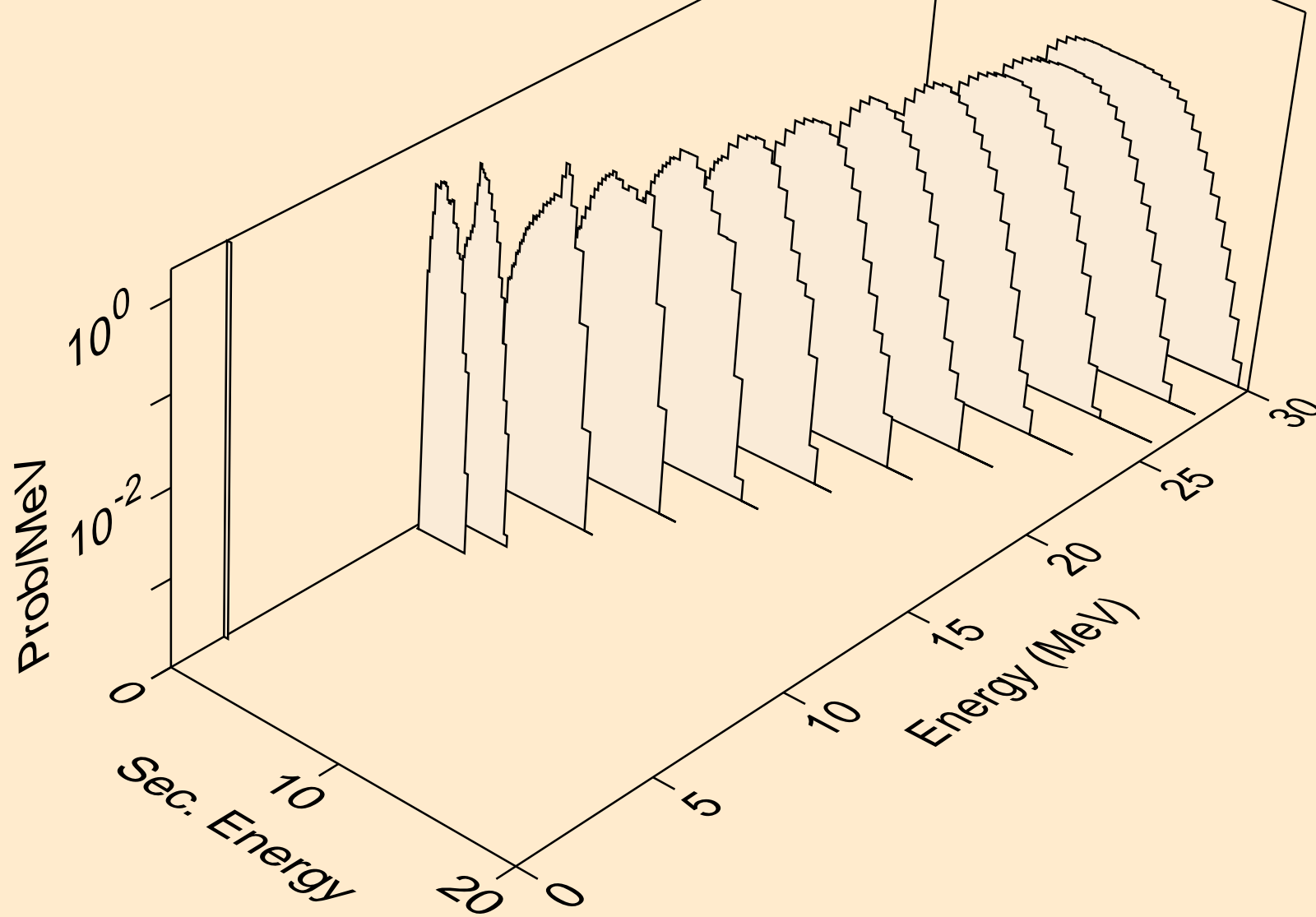

BA136 TRITON ACER TENDL-2021 LIBRARY; T=0.K
he3s from (t,x)

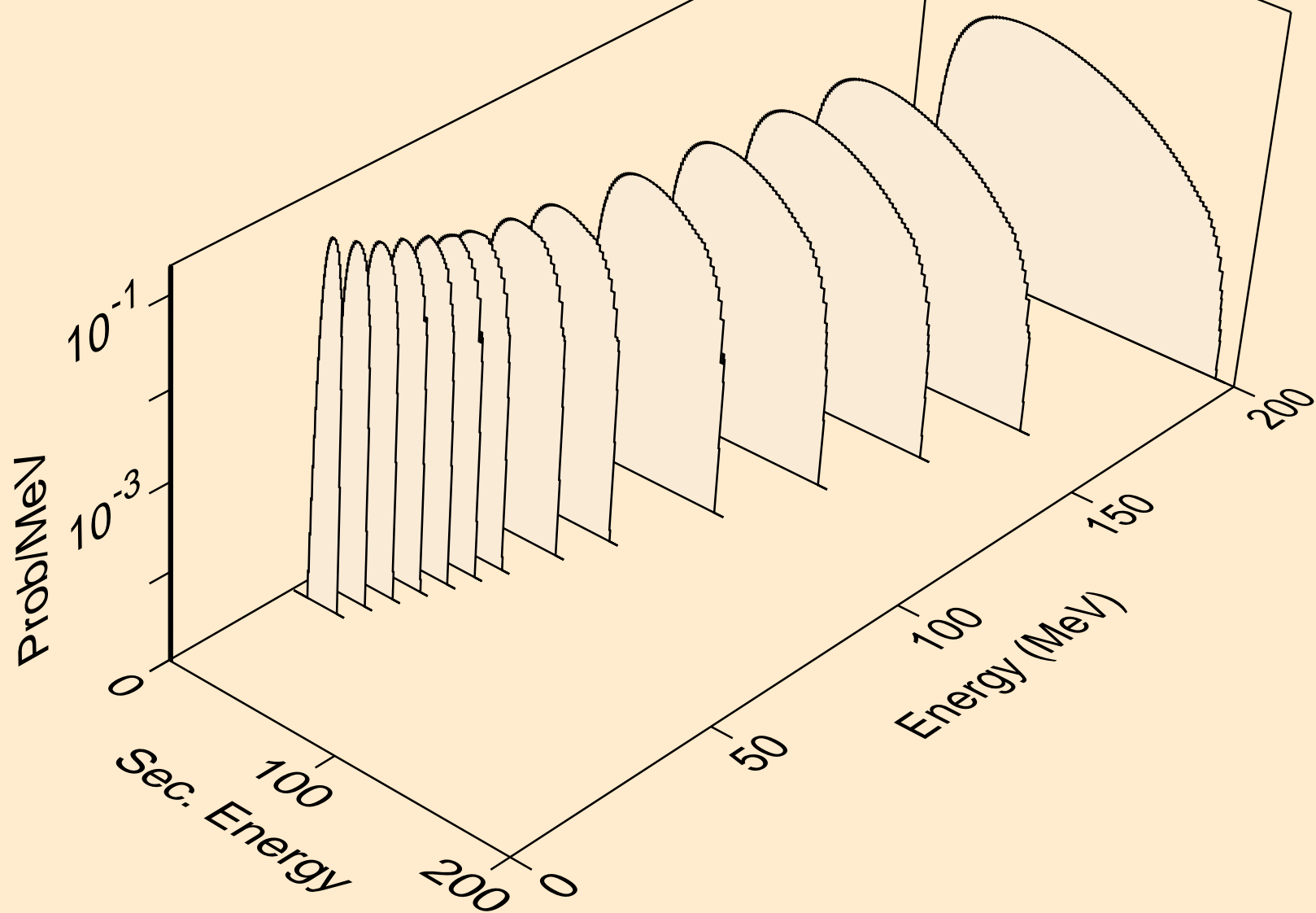

BA136 TRITON ACER TENDL-2021 LIBRARY; T=0.K
he3s from (t,n*)he3

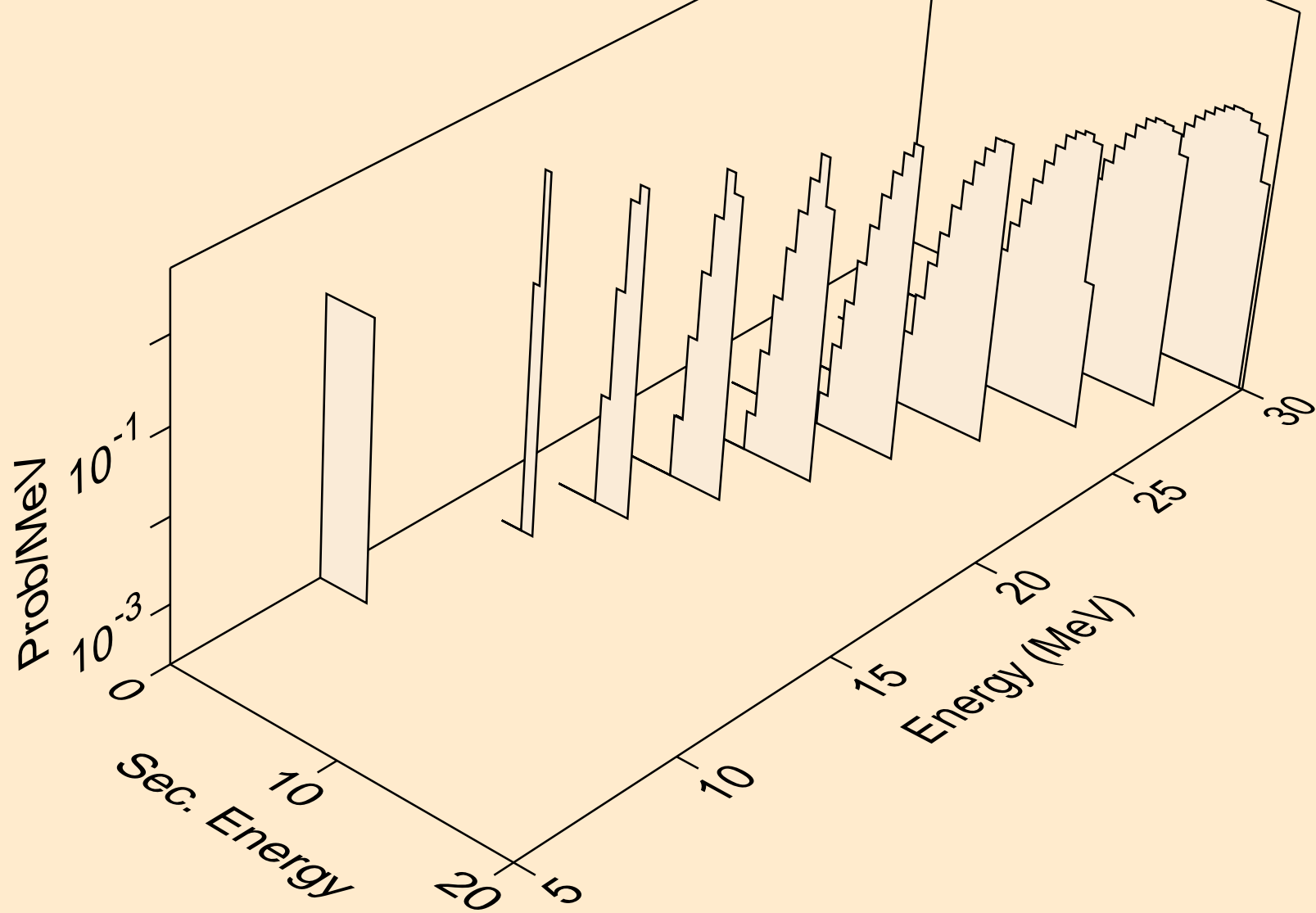

BA136 TRITON ACER TENDL-2021 LIBRARY; T=0.K
he3s from (t,he3)

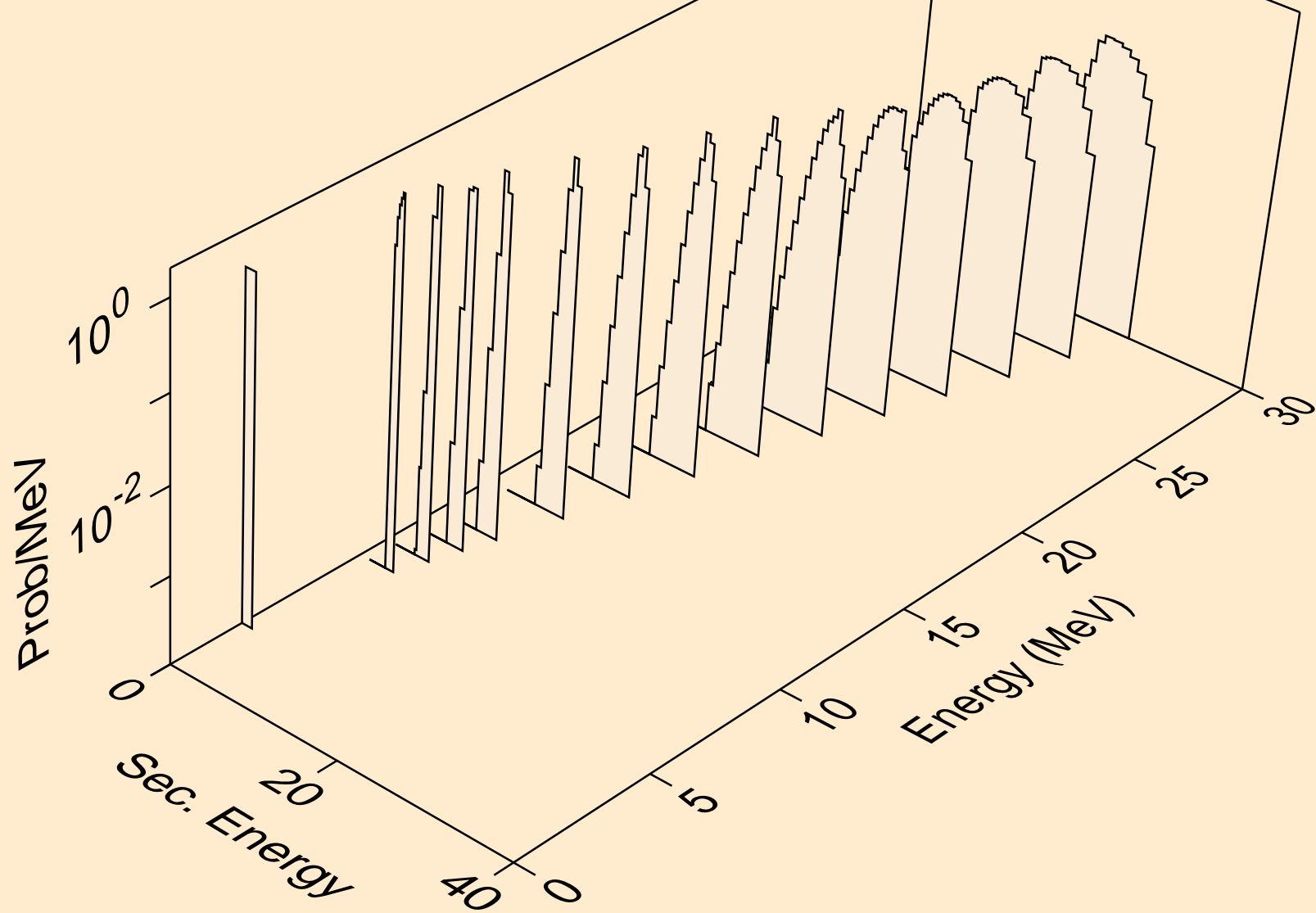

BA136 TRITON ACER TENDL-2021 LIBRARY; T=0.K
alphas from (t,x)

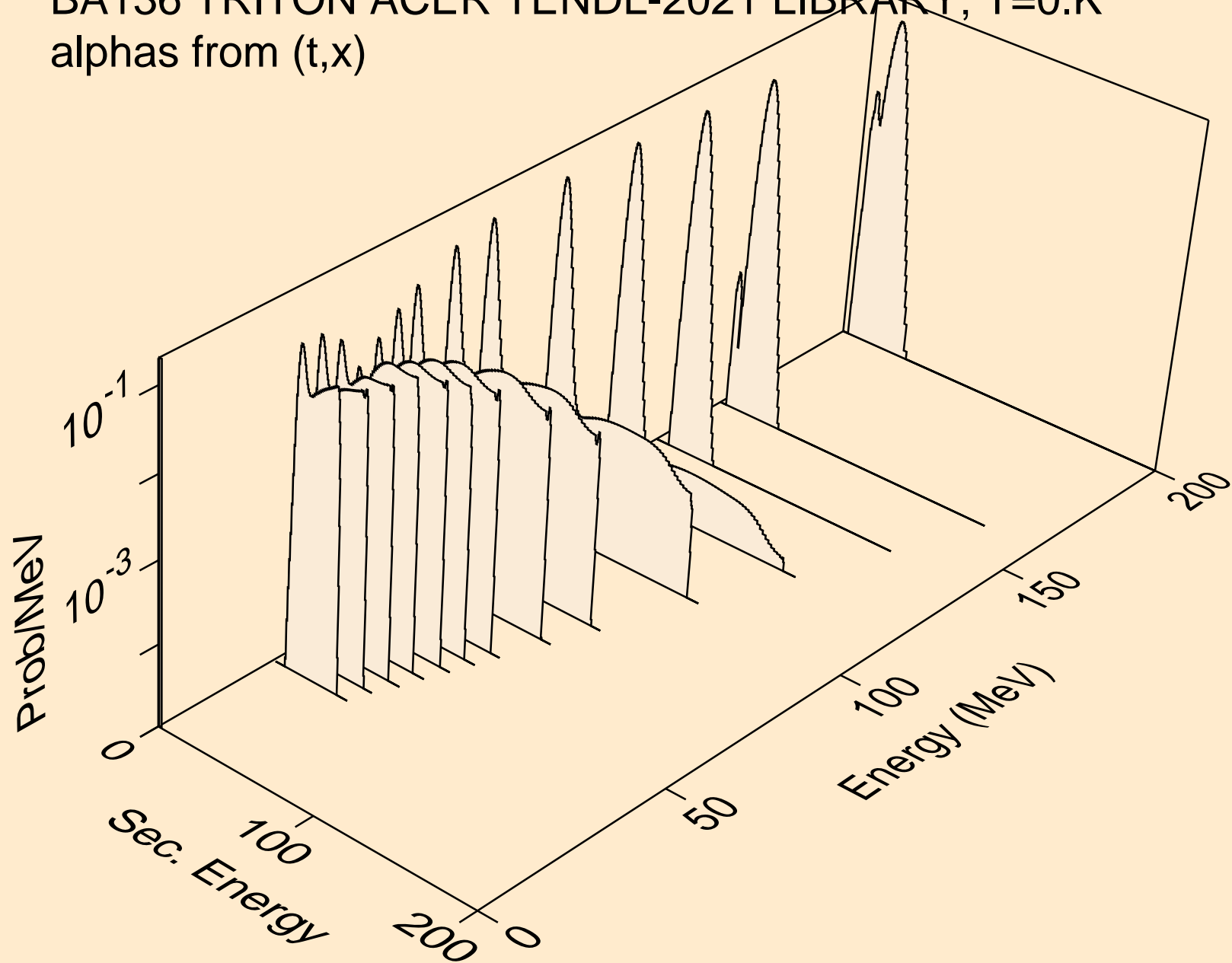

BA136 TRITON ACER TENDL-2021 LIBRARY; T=0.K
alphas from (t,n*)a

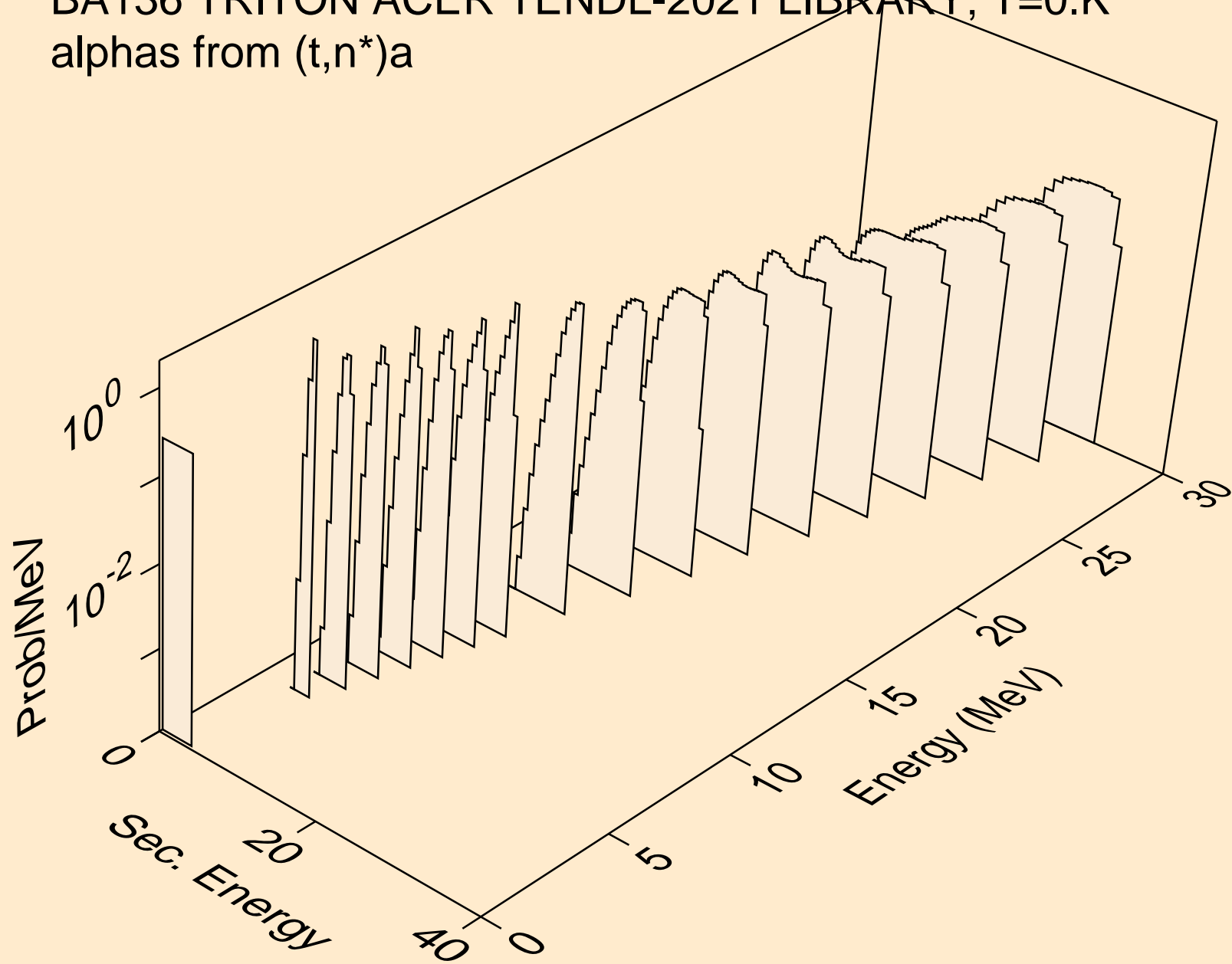

BA136 TRITON ACER TENDL-2021 LIBRARY; T=0.K
alphas from (t,2n)a

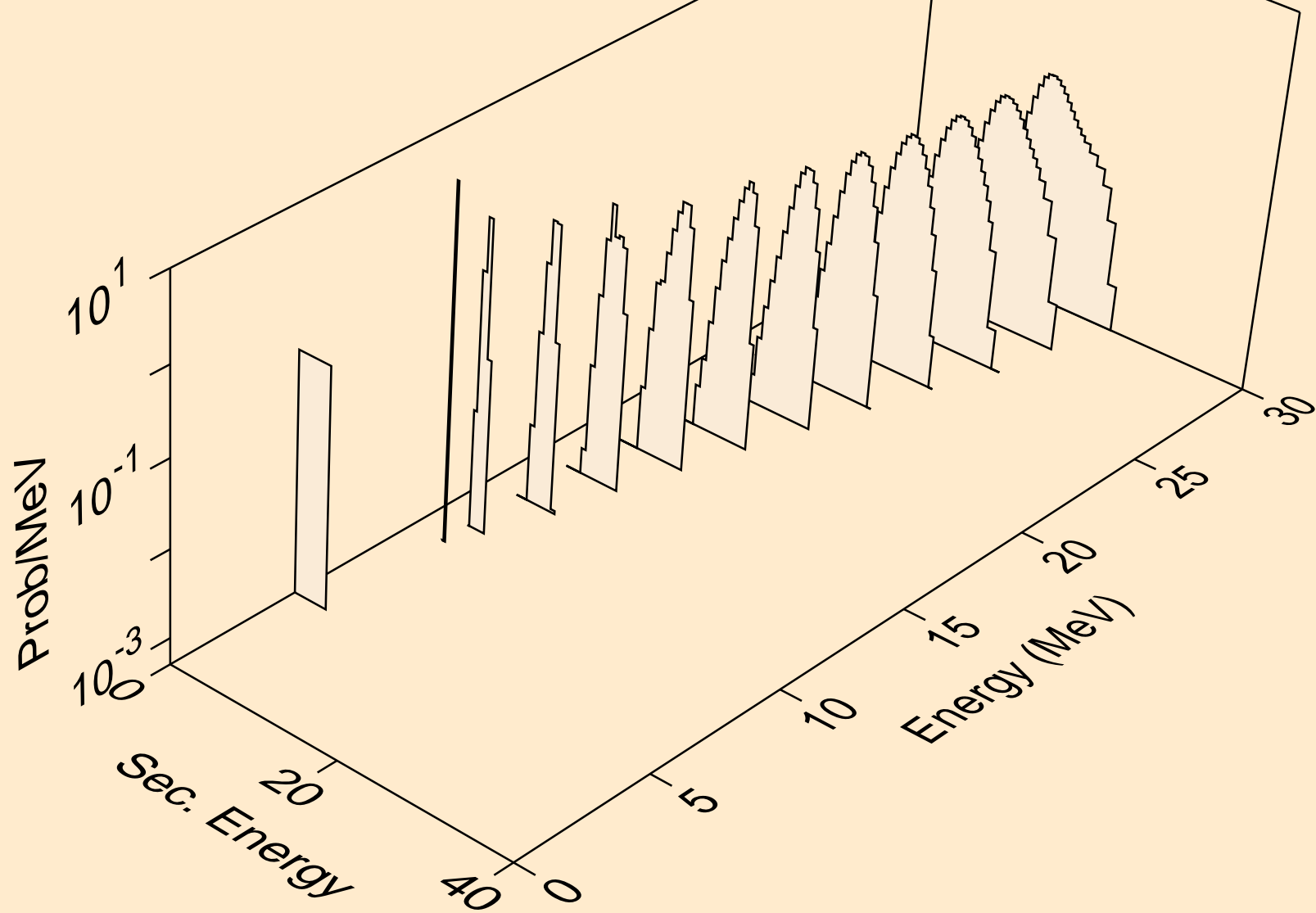

BA136 TRITON ACER TENDL-2021 LIBRARY; T=0.K
alphas from (t,3n)a

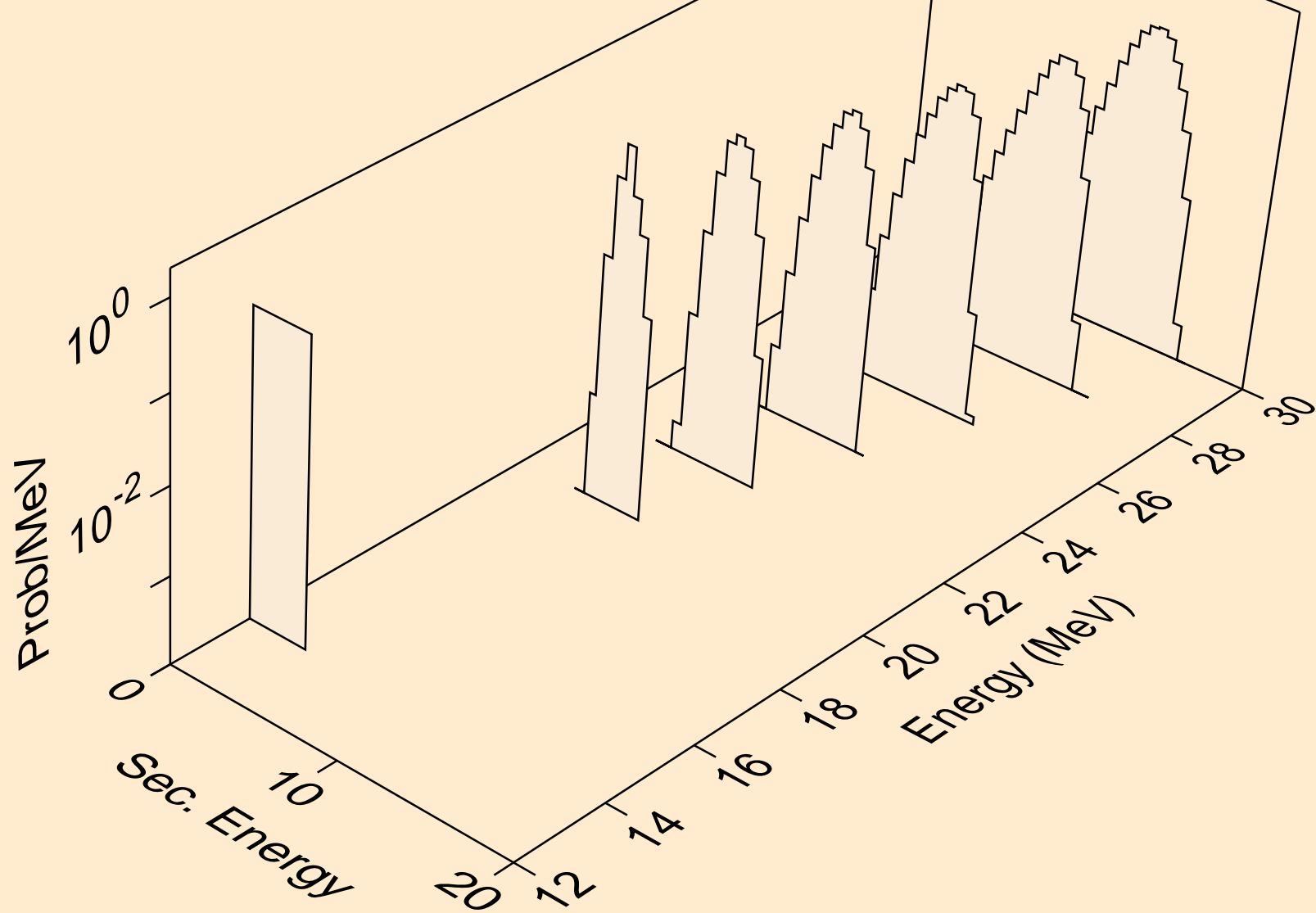

BA136 TRITON ACER TENDL-2021 LIBRARY; T=0.K
alphas from (t,n*)2a

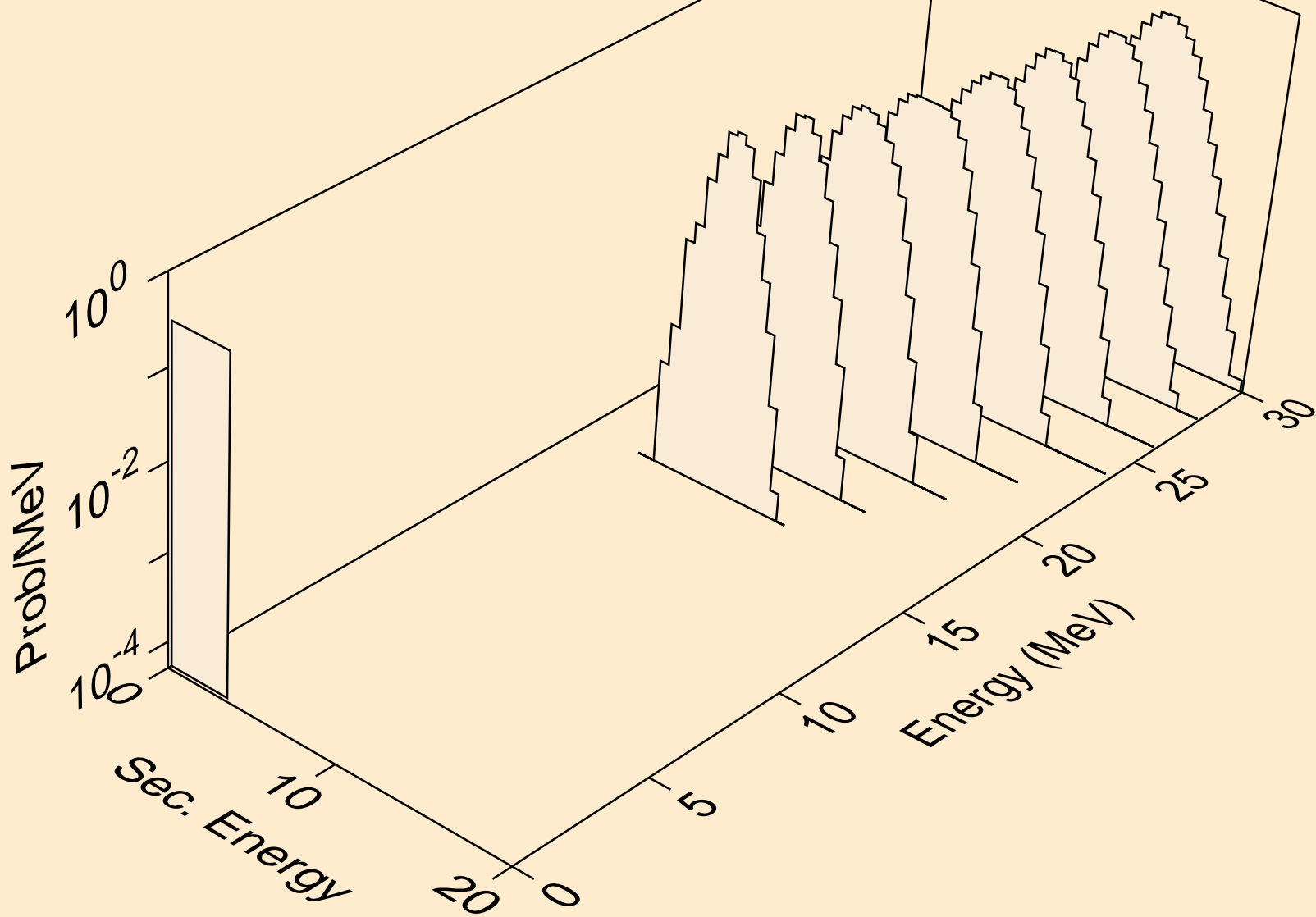

BA136 TRITON ACER TENDL-2021 LIBRARY; T=0.K
alphas from (t,npa)

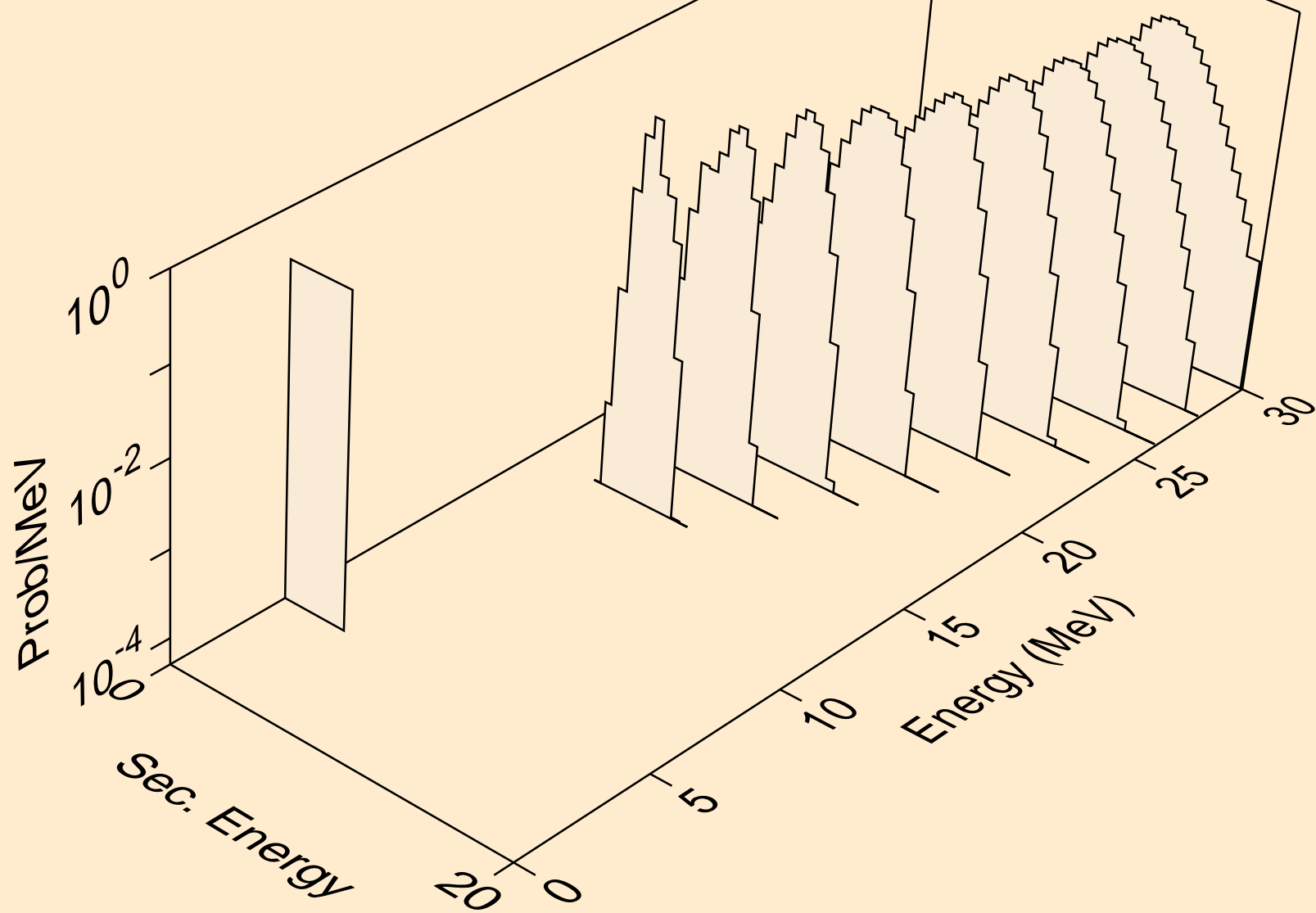

BA136 TRITON ACER TENDL-2021 LIBRARY; T=0.K
alphas from (t,a)

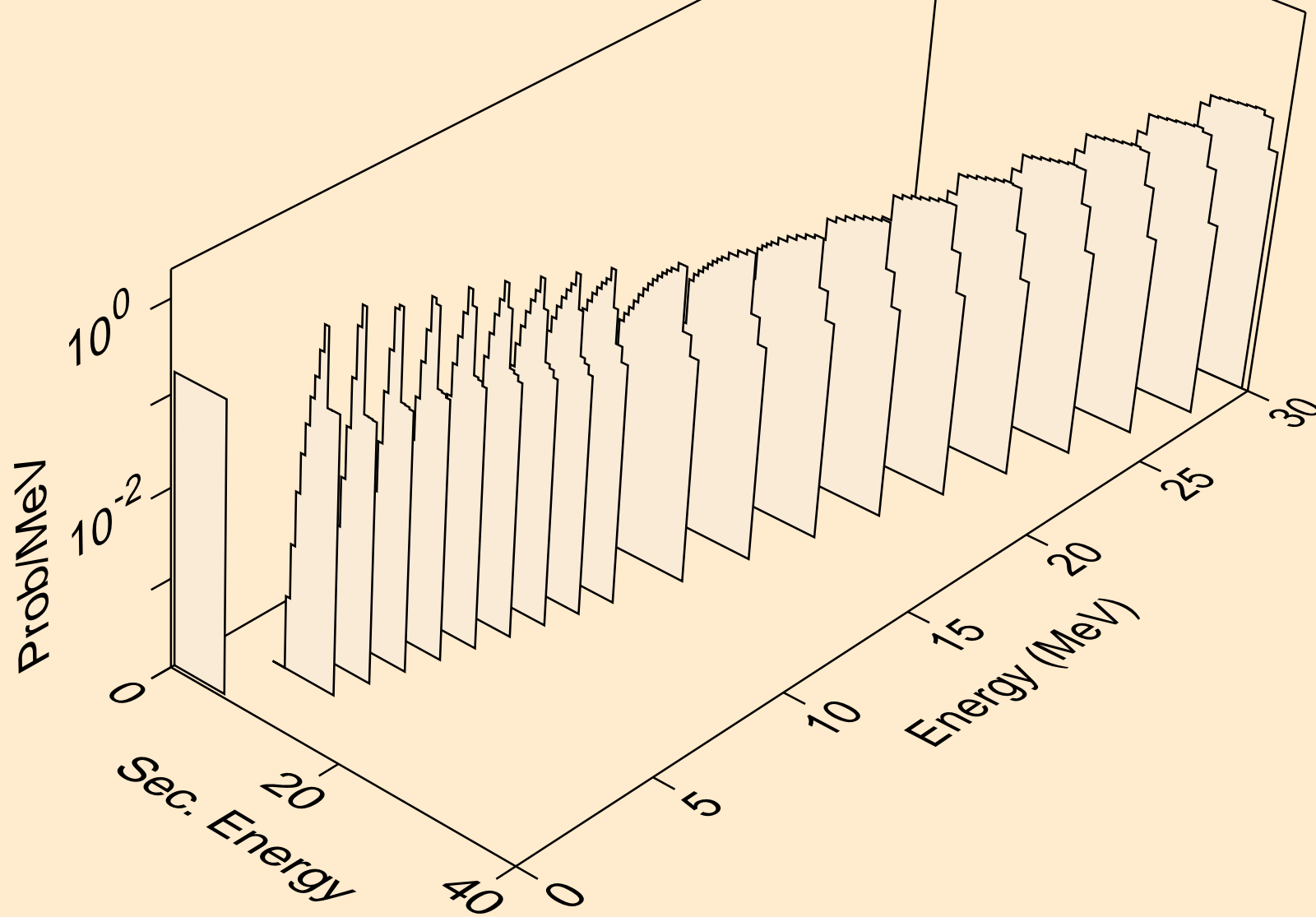

BA136 TRITON ACER TENDL-2021 LIBRARY; T=0.K
alphas from (t,2a)

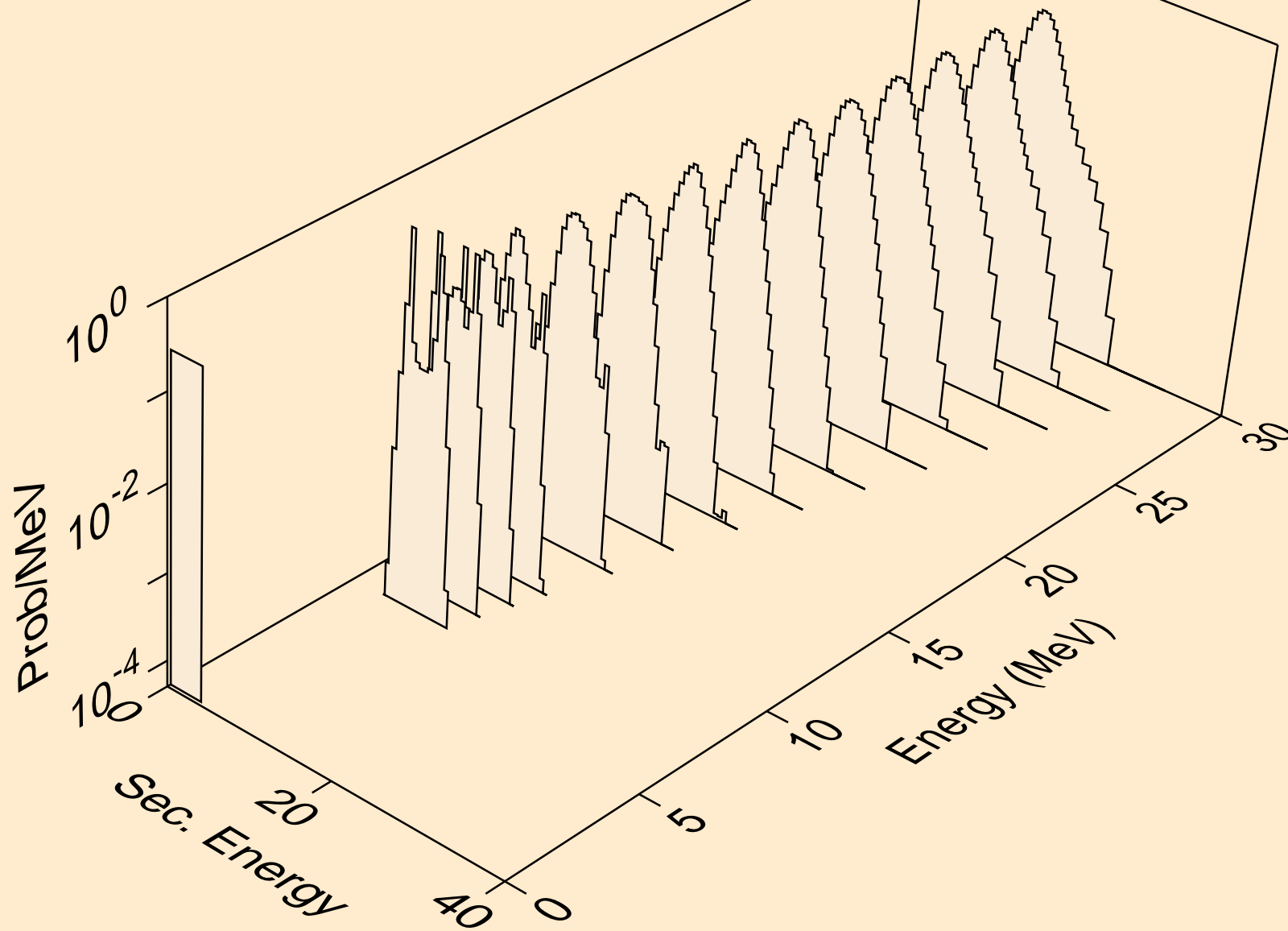

BA136 TRITON ACER TENDL-2021 LIBRARY; T=0.K
alphas from (t,pa)

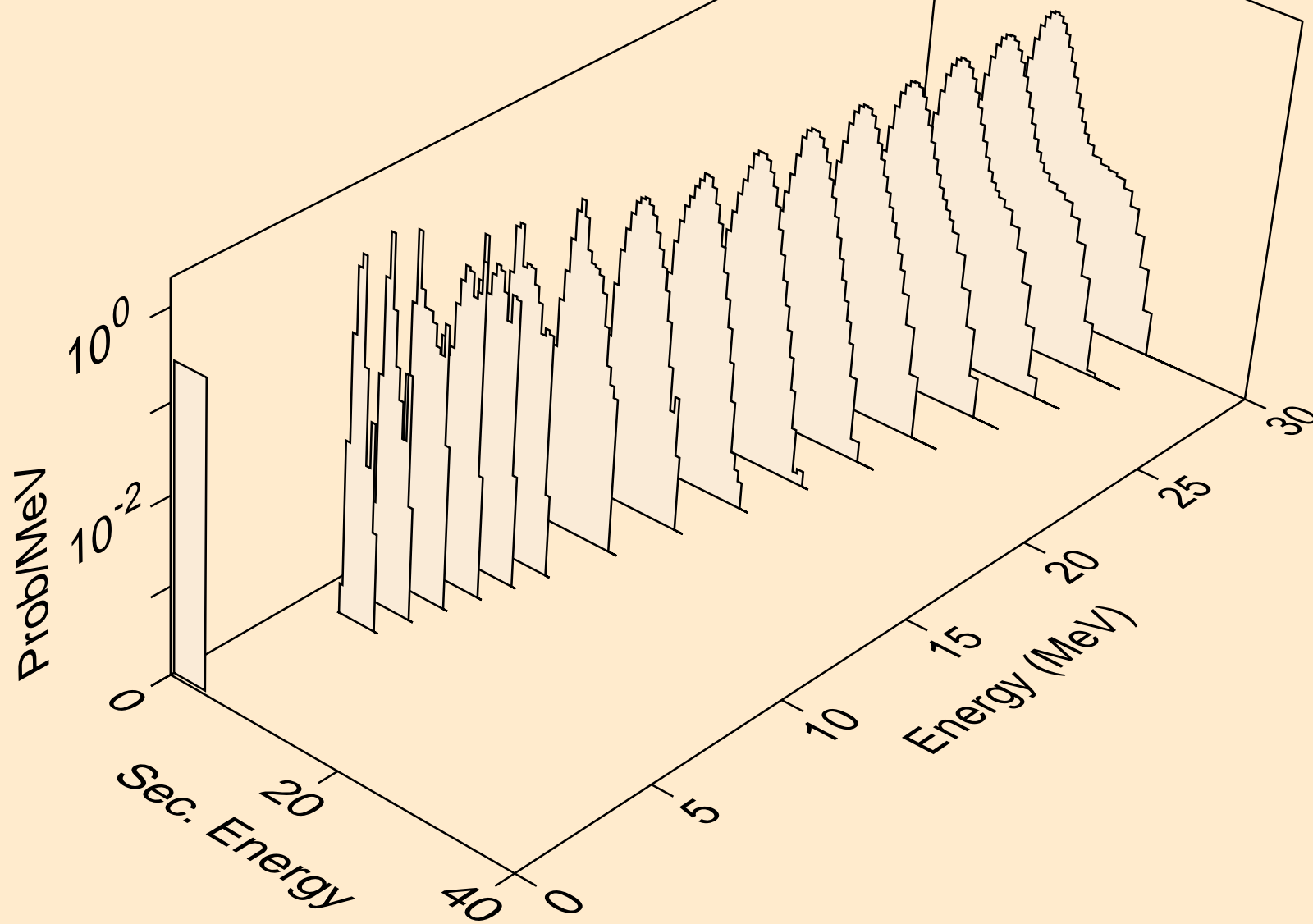

BA136 TRITON ACER TENDL-2021 LIBRARY; T=0.K
alphas from (t,da)

