

BI192 TRITON ACER TENDL-2021 LIBRARY; T=0.K  
Principal cross sections

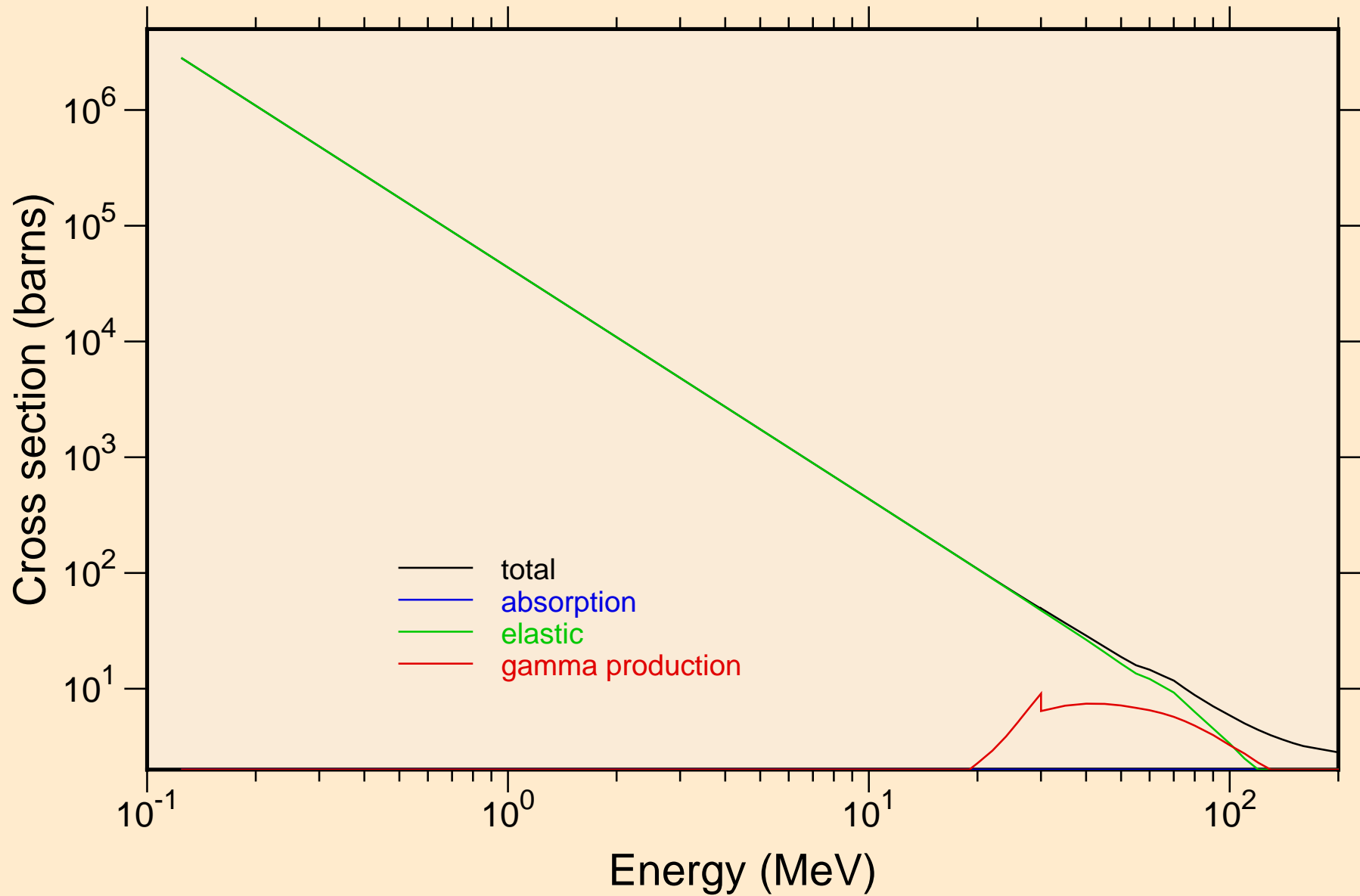

BI192 TRITON ACER TENDL-2021 LIBRARY; T=0.K

Heating

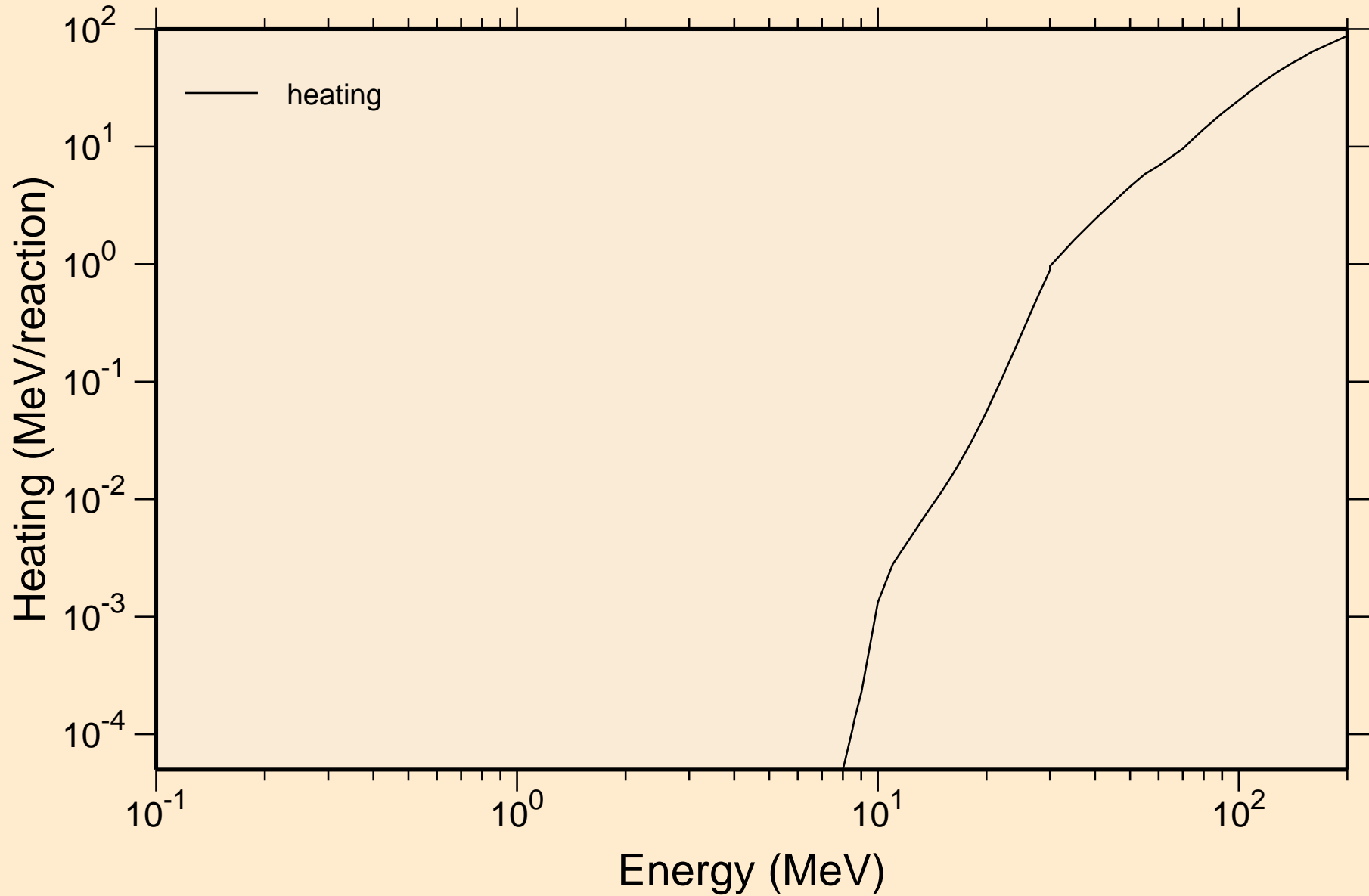

# BI192 TRITON ACER TENDL-2021 LIBRARY; T=0.K

## Principal cross sections

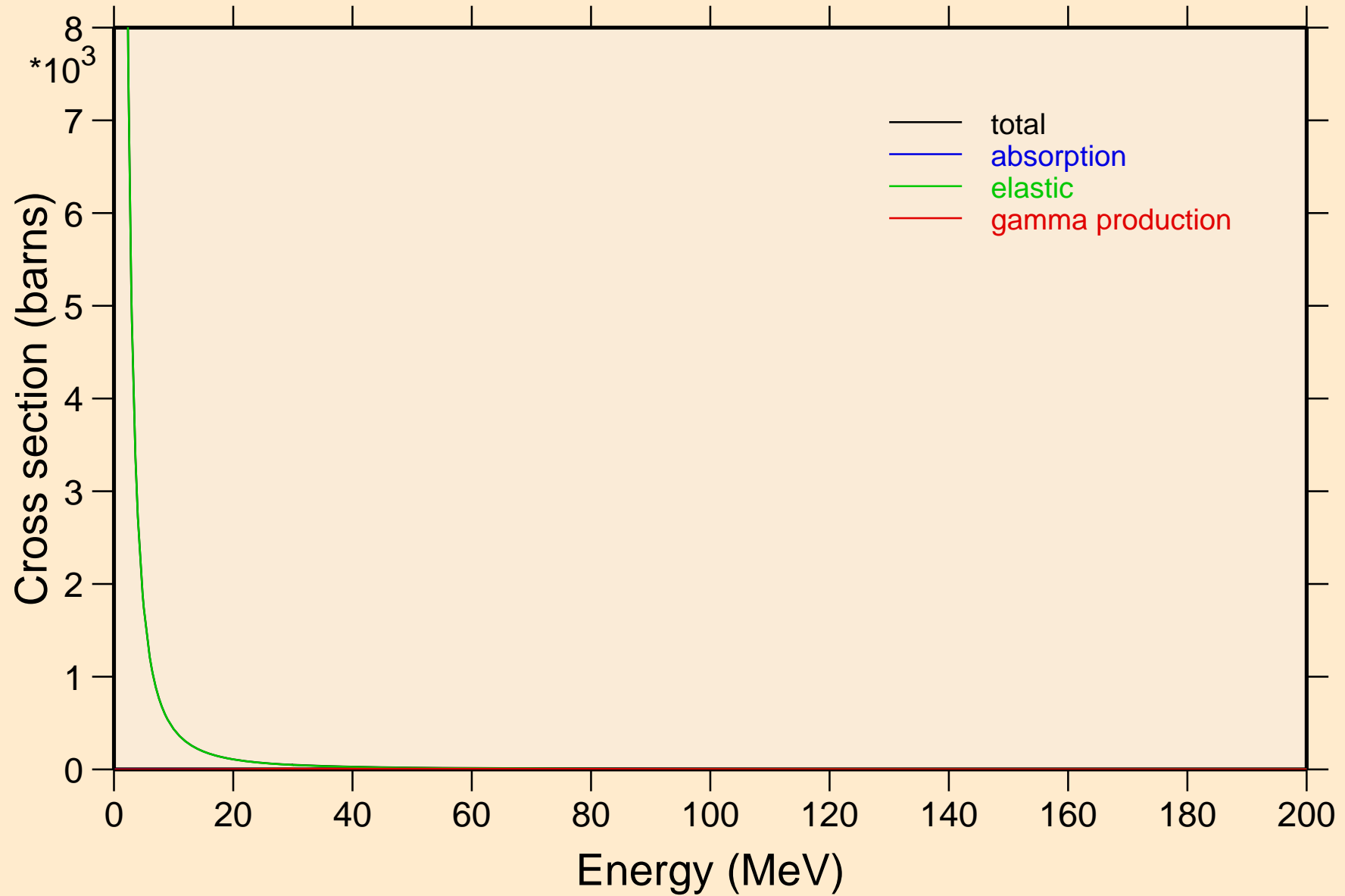

BI192 TRITON ACER TENDL-2021 LIBRARY; T=0.K

Heating

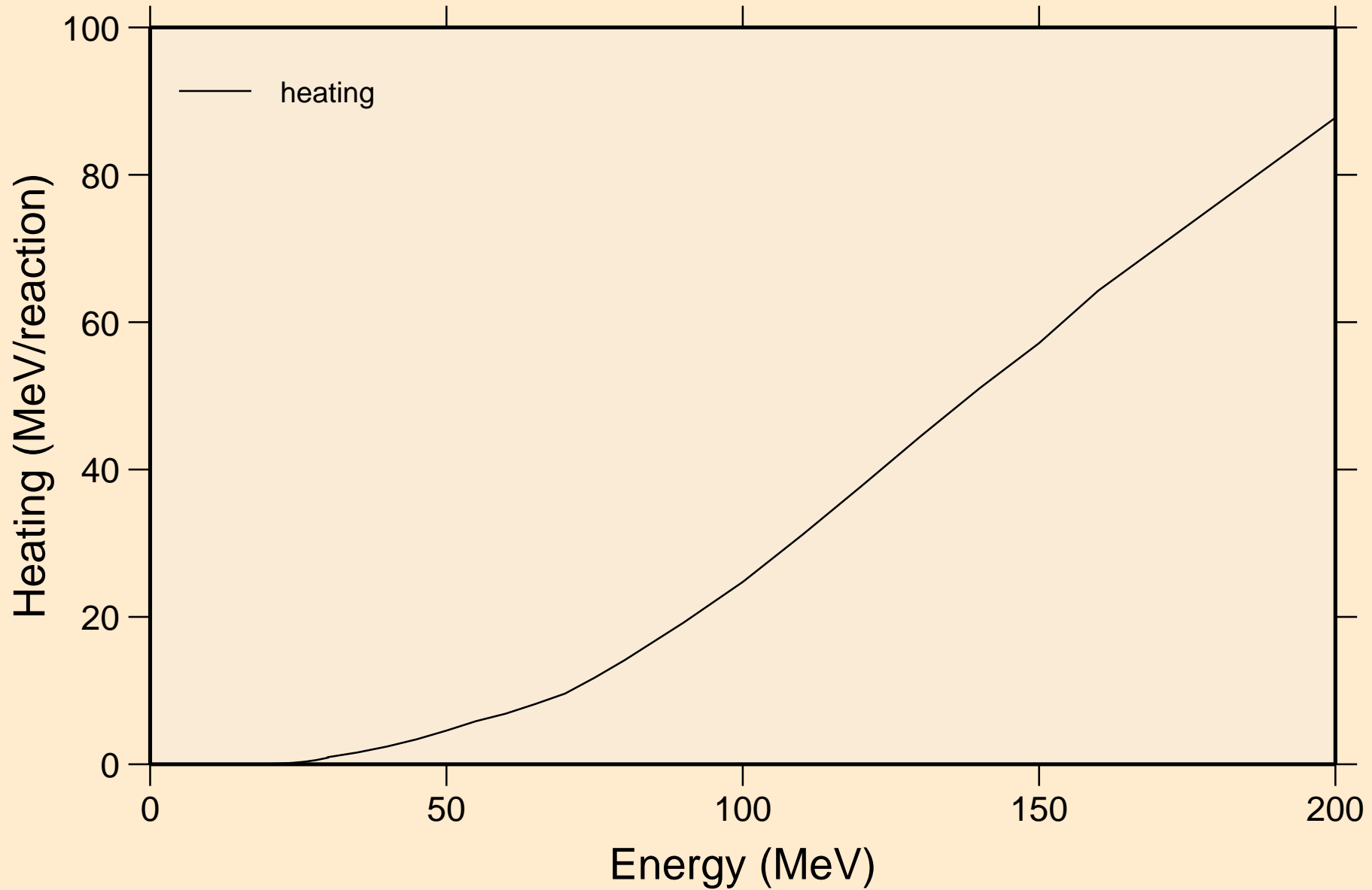

BI192 TRITON ACER TENDL-2021 LIBRARY; T=0.K  
Threshold reactions

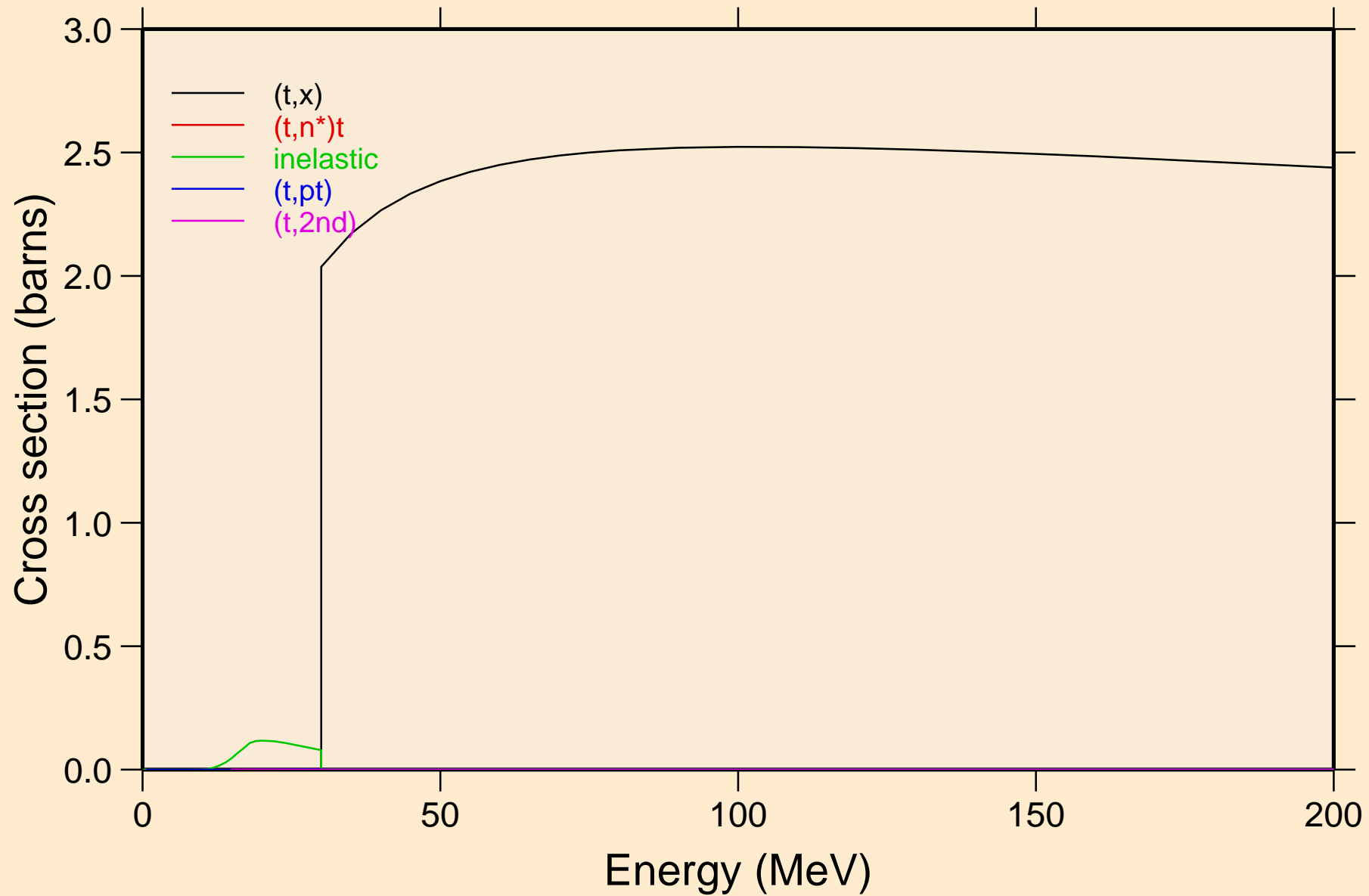

BI192 TRITON ACER TENDL-2021 LIBRARY; T=0.K  
Threshold reactions

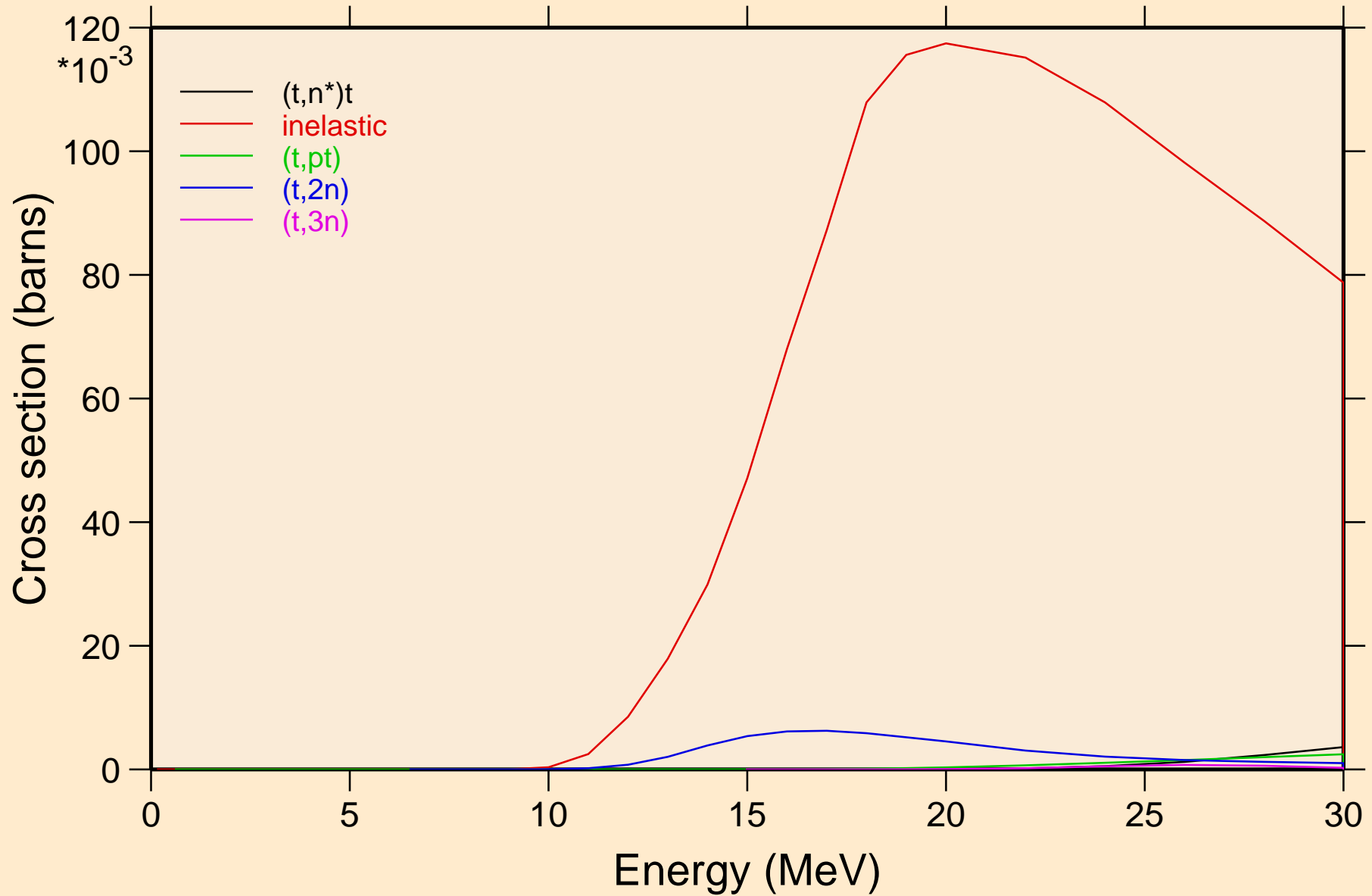

BI192 TRITON ACER TENDL-2021 LIBRARY; T=0.K  
Threshold reactions

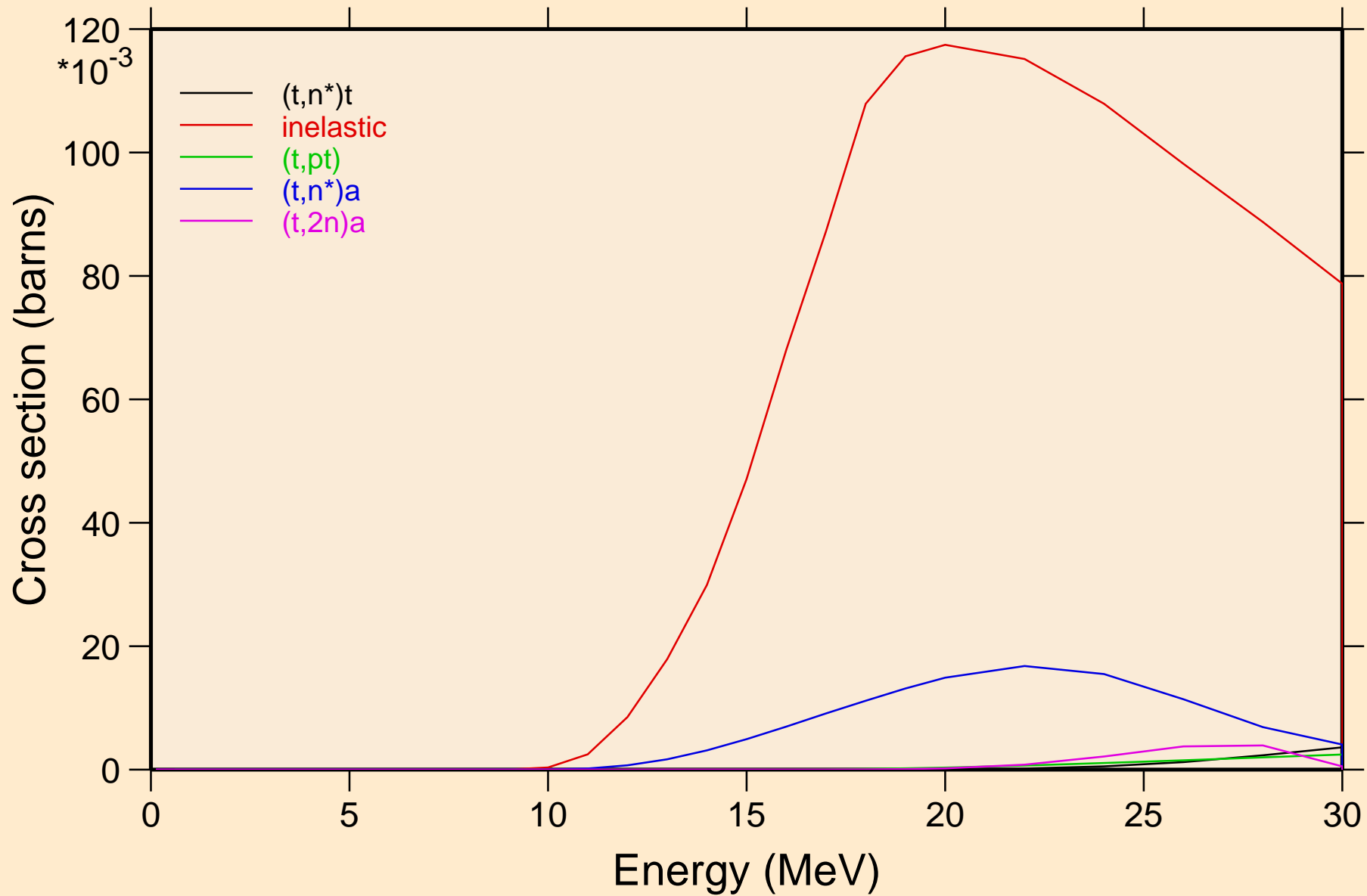

BI192 TRITON ACER TENDL-2021 LIBRARY; T=0.K  
Threshold reactions

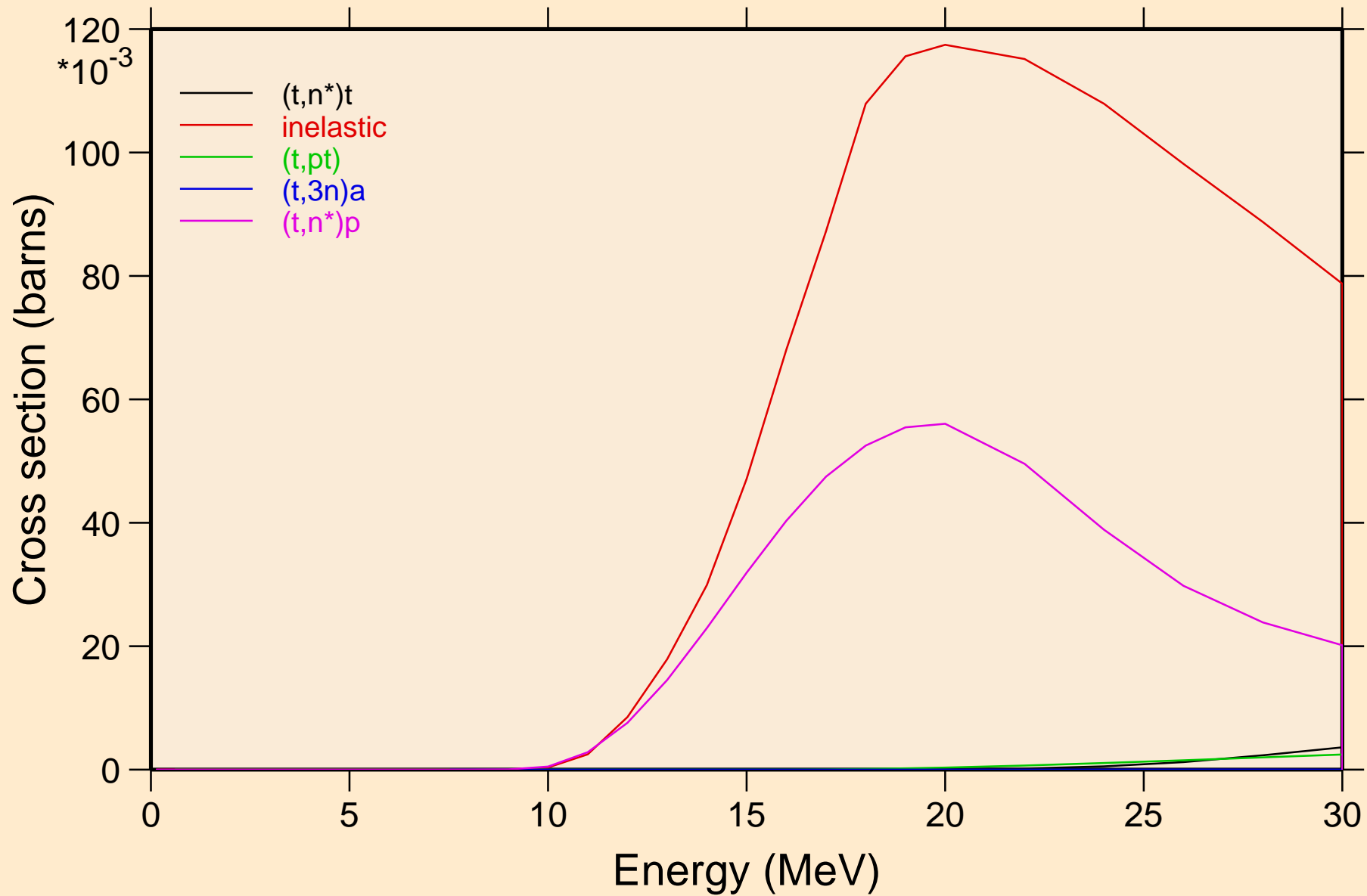



BI192 TRITON ACER TENDL-2021 LIBRARY; T=0.K  
Threshold reactions

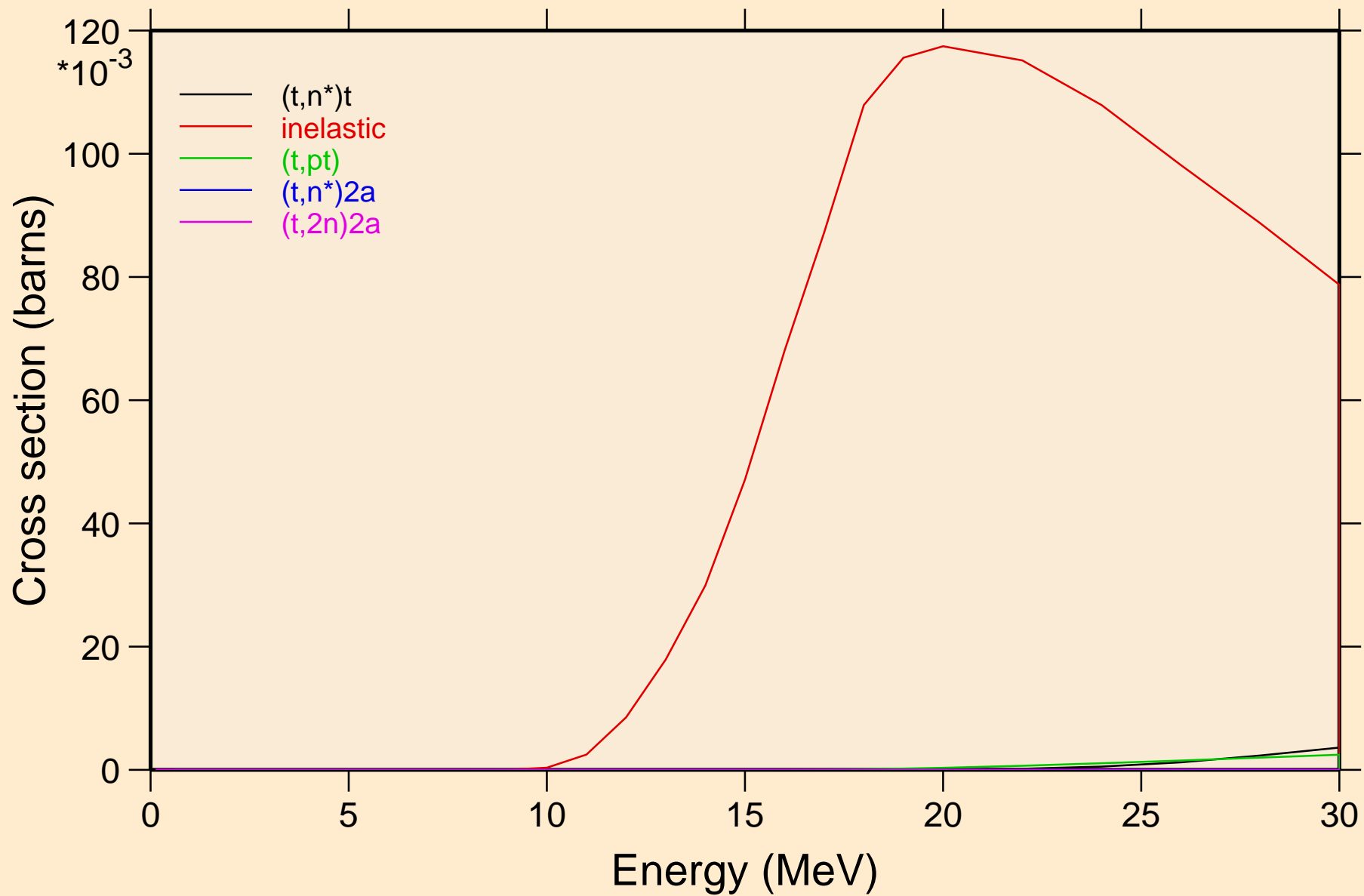

BI192 TRITON ACER TENDL-2021 LIBRARY; T=0.K  
Threshold reactions

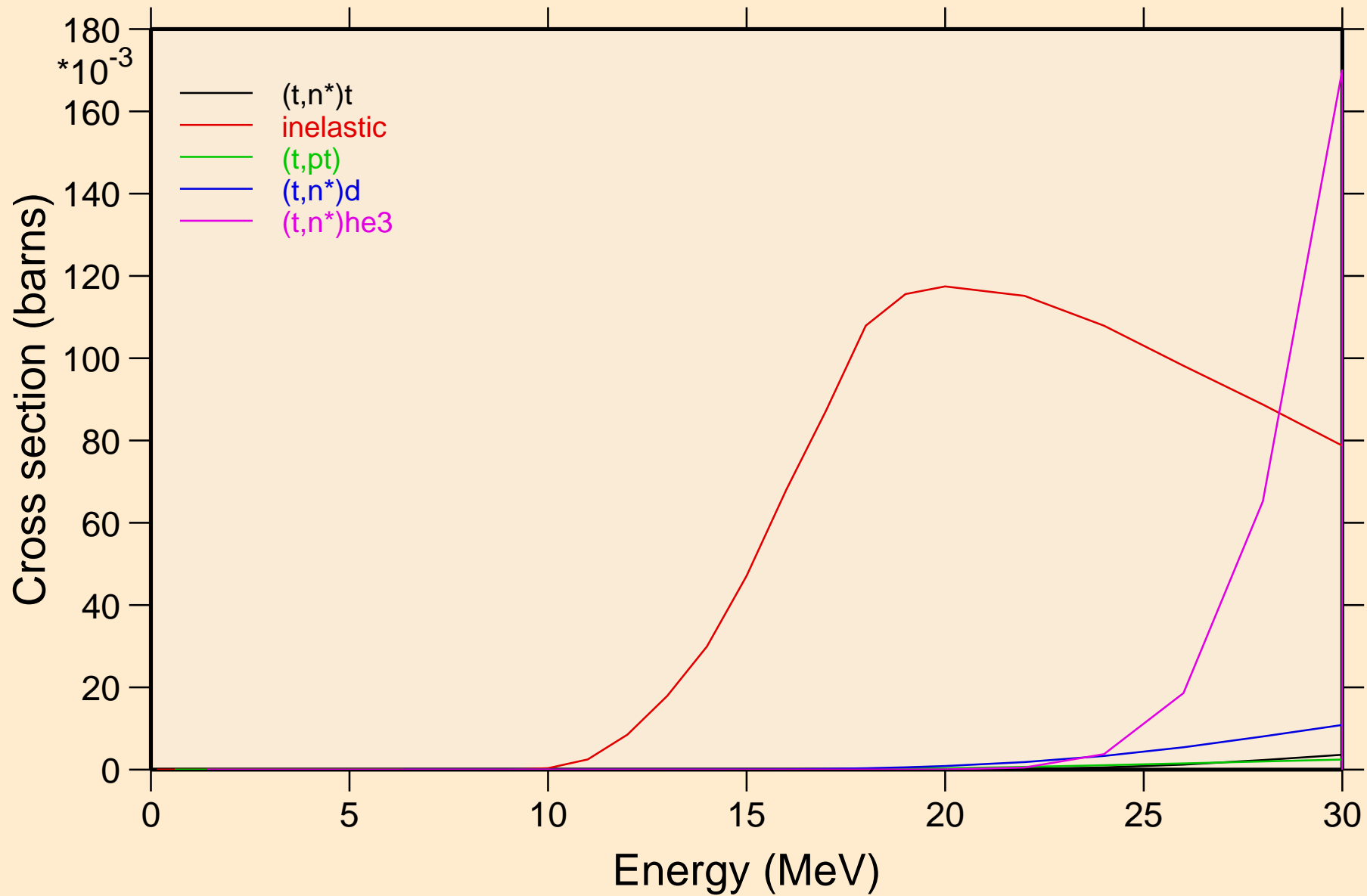

BI192 TRITON ACER TENDL-2021 LIBRARY; T=0.K  
Threshold reactions

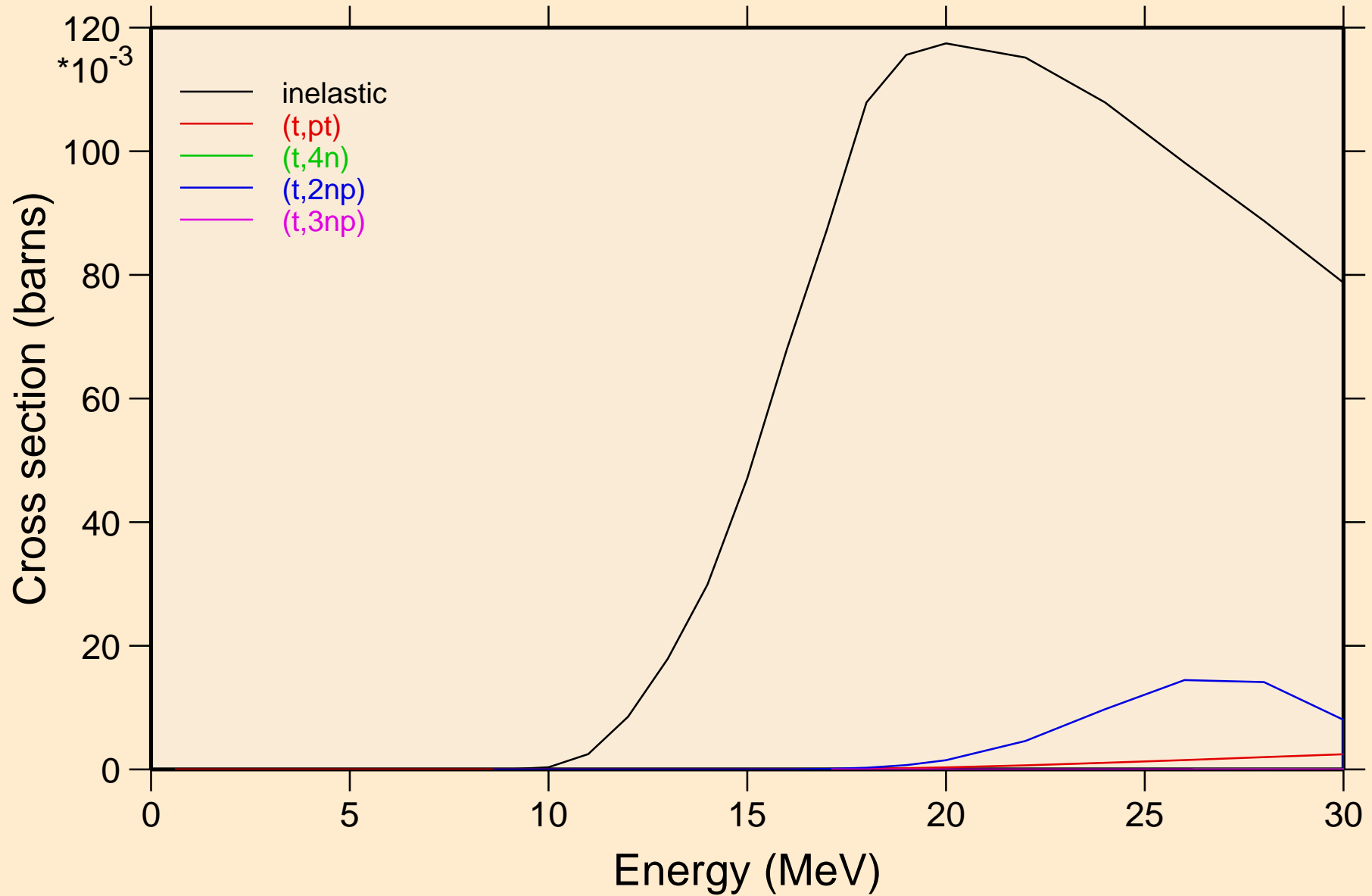

BI192 TRITON ACER TENDL-2021 LIBRARY; T=0.K  
Threshold reactions

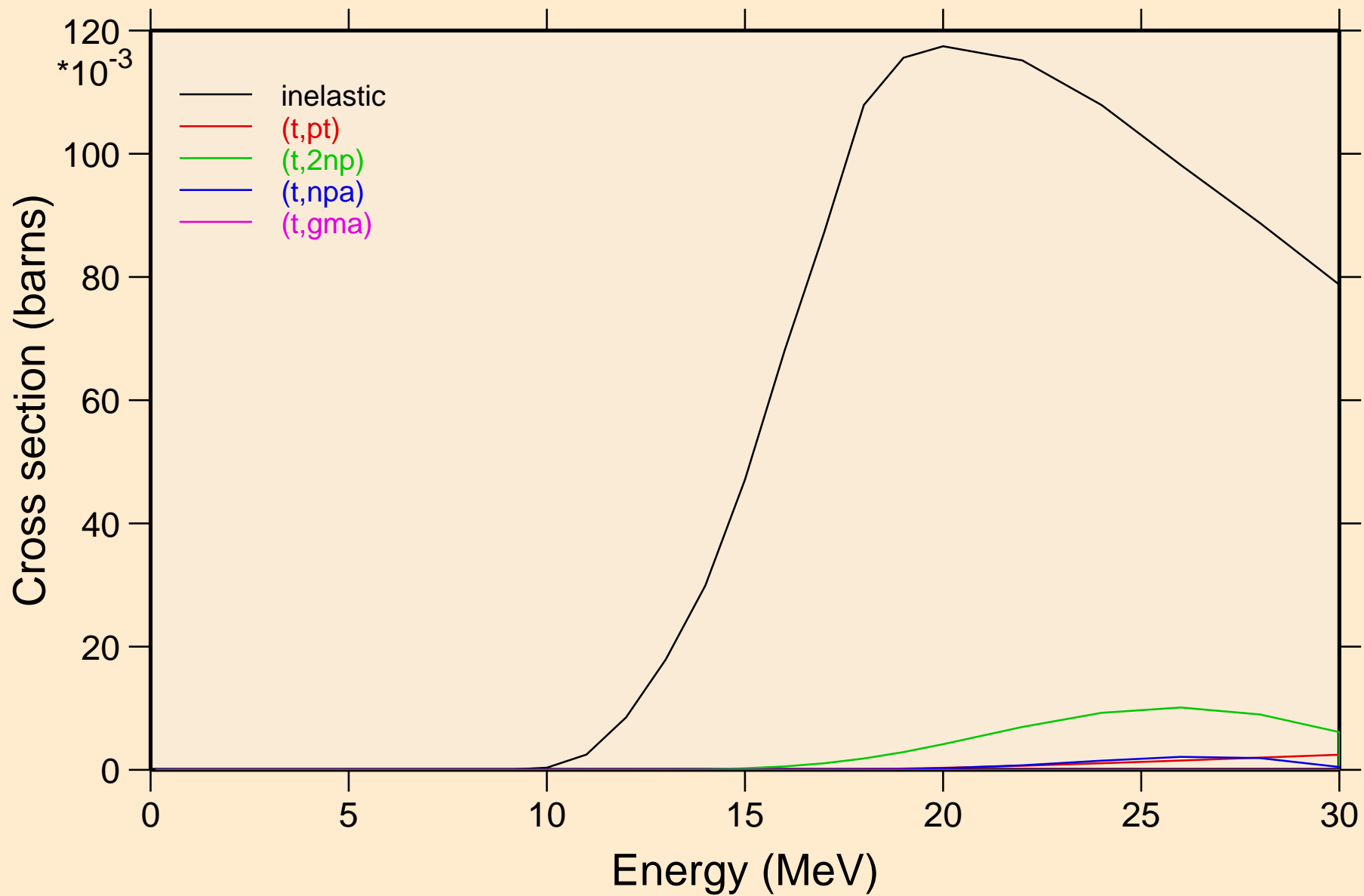

BI192 TRITON ACER TENDL-2021 LIBRARY; T=0.K  
Threshold reactions

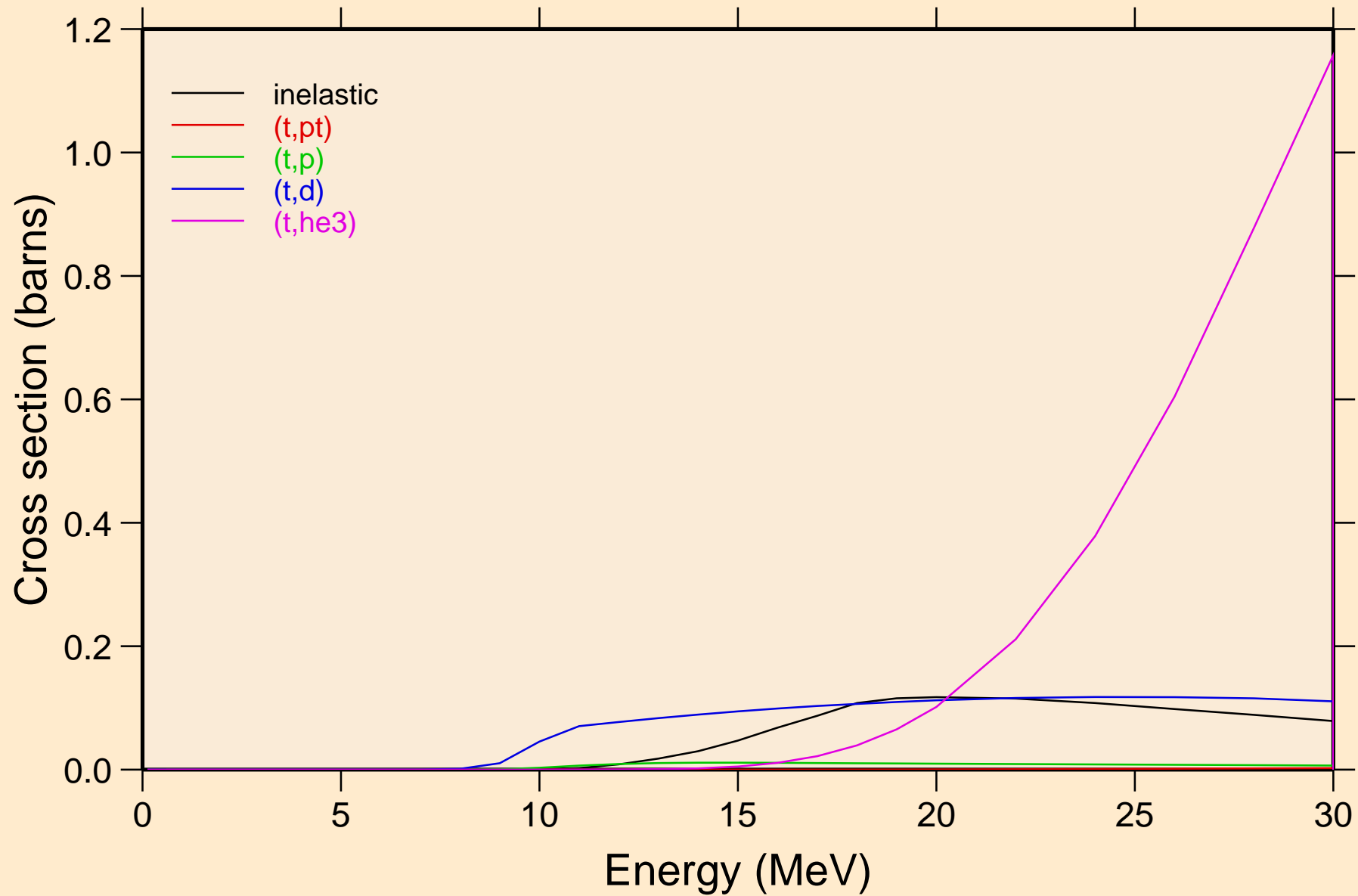

BI192 TRITON ACER TENDL-2021 LIBRARY; T=0.K  
Threshold reactions

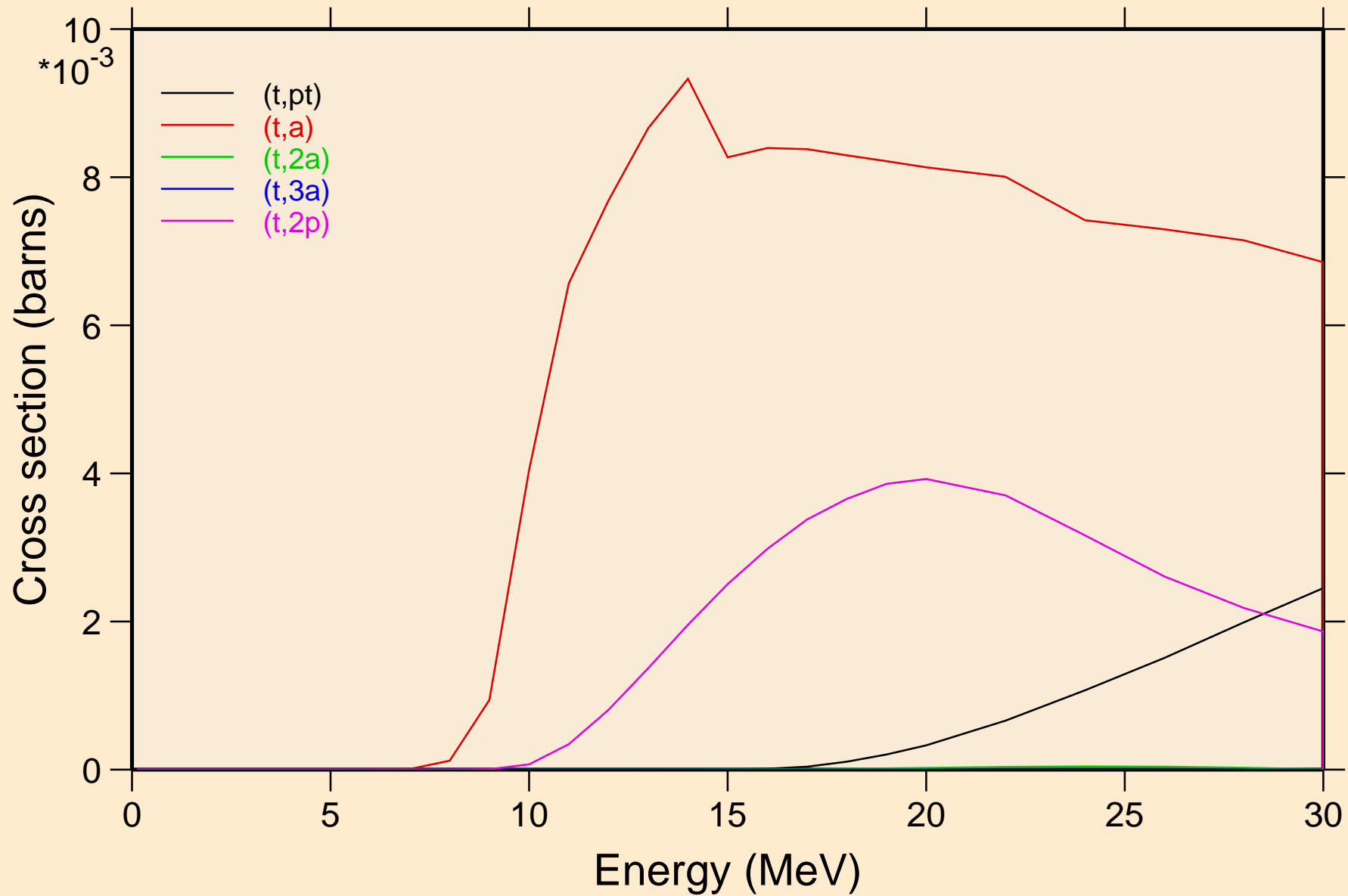

BI192 TRITON ACER TENDL-2021 LIBRARY; T=0.K  
Threshold reactions

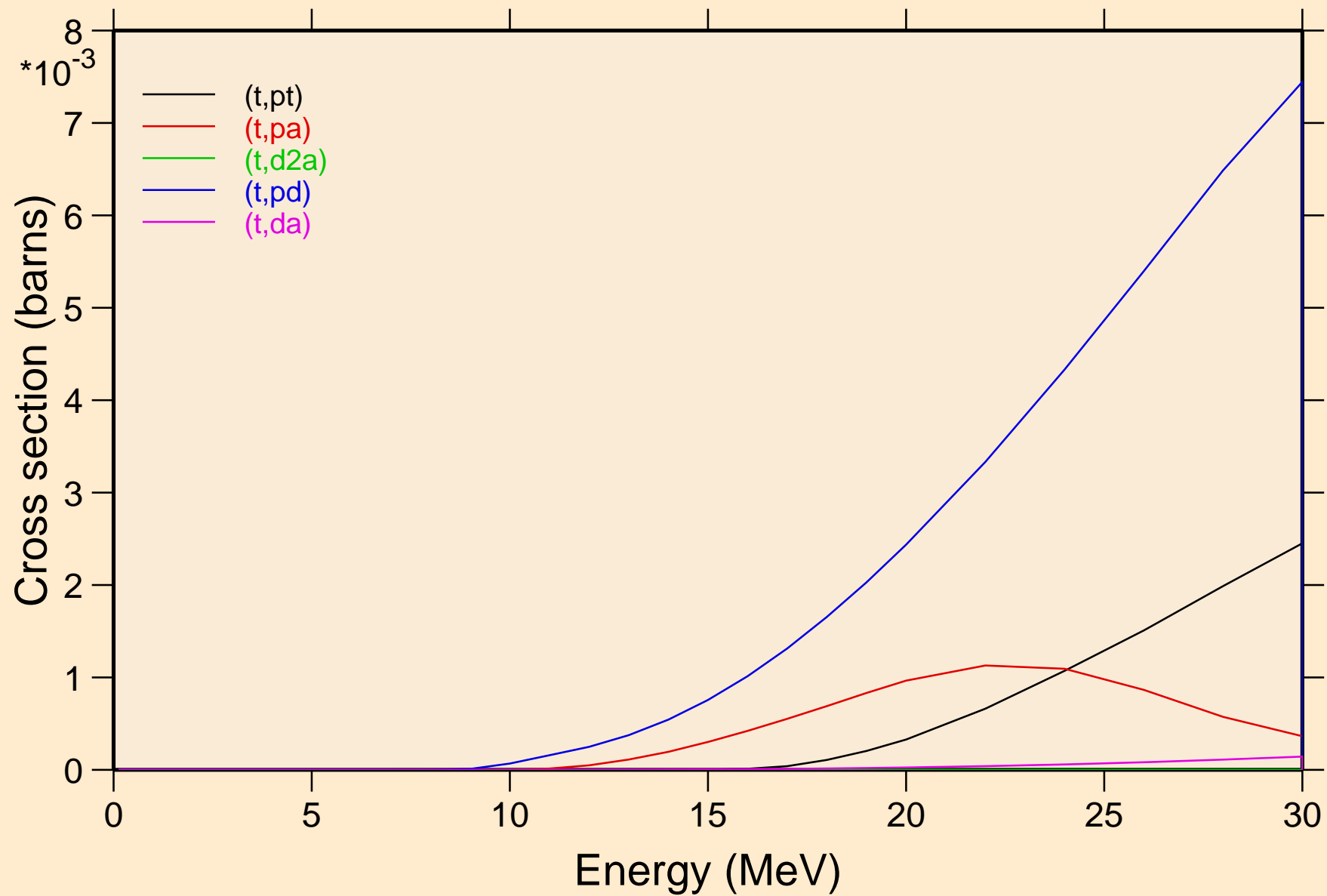

BI192 TRITON ACER TENDL-2021 LIBRARY; T=0.K  
angular distribution for elastic

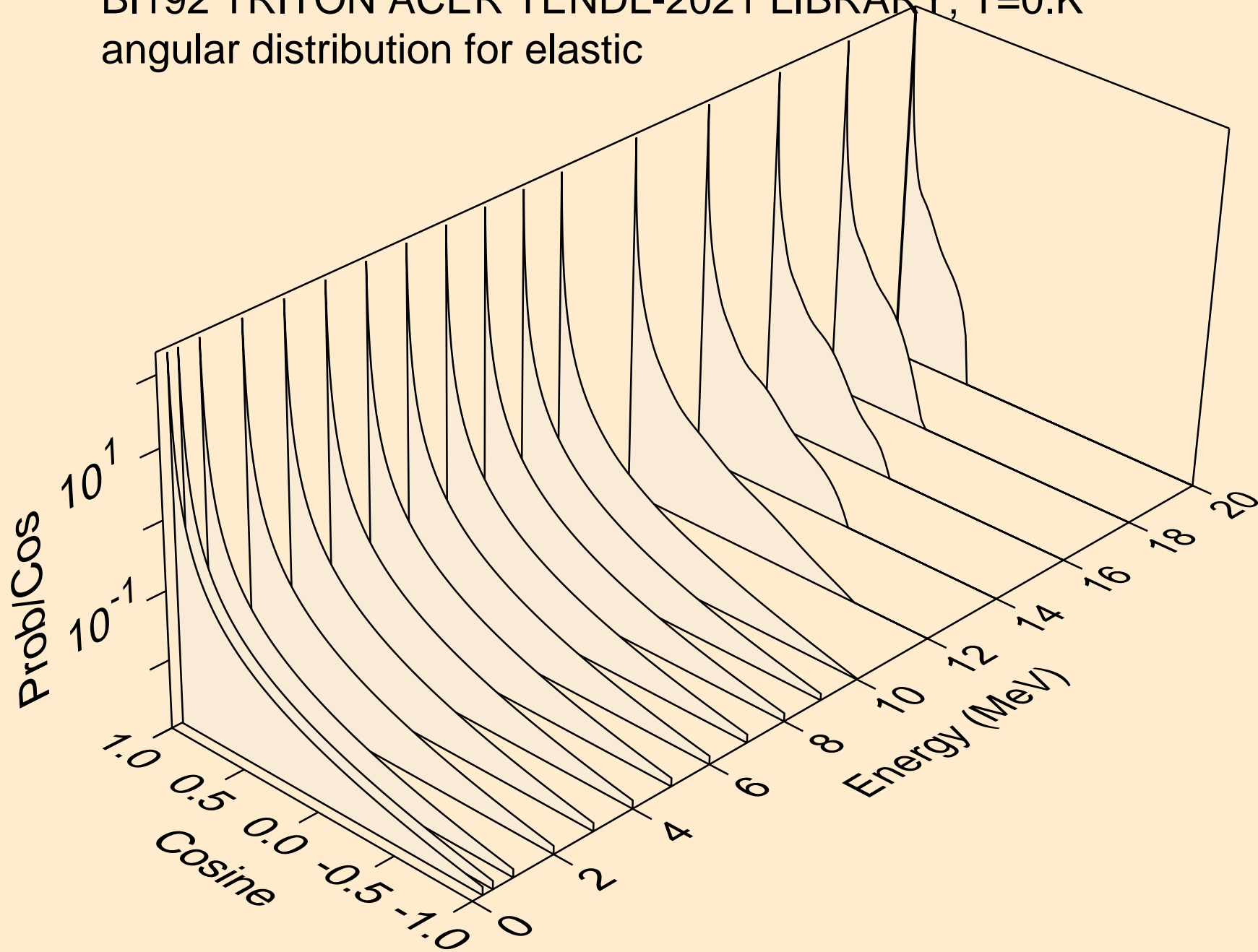



BI192 TRITON ACER TENDL-2021 LIBRARY; T=0.K  
angular distribution for elastic

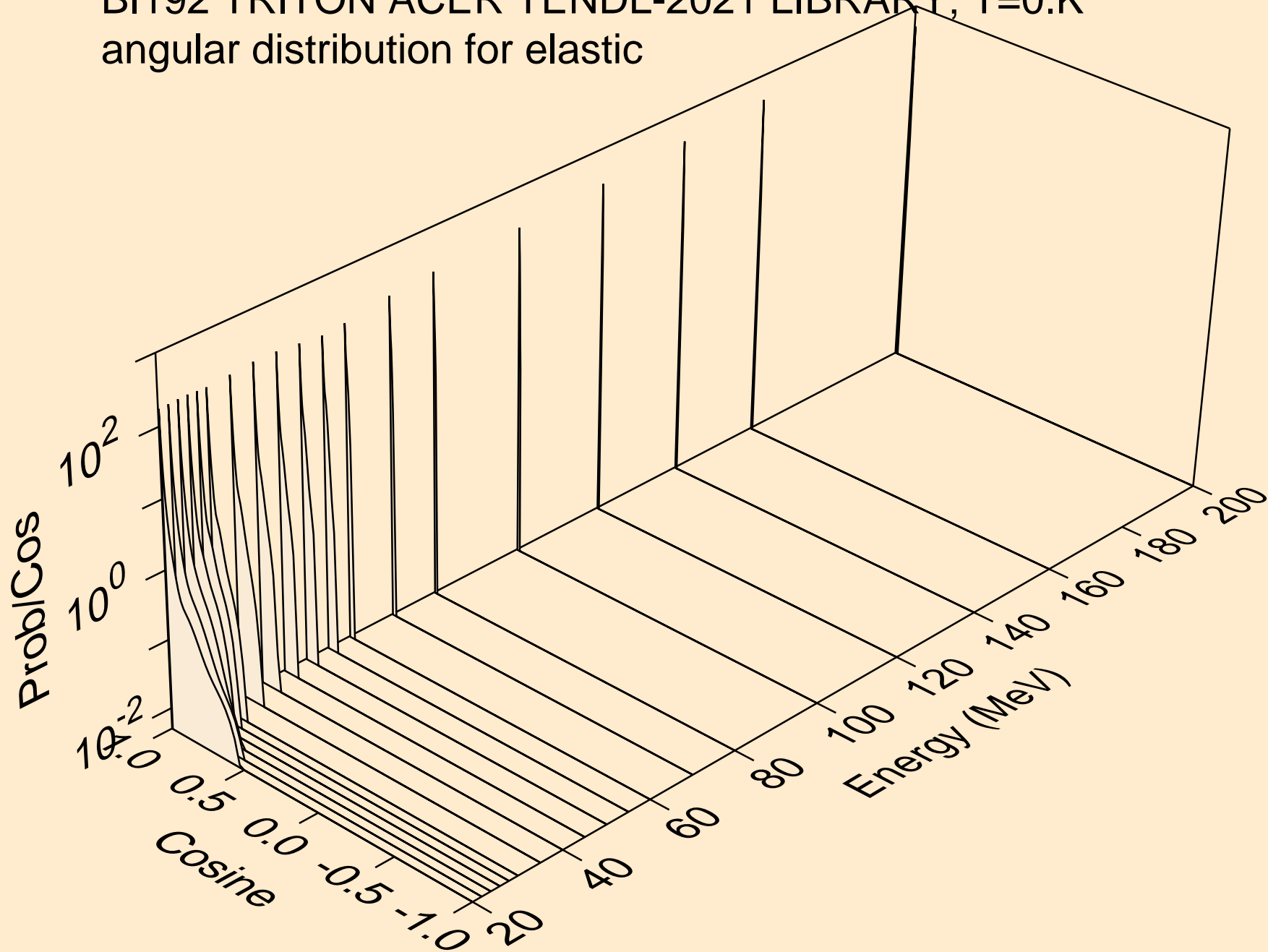

BI192 TRITON ACER TENDL-2021 LIBRARY; T=0.K  
Triton emission for (t,x)

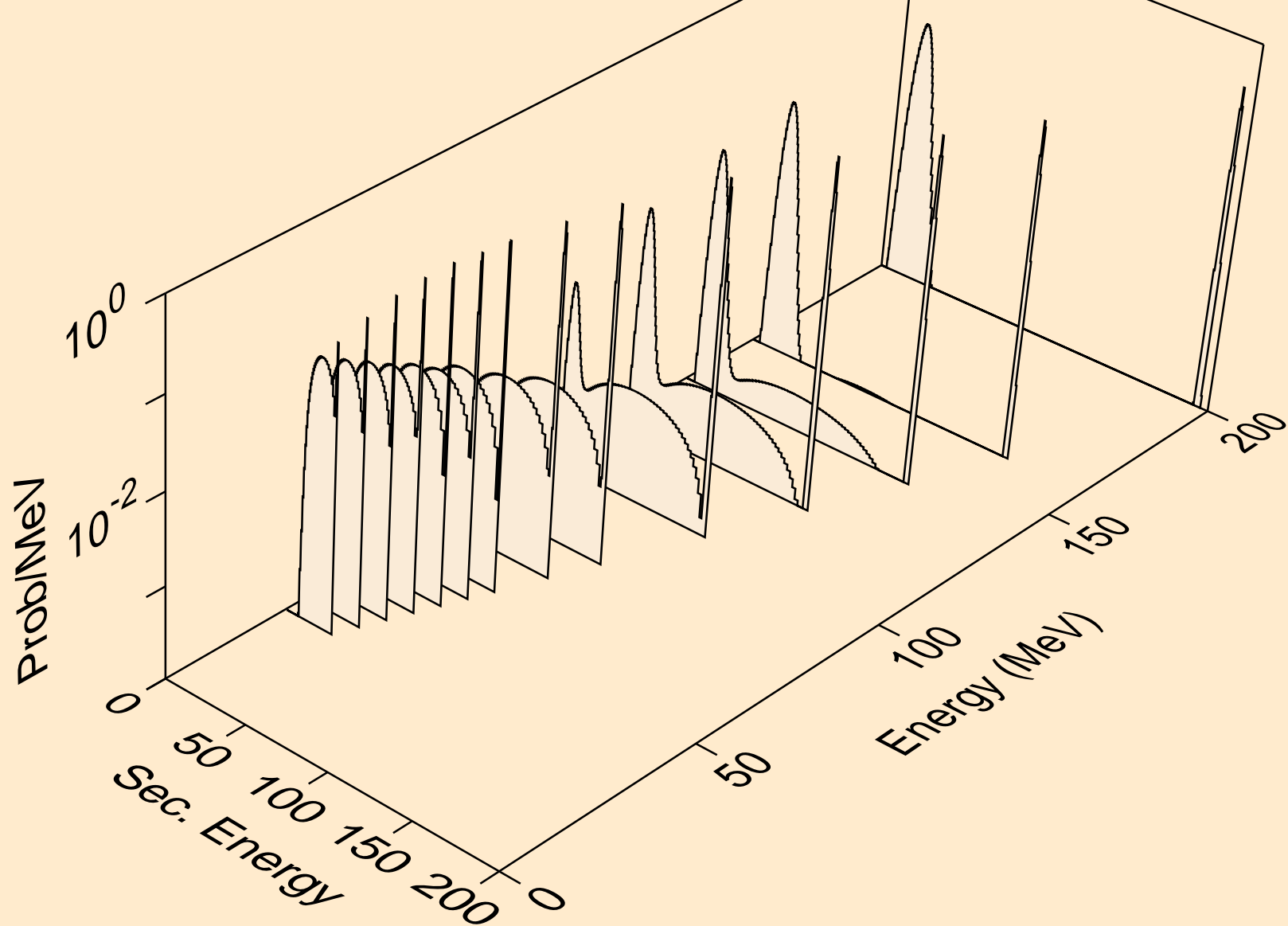

BI192 TRITON ACER TENDL-2021 LIBRARY; T=0.K  
Triton emission for (t,n\*)t

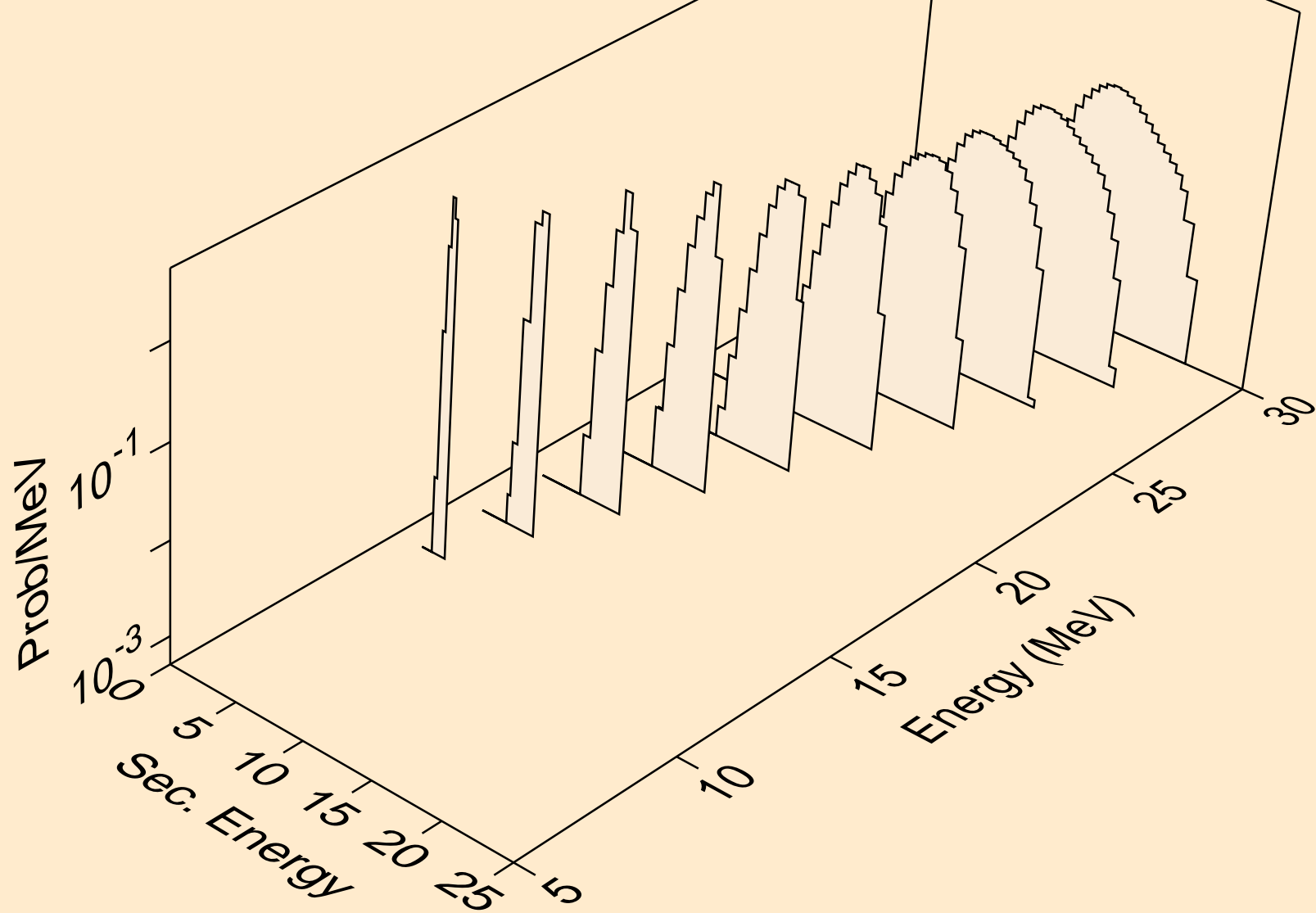

BI192 TRITON ACER TENDL-2021 LIBRARY; T=0.K  
Triton emission for inelastic

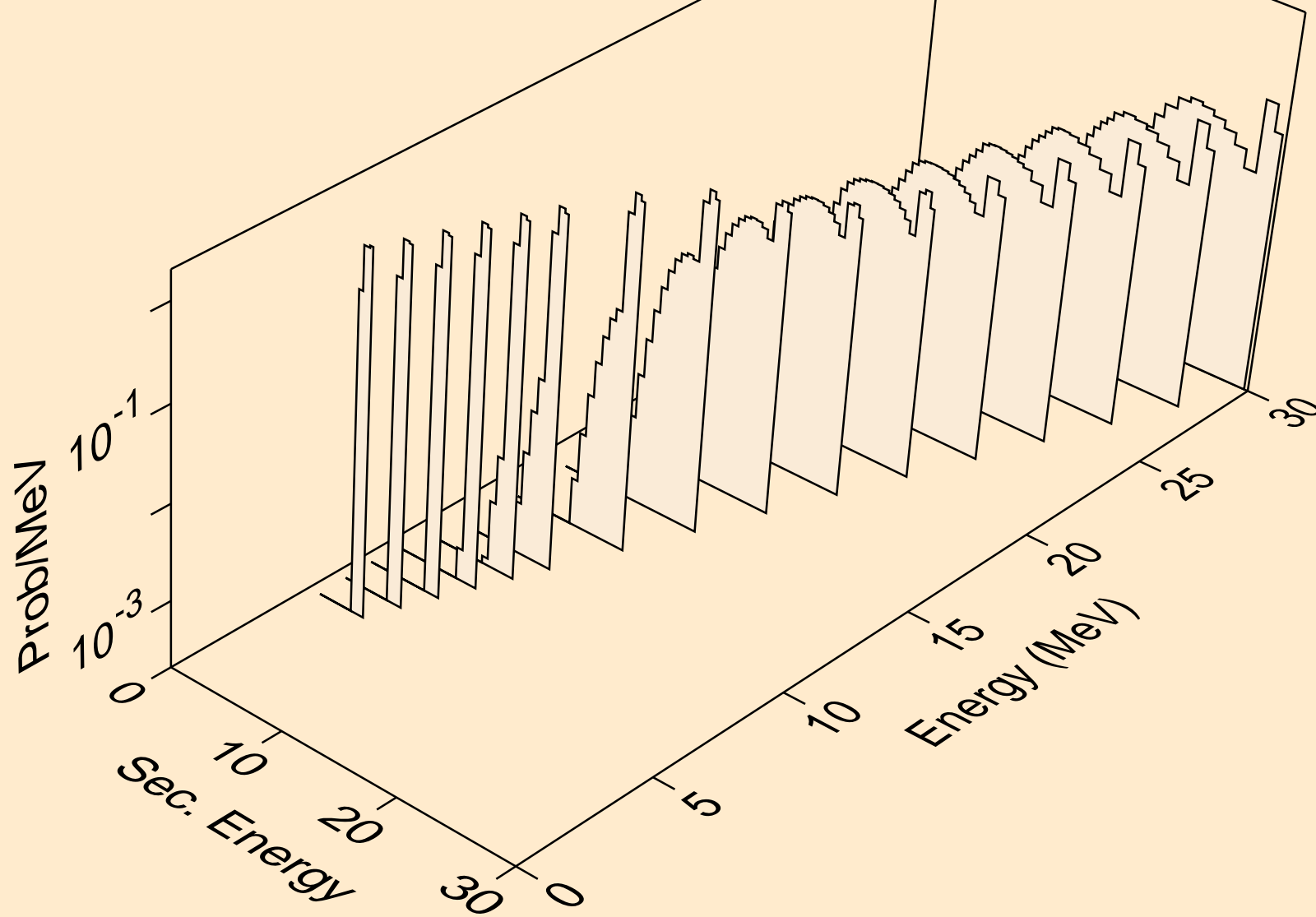

BI192 TRITON ACER TENDL-2021 LIBRARY; T=0.K  
Triton emission for (t,pt)

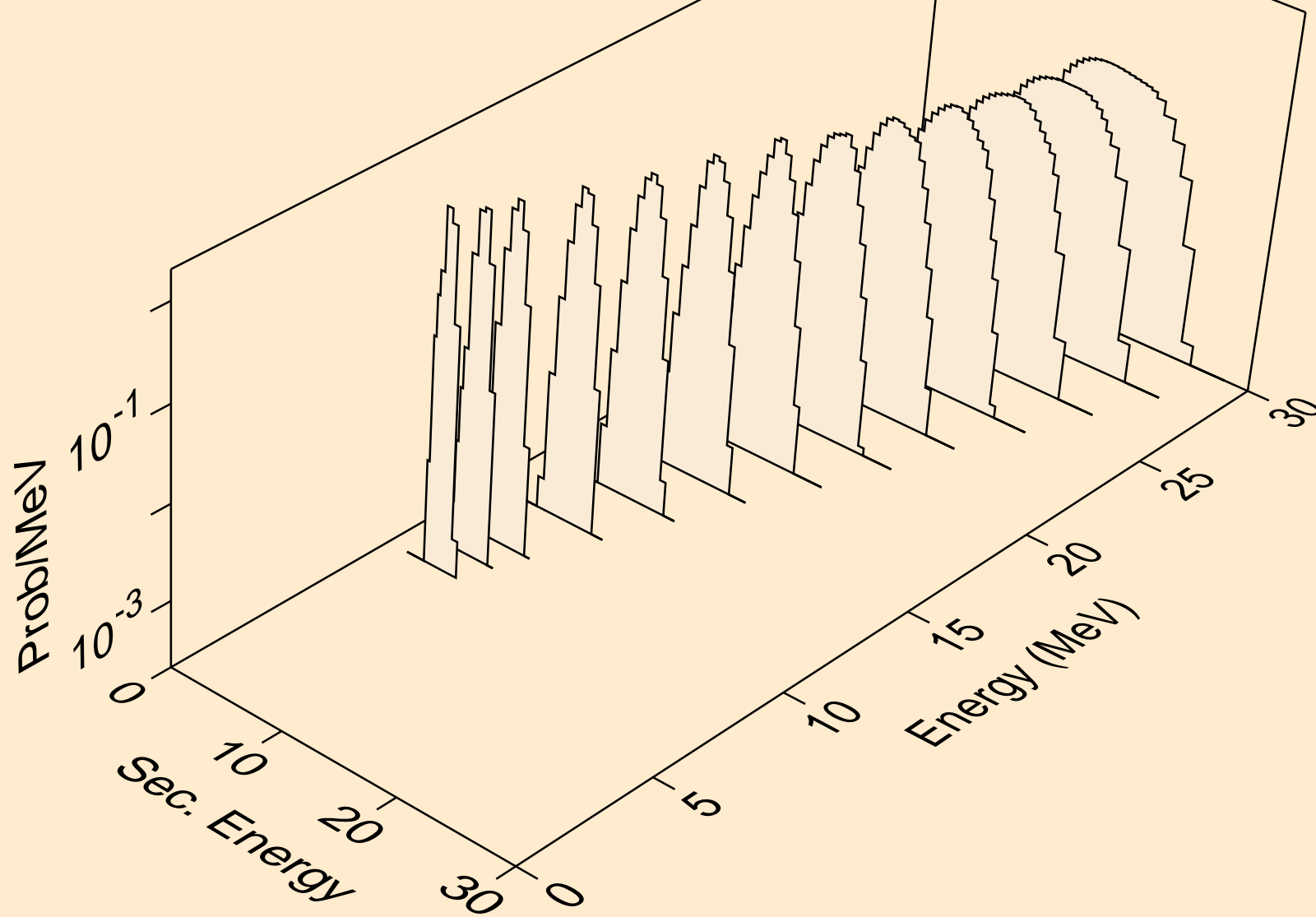

BI192 TRITON ACER TENDL-2021 LIBRARY; T=0.K  
Photon emission for (z,n)

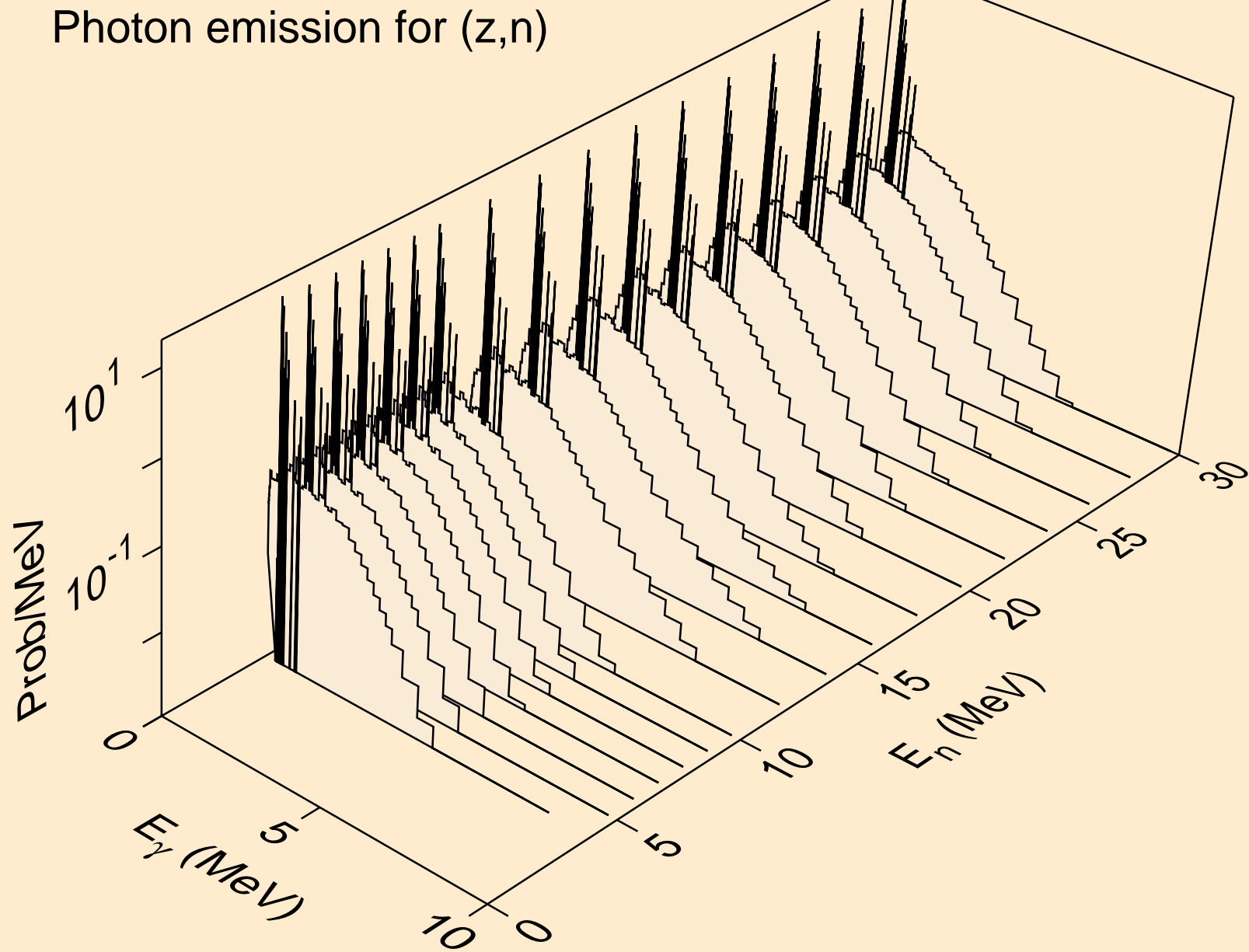

BI192 TRITON ACER TENDL-2021 LIBRARY; T=0.K  
Photon emission for (n,x)

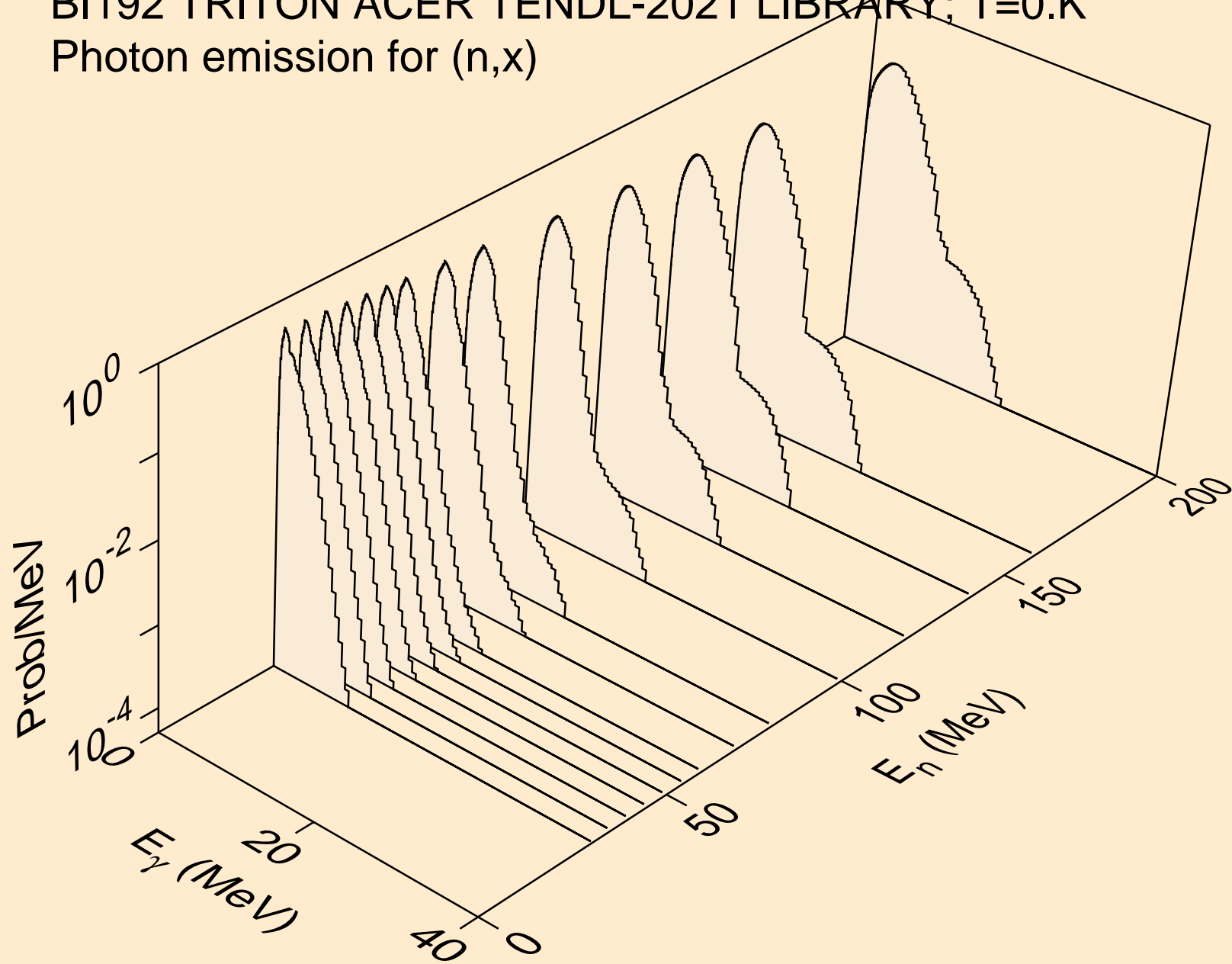

BI192 TRITON ACER TENDL-2021 LIBRARY; T=0.K  
Photon emission for (n,2nd)

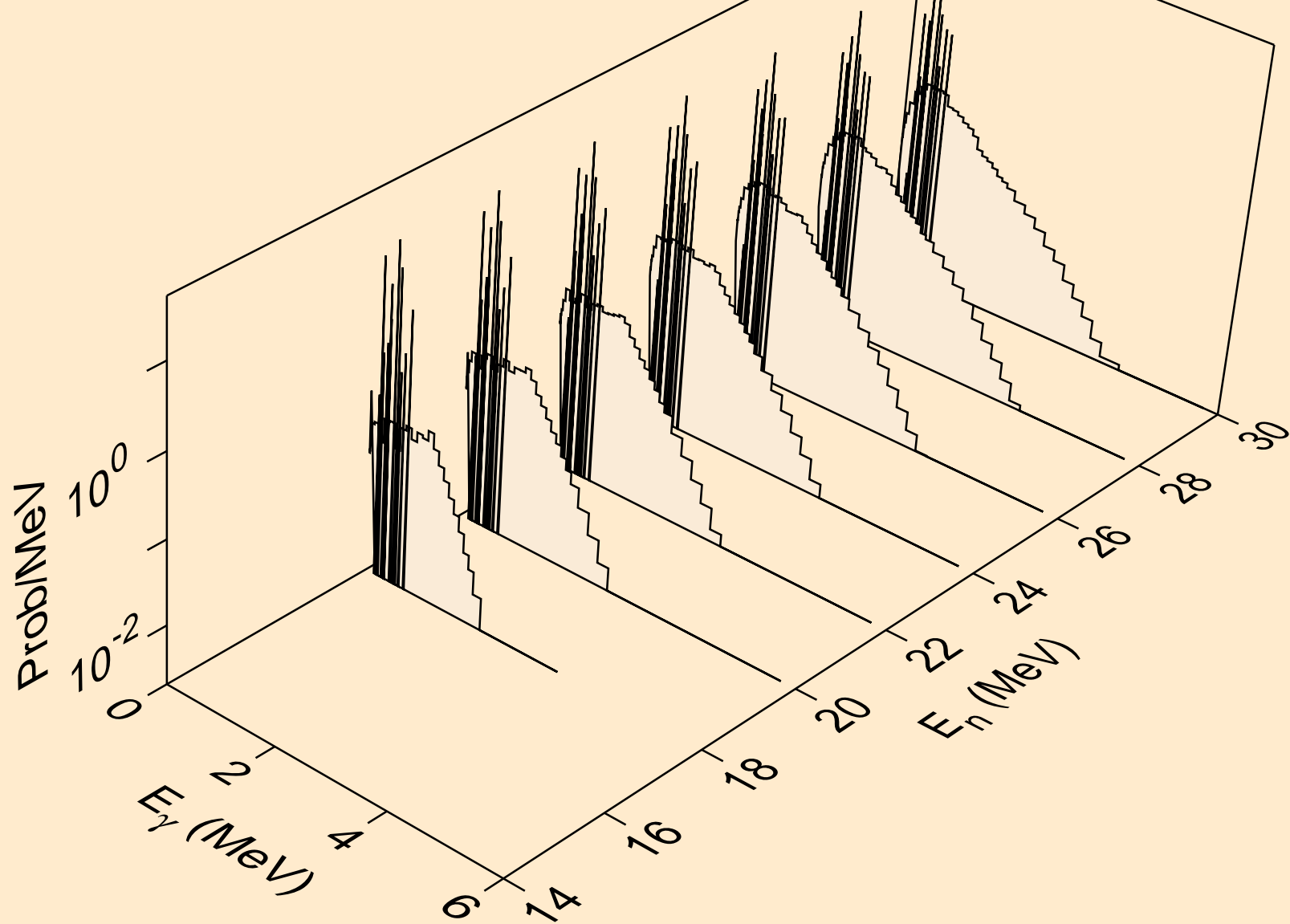



BI192 TRITON ACER TENDL-2021 LIBRARY; T=0.K  
Photon emission for (n,2n)

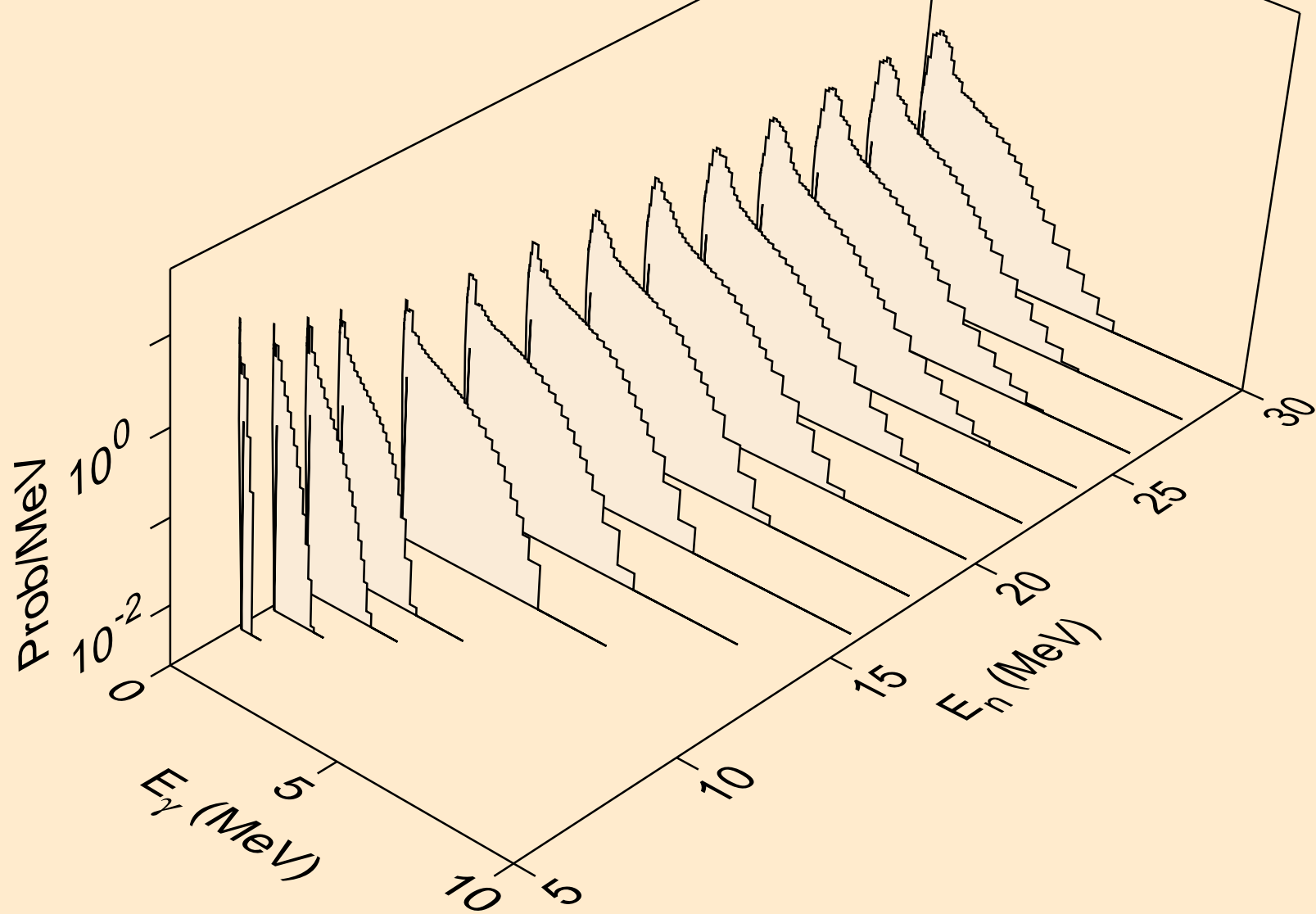

BI192 TRITON ACER TENDL-2021 LIBRARY; T=0.K  
Photon emission for (n,3n)

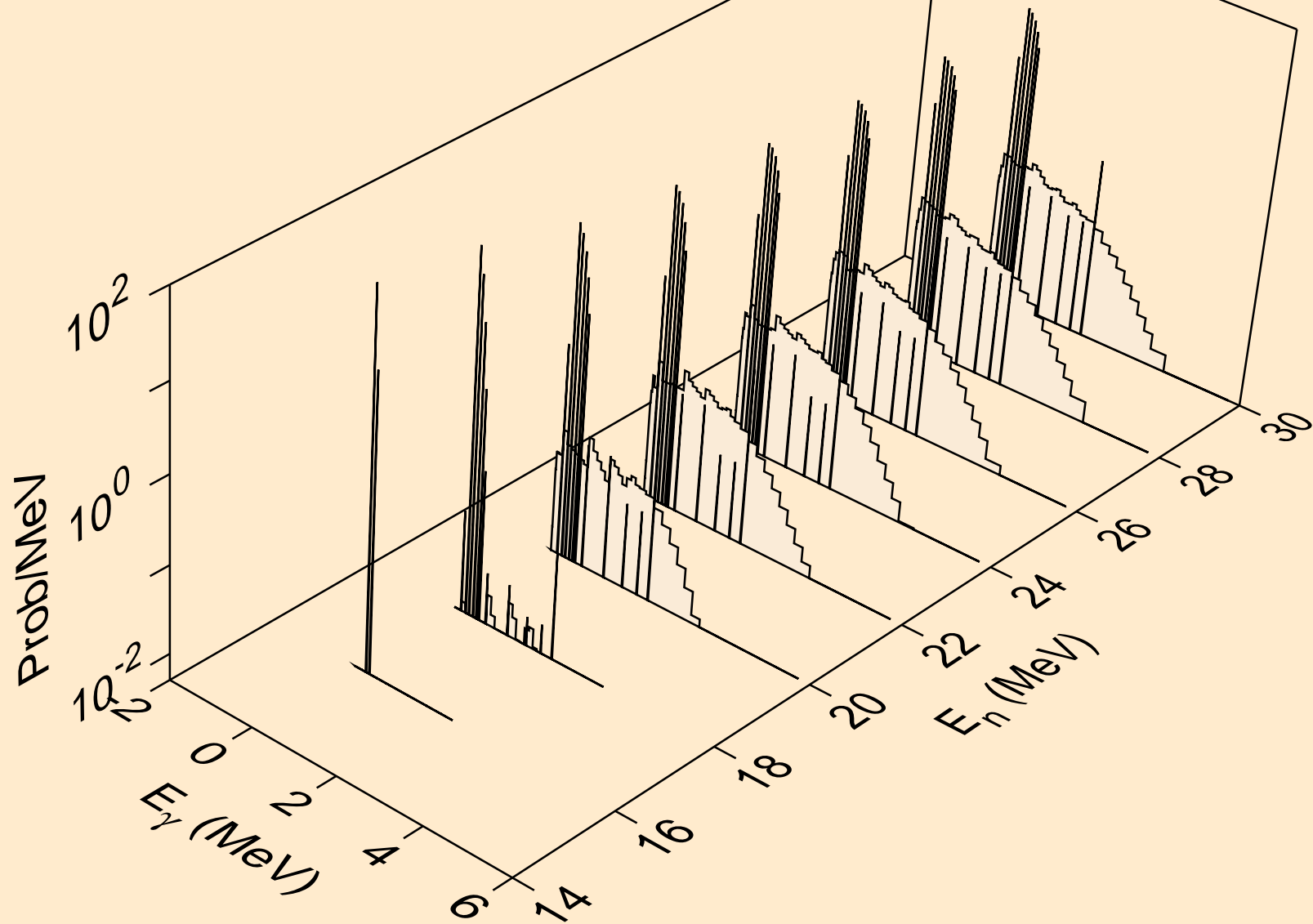

BI192 TRITON ACER TENDL-2021 LIBRARY; T=0.K  
Photon emission for (n,n\*)a

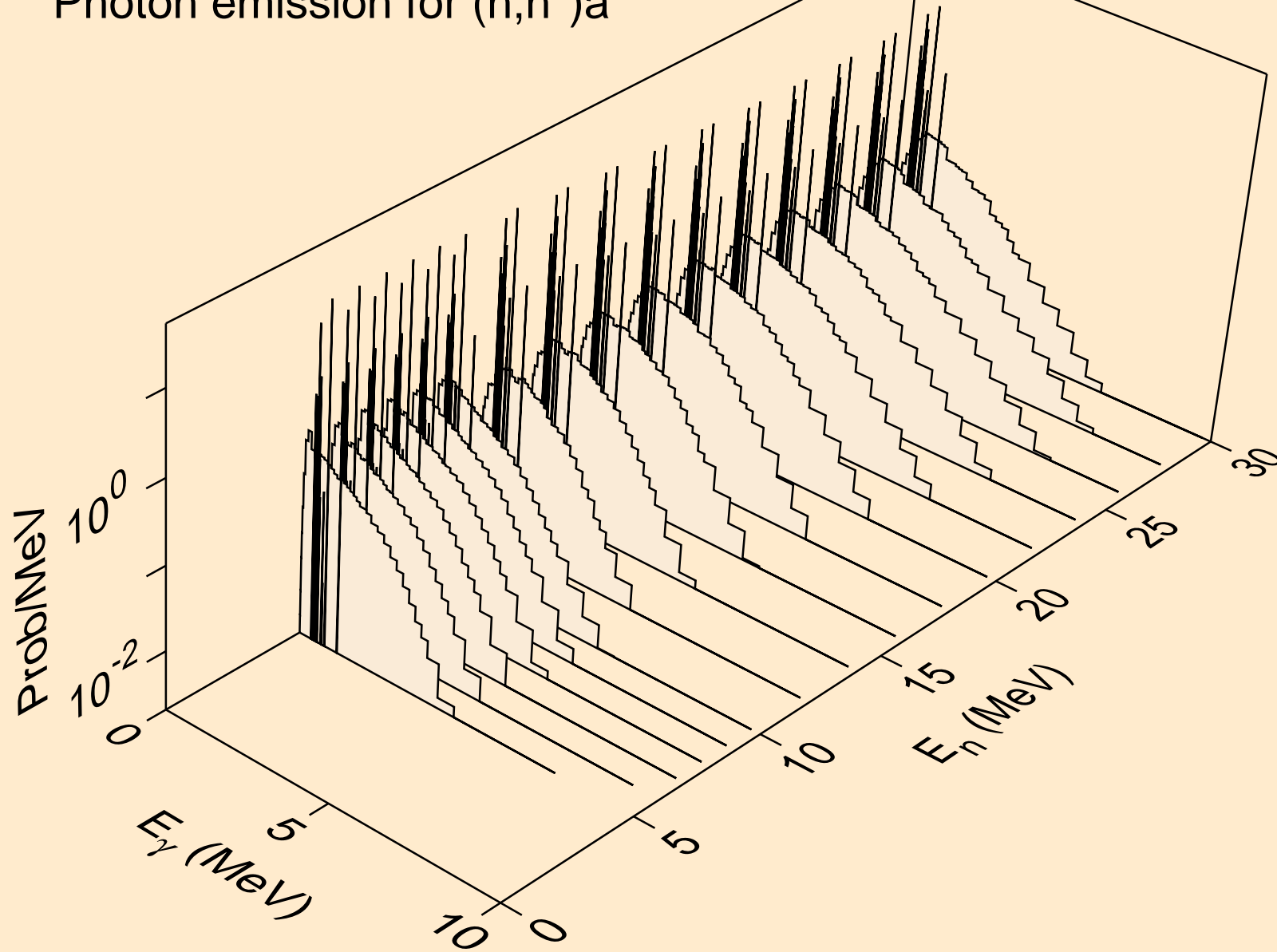

BI192 TRITON ACER TENDL-2021 LIBRARY; T=0.K  
Photon emission for (n,2n)a

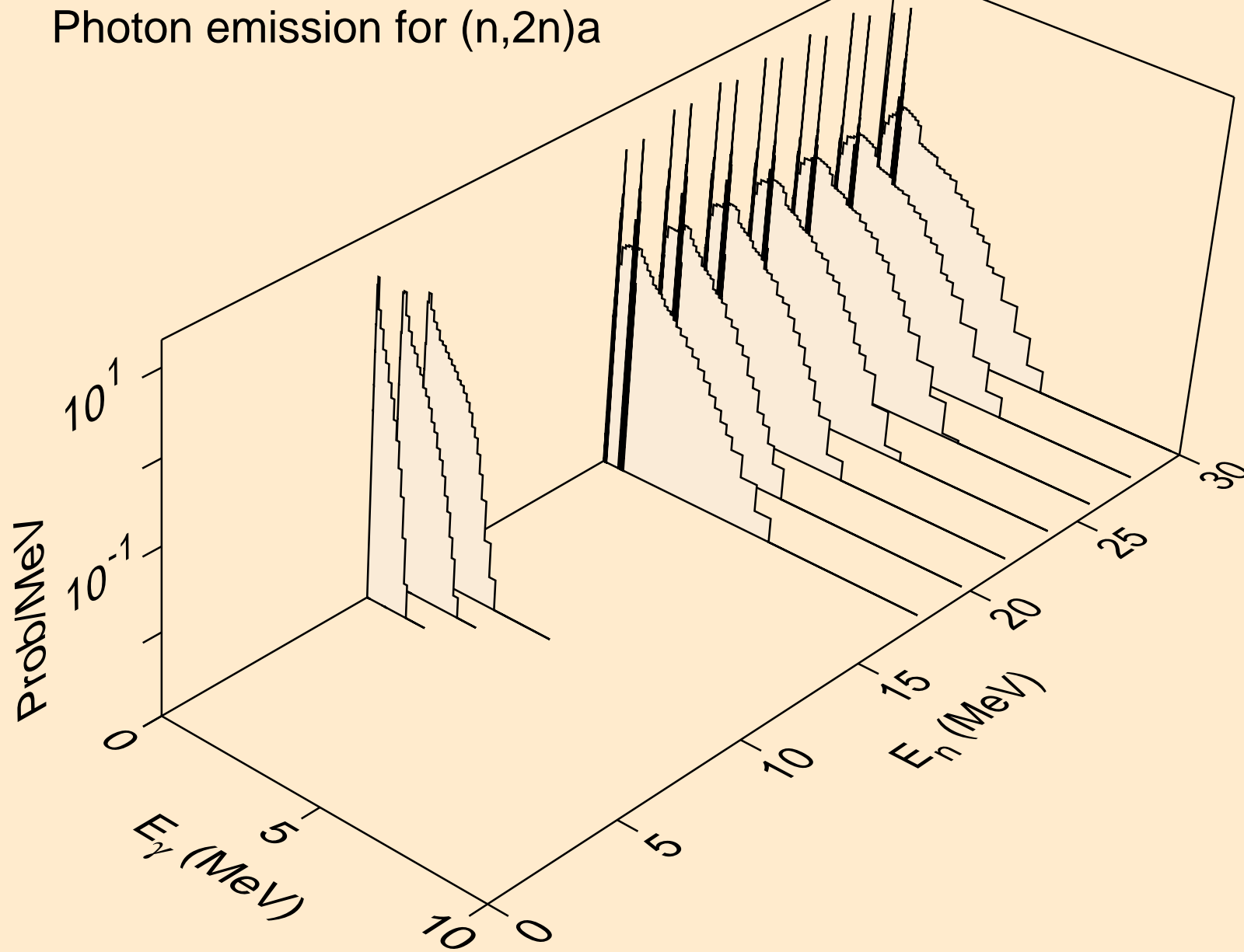

BI192 TRITON ACER TENDL-2021 LIBRARY; T=0.K  
Photon emission for (n,3n)a

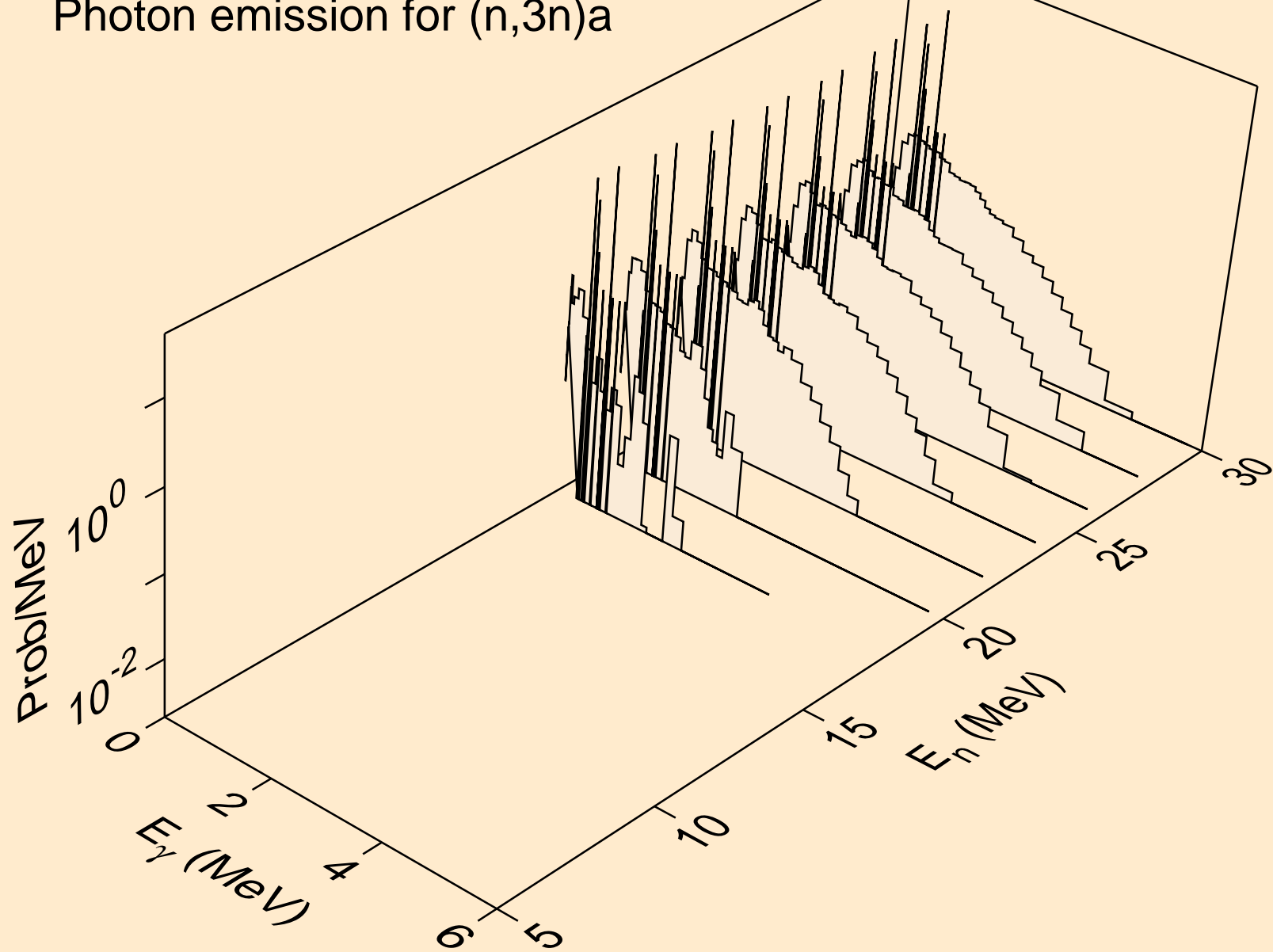

BI192 TRITON ACER TENDL-2021 LIBRARY; T=0.K  
Photon emission for (n,n\*)p

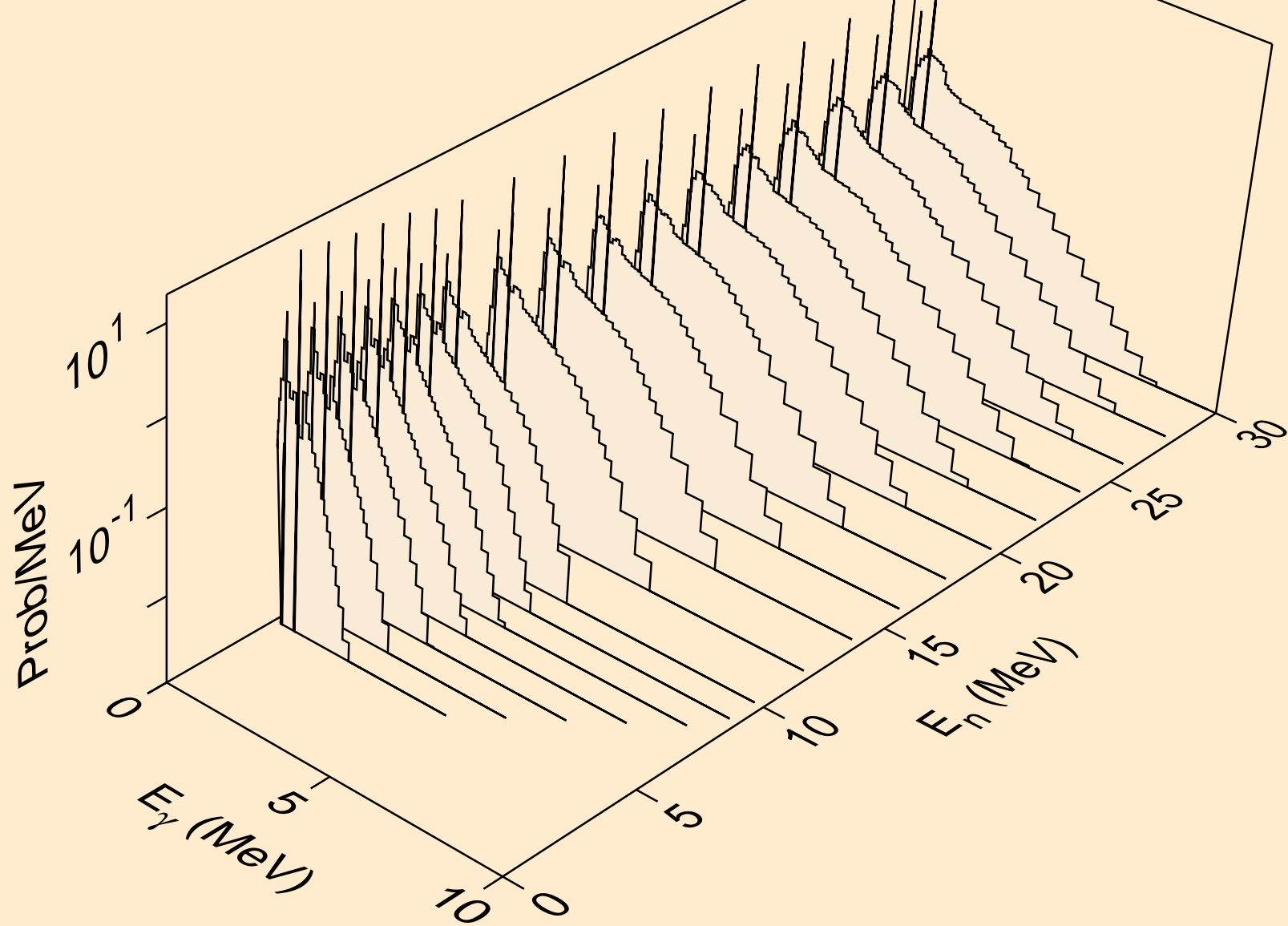

BI192 TRITON ACER TENDL-2021 LIBRARY; T=0.K  
Photon emission for (n,n\*)2a

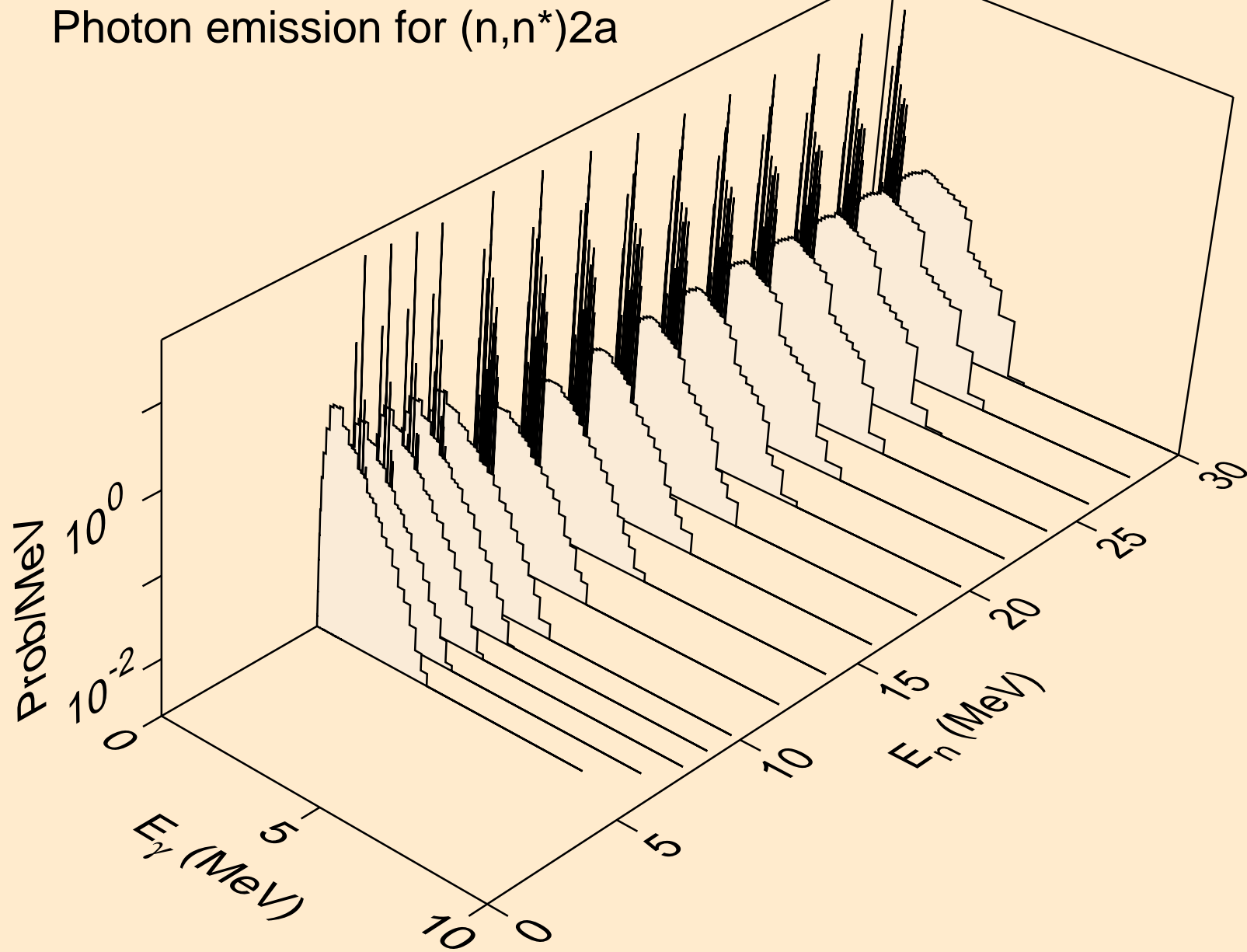

BI192 TRITON ACER TENDL-2021 LIBRARY; T=0.K  
Photon emission for (n,2n)2a

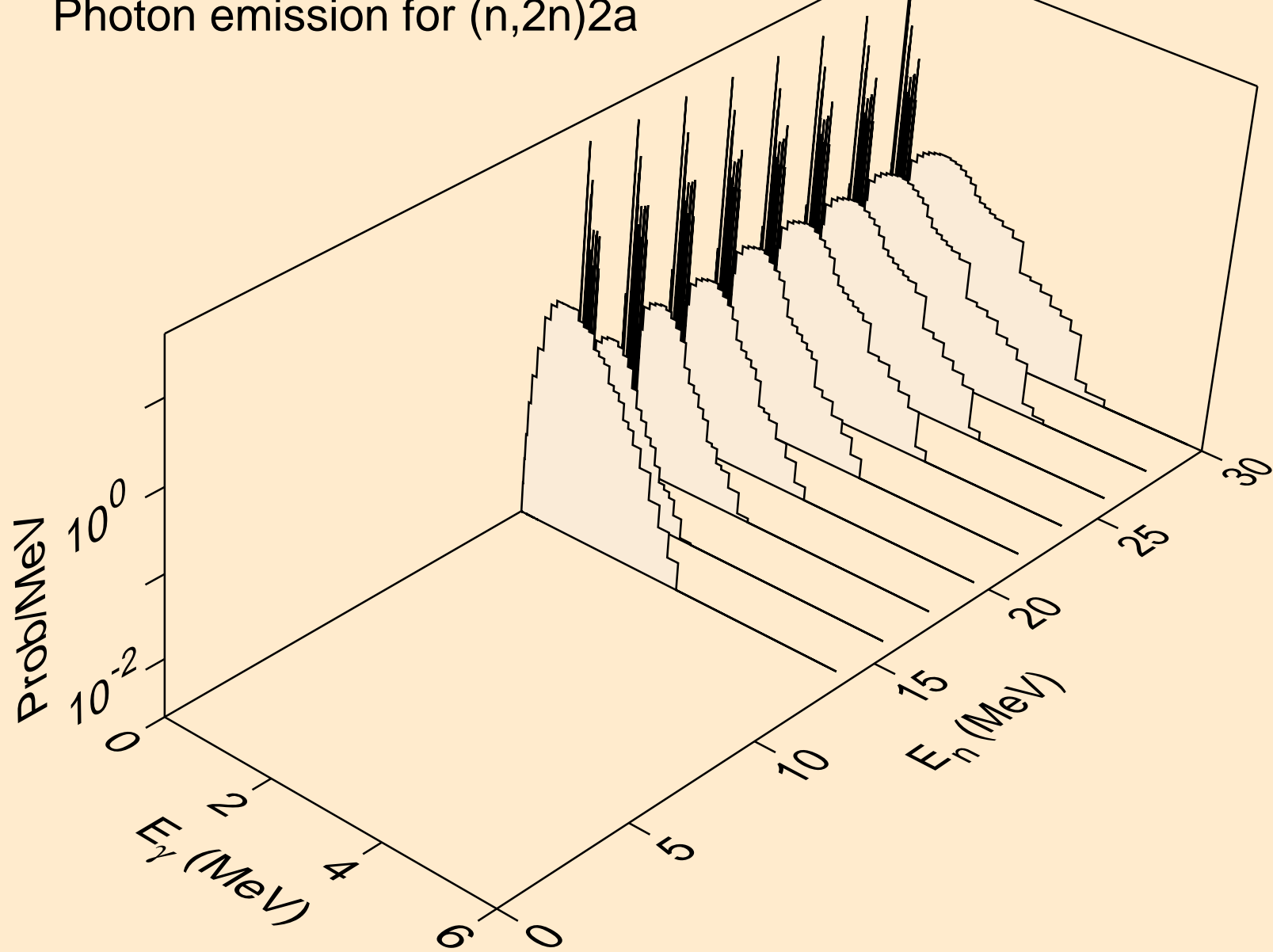



BI192 TRITON ACER TENDL-2021 LIBRARY; T=0.K  
Photon emission for (n,n\*)d

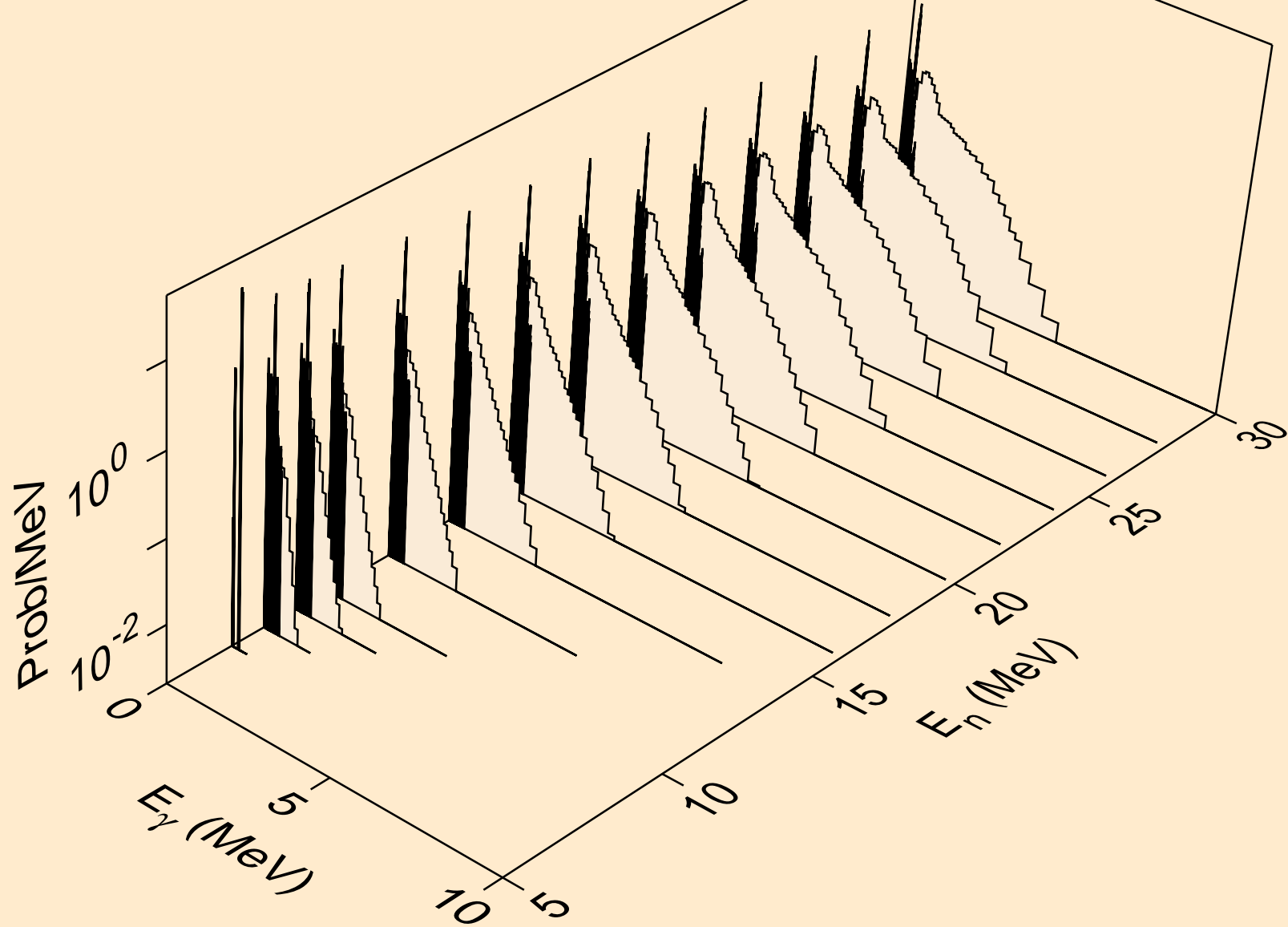

BI192 TRITON ACER TENDL-2021 LIBRARY; T=0.K  
Photon emission for (n,n\*)t

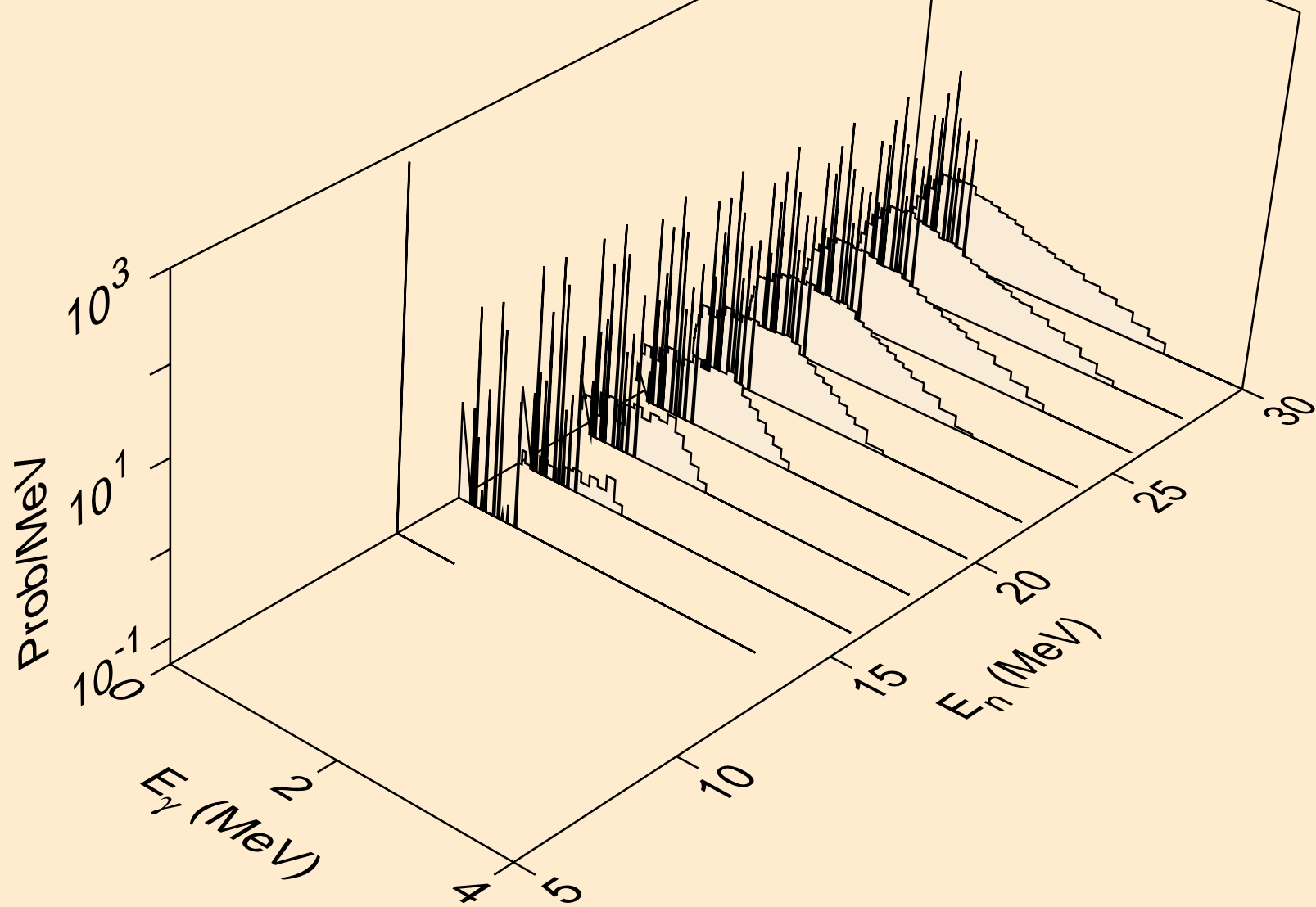

BI192 TRITON ACER TENDL-2021 LIBRARY; T=0.K  
Photon emission for (n,n\*)he3

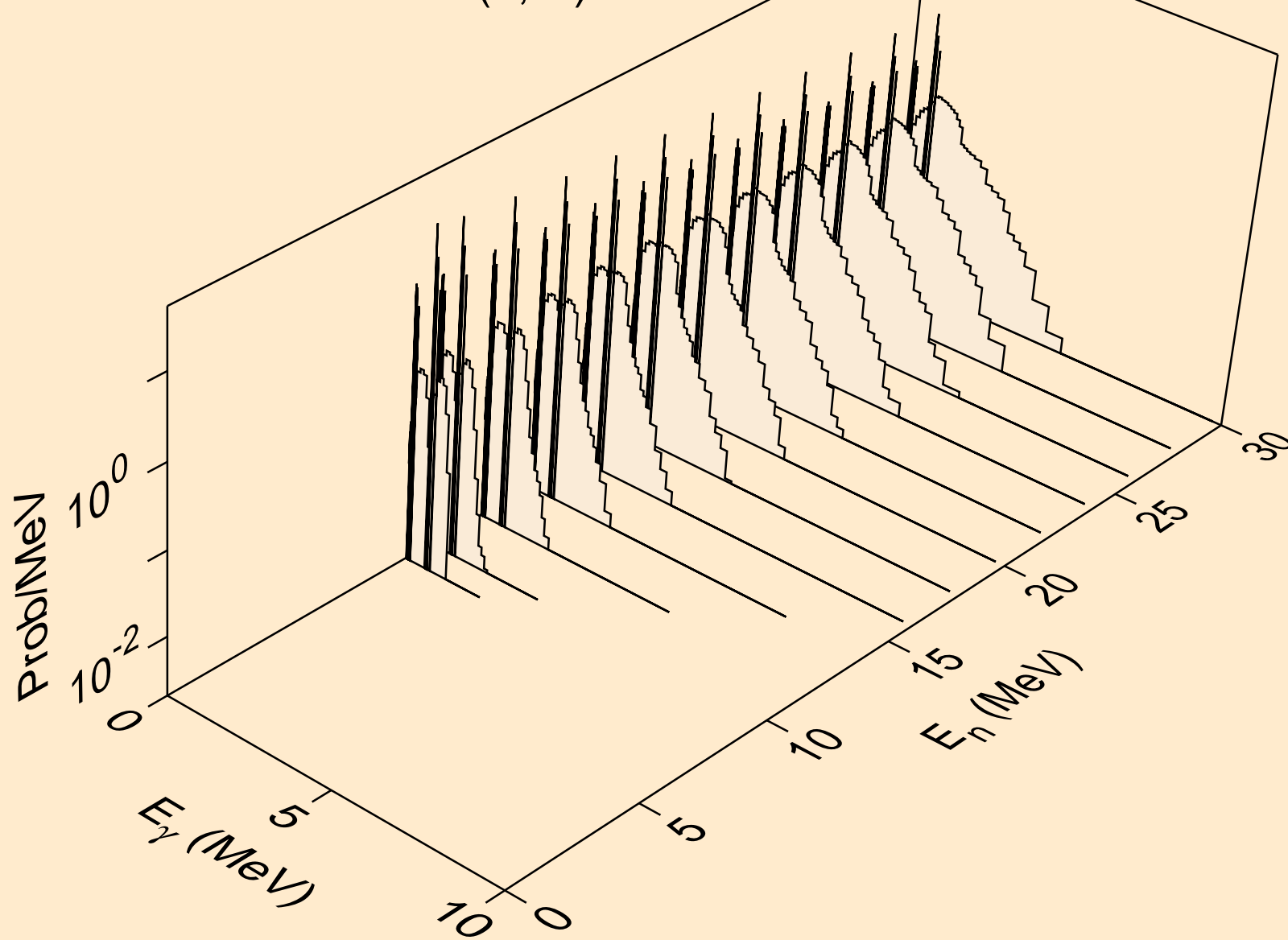

BI192 TRITON ACER TENDL-2021 LIBRARY; T=0.K  
Photon emission for (n,4n)

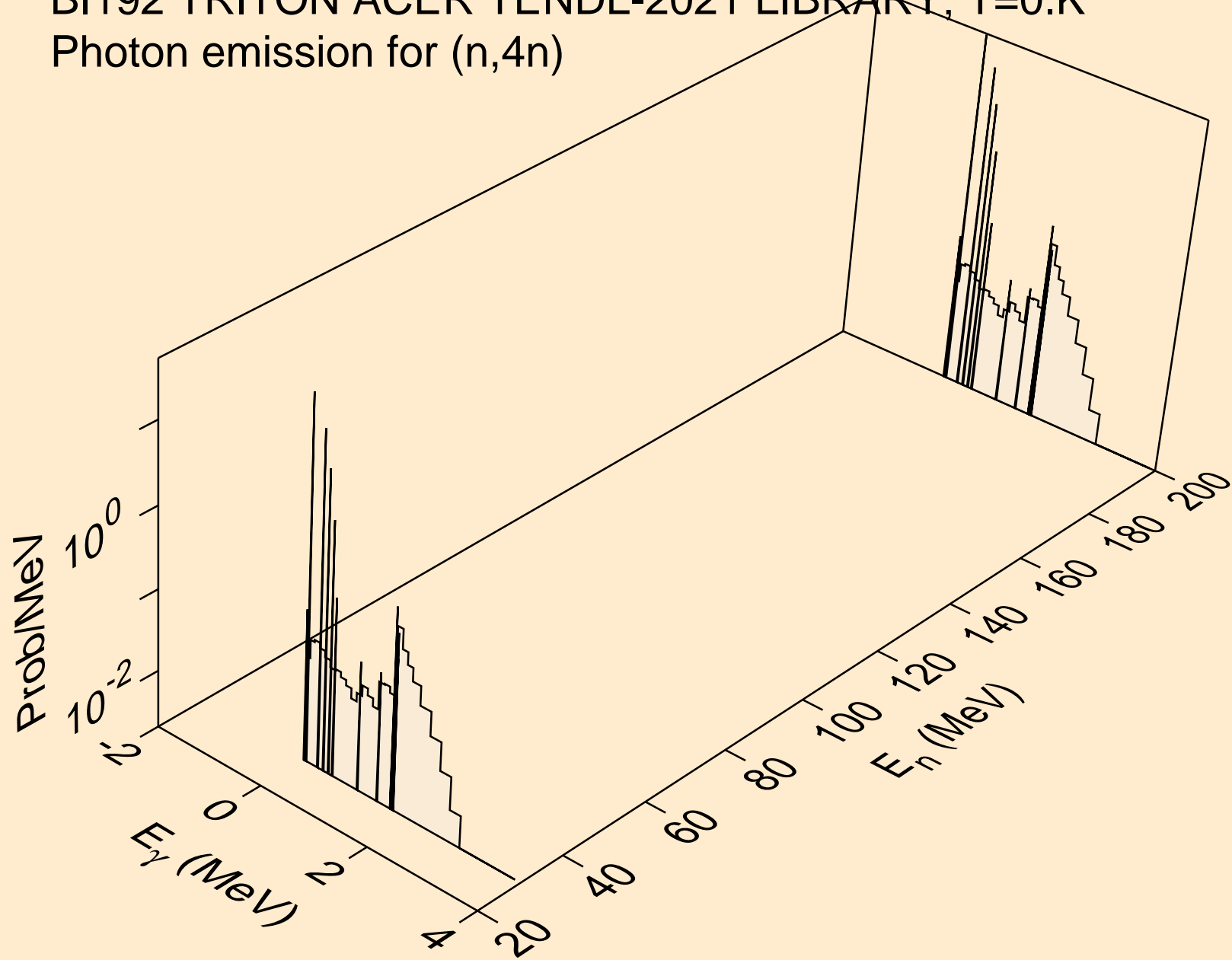

BI192 TRITON ACER TENDL-2021 LIBRARY; T=0.K  
Photon emission for (n,2np)

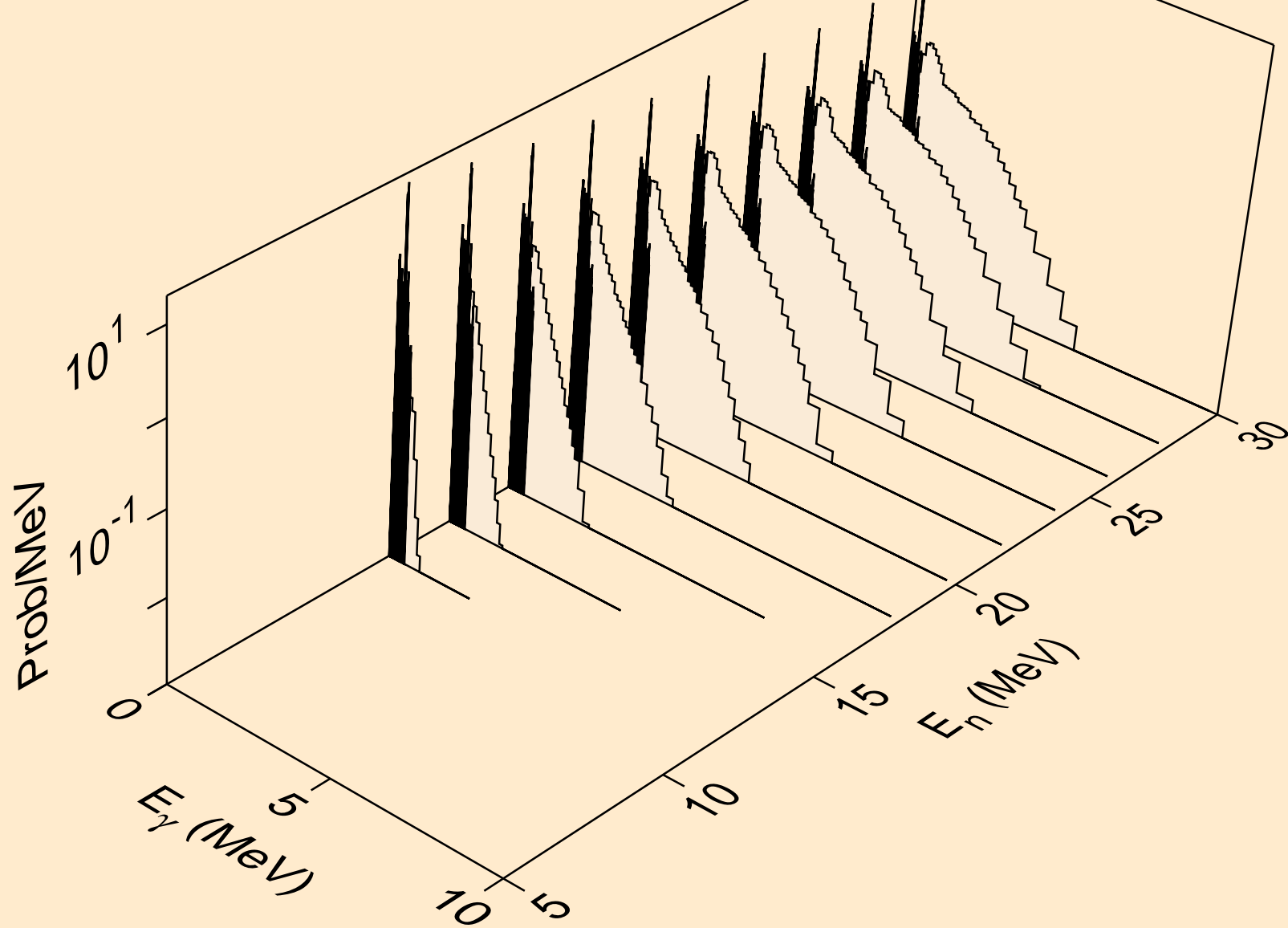

BI192 TRITON ACER TENDL-2021 LIBRARY; T=0.K  
Photon emission for (n,3np)

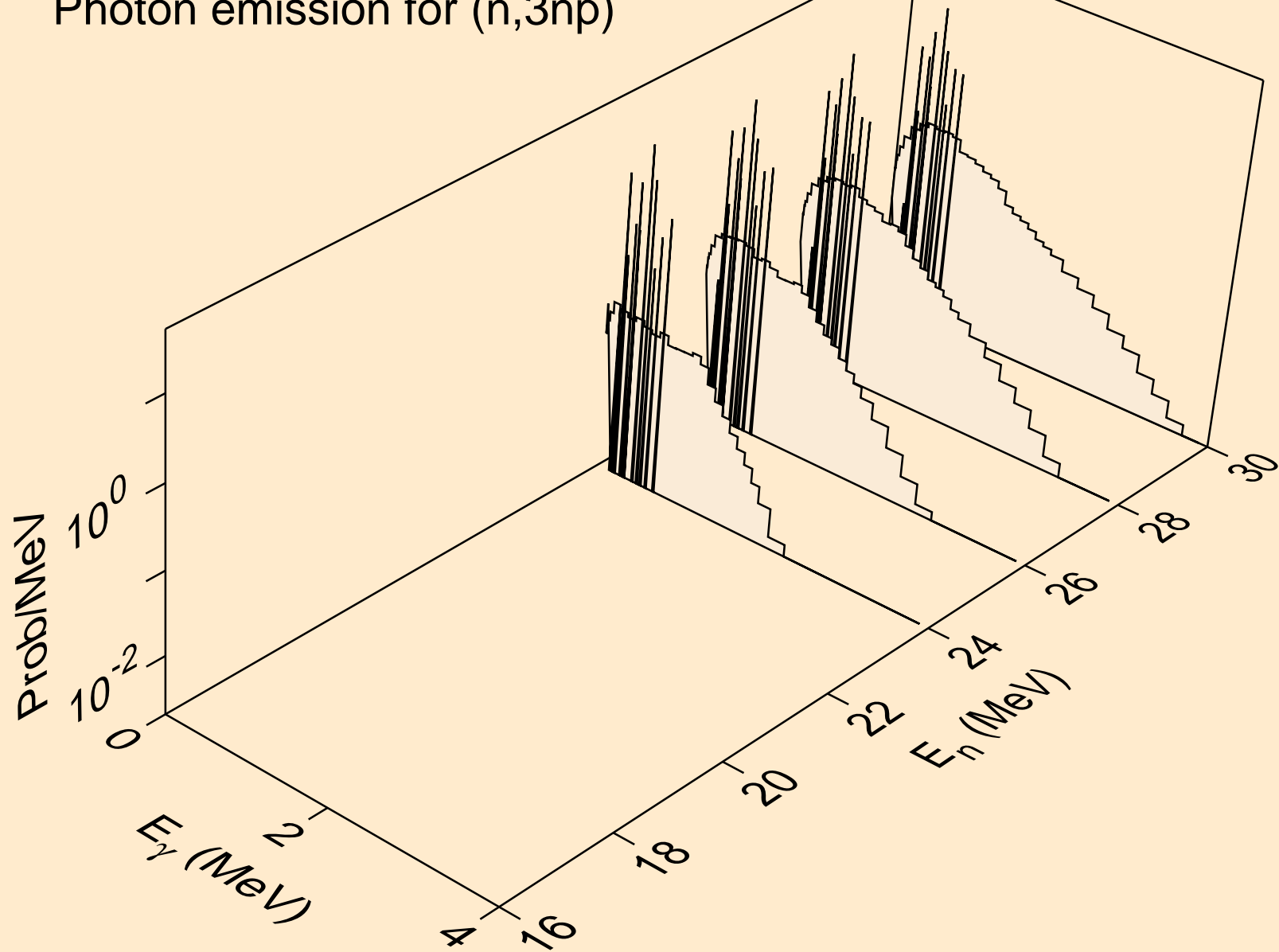

BI192 TRITON ACER TENDL-2021 LIBRARY; T=0.K  
Photon emission for (n,2np)

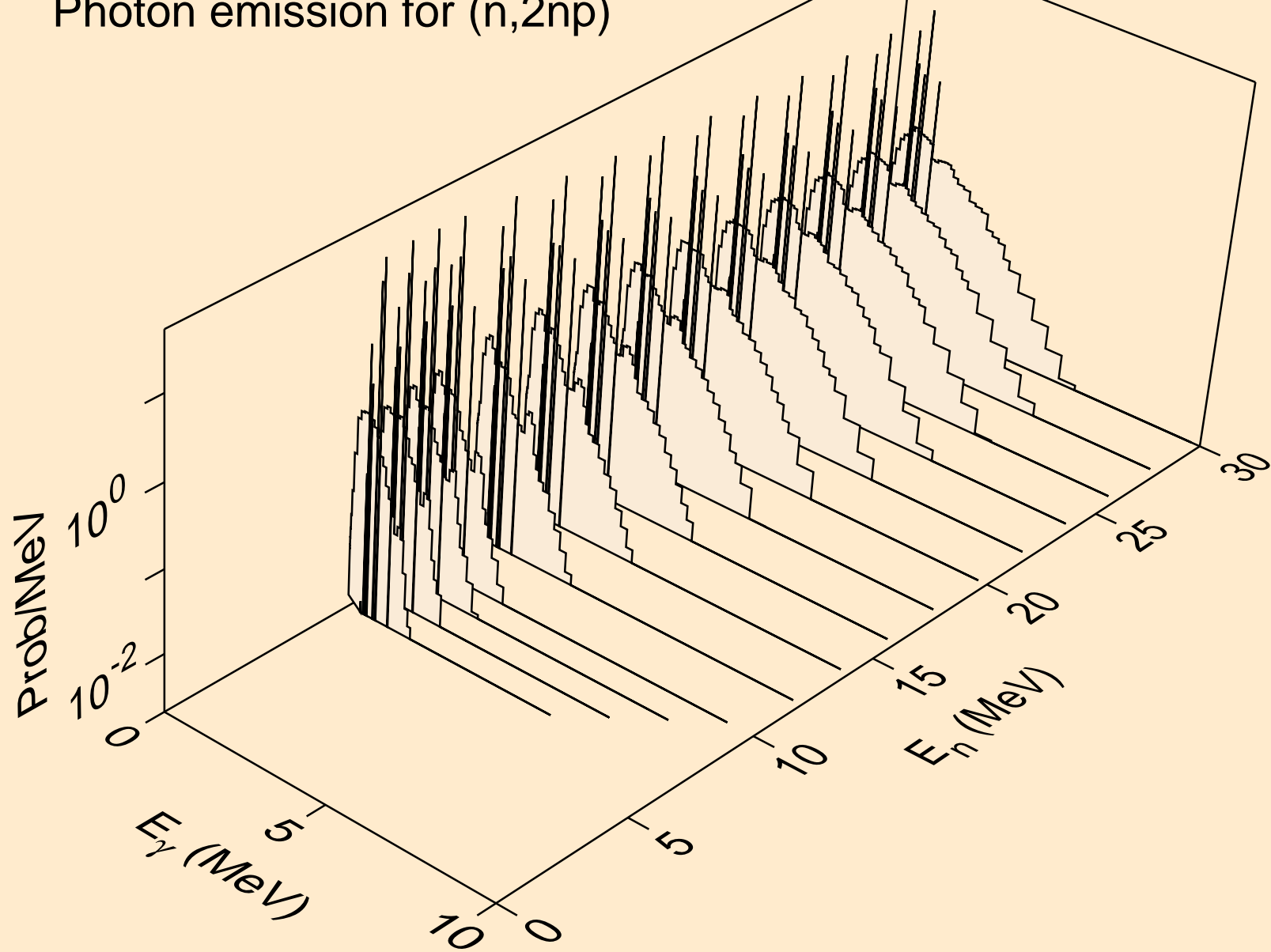

BI192 TRITON ACER TENDL-2021 LIBRARY; T=0.K  
Photon emission for (n,npa)

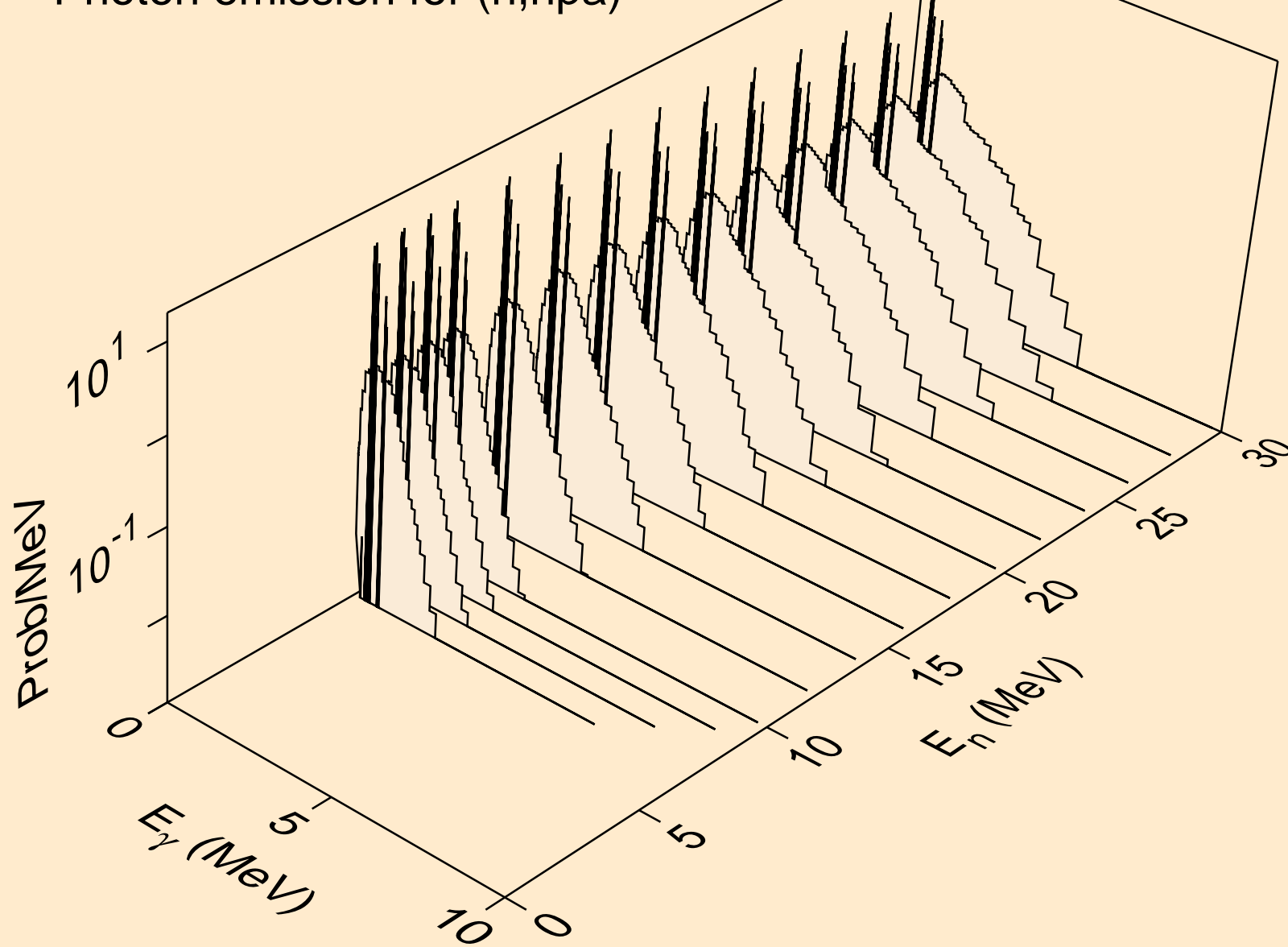



BI192 TRITON ACER TENDL-2021 LIBRARY; T=0.K  
Photon emission for (n,gma)

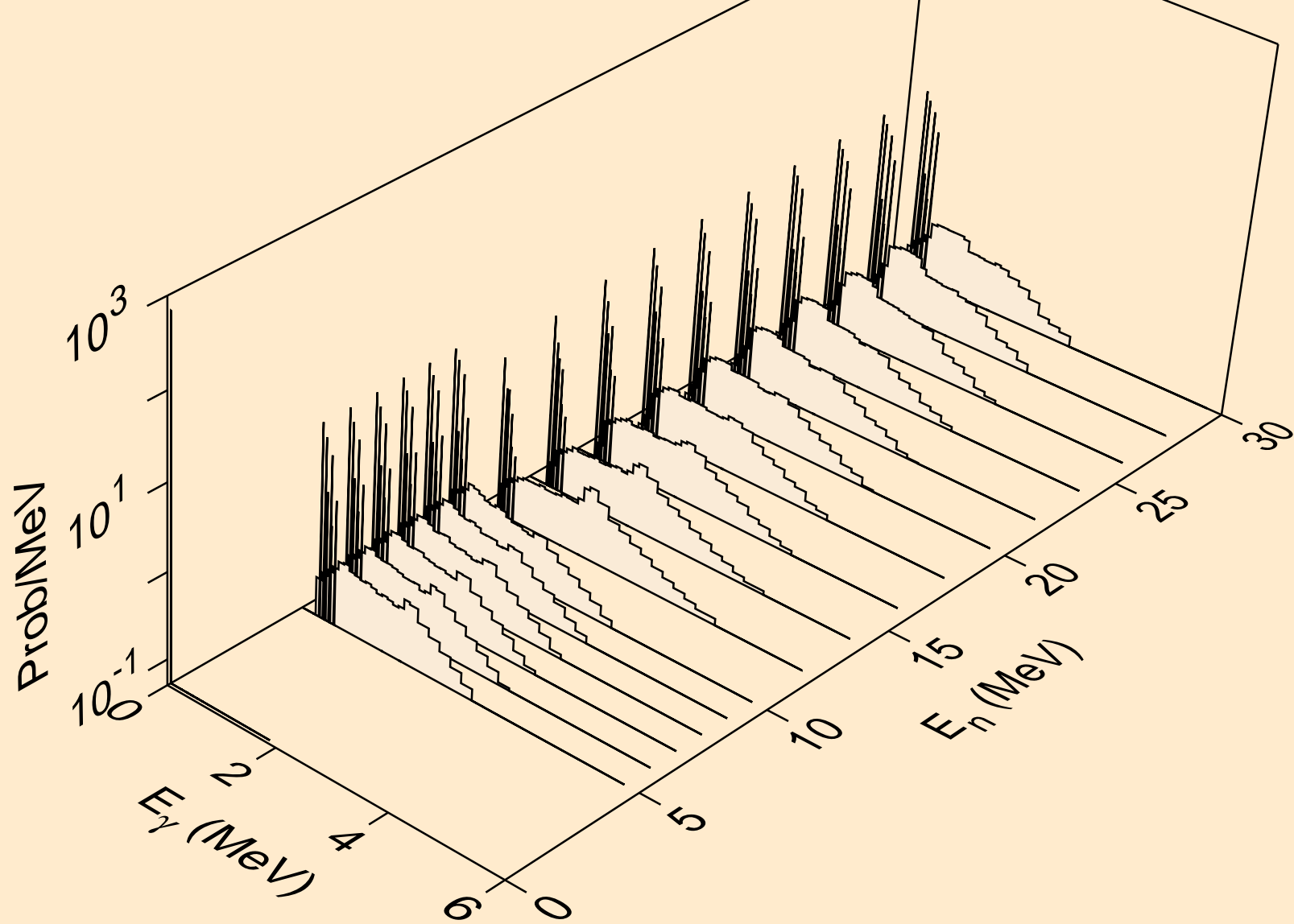

BI192 TRITON ACER TENDL-2021 LIBRARY; T=0.K  
Photon emission for (n,p)

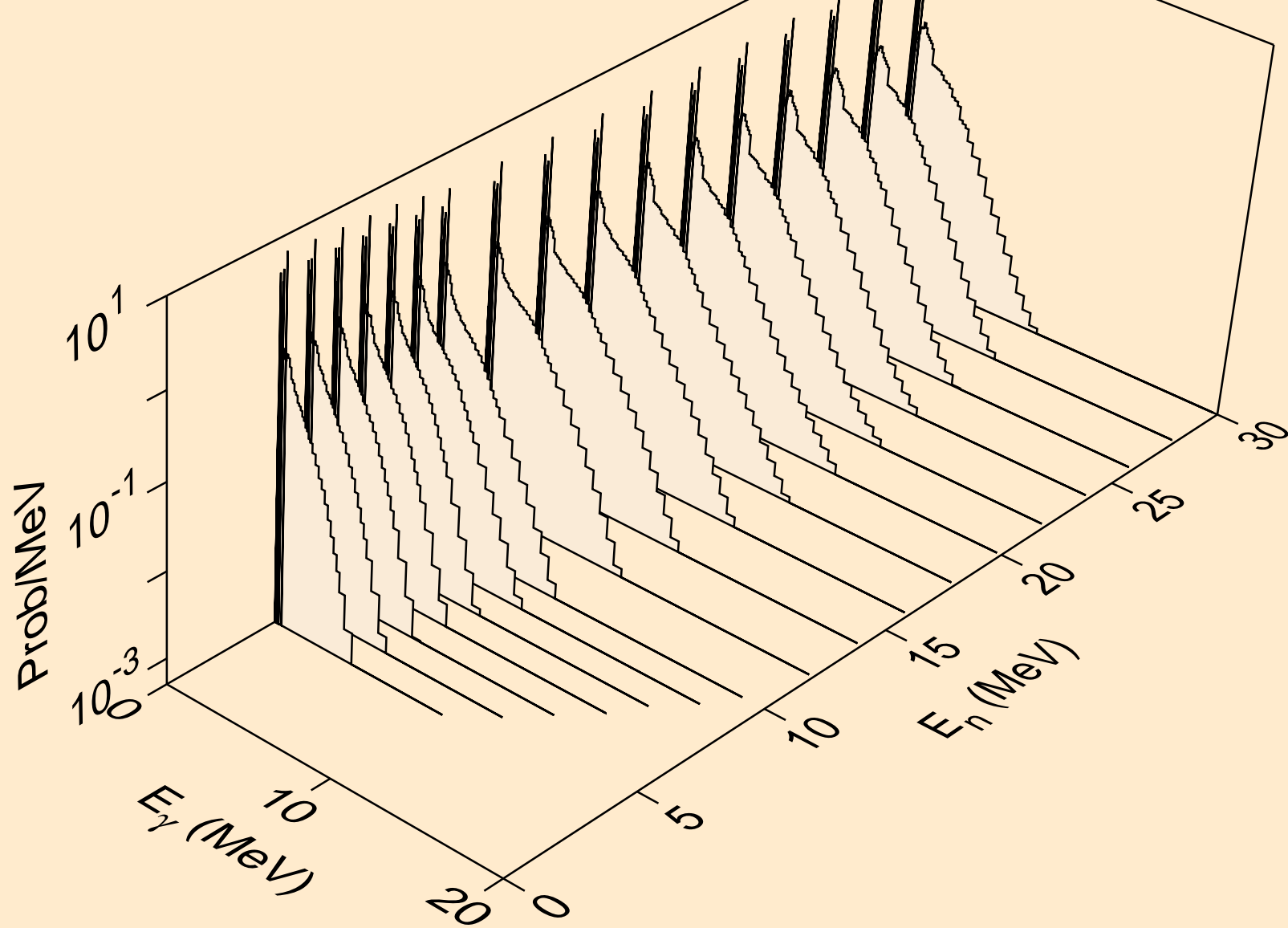

BI192 TRITON ACER TENDL-2021 LIBRARY; T=0.K  
Photon emission for (n,d)

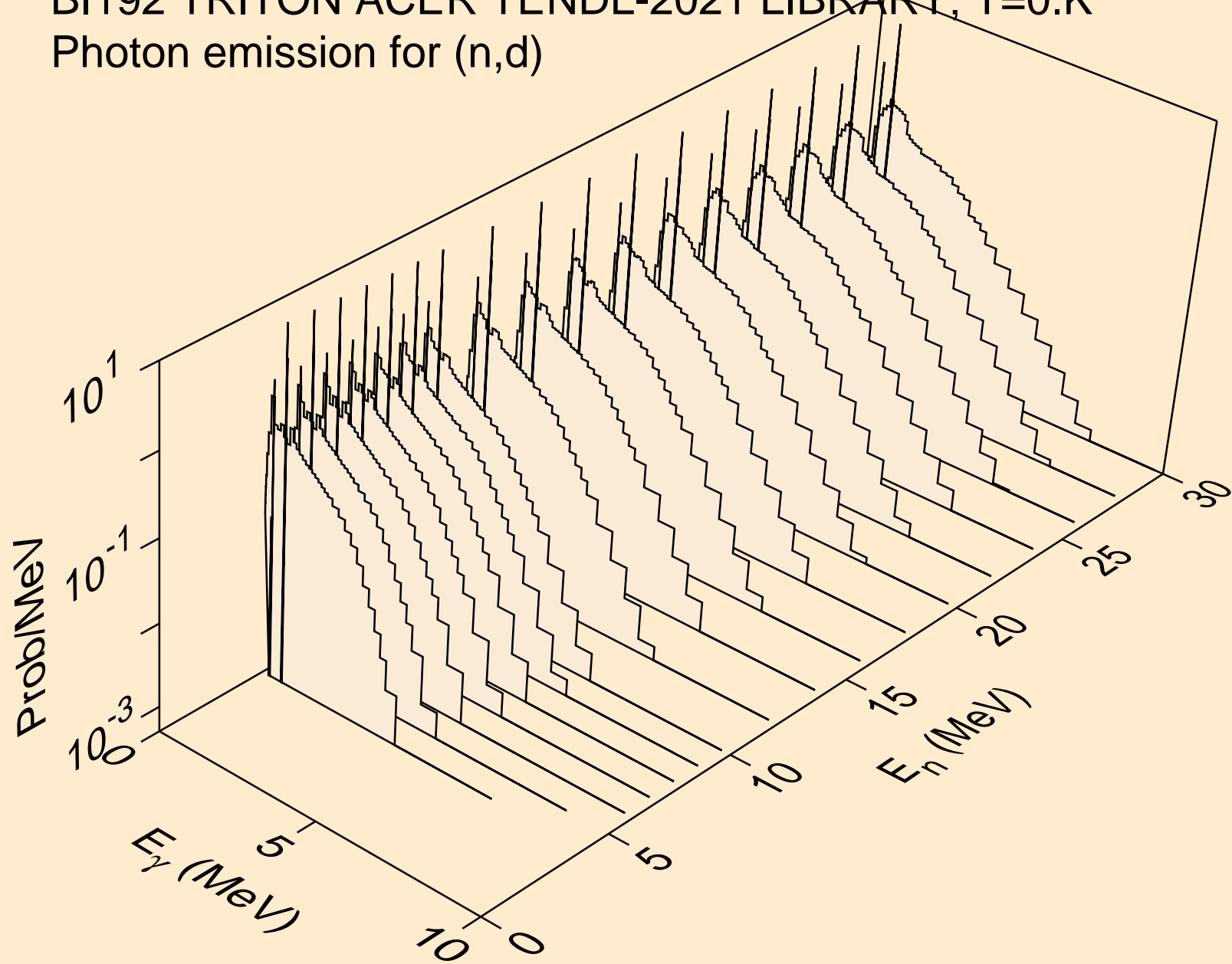

BI192 TRITON ACER TENDL-2021 LIBRARY; T=0.K  
Photon emission for inelastic

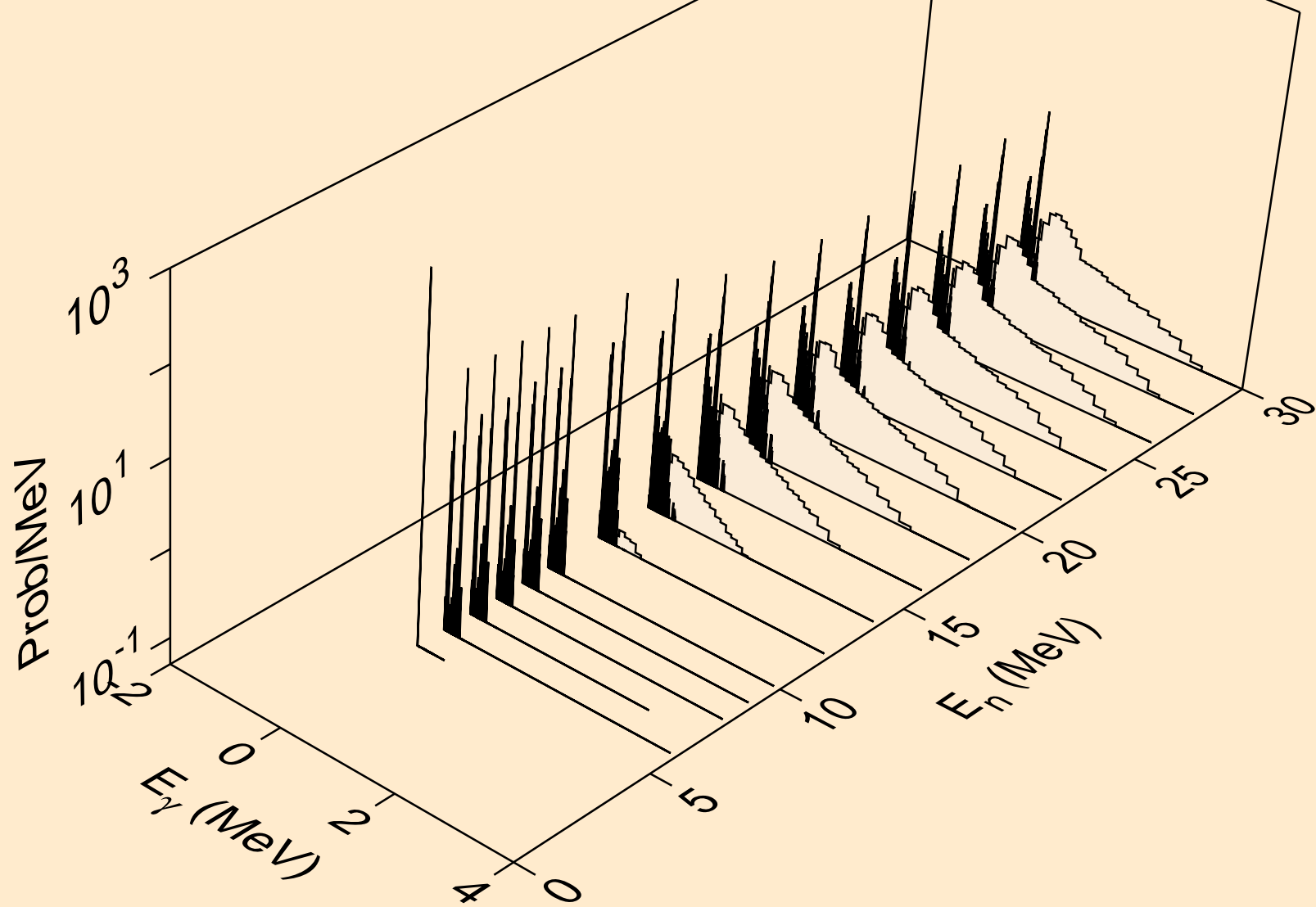

BI192 TRITON ACER TENDL-2021 LIBRARY; T=0.K  
Photon emission for (n,he3)

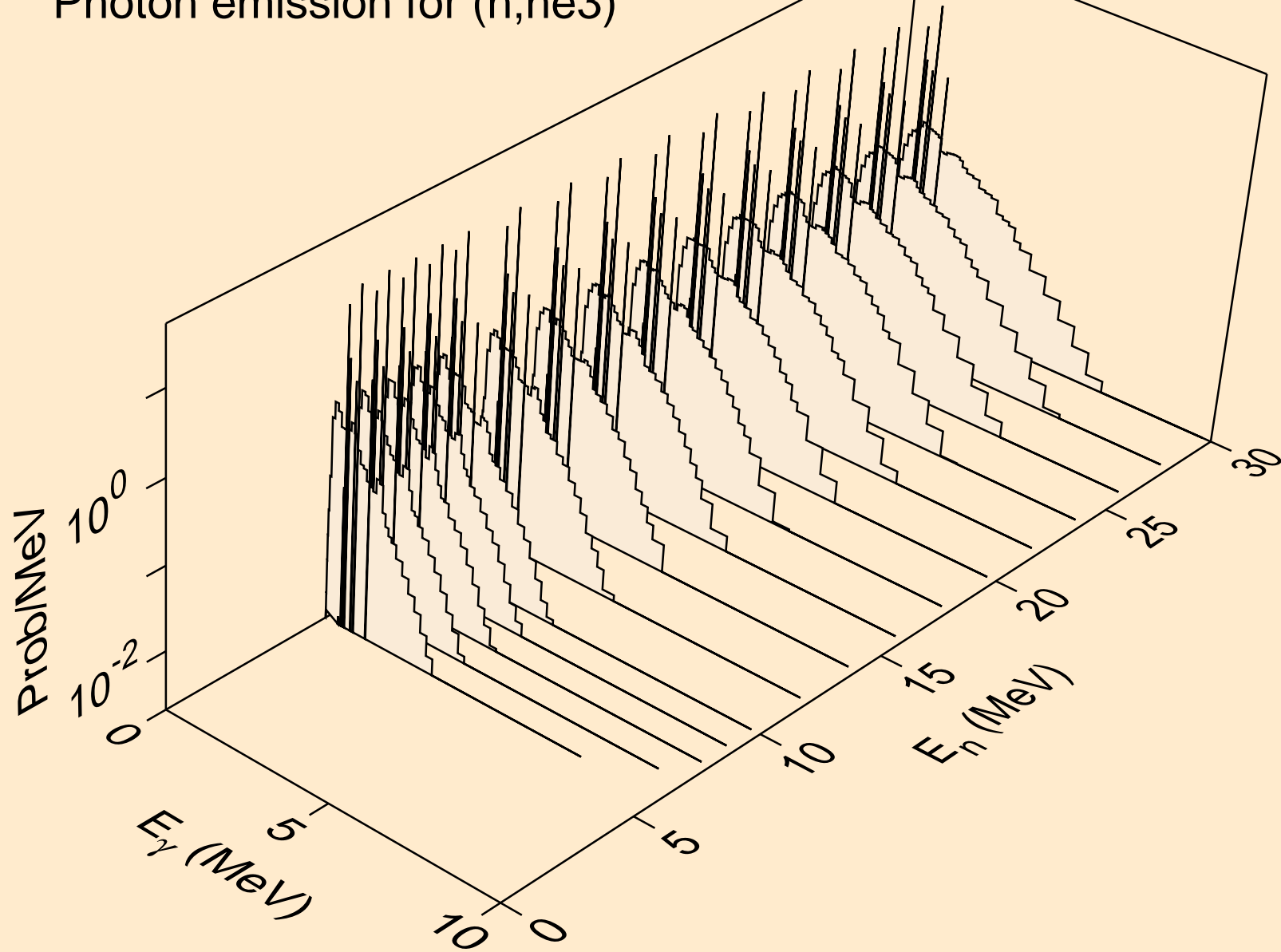

BI192 TRITON ACER TENDL-2021 LIBRARY; T=0.K  
Photon emission for (n,a)

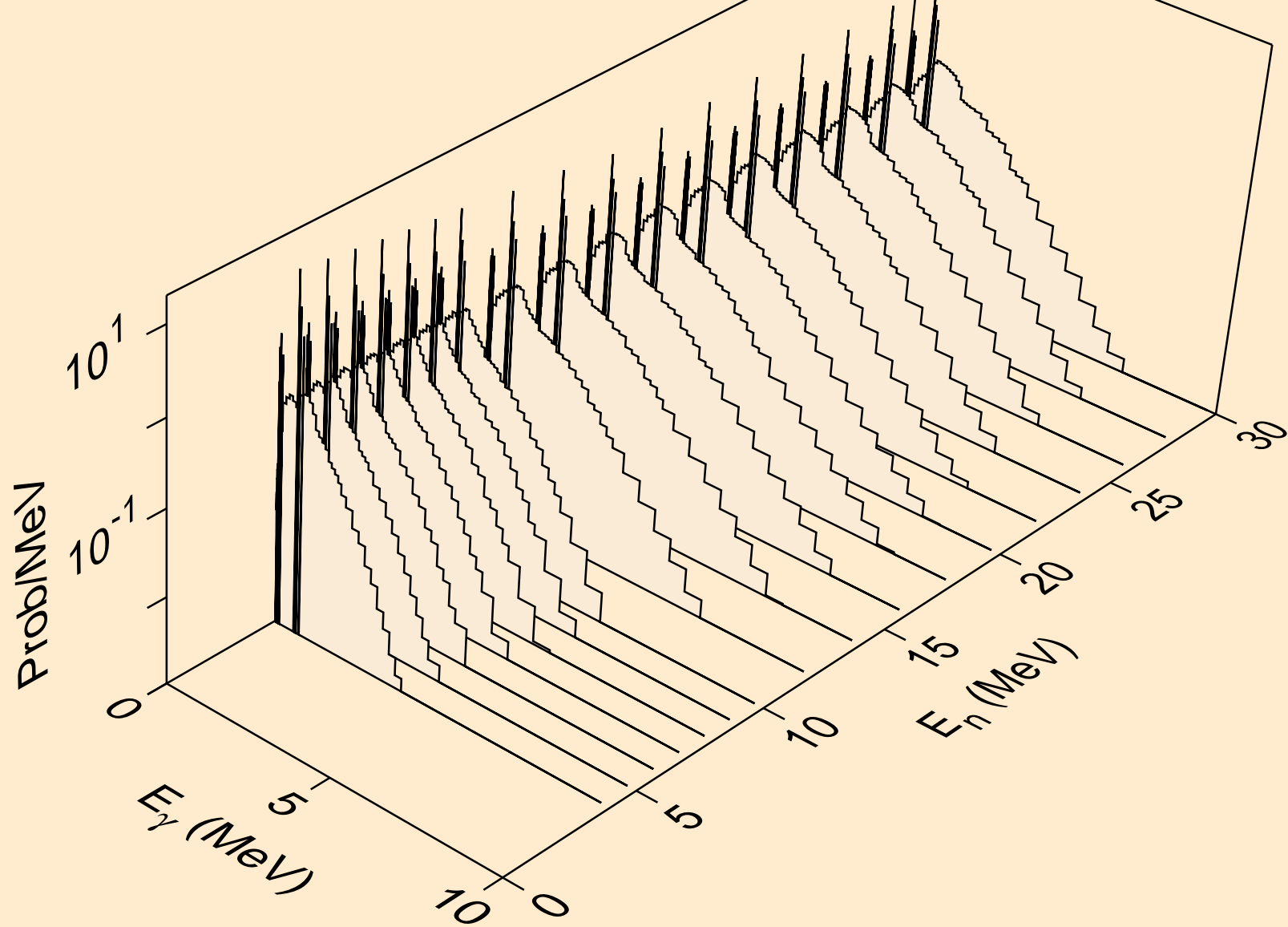

BI192 TRITON ACER TENDL-2021 LIBRARY; T=0.K  
Photon emission for (n,2a)

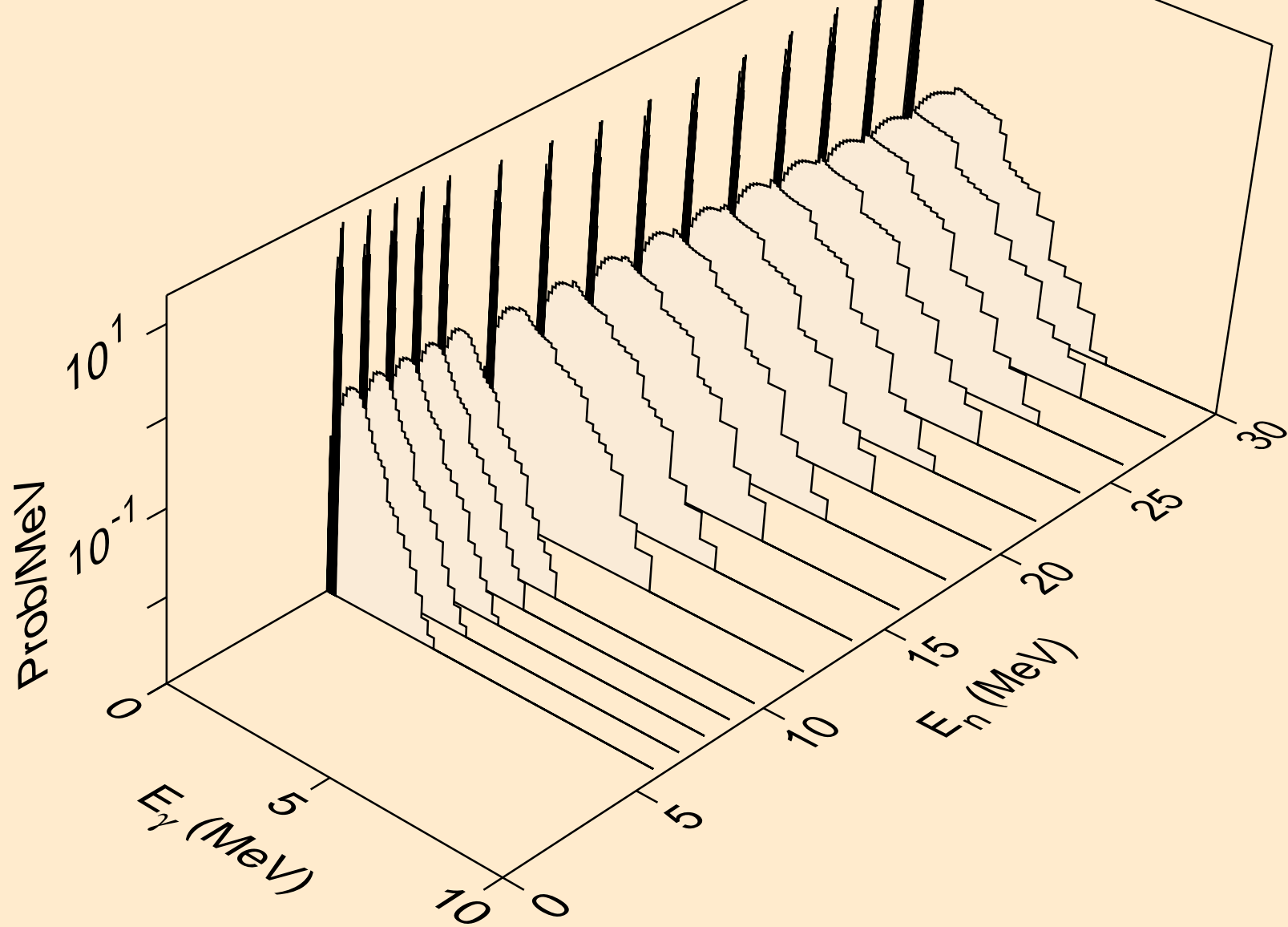

BI192 TRITON ACER TENDL-2021 LIBRARY; T=0.K  
Photon emission for (n,3a)

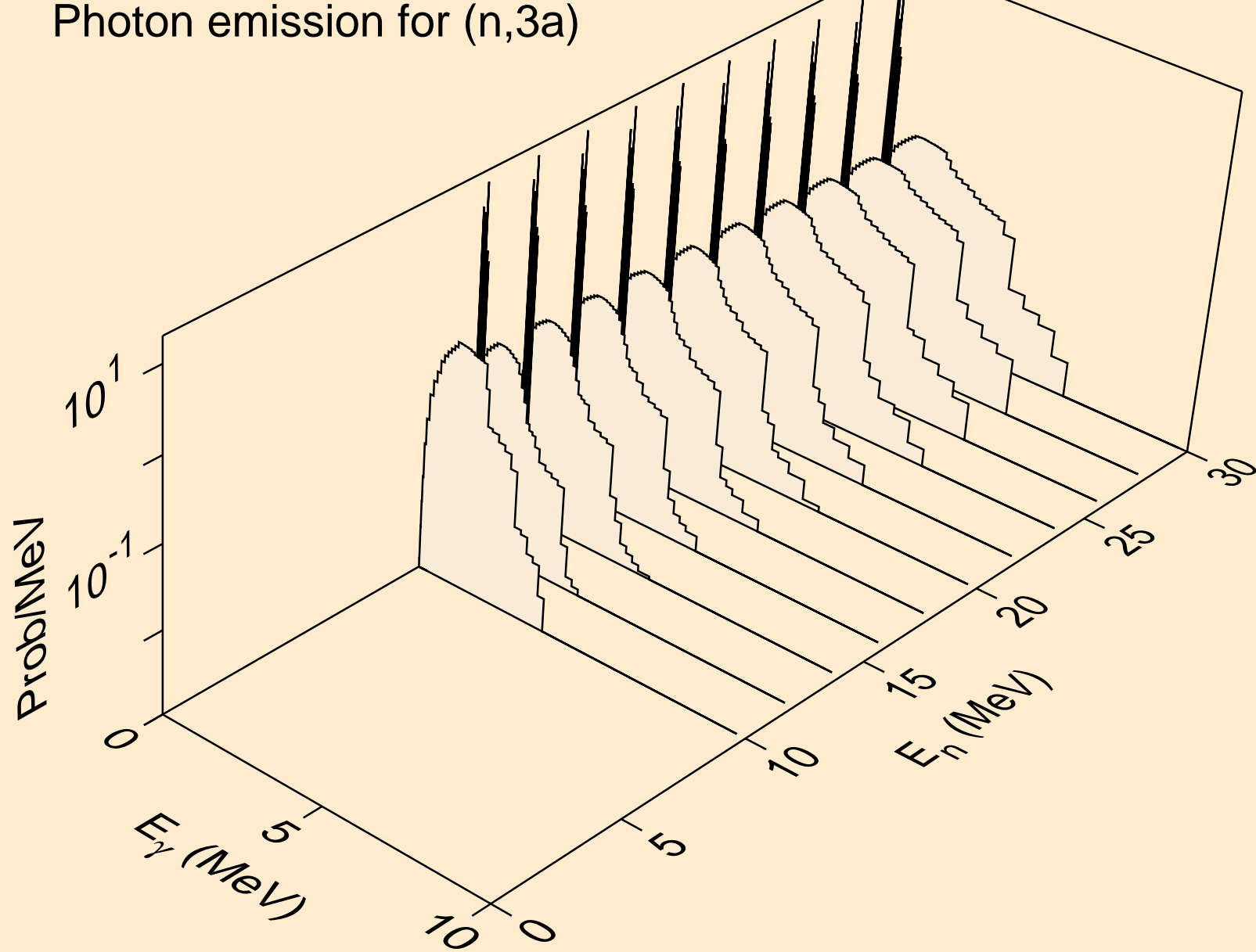



BI192 TRITON ACER TENDL-2021 LIBRARY; T=0.K  
Photon emission for (n,2p)

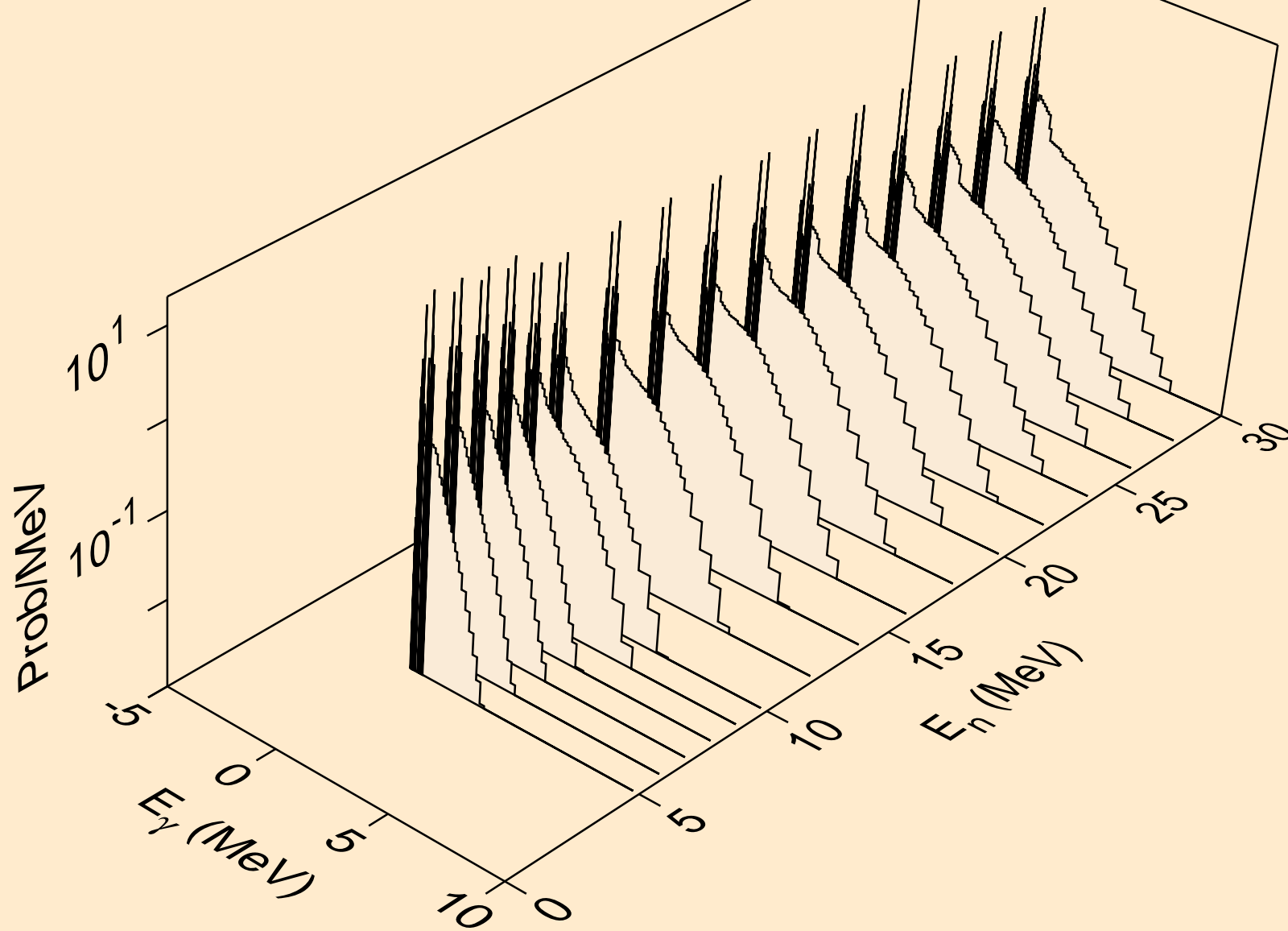

BI192 TRITON ACER TENDL-2021 LIBRARY; T=0.K  
Photon emission for (n,pa)

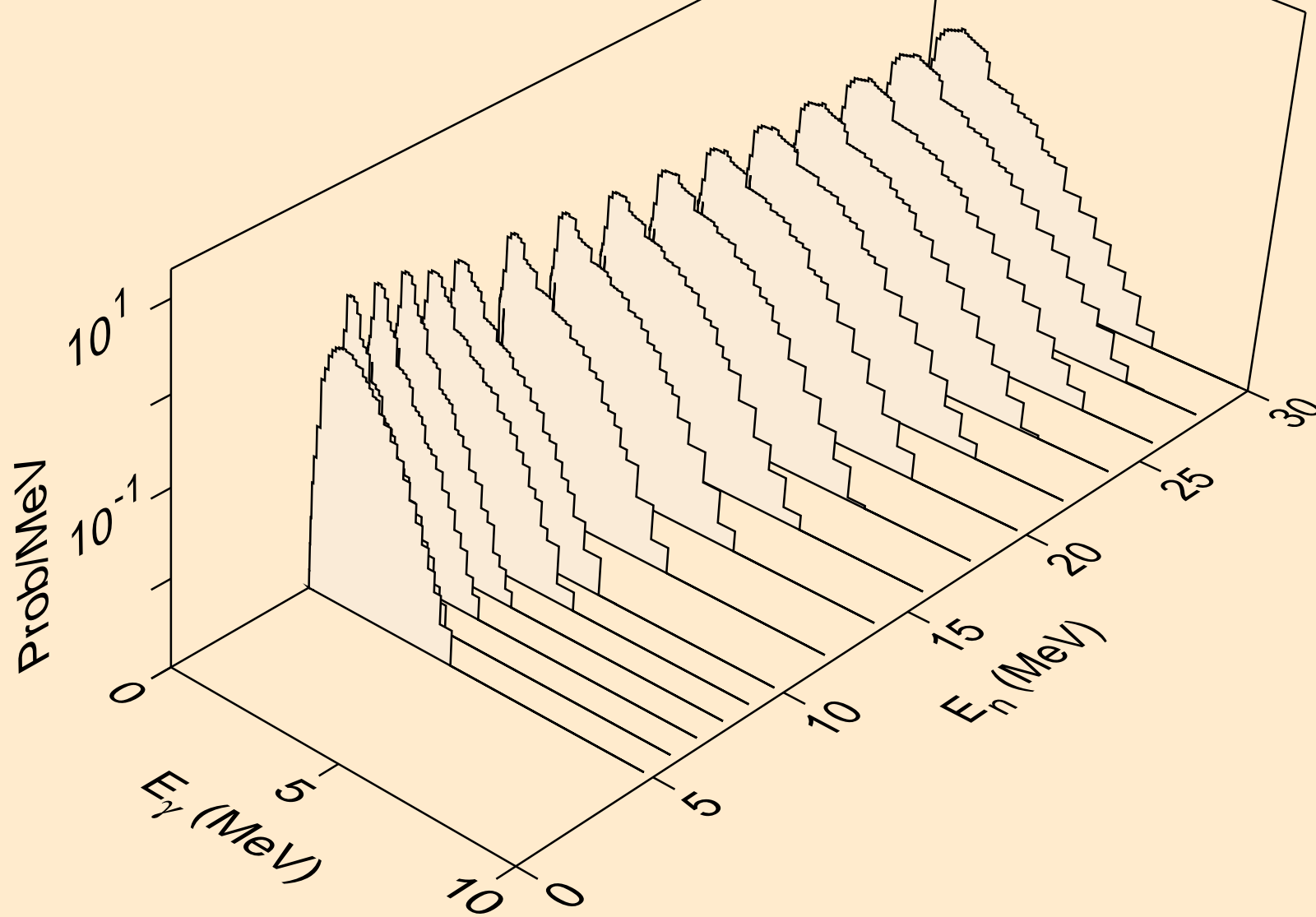

BI192 TRITON ACER TENDL-2021 LIBRARY; T=0.K  
Photon emission for (n,d2a)

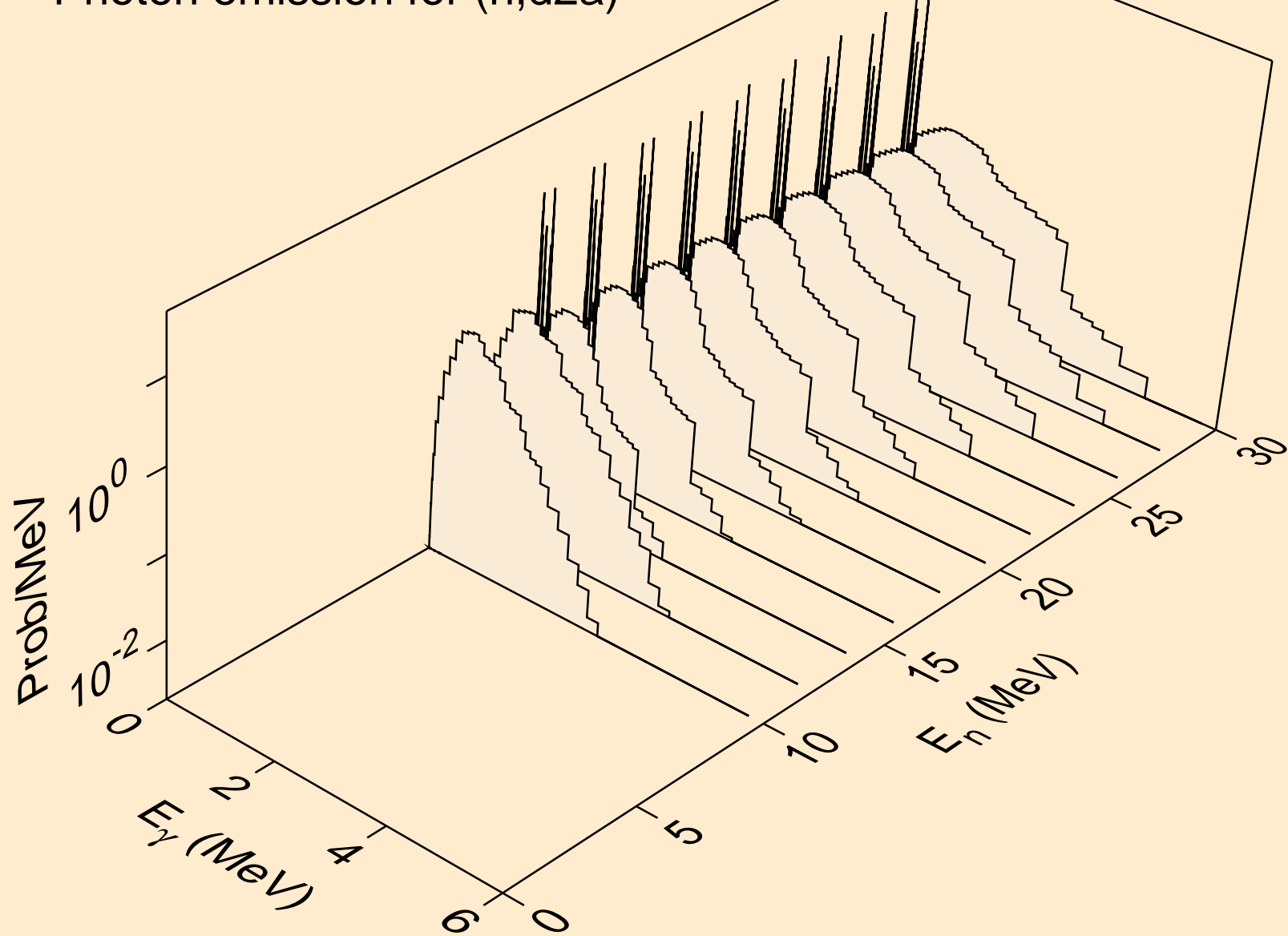

BI192 TRITON ACER TENDL-2021 LIBRARY; T=0.K  
Photon emission for (n,pd)

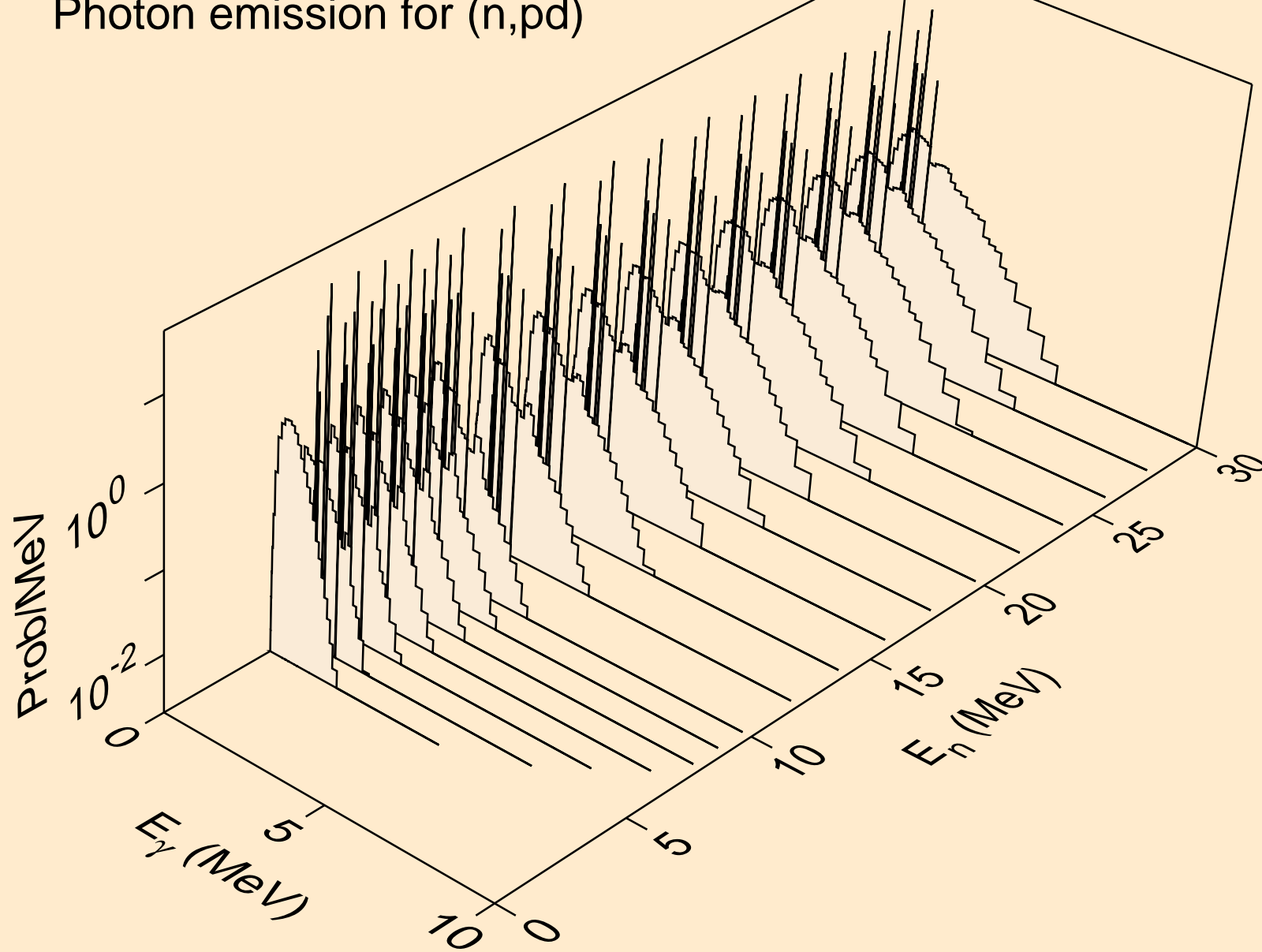

BI192 TRITON ACER TENDL-2021 LIBRARY; T=0.K  
Photon emission for (n,pt)

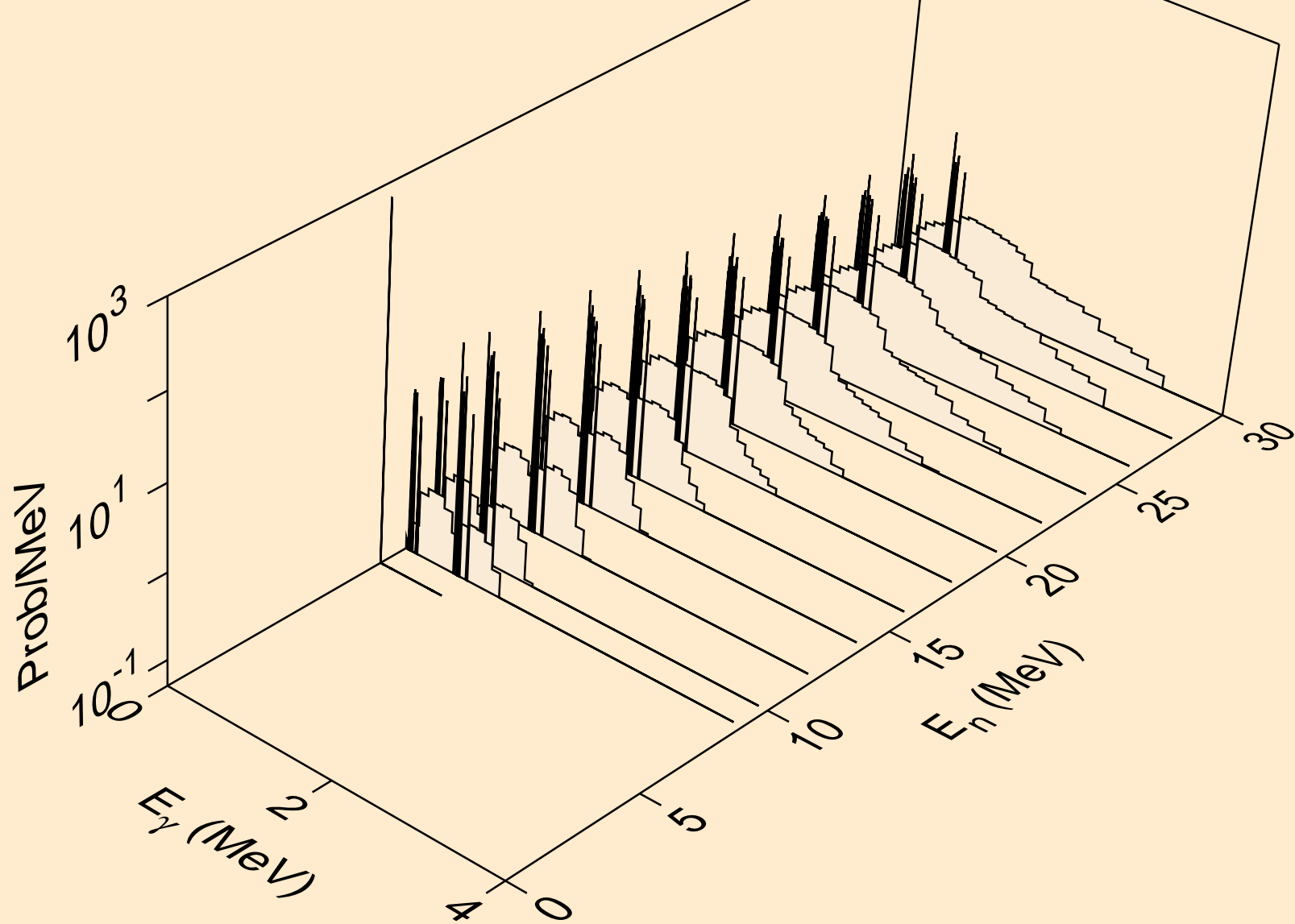

BI192 TRITON ACER TENDL-2021 LIBRARY; T=0.K  
Photon emission for (n,da)

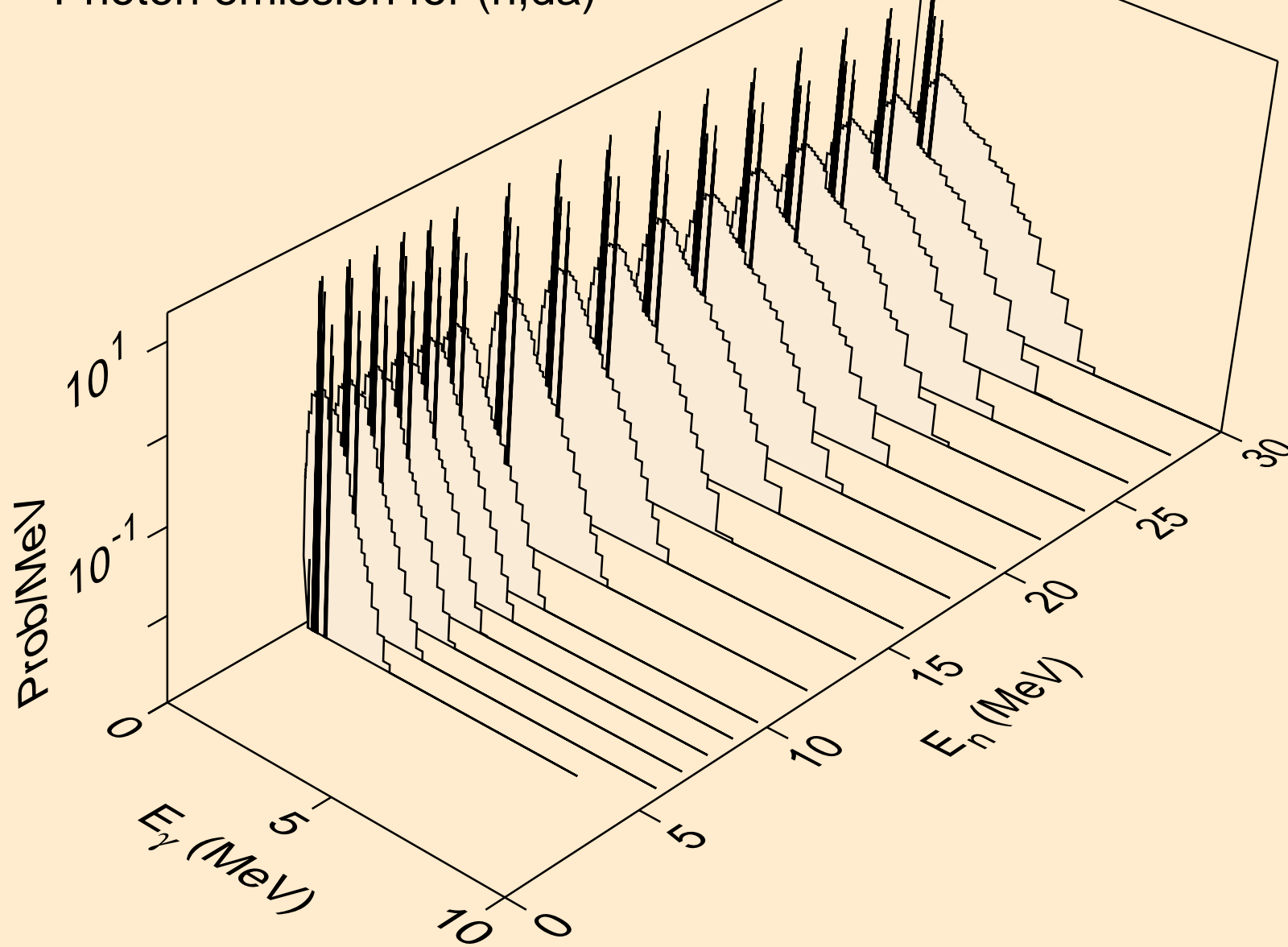

BI192 TRITON ACER TENDL-2021 LIBRARY; T=0.K  
Particle heating contributions

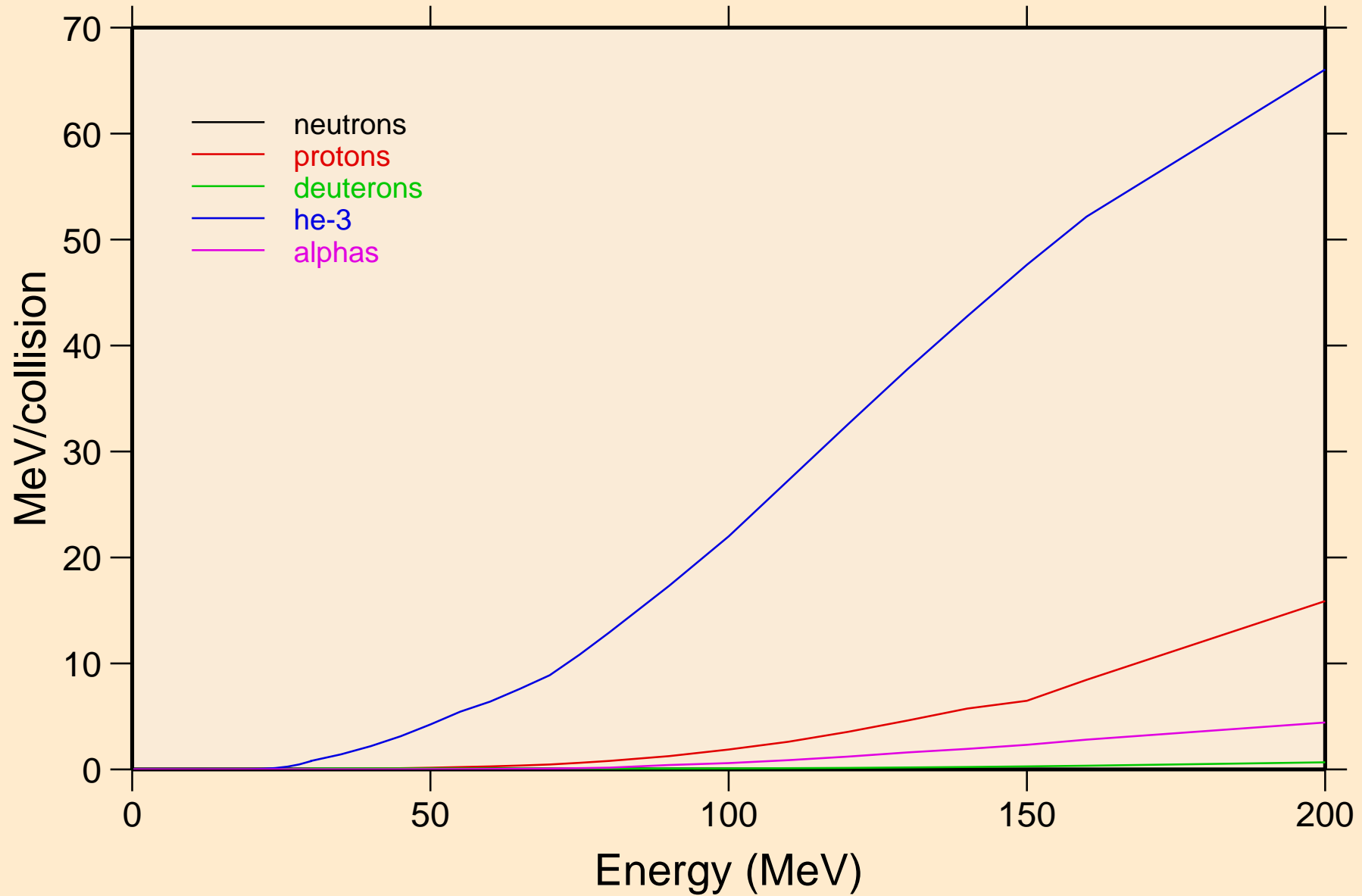

BI192 TRITON ACER TENDL-2021 LIBRARY; T=0.K  
Recoil Heating

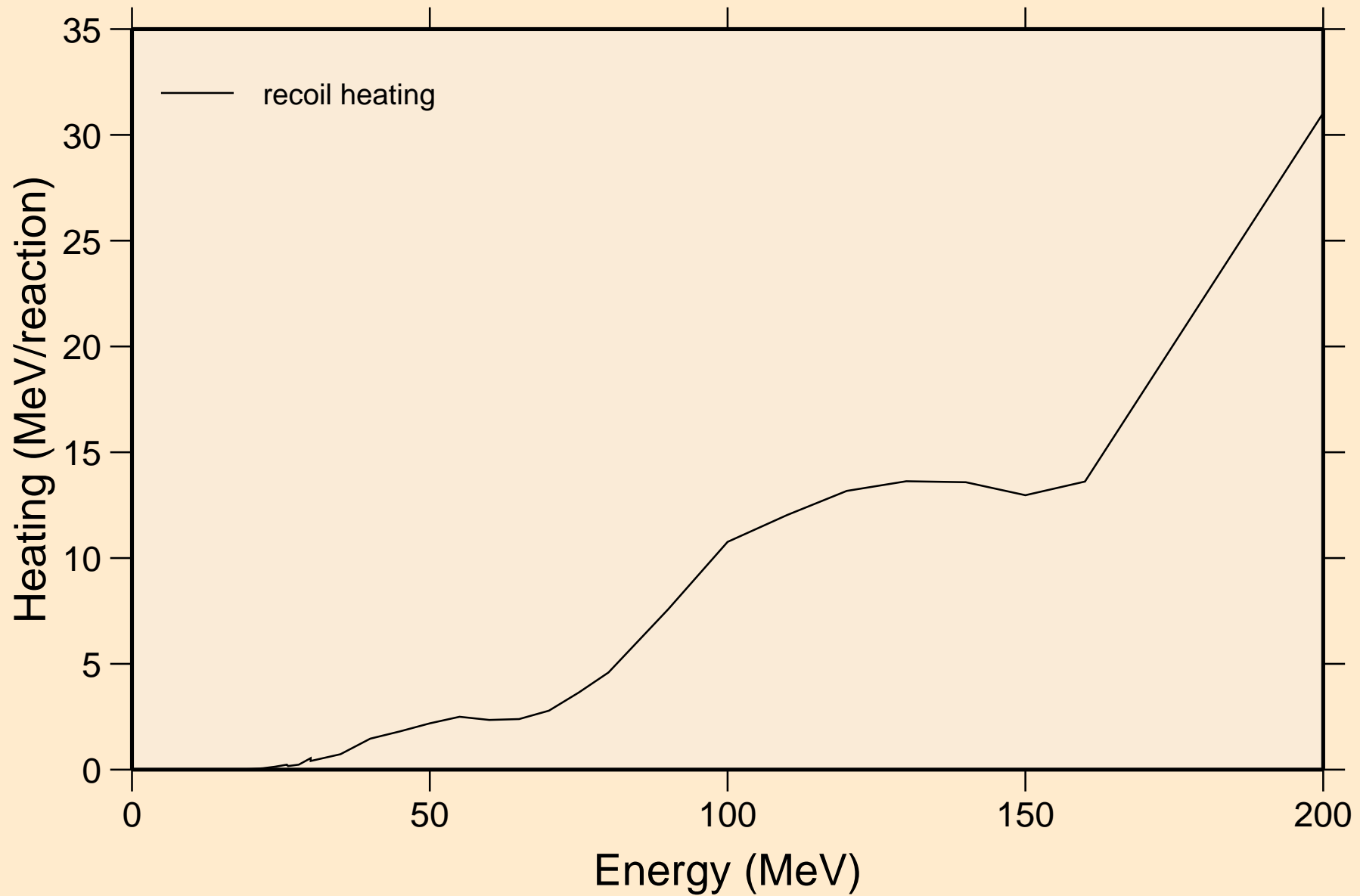



BI192 TRITON ACER TENDL-2021 LIBRARY; T=0.K  
Particle production cross sections

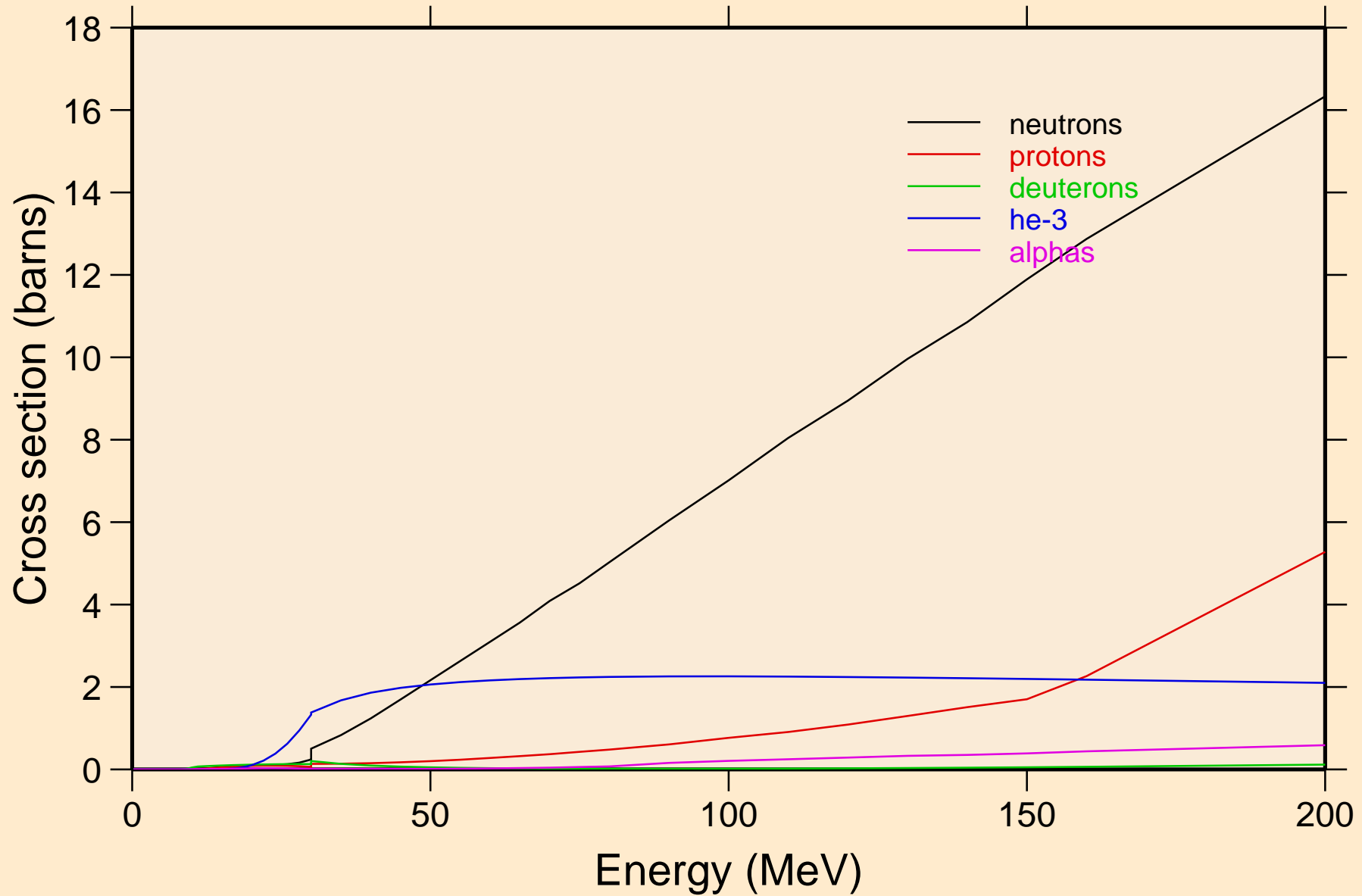

BI192 TRITON ACER TENDL-2021 LIBRARY; T=0.K  
neutrons from (t,n)

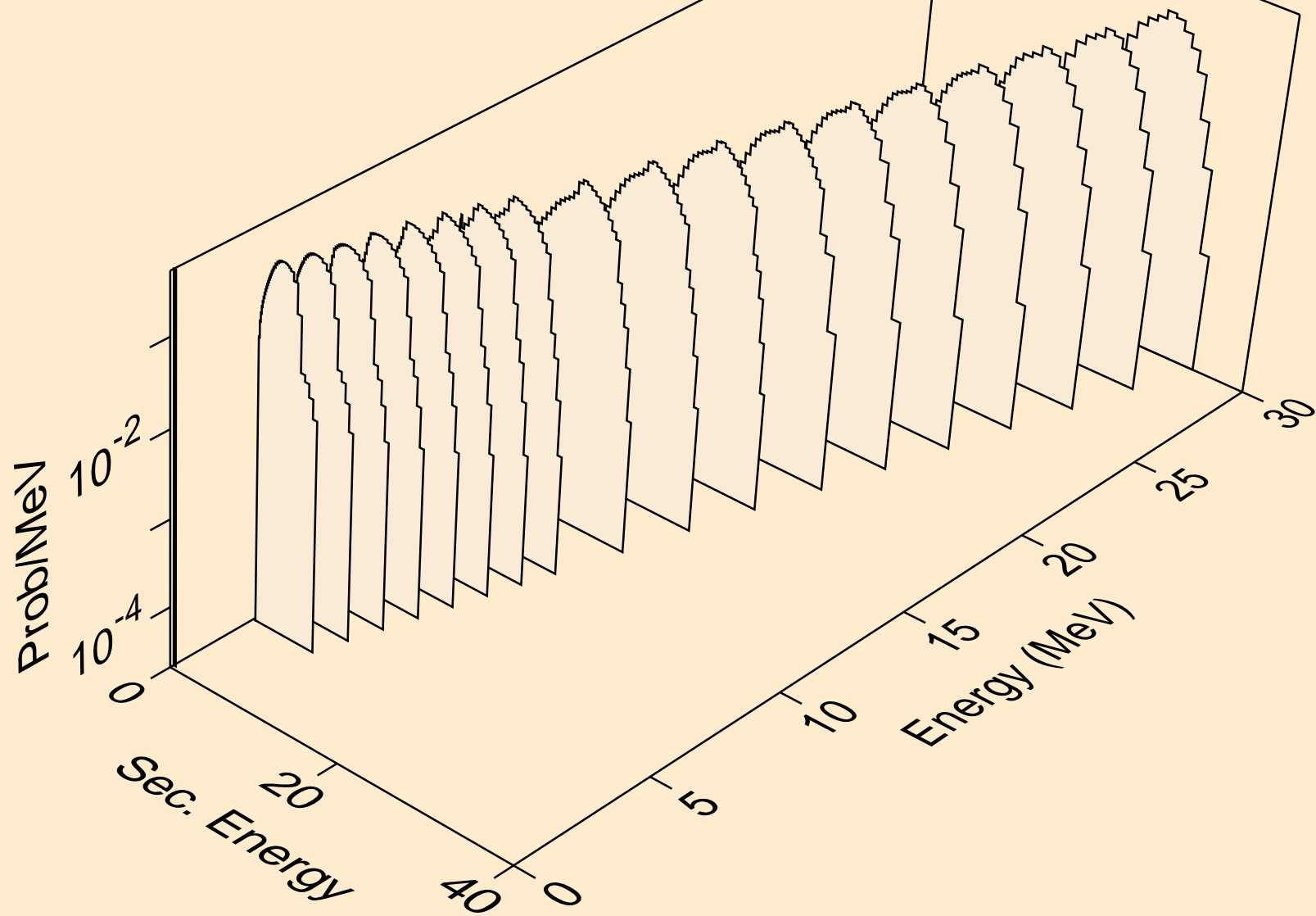

BI192 TRITON ACER TENDL-2021 LIBRARY; T=0.K  
neutrons from (t,x)

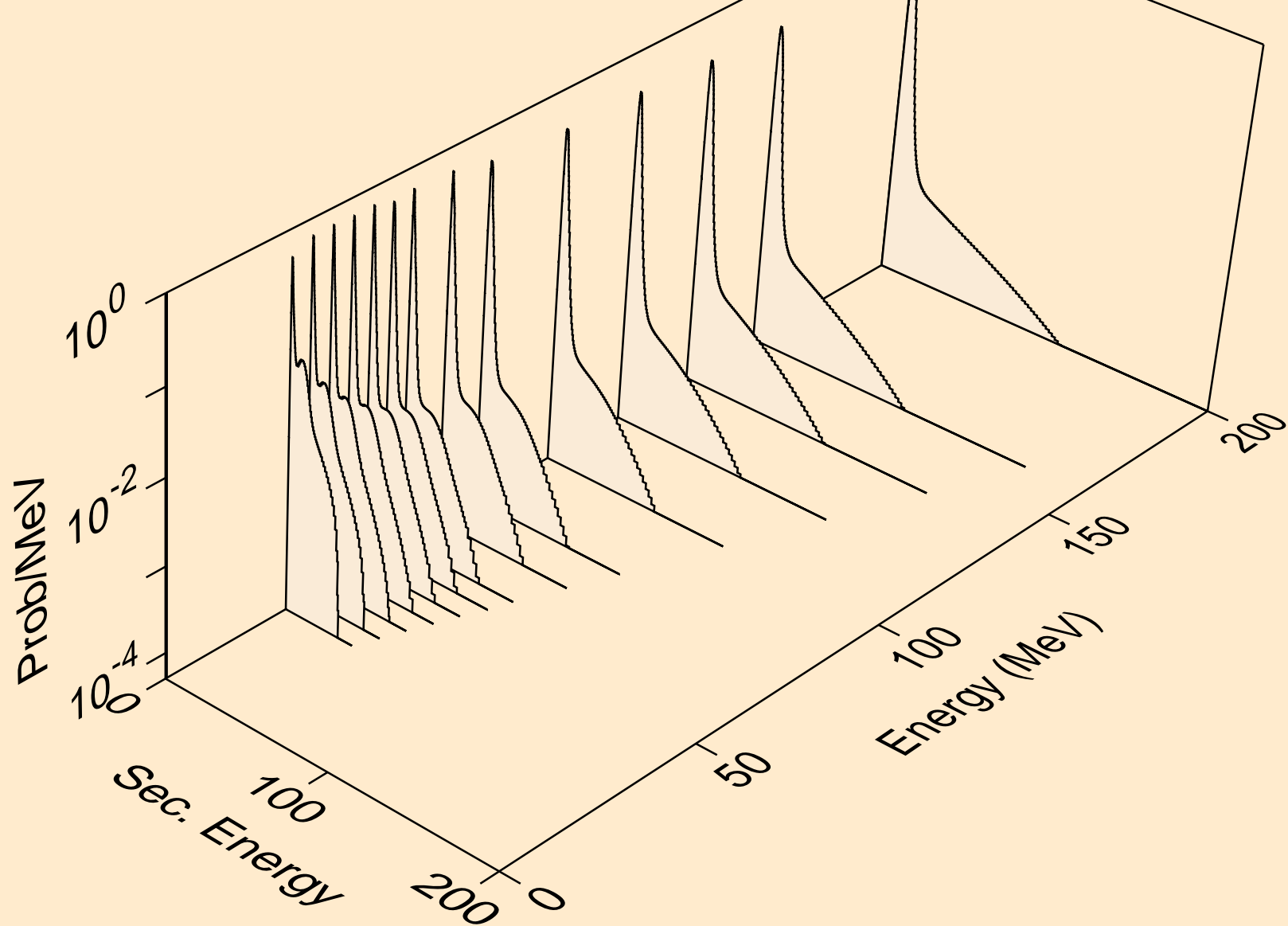

BI192 TRITON ACER TENDL-2021 LIBRARY; T=0.K  
neutrons from (t,2nd)

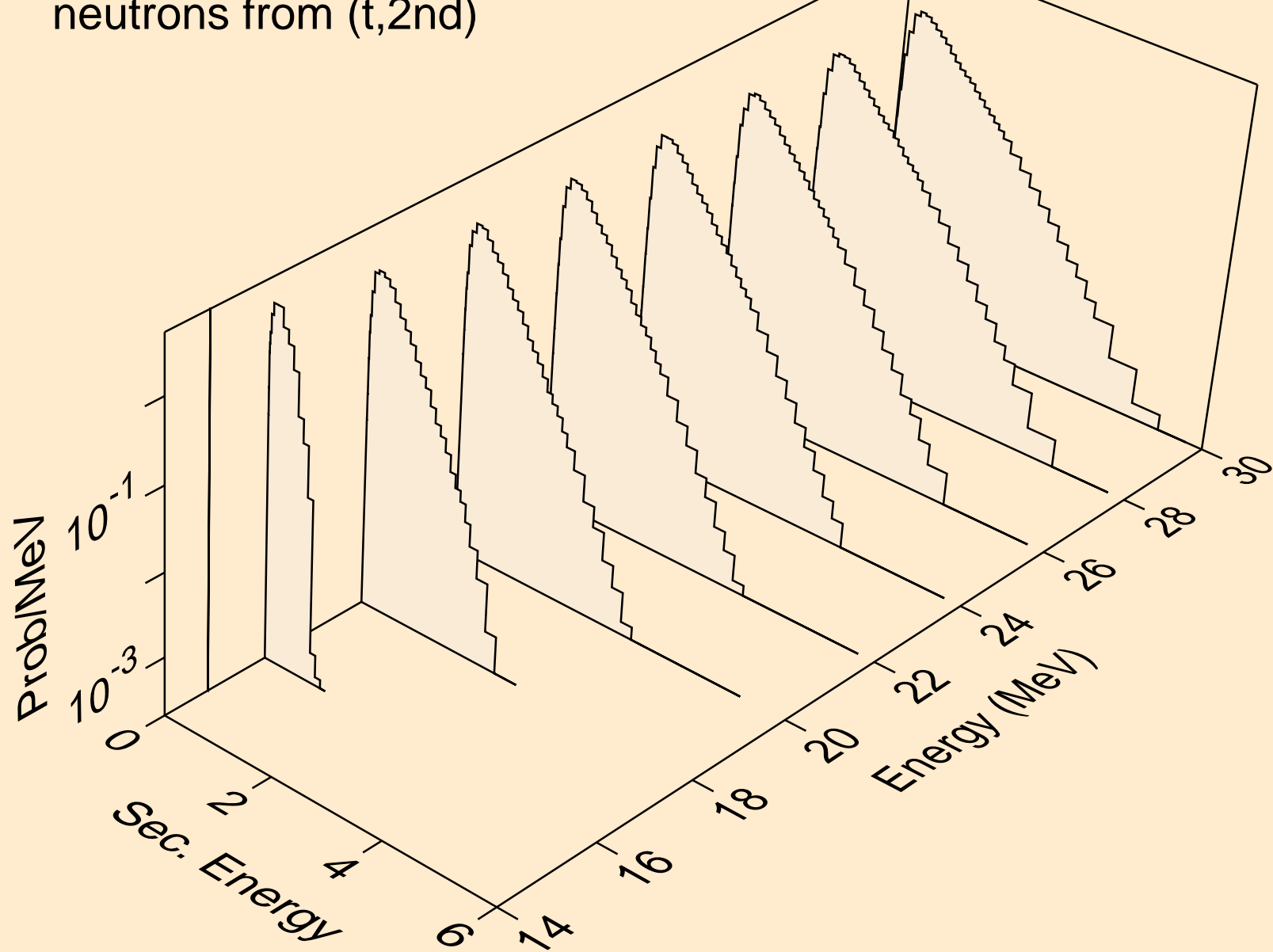

BI192 TRITON ACER TENDL-2021 LIBRARY; T=0.K  
neutrons from (t,2n)

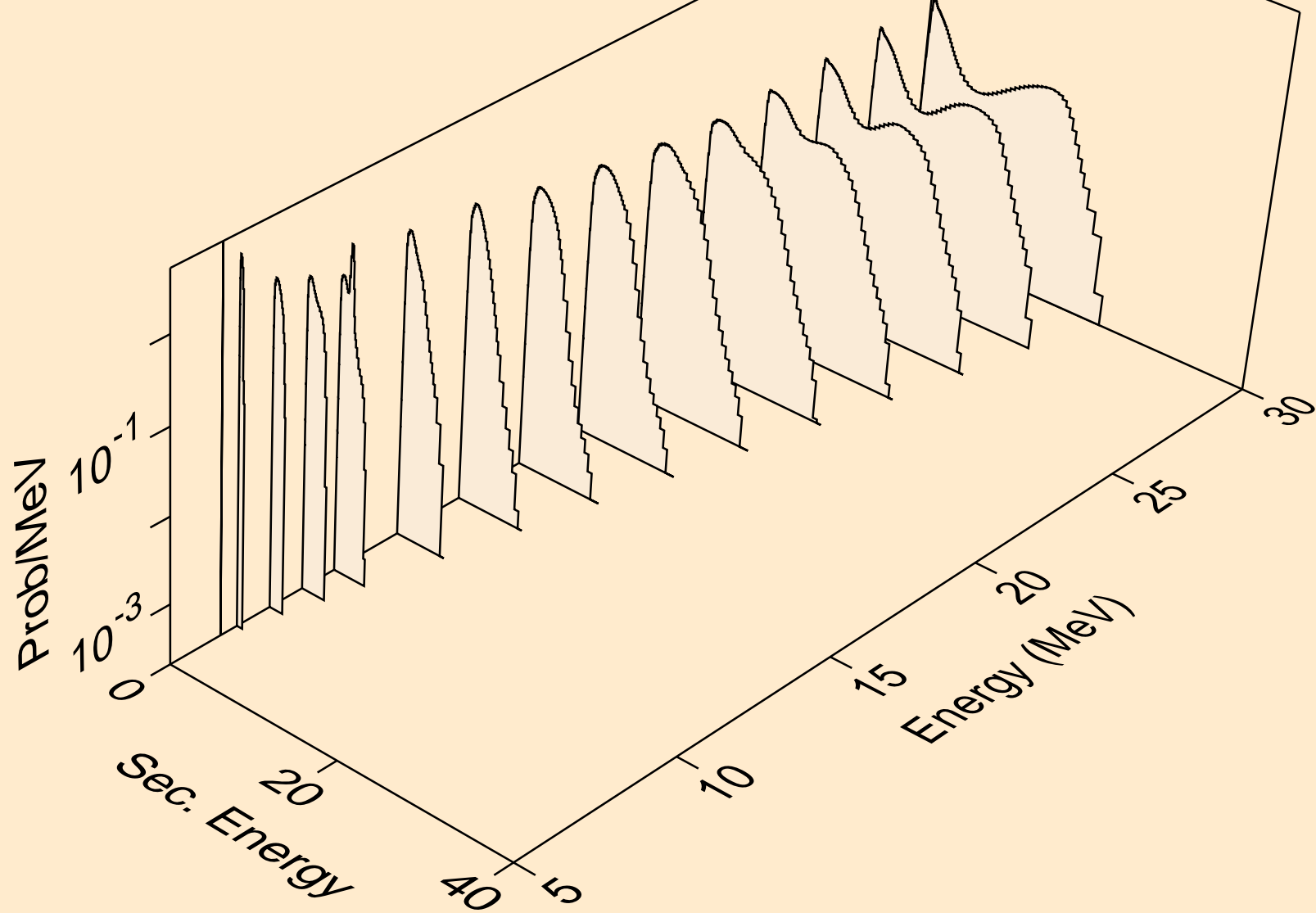

BI192 TRITON ACER TENDL-2021 LIBRARY; T=0.K  
neutrons from (t,3n)

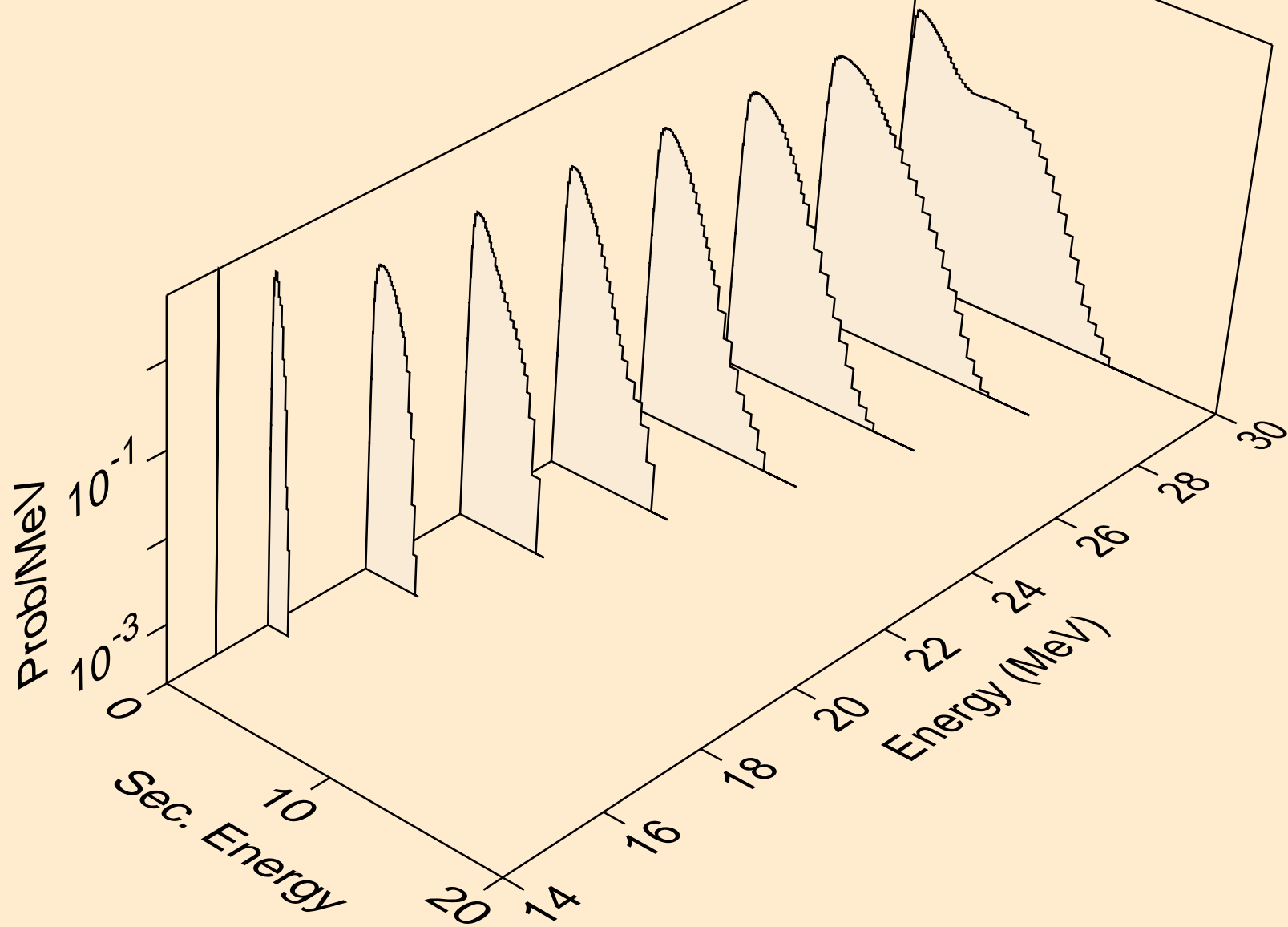

BI192 TRITON ACER TENDL-2021 LIBRARY; T=0.K  
neutrons from (t,n\*)a

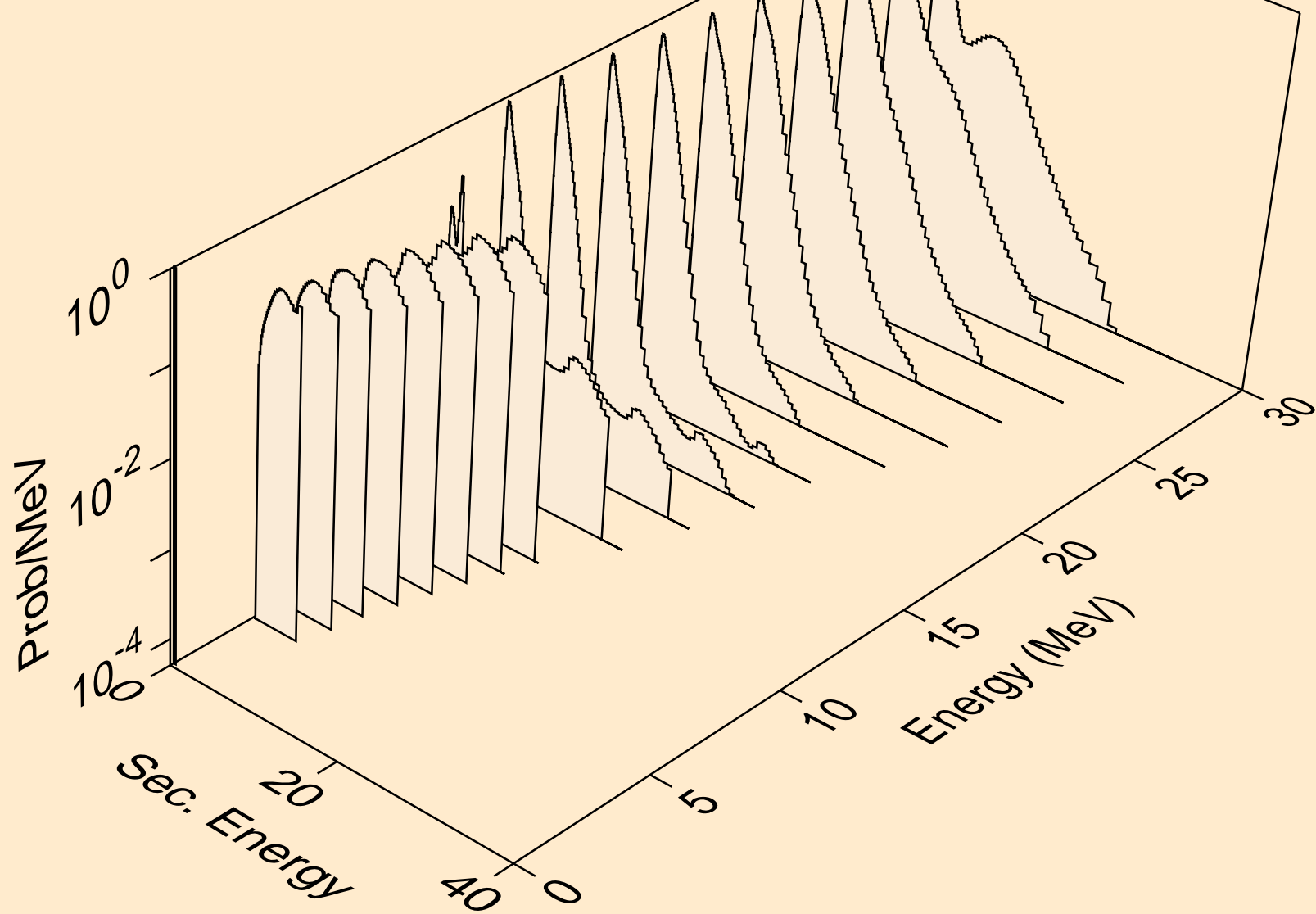

BI192 TRITON ACER TENDL-2021 LIBRARY; T=0.K  
neutrons from (t,2n)a

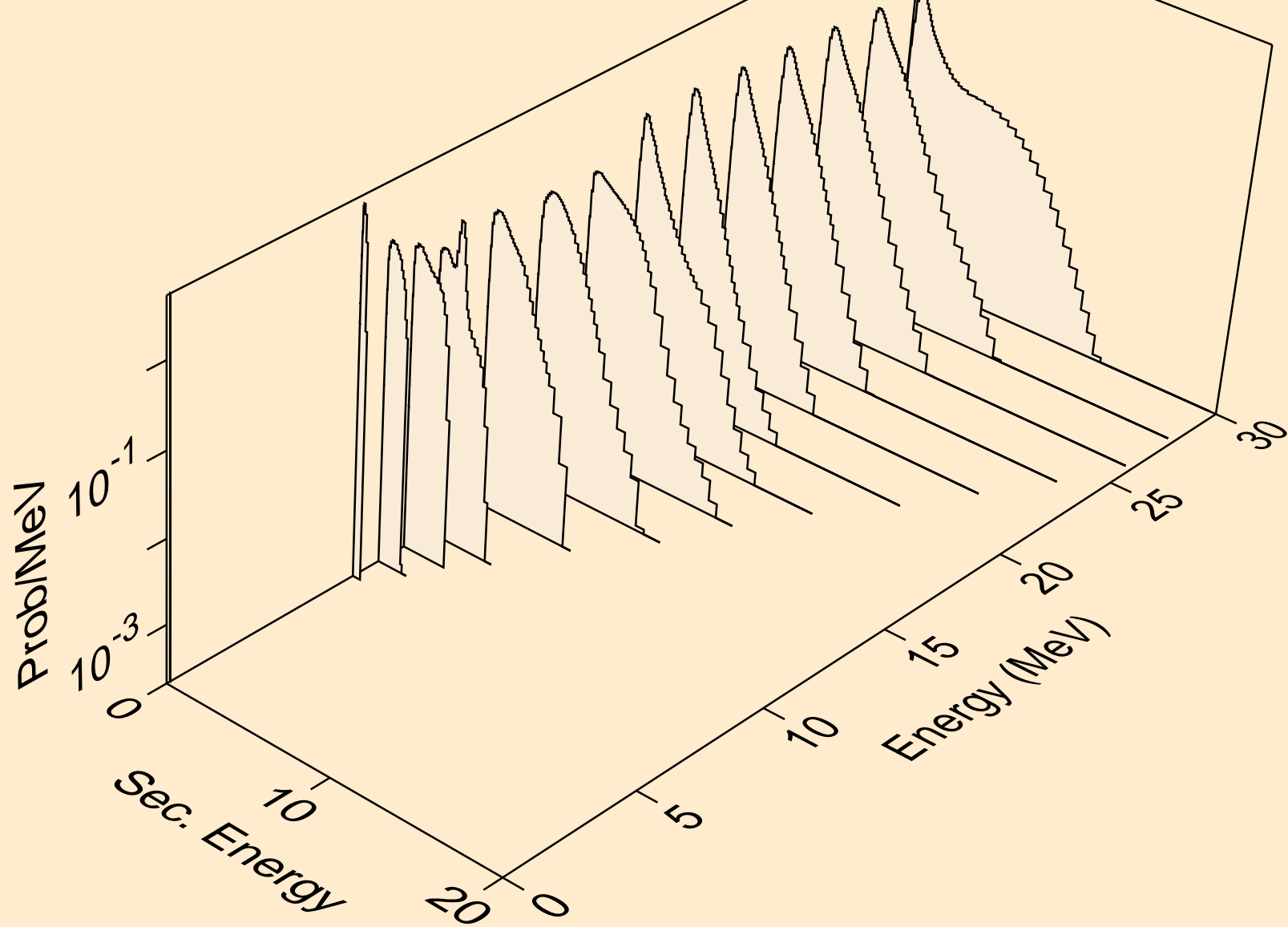



BI192 TRITON ACER TENDL-2021 LIBRARY; T=0.K  
neutrons from (t,3n)a

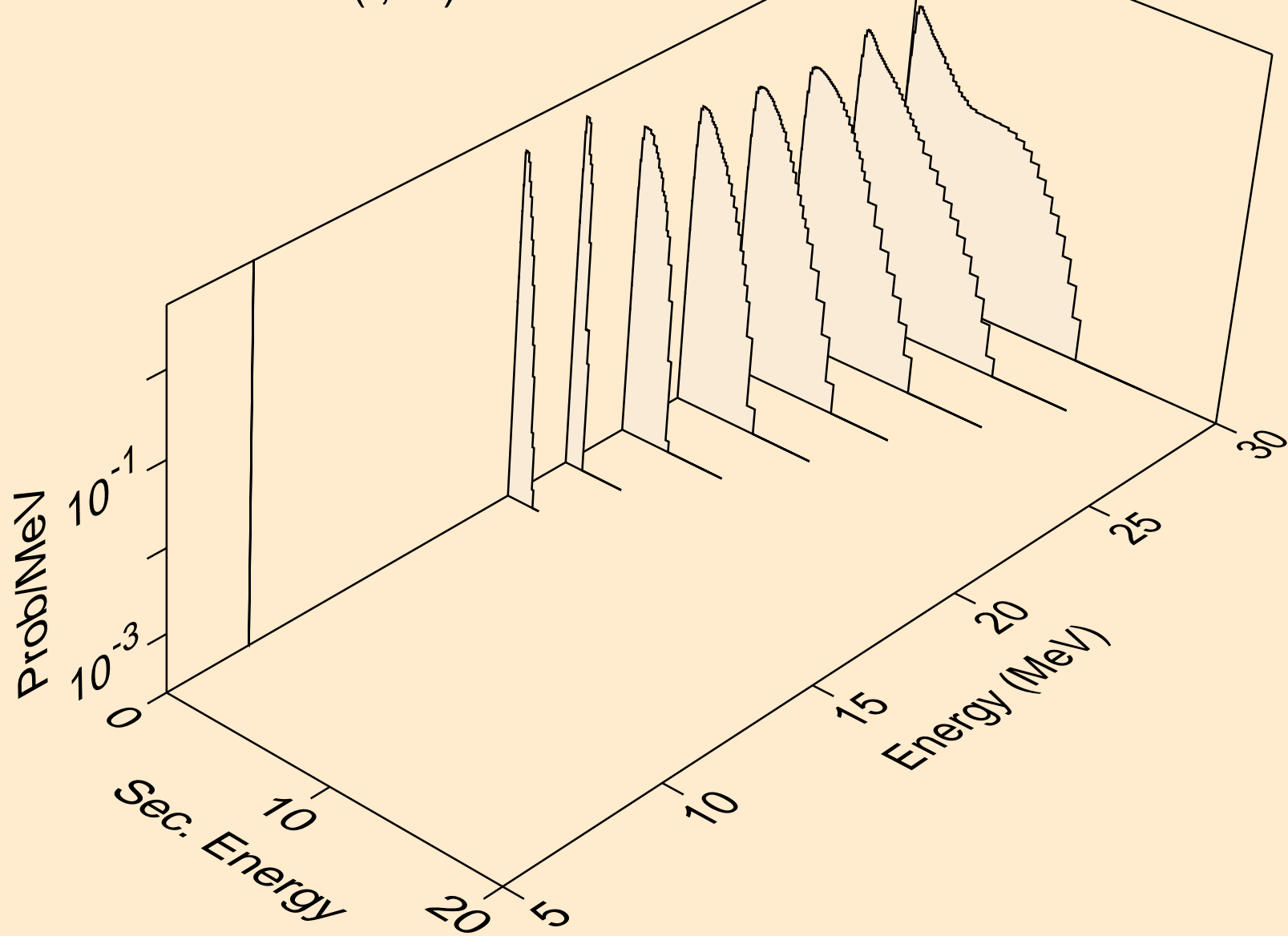

BI192 TRITON ACER TENDL-2021 LIBRARY; T=0.K  
neutrons from (t,n\*)p

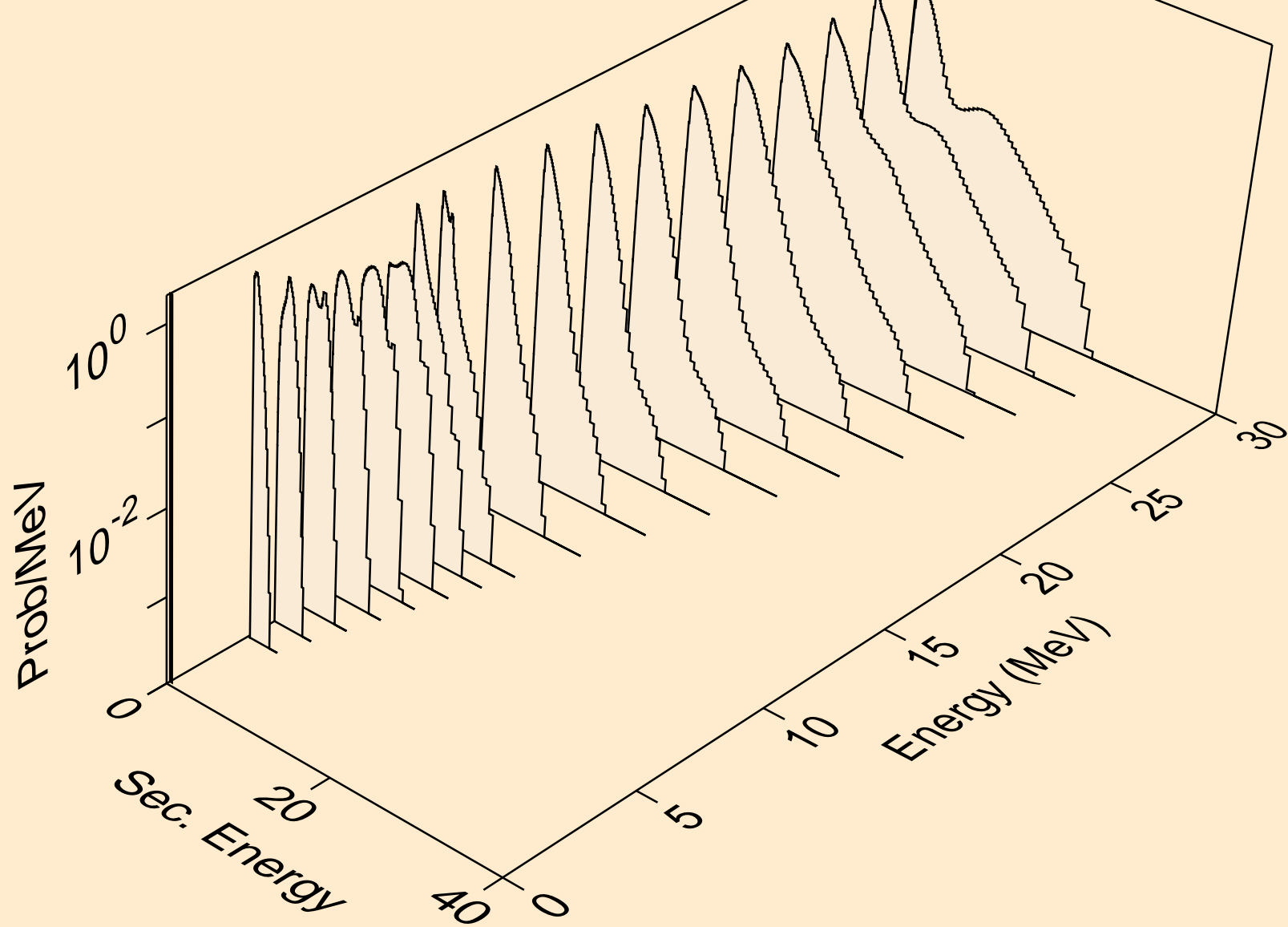

BI192 TRITON ACER TENDL-2021 LIBRARY; T=0.K  
neutrons from (t,n\*)2a

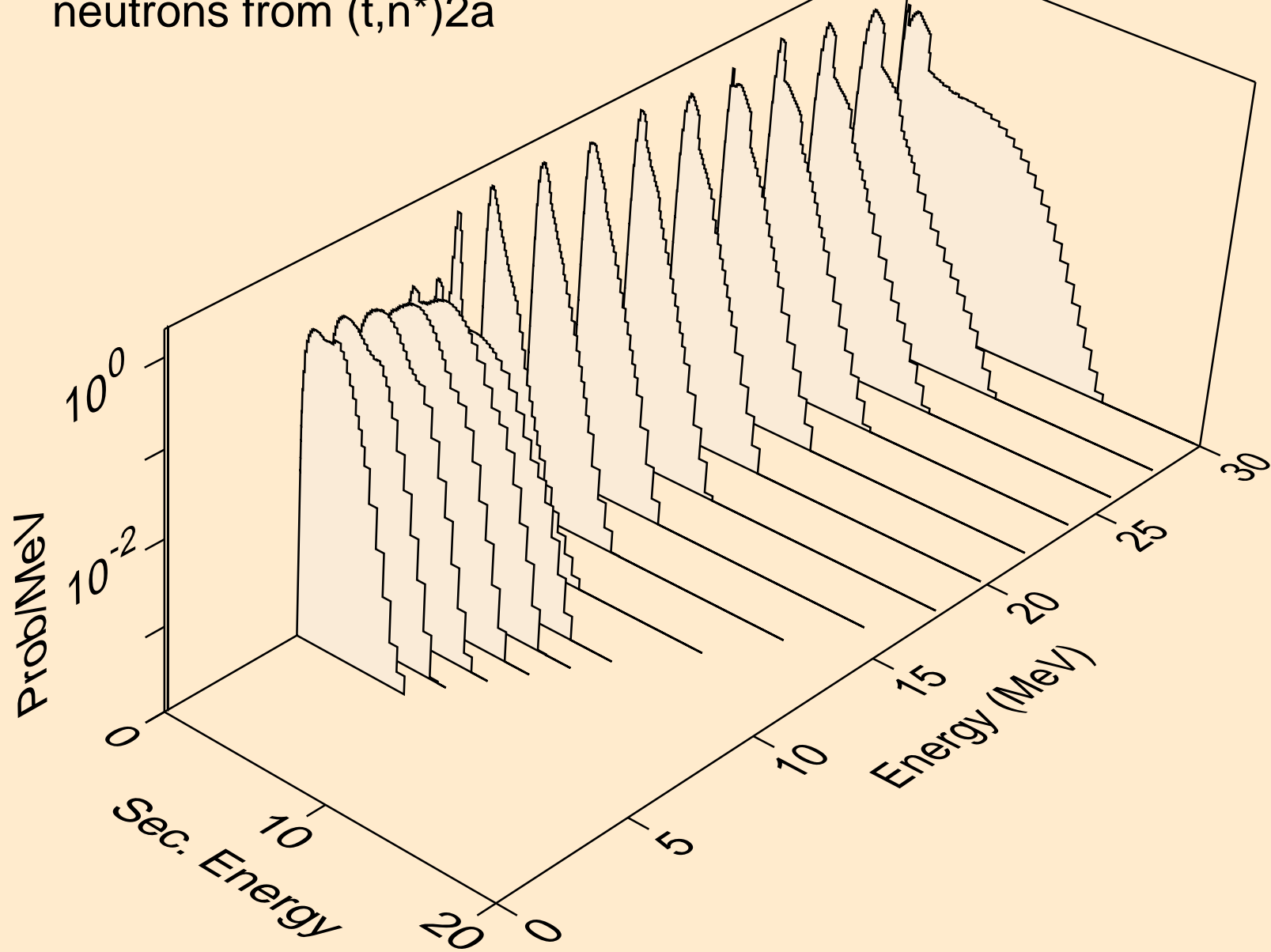

BI192 TRITON ACER TENDL-2021 LIBRARY; T=0.K  
neutrons from (t,2n)2a

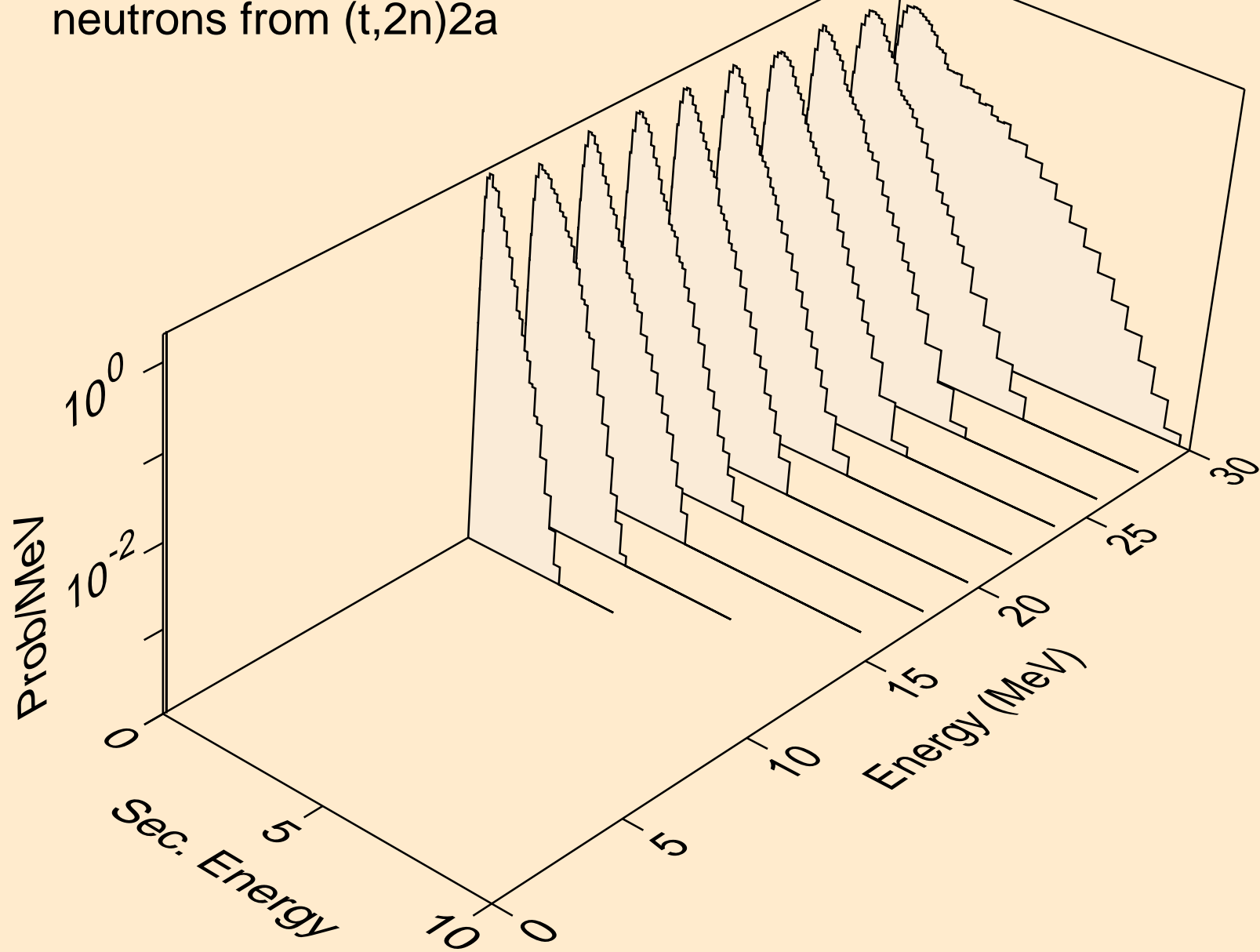

BI192 TRITON ACER TENDL-2021 LIBRARY; T=0.K  
neutrons from (t,n\*)d

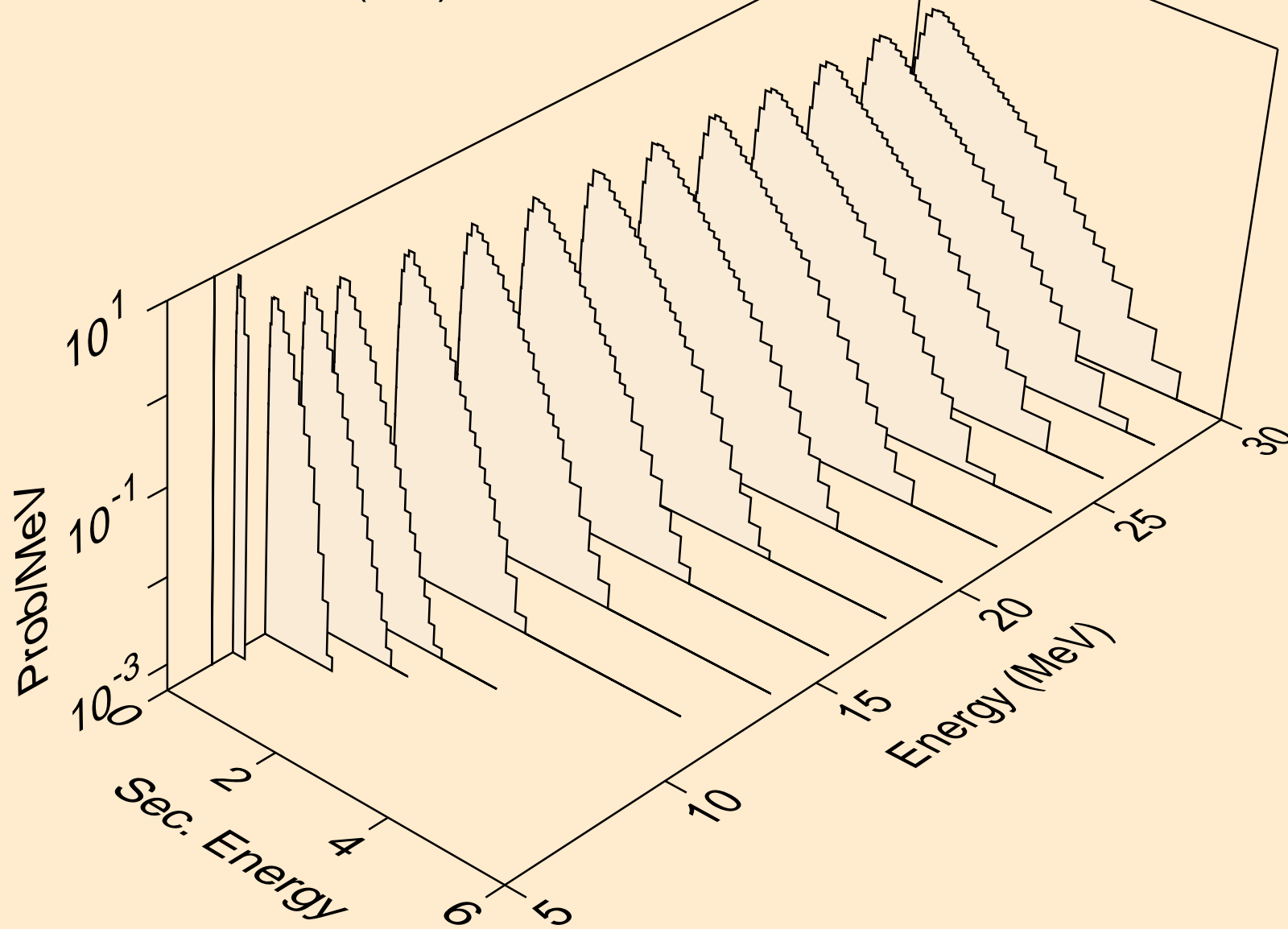

BI192 TRITON ACER TENDL-2021 LIBRARY; T=0.K  
neutrons from (t,n\*)t

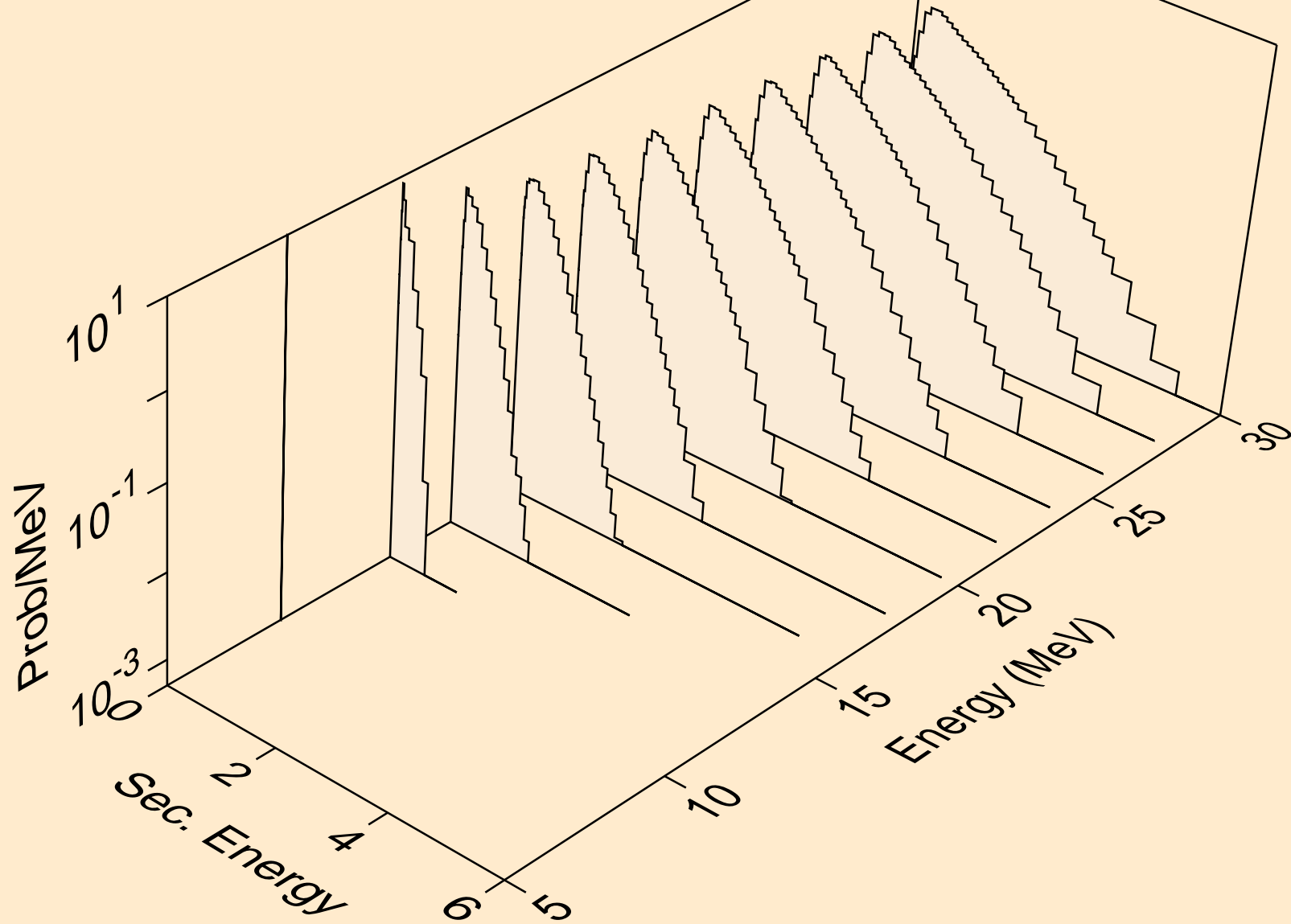

BI192 TRITON ACER TENDL-2021 LIBRARY; T=0.K  
neutrons from (t,n\*)he3

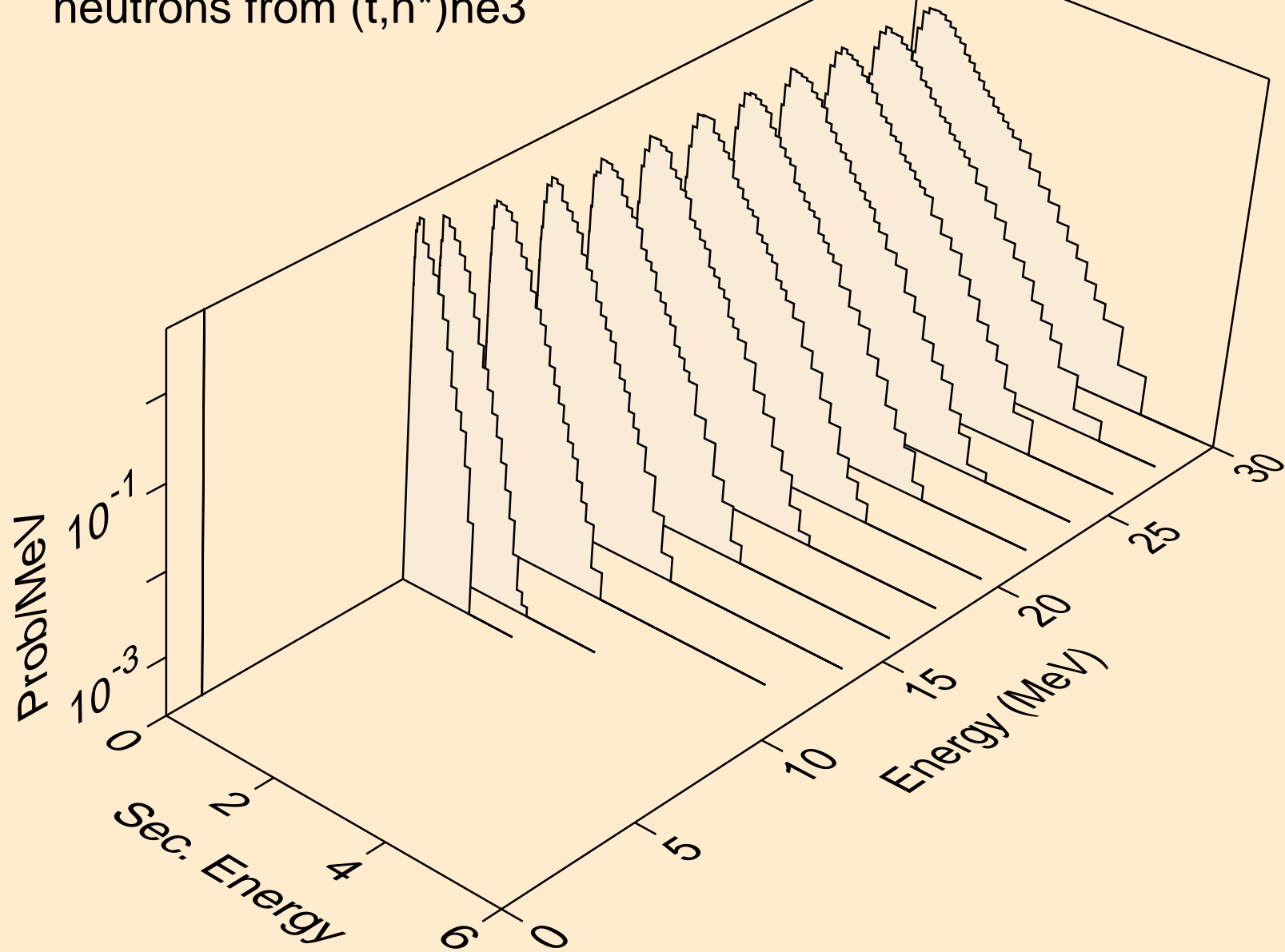

BI192 TRITON ACER TENDL-2021 LIBRARY; T=0.K  
neutrons from (t,4n)

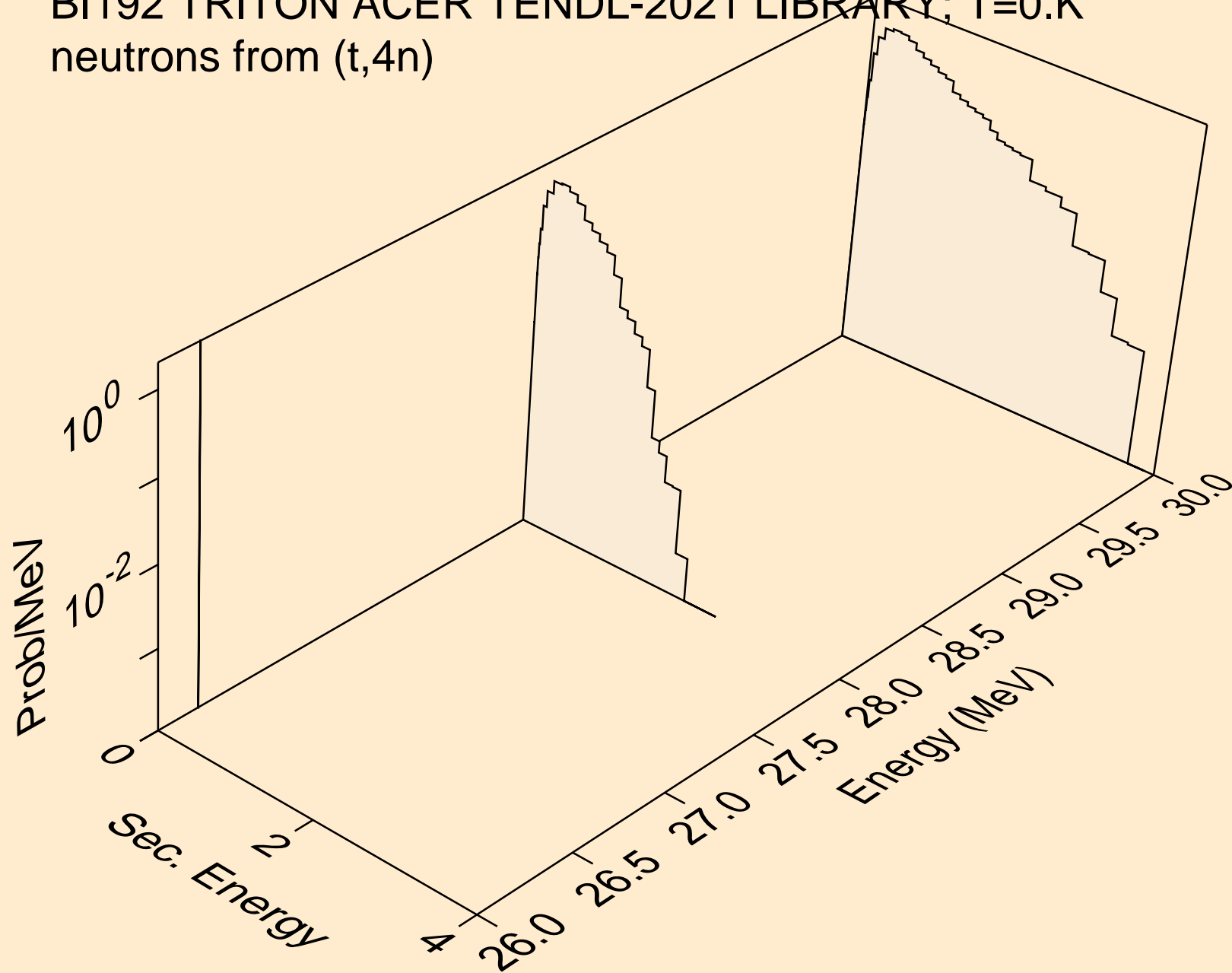



BI192 TRITON ACER TENDL-2021 LIBRARY; T=0.K  
neutrons from (t,2np)

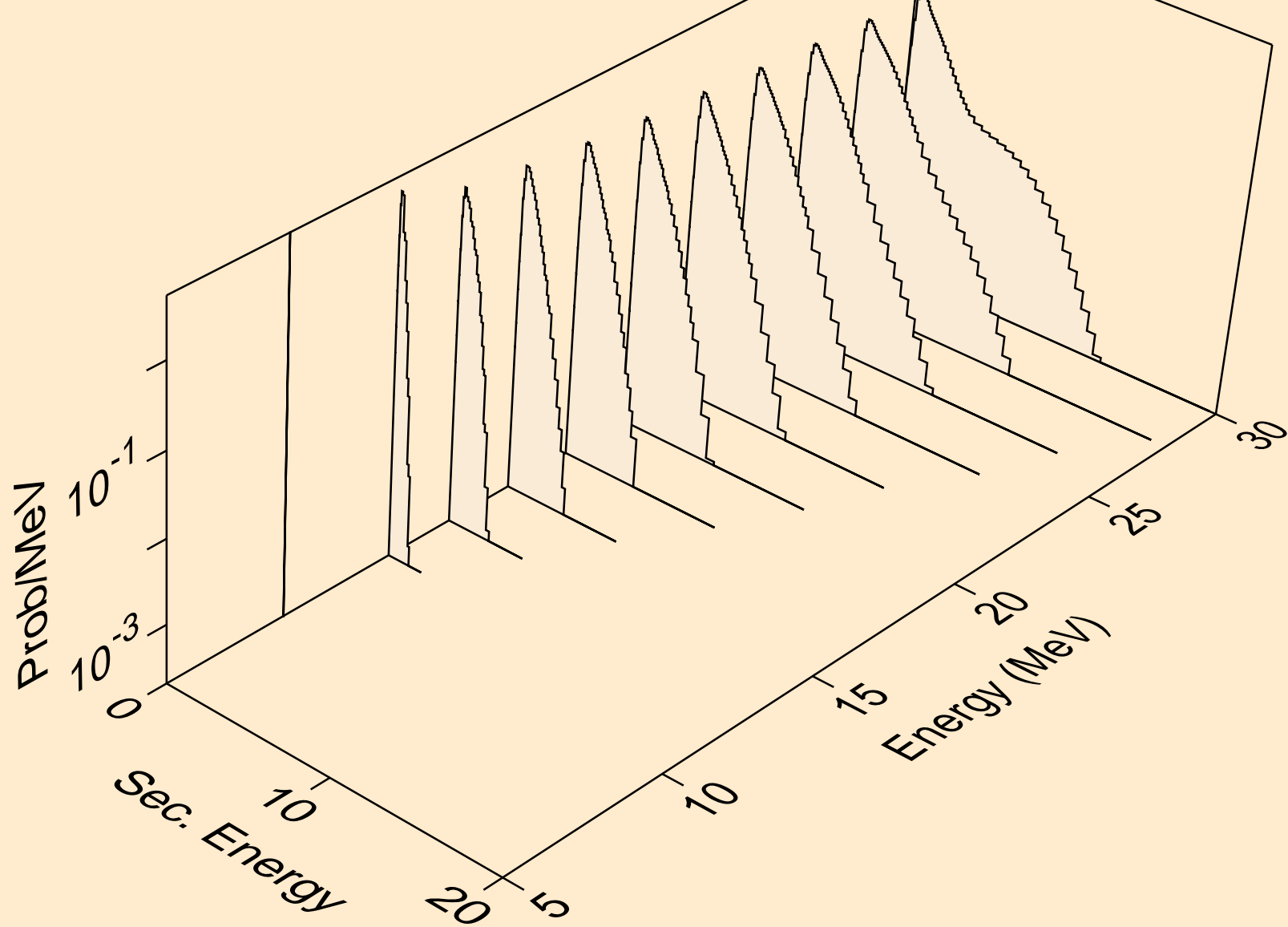

BI192 TRITON ACER TENDL-2021 LIBRARY; T=0.K  
neutrons from (t,3np)

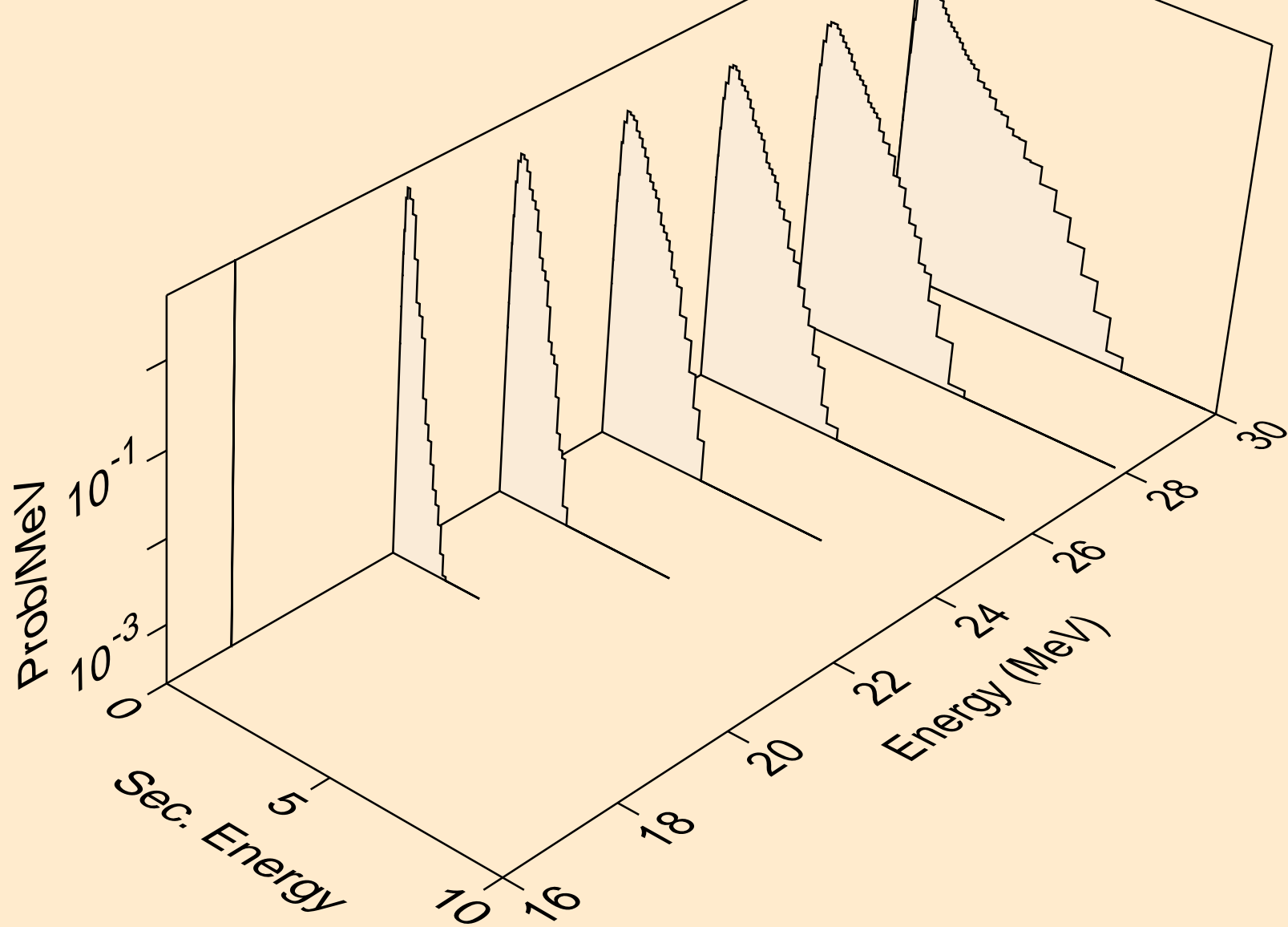

BI192 TRITON ACER TENDL-2021 LIBRARY; T=0.K  
neutrons from (t,2np)

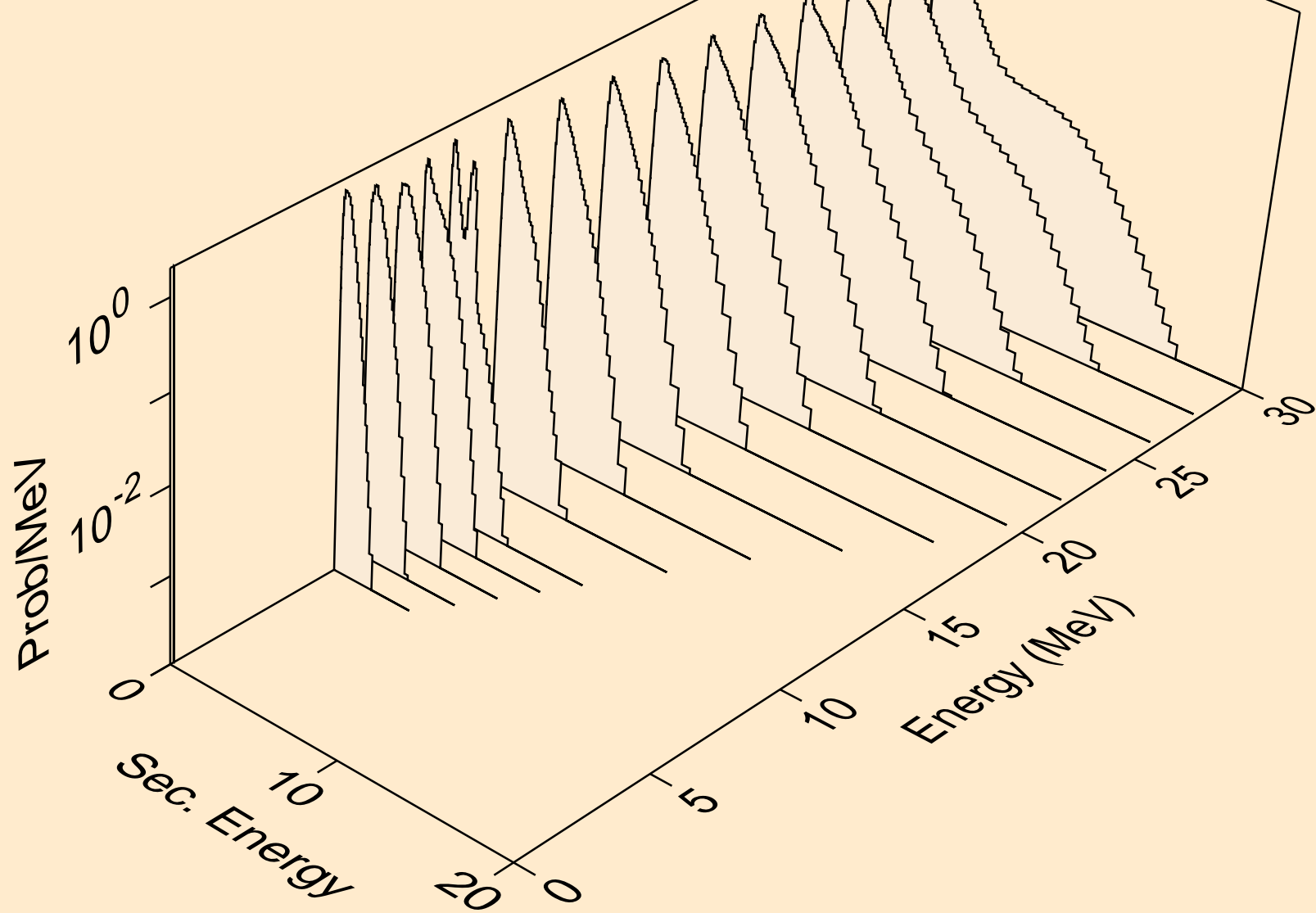

BI192 TRITON ACER TENDL-2021 LIBRARY; T=0.K  
neutrons from (t,npa)

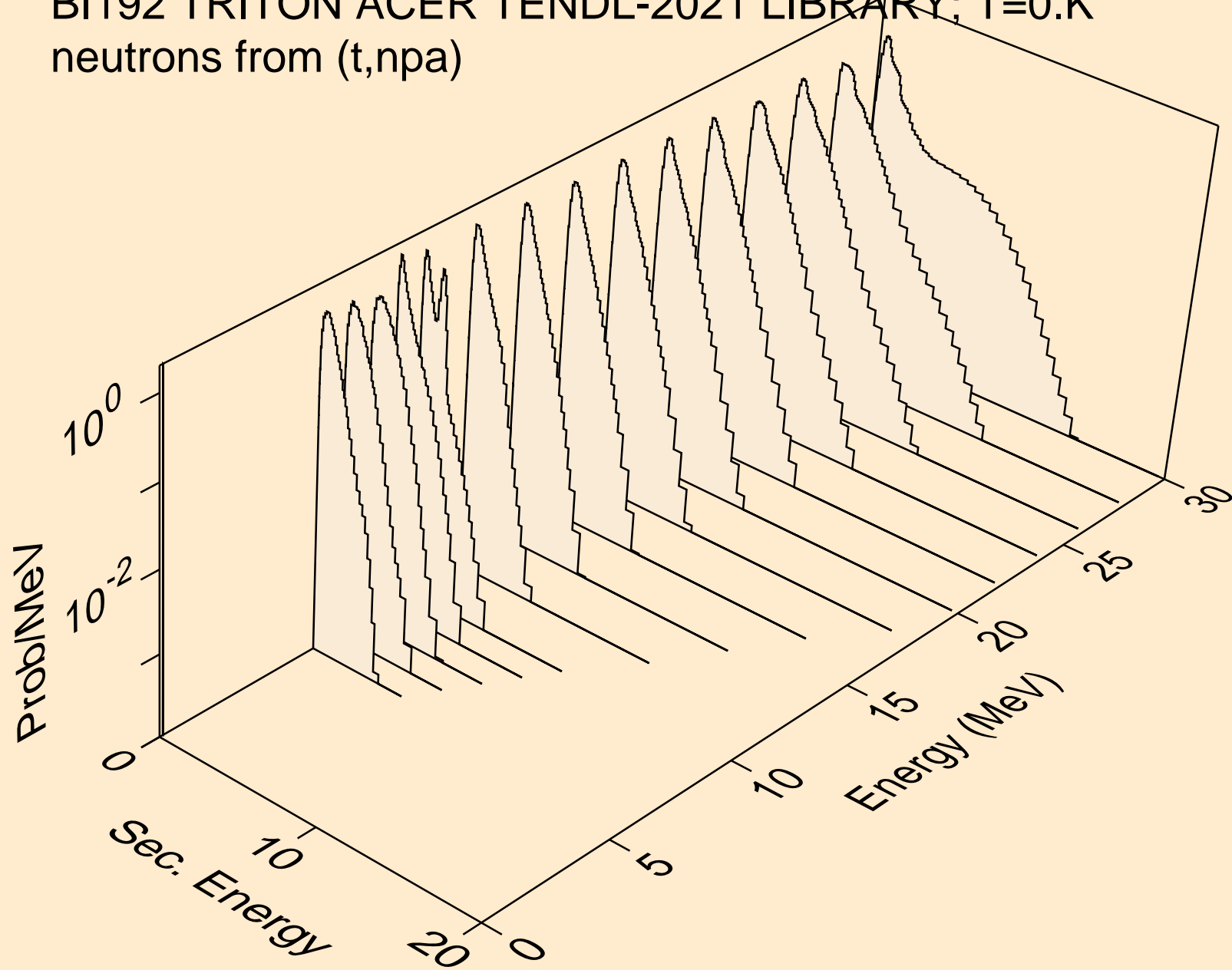

BI192 TRITON ACER TENDL-2021 LIBRARY; T=0.K  
protons from (t,x)

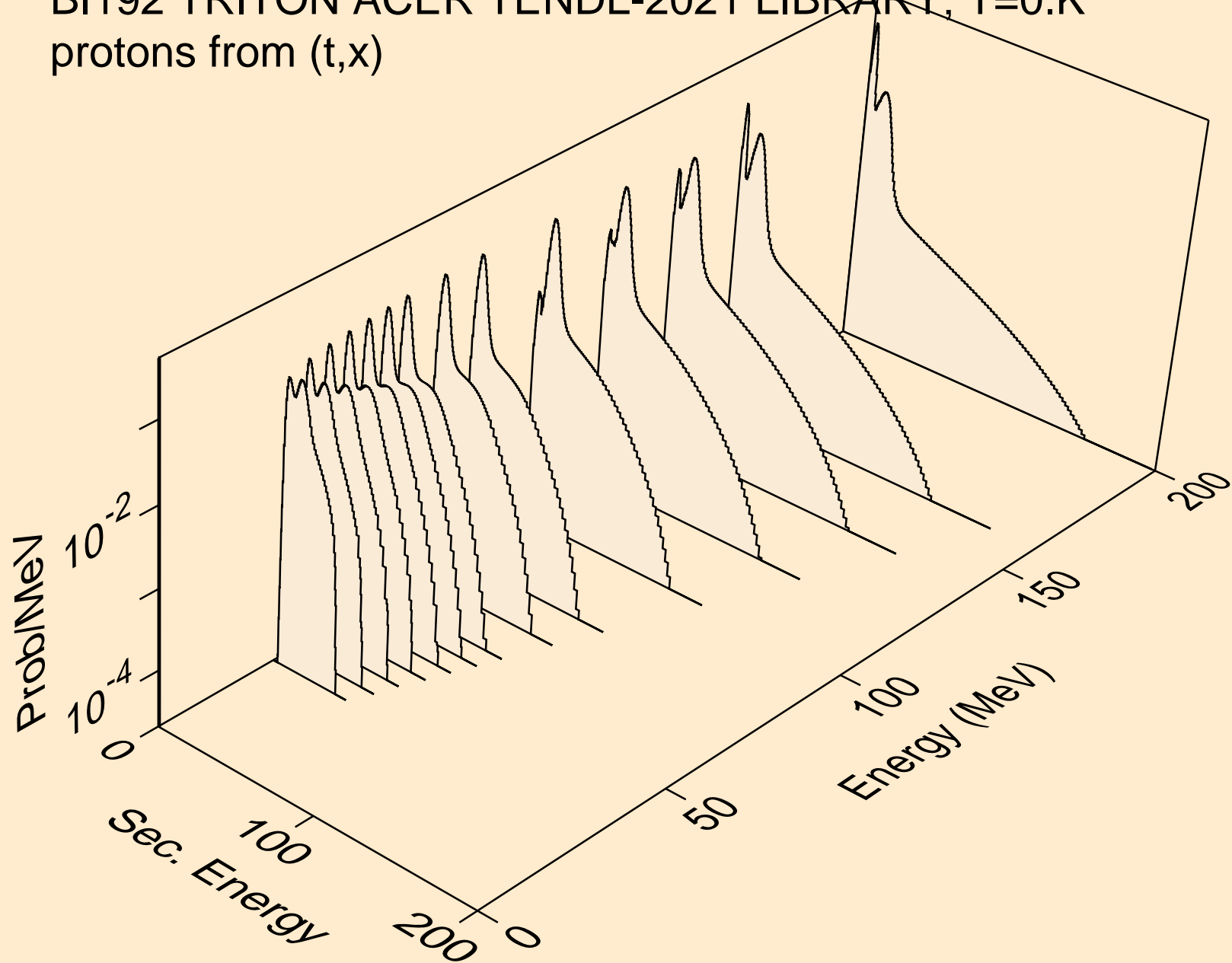

BI192 TRITON ACER TENDL-2021 LIBRARY; T=0.K  
protons from (t,n\*)p

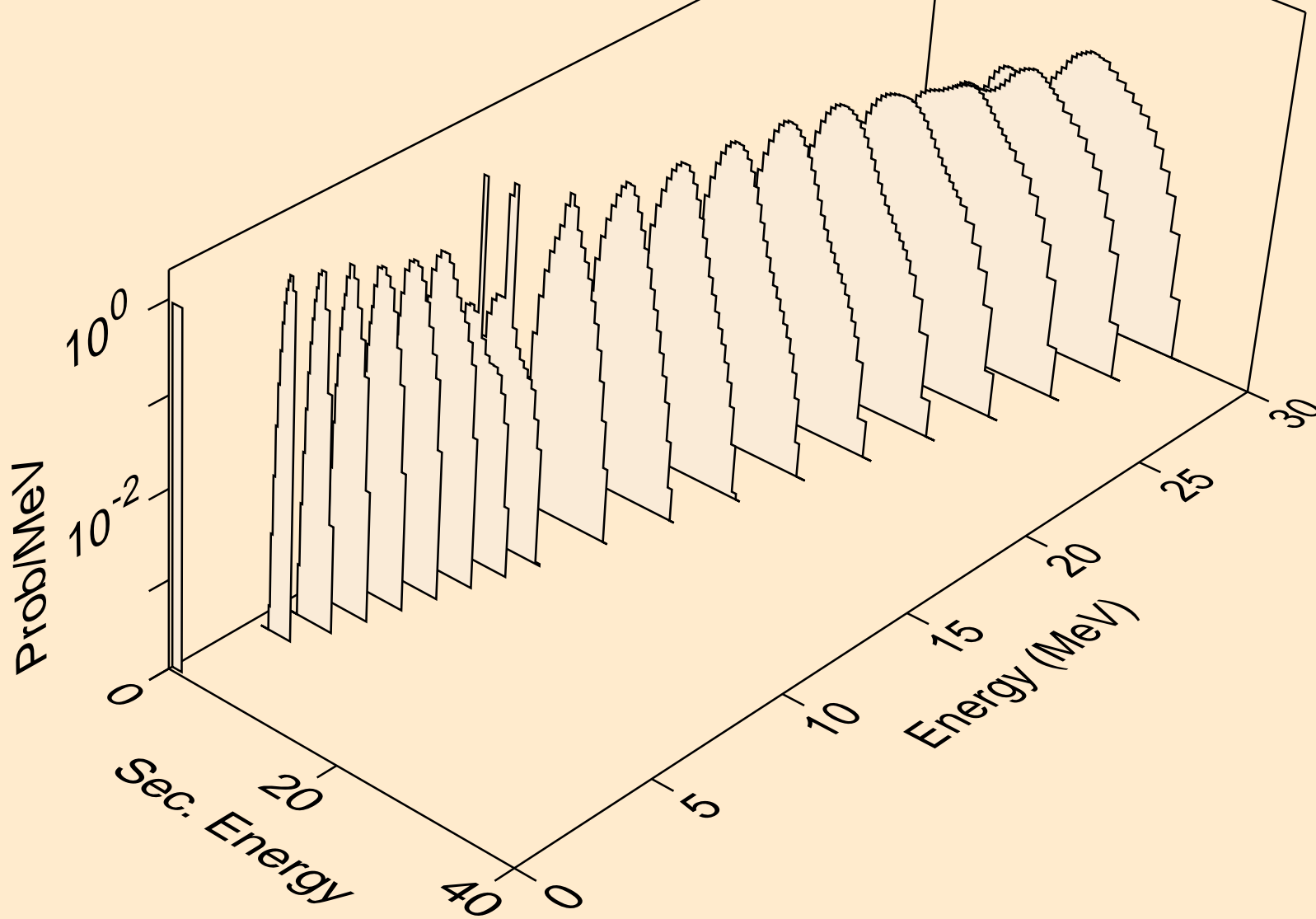

BI192 TRITON ACER TENDL-2021 LIBRARY; T=0.K  
protons from (t,2np)

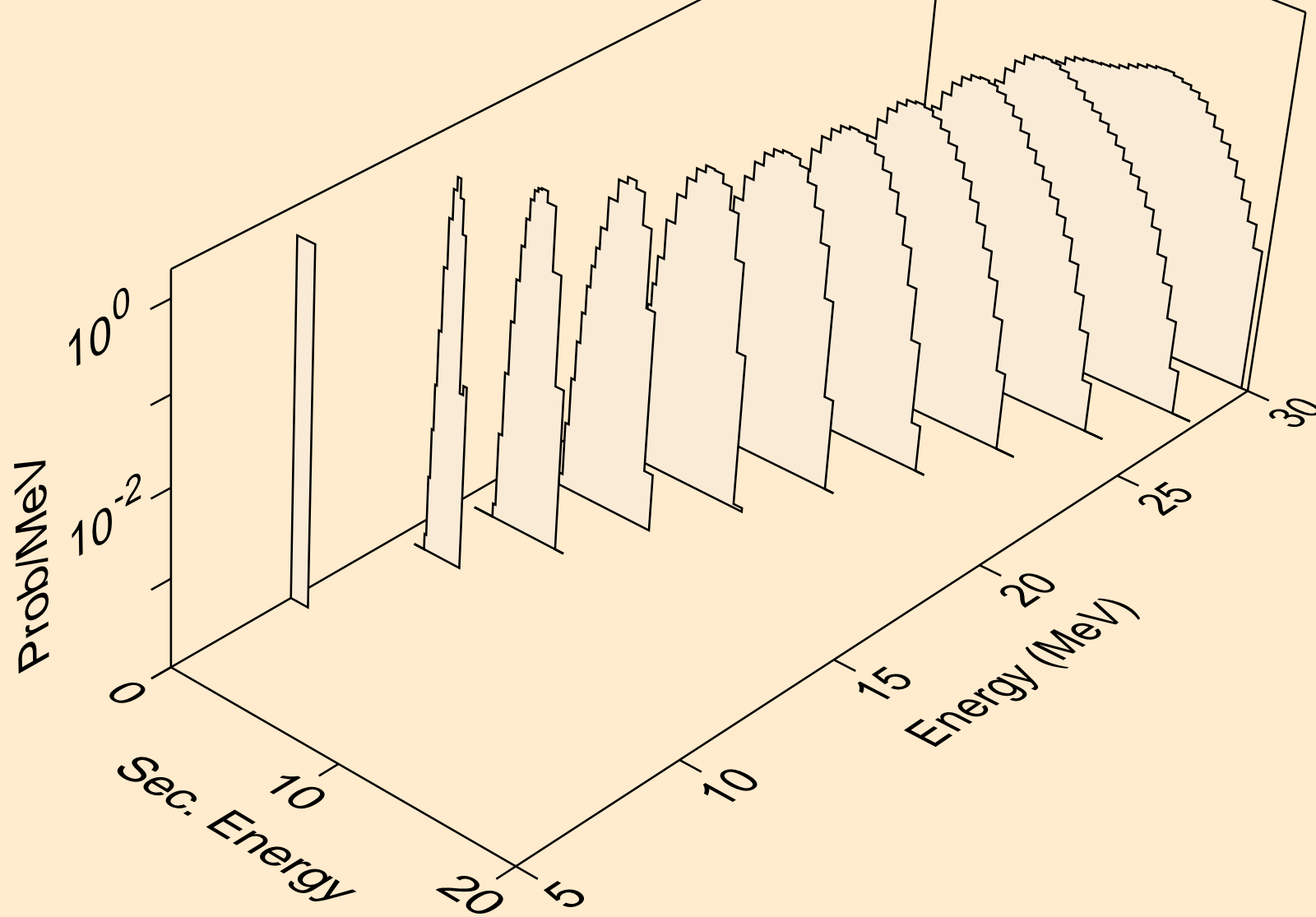

BI192 TRITON ACER TENDL-2021 LIBRARY; T=0.K  
protons from (t,3np)

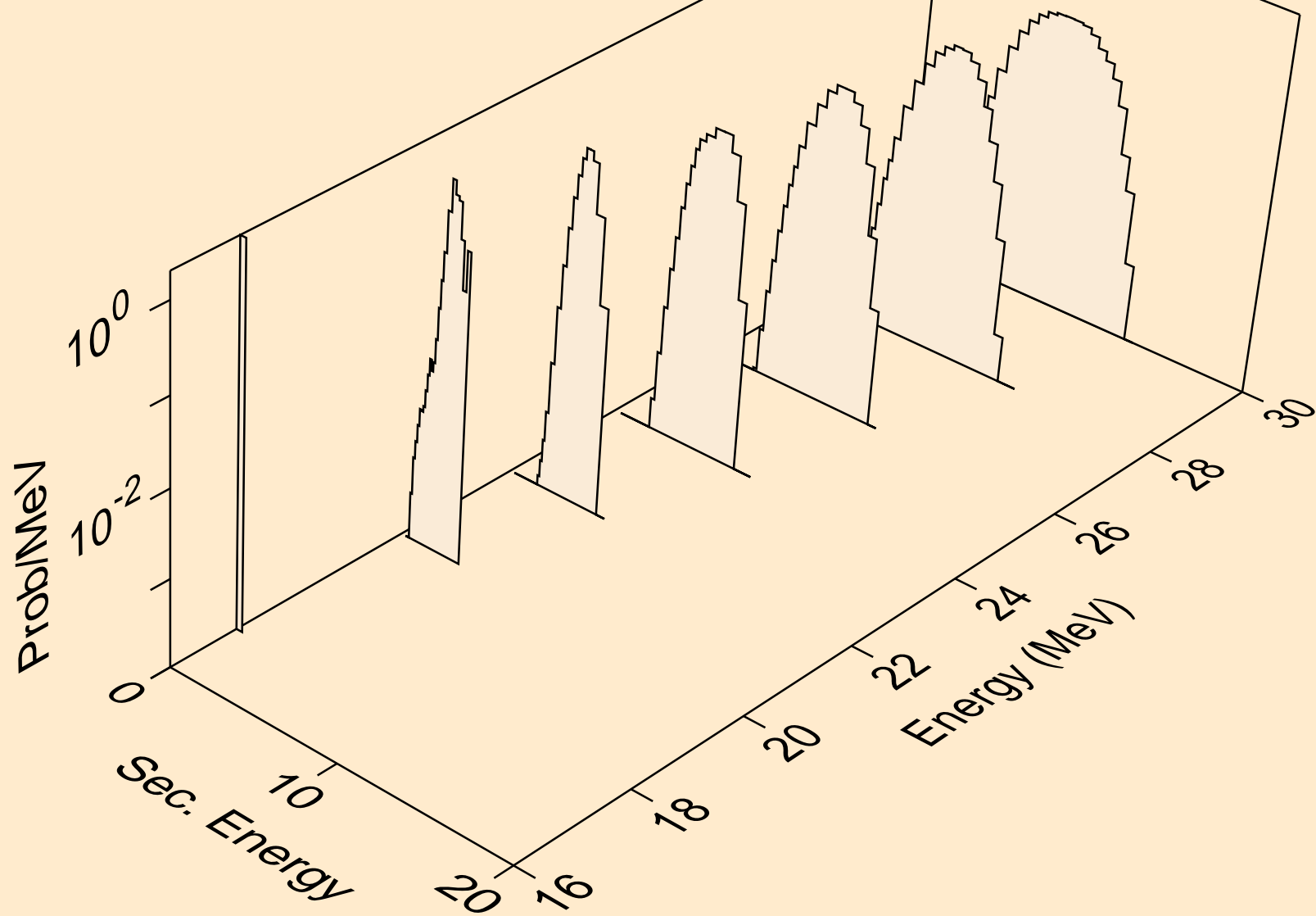



BI192 TRITON ACER TENDL-2021 LIBRARY; T=0.K  
protons from (t,2np)

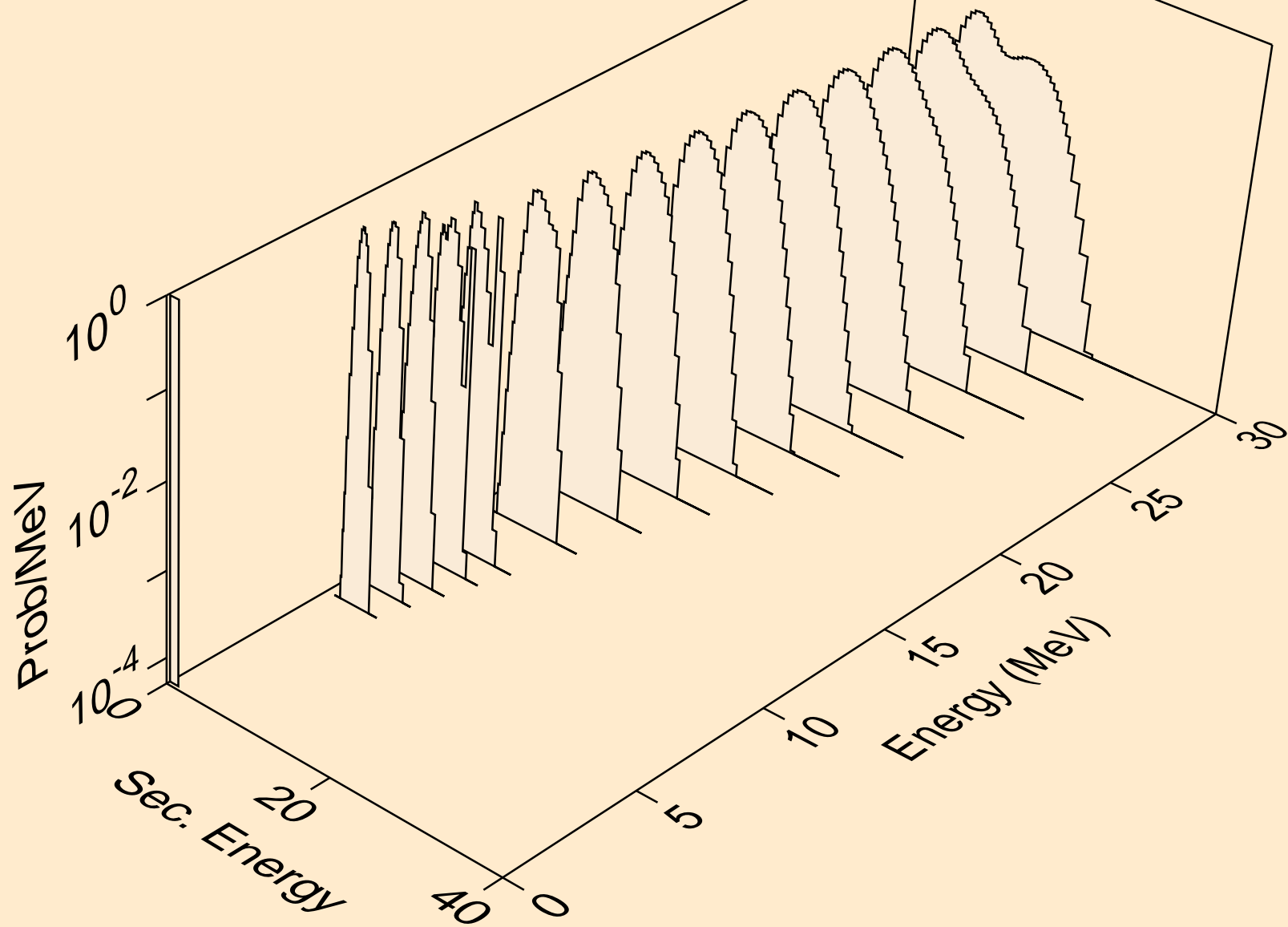

BI192 TRITON ACER TENDL-2021 LIBRARY; T=0.K  
protons from (t,npa)

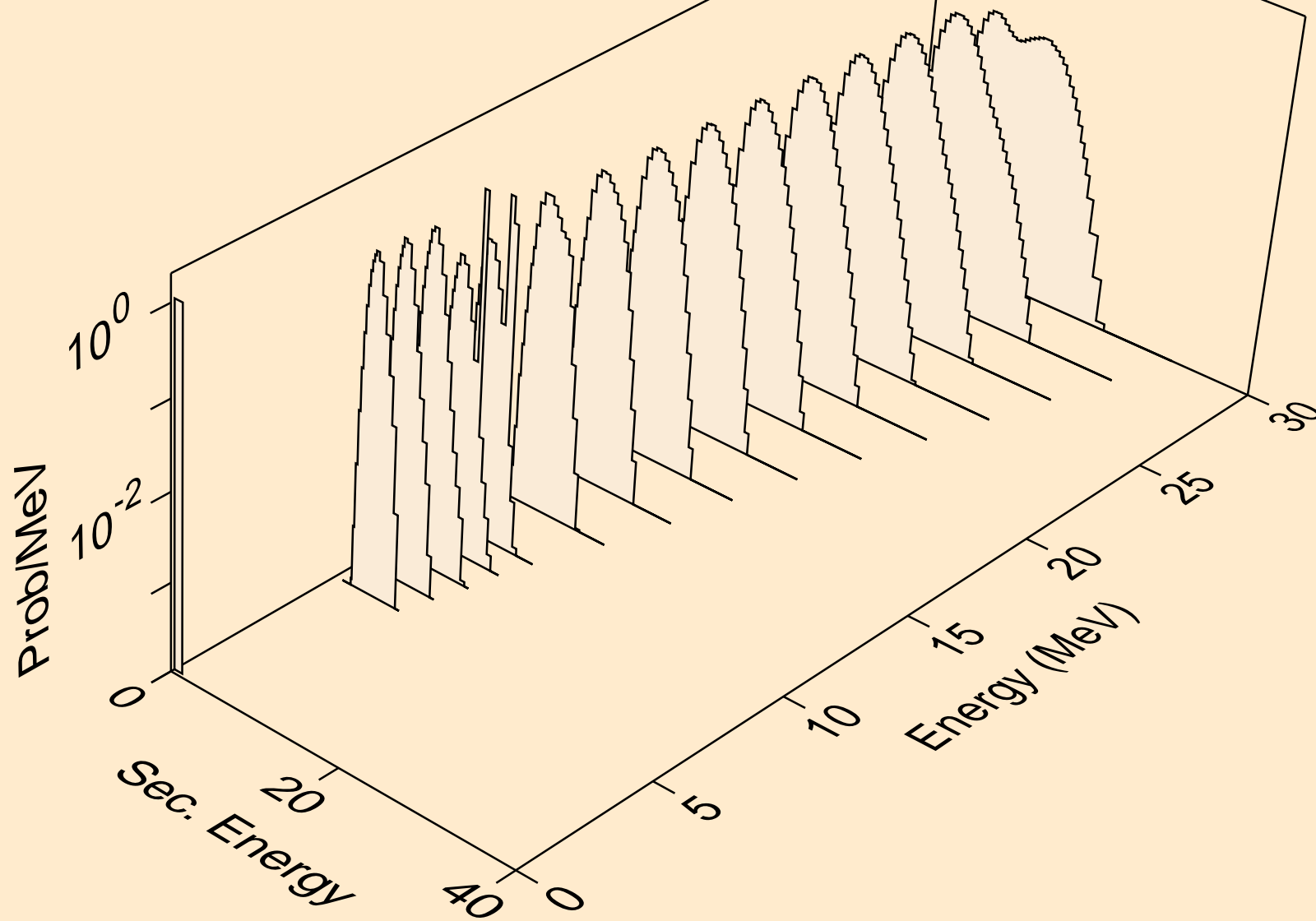

BI192 TRITON ACER TENDL-2021 LIBRARY; T=0.K  
protons from (t,p)

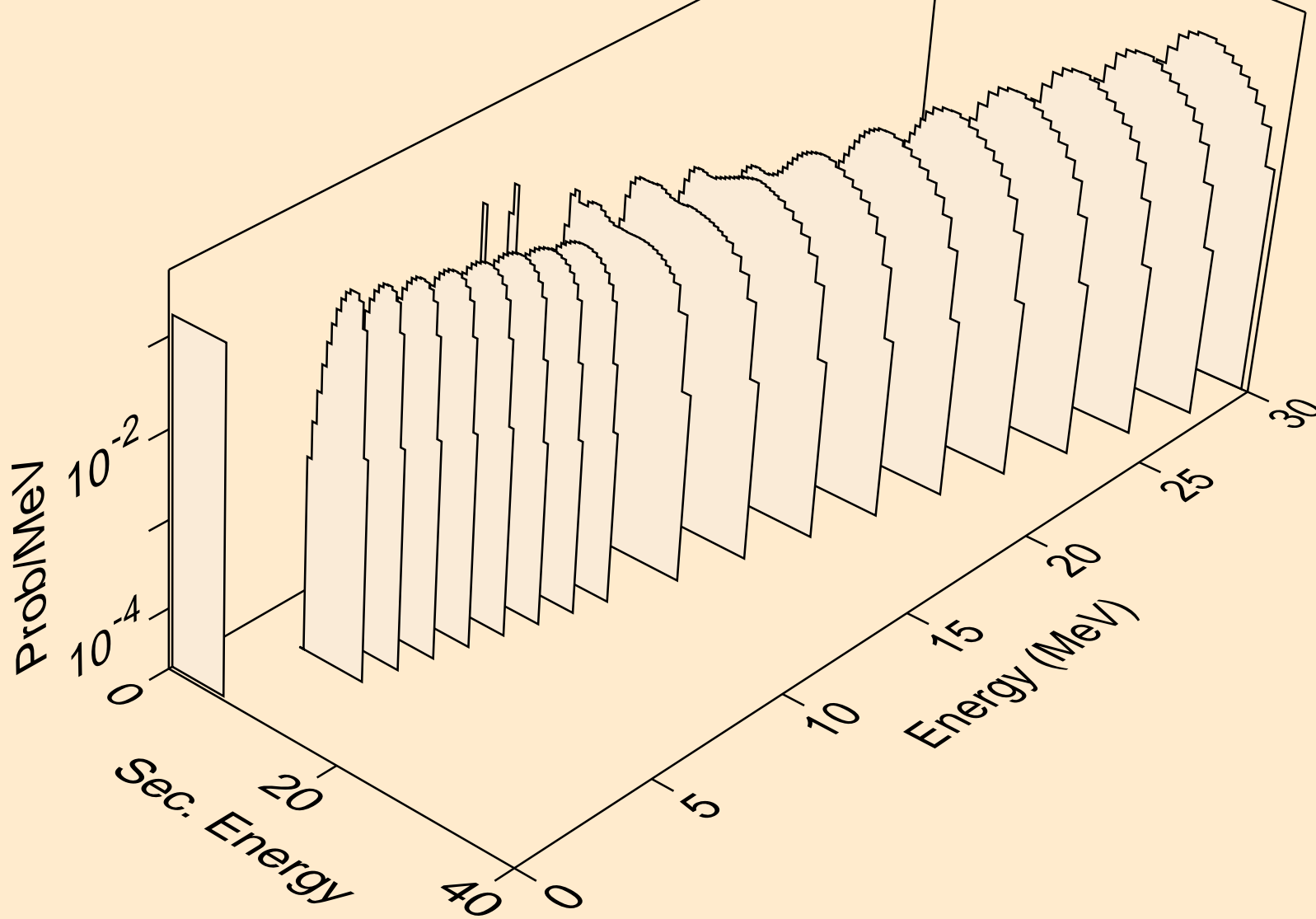

BI192 TRITON ACER TENDL-2021 LIBRARY; T=0.K  
protons from (t,2p)

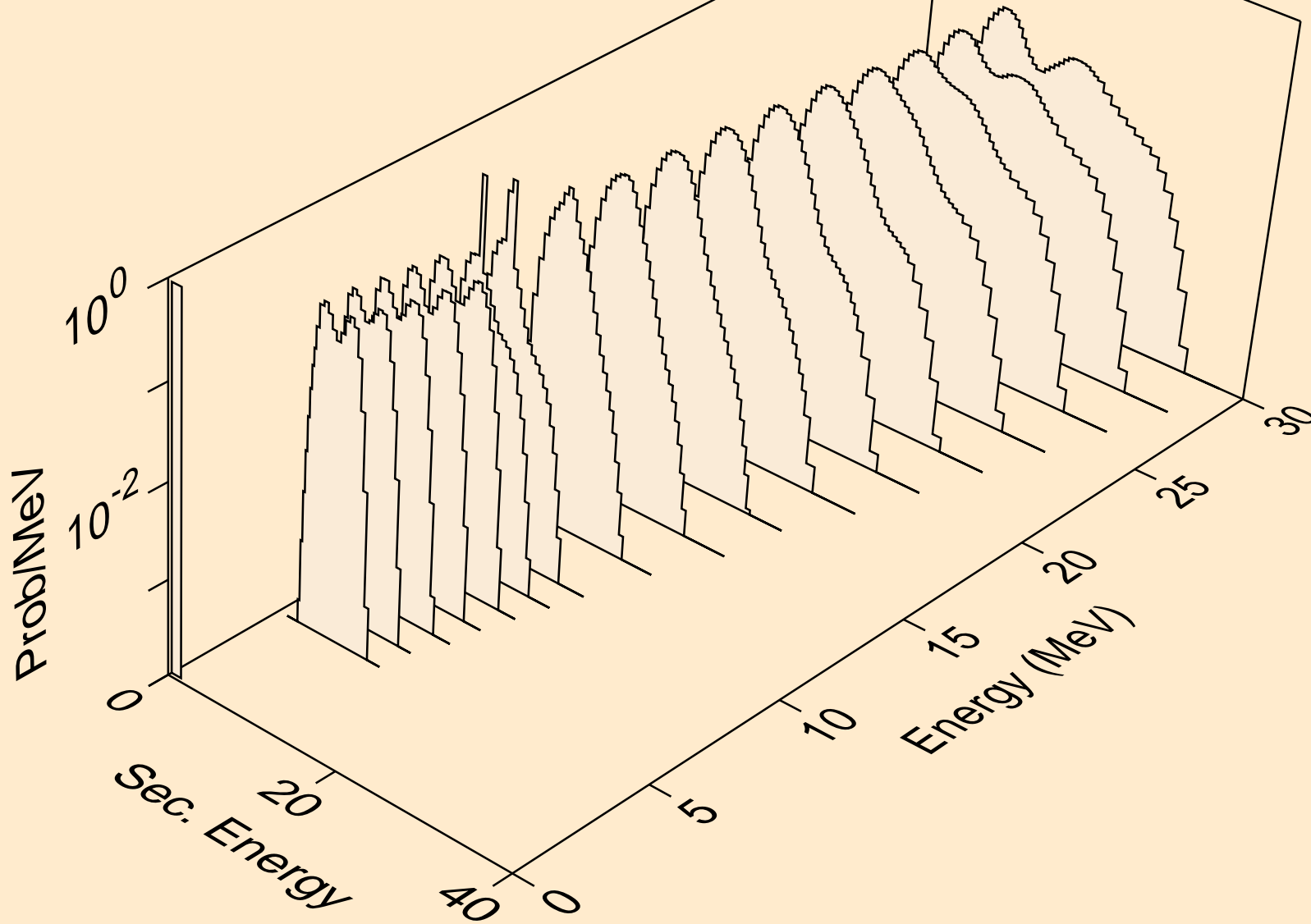

BI192 TRITON ACER TENDL-2021 LIBRARY; T=0.K  
protons from (t,pa)

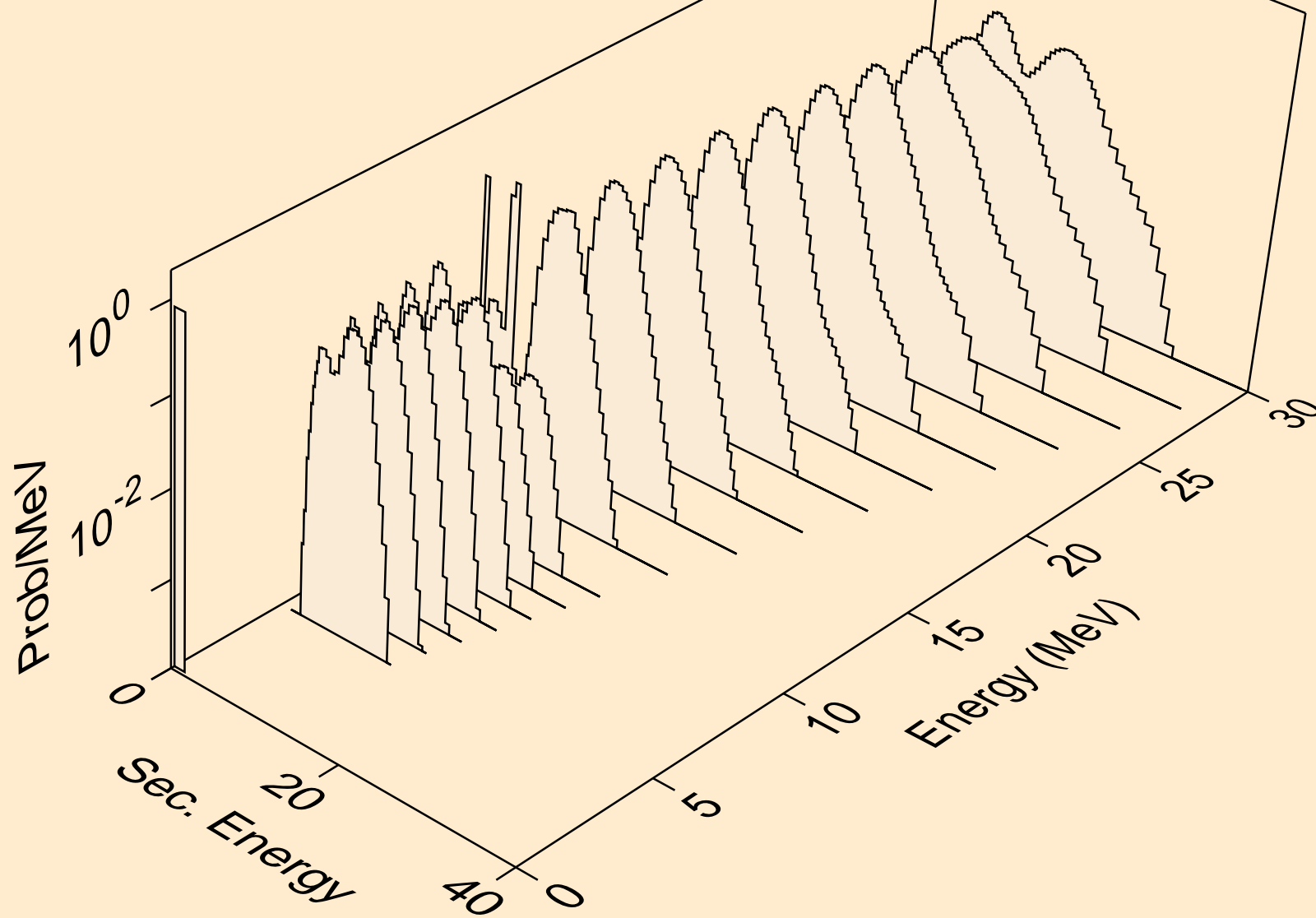

BI192 TRITON ACER TENDL-2021 LIBRARY; T=0.K  
protons from (t,pd)

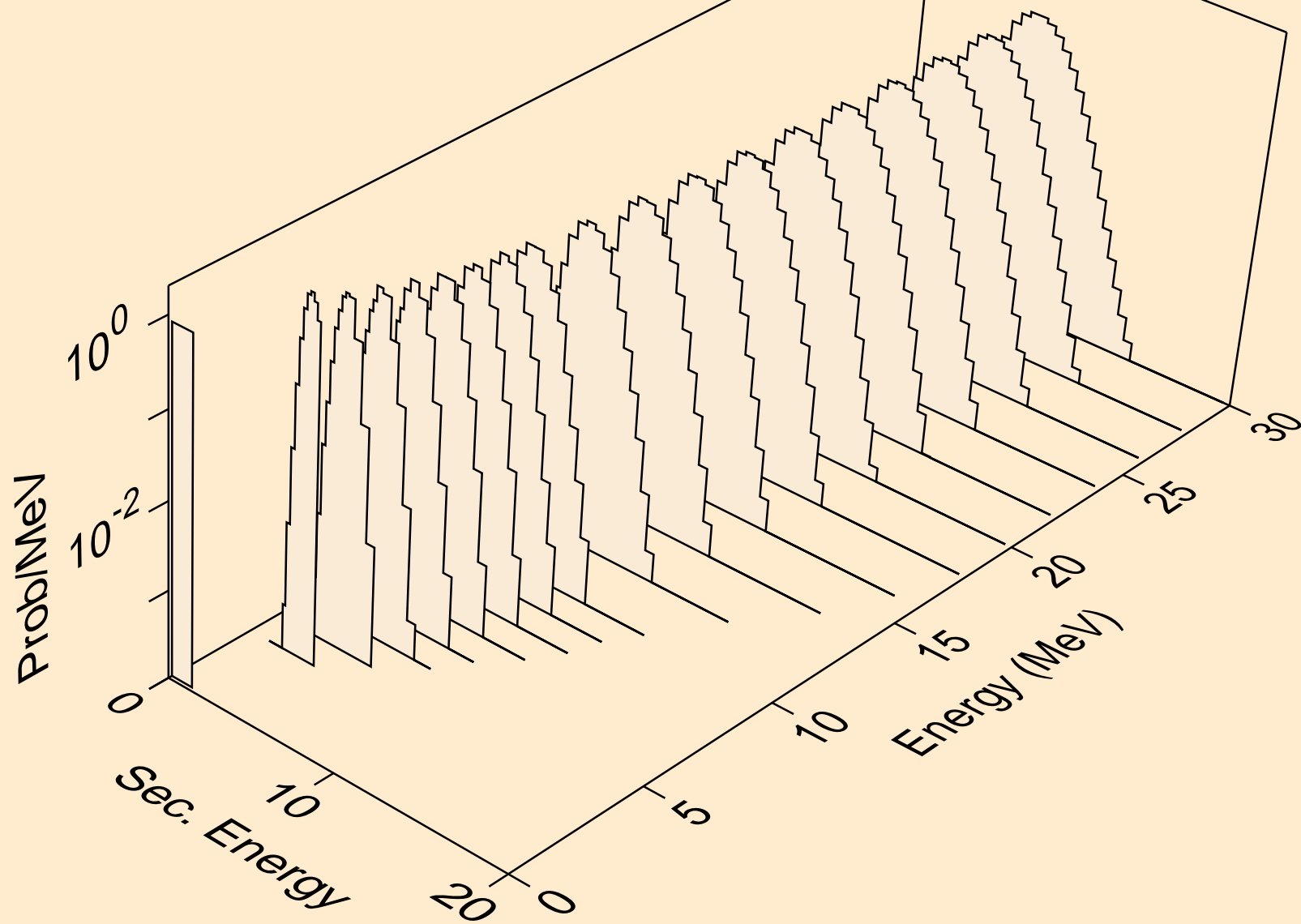

BI192 TRITON ACER TENDL-2021 LIBRARY; T=0.K  
protons from (t,pt)

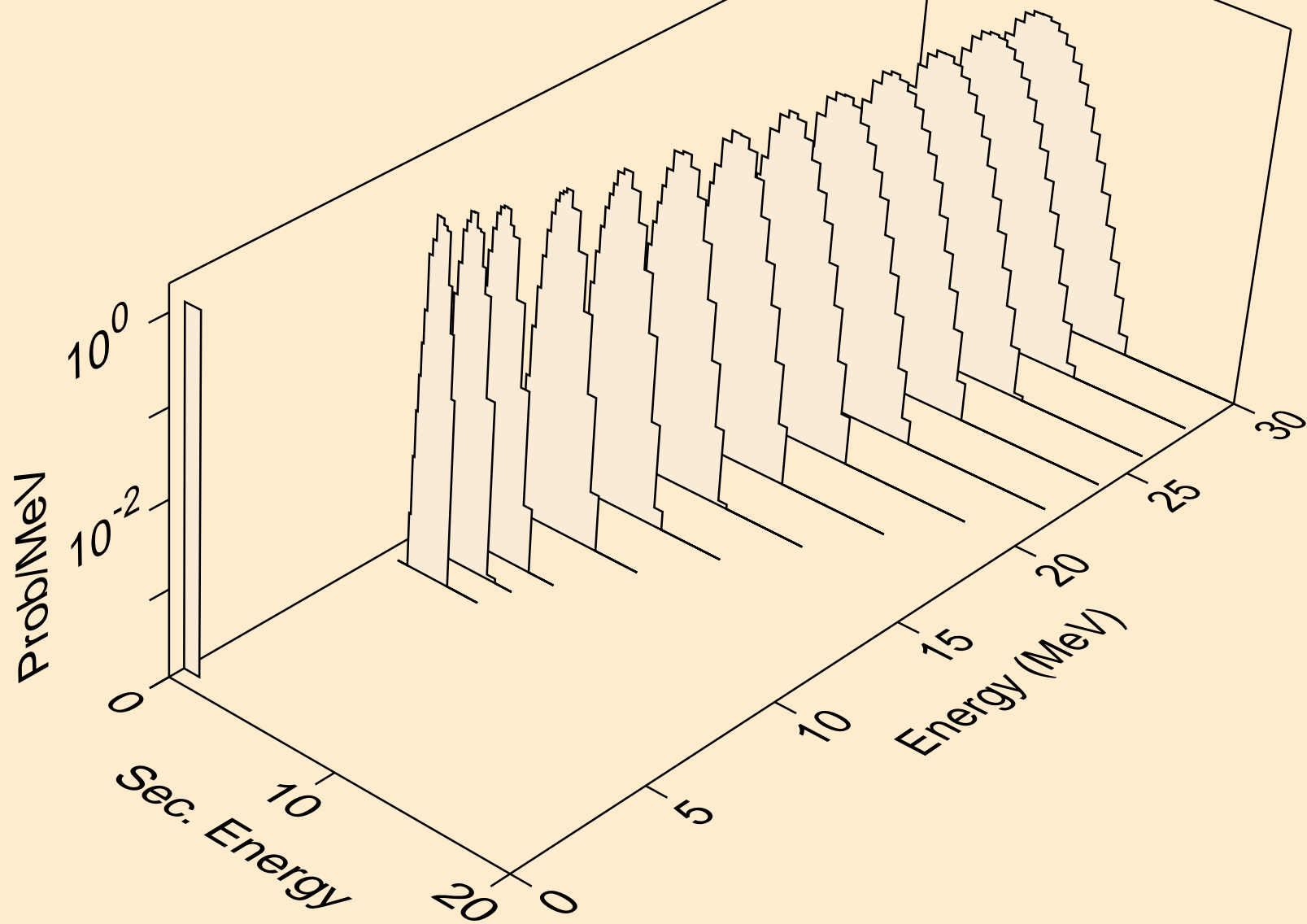

BI192 TRITON ACER TENDL-2021 LIBRARY; T=0.K  
deuterons from (t,x)

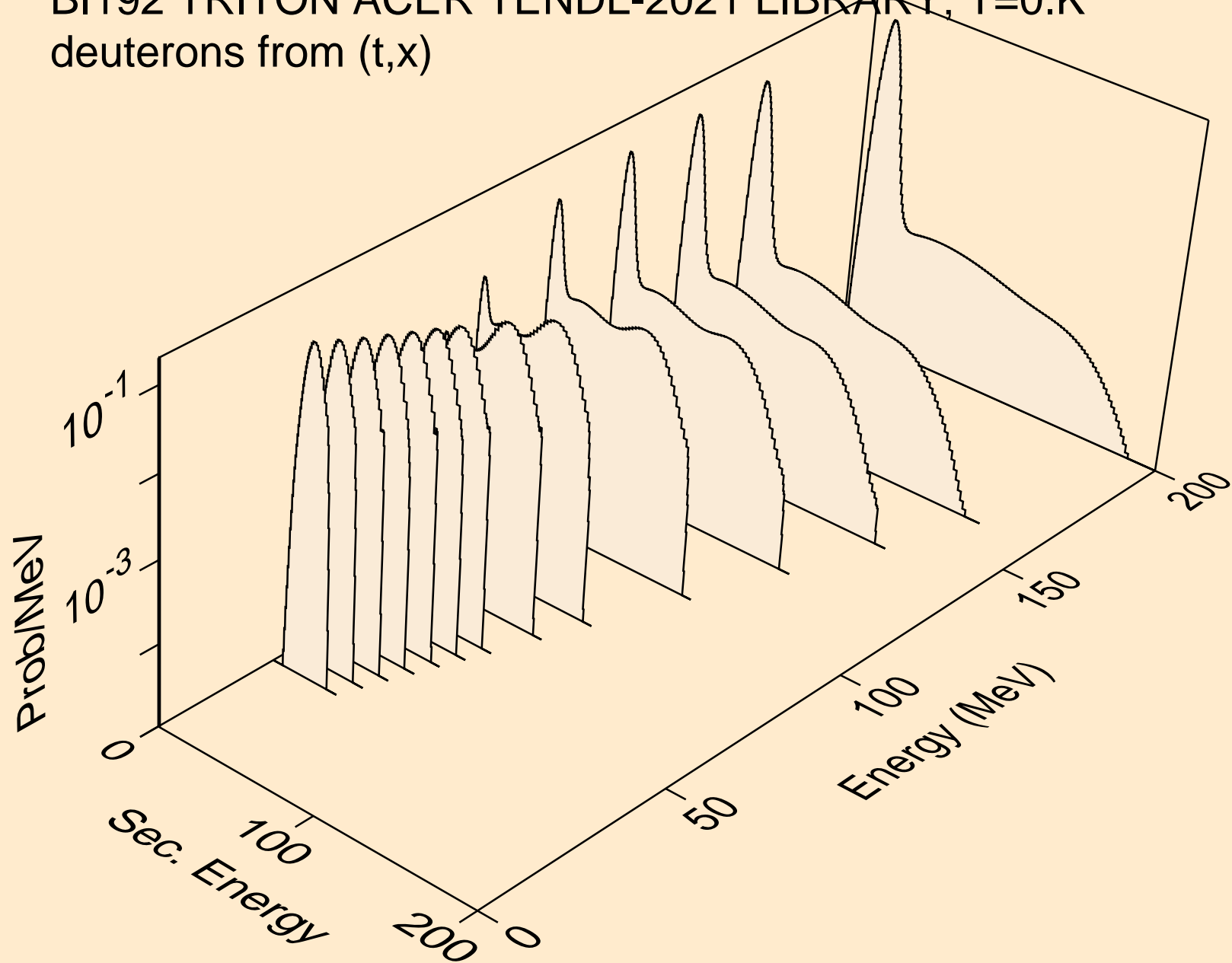



BI192 TRITON ACER TENDL-2021 LIBRARY; T=0.K  
deuterons from (t,2nd)

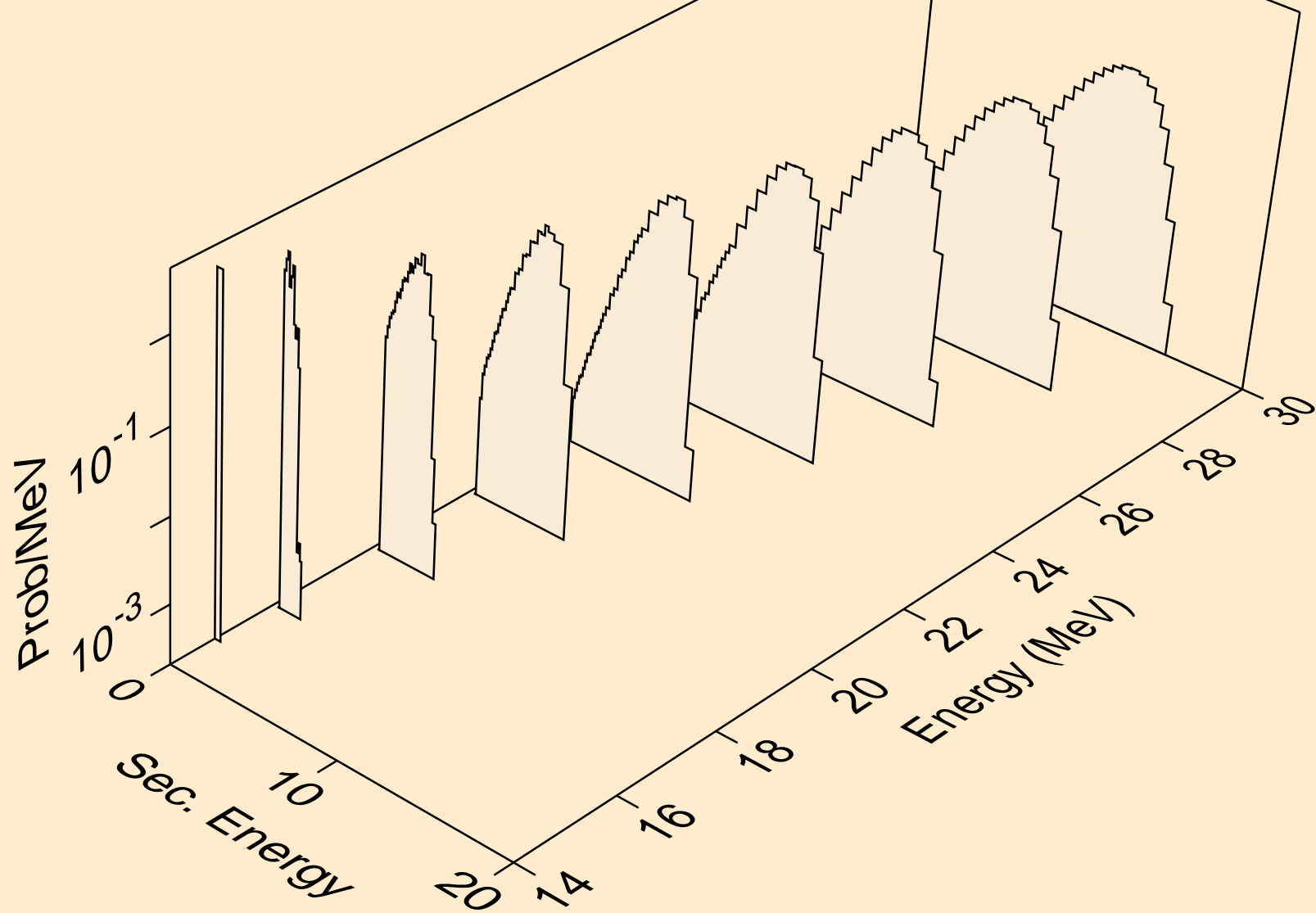

BI192 TRITON ACER TENDL-2021 LIBRARY; T=0.K  
deuterons from (t,n\*)d

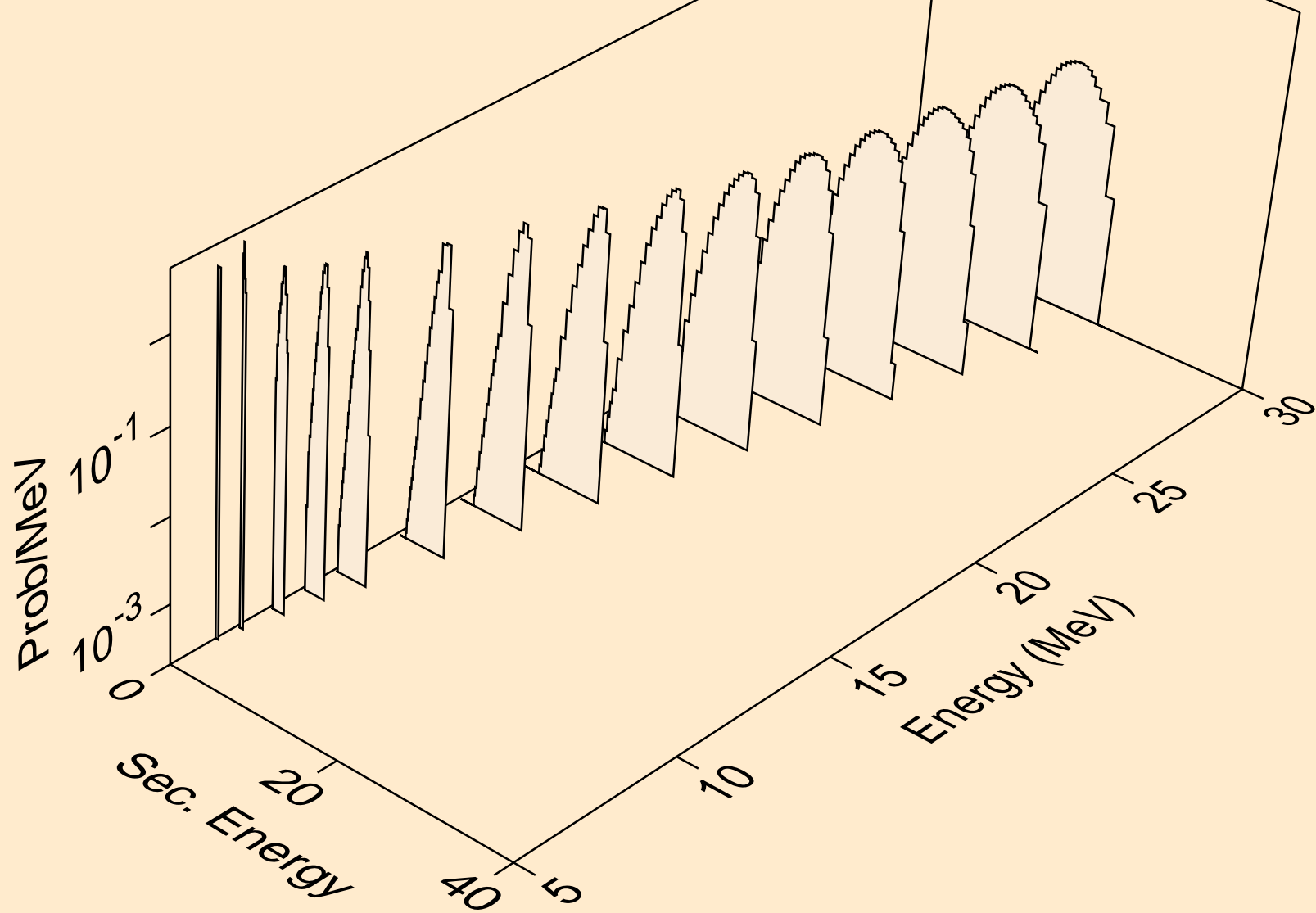

BI192 TRITON ACER TENDL-2021 LIBRARY; T=0.K  
deuterons from (t,d)

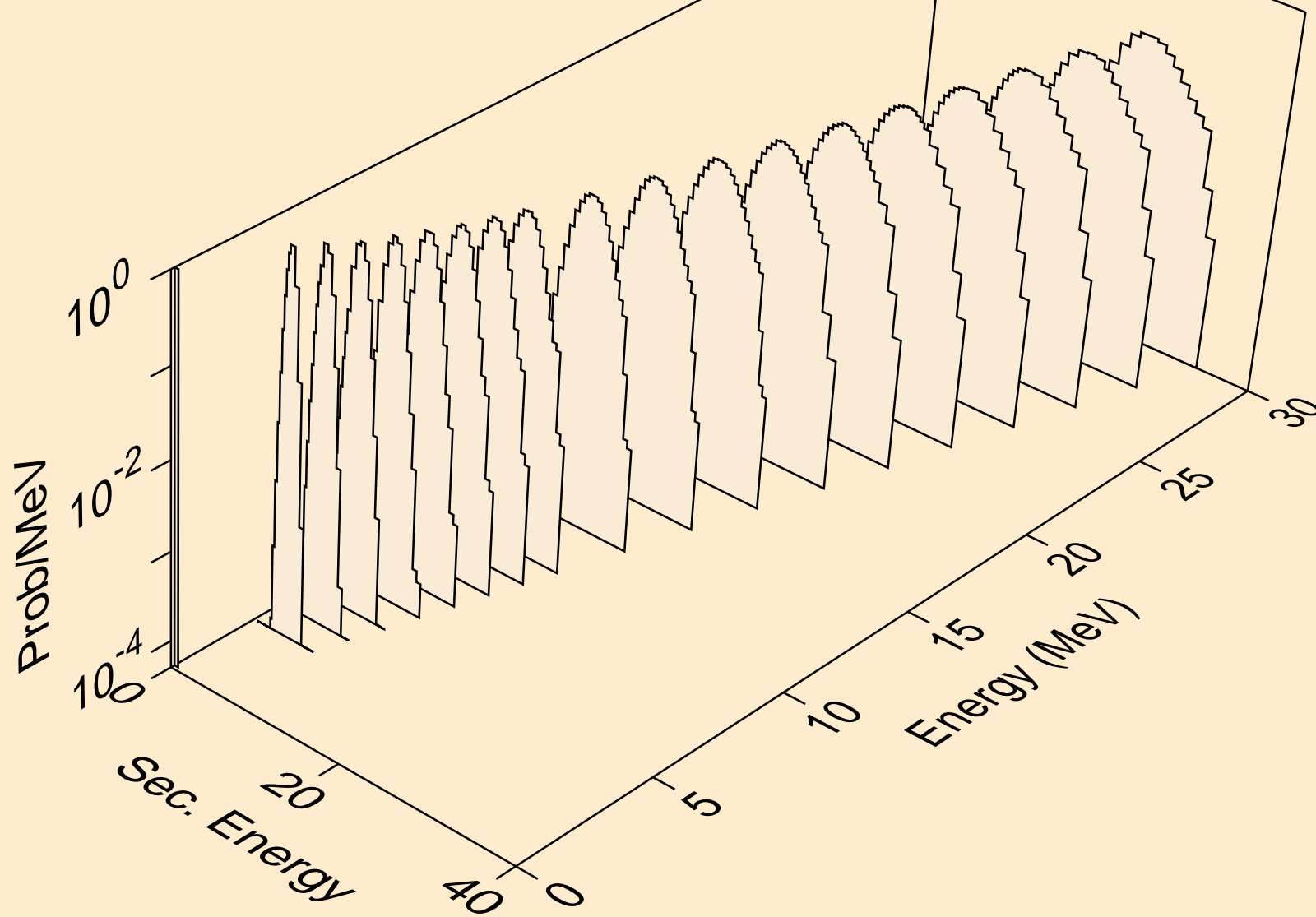

BI192 TRITON ACER TENDL-2021 LIBRARY; T=0.K  
deuterons from (t,d2a)

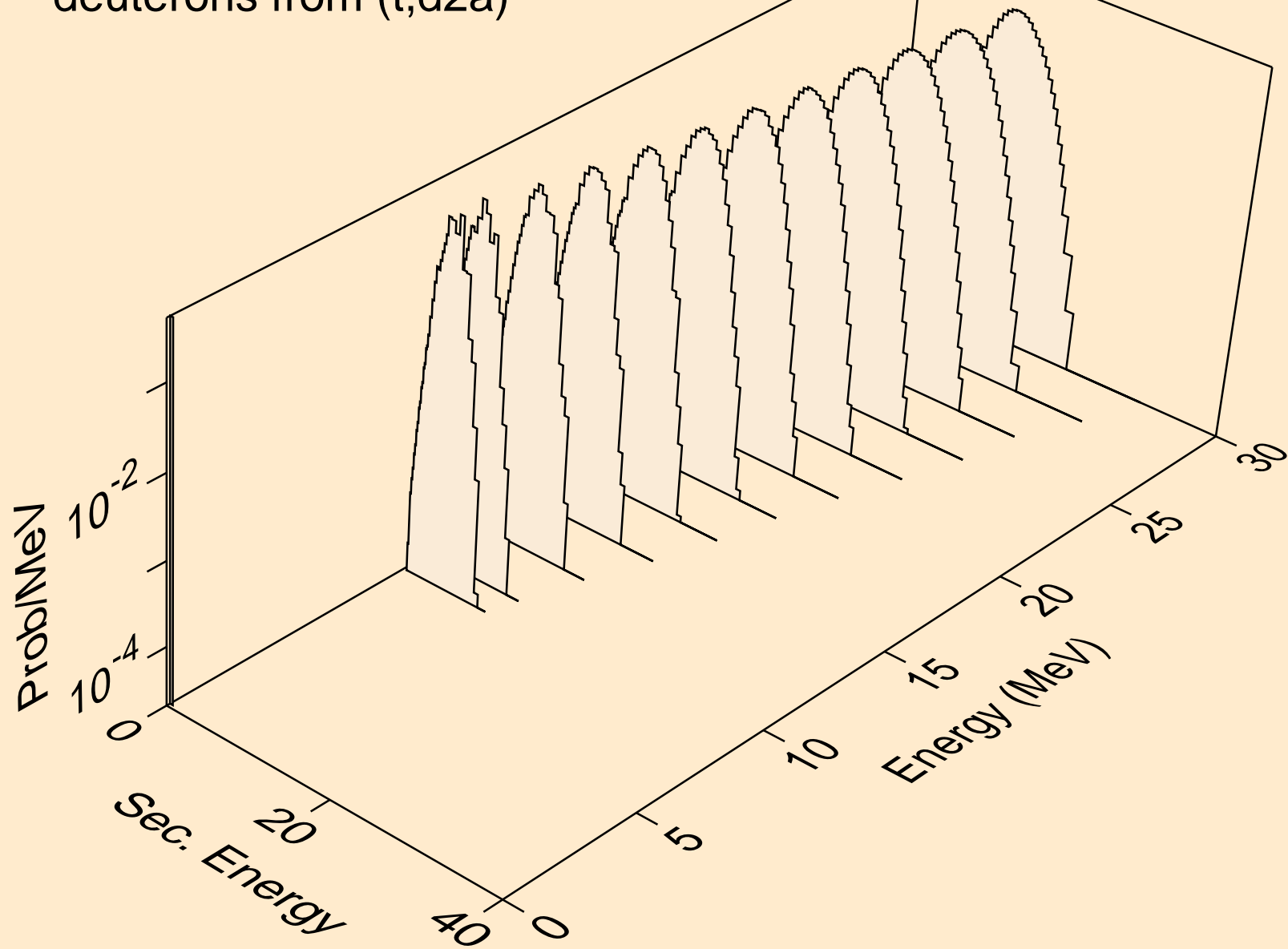

BI192 TRITON ACER TENDL-2021 LIBRARY; T=0.K  
deuterons from (t,pd)

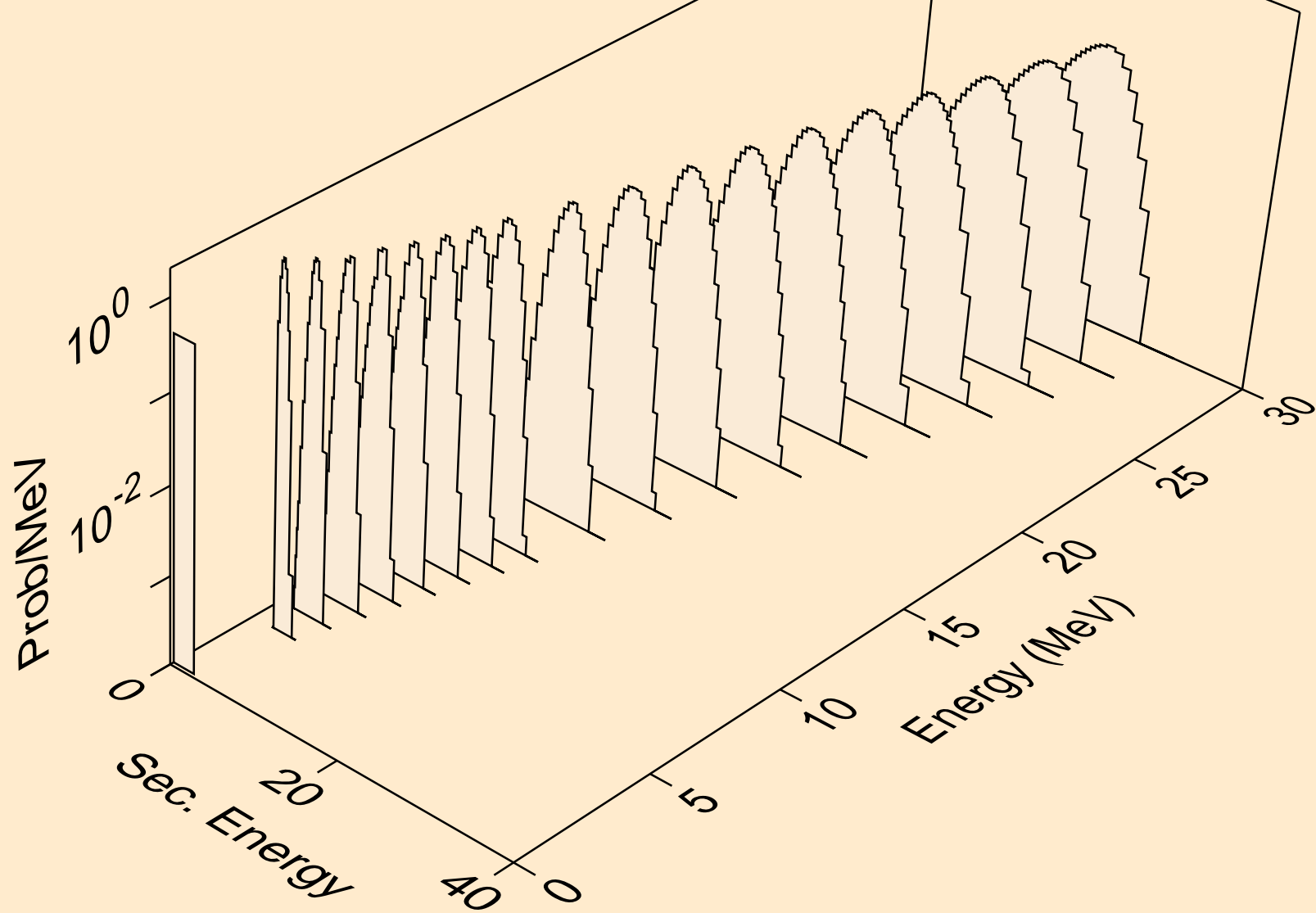

BI192 TRITON ACER TENDL-2021 LIBRARY; T=0.K  
deuterons from (t,da)

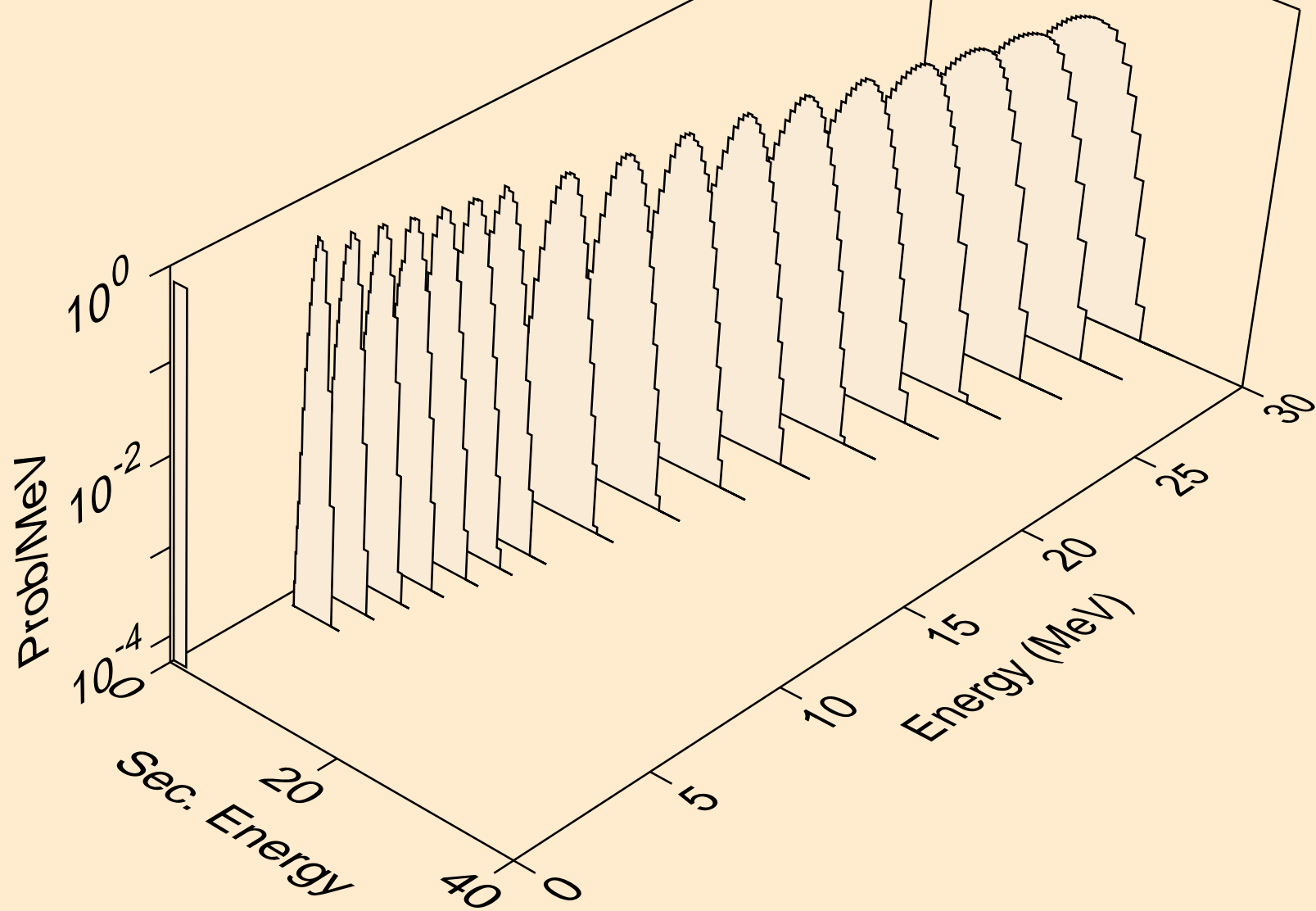

BI192 TRITON ACER TENDL-2021 LIBRARY; T=0.K  
he3s from (t,x)

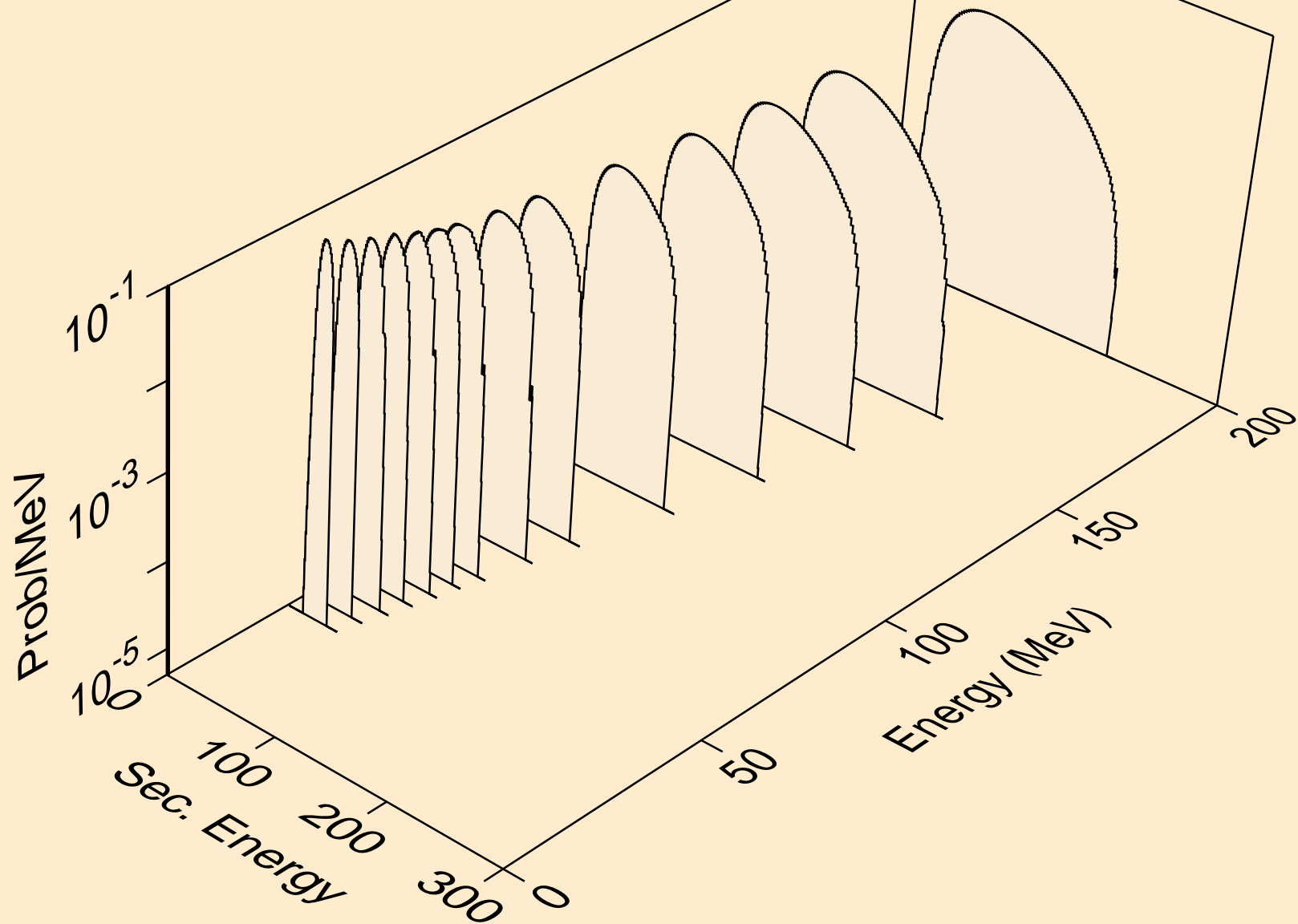

BI192 TRITON ACER TENDL-2021 LIBRARY; T=0.K  
he3s from (t,n\*)he3

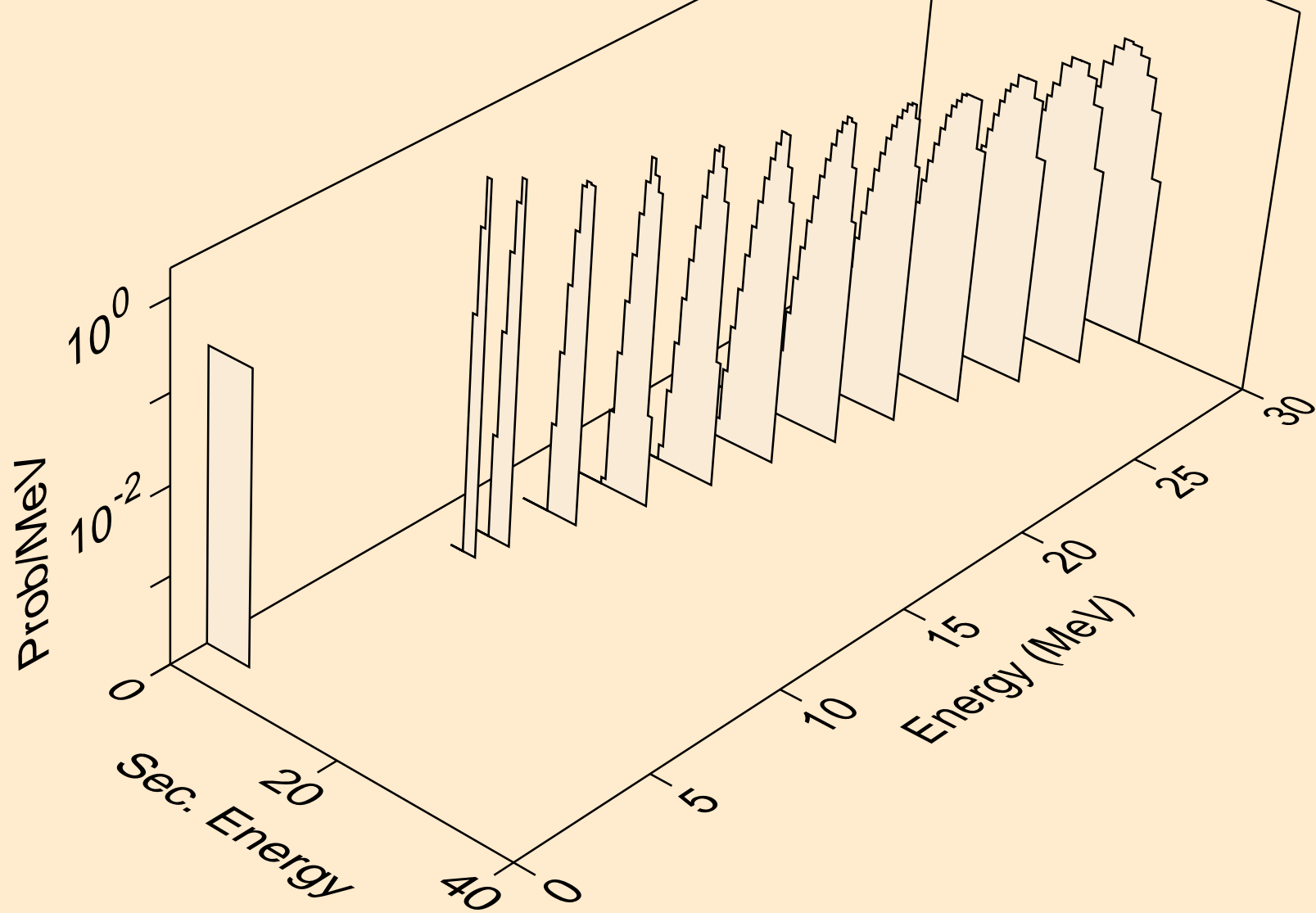



BI192 TRITON ACER TENDL-2021 LIBRARY; T=0.K  
he3s from (t,he3)

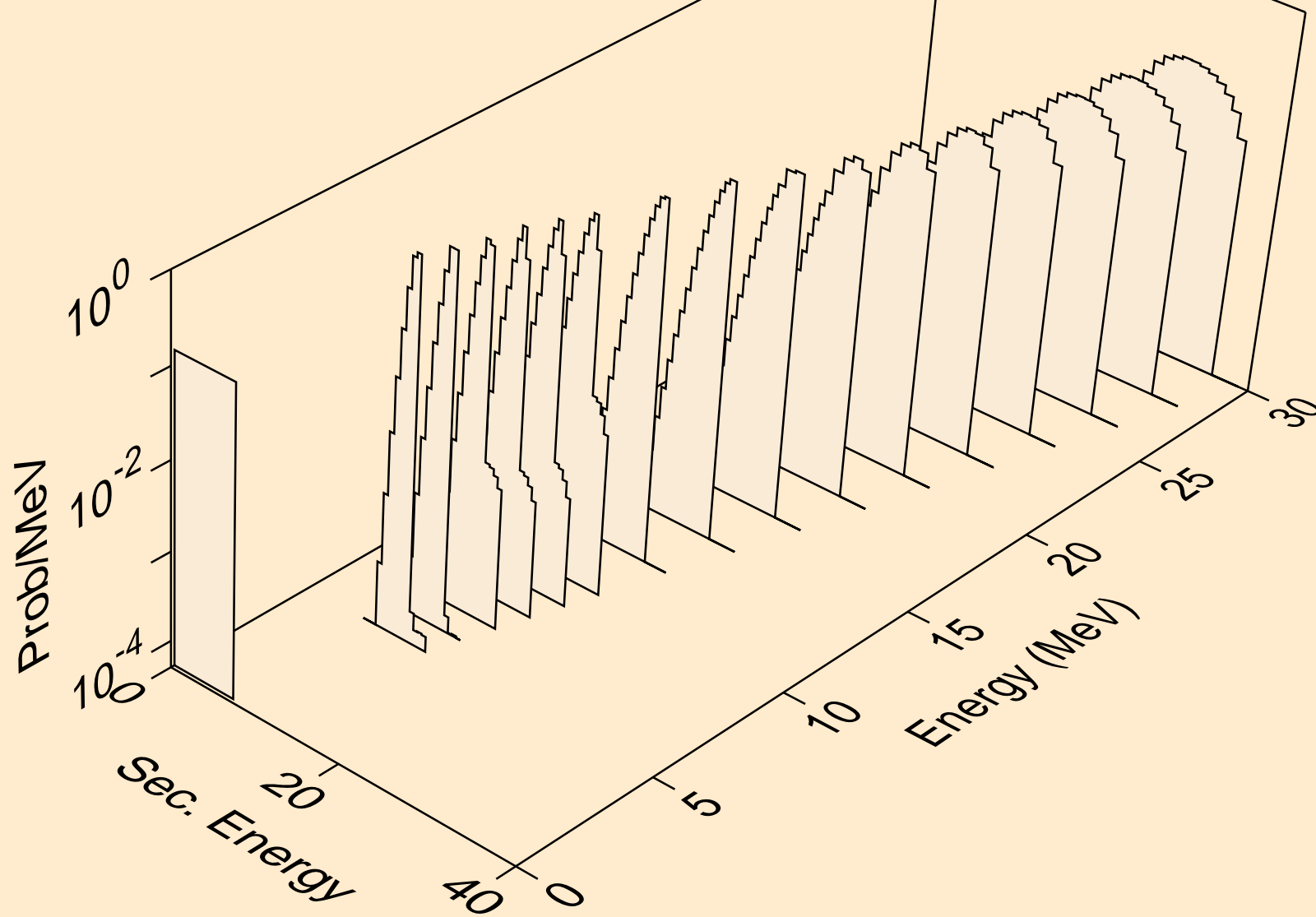

BI192 TRITON ACER TENDL-2021 LIBRARY; T=0.K  
alphas from (t,x)

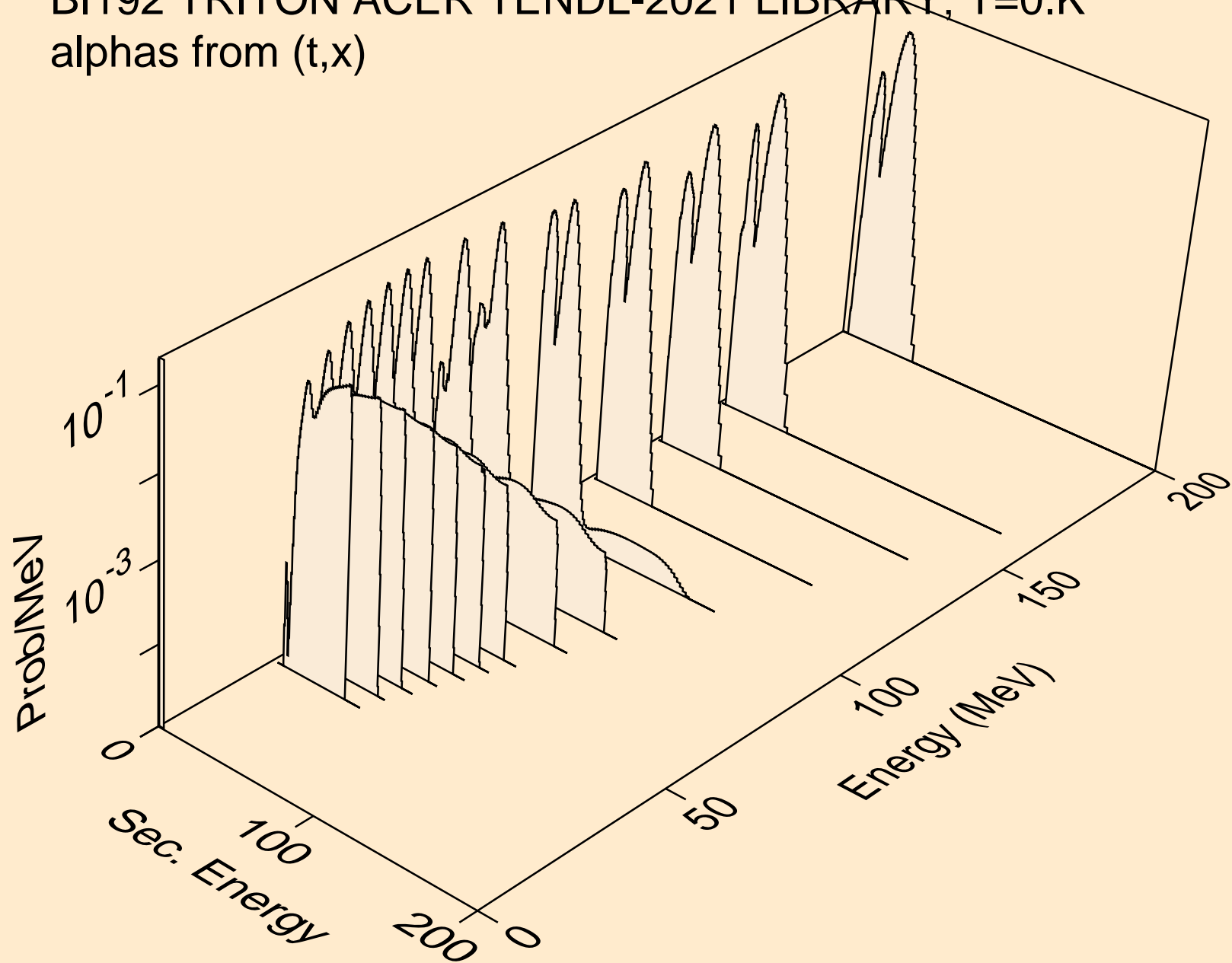

BI192 TRITON ACER TENDL-2021 LIBRARY; T=0.K  
alphas from (t,n\*)a

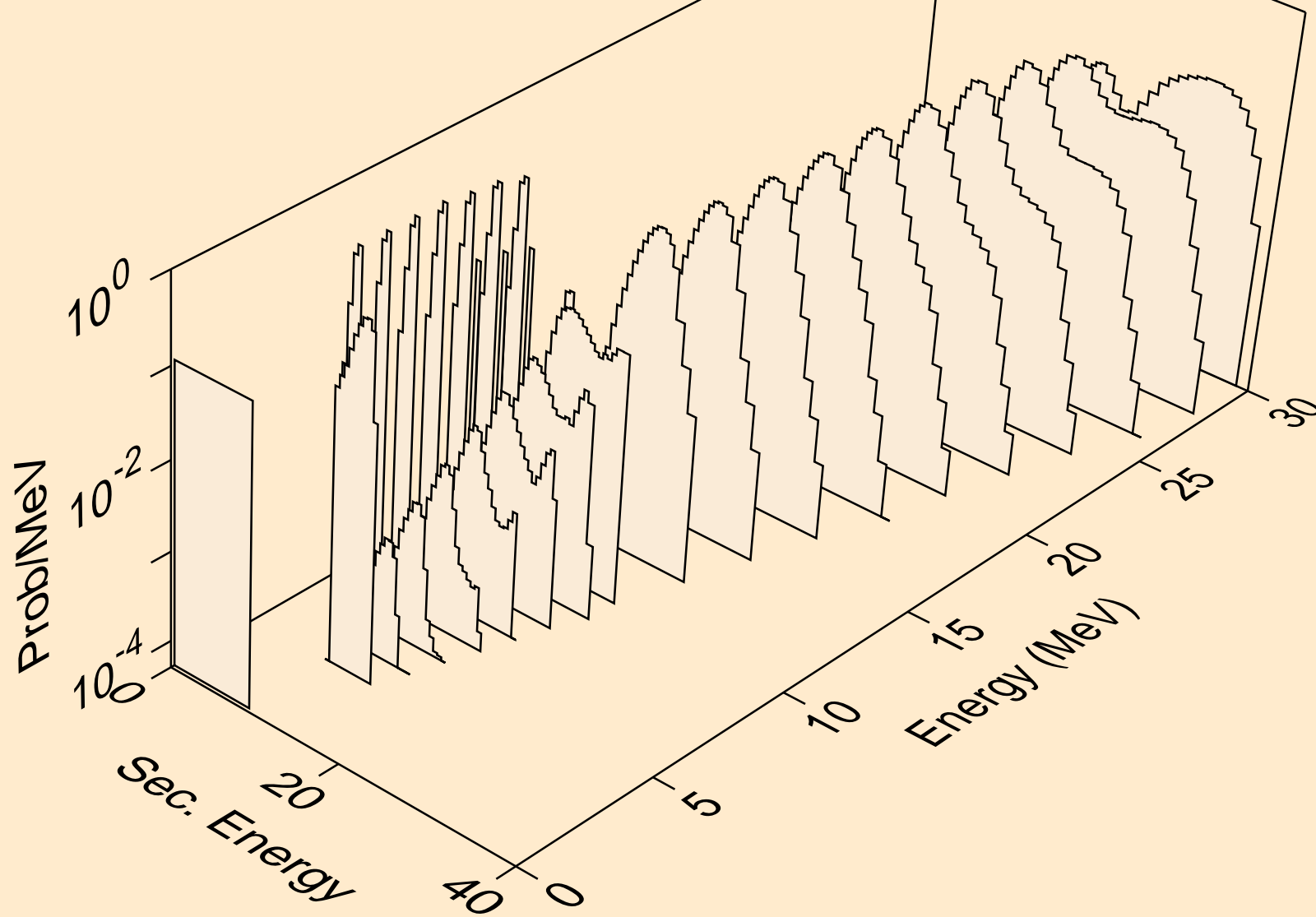

BI192 TRITON ACER TENDL-2021 LIBRARY; T=0.K  
alphas from (t,2n)a

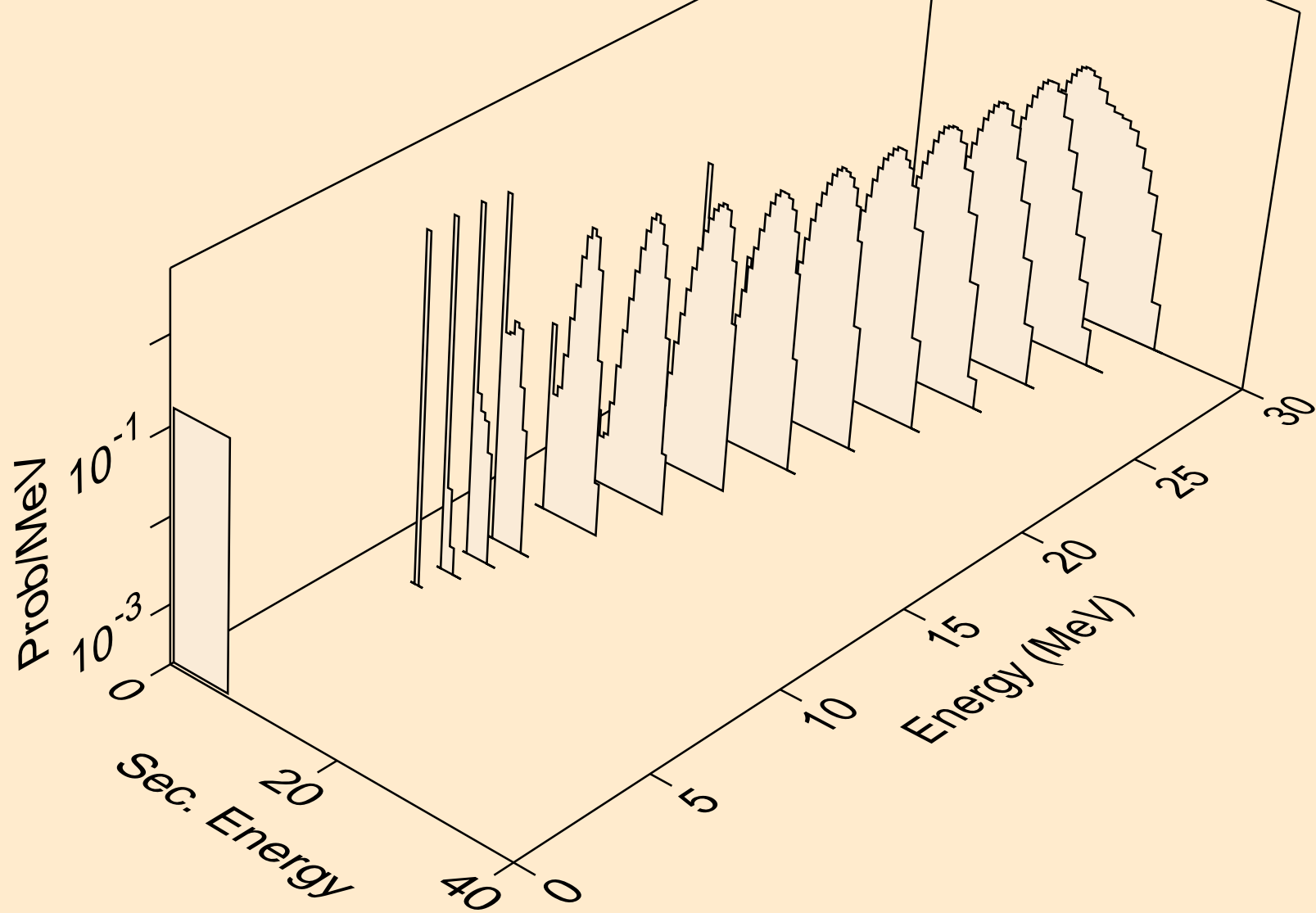

BI192 TRITON ACER TENDL-2021 LIBRARY; T=0.K  
alphas from (t,3n)a

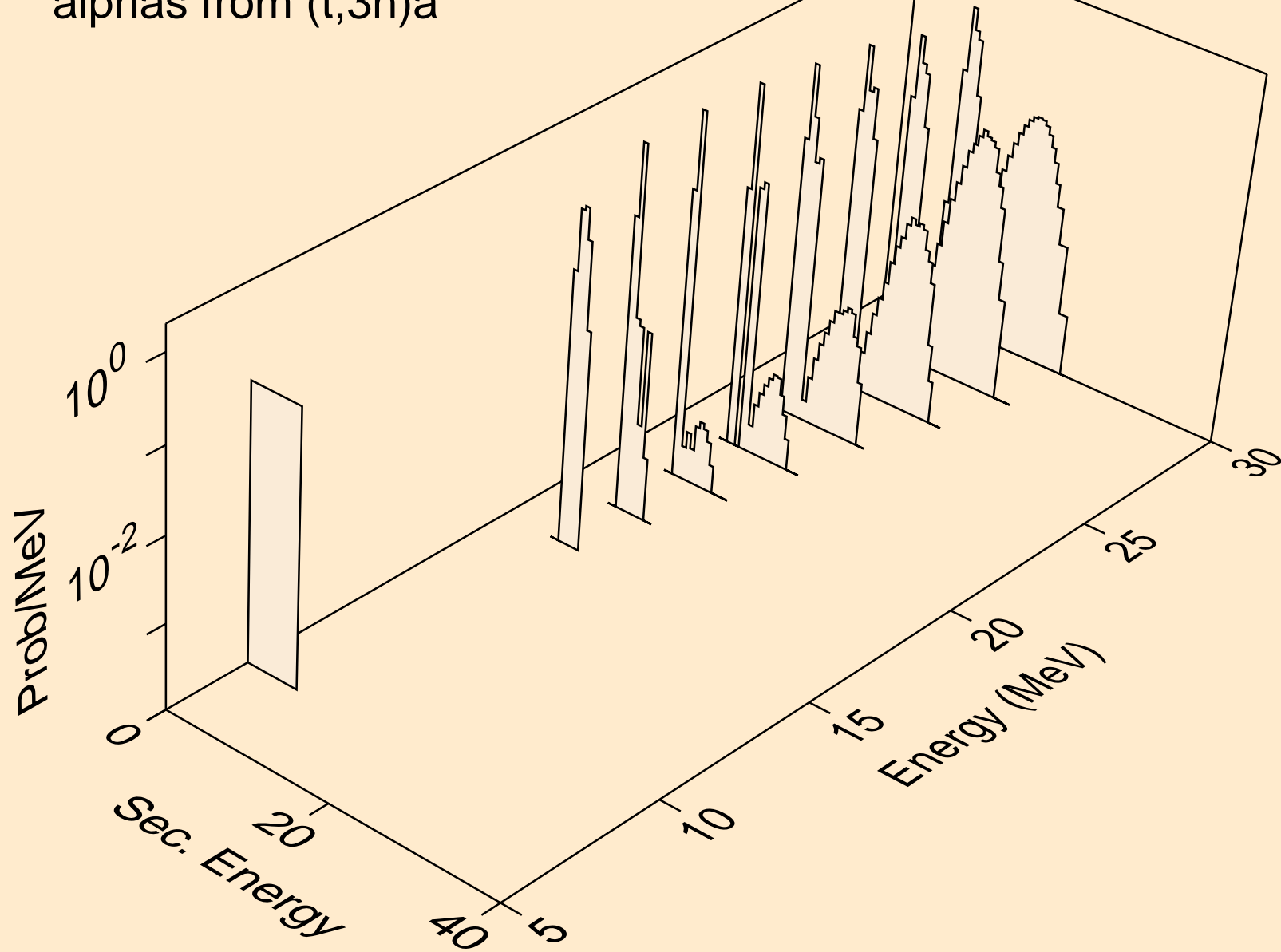

BI192 TRITON ACER TENDL-2021 LIBRARY; T=0.K  
alphas from (t,n\*)2a

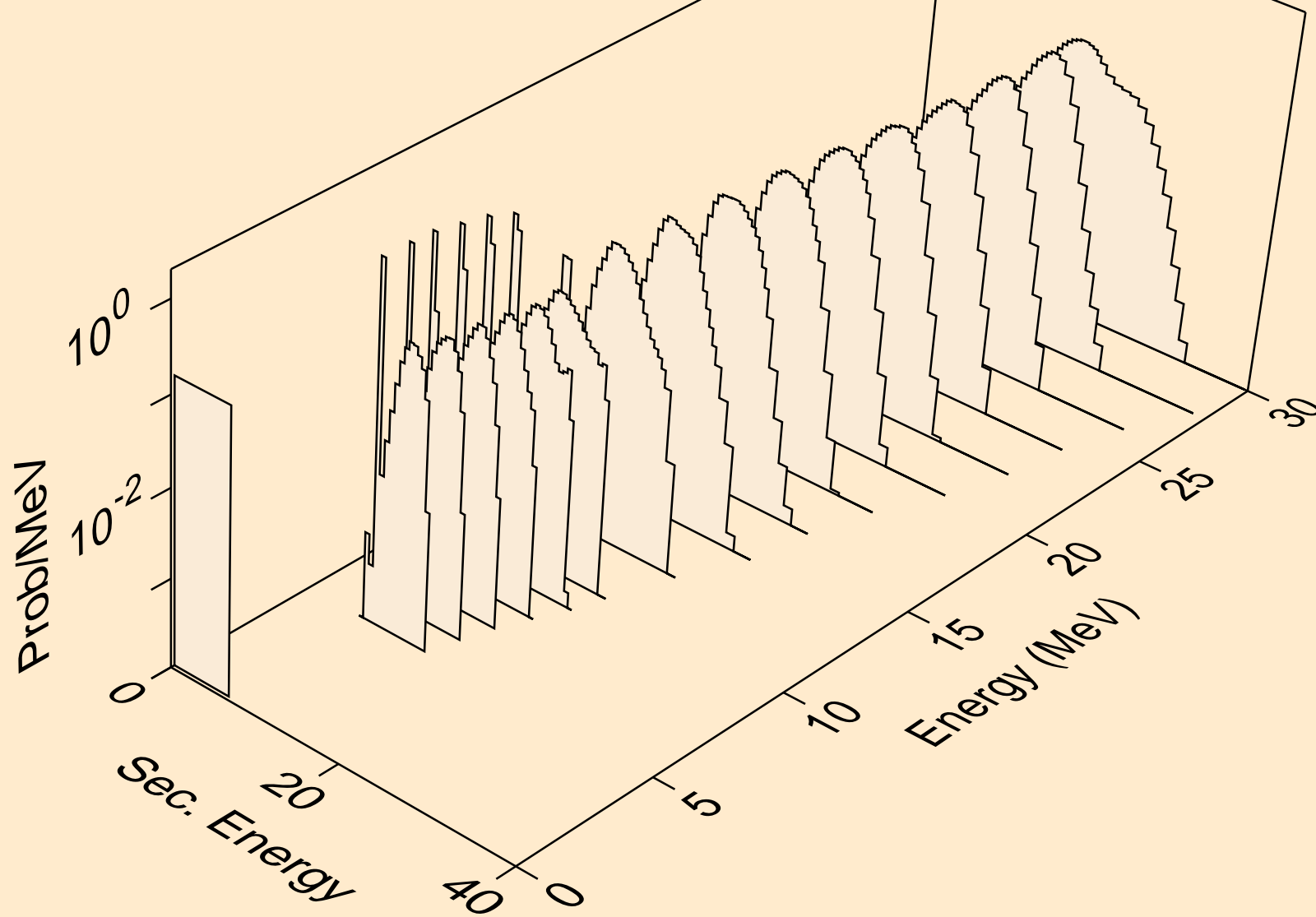

BI192 TRITON ACER TENDL-2021 LIBRARY; T=0.K  
alphas from (t,2n)2a

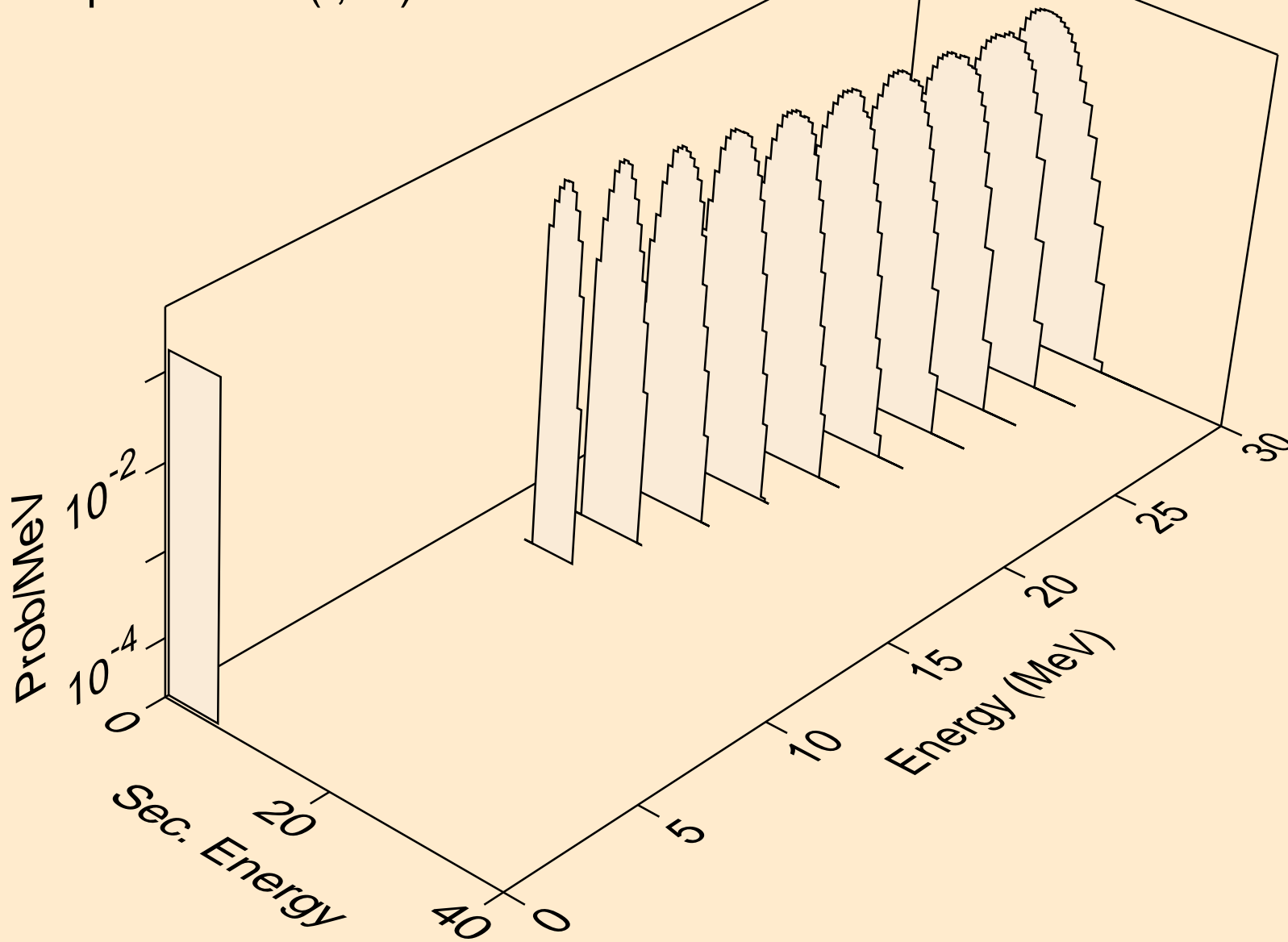

BI192 TRITON ACER TENDL-2021 LIBRARY; T=0.K  
alphas from (t,npa)

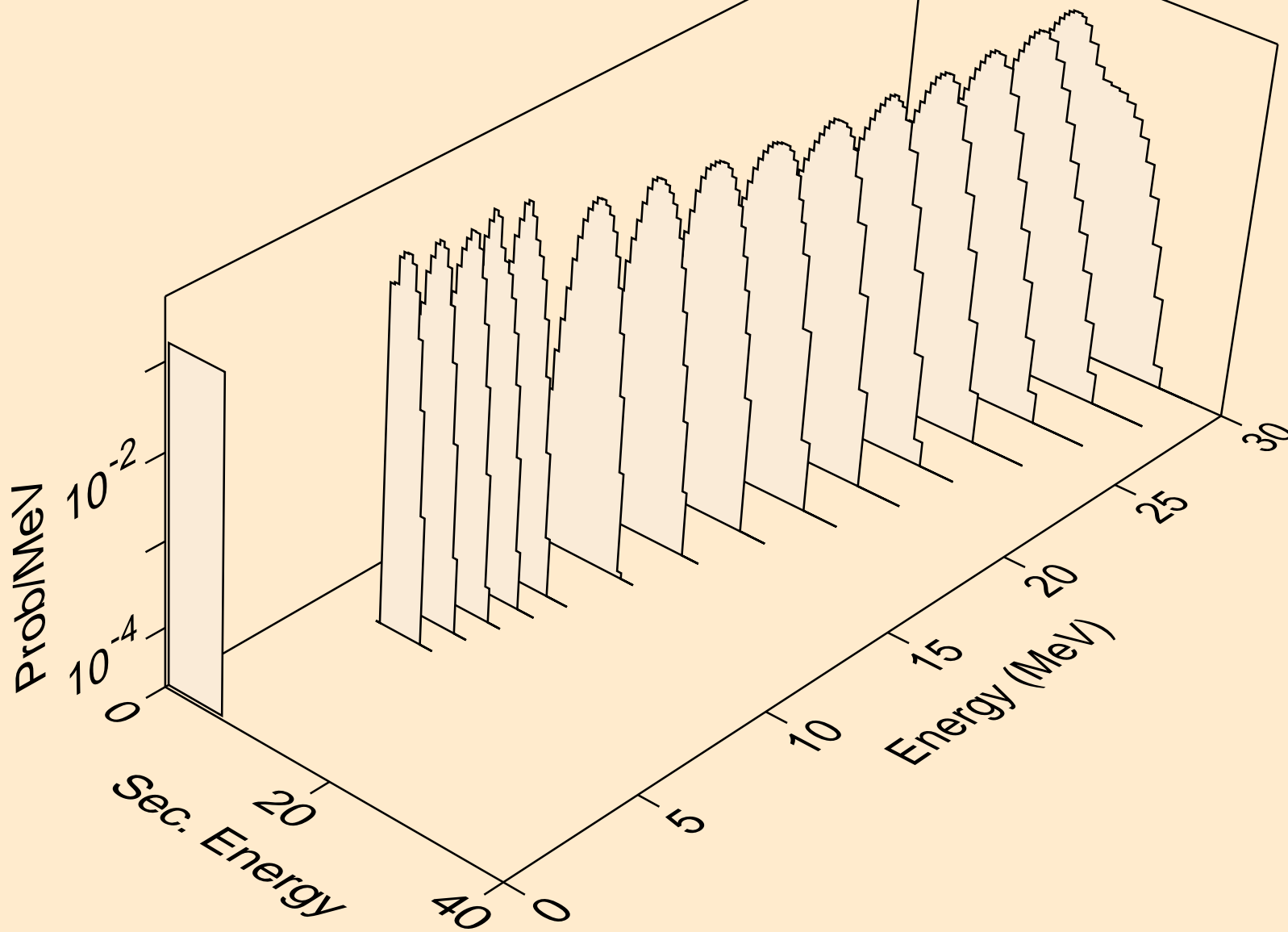



BI192 TRITON ACER TENDL-2021 LIBRARY; T=0.K  
alphas from (t,a)

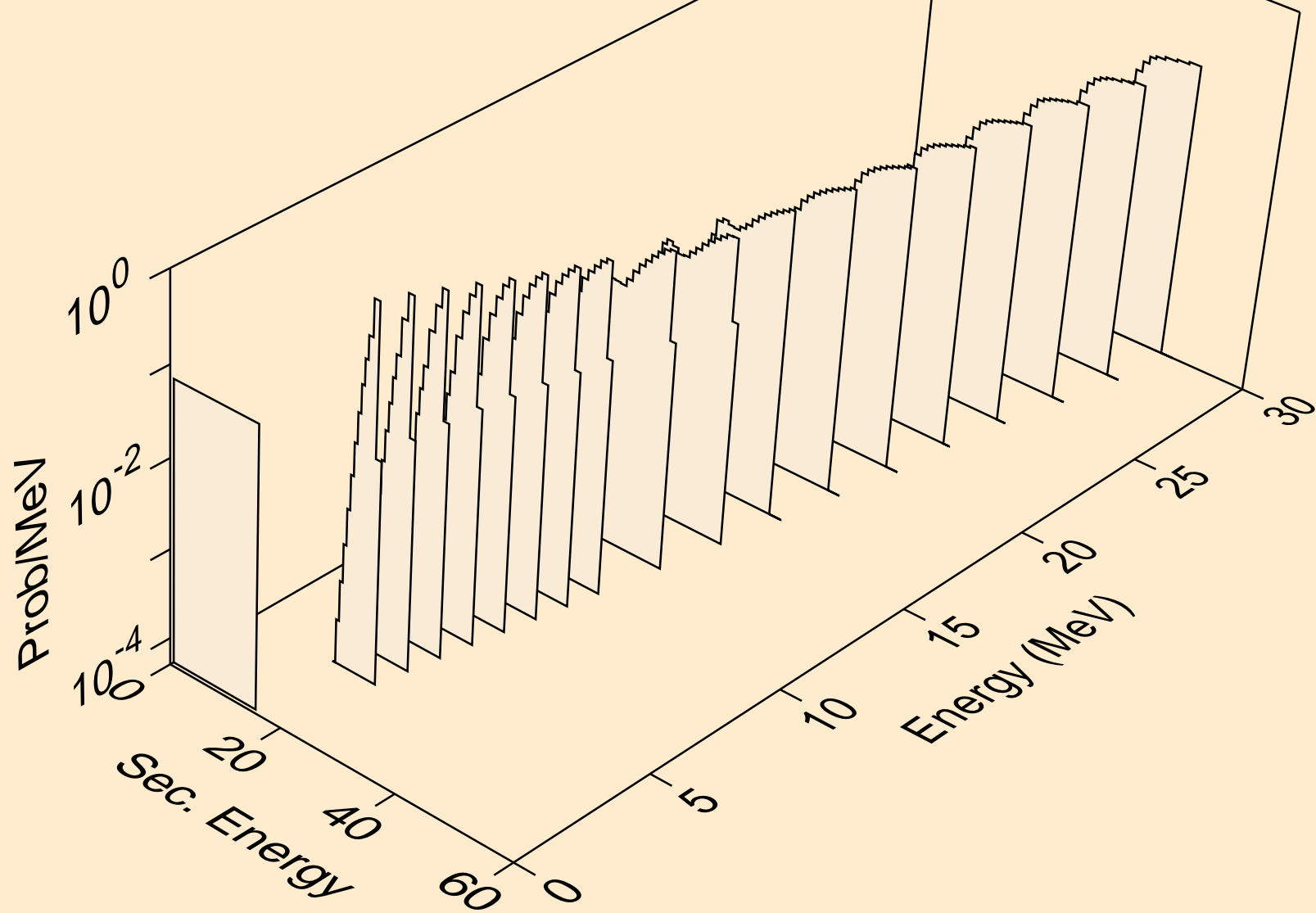

BI192 TRITON ACER TENDL-2021 LIBRARY; T=0.K  
alphas from (t,2a)

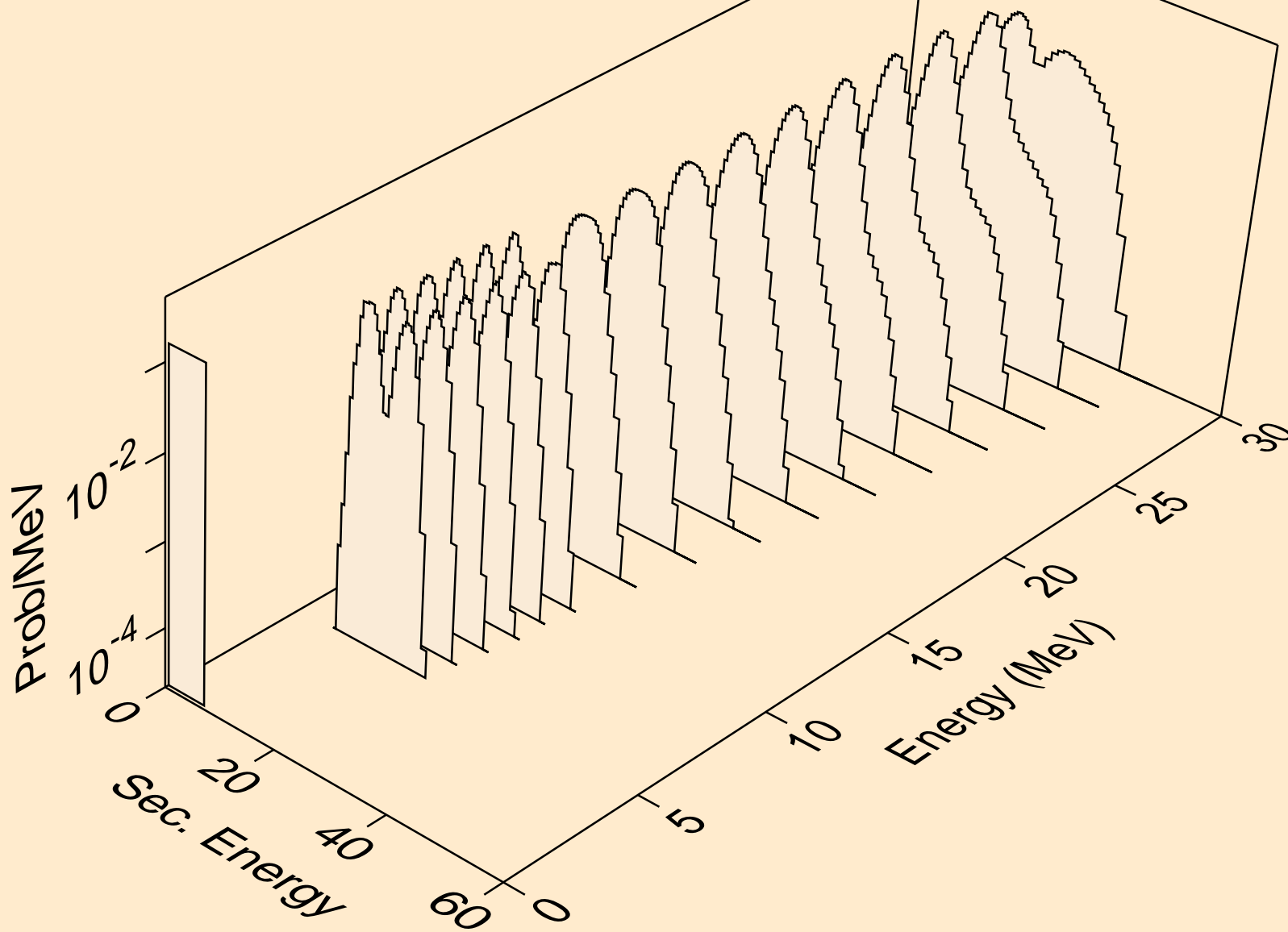

BI192 TRITON ACER TENDL-2021 LIBRARY; T=0.K  
alphas from (t,3a)

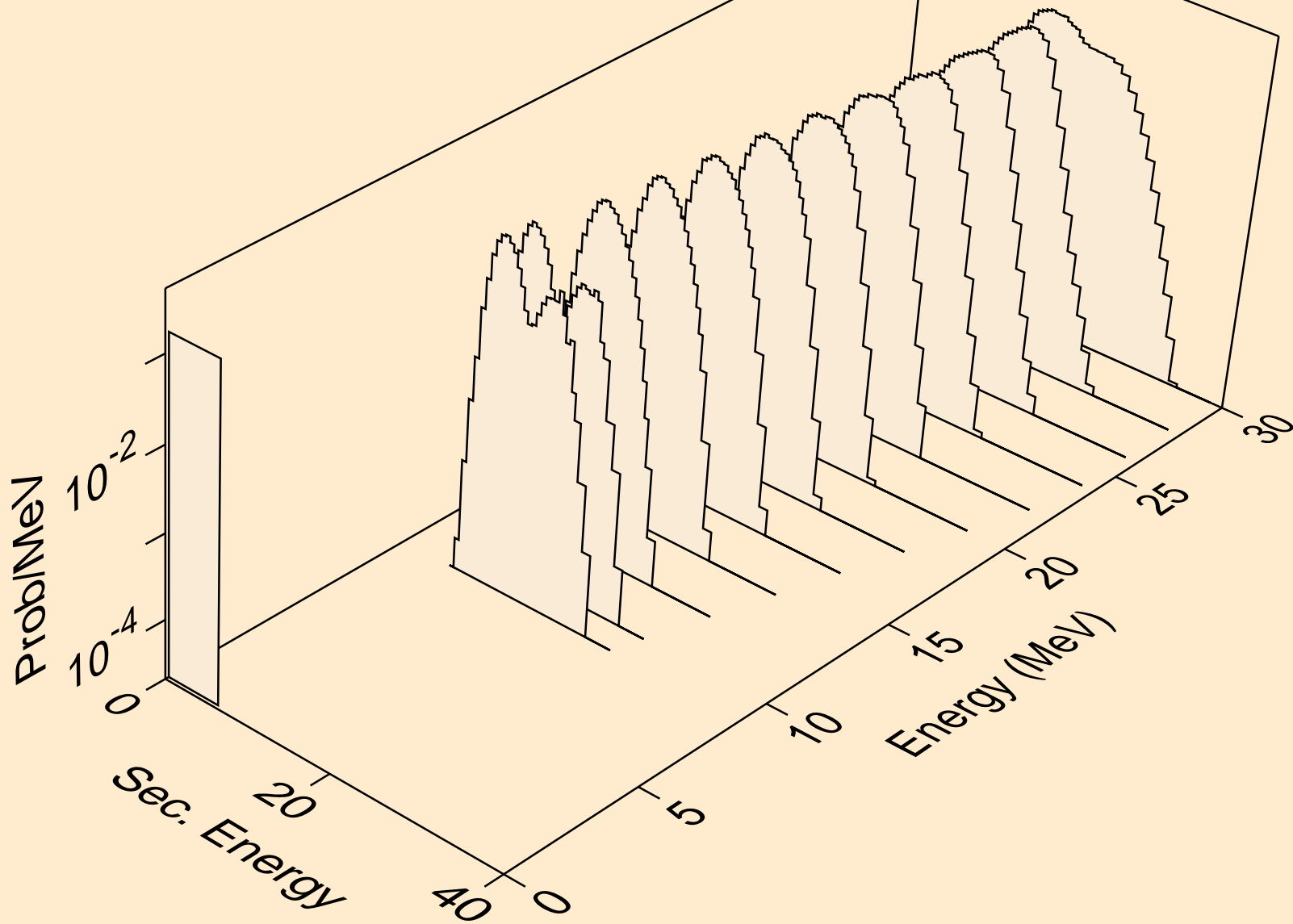

BI192 TRITON ACER TENDL-2021 LIBRARY; T=0.K  
alphas from (t,pa)

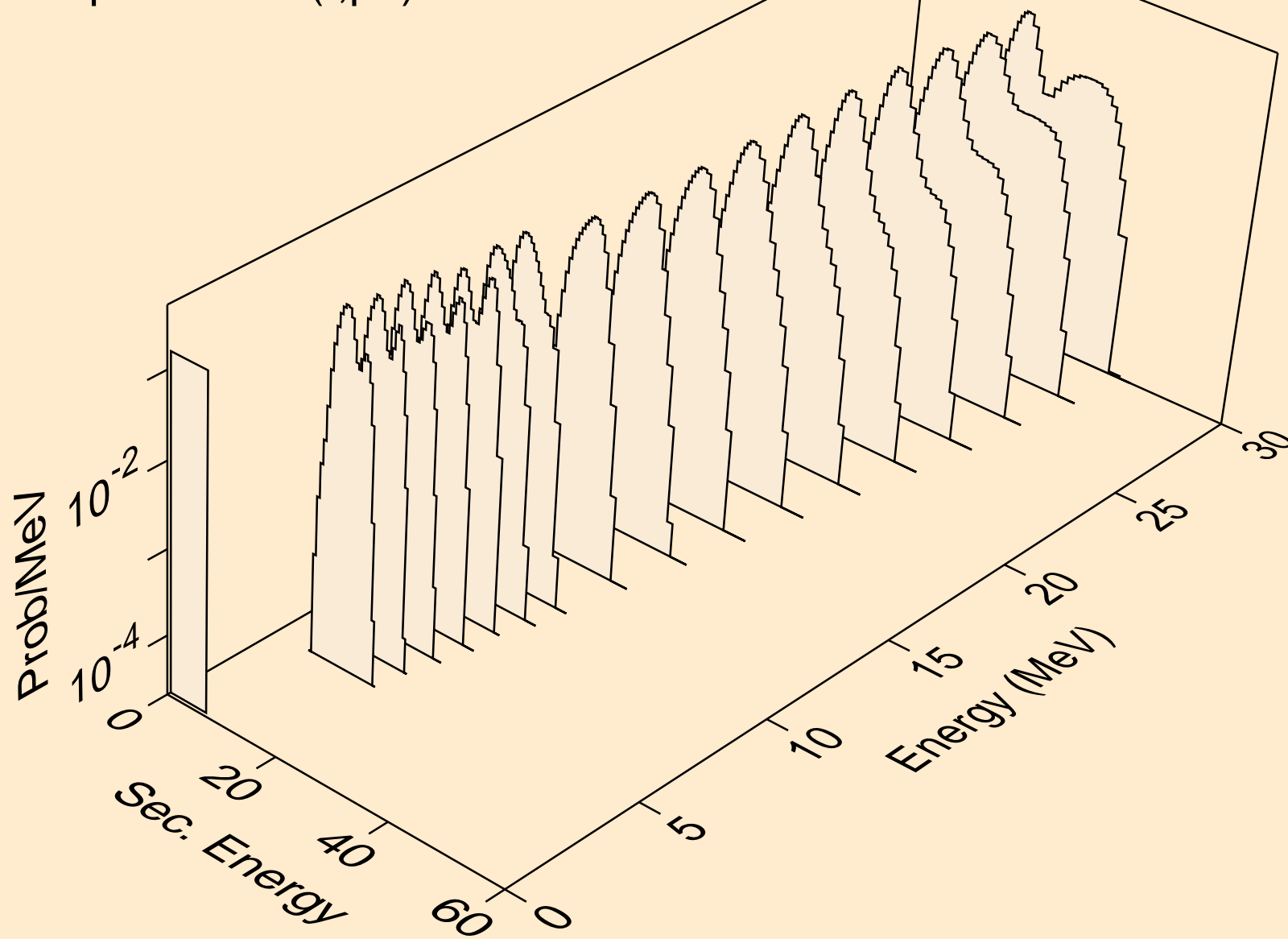

BI192 TRITON ACER TENDL-2021 LIBRARY; T=0.K  
alphas from (t,d2a)

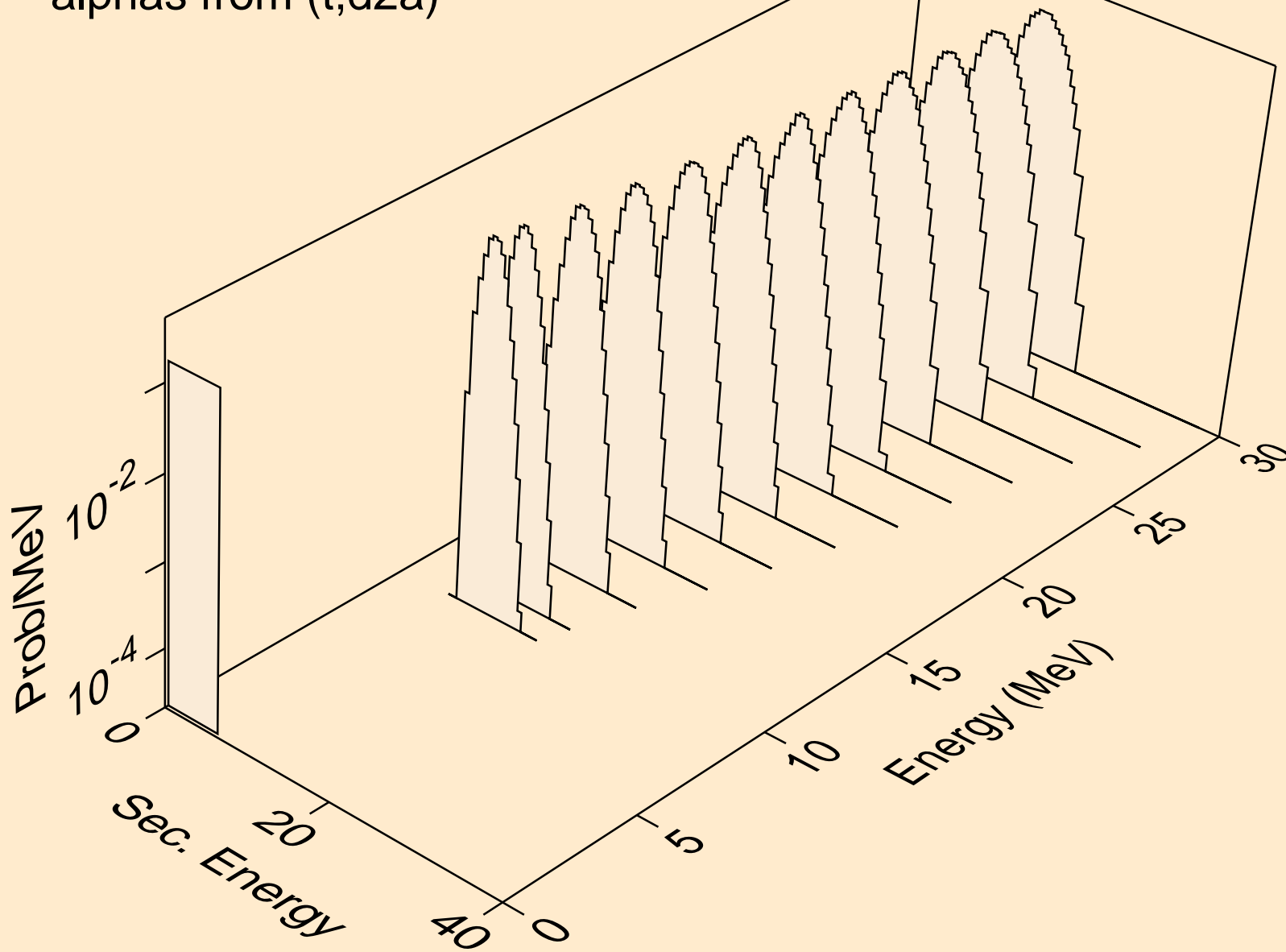

BI192 TRITON ACER TENDL-2021 LIBRARY; T=0.K  
alphas from (t,da)

