

# BI212M TRITON ACER TENDL-2021 LIBRARY; T=0.K

## Principal cross sections

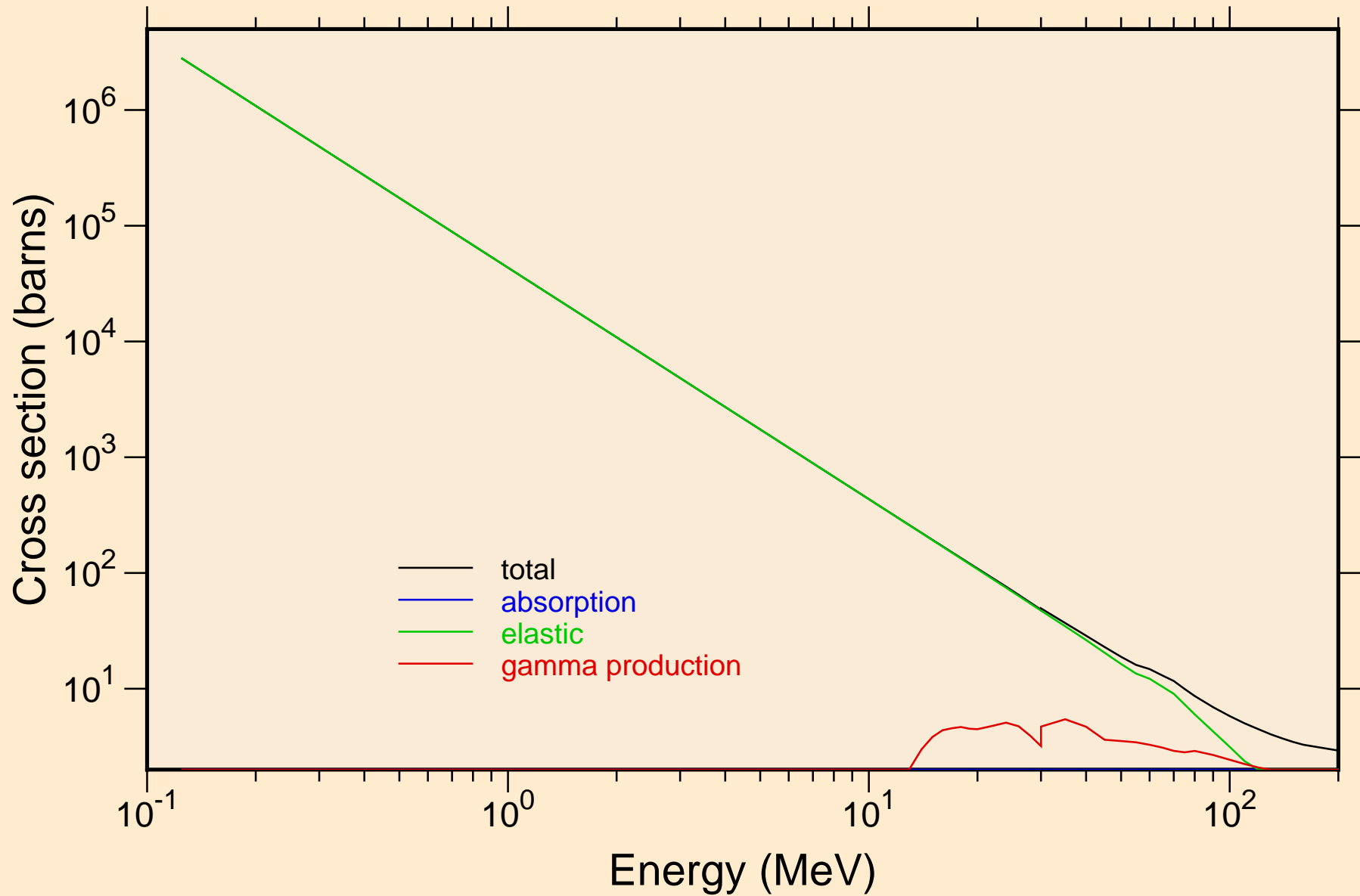

BI212M TRITON ACER TENDL-2021 LIBRARY; T=0.K

Heating

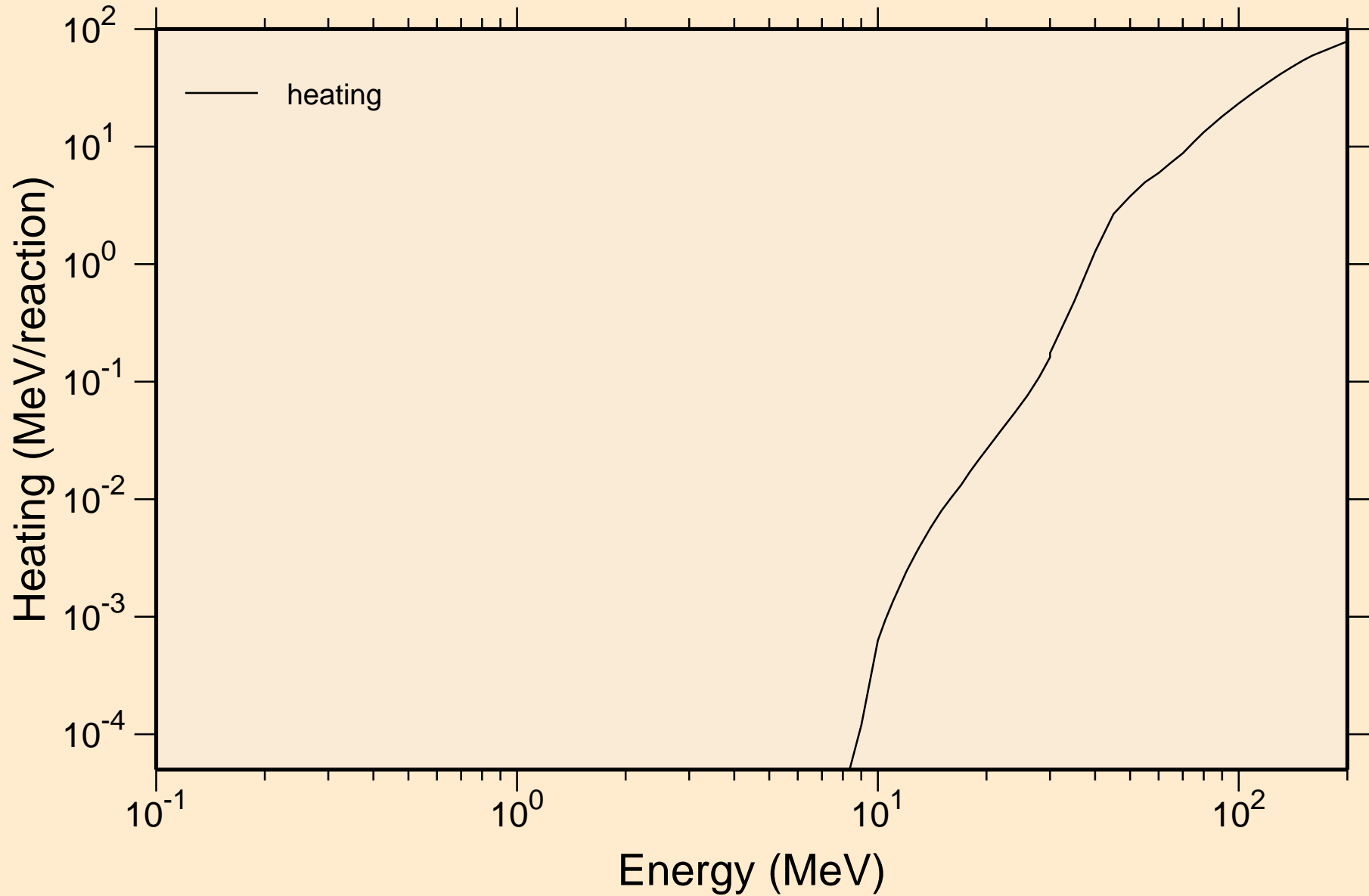

# BI212M TRITON ACER TENDL-2021 LIBRARY; T=0.K

## Principal cross sections

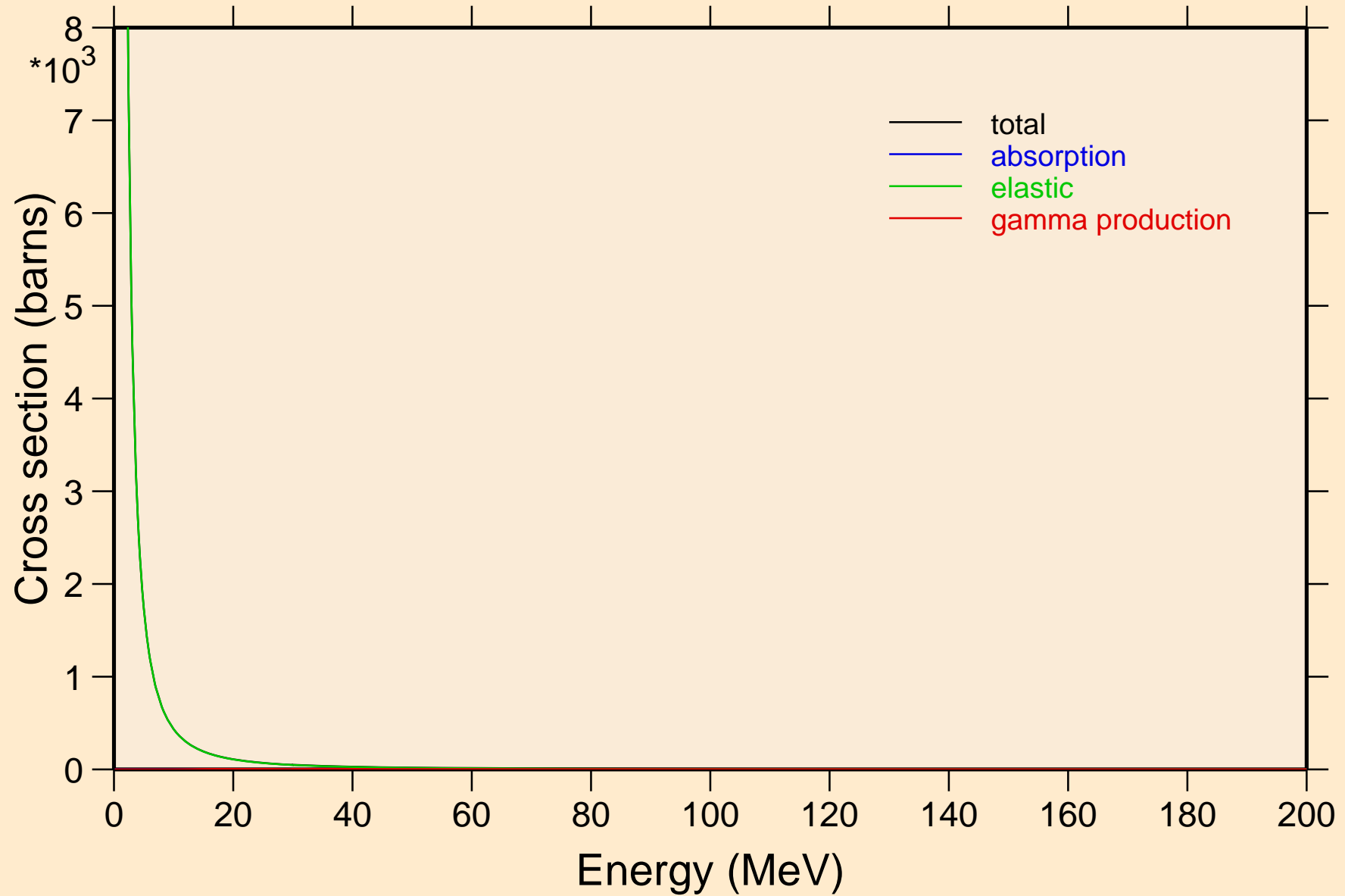

BI212M TRITON ACER TENDL-2021 LIBRARY; T=0.K

Heating

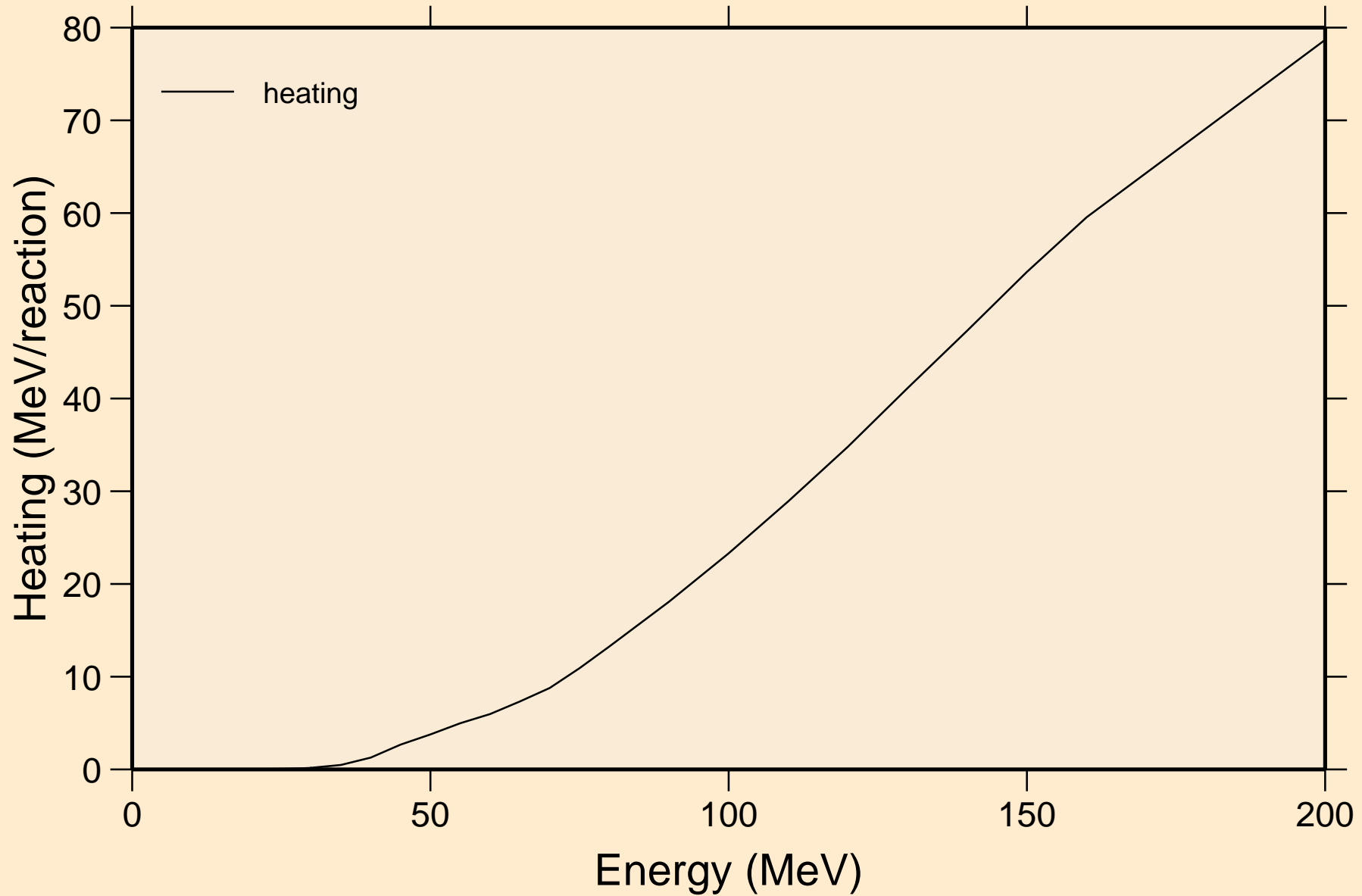

BI212M TRITON ACER TENDL-2021 LIBRARY; T=0.K  
Threshold reactions

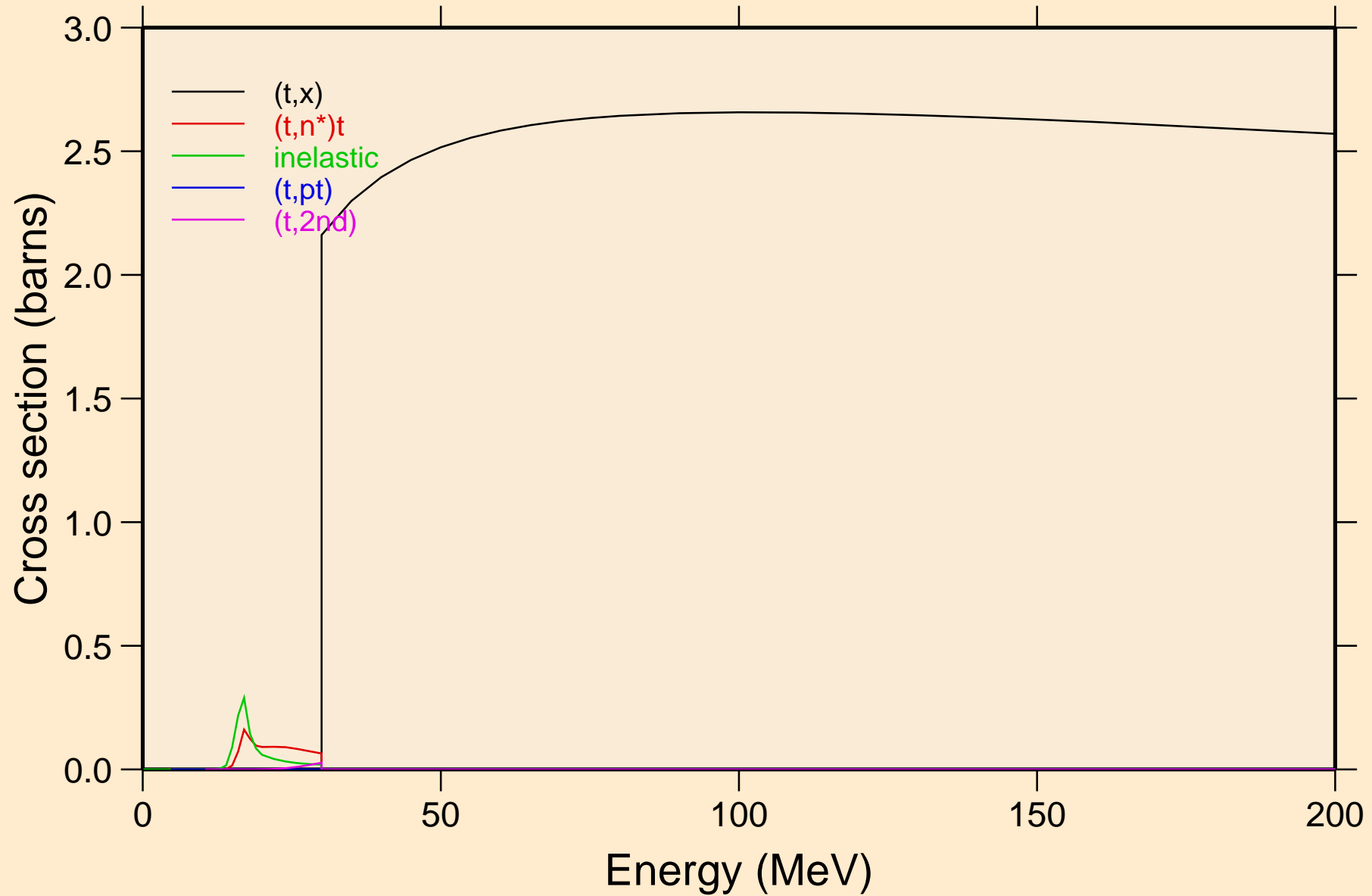

BI212M TRITON ACER TENDL-2021 LIBRARY; T=0.K  
Threshold reactions

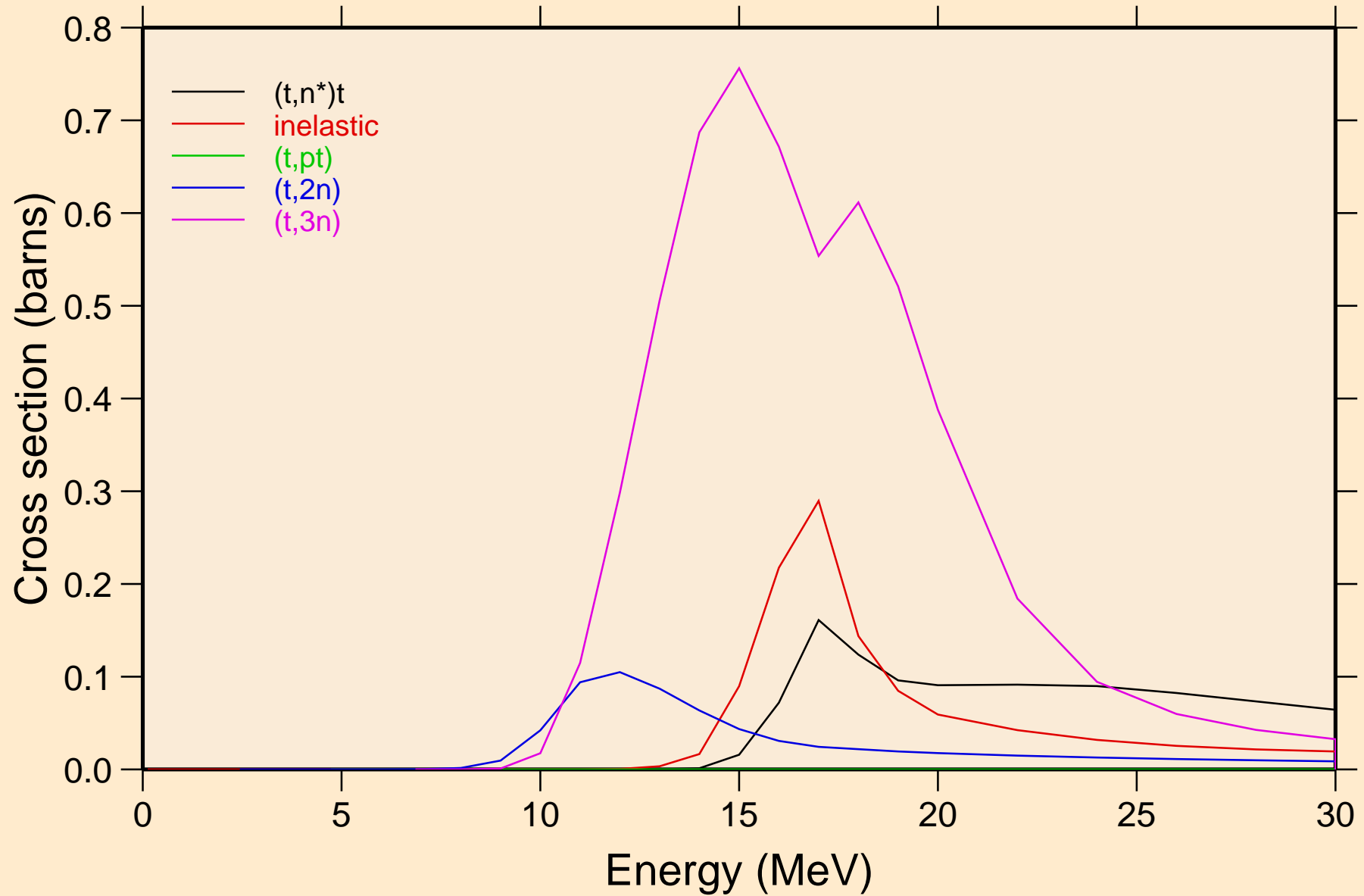

BI212M TRITON ACER TENDL-2021 LIBRARY; T=0.K  
Threshold reactions

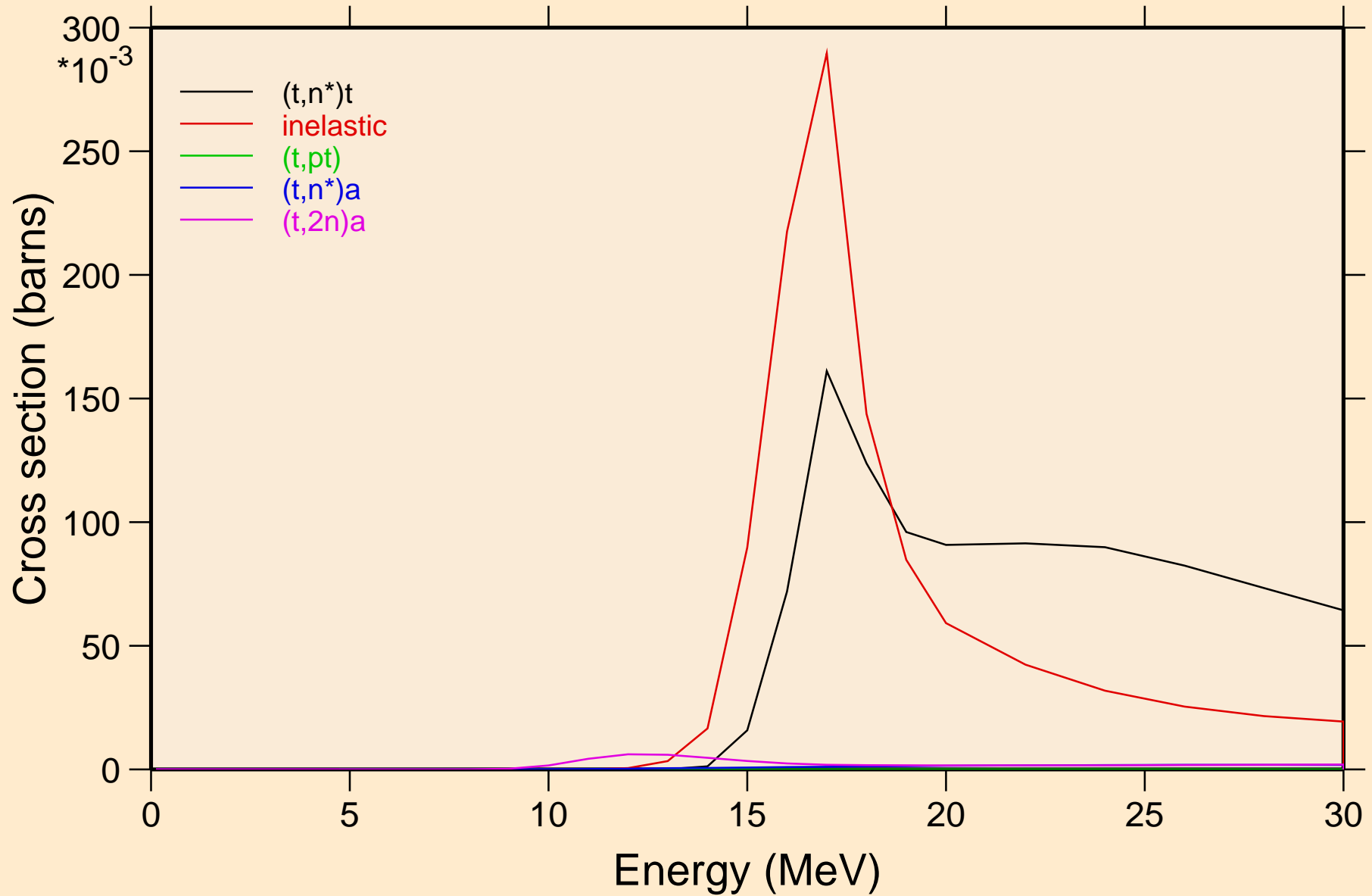

BI212M TRITON ACER TENDL-2021 LIBRARY; T=0.K  
Threshold reactions

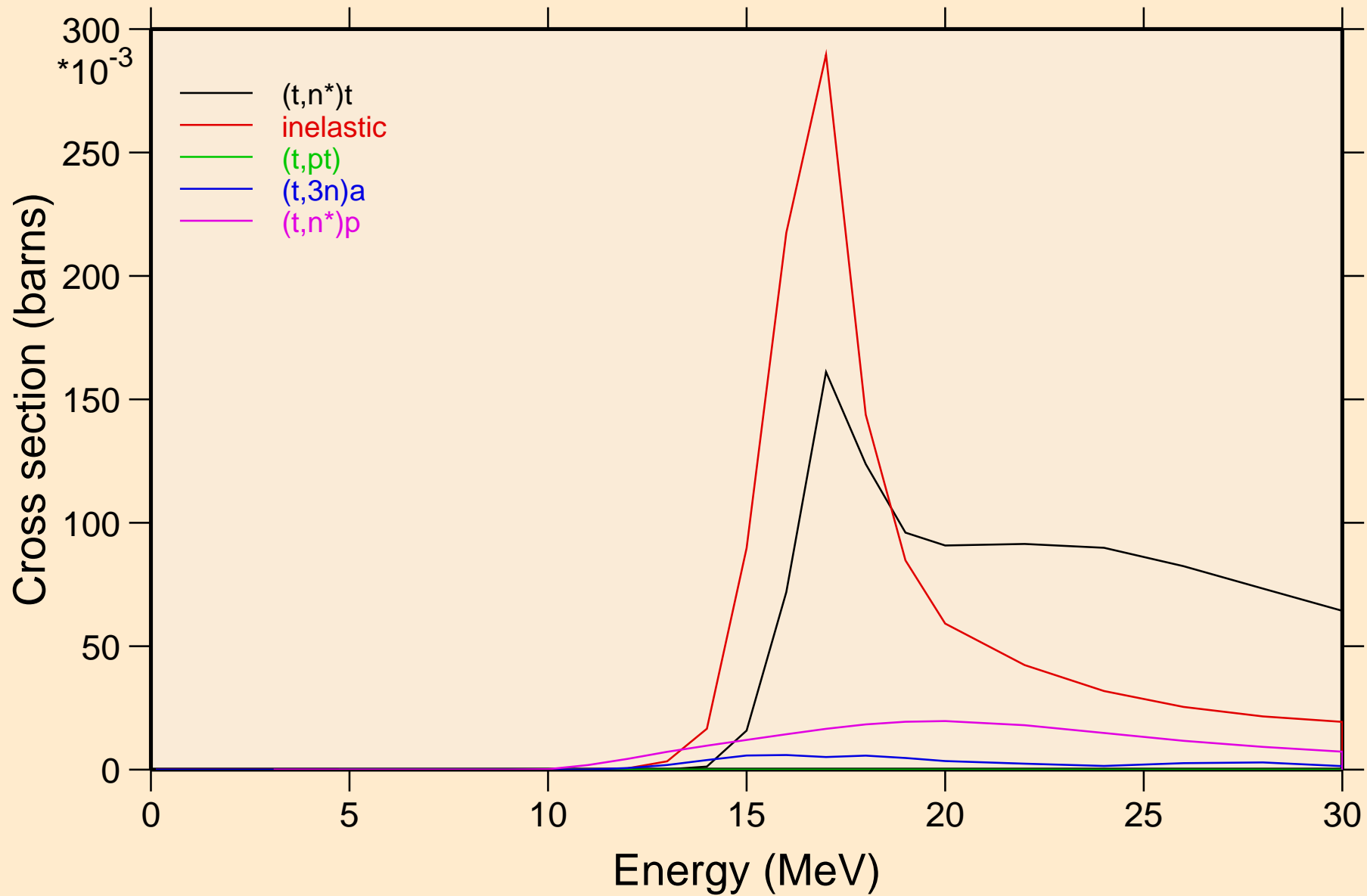



BI212M TRITON ACER TENDL-2021 LIBRARY; T=0.K  
Threshold reactions

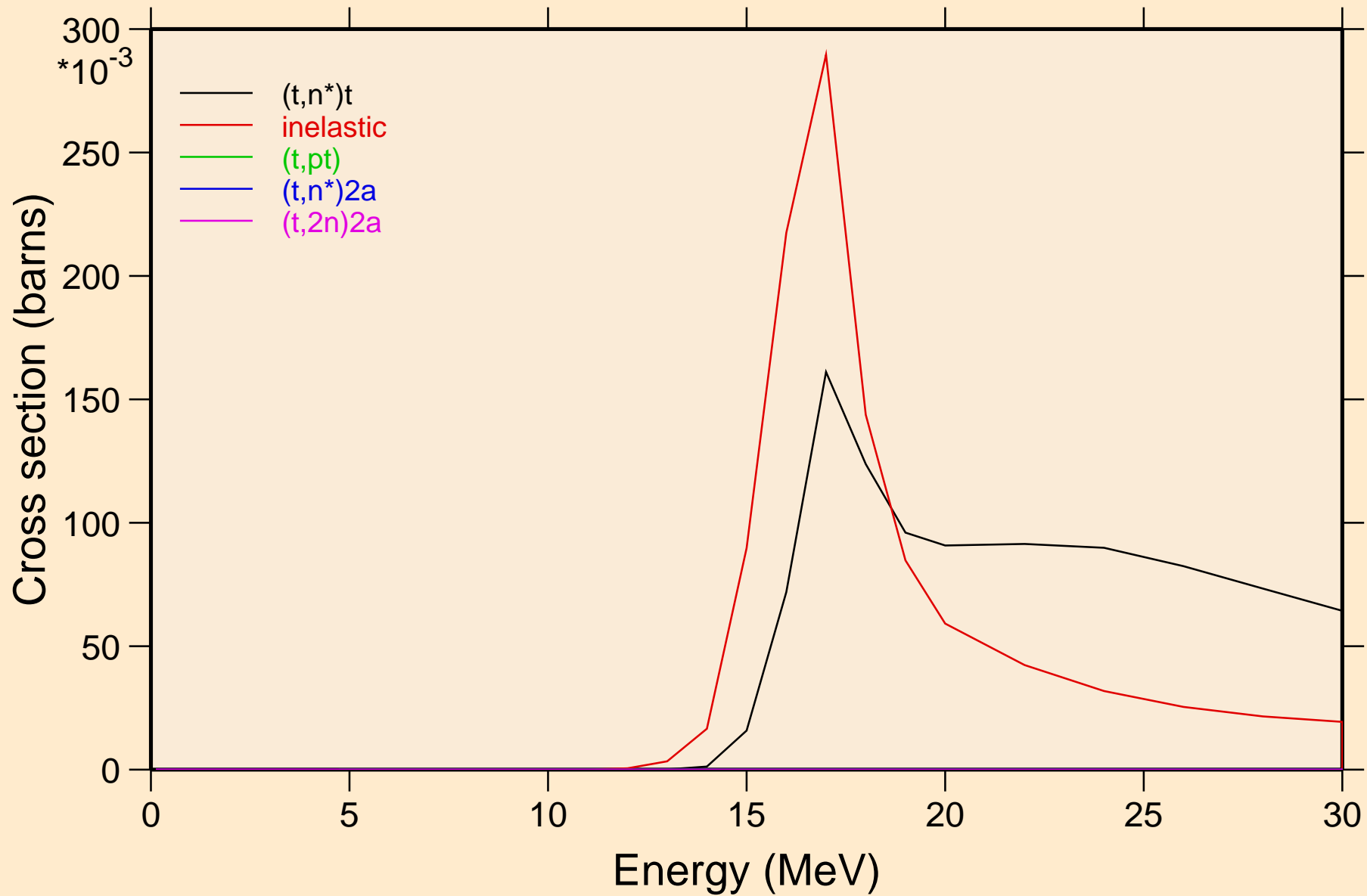

BI212M TRITON ACER TENDL-2021 LIBRARY; T=0.K  
Threshold reactions

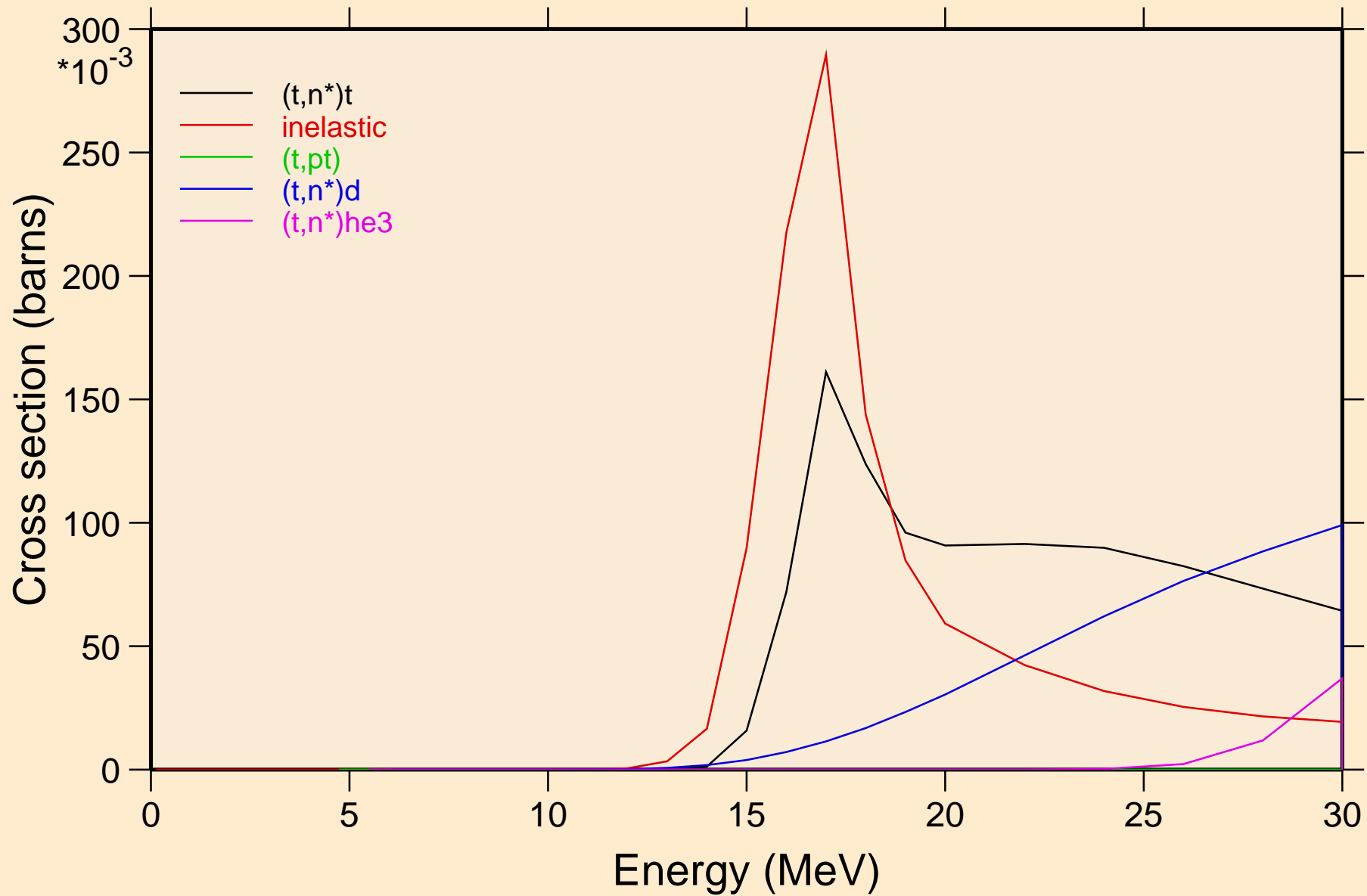

BI212M TRITON ACER TENDL-2021 LIBRARY; T=0.K  
Threshold reactions

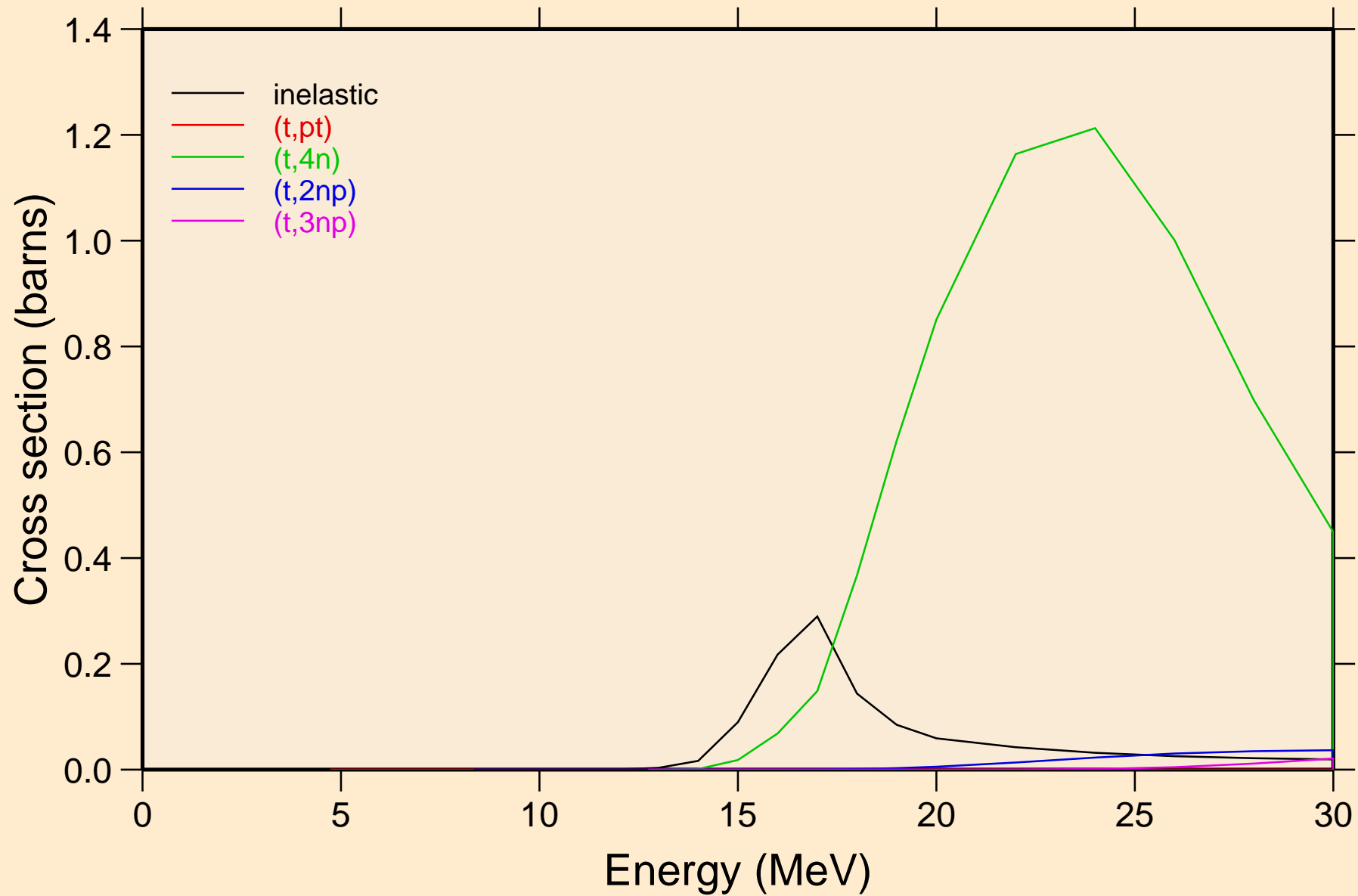

BI212M TRITON ACER TENDL-2021 LIBRARY; T=0.K  
Threshold reactions

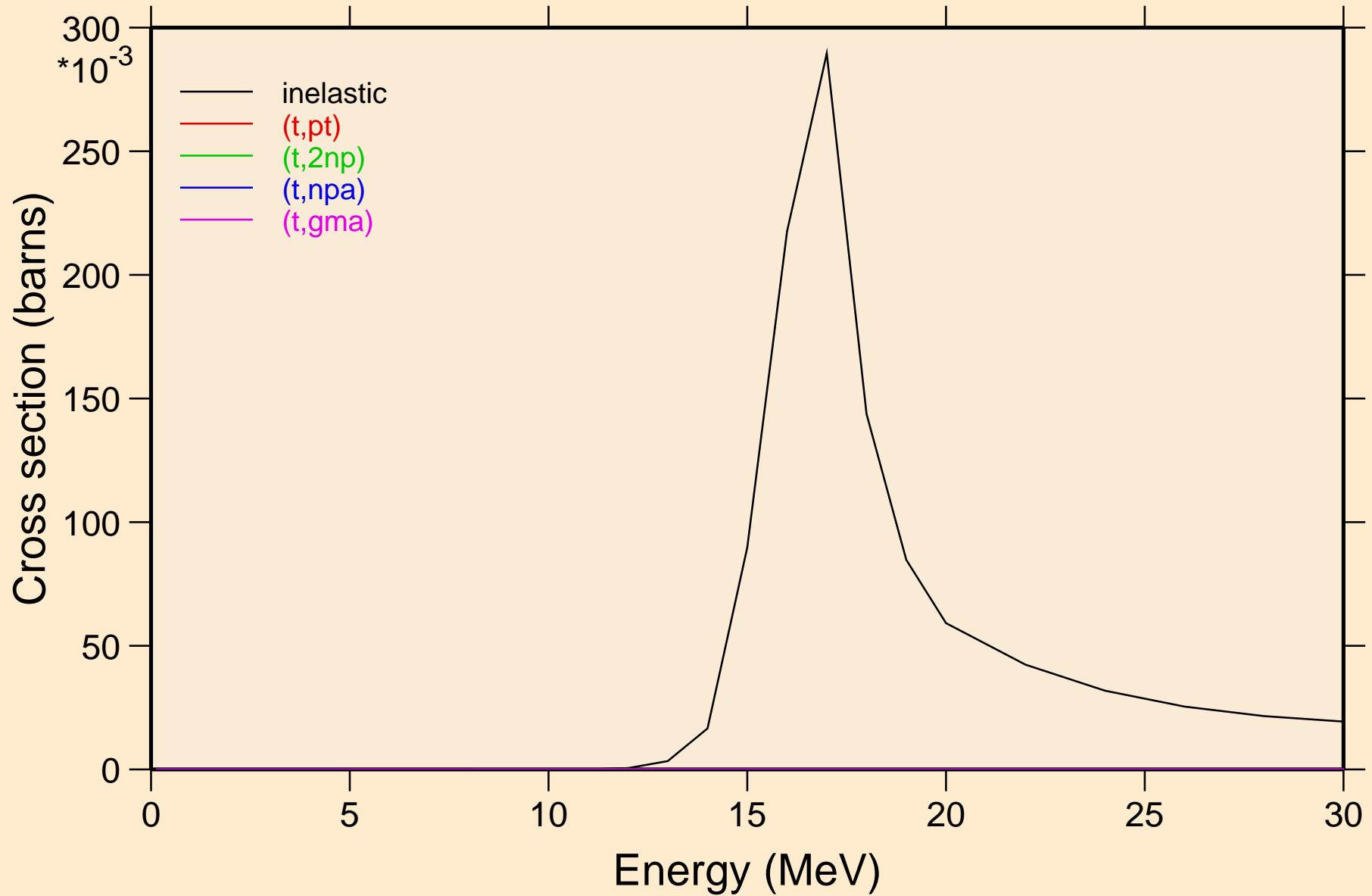

BI212M TRITON ACER TENDL-2021 LIBRARY; T=0.K  
Threshold reactions

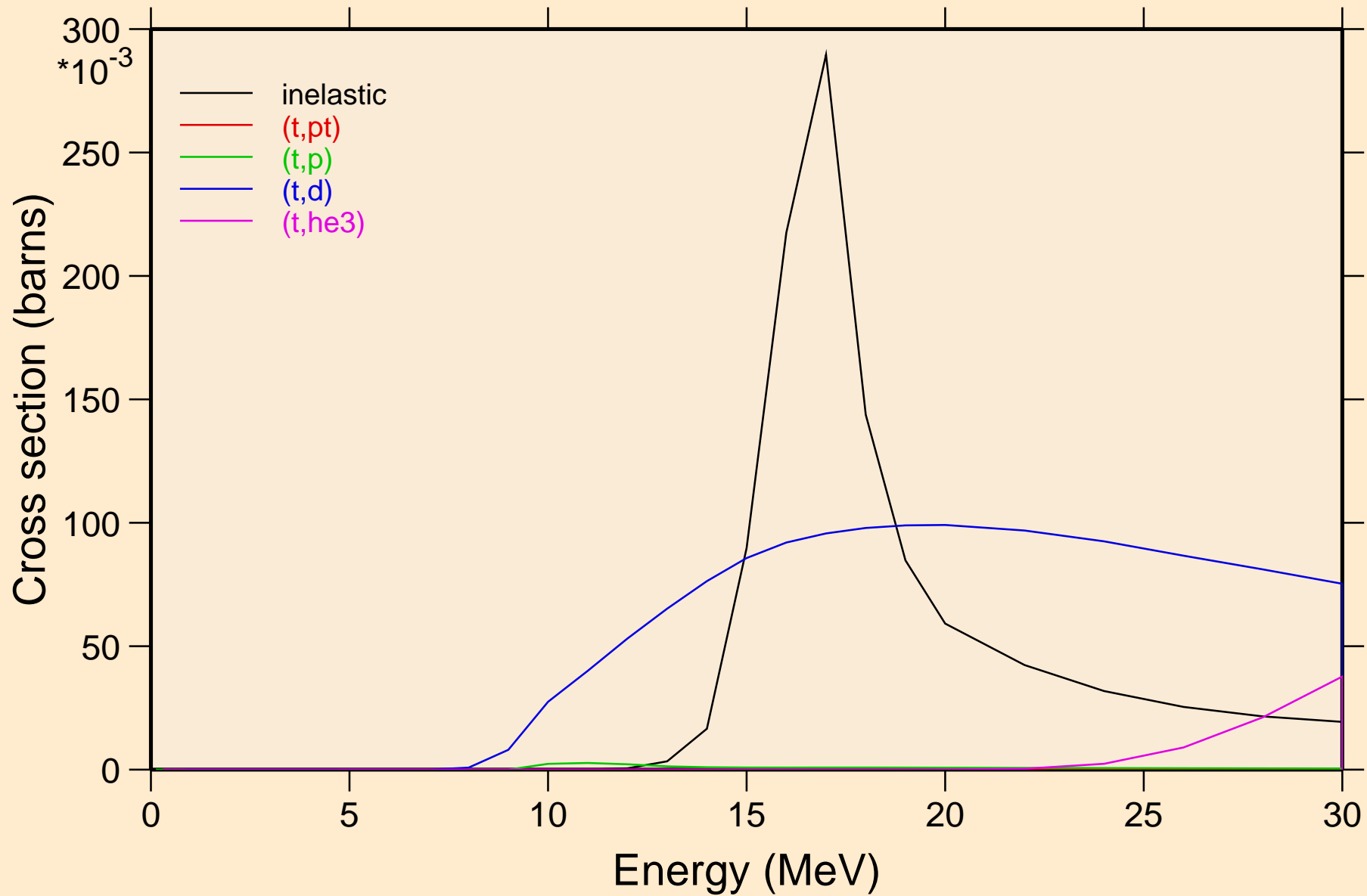

BI212M TRITON ACER TENDL-2021 LIBRARY; T=0.K  
Threshold reactions

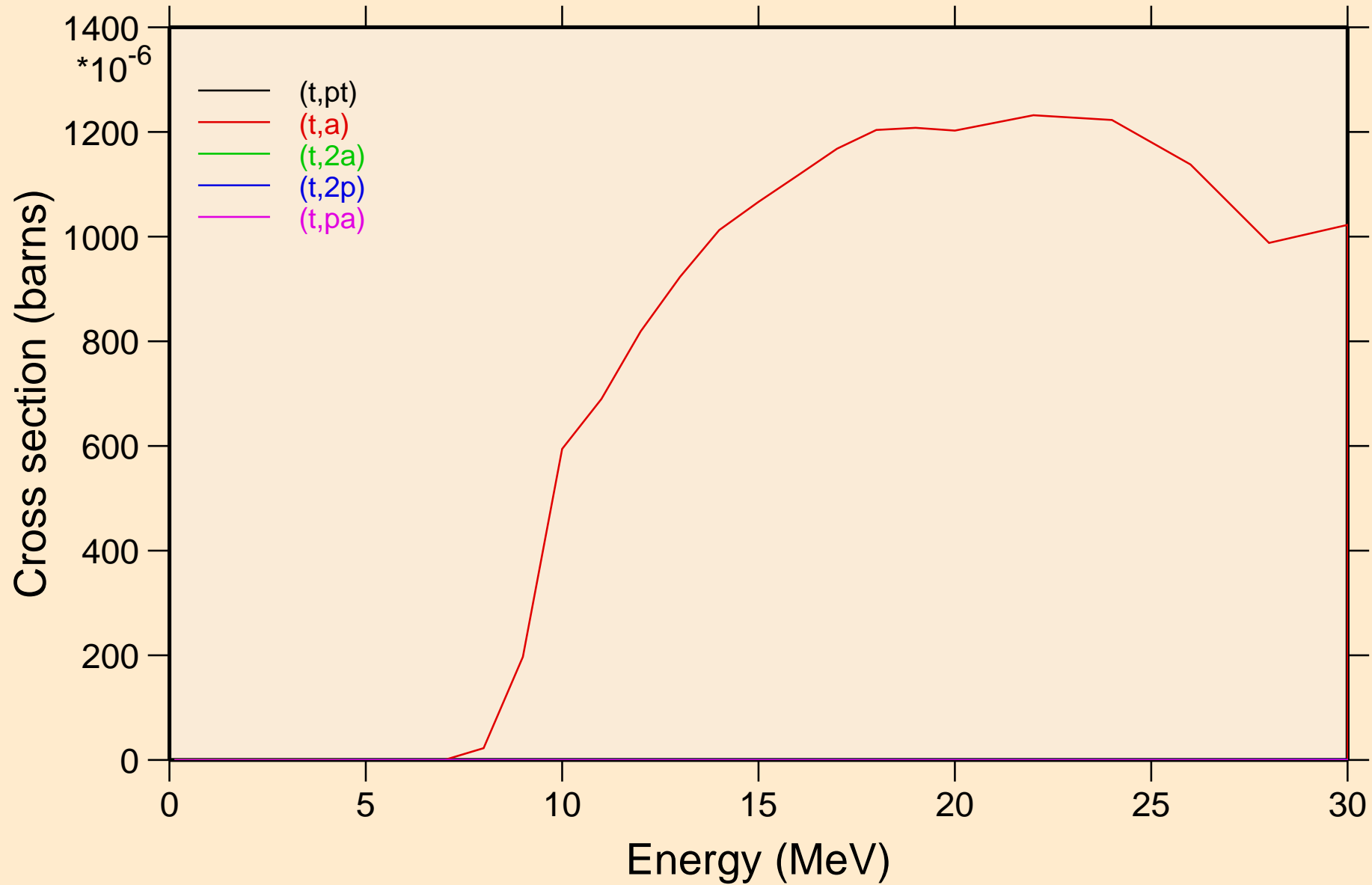

BI212M TRITON ACER TENDL-2021 LIBRARY; T=0.K  
Threshold reactions

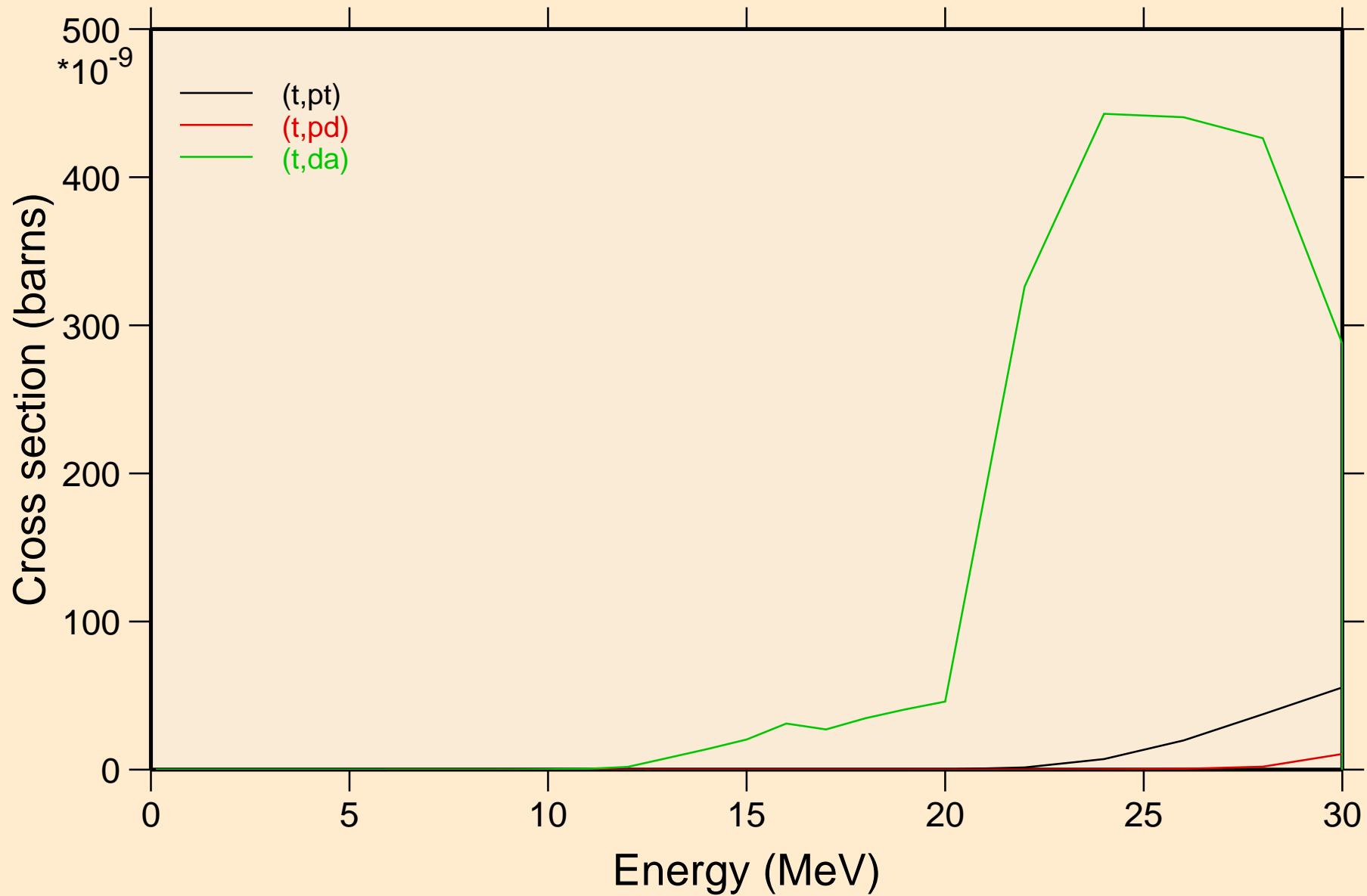

BI212M TRITON ACER TENDL-2021 LIBRARY; T=0.K  
angular distribution for elastic

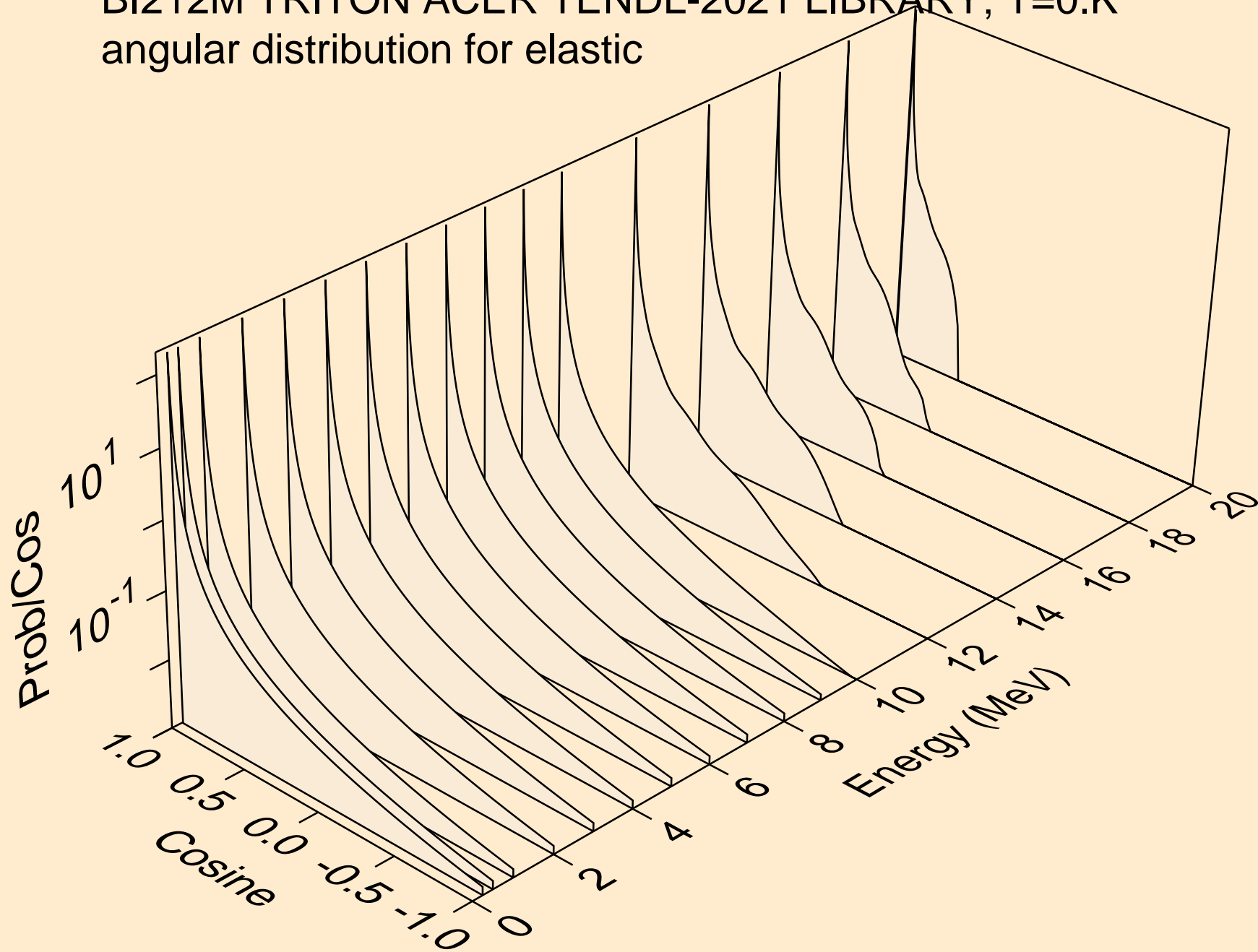



BI212M TRITON ACER TENDL-2021 LIBRARY; T=0.K  
angular distribution for elastic

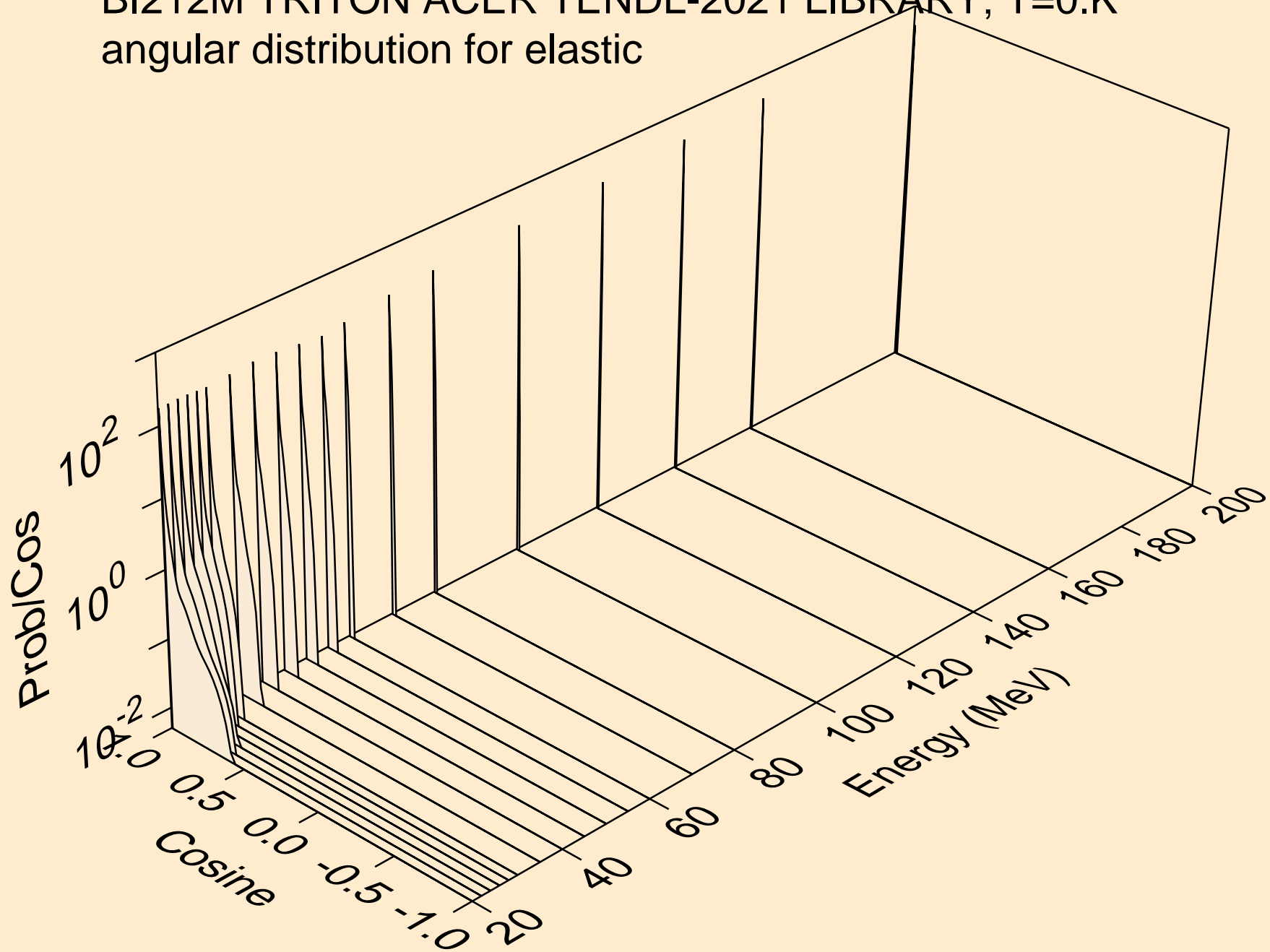

BI212M TRITON ACER TENDL-2021 LIBRARY; T=0.K  
Triton emission for (t,x)

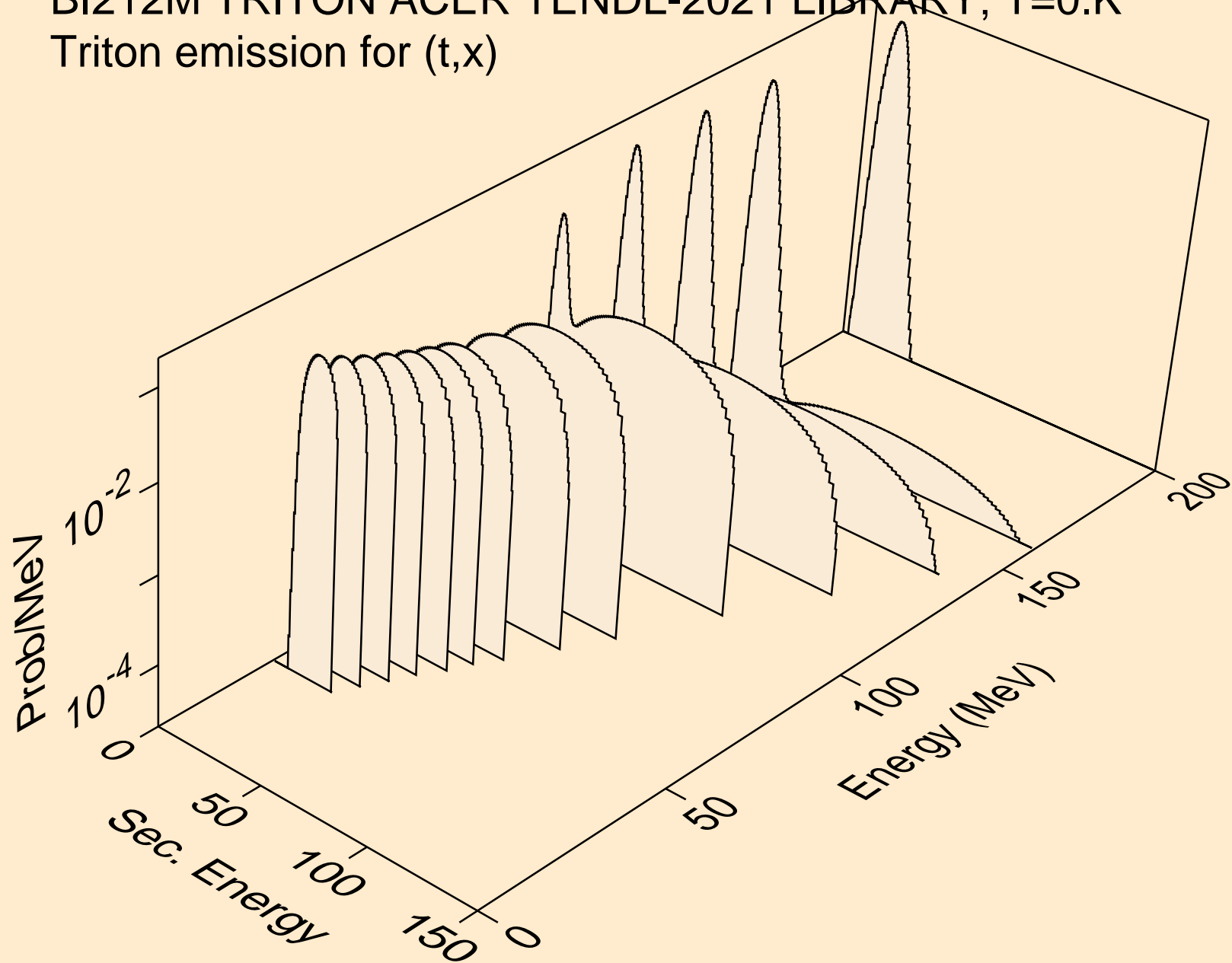

BI212M TRITON ACER TENDL-2021 LIBRARY; T=0.K  
Triton emission for (t,n\*)t

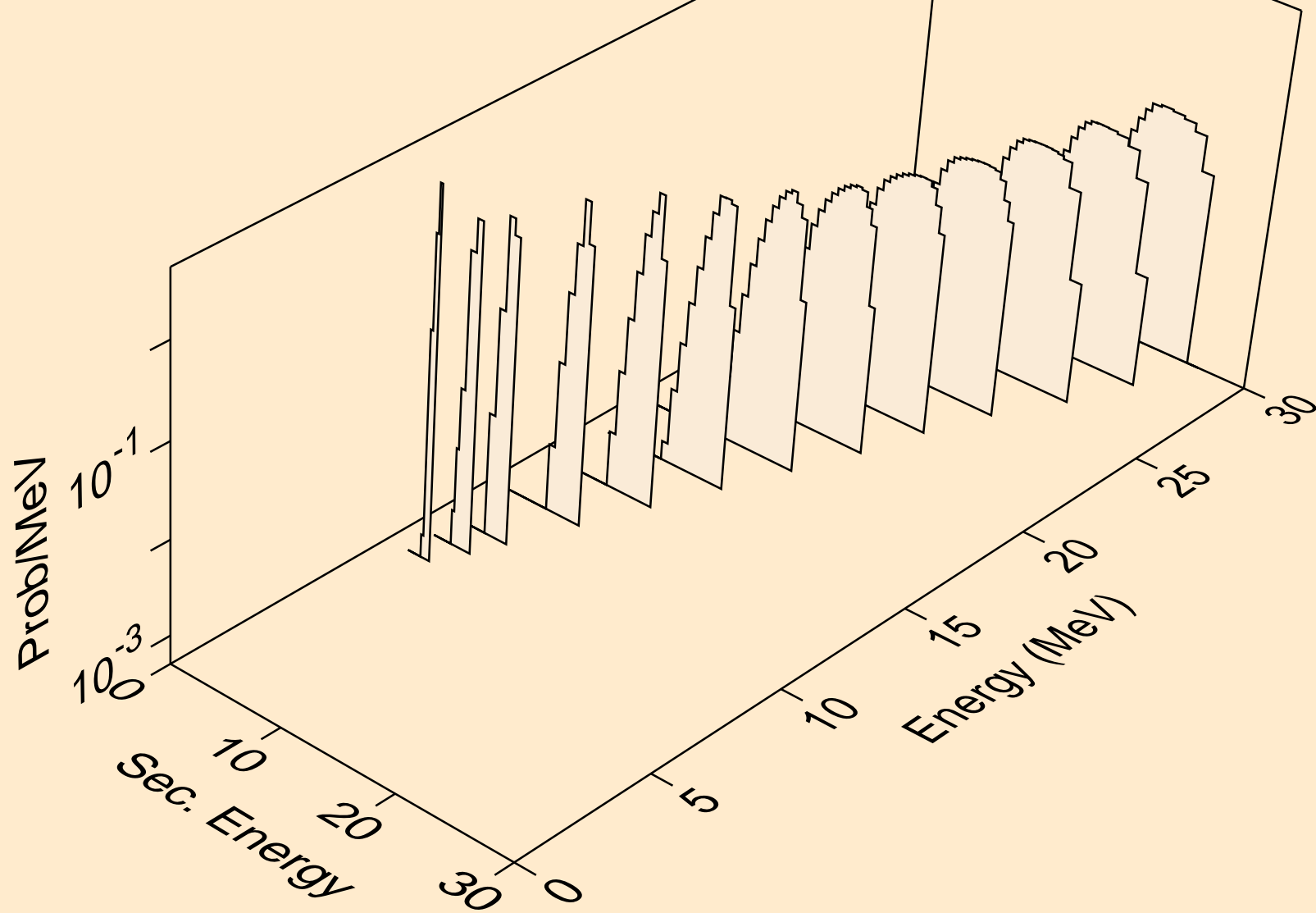

BI212M TRITON ACER TENDL-2021 LIBRARY; T=0.K  
Triton emission for inelastic

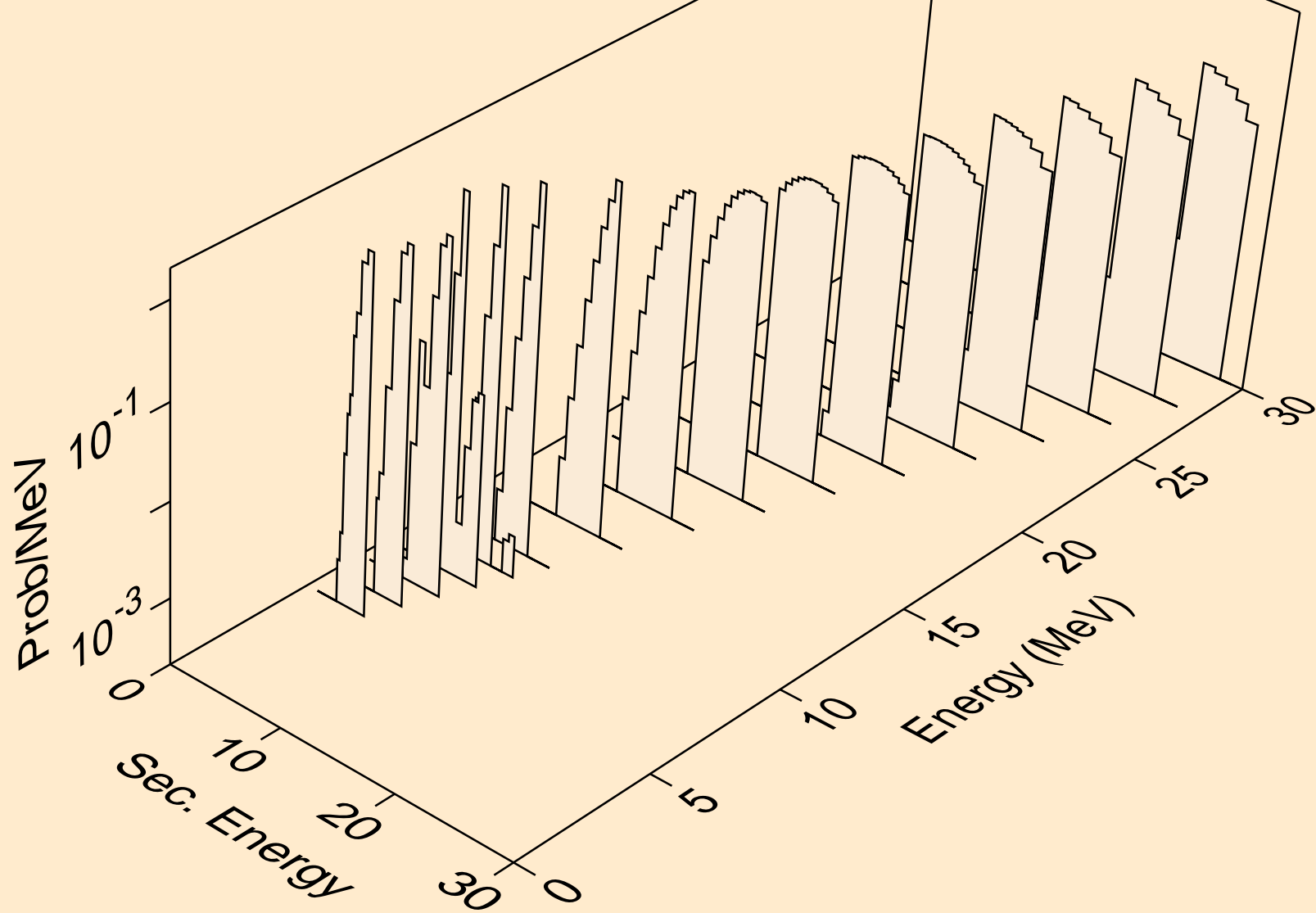

BI212M TRITON ACER TENDL-2021 LIBRARY; T=0.K  
Triton emission for (t,pt)

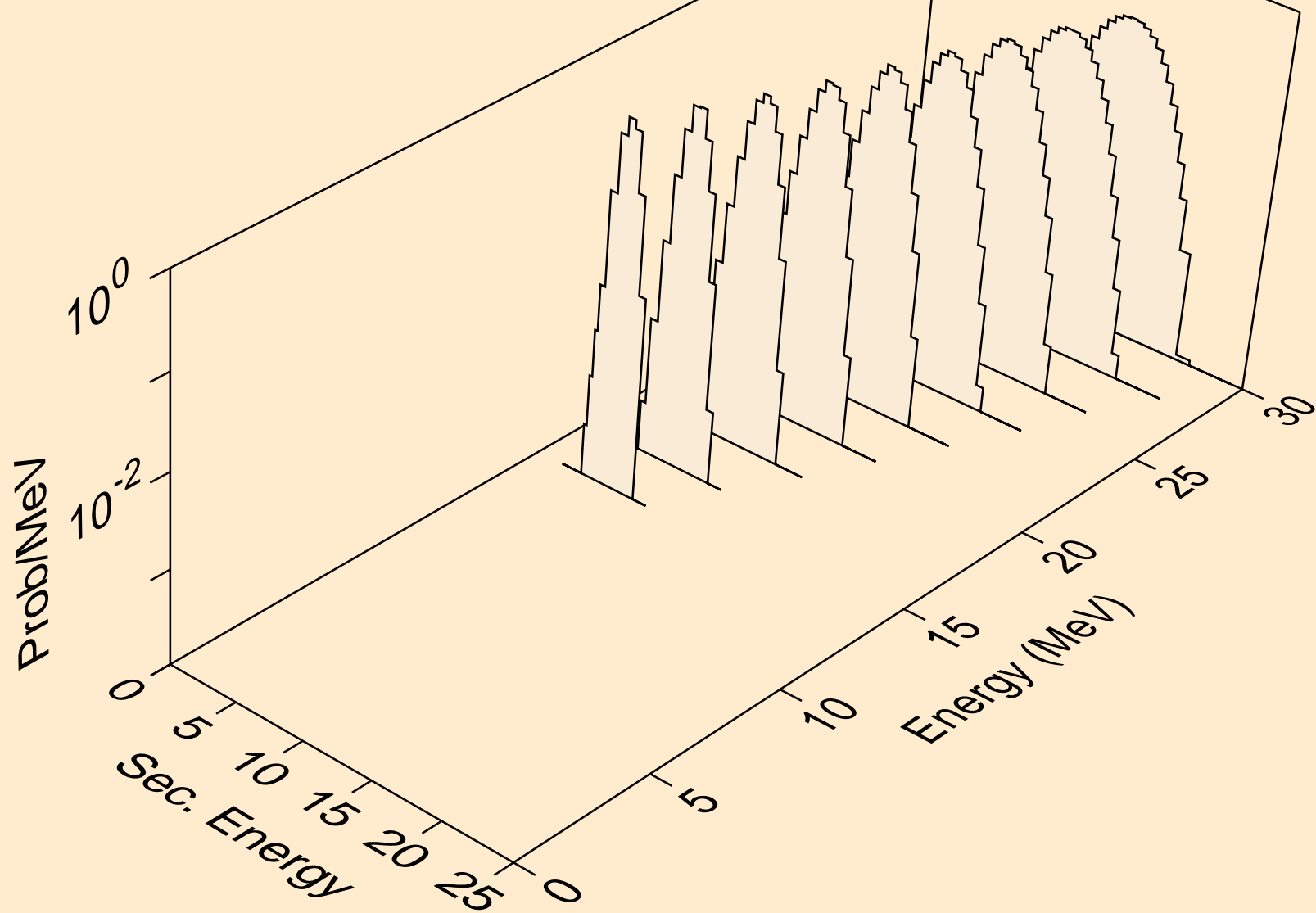

BI212M TRITON ACER TENDL-2021 LIBRARY; T=0.K  
Photon emission for (z,n)

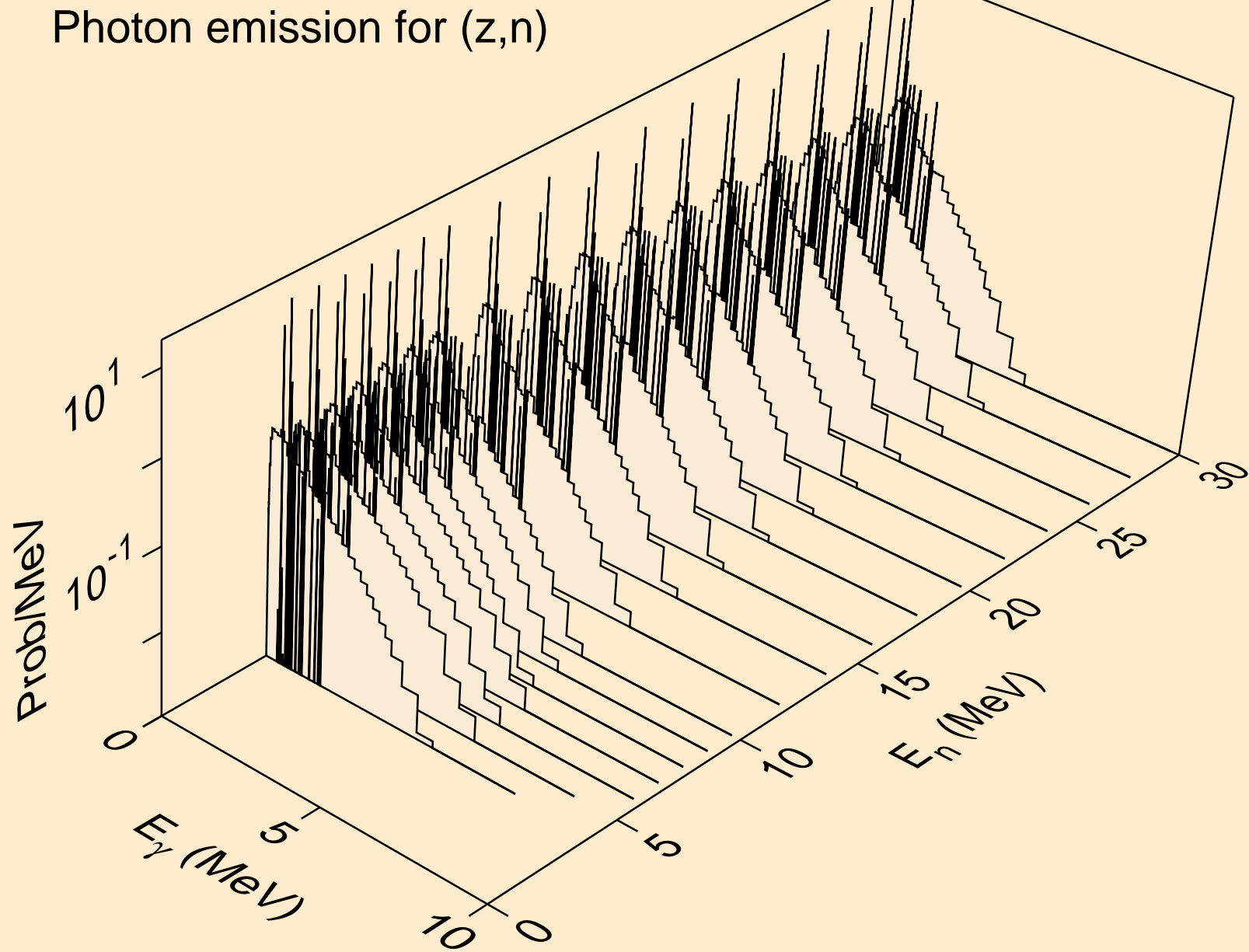

BI212M TRITON ACER TENDL-2021 LIBRARY; T=0.K  
Photon emission for (n,x)

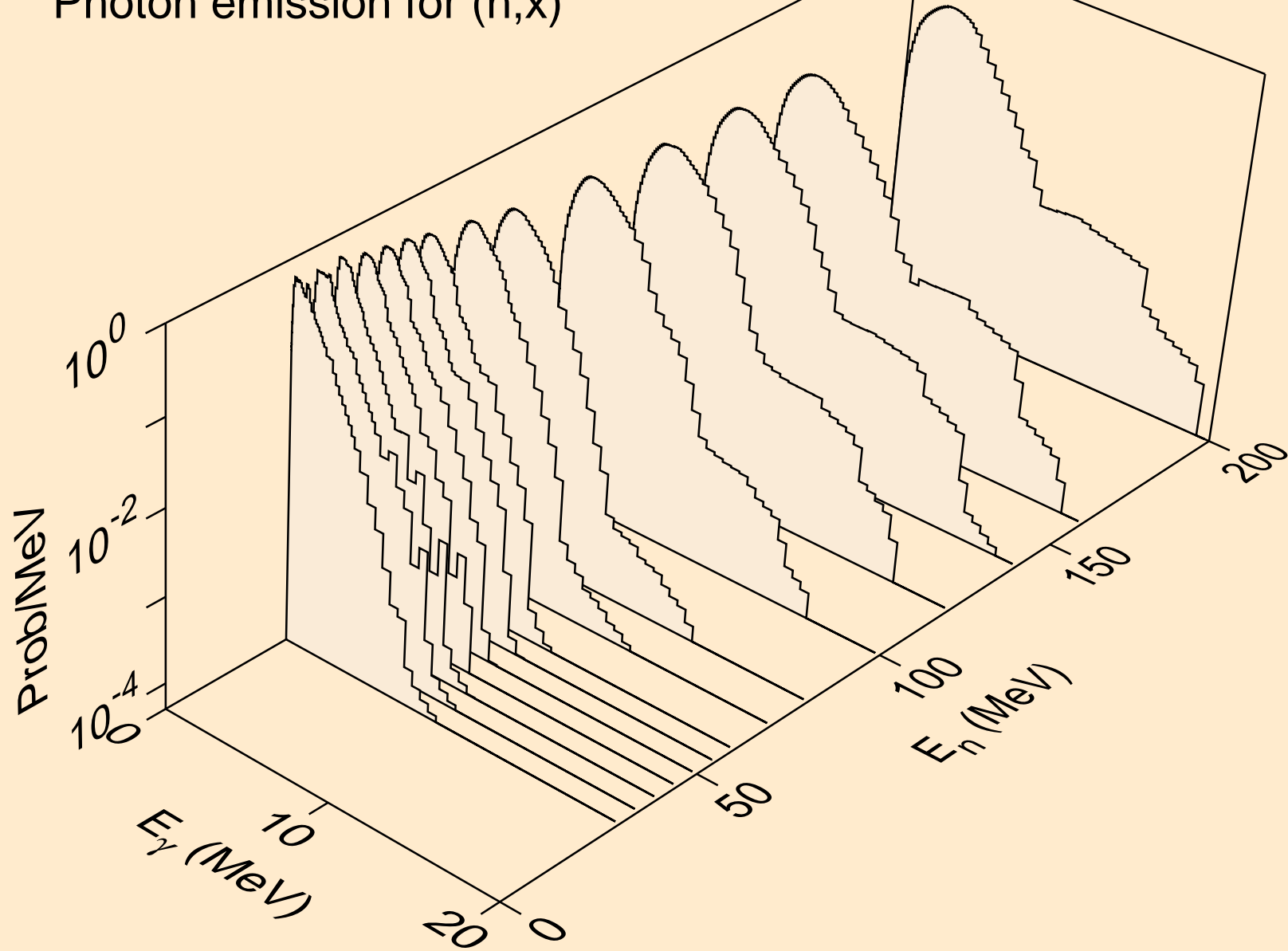

BI212M TRITON ACER TENDL-2021 LIBRARY; T=0.K  
Photon emission for (n,2nd)

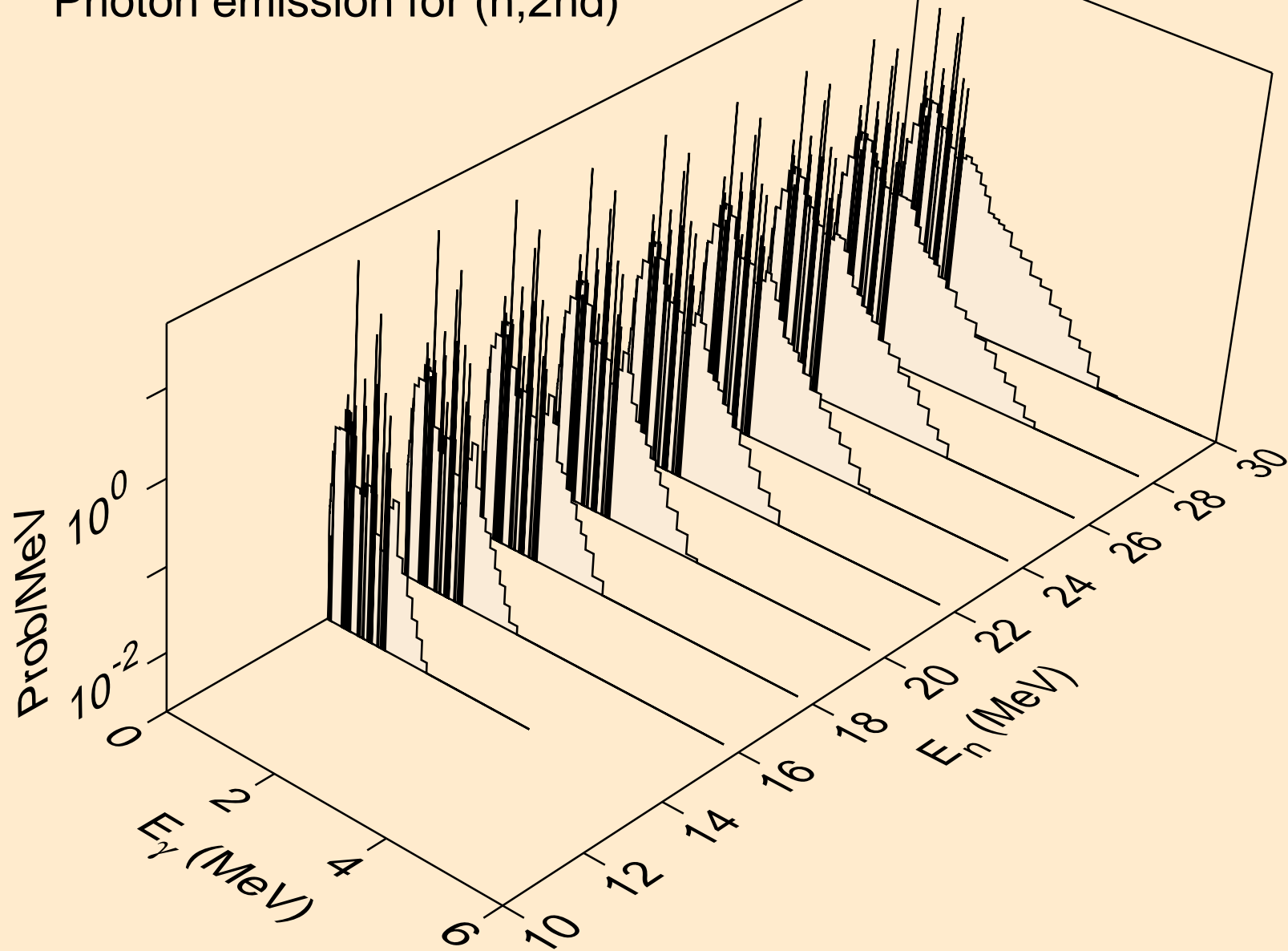



BI212M TRITON ACER TENDL-2021 LIBRARY; T=0.K  
Photon emission for (n,2n)

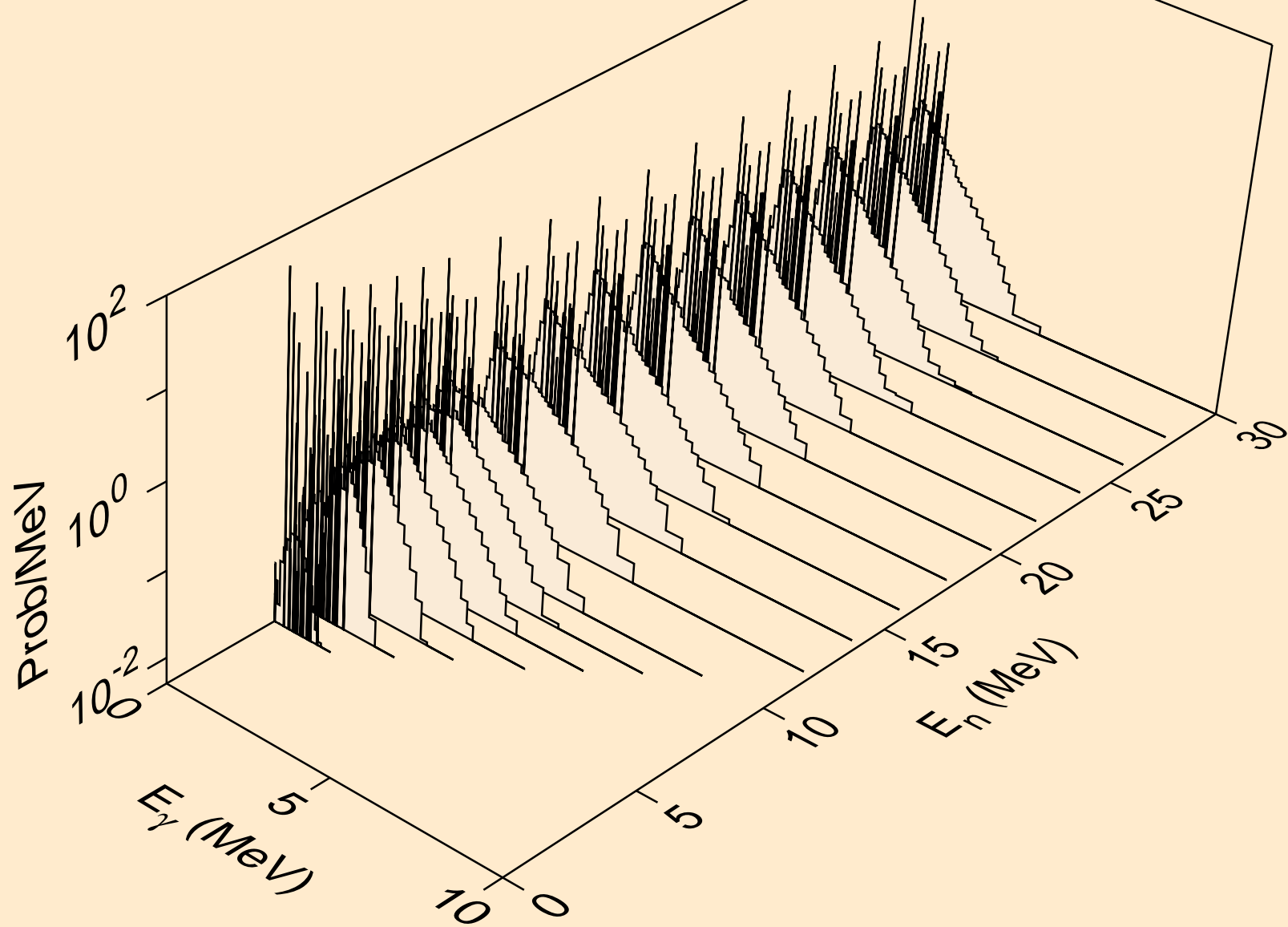

BI212M TRITON ACER TENDL-2021 LIBRARY; T=0.K  
Photon emission for (n,3n)

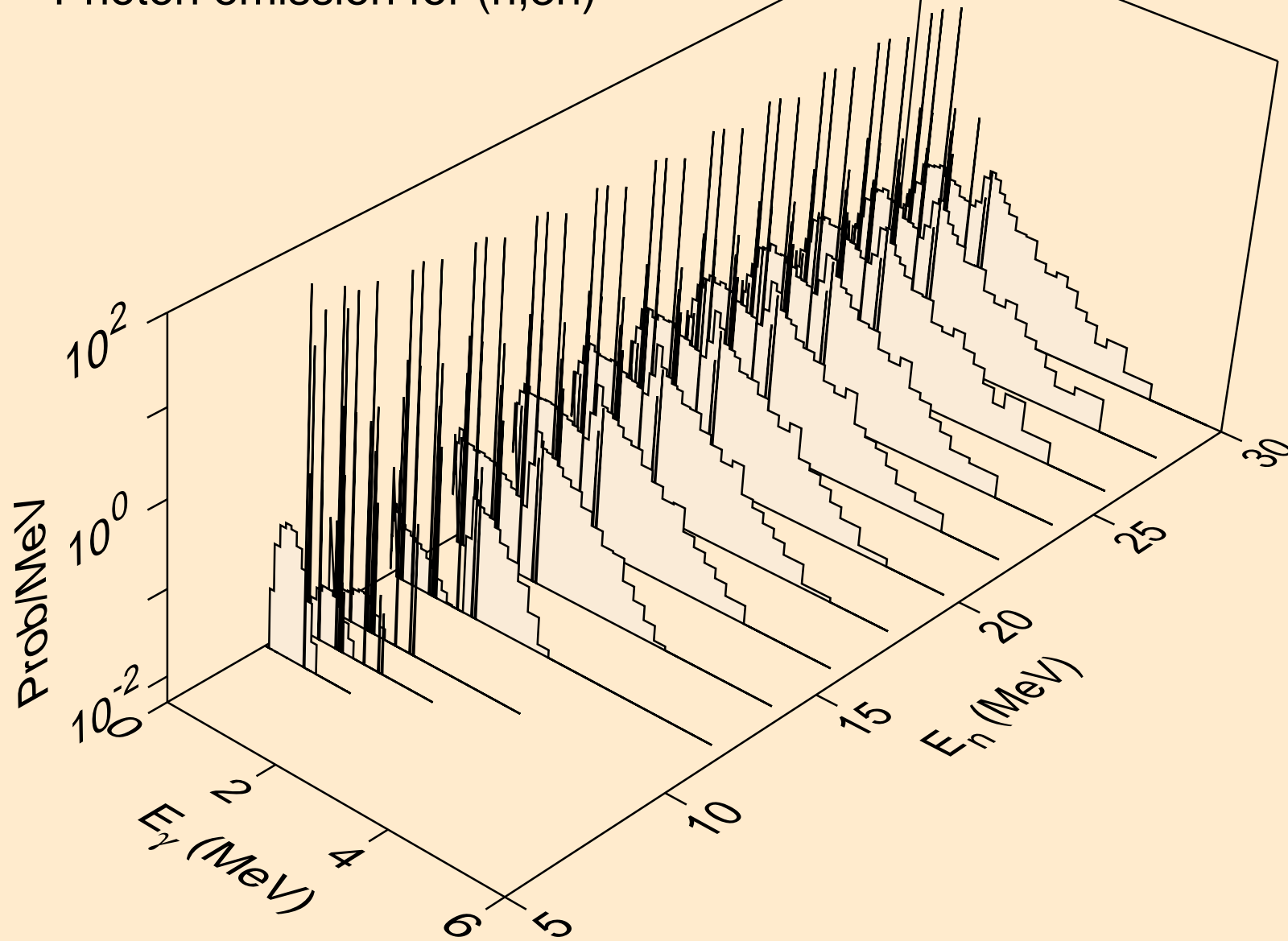

BI212M TRITON ACER TENDL-2021 LIBRARY; T=0.K  
Photon emission for (n,n\*)a

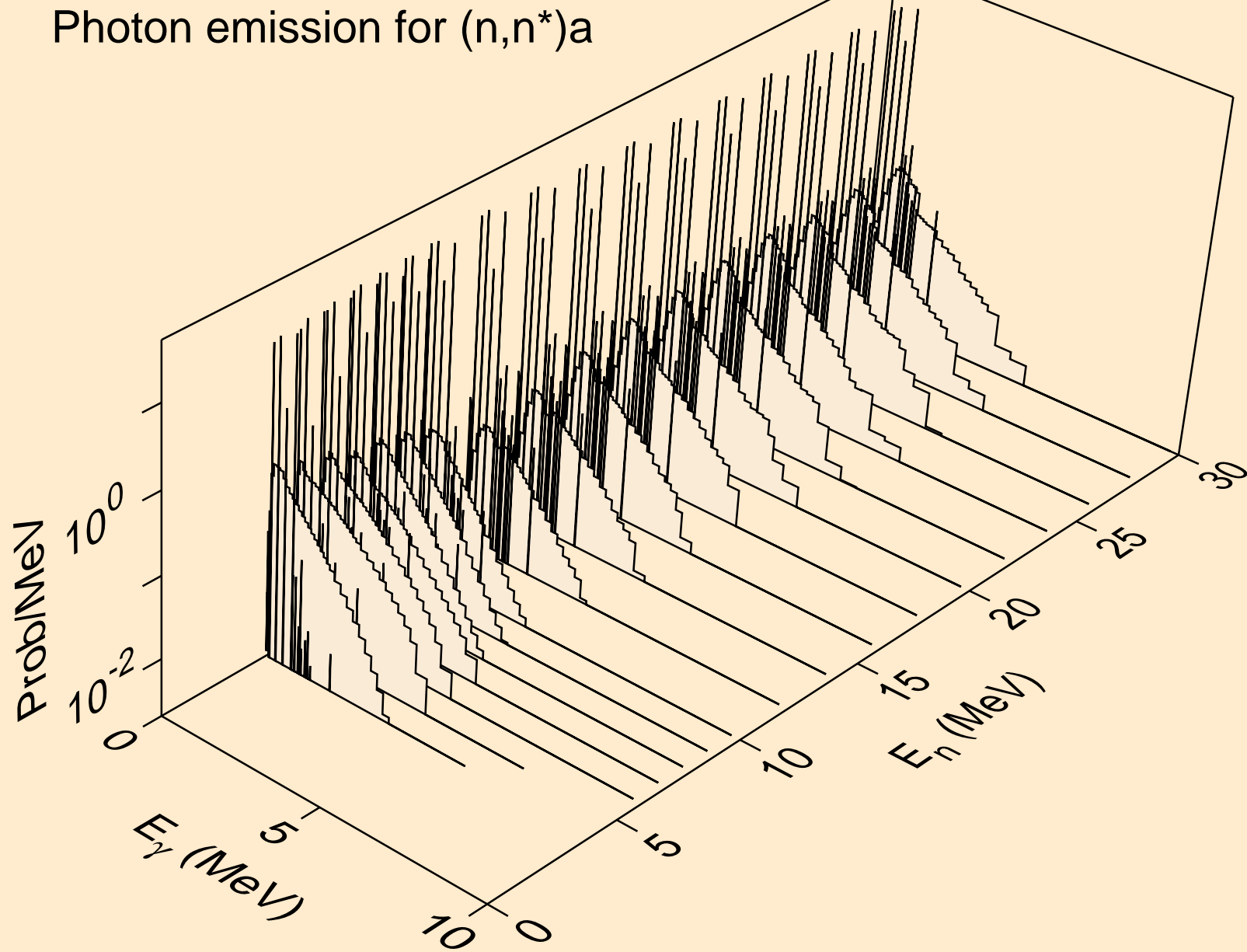

BI212M TRITON ACER TENDL-2021 LIBRARY; T=0.K  
Photon emission for (n,2n)a

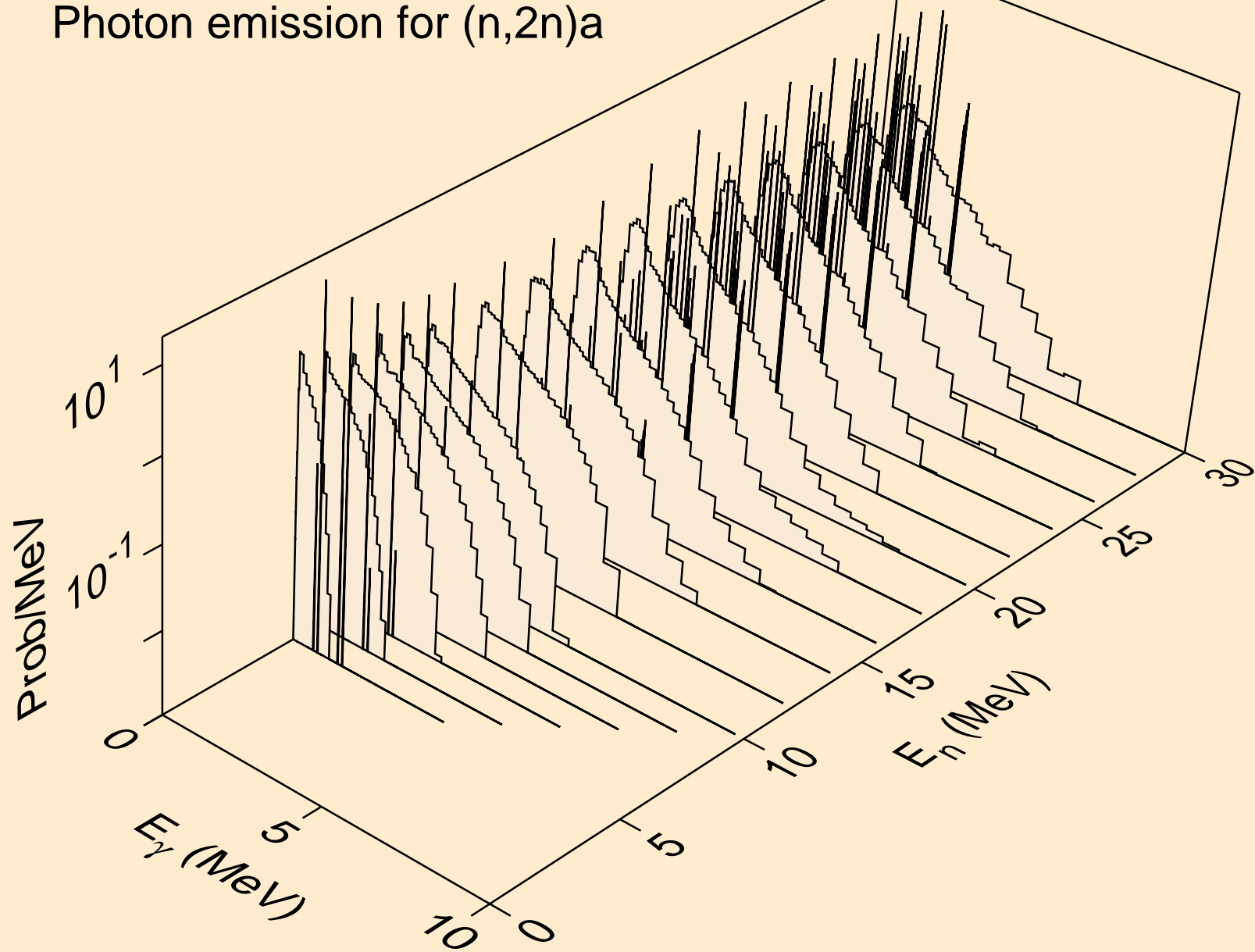

BI212M TRITON ACER TENDL-2021 LIBRARY; T=0.K  
Photon emission for (n,3n)a

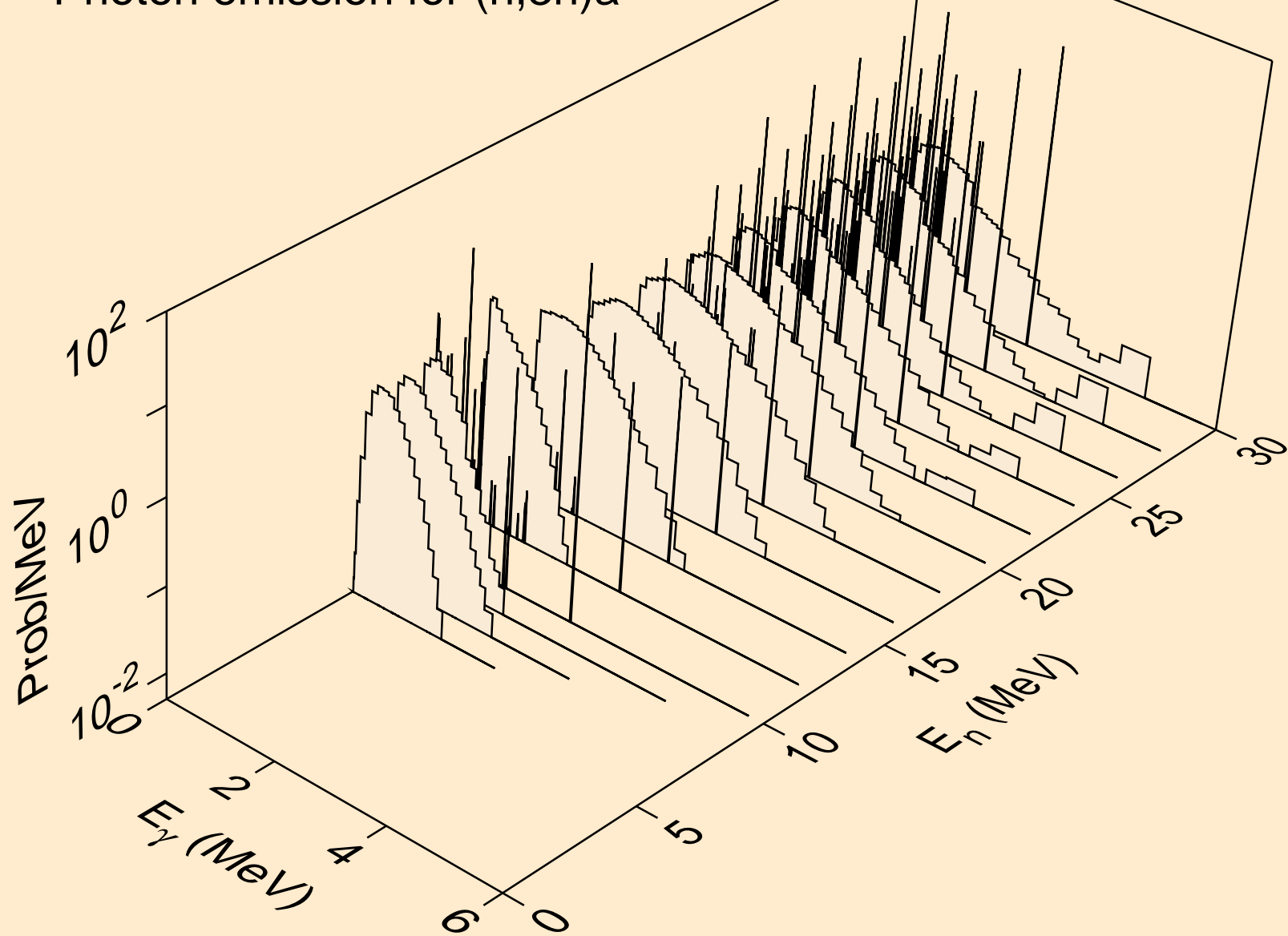

BI212M TRITON ACER TENDL-2021 LIBRARY; T=0.K  
Photon emission for (n,n\*)p

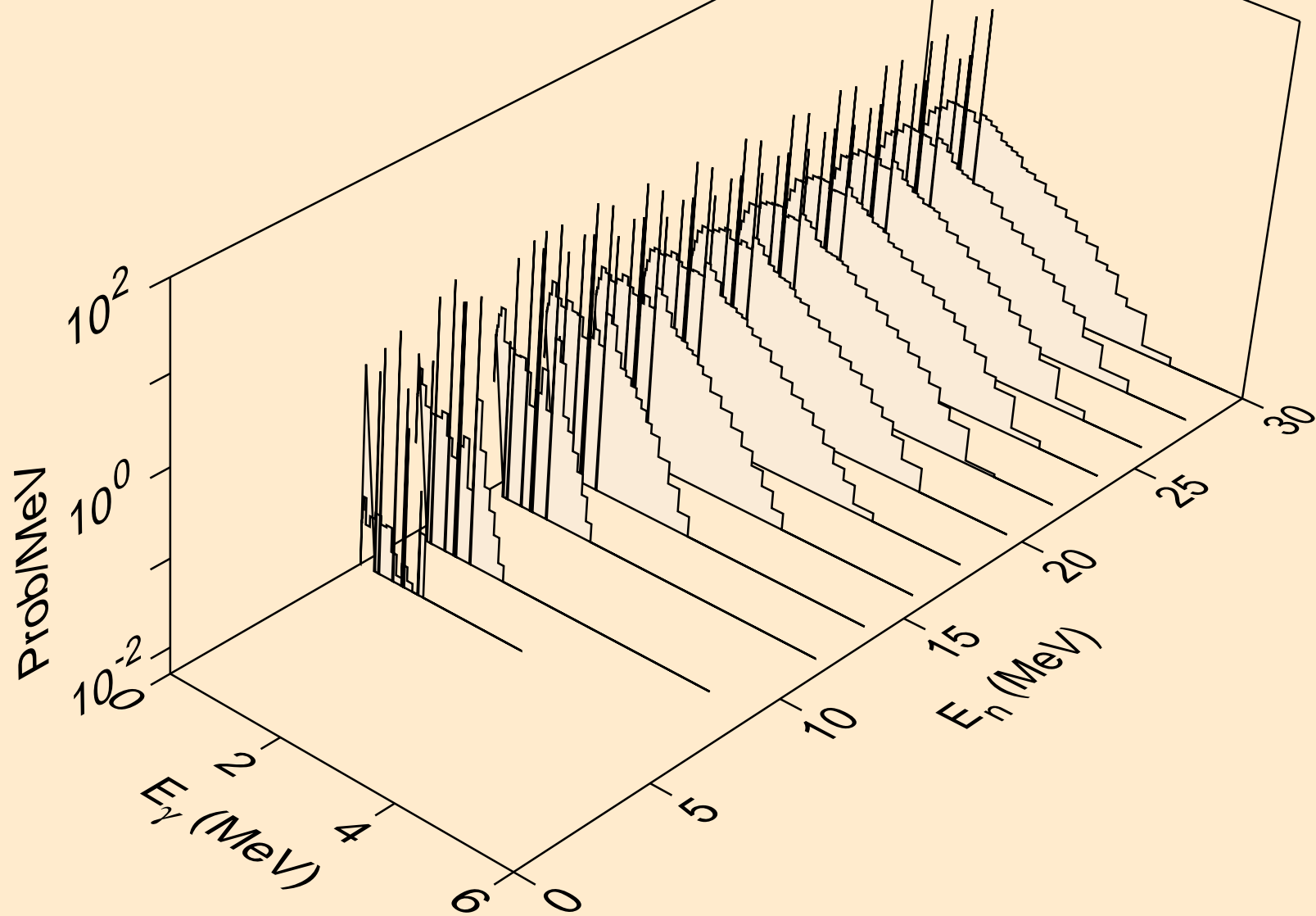

BI212M TRITON ACER TENDL-2021 LIBRARY; T=0.K  
Photon emission for (n,n\*)2a

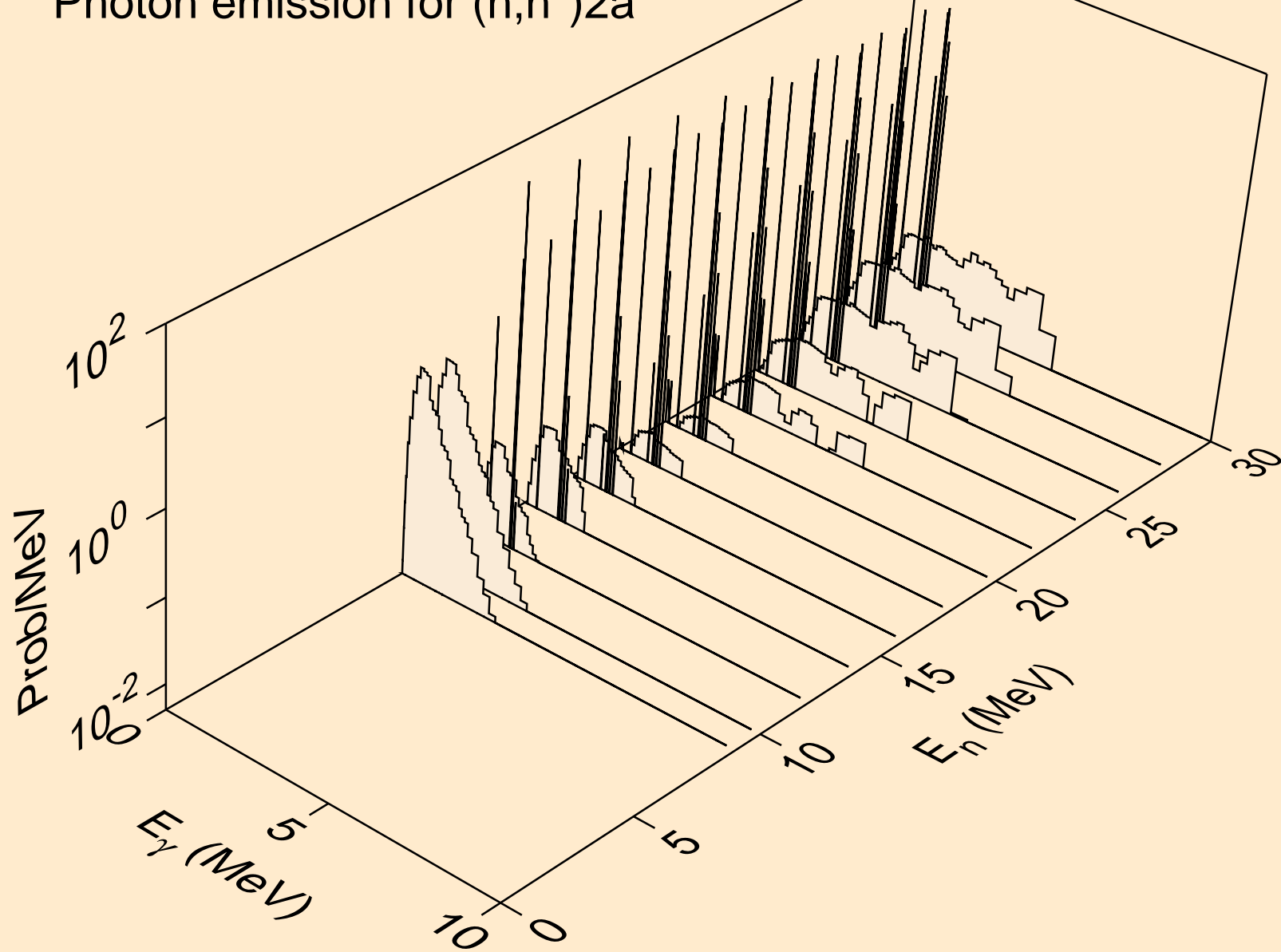

BI212M TRITON ACER TENDL-2021 LIBRARY; T=0.K  
Photon emission for (n,2n)2a

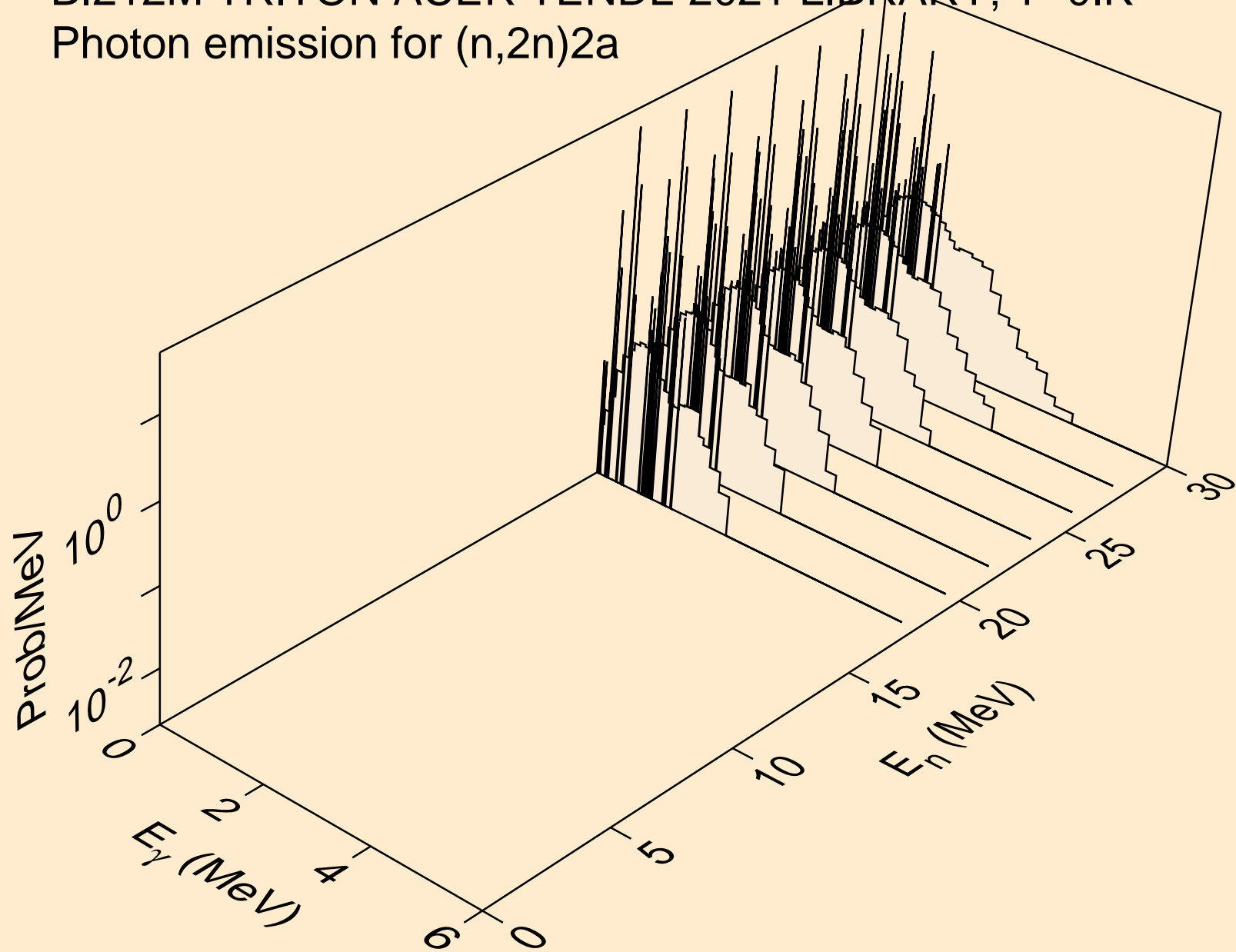



BI212M TRITON ACER TENDL-2021 LIBRARY; T=0.K  
Photon emission for (n,n\*)d

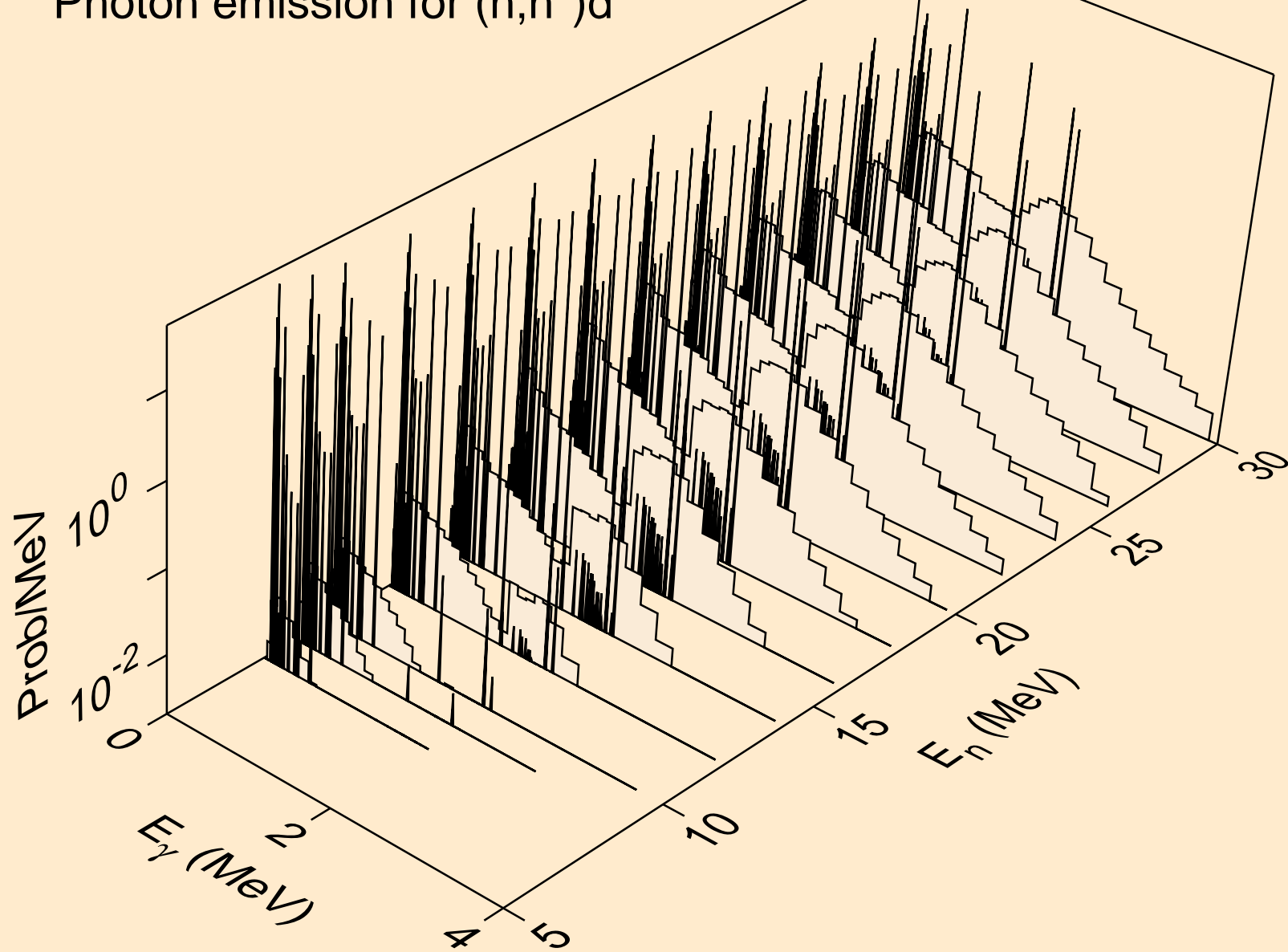

BI212M TRITON ACER TENDL-2021 LIBRARY; T=0.K  
Photon emission for (n,n\*)t

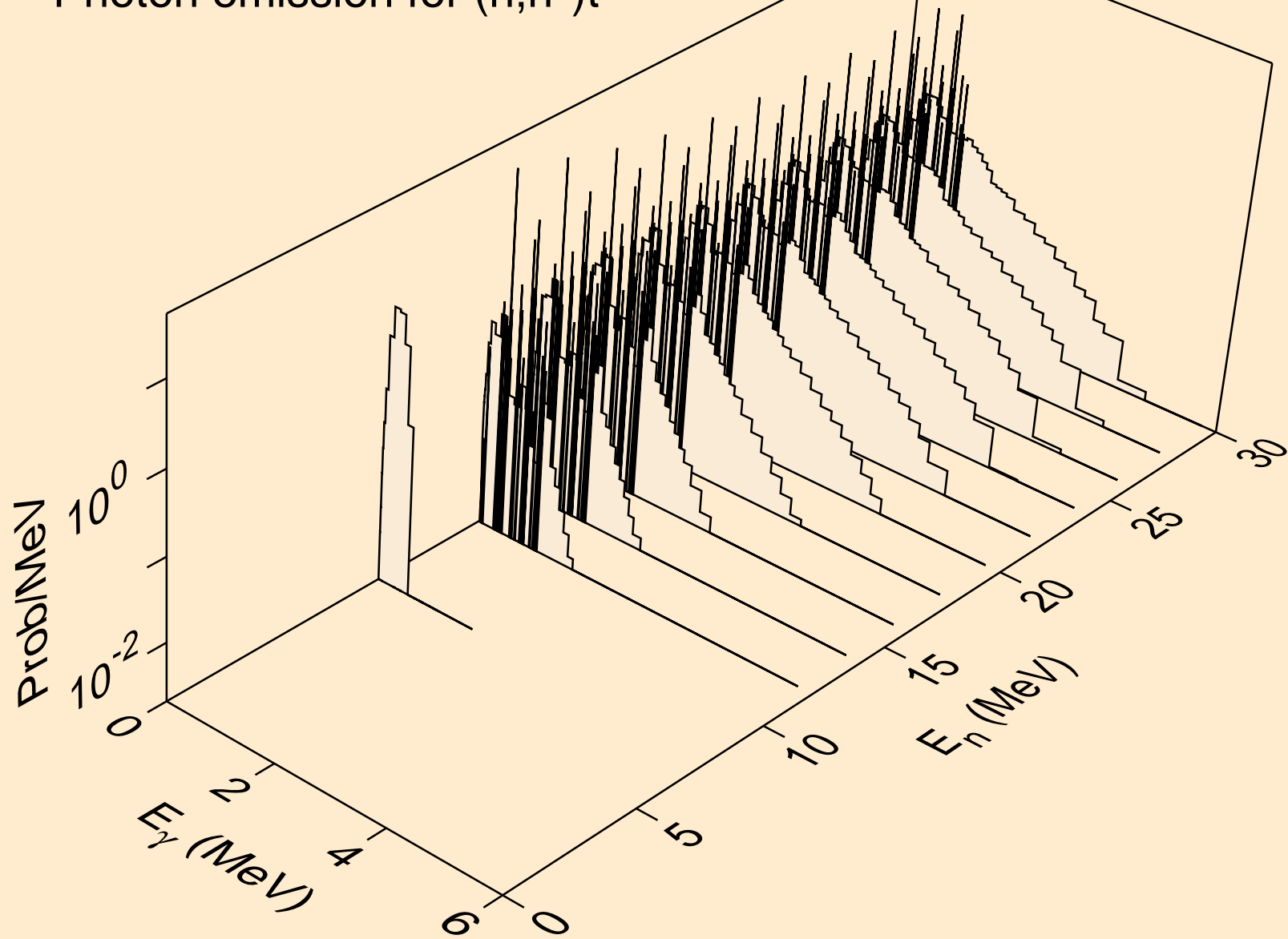

BI212M TRITON ACER TENDL-2021 LIBRARY; T=0.K  
Photon emission for (n,n\*)he3

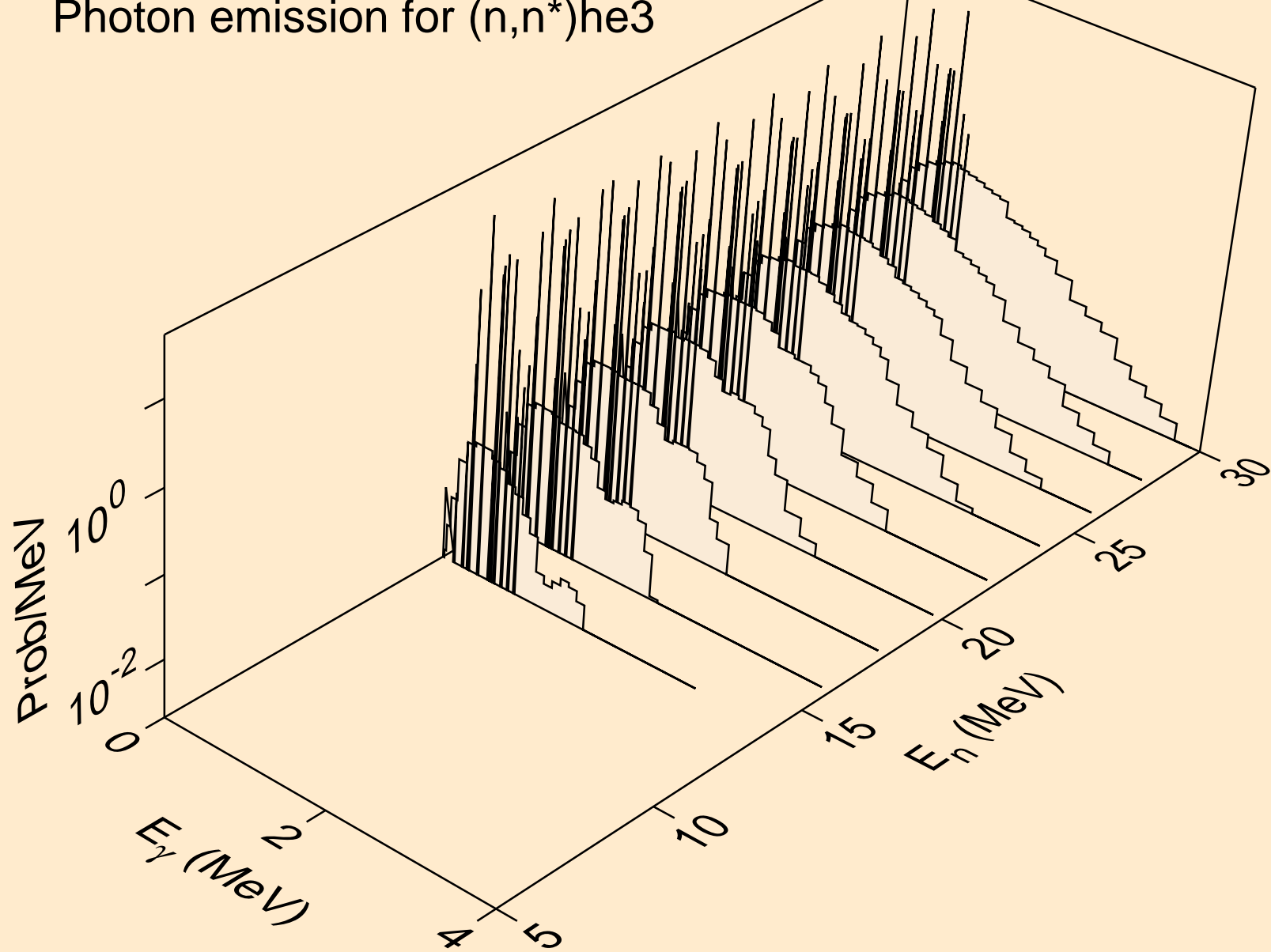

BI212M TRITON ACER TENDL-2021 LIBRARY; T=0.K  
Photon emission for (n,4n)

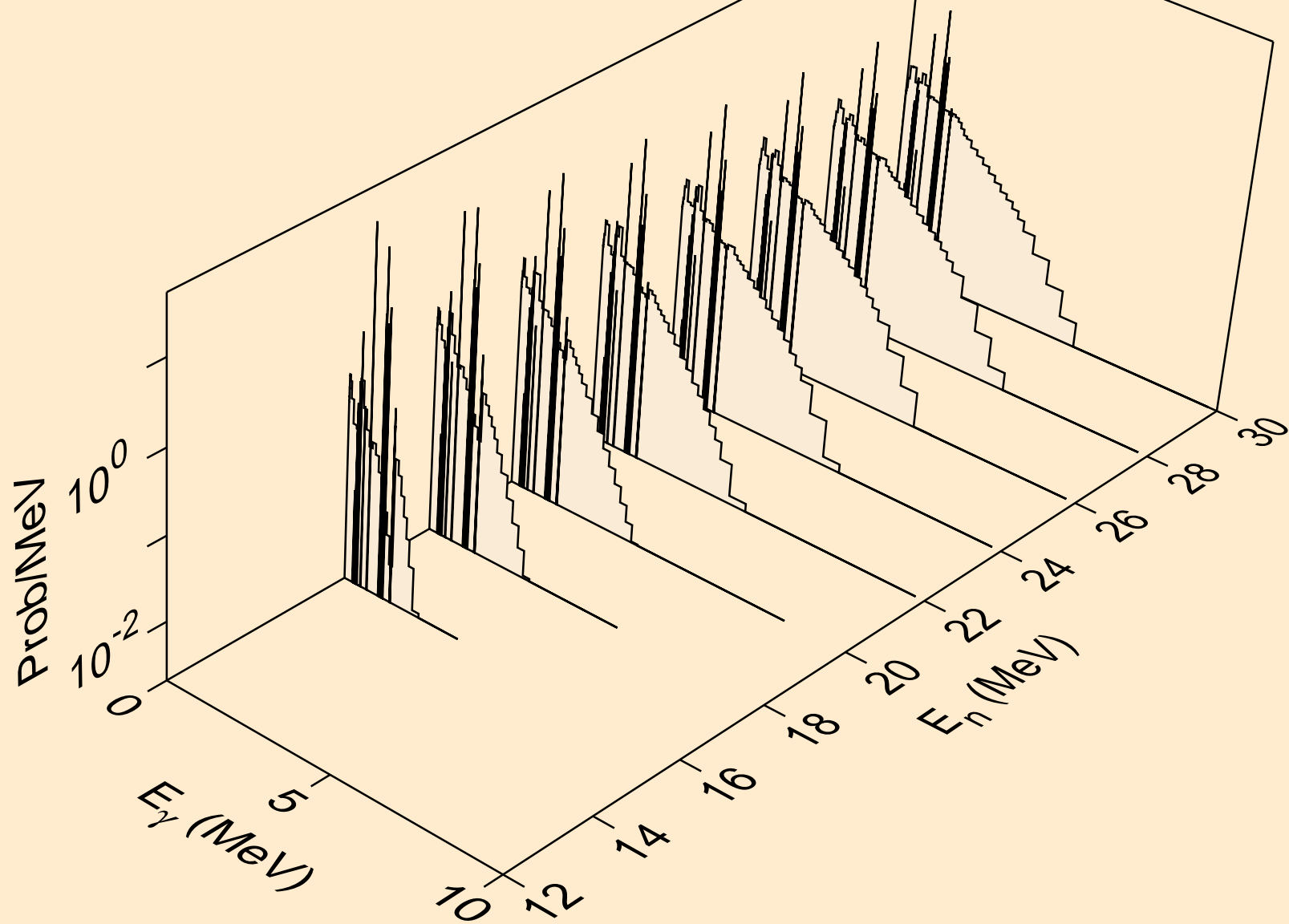

BI212M TRITON ACER TENDL-2021 LIBRARY; T=0.K  
Photon emission for (n,2np)

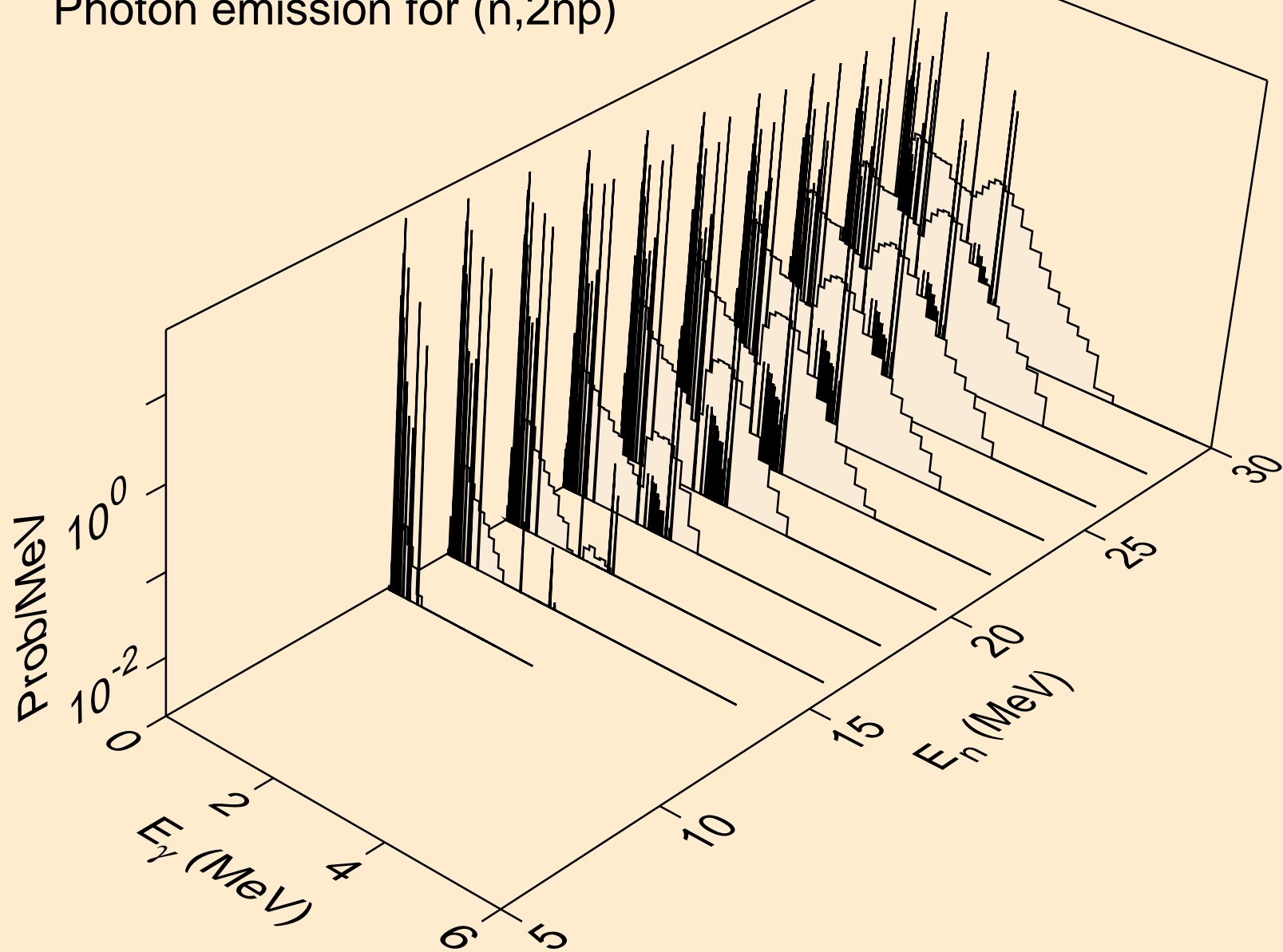

BI212M TRITON ACER TENDL-2021 LIBRARY; T=0.K  
Photon emission for (n,3np)

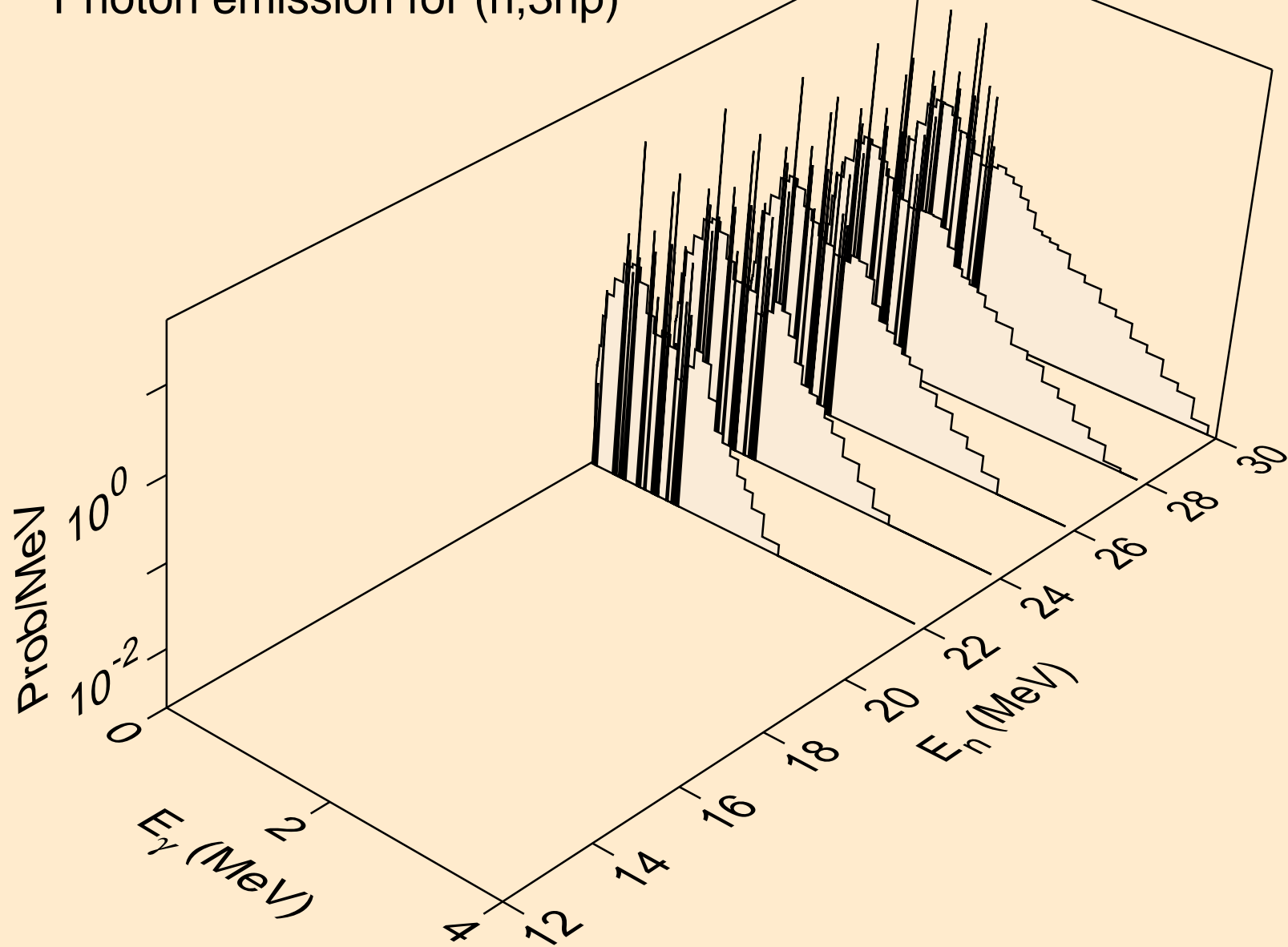

BI212M TRITON ACER TENDL-2021 LIBRARY; T=0.K  
Photon emission for (n,2np)

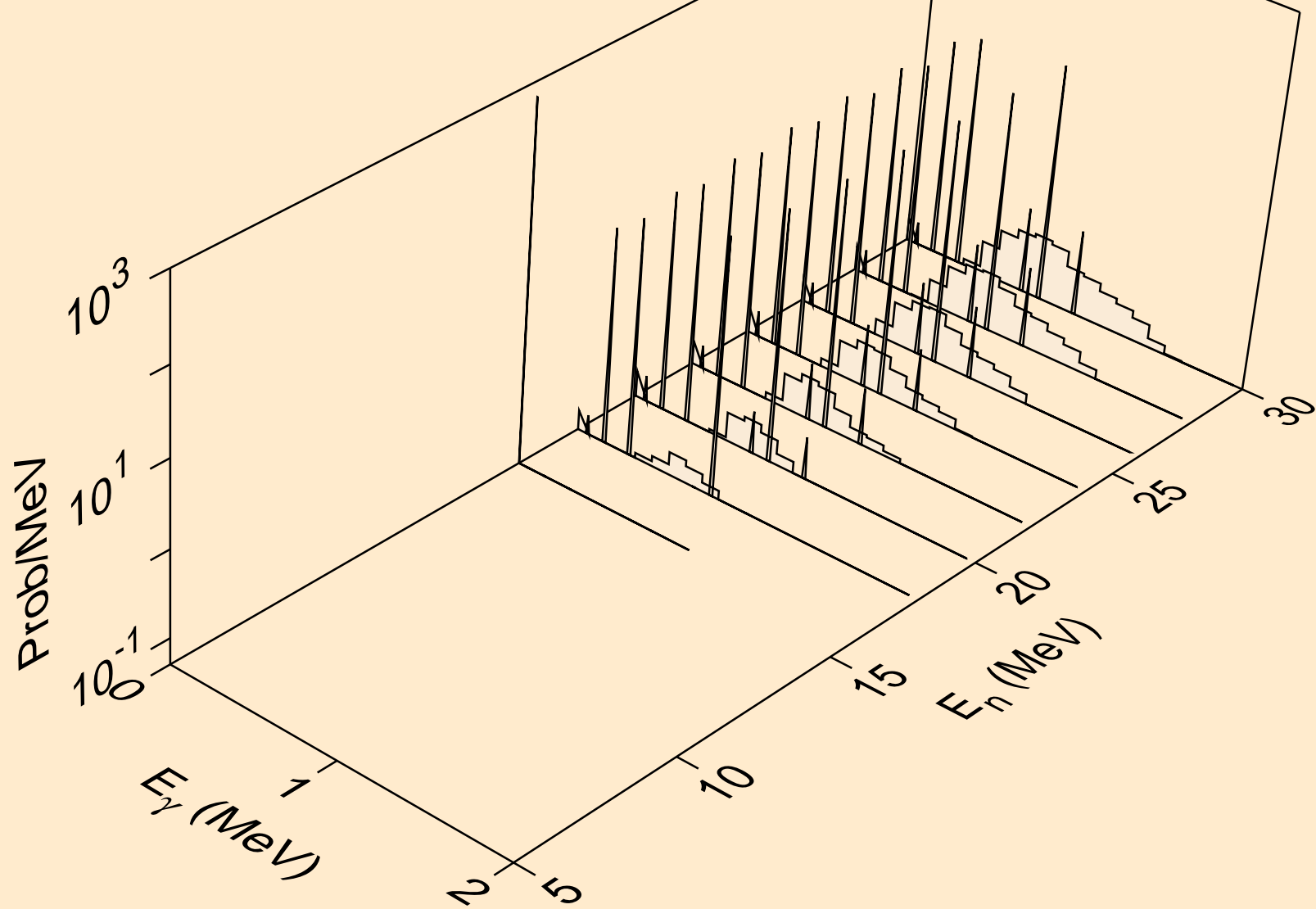

BI212M TRITON ACER TENDL-2021 LIBRARY; T=0.K  
Photon emission for (n,npa)

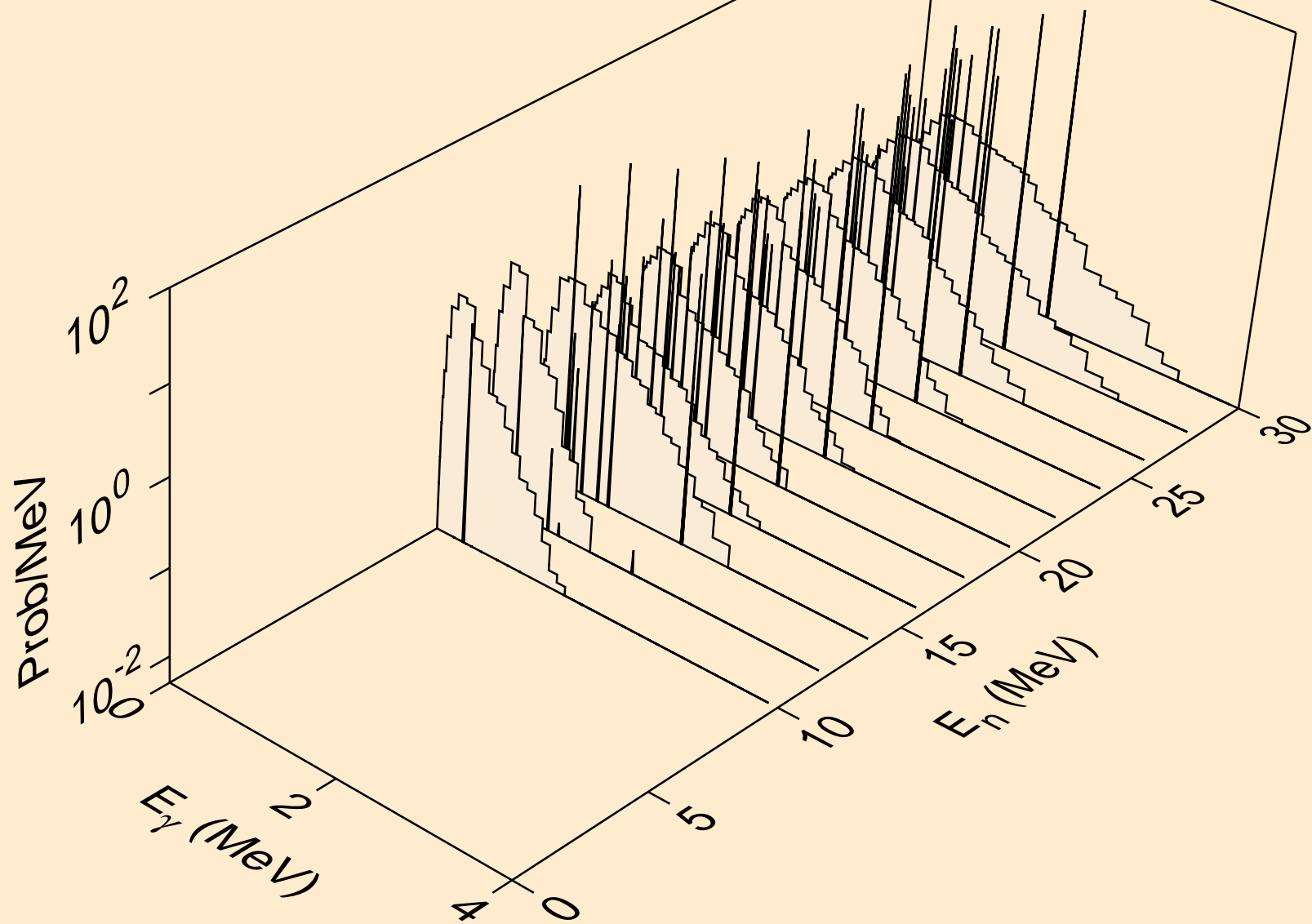



BI212M TRITON ACER TENDL-2021 LIBRARY; T=0.K  
Photon emission for (n,gma)

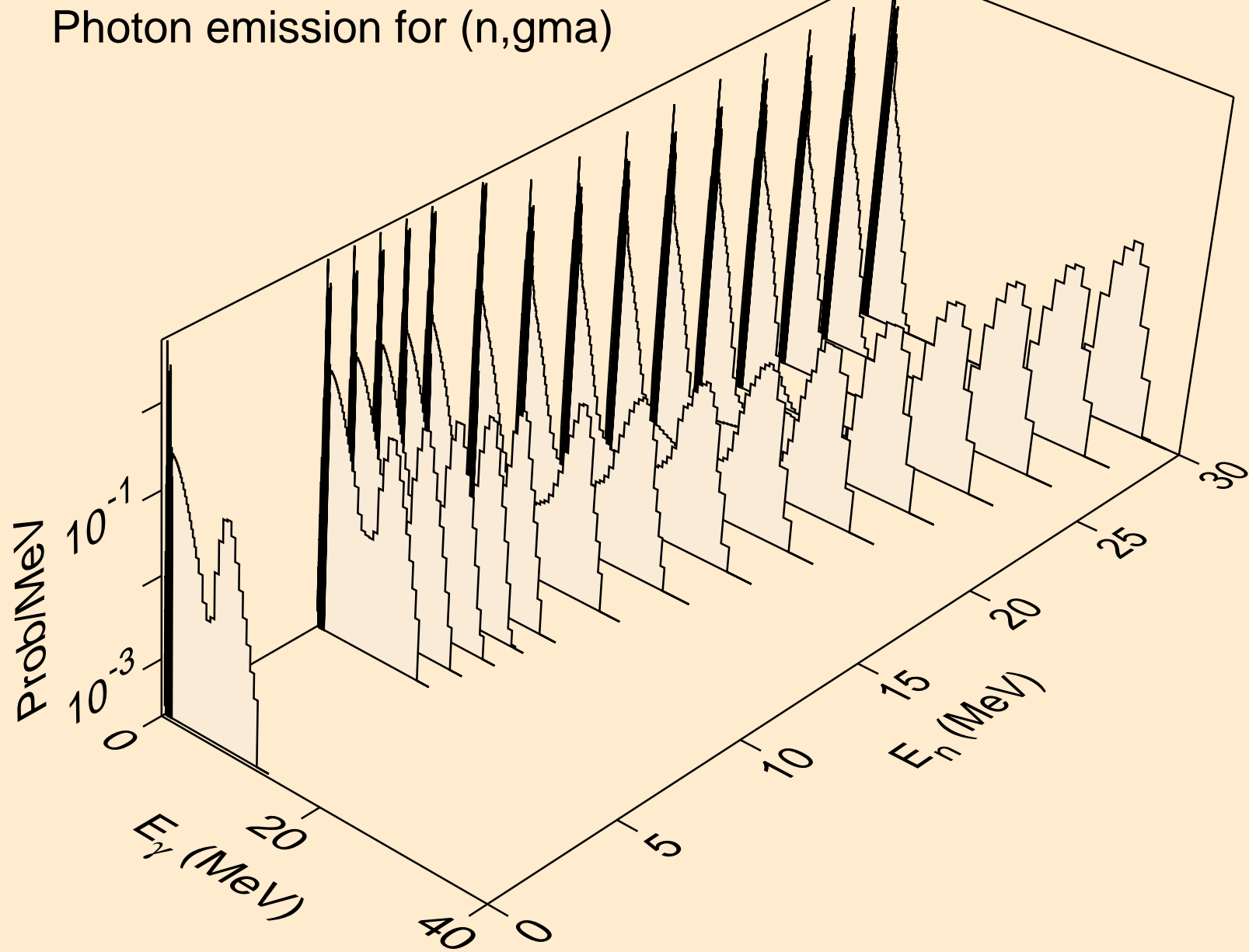

BI212M TRITON ACER TENDL-2021 LIBRARY; T=0.K  
Photon emission for (n,p)

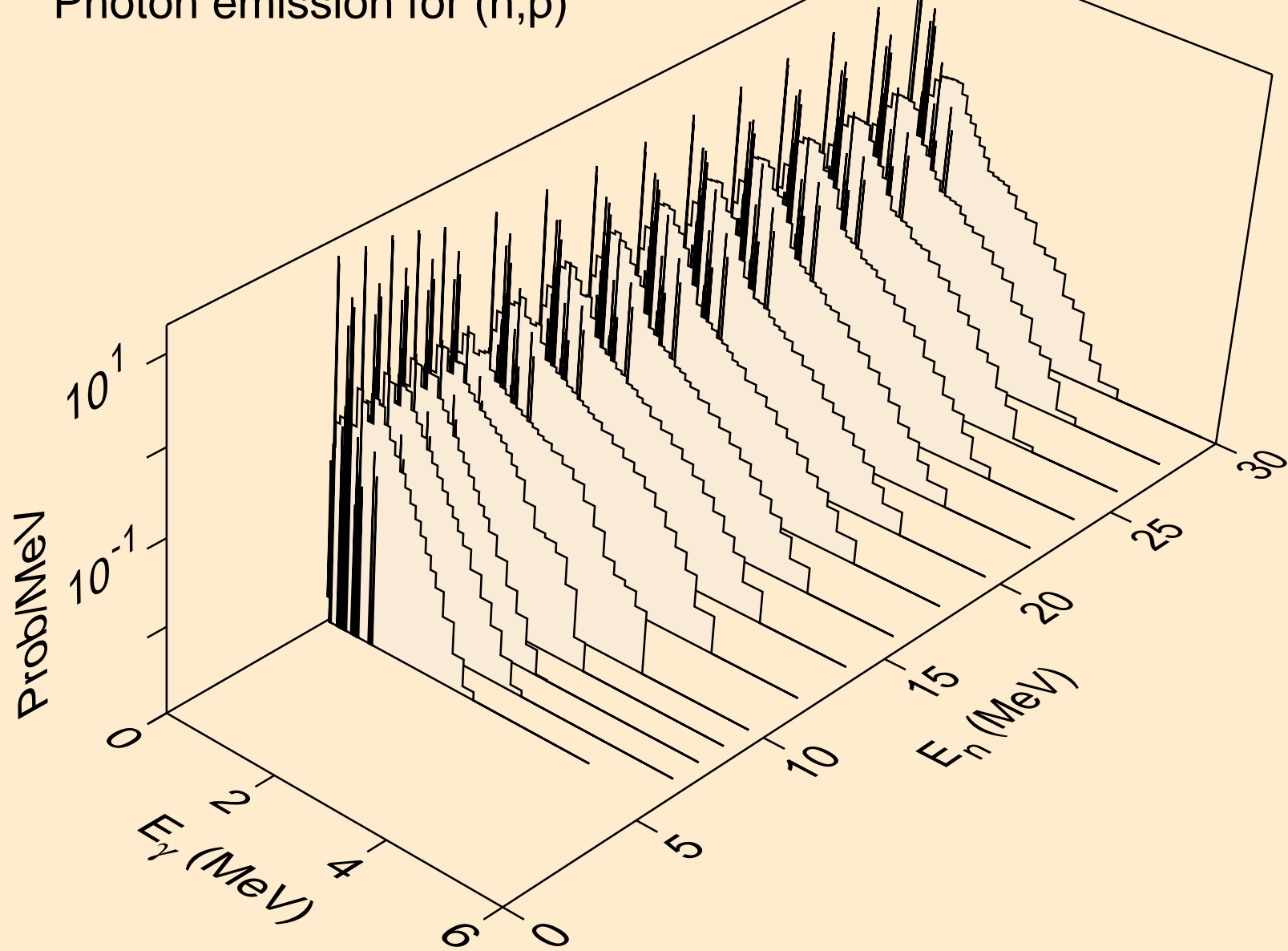

BI212M TRITON ACER TENDL-2021 LIBRARY; T=0.K  
Photon emission for (n,d)

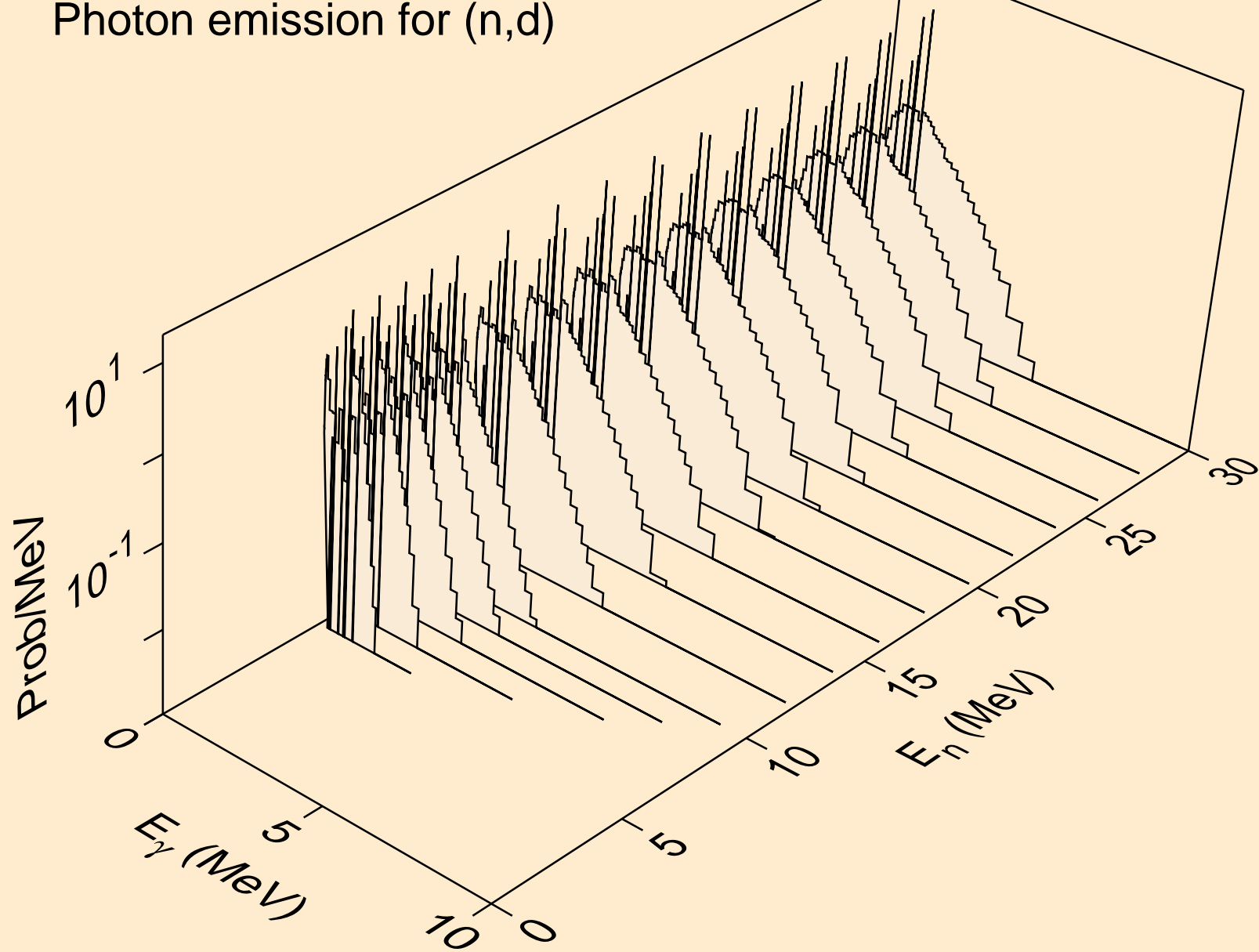

BI212M TRITON ACER TENDL-2021 LIBRARY; T=0.K  
Photon emission for inelastic

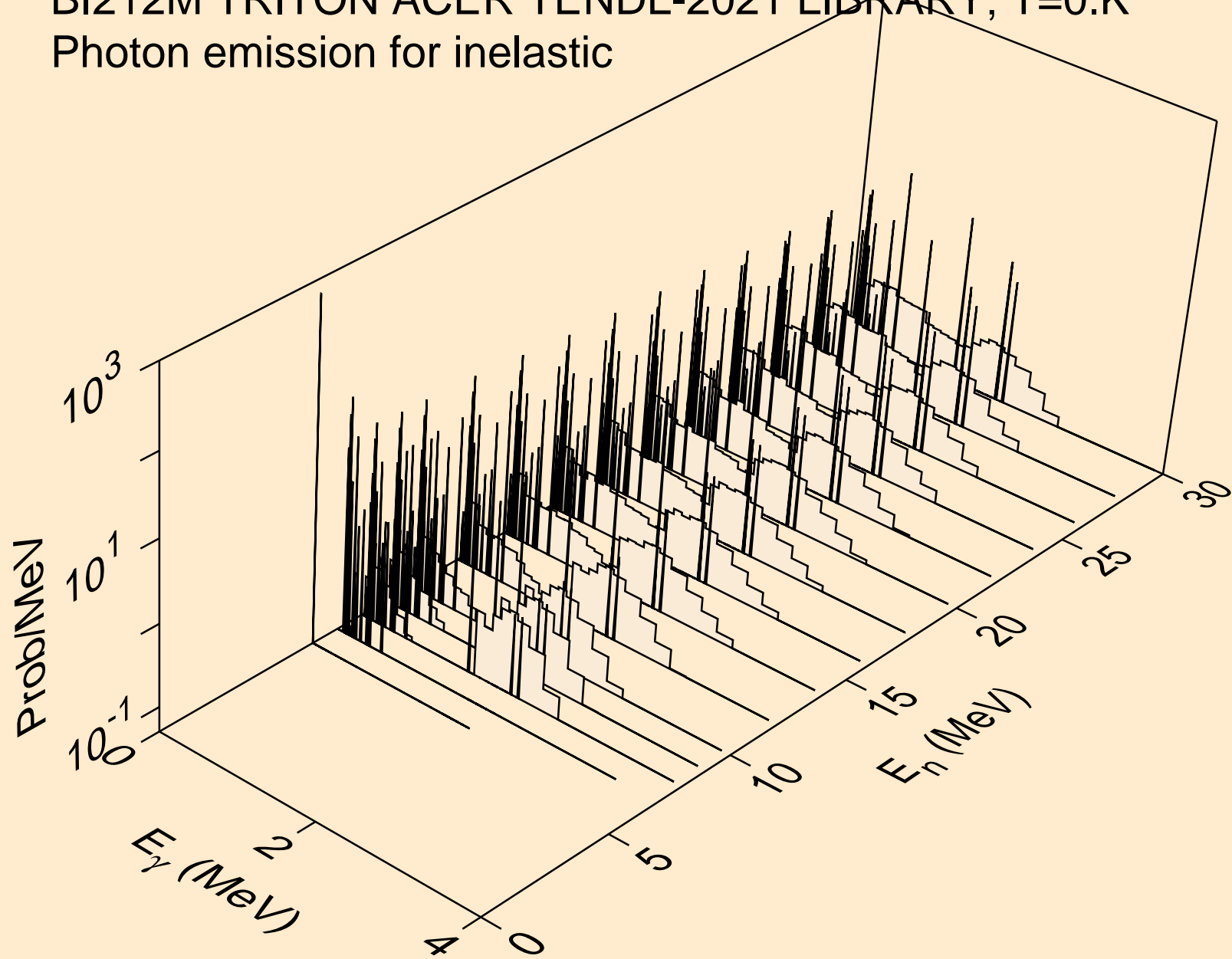

BI212M TRITON ACER TENDL-2021 LIBRARY; T=0.K  
Photon emission for (n,he3)

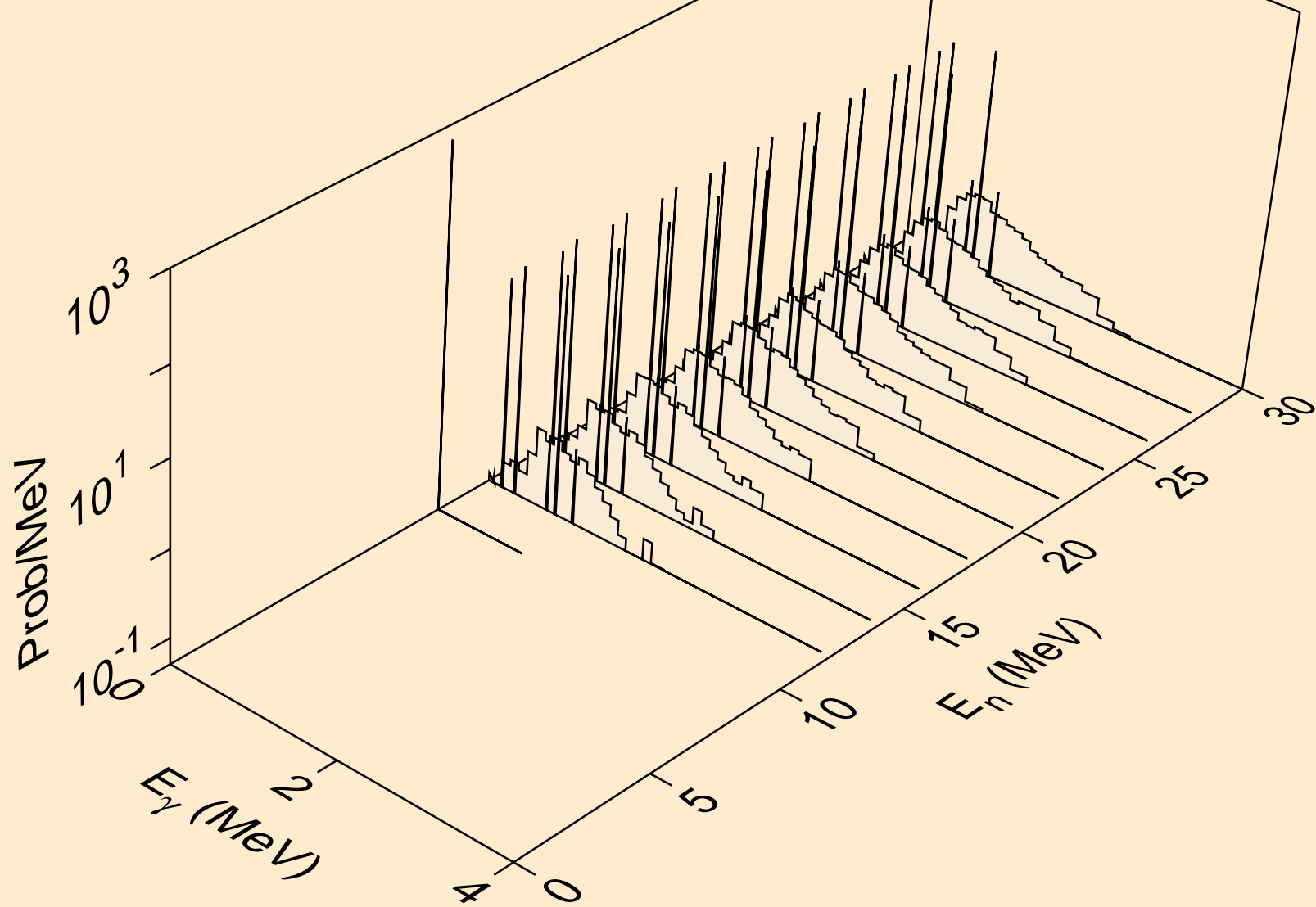

BI212M TRITON ACER TENDL-2021 LIBRARY; T=0.K  
Photon emission for (n,a)

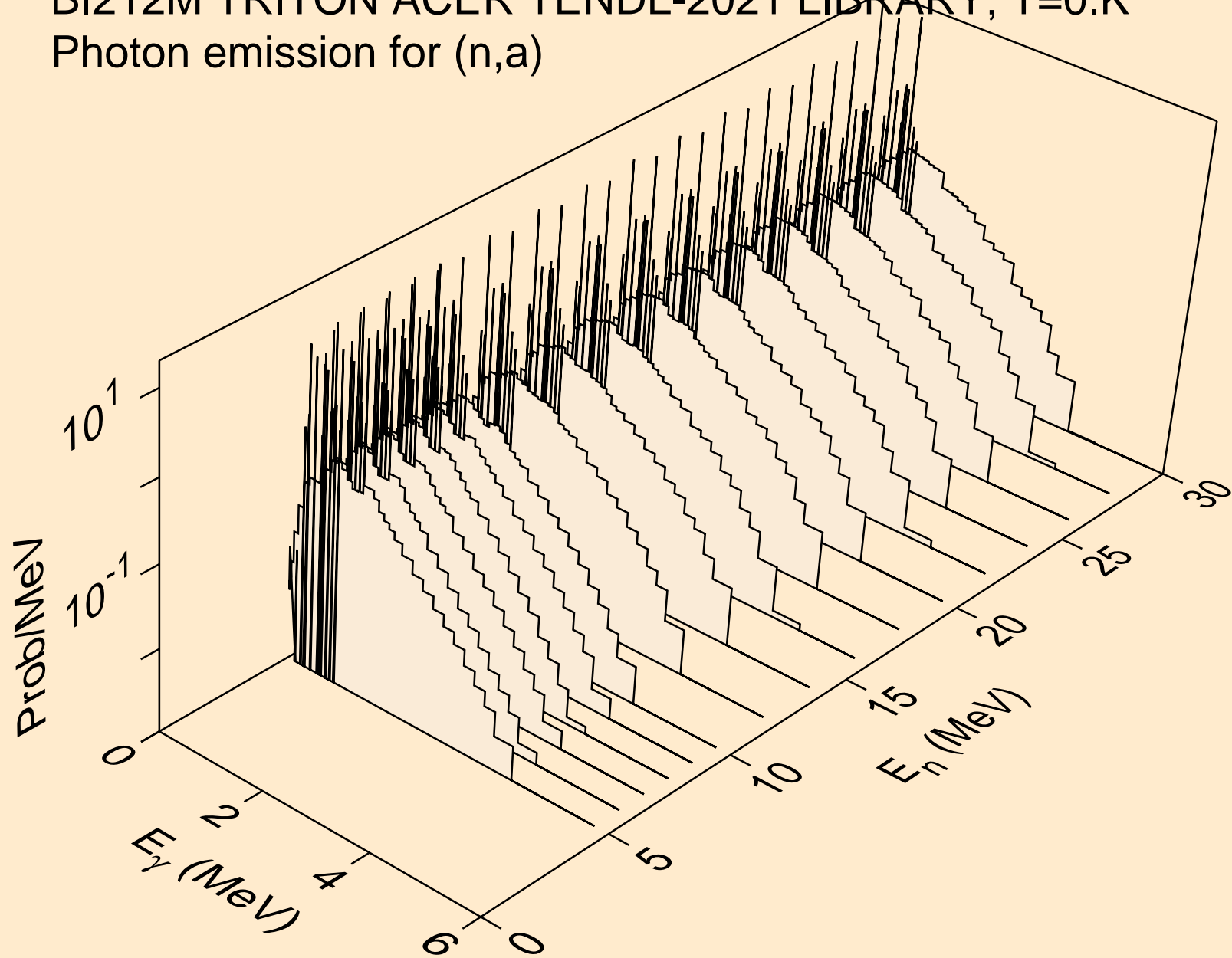

BI212M TRITON ACER TENDL-2021 LIBRARY; T=0.K  
Photon emission for (n,2a)

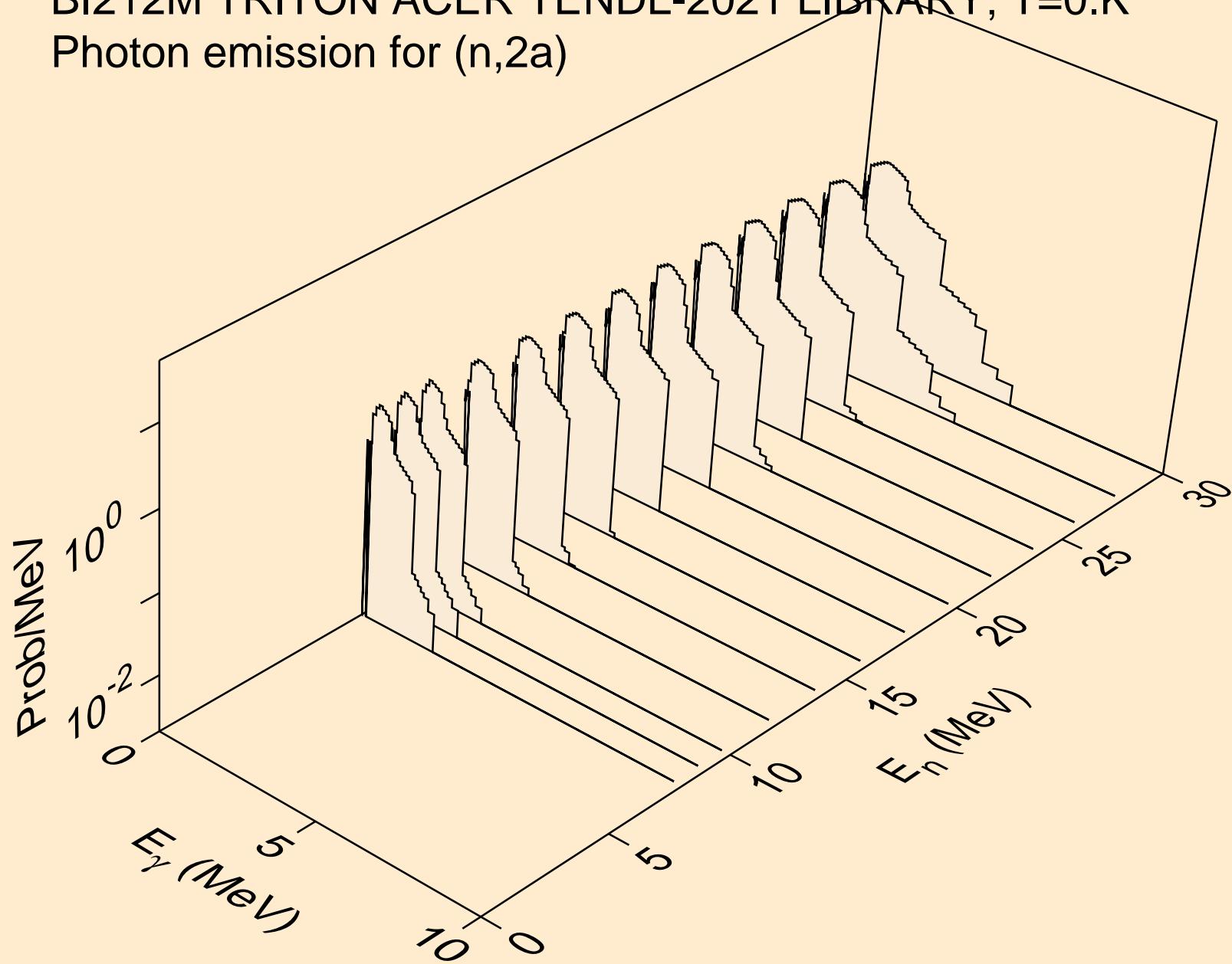

BI212M TRITON ACER TENDL-2021 LIBRARY; T=0.K  
Photon emission for (n,2p)

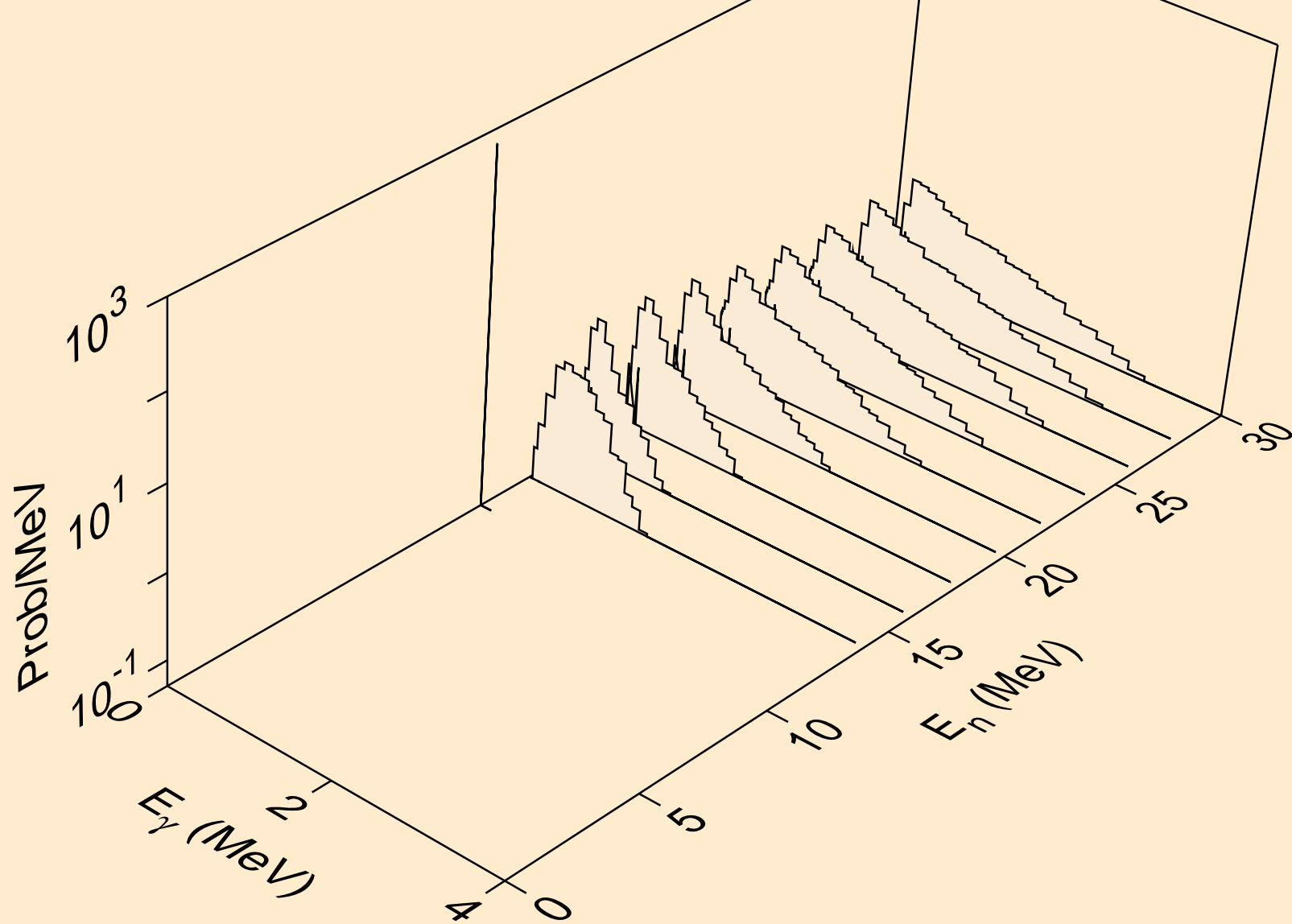



BI212M TRITON ACER TENDL-2021 LIBRARY; T=0.K  
Photon emission for (n,pa)

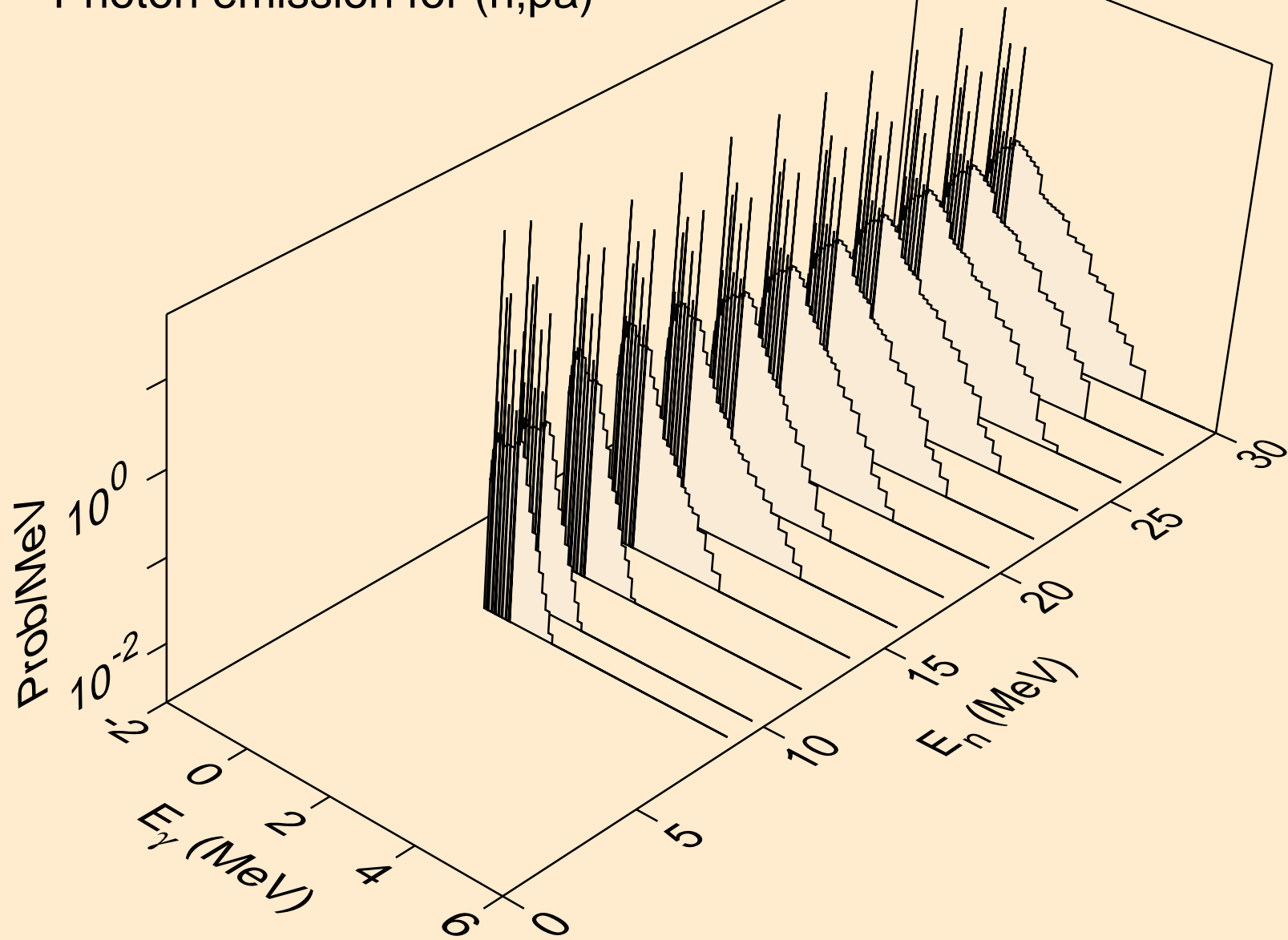

BI212M TRITON ACER TENDL-2021 LIBRARY; T=0.K  
Photon emission for (n,pd)

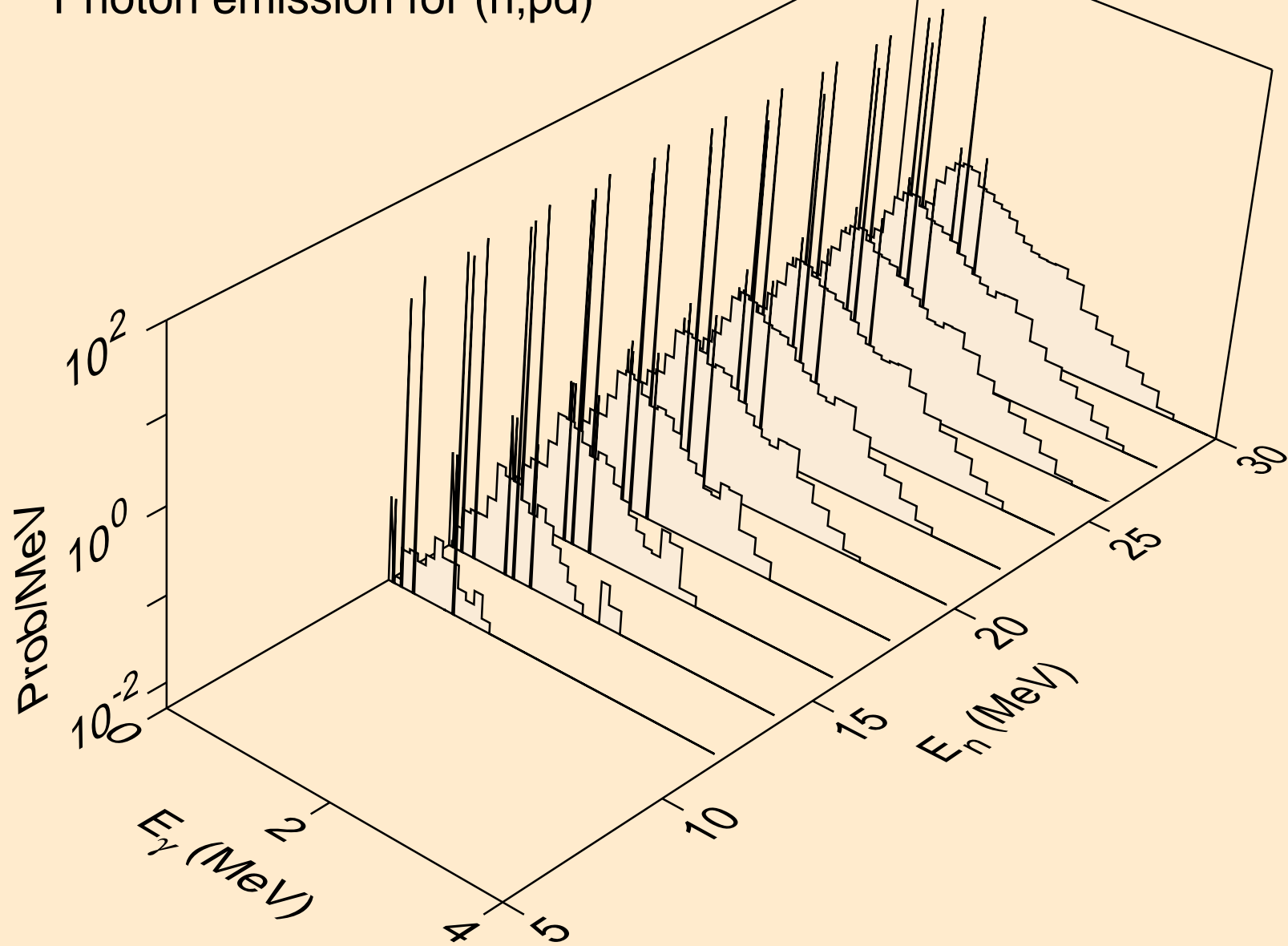

BI212M TRITON ACER TENDL-2021 LIBRARY; T=0.K  
Photon emission for (n,pt)

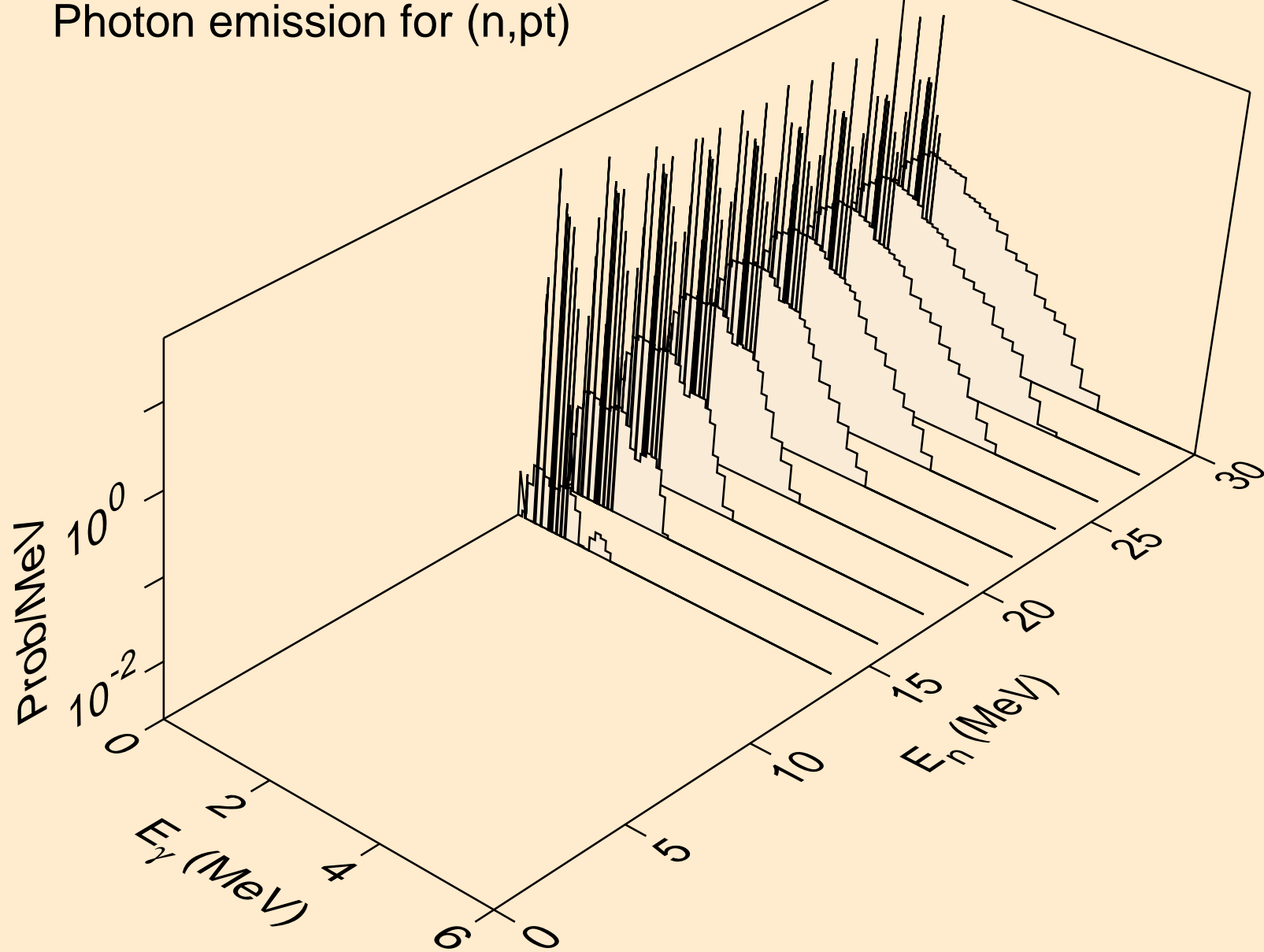

BI212M TRITON ACER TENDL-2021 LIBRARY; T=0.K  
Photon emission for (n,da)

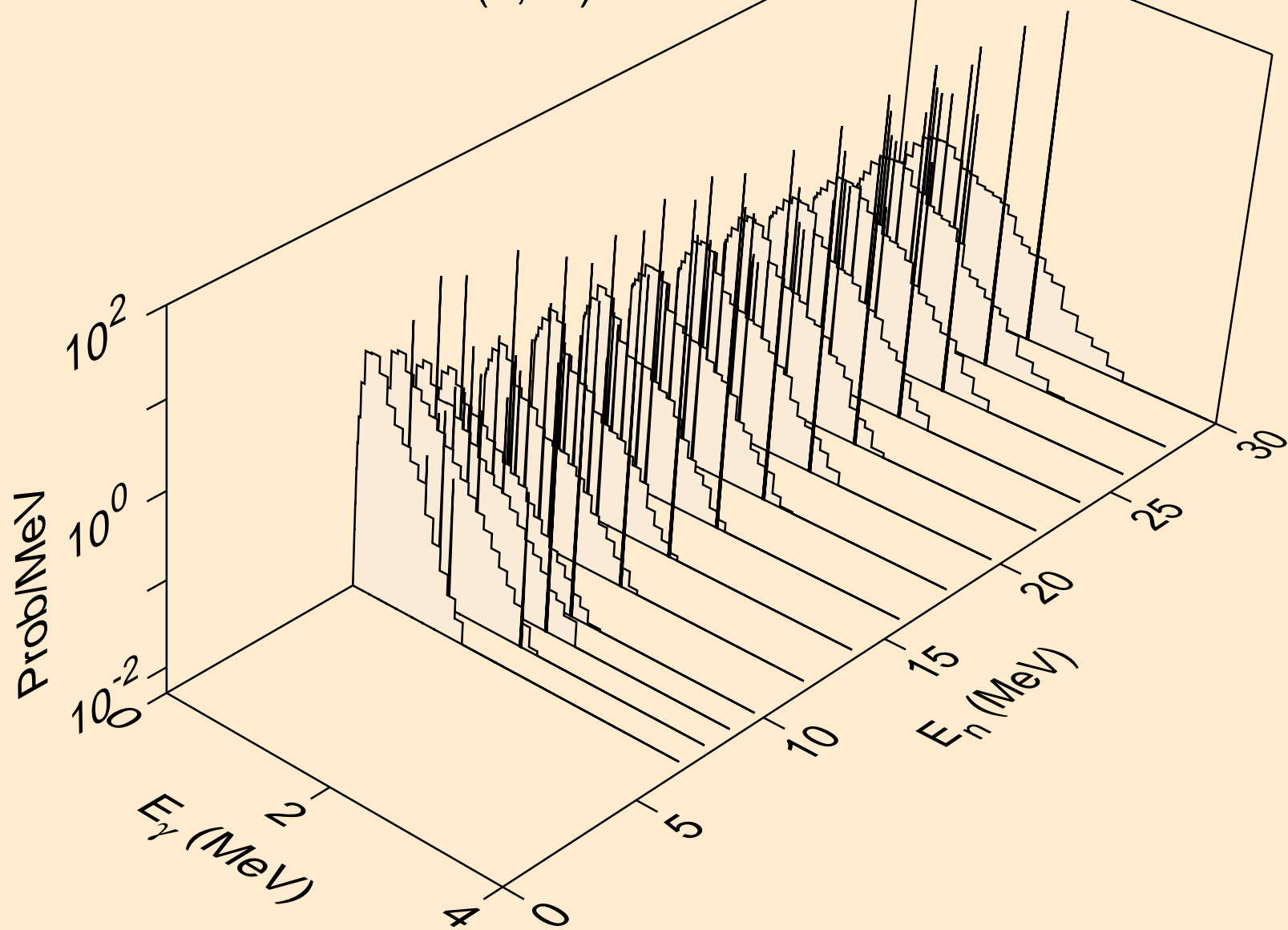

BI212M TRITON ACER TENDL-2021 LIBRARY; T=0.K  
Particle heating contributions

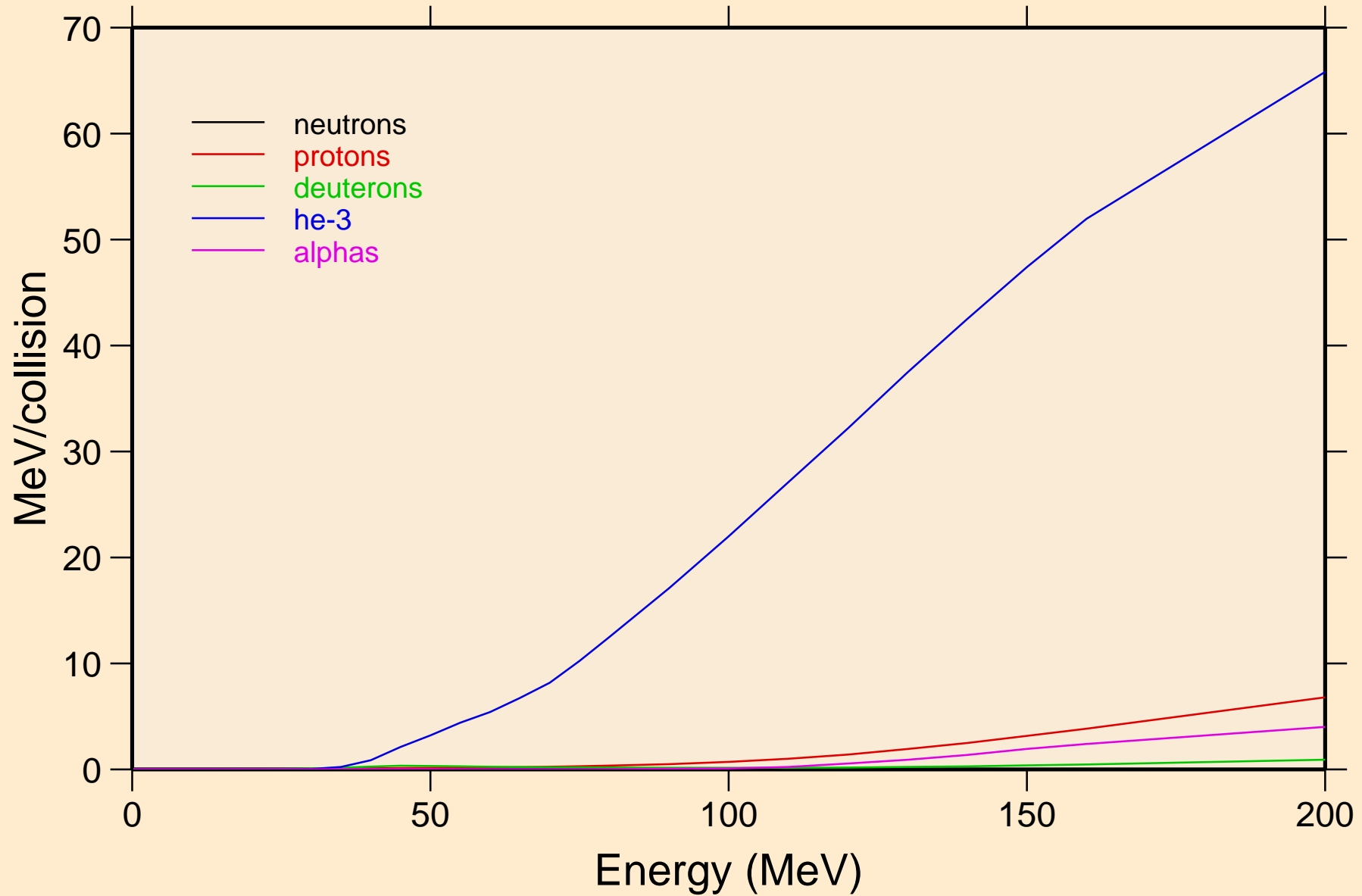

BI212M TRITON ACER TENDL-2021 LIBRARY; T=0.K  
Recoil Heating

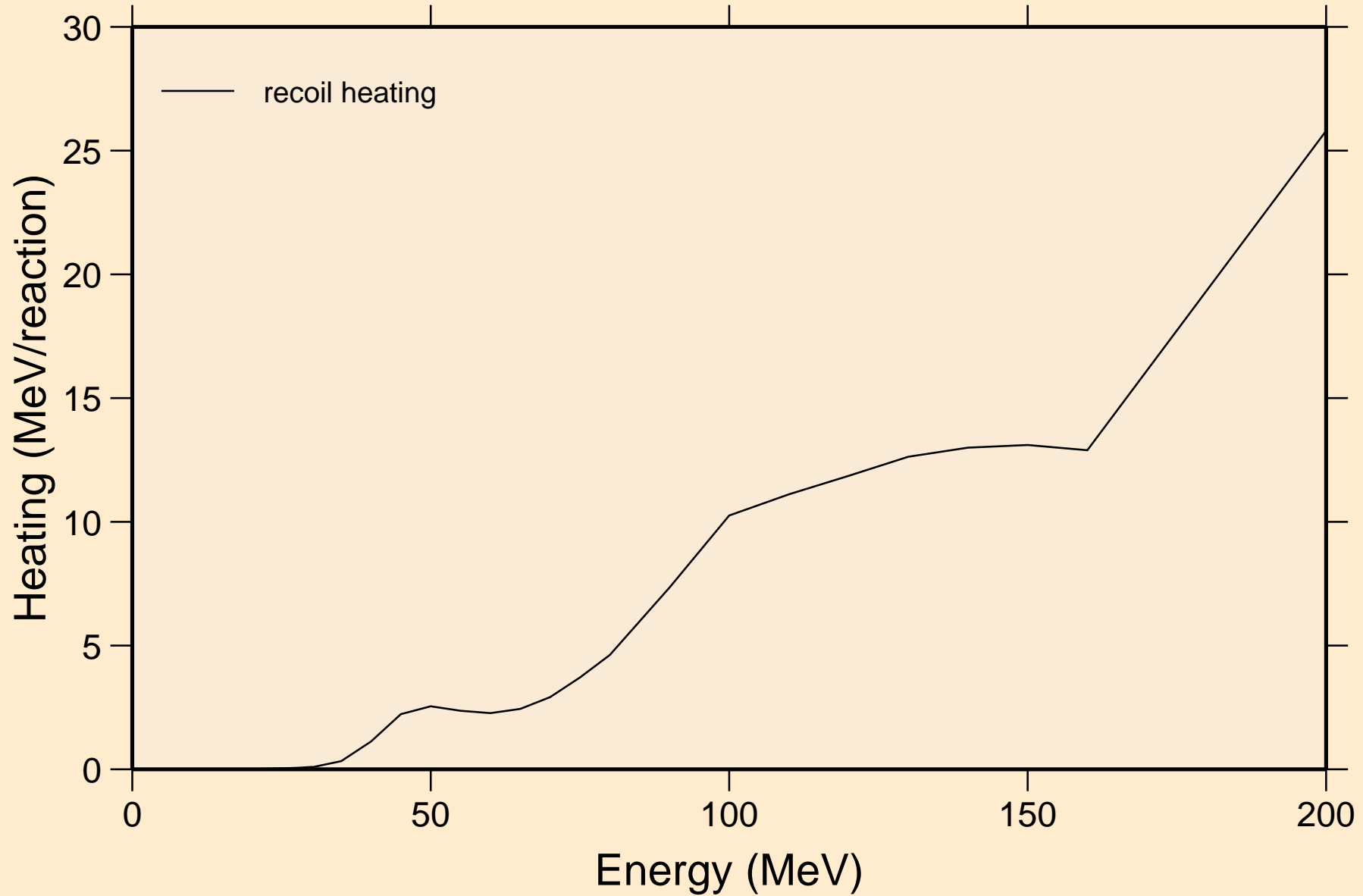

BI212M TRITON ACER TENDL-2021 LIBRARY; T=0.K  
Particle production cross sections

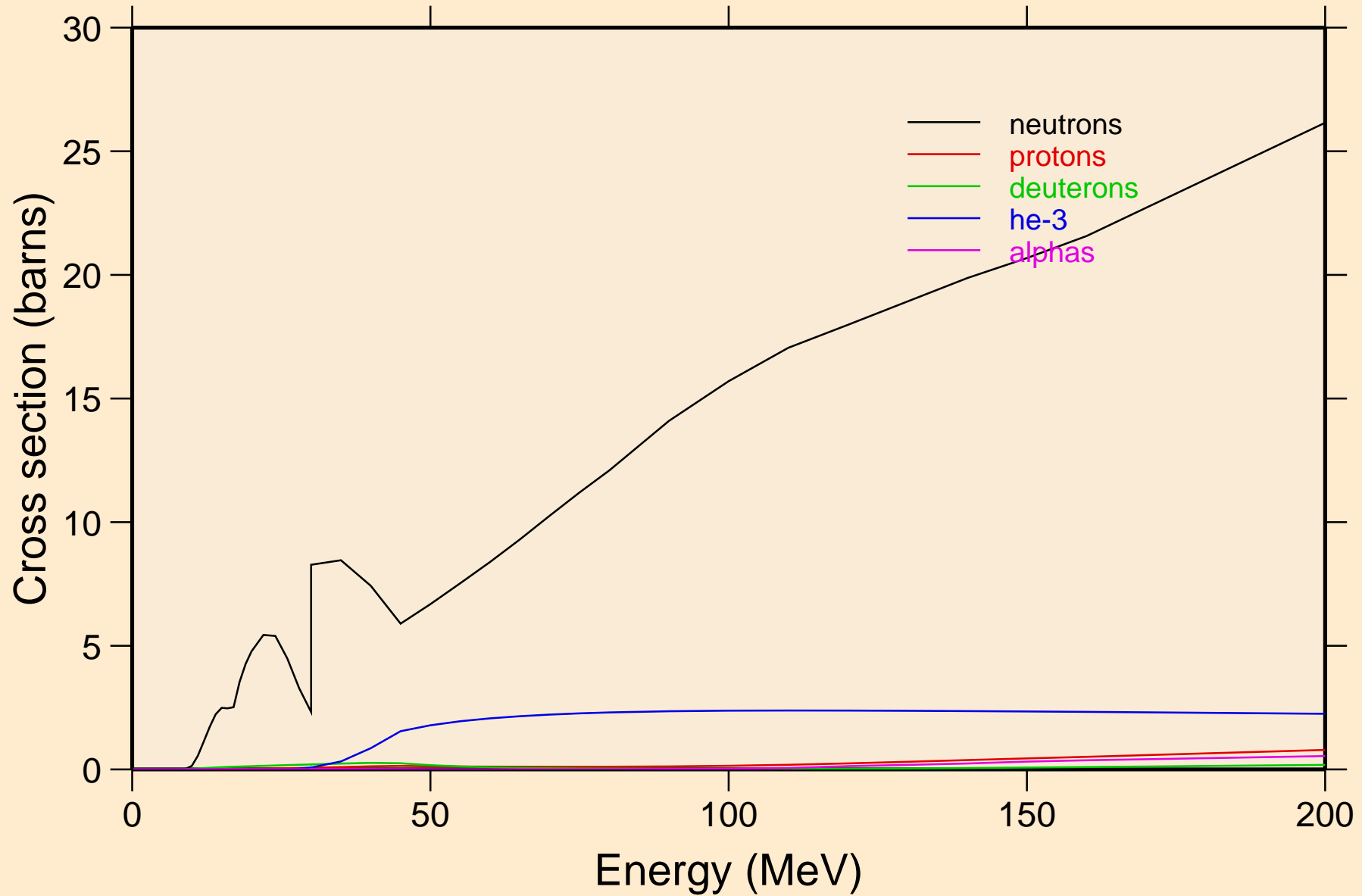

BI212M TRITON ACER TENDL-2021 LIBRARY; T=0.K  
neutrons from (t,n)

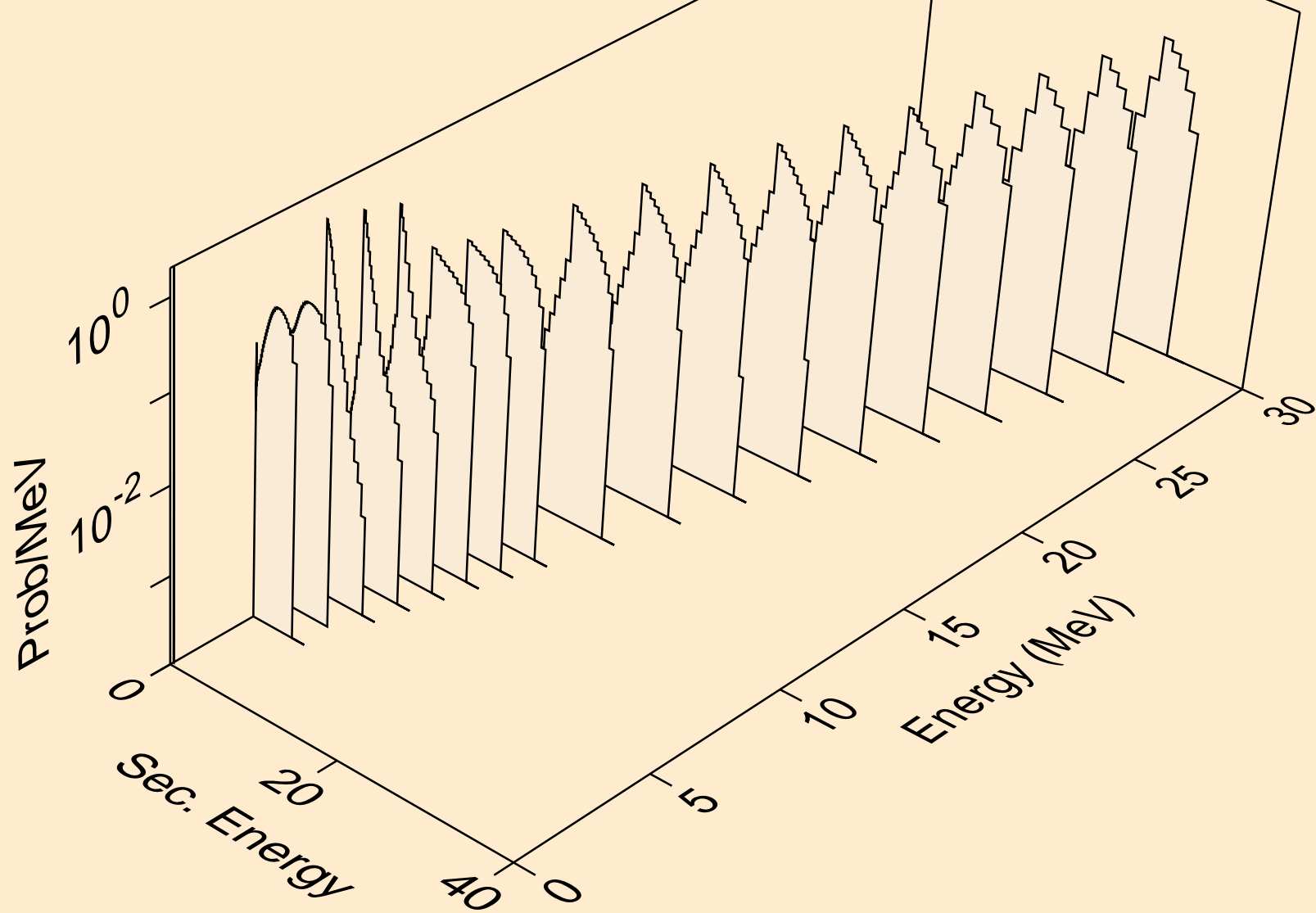



BI212M TRITON ACER TENDL-2021 LIBRARY; T=0.K  
neutrons from (t,x)

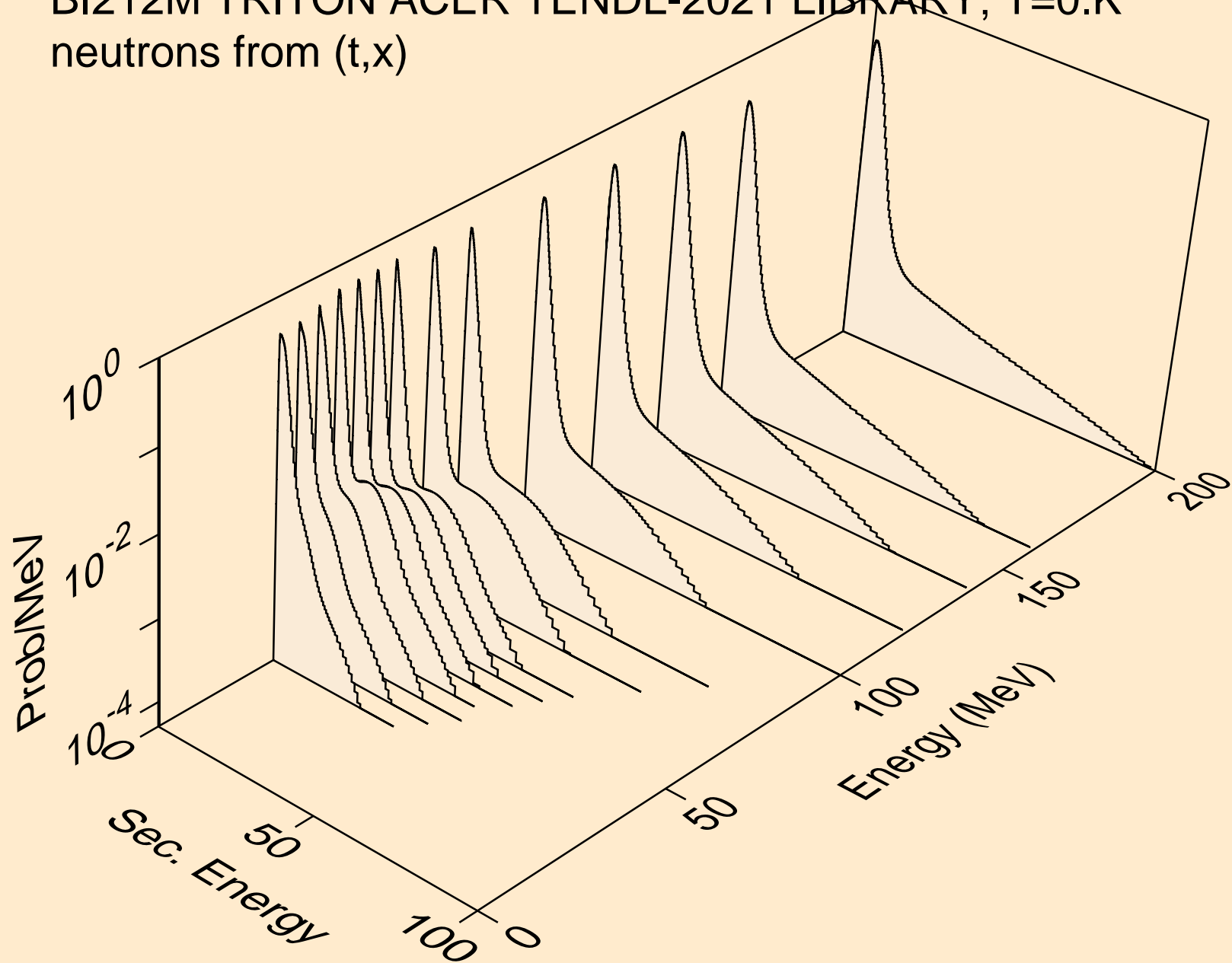

BI212M TRITON ACER TENDL-2021 LIBRARY; T=0.K  
neutrons from (t,2nd)

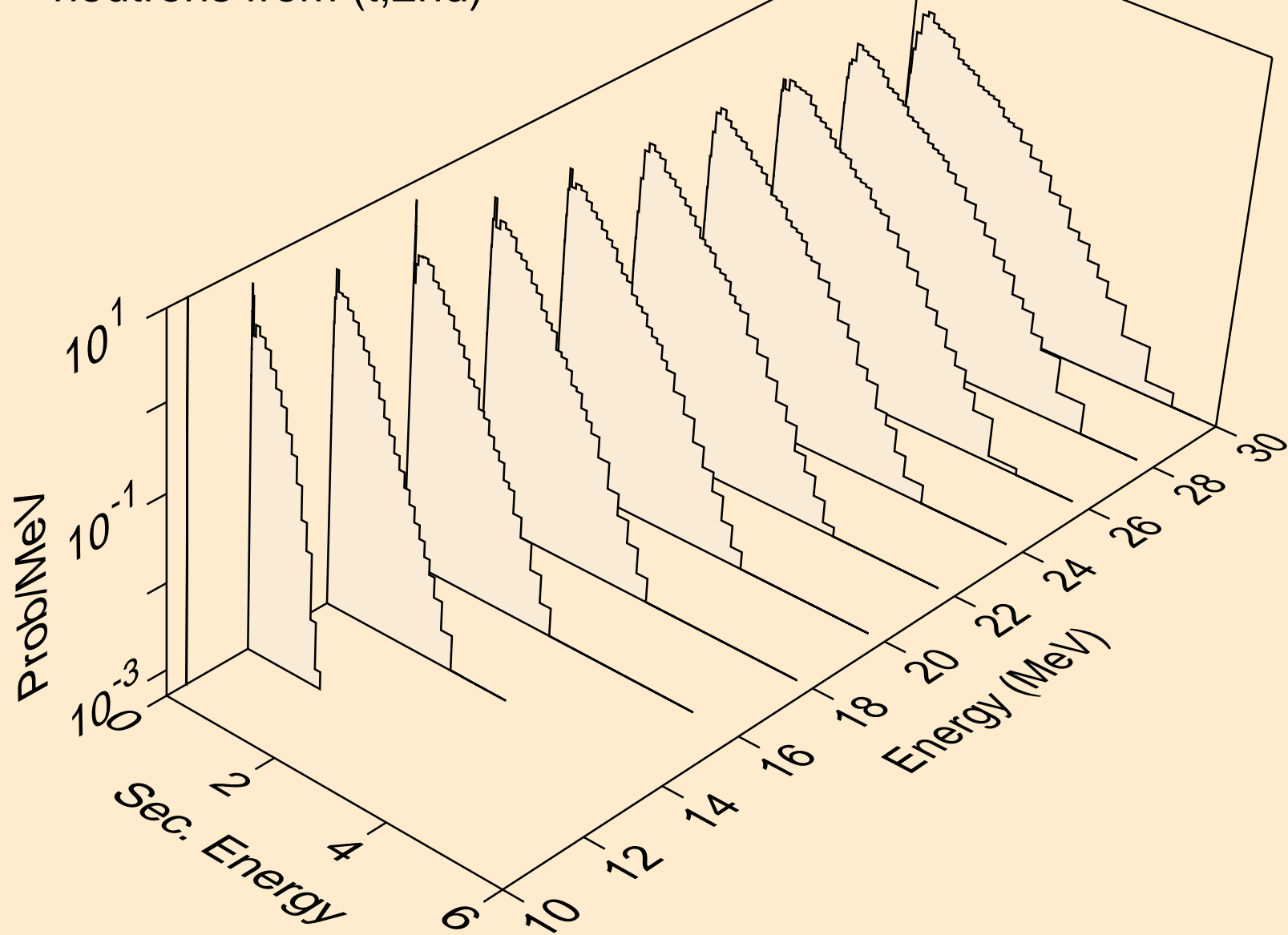

BI212M TRITON ACER TENDL-2021 LIBRARY; T=0.K  
neutrons from (t,2n)

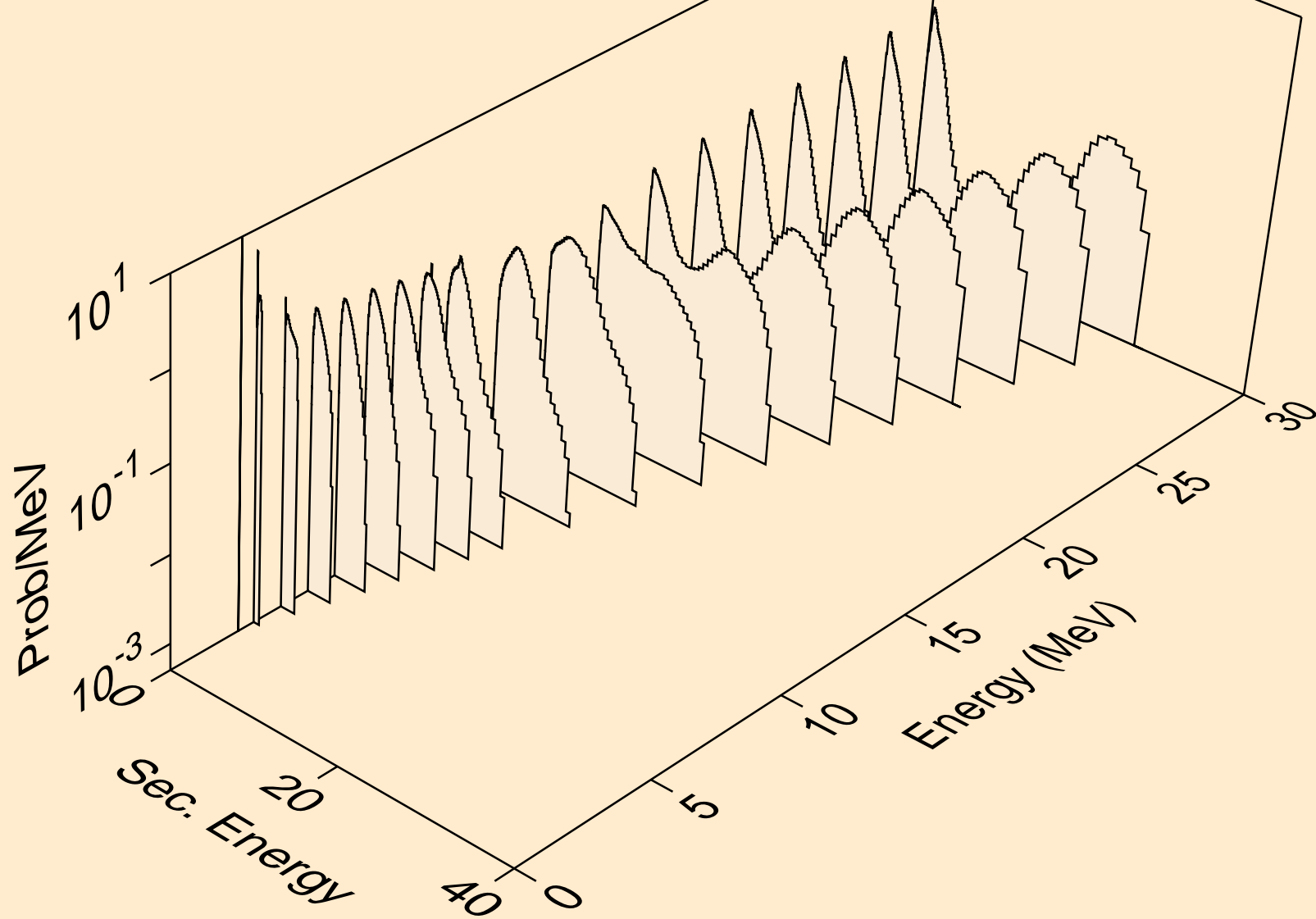

BI212M TRITON ACER TENDL-2021 LIBRARY; T=0.K  
neutrons from (t,3n)

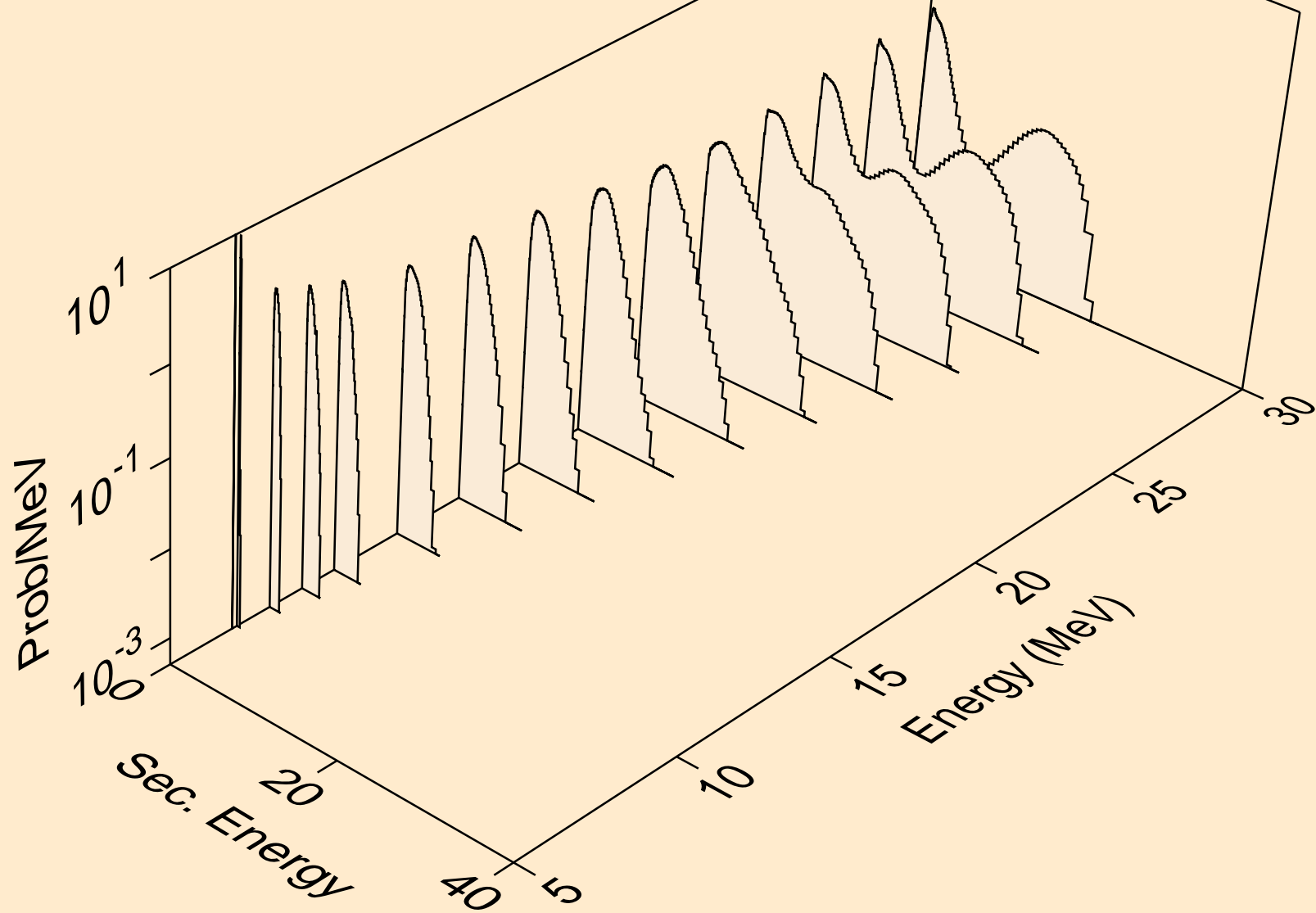

BI212M TRITON ACER TENDL-2021 LIBRARY; T=0.K  
neutrons from (t,n\*)a

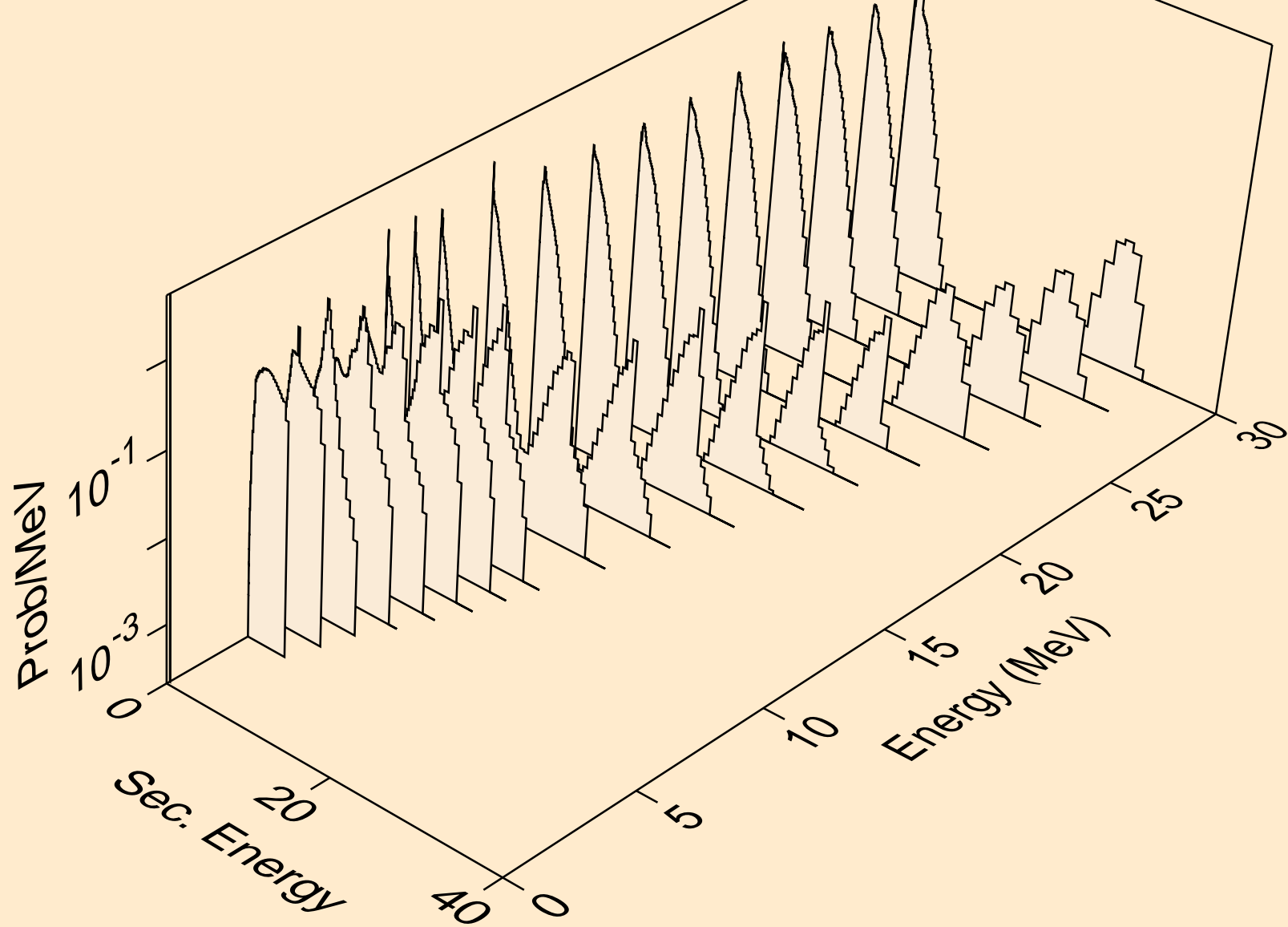

BI212M TRITON ACER TENDL-2021 LIBRARY; T=0.K  
neutrons from (t,2n)a

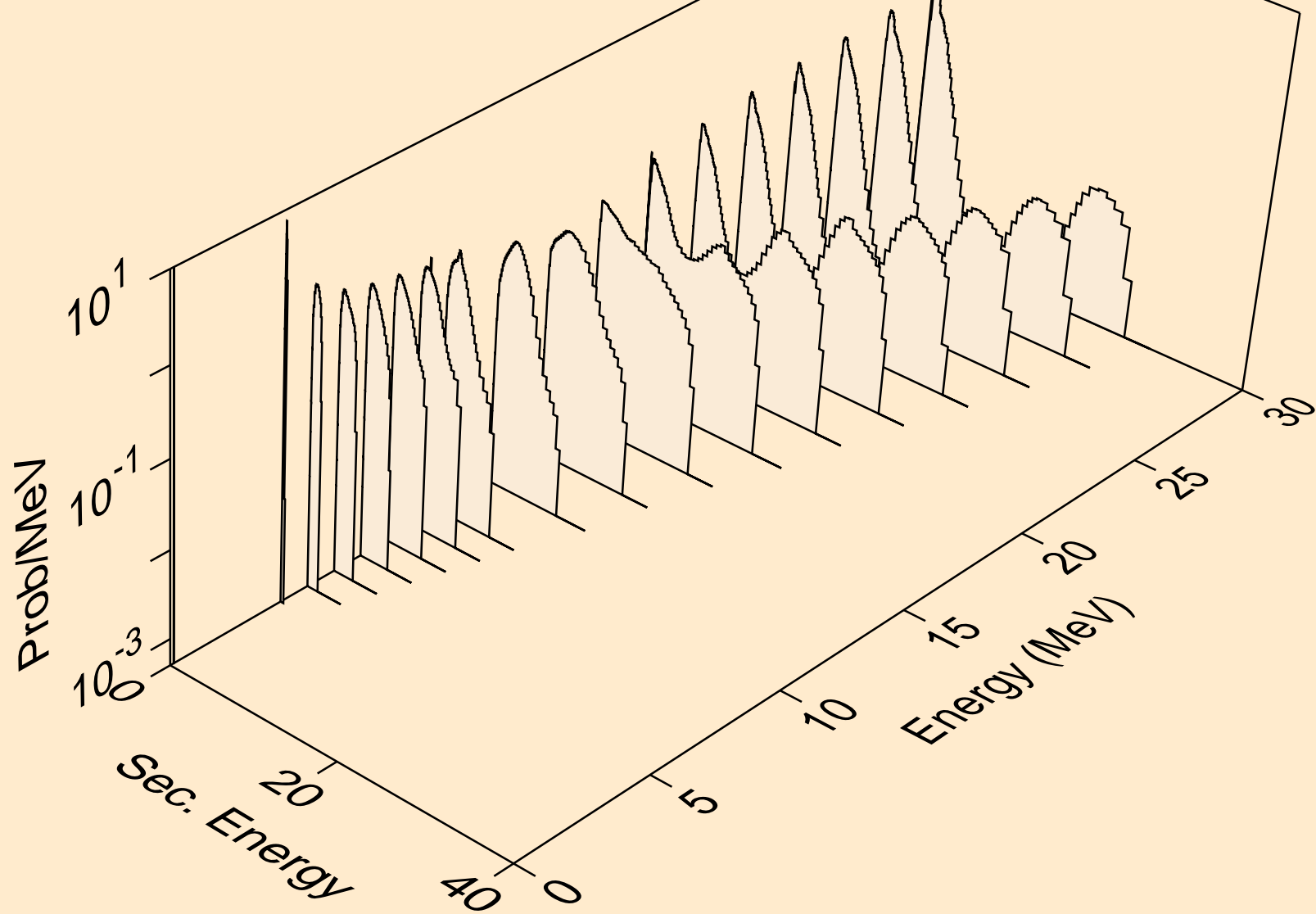

BI212M TRITON ACER TENDL-2021 LIBRARY; T=0.K  
neutrons from (t,3n)a

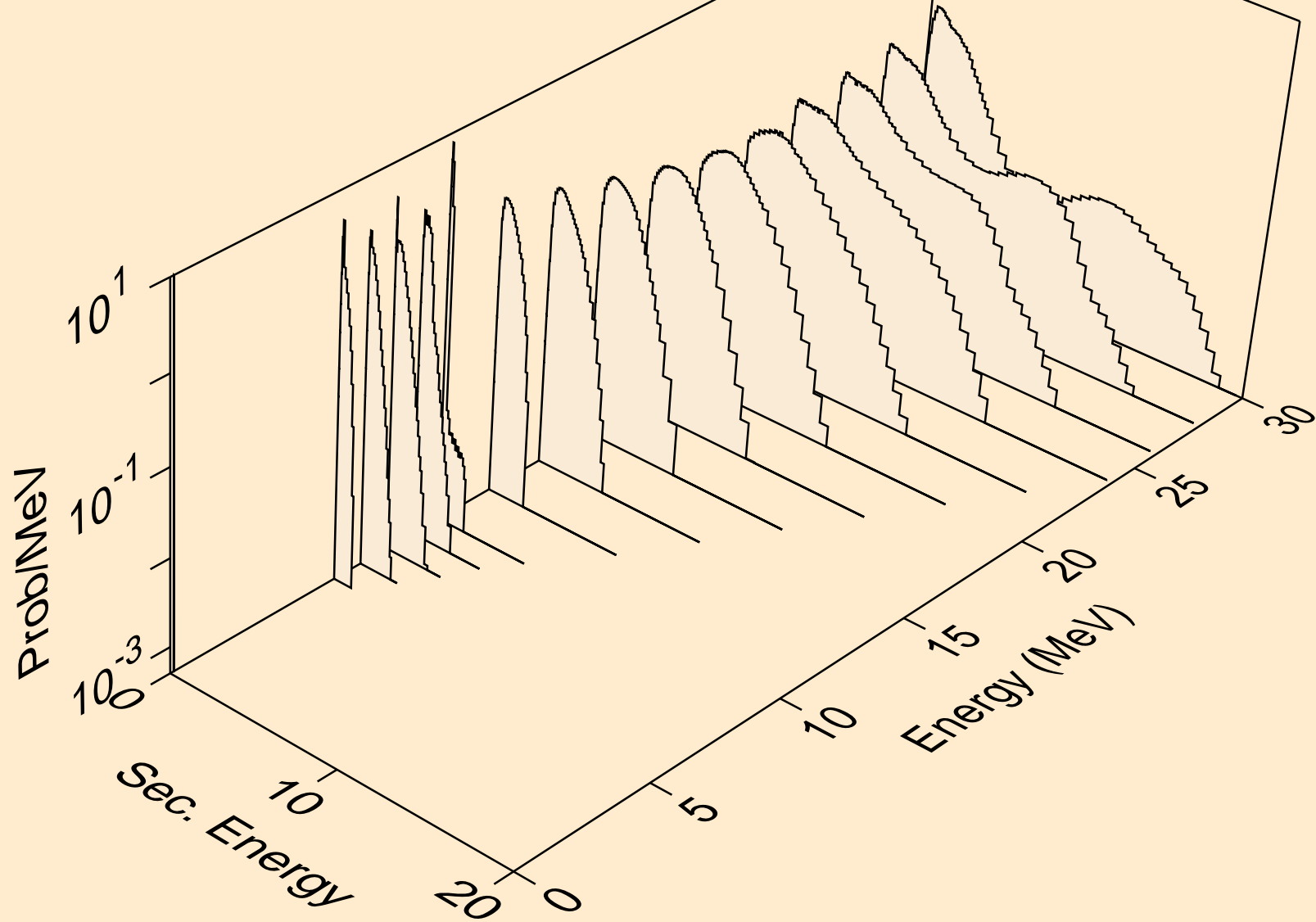

BI212M TRITON ACER TENDL-2021 LIBRARY; T=0.K  
neutrons from (t,n\*)p

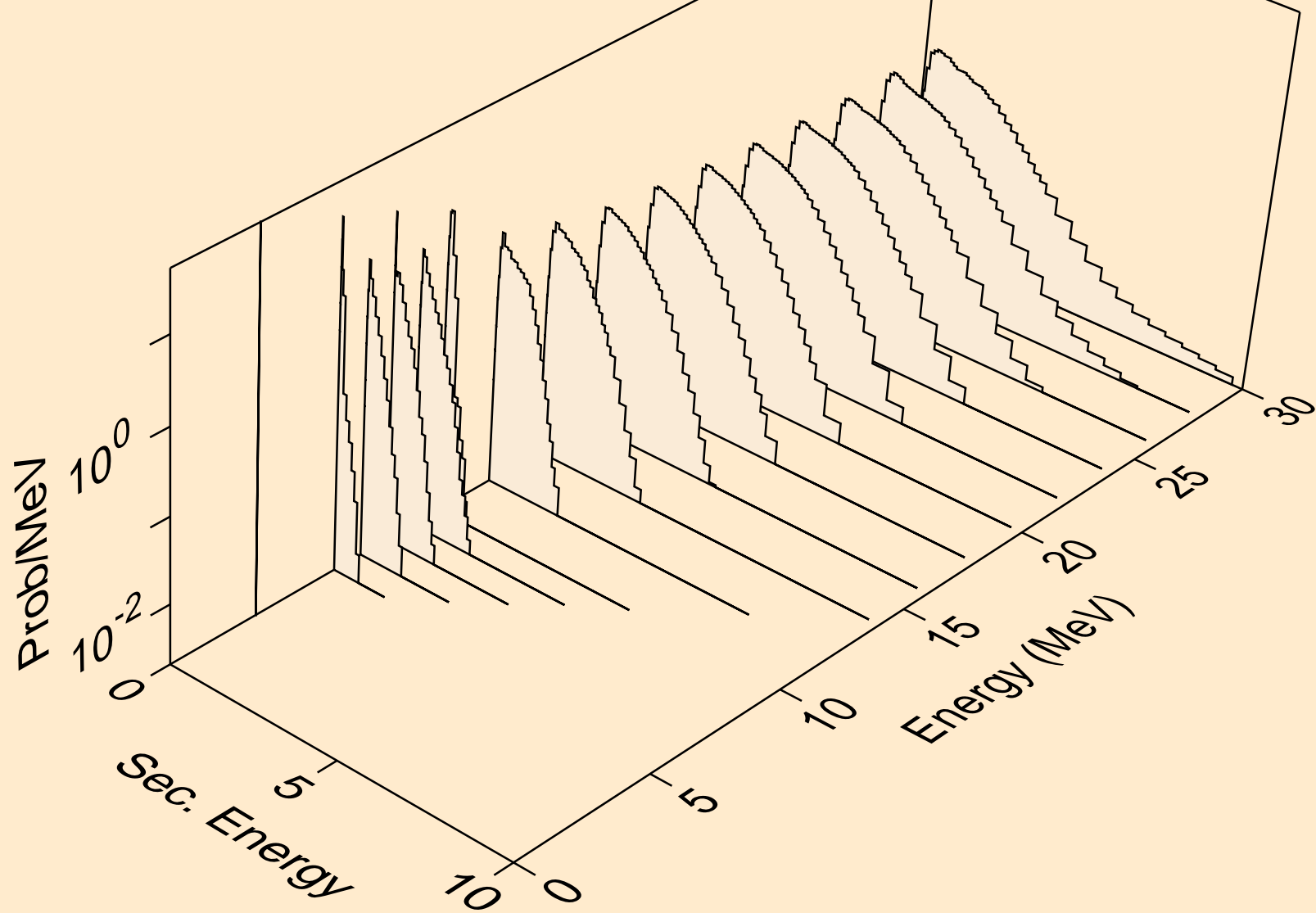



BI212M TRITON ACER TENDL-2021 LIBRARY; T=0.K  
neutrons from (t,n\*)2a

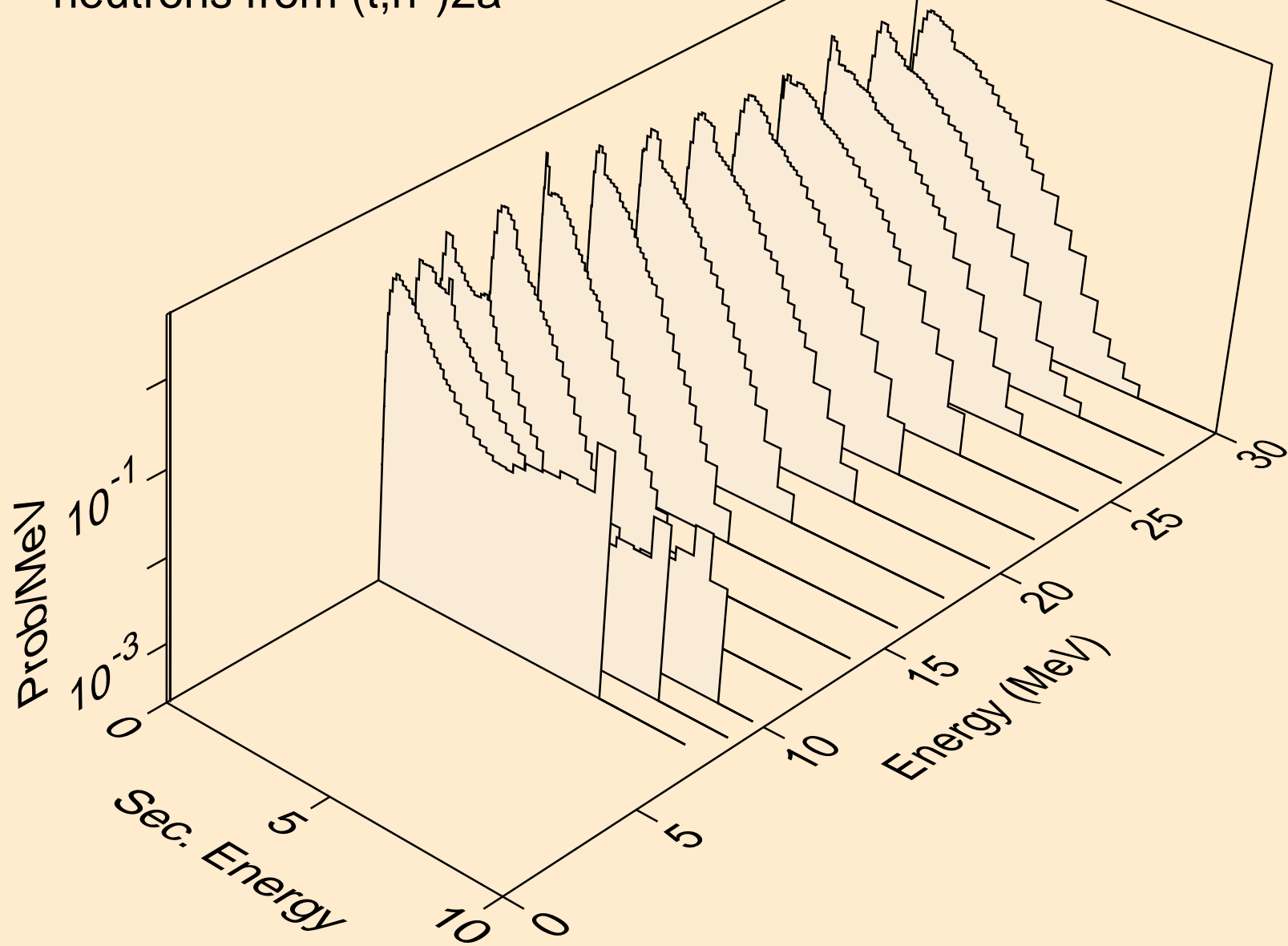

BI212M TRITON ACER TENDL-2021 LIBRARY; T=0.K  
neutrons from (t,2n)2a

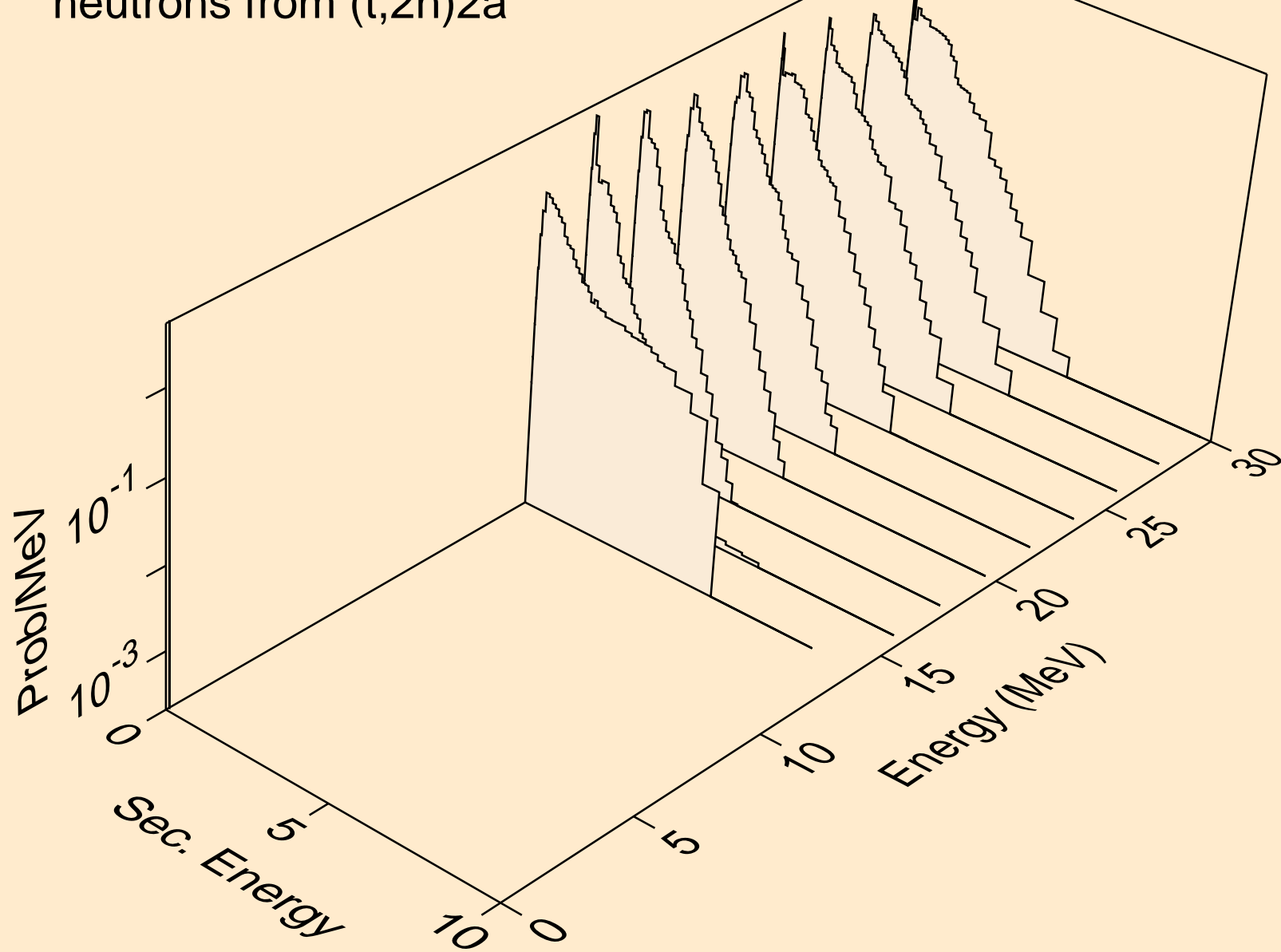

BI212M TRITON ACER TENDL-2021 LIBRARY; T=0.K  
neutrons from (t,n\*)d

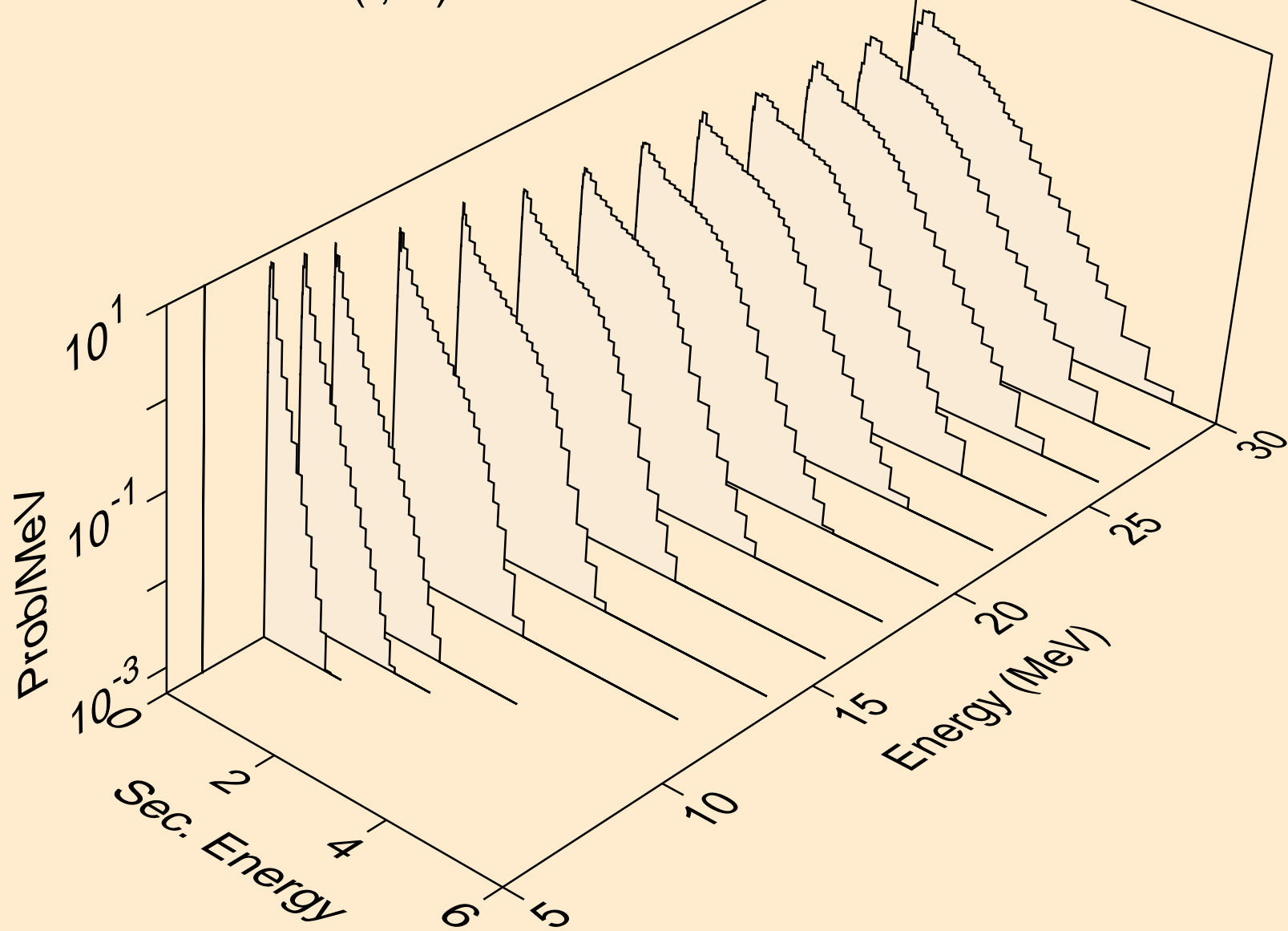

BI212M TRITON ACER TENDL-2021 LIBRARY; T=0.K  
neutrons from (t,n\*)t

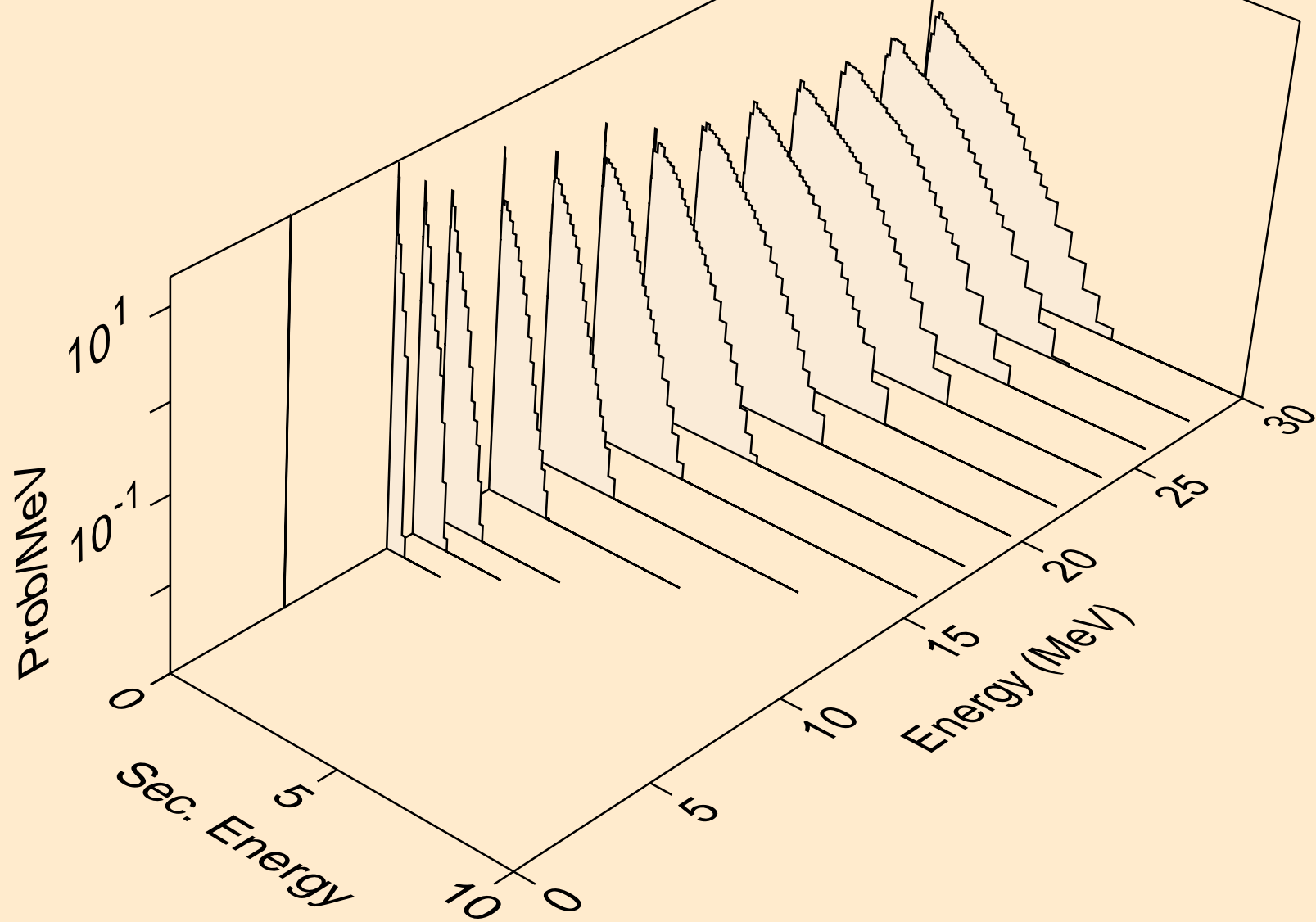

BI212M TRITON ACER TENDL-2021 LIBRARY; T=0.K  
neutrons from (t,n\*)he3

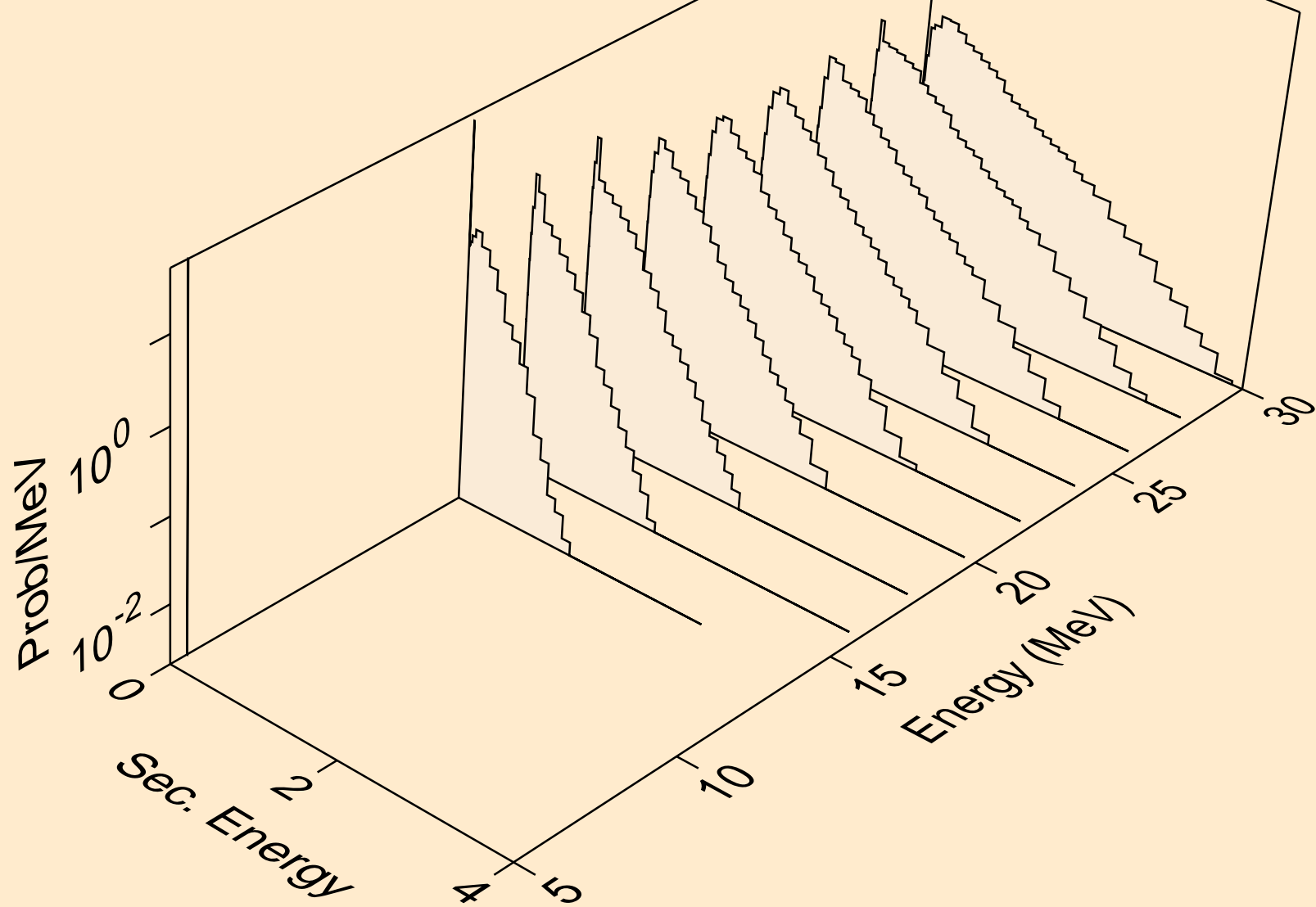

BI212M TRITON ACER TENDL-2021 LIBRARY; T=0.K  
neutrons from (t,4n)

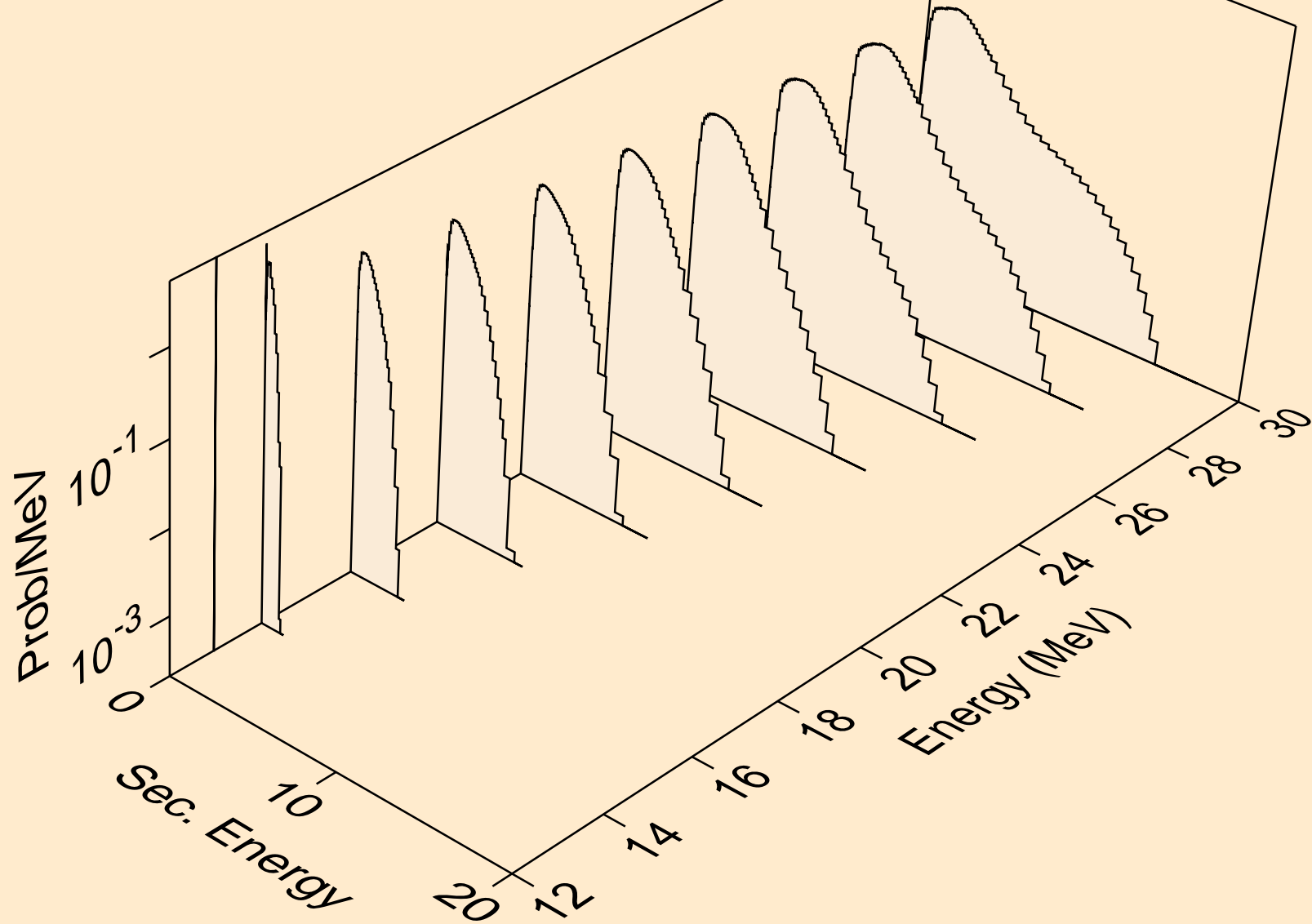

BI212M TRITON ACER TENDL-2021 LIBRARY; T=0.K  
neutrons from (t,2np)

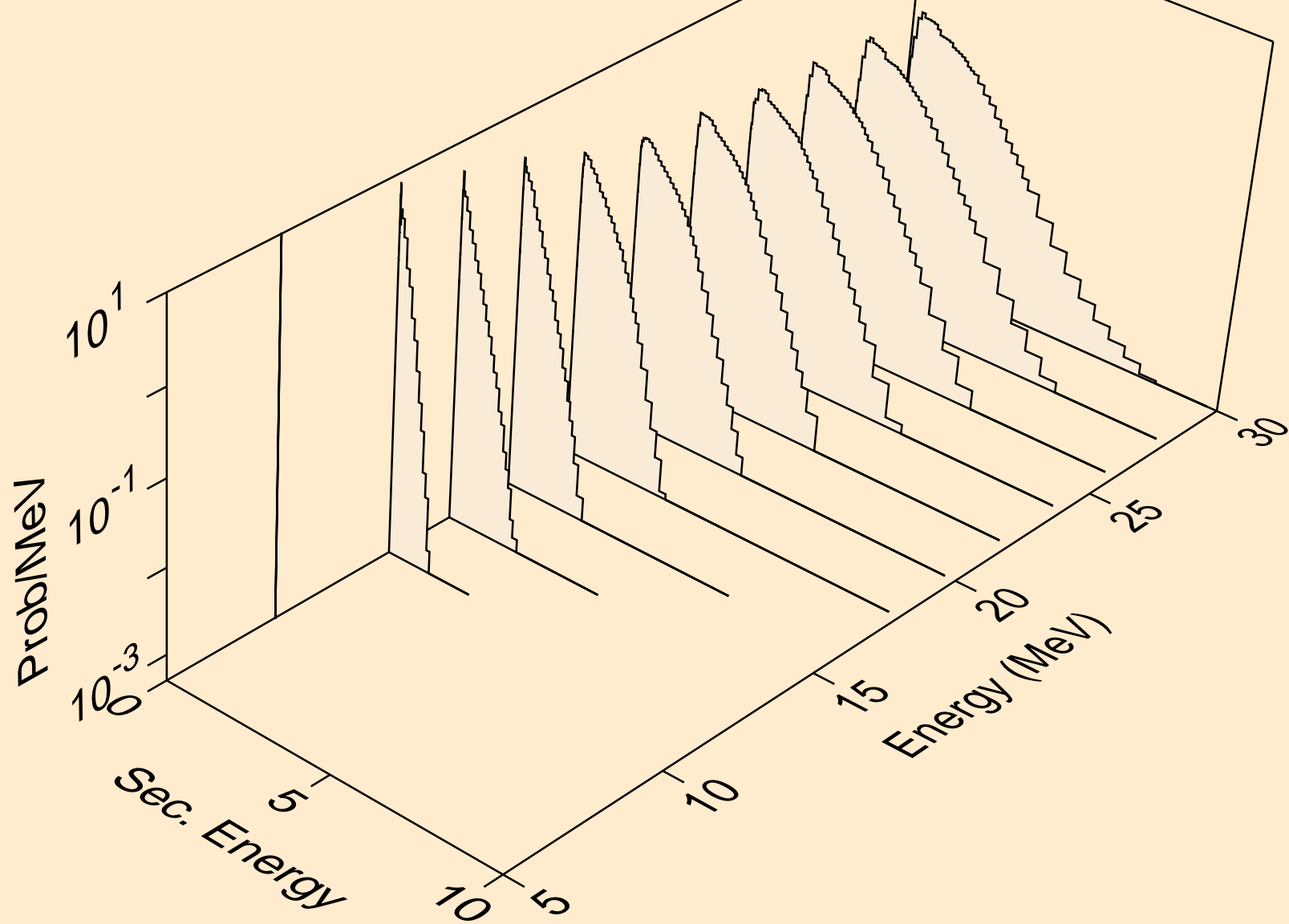

BI212M TRITON ACER TENDL-2021 LIBRARY; T=0.K  
neutrons from (t,3np)

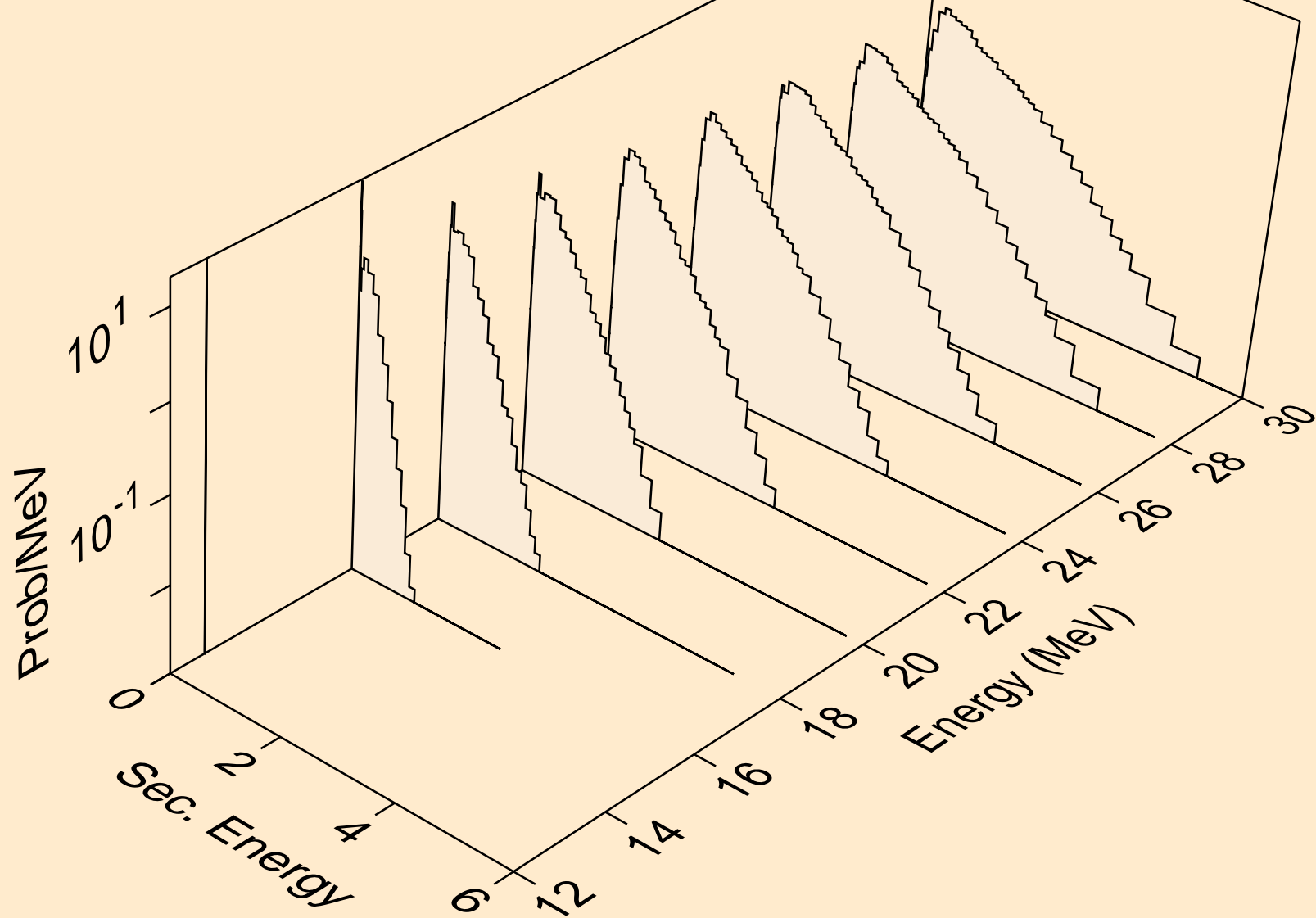



BI212M TRITON ACER TENDL-2021 LIBRARY; T=0.K  
neutrons from (t,2np)

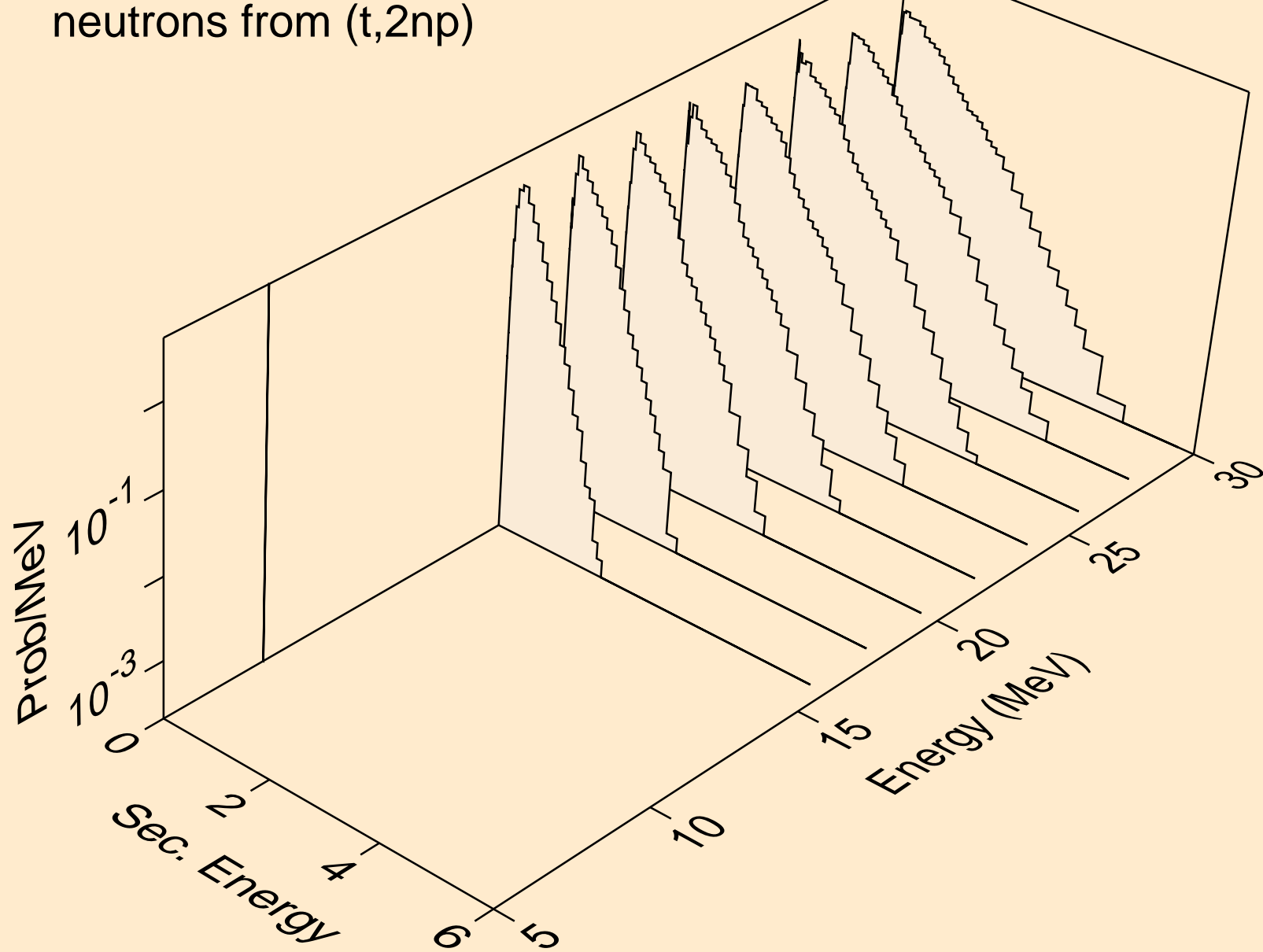

BI212M TRITON ACER TENDL-2021 LIBRARY; T=0.K  
neutrons from (t,npa)

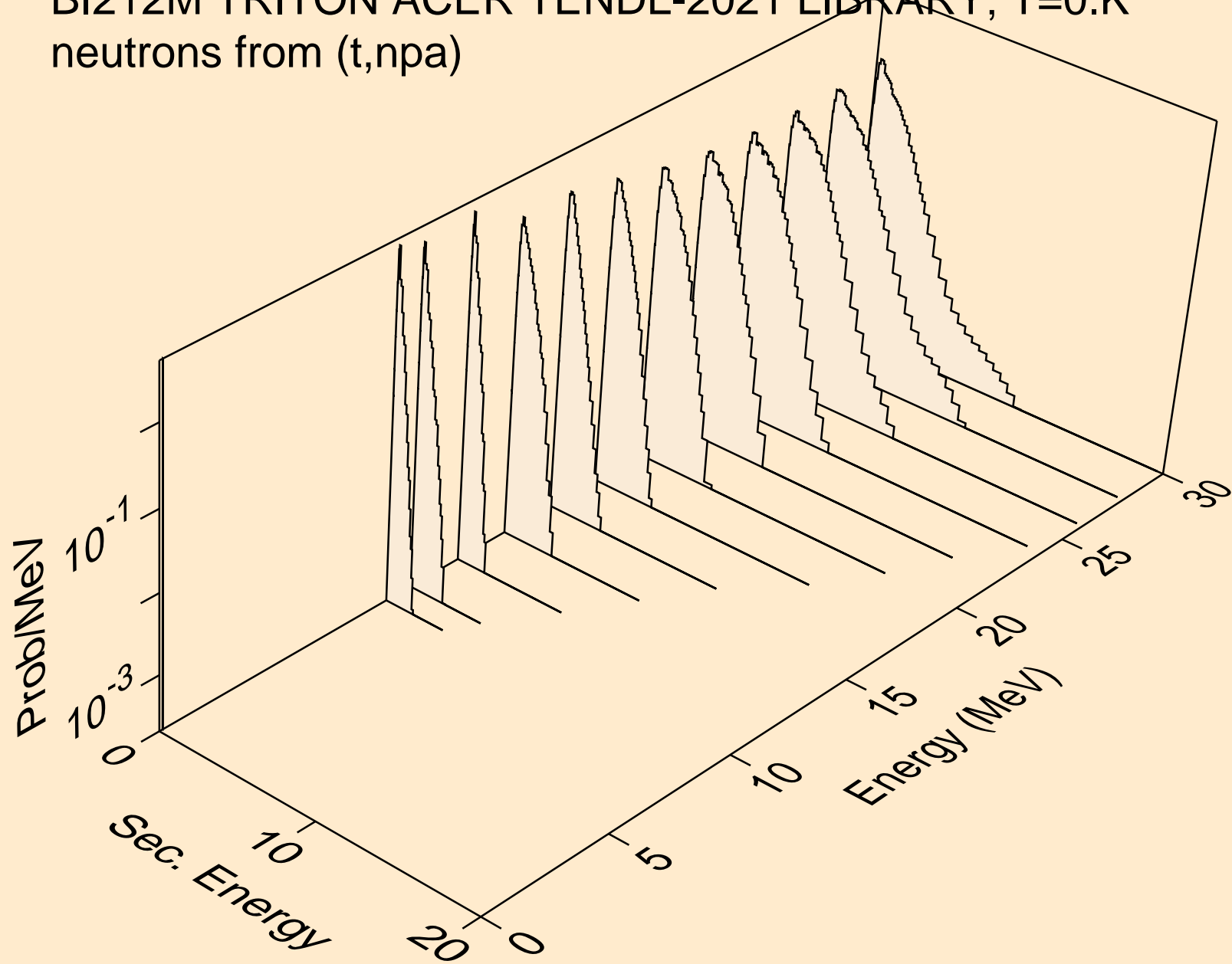

BI212M TRITON ACER TENDL-2021 LIBRARY; T=0.K  
protons from (t,x)

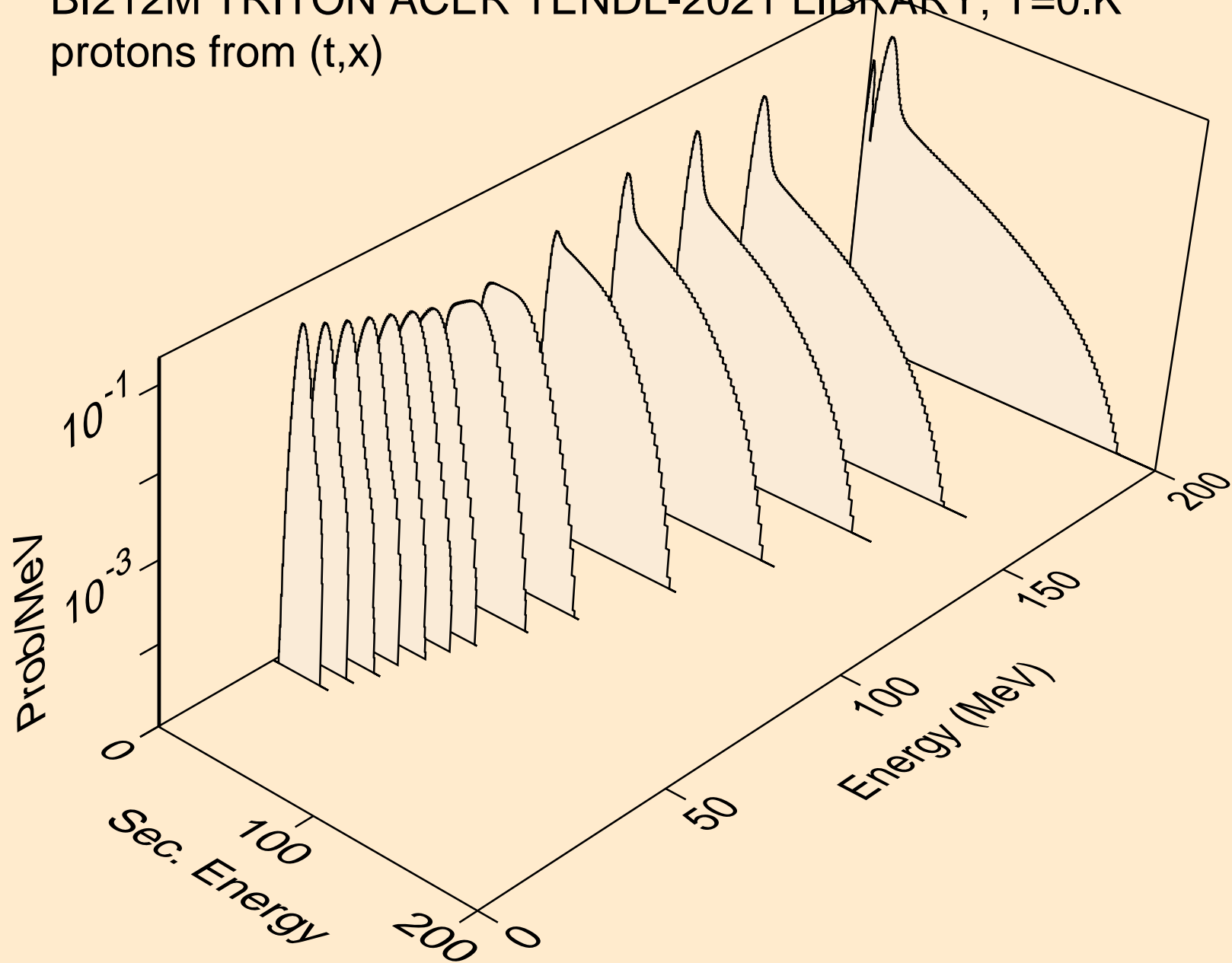

BI212M TRITON ACER TENDL-2021 LIBRARY; T=0.K  
protons from (t,n\*)p

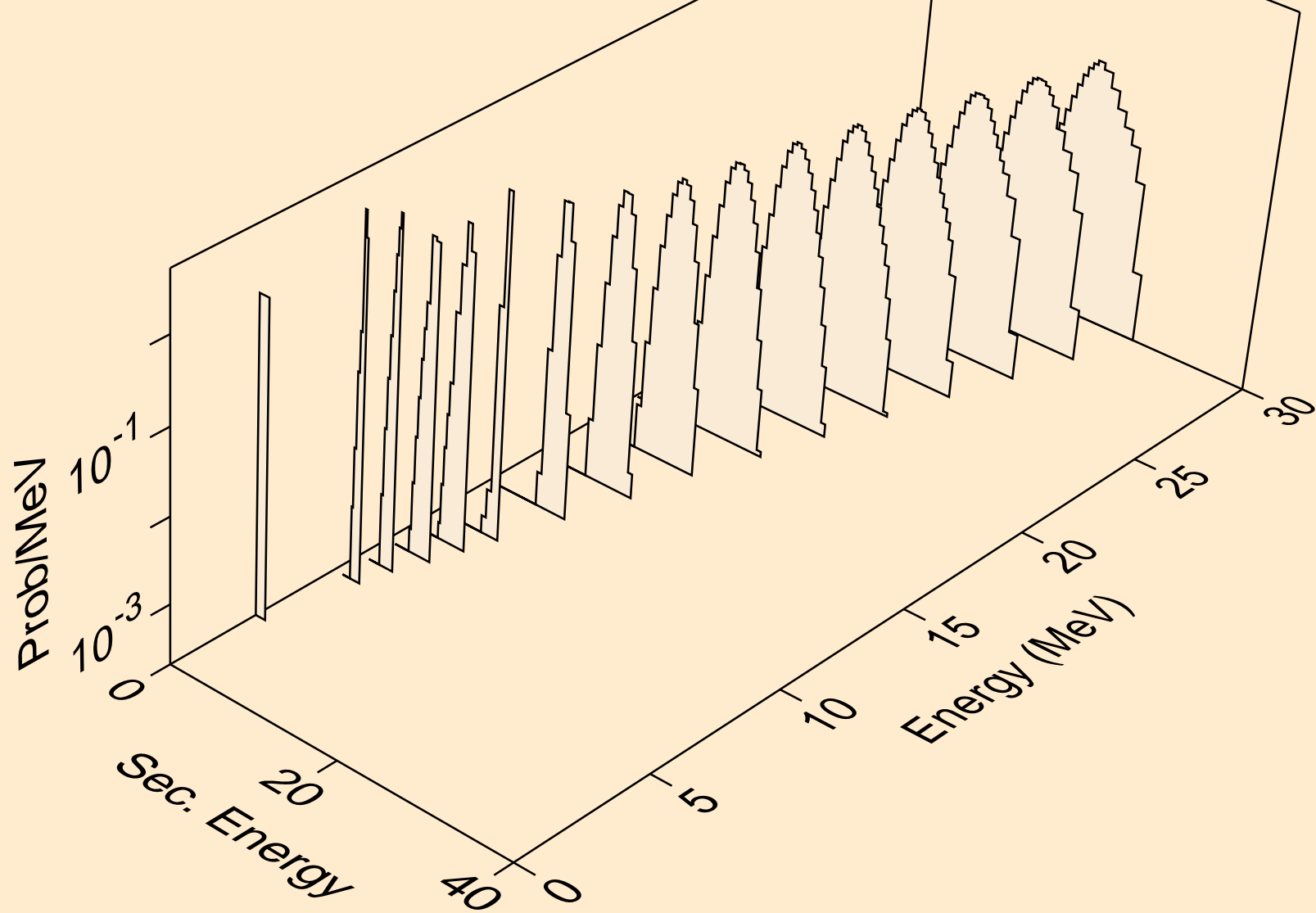

BI212M TRITON ACER TENDL-2021 LIBRARY; T=0.K  
protons from (t,2np)

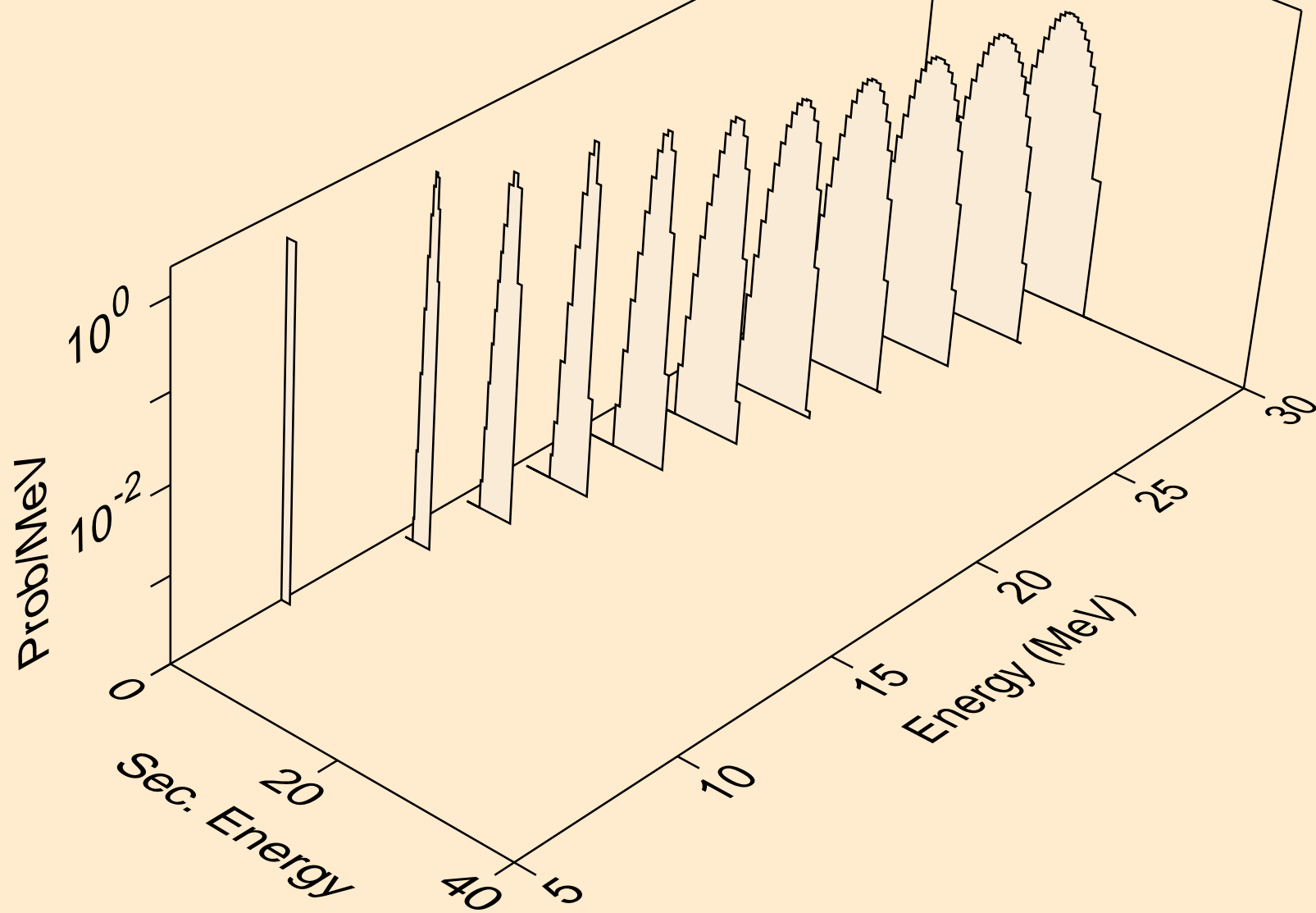

BI212M TRITON ACER TENDL-2021 LIBRARY; T=0.K  
protons from (t,3np)

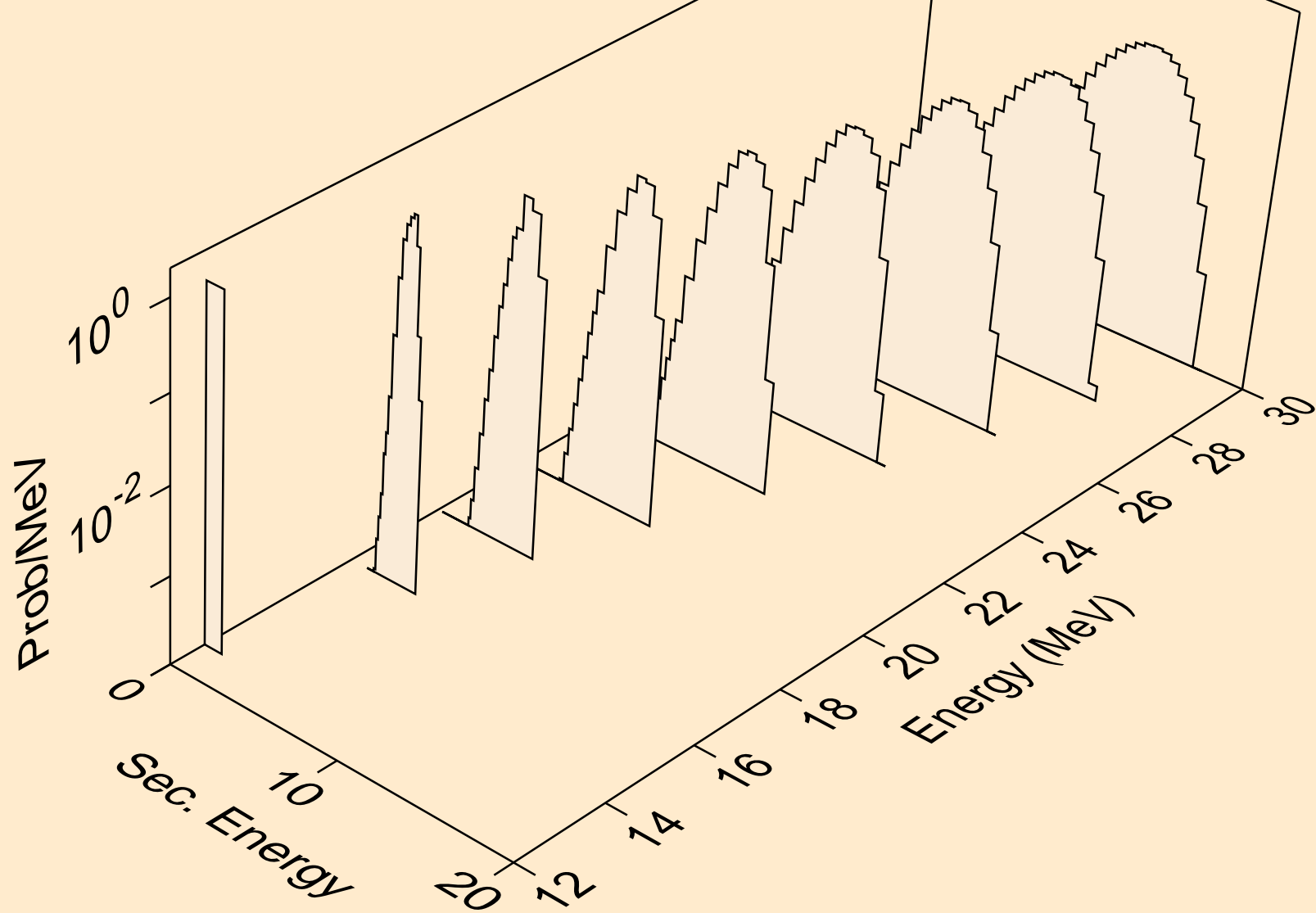

BI212M TRITON ACER TENDL-2021 LIBRARY; T=0.K  
protons from (t,2np)

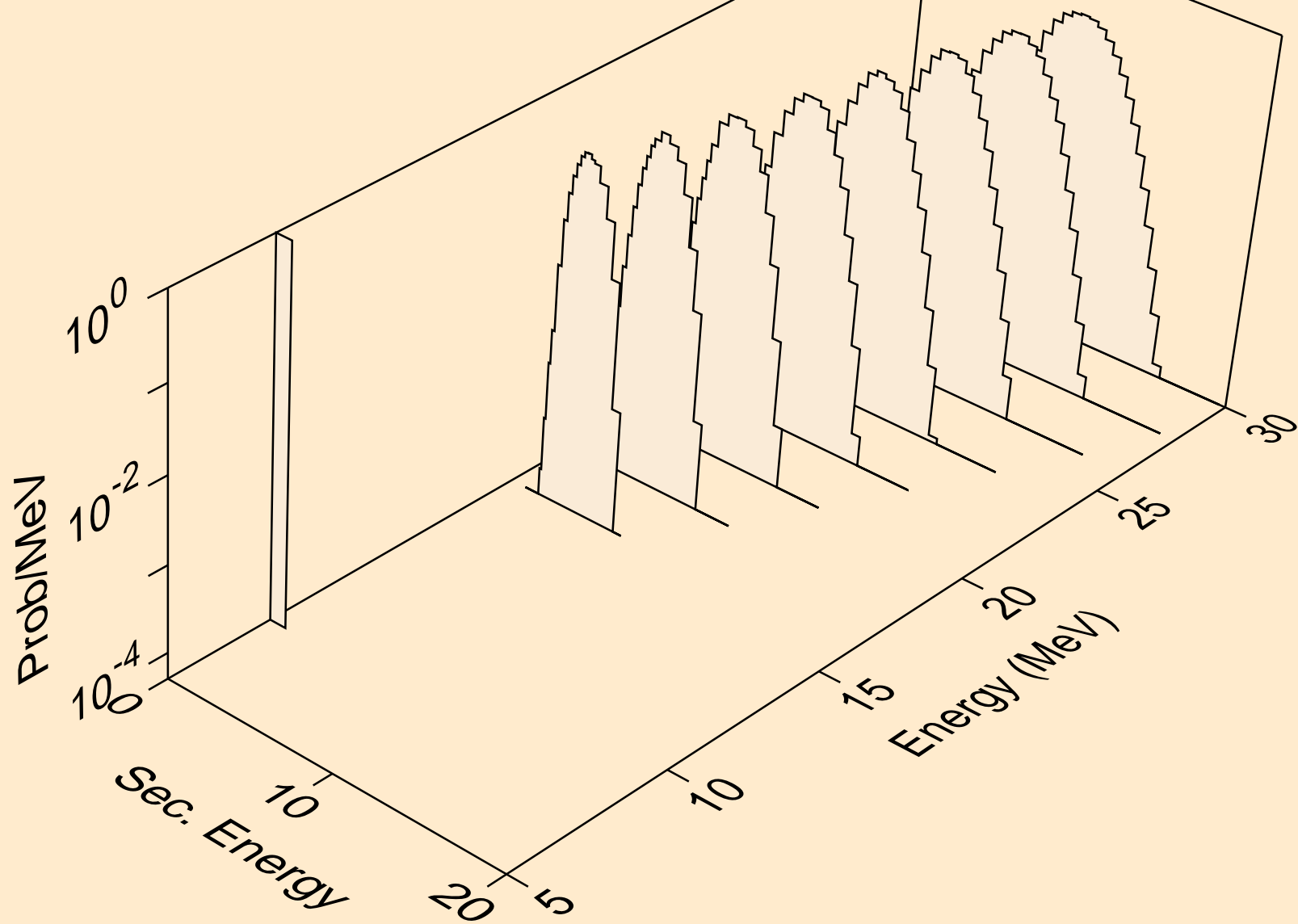

BI212M TRITON ACER TENDL-2021 LIBRARY; T=0.K  
protons from (t,npa)

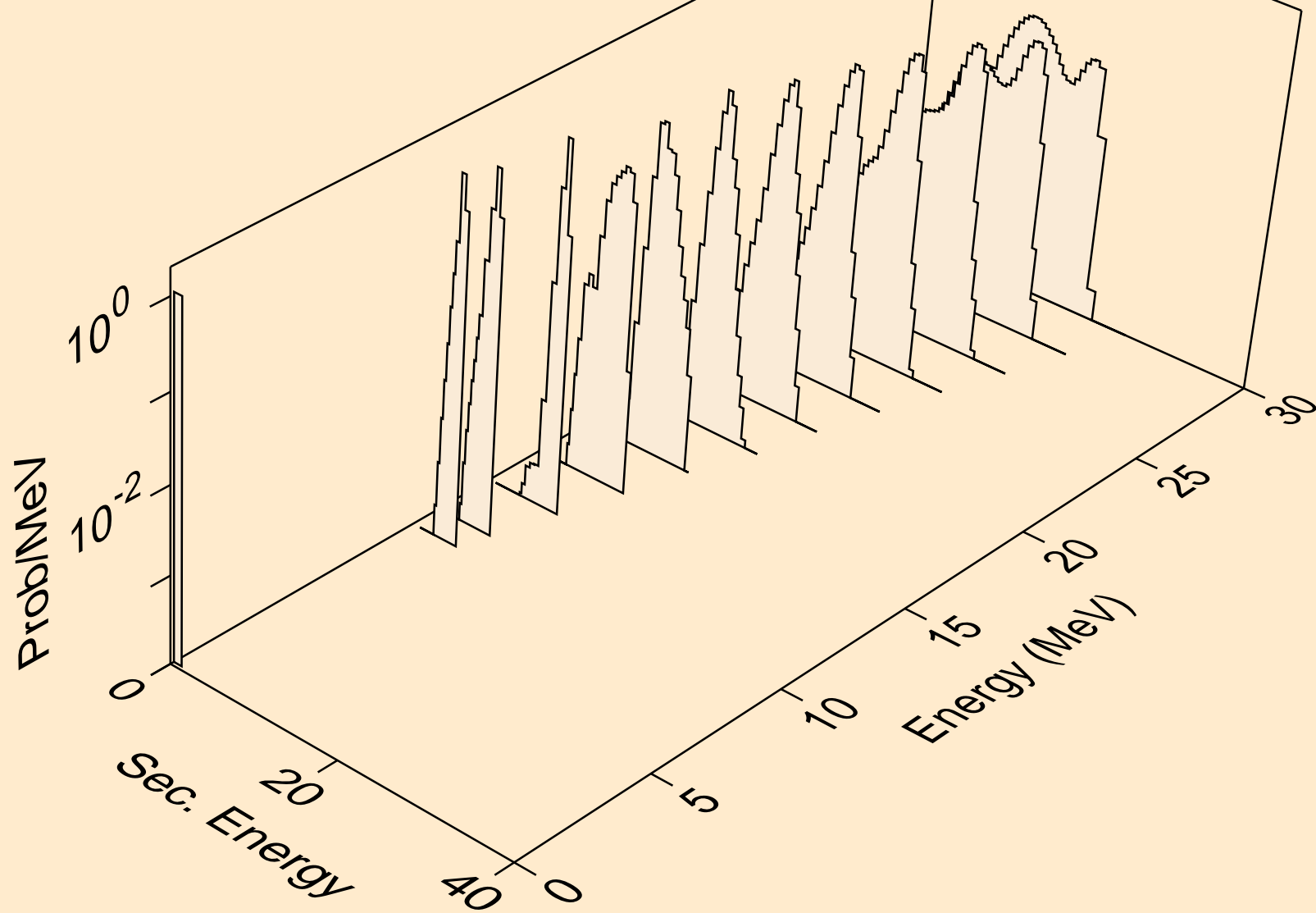



BI212M TRITON ACER TENDL-2021 LIBRARY; T=0.K  
protons from (t,p)

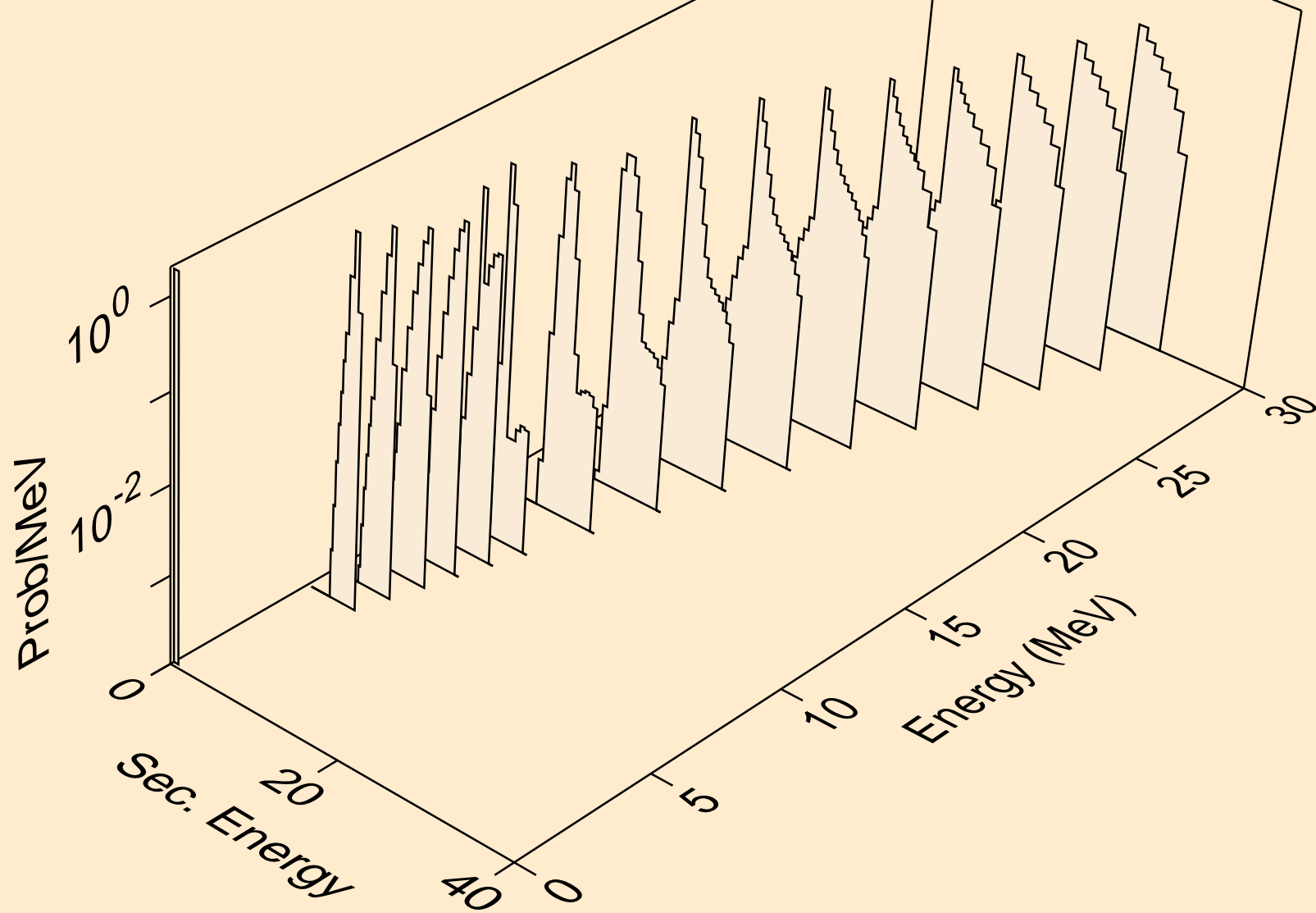

BI212M TRITON ACER TENDL-2021 LIBRARY; T=0.K  
protons from (t,2p)

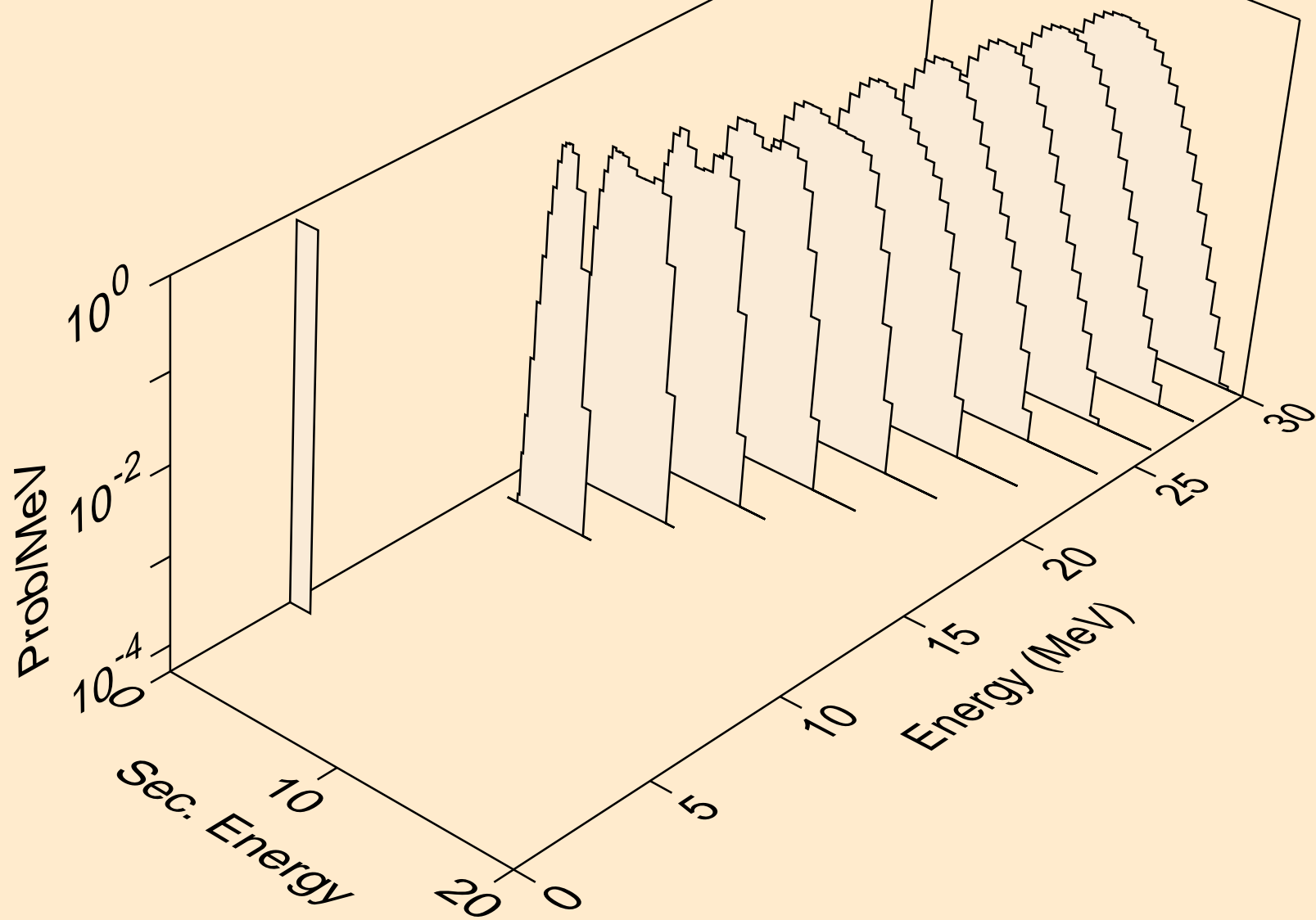

BI212M TRITON ACER TENDL-2021 LIBRARY; T=0.K  
protons from (t,pa)

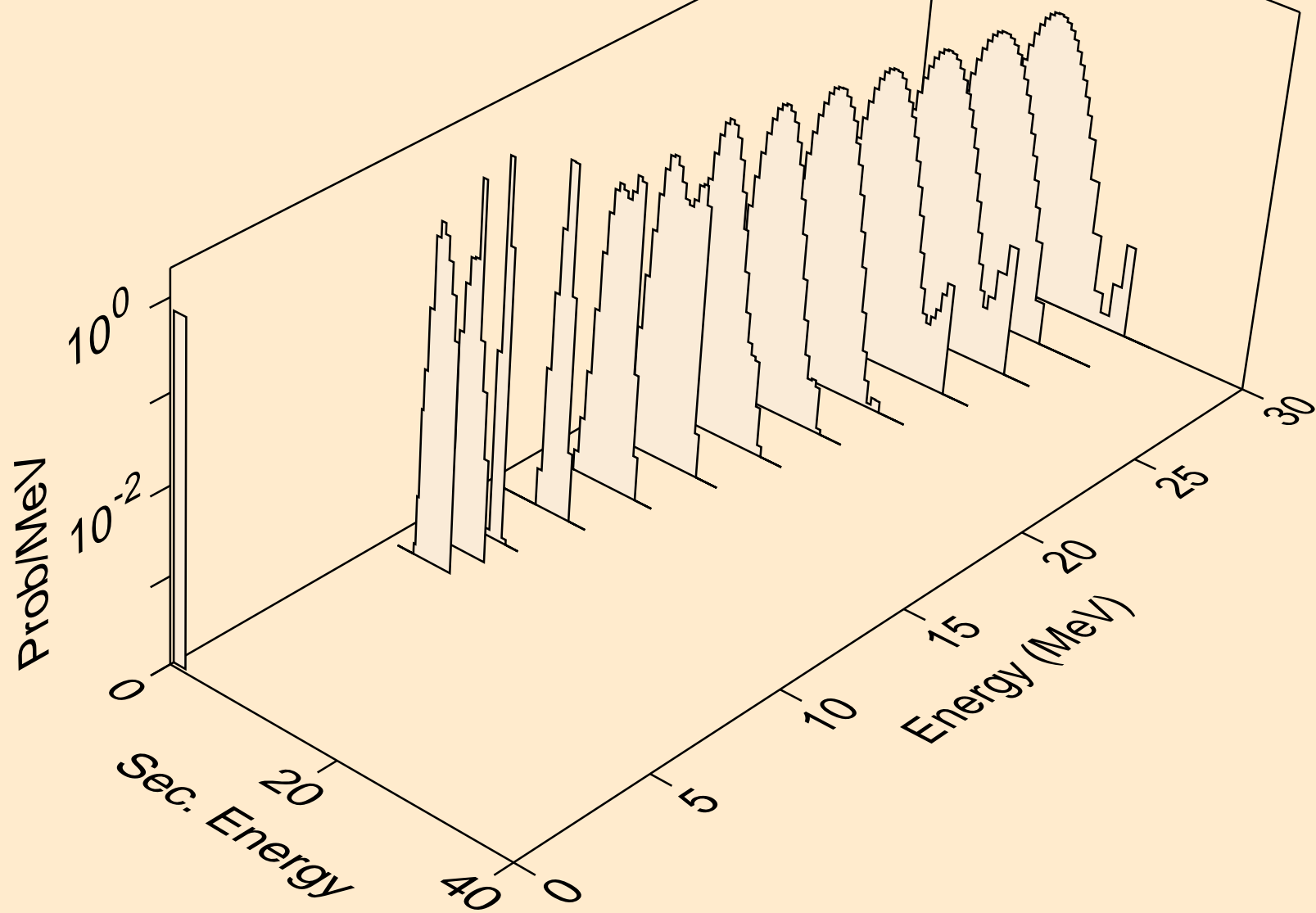

BI212M TRITON ACER TENDL-2021 LIBRARY; T=0.K  
protons from (t,pd)

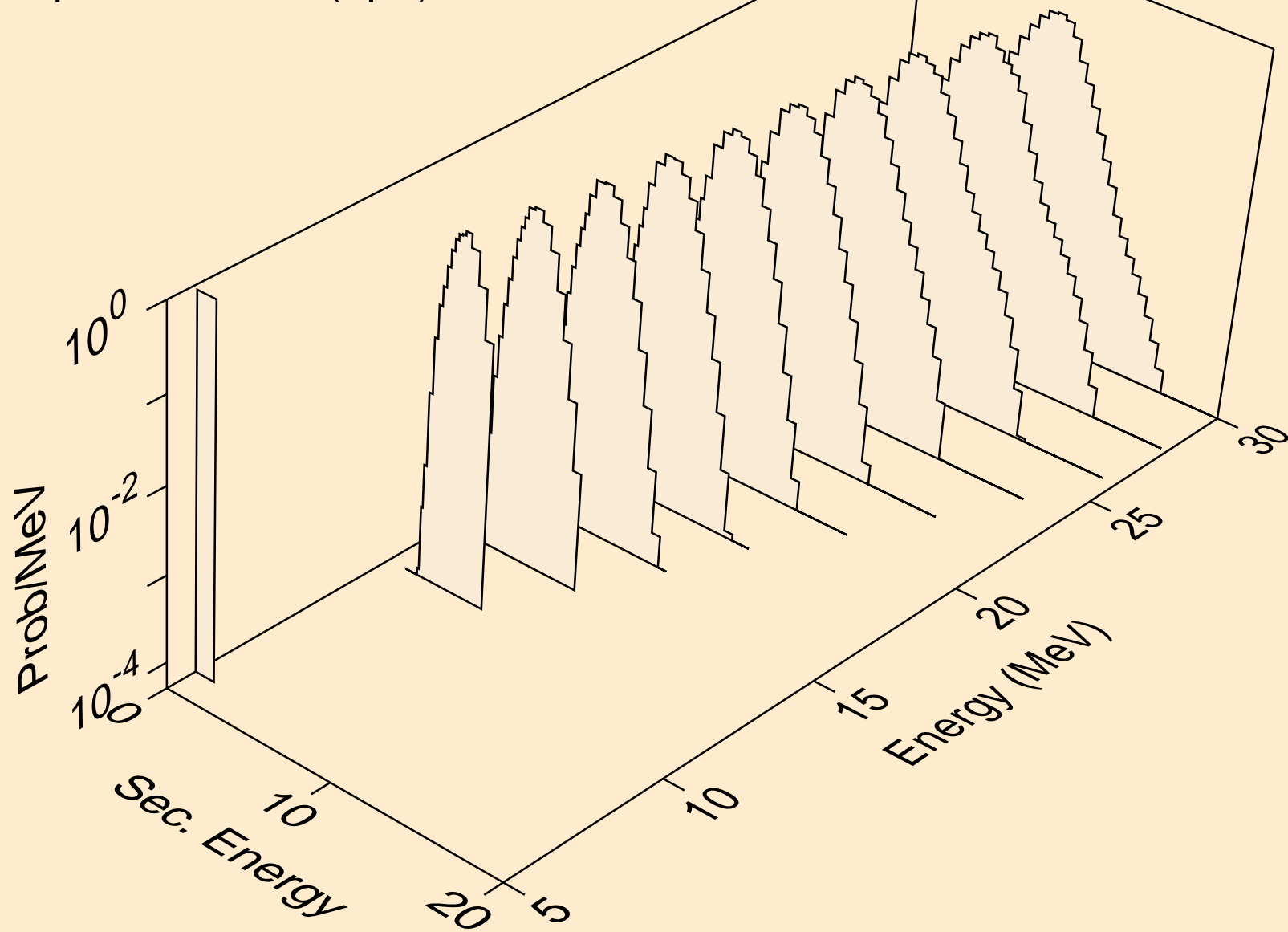

BI212M TRITON ACER TENDL-2021 LIBRARY; T=0.K  
protons from (t,pt)

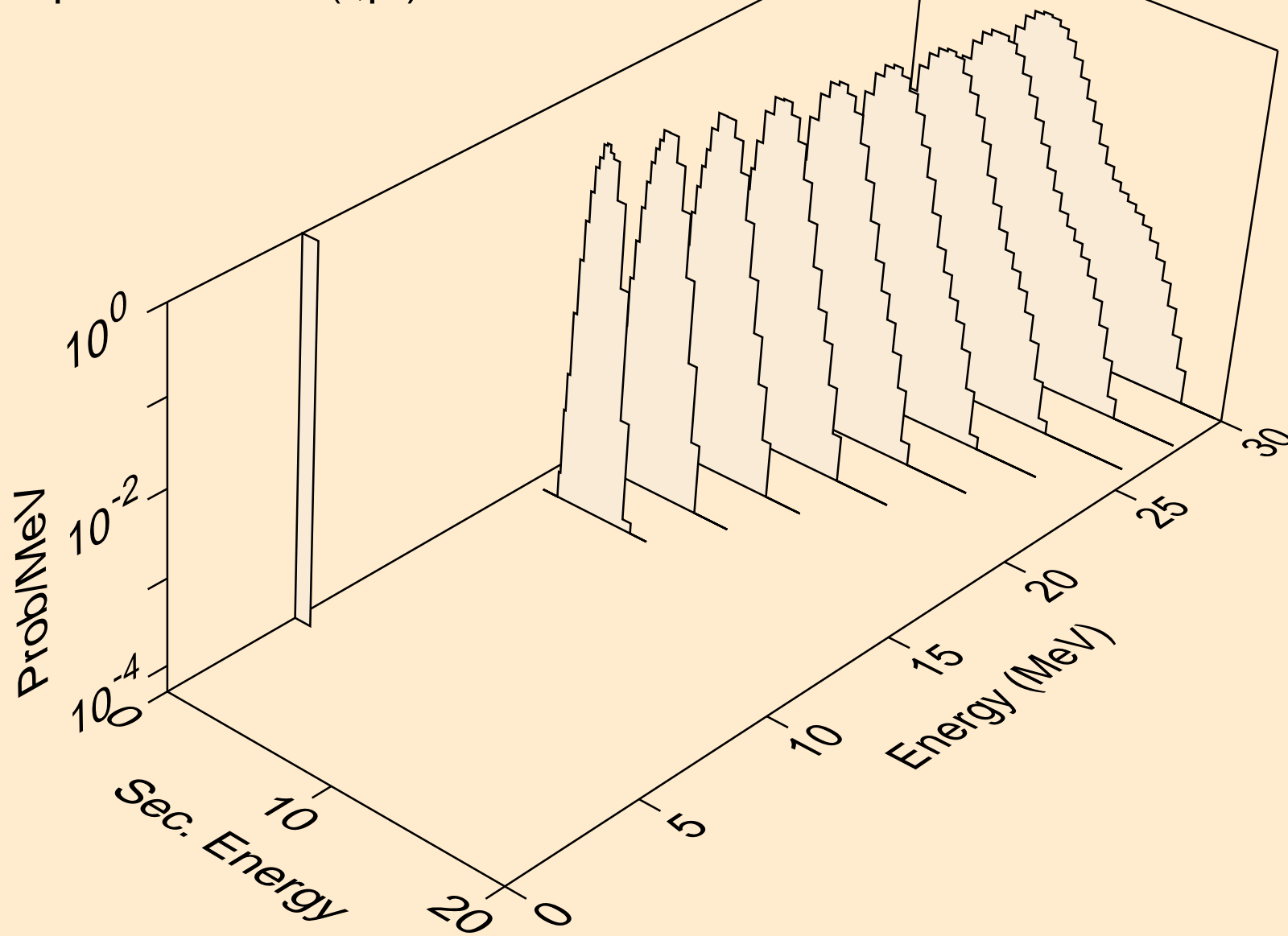

BI212M TRITON ACER TENDL-2021 LIBRARY; T=0.K  
deuterons from (t,x)

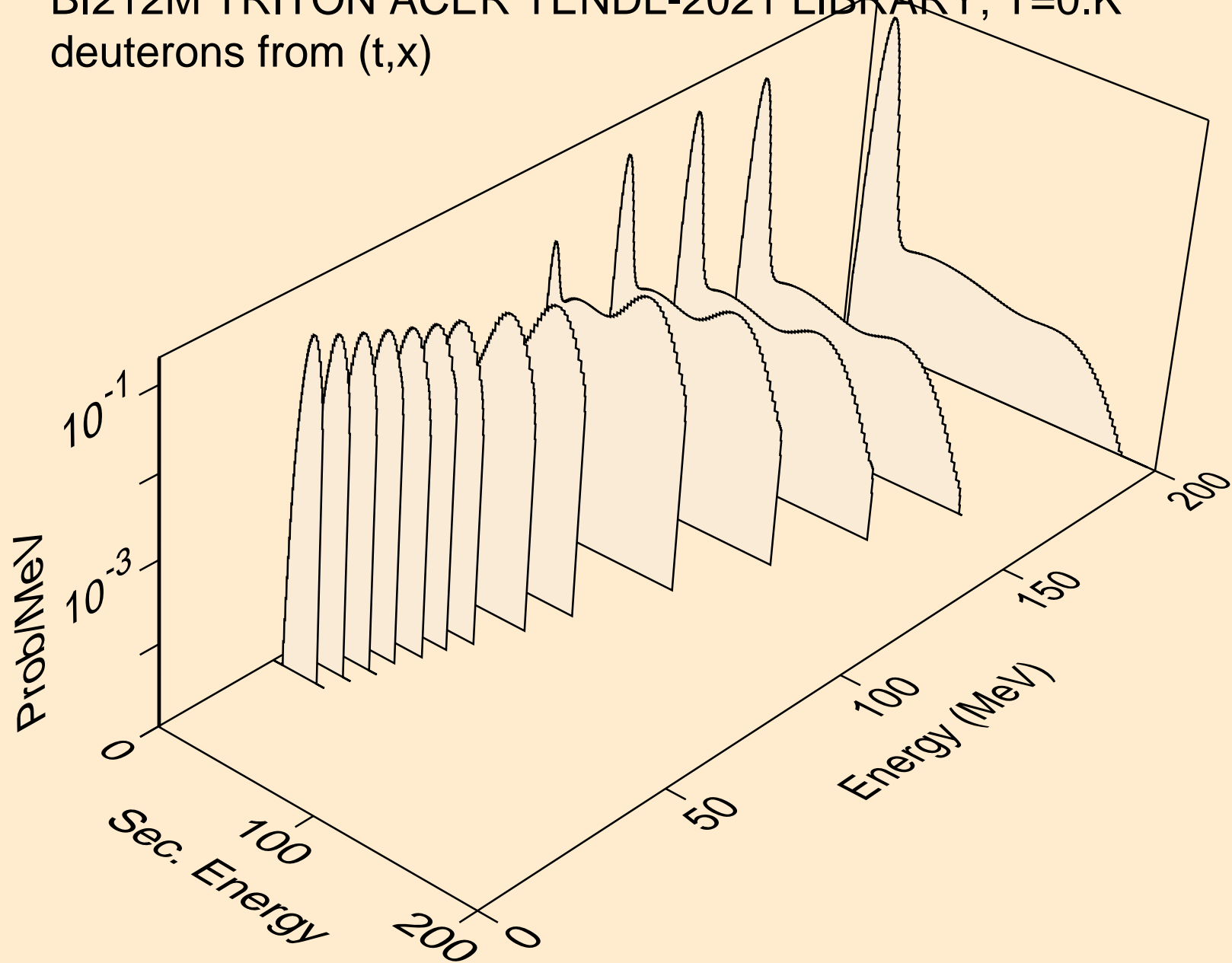

BI212M TRITON ACER TENDL-2021 LIBRARY; T=0.K  
deuterons from (t,2nd)

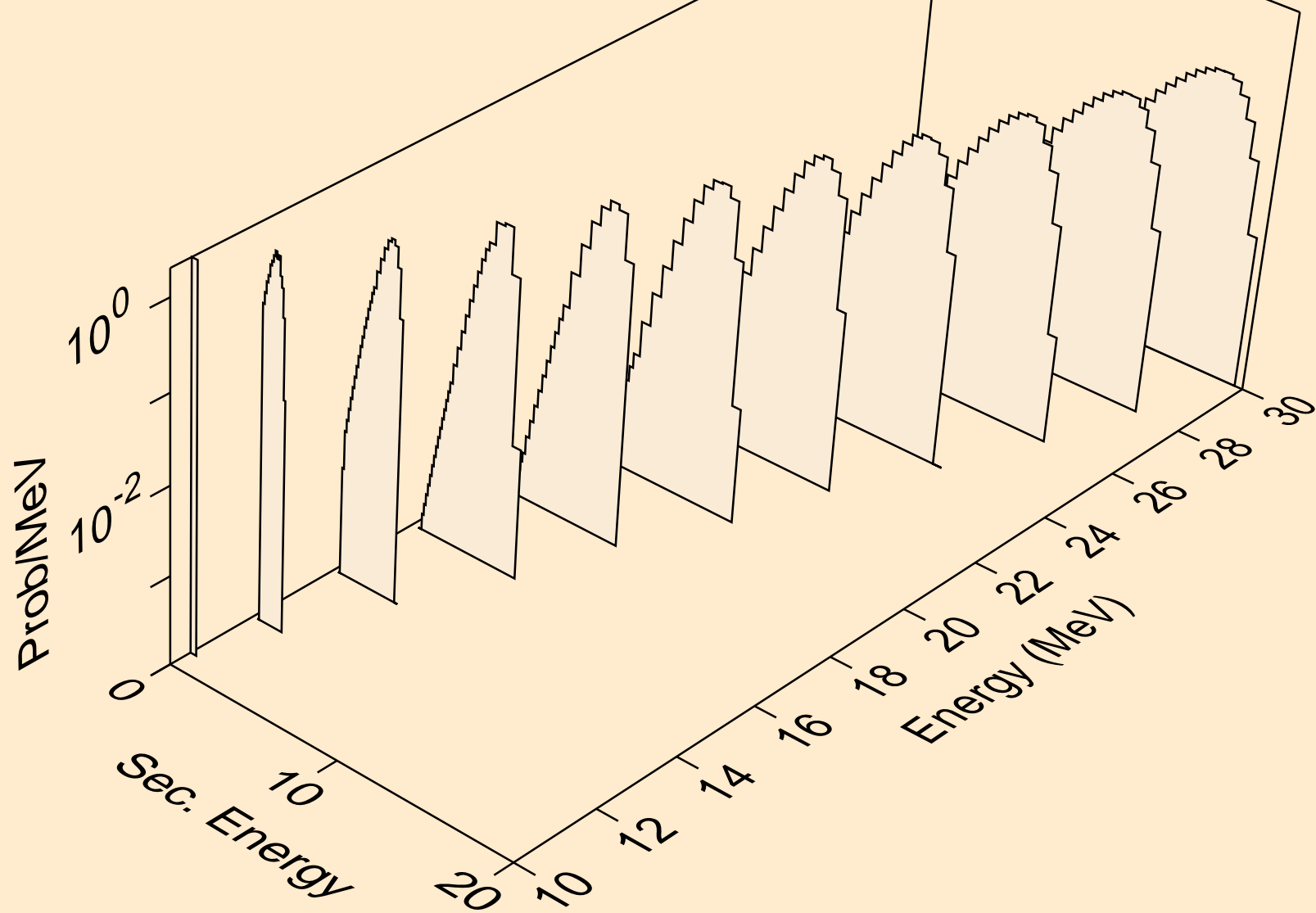

BI212M TRITON ACER TENDL-2021 LIBRARY; T=0.K  
deuterons from (t,n\*)d

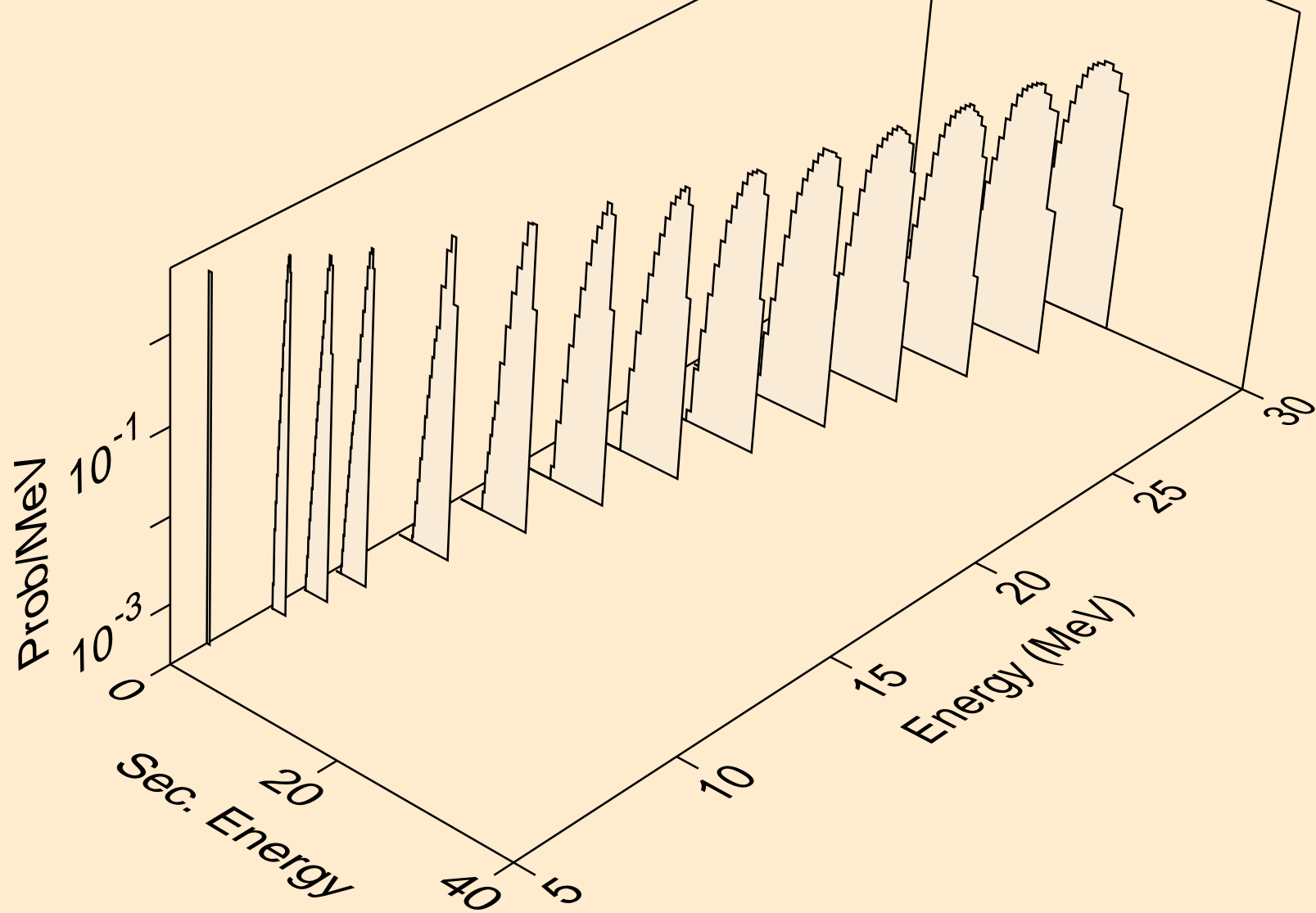



BI212M TRITON ACER TENDL-2021 LIBRARY; T=0.K  
deuterons from (t,d)

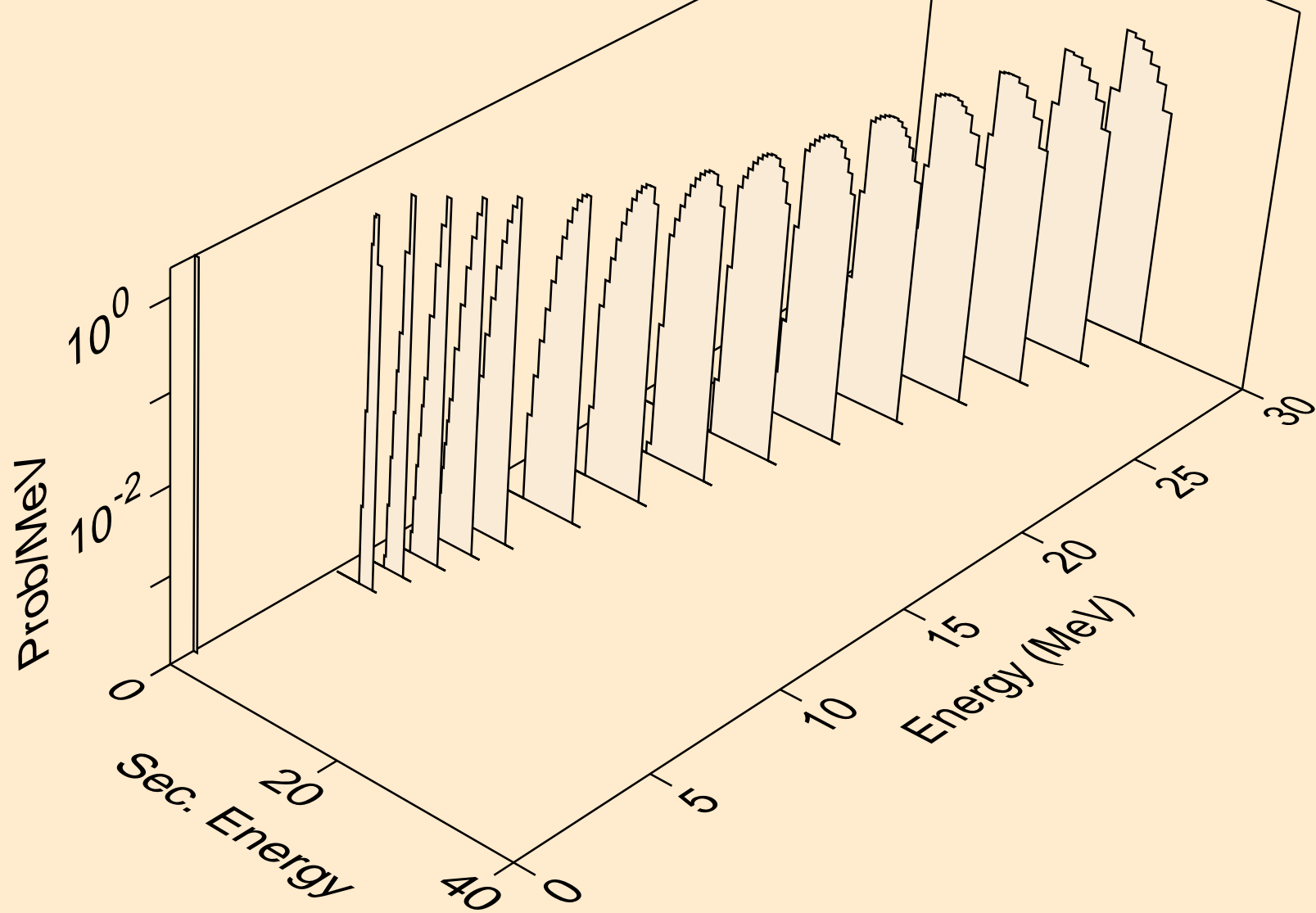

BI212M TRITON ACER TENDL-2021 LIBRARY; T=0.K  
deuterons from (t,pd)

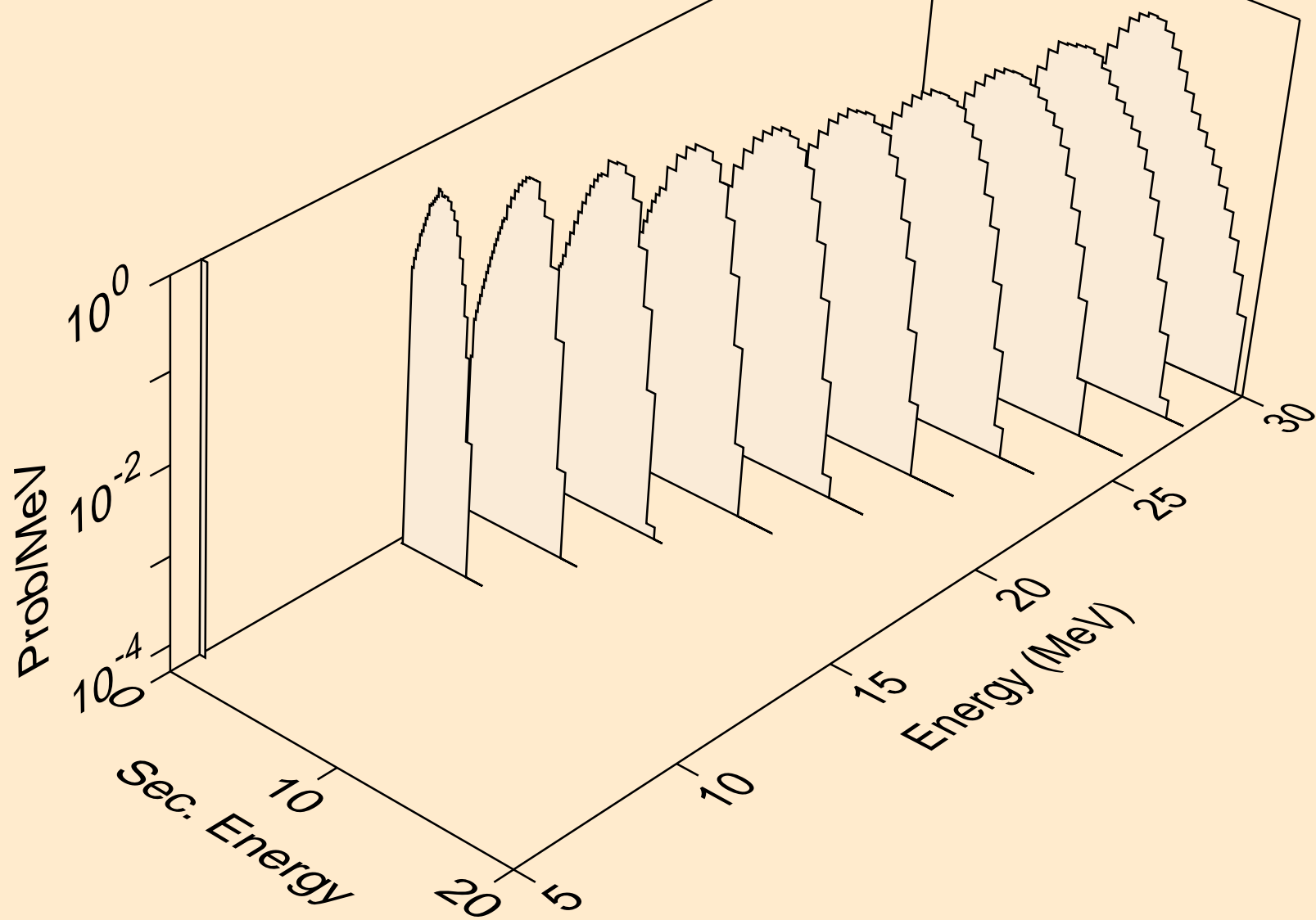

BI212M TRITON ACER TENDL-2021 LIBRARY; T=0.K  
deuterons from (t,da)

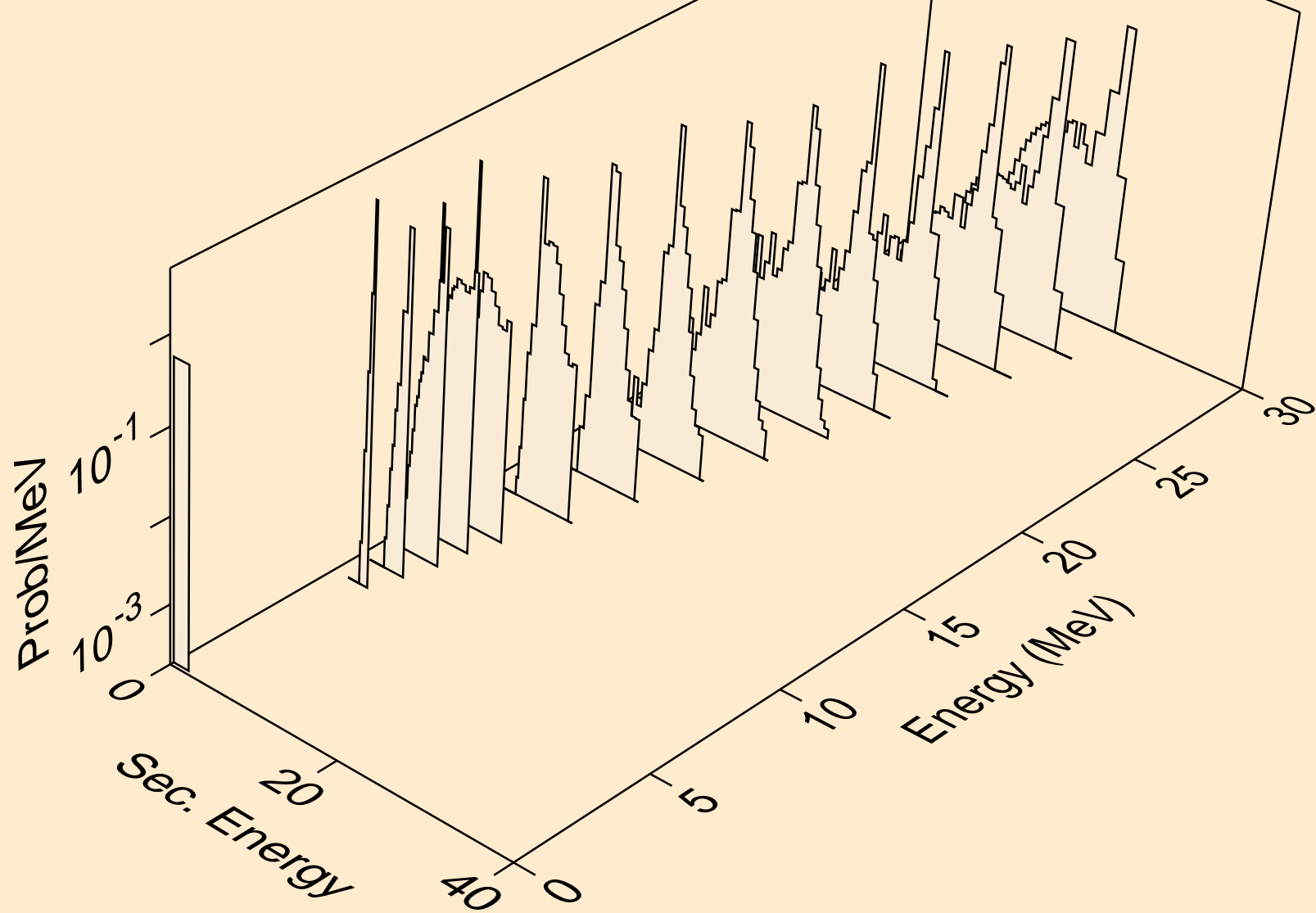

BI212M TRITON ACER TENDL-2021 LIBRARY; T=0.K  
he3s from (t,x)

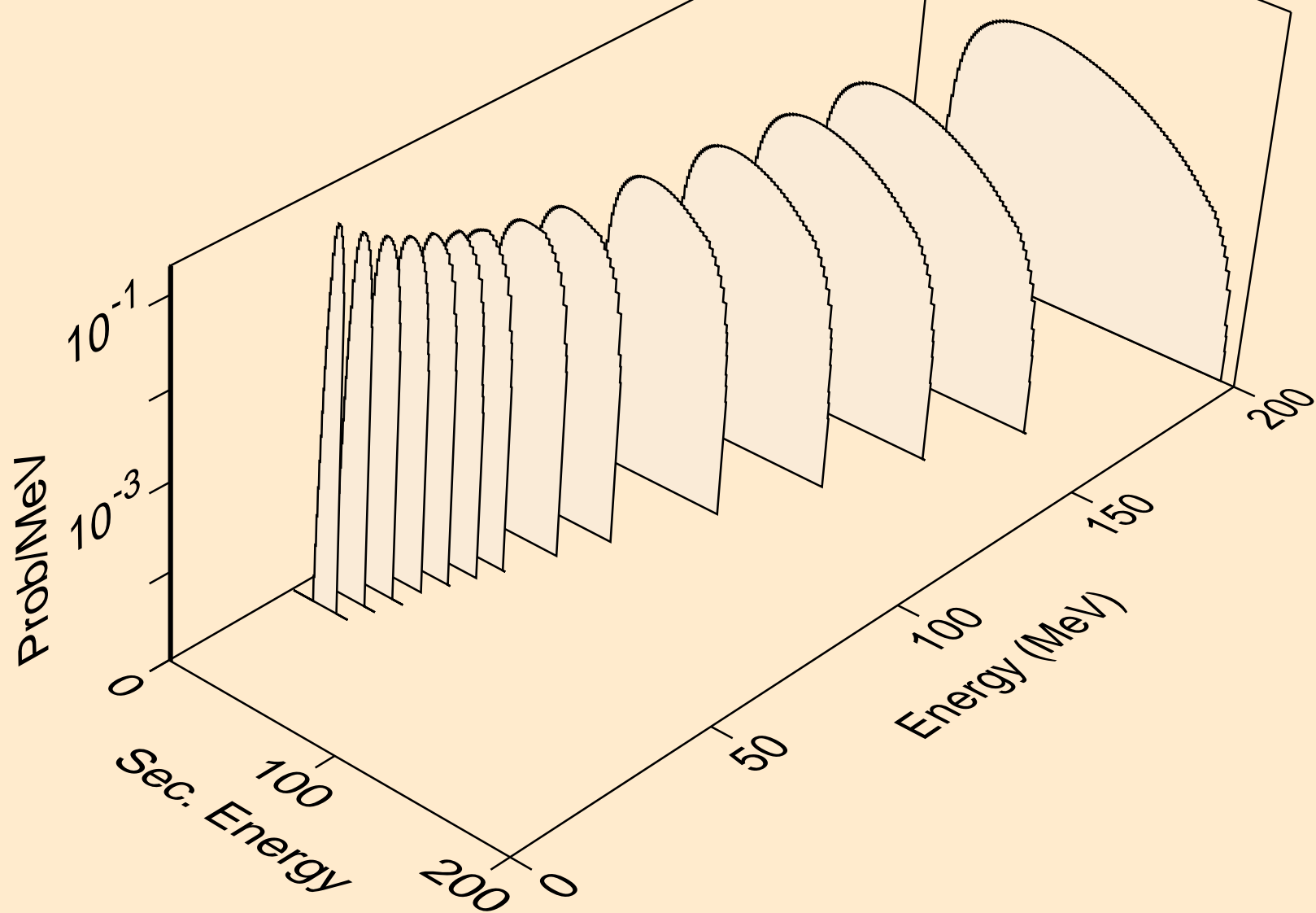

BI212M TRITON ACER TENDL-2021 LIBRARY; T=0.K  
he3s from (t,n\*)he3

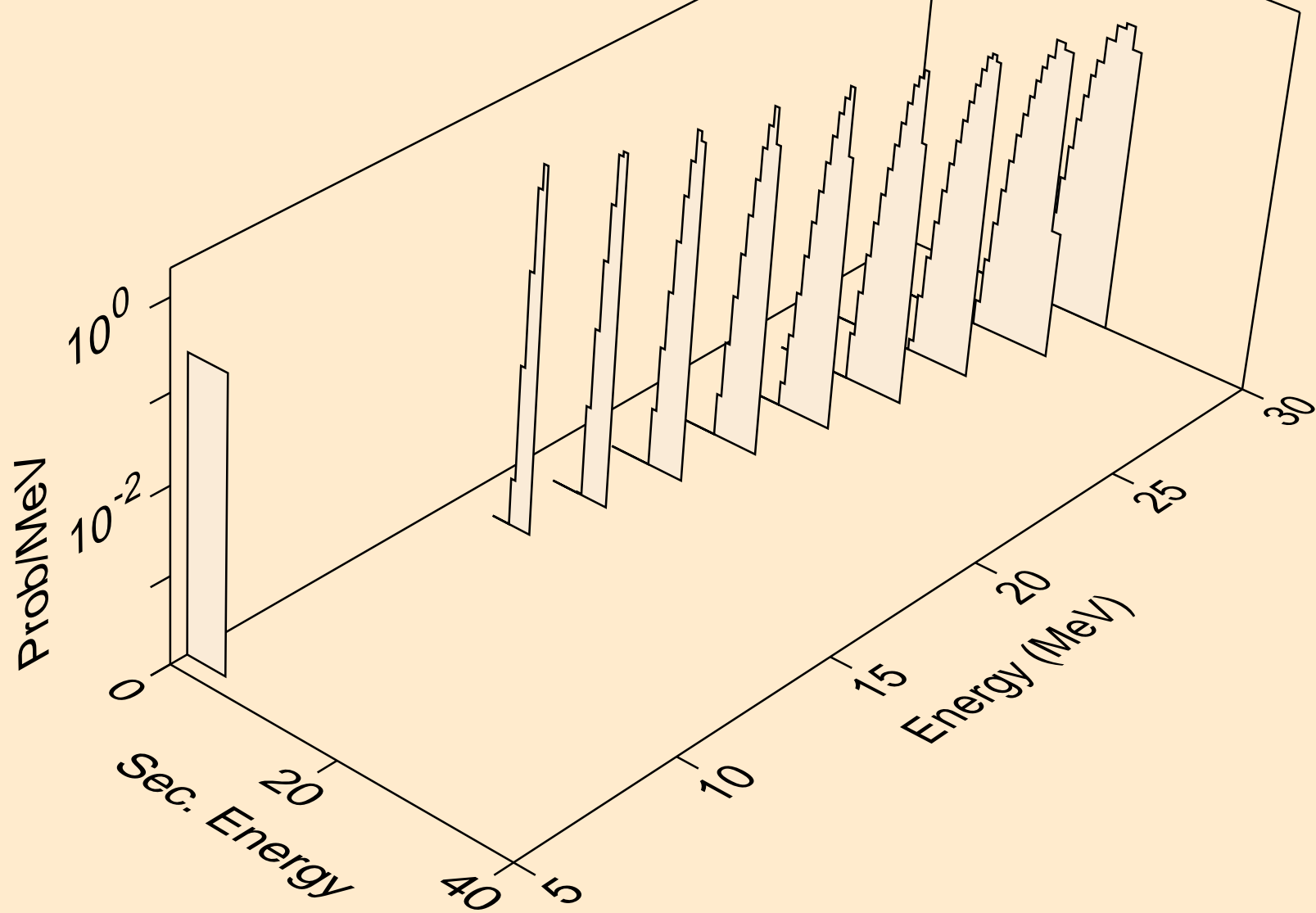

BI212M TRITON ACER TENDL-2021 LIBRARY; T=0.K  
he3s from (t,he3)

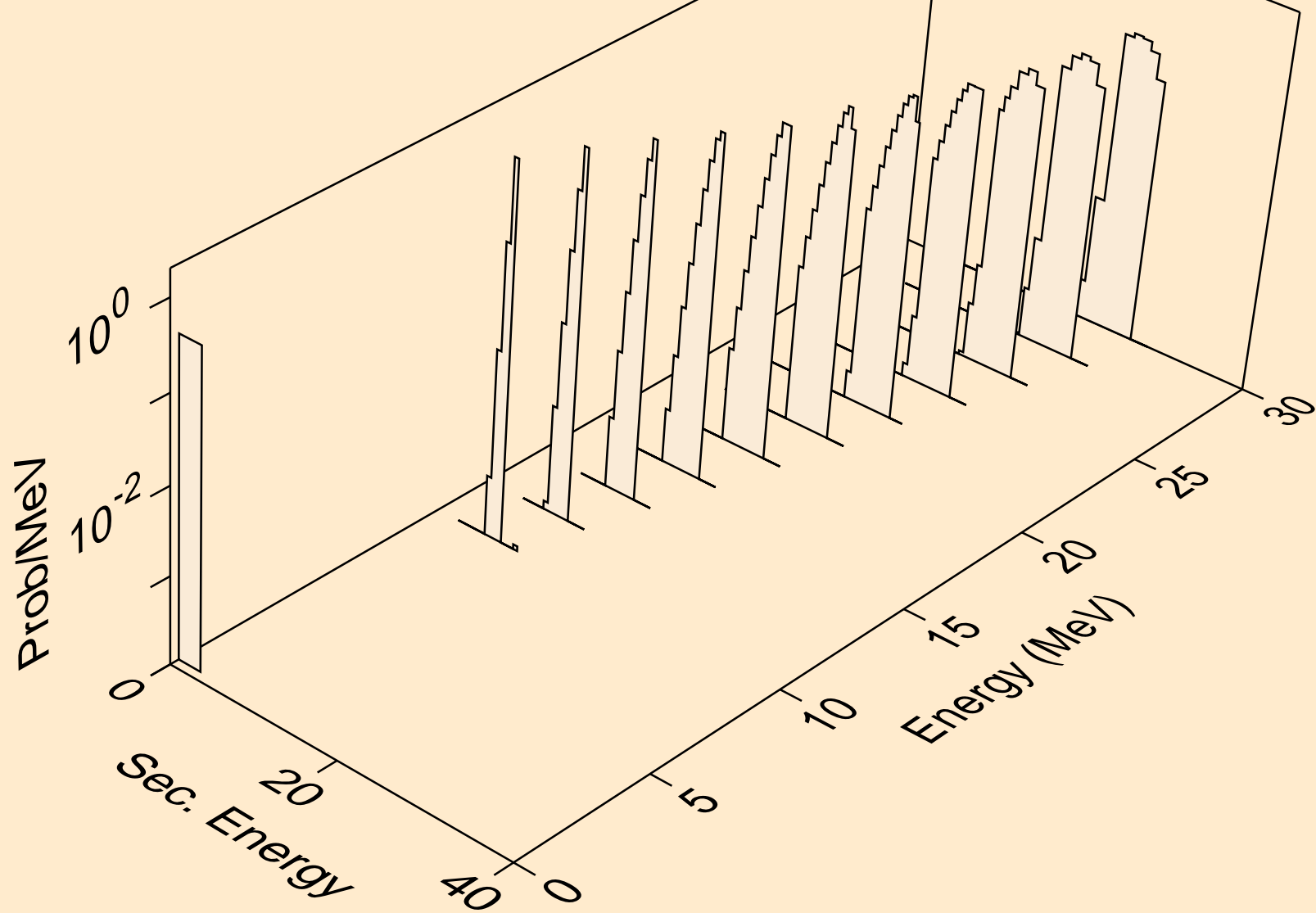

BI212M TRITON ACER TENDL-2021 LIBRARY; T=0.K  
alphas from (t,x)

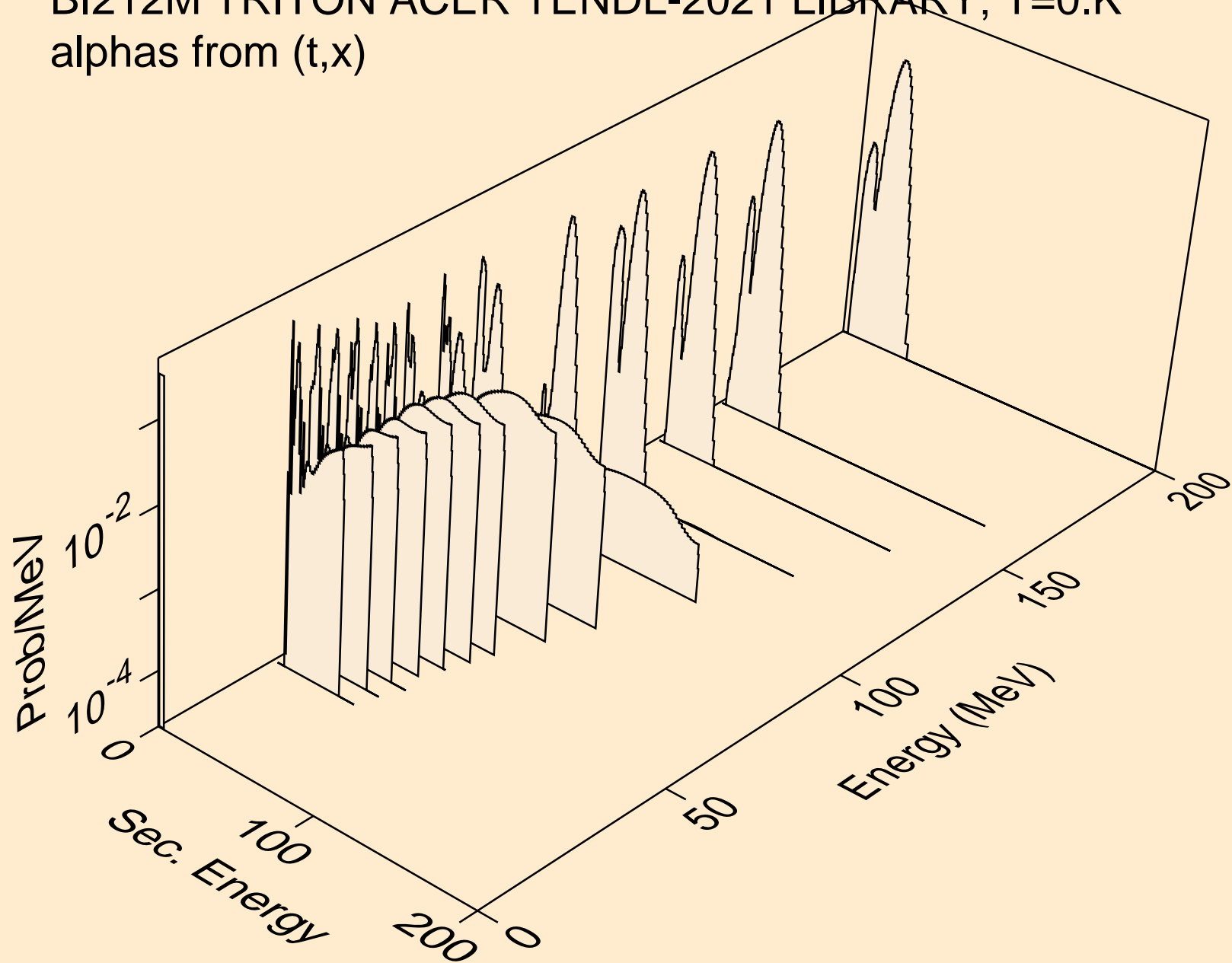

BI212M TRITON ACER TENDL-2021 LIBRARY; T=0.K  
alphas from (t,n\*)a

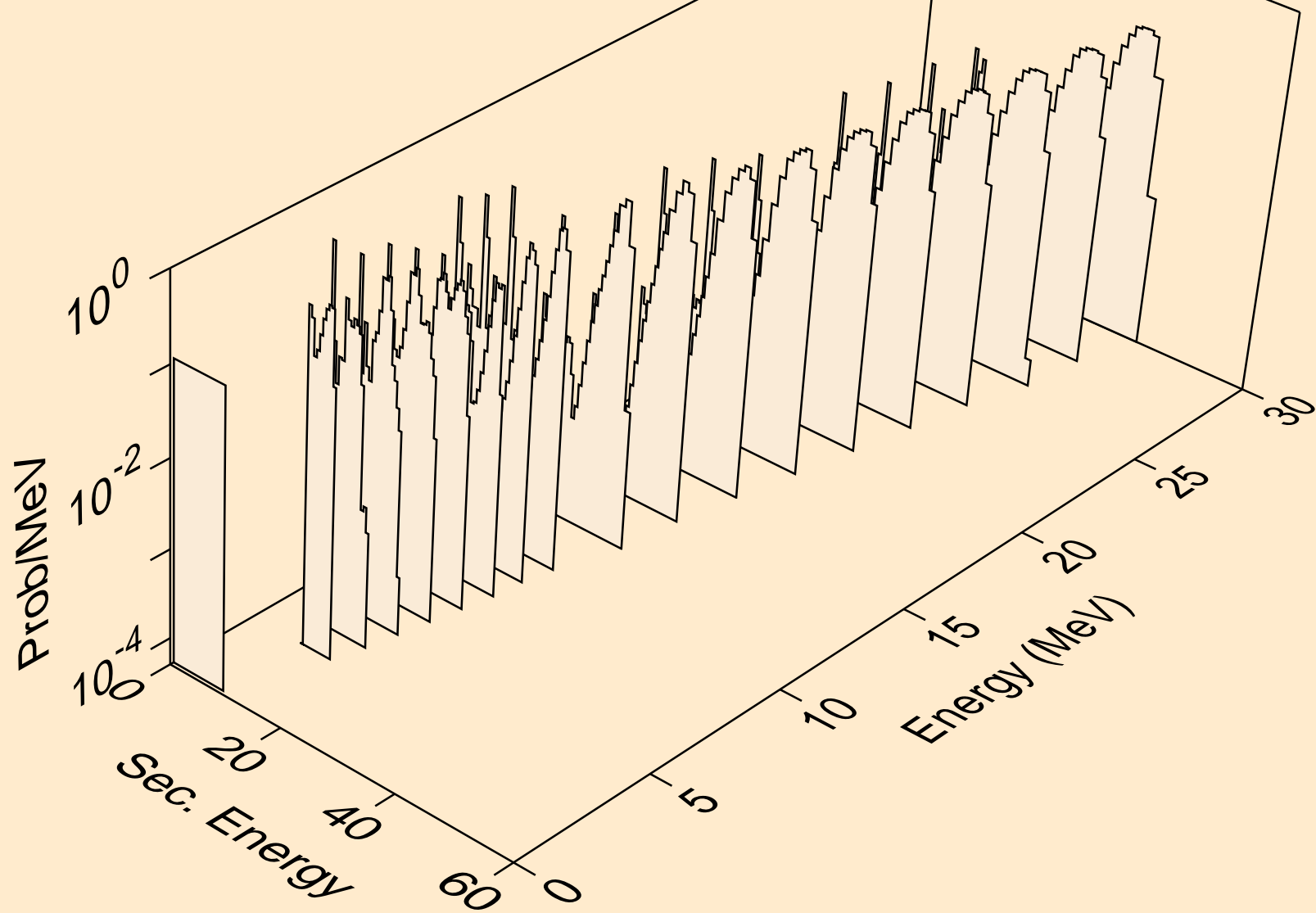



BI212M TRITON ACER TENDL-2021 LIBRARY; T=0.K  
alphas from (t,2n)a

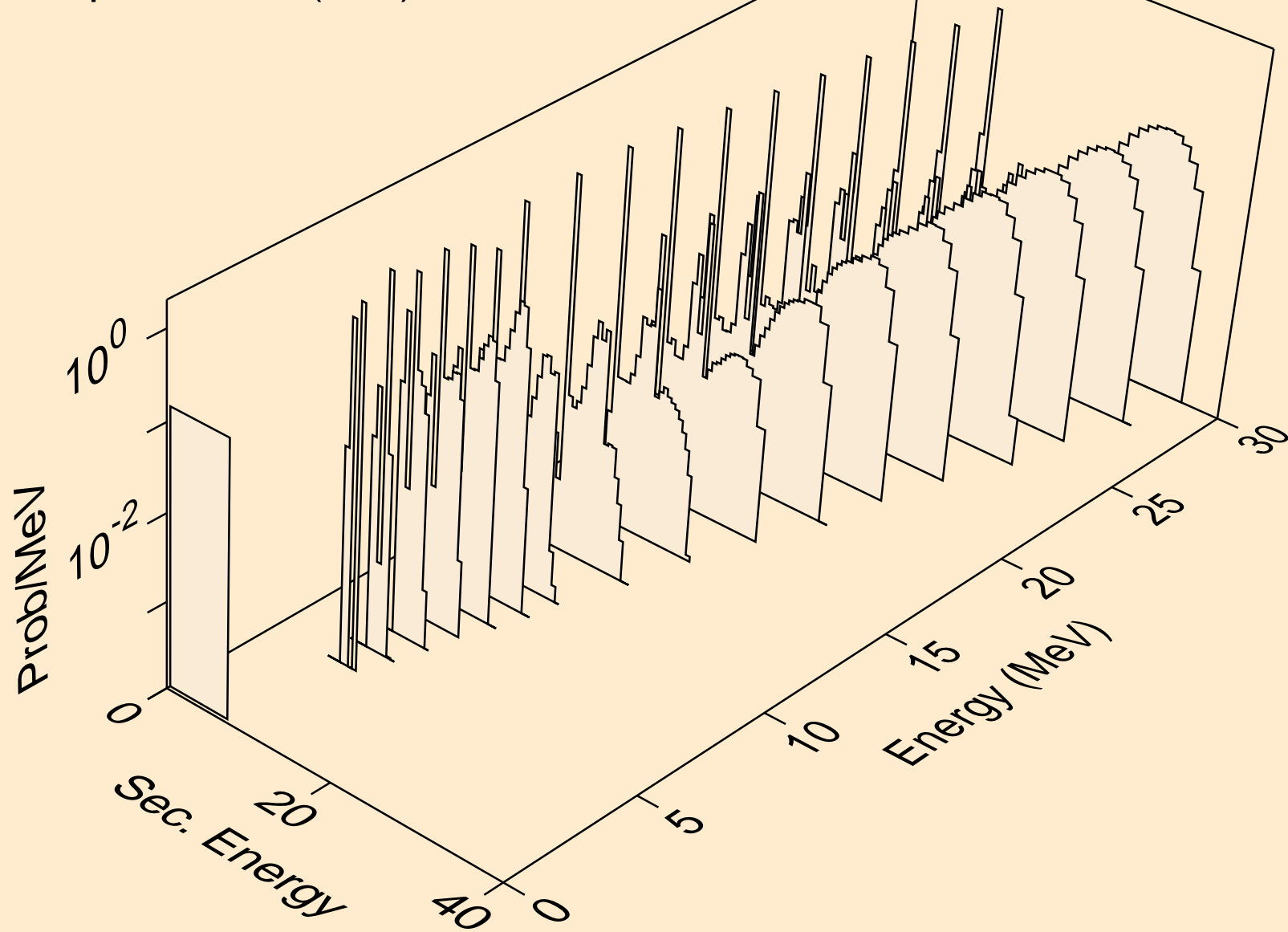

BI212M TRITON ACER TENDL-2021 LIBRARY; T=0.K  
alphas from (t,3n)a

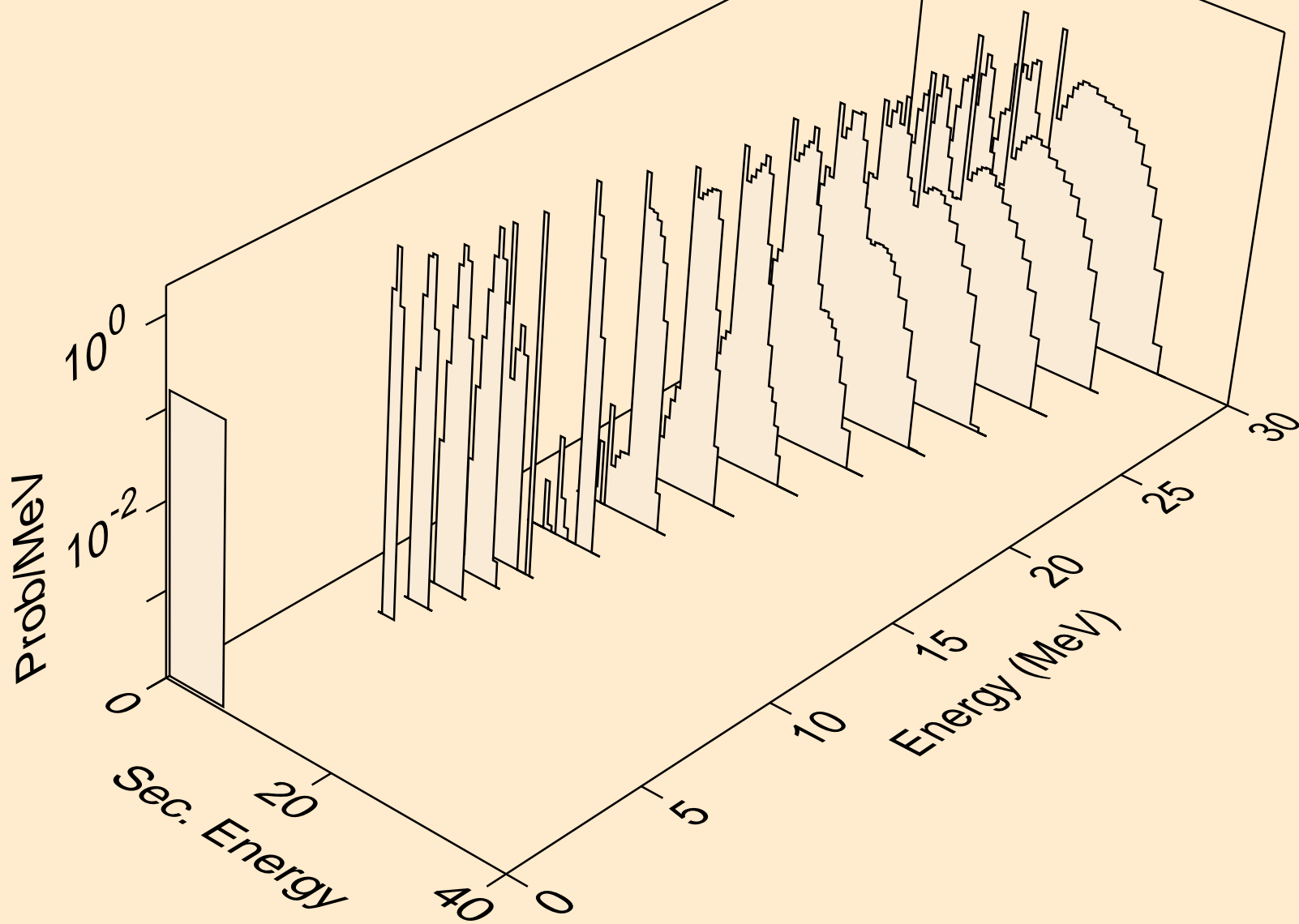

BI212M TRITON ACER TENDL-2021 LIBRARY; T=0.K  
alphas from (t,n\*)2a

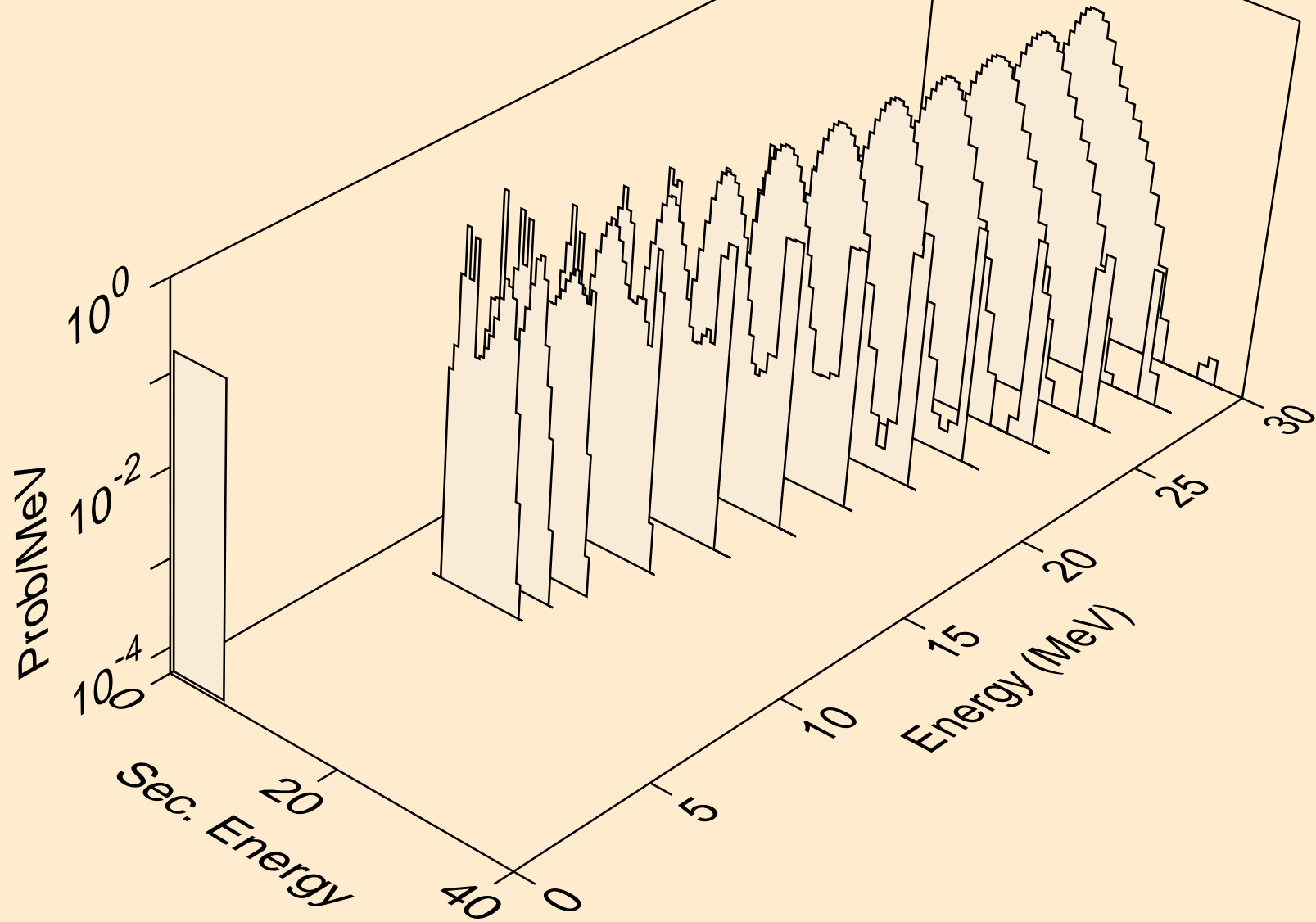

BI212M TRITON ACER TENDL-2021 LIBRARY; T=0.K  
alphas from (t,2n)2a

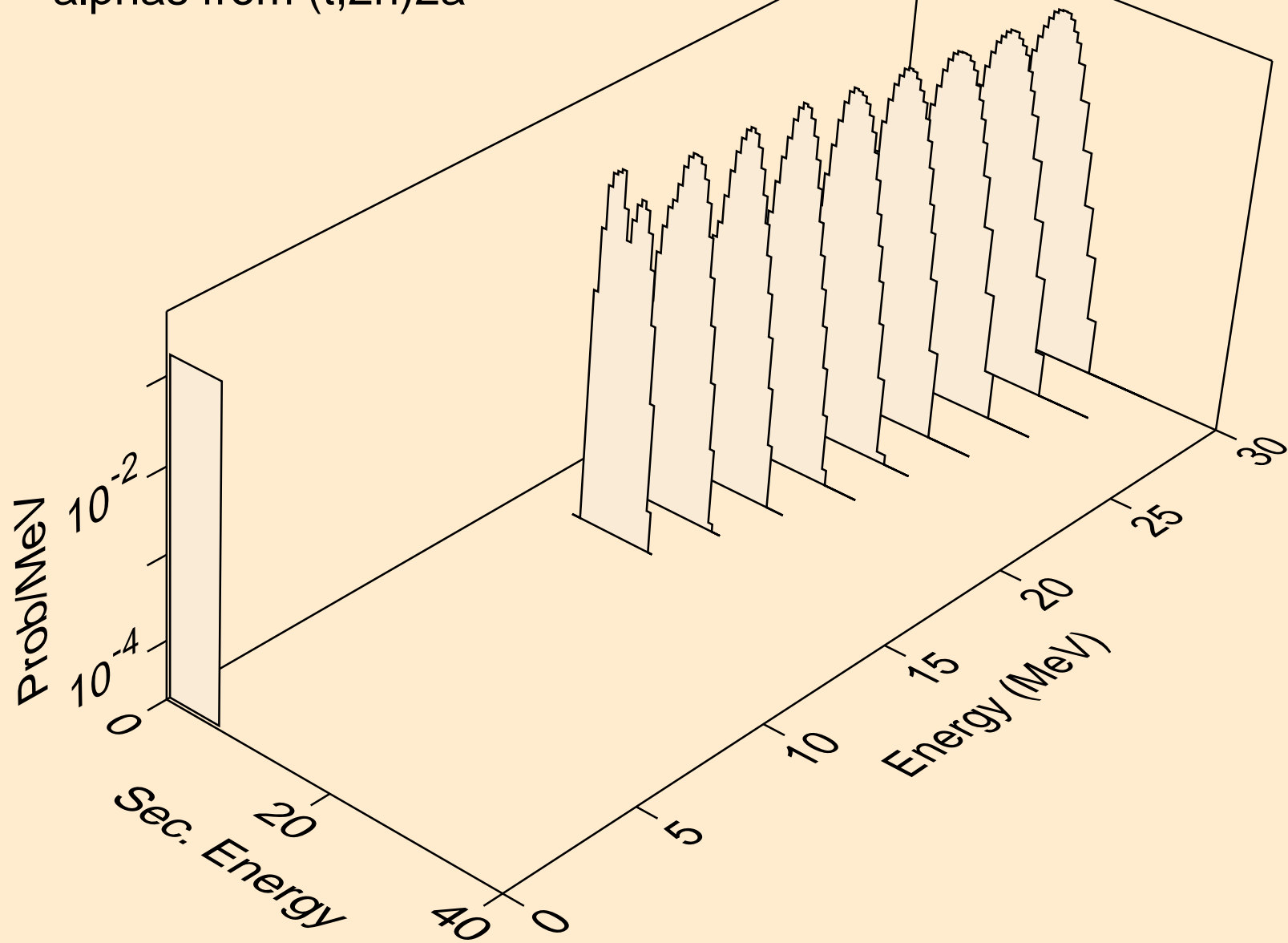

BI212M TRITON ACER TENDL-2021 LIBRARY; T=0.K  
alphas from (t,npa)

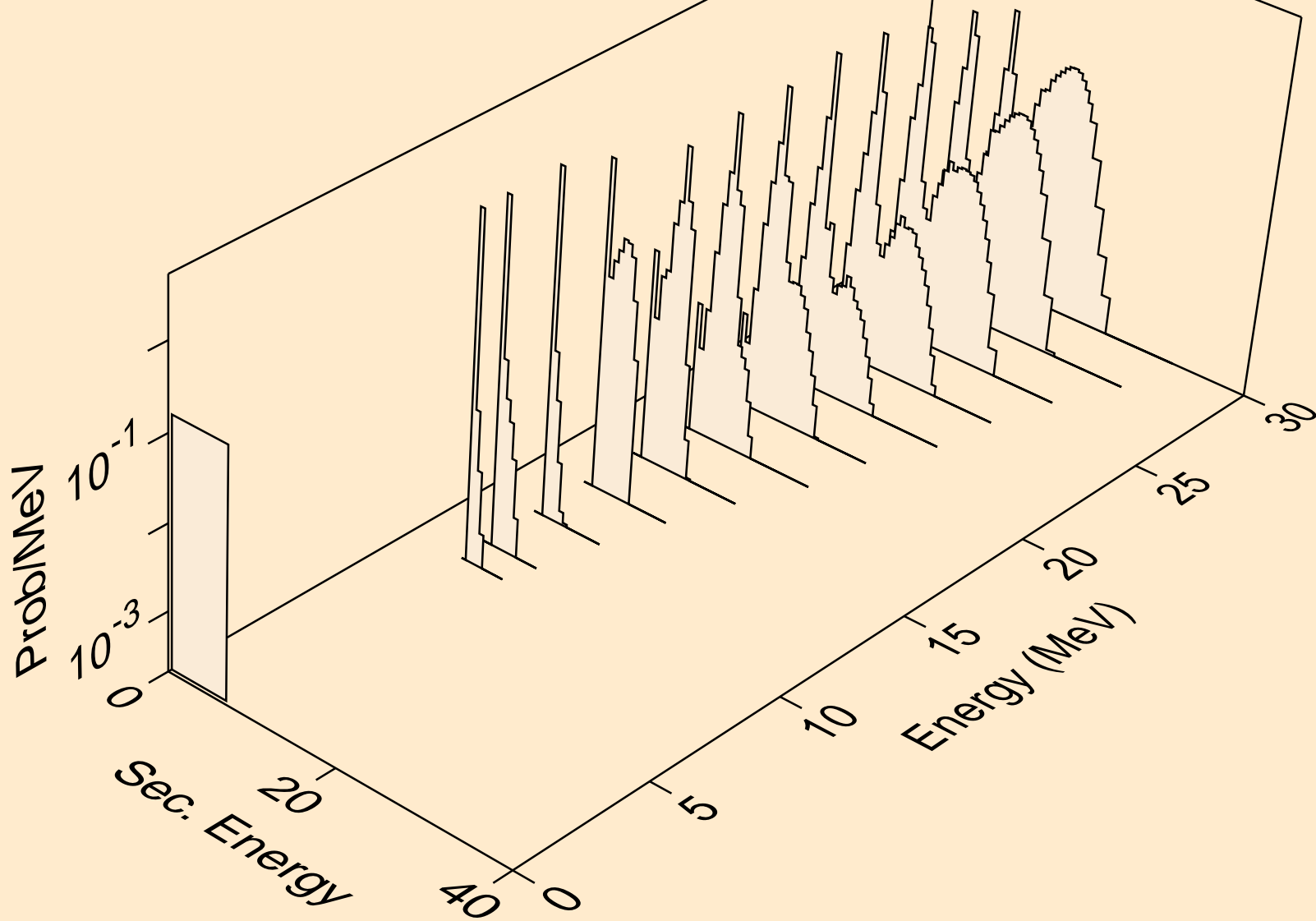

BI212M TRITON ACER TENDL-2021 LIBRARY; T=0.K  
alphas from (t,a)

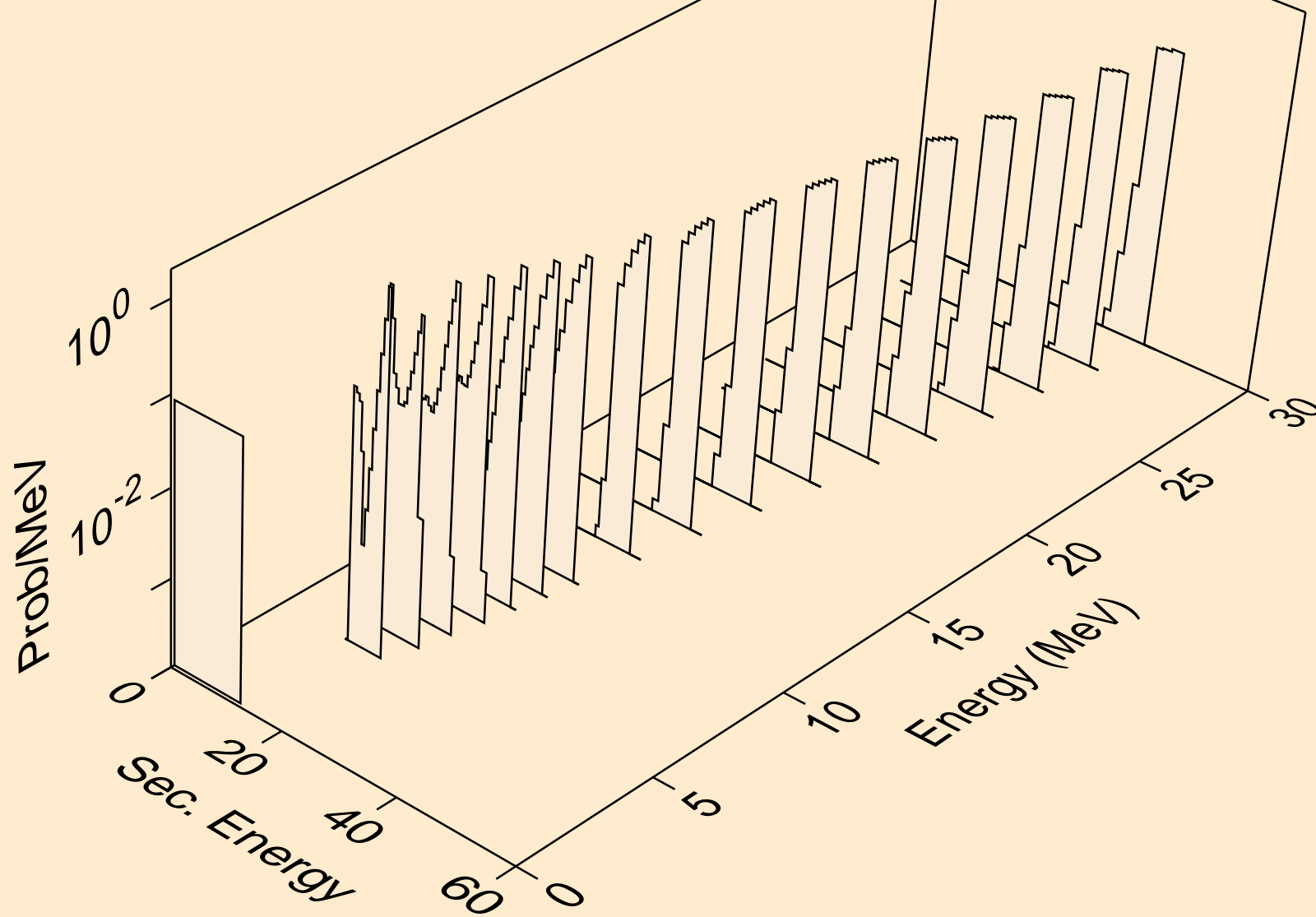

BI212M TRITON ACER TENDL-2021 LIBRARY; T=0.K  
alphas from (t,2a)

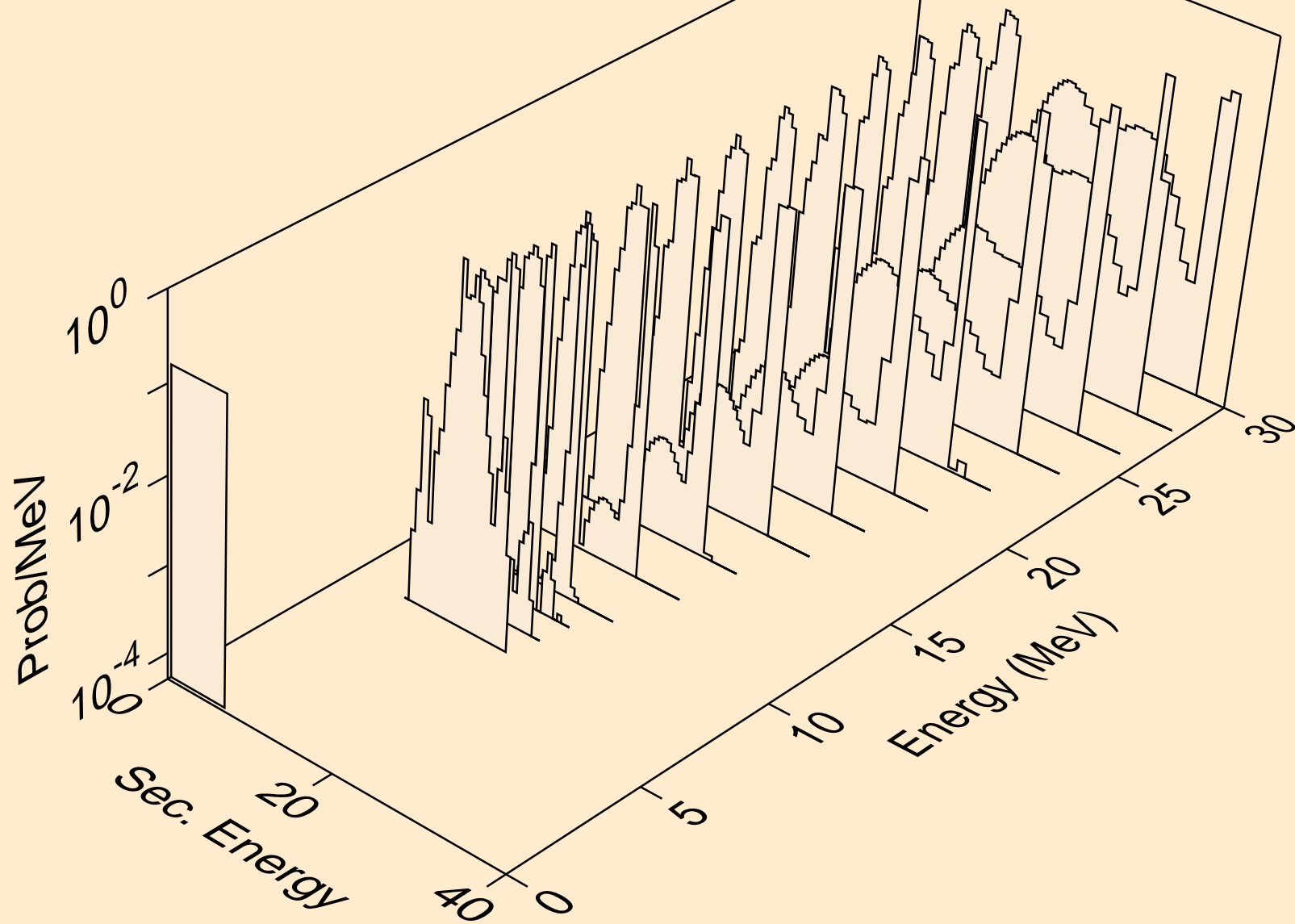

BI212M TRITON ACER TENDL-2021 LIBRARY; T=0.K  
alphas from (t,pa)

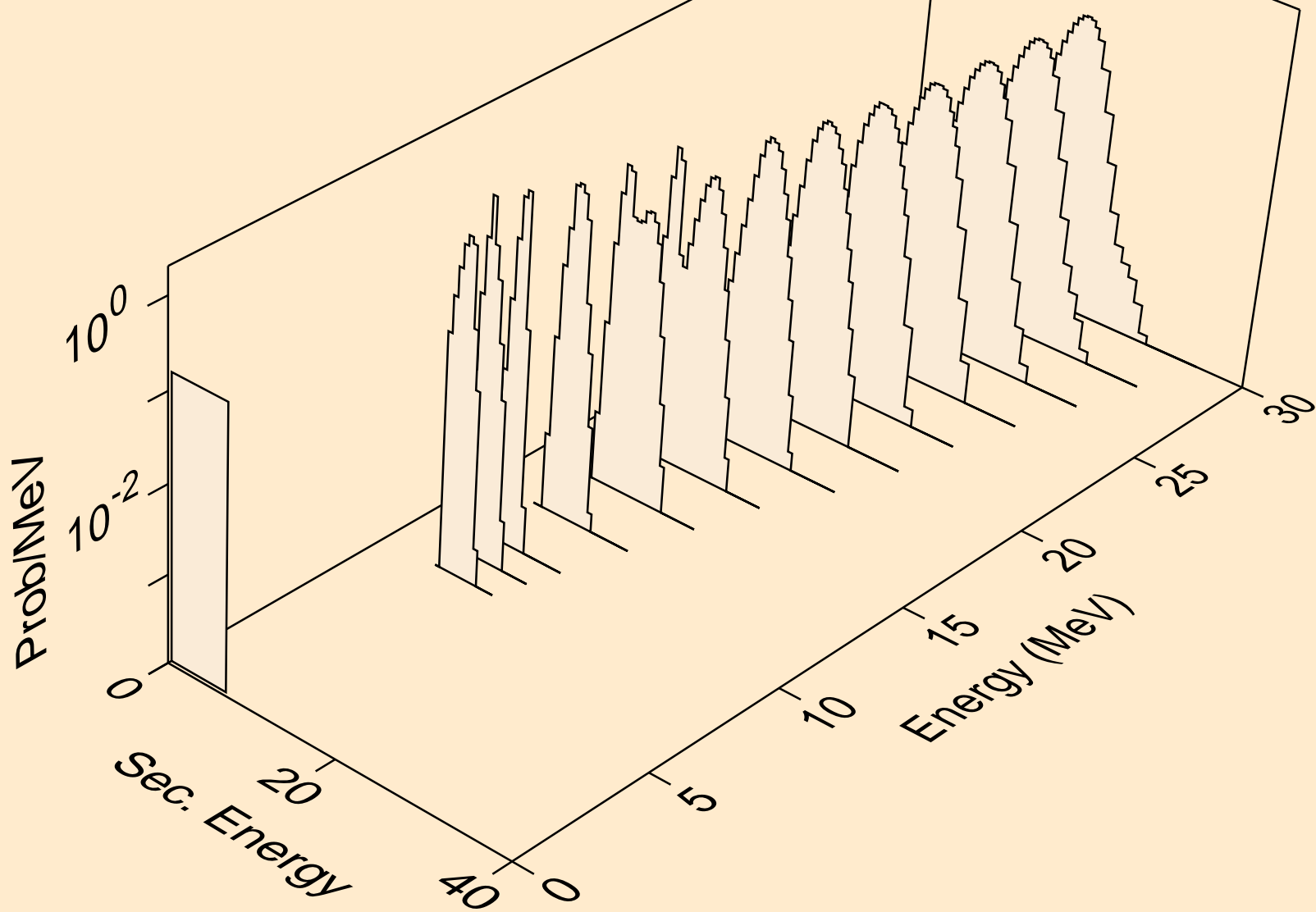



BI212M TRITON ACER TENDL-2021 LIBRARY; T=0.K  
alphas from (t,da)

