

# C014 TRITON ACER TENDL-2021 LIBRARY; T=0.K

## Principal cross sections

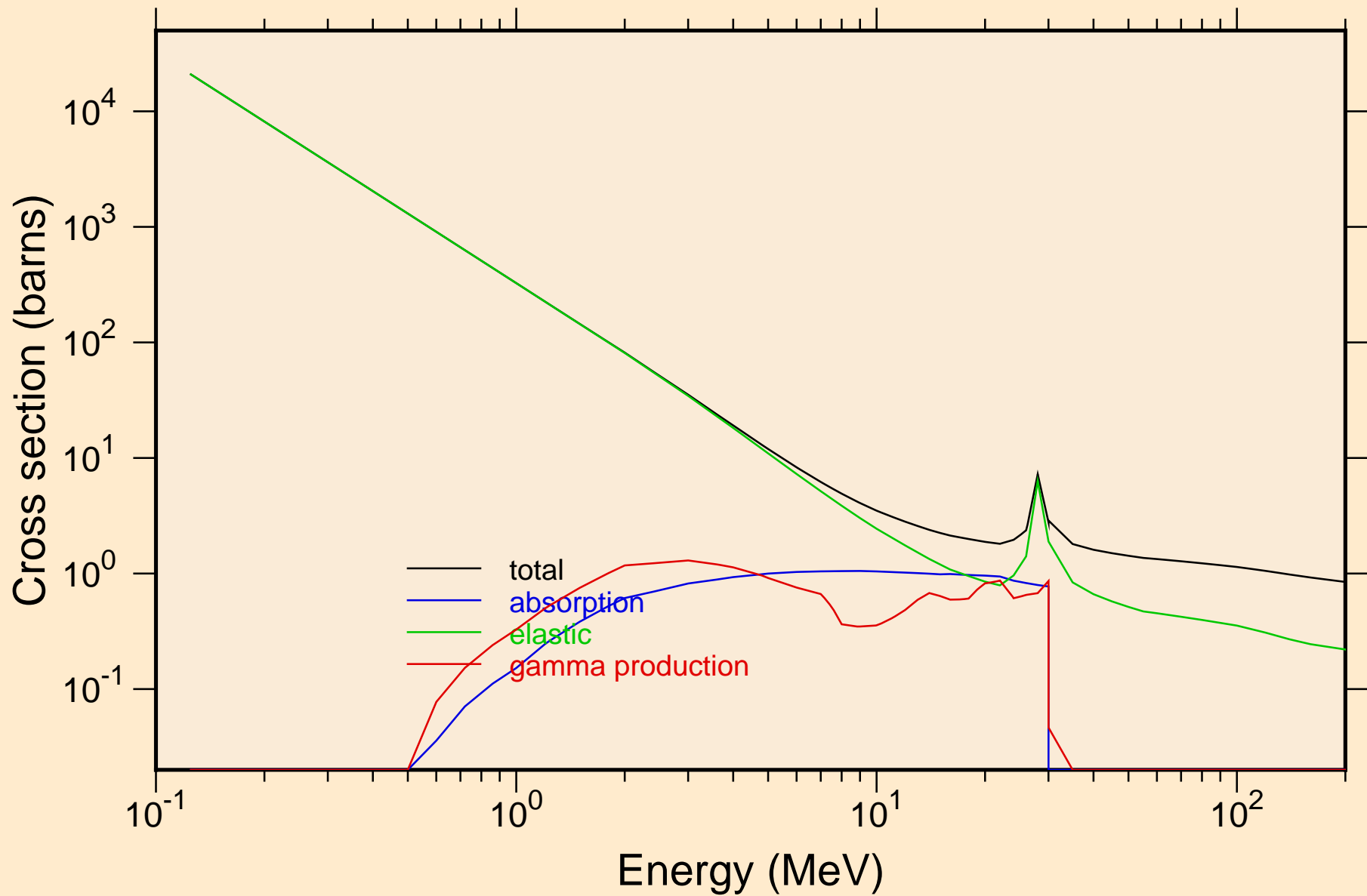

C014 TRITON ACER TENDL-2021 LIBRARY; T=0.K

Heating

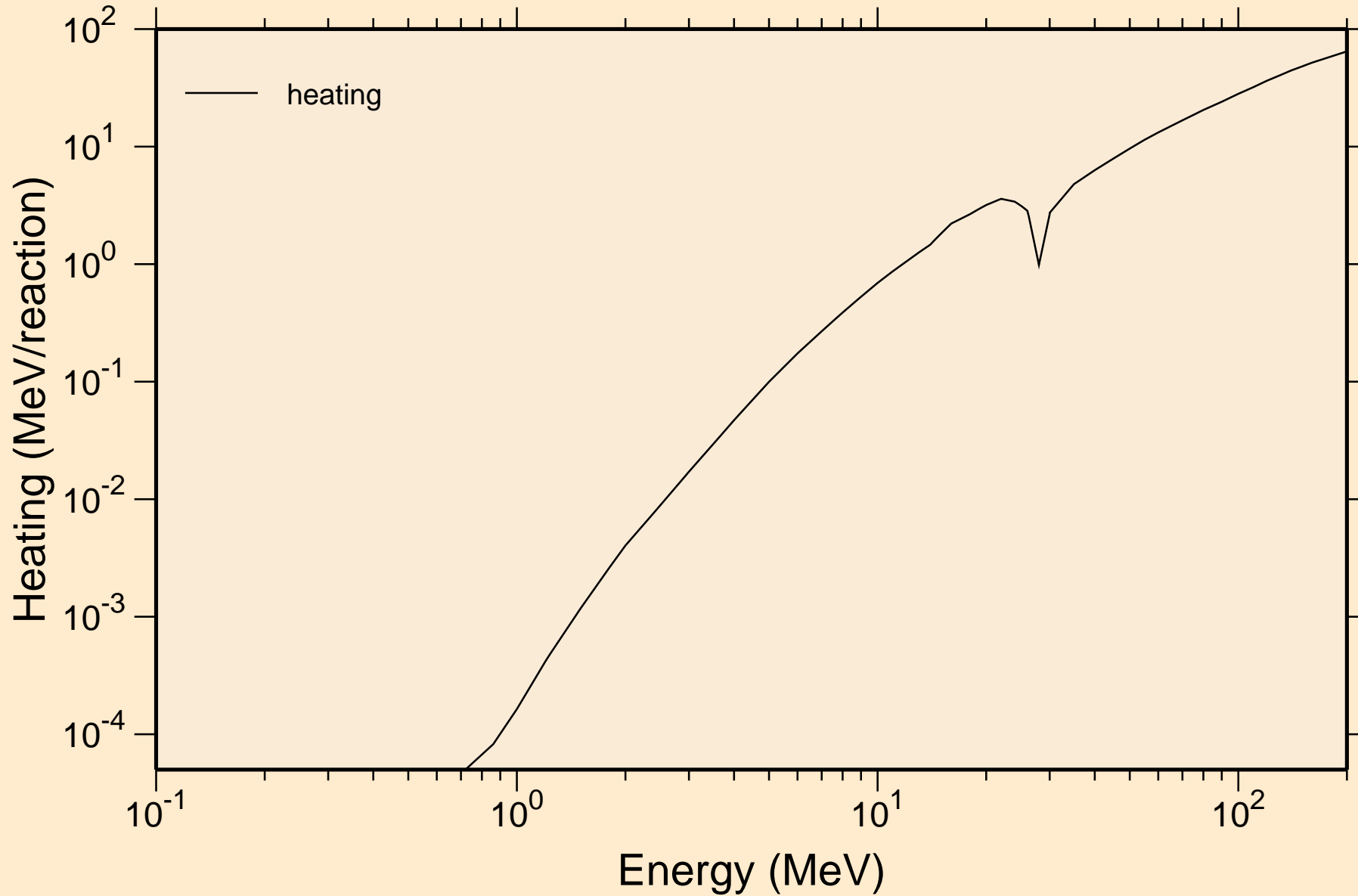

# C014 TRITON ACER TENDL-2021 LIBRARY; T=0.K

## Principal cross sections

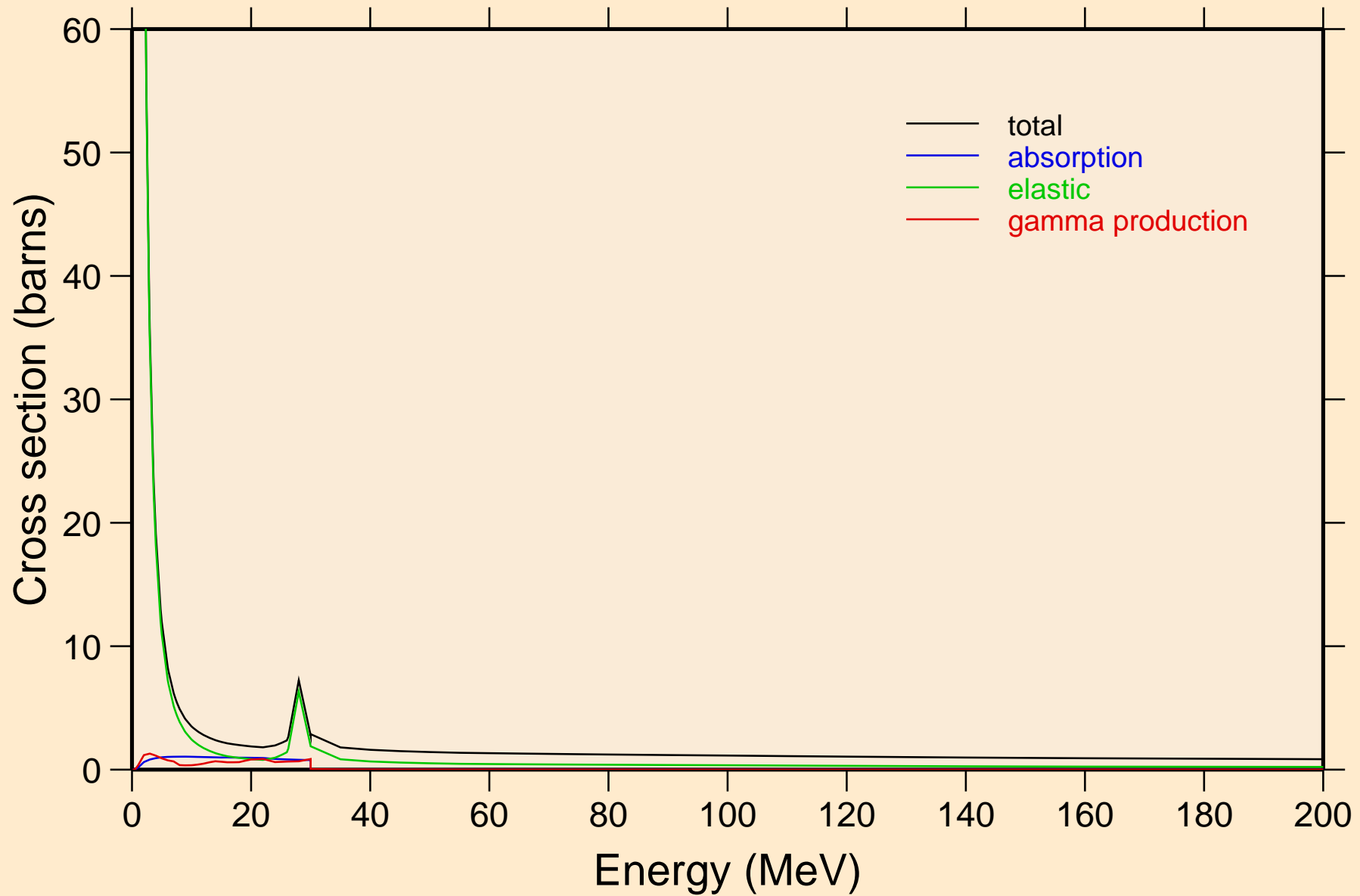

C014 TRITON ACER TENDL-2021 LIBRARY; T=0.K

Heating

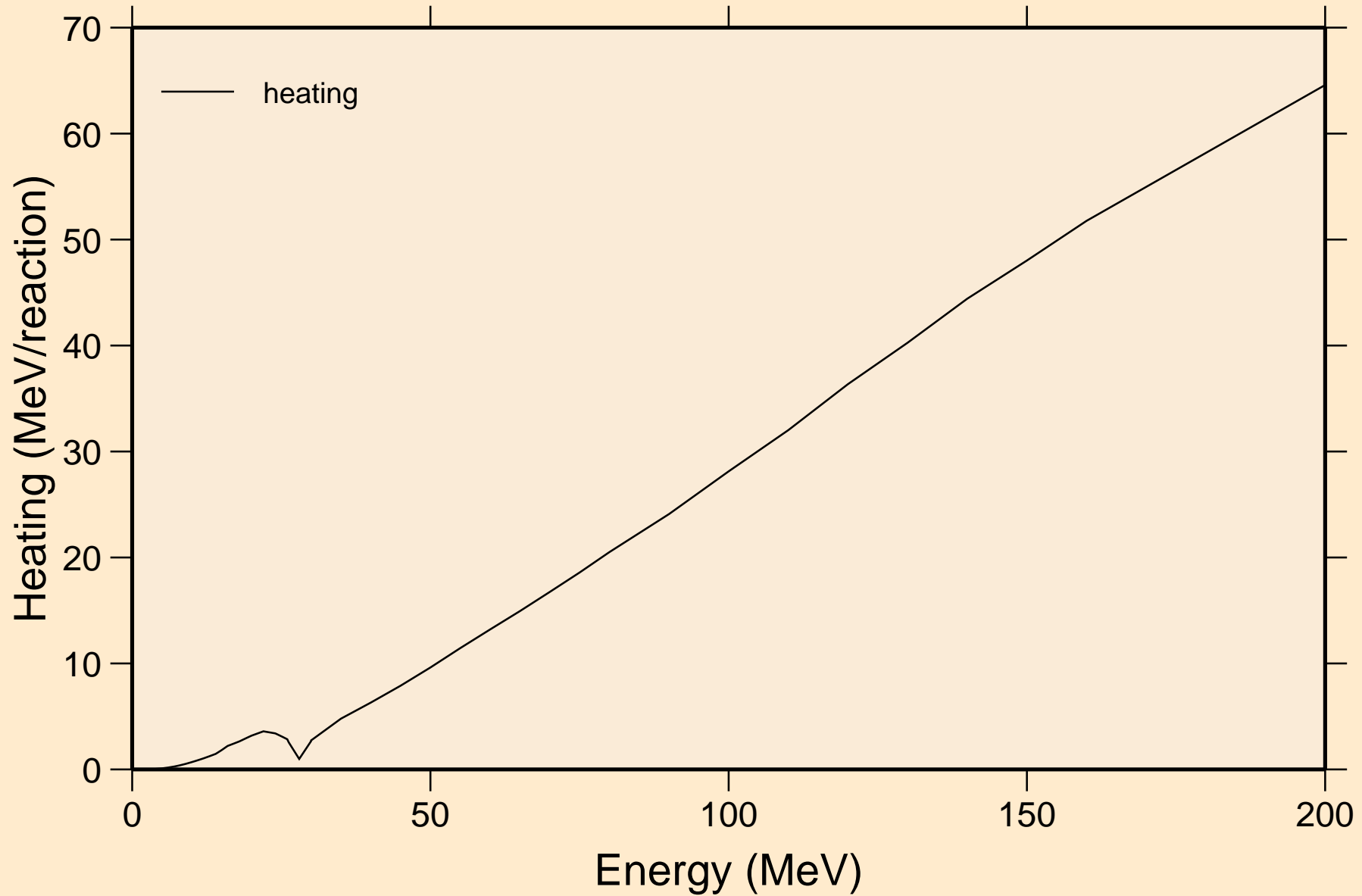

# C014 TRITON ACER TENDL-2021 LIBRARY; T=0.K

## Threshold reactions

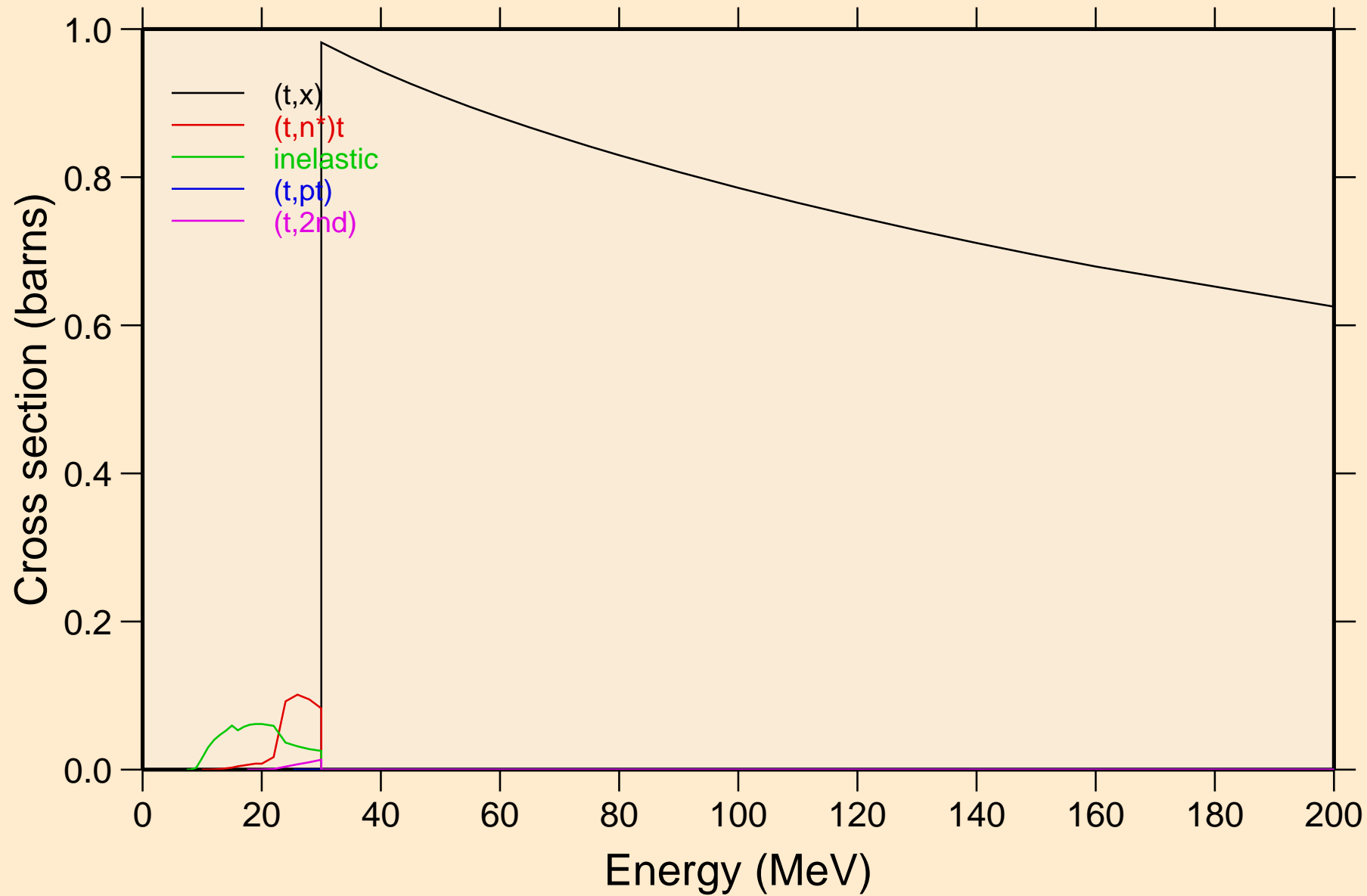

C014 TRITON ACER TENDL-2021 LIBRARY; T=0.K  
Threshold reactions

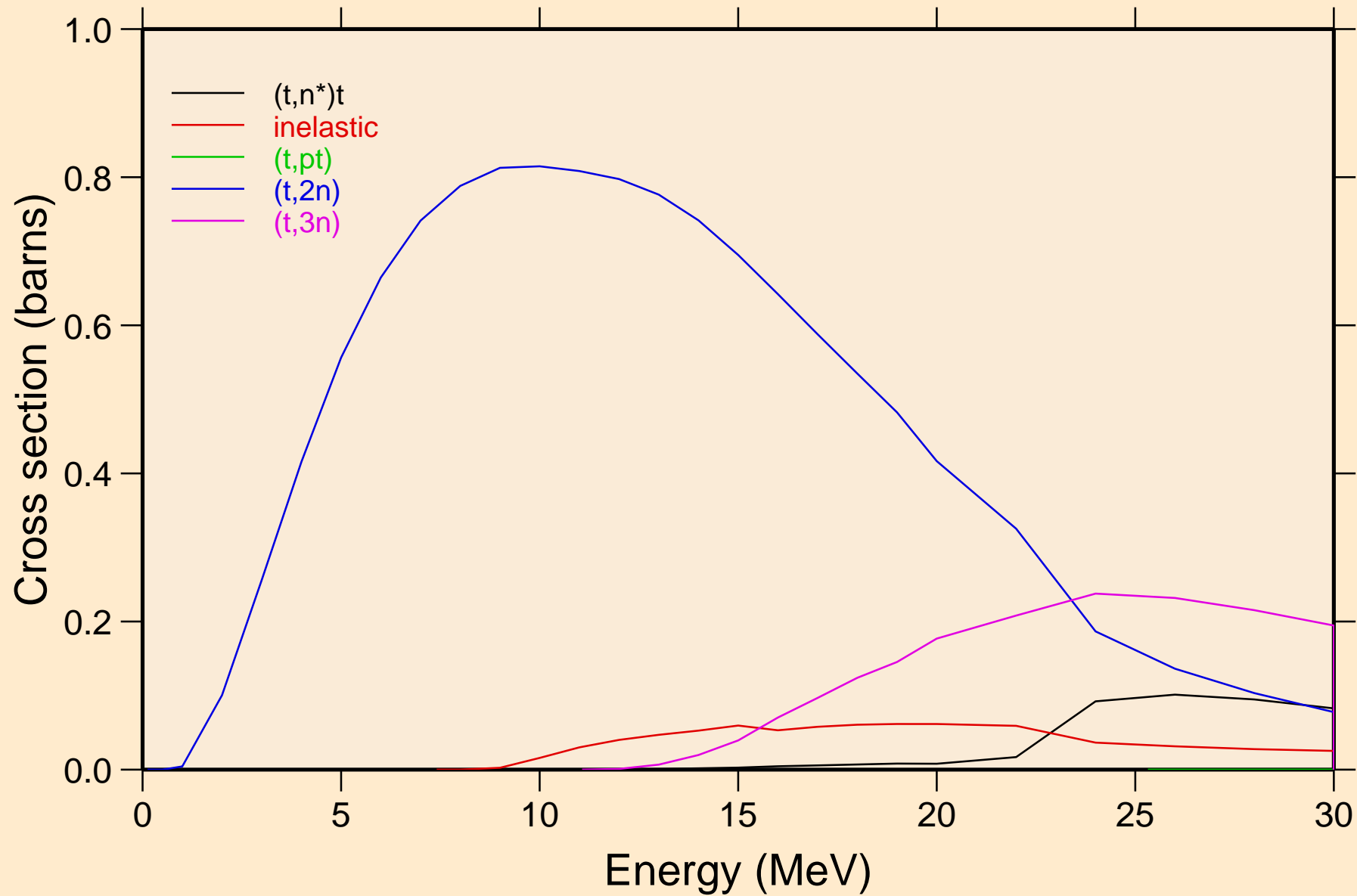

# C014 TRITON ACER TENDL-2021 LIBRARY; T=0.K

## Threshold reactions

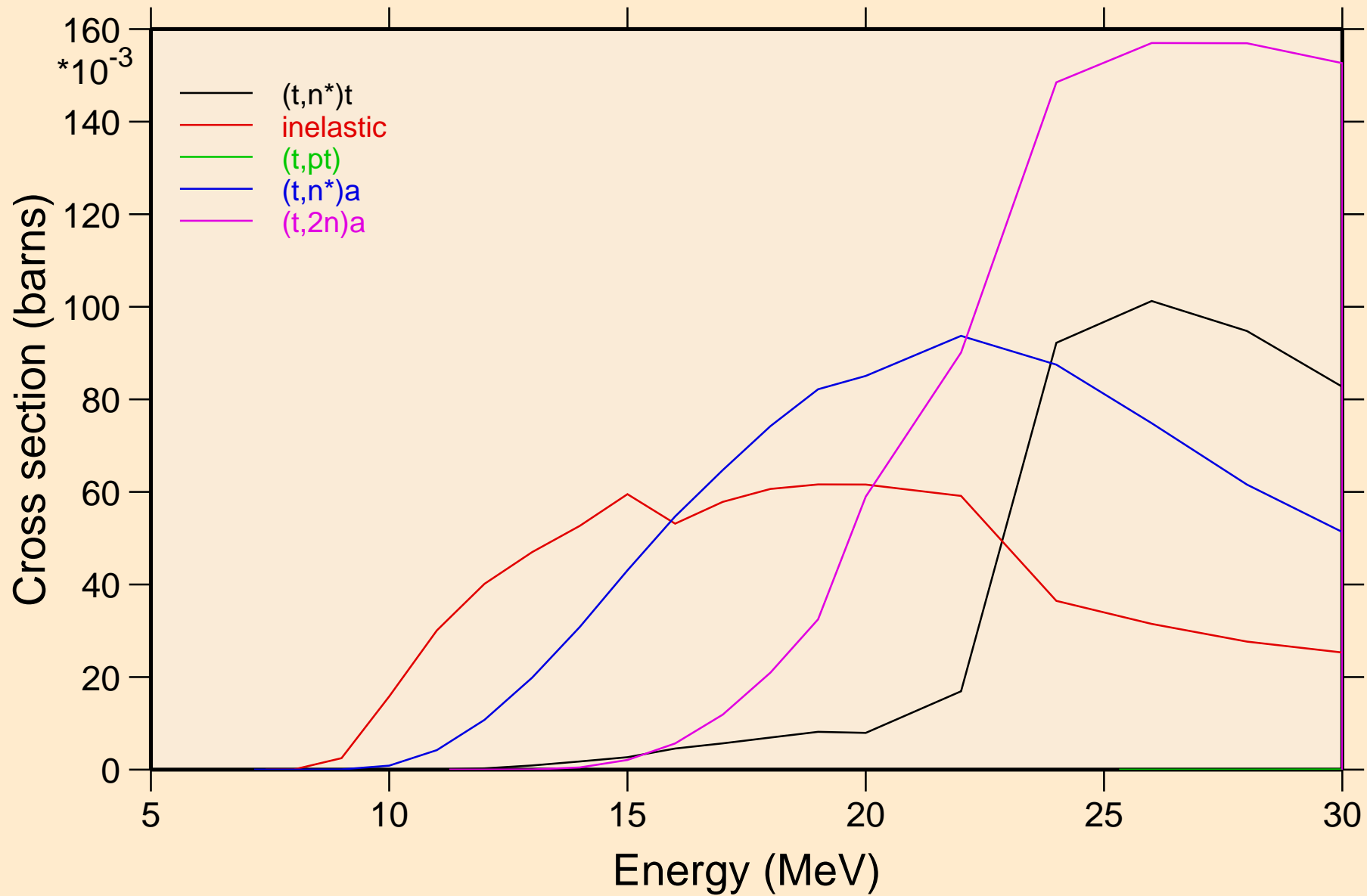

C014 TRITON ACER TENDL-2021 LIBRARY; T=0.K  
Threshold reactions

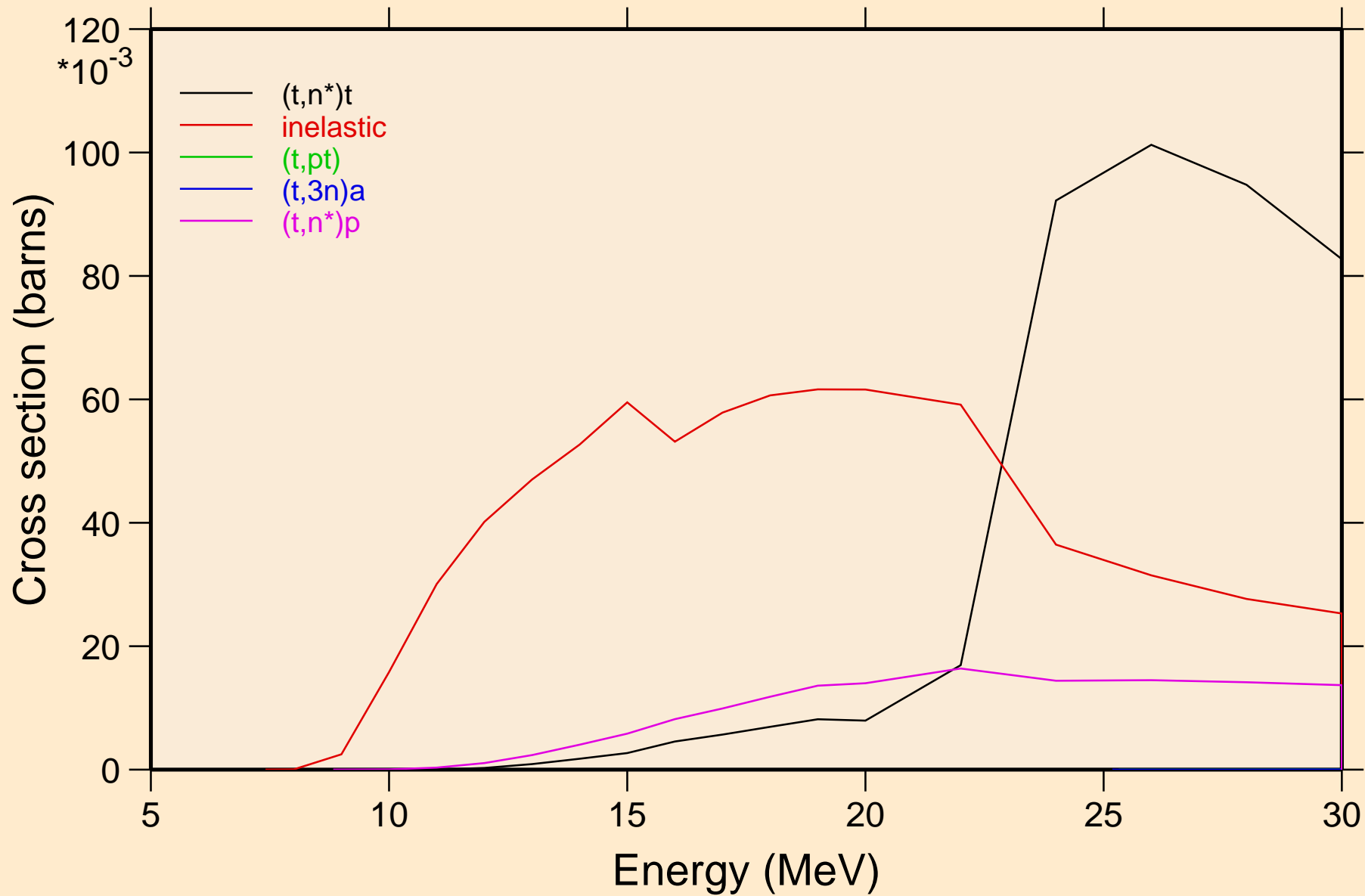



C014 TRITON ACER TENDL-2021 LIBRARY; T=0.K  
Threshold reactions

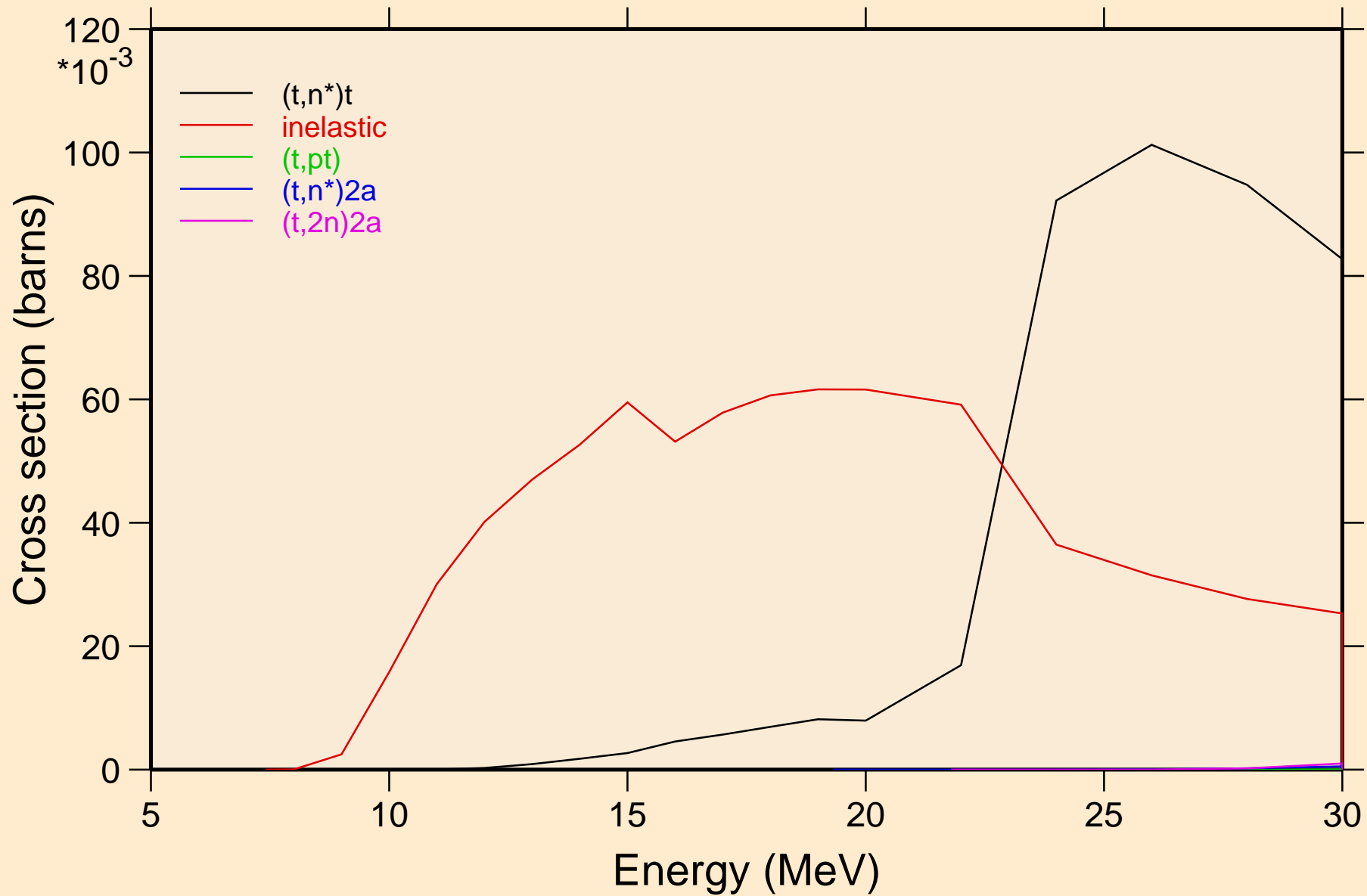

C014 TRITON ACER TENDL-2021 LIBRARY; T=0.K  
Threshold reactions

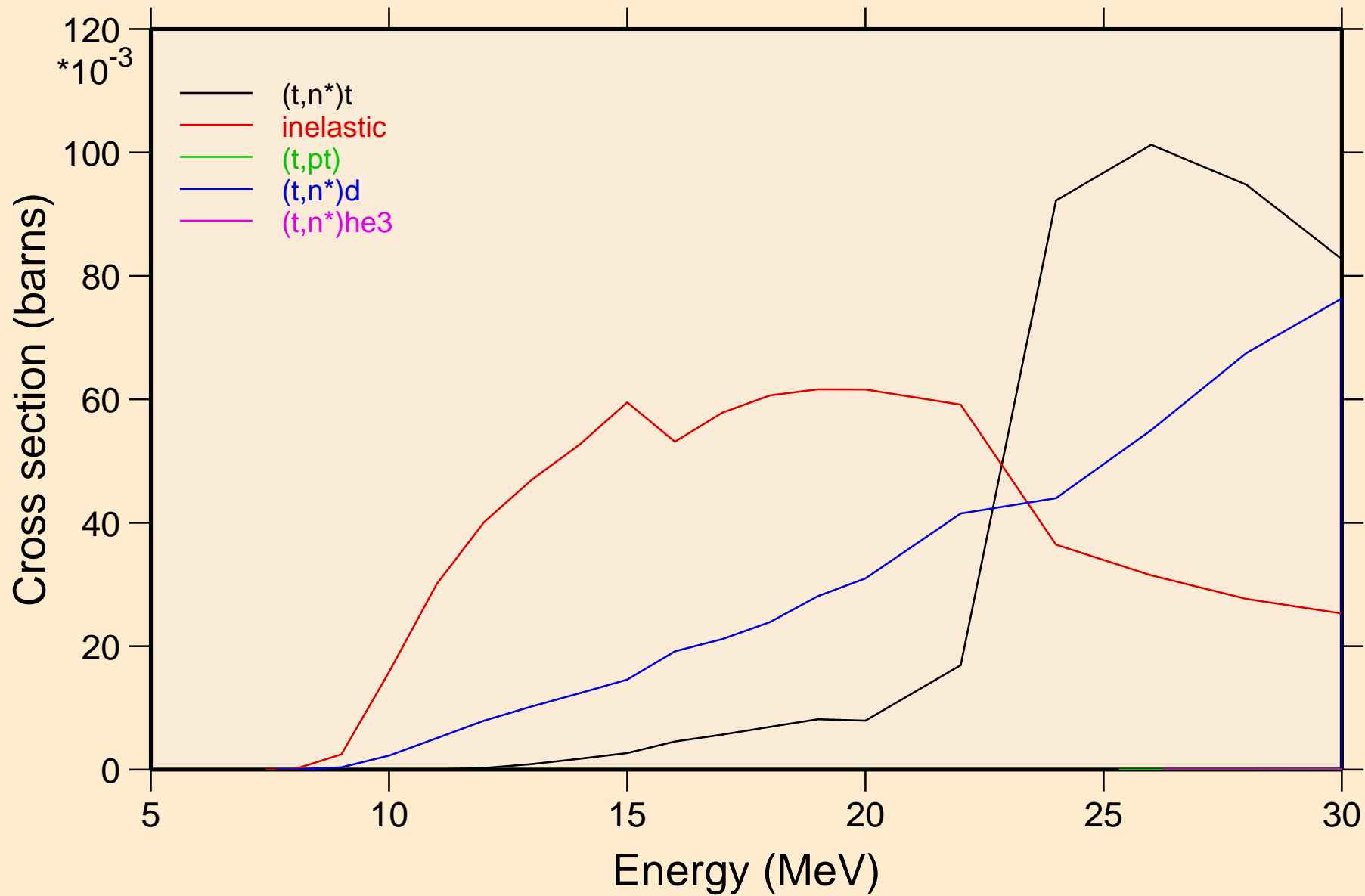

# C014 TRITON ACER TENDL-2021 LIBRARY; T=0.K

## Threshold reactions

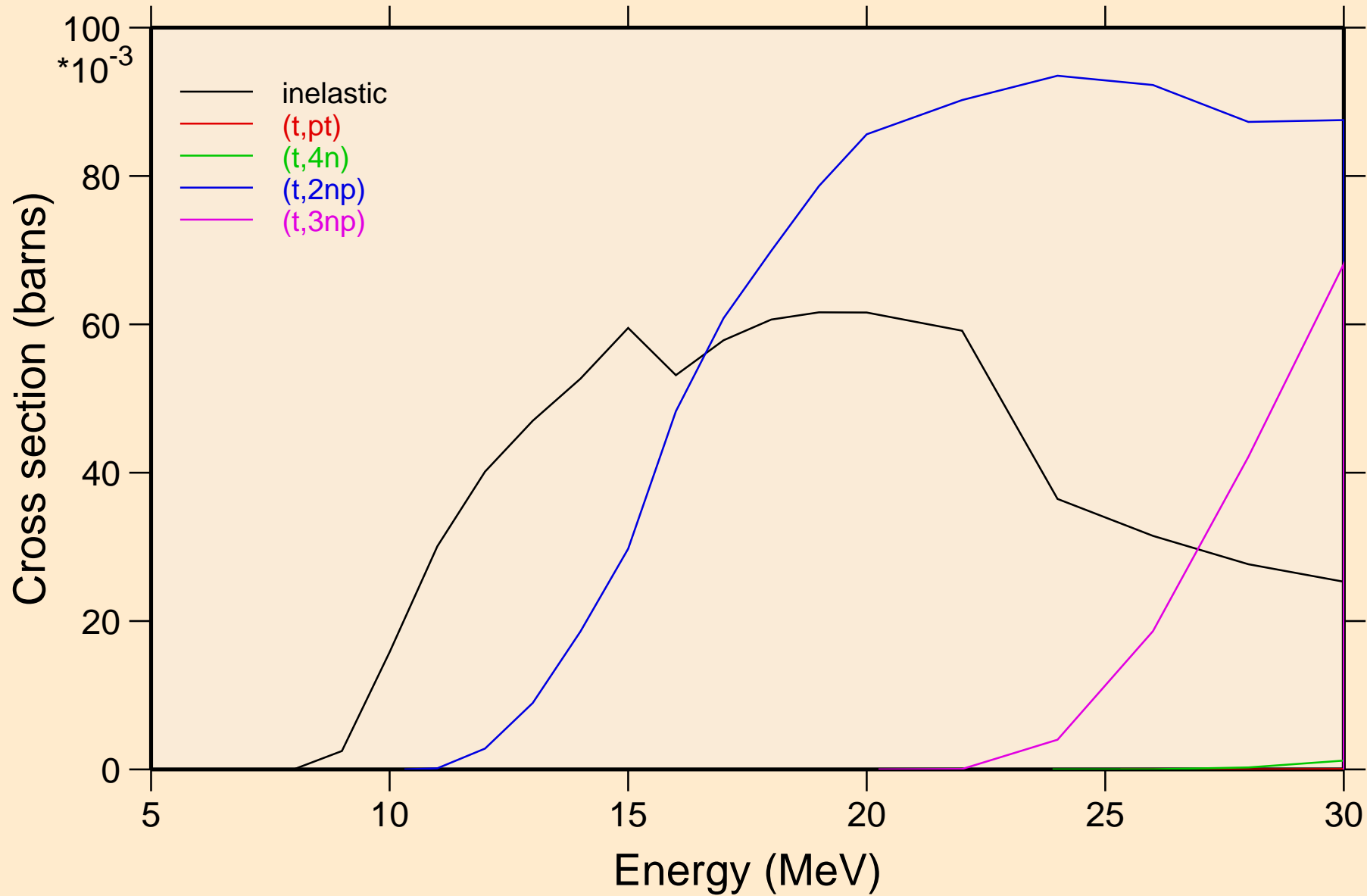

C014 TRITON ACER TENDL-2021 LIBRARY; T=0.K  
Threshold reactions

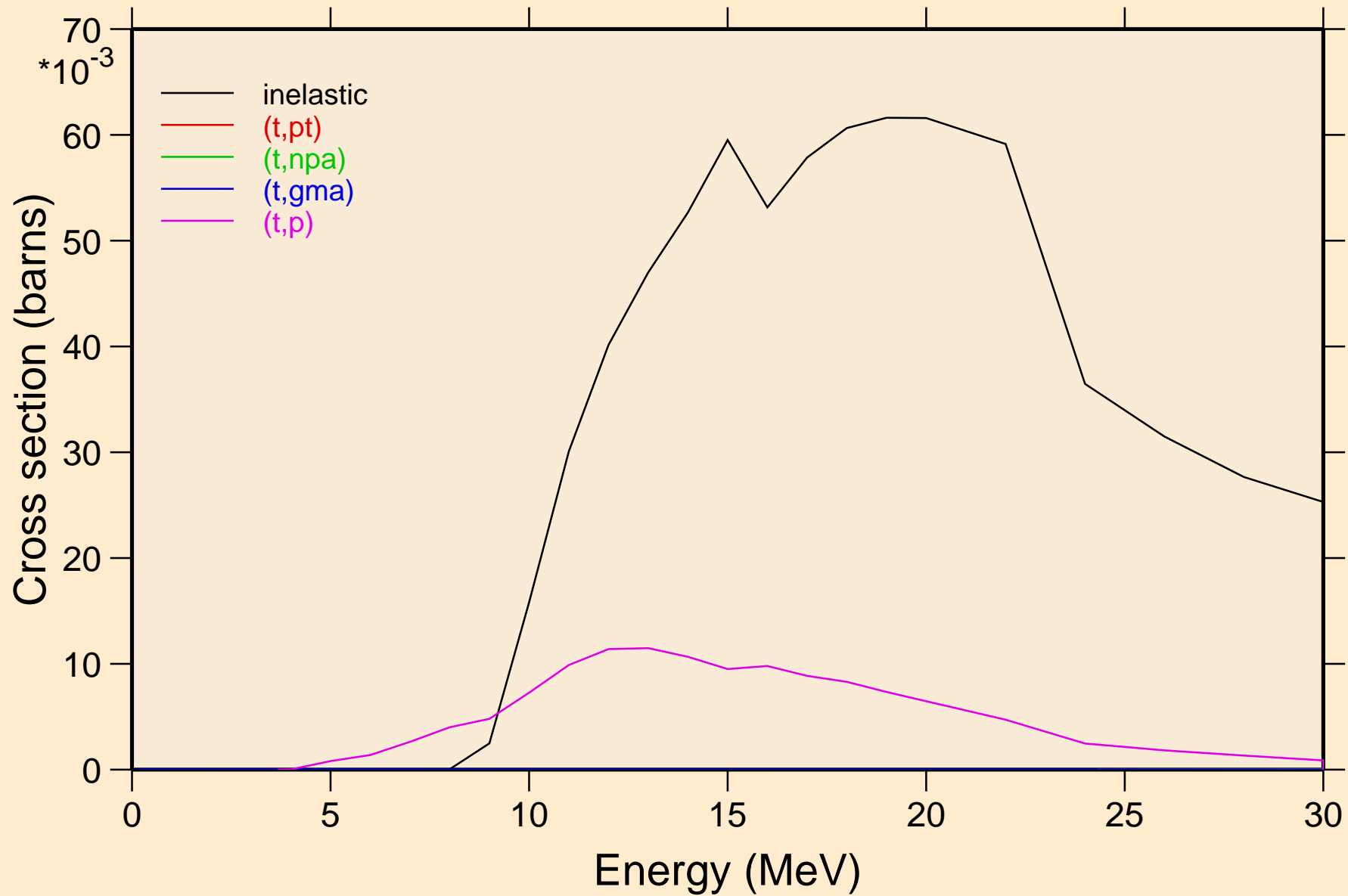

# C014 TRITON ACER TENDL-2021 LIBRARY; T=0.K

## Threshold reactions

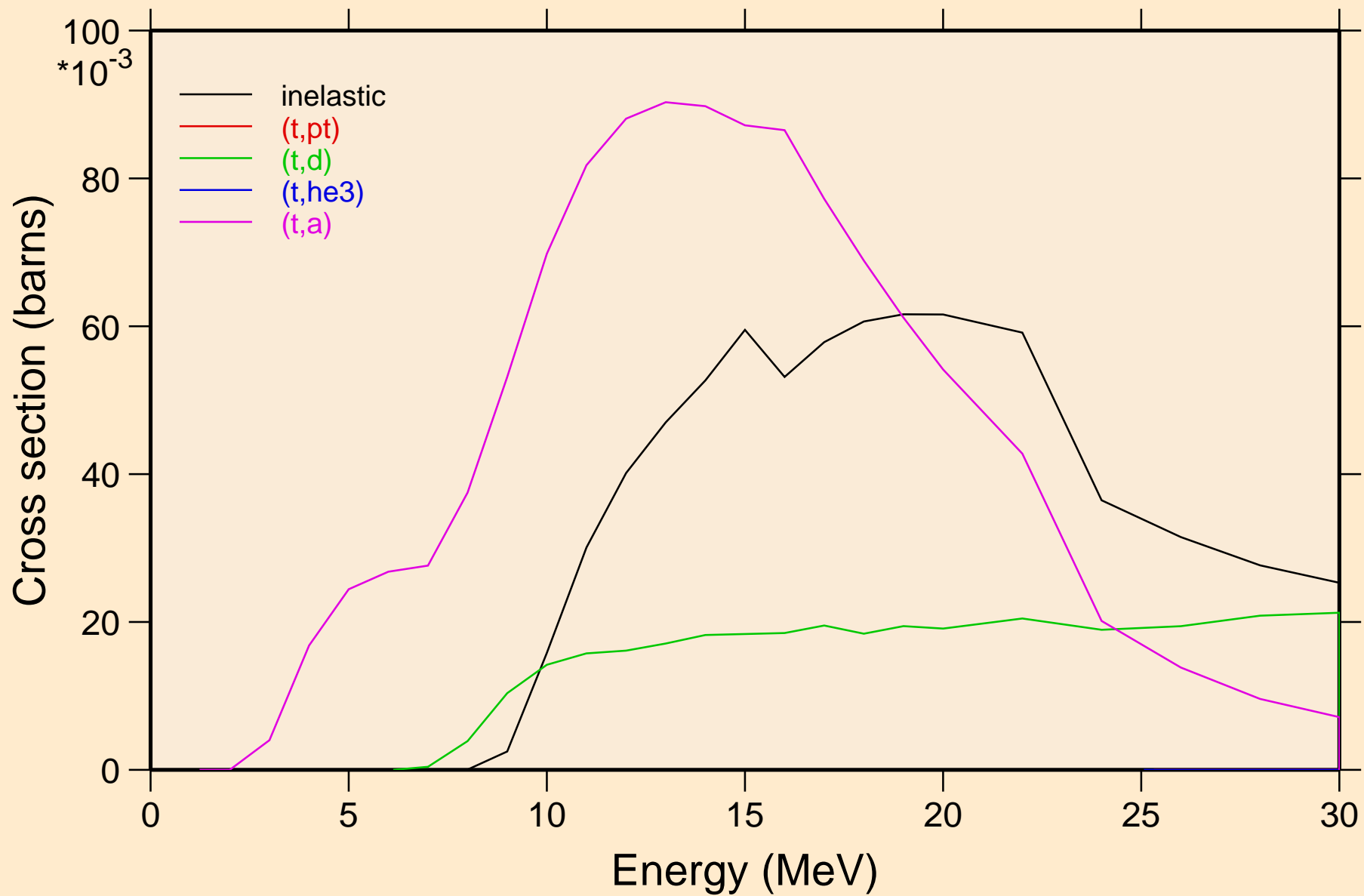

C014 TRITON ACER TENDL-2021 LIBRARY; T=0.K  
Threshold reactions

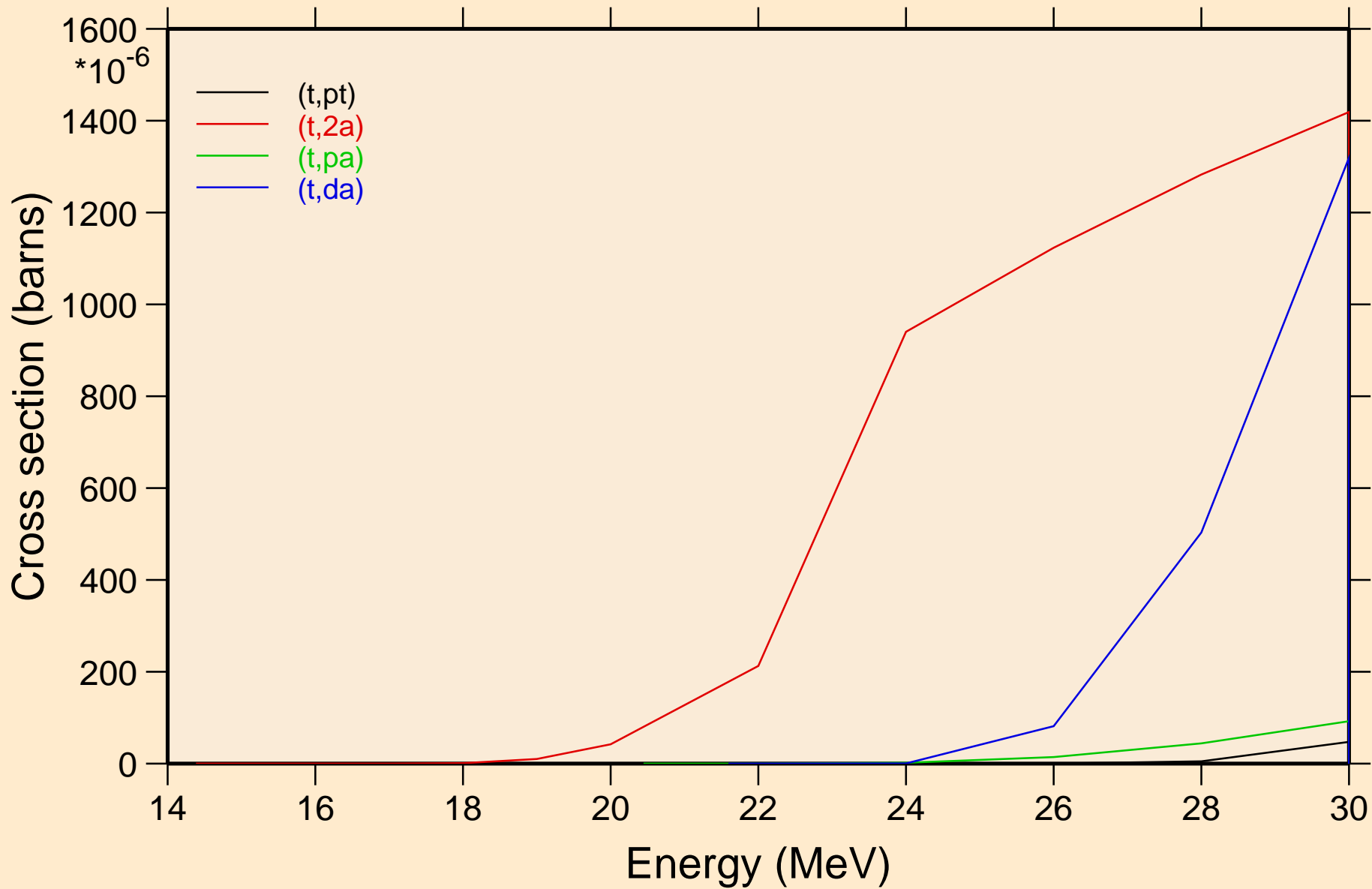

C014 TRITON ACER TENDL-2021 LIBRARY; T=0.K  
angular distribution for elastic

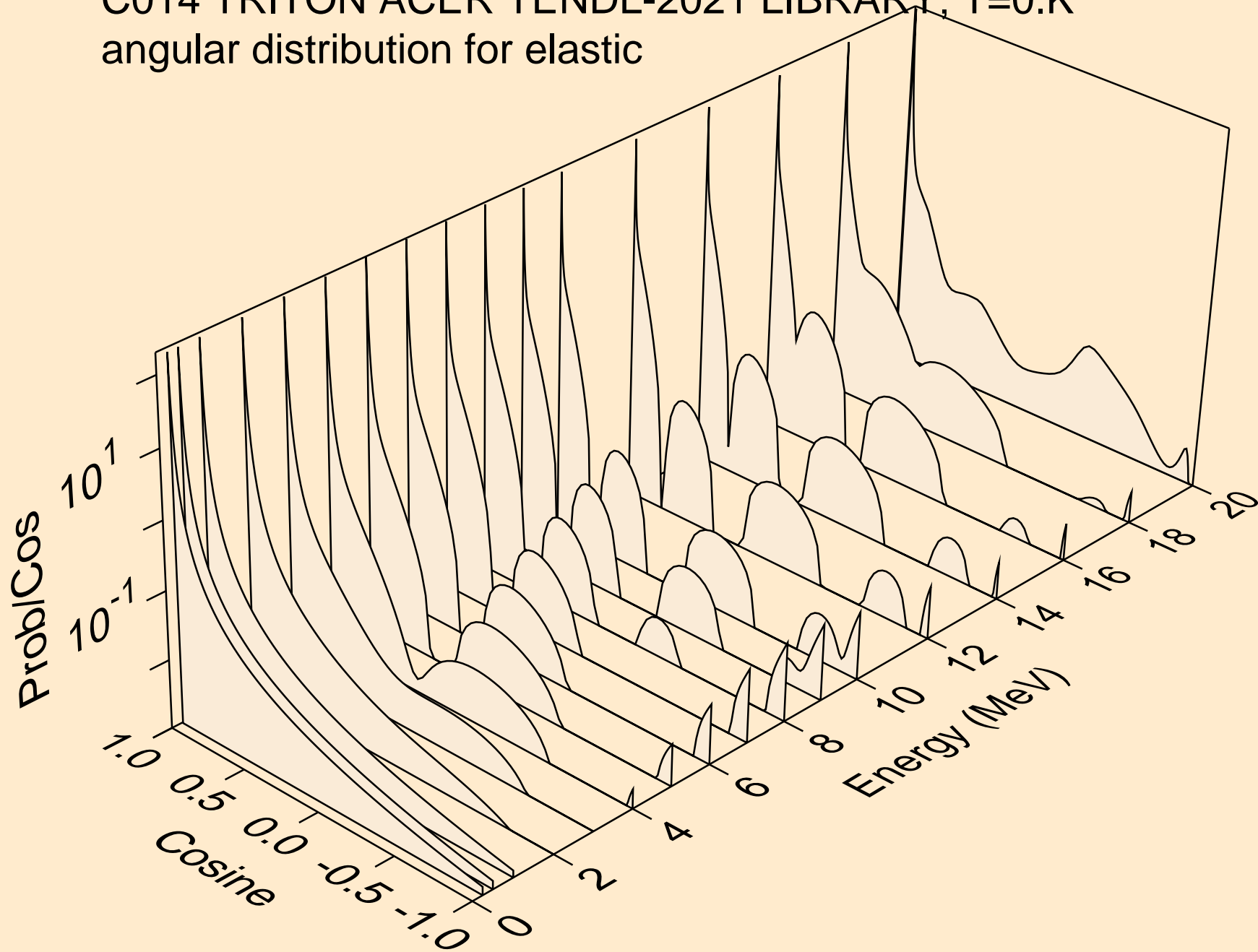

C014 TRITON ACER TENDL-2021 LIBRARY; T=0.K  
angular distribution for elastic

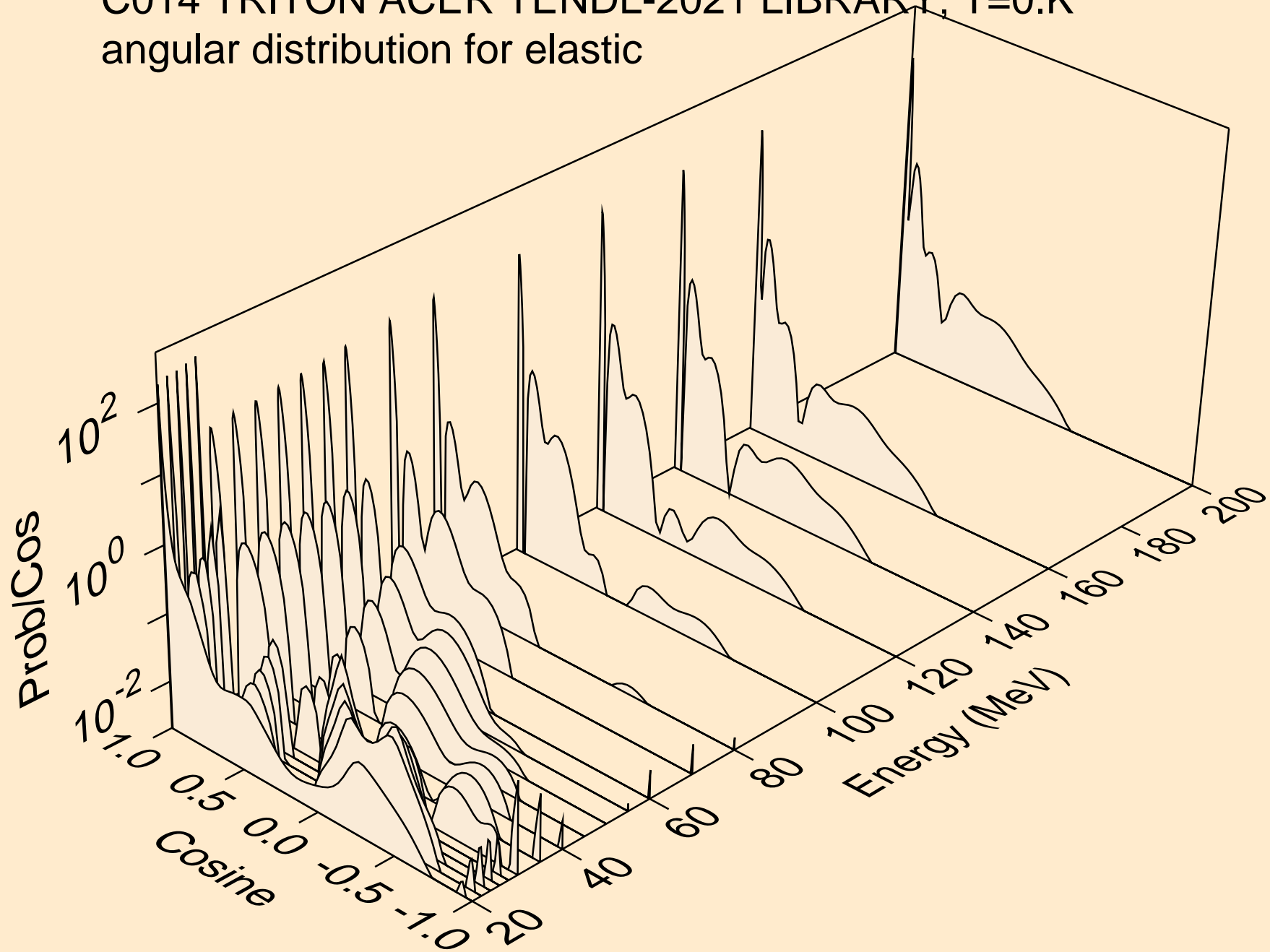



C014 TRITON ACER TENDL-2021 LIBRARY; T=0.K  
Triton emission for (t,x)

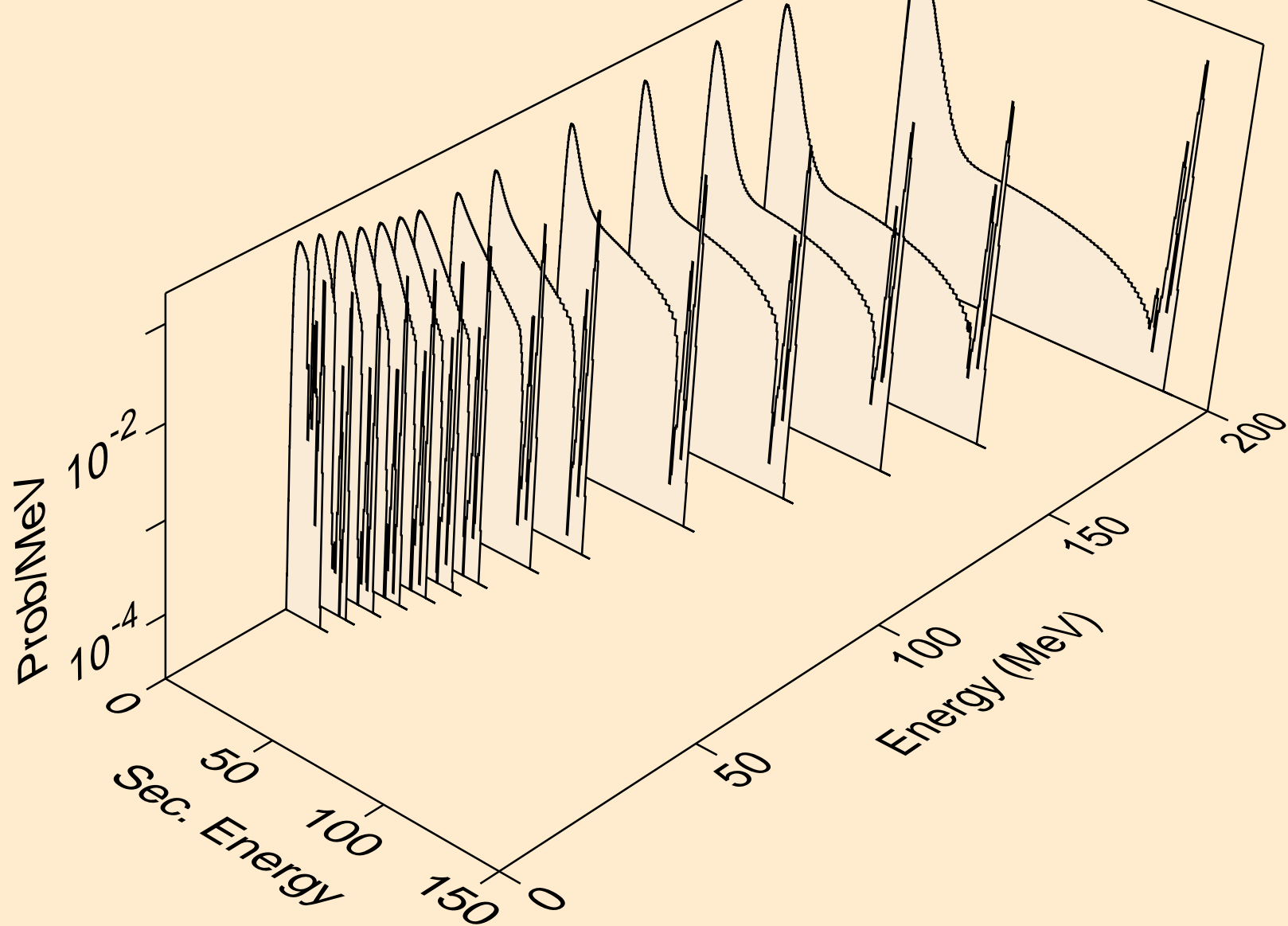

C014 TRITON ACER TENDL-2021 LIBRARY; T=0.K  
Triton emission for (t,n\*)t

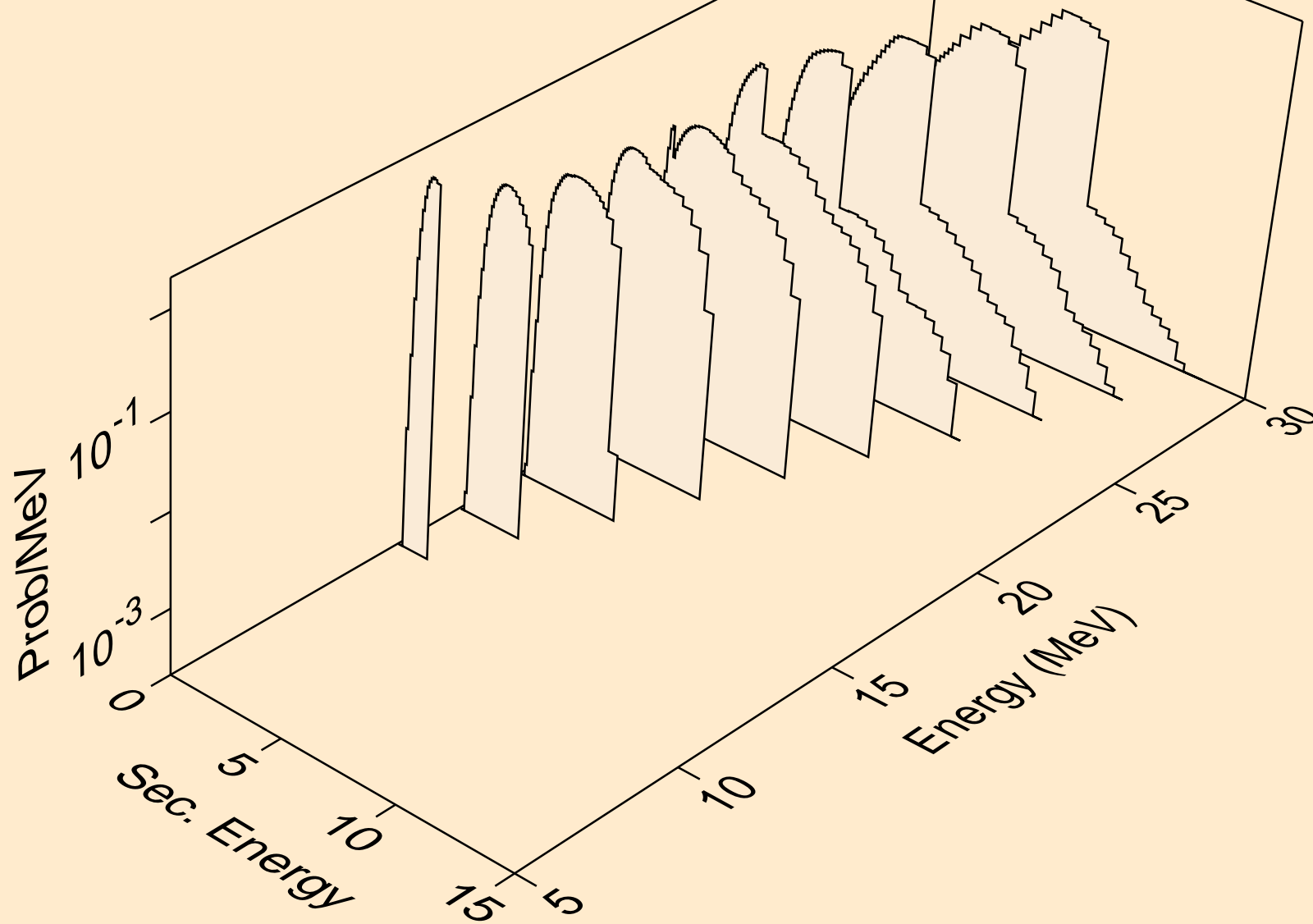

C014 TRITON ACER TENDL-2021 LIBRARY; T=0.K  
Triton emission for inelastic

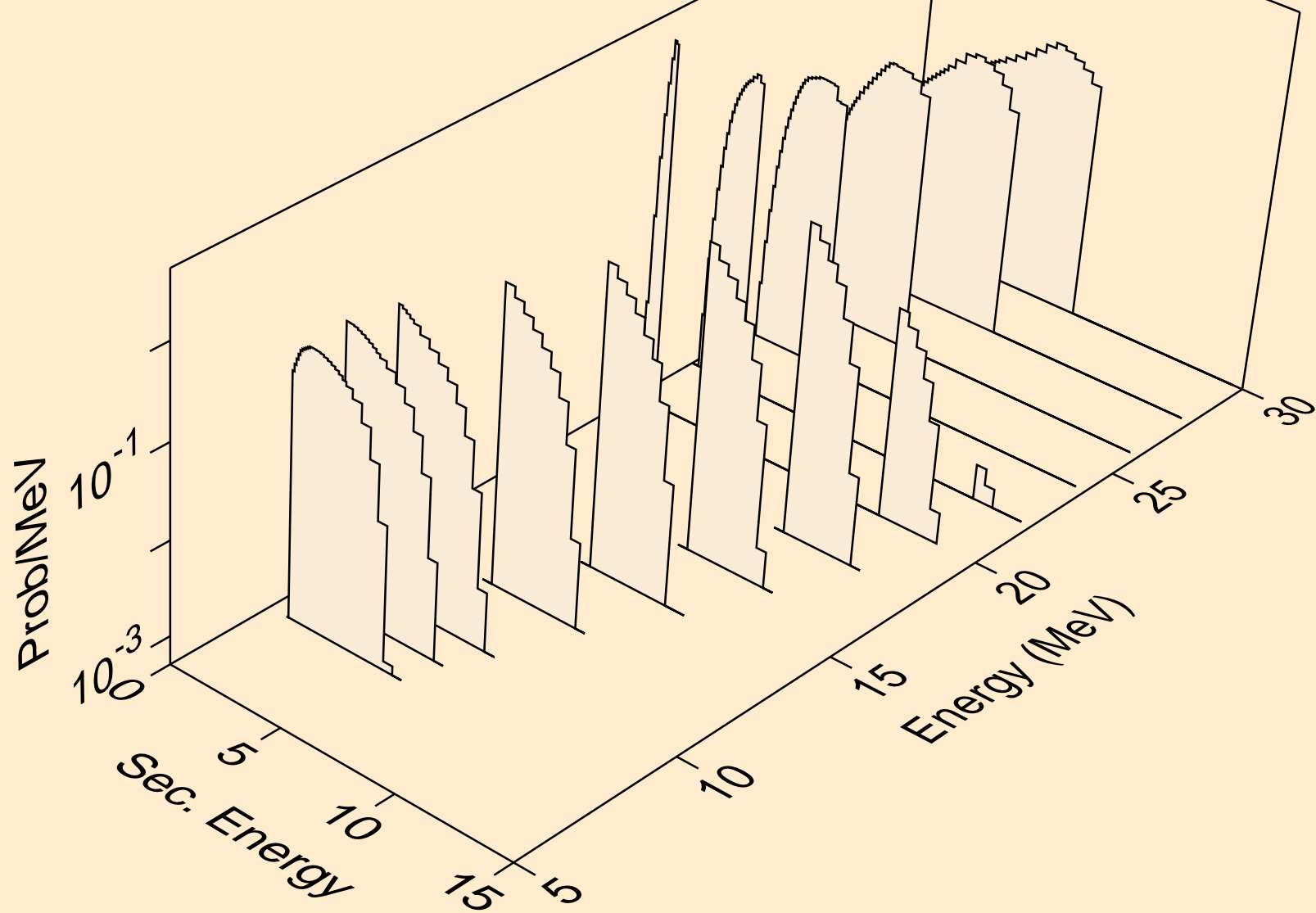

C014 TRITON ACER TENDL-2021 LIBRARY; T=0.K  
Triton emission for (t,pt)

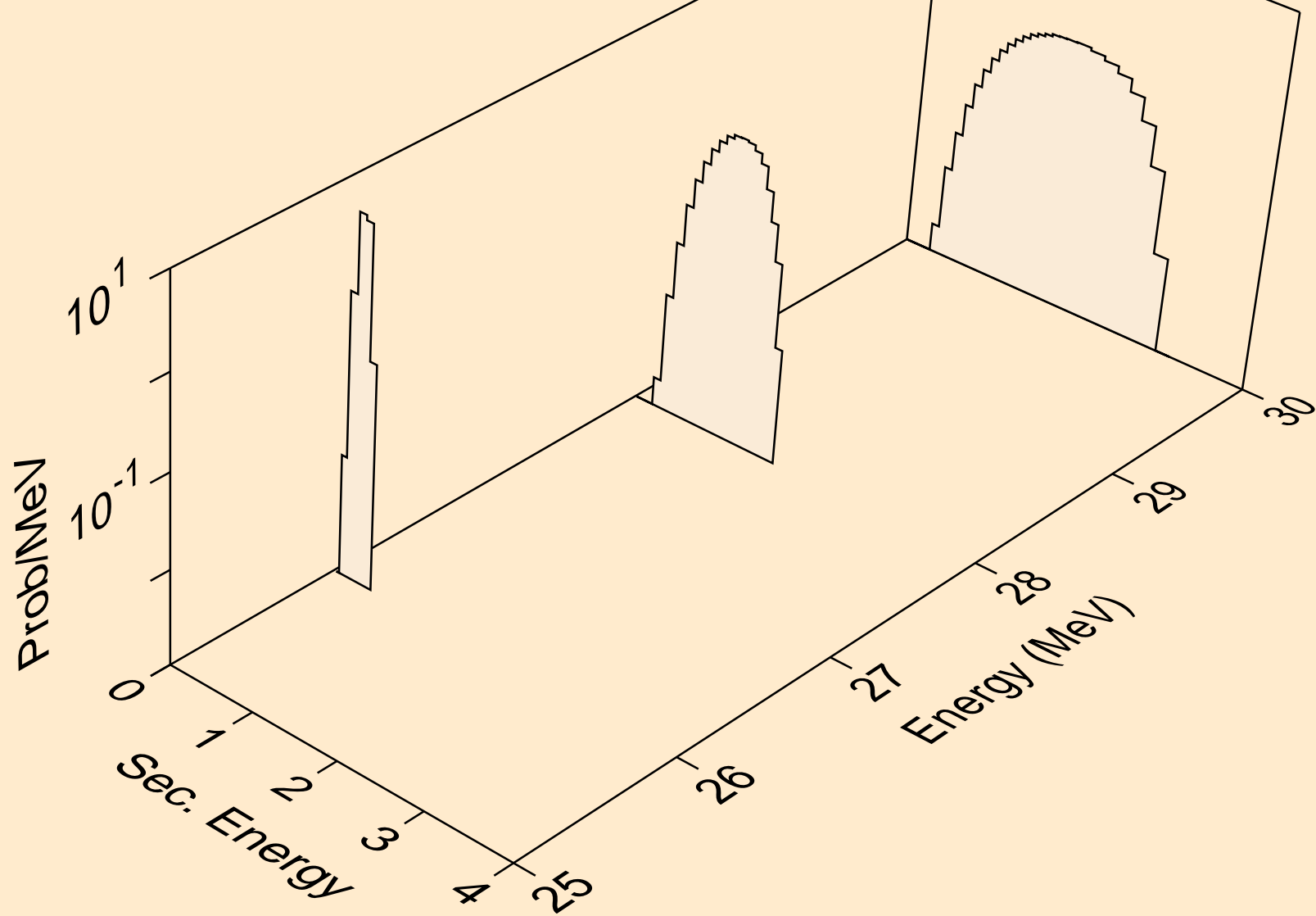

C014 TRITON ACER TENDL-2021 LIBRARY; T=0.K  
Photon emission for (z,n)

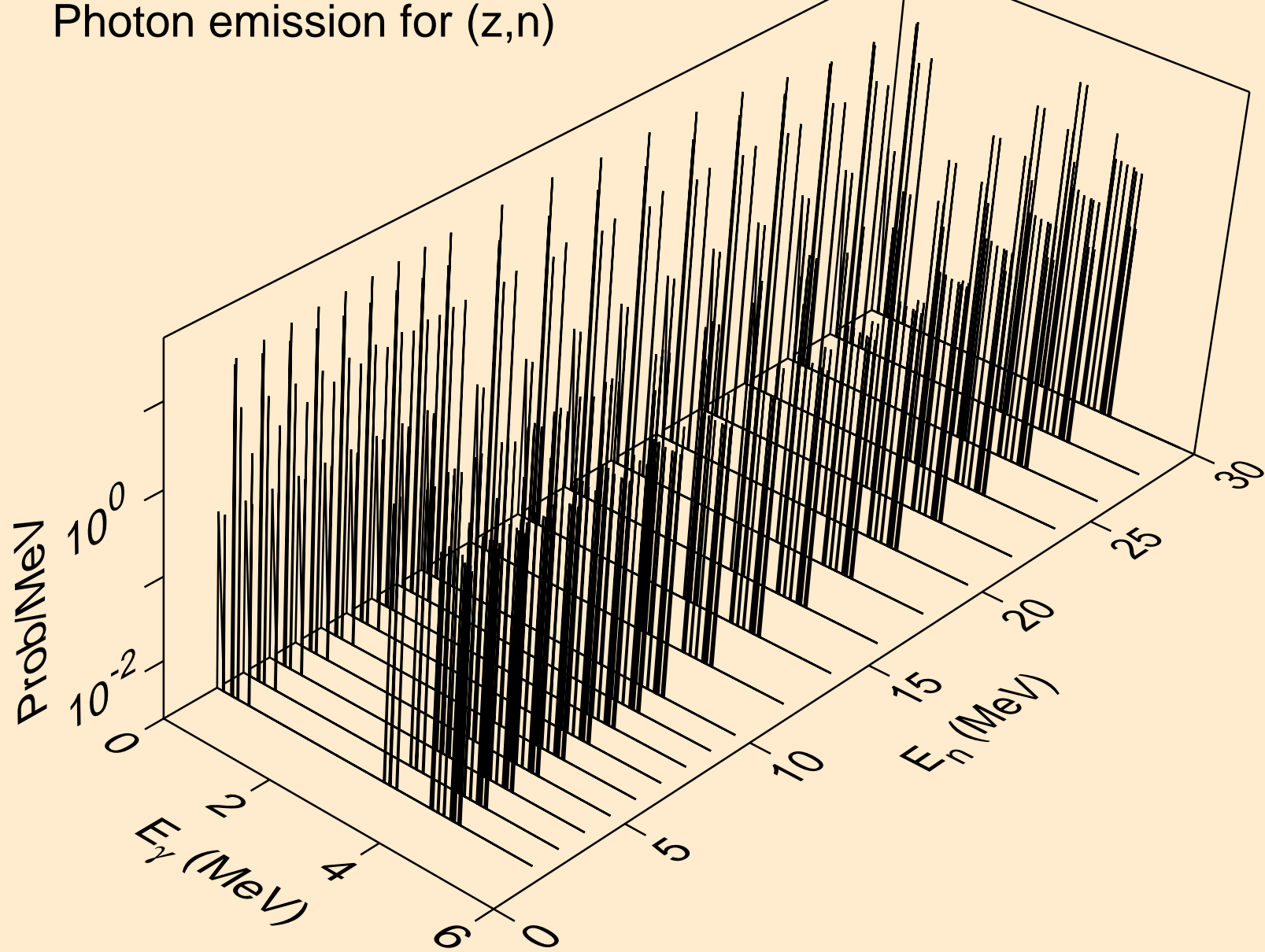

C014 TRITON ACER TENDL-2021 LIBRARY; T=0.K  
Photon emission for (n,x)

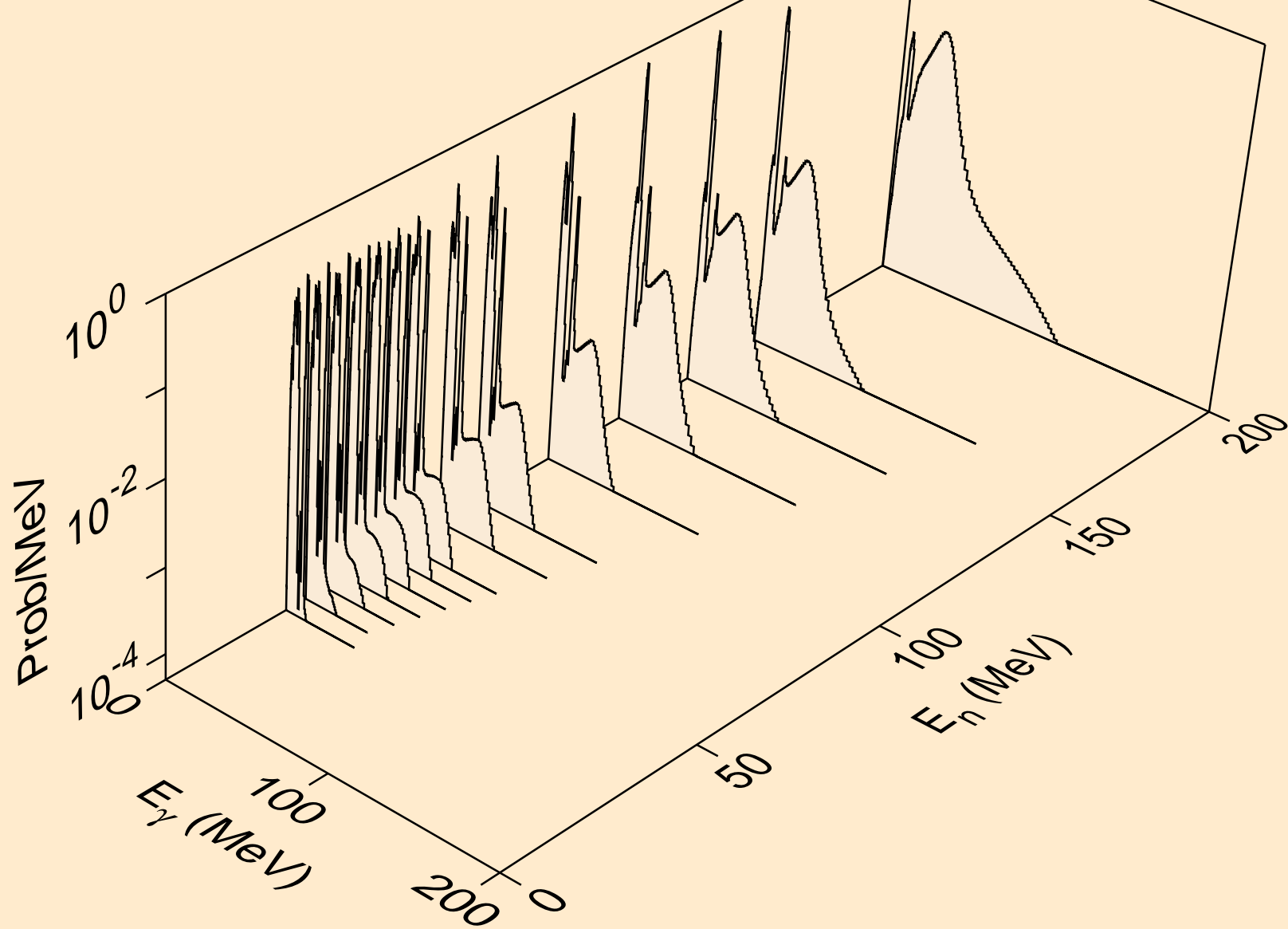

C014 TRITON ACER TENDL-2021 LIBRARY; T=0.K  
Photon emission for (n,2nd)

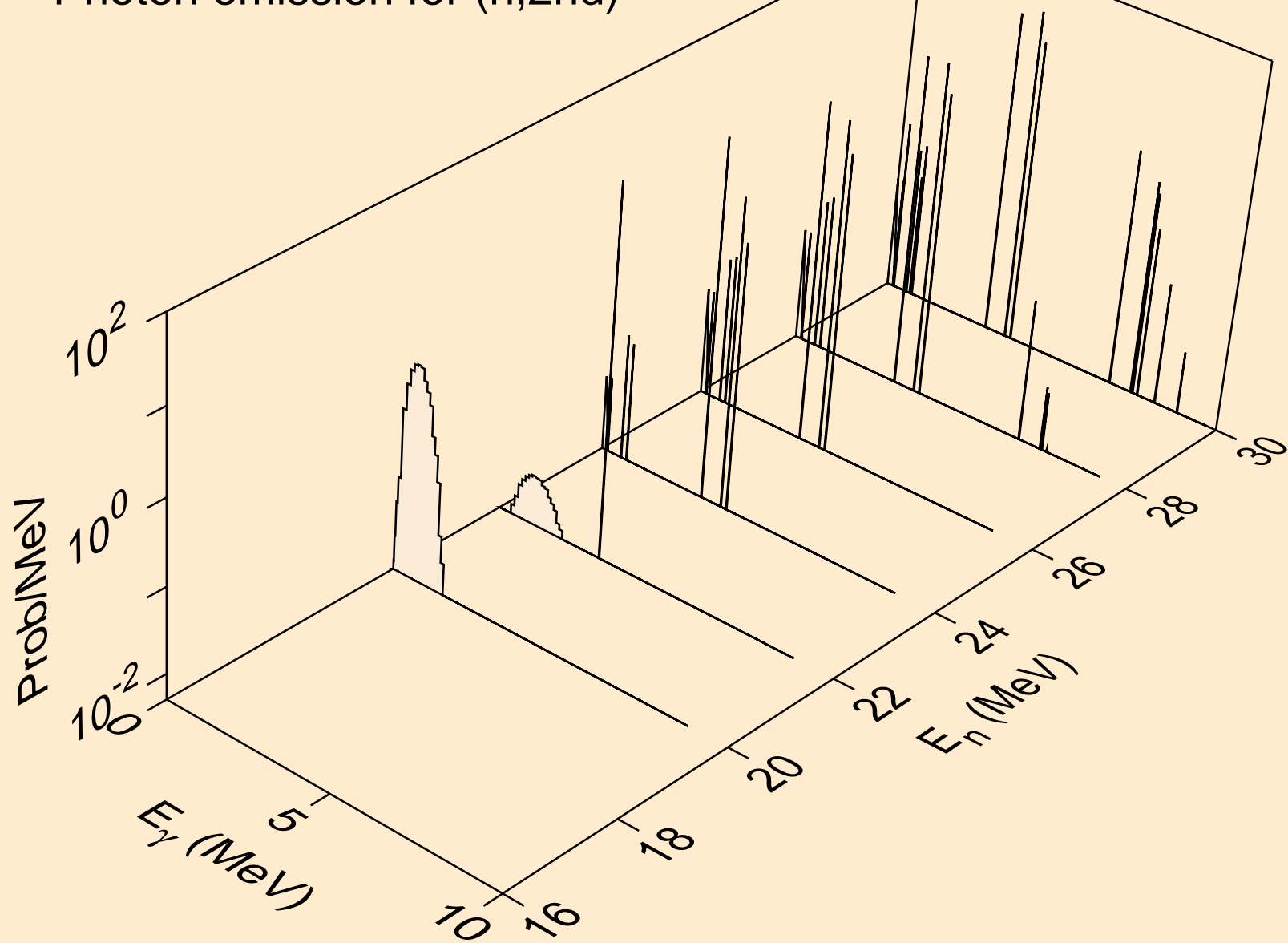

C014 TRITON ACER TENDL-2021 LIBRARY; T=0.K  
Photon emission for (n,2n)

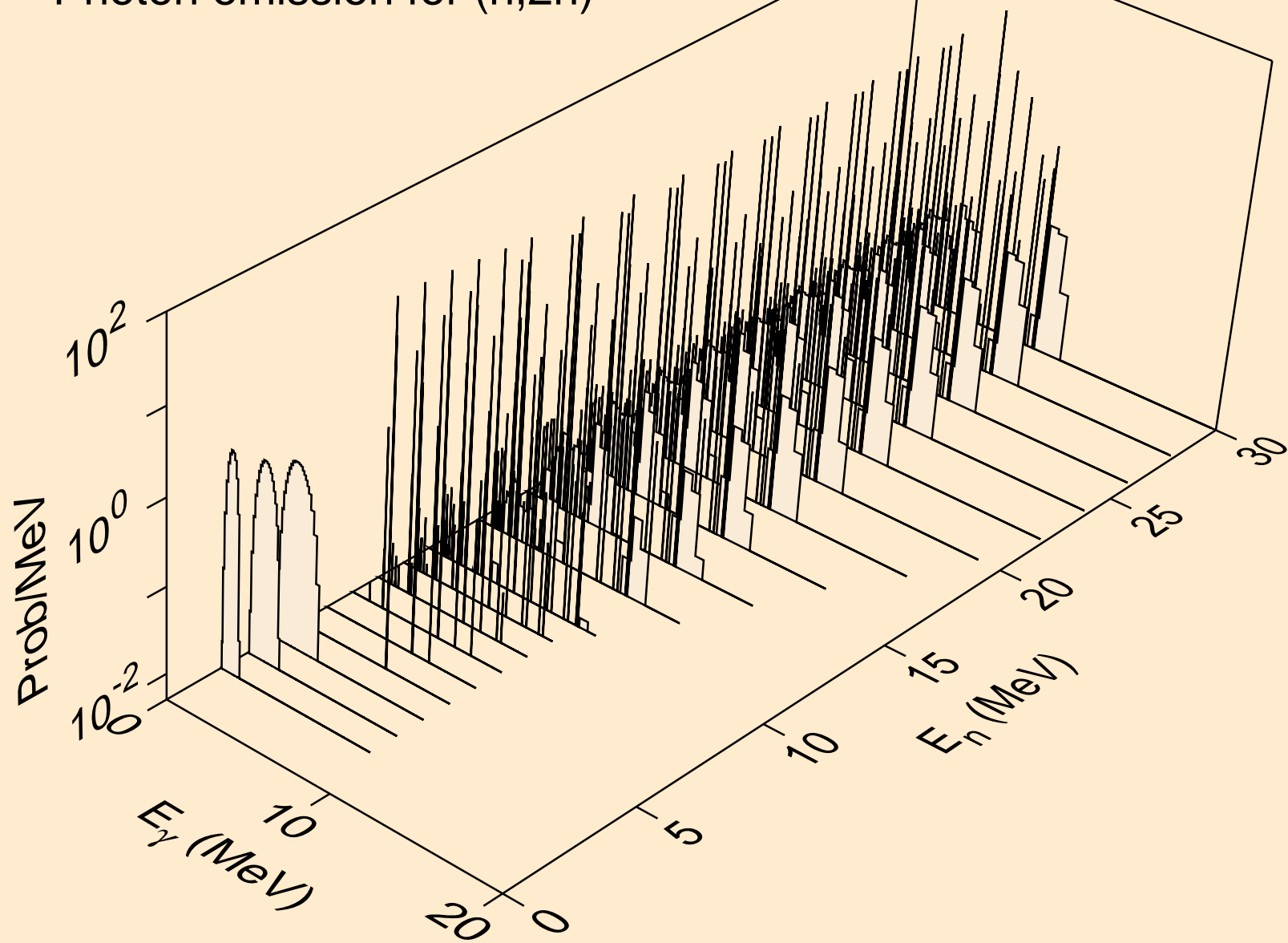



C014 TRITON ACER TENDL-2021 LIBRARY; T=0.K  
Photon emission for (n,3n)

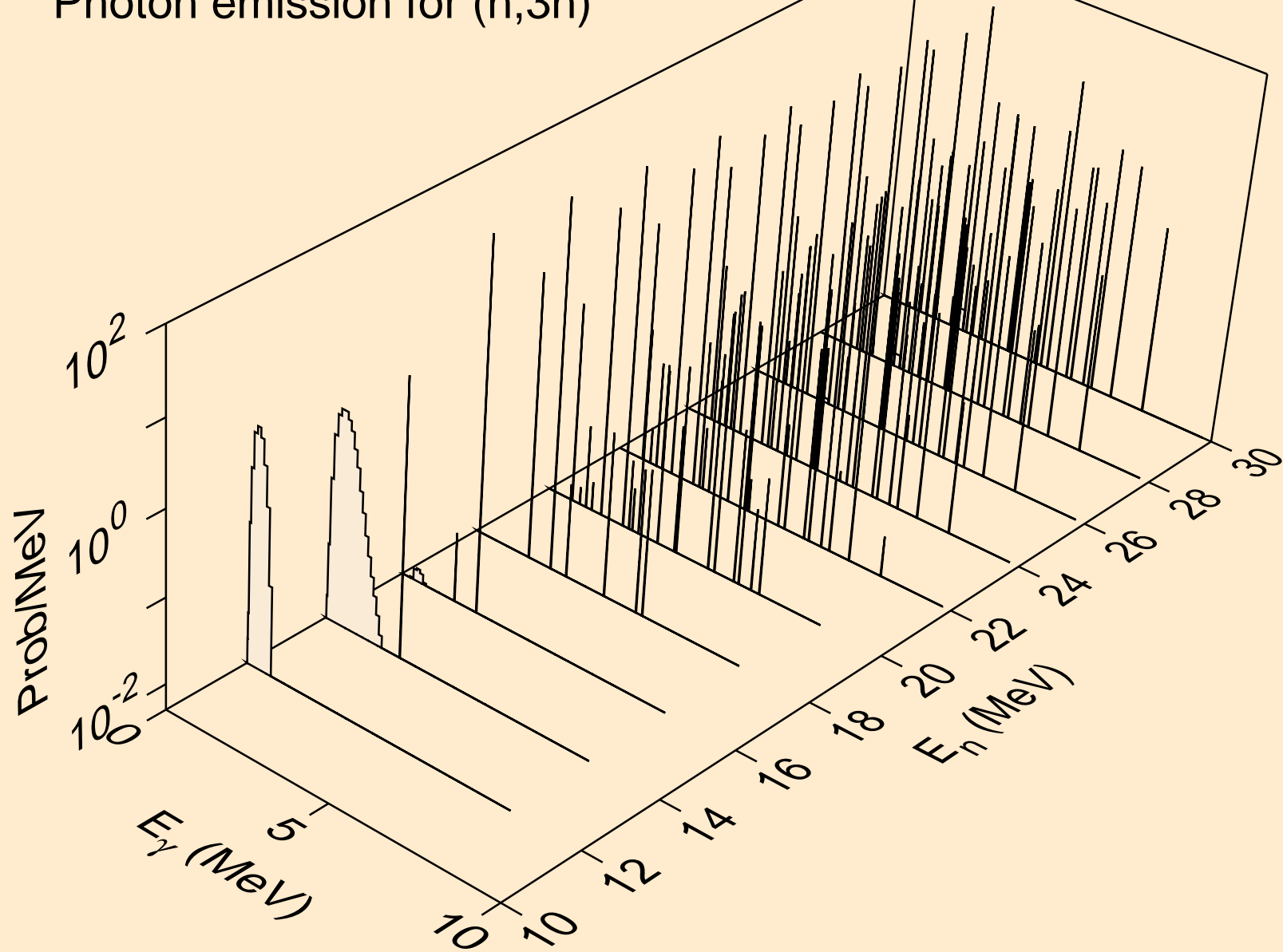

C014 TRITON ACER TENDL-2021 LIBRARY; T=0.K  
Photon emission for (n,n\*)a

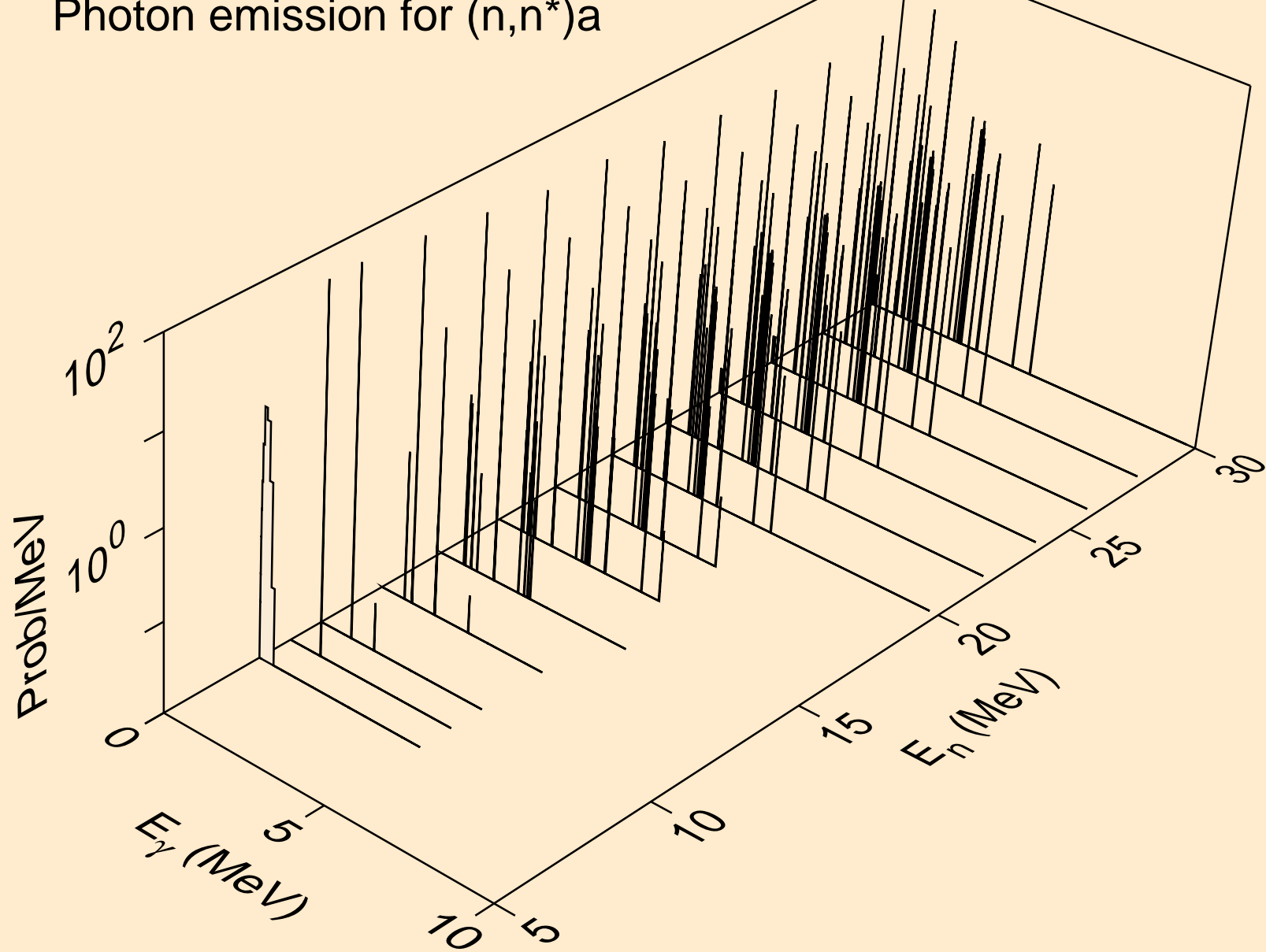

C014 TRITON ACER TENDL-2021 LIBRARY; T=0.K  
Photon emission for (n,2n)a

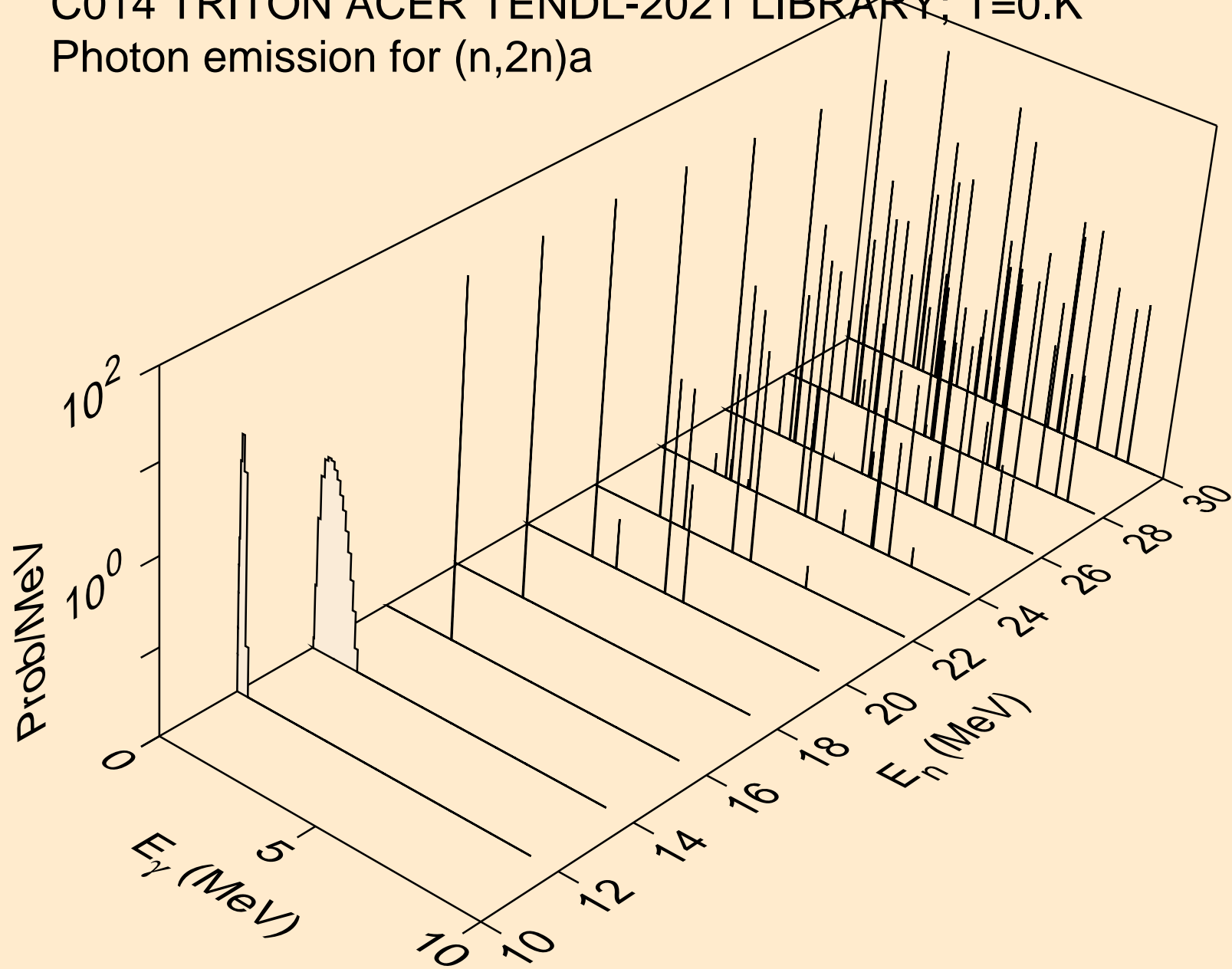

C014 TRITON ACER TENDL-2021 LIBRARY; T=0.K  
Photon emission for (n,3n)a

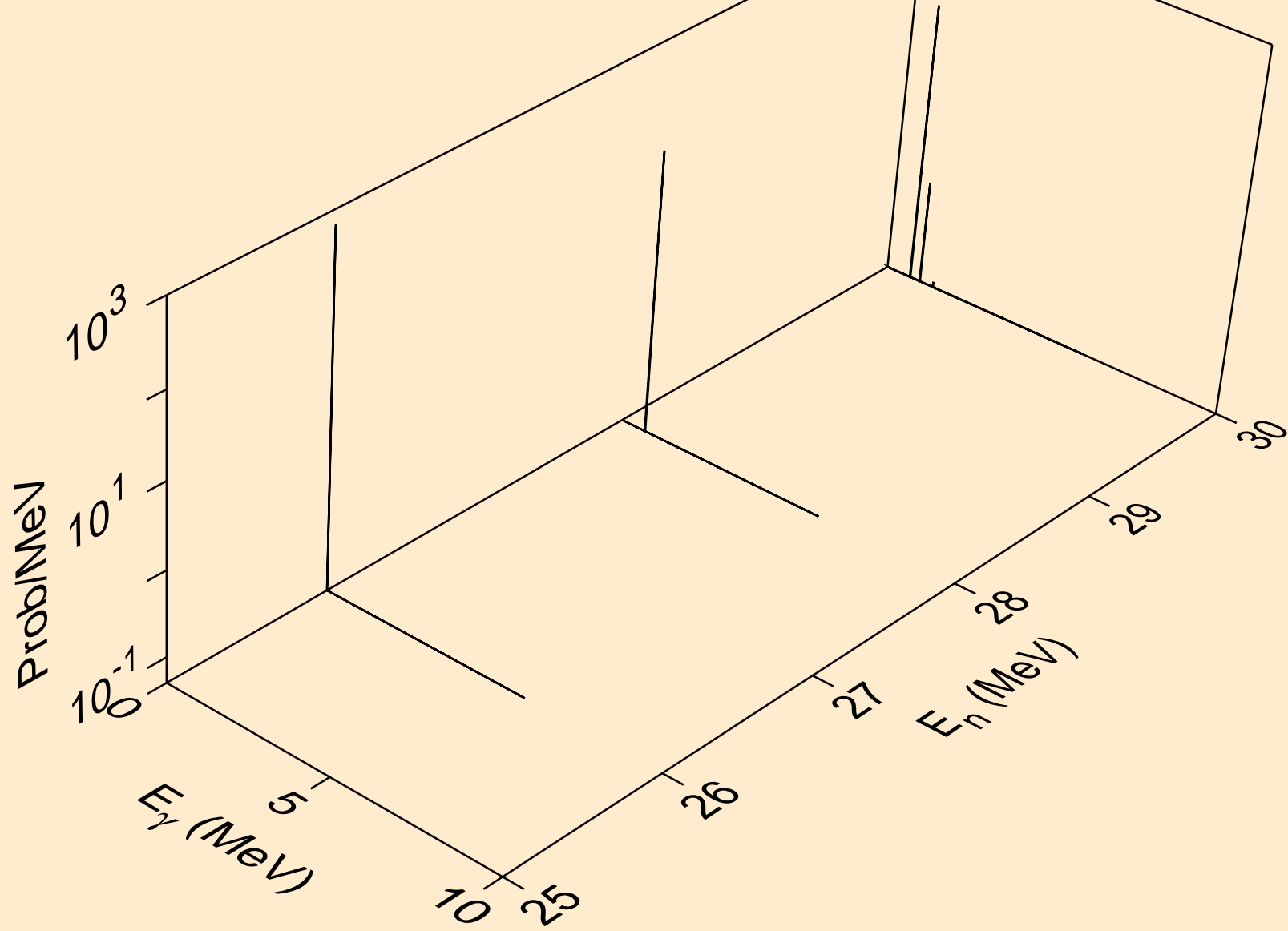

C014 TRITON ACER TENDL-2021 LIBRARY; T=0.K  
Photon emission for (n,n\*)p

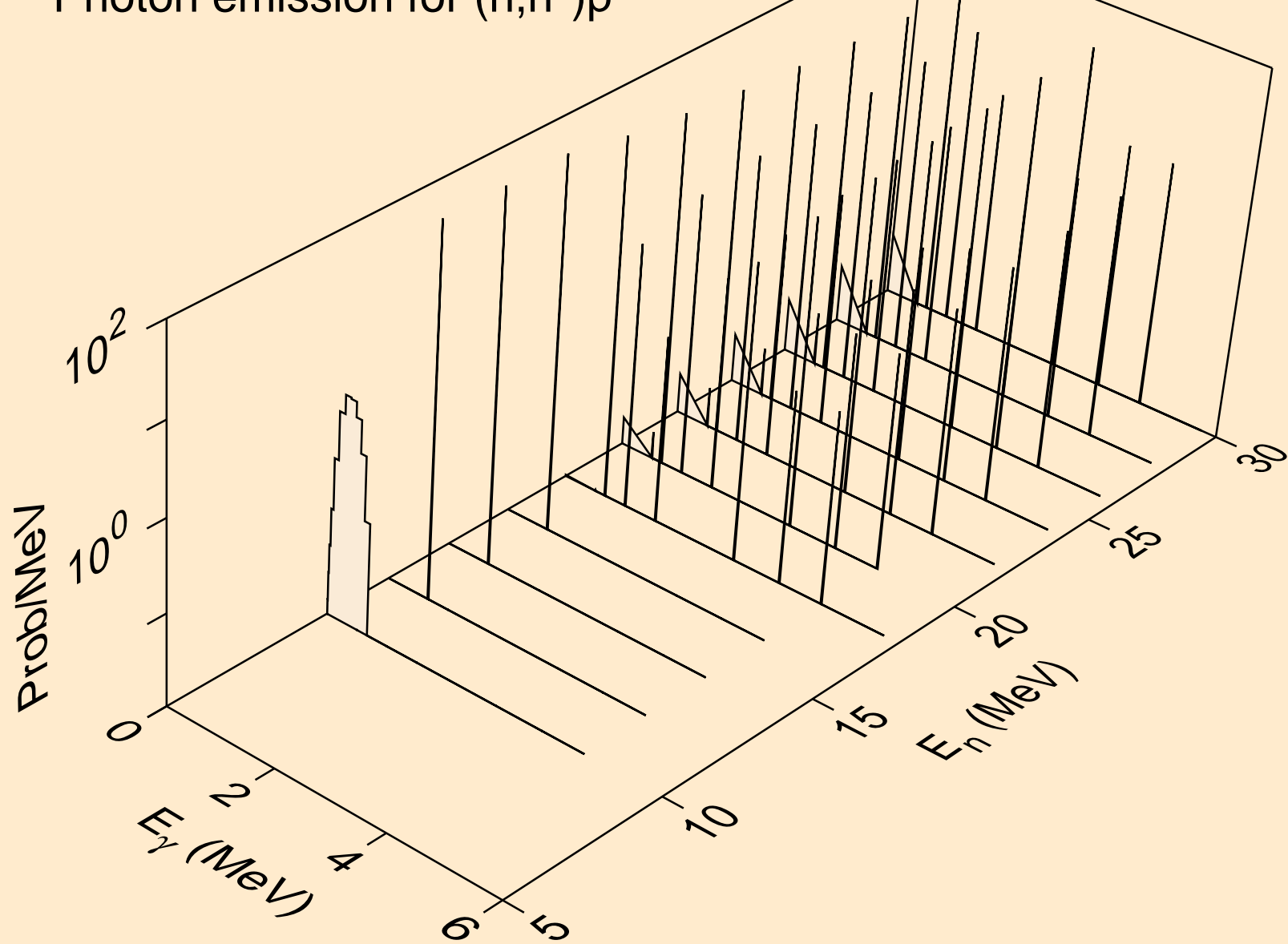

C014 TRITON ACER TENDL-2021 LIBRARY; T=0.K  
Photon emission for (n,n\*)2a

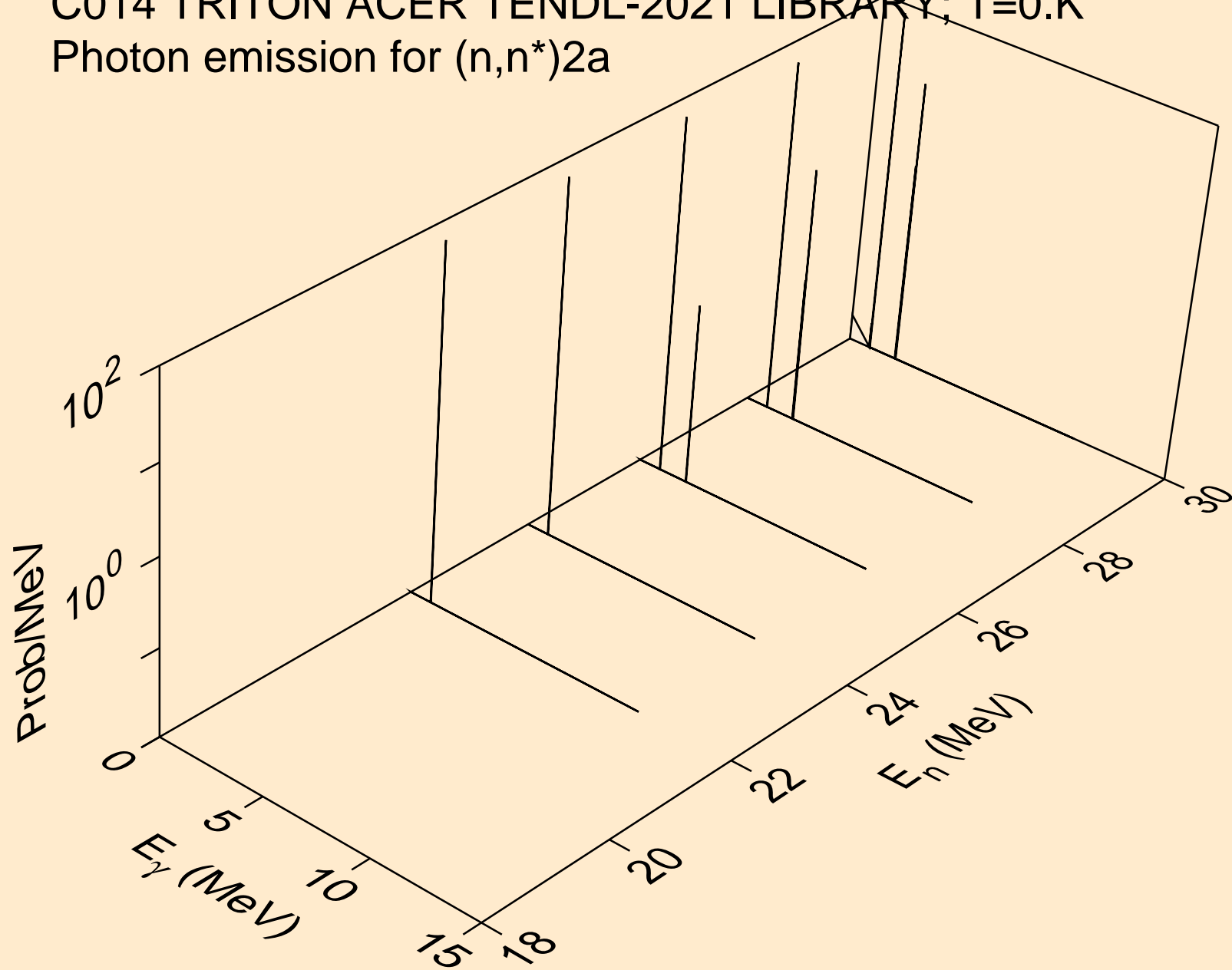

C014 TRITON ACER TENDL-2021 LIBRARY; T=0.K  
Photon emission for (n,2n)2a

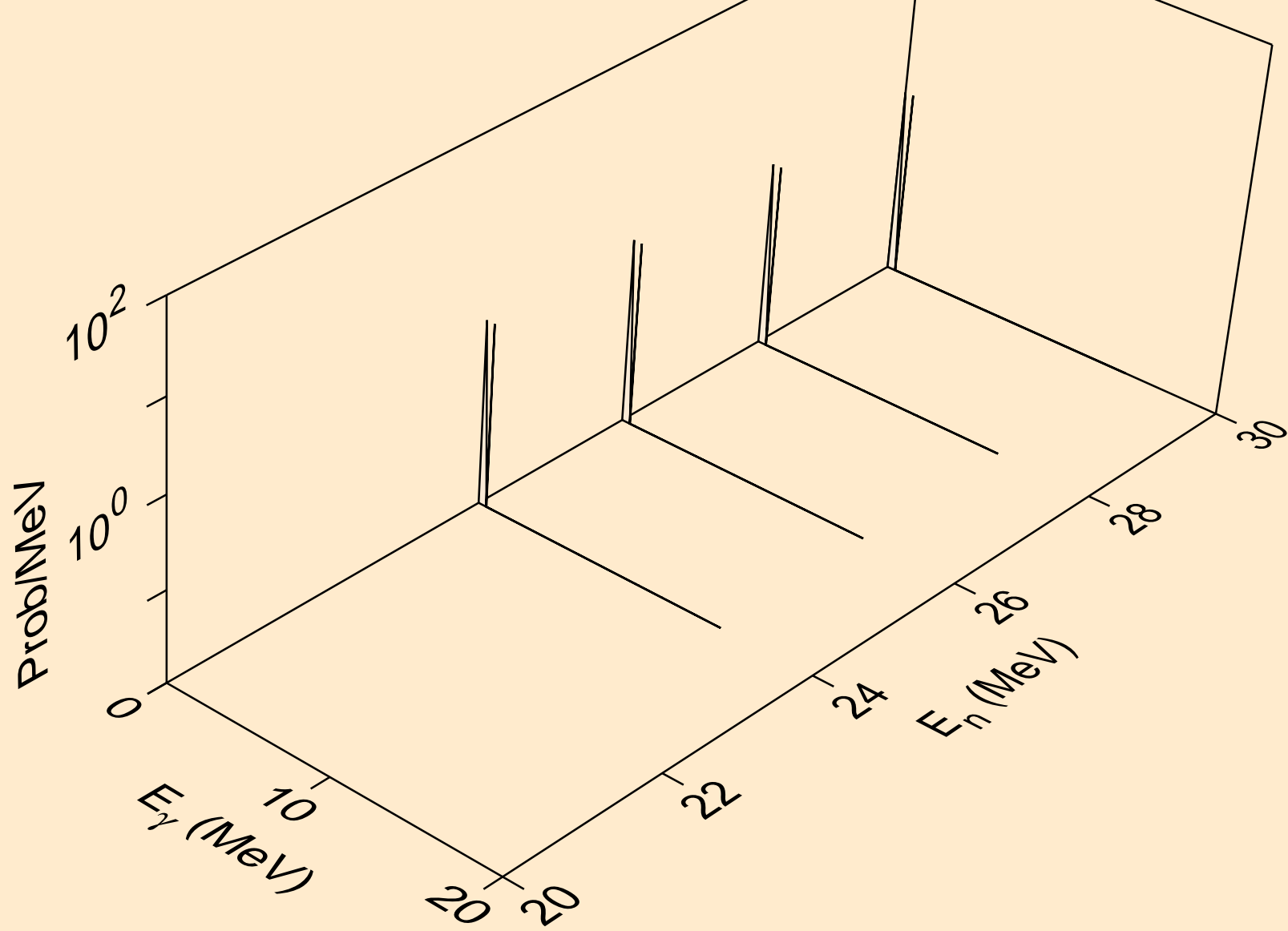

C014 TRITON ACER TENDL-2021 LIBRARY; T=0.K  
Photon emission for (n,n\*)d

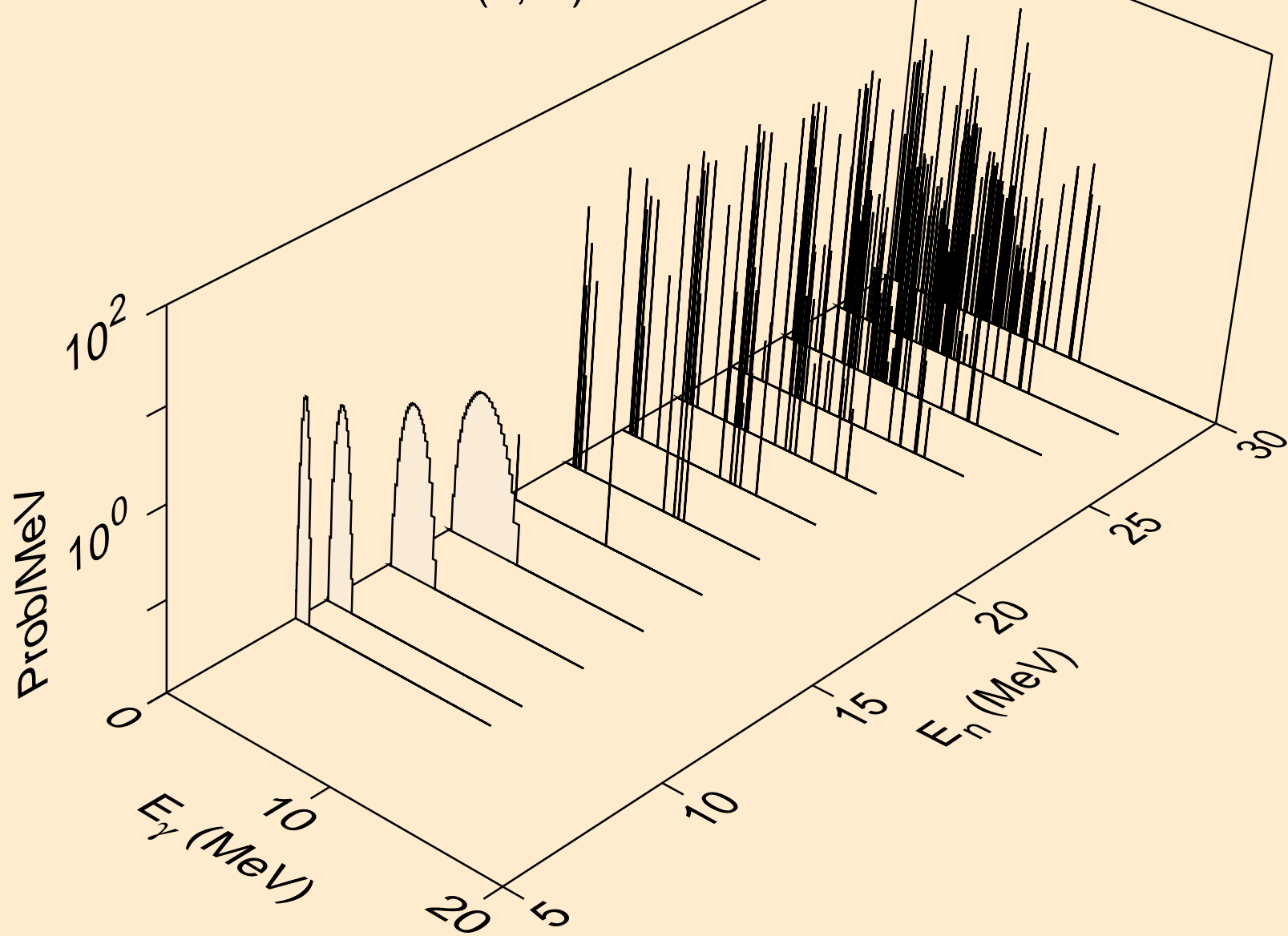



C014 TRITON ACER TENDL-2021 LIBRARY; T=0.K  
Photon emission for (n,n\*)t

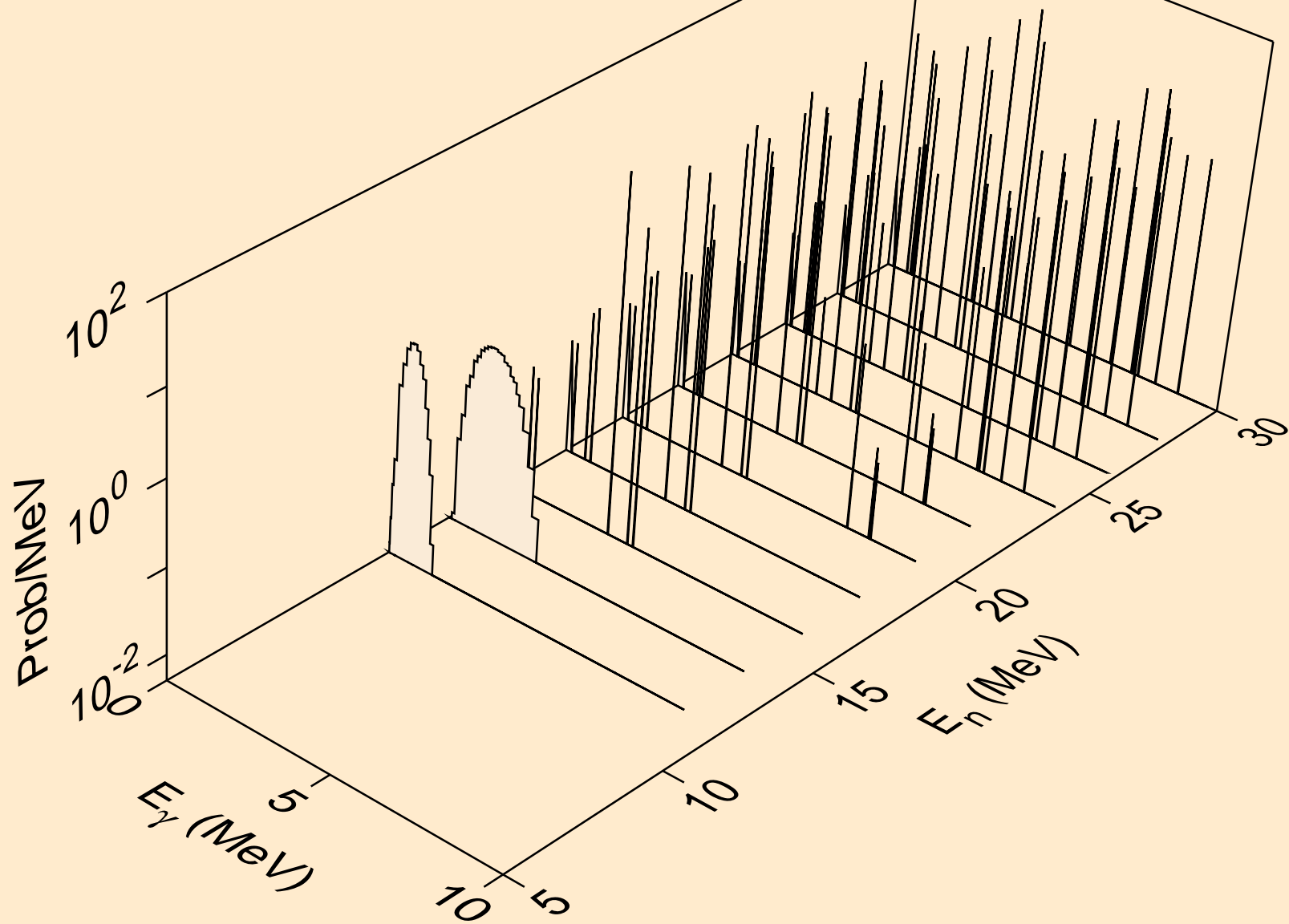

C014 TRITON ACER TENDL-2021 LIBRARY; T=0.K  
Photon emission for (n,n\*)he3

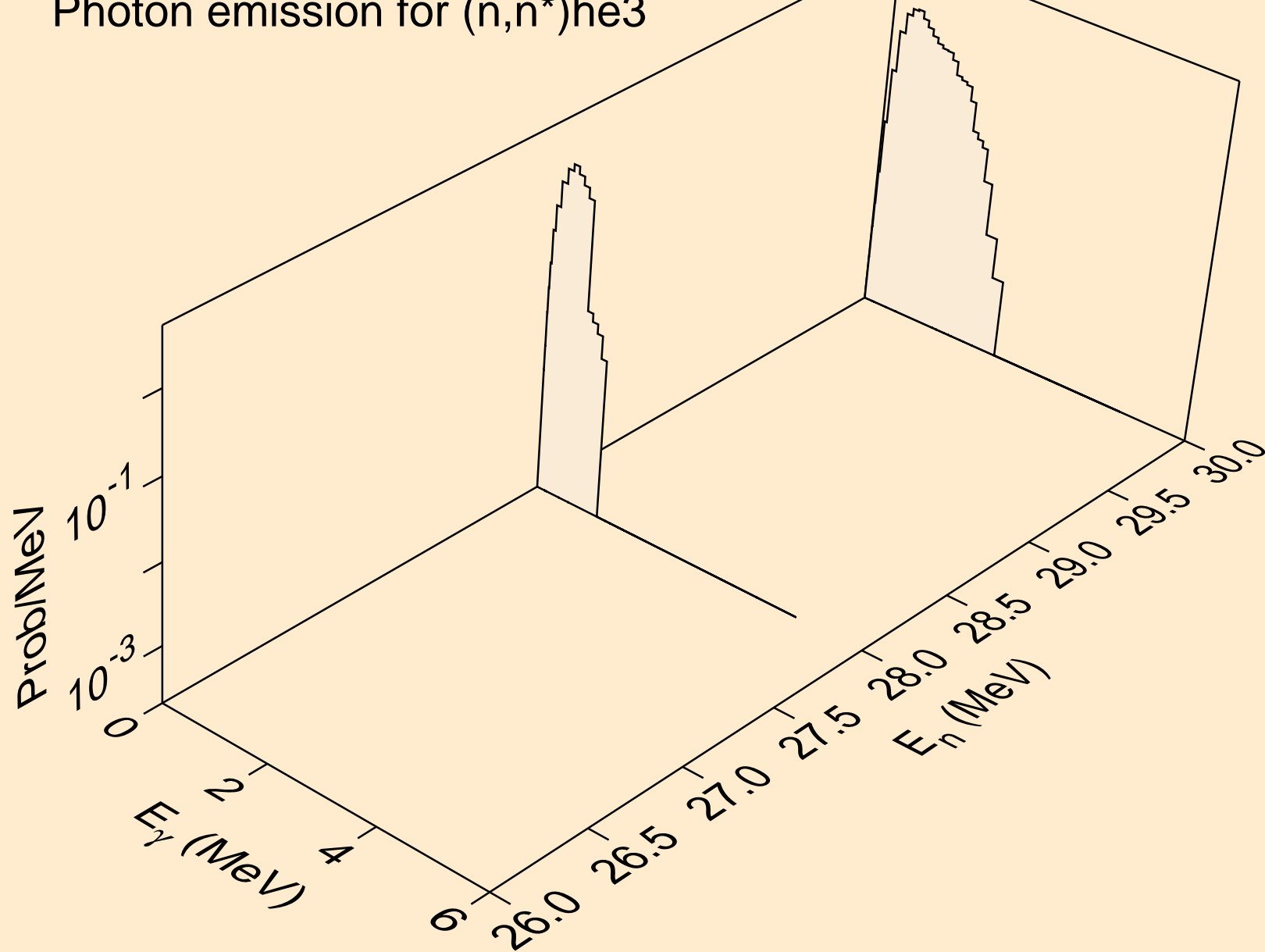

C014 TRITON ACER TENDL-2021 LIBRARY; T=0.K  
Photon emission for (n,4n)

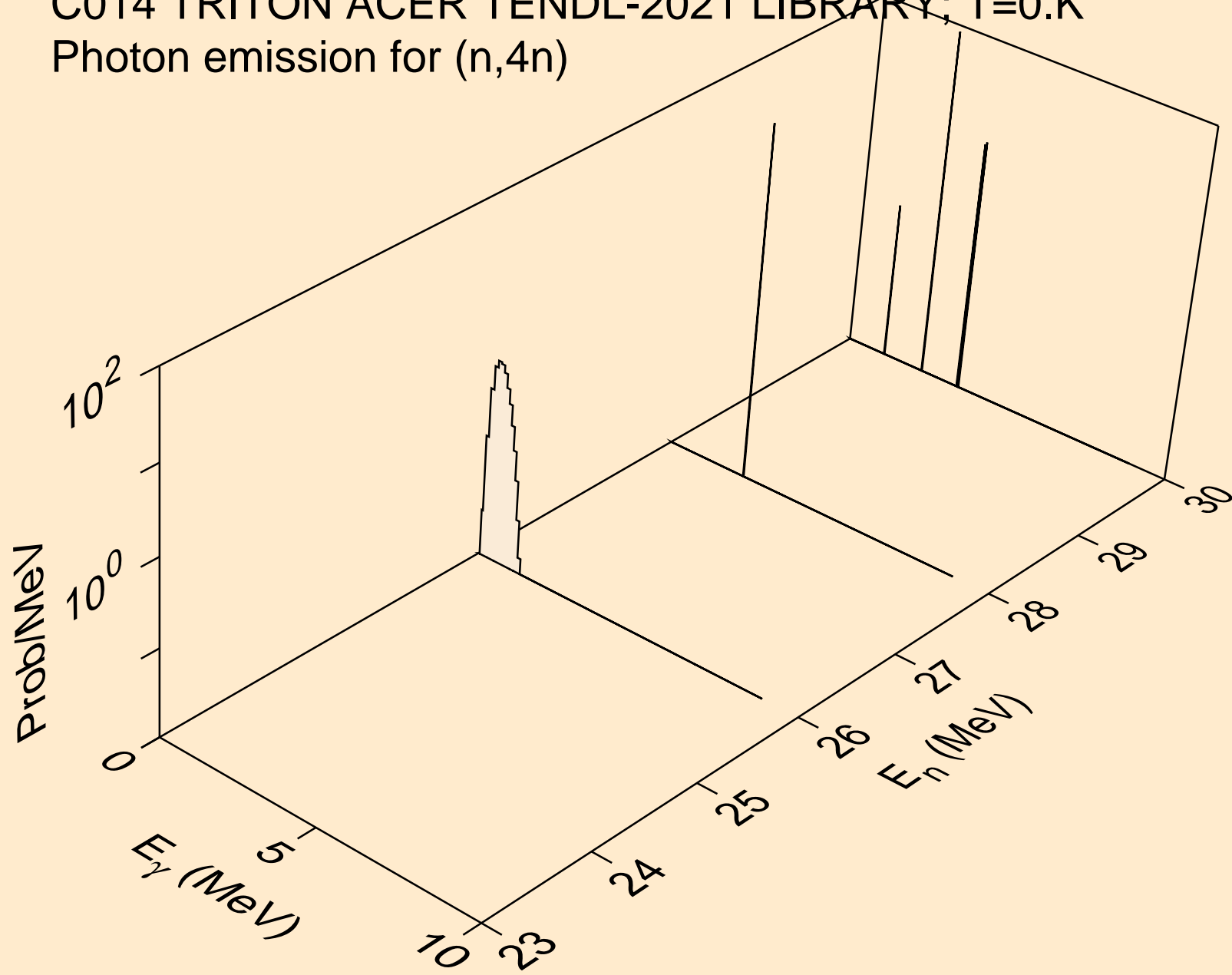

C014 TRITON ACER TENDL-2021 LIBRARY; T=0.K  
Photon emission for (n,2np)

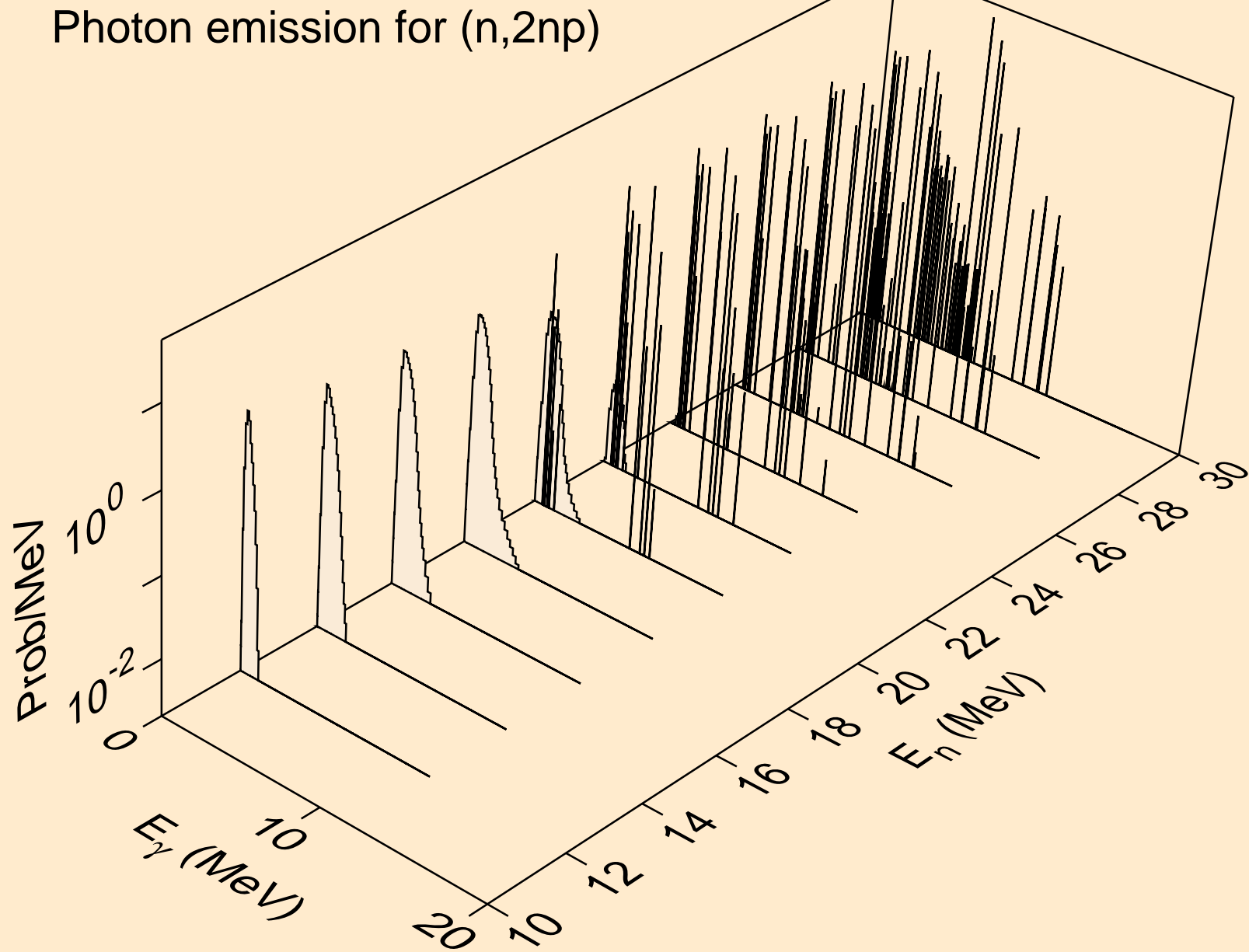

C014 TRITON ACER TENDL-2021 LIBRARY; T=0.K  
Photon emission for (n,3np)

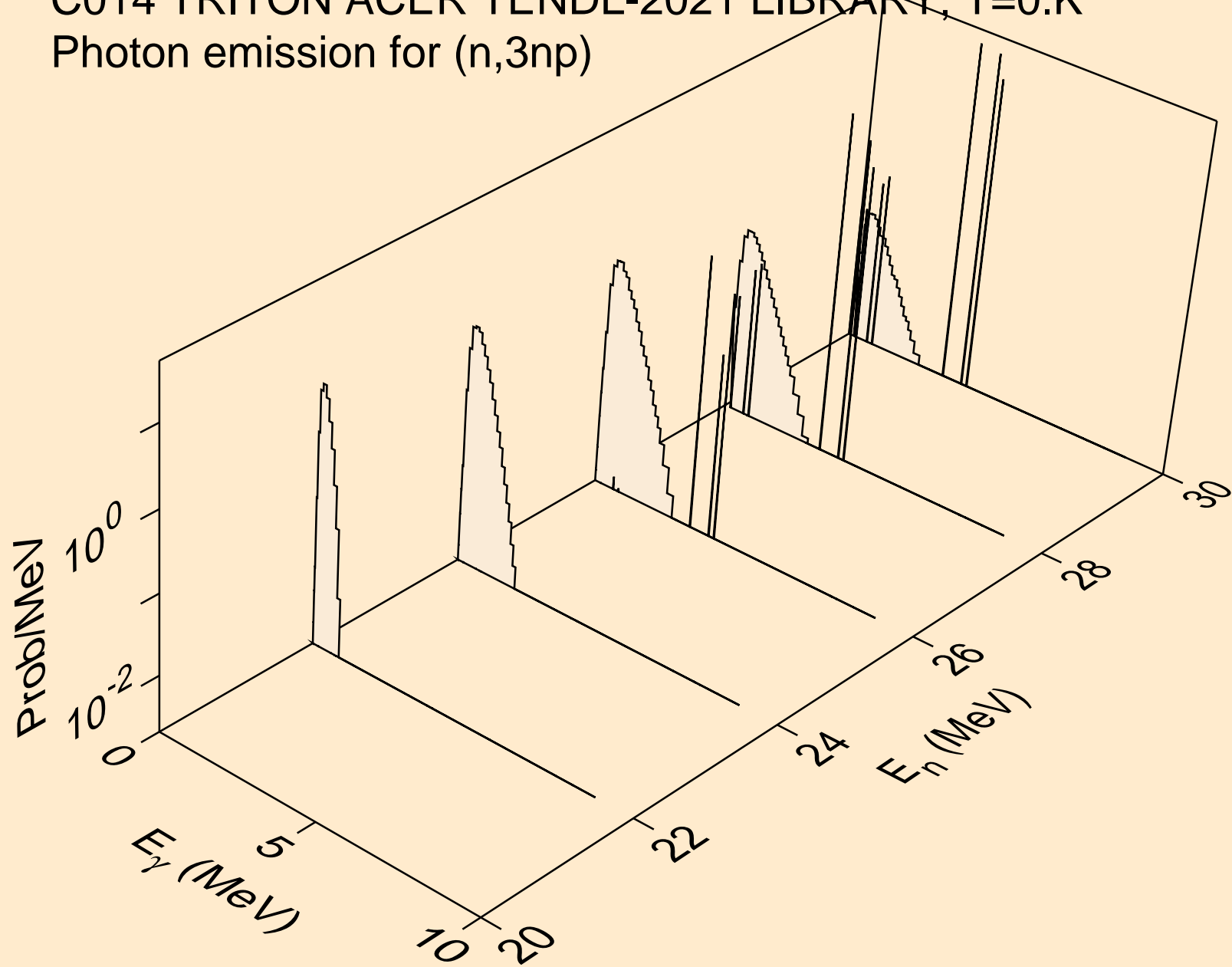

C014 TRITON ACER TENDL-2021 LIBRARY; T=0.K  
Photon emission for (n,npa)

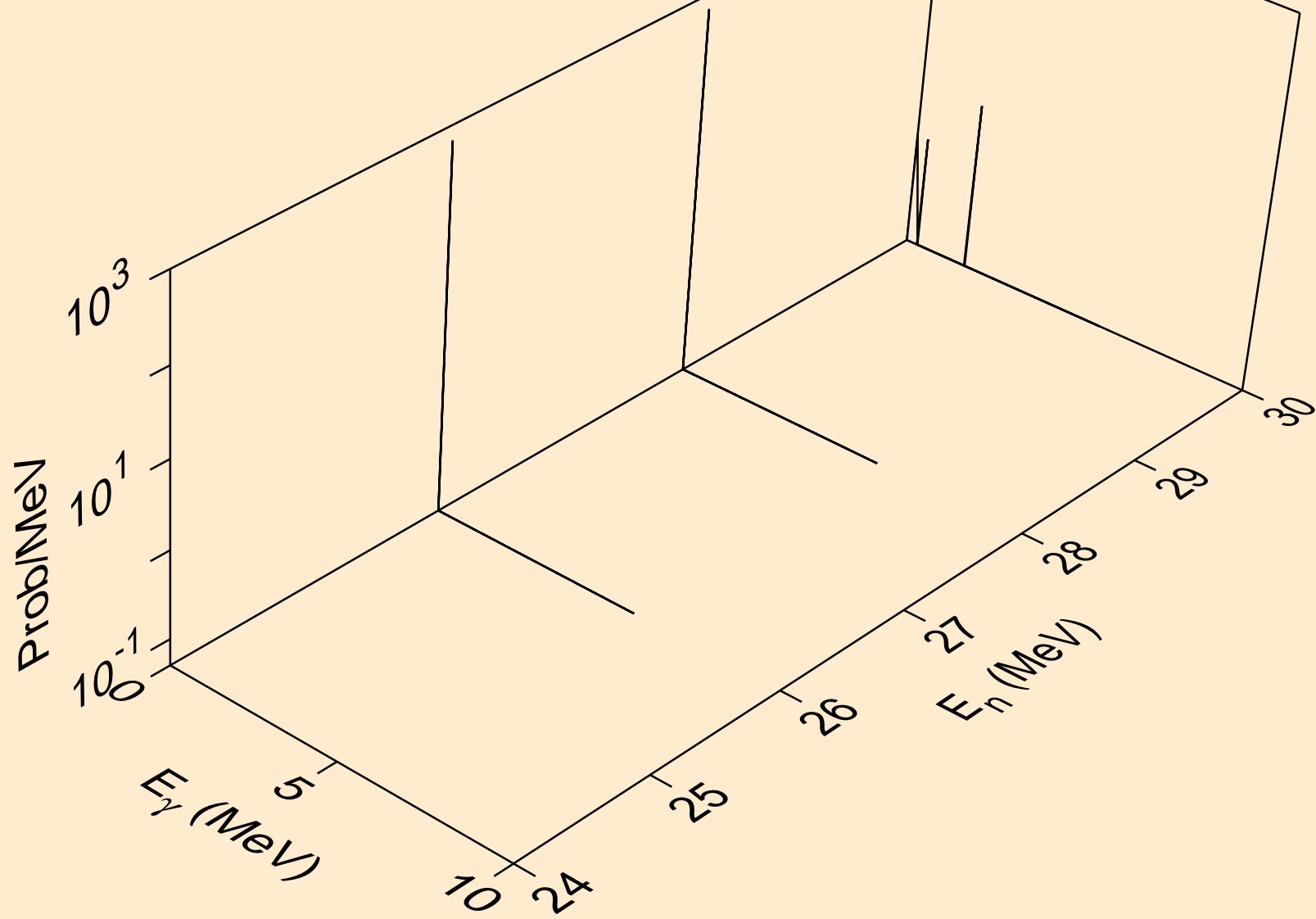

C014 TRITON ACER TENDL-2021 LIBRARY; T=0.K  
Photon emission for (n,gma)

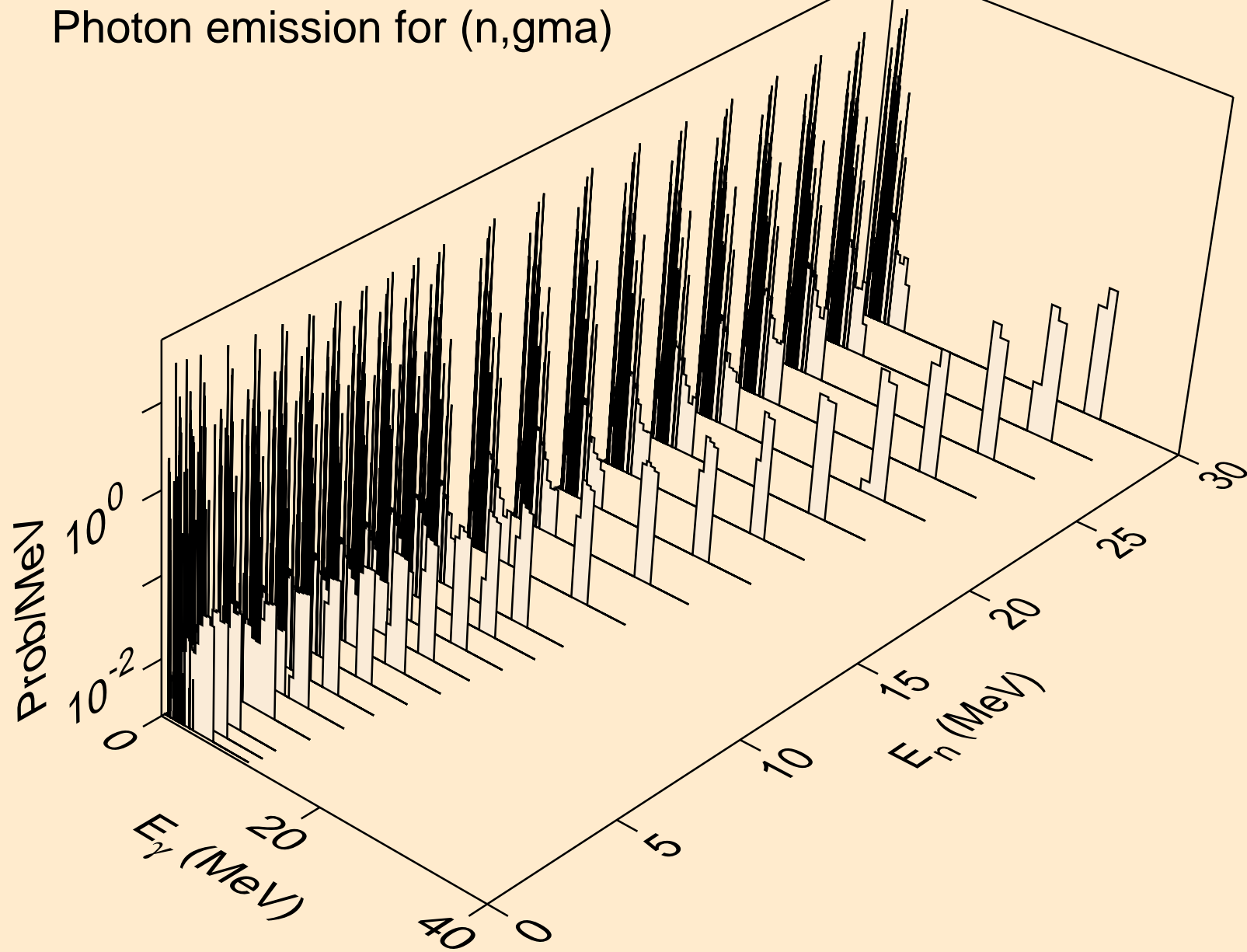

C014 TRITON ACER TENDL-2021 LIBRARY; T=0.K  
Photon emission for (n,p)

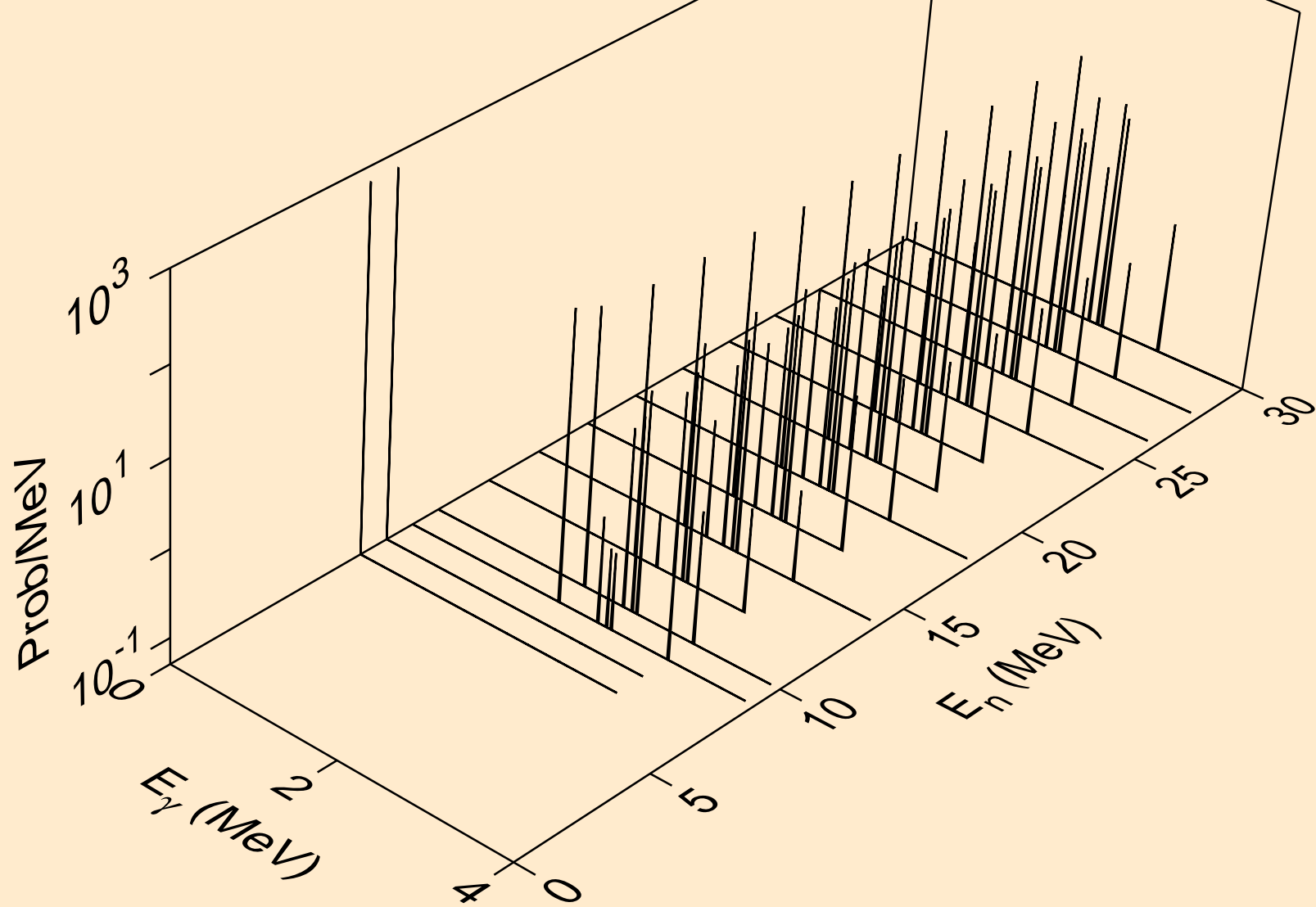



C014 TRITON ACER TENDL-2021 LIBRARY; T=0.K  
Photon emission for (n,d)

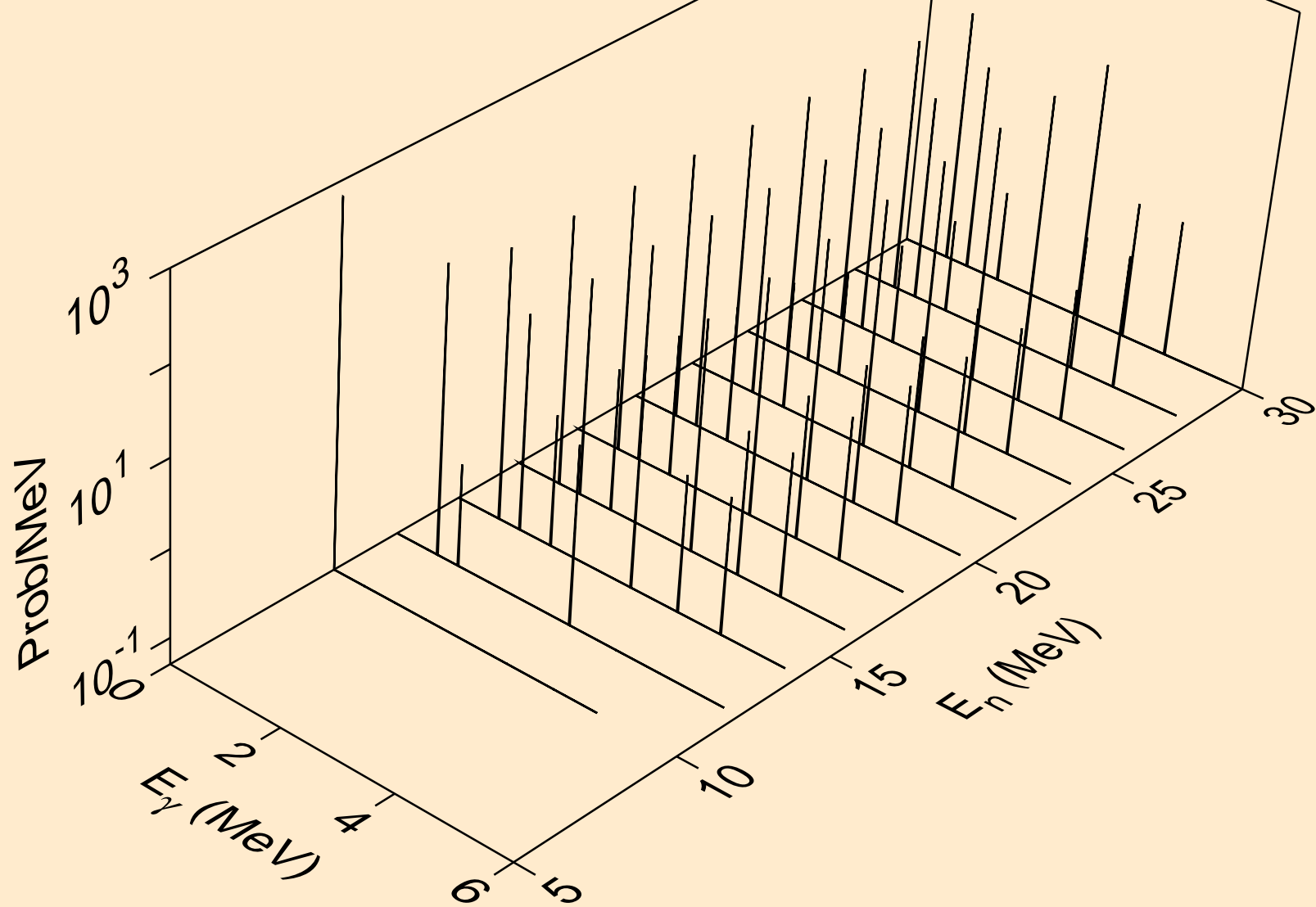

C014 TRITON ACER TENDL-2021 LIBRARY; T=0.K  
Photon emission for inelastic

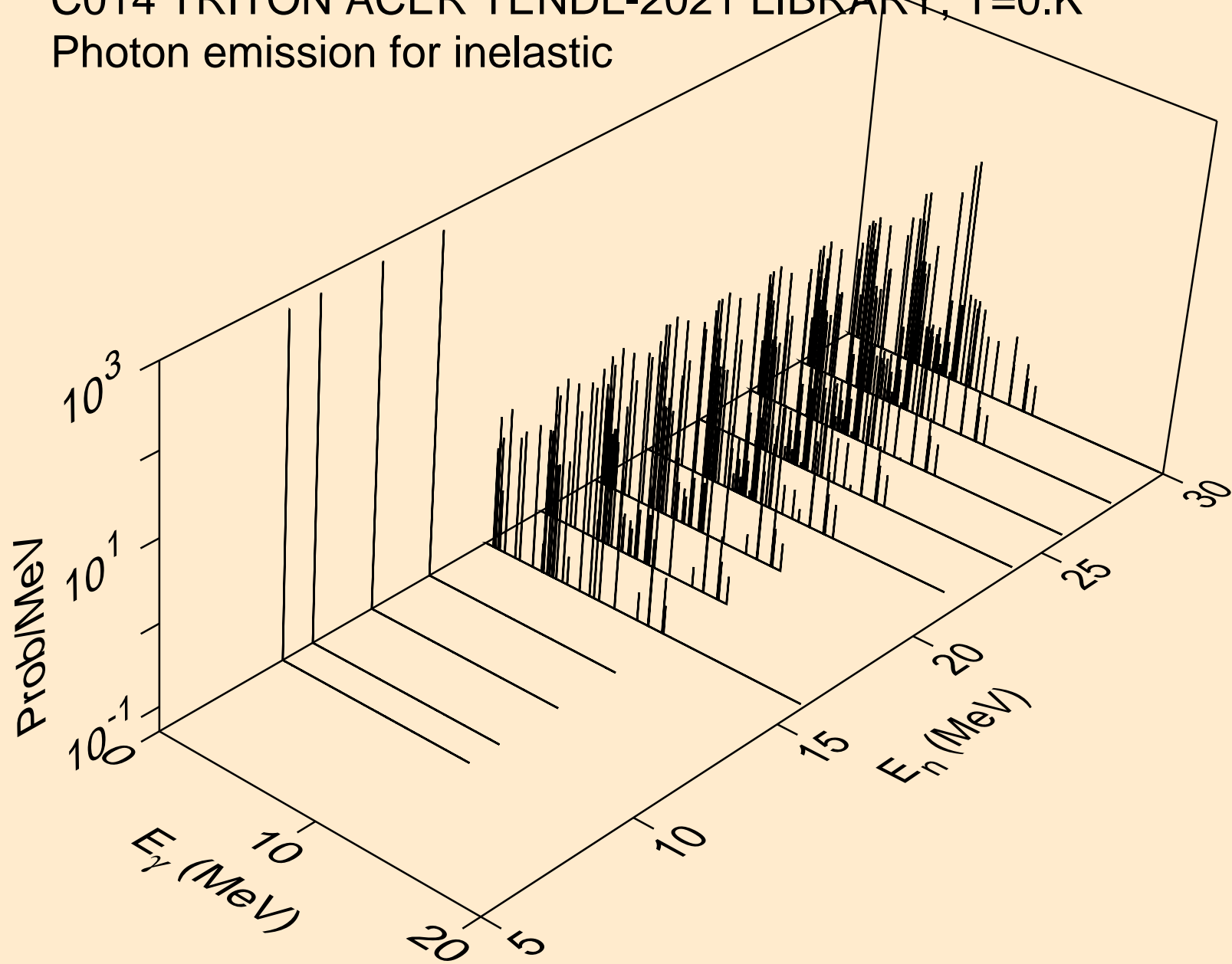

C014 TRITON ACER TENDL-2021 LIBRARY; T=0.K  
Photon emission for (n,he3)

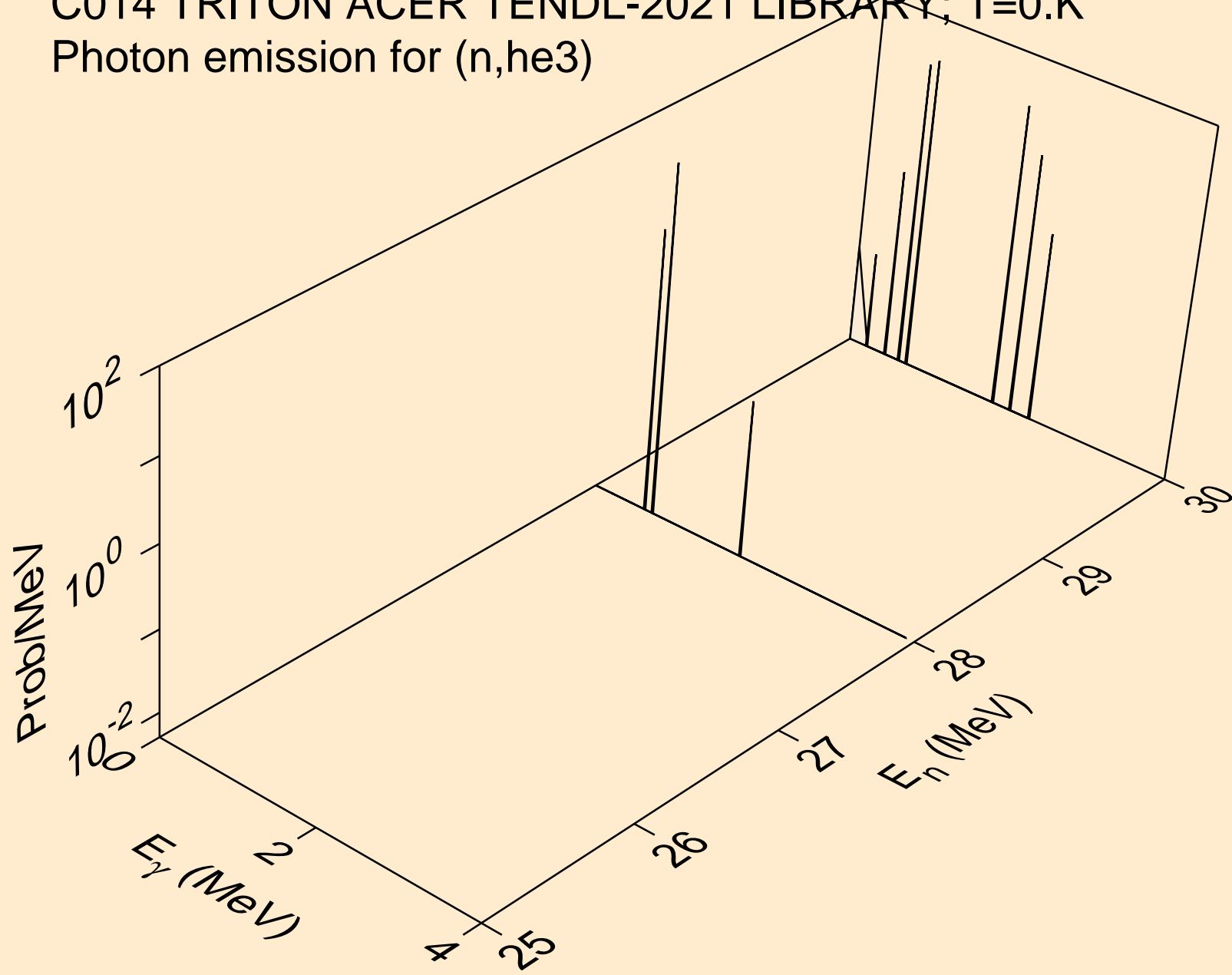

C014 TRITON ACER TENDL-2021 LIBRARY; T=0.K  
Photon emission for (n,a)

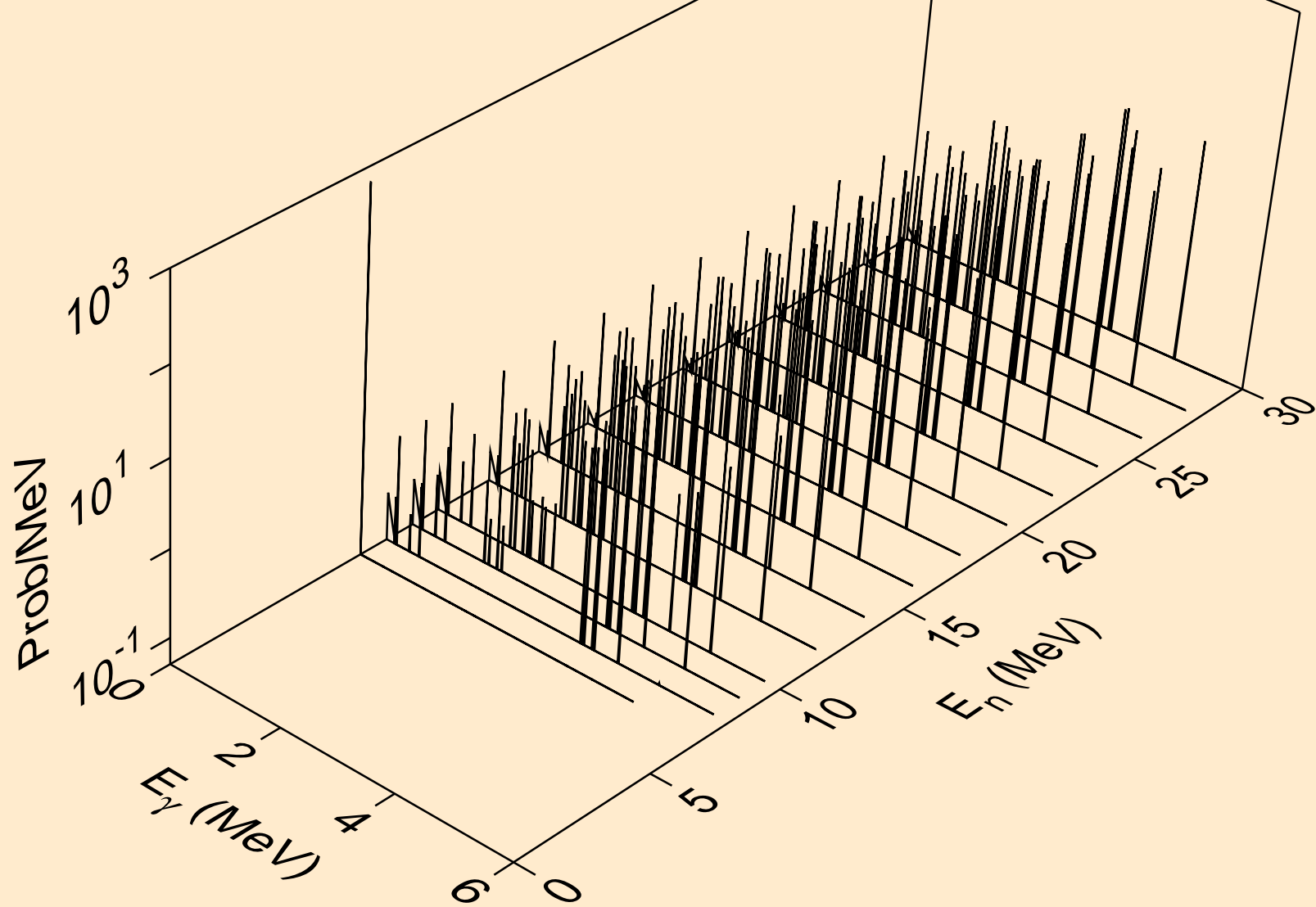

C014 TRITON ACER TENDL-2021 LIBRARY; T=0.K  
Photon emission for (n,2a)

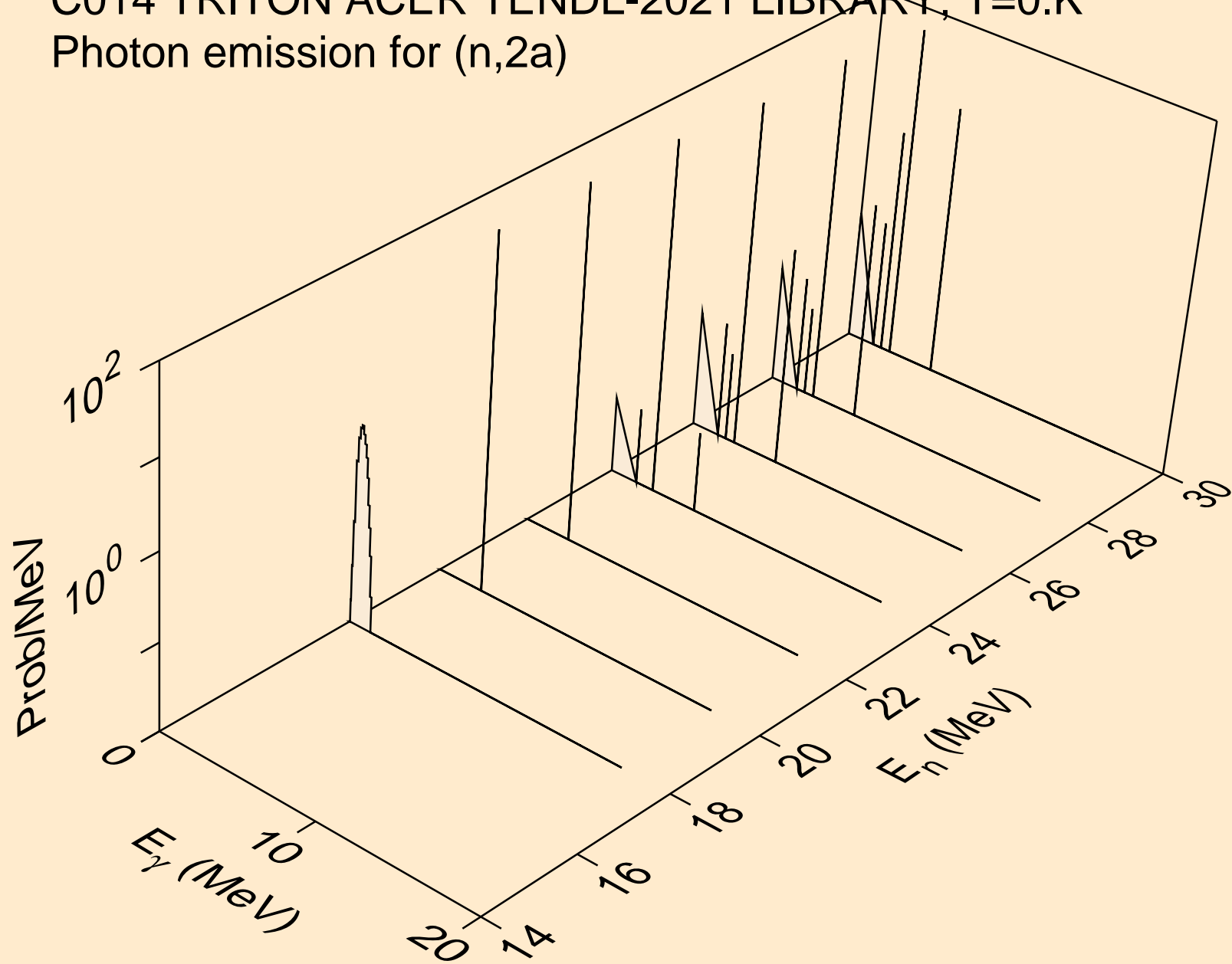

C014 TRITON ACER TENDL-2021 LIBRARY; T=0.K  
Photon emission for (n,pa)

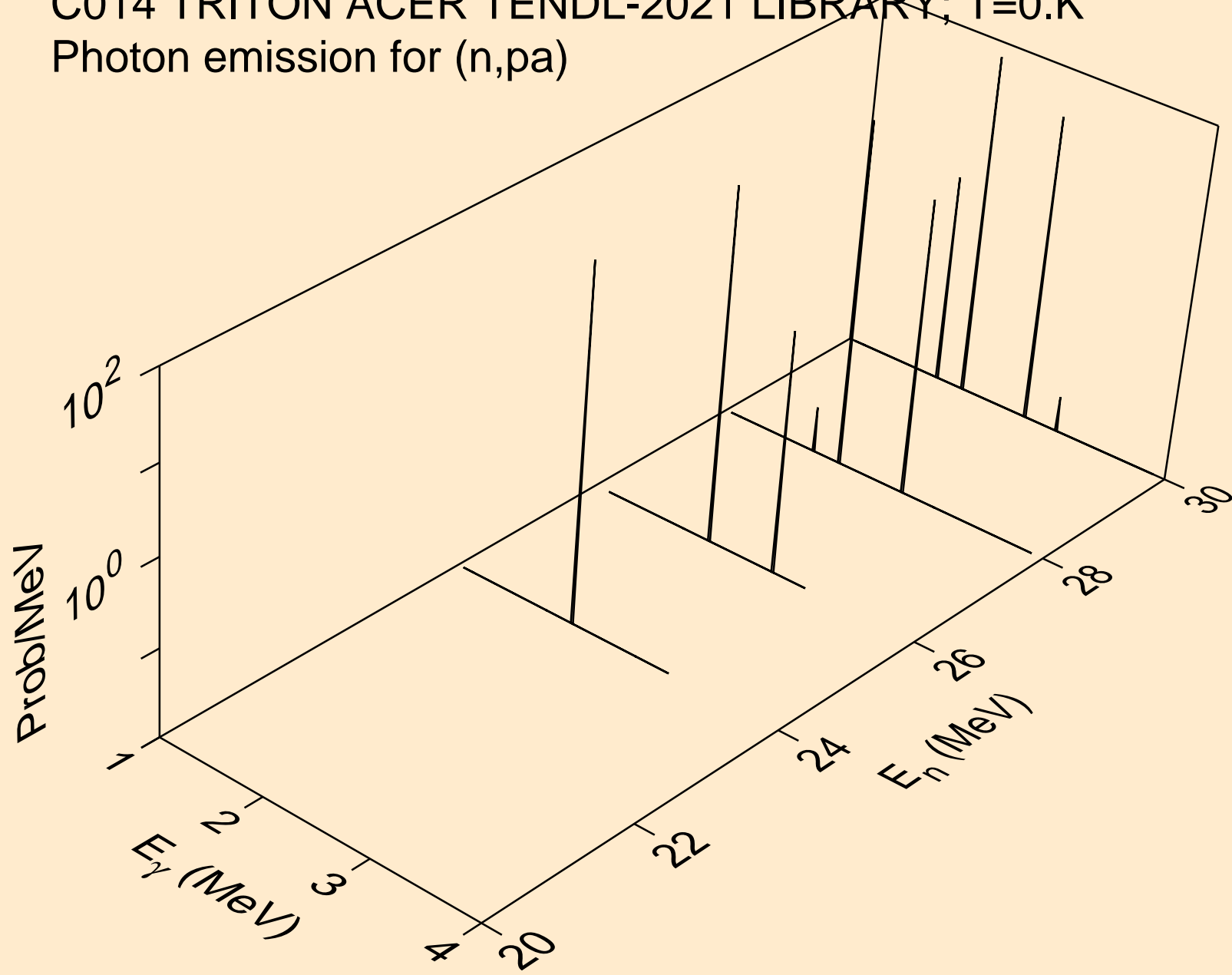

C014 TRITON ACER TENDL-2021 LIBRARY; T=0.K  
Photon emission for (n,pt)

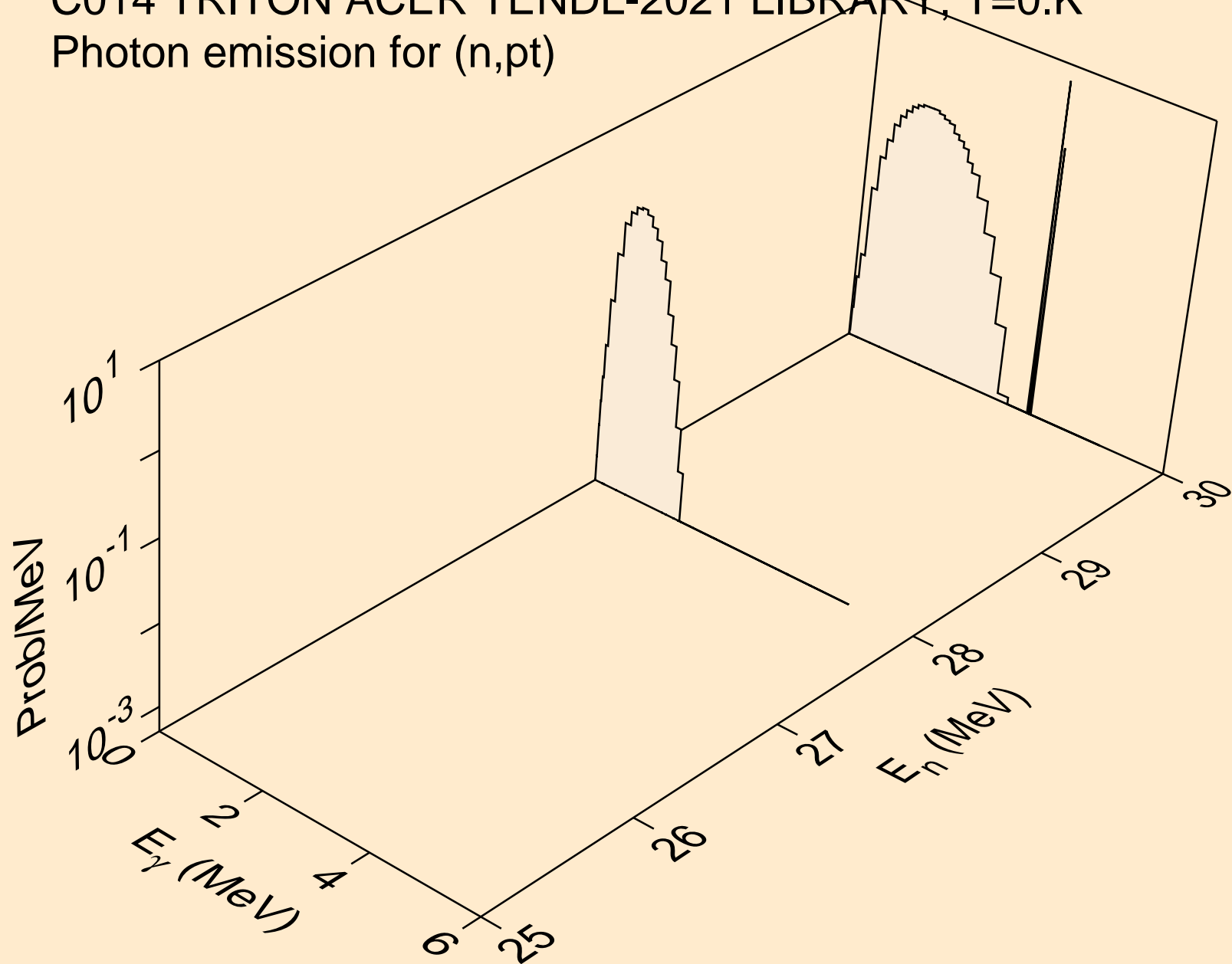

C014 TRITON ACER TENDL-2021 LIBRARY; T=0.K  
Photon emission for (n,da)

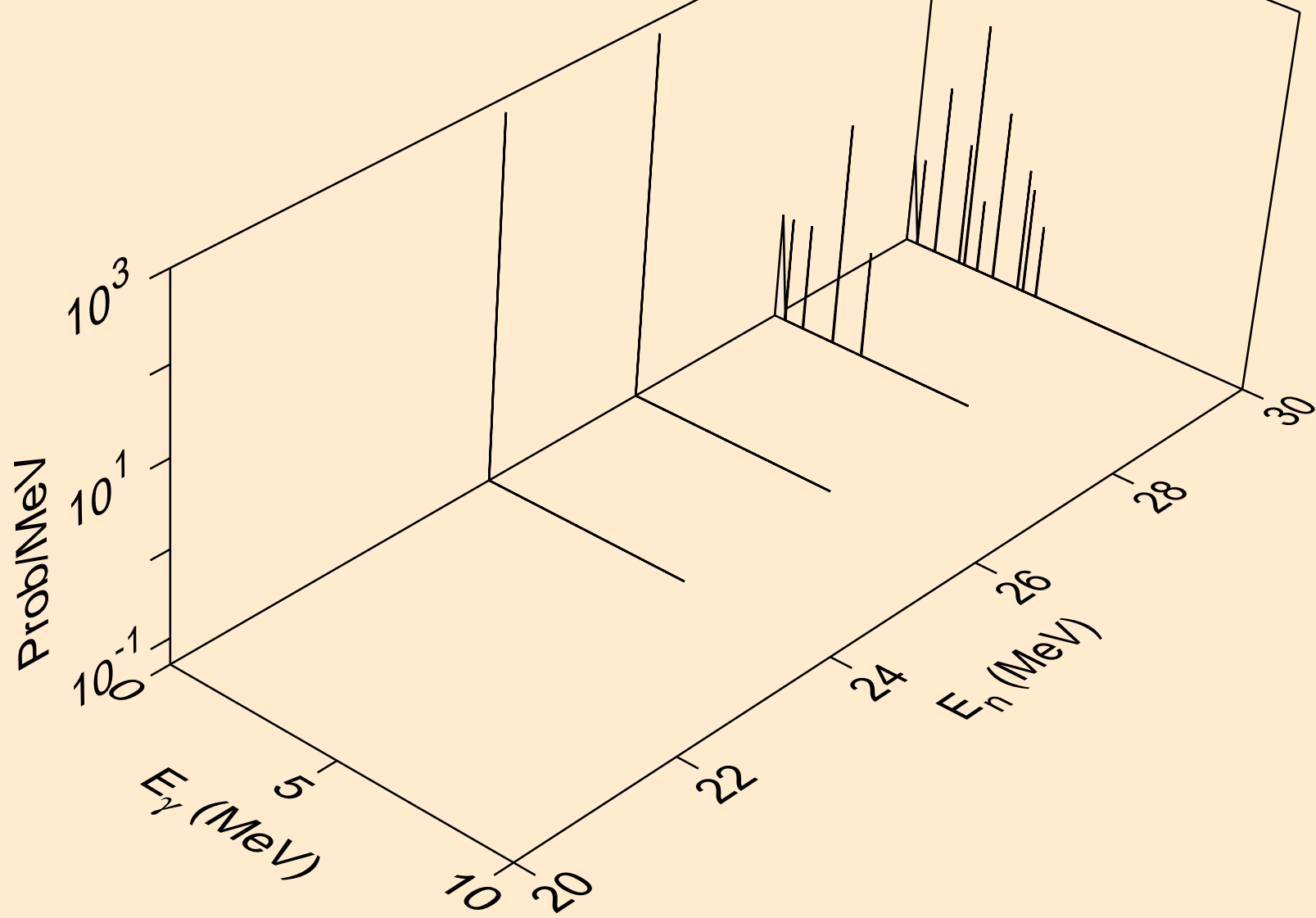



C014 TRITON ACER TENDL-2021 LIBRARY; T=0.K  
Particle heating contributions

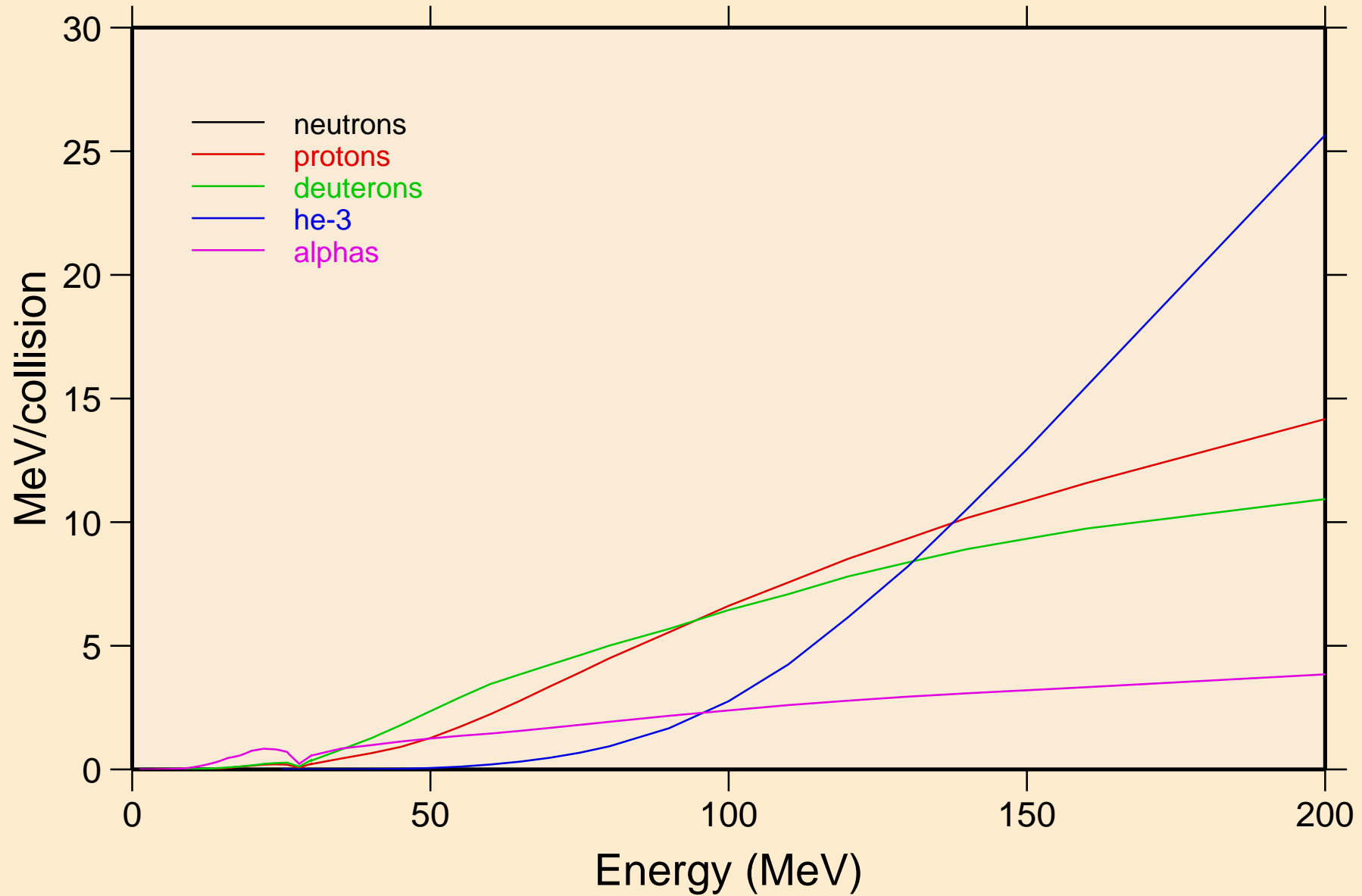

C014 TRITON ACER TENDL-2021 LIBRARY; T=0.K  
Recoil Heating

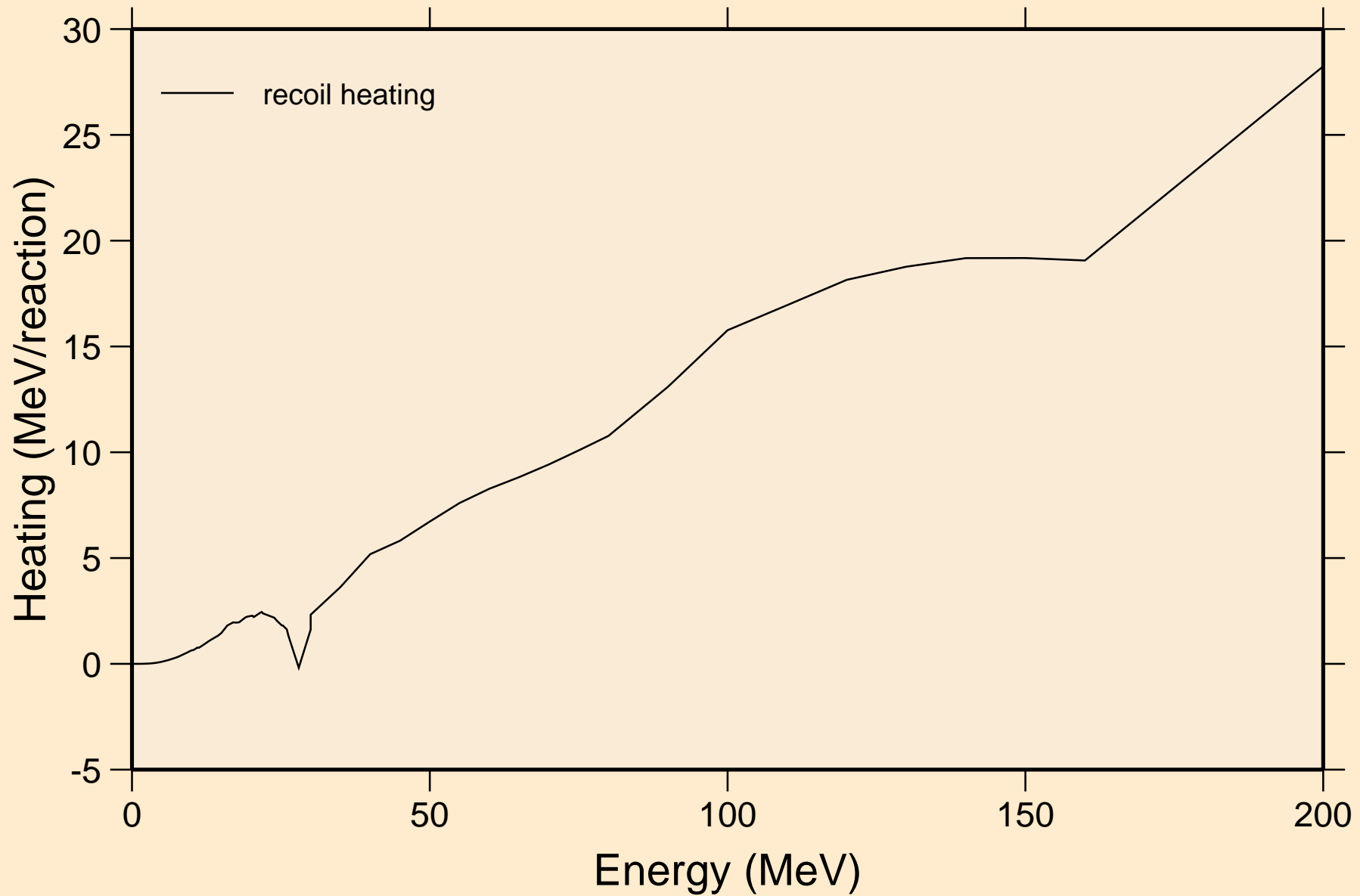

C014 TRITON ACER TENDL-2021 LIBRARY; T=0.K  
Particle production cross sections

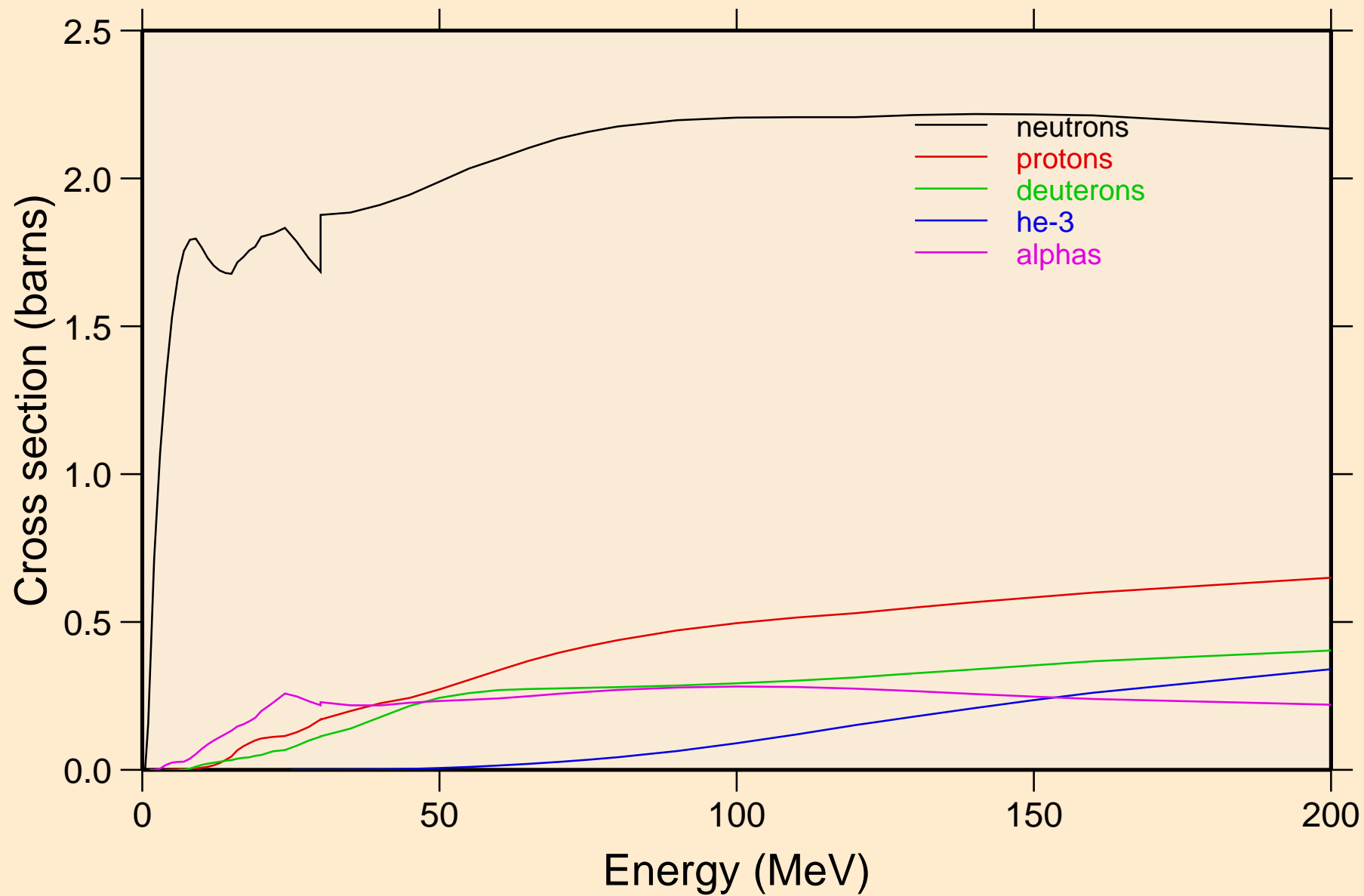

C014 TRITON ACER TENDL-2021 LIBRARY; T=0.K  
neutrons from (t,n)

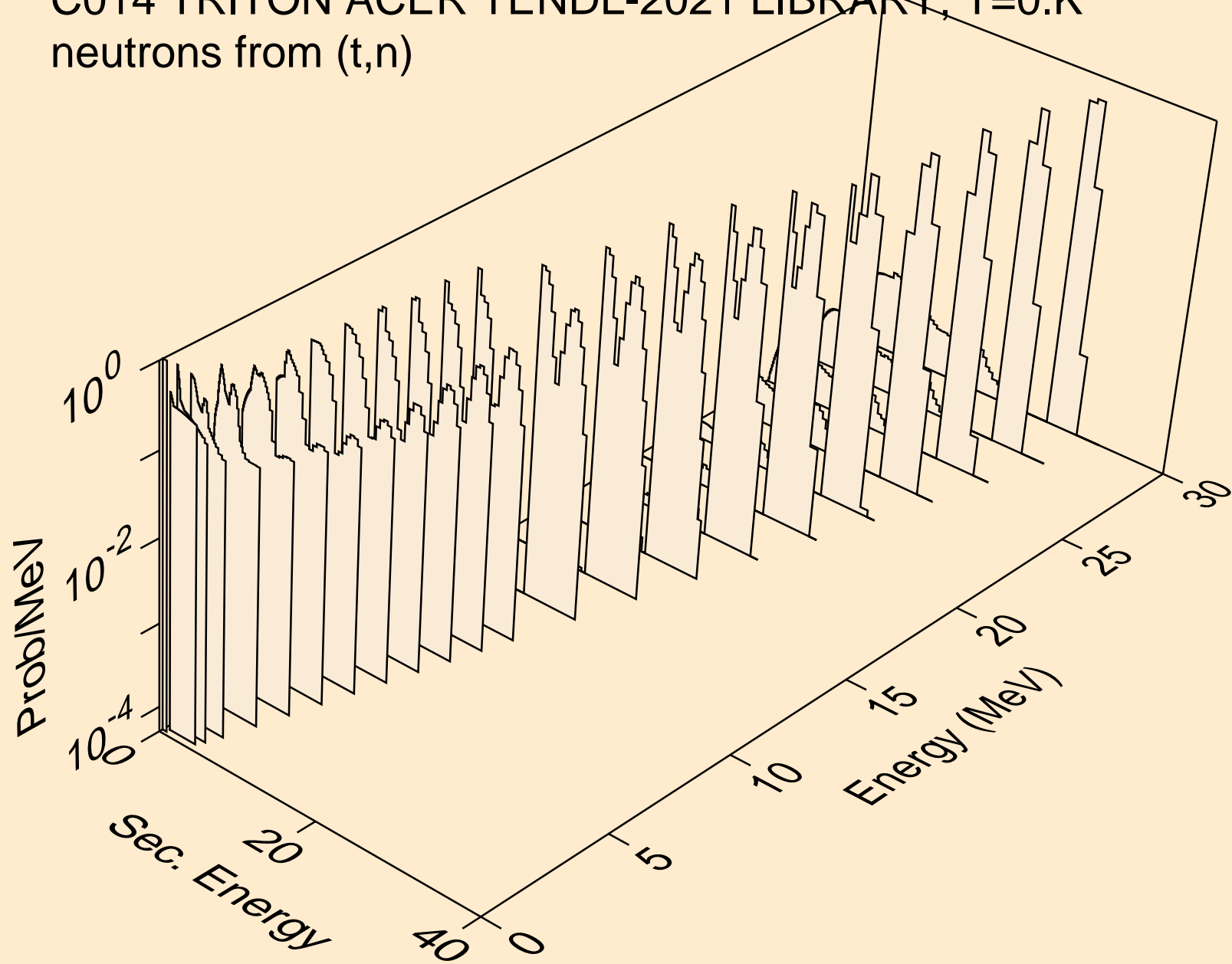

C014 TRITON ACER TENDL-2021 LIBRARY; T=0.K  
neutrons from (t,x)

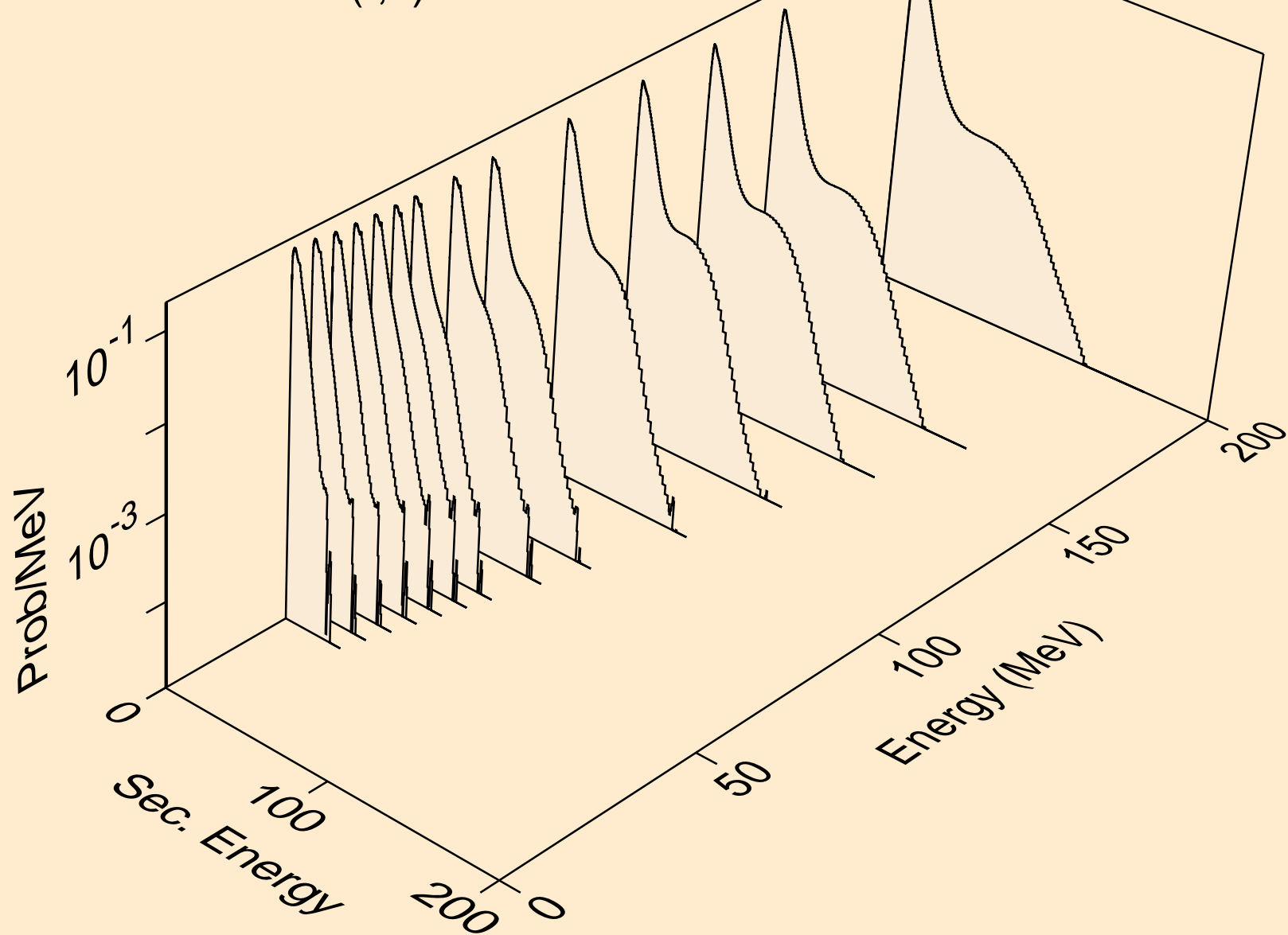

C014 TRITON ACER TENDL-2021 LIBRARY; T=0.K  
neutrons from (t,2nd)

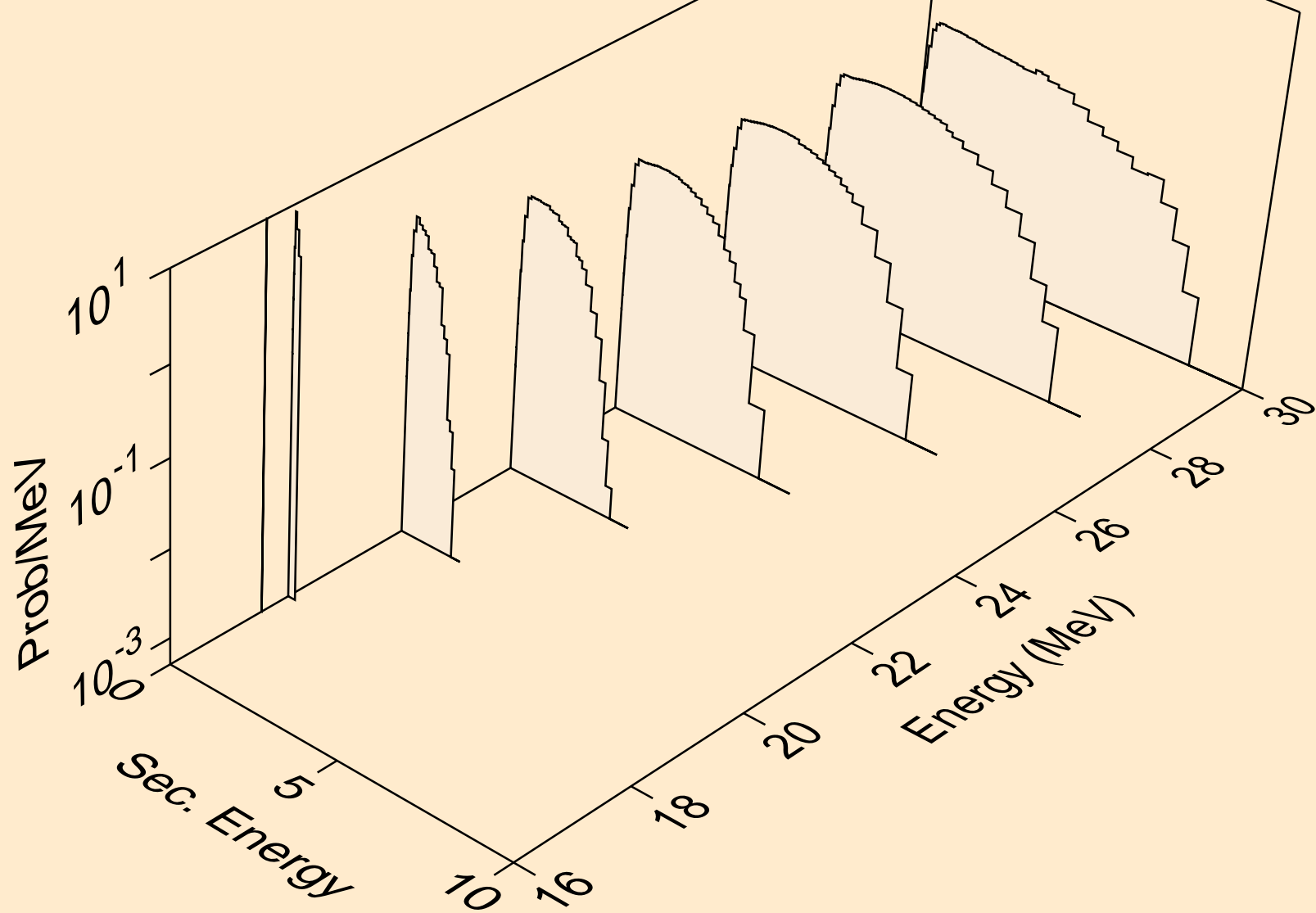

C014 TRITON ACER TENDL-2021 LIBRARY; T=0.K  
neutrons from (t,2n)

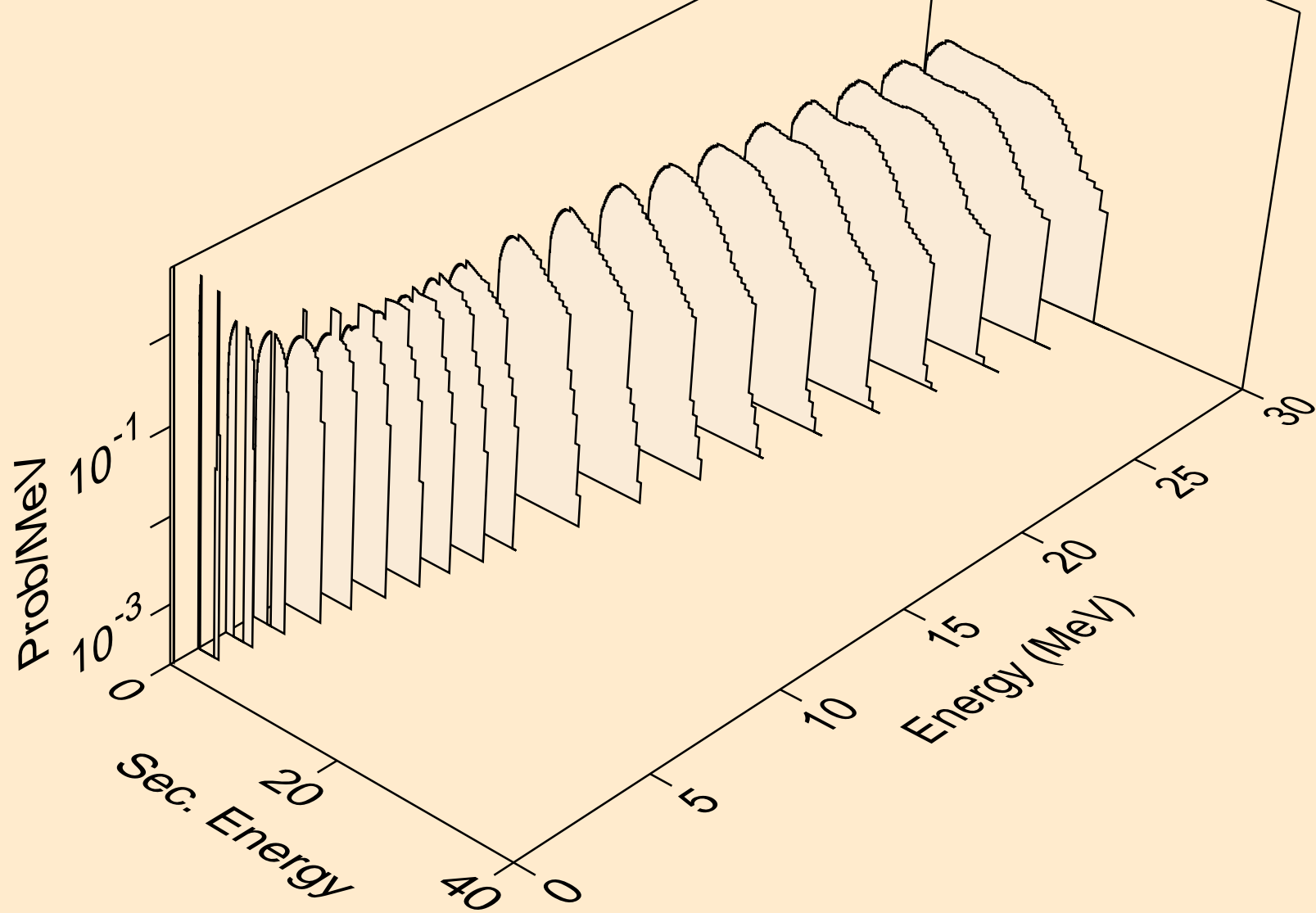

C014 TRITON ACER TENDL-2021 LIBRARY; T=0.K  
neutrons from (t,3n)

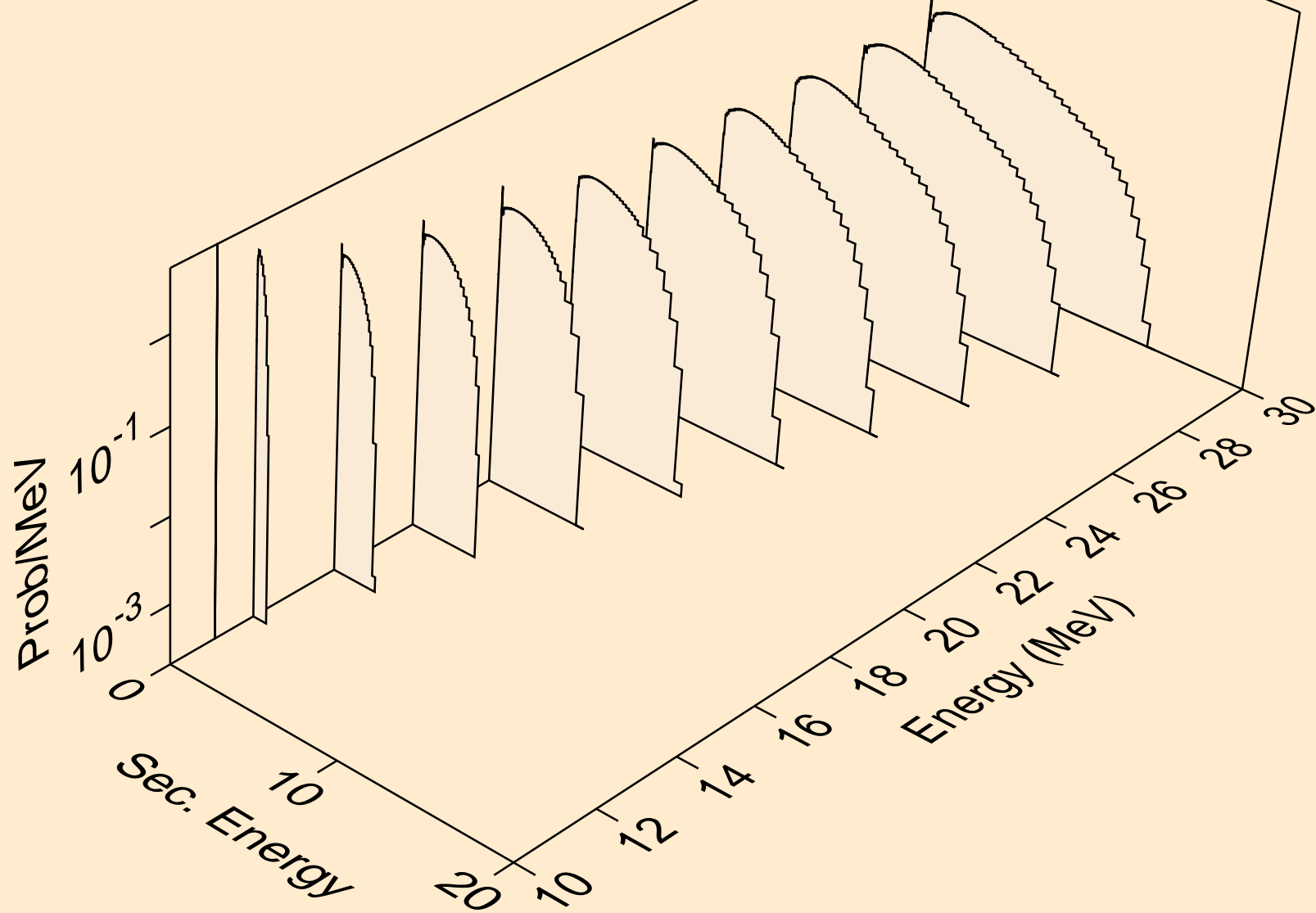



C014 TRITON ACER TENDL-2021 LIBRARY; T=0.K  
neutrons from (t,n\*)a

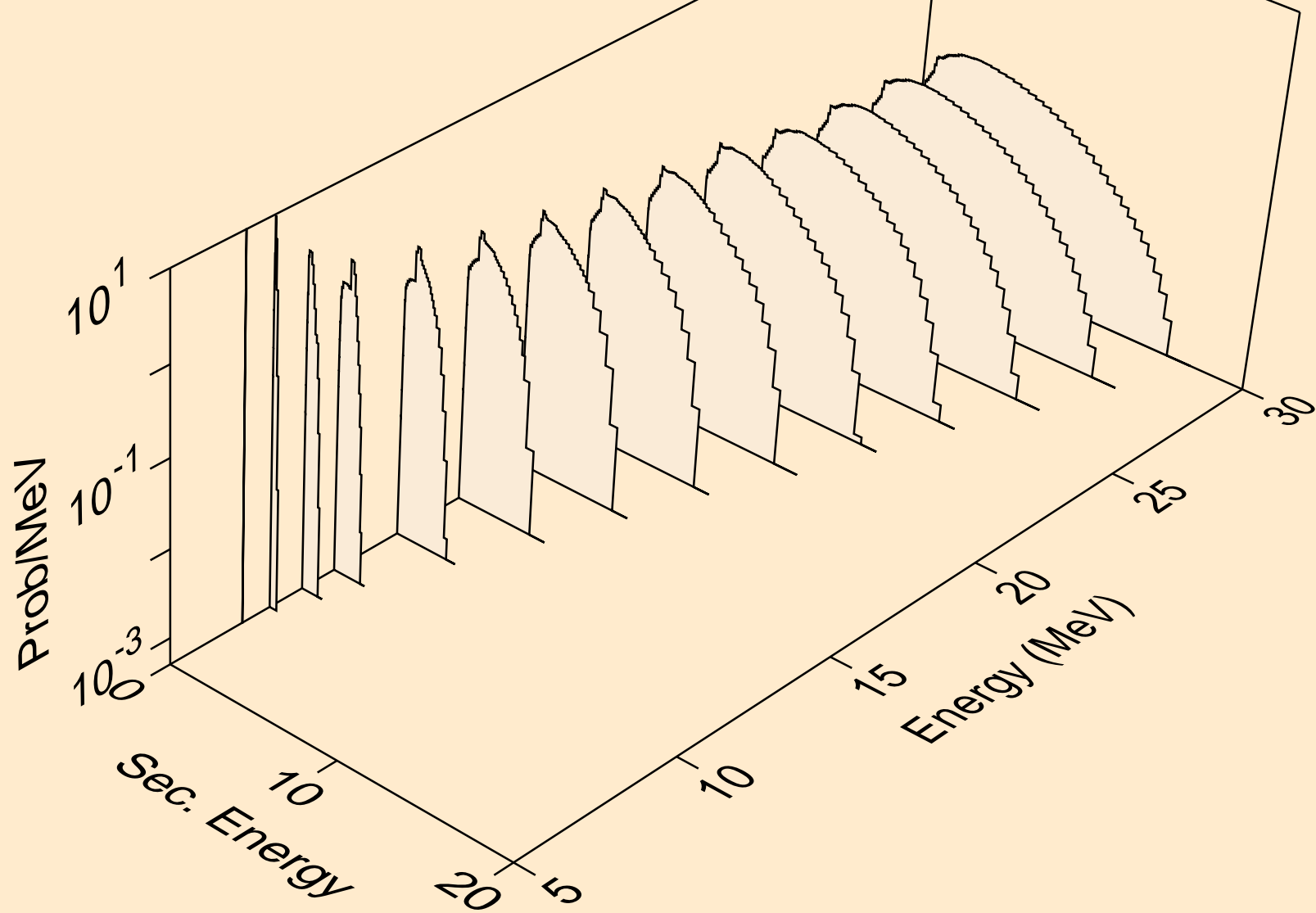

C014 TRITON ACER TENDL-2021 LIBRARY; T=0.K  
neutrons from (t,2n)a

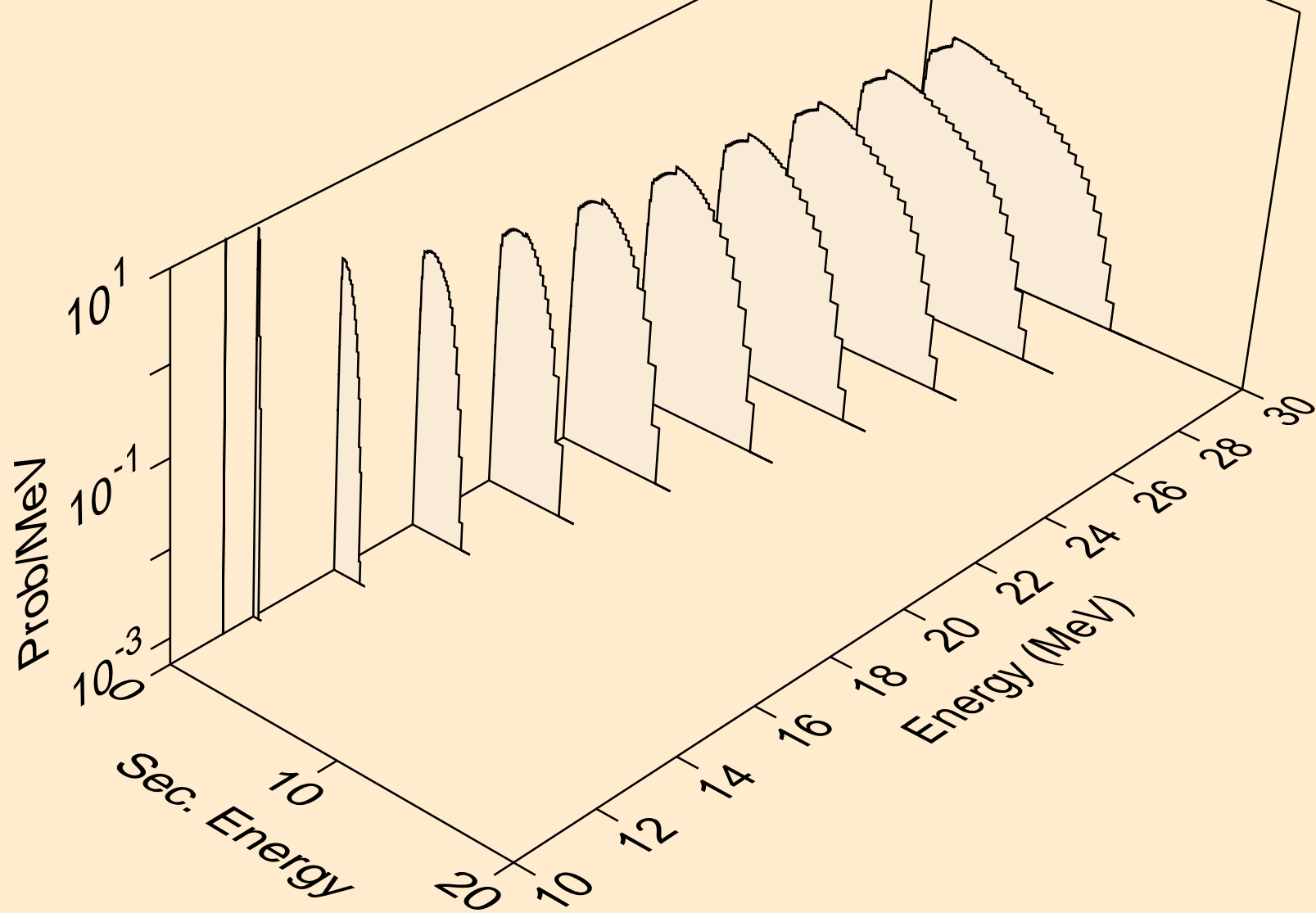

C014 TRITON ACER TENDL-2021 LIBRARY; T=0.K  
neutrons from (t,3n)a

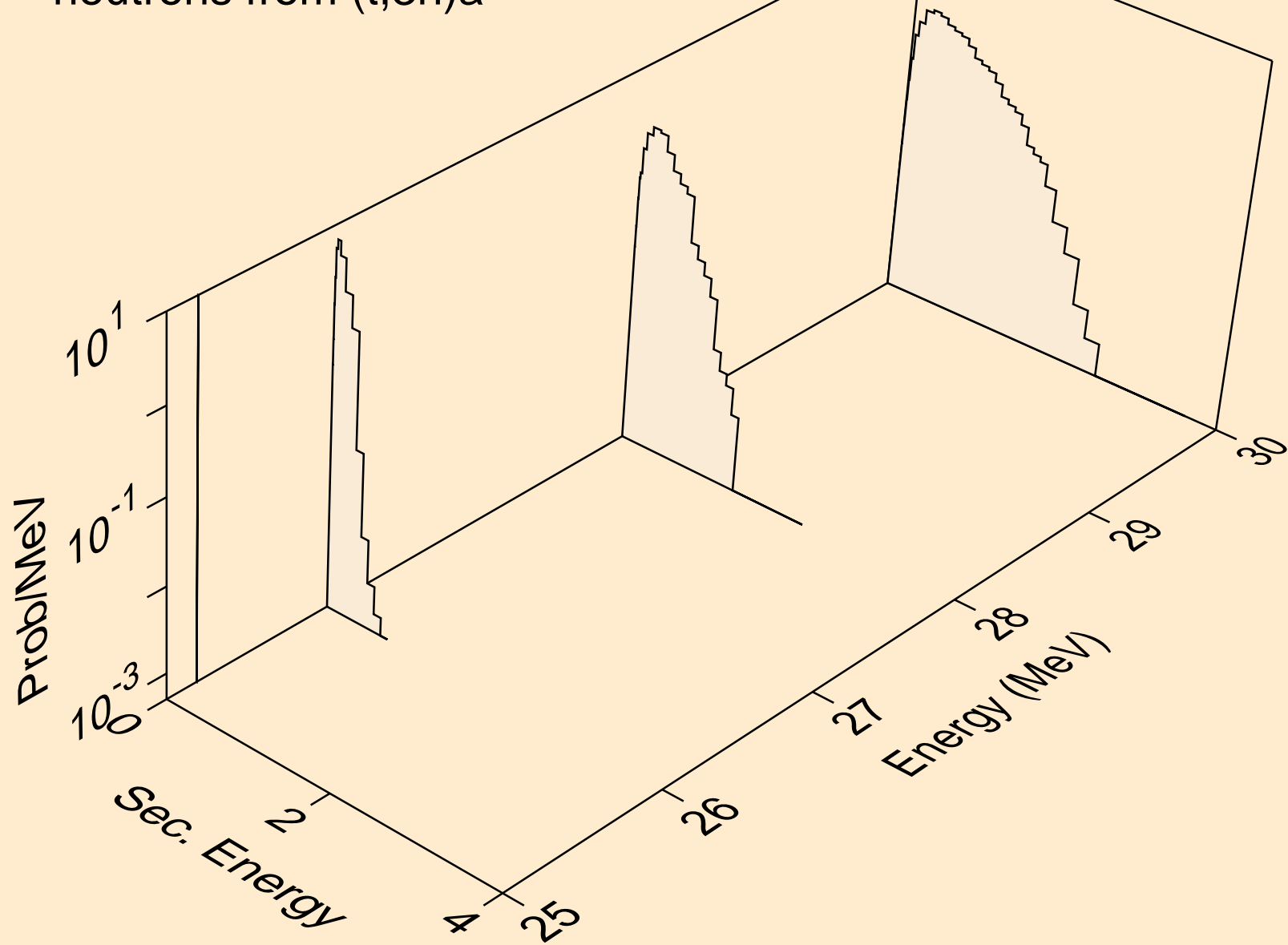

C014 TRITON ACER TENDL-2021 LIBRARY; T=0.K  
neutrons from (t,n\*)p

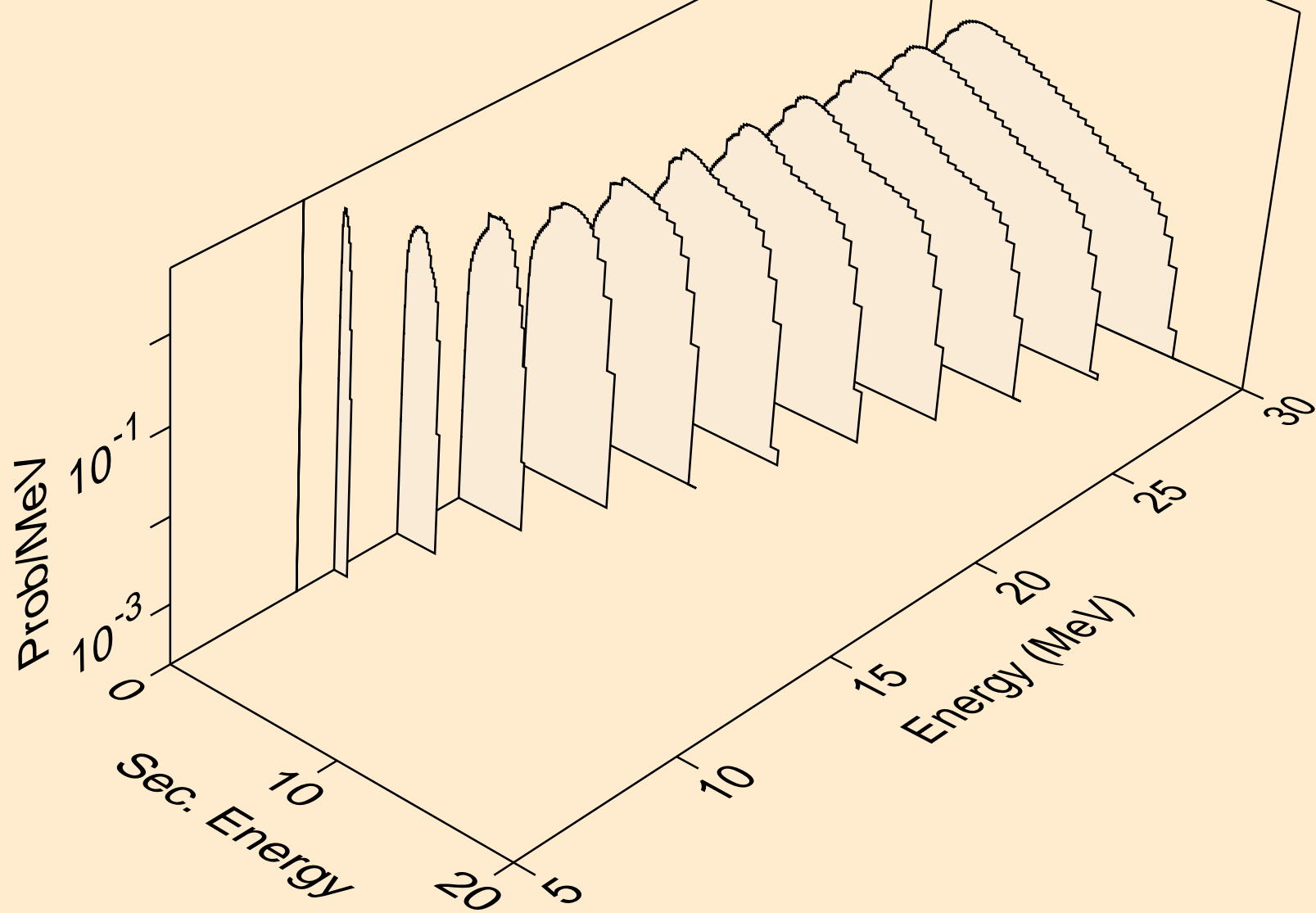

C014 TRITON ACER TENDL-2021 LIBRARY; T=0.K  
neutrons from (t,n\*)2a

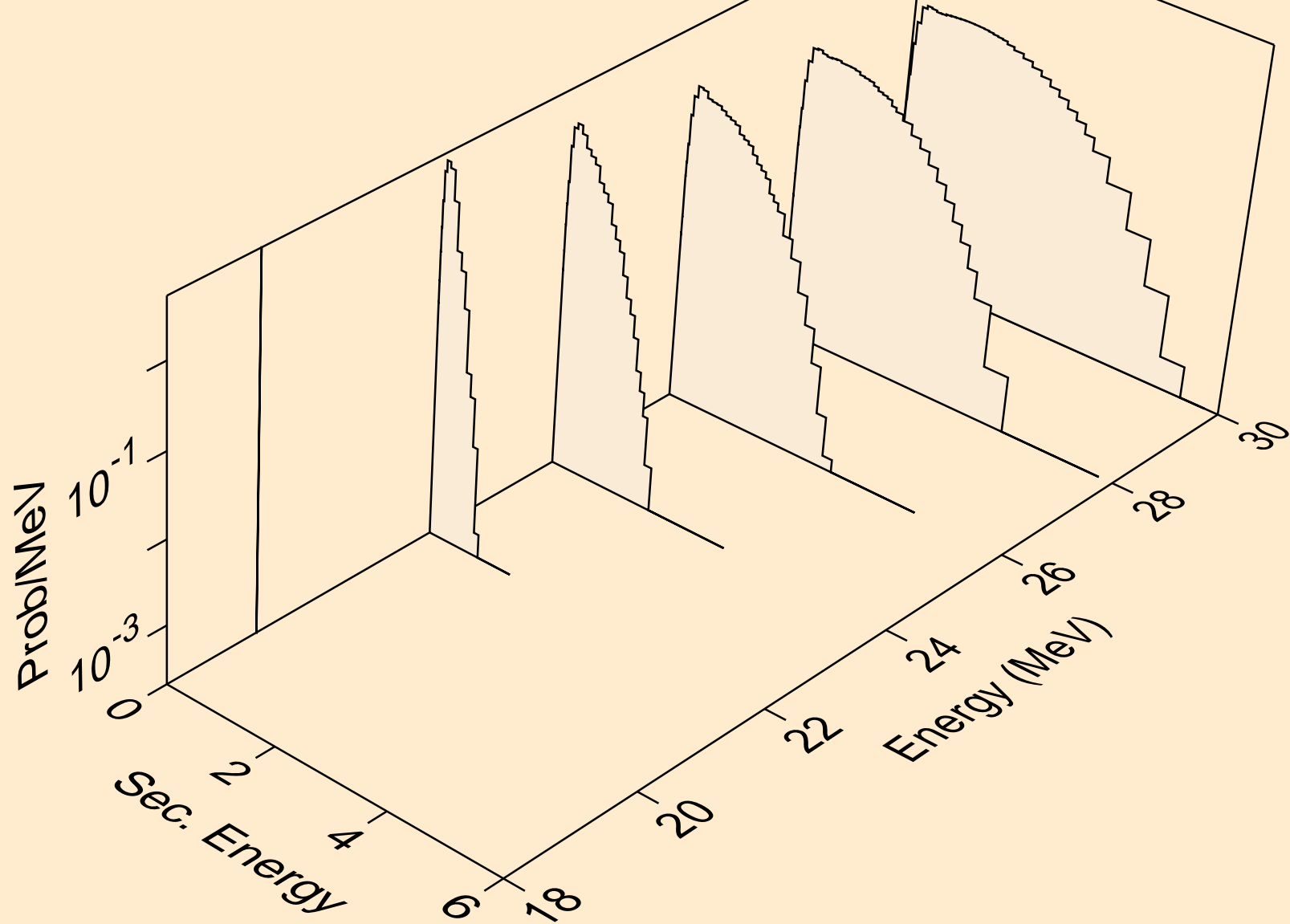

C014 TRITON ACER TENDL-2021 LIBRARY; T=0.K  
neutrons from (t,2n)2a

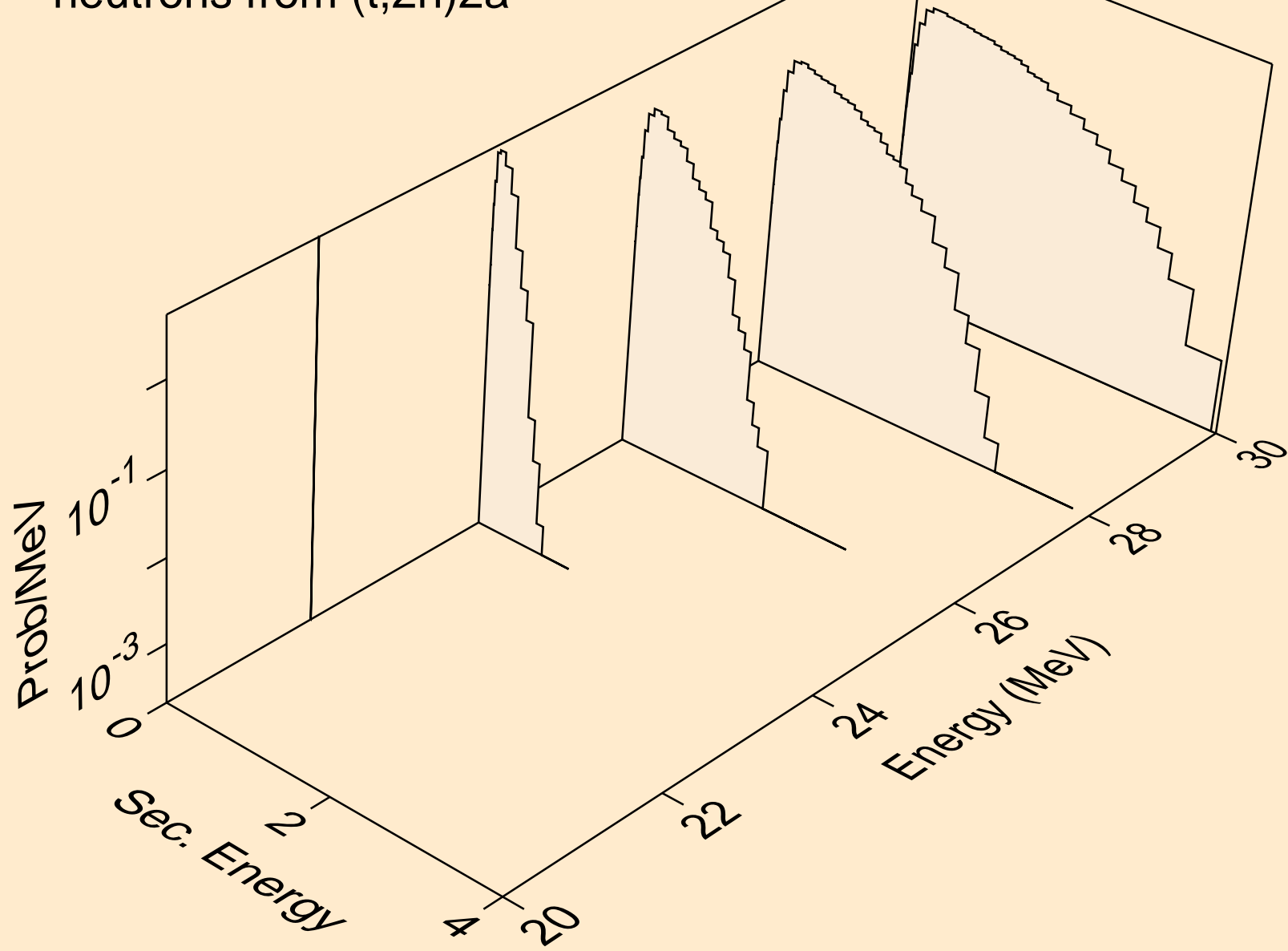

C014 TRITON ACER TENDL-2021 LIBRARY; T=0.K  
neutrons from (t,n\*)d

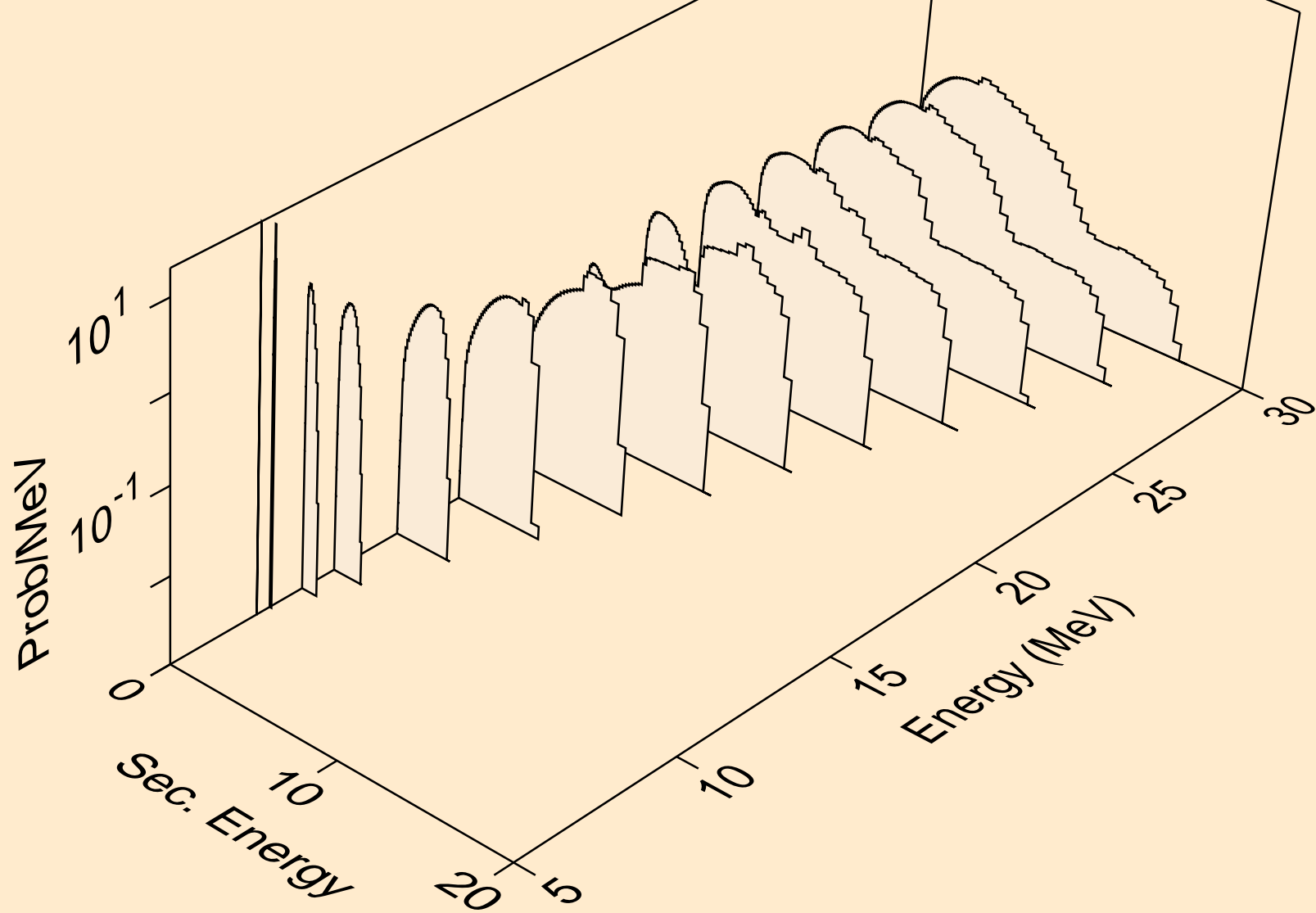

C014 TRITON ACER TENDL-2021 LIBRARY; T=0.K  
neutrons from (t,n\*)t

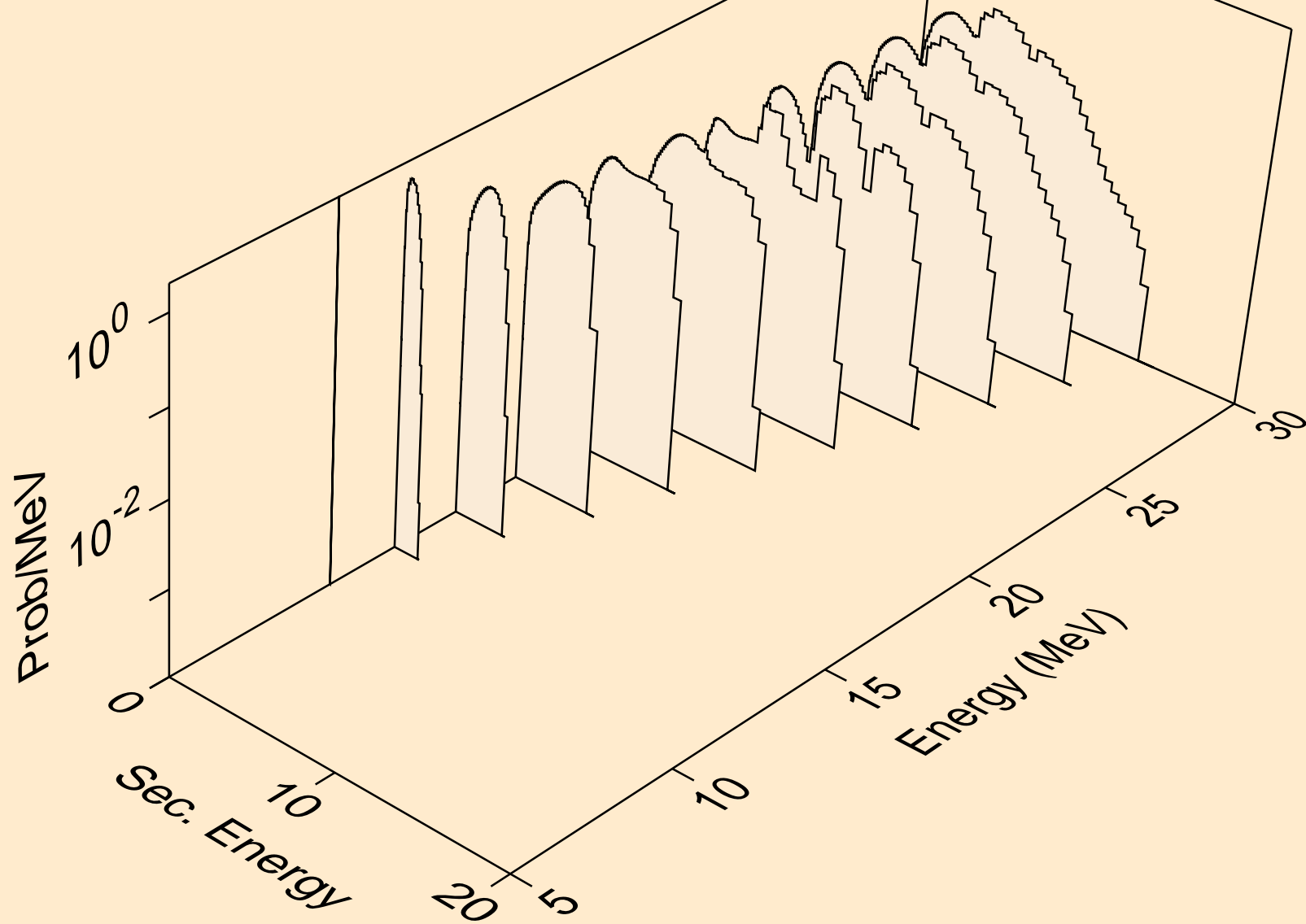



C014 TRITON ACER TENDL-2021 LIBRARY; T=0.K  
neutrons from (t,n\*)he3

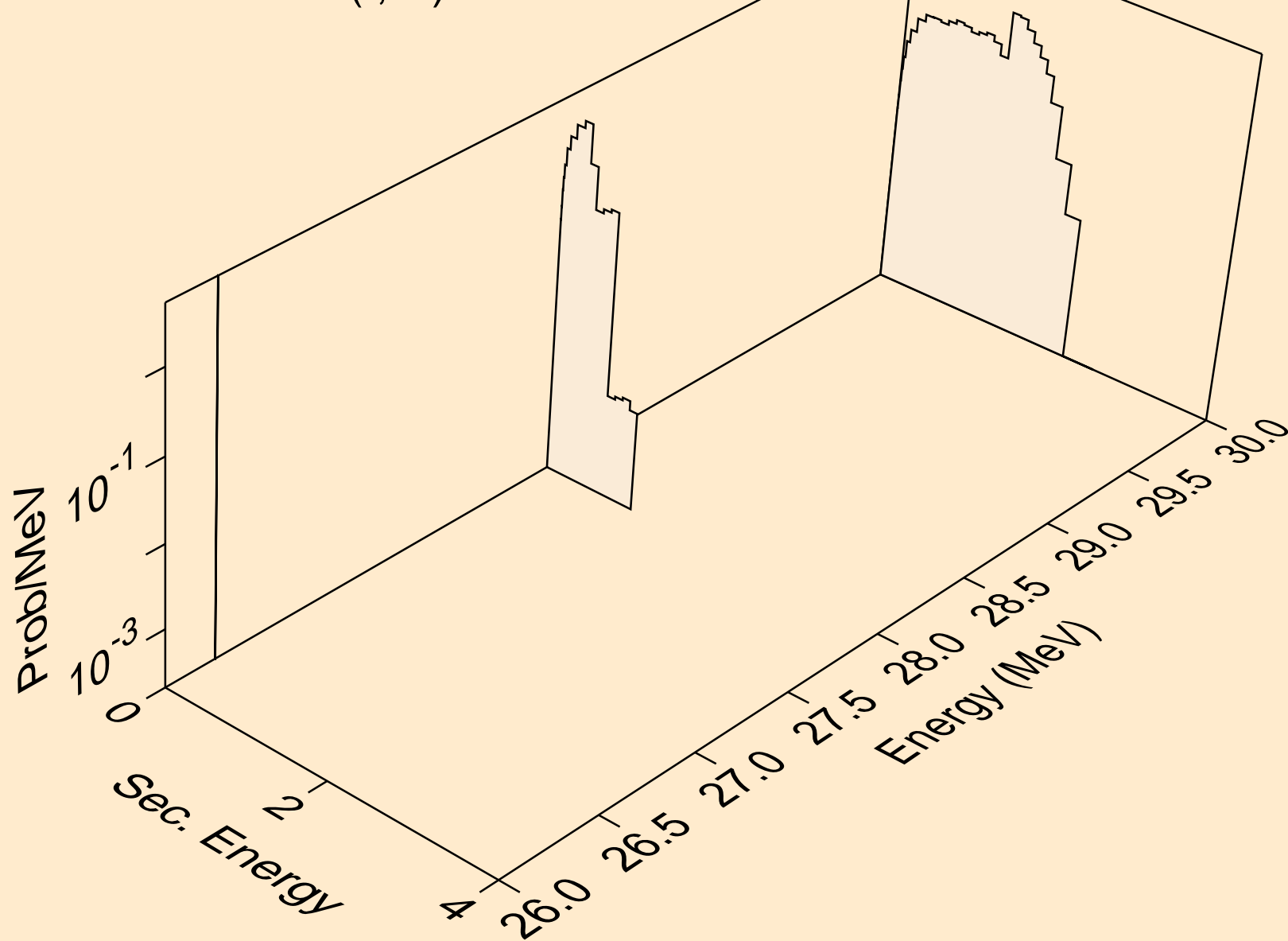

C014 TRITON ACER TENDL-2021 LIBRARY; T=0.K  
neutrons from (t,4n)

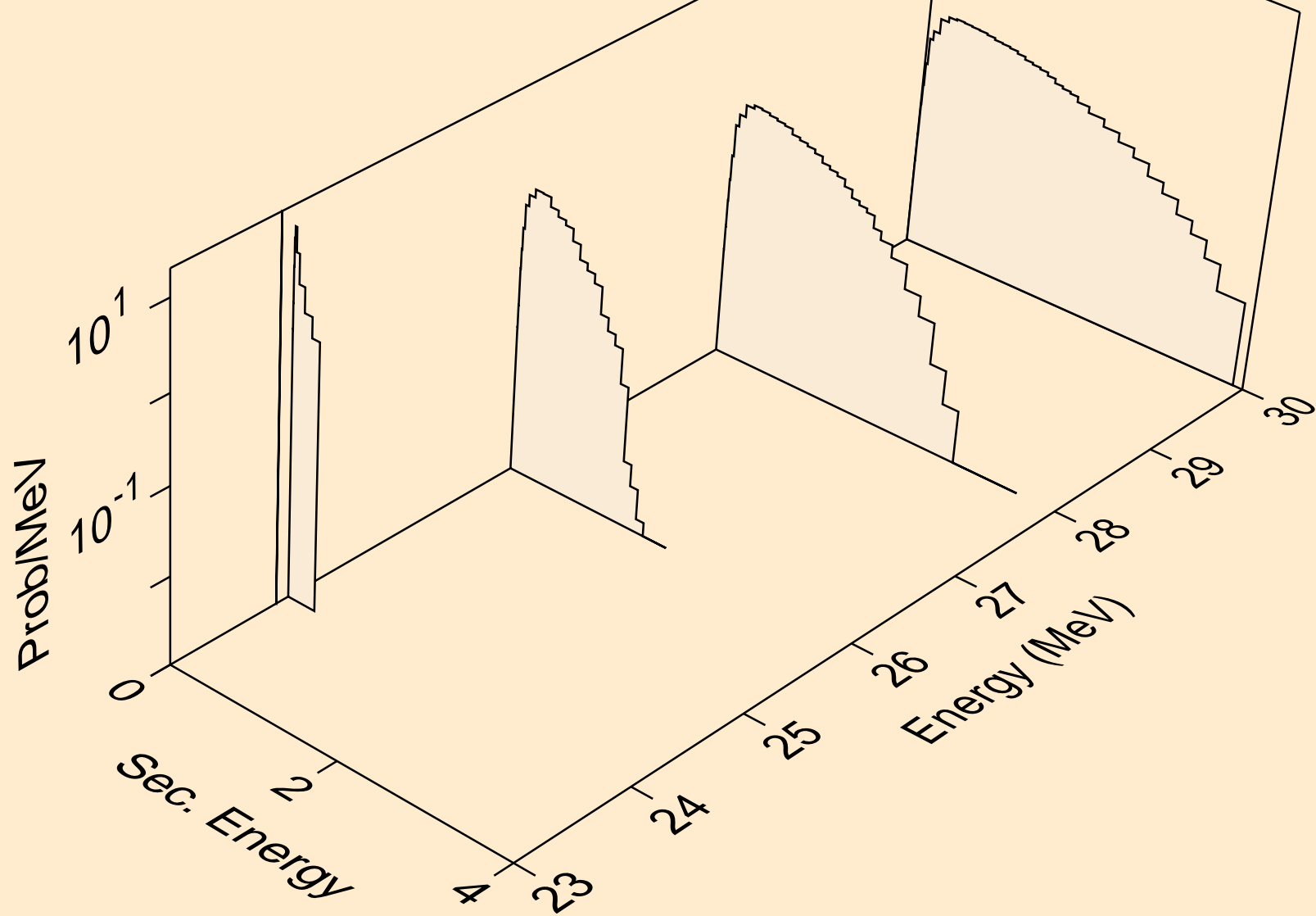

C014 TRITON ACER TENDL-2021 LIBRARY; T=0.K  
neutrons from (t,2np)

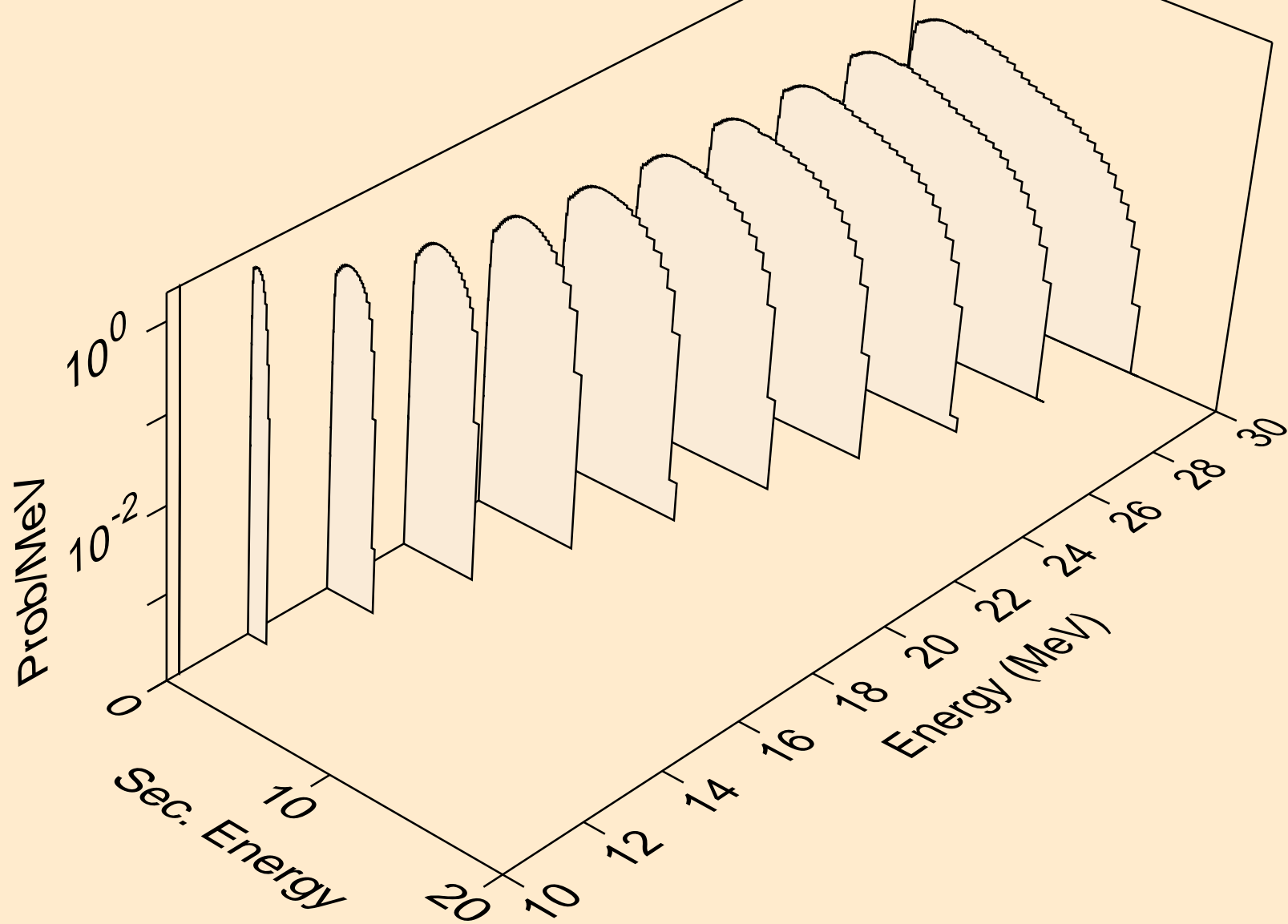

C014 TRITON ACER TENDL-2021 LIBRARY; T=0.K  
neutrons from (t,3np)

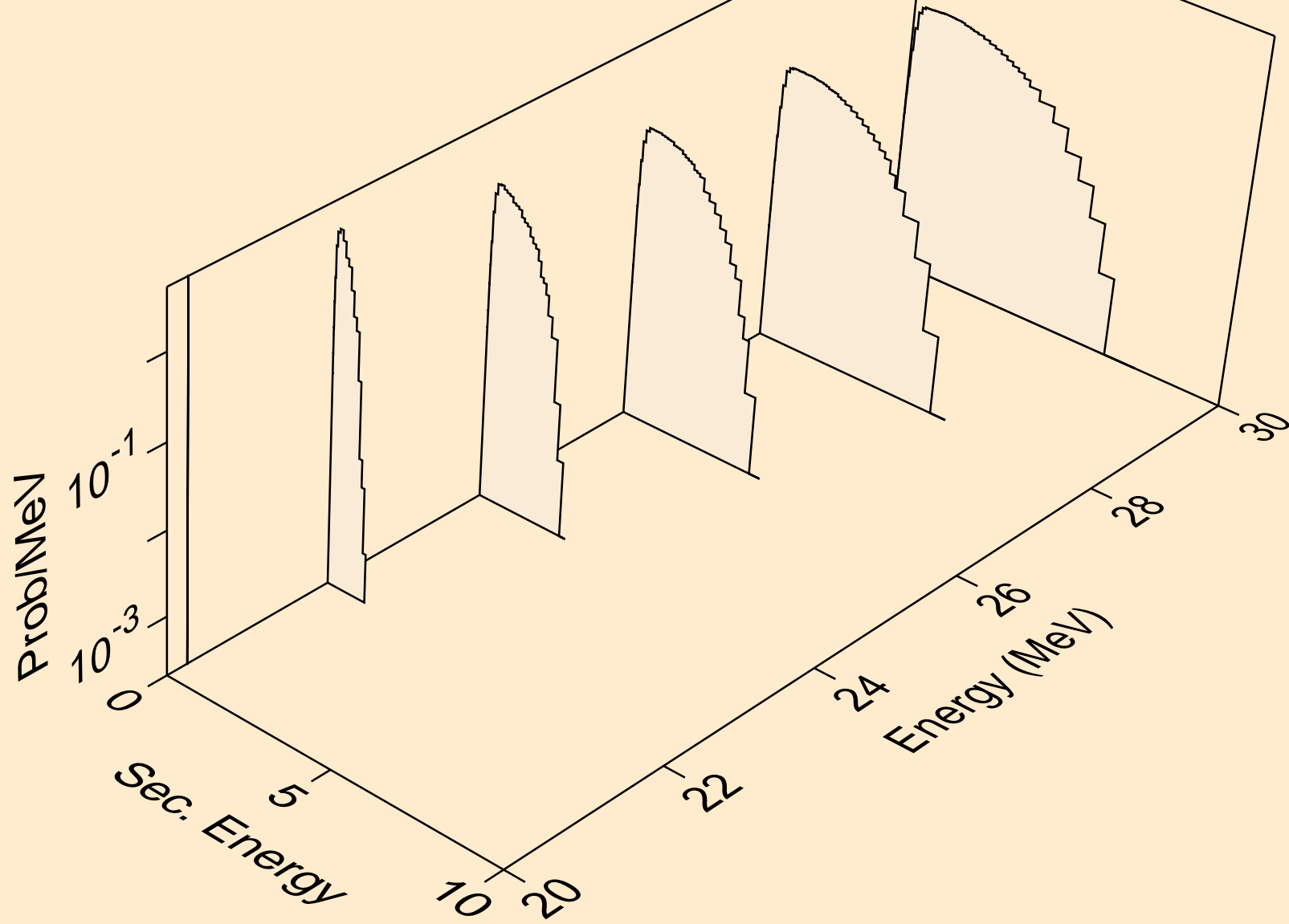

C014 TRITON ACER TENDL-2021 LIBRARY; T=0.K  
neutrons from (t,npa)

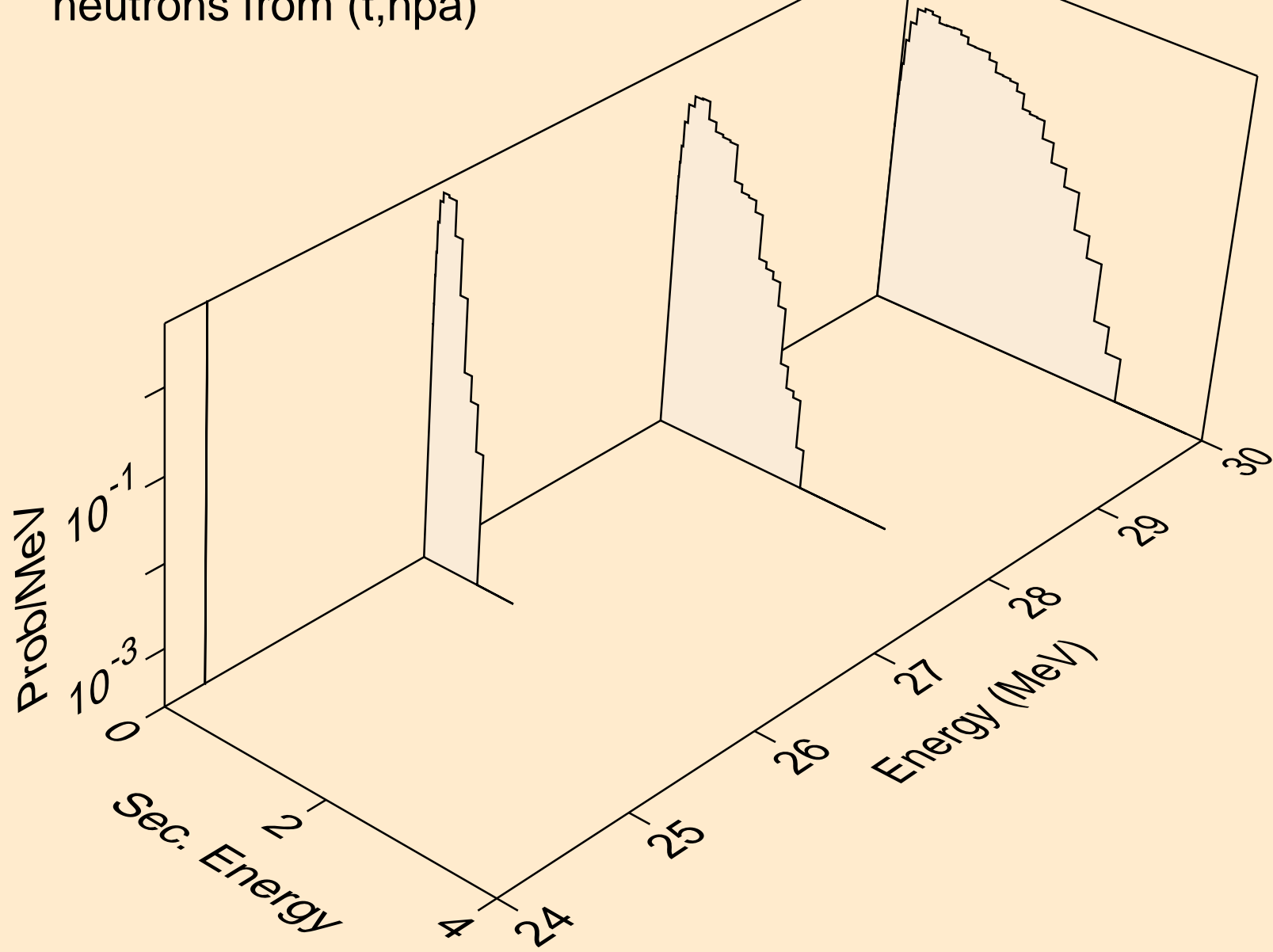

C014 TRITON ACER TENDL-2021 LIBRARY; T=0.K  
protons from (t,x)

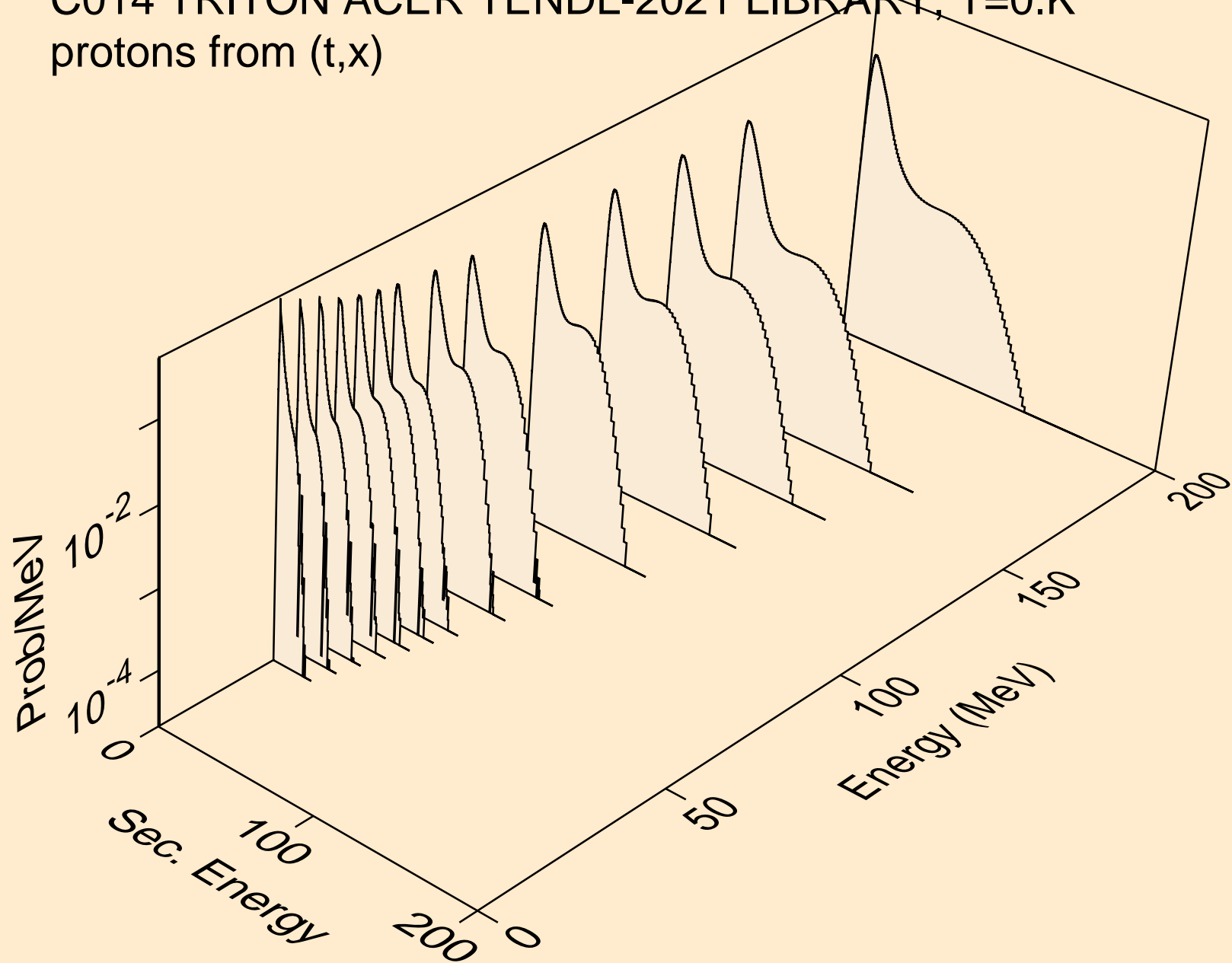

C014 TRITON ACER TENDL-2021 LIBRARY; T=0.K  
protons from (t,n\*)p

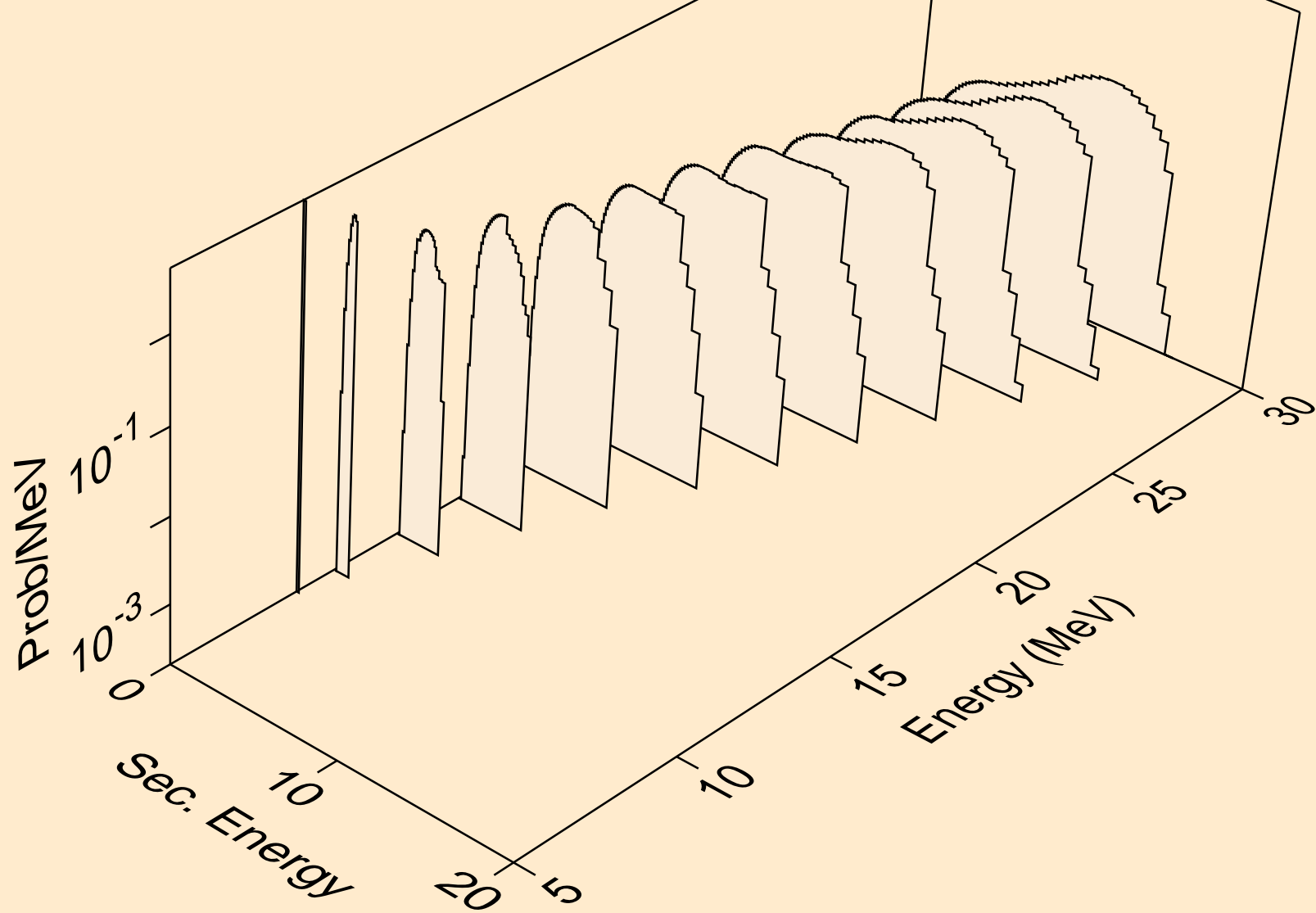

C014 TRITON ACER TENDL-2021 LIBRARY; T=0.K  
protons from (t,2np)

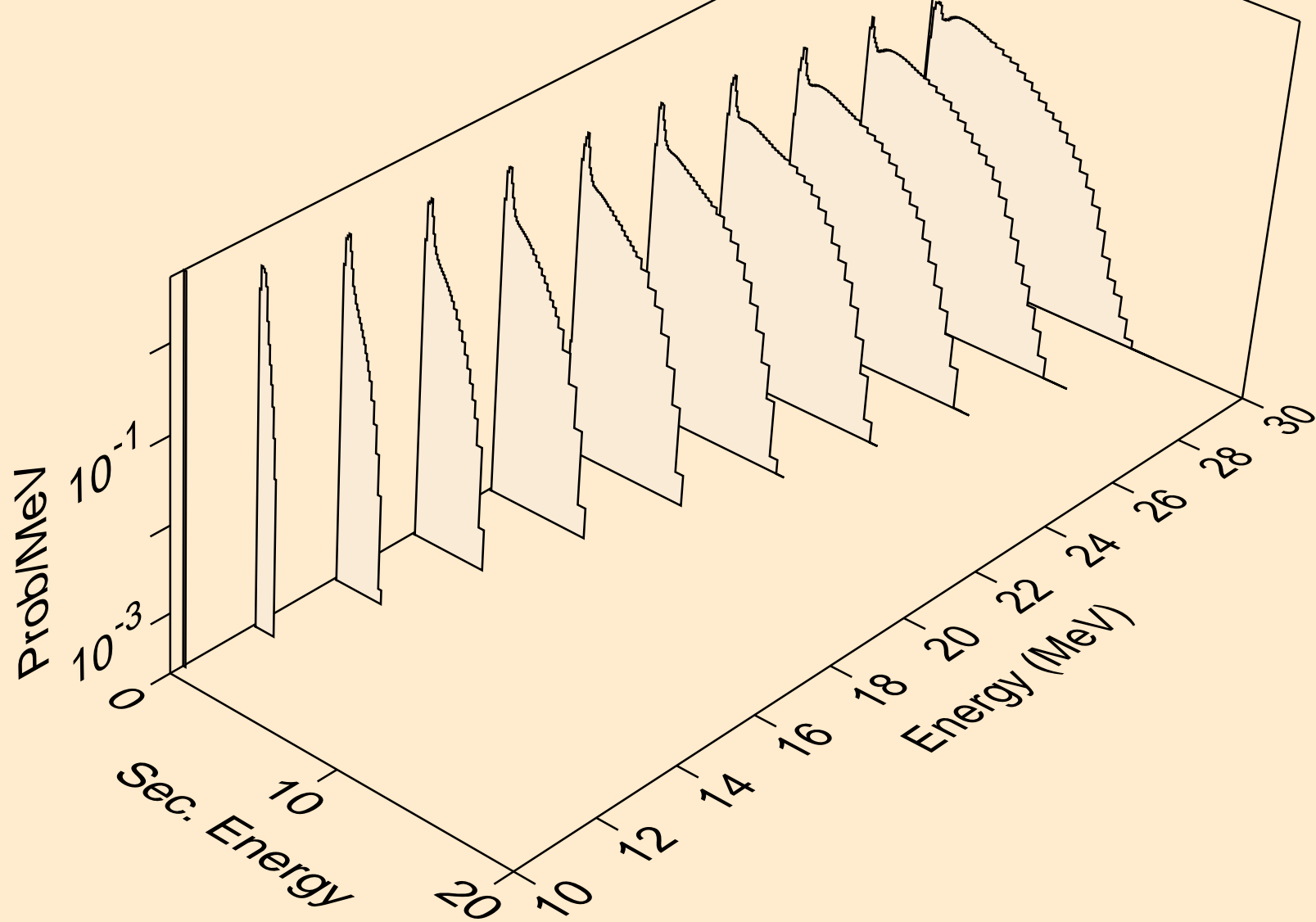



C014 TRITON ACER TENDL-2021 LIBRARY; T=0.K  
protons from (t,3np)

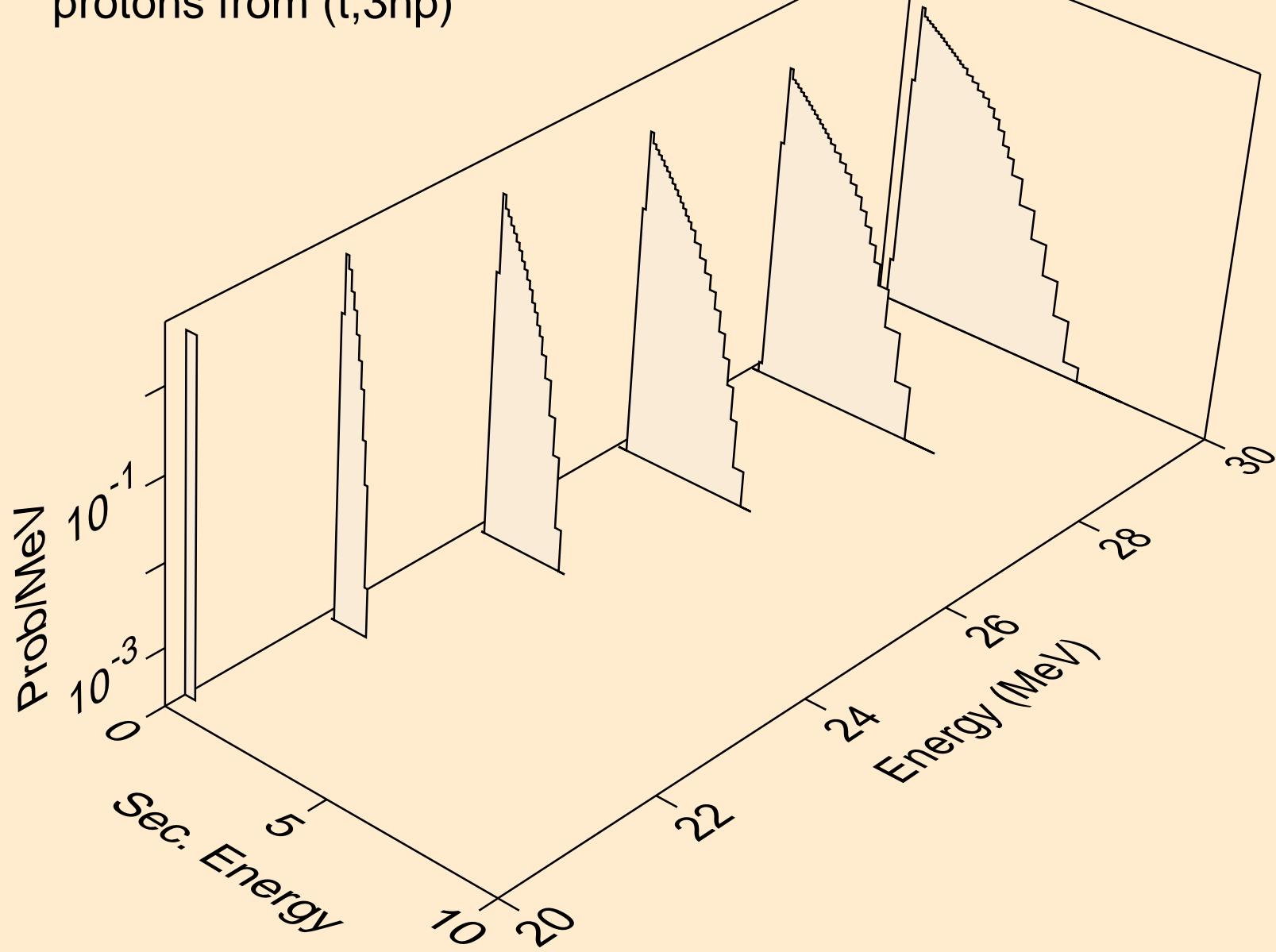

C014 TRITON ACER TENDL-2021 LIBRARY; T=0.K  
protons from (t,npa)

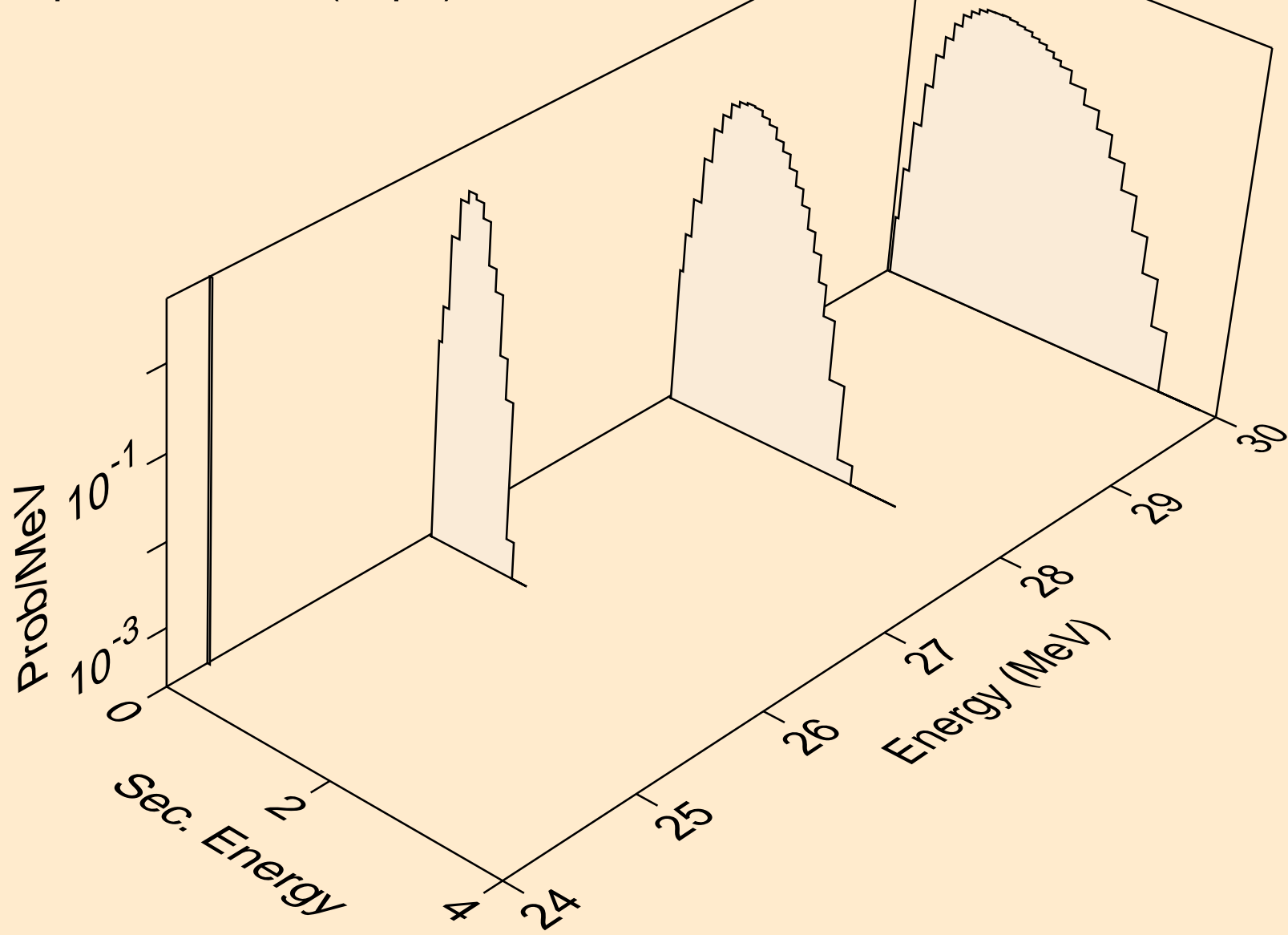

C014 TRITON ACER TENDL-2021 LIBRARY; T=0.K  
protons from (t,p)

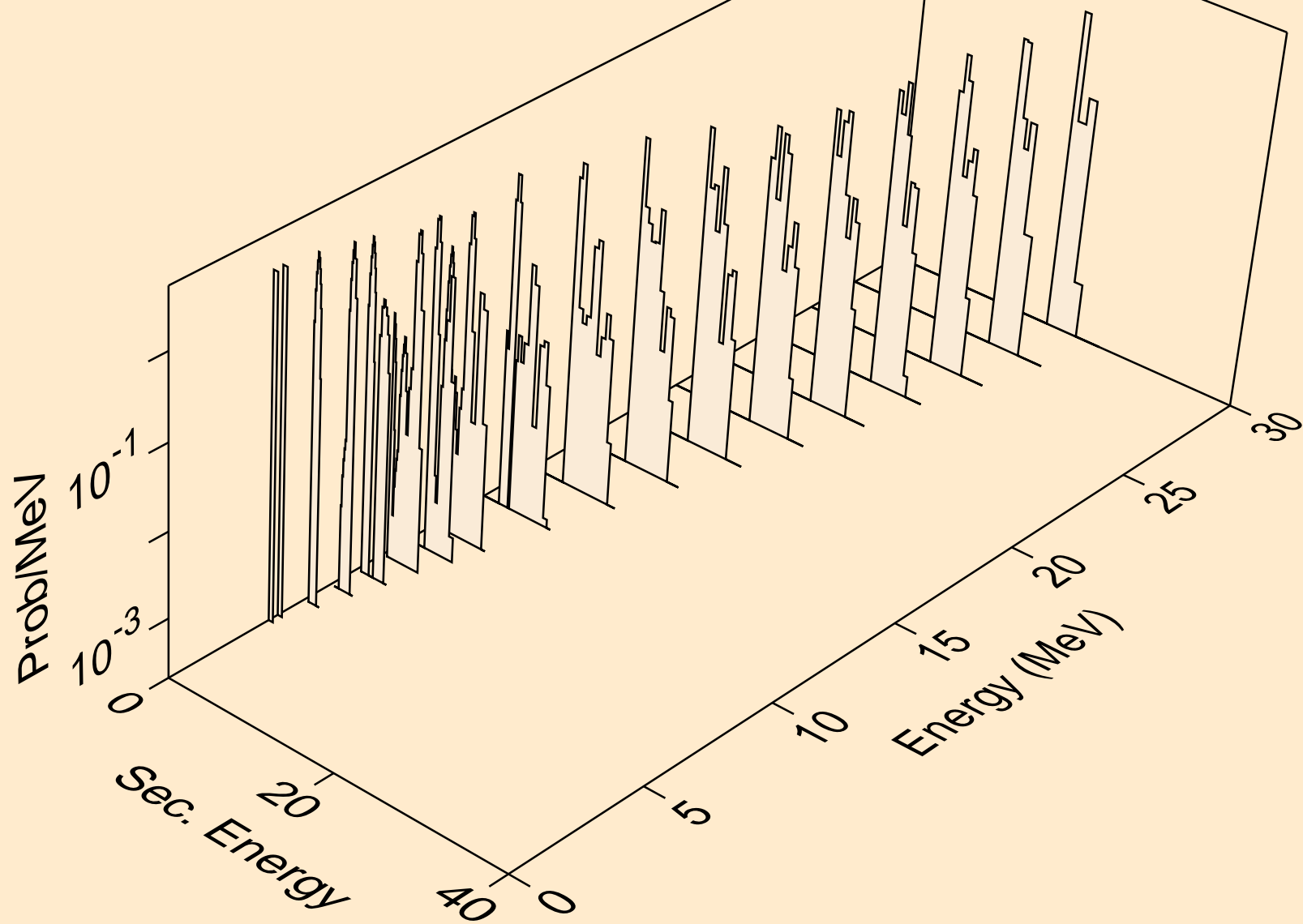

C014 TRITON ACER TENDL-2021 LIBRARY; T=0.K  
protons from (t,pa)

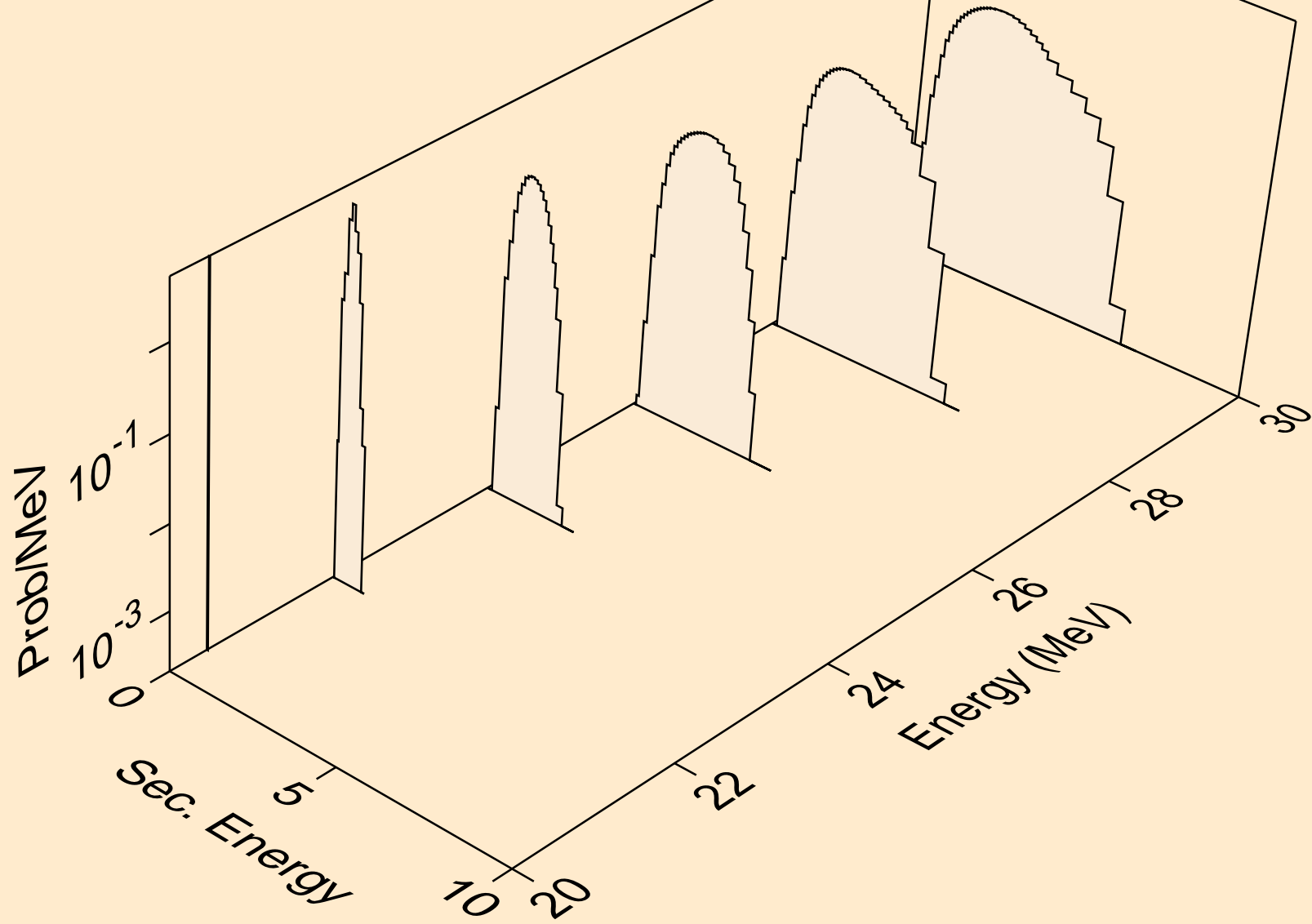

C014 TRITON ACER TENDL-2021 LIBRARY; T=0.K  
protons from (t,pt)

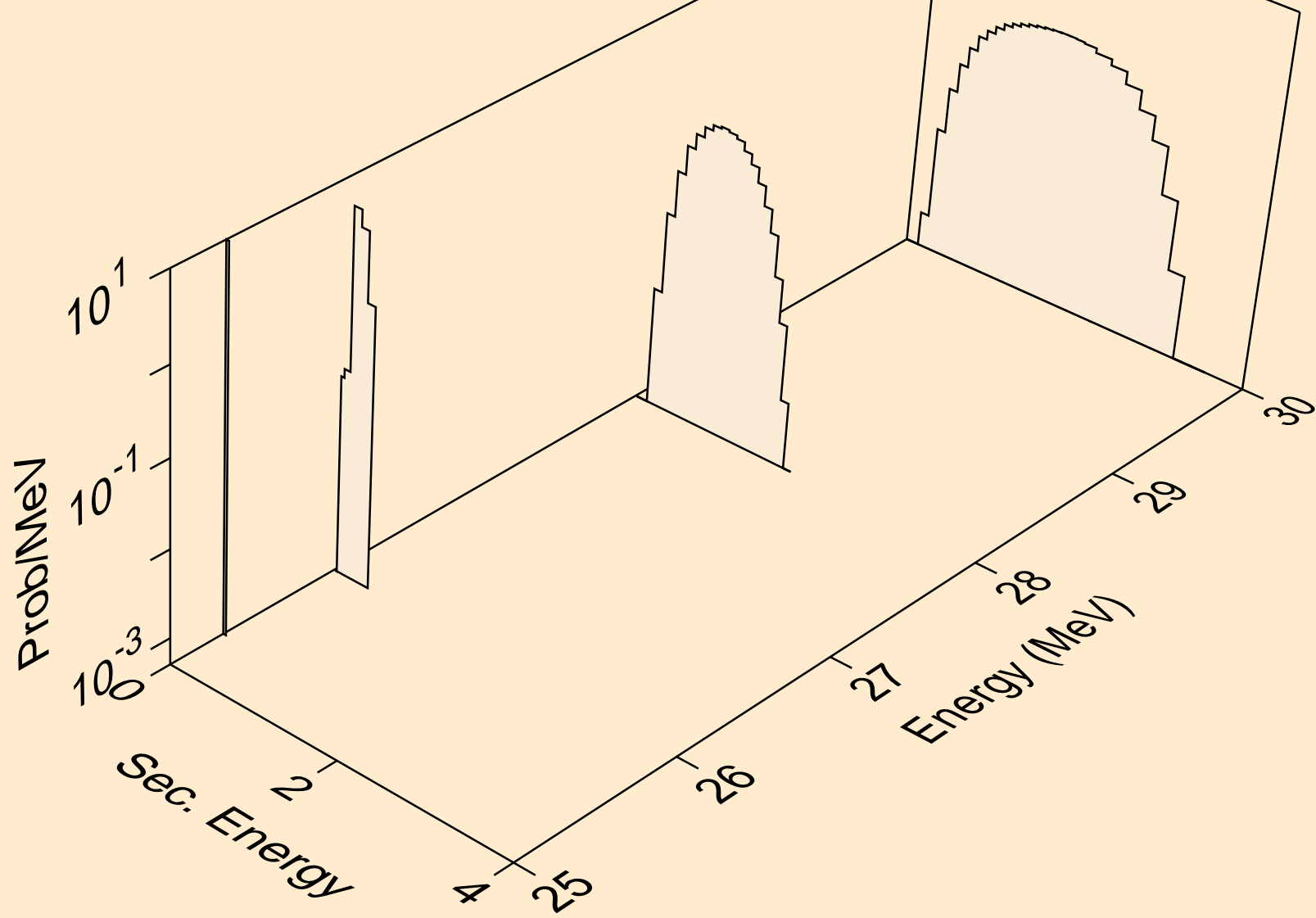

C014 TRITON ACER TENDL-2021 LIBRARY; T=0.K  
deuterons from (t,x)

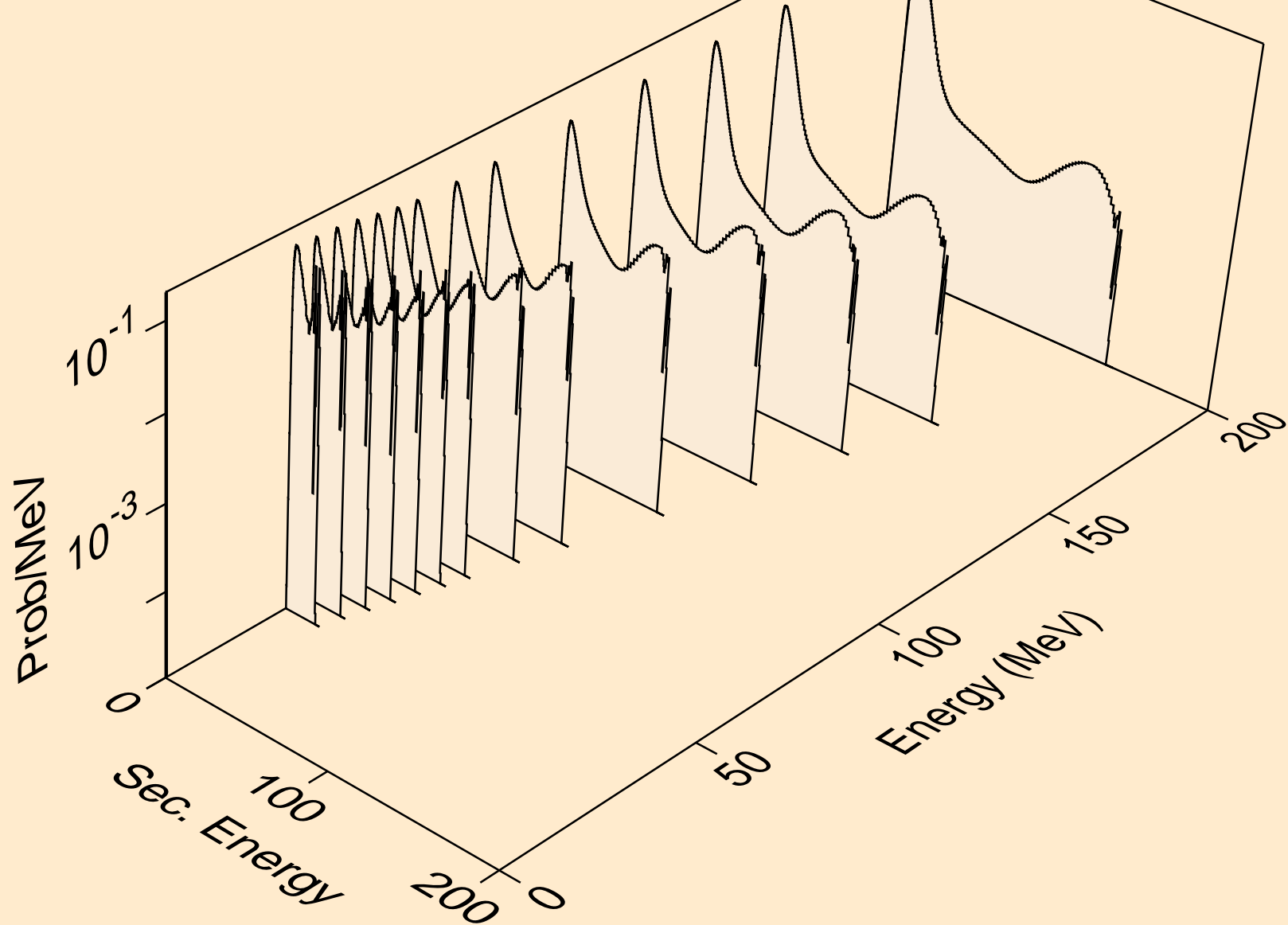

C014 TRITON ACER TENDL-2021 LIBRARY; T=0.K  
deuterons from (t,2nd)

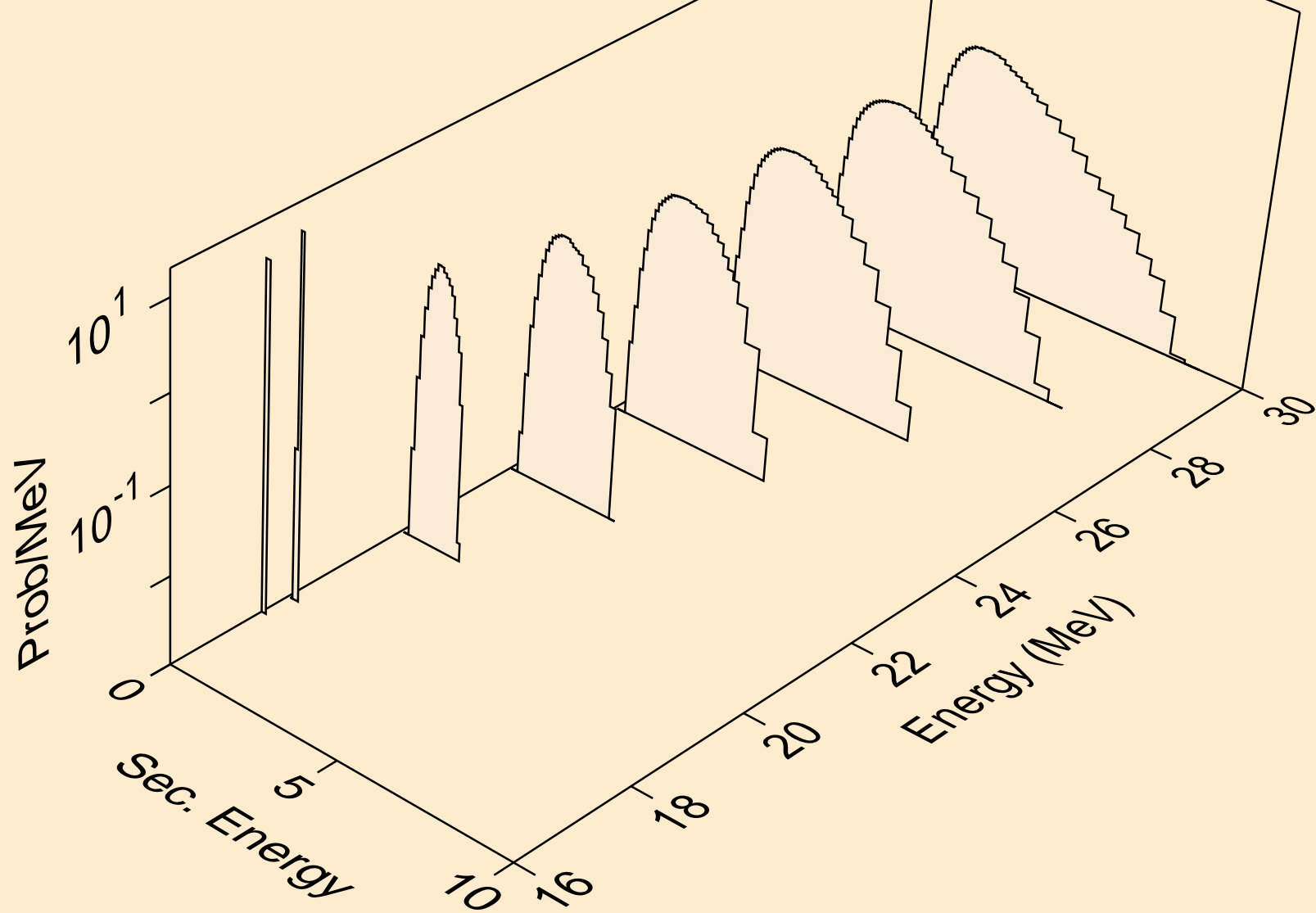

C014 TRITON ACER TENDL-2021 LIBRARY; T=0.K  
deuterons from (t,n\*)d

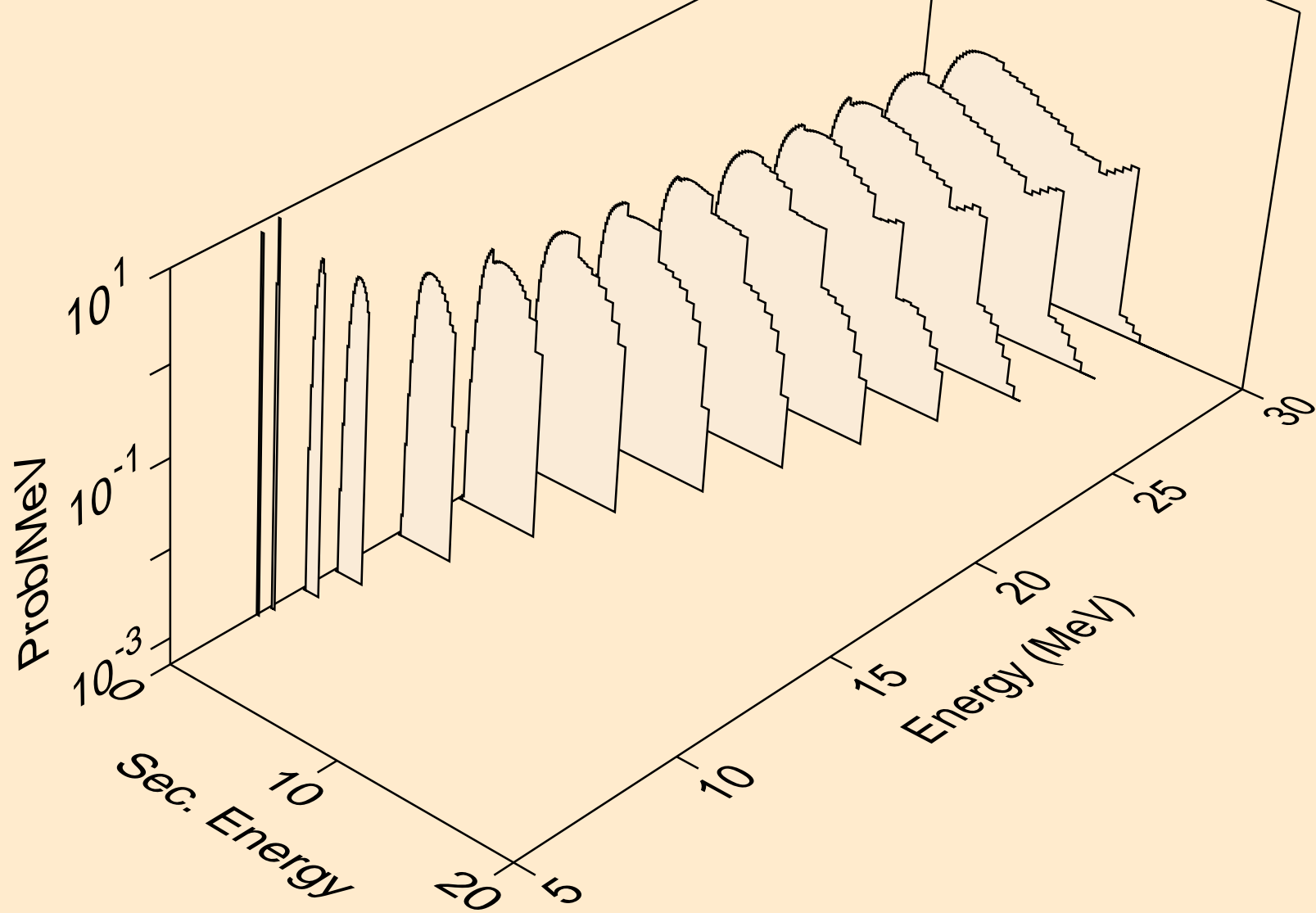



C014 TRITON ACER TENDL-2021 LIBRARY; T=0.K  
deuterons from (t,d)

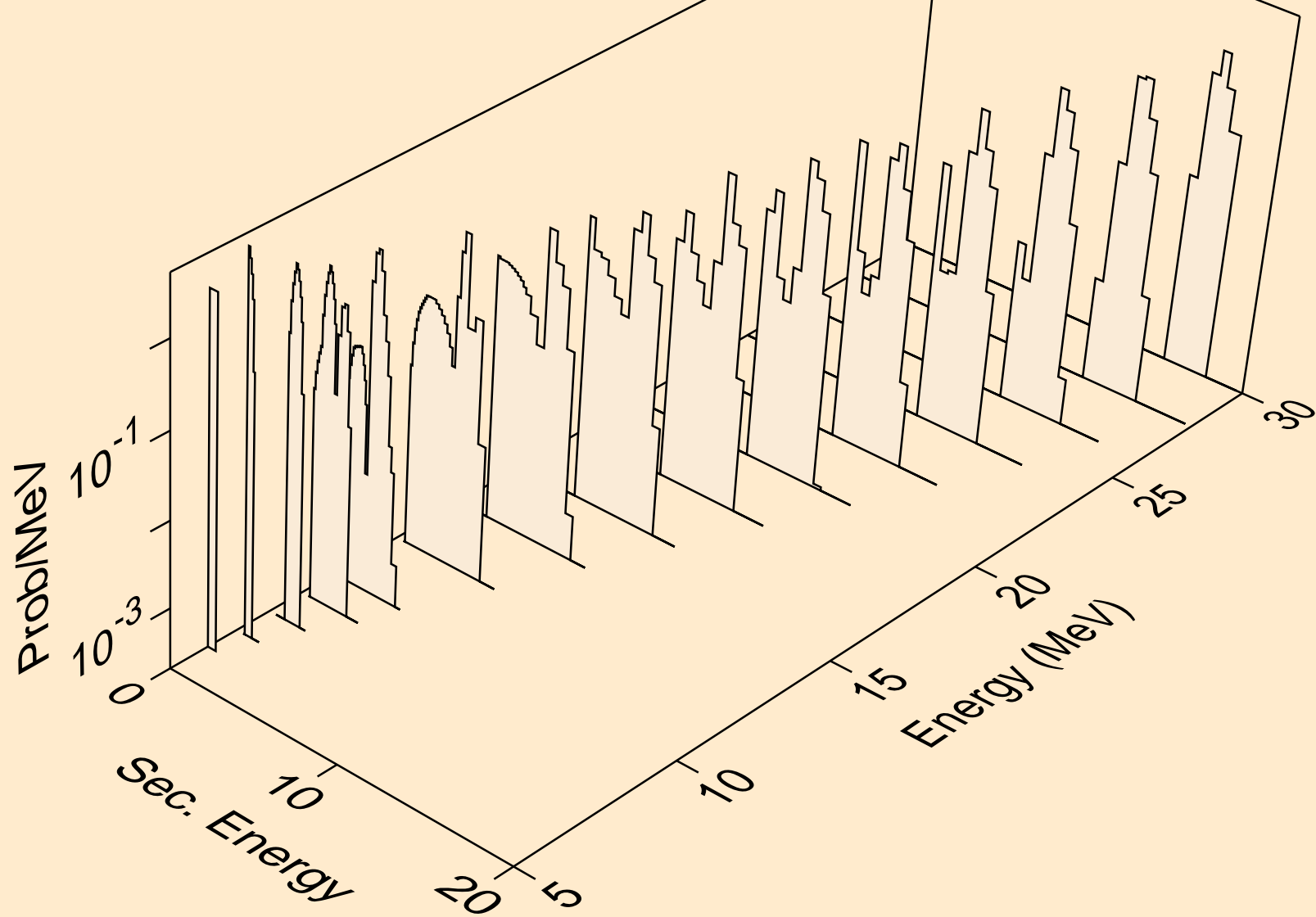

C014 TRITON ACER TENDL-2021 LIBRARY; T=0.K  
deuterons from (t,da)

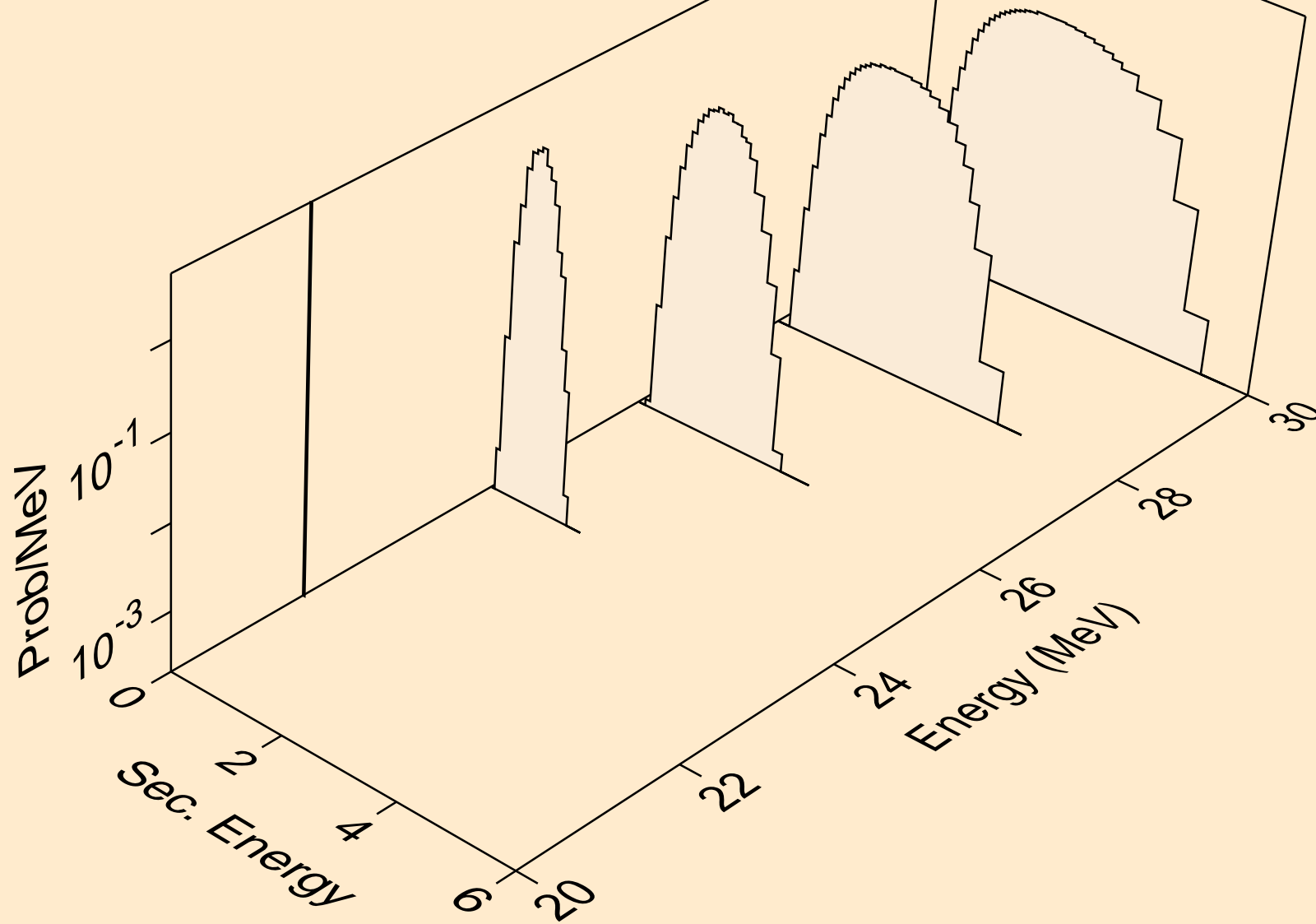

C014 TRITON ACER TENDL-2021 LIBRARY; T=0.K  
he3s from (t,x)

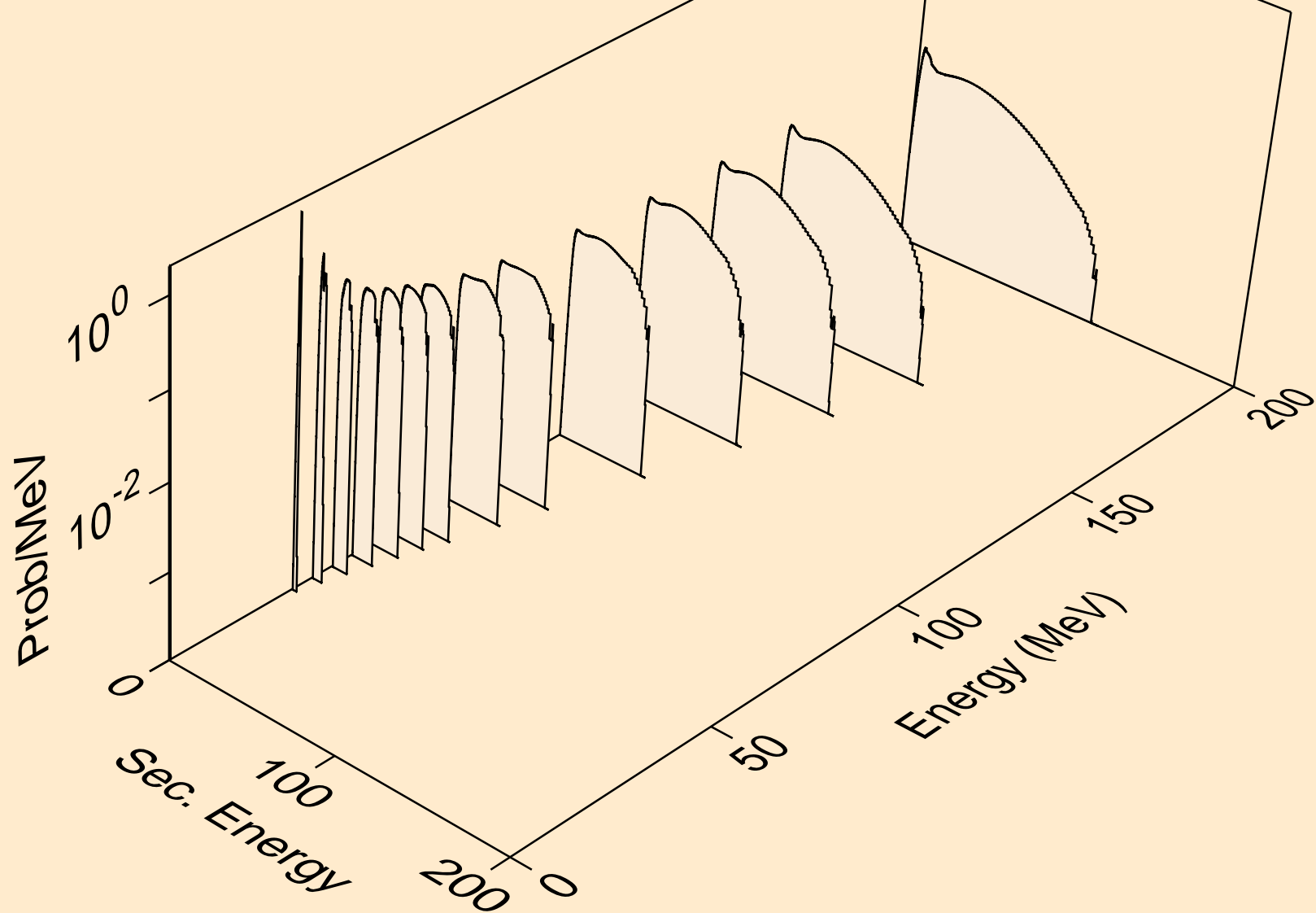

C014 TRITON ACER TENDL-2021 LIBRARY; T=0.K  
he3s from (t,n\*)he3

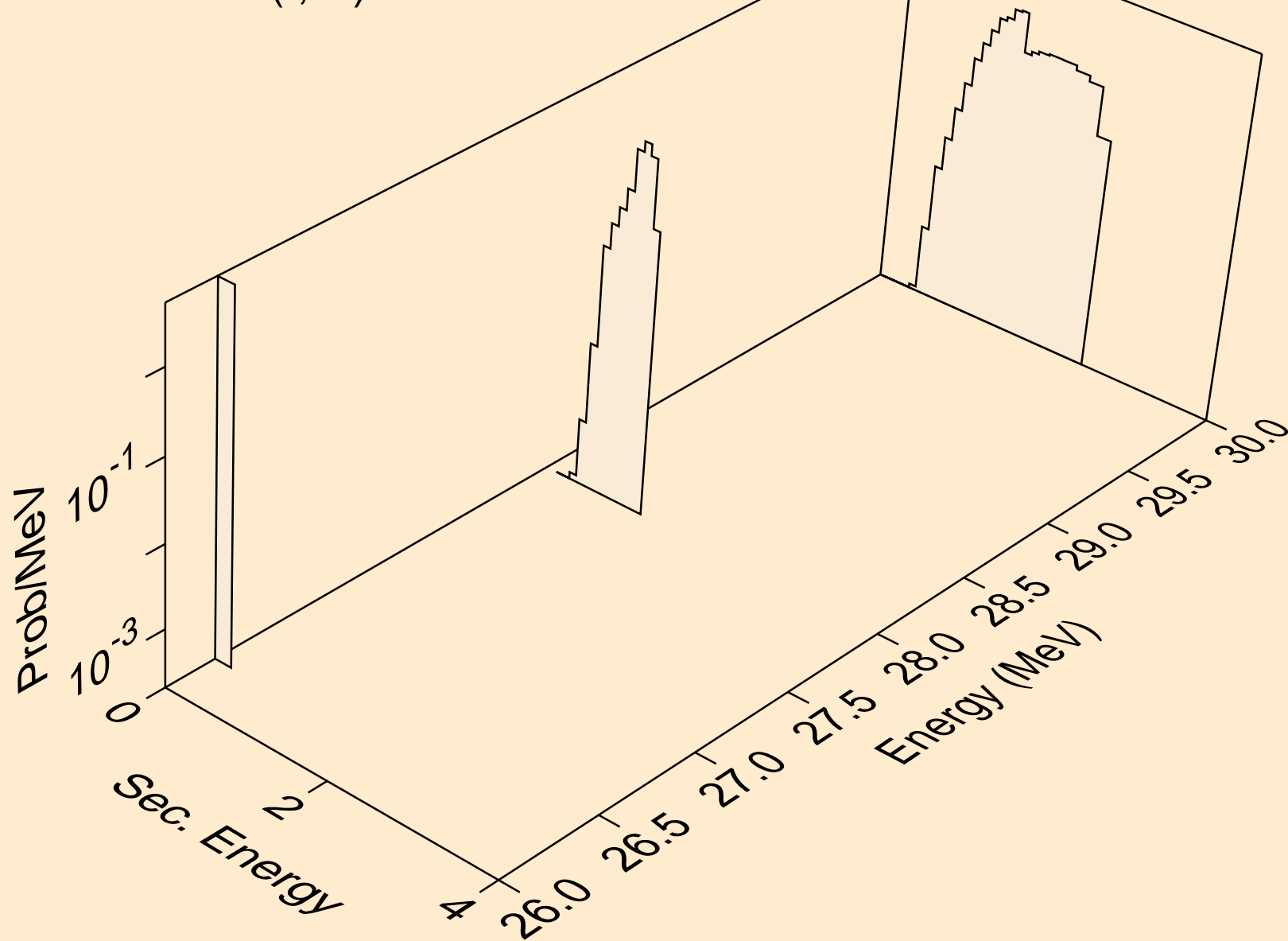

C014 TRITON ACER TENDL-2021 LIBRARY; T=0.K  
he3s from (t,he3)

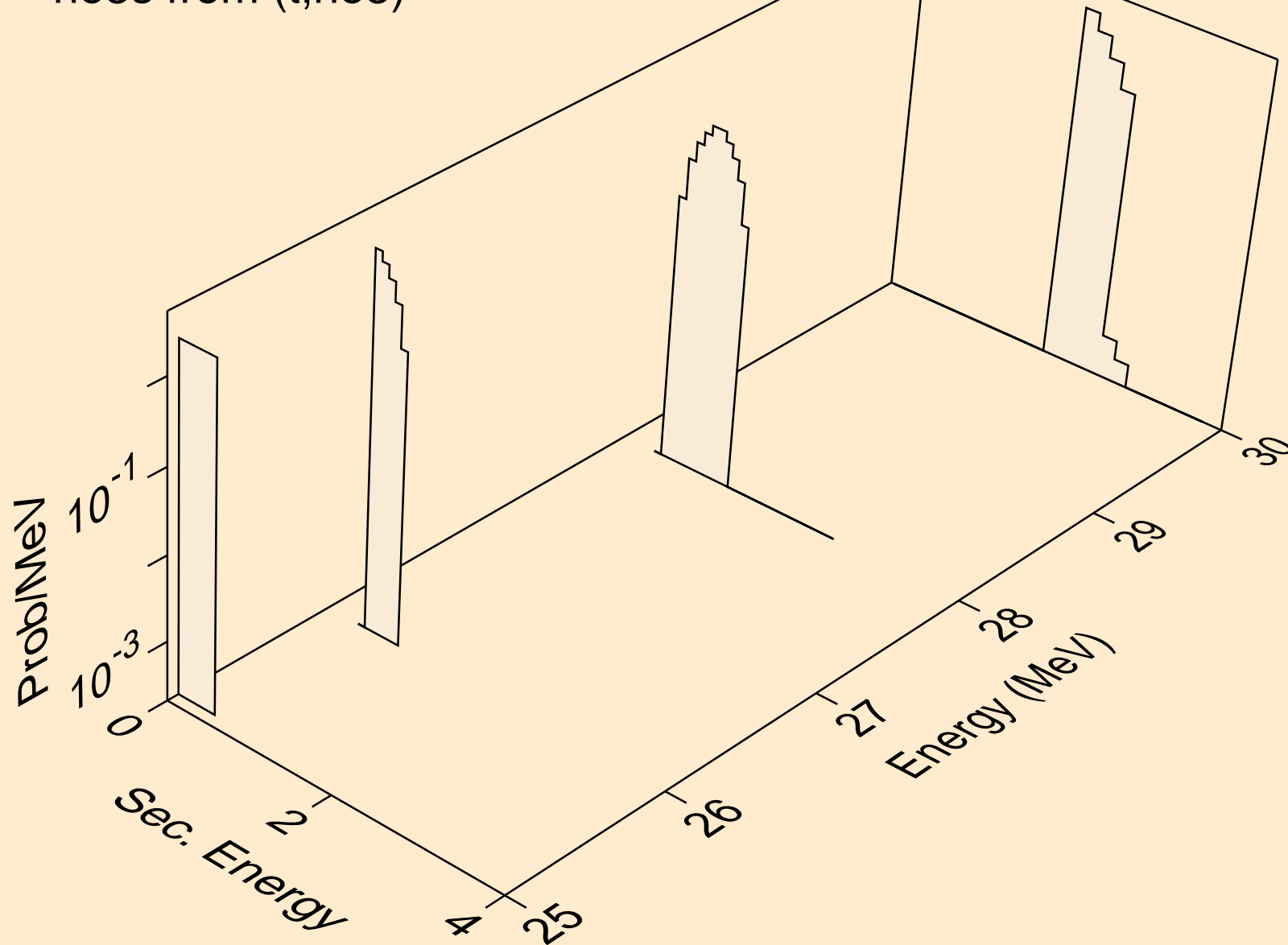

C014 TRITON ACER TENDL-2021 LIBRARY; T=0.K  
alphas from (t,x)

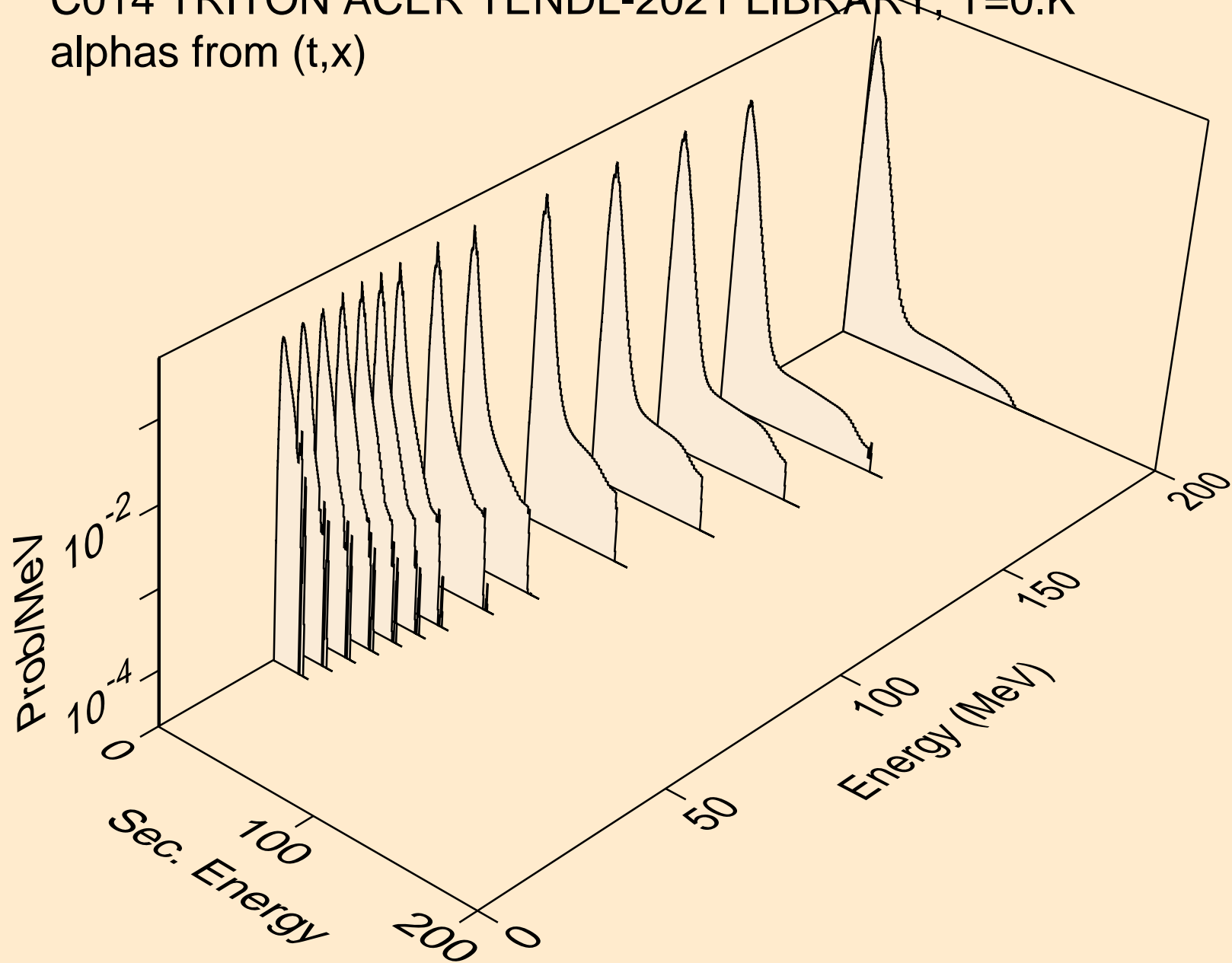

C014 TRITON ACER TENDL-2021 LIBRARY; T=0.K  
alphas from (t,n\*)a

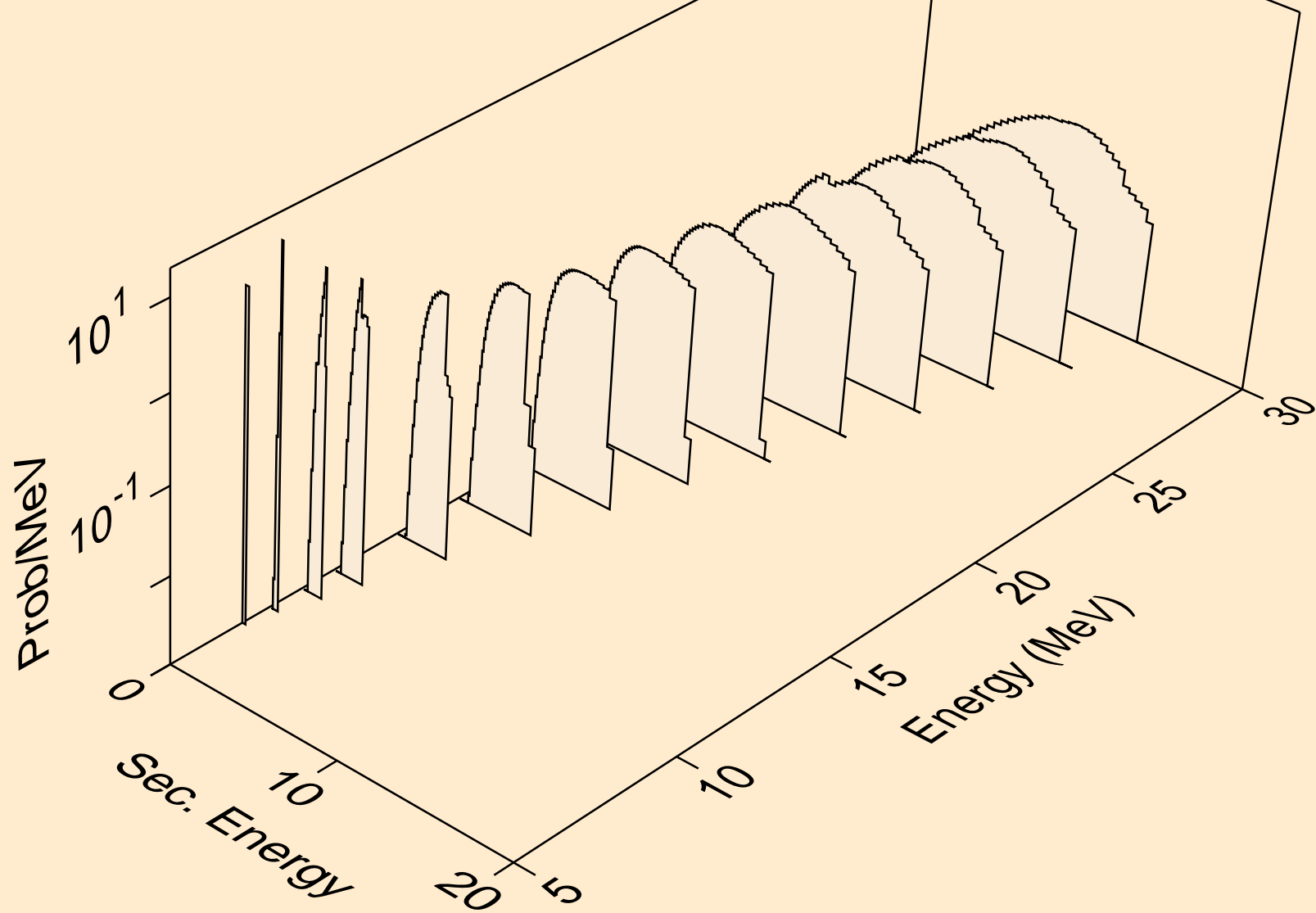

C014 TRITON ACER TENDL-2021 LIBRARY; T=0.K  
alphas from (t,2n)a

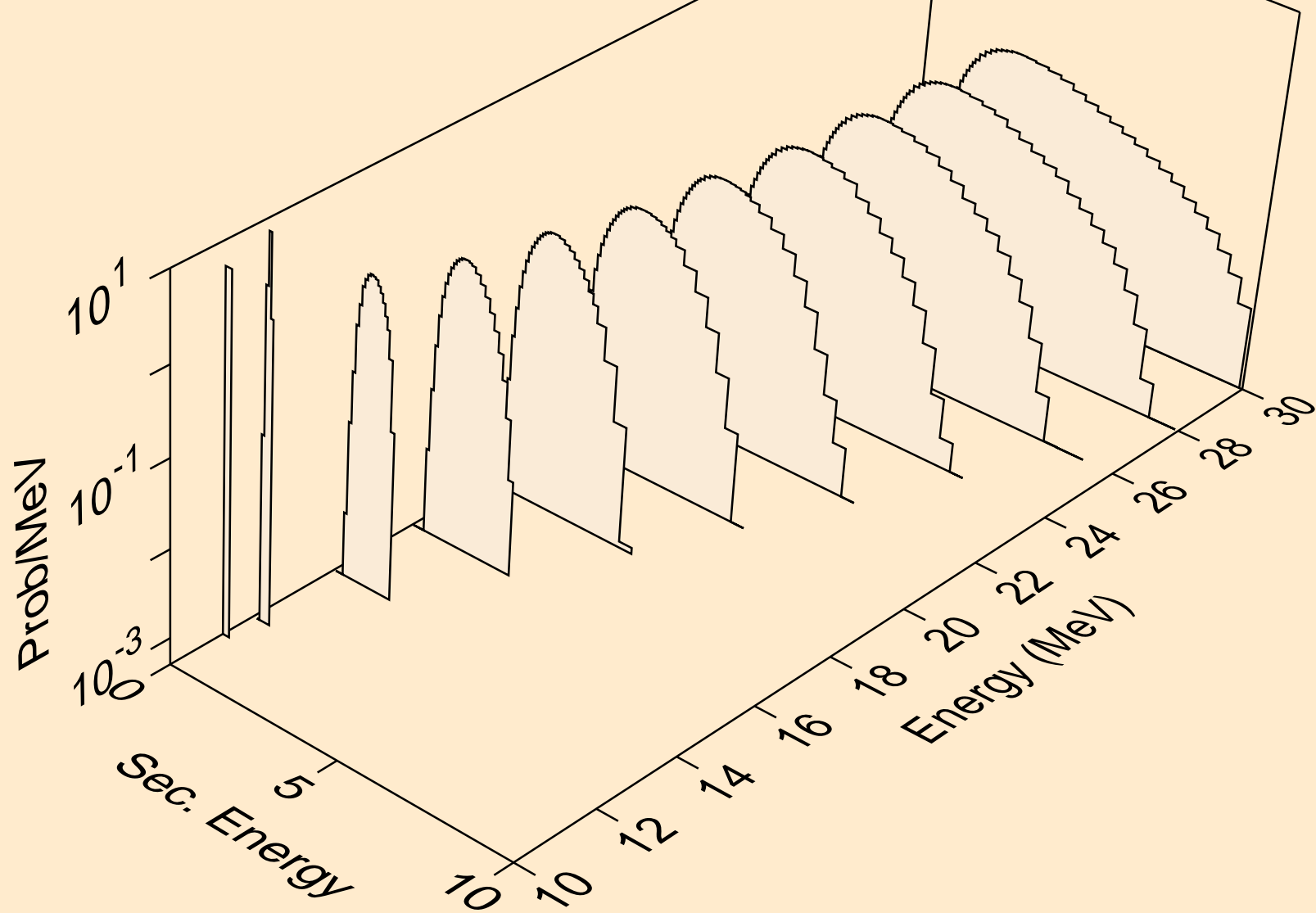



C014 TRITON ACER TENDL-2021 LIBRARY; T=0.K  
alphas from (t,3n)a

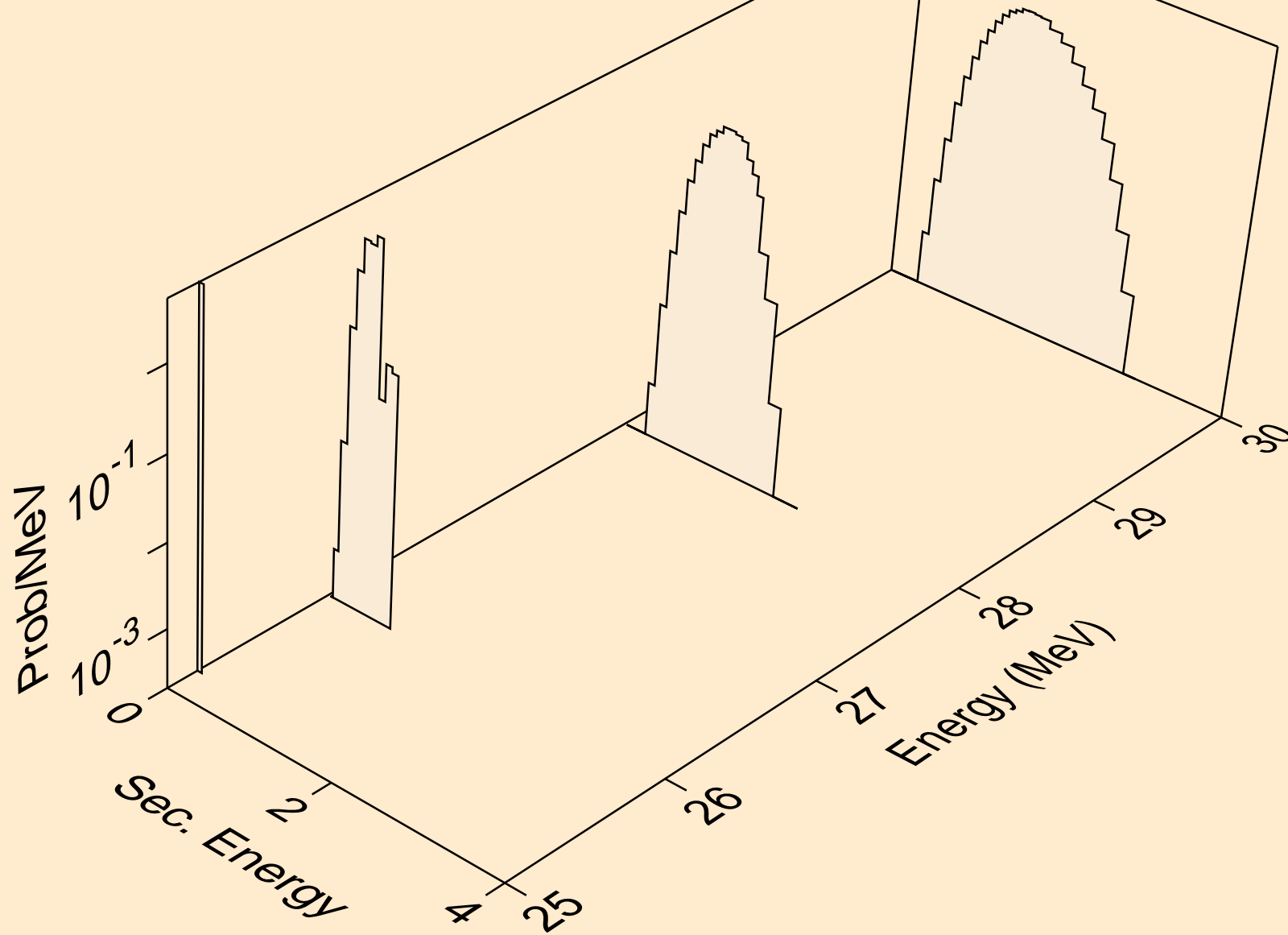

C014 TRITON ACER TENDL-2021 LIBRARY; T=0.K  
alphas from (t,n\*)2a

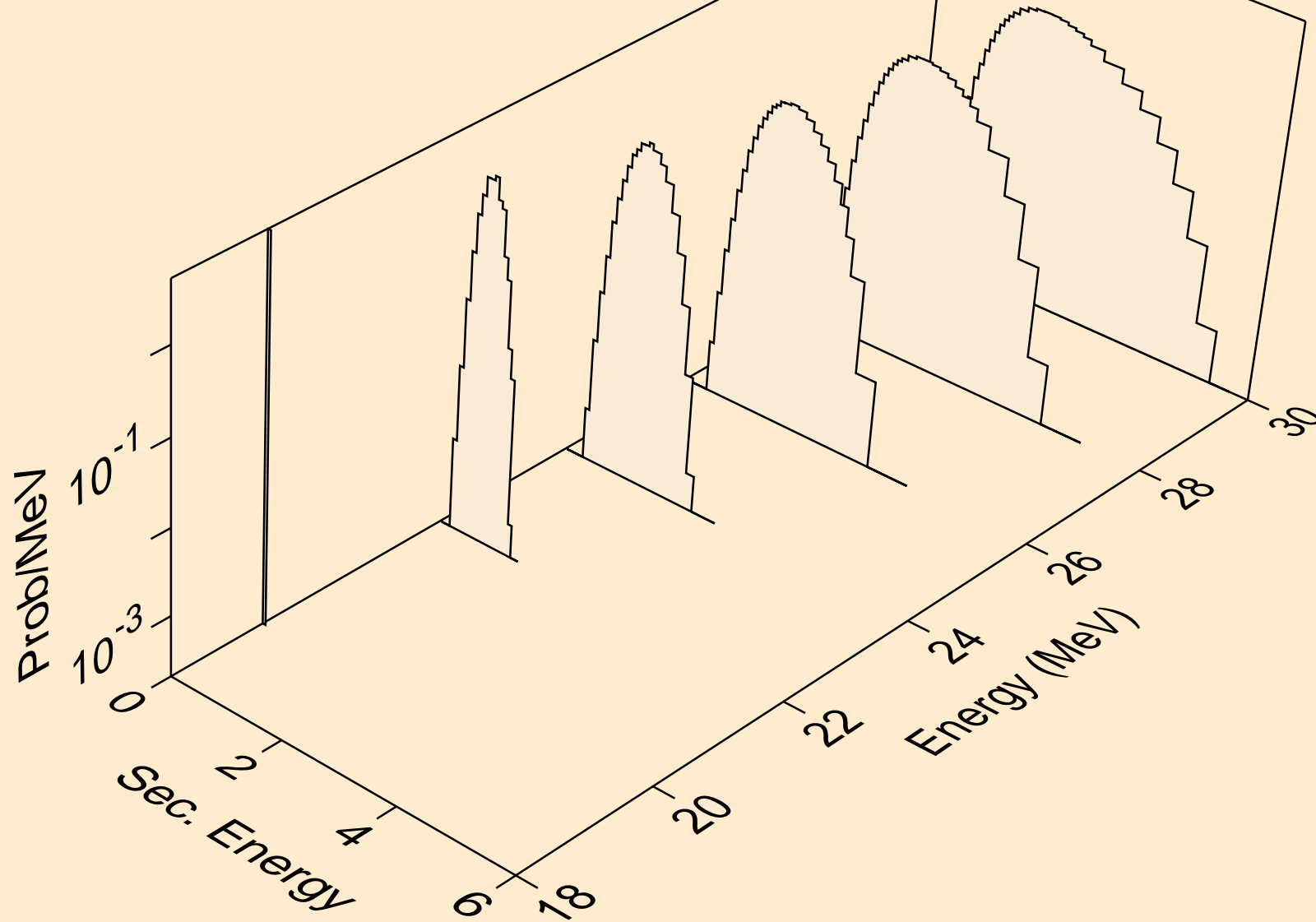

C014 TRITON ACER TENDL-2021 LIBRARY; T=0.K  
alphas from (t,2n)2a

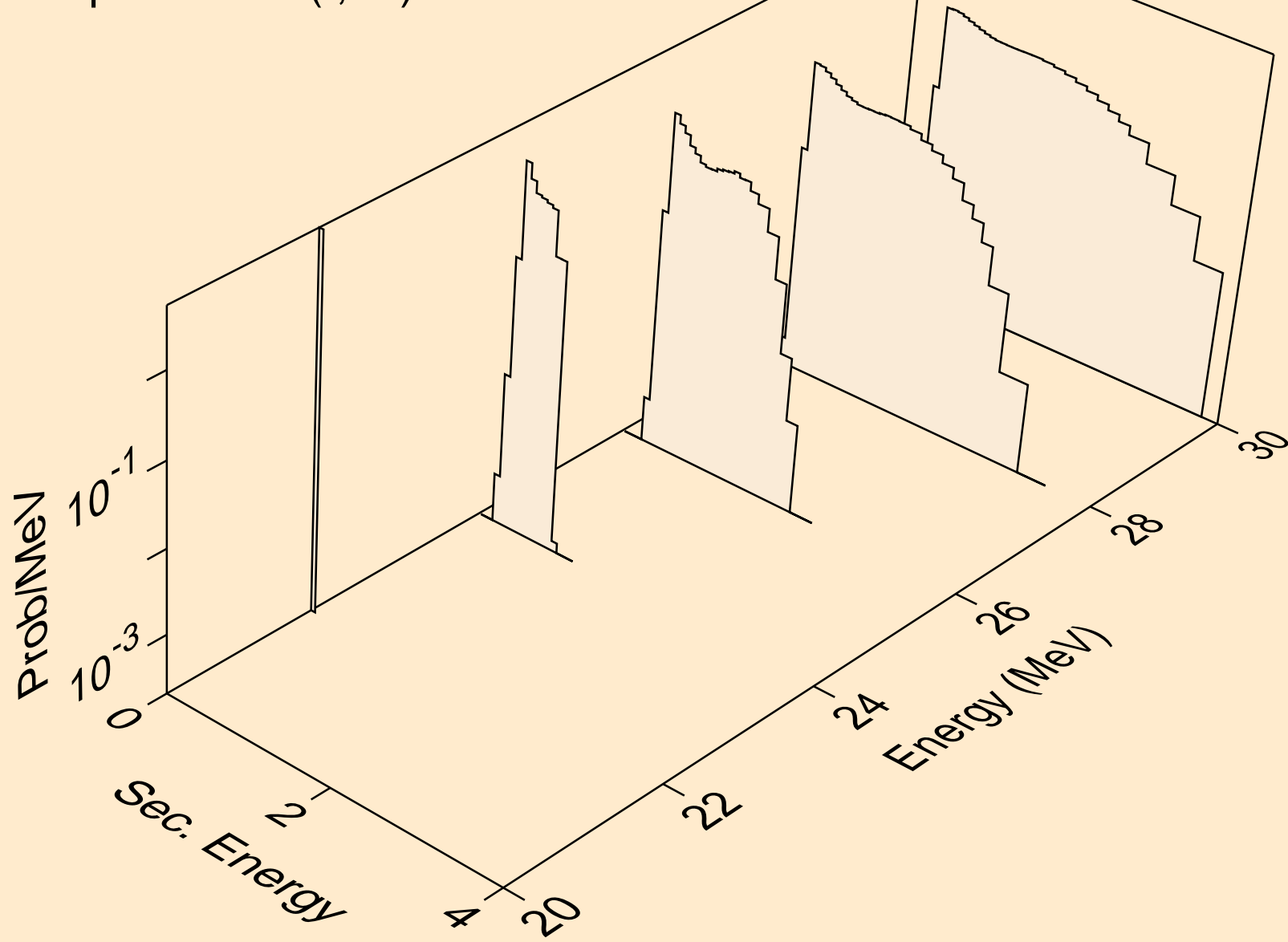

C014 TRITON ACER TENDL-2021 LIBRARY; T=0.K  
alphas from (t,npa)

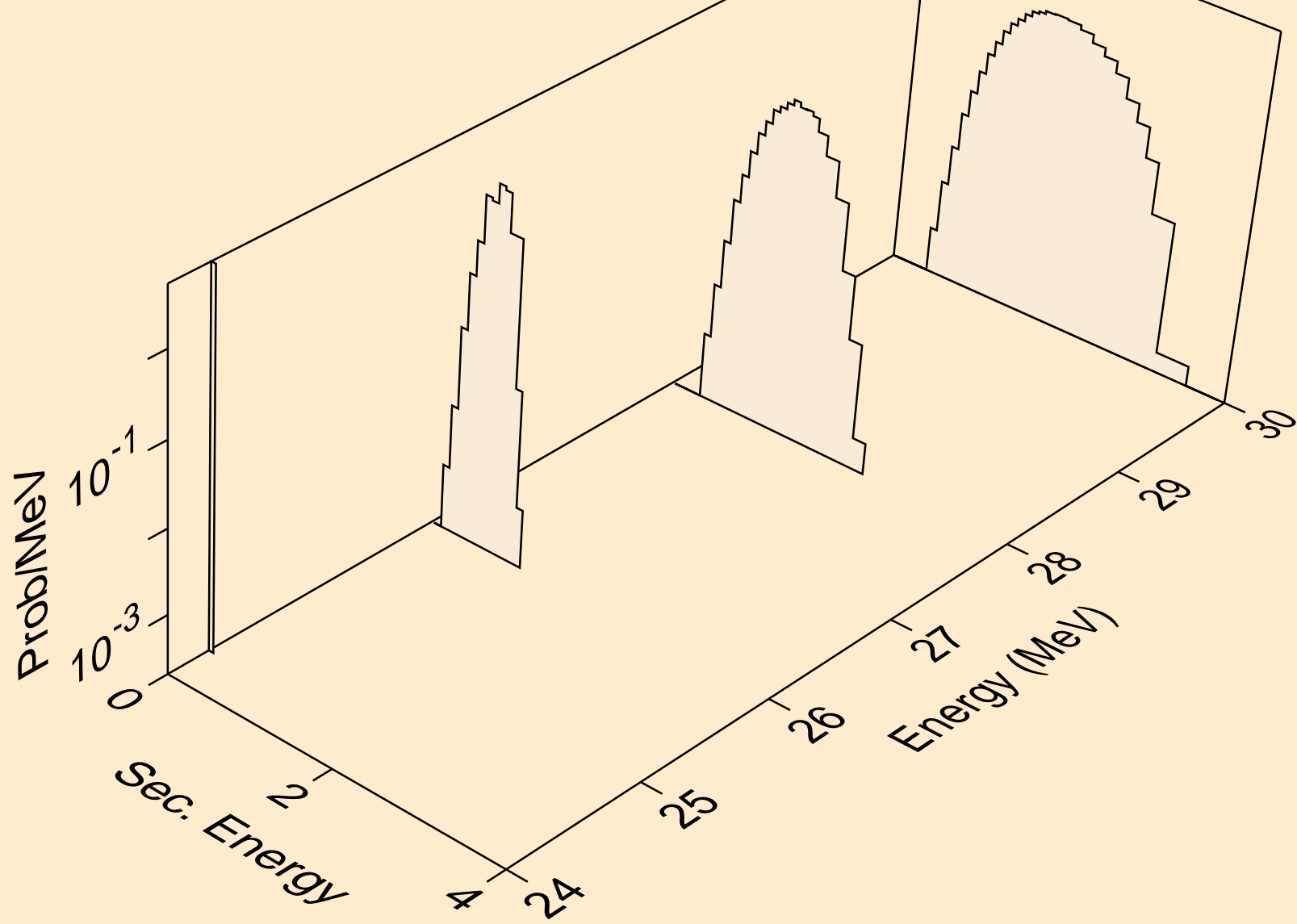

C014 TRITON ACER TENDL-2021 LIBRARY; T=0.K  
alphas from (t,a)

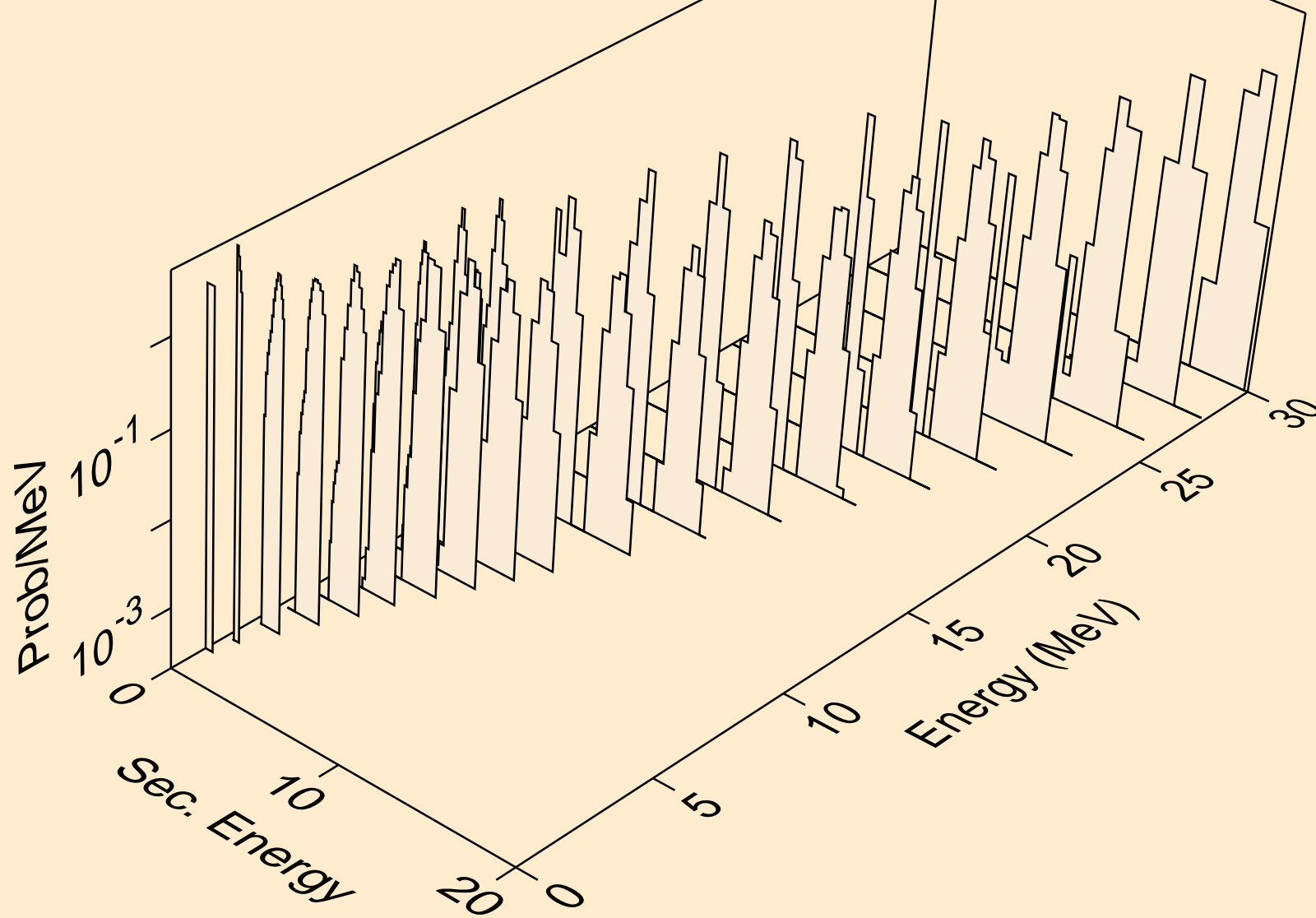

C014 TRITON ACER TENDL-2021 LIBRARY; T=0.K  
alphas from (t,2a)

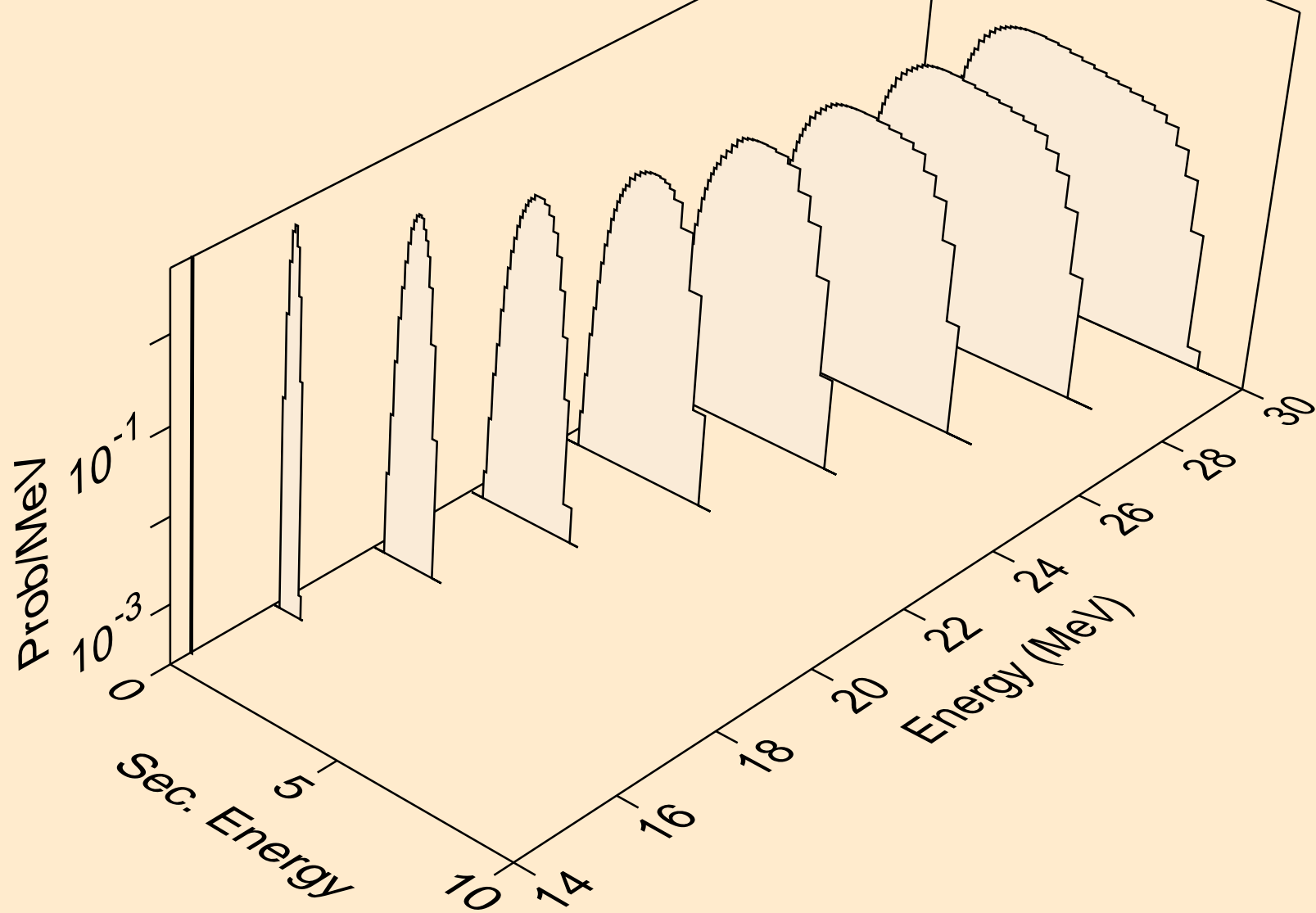

C014 TRITON ACER TENDL-2021 LIBRARY; T=0.K  
alphas from (t,pa)

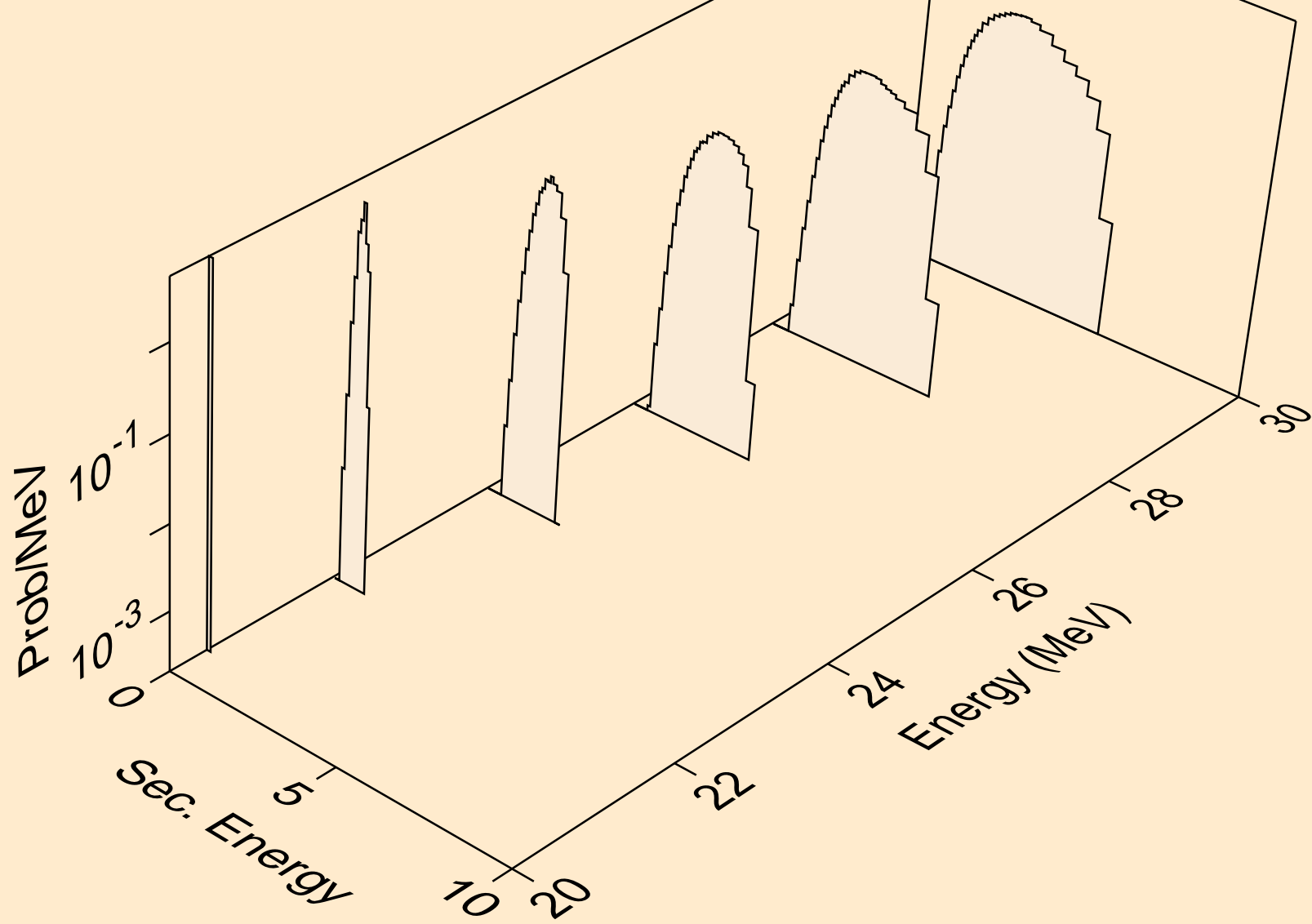

C014 TRITON ACER TENDL-2021 LIBRARY; T=0.K  
alphas from (t,da)

