

CE125 TRITON ACER TENDL-2021 LIBRARY; T=0.K  
Principal cross sections

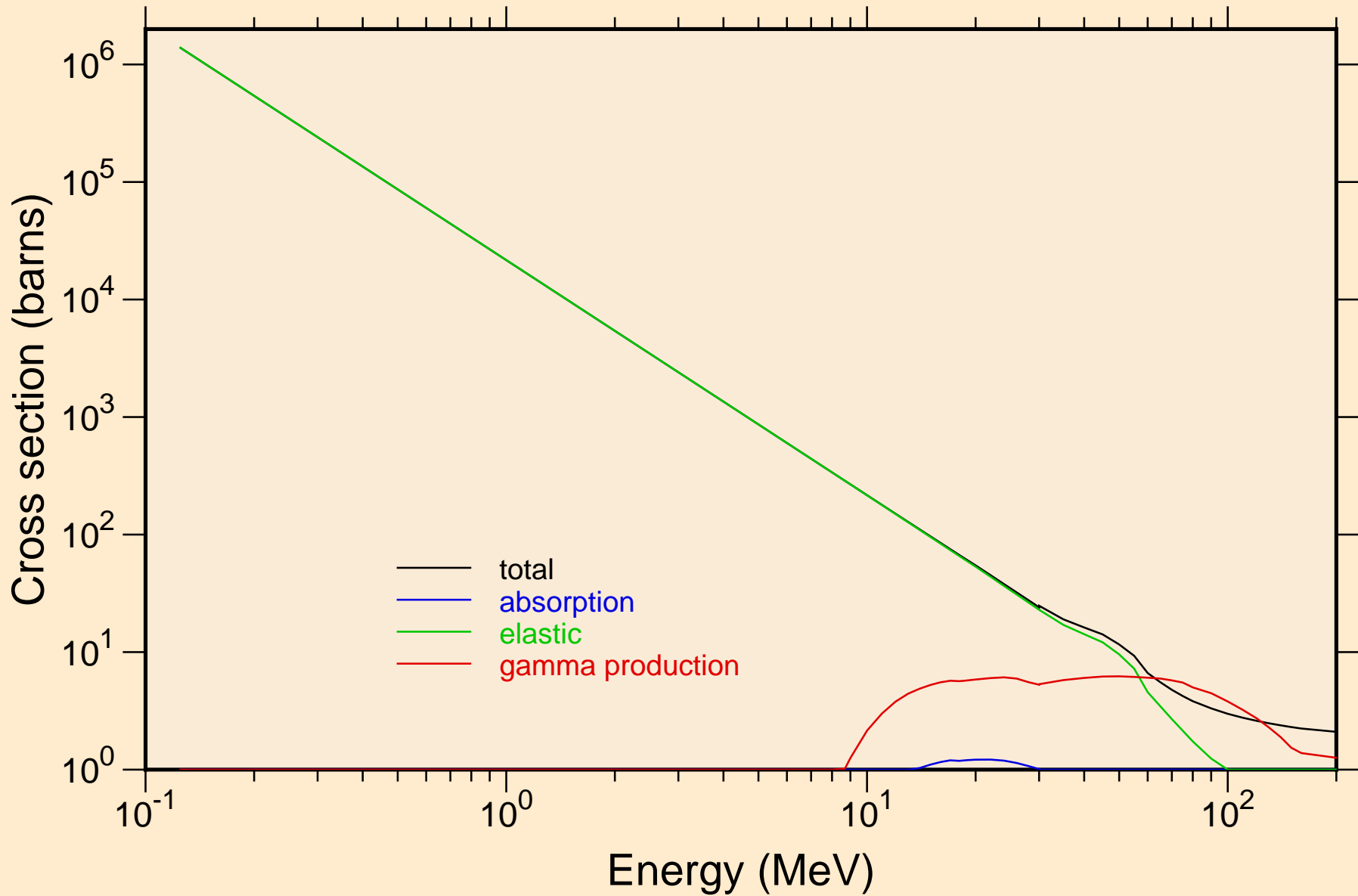

CE125 TRITON ACER TENDL-2021 LIBRARY; T=0.K  
Heating

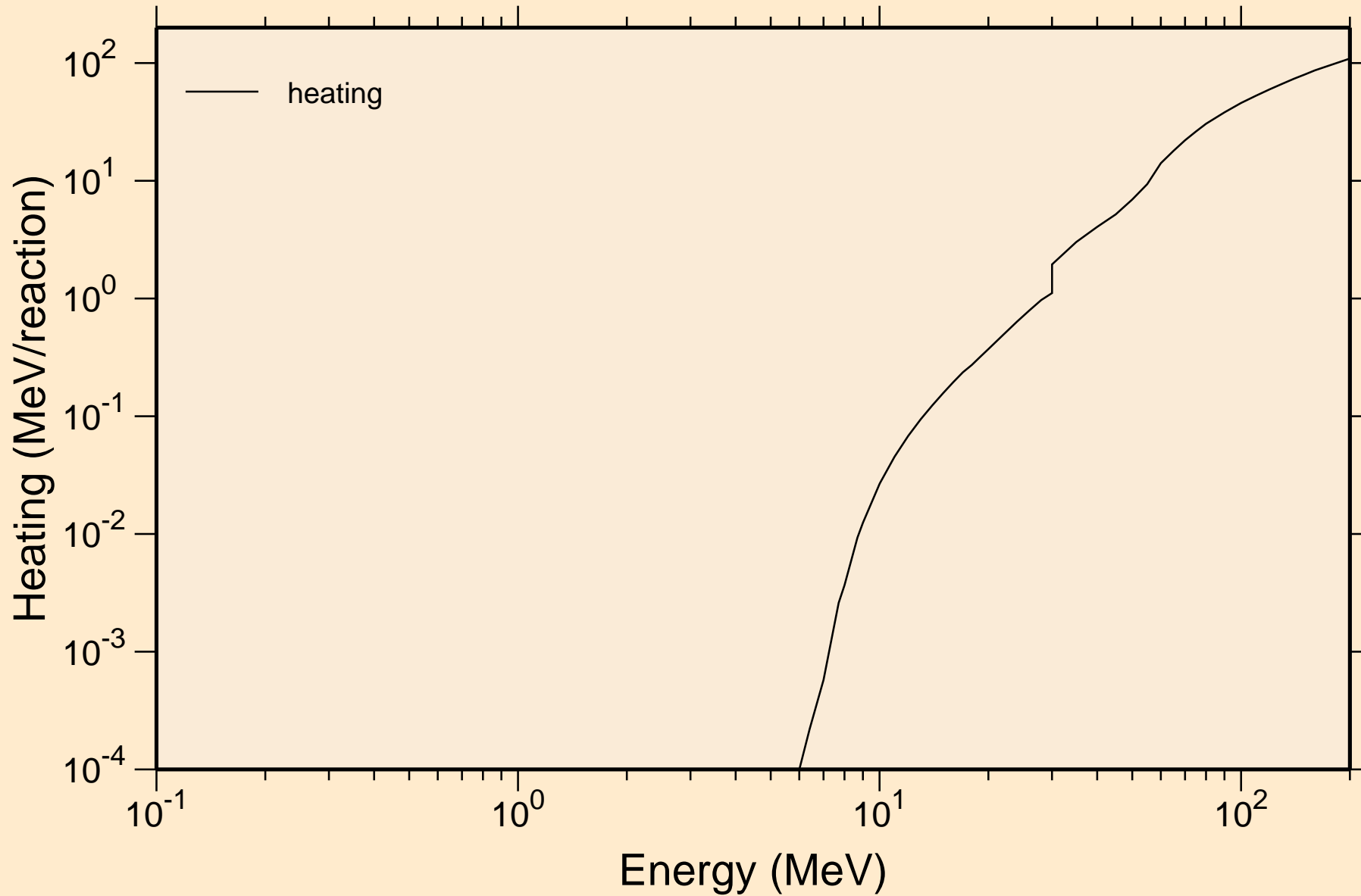

# CE125 TRITON ACER TENDL-2021 LIBRARY; T=0.K

## Principal cross sections

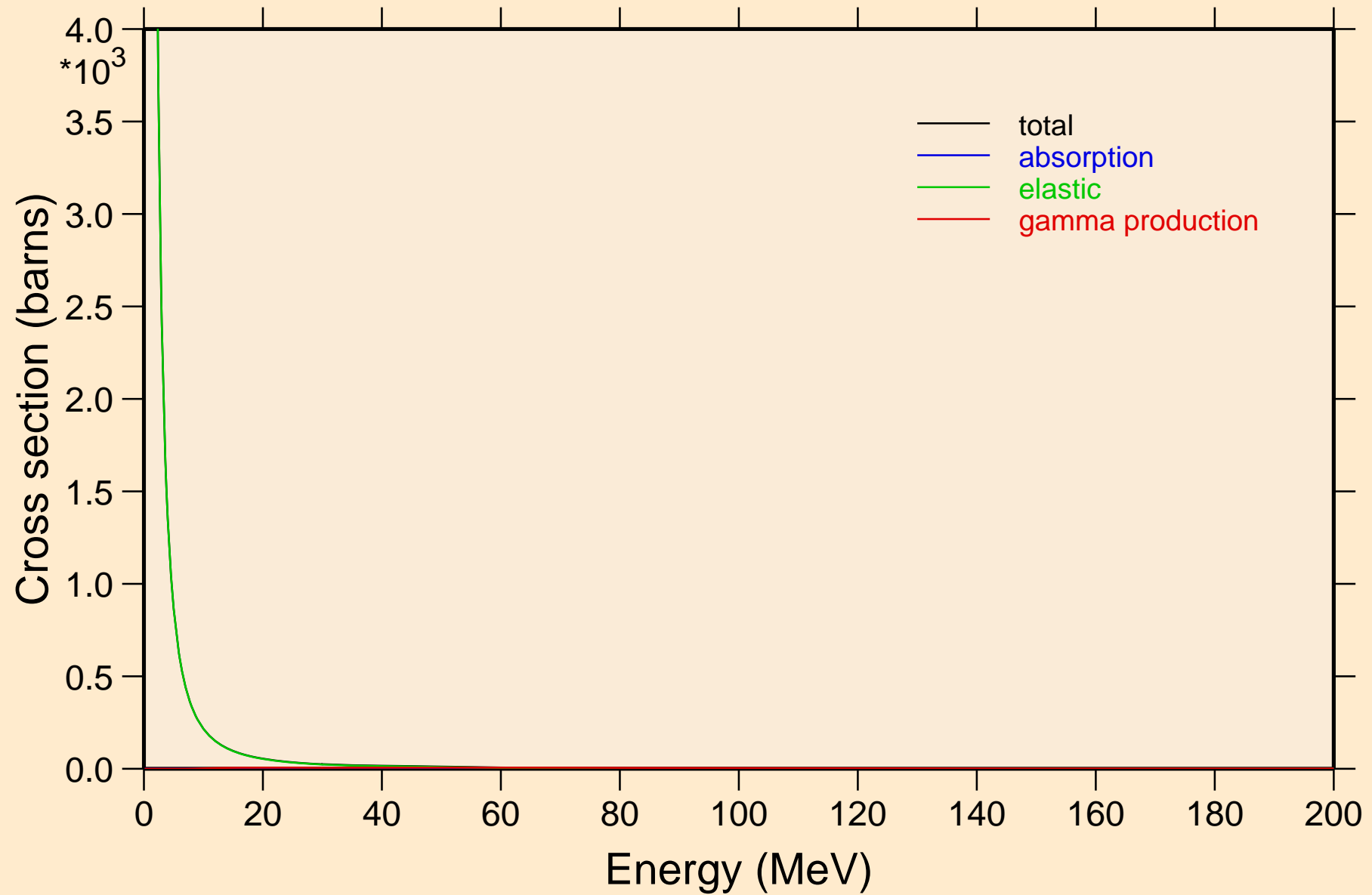

# CE125 TRITON ACER TENDL-2021 LIBRARY; T=0.K

## Heating

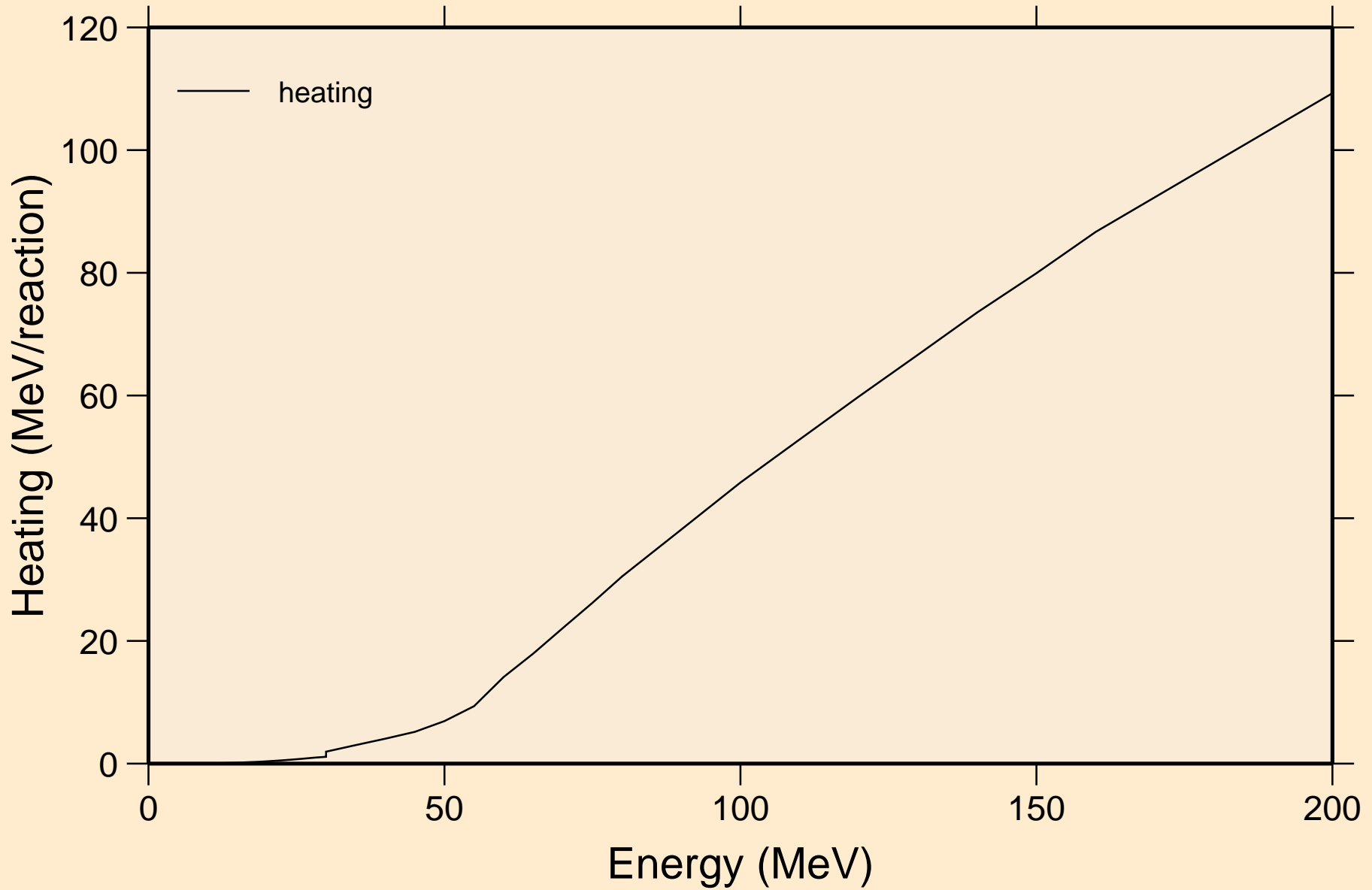

CE125 TRITON ACER TENDL-2021 LIBRARY; T=0.K  
Threshold reactions

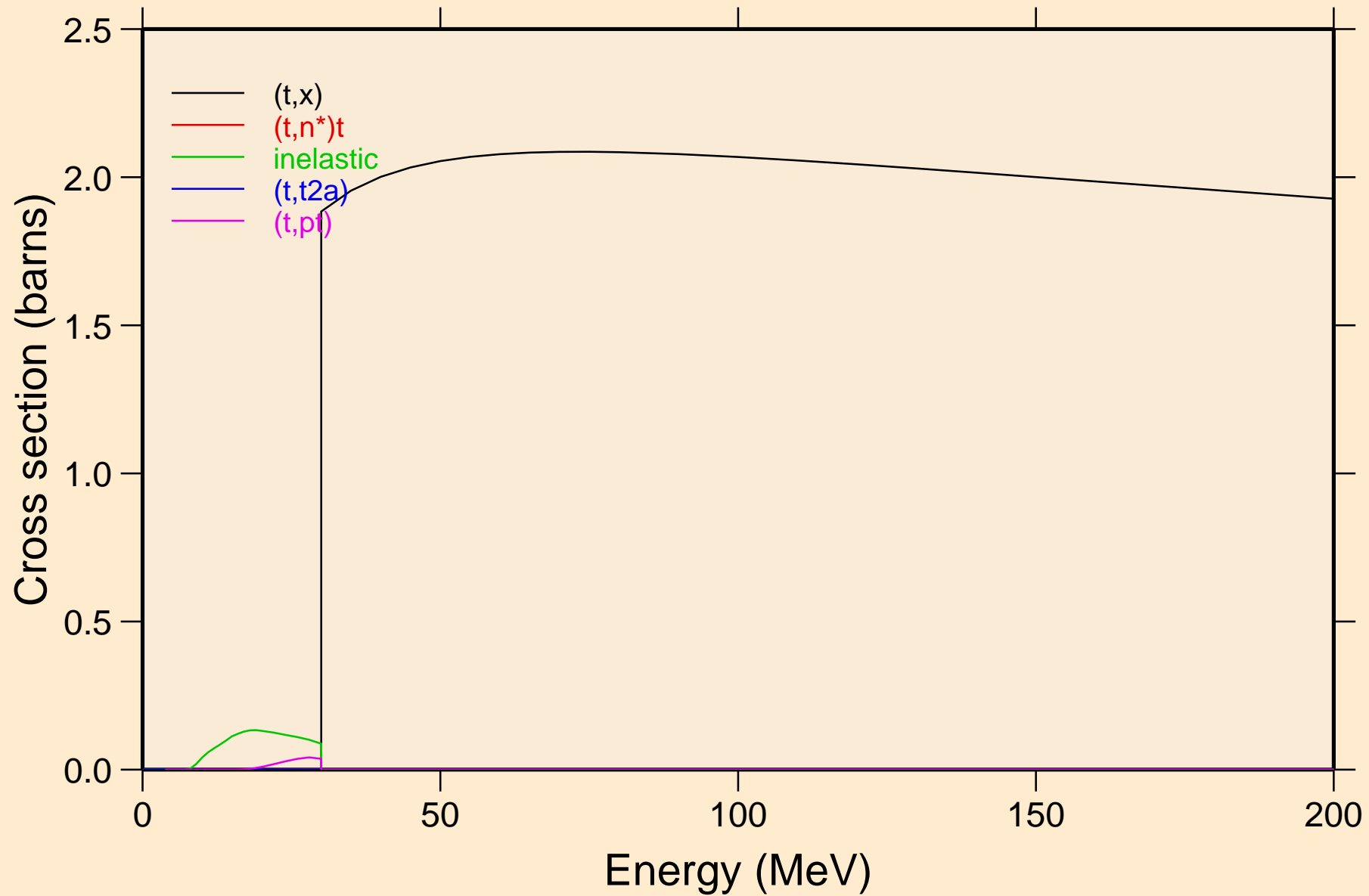

CE125 TRITON ACER TENDL-2021 LIBRARY; T=0.K  
Threshold reactions

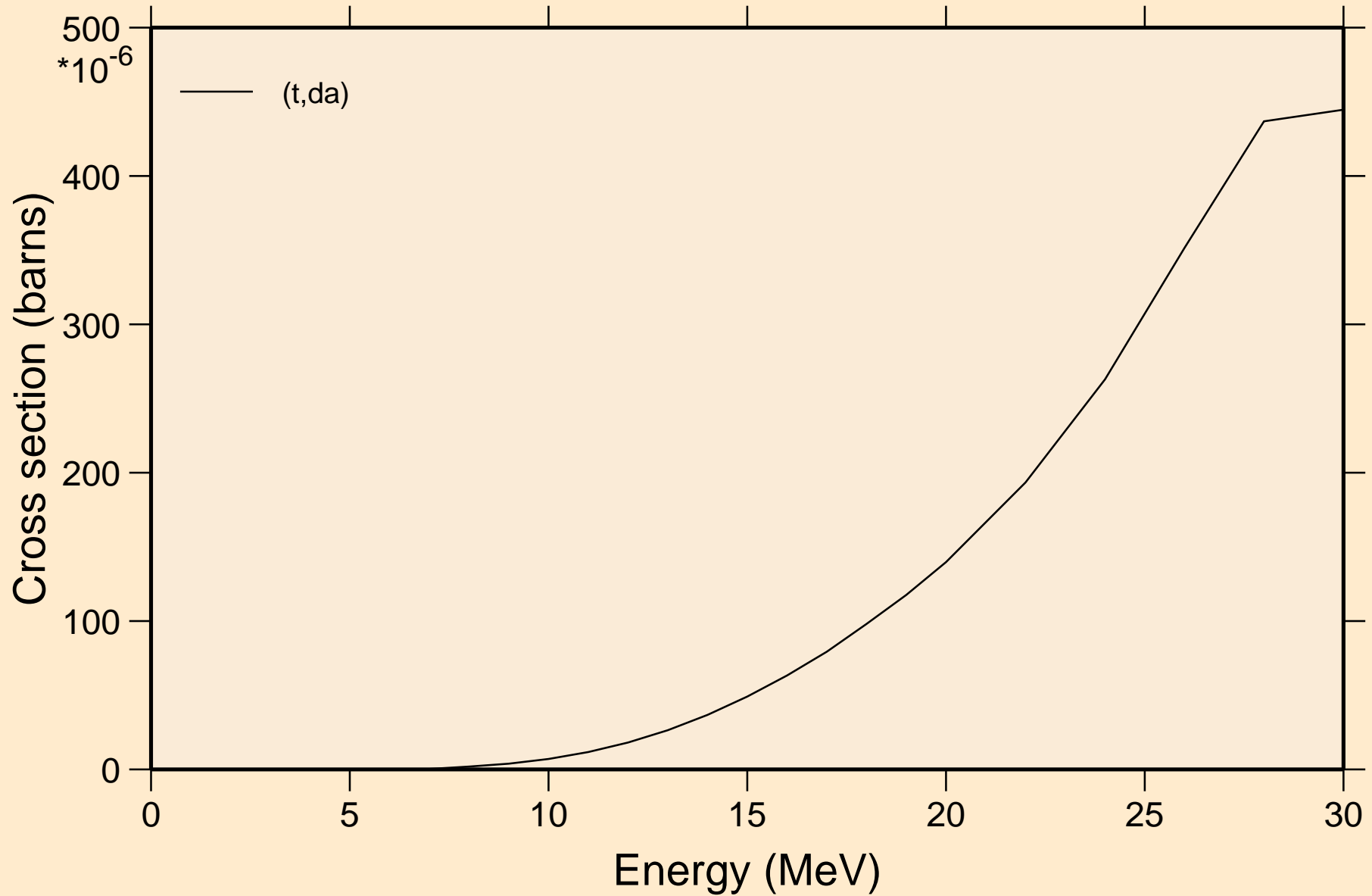

CE125 TRITON ACER TENDL-2021 LIBRARY; T=0.K  
angular distribution for elastic

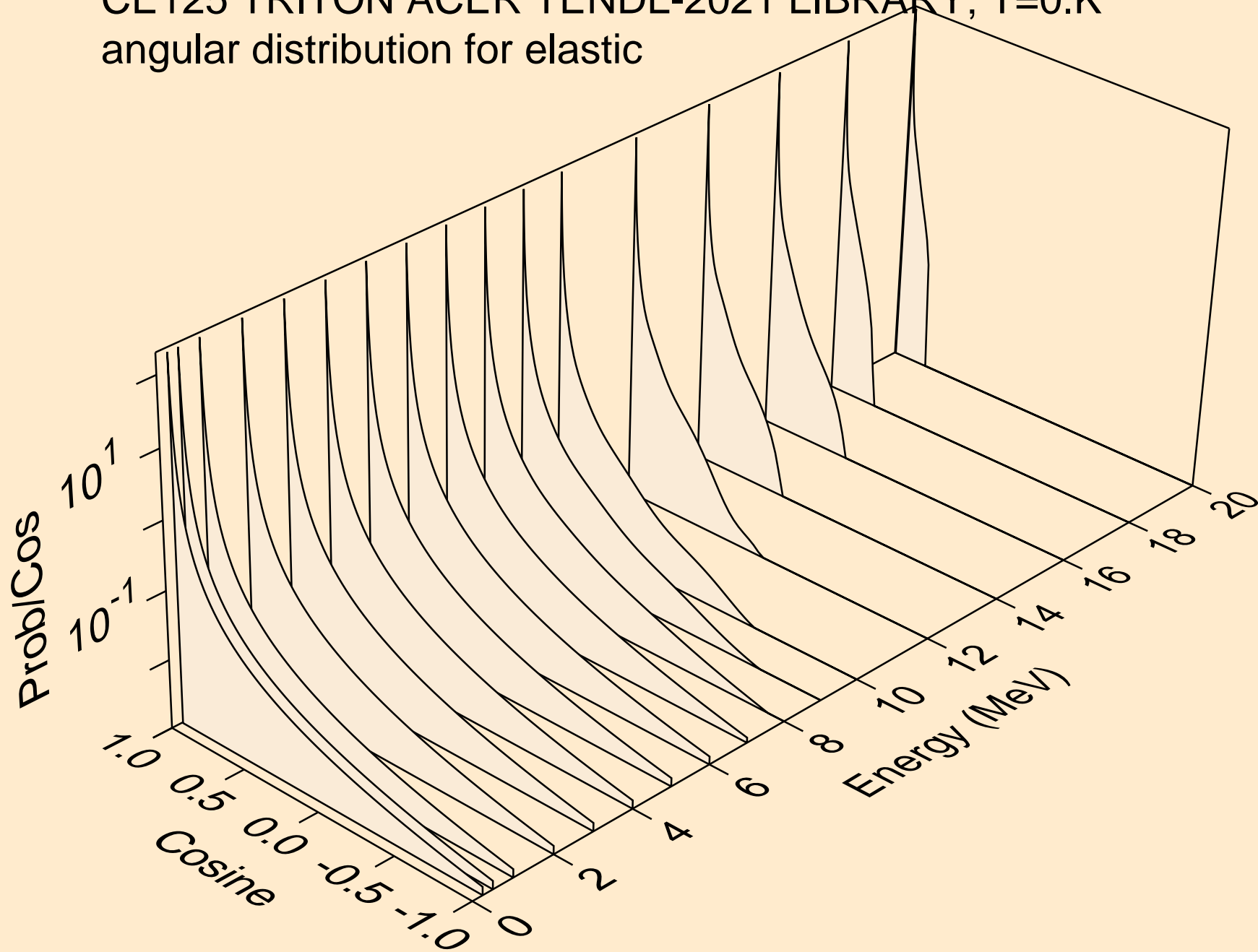

CE125 TRITON ACER TENDL-2021 LIBRARY; T=0.K  
angular distribution for elastic

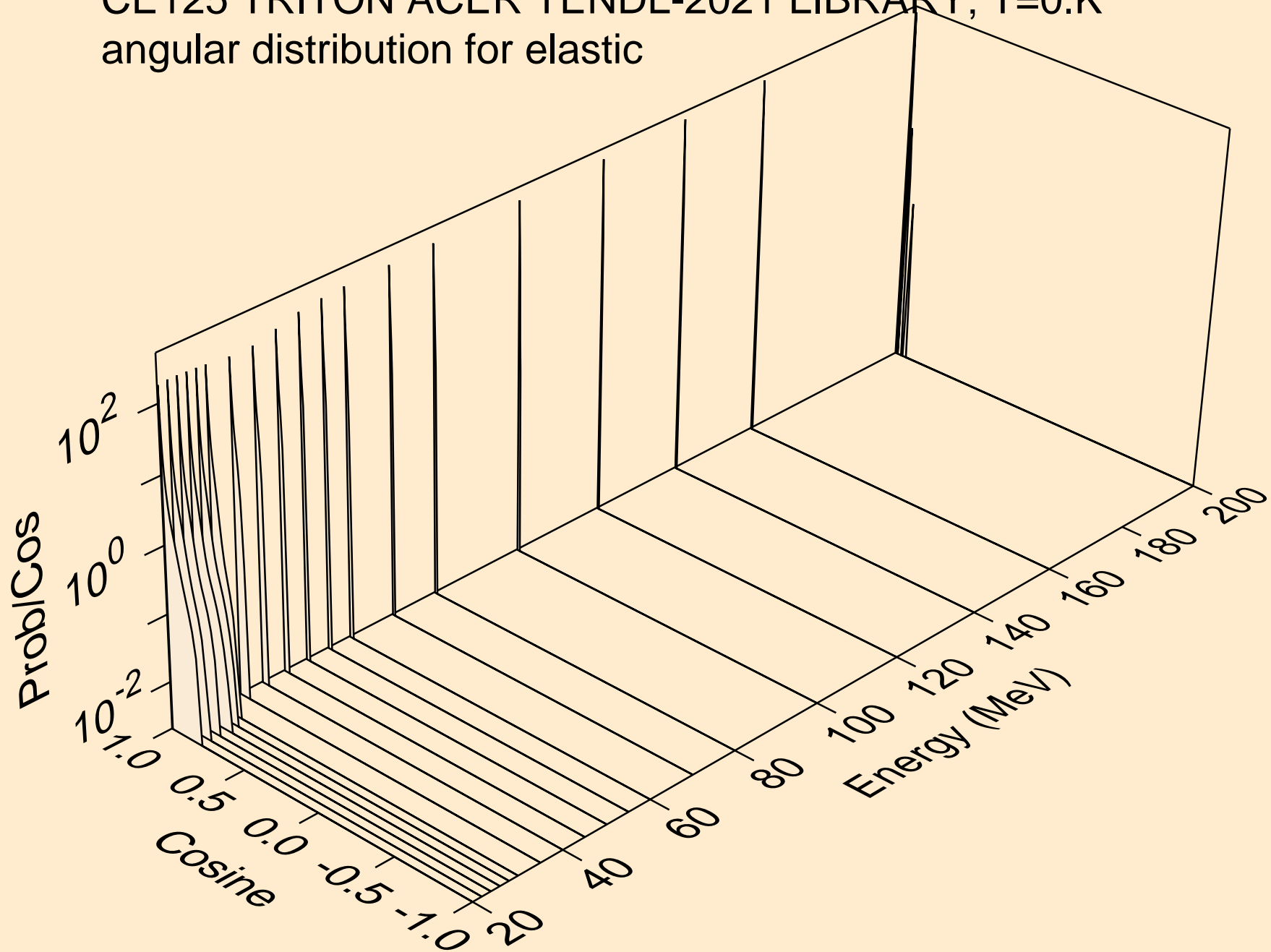



CE125 TRITON ACER TENDL-2021 LIBRARY; T=0.K  
Triton emission for (t,x)

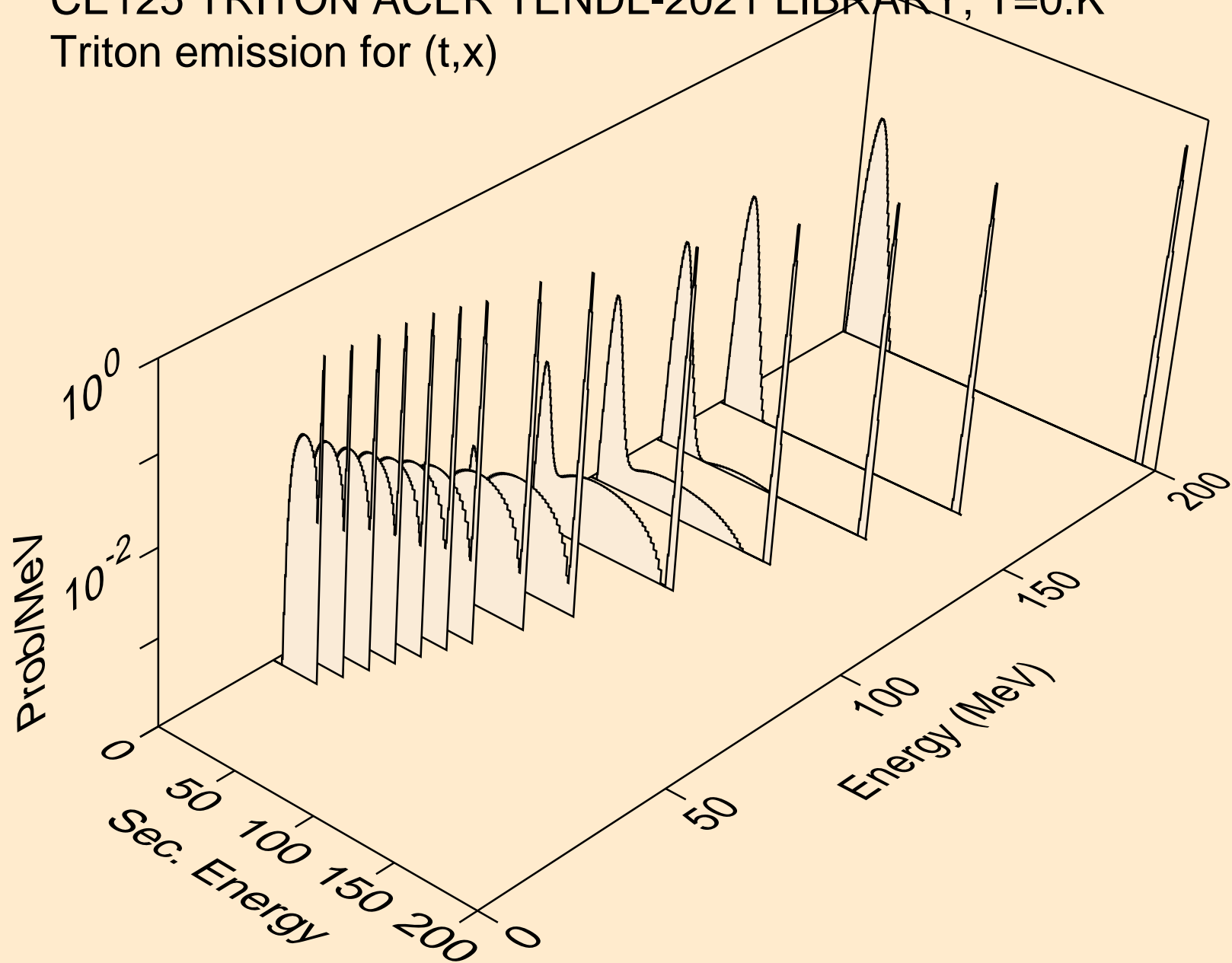

CE125 TRITON ACER TENDL-2021 LIBRARY; T=0.K  
Triton emission for (t,n\*)t

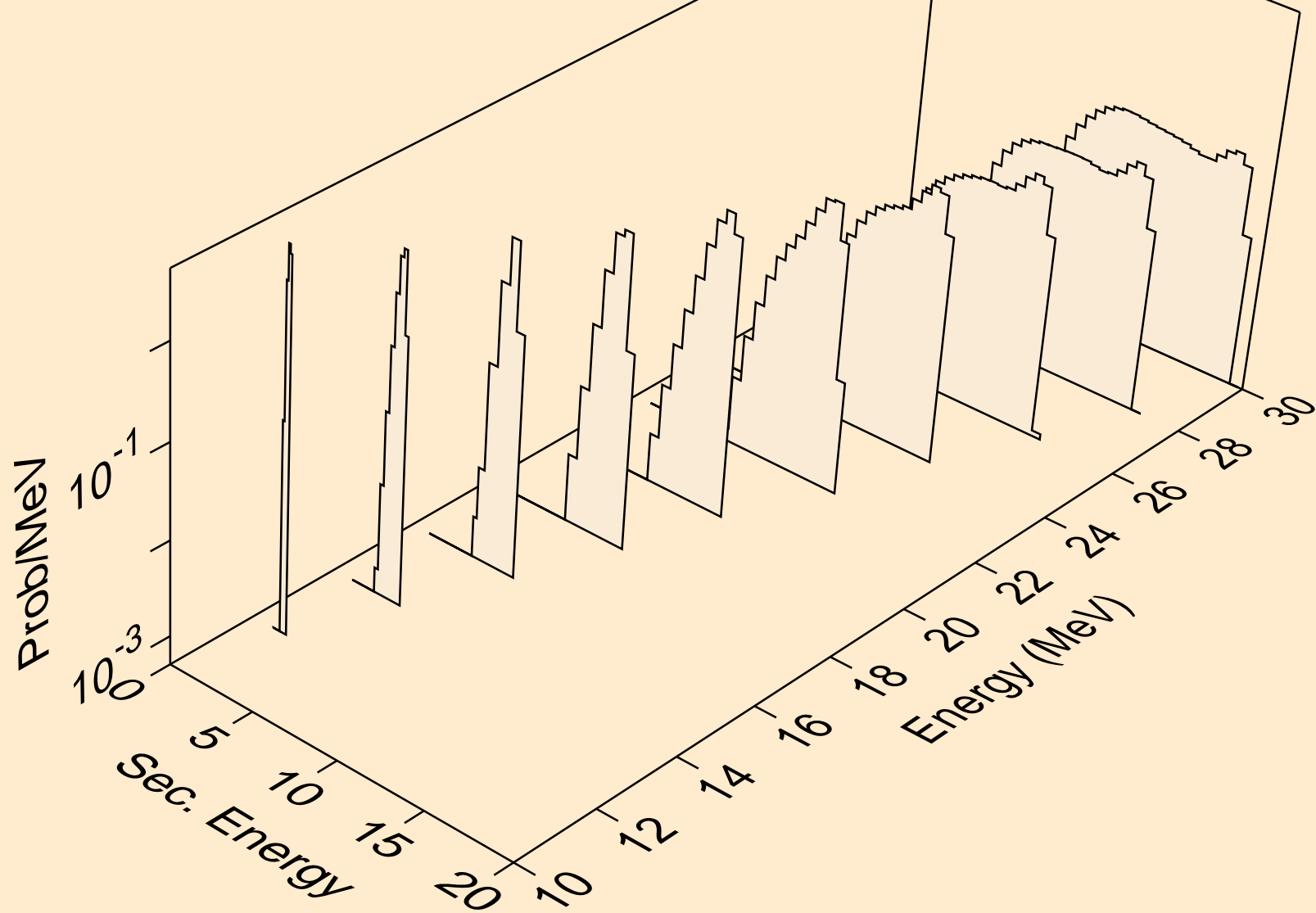

CE125 TRITON ACER TENDL-2021 LIBRARY; T=0.K  
Triton emission for inelastic

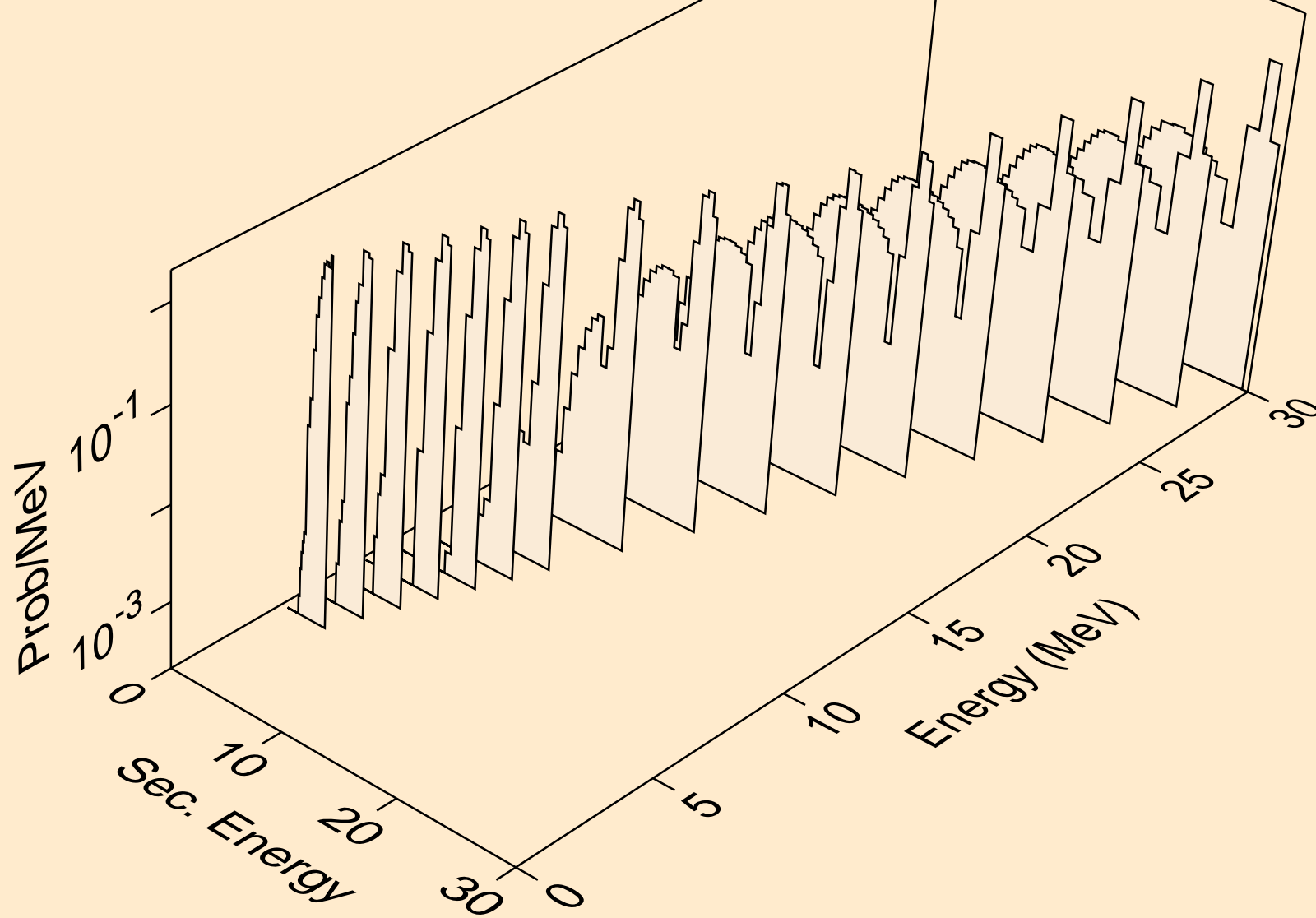

CE125 TRITON ACER TENDL-2021 LIBRARY; T=0.K  
Triton emission for (t,t2a)

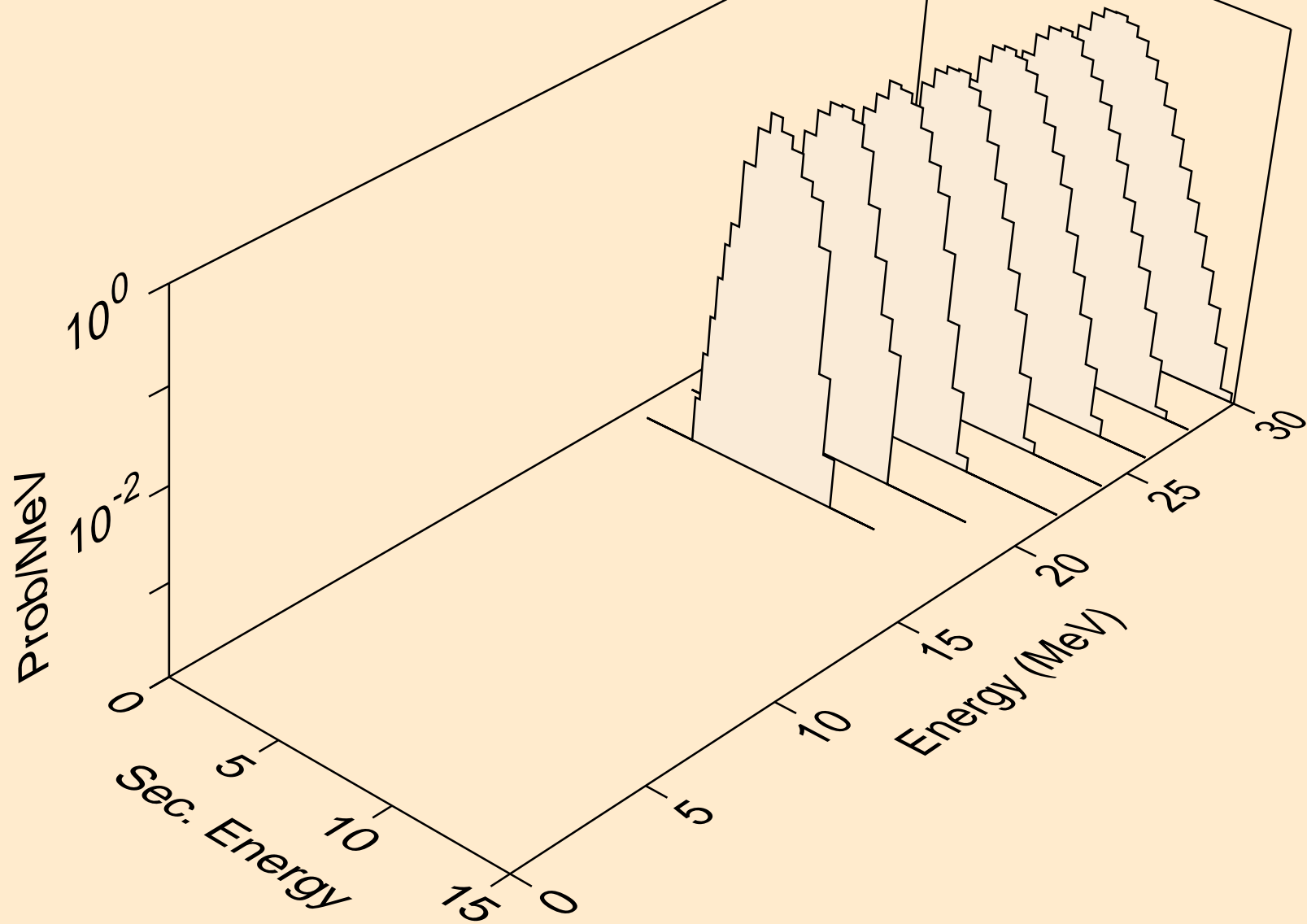

CE125 TRITON ACER TENDL-2021 LIBRARY; T=0.K  
Triton emission for (t,pt)

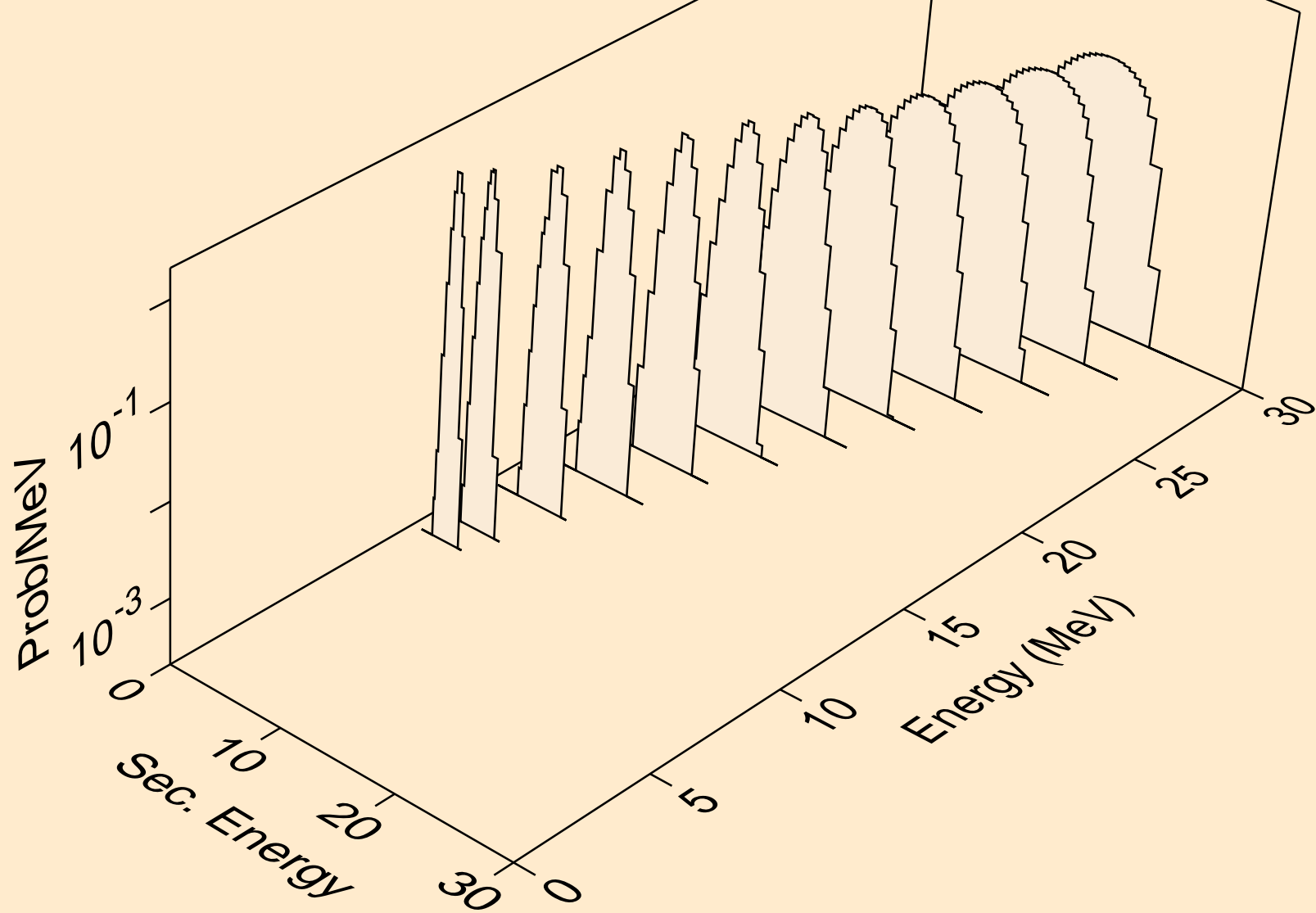

CE125 TRITON ACER TENDL-2021 LIBRARY; T=0.K  
Photon emission for (z,n)

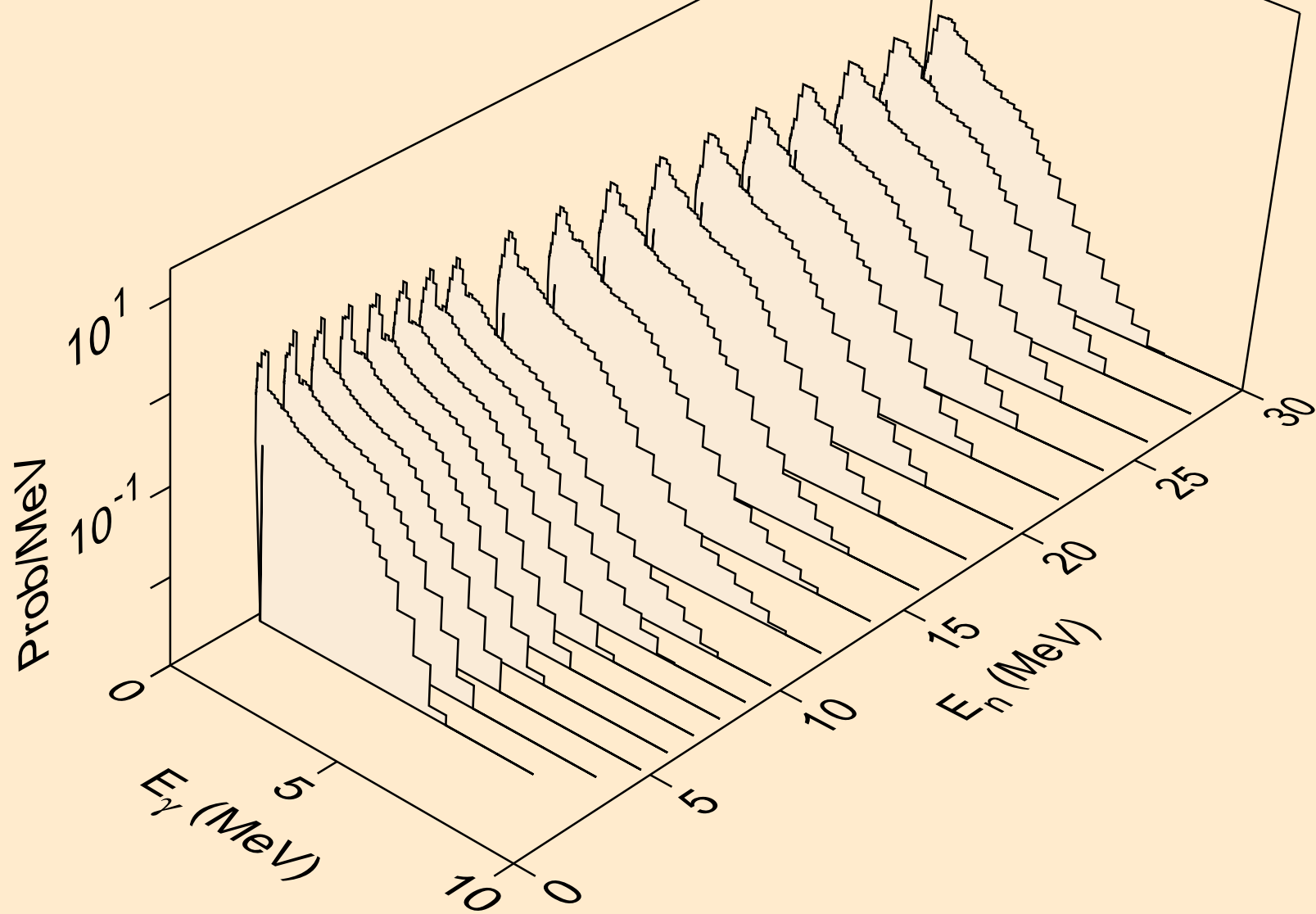

CE125 TRITON ACER TENDL-2021 LIBRARY; T=0.K  
Photon emission for (n,x)

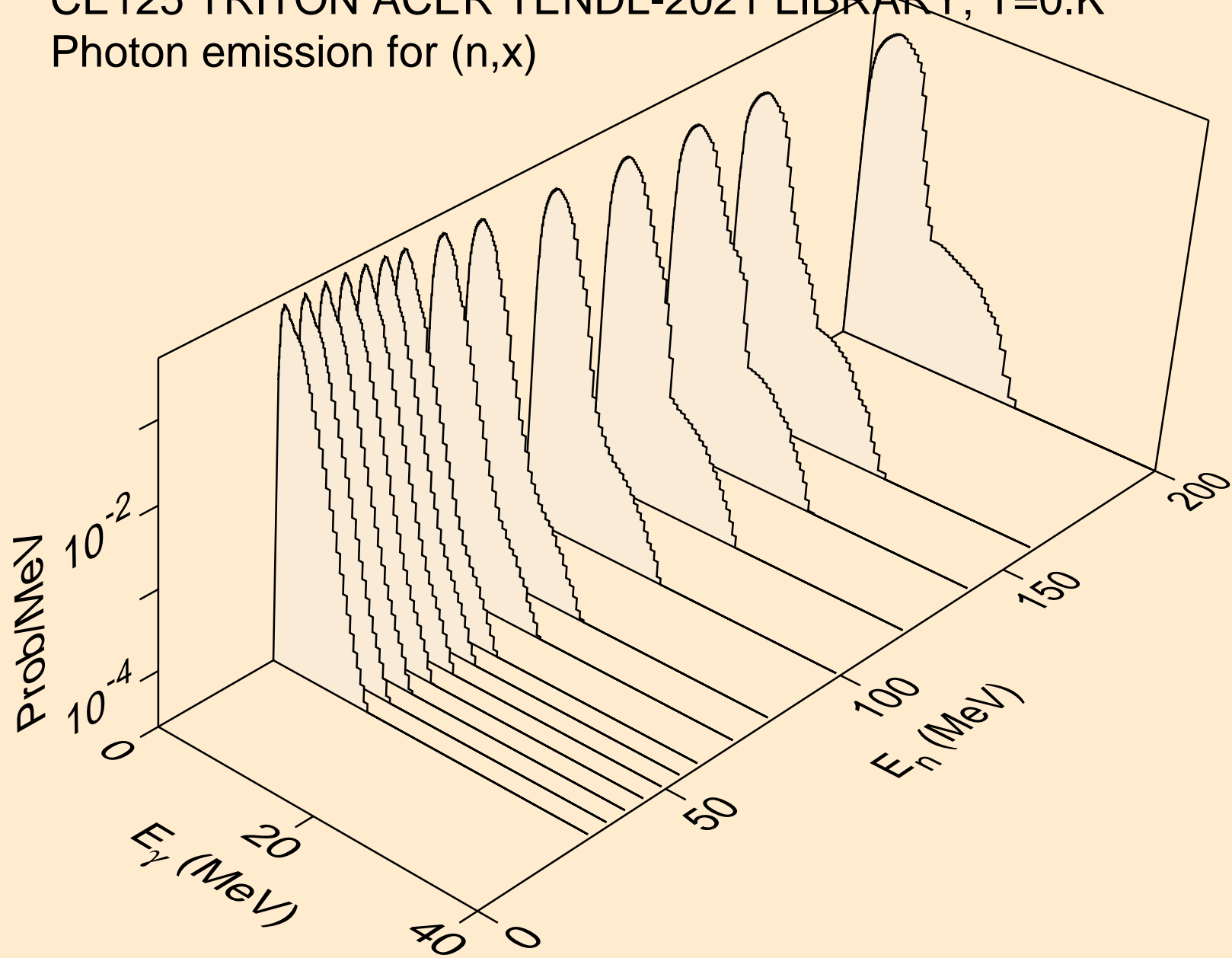

CE125 TRITON ACER TENDL-2021 LIBRARY; T=0.K  
Photon emission for (n,2nd)

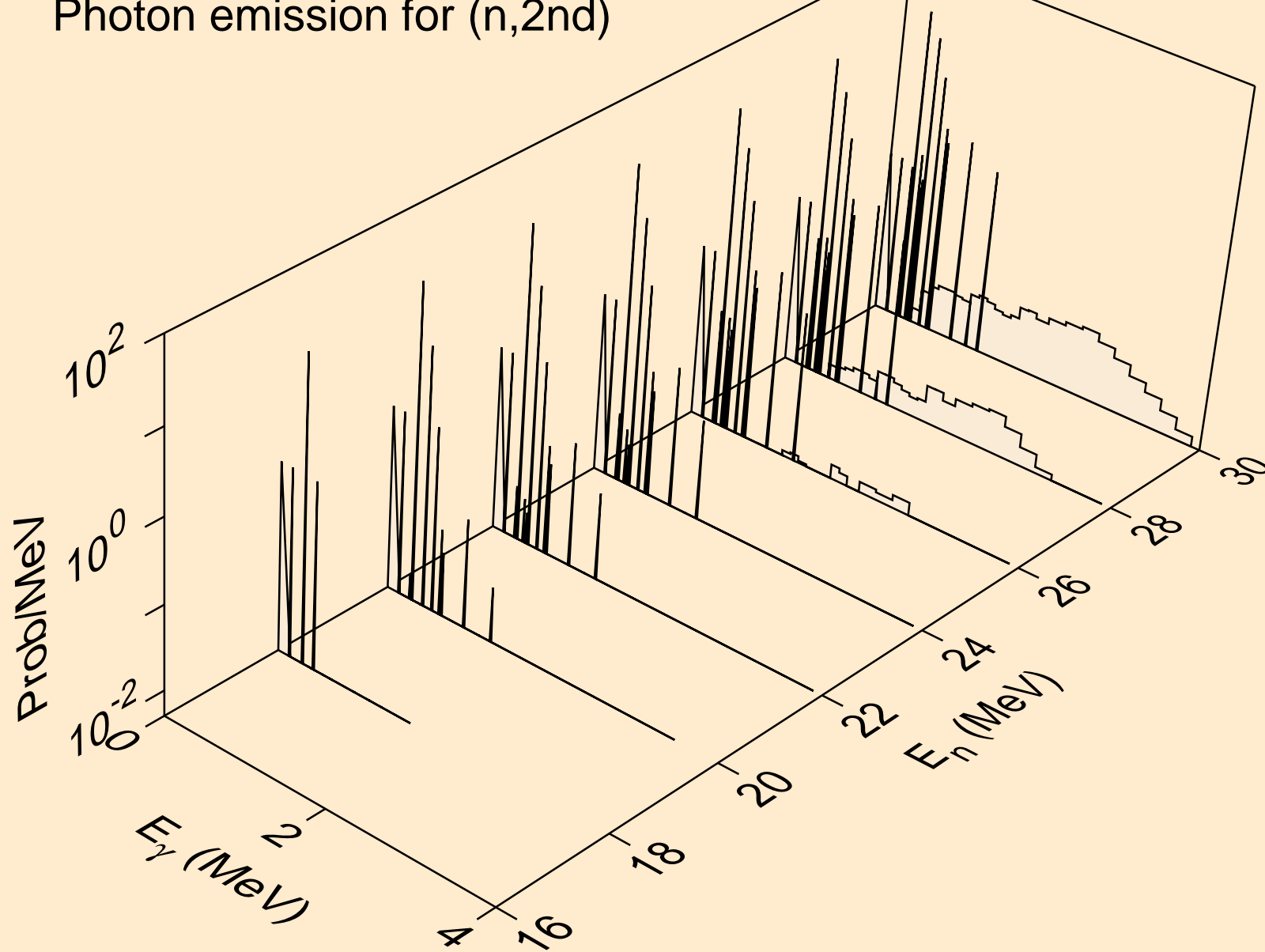



CE125 TRITON ACER TENDL-2021 LIBRARY; T=0.K  
Photon emission for (n,2n)

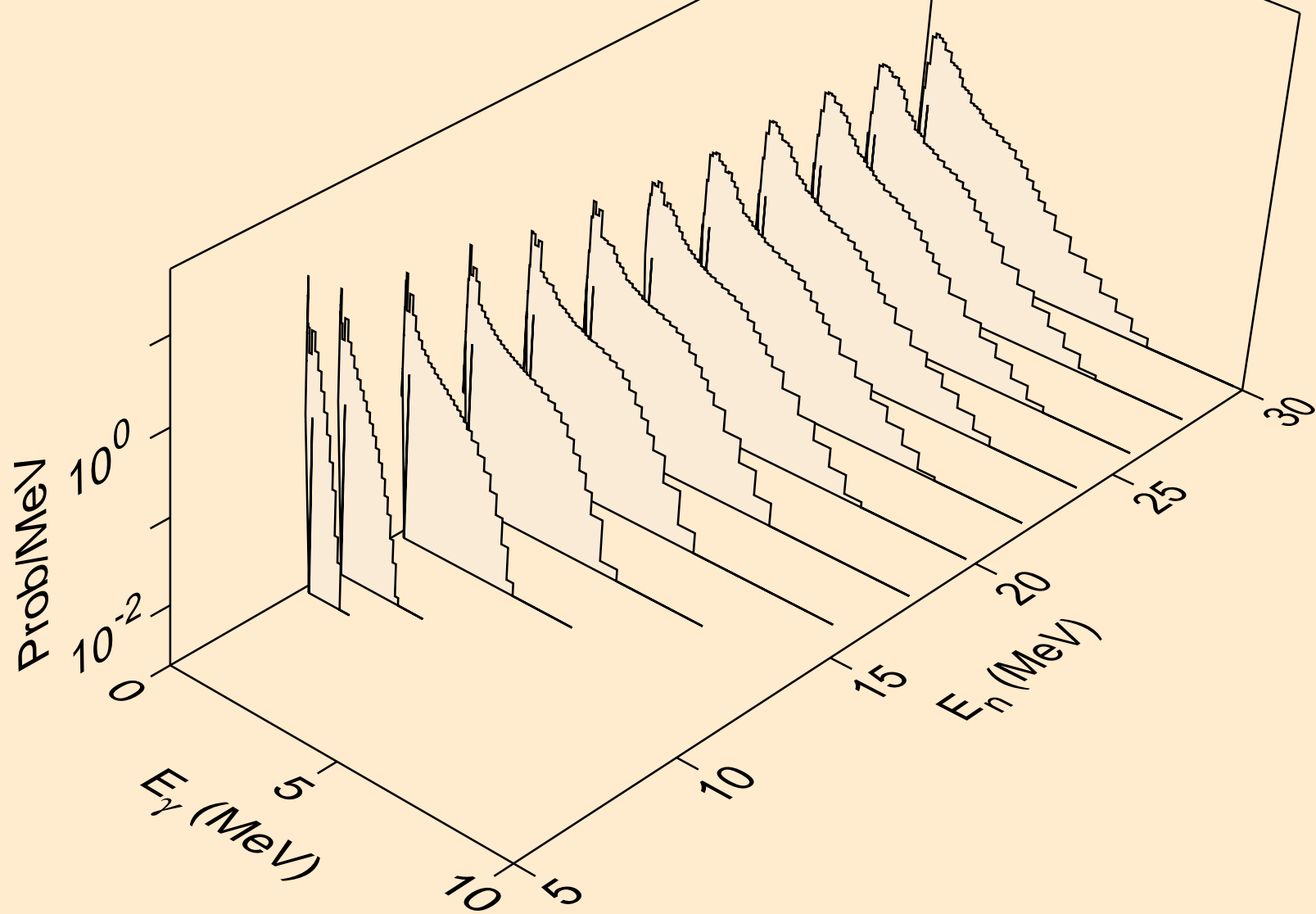

CE125 TRITON ACER TENDL-2021 LIBRARY; T=0.K  
Photon emission for (n,3n)

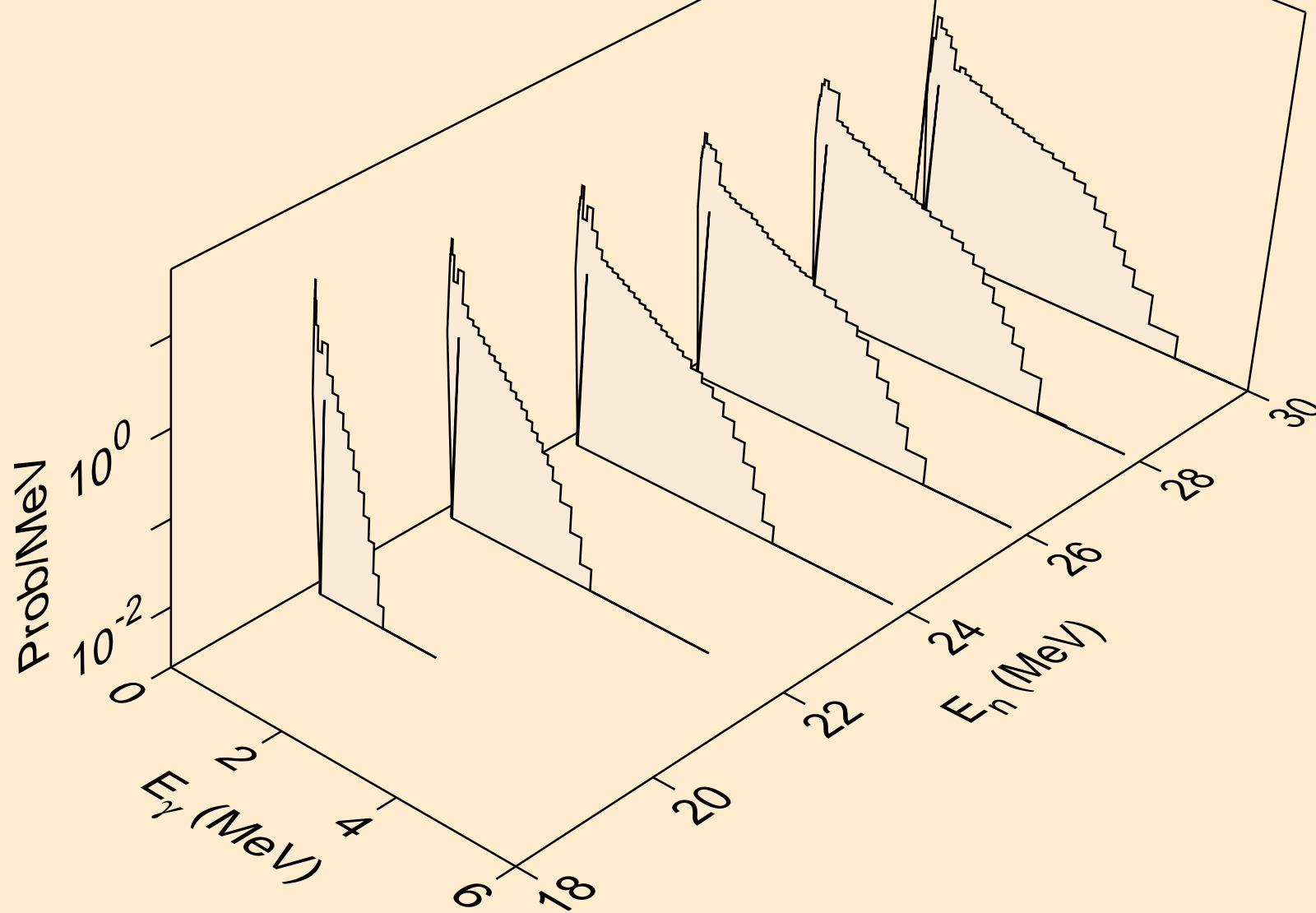

CE125 TRITON ACER TENDL-2021 LIBRARY; T=0.K  
Photon emission for (n,n\*)a

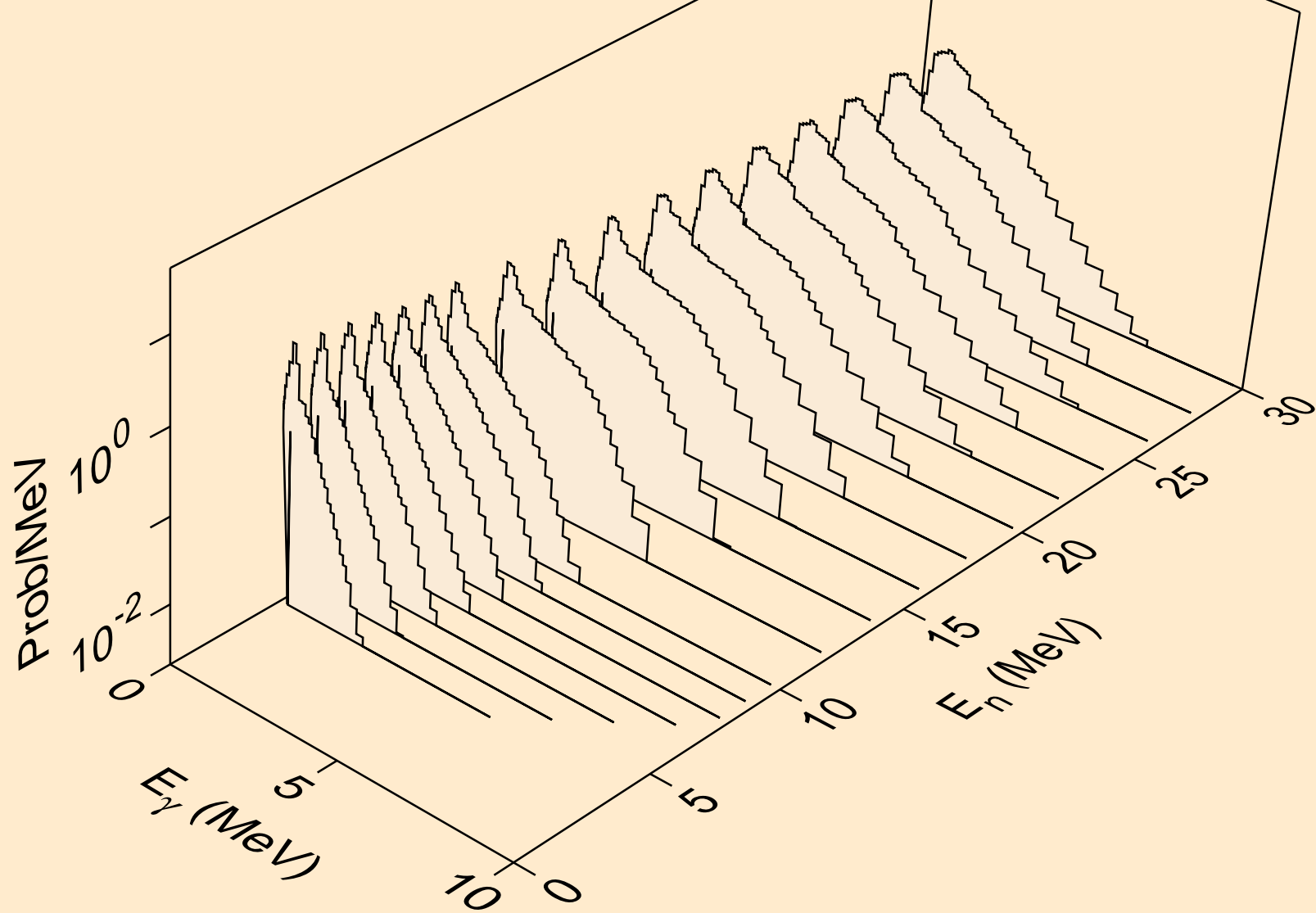

CE125 TRITON ACER TENDL-2021 LIBRARY; T=0.K  
Photon emission for (n,2n)a

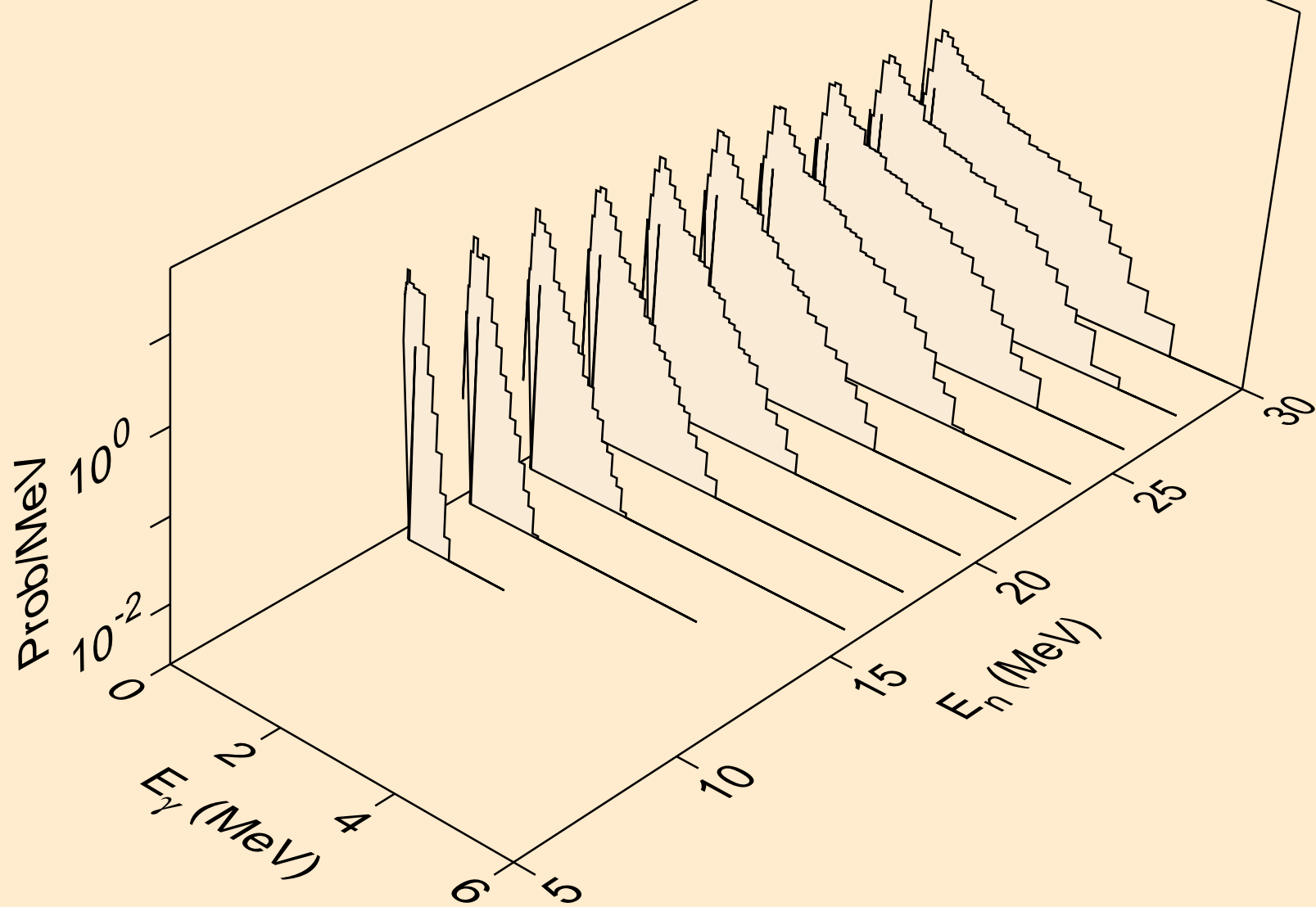

CE125 TRITON ACER TENDL-2021 LIBRARY; T=0.K  
Photon emission for (n,n\*)p

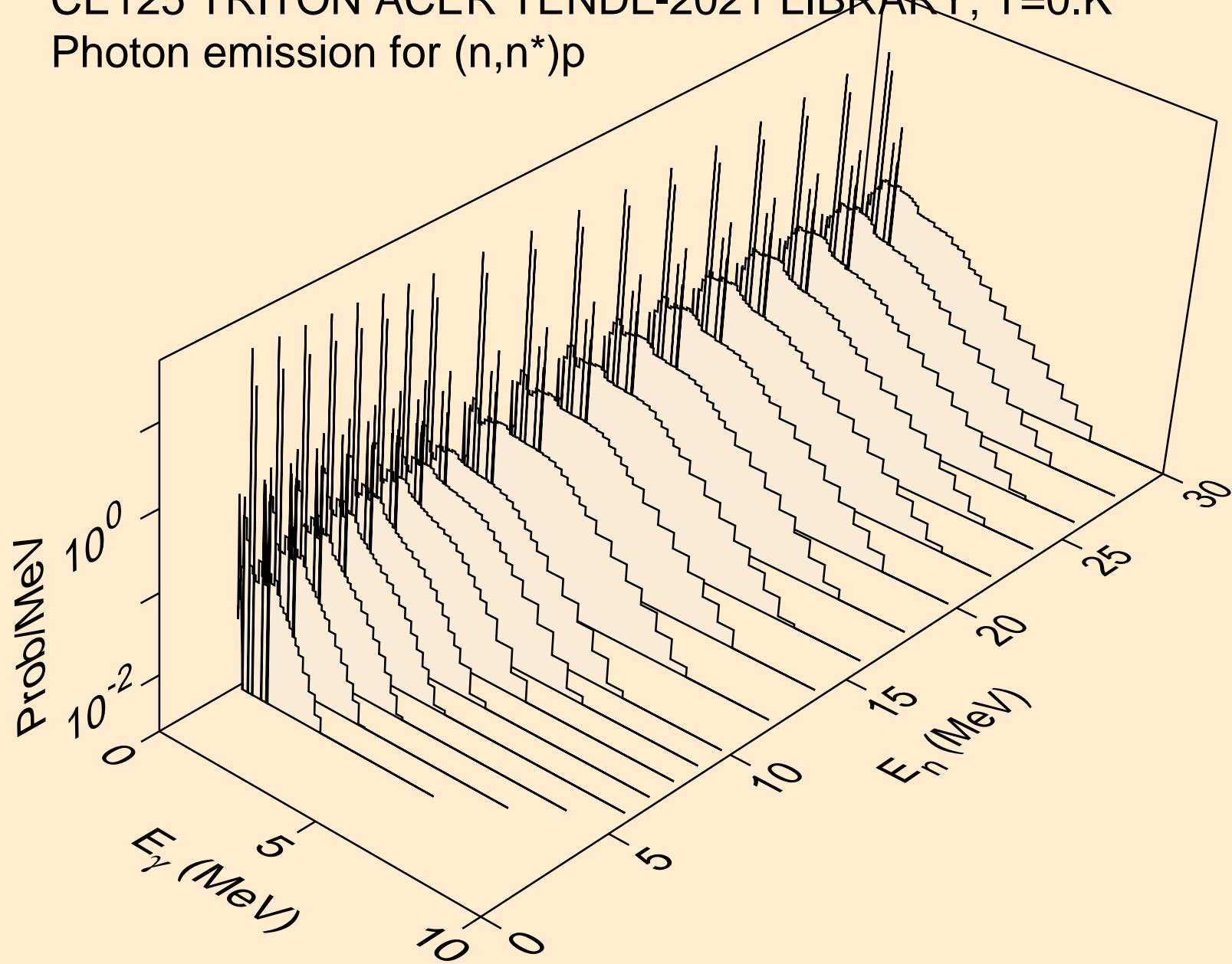

CE125 TRITON ACER TENDL-2021 LIBRARY; T=0.K  
Photon emission for (n,n\*)2a

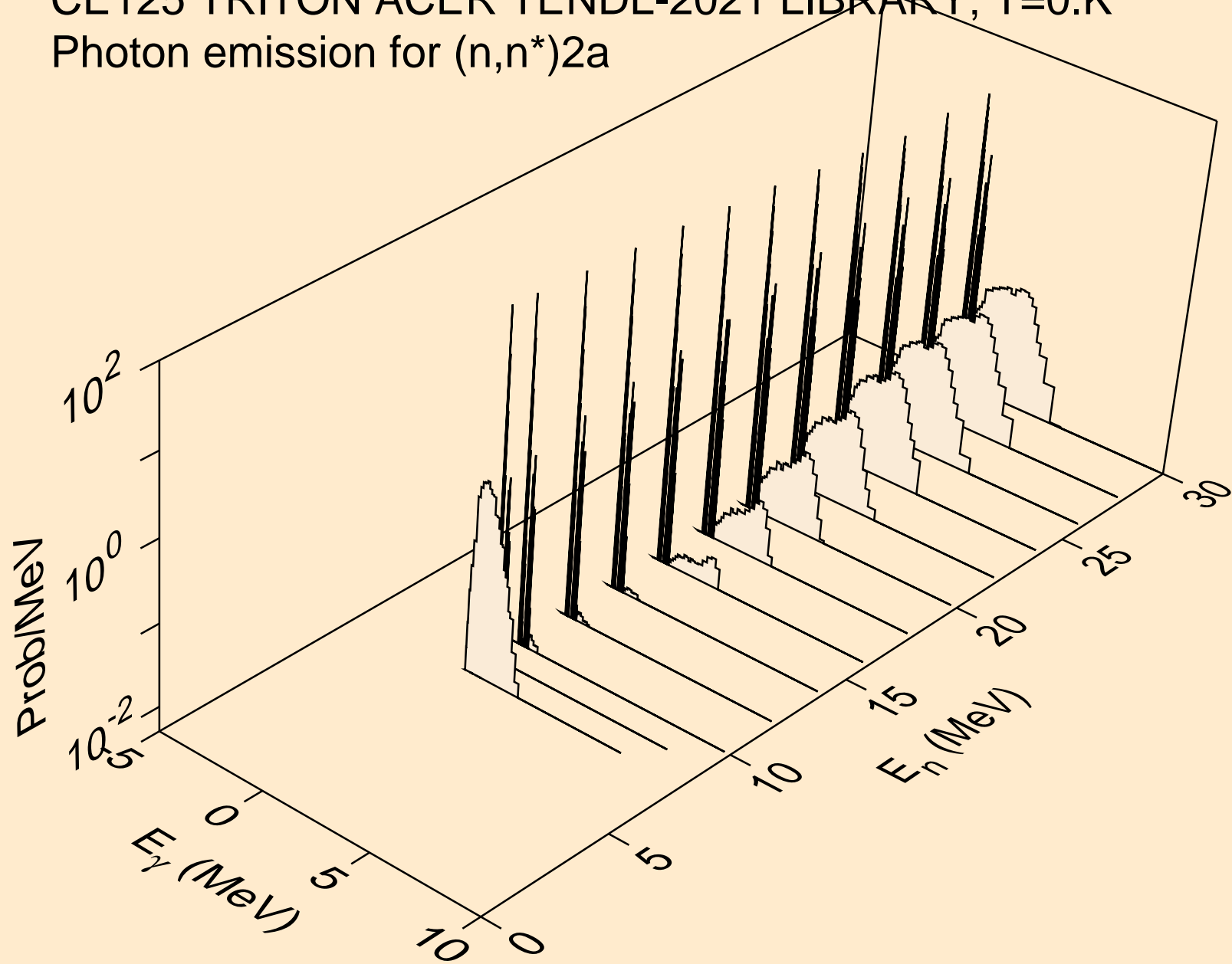

CE125 TRITON ACER TENDL-2021 LIBRARY; T=0.K  
Photon emission for (n,n\*)d

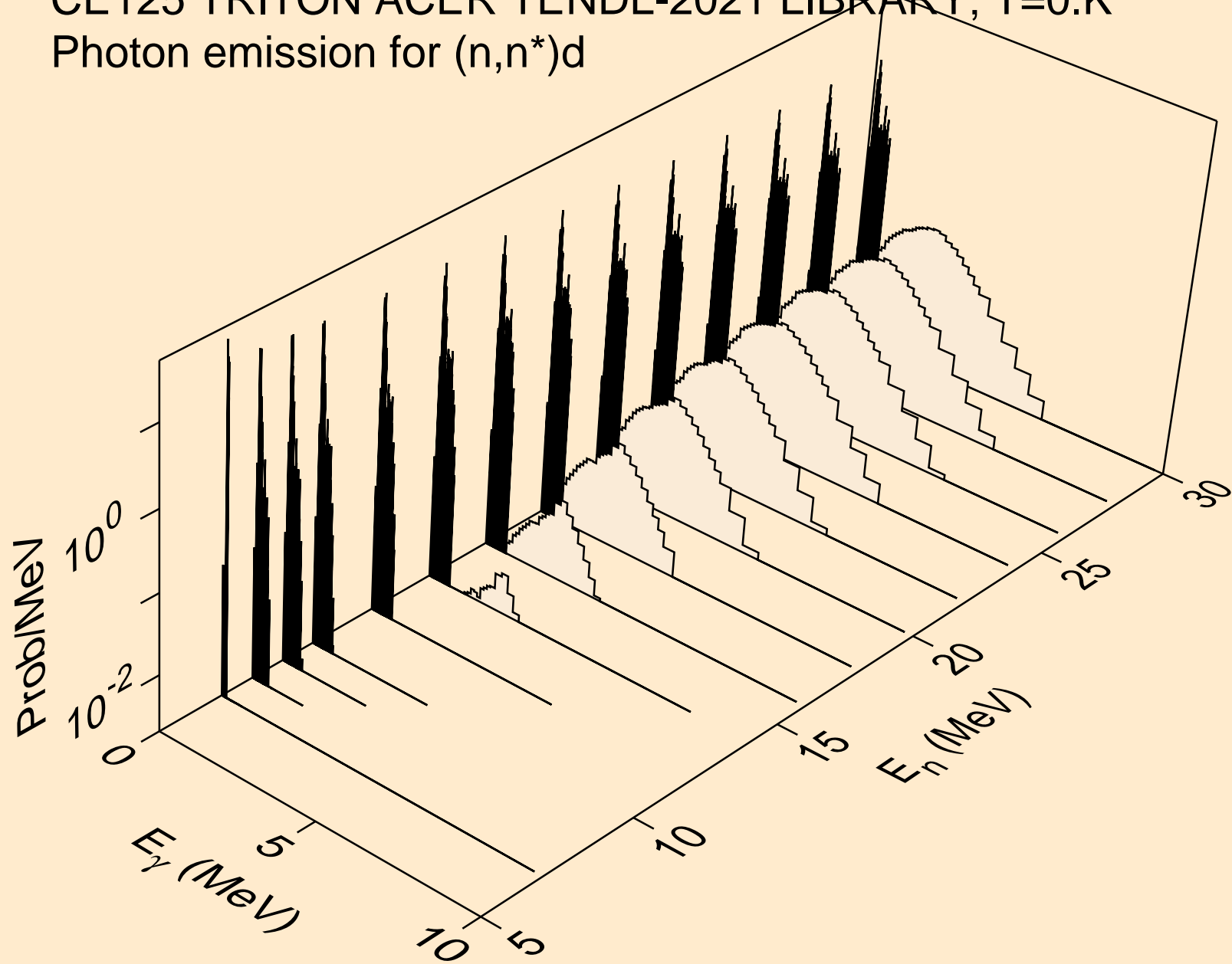

CE125 TRITON ACER TENDL-2021 LIBRARY; T=0.K  
Photon emission for (n,n\*)t

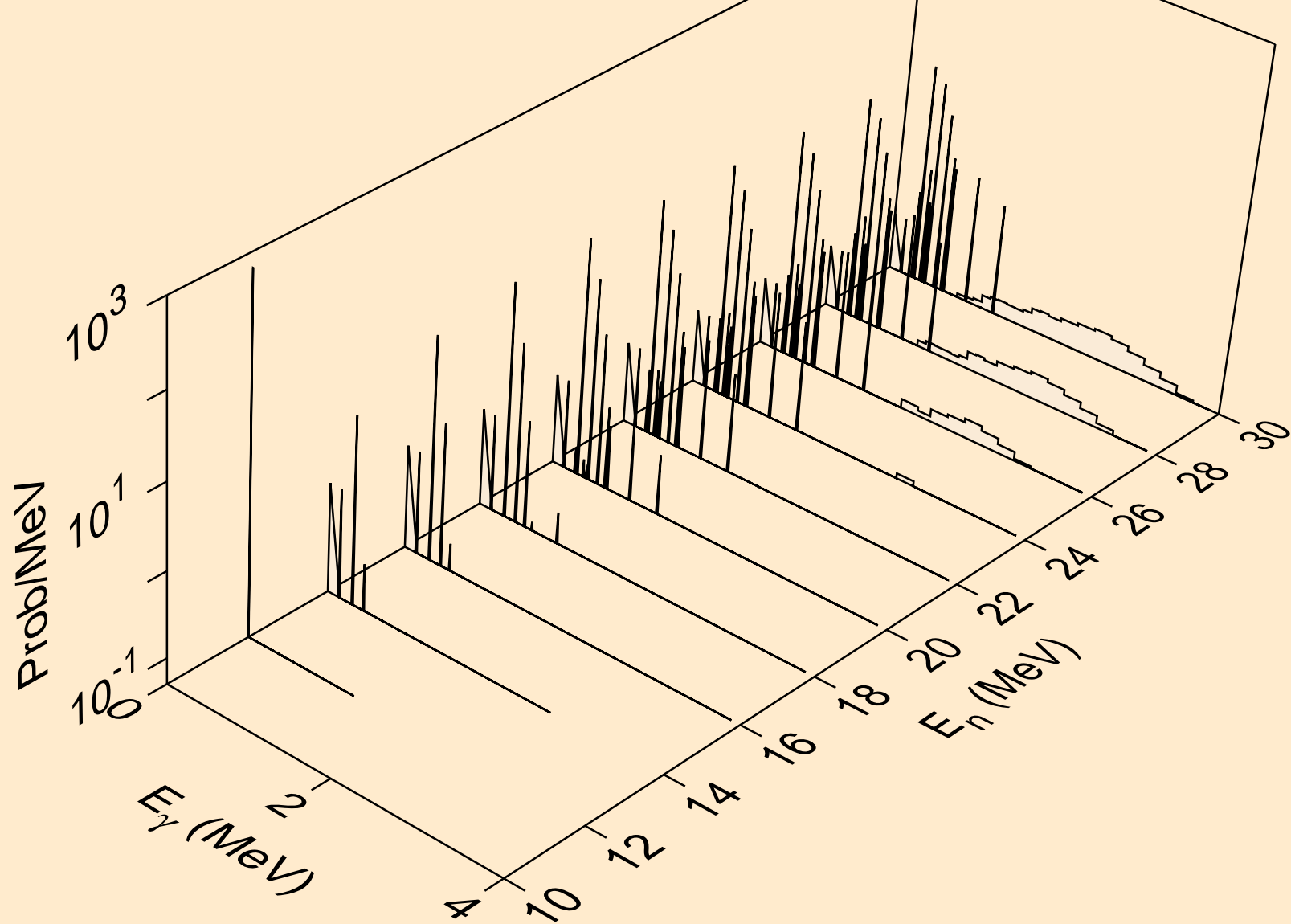



CE125 TRITON ACER TENDL-2021 LIBRARY; T=0.K  
Photon emission for (n,n\*)he3

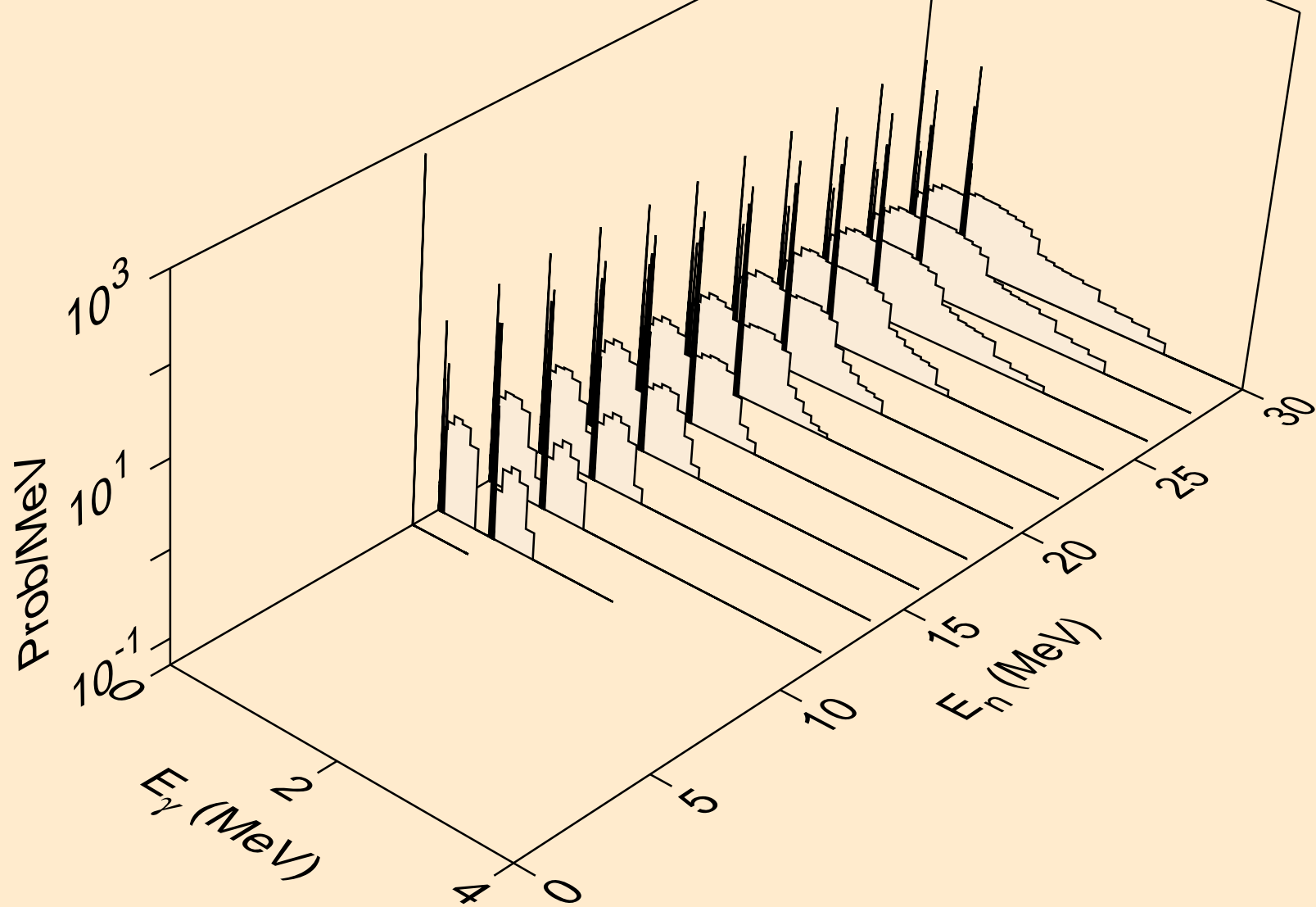

CE125 TRITON ACER TENDL-2021 LIBRARY; T=0.K  
Photon emission for (n,2np)

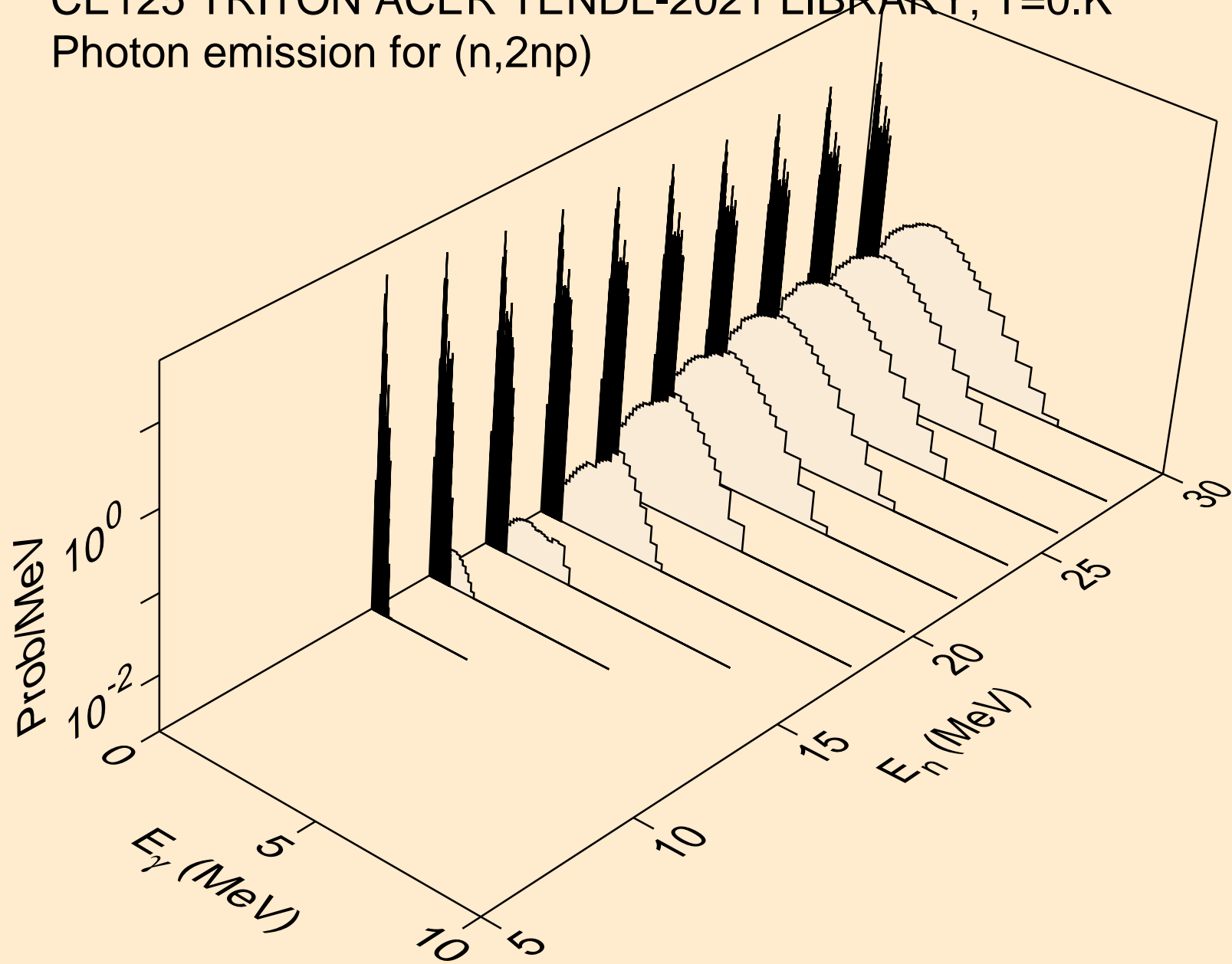

CE125 TRITON ACER TENDL-2021 LIBRARY; T=0.K  
Photon emission for (n,3np)

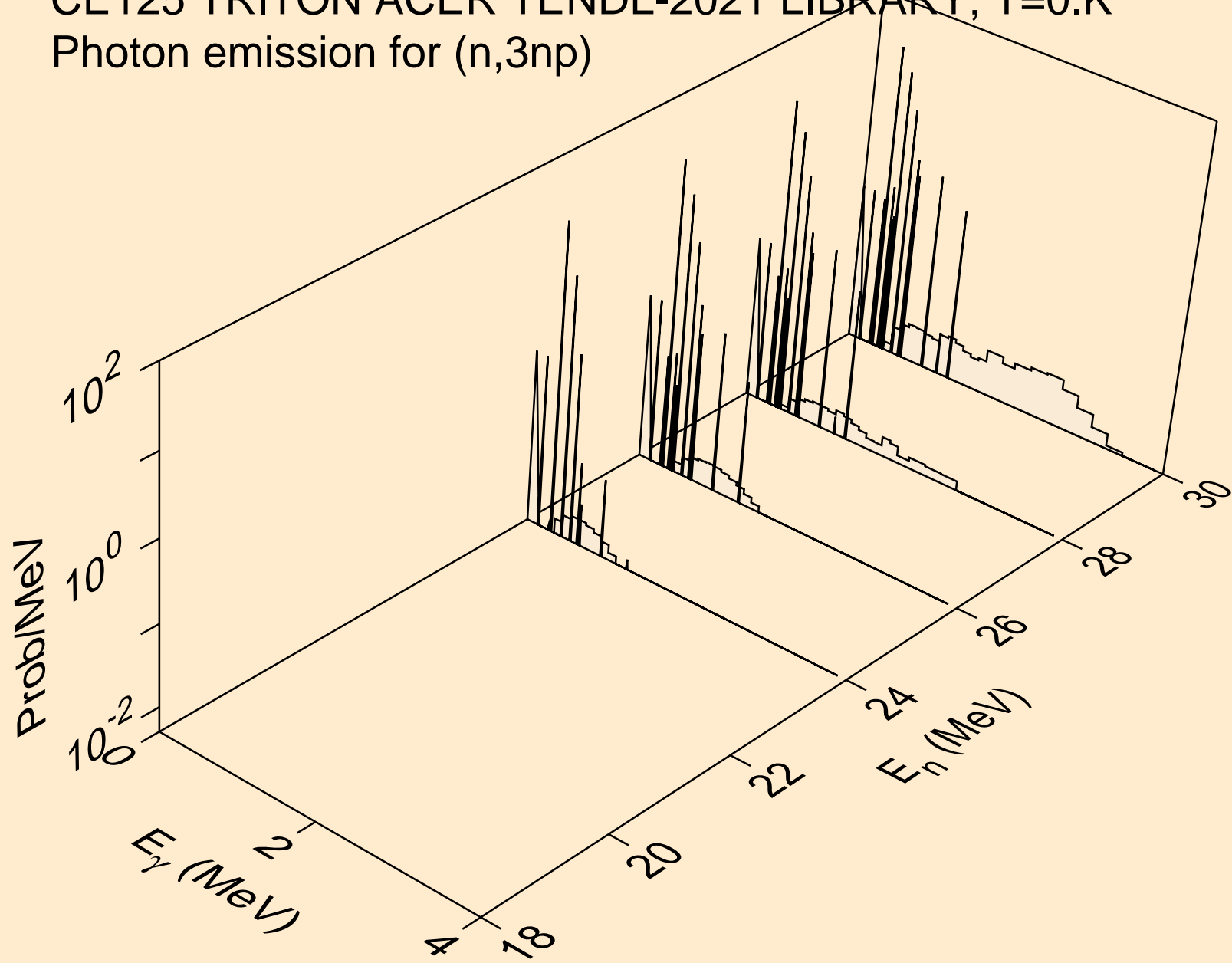

CE125 TRITON ACER TENDL-2021 LIBRARY; T=0.K  
Photon emission for (n,2np)

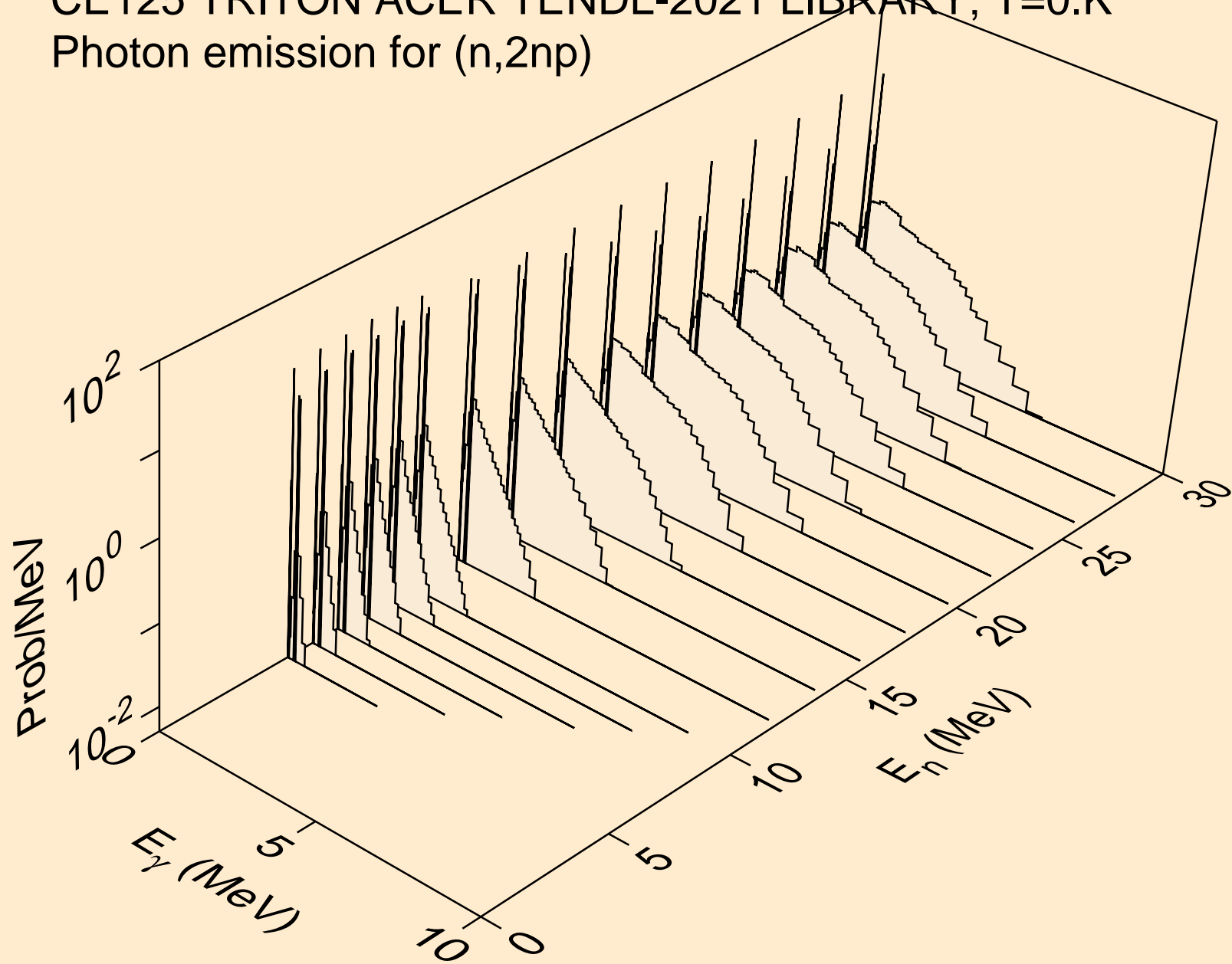

CE125 TRITON ACER TENDL-2021 LIBRARY; T=0.K  
Photon emission for (n,npa)

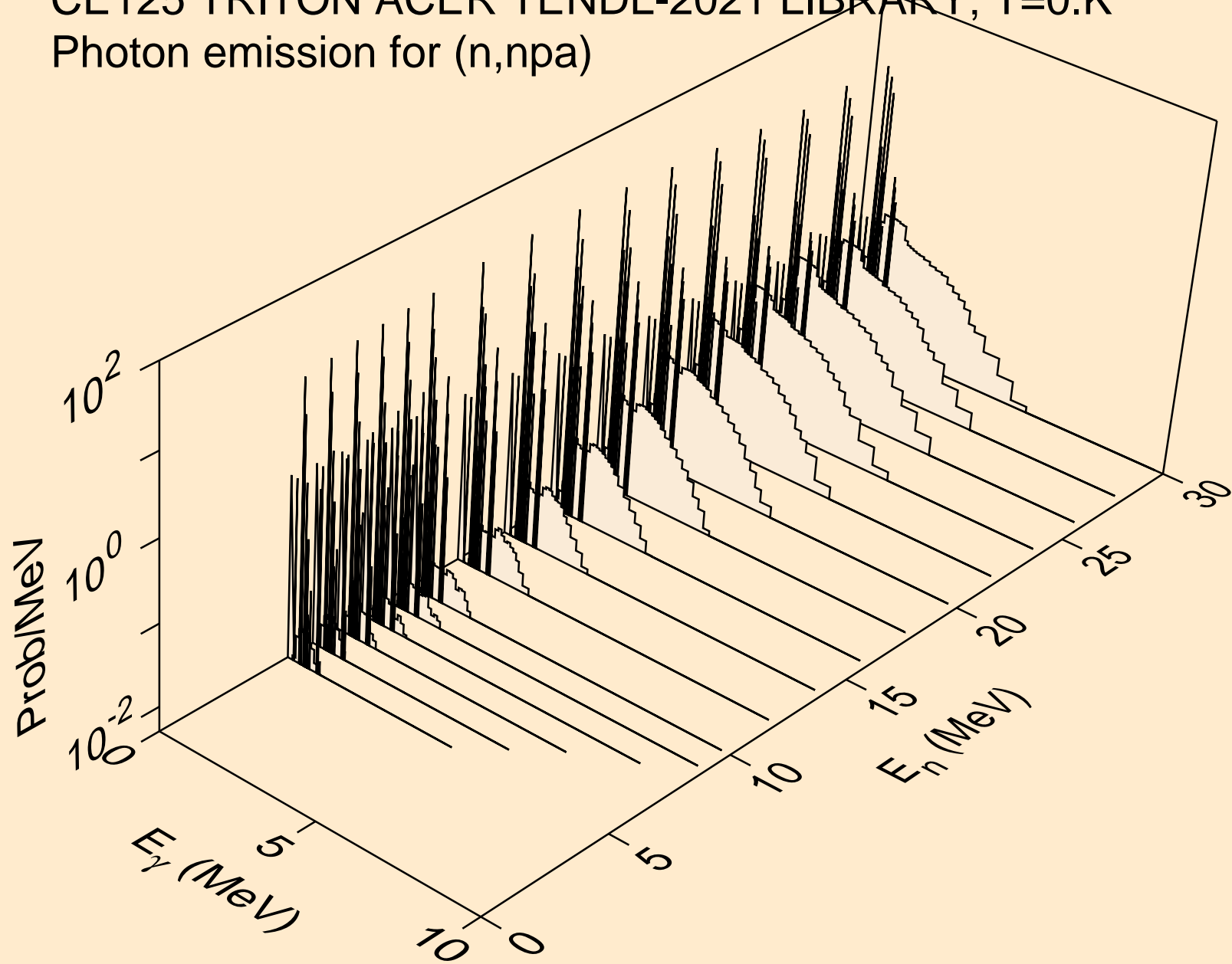

CE125 TRITON ACER TENDL-2021 LIBRARY; T=0.K  
Photon emission for (n,gma)

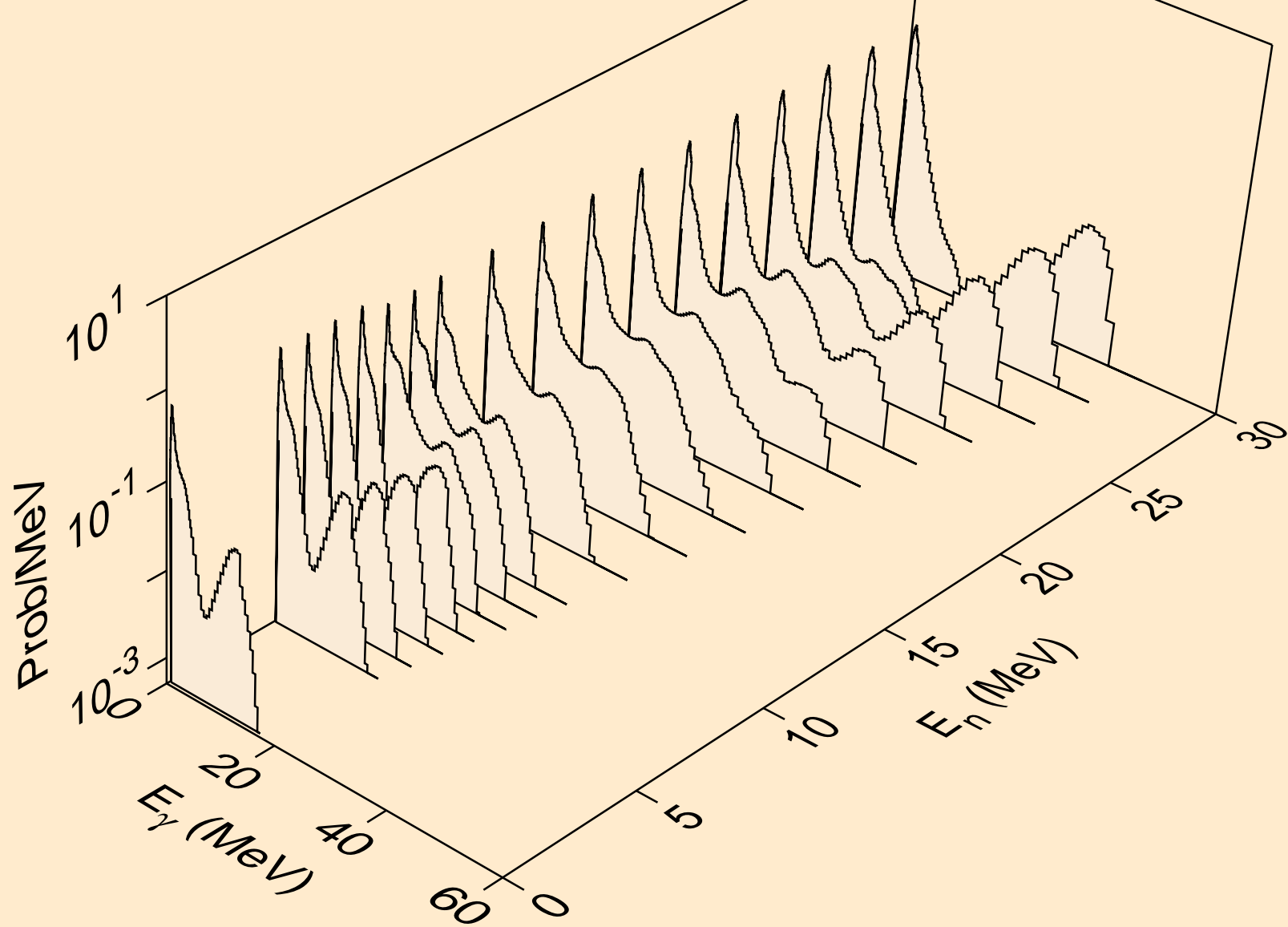

CE125 TRITON ACER TENDL-2021 LIBRARY; T=0.K  
Photon emission for (n,p)

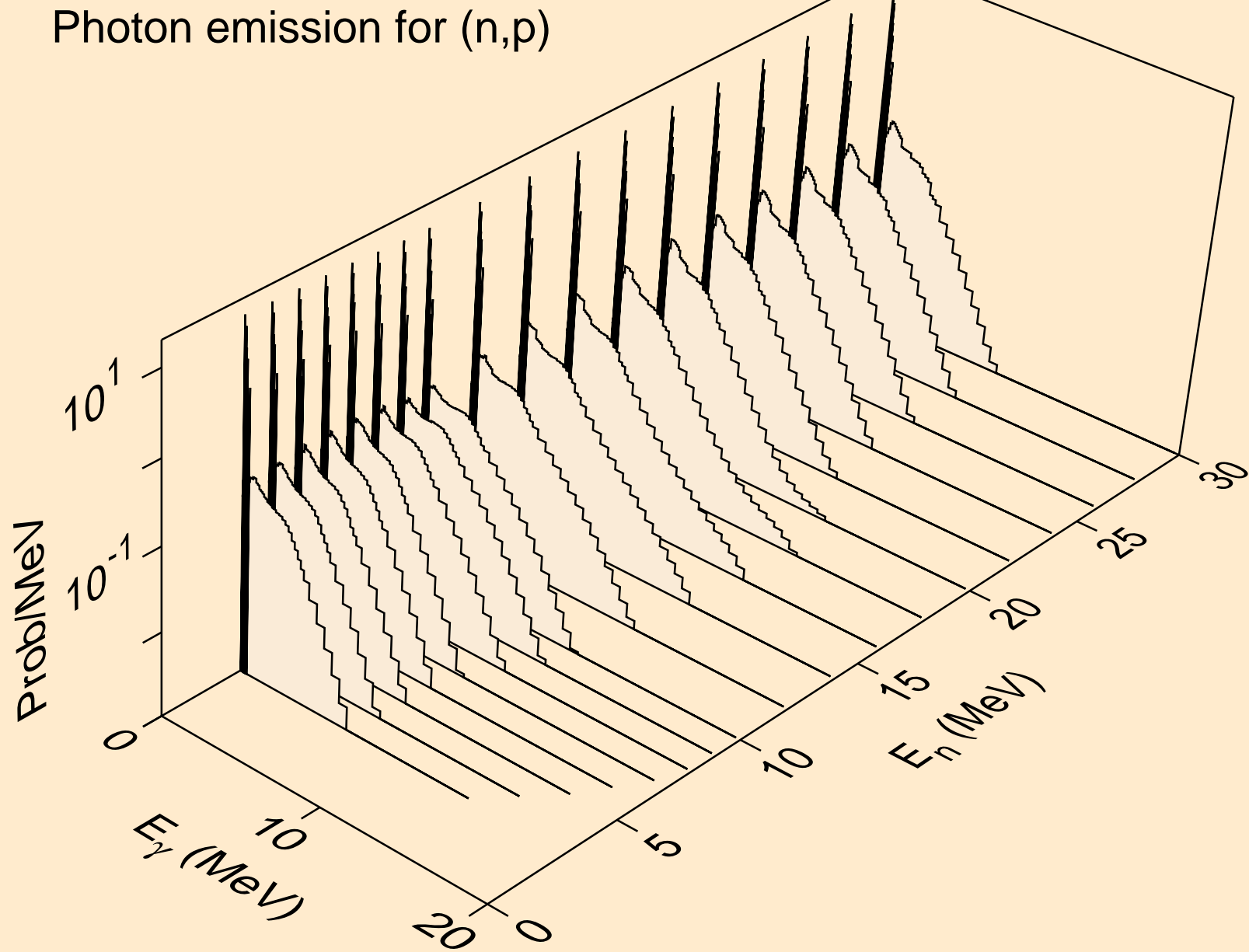

CE125 TRITON ACER TENDL-2021 LIBRARY; T=0.K  
Photon emission for (n,d)

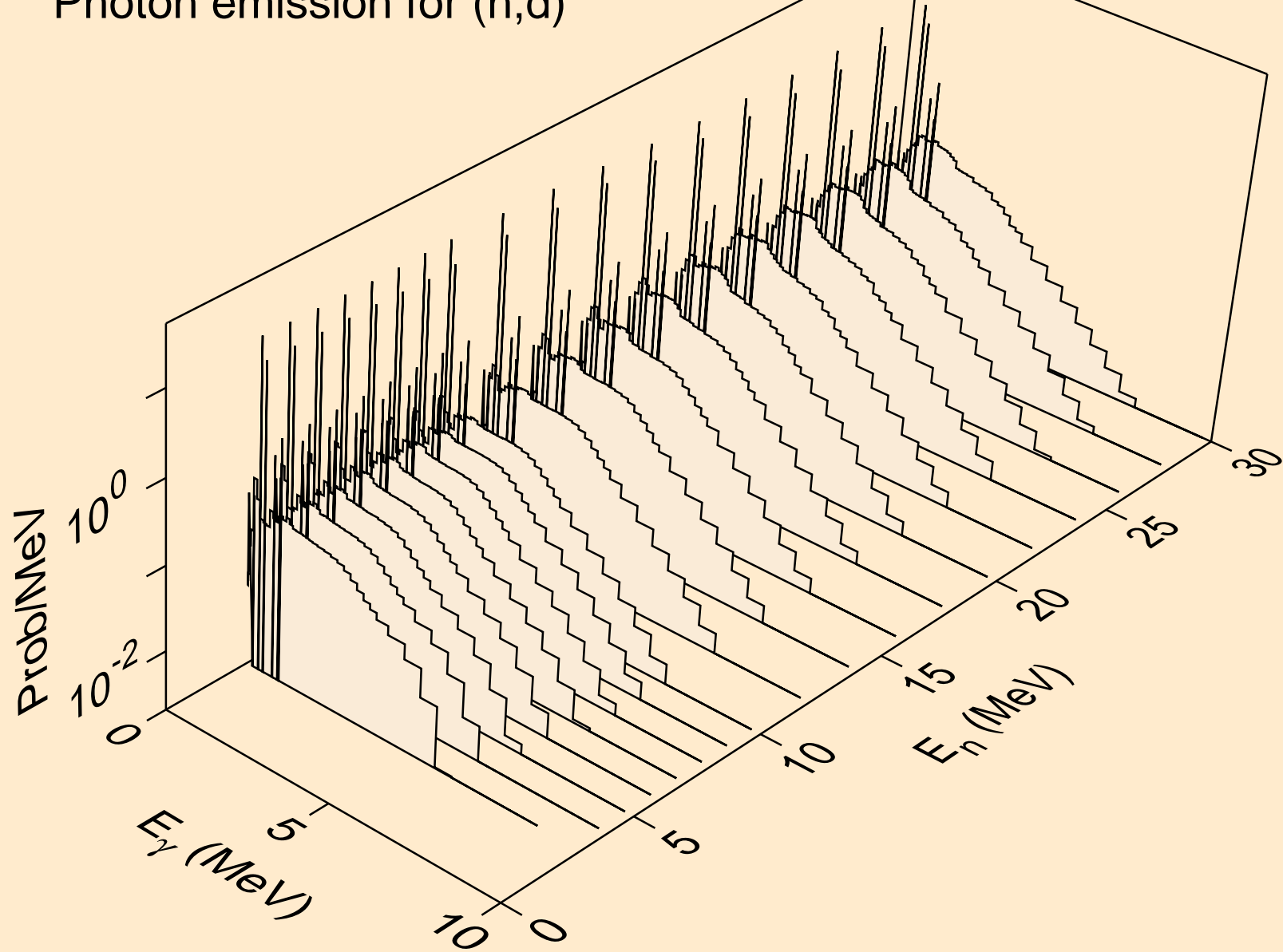



CE125 TRITON ACER TENDL-2021 LIBRARY; T=0.K  
Photon emission for inelastic

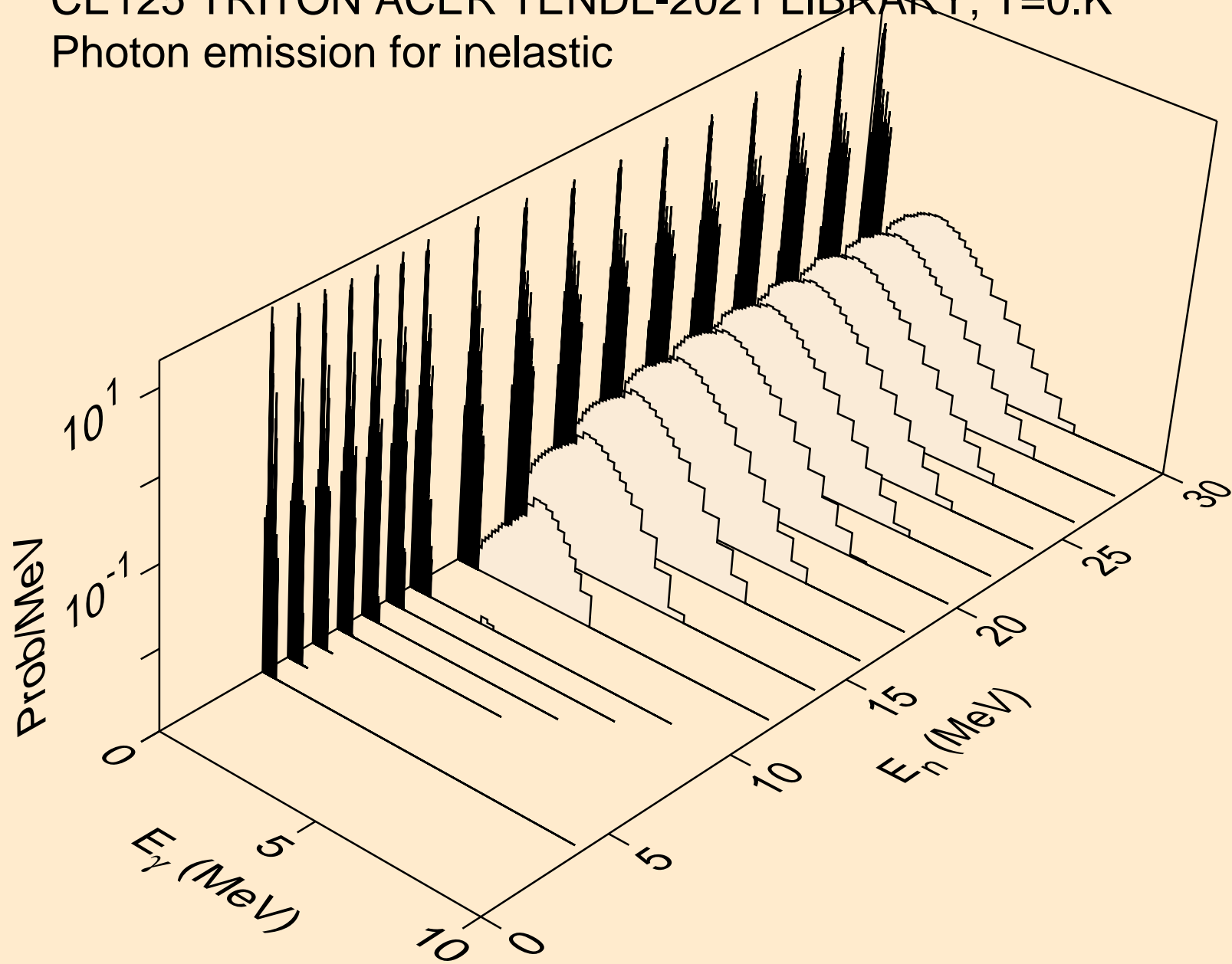

CE125 TRITON ACER TENDL-2021 LIBRARY; T=0.K  
Photon emission for (n,he3)

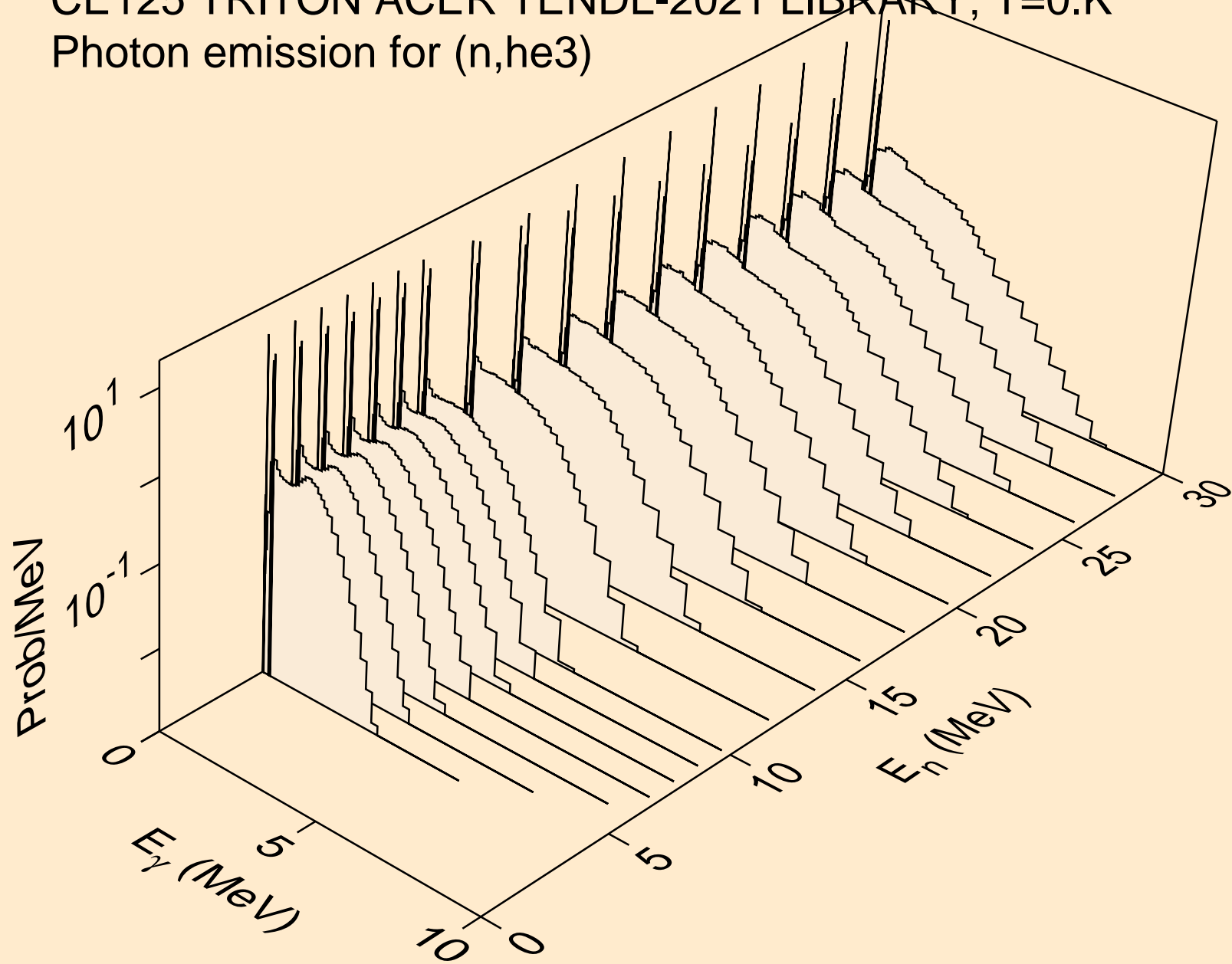

CE125 TRITON ACER TENDL-2021 LIBRARY; T=0.K  
Photon emission for (n,a)

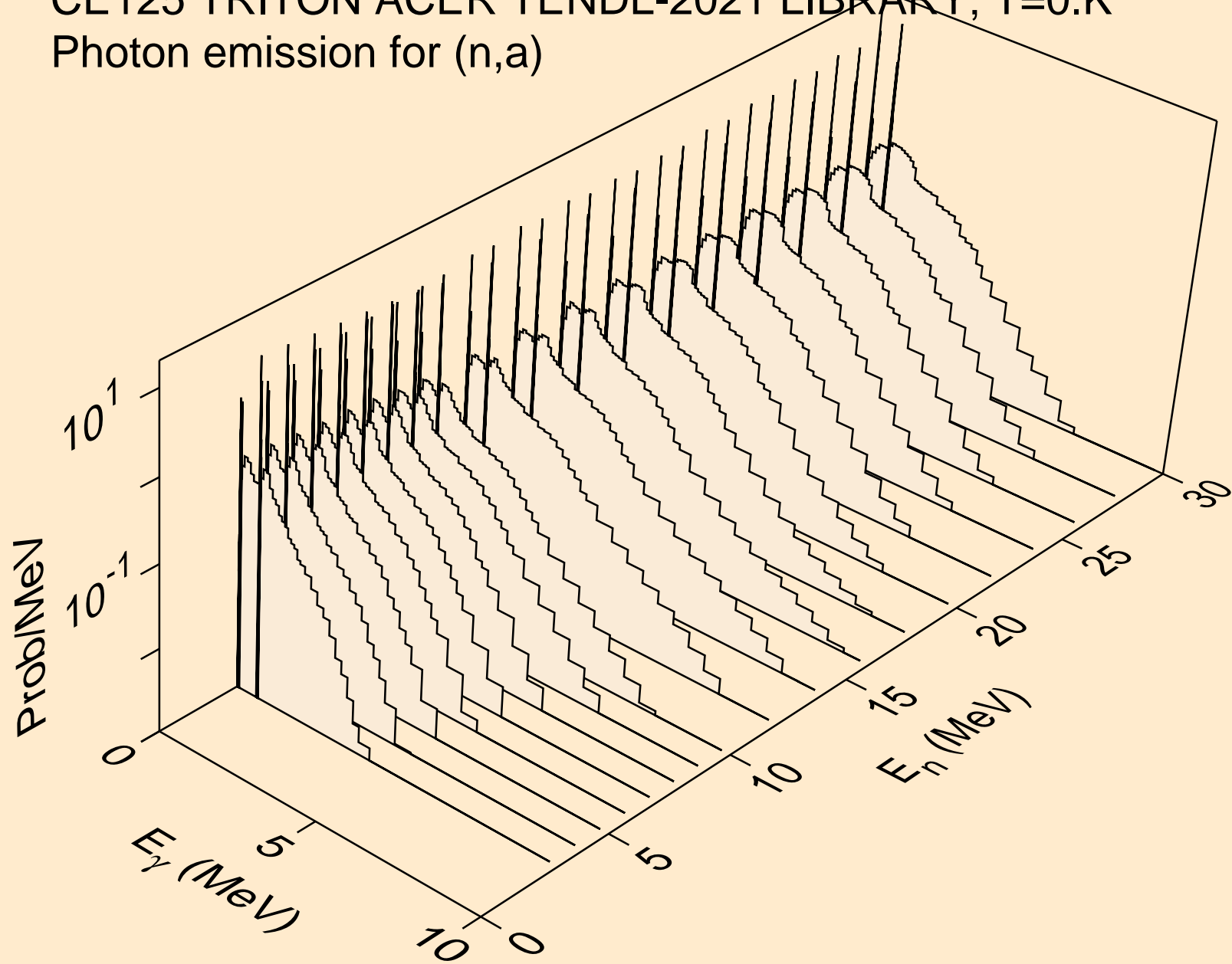

CE125 TRITON ACER TENDL-2021 LIBRARY; T=0.K  
Photon emission for (n,2a)

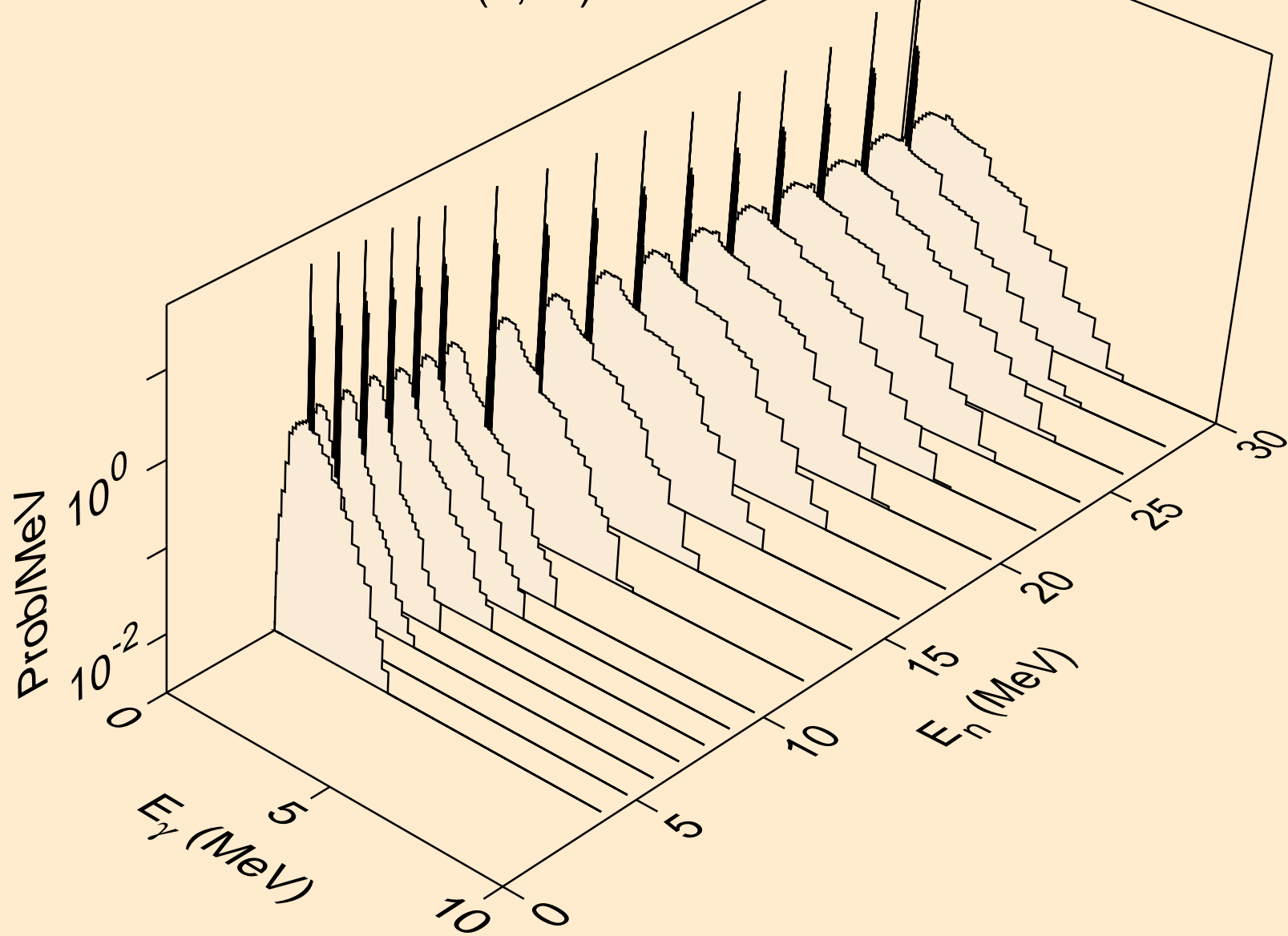

CE125 TRITON ACER TENDL-2021 LIBRARY; T=0.K  
Photon emission for (n,3a)

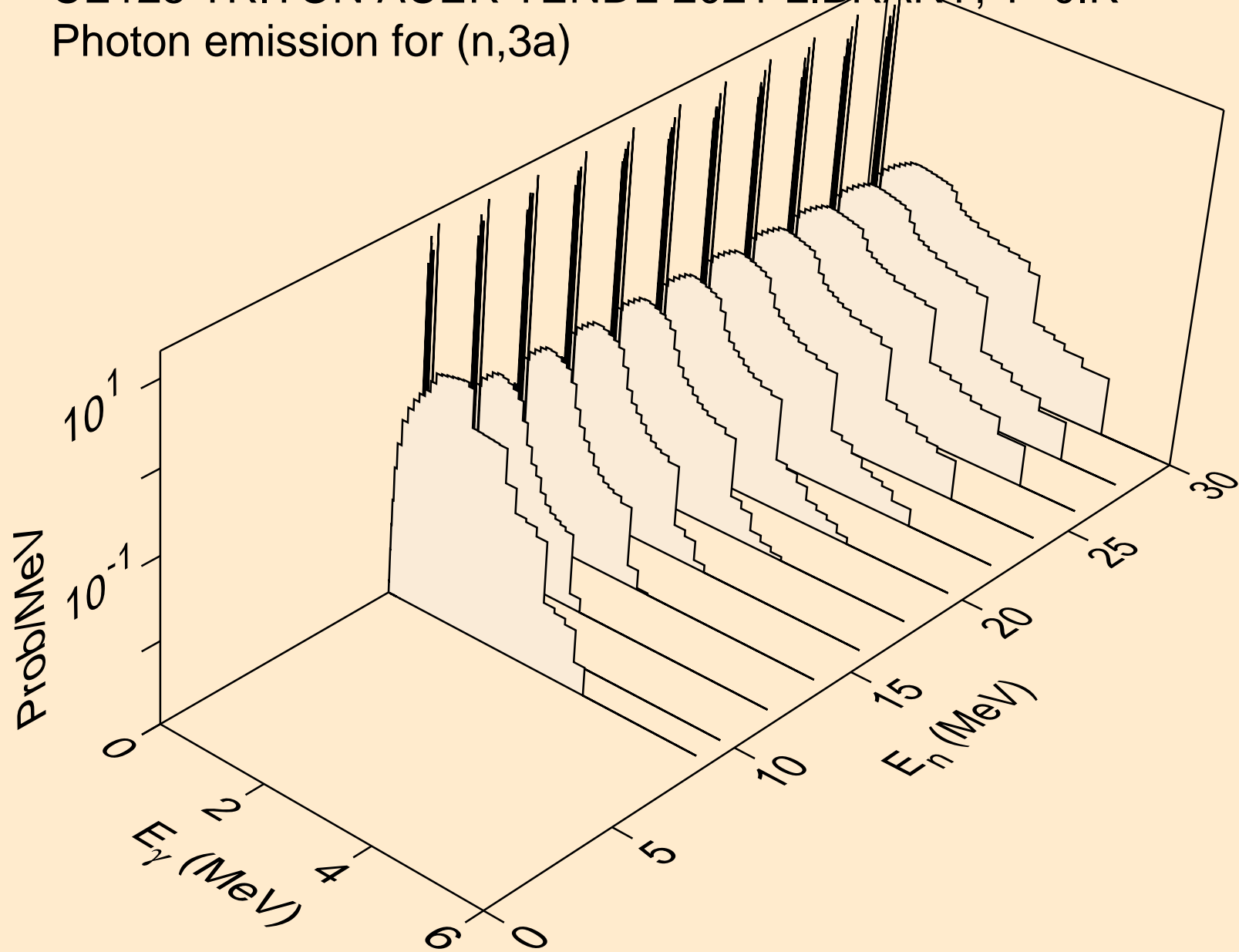

CE125 TRITON ACER TENDL-2021 LIBRARY; T=0.K  
Photon emission for (n,2p)

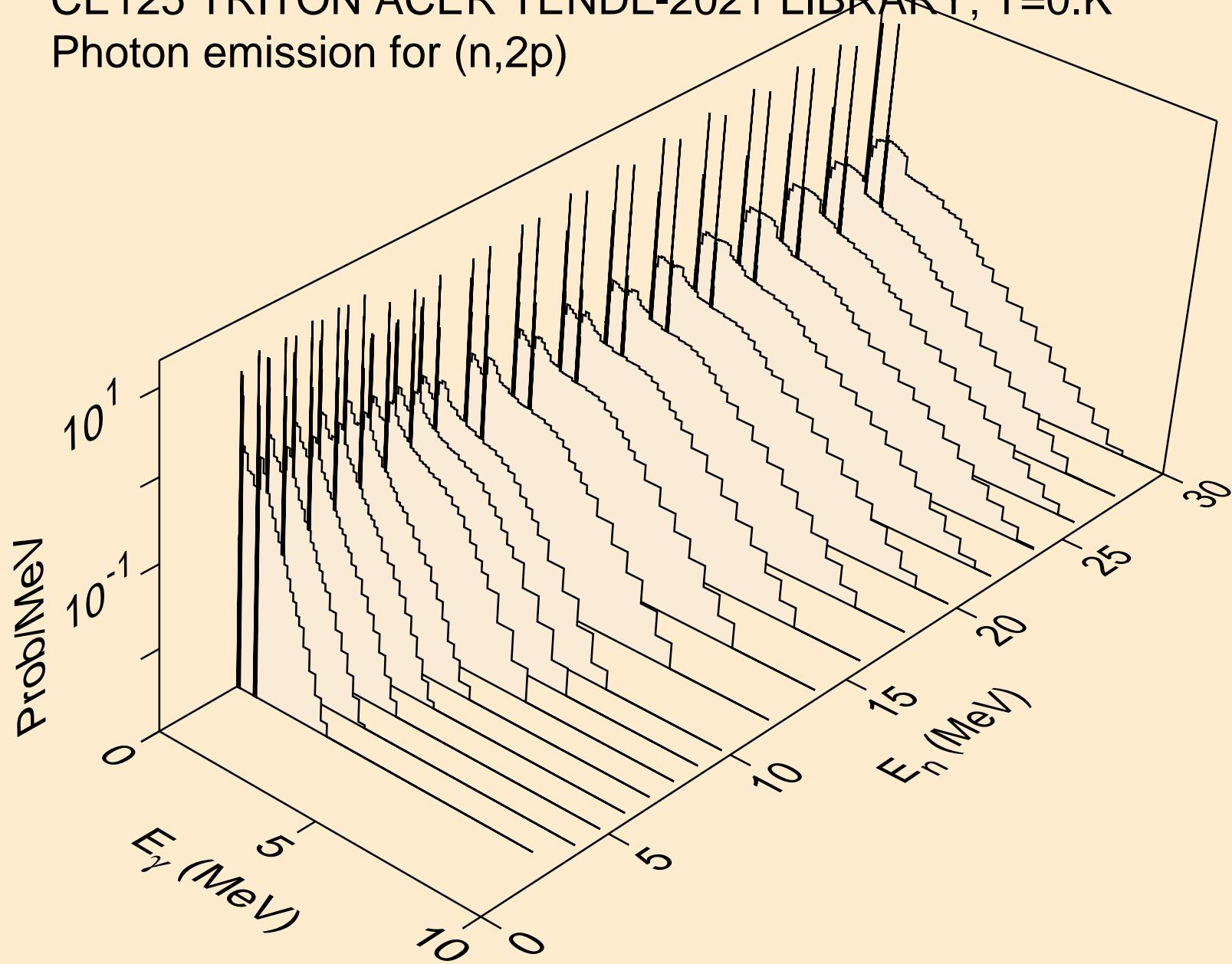

CE125 TRITON ACER TENDL-2021 LIBRARY; T=0.K  
Photon emission for (n,pa)

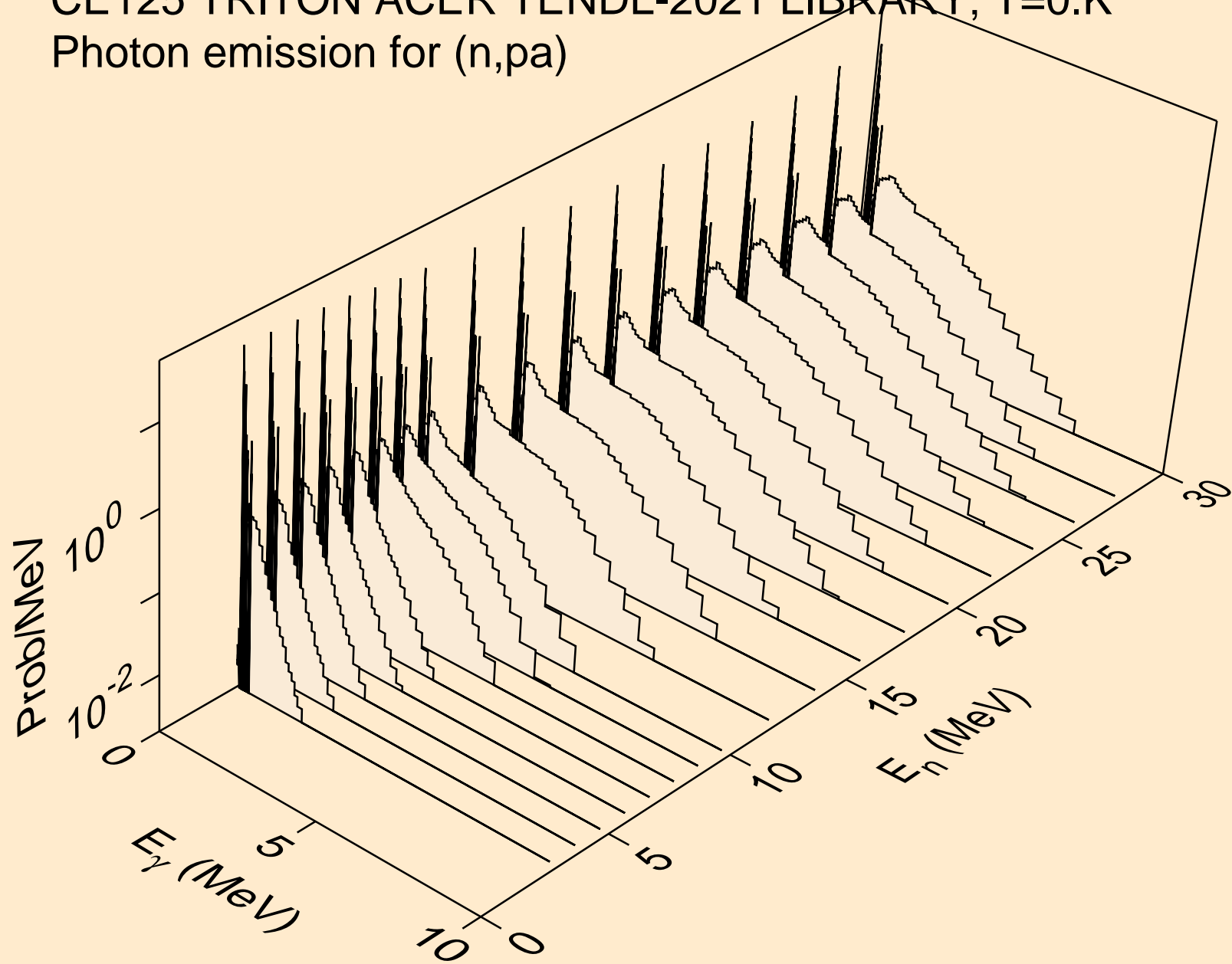

CE125 TRITON ACER TENDL-2021 LIBRARY; T=0.K  
Photon emission for (n,t2a)

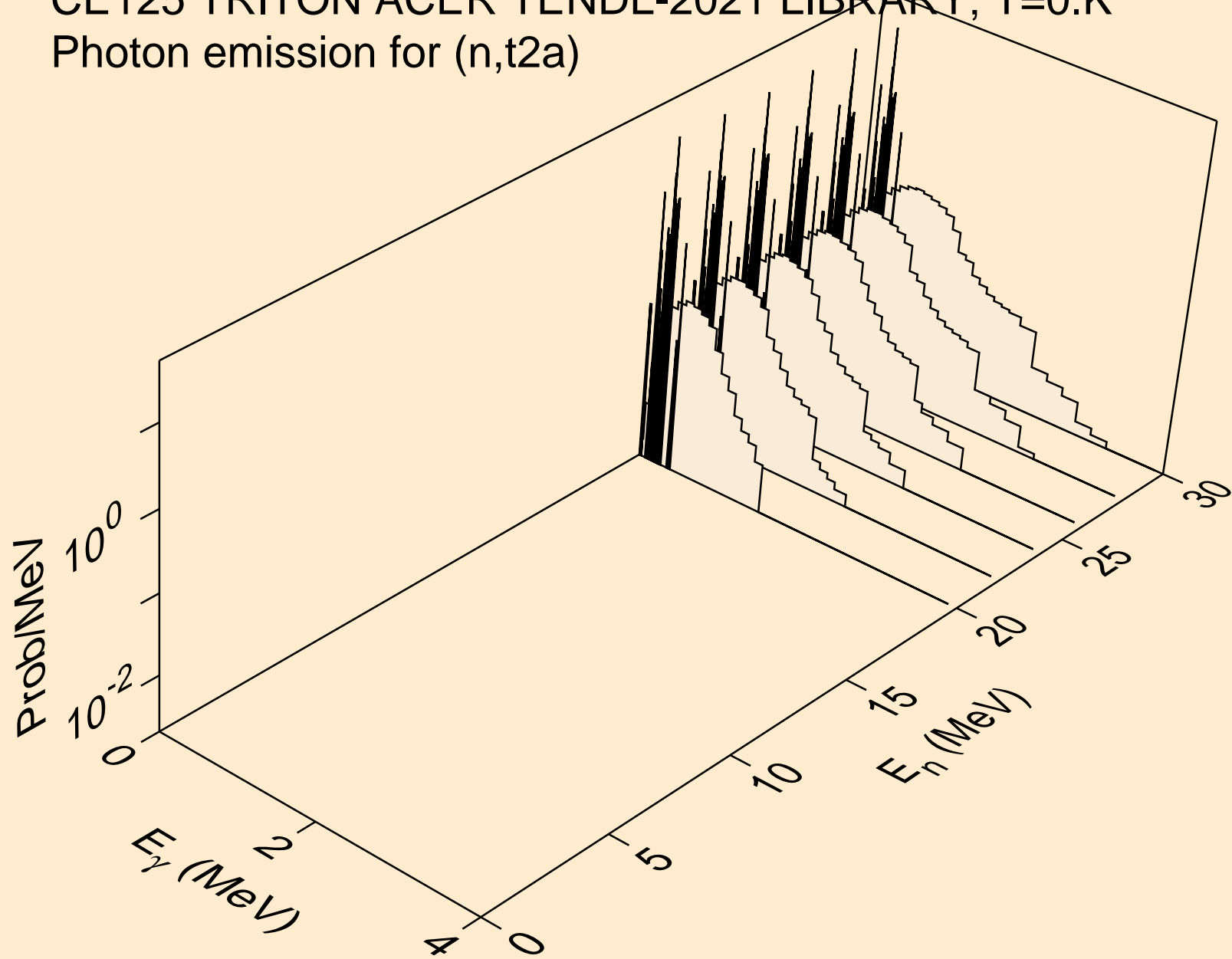



CE125 TRITON ACER TENDL-2021 LIBRARY; T=0.K  
Photon emission for (n,d2a)

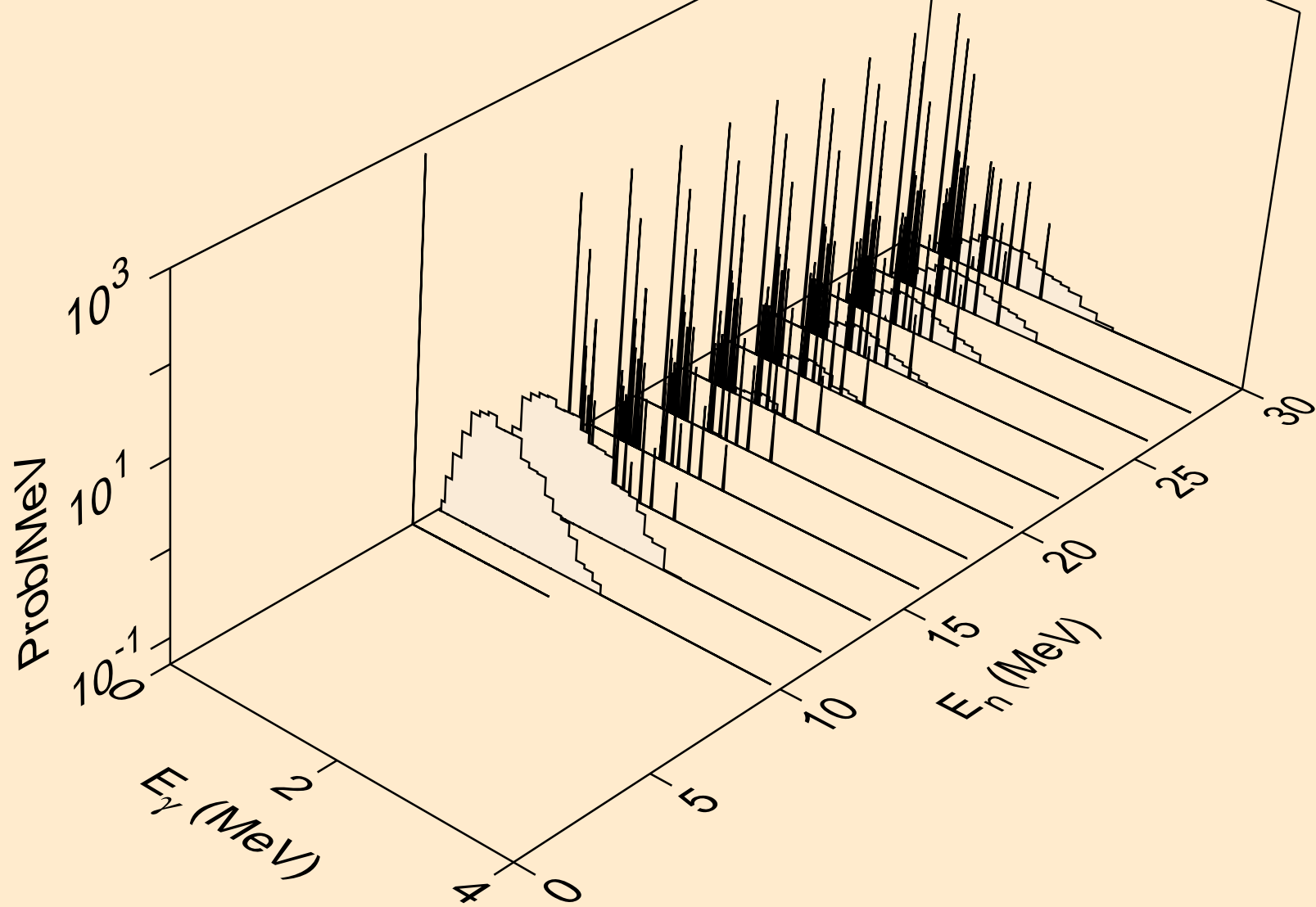

CE125 TRITON ACER TENDL-2021 LIBRARY; T=0.K  
Photon emission for (n,pd)

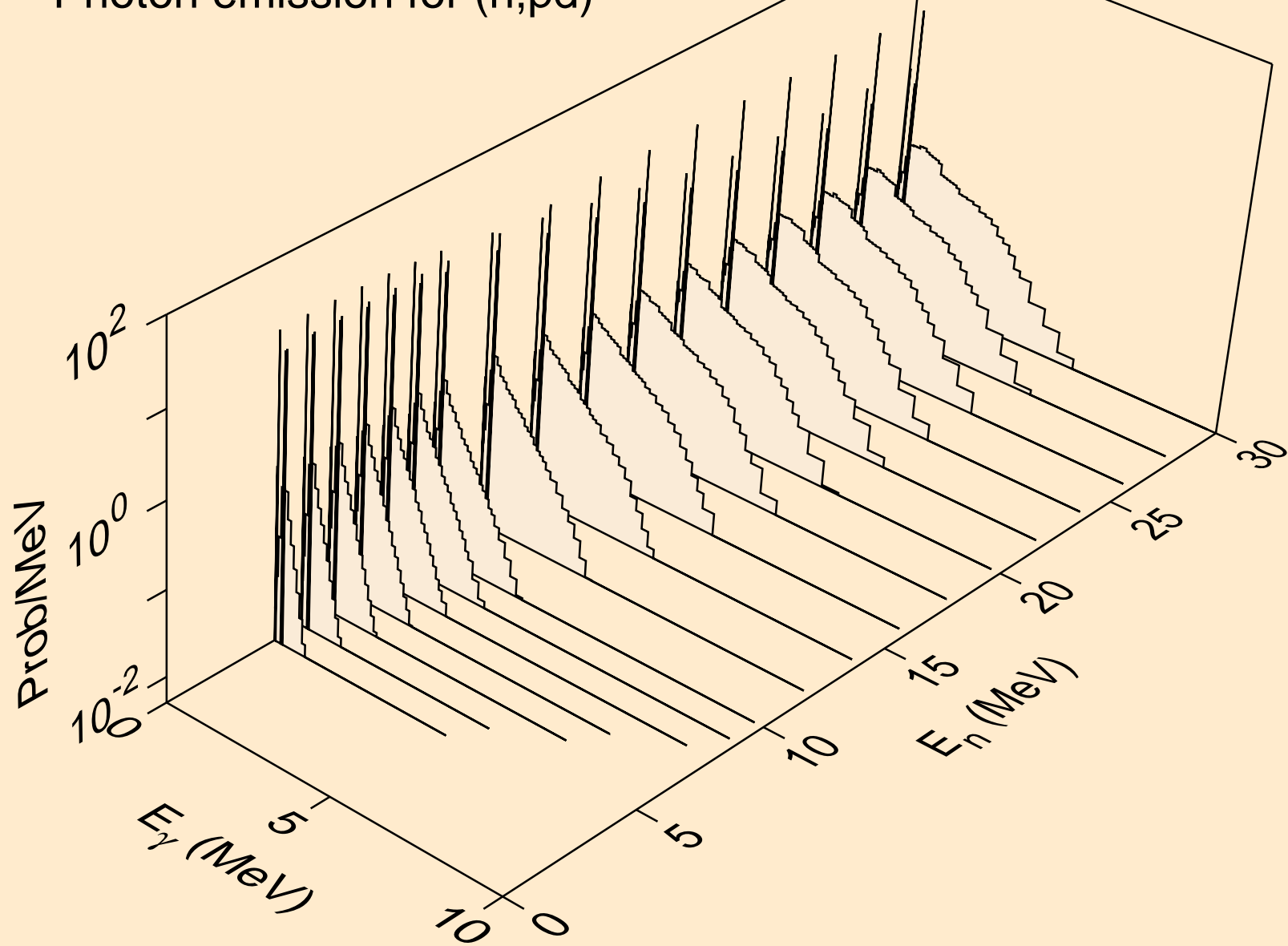

CE125 TRITON ACER TENDL-2021 LIBRARY; T=0.K  
Photon emission for (n,pt)

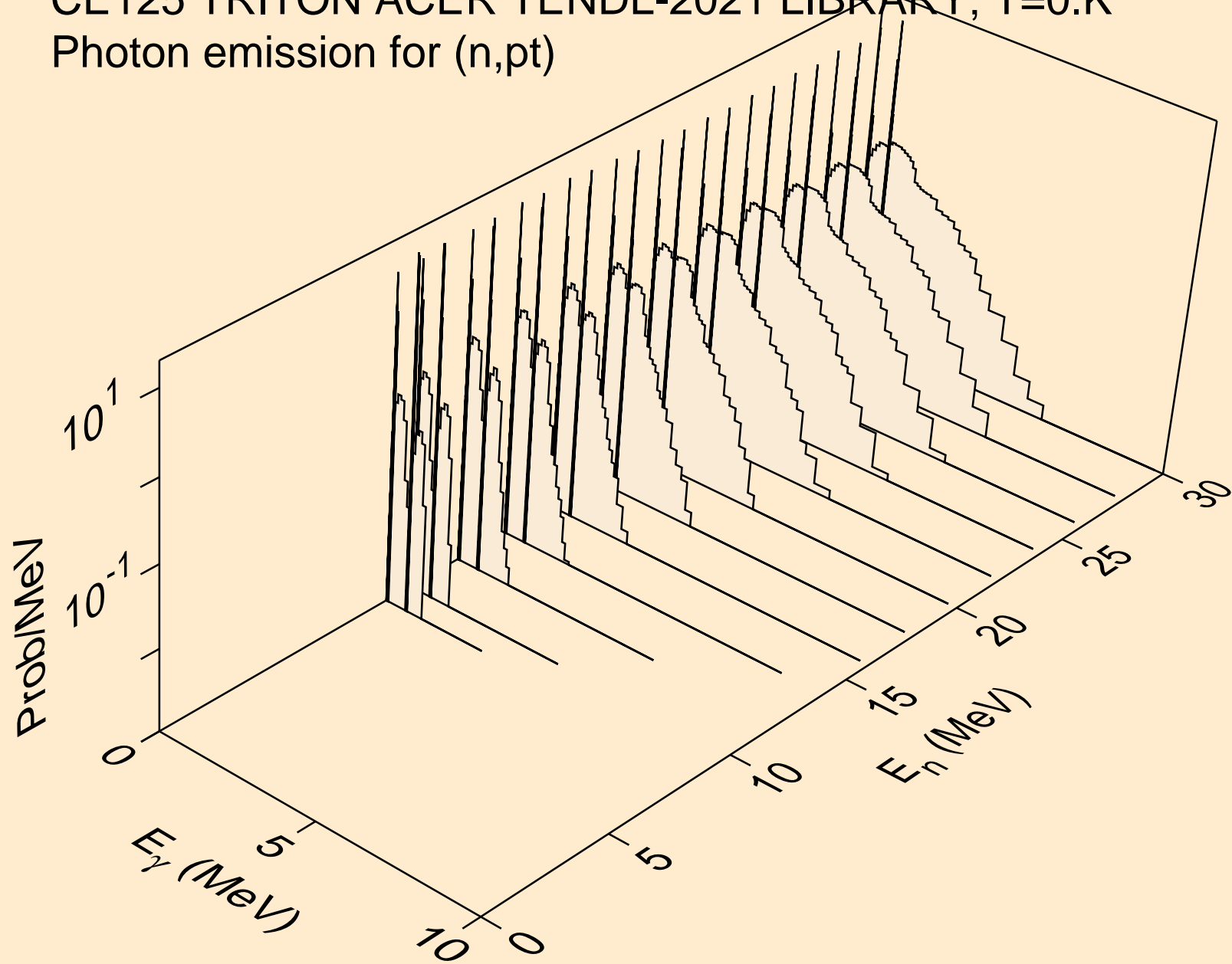

CE125 TRITON ACER TENDL-2021 LIBRARY; T=0.K  
Photon emission for (n,da)

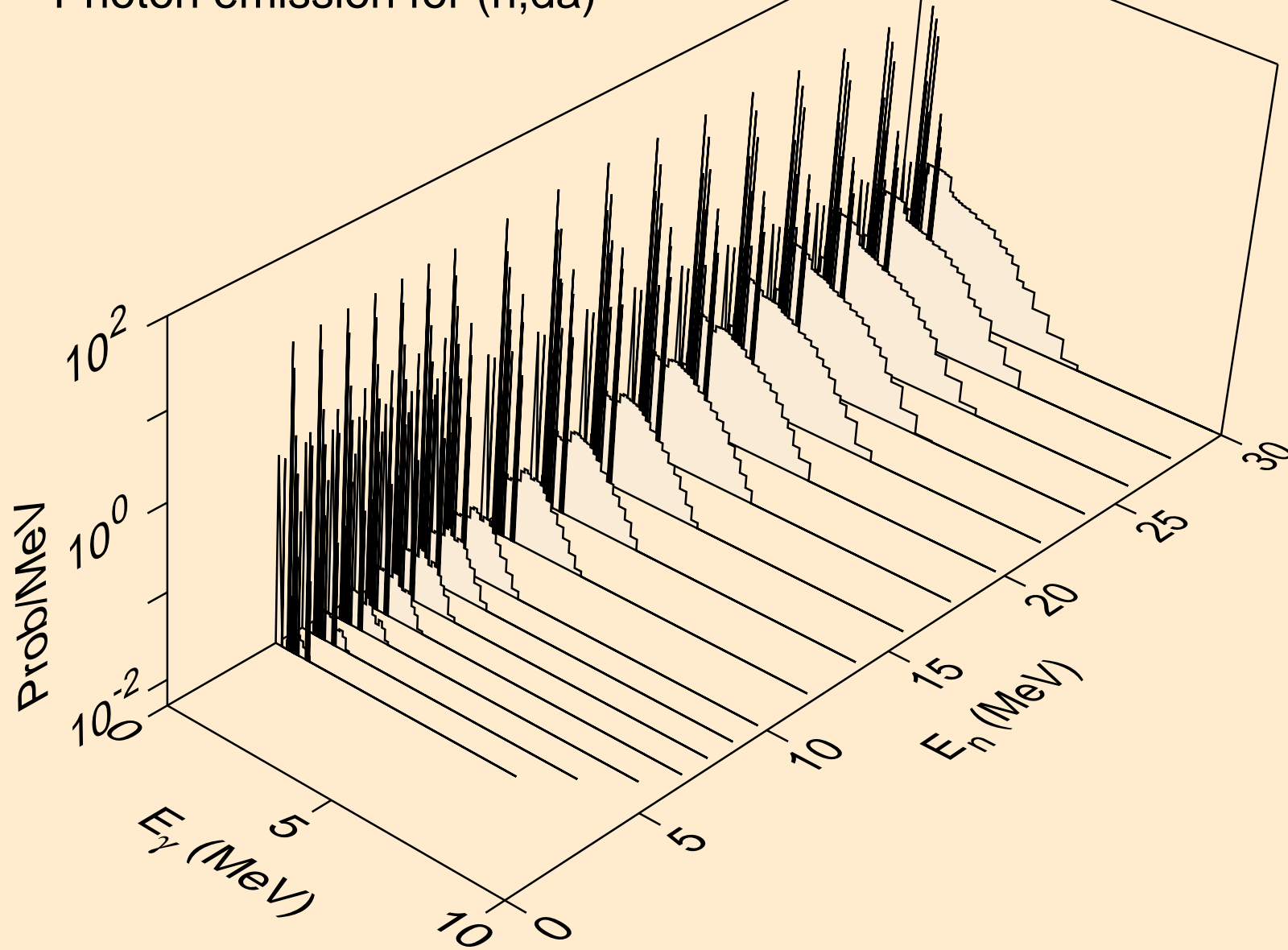

CE125 TRITON ACER TENDL-2021 LIBRARY; T=0.K  
Particle heating contributions

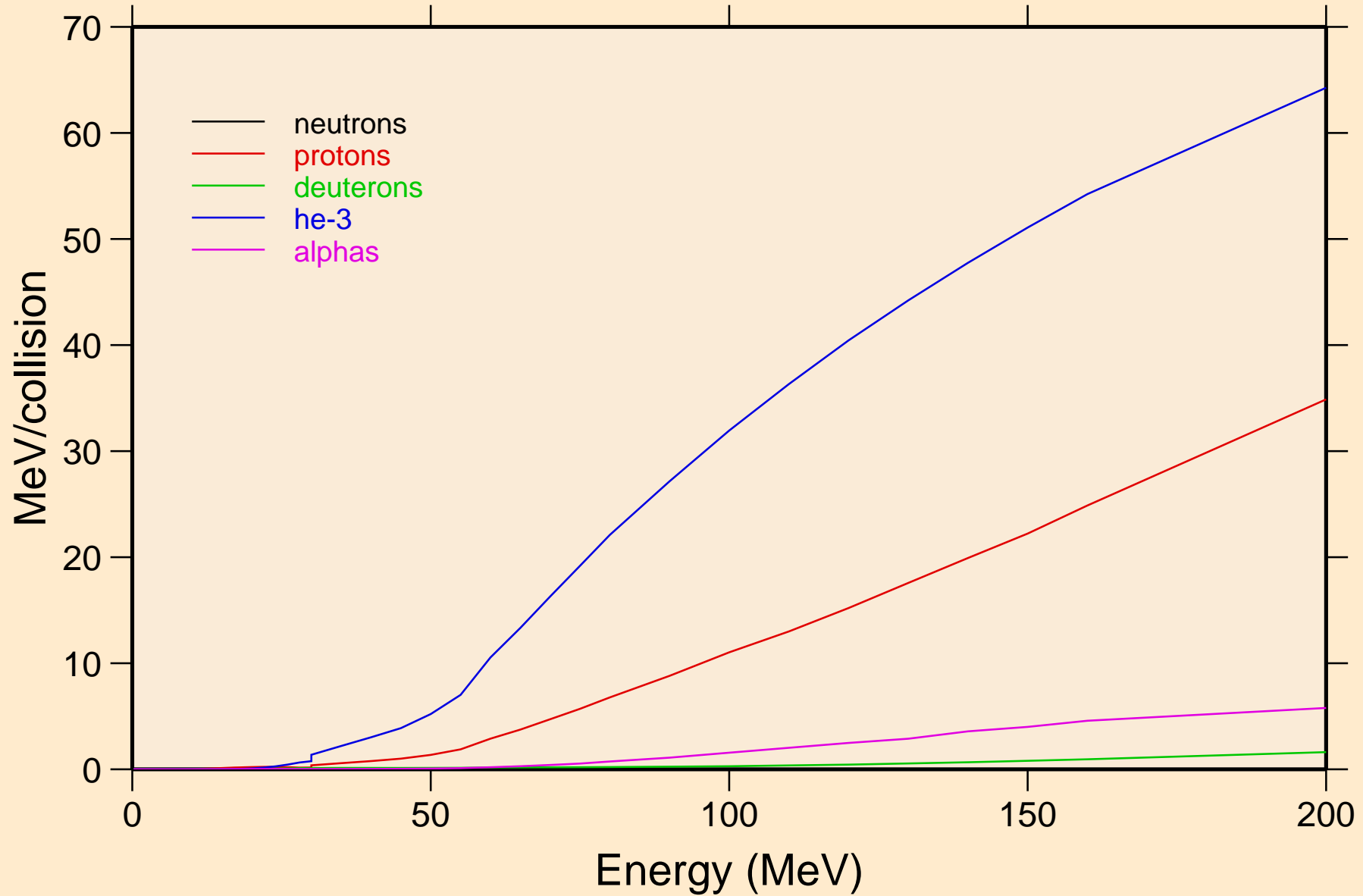

CE125 TRITON ACER TENDL-2021 LIBRARY; T=0.K  
Recoil Heating

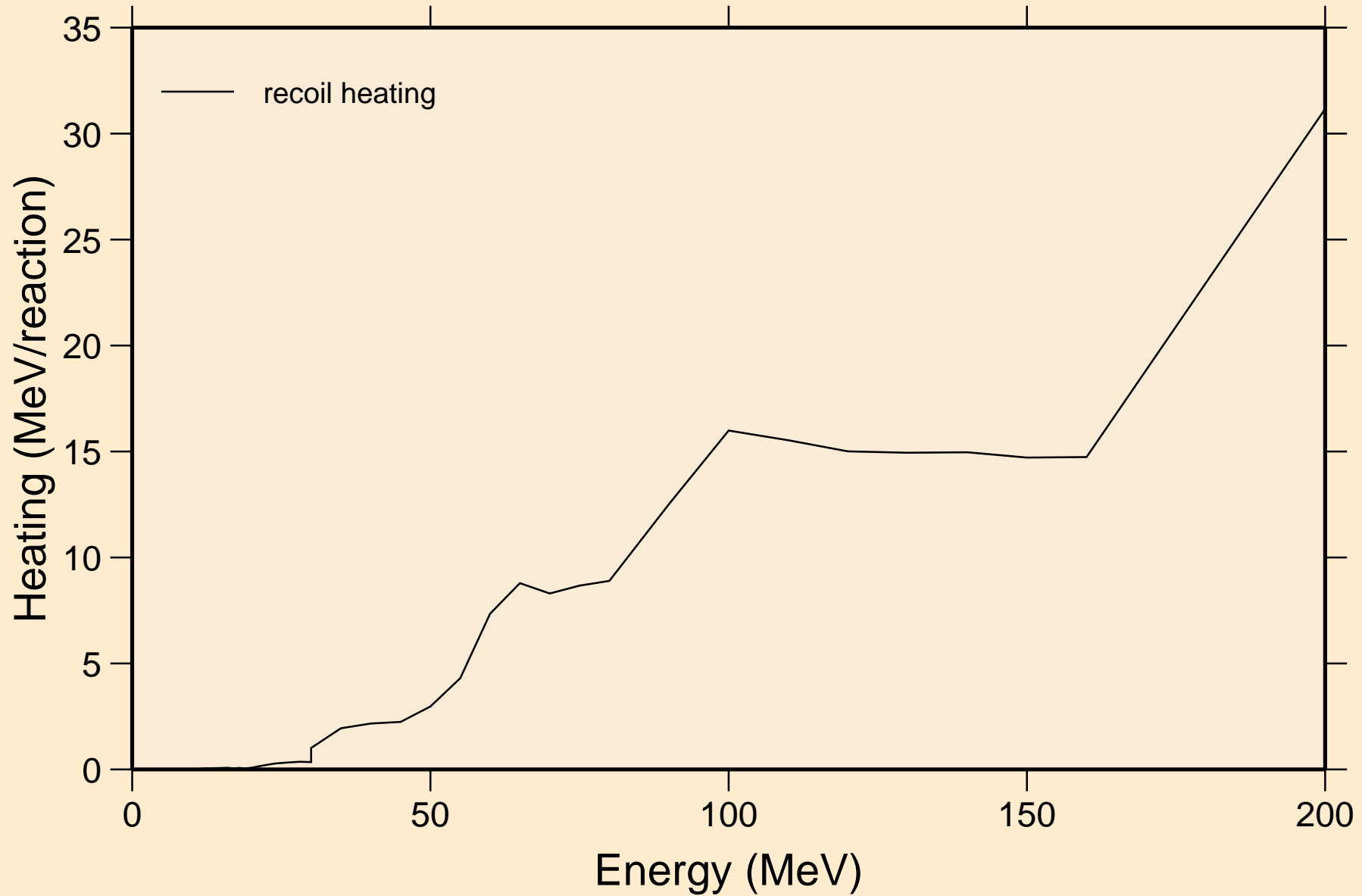

CE125 TRITON ACER TENDL-2021 LIBRARY; T=0.K  
Particle production cross sections

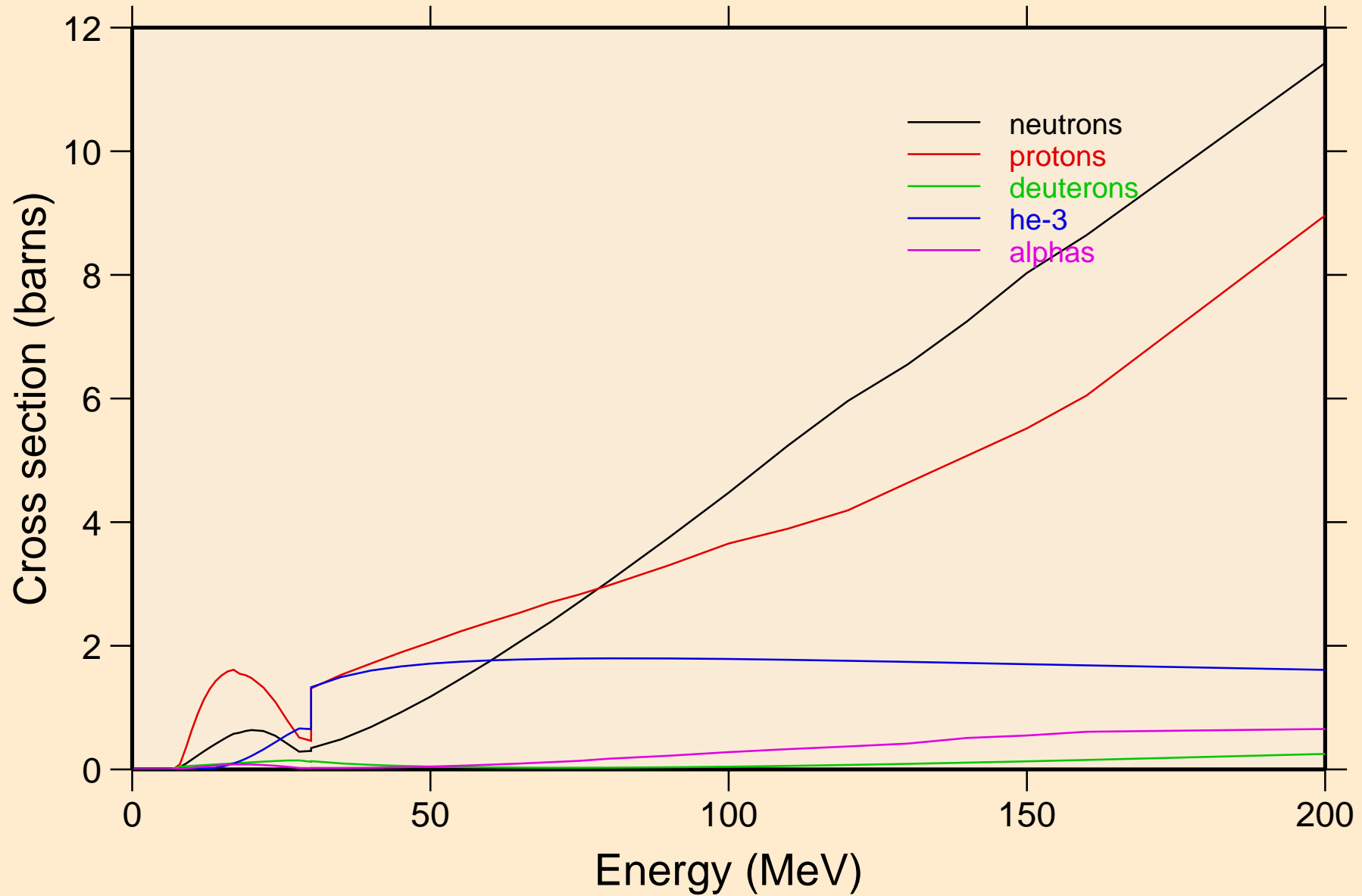

CE125 TRITON ACER TENDL-2021 LIBRARY; T=0.K  
neutrons from (t,n)

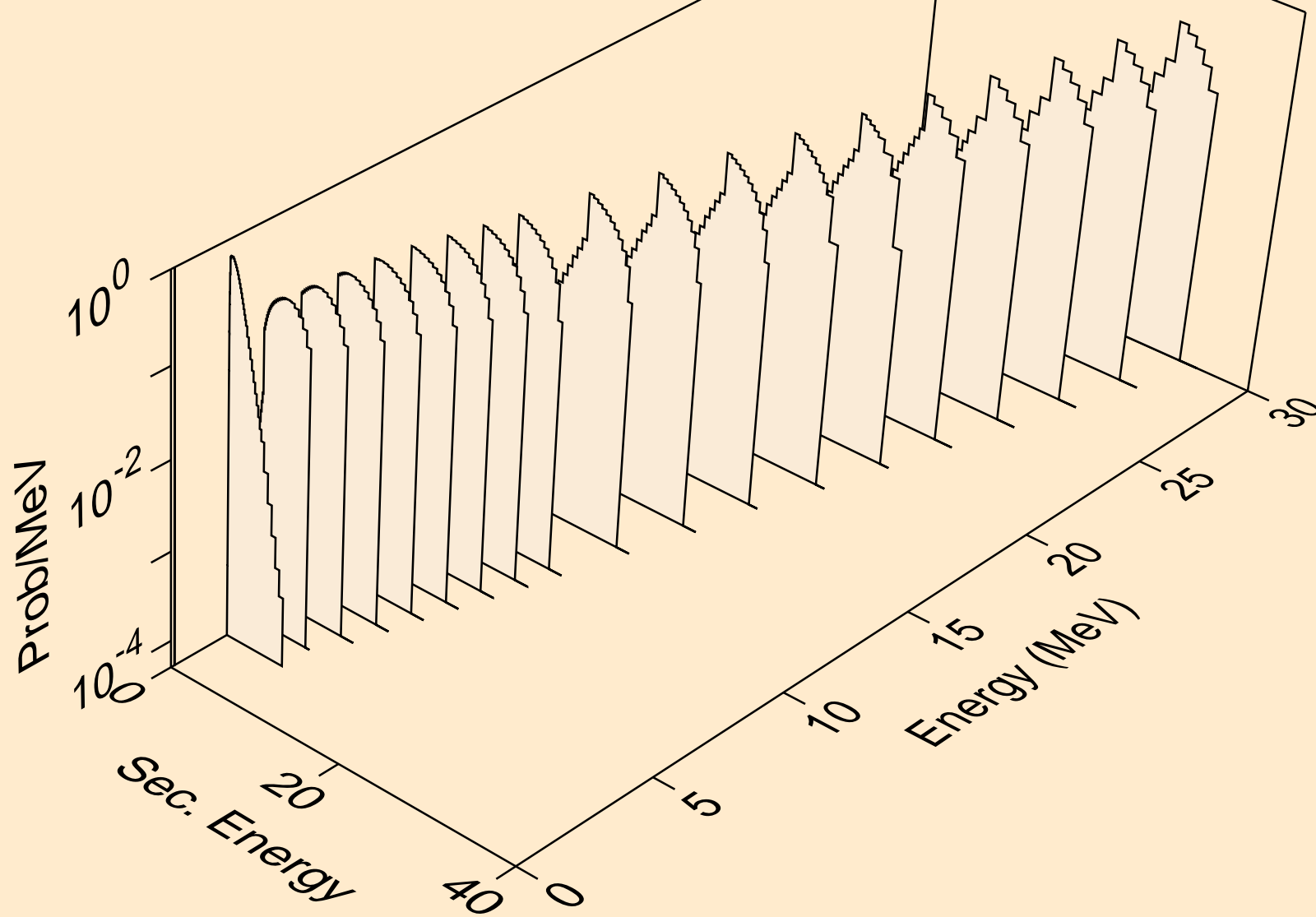



CE125 TRITON ACER TENDL-2021 LIBRARY; T=0.K  
neutrons from (t,x)

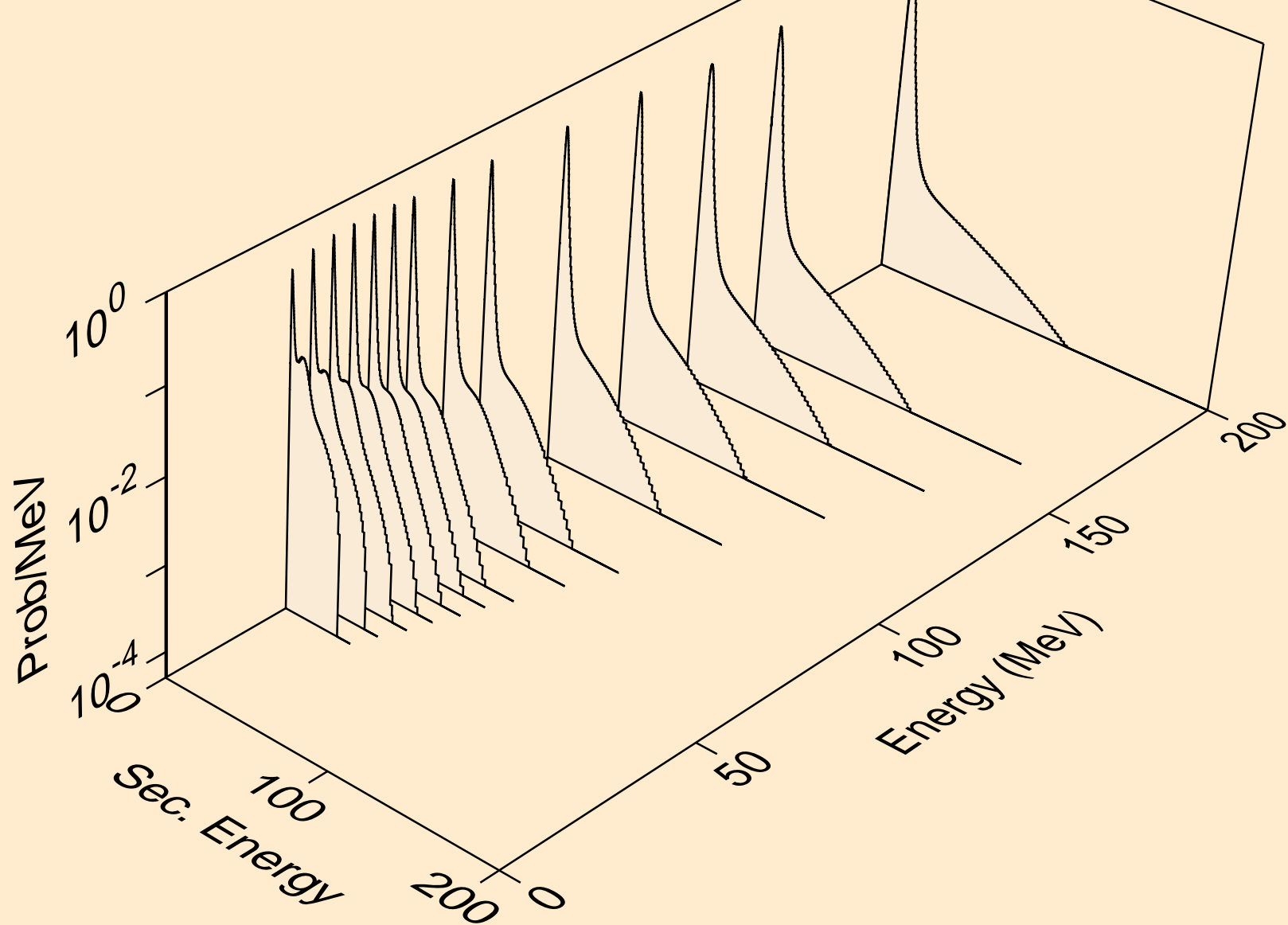

CE125 TRITON ACER TENDL-2021 LIBRARY; T=0.K  
neutrons from (t,2nd)

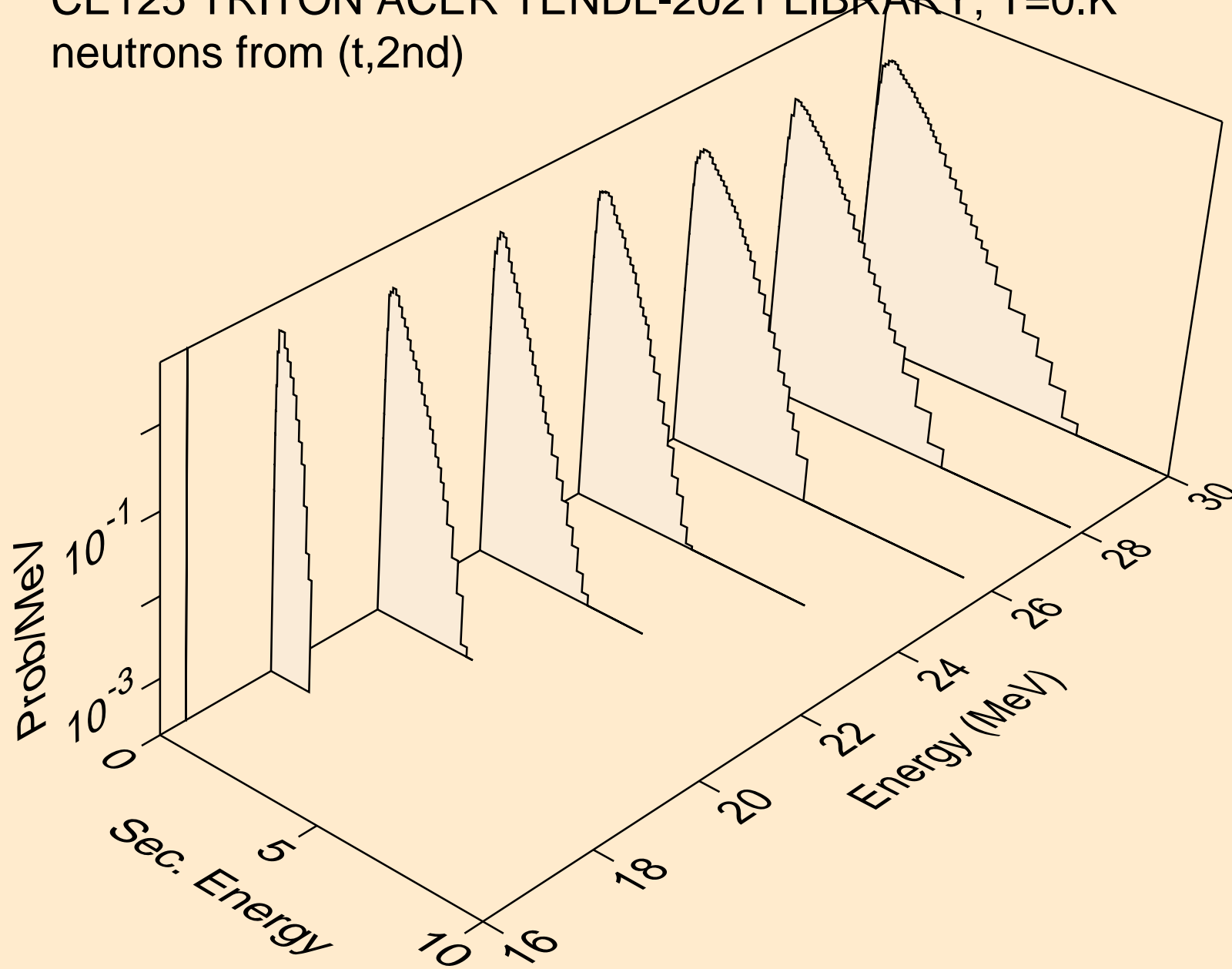

CE125 TRITON ACER TENDL-2021 LIBRARY; T=0.K  
neutrons from (t,2n)

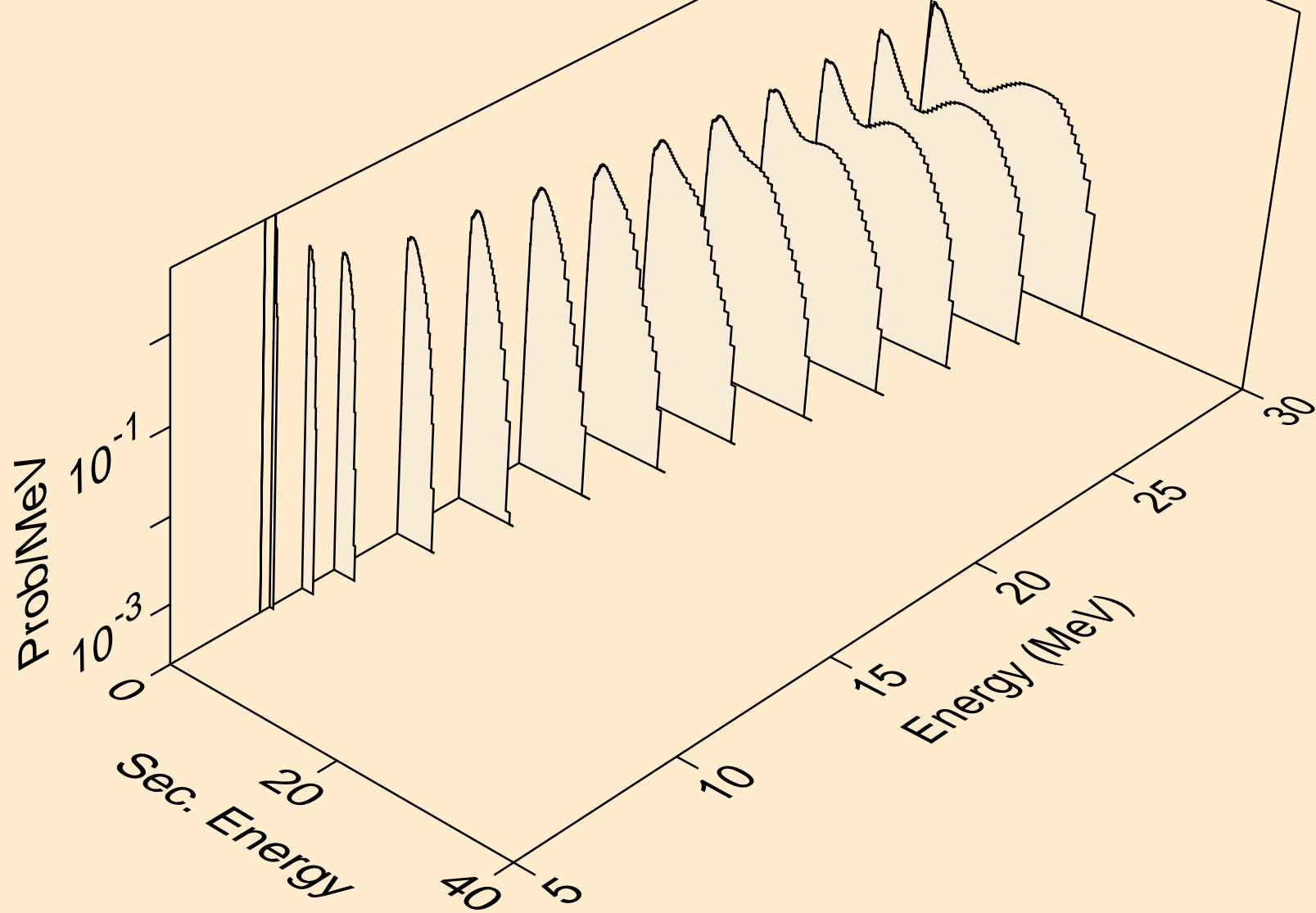

CE125 TRITON ACER TENDL-2021 LIBRARY; T=0.K  
neutrons from (t,3n)

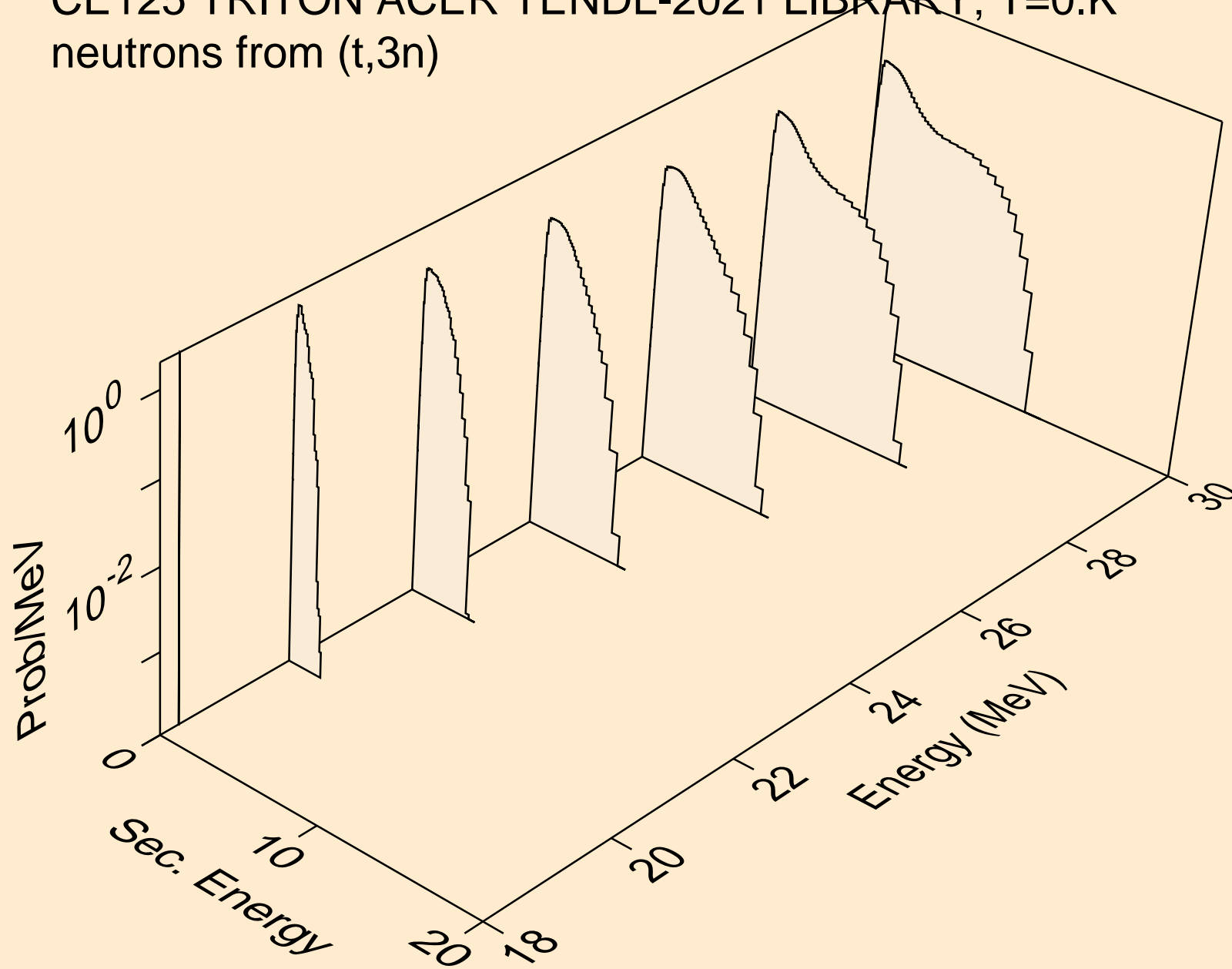

CE125 TRITON ACER TENDL-2021 LIBRARY; T=0.K  
neutrons from (t,n\*)a

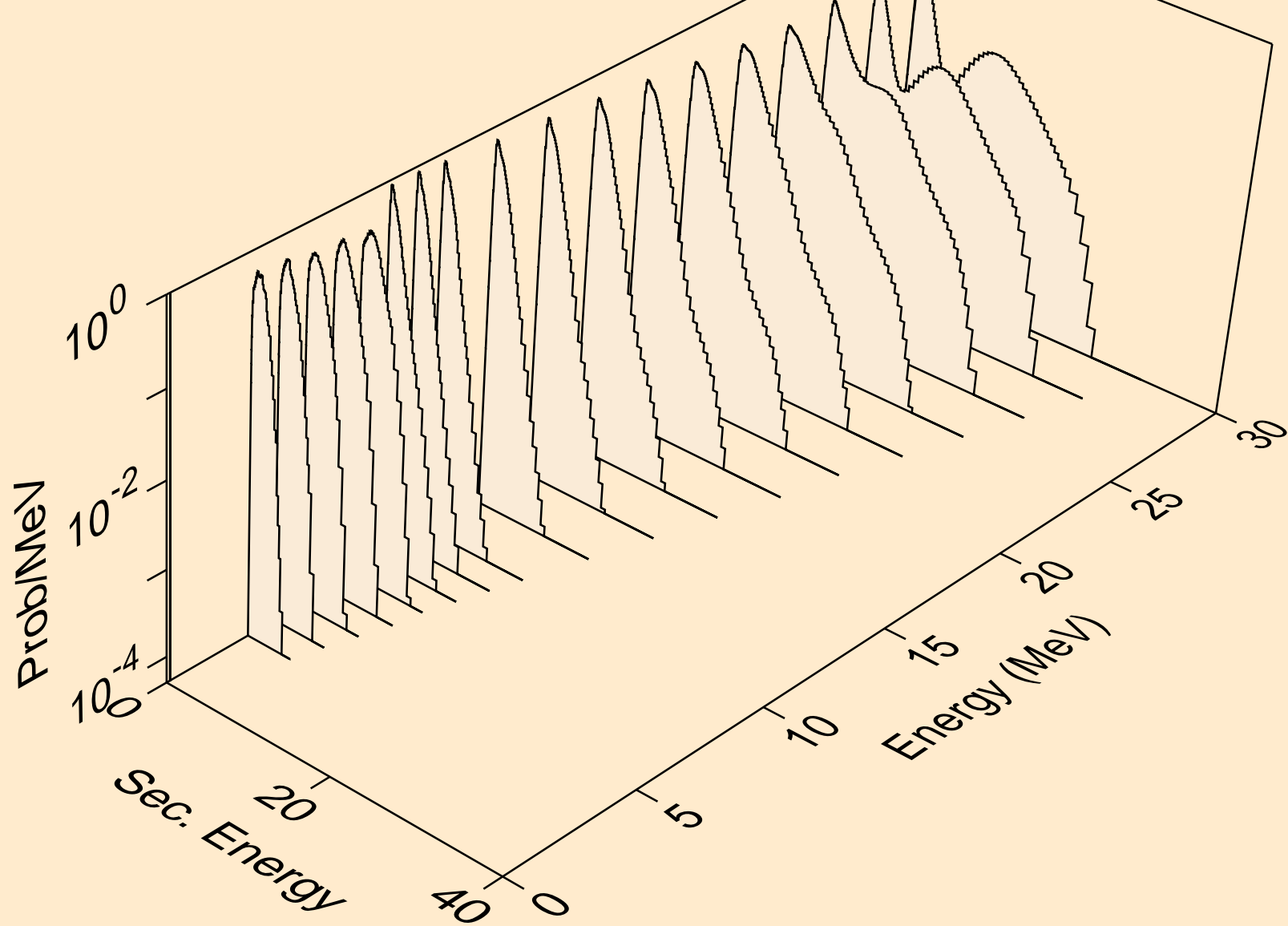

CE125 TRITON ACER TENDL-2021 LIBRARY; T=0.K  
neutrons from (t,2n)a

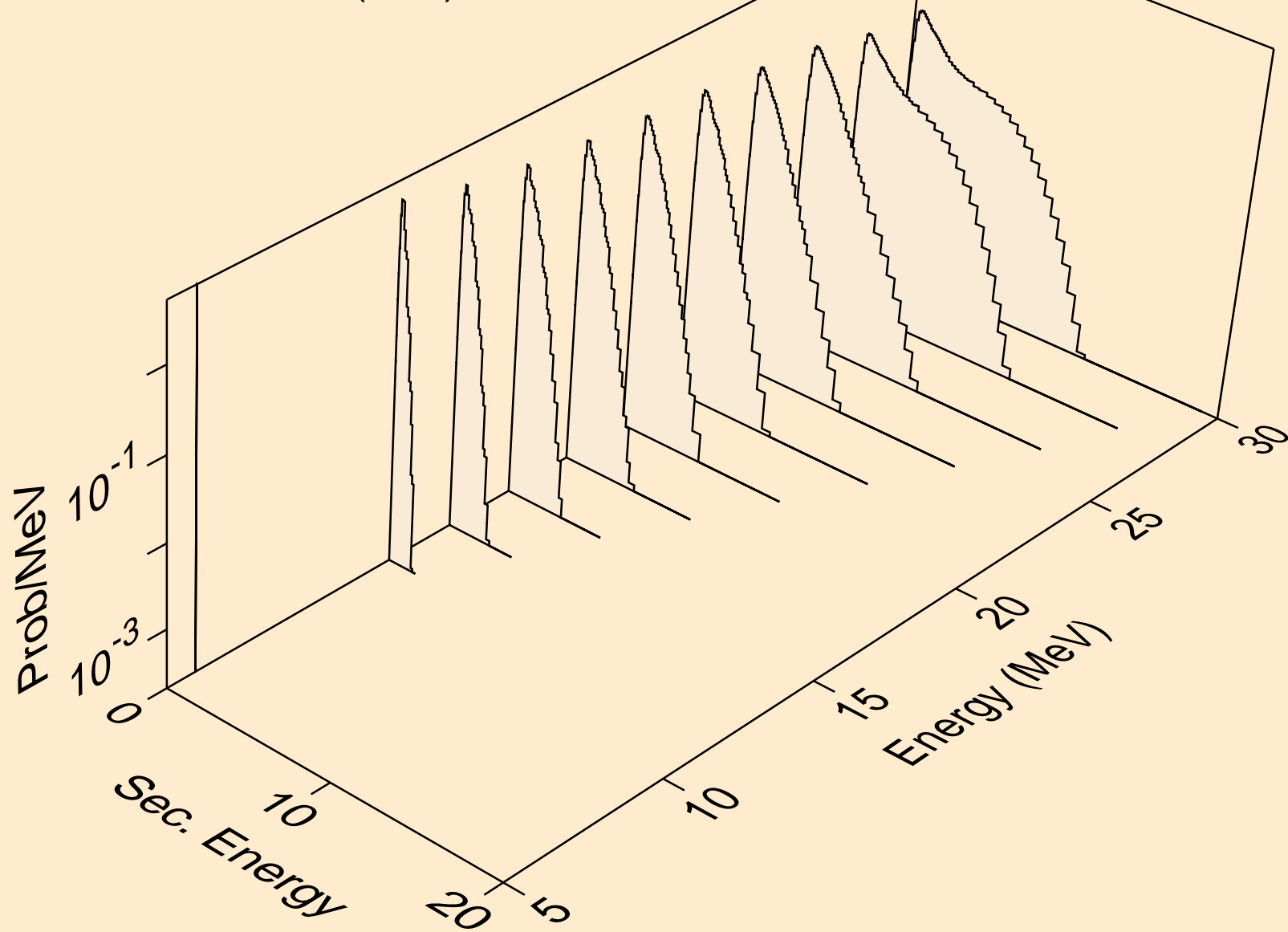

CE125 TRITON ACER TENDL-2021 LIBRARY; T=0.K  
neutrons from (t,n\*)p

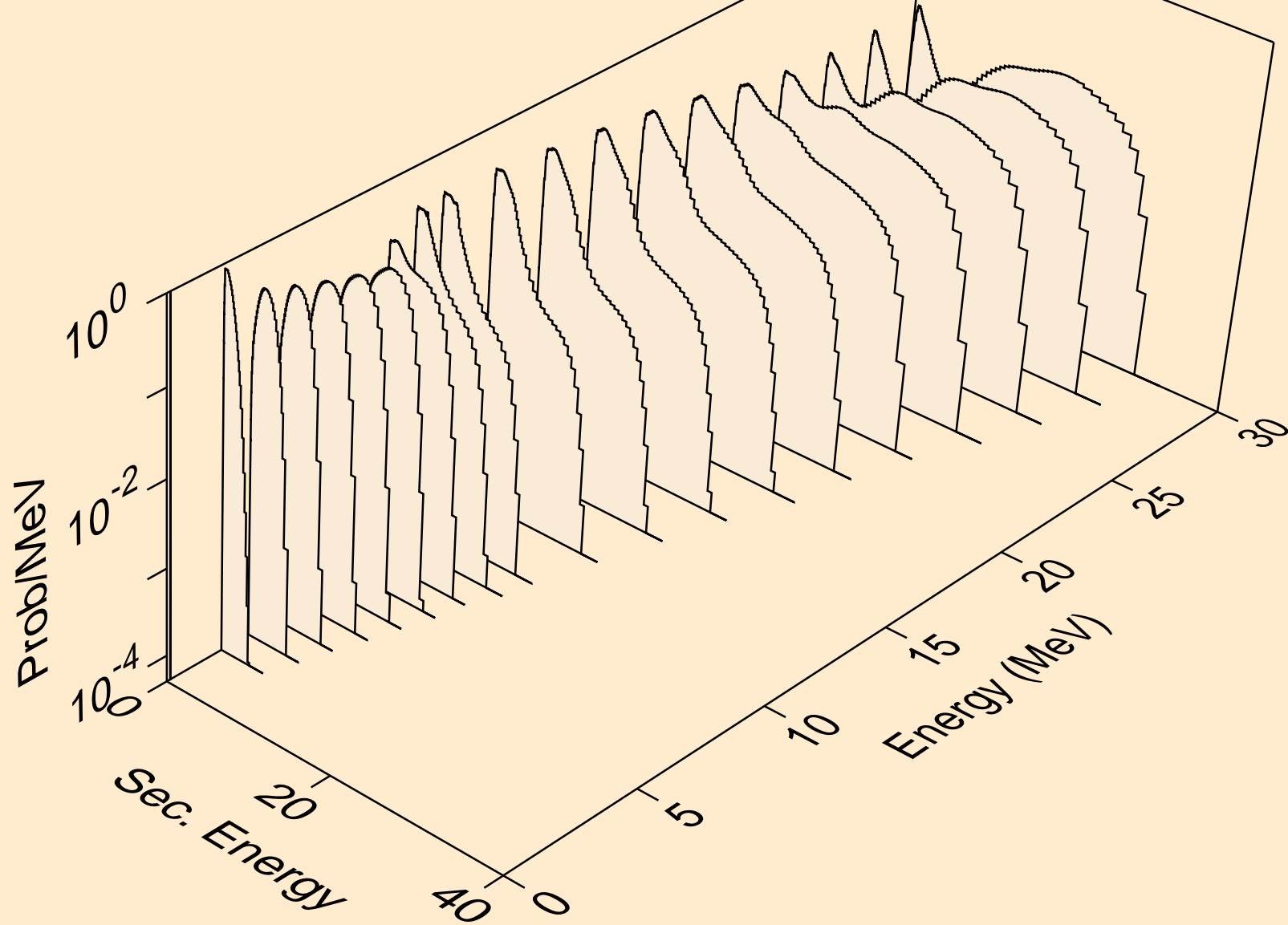

CE125 TRITON ACER TENDL-2021 LIBRARY; T=0.K  
neutrons from (t,n\*)2a

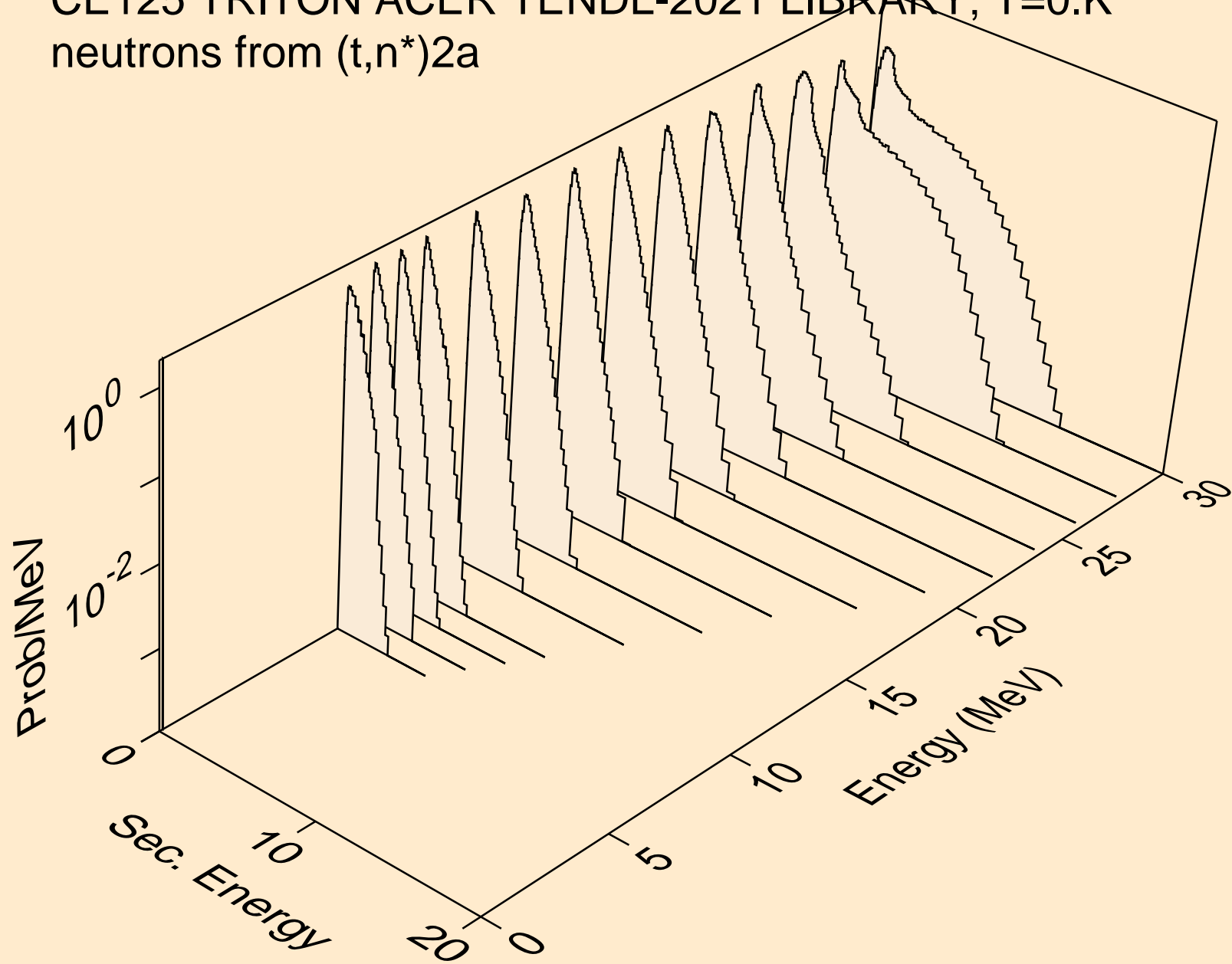



CE125 TRITON ACER TENDL-2021 LIBRARY; T=0.K  
neutrons from (t,n\*)d

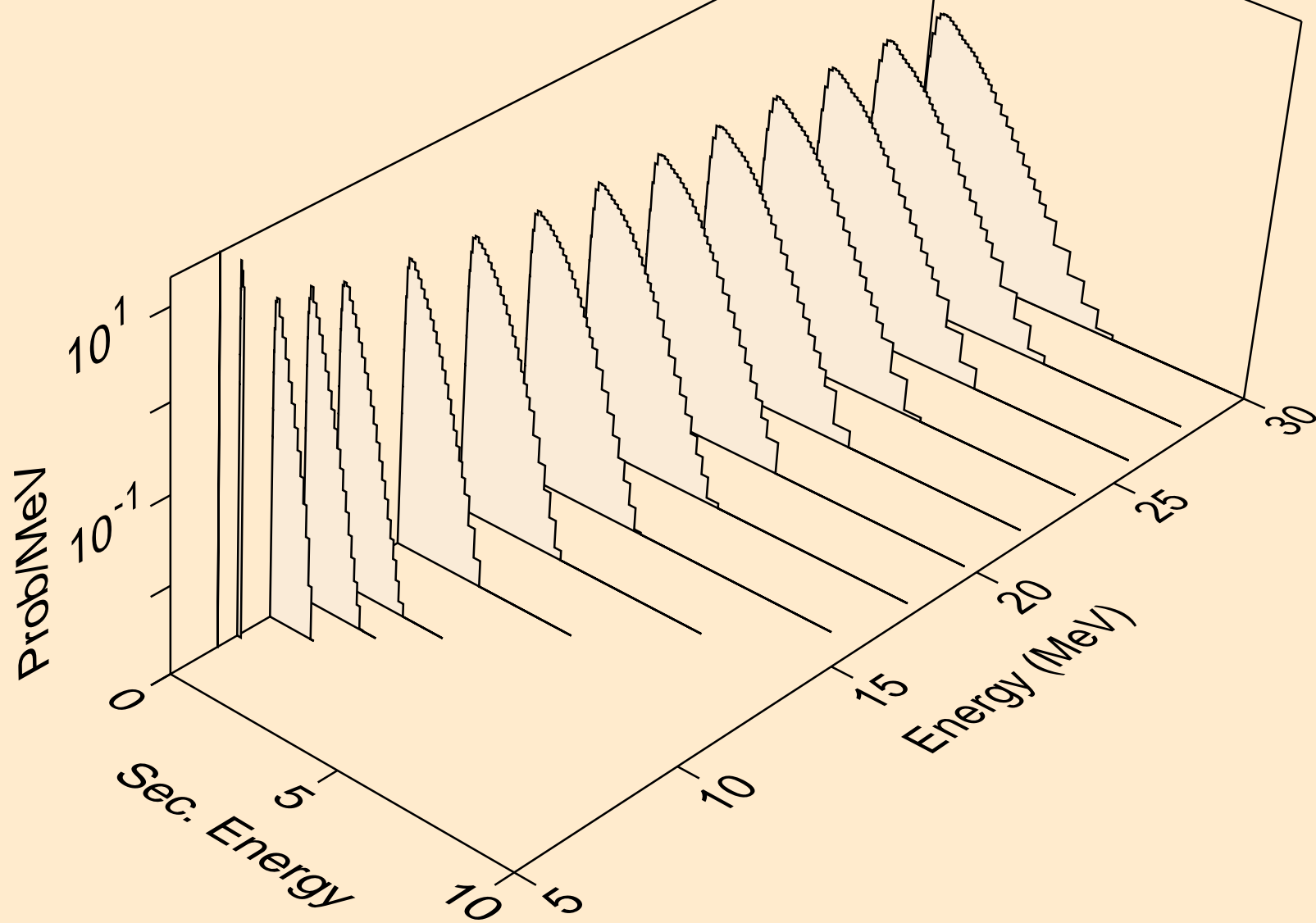

CE125 TRITON ACER TENDL-2021 LIBRARY; T=0.K  
neutrons from (t,n\*)t

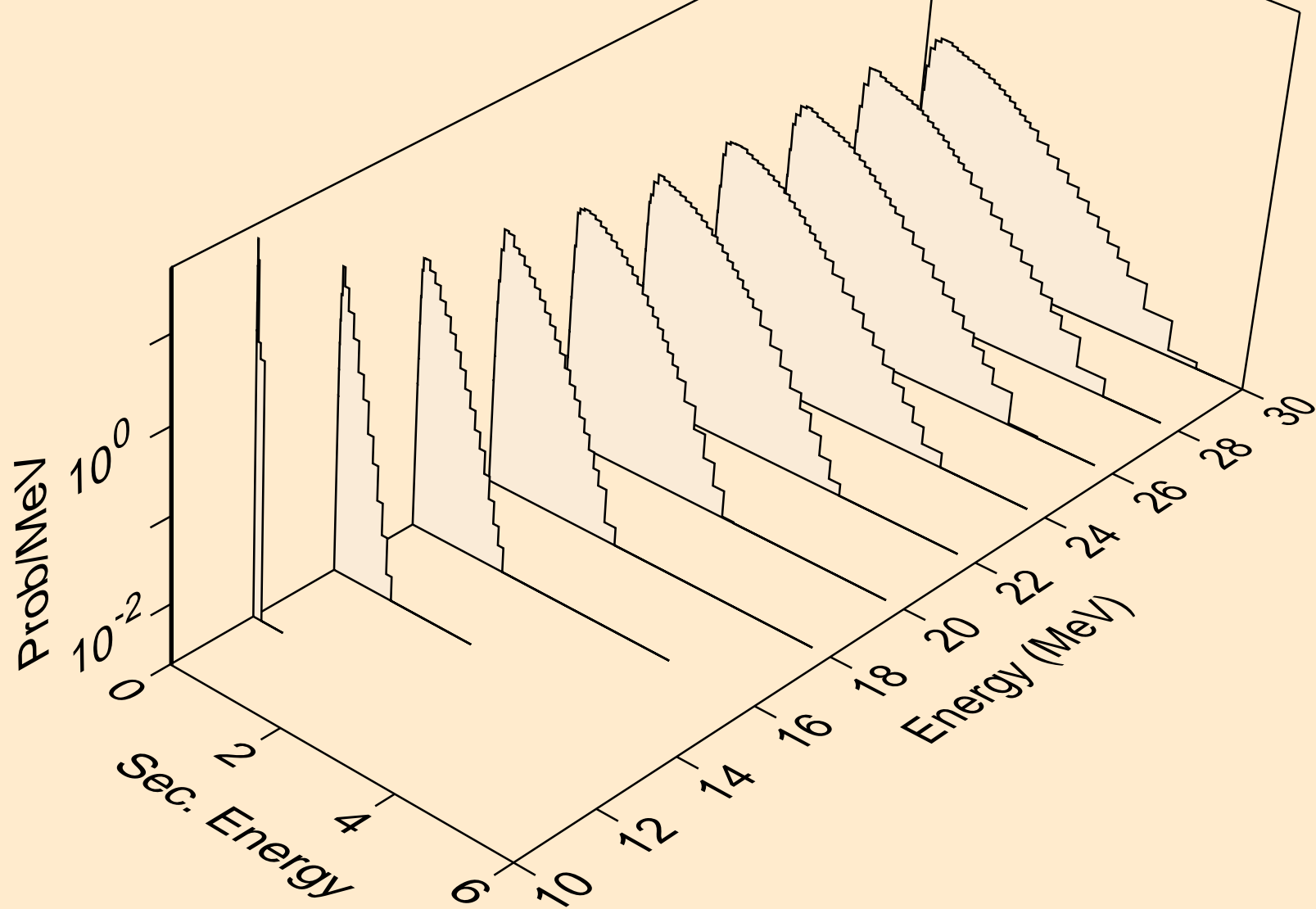

CE125 TRITON ACER TENDL-2021 LIBRARY; T=0.K  
neutrons from (t,n\*)he3

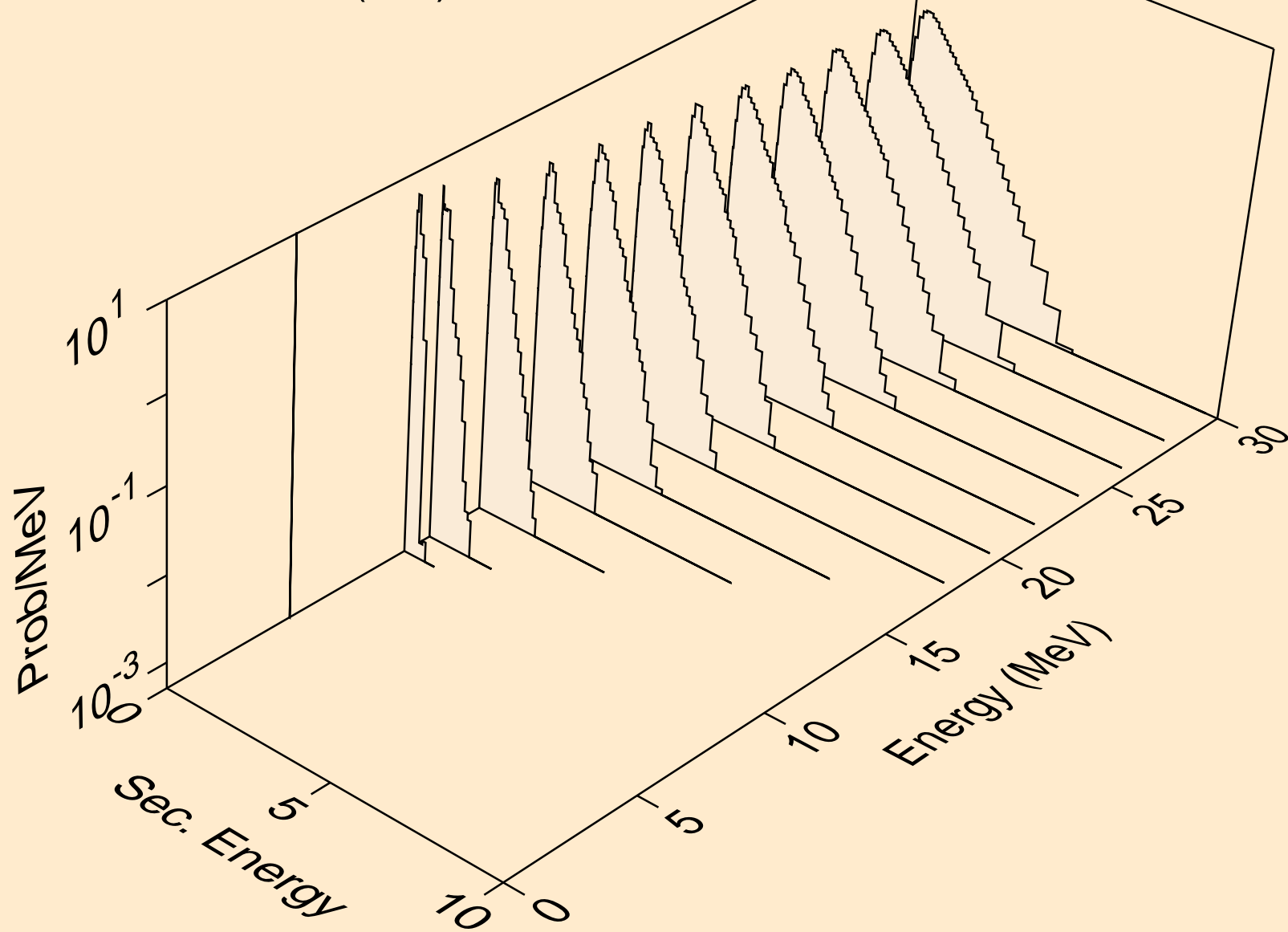

CE125 TRITON ACER TENDL-2021 LIBRARY; T=0.K  
neutrons from (t,2np)

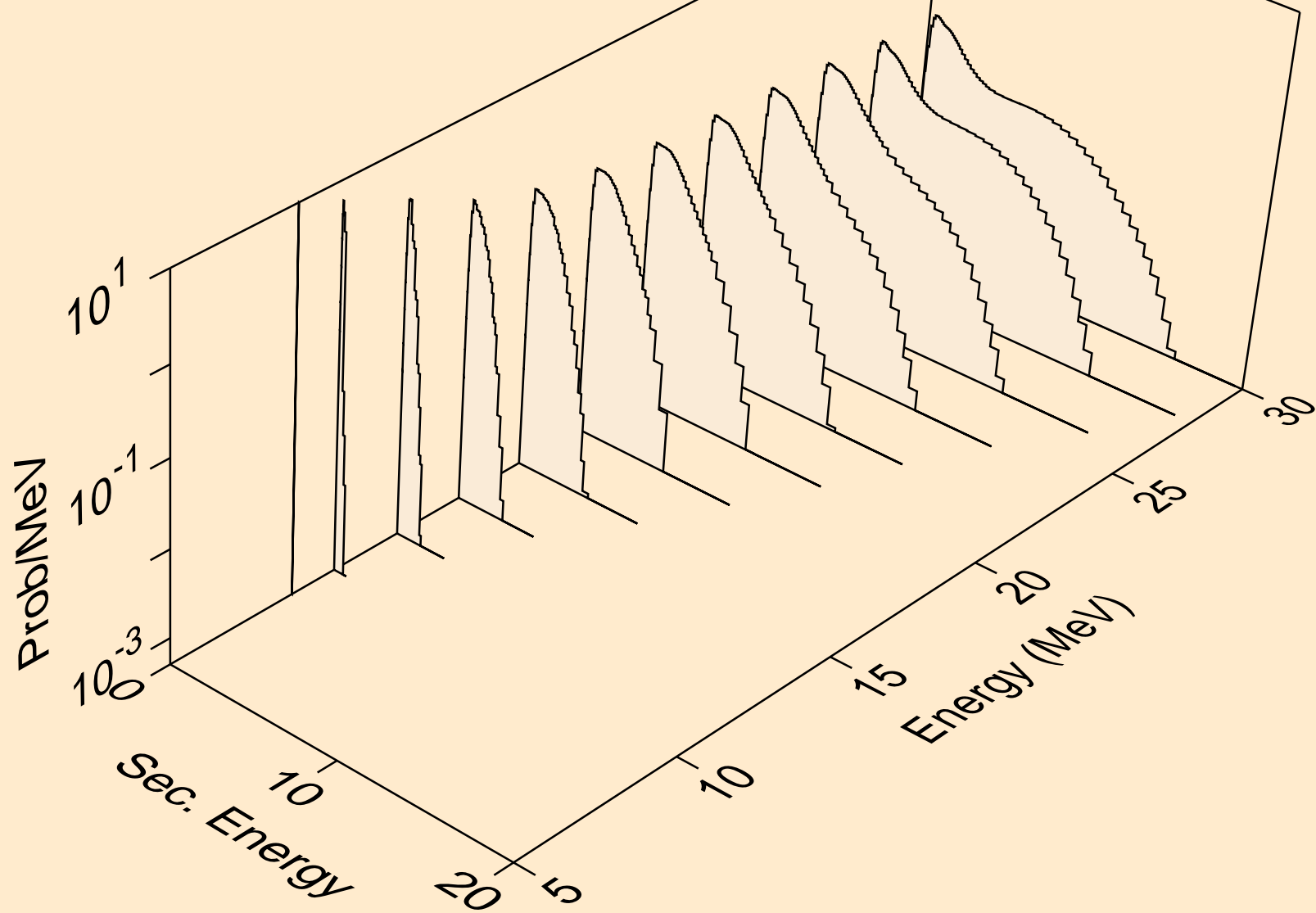

CE125 TRITON ACER TENDL-2021 LIBRARY; T=0.K  
neutrons from (t,3np)

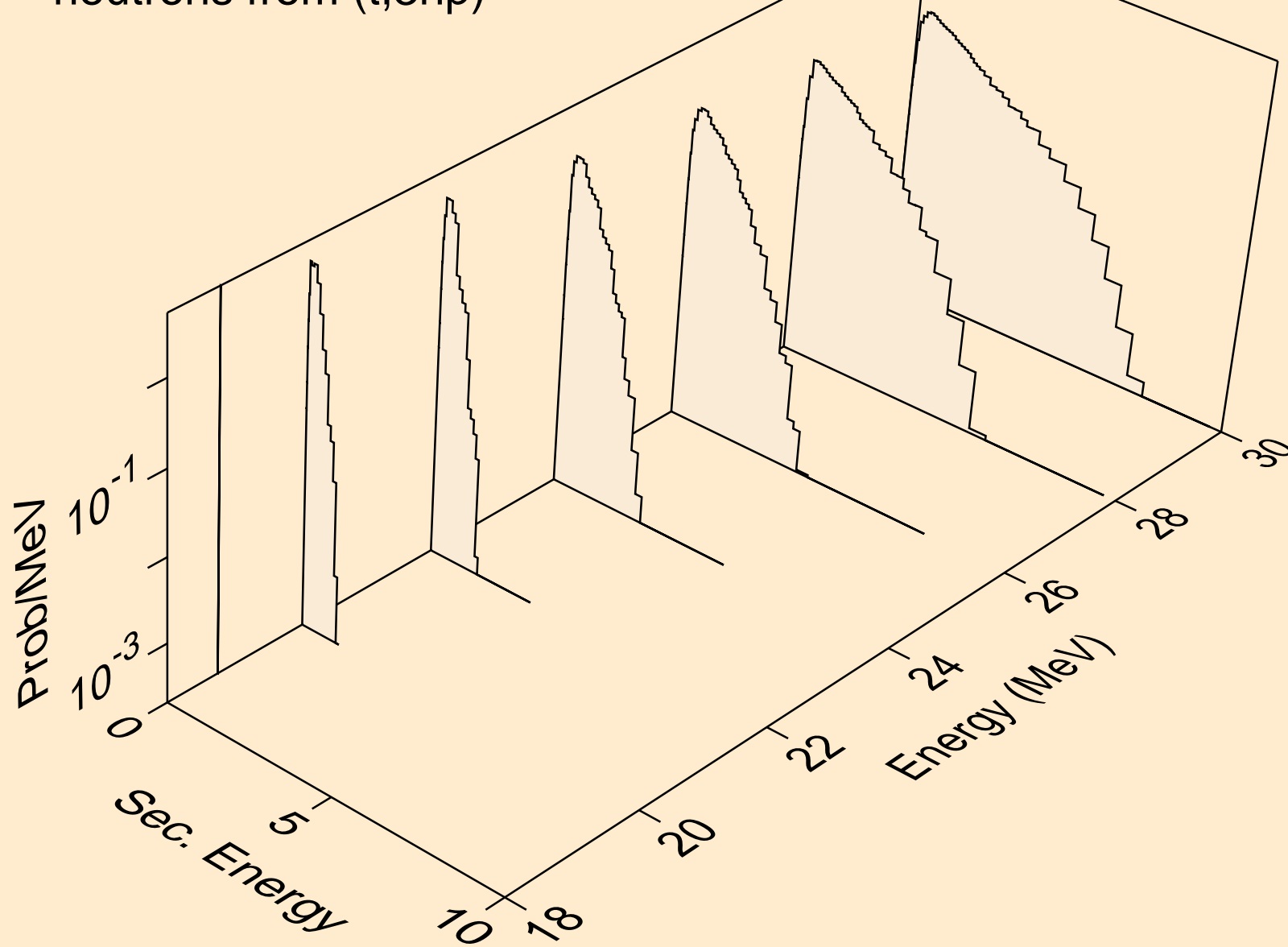

CE125 TRITON ACER TENDL-2021 LIBRARY; T=0.K  
neutrons from (t,2np)

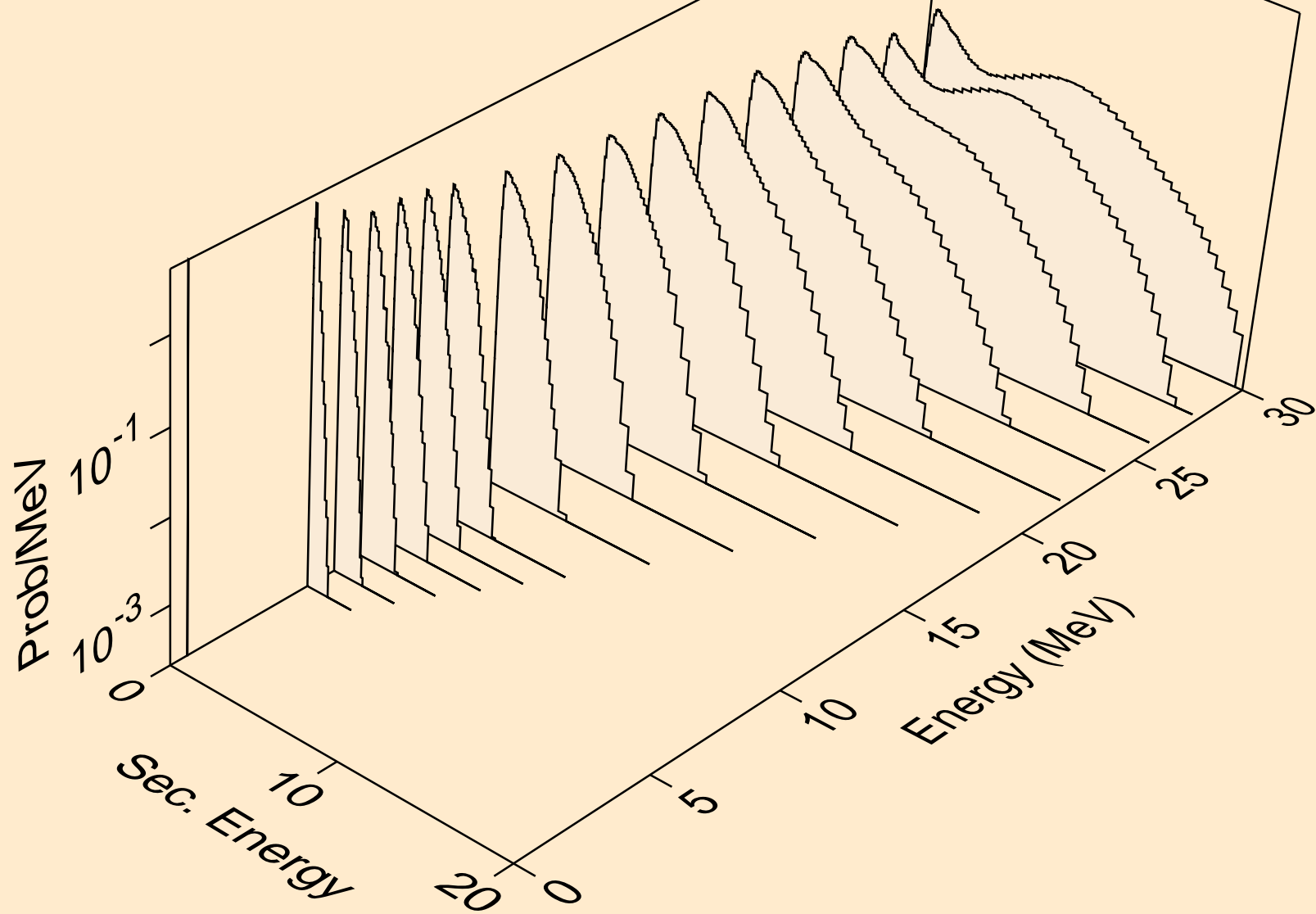

CE125 TRITON ACER TENDL-2021 LIBRARY; T=0.K  
neutrons from (t,npa)

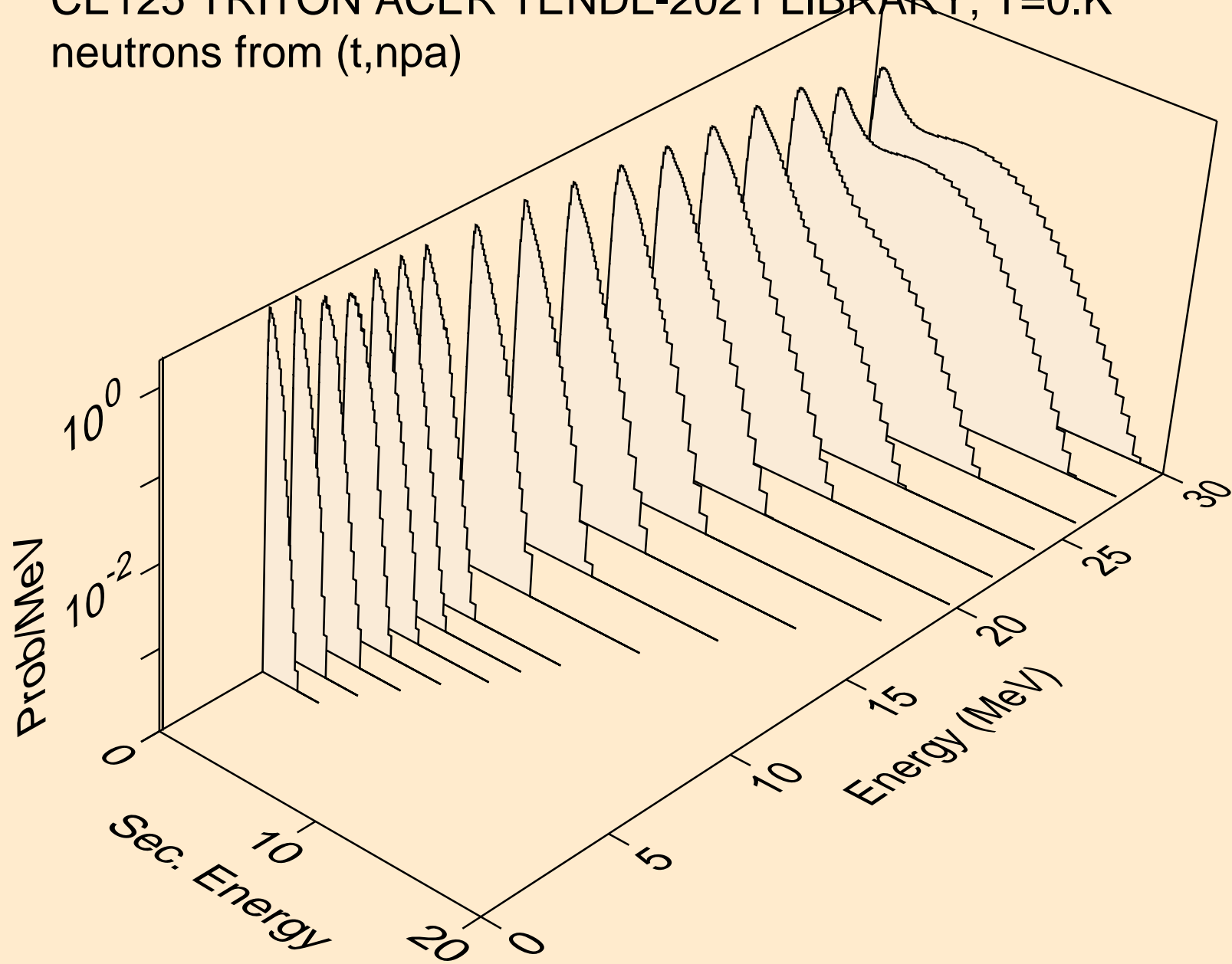

CE125 TRITON ACER TENDL-2021 LIBRARY; T=0.K  
protons from (t,x)

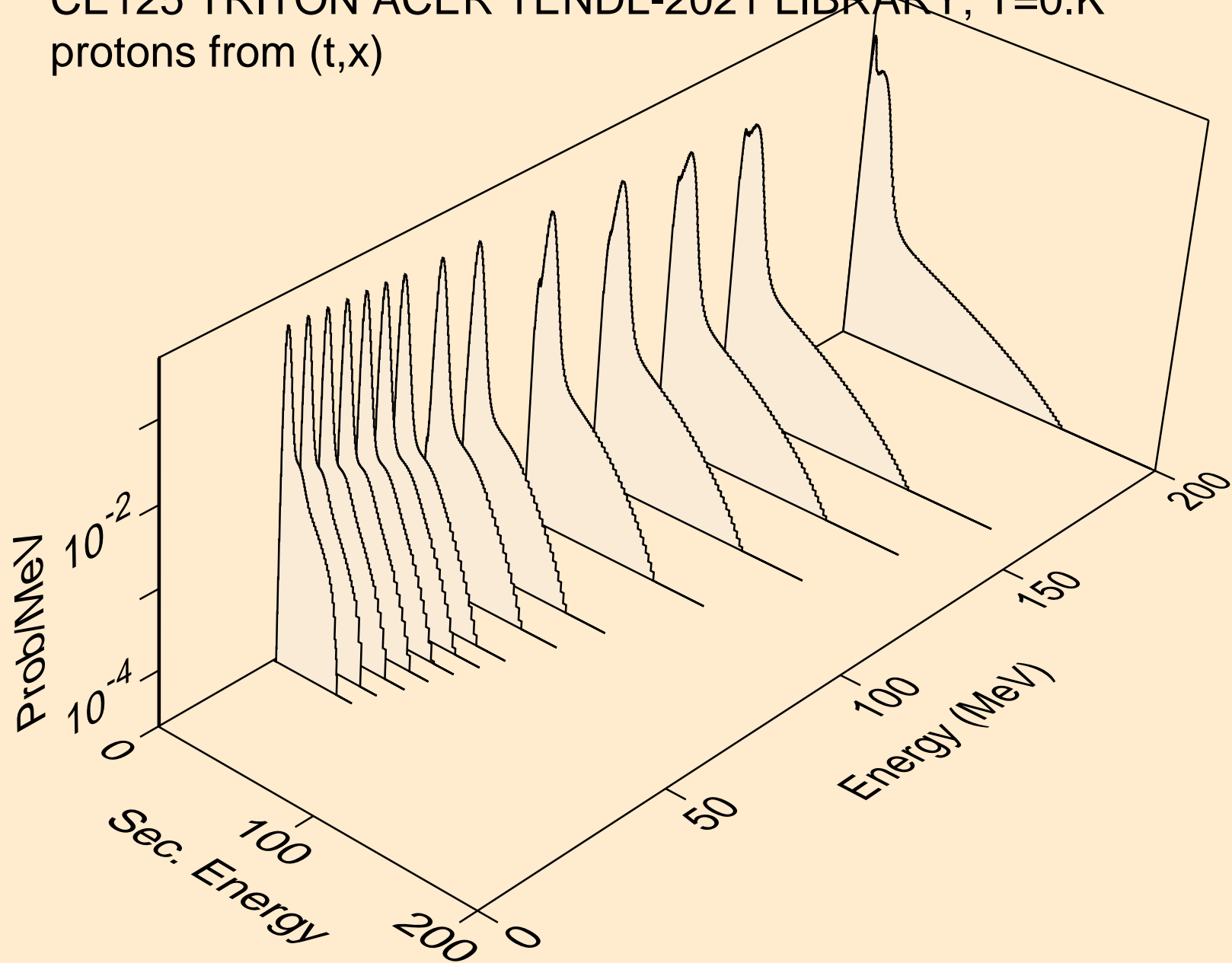



CE125 TRITON ACER TENDL-2021 LIBRARY; T=0.K  
protons from (t,n\*)p

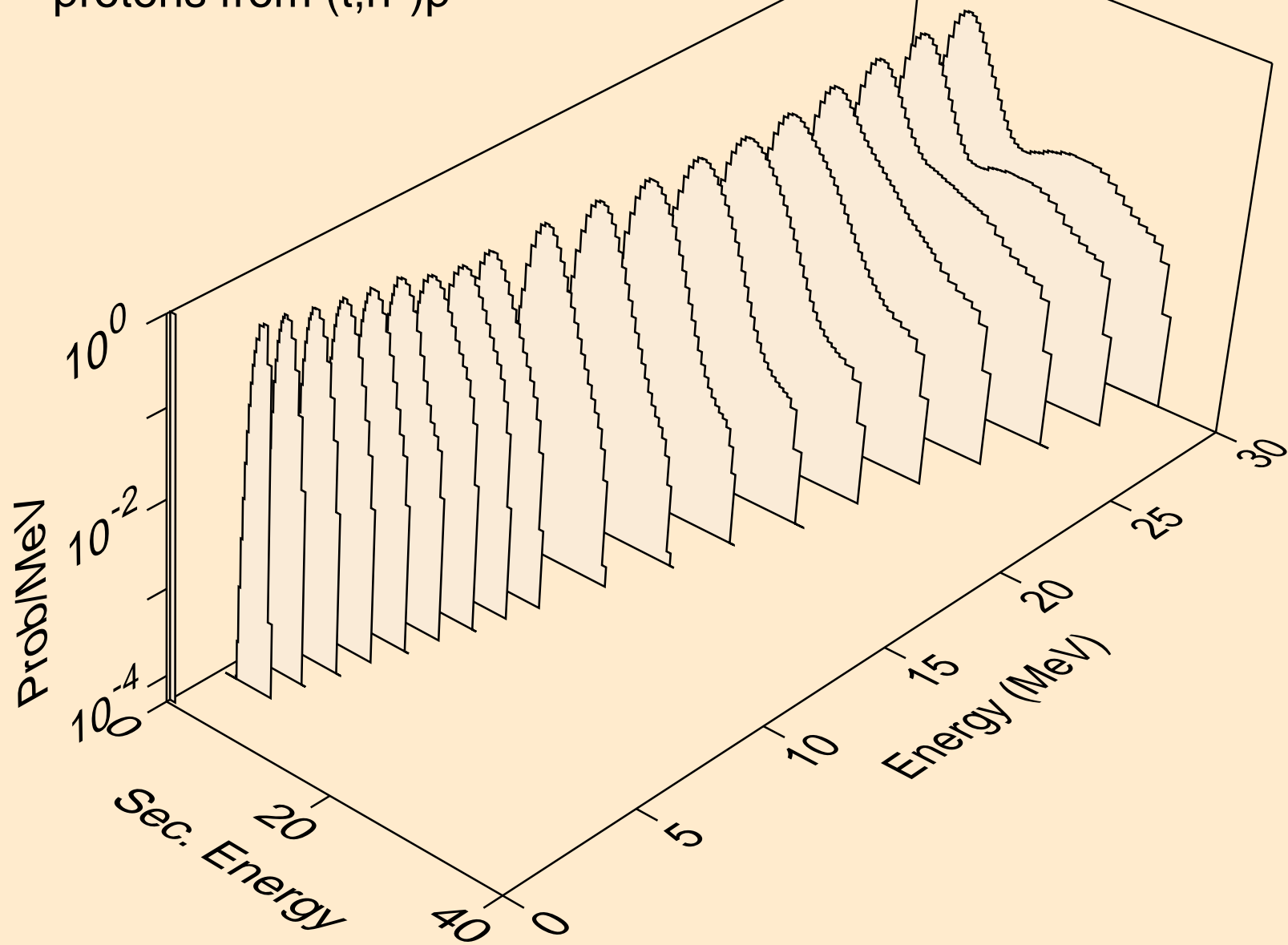

CE125 TRITON ACER TENDL-2021 LIBRARY; T=0.K  
protons from (t,2np)

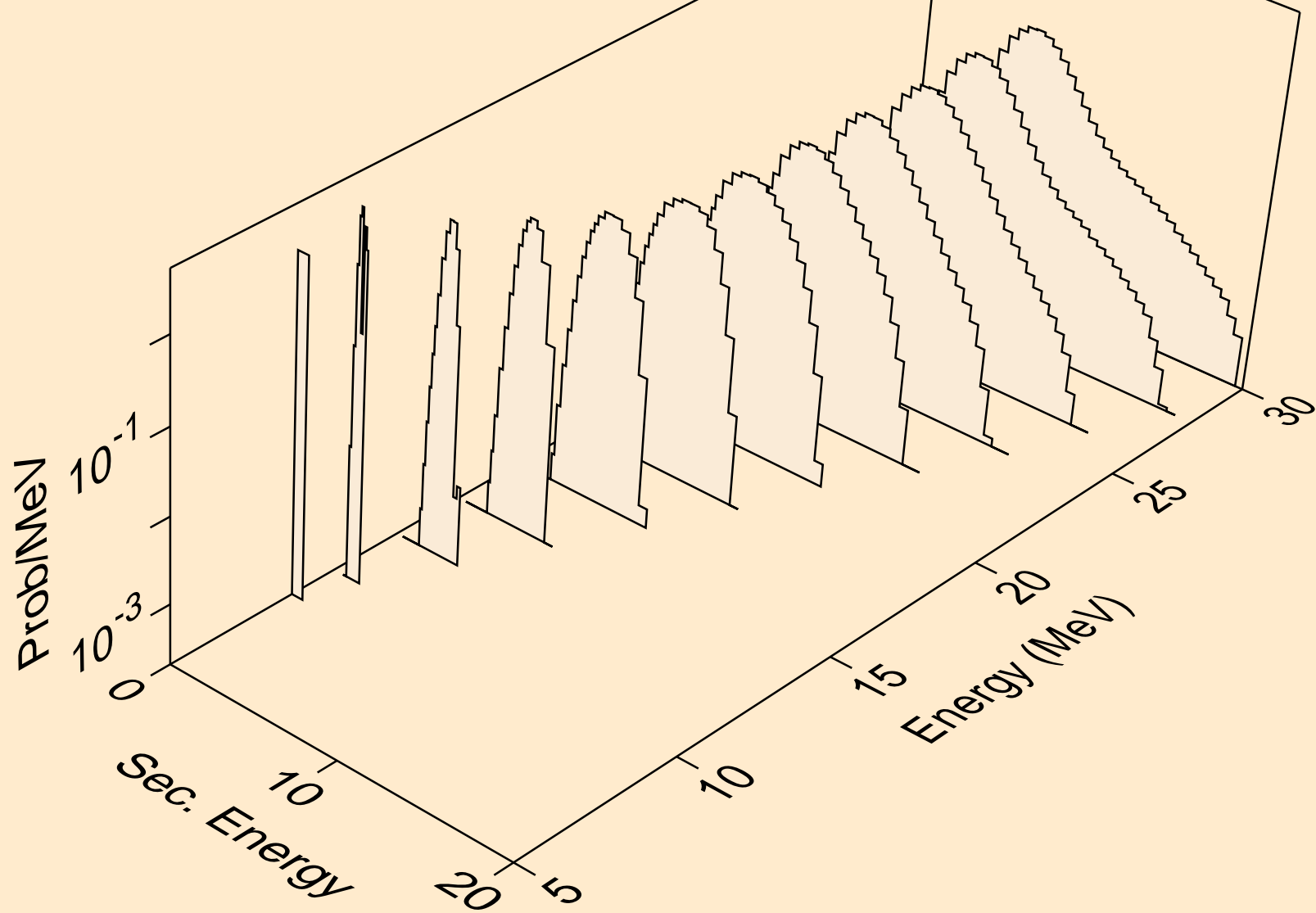

CE125 TRITON ACER TENDL-2021 LIBRARY; T=0.K  
protons from (t,3np)

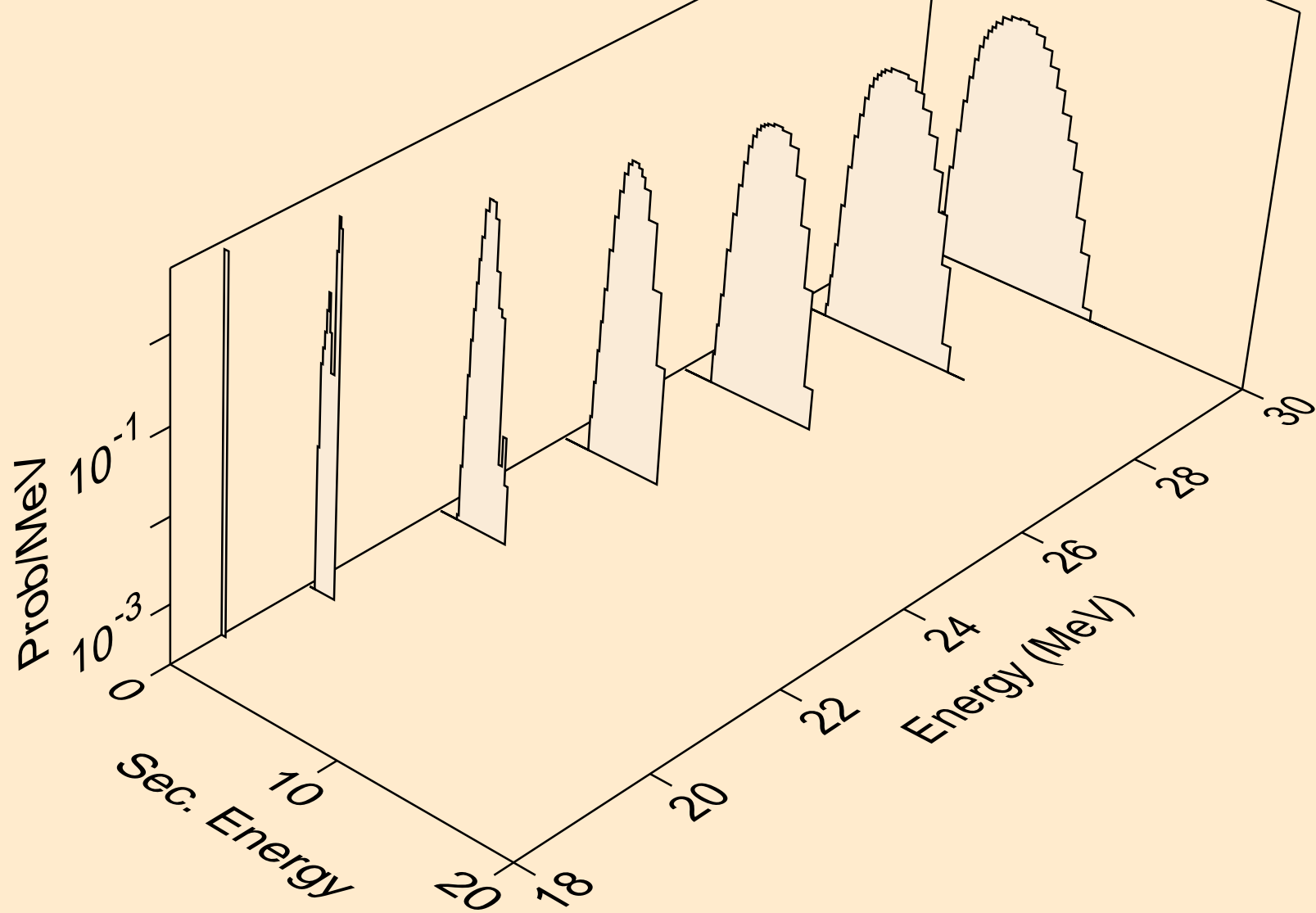

CE125 TRITON ACER TENDL-2021 LIBRARY; T=0.K  
protons from (t,2np)

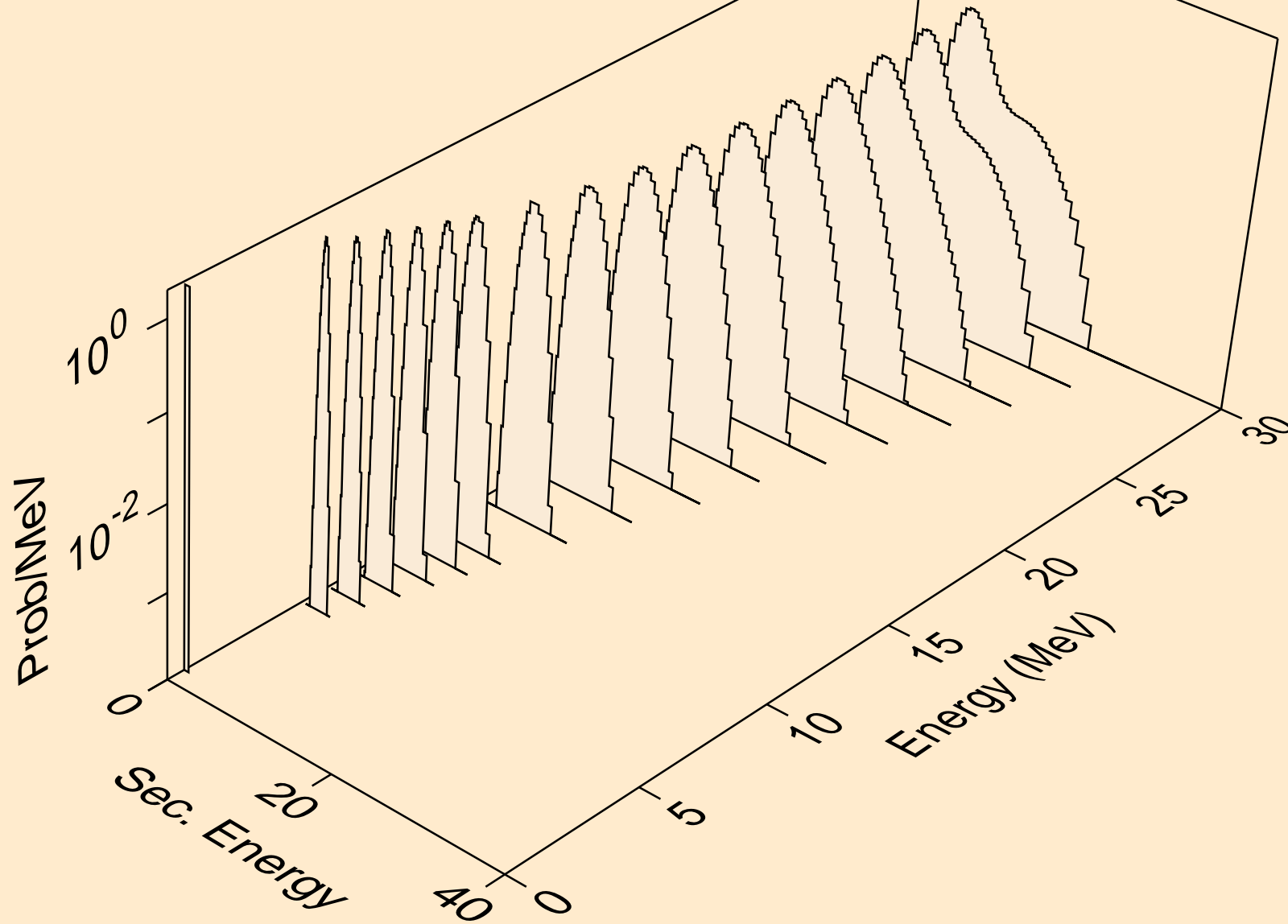

CE125 TRITON ACER TENDL-2021 LIBRARY; T=0.K  
protons from (t,npa)

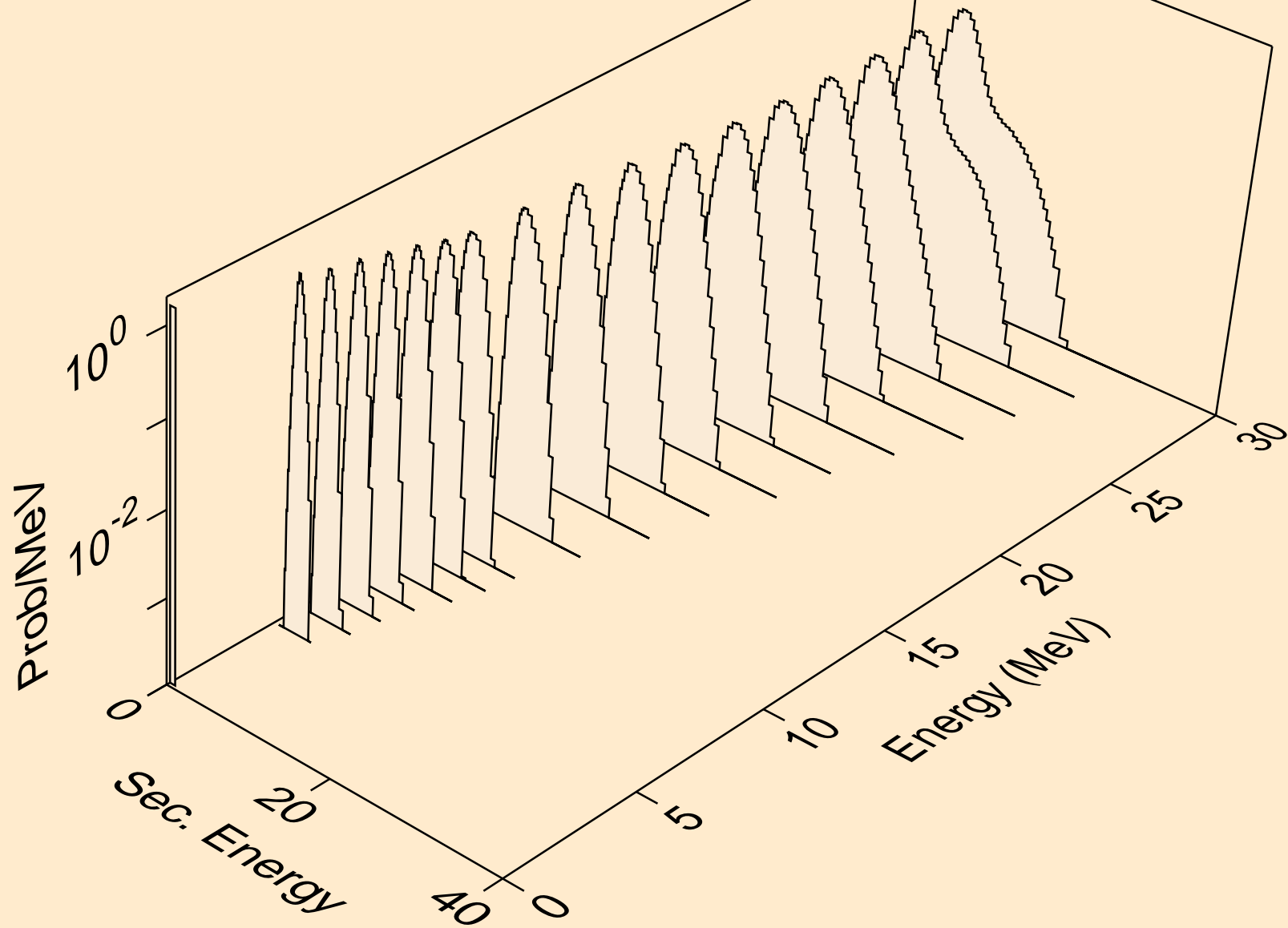

CE125 TRITON ACER TENDL-2021 LIBRARY; T=0.K  
protons from (t,p)

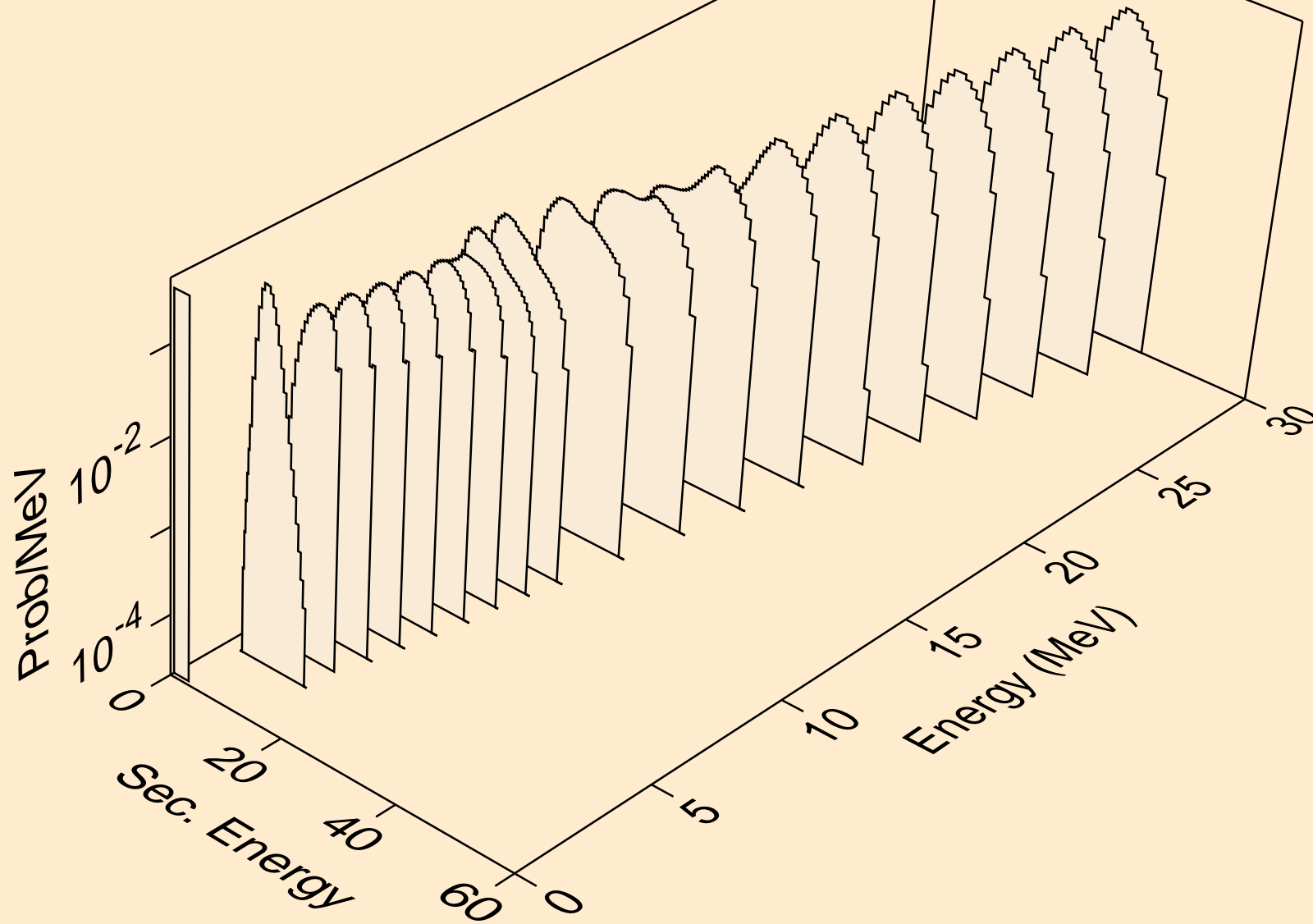

CE125 TRITON ACER TENDL-2021 LIBRARY; T=0.K  
protons from (t,2p)

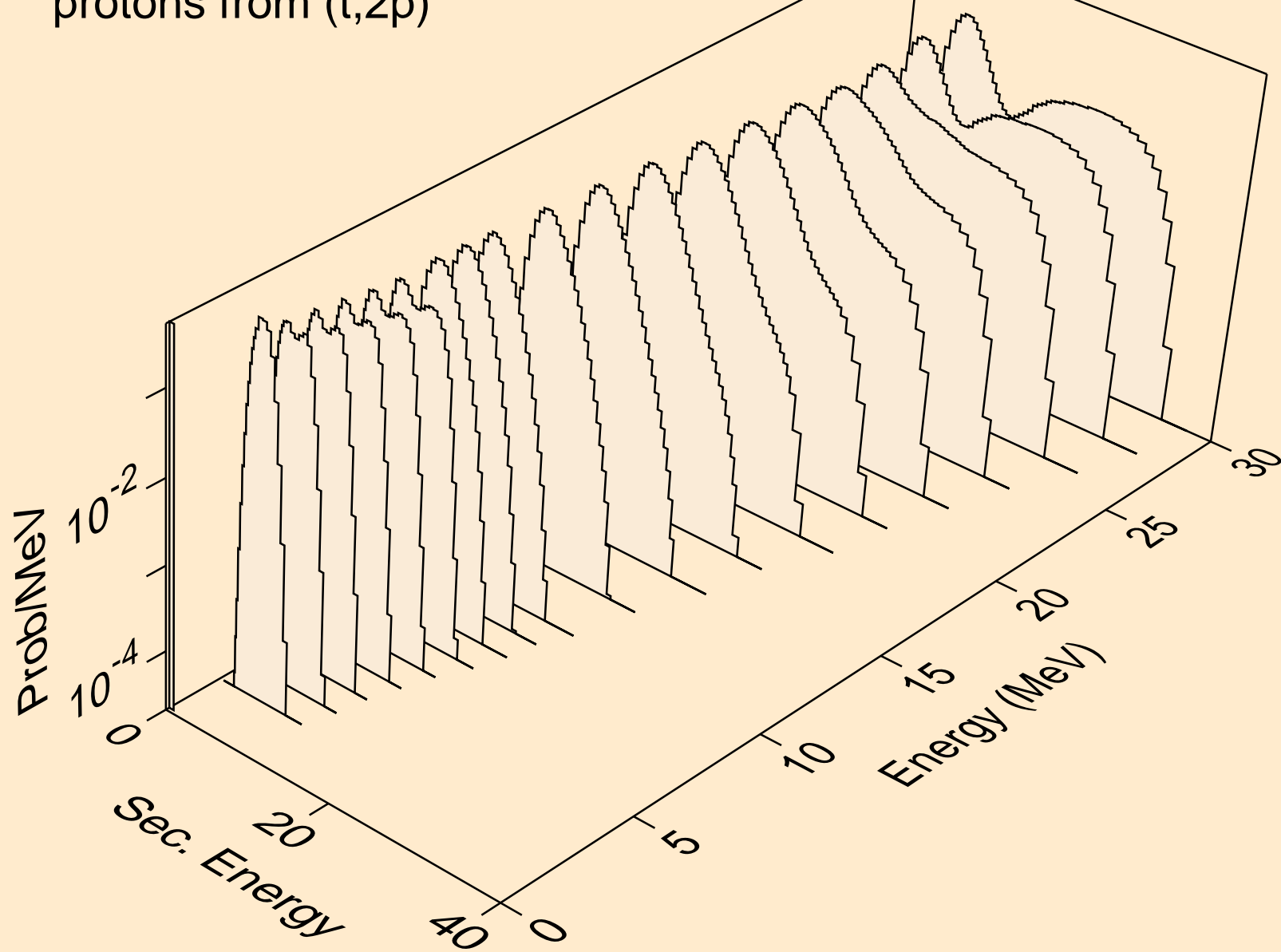

CE125 TRITON ACER TENDL-2021 LIBRARY; T=0.K  
protons from (t,pa)

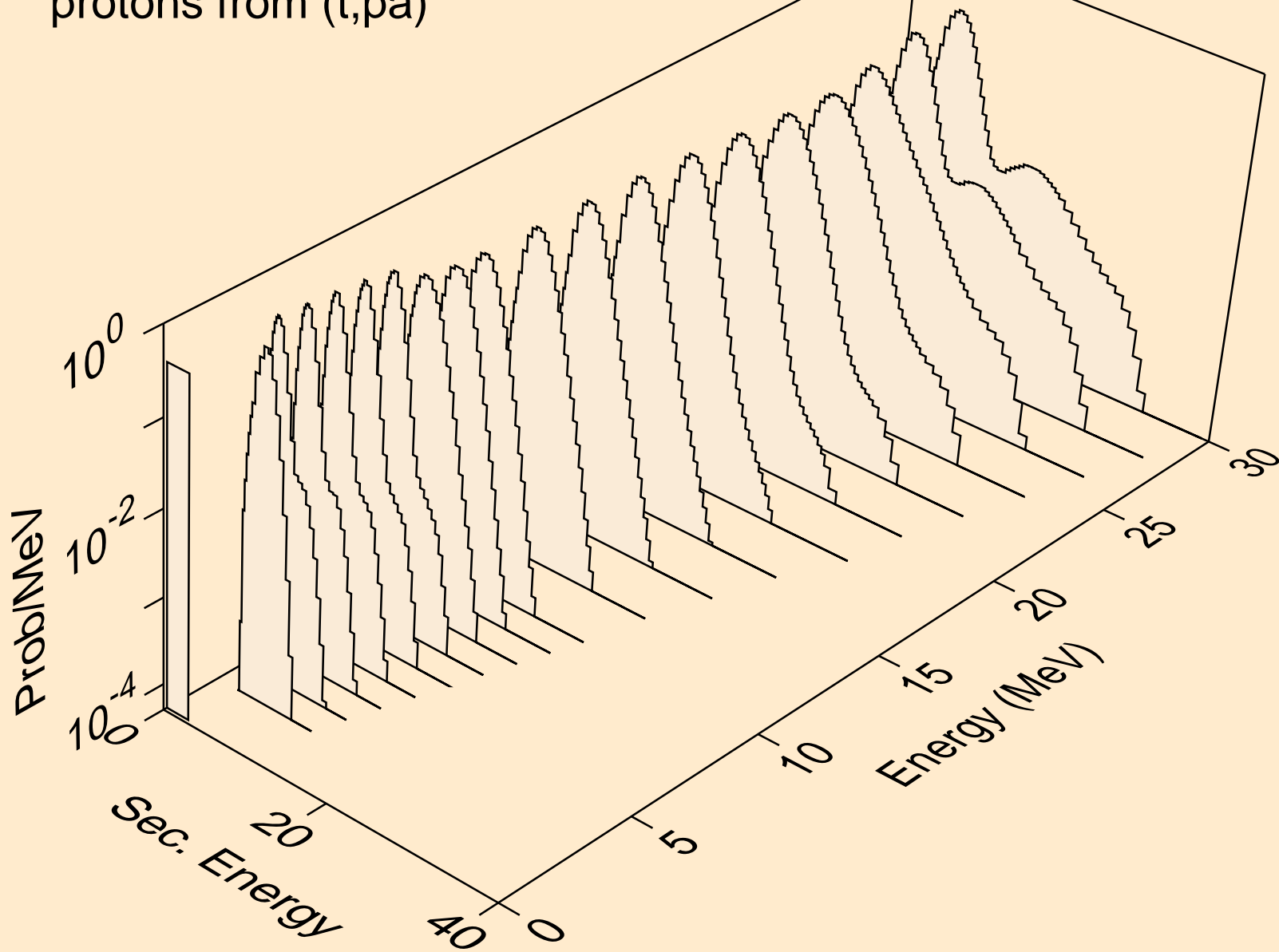



CE125 TRITON ACER TENDL-2021 LIBRARY; T=0.K  
protons from (t,pd)

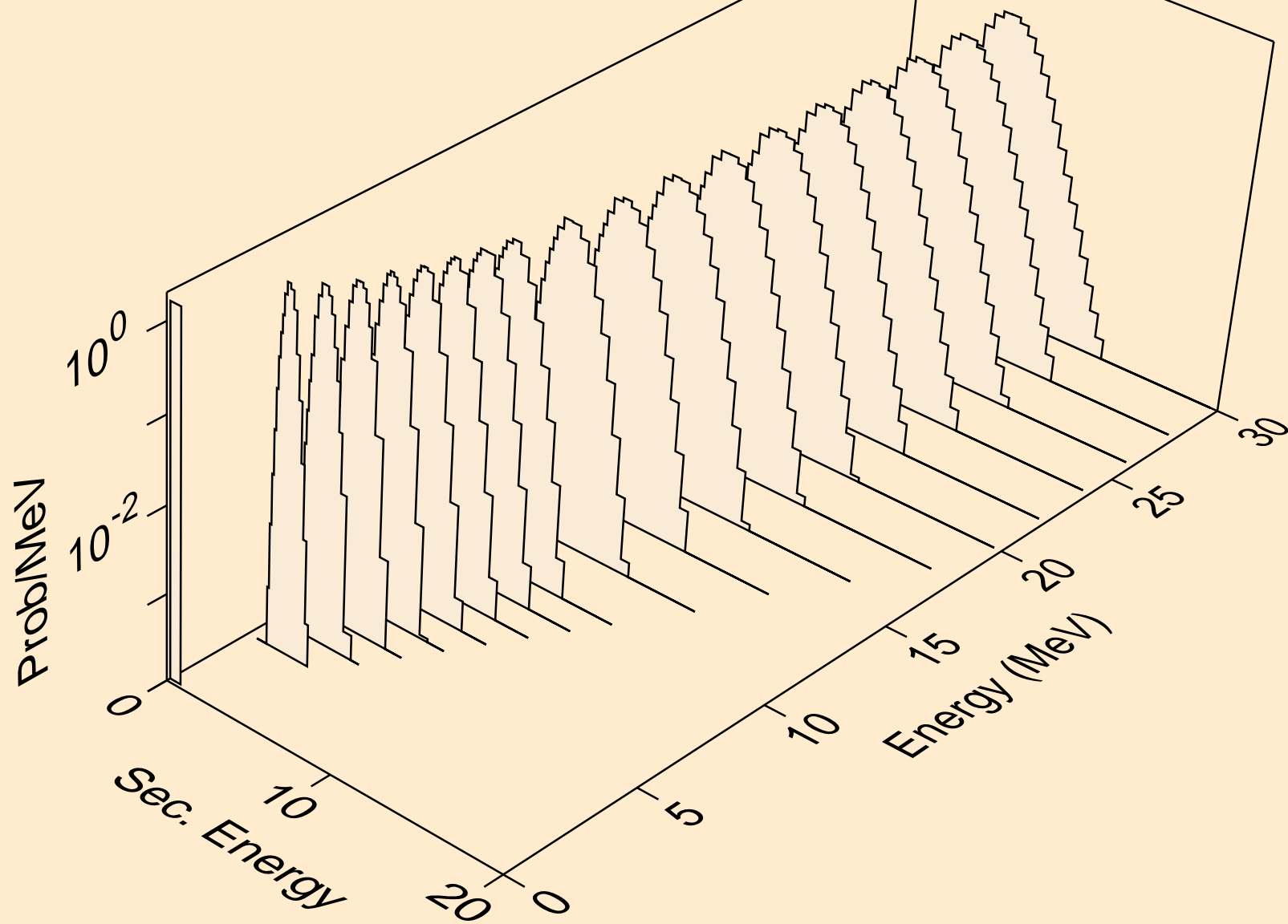

CE125 TRITON ACER TENDL-2021 LIBRARY; T=0.K  
protons from (t,pt)

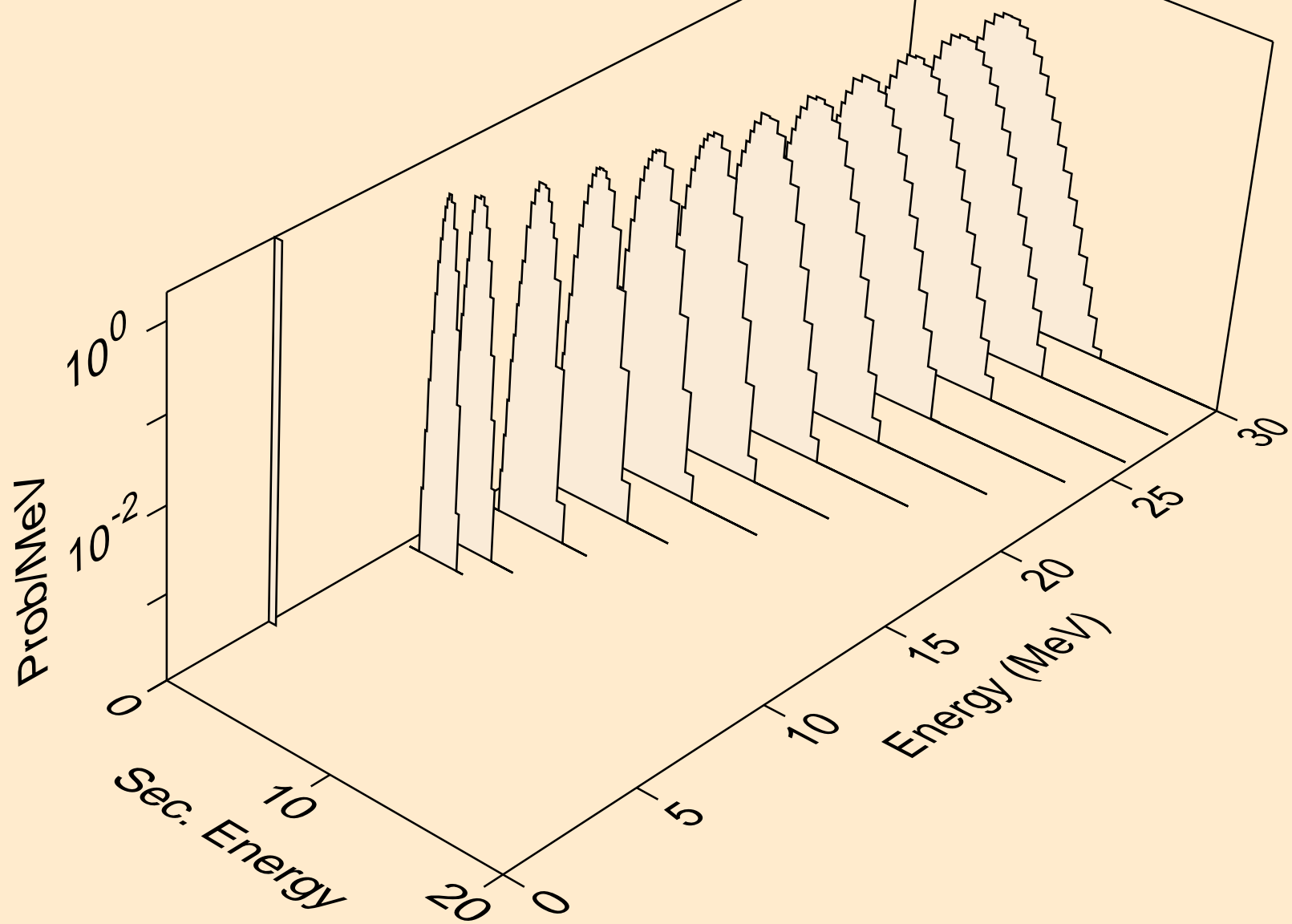

CE125 TRITON ACER TENDL-2021 LIBRARY; T=0.K  
deuterons from (t,x)

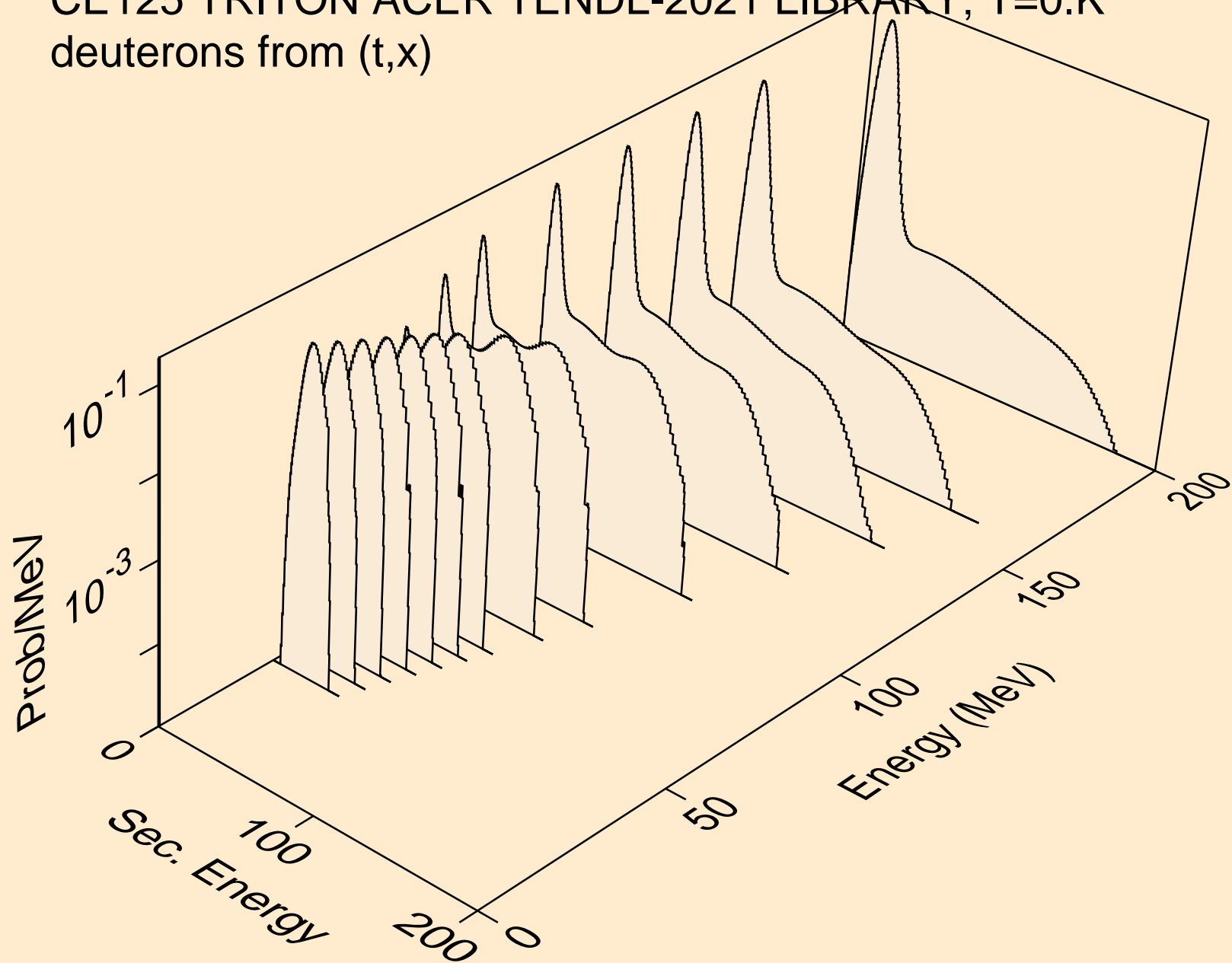

CE125 TRITON ACER TENDL-2021 LIBRARY; T=0.K  
deuterons from (t,2nd)

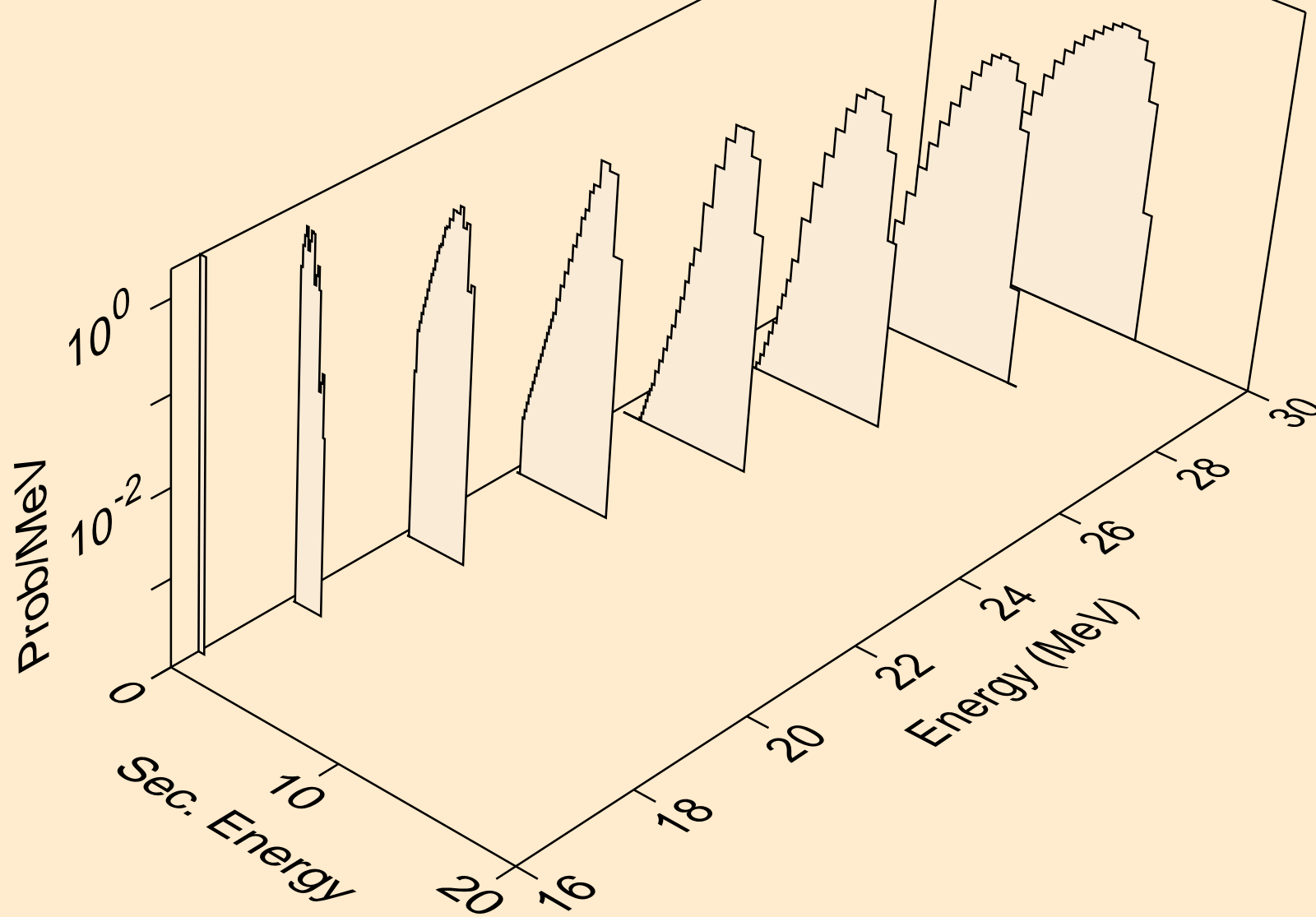

CE125 TRITON ACER TENDL-2021 LIBRARY; T=0.K  
deuterons from (t,n\*)d

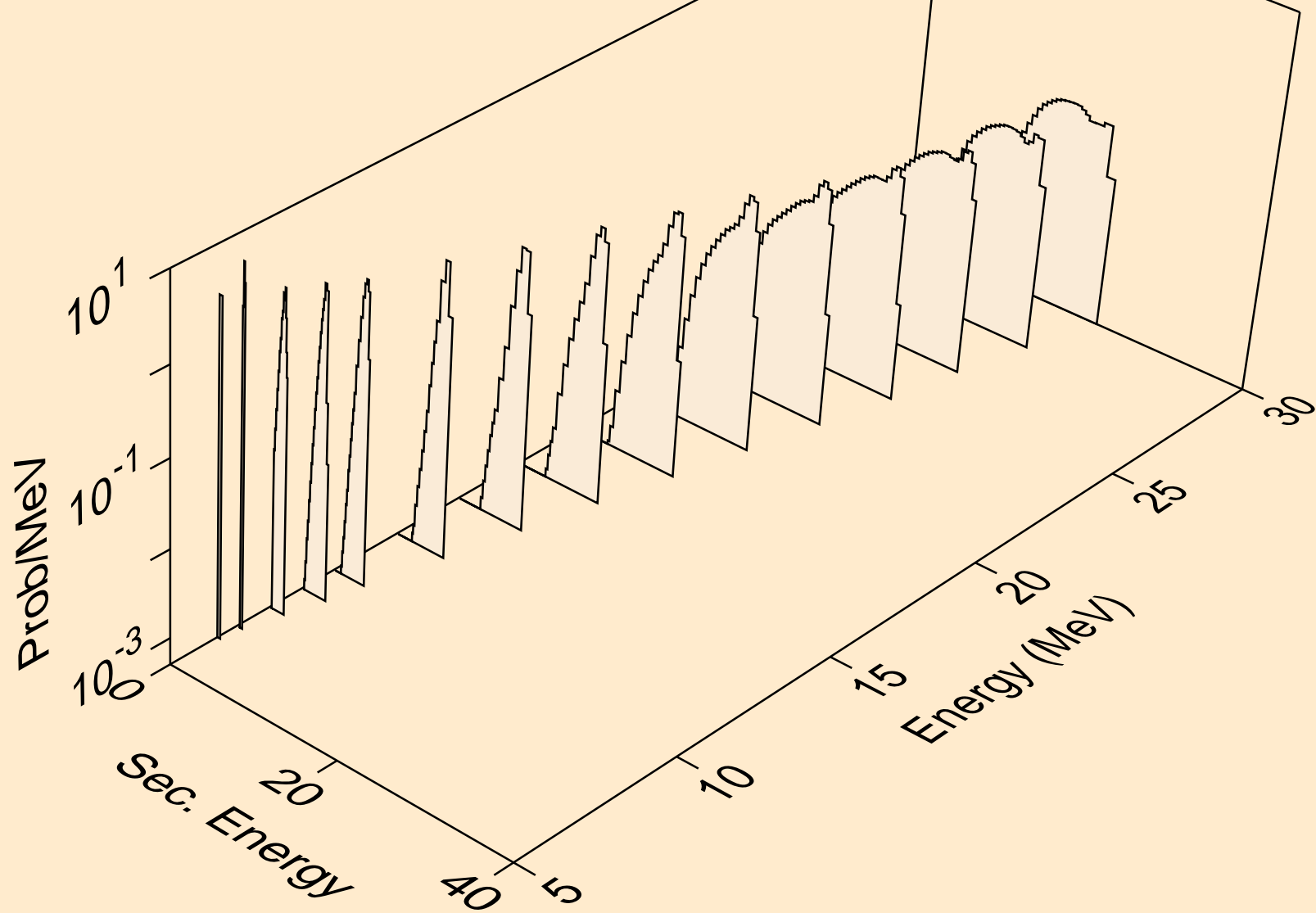

CE125 TRITON ACER TENDL-2021 LIBRARY; T=0.K  
deuterons from (t,d)

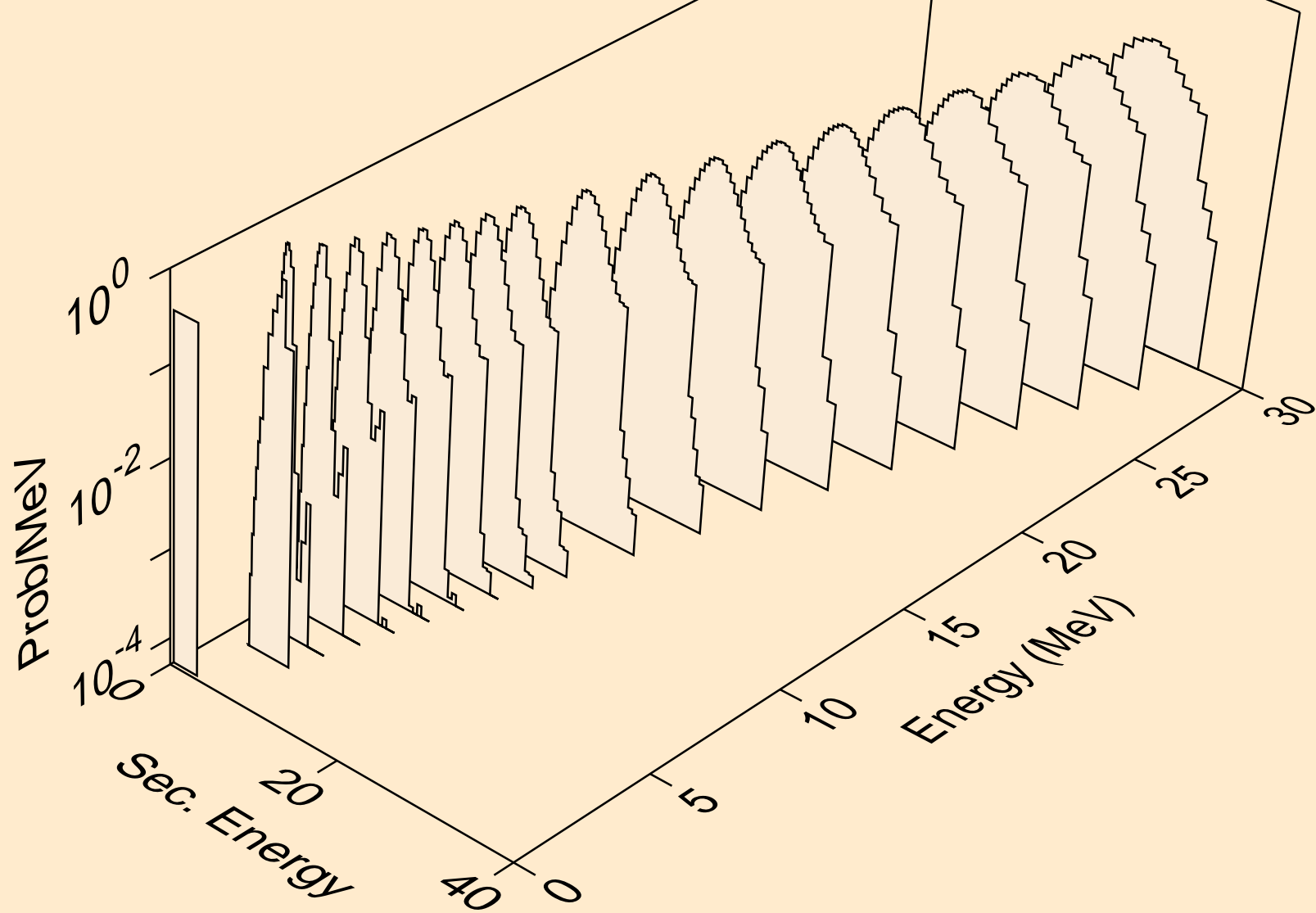

CE125 TRITON ACER TENDL-2021 LIBRARY; T=0.K  
deuterons from (t,d2a)

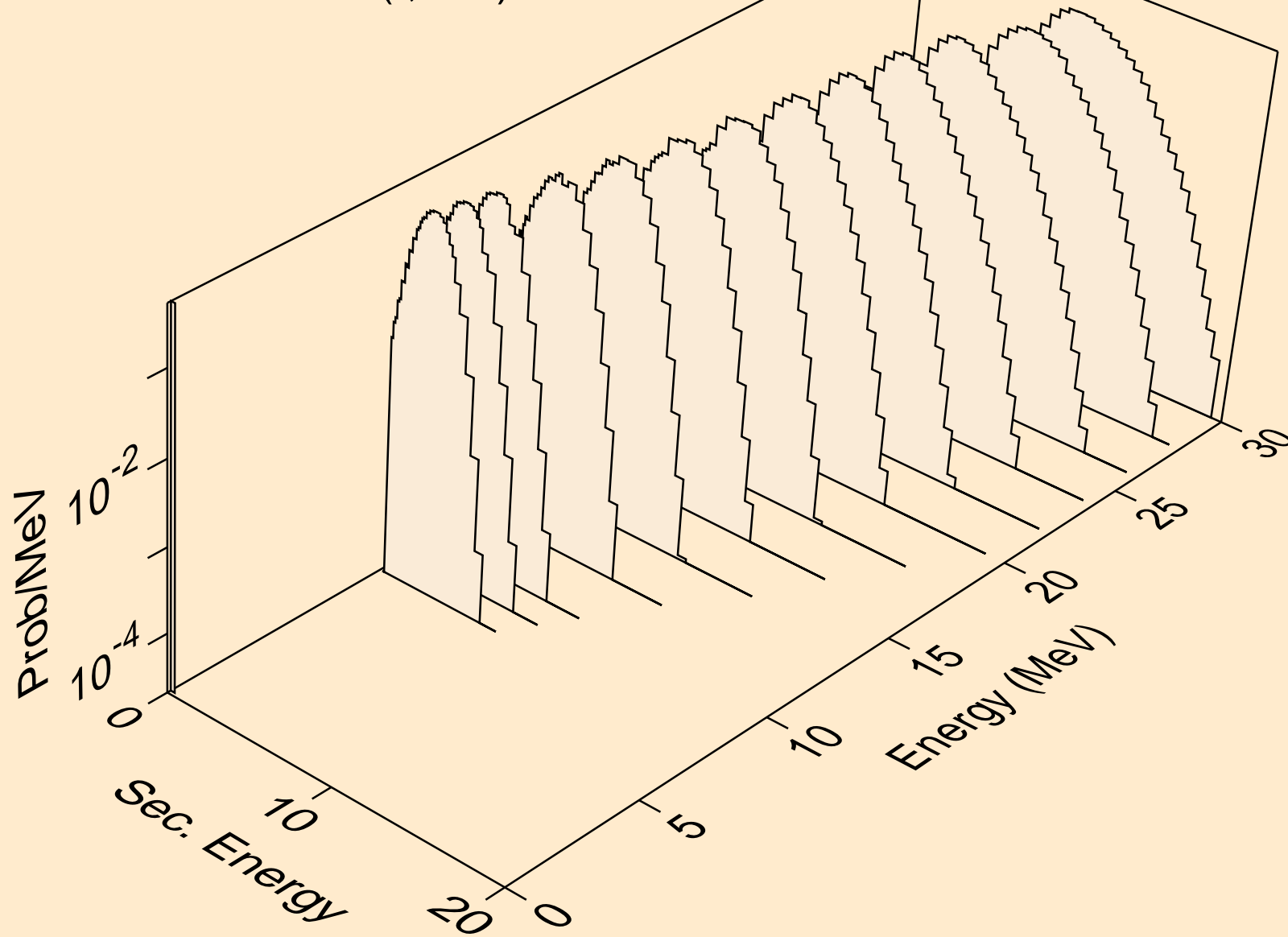

CE125 TRITON ACER TENDL-2021 LIBRARY; T=0.K  
deuterons from (t,pd)

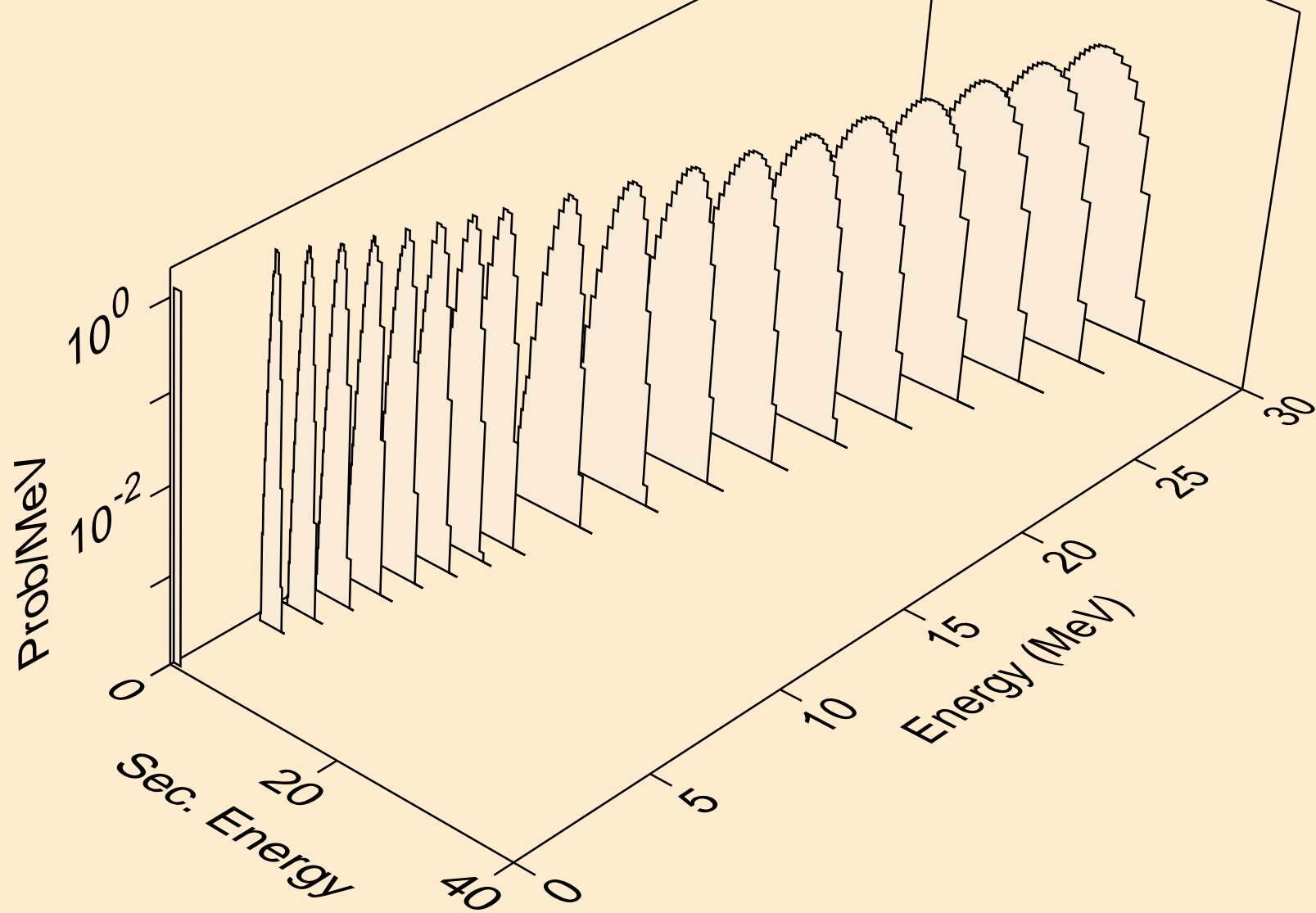



CE125 TRITON ACER TENDL-2021 LIBRARY; T=0.K  
deuterons from (t,da)

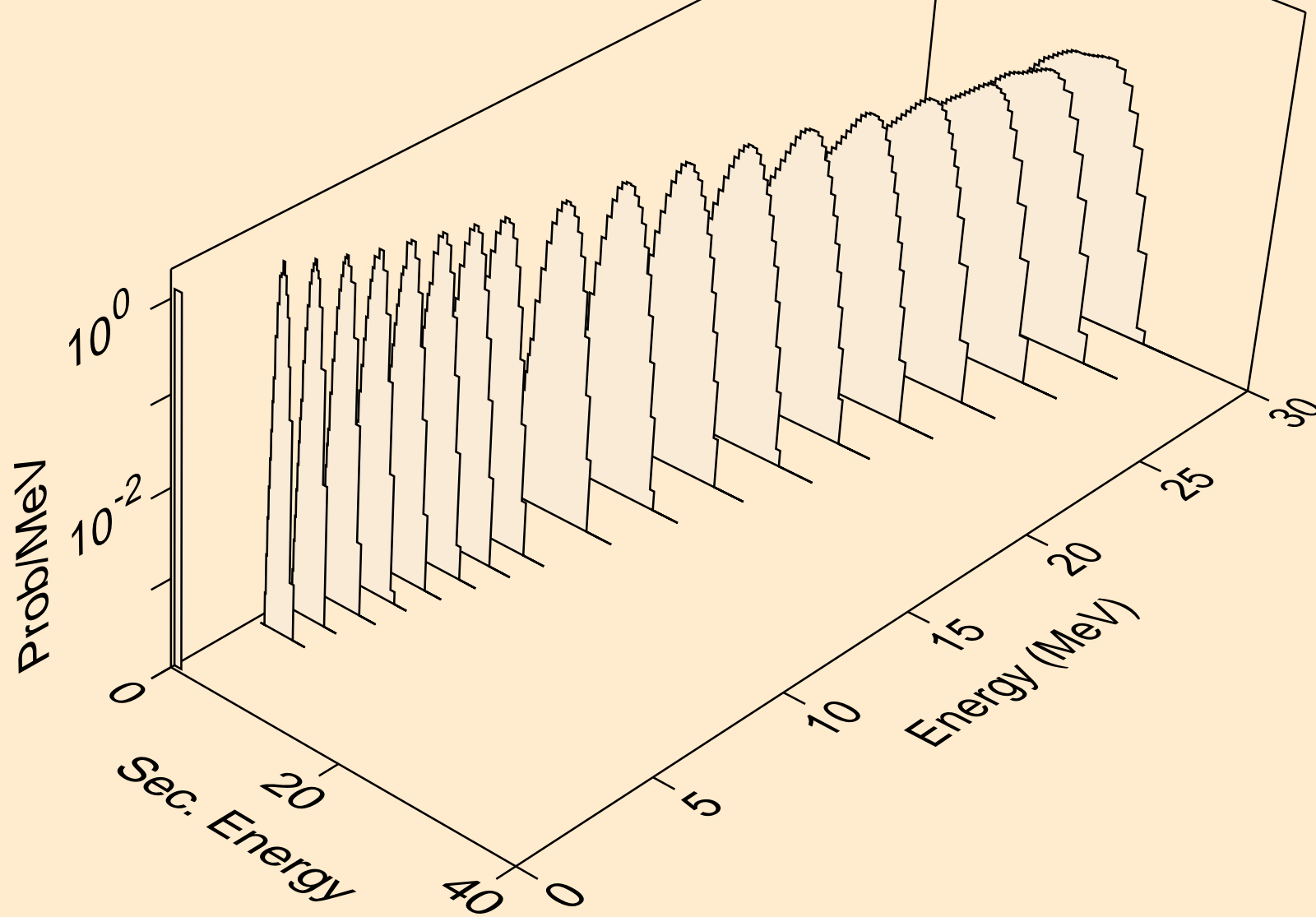

CE125 TRITON ACER TENDL-2021 LIBRARY; T=0.K  
he3s from (t,x)

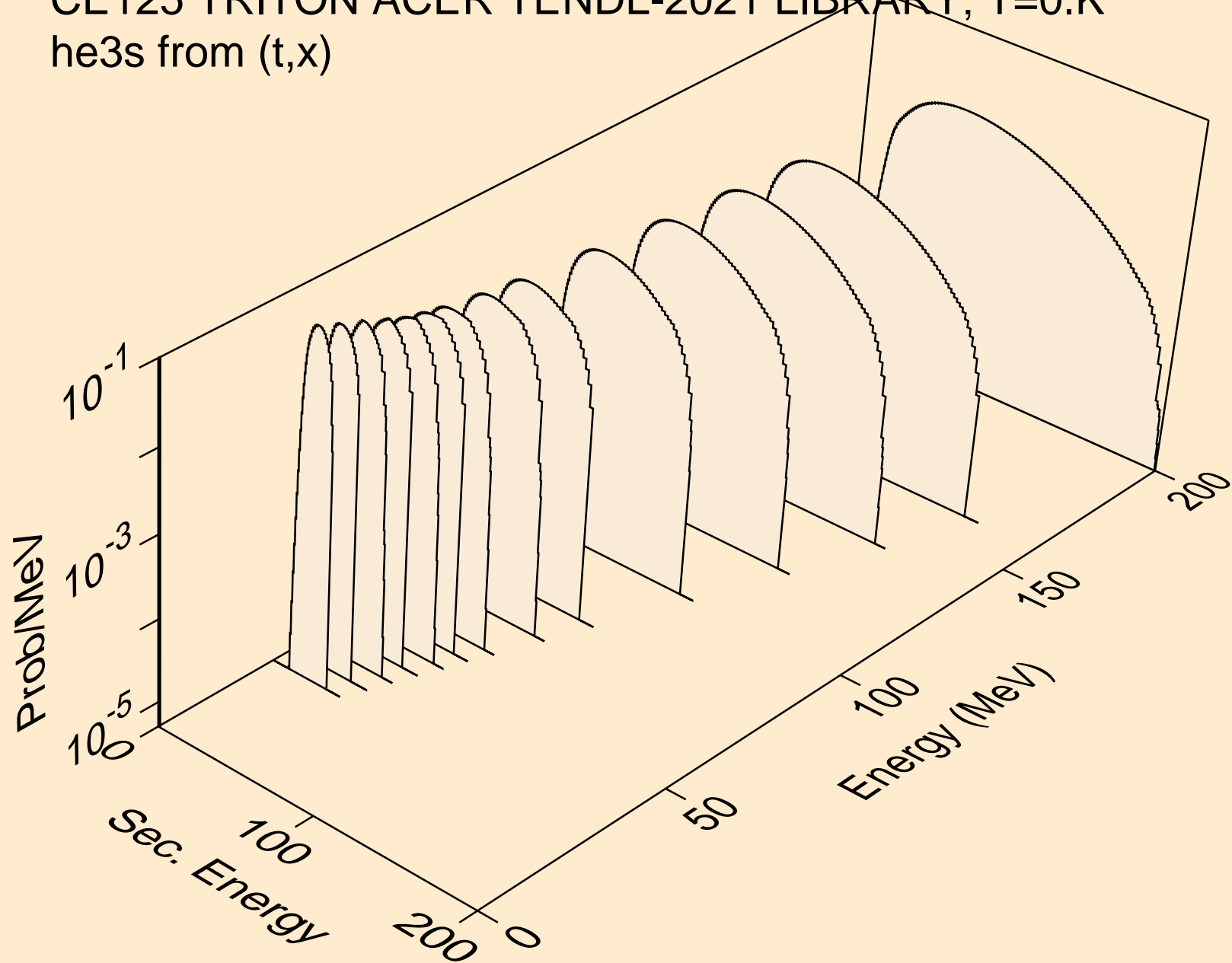

CE125 TRITON ACER TENDL-2021 LIBRARY; T=0.K  
he3s from (t,n\*)he3

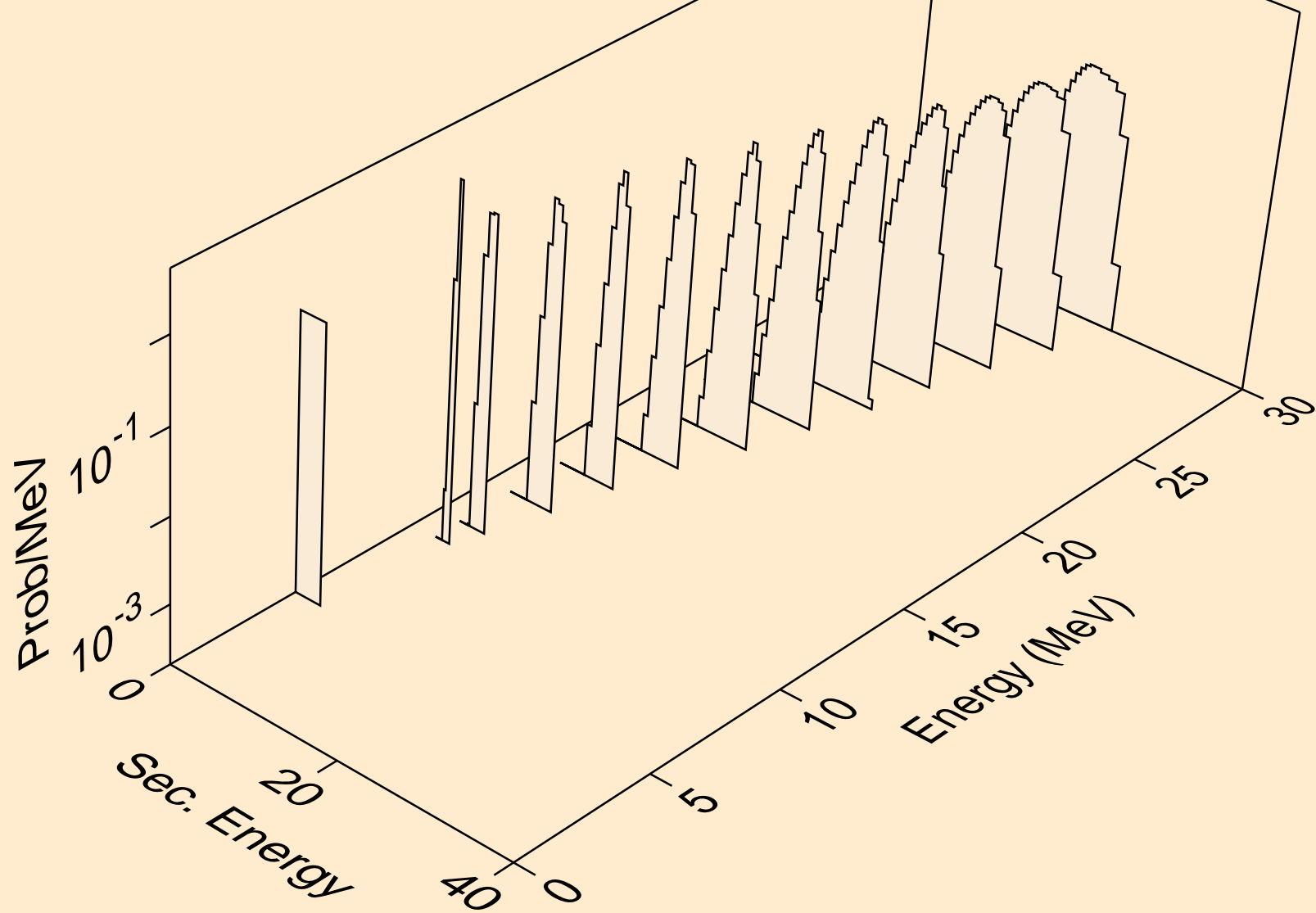

CE125 TRITON ACER TENDL-2021 LIBRARY; T=0.K  
he3s from (t,he3)

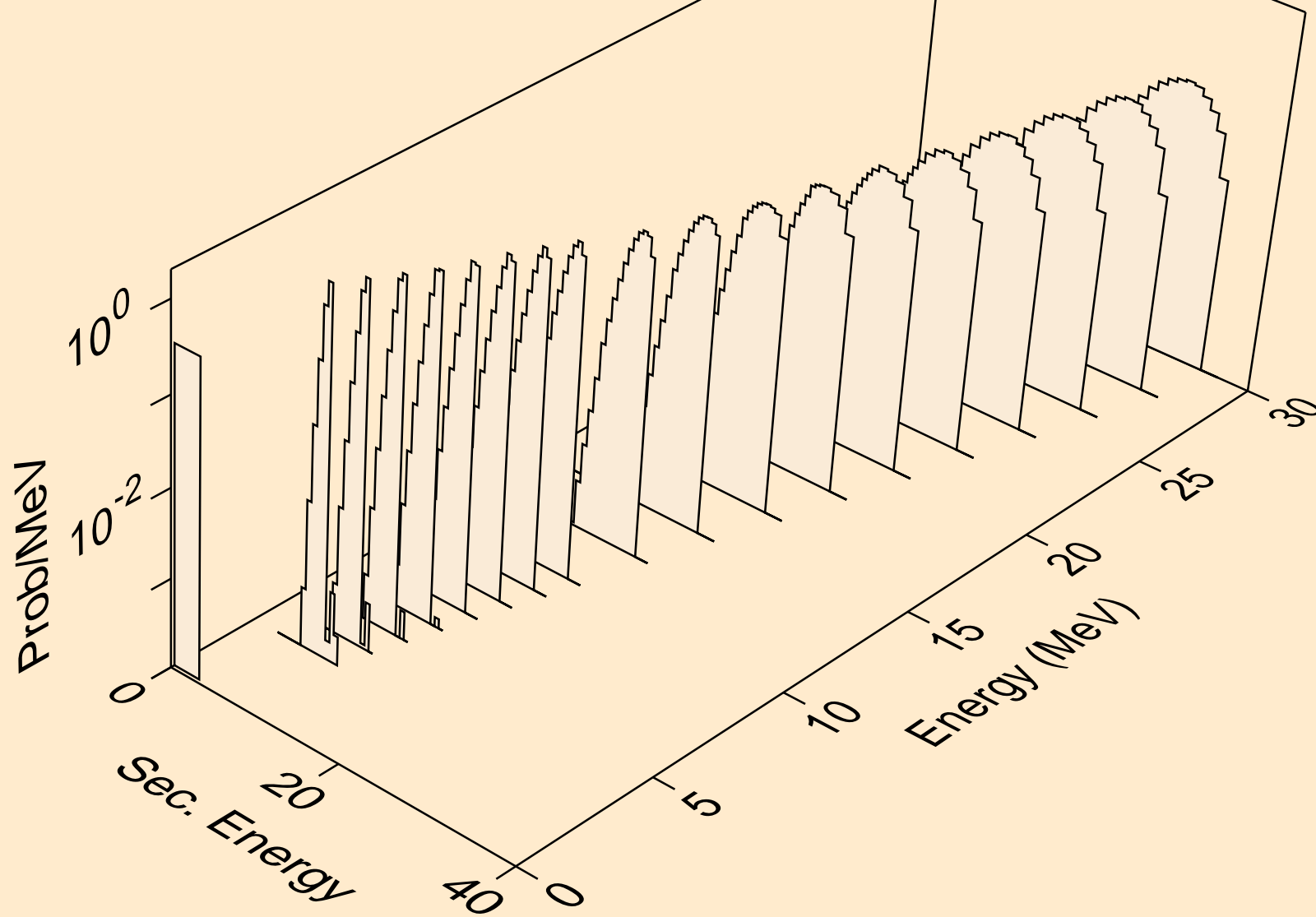

CE125 TRITON ACER TENDL-2021 LIBRARY; T=0.K  
alphas from (t,x)

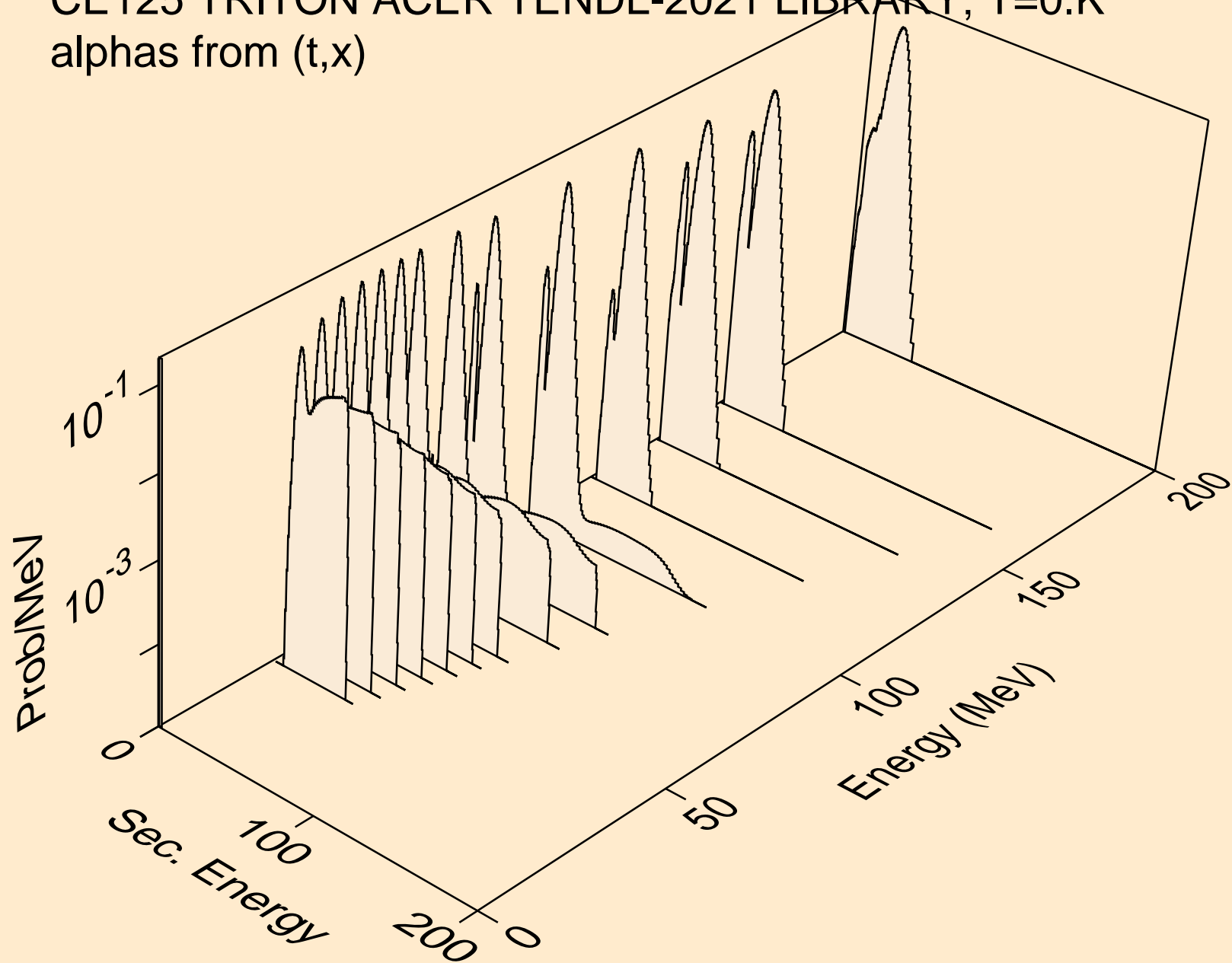

CE125 TRITON ACER TENDL-2021 LIBRARY; T=0.K  
alphas from (t,n\*)a

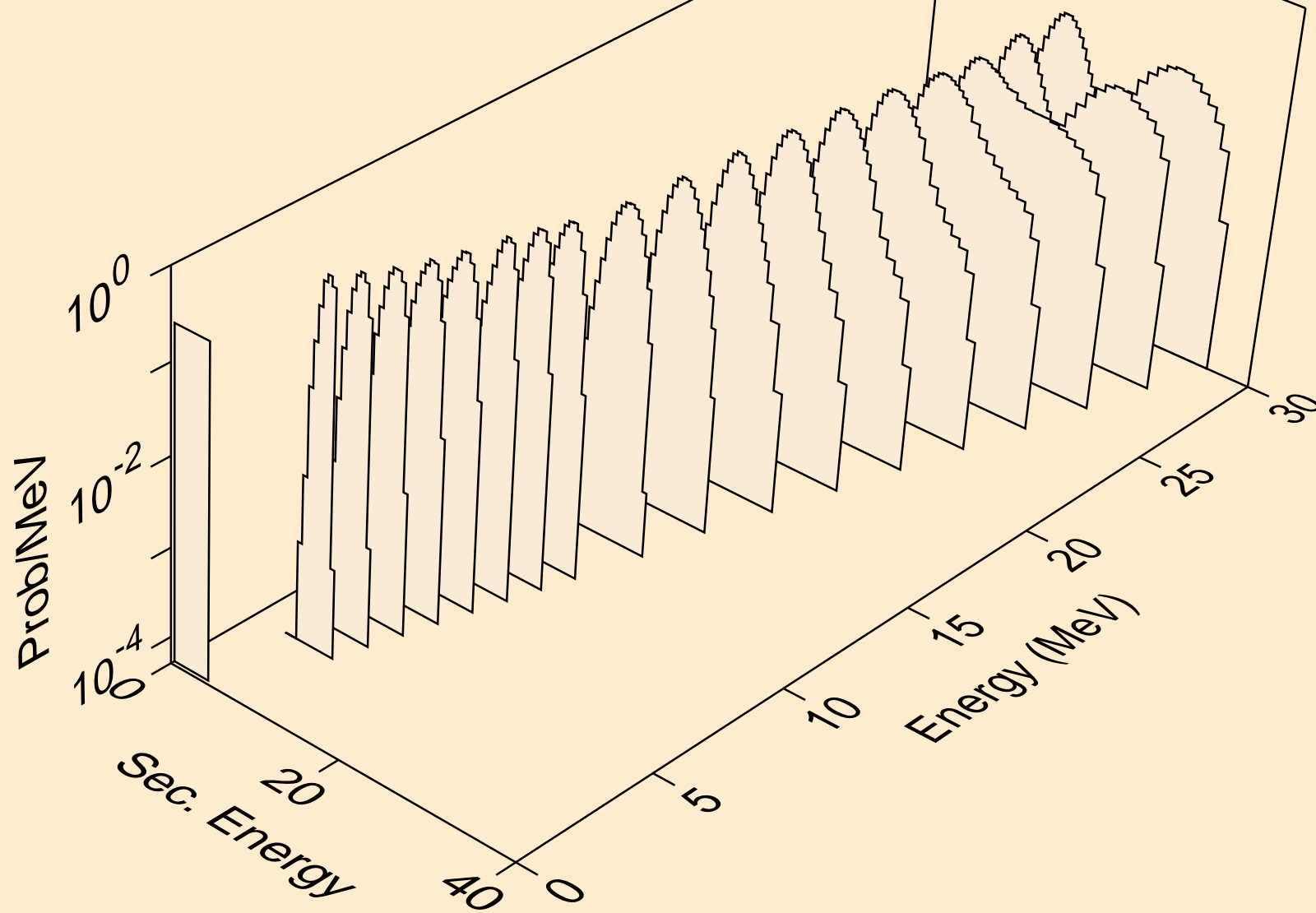

CE125 TRITON ACER TENDL-2021 LIBRARY; T=0.K  
alphas from (t,2n)a

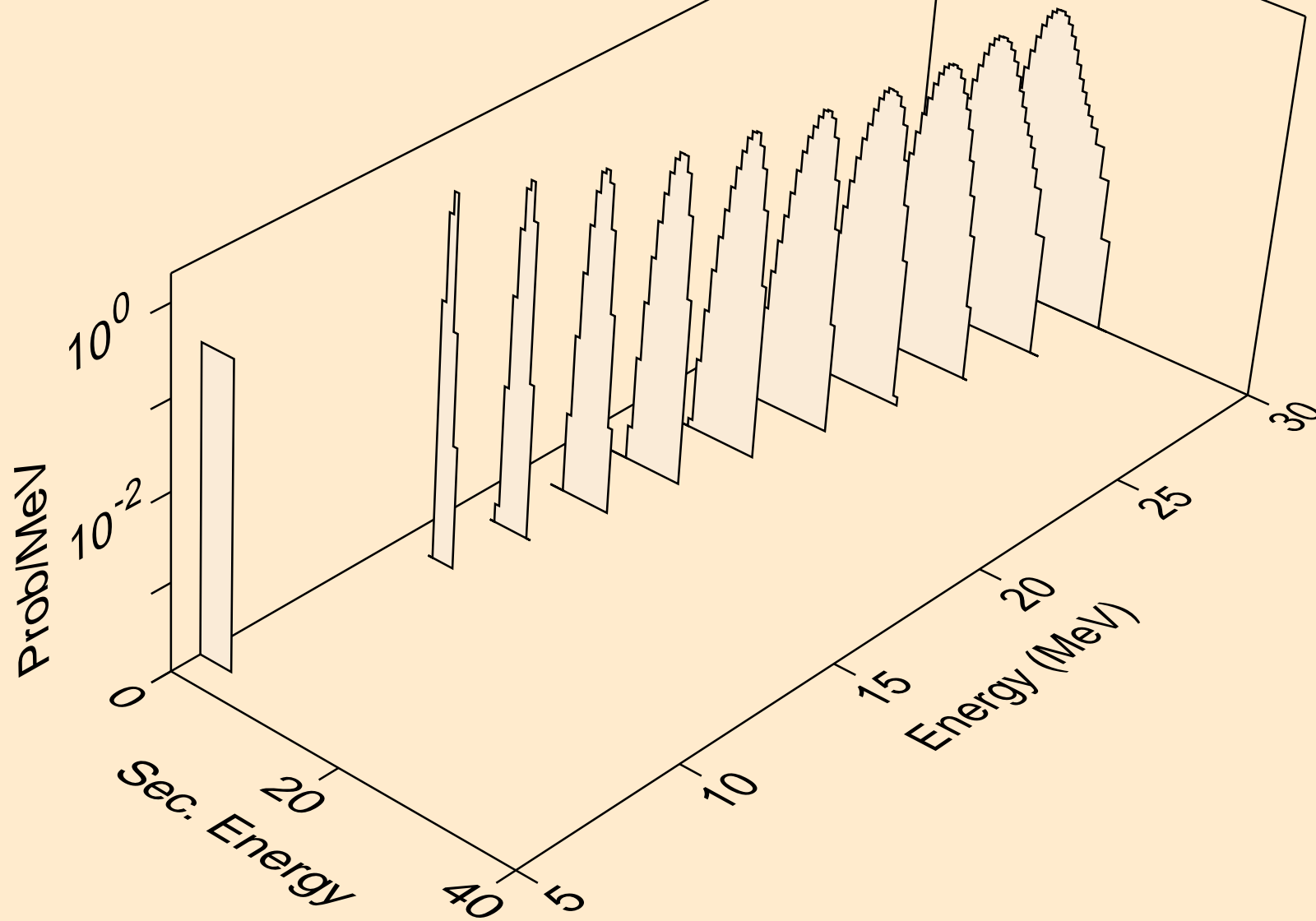

CE125 TRITON ACER TENDL-2021 LIBRARY; T=0.K  
alphas from (t,n\*)2a

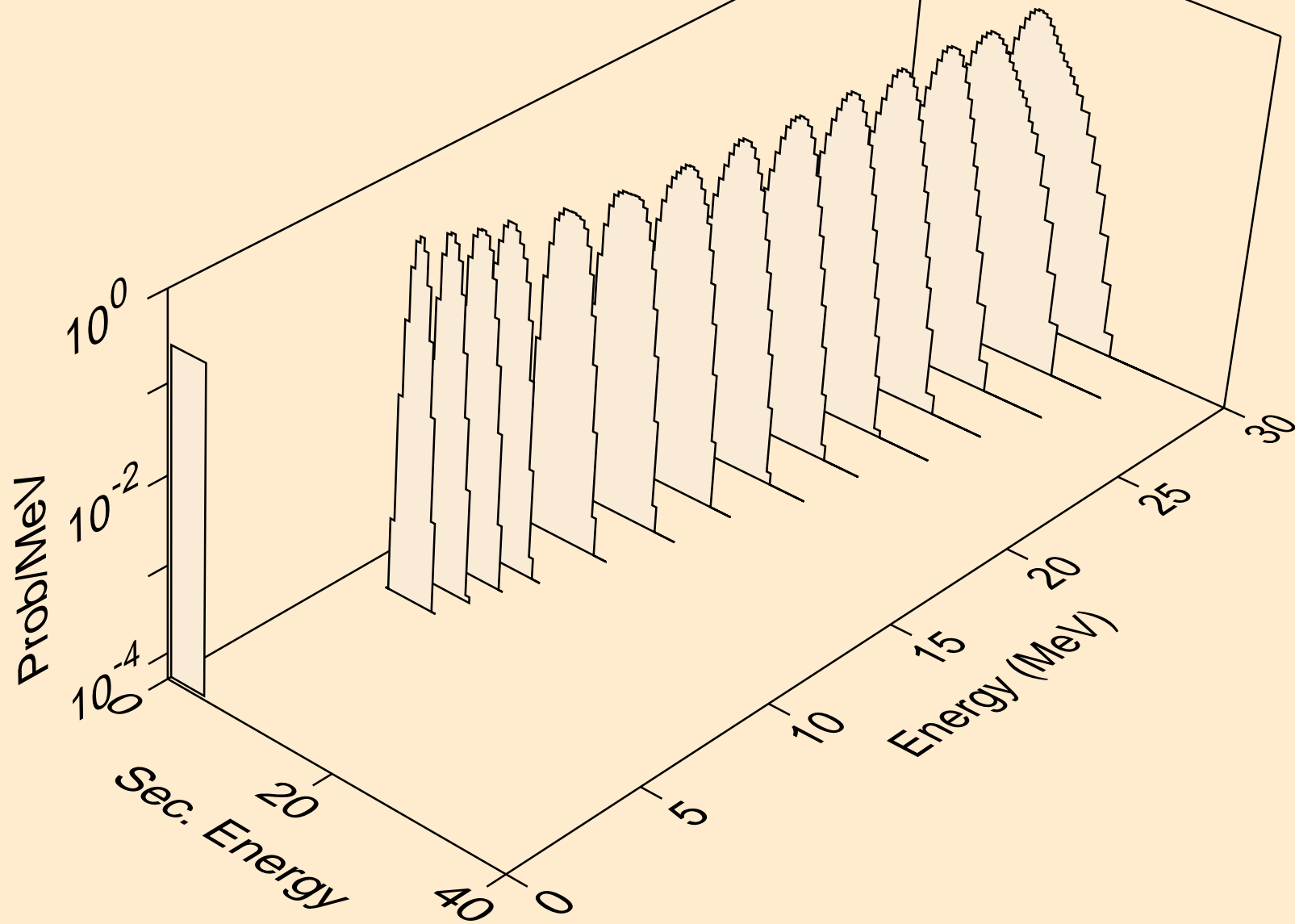



CE125 TRITON ACER TENDL-2021 LIBRARY; T=0.K  
alphas from (t,npa)

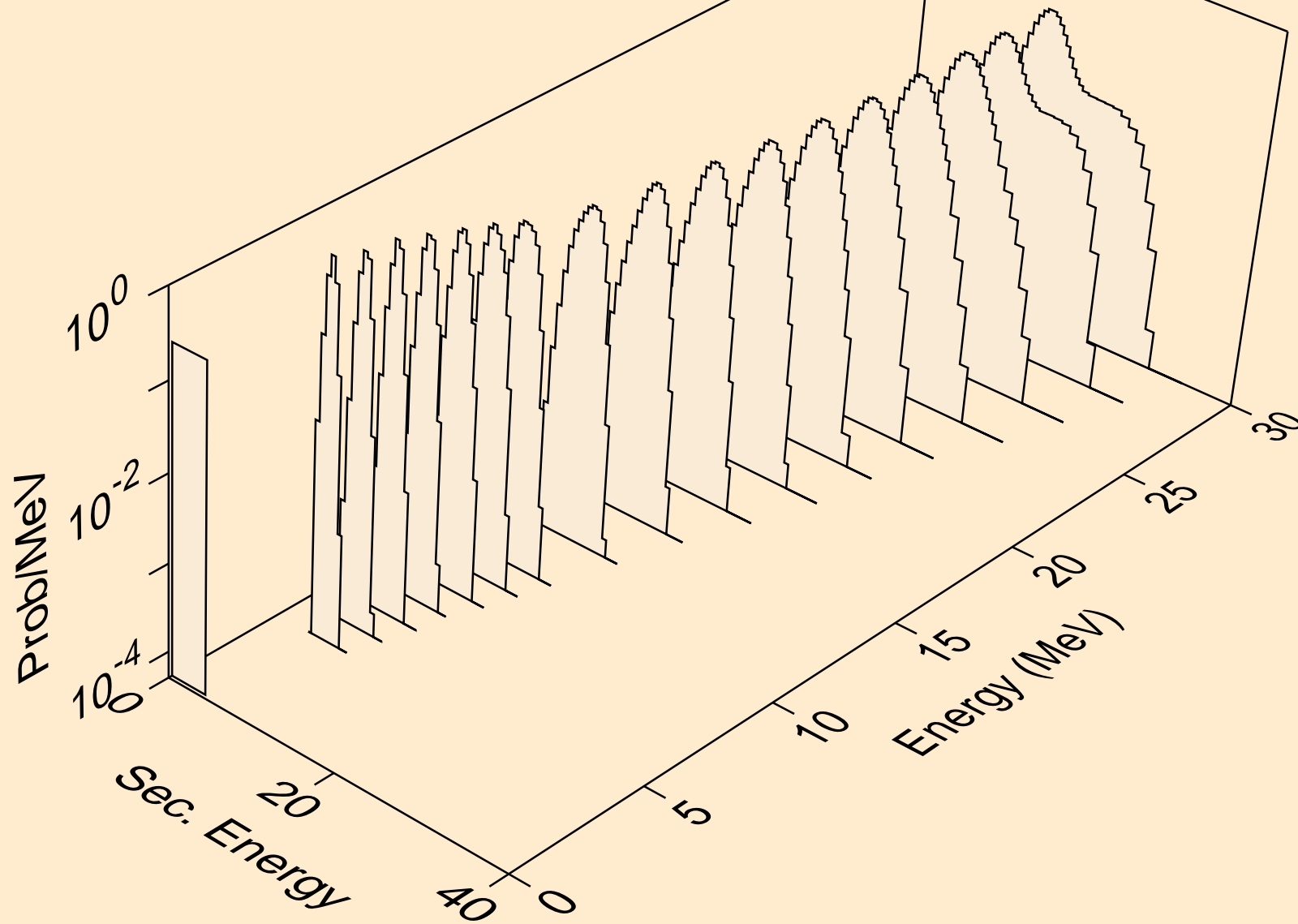

CE125 TRITON ACER TENDL-2021 LIBRARY; T=0.K  
alphas from (t,a)

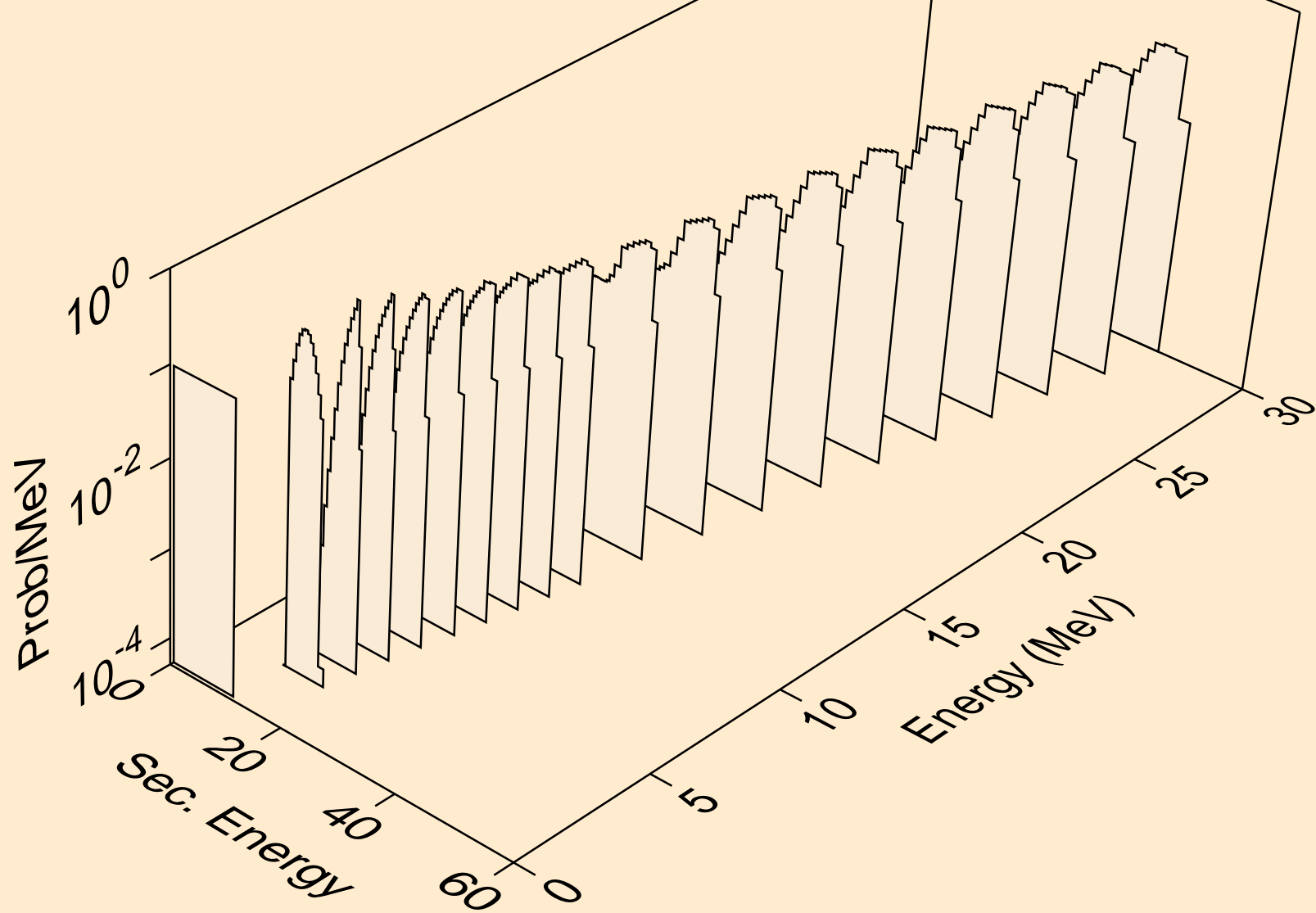

CE125 TRITON ACER TENDL-2021 LIBRARY; T=0.K  
alphas from (t,2a)

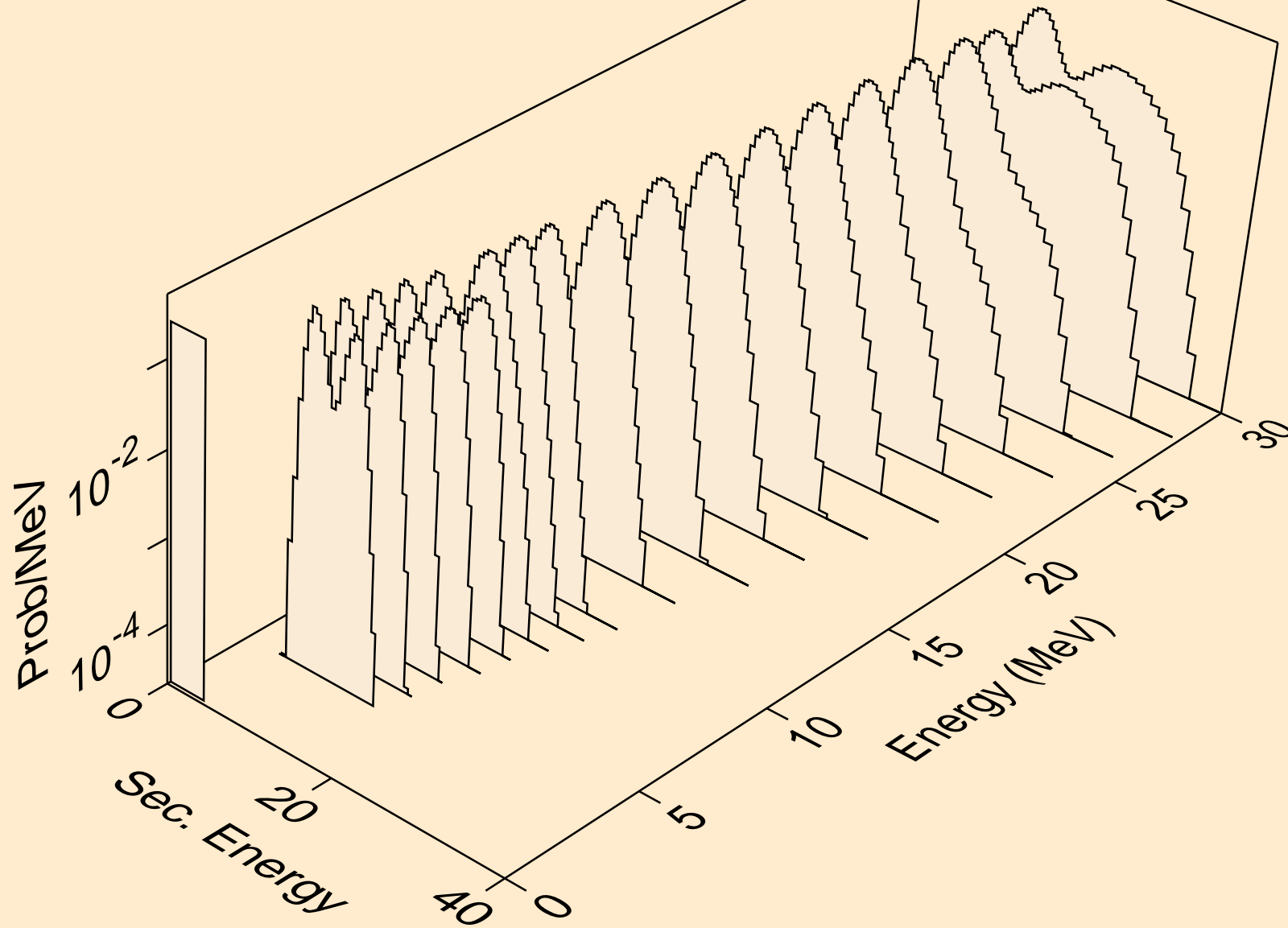

CE125 TRITON ACER TENDL-2021 LIBRARY; T=0.K  
alphas from (t,3a)

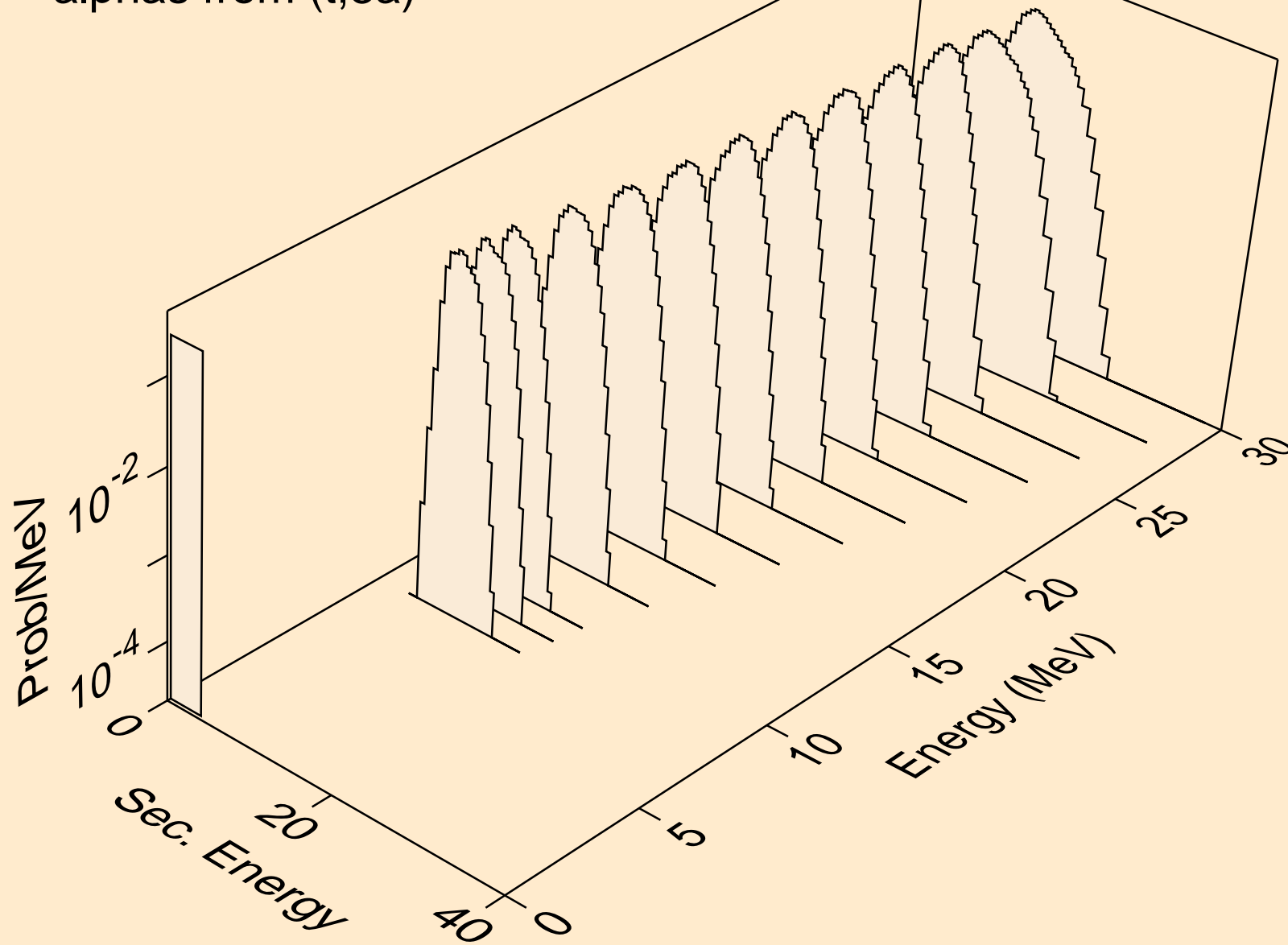

CE125 TRITON ACER TENDL-2021 LIBRARY; T=0.K  
alphas from (t,pa)

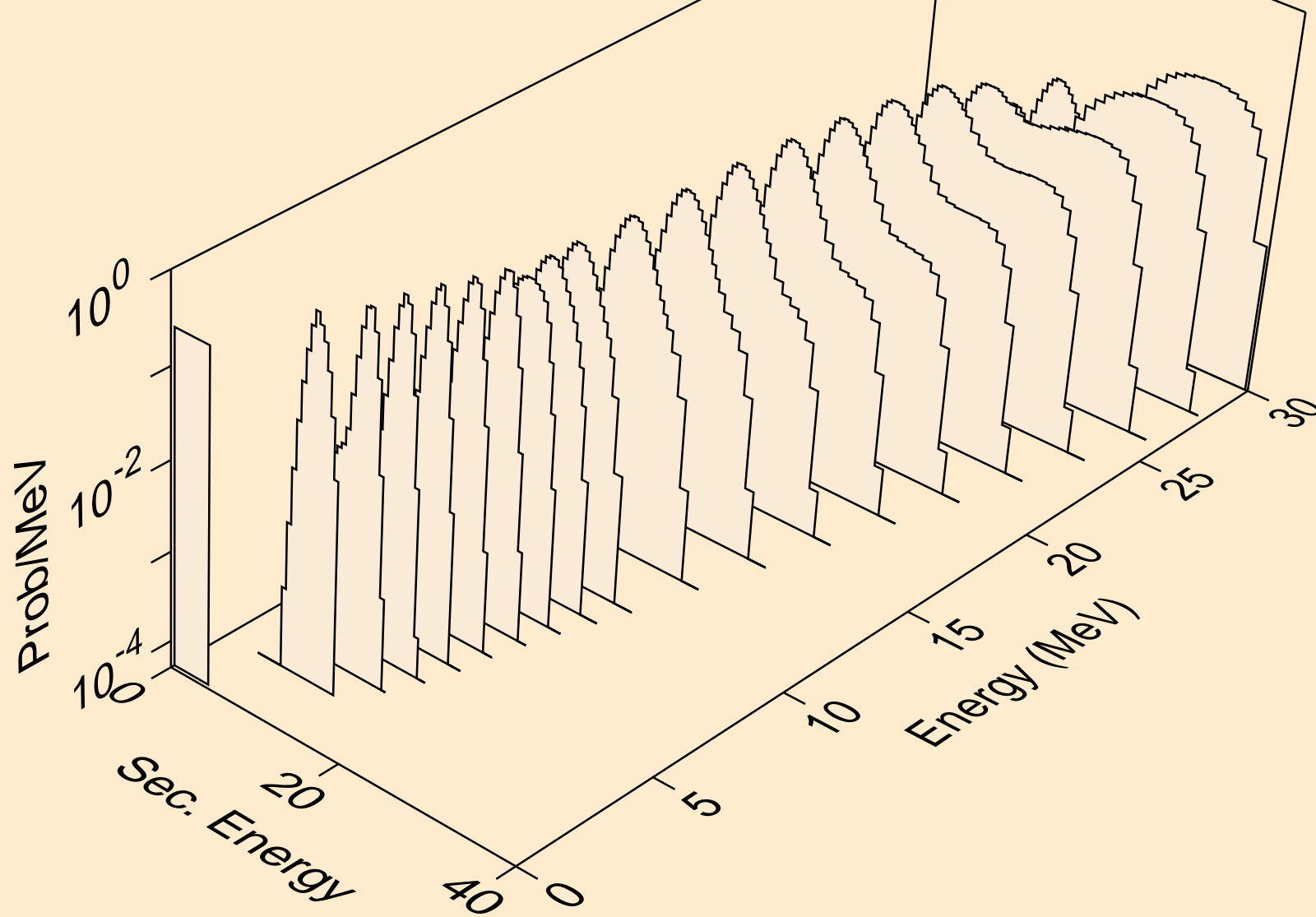

CE125 TRITON ACER TENDL-2021 LIBRARY; T=0.K  
alphas from (t,t2a)

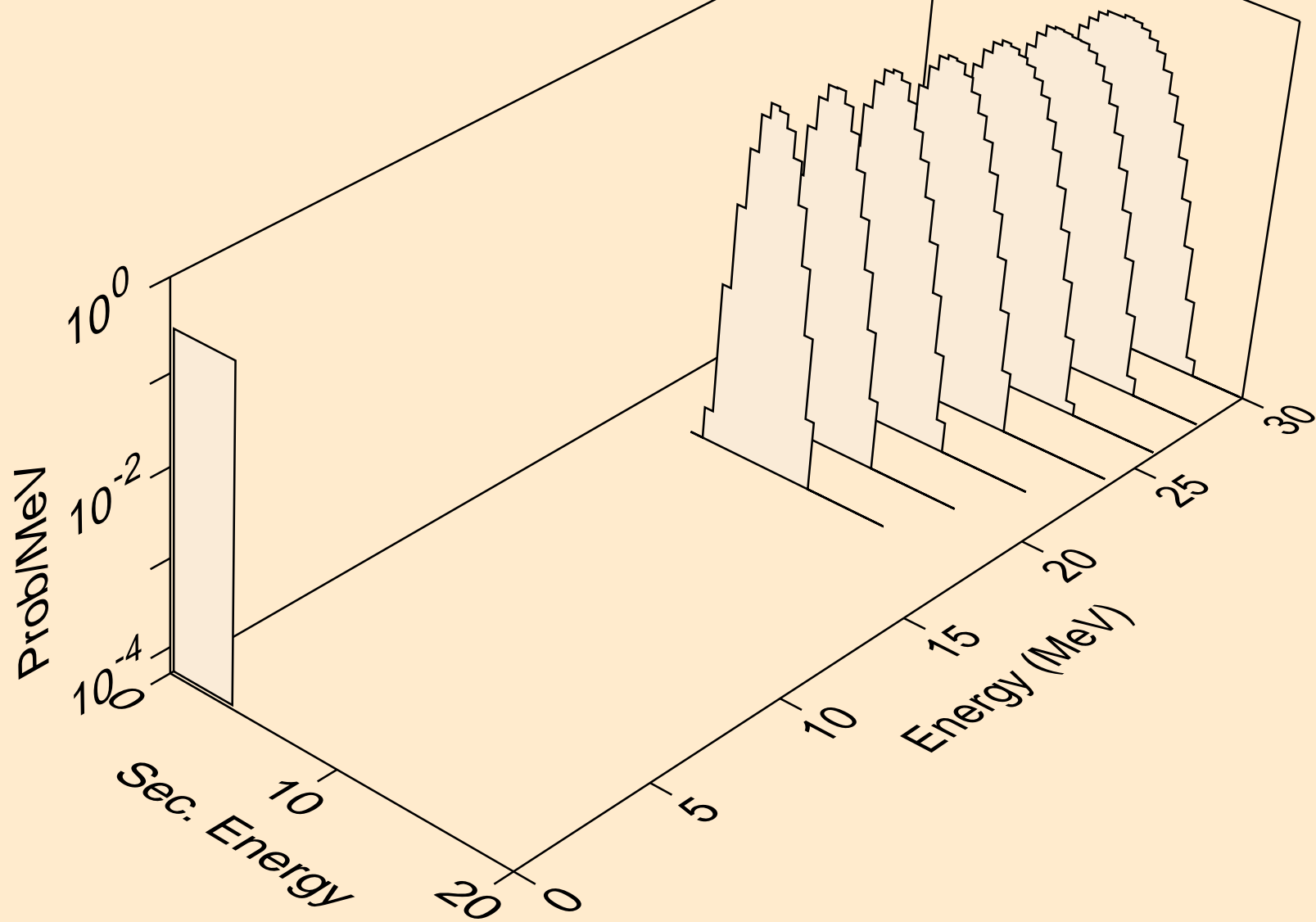

CE125 TRITON ACER TENDL-2021 LIBRARY; T=0.K  
alphas from (t,d2a)

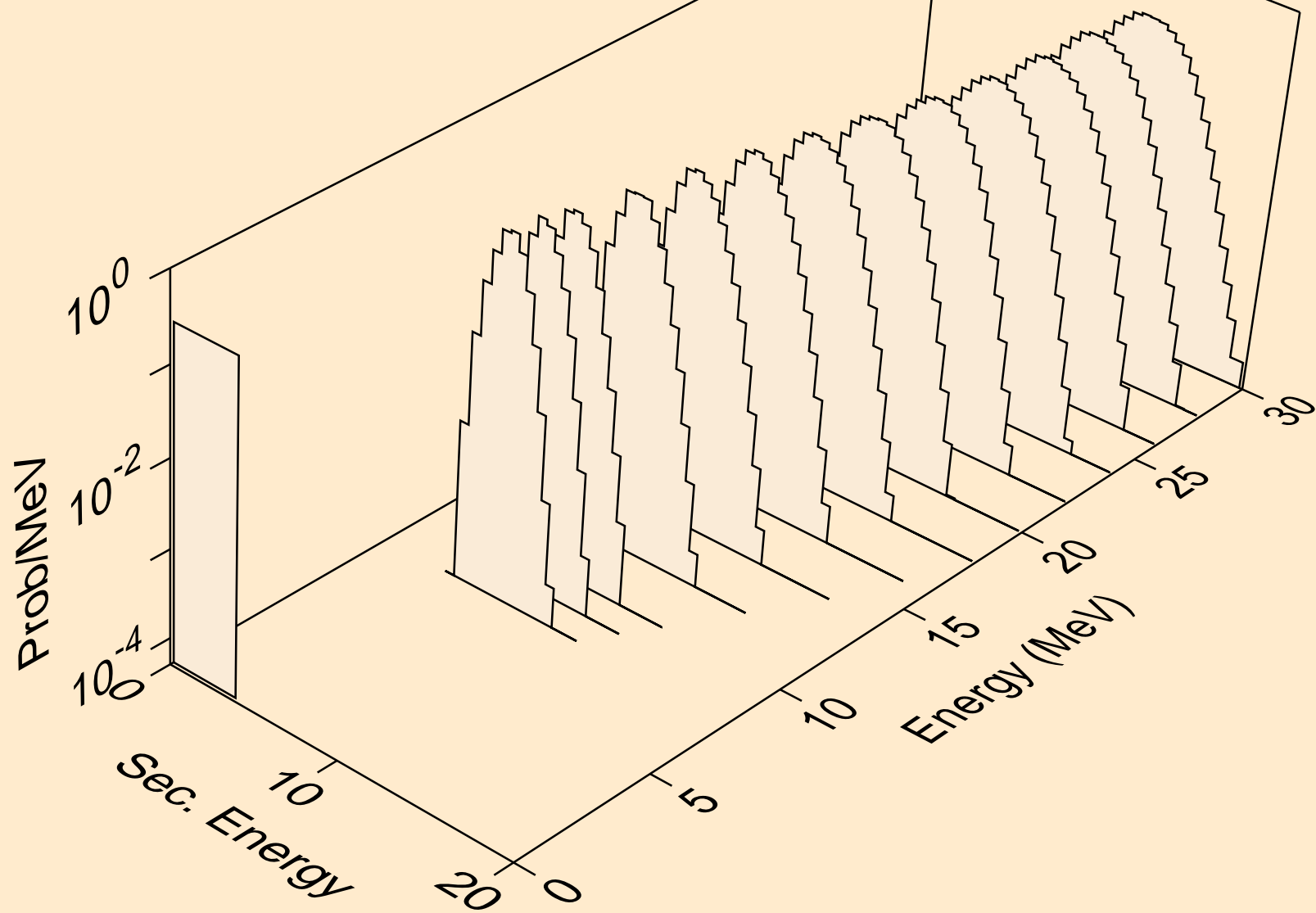

CE125 TRITON ACER TENDL-2021 LIBRARY; T=0.K  
alphas from (t,da)

