

CF256 TRITON ACER TENDL-2021 LIBRARY; T=0.K  
Principal cross sections

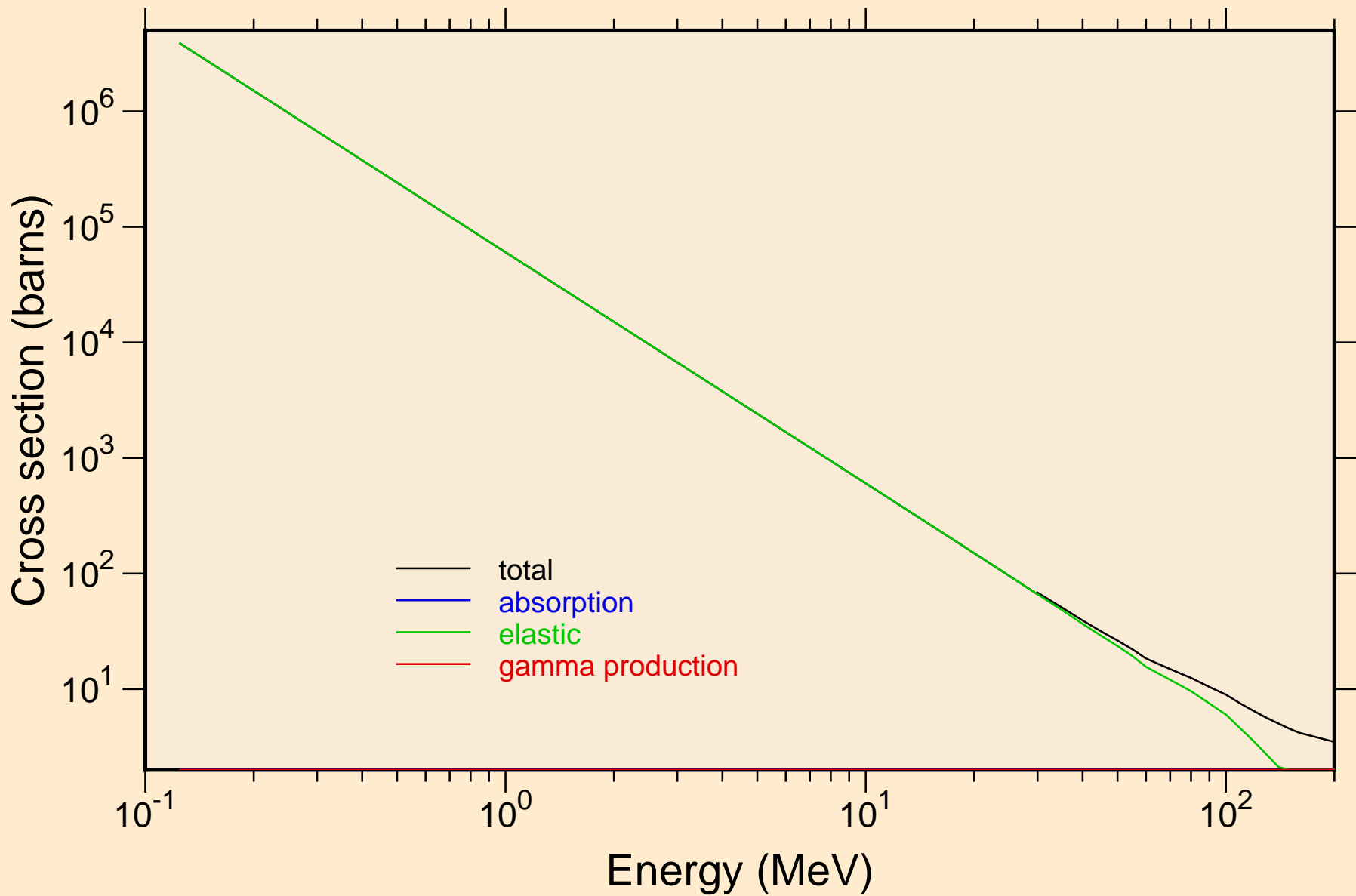

CF256 TRITON ACER TENDL-2021 LIBRARY; T=0.K

Heating

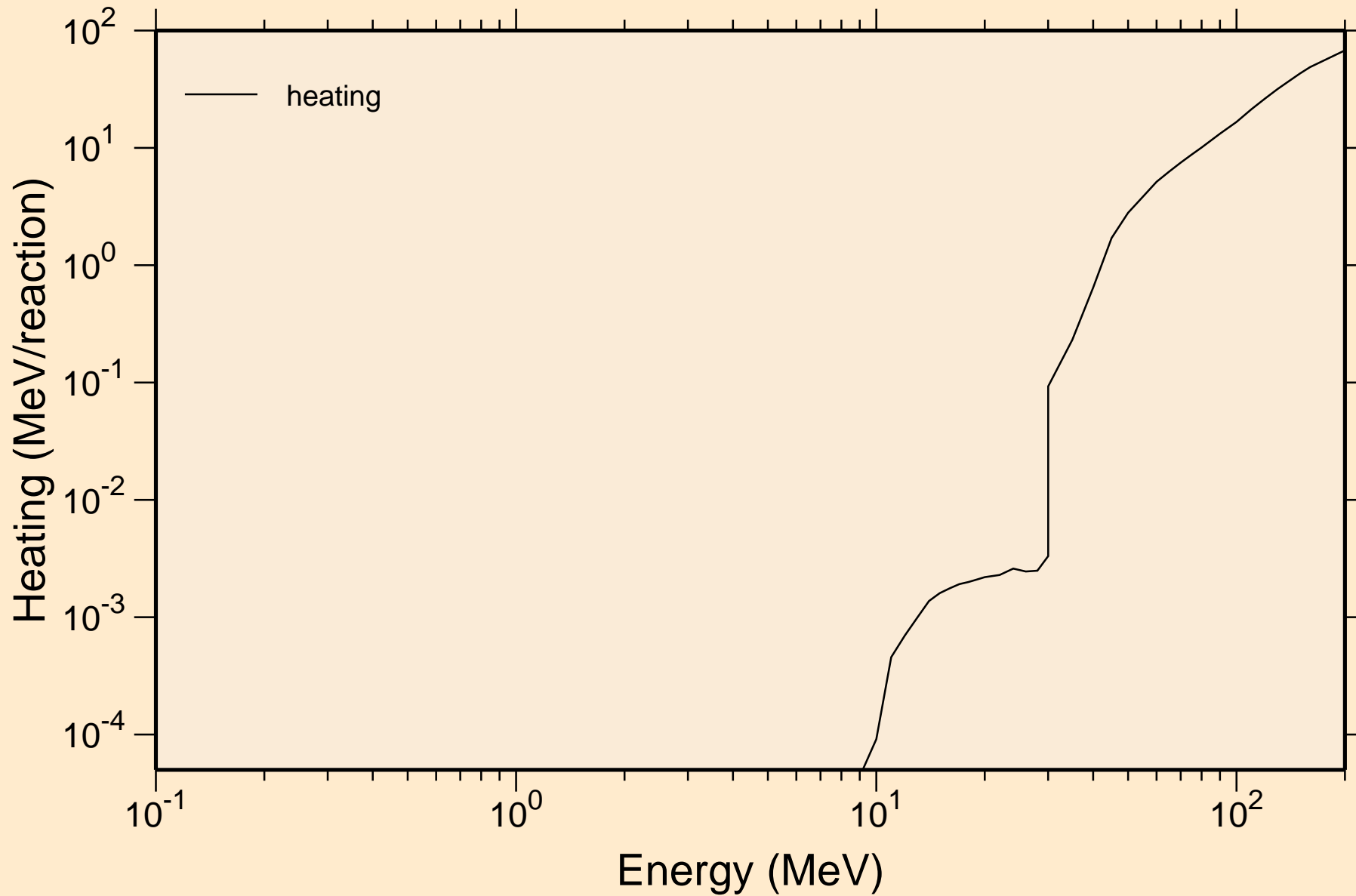

# CF256 TRITON ACER TENDL-2021 LIBRARY; T=0.K

## Principal cross sections

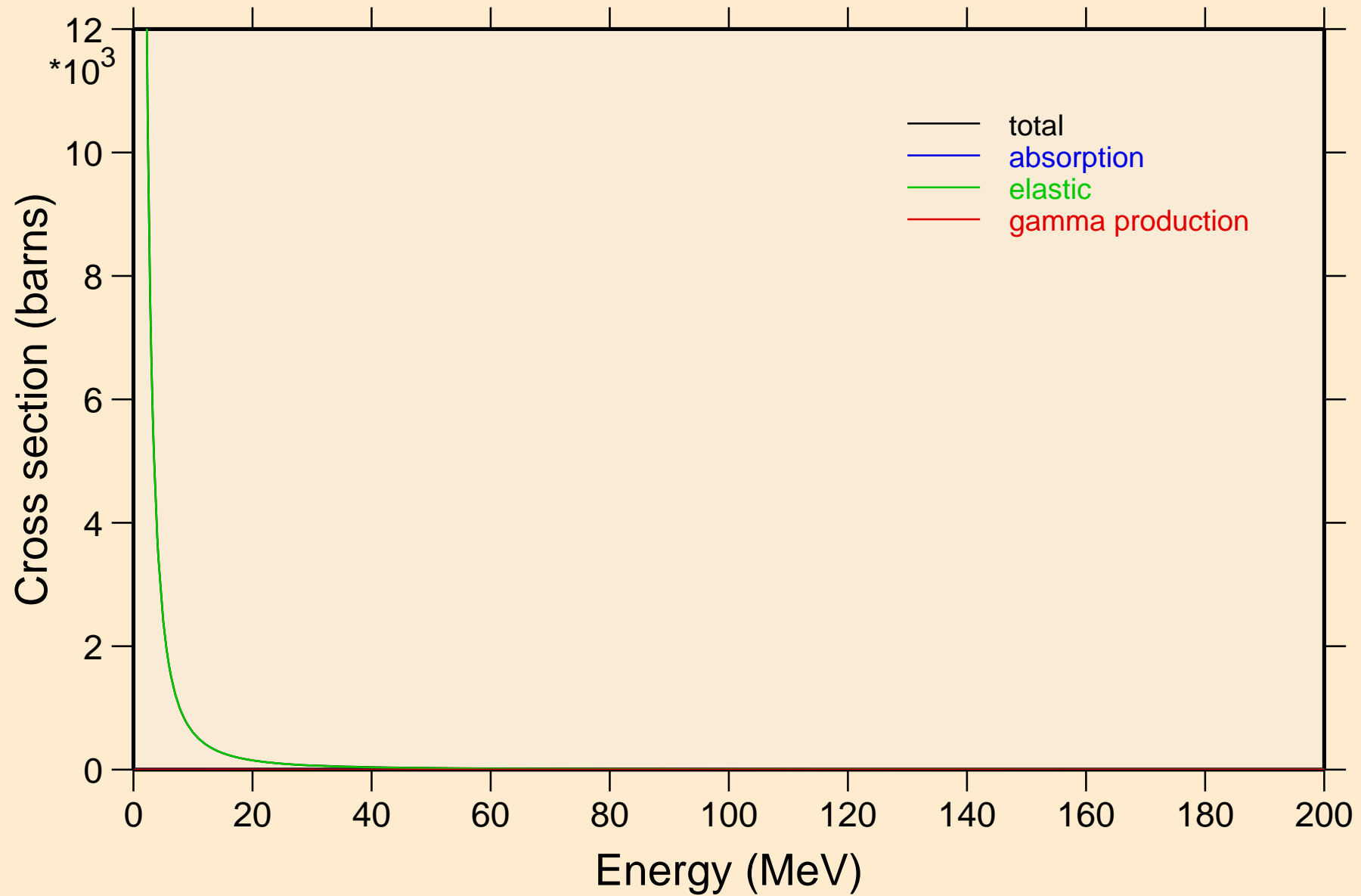

CF256 TRITON ACER TENDL-2021 LIBRARY; T=0.K

Heating

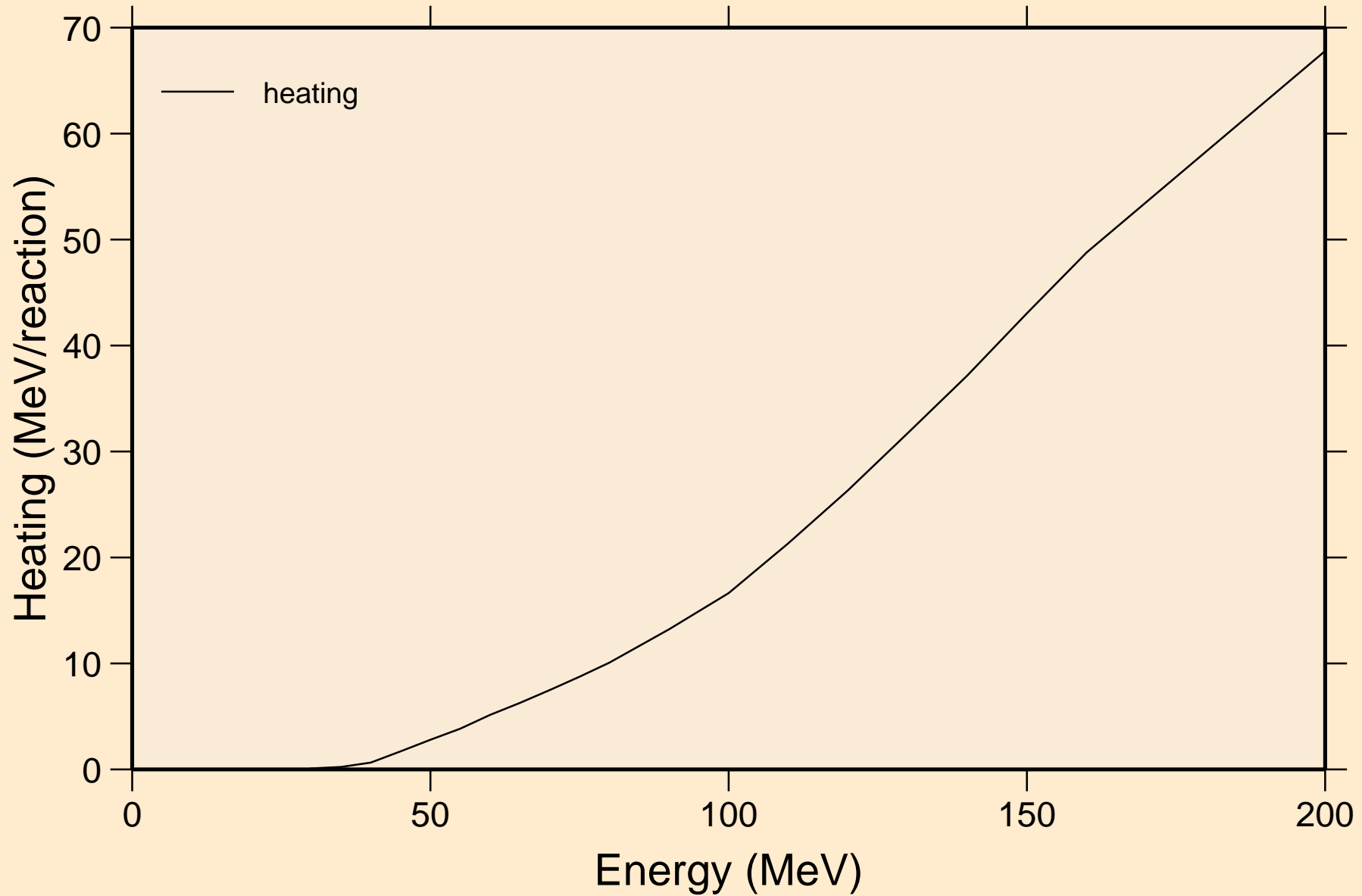

# CF256 TRITON ACER TENDL-2021 LIBRARY; T=0.K

## Threshold reactions

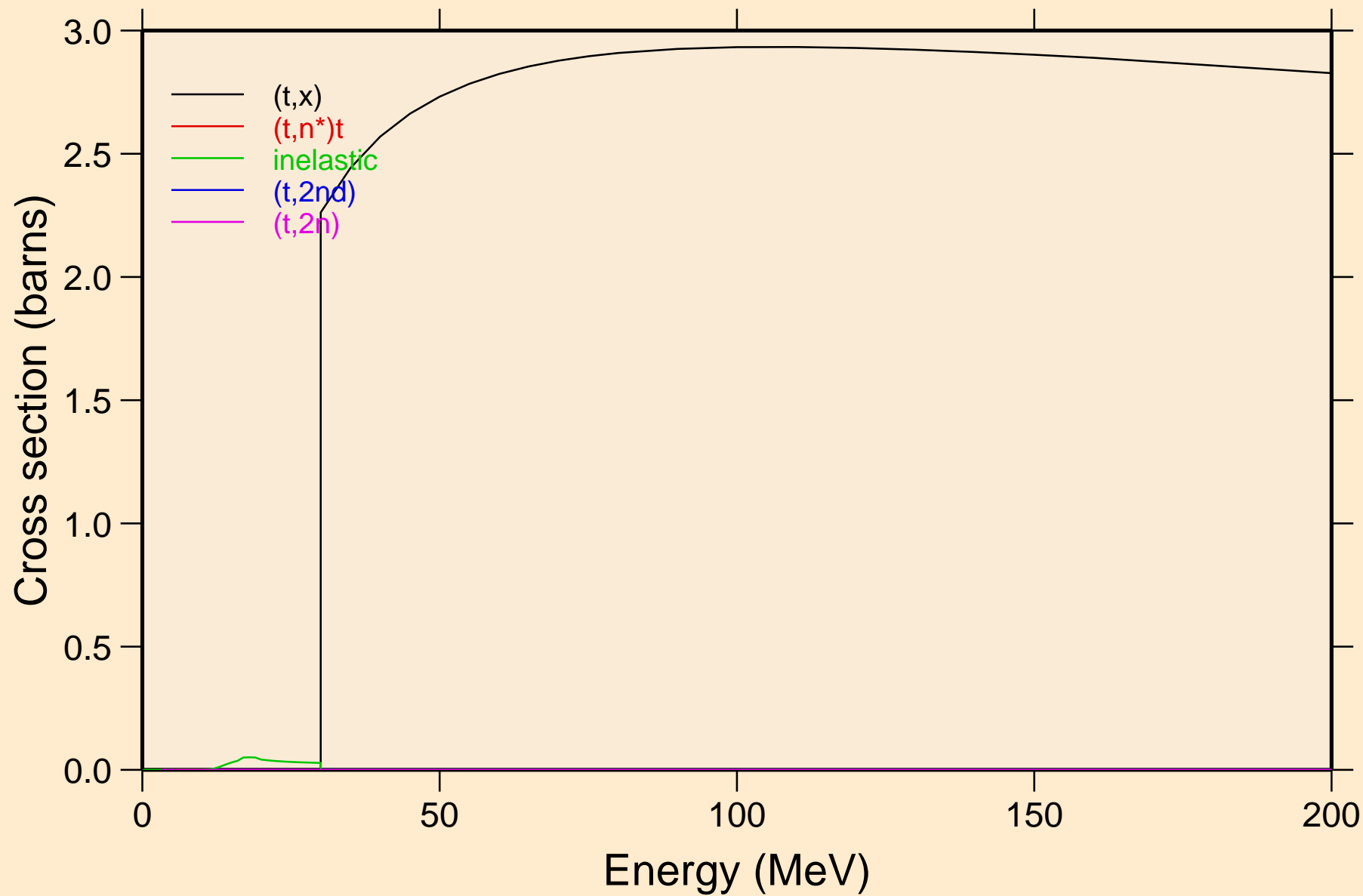

CF256 TRITON ACER TENDL-2021 LIBRARY; T=0.K  
Threshold reactions

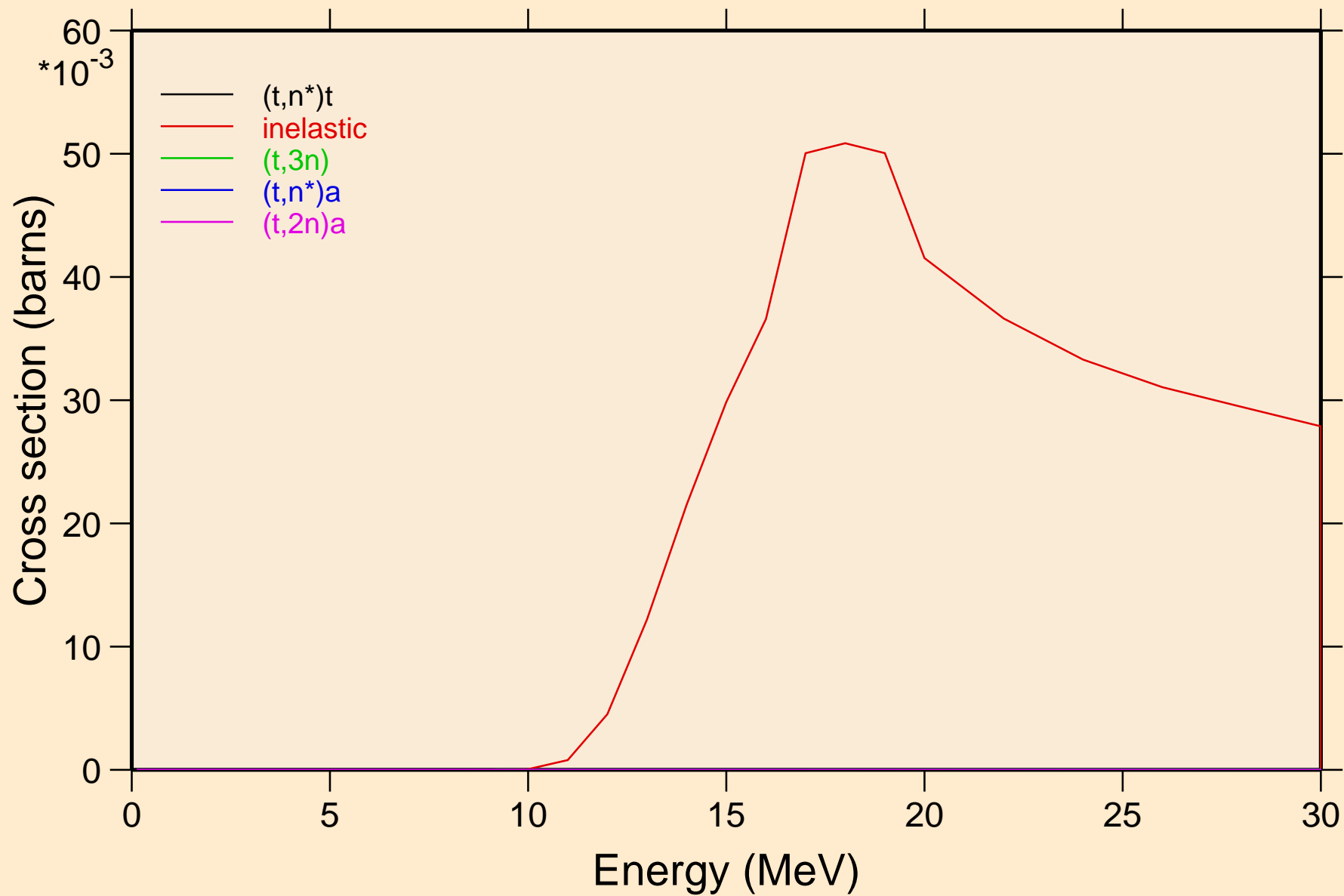

CF256 TRITON ACER TENDL-2021 LIBRARY; T=0.K  
Threshold reactions

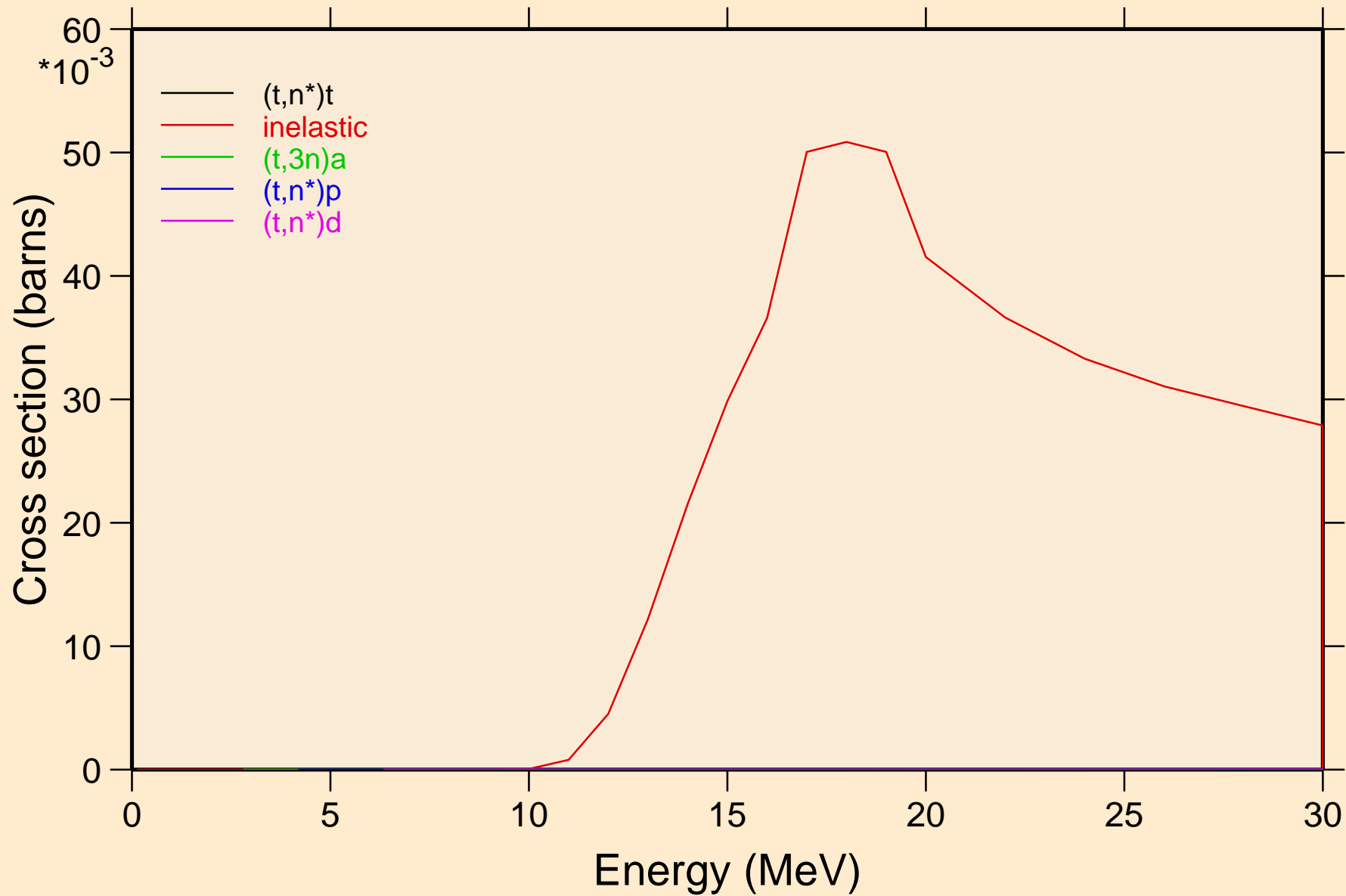

CF256 TRITON ACER TENDL-2021 LIBRARY; T=0.K  
Threshold reactions

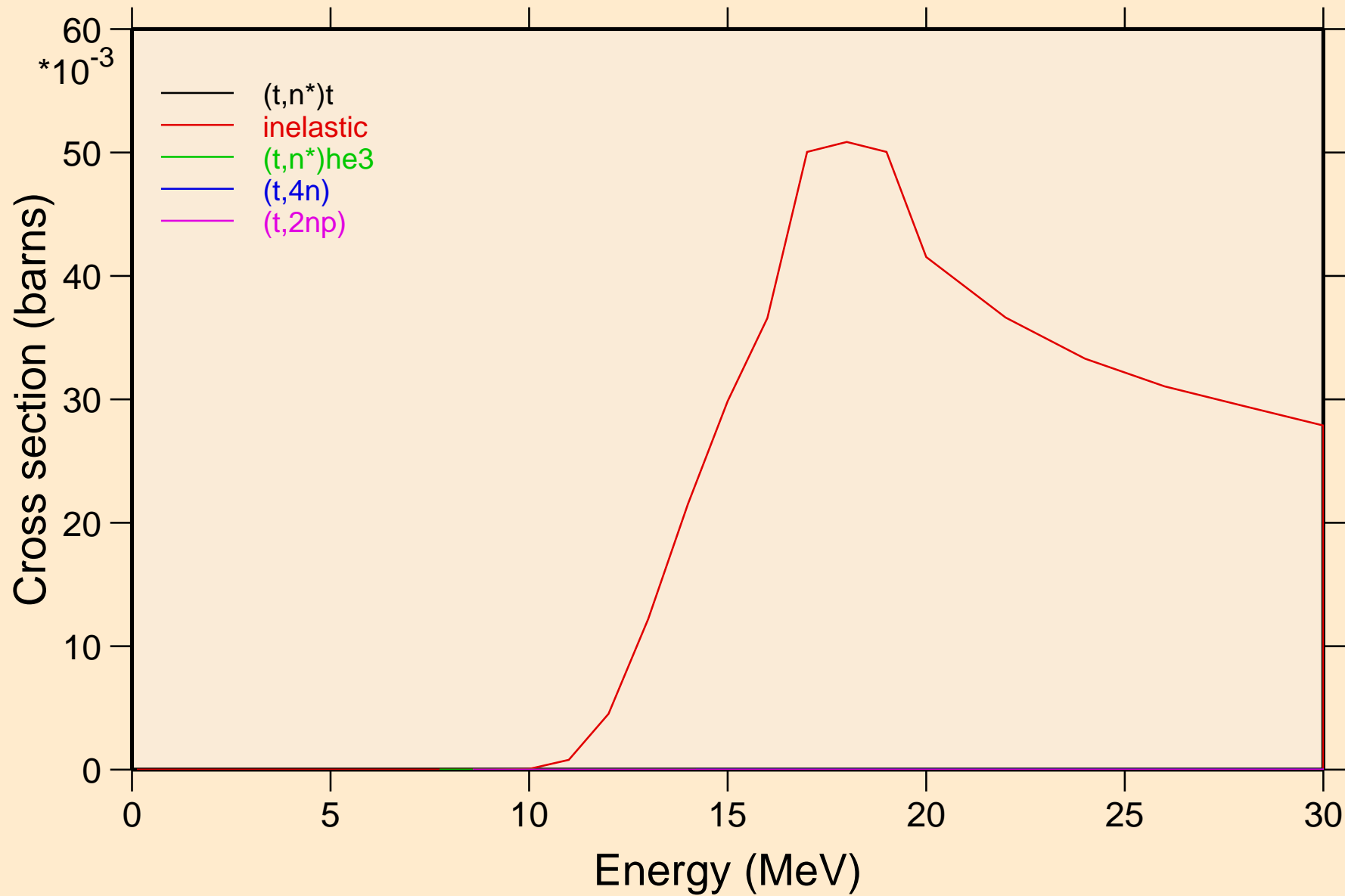



CF256 TRITON ACER TENDL-2021 LIBRARY; T=0.K  
Threshold reactions

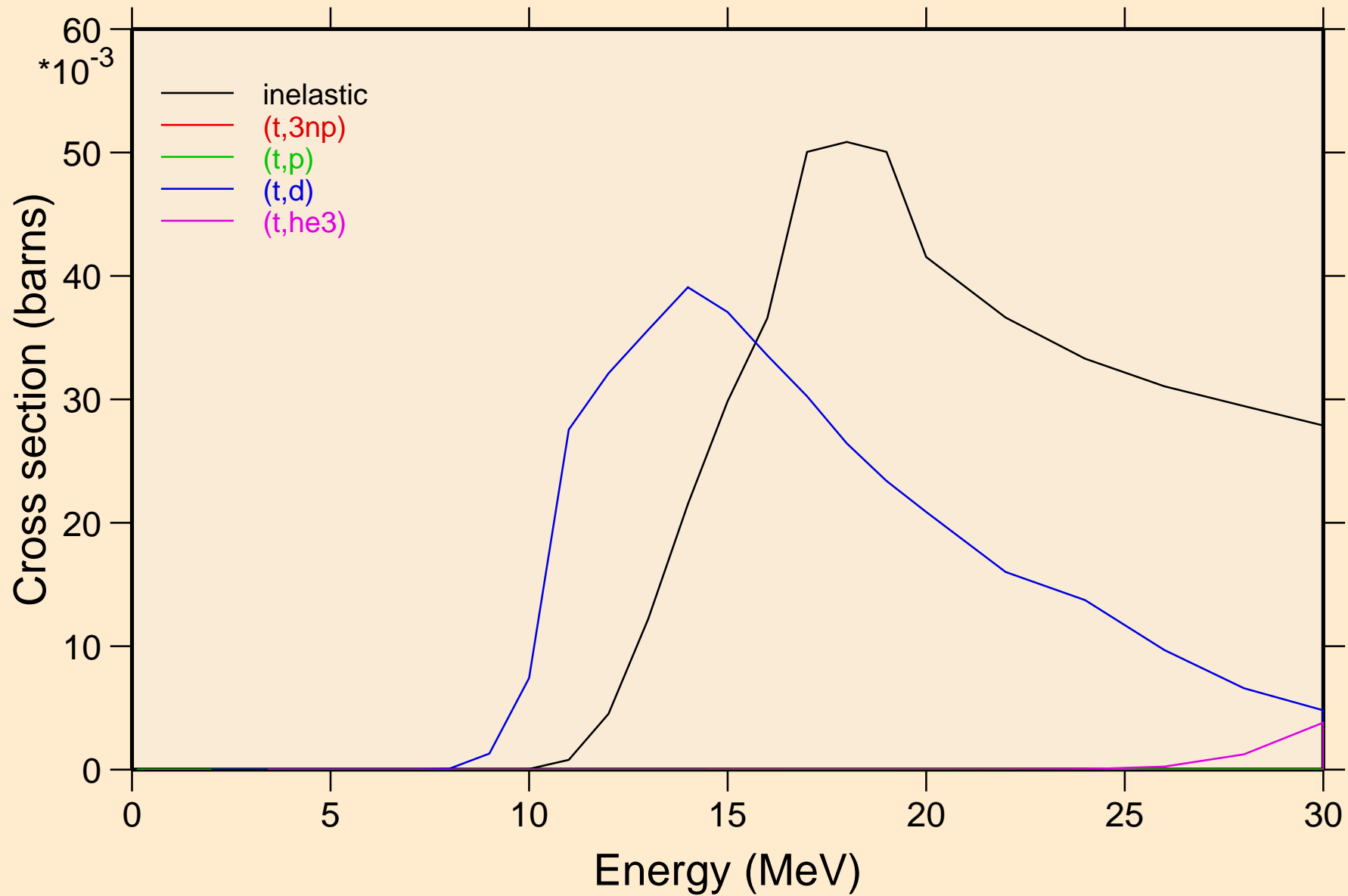

CF256 TRITON ACER TENDL-2021 LIBRARY; T=0.K  
Threshold reactions

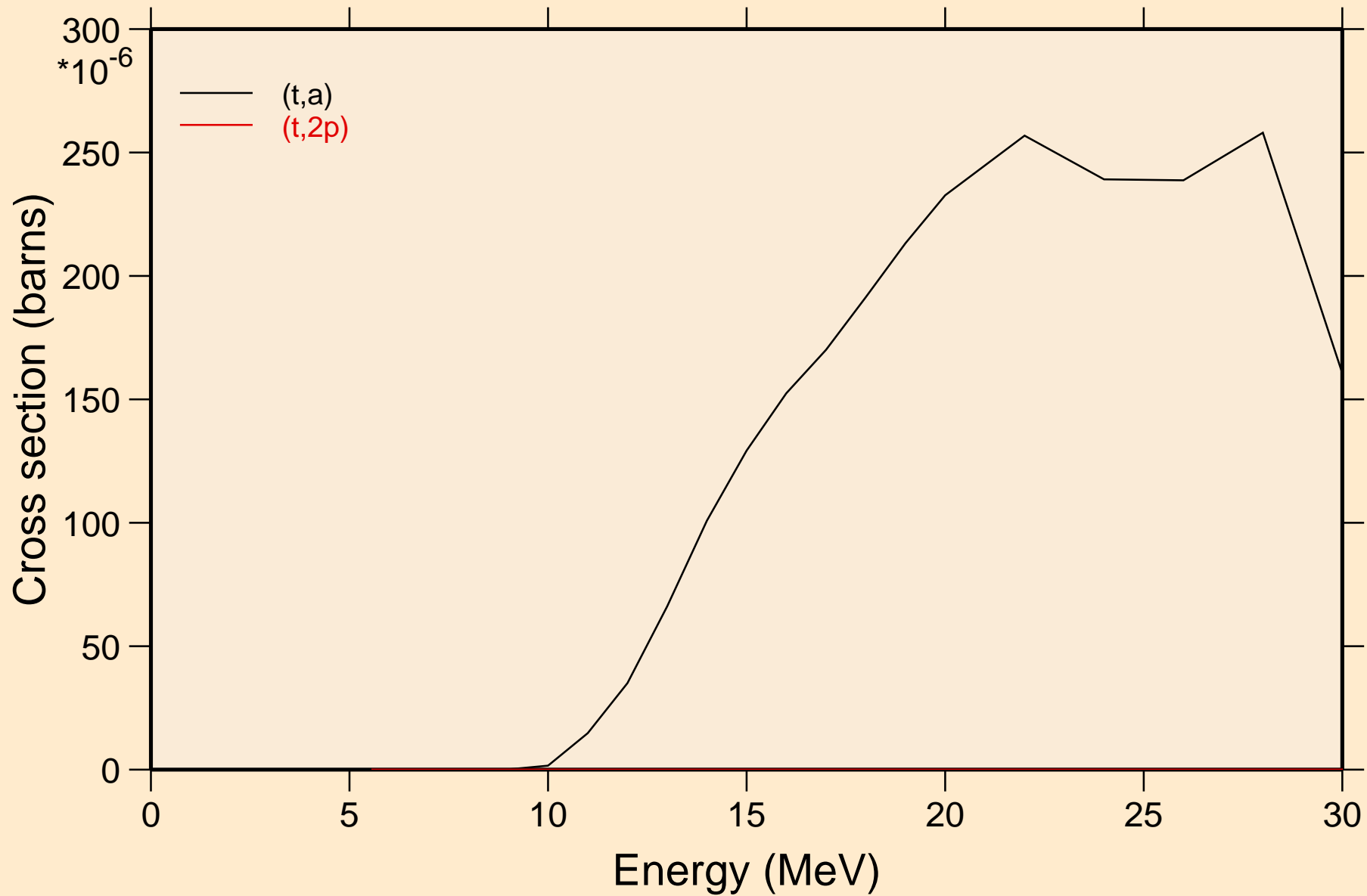

CF256 TRITON ACER TENDL-2021 LIBRARY; T=0.K  
angular distribution for elastic

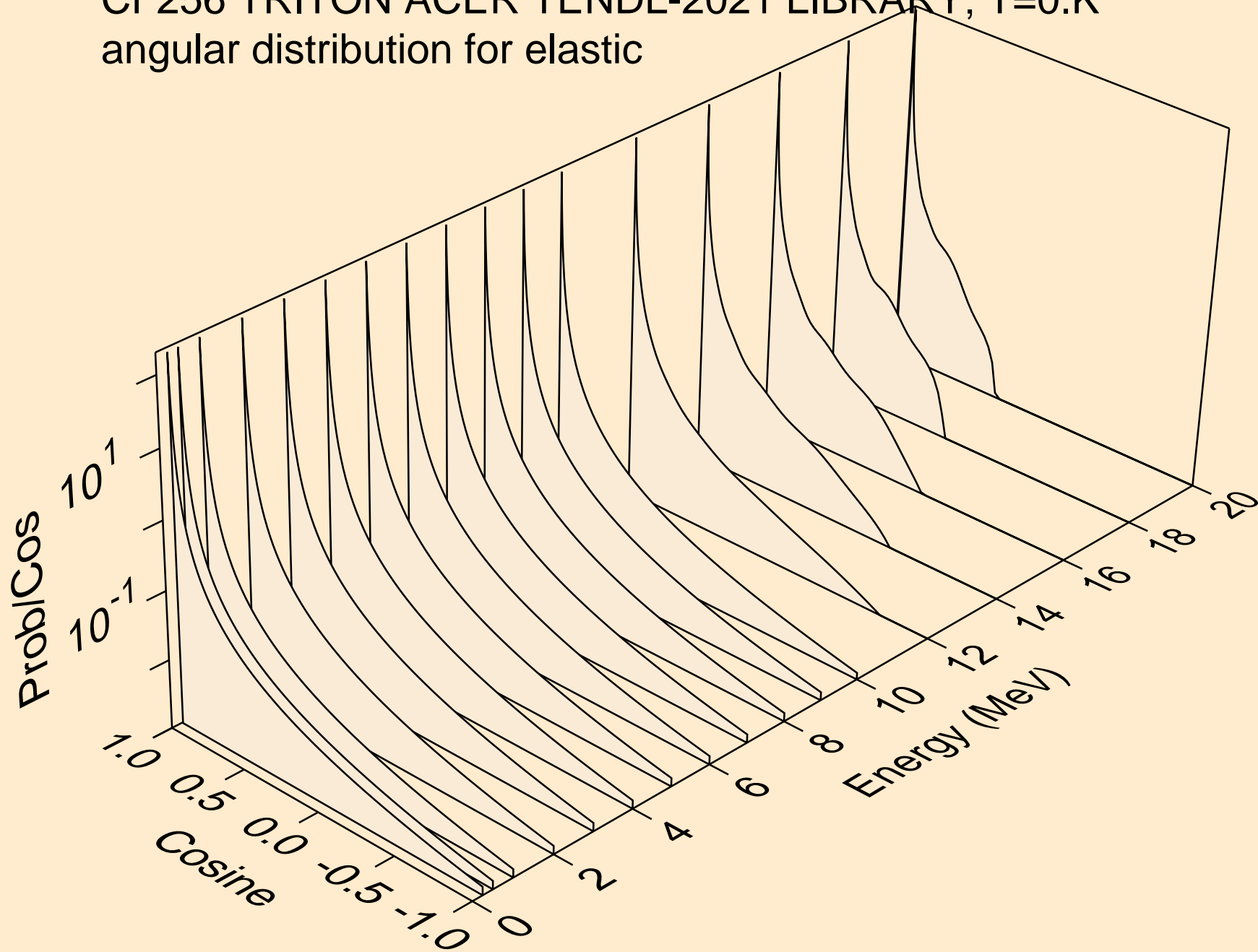

CF256 TRITON ACER TENDL-2021 LIBRARY; T=0.K  
angular distribution for elastic

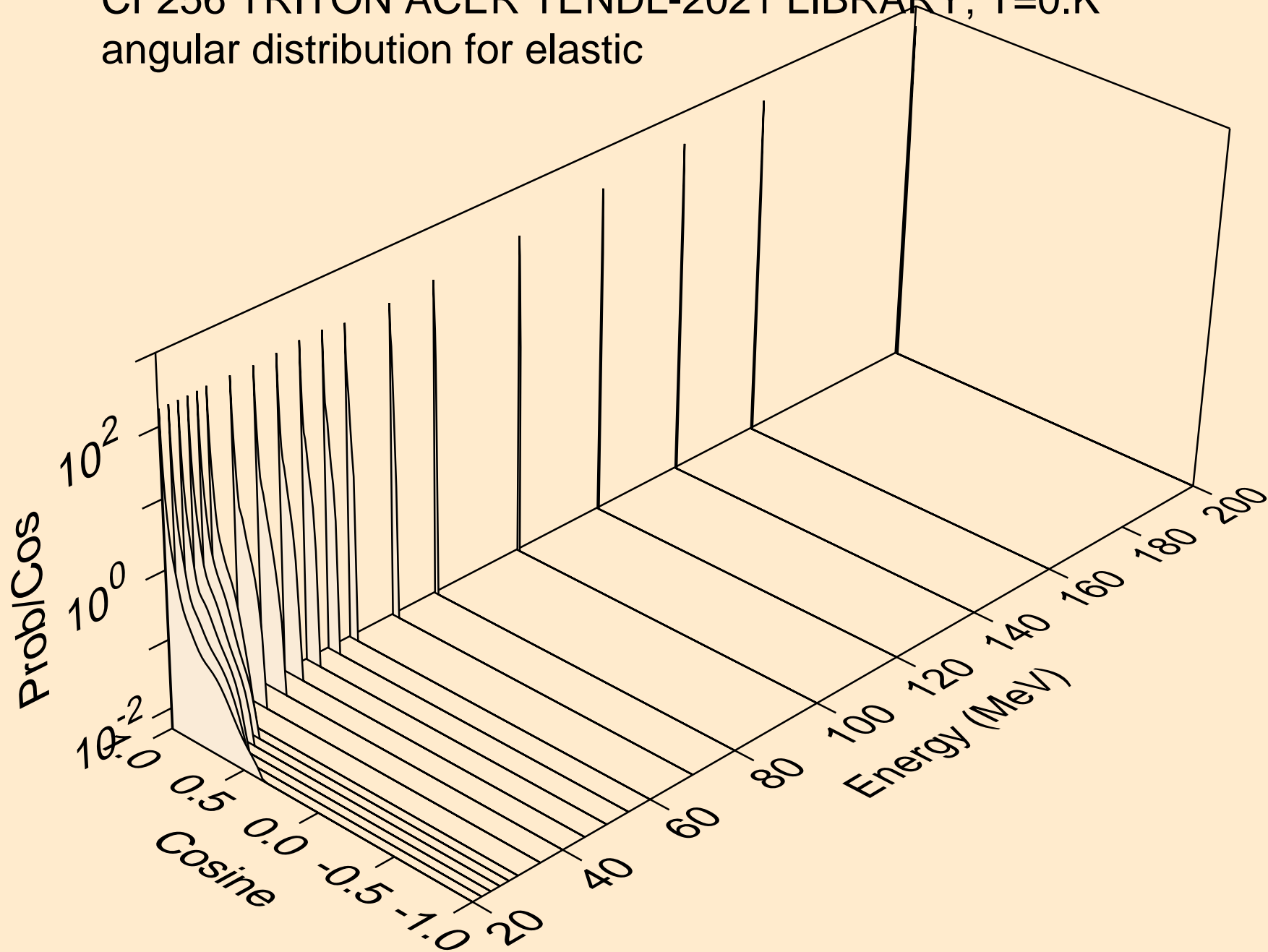

CF256 TRITON ACER TENDL-2021 LIBRARY; T=0.K  
Triton emission for (t,x)

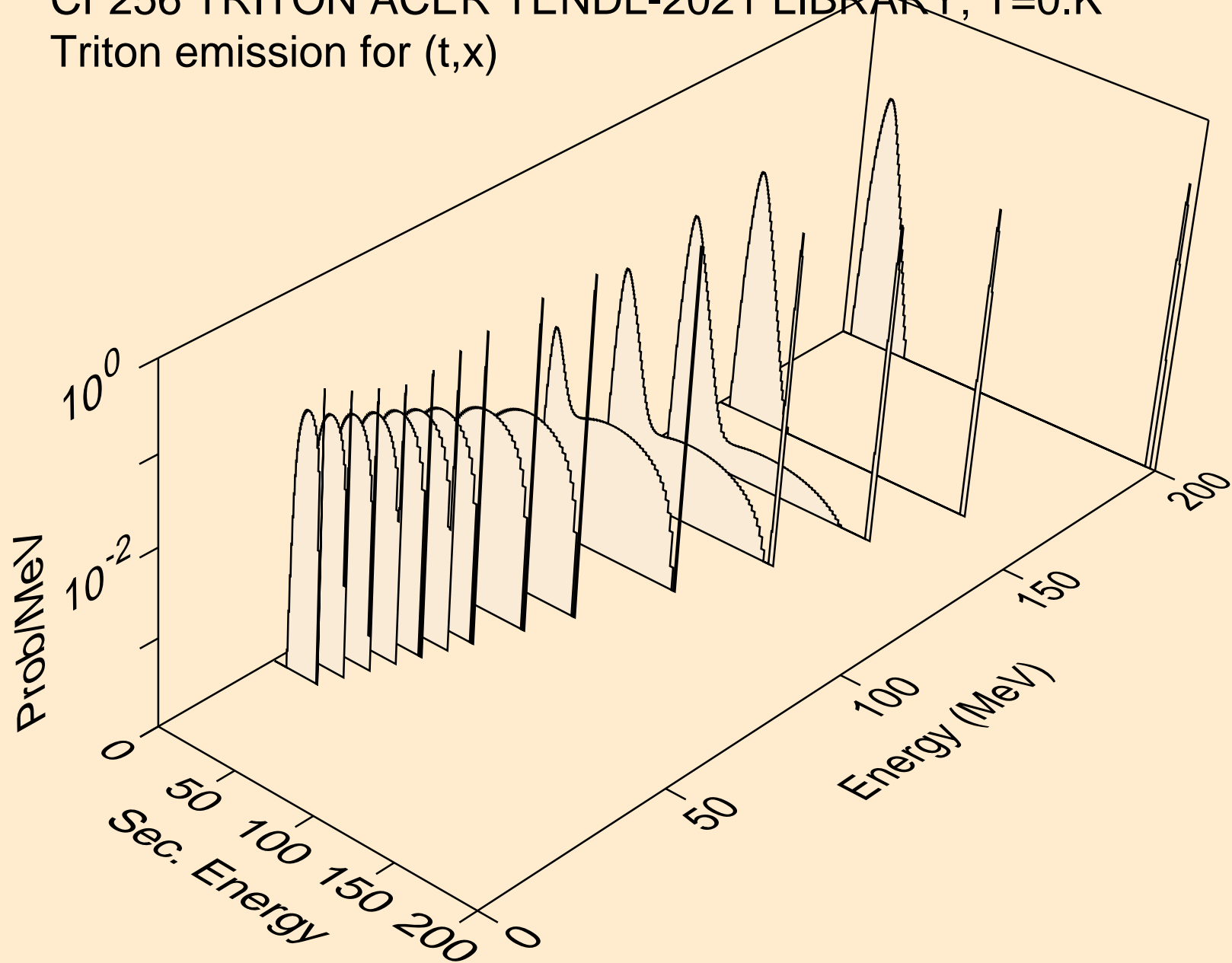

CF256 TRITON ACER TENDL-2021 LIBRARY; T=0.K  
Triton emission for (t,n\*)t

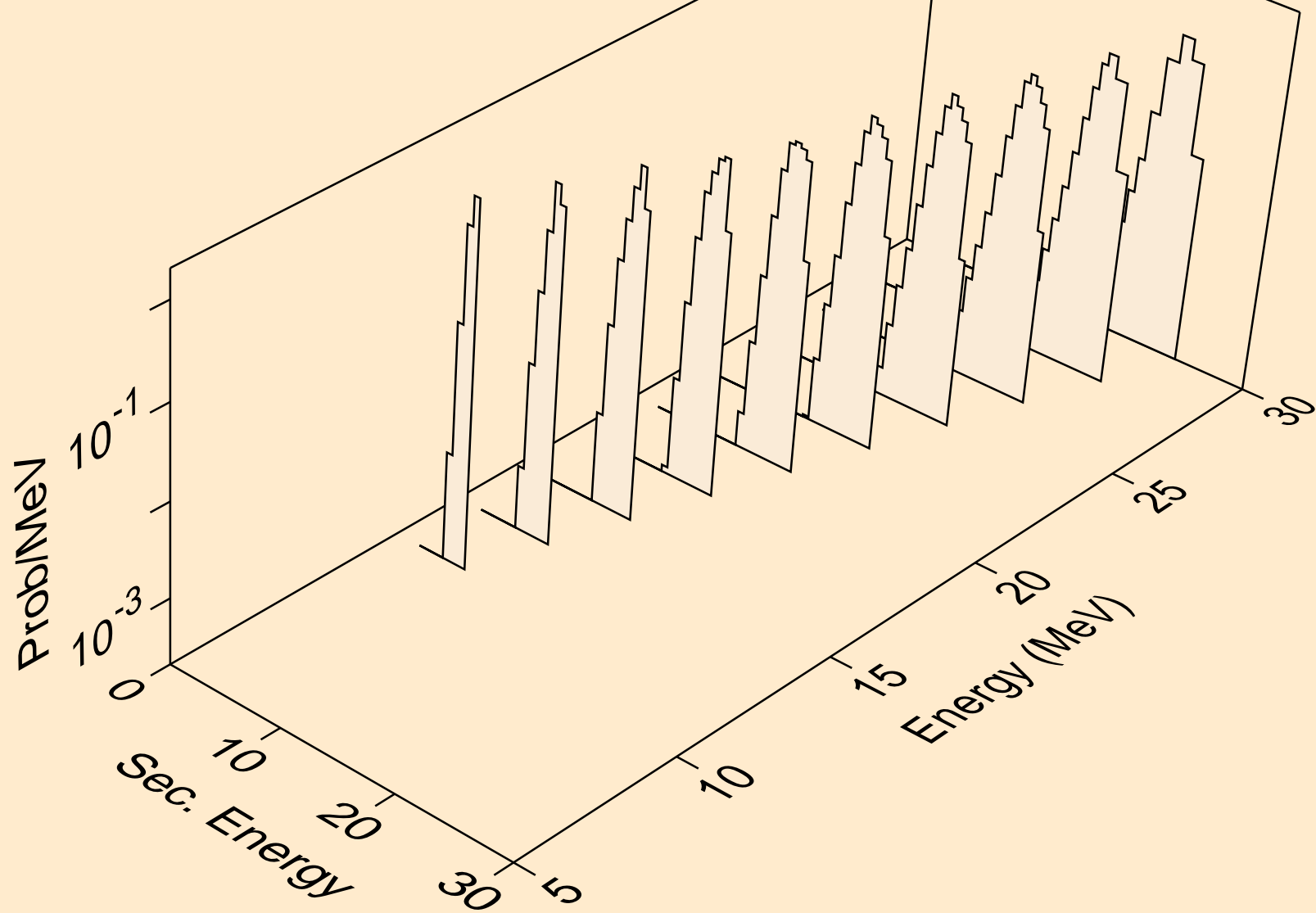

CF256 TRITON ACER TENDL-2021 LIBRARY; T=0.K  
Triton emission for inelastic

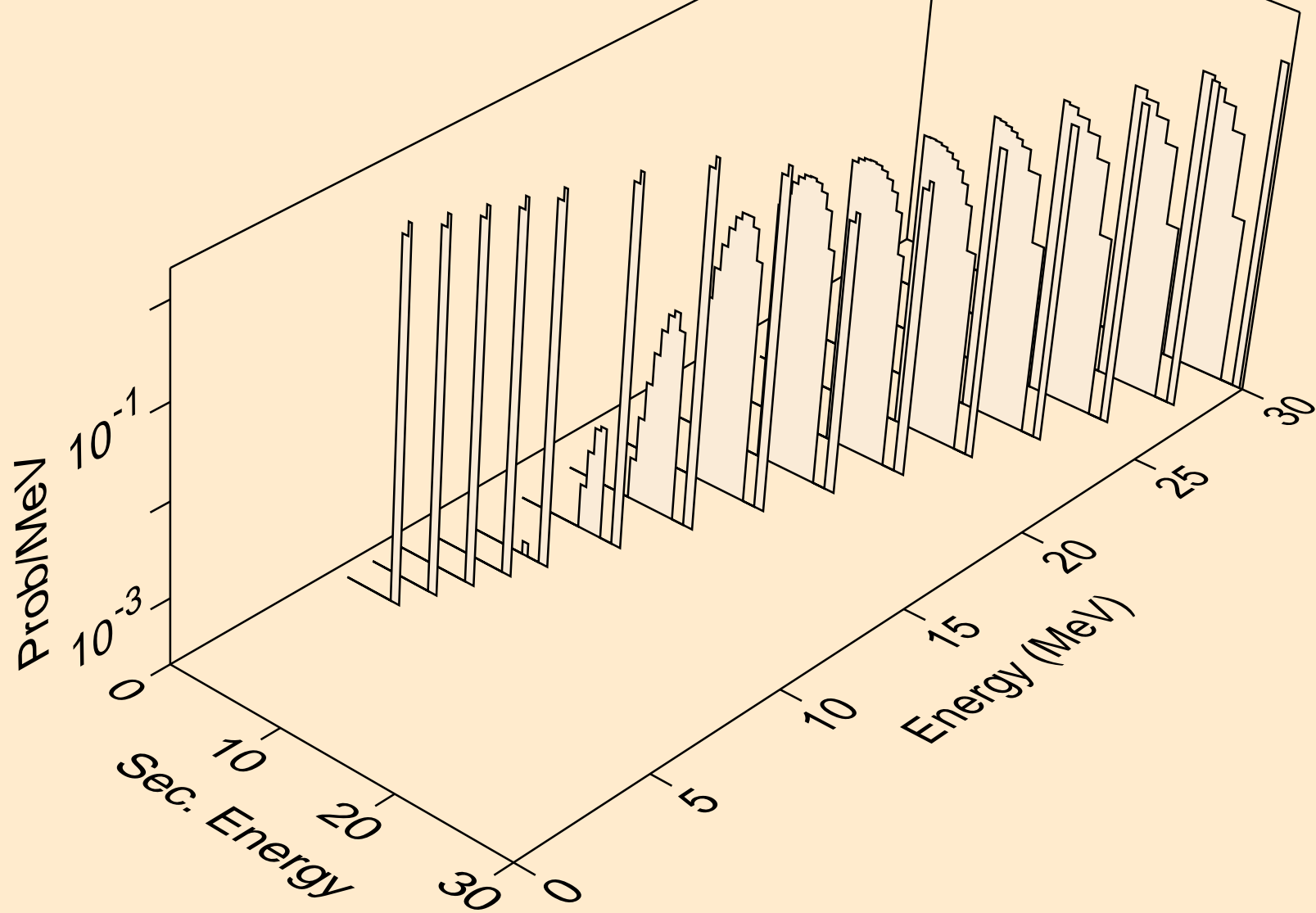

CF256 TRITON ACER TENDL-2021 LIBRARY; T=0.K  
Photon emission for (z,n)

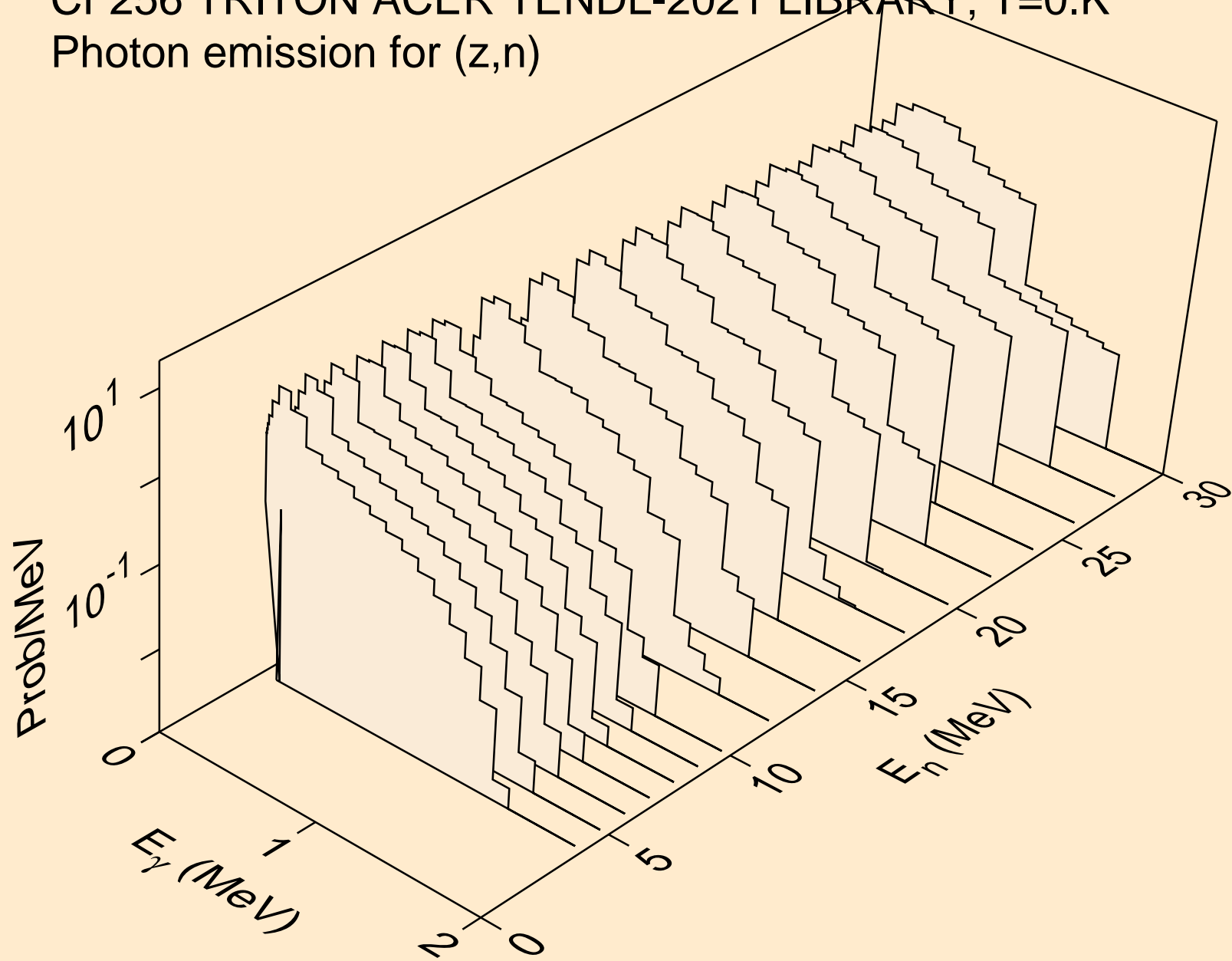



CF256 TRITON ACER TENDL-2021 LIBRARY; T=0.K  
Photon emission for (n,x)

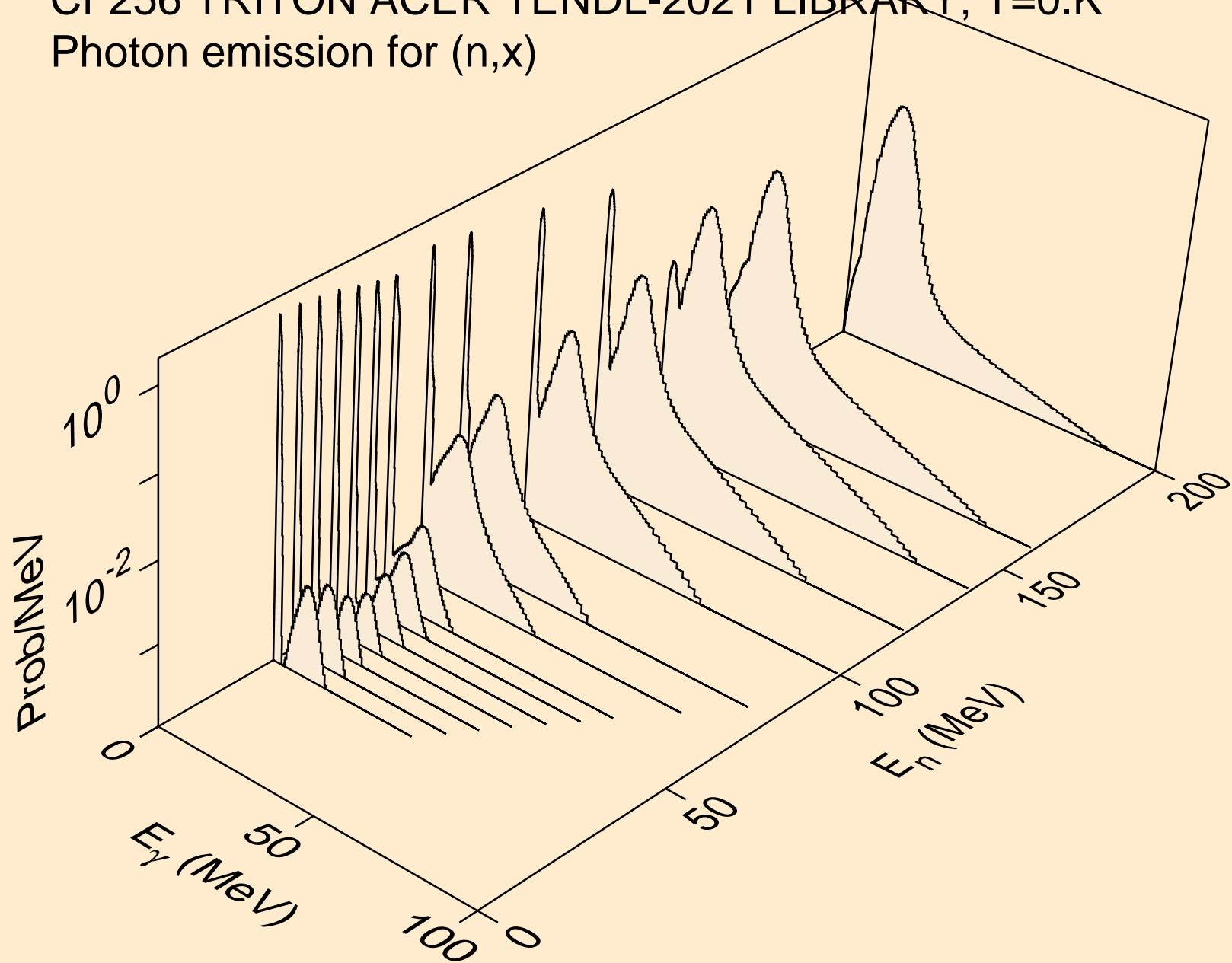

CF256 TRITON ACER TENDL-2021 LIBRARY; T=0.K  
Photon emission for (n,2nd)

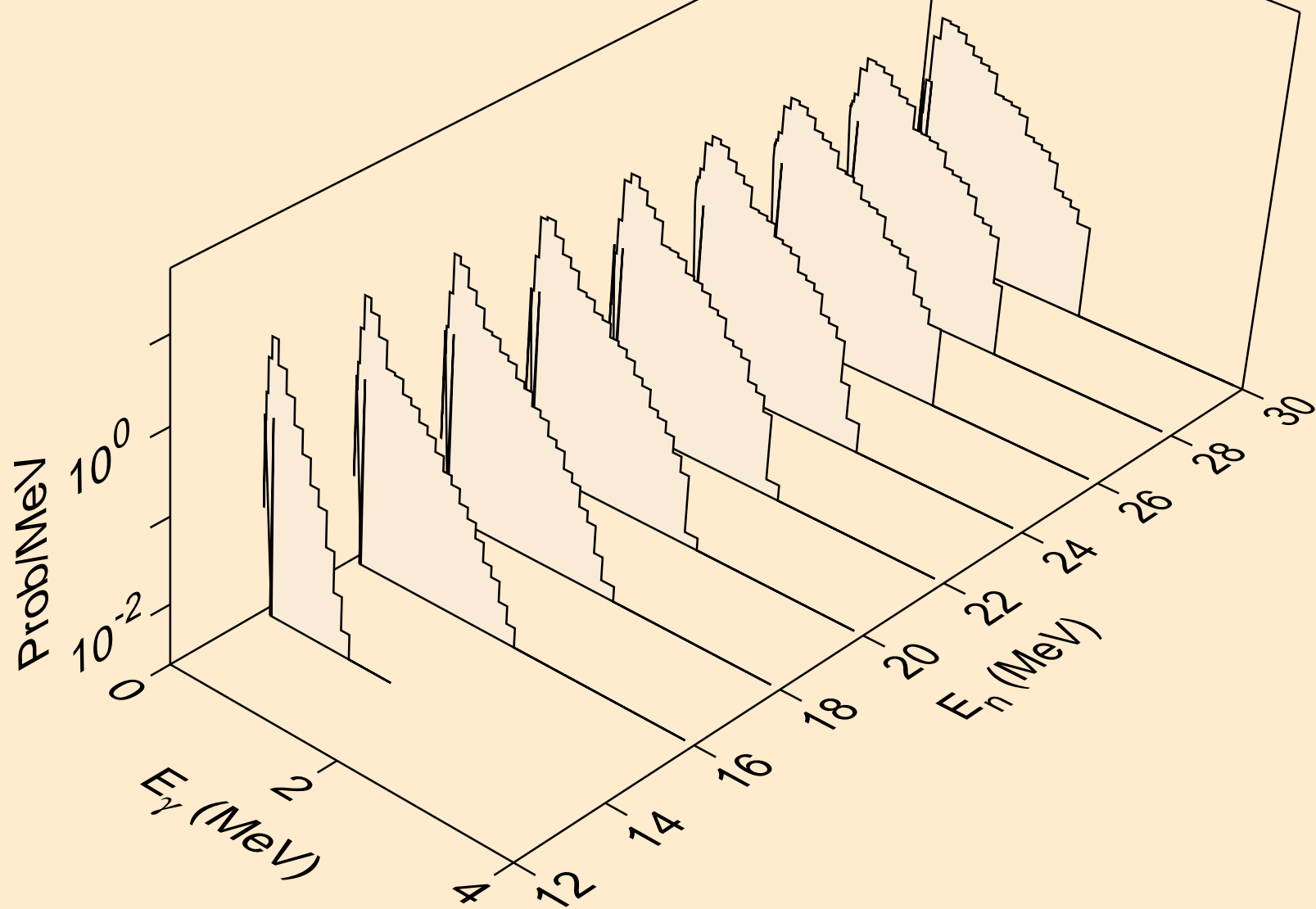

CF256 TRITON ACER TENDL-2021 LIBRARY; T=0.K  
Photon emission for (n,2n)

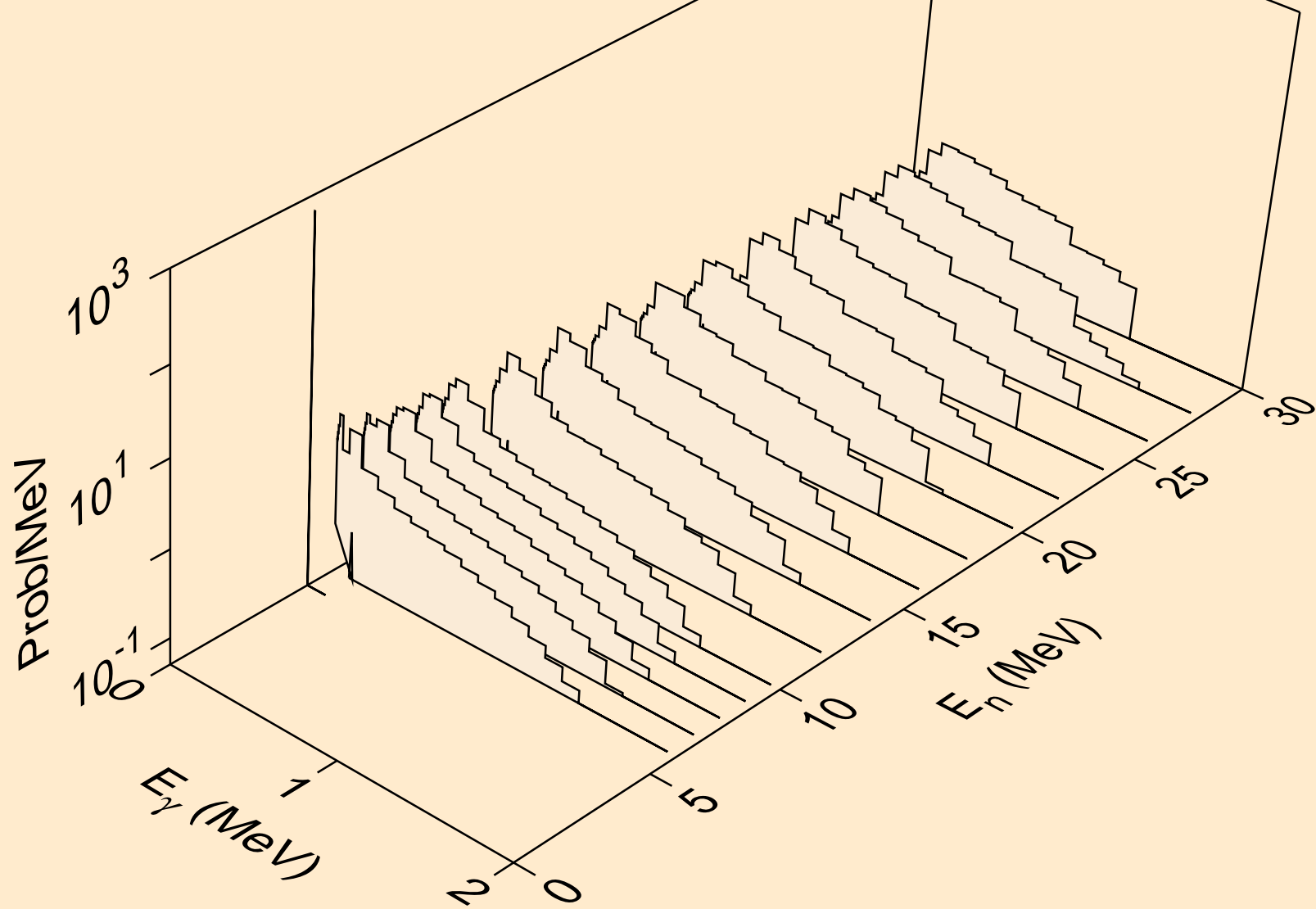

CF256 TRITON ACER TENDL-2021 LIBRARY; T=0.K  
Photon emission for (n,3n)

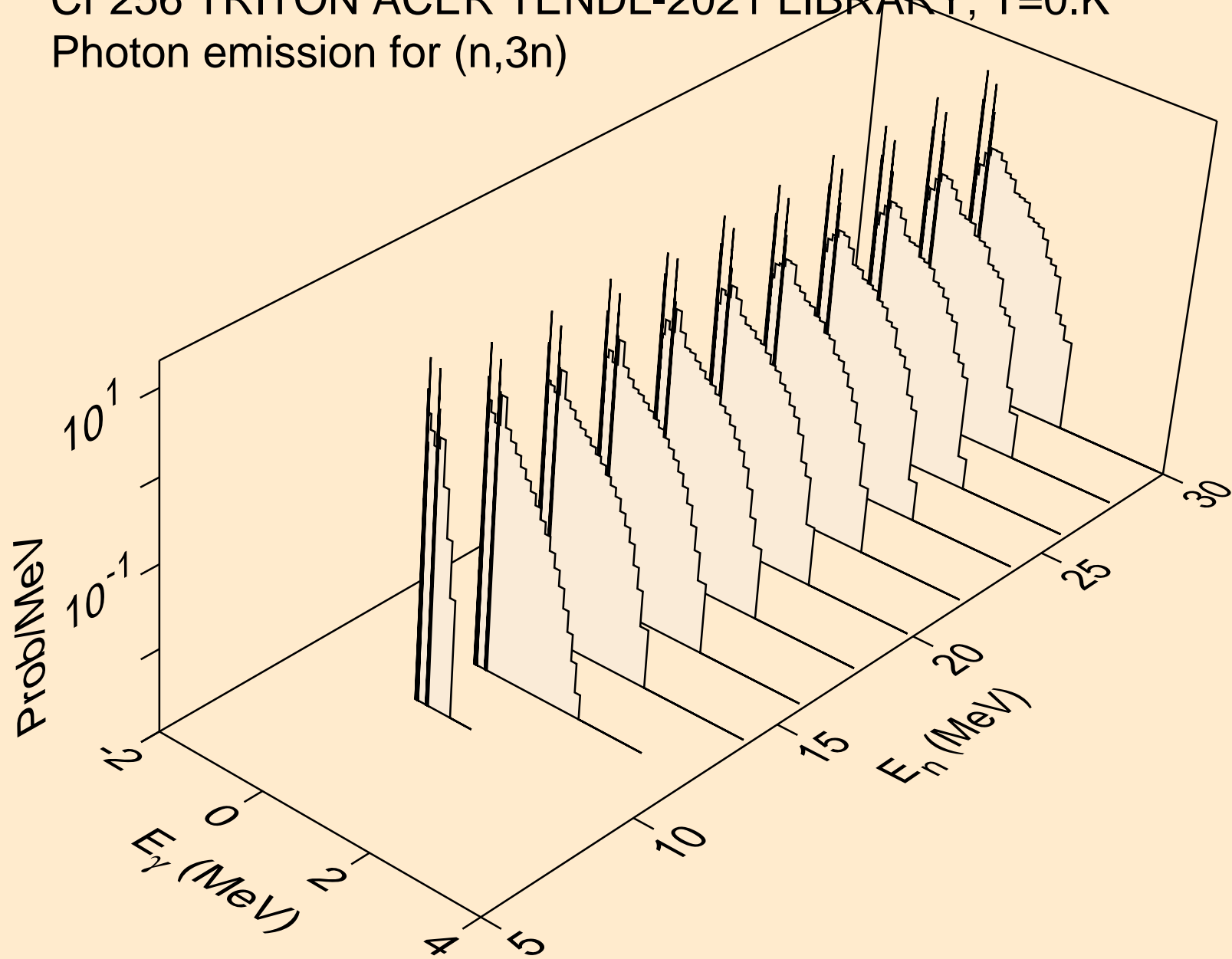

CF256 TRITON ACER TENDL-2021 LIBRARY; T=0.K  
Photon emission for (n,n\*)a

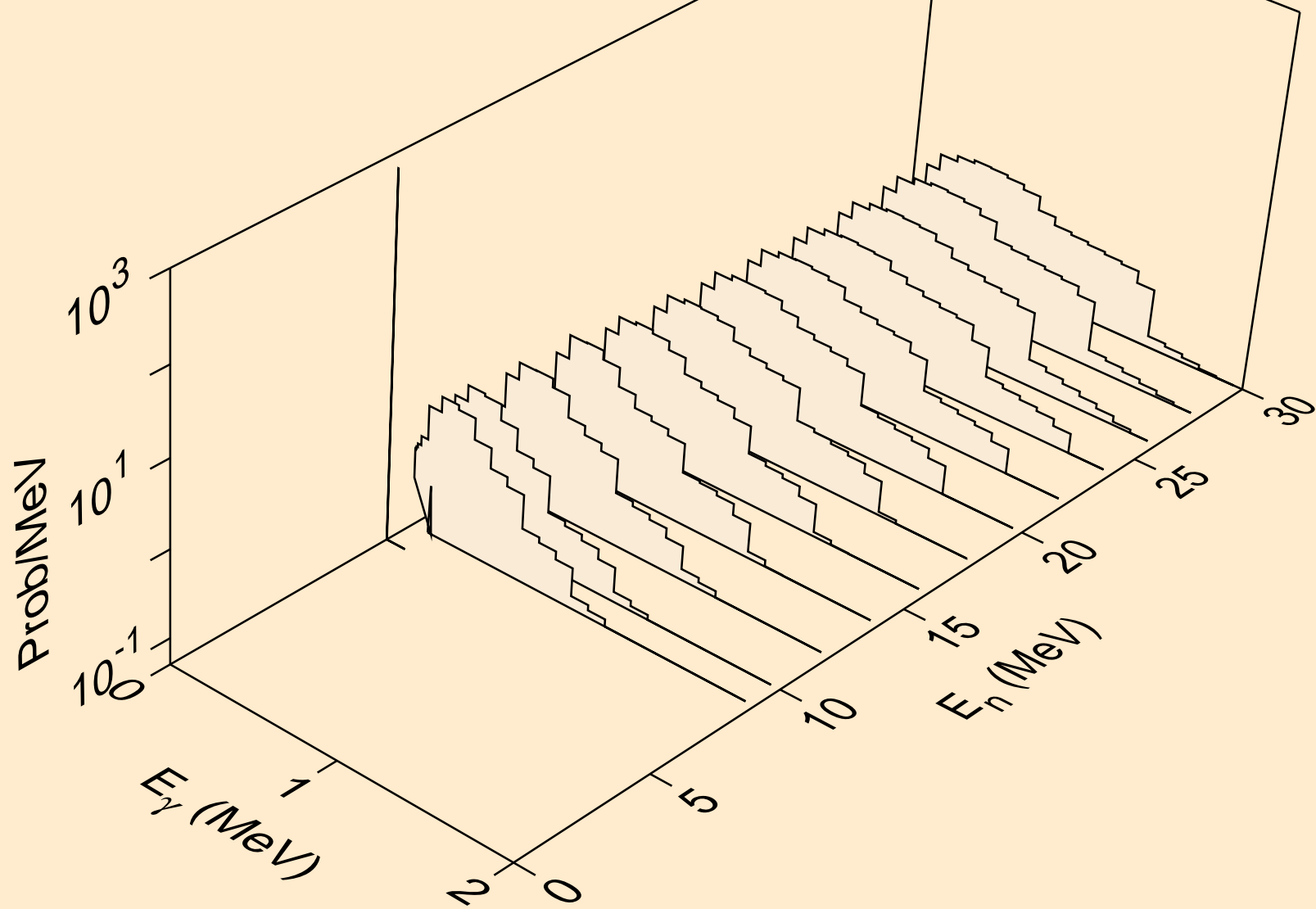

CF256 TRITON ACER TENDL-2021 LIBRARY; T=0.K  
Photon emission for (n,2n)a

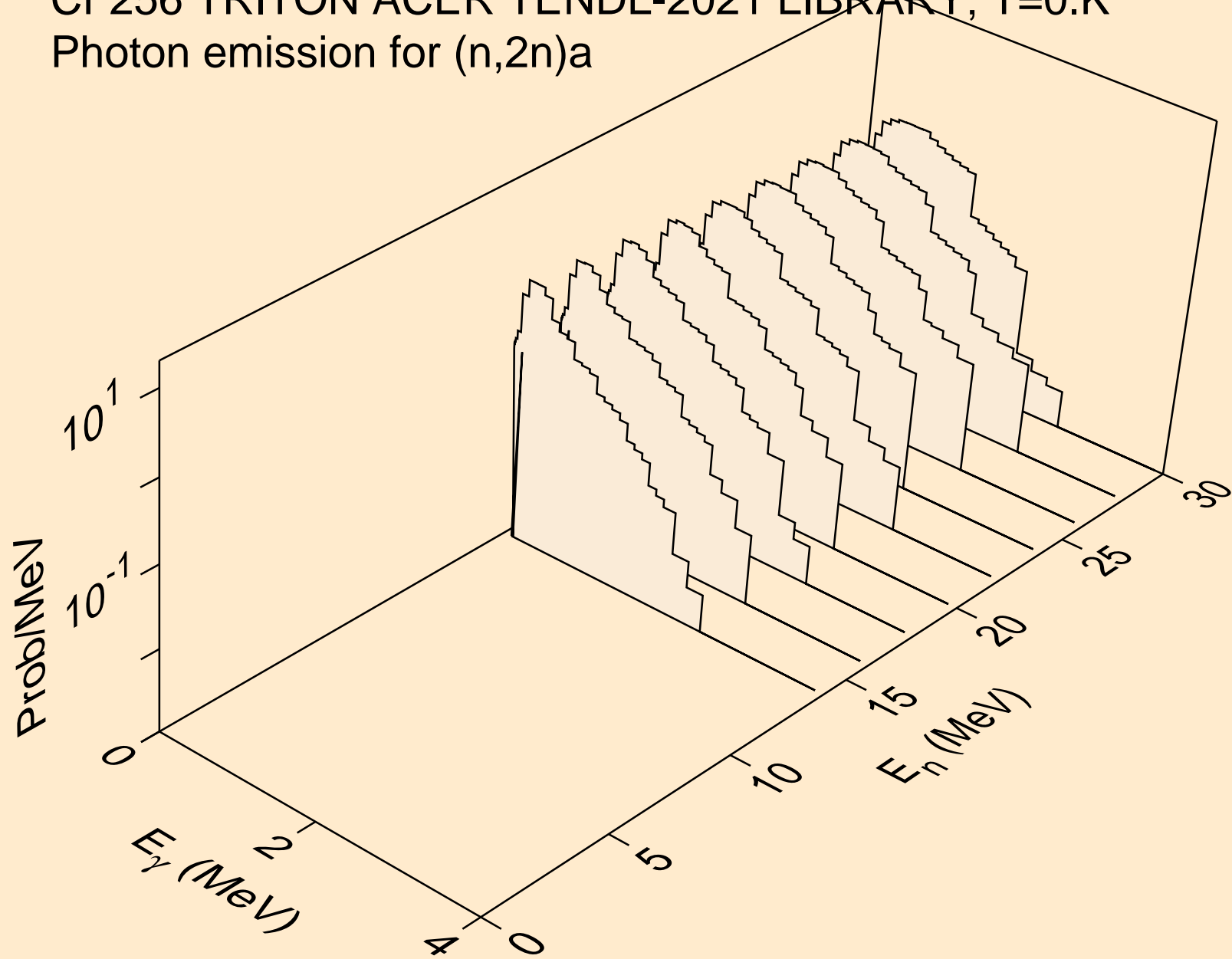

CF256 TRITON ACER TENDL-2021 LIBRARY; T=0.K  
Photon emission for (n,3n)a

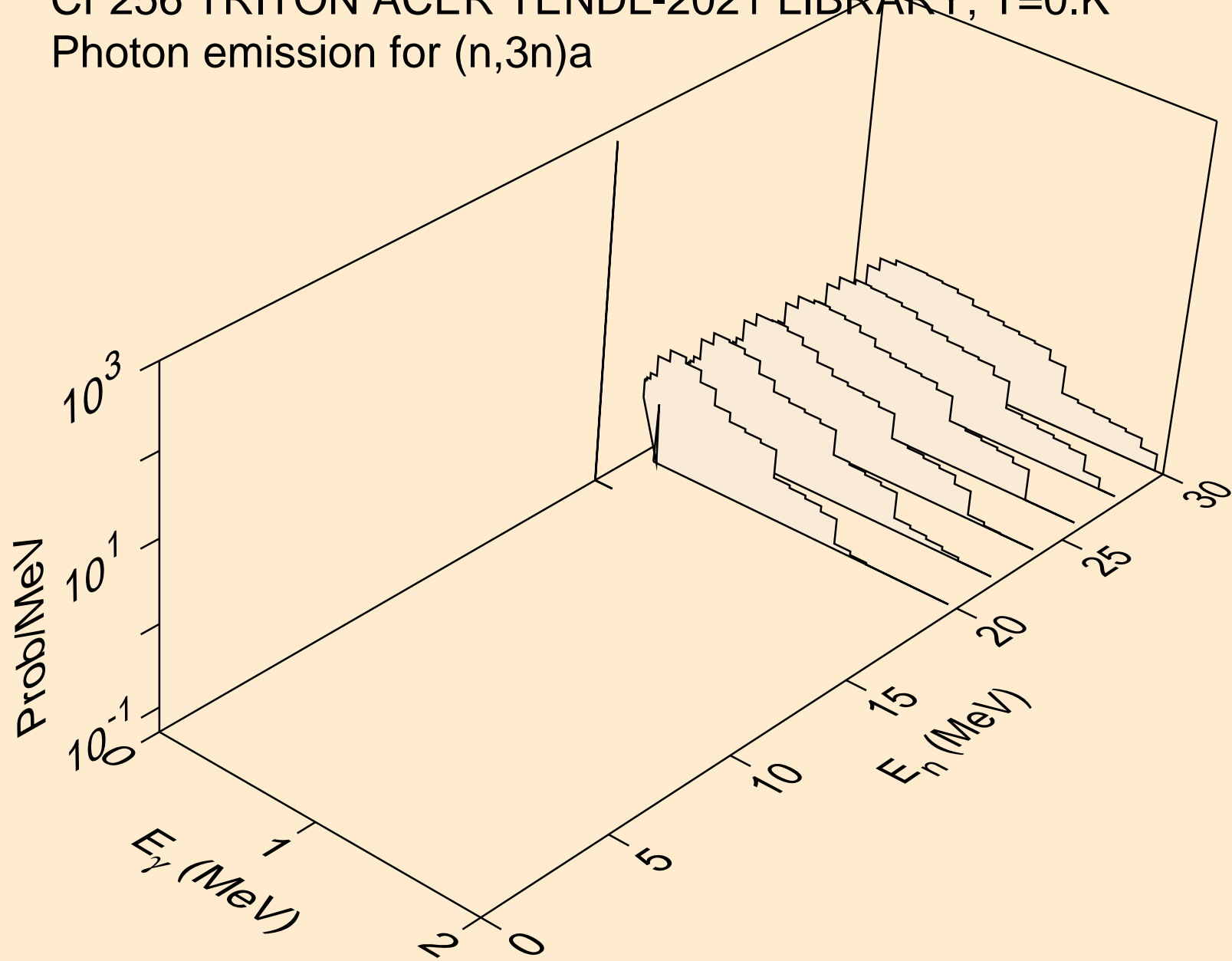

CF256 TRITON ACER TENDL-2021 LIBRARY; T=0.K  
Photon emission for (n,n\*)p

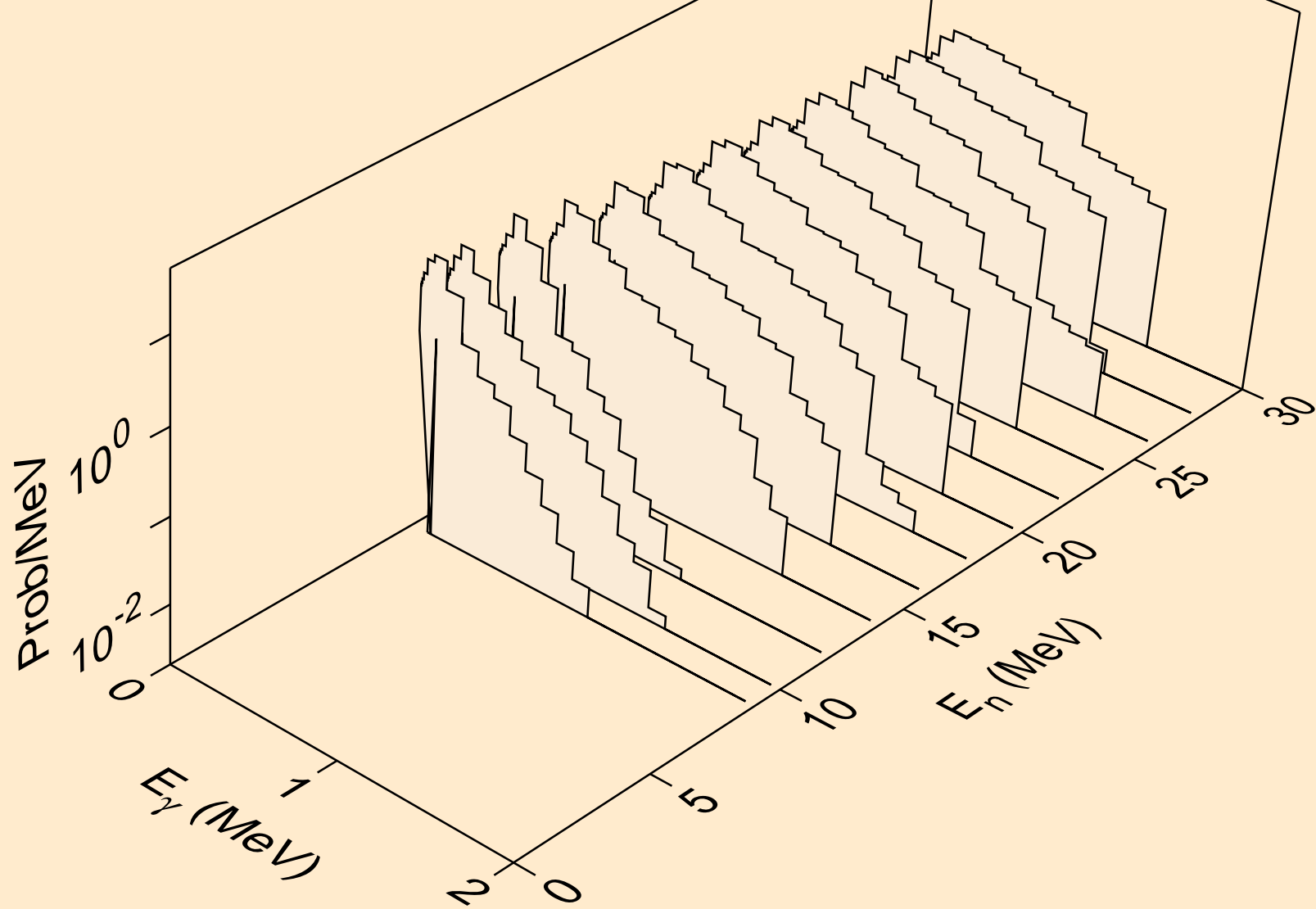



CF256 TRITON ACER TENDL-2021 LIBRARY; T=0.K  
Photon emission for (n,n\*)d

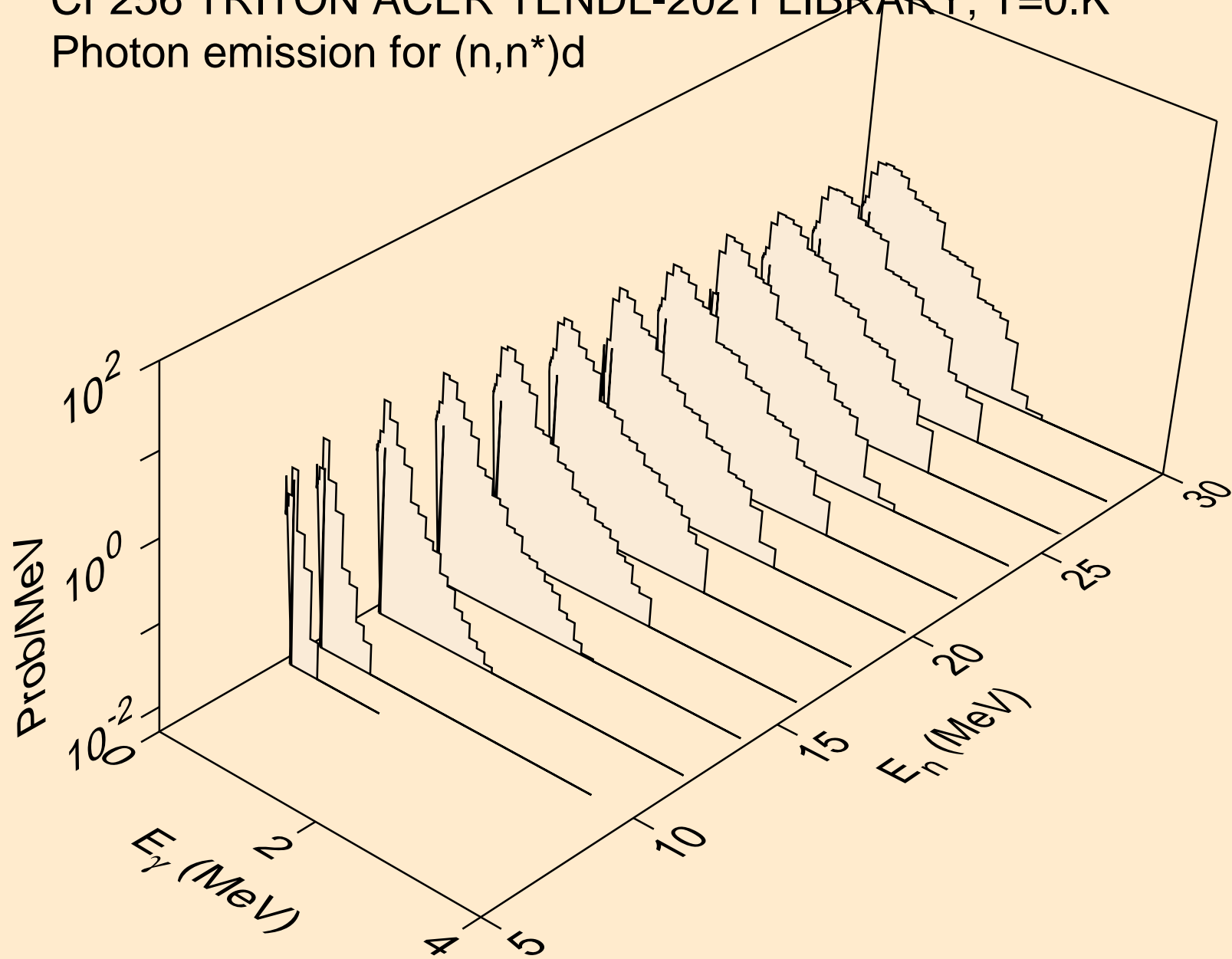

CF256 TRITON ACER TENDL-2021 LIBRARY; T=0.K  
Photon emission for (n,n\*)t

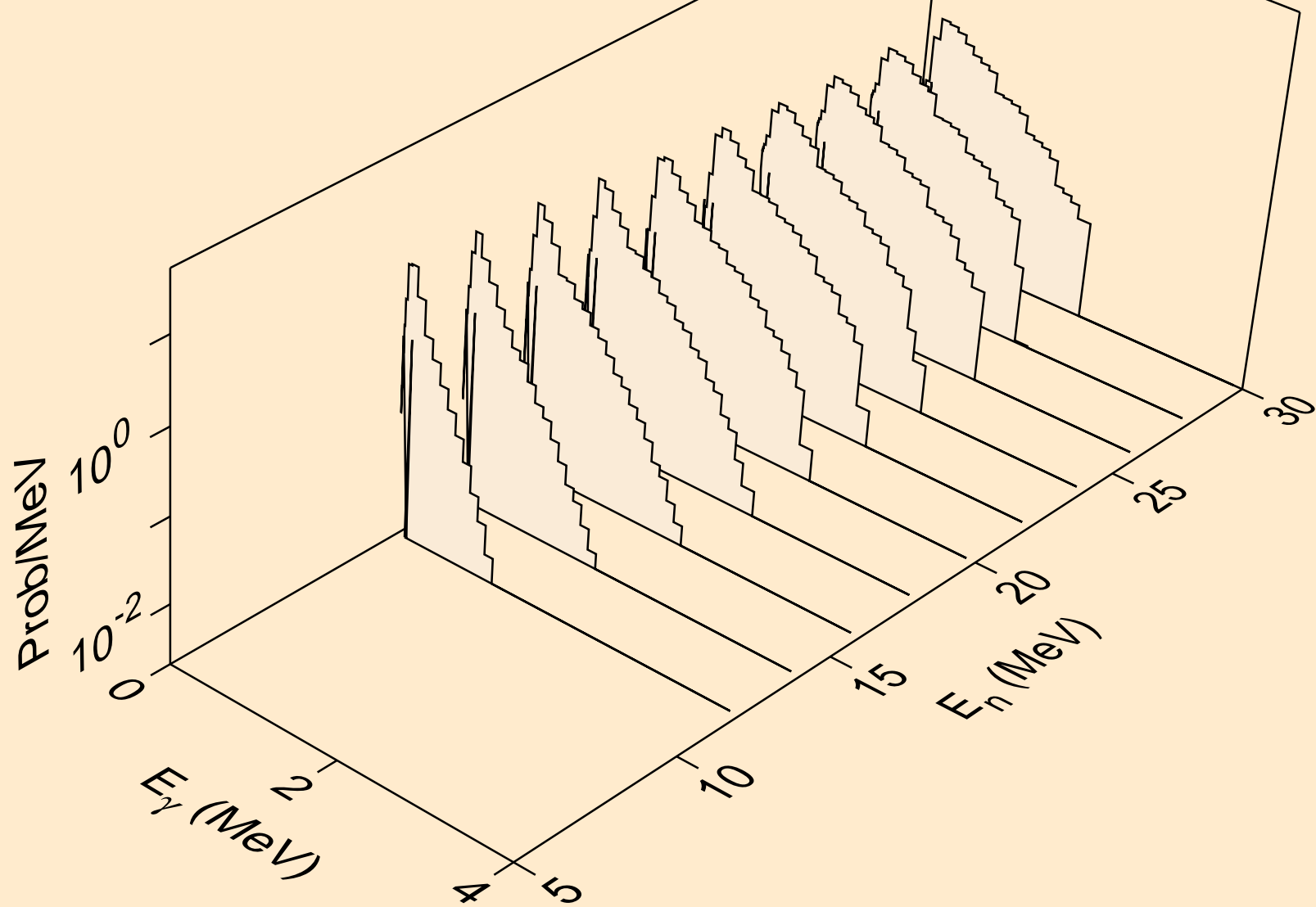

CF256 TRITON ACER TENDL-2021 LIBRARY; T=0.K  
Photon emission for (n,n\*)he3

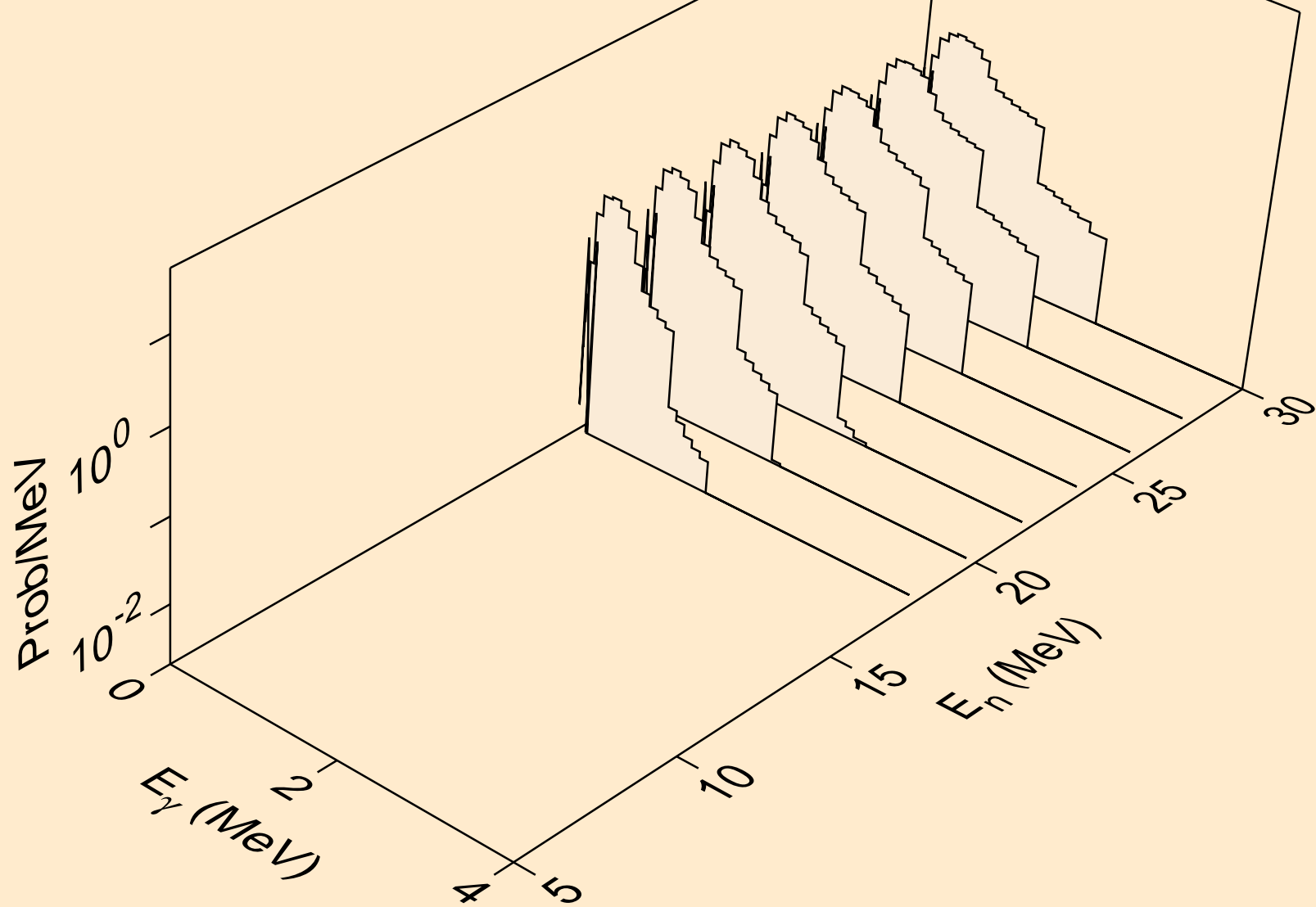

CF256 TRITON ACER TENDL-2021 LIBRARY; T=0.K  
Photon emission for (n,4n)

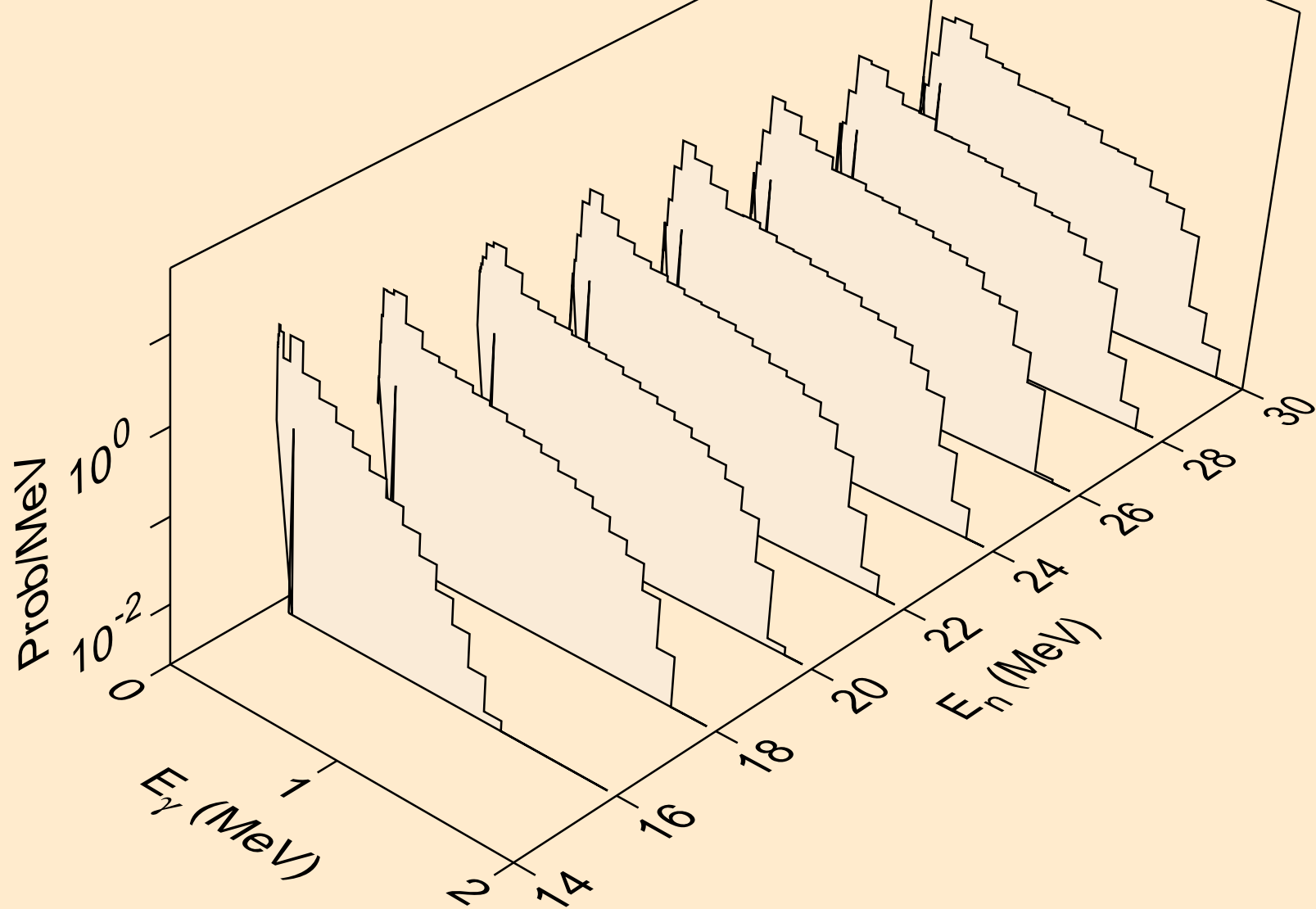

CF256 TRITON ACER TENDL-2021 LIBRARY; T=0.K  
Photon emission for (n,2np)

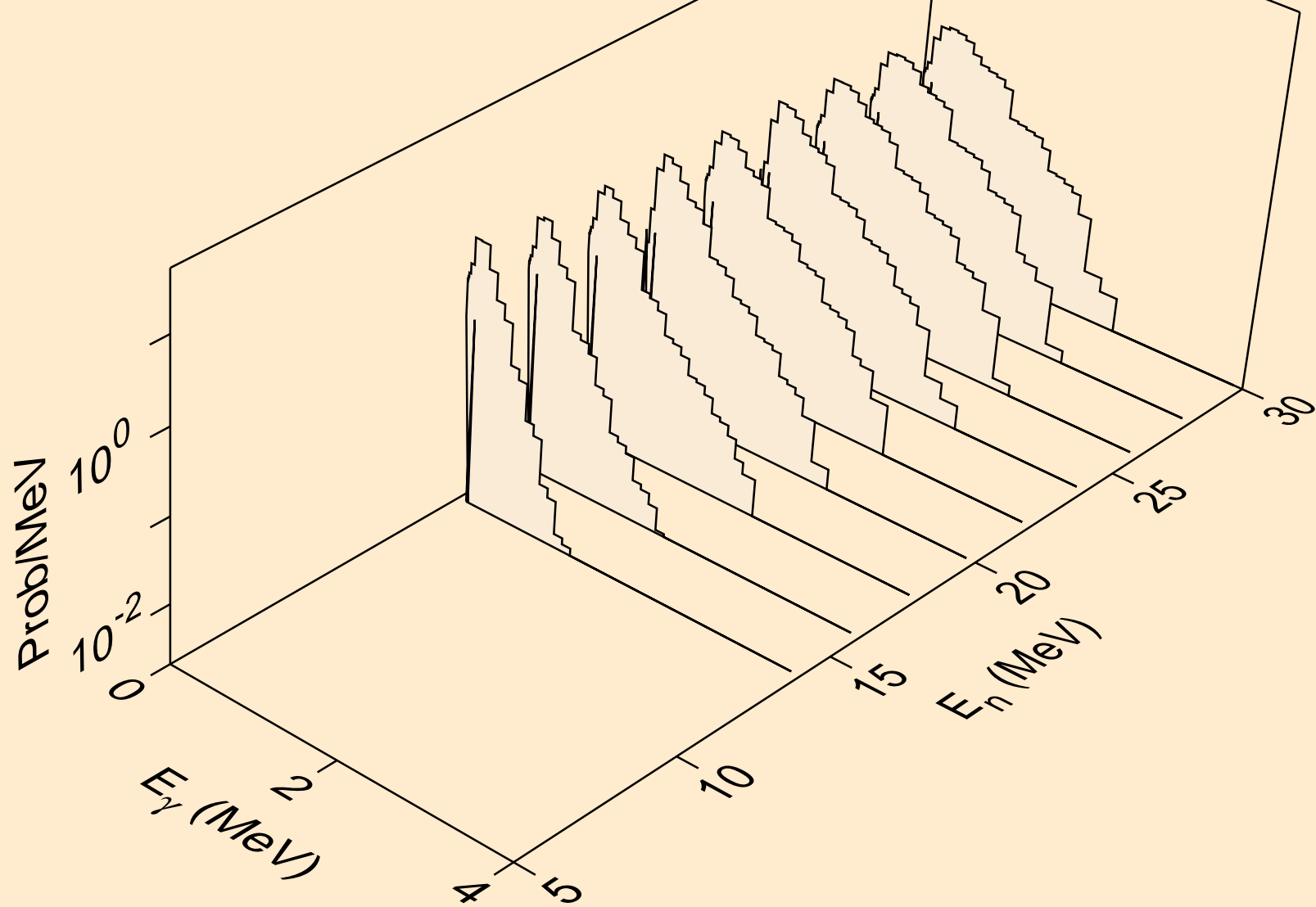

CF256 TRITON ACER TENDL-2021 LIBRARY; T=0.K  
Photon emission for (n,3np)

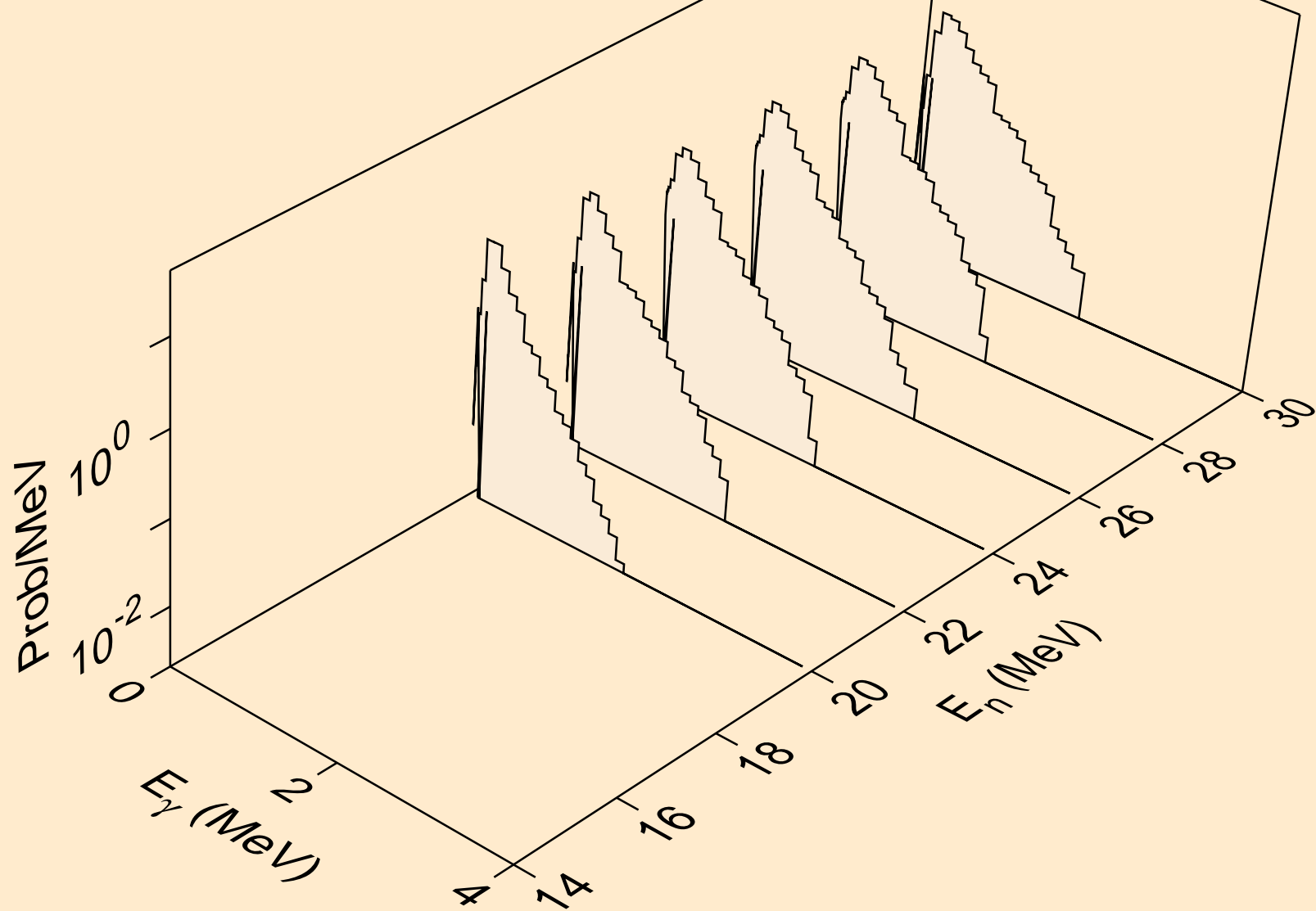

CF256 TRITON ACER TENDL-2021 LIBRARY; T=0.K  
Photon emission for (n,p)

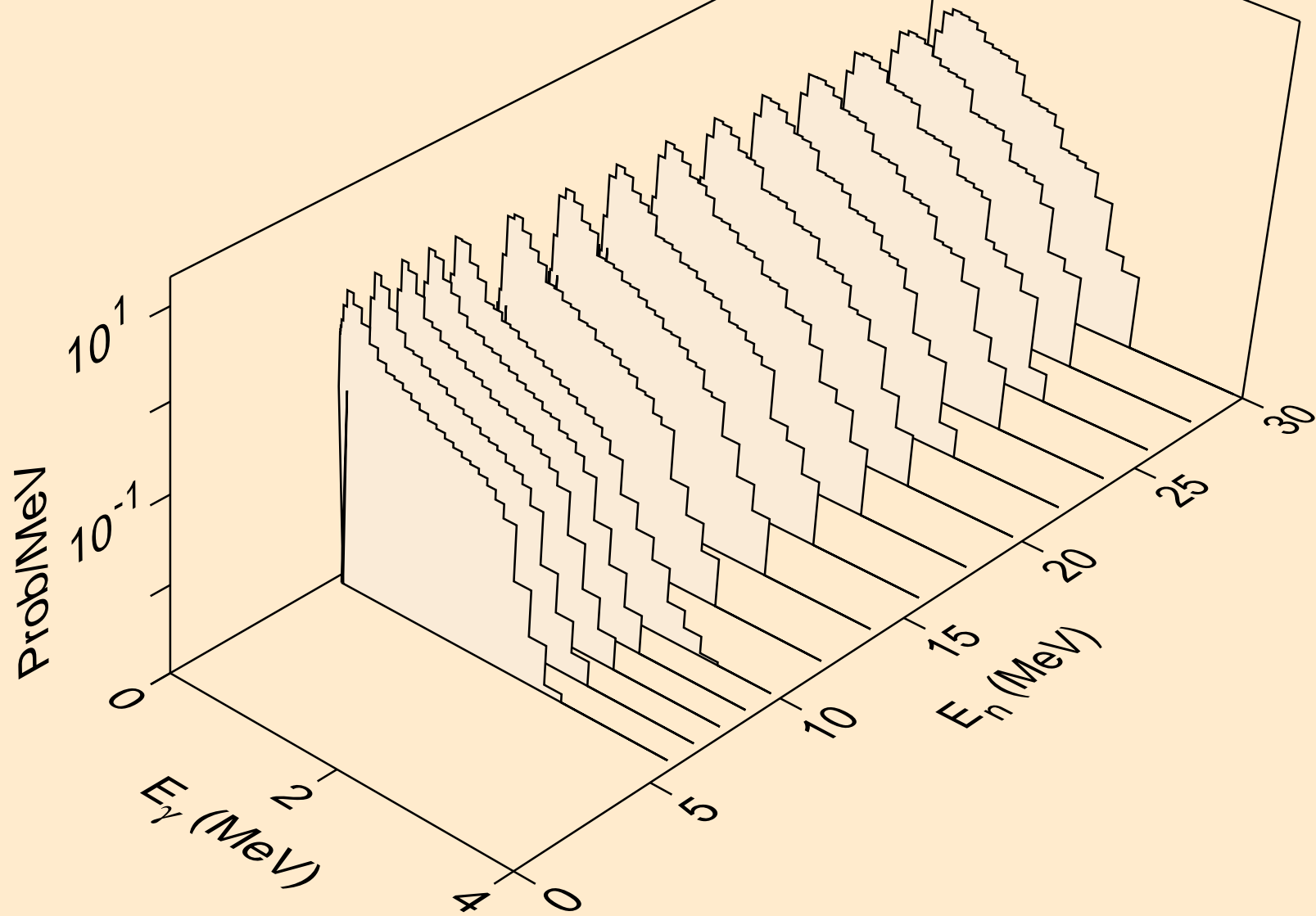

CF256 TRITON ACER TENDL-2021 LIBRARY; T=0.K  
Photon emission for (n,d)

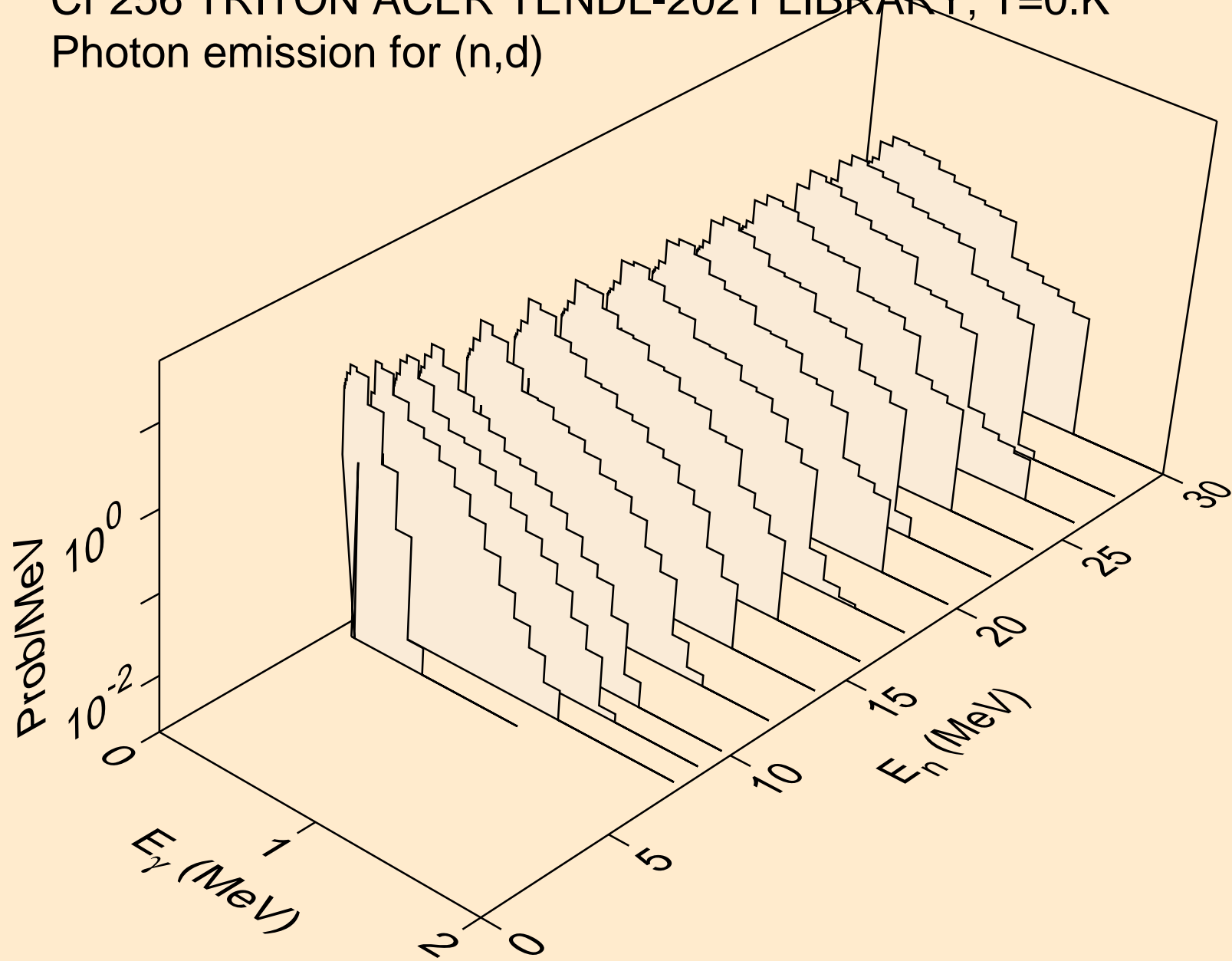



CF256 TRITON ACER TENDL-2021 LIBRARY; T=0.K  
Photon emission for inelastic

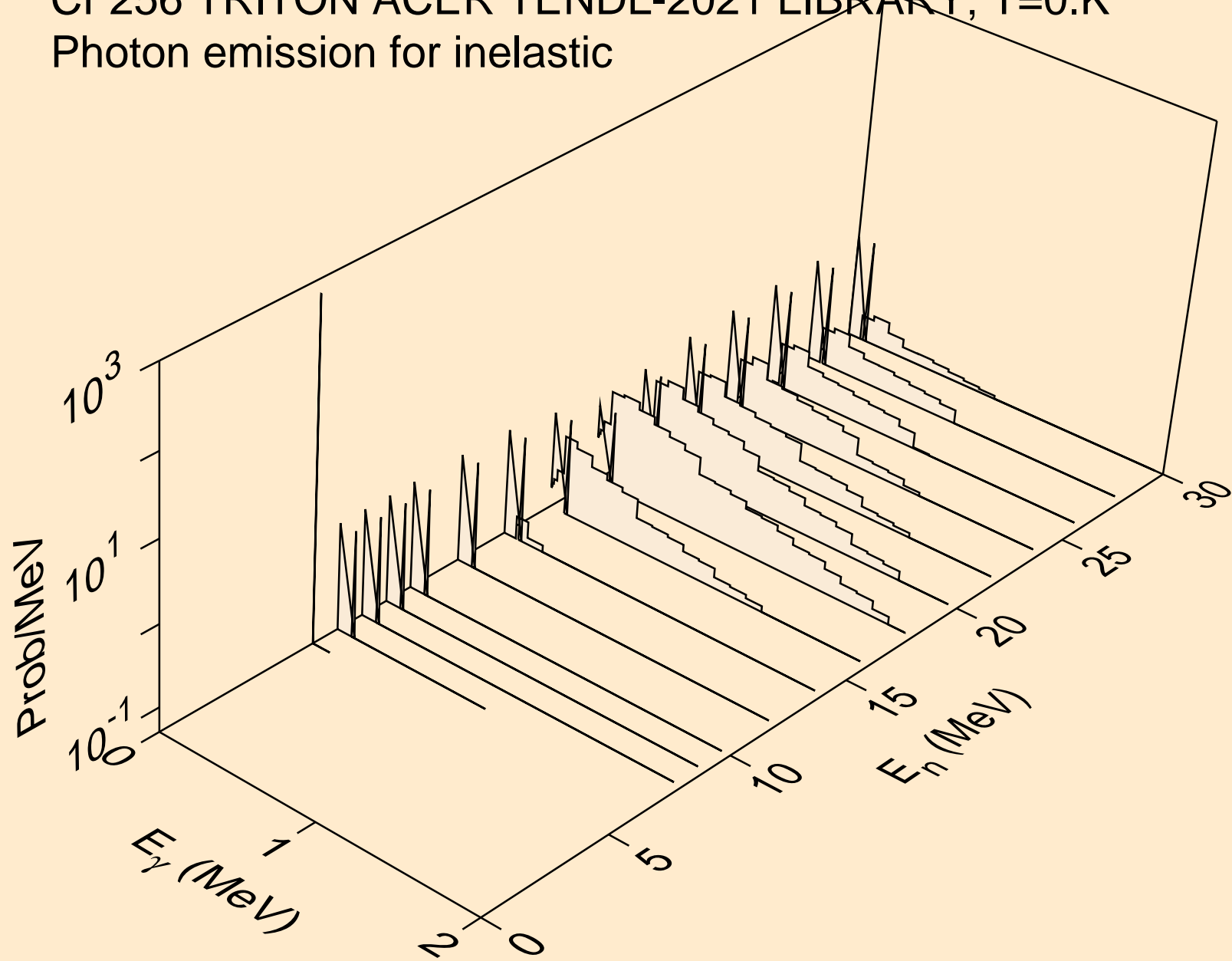

CF256 TRITON ACER TENDL-2021 LIBRARY; T=0.K  
Photon emission for (n,he3)

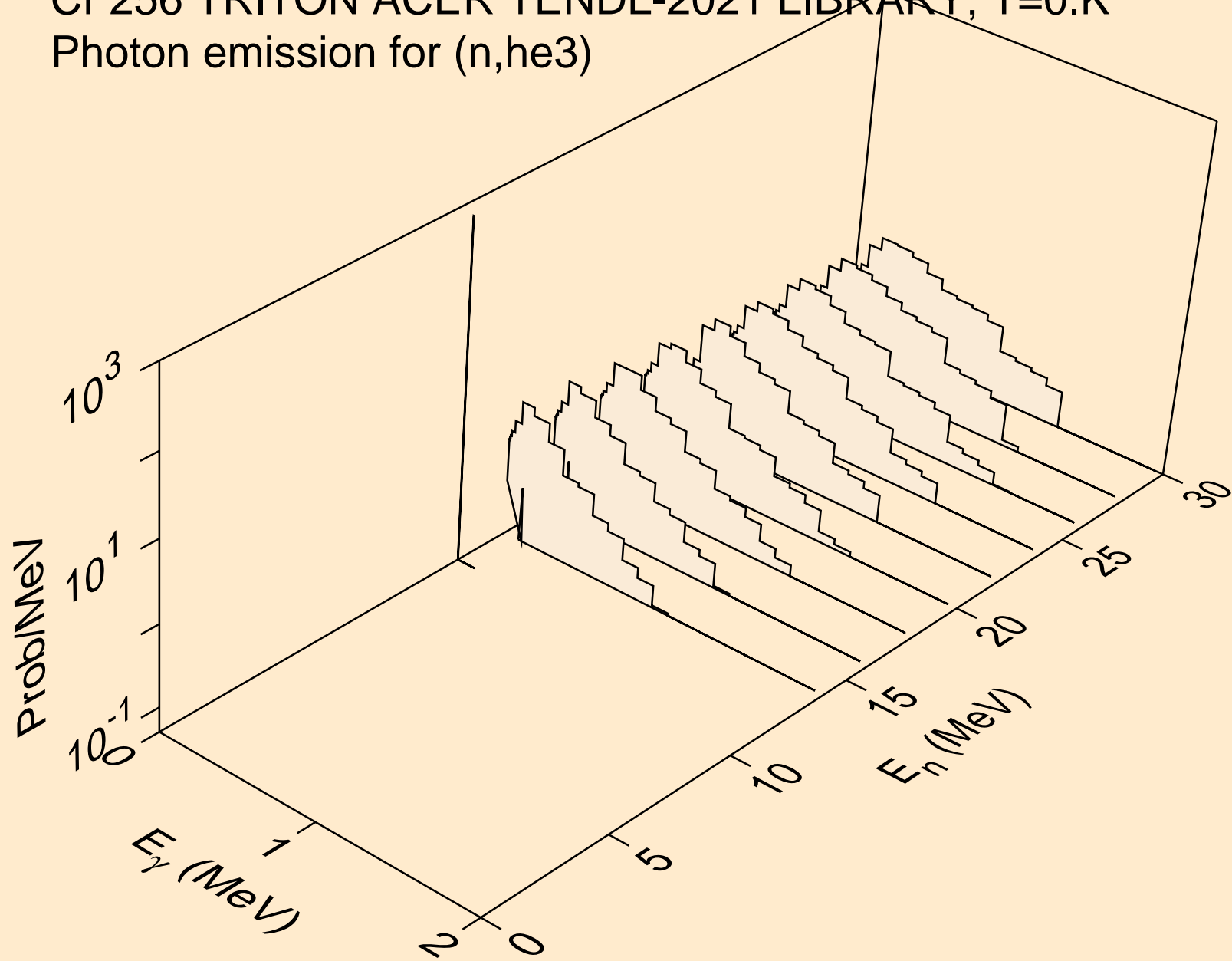

CF256 TRITON ACER TENDL-2021 LIBRARY; T=0.K  
Photon emission for (n,a)

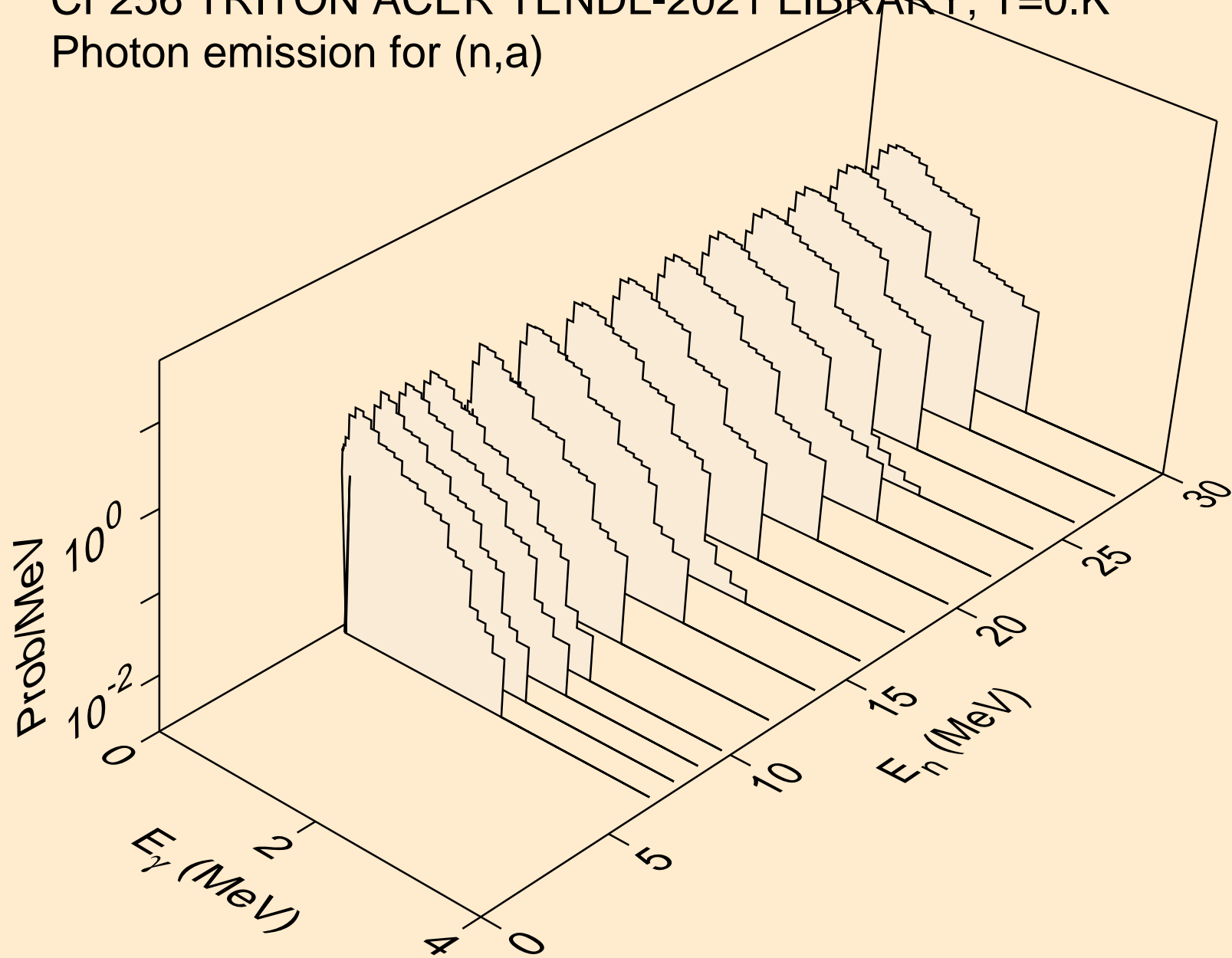

CF256 TRITON ACER TENDL-2021 LIBRARY; T=0.K  
Photon emission for (n,2p)

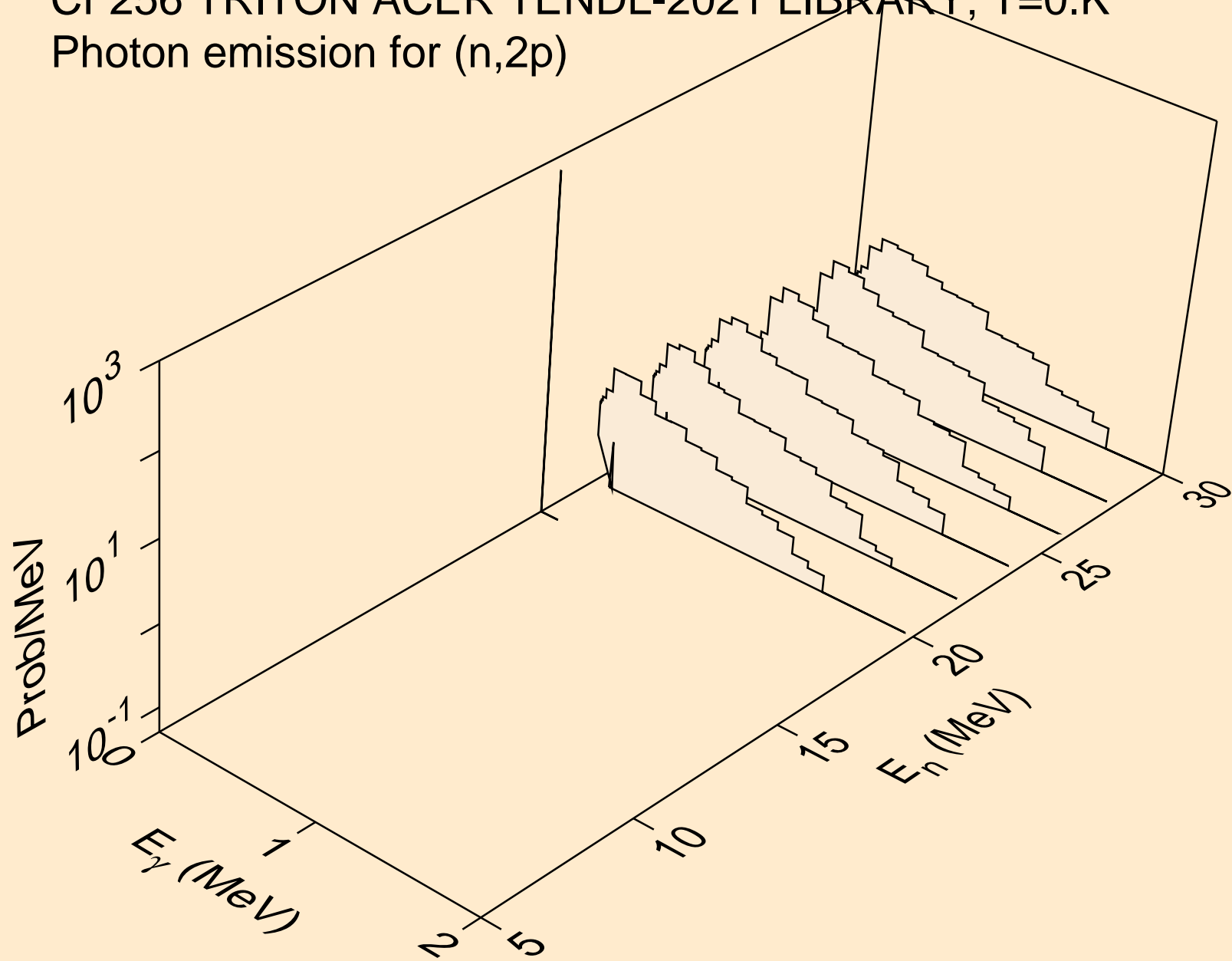

CF256 TRITON ACER TENDL-2021 LIBRARY; T=0.K  
Particle heating contributions

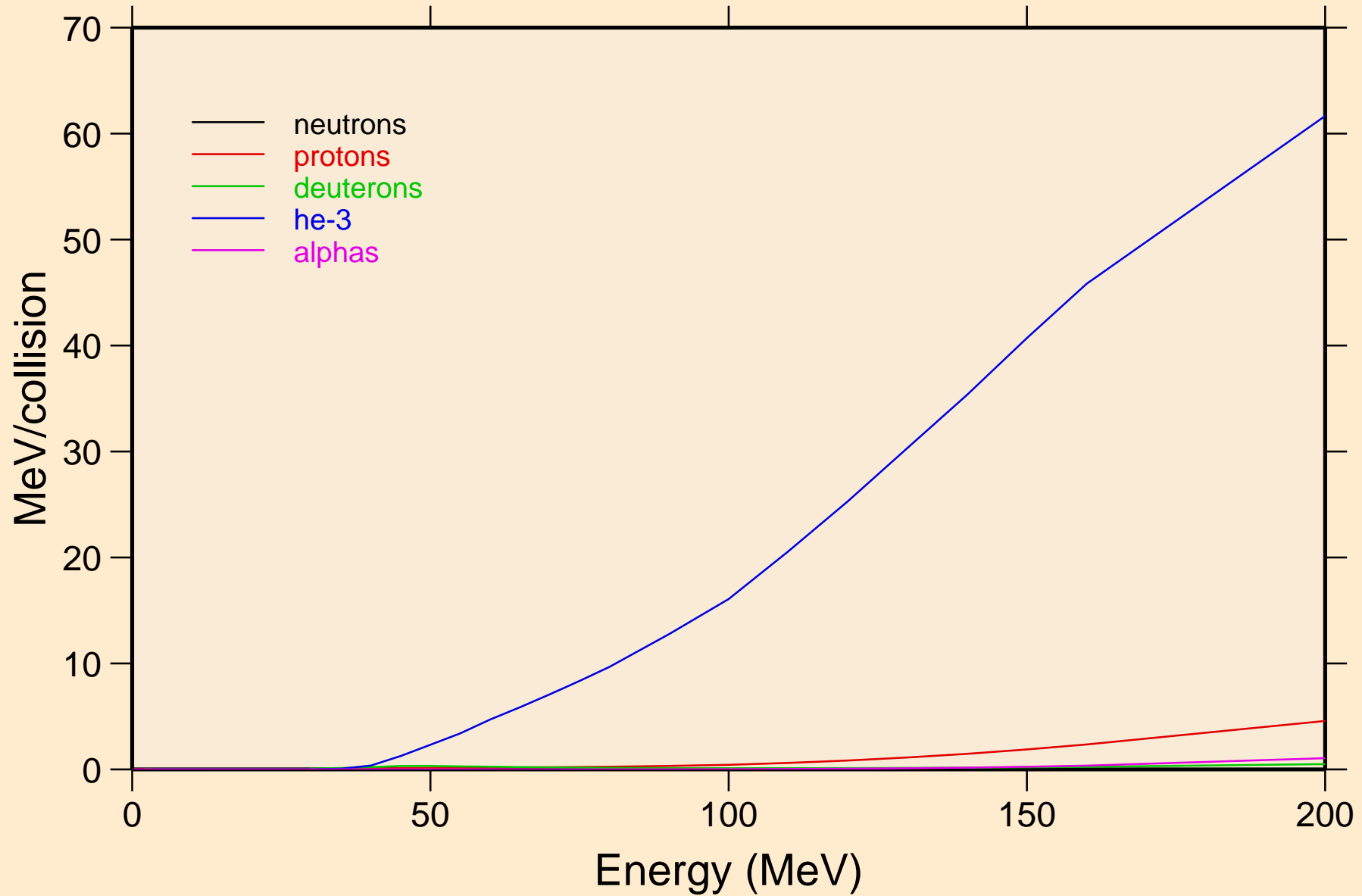

CF256 TRITON ACER TENDL-2021 LIBRARY; T=0.K  
Recoil Heating

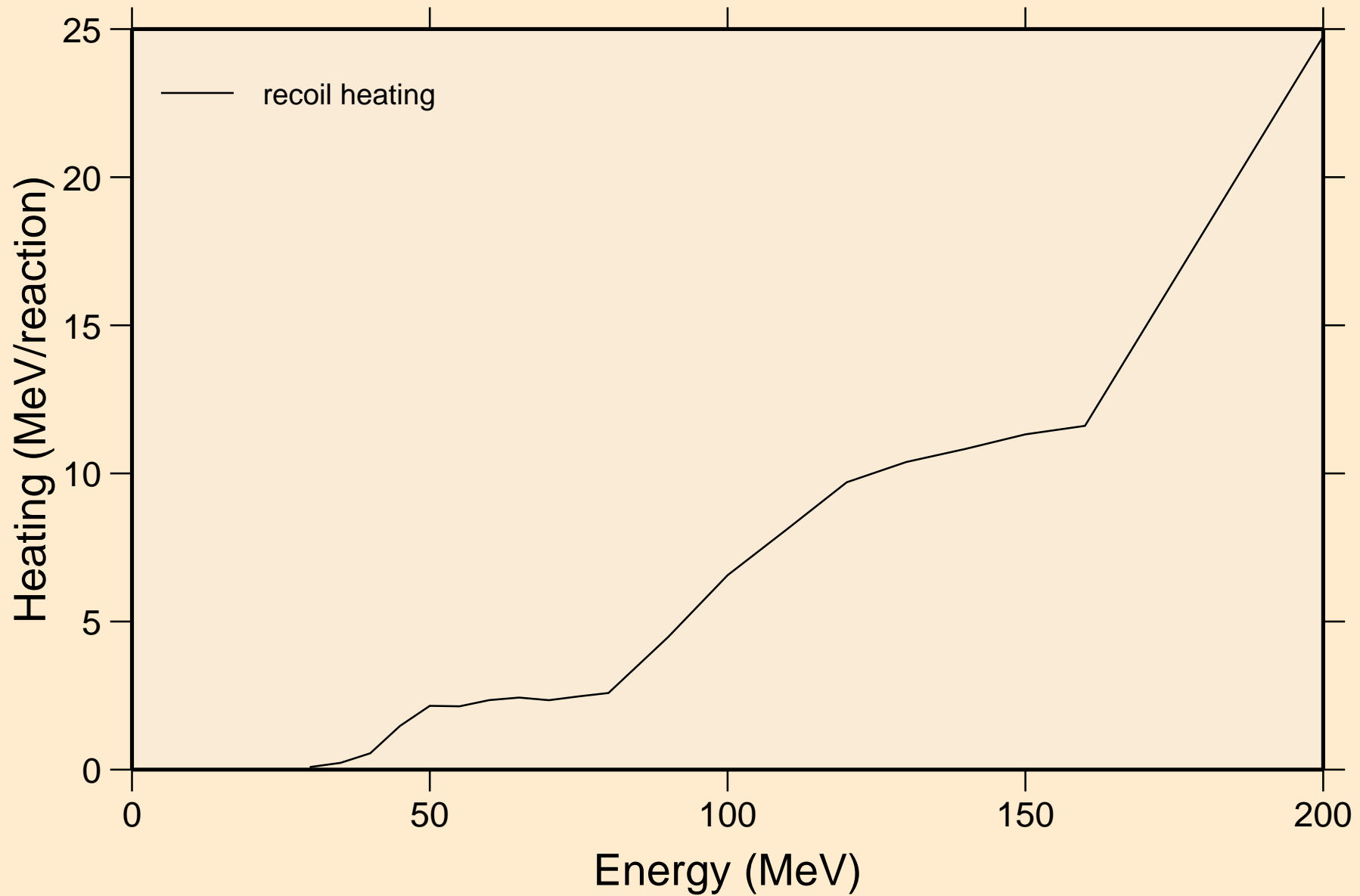

CF256 TRITON ACER TENDL-2021 LIBRARY; T=0.K  
Particle production cross sections

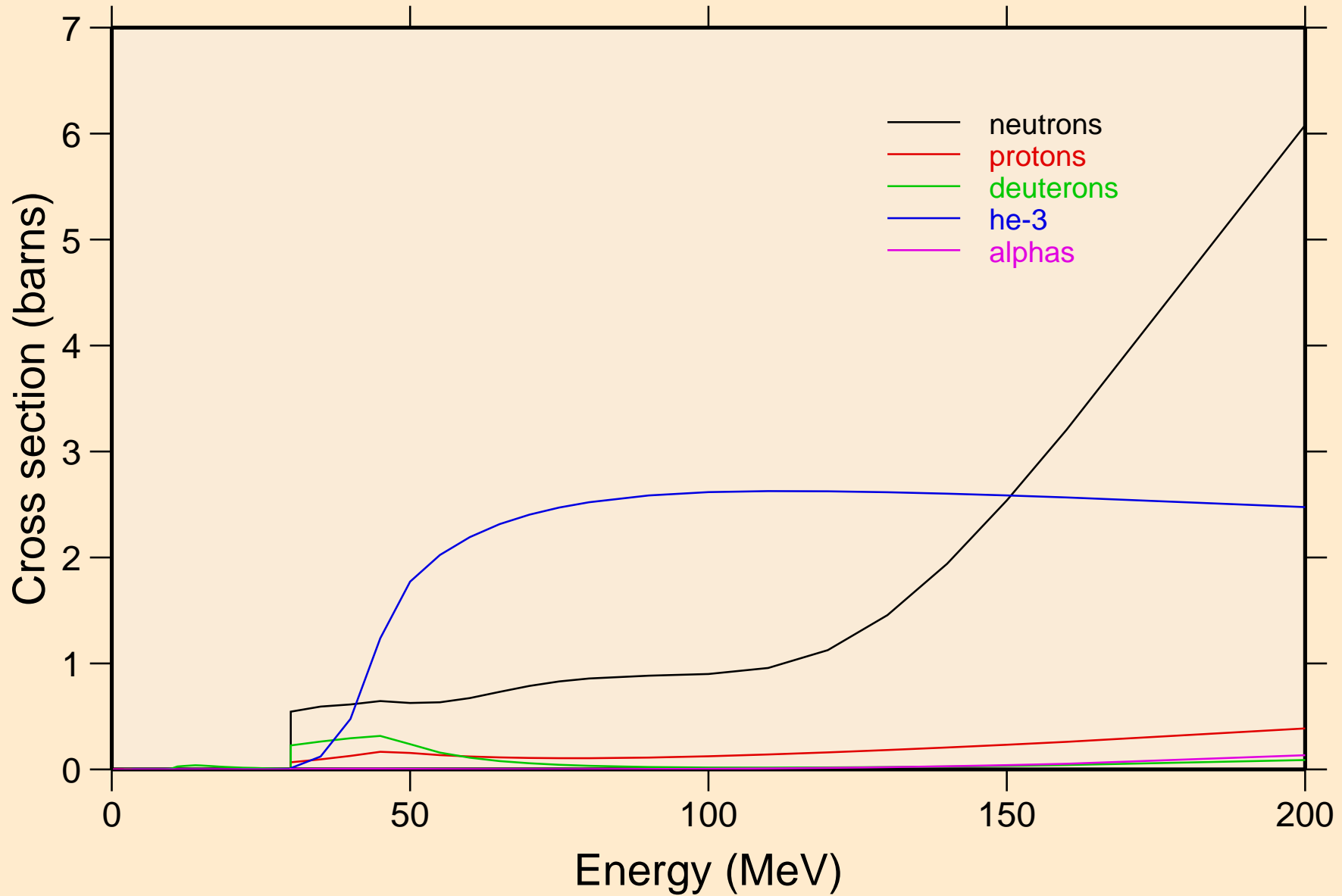

CF256 TRITON ACER TENDL-2021 LIBRARY; T=0.K  
neutrons from (t,n)

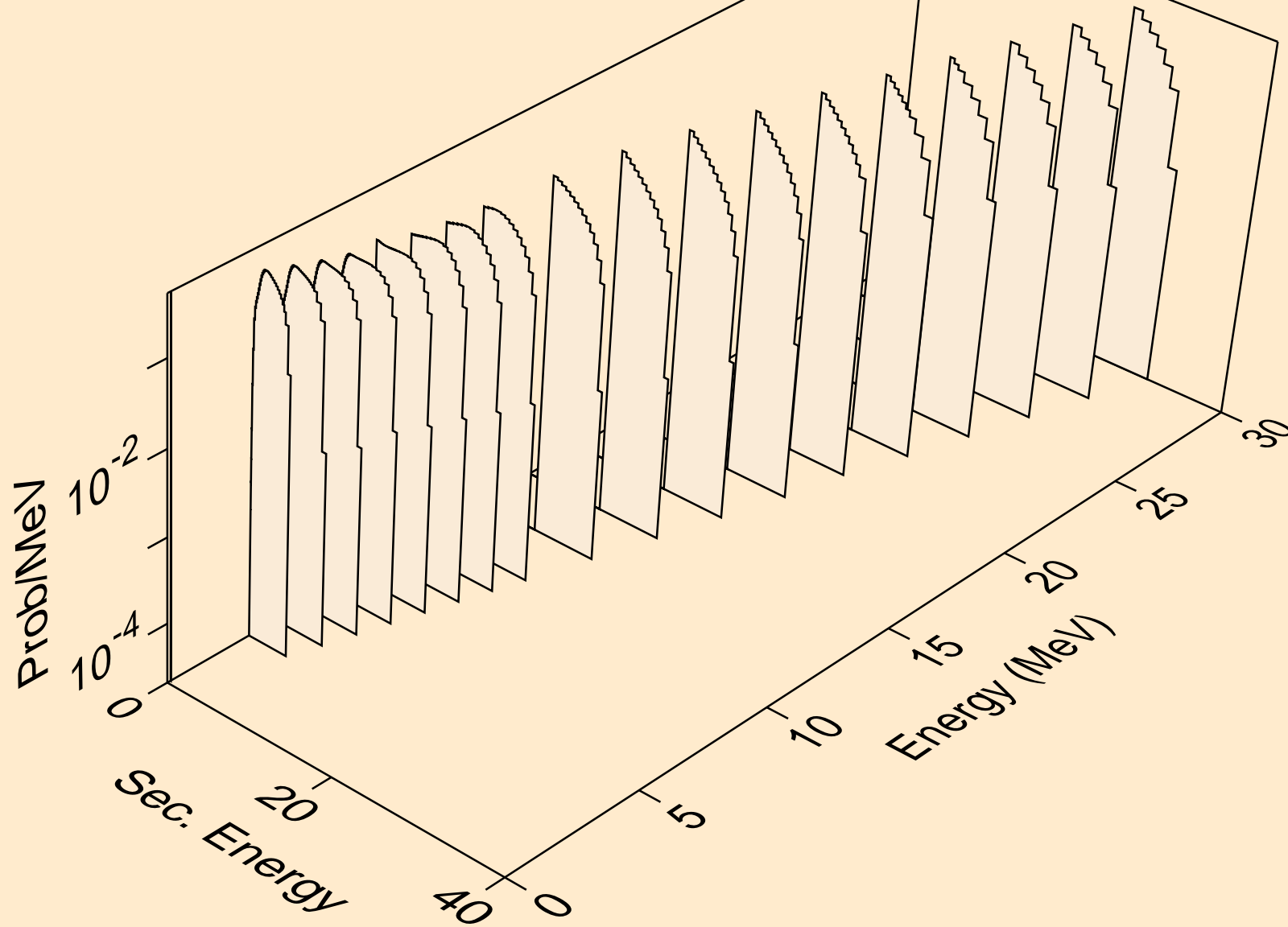



CF256 TRITON ACER TENDL-2021 LIBRARY; T=0.K  
neutrons from (t,x)

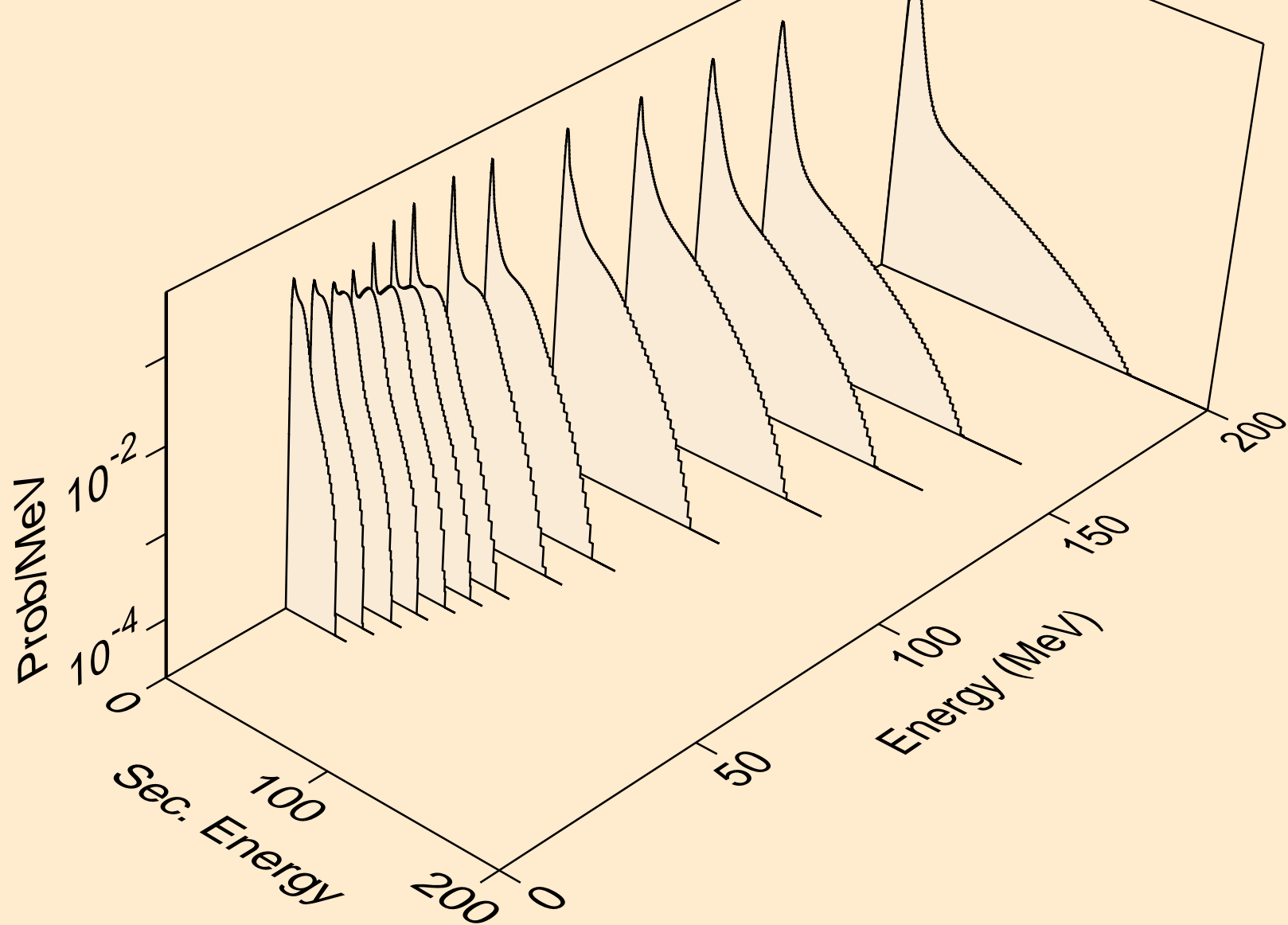

CF256 TRITON ACER TENDL-2021 LIBRARY; T=0.K  
neutrons from (t,2nd)

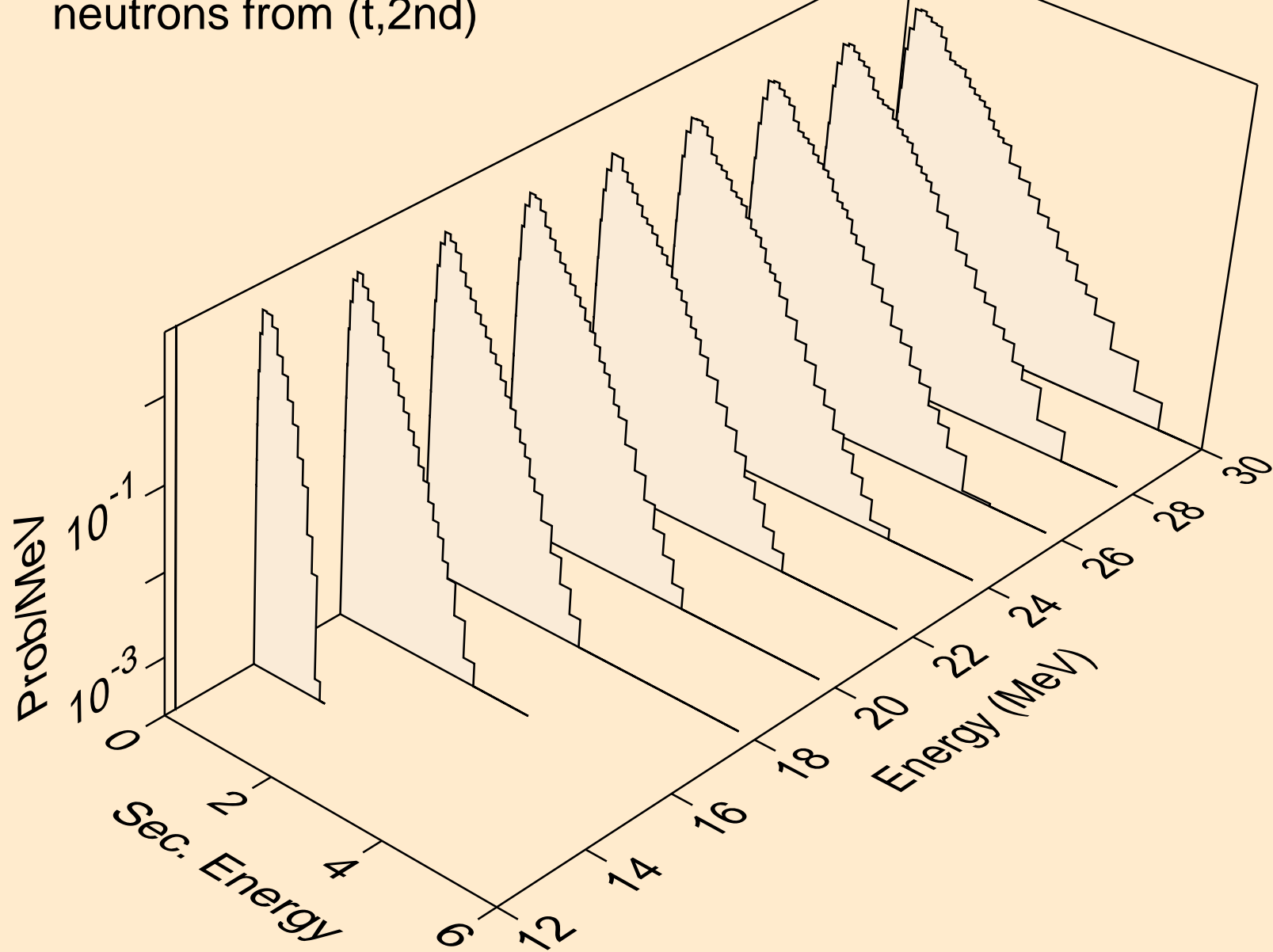

CF256 TRITON ACER TENDL-2021 LIBRARY; T=0.K  
neutrons from (t,2n)

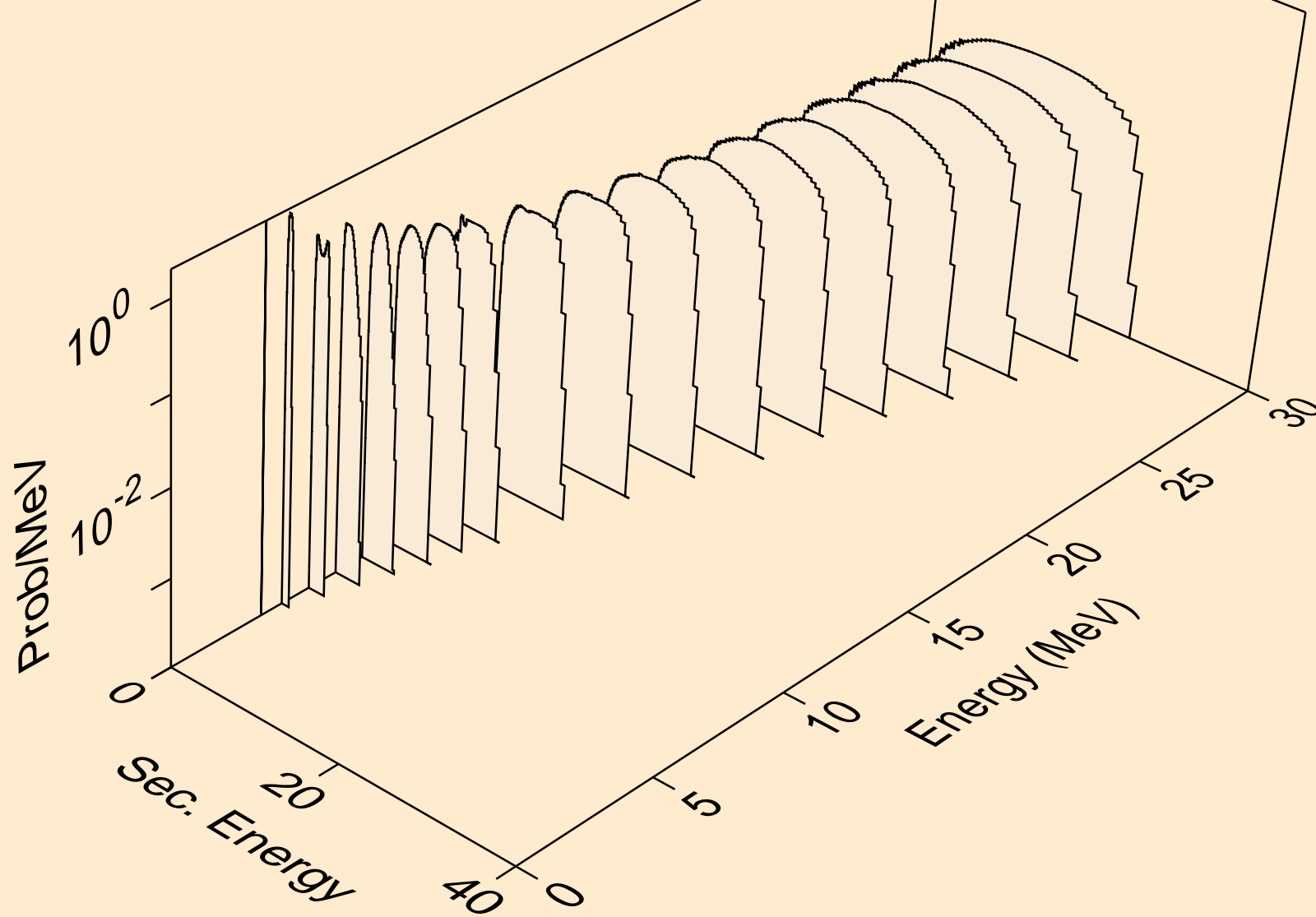

CF256 TRITON ACER TENDL-2021 LIBRARY; T=0.K  
neutrons from (t,3n)

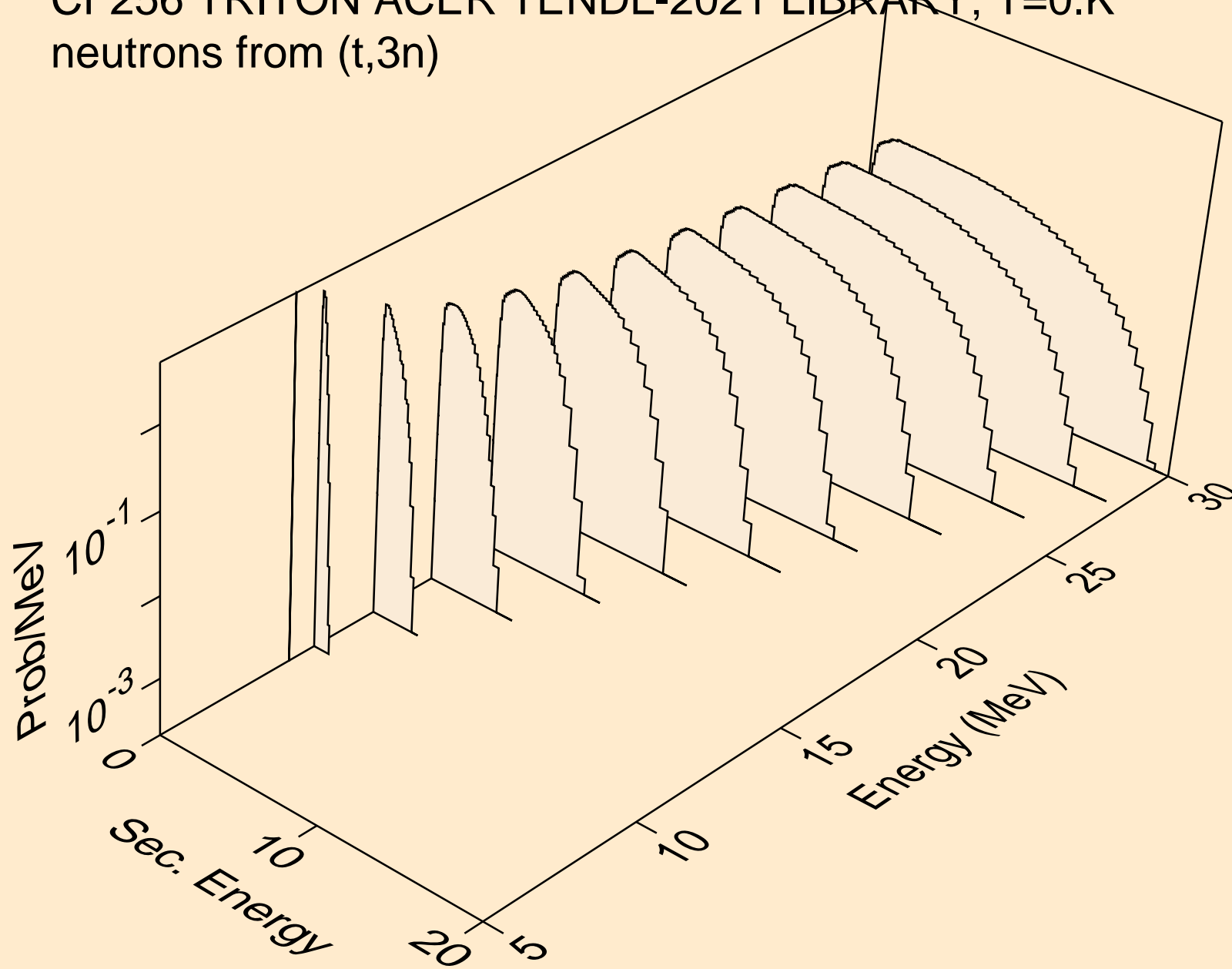

CF256 TRITON ACER TENDL-2021 LIBRARY; T=0.K  
neutrons from (t,n\*)a

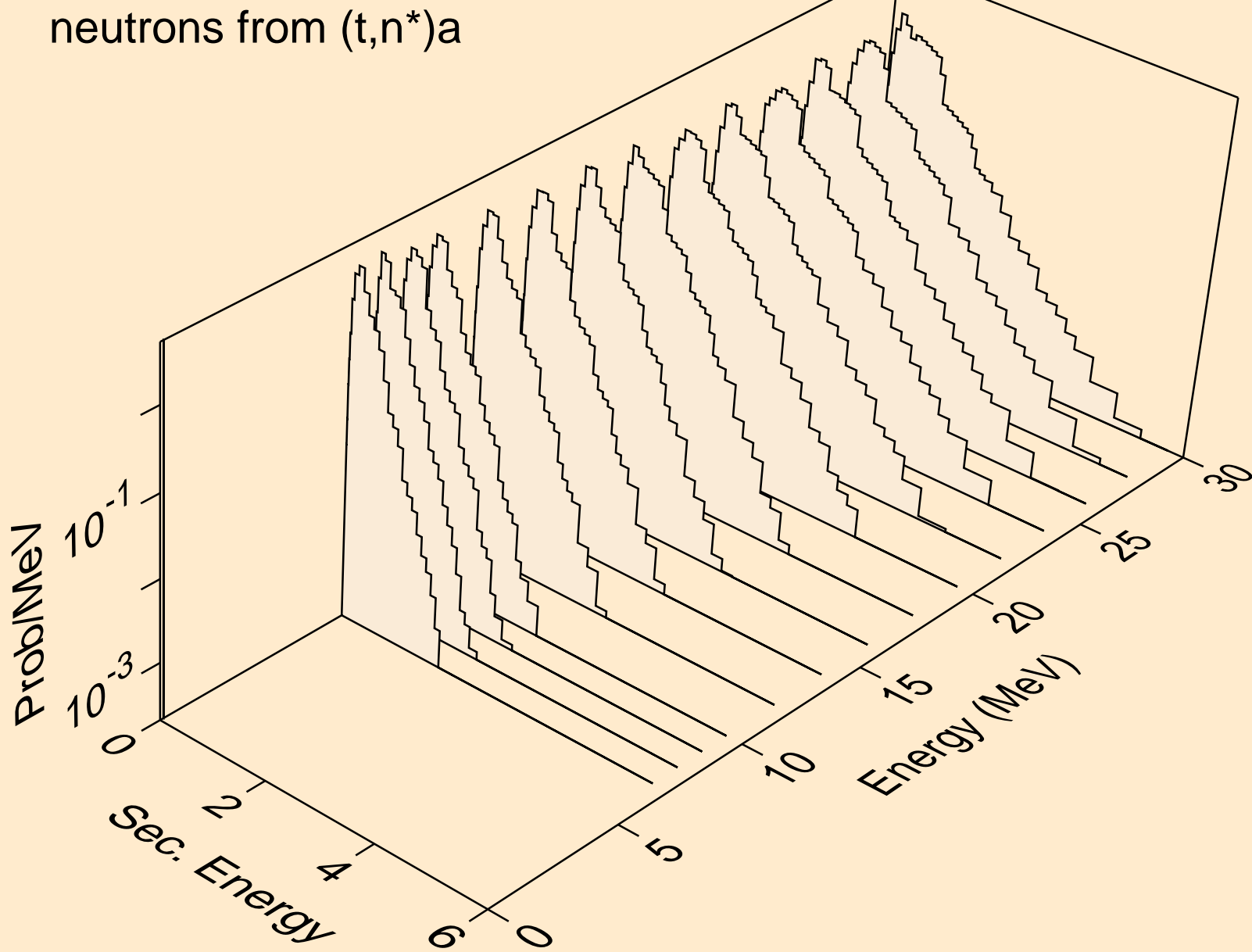

CF256 TRITON ACER TENDL-2021 LIBRARY; T=0.K  
neutrons from (t,2n)a

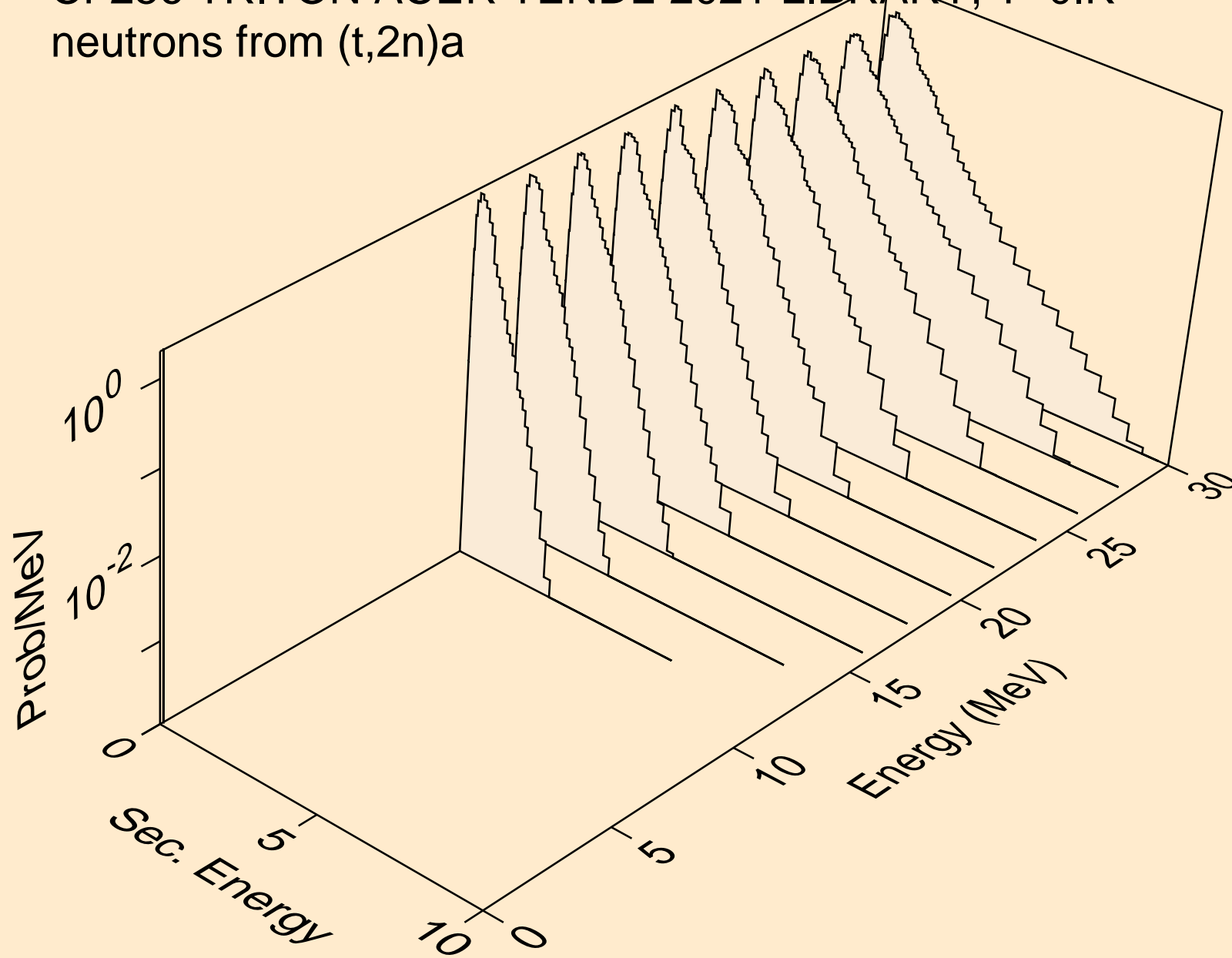

CF256 TRITON ACER TENDL-2021 LIBRARY; T=0.K  
neutrons from (t,3n)a

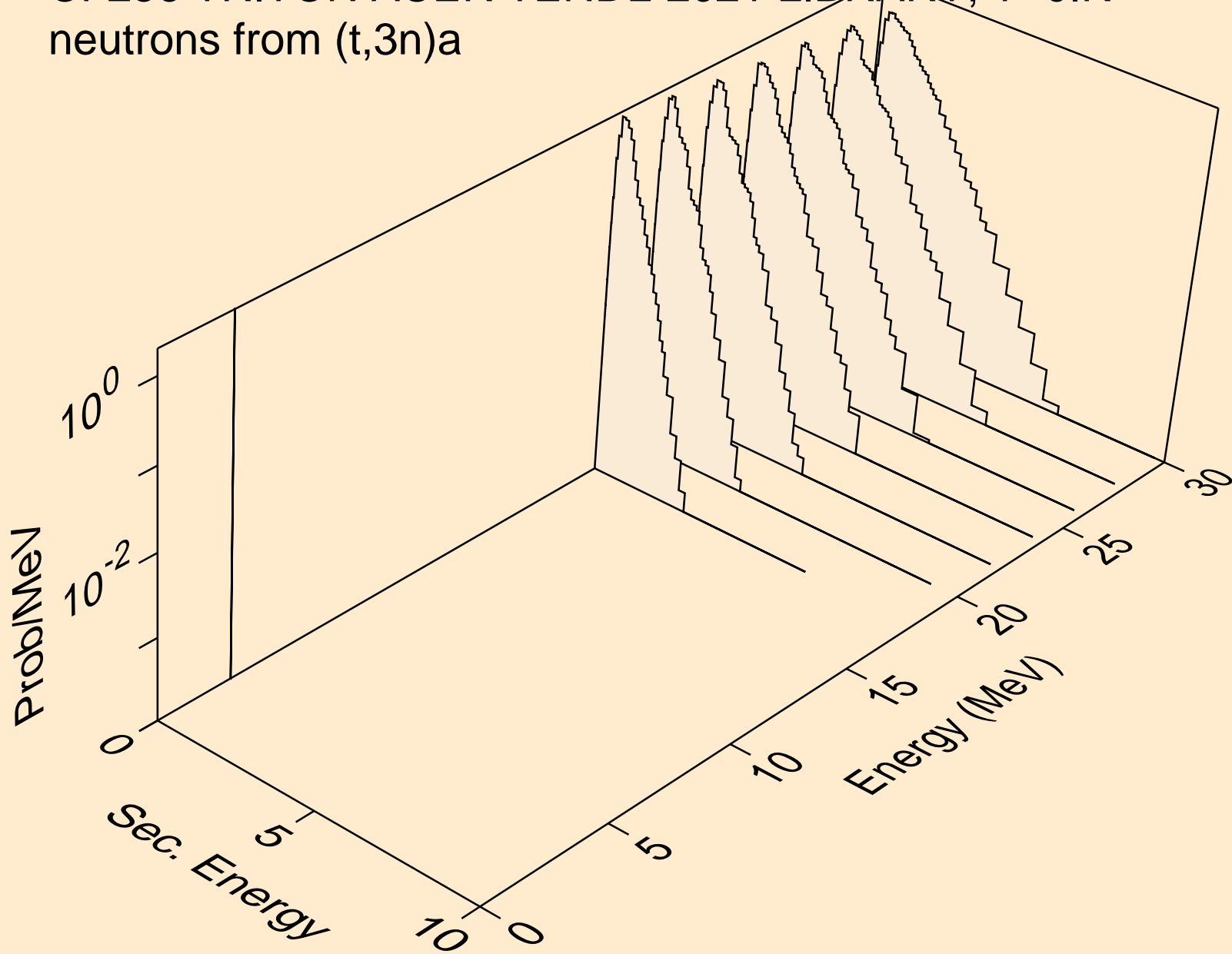

CF256 TRITON ACER TENDL-2021 LIBRARY; T=0.K  
neutrons from (t,n\*)p

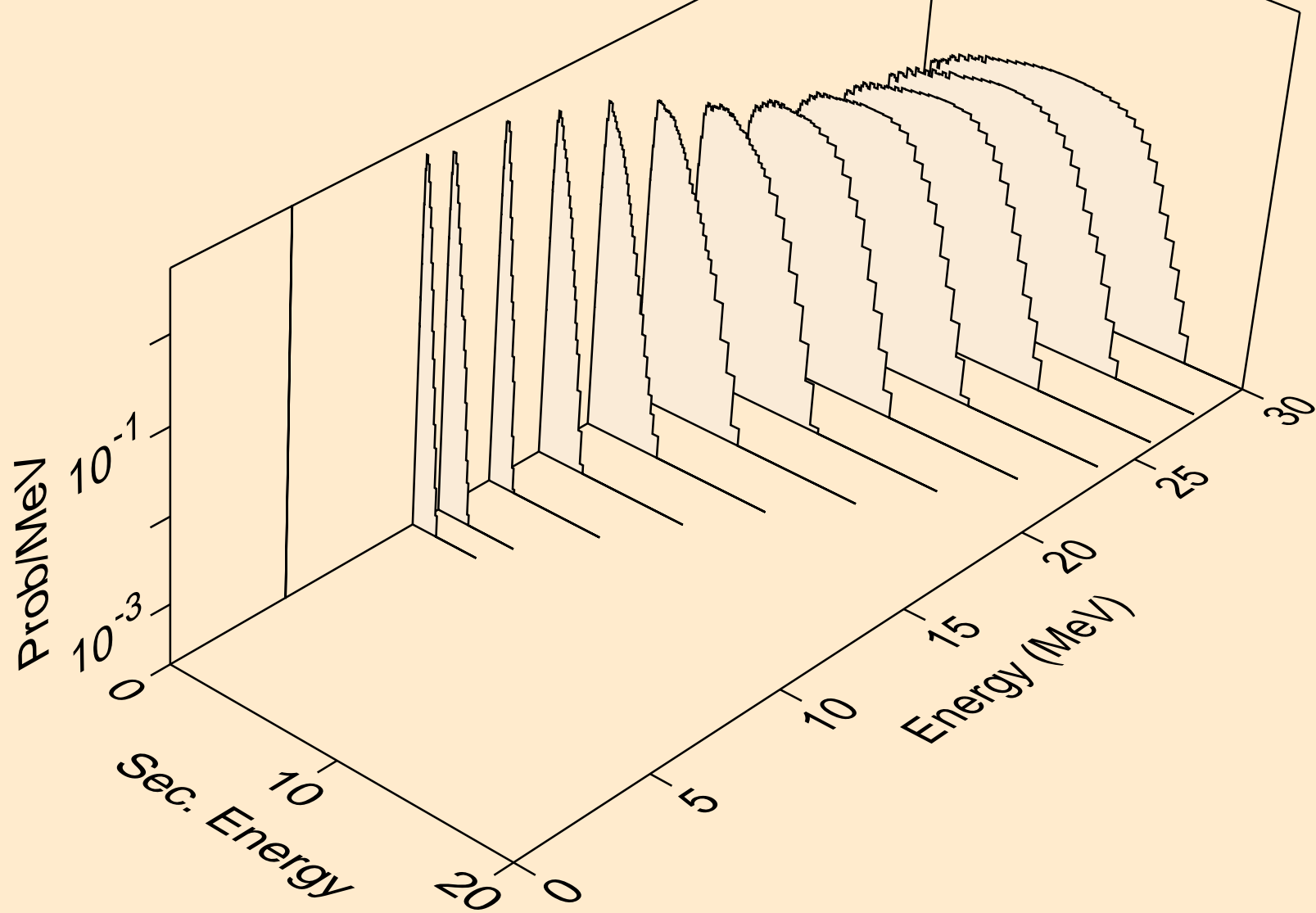



CF256 TRITON ACER TENDL-2021 LIBRARY; T=0.K  
neutrons from (t,n\*)d

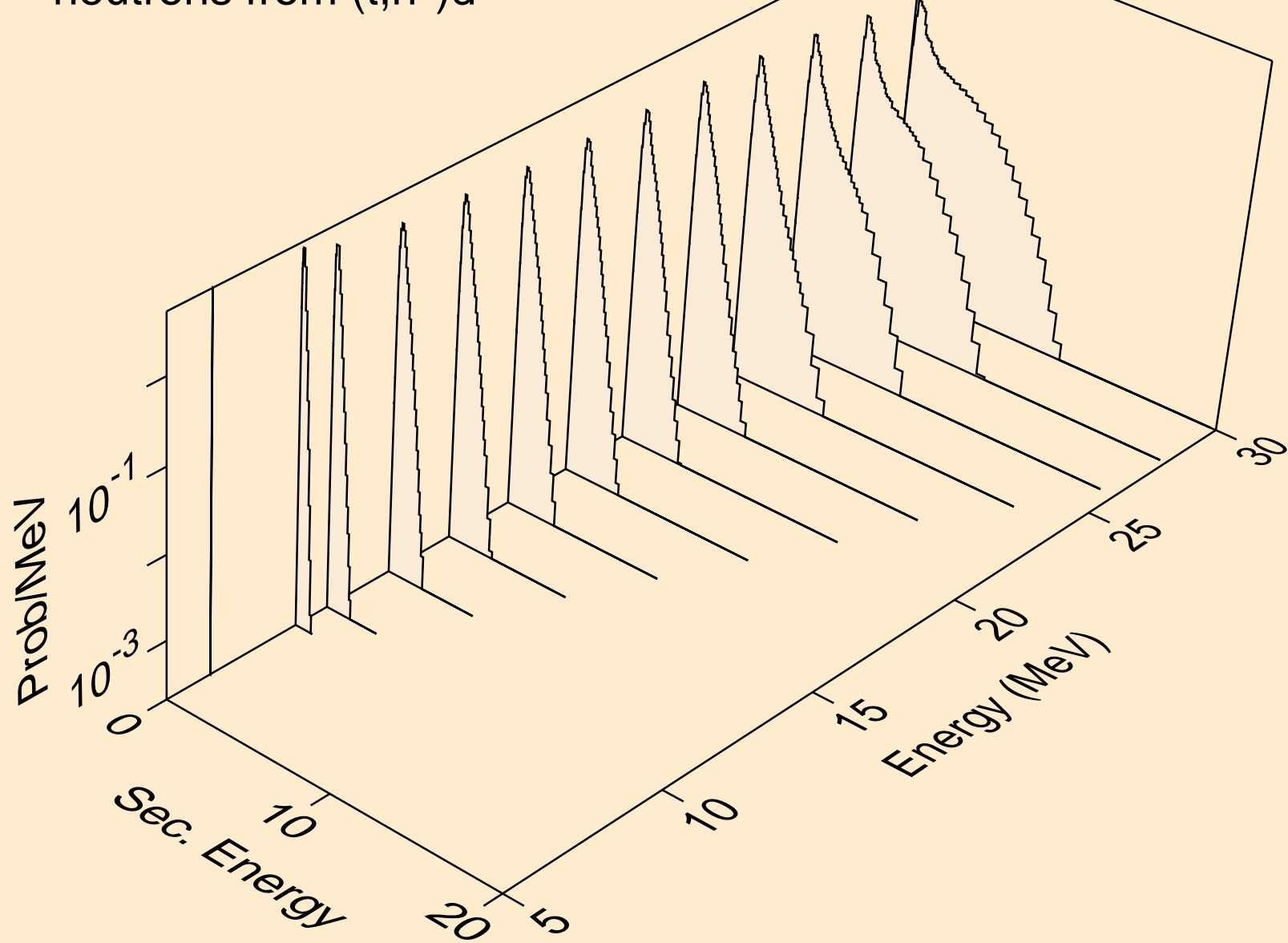

CF256 TRITON ACER TENDL-2021 LIBRARY; T=0.K  
neutrons from (t,n\*)t

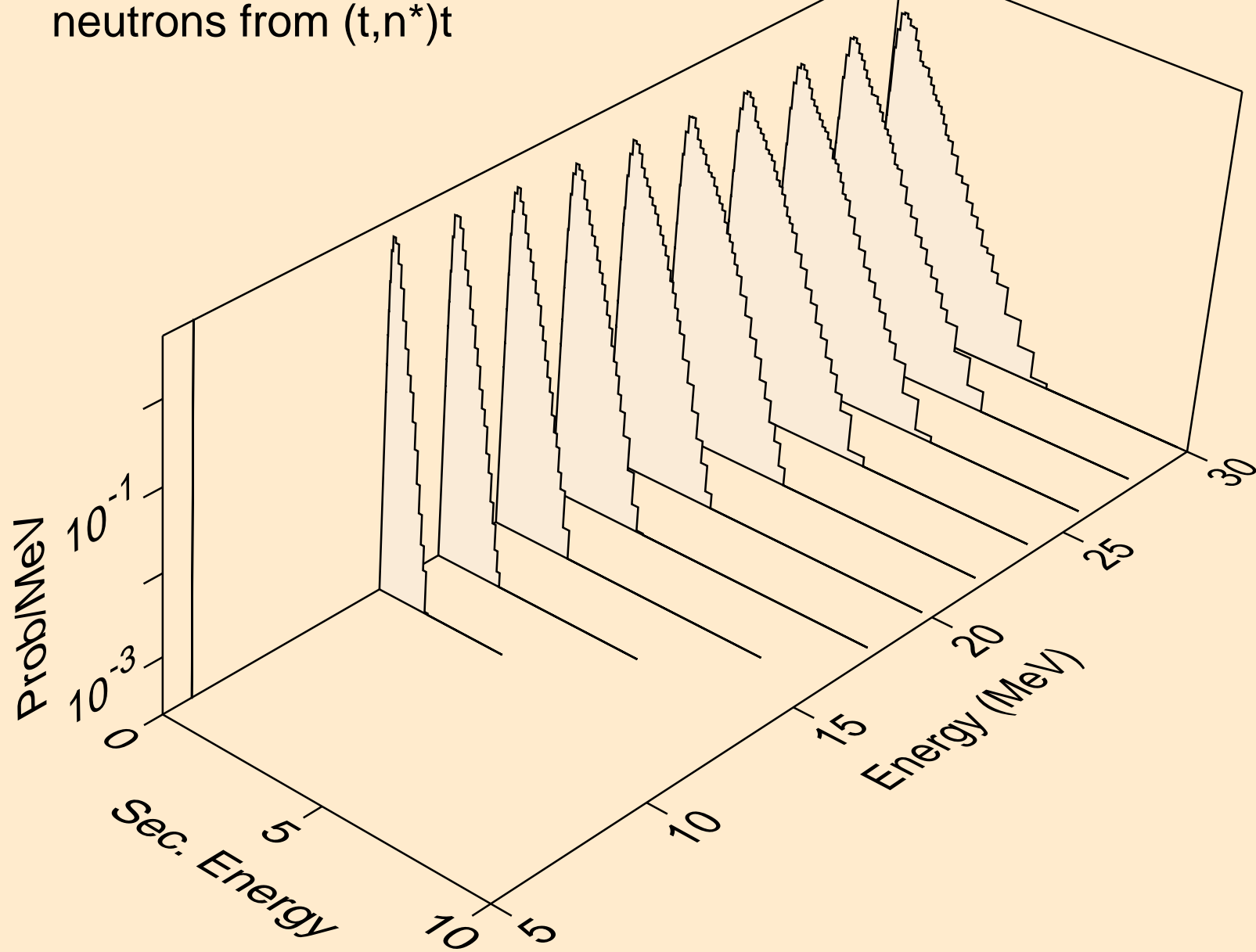

CF256 TRITON ACER TENDL-2021 LIBRARY; T=0.K  
neutrons from (t,n\*)he3

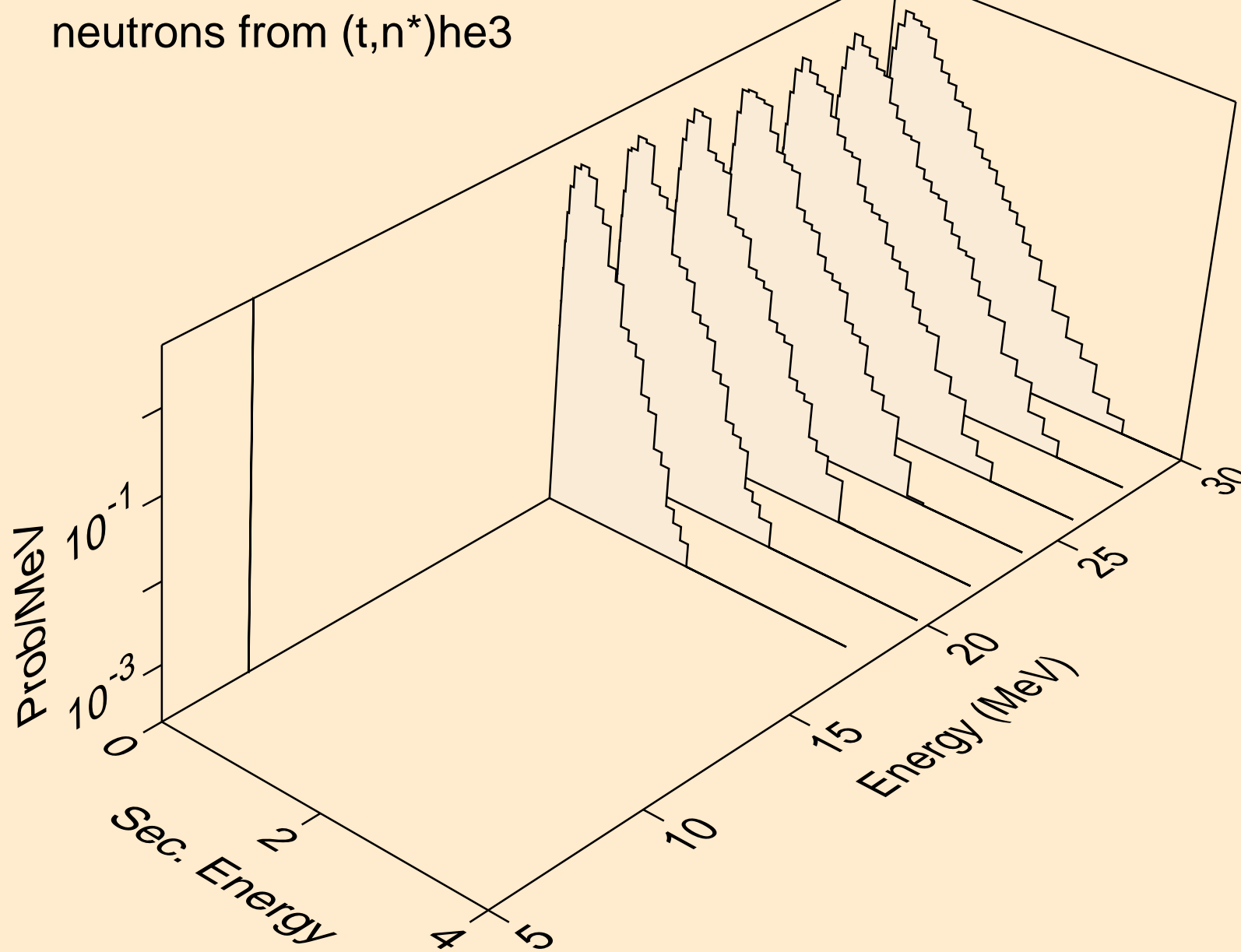

CF256 TRITON ACER TENDL-2021 LIBRARY; T=0.K  
neutrons from (t,4n)

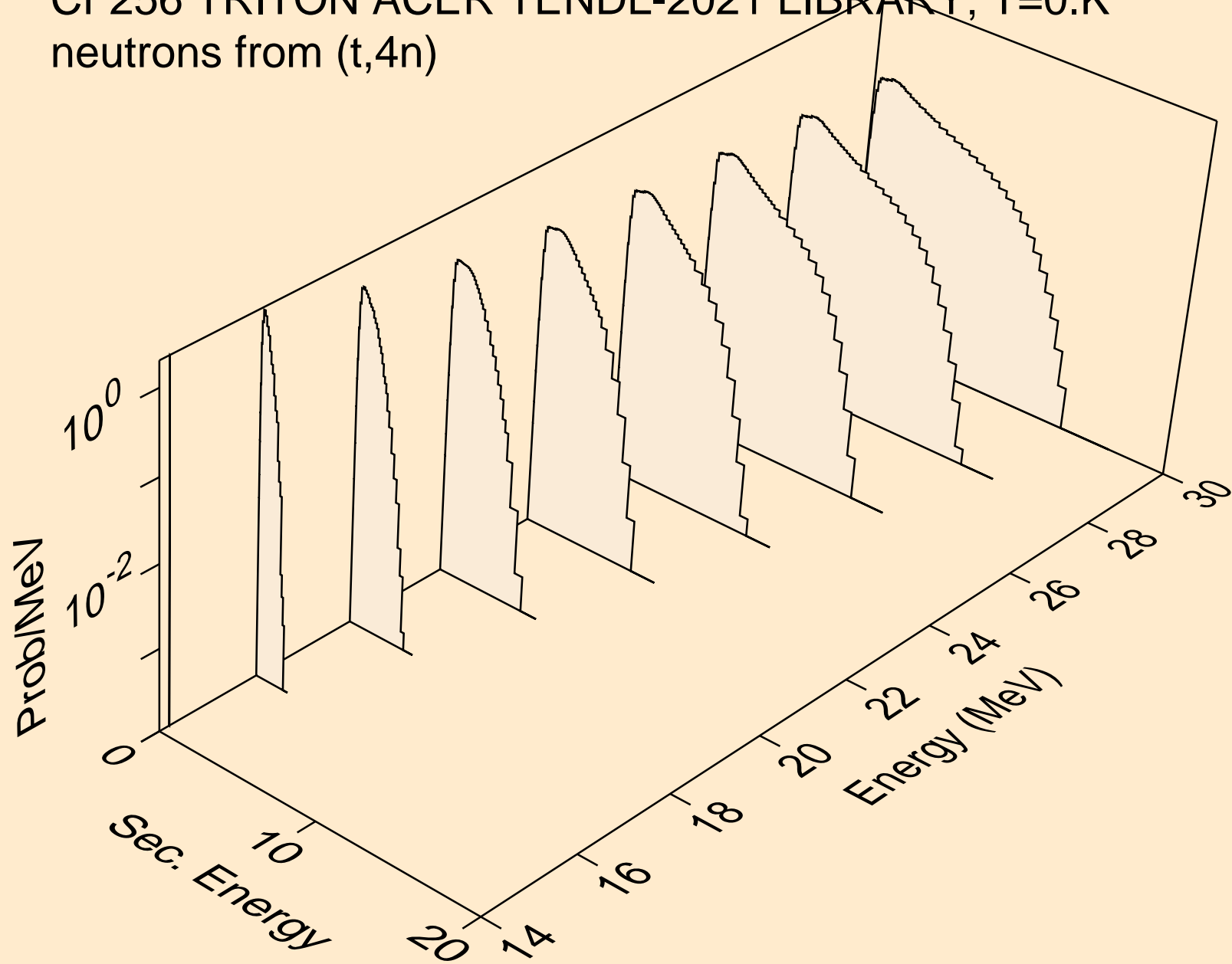

CF256 TRITON ACER TENDL-2021 LIBRARY; T=0.K  
neutrons from (t,2np)

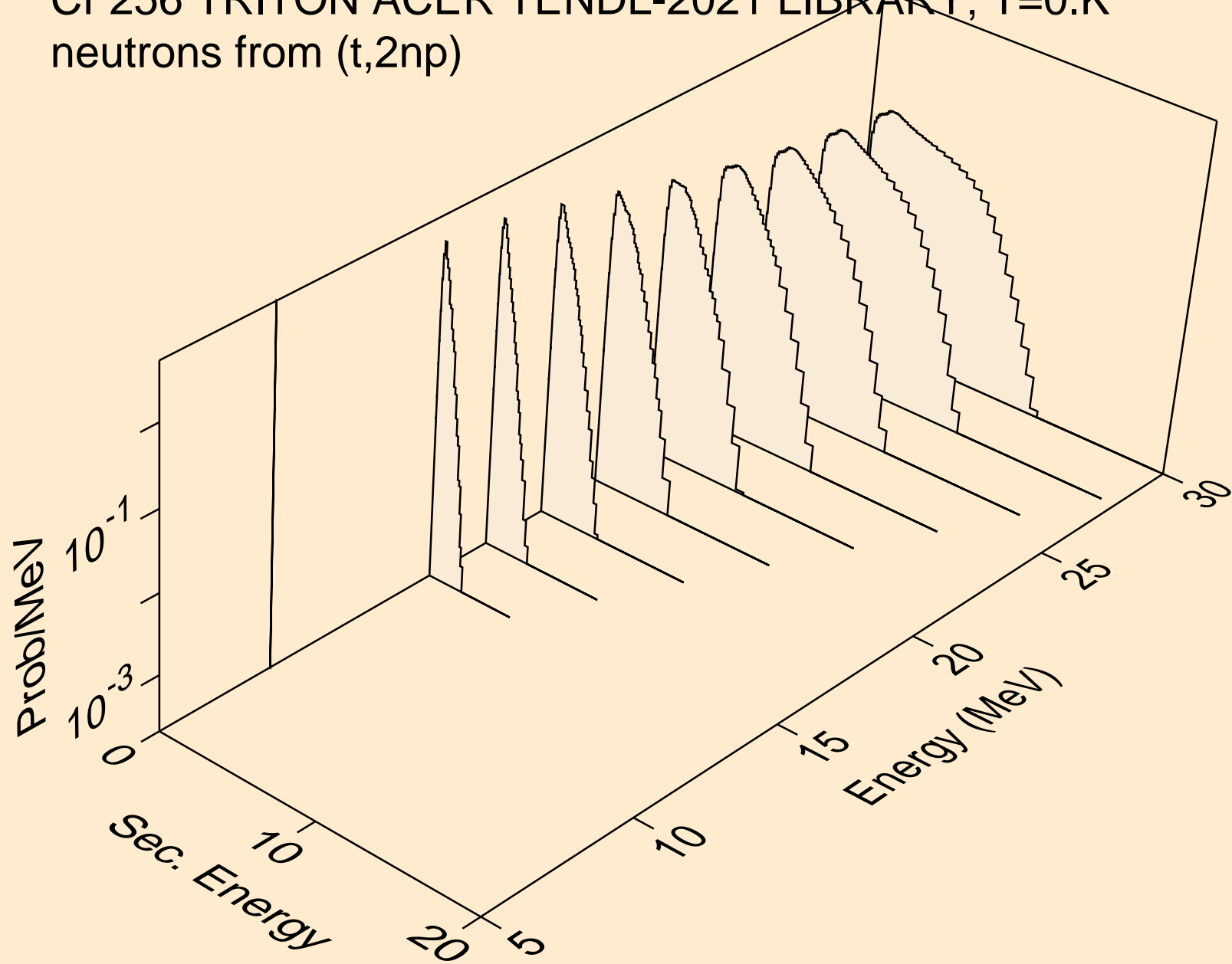

CF256 TRITON ACER TENDL-2021 LIBRARY; T=0.K  
neutrons from (t,3np)

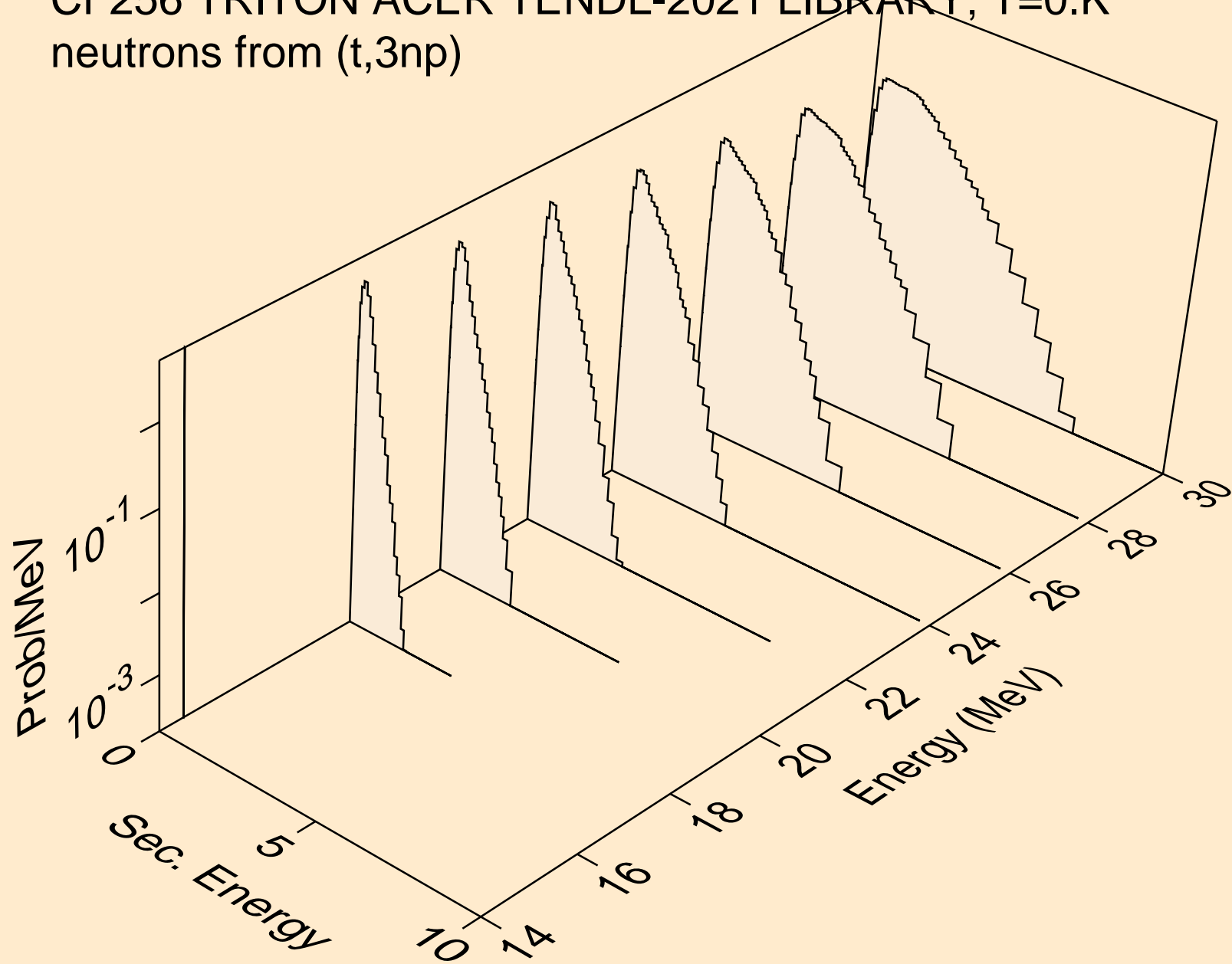

CF256 TRITON ACER TENDL-2021 LIBRARY; T=0.K  
protons from (t,x)

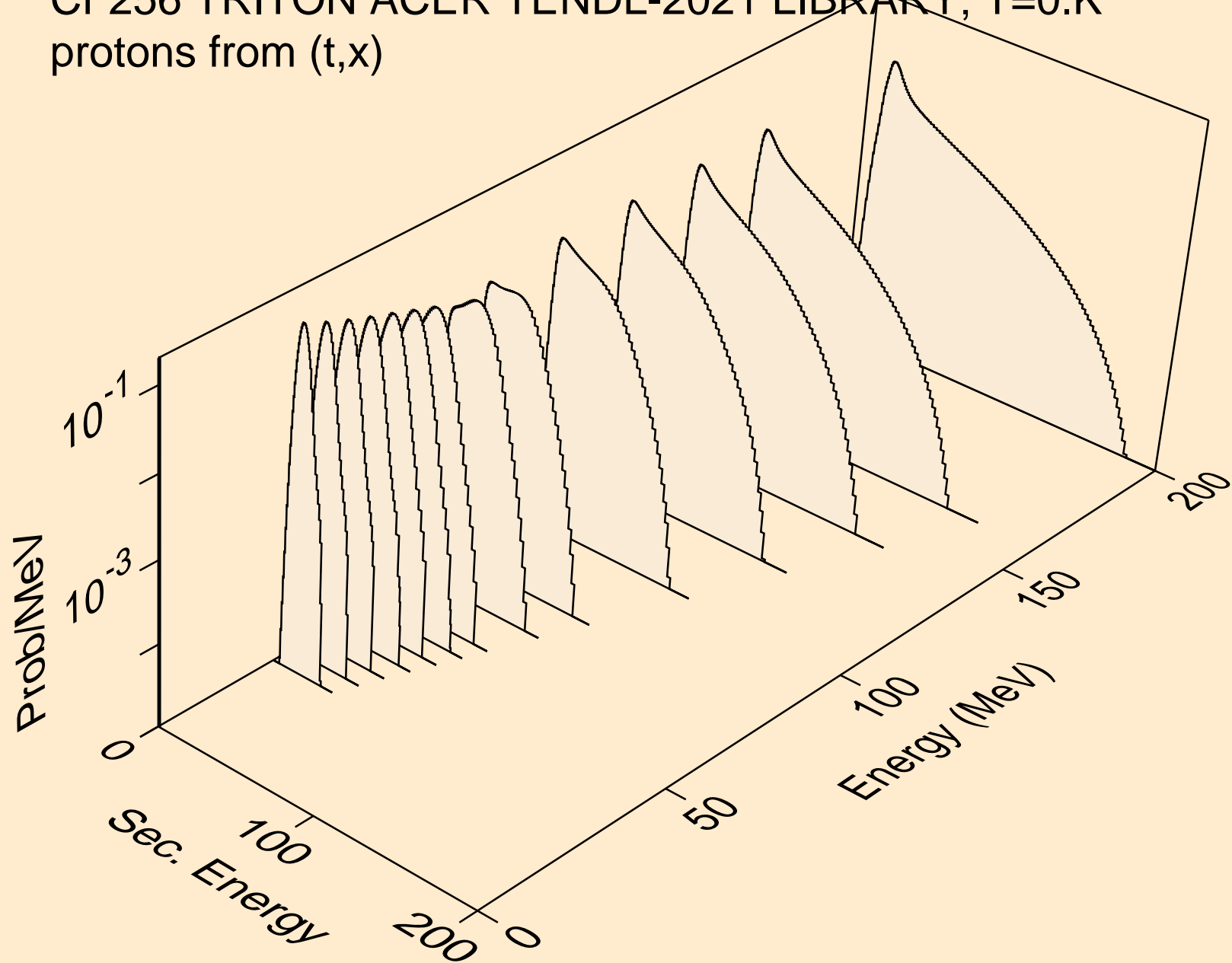

CF256 TRITON ACER TENDL-2021 LIBRARY; T=0.K  
protons from (t,n\*)p

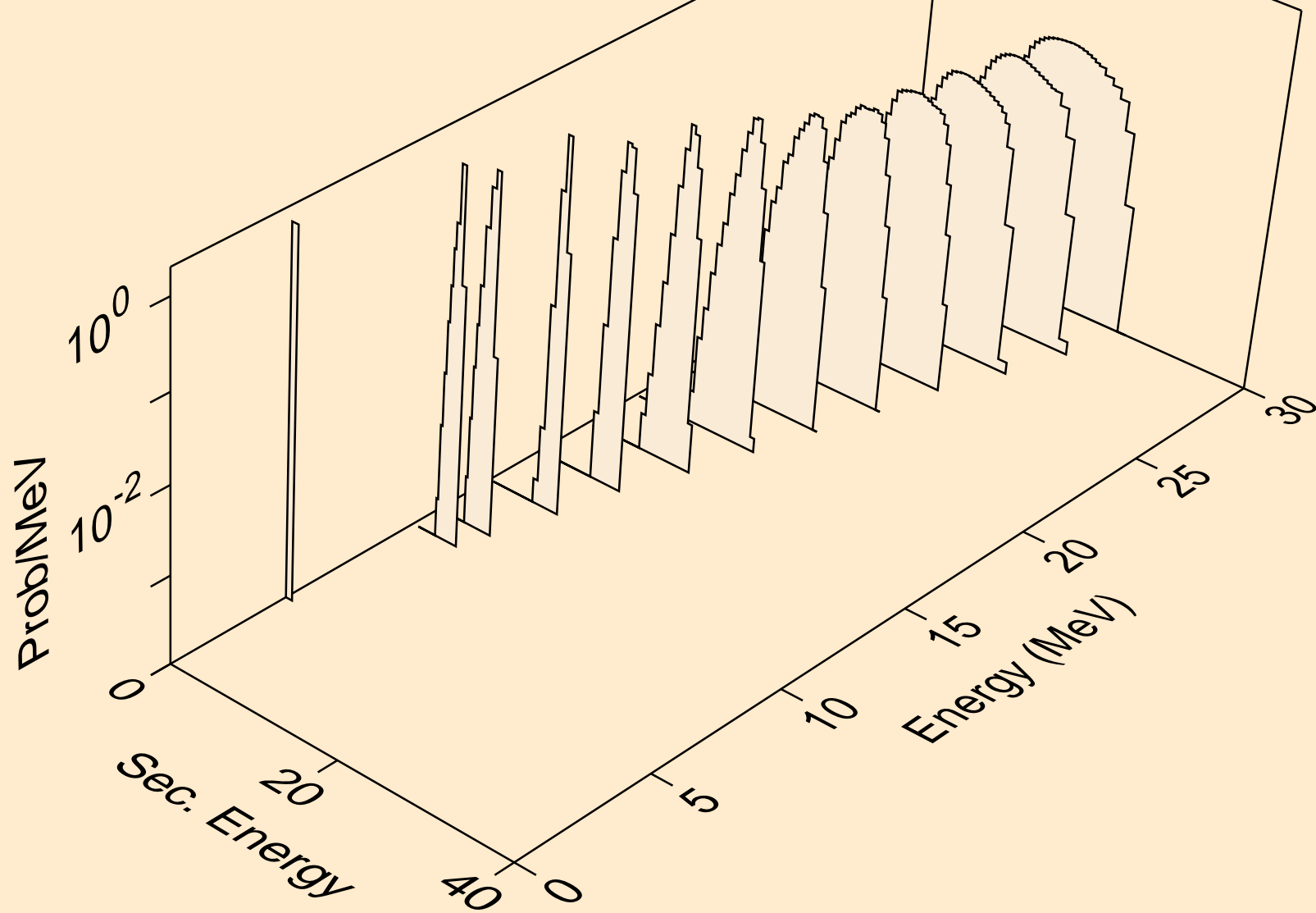



CF256 TRITON ACER TENDL-2021 LIBRARY; T=0.K  
protons from (t,2np)

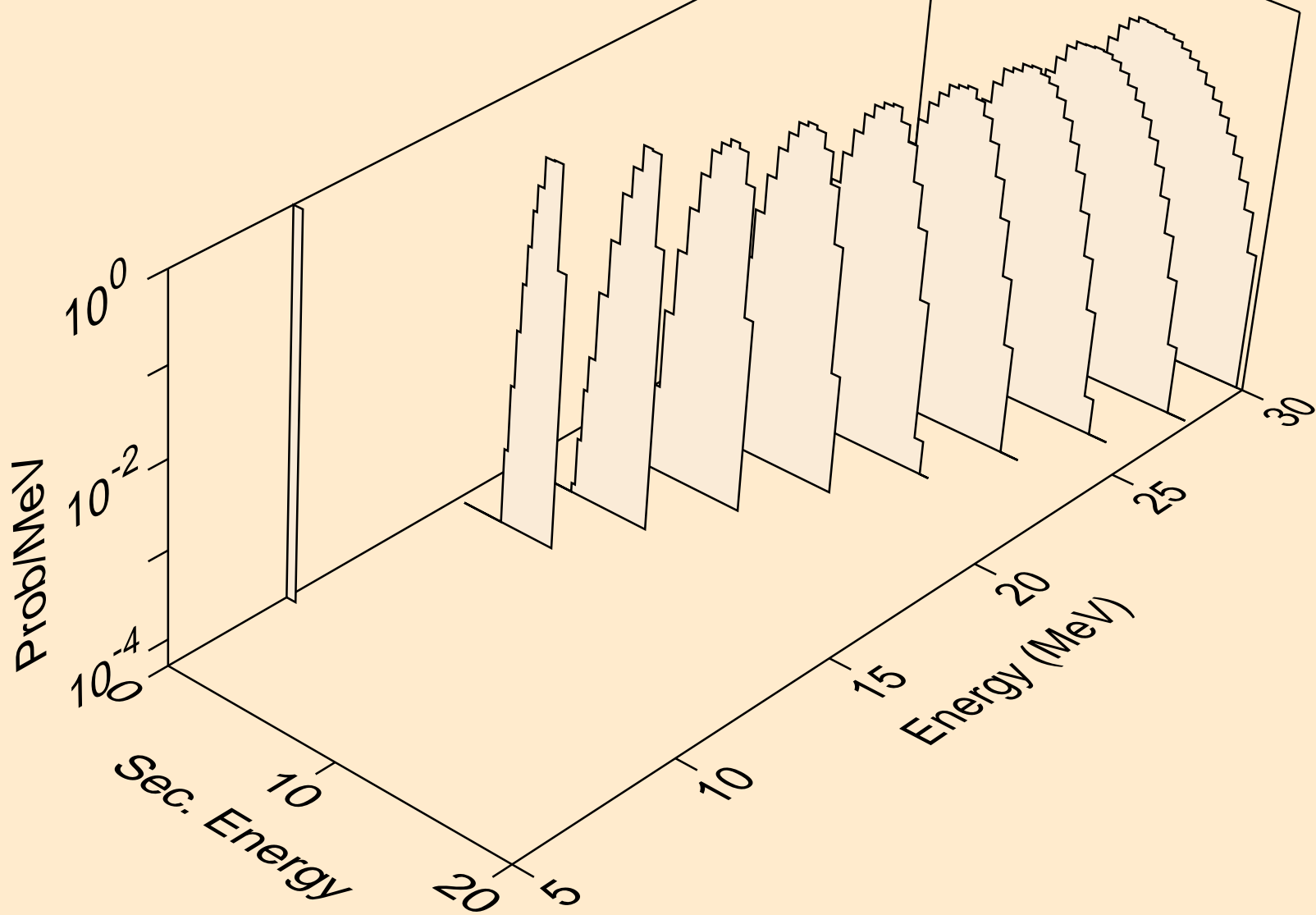

CF256 TRITON ACER TENDL-2021 LIBRARY; T=0.K  
protons from (t,3np)

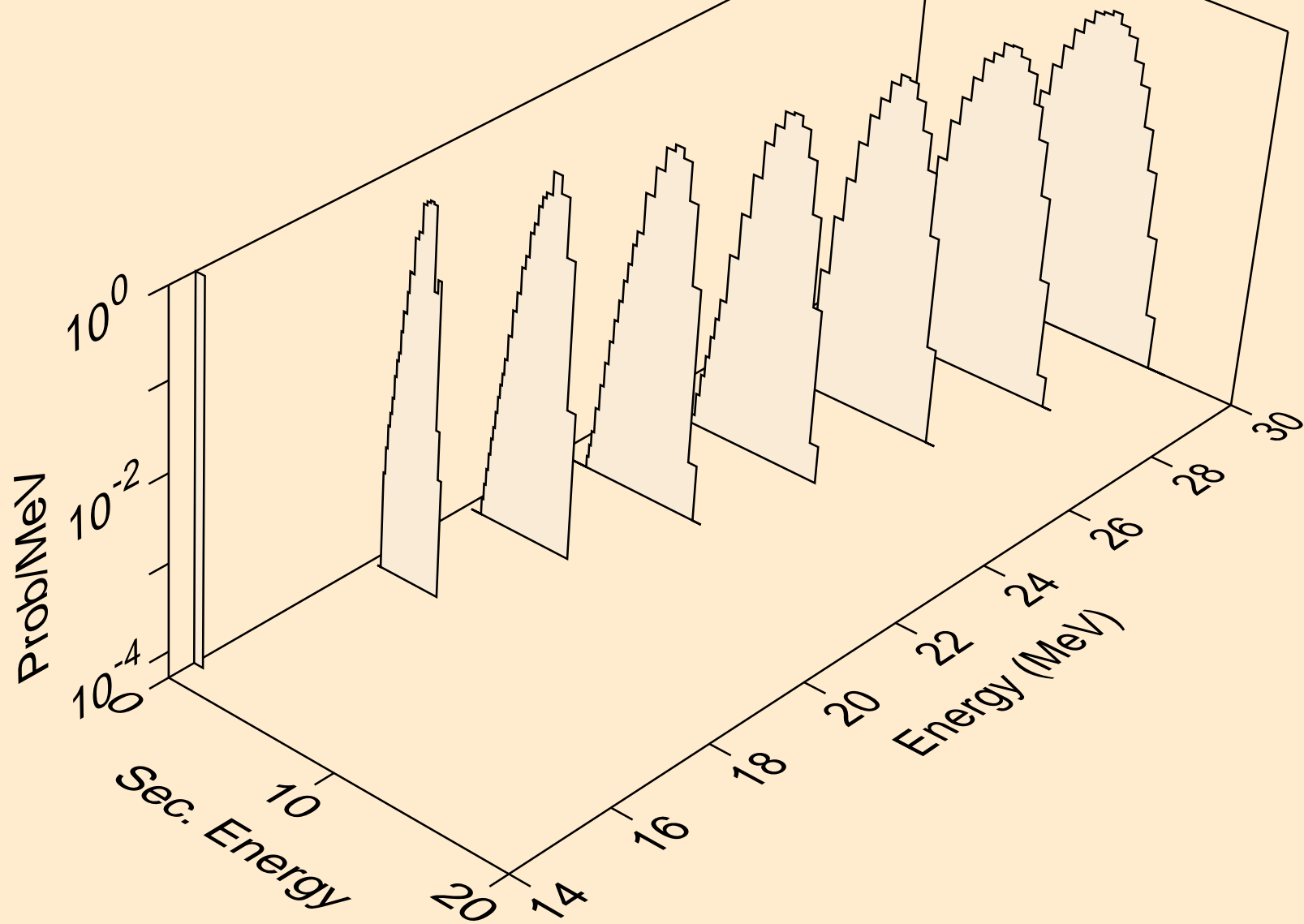

CF256 TRITON ACER TENDL-2021 LIBRARY; T=0.K  
protons from (t,p)

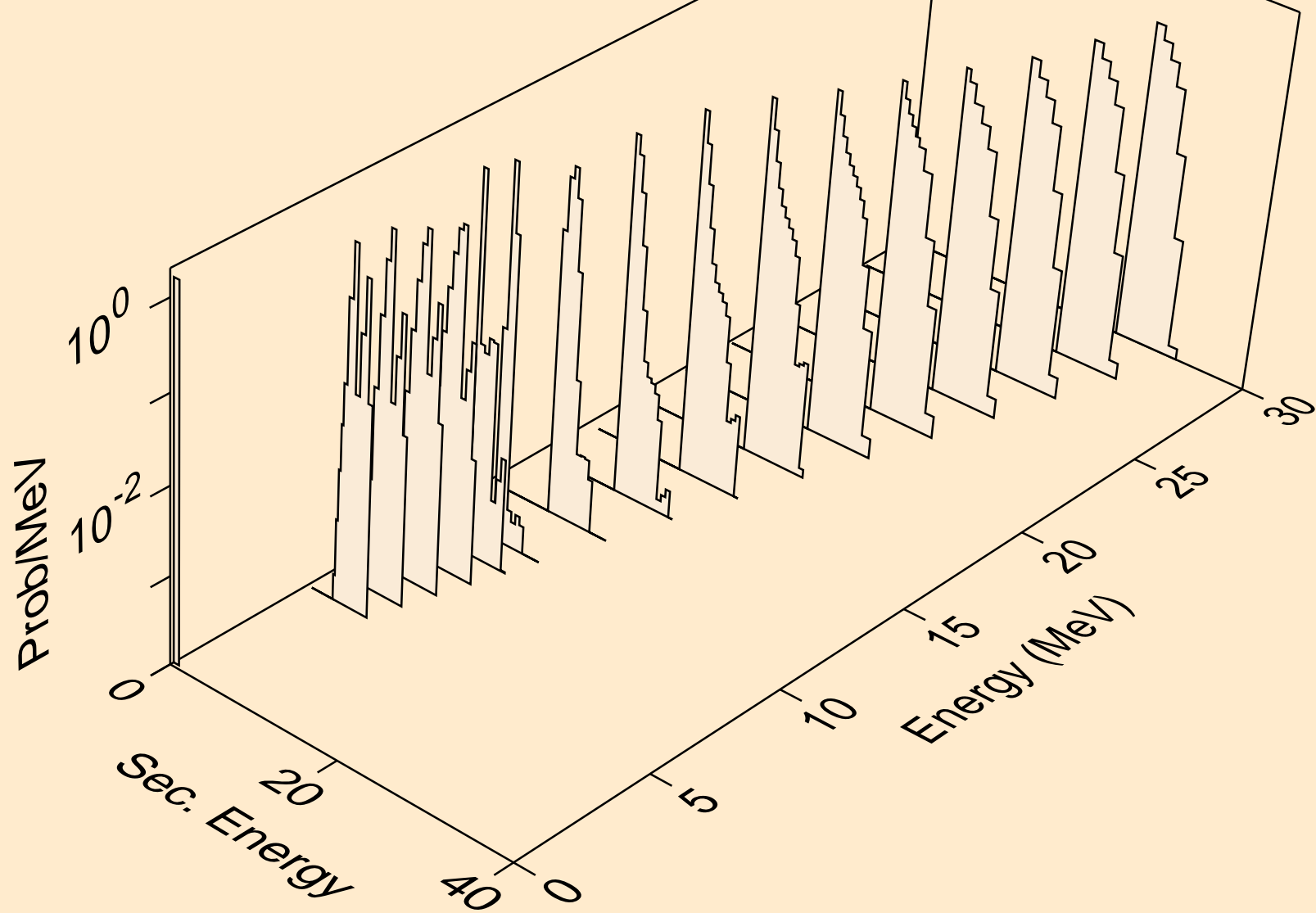

CF256 TRITON ACER TENDL-2021 LIBRARY; T=0.K  
protons from (t,2p)

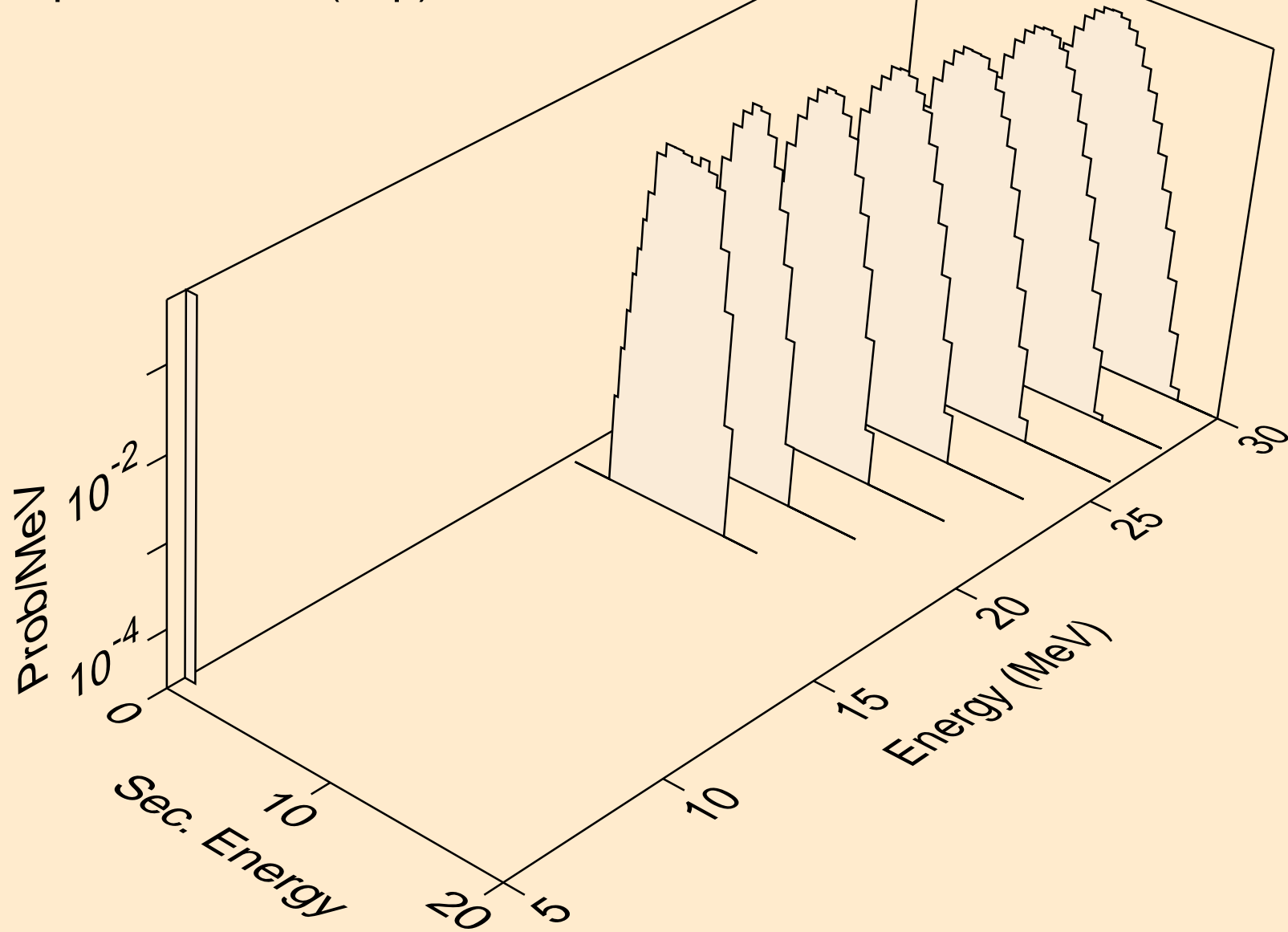

CF256 TRITON ACER TENDL-2021 LIBRARY; T=0.K  
deuterons from (t,x)

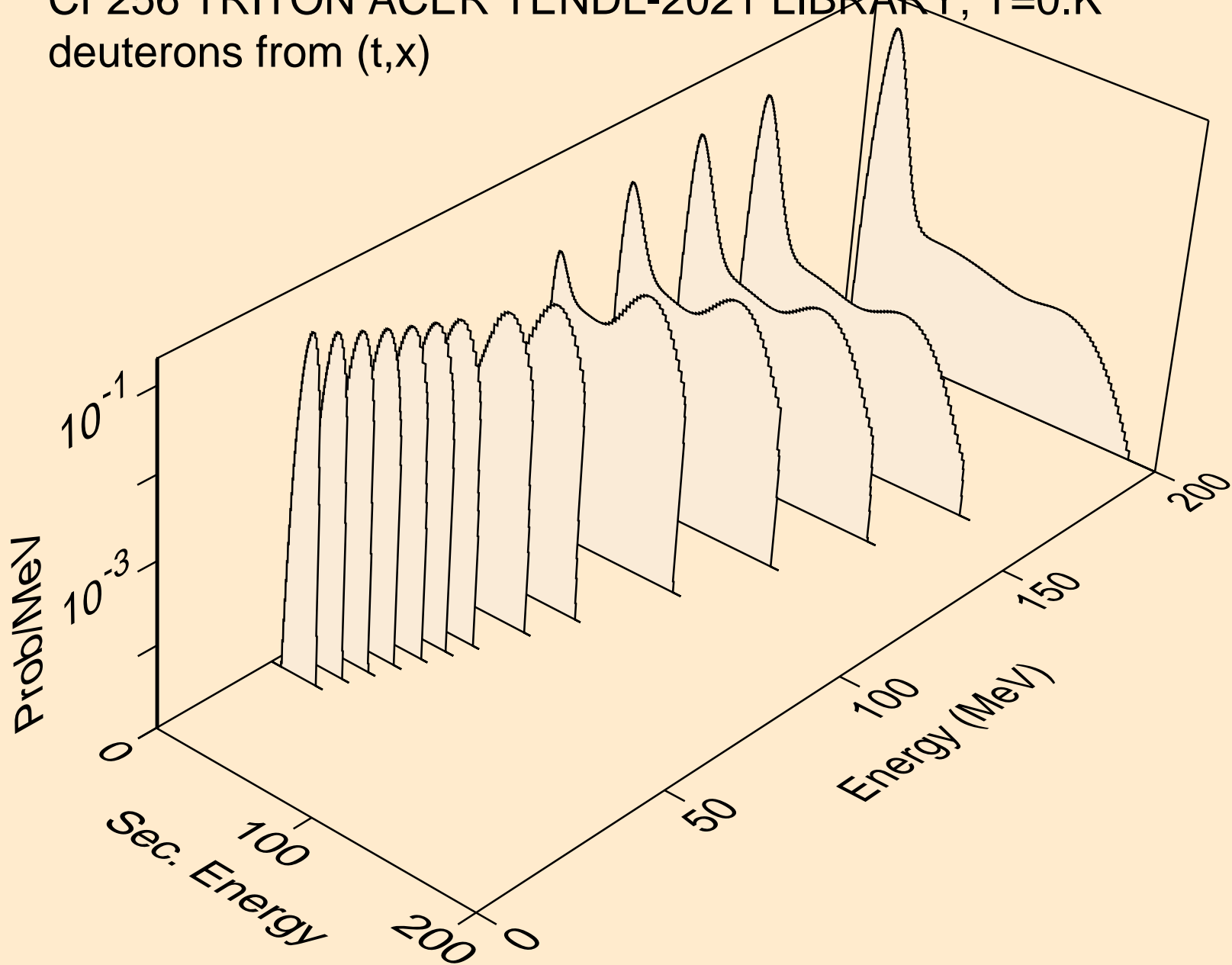

CF256 TRITON ACER TENDL-2021 LIBRARY; T=0.K  
deuterons from (t,2nd)

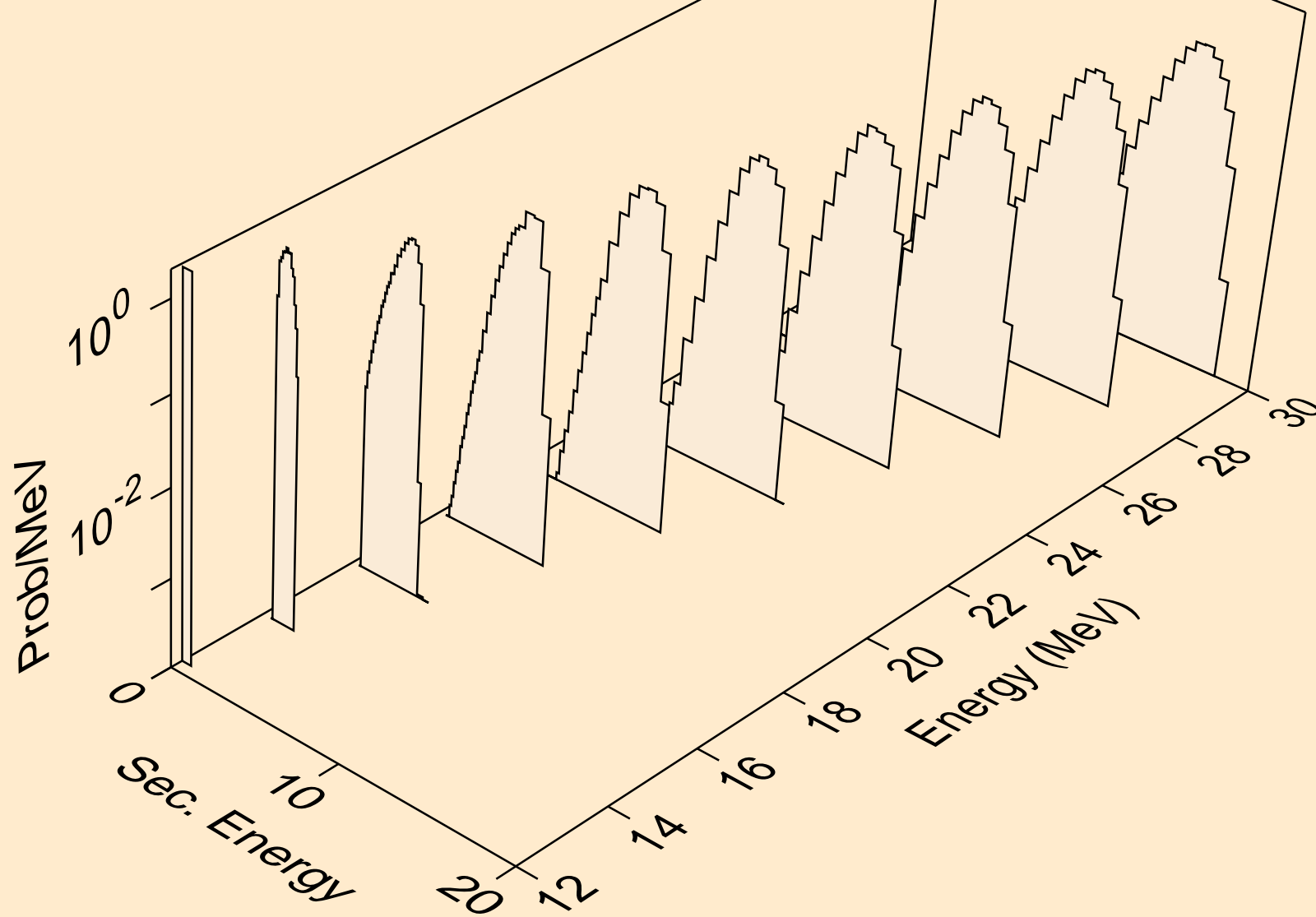

CF256 TRITON ACER TENDL-2021 LIBRARY; T=0.K  
deuterons from (t,n\*)d

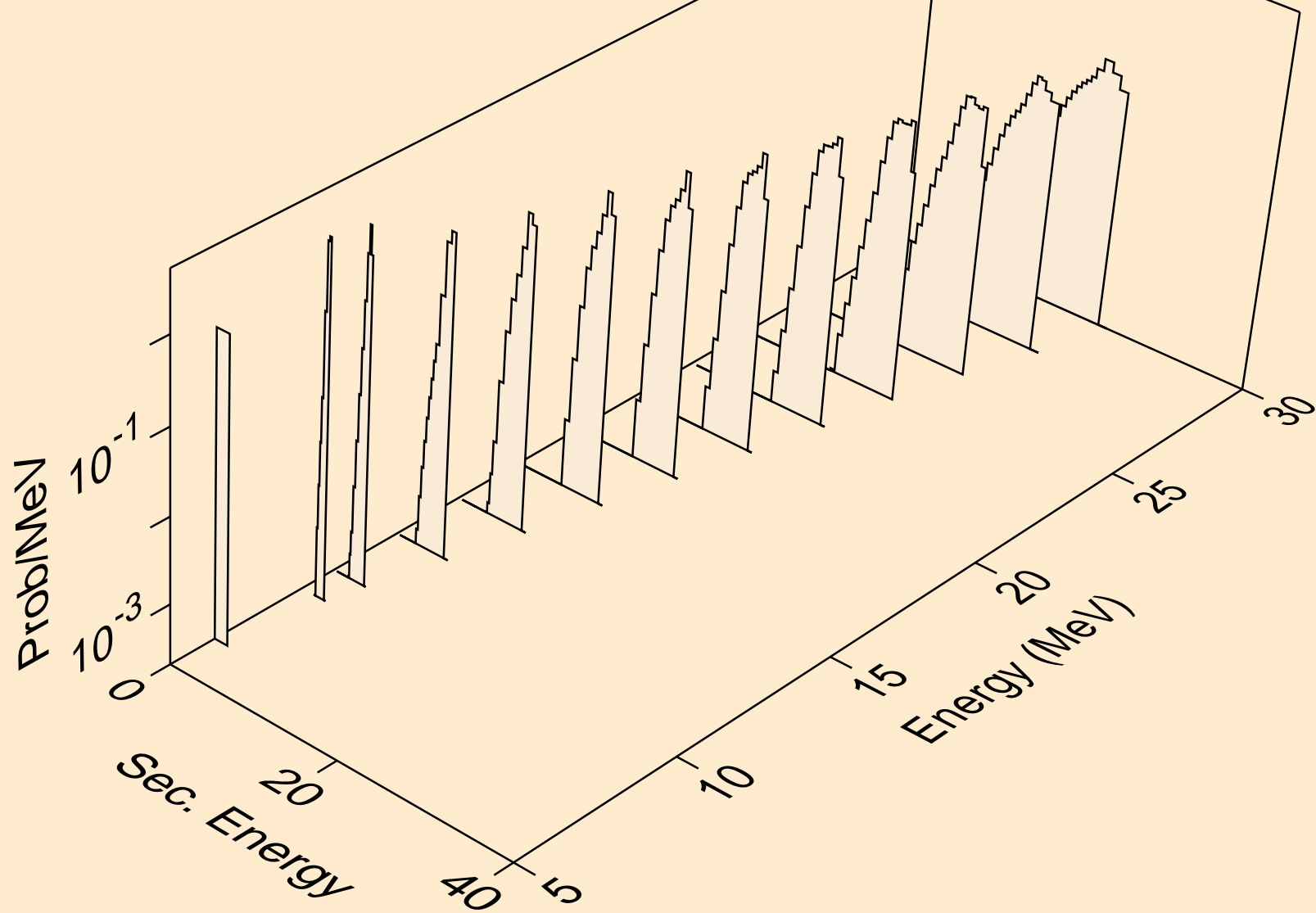

CF256 TRITON ACER TENDL-2021 LIBRARY; T=0.K  
deuterons from (t,d)

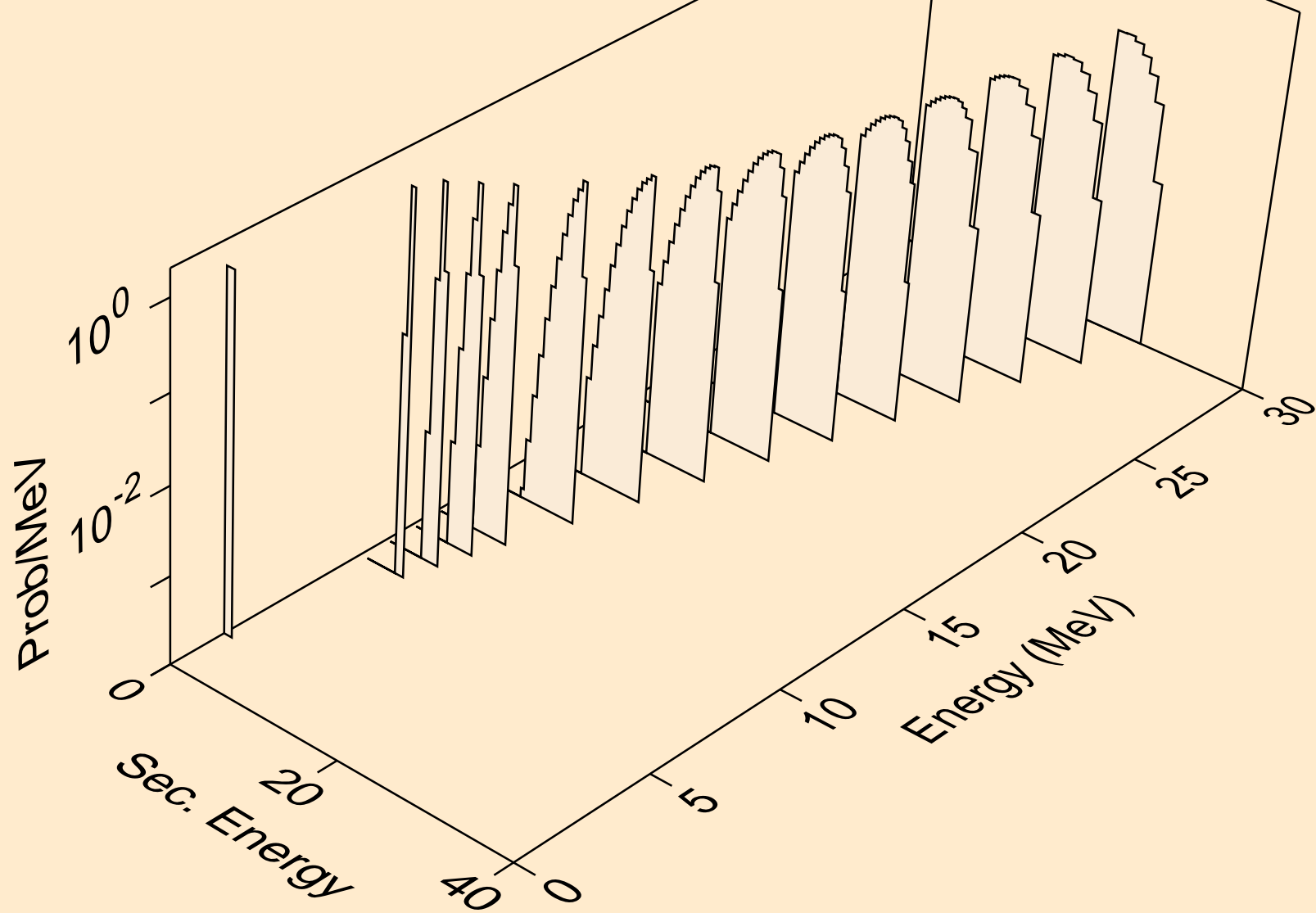



CF256 TRITON ACER TENDL-2021 LIBRARY; T=0.K  
he3s from (t,x)

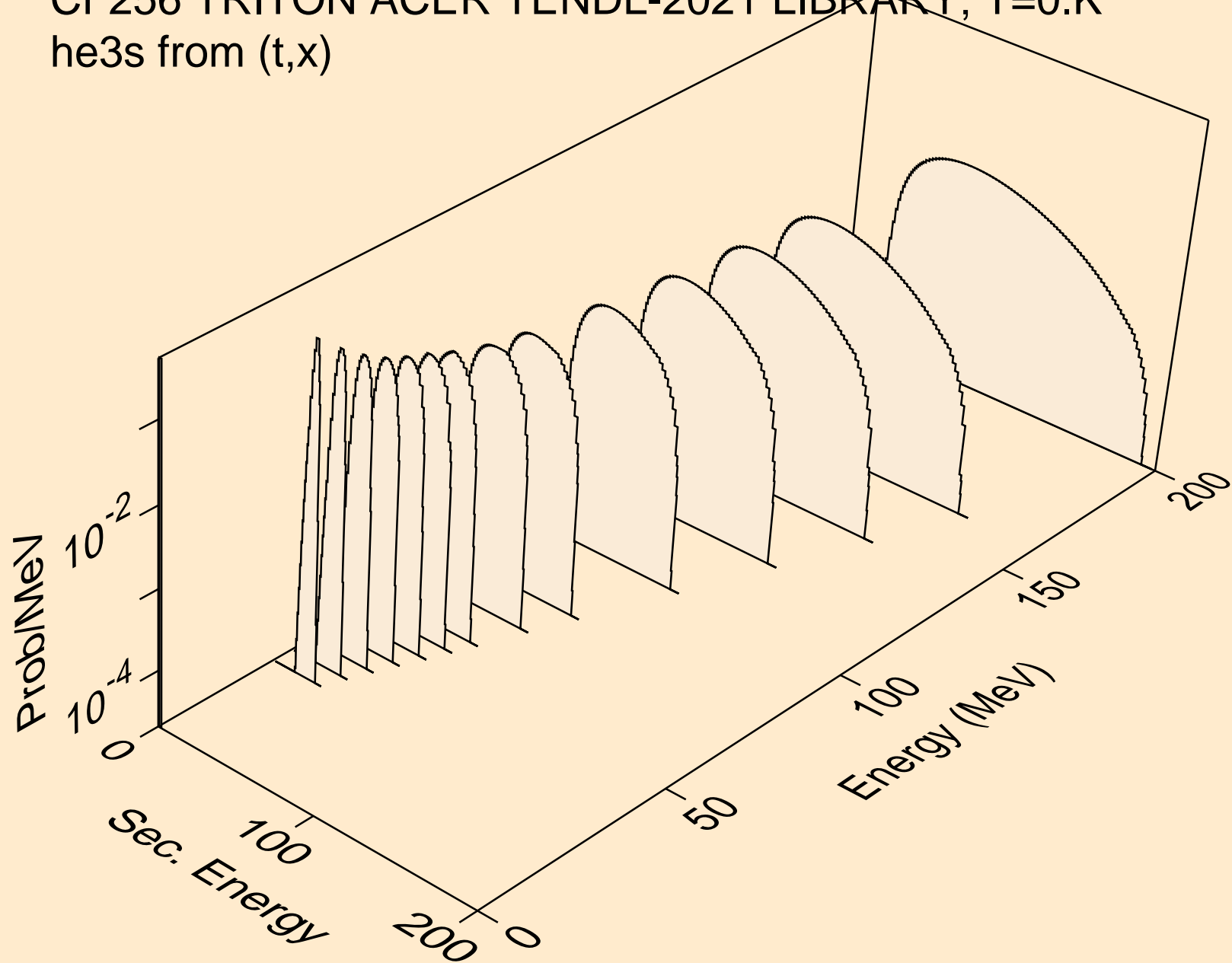

CF256 TRITON ACER TENDL-2021 LIBRARY; T=0.K  
he3s from (t,n\*)he3

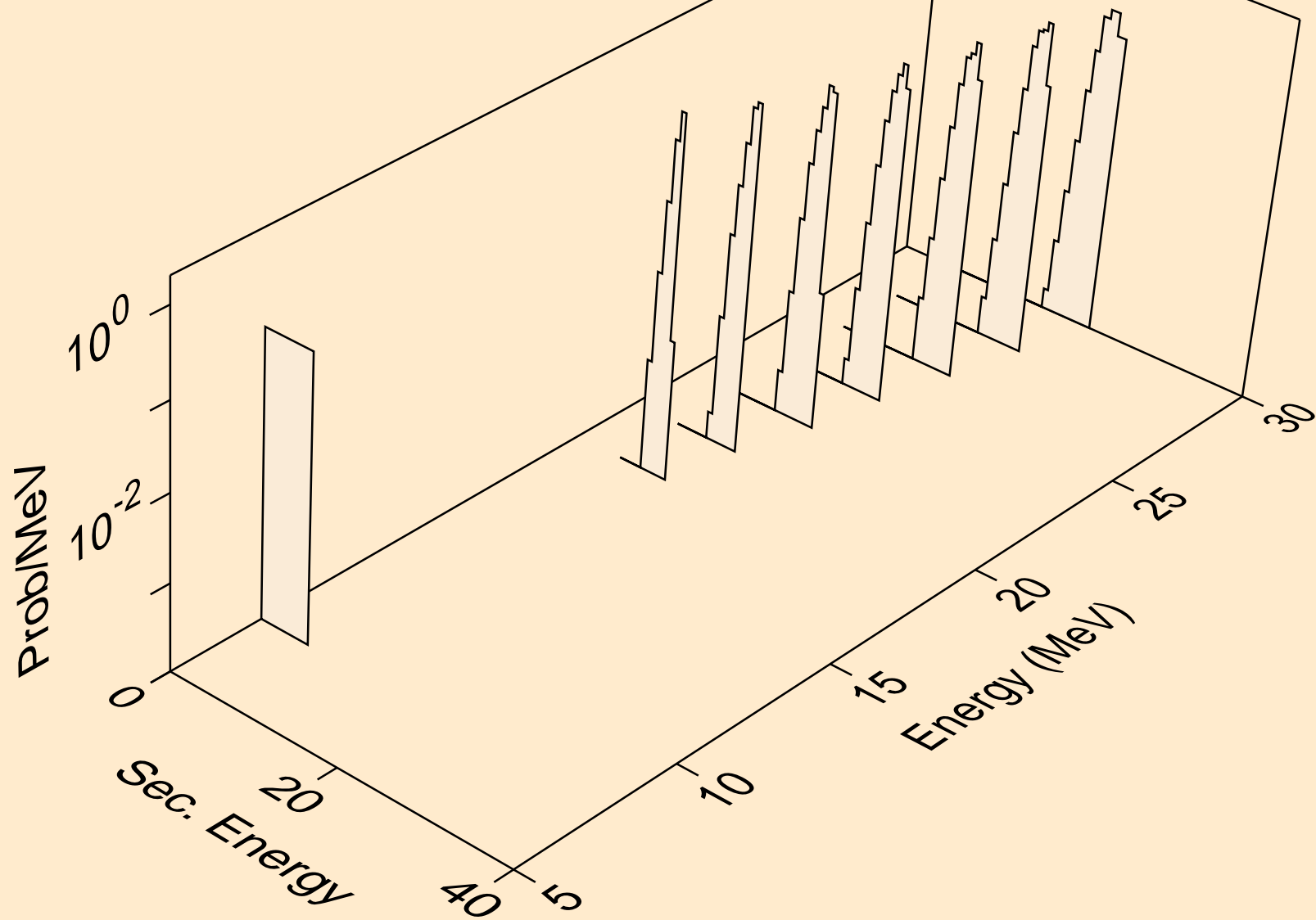

CF256 TRITON ACER TENDL-2021 LIBRARY; T=0.K  
he3s from (t,he3)

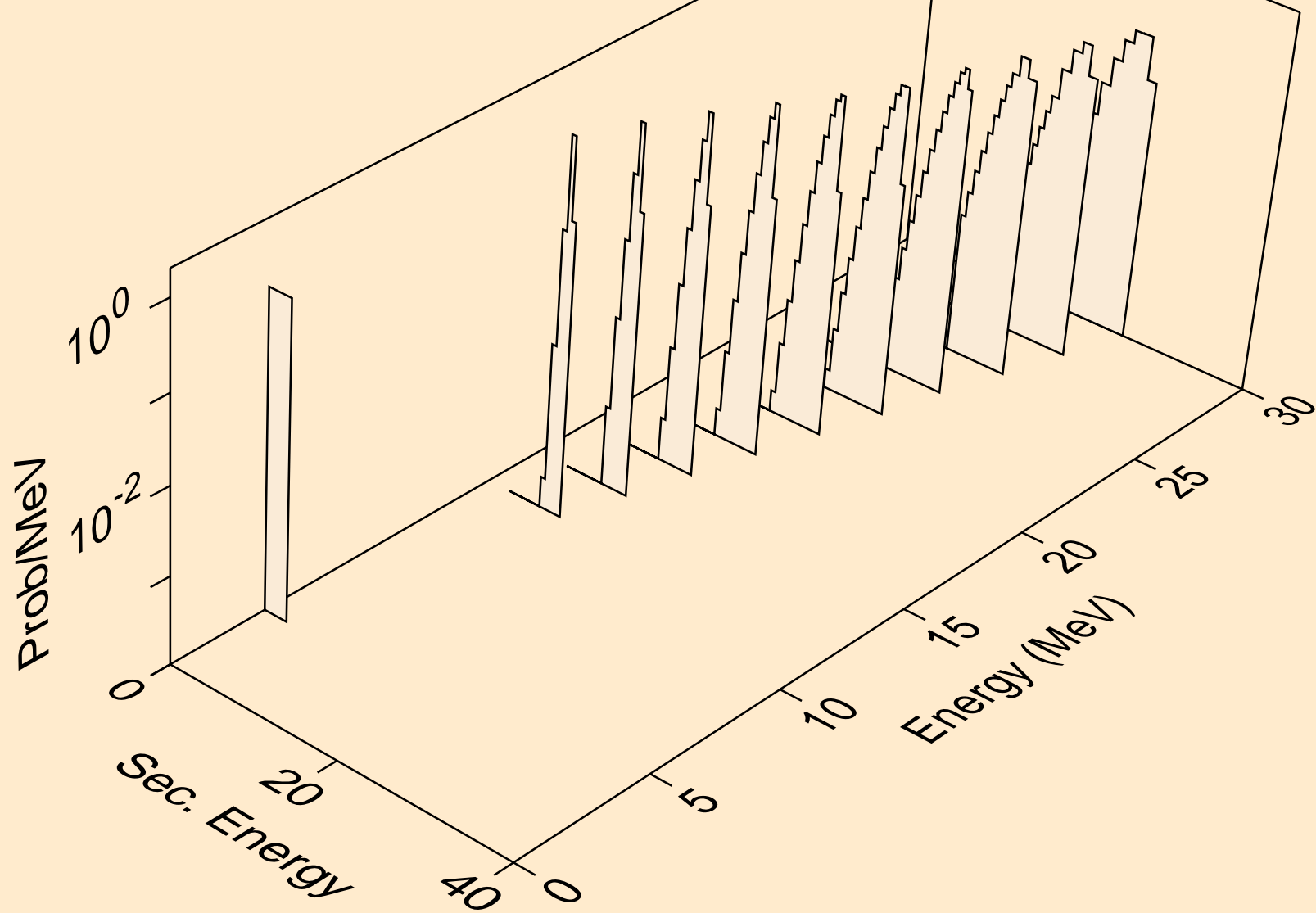

CF256 TRITON ACER TENDL-2021 LIBRARY; T=0.K  
alphas from (t,x)

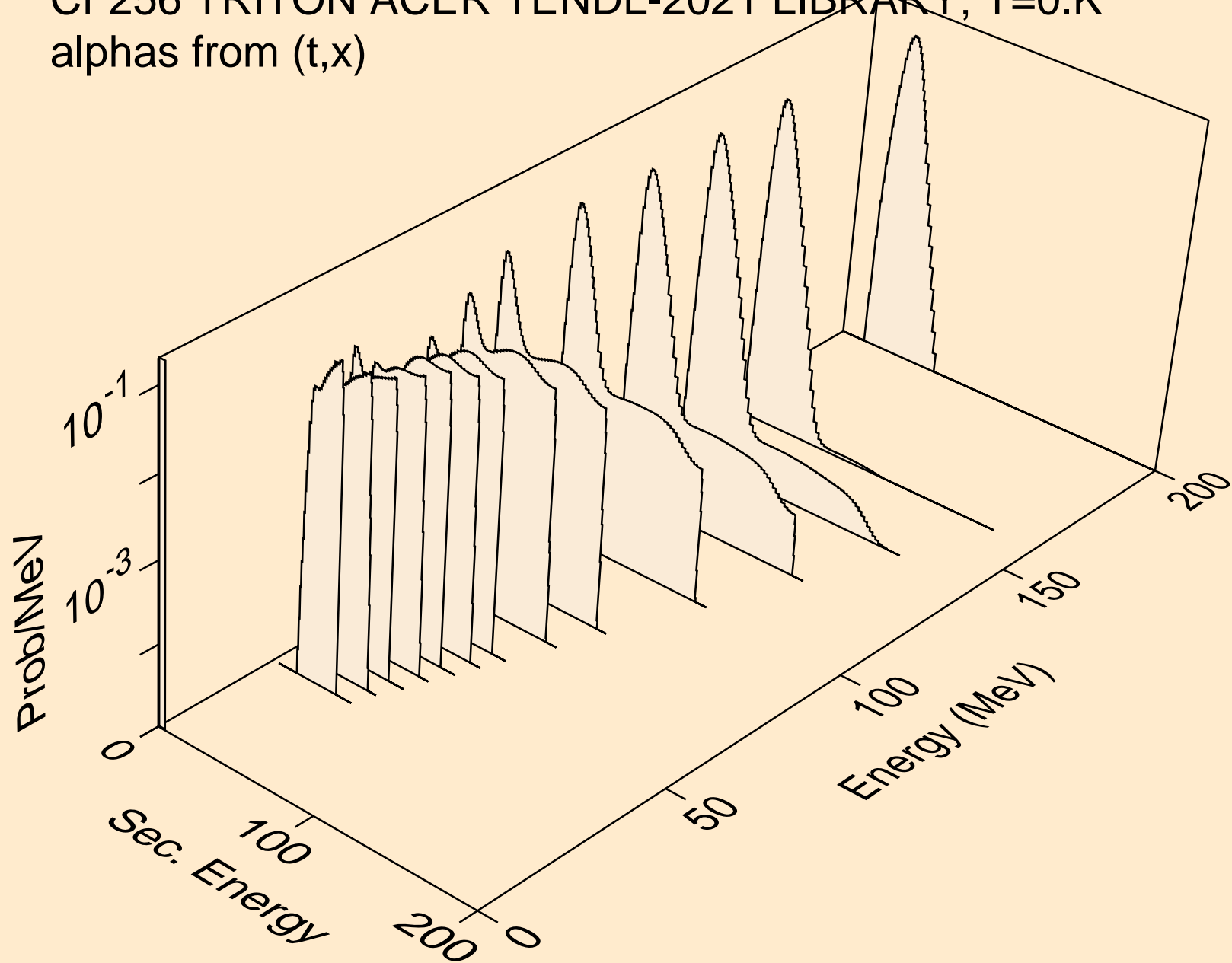

CF256 TRITON ACER TENDL-2021 LIBRARY; T=0.K  
alphas from (t,n\*)a

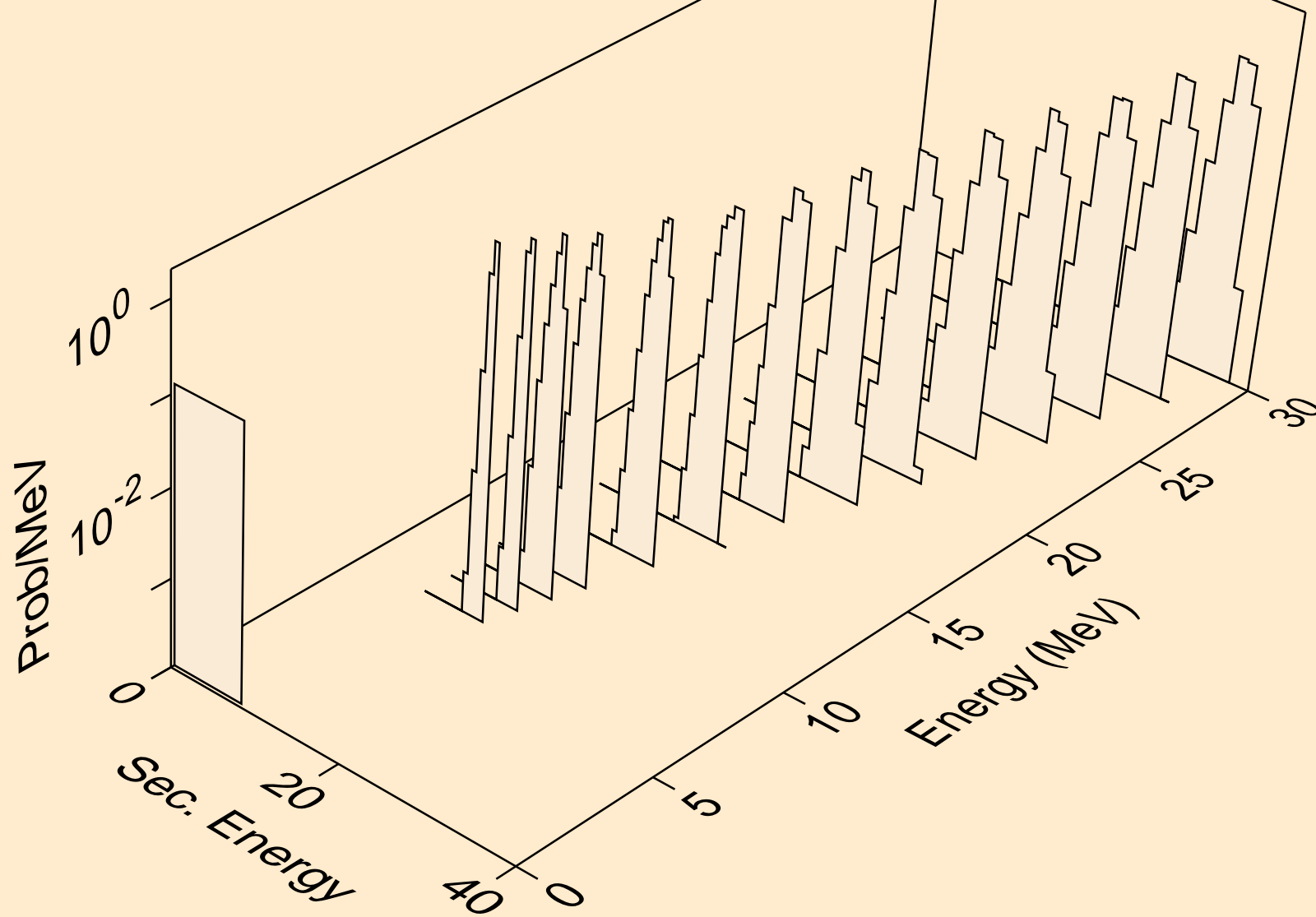

CF256 TRITON ACER TENDL-2021 LIBRARY; T=0.K  
alphas from (t,2n)a

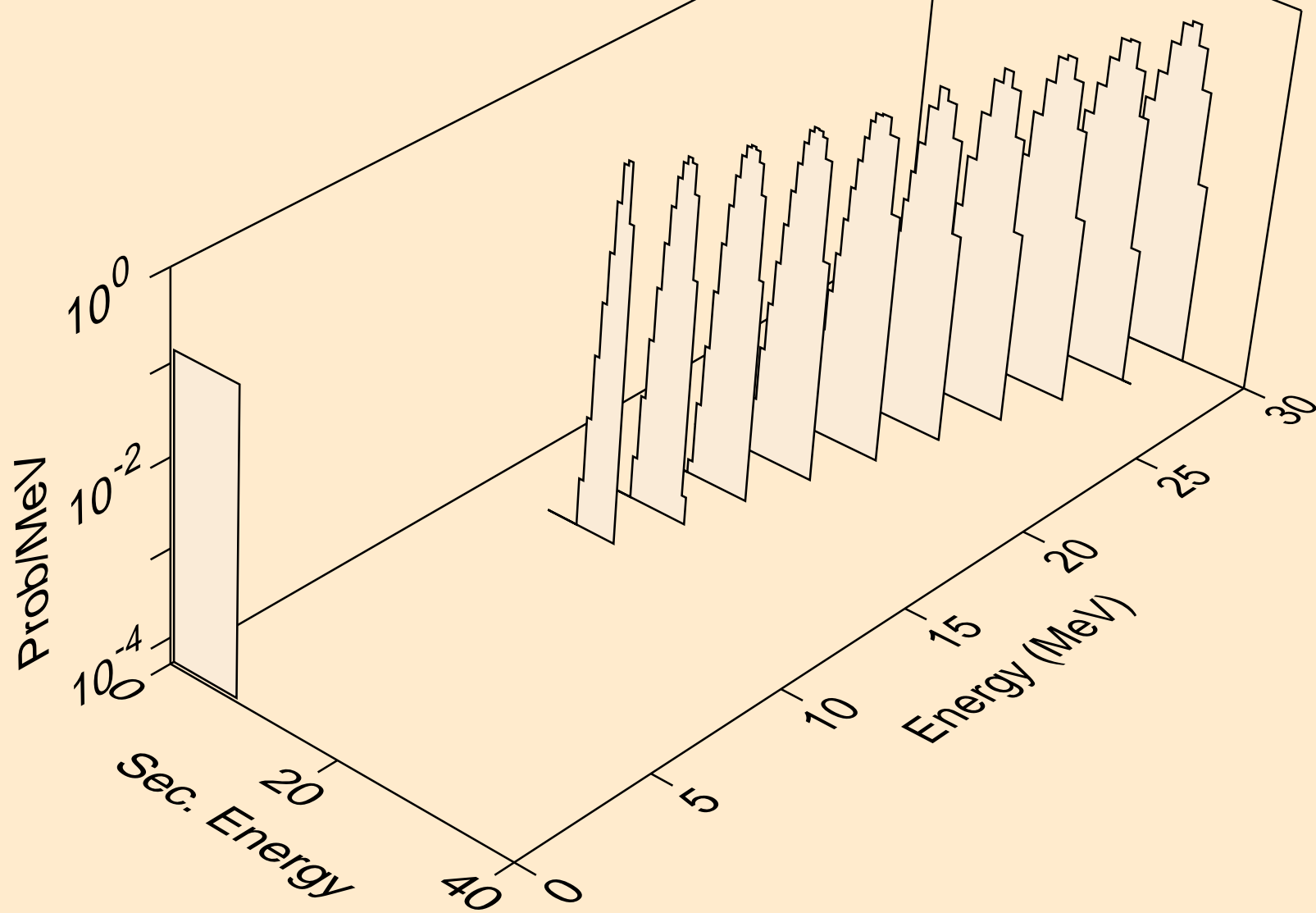

CF256 TRITON ACER TENDL-2021 LIBRARY; T=0.K  
alphas from (t,3n)a

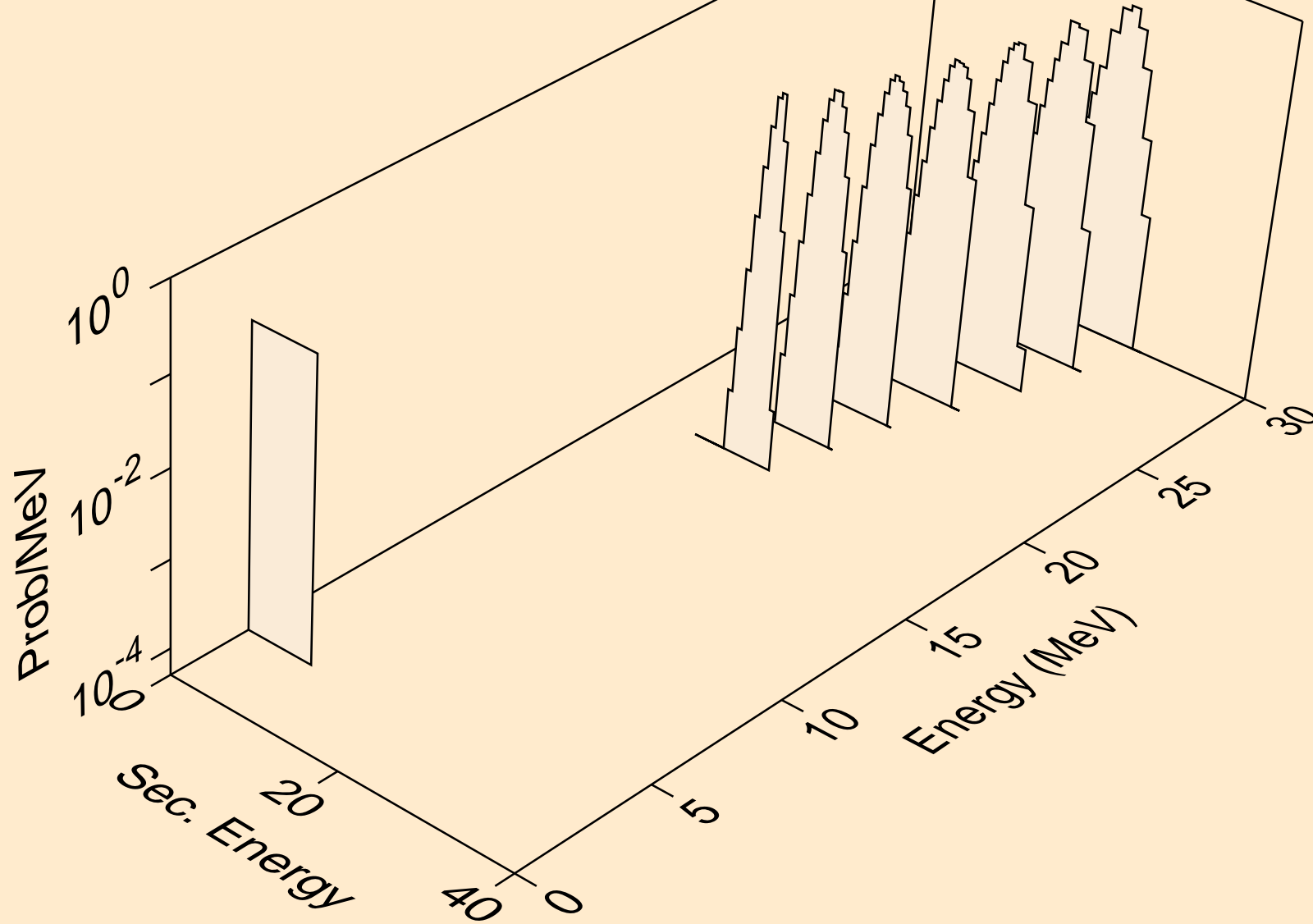

CF256 TRITON ACER TENDL-2021 LIBRARY; T=0.K  
alphas from (t,a)

