

CO060M TRITON ACER TENDL-2021 LIBRARY; T=0.K  
Principal cross sections

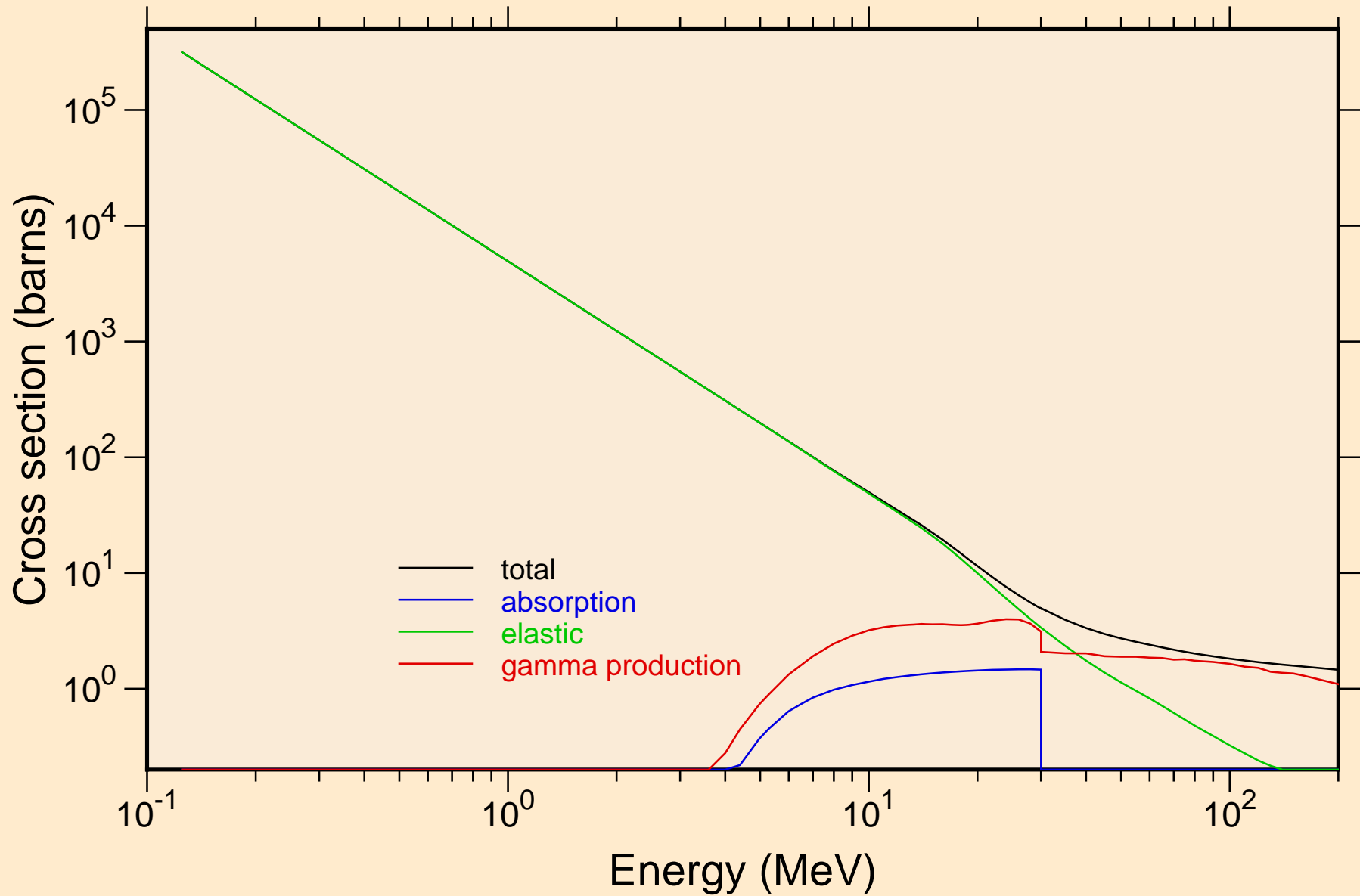

CO060M TRITON ACER TENDL-2021 LIBRARY; T=0.K

Heating

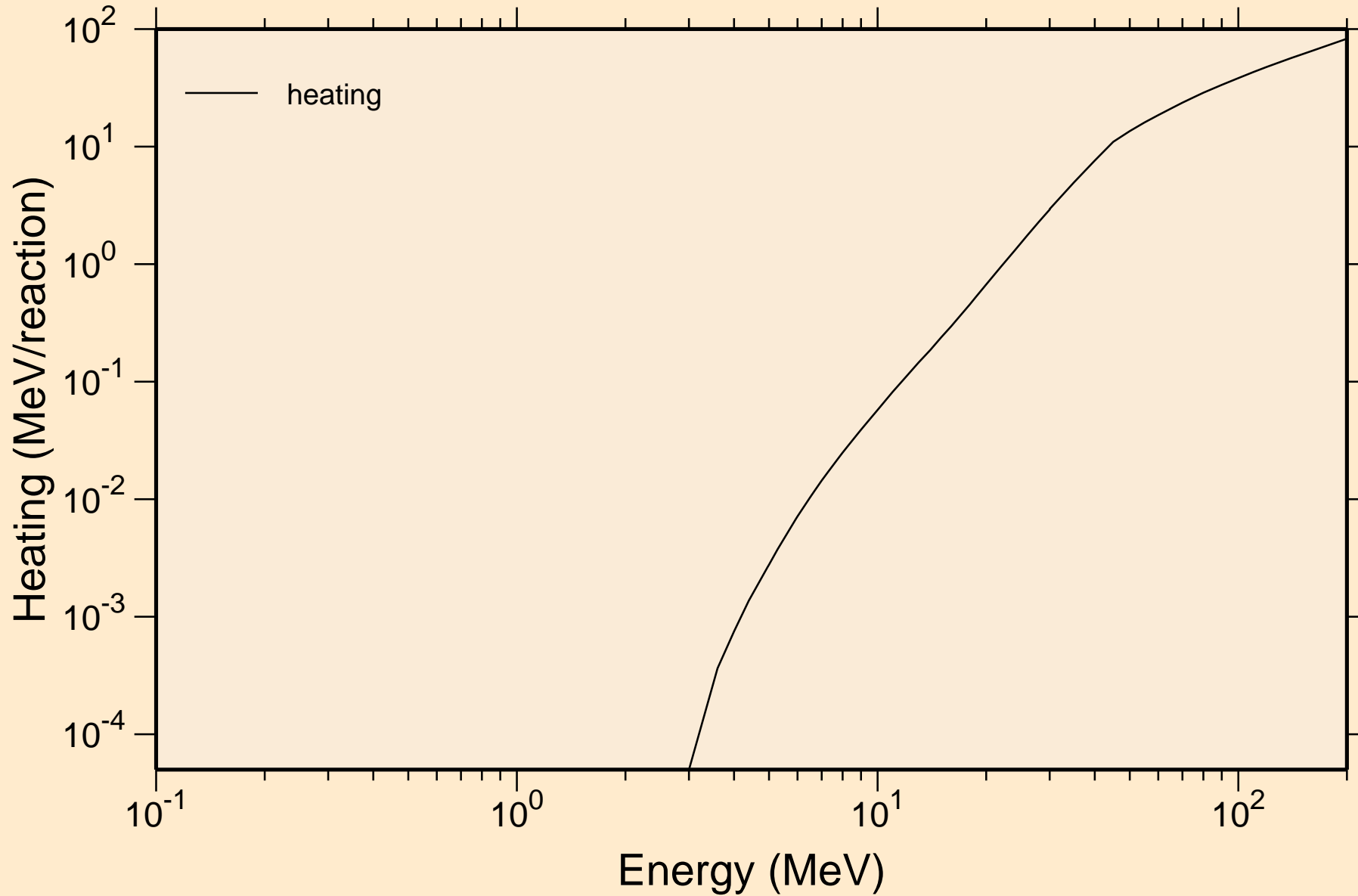

CO060M TRITON ACER TENDL-2021 LIBRARY; T=0.K  
Principal cross sections

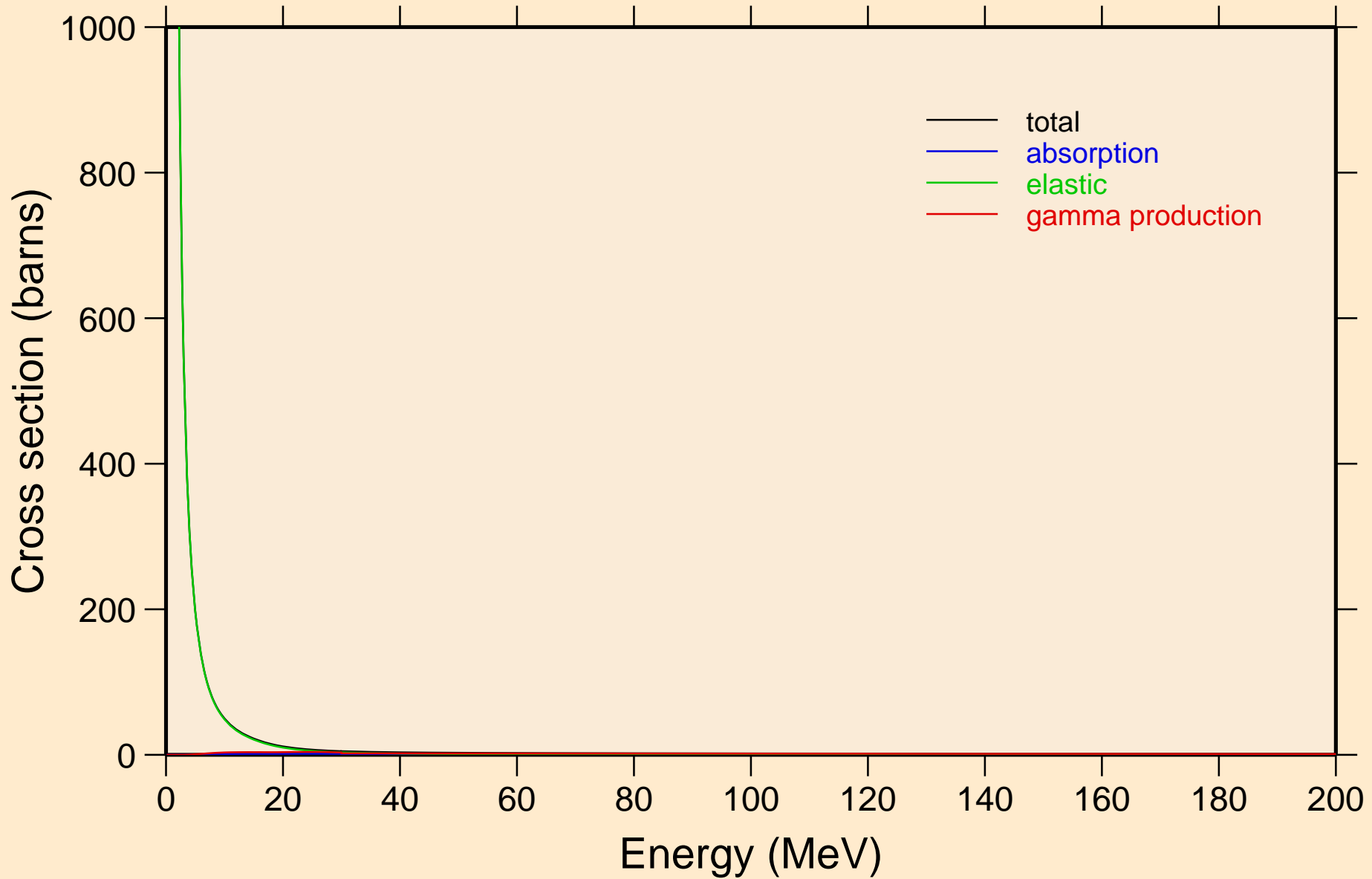

CO060M TRITON ACER TENDL-2021 LIBRARY; T=0.K

Heating

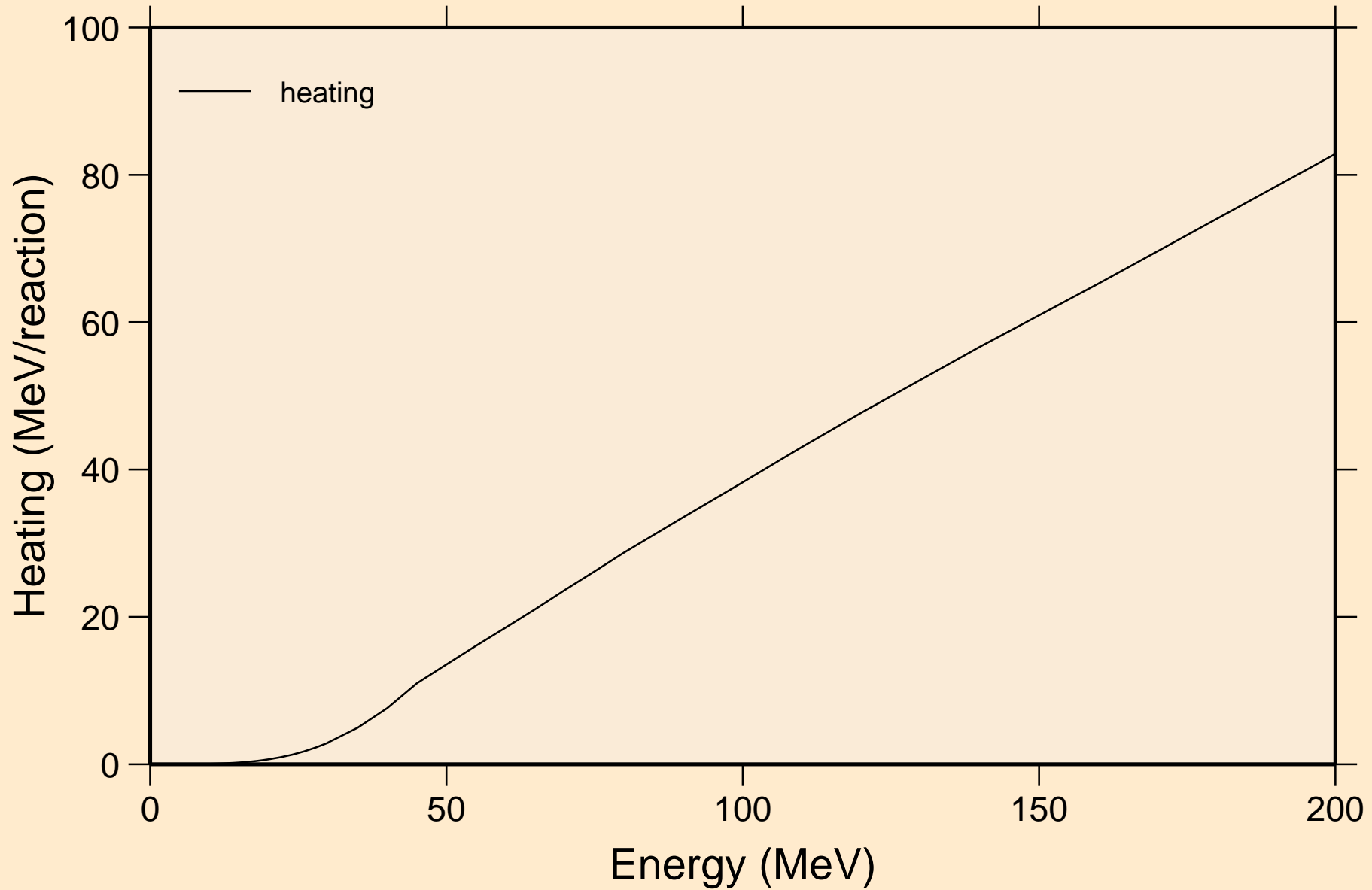

CO060M TRITON ACER TENDL-2021 LIBRARY; T=0.K  
Threshold reactions

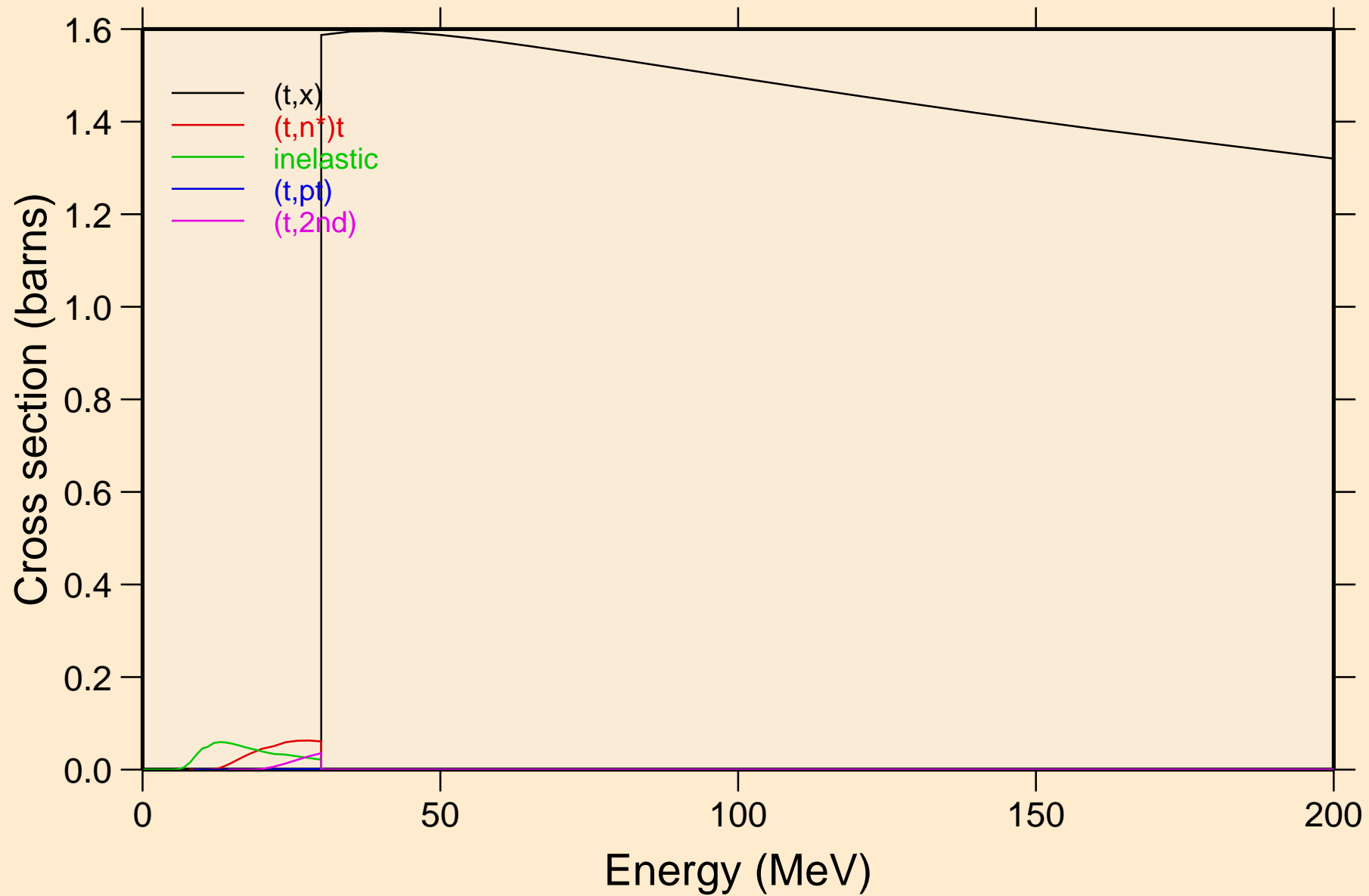

CO060M TRITON ACER TENDL-2021 LIBRARY; T=0.K  
Threshold reactions

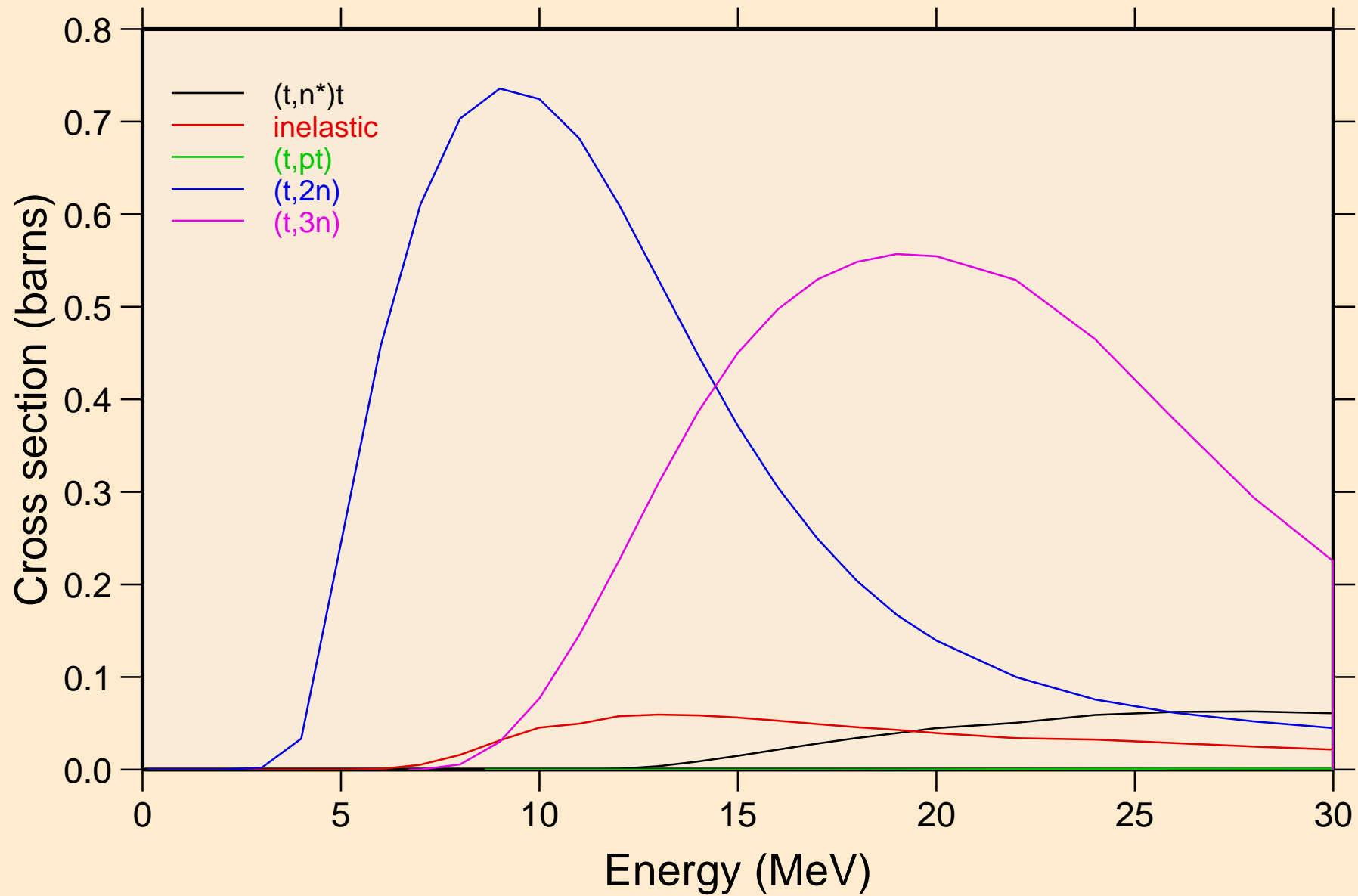

CO060M TRITON ACER TENDL-2021 LIBRARY; T=0.K  
Threshold reactions

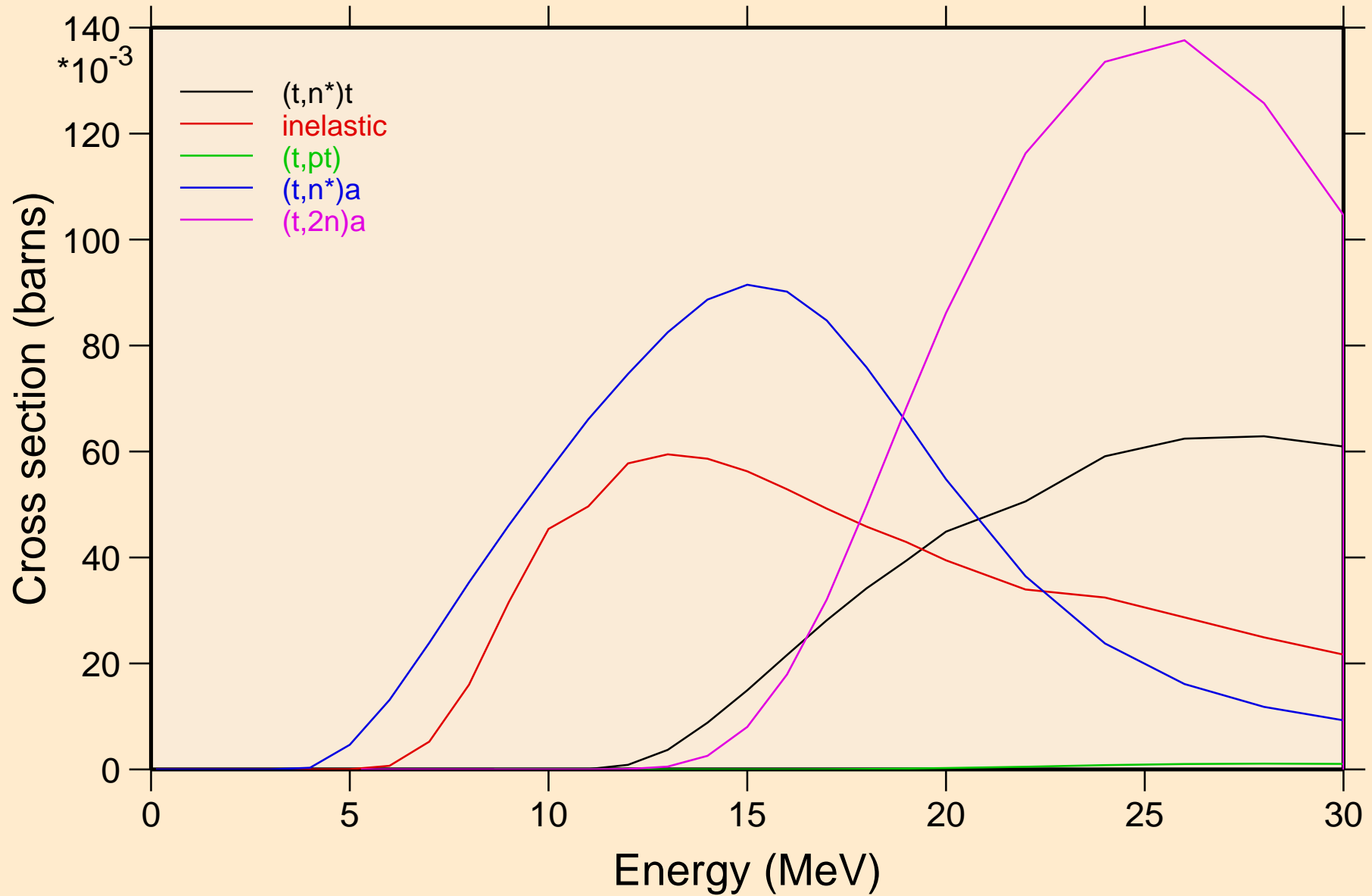

CO060M TRITON ACER TENDL-2021 LIBRARY; T=0.K  
Threshold reactions

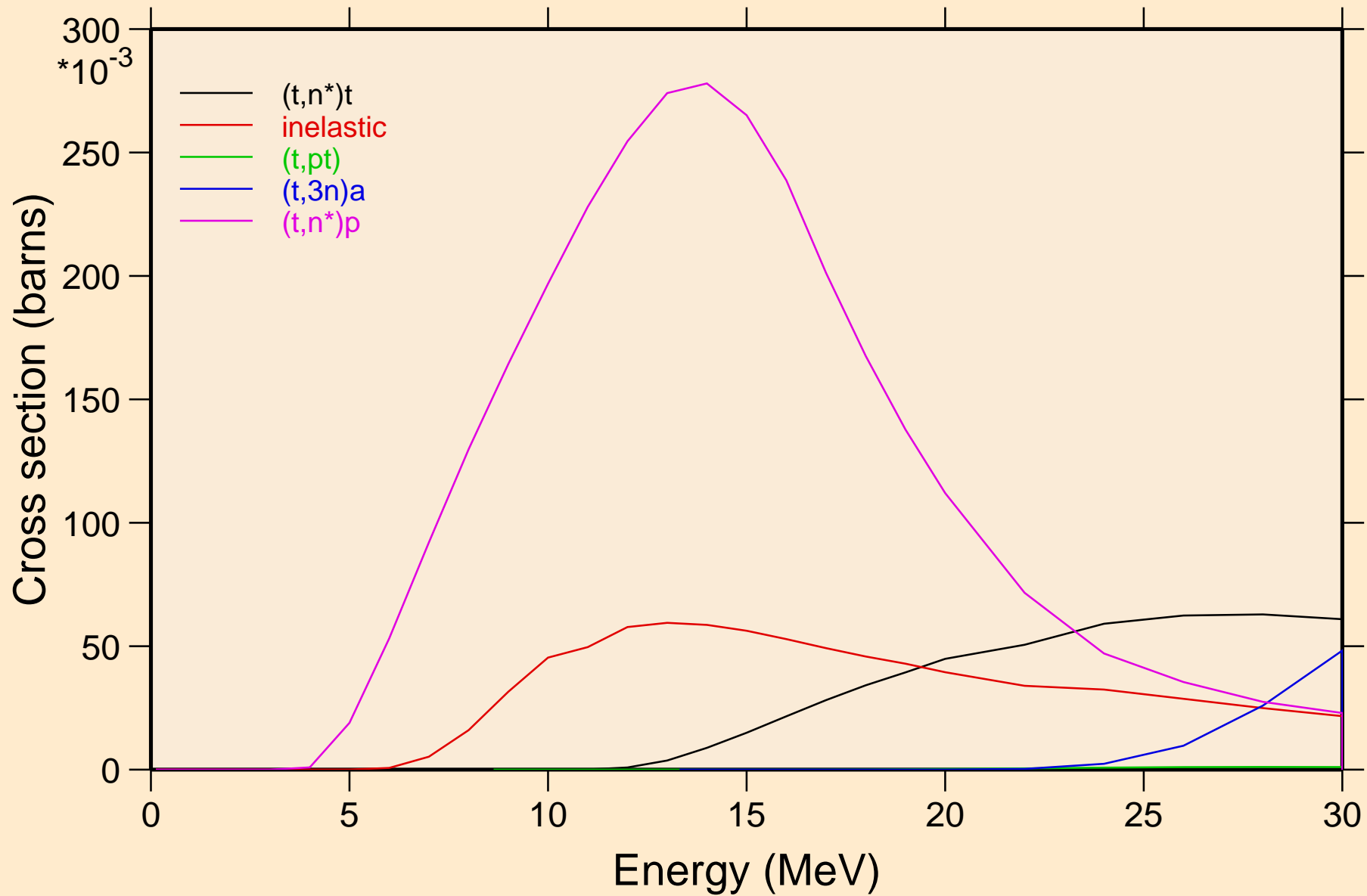



CO060M TRITON ACER TENDL-2021 LIBRARY; T=0.K  
Threshold reactions

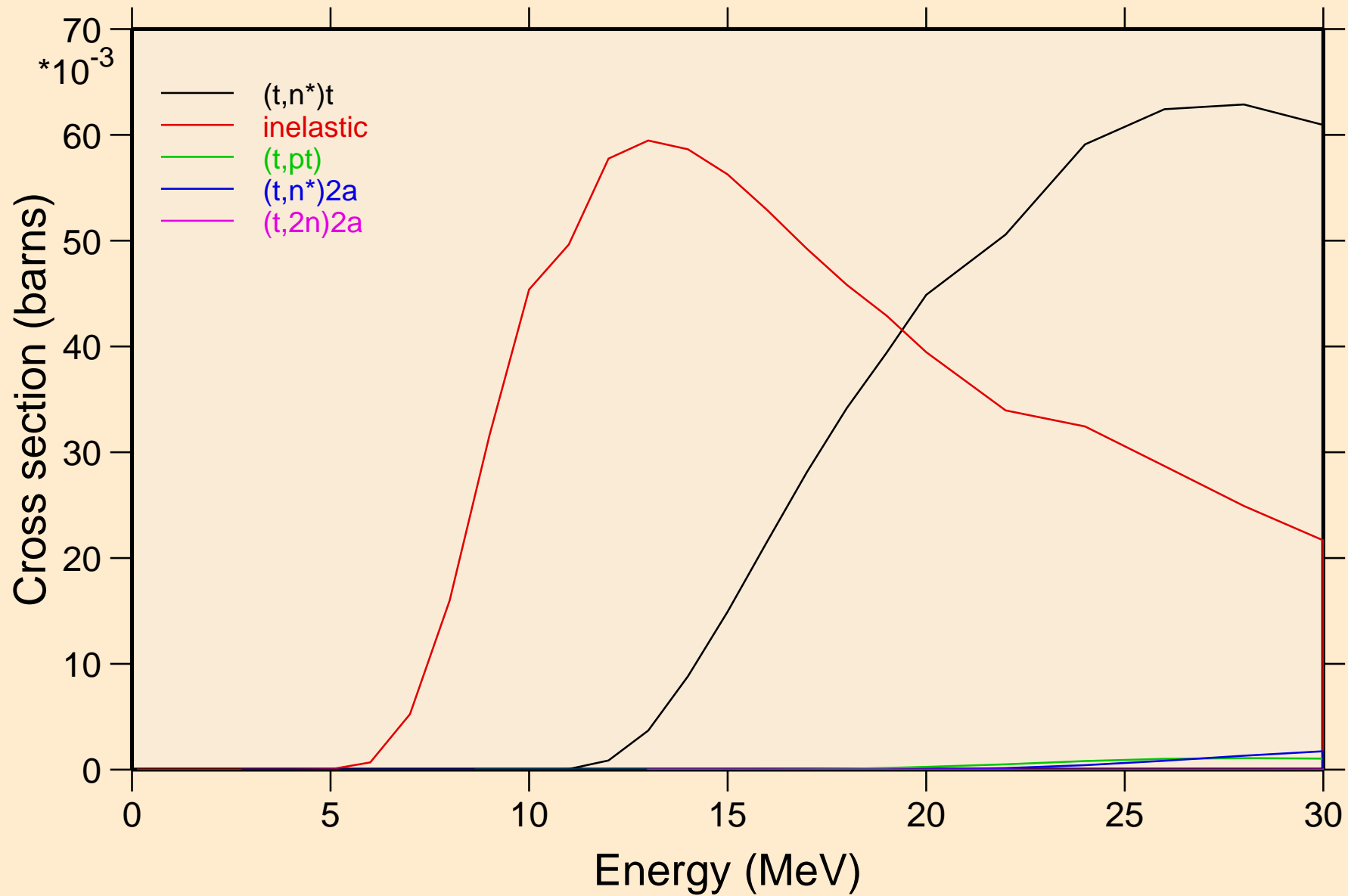

CO060M TRITON ACER TENDL-2021 LIBRARY; T=0.K  
Threshold reactions

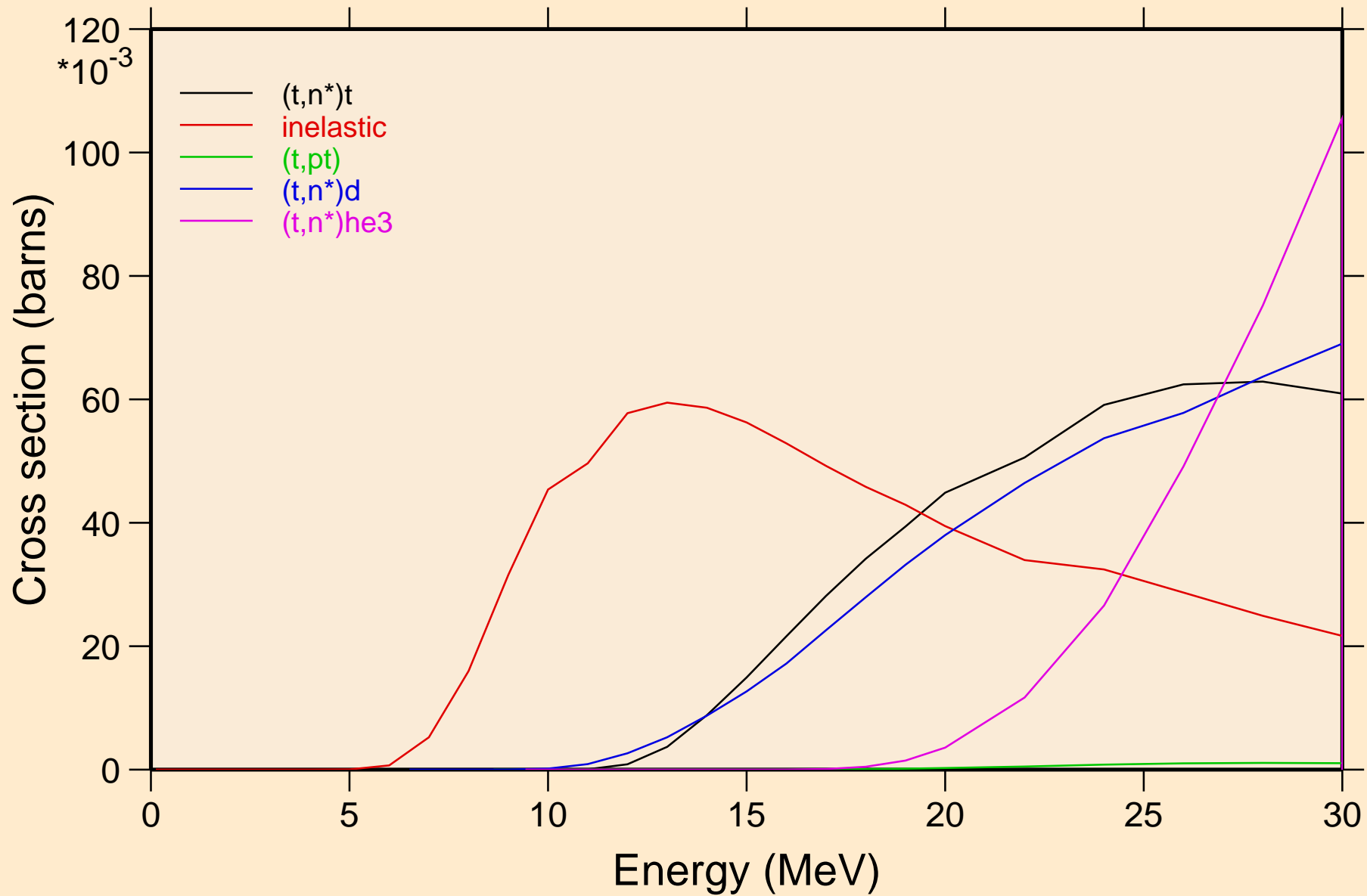

CO060M TRITON ACER TENDL-2021 LIBRARY; T=0.K  
Threshold reactions

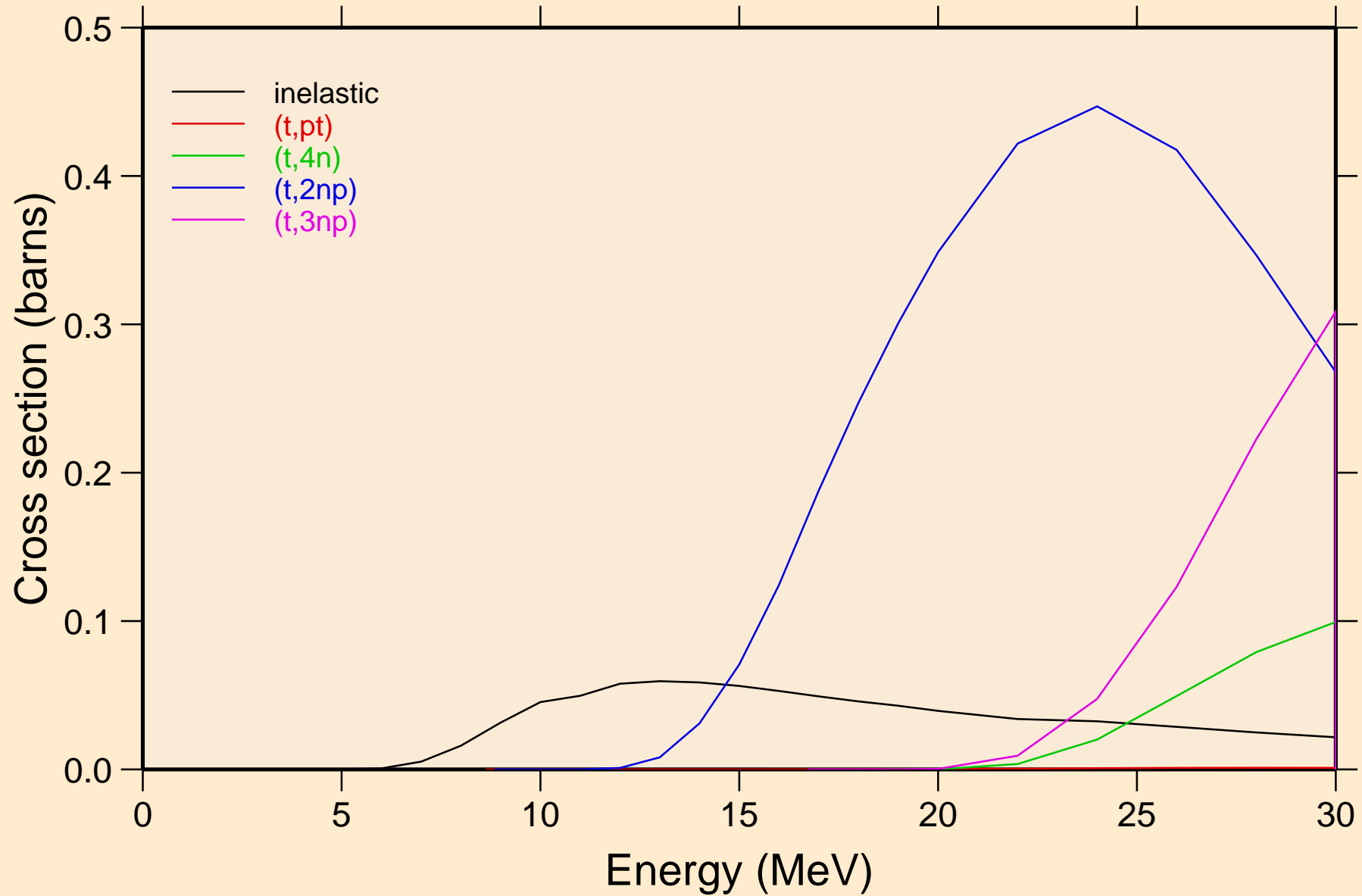

CO060M TRITON ACER TENDL-2021 LIBRARY; T=0.K  
Threshold reactions

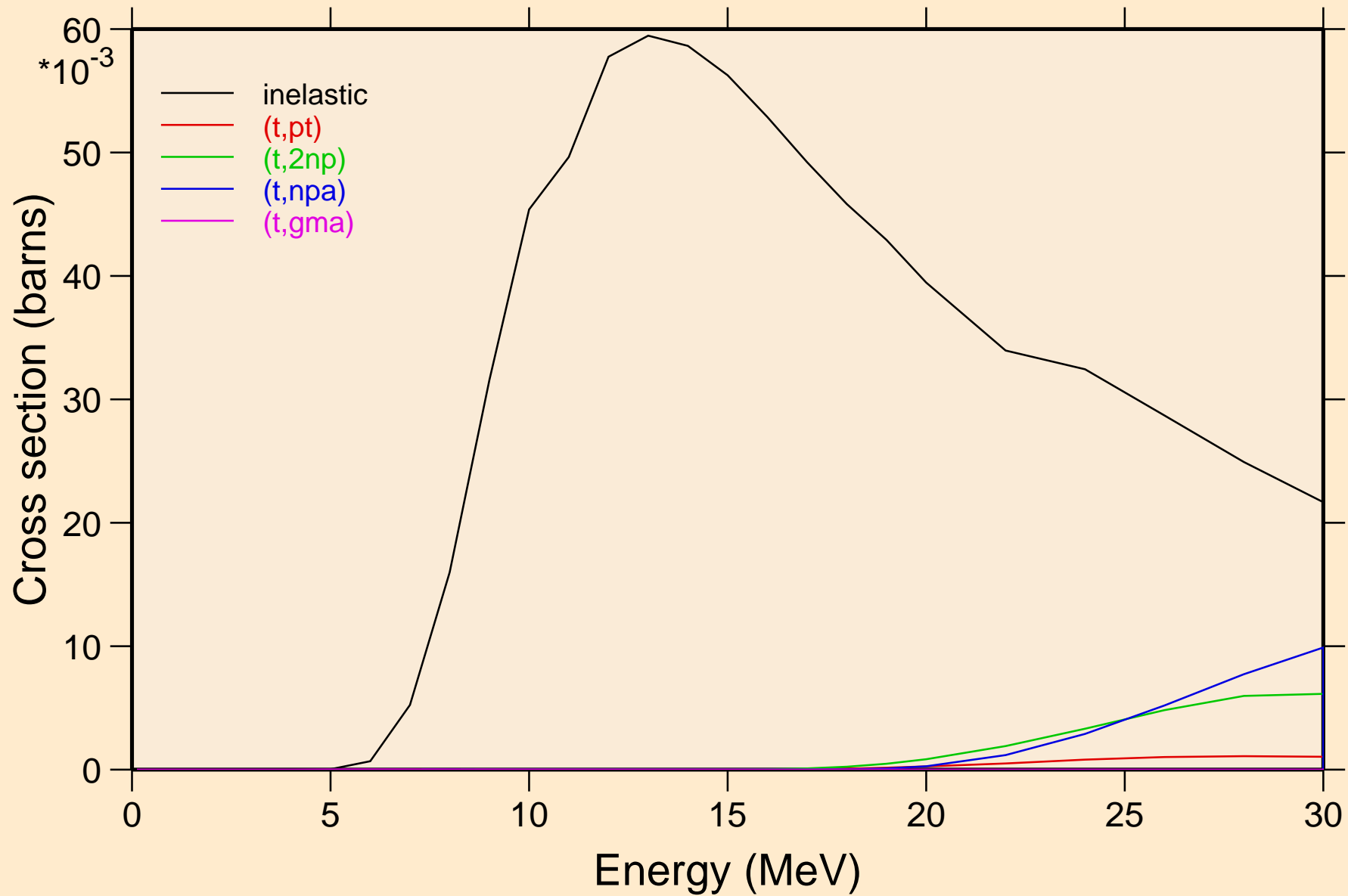

CO060M TRITON ACER TENDL-2021 LIBRARY; T=0.K  
Threshold reactions

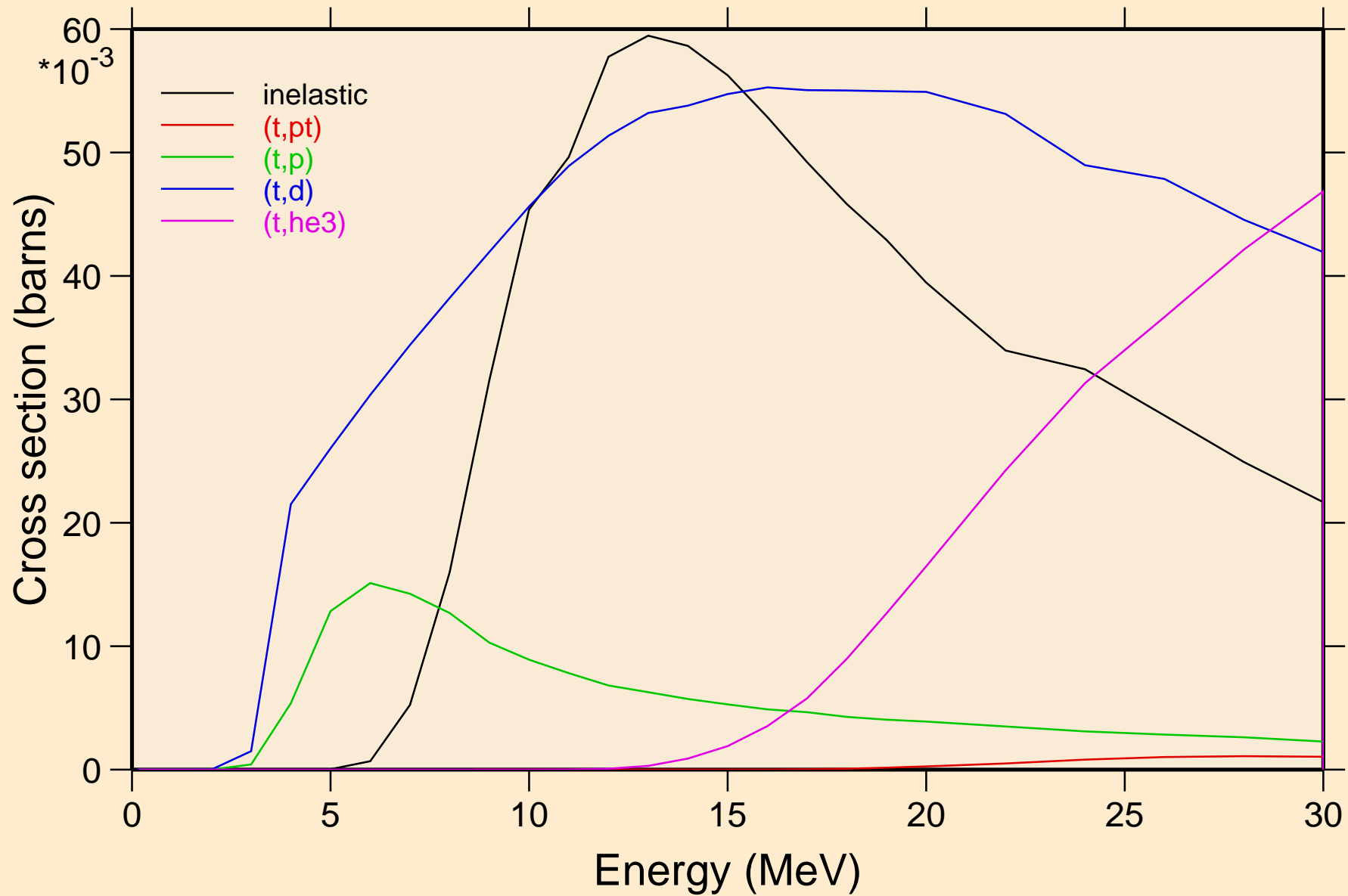

CO060M TRITON ACER TENDL-2021 LIBRARY; T=0.K  
Threshold reactions

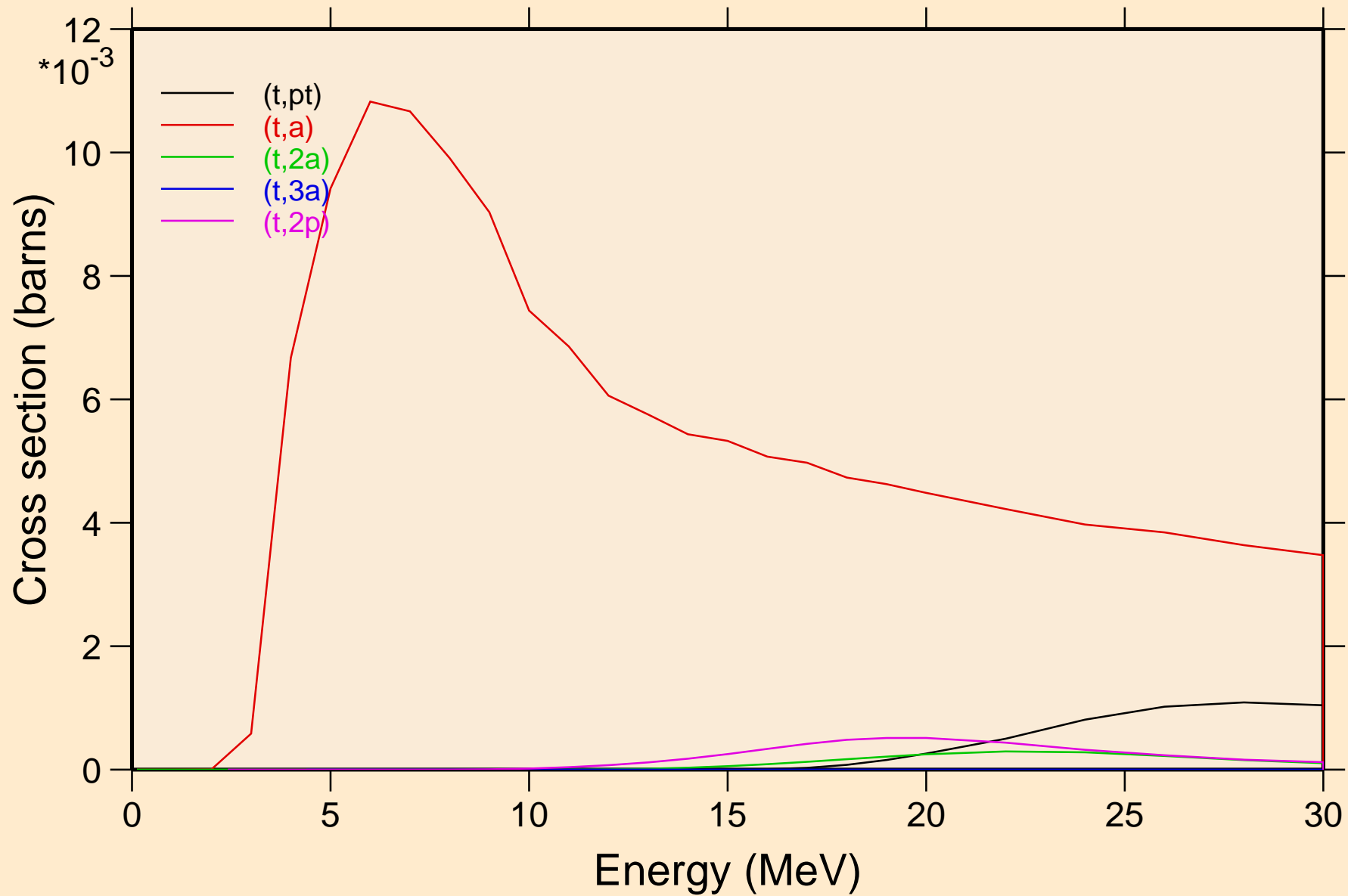

CO060M TRITON ACER TENDL-2021 LIBRARY; T=0.K  
Threshold reactions

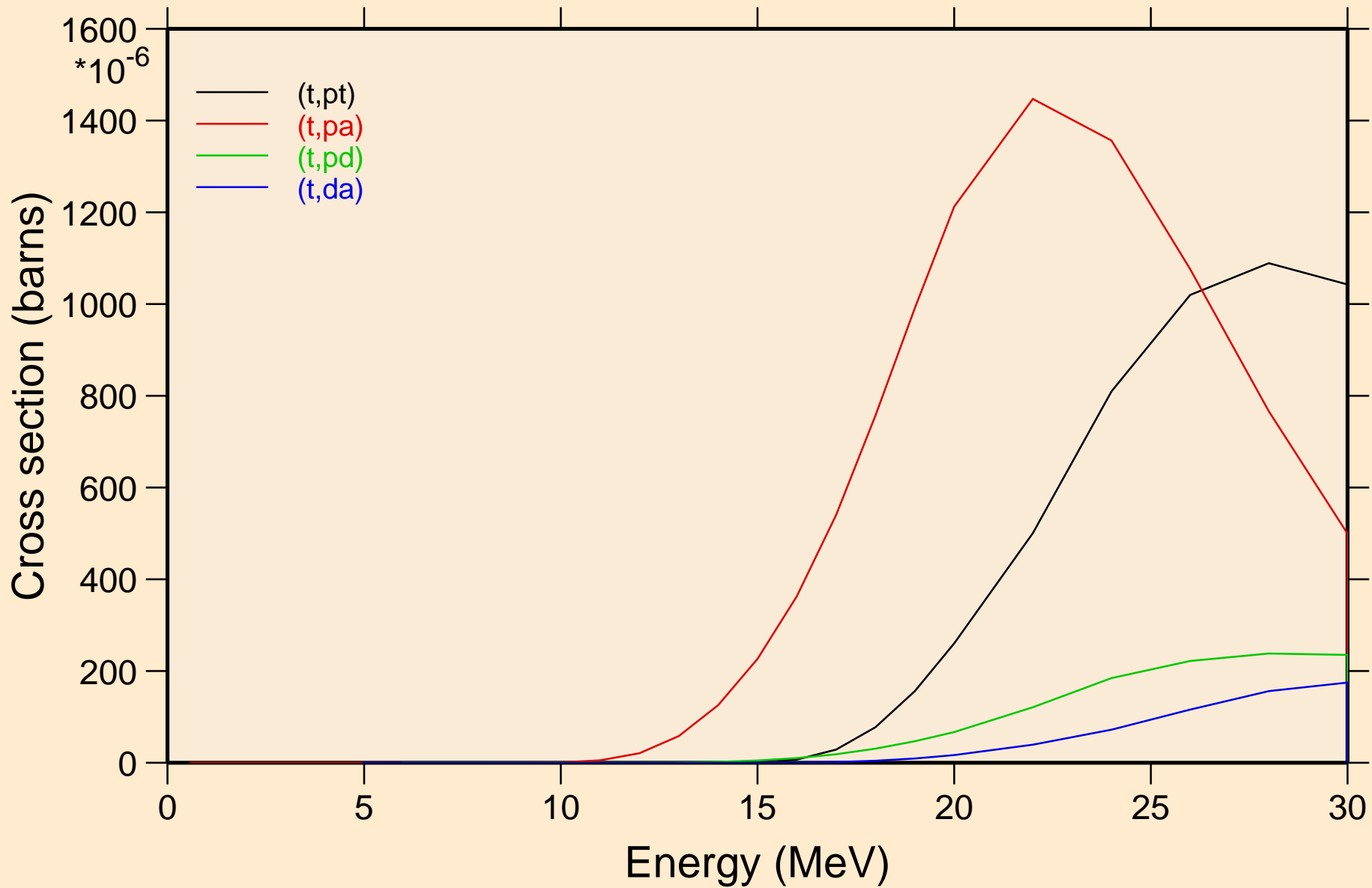

CO060M TRITON ACER TENDL-2021 LIBRARY; T=0.K  
angular distribution for elastic

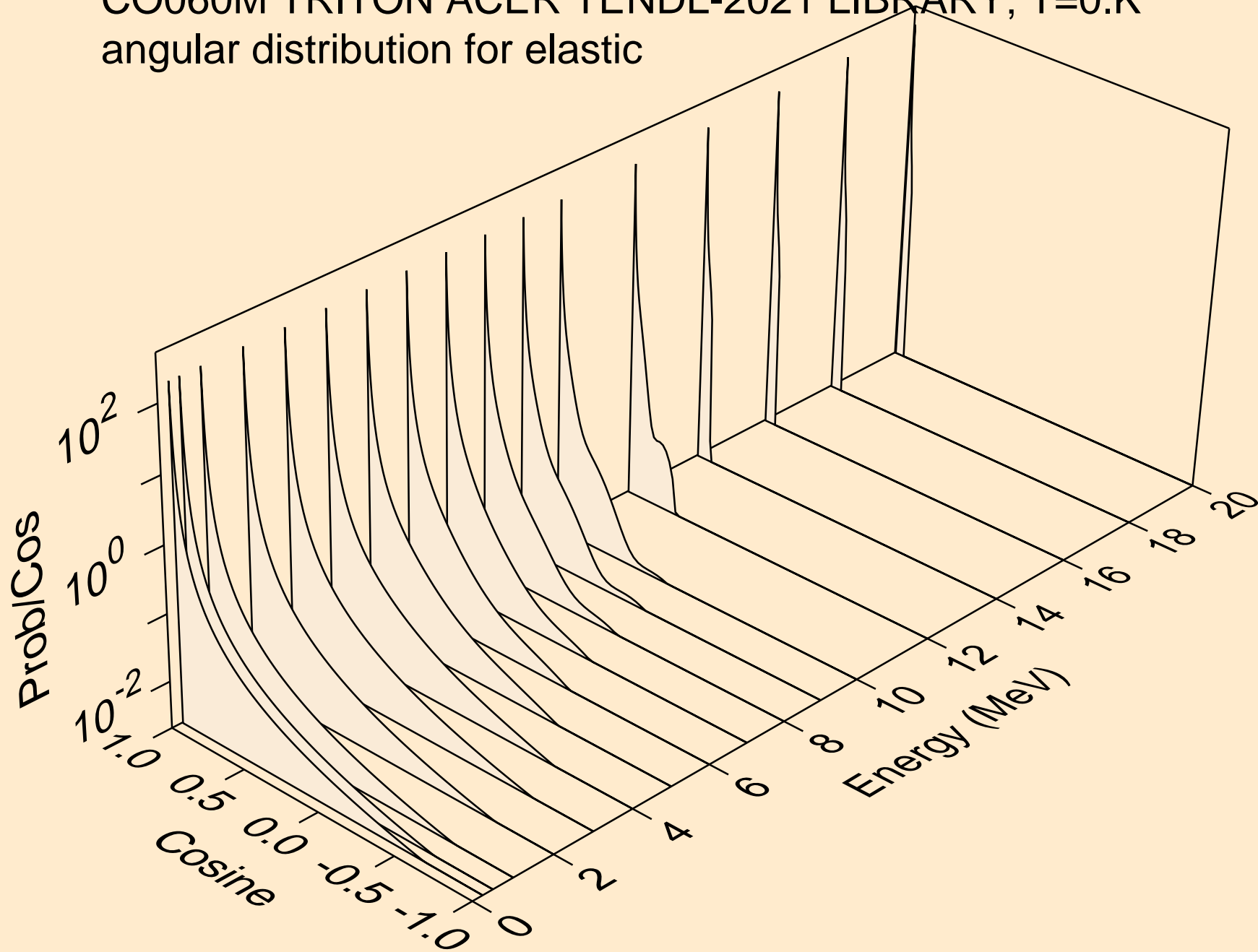



CO060M TRITON ACER TENDL-2021 LIBRARY; T=0.K  
angular distribution for elastic

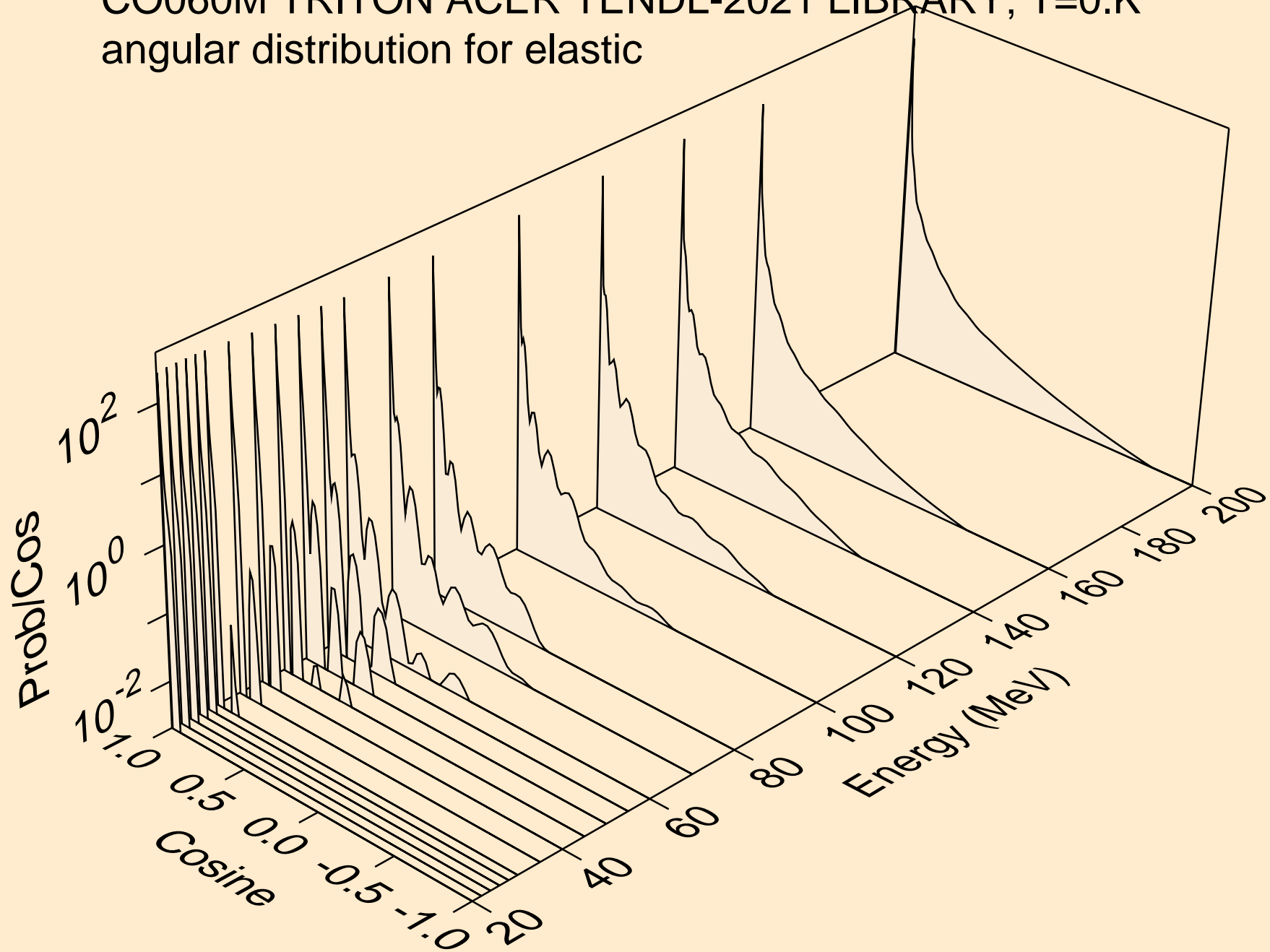

CO060M TRITON ACER TENDL-2021 LIBRARY; T=0.K  
Triton emission for (t,x)

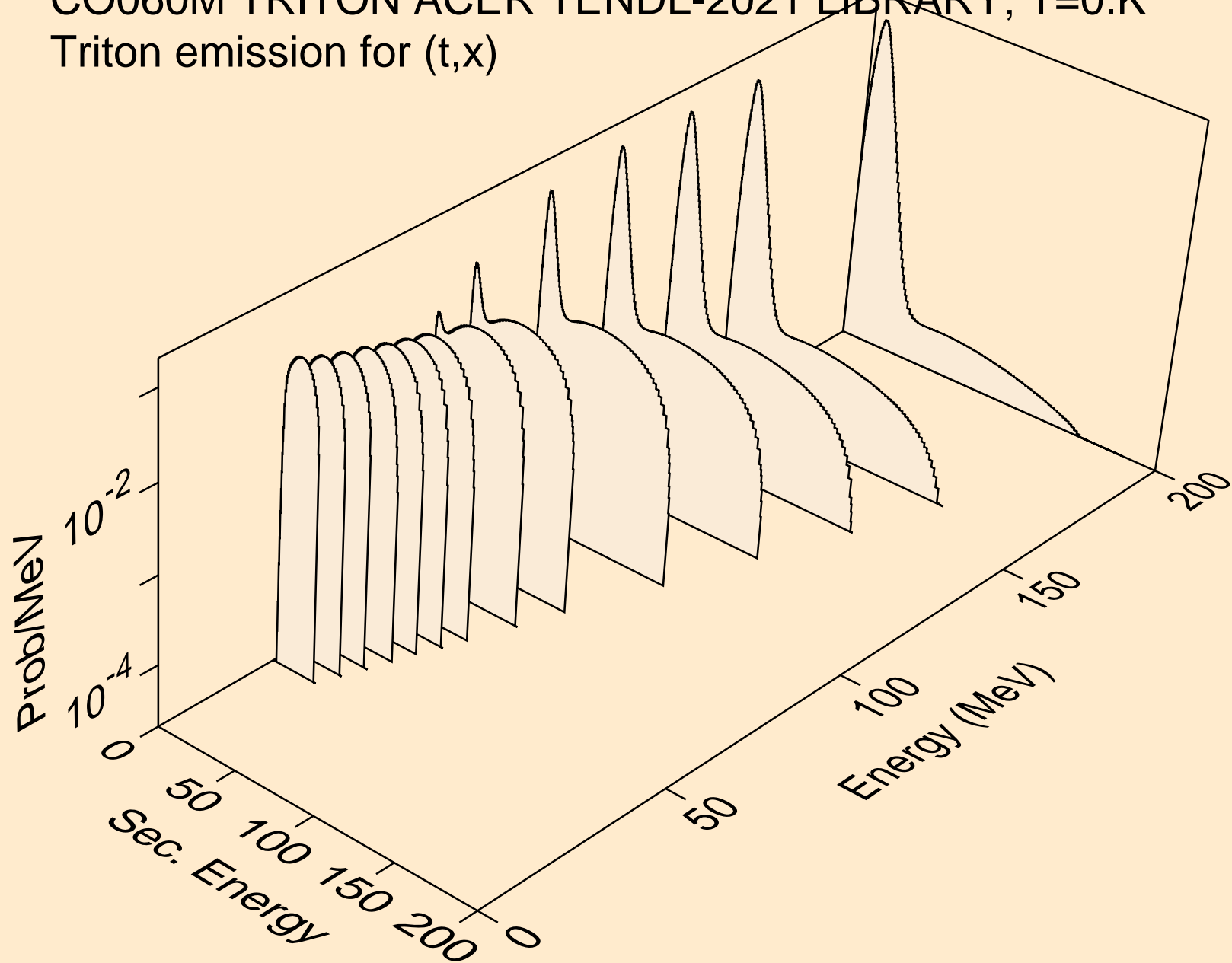

CO060M TRITON ACER TENDL-2021 LIBRARY; T=0.K  
Triton emission for (t,n\*)t

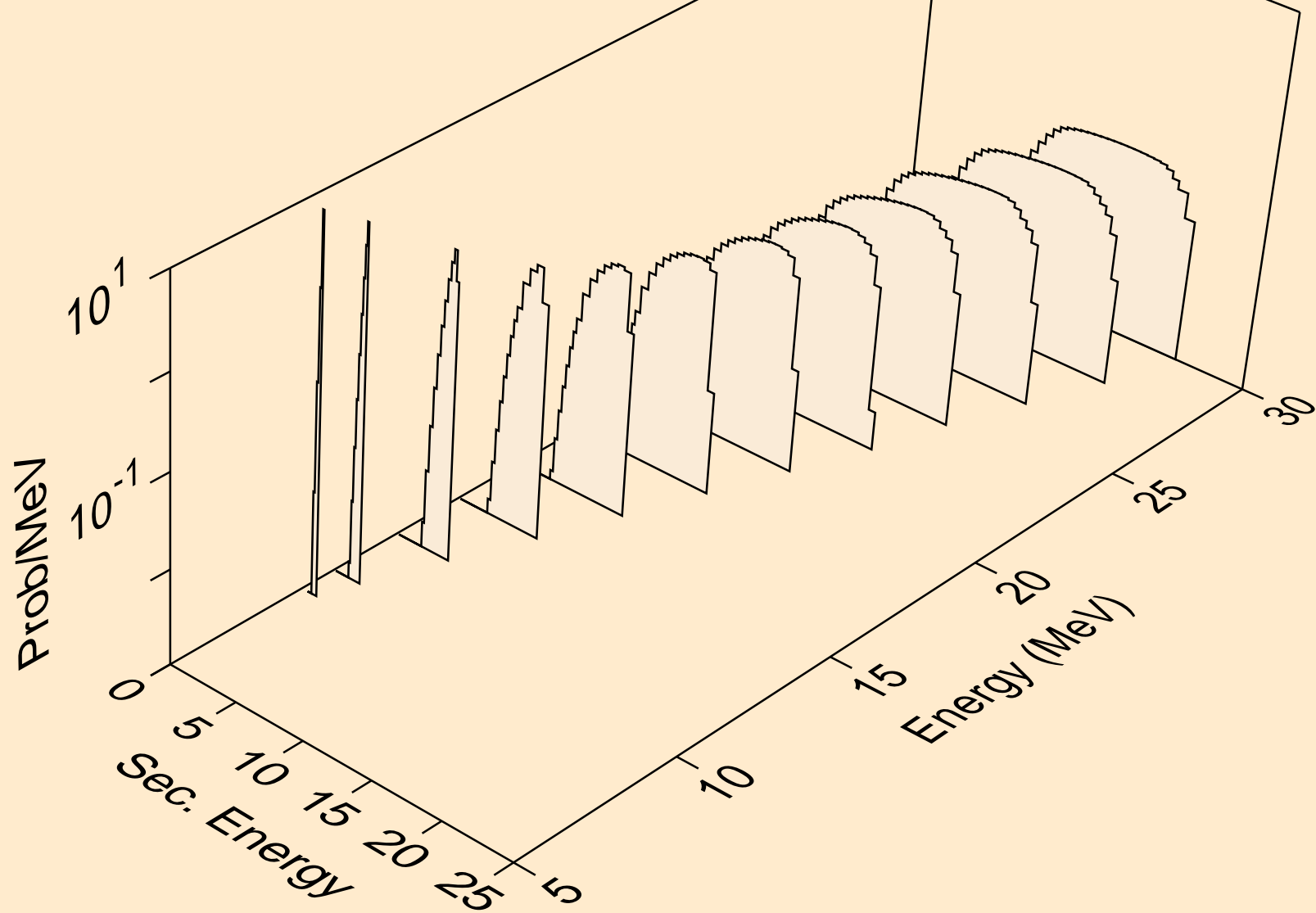

CO060M TRITON ACER TENDL-2021 LIBRARY; T=0.K  
Triton emission for inelastic

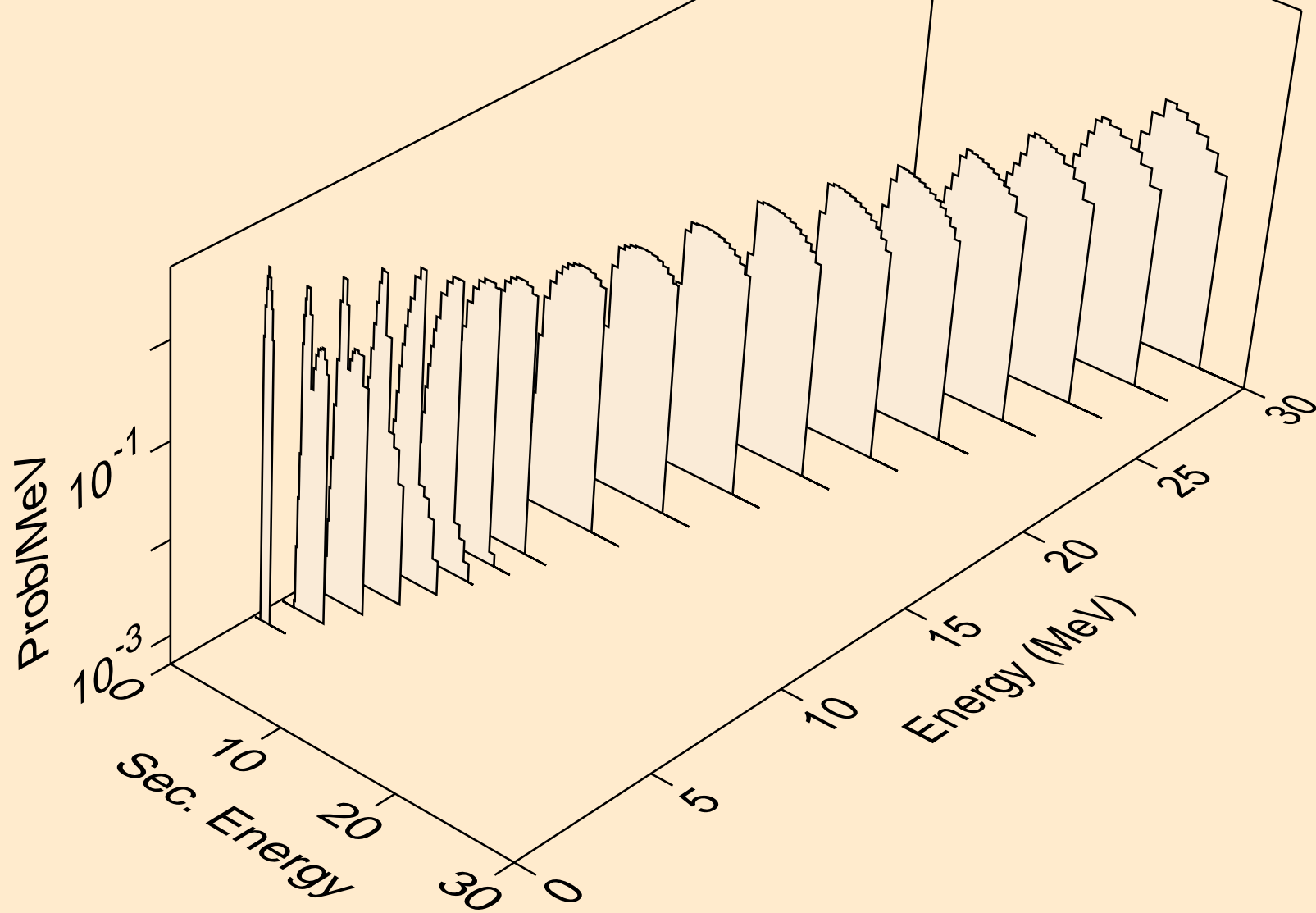

CO060M TRITON ACER TENDL-2021 LIBRARY; T=0.K  
Triton emission for (t,pt)

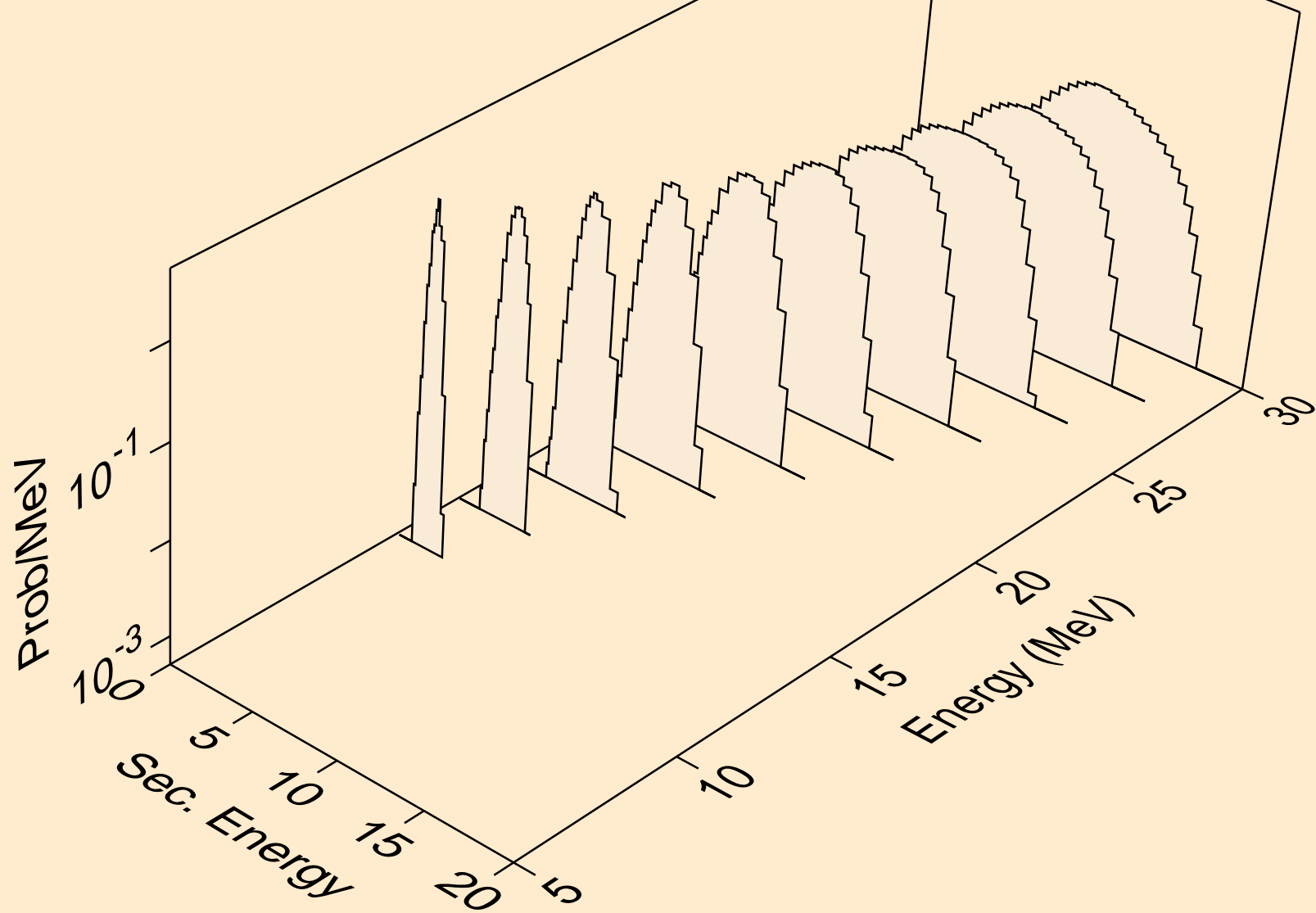

CO060M TRITON ACER TENDL-2021 LIBRARY; T=0.K  
Photon emission for (z,n)

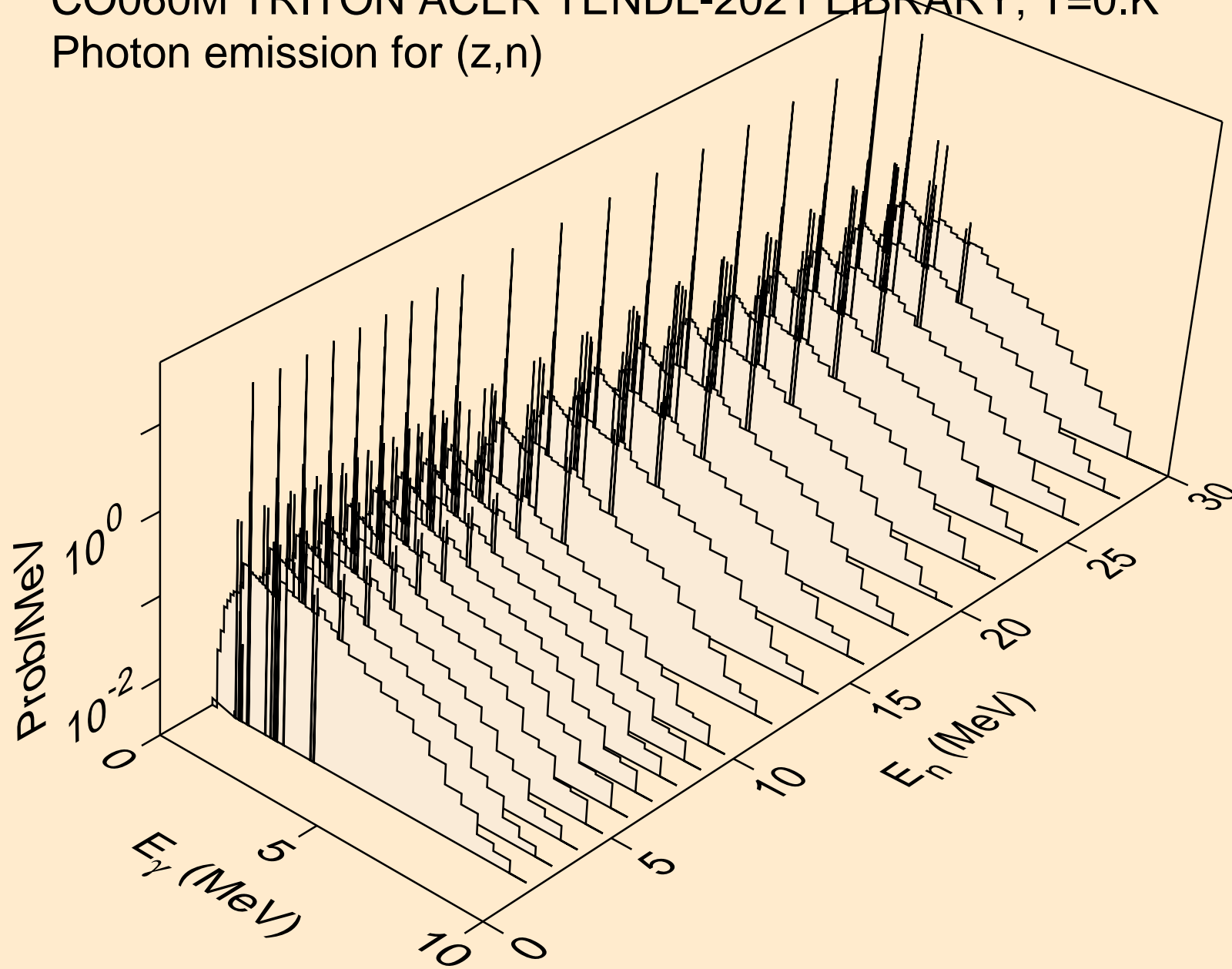

CO060M TRITON ACER TENDL-2021 LIBRARY; T=0.K  
Photon emission for (n,x)

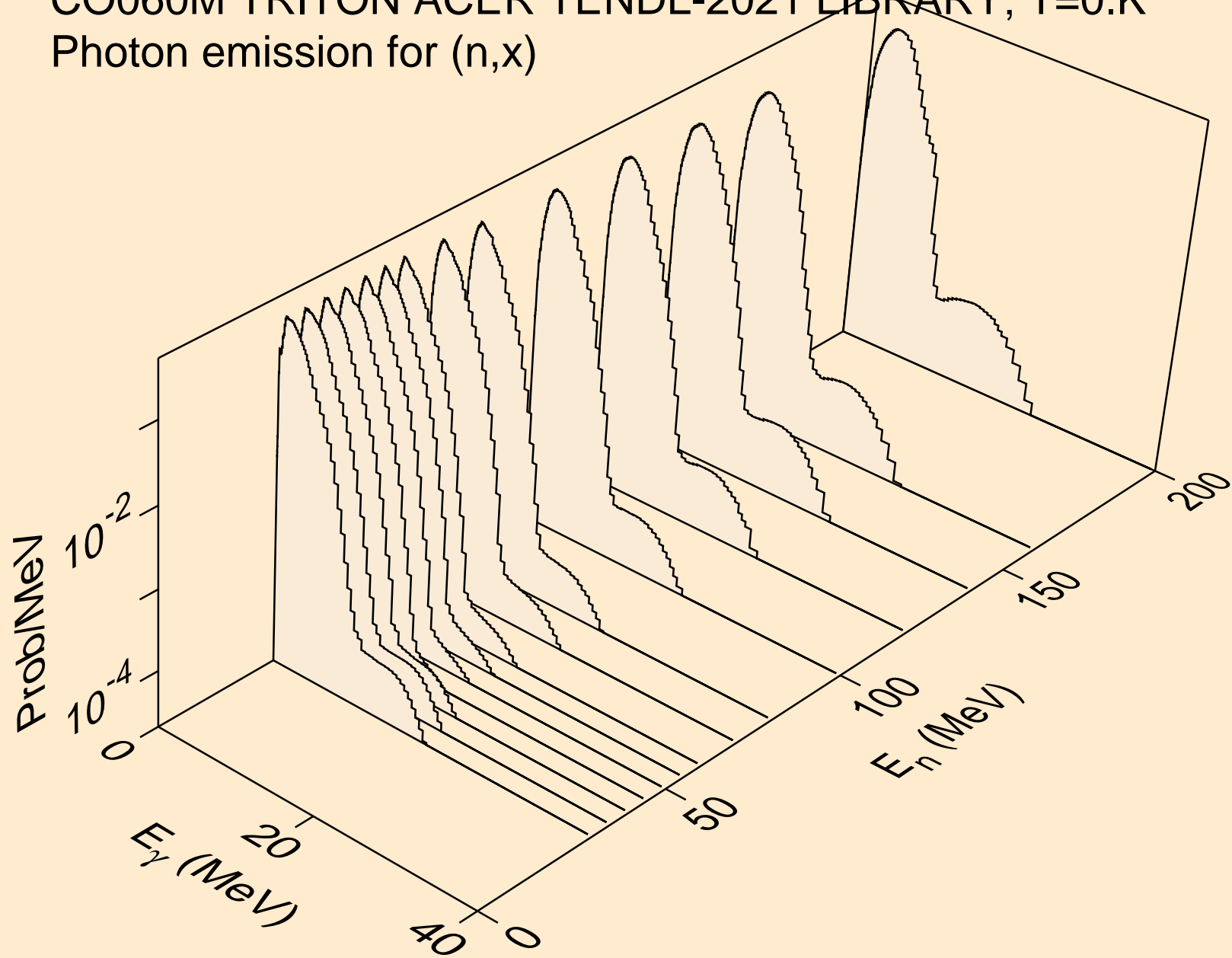

CO060M TRITON ACER TENDL-2021 LIBRARY; T=0.K  
Photon emission for (n,2nd)

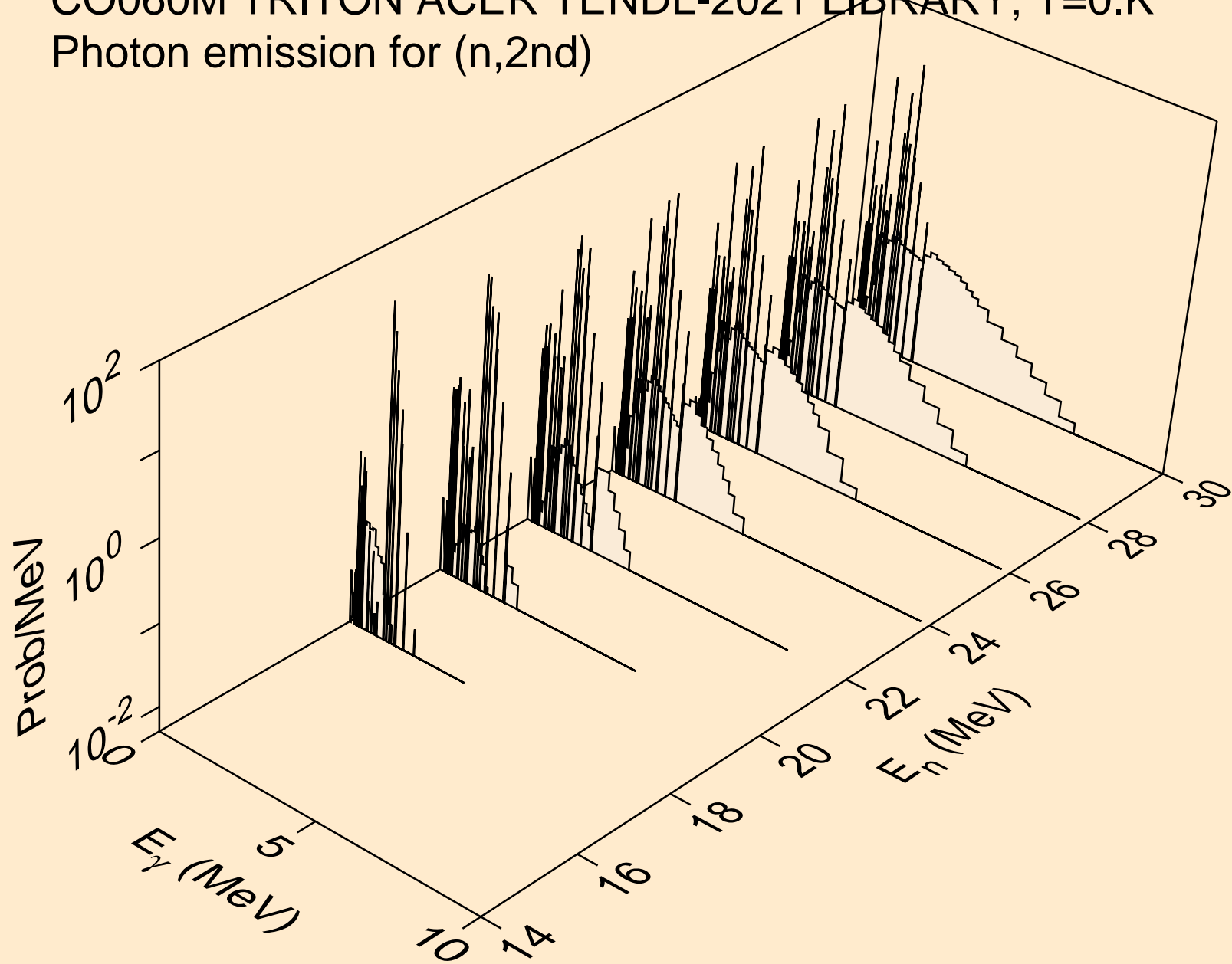



CO060M TRITON ACER TENDL-2021 LIBRARY; T=0.K  
Photon emission for (n,2n)

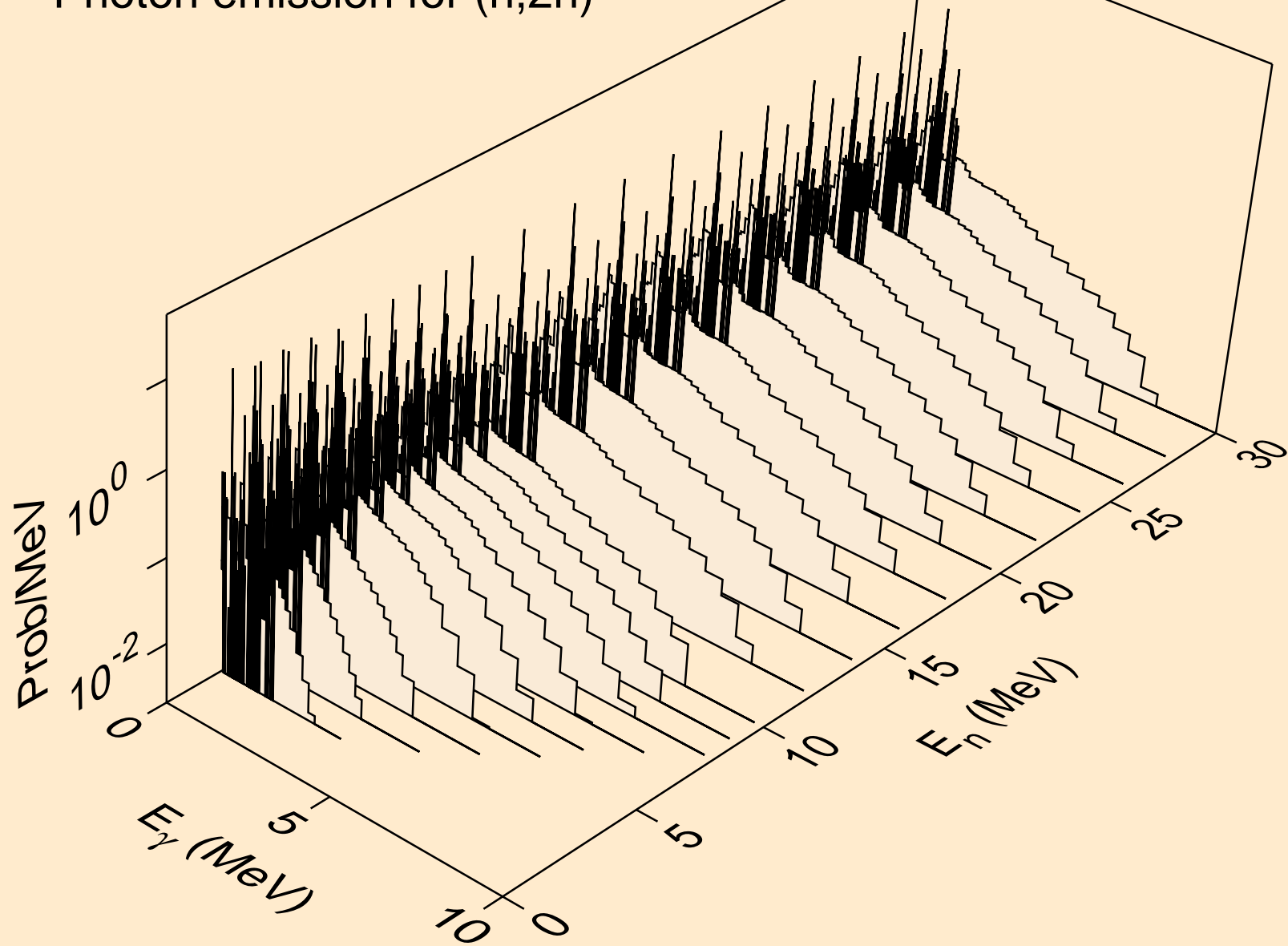

CO060M TRITON ACER TENDL-2021 LIBRARY; T=0.K  
Photon emission for (n,3n)

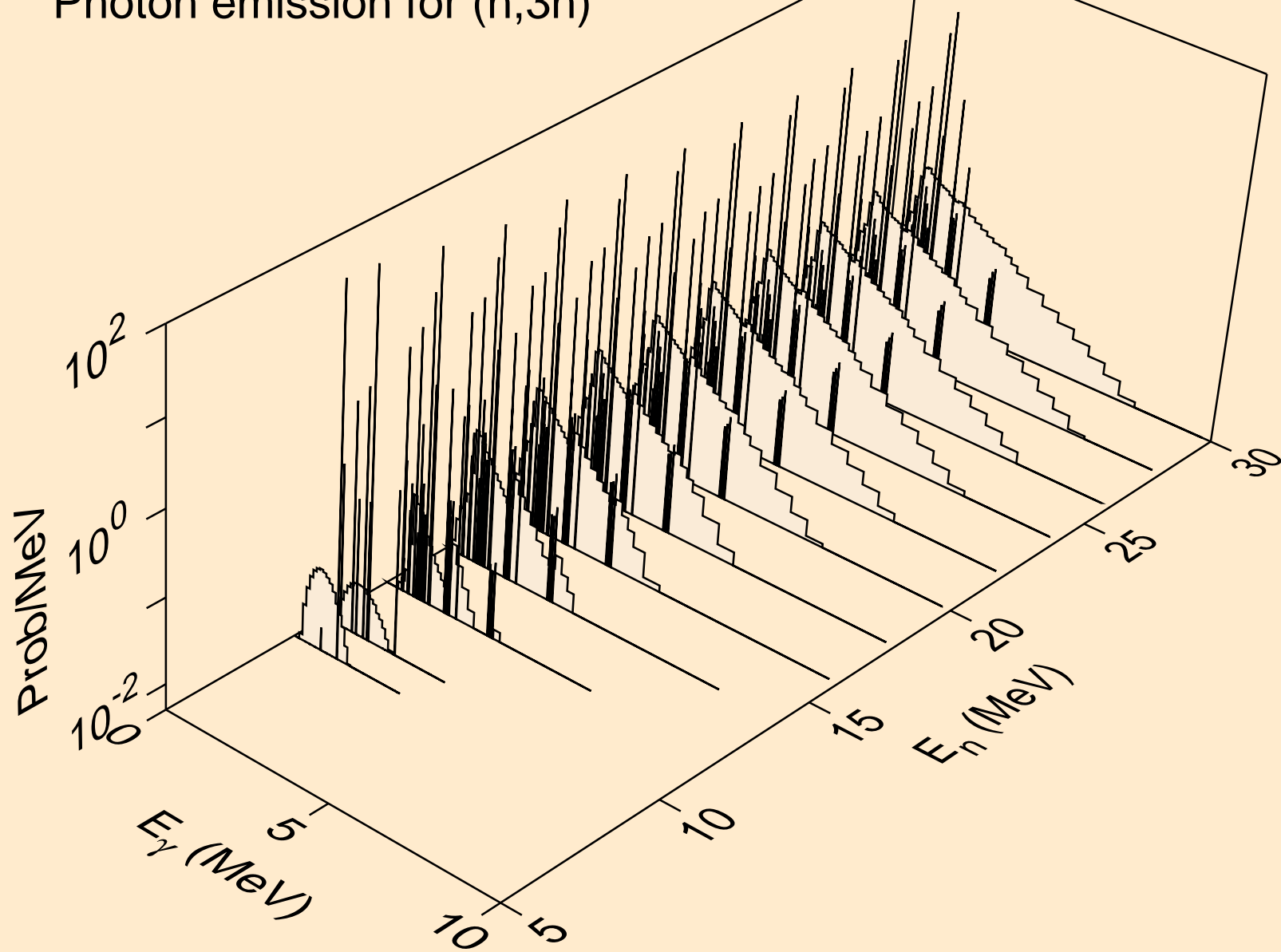

CO060M TRITON ACER TENDL-2021 LIBRARY; T=0.K  
Photon emission for (n,n\*)a

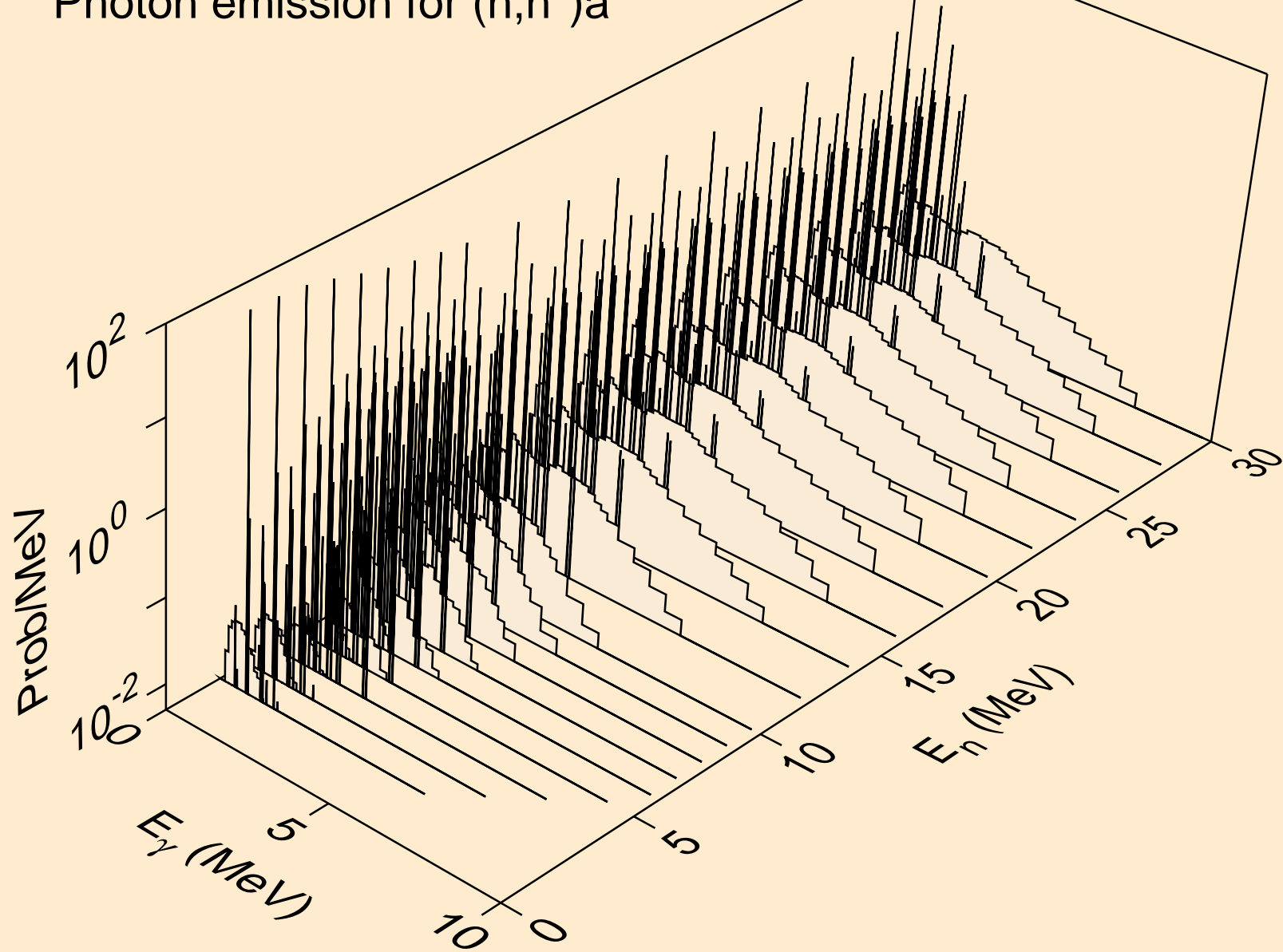

CO060M TRITON ACER TENDL-2021 LIBRARY; T=0.K  
Photon emission for (n,2n)a

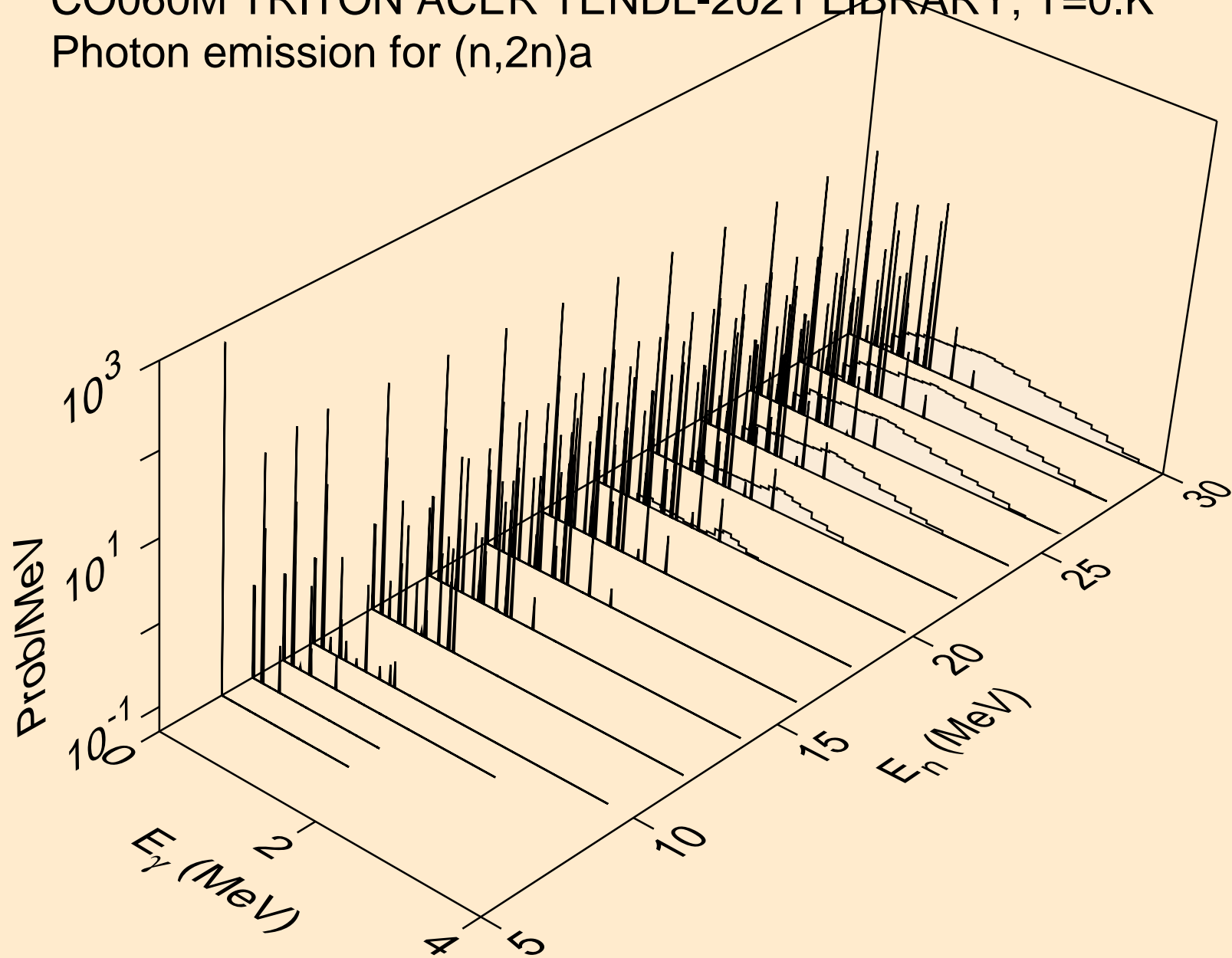

CO060M TRITON ACER TENDL-2021 LIBRARY; T=0.K  
Photon emission for (n,3n)a

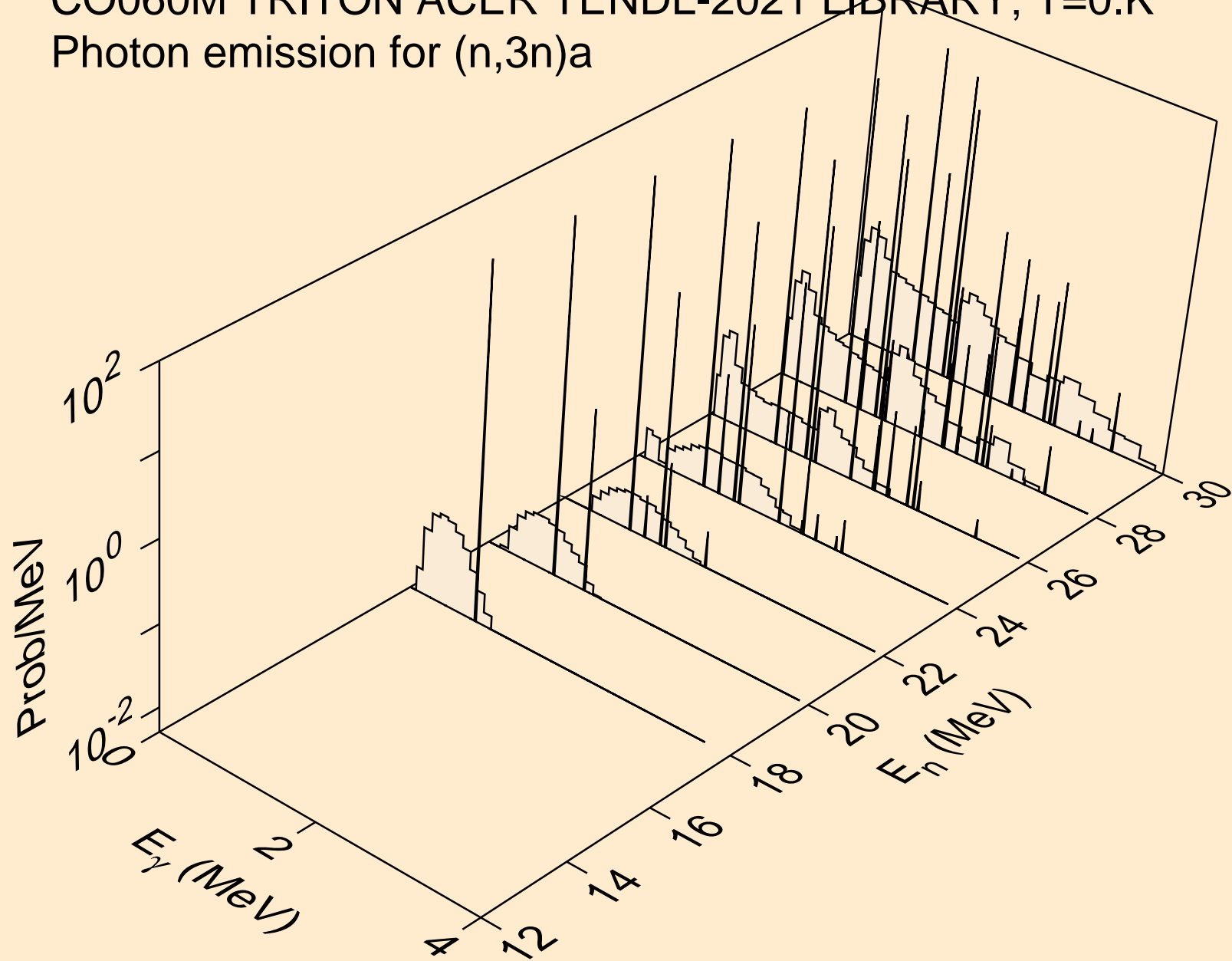

CO060M TRITON ACER TENDL-2021 LIBRARY; T=0.K  
Photon emission for (n,n\*)p

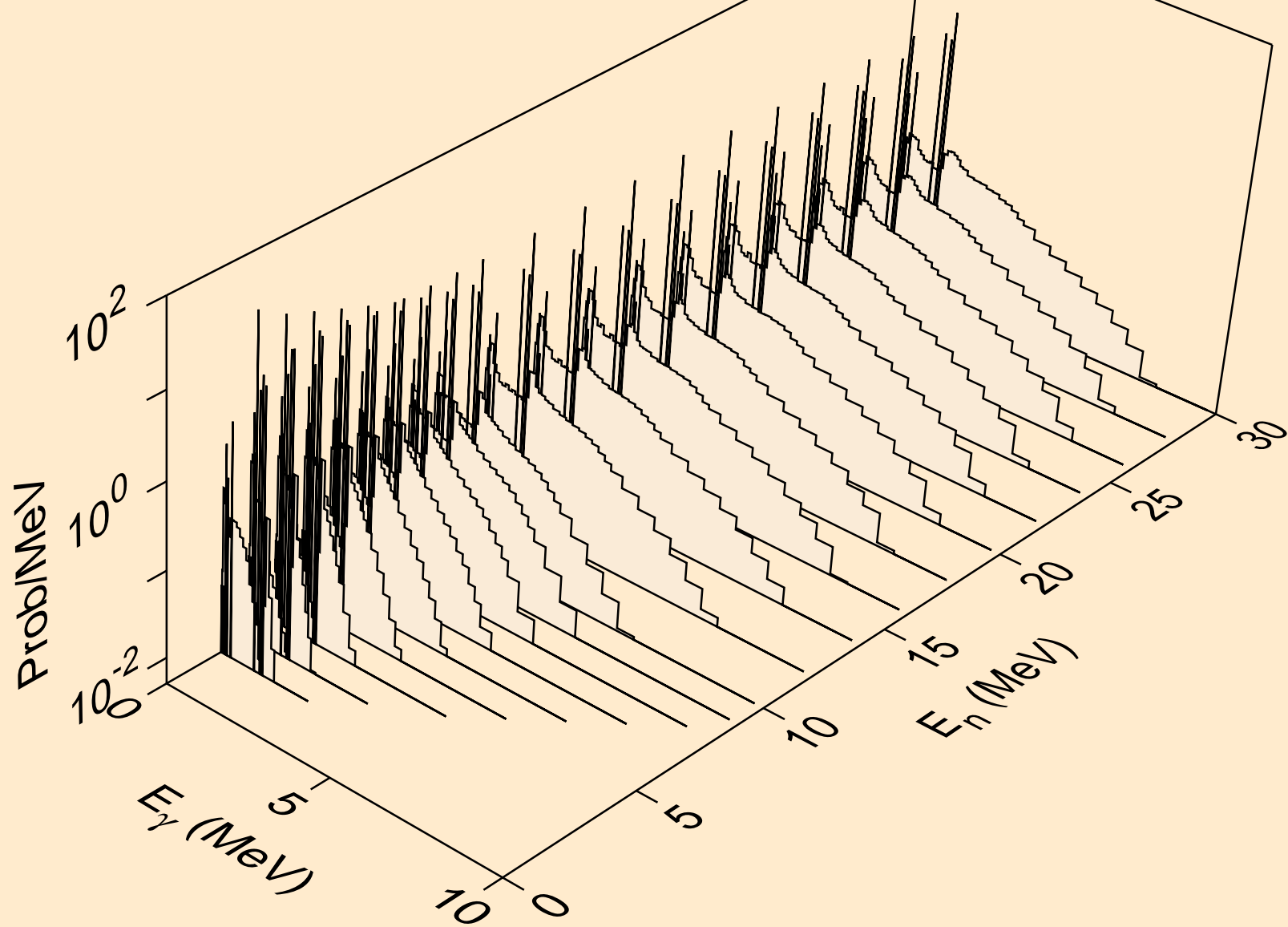

CO060M TRITON ACER TENDL-2021 LIBRARY; T=0.K  
Photon emission for (n,n\*)2a

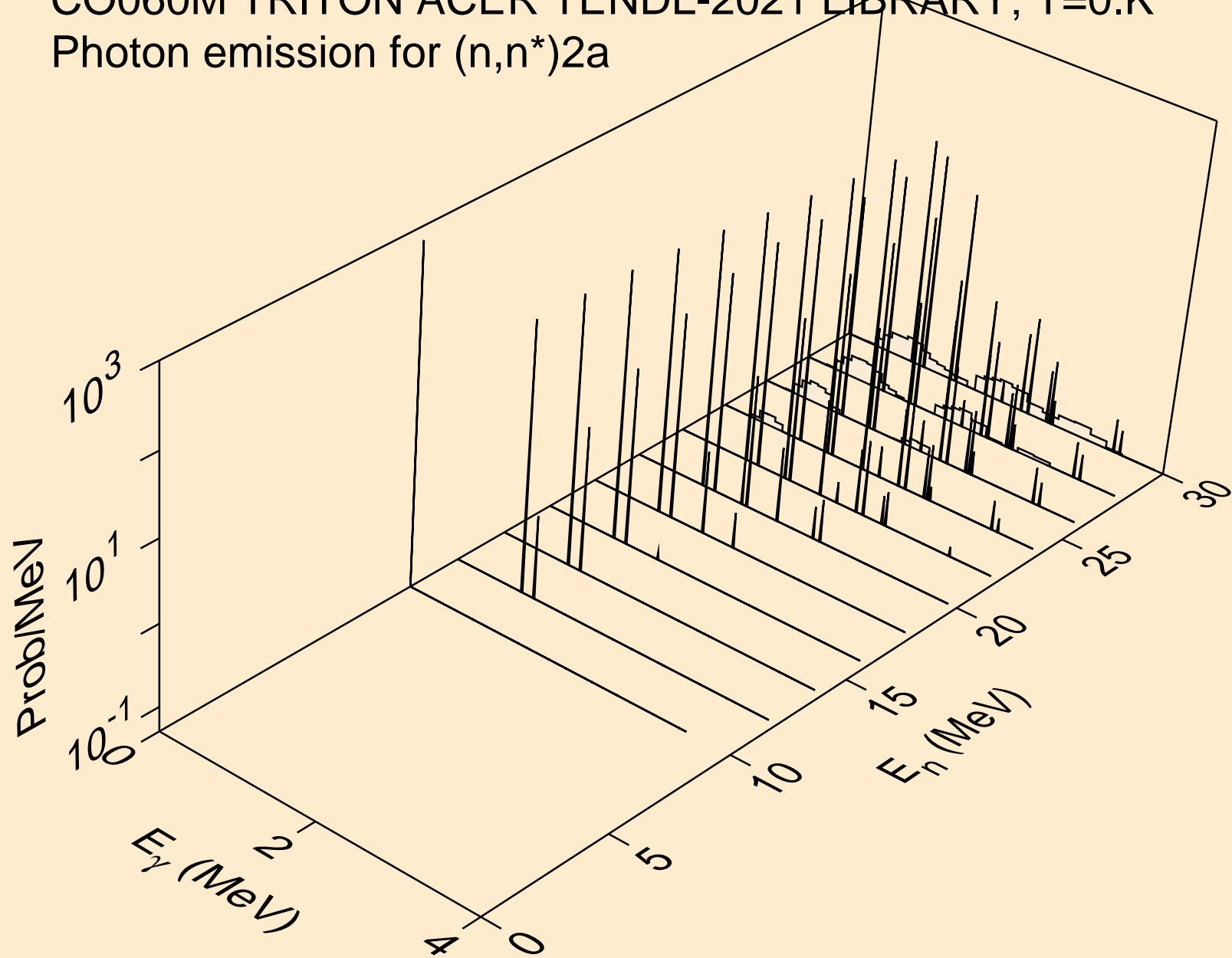

CO060M TRITON ACER TENDL-2021 LIBRARY; T=0.K  
Photon emission for (n,2n)2a

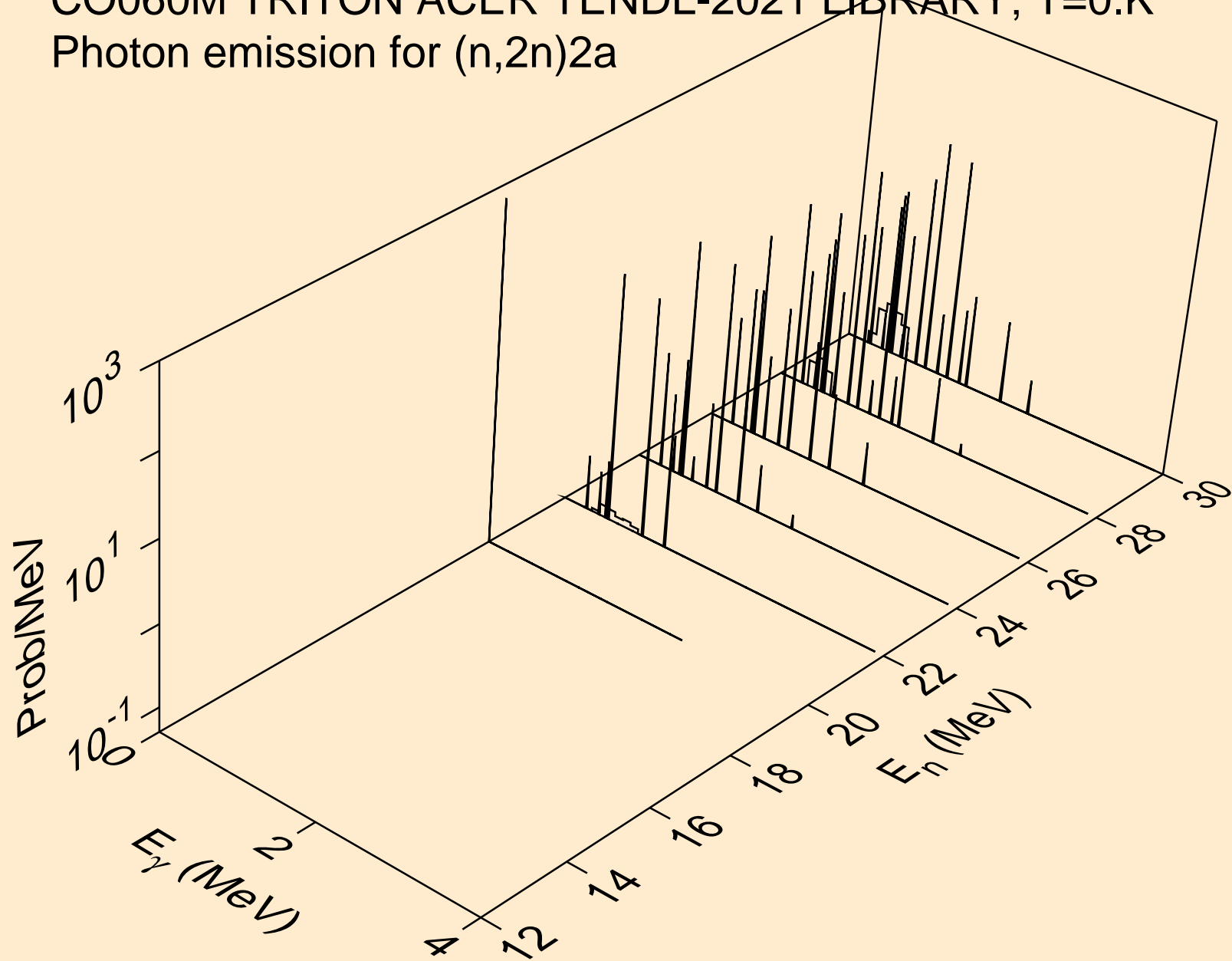



CO060M TRITON ACER TENDL-2021 LIBRARY; T=0.K  
Photon emission for (n,n\*)d

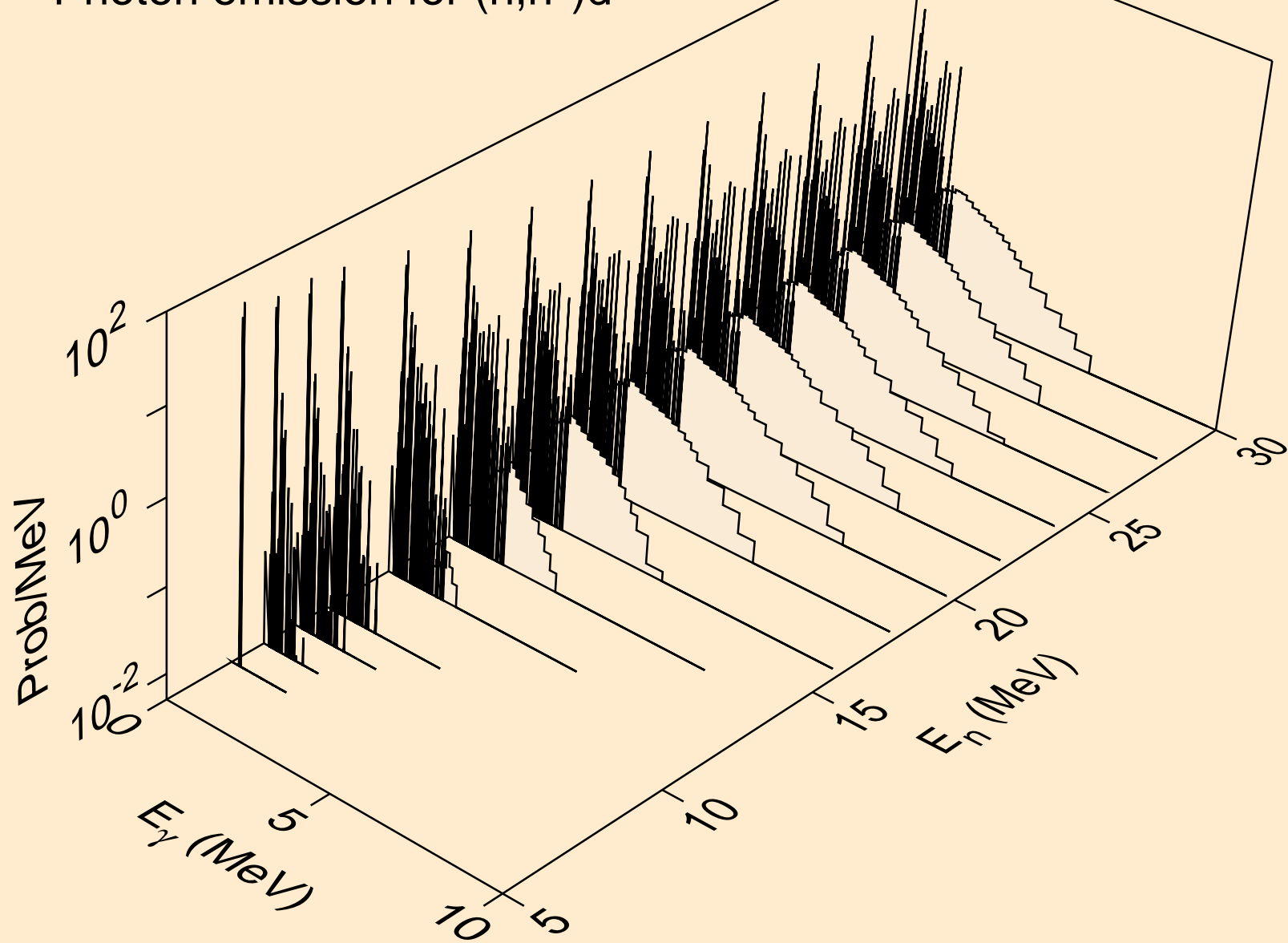

CO060M TRITON ACER TENDL-2021 LIBRARY; T=0.K  
Photon emission for (n,n\*)t

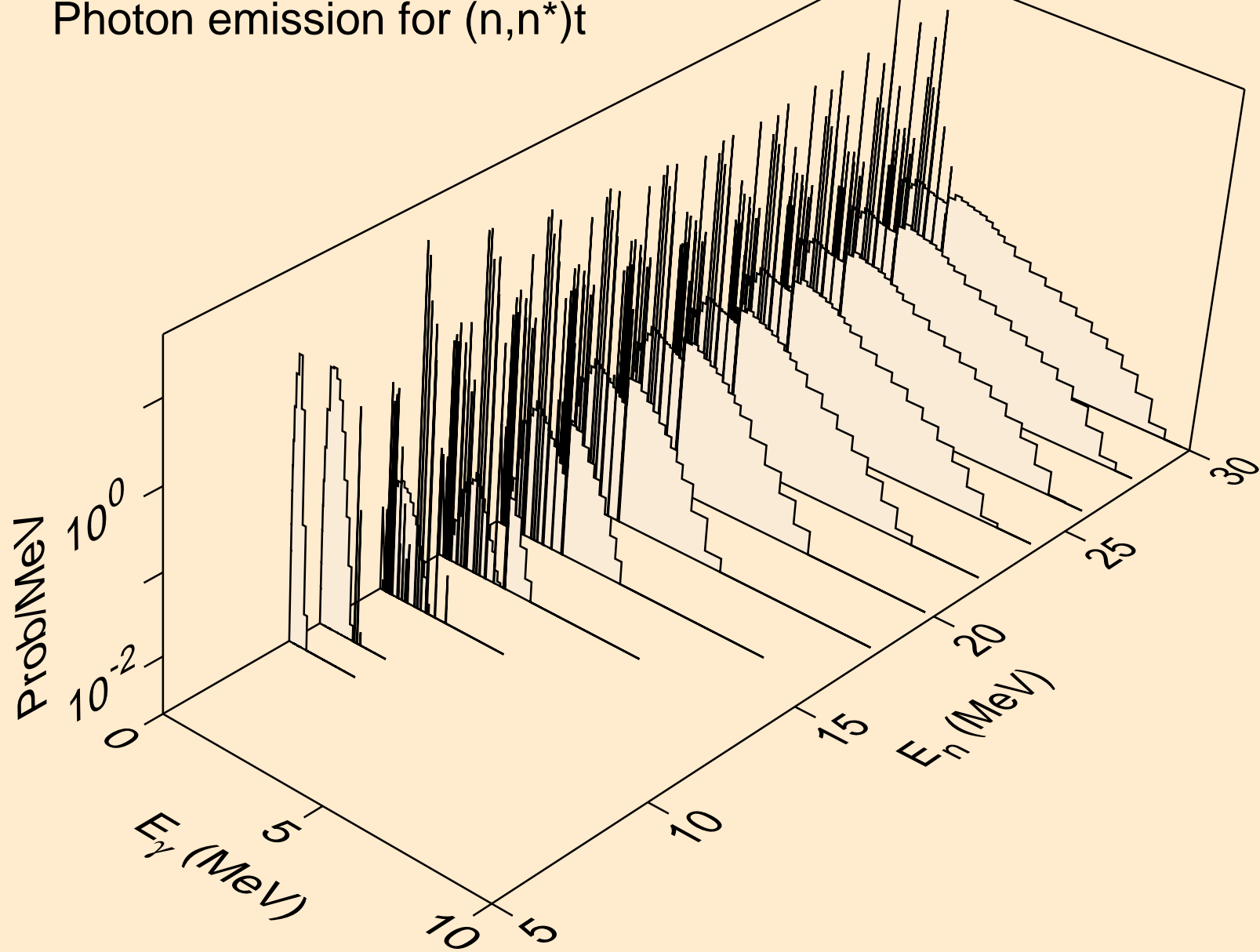

CO060M TRITON ACER TENDL-2021 LIBRARY; T=0.K  
Photon emission for (n,n\*)he3

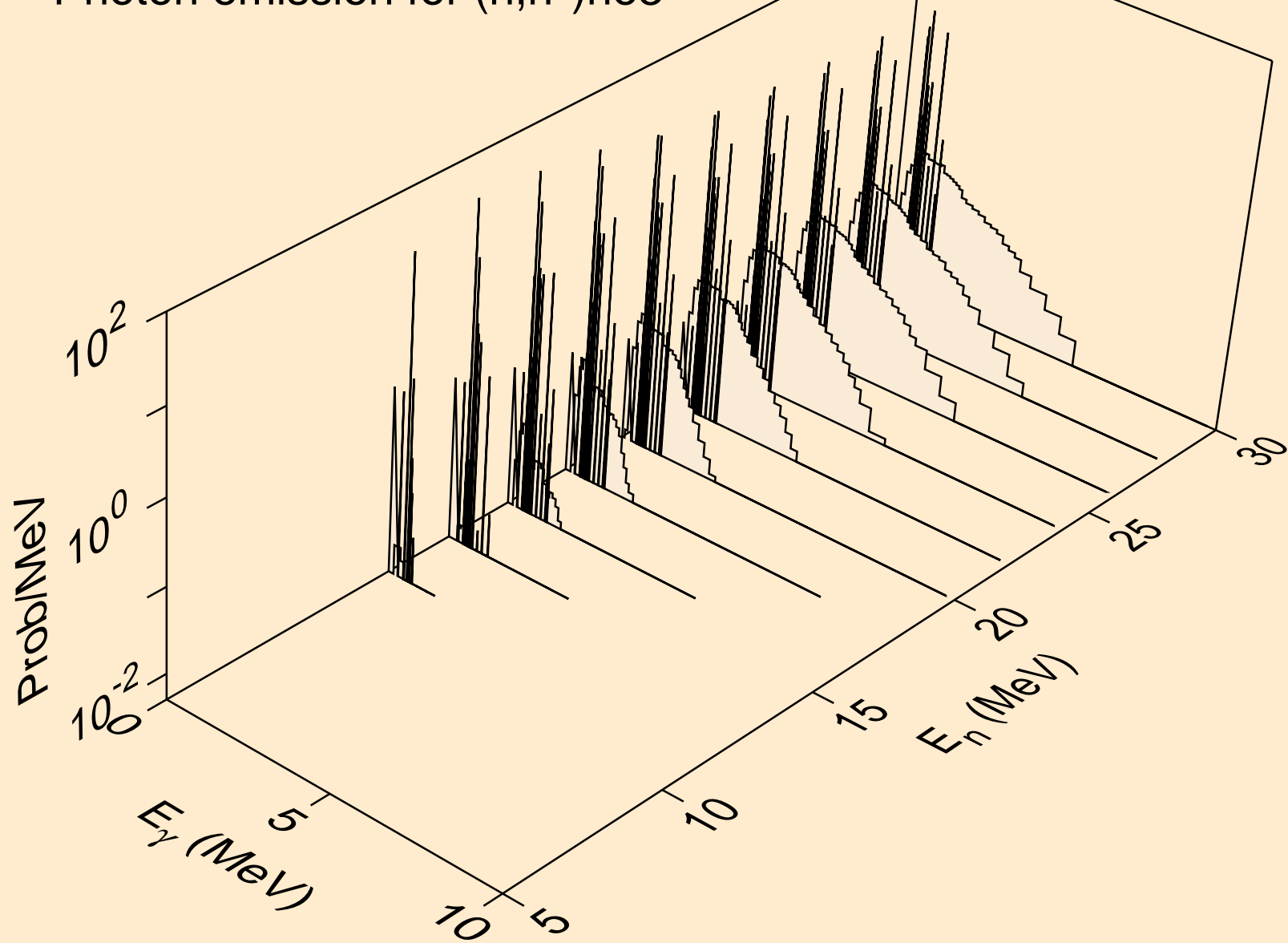

CO060M TRITON ACER TENDL-2021 LIBRARY; T=0.K  
Photon emission for (n,4n)

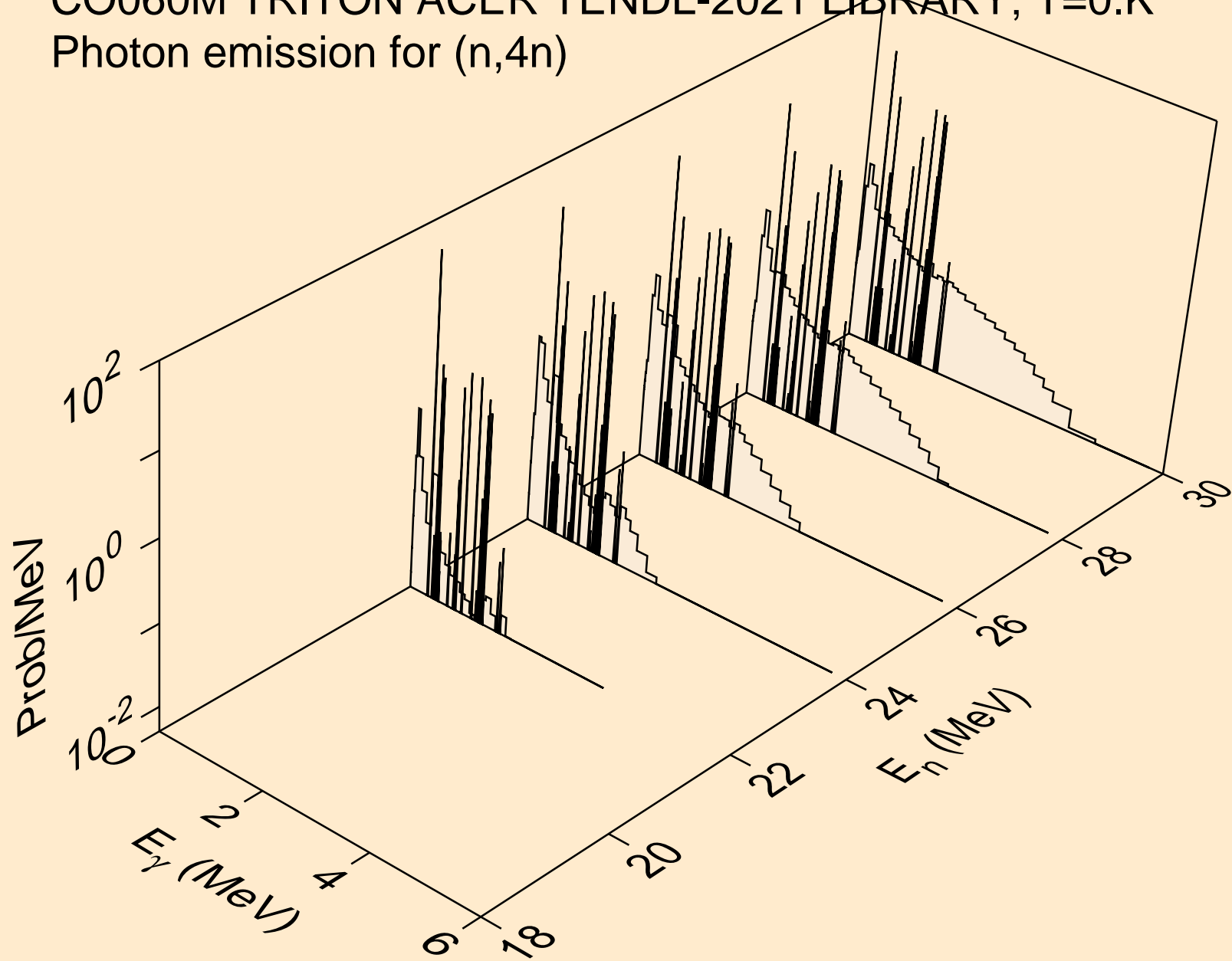

CO060M TRITON ACER TENDL-2021 LIBRARY; T=0.K  
Photon emission for (n,2np)

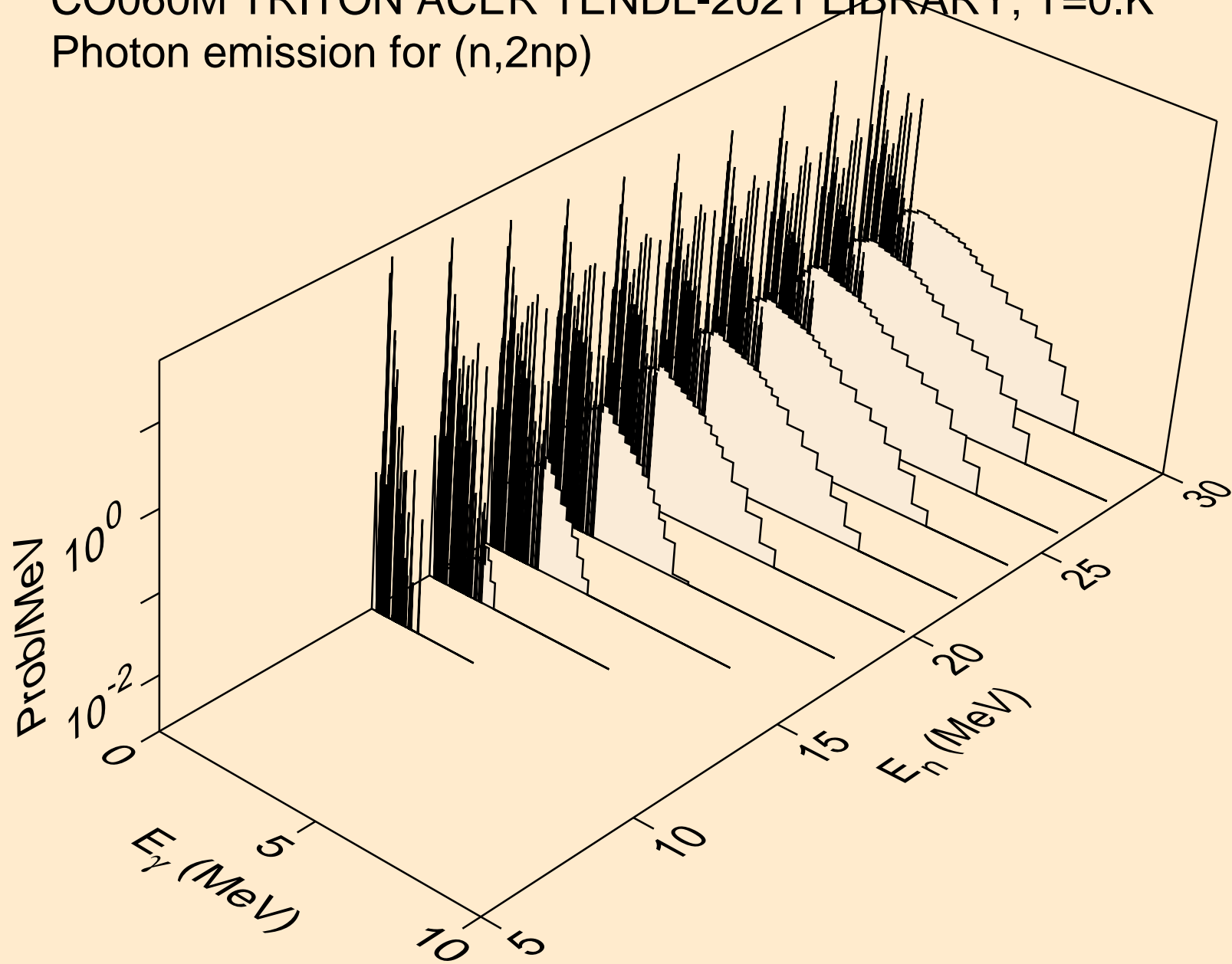

CO060M TRITON ACER TENDL-2021 LIBRARY; T=0.K  
Photon emission for (n,3np)

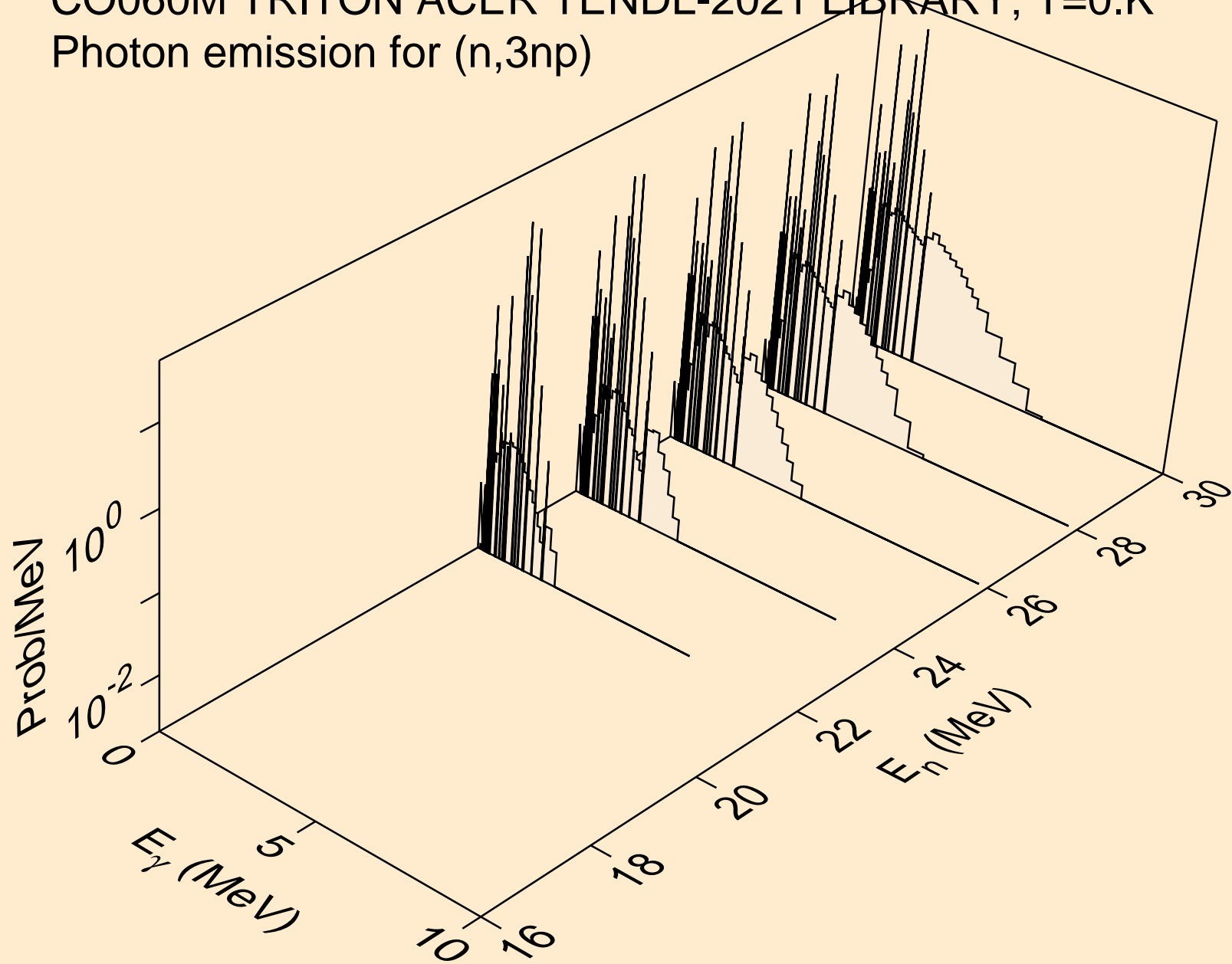

CO060M TRITON ACER TENDL-2021 LIBRARY; T=0.K  
Photon emission for (n,2np)

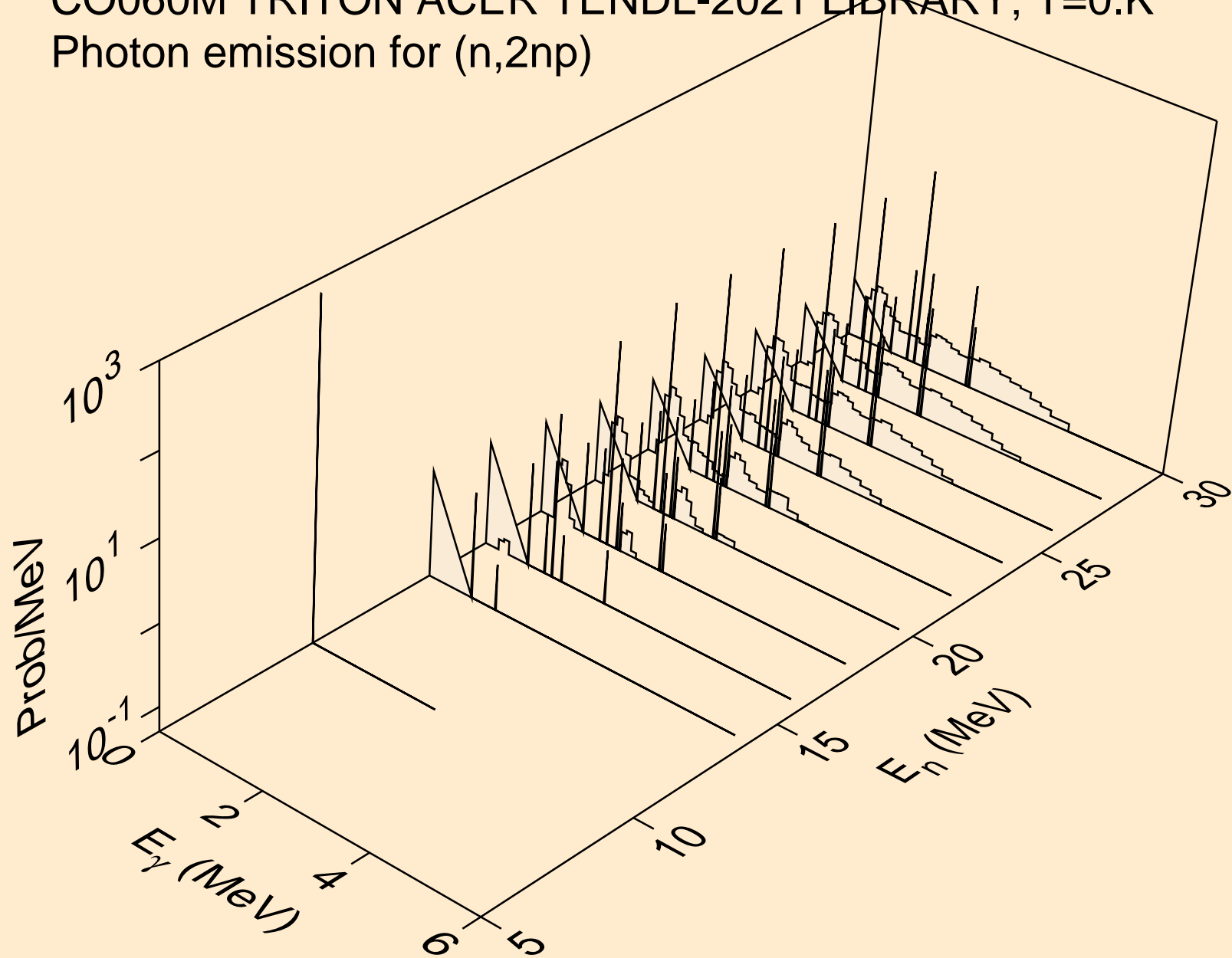

CO060M TRITON ACER TENDL-2021 LIBRARY; T=0.K  
Photon emission for (n,npa)

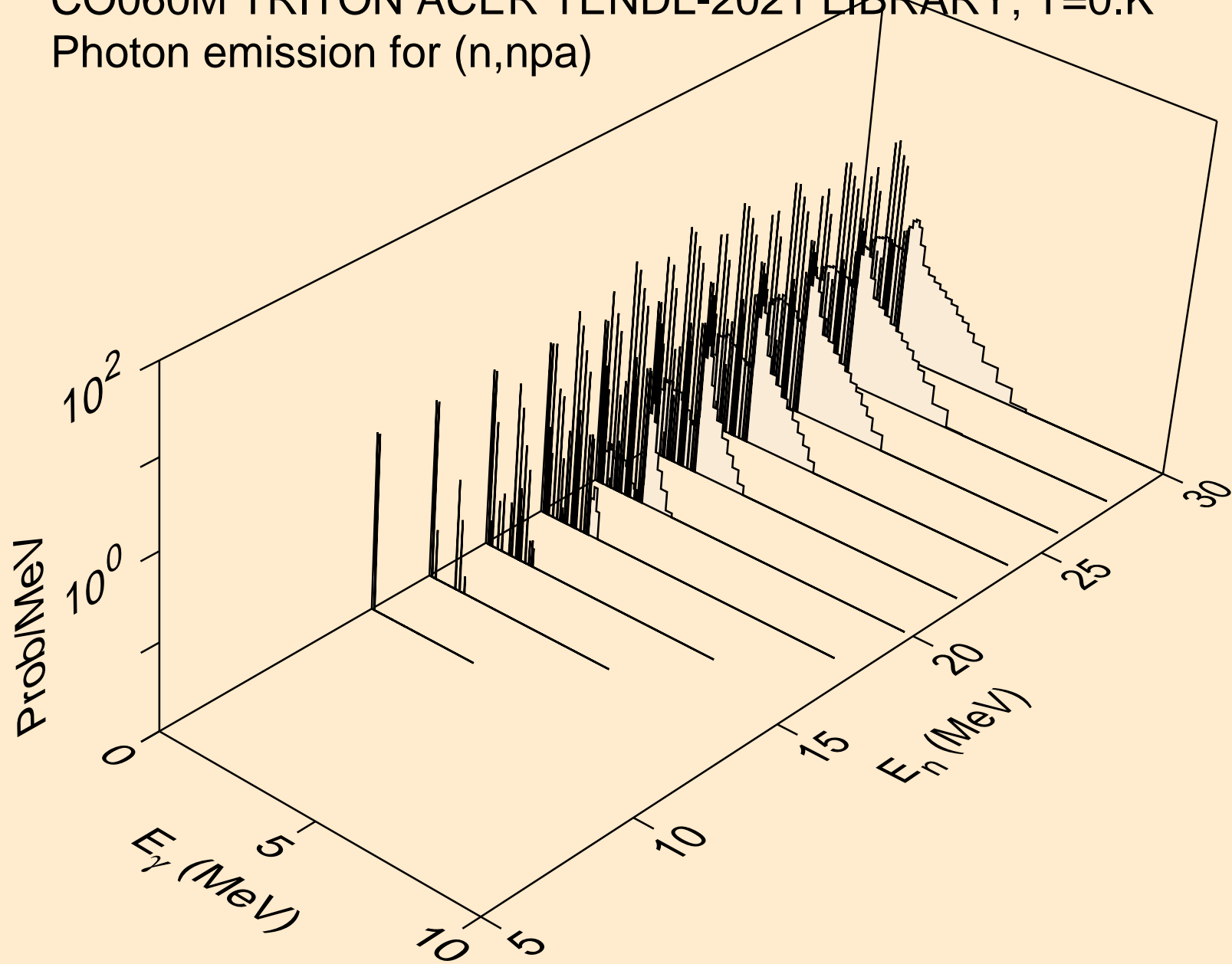



CO060M TRITON ACER TENDL-2021 LIBRARY; T=0.K  
Photon emission for (n,gma)

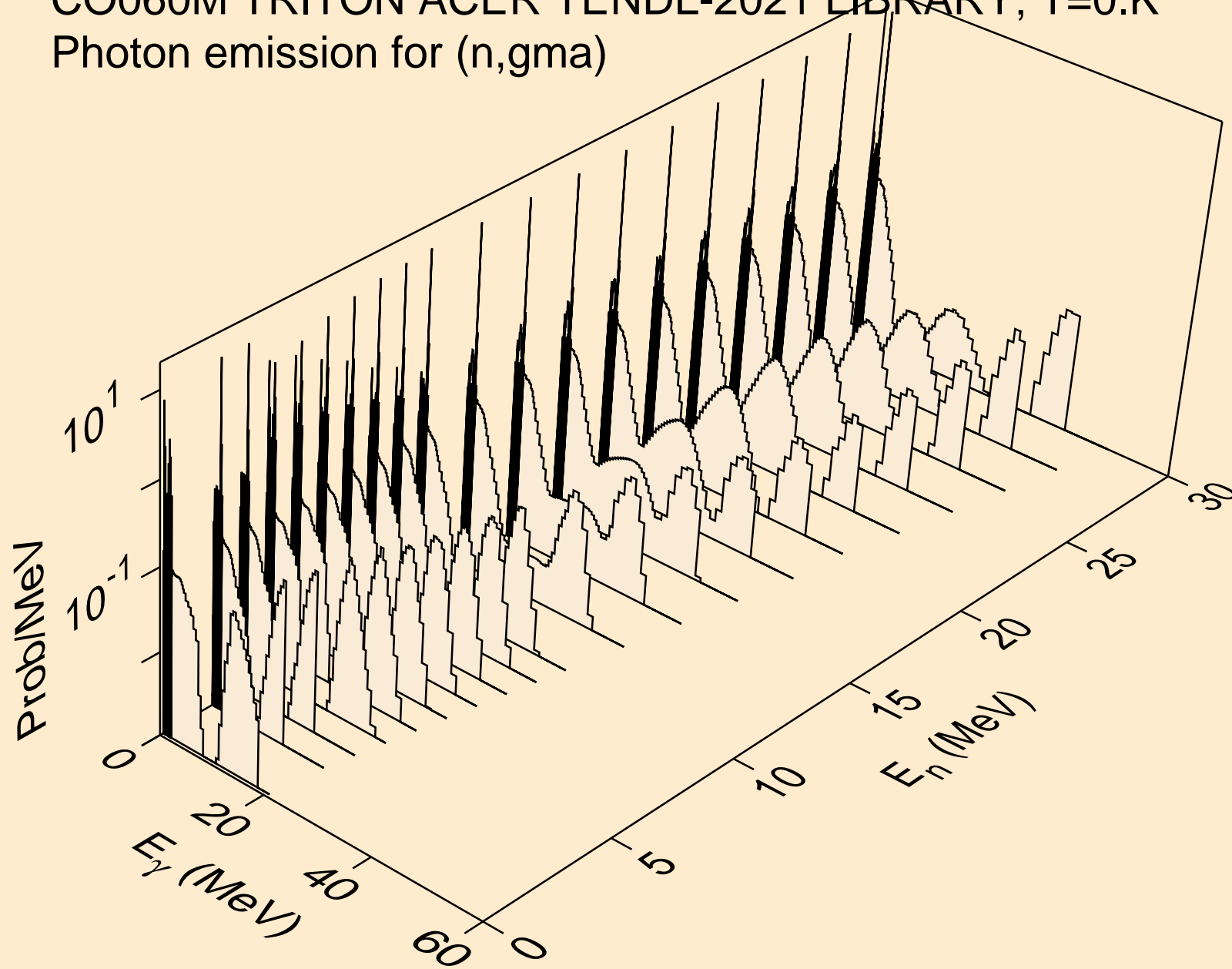

CO060M TRITON ACER TENDL-2021 LIBRARY; T=0.K  
Photon emission for (n,p)

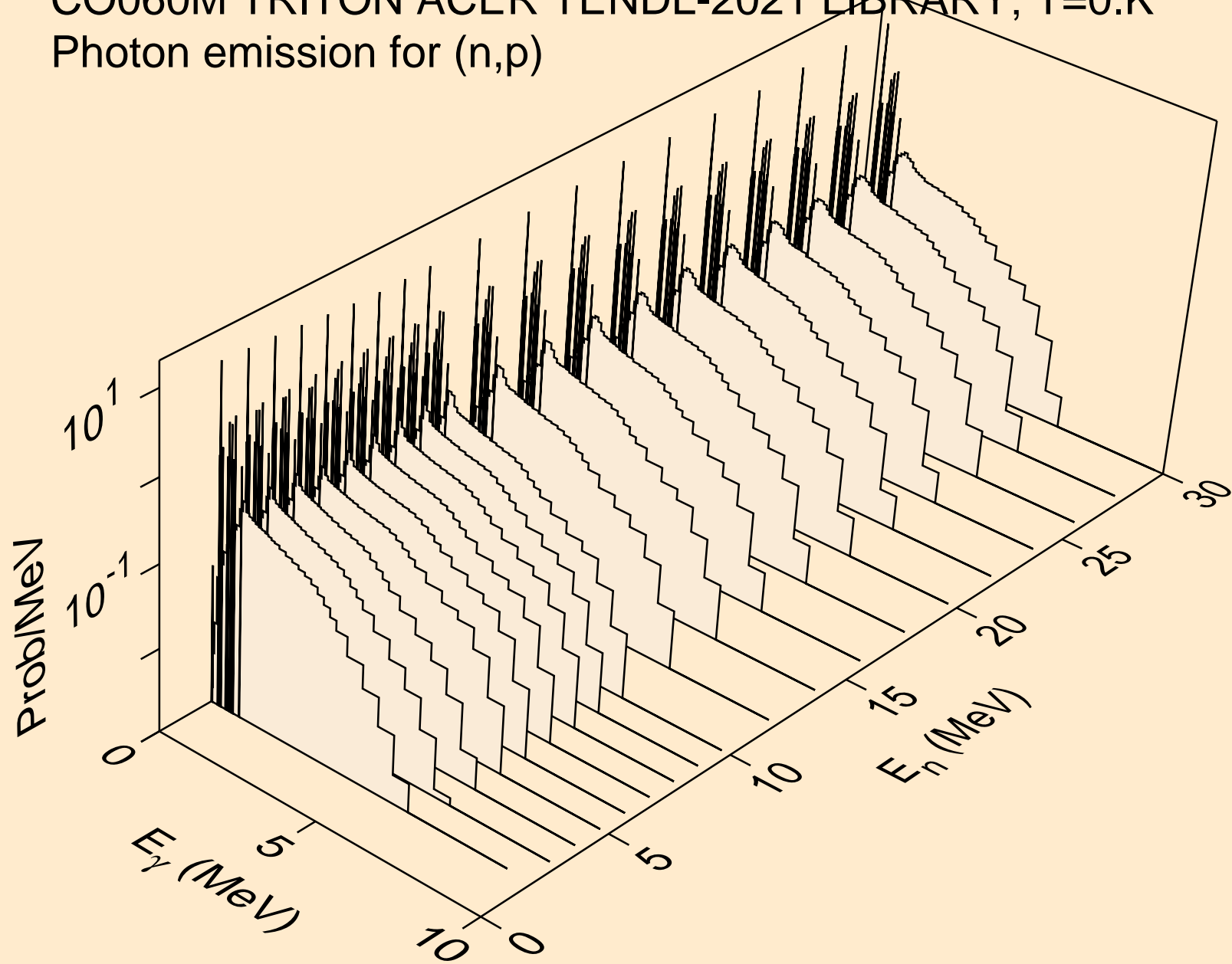

CO060M TRITON ACER TENDL-2021 LIBRARY; T=0.K  
Photon emission for (n,d)

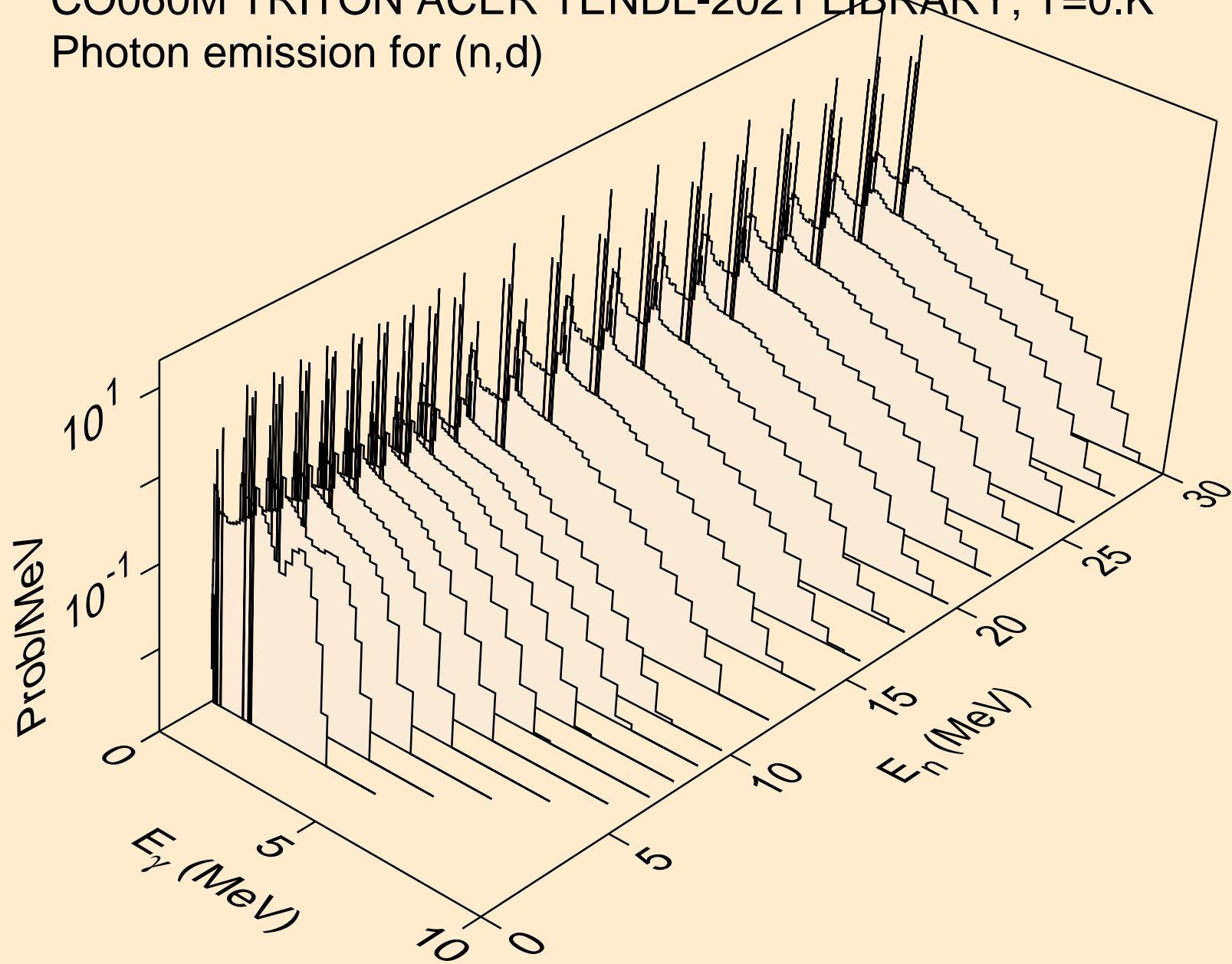

CO060M TRITON ACER TENDL-2021 LIBRARY; T=0.K  
Photon emission for inelastic

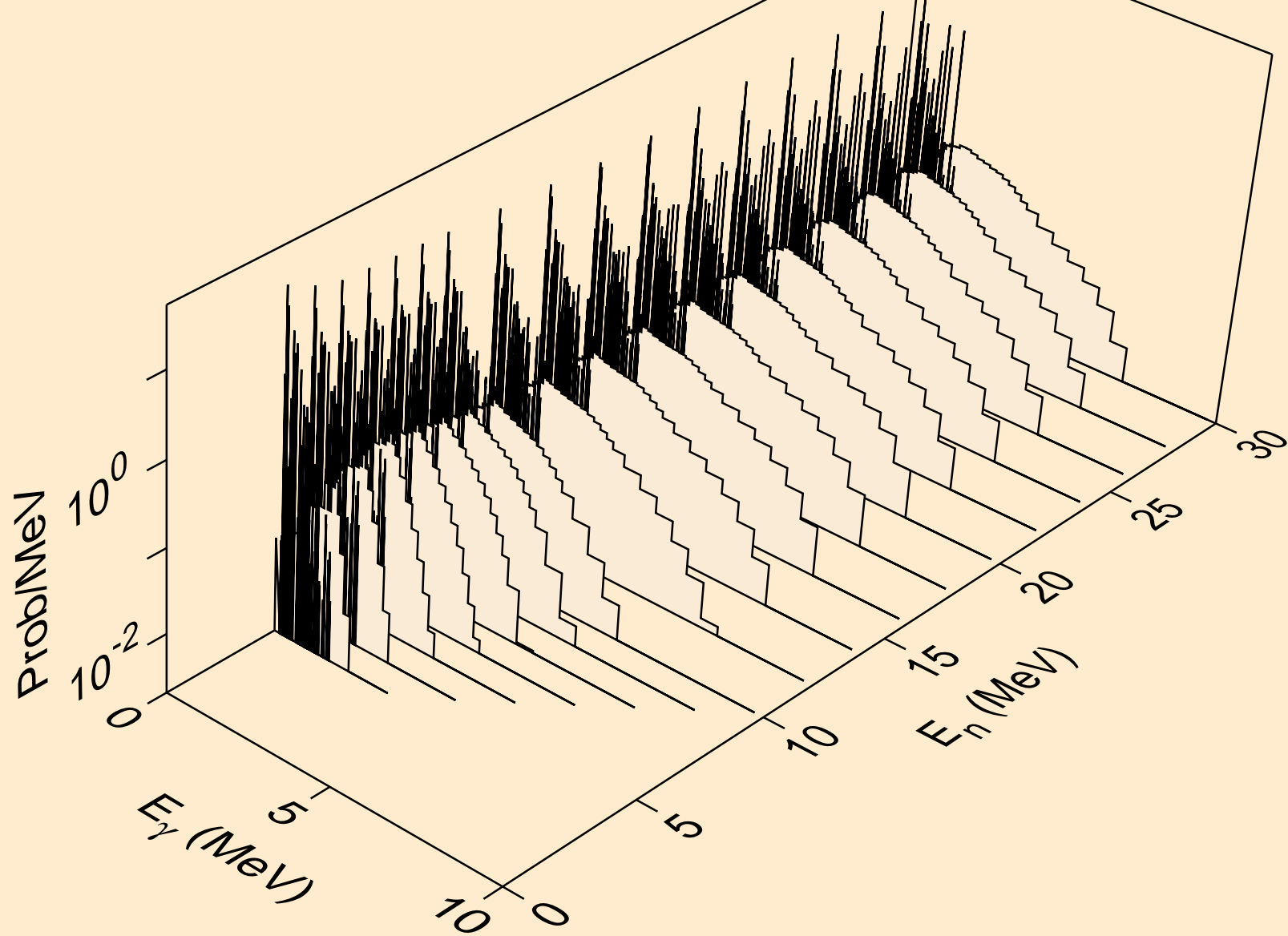

CO060M TRITON ACER TENDL-2021 LIBRARY; T=0.K  
Photon emission for (n,he3)

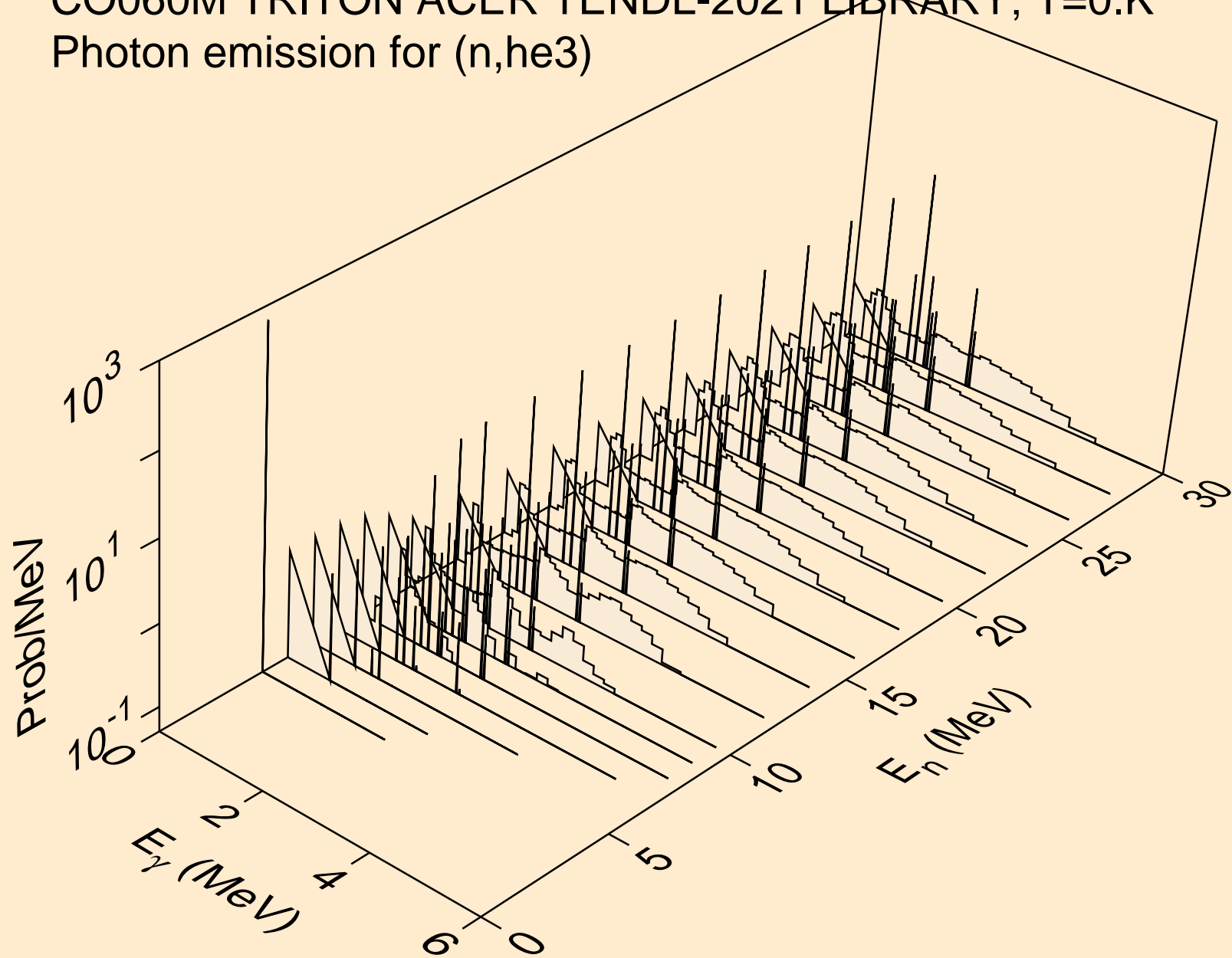

CO060M TRITON ACER TENDL-2021 LIBRARY; T=0.K  
Photon emission for (n,a)

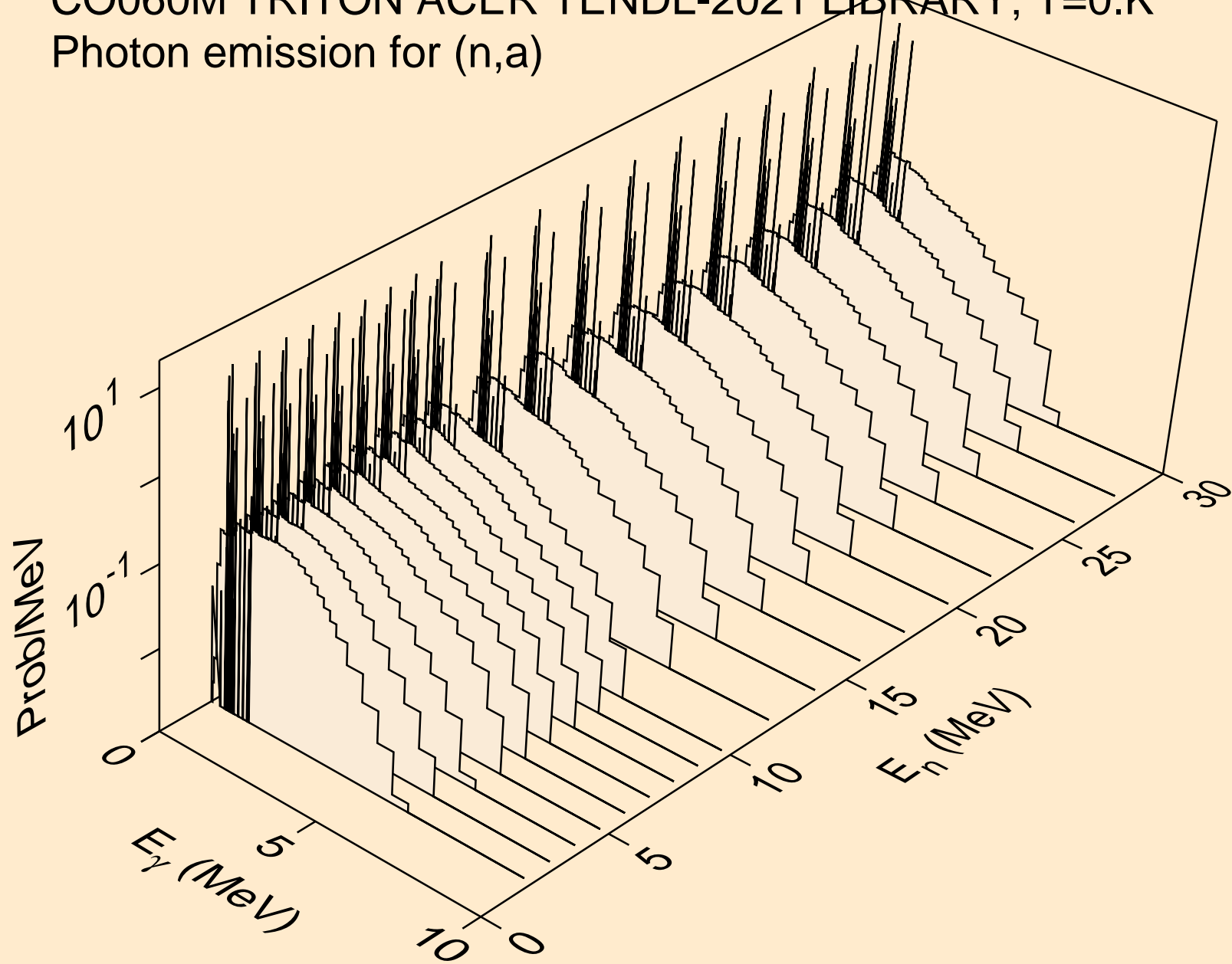

CO060M TRITON ACER TENDL-2021 LIBRARY; T=0.K  
Photon emission for (n,2a)

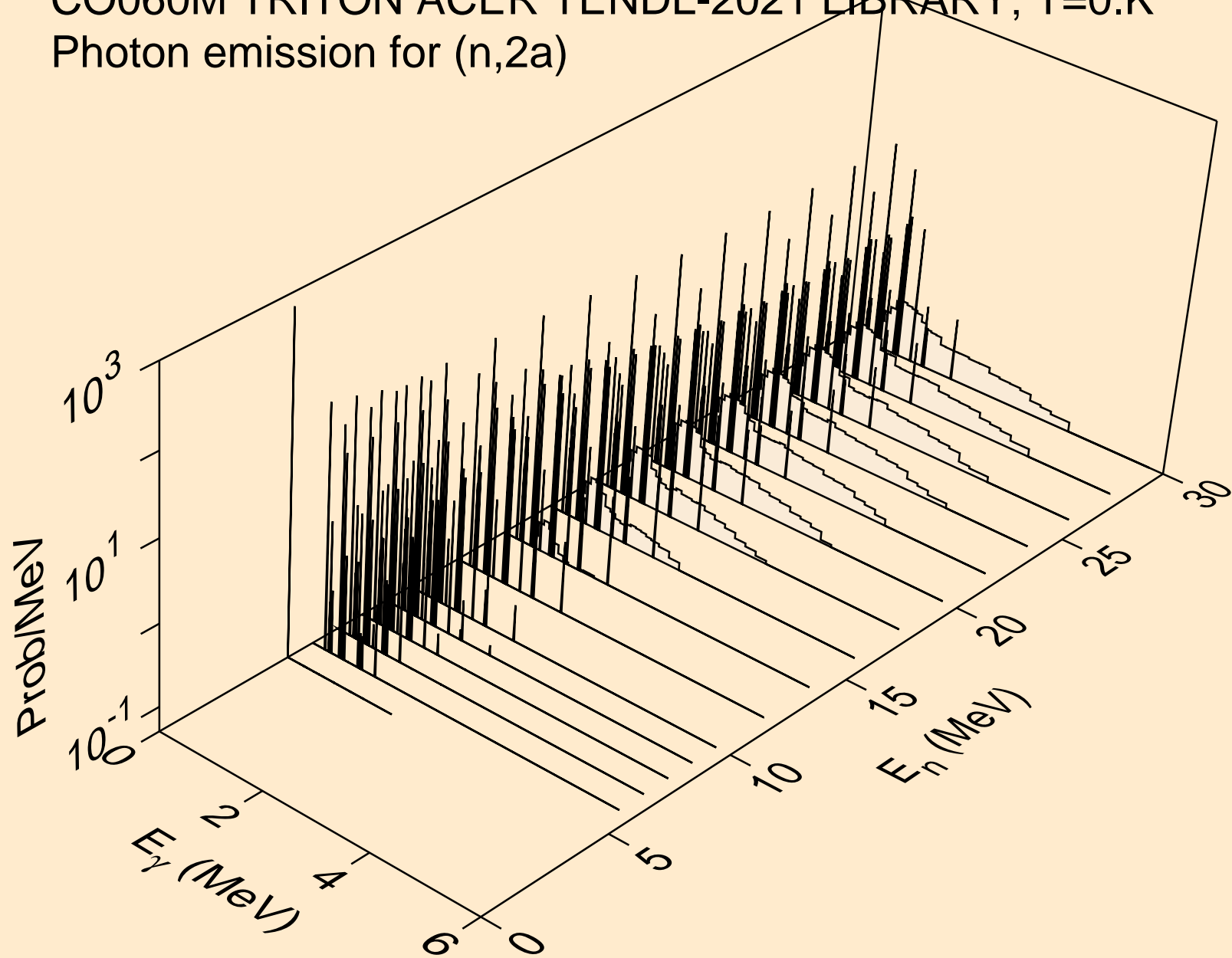

CO060M TRITON ACER TENDL-2021 LIBRARY; T=0.K  
Photon emission for (n,3a)

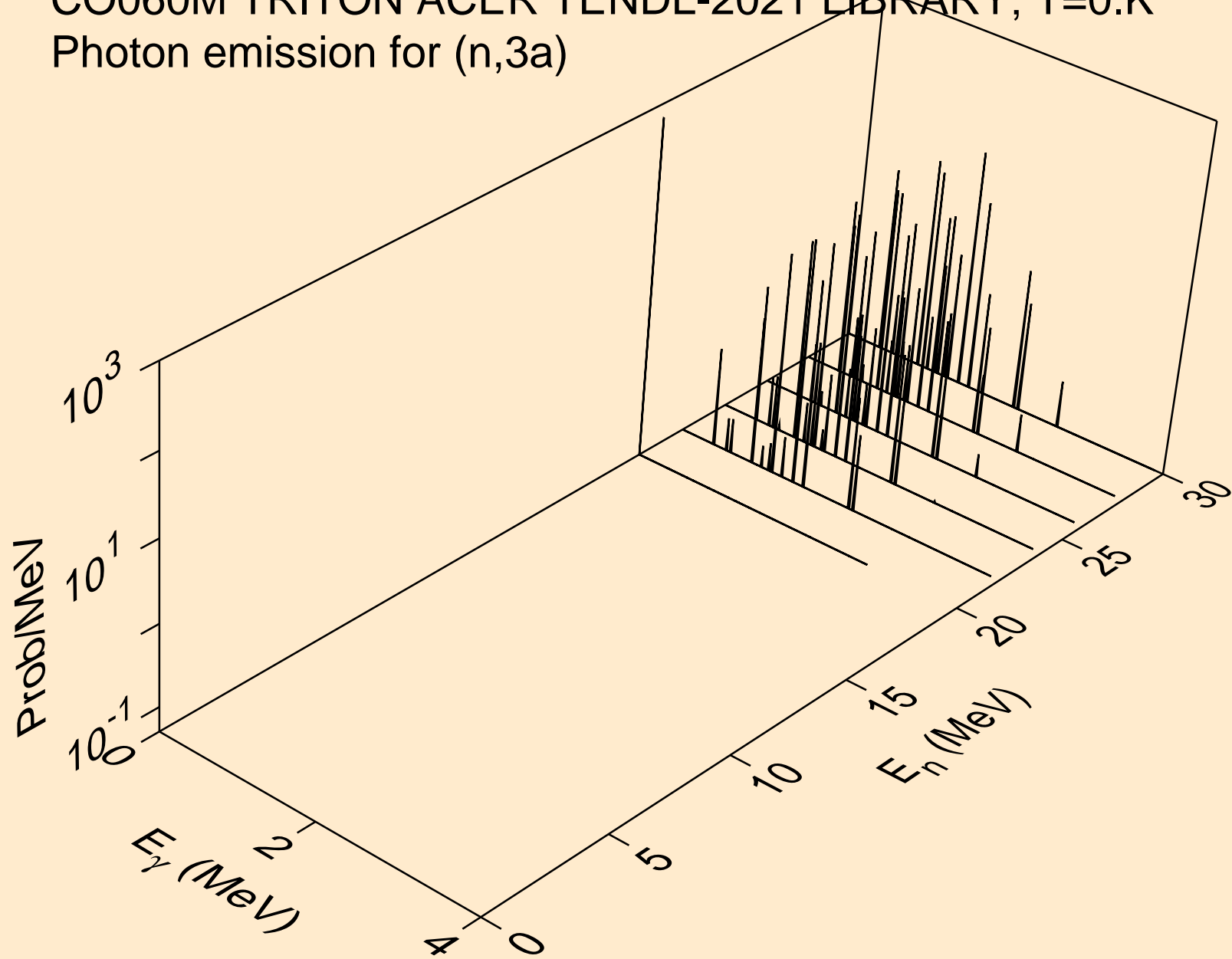



CO060M TRITON ACER TENDL-2021 LIBRARY; T=0.K  
Photon emission for (n,2p)

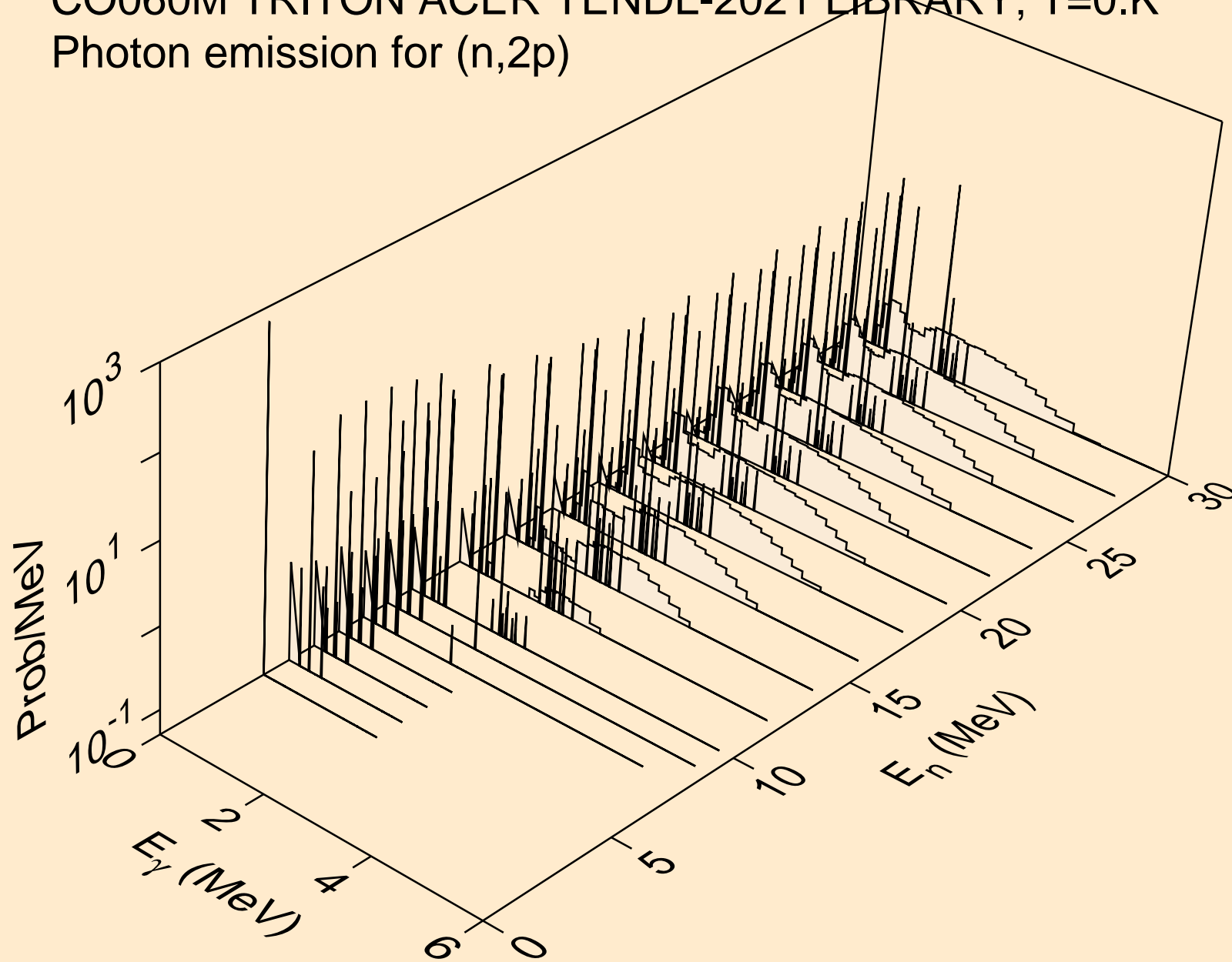

CO060M TRITON ACER TENDL-2021 LIBRARY; T=0.K  
Photon emission for (n,pa)

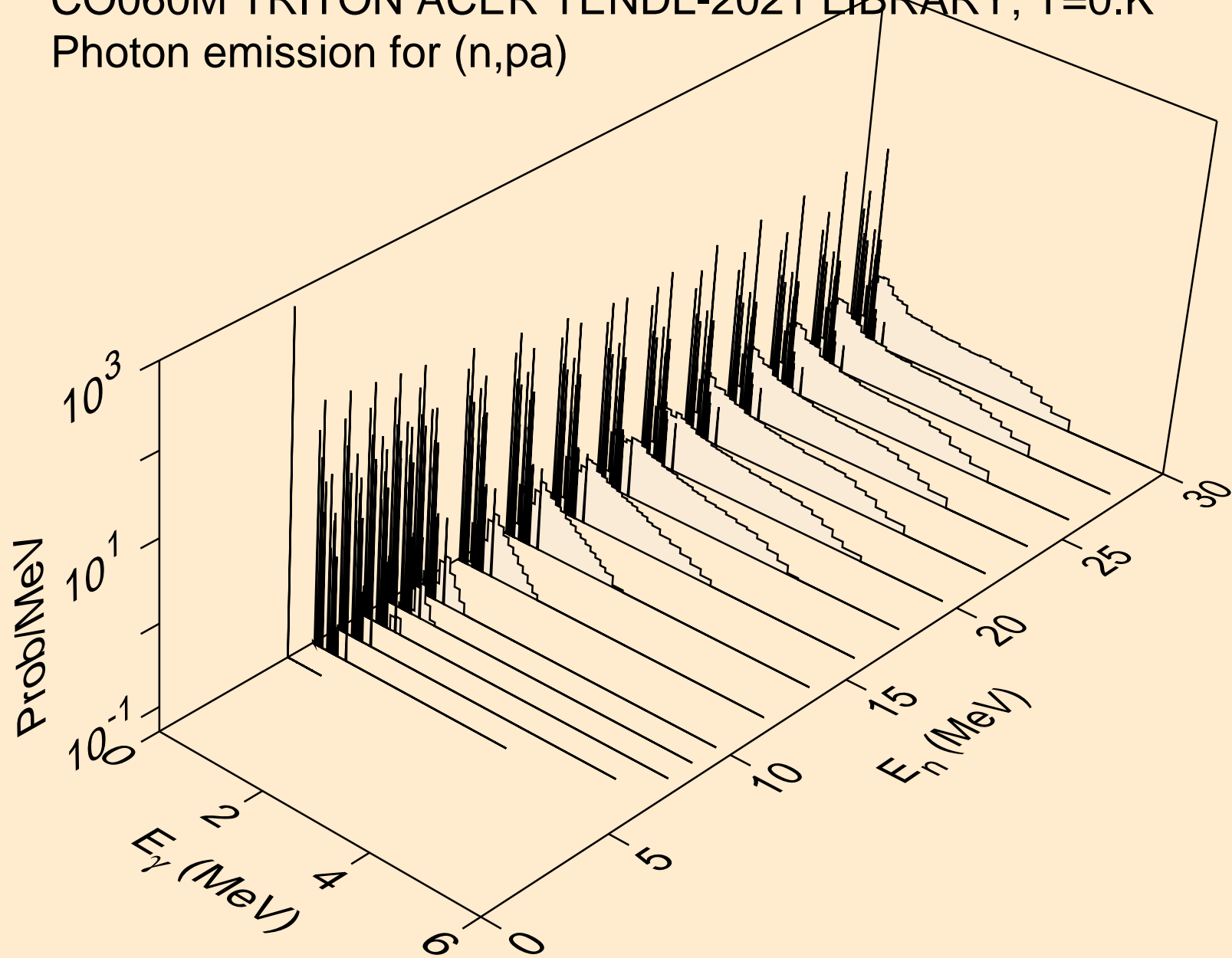

CO060M TRITON ACER TENDL-2021 LIBRARY; T=0.K  
Photon emission for (n,pd)

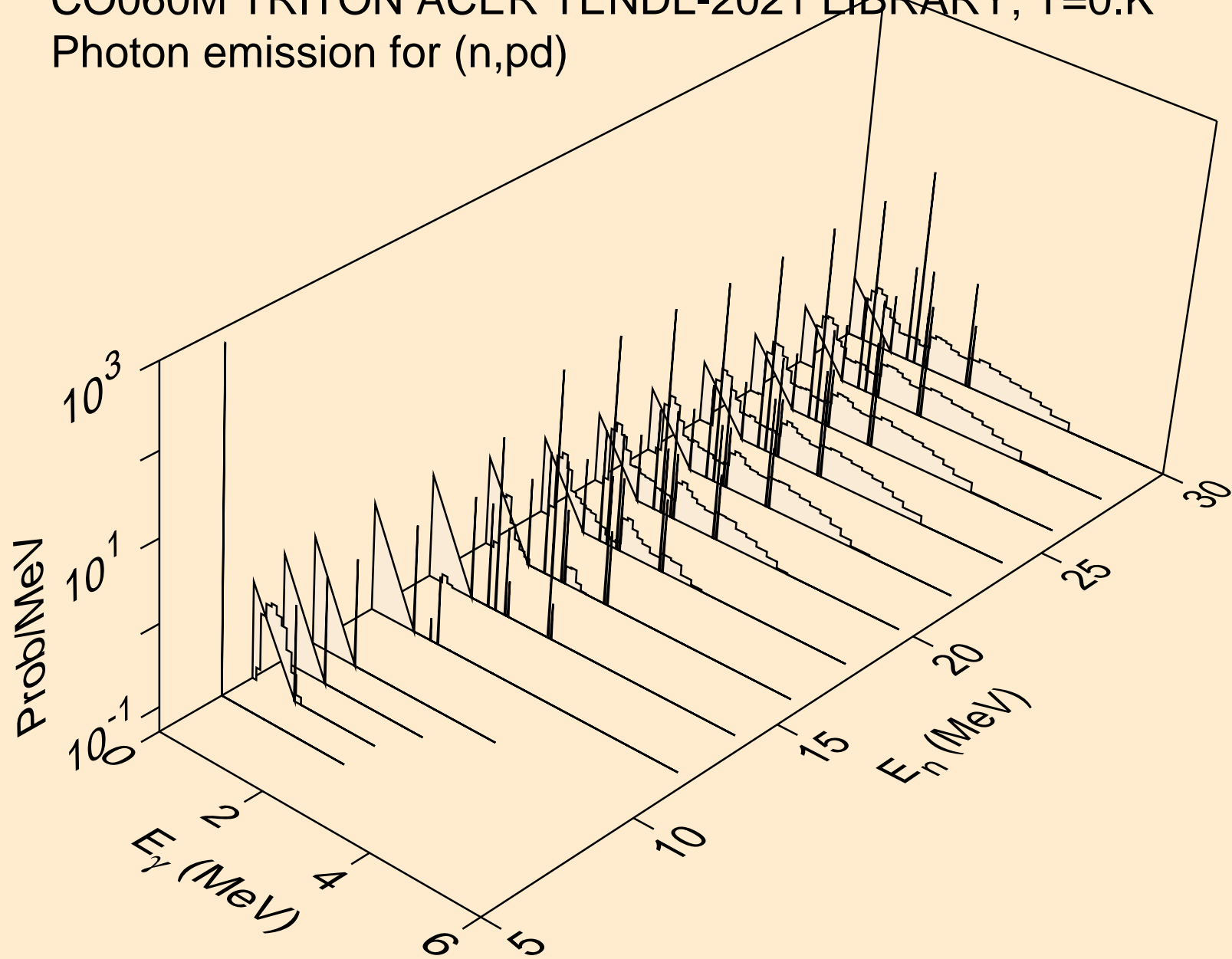

CO060M TRITON ACER TENDL-2021 LIBRARY; T=0.K  
Photon emission for (n,pt)

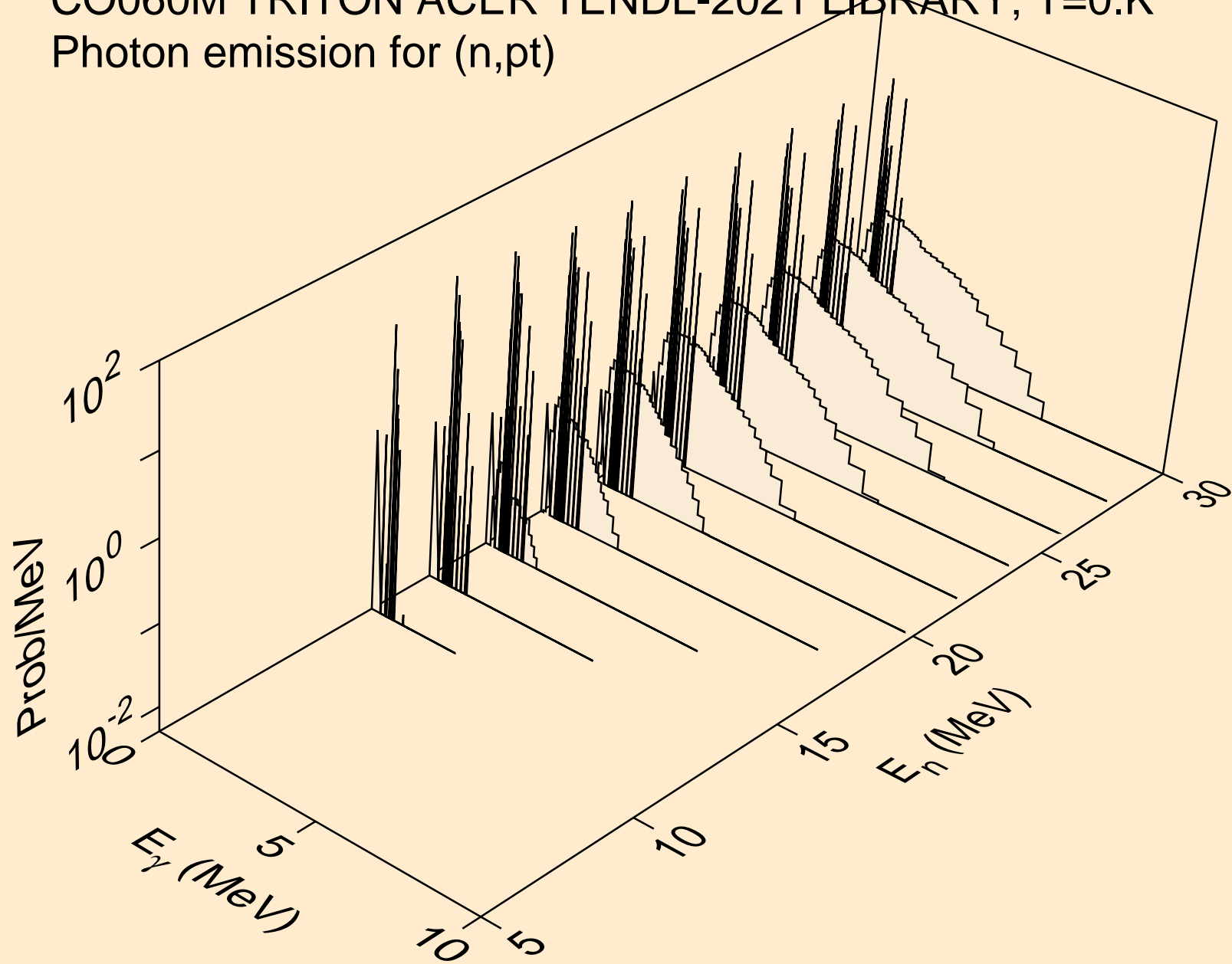

CO060M TRITON ACER TENDL-2021 LIBRARY; T=0.K  
Photon emission for (n,da)

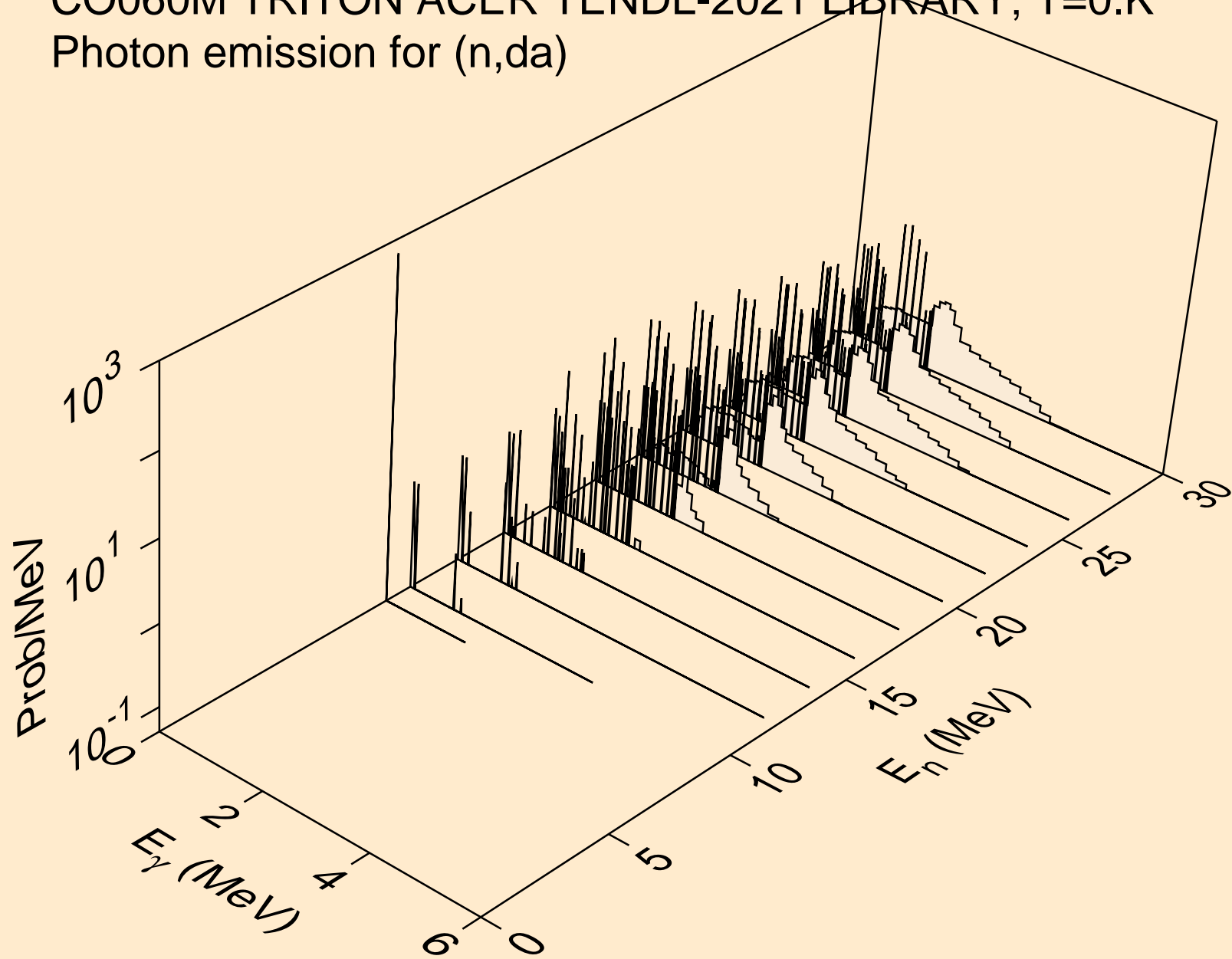

CO060M TRITON ACER TENDL-2021 LIBRARY; T=0.K  
Particle heating contributions

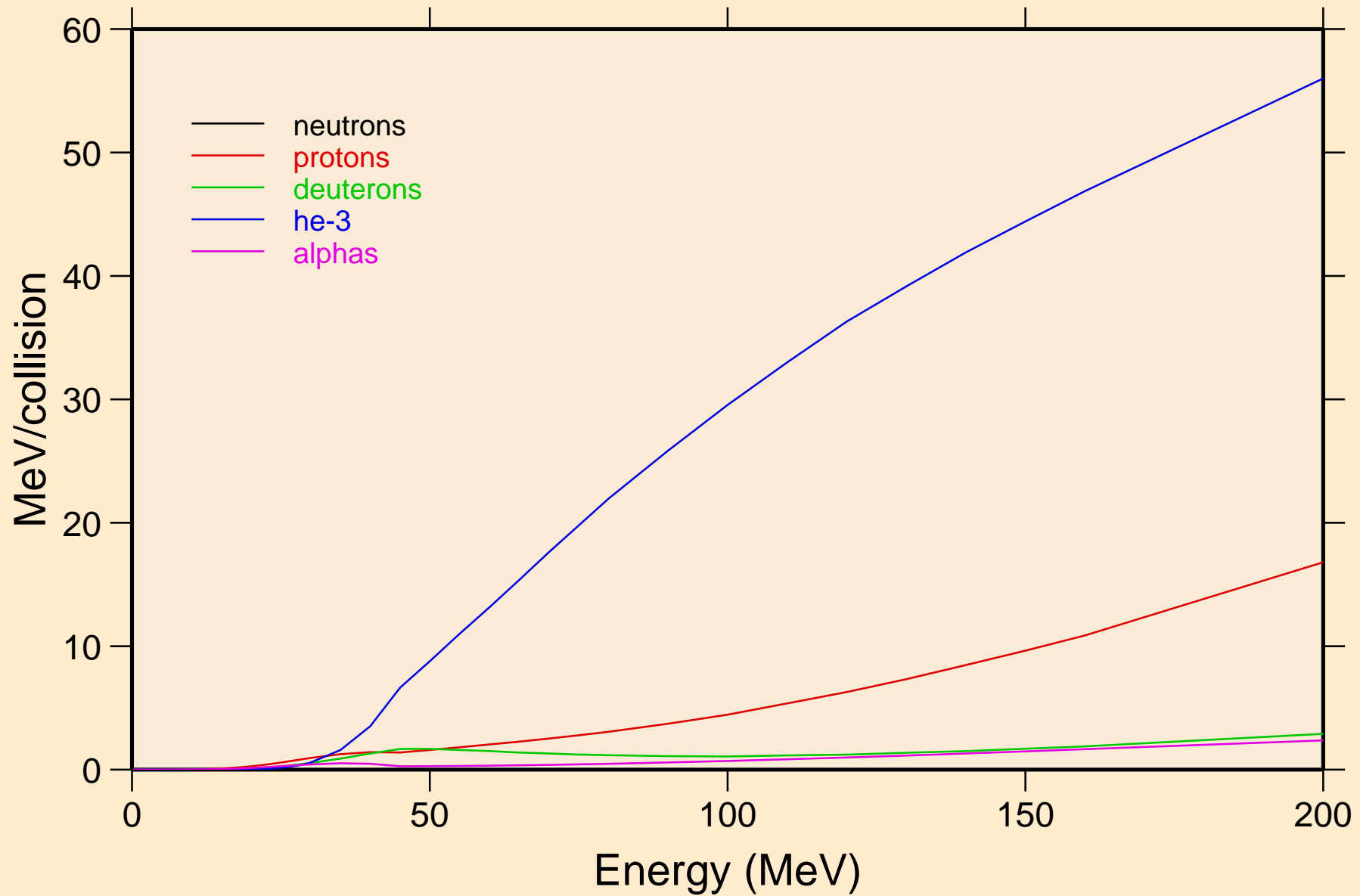

CO060M TRITON ACER TENDL-2021 LIBRARY; T=0.K  
Recoil Heating

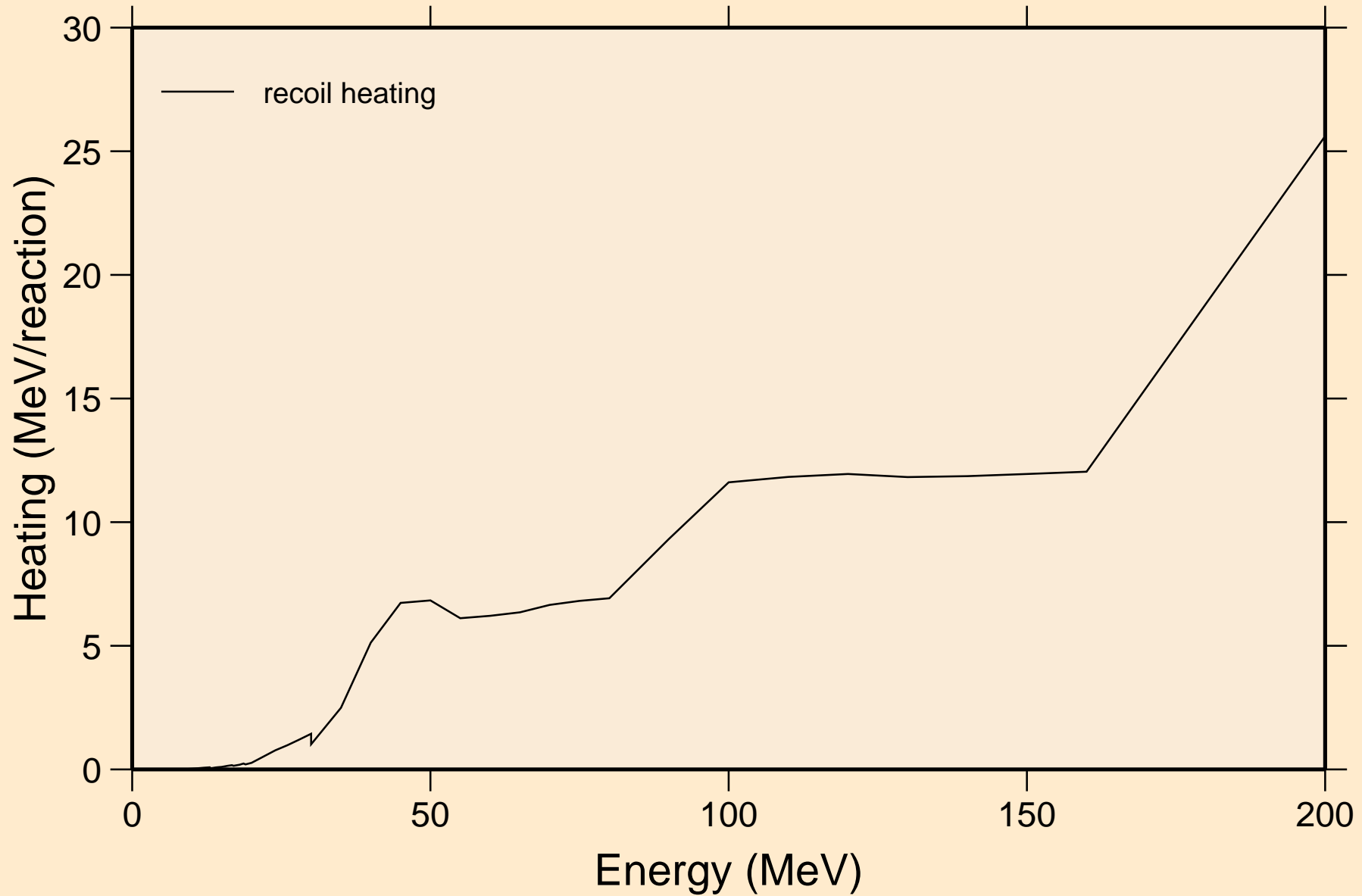

CO060M TRITON ACER TENDL-2021 LIBRARY; T=0.K  
Particle production cross sections

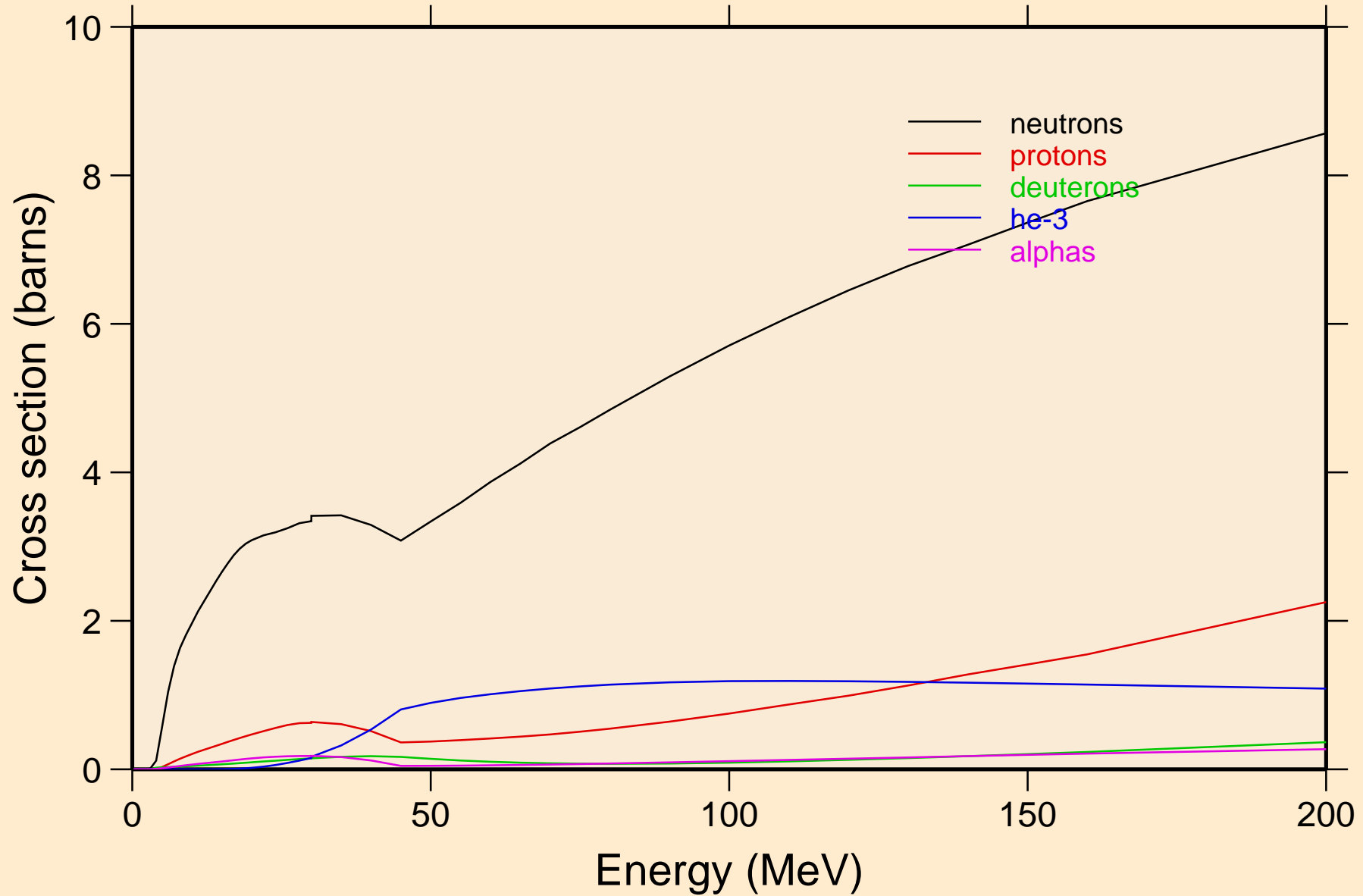



CO060M TRITON ACER TENDL-2021 LIBRARY; T=0.K  
neutrons from (t,n)

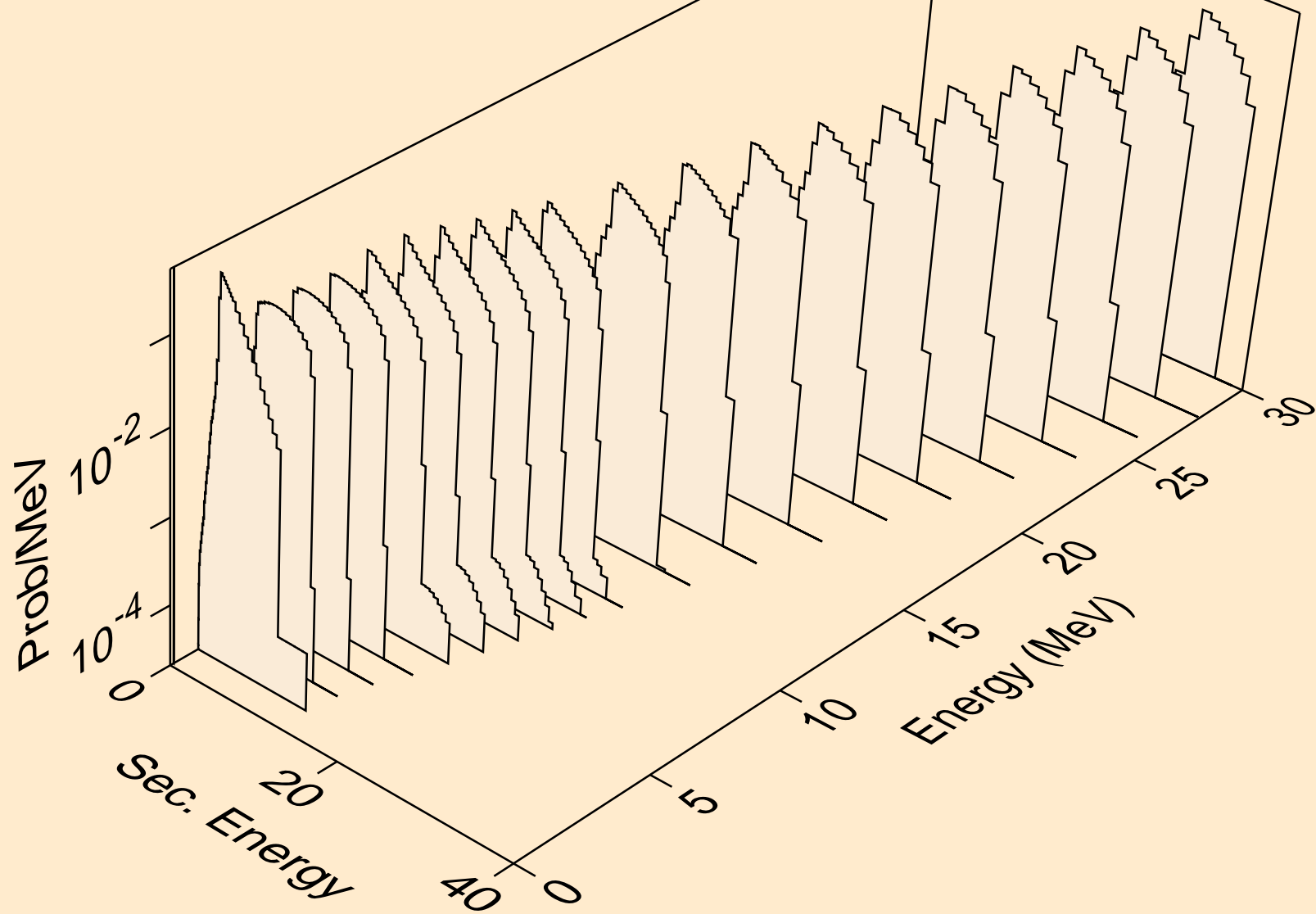

CO060M TRITON ACER TENDL-2021 LIBRARY; T=0.K  
neutrons from (t,x)

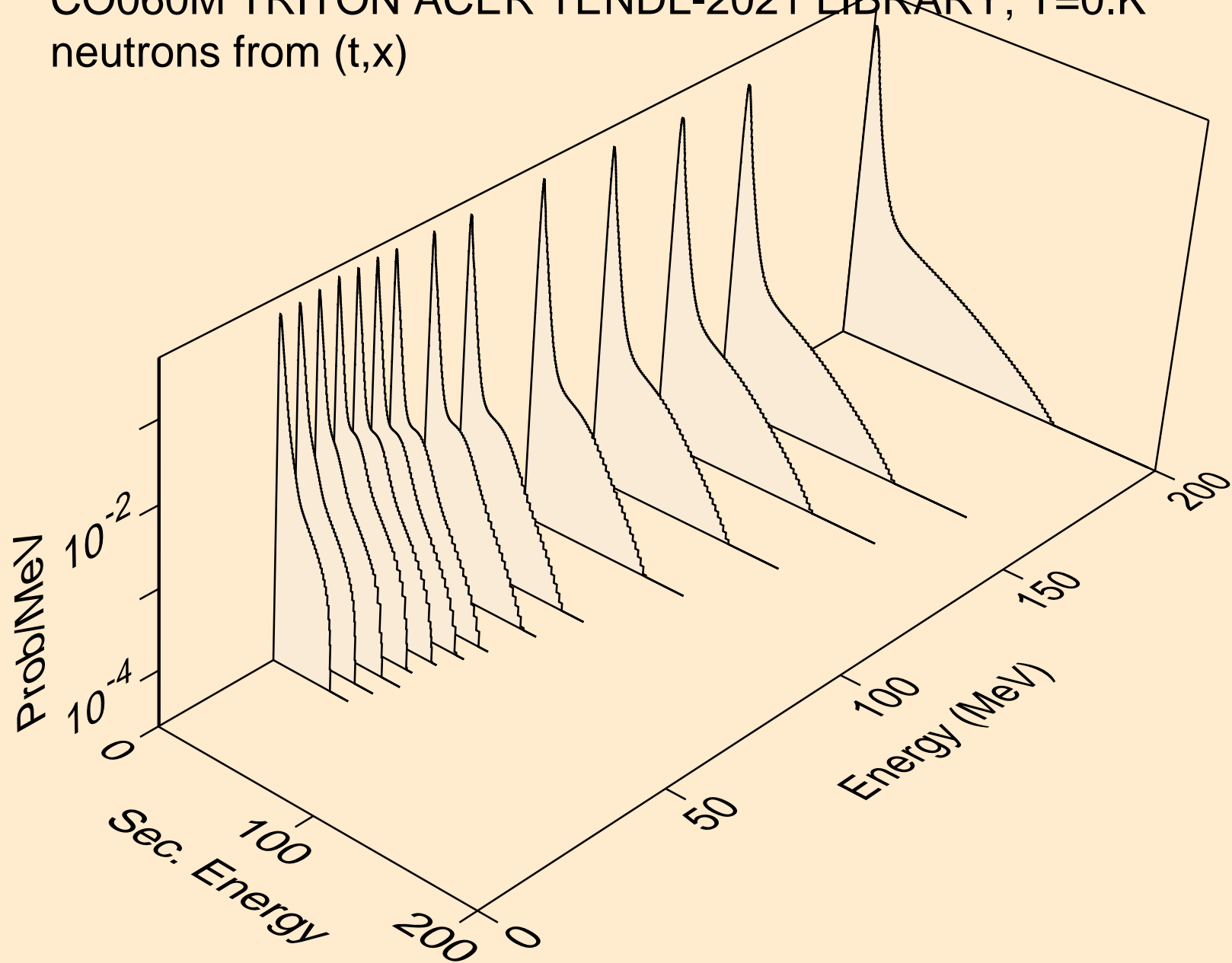

CO060M TRITON ACER TENDL-2021 LIBRARY; T=0.K  
neutrons from (t,2nd)

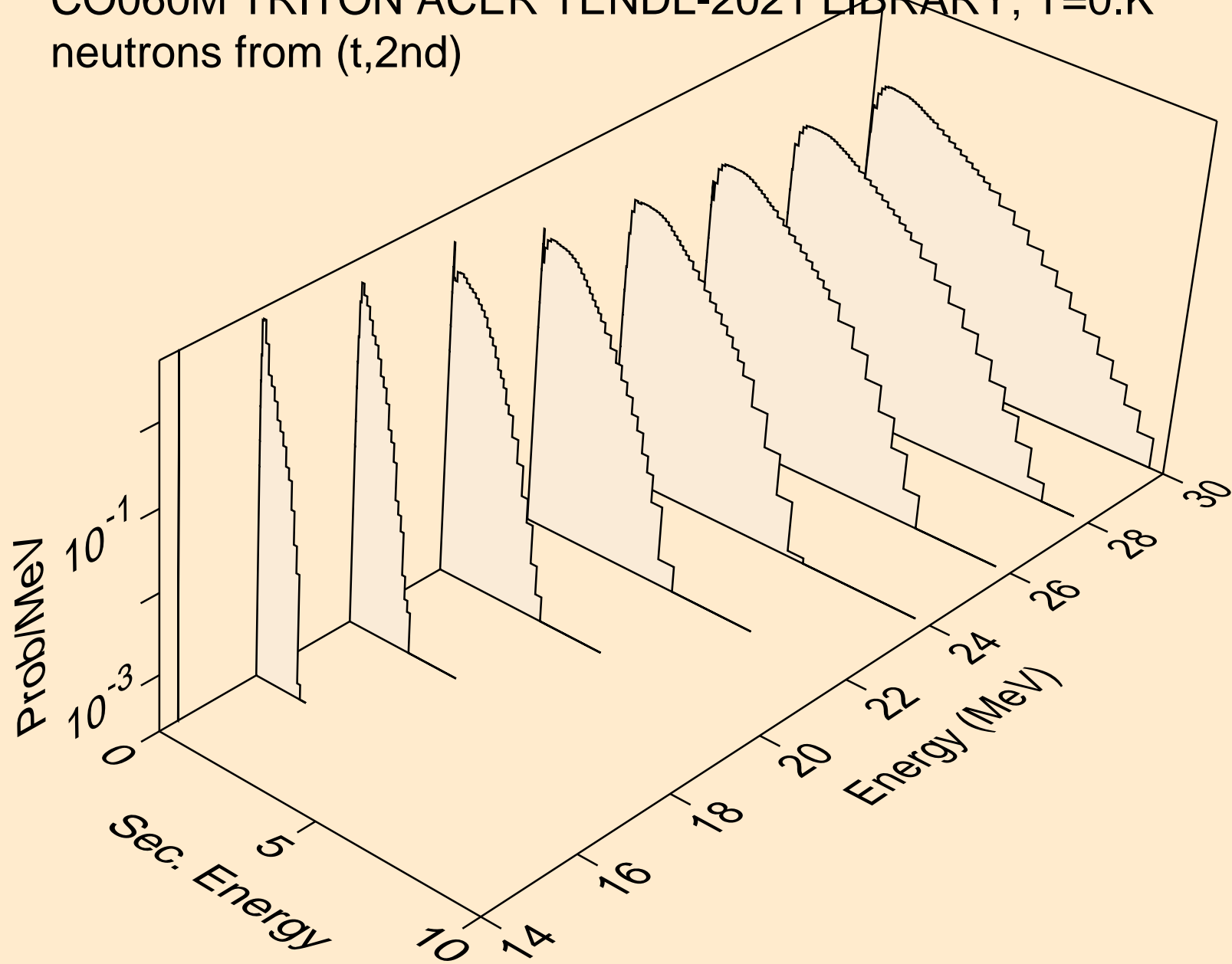

CO060M TRITON ACER TENDL-2021 LIBRARY; T=0.K  
neutrons from (t,2n)

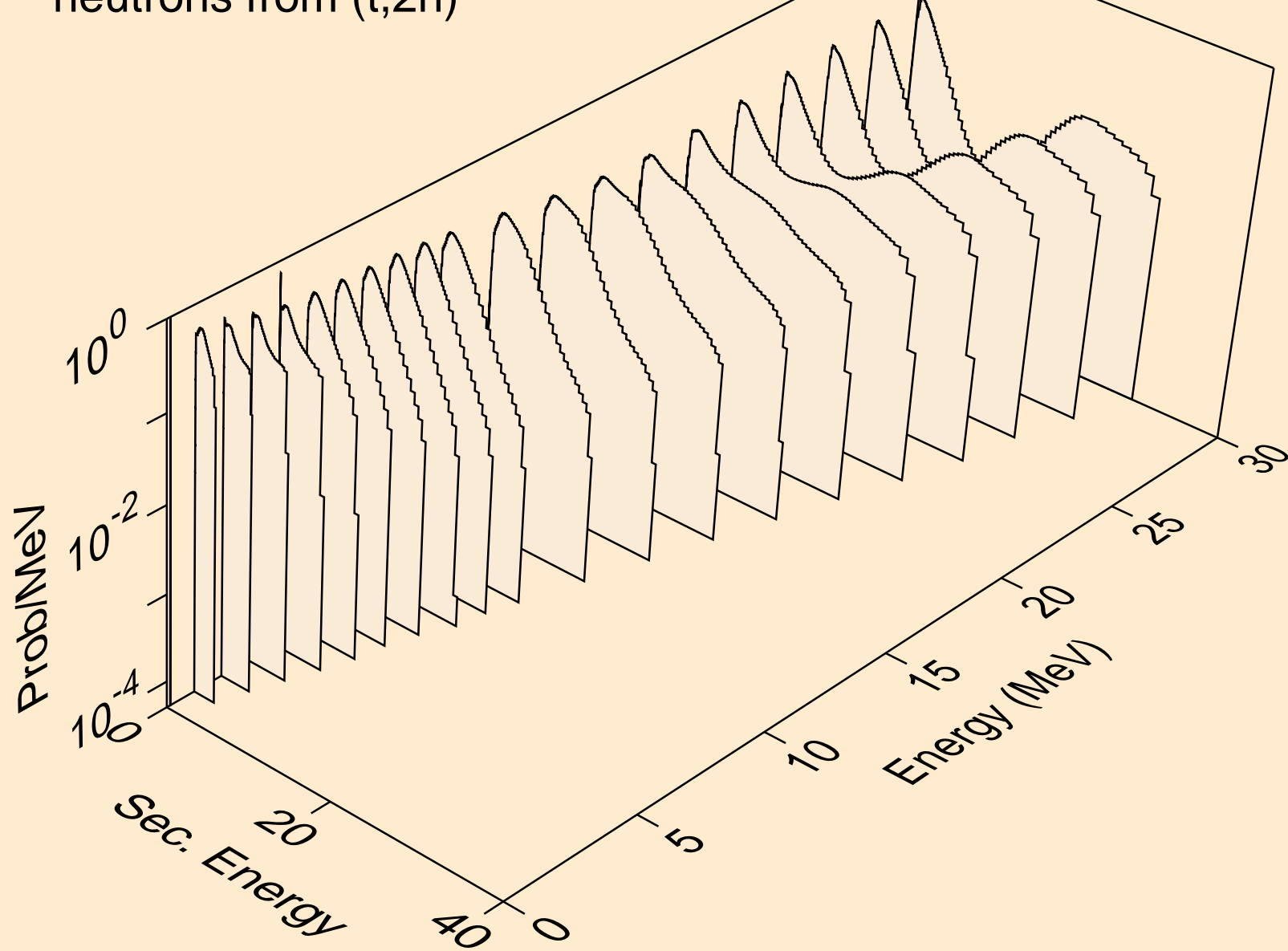

CO060M TRITON ACER TENDL-2021 LIBRARY; T=0.K  
neutrons from (t,3n)

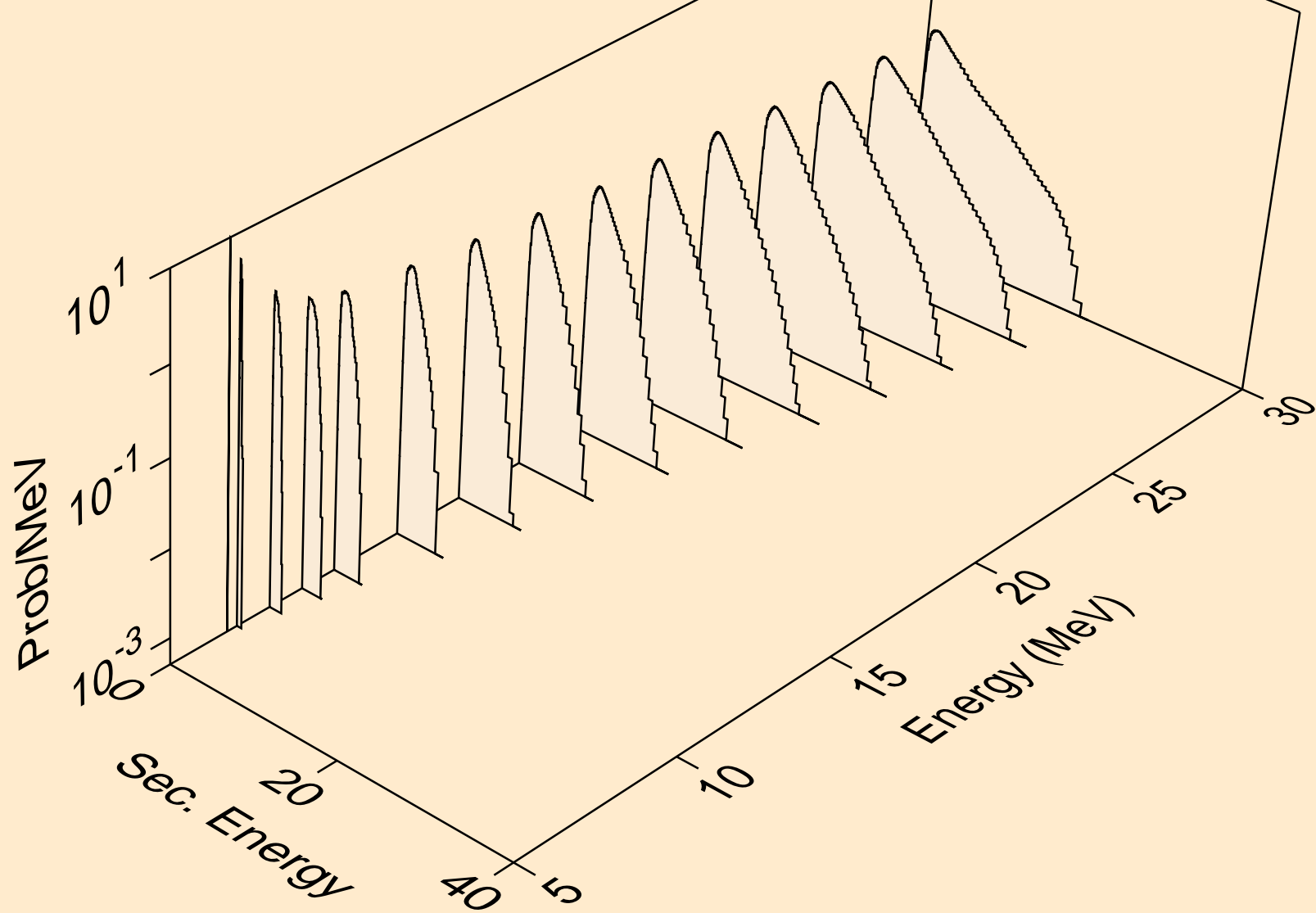

CO060M TRITON ACER TENDL-2021 LIBRARY; T=0.K  
neutrons from (t,n\*)a

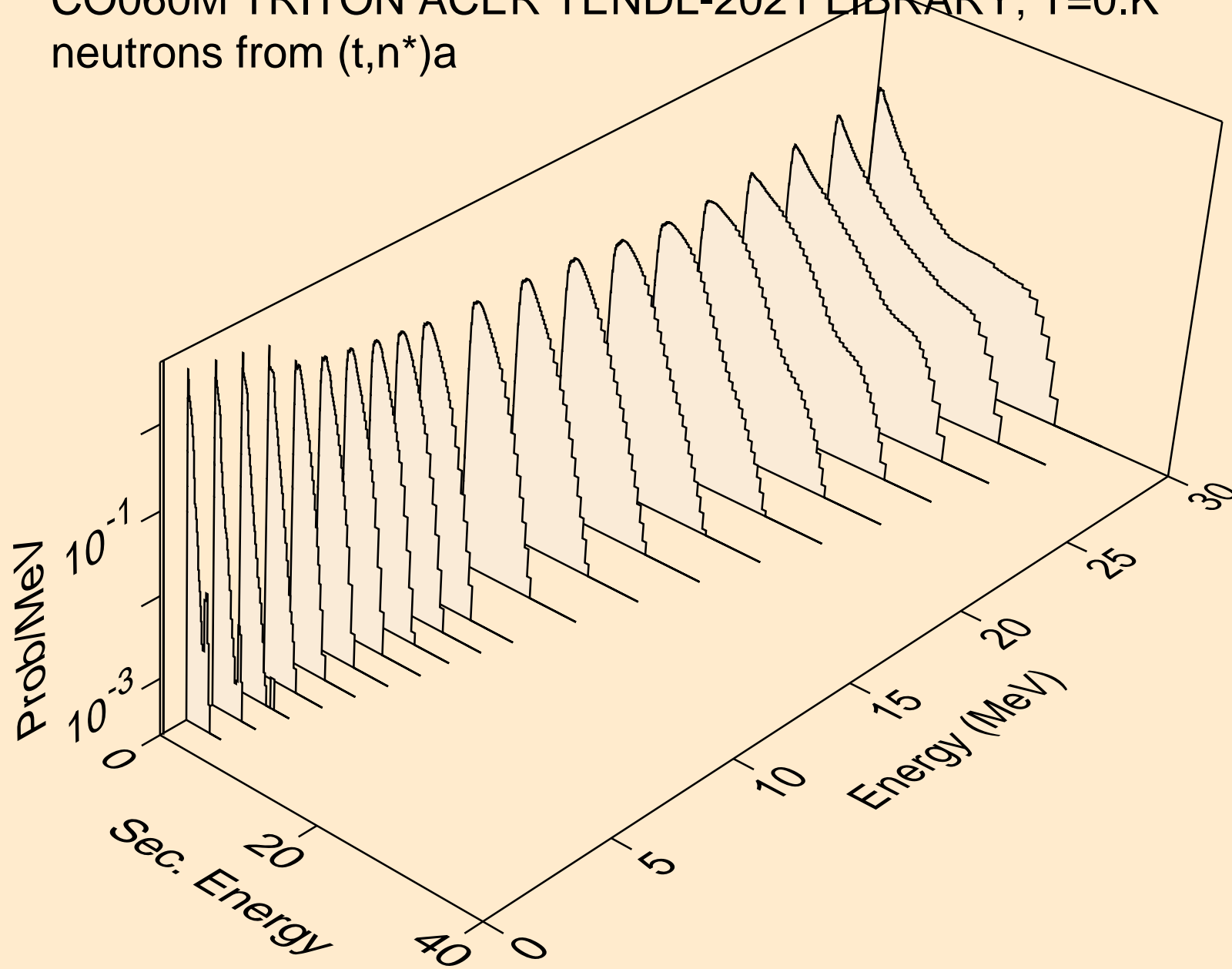

CO060M TRITON ACER TENDL-2021 LIBRARY; T=0.K  
neutrons from (t,2n)a

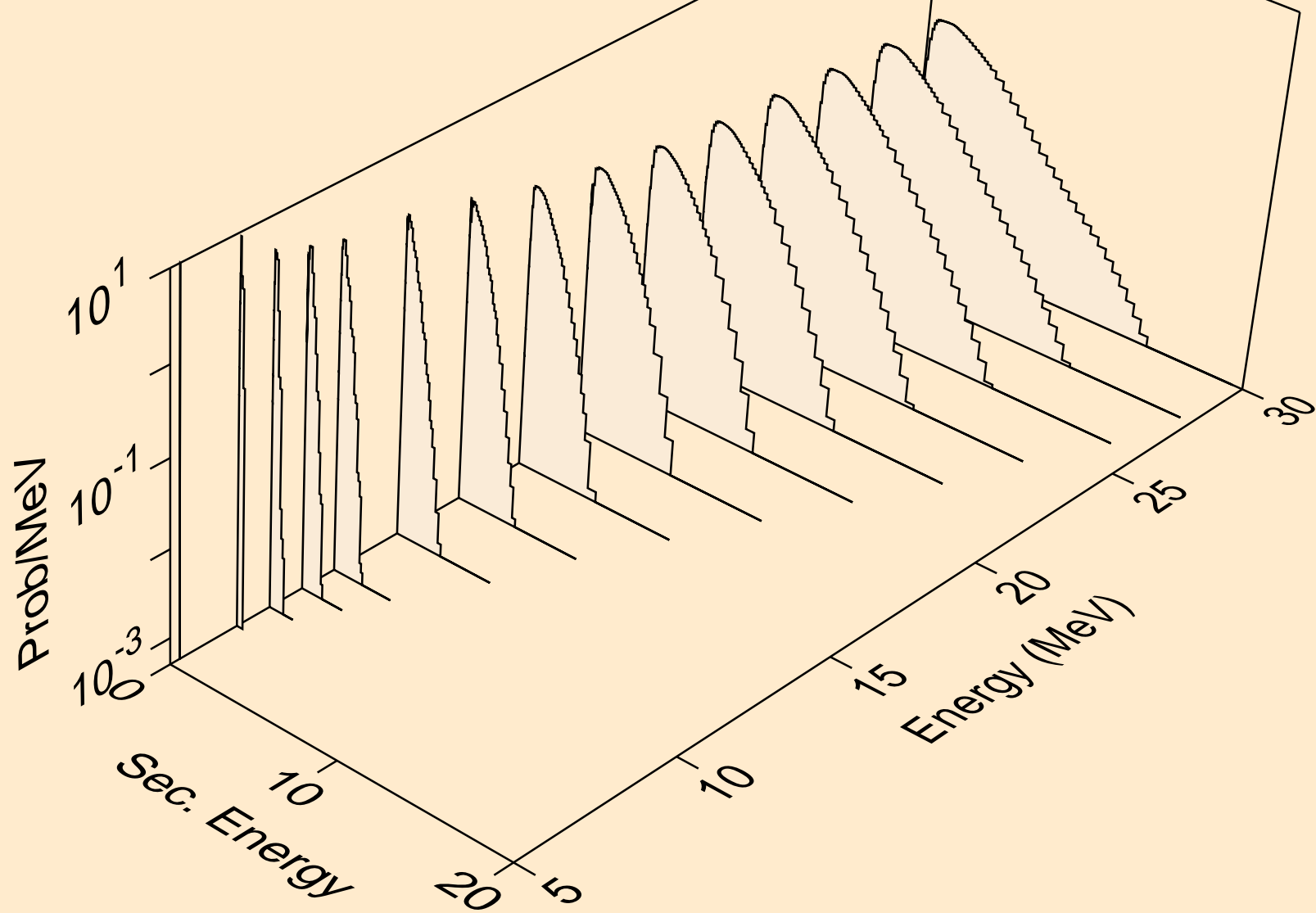

CO060M TRITON ACER TENDL-2021 LIBRARY; T=0.K  
neutrons from (t,3n)a

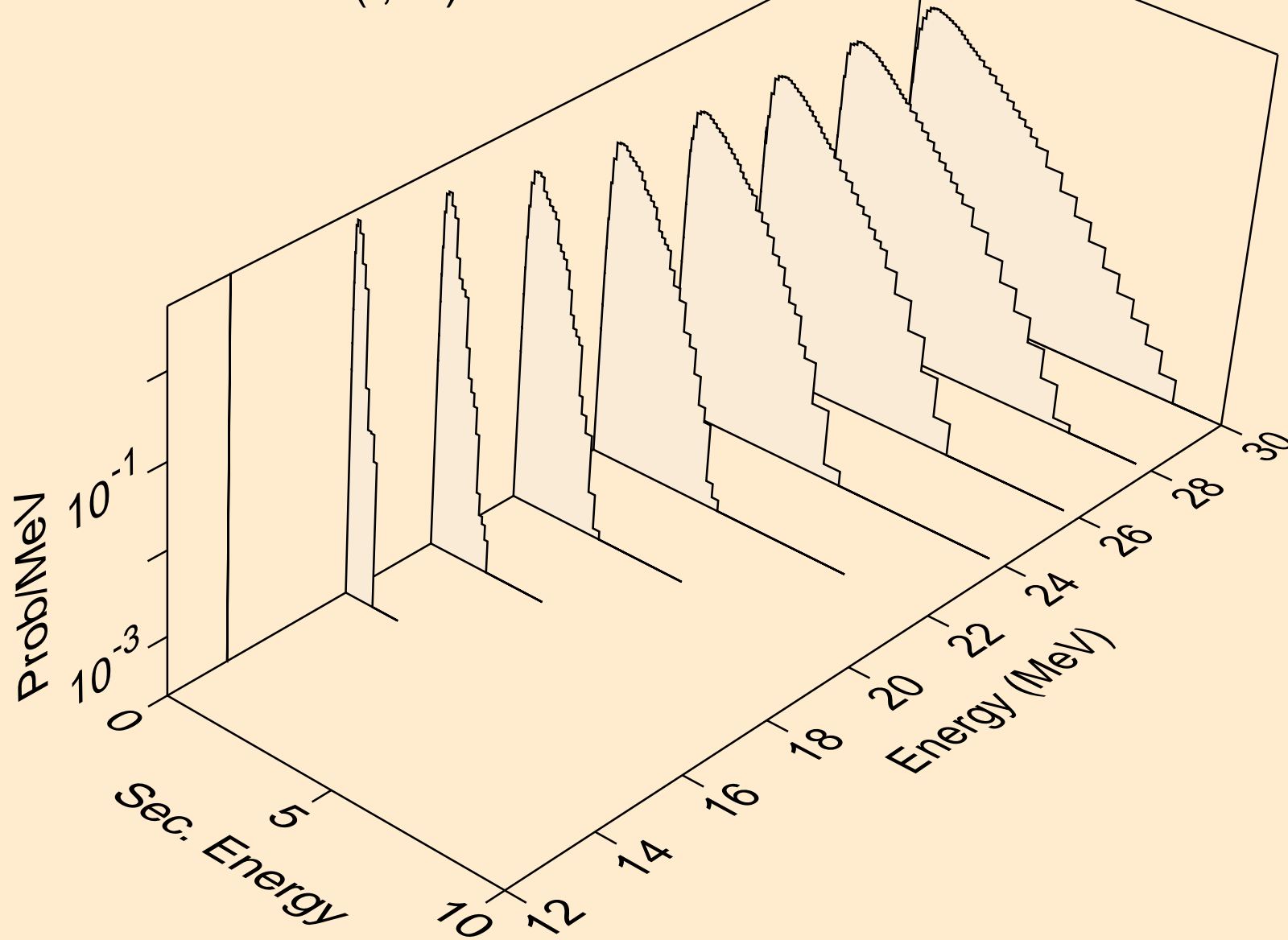



CO060M TRITON ACER TENDL-2021 LIBRARY; T=0.K  
neutrons from (t,n\*)p

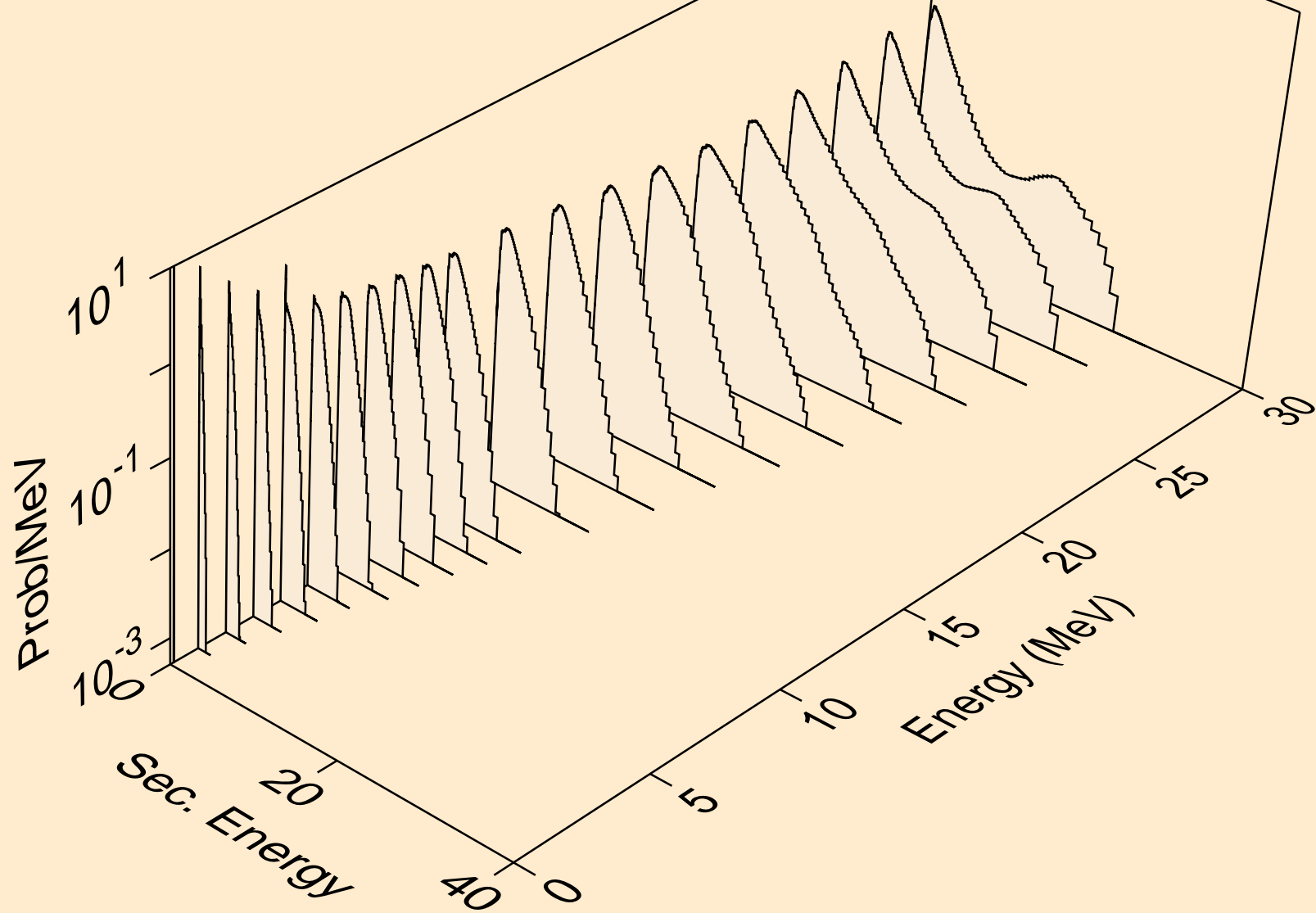

CO060M TRITON ACER TENDL-2021 LIBRARY; T=0.K  
neutrons from (t,n\*)2a

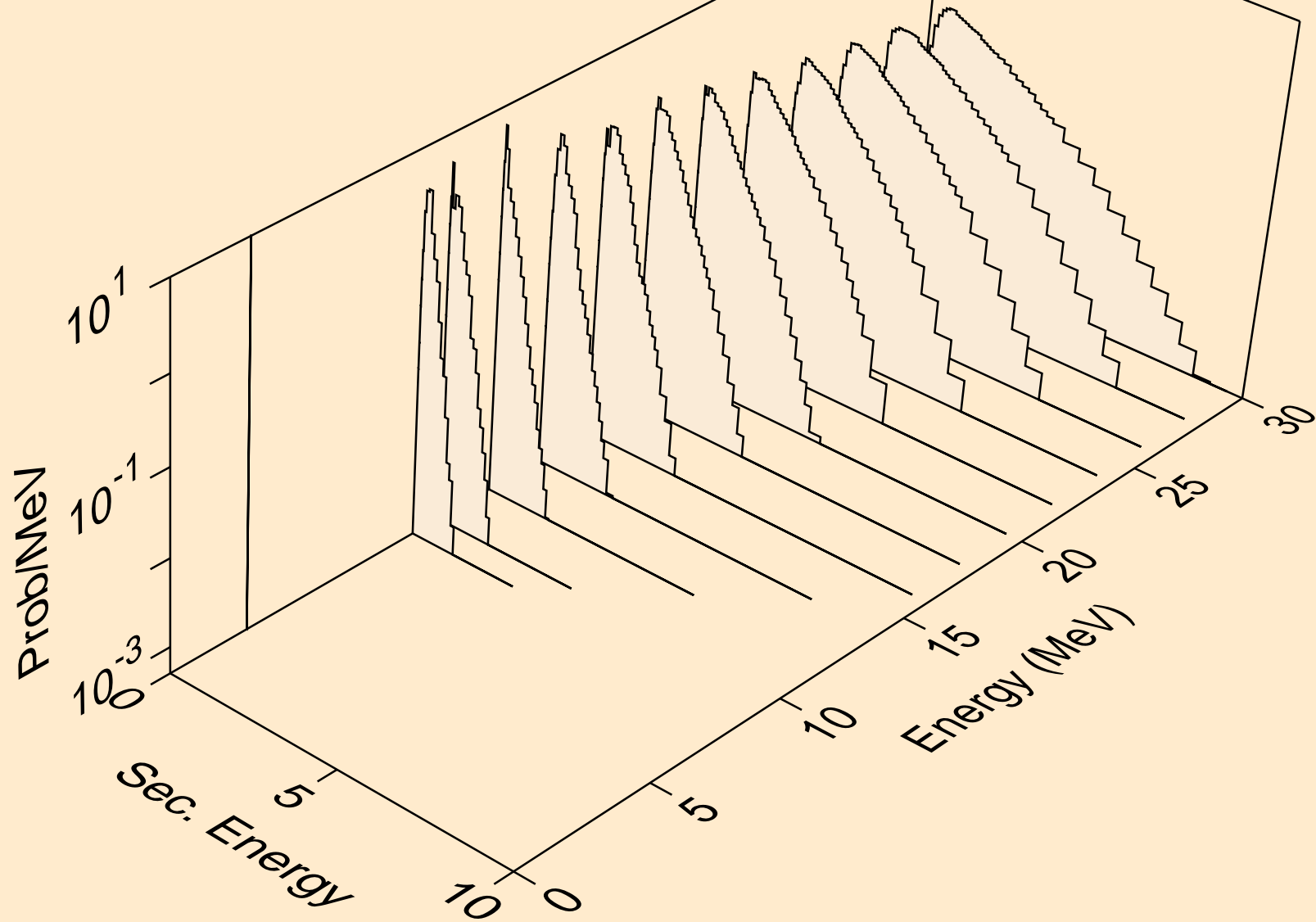

CO060M TRITON ACER TENDL-2021 LIBRARY; T=0.K  
neutrons from (t,2n)2a

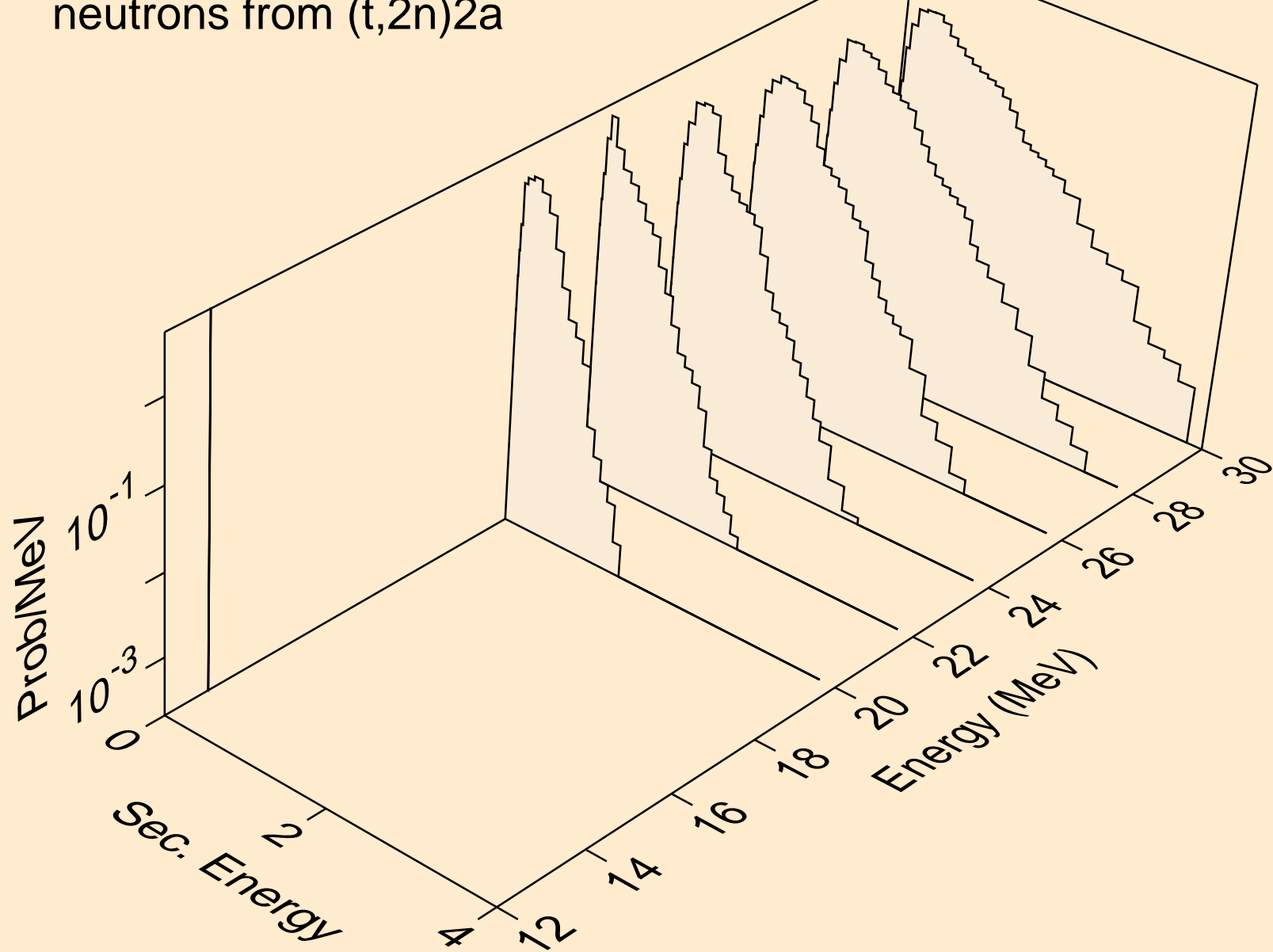

CO060M TRITON ACER TENDL-2021 LIBRARY; T=0.K  
neutrons from (t,n\*)d

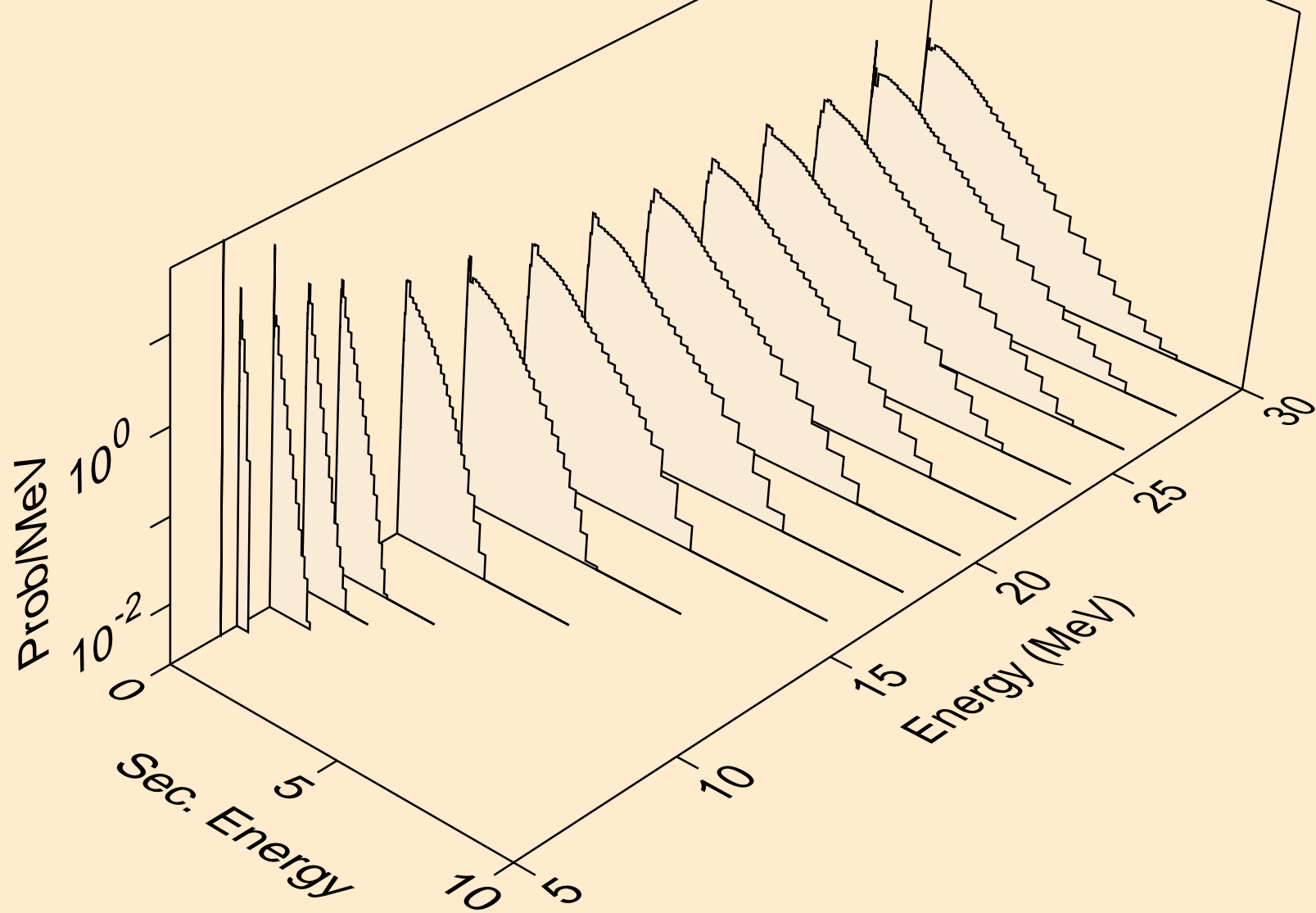

CO060M TRITON ACER TENDL-2021 LIBRARY; T=0.K  
neutrons from (t,n\*)t

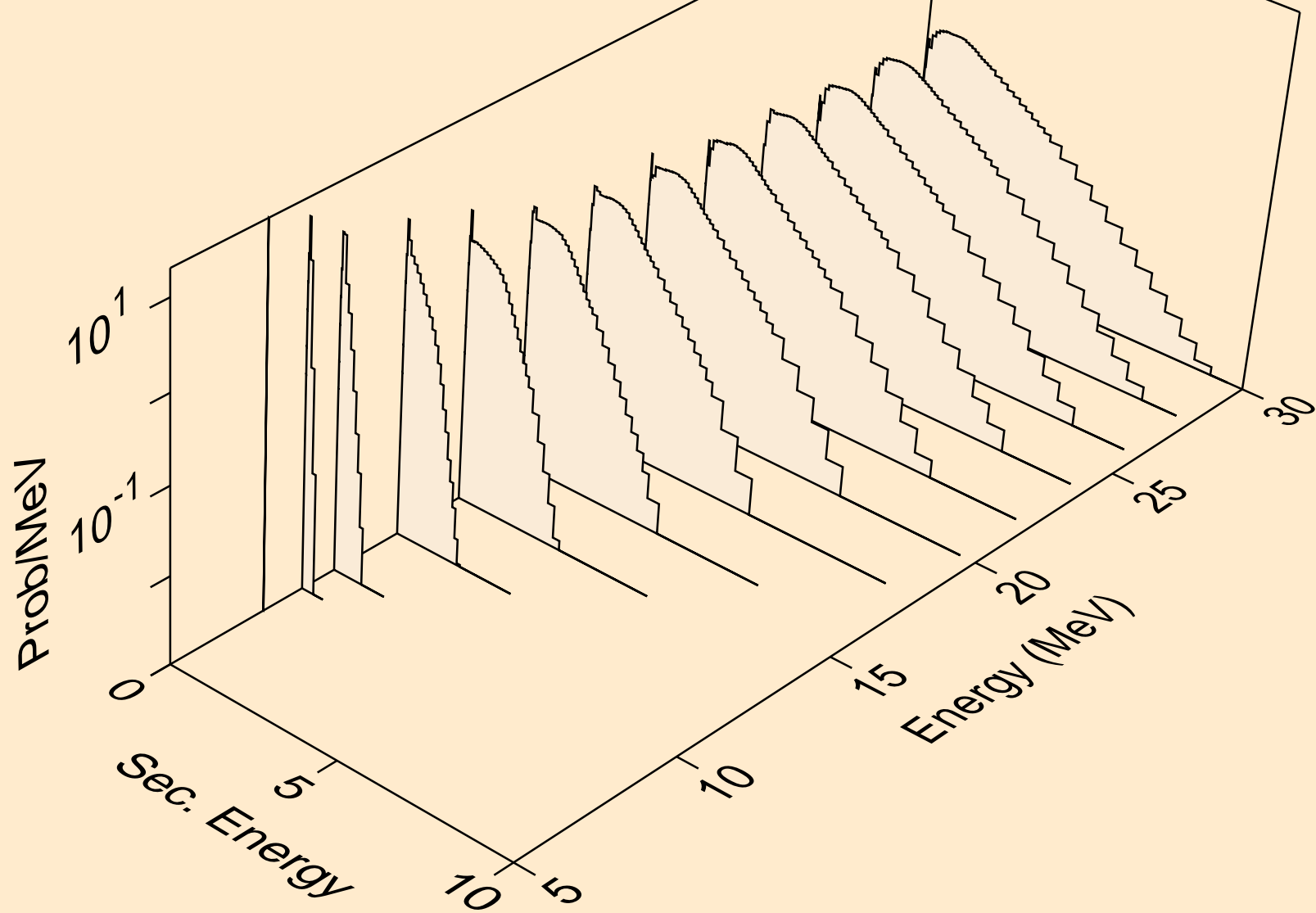

CO060M TRITON ACER TENDL-2021 LIBRARY; T=0.K  
neutrons from (t,n\*)he3

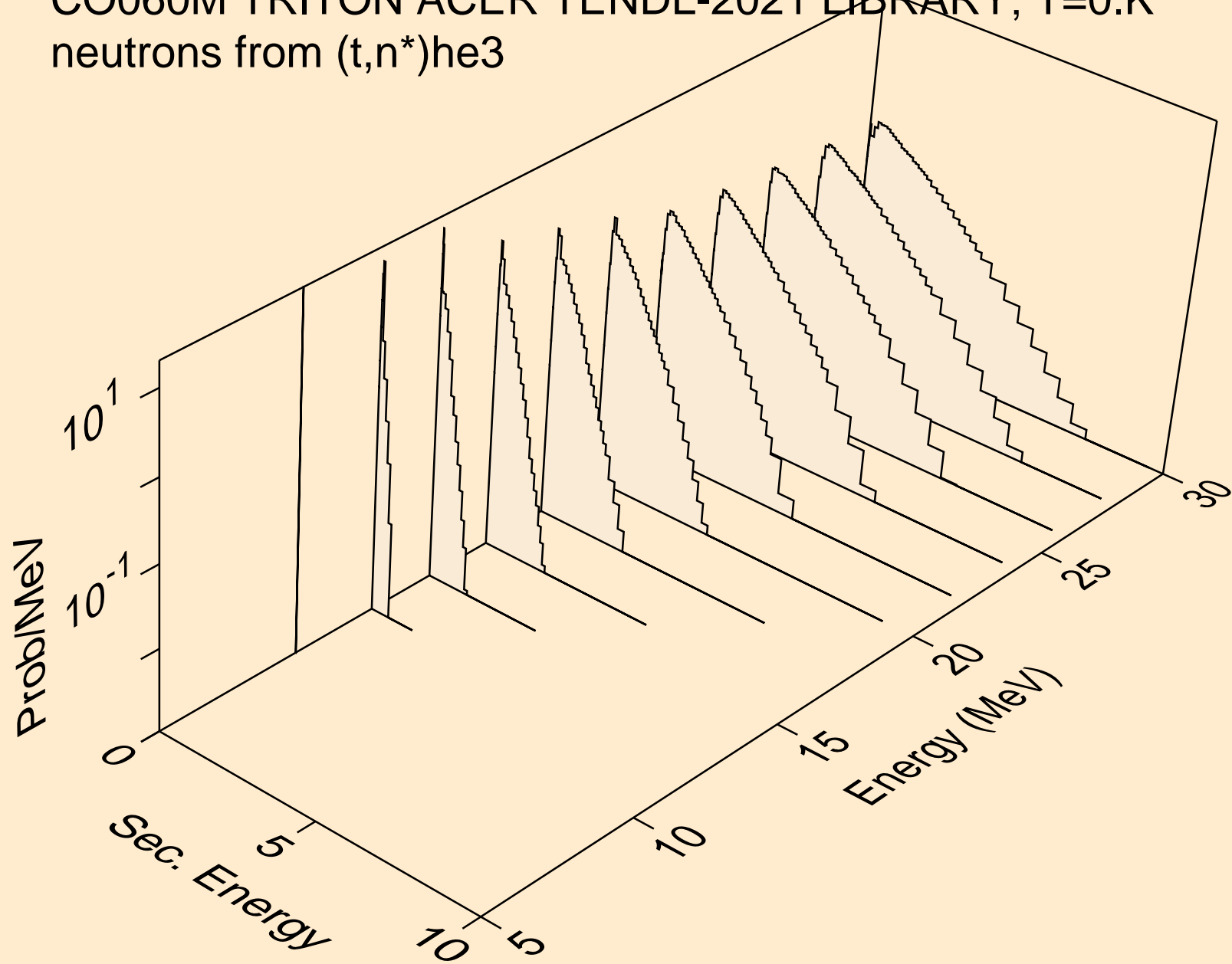

CO060M TRITON ACER TENDL-2021 LIBRARY; T=0.K  
neutrons from (t,4n)

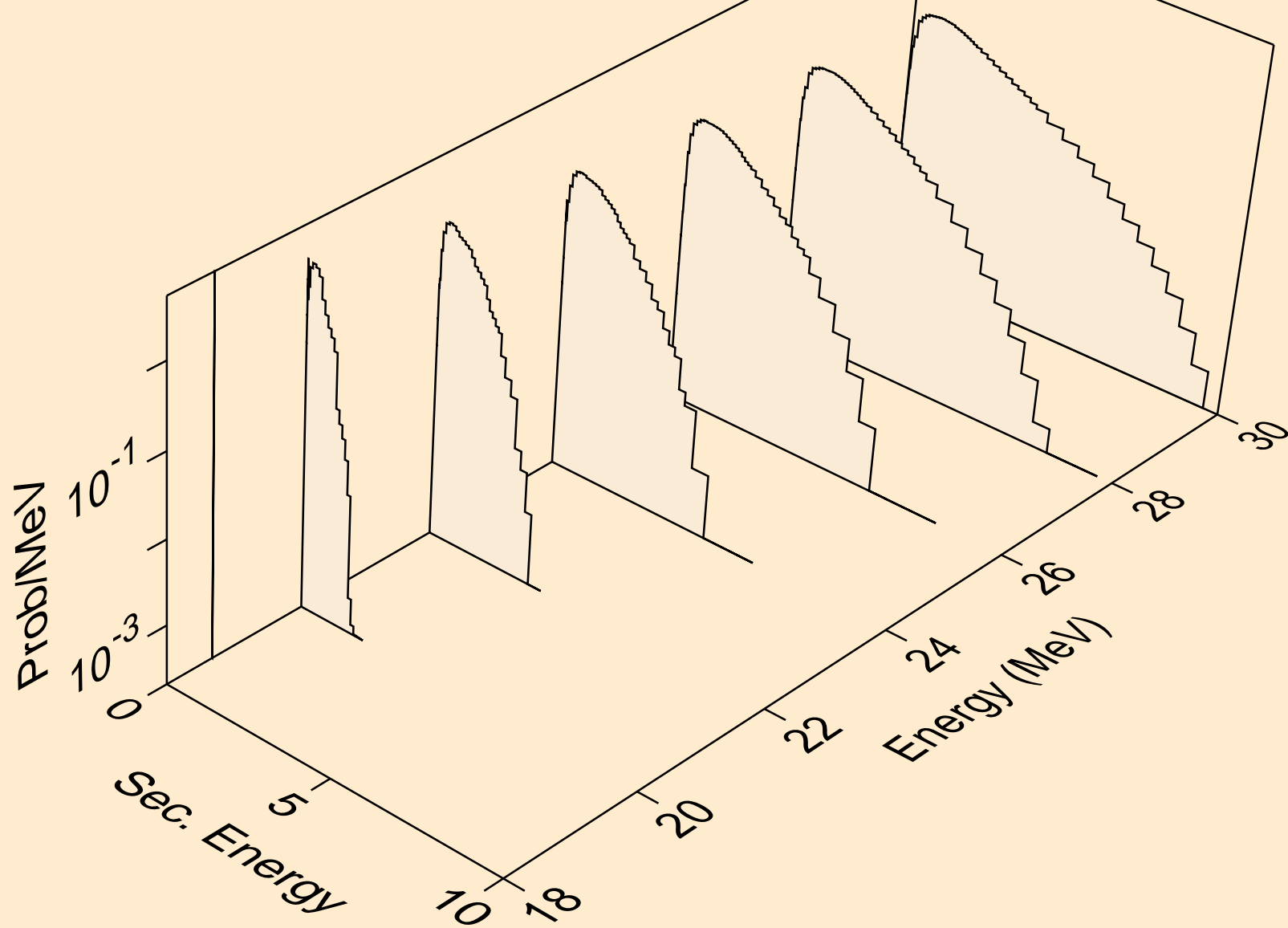

CO060M TRITON ACER TENDL-2021 LIBRARY; T=0.K  
neutrons from (t,2np)

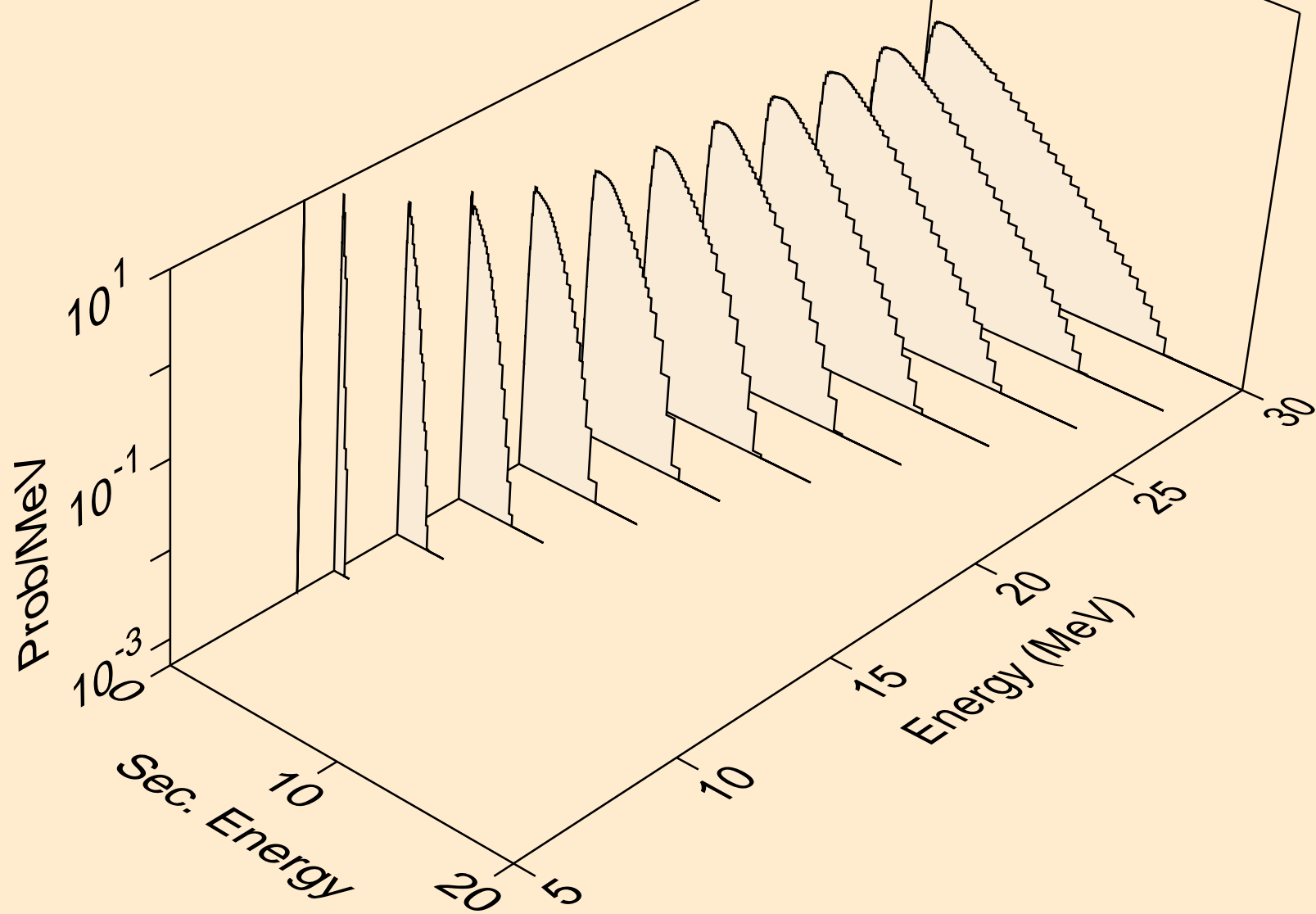



CO060M TRITON ACER TENDL-2021 LIBRARY; T=0.K  
neutrons from (t,3np)

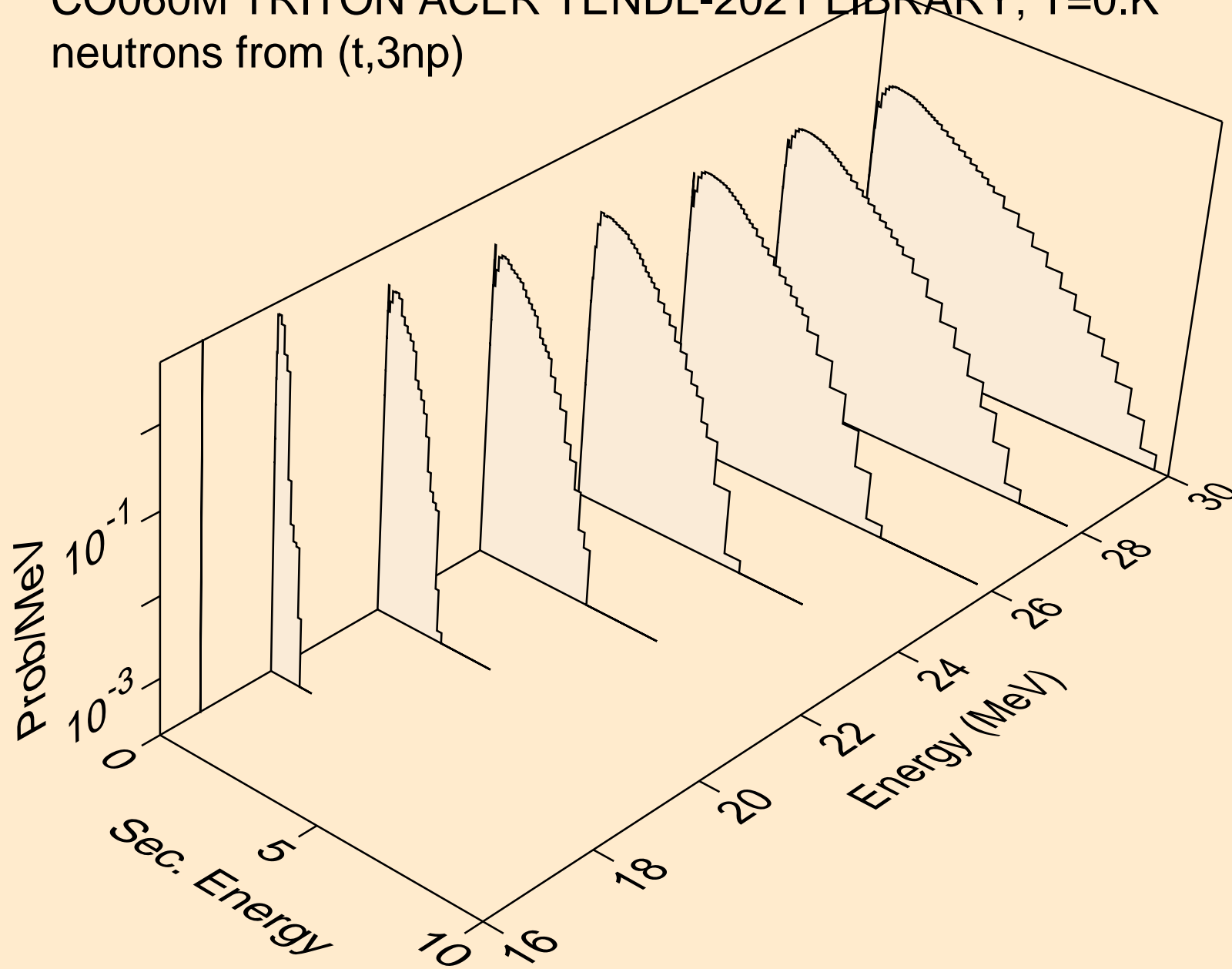

CO060M TRITON ACER TENDL-2021 LIBRARY; T=0.K  
neutrons from (t,2np)

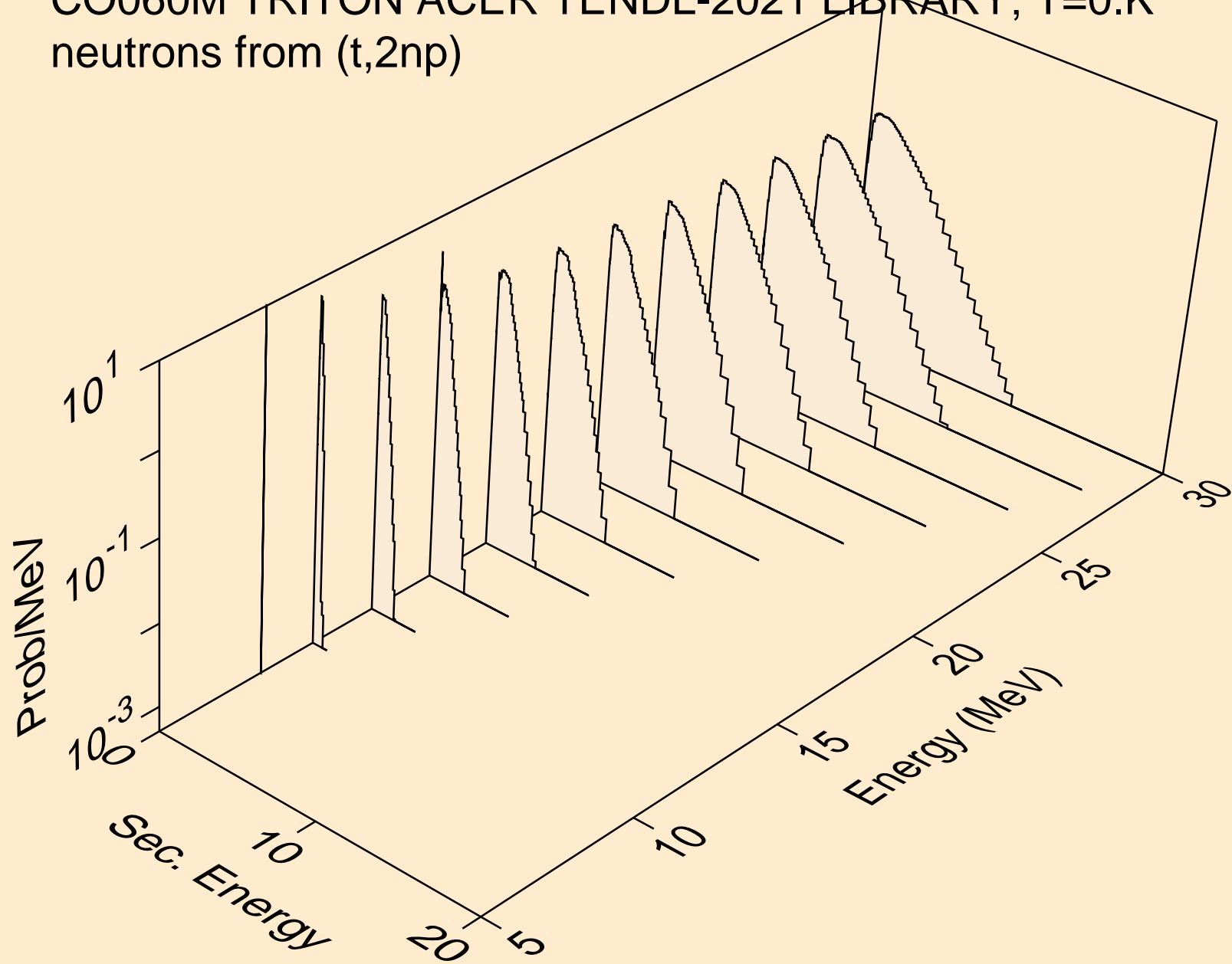

CO060M TRITON ACER TENDL-2021 LIBRARY; T=0.K  
neutrons from (t,npa)

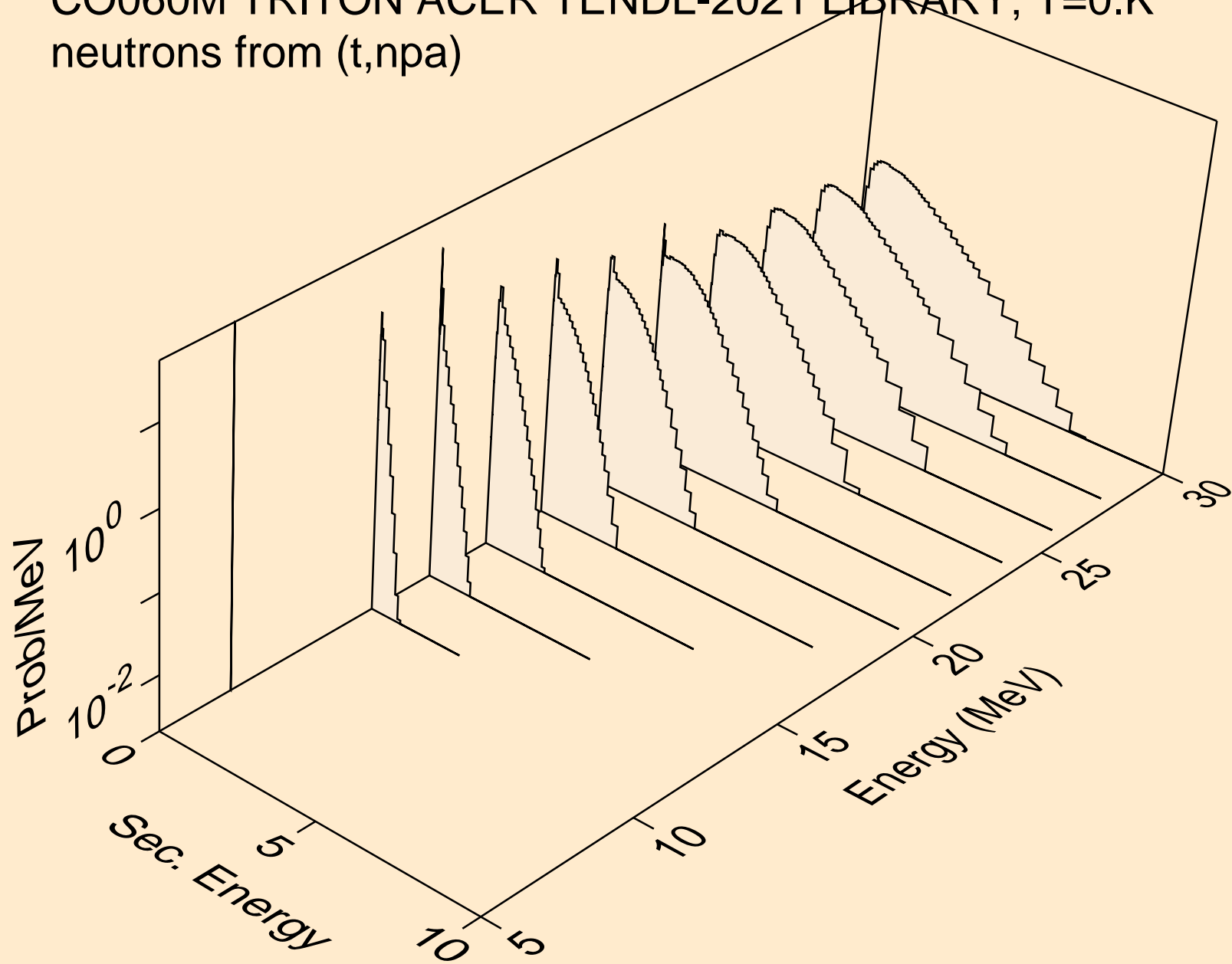

CO060M TRITON ACER TENDL-2021 LIBRARY; T=0.K  
protons from (t,x)

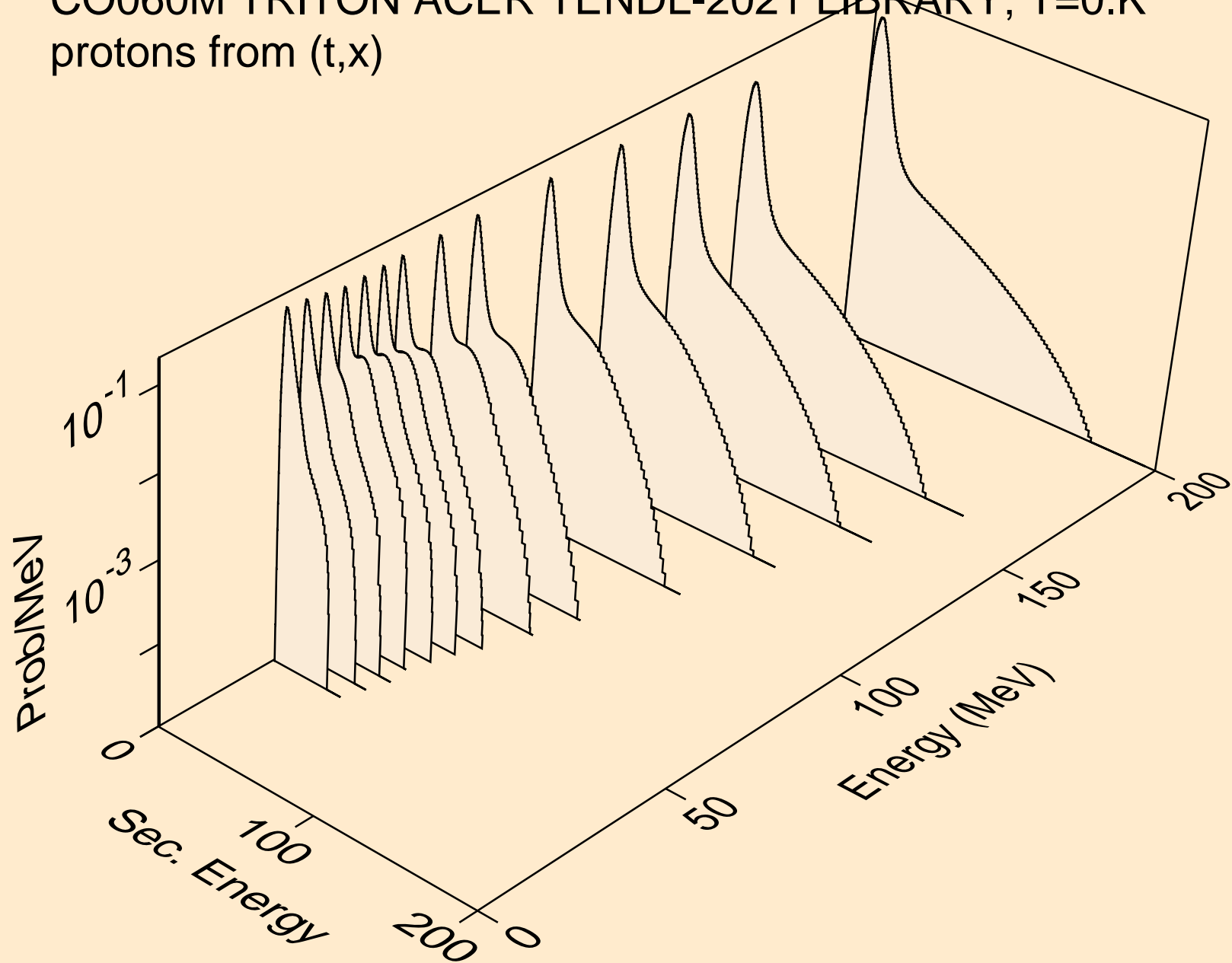

CO060M TRITON ACER TENDL-2021 LIBRARY; T=0.K  
protons from (t,n\*)p

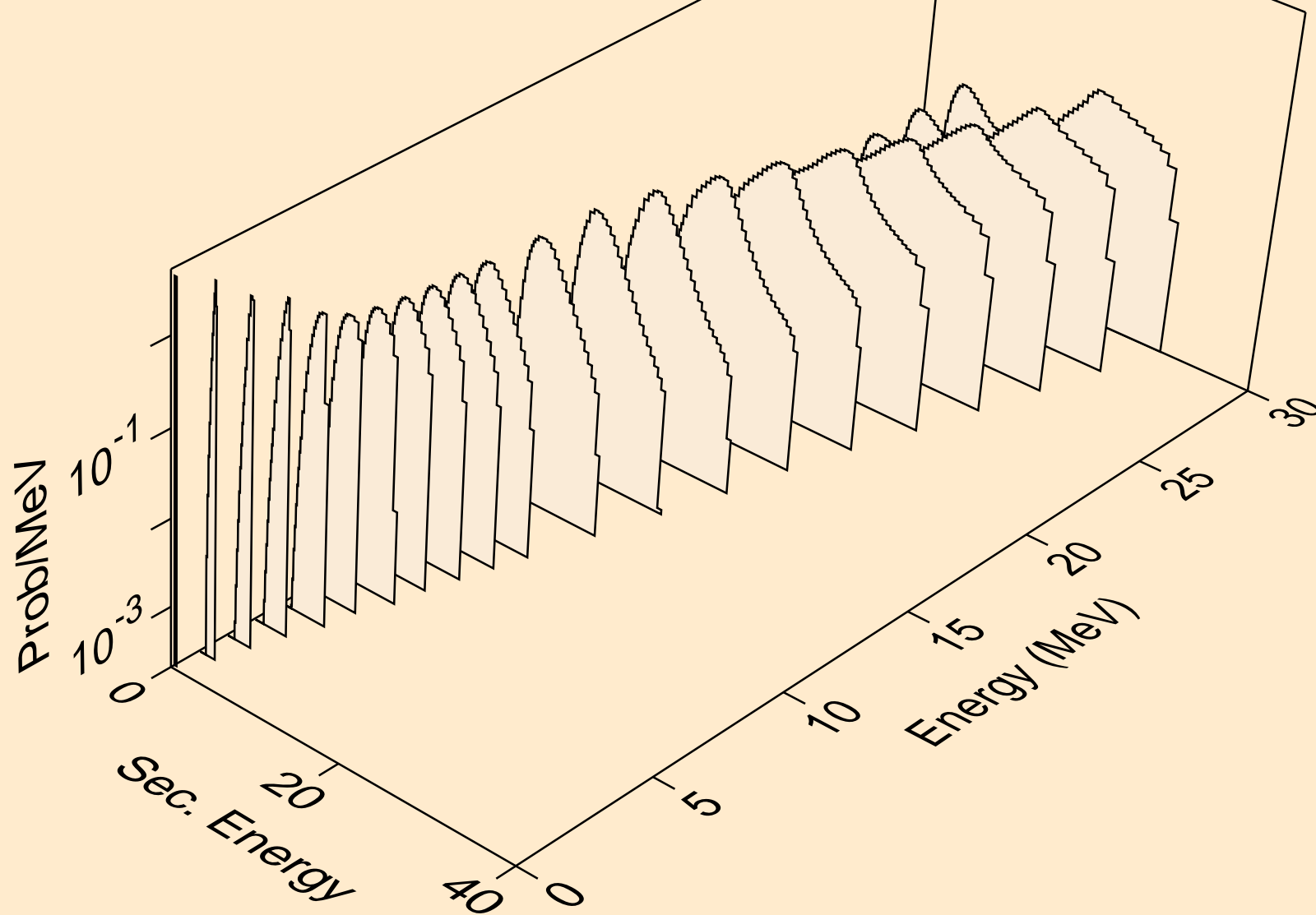

CO060M TRITON ACER TENDL-2021 LIBRARY; T=0.K  
protons from (t,2np)

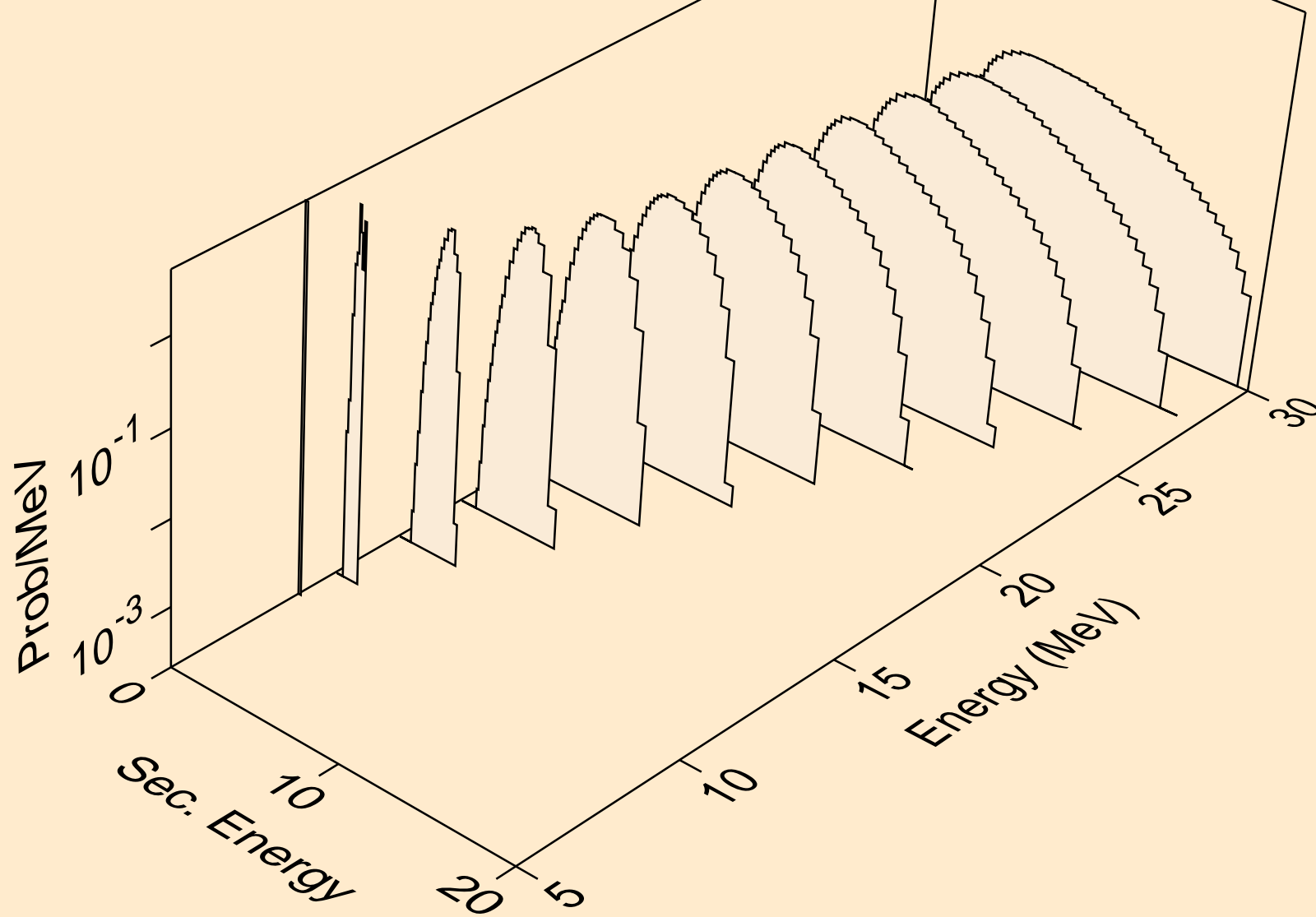

CO060M TRITON ACER TENDL-2021 LIBRARY; T=0.K  
protons from (t,3np)

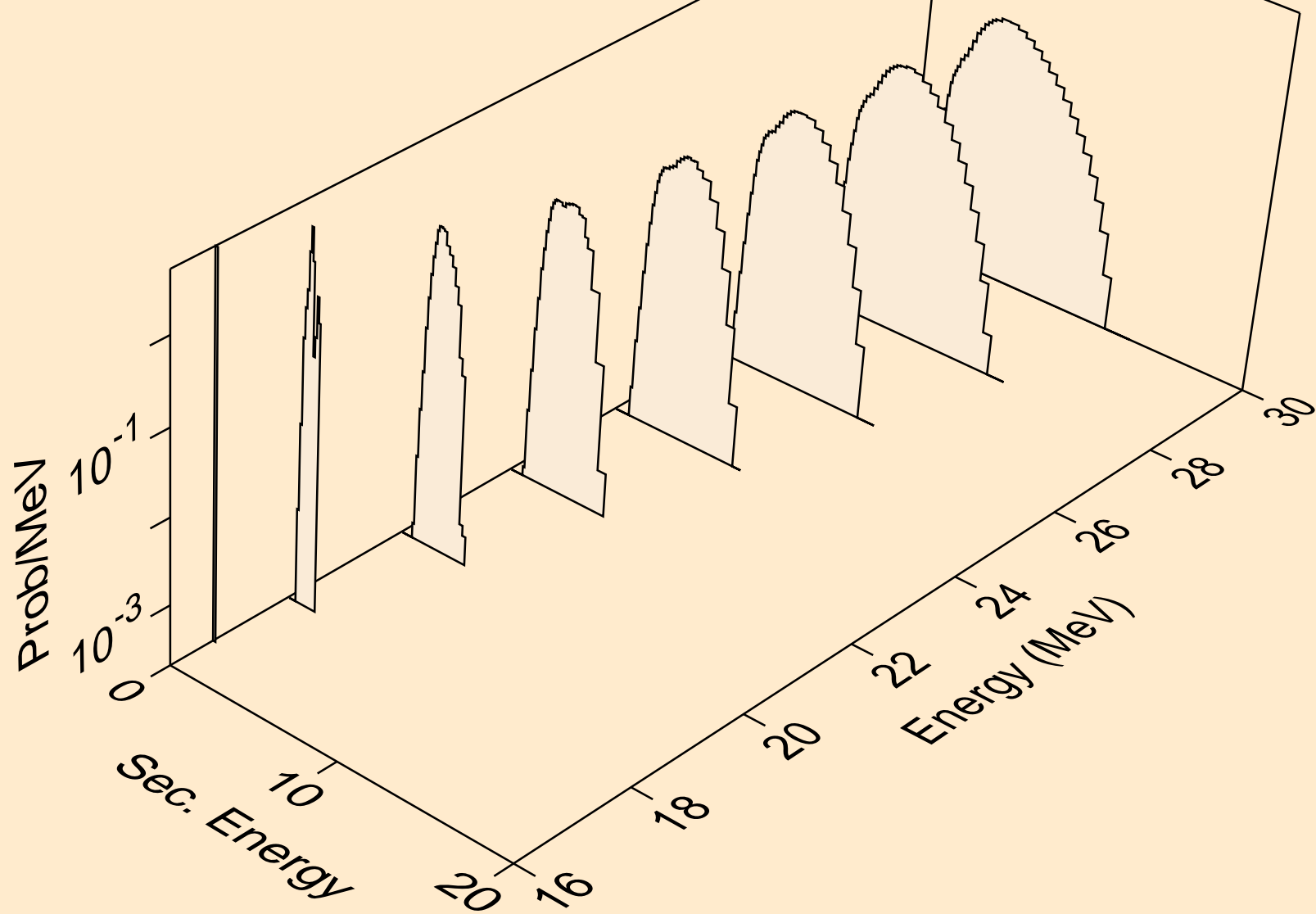

CO060M TRITON ACER TENDL-2021 LIBRARY; T=0.K  
protons from (t,2np)

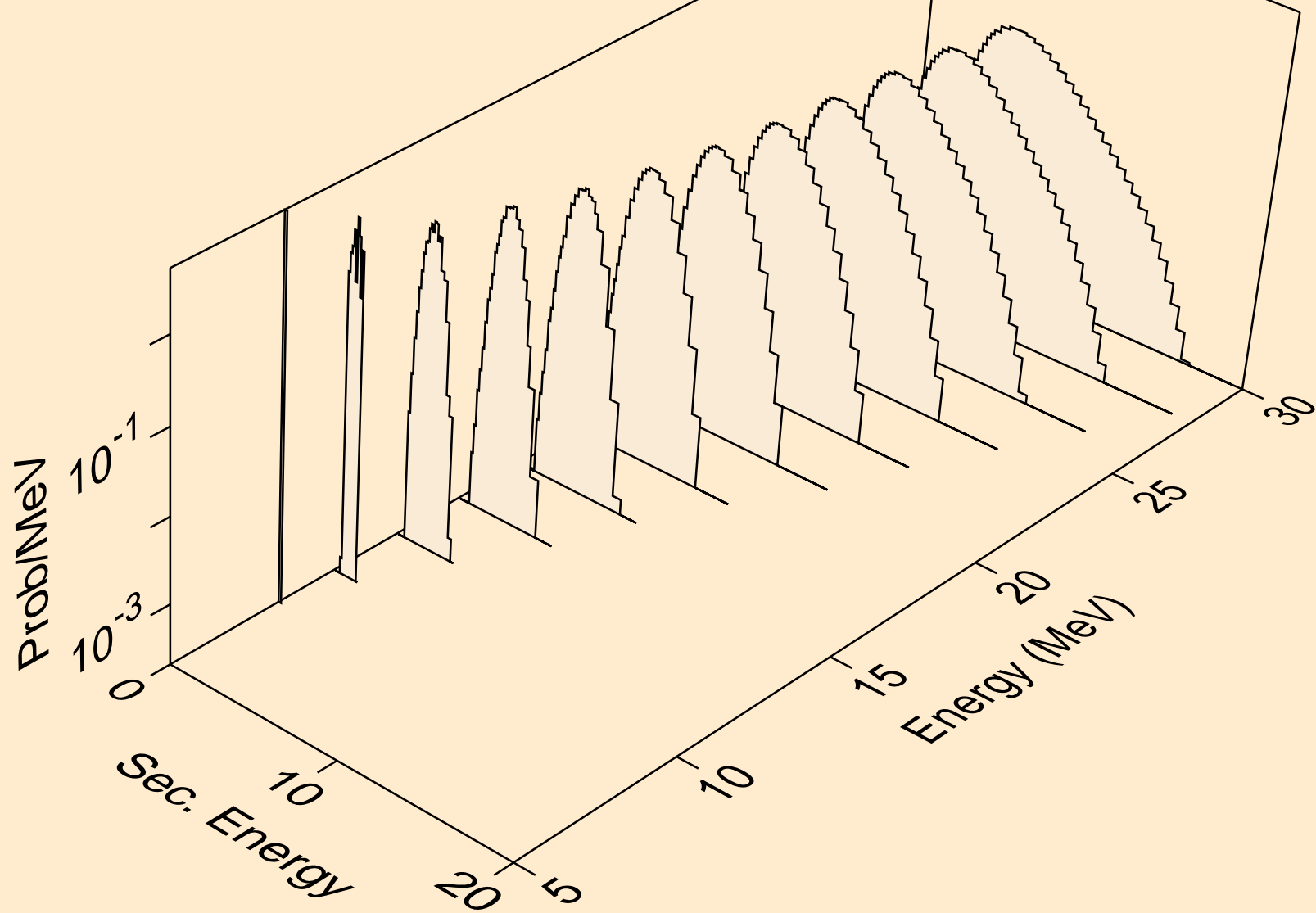



CO060M TRITON ACER TENDL-2021 LIBRARY; T=0.K  
protons from (t,npa)

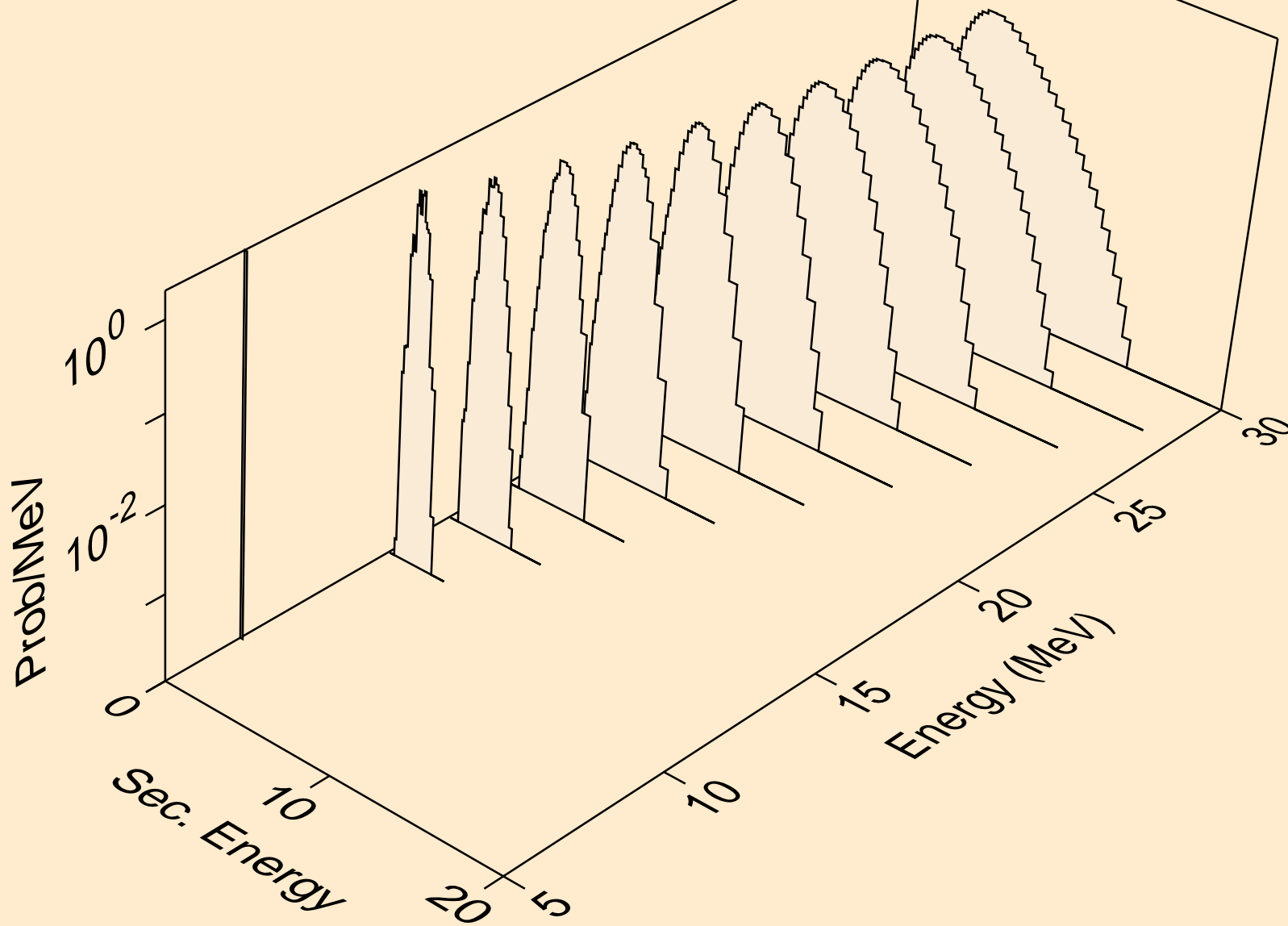

CO060M TRITON ACER TENDL-2021 LIBRARY; T=0.K  
protons from (t,p)

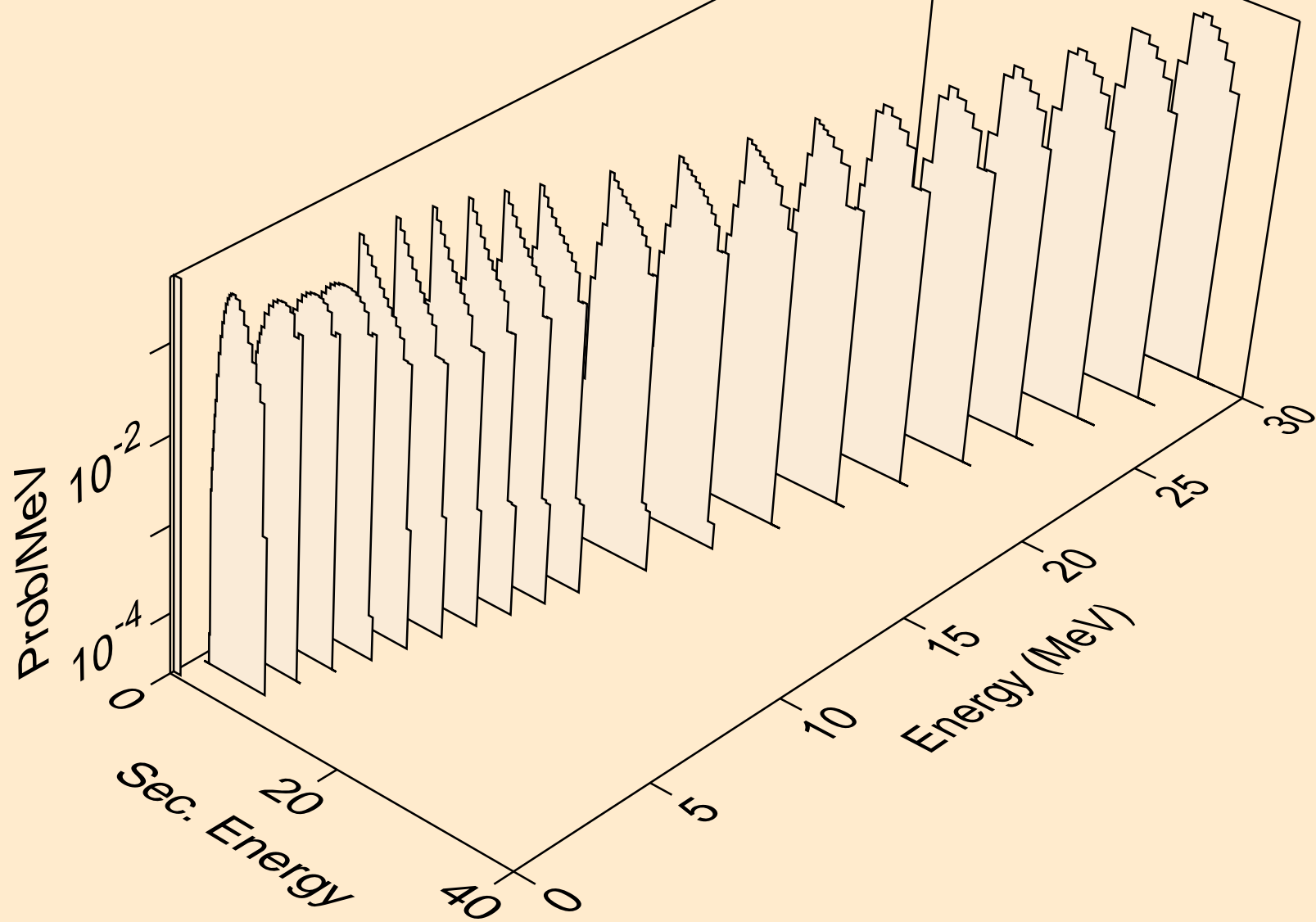

CO060M TRITON ACER TENDL-2021 LIBRARY; T=0.K  
protons from (t,2p)

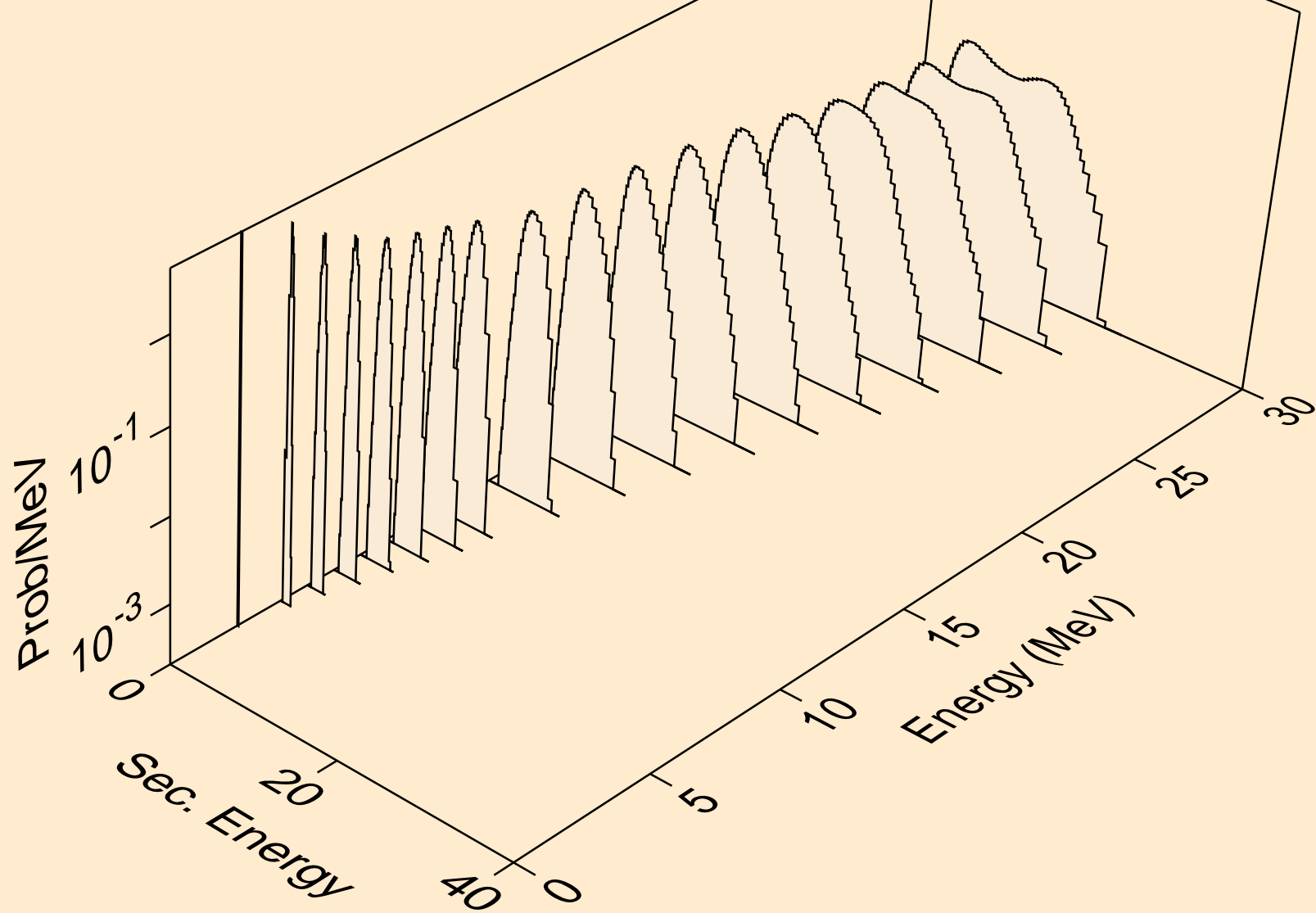

CO060M TRITON ACER TENDL-2021 LIBRARY; T=0.K  
protons from (t,pa)

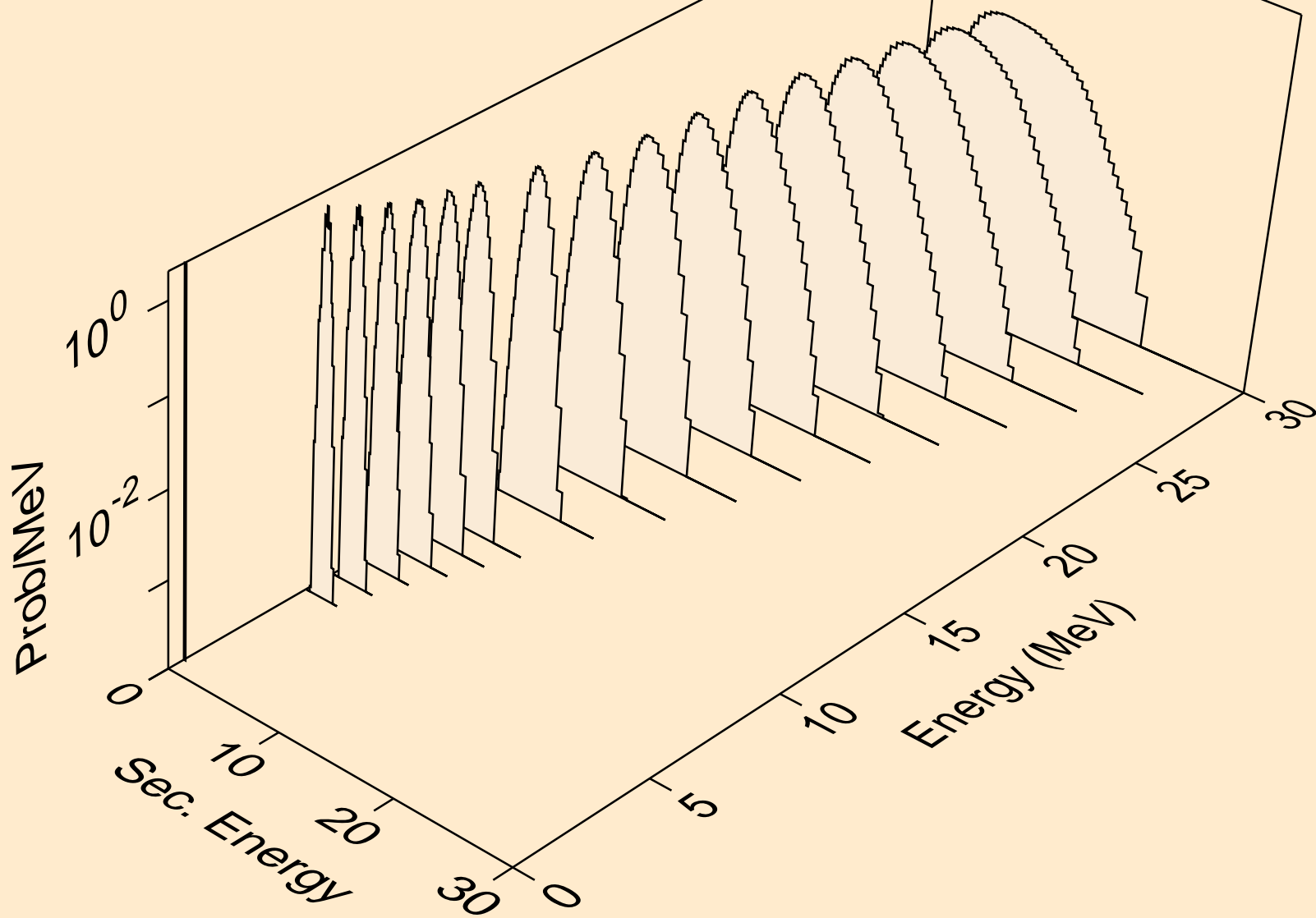

CO060M TRITON ACER TENDL-2021 LIBRARY; T=0.K  
protons from (t,pd)

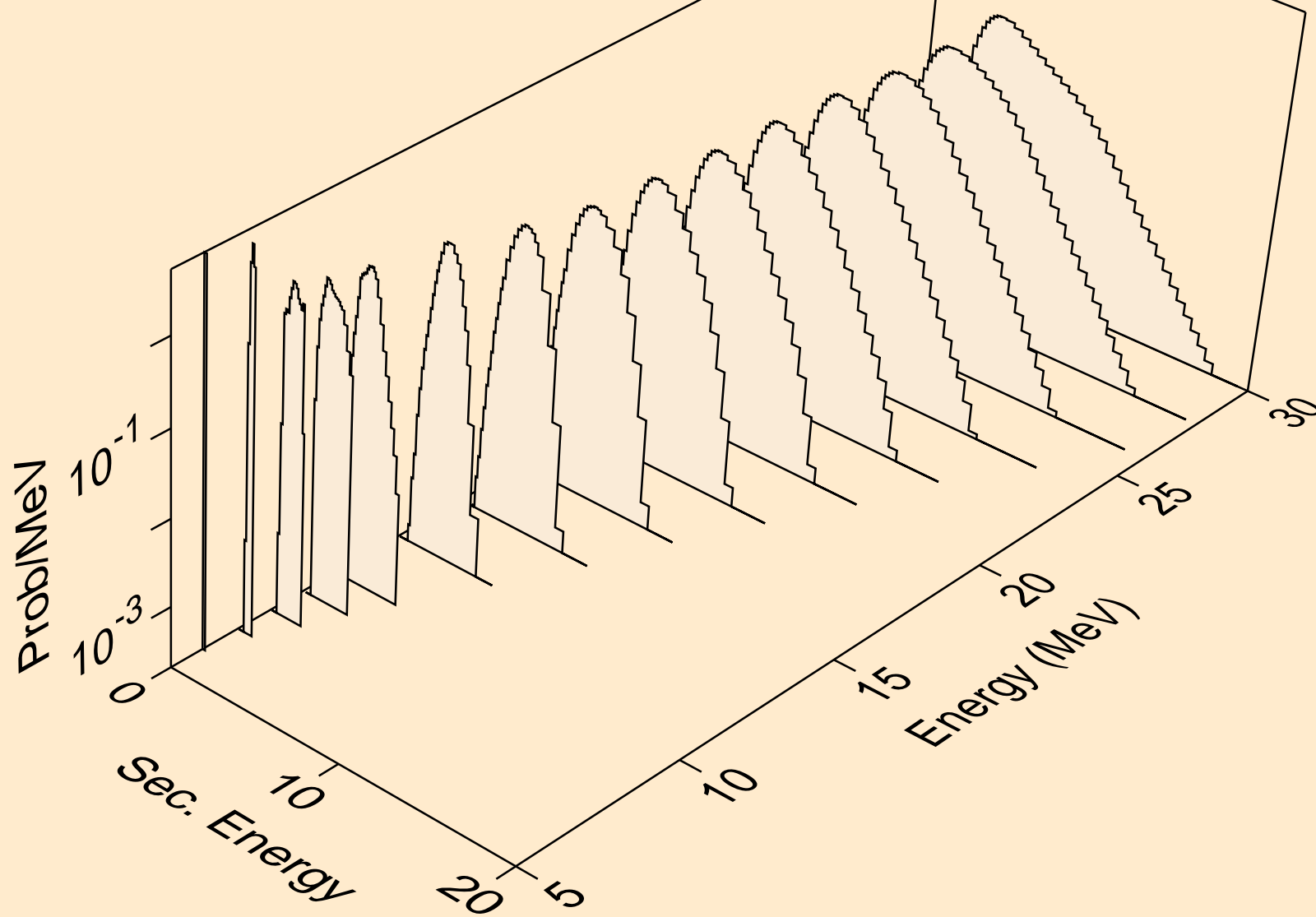

CO060M TRITON ACER TENDL-2021 LIBRARY; T=0.K  
protons from (t,pt)

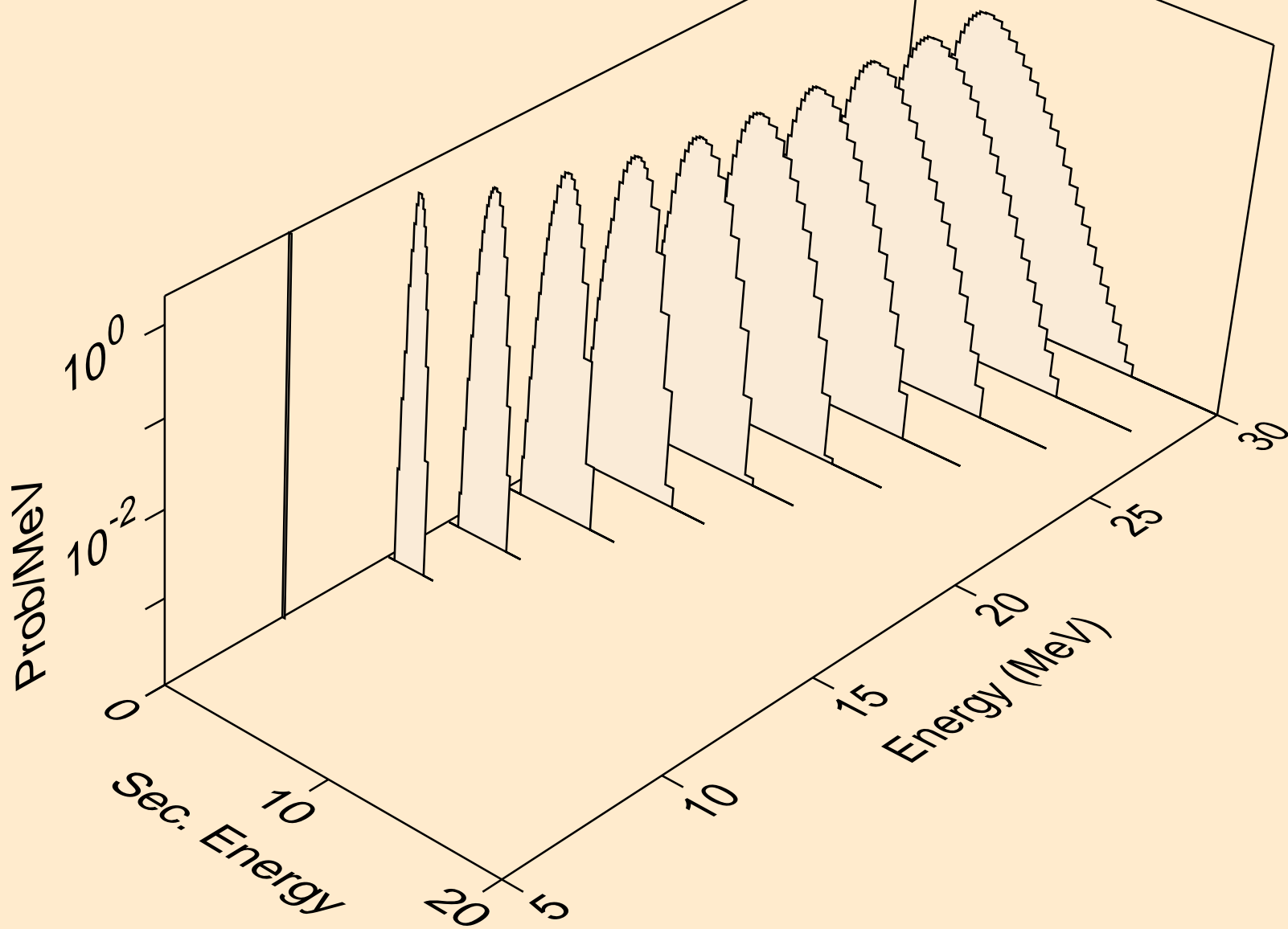

CO060M TRITON ACER TENDL-2021 LIBRARY; T=0.K  
deuterons from (t,x)

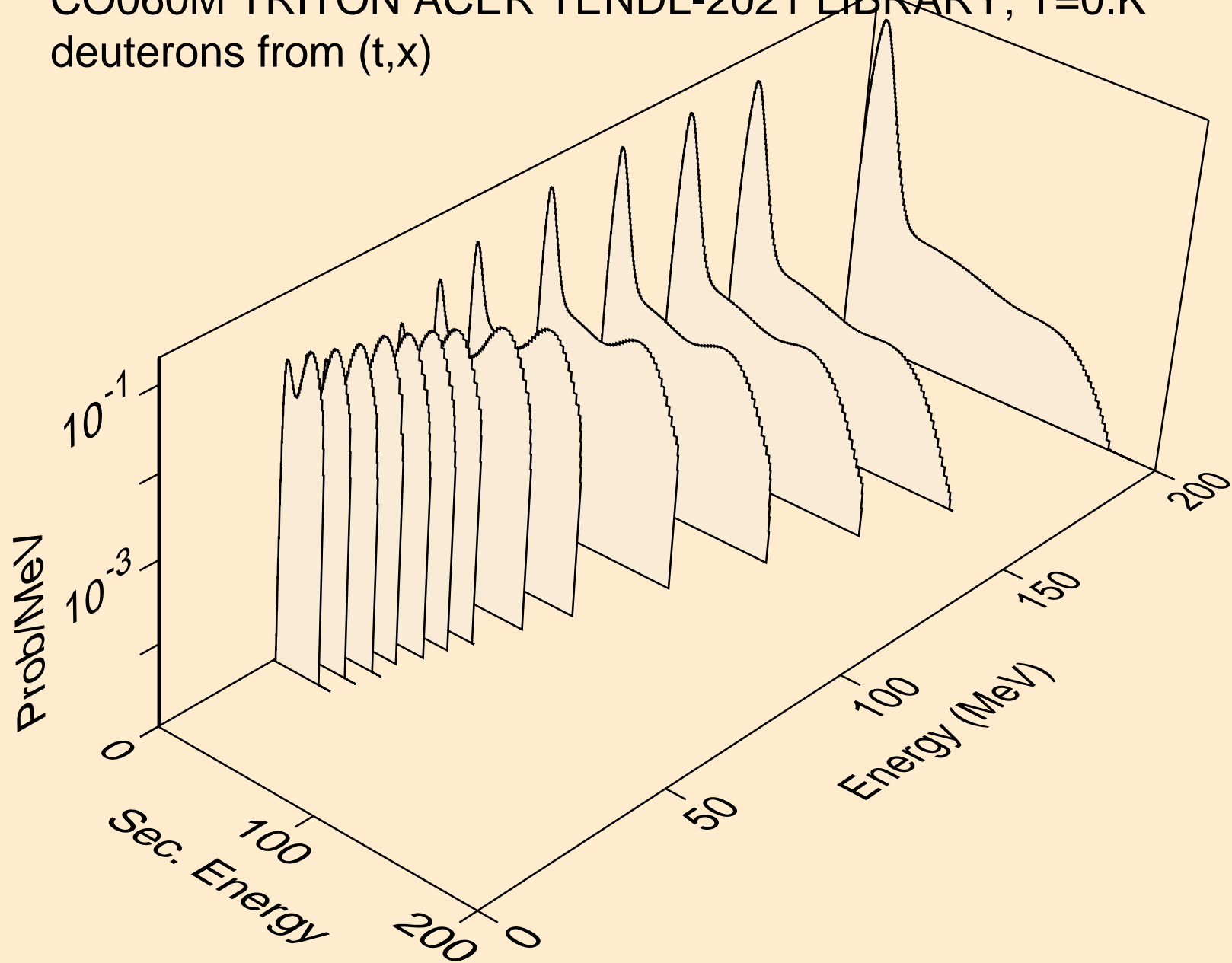

CO060M TRITON ACER TENDL-2021 LIBRARY; T=0.K  
deuterons from (t,2nd)

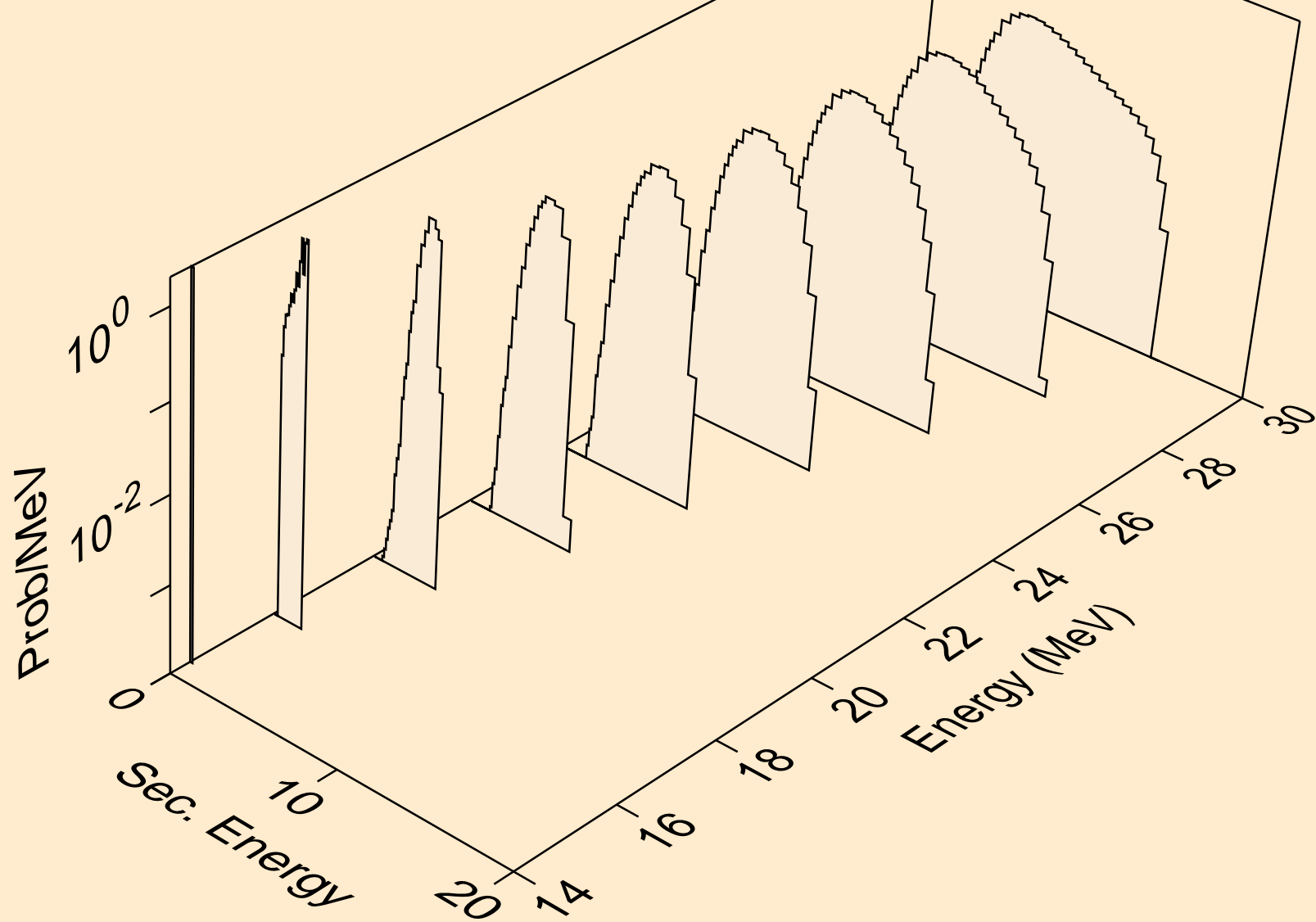



CO060M TRITON ACER TENDL-2021 LIBRARY; T=0.K  
deuterons from (t,n\*)d

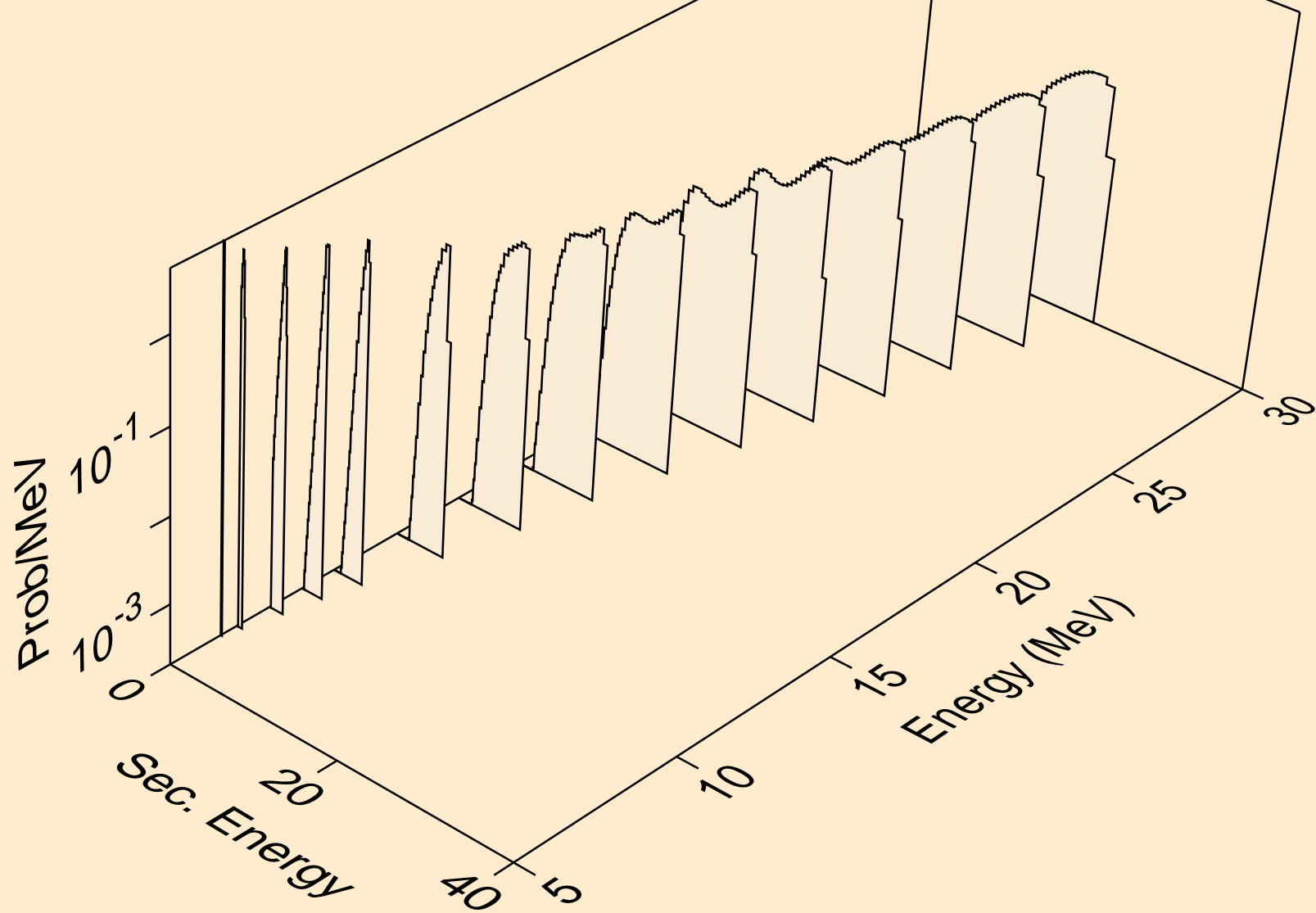

CO060M TRITON ACER TENDL-2021 LIBRARY; T=0.K  
deuterons from (t,d)

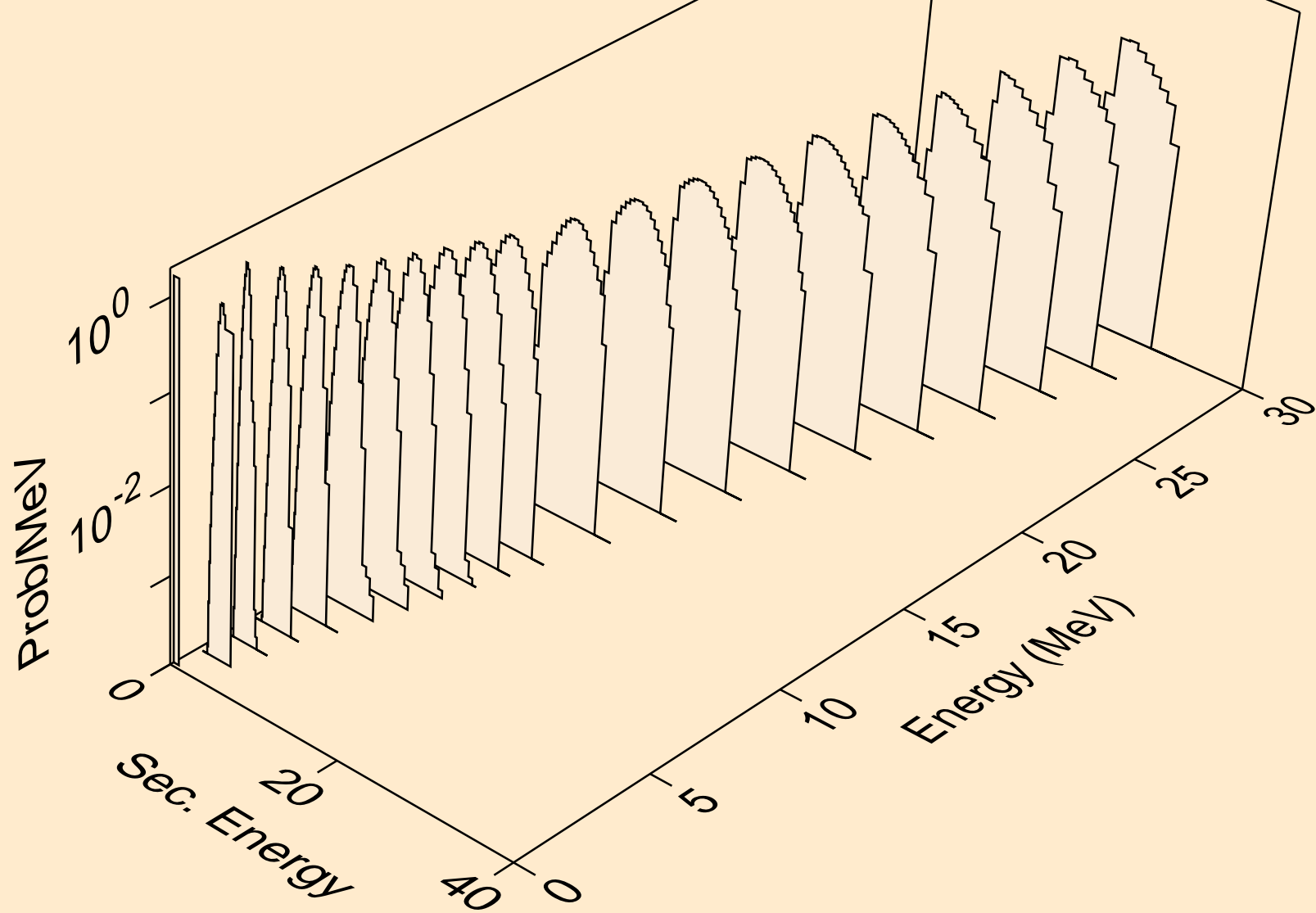

CO060M TRITON ACER TENDL-2021 LIBRARY; T=0.K  
deuterons from (t,pd)

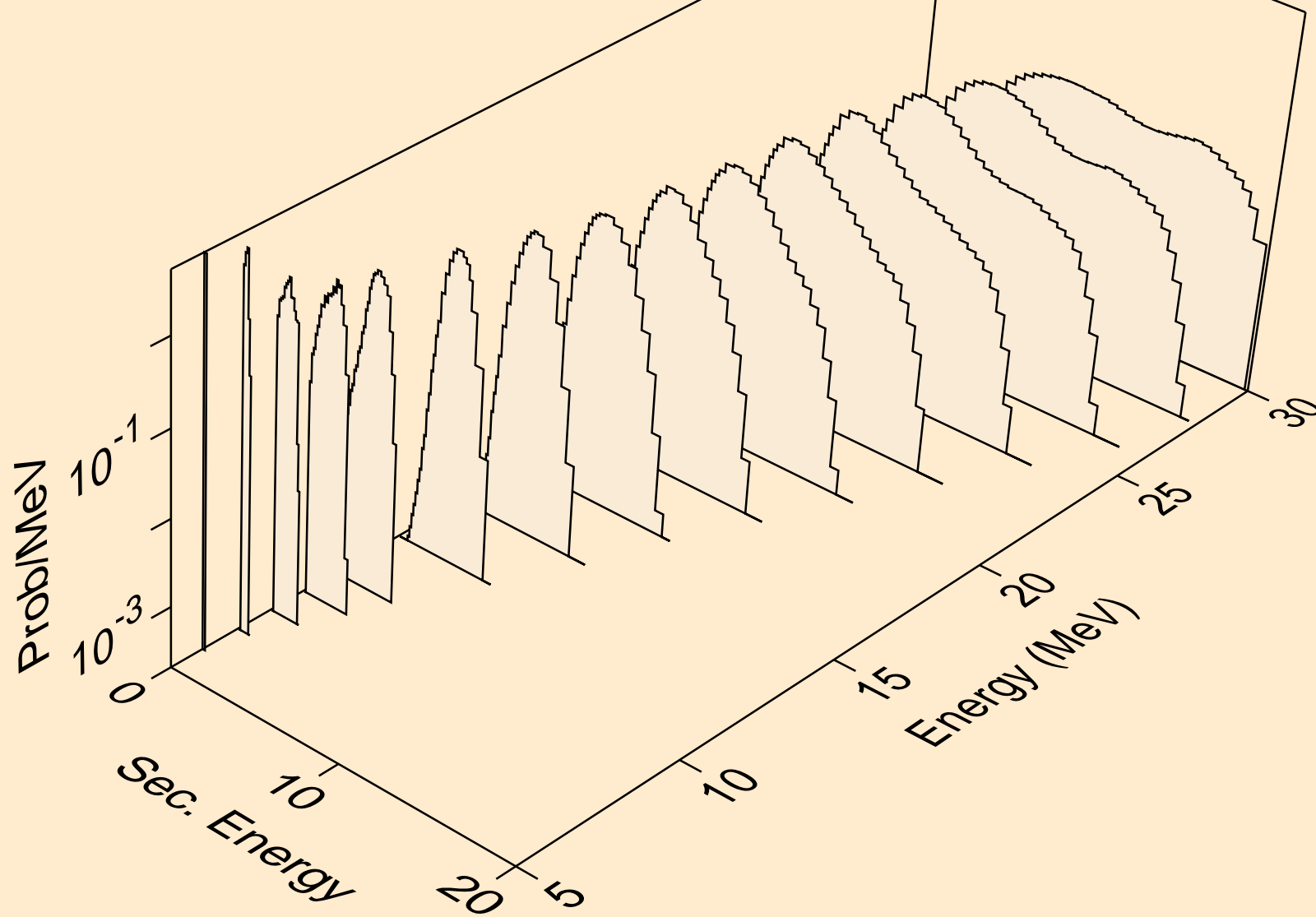

CO060M TRITON ACER TENDL-2021 LIBRARY; T=0.K  
deuterons from (t,da)

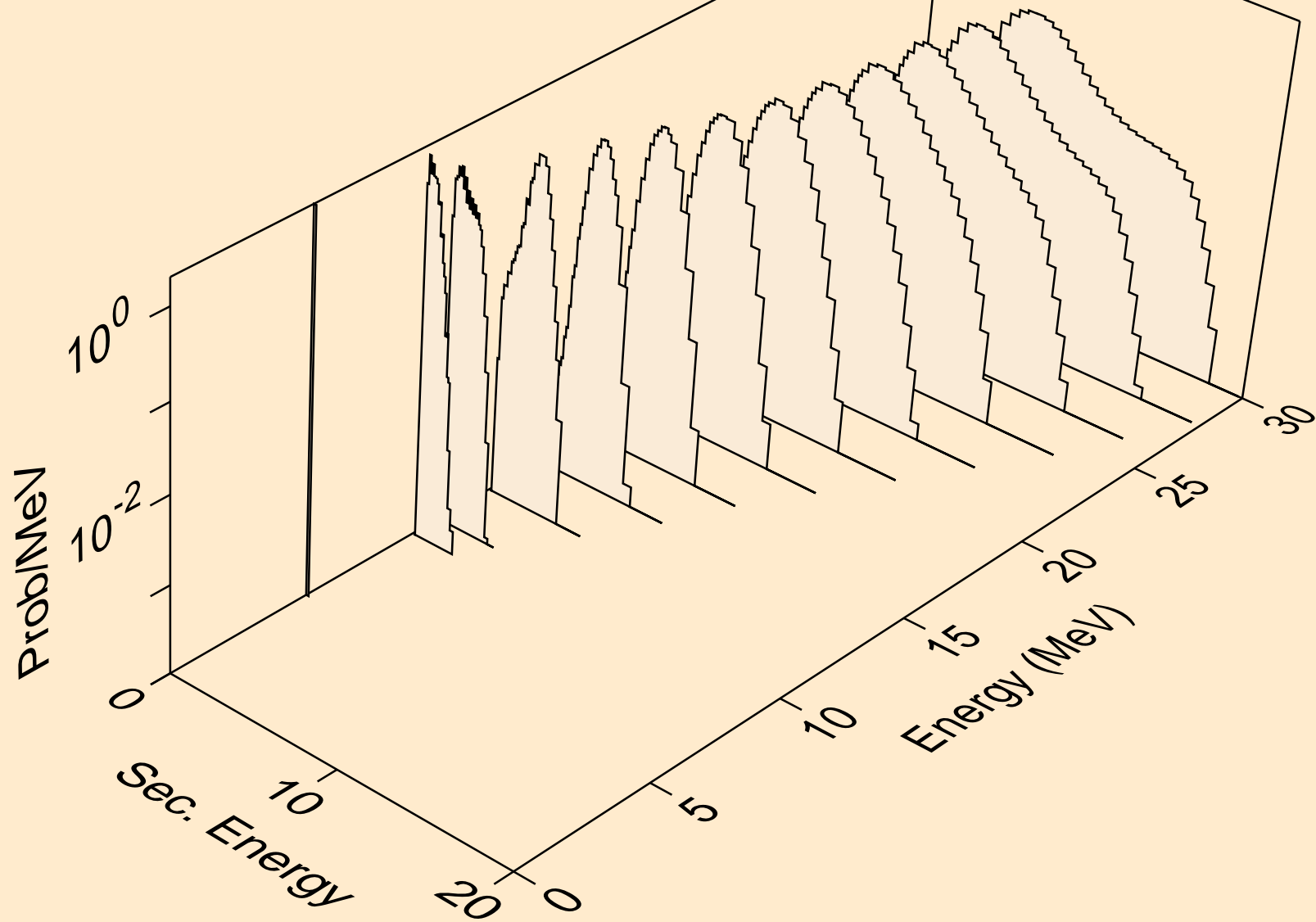

CO060M TRITON ACER TENDL-2021 LIBRARY; T=0.K  
he3s from (t,x)

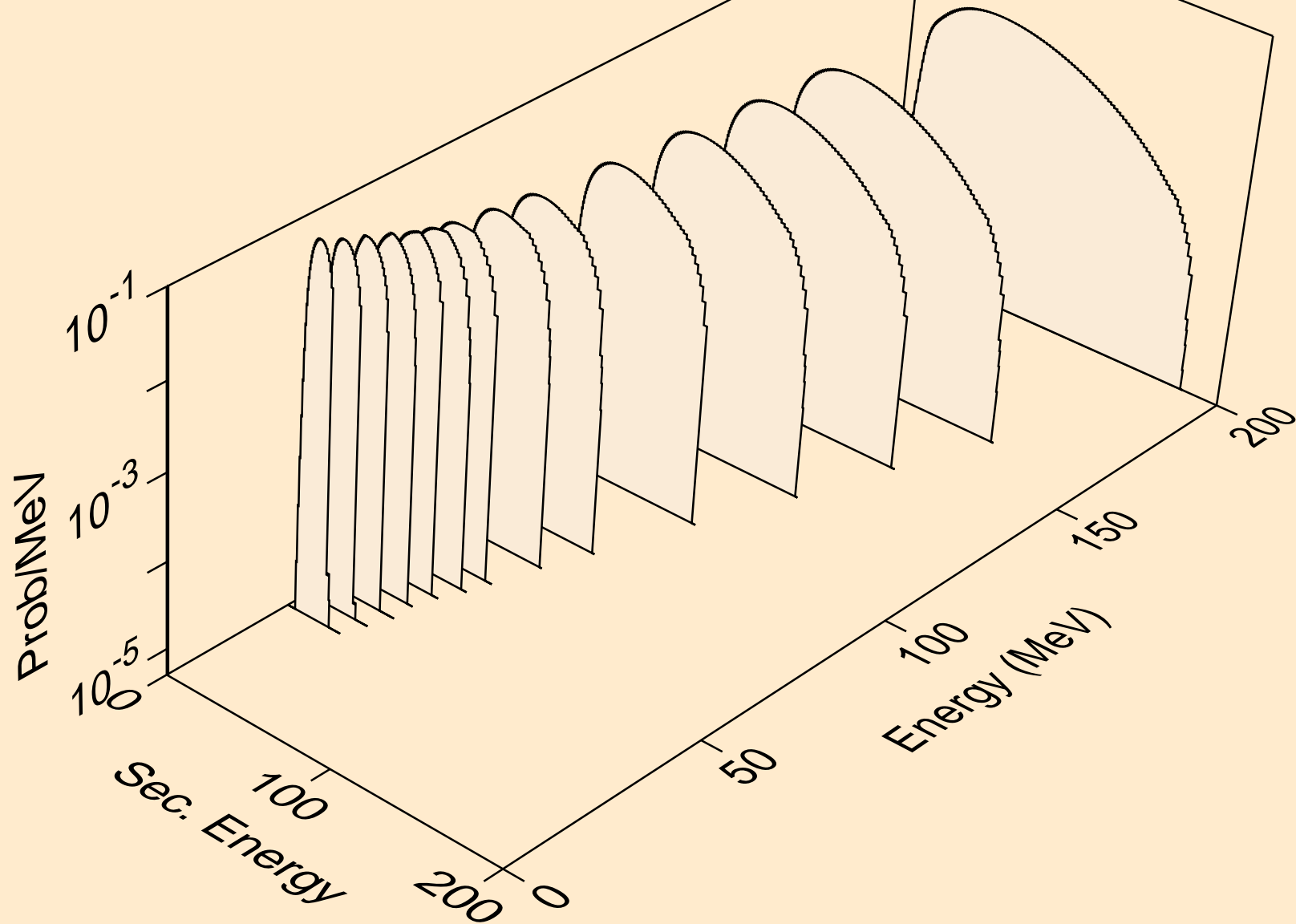

CO060M TRITON ACER TENDL-2021 LIBRARY; T=0.K  
he3s from (t,n\*)he3

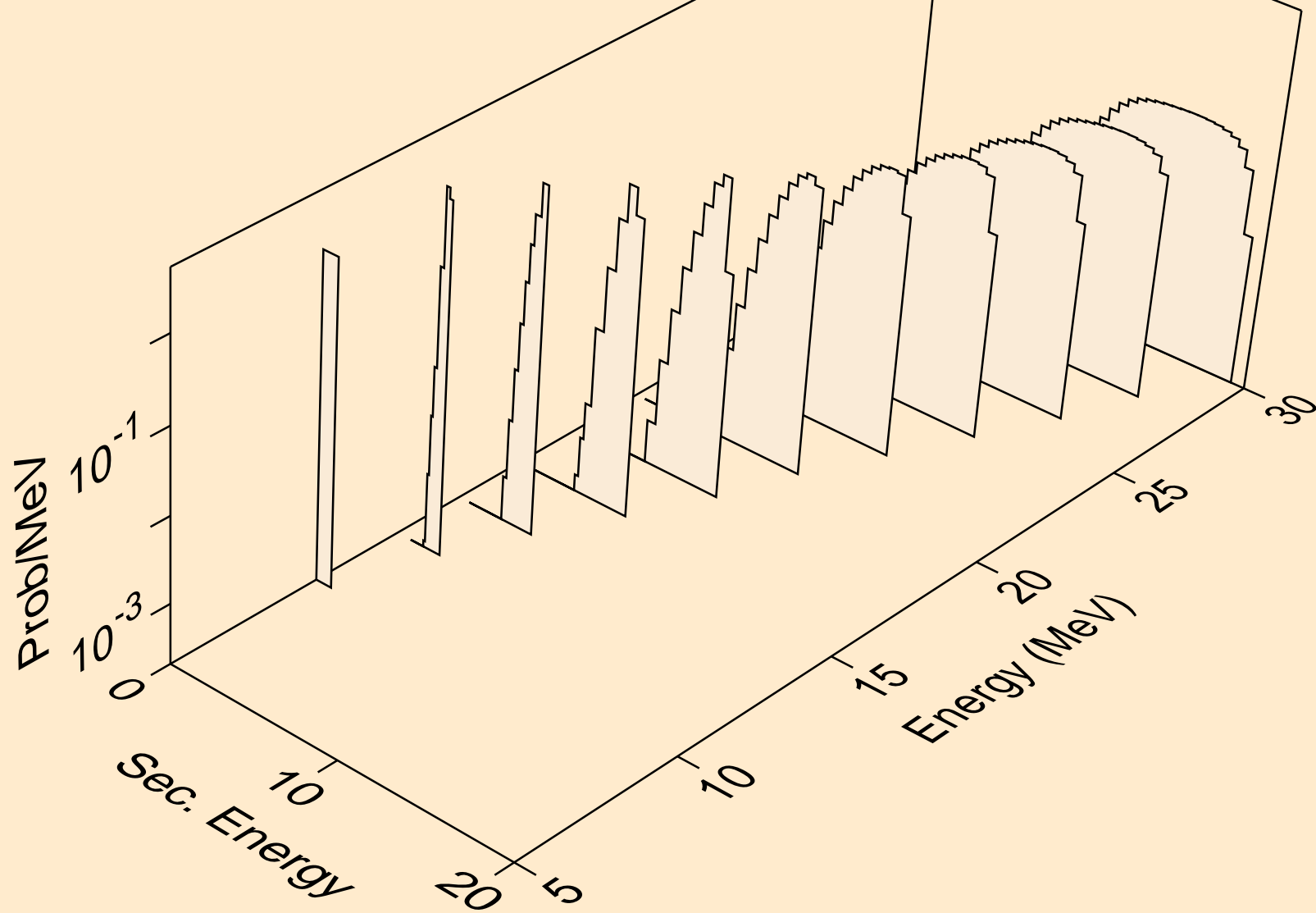

CO060M TRITON ACER TENDL-2021 LIBRARY; T=0.K  
he3s from (t,he3)

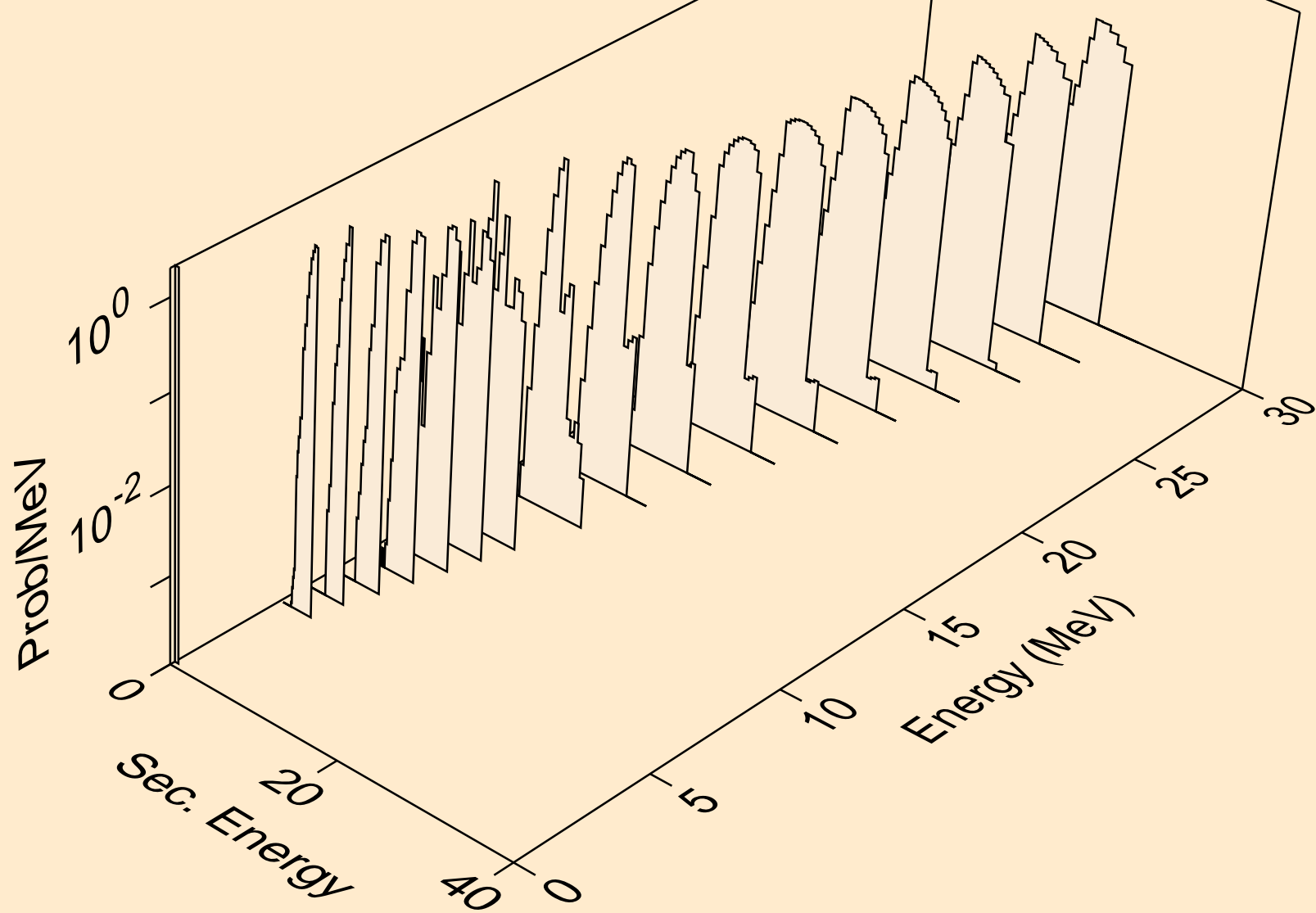

CO060M TRITON ACER TENDL-2021 LIBRARY; T=0.K  
alphas from (t,x)

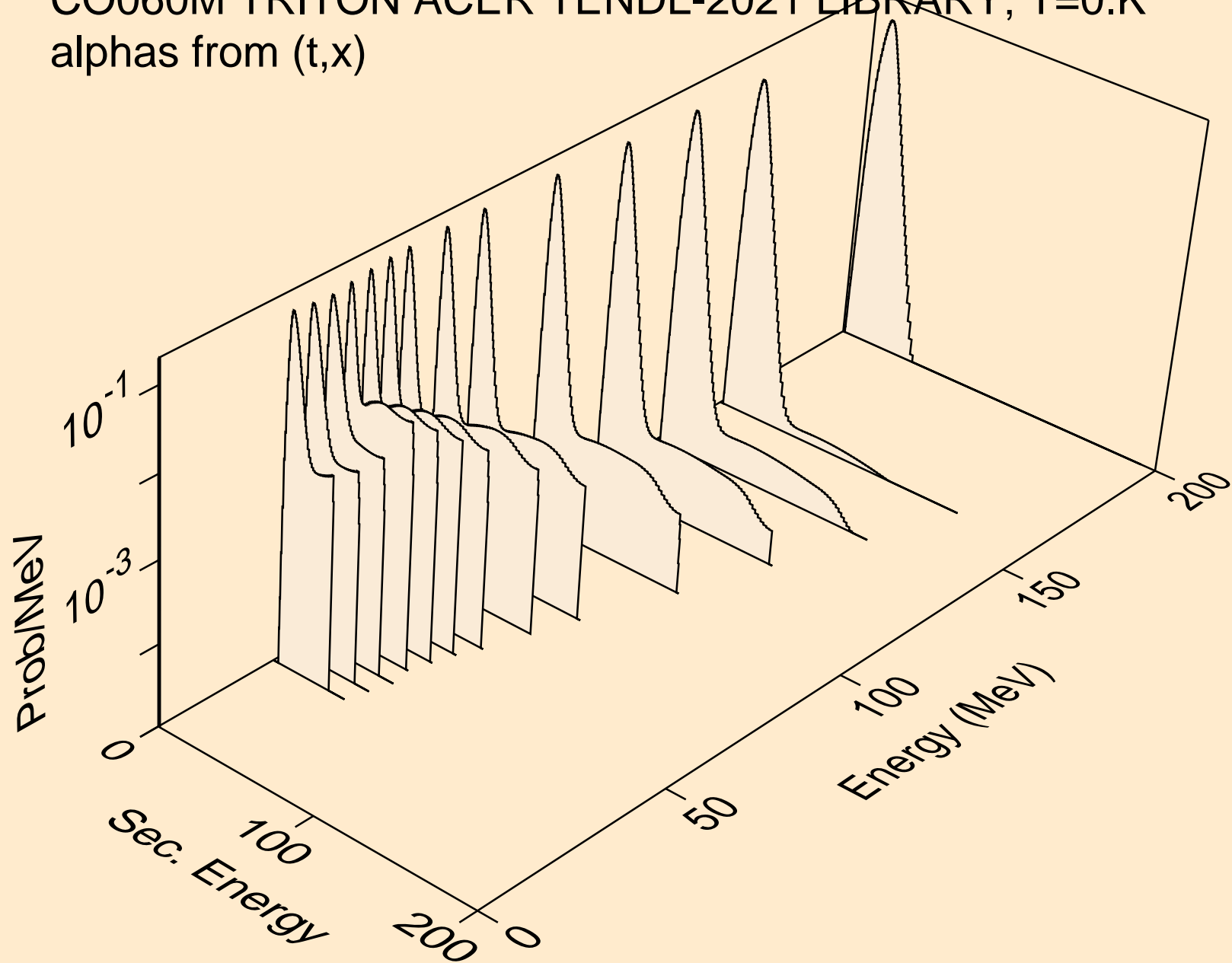



CO060M TRITON ACER TENDL-2021 LIBRARY; T=0.K  
alphas from (t,n\*)a

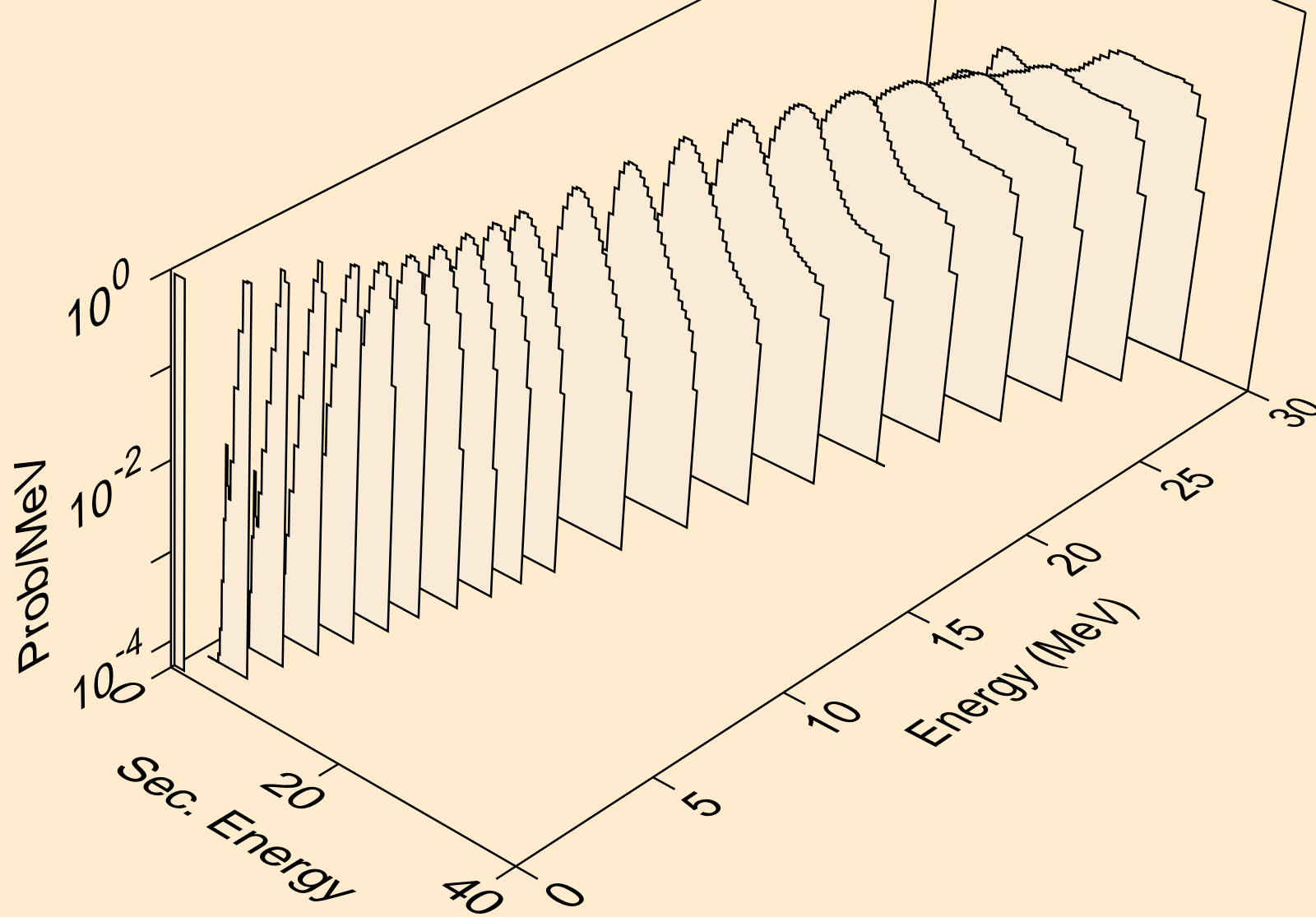

CO060M TRITON ACER TENDL-2021 LIBRARY; T=0.K  
alphas from (t,2n)a

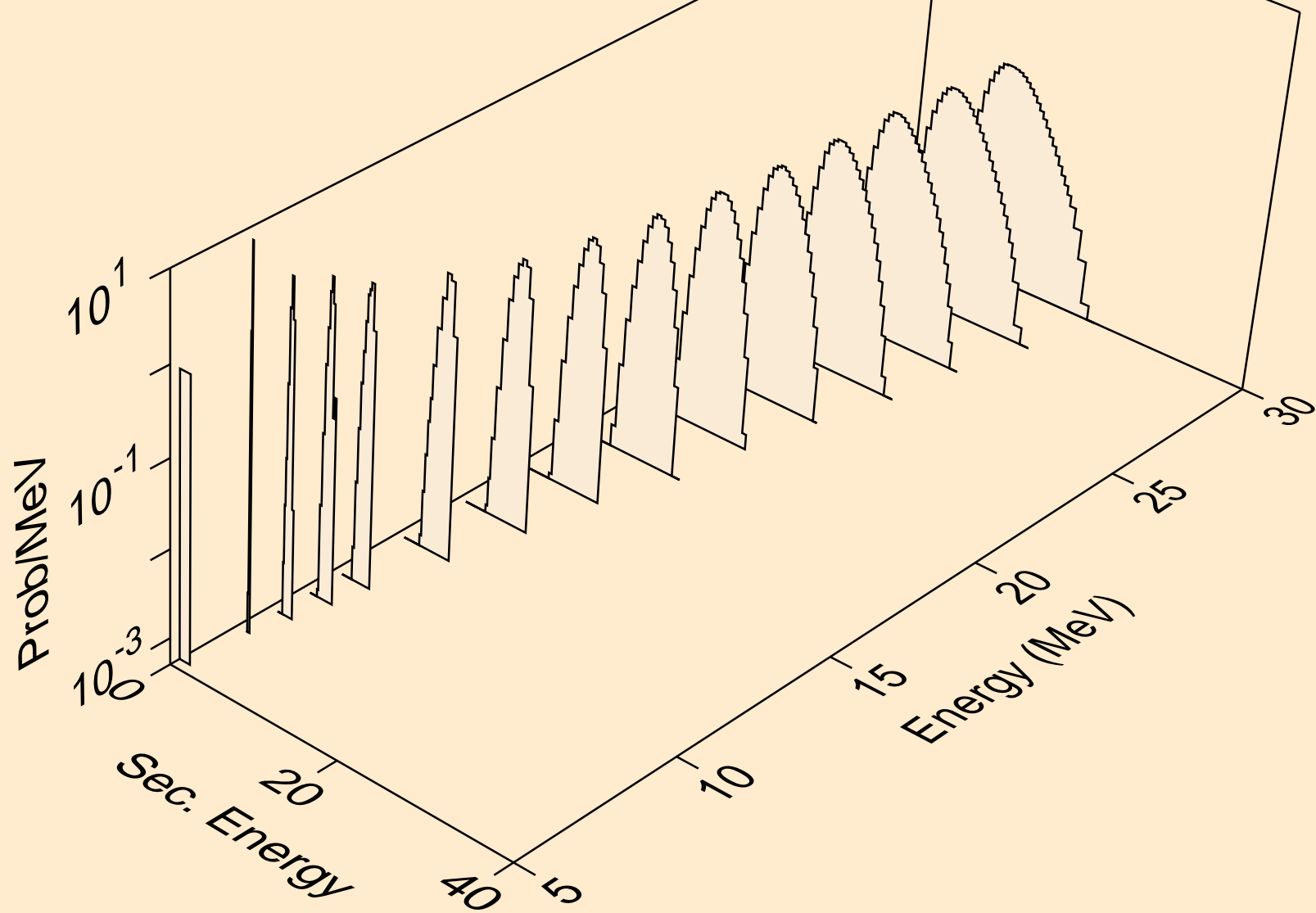

CO060M TRITON ACER TENDL-2021 LIBRARY; T=0.K  
alphas from (t,3n)a

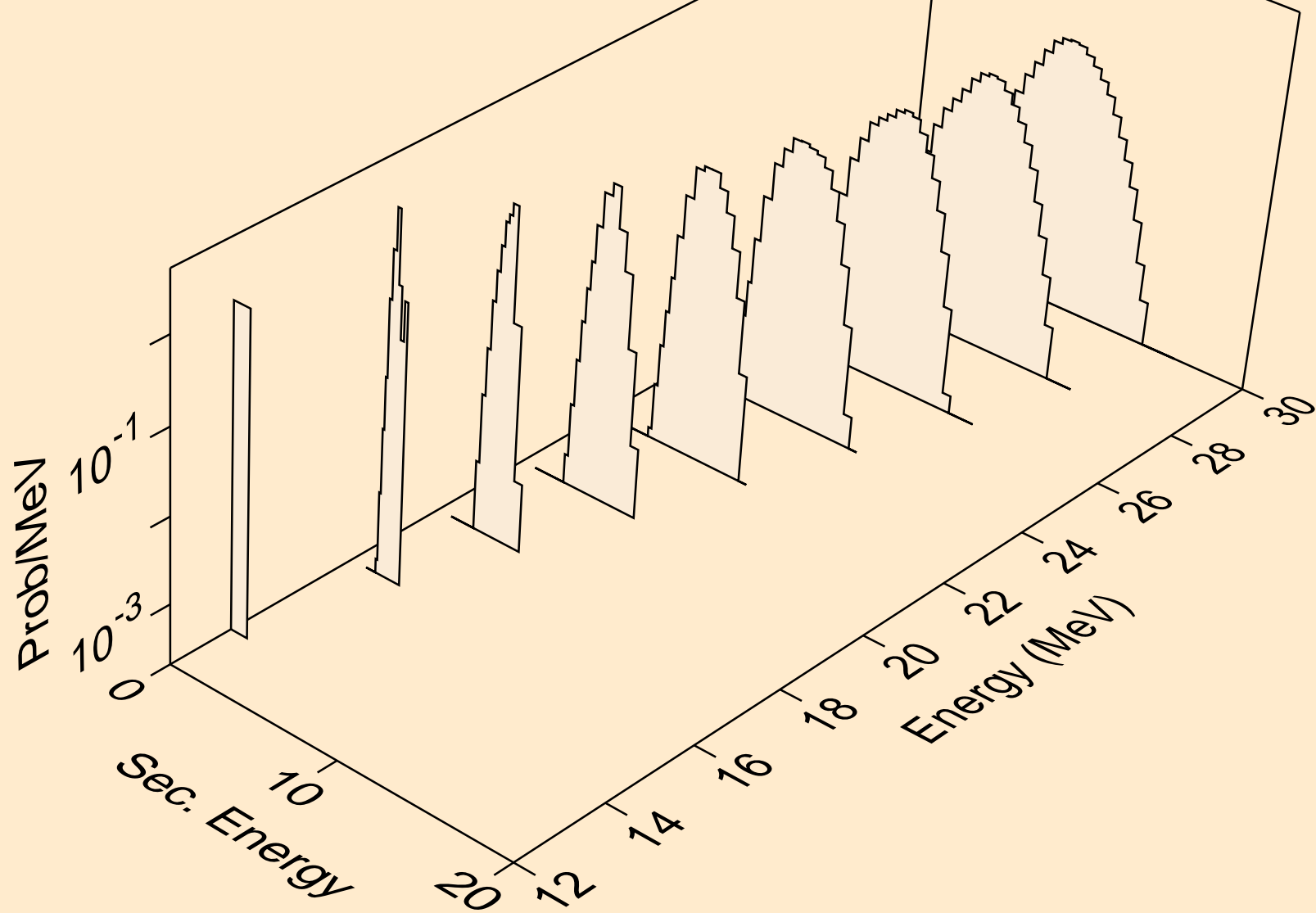

CO060M TRITON ACER TENDL-2021 LIBRARY; T=0.K  
alphas from (t,n\*)2a

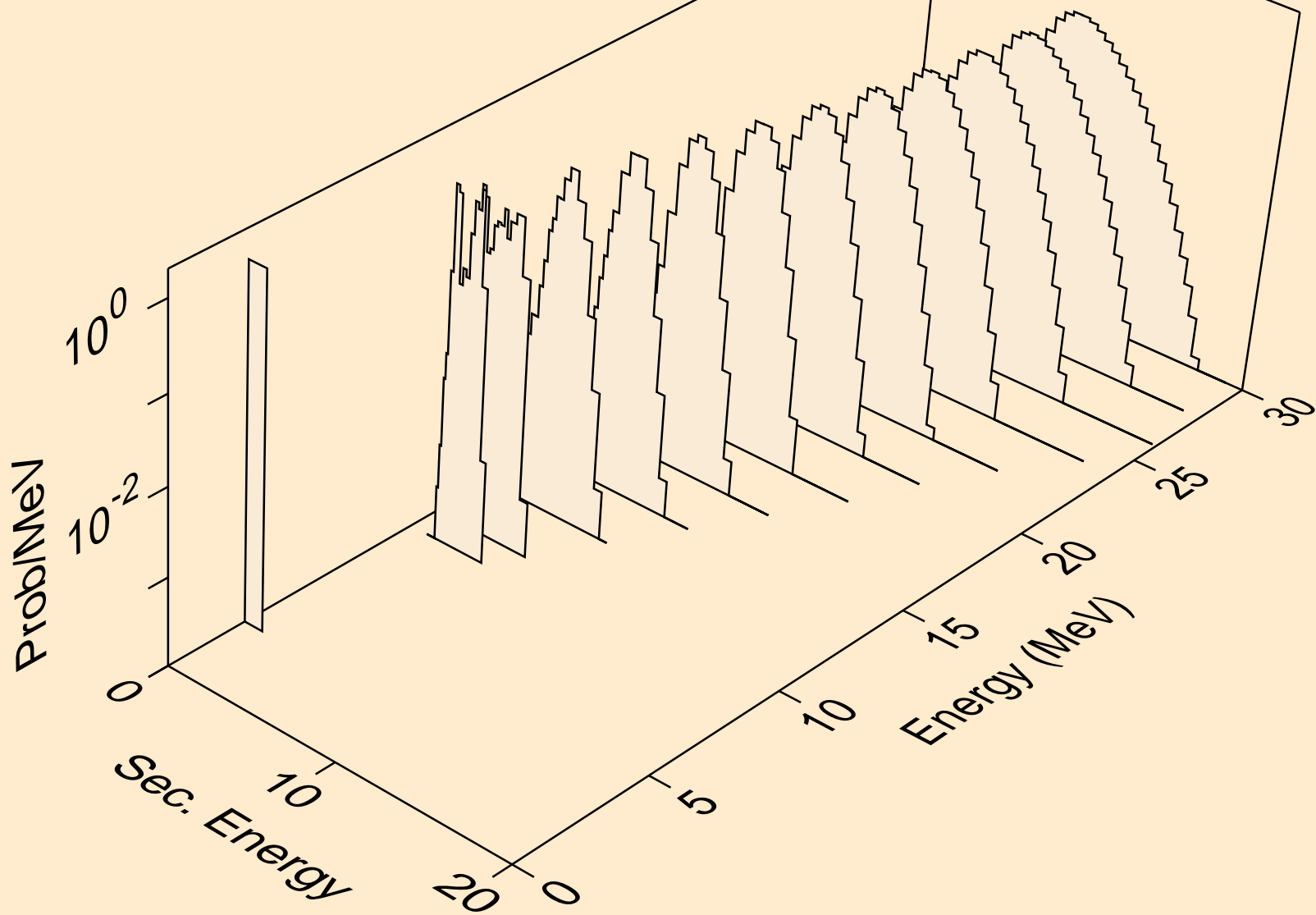

CO060M TRITON ACER TENDL-2021 LIBRARY; T=0.K  
alphas from (t,2n)2a

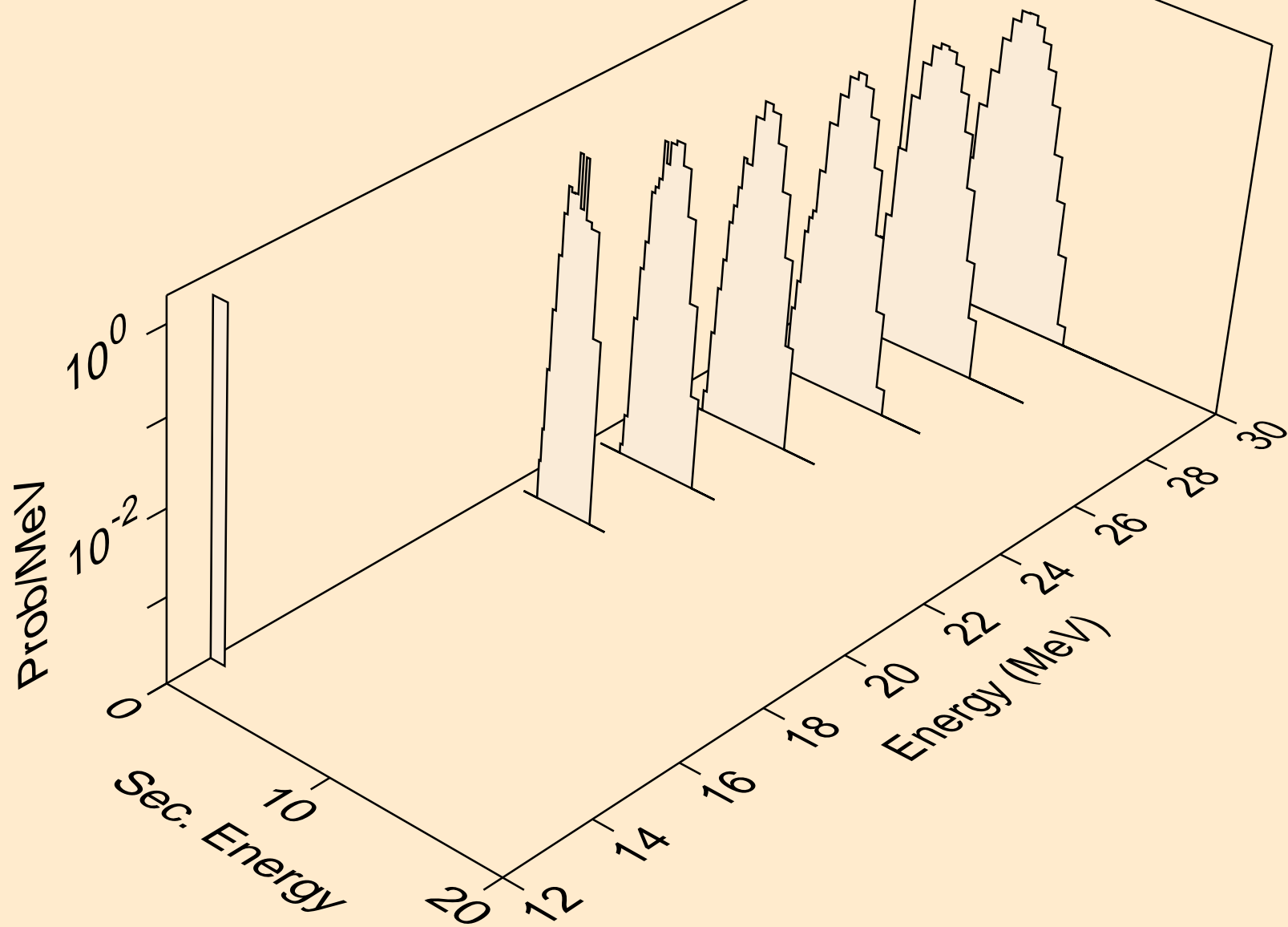

CO060M TRITON ACER TENDL-2021 LIBRARY; T=0.K  
alphas from (t,npa)

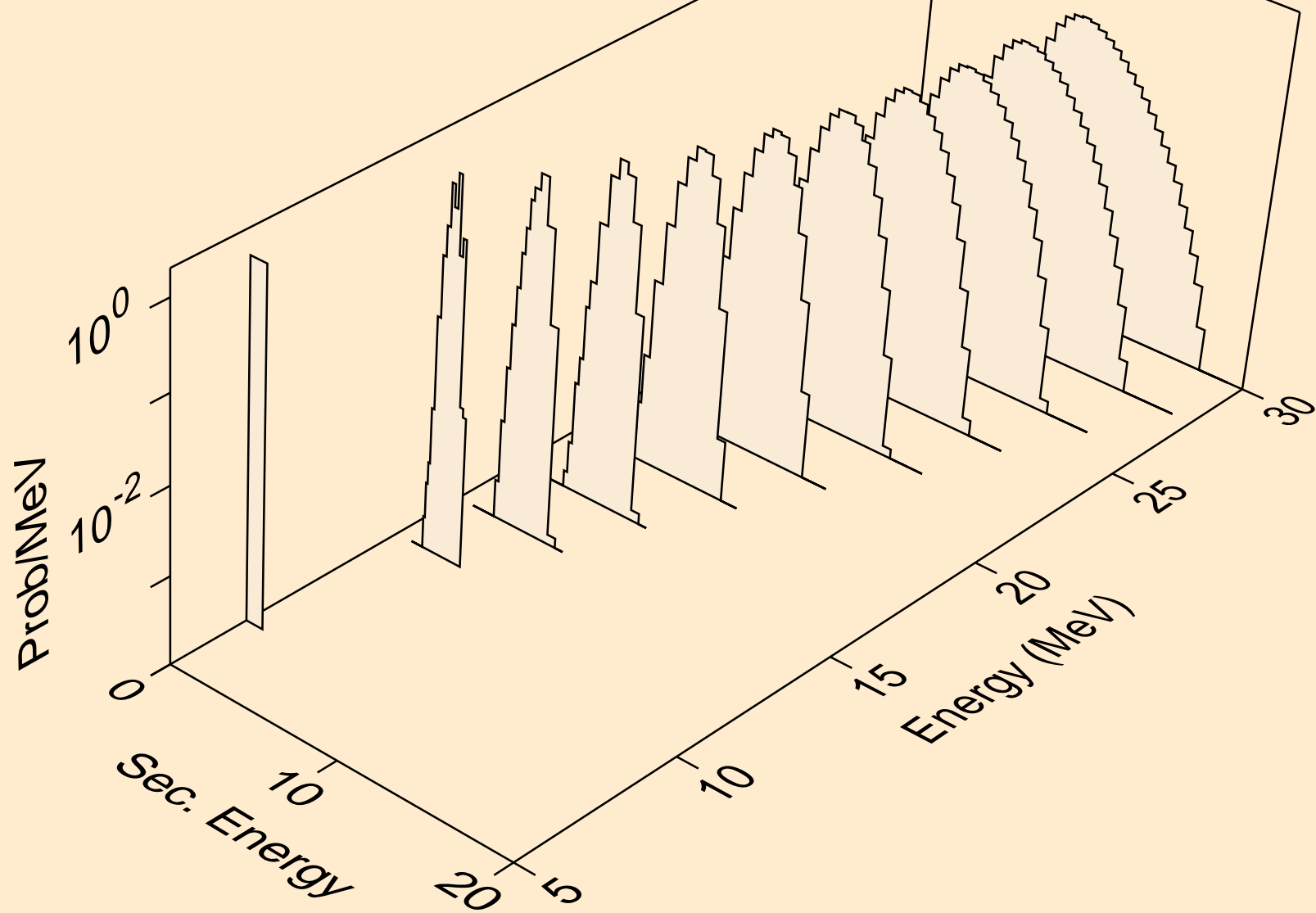

CO060M TRITON ACER TENDL-2021 LIBRARY; T=0.K  
alphas from (t,a)

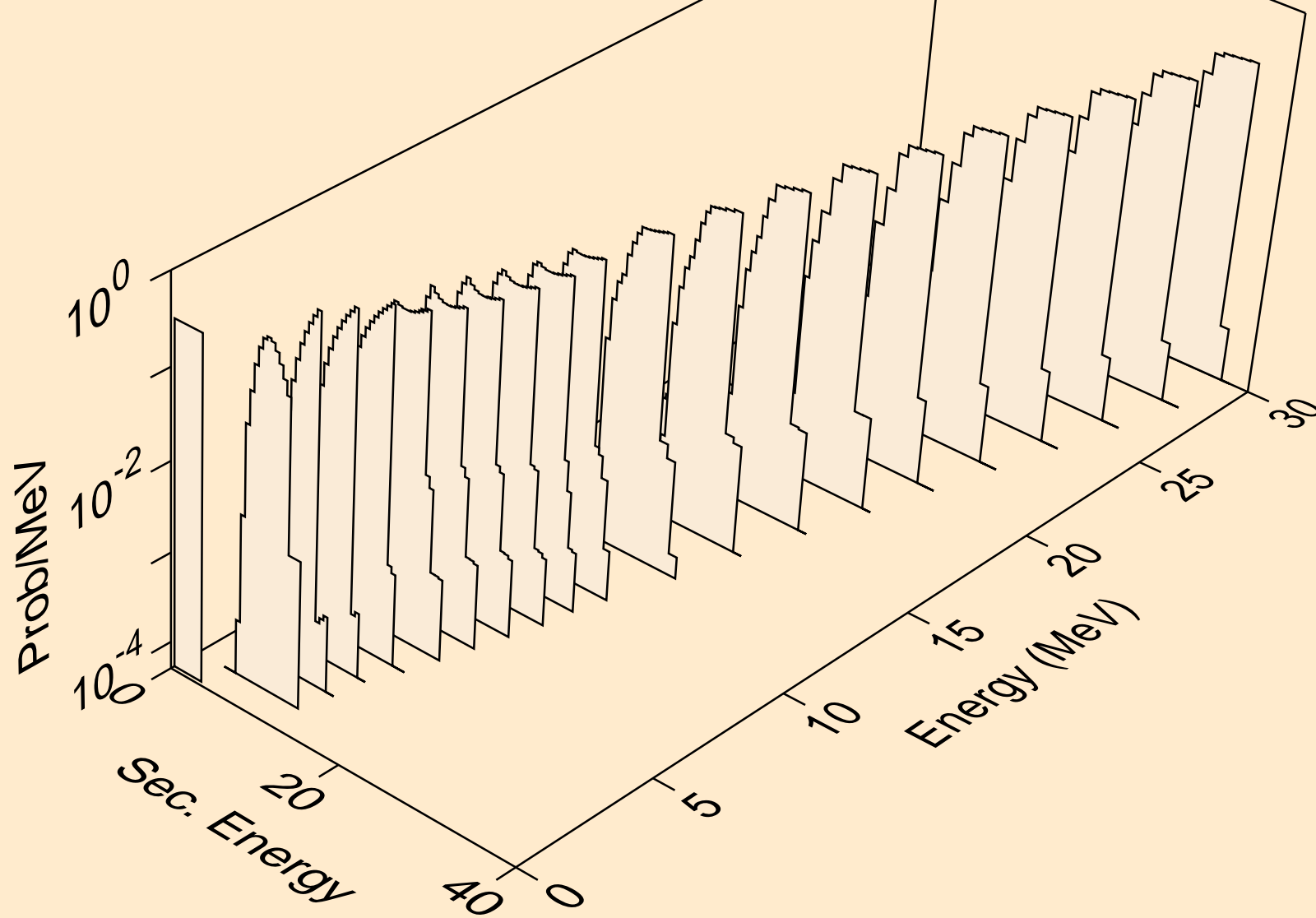

CO060M TRITON ACER TENDL-2021 LIBRARY; T=0.K  
alphas from (t,2a)

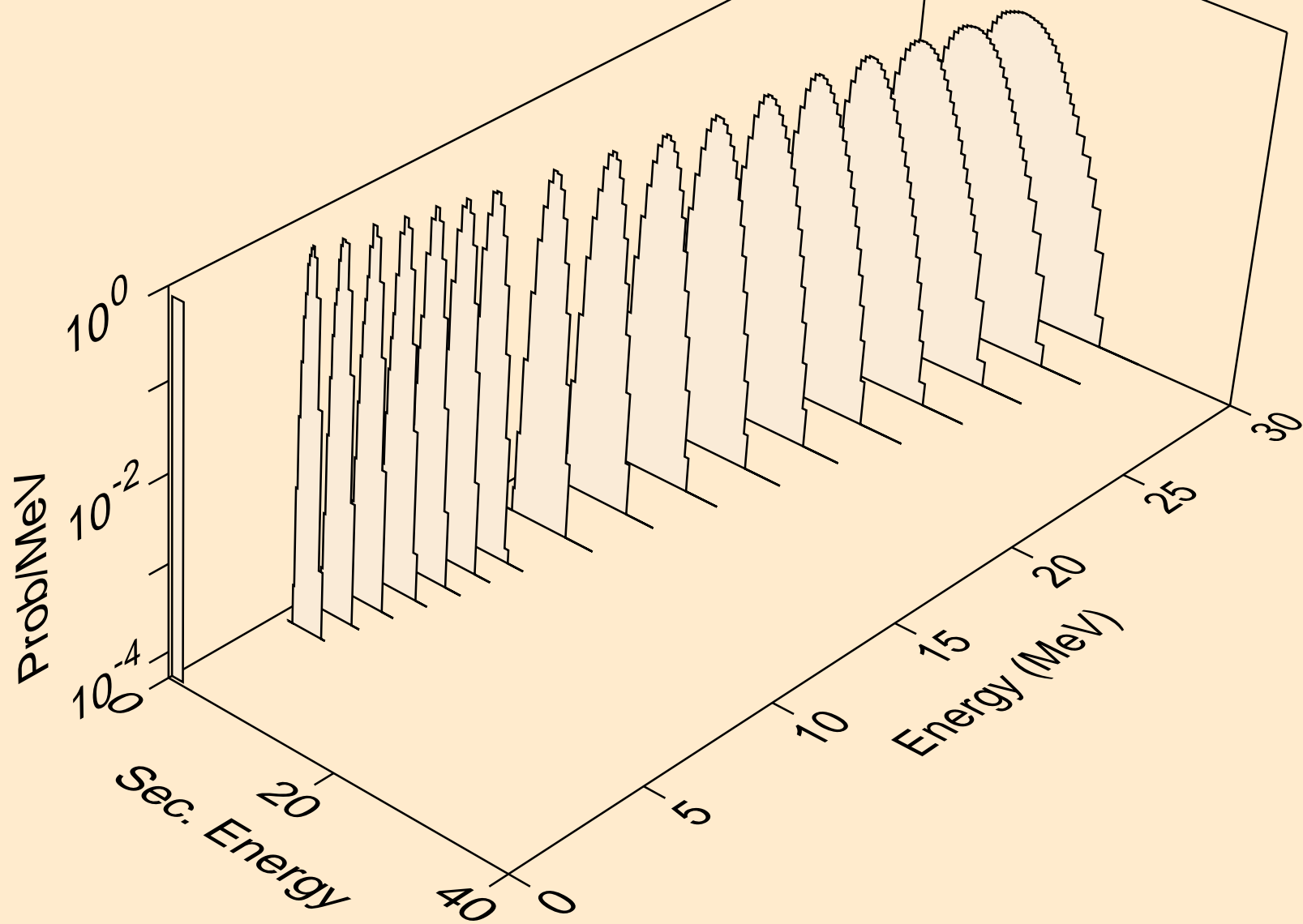



CO060M TRITON ACER TENDL-2021 LIBRARY; T=0.K  
alphas from (t,3a)

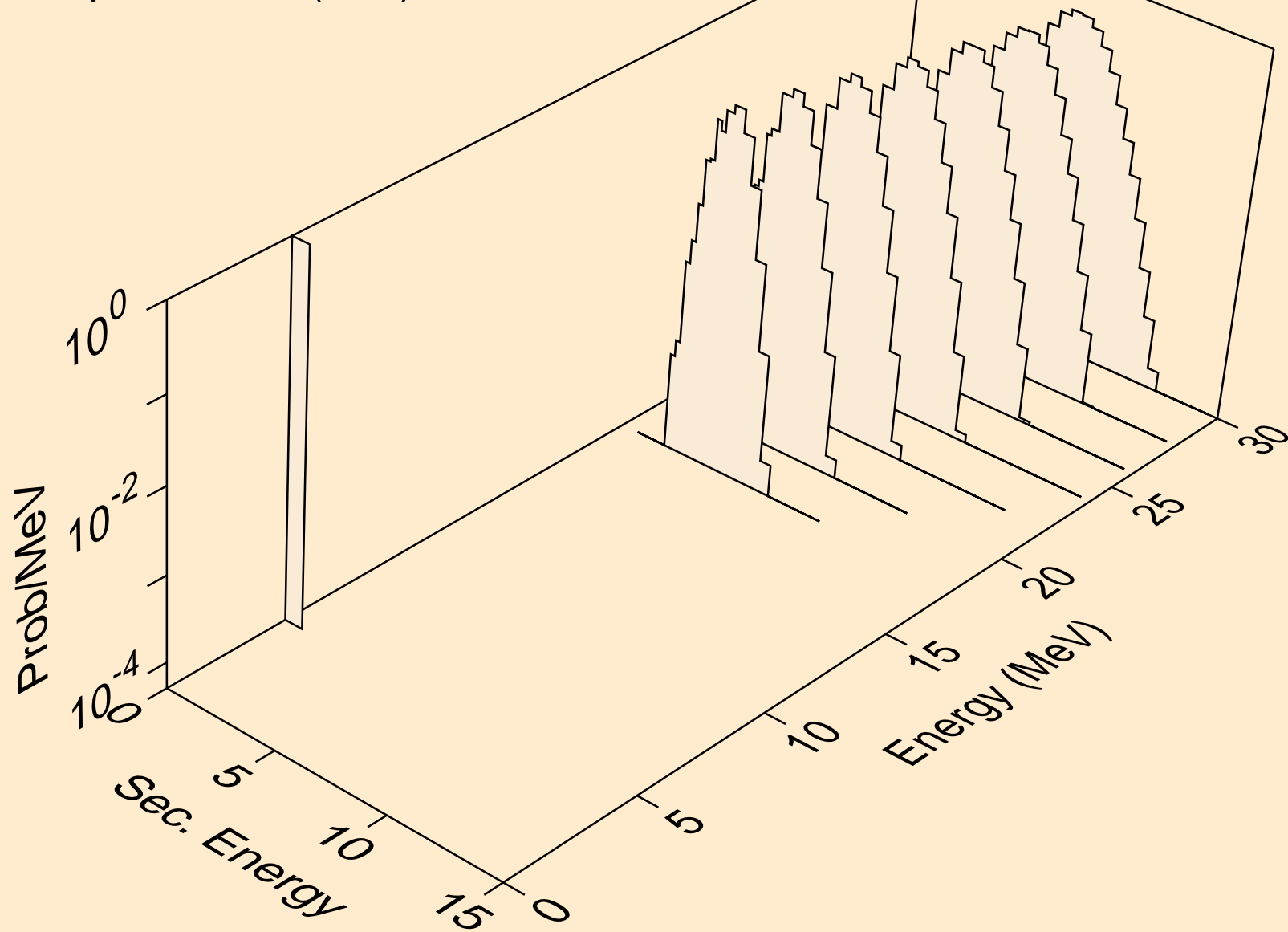

CO060M TRITON ACER TENDL-2021 LIBRARY; T=0.K  
alphas from (t,pa)

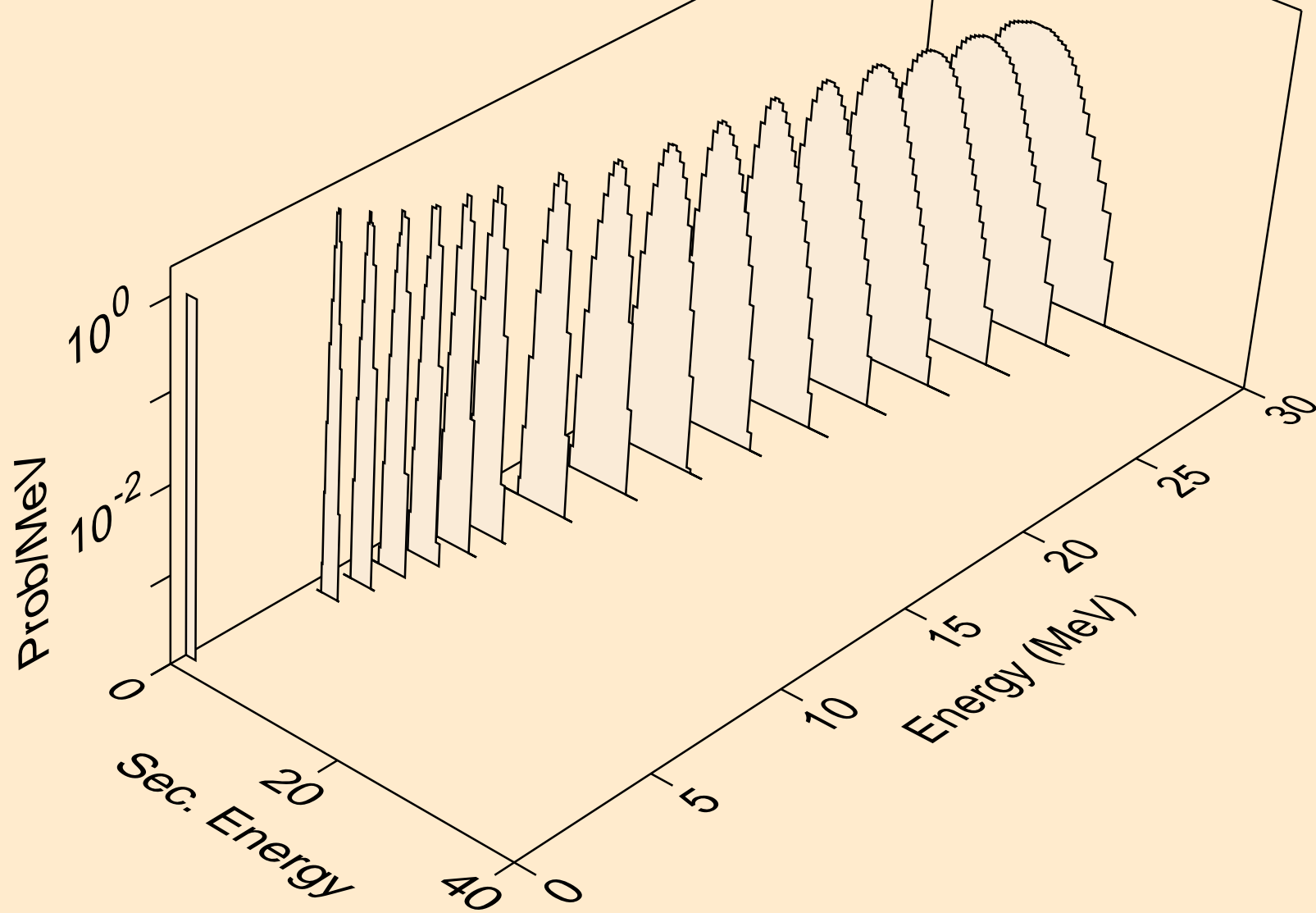

CO060M TRITON ACER TENDL-2021 LIBRARY; T=0.K  
alphas from (t,da)

