

DY145M TRITON ACER TENDL-2021 LIBRARY; T=0.K  
Principal cross sections

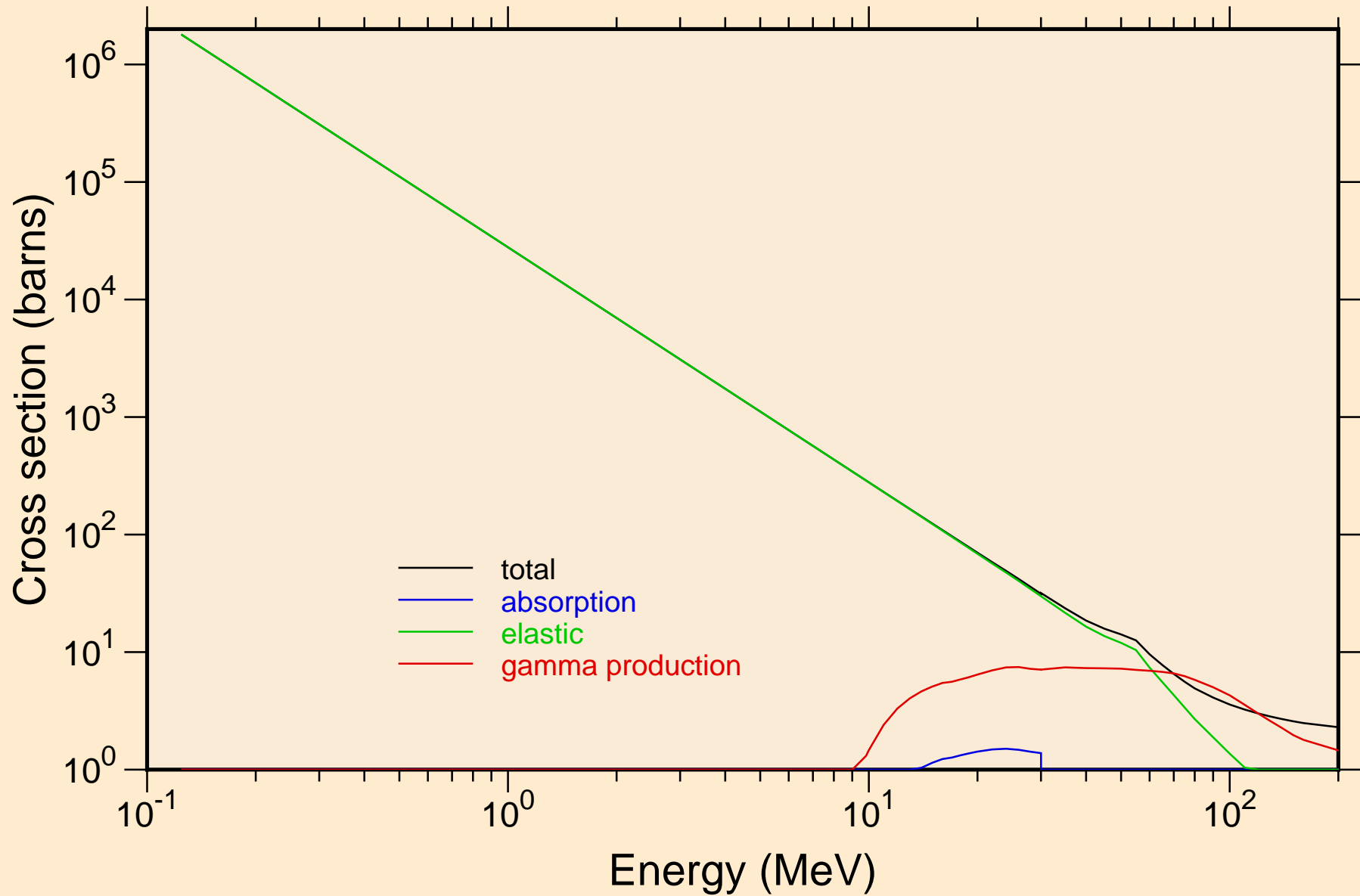

DY145M TRITON ACER TENDL-2021 LIBRARY; T=0.K  
Heating

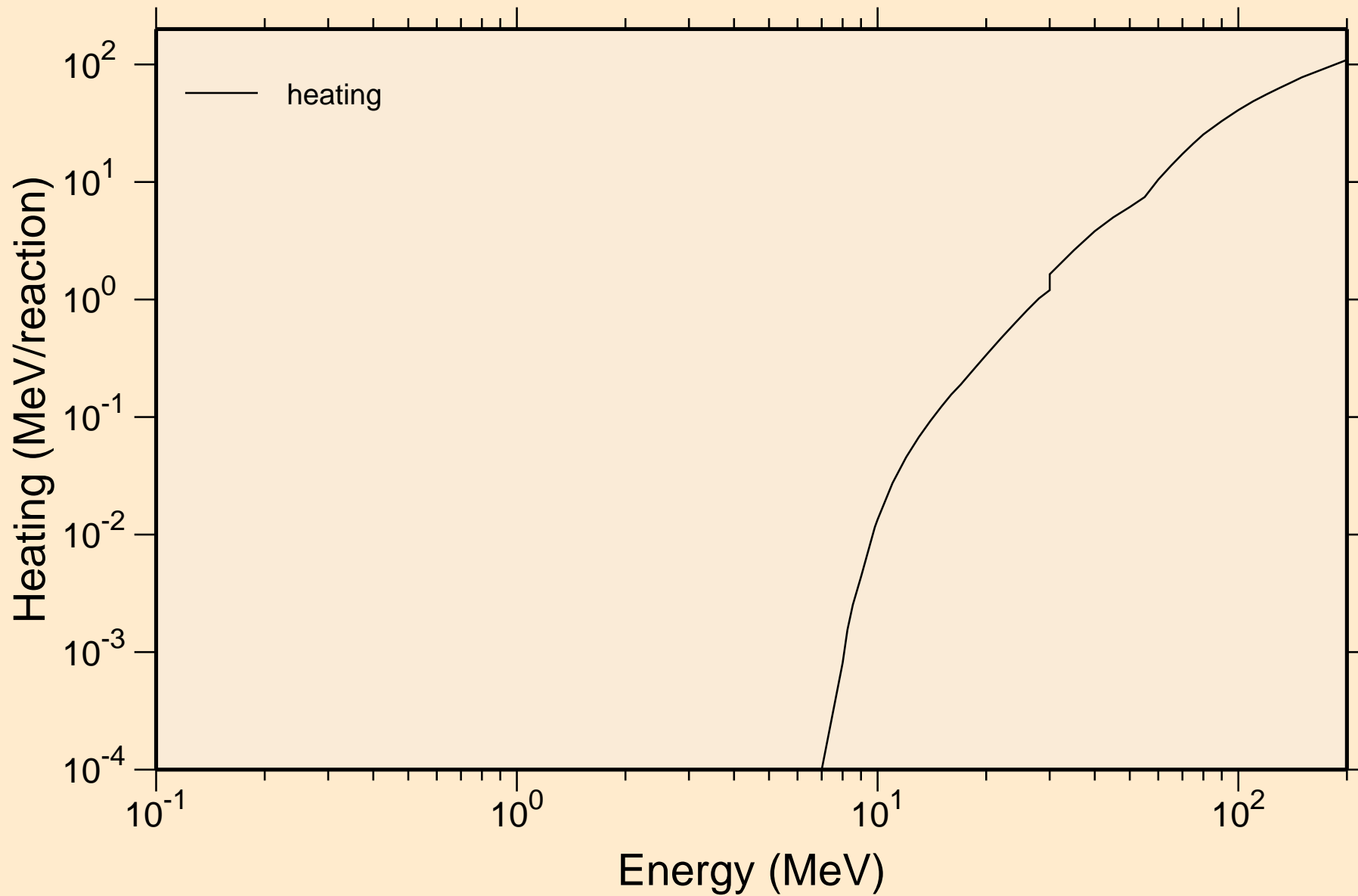

# DY145M TRITON ACER TENDL-2021 LIBRARY; T=0.K

## Principal cross sections

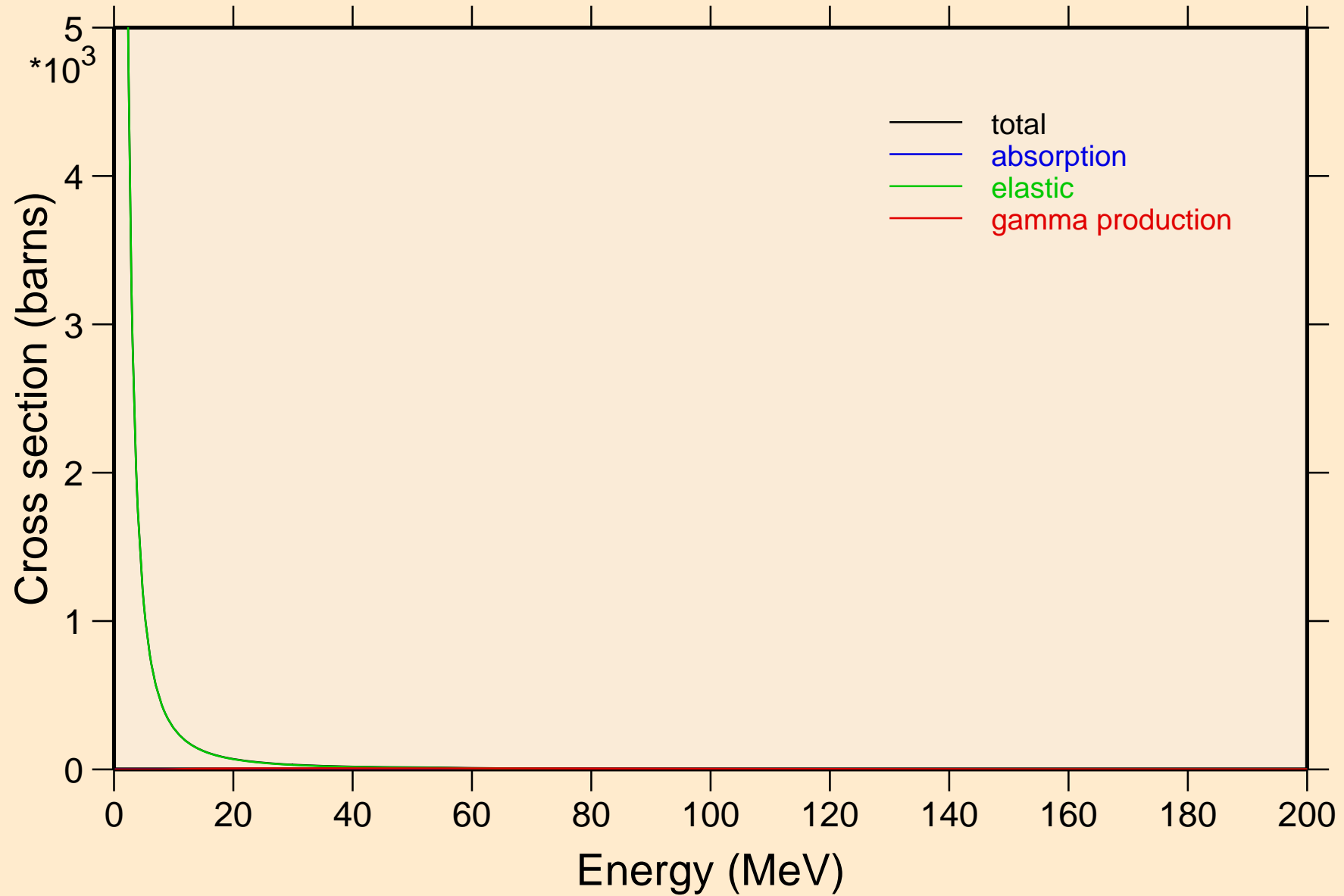

DY145M TRITON ACER TENDL-2021 LIBRARY; T=0.K

Heating

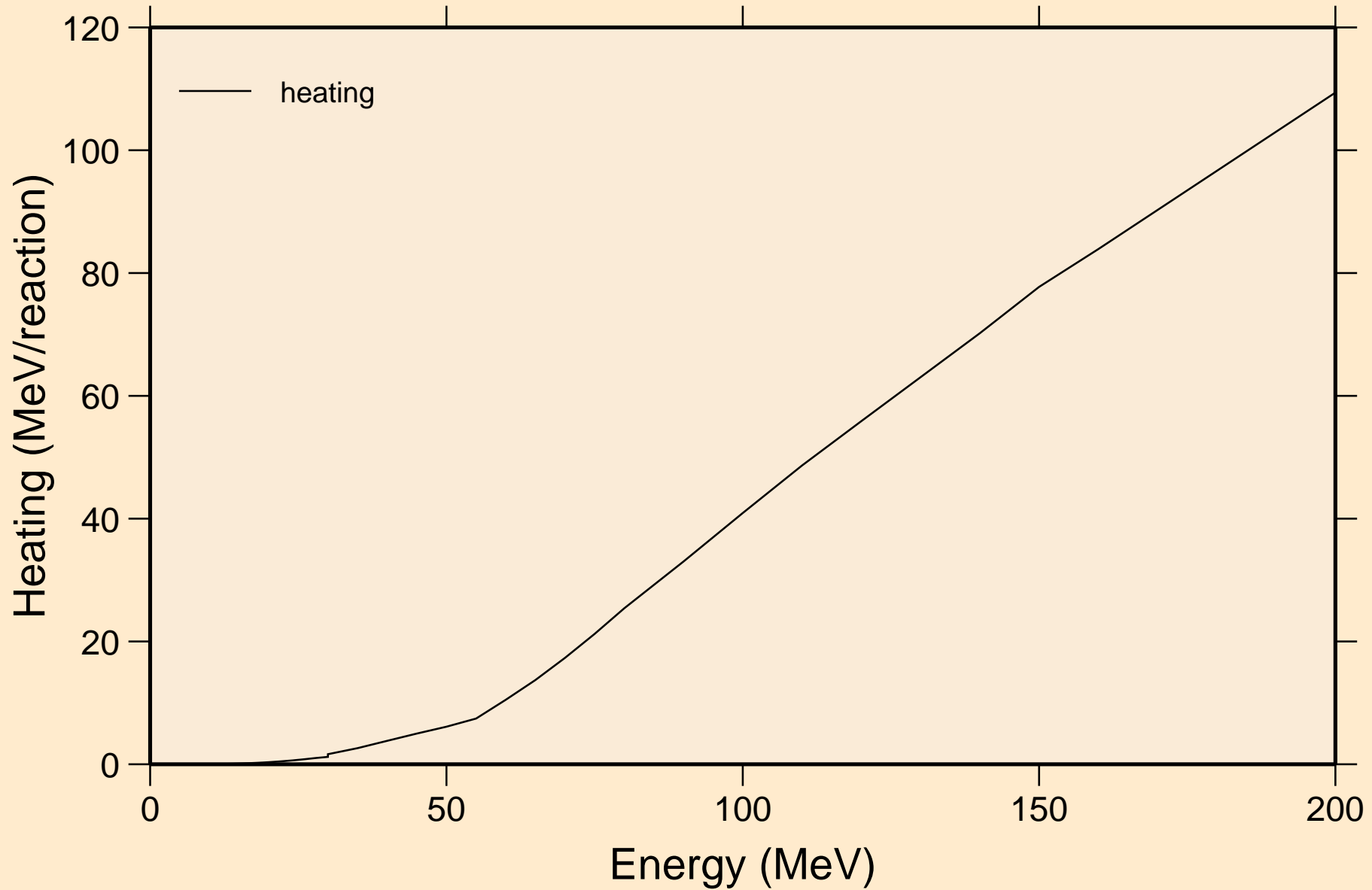

DY145M TRITON ACER TENDL-2021 LIBRARY; T=0.K  
Threshold reactions

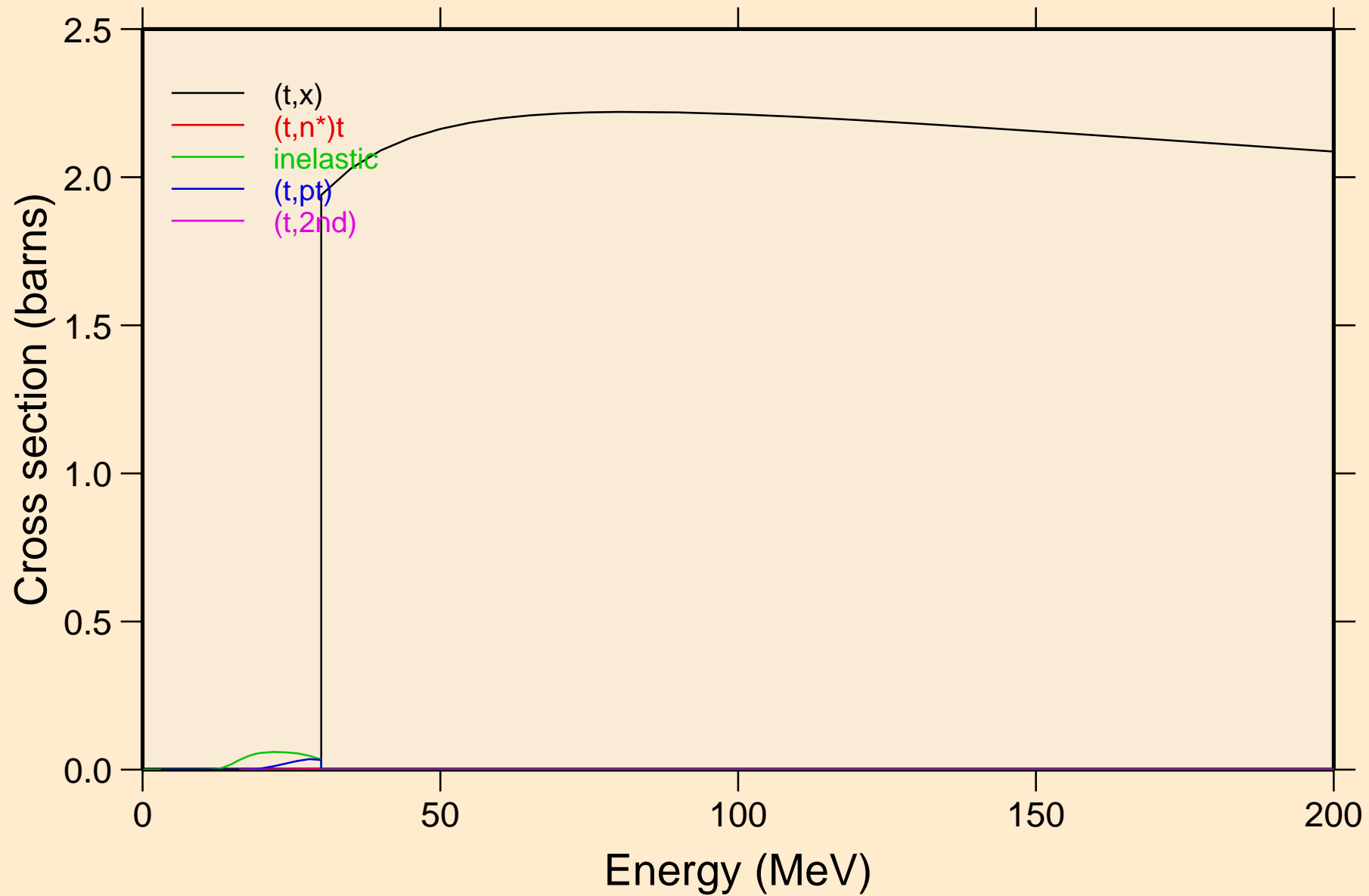

DY145M TRITON ACER TENDL-2021 LIBRARY; T=0.K  
Threshold reactions

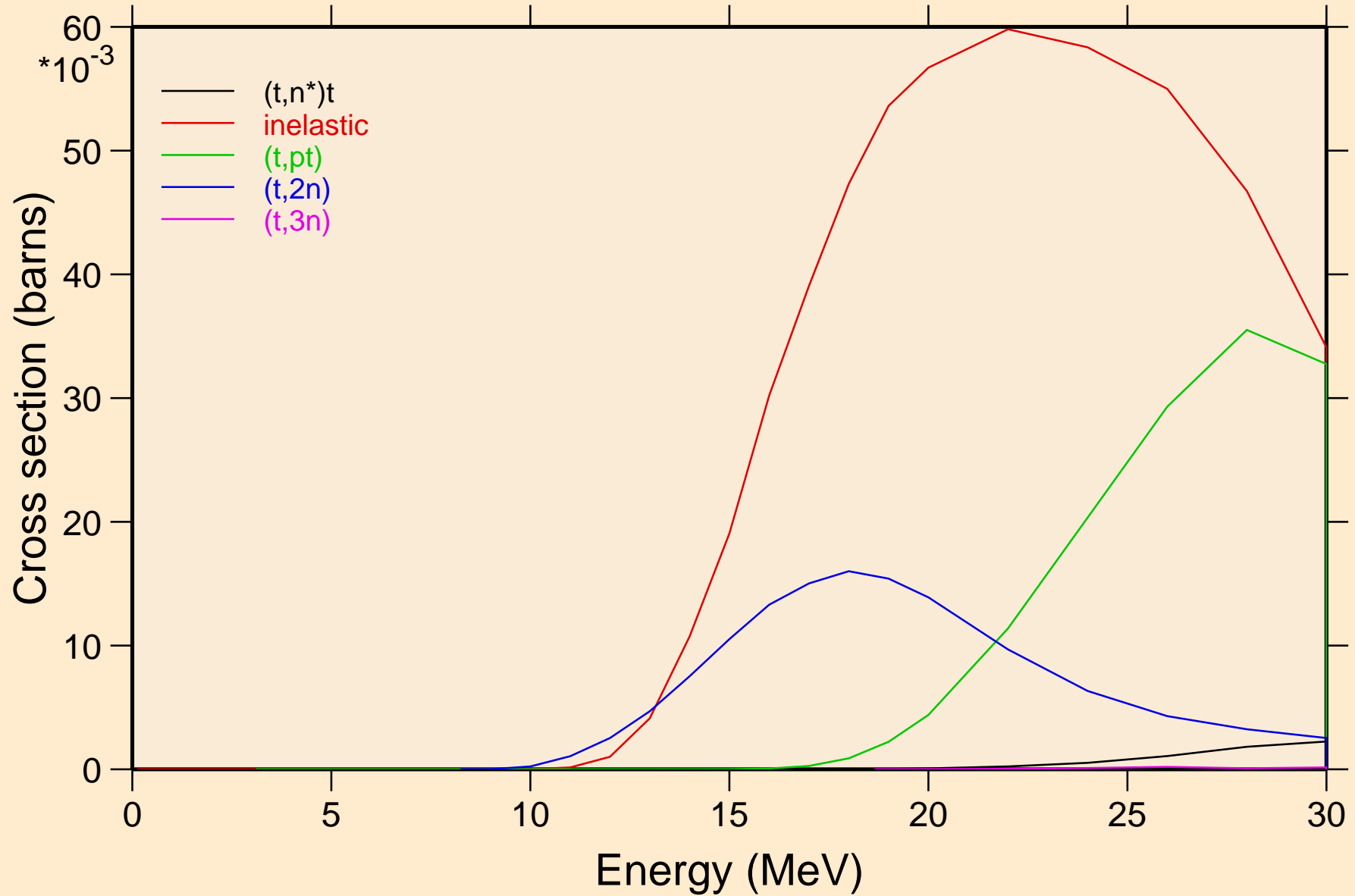

DY145M TRITON ACER TENDL-2021 LIBRARY; T=0.K  
Threshold reactions

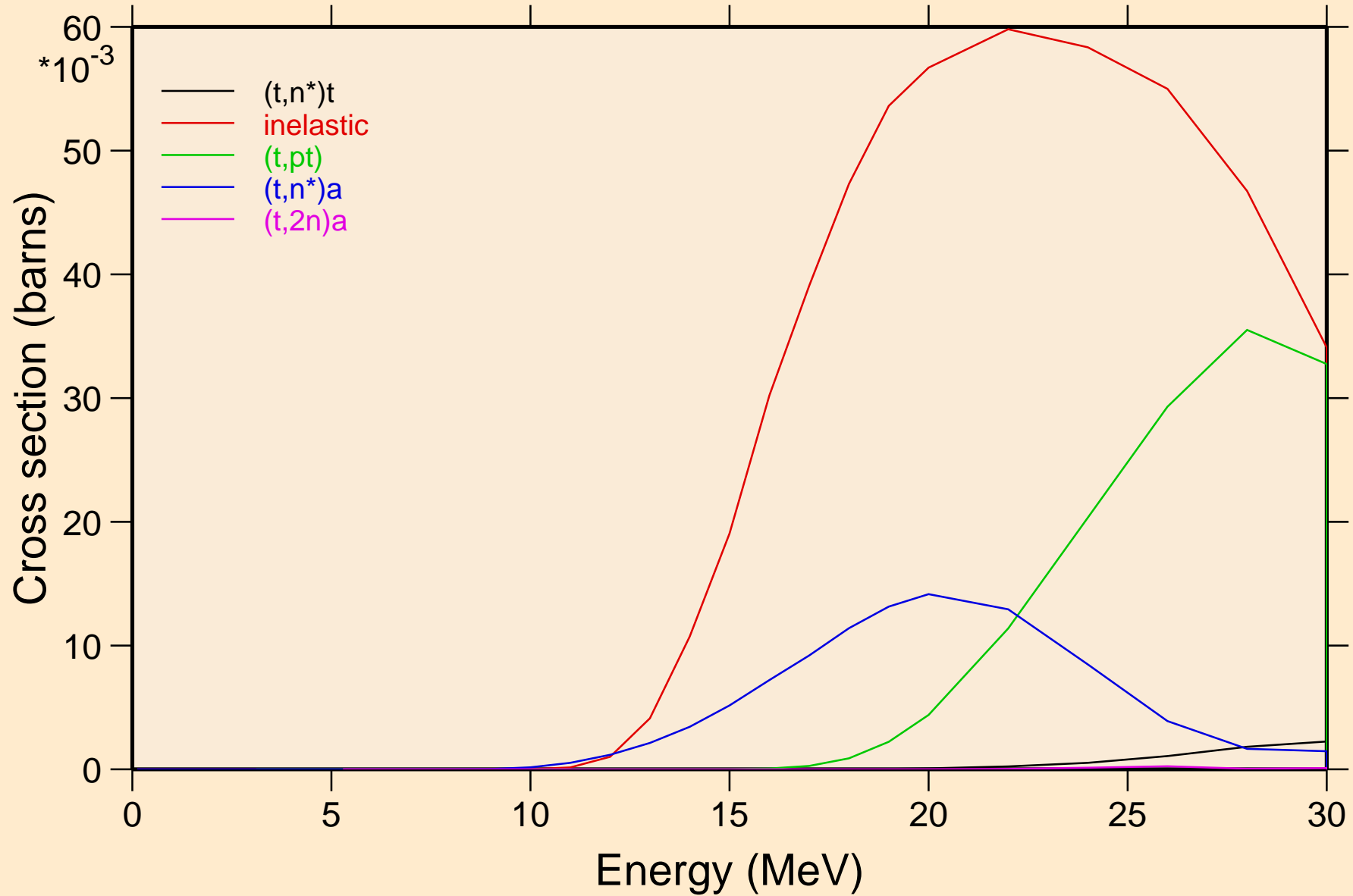

DY145M TRITON ACER TENDL-2021 LIBRARY; T=0.K  
Threshold reactions

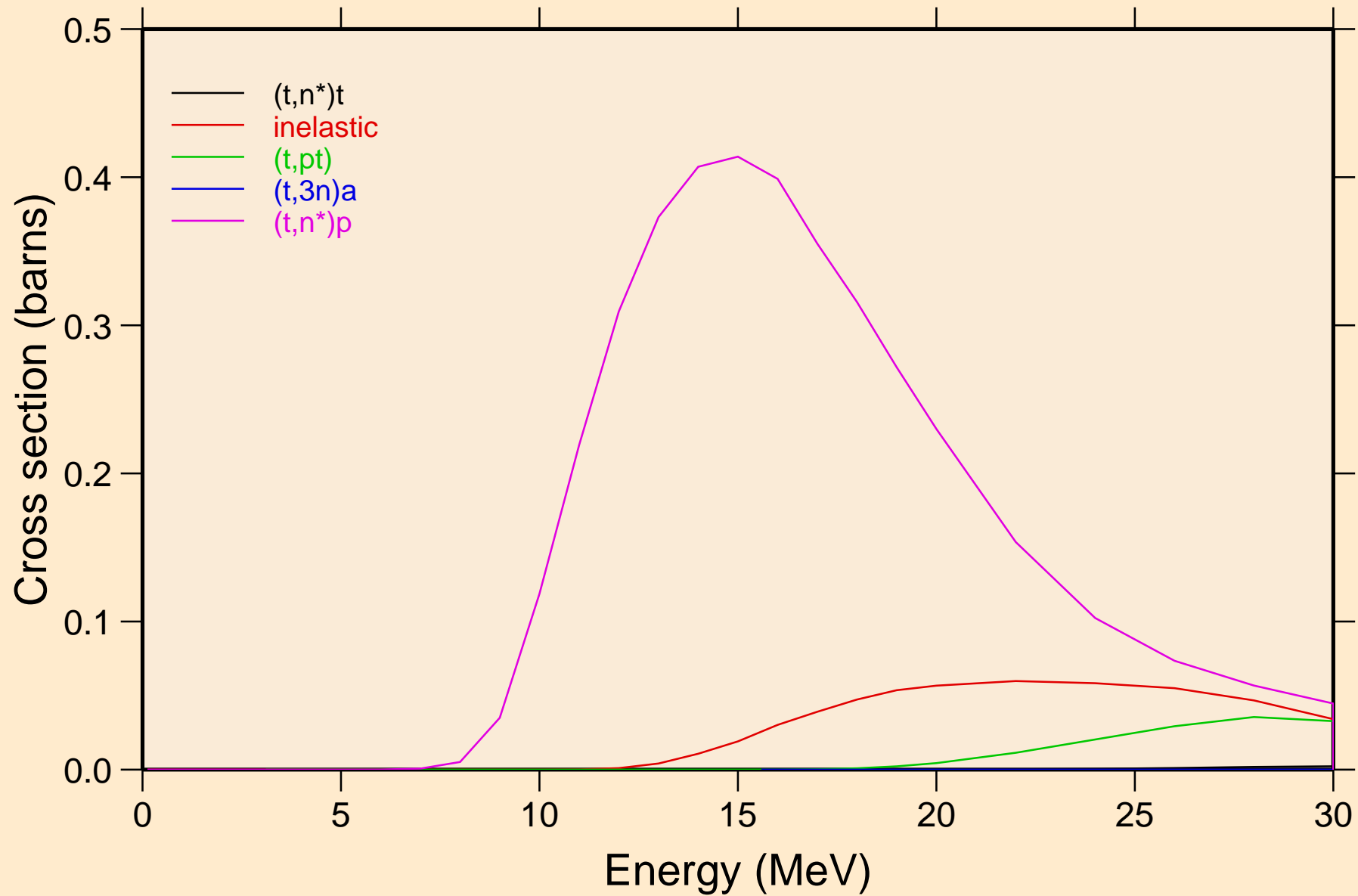



DY145M TRITON ACER TENDL-2021 LIBRARY; T=0.K  
Threshold reactions

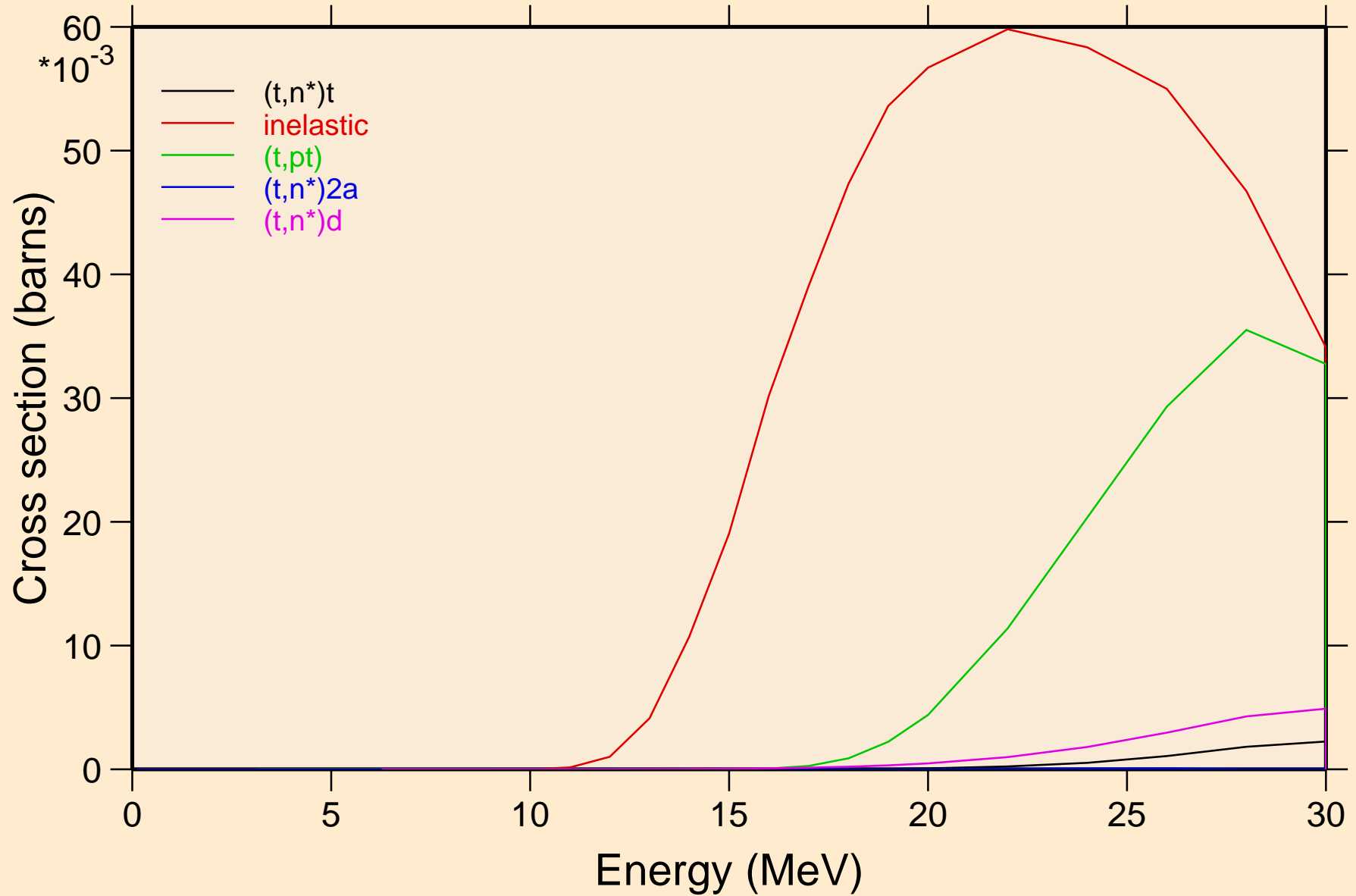

DY145M TRITON ACER TENDL-2021 LIBRARY; T=0.K  
Threshold reactions

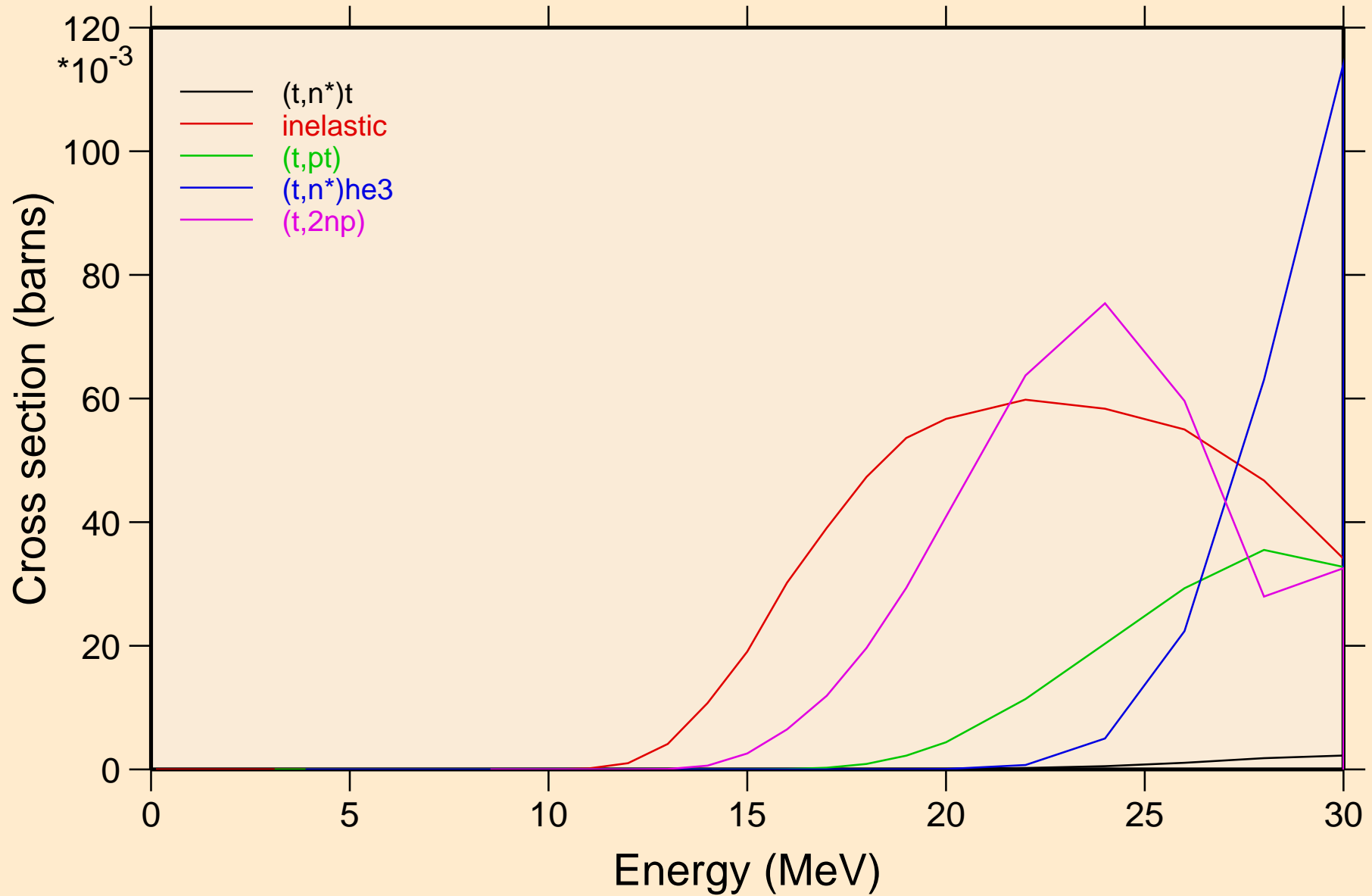

DY145M TRITON ACER TENDL-2021 LIBRARY; T=0.K  
Threshold reactions

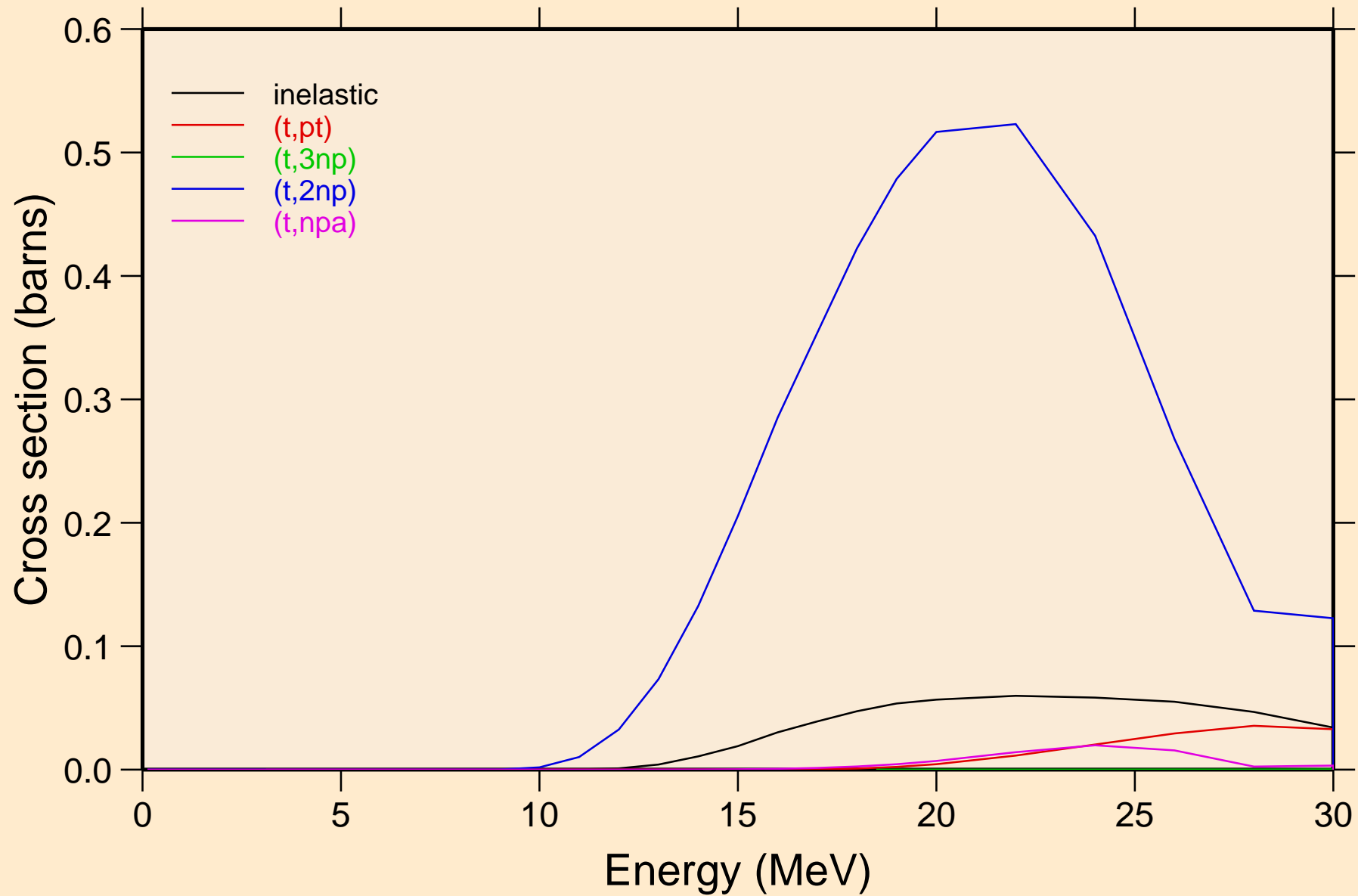

DY145M TRITON ACER TENDL-2021 LIBRARY; T=0.K  
Threshold reactions

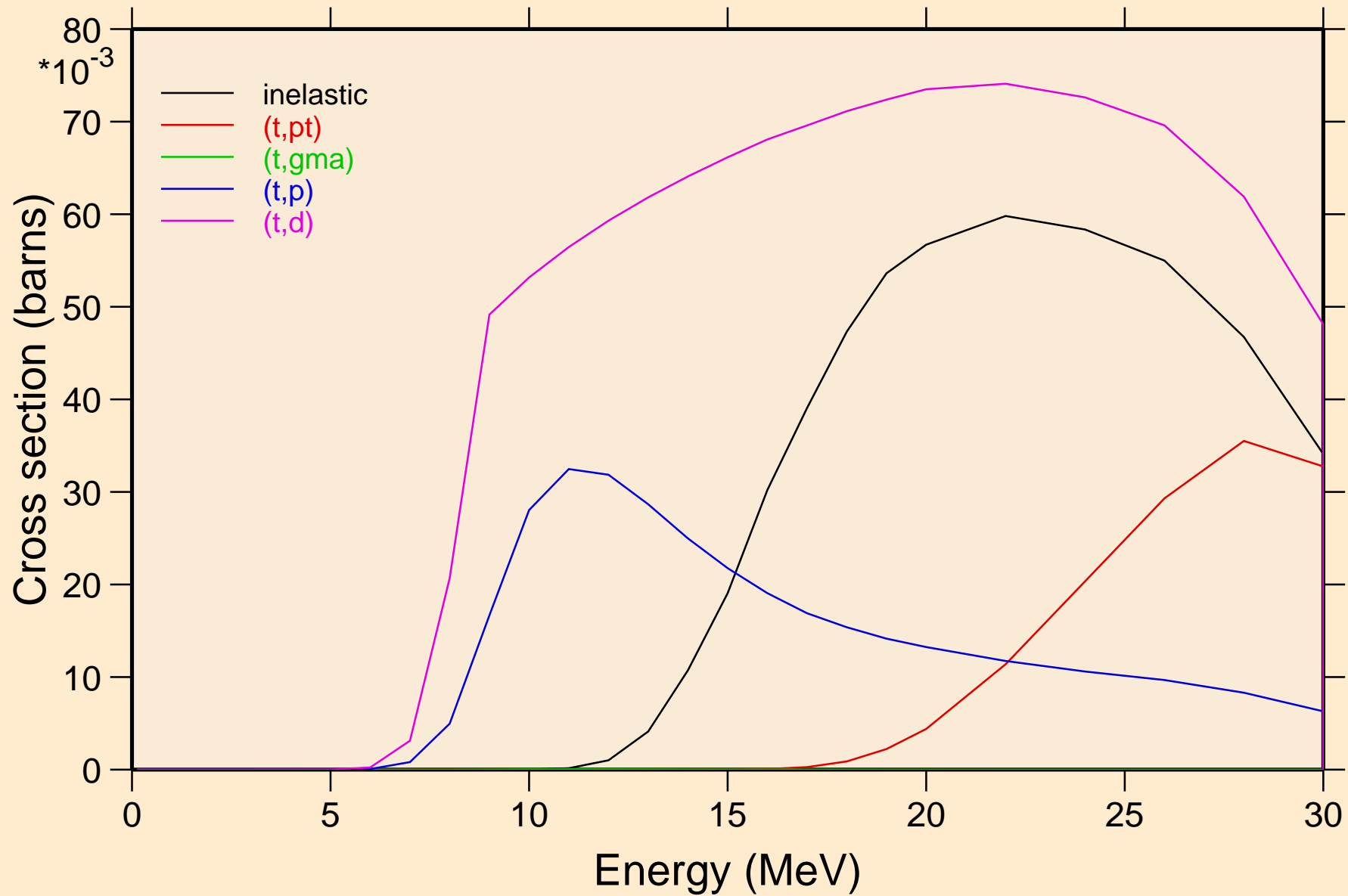

DY145M TRITON ACER TENDL-2021 LIBRARY; T=0.K  
Threshold reactions

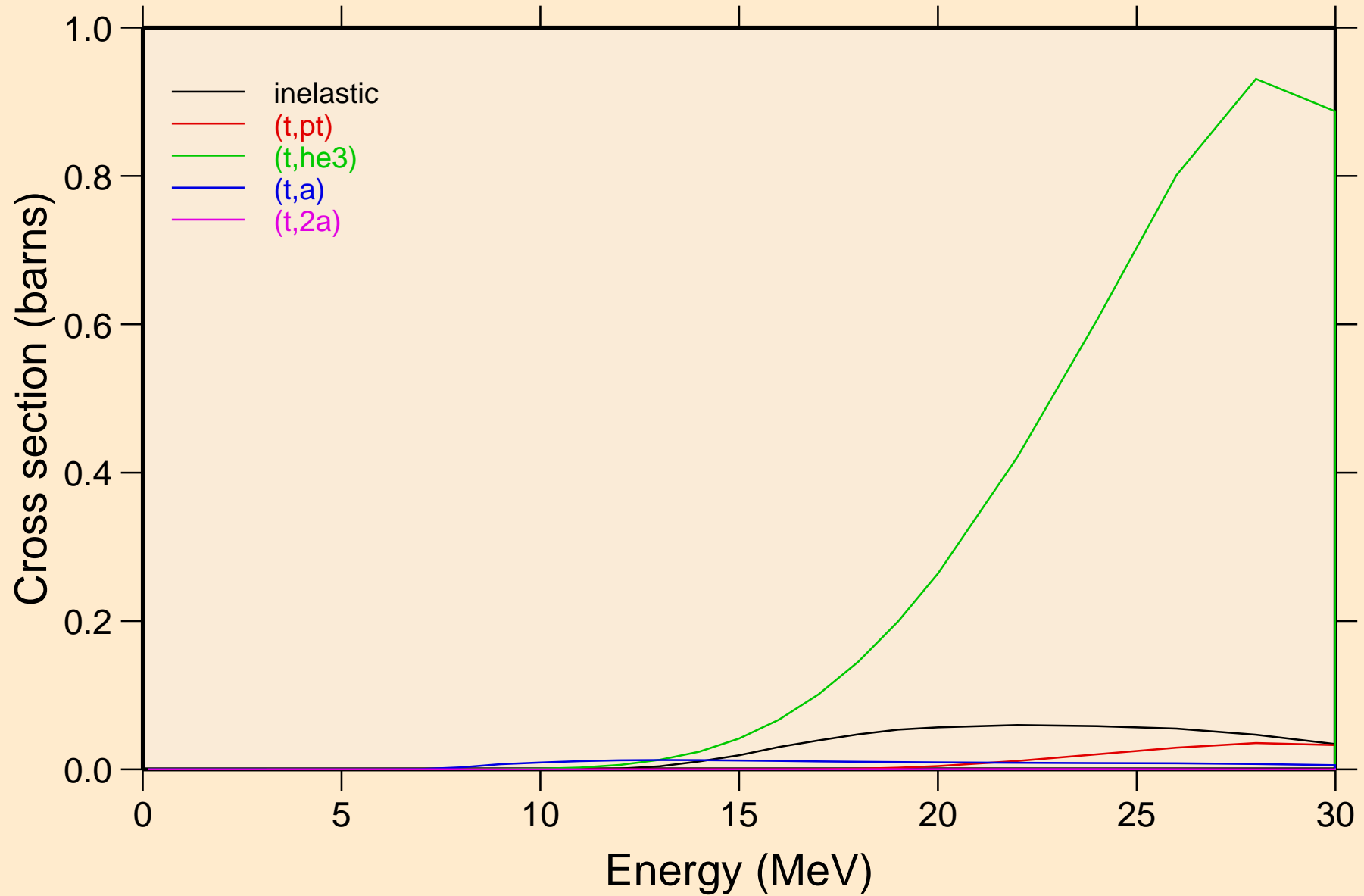

DY145M TRITON ACER TENDL-2021 LIBRARY; T=0.K  
Threshold reactions

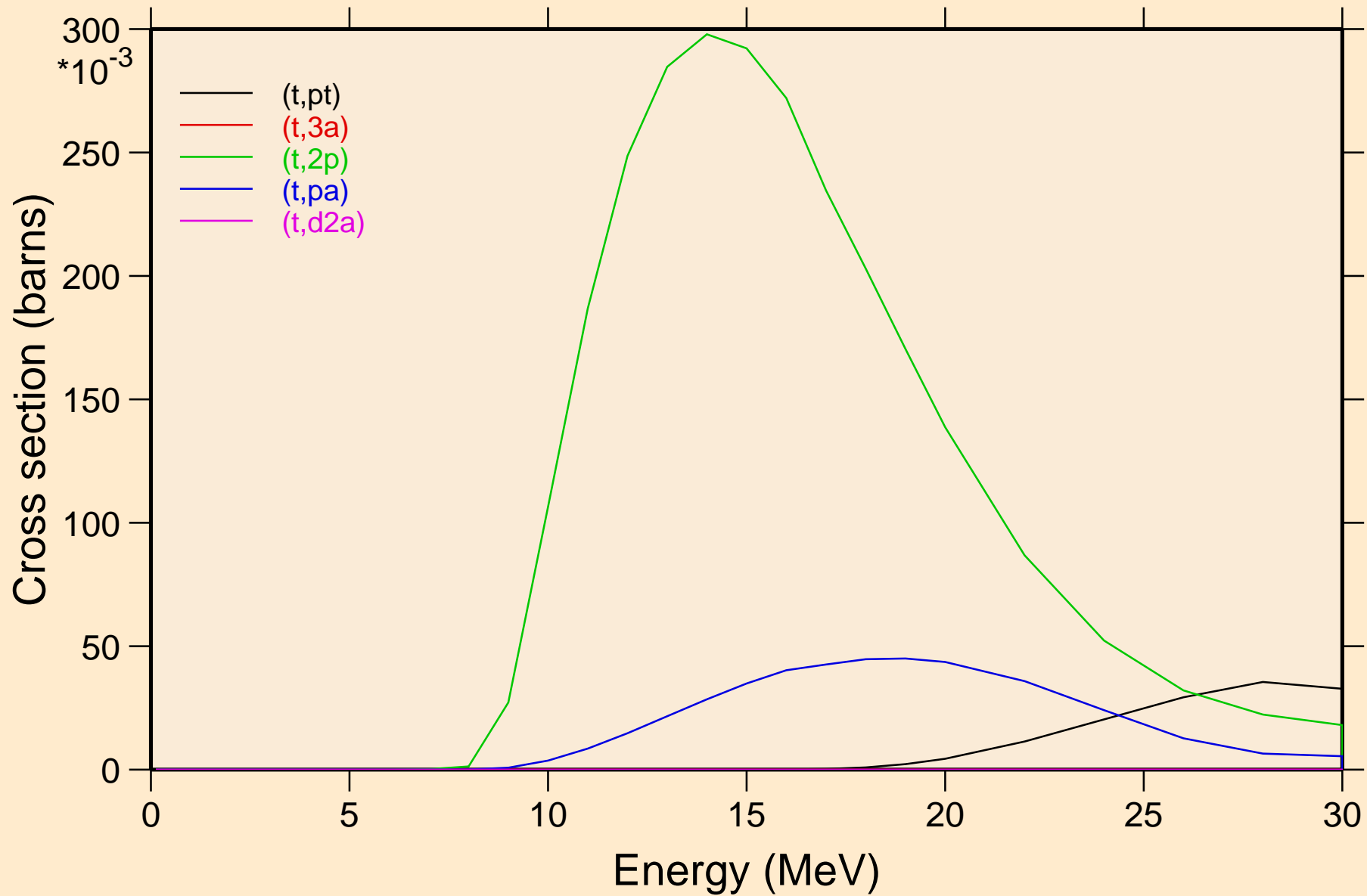

DY145M TRITON ACER TENDL-2021 LIBRARY; T=0.K  
Threshold reactions

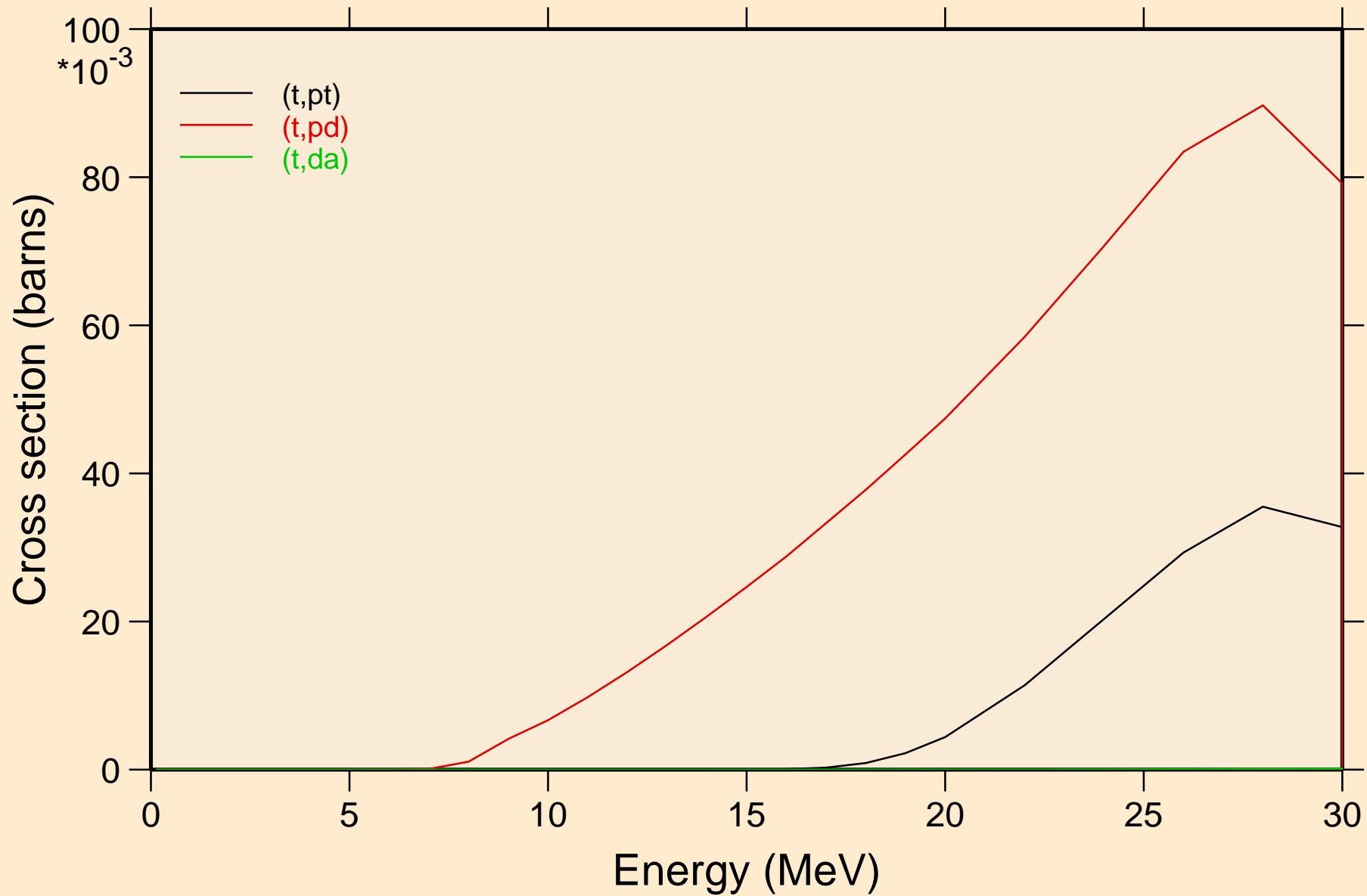

DY145M TRITON ACER TENDL-2021 LIBRARY; T=0.K  
angular distribution for elastic

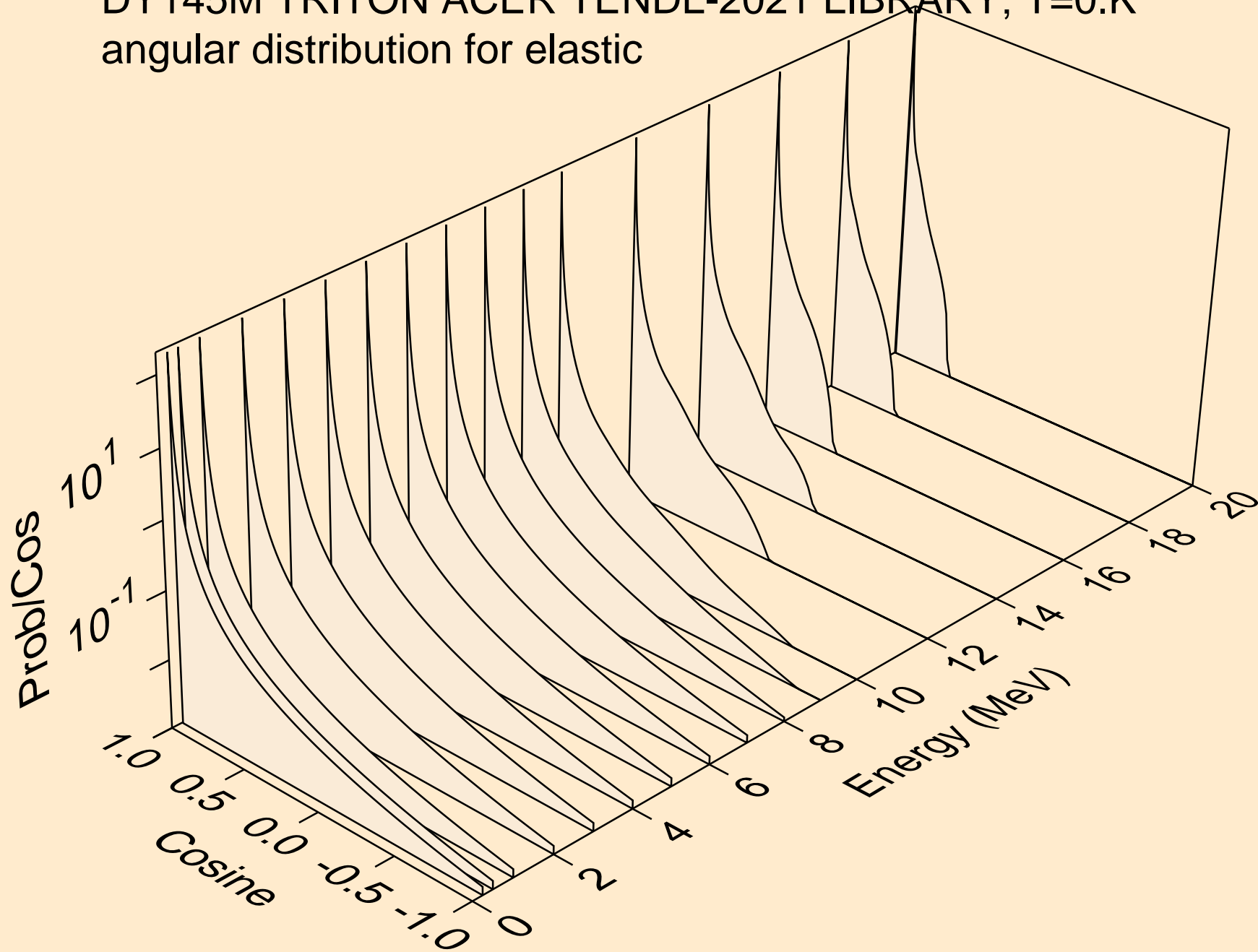



DY145M TRITON ACER TENDL-2021 LIBRARY; T=0.K  
angular distribution for elastic

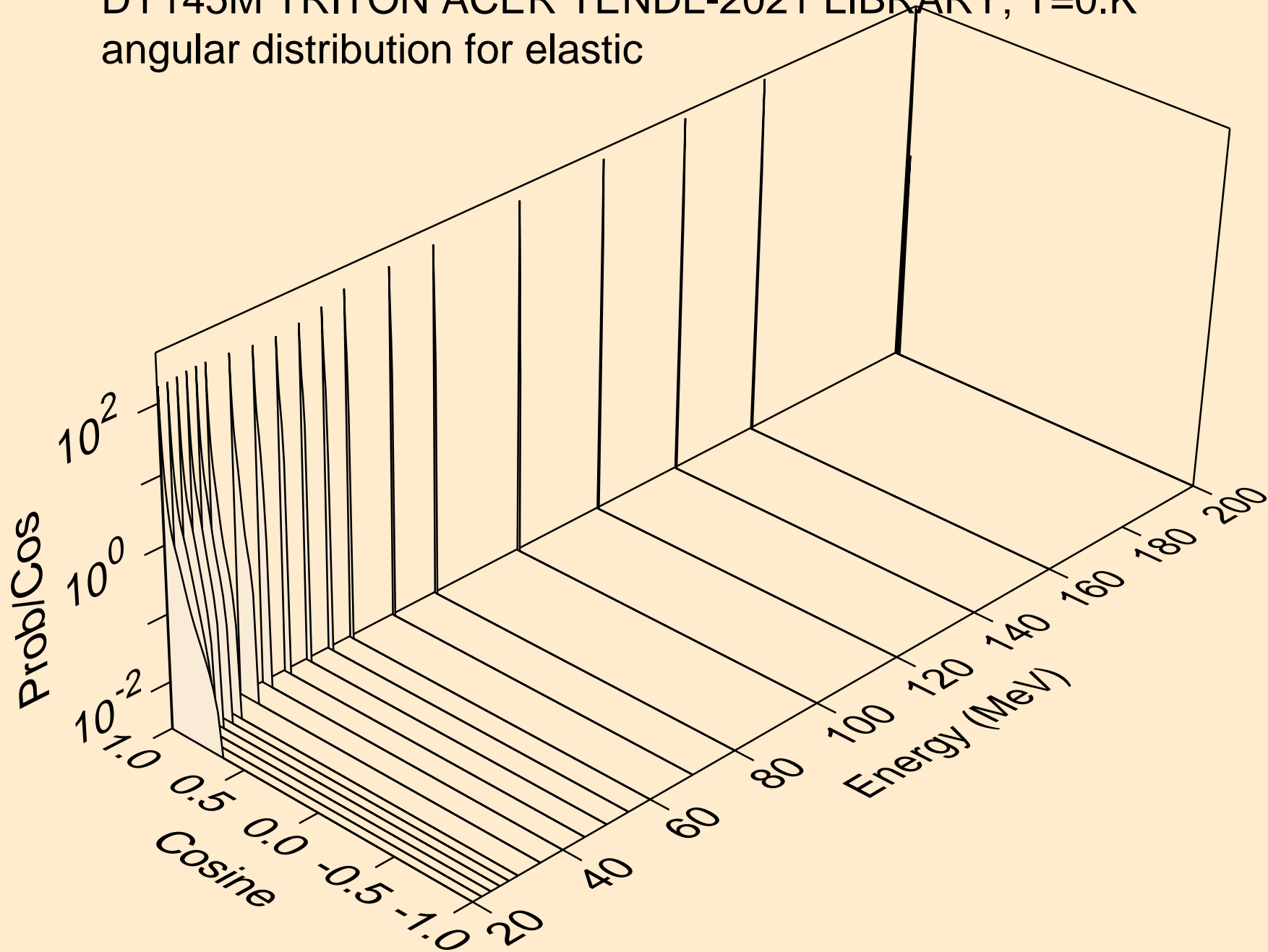

DY145M TRITON ACER TENDL-2021 LIBRARY; T=0.K  
Triton emission for (t,x)

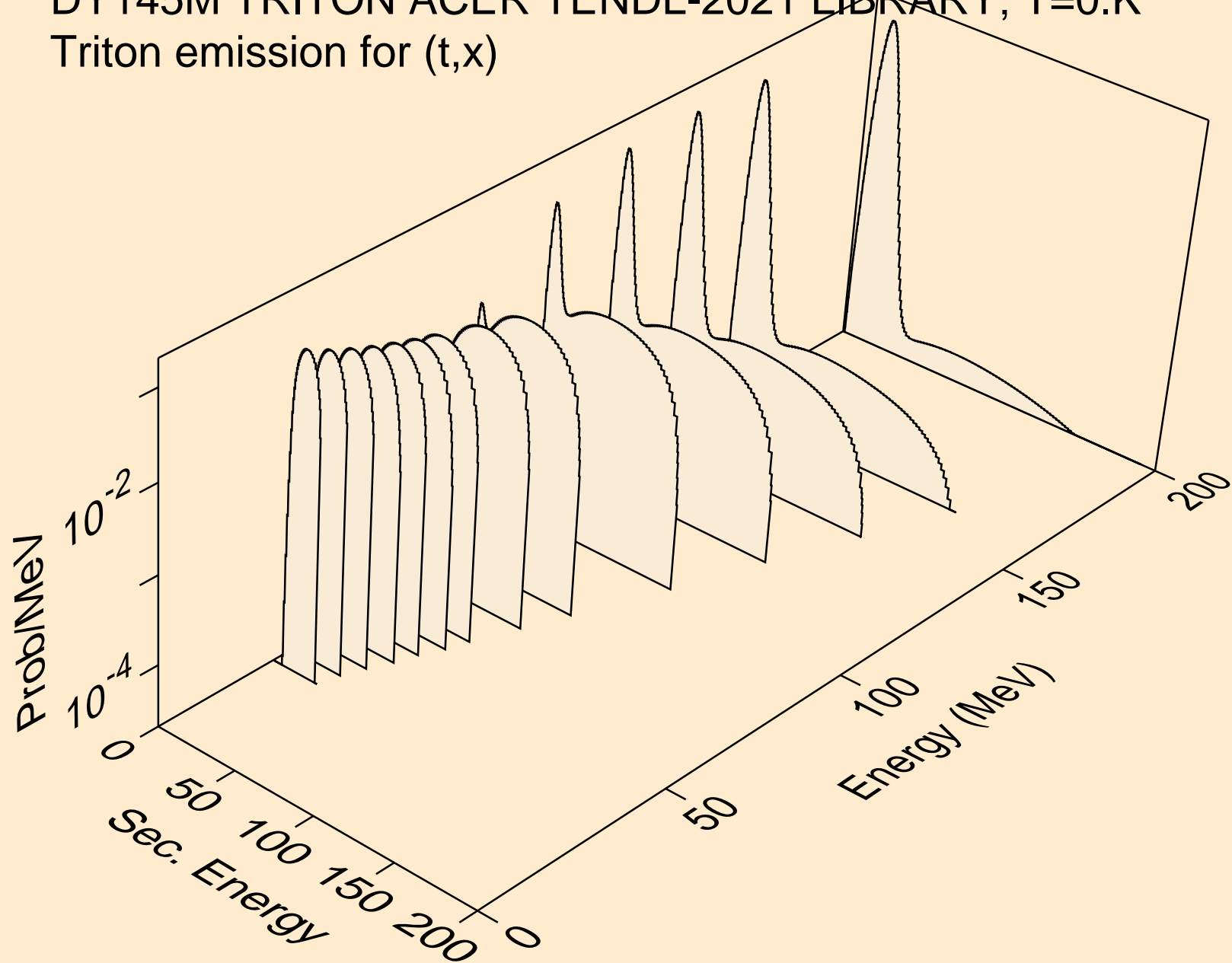

DY145M TRITON ACER TENDL-2021 LIBRARY; T=0.K  
Triton emission for (t,n\*)t

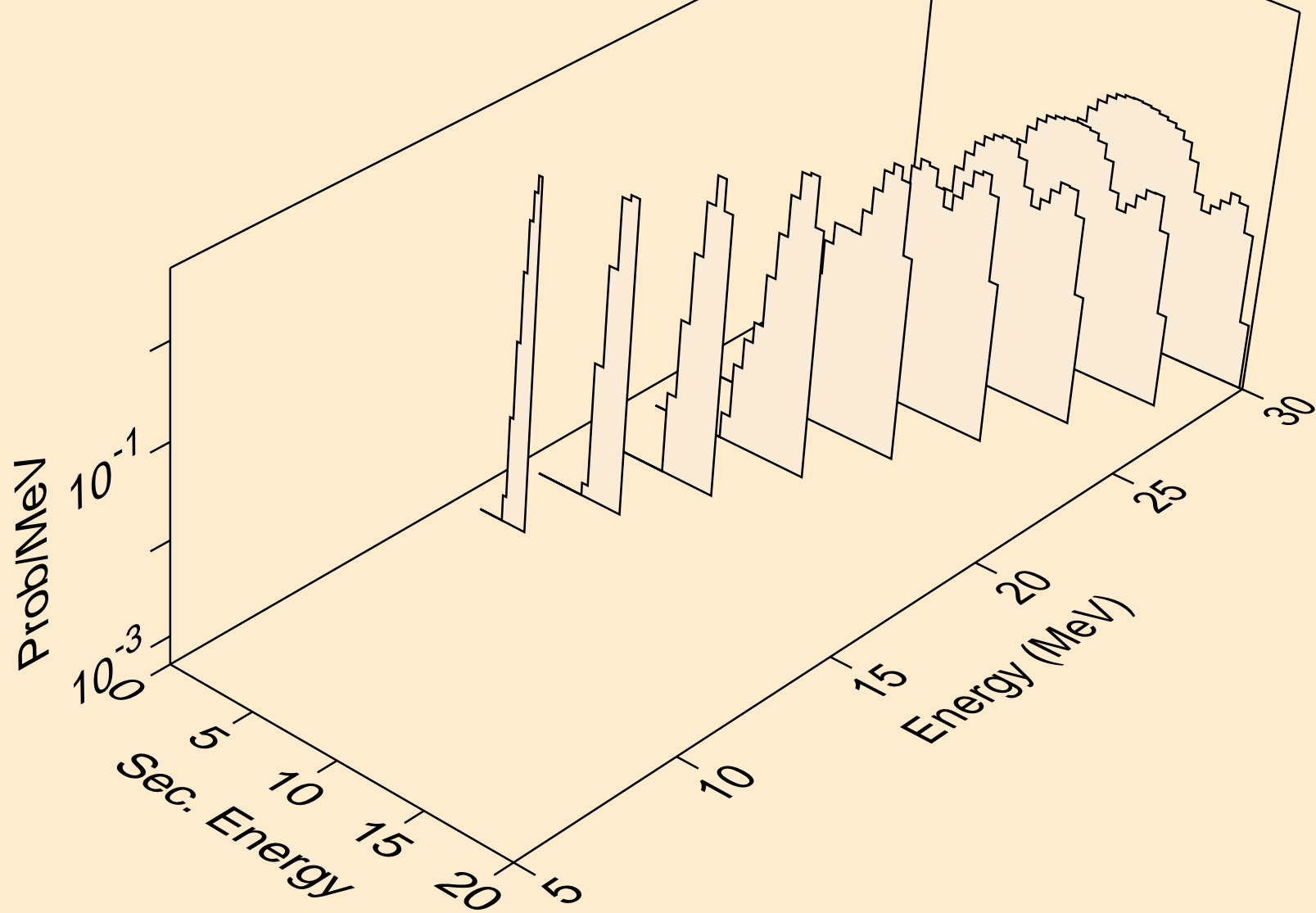

DY145M TRITON ACER TENDL-2021 LIBRARY; T=0.K  
Triton emission for inelastic

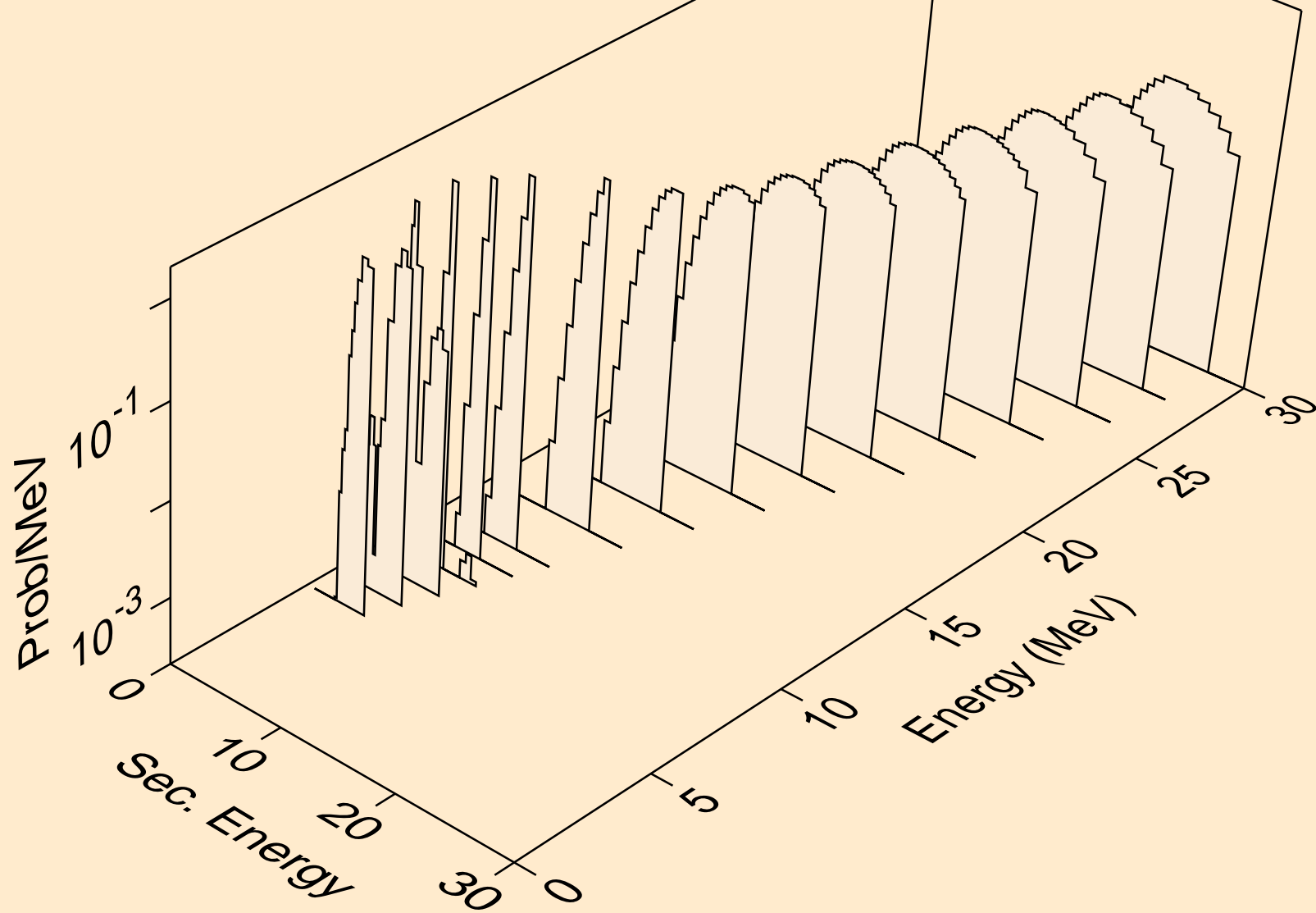

DY145M TRITON ACER TENDL-2021 LIBRARY; T=0.K  
Triton emission for (t,pt)

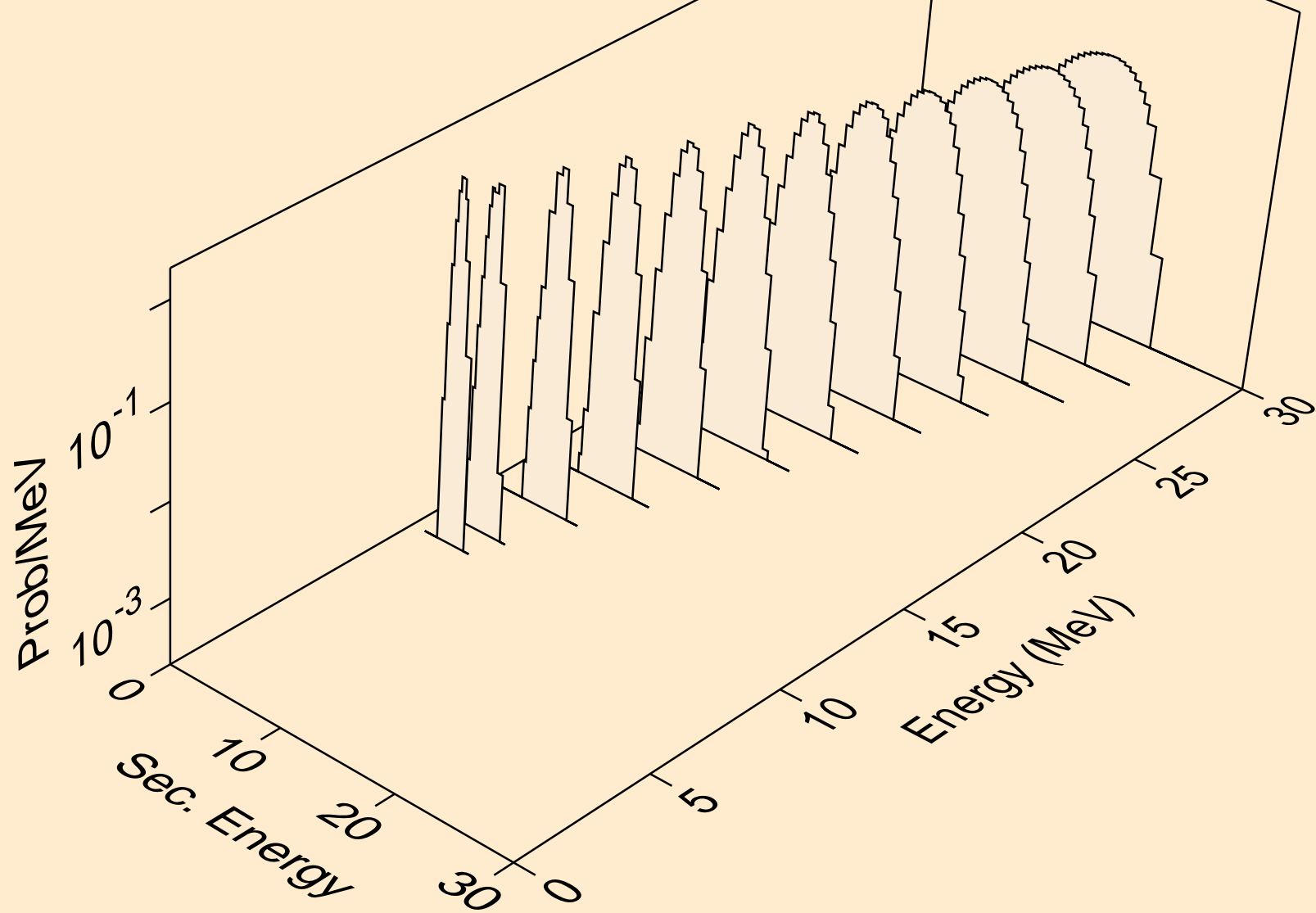

DY145M TRITON ACER TENDL-2021 LIBRARY; T=0.K  
Photon emission for (z,n)

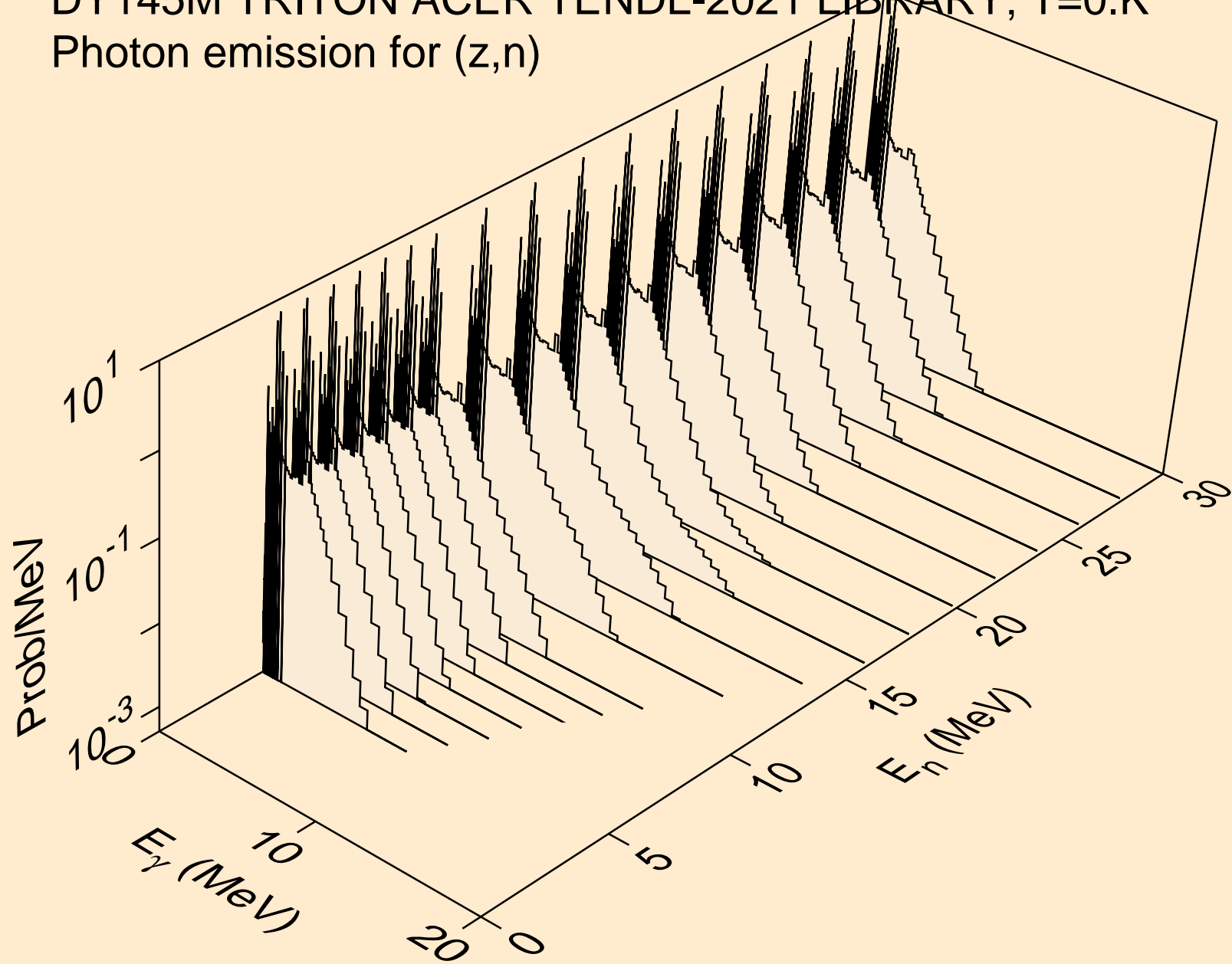

DY145M TRITON ACER TENDL-2021 LIBRARY; T=0.K  
Photon emission for (n,x)

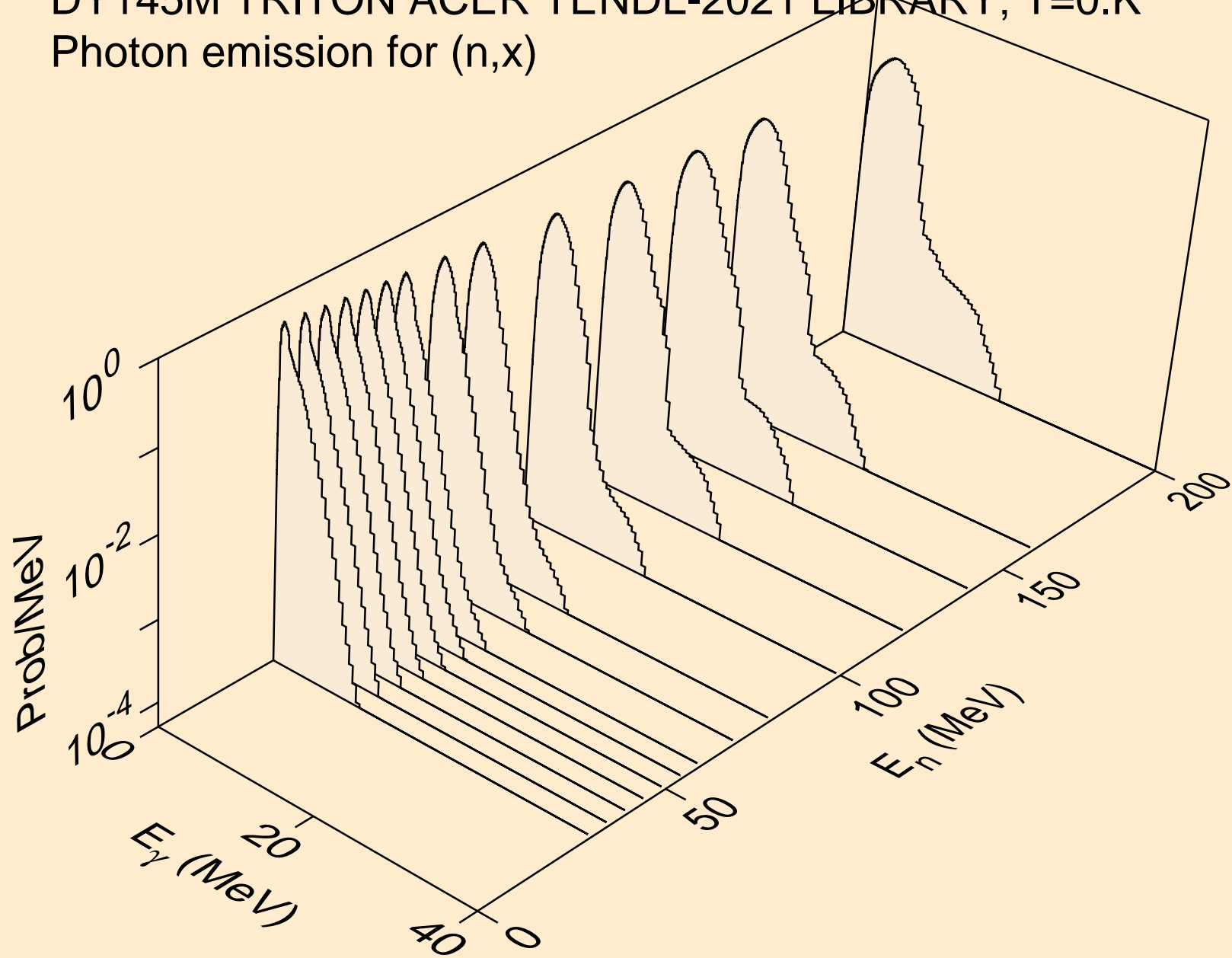

DY145M TRITON ACER TENDL-2021 LIBRARY; T=0.K  
Photon emission for (n,2nd)

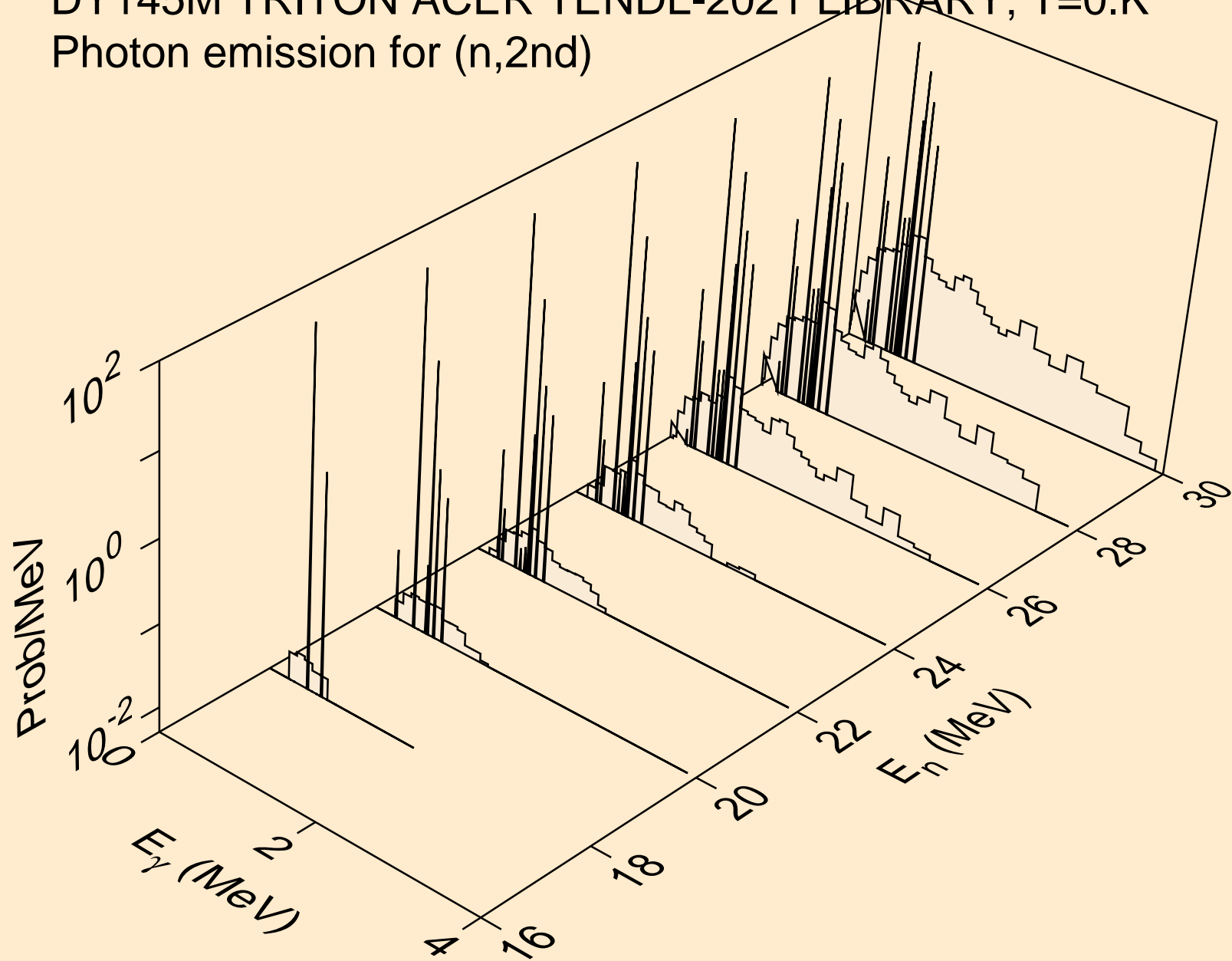



DY145M TRITON ACER TENDL-2021 LIBRARY; T=0.K  
Photon emission for (n,2n)

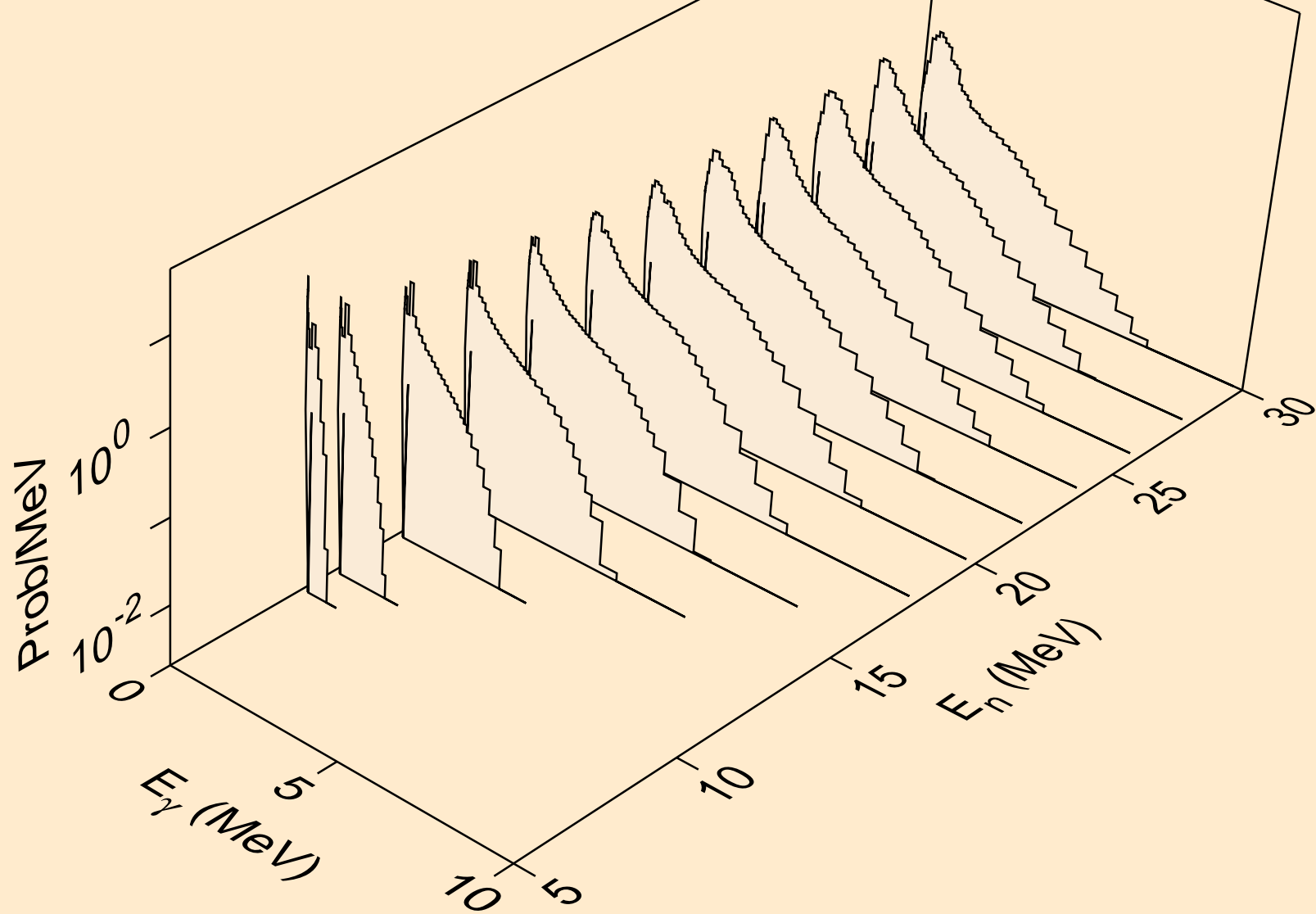

DY145M TRITON ACER TENDL-2021 LIBRARY; T=0.K  
Photon emission for (n,3n)

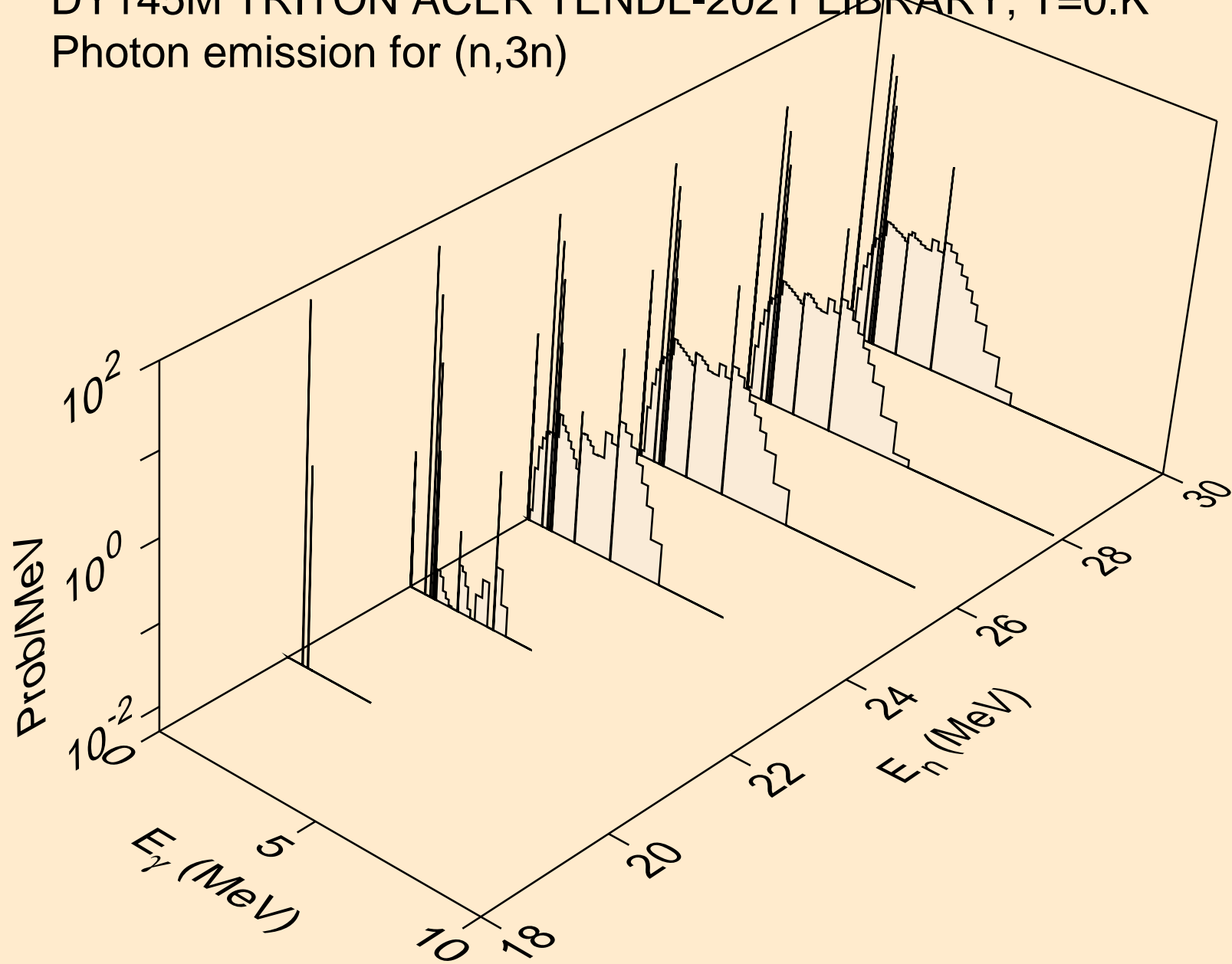

DY145M TRITON ACER TENDL-2021 LIBRARY; T=0.K  
Photon emission for (n,n\*)a

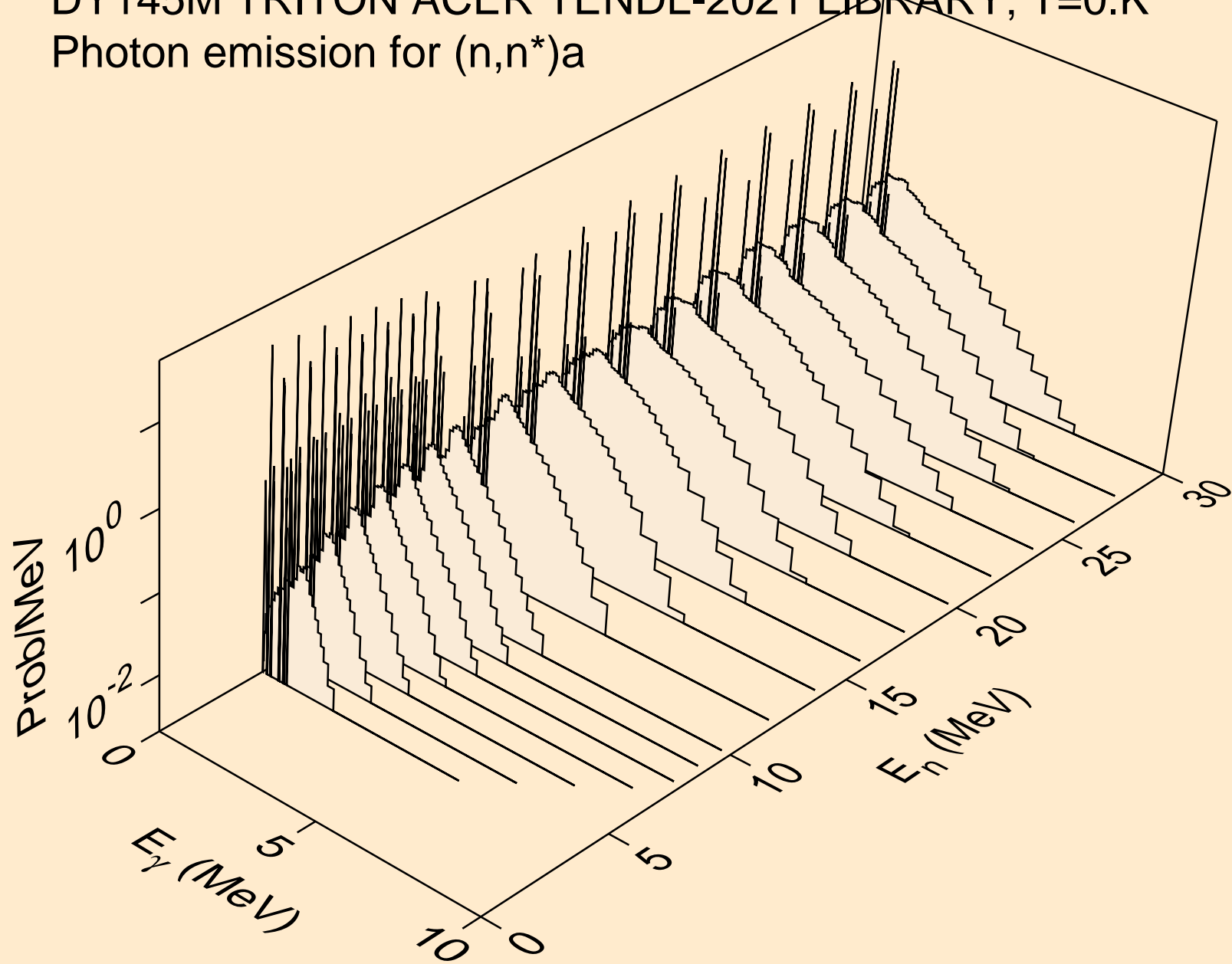

DY145M TRITON ACER TENDL-2021 LIBRARY; T=0.K  
Photon emission for (n,2n)a

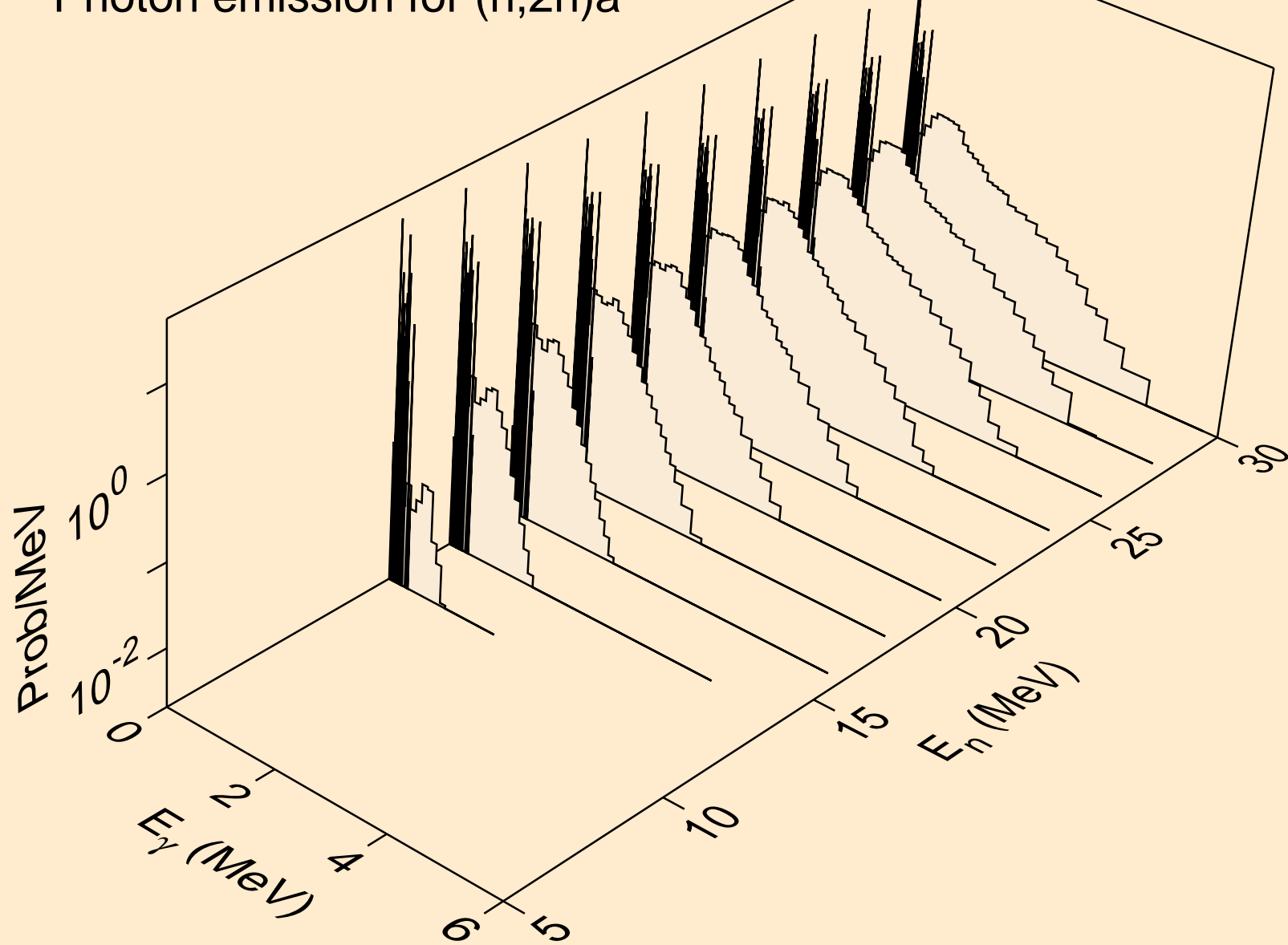

DY145M TRITON ACER TENDL-2021 LIBRARY; T=0.K  
Photon emission for (n,3n)a

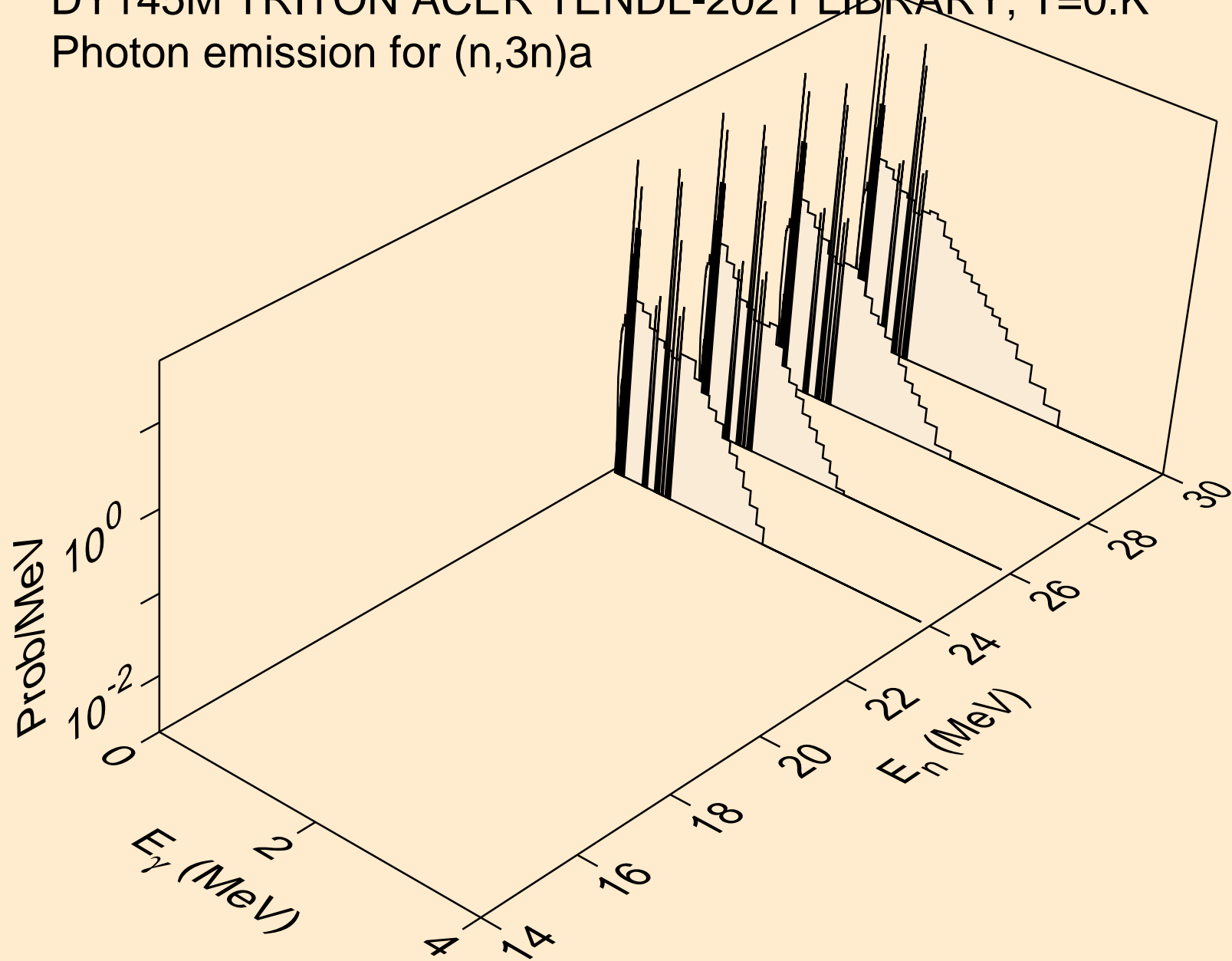

DY145M TRITON ACER TENDL-2021 LIBRARY; T=0.K  
Photon emission for (n,n\*)p

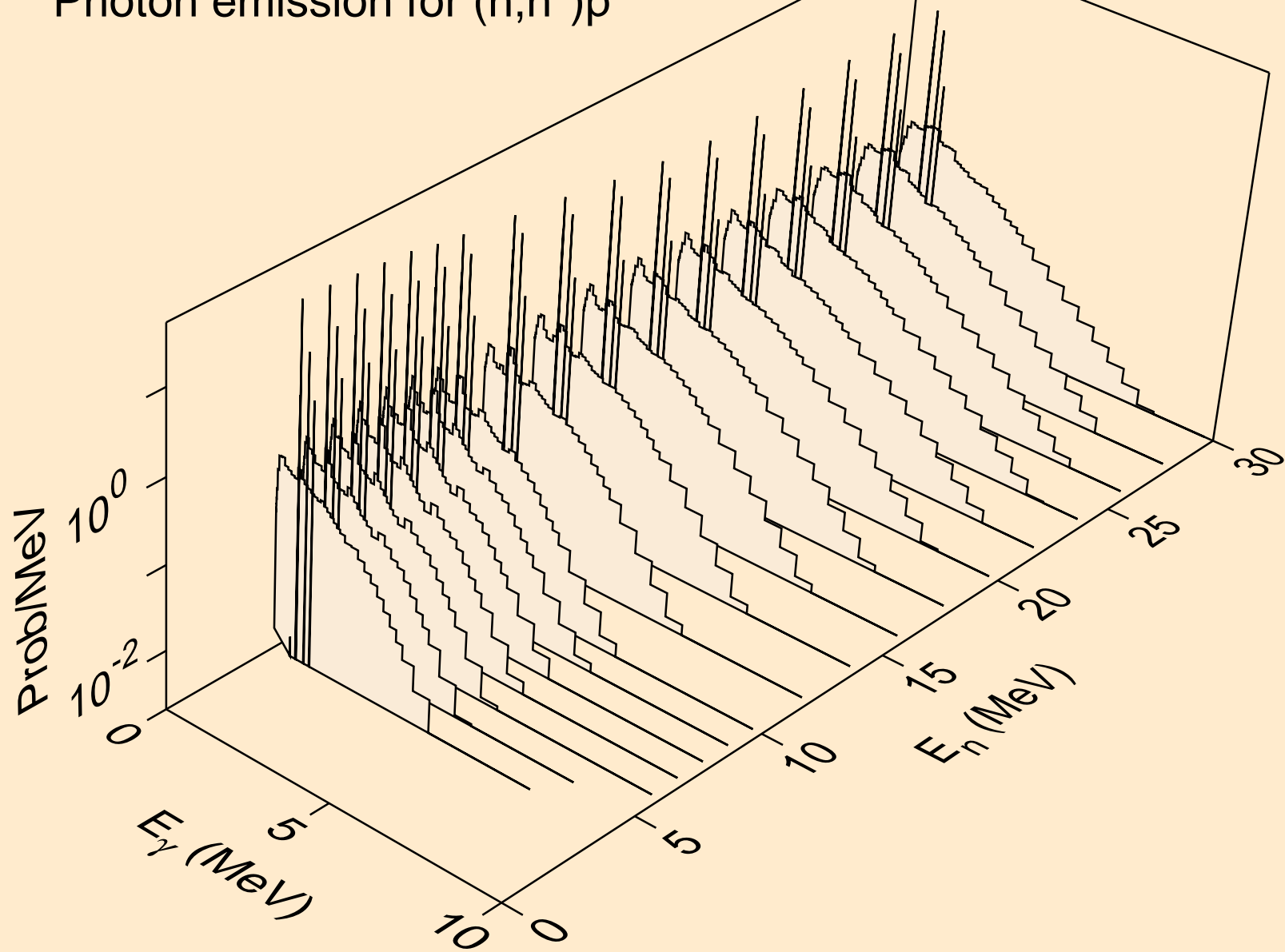

DY145M TRITON ACER TENDL-2021 LIBRARY; T=0.K  
Photon emission for (n,n\*)2a

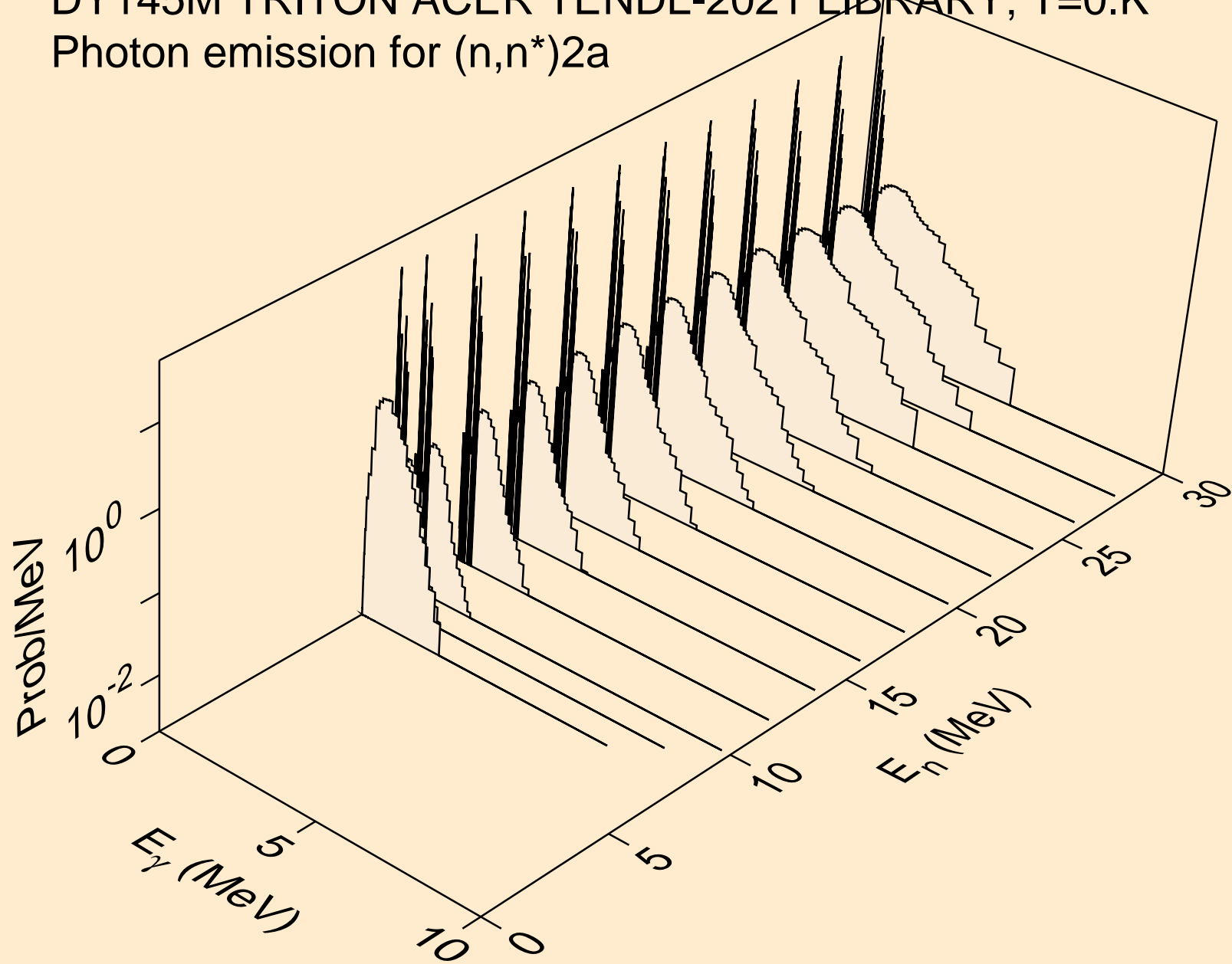

DY145M TRITON ACER TENDL-2021 LIBRARY; T=0.K  
Photon emission for (n,n\*)d

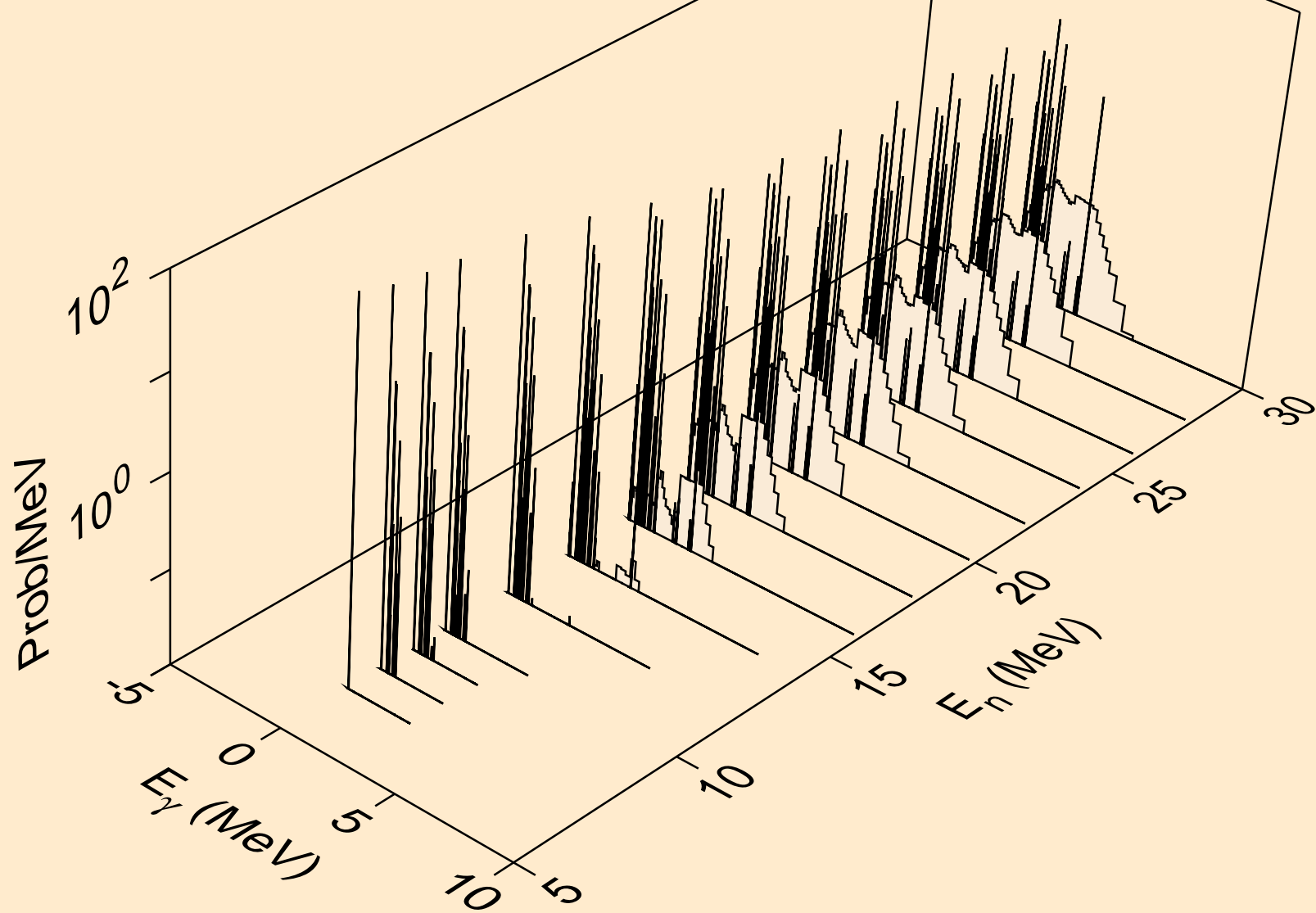



DY145M TRITON ACER TENDL-2021 LIBRARY; T=0.K  
Photon emission for (n,n\*)t

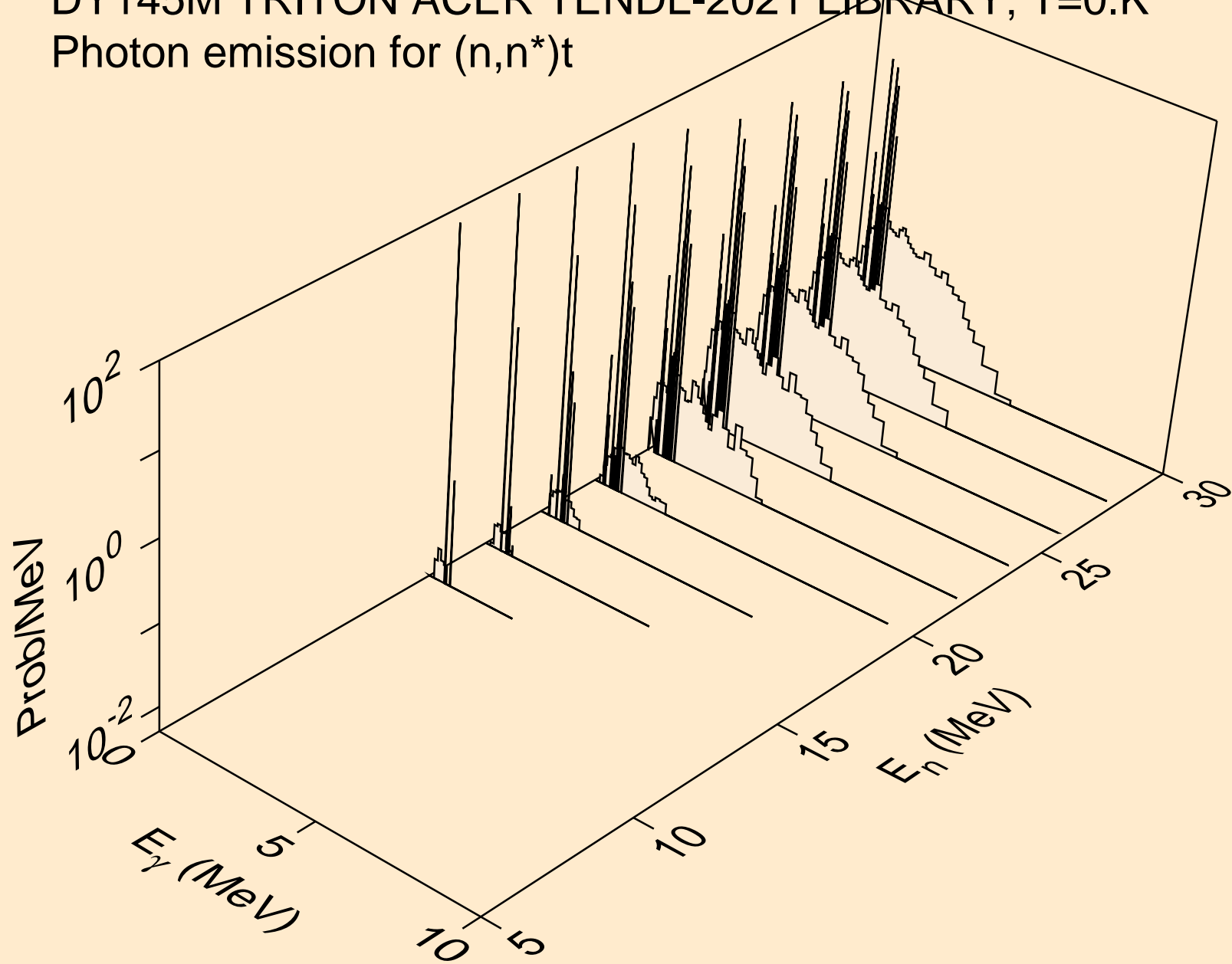

DY145M TRITON ACER TENDL-2021 LIBRARY; T=0.K  
Photon emission for (n,n\*)he3

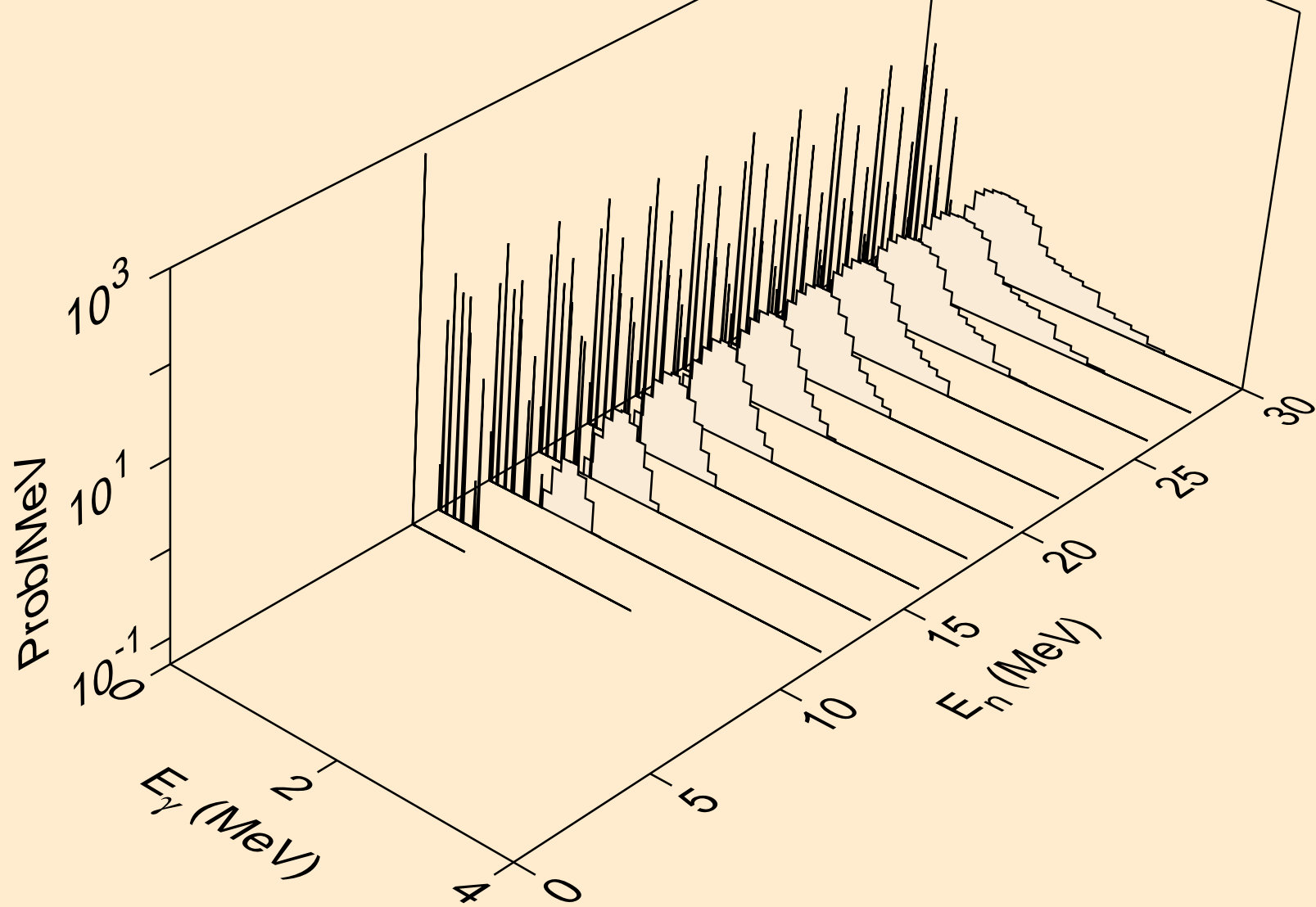

DY145M TRITON ACER TENDL-2021 LIBRARY; T=0.K  
Photon emission for (n,2np)

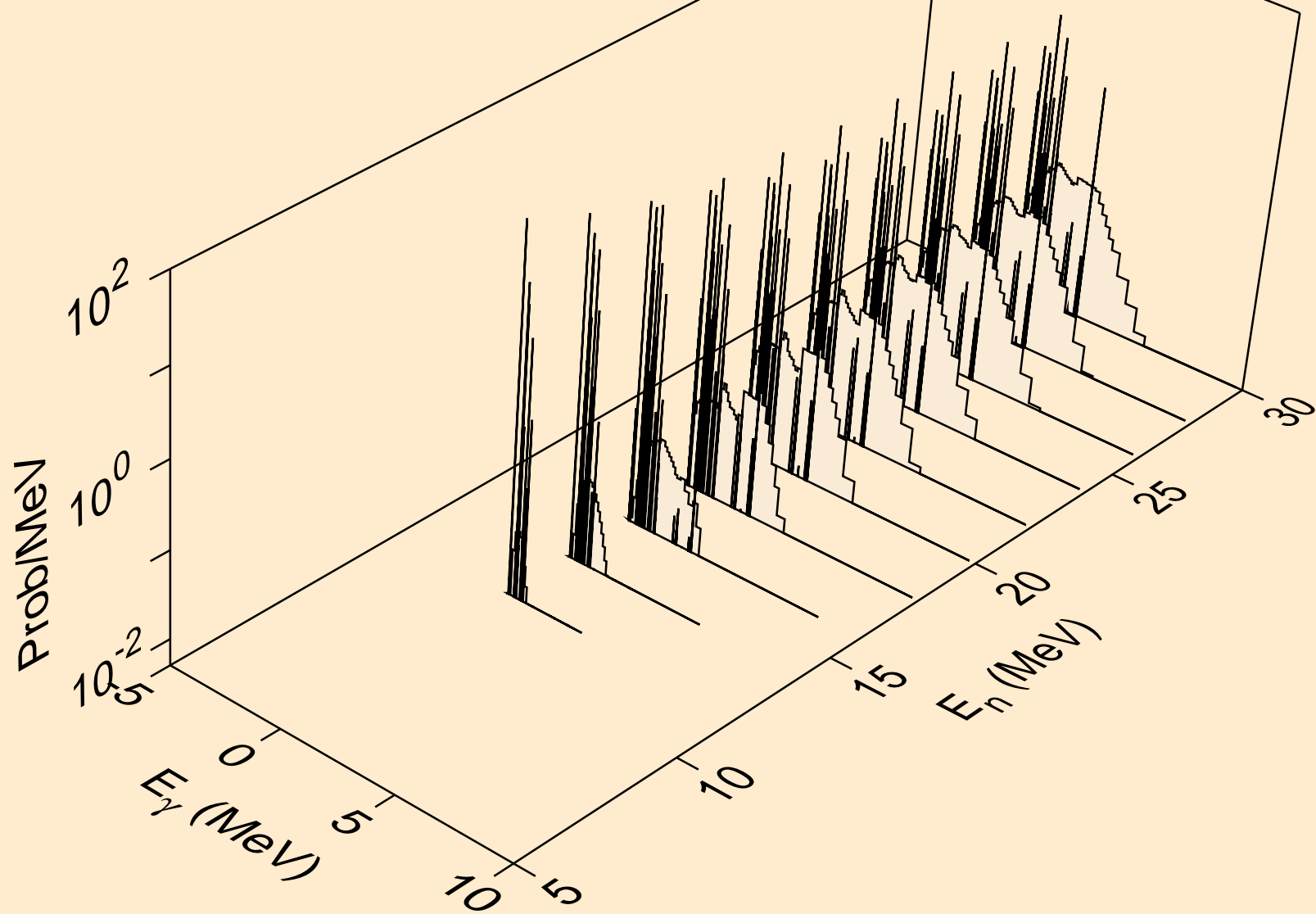

DY145M TRITON ACER TENDL-2021 LIBRARY; T=0.K  
Photon emission for (n,3np)

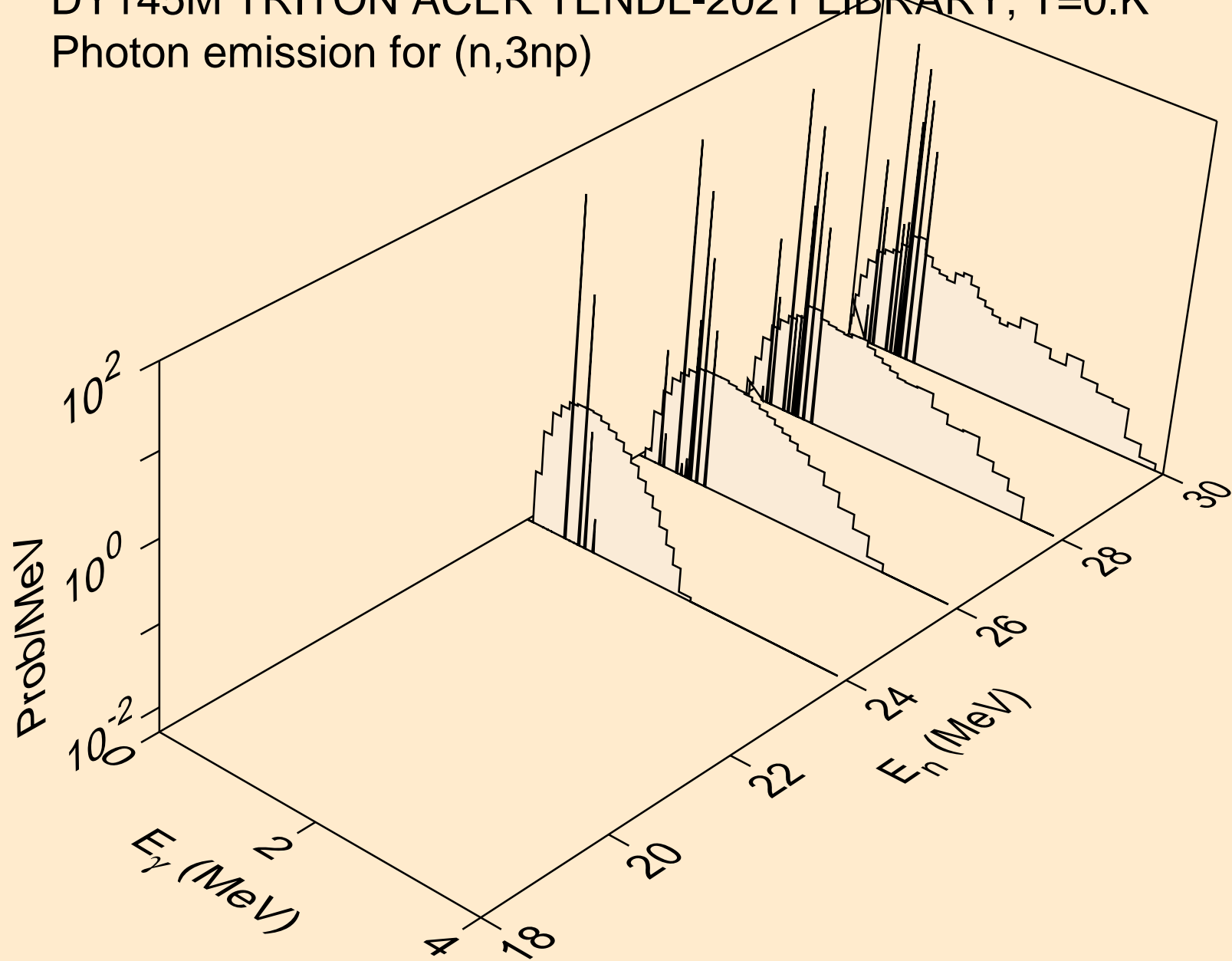

DY145M TRITON ACER TENDL-2021 LIBRARY; T=0.K  
Photon emission for (n,2np)

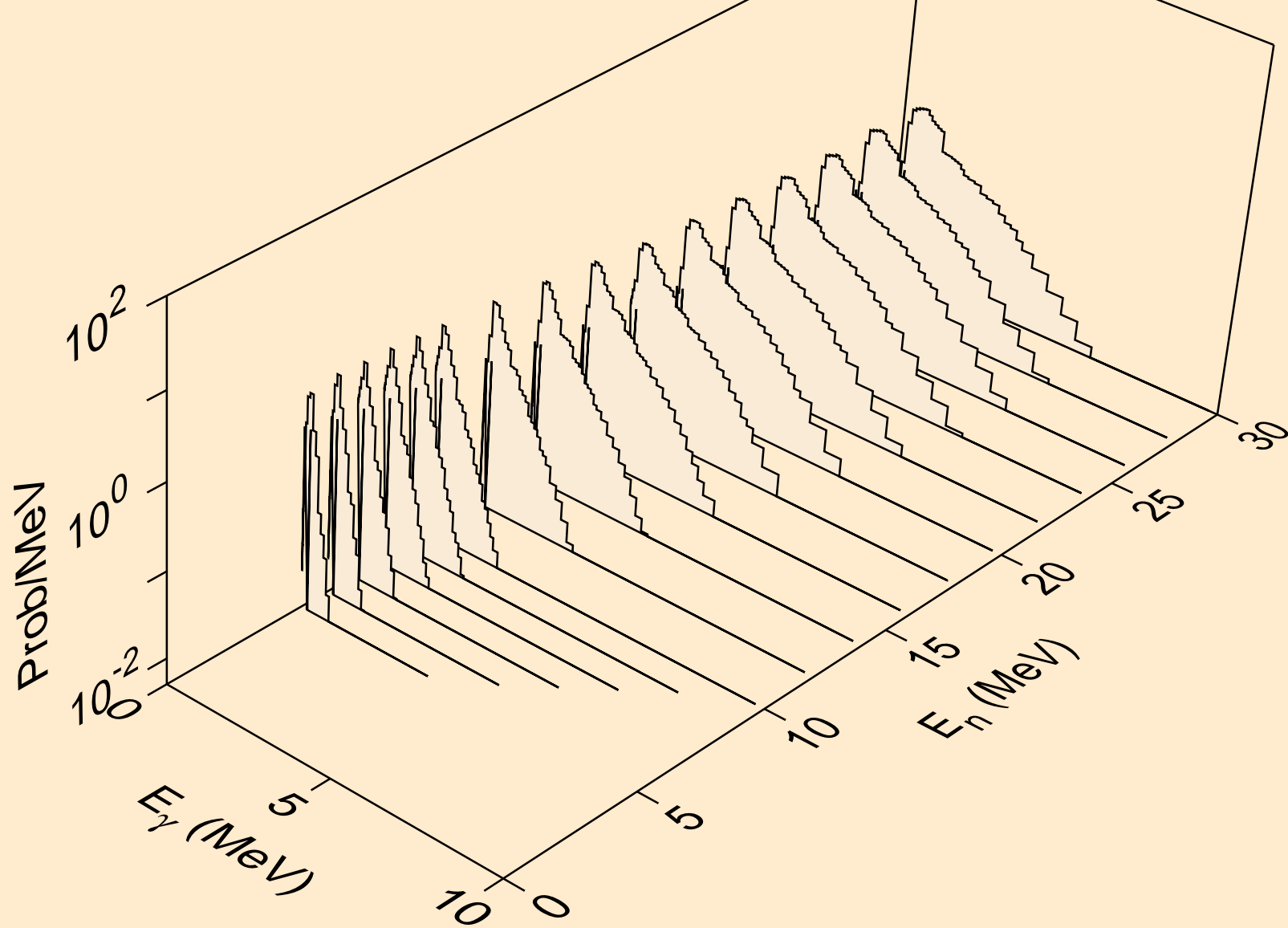

DY145M TRITON ACER TENDL-2021 LIBRARY; T=0.K  
Photon emission for (n,npa)

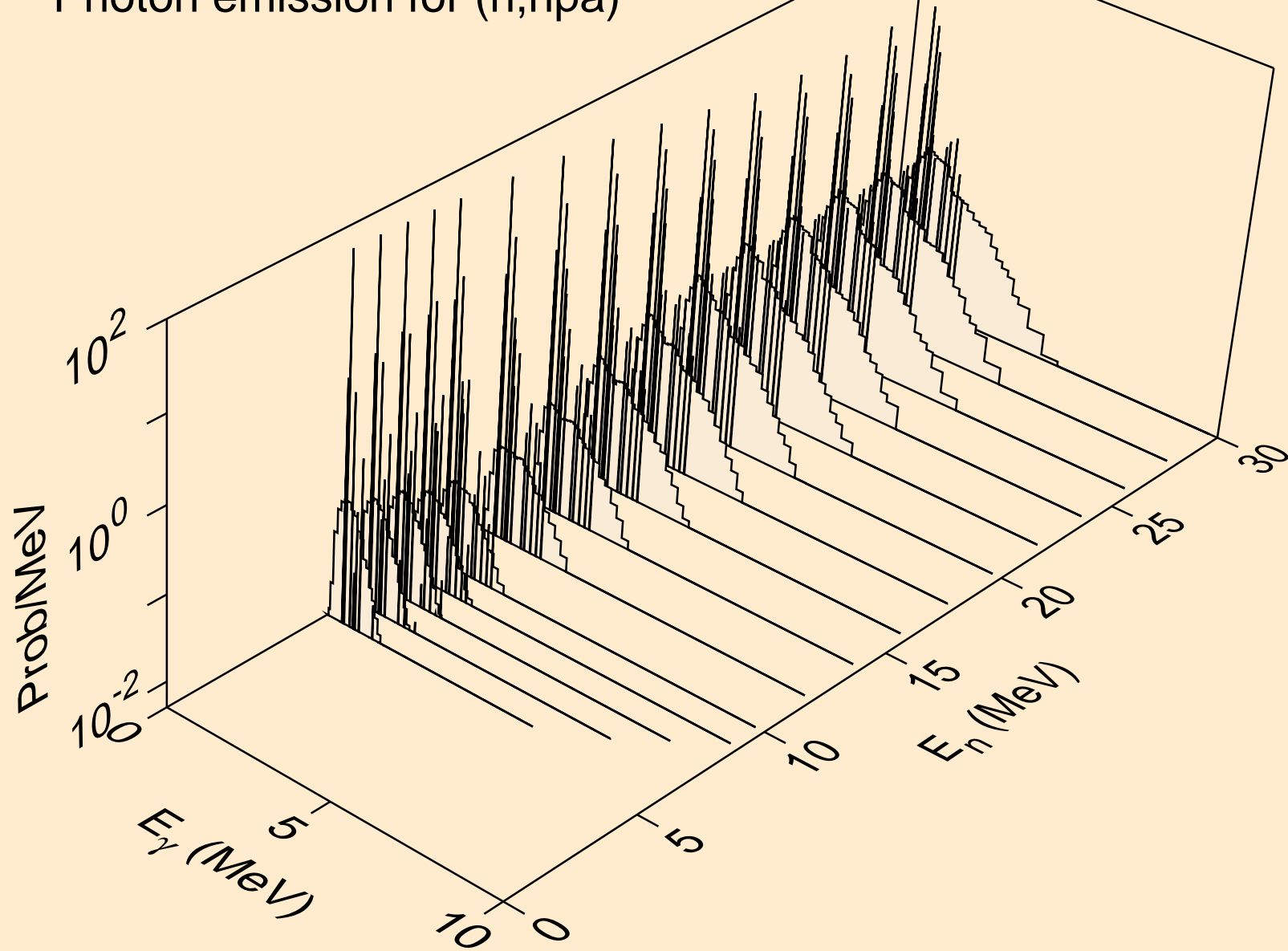

DY145M TRITON ACER TENDL-2021 LIBRARY; T=0.K  
Photon emission for (n,gma)

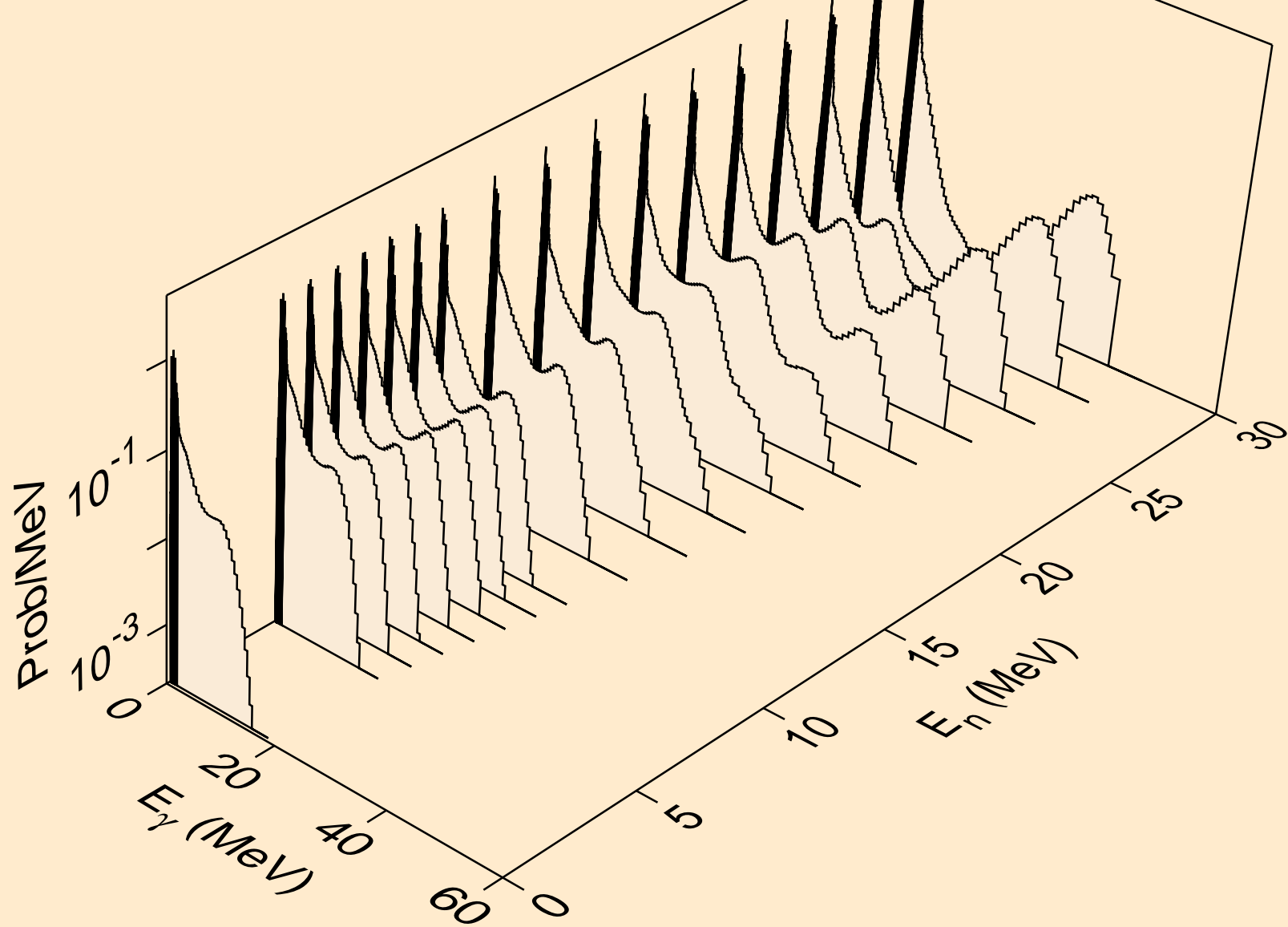

DY145M TRITON ACER TENDL-2021 LIBRARY; T=0.K  
Photon emission for (n,p)

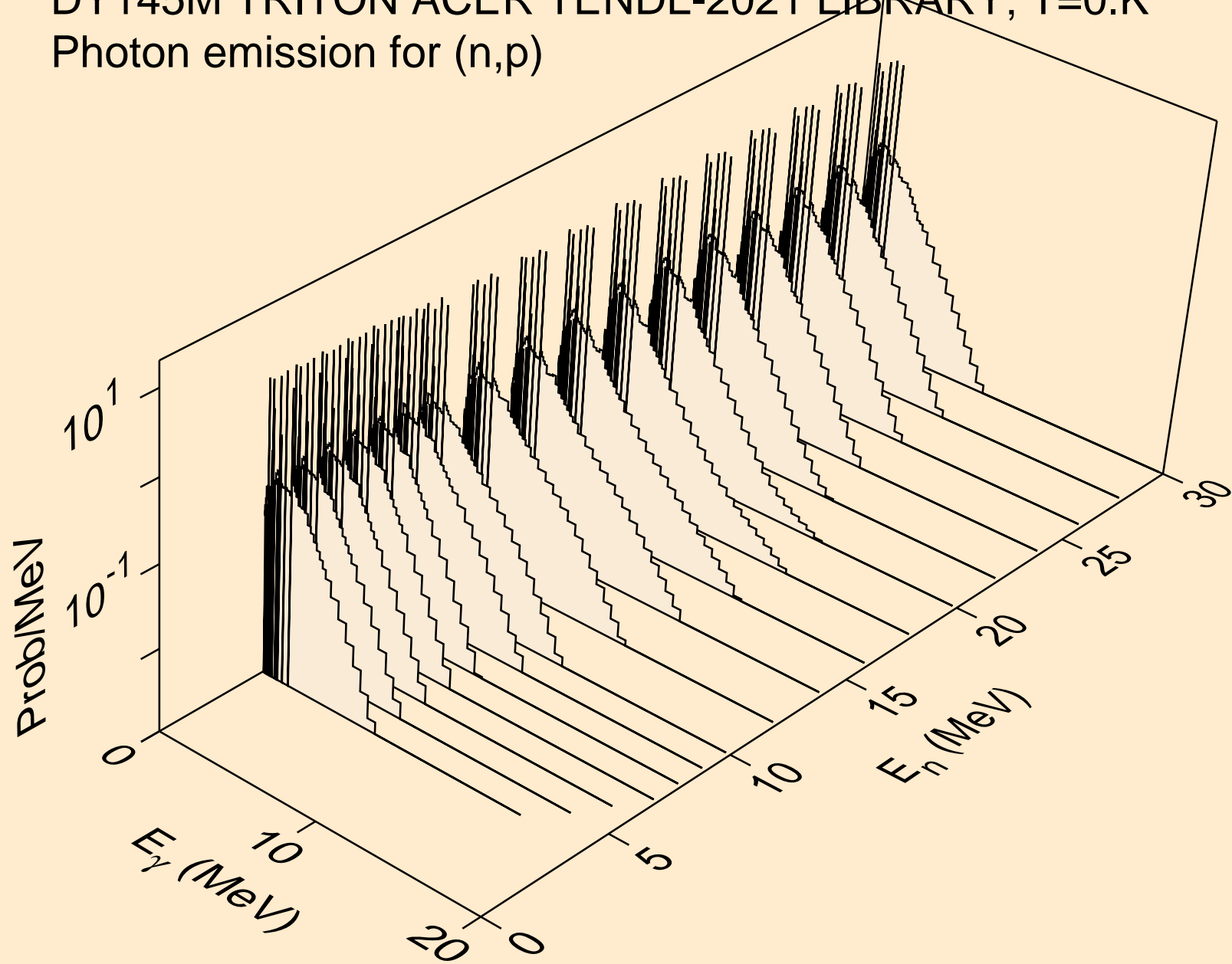



DY145M TRITON ACER TENDL-2021 LIBRARY; T=0.K  
Photon emission for (n,d)

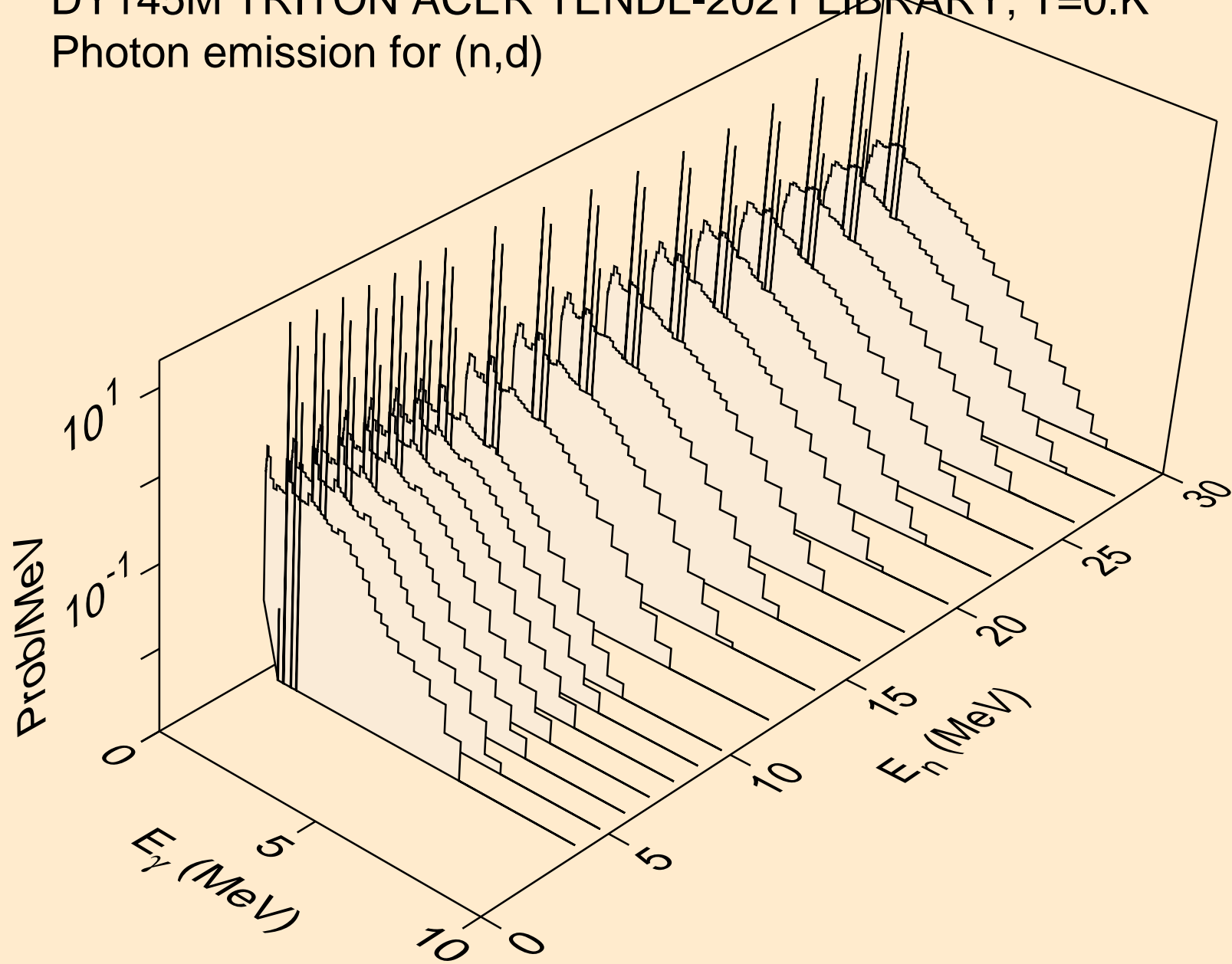

DY145M TRITON ACER TENDL-2021 LIBRARY; T=0.K  
Photon emission for inelastic

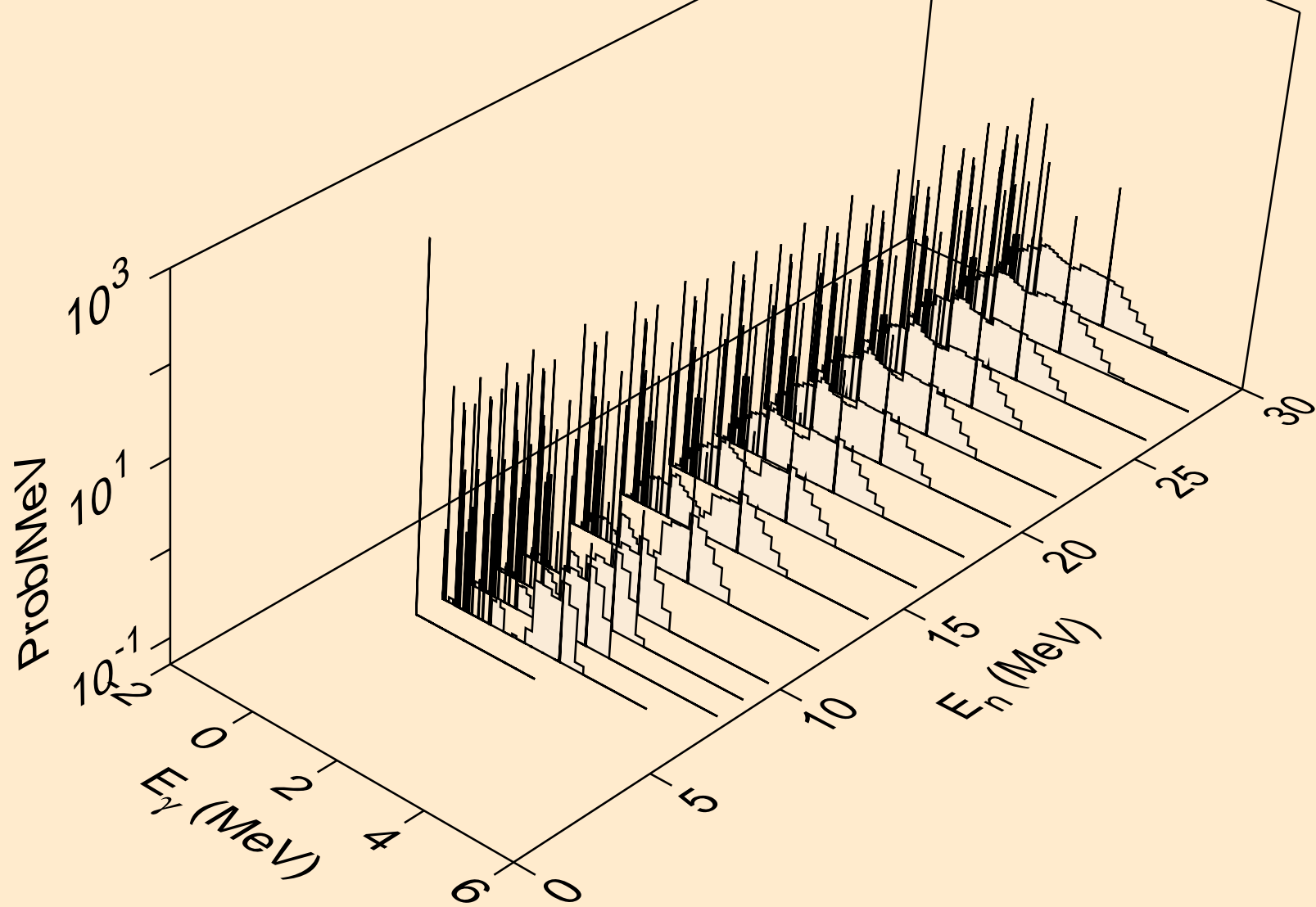

DY145M TRITON ACER TENDL-2021 LIBRARY; T=0.K  
Photon emission for (n,he3)

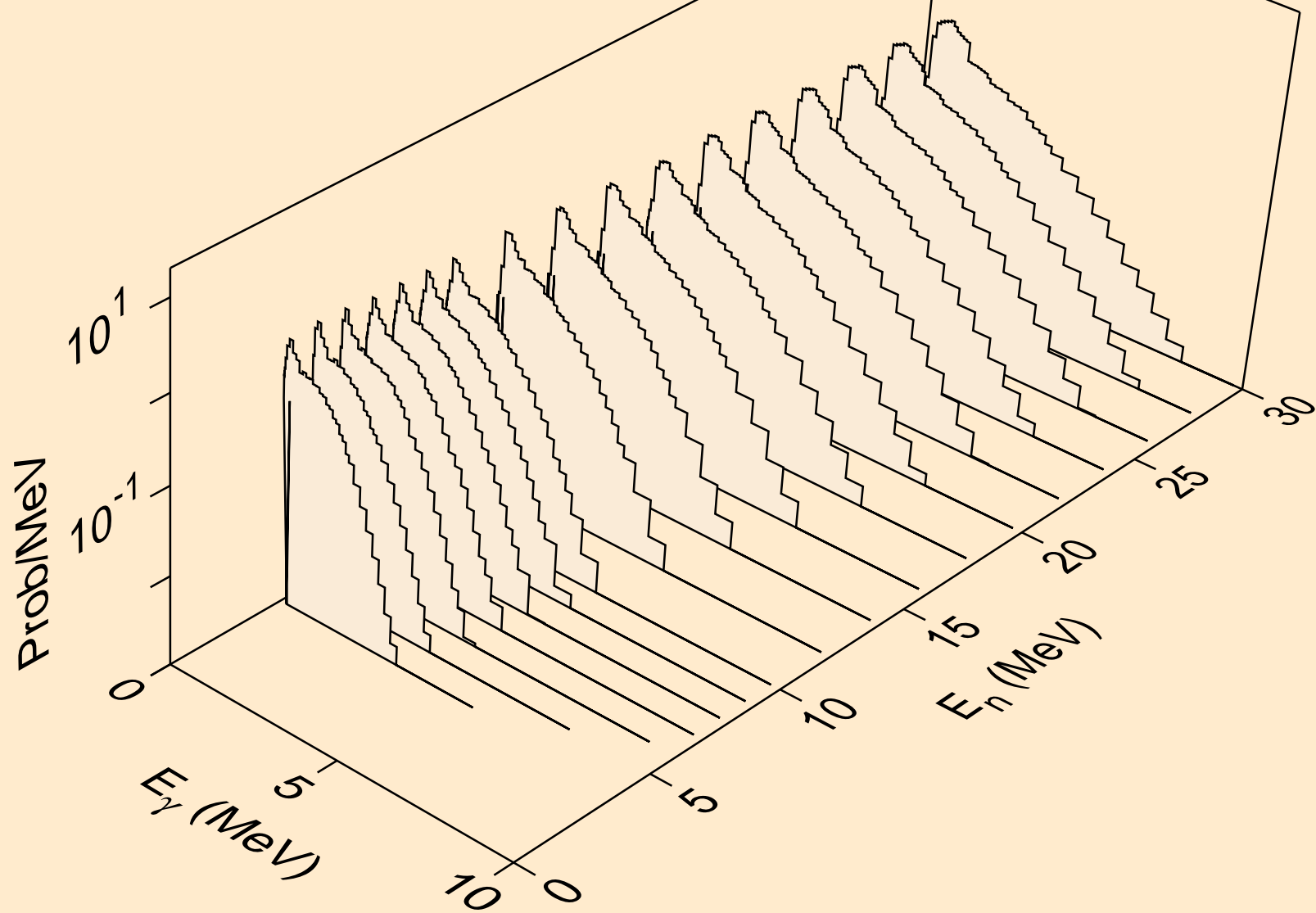

DY145M TRITON ACER TENDL-2021 LIBRARY; T=0.K  
Photon emission for (n,a)

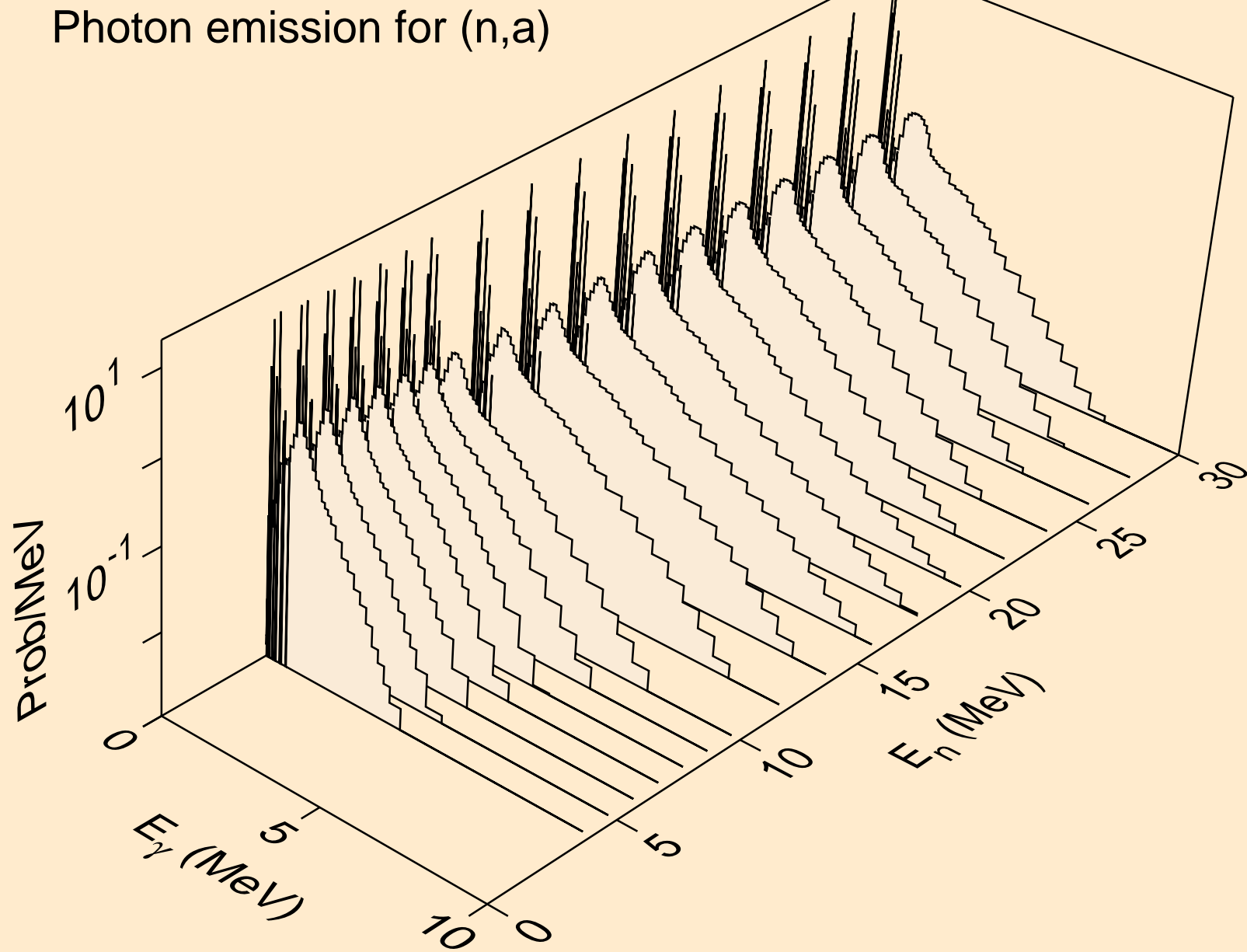

DY145M TRITON ACER TENDL-2021 LIBRARY; T=0.K  
Photon emission for (n,2a)

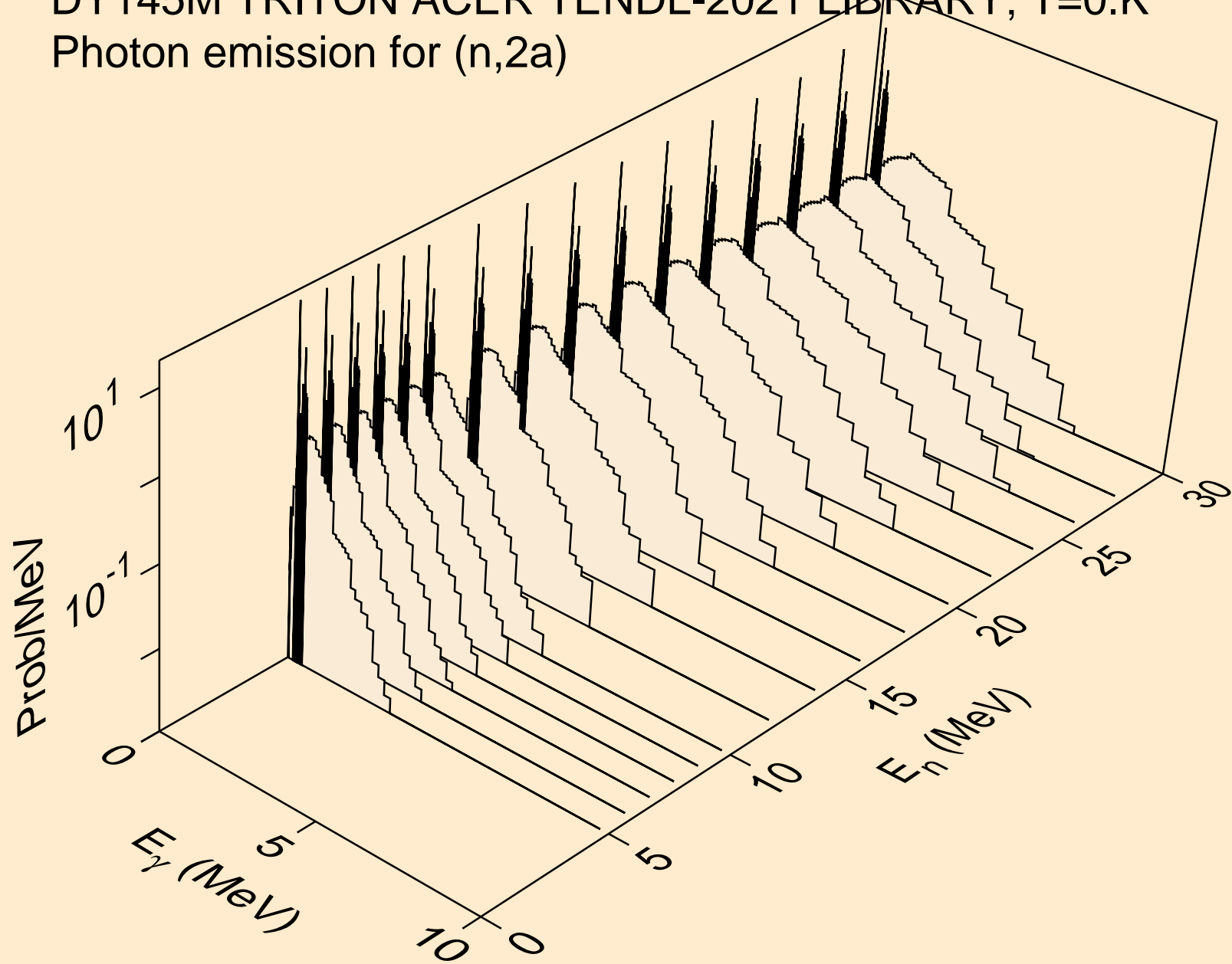

DY145M TRITON ACER TENDL-2021 LIBRARY; T=0.K  
Photon emission for (n,3a)

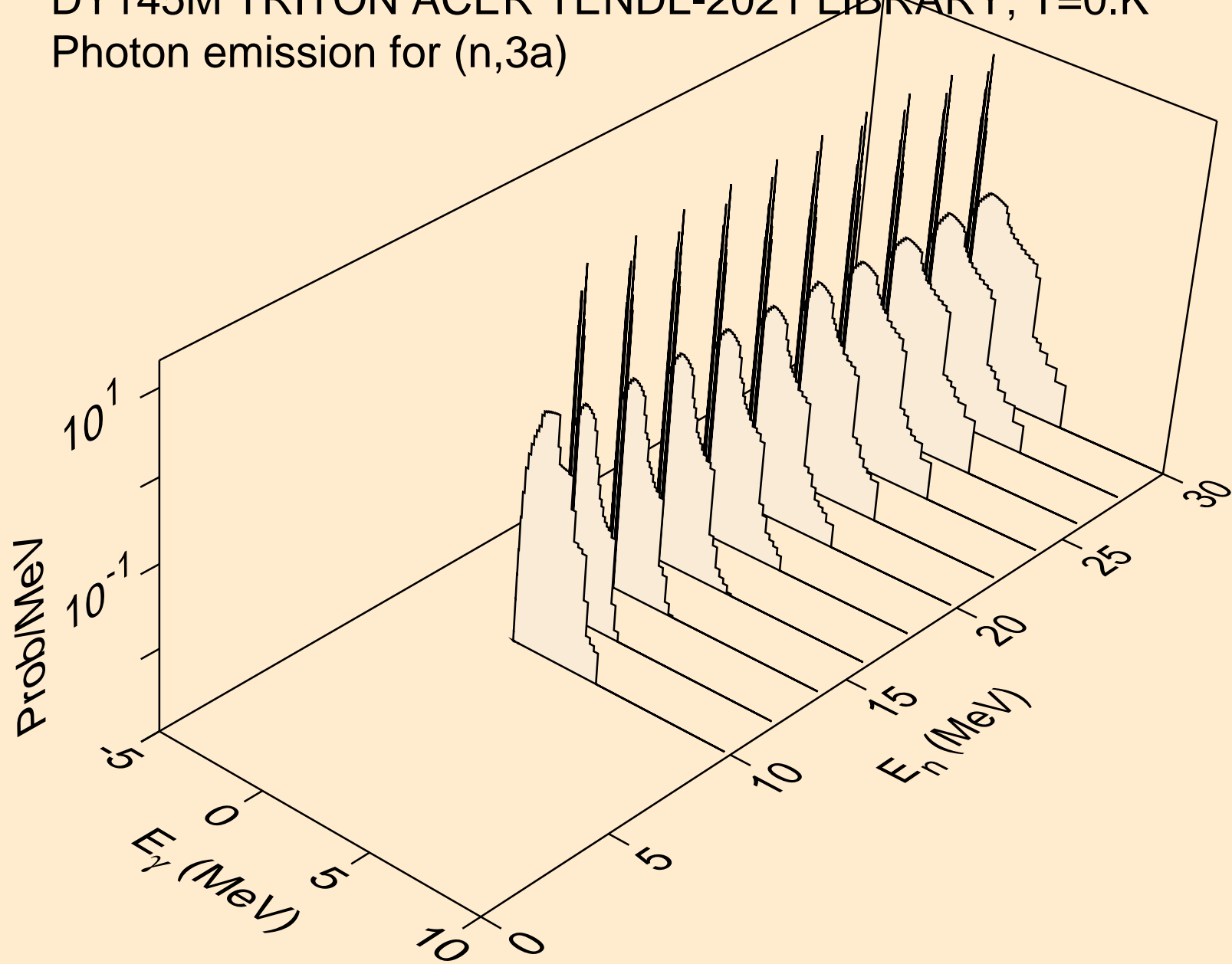

DY145M TRITON ACER TENDL-2021 LIBRARY; T=0.K  
Photon emission for (n,2p)

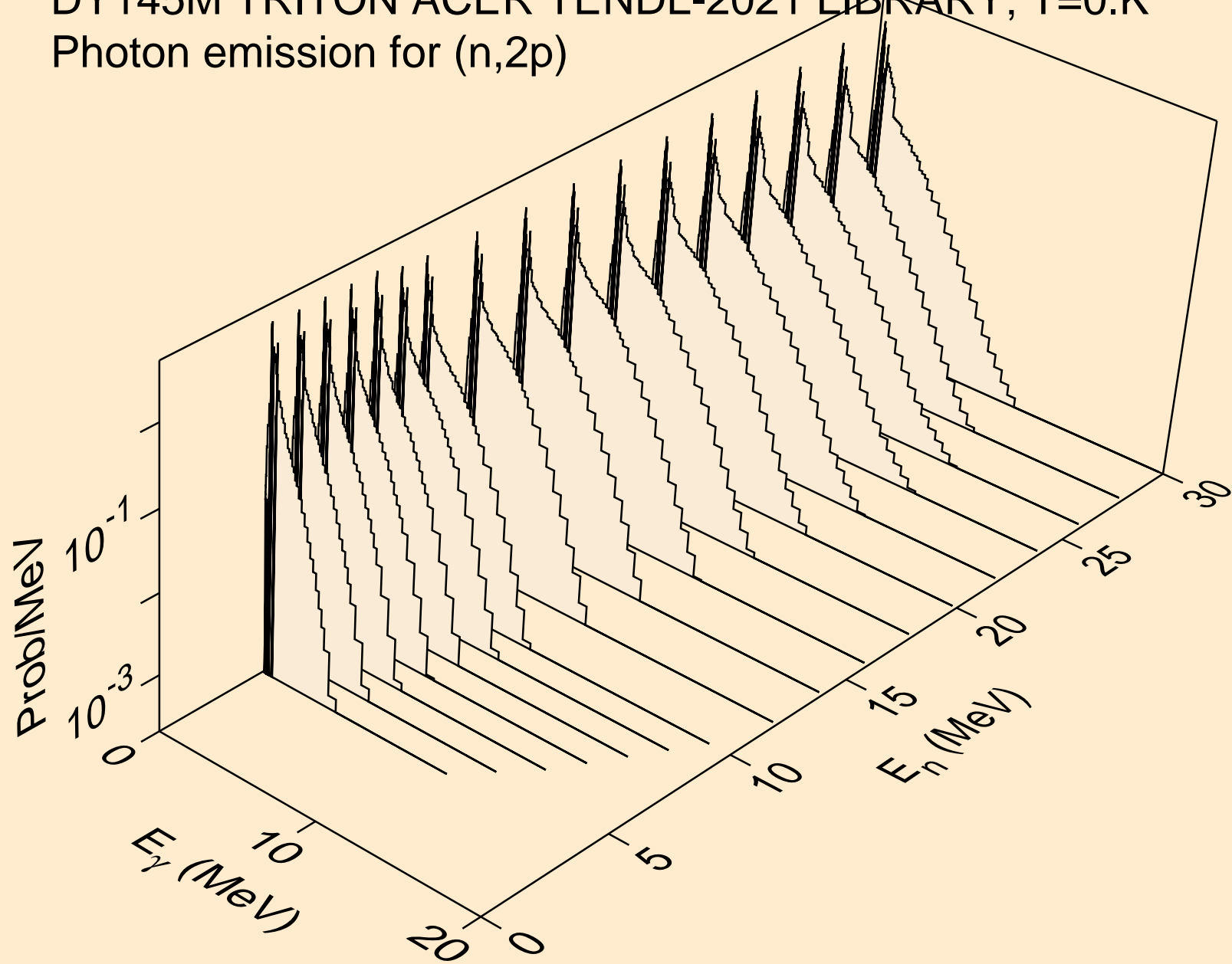

DY145M TRITON ACER TENDL-2021 LIBRARY; T=0.K  
Photon emission for (n,pa)

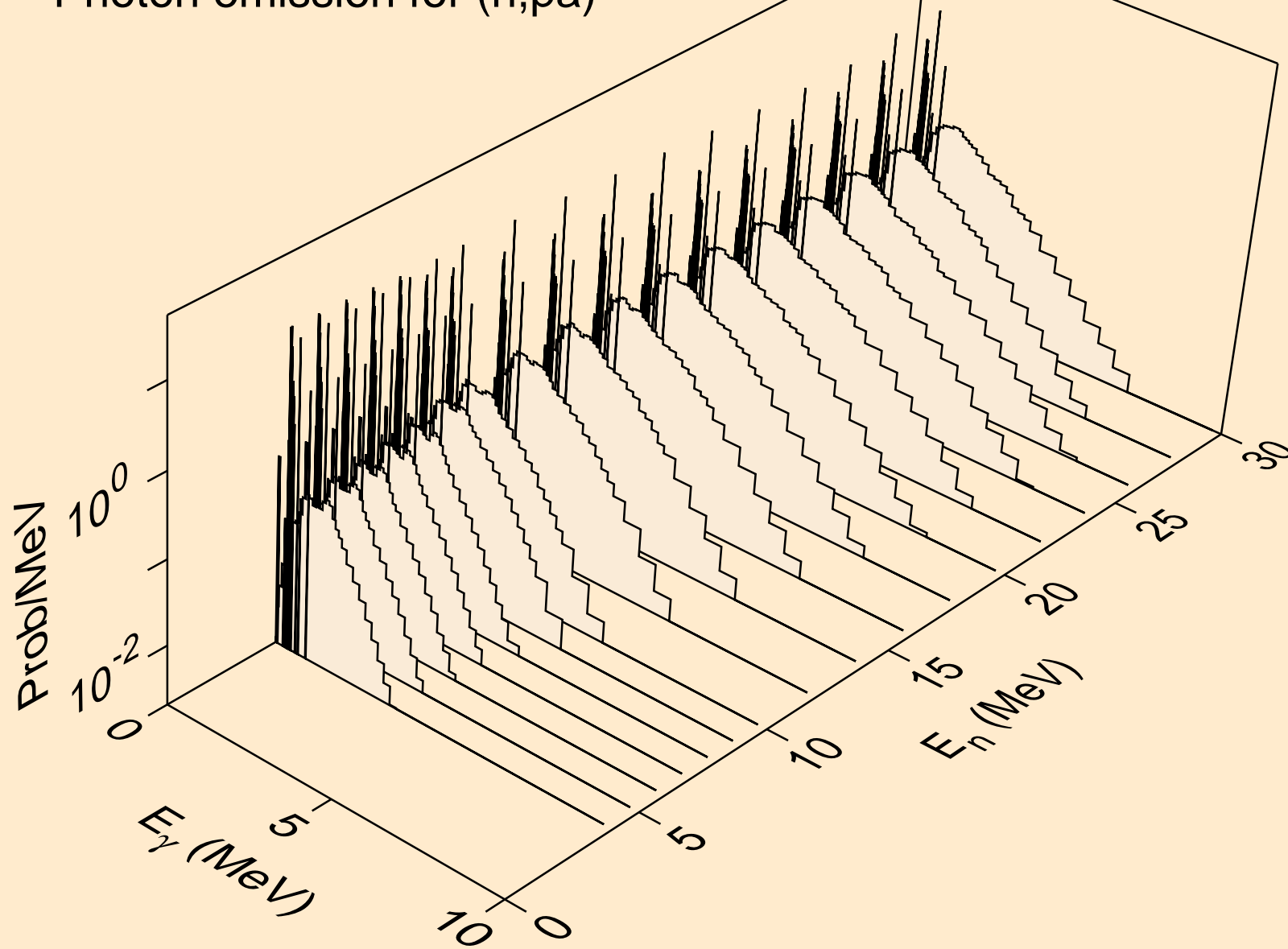



DY145M TRITON ACER TENDL-2021 LIBRARY; T=0.K  
Photon emission for (n,d2a)

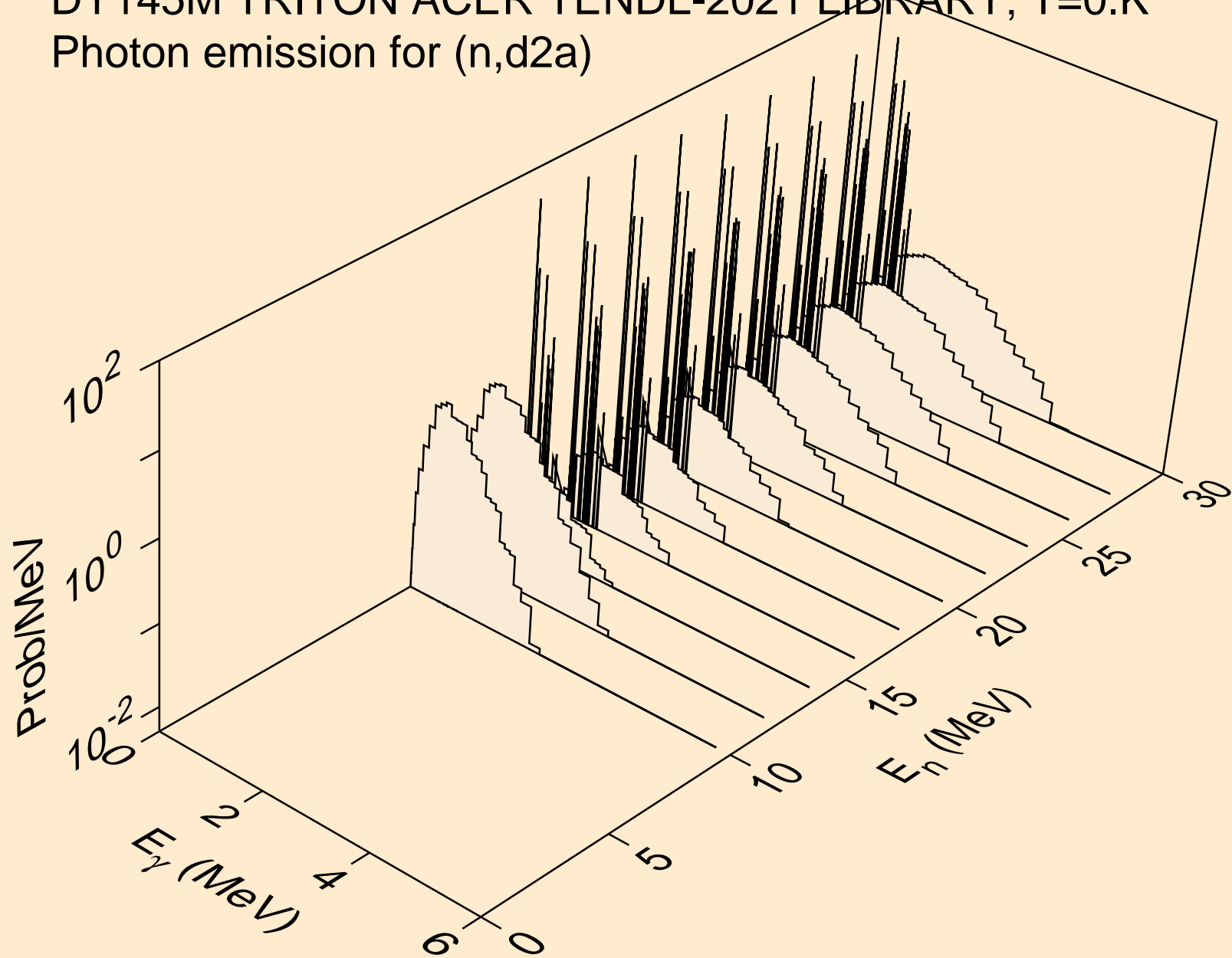

DY145M TRITON ACER TENDL-2021 LIBRARY; T=0.K  
Photon emission for (n,pd)

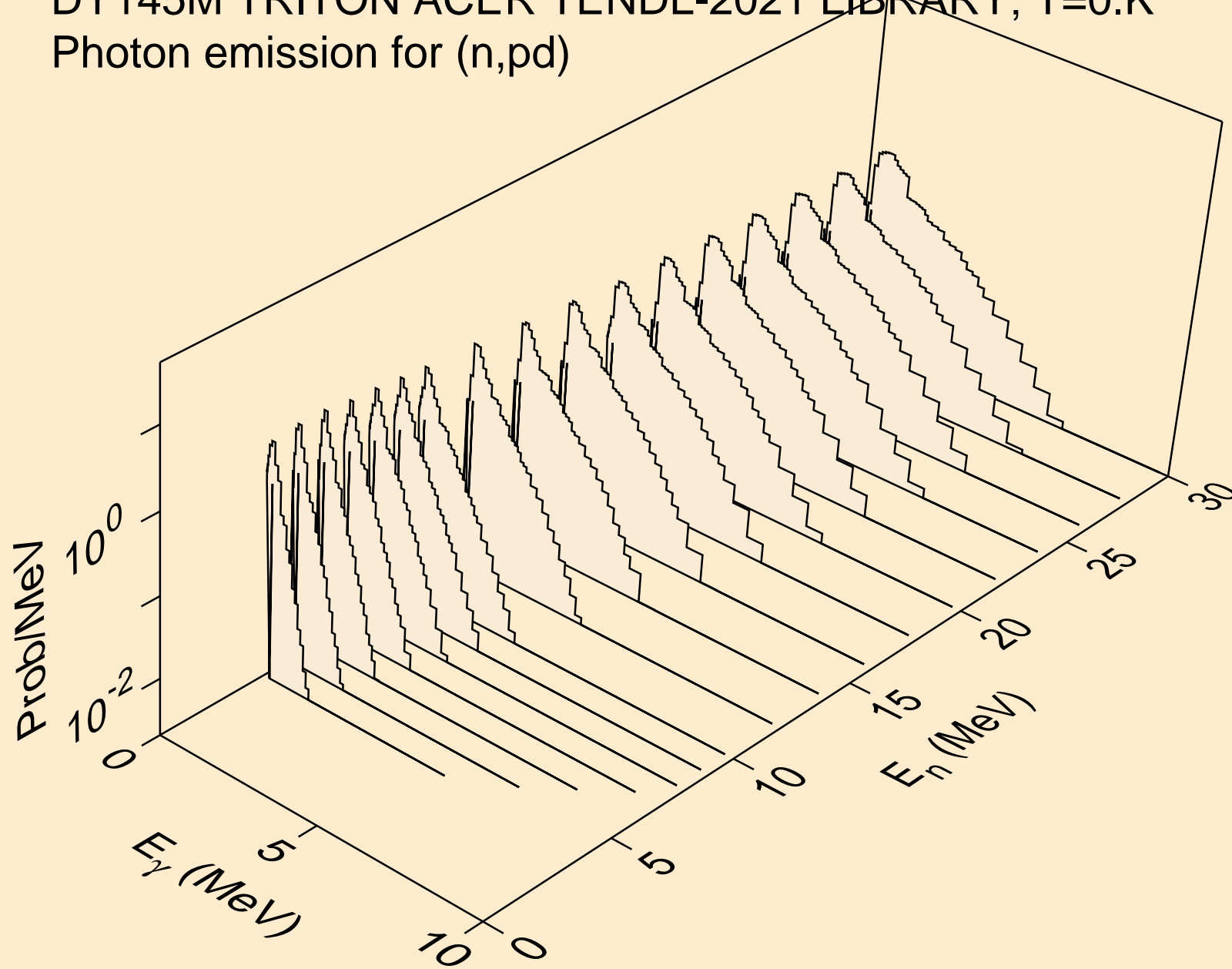

DY145M TRITON ACER TENDL-2021 LIBRARY; T=0.K  
Photon emission for (n,pt)

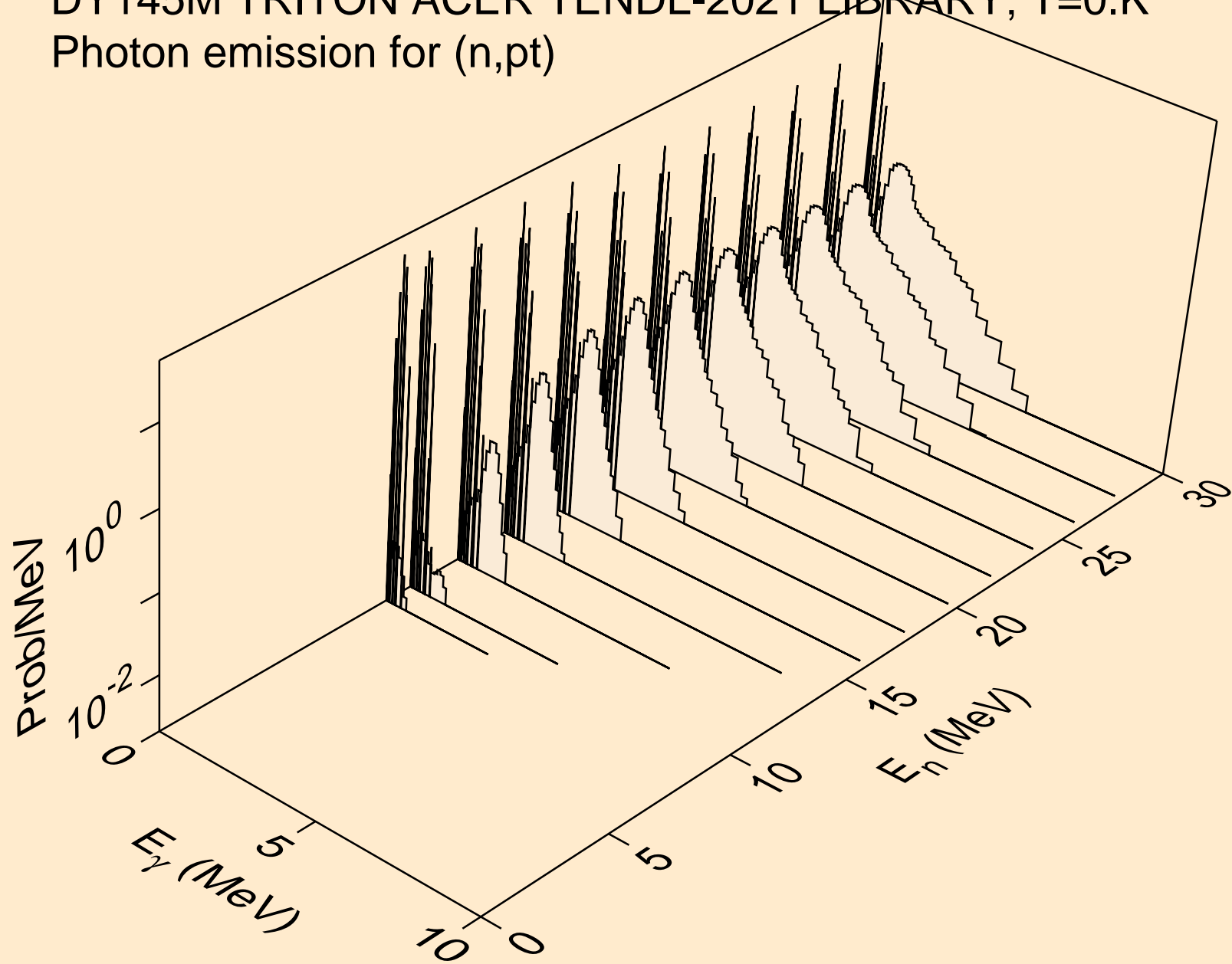

DY145M TRITON ACER TENDL-2021 LIBRARY; T=0.K  
Photon emission for (n,da)

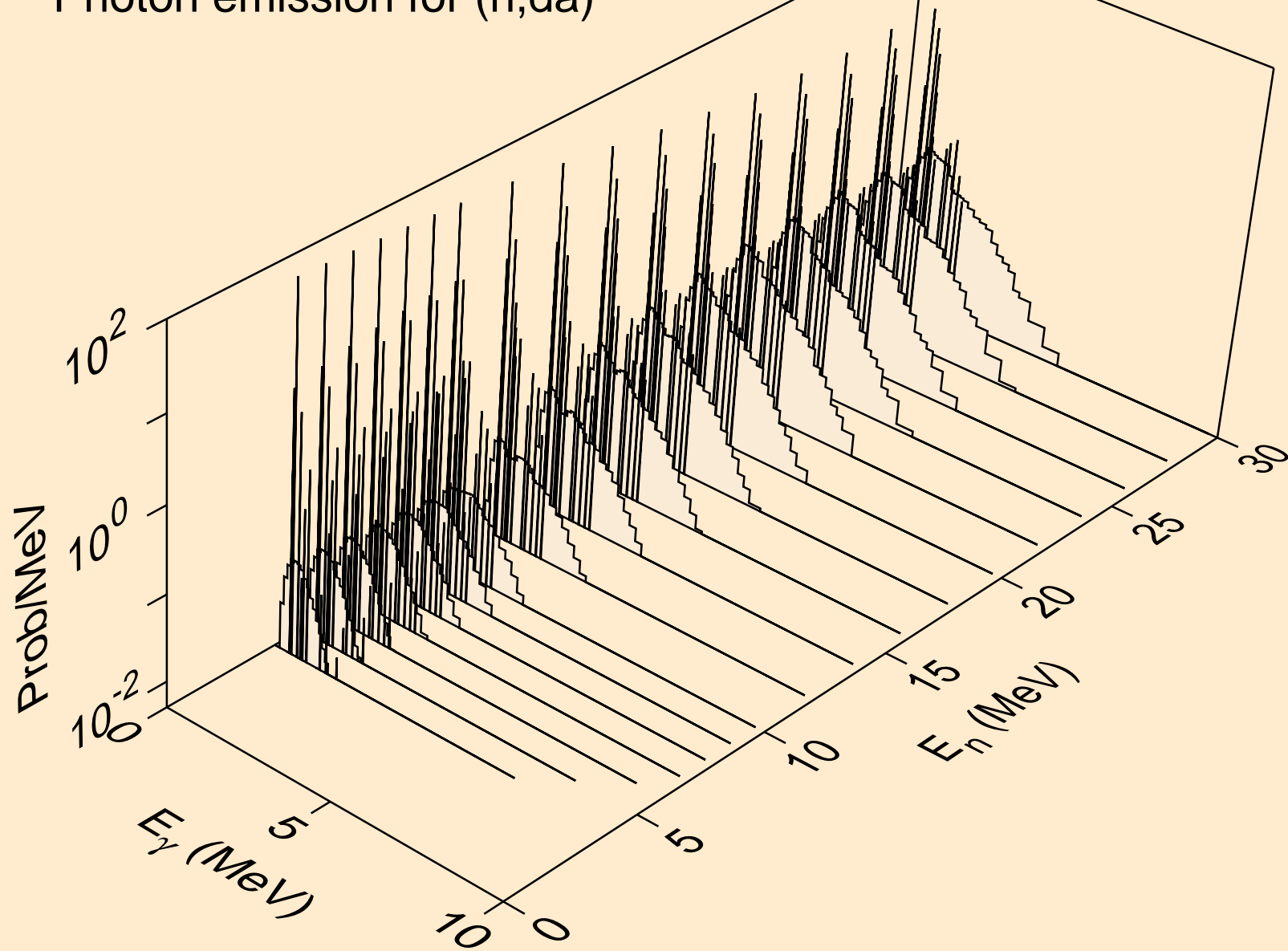

DY145M TRITON ACER TENDL-2021 LIBRARY; T=0.K  
Particle heating contributions

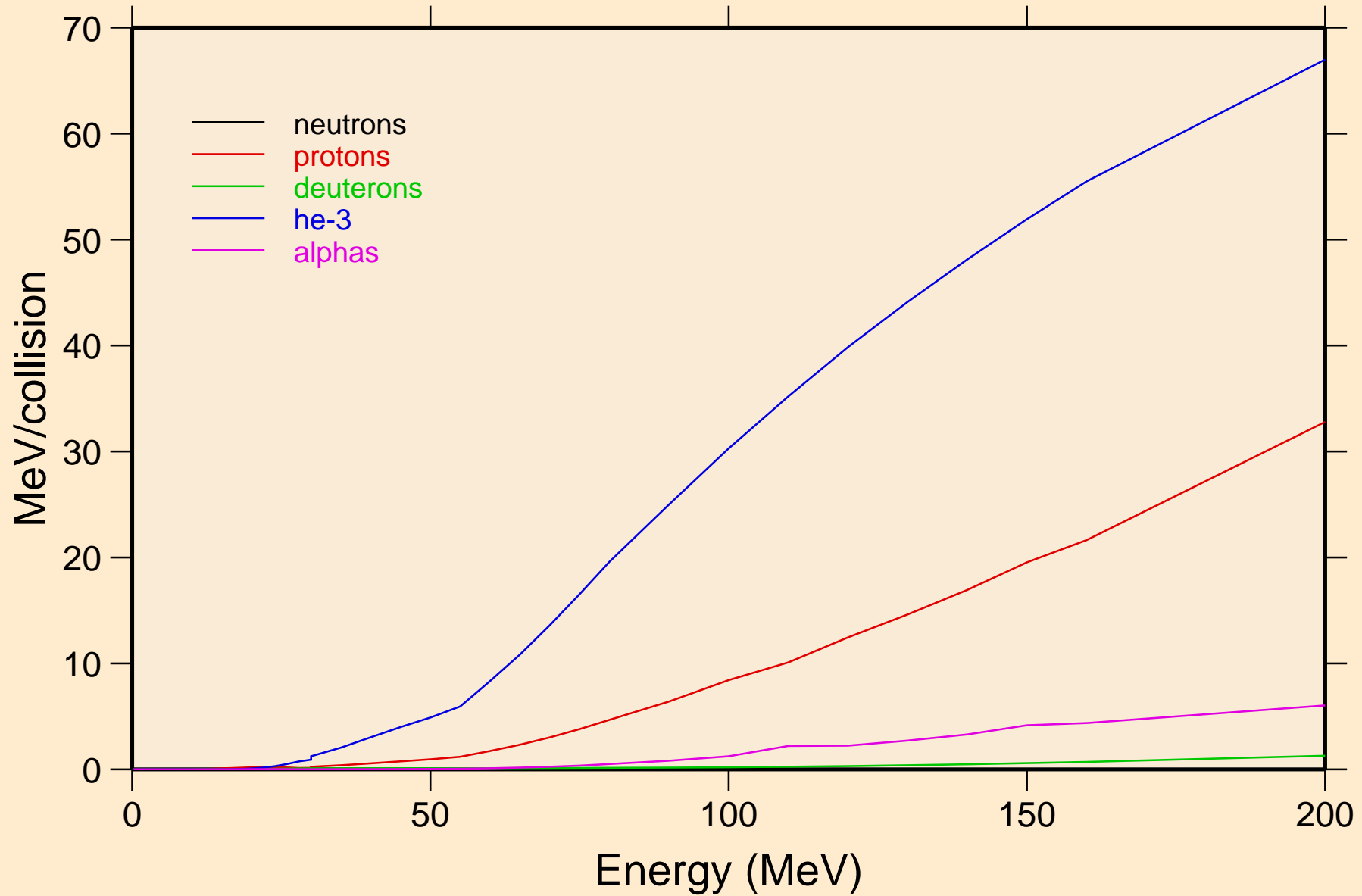

DY145M TRITON ACER TENDL-2021 LIBRARY; T=0.K  
Recoil Heating

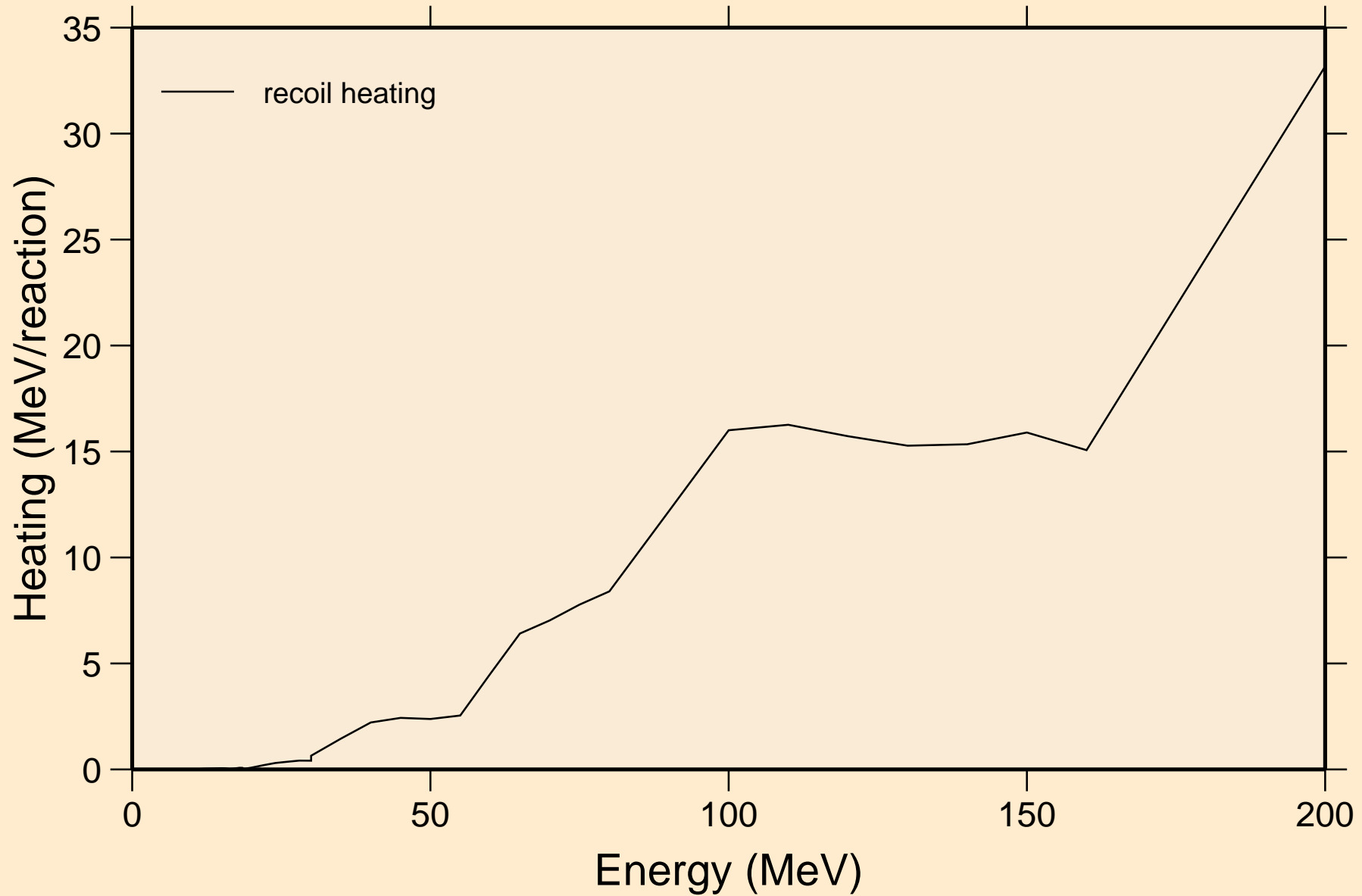

DY145M TRITON ACER TENDL-2021 LIBRARY; T=0.K  
Particle production cross sections

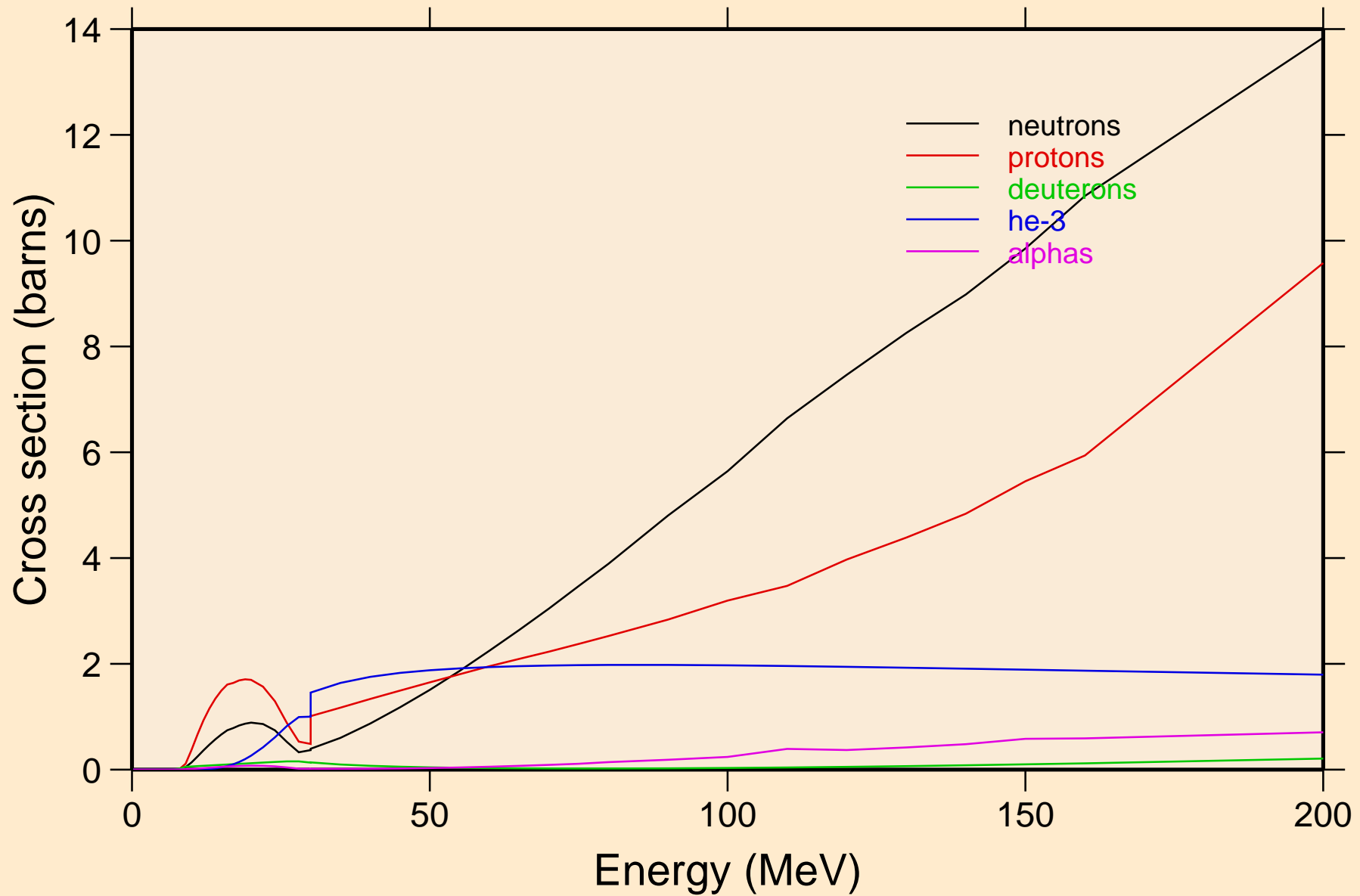

DY145M TRITON ACER TENDL-2021 LIBRARY; T=0.K  
neutrons from (t,n)

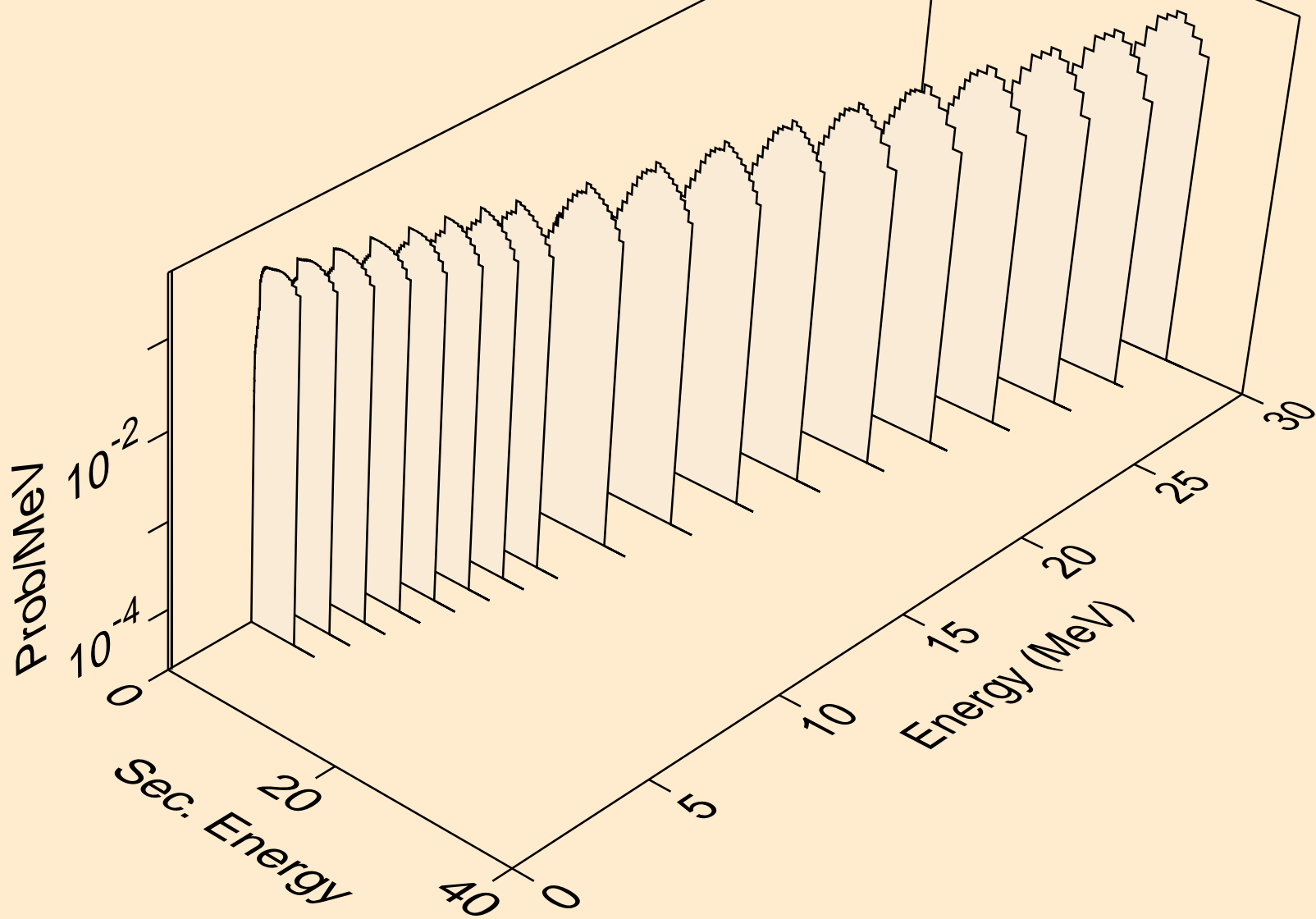



DY145M TRITON ACER TENDL-2021 LIBRARY; T=0.K  
neutrons from (t,x)

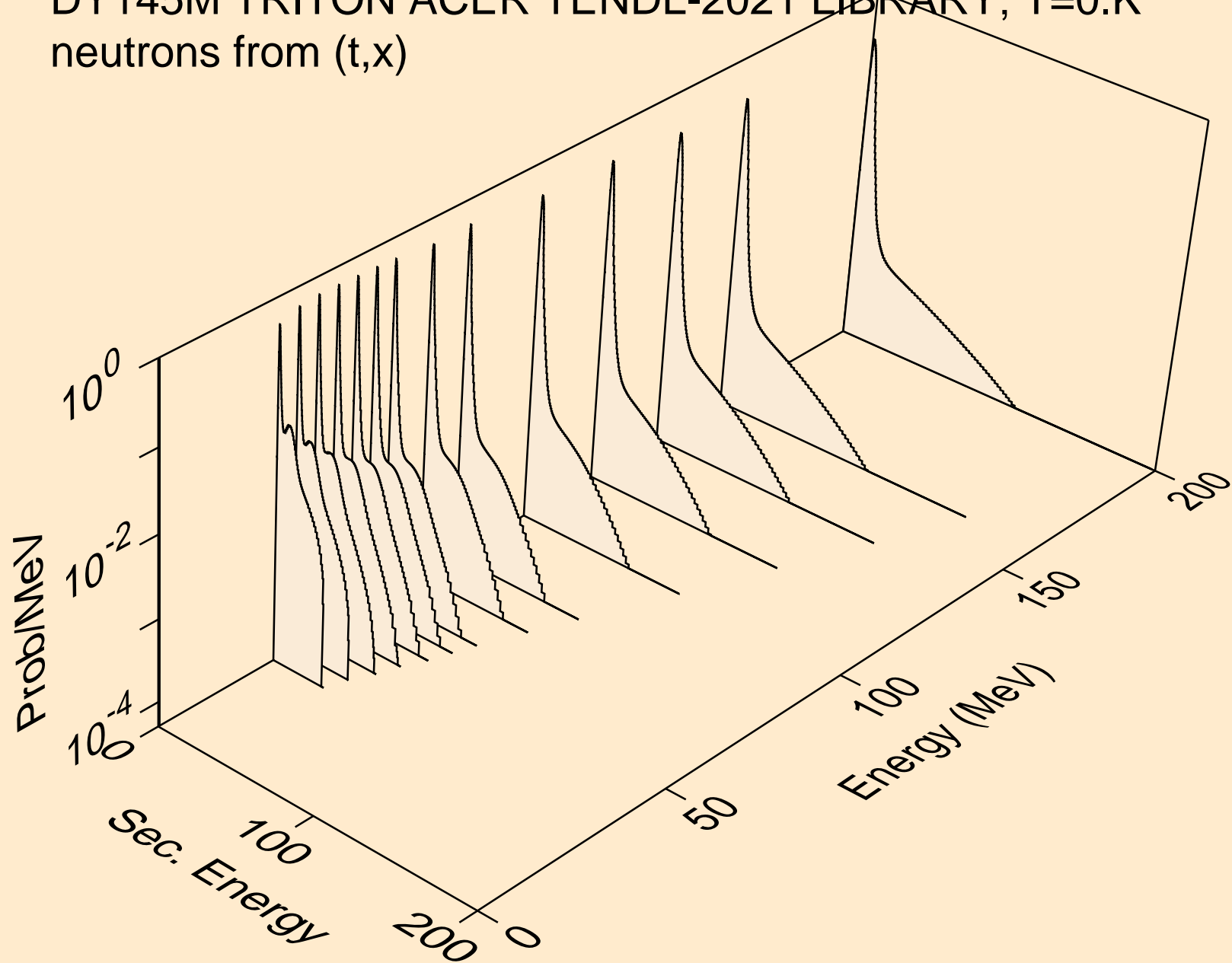

DY145M TRITON ACER TENDL-2021 LIBRARY; T=0.K  
neutrons from (t,2nd)

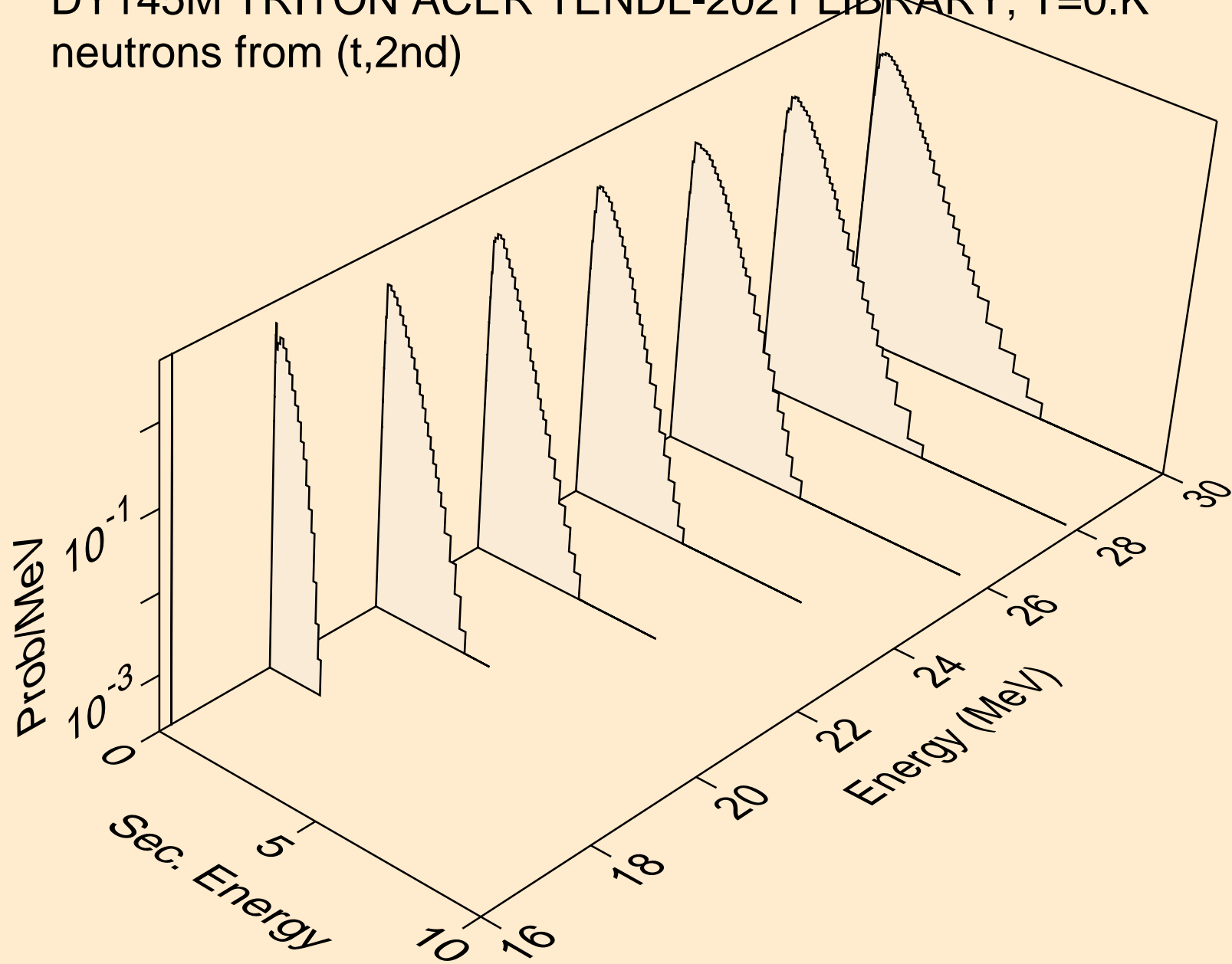

DY145M TRITON ACER TENDL-2021 LIBRARY; T=0.K  
neutrons from (t,2n)

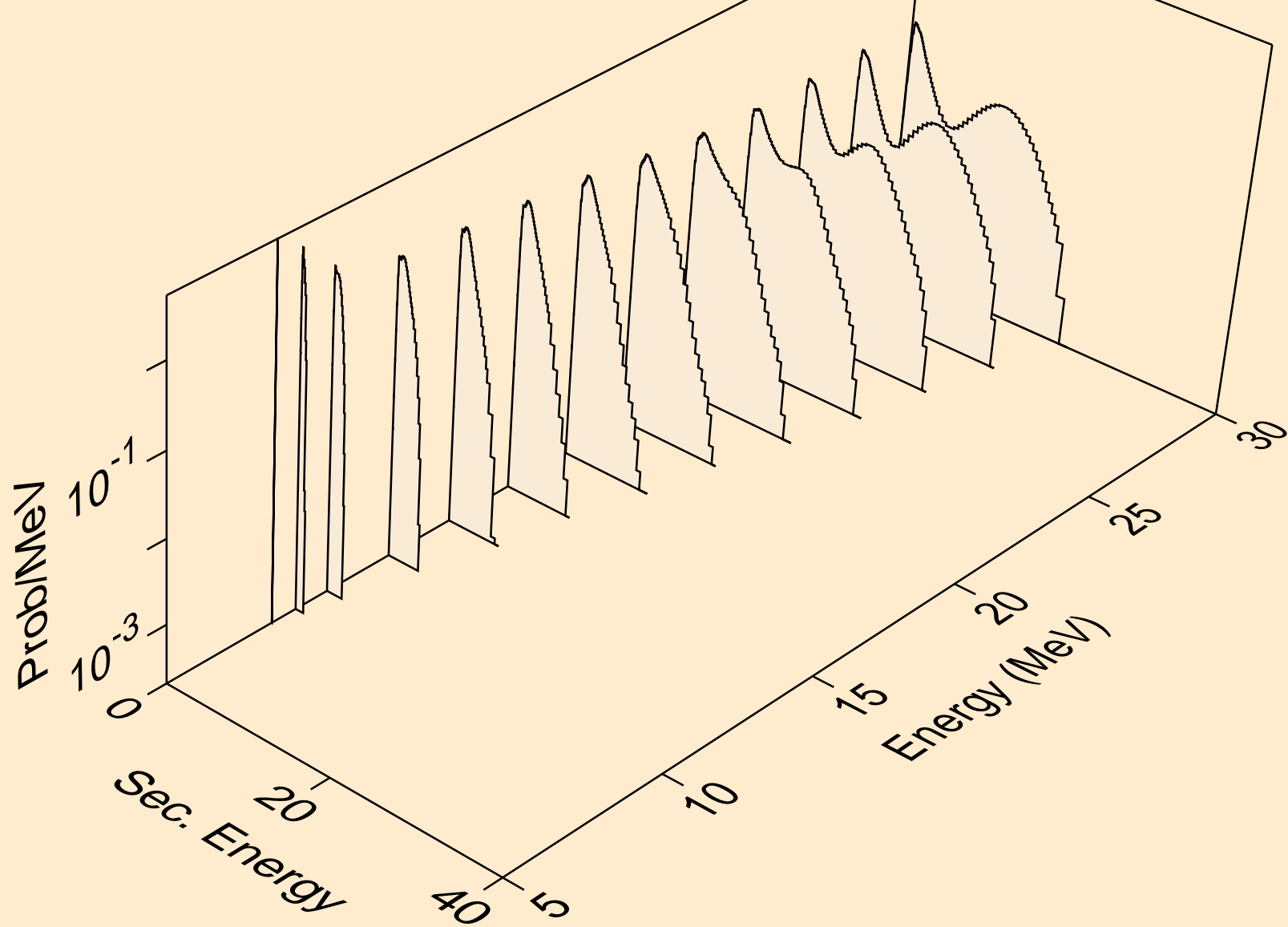

DY145M TRITON ACER TENDL-2021 LIBRARY; T=0.K  
neutrons from (t,3n)

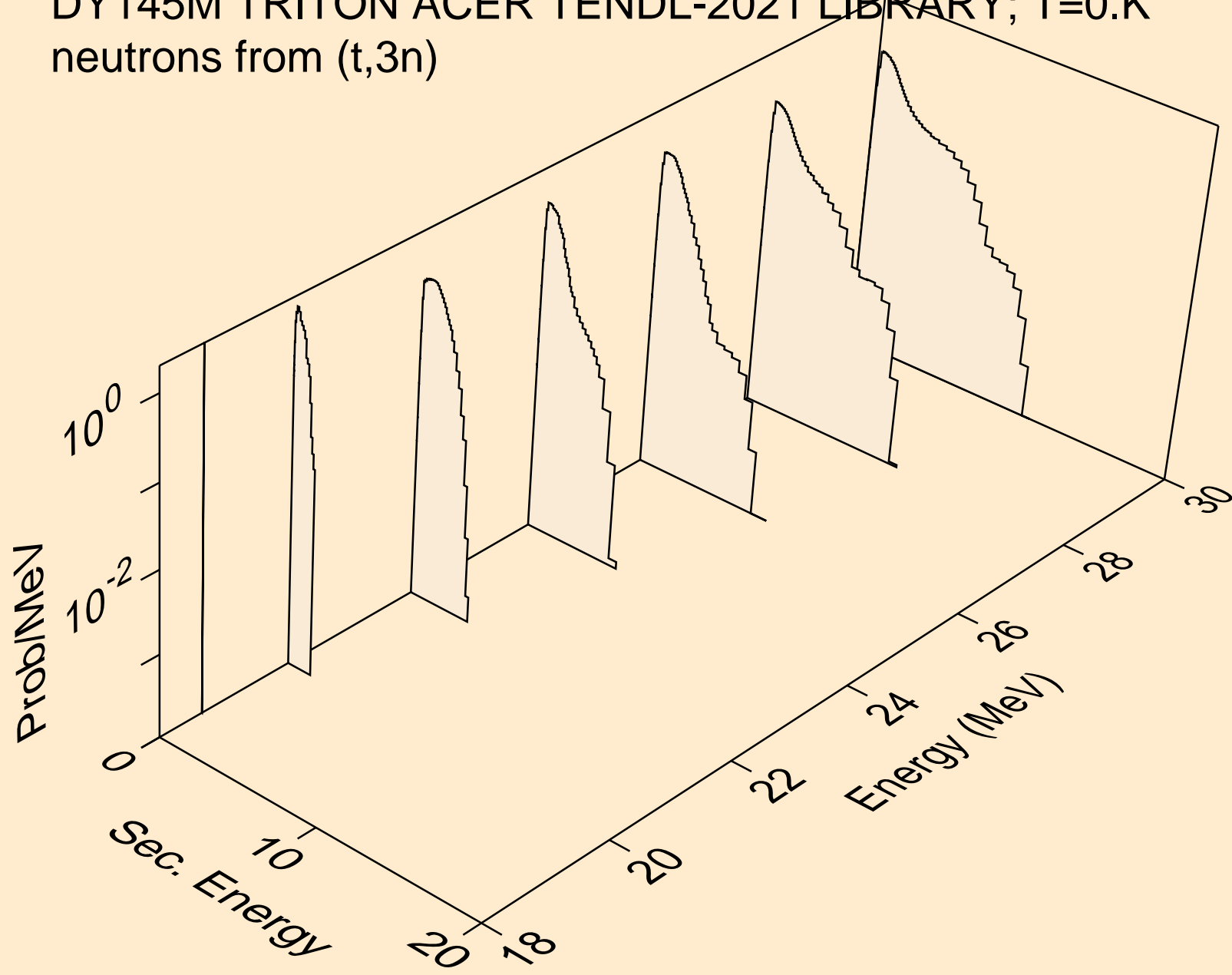

DY145M TRITON ACER TENDL-2021 LIBRARY; T=0.K  
neutrons from (t,n\*)a

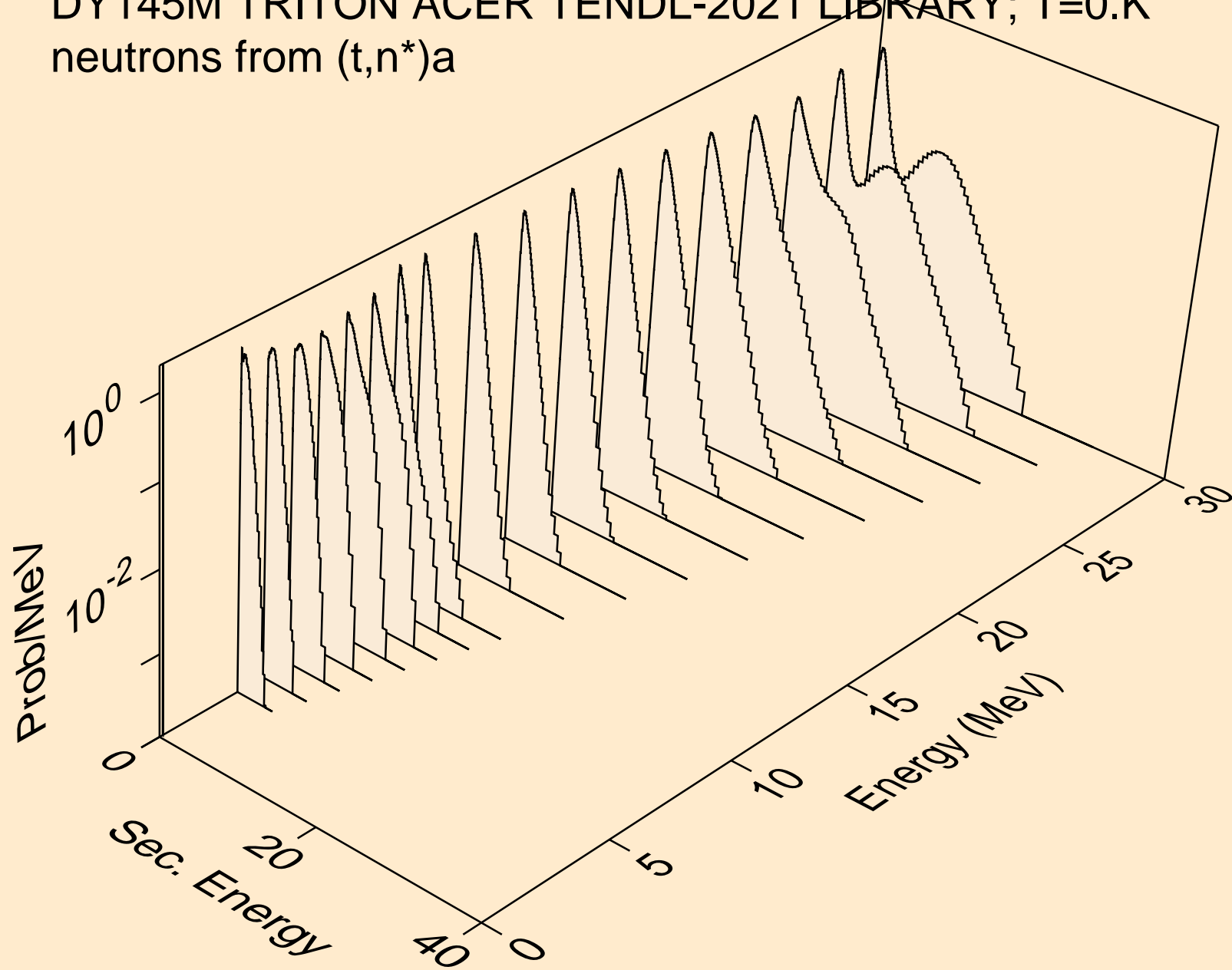

DY145M TRITON ACER TENDL-2021 LIBRARY; T=0.K  
neutrons from (t,2n)a

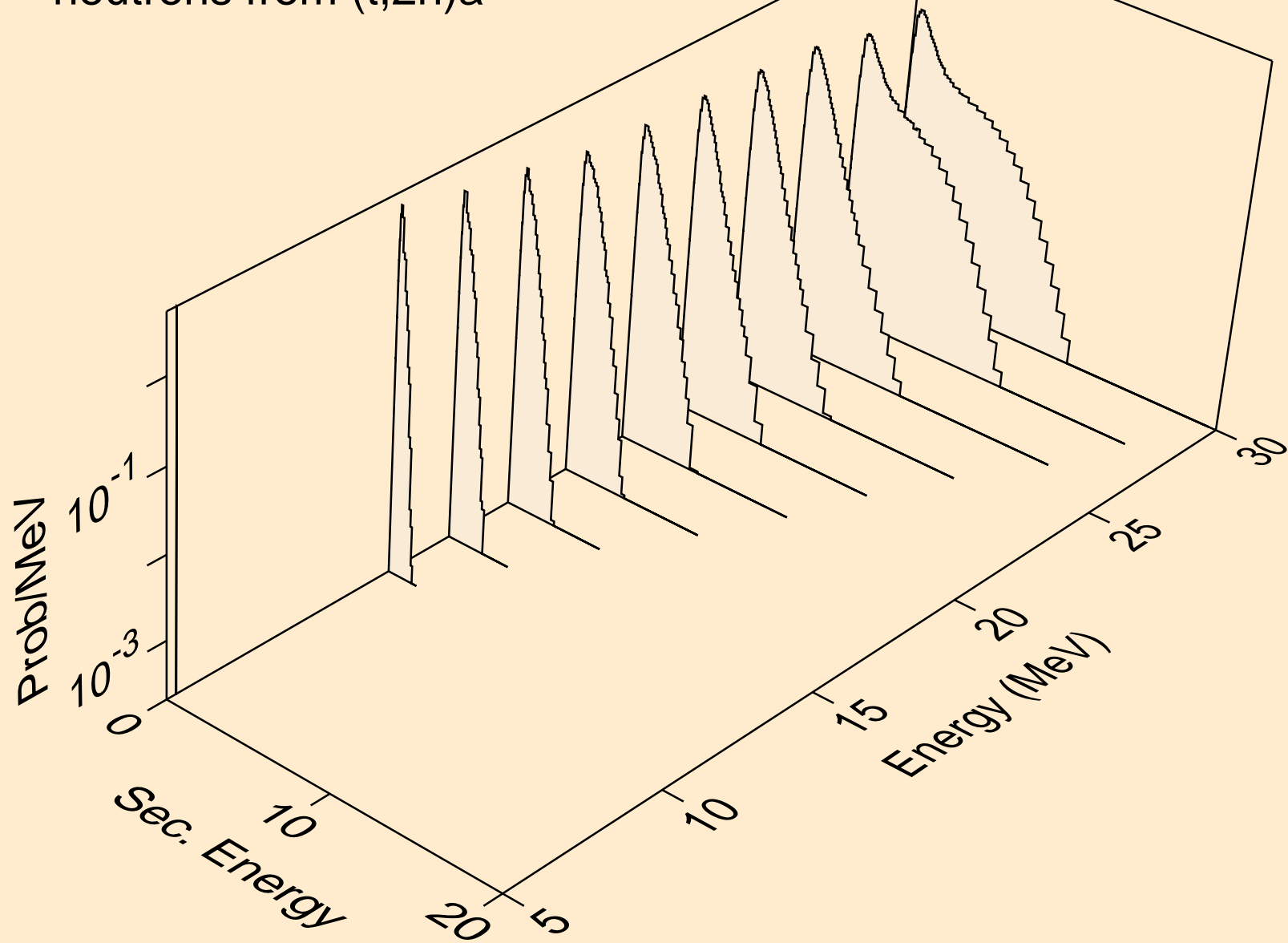

DY145M TRITON ACER TENDL-2021 LIBRARY; T=0.K  
neutrons from (t,3n)a

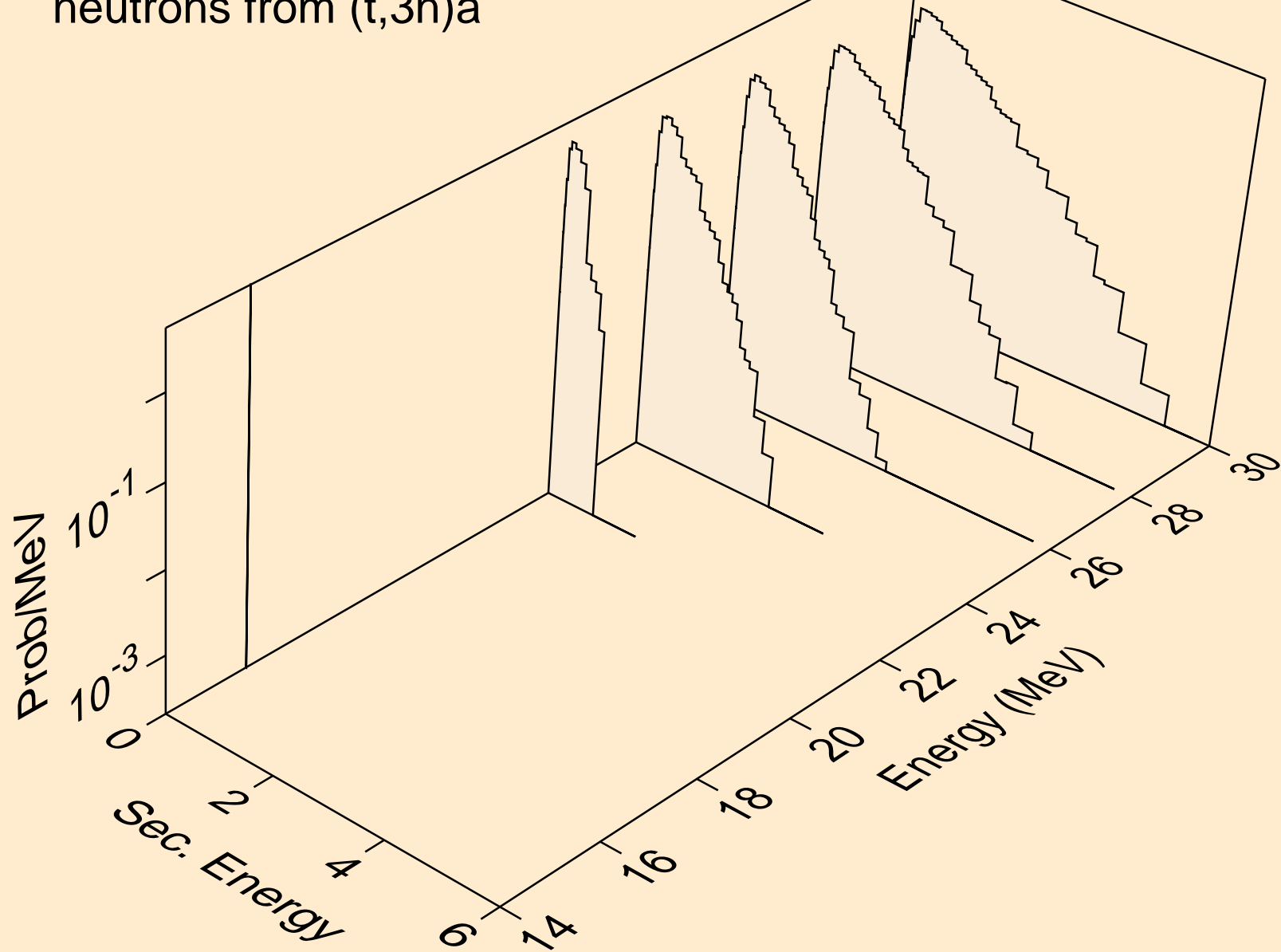

DY145M TRITON ACER TENDL-2021 LIBRARY; T=0.K  
neutrons from (t,n\*)p

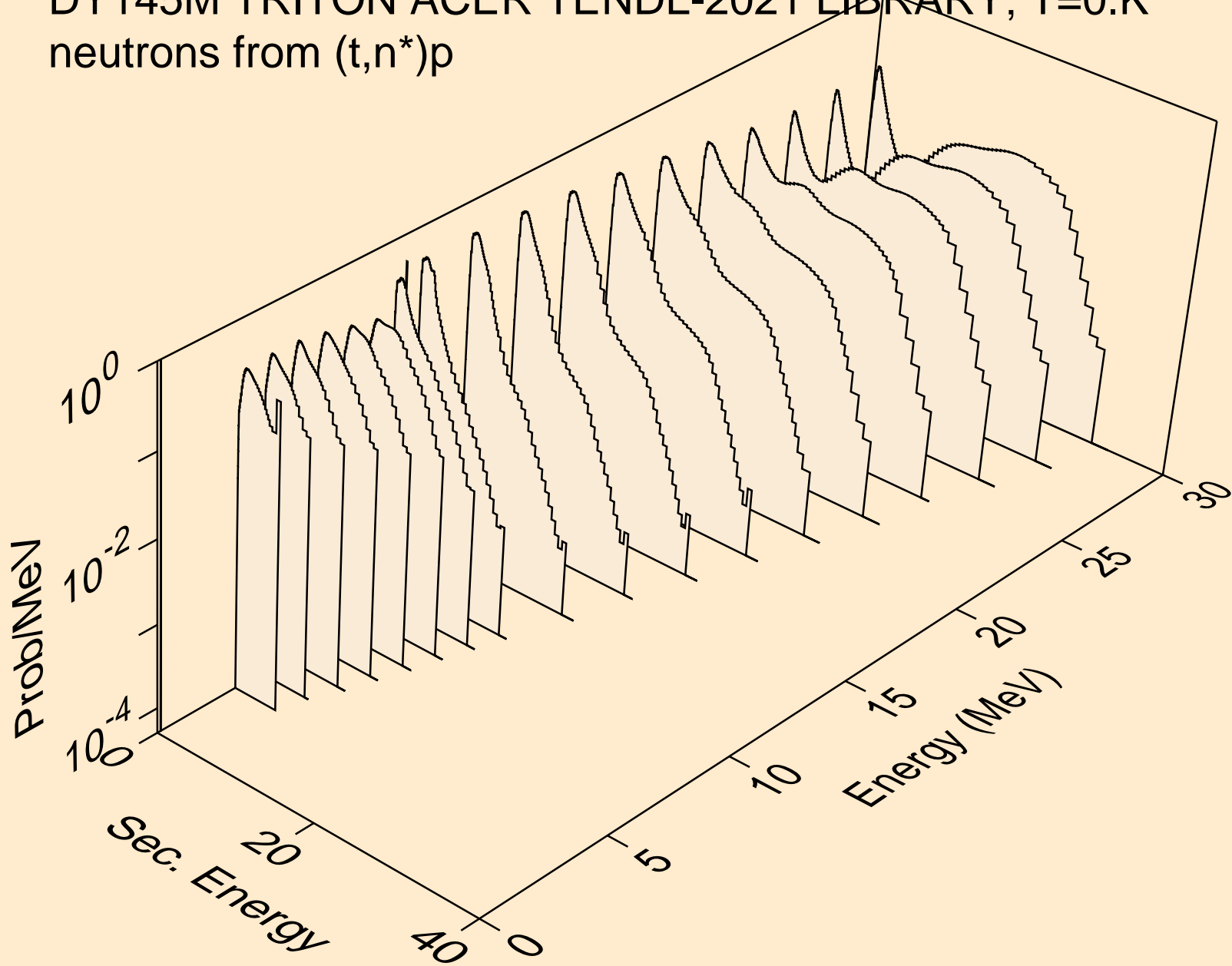



DY145M TRITON ACER TENDL-2021 LIBRARY; T=0.K  
neutrons from (t,n\*)2a

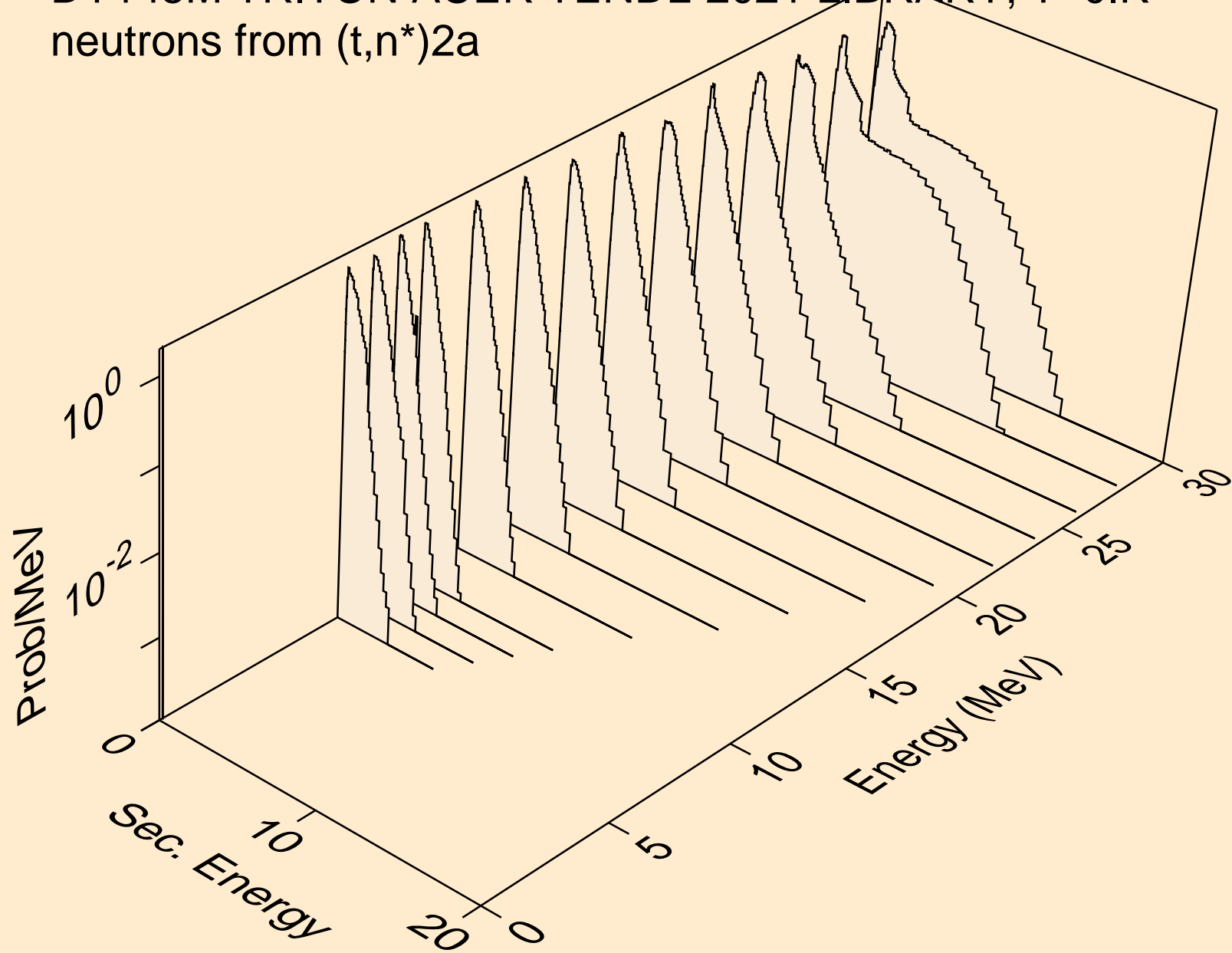

DY145M TRITON ACER TENDL-2021 LIBRARY; T=0.K  
neutrons from (t,n\*)d

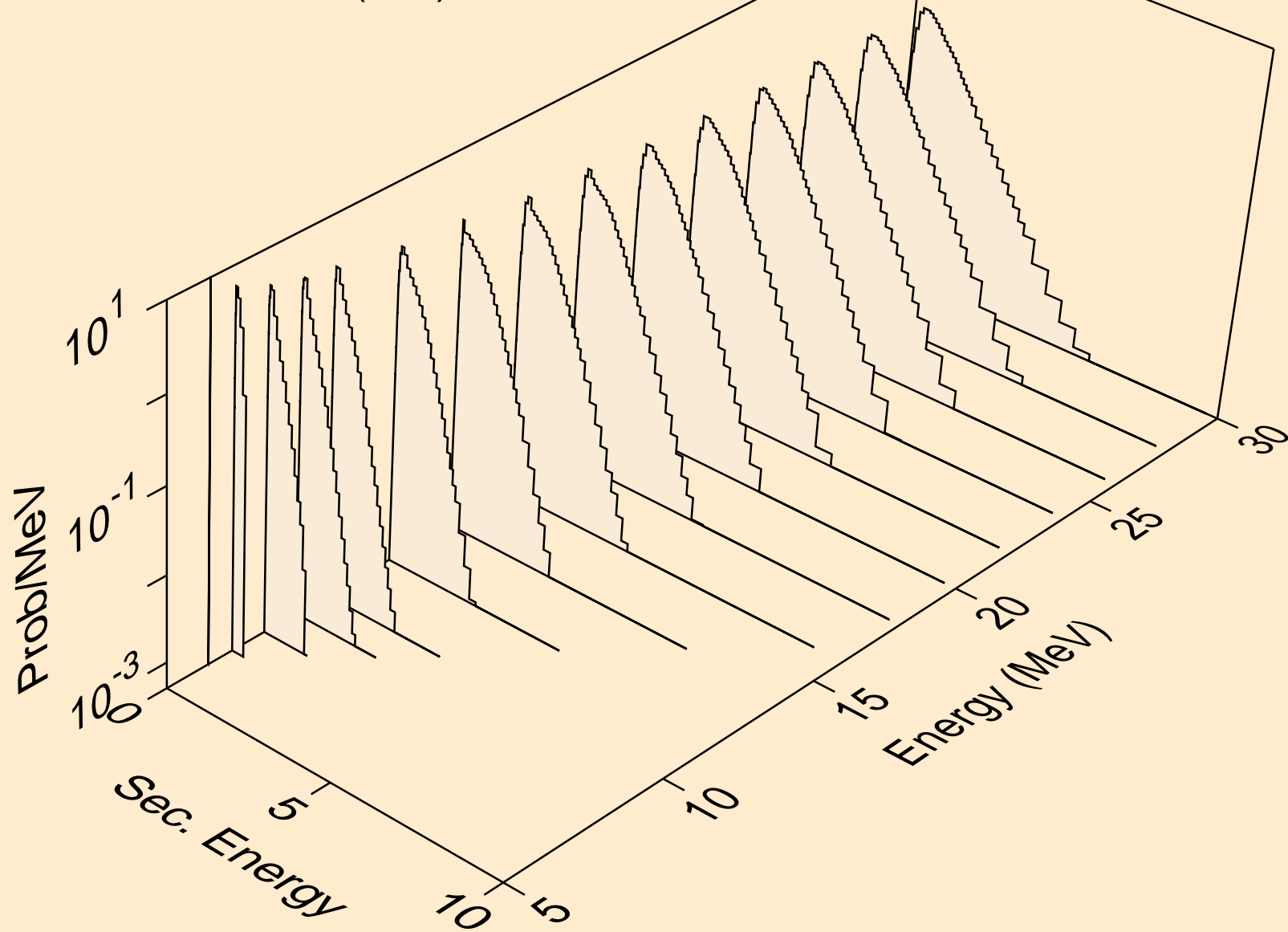

DY145M TRITON ACER TENDL-2021 LIBRARY; T=0.K  
neutrons from (t,n\*)t

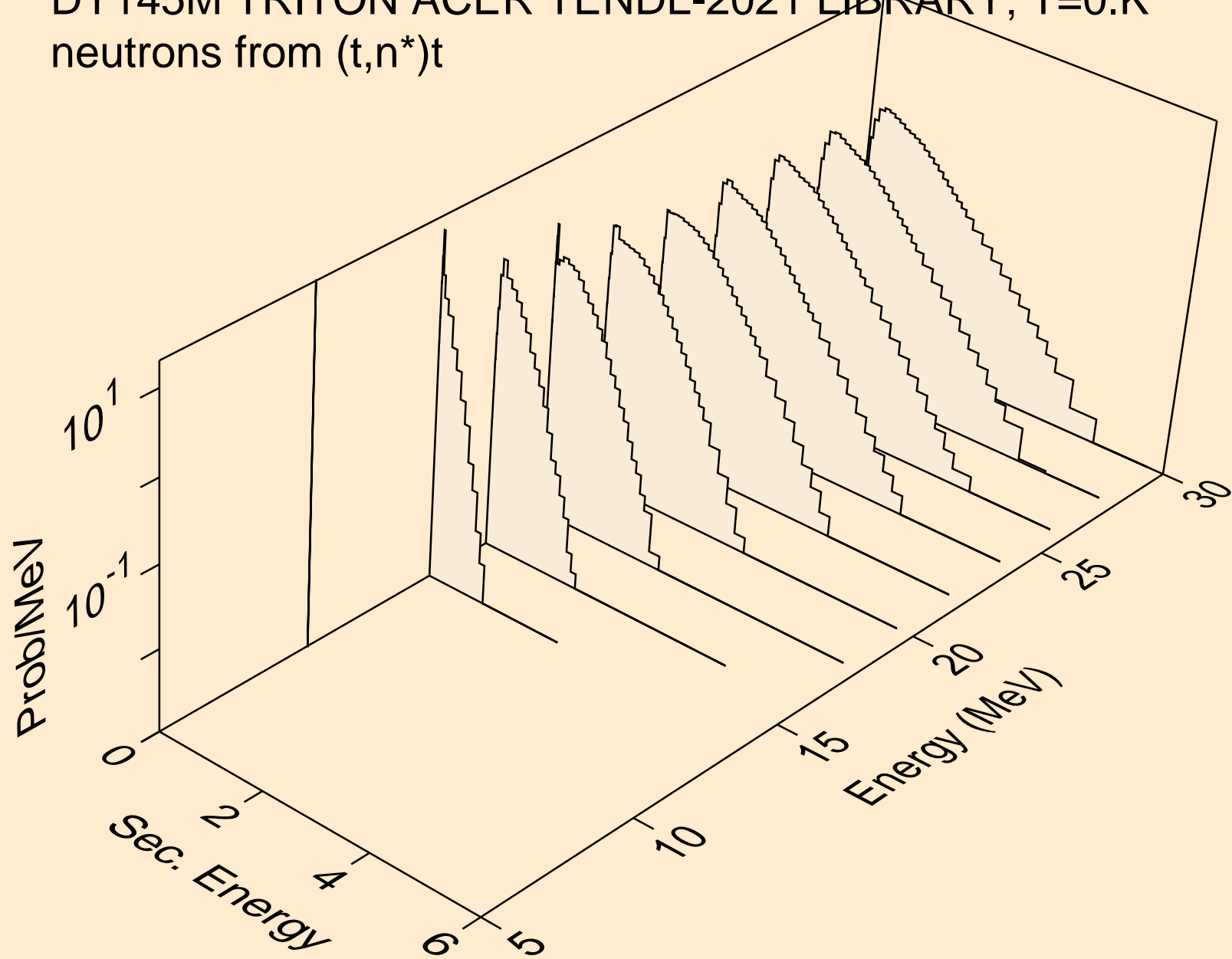

DY145M TRITON ACER TENDL-2021 LIBRARY; T=0.K  
neutrons from (t,n\*)he3

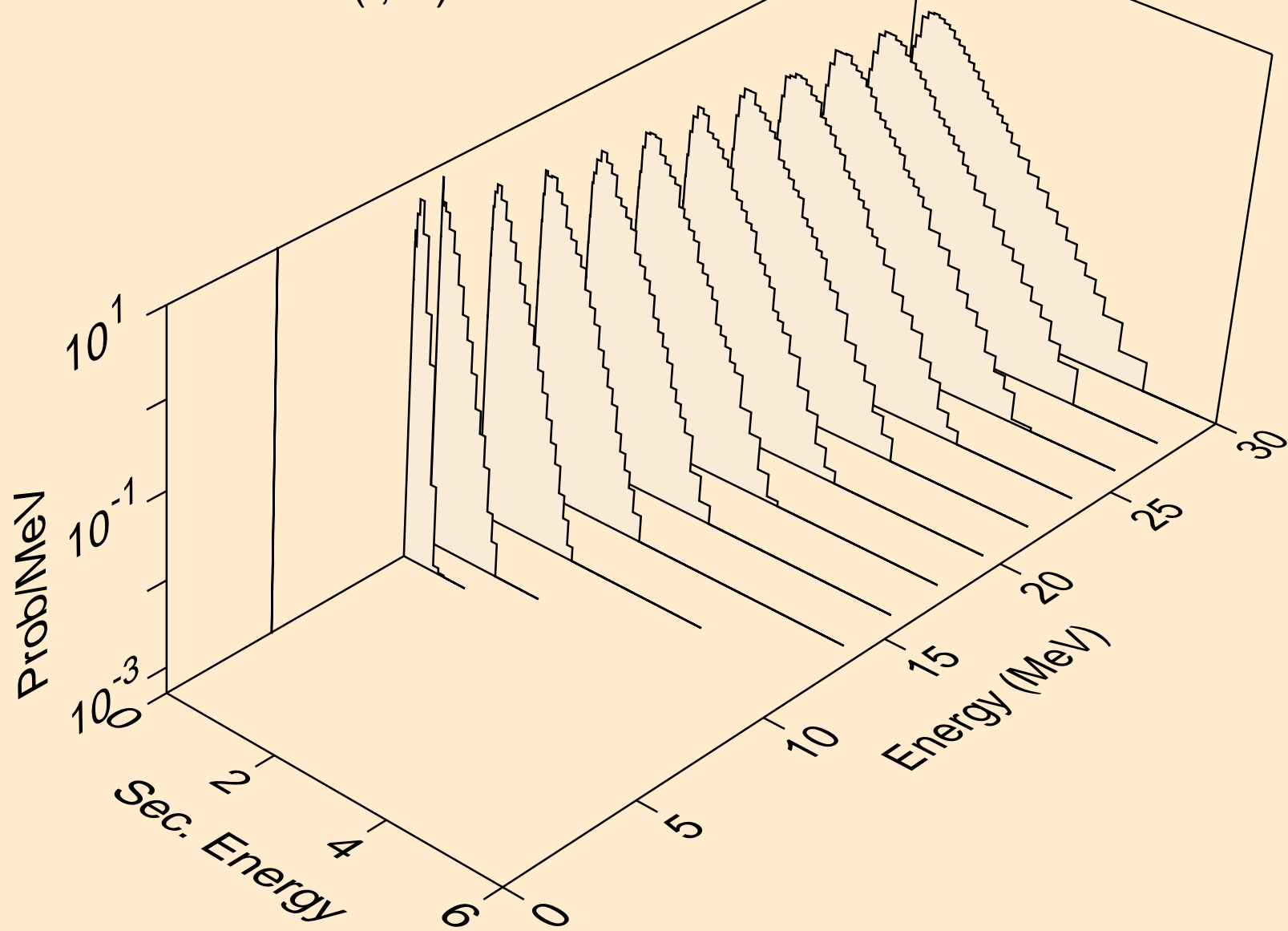

DY145M TRITON ACER TENDL-2021 LIBRARY; T=0.K  
neutrons from (t,2np)

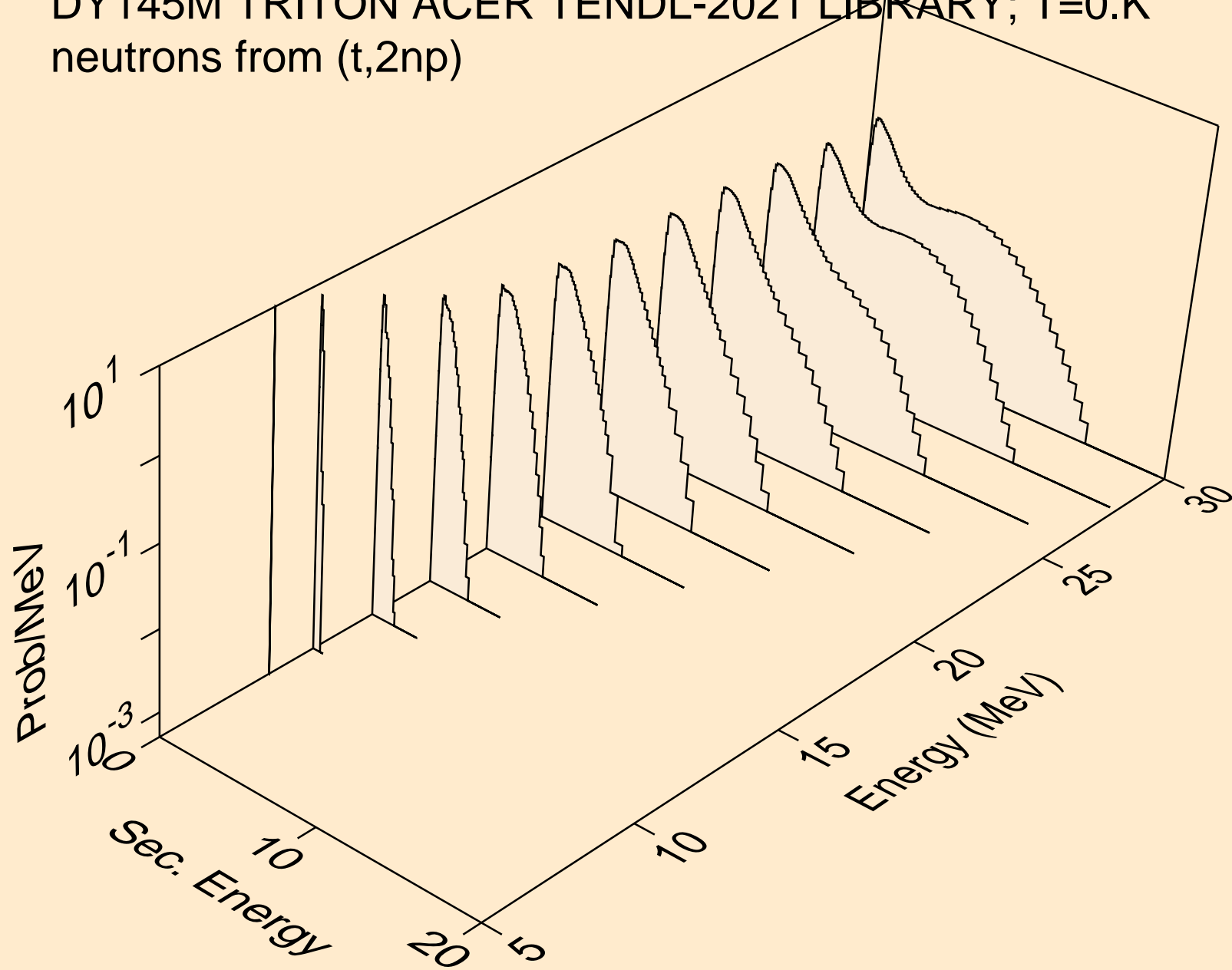

DY145M TRITON ACER TENDL-2021 LIBRARY; T=0.K  
neutrons from (t,3np)

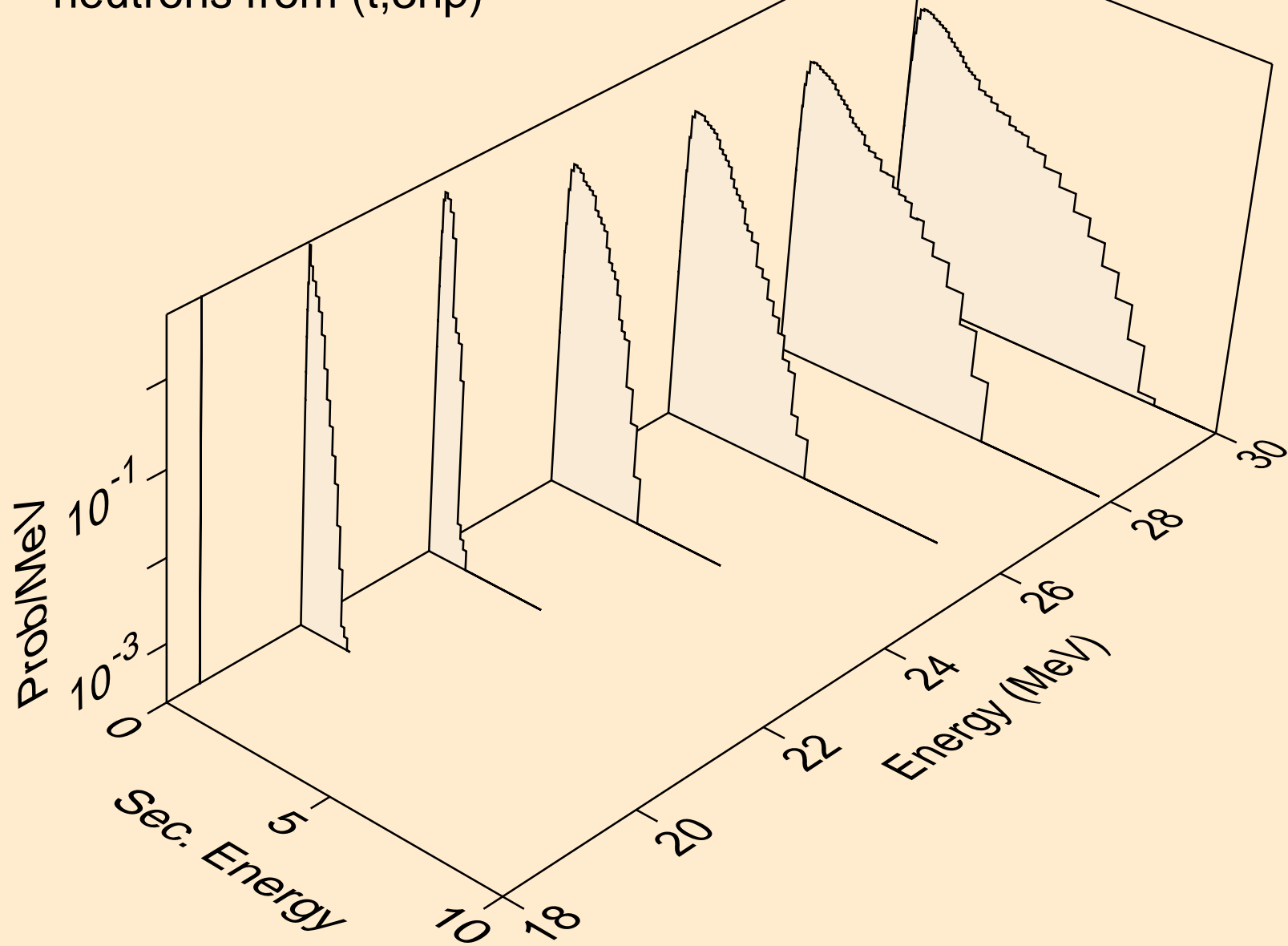

DY145M TRITON ACER TENDL-2021 LIBRARY; T=0.K  
neutrons from (t,2np)

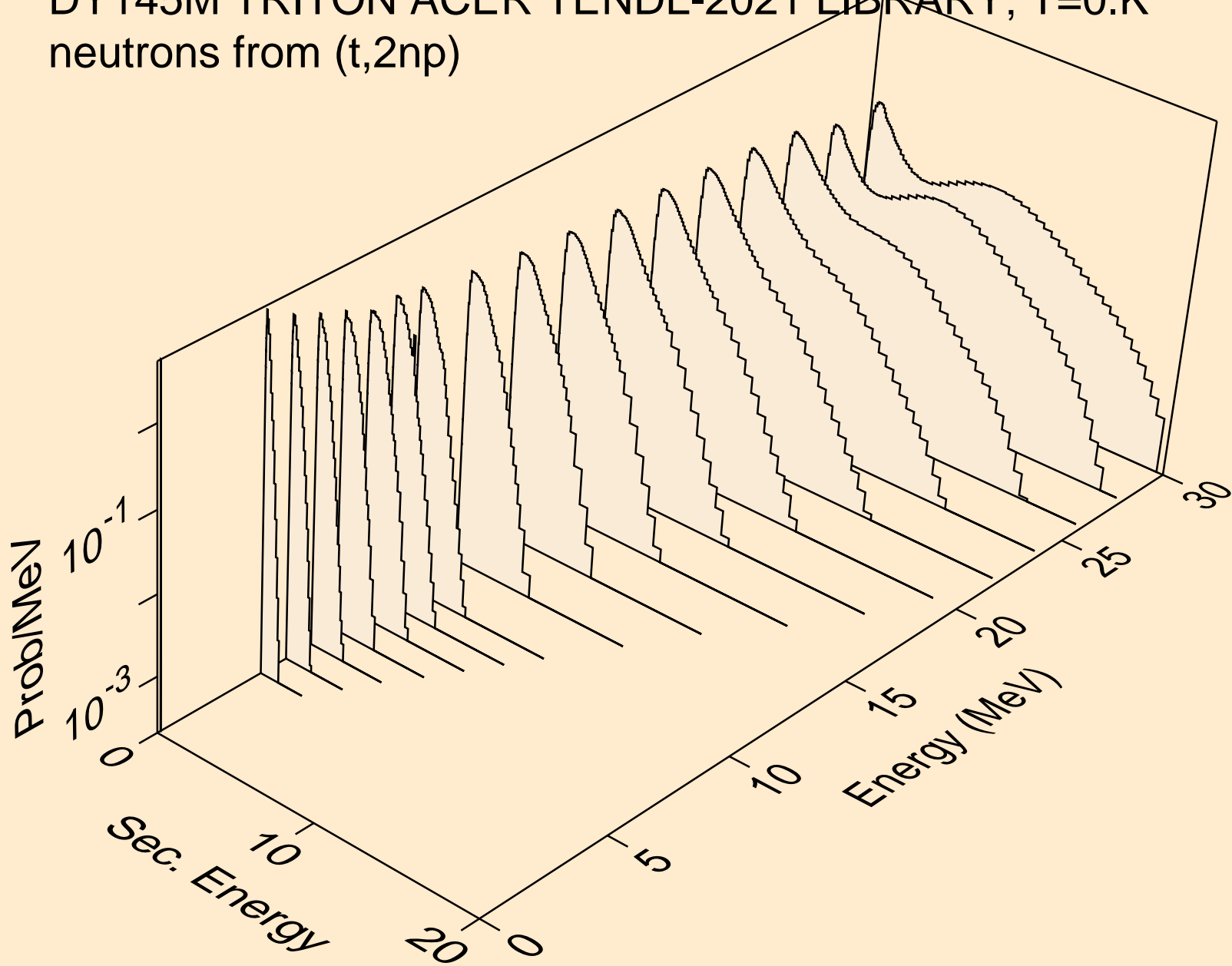

DY145M TRITON ACER TENDL-2021 LIBRARY; T=0.K  
neutrons from (t,npa)

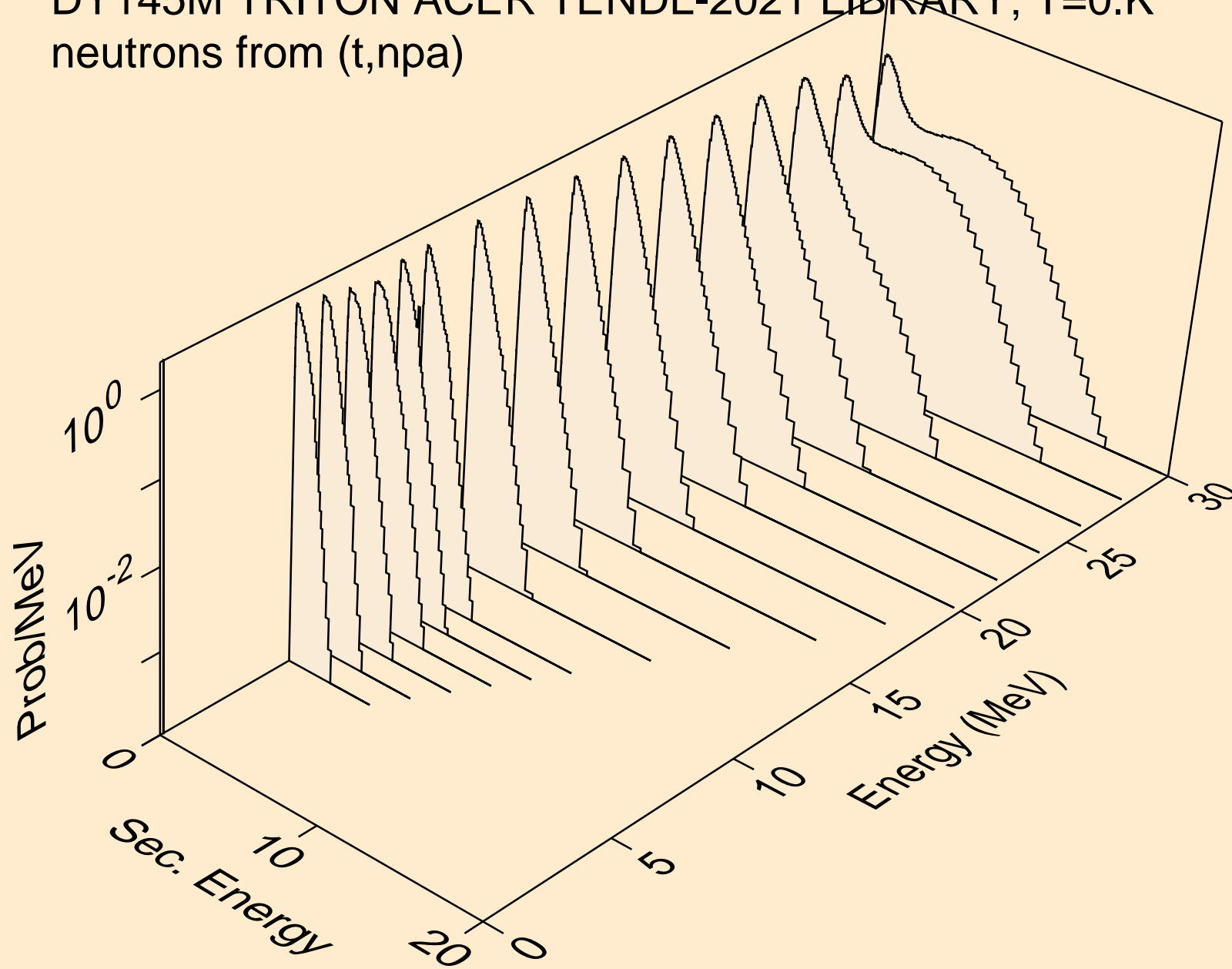



DY145M TRITON ACER TENDL-2021 LIBRARY; T=0.K  
protons from (t,x)

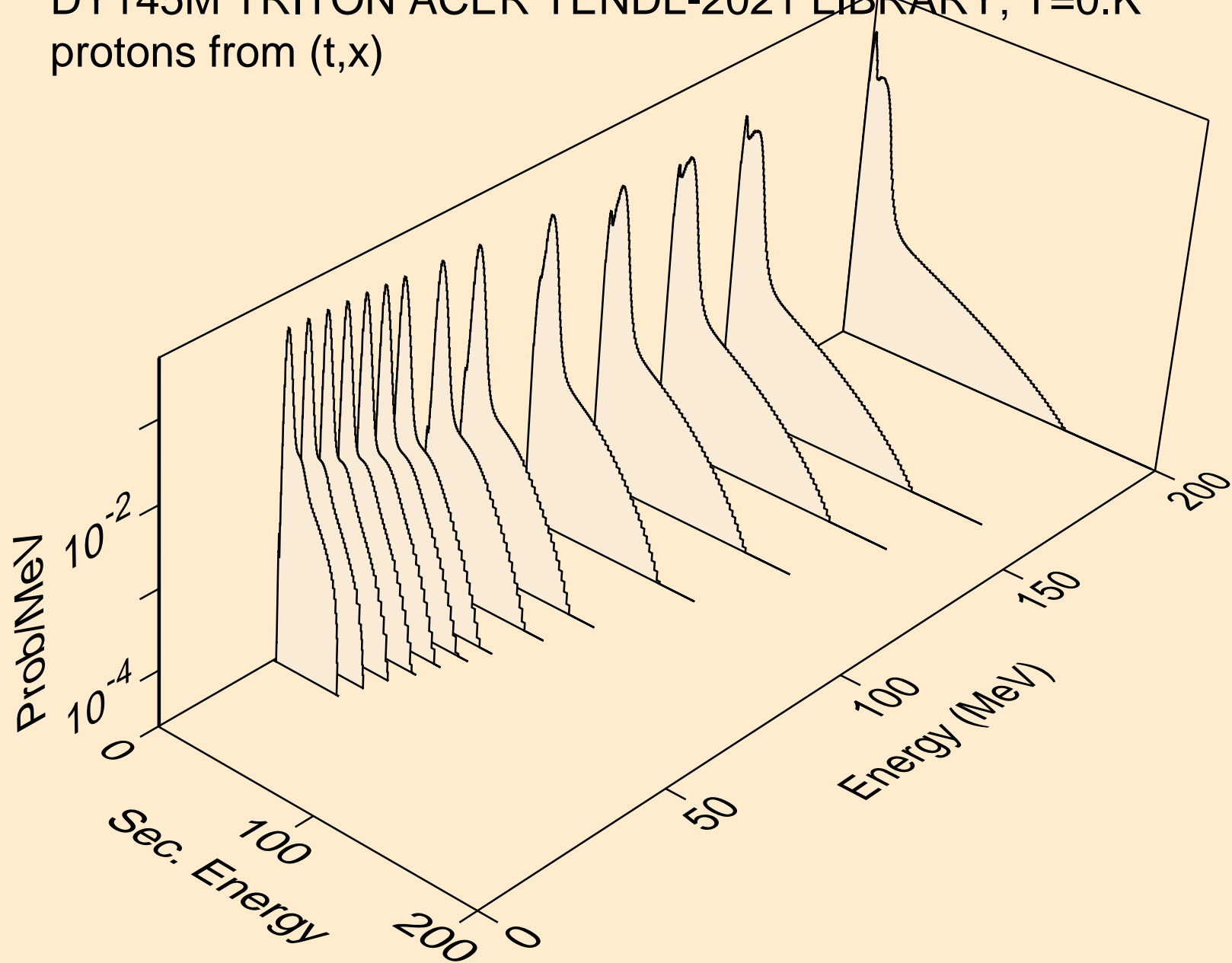

DY145M TRITON ACER TENDL-2021 LIBRARY; T=0.K  
protons from (t,n\*)p

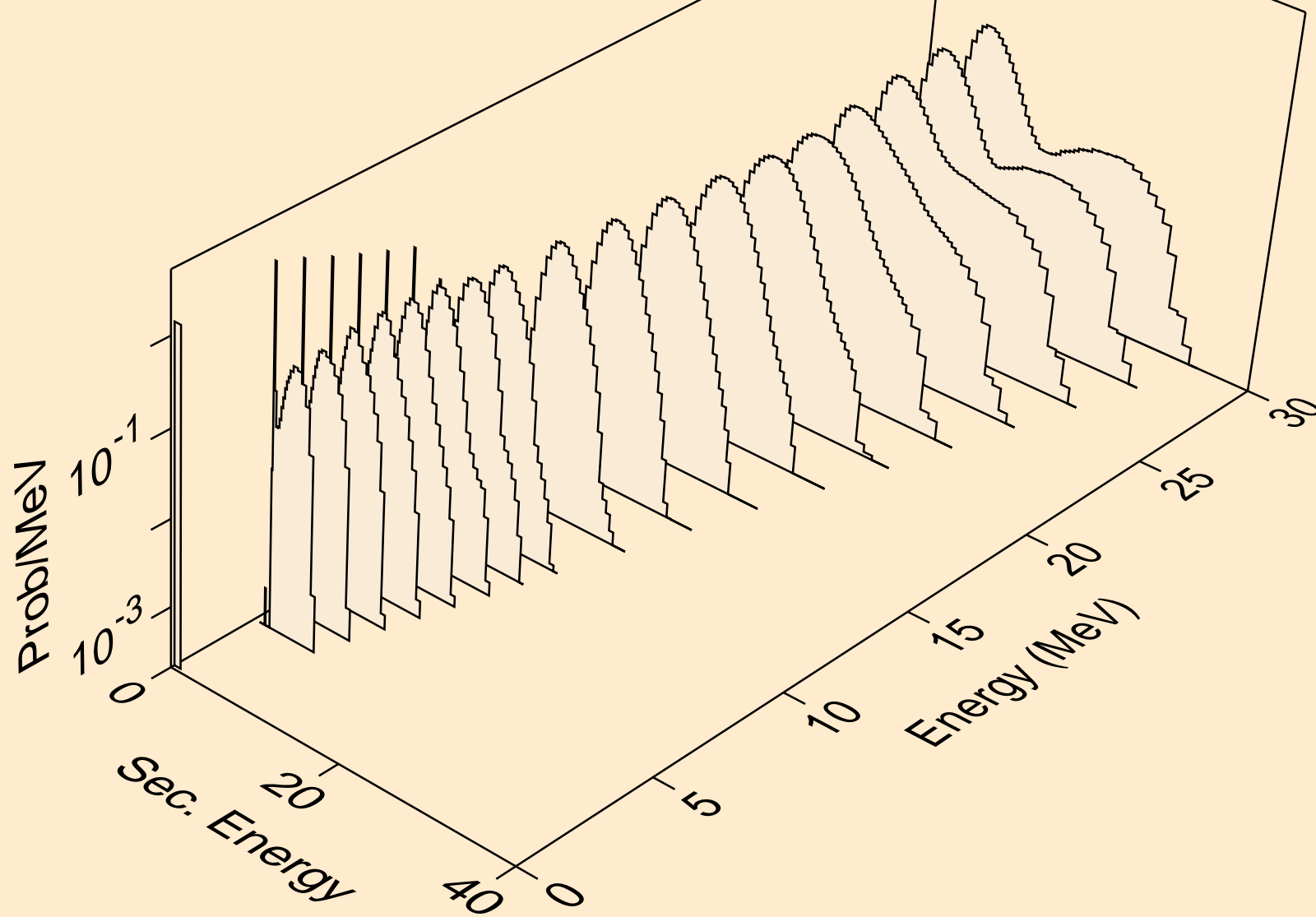

DY145M TRITON ACER TENDL-2021 LIBRARY; T=0.K  
protons from (t,2np)

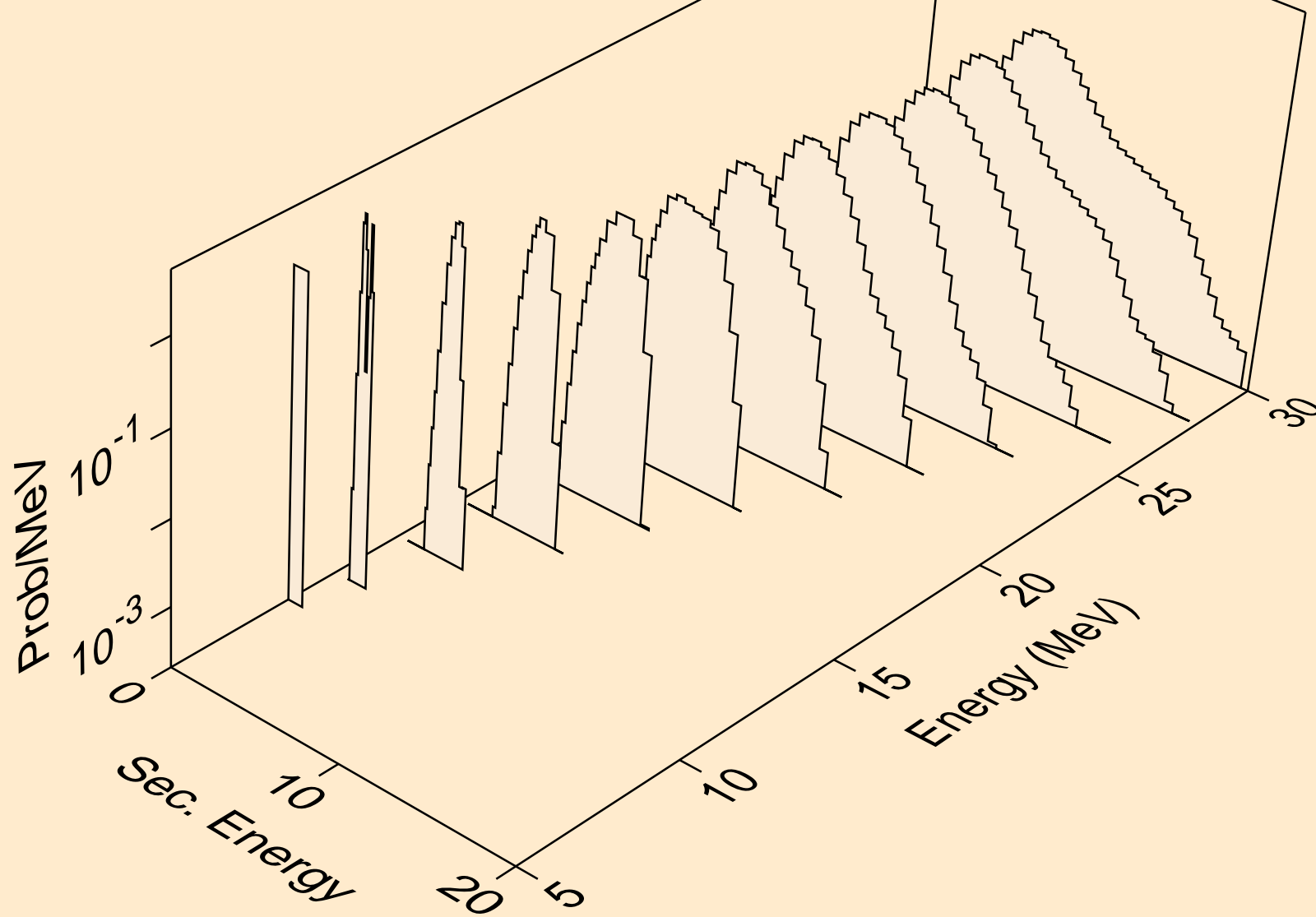

DY145M TRITON ACER TENDL-2021 LIBRARY; T=0.K  
protons from (t,3np)

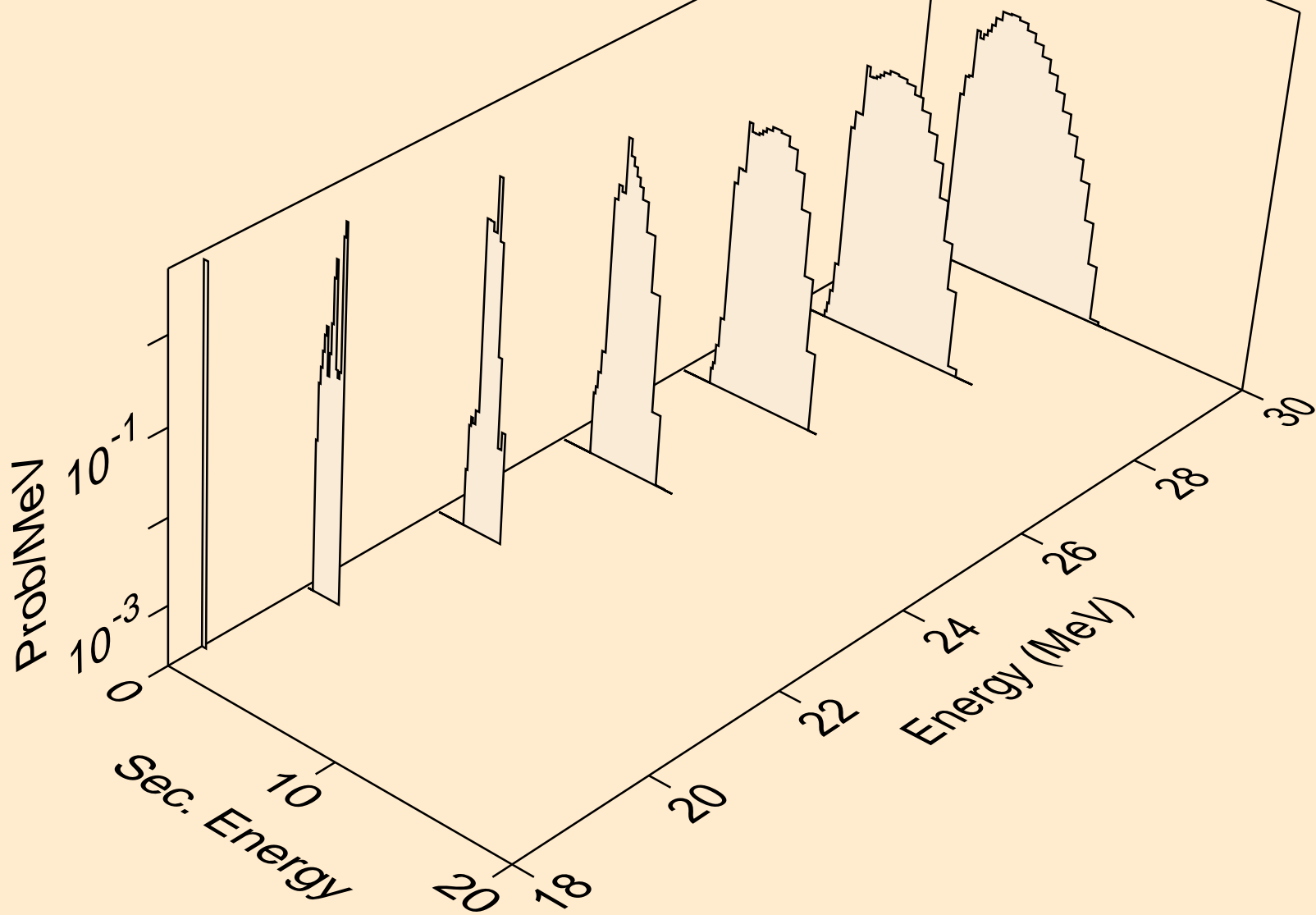

DY145M TRITON ACER TENDL-2021 LIBRARY; T=0.K  
protons from (t,2np)

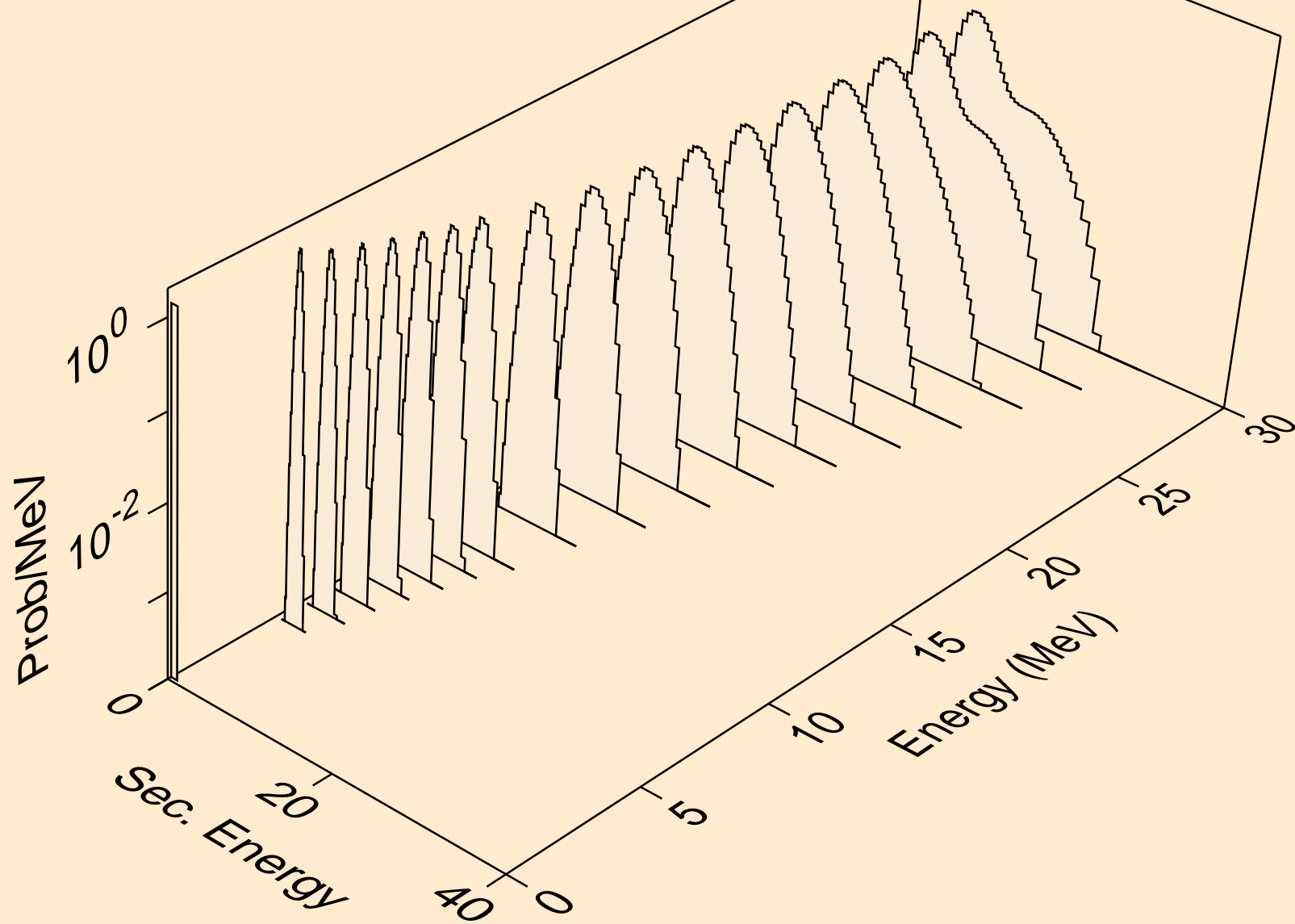

DY145M TRITON ACER TENDL-2021 LIBRARY; T=0.K  
protons from (t,npa)

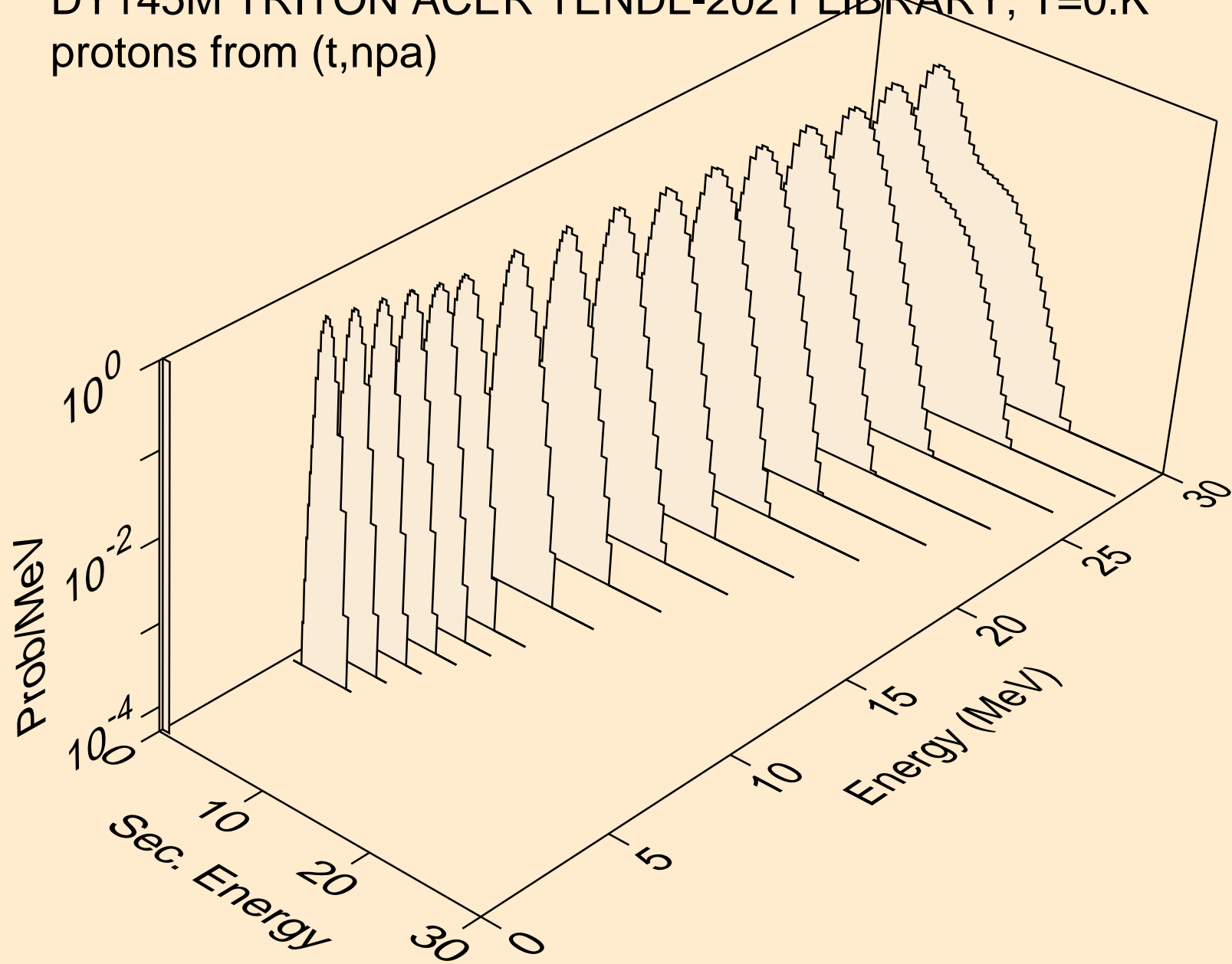

DY145M TRITON ACER TENDL-2021 LIBRARY; T=0.K  
protons from (t,p)

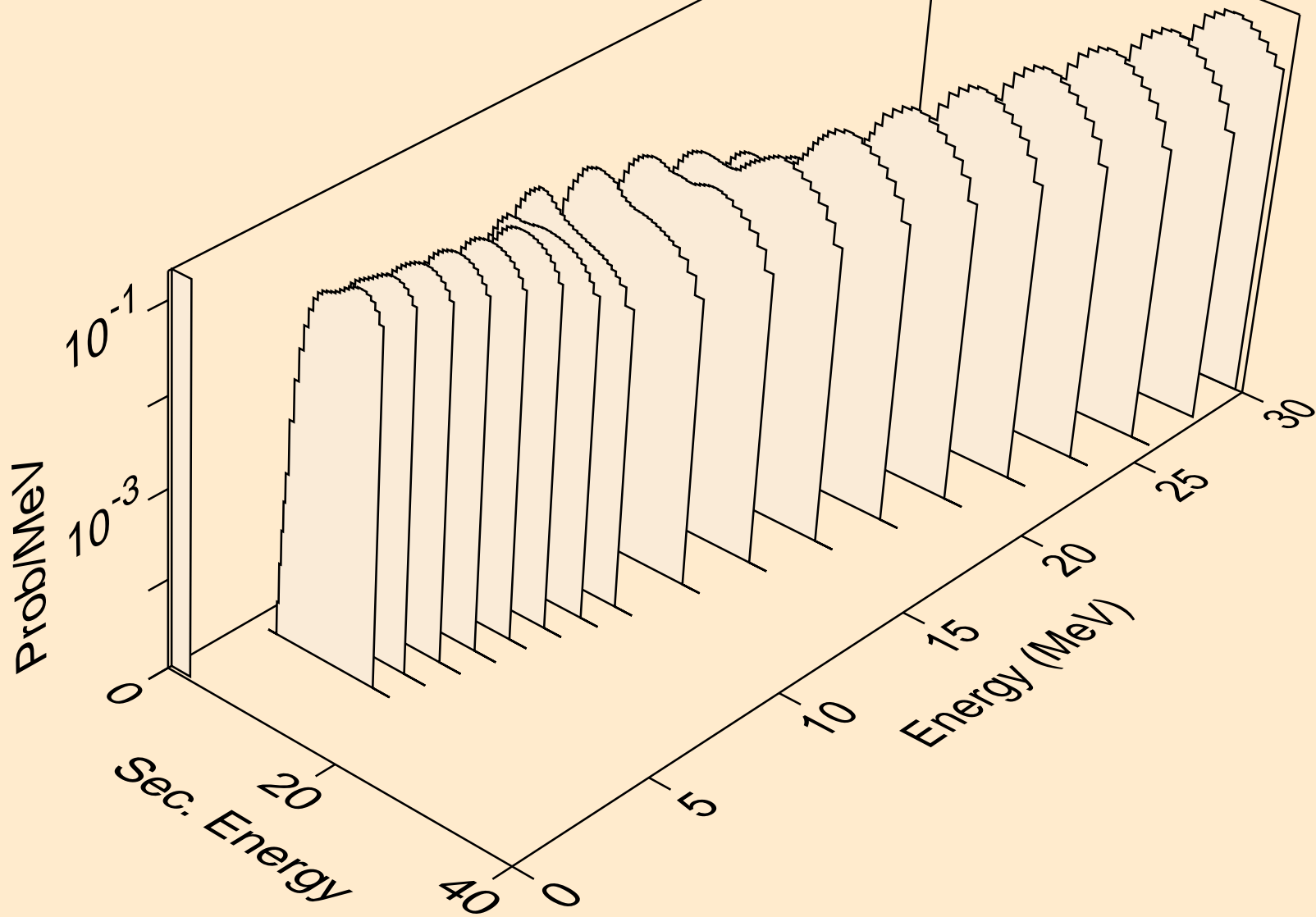

DY145M TRITON ACER TENDL-2021 LIBRARY; T=0.K  
protons from (t,2p)

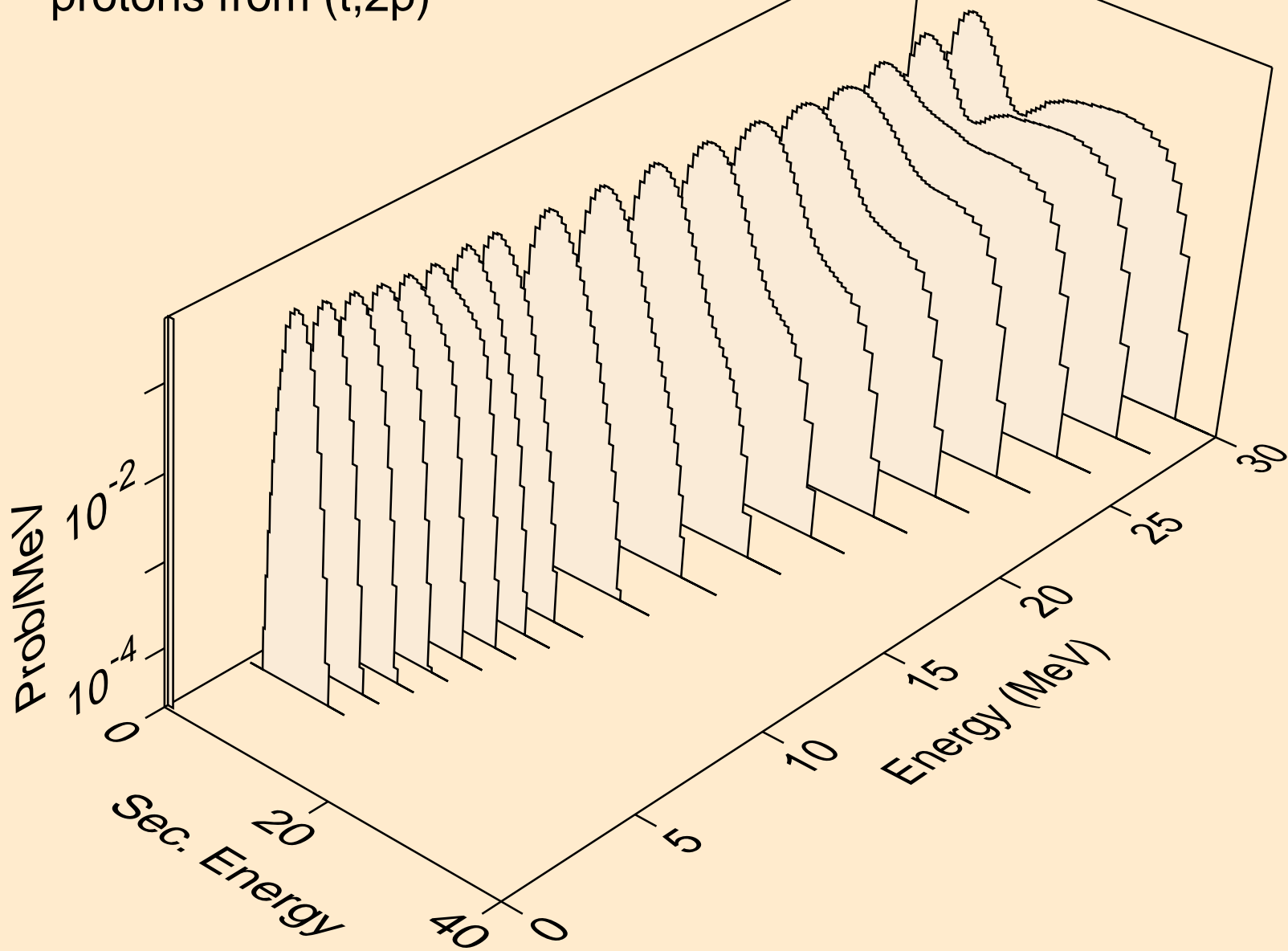



DY145M TRITON ACER TENDL-2021 LIBRARY; T=0.K  
protons from (t,pa)

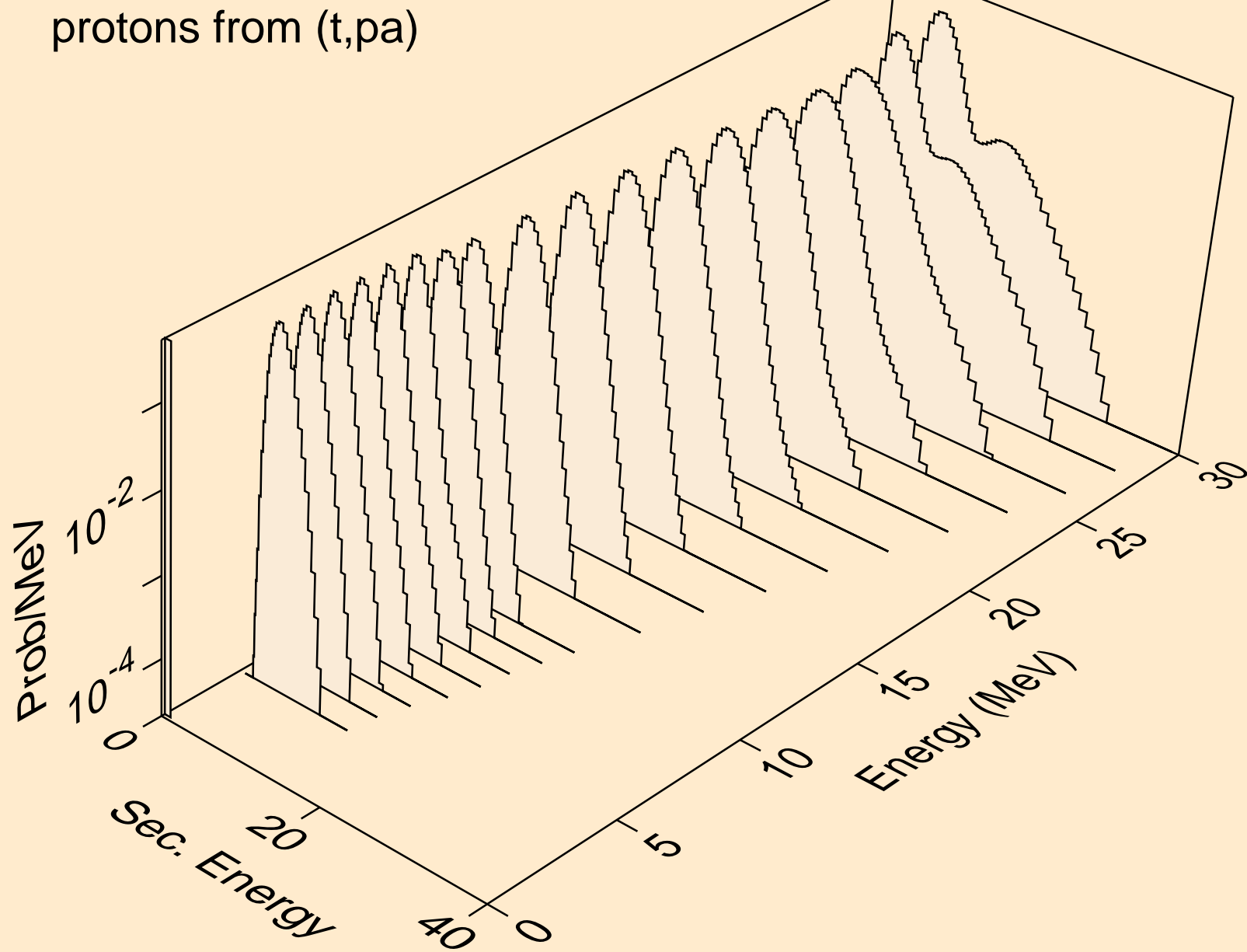

DY145M TRITON ACER TENDL-2021 LIBRARY; T=0.K  
protons from (t,pd)

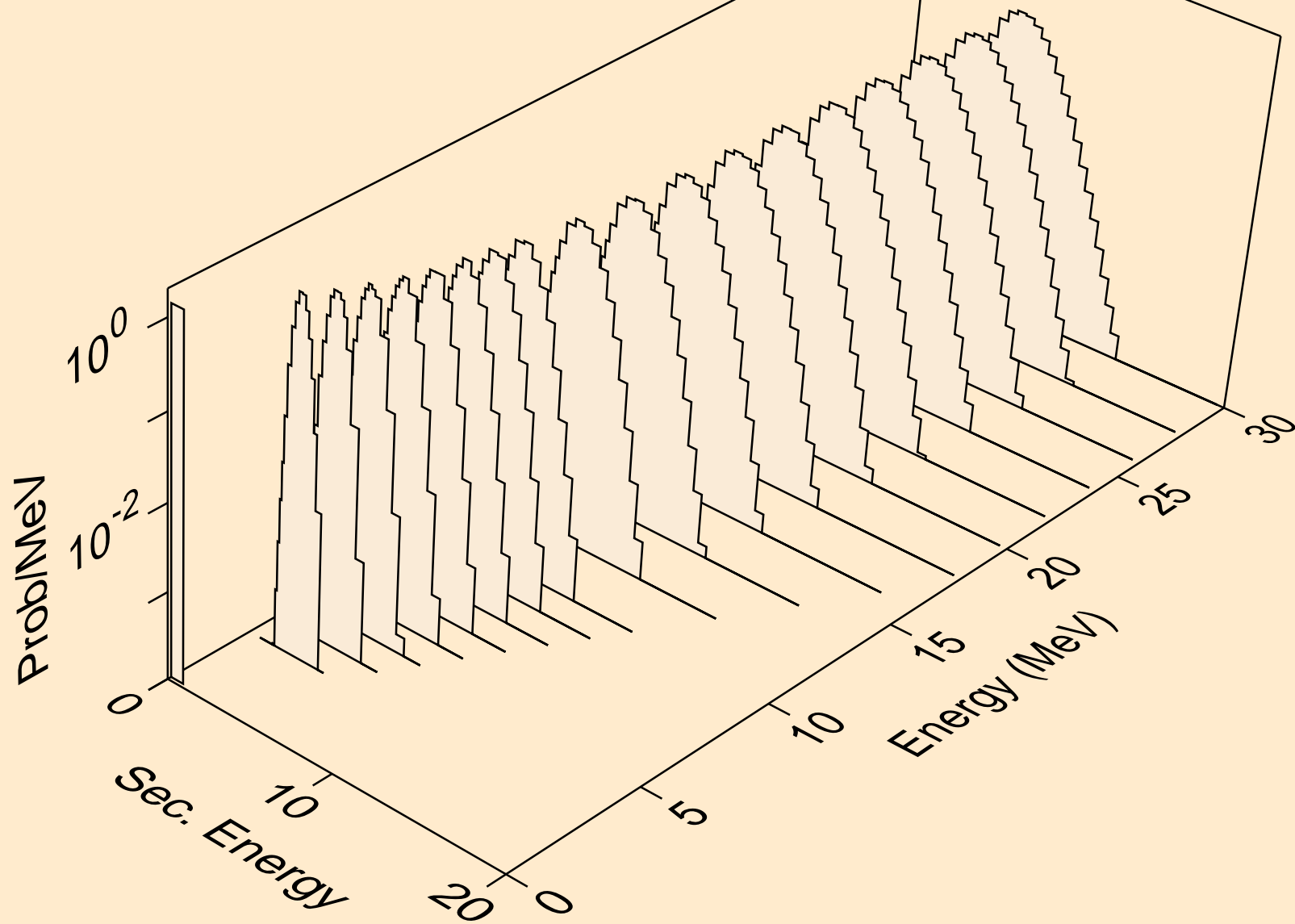

DY145M TRITON ACER TENDL-2021 LIBRARY; T=0.K  
protons from (t,pt)

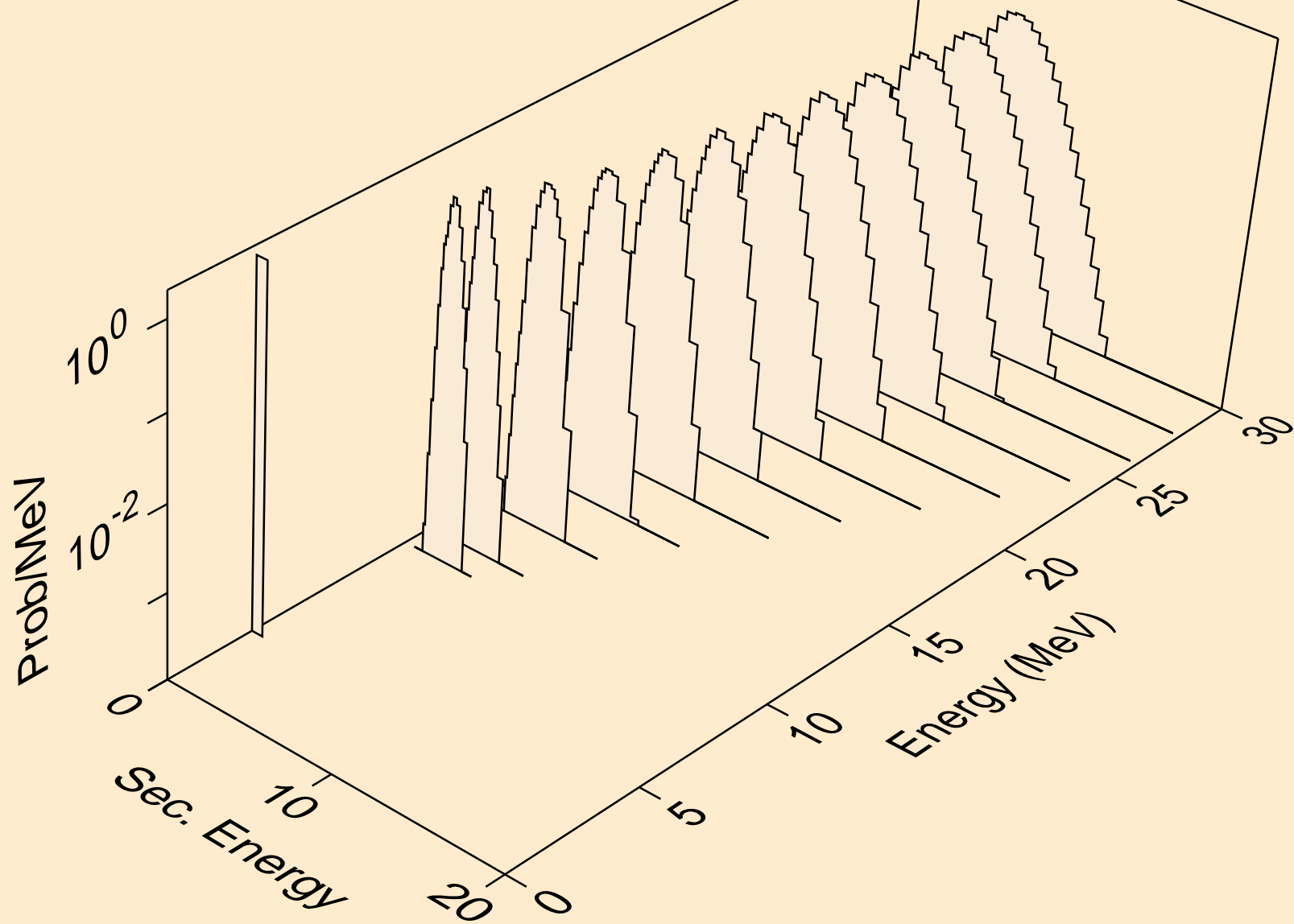

DY145M TRITON ACER TENDL-2021 LIBRARY; T=0.K  
deuterons from (t,x)

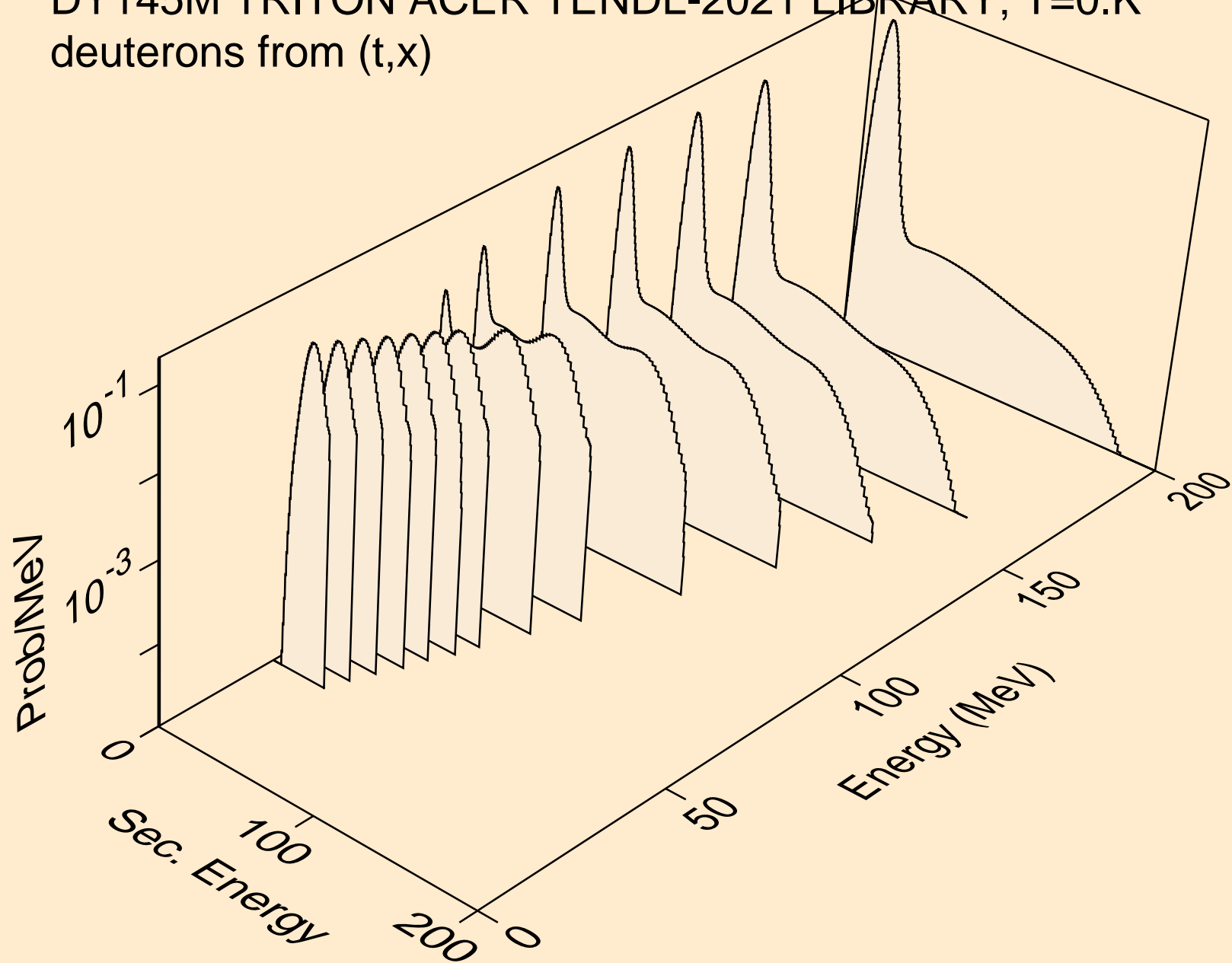

DY145M TRITON ACER TENDL-2021 LIBRARY; T=0.K  
deuterons from (t,2nd)

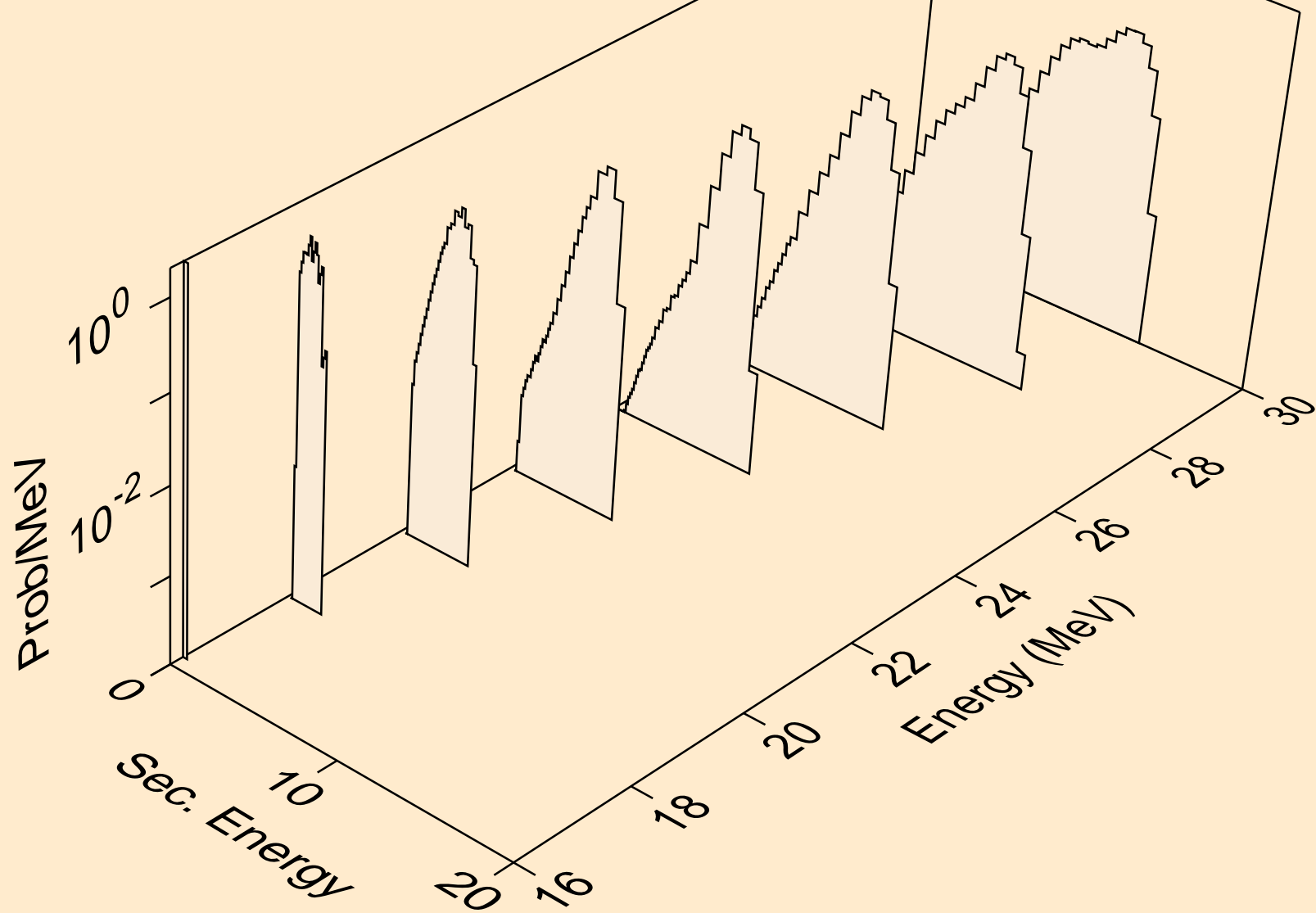

DY145M TRITON ACER TENDL-2021 LIBRARY; T=0.K  
deuterons from (t,n\*)d

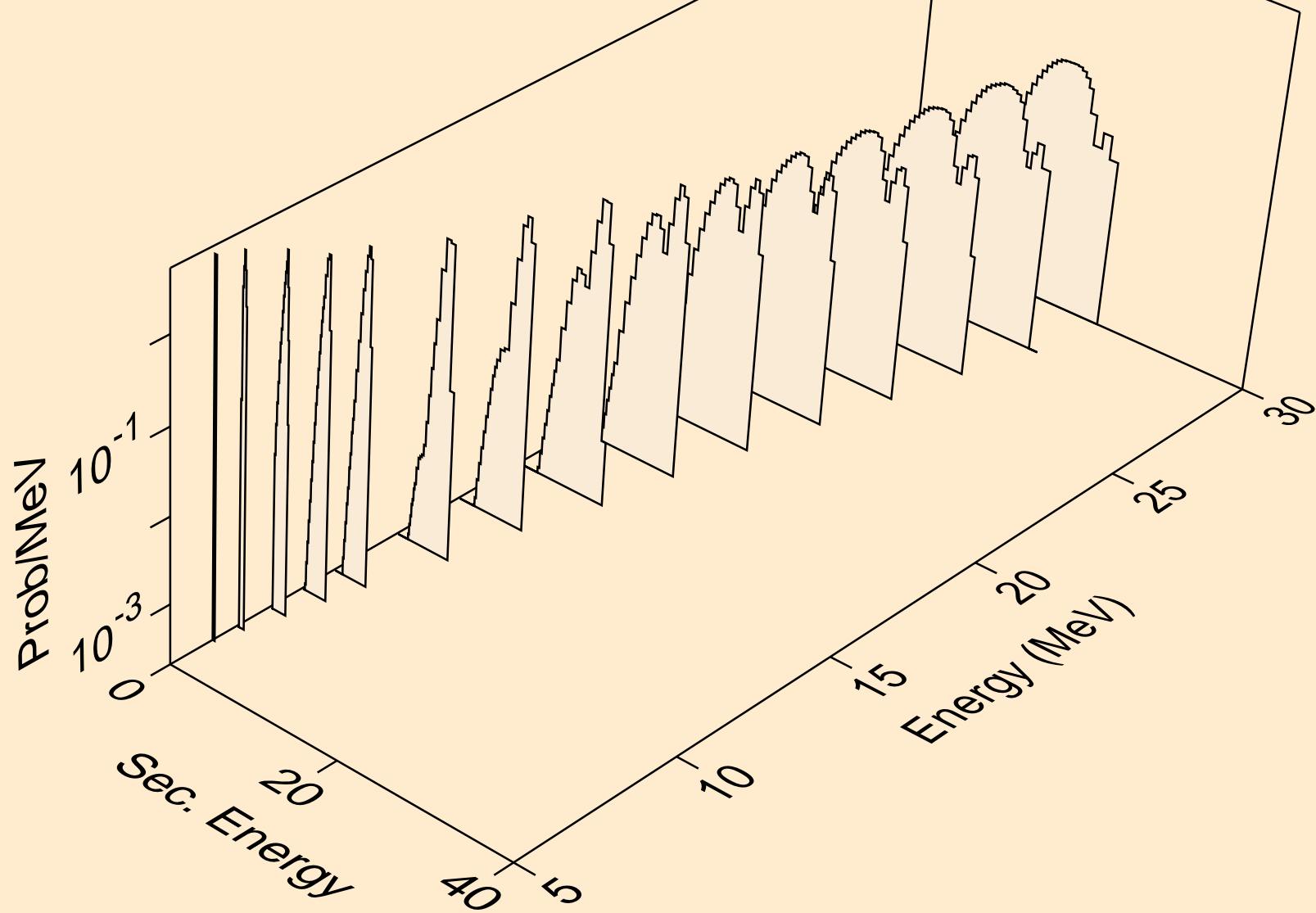

DY145M TRITON ACER TENDL-2021 LIBRARY; T=0.K  
deuterons from (t,d)

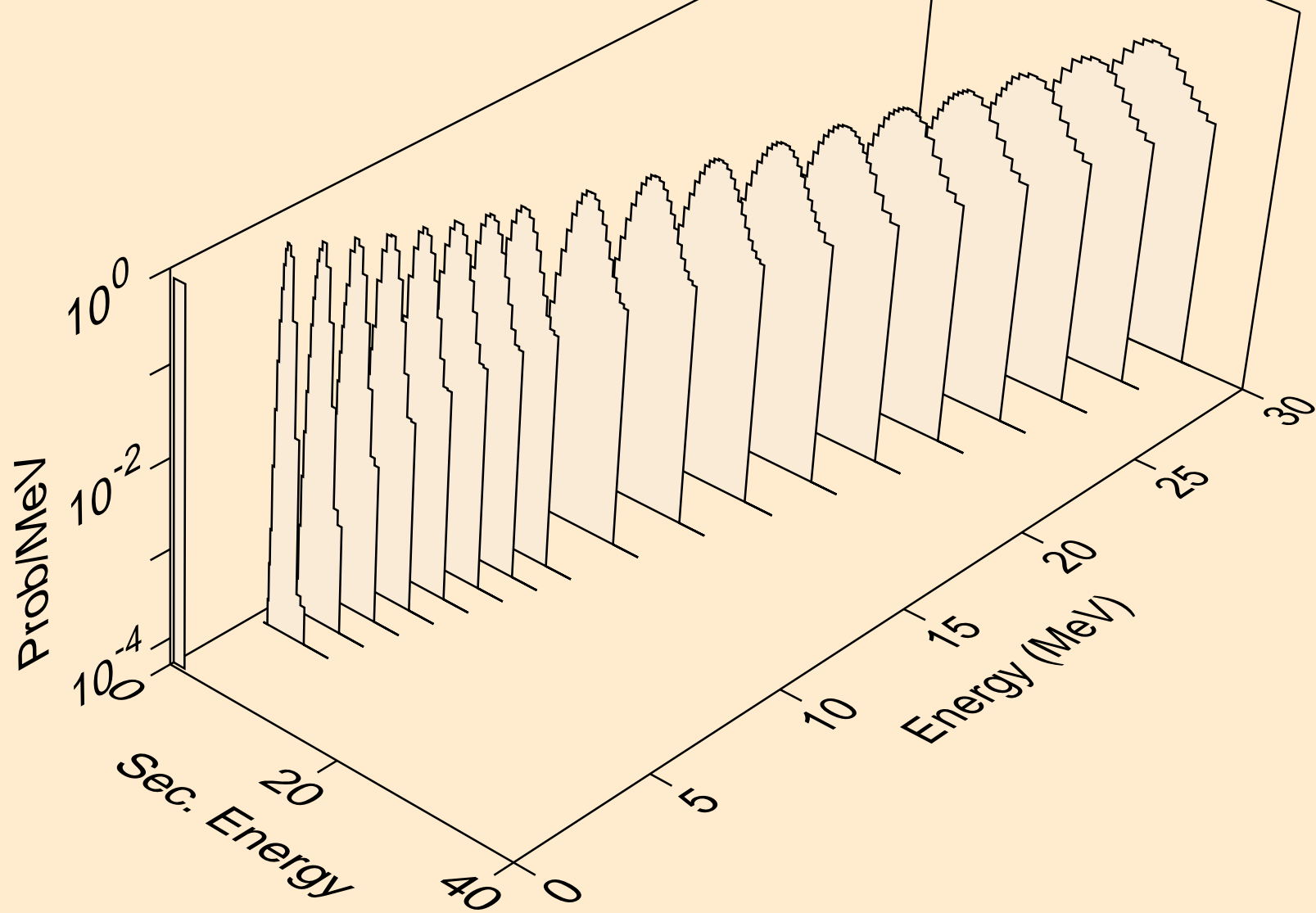

DY145M TRITON ACER TENDL-2021 LIBRARY; T=0.K  
deuterons from (t,d2a)

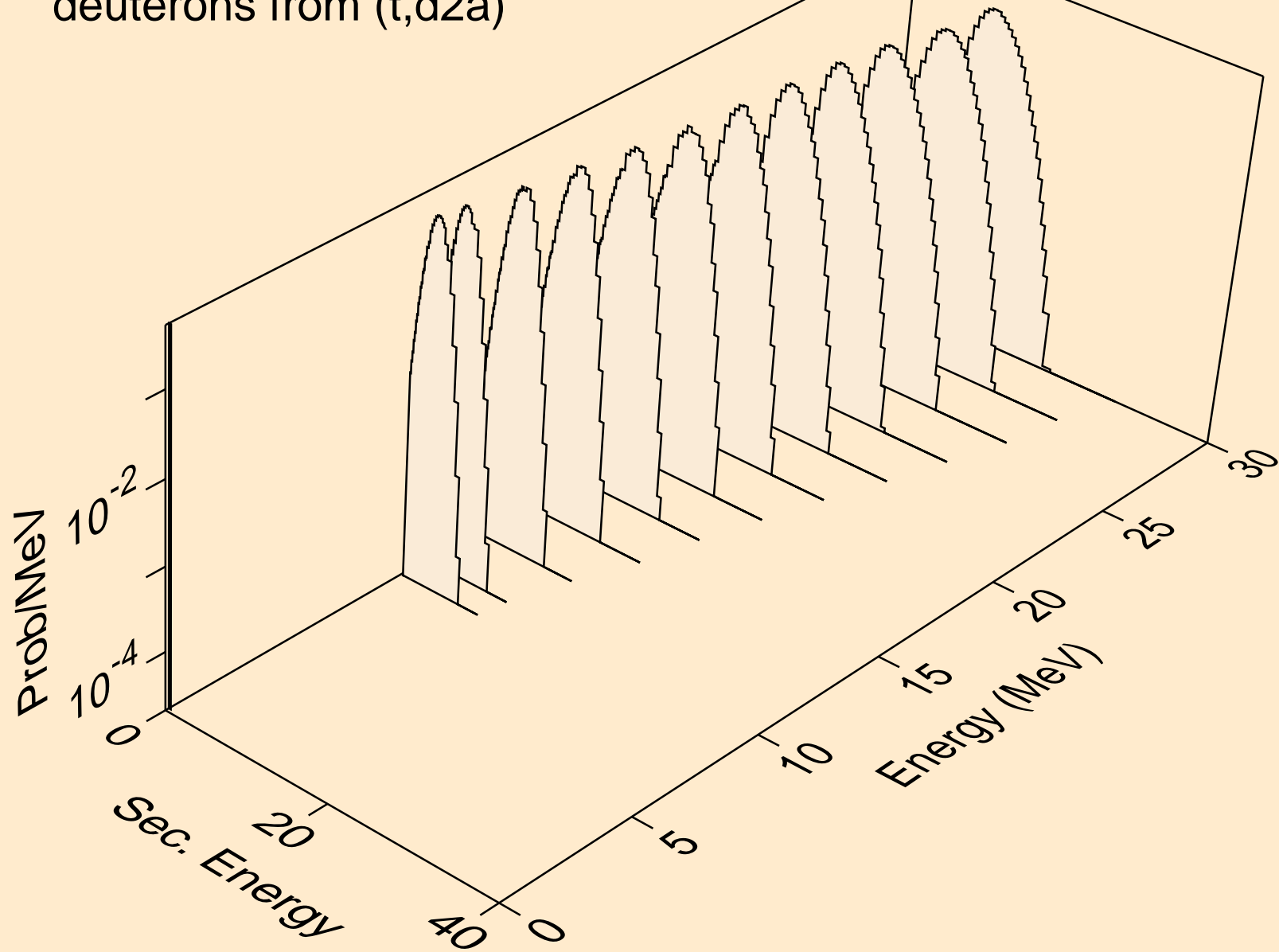



DY145M TRITON ACER TENDL-2021 LIBRARY; T=0.K  
deuterons from (t,pd)

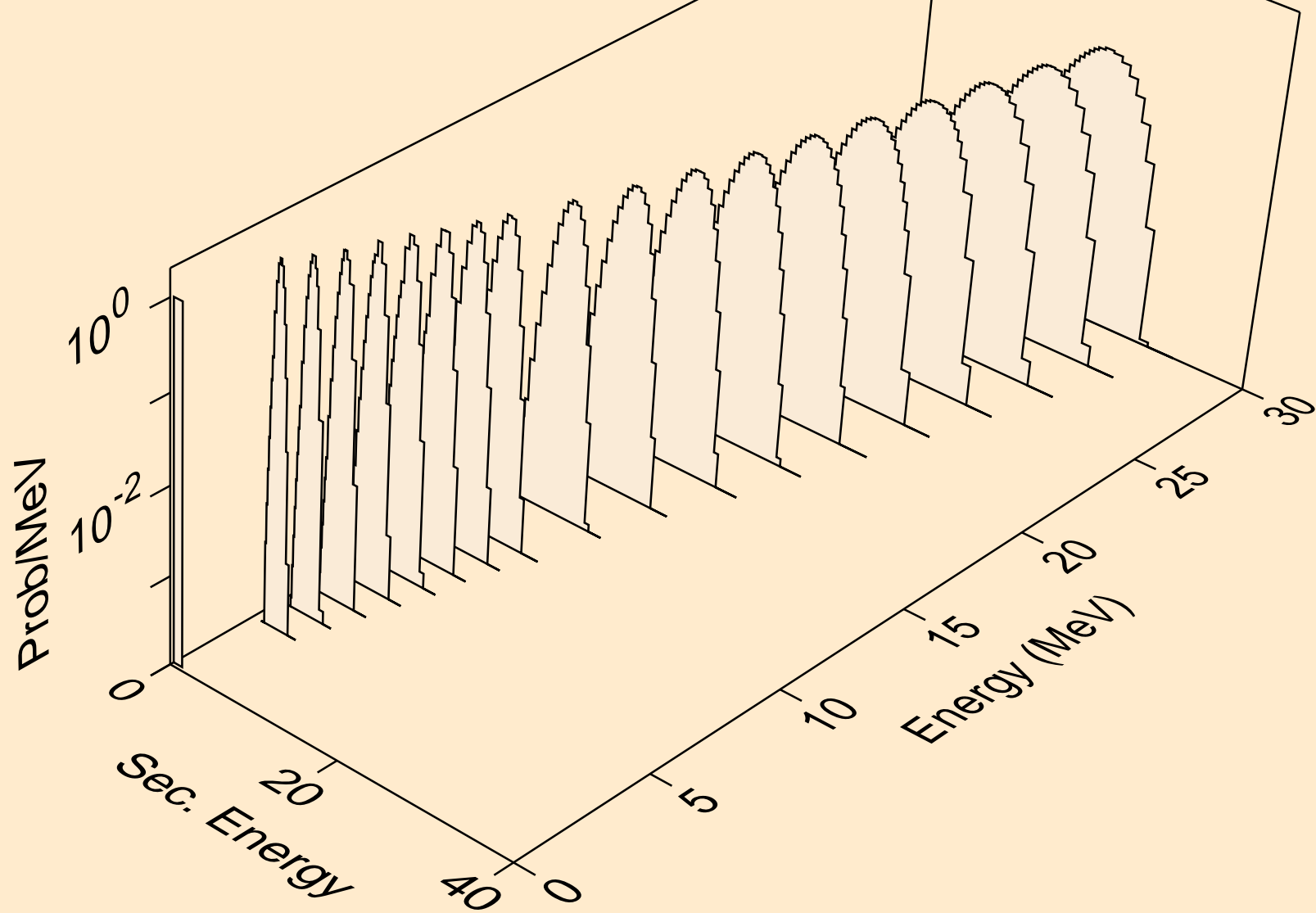

DY145M TRITON ACER TENDL-2021 LIBRARY; T=0.K  
deuterons from (t,da)

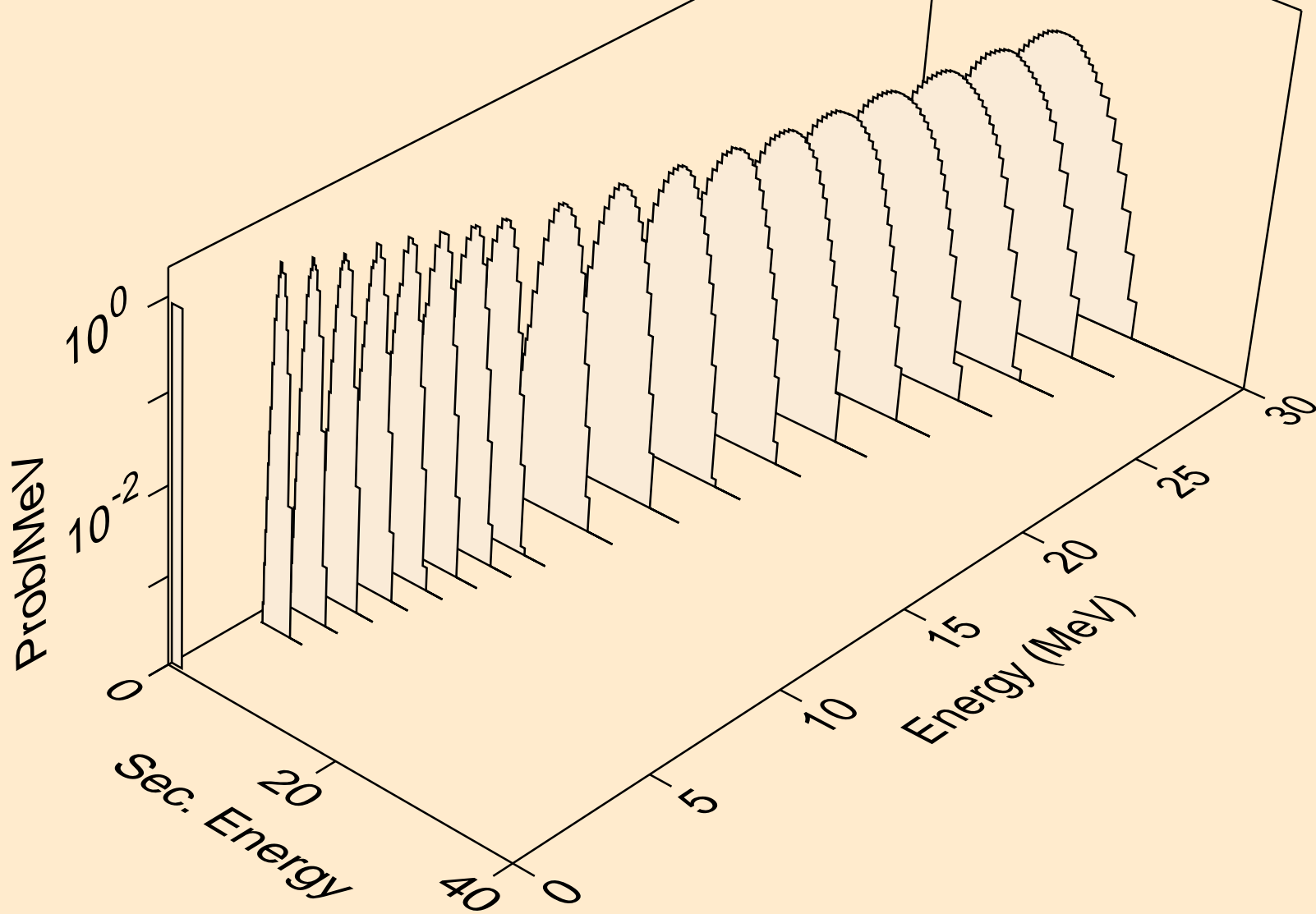

DY145M TRITON ACER TENDL-2021 LIBRARY; T=0.K  
he3s from (t,x)

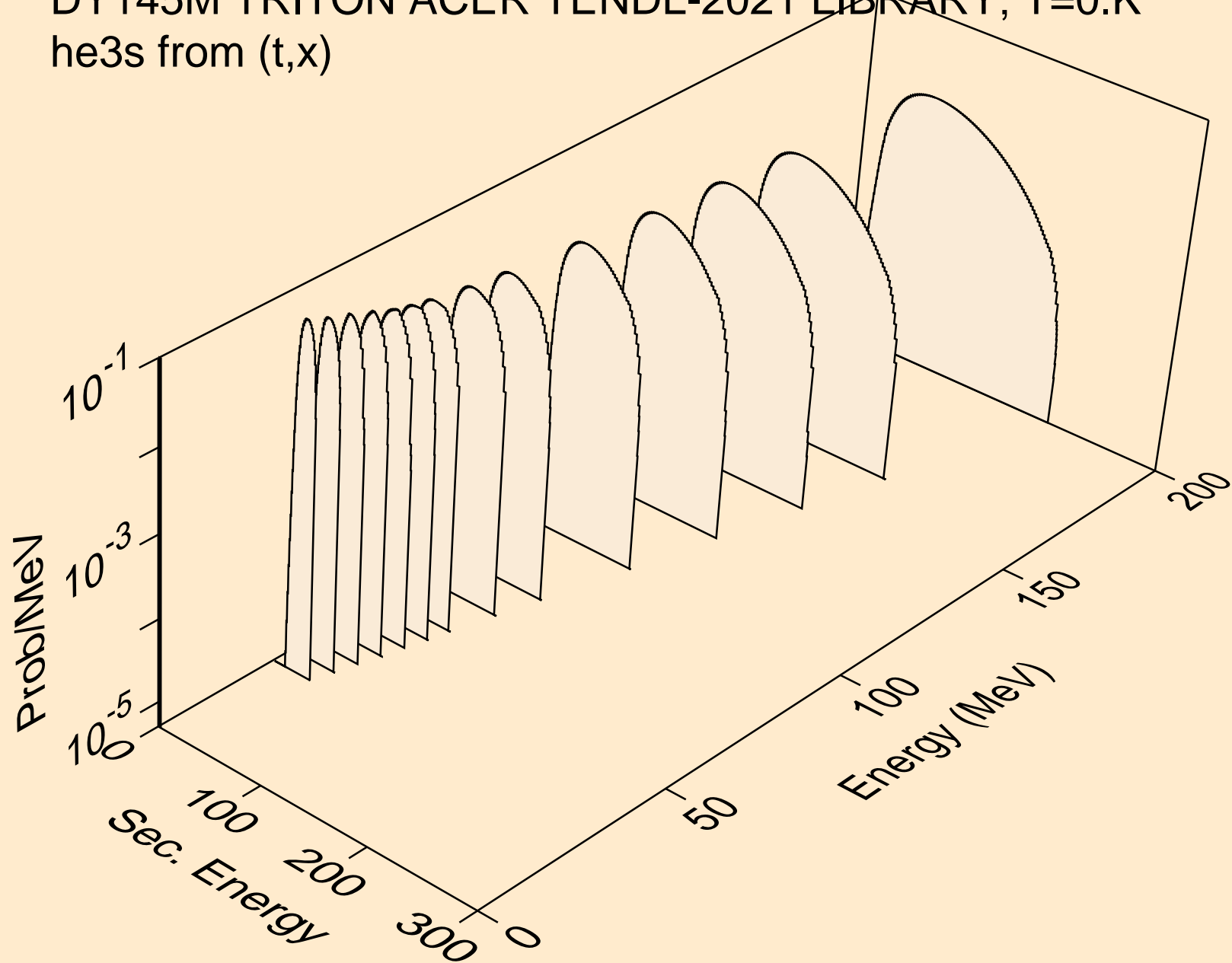

DY145M TRITON ACER TENDL-2021 LIBRARY; T=0.K  
he3s from (t,n\*)he3

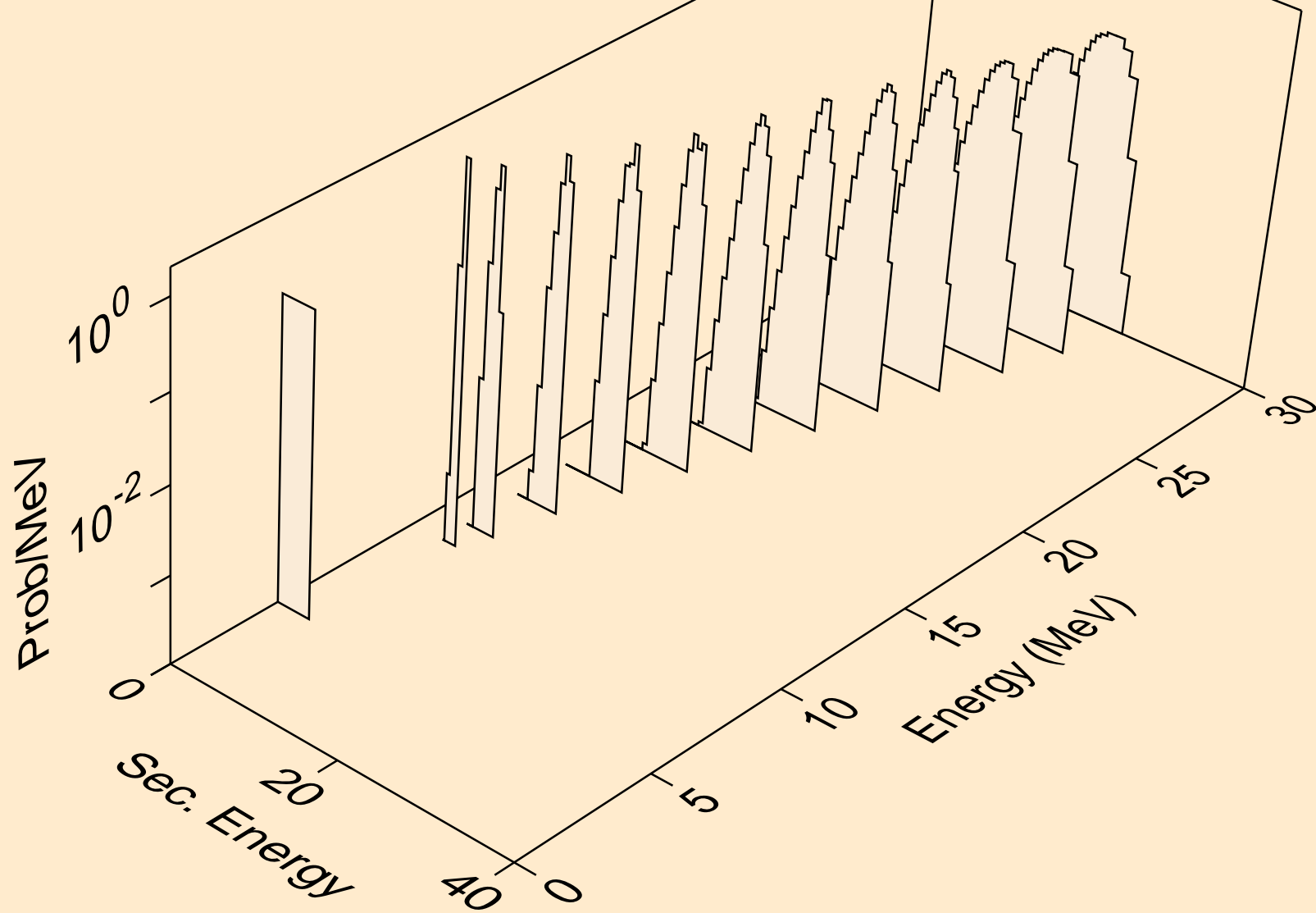

DY145M TRITON ACER TENDL-2021 LIBRARY; T=0.K  
he3s from (t,he3)

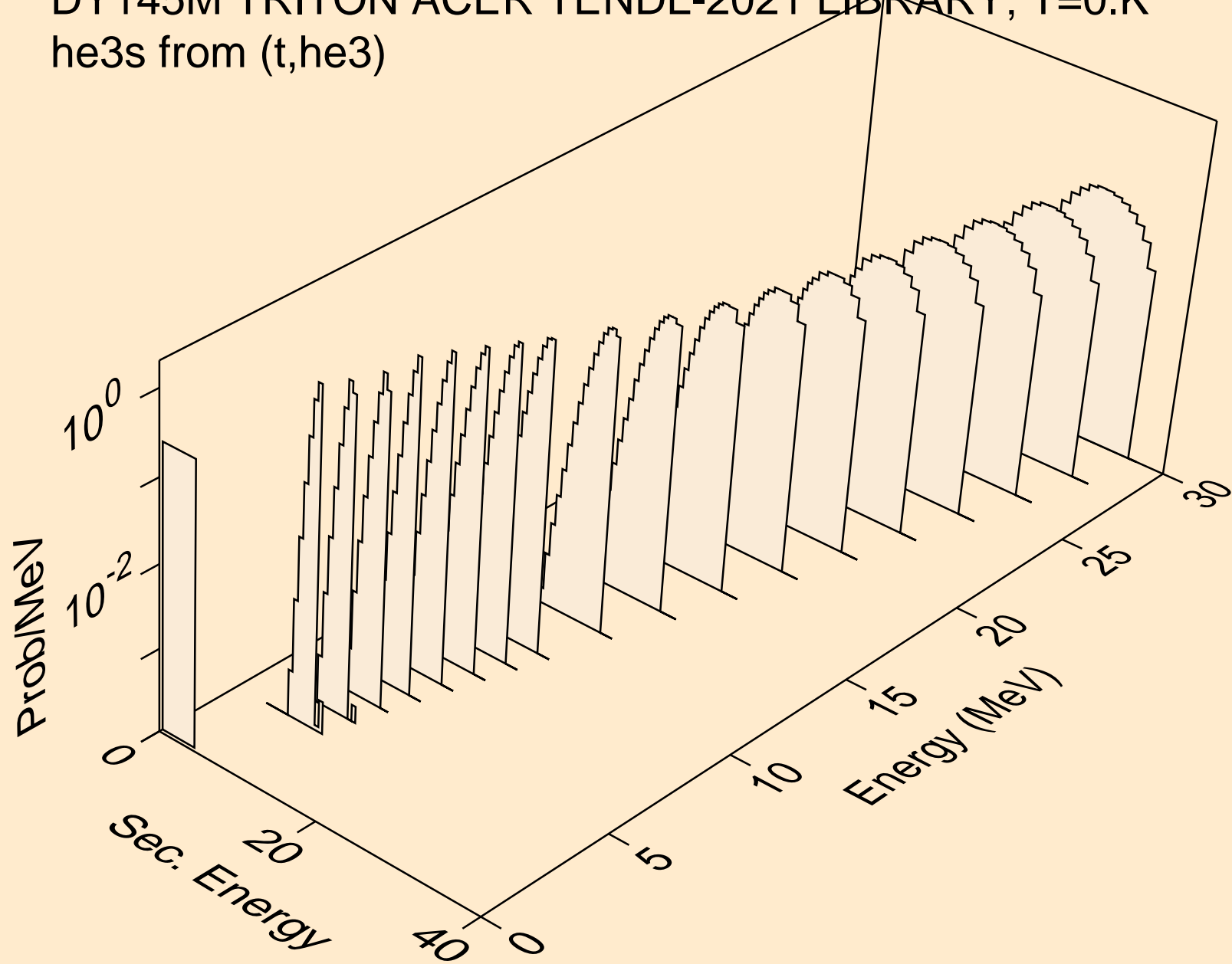

DY145M TRITON ACER TENDL-2021 LIBRARY; T=0.K  
alphas from (t,x)

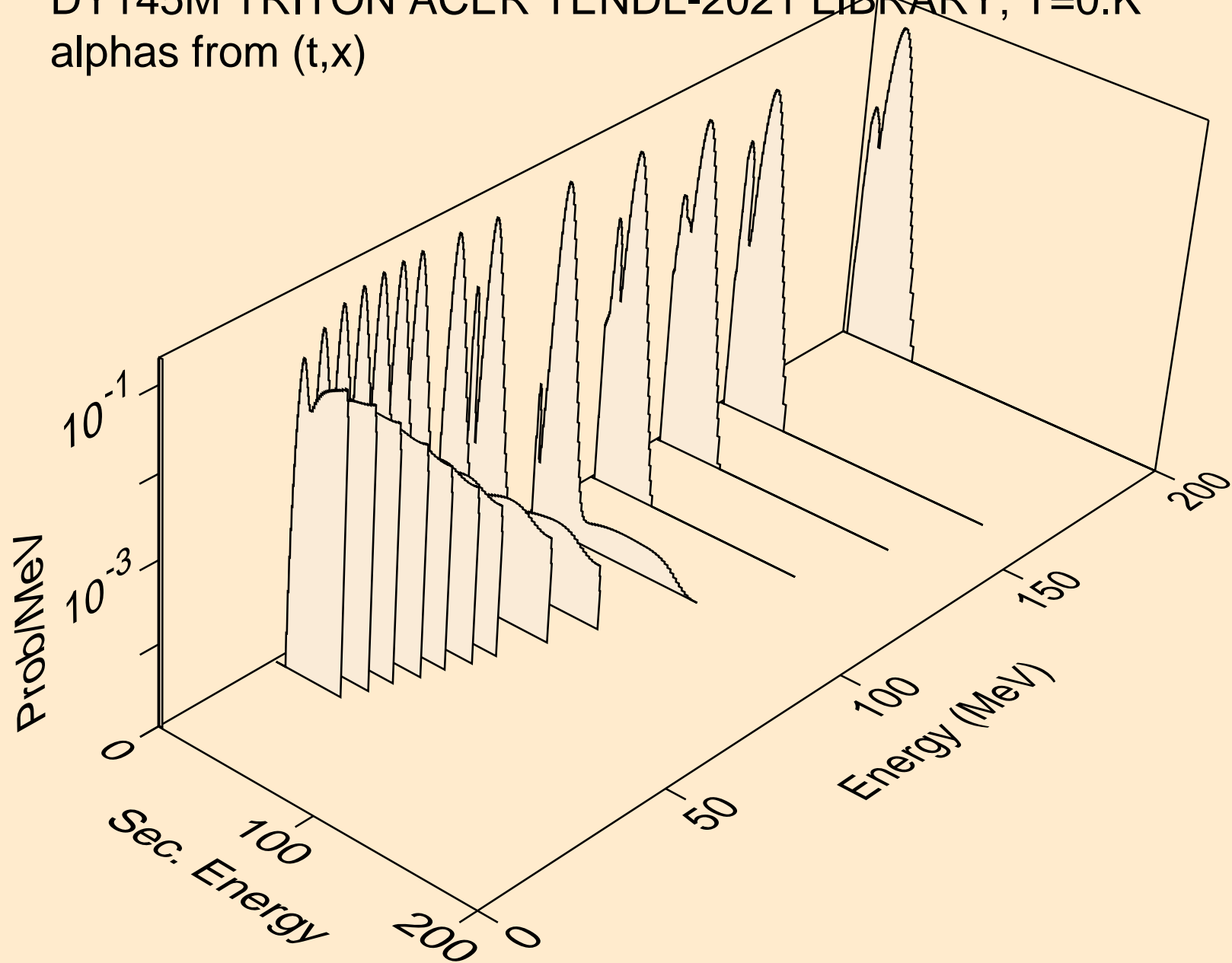

DY145M TRITON ACER TENDL-2021 LIBRARY; T=0.K  
alphas from (t,n\*)a

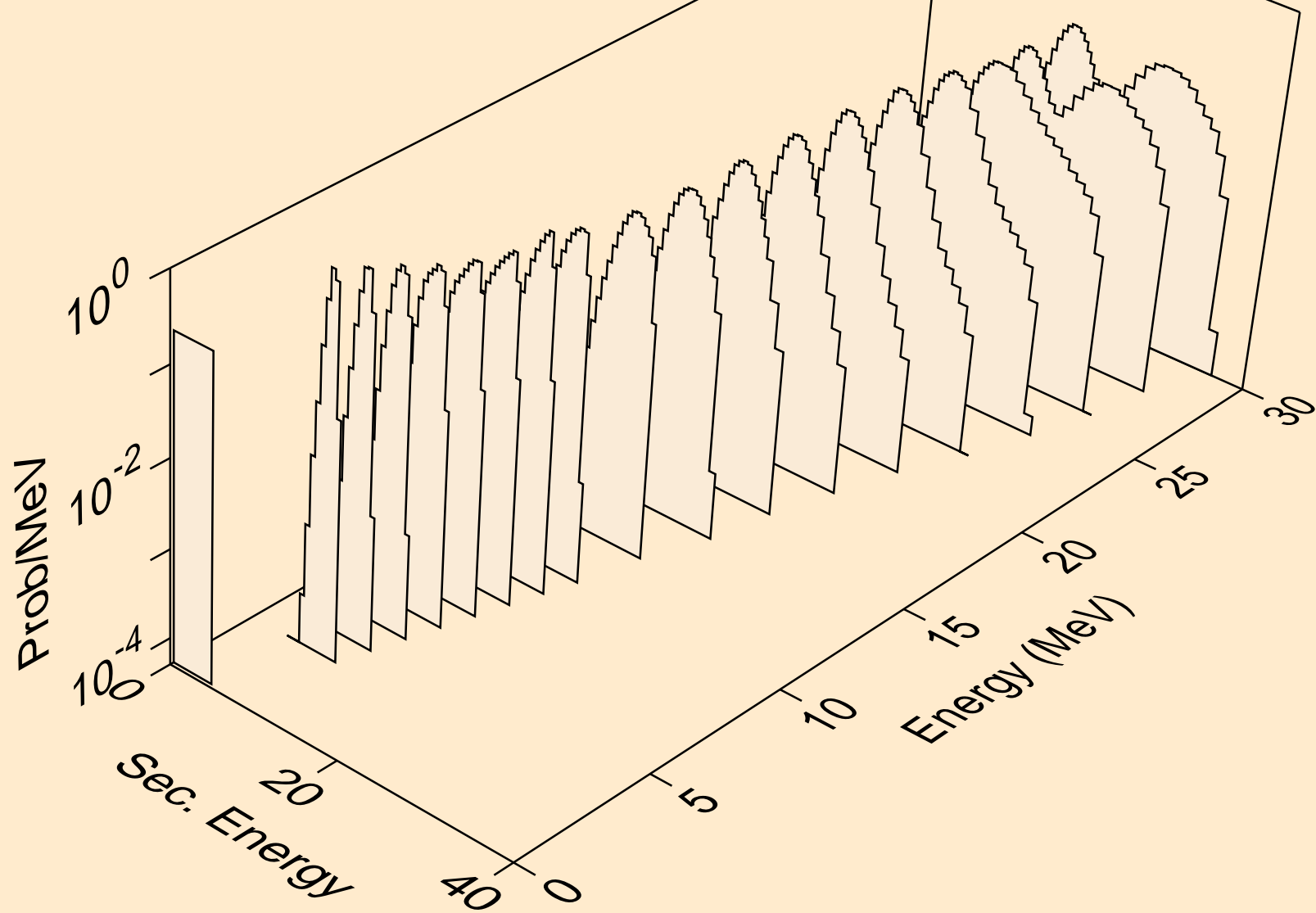

DY145M TRITON ACER TENDL-2021 LIBRARY; T=0.K  
alphas from (t,2n)a

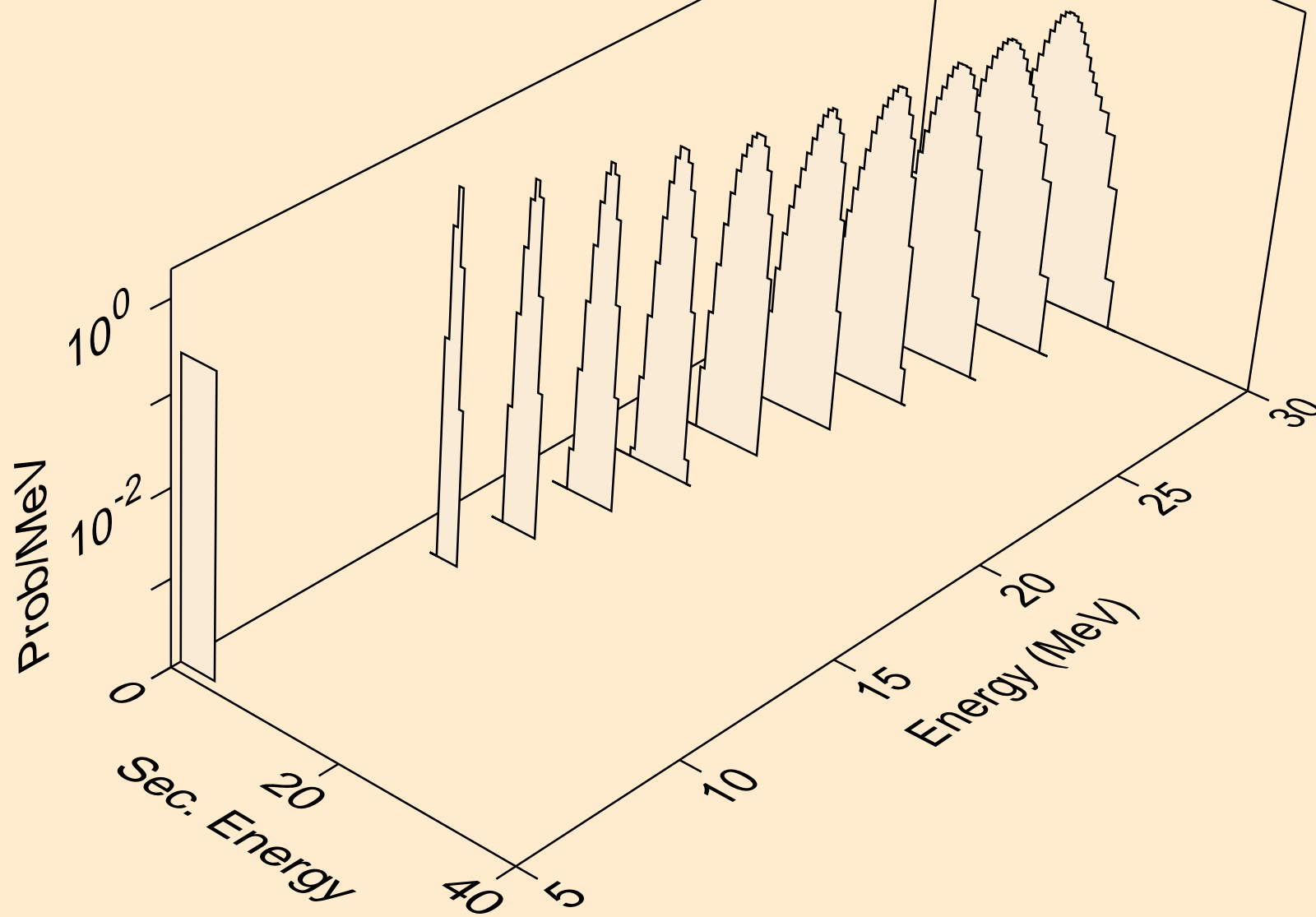



DY145M TRITON ACER TENDL-2021 LIBRARY; T=0.K  
alphas from (t,3n)a

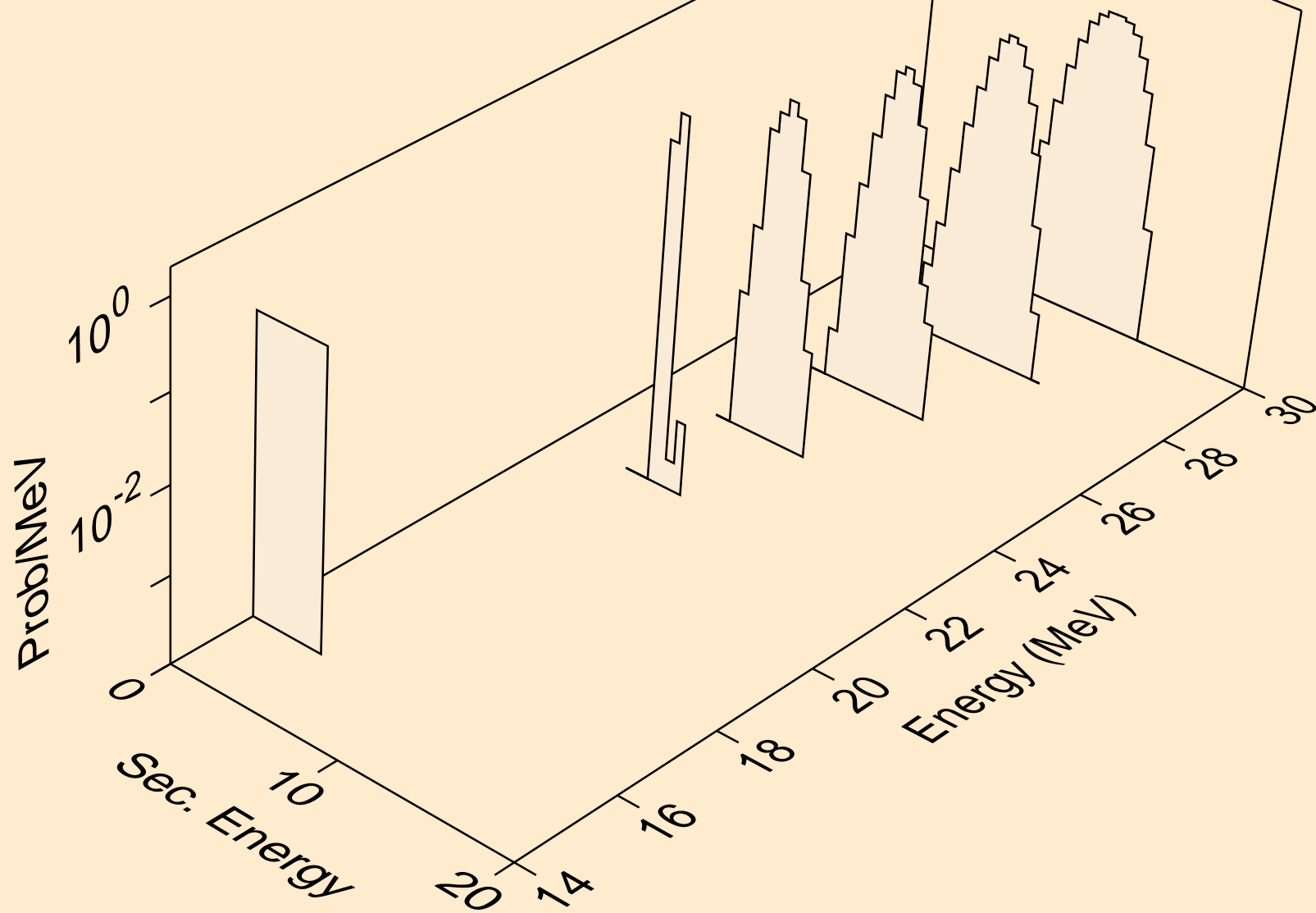

DY145M TRITON ACER TENDL-2021 LIBRARY; T=0.K  
alphas from (t,n\*)2a

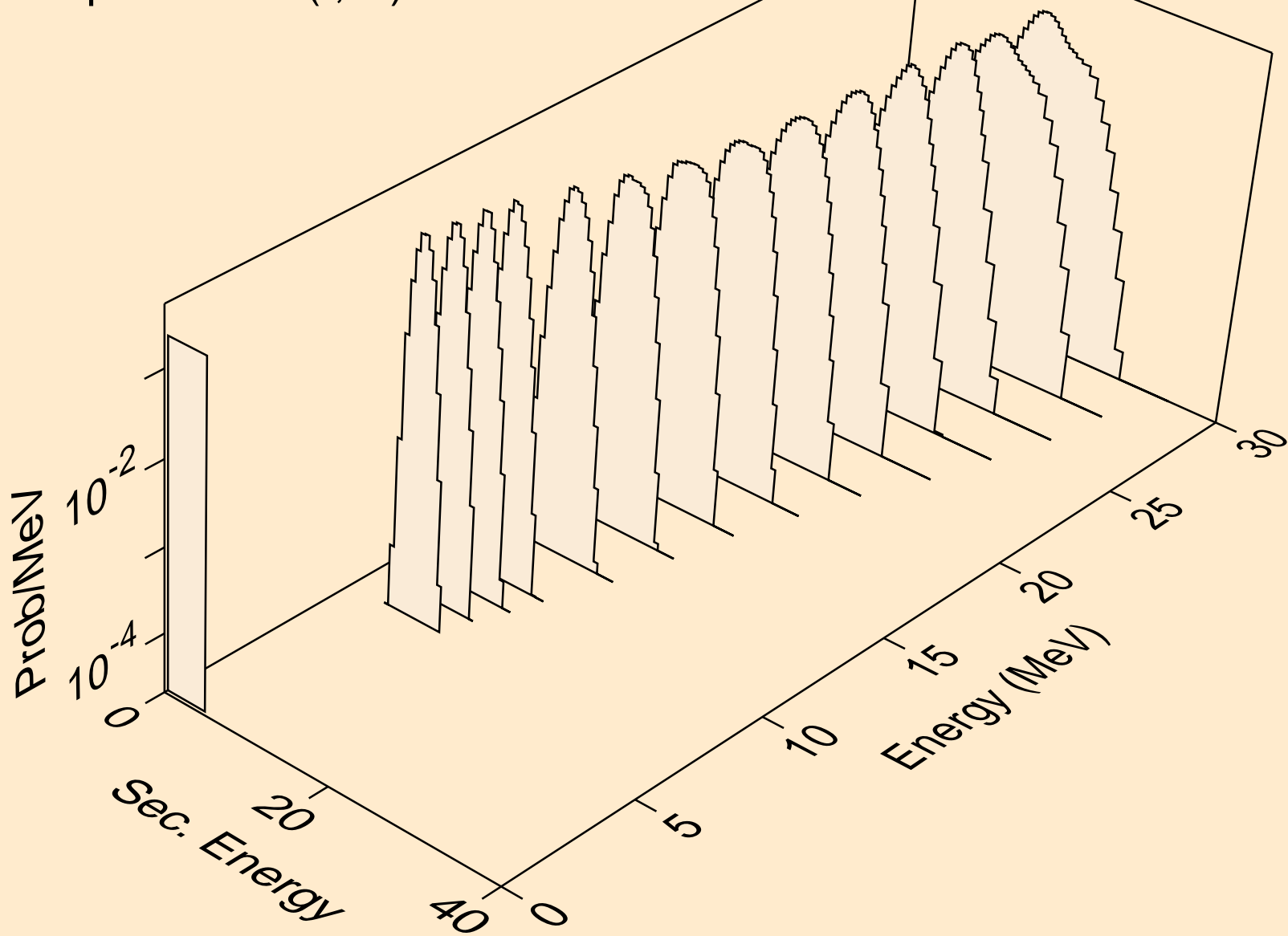

DY145M TRITON ACER TENDL-2021 LIBRARY; T=0.K  
alphas from (t,npa)

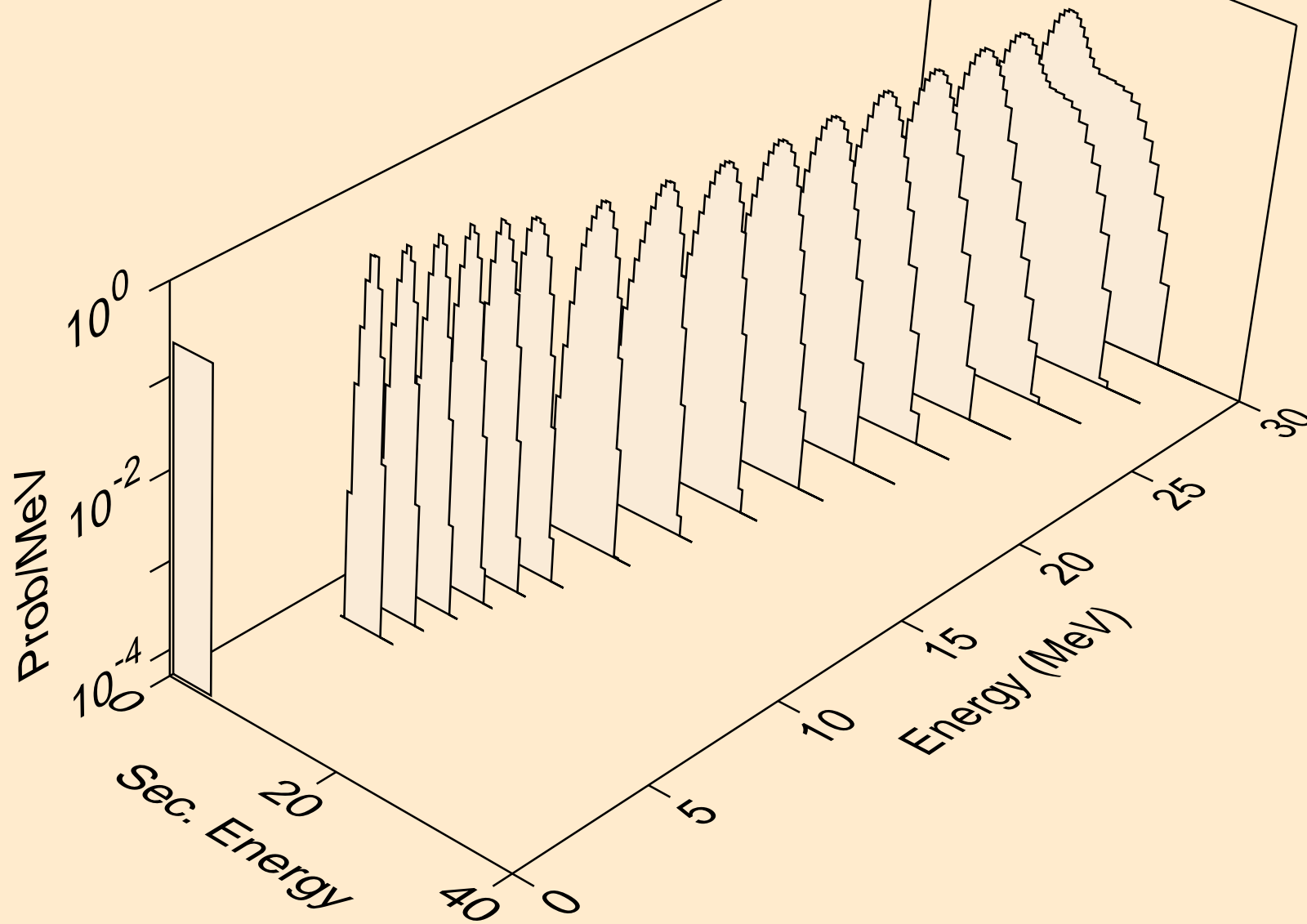

DY145M TRITON ACER TENDL-2021 LIBRARY; T=0.K  
alphas from (t,a)

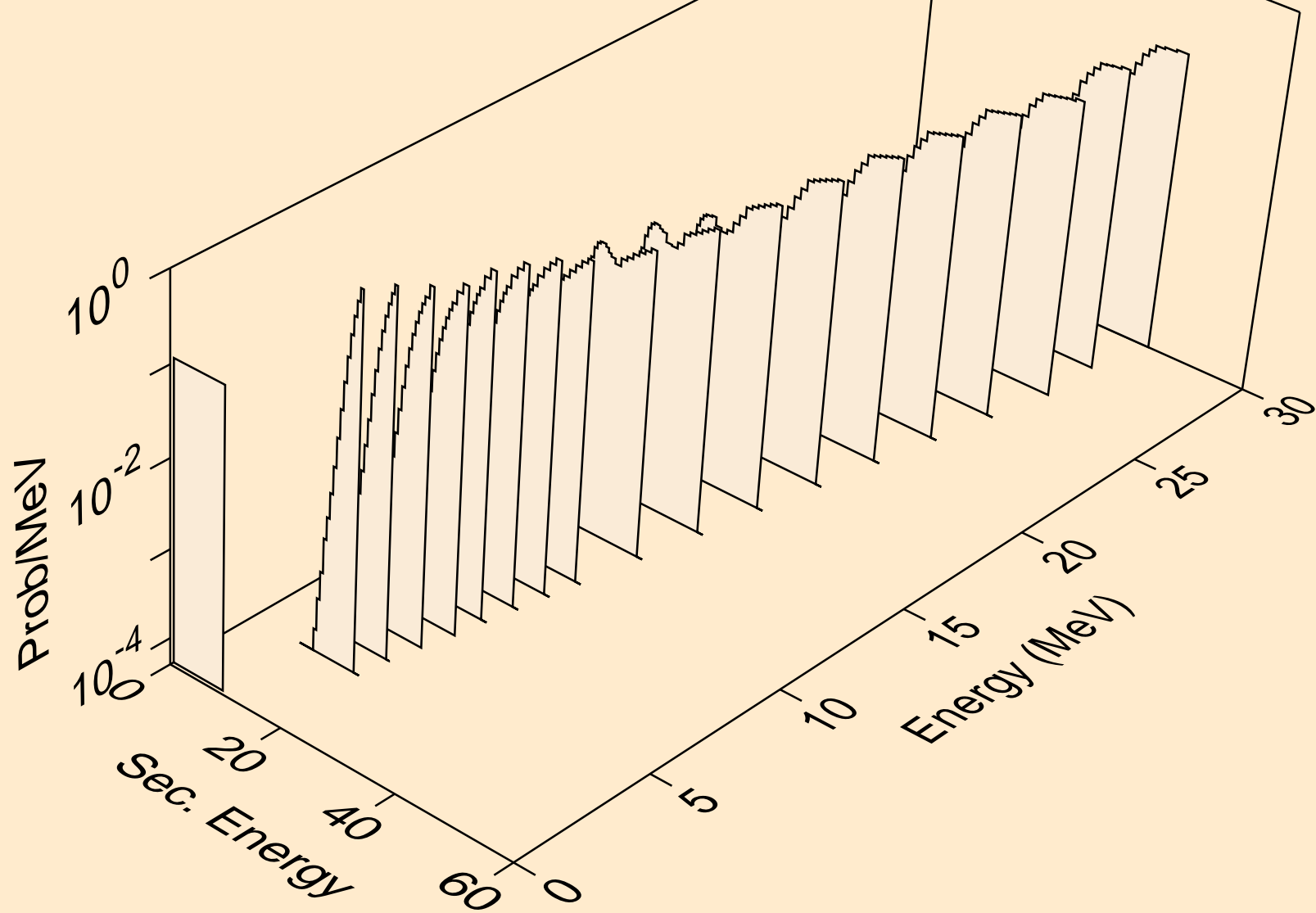

DY145M TRITON ACER TENDL-2021 LIBRARY; T=0.K  
alphas from (t,2a)

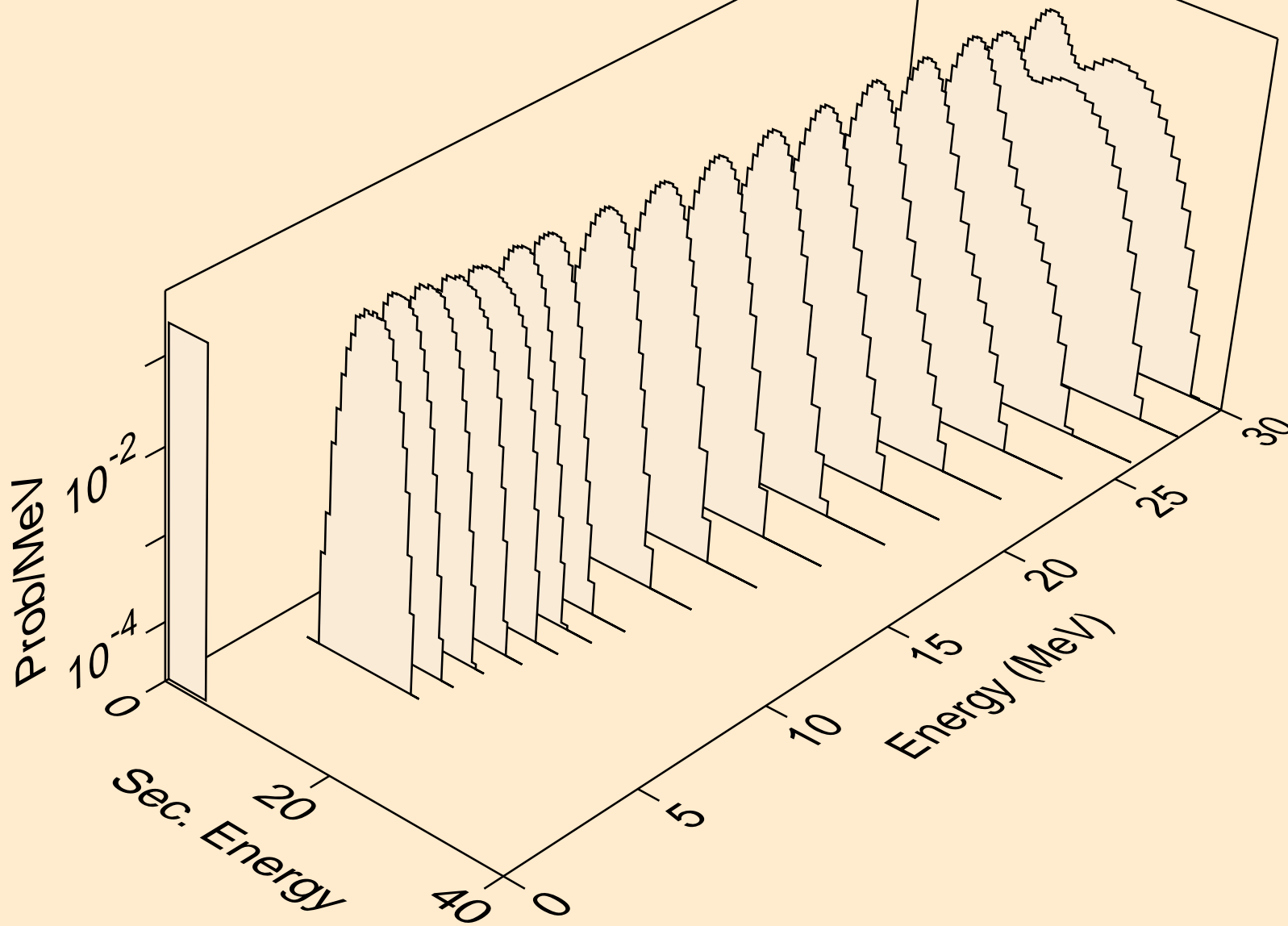

DY145M TRITON ACER TENDL-2021 LIBRARY; T=0.K  
alphas from (t,3a)

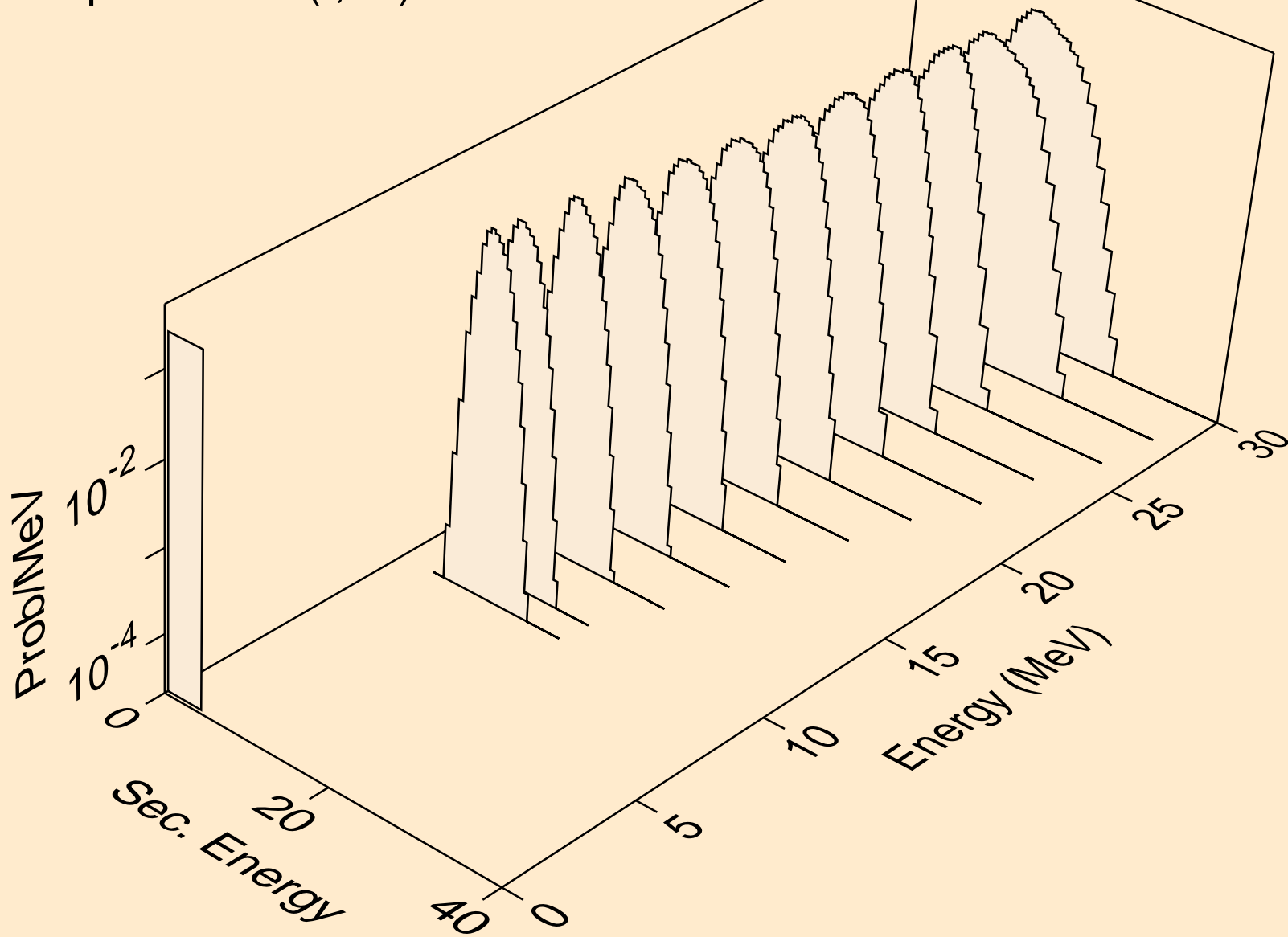

DY145M TRITON ACER TENDL-2021 LIBRARY; T=0.K  
alphas from (t,pa)

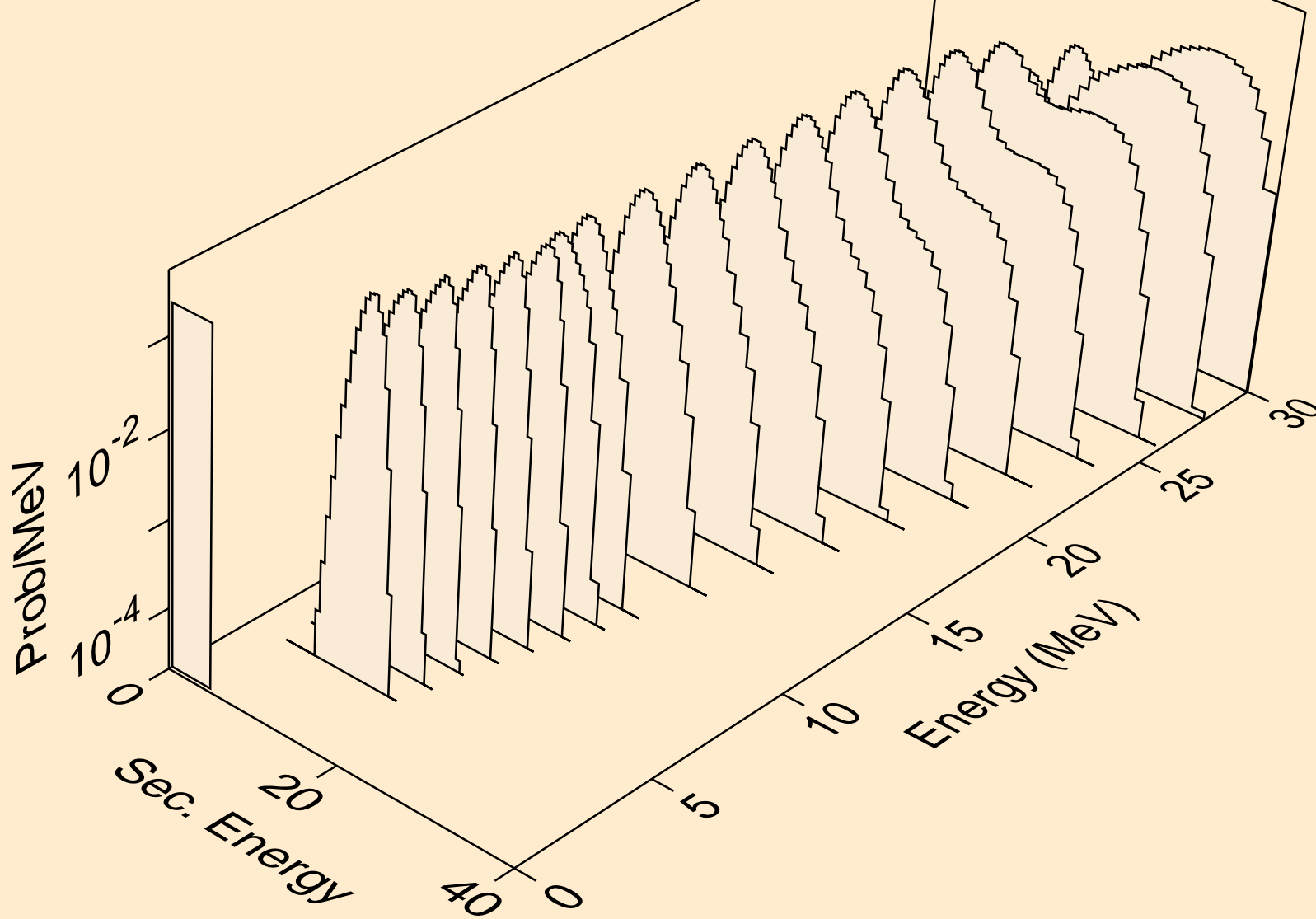

DY145M TRITON ACER TENDL-2021 LIBRARY; T=0.K  
alphas from (t,d2a)

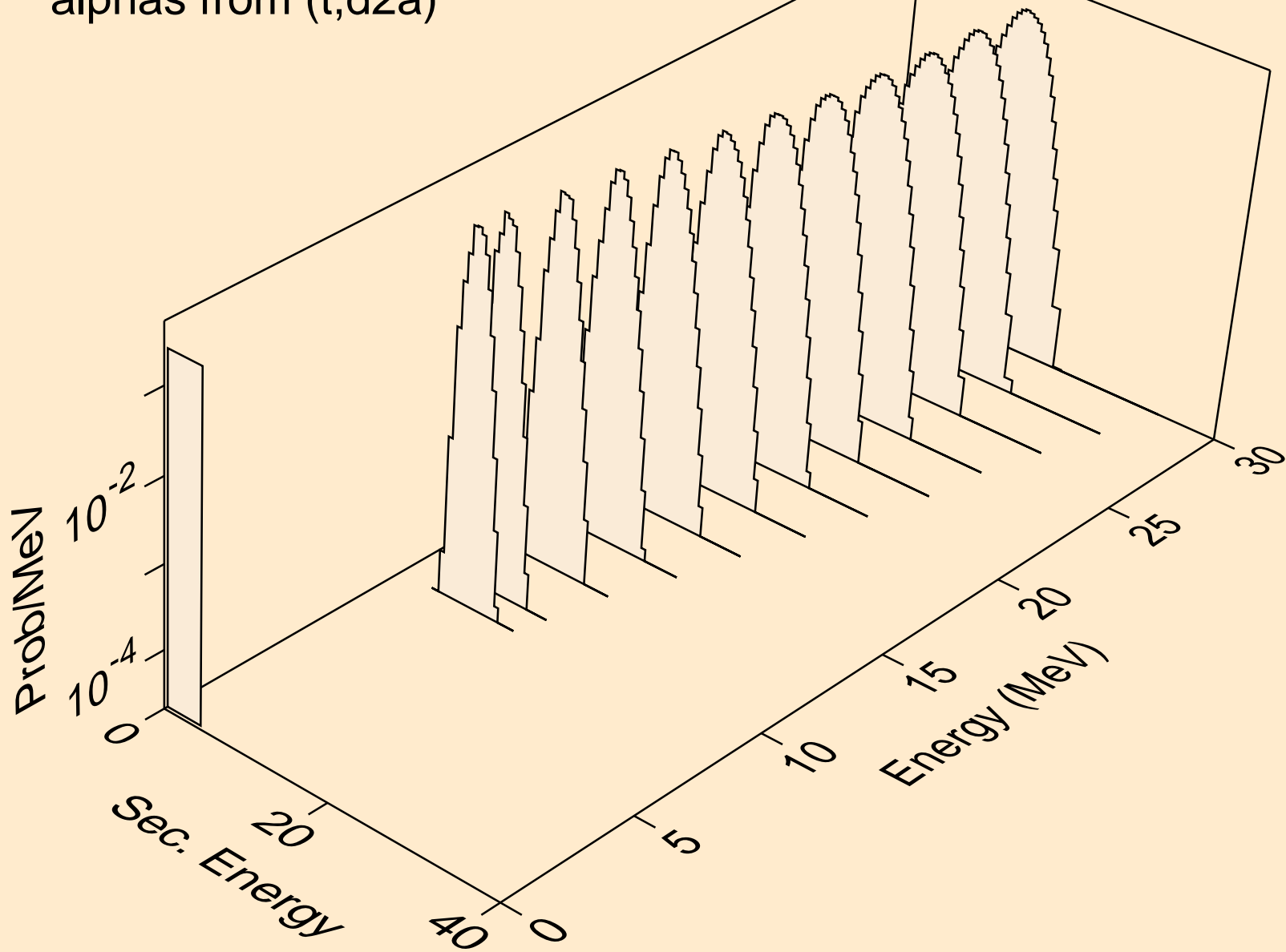



DY145M TRITON ACER TENDL-2021 LIBRARY; T=0.K  
alphas from (t,da)

