

ES246 TRITON ACER TENDL-2021 LIBRARY; T=0.K  
Principal cross sections

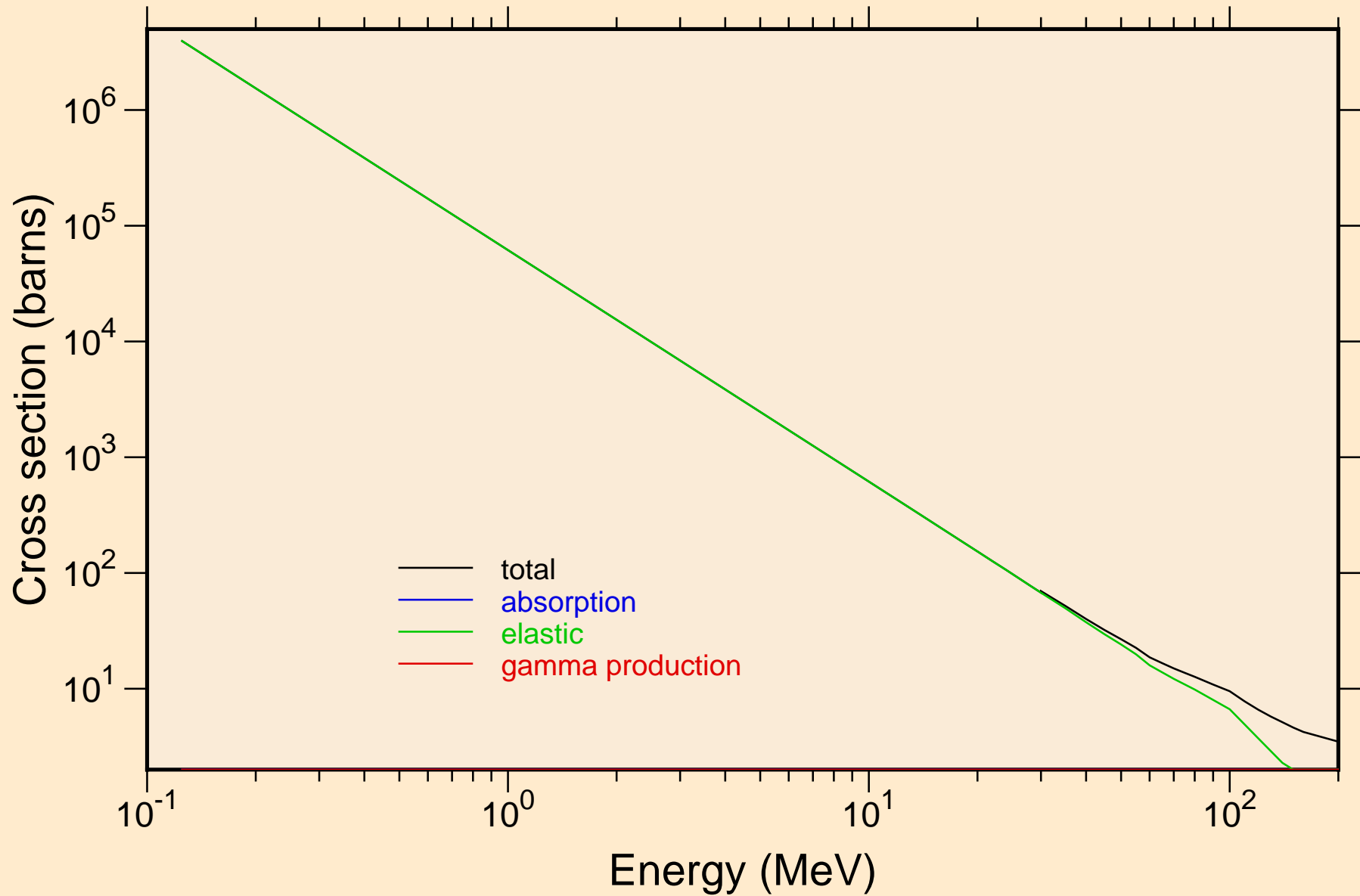

# ES246 TRITON ACER TENDL-2021 LIBRARY; T=0.K

## Heating

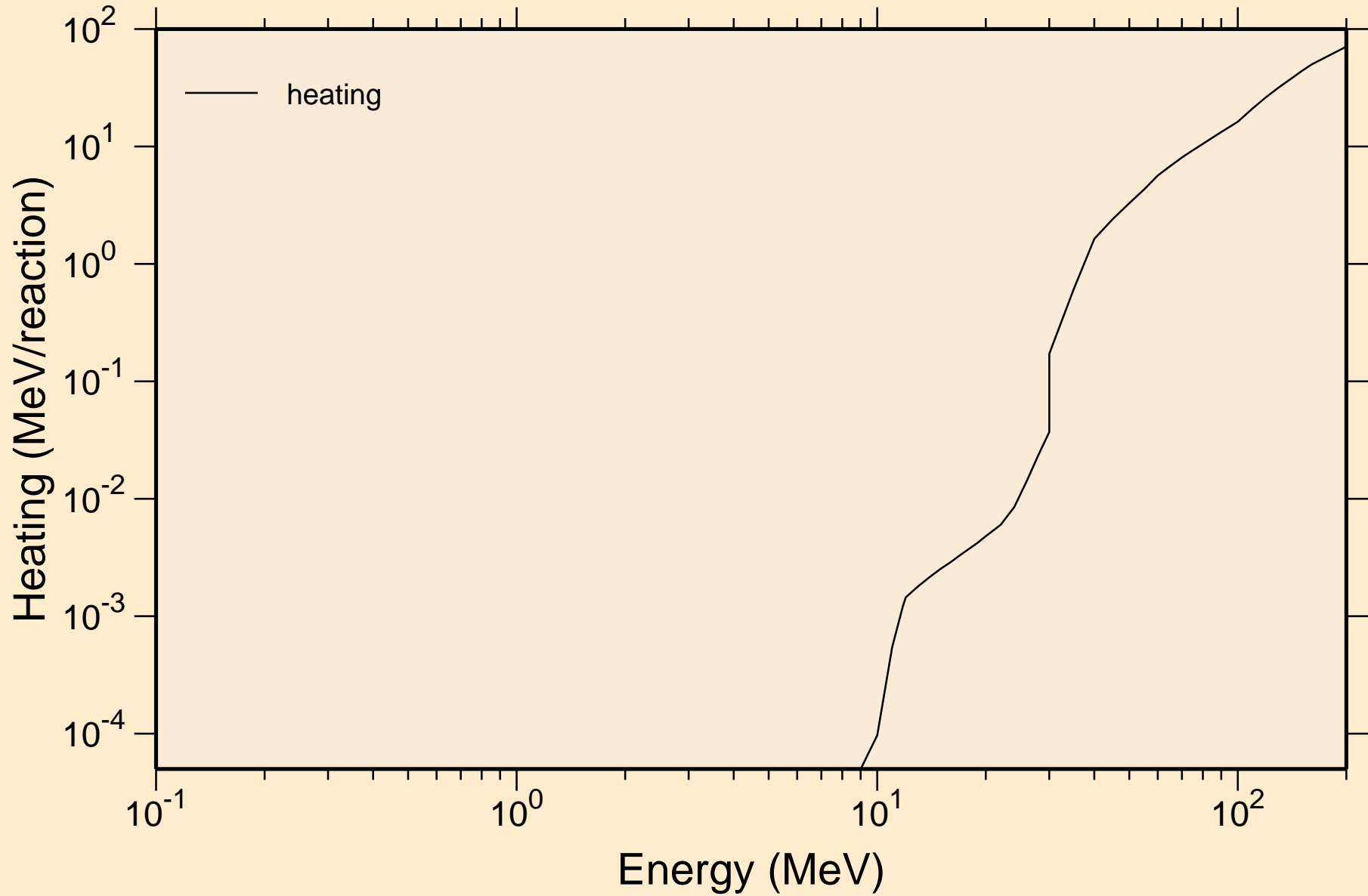

# ES246 TRITON ACER TENDL-2021 LIBRARY; T=0.K

## Principal cross sections

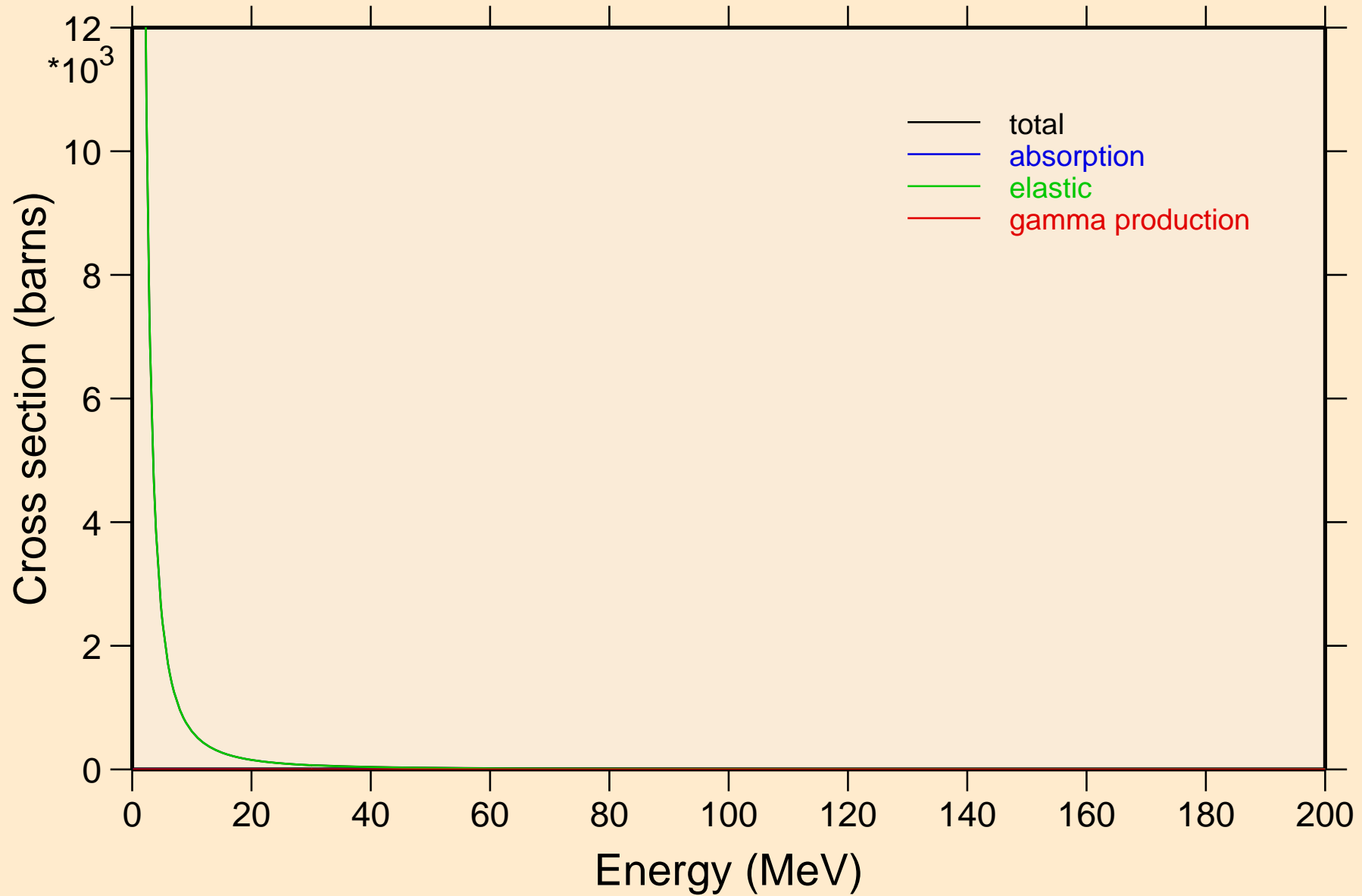

ES246 TRITON ACER TENDL-2021 LIBRARY; T=0.K

Heating

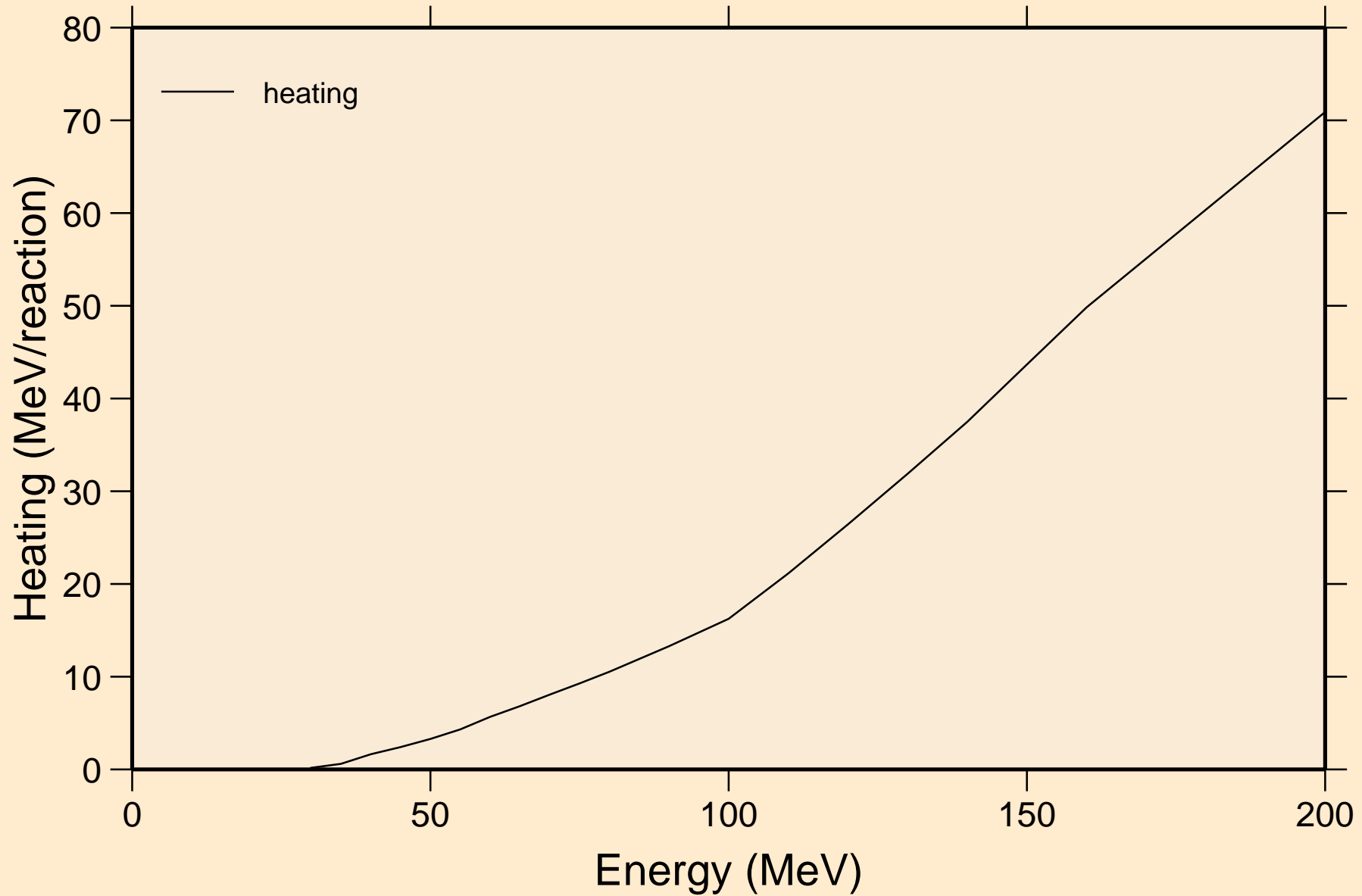

ES246 TRITON ACER TENDL-2021 LIBRARY; T=0.K  
Threshold reactions

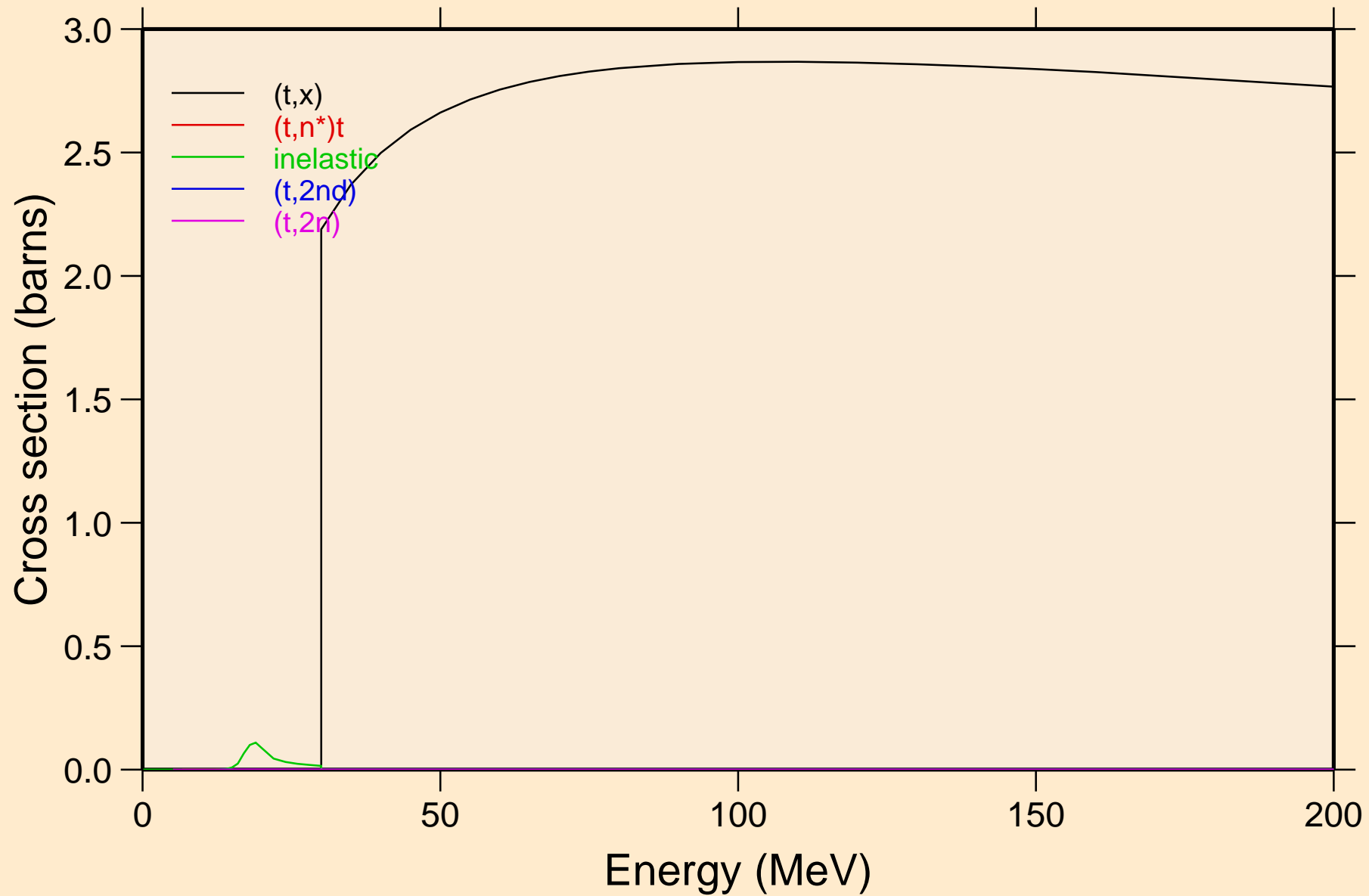

ES246 TRITON ACER TENDL-2021 LIBRARY; T=0.K  
Threshold reactions

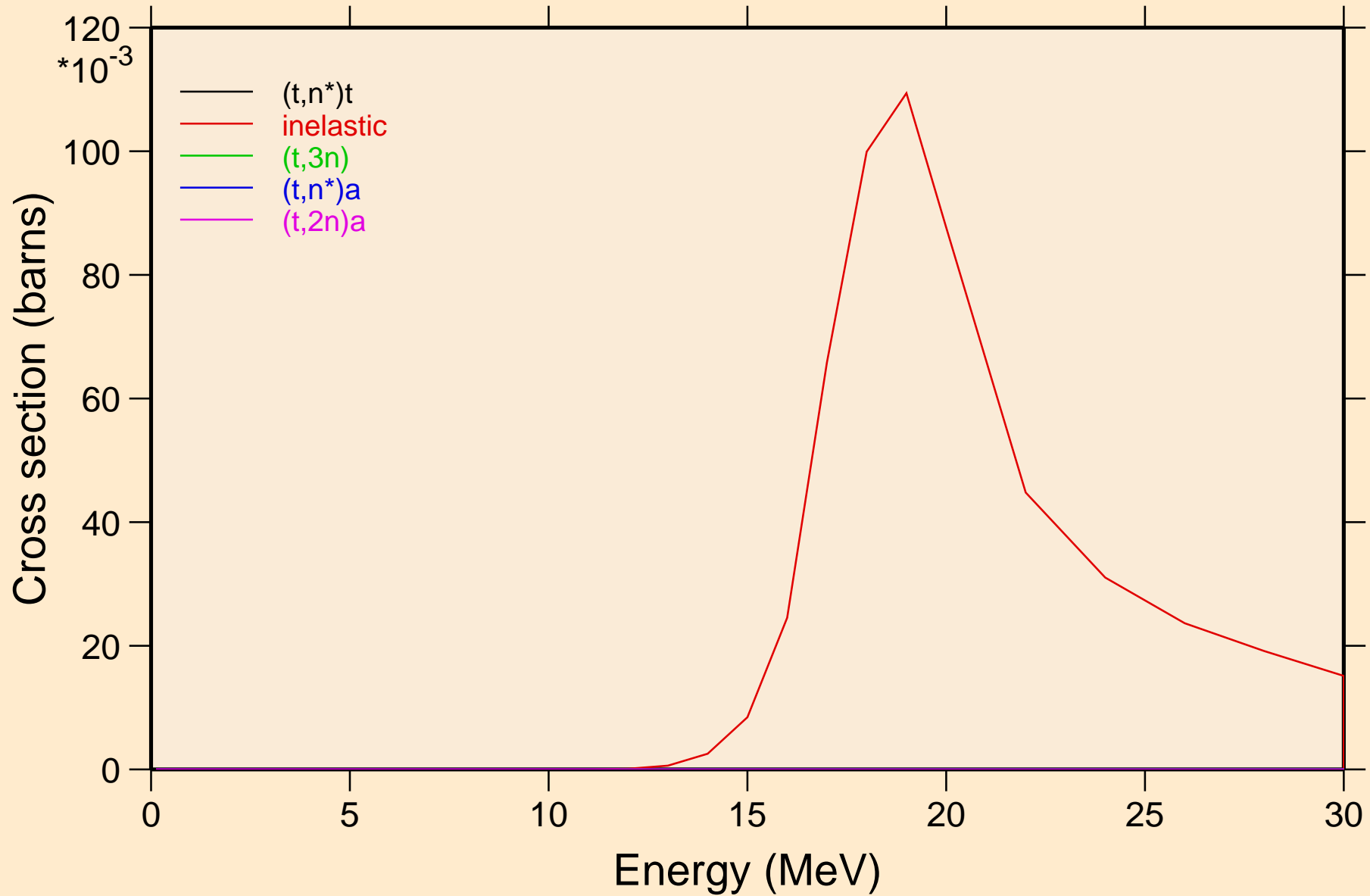

ES246 TRITON ACER TENDL-2021 LIBRARY; T=0.K  
Threshold reactions

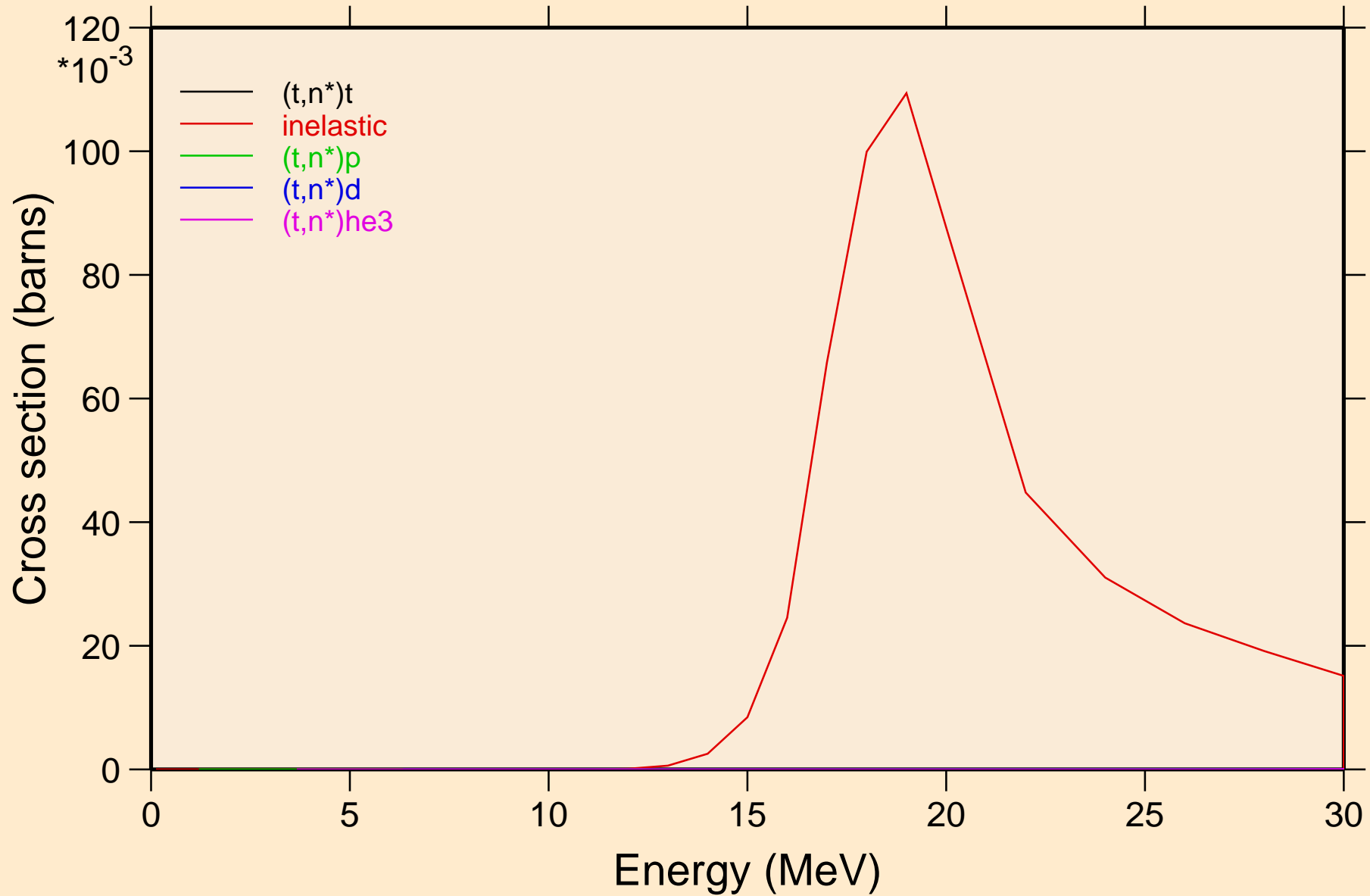

ES246 TRITON ACER TENDL-2021 LIBRARY; T=0.K  
Threshold reactions

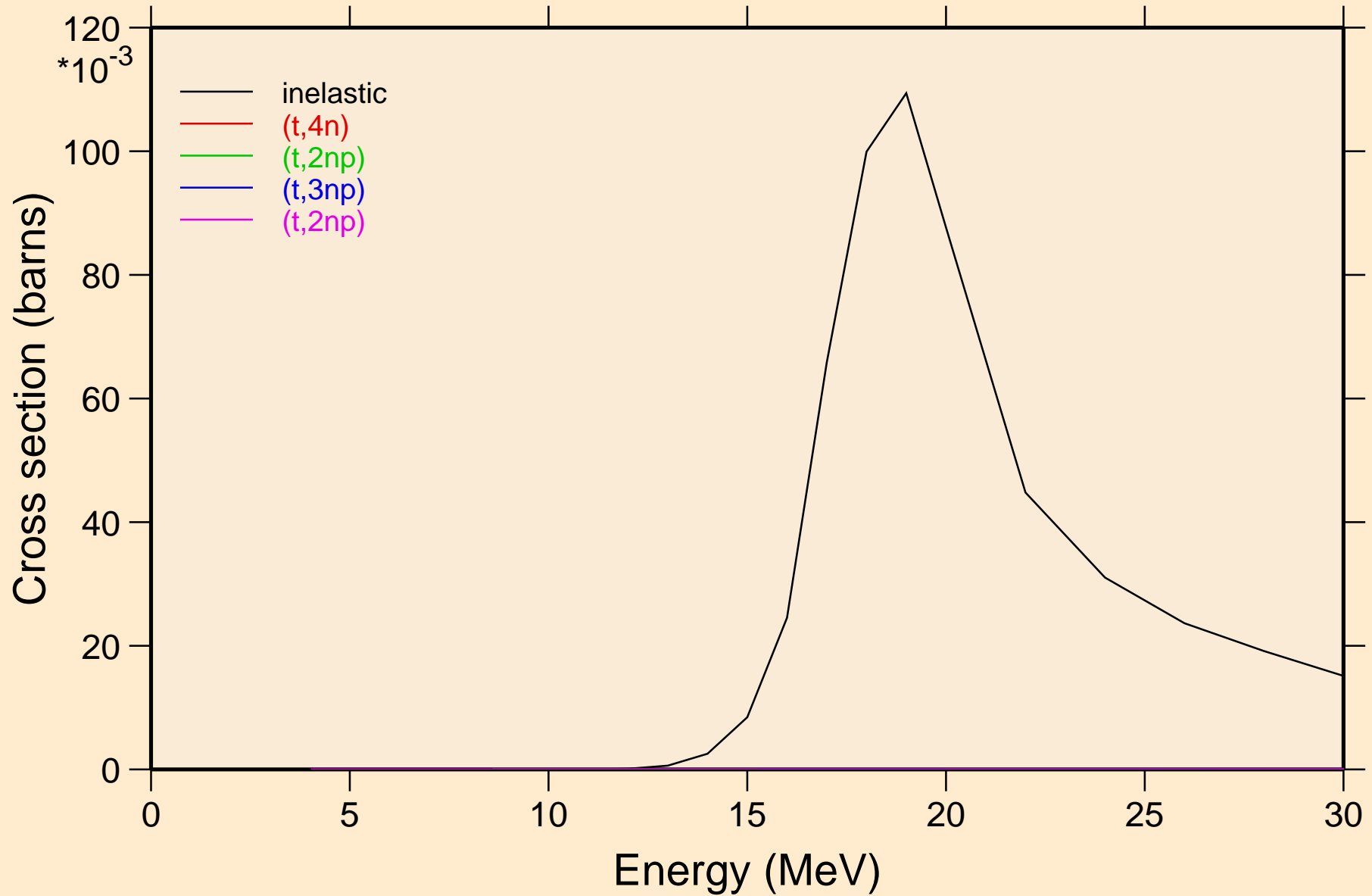



ES246 TRITON ACER TENDL-2021 LIBRARY; T=0.K  
Threshold reactions

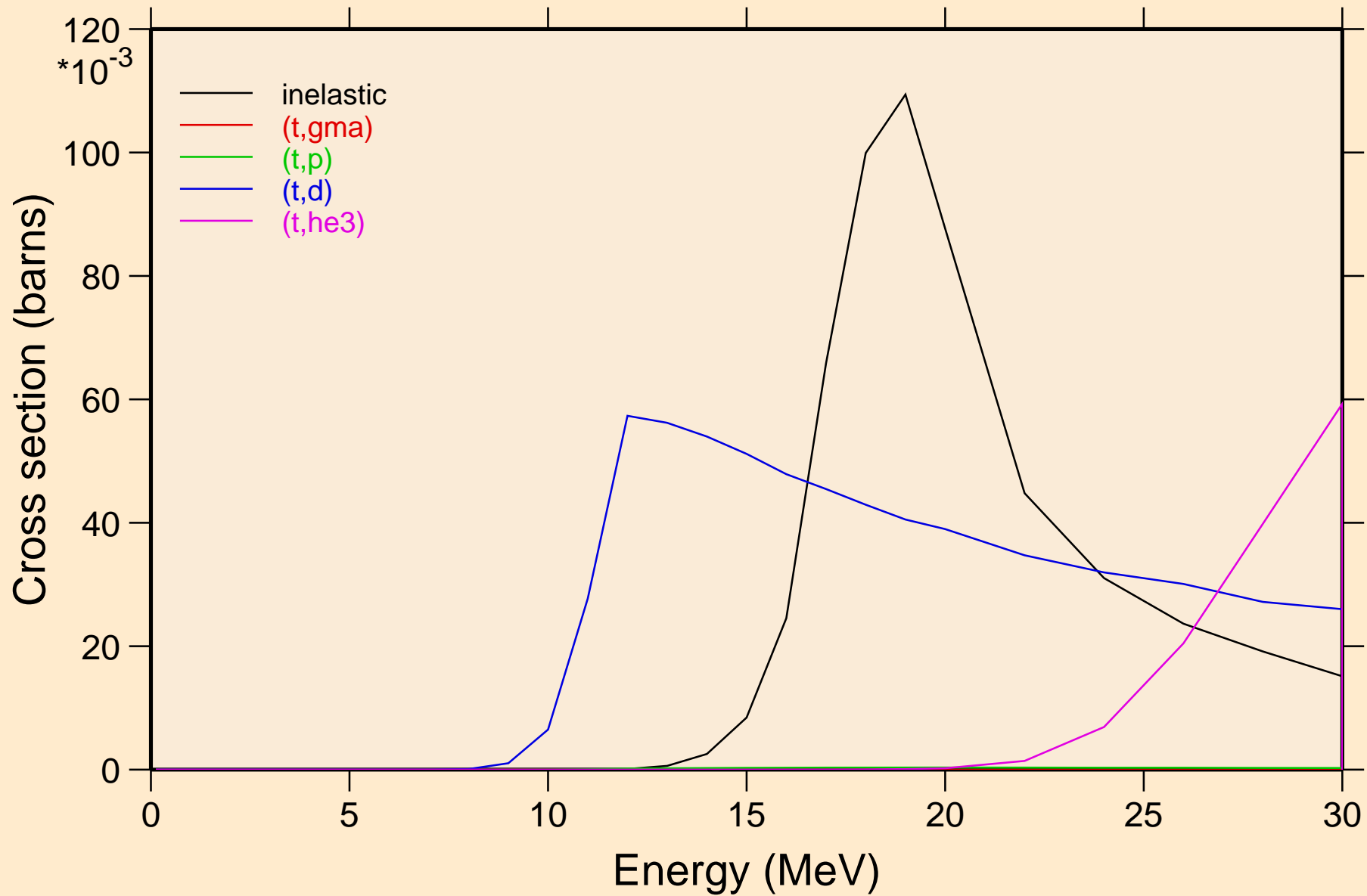

ES246 TRITON ACER TENDL-2021 LIBRARY; T=0.K  
Threshold reactions

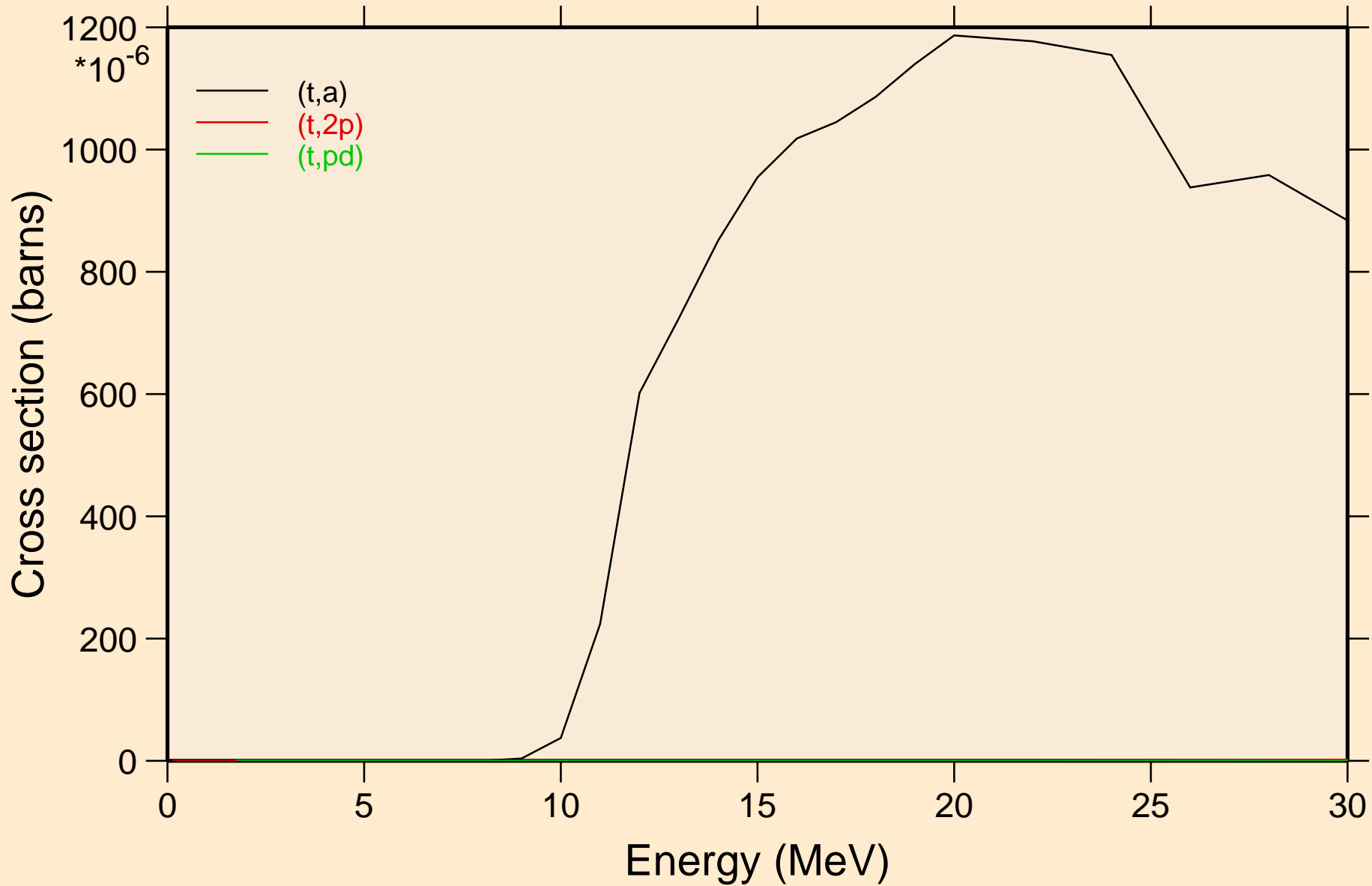

ES246 TRITON ACER TENDL-2021 LIBRARY; T=0.K  
angular distribution for elastic

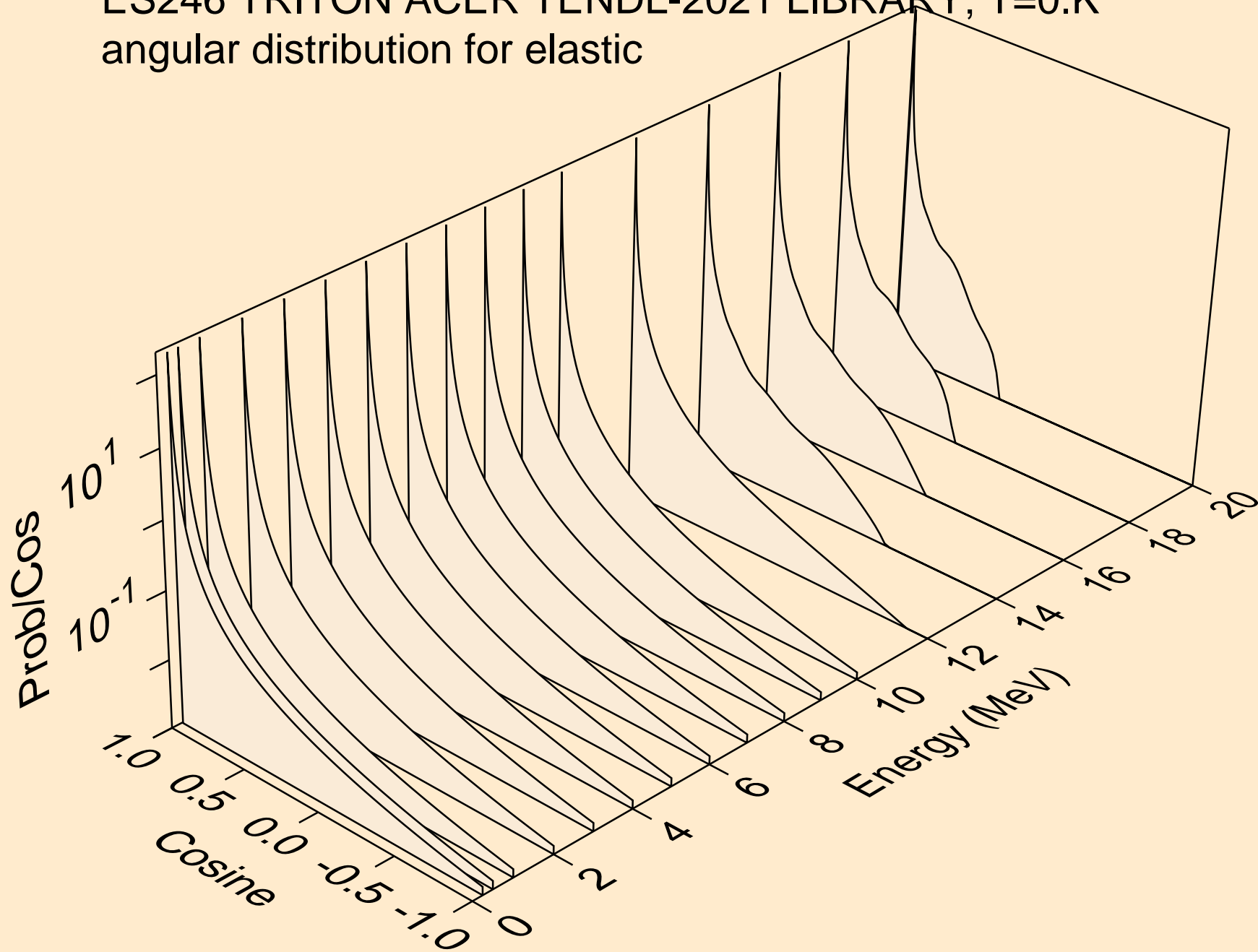

ES246 TRITON ACER TENDL-2021 LIBRARY; T=0.K  
angular distribution for elastic

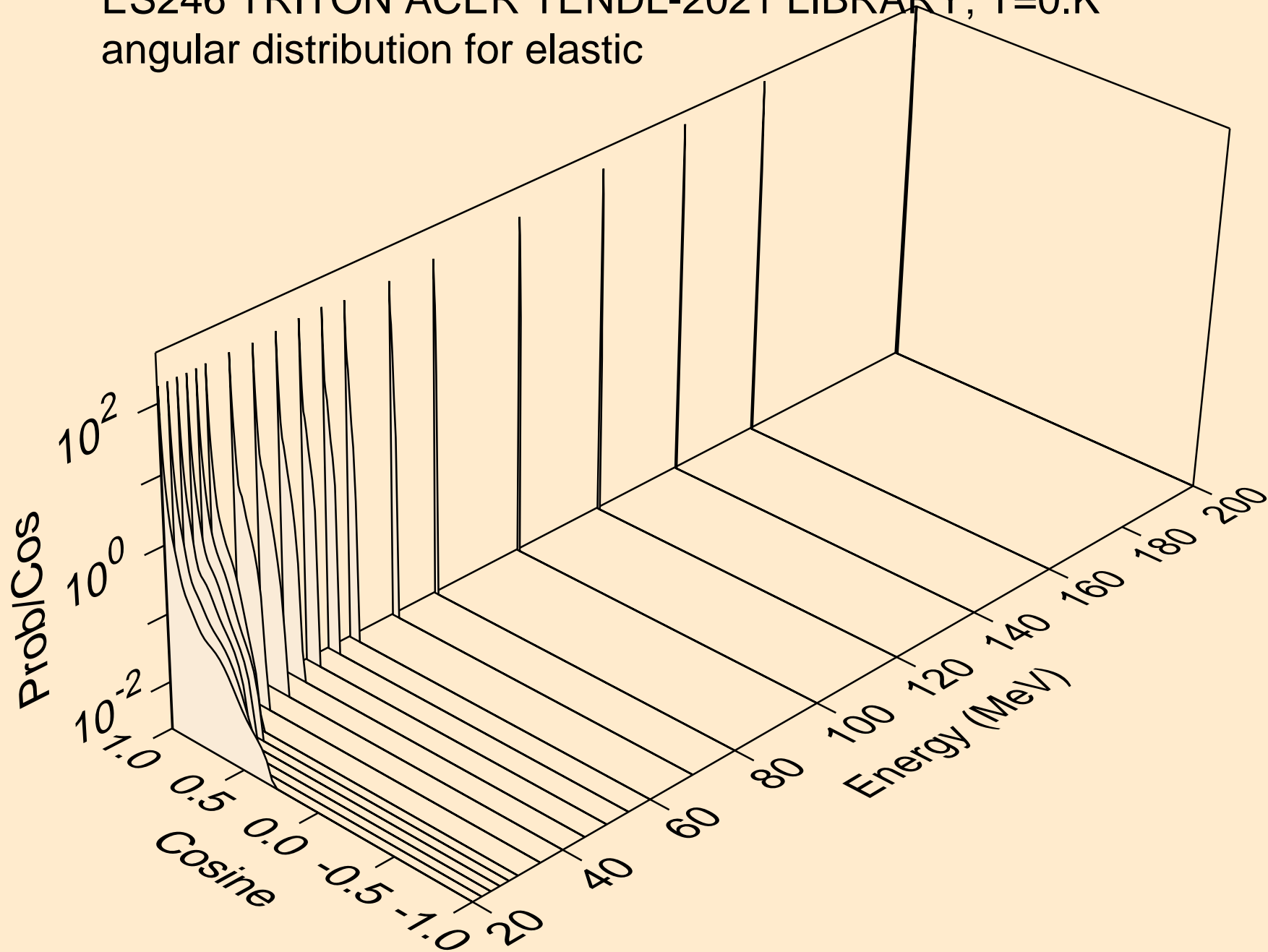

ES246 TRITON ACER TENDL-2021 LIBRARY; T=0.K  
Triton emission for (t,x)

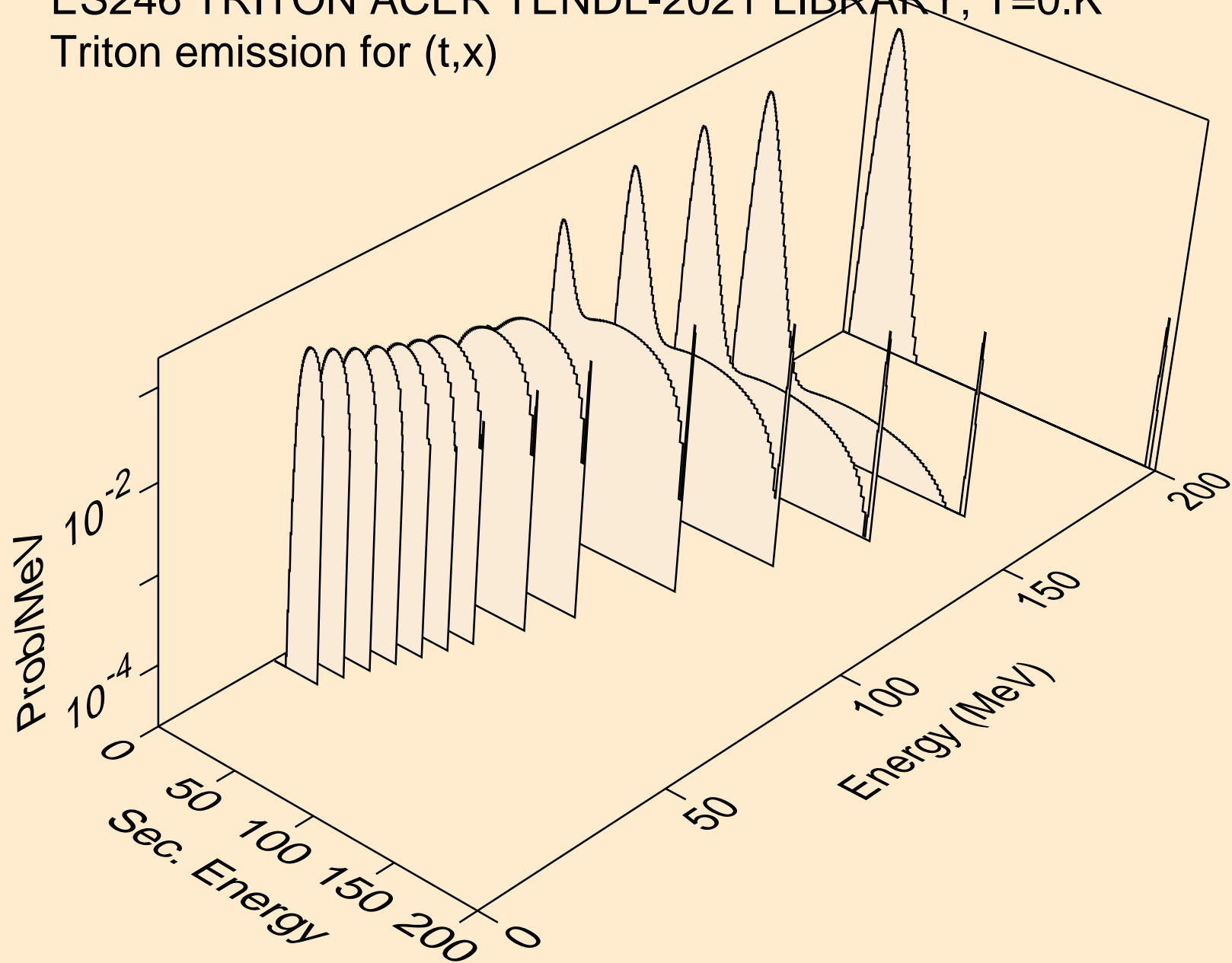

ES246 TRITON ACER TENDL-2021 LIBRARY; T=0.K  
Triton emission for (t,n\*)t

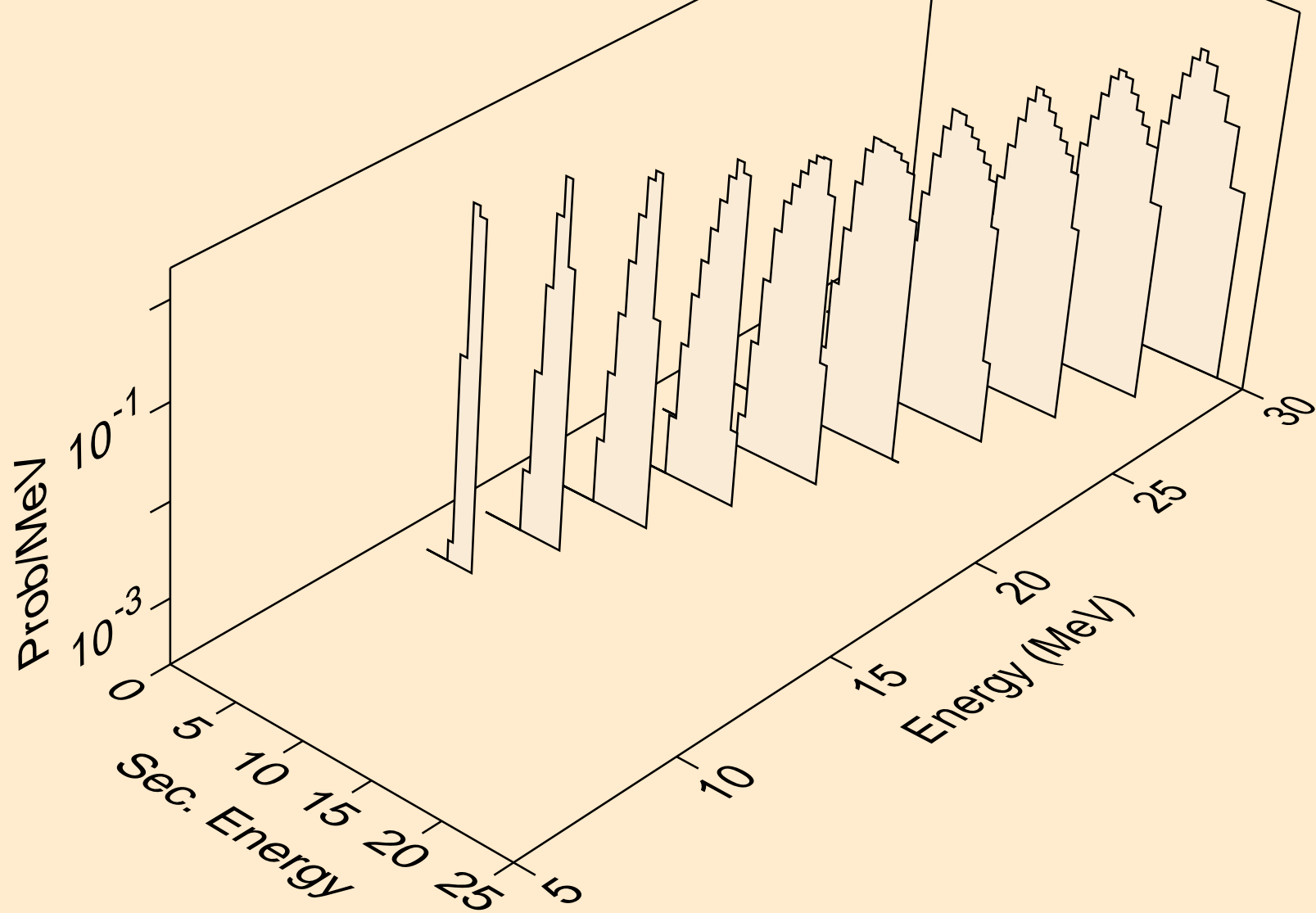

ES246 TRITON ACER TENDL-2021 LIBRARY; T=0.K  
Triton emission for inelastic

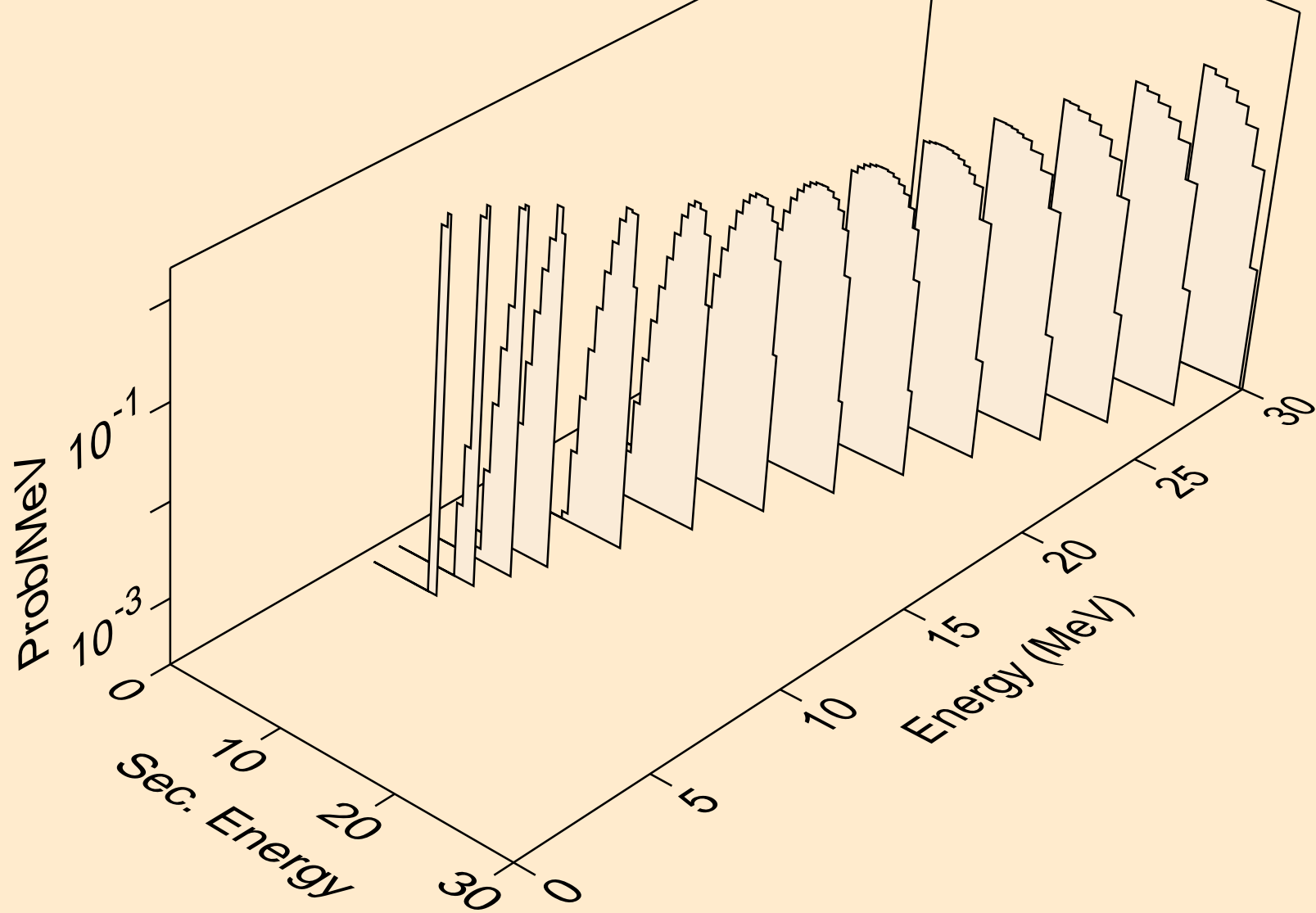

ES246 TRITON ACER TENDL-2021 LIBRARY; T=0.K  
Photon emission for (z,n)

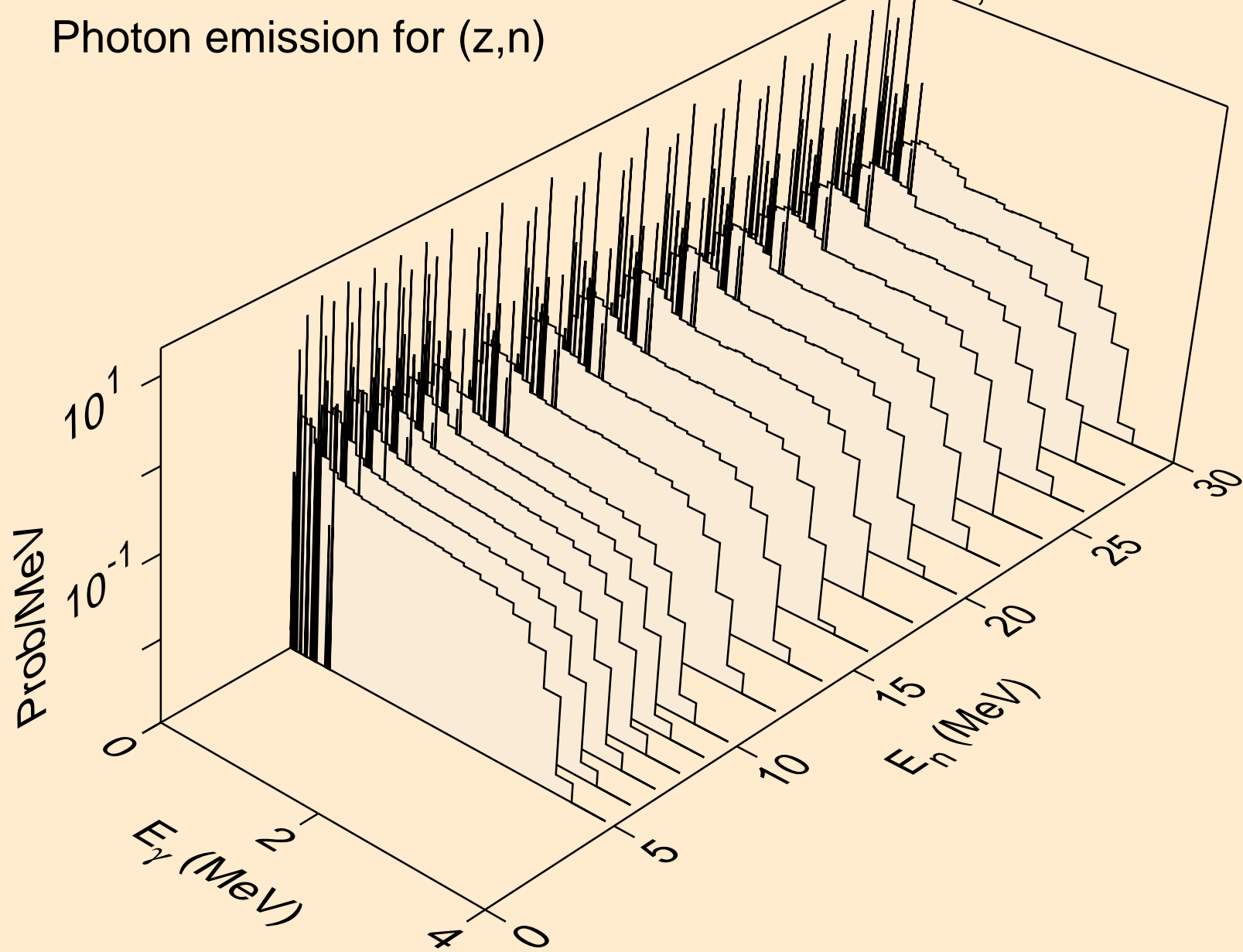



ES246 TRITON ACER TENDL-2021 LIBRARY; T=0.K  
Photon emission for (n,x)

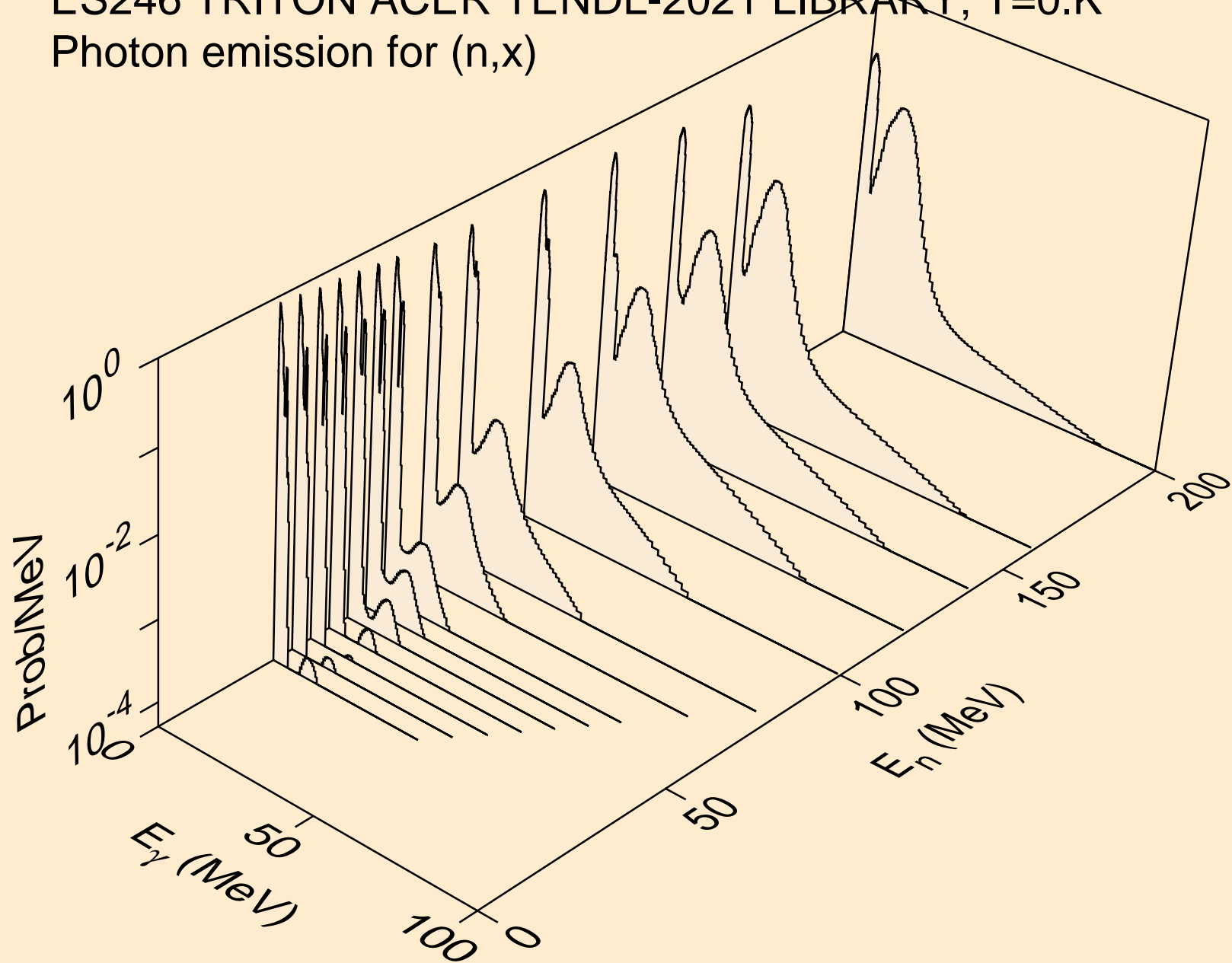

ES246 TRITON ACER TENDL-2021 LIBRARY; T=0.K  
Photon emission for (n,2nd)

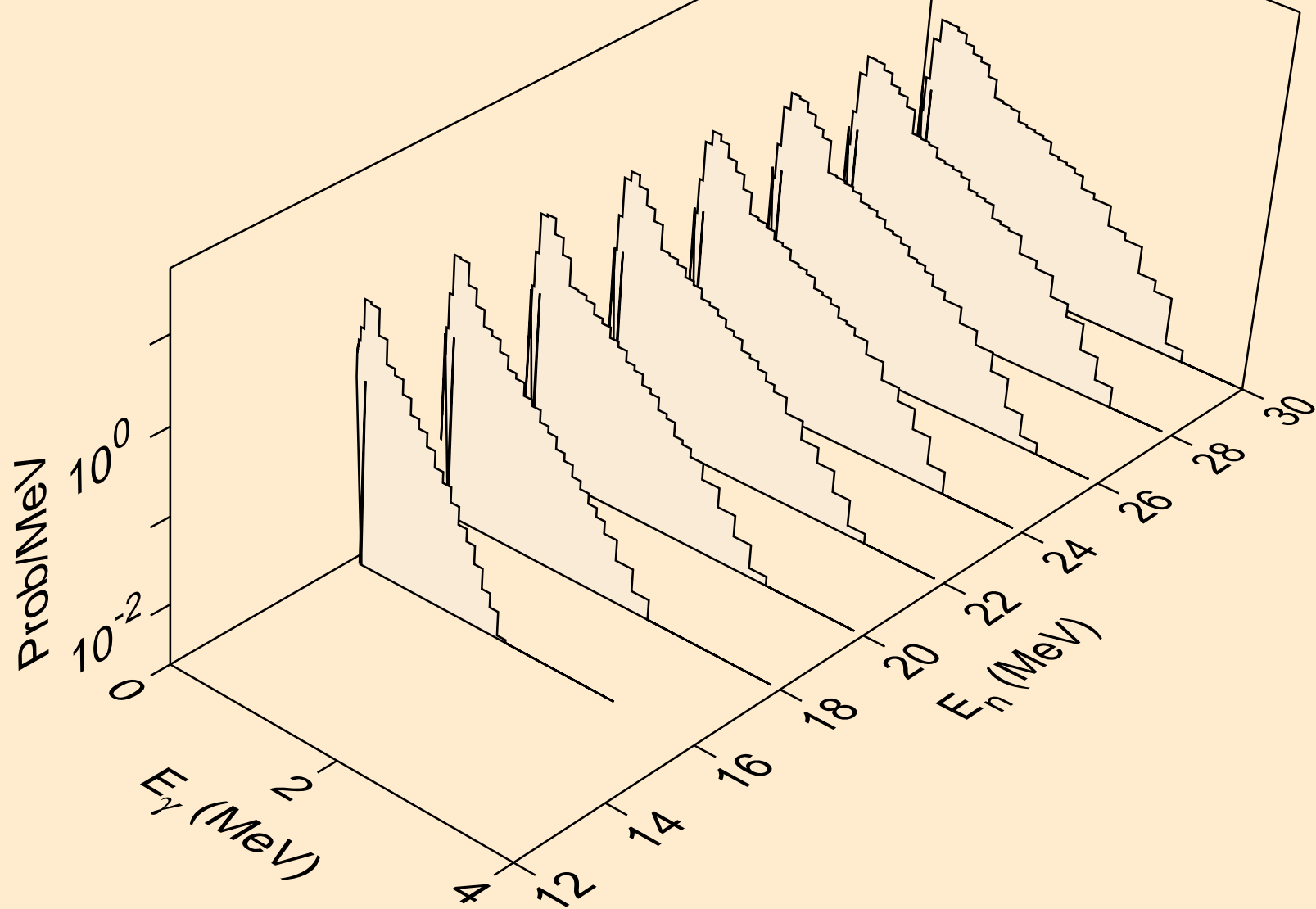

ES246 TRITON ACER TENDL-2021 LIBRARY; T=0.K  
Photon emission for (n,2n)

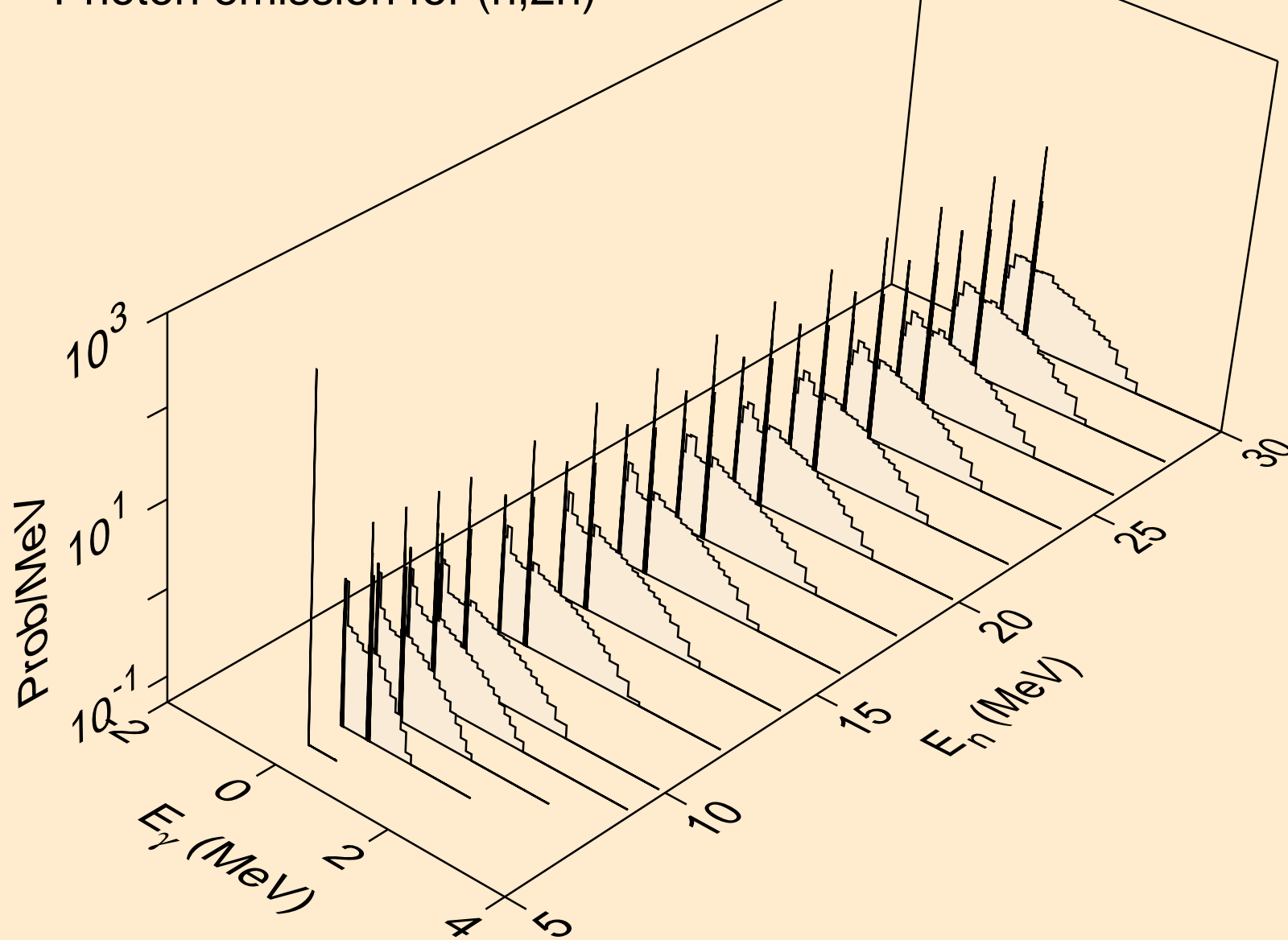

ES246 TRITON ACER TENDL-2021 LIBRARY; T=0.K  
Photon emission for (n,3n)

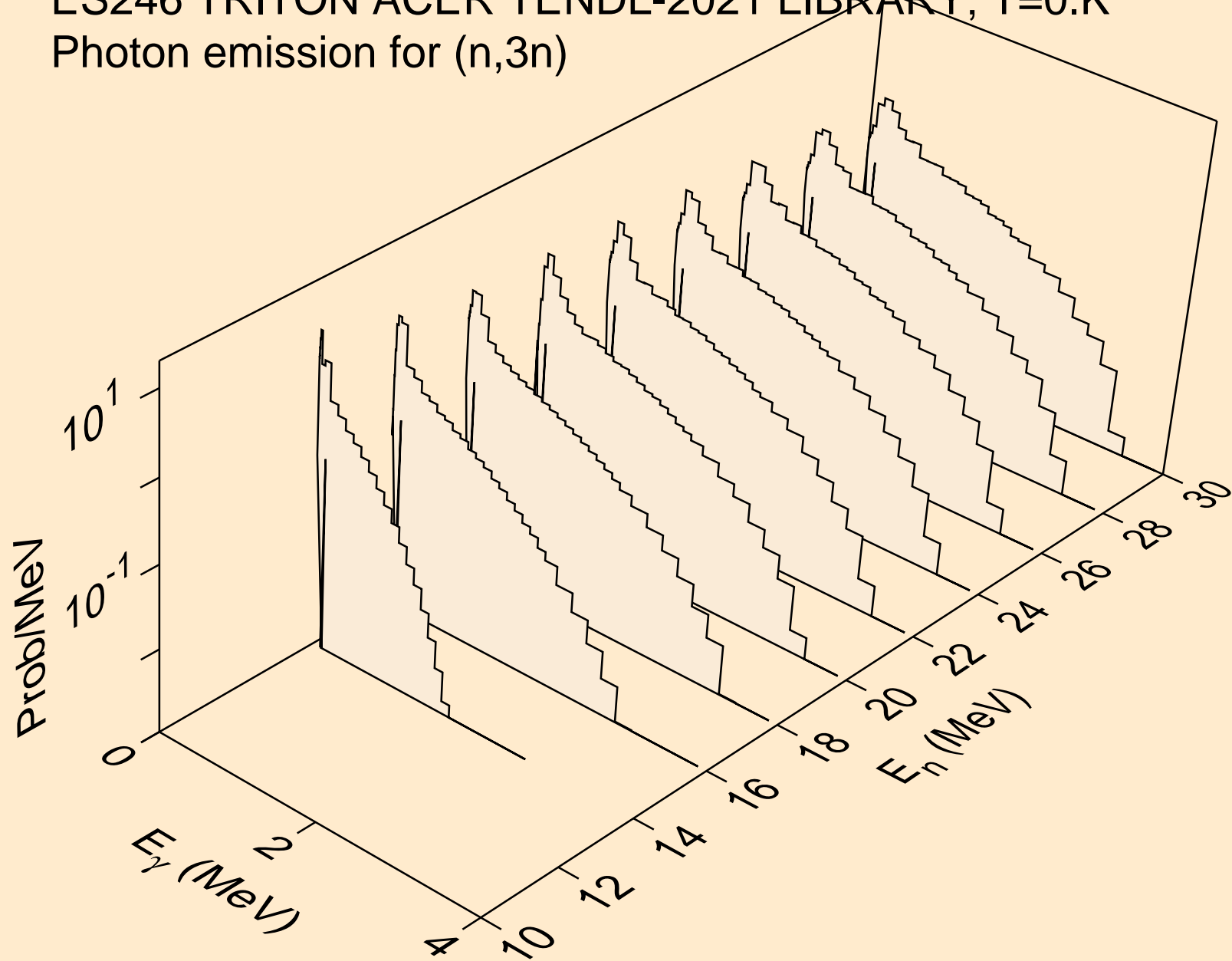

ES246 TRITON ACER TENDL-2021 LIBRARY; T=0.K  
Photon emission for (n,n\*)a

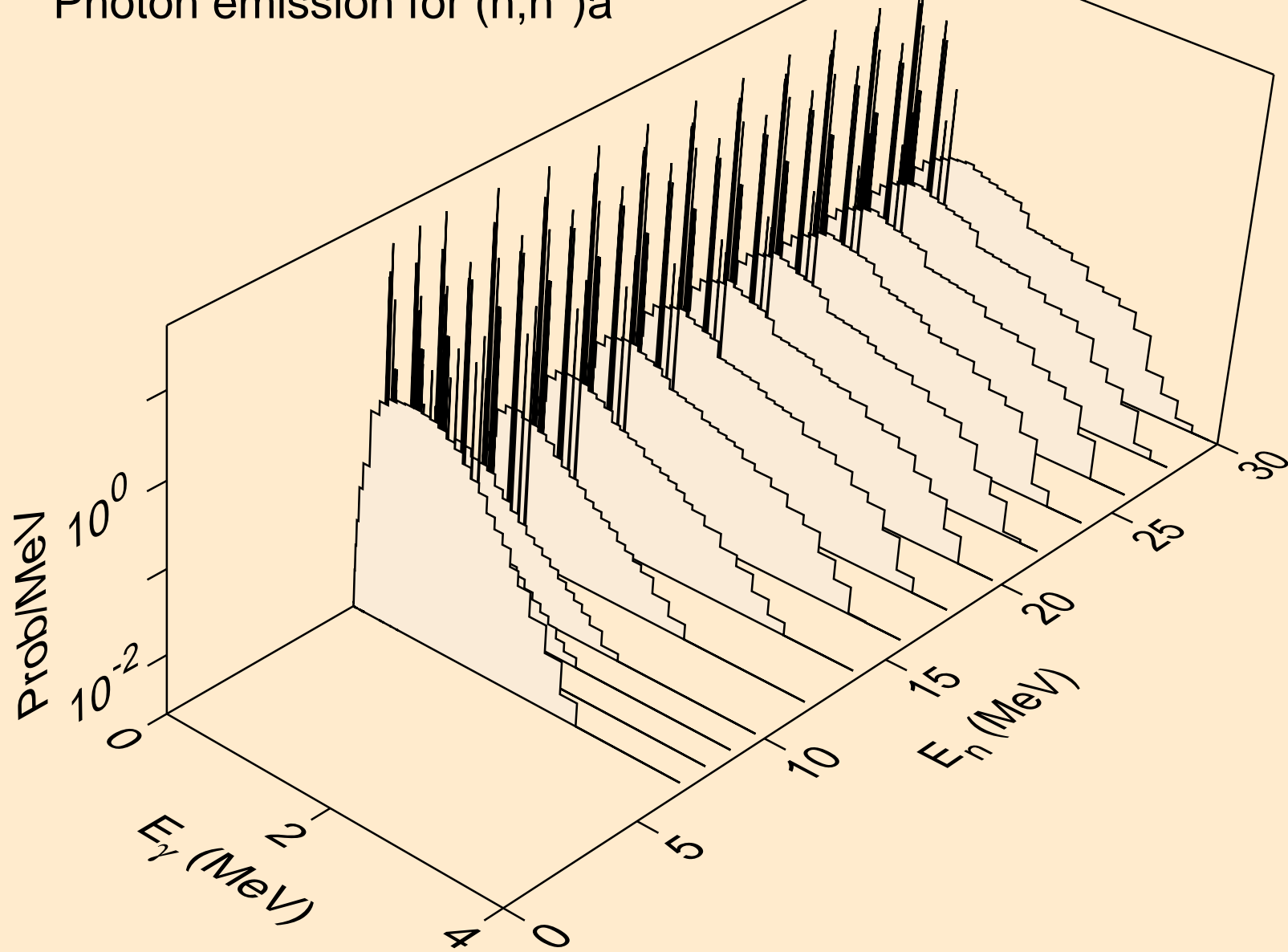

ES246 TRITON ACER TENDL-2021 LIBRARY; T=0.K  
Photon emission for (n,2n)a

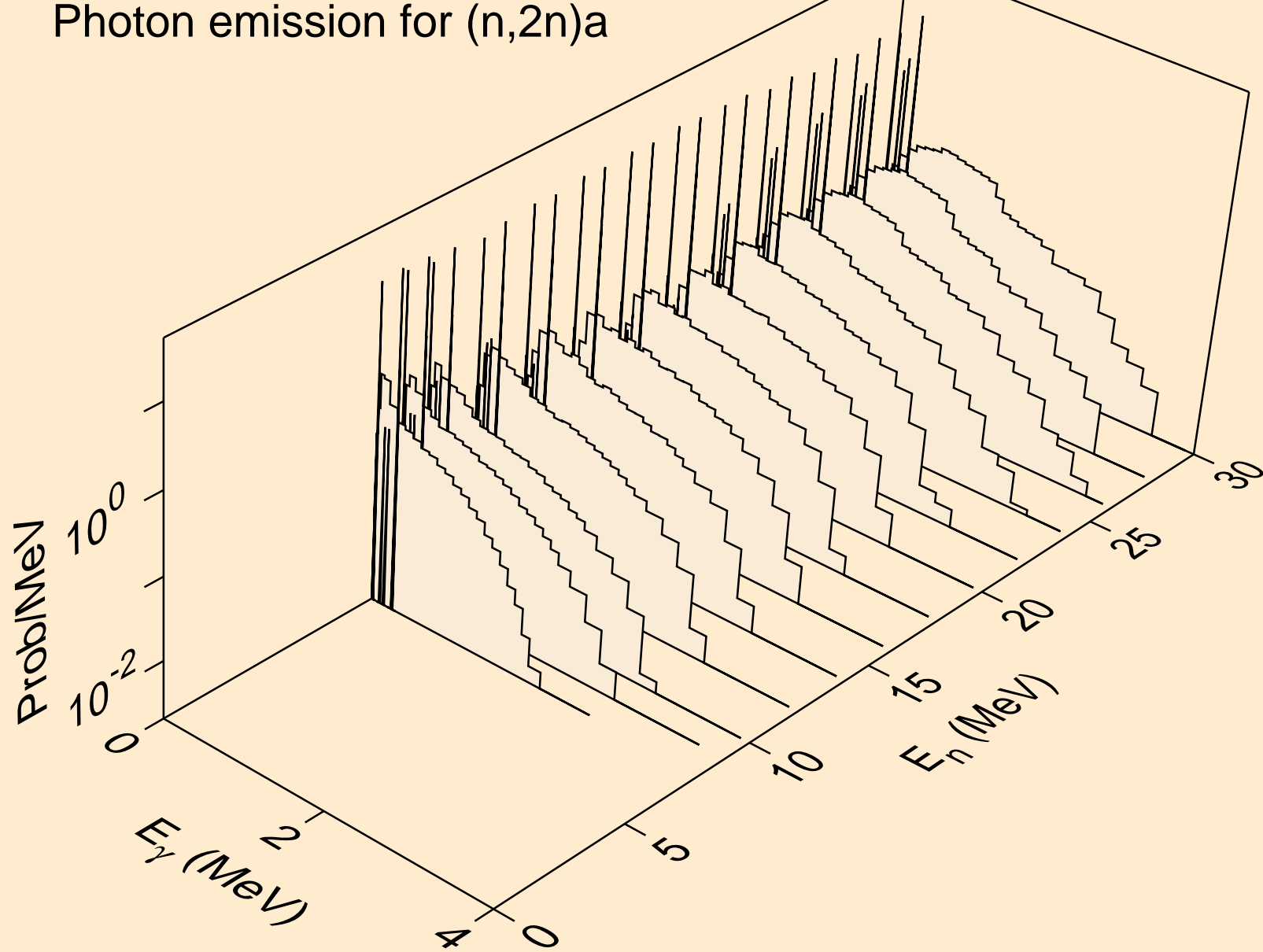

ES246 TRITON ACER TENDL-2021 LIBRARY; T=0.K  
Photon emission for (n,n\*)p

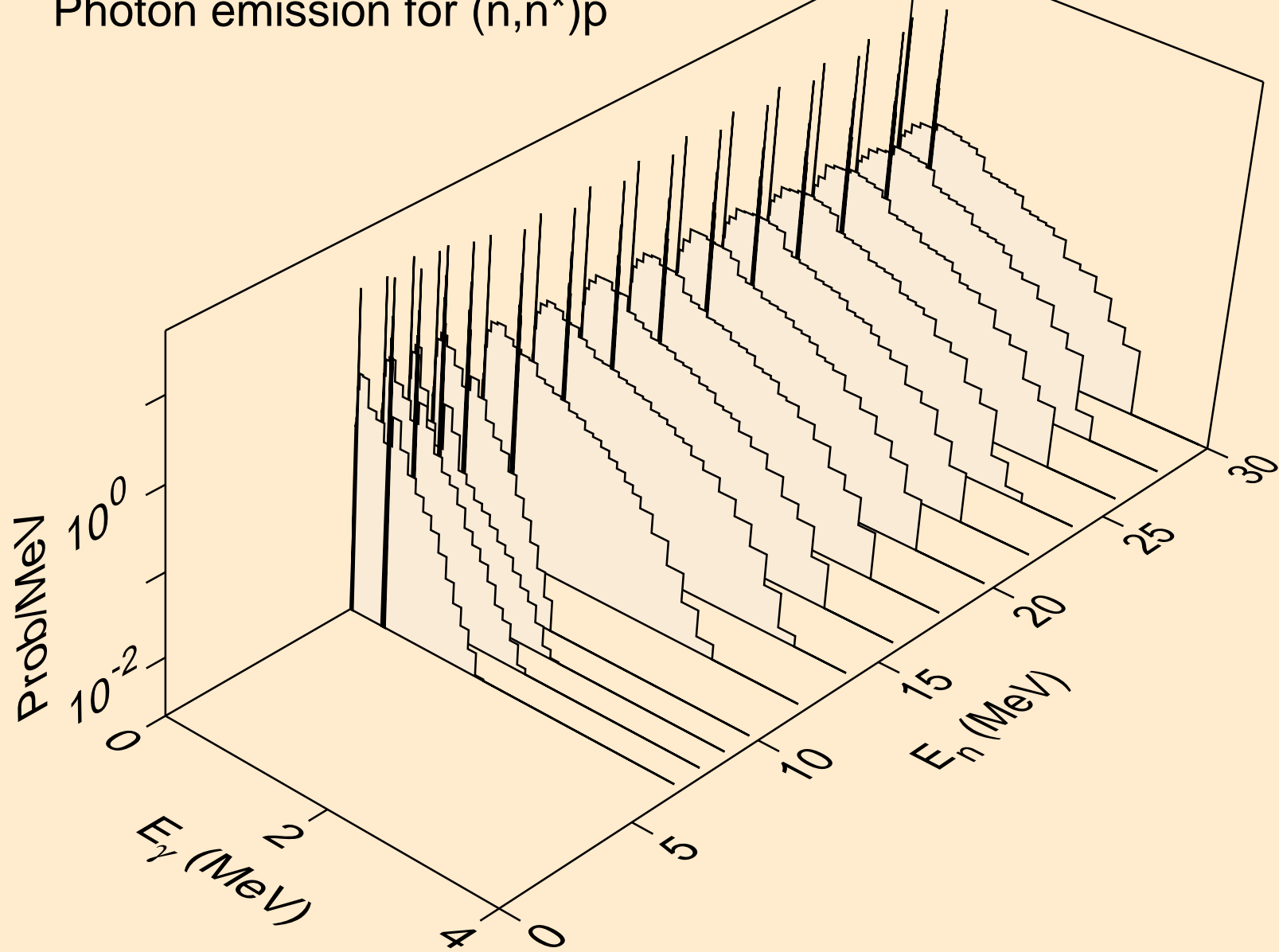

ES246 TRITON ACER TENDL-2021 LIBRARY; T=0.K  
Photon emission for (n,n\*)d

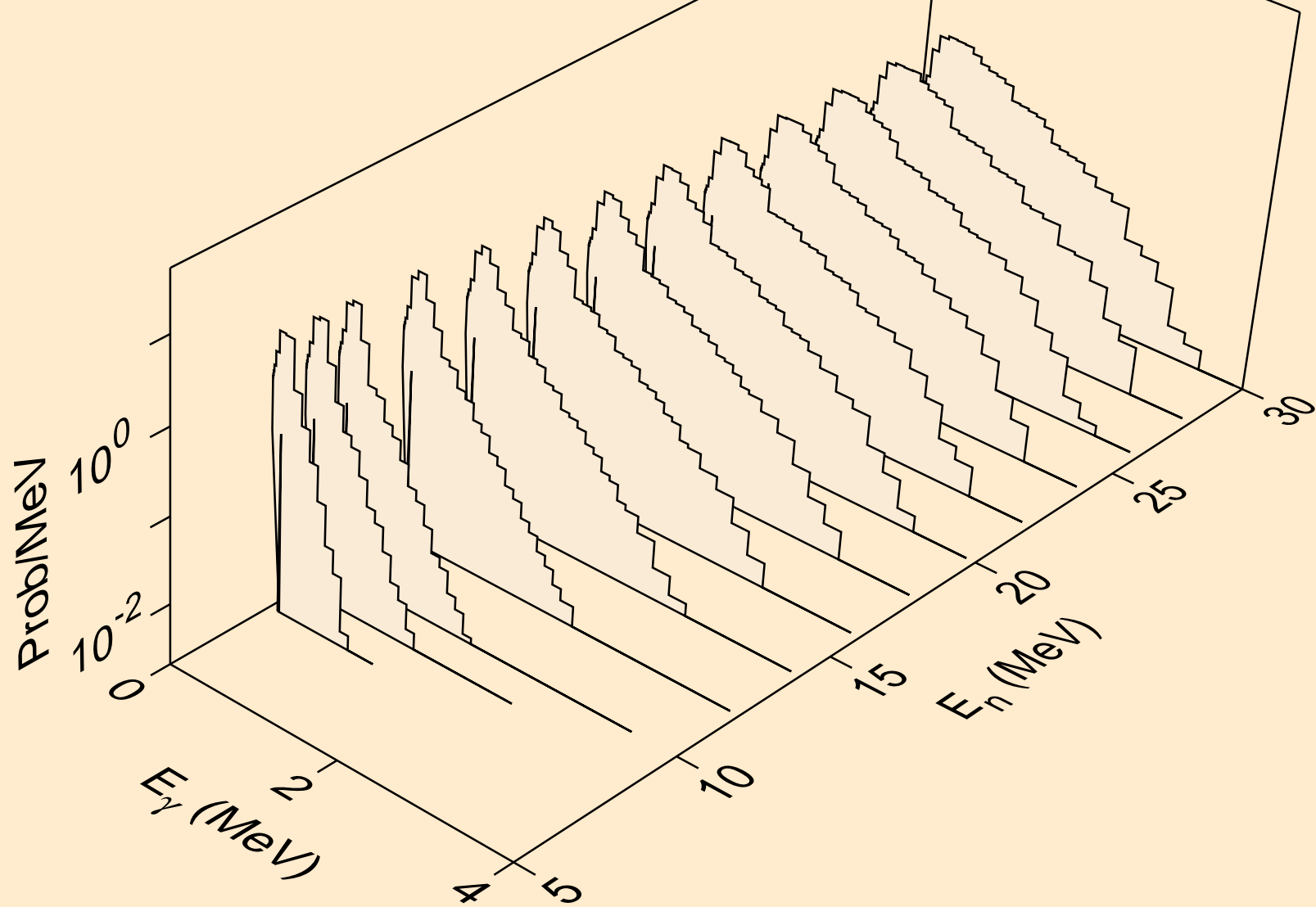



ES246 TRITON ACER TENDL-2021 LIBRARY; T=0.K  
Photon emission for (n,n\*)t

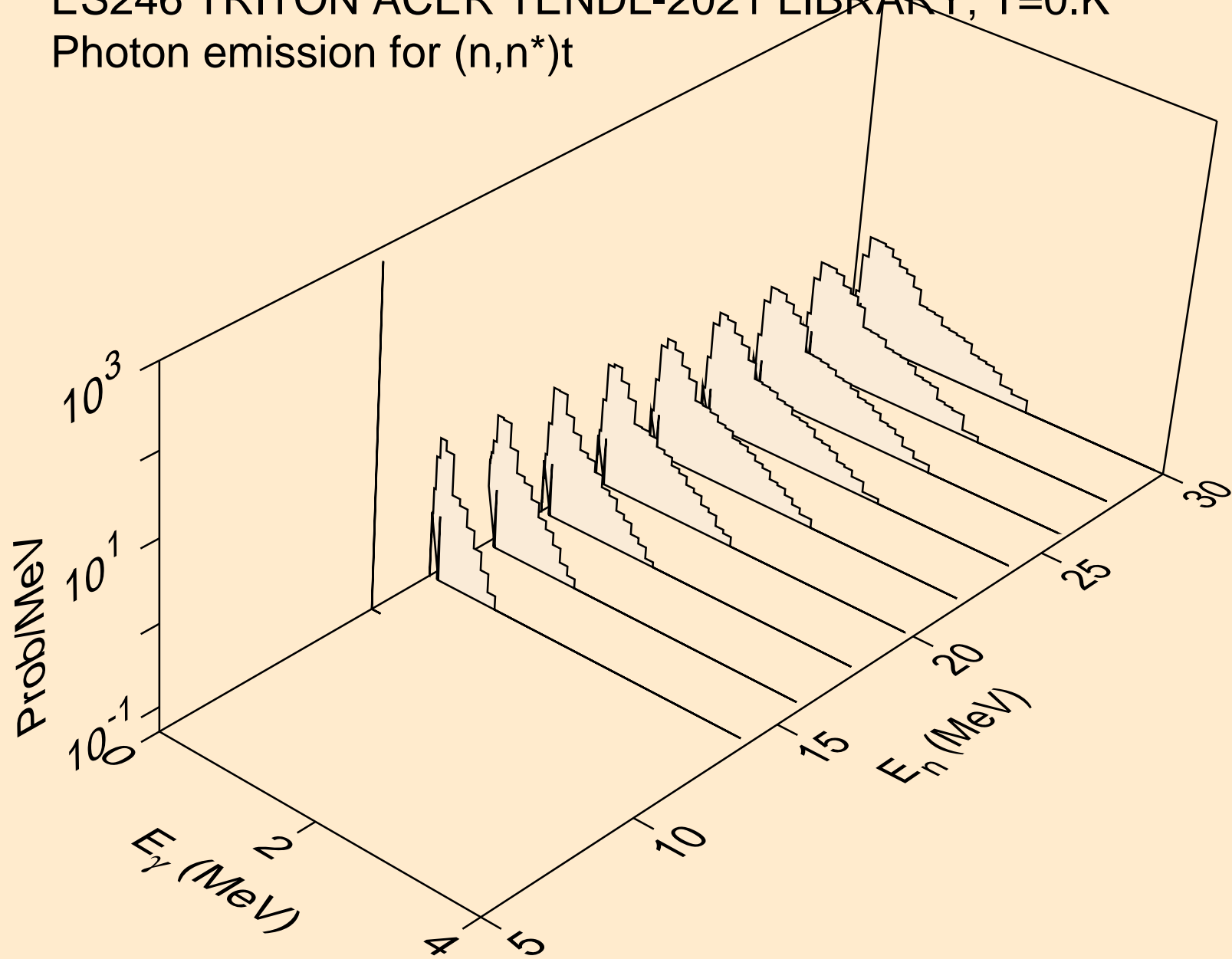

ES246 TRITON ACER TENDL-2021 LIBRARY; T=0.K  
Photon emission for (n,n\*)he3

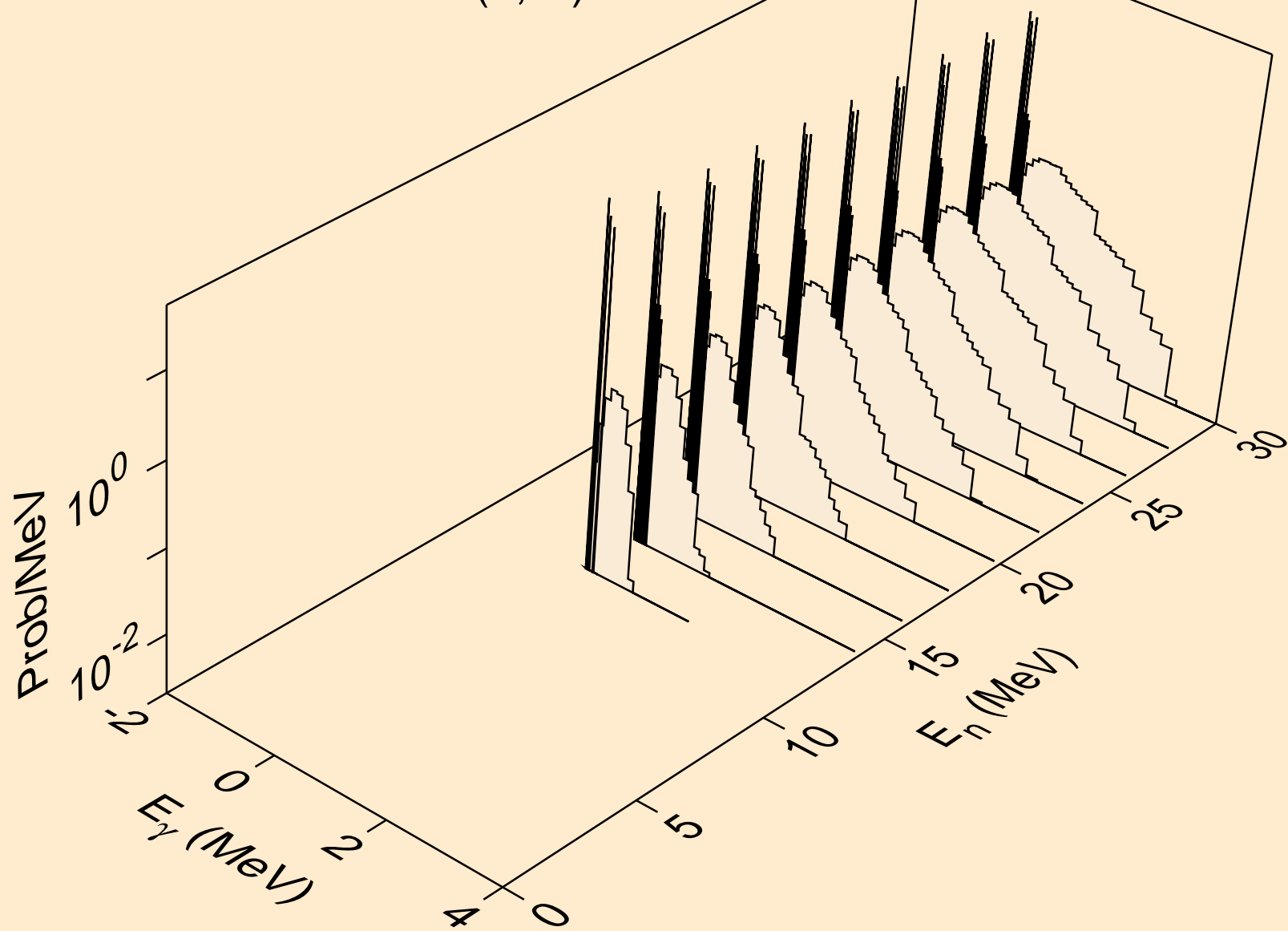

ES246 TRITON ACER TENDL-2021 LIBRARY; T=0.K  
Photon emission for (n,4n)

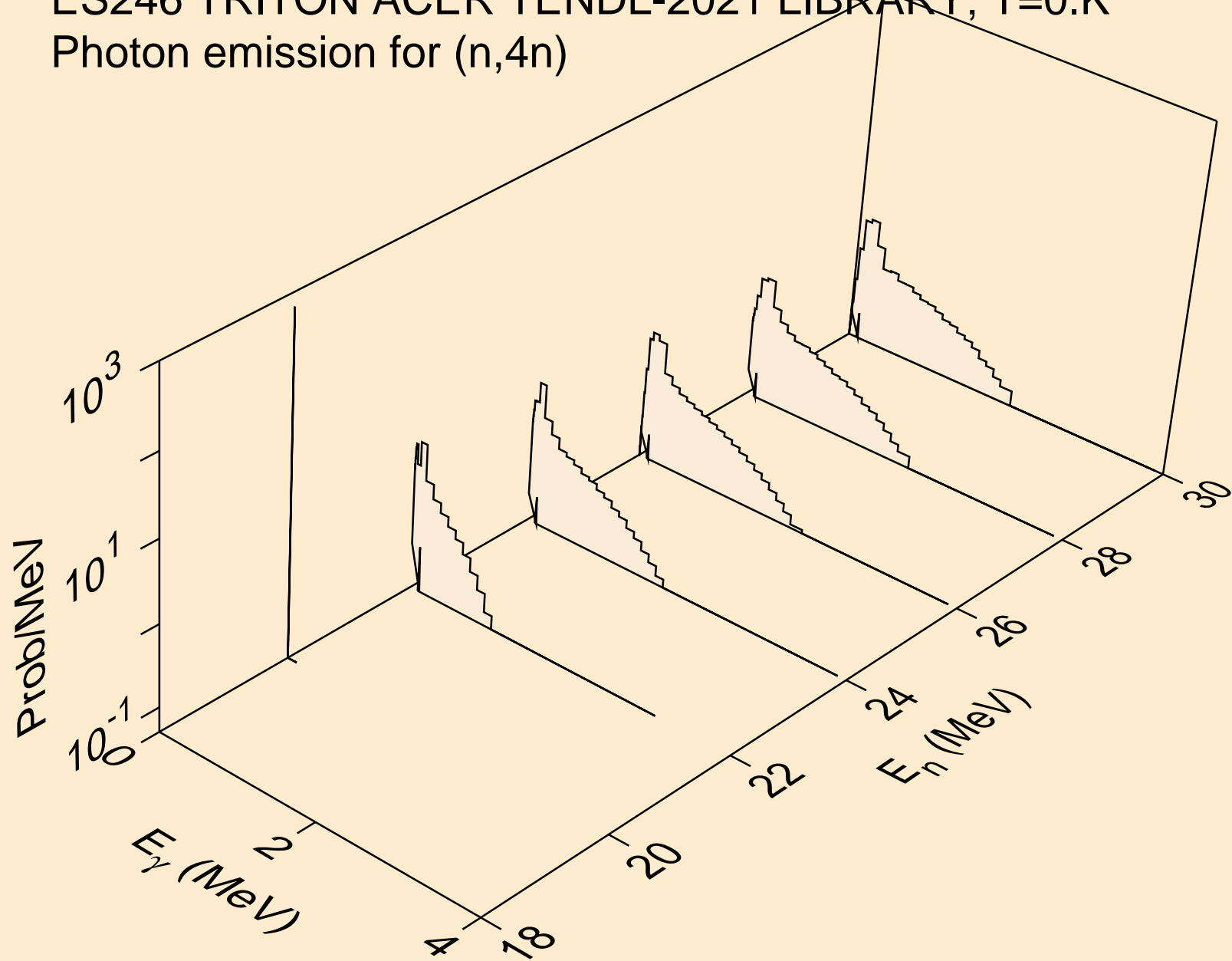

ES246 TRITON ACER TENDL-2021 LIBRARY; T=0.K  
Photon emission for (n,2np)

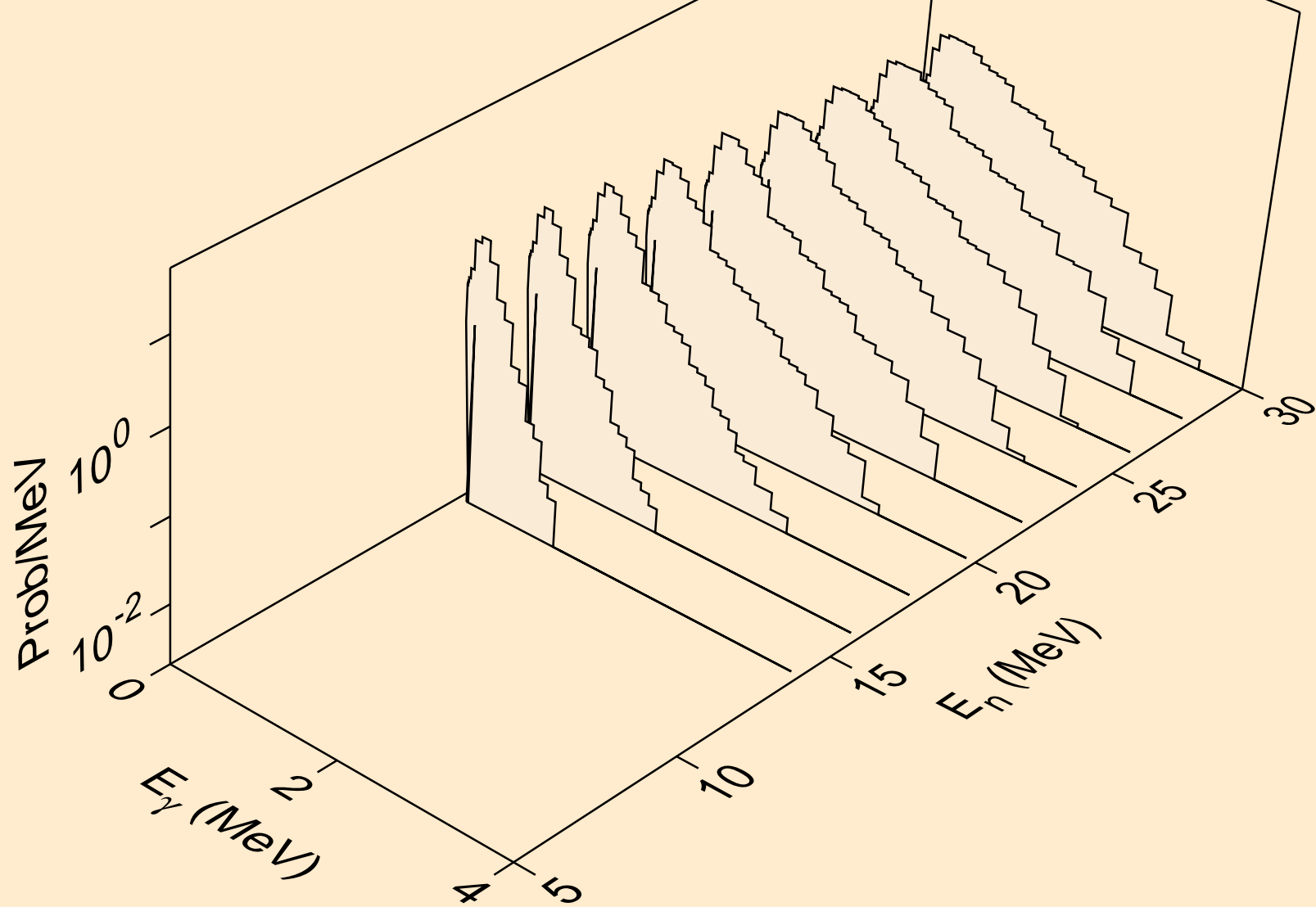

ES246 TRITON ACER TENDL-2021 LIBRARY; T=0.K  
Photon emission for (n,3np)

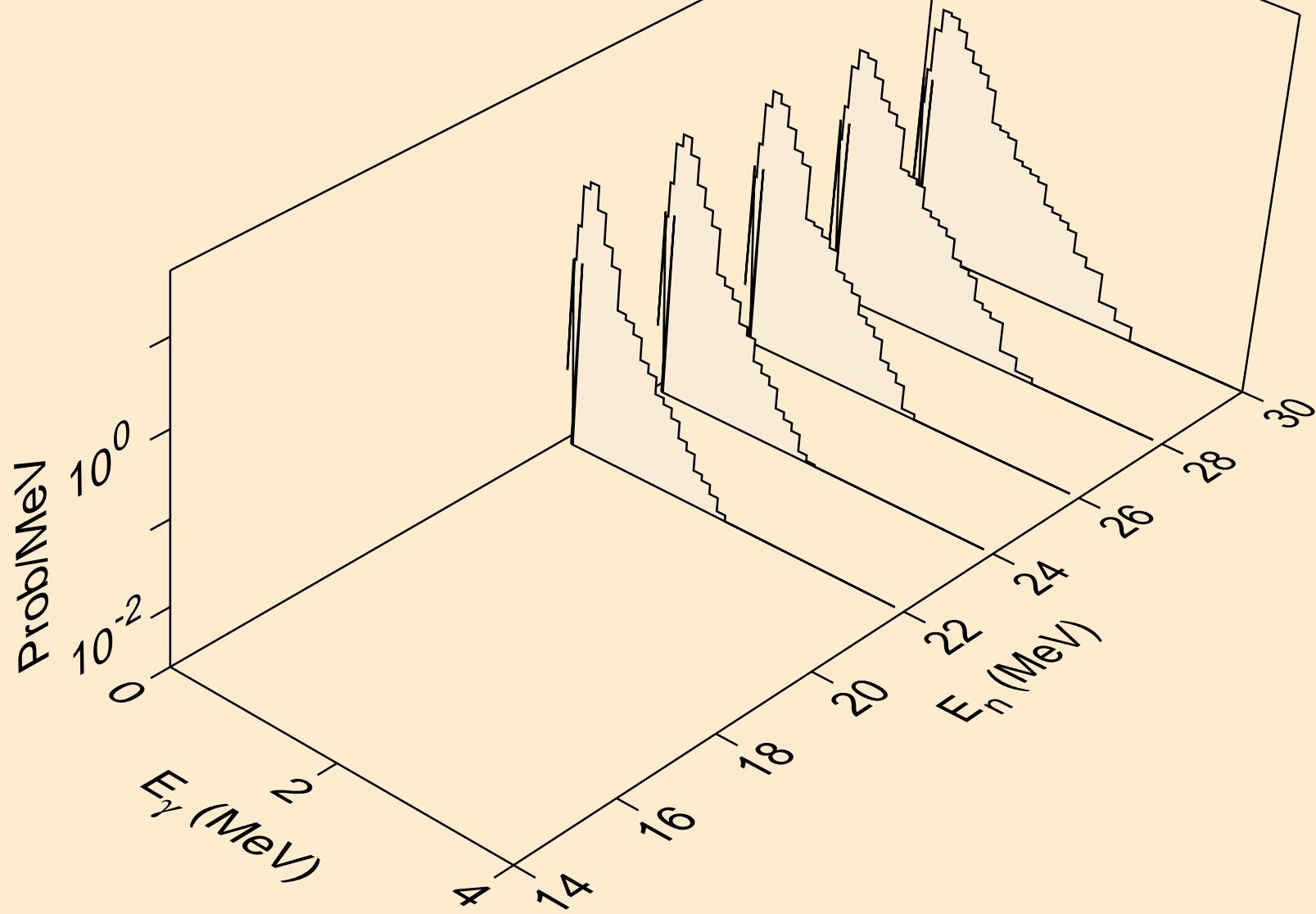

ES246 TRITON ACER TENDL-2021 LIBRARY; T=0.K  
Photon emission for (n,2np)

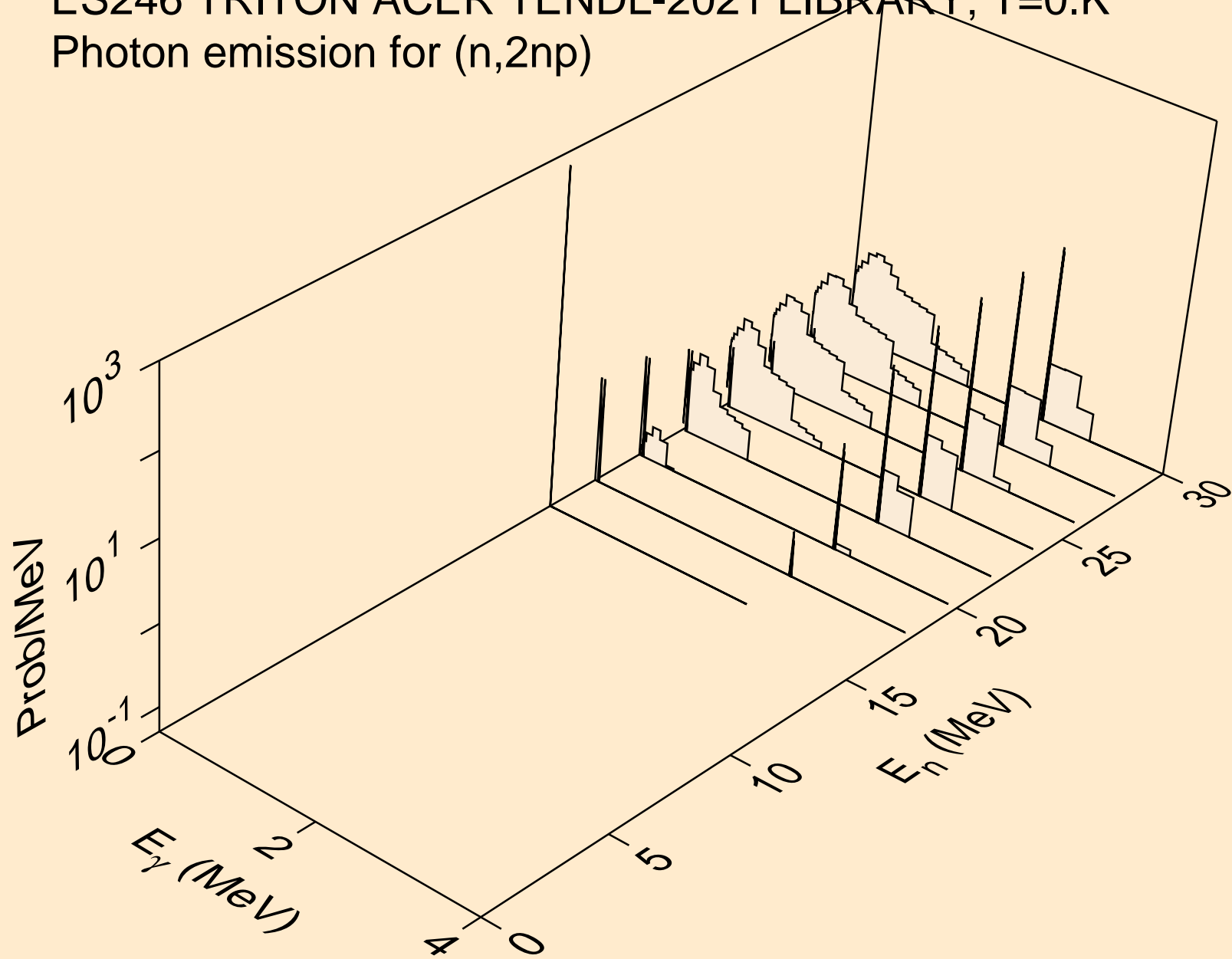

ES246 TRITON ACER TENDL-2021 LIBRARY; T=0.K  
Photon emission for (n,gma)

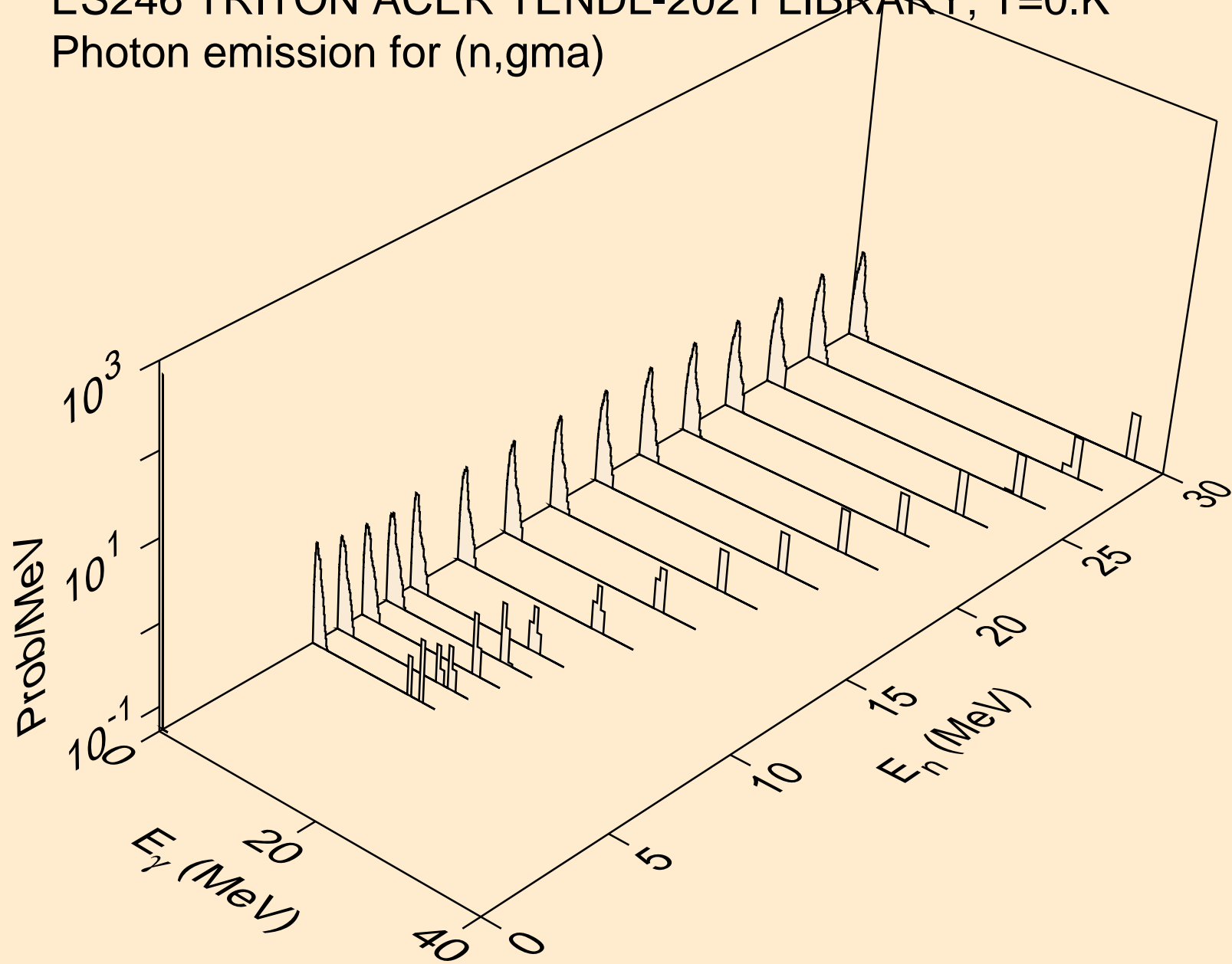

ES246 TRITON ACER TENDL-2021 LIBRARY; T=0.K  
Photon emission for (n,p)

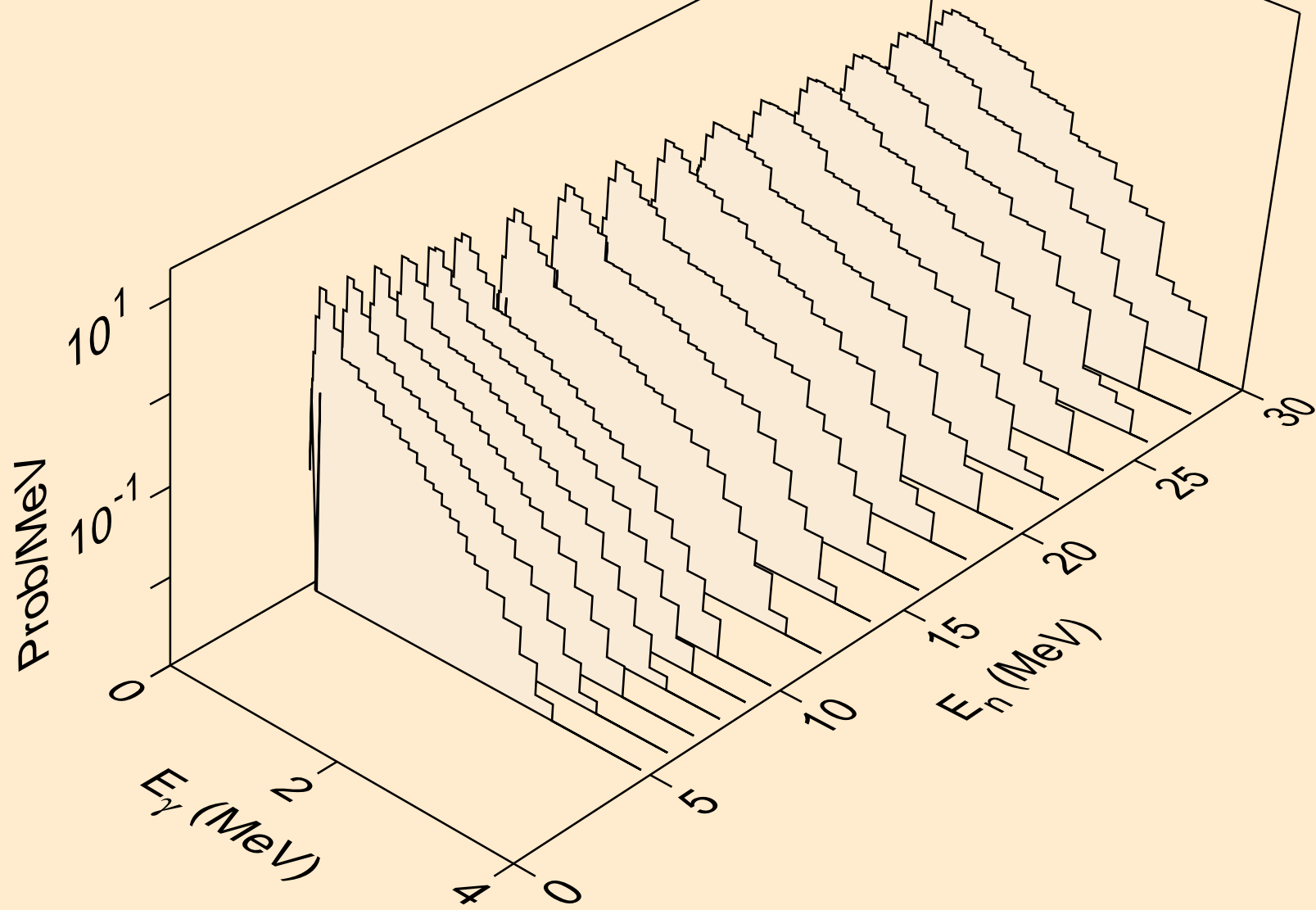



ES246 TRITON ACER TENDL-2021 LIBRARY; T=0.K  
Photon emission for (n,d)

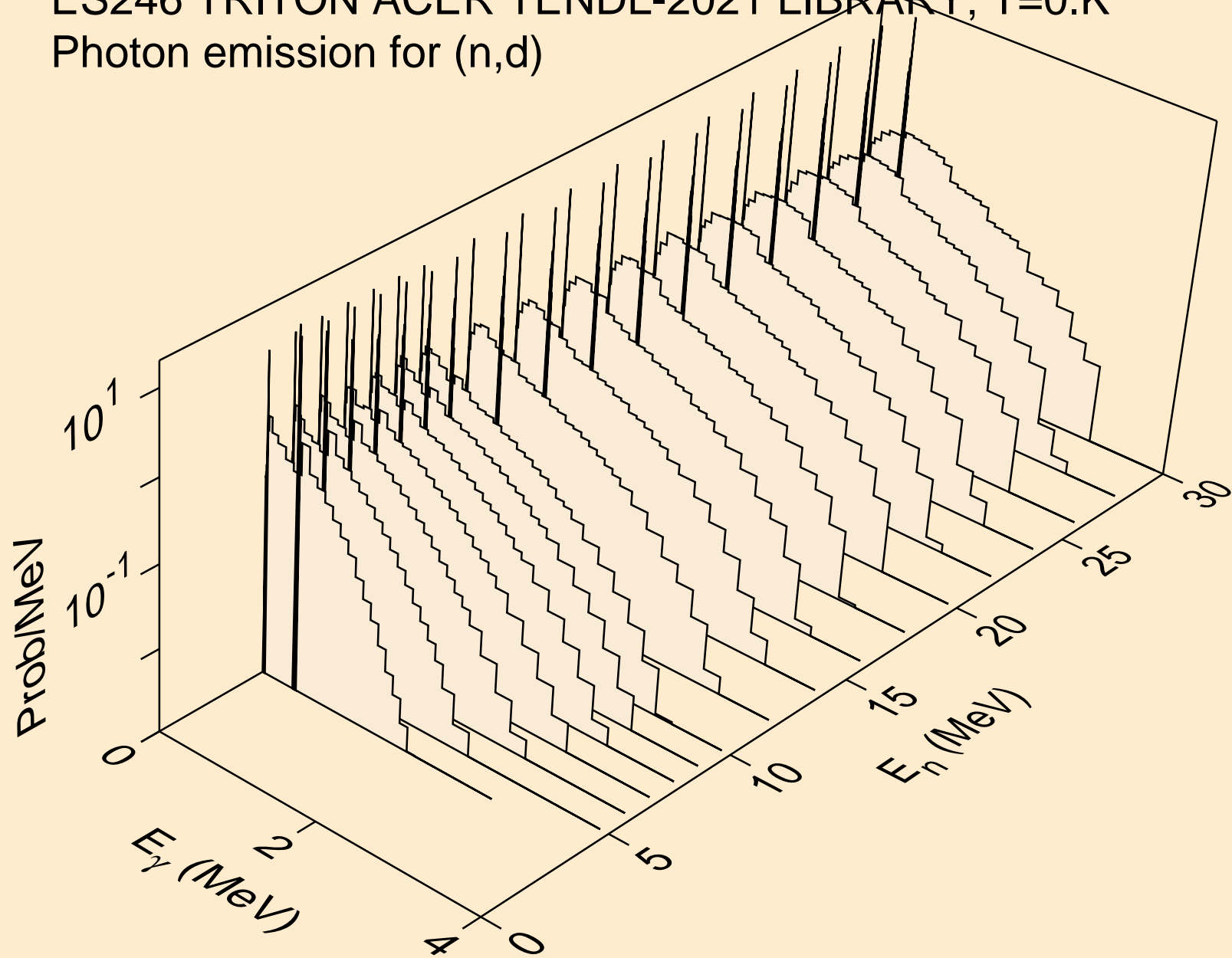

ES246 TRITON ACER TENDL-2021 LIBRARY; T=0.K  
Photon emission for inelastic

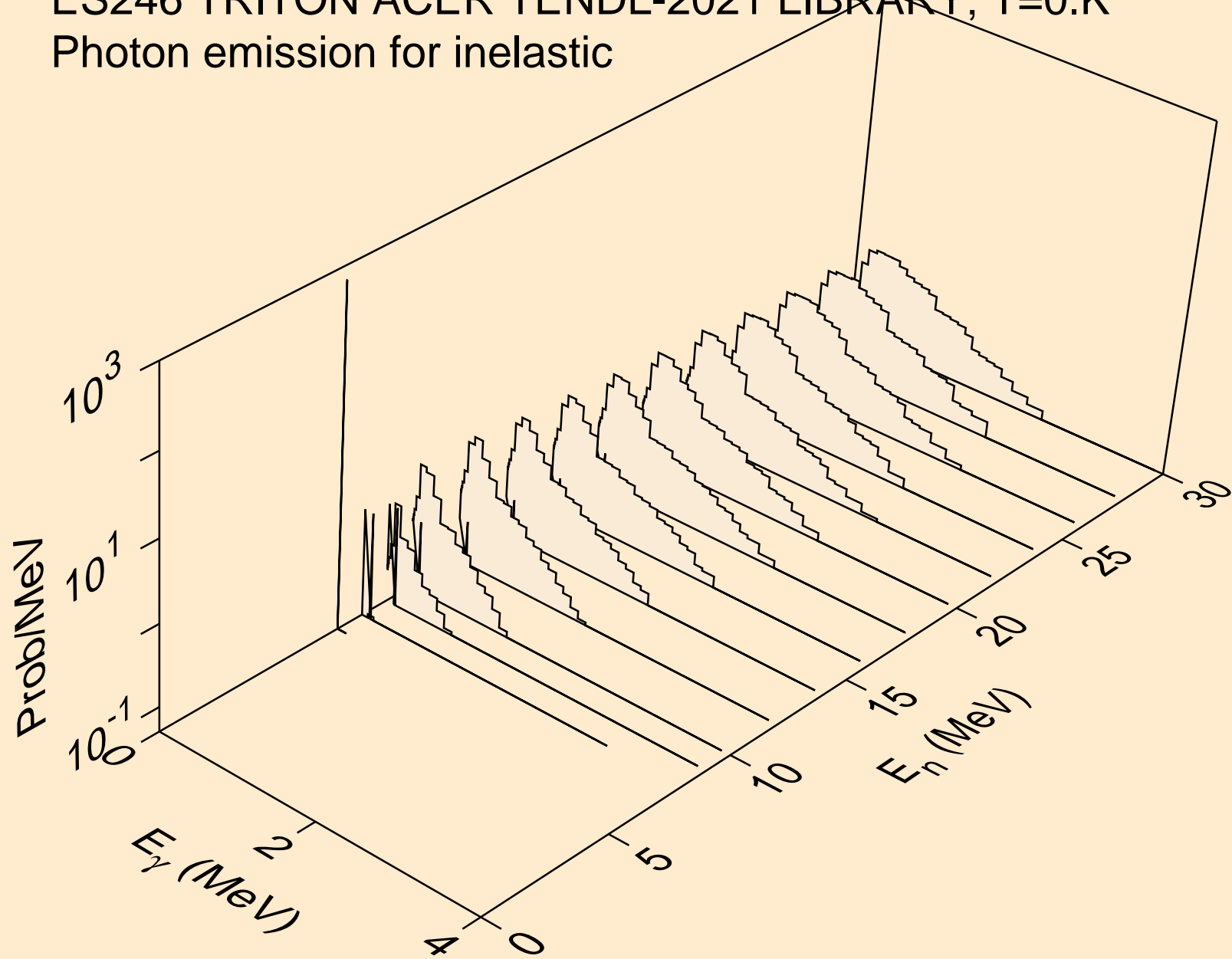

ES246 TRITON ACER TENDL-2021 LIBRARY; T=0.K  
Photon emission for (n,he3)

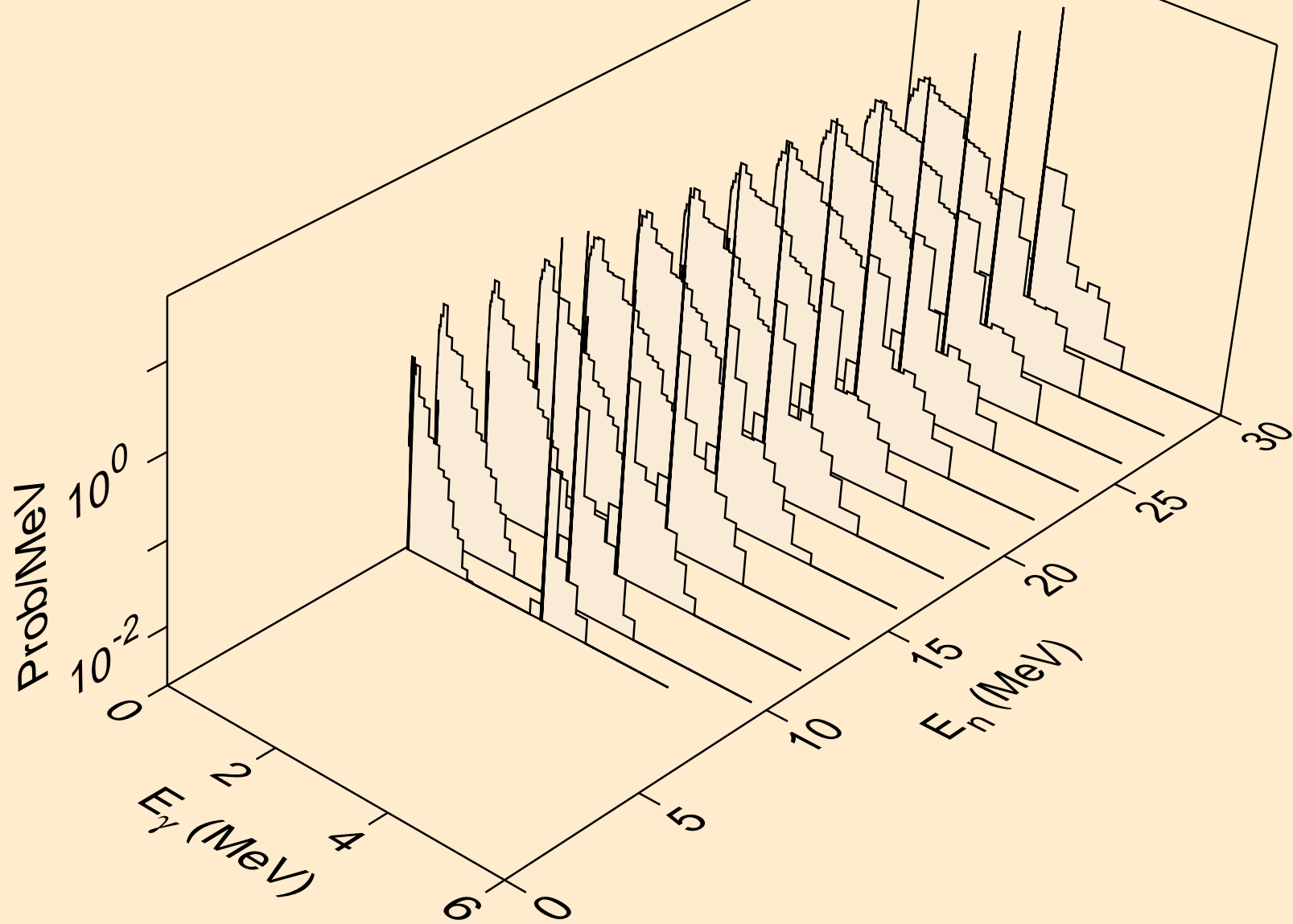

ES246 TRITON ACER TENDL-2021 LIBRARY; T=0.K  
Photon emission for (n,a)

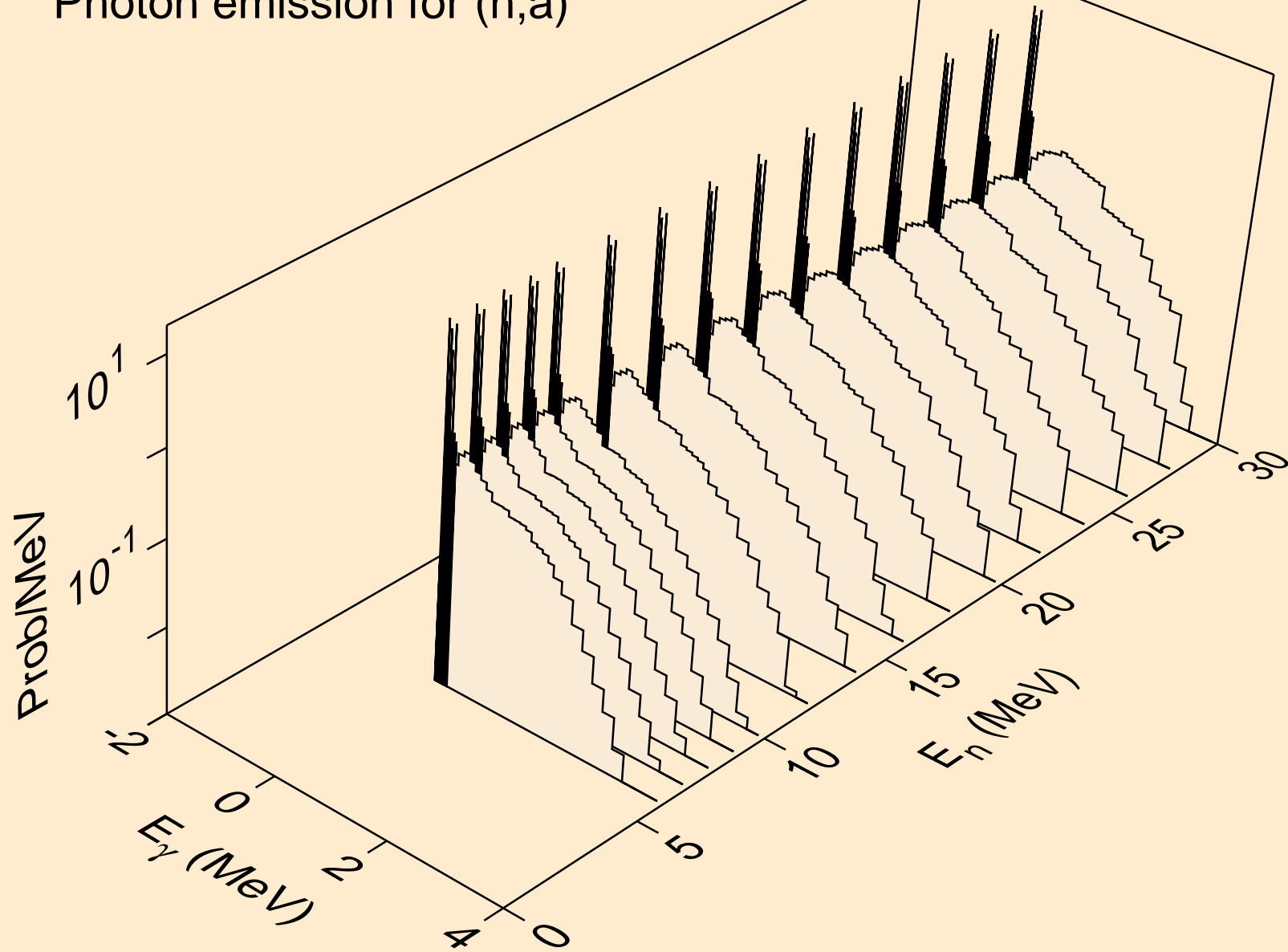

ES246 TRITON ACER TENDL-2021 LIBRARY; T=0.K  
Photon emission for (n,2p)

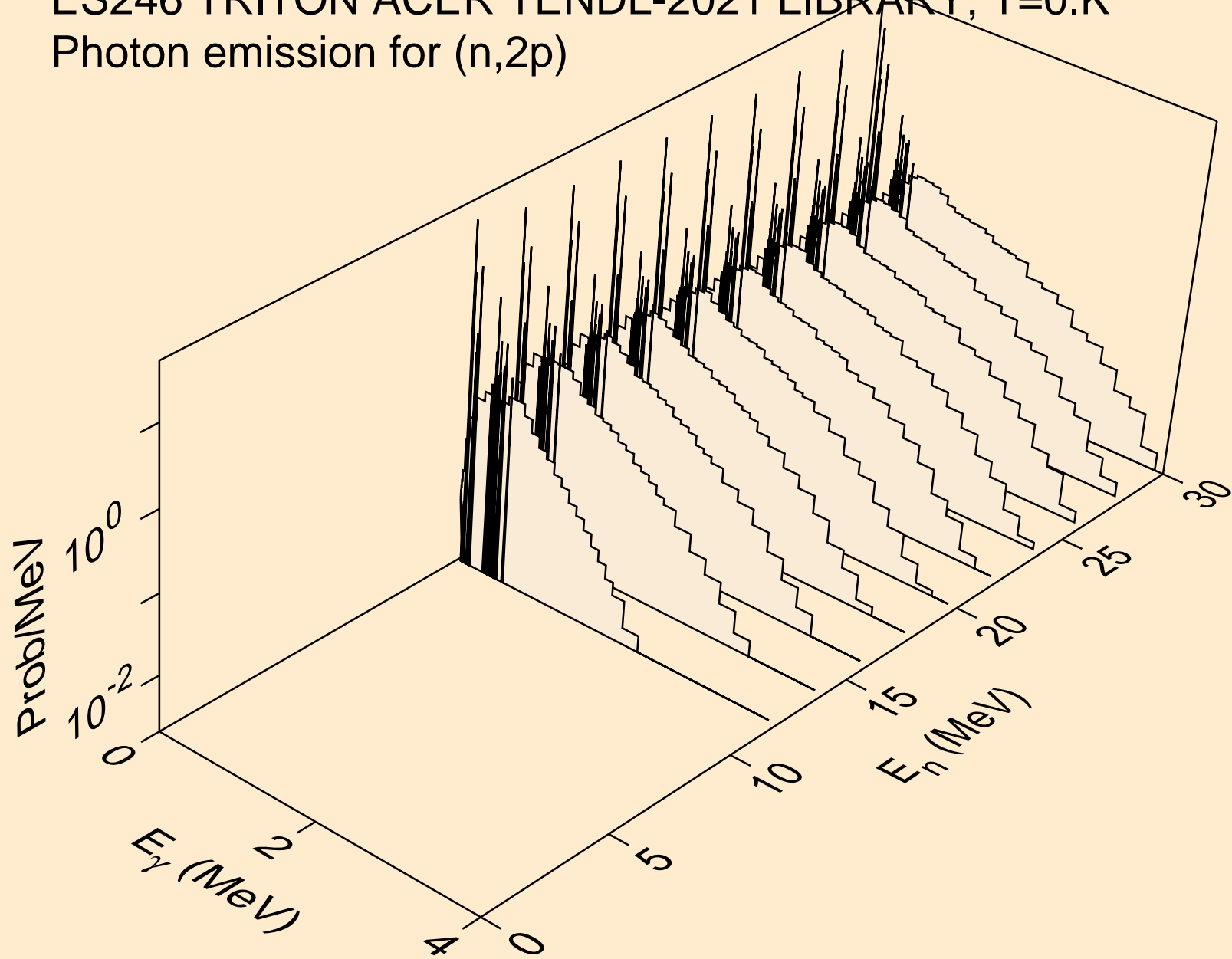

ES246 TRITON ACER TENDL-2021 LIBRARY; T=0.K  
Photon emission for (n,pd)

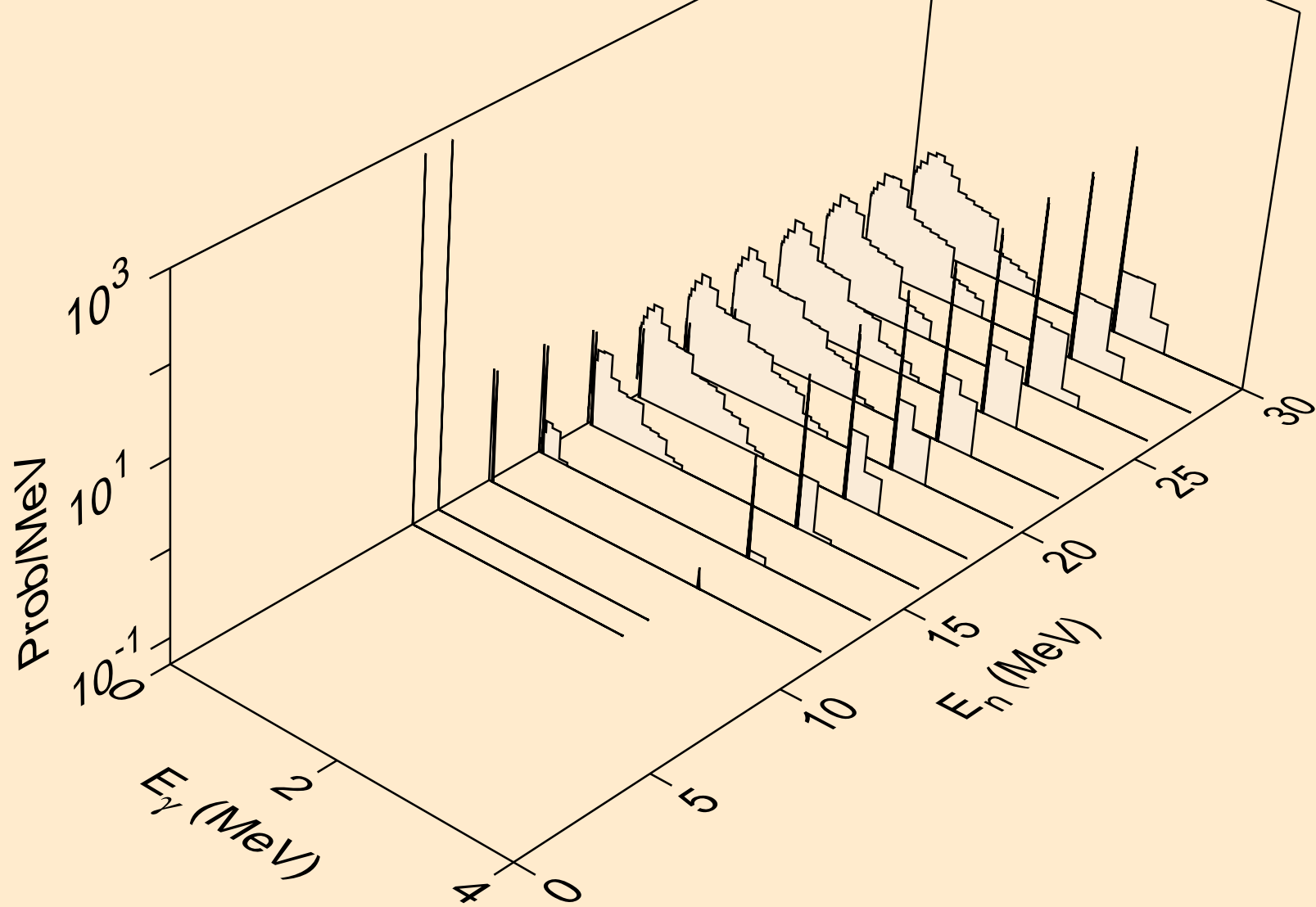

ES246 TRITON ACER TENDL-2021 LIBRARY; T=0.K  
Particle heating contributions

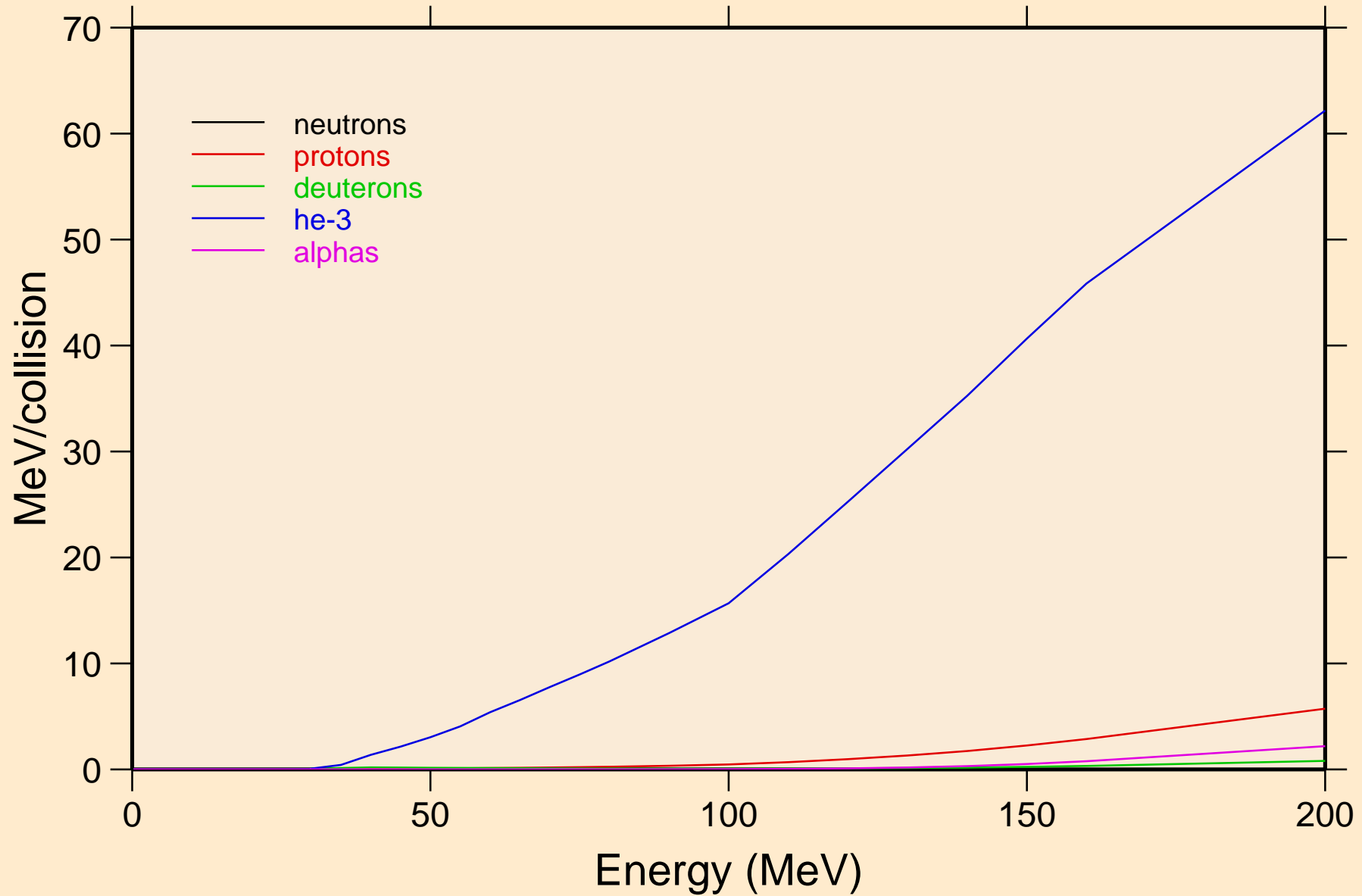

ES246 TRITON ACER TENDL-2021 LIBRARY; T=0.K  
Recoil Heating

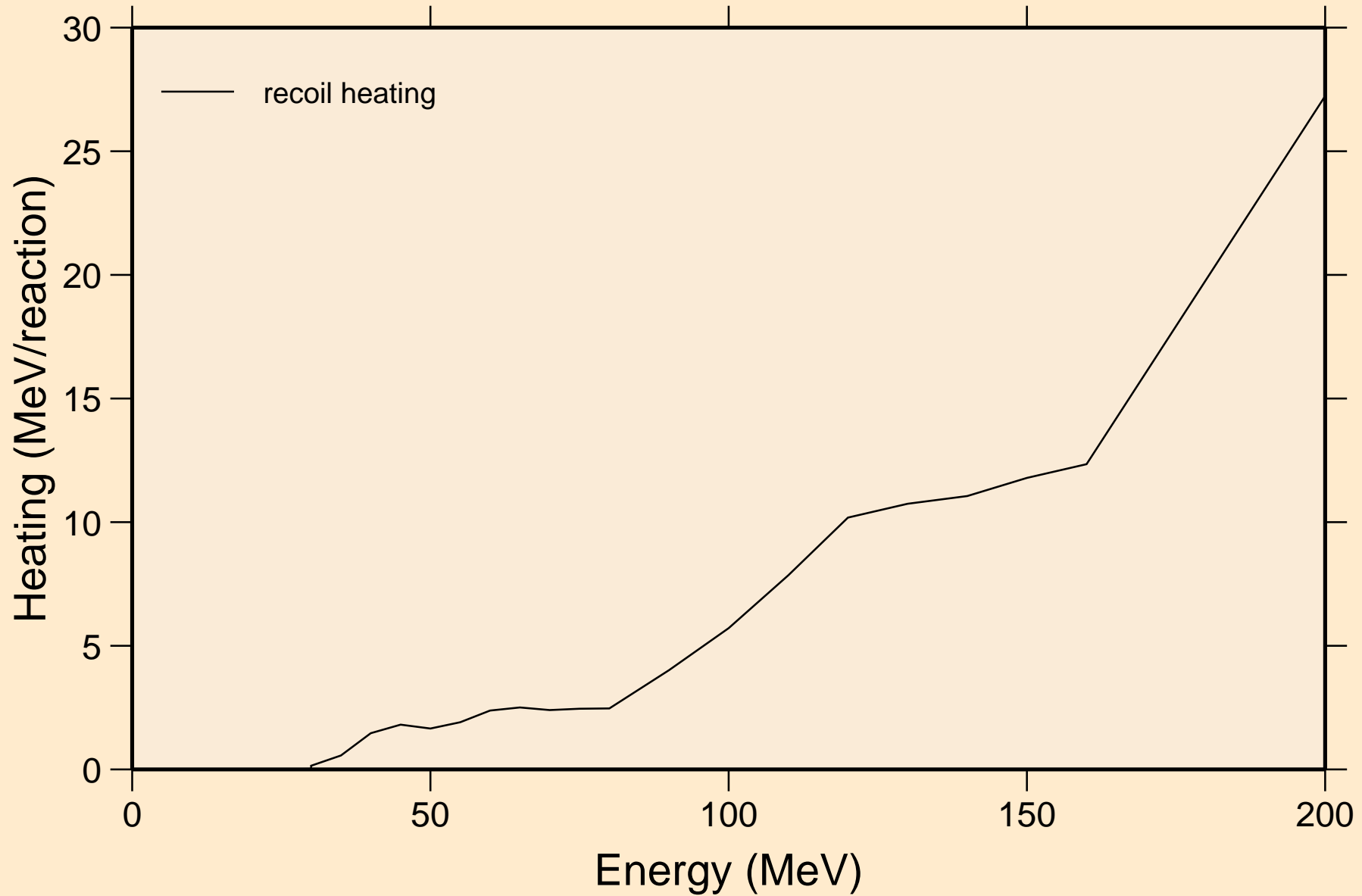



ES246 TRITON ACER TENDL-2021 LIBRARY; T=0.K  
Particle production cross sections

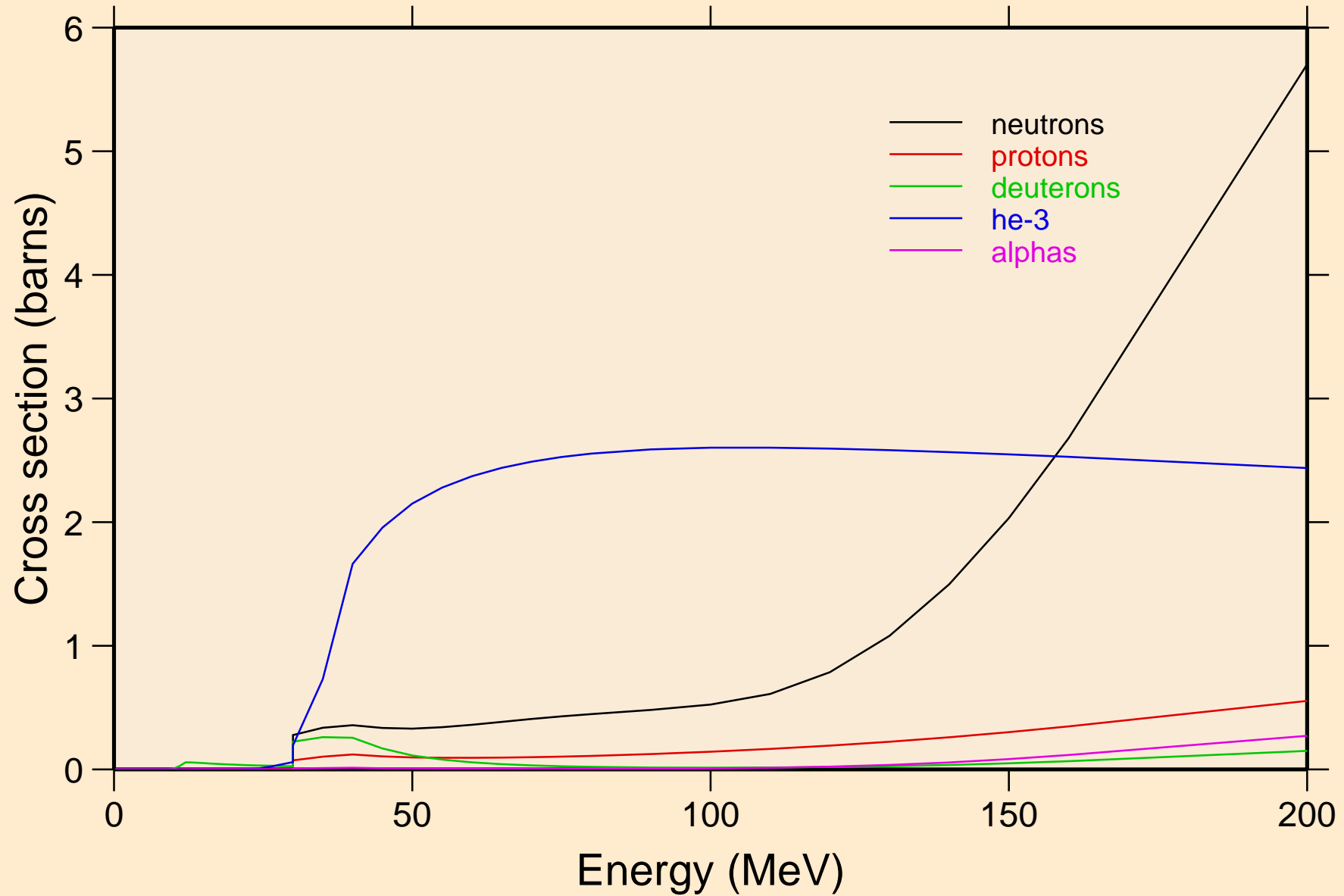

ES246 TRITON ACER TENDL-2021 LIBRARY; T=0.K  
neutrons from (t,n)

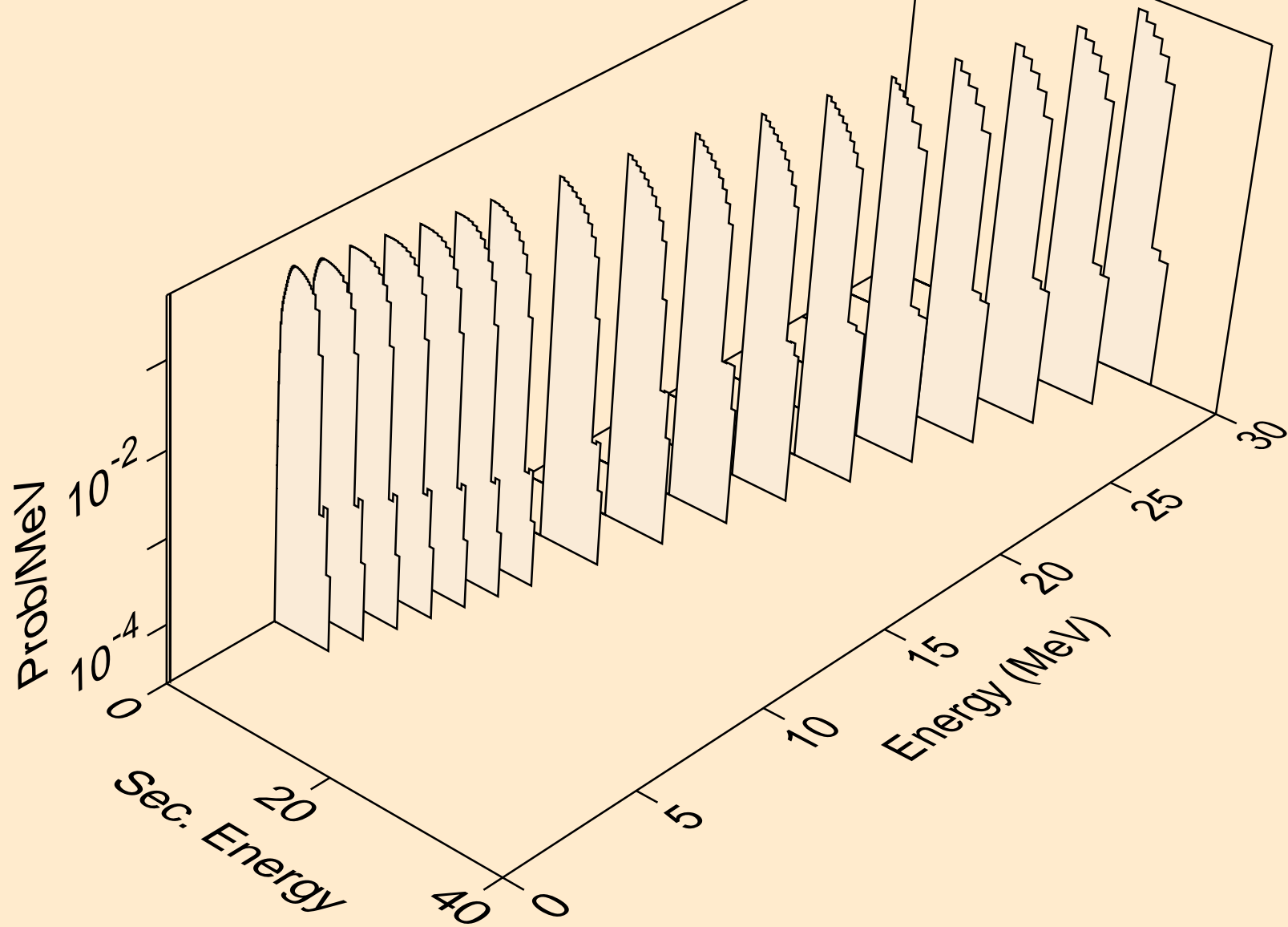

ES246 TRITON ACER TENDL-2021 LIBRARY; T=0.K  
neutrons from (t,x)

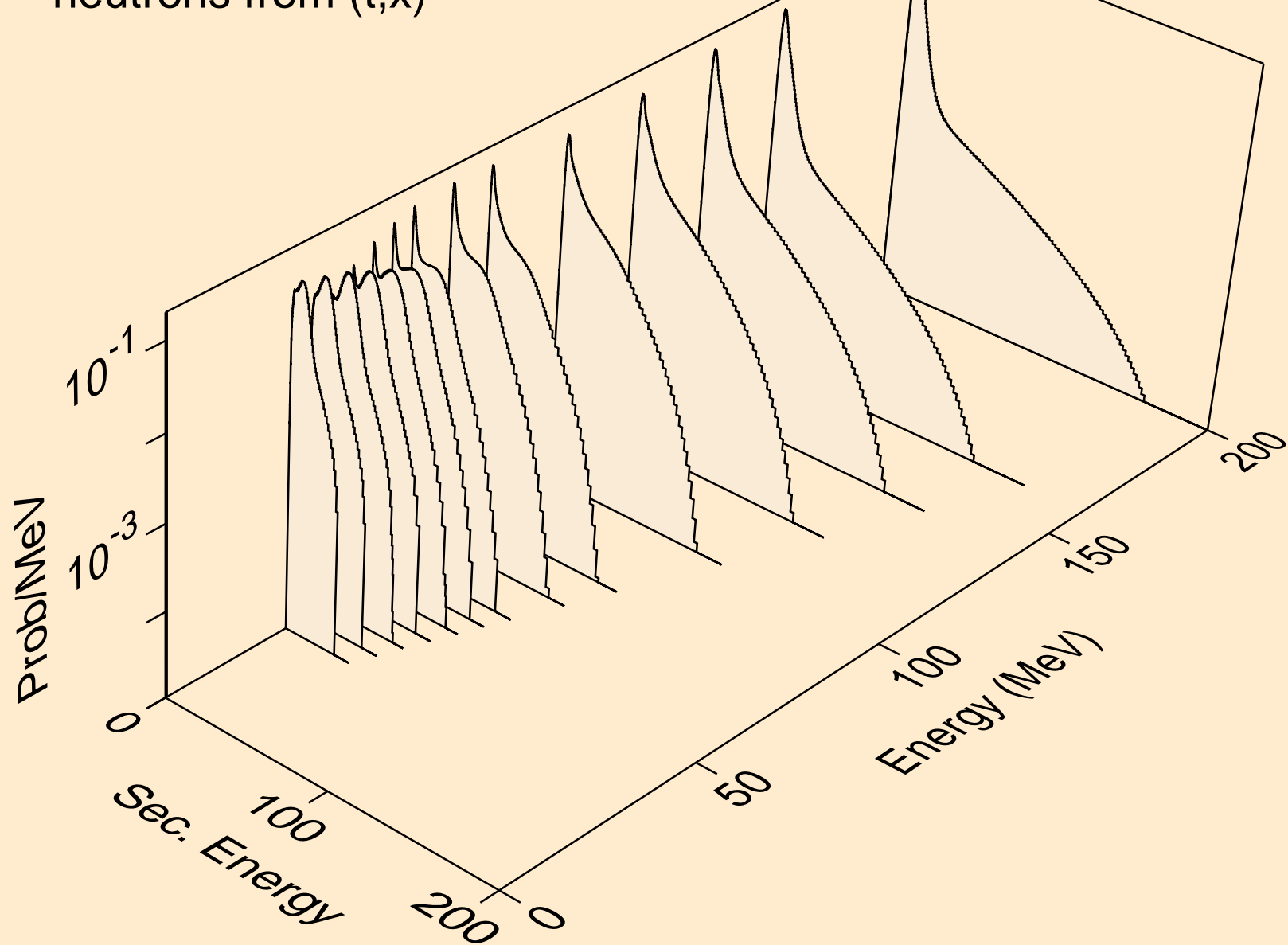

ES246 TRITON ACER TENDL-2021 LIBRARY; T=0.K  
neutrons from (t,2nd)

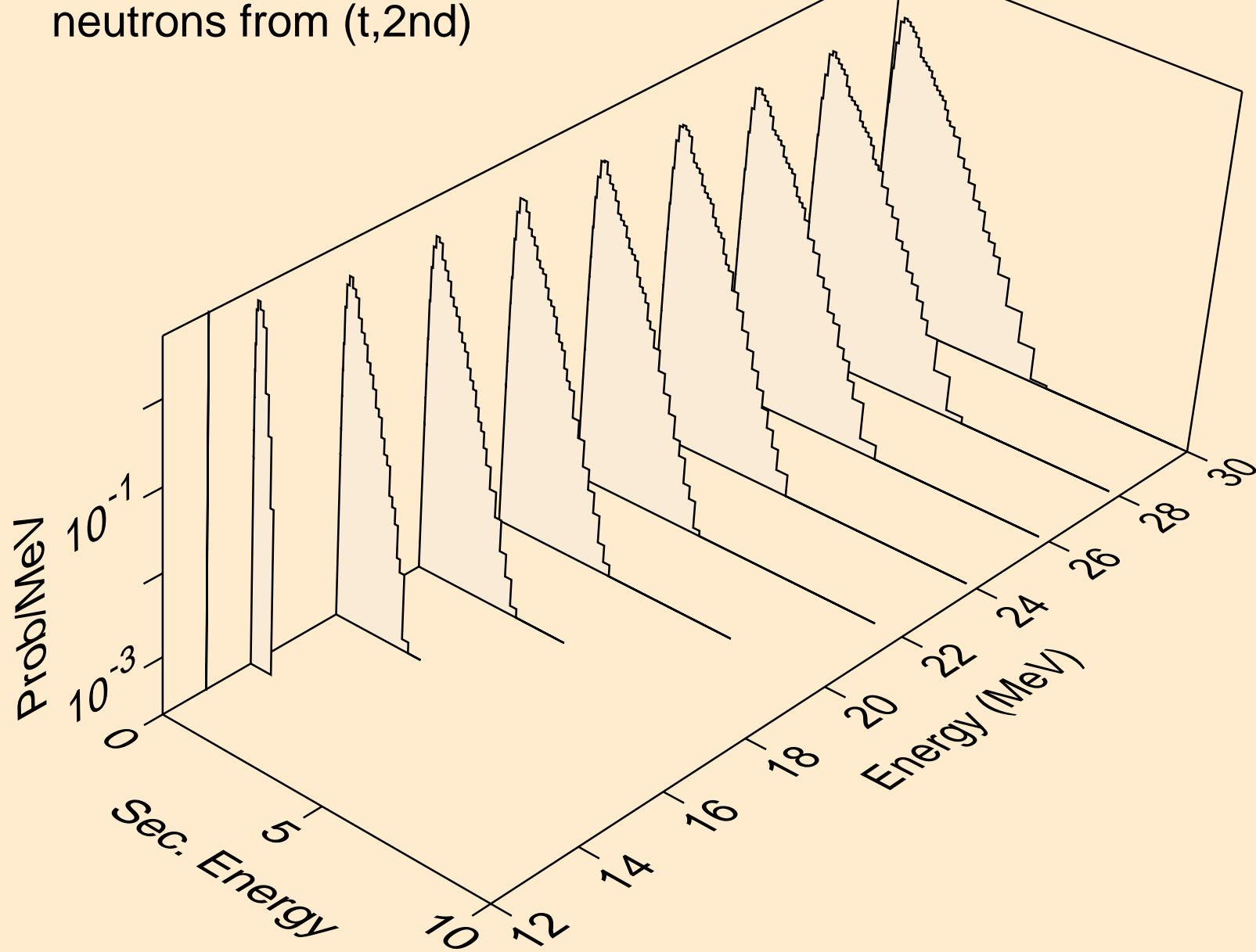

ES246 TRITON ACER TENDL-2021 LIBRARY; T=0.K  
neutrons from (t,2n)

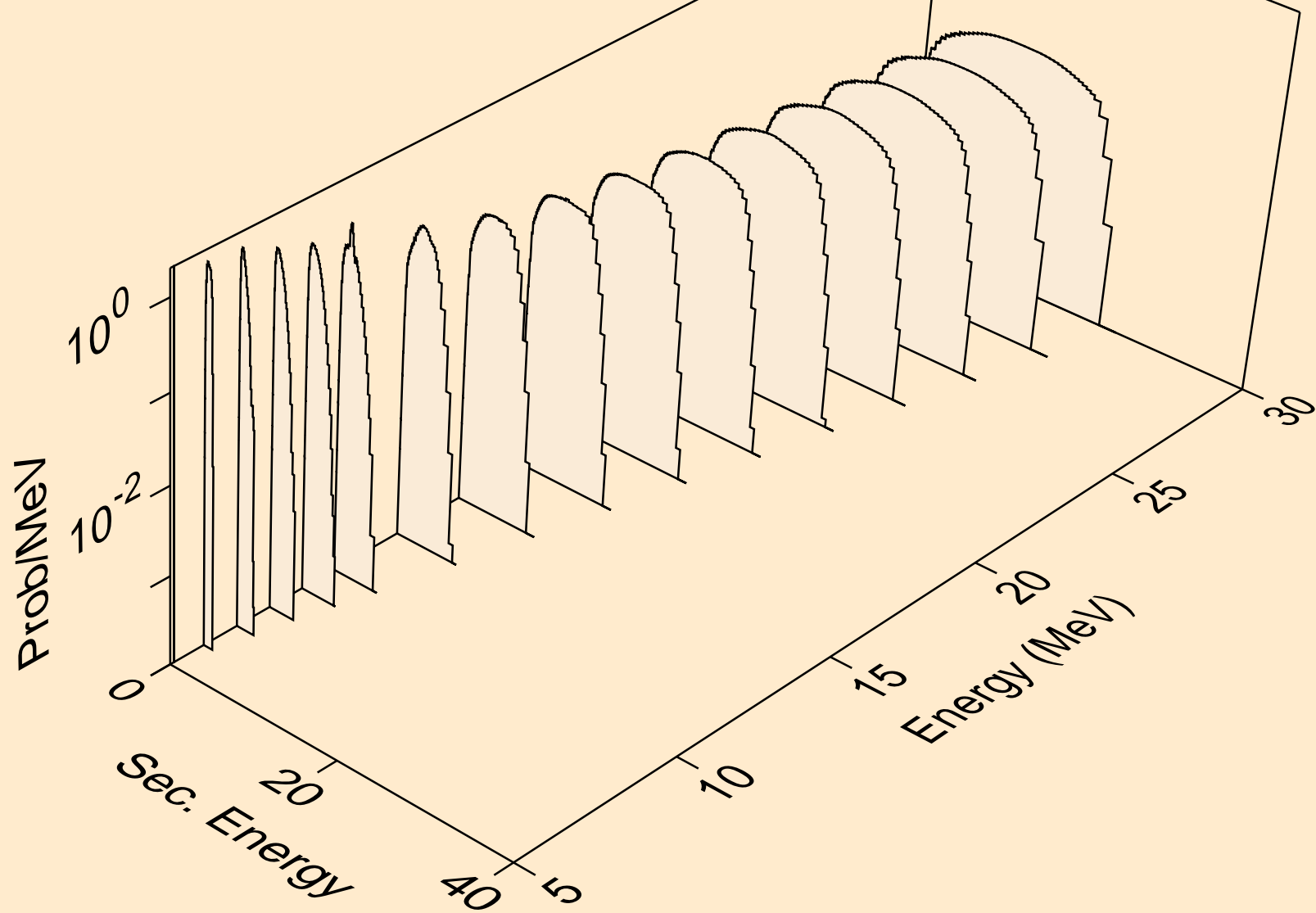

ES246 TRITON ACER TENDL-2021 LIBRARY; T=0.K  
neutrons from (t,3n)

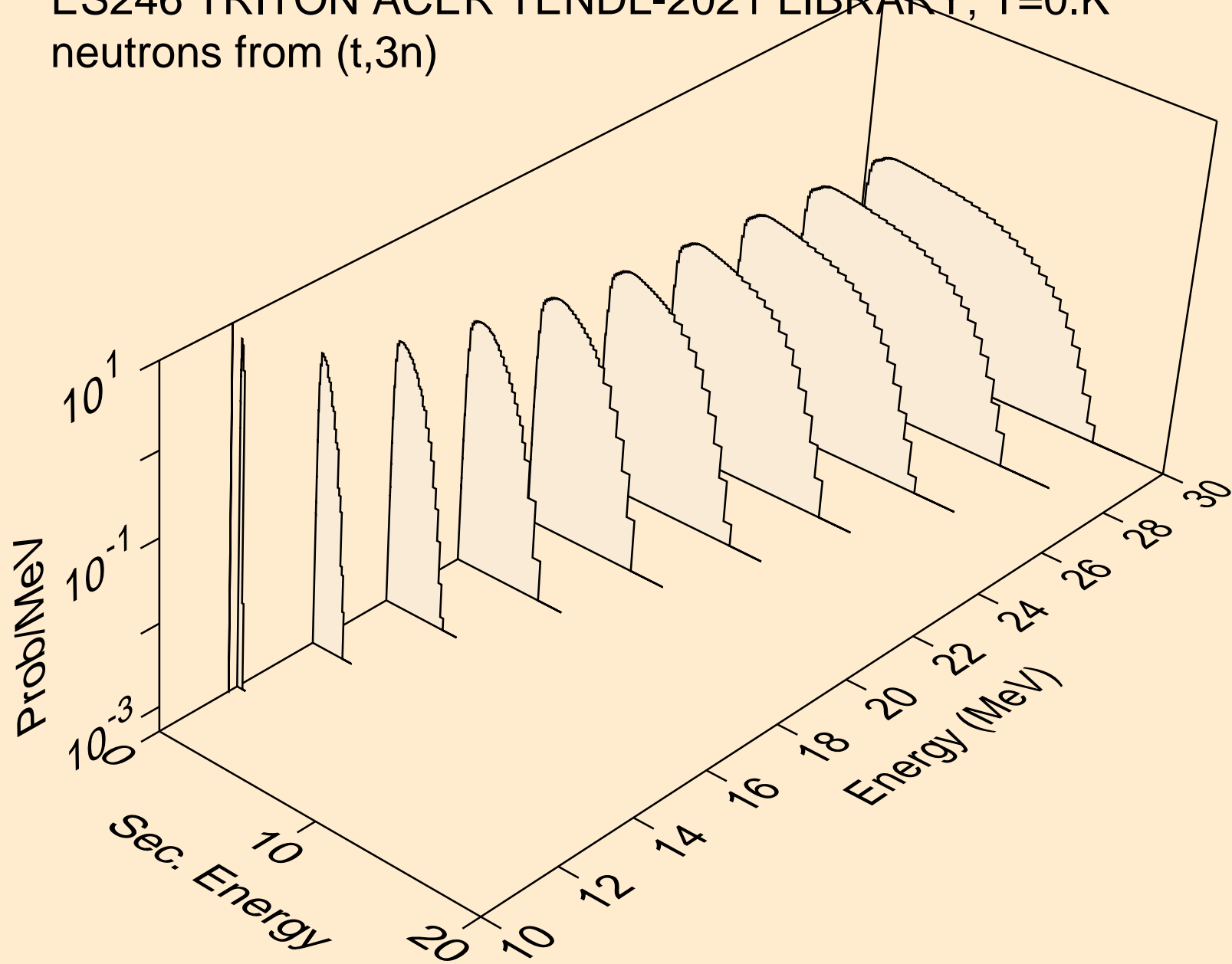

ES246 TRITON ACER TENDL-2021 LIBRARY; T=0.K  
neutrons from (t,n\*)a

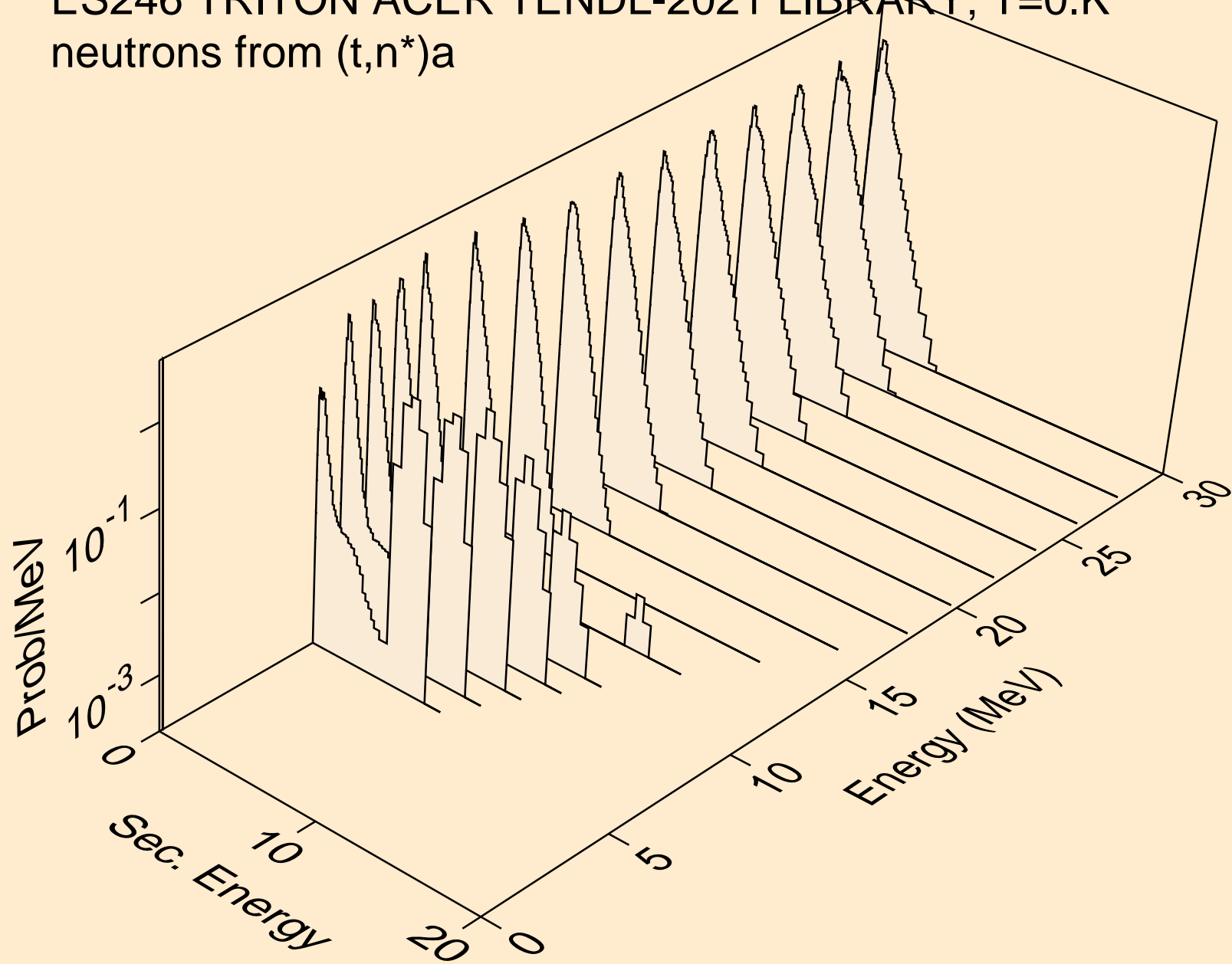

ES246 TRITON ACER TENDL-2021 LIBRARY; T=0.K  
neutrons from (t,2n)a

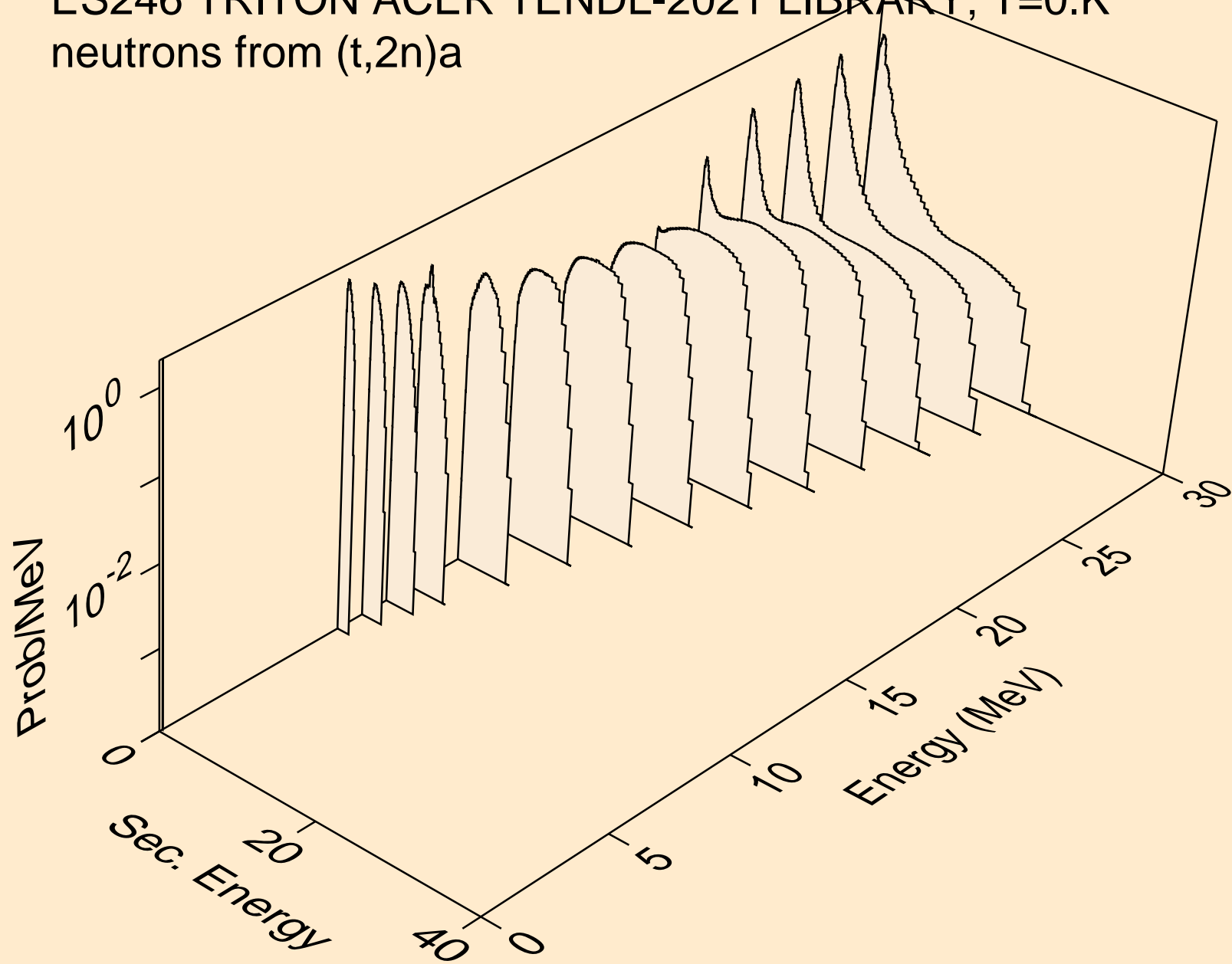



ES246 TRITON ACER TENDL-2021 LIBRARY; T=0.K  
neutrons from (t,n\*)p

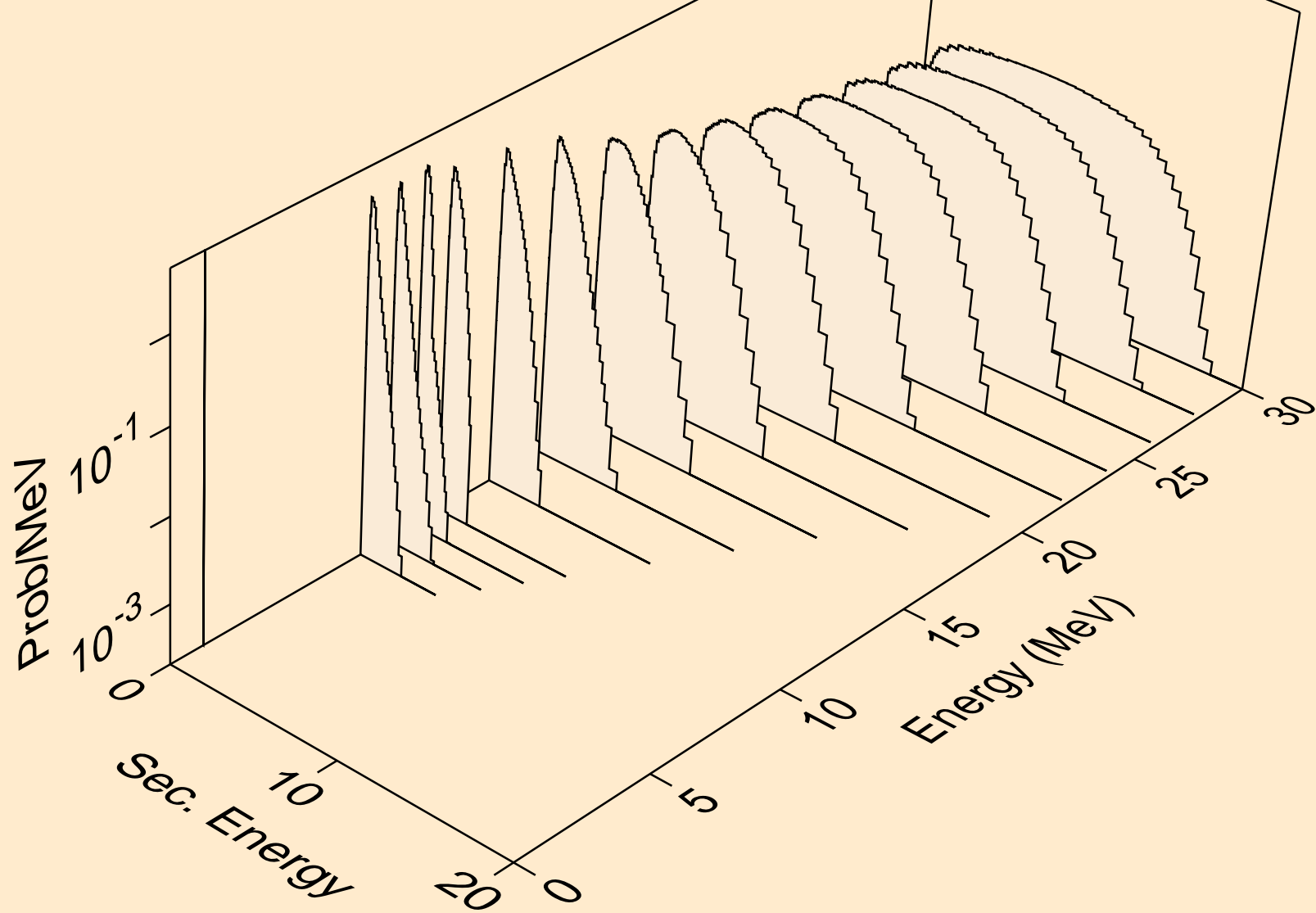

ES246 TRITON ACER TENDL-2021 LIBRARY; T=0.K  
neutrons from (t,n\*)d

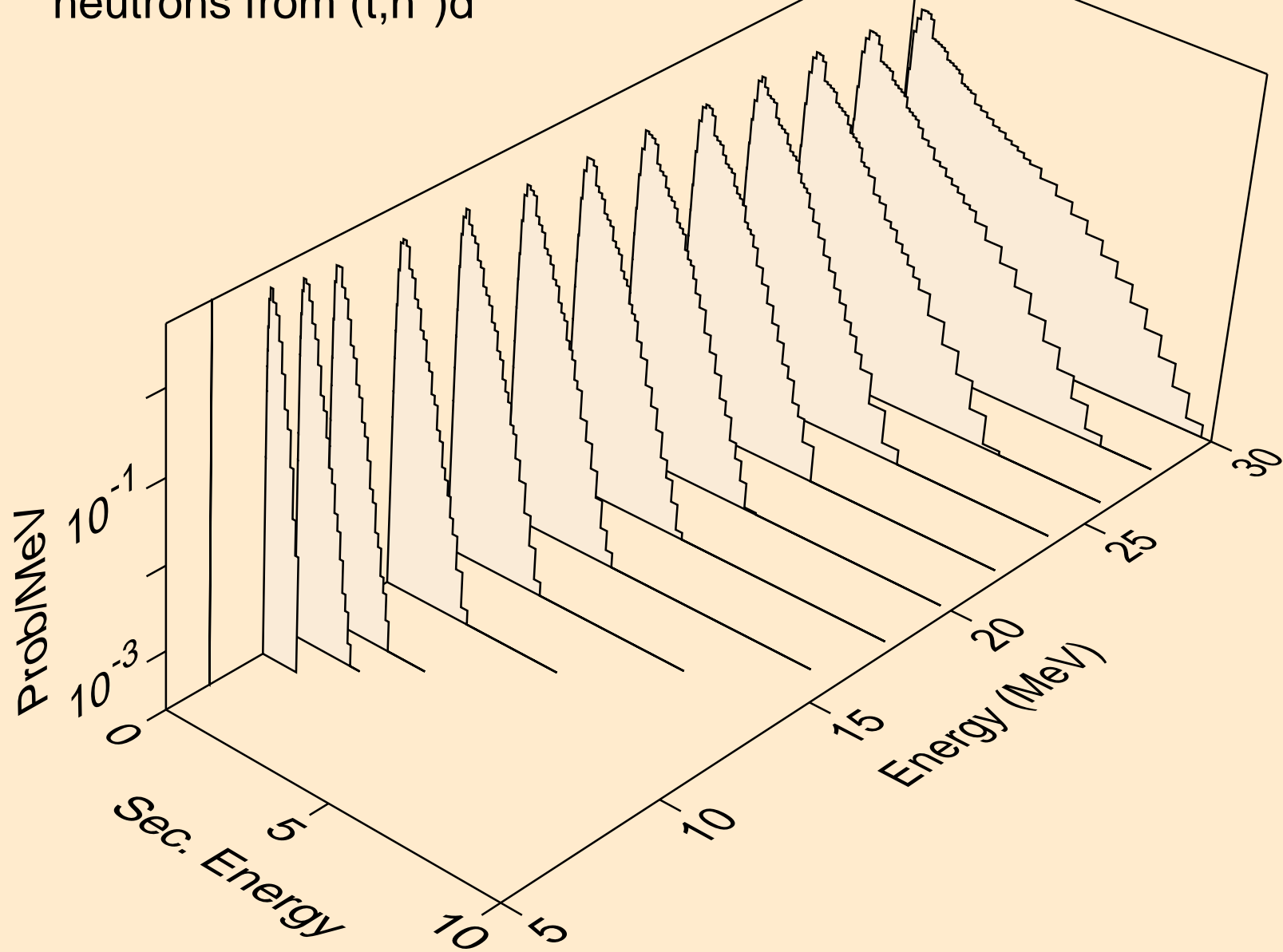

ES246 TRITON ACER TENDL-2021 LIBRARY; T=0.K  
neutrons from (t,n\*)t

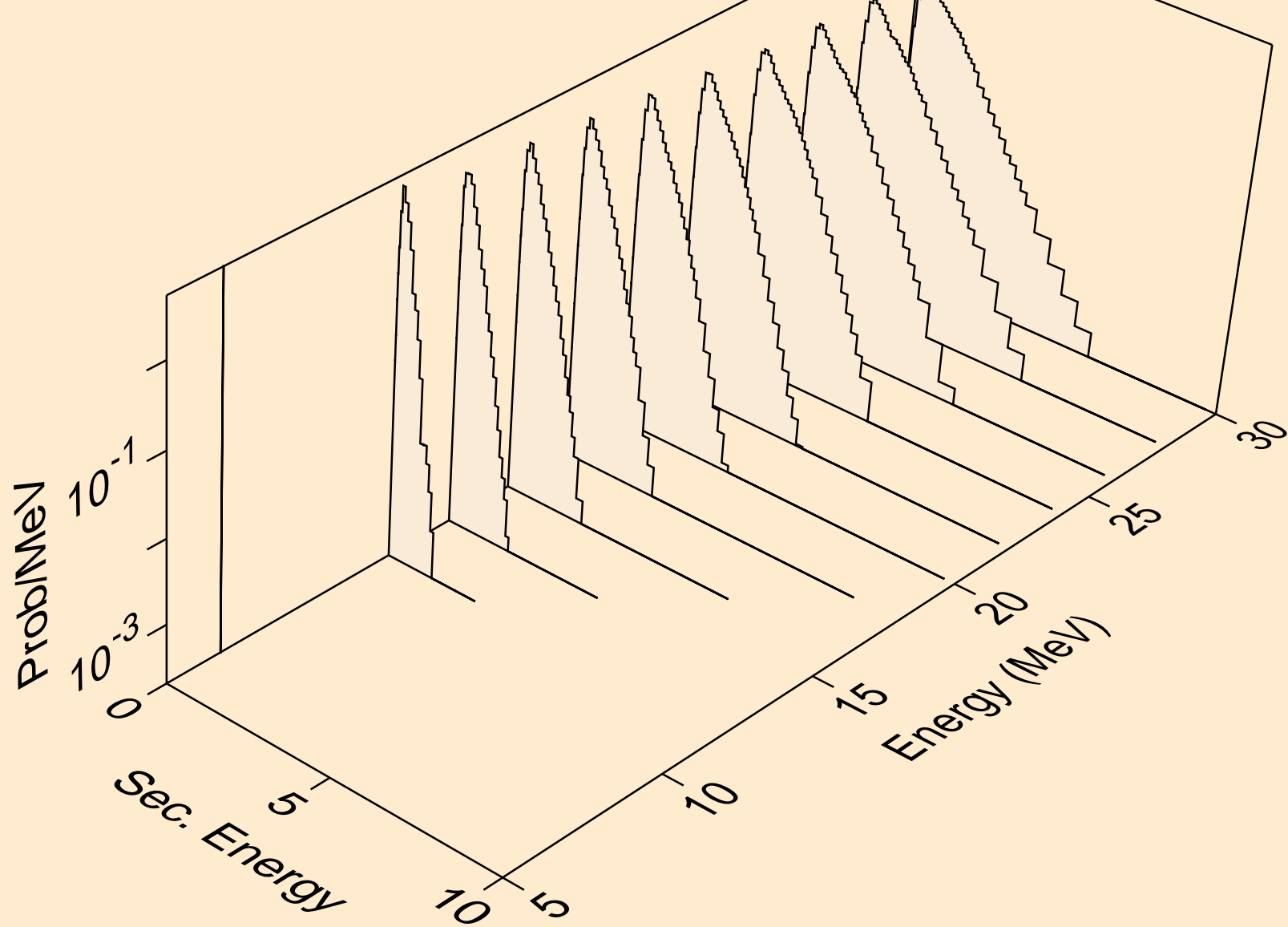

ES246 TRITON ACER TENDL-2021 LIBRARY; T=0.K  
neutrons from (t,n\*)he3

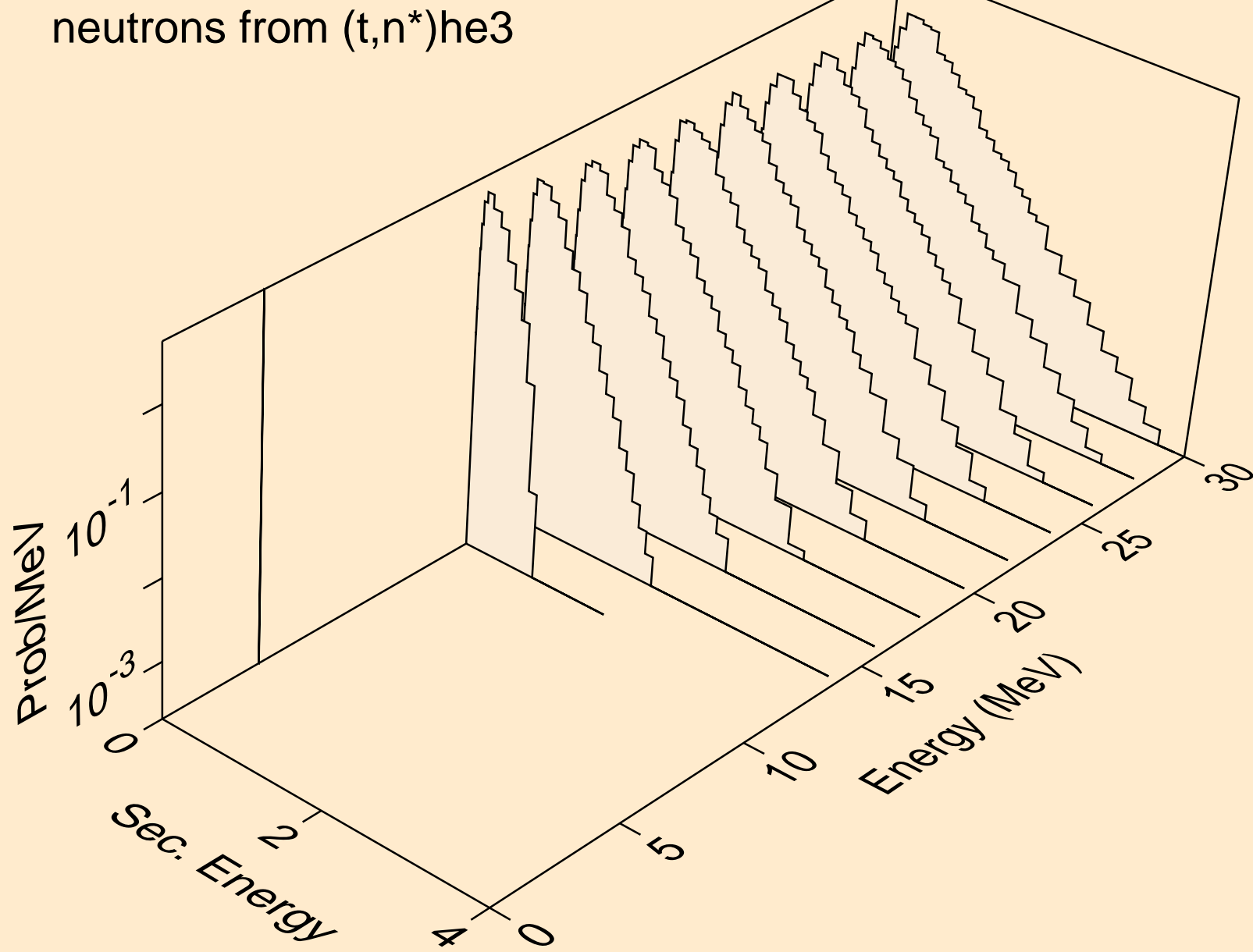

ES246 TRITON ACER TENDL-2021 LIBRARY; T=0.K  
neutrons from (t,4n)

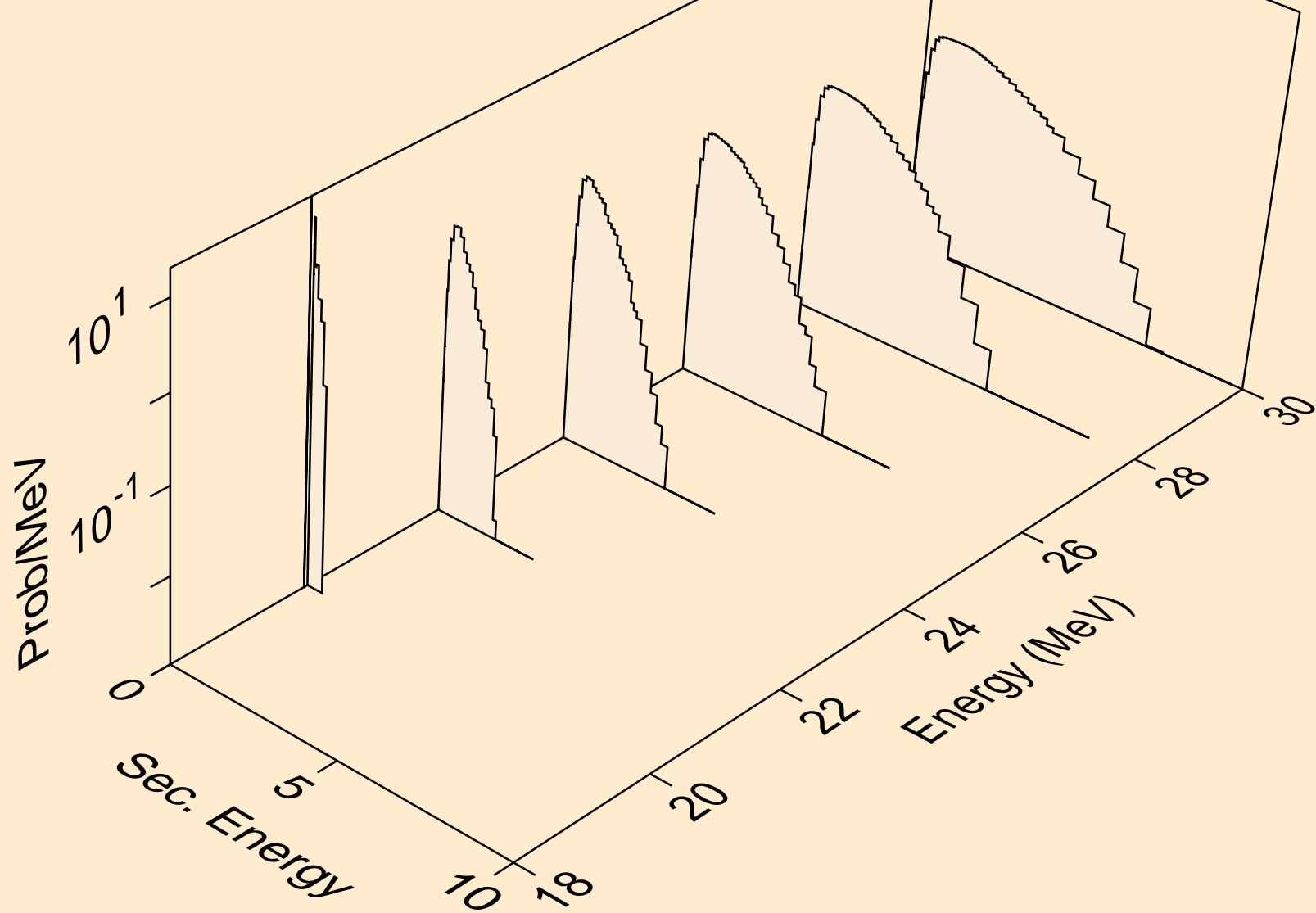

ES246 TRITON ACER TENDL-2021 LIBRARY; T=0.K  
neutrons from (t,2np)

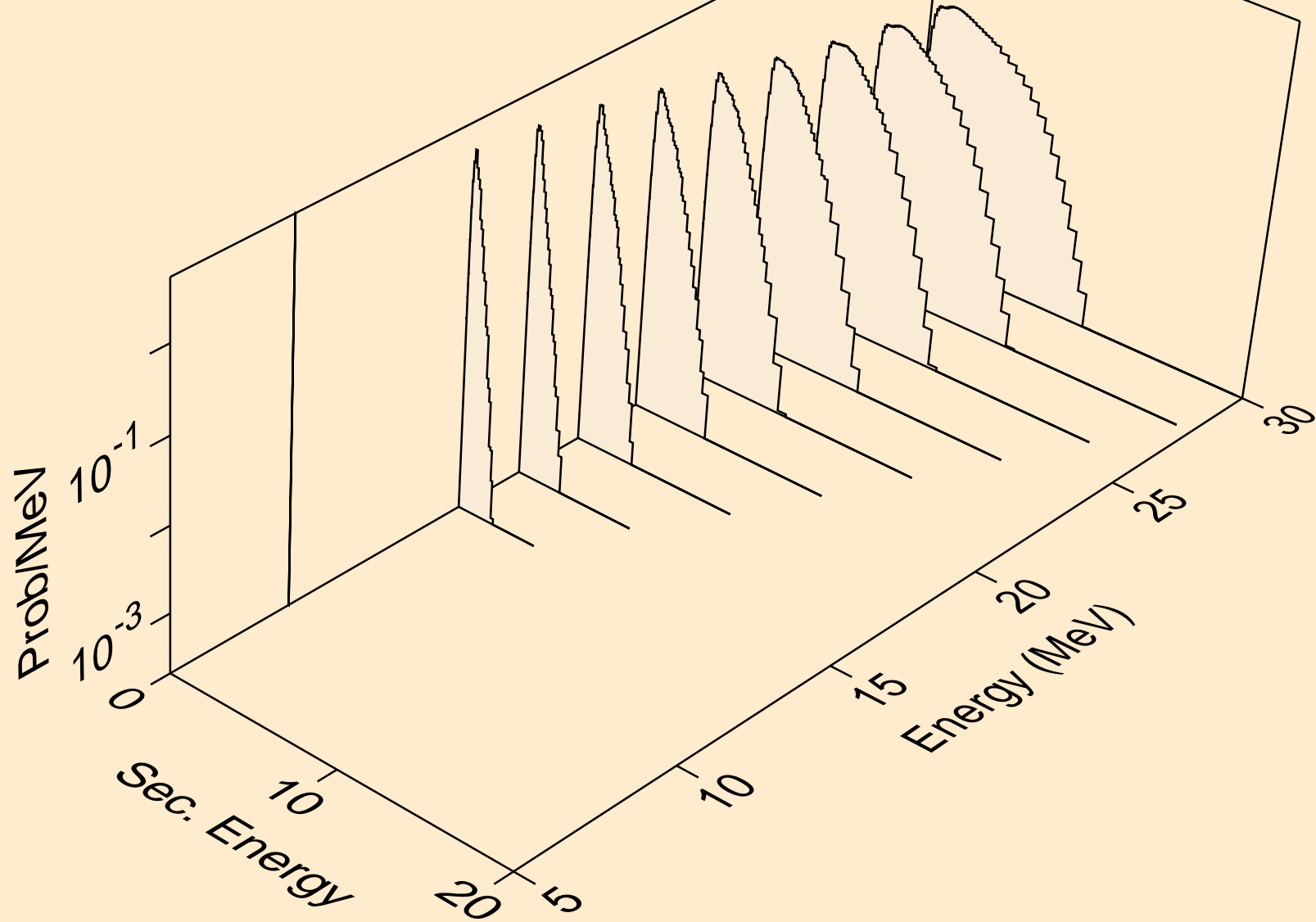

ES246 TRITON ACER TENDL-2021 LIBRARY; T=0.K  
neutrons from (t,3np)

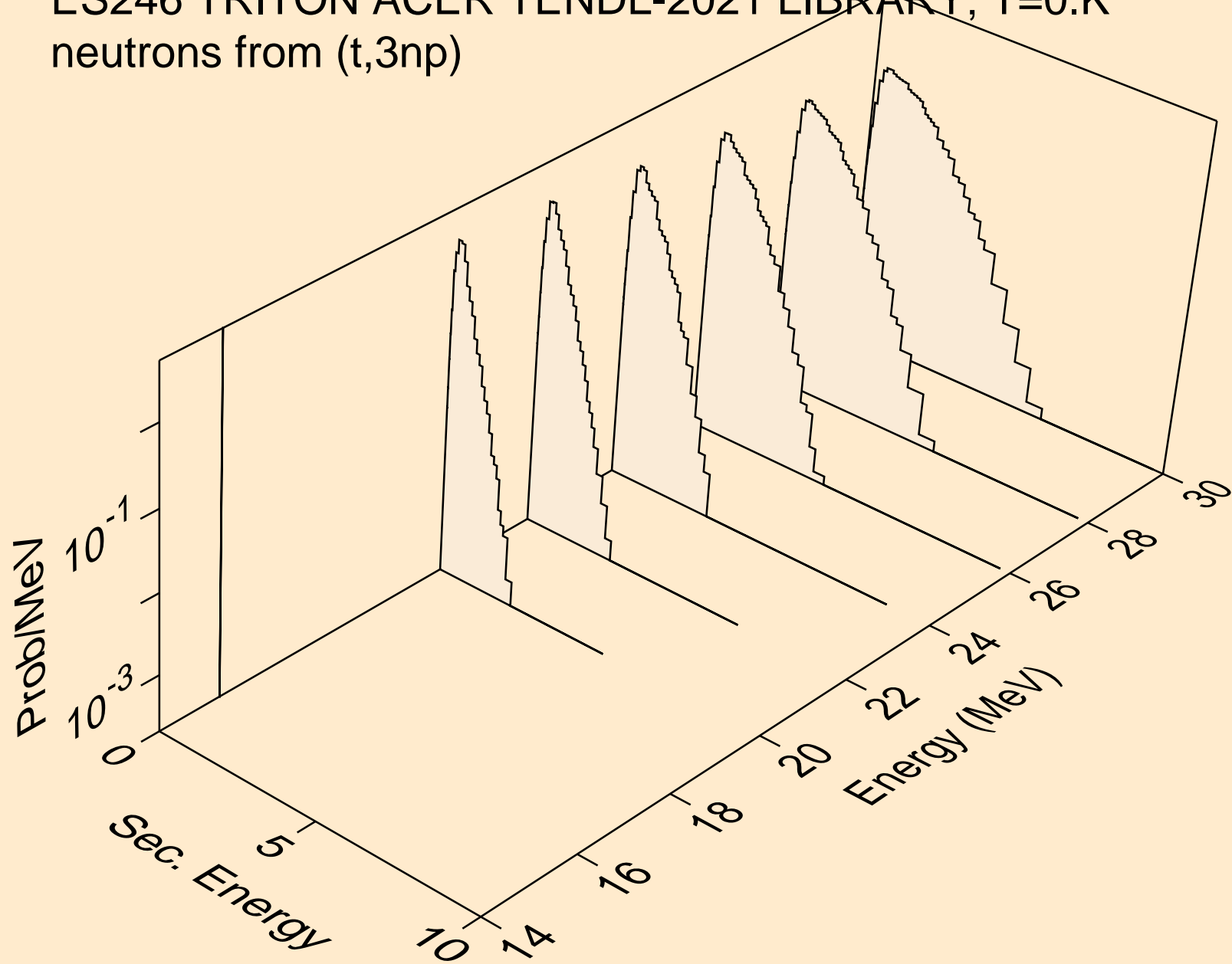

ES246 TRITON ACER TENDL-2021 LIBRARY; T=0.K  
neutrons from (t,2np)

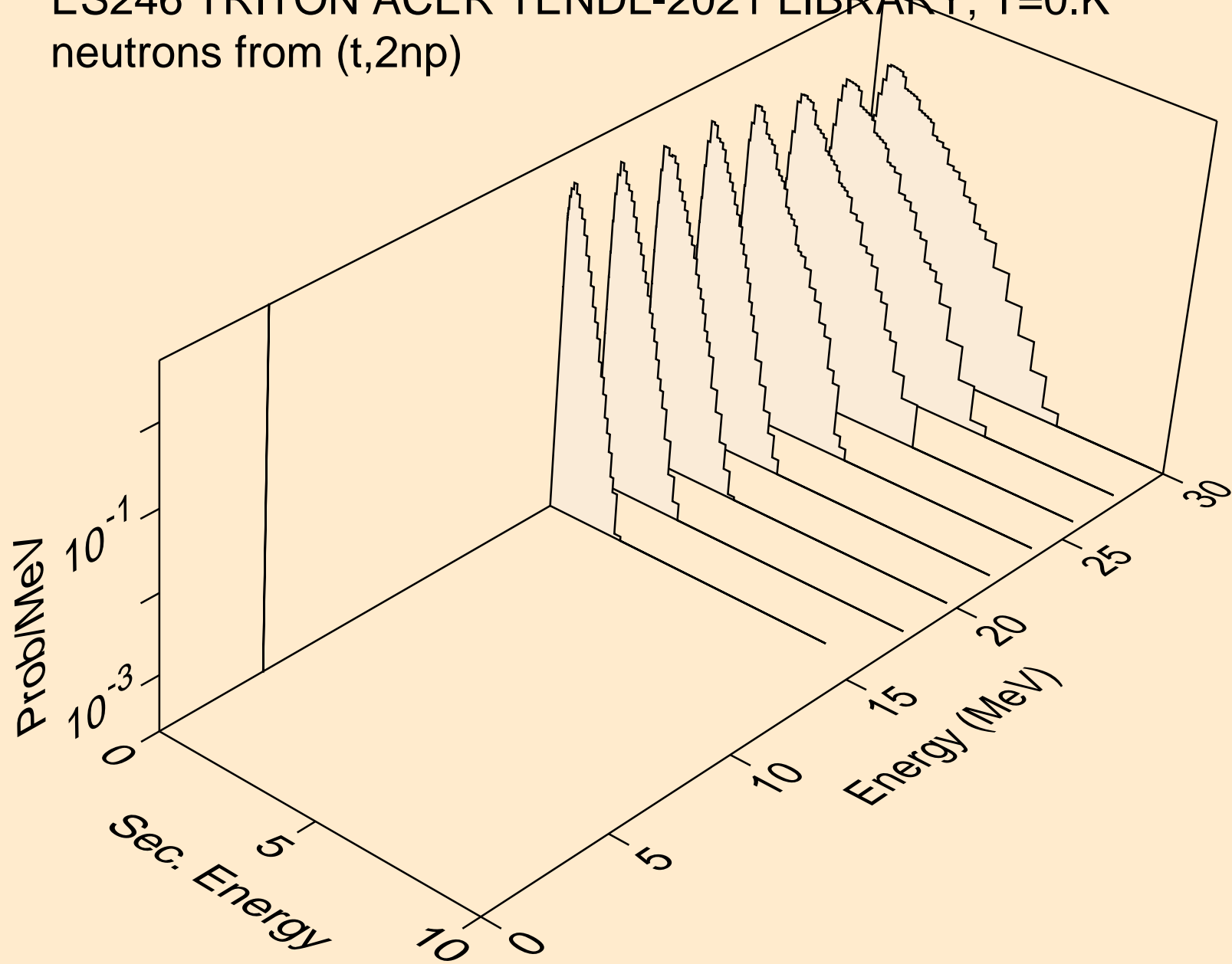



ES246 TRITON ACER TENDL-2021 LIBRARY; T=0.K  
protons from (t,x)

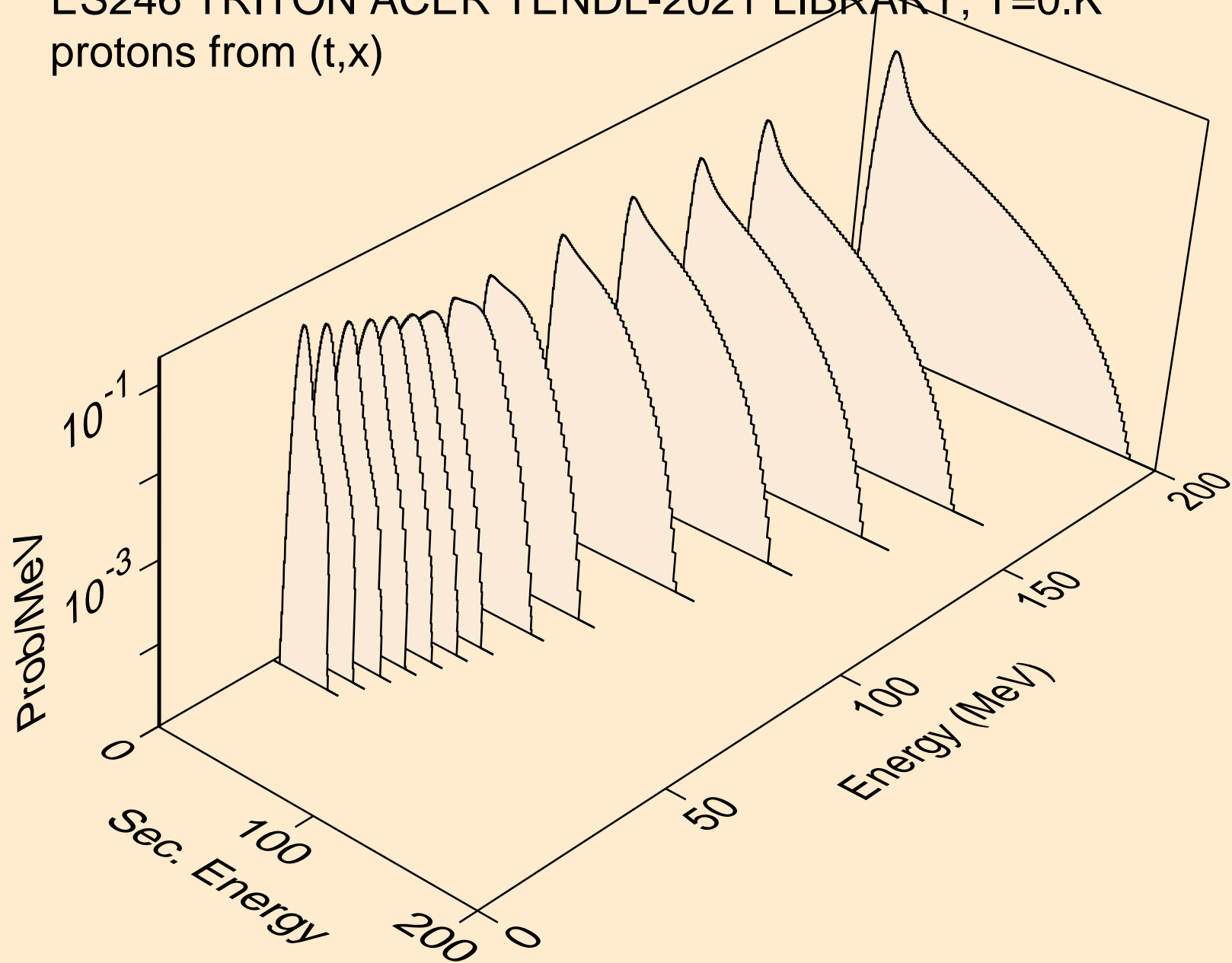

ES246 TRITON ACER TENDL-2021 LIBRARY; T=0.K  
protons from (t,n\*)p

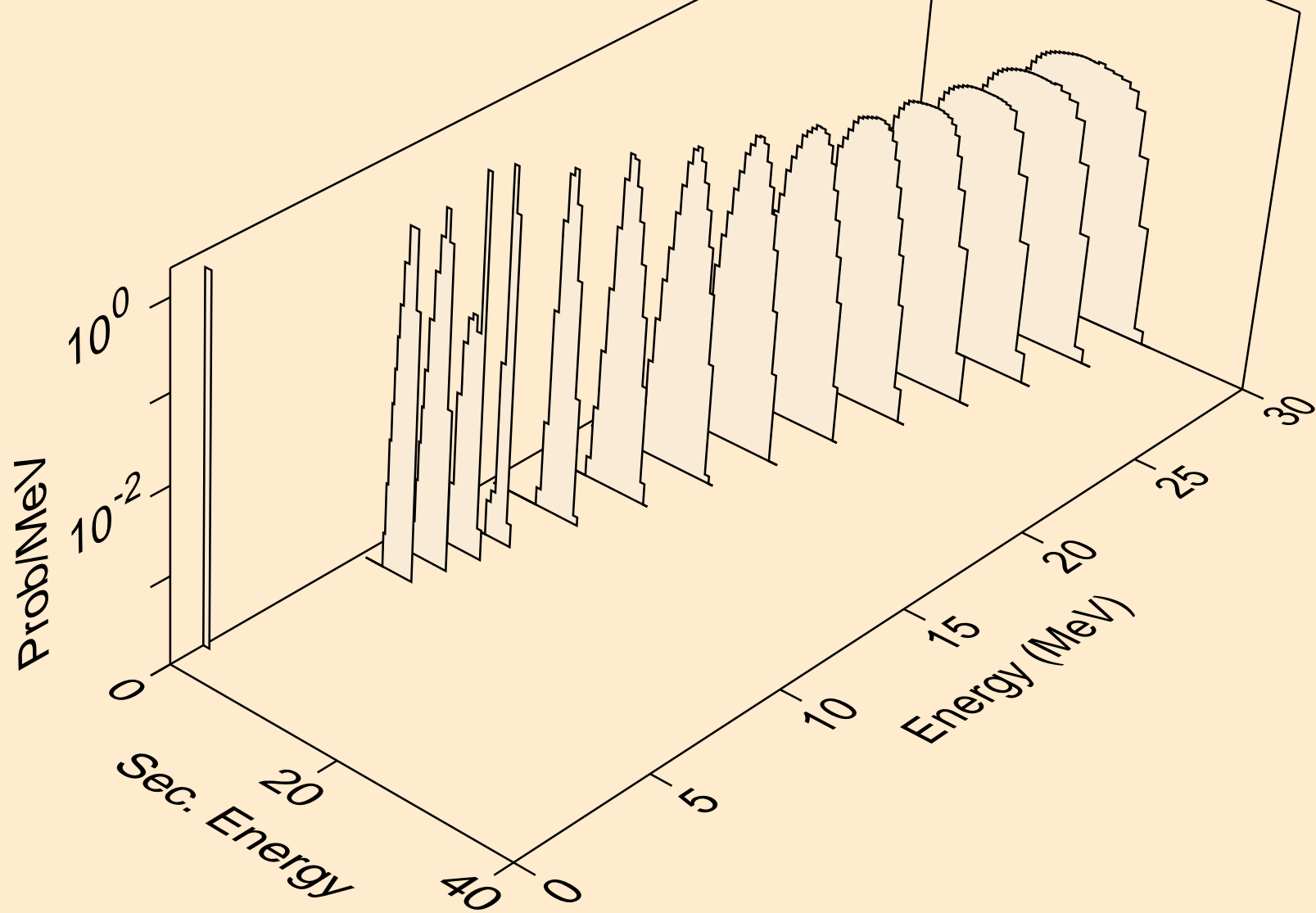

ES246 TRITON ACER TENDL-2021 LIBRARY; T=0.K  
protons from (t,2np)

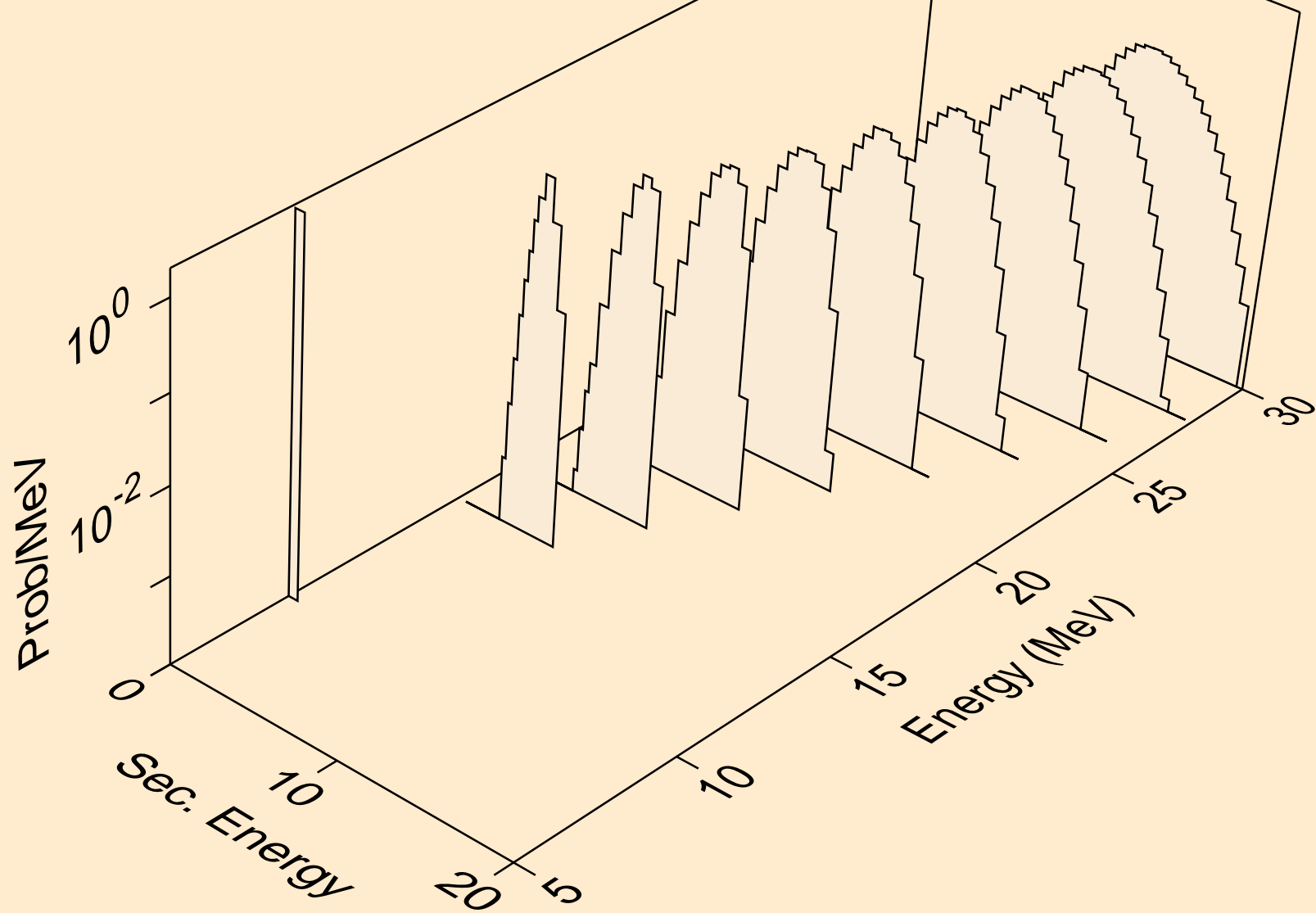

ES246 TRITON ACER TENDL-2021 LIBRARY; T=0.K  
protons from (t,3np)

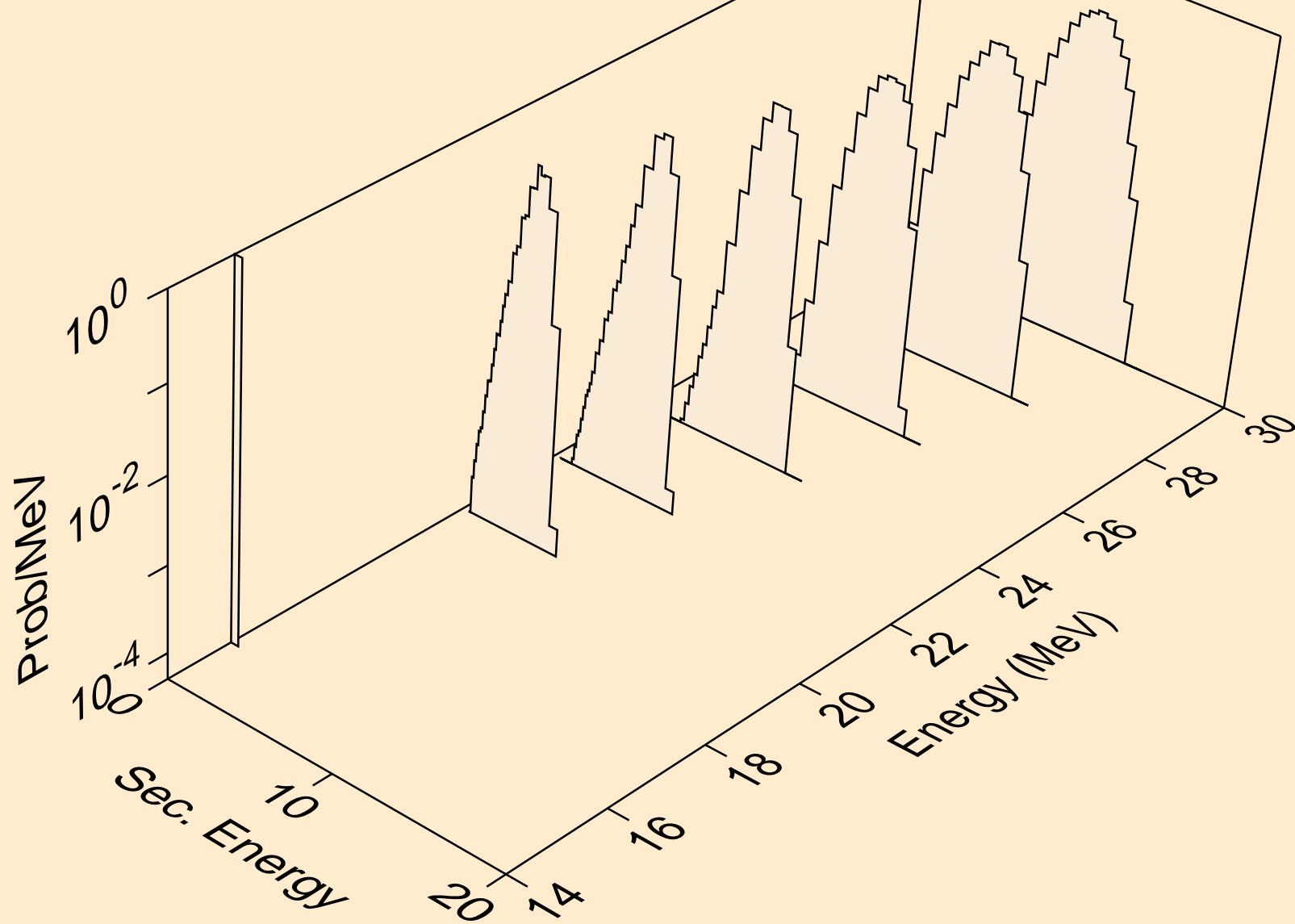

ES246 TRITON ACER TENDL-2021 LIBRARY; T=0.K  
protons from (t,2np)

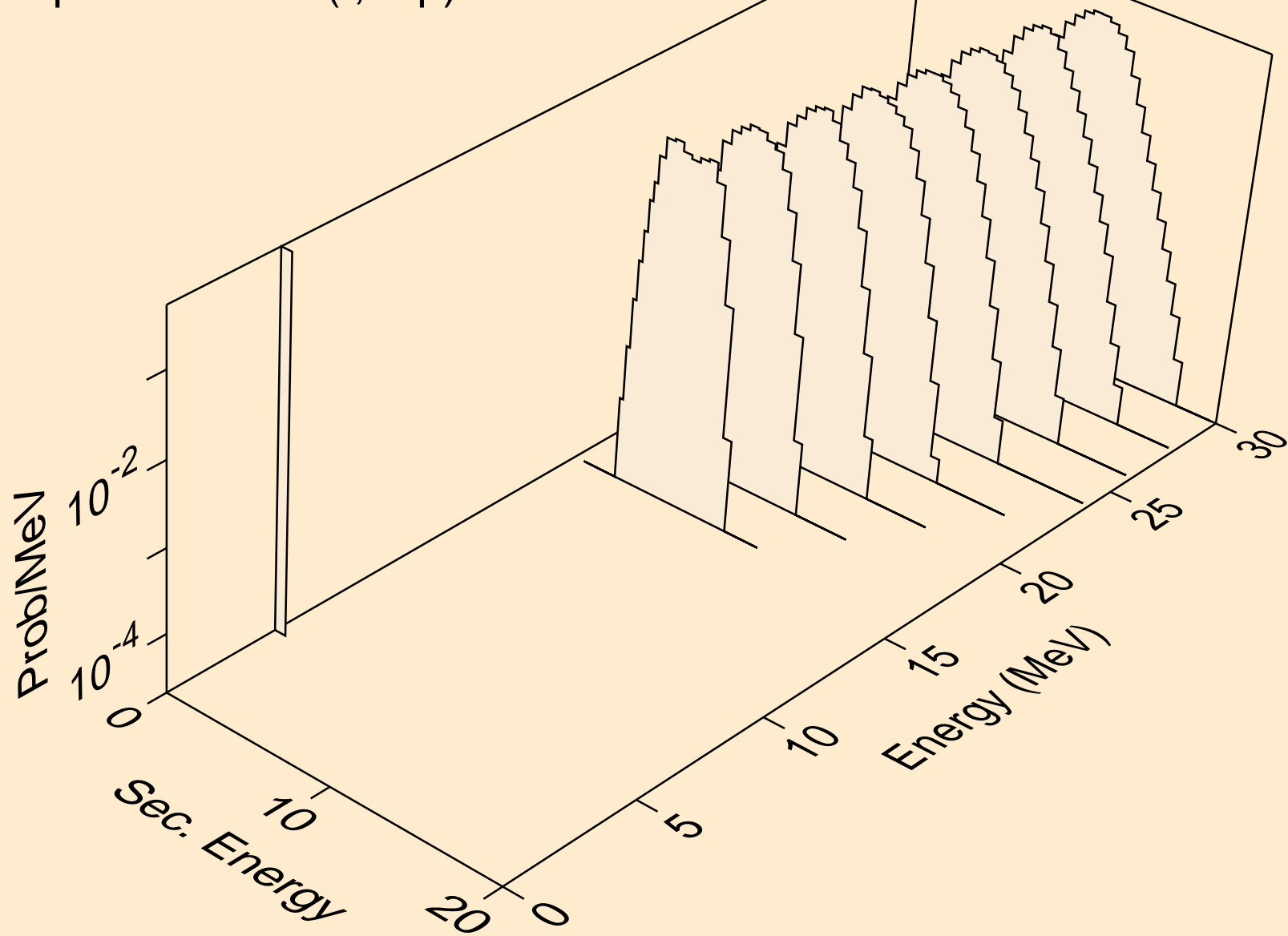

ES246 TRITON ACER TENDL-2021 LIBRARY; T=0.K  
protons from (t,p)

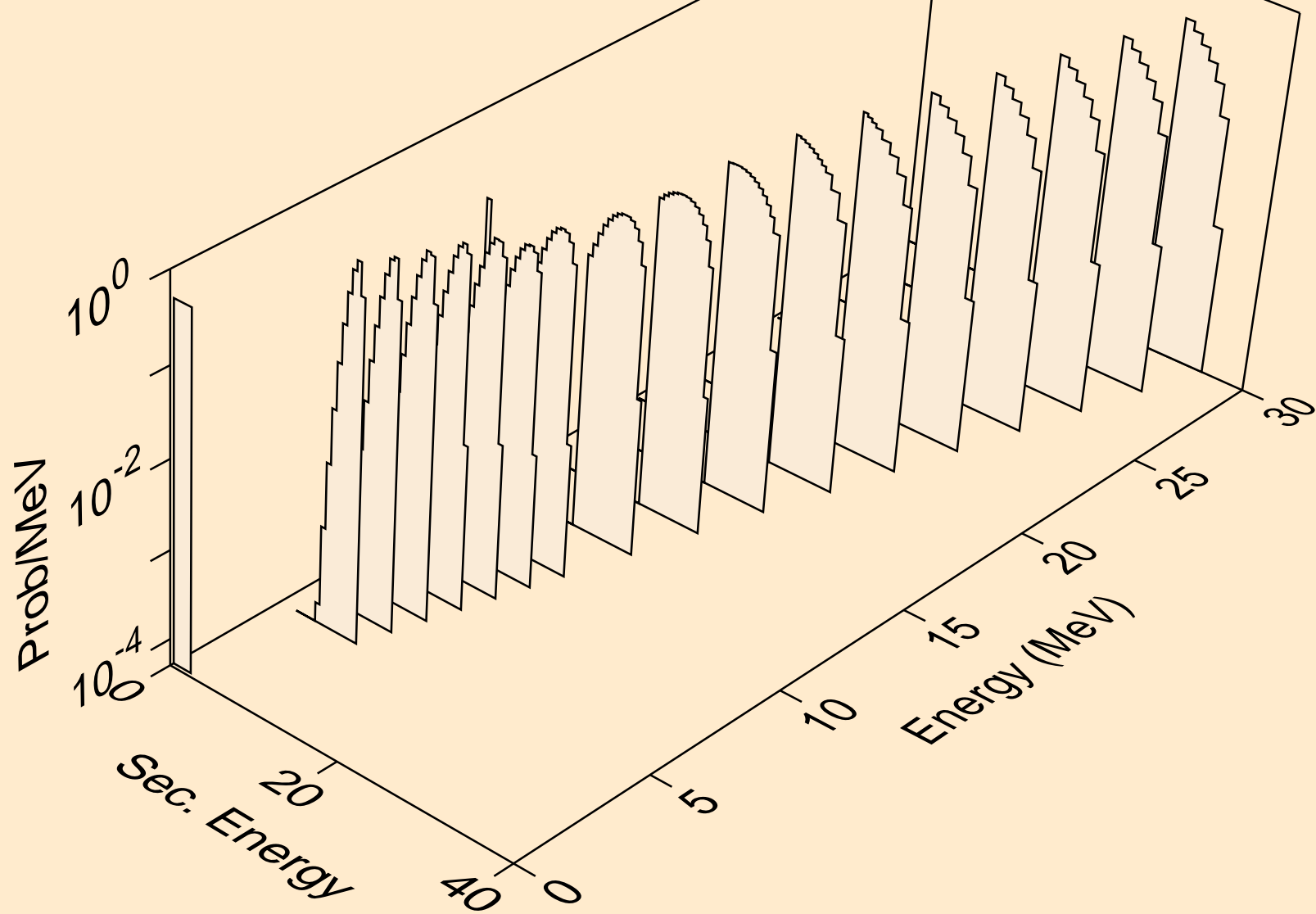

ES246 TRITON ACER TENDL-2021 LIBRARY; T=0.K  
protons from (t,2p)

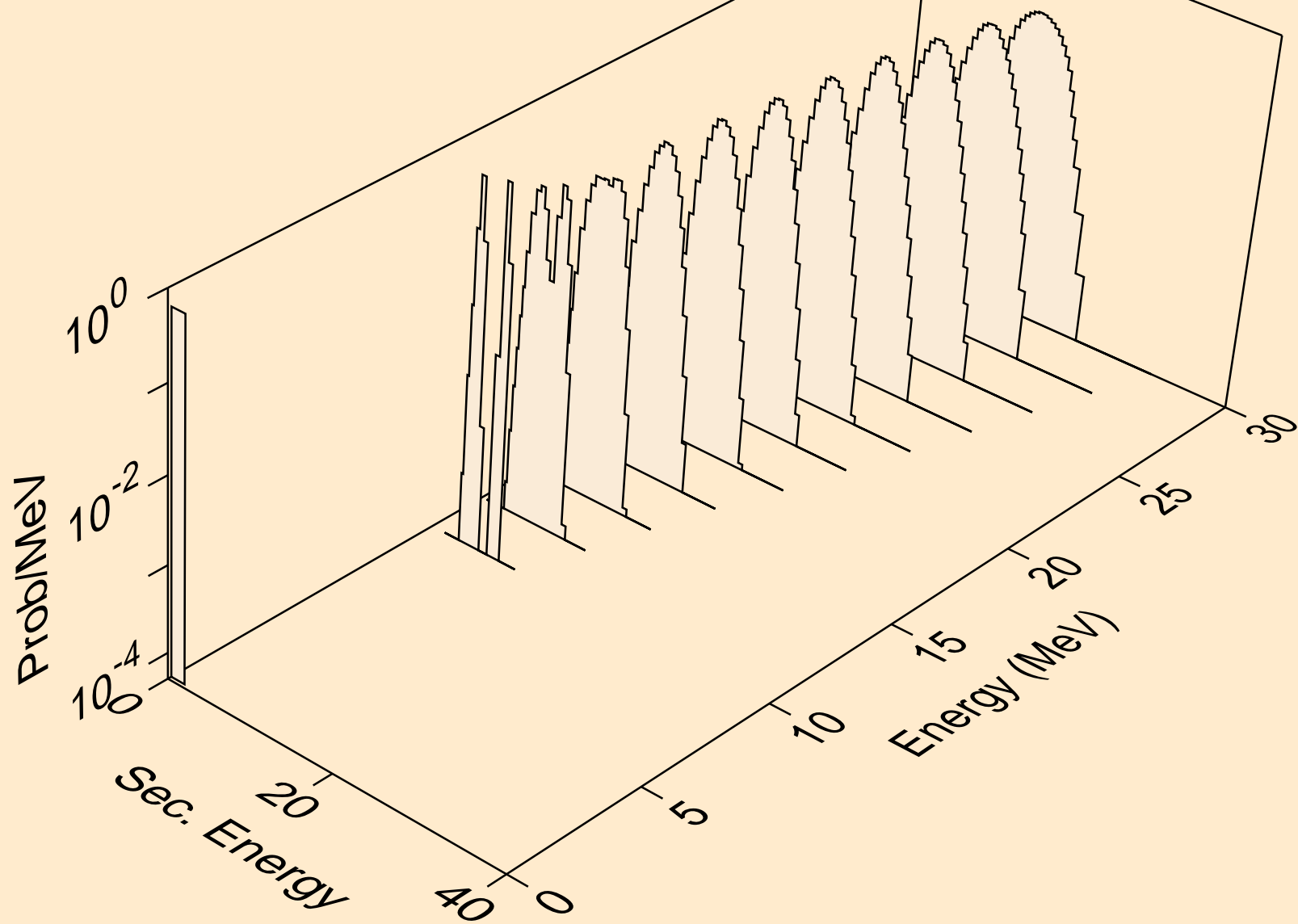

ES246 TRITON ACER TENDL-2021 LIBRARY; T=0.K  
protons from (t,pd)

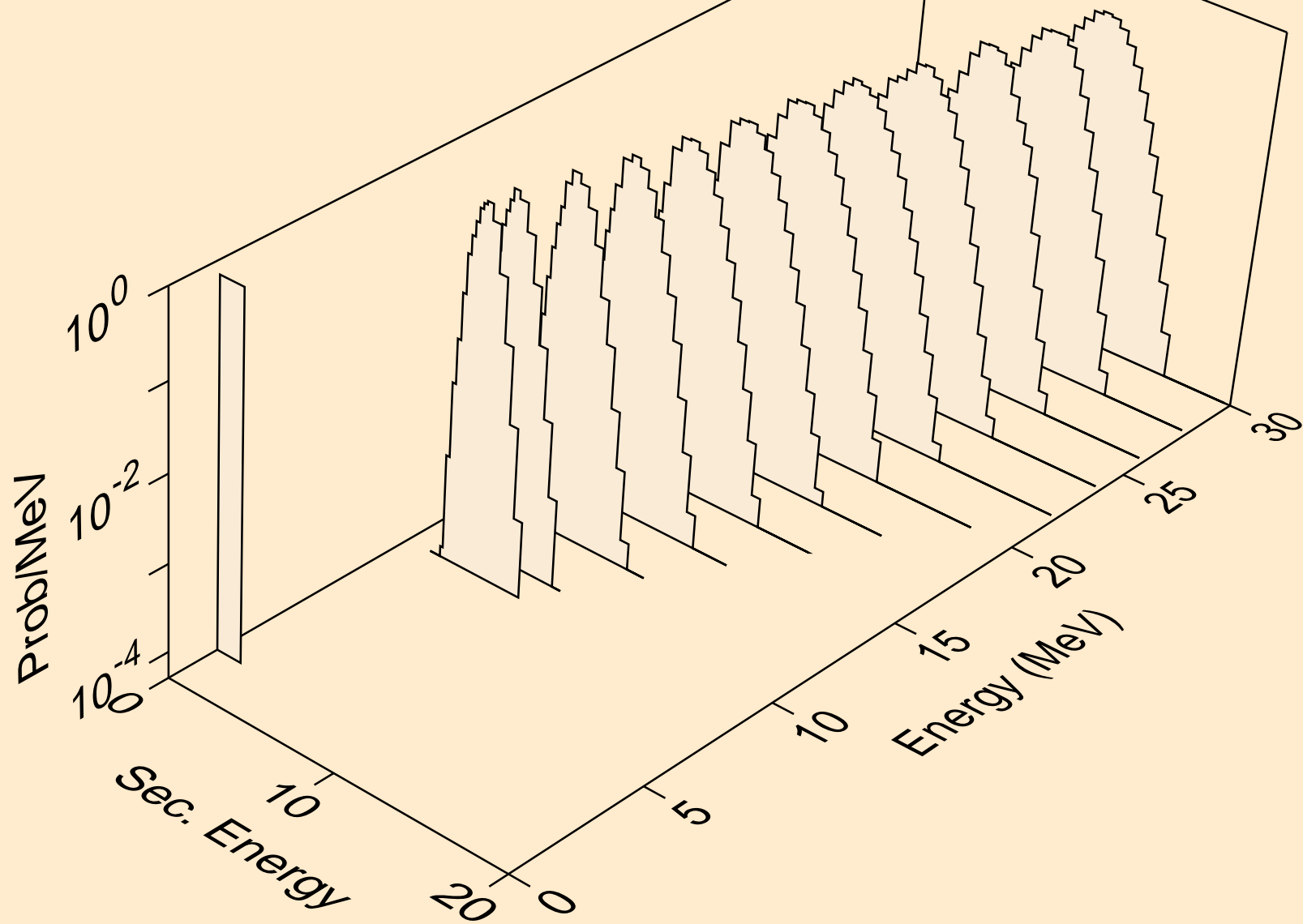



ES246 TRITON ACER TENDL-2021 LIBRARY; T=0.K  
deuterons from (t,x)

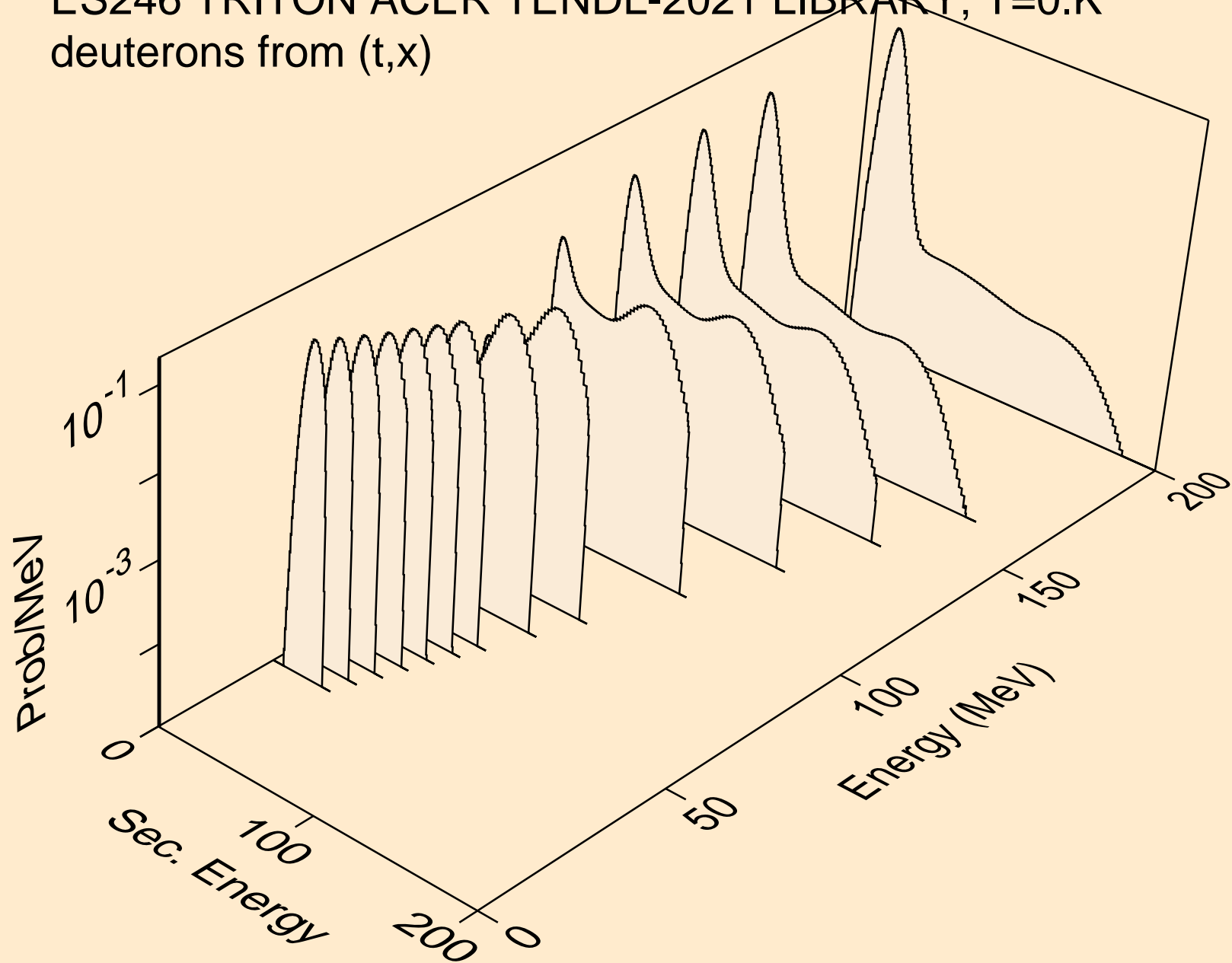

ES246 TRITON ACER TENDL-2021 LIBRARY; T=0.K  
deuterons from (t,2nd)

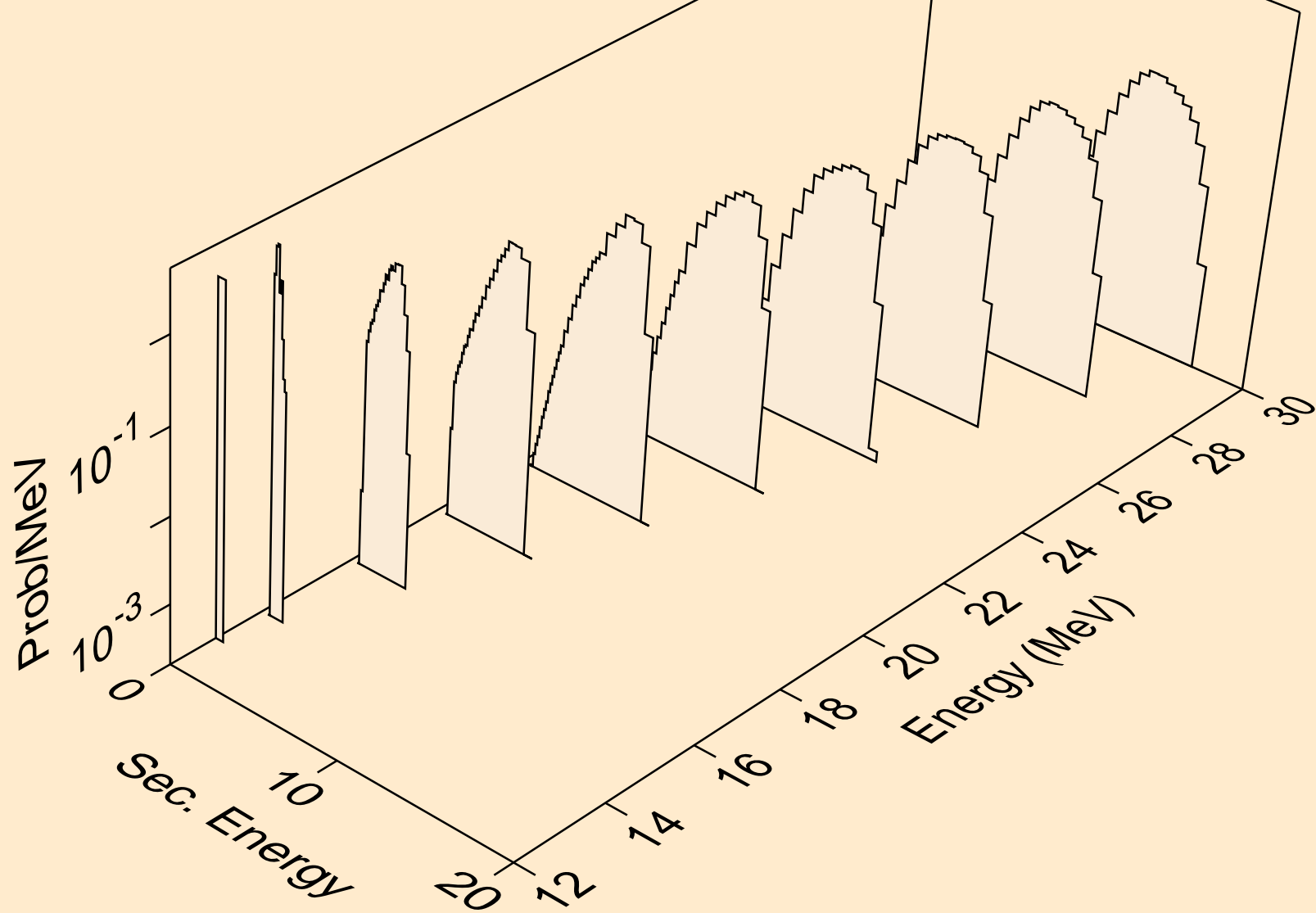

ES246 TRITON ACER TENDL-2021 LIBRARY; T=0.K  
deuterons from (t,n\*)d

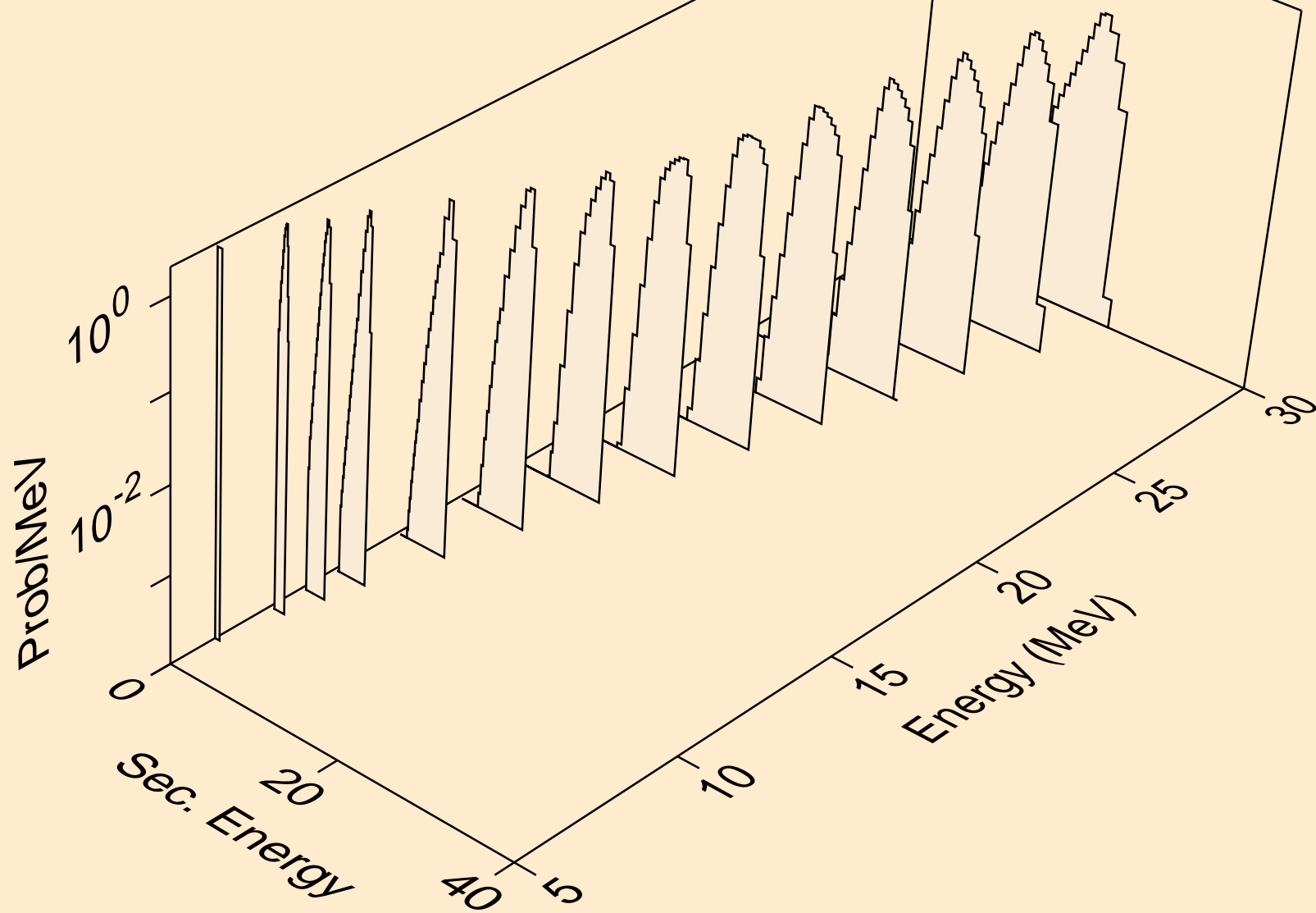

ES246 TRITON ACER TENDL-2021 LIBRARY; T=0.K  
deuterons from (t,d)

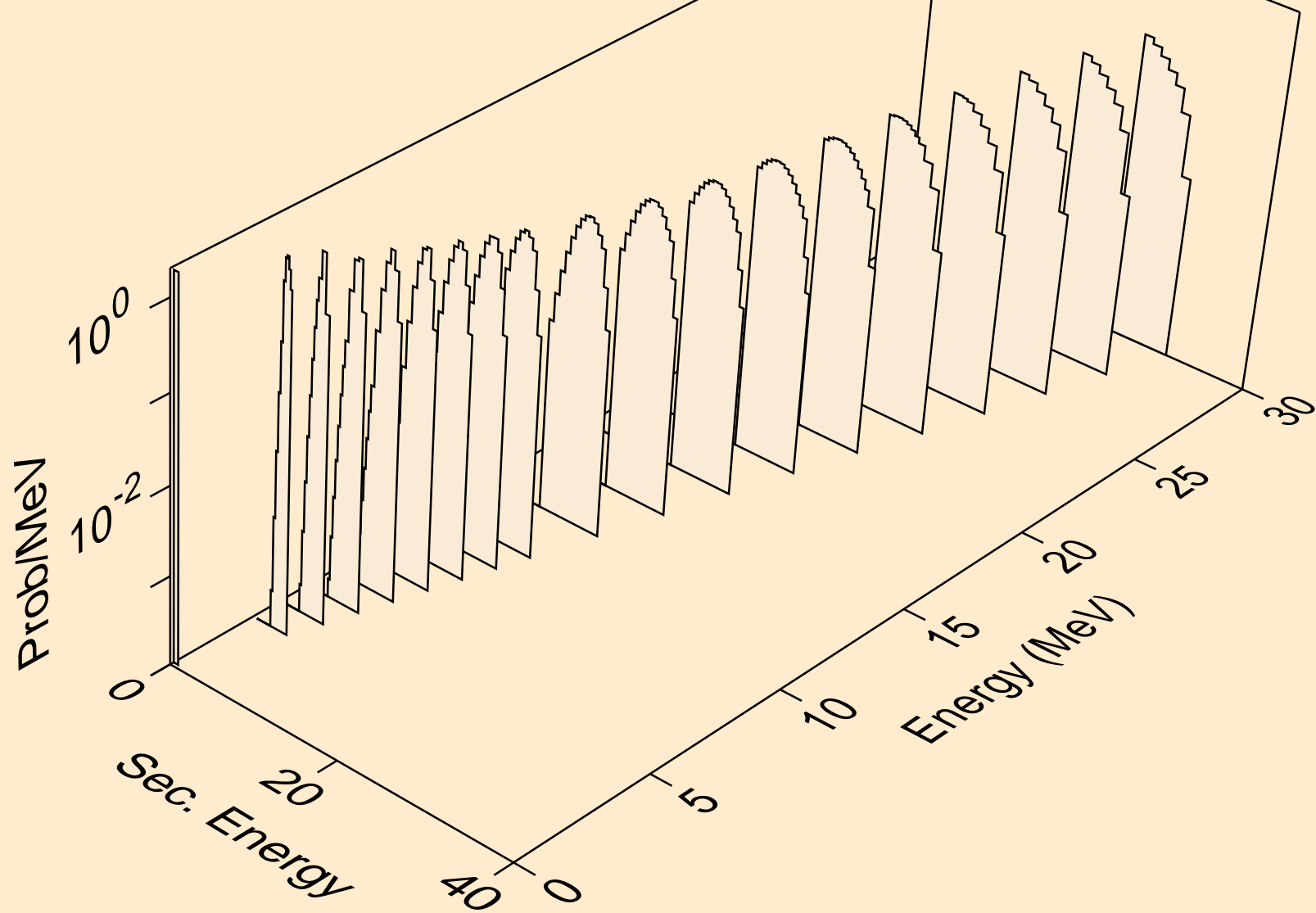

ES246 TRITON ACER TENDL-2021 LIBRARY; T=0.K  
deuterons from (t,pd)

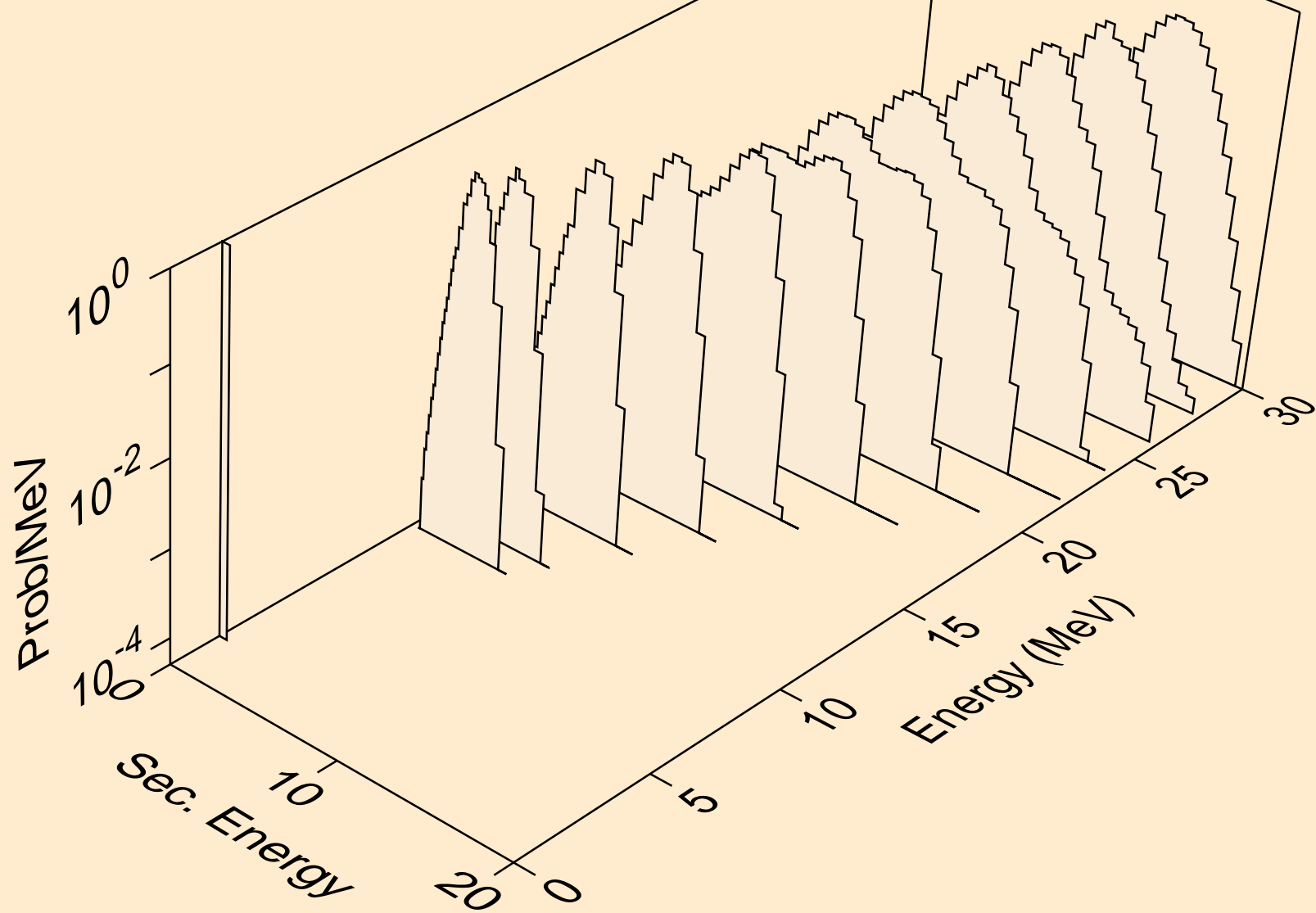

ES246 TRITON ACER TENDL-2021 LIBRARY; T=0.K  
he3s from (t,x)

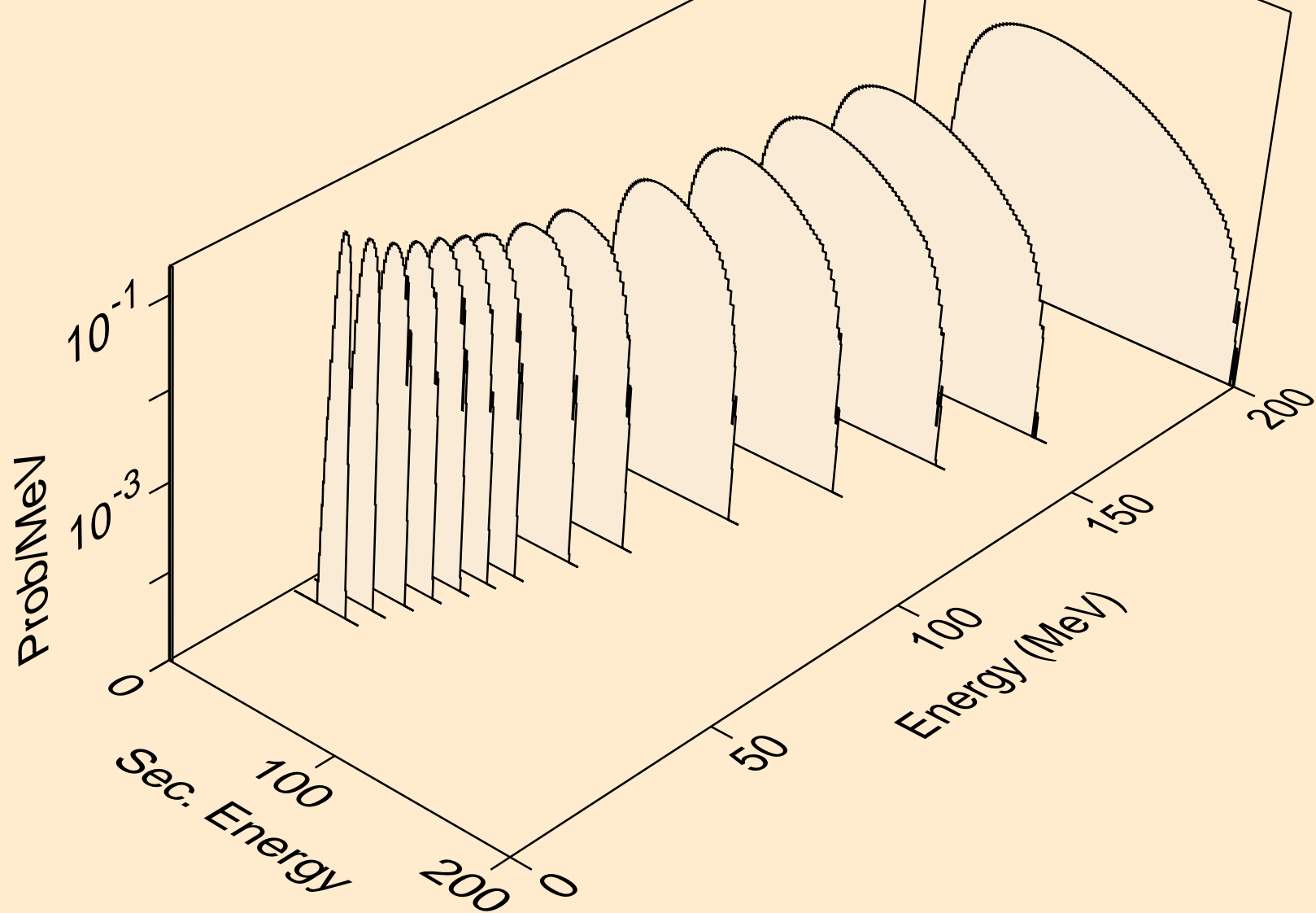

ES246 TRITON ACER TENDL-2021 LIBRARY; T=0.K  
he3s from (t,n\*)he3

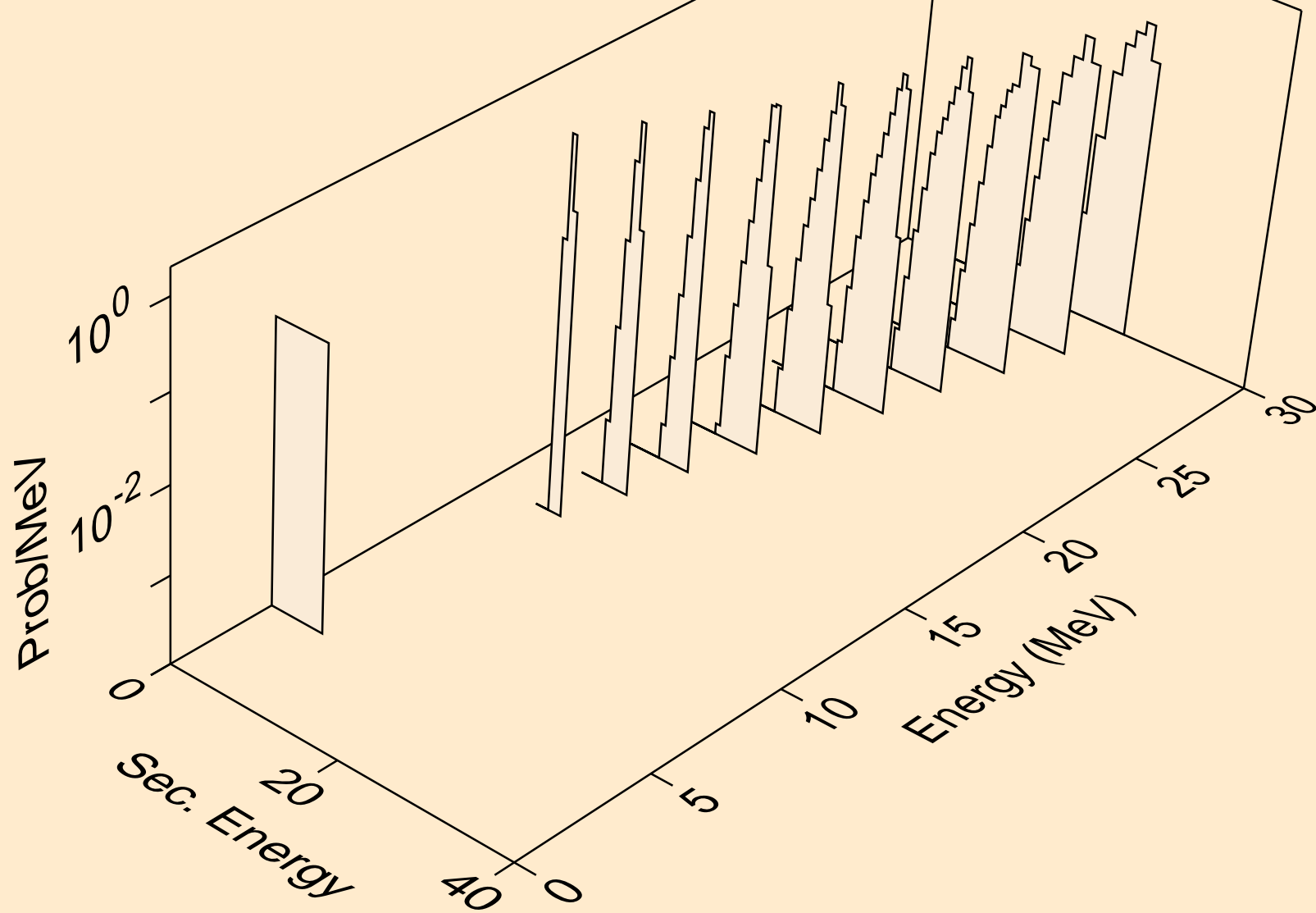

ES246 TRITON ACER TENDL-2021 LIBRARY; T=0.K  
he3s from (t,he3)

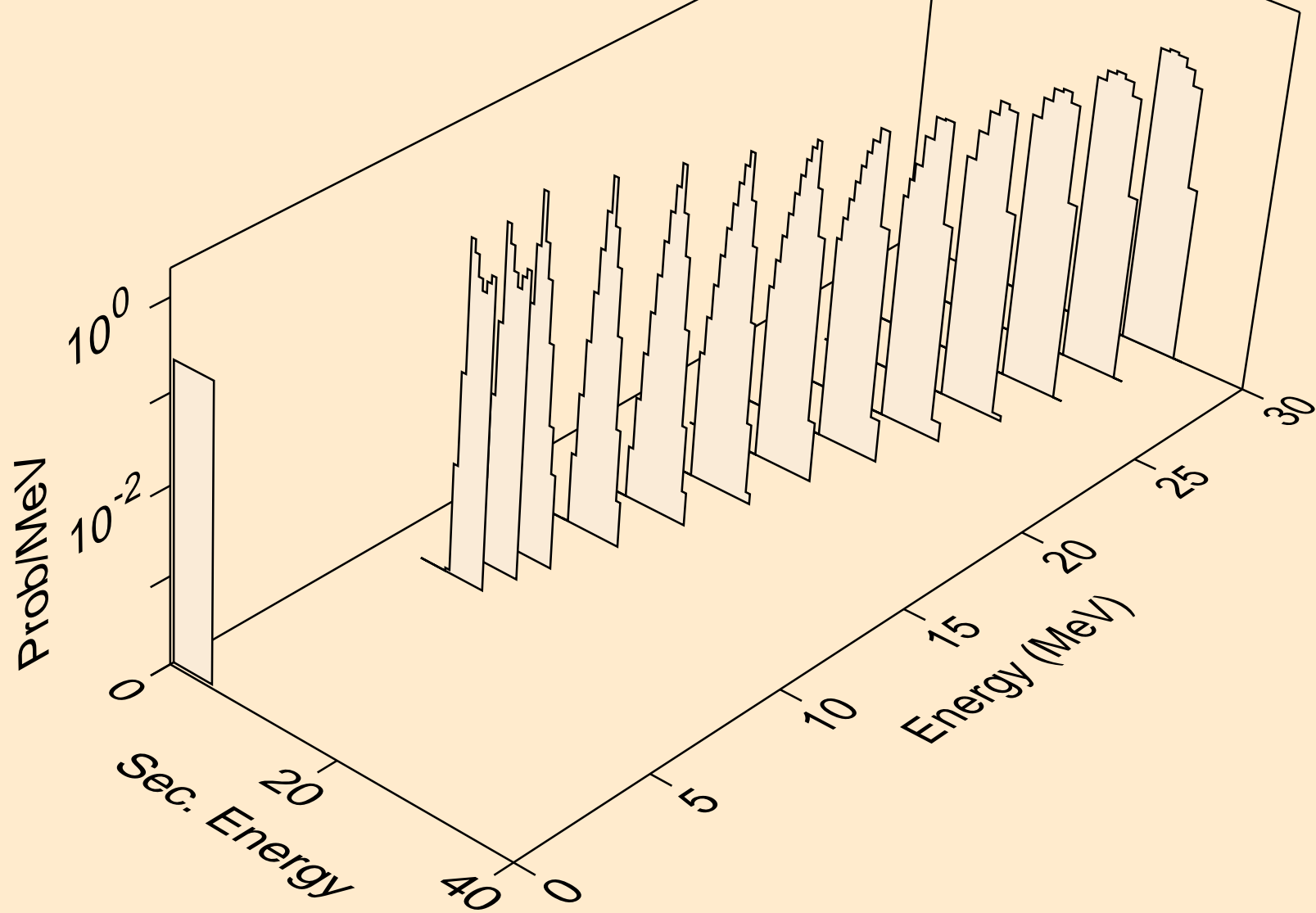



ES246 TRITON ACER TENDL-2021 LIBRARY; T=0.K  
alphas from (t,x)

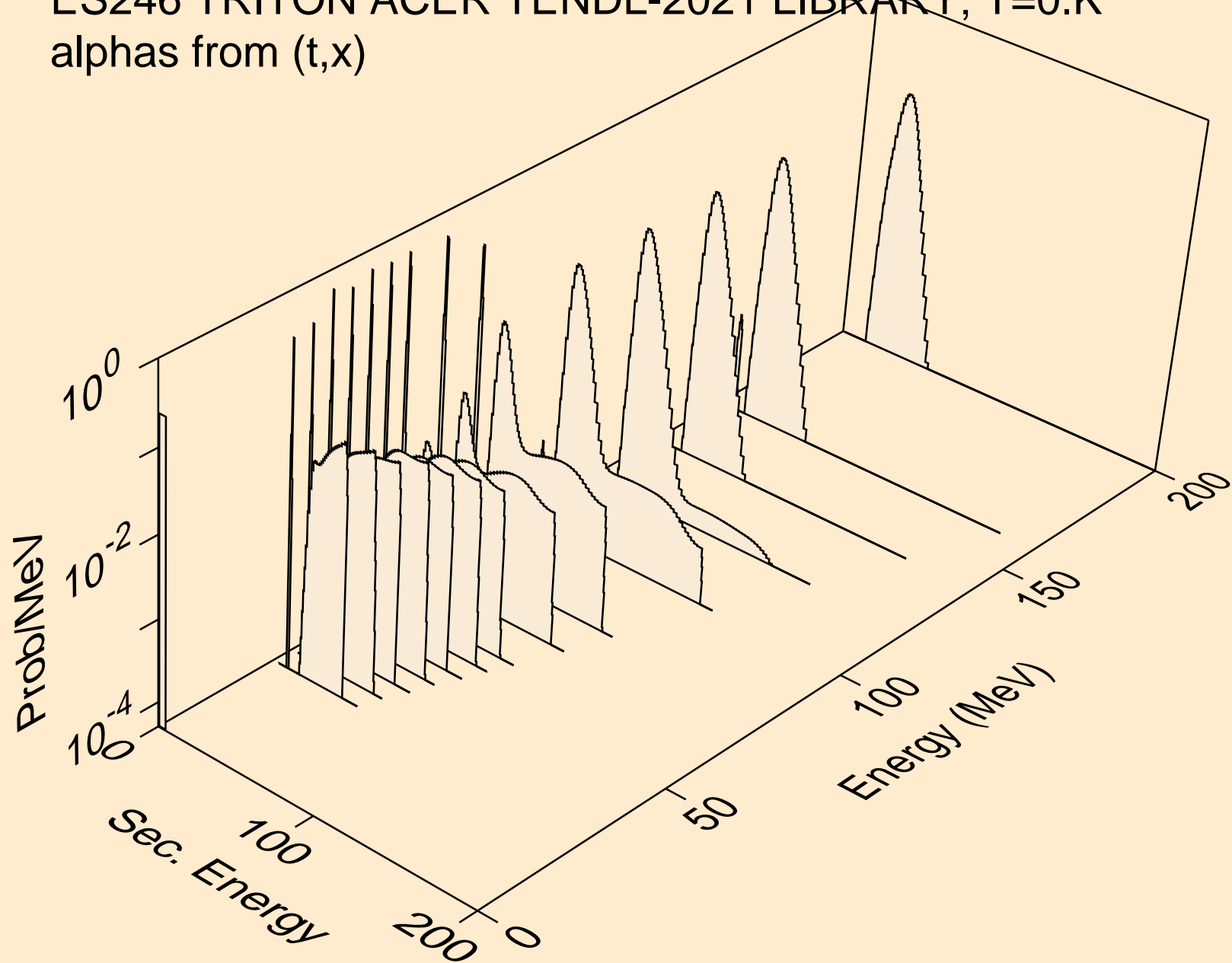

ES246 TRITON ACER TENDL-2021 LIBRARY; T=0.K  
alphas from (t,n\*)a

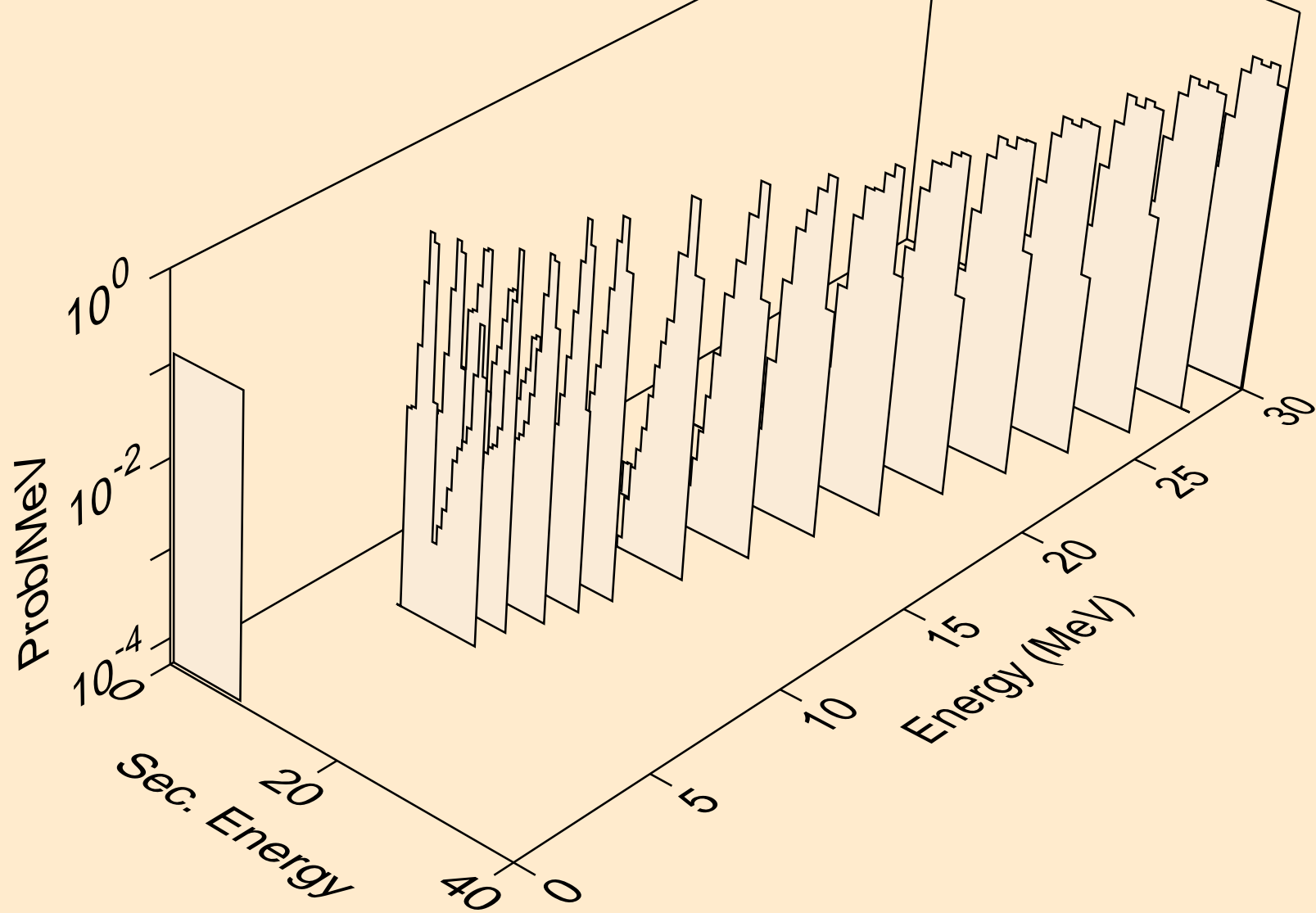

ES246 TRITON ACER TENDL-2021 LIBRARY; T=0.K  
alphas from (t,2n)a

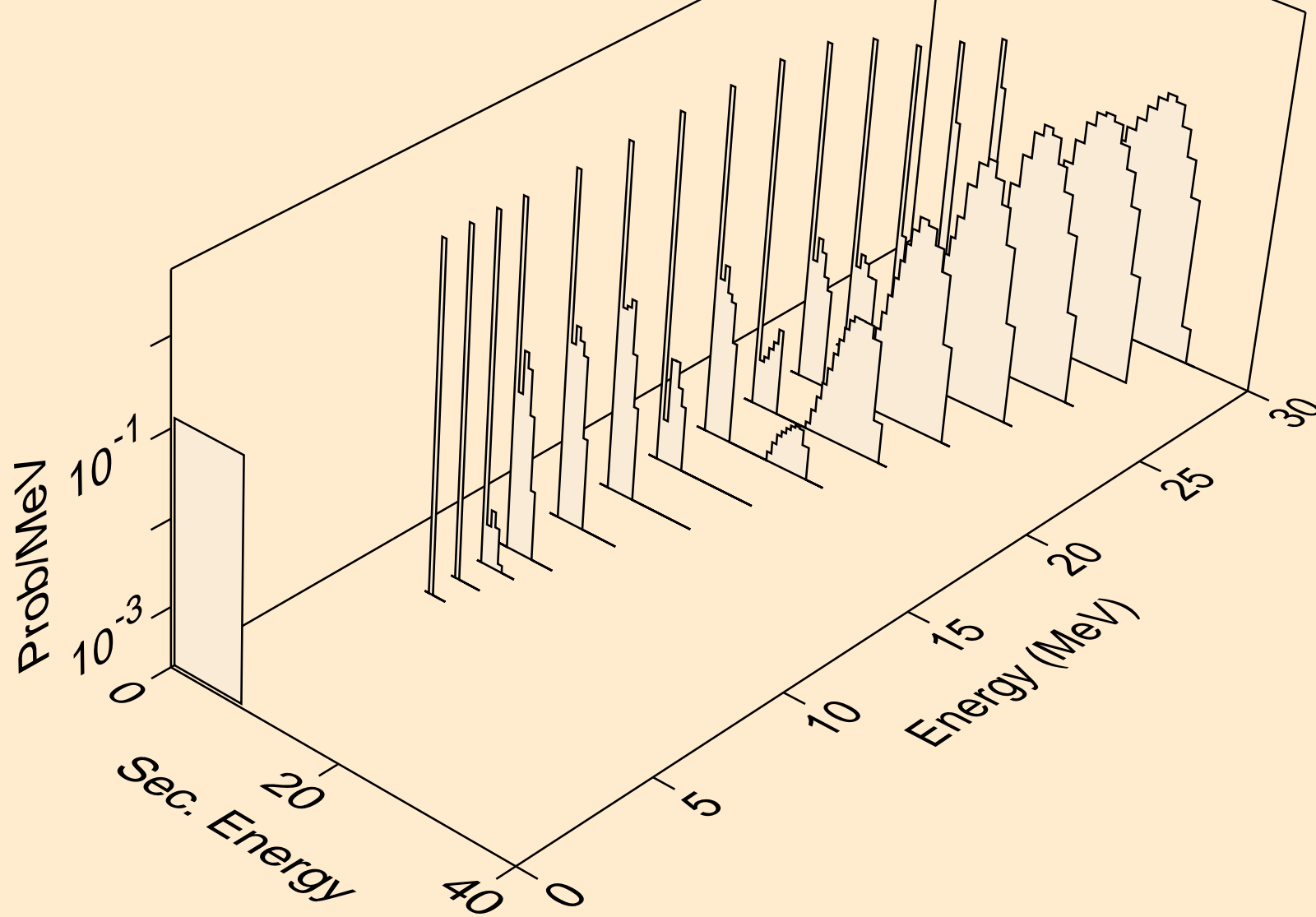

ES246 TRITON ACER TENDL-2021 LIBRARY; T=0.K  
alphas from (t,a)

