

# EU146 TRITON ACER TENDL-2021 LIBRARY; T=0.K

## Principal cross sections

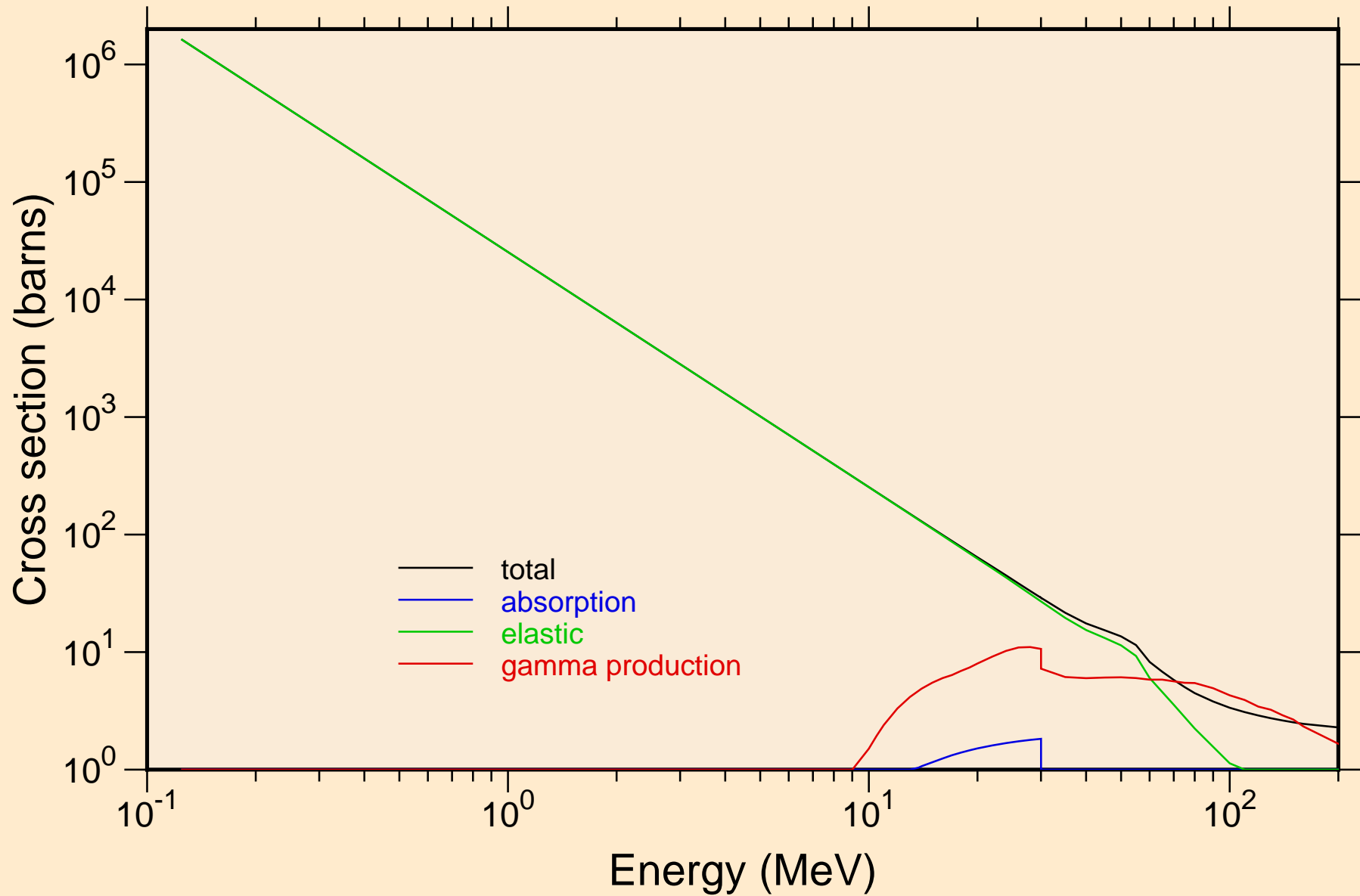

# EU146 TRITON ACER TENDL-2021 LIBRARY; T=0.K

## Heating

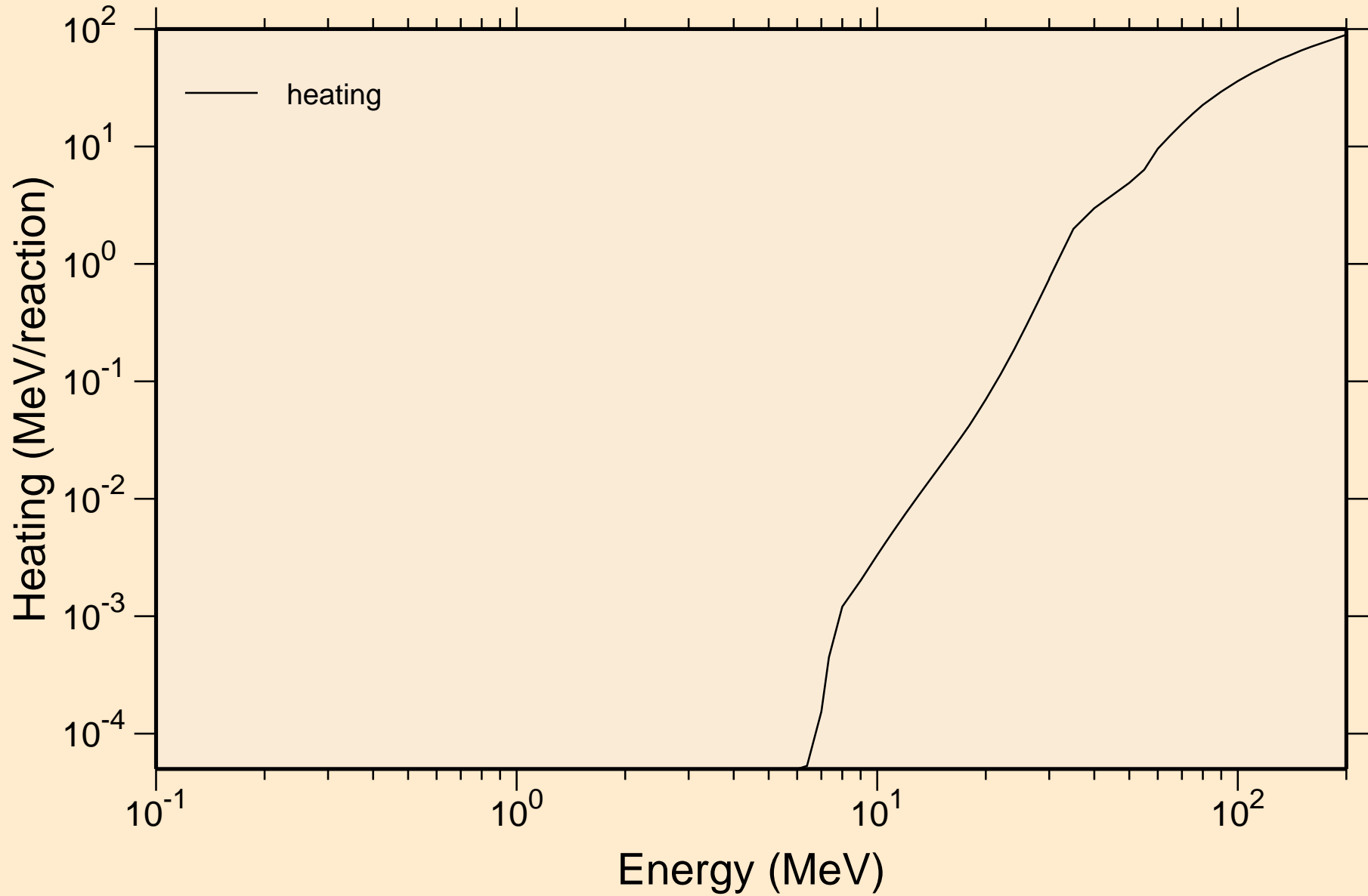

# EU146 TRITON ACER TENDL-2021 LIBRARY; T=0.K

## Principal cross sections

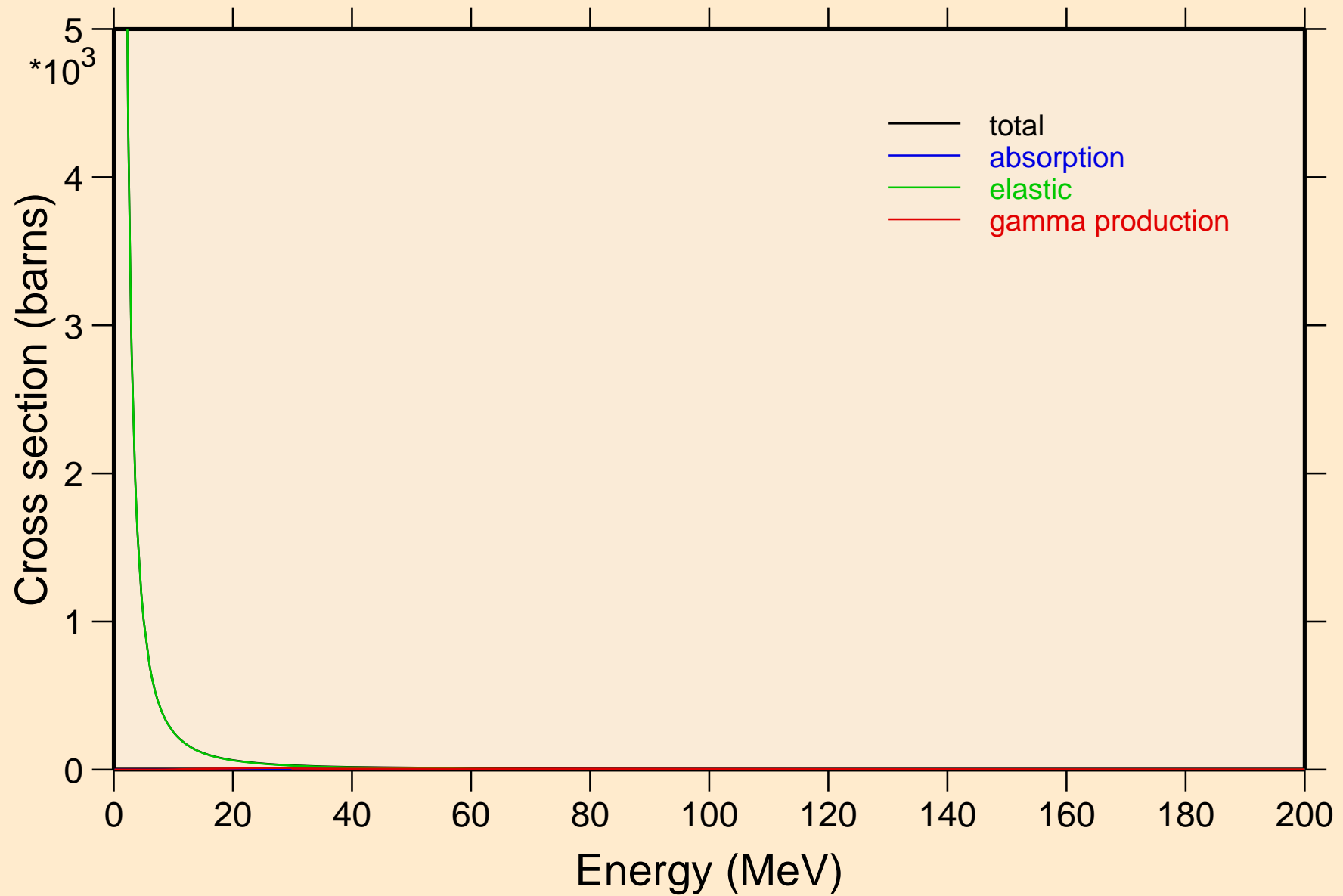

EU146 TRITON ACER TENDL-2021 LIBRARY; T=0.K

Heating

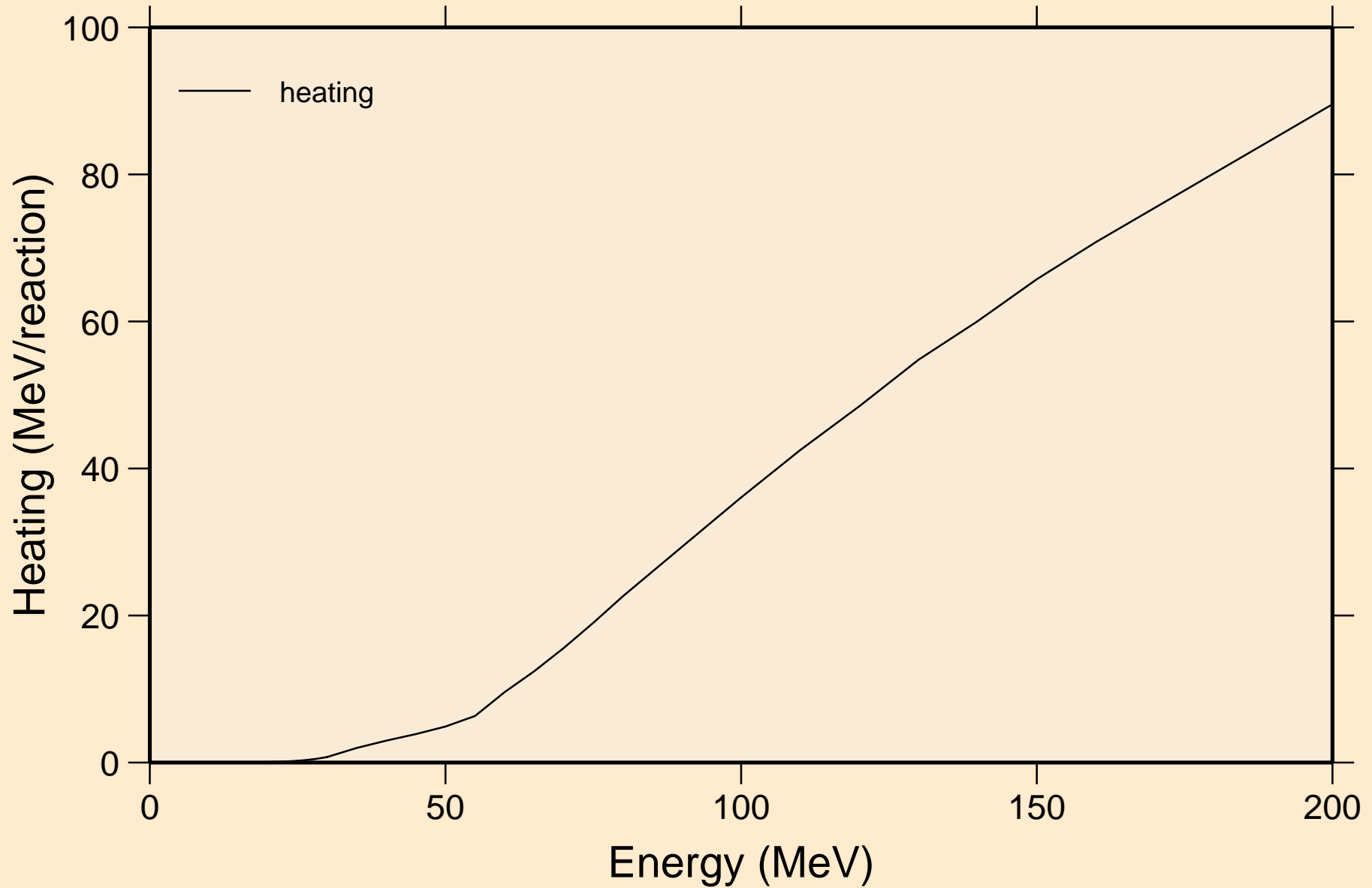

EU146 TRITON ACER TENDL-2021 LIBRARY; T=0.K  
Threshold reactions

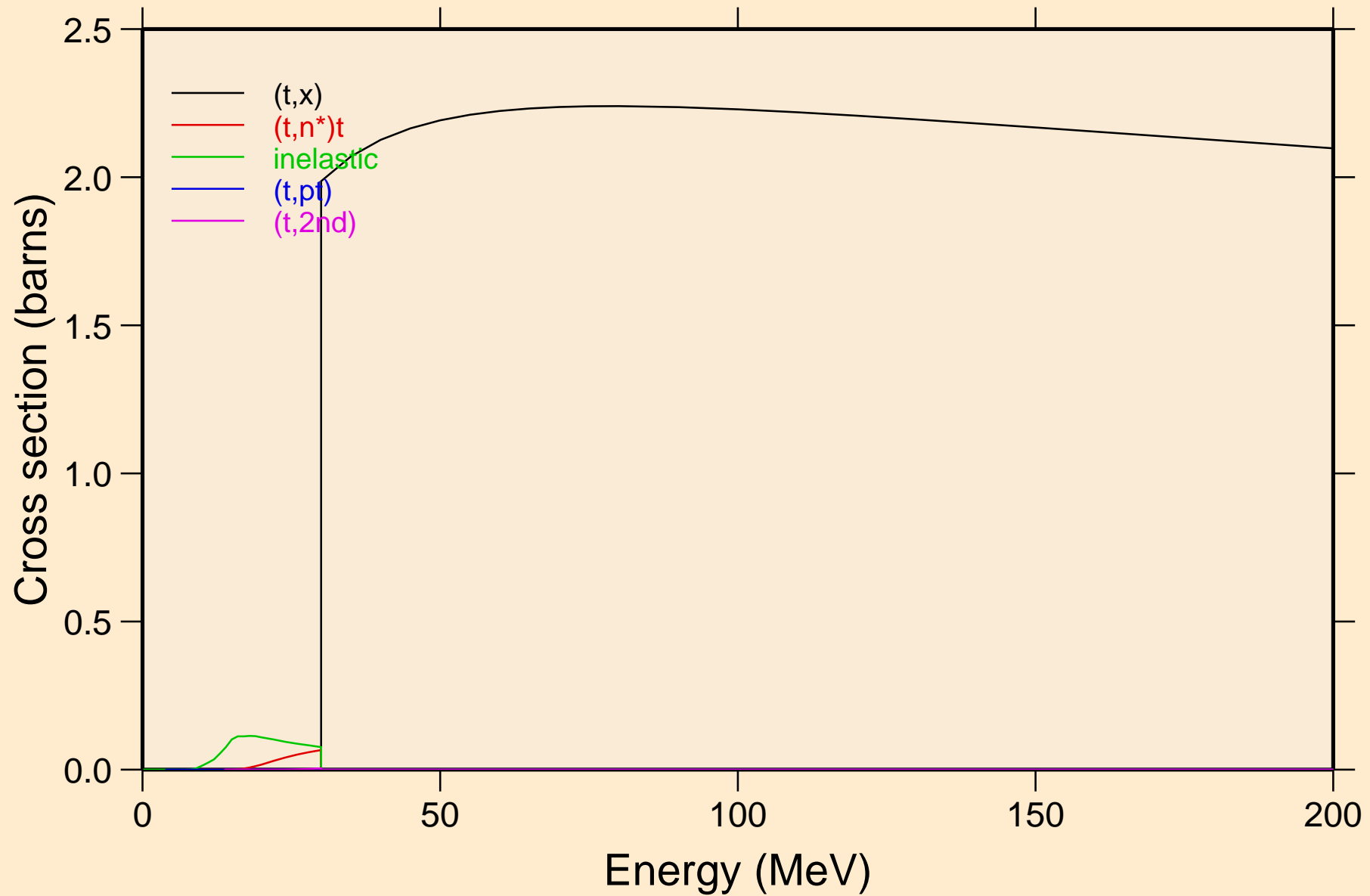

EU146 TRITON ACER TENDL-2021 LIBRARY; T=0.K  
Threshold reactions

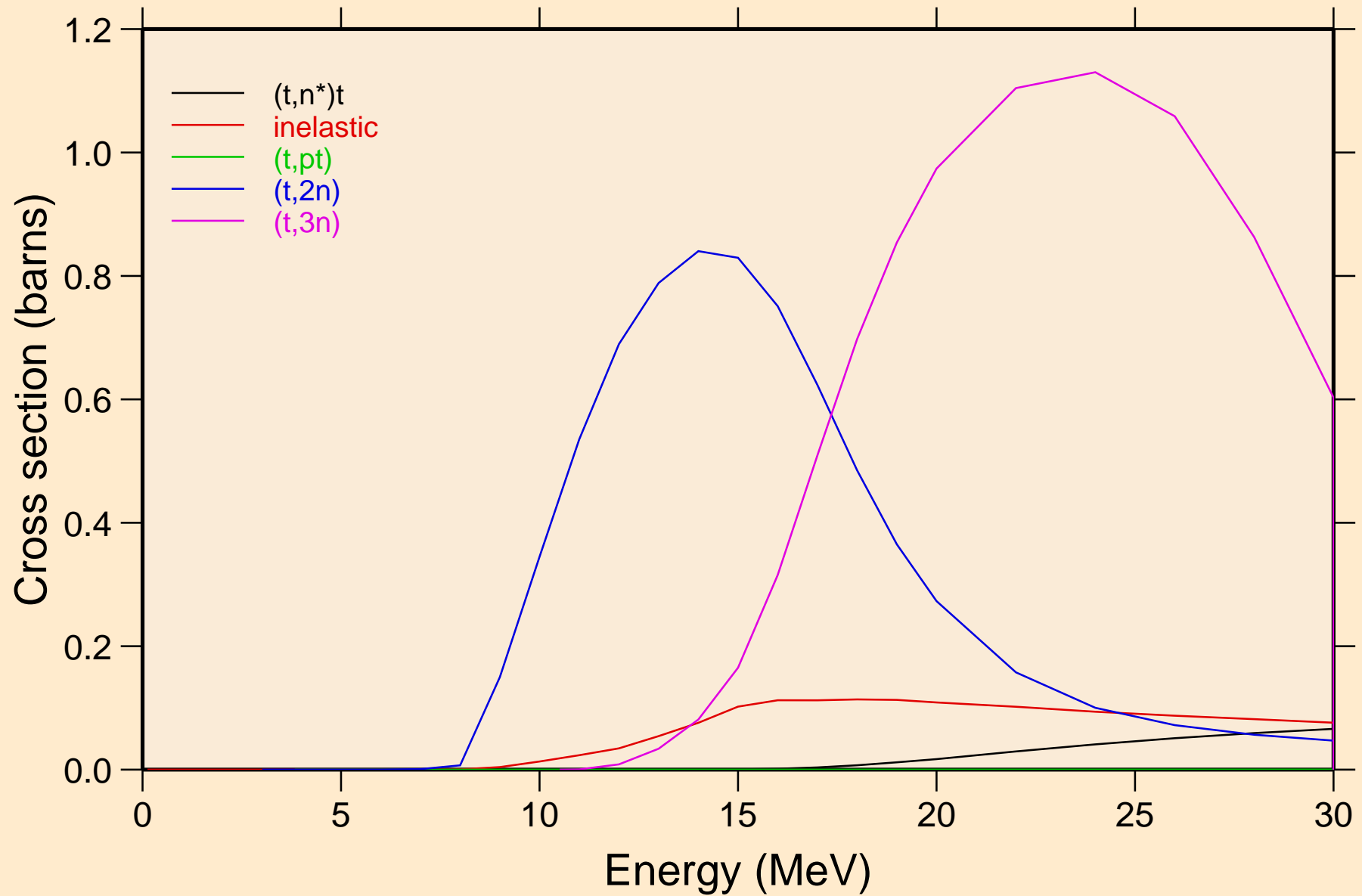

EU146 TRITON ACER TENDL-2021 LIBRARY; T=0.K  
Threshold reactions

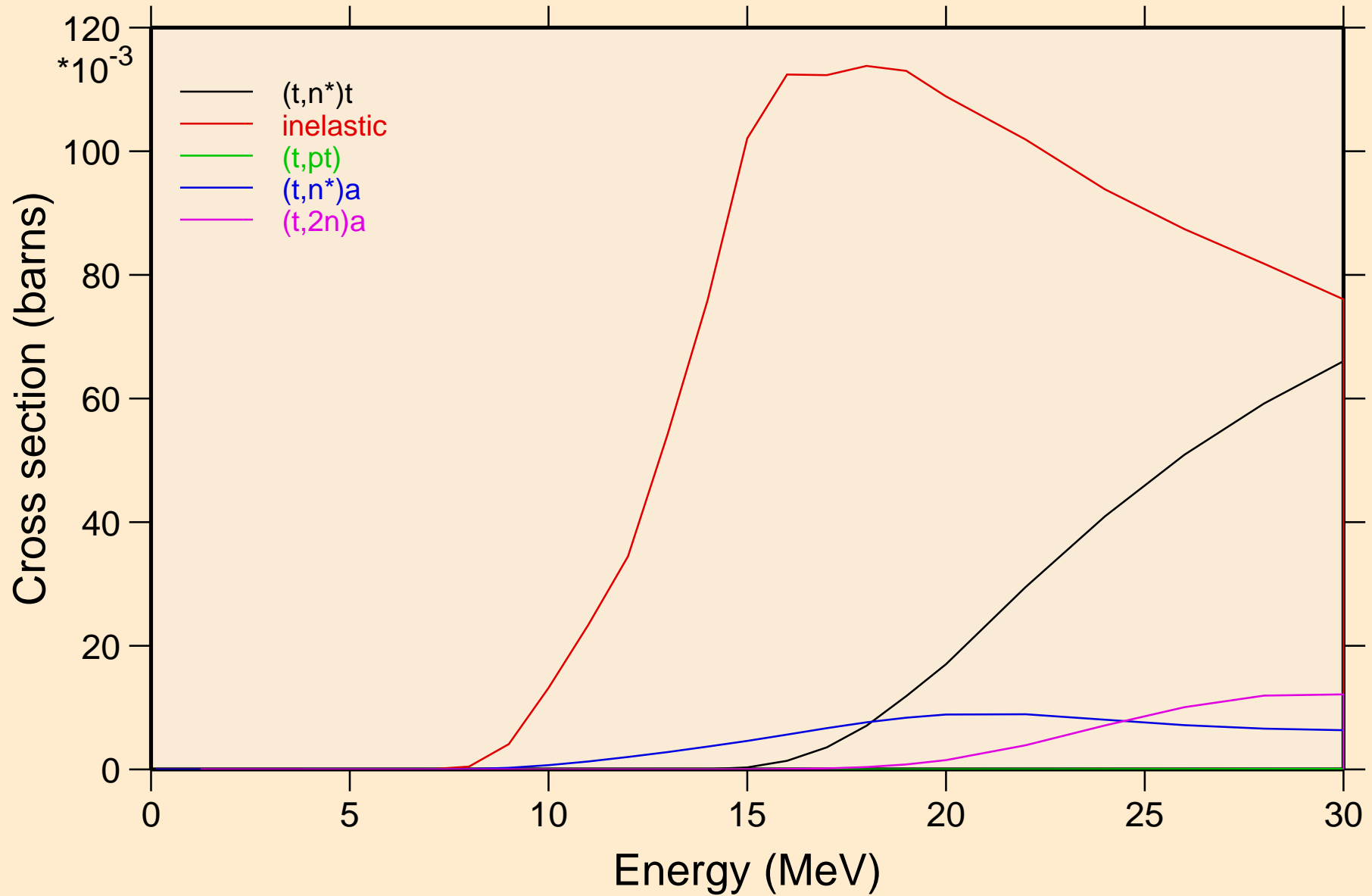

EU146 TRITON ACER TENDL-2021 LIBRARY; T=0.K  
Threshold reactions

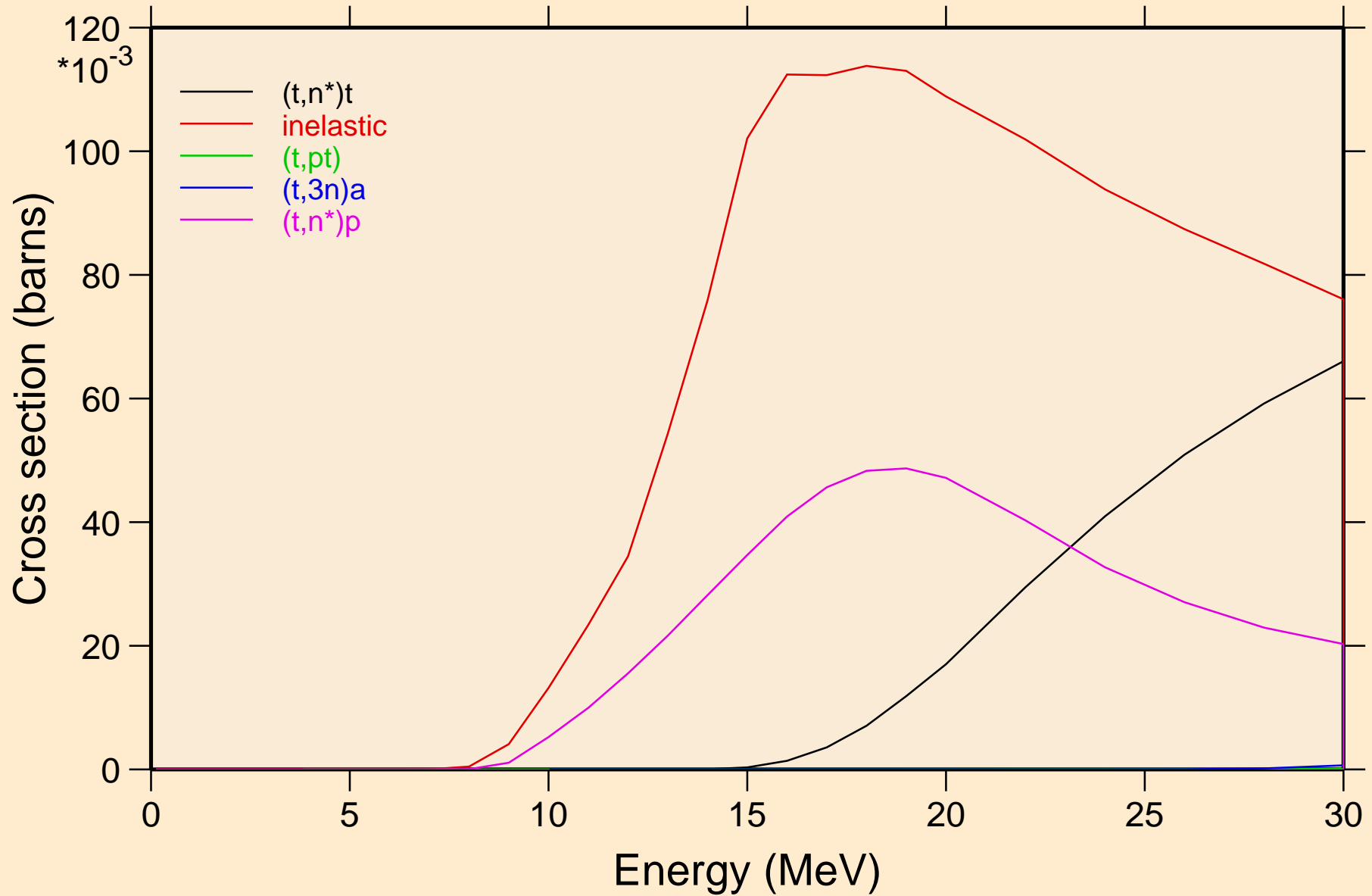



EU146 TRITON ACER TENDL-2021 LIBRARY; T=0.K  
Threshold reactions

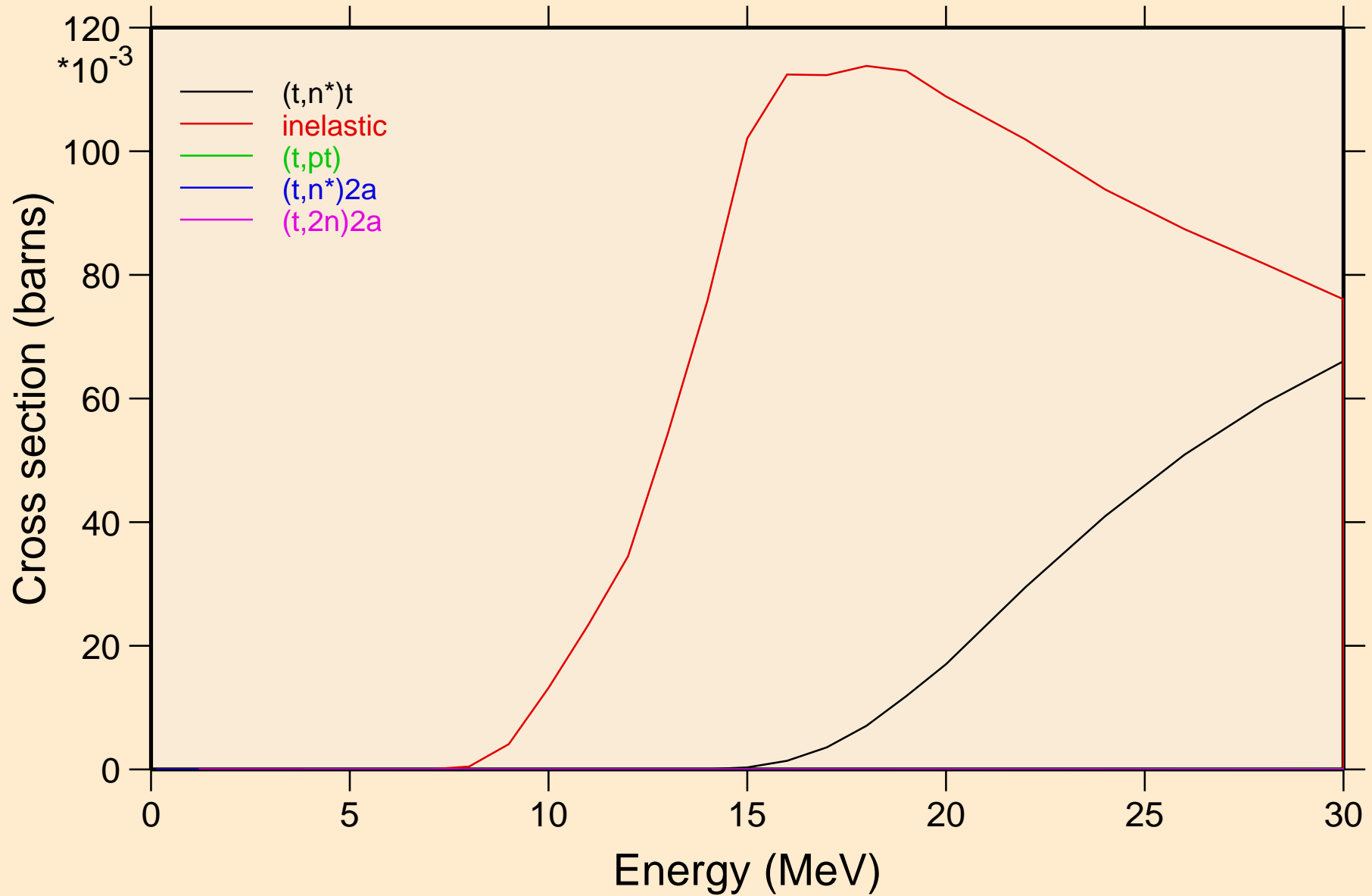

EU146 TRITON ACER TENDL-2021 LIBRARY; T=0.K  
Threshold reactions

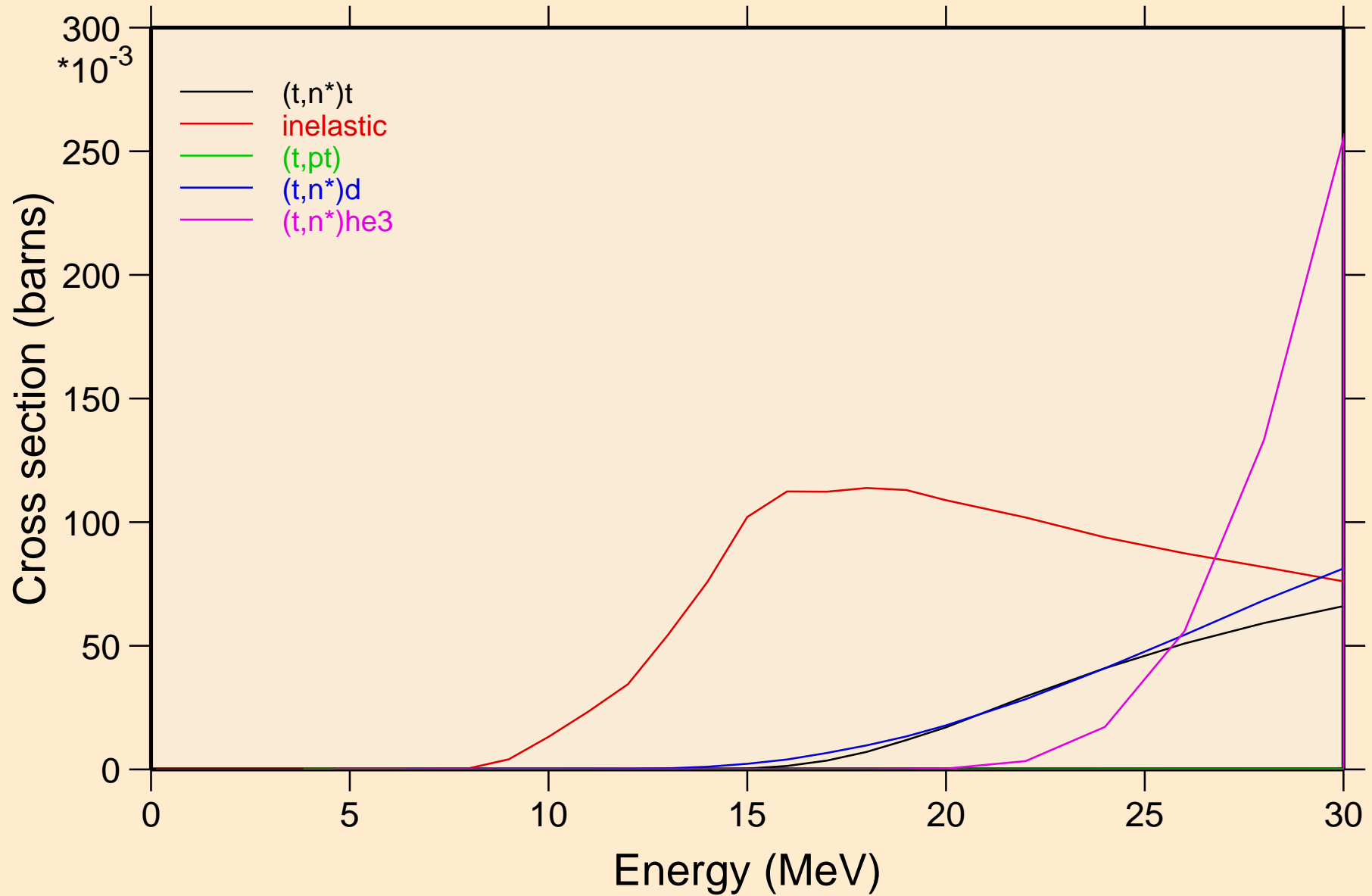

# EU146 TRITON ACER TENDL-2021 LIBRARY; T=0.K

## Threshold reactions

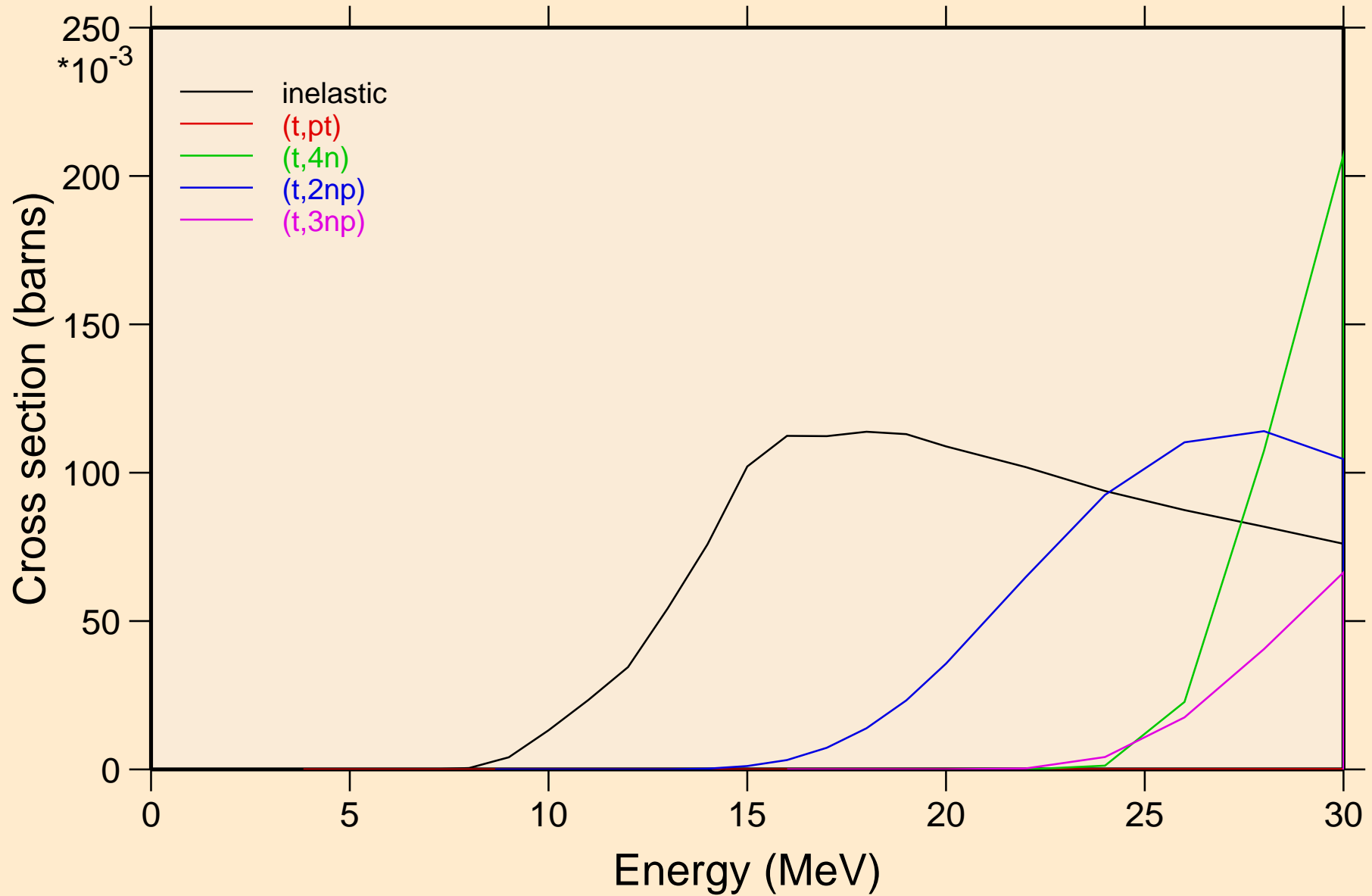

EU146 TRITON ACER TENDL-2021 LIBRARY; T=0.K  
Threshold reactions

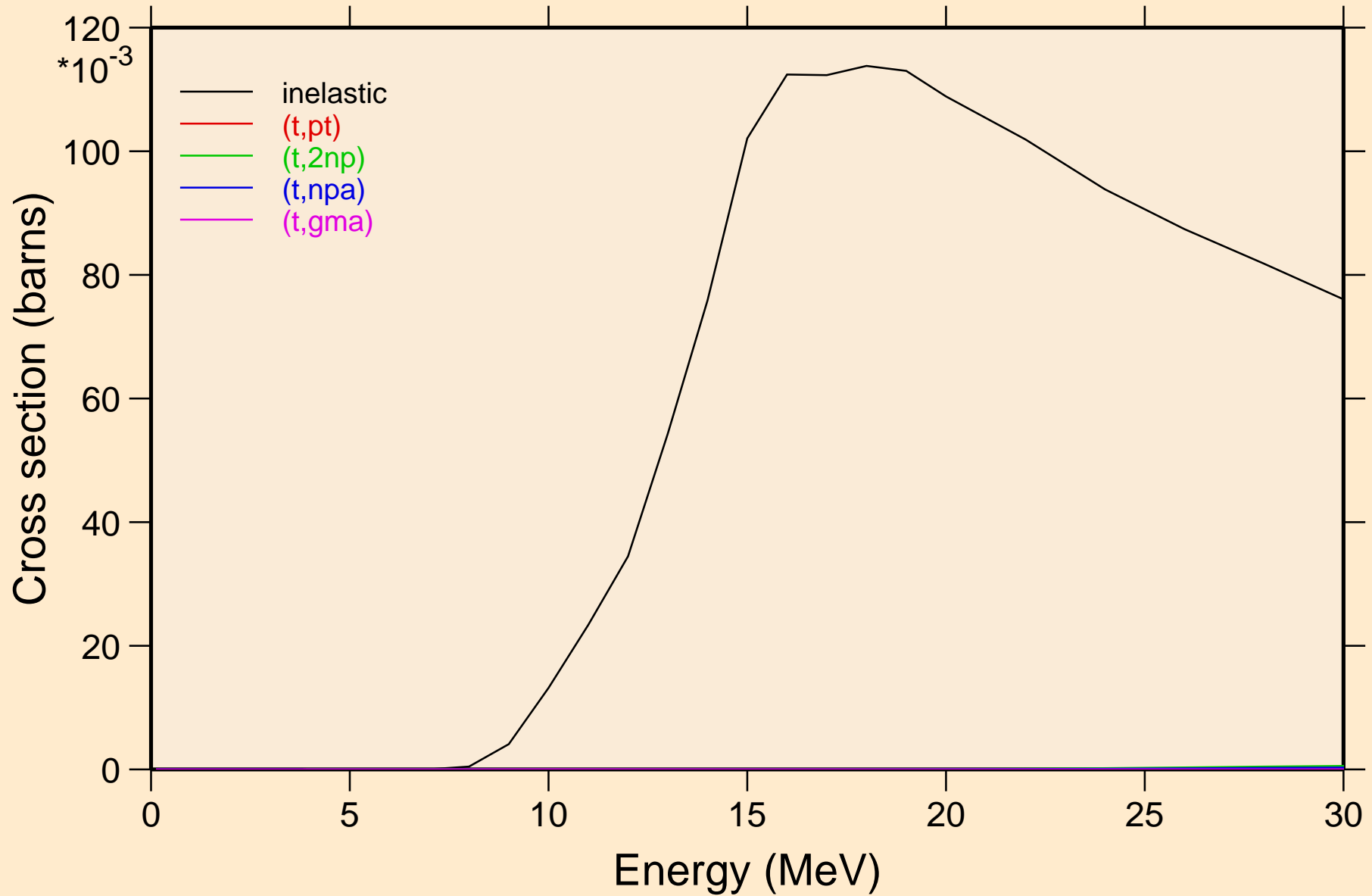

# EU146 TRITON ACER TENDL-2021 LIBRARY; T=0.K

## Threshold reactions

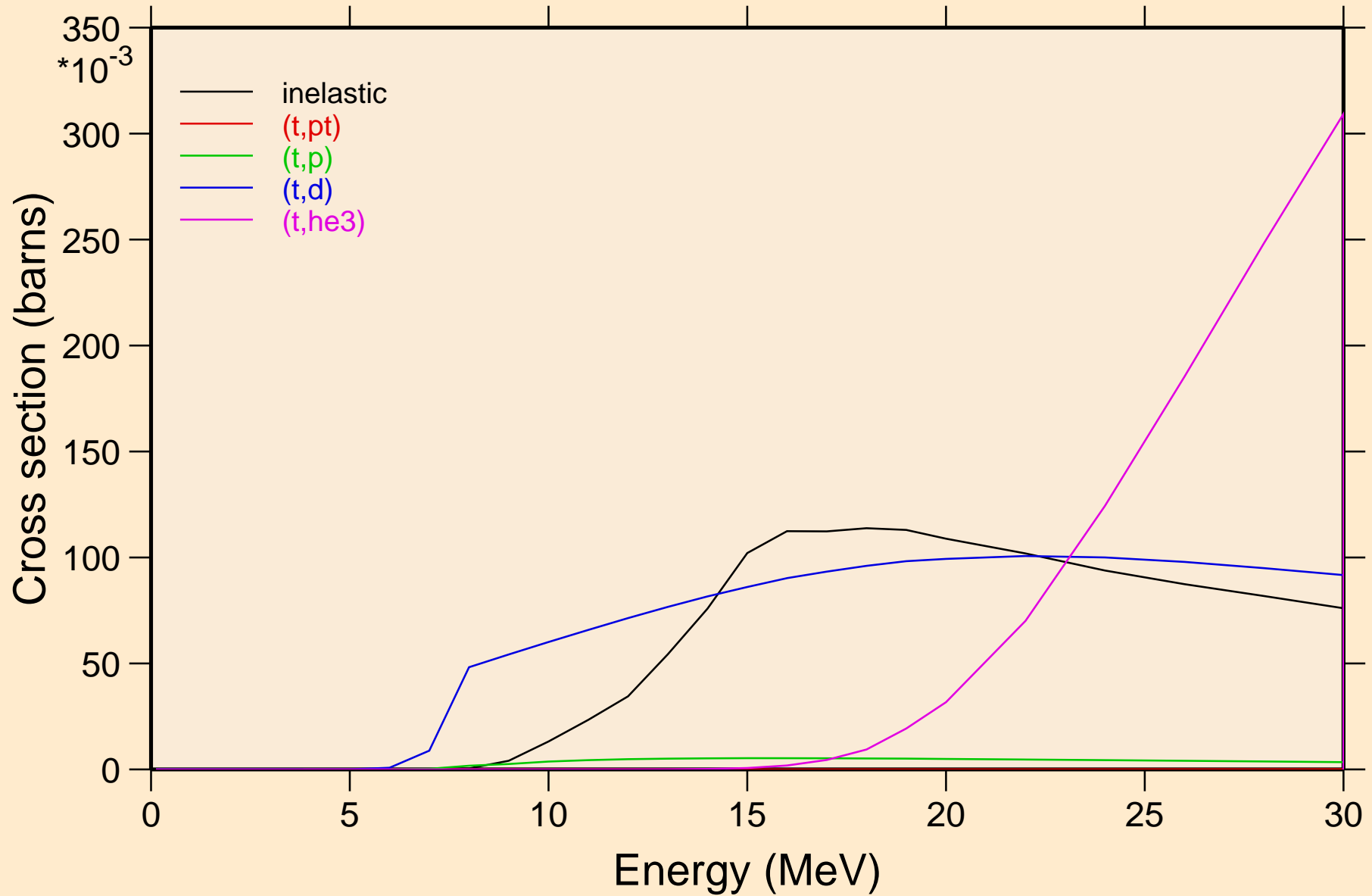

EU146 TRITON ACER TENDL-2021 LIBRARY; T=0.K  
Threshold reactions

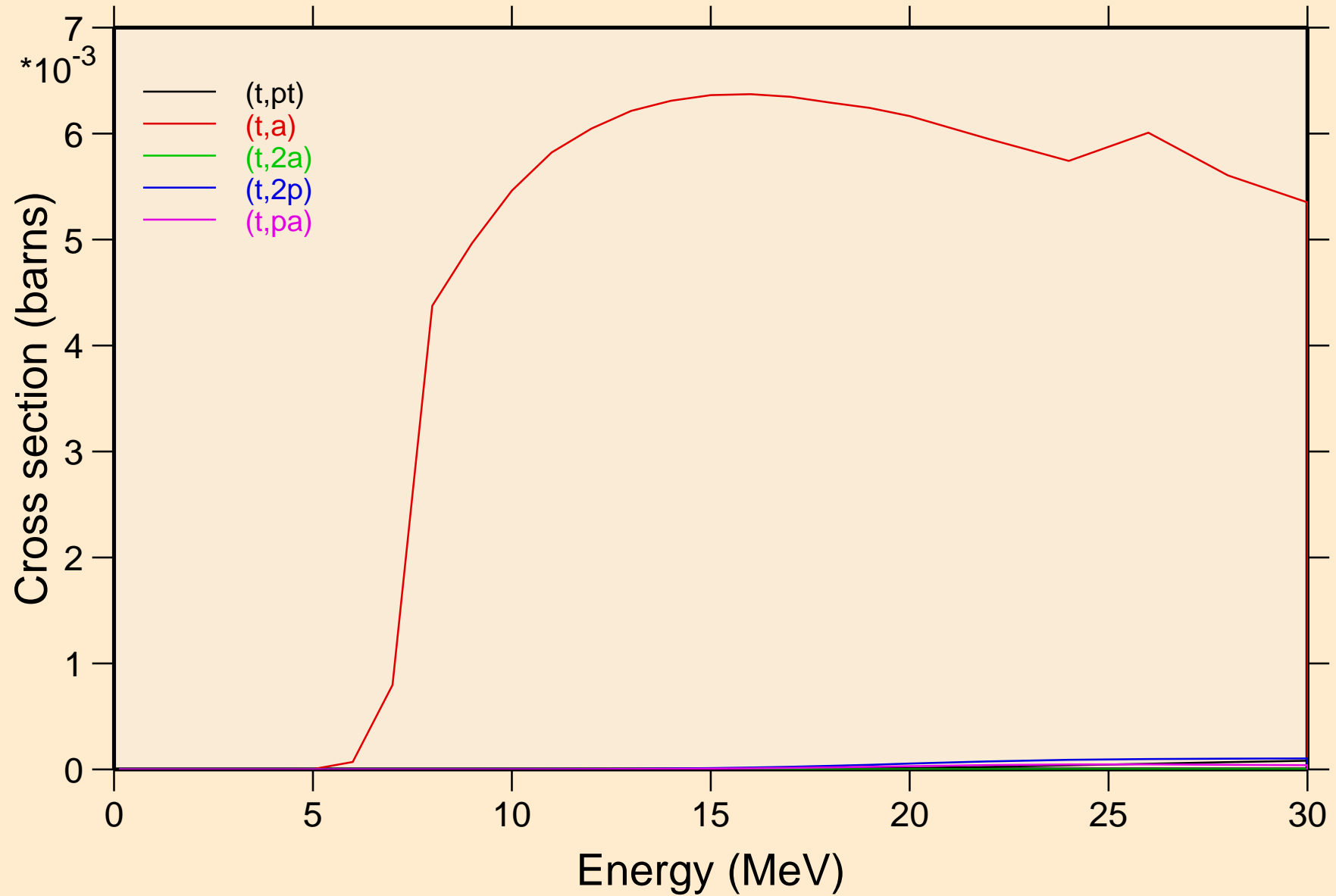

EU146 TRITON ACER TENDL-2021 LIBRARY; T=0.K  
Threshold reactions

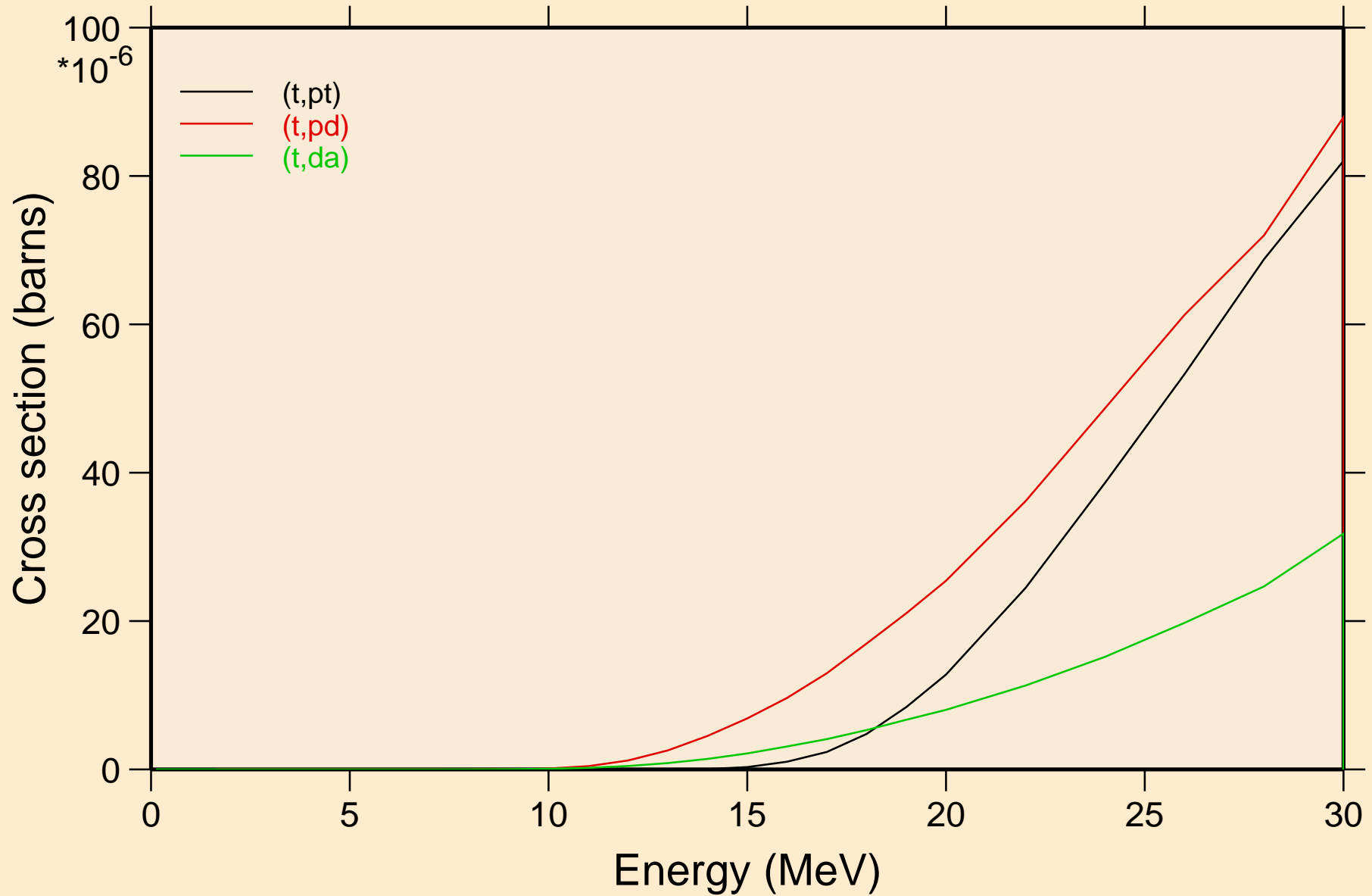

EU146 TRITON ACER TENDL-2021 LIBRARY; T=0.K  
angular distribution for elastic

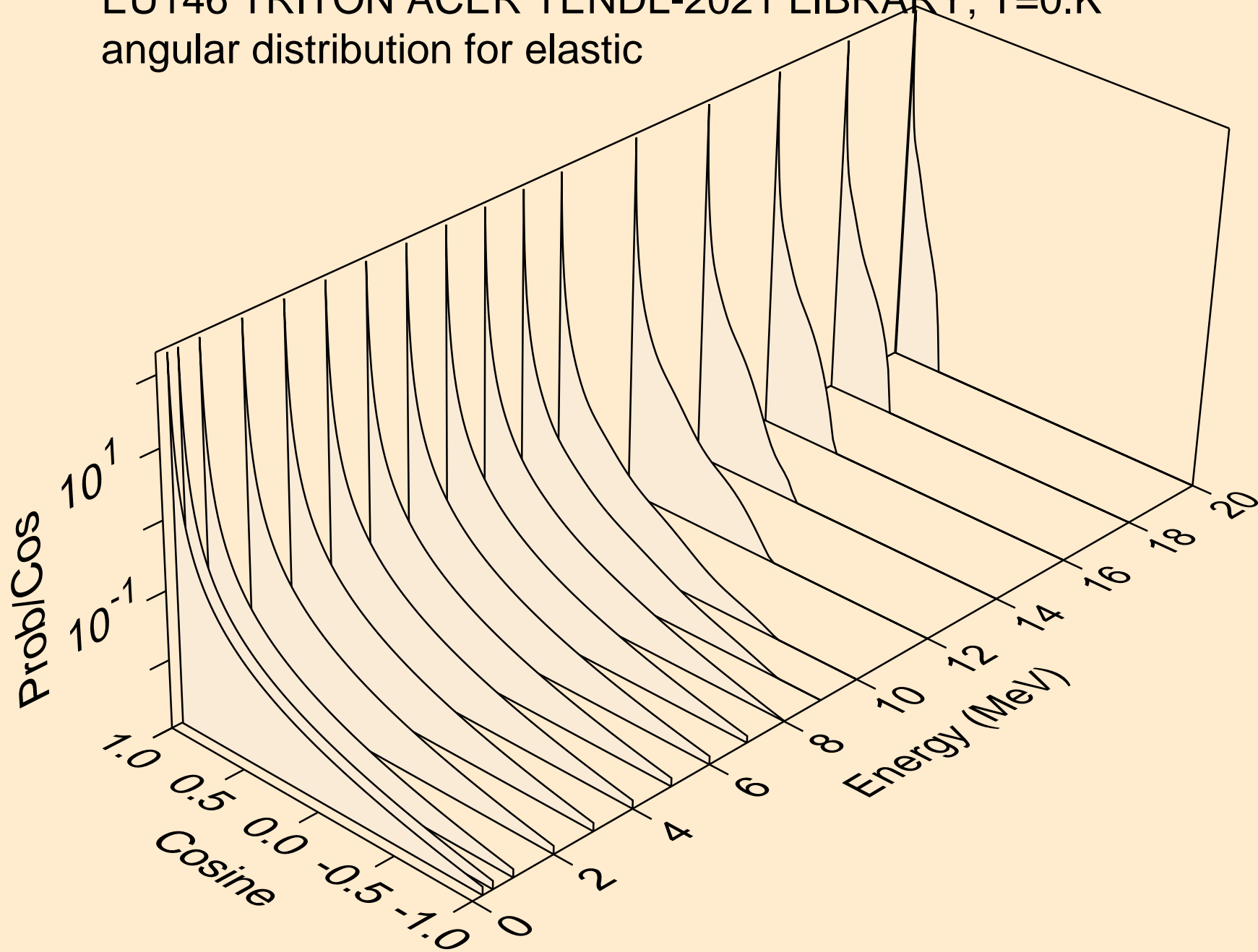



EU146 TRITON ACER TENDL-2021 LIBRARY; T=0.K  
angular distribution for elastic

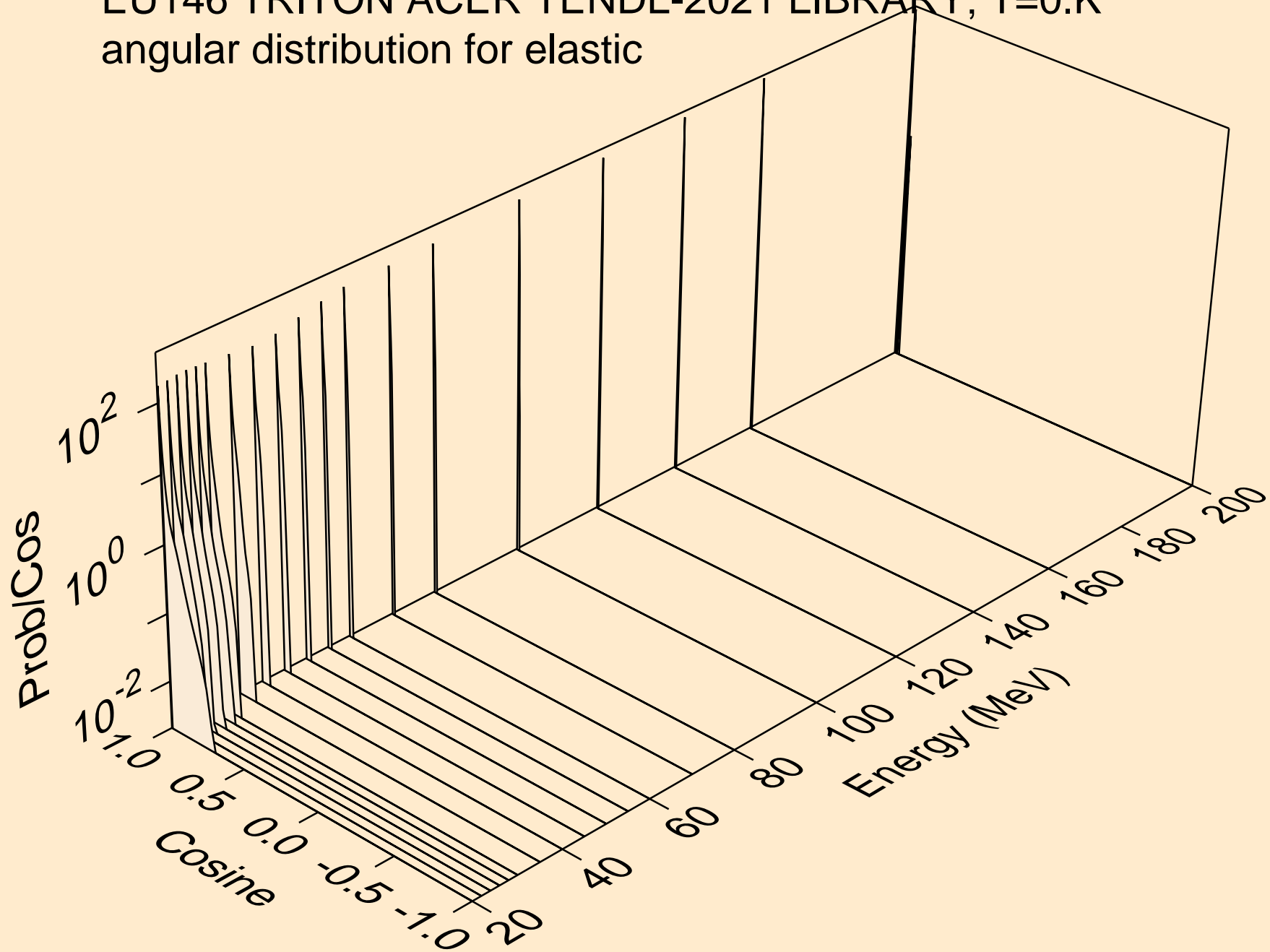

EU146 TRITON ACER TENDL-2021 LIBRARY; T=0.K  
Triton emission for (t,x)

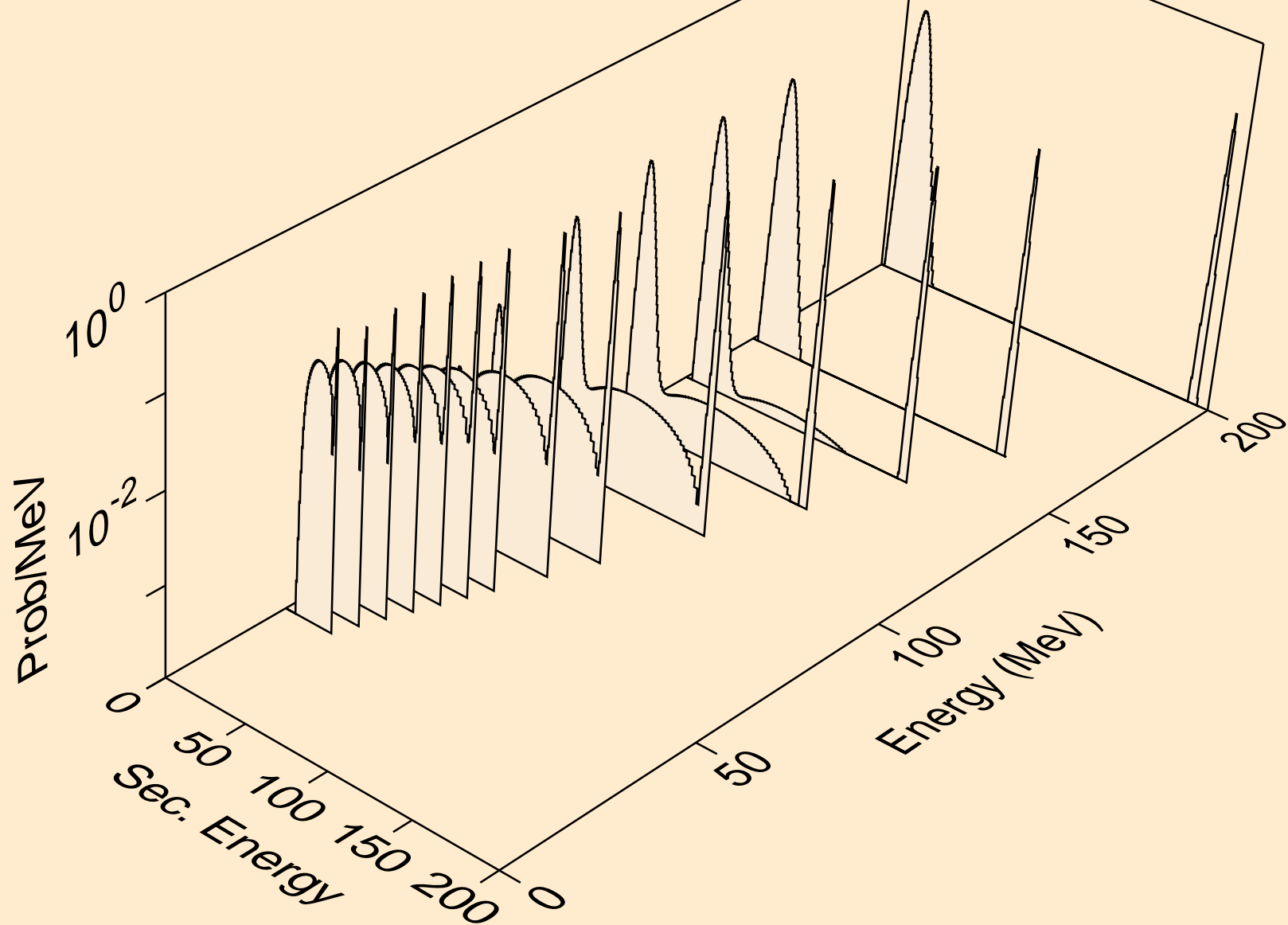

EU146 TRITON ACER TENDL-2021 LIBRARY; T=0.K  
Triton emission for (t,n\*)t

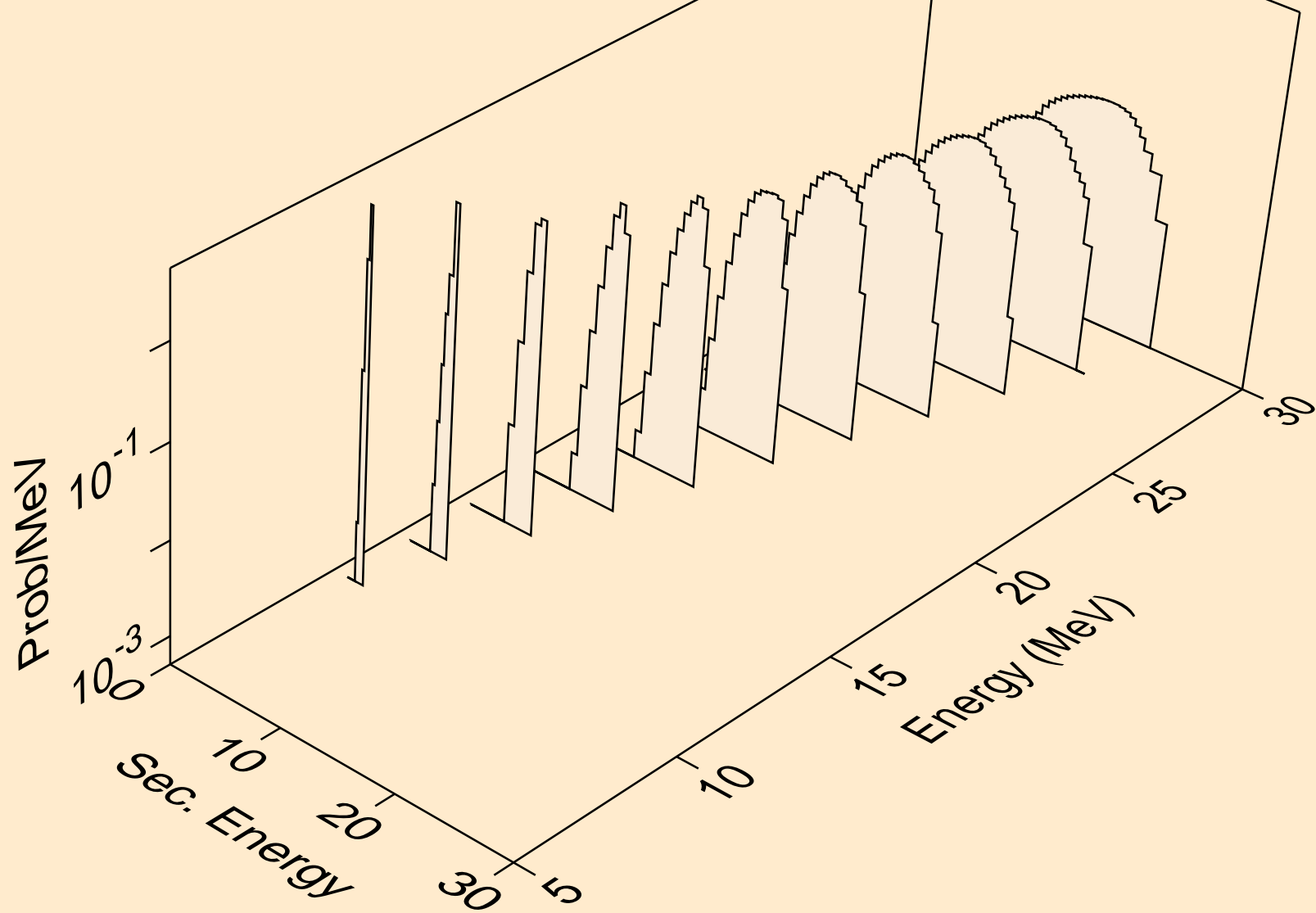

EU146 TRITON ACER TENDL-2021 LIBRARY; T=0.K  
Triton emission for inelastic

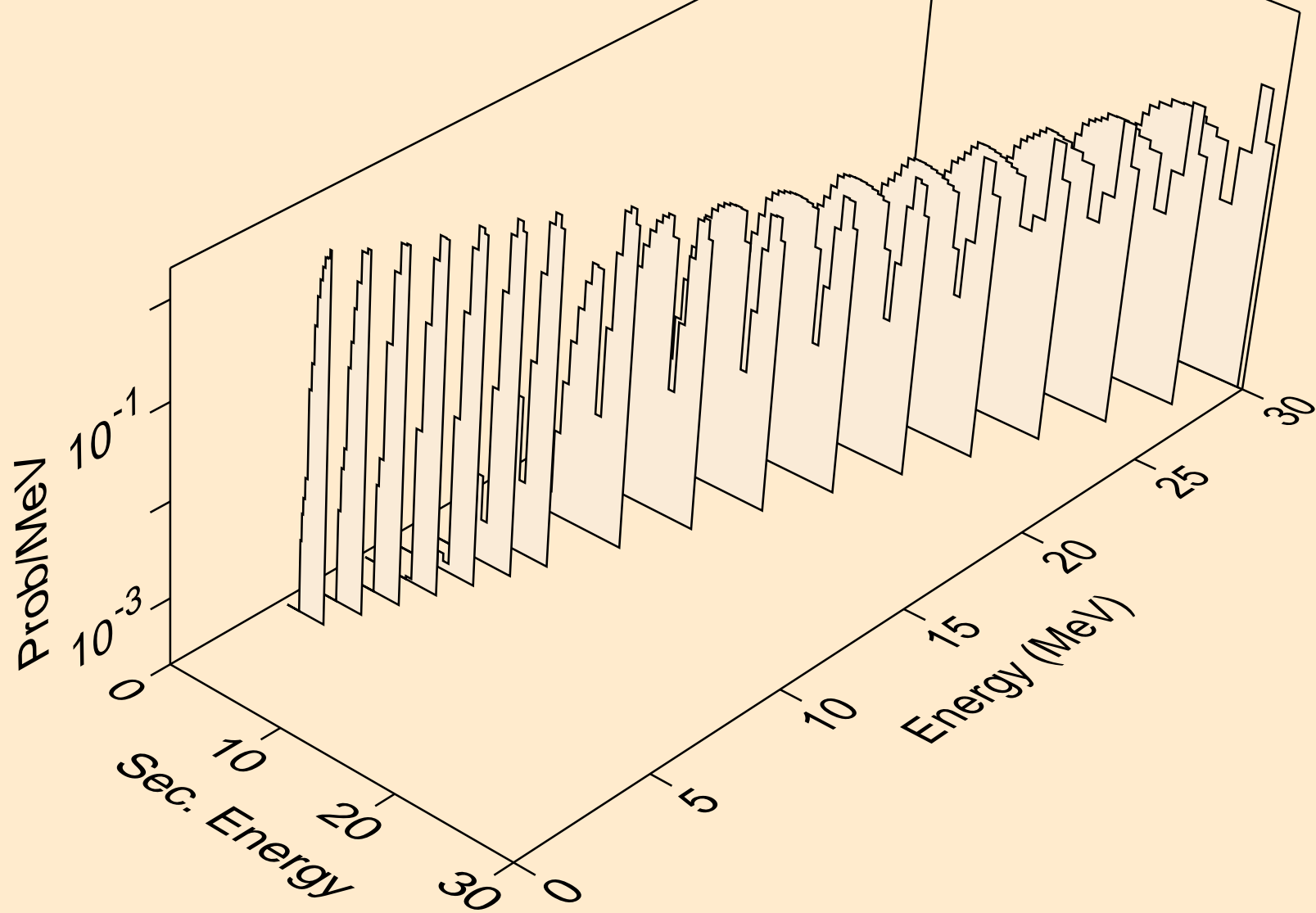

EU146 TRITON ACER TENDL-2021 LIBRARY; T=0.K  
Triton emission for (t,pt)

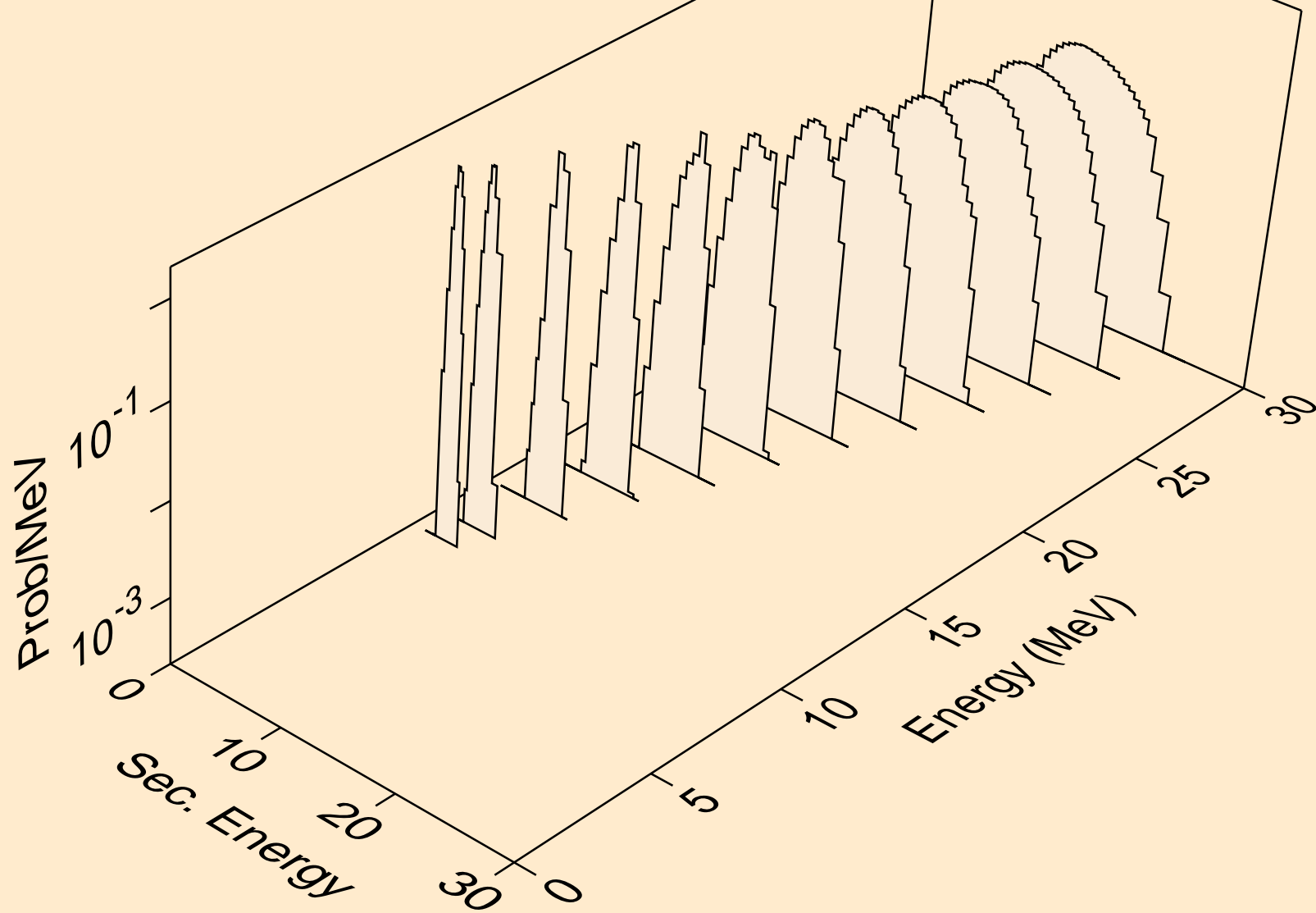

EU146 TRITON ACER TENDL-2021 LIBRARY; T=0.K  
Photon emission for (z,n)

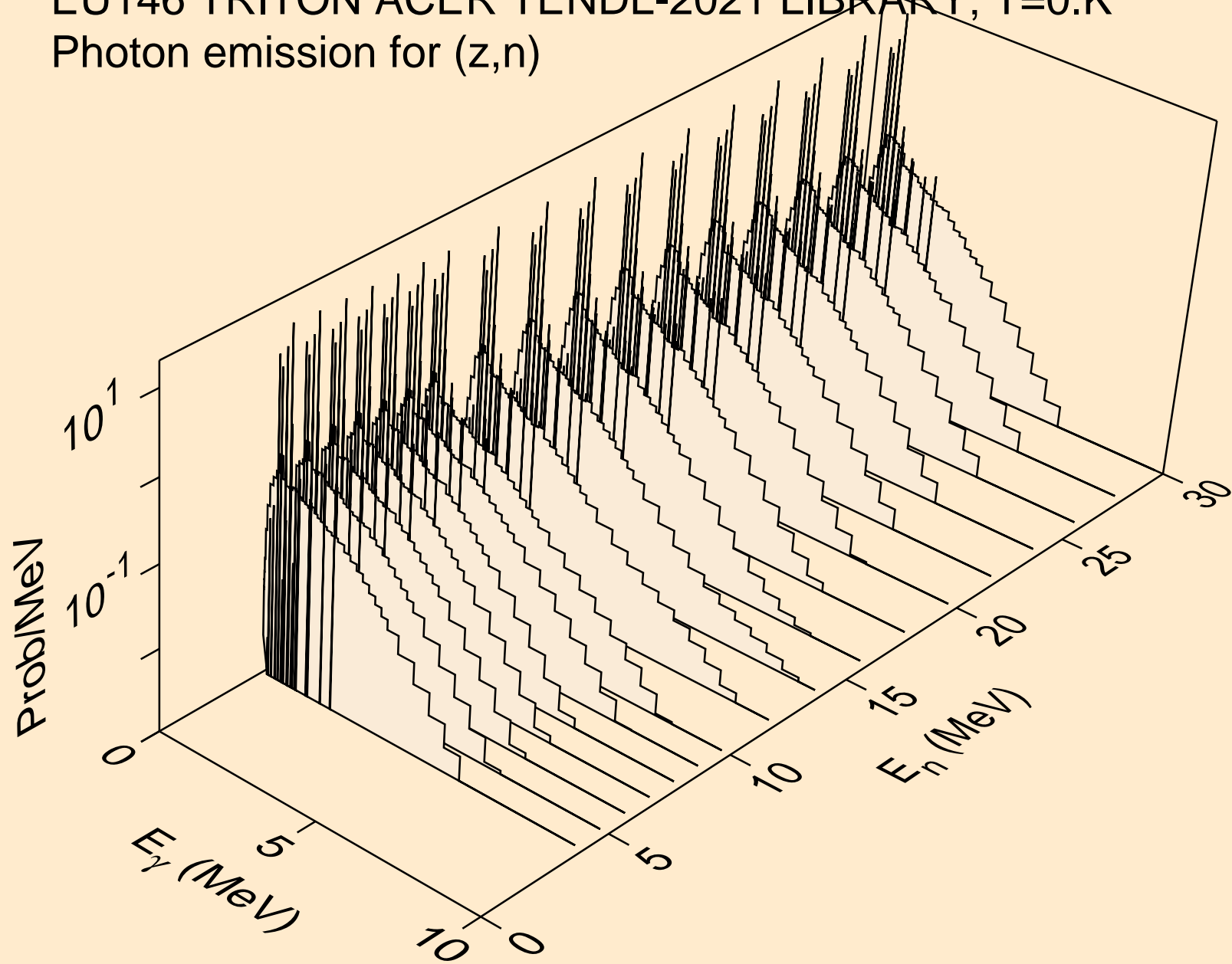

EU146 TRITON ACER TENDL-2021 LIBRARY; T=0.K  
Photon emission for (n,x)

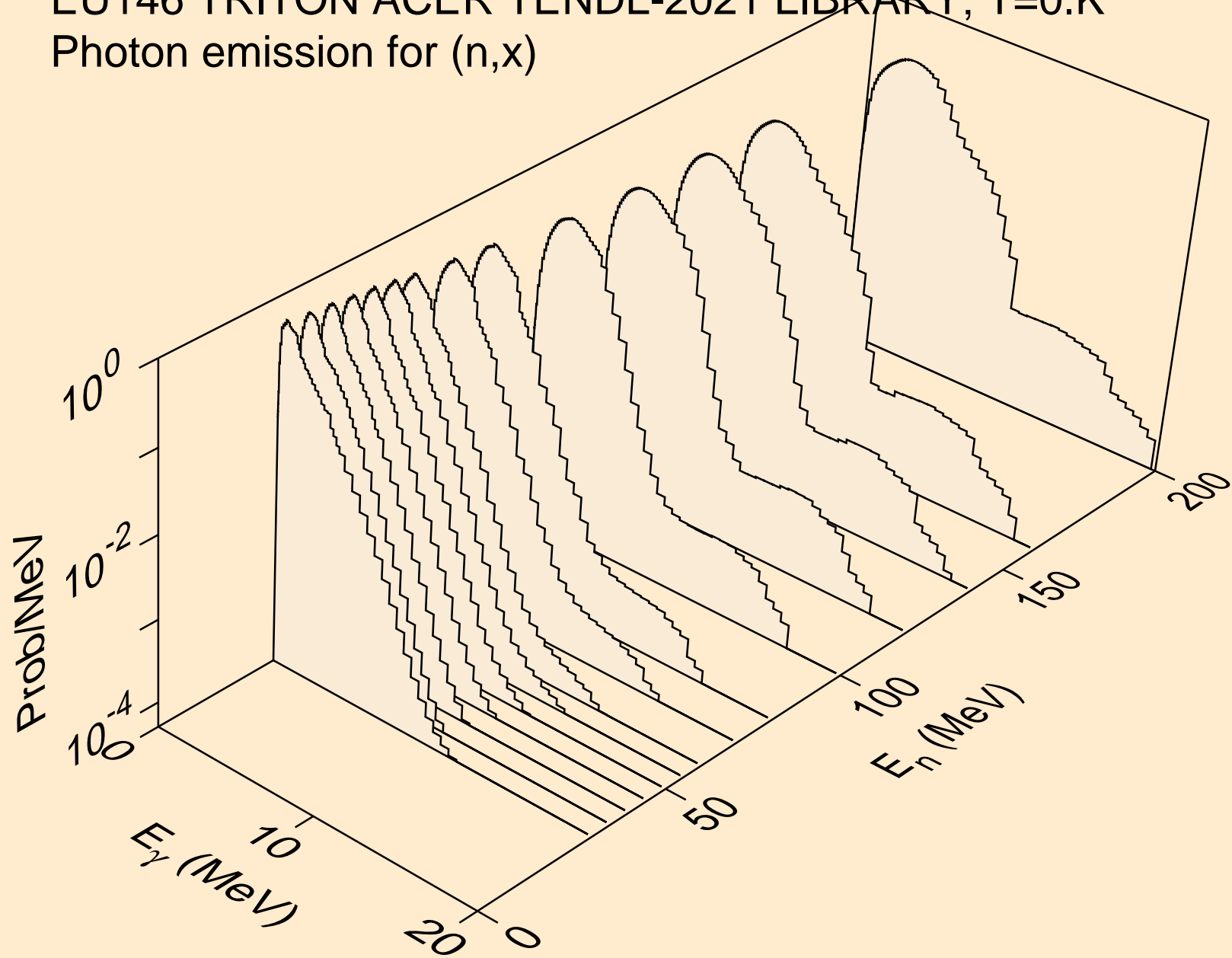

EU146 TRITON ACER TENDL-2021 LIBRARY; T=0.K  
Photon emission for (n,2nd)

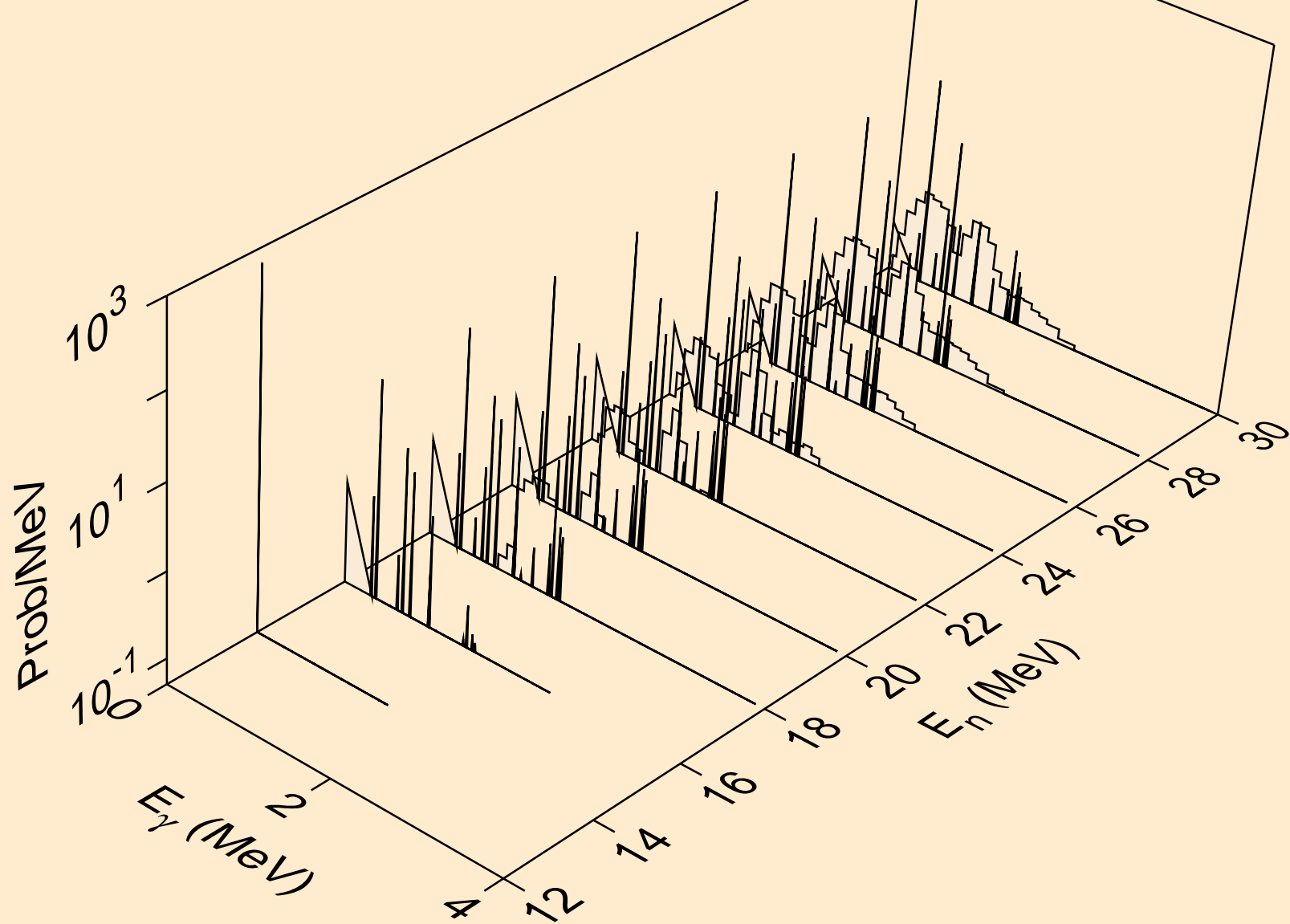



EU146 TRITON ACER TENDL-2021 LIBRARY; T=0.K  
Photon emission for (n,2n)

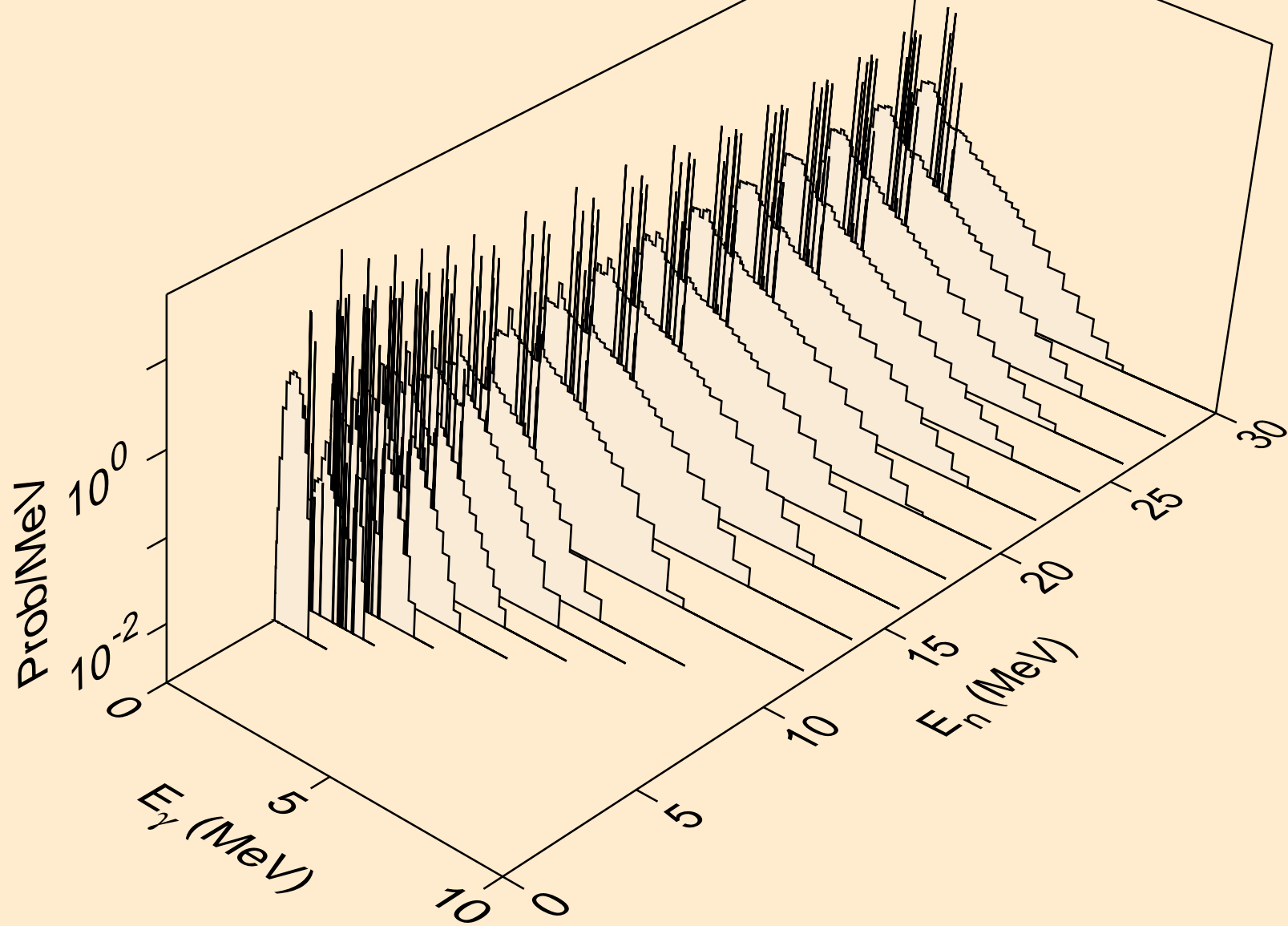

EU146 TRITON ACER TENDL-2021 LIBRARY; T=0.K  
Photon emission for (n,3n)

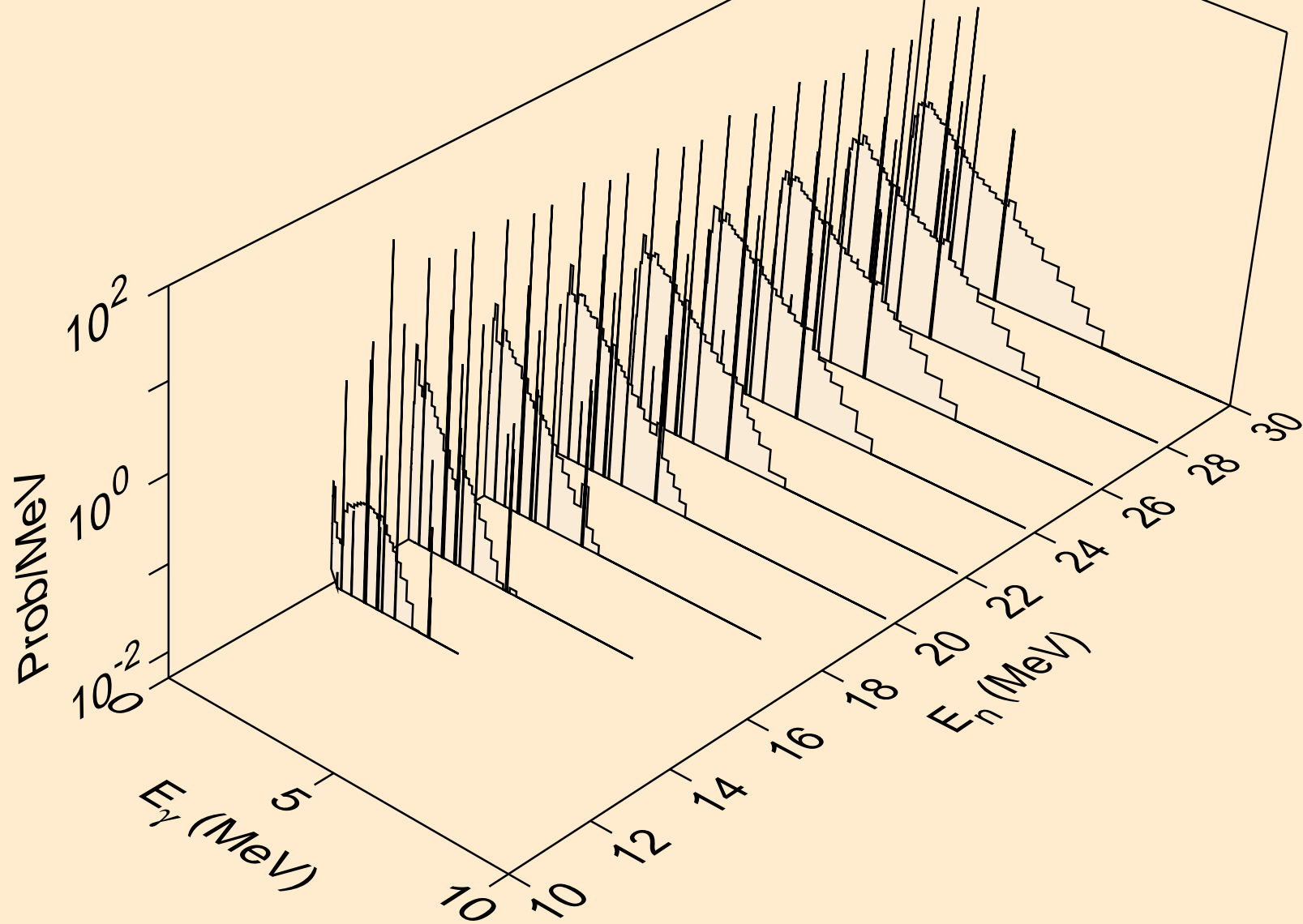

EU146 TRITON ACER TENDL-2021 LIBRARY; T=0.K  
Photon emission for (n,n\*)a

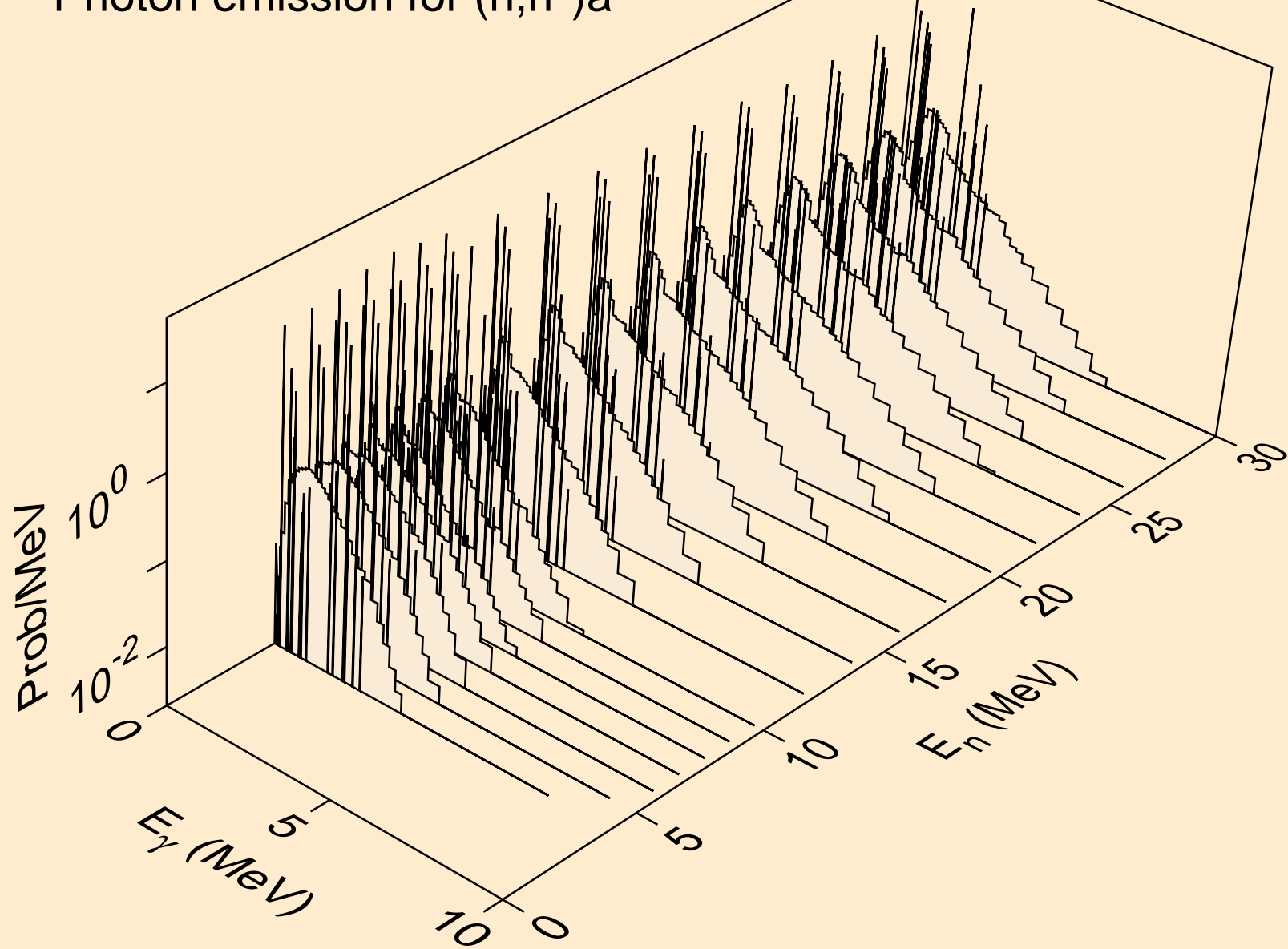

EU146 TRITON ACER TENDL-2021 LIBRARY; T=0.K  
Photon emission for (n,2n)a

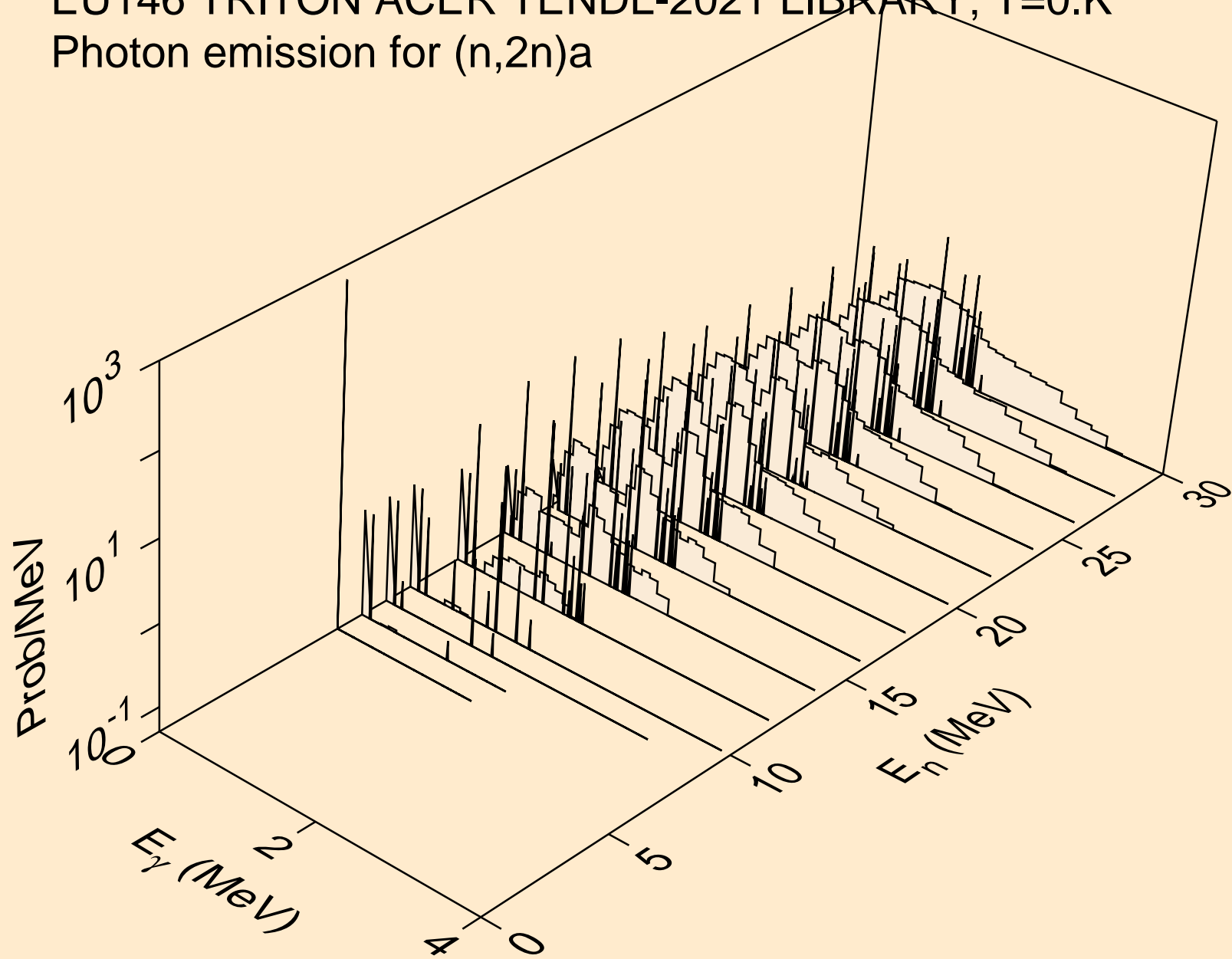

EU146 TRITON ACER TENDL-2021 LIBRARY; T=0.K  
Photon emission for (n,3n)a

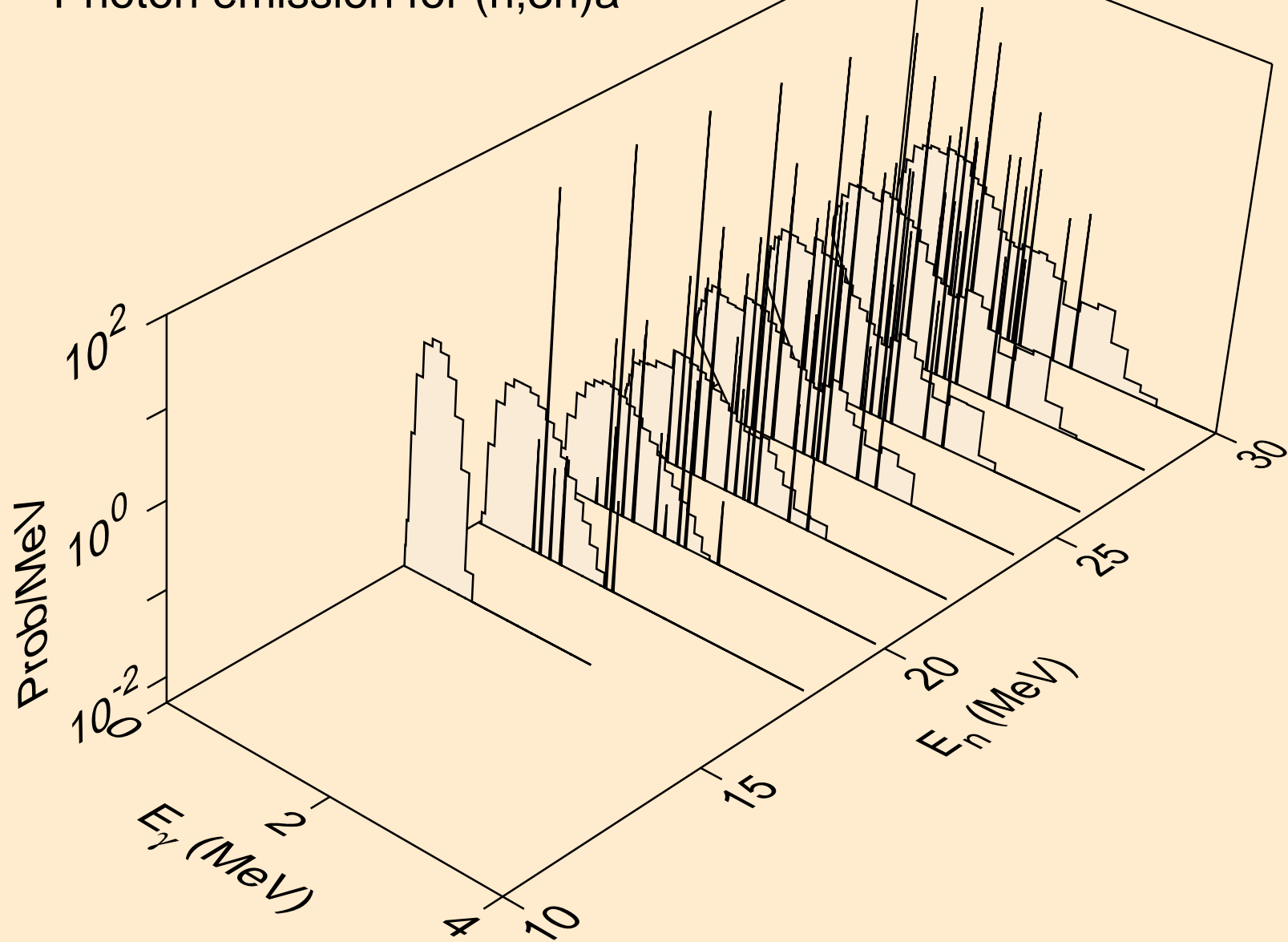

EU146 TRITON ACER TENDL-2021 LIBRARY; T=0.K  
Photon emission for (n,n\*)p

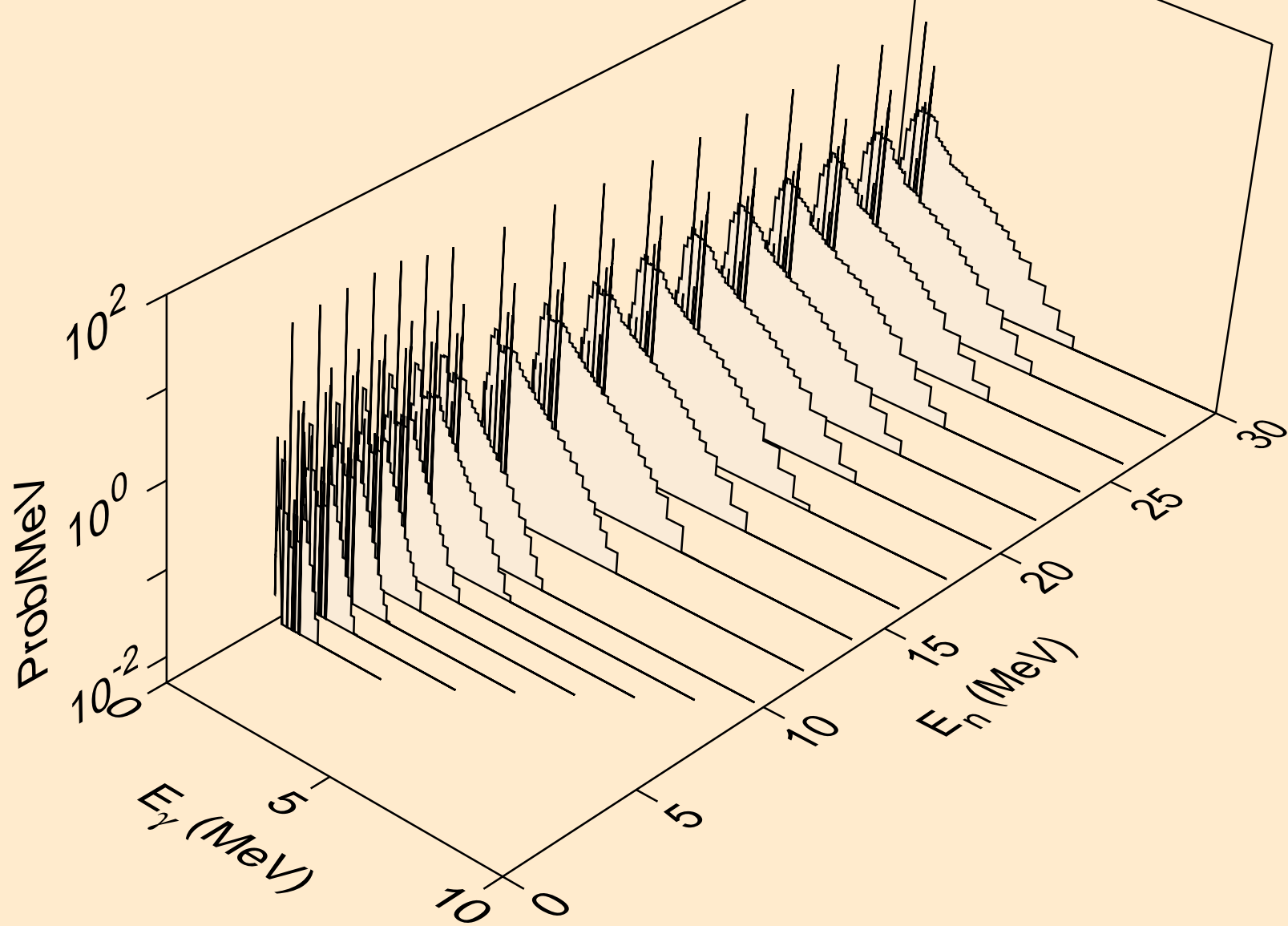

EU146 TRITON ACER TENDL-2021 LIBRARY; T=0.K  
Photon emission for (n,n\*)2a

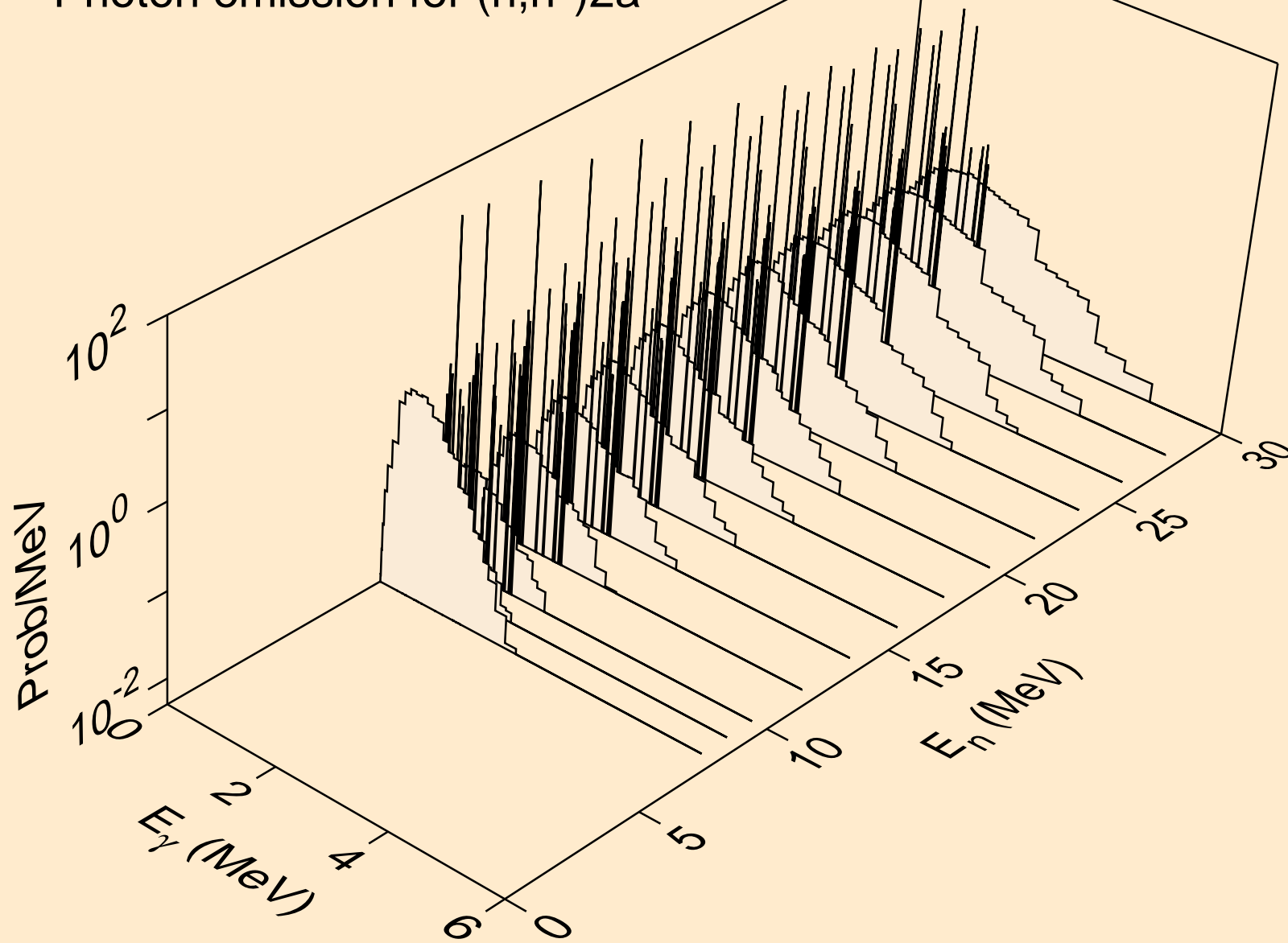

EU146 TRITON ACER TENDL-2021 LIBRARY; T=0.K  
Photon emission for (n,2n)2a

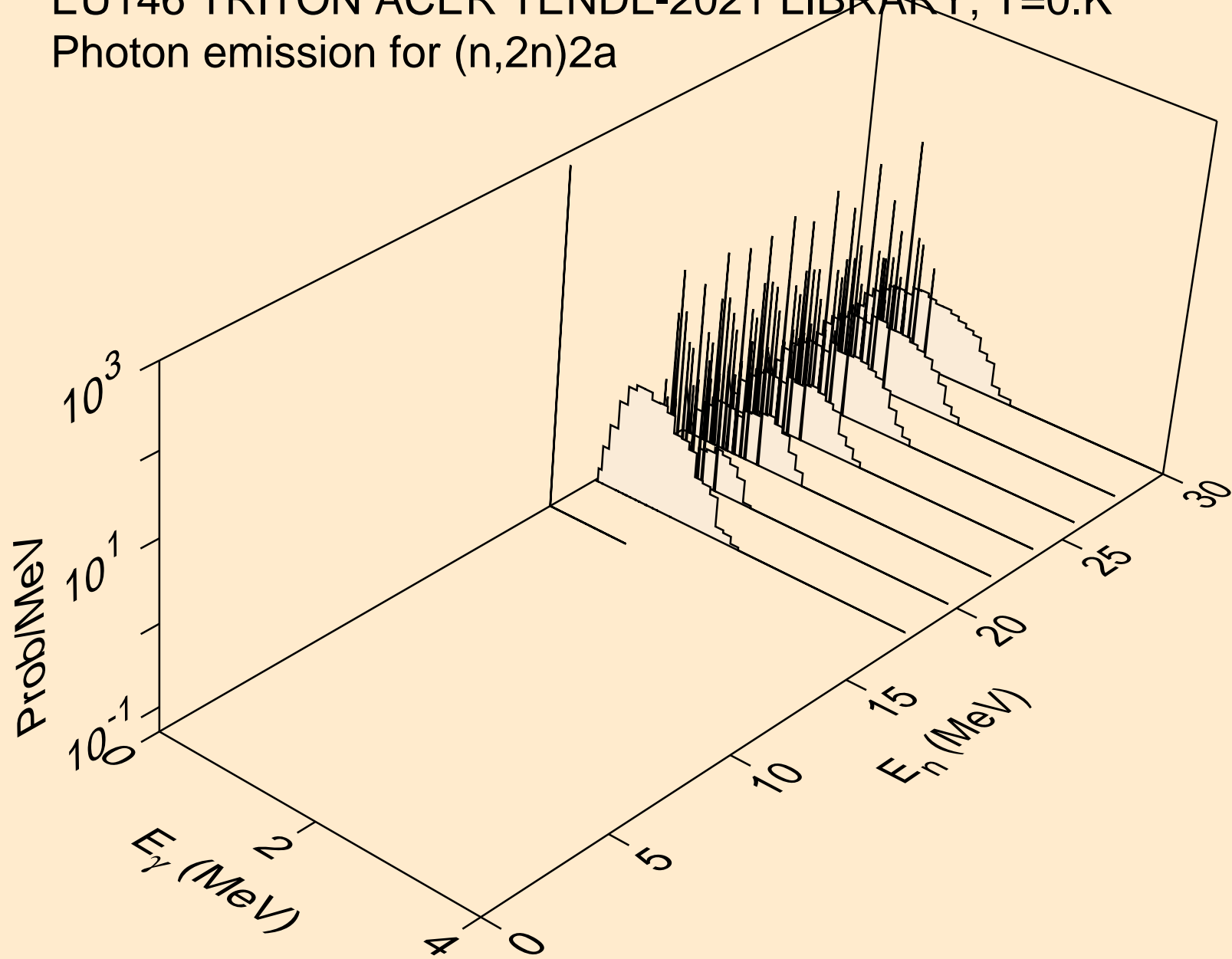



EU146 TRITON ACER TENDL-2021 LIBRARY; T=0.K  
Photon emission for (n,n\*)d

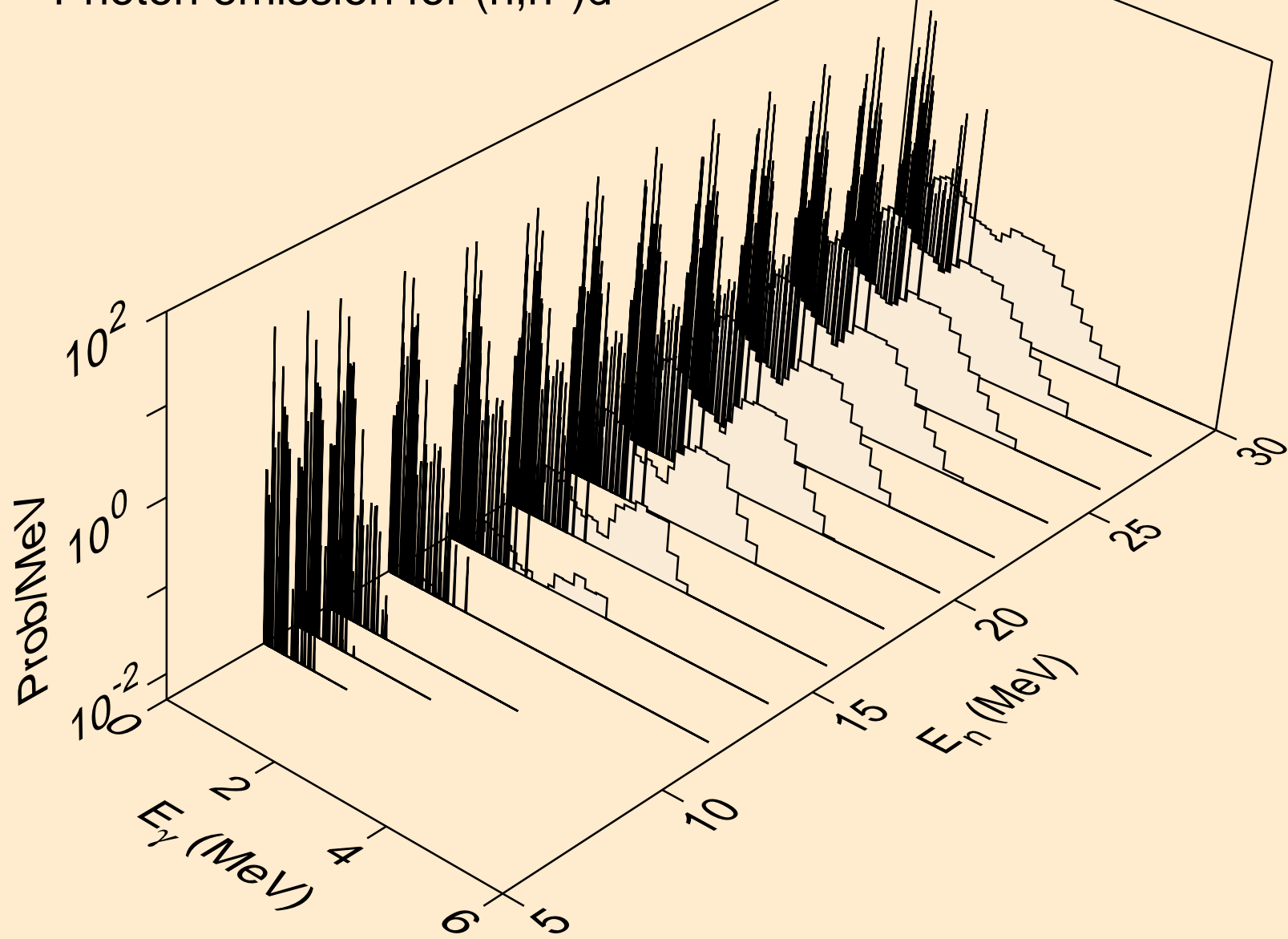

EU146 TRITON ACER TENDL-2021 LIBRARY; T=0.K  
Photon emission for (n,n\*)t

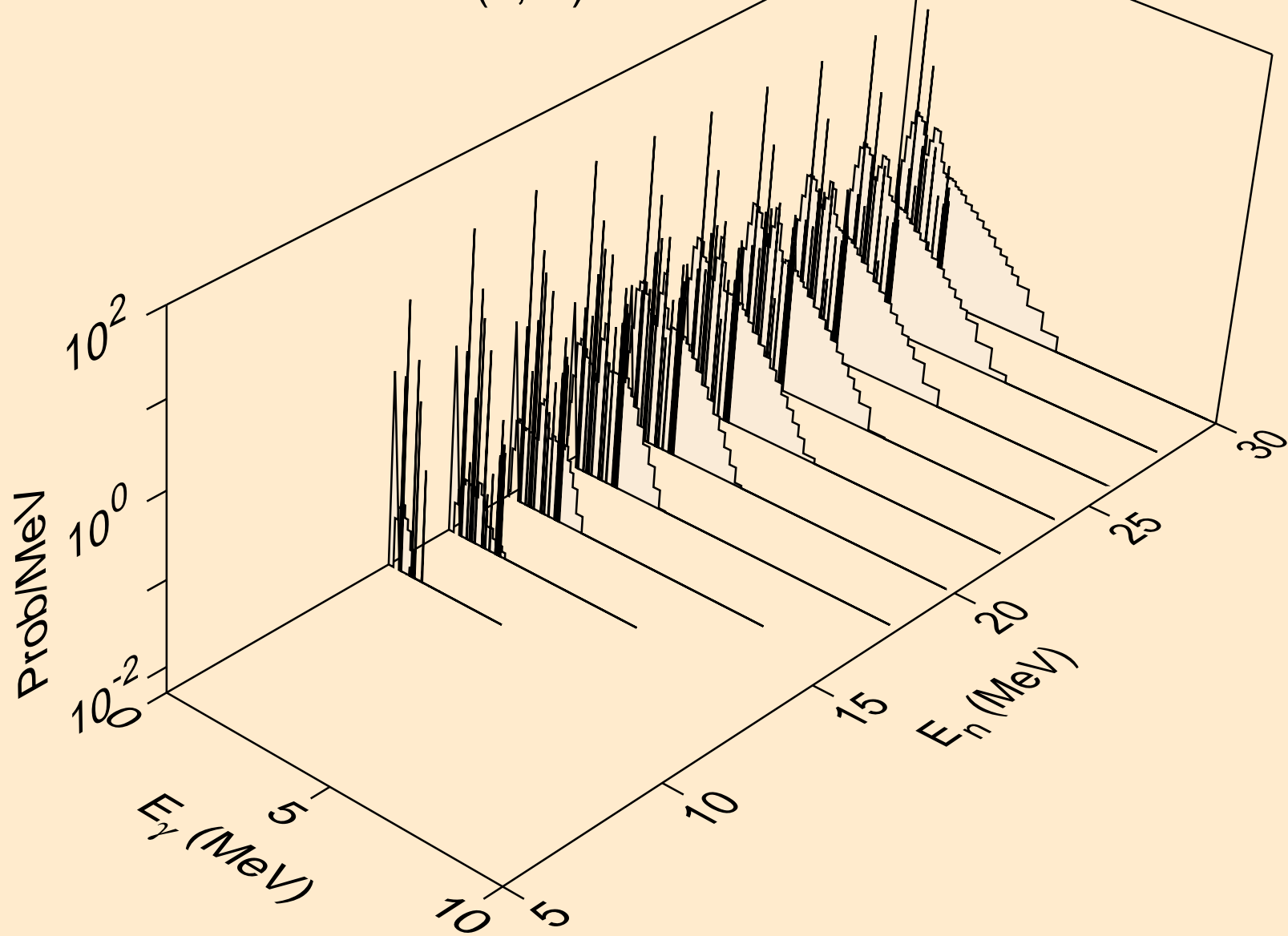

EU146 TRITON ACER TENDL-2021 LIBRARY; T=0.K  
Photon emission for (n,n\*)he3

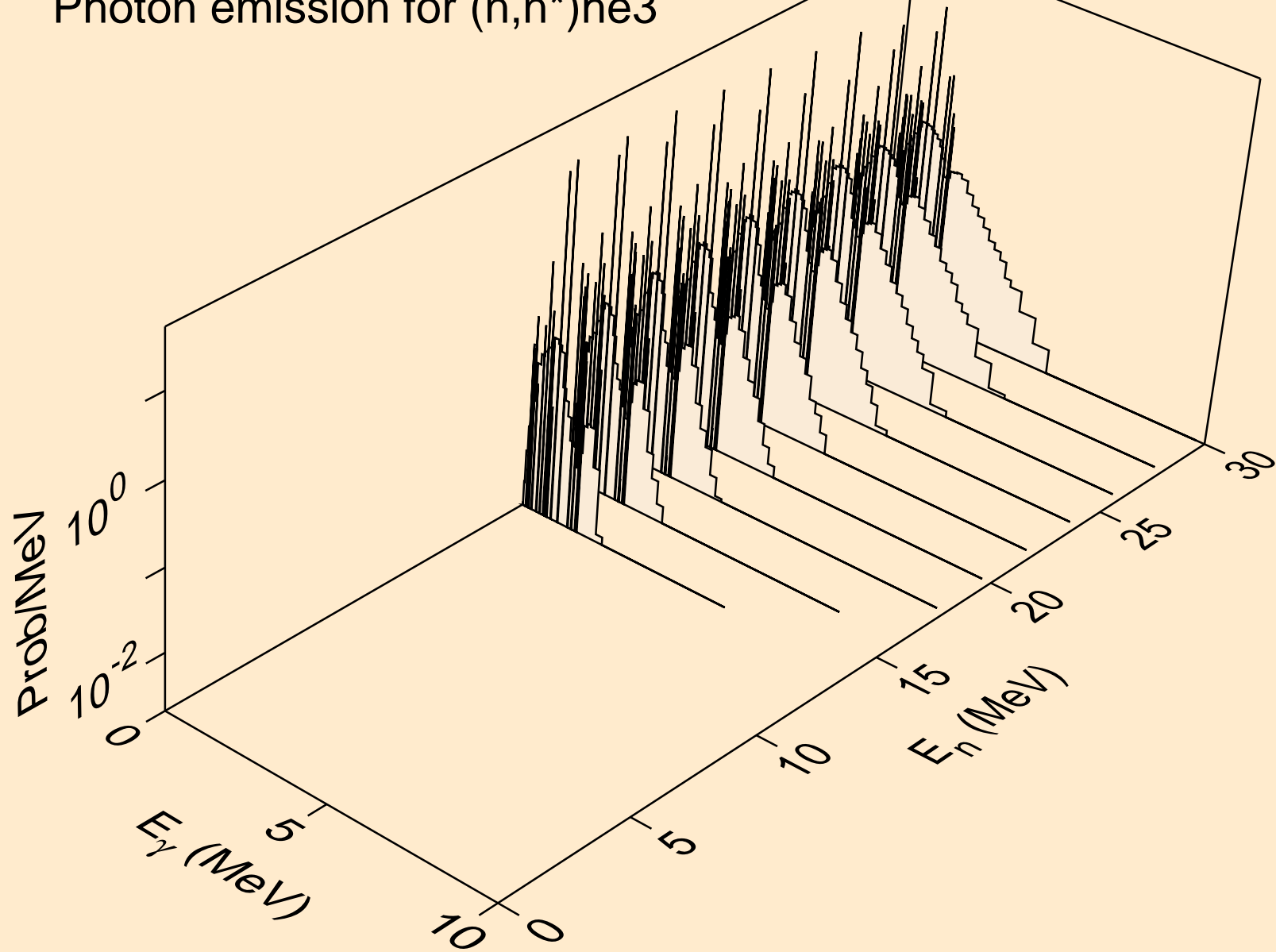

EU146 TRITON ACER TENDL-2021 LIBRARY; T=0.K  
Photon emission for (n,4n)

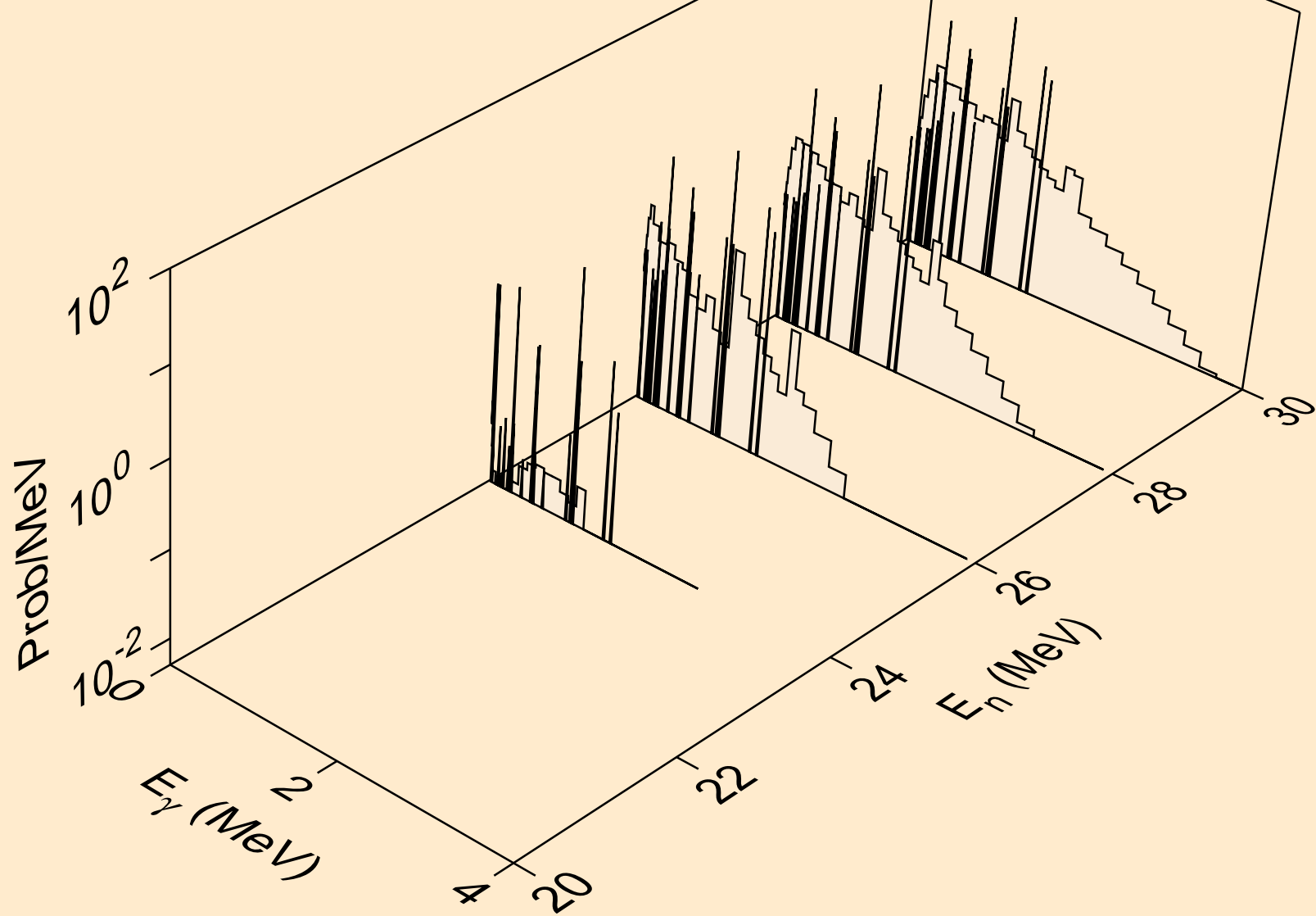

EU146 TRITON ACER TENDL-2021 LIBRARY; T=0.K  
Photon emission for (n,2np)

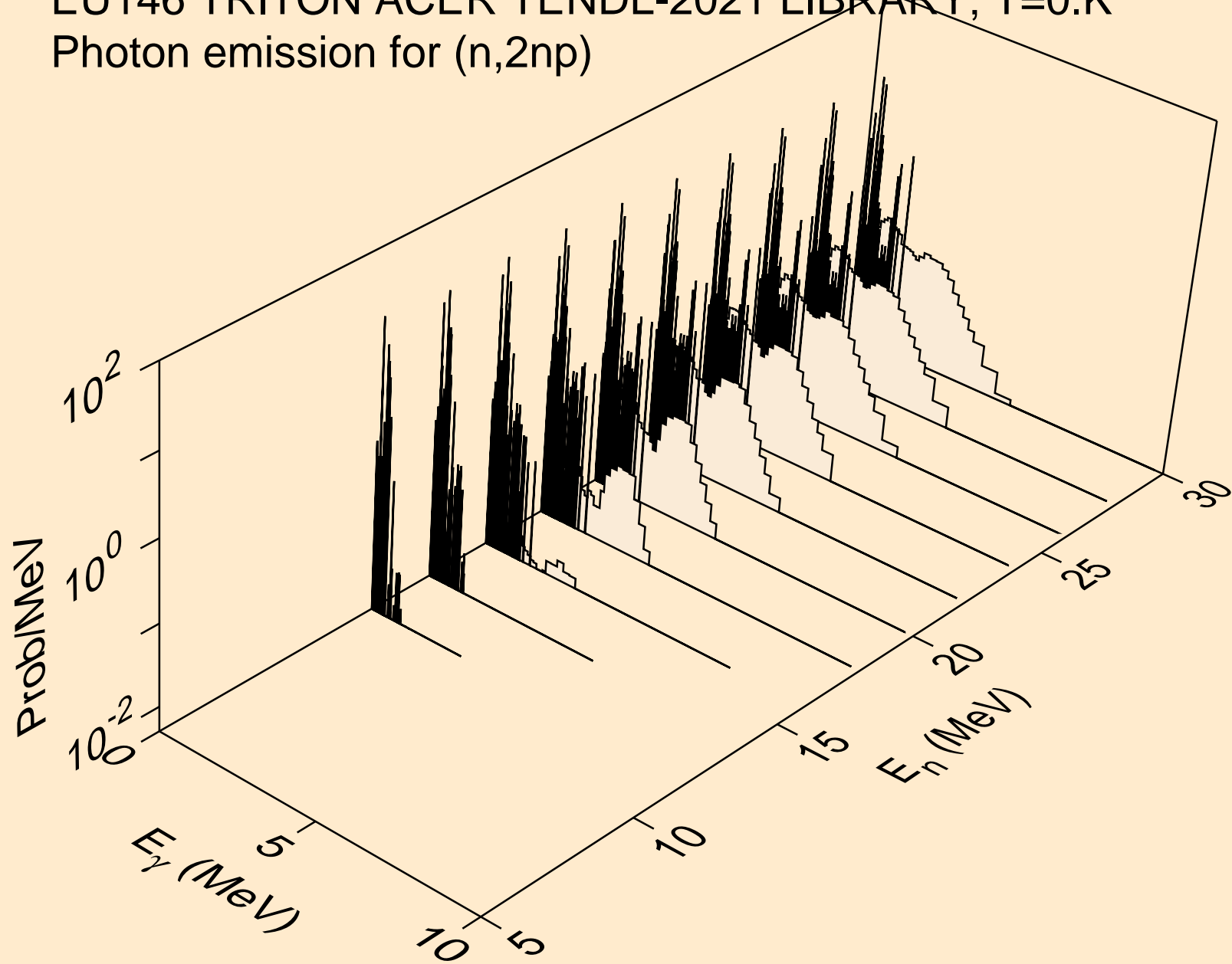

EU146 TRITON ACER TENDL-2021 LIBRARY; T=0.K  
Photon emission for (n,3np)

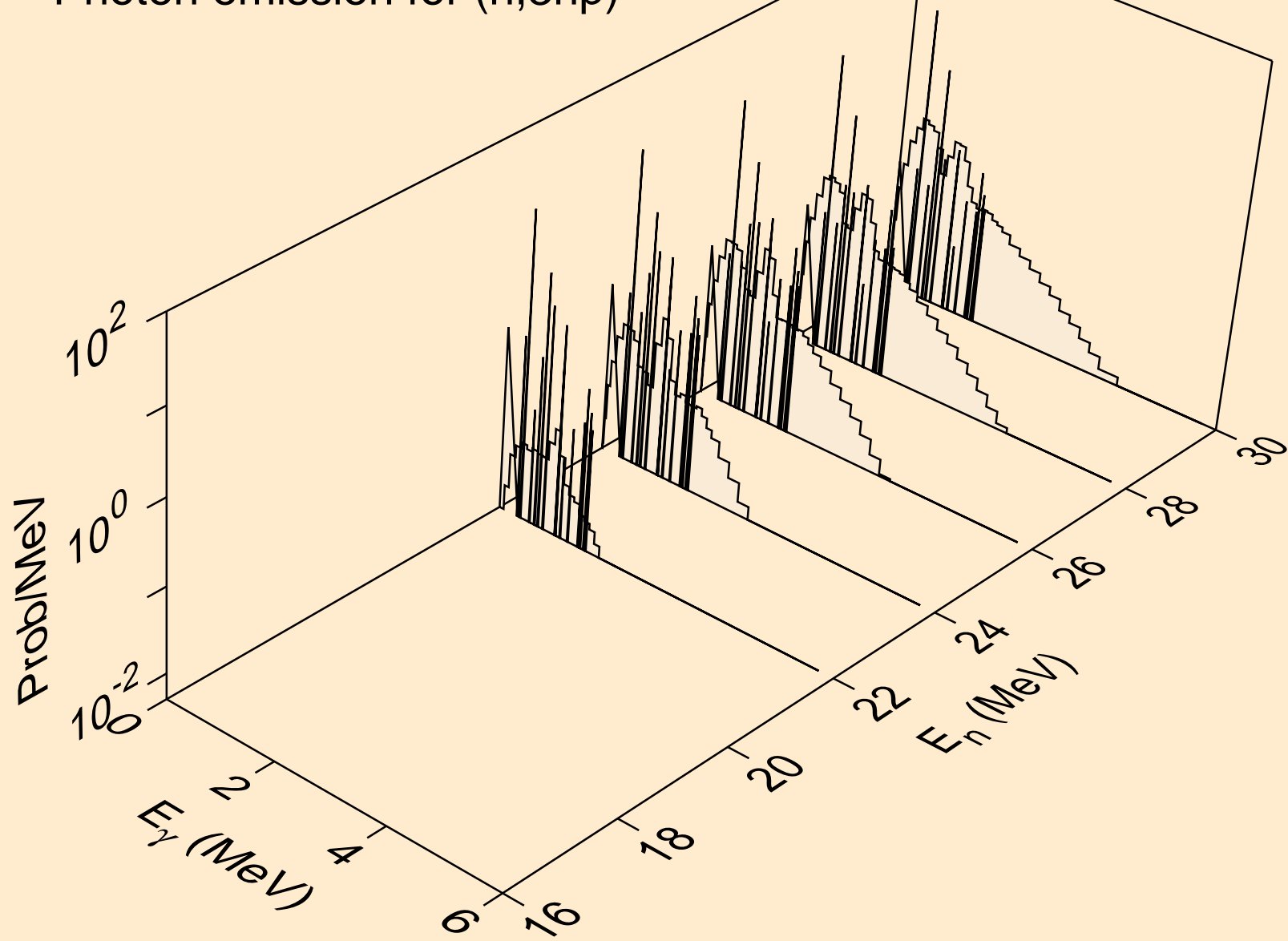

EU146 TRITON ACER TENDL-2021 LIBRARY; T=0.K  
Photon emission for (n,2np)

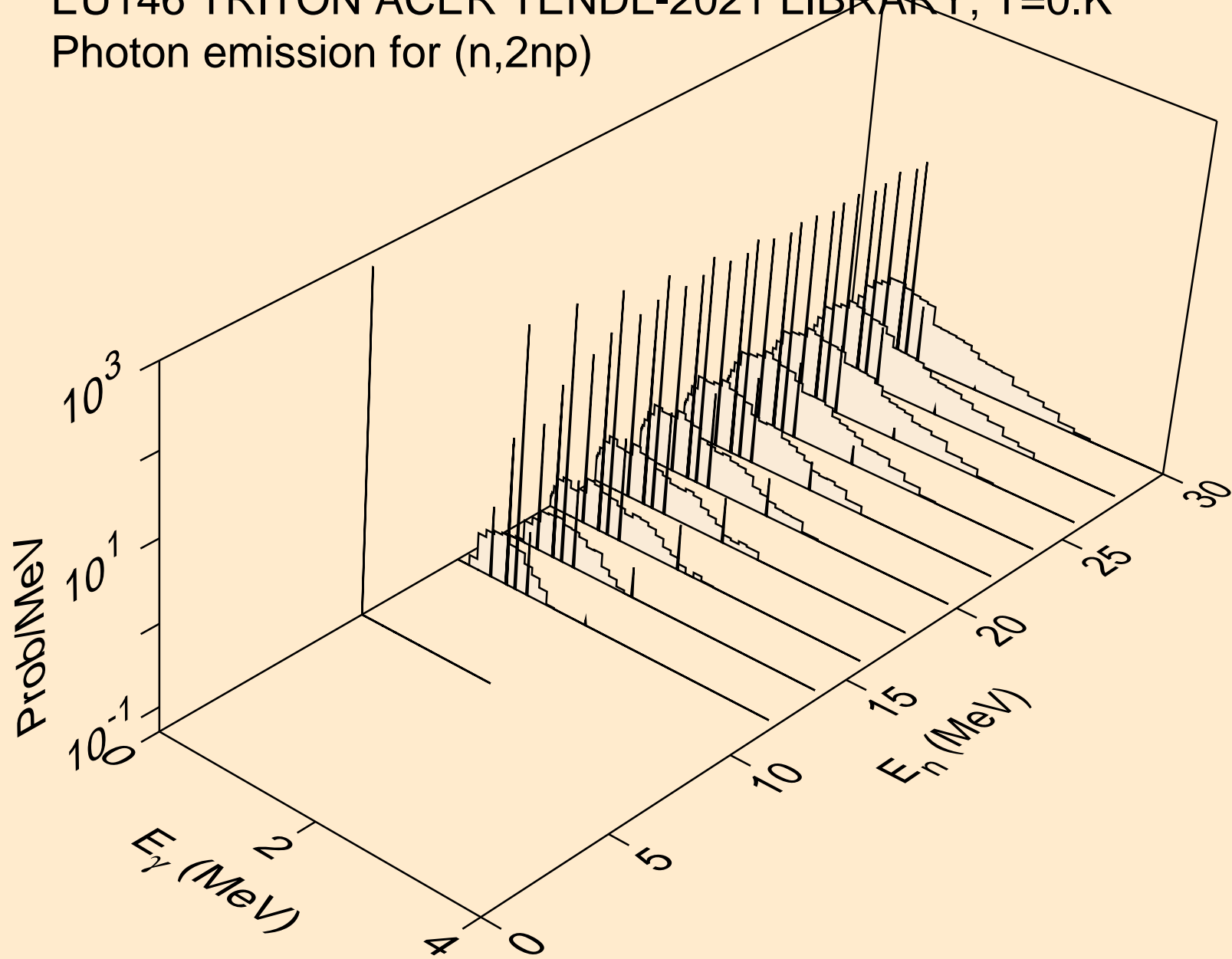

EU146 TRITON ACER TENDL-2021 LIBRARY; T=0.K  
Photon emission for (n,npa)

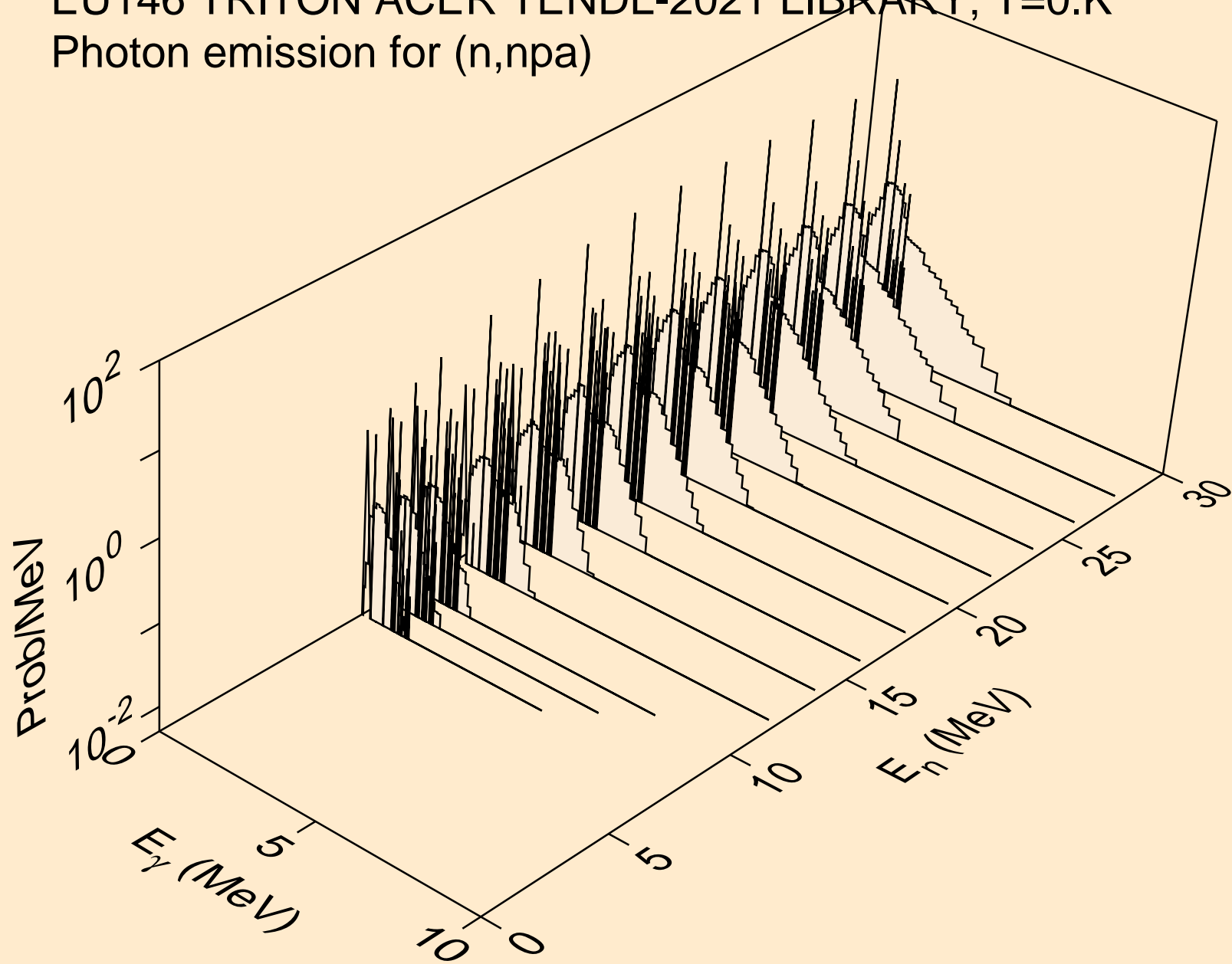



EU146 TRITON ACER TENDL-2021 LIBRARY; T=0.K  
Photon emission for (n,gma)

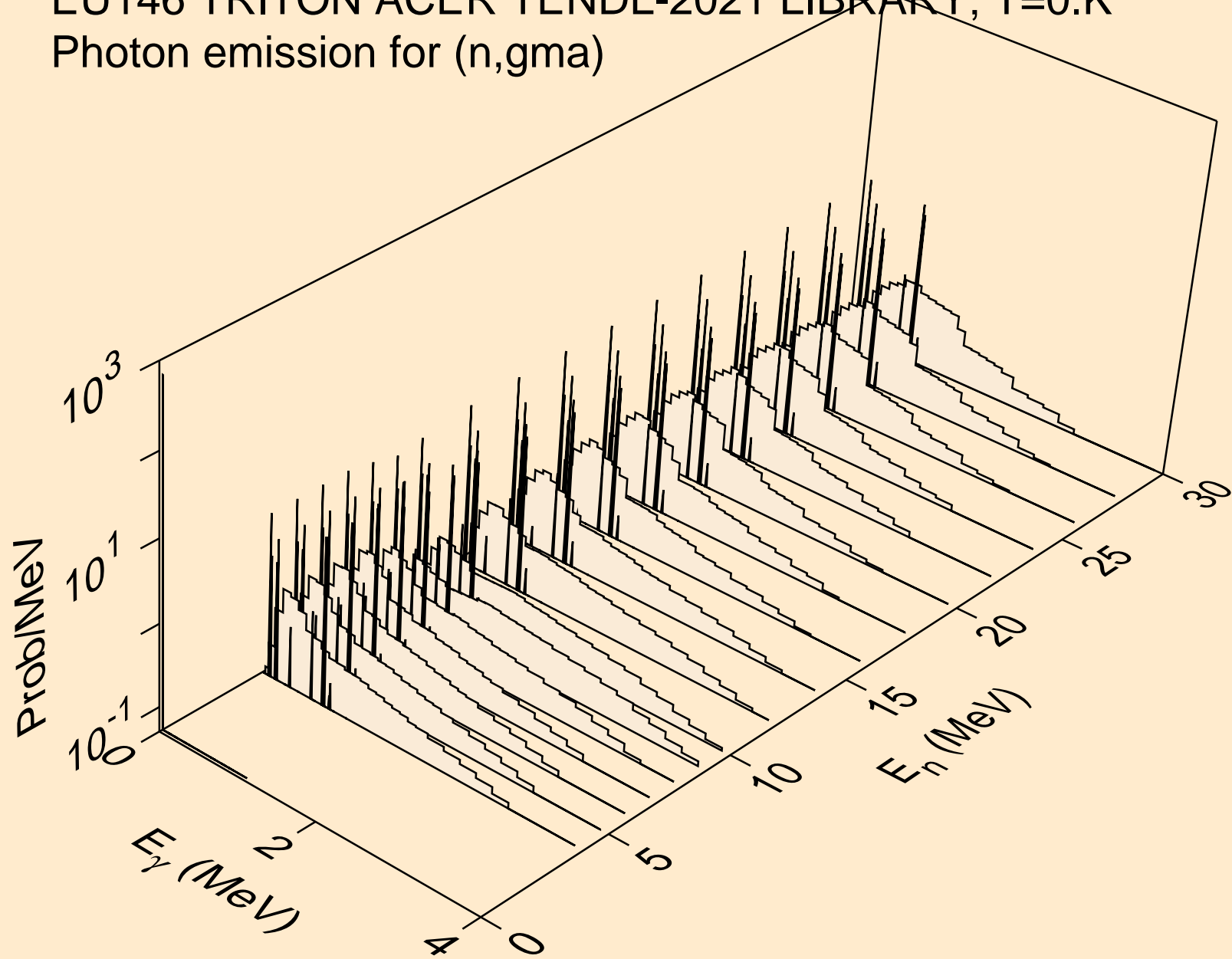

EU146 TRITON ACER TENDL-2021 LIBRARY; T=0.K  
Photon emission for (n,p)

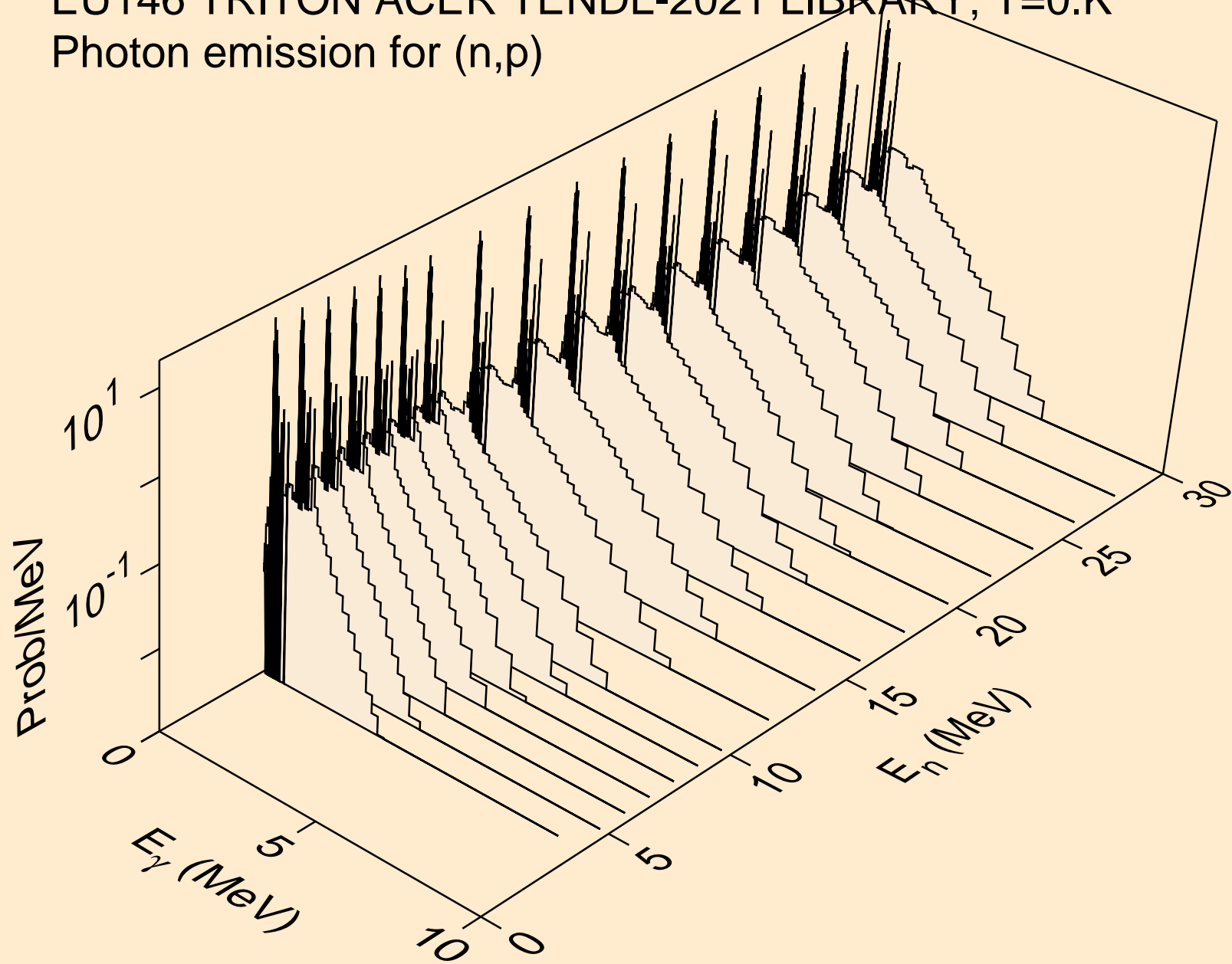

EU146 TRITON ACER TENDL-2021 LIBRARY; T=0.K  
Photon emission for (n,d)

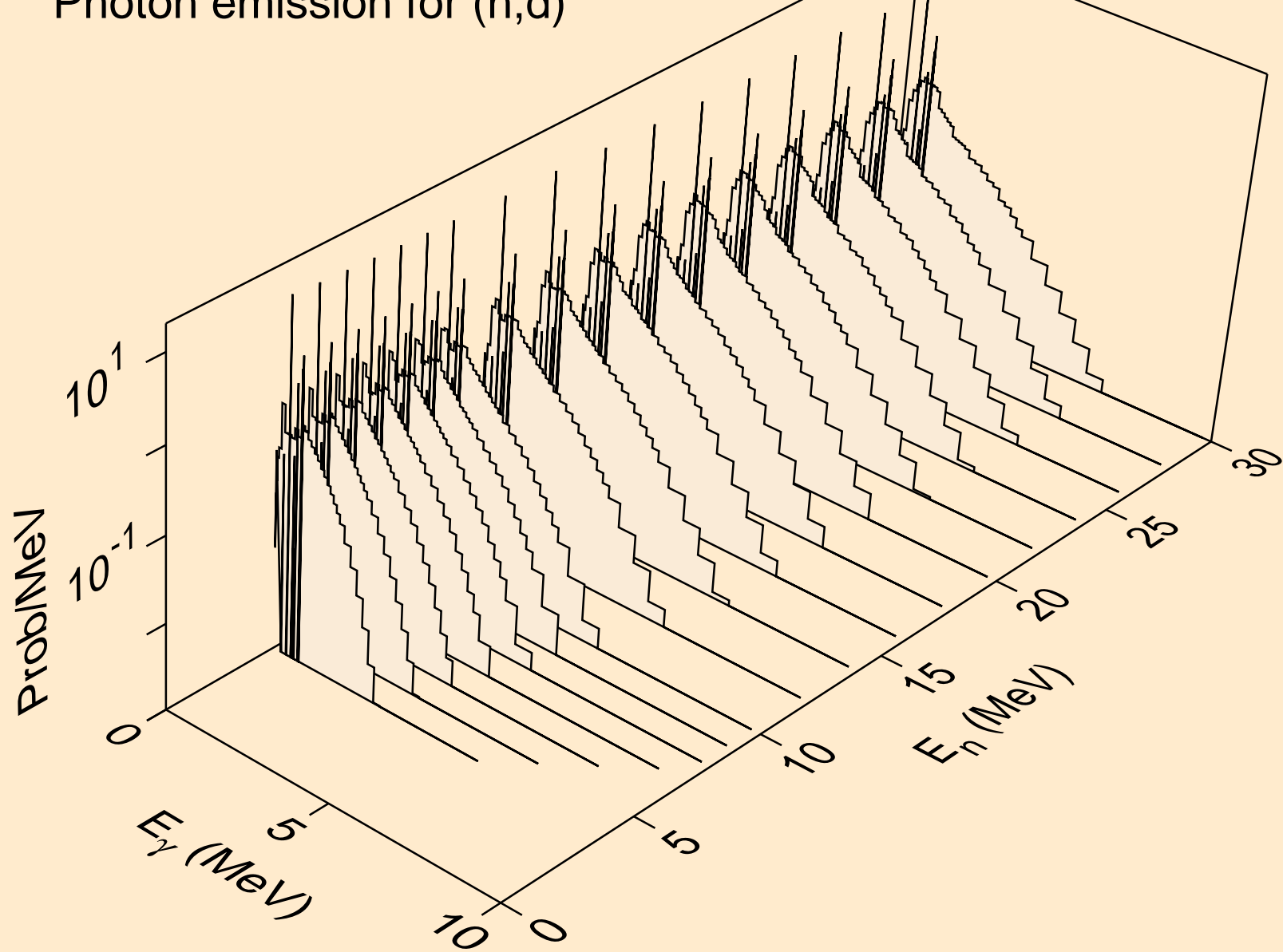

EU146 TRITON ACER TENDL-2021 LIBRARY; T=0.K  
Photon emission for inelastic

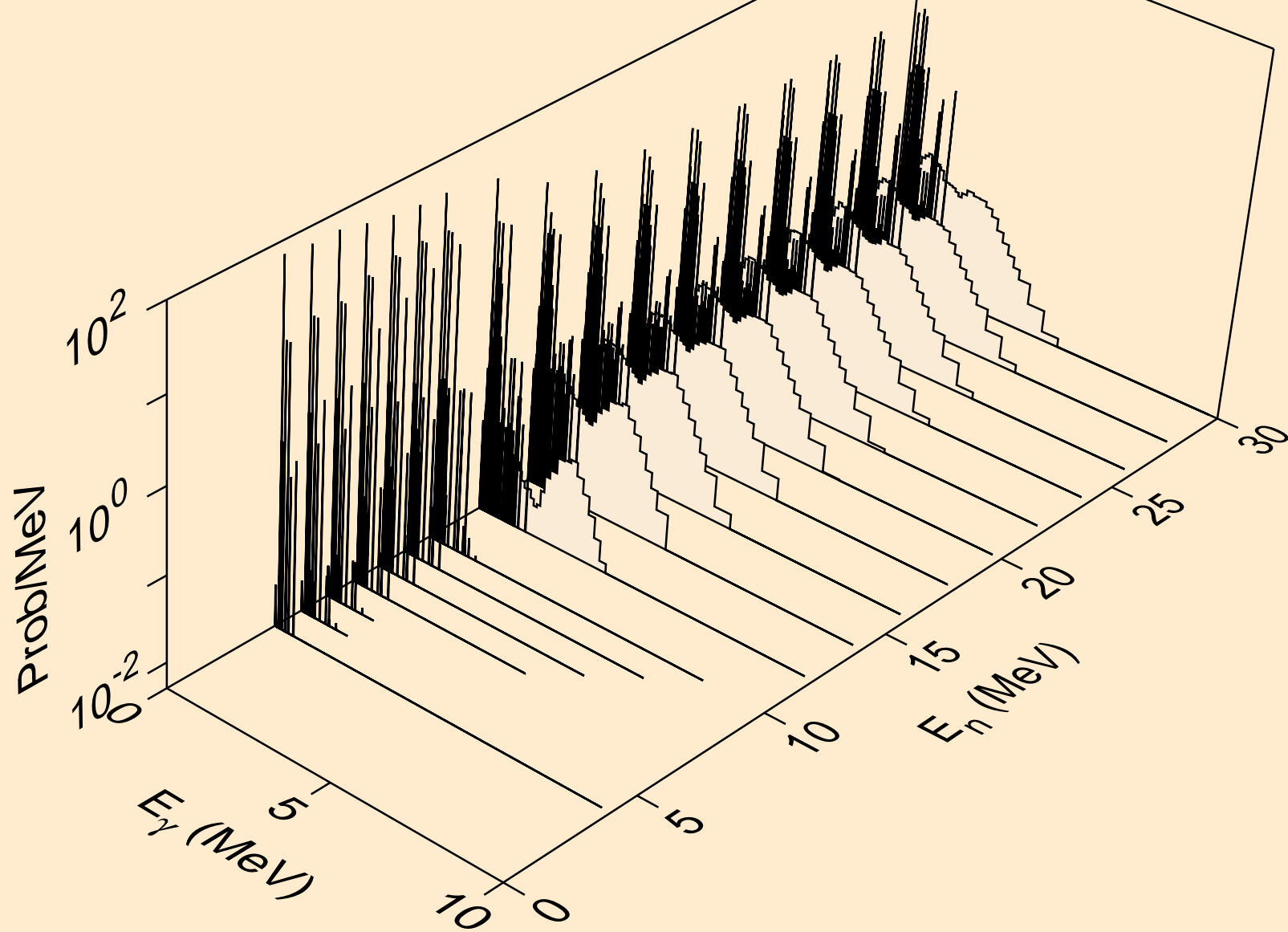

EU146 TRITON ACER TENDL-2021 LIBRARY; T=0.K  
Photon emission for (n,he3)

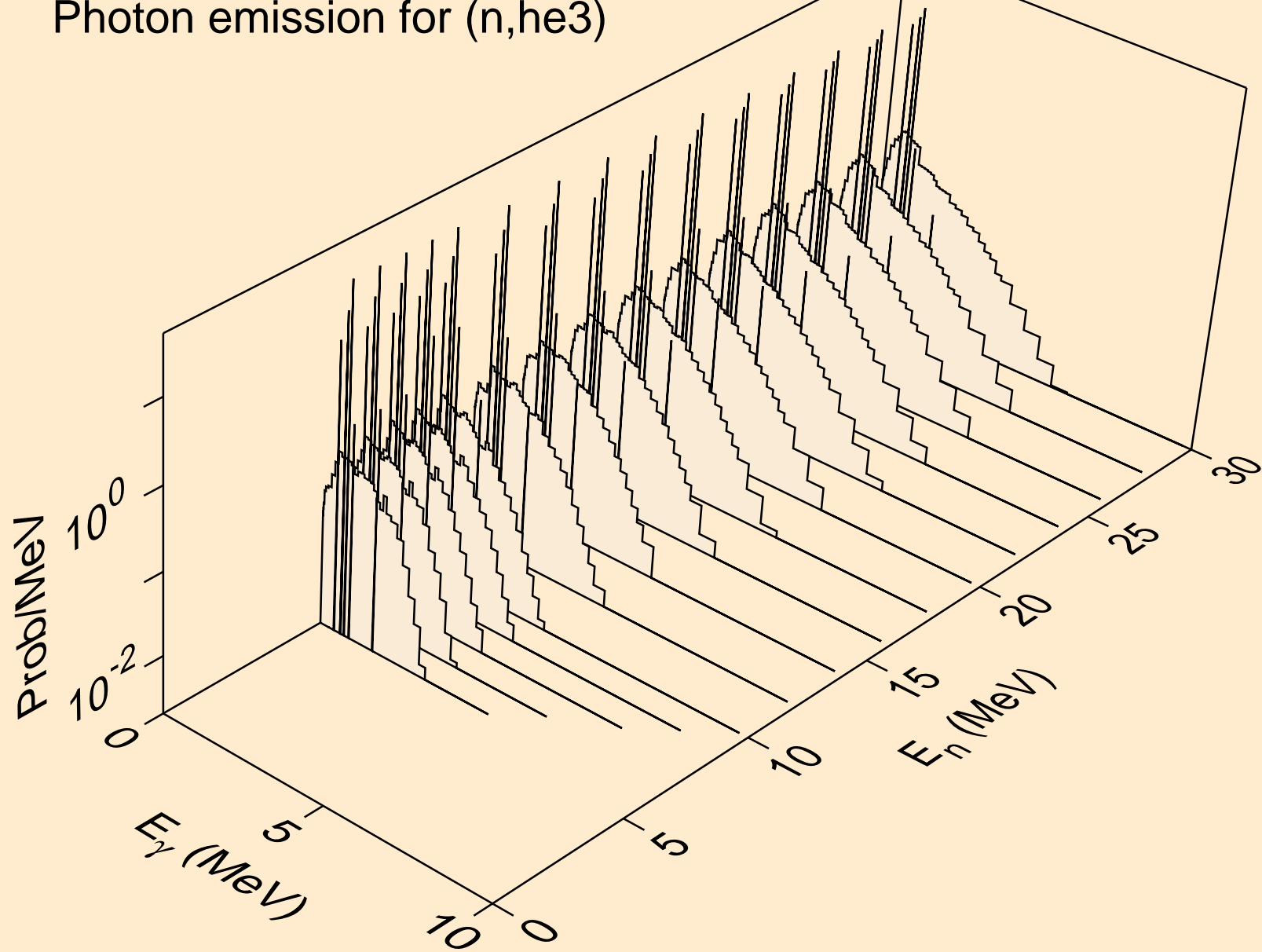

EU146 TRITON ACER TENDL-2021 LIBRARY; T=0.K  
Photon emission for (n,a)

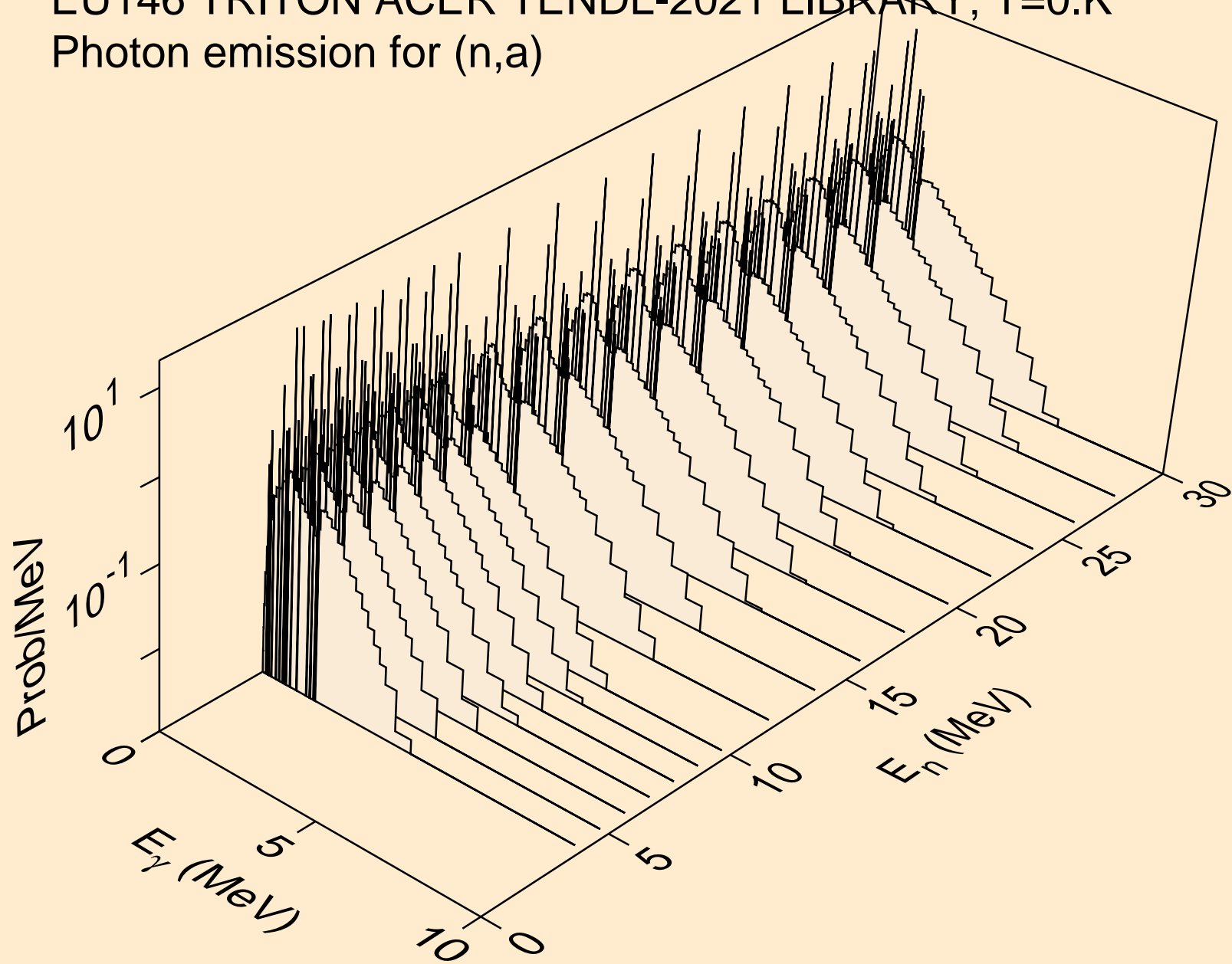

EU146 TRITON ACER TENDL-2021 LIBRARY; T=0.K  
Photon emission for (n,2a)

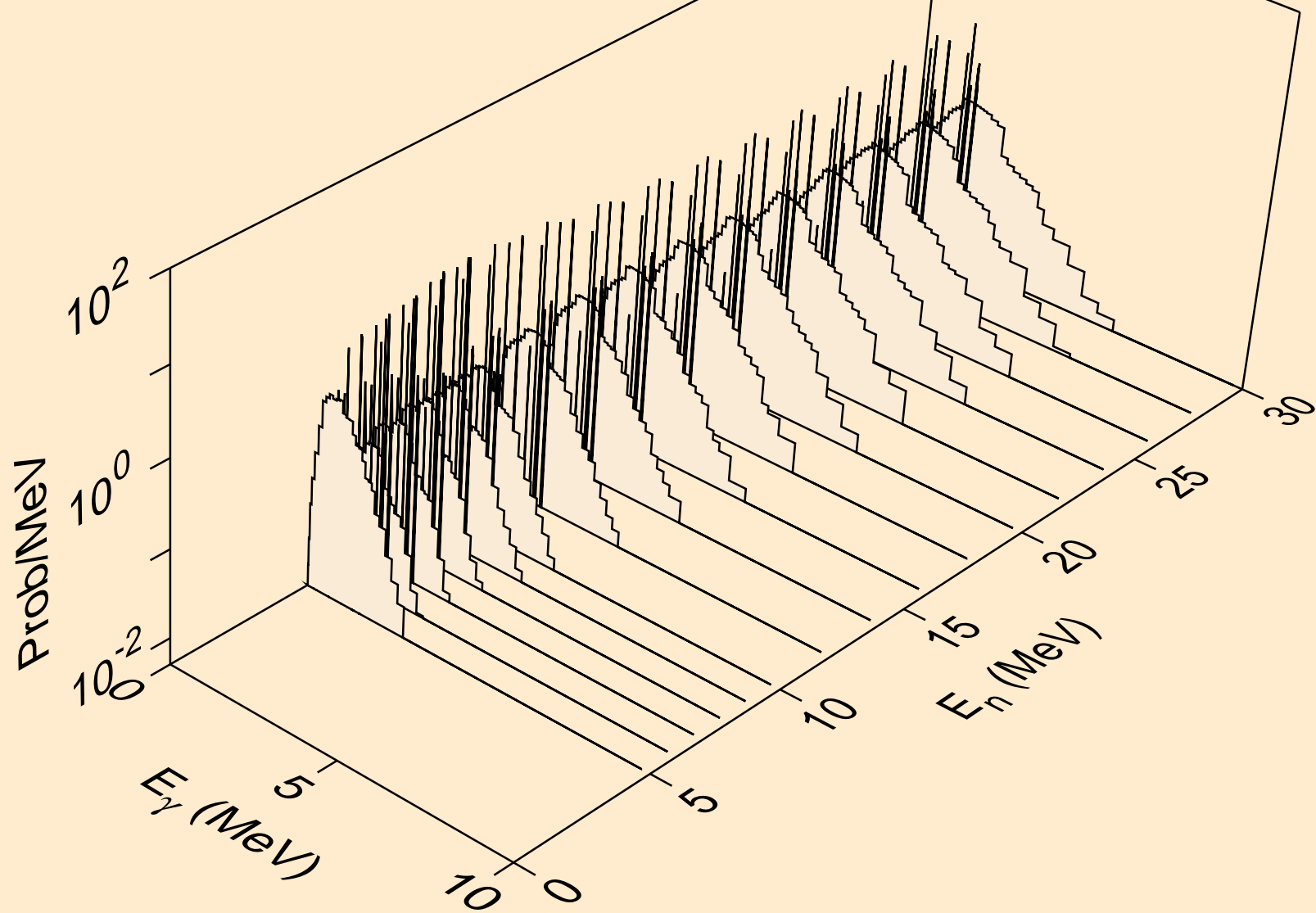

EU146 TRITON ACER TENDL-2021 LIBRARY; T=0.K  
Photon emission for (n,2p)

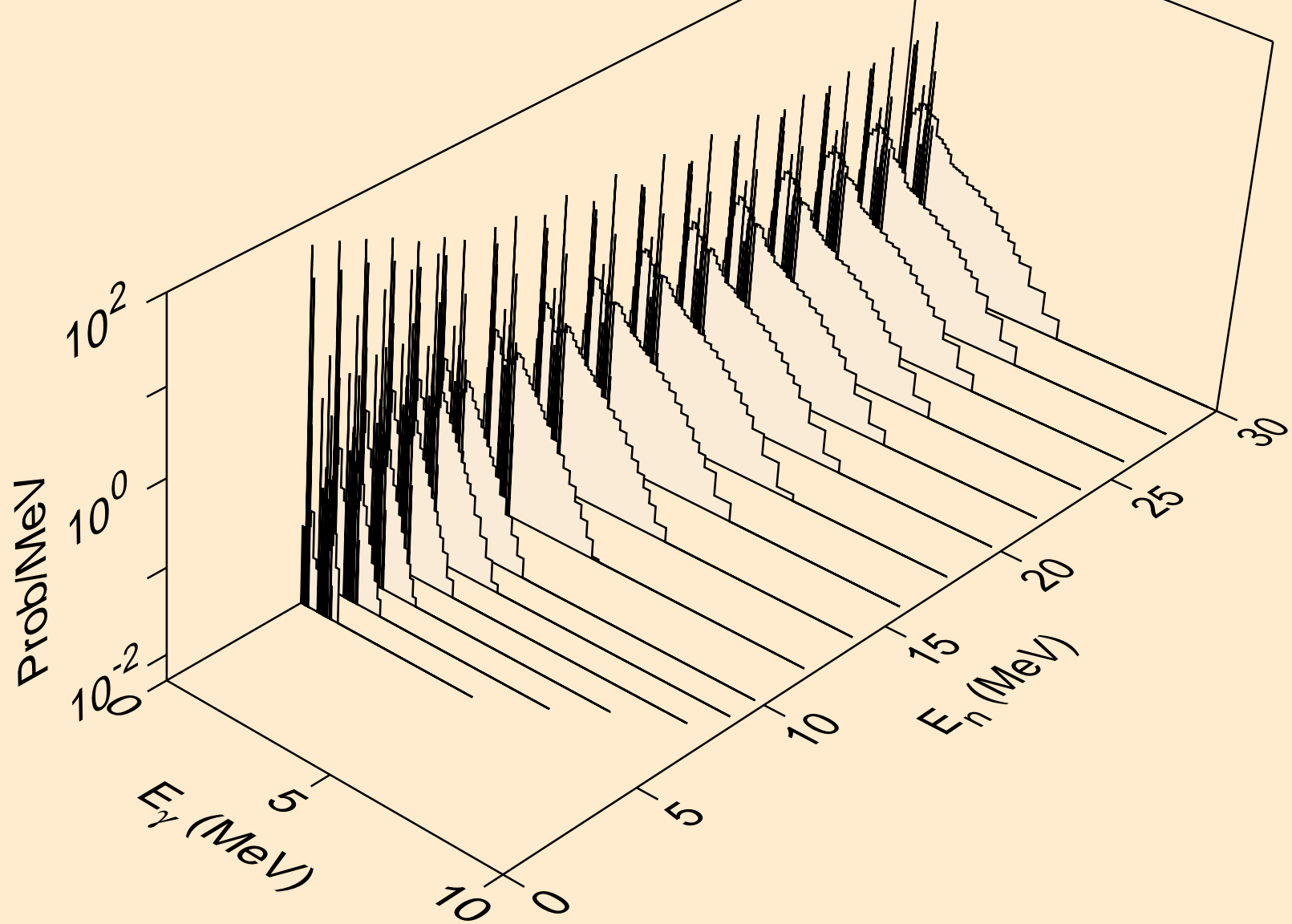



EU146 TRITON ACER TENDL-2021 LIBRARY; T=0.K  
Photon emission for (n,pa)

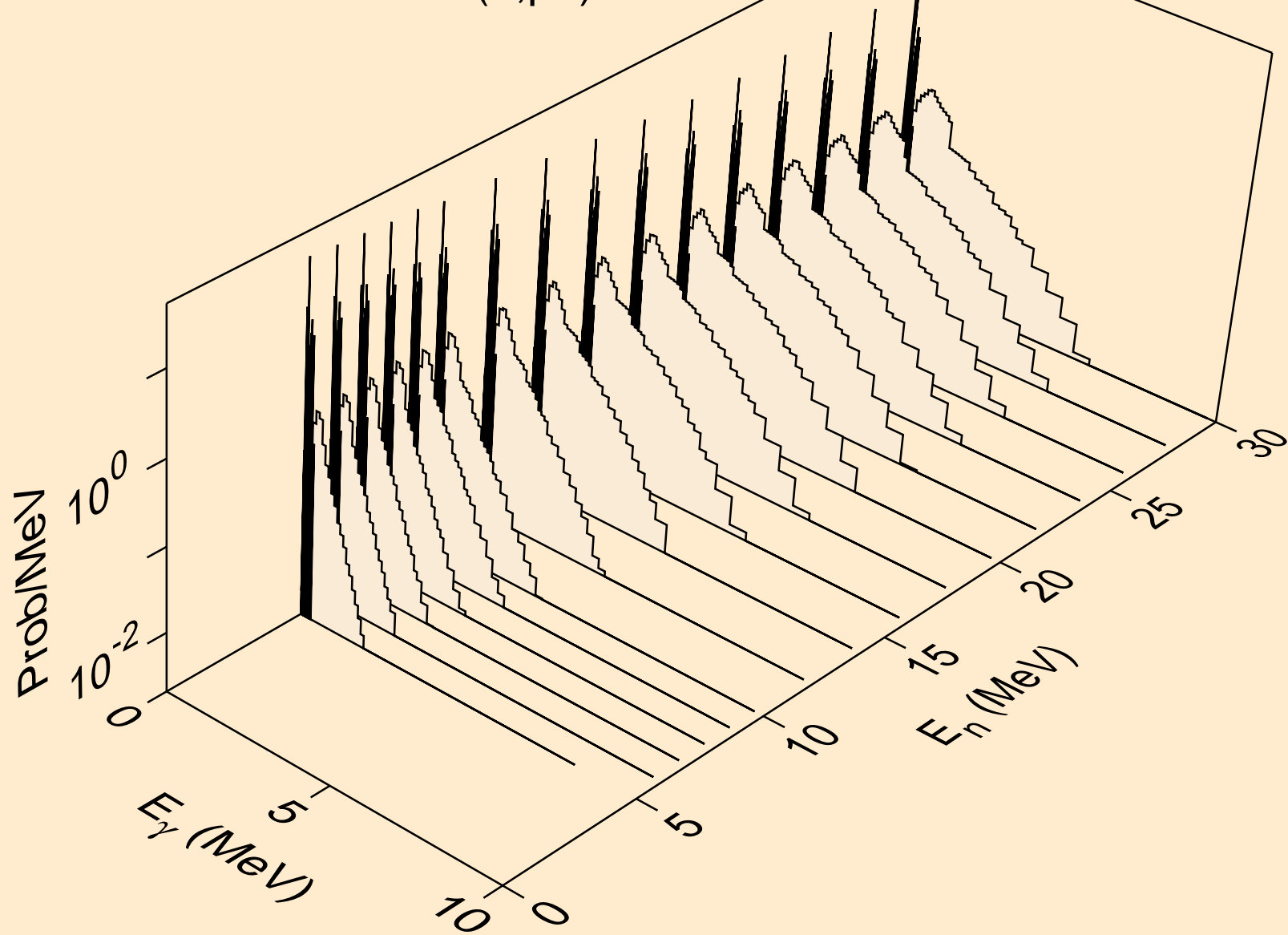

EU146 TRITON ACER TENDL-2021 LIBRARY; T=0.K  
Photon emission for (n,pd)

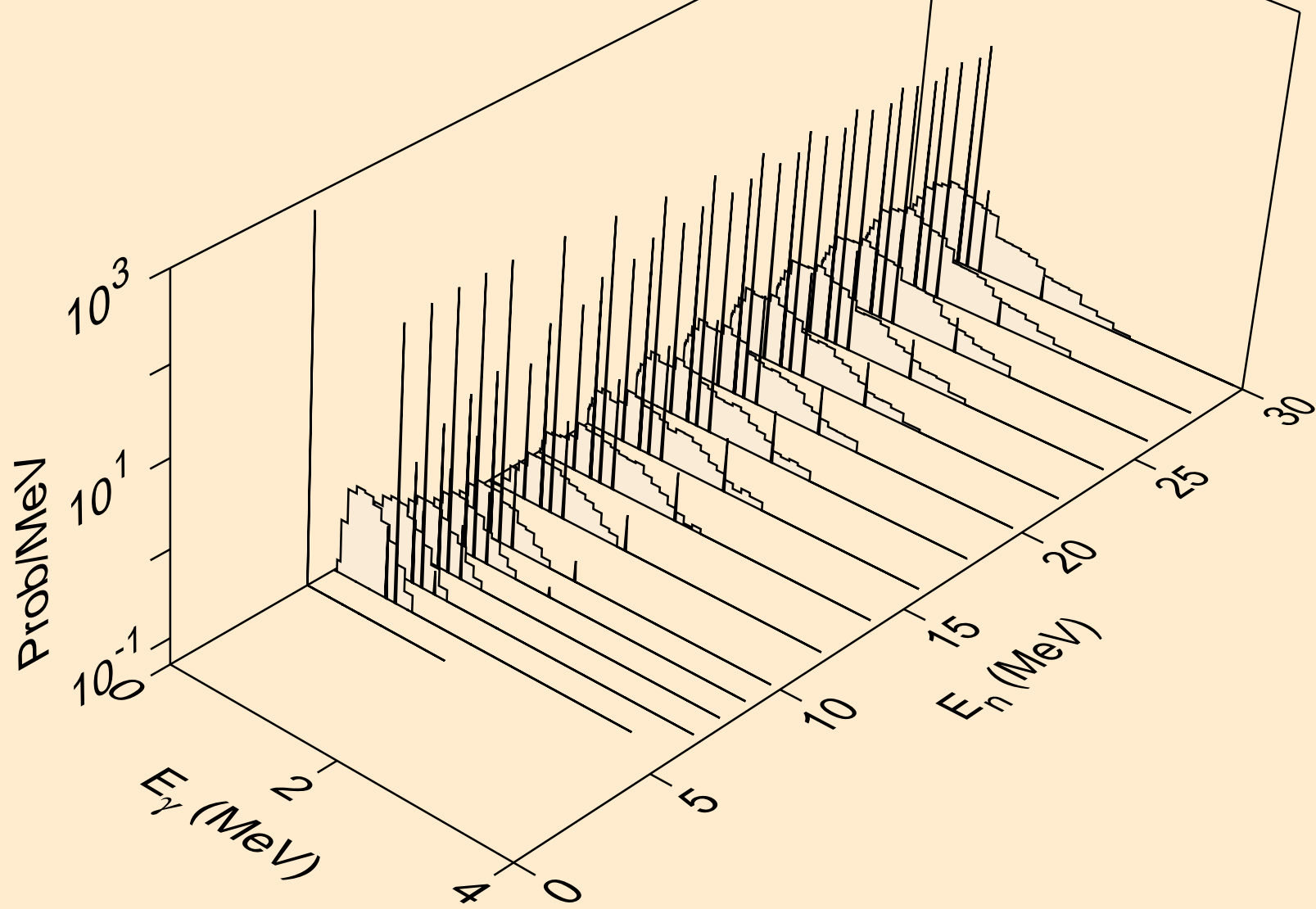

EU146 TRITON ACER TENDL-2021 LIBRARY; T=0.K  
Photon emission for (n,pt)

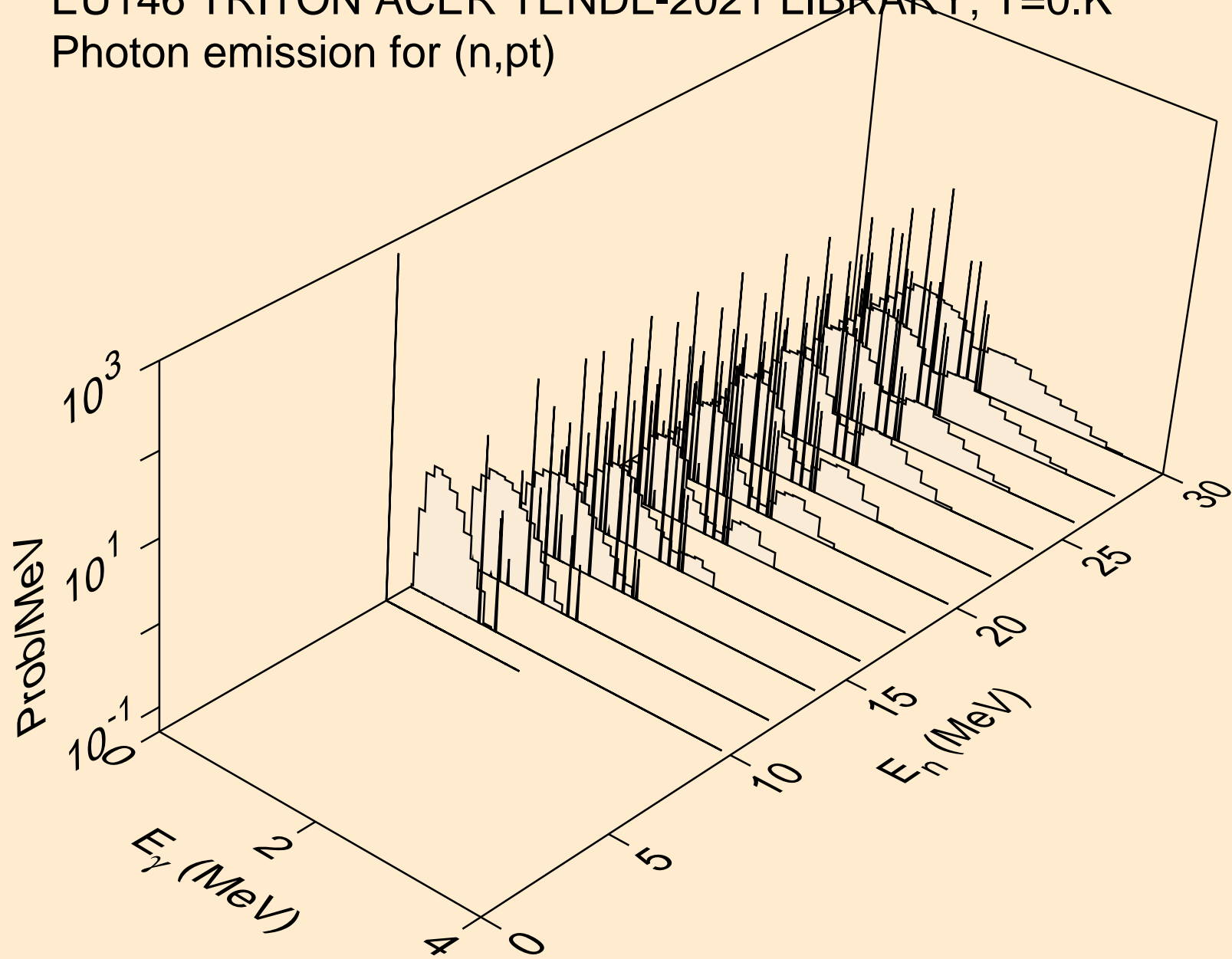

EU146 TRITON ACER TENDL-2021 LIBRARY; T=0.K  
Photon emission for (n,da)

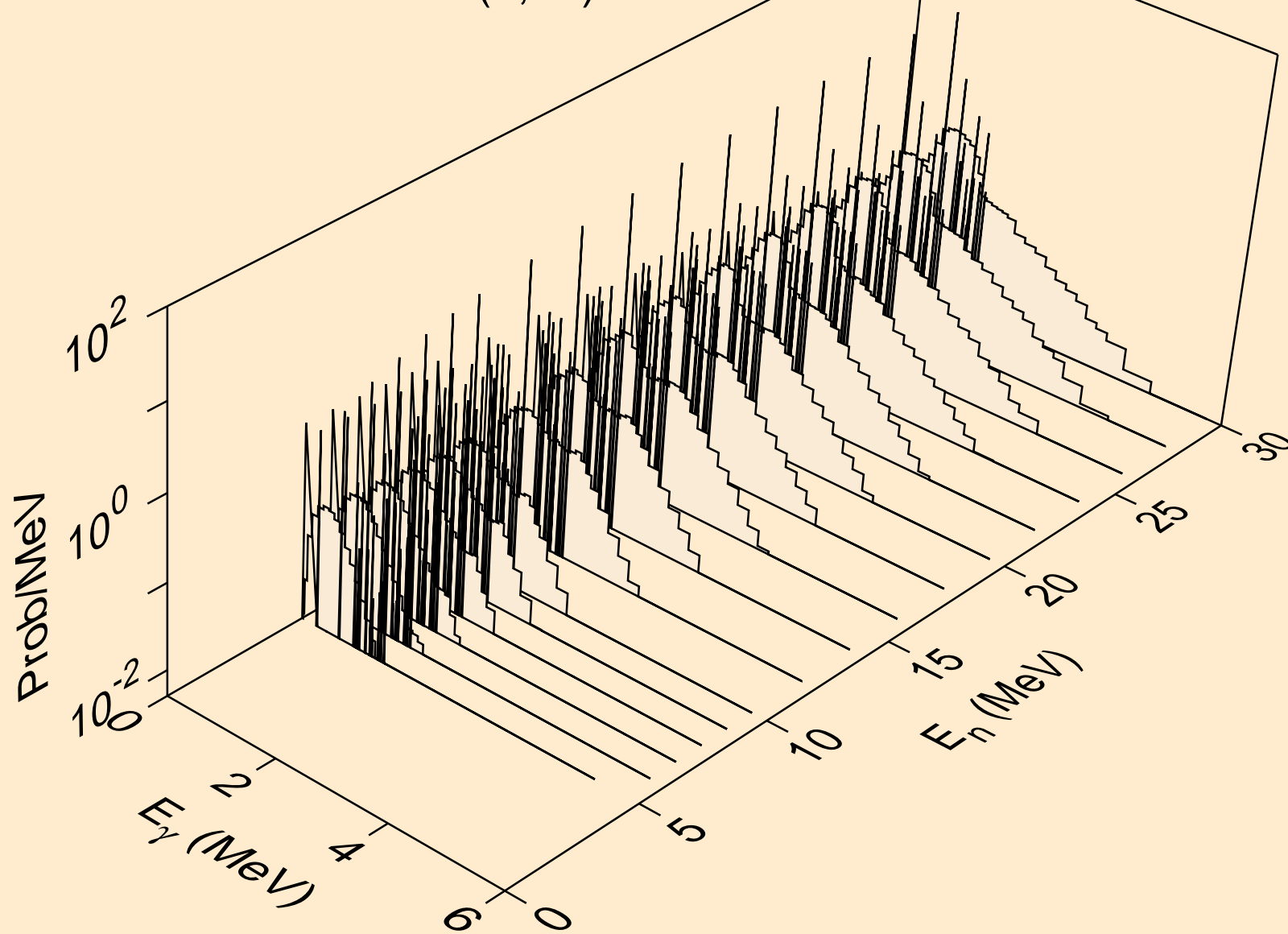

EU146 TRITON ACER TENDL-2021 LIBRARY; T=0.K  
Particle heating contributions

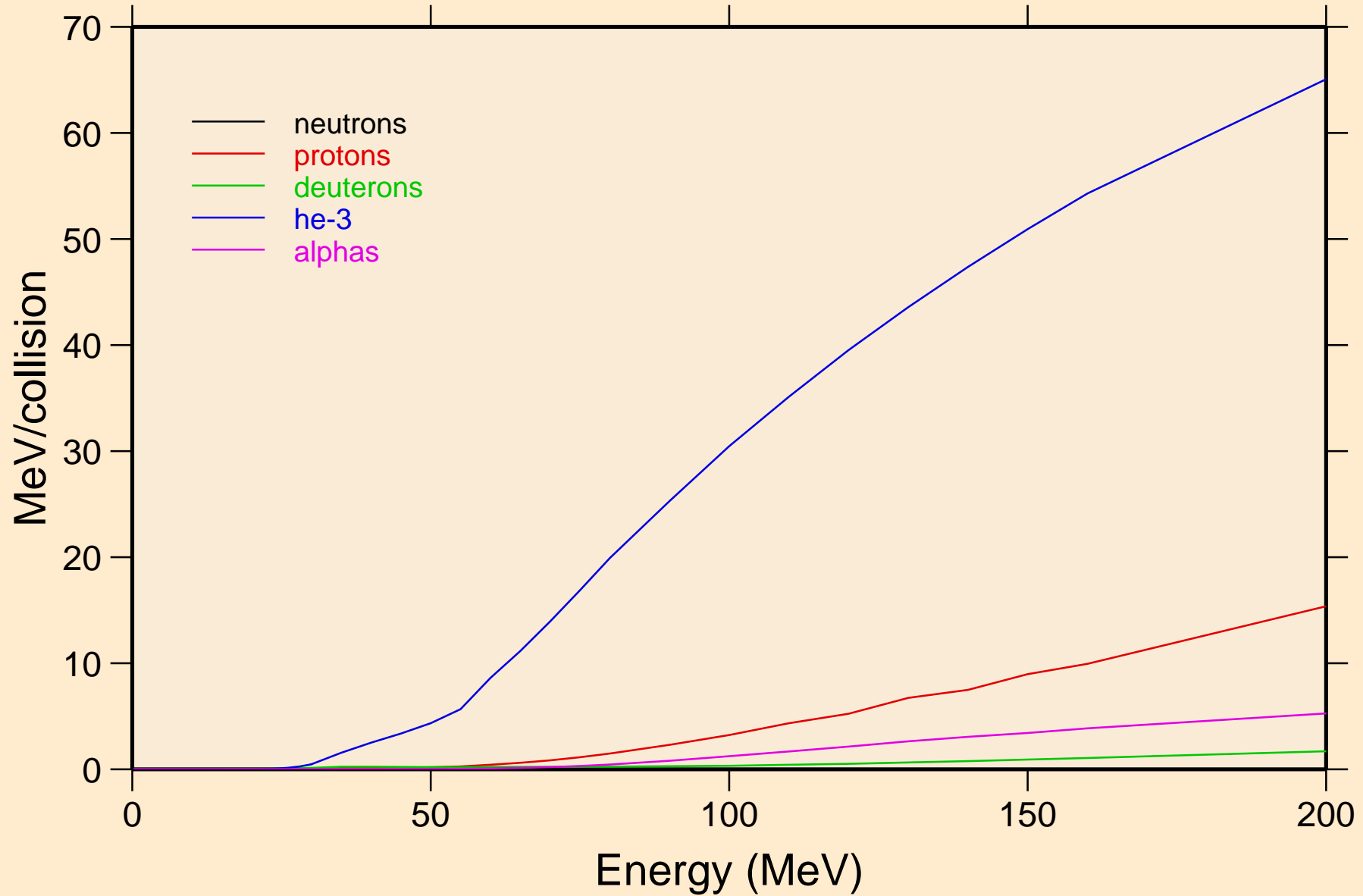

EU146 TRITON ACER TENDL-2021 LIBRARY; T=0.K  
Recoil Heating

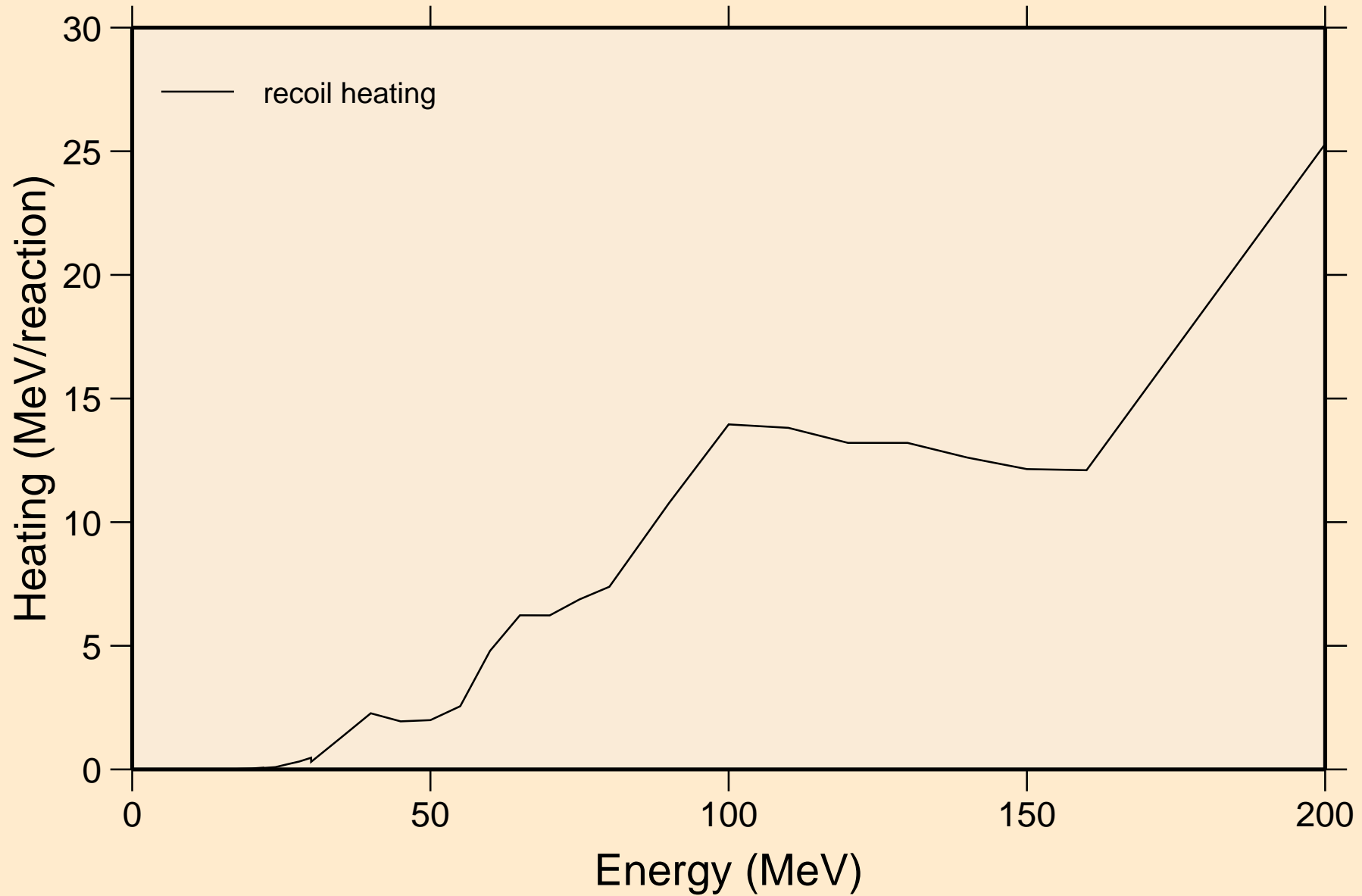

EU146 TRITON ACER TENDL-2021 LIBRARY; T=0.K  
Particle production cross sections

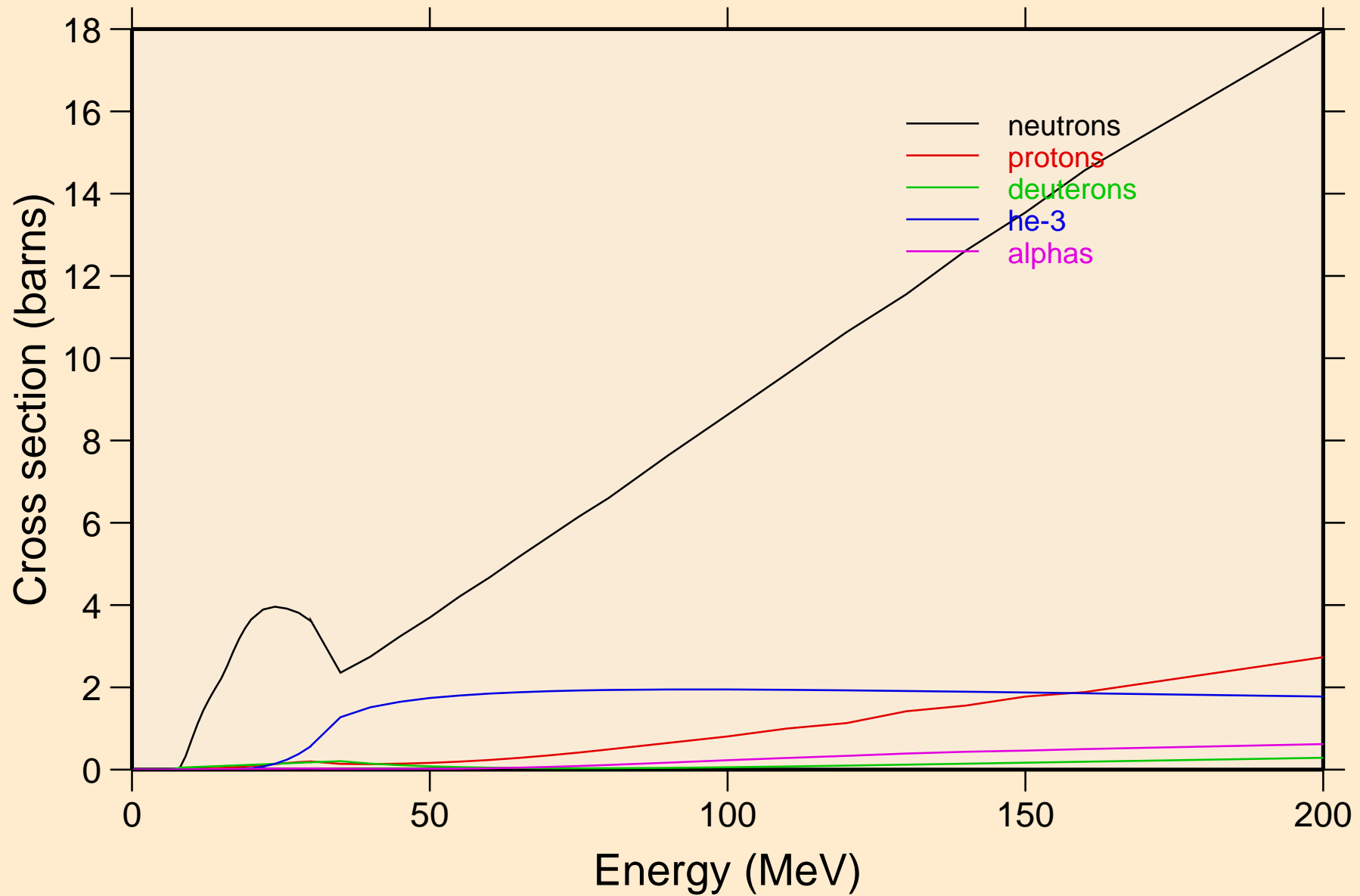

EU146 TRITON ACER TENDL-2021 LIBRARY; T=0.K  
neutrons from (t,n)

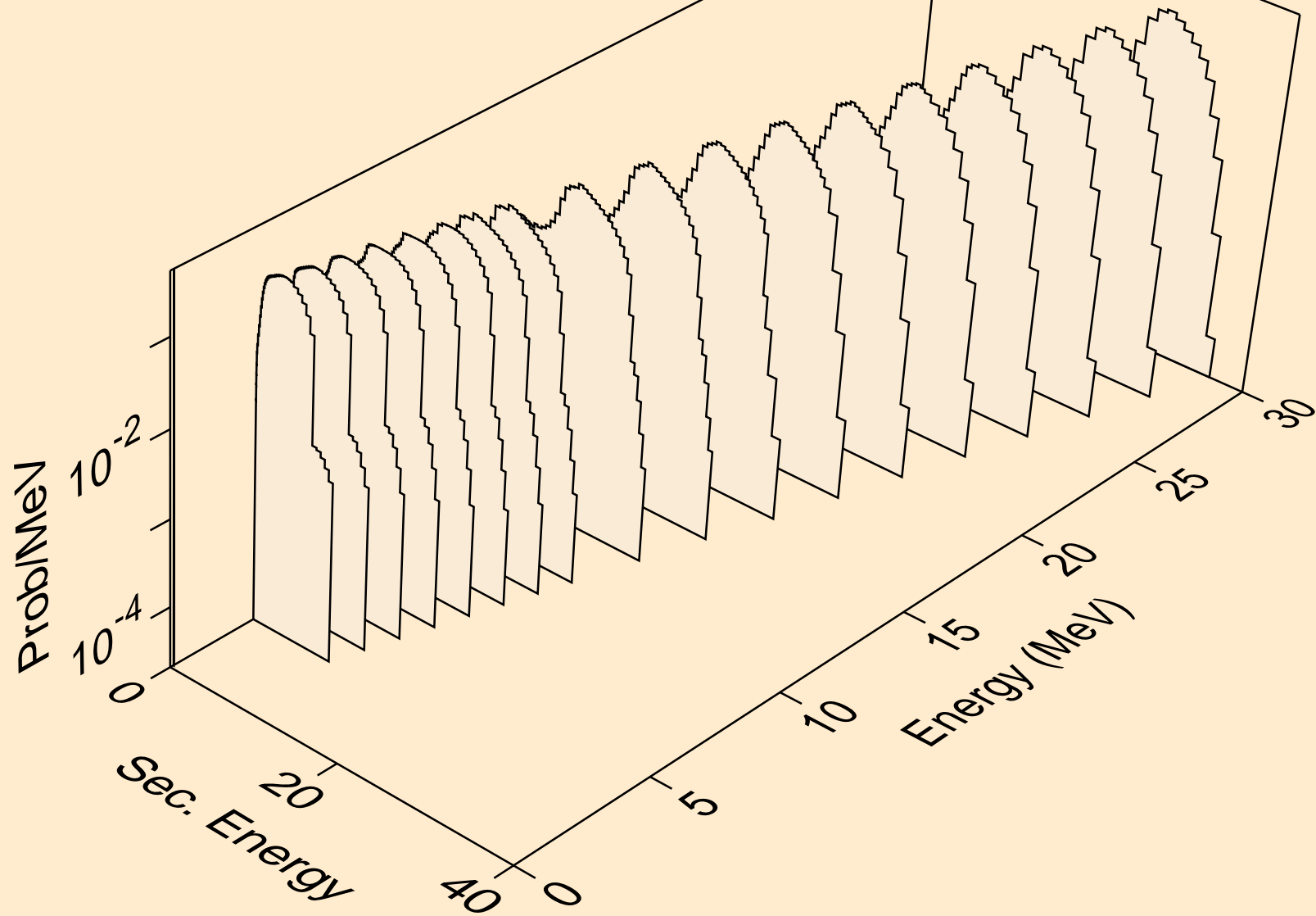



EU146 TRITON ACER TENDL-2021 LIBRARY; T=0.K  
neutrons from (t,x)

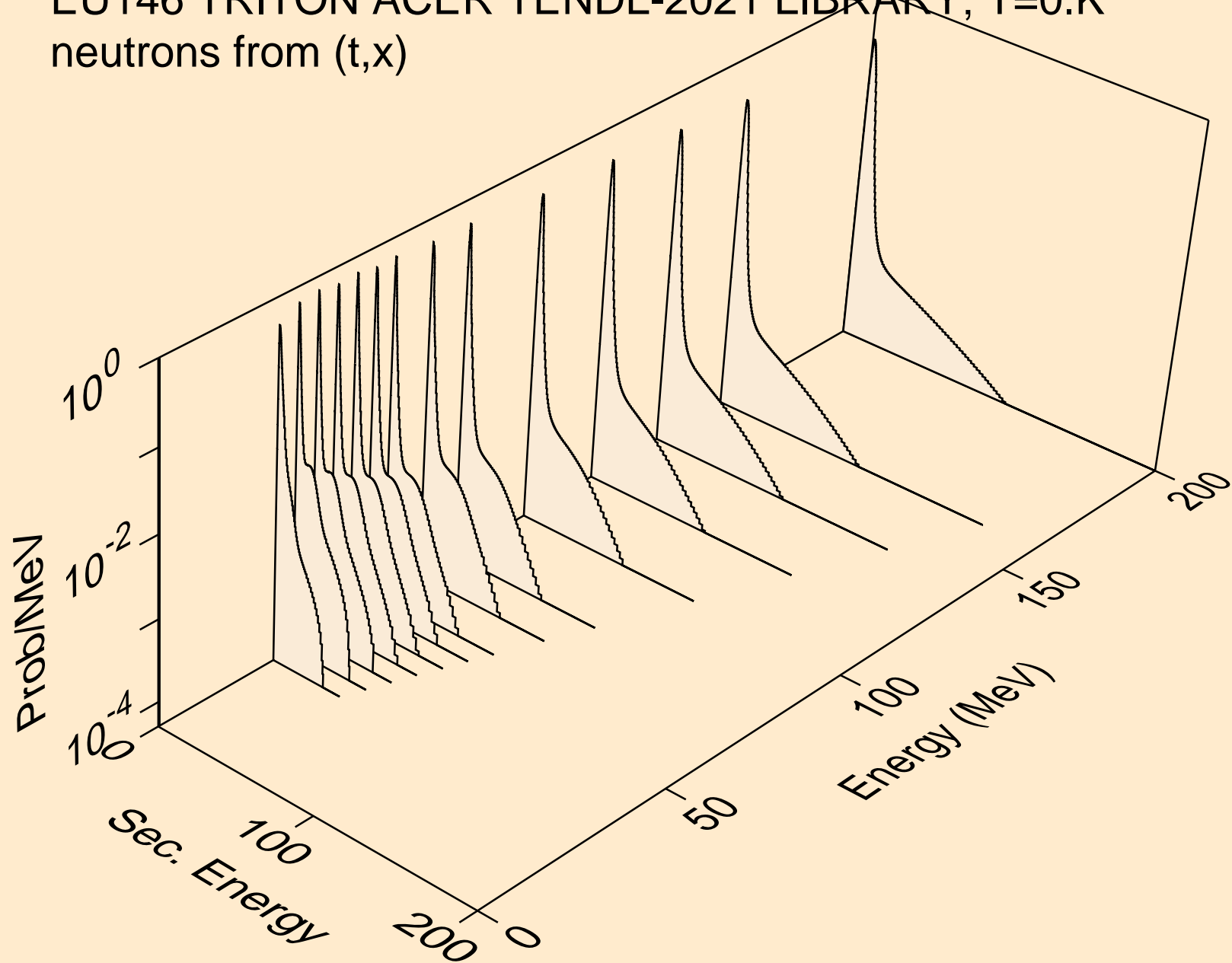

EU146 TRITON ACER TENDL-2021 LIBRARY; T=0.K  
neutrons from (t,2nd)

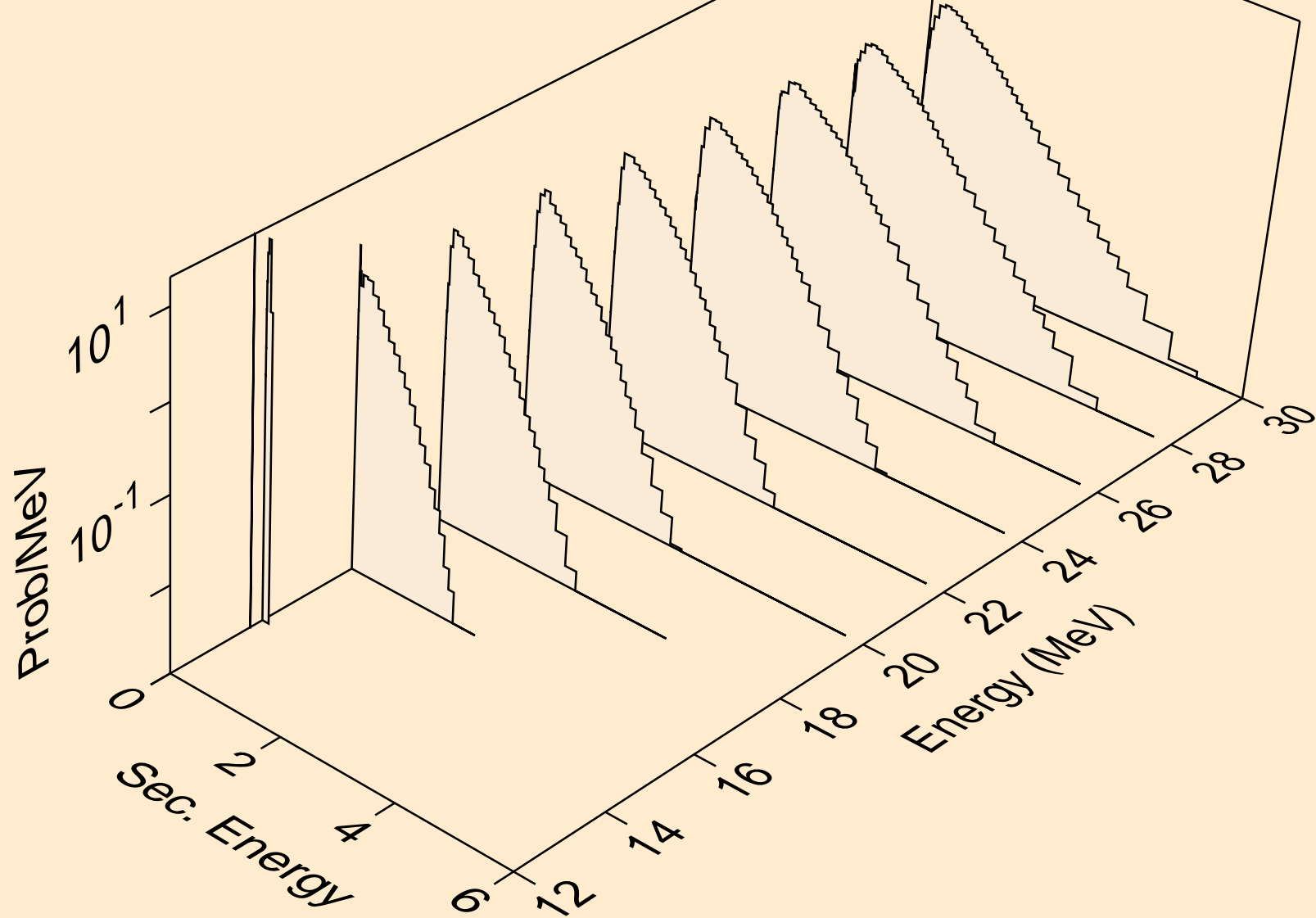

EU146 TRITON ACER TENDL-2021 LIBRARY; T=0.K  
neutrons from (t,2n)

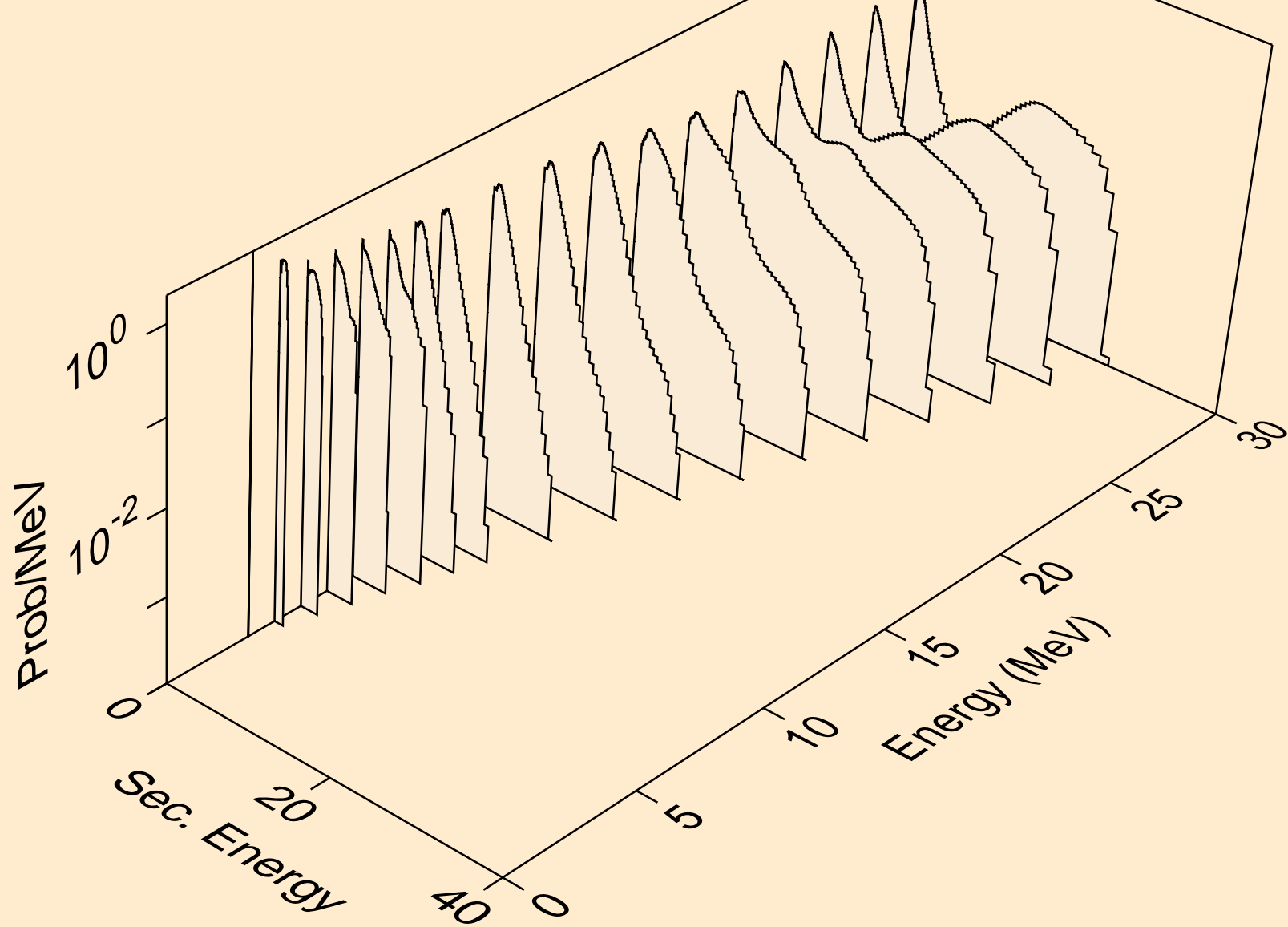

EU146 TRITON ACER TENDL-2021 LIBRARY; T=0.K  
neutrons from (t,3n)

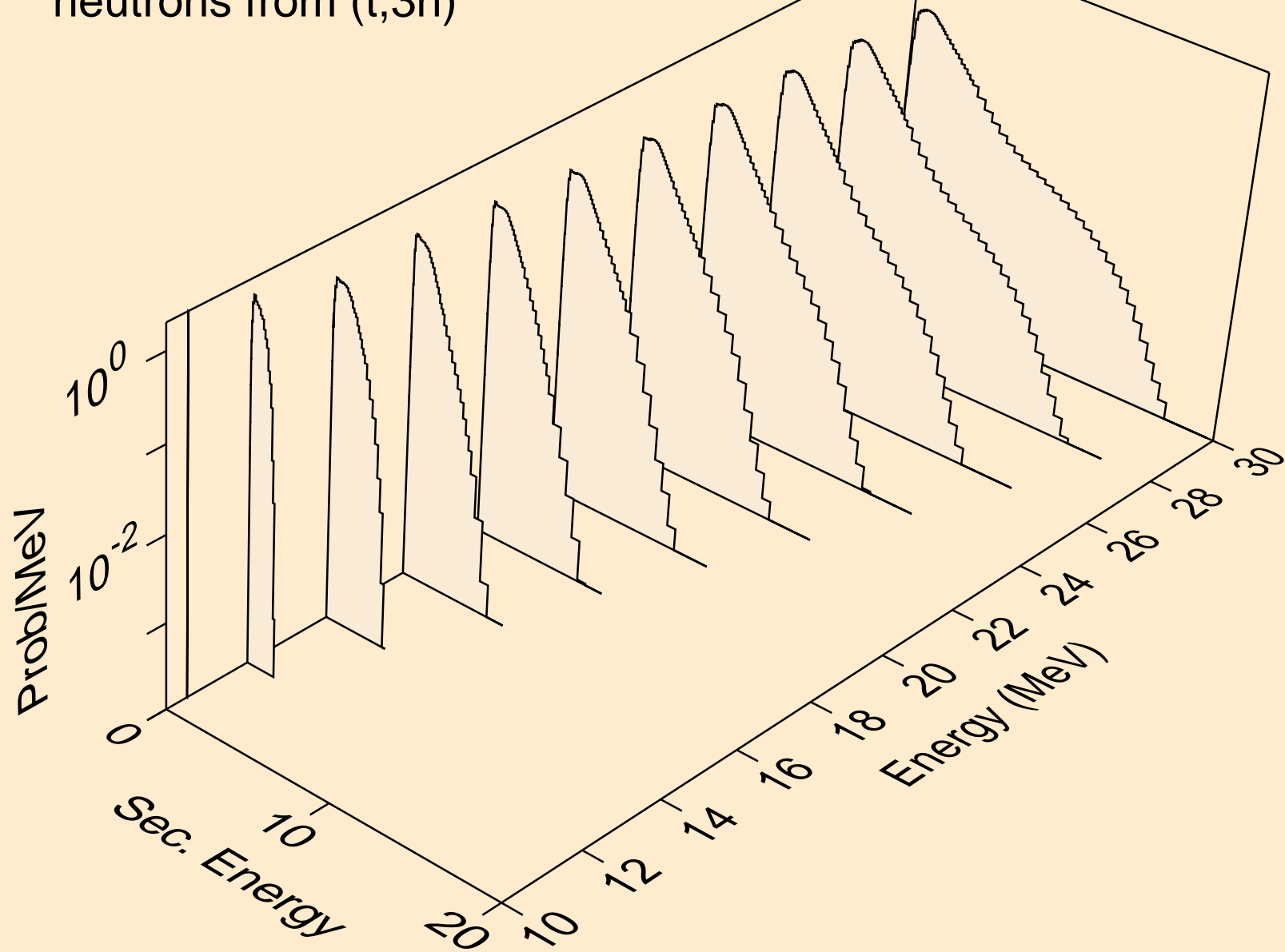

EU146 TRITON ACER TENDL-2021 LIBRARY; T=0.K  
neutrons from (t,n\*)a

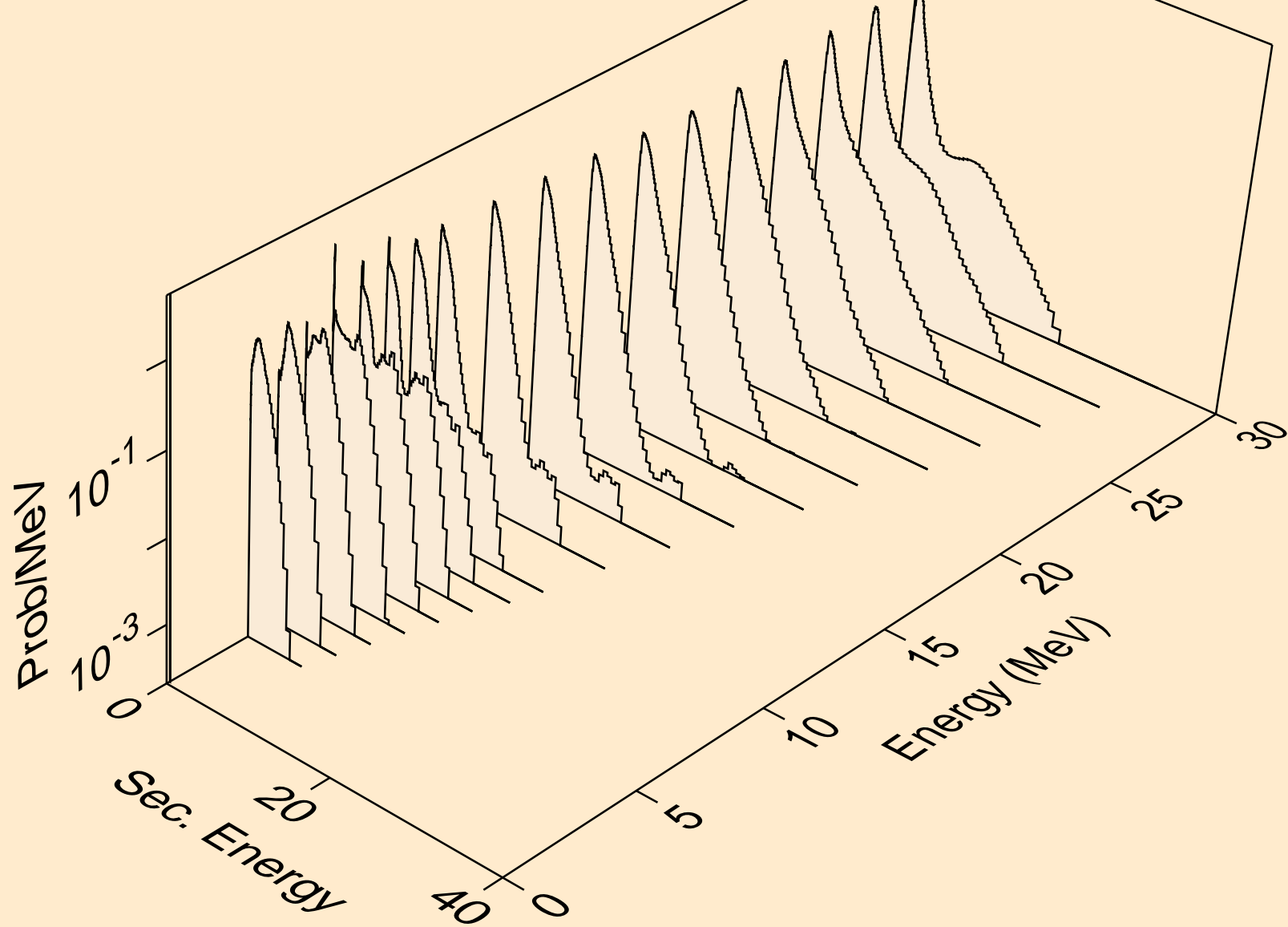

EU146 TRITON ACER TENDL-2021 LIBRARY; T=0.K  
neutrons from (t,2n)a

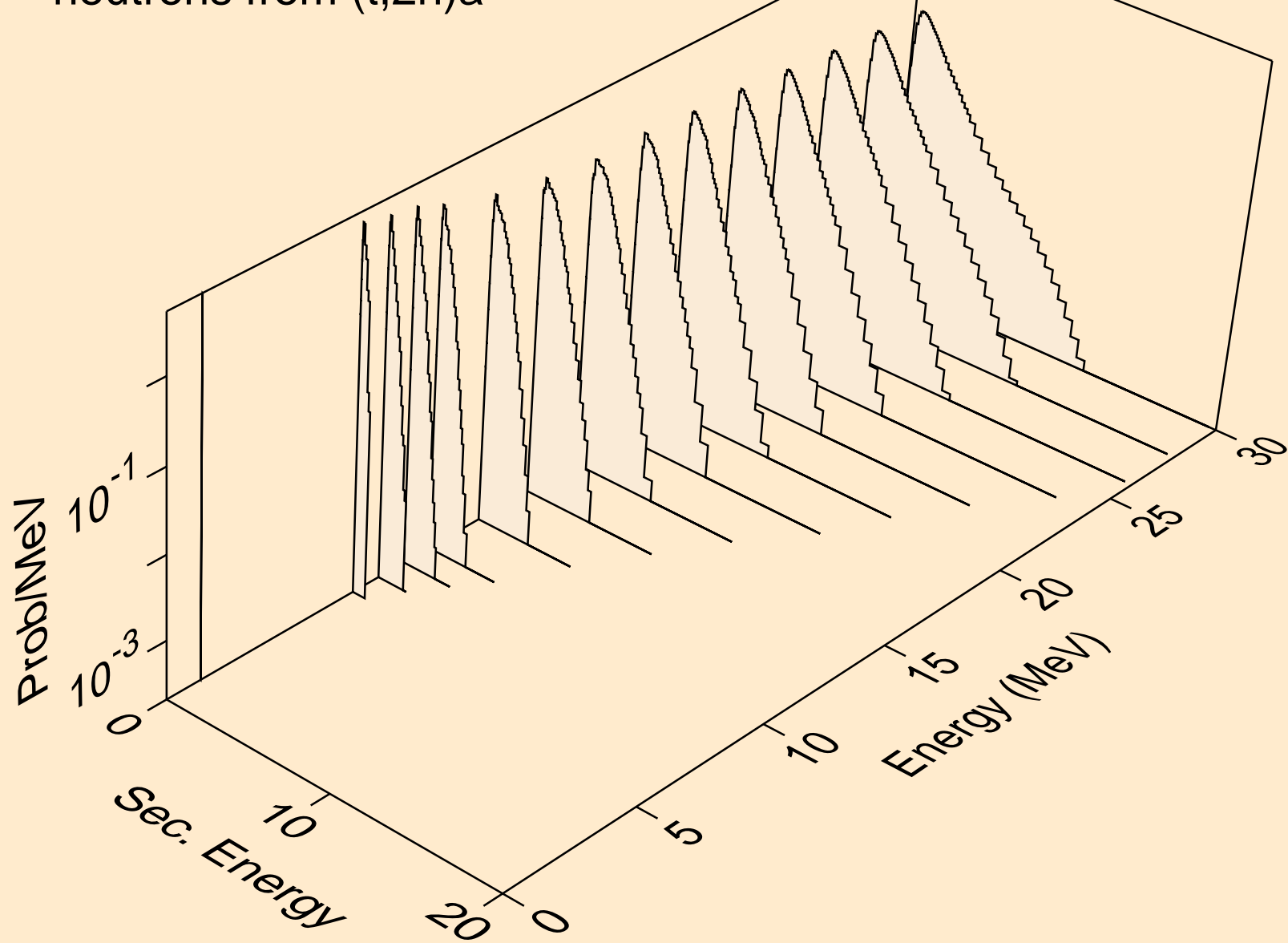

EU146 TRITON ACER TENDL-2021 LIBRARY; T=0.K  
neutrons from (t,3n)a

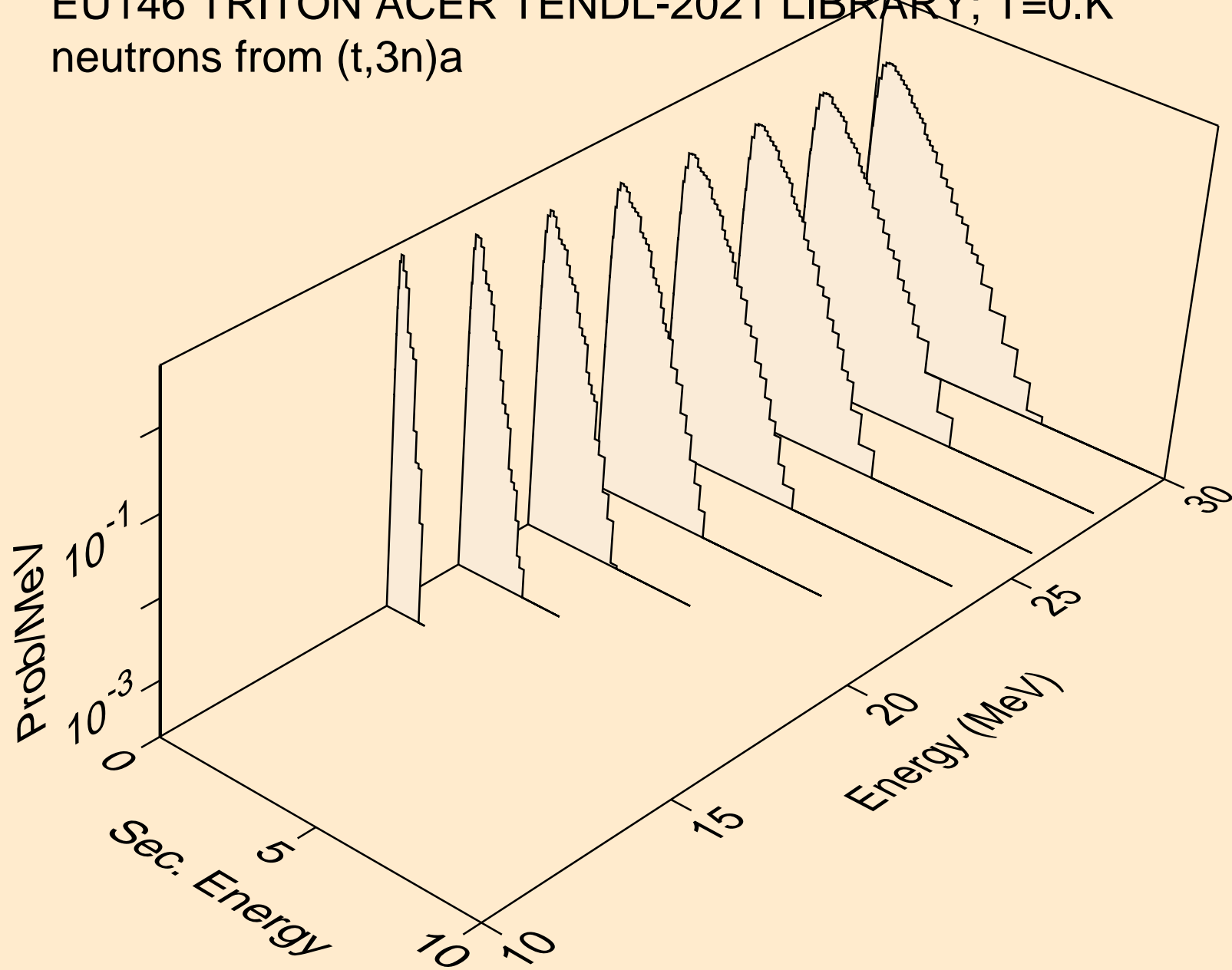

EU146 TRITON ACER TENDL-2021 LIBRARY; T=0.K  
neutrons from (t,n\*)p

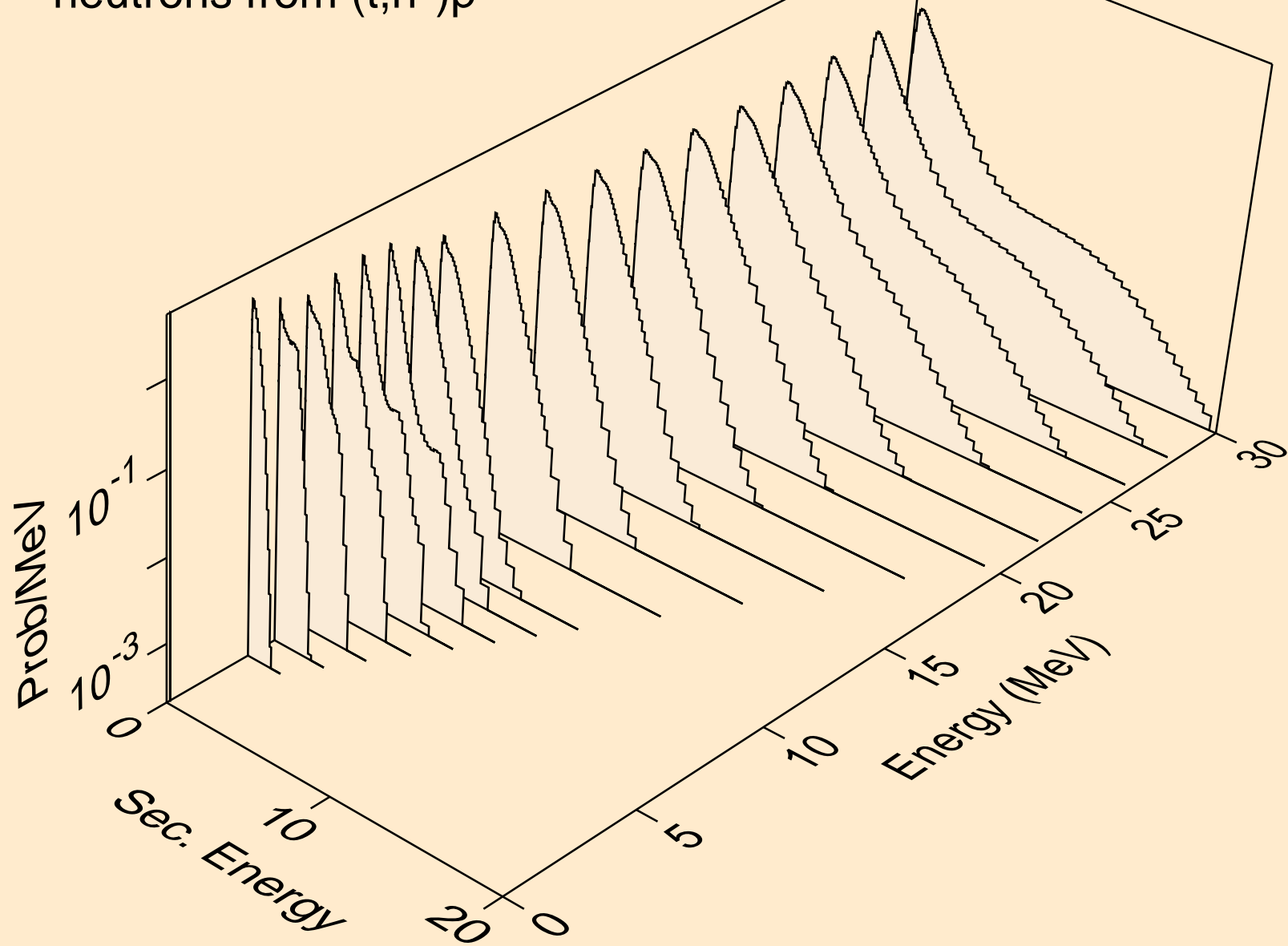



EU146 TRITON ACER TENDL-2021 LIBRARY; T=0.K  
neutrons from (t,n\*)2a

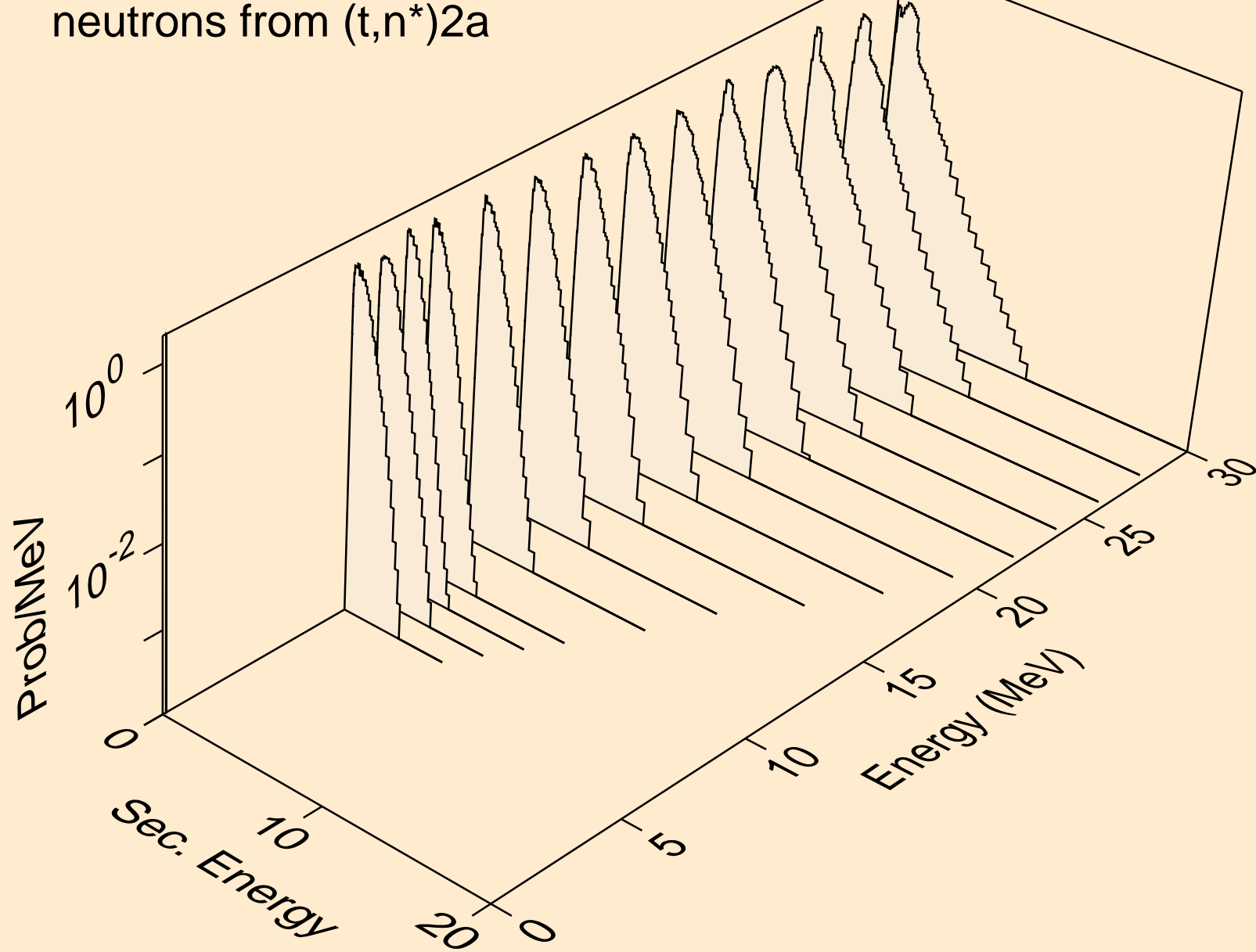

EU146 TRITON ACER TENDL-2021 LIBRARY; T=0.K  
neutrons from (t,2n)2a

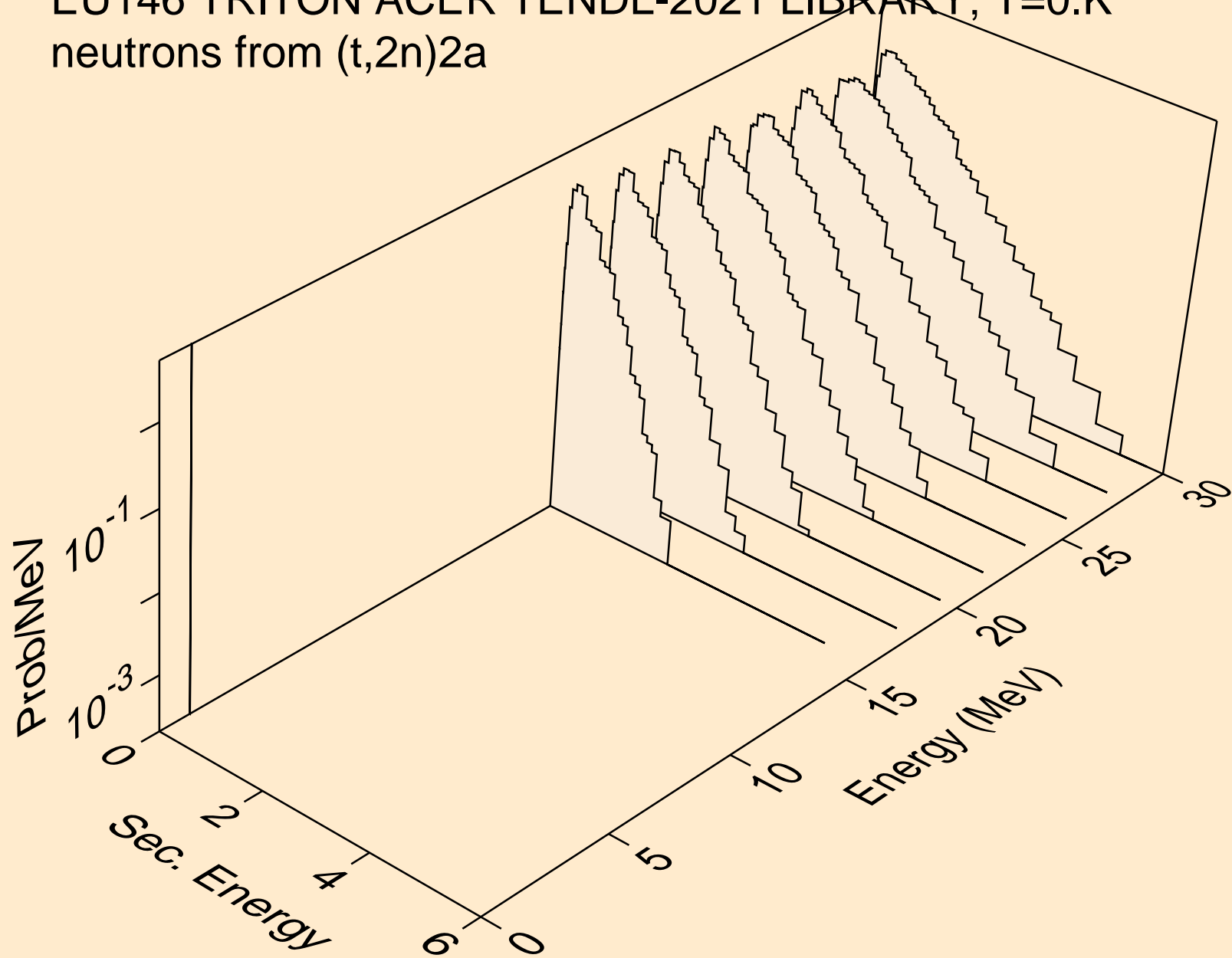

EU146 TRITON ACER TENDL-2021 LIBRARY; T=0.K  
neutrons from (t,n\*)d

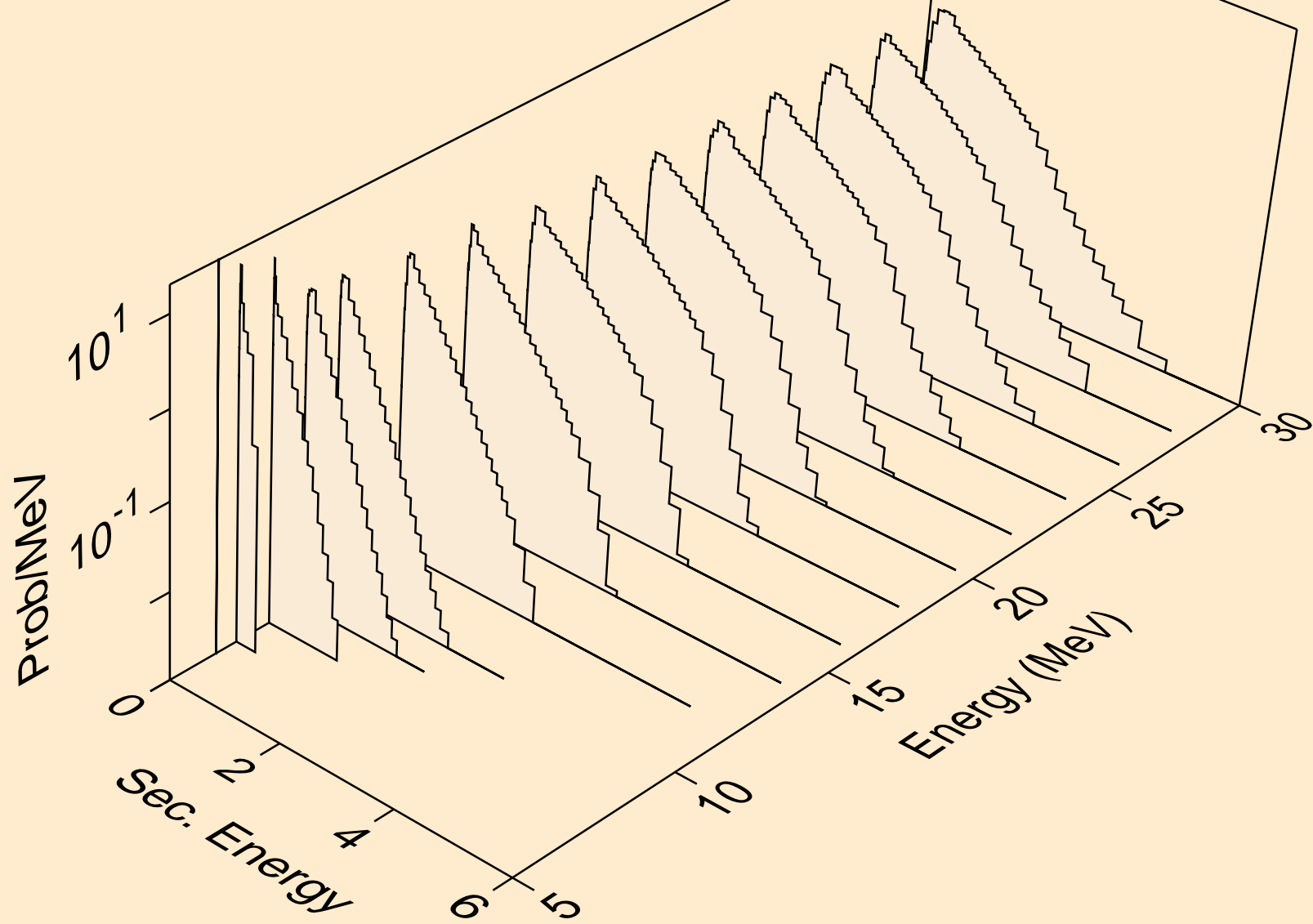

EU146 TRITON ACER TENDL-2021 LIBRARY; T=0.K  
neutrons from (t,n\*)t

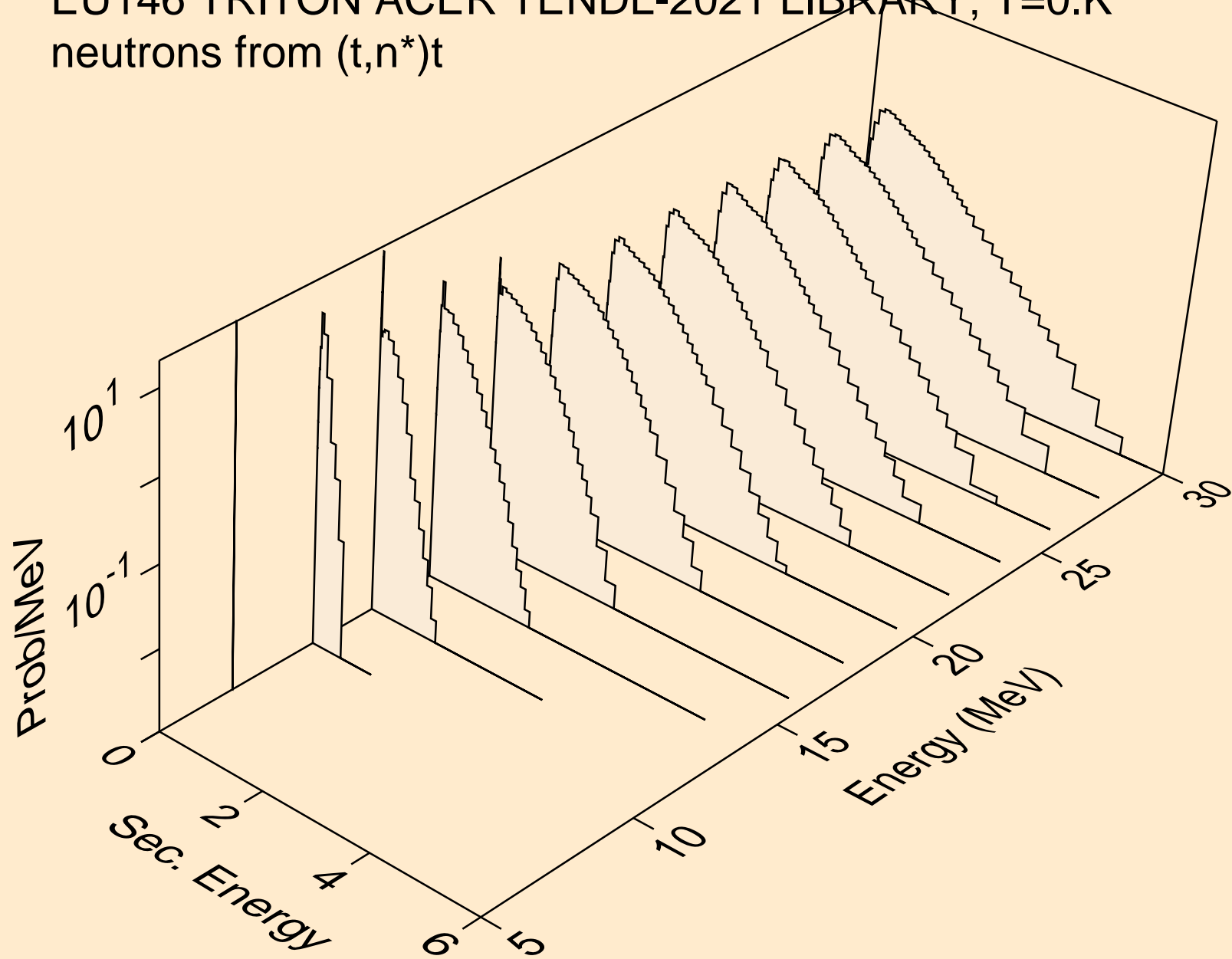

EU146 TRITON ACER TENDL-2021 LIBRARY; T=0.K  
neutrons from (t,n\*)he3

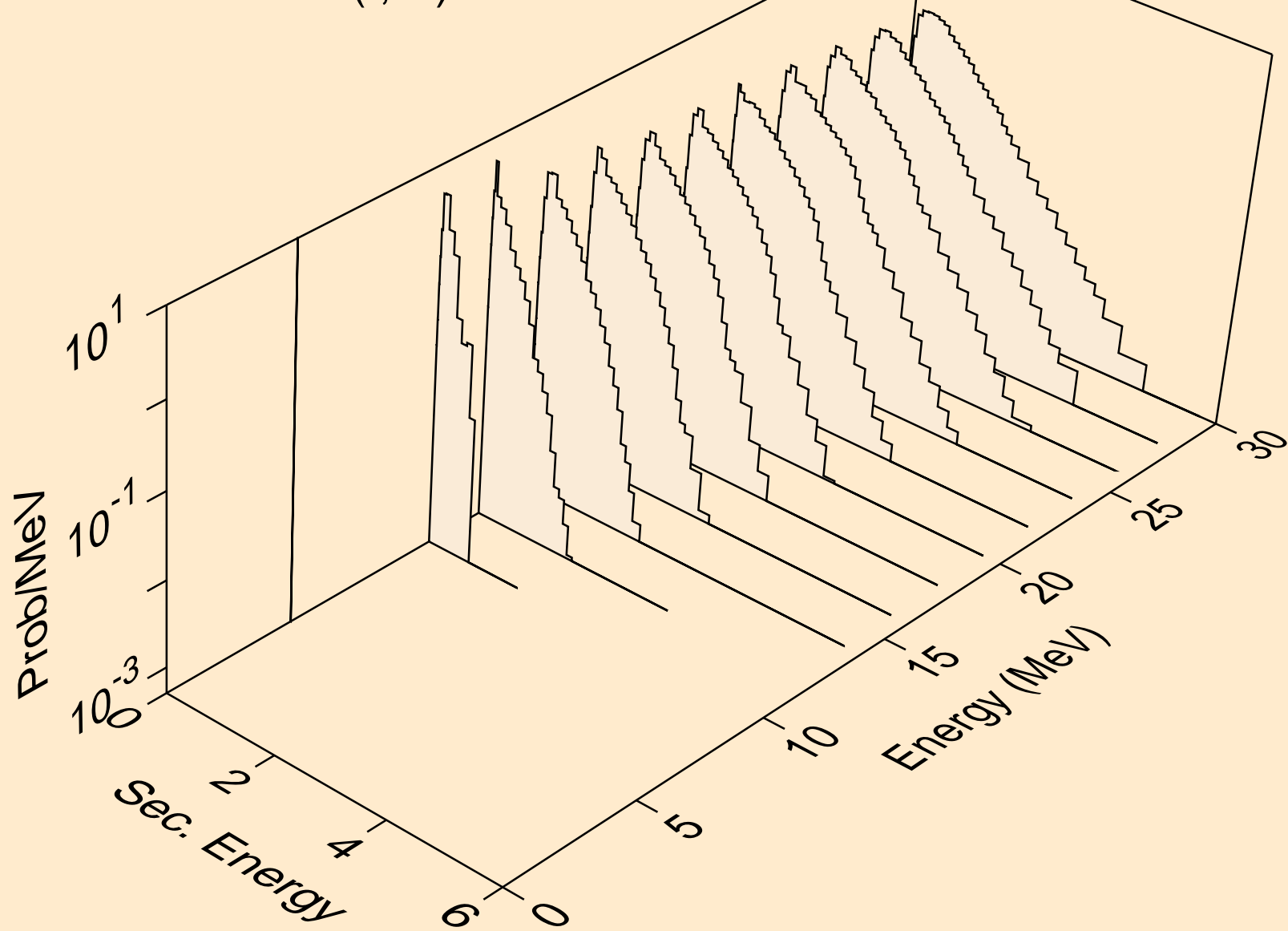

EU146 TRITON ACER TENDL-2021 LIBRARY; T=0.K  
neutrons from (t,4n)

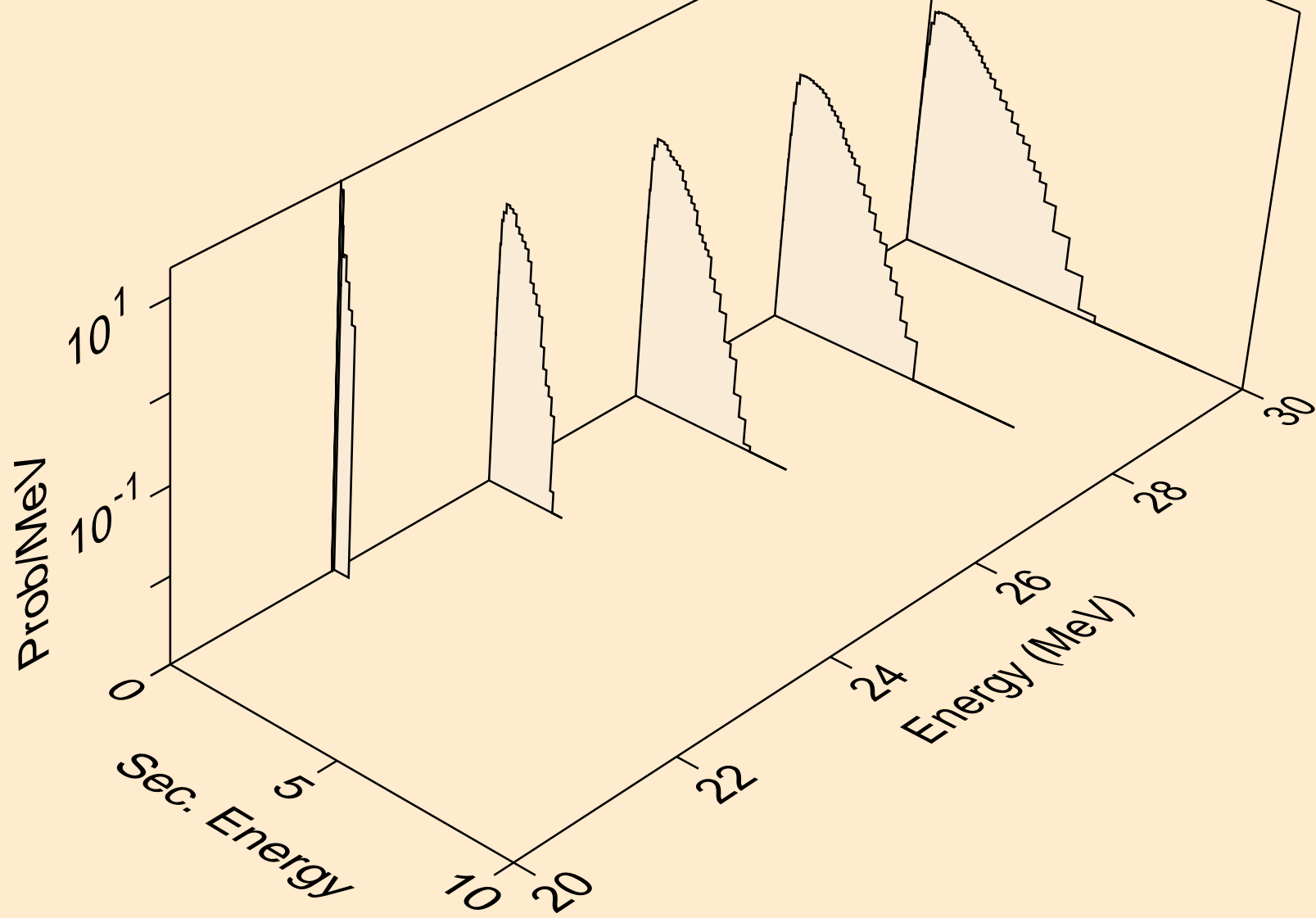

EU146 TRITON ACER TENDL-2021 LIBRARY; T=0.K  
neutrons from (t,2np)

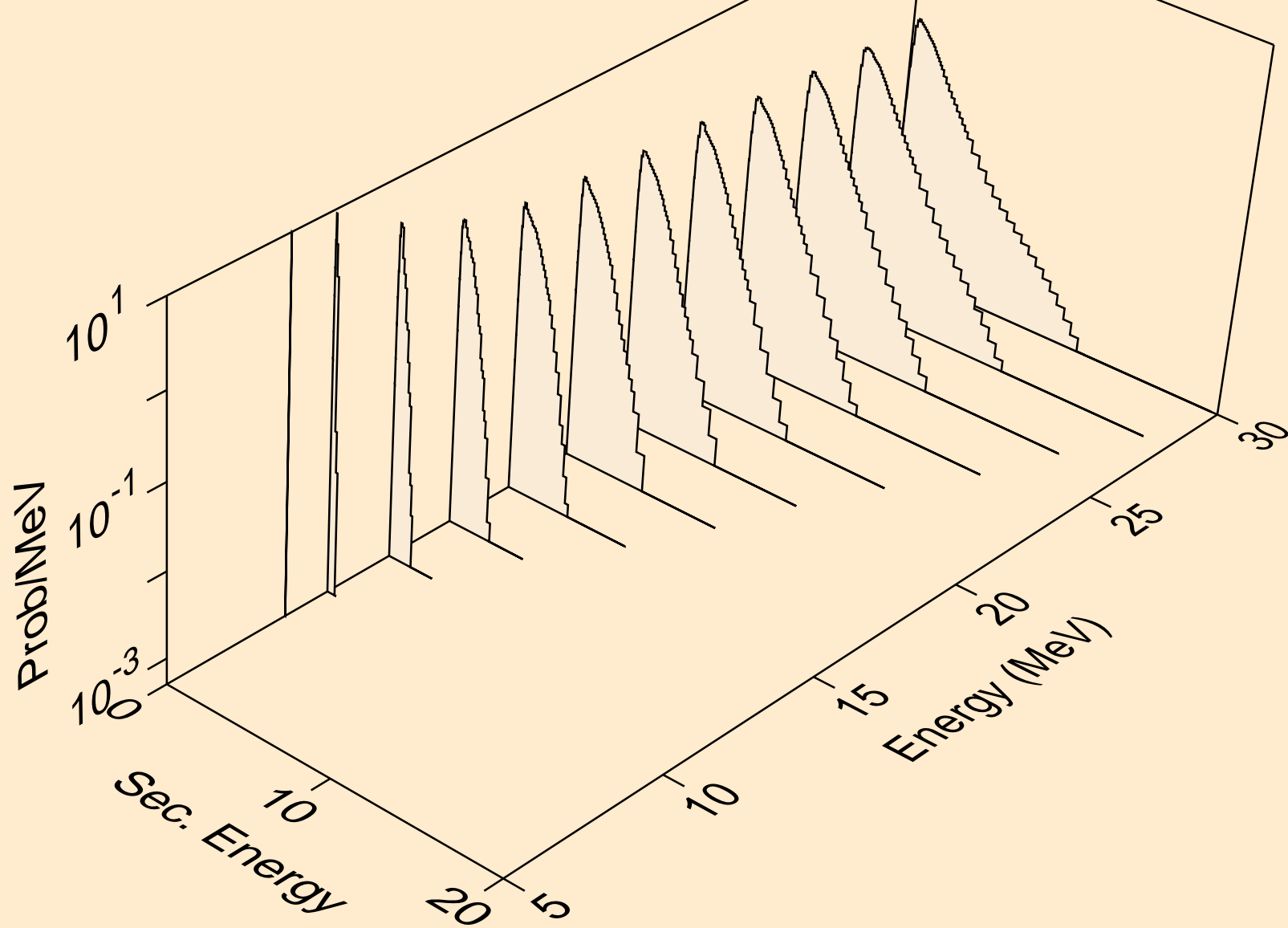

EU146 TRITON ACER TENDL-2021 LIBRARY; T=0.K  
neutrons from (t,3np)

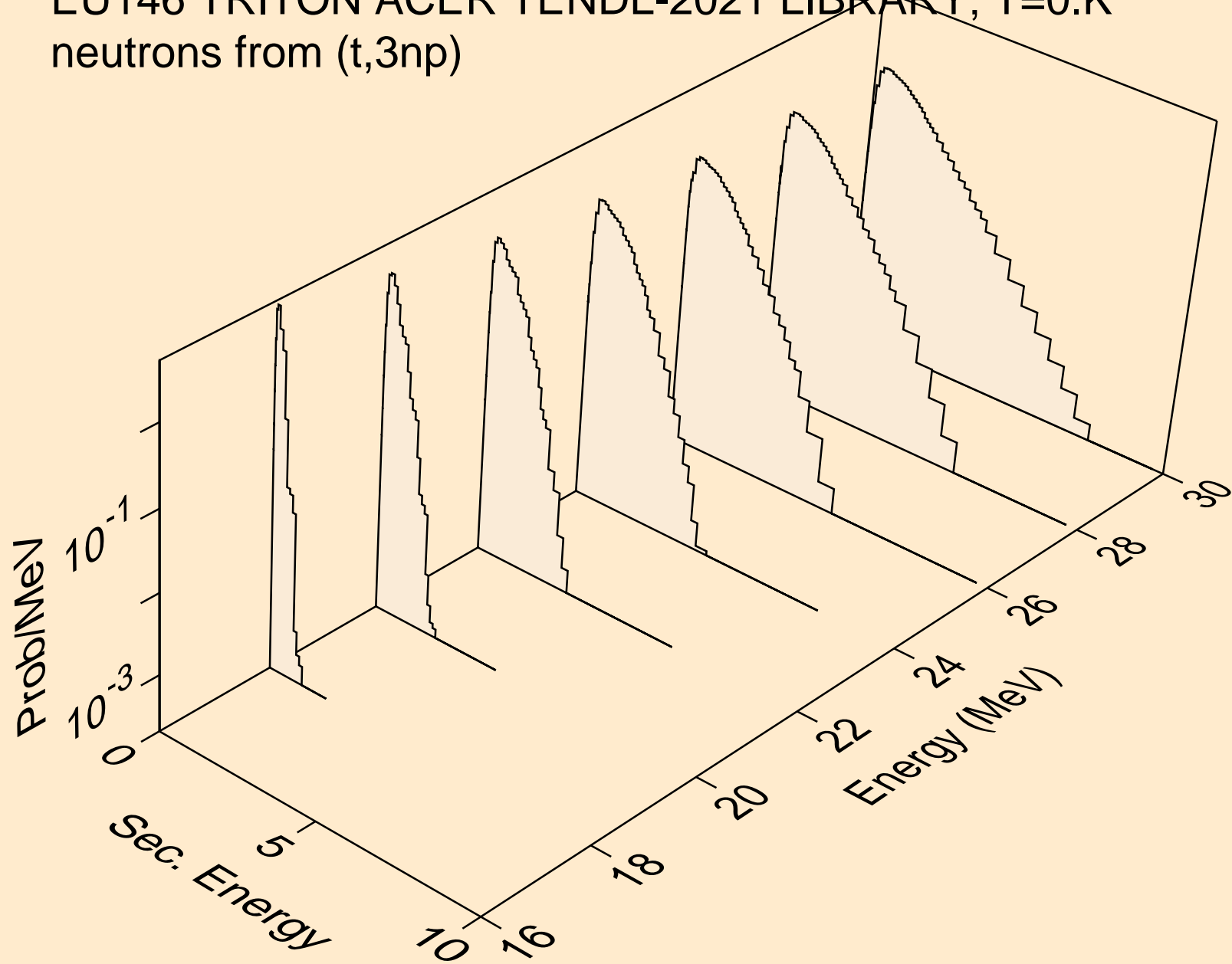



EU146 TRITON ACER TENDL-2021 LIBRARY; T=0.K  
neutrons from (t,2np)

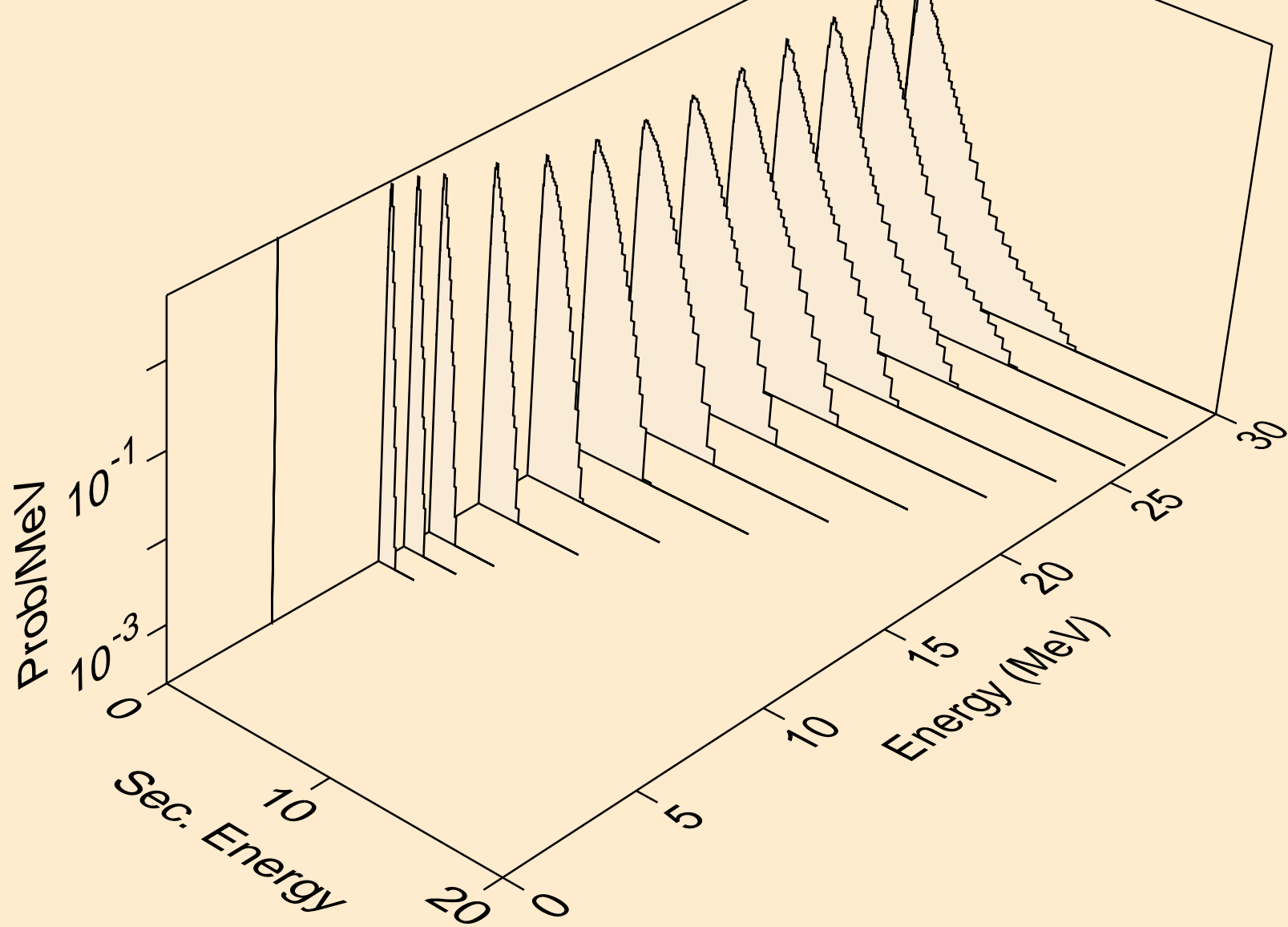

EU146 TRITON ACER TENDL-2021 LIBRARY; T=0.K  
neutrons from (t,npa)

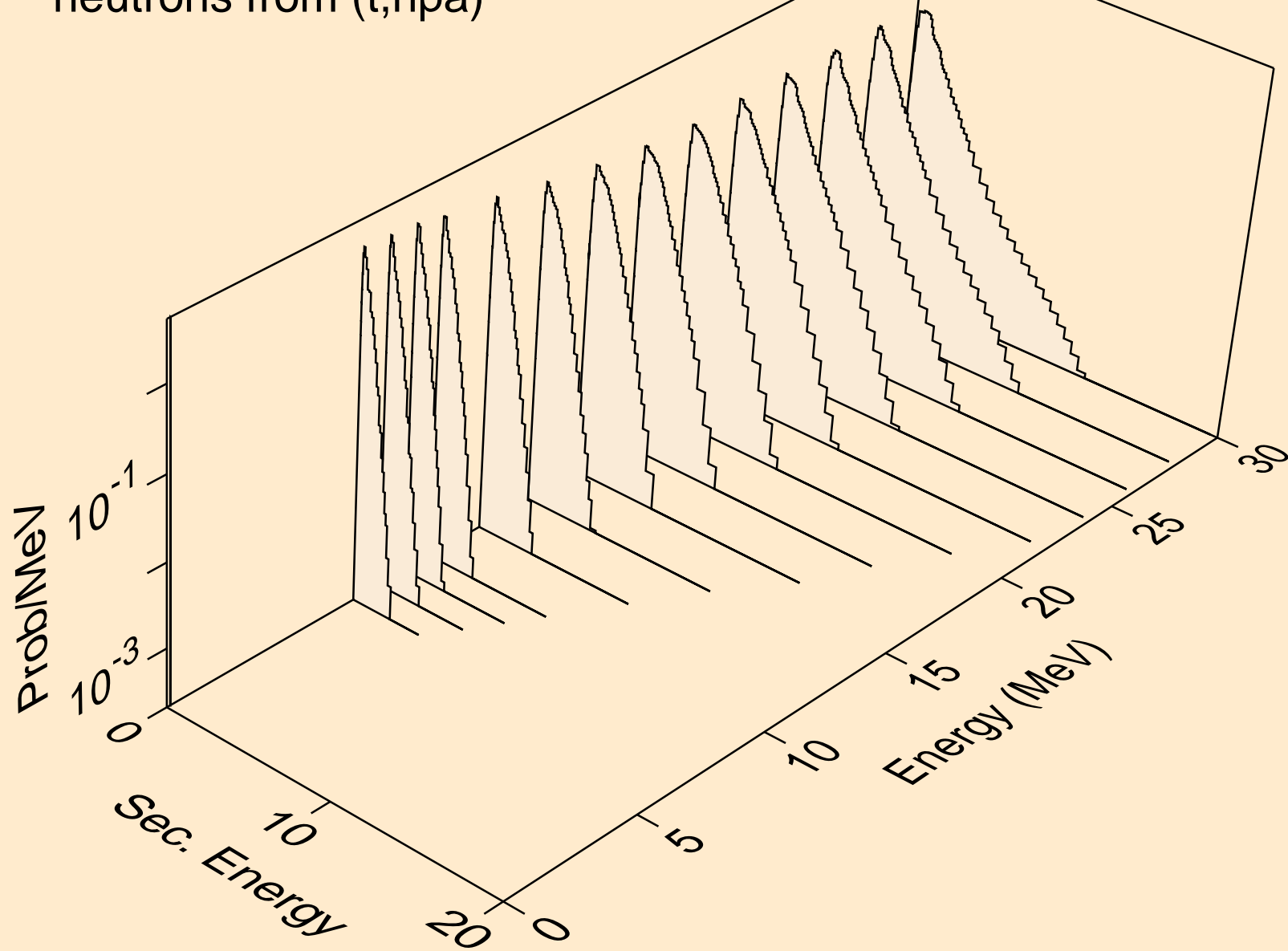

EU146 TRITON ACER TENDL-2021 LIBRARY; T=0.K  
protons from (t,x)

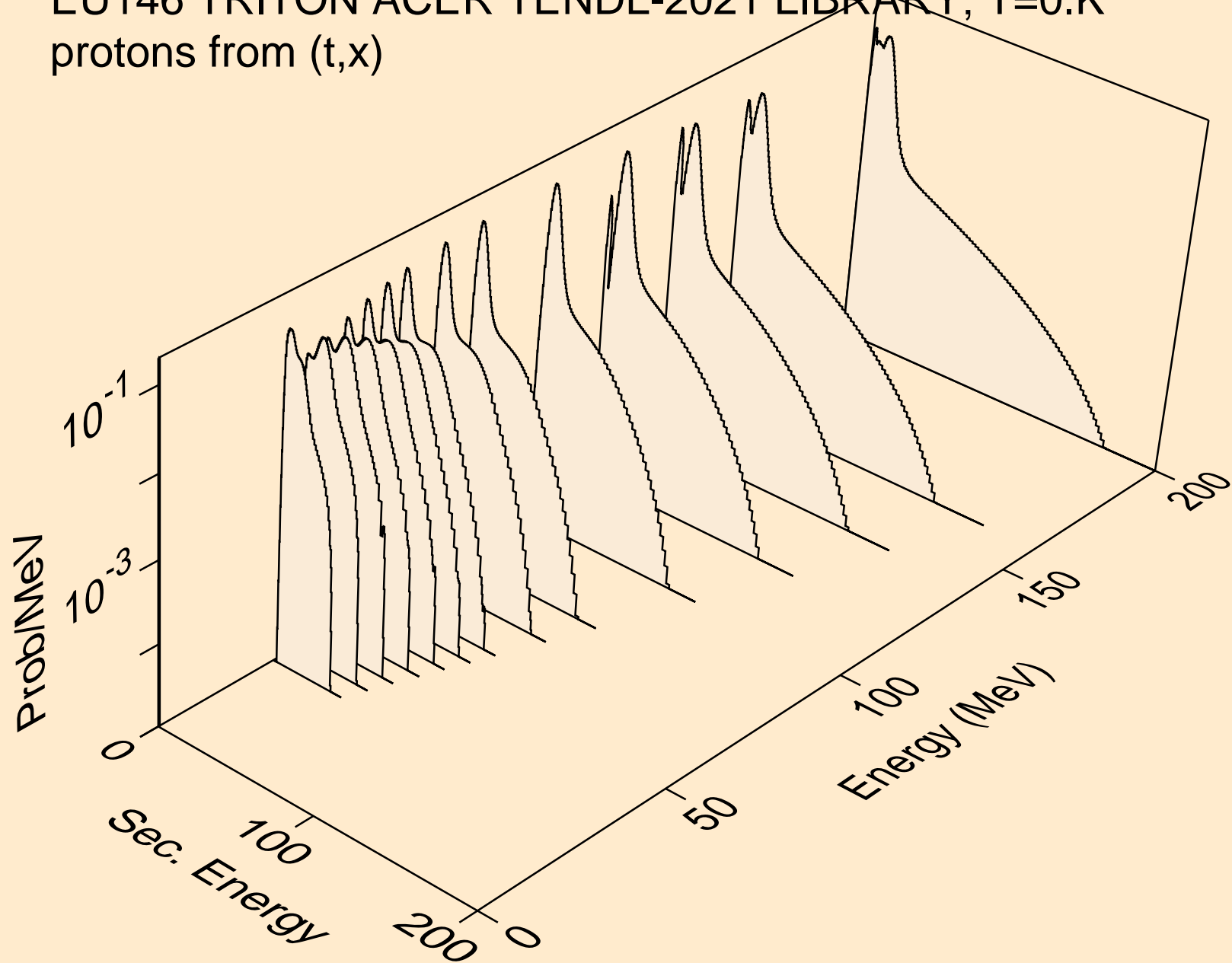

EU146 TRITON ACER TENDL-2021 LIBRARY; T=0.K  
protons from (t,n\*)p

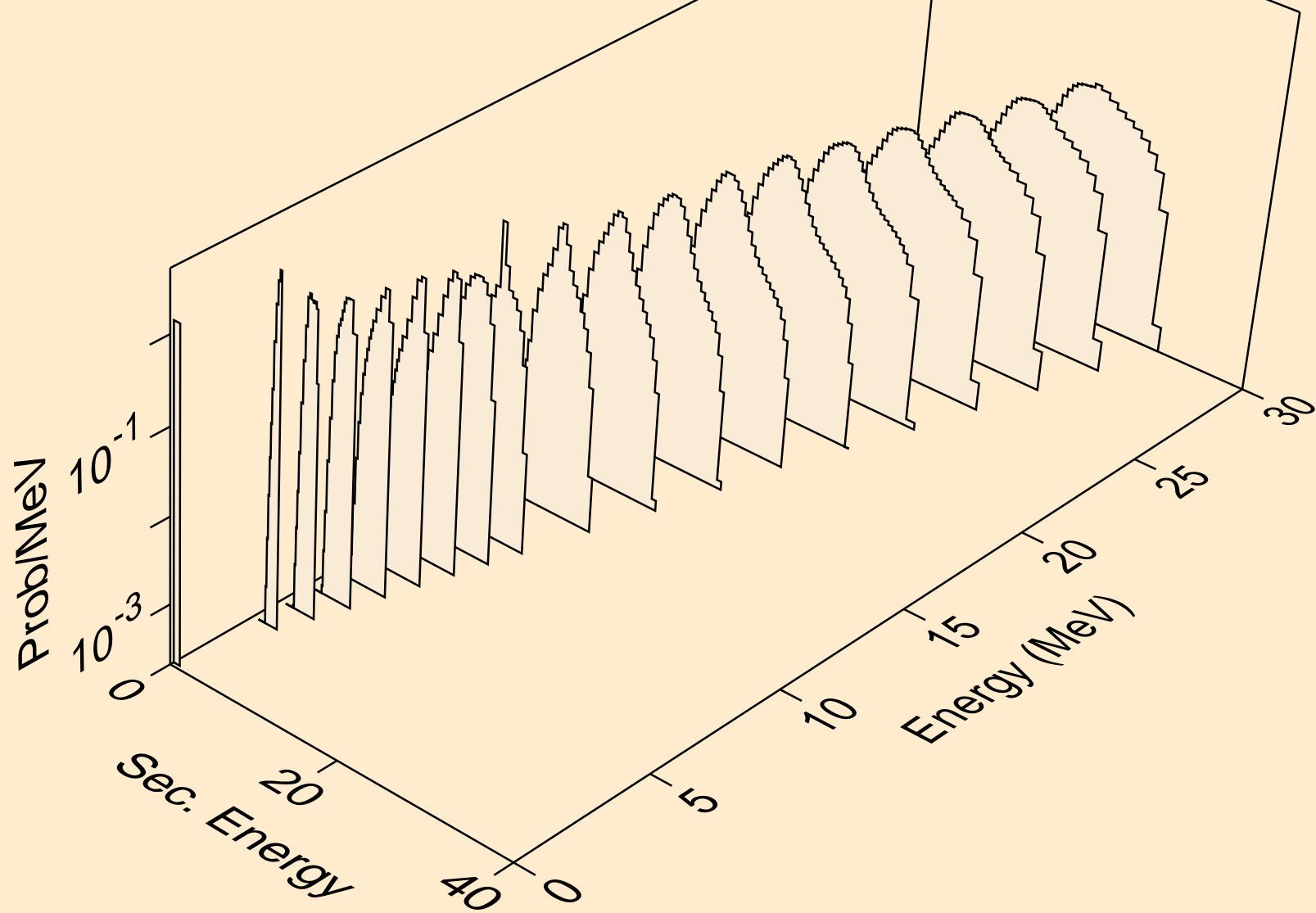

EU146 TRITON ACER TENDL-2021 LIBRARY; T=0.K  
protons from (t,2np)

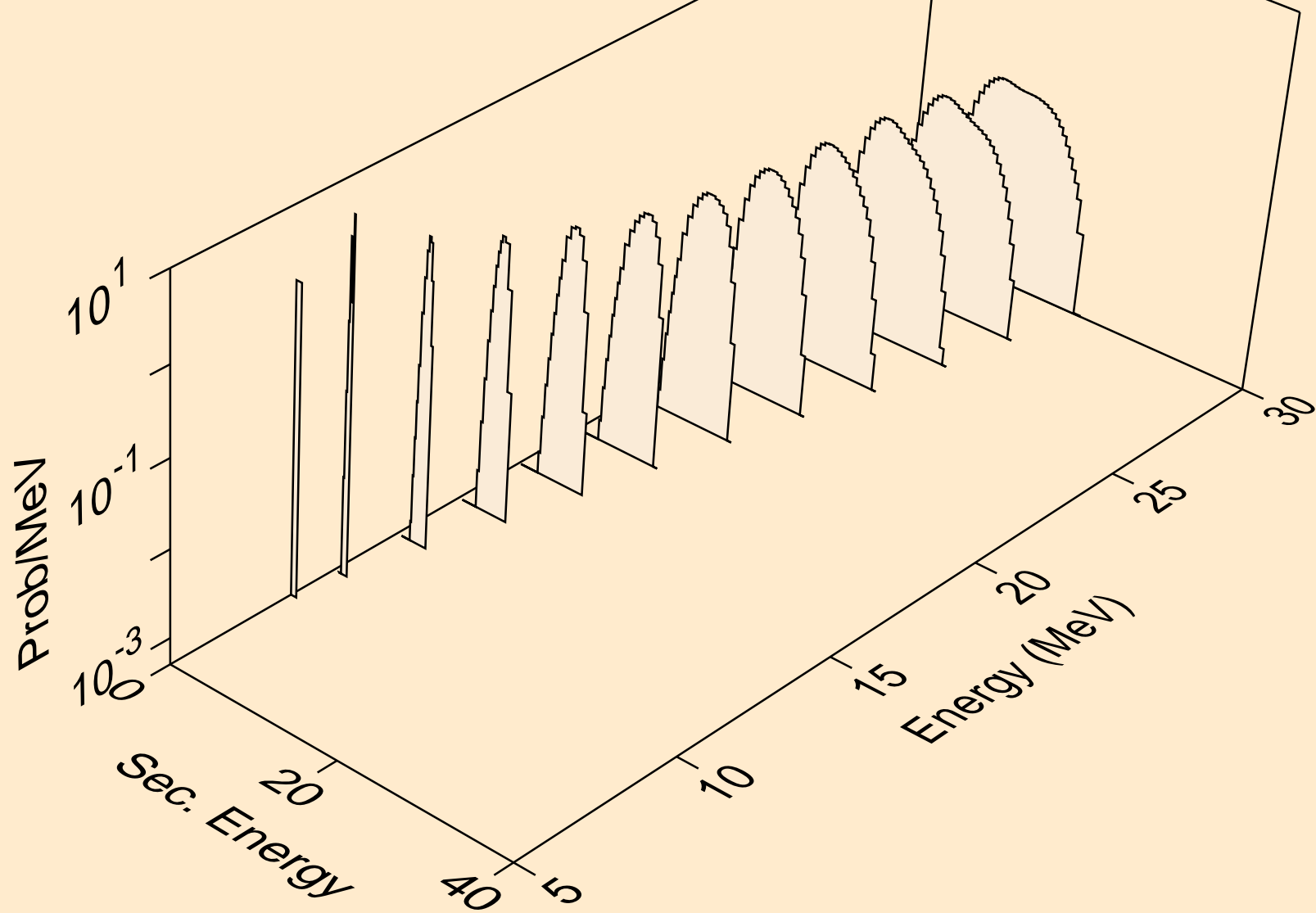

EU146 TRITON ACER TENDL-2021 LIBRARY; T=0.K  
protons from (t,3np)

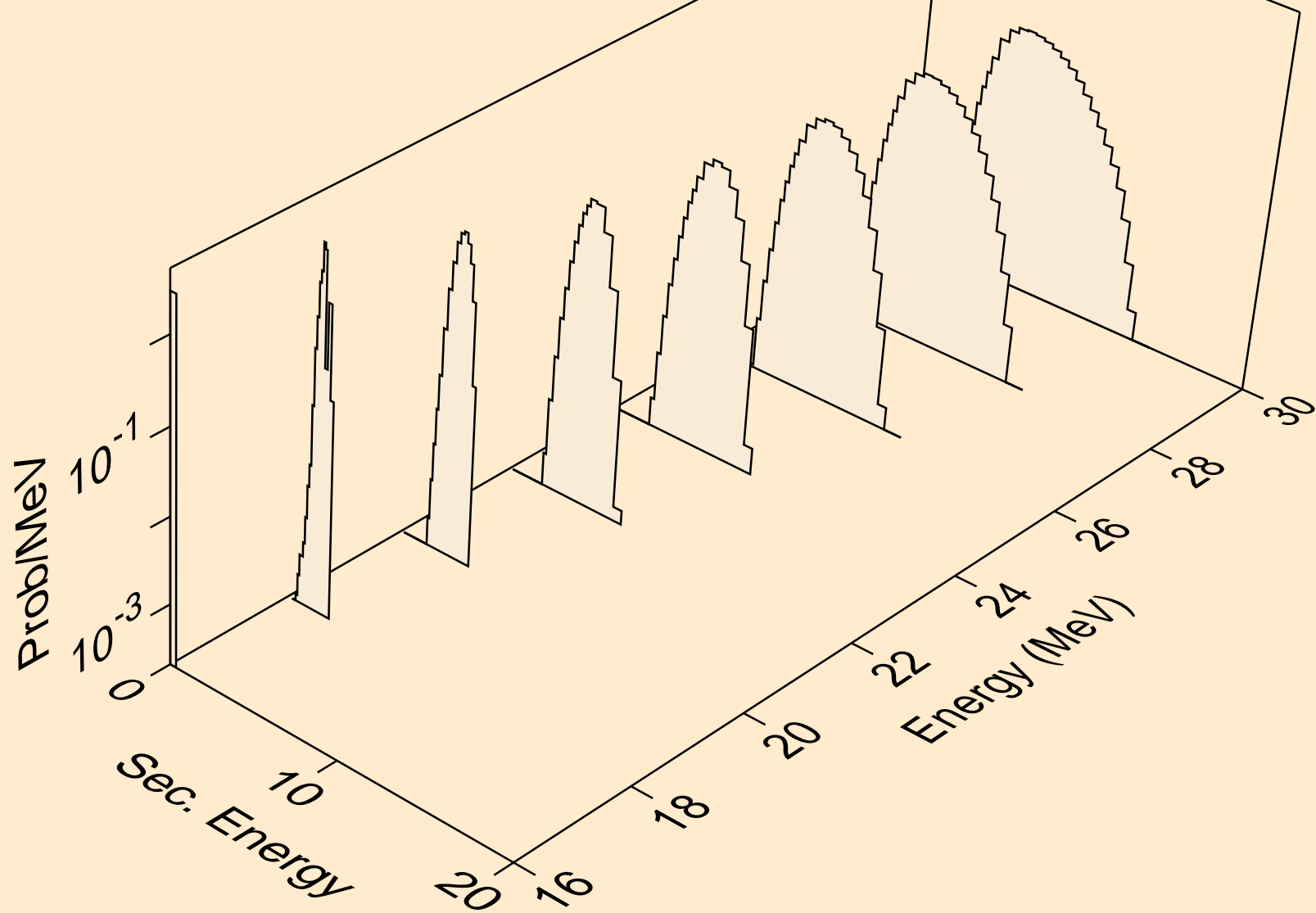

EU146 TRITON ACER TENDL-2021 LIBRARY; T=0.K  
protons from (t,2np)

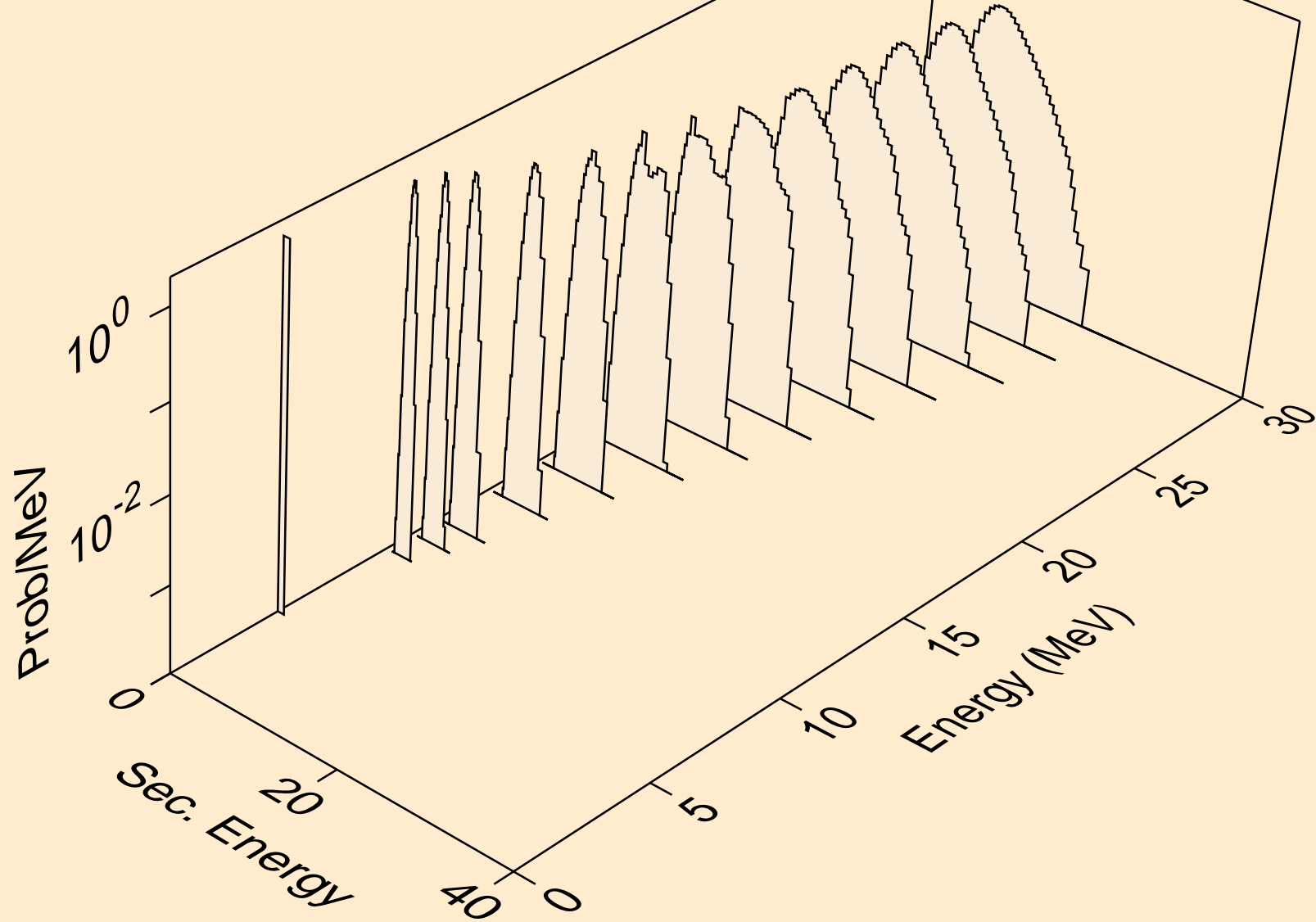

EU146 TRITON ACER TENDL-2021 LIBRARY; T=0.K  
protons from (t,npa)

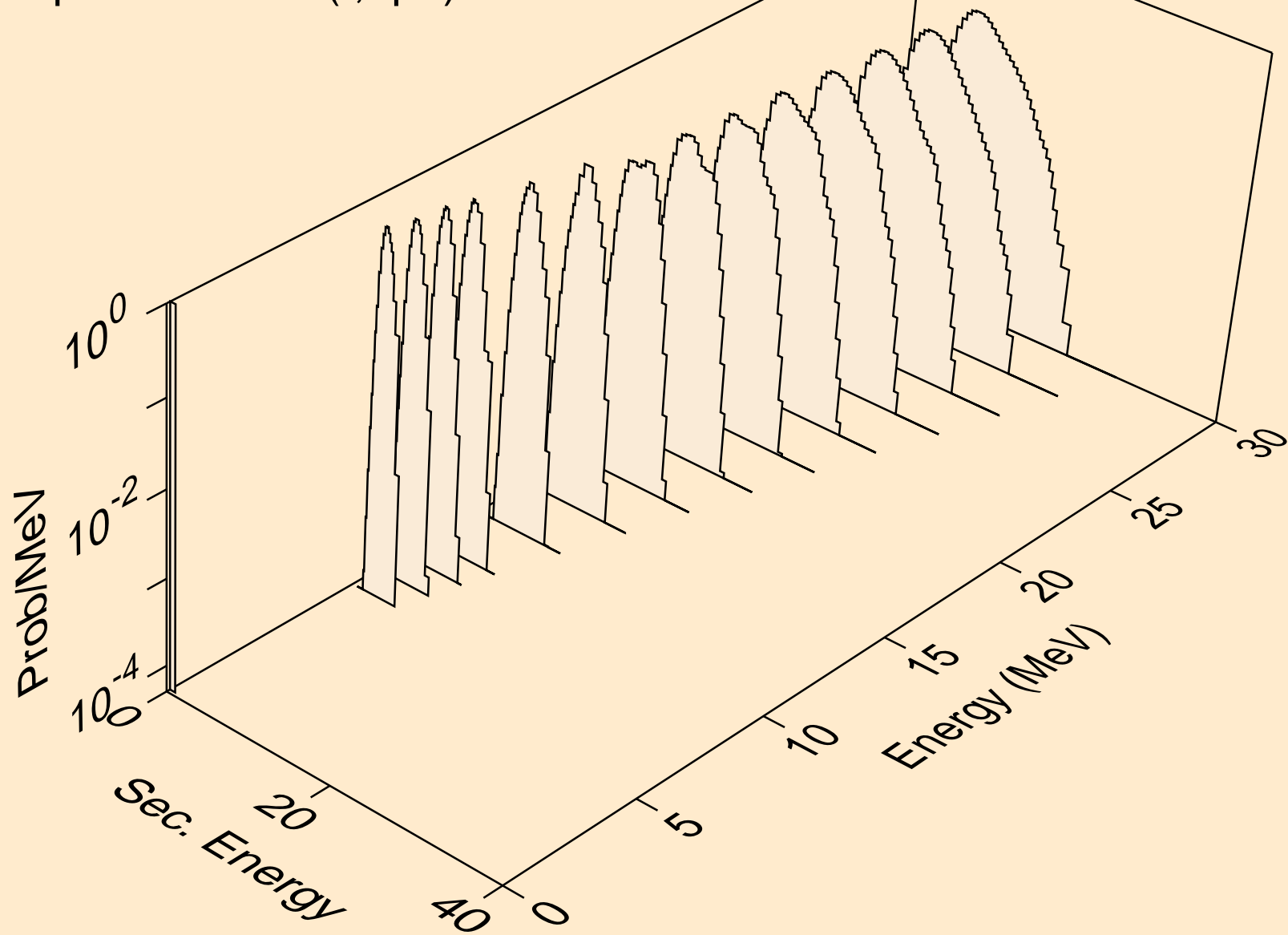



EU146 TRITON ACER TENDL-2021 LIBRARY; T=0.K  
protons from (t,p)

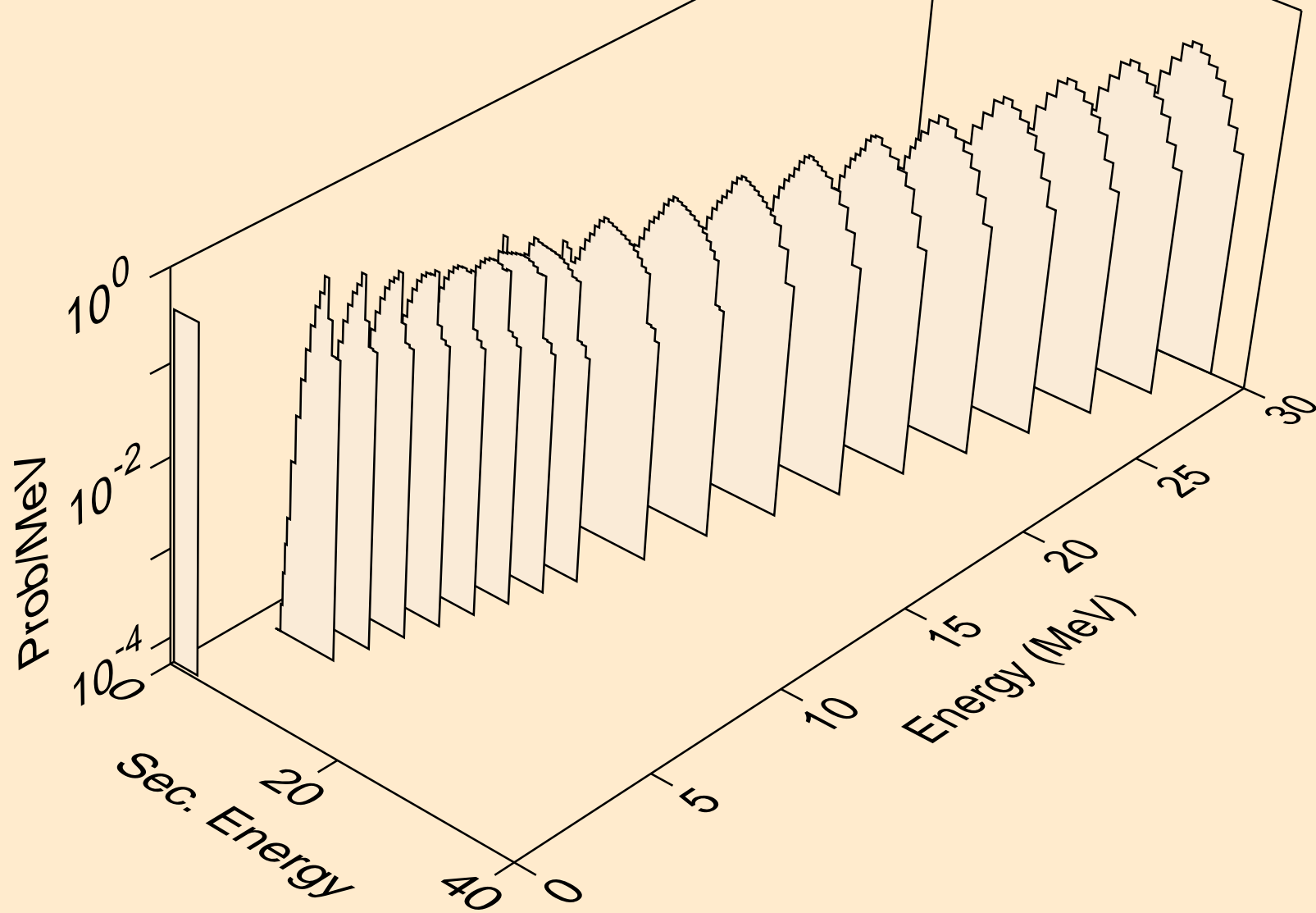

EU146 TRITON ACER TENDL-2021 LIBRARY; T=0.K  
protons from (t,2p)

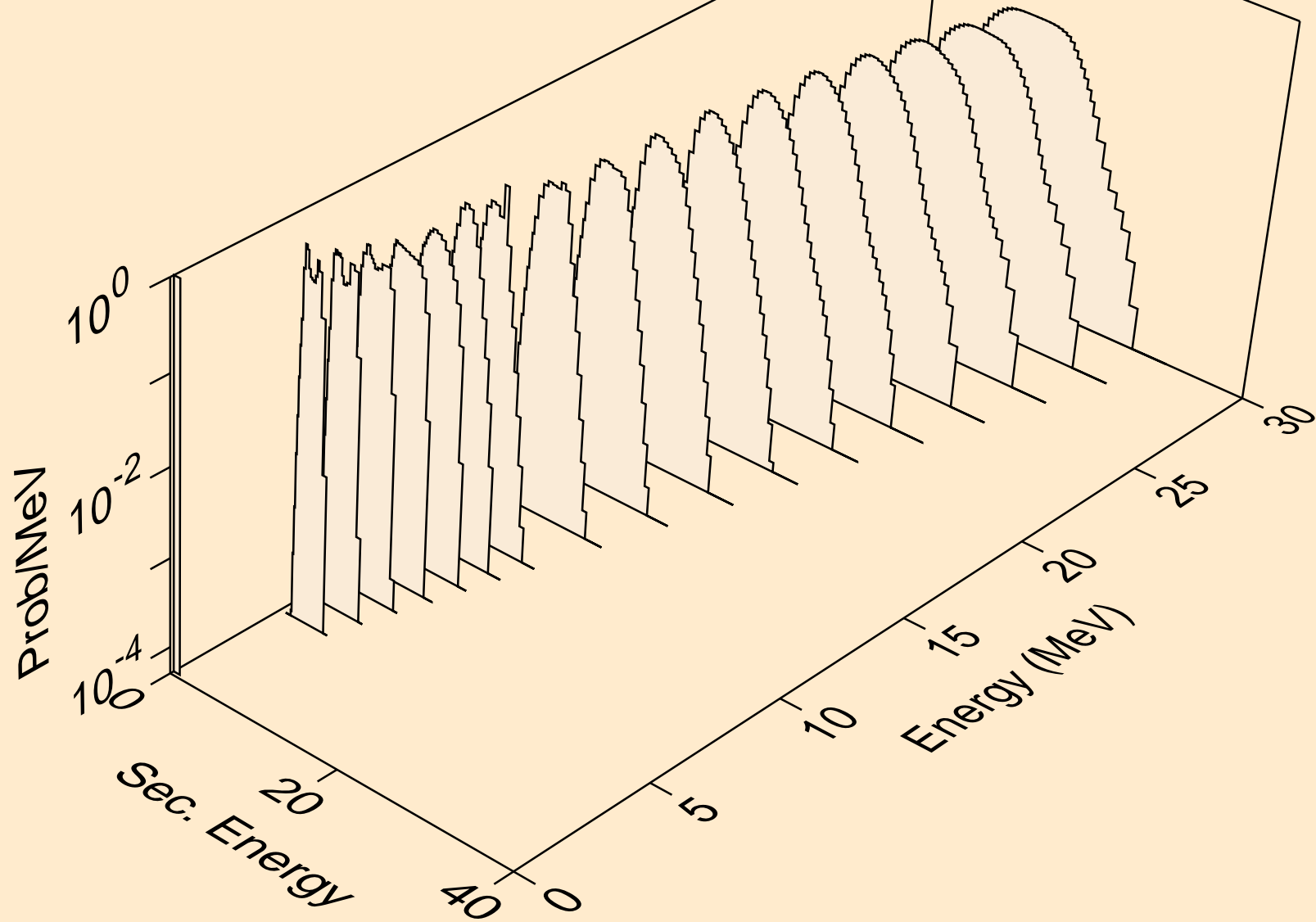

EU146 TRITON ACER TENDL-2021 LIBRARY; T=0.K  
protons from (t,pa)

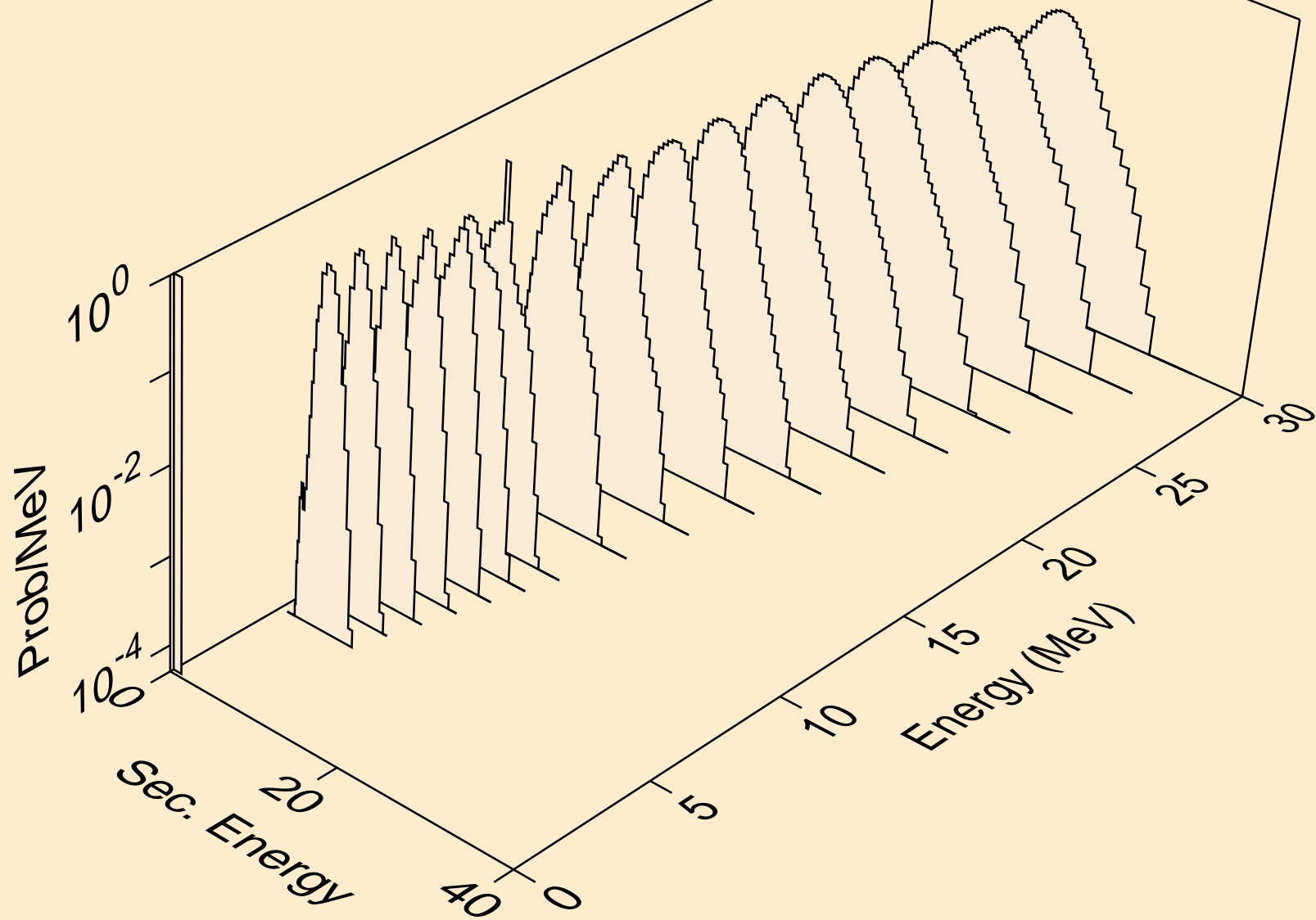

EU146 TRITON ACER TENDL-2021 LIBRARY; T=0.K  
protons from (t,pd)

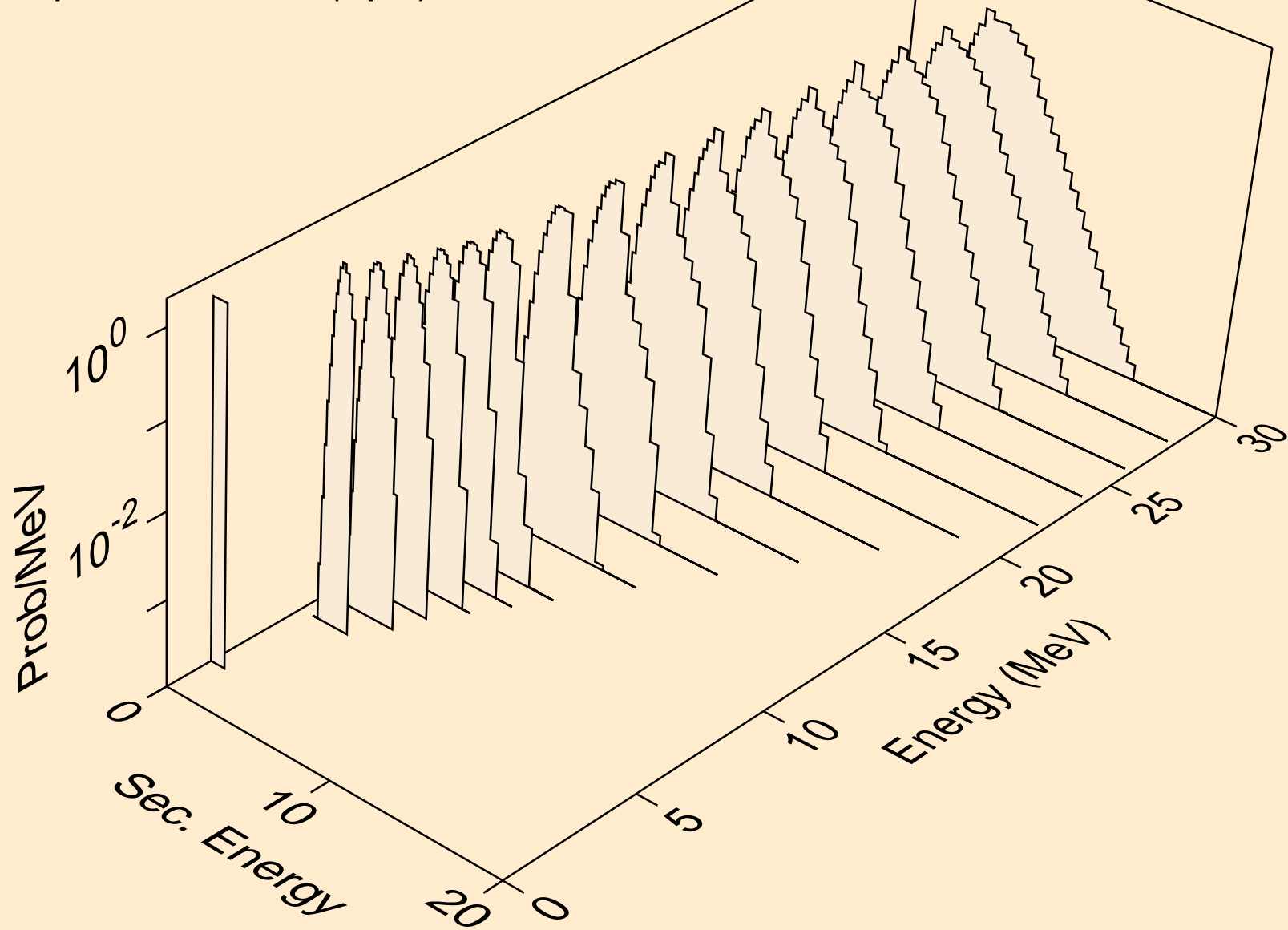

EU146 TRITON ACER TENDL-2021 LIBRARY; T=0.K  
protons from (t,pt)

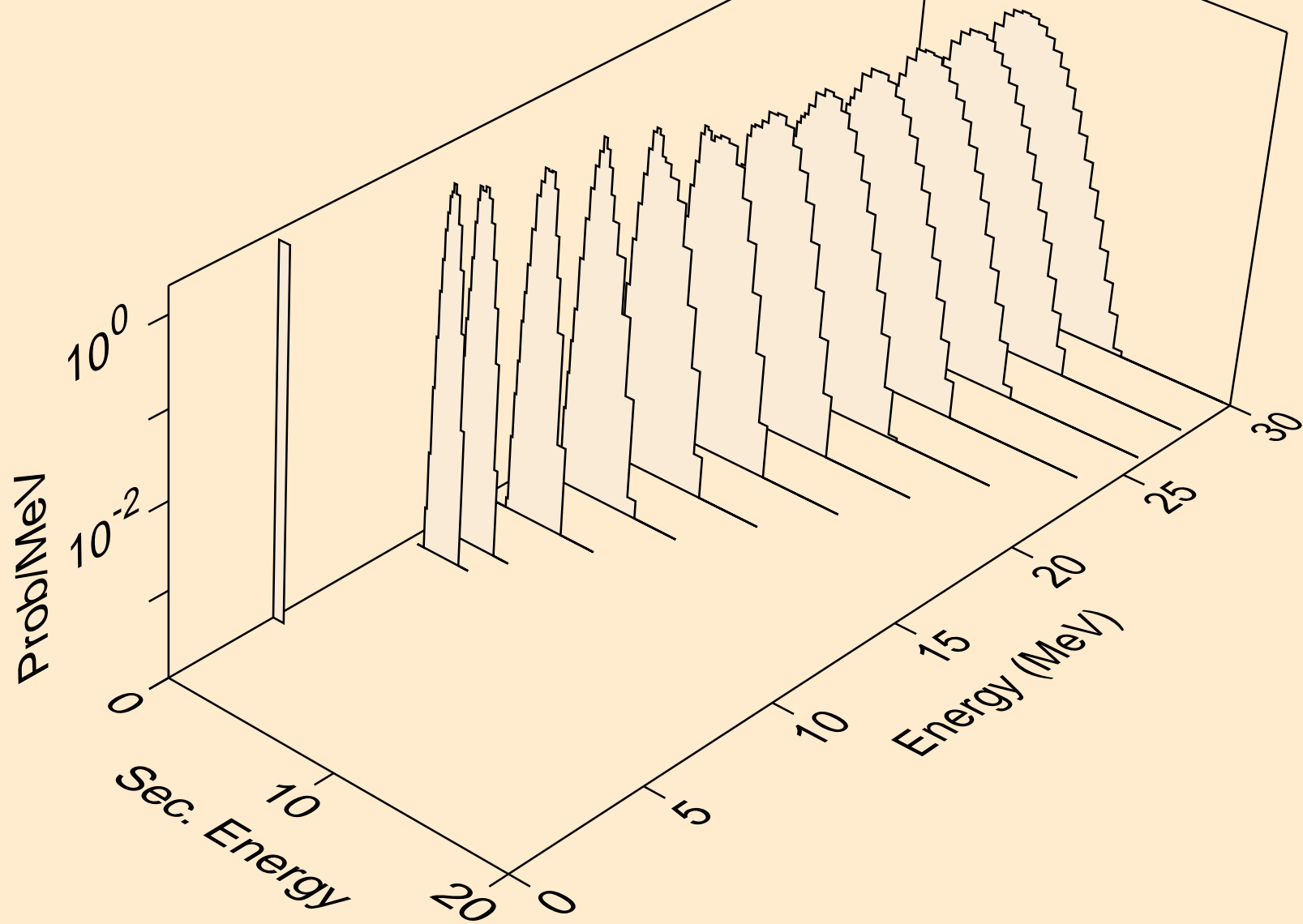

EU146 TRITON ACER TENDL-2021 LIBRARY; T=0.K  
deuterons from (t,x)

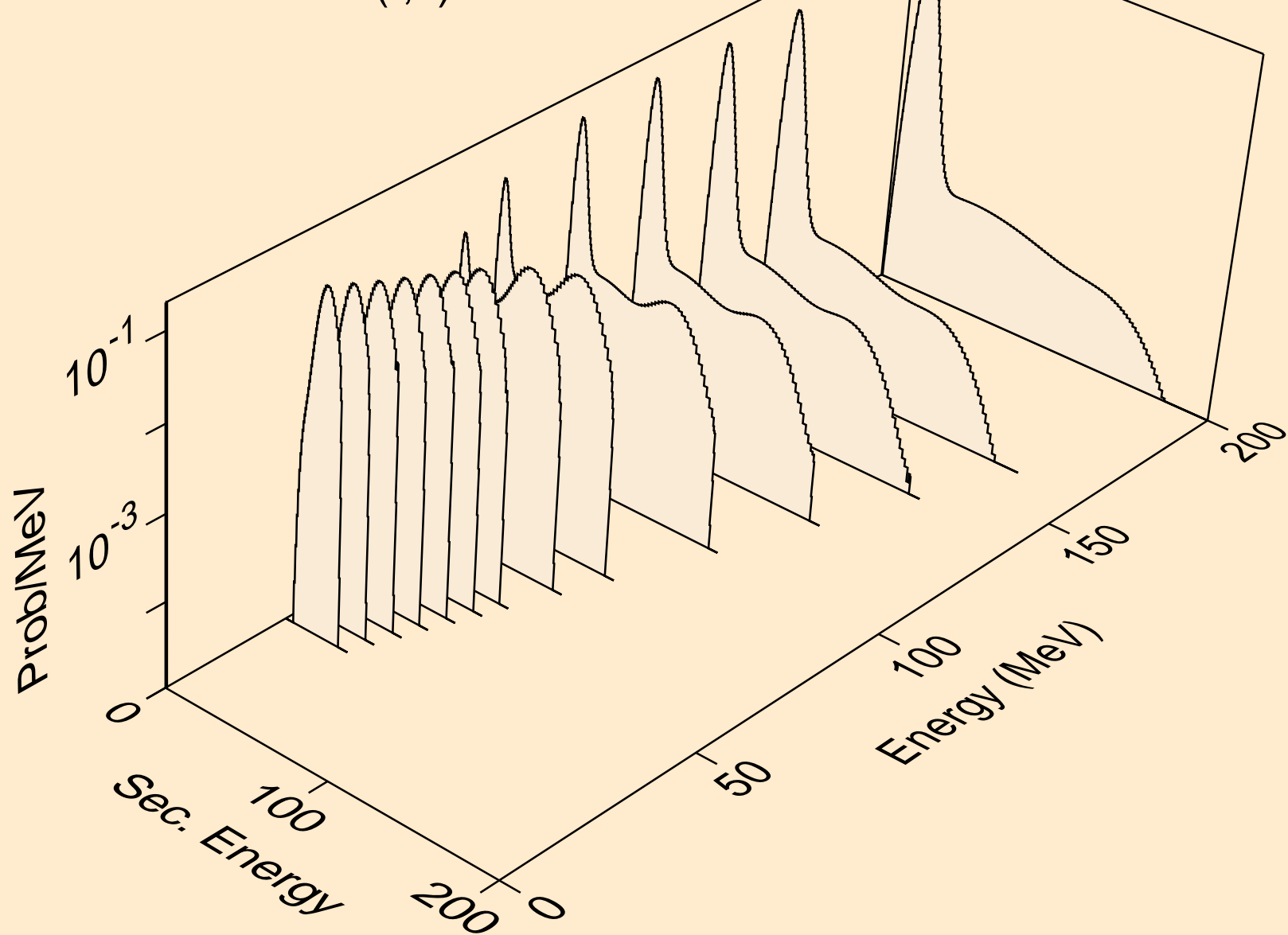

EU146 TRITON ACER TENDL-2021 LIBRARY; T=0.K  
deuterons from (t,2nd)

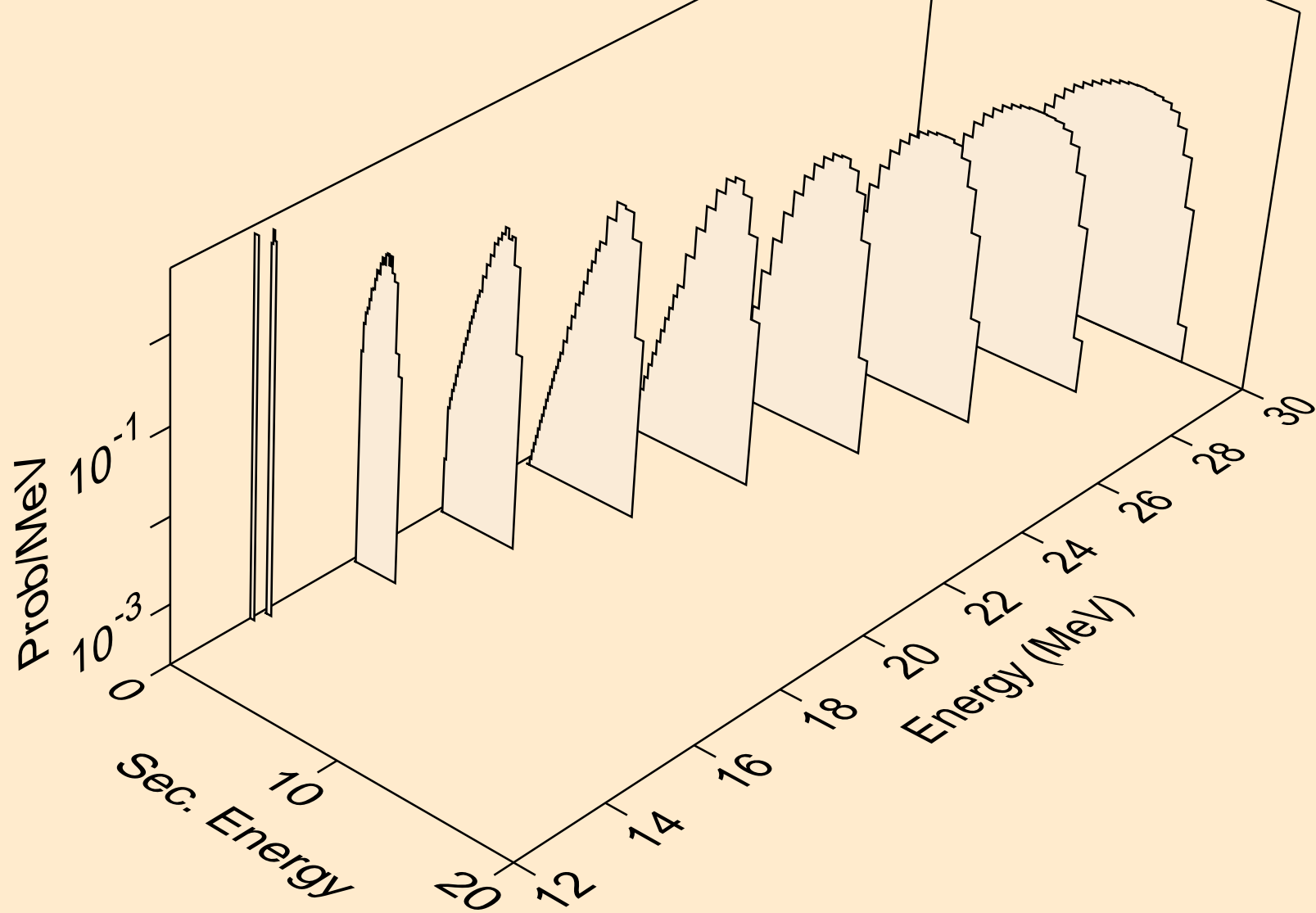

EU146 TRITON ACER TENDL-2021 LIBRARY; T=0.K  
deuterons from (t,n\*)d

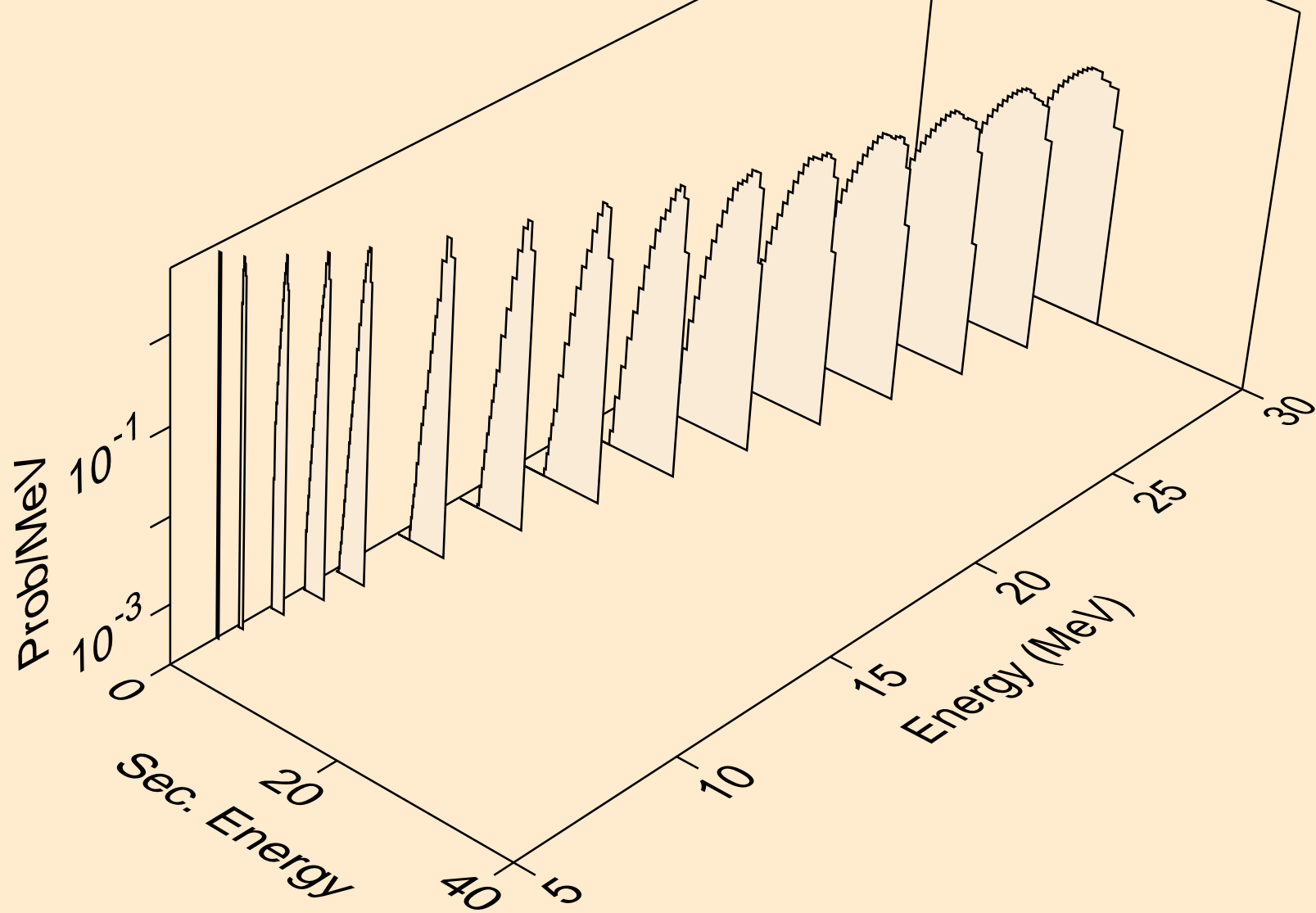



EU146 TRITON ACER TENDL-2021 LIBRARY; T=0.K  
deuterons from (t,d)

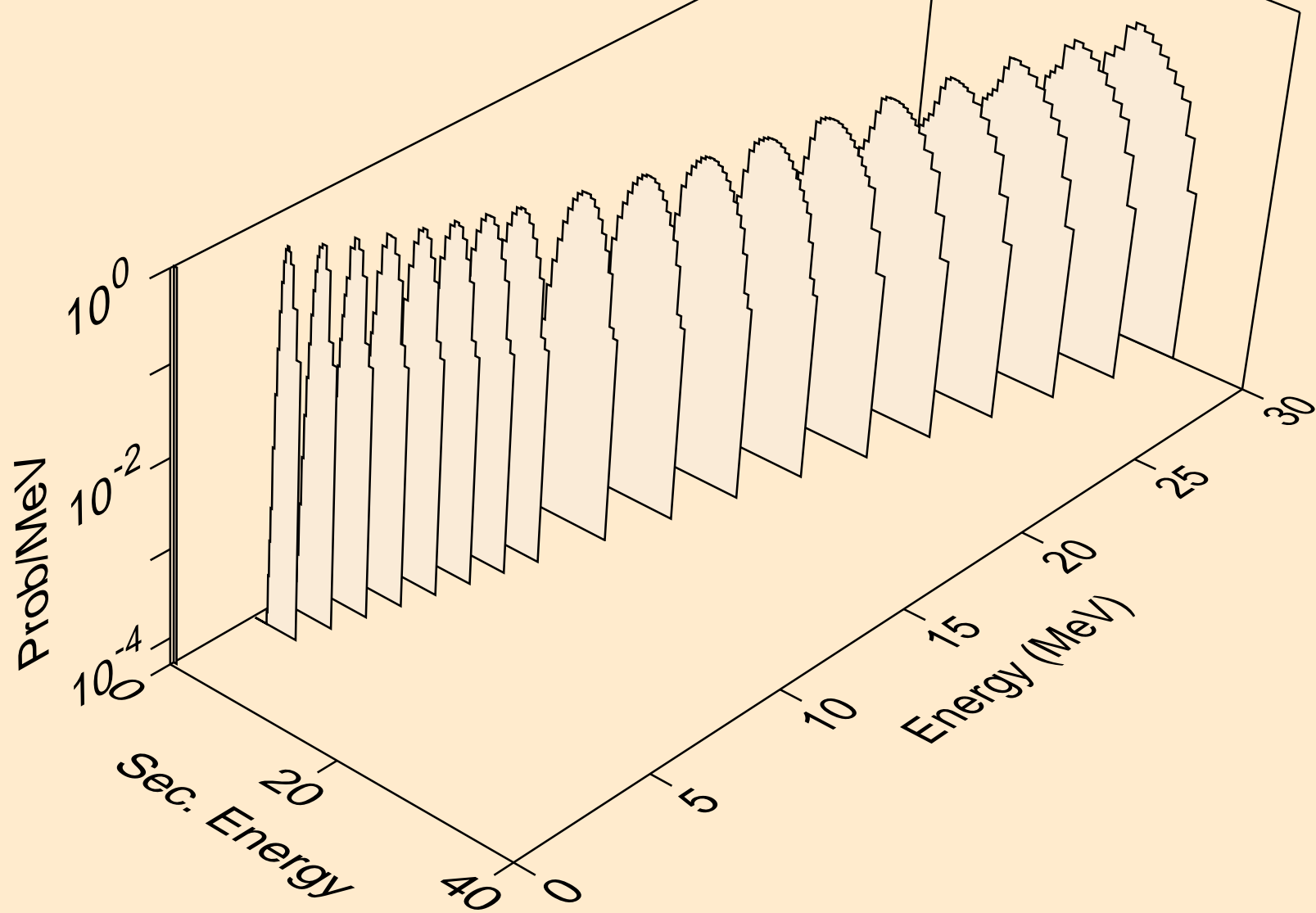

EU146 TRITON ACER TENDL-2021 LIBRARY; T=0.K  
deuterons from (t,pd)

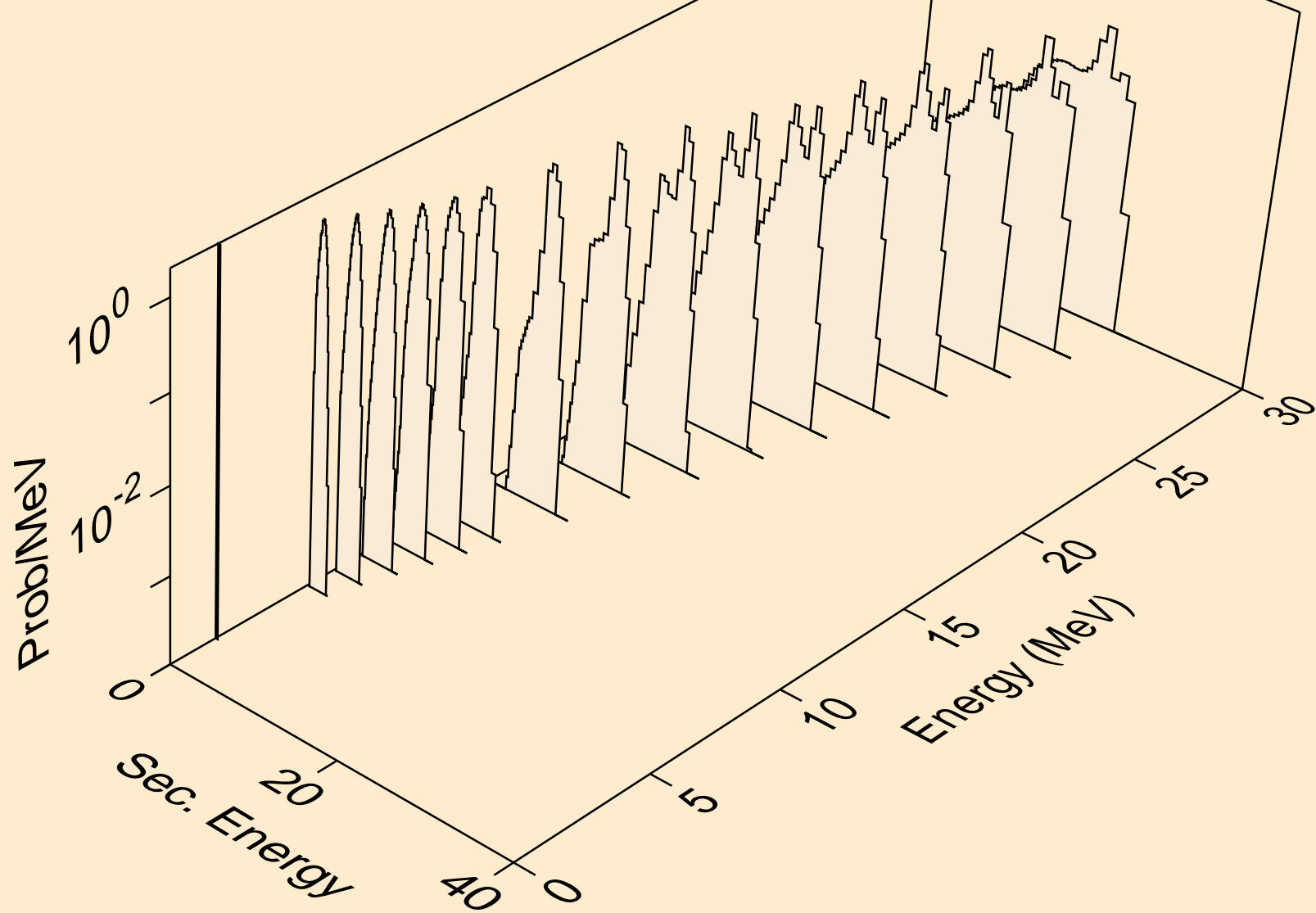

EU146 TRITON ACER TENDL-2021 LIBRARY; T=0.K  
deuterons from (t,da)

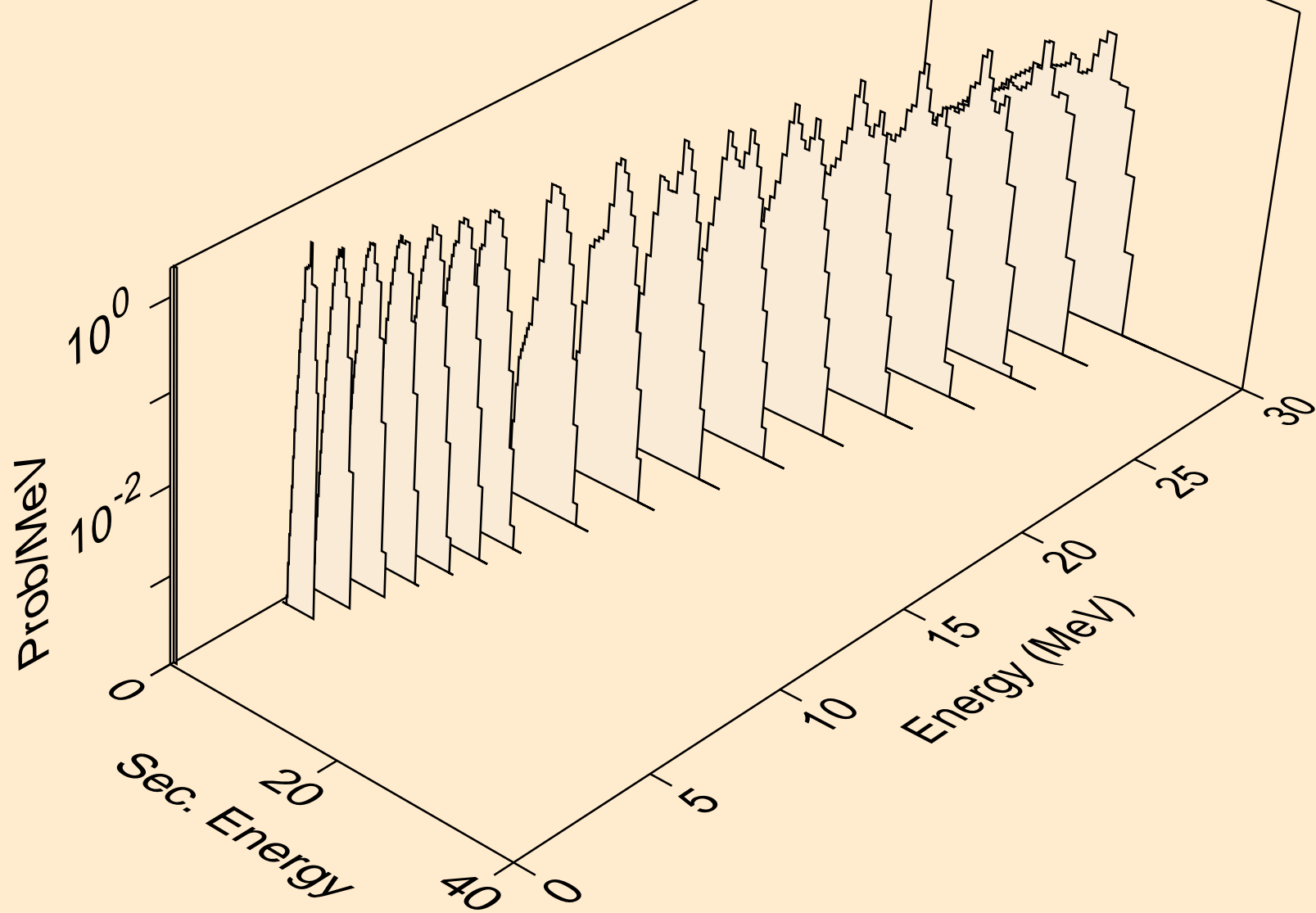

EU146 TRITON ACER TENDL-2021 LIBRARY; T=0.K  
he3s from (t,x)

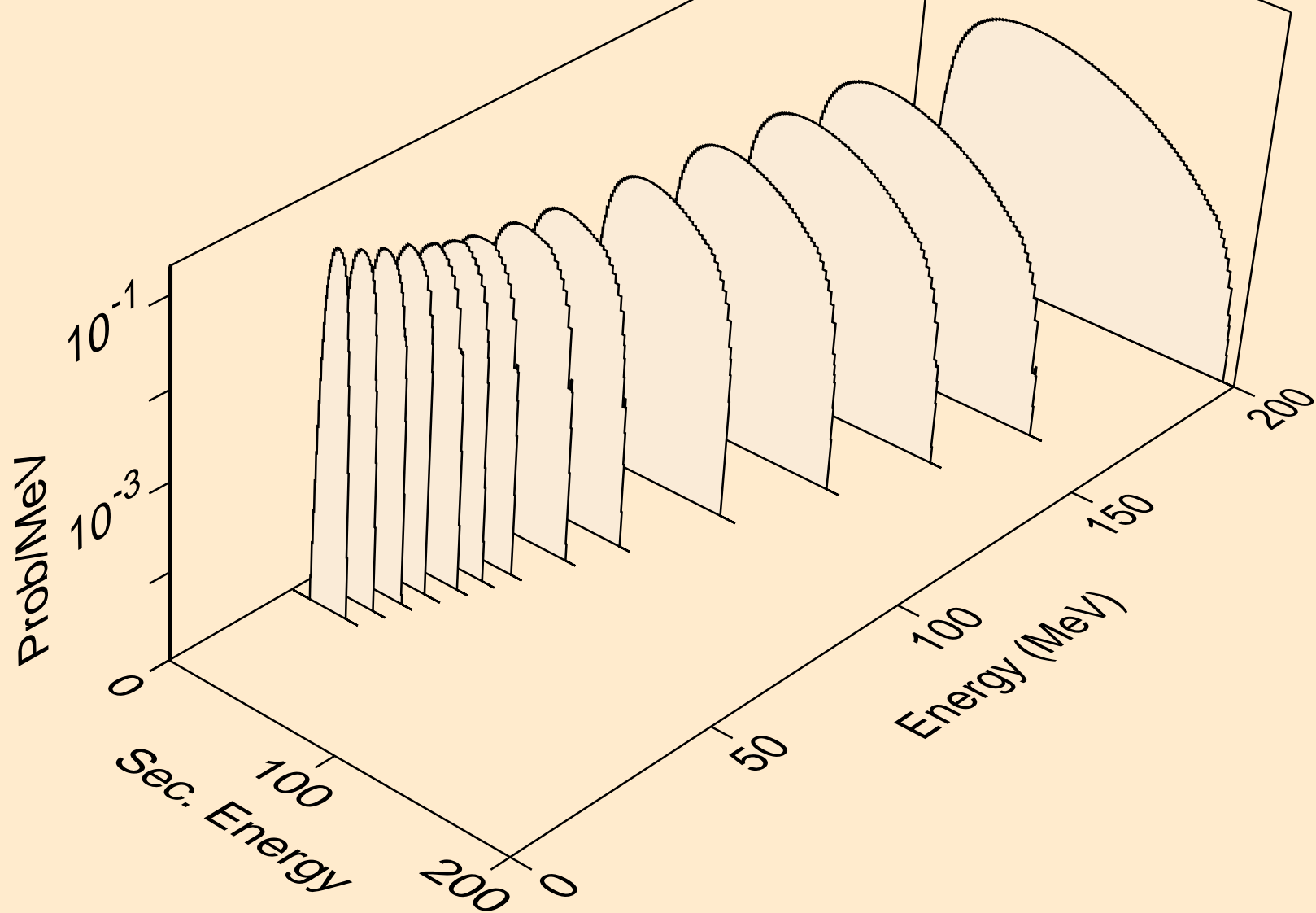

EU146 TRITON ACER TENDL-2021 LIBRARY; T=0.K  
he3s from (t,n\*)he3

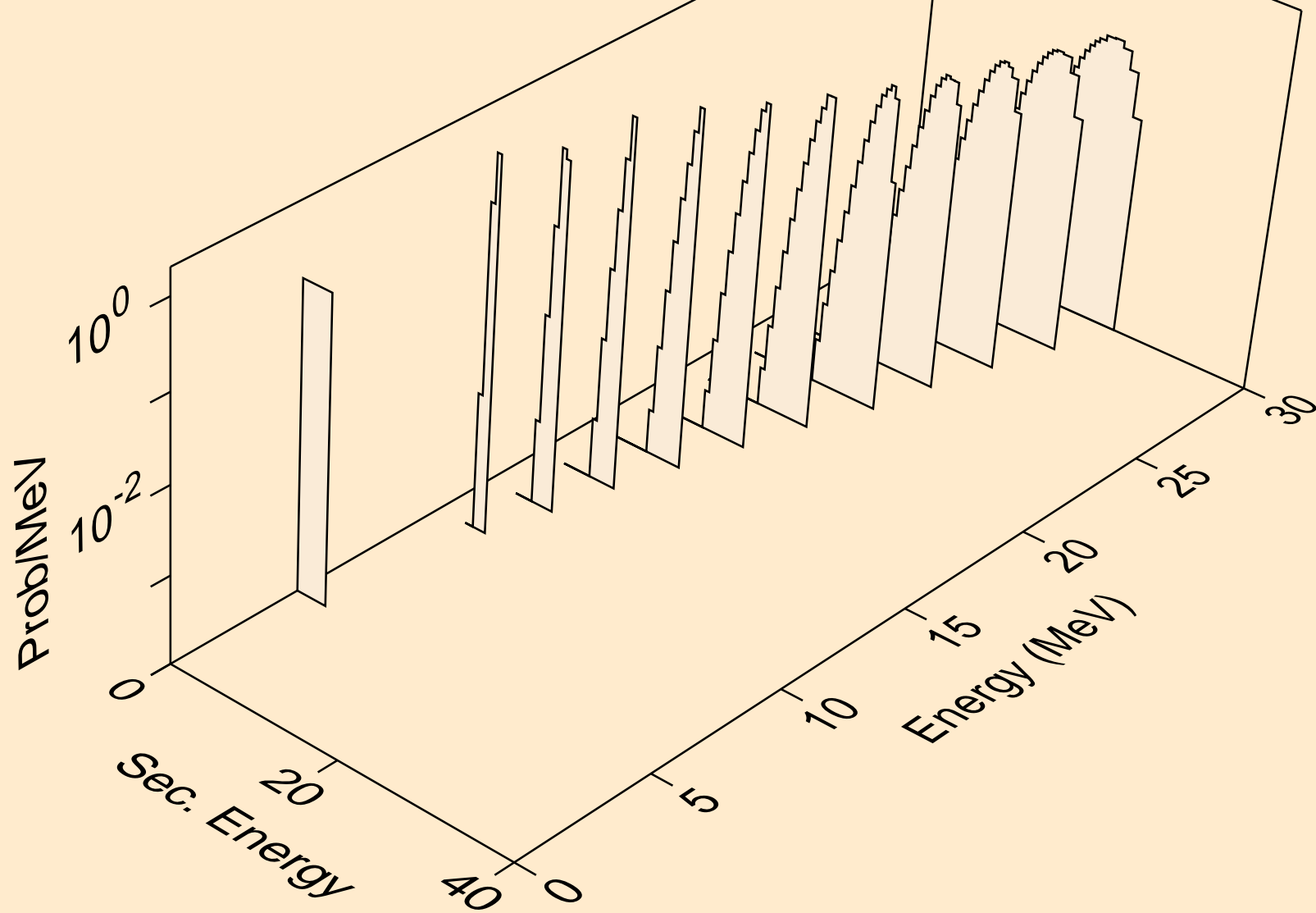

EU146 TRITON ACER TENDL-2021 LIBRARY; T=0.K  
he3s from (t,he3)

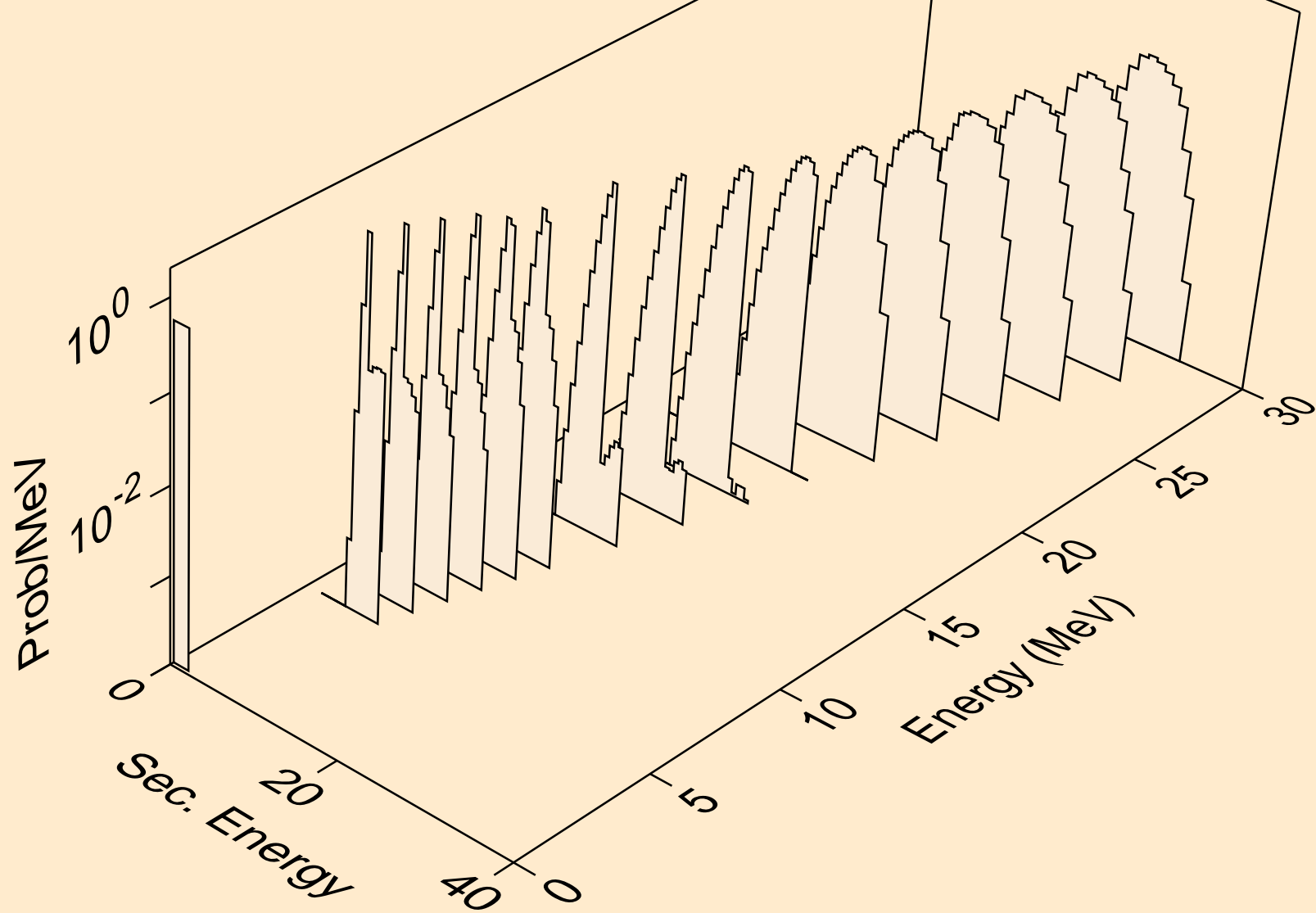

EU146 TRITON ACER TENDL-2021 LIBRARY; T=0.K  
alphas from (t,x)

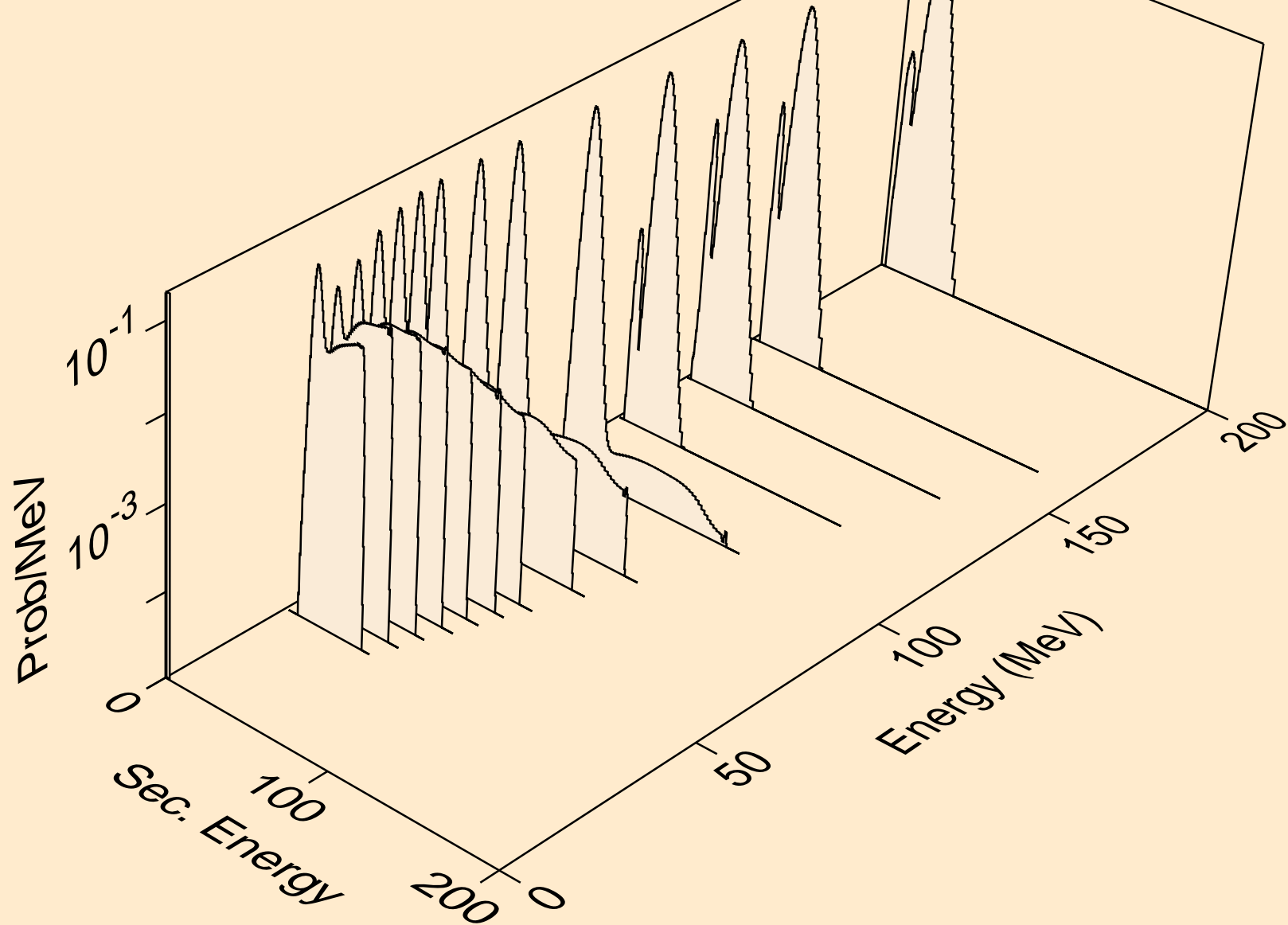

EU146 TRITON ACER TENDL-2021 LIBRARY; T=0.K  
alphas from (t,n\*)a

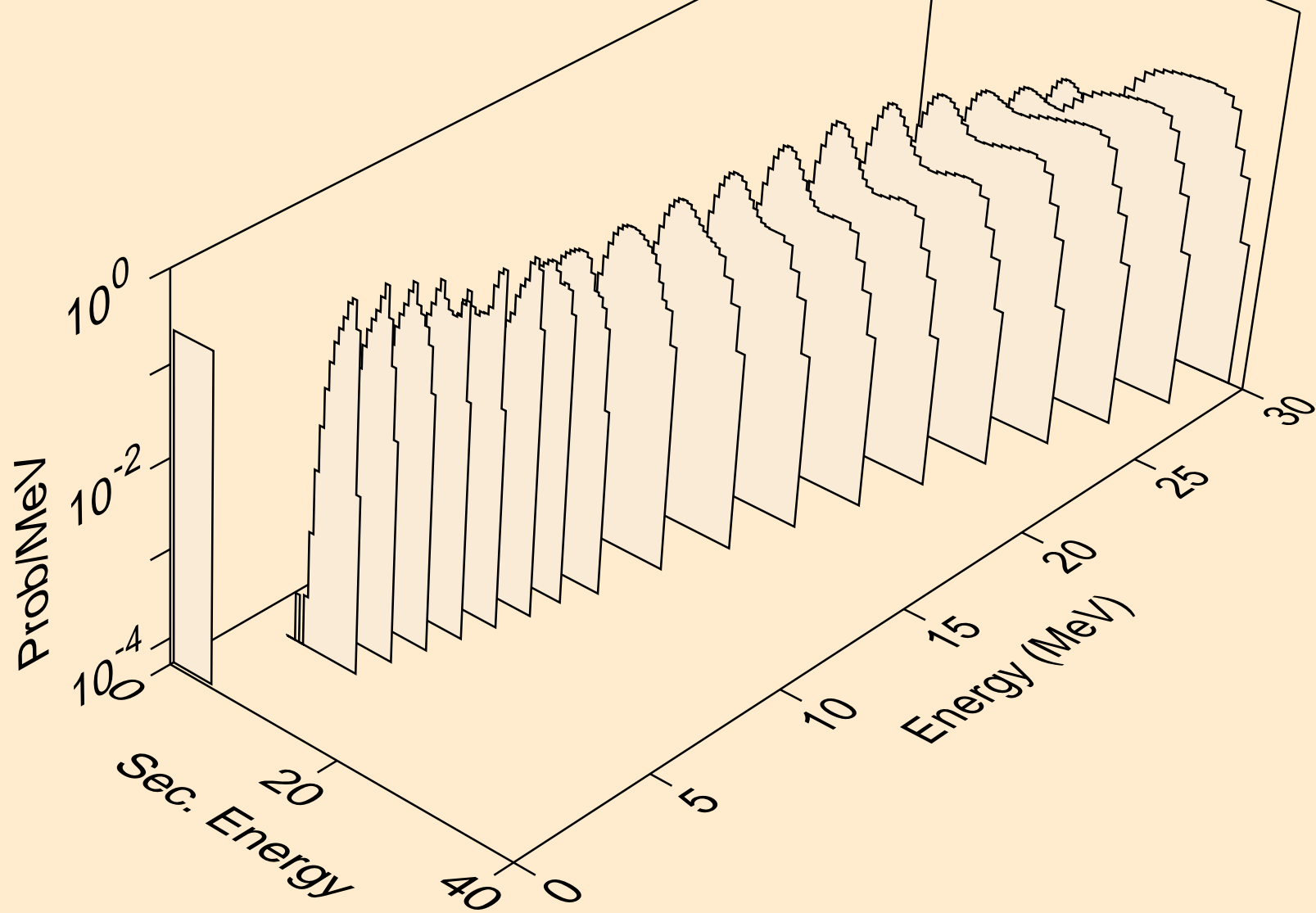



EU146 TRITON ACER TENDL-2021 LIBRARY; T=0.K  
alphas from (t,2n)a

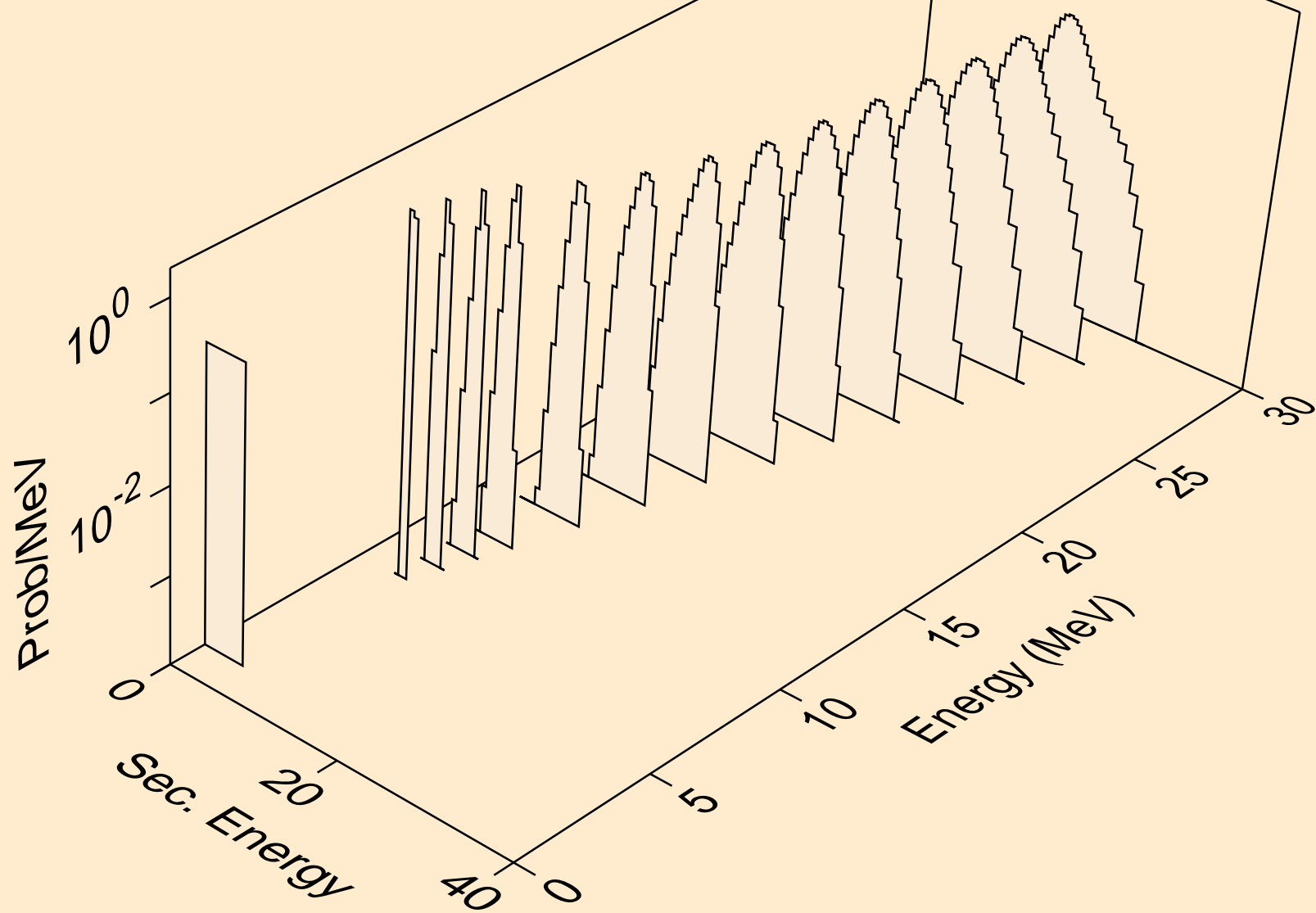

EU146 TRITON ACER TENDL-2021 LIBRARY; T=0.K  
alphas from (t,3n)a

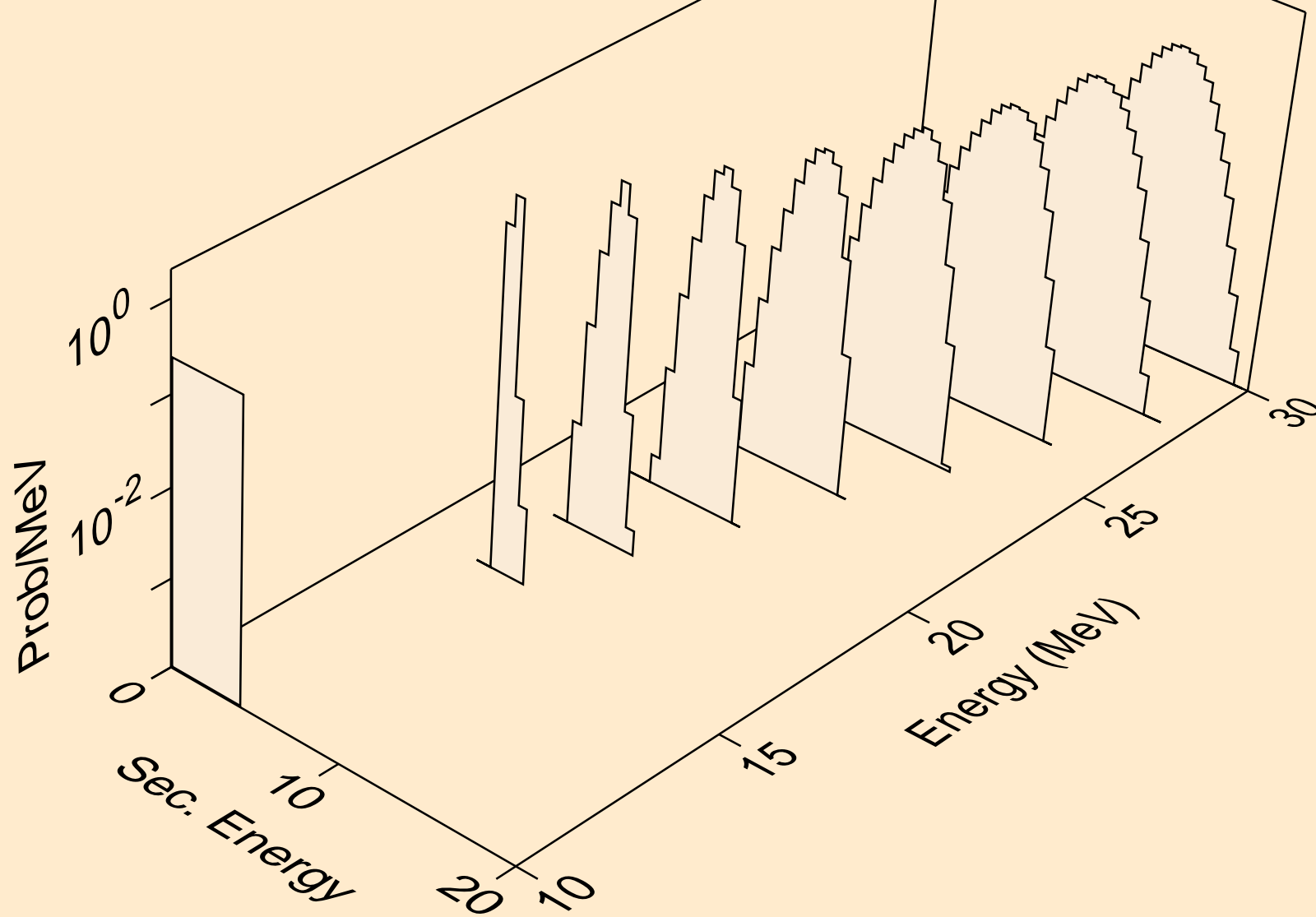

EU146 TRITON ACER TENDL-2021 LIBRARY; T=0.K  
alphas from (t,n\*)2a

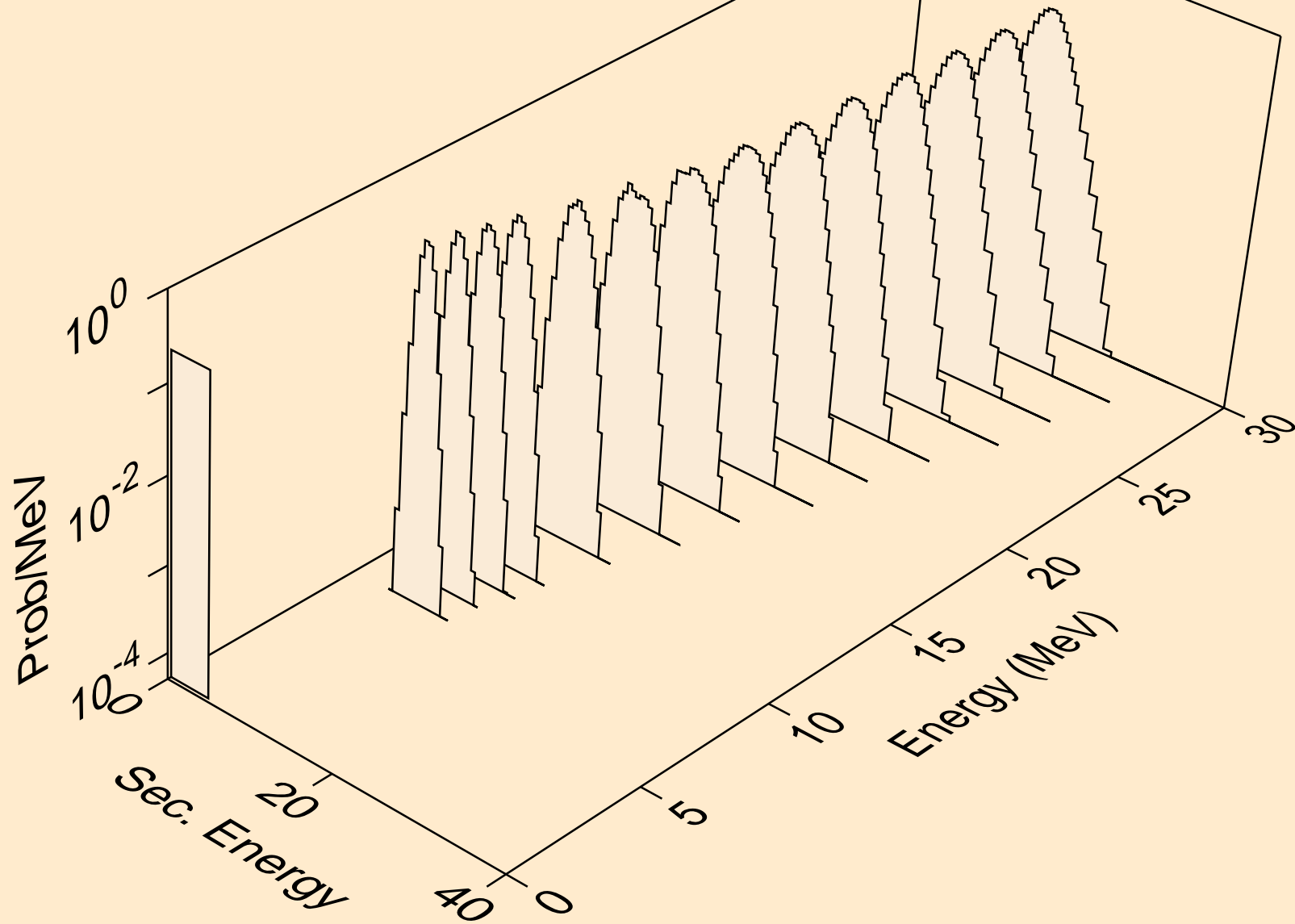

EU146 TRITON ACER TENDL-2021 LIBRARY; T=0.K  
alphas from (t,2n)2a

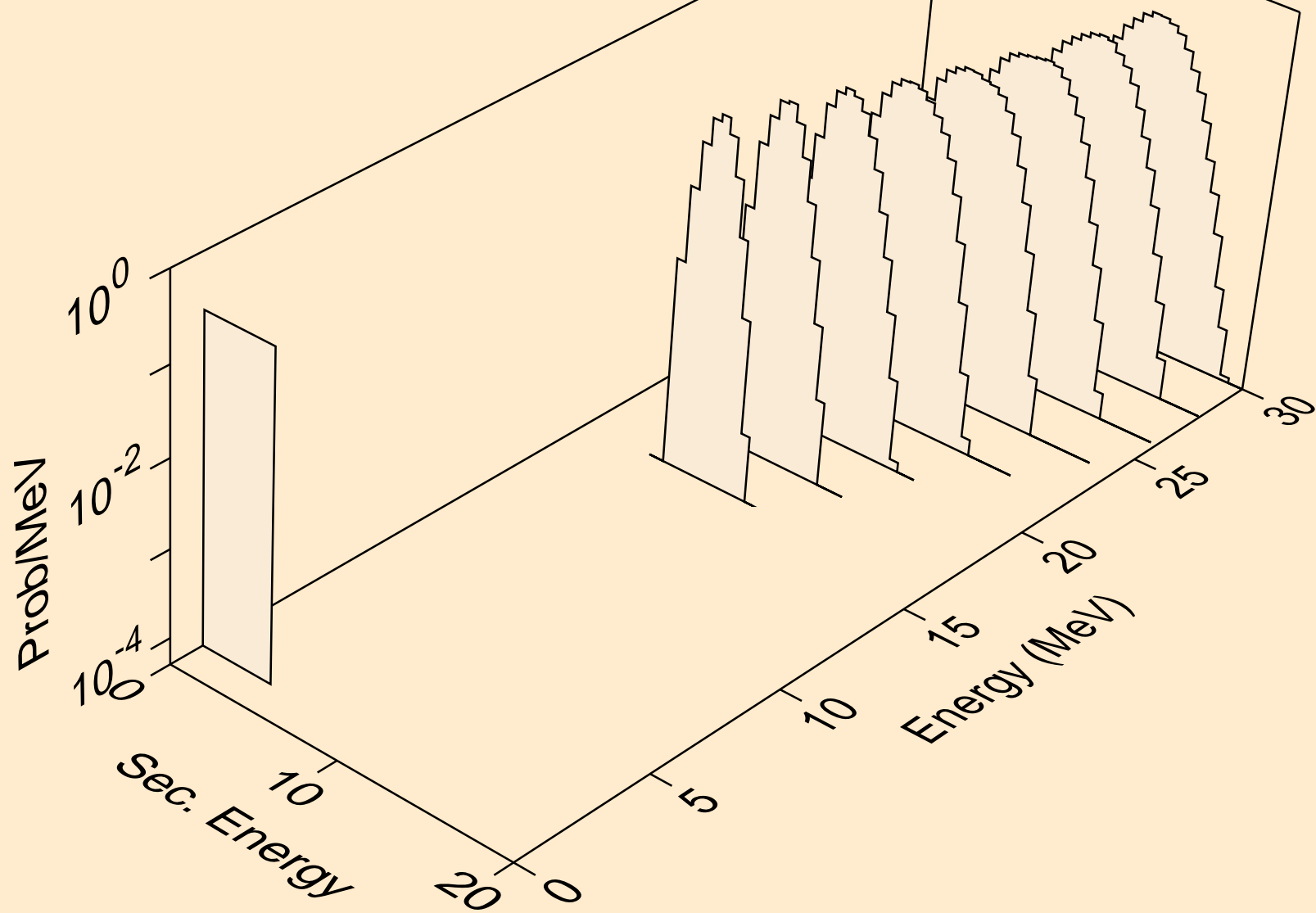

EU146 TRITON ACER TENDL-2021 LIBRARY; T=0.K  
alphas from (t,npa)

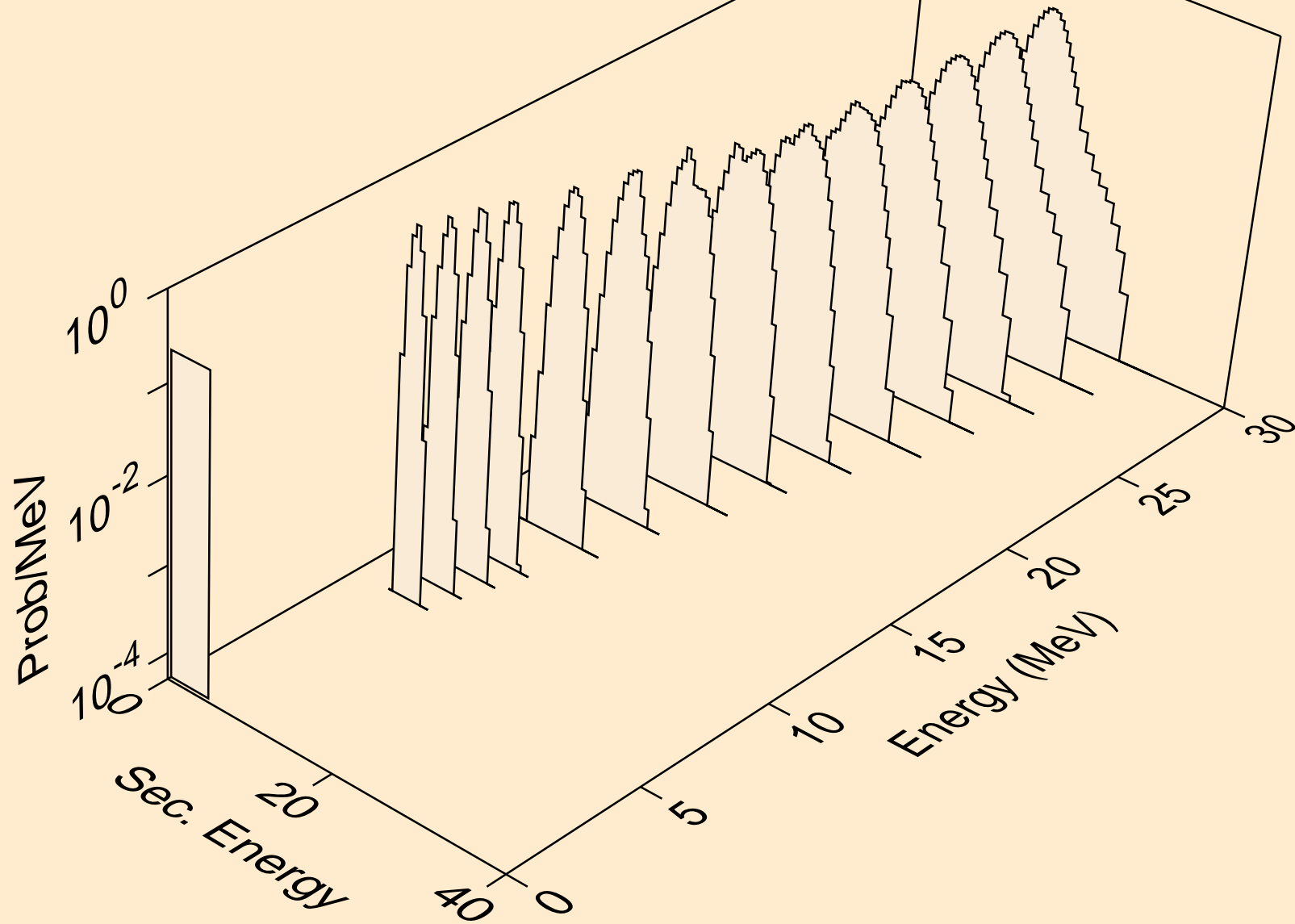

EU146 TRITON ACER TENDL-2021 LIBRARY; T=0.K  
alphas from (t,a)

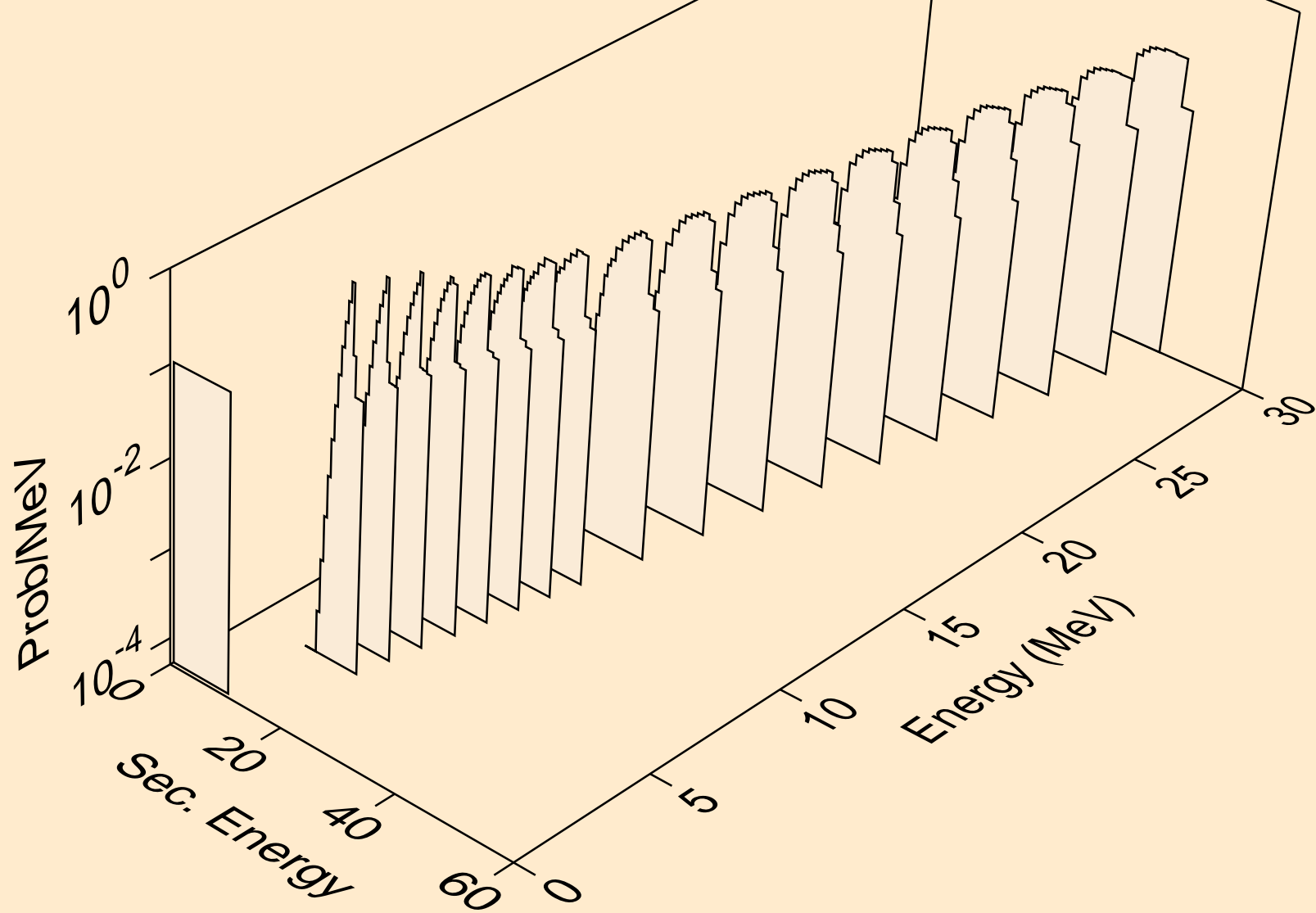

EU146 TRITON ACER TENDL-2021 LIBRARY; T=0.K  
alphas from (t,2a)

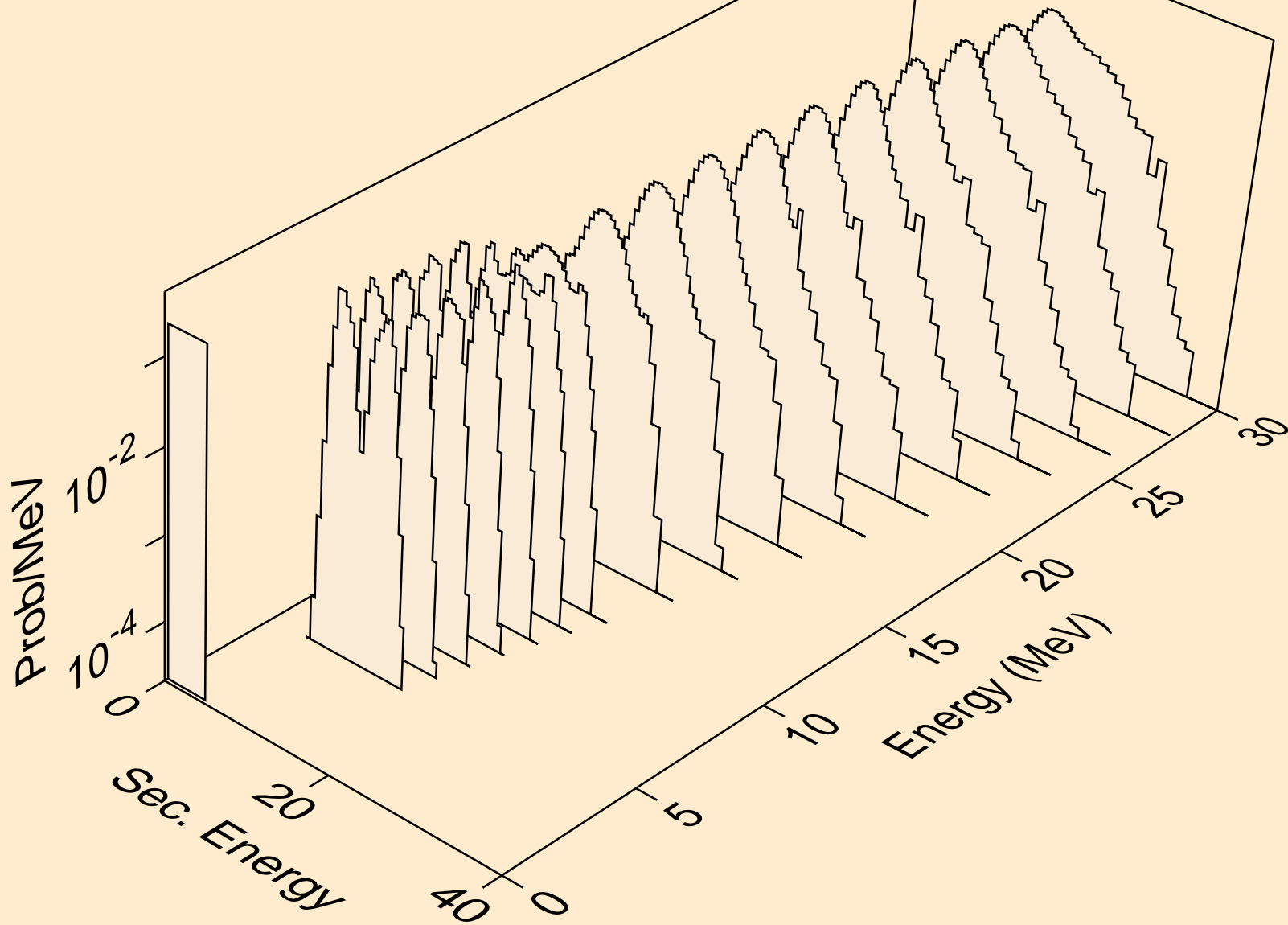

EU146 TRITON ACER TENDL-2021 LIBRARY; T=0.K  
alphas from (t,pa)

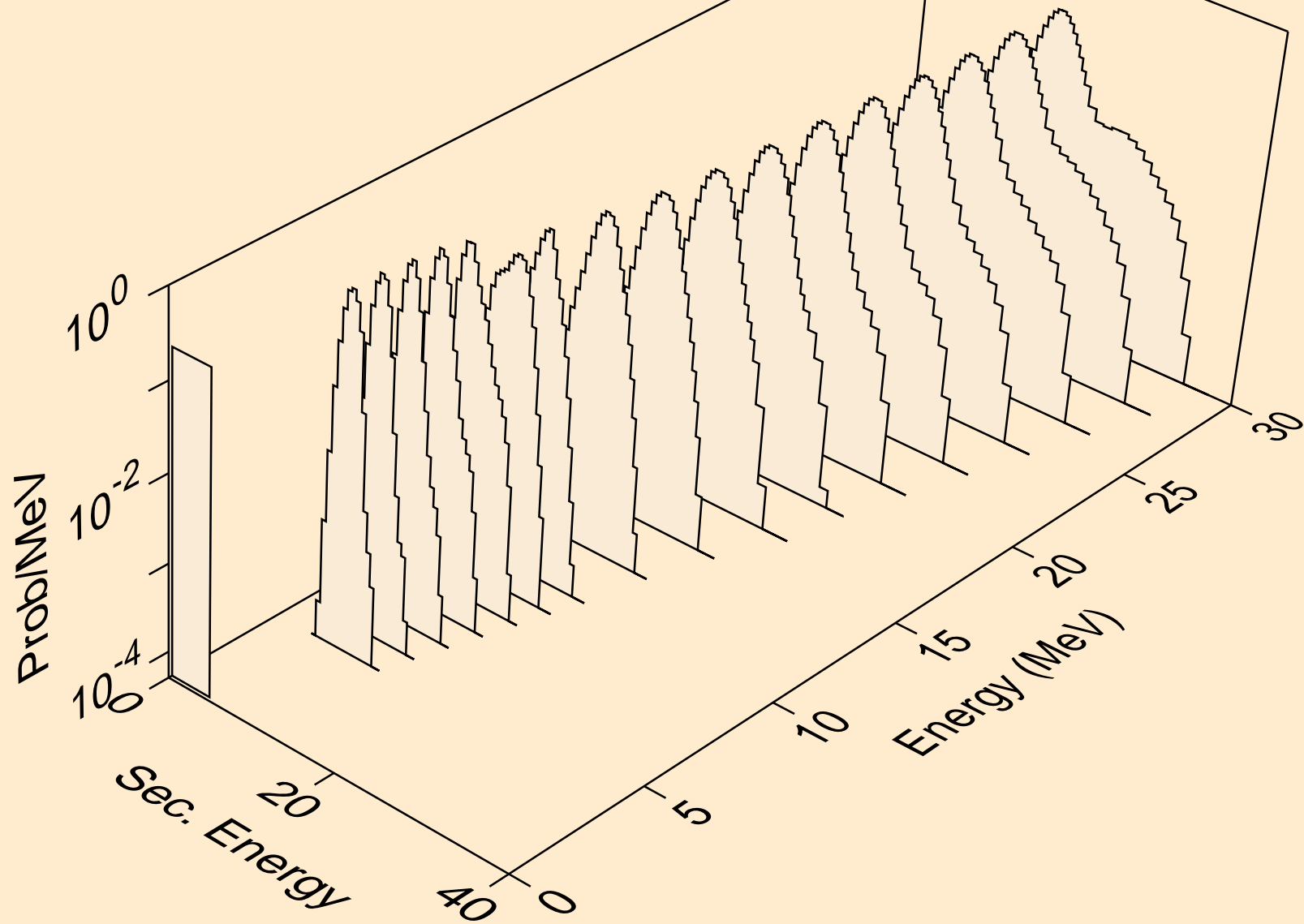



EU146 TRITON ACER TENDL-2021 LIBRARY; T=0.K  
alphas from (t,da)

