

FR224 TRITON ACER TENDL-2021 LIBRARY; T=0.K  
Principal cross sections

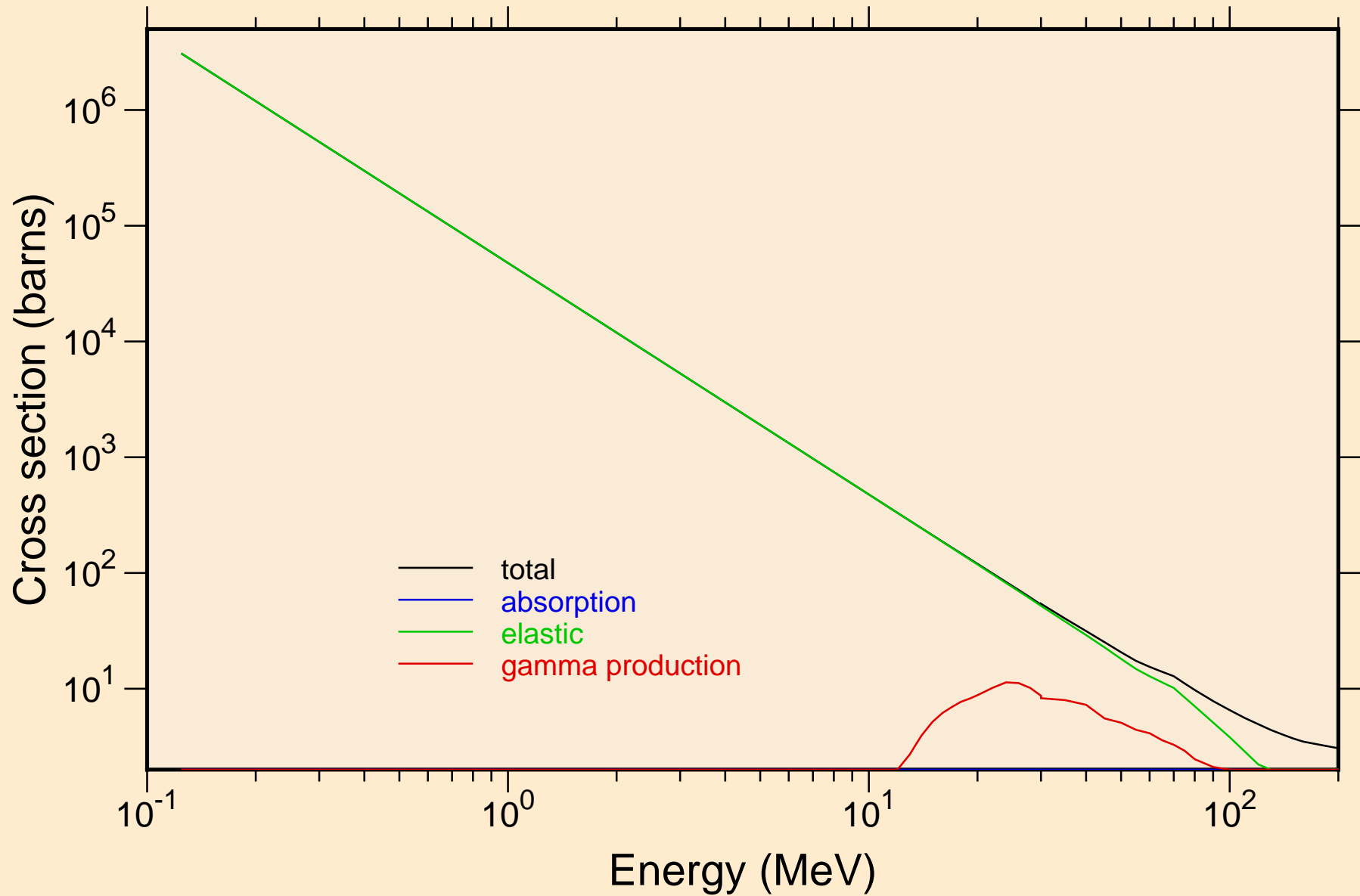

FR224 TRITON ACER TENDL-2021 LIBRARY; T=0.K

Heating

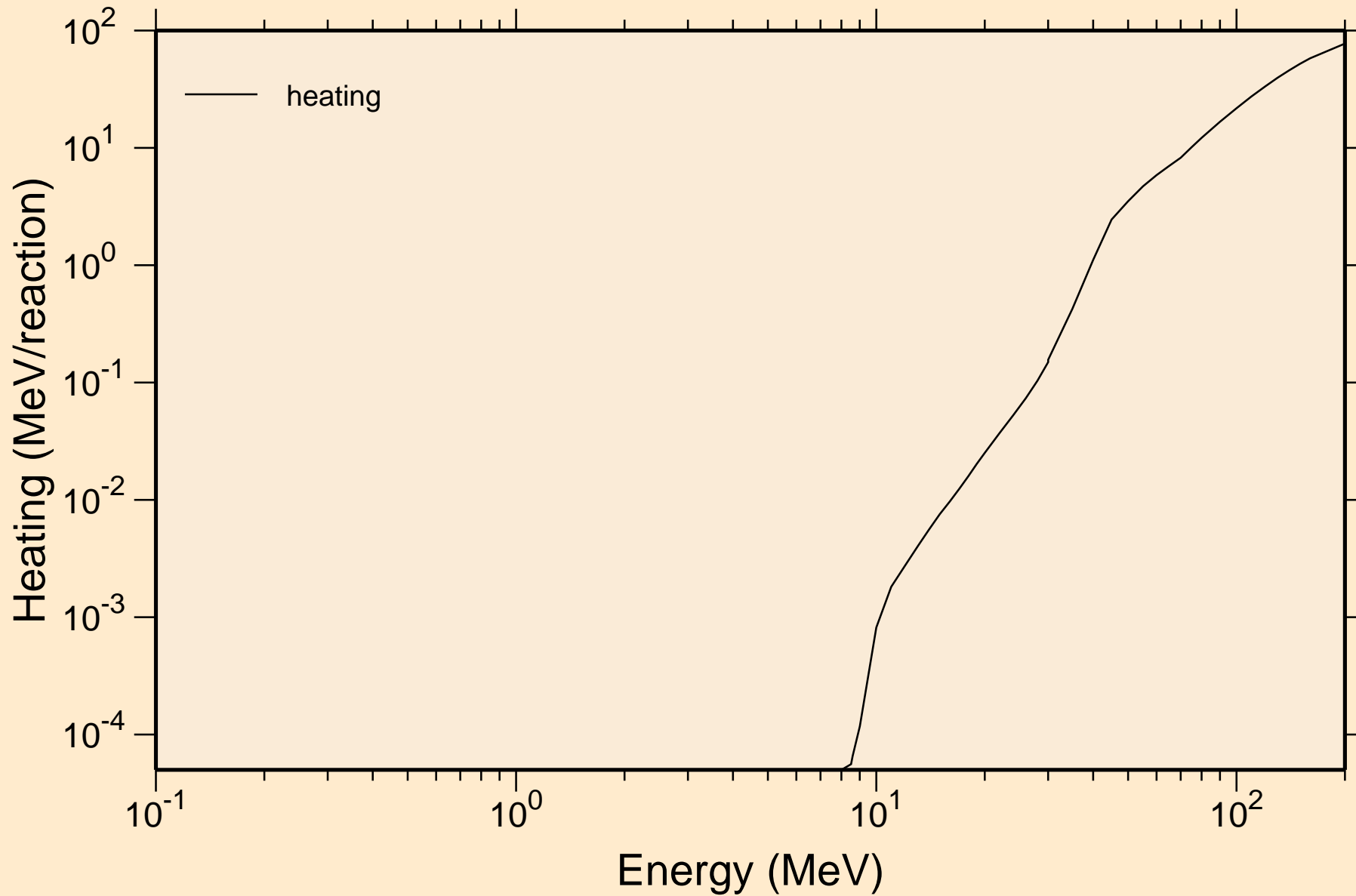

# FR224 TRITON ACER TENDL-2021 LIBRARY; T=0.K

## Principal cross sections

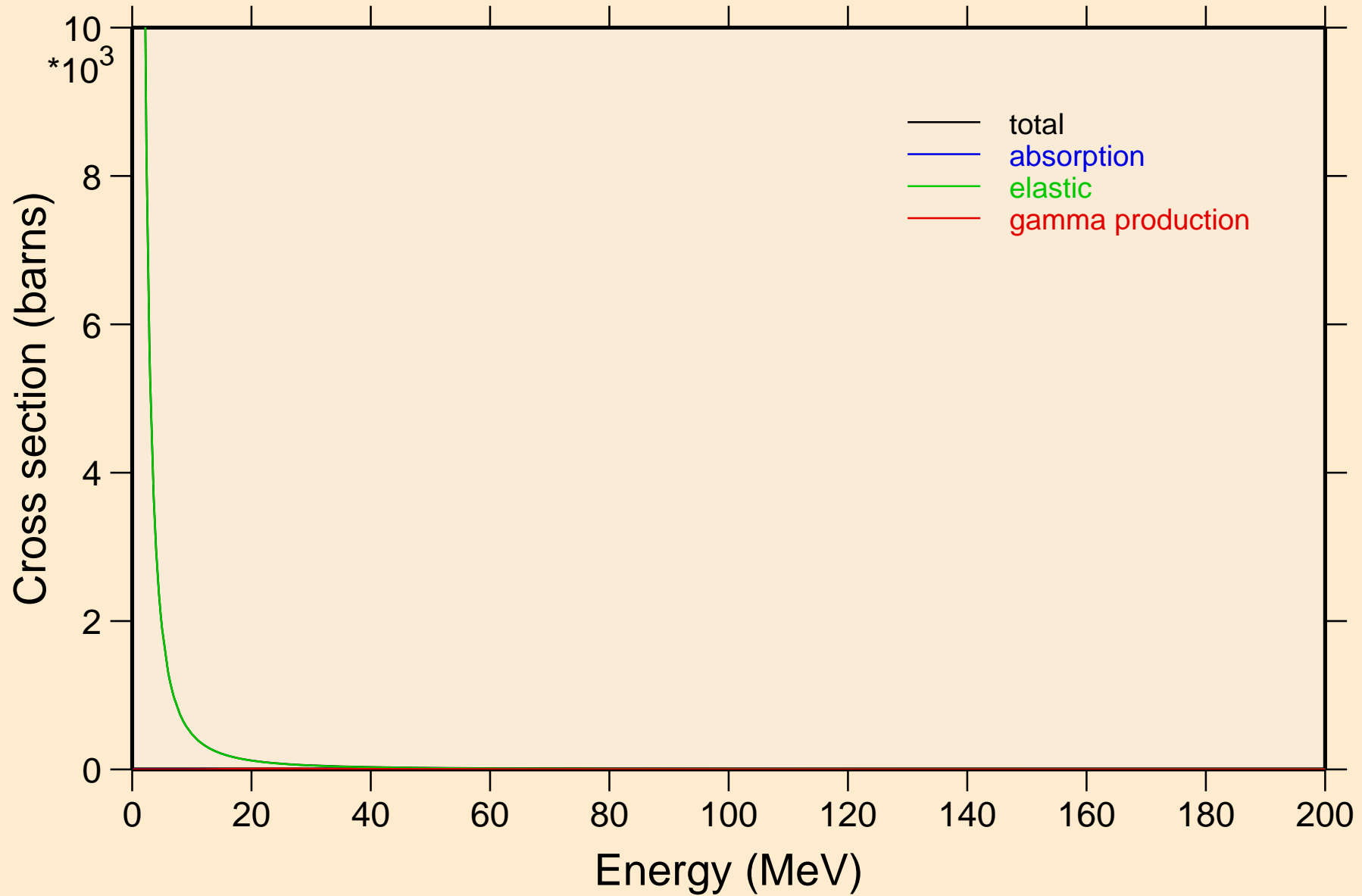

FR224 TRITON ACER TENDL-2021 LIBRARY; T=0.K

Heating

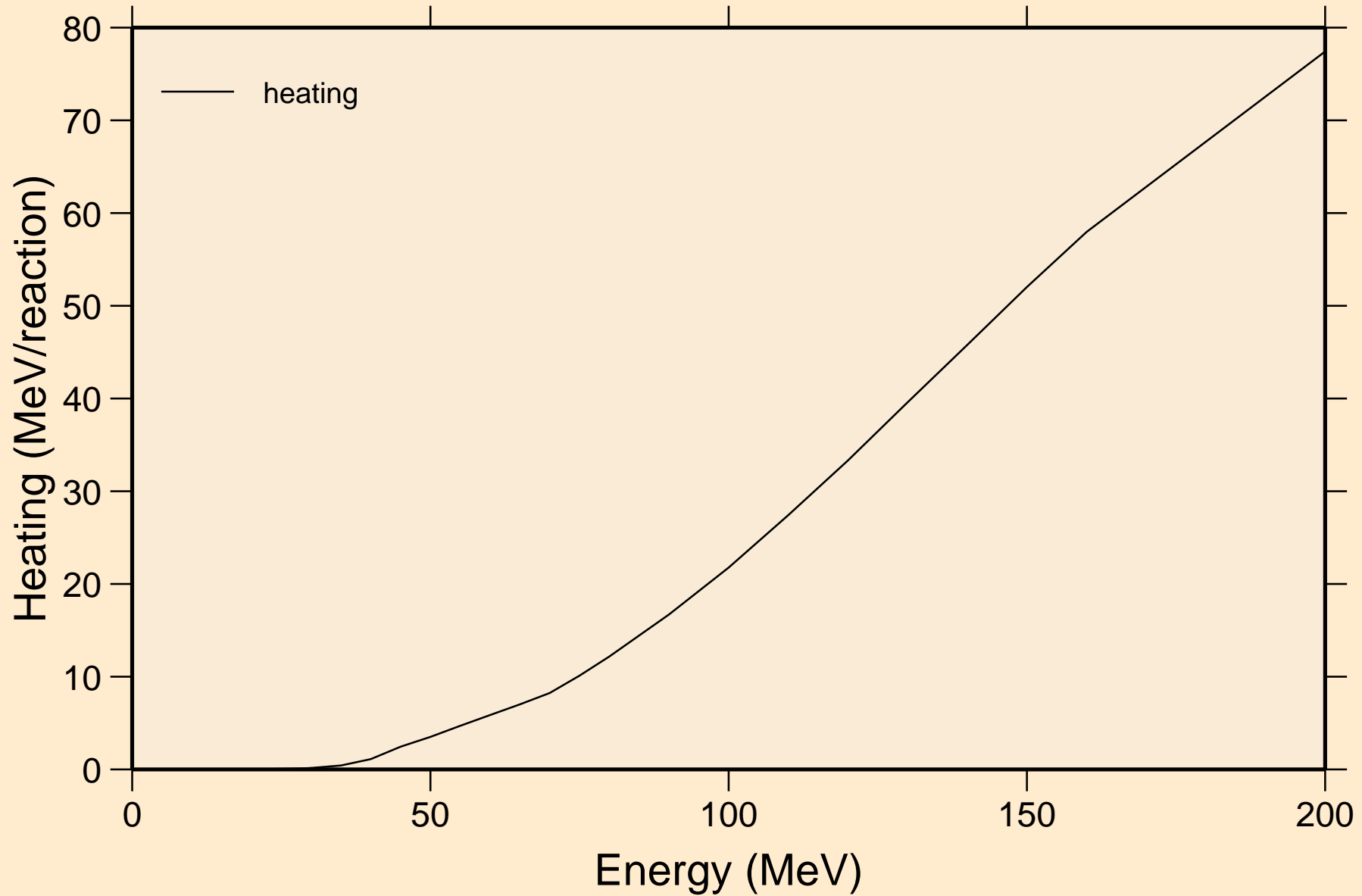

FR224 TRITON ACER TENDL-2021 LIBRARY; T=0.K  
Threshold reactions

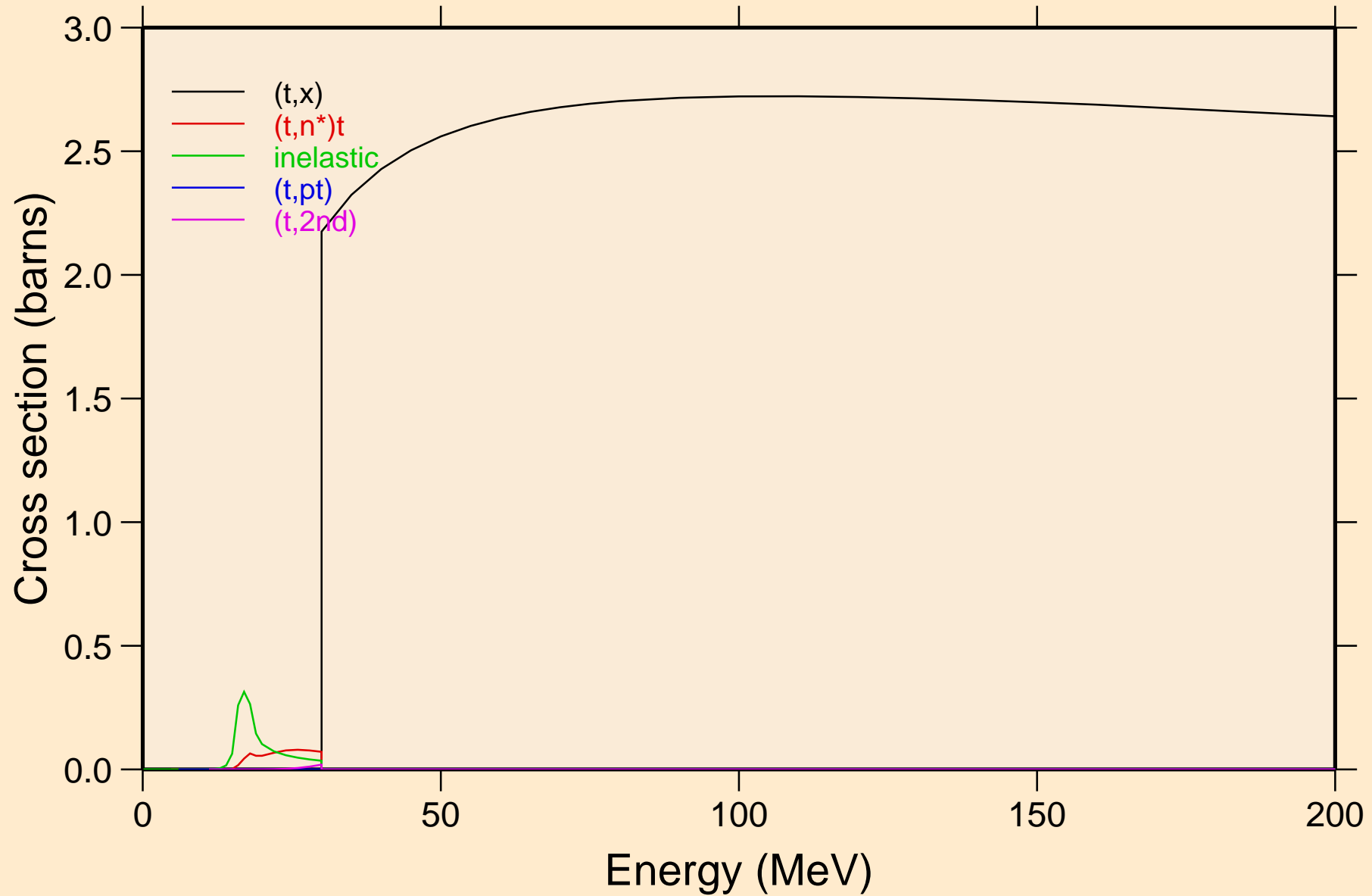

FR224 TRITON ACER TENDL-2021 LIBRARY; T=0.K  
Threshold reactions

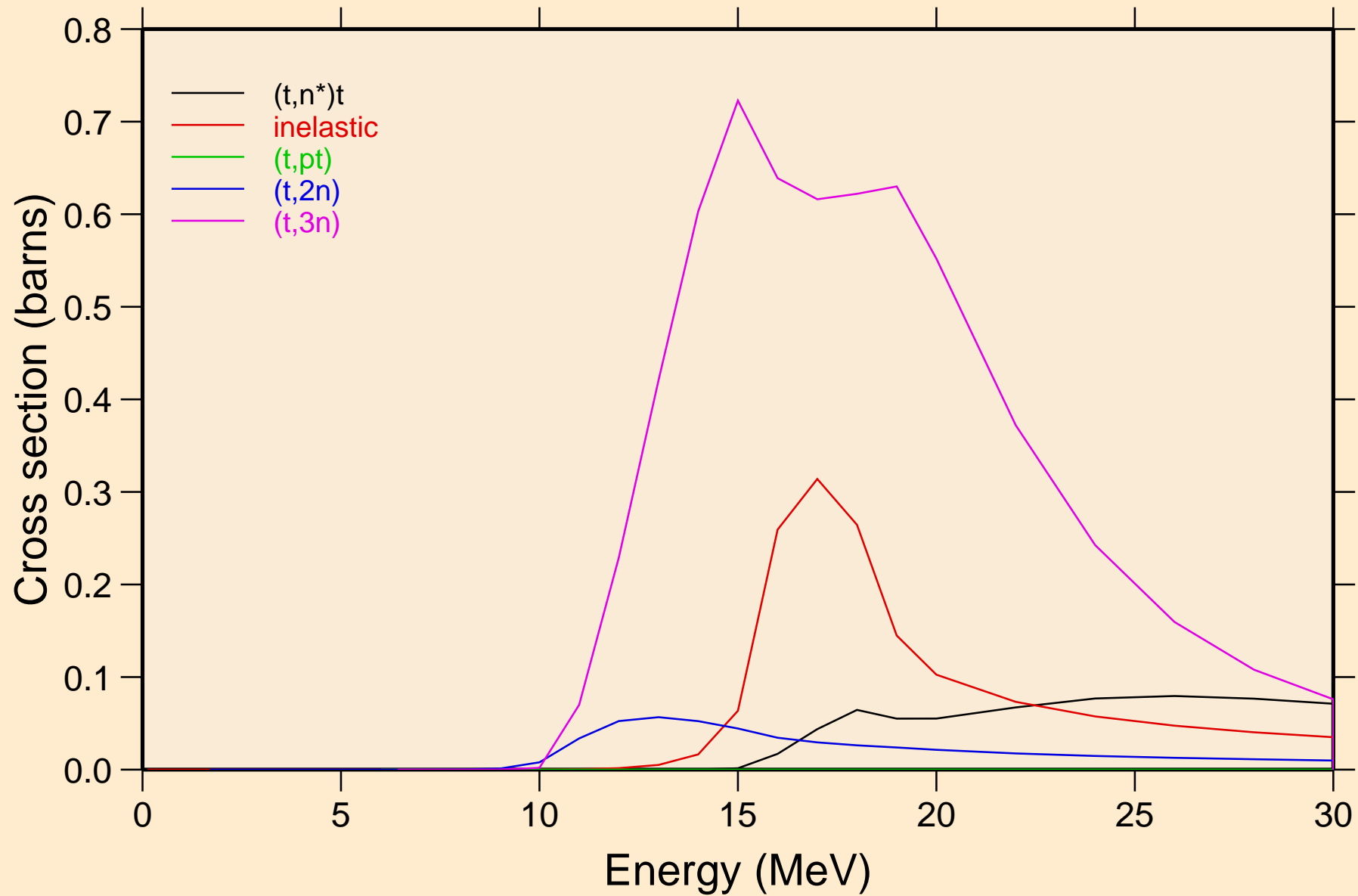

FR224 TRITON ACER TENDL-2021 LIBRARY; T=0.K  
Threshold reactions

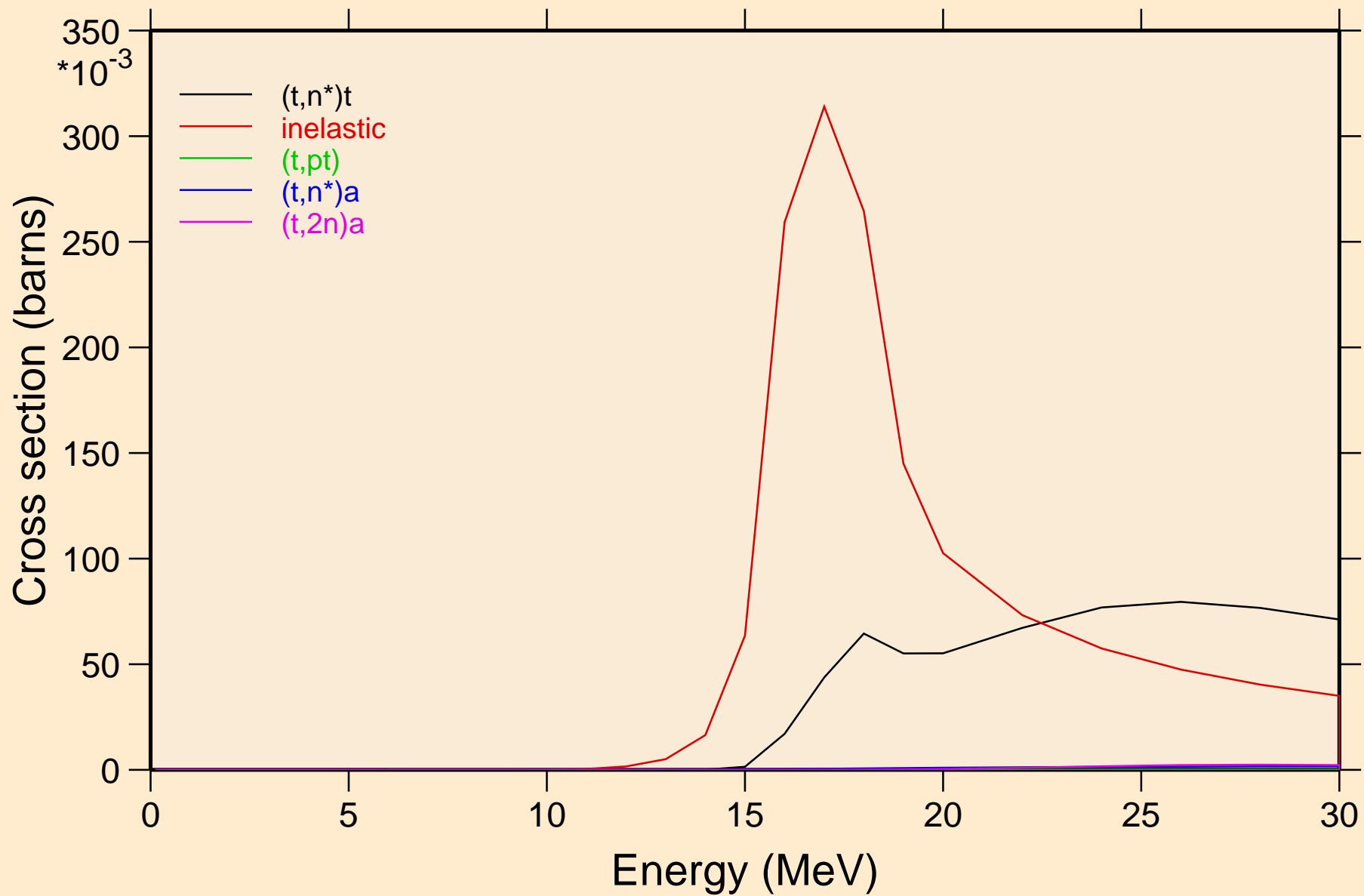

FR224 TRITON ACER TENDL-2021 LIBRARY; T=0.K  
Threshold reactions

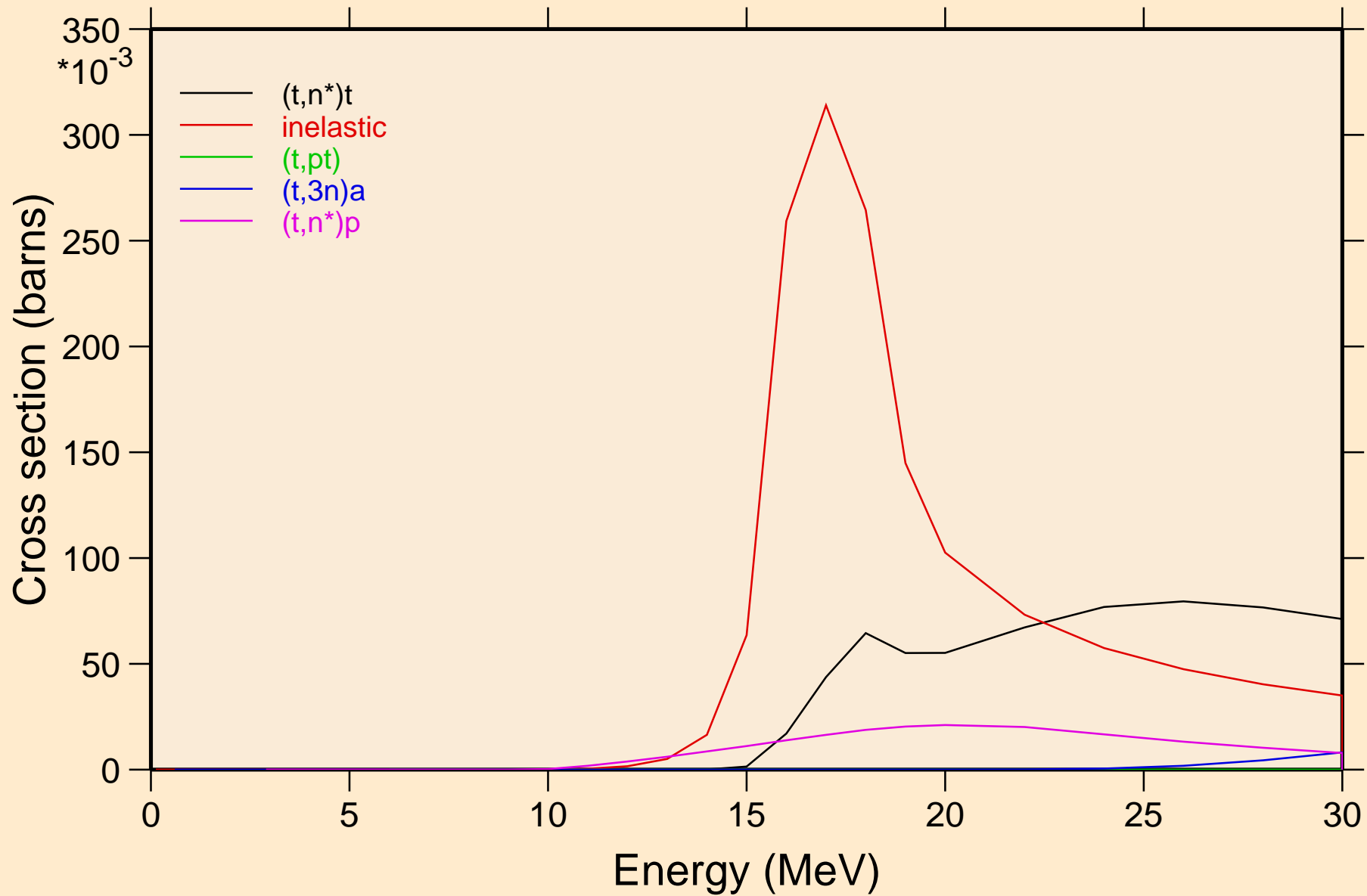



FR224 TRITON ACER TENDL-2021 LIBRARY; T=0.K  
Threshold reactions

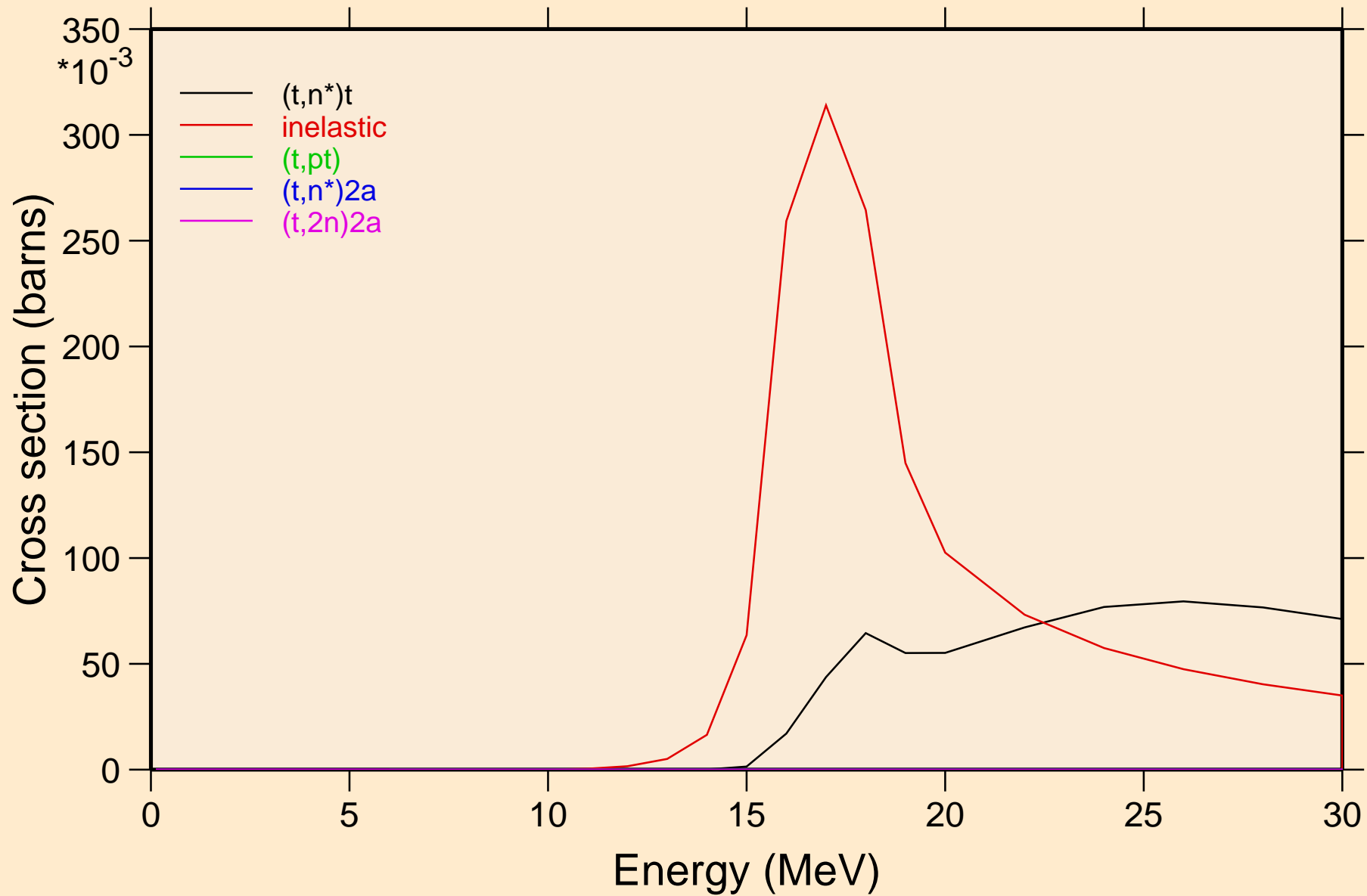

FR224 TRITON ACER TENDL-2021 LIBRARY; T=0.K  
Threshold reactions

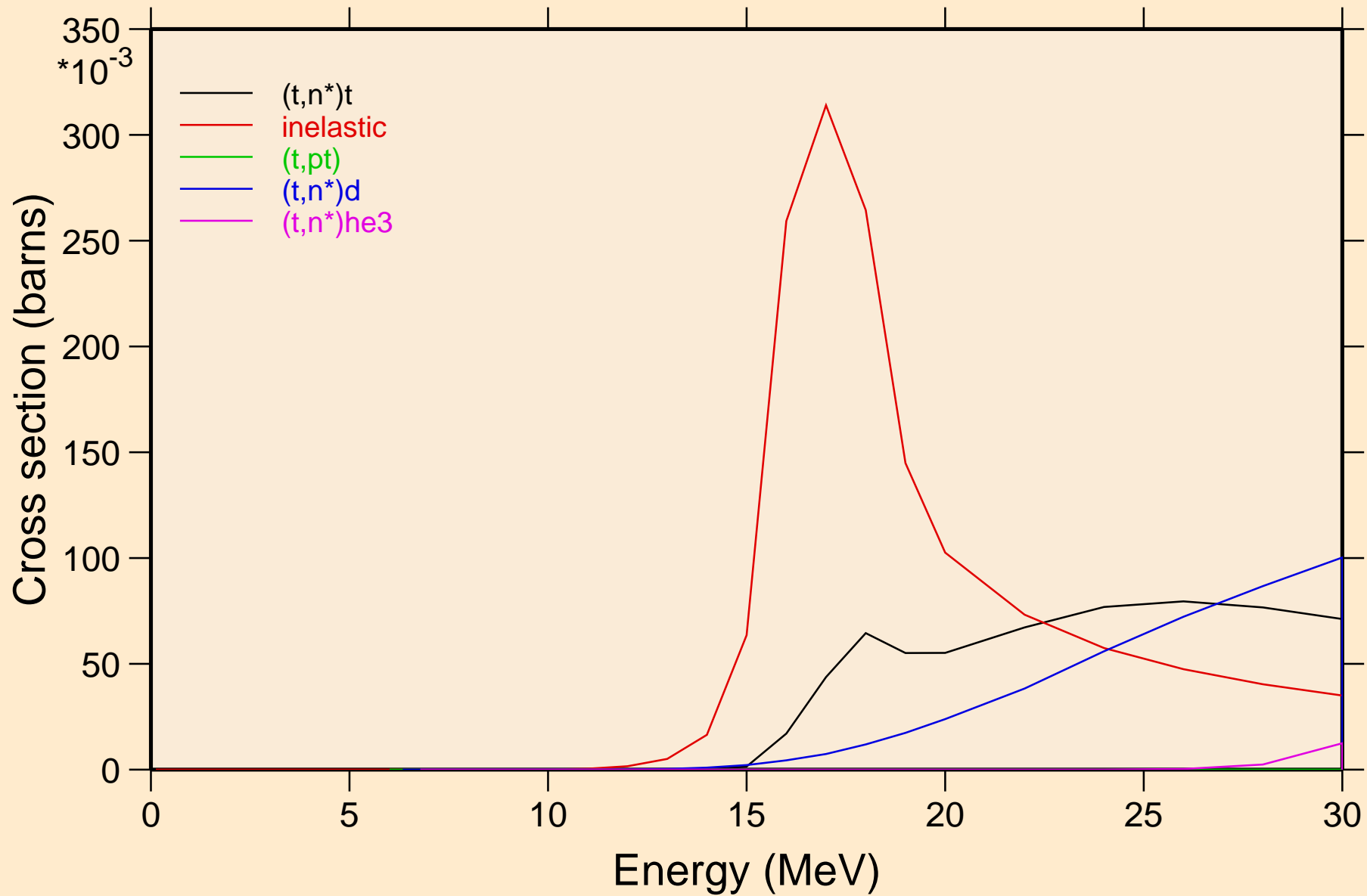

FR224 TRITON ACER TENDL-2021 LIBRARY; T=0.K  
Threshold reactions

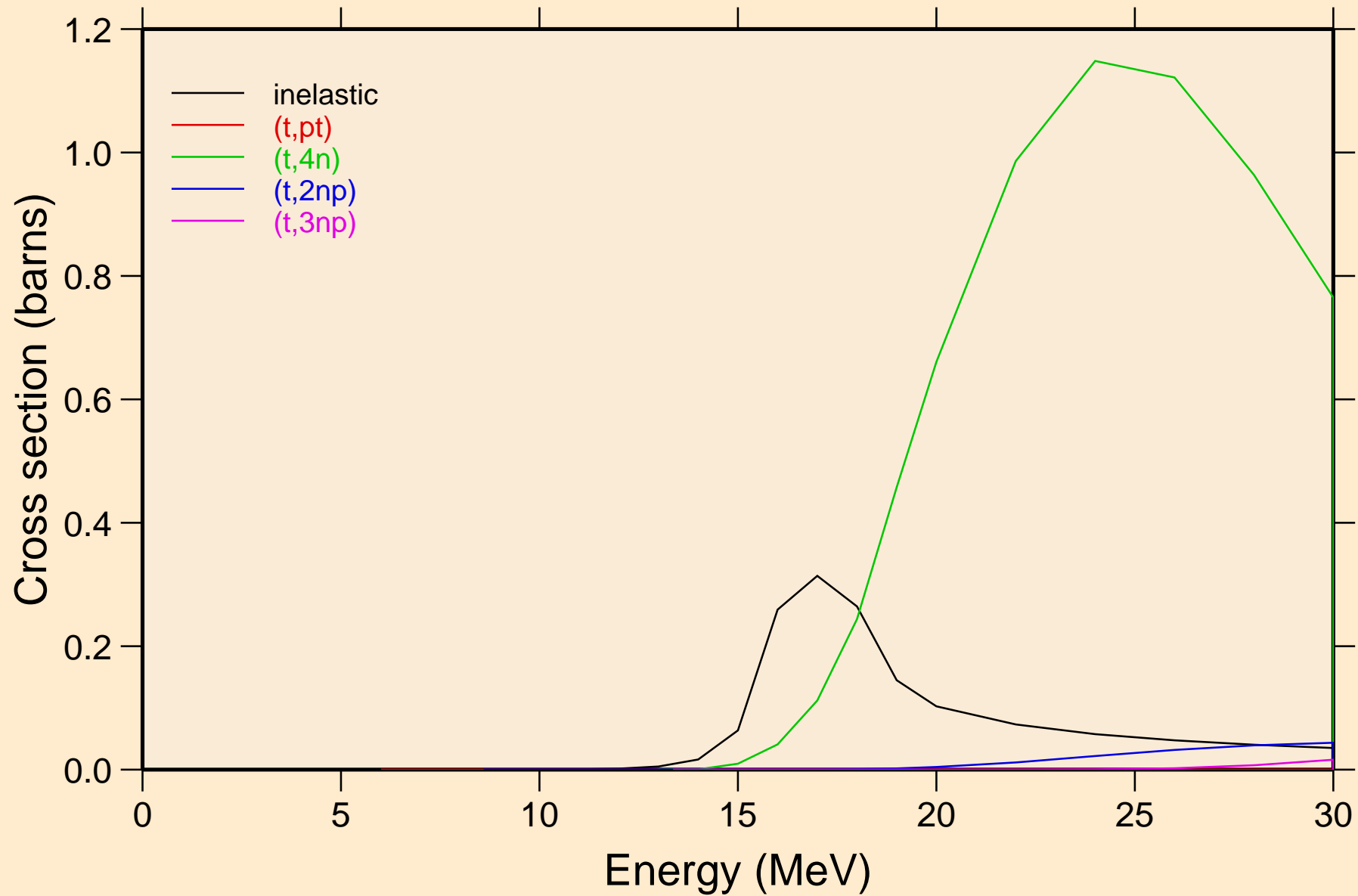

FR224 TRITON ACER TENDL-2021 LIBRARY; T=0.K  
Threshold reactions

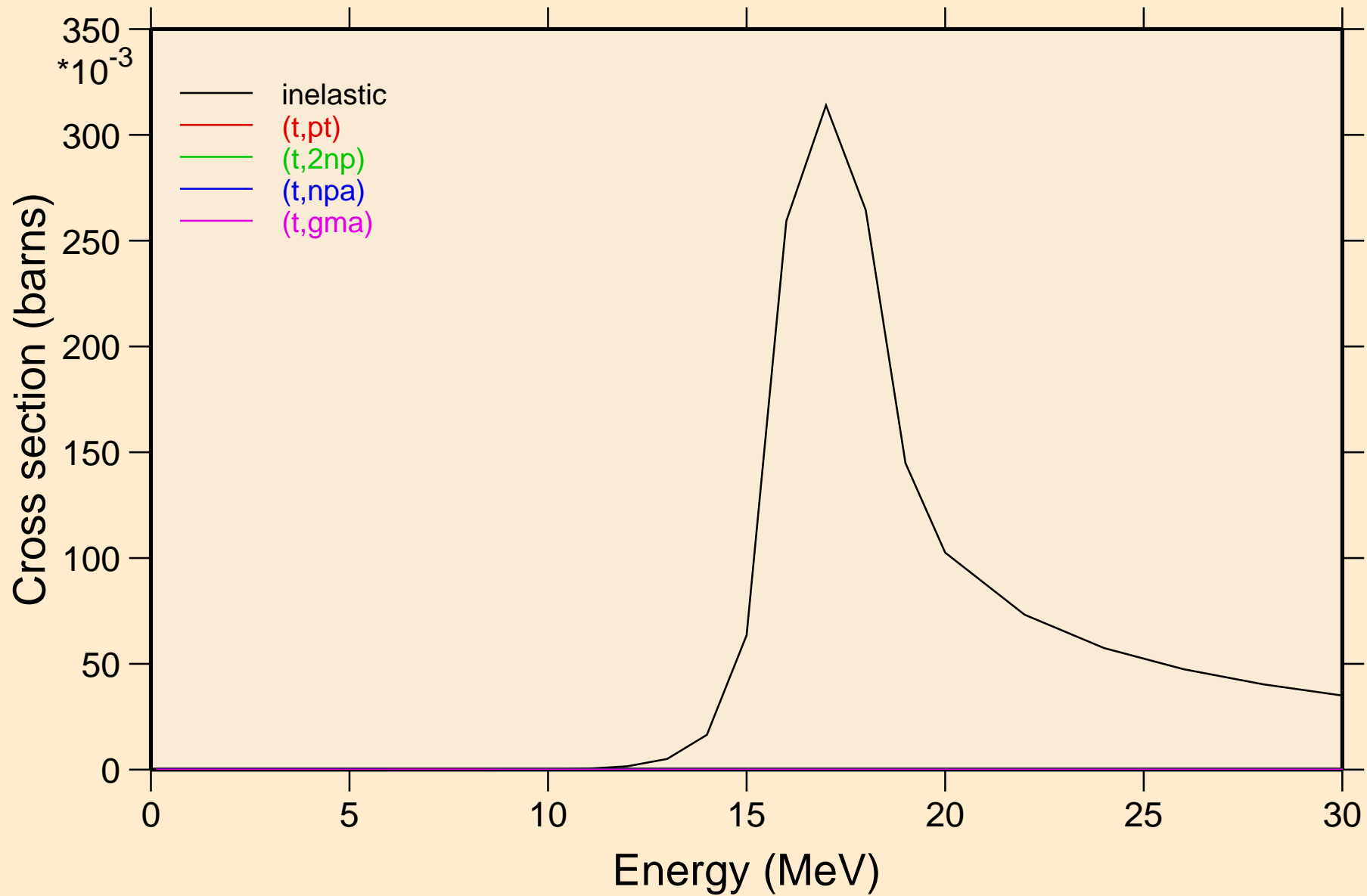

FR224 TRITON ACER TENDL-2021 LIBRARY; T=0.K  
Threshold reactions

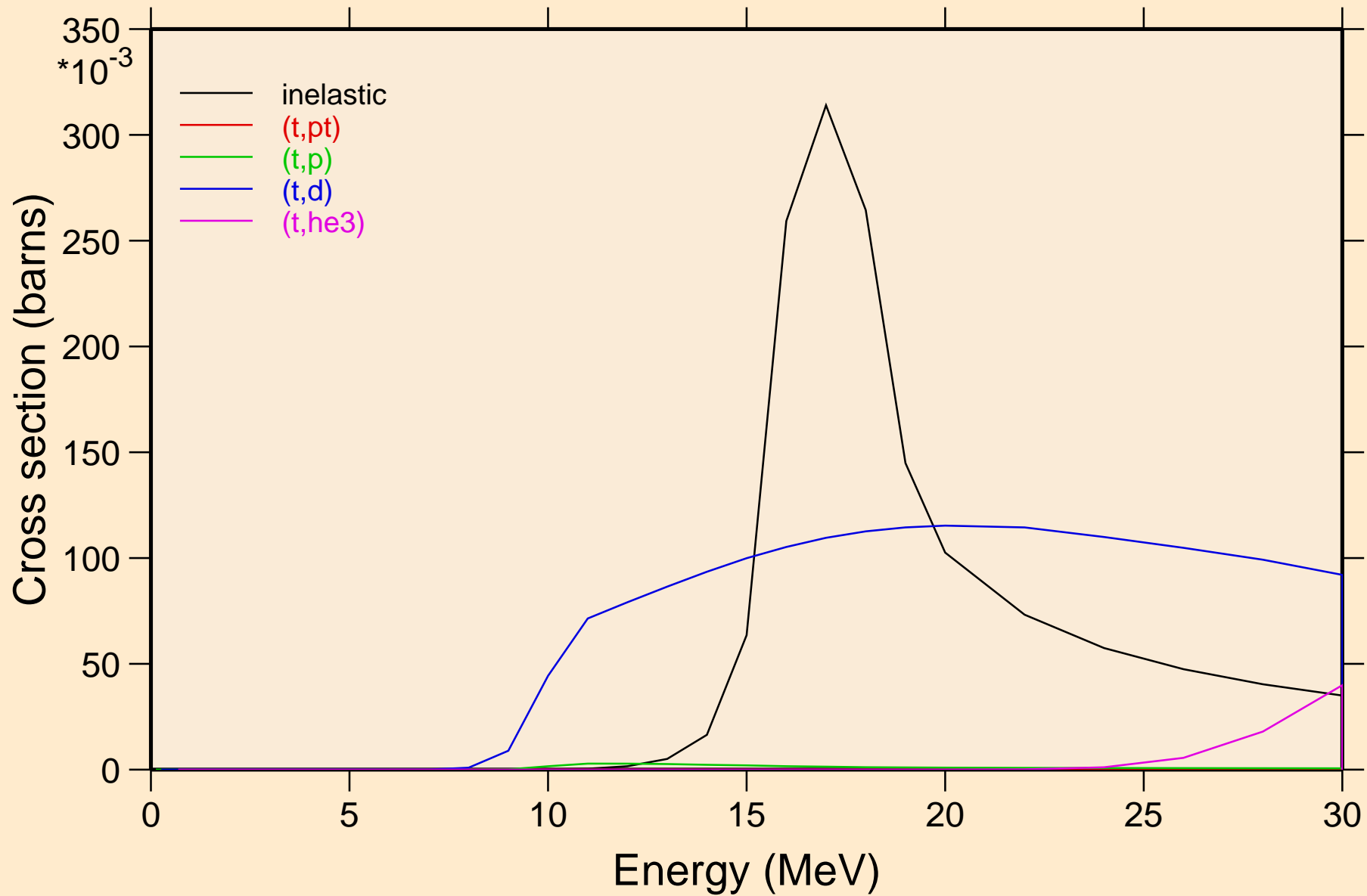

FR224 TRITON ACER TENDL-2021 LIBRARY; T=0.K  
Threshold reactions

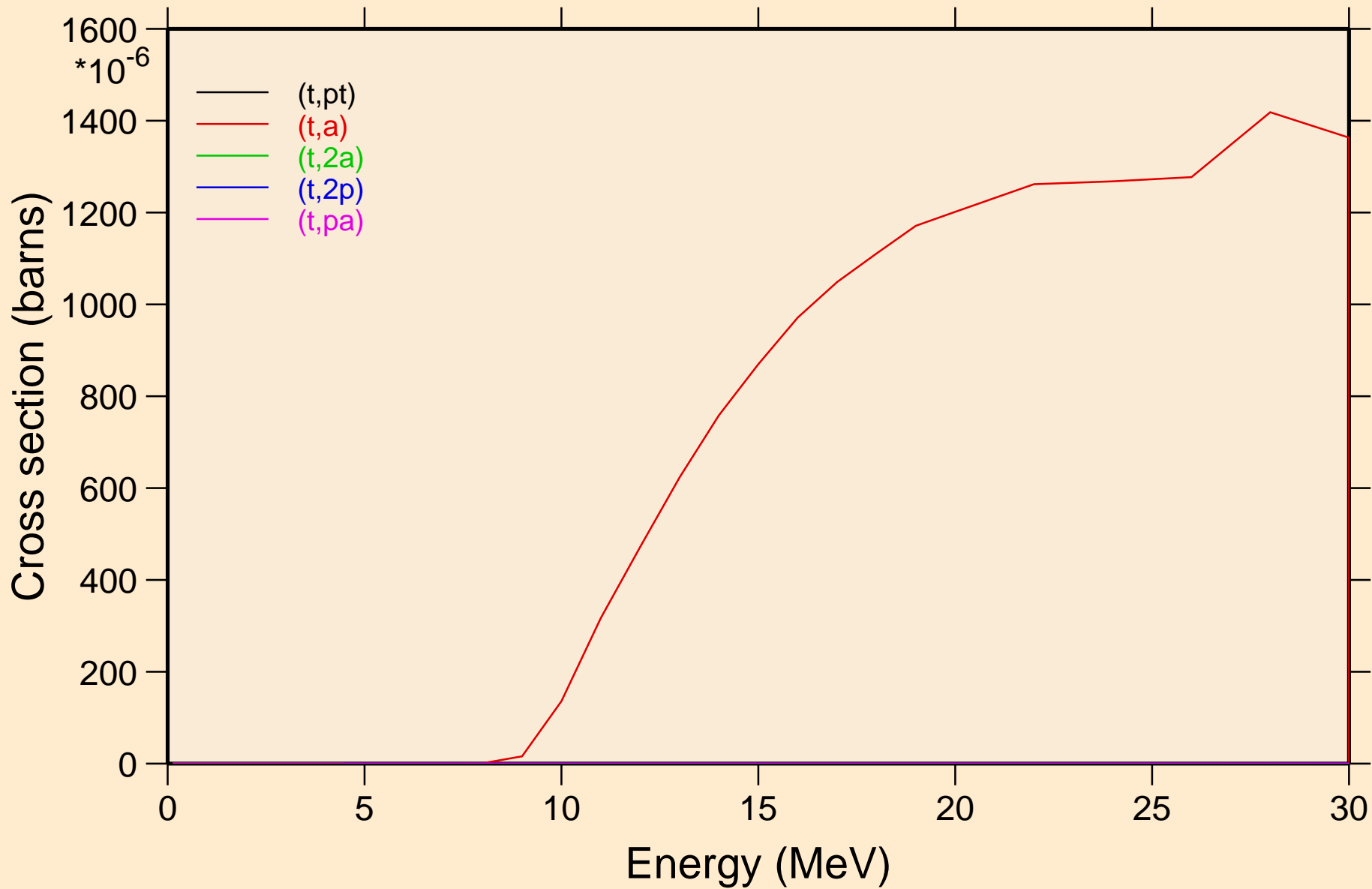

FR224 TRITON ACER TENDL-2021 LIBRARY; T=0.K  
Threshold reactions

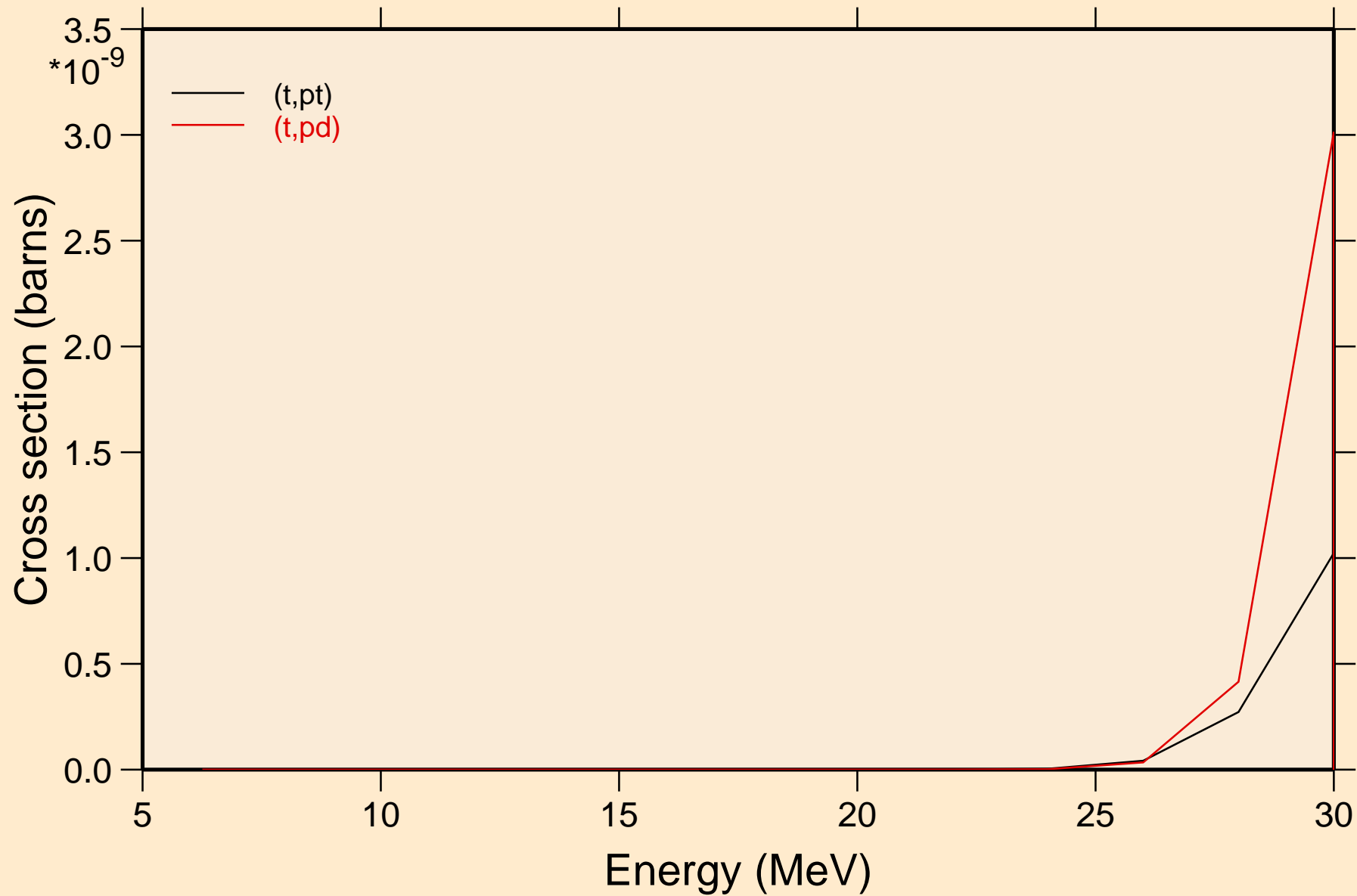

FR224 TRITON ACER TENDL-2021 LIBRARY; T=0.K  
Threshold reactions

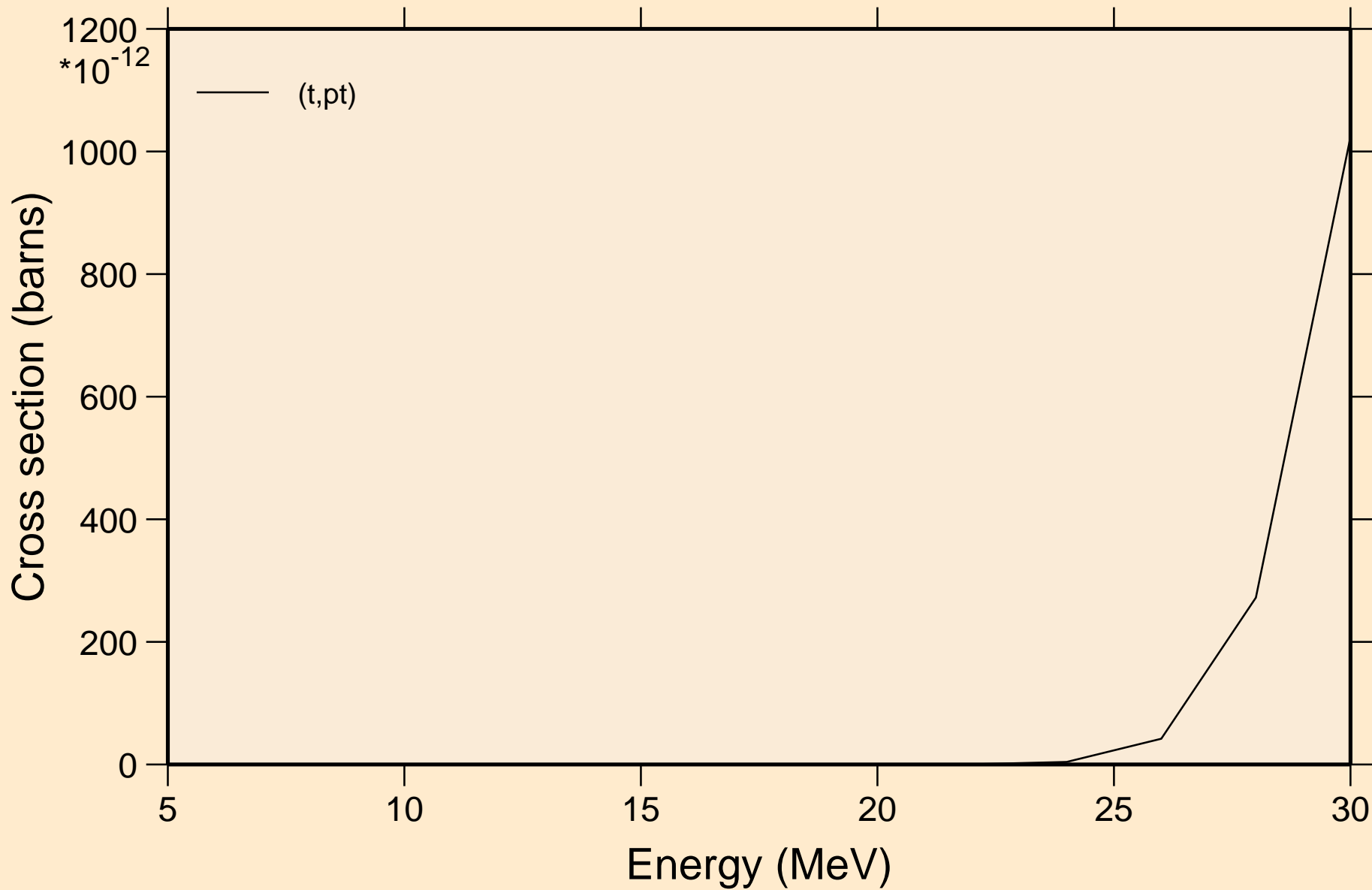



FR224 TRITON ACER TENDL-2021 LIBRARY; T=0.K  
angular distribution for elastic

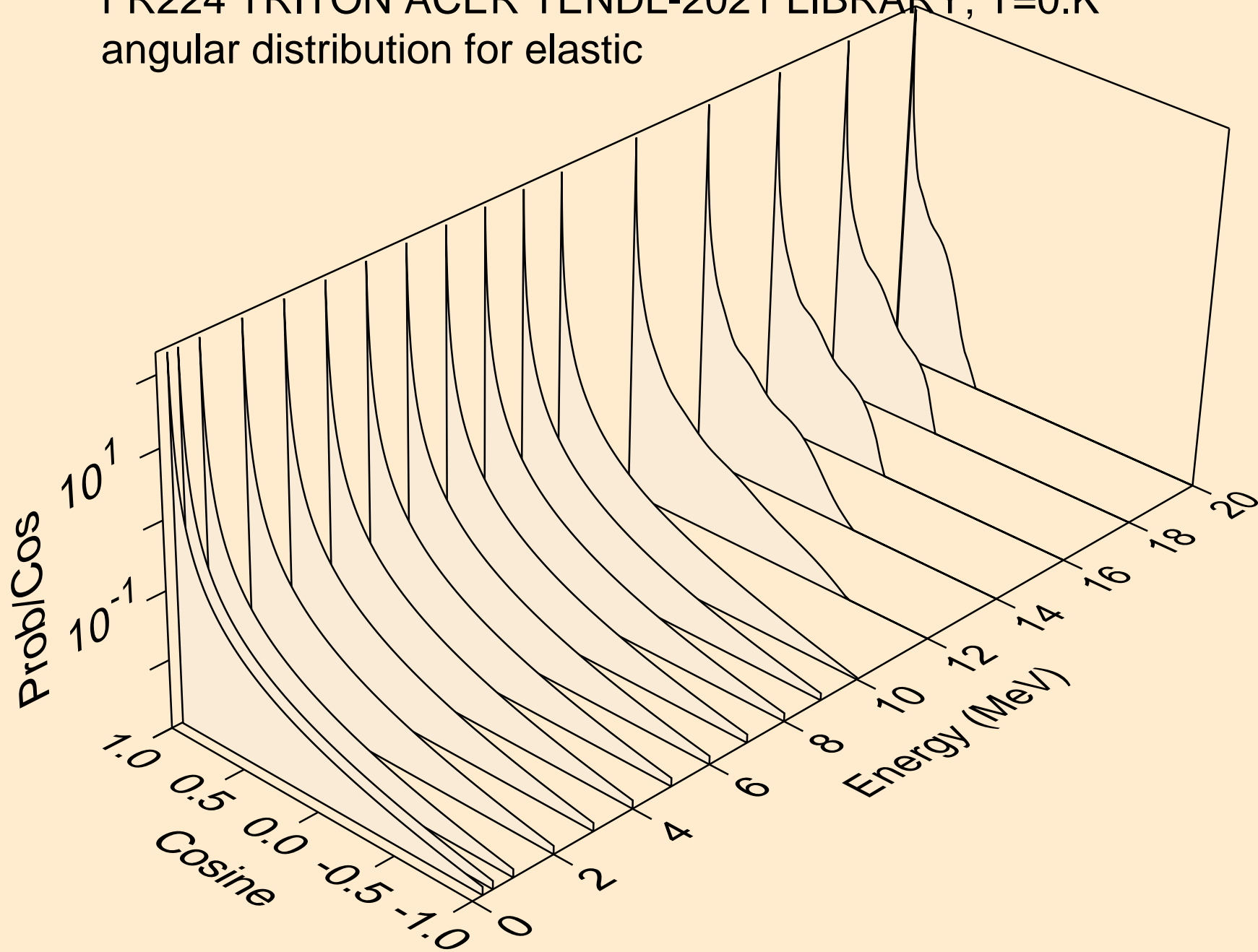

FR224 TRITON ACER TENDL-2021 LIBRARY; T=0.K  
angular distribution for elastic

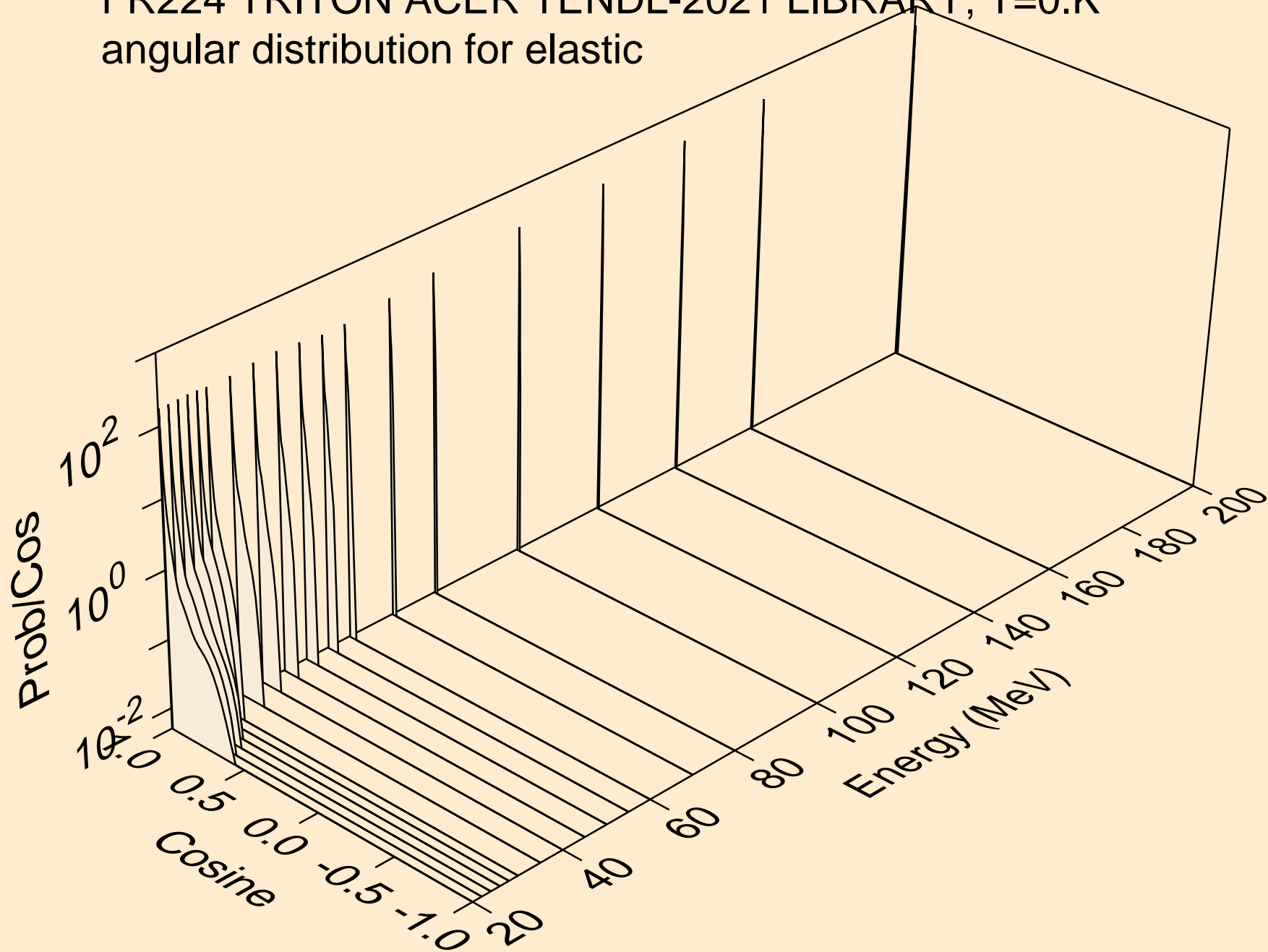

FR224 TRITON ACER TENDL-2021 LIBRARY; T=0.K  
Triton emission for (t,x)

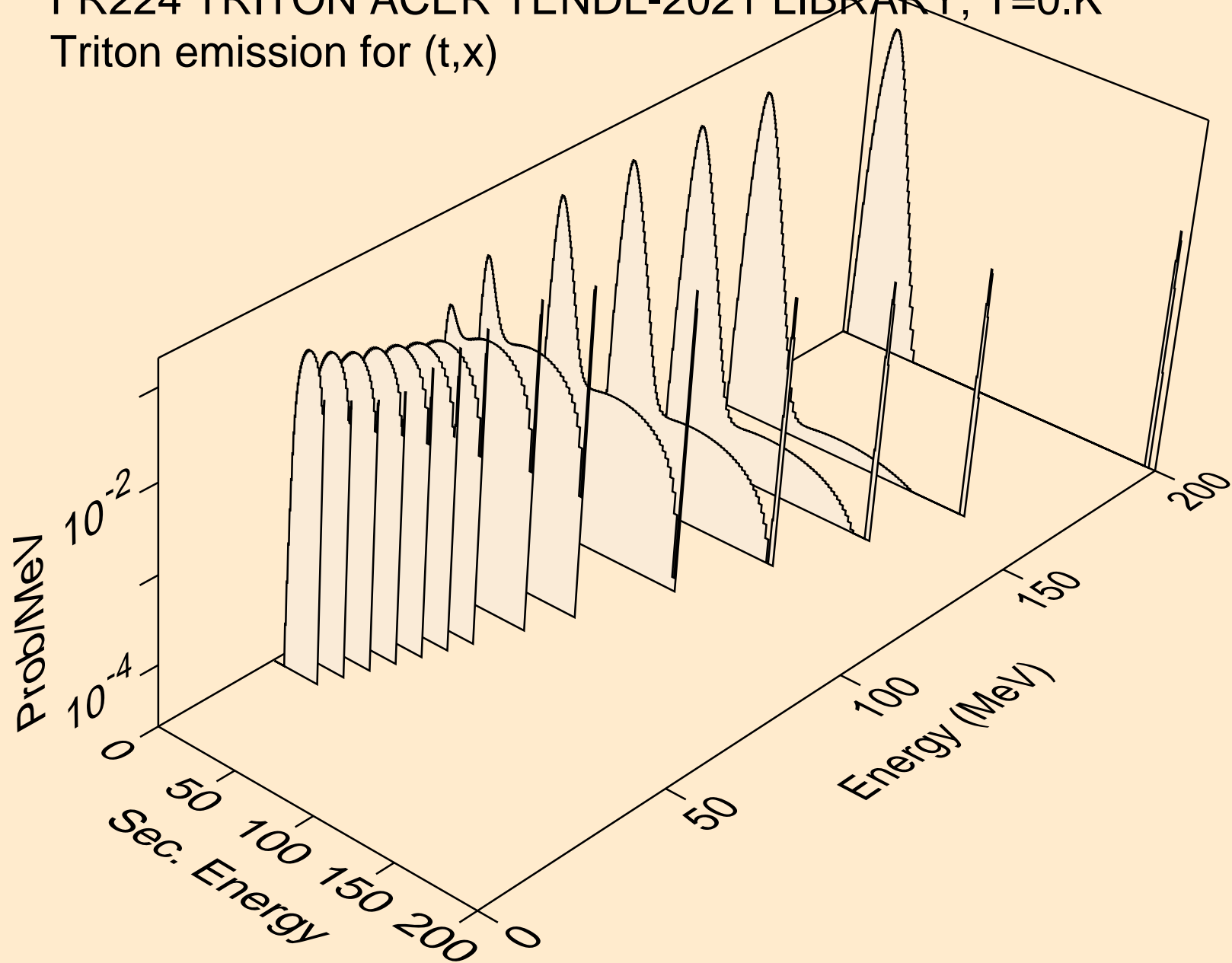

FR224 TRITON ACER TENDL-2021 LIBRARY; T=0.K  
Triton emission for (t,n\*)t

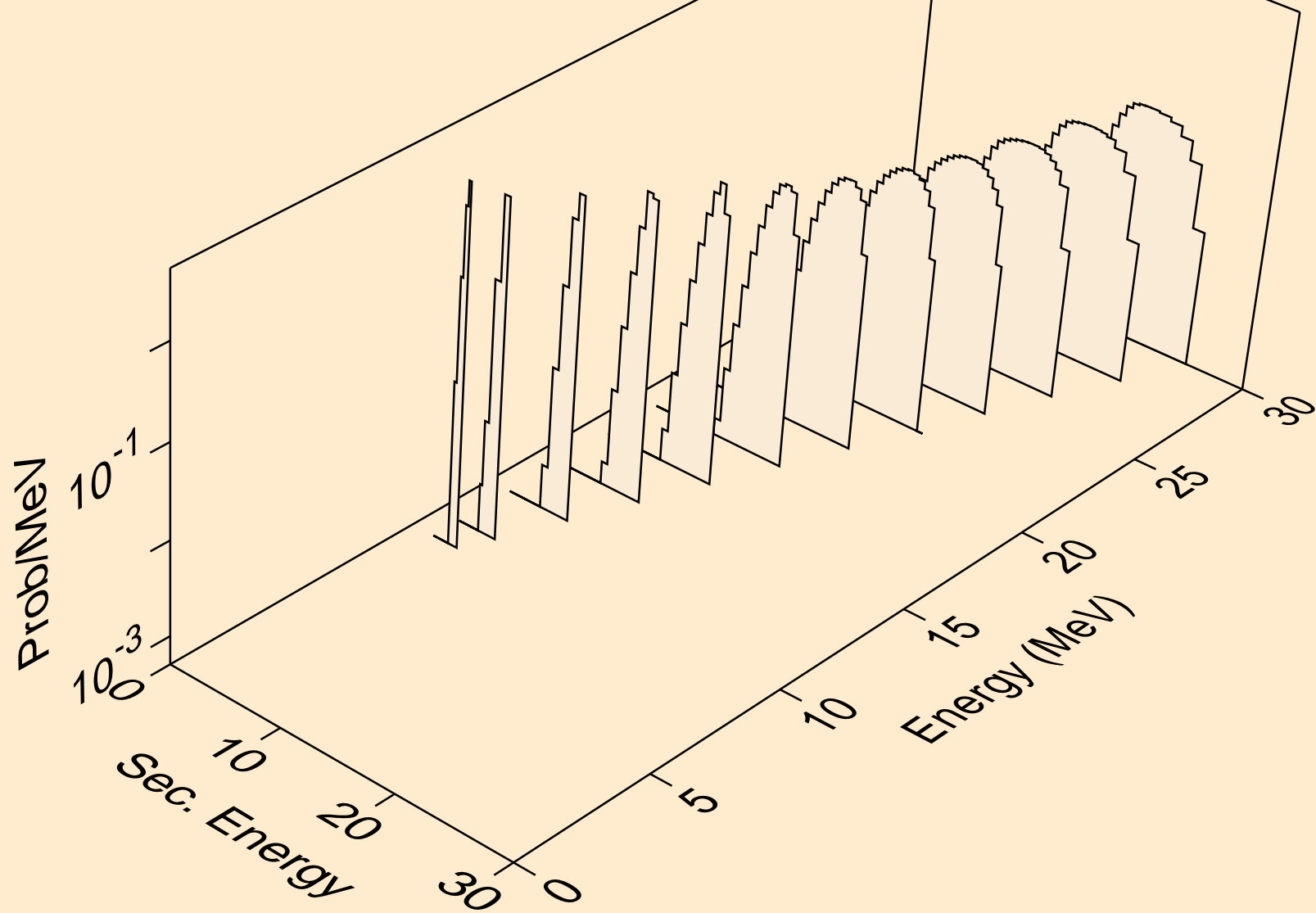

FR224 TRITON ACER TENDL-2021 LIBRARY; T=0.K  
Triton emission for inelastic

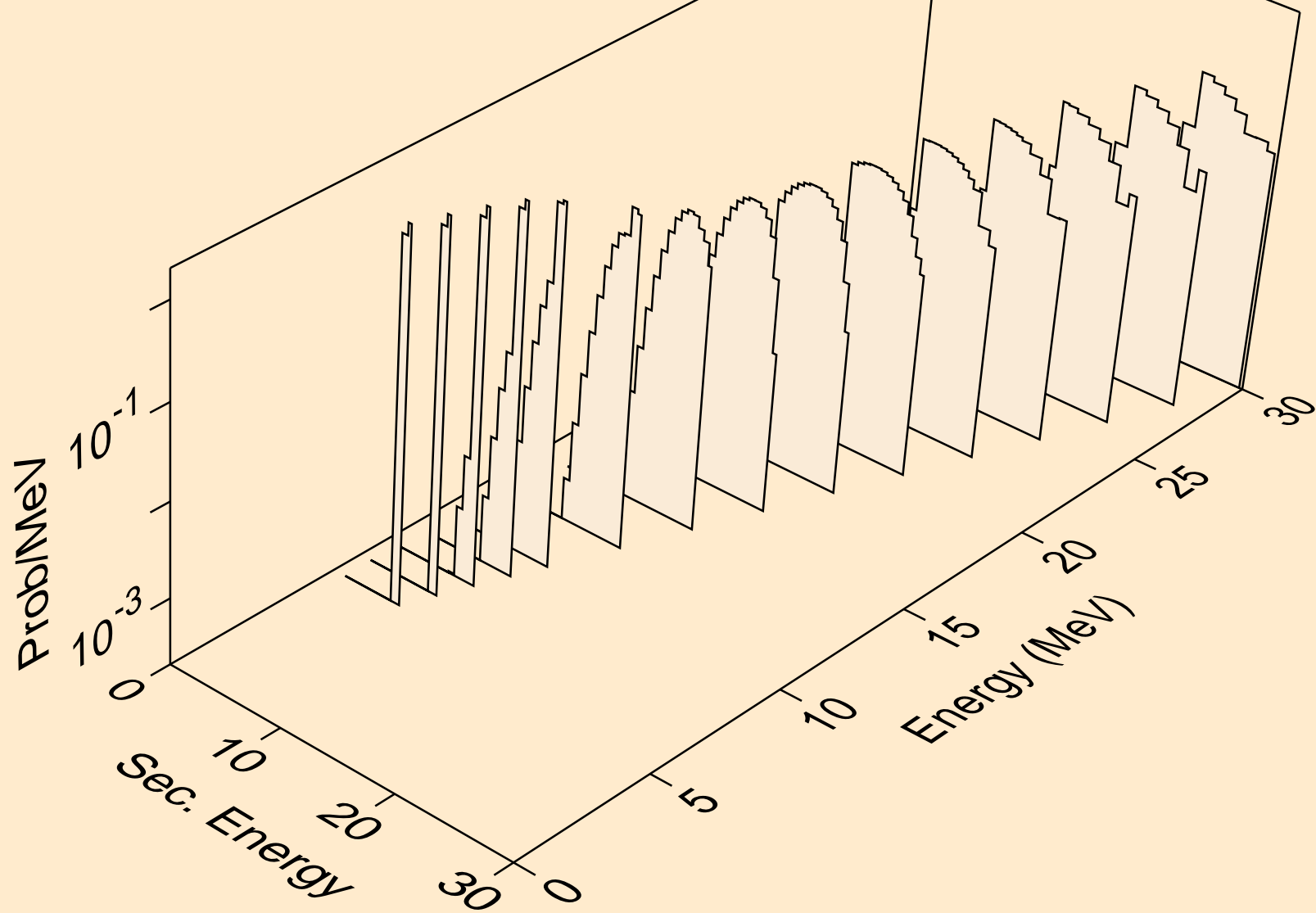

FR224 TRITON ACER TENDL-2021 LIBRARY; T=0.K  
Triton emission for (t,pt)

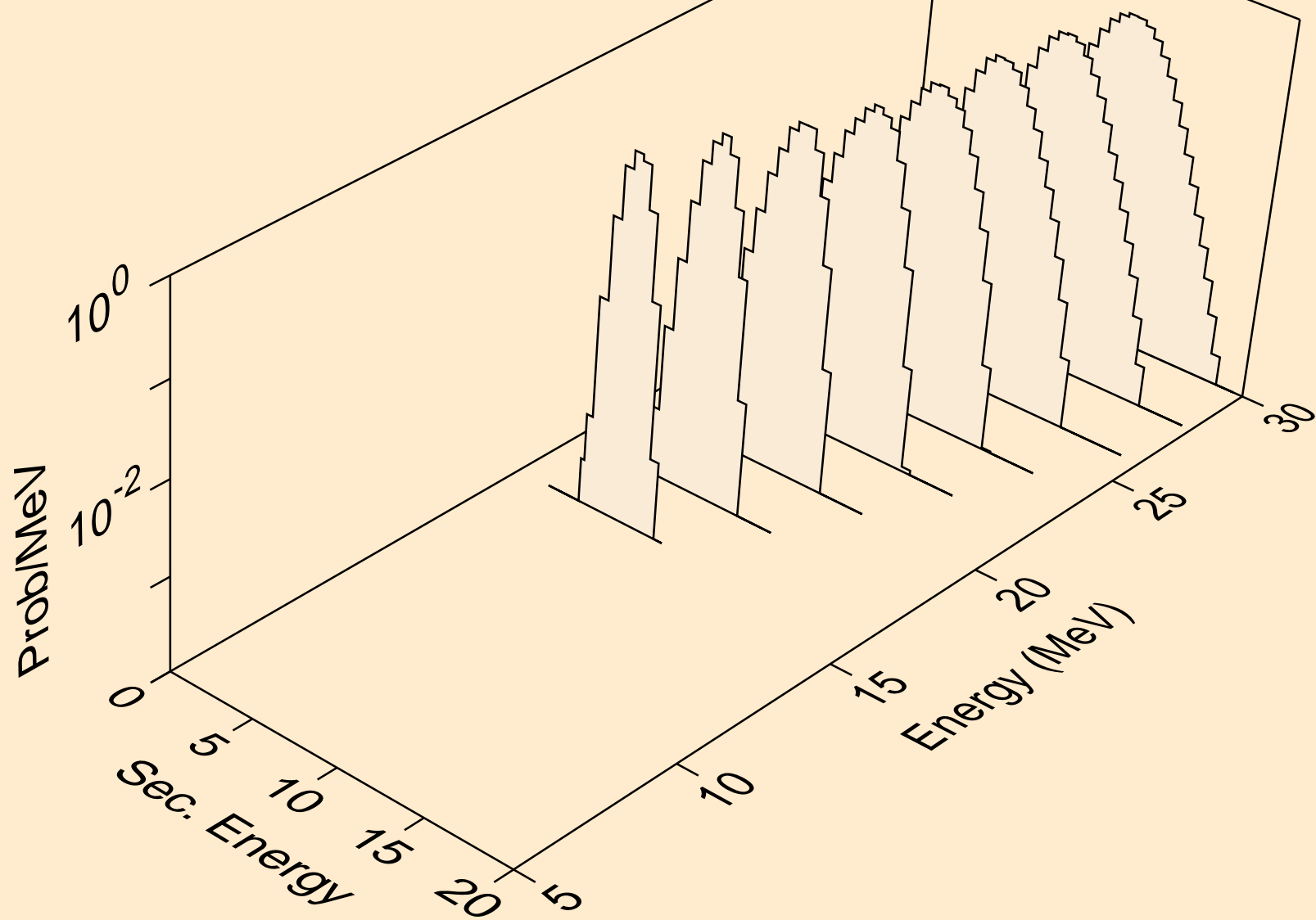

FR224 TRITON ACER TENDL-2021 LIBRARY; T=0.K  
Photon emission for (z,n)

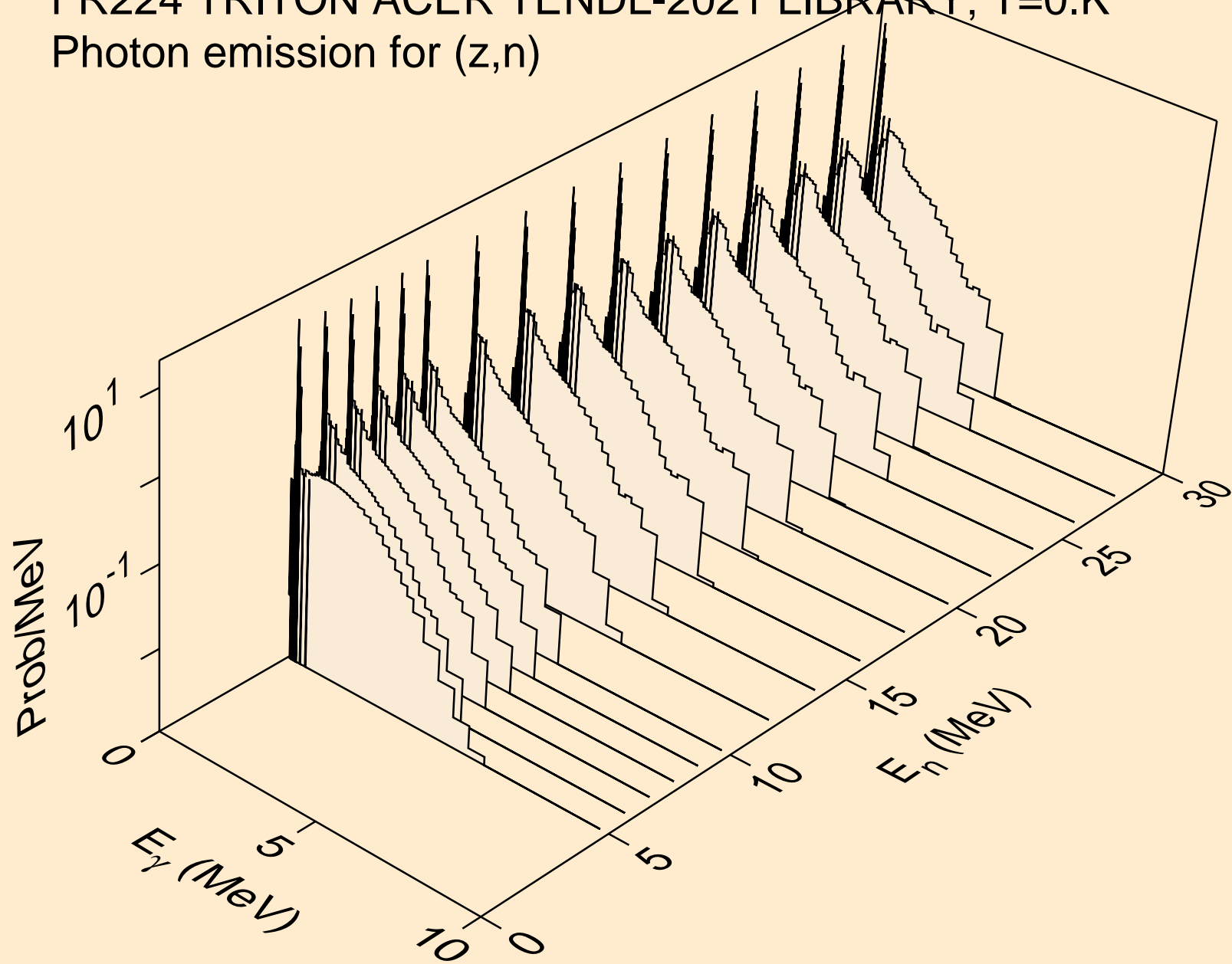

FR224 TRITON ACER TENDL-2021 LIBRARY; T=0.K  
Photon emission for (n,x)

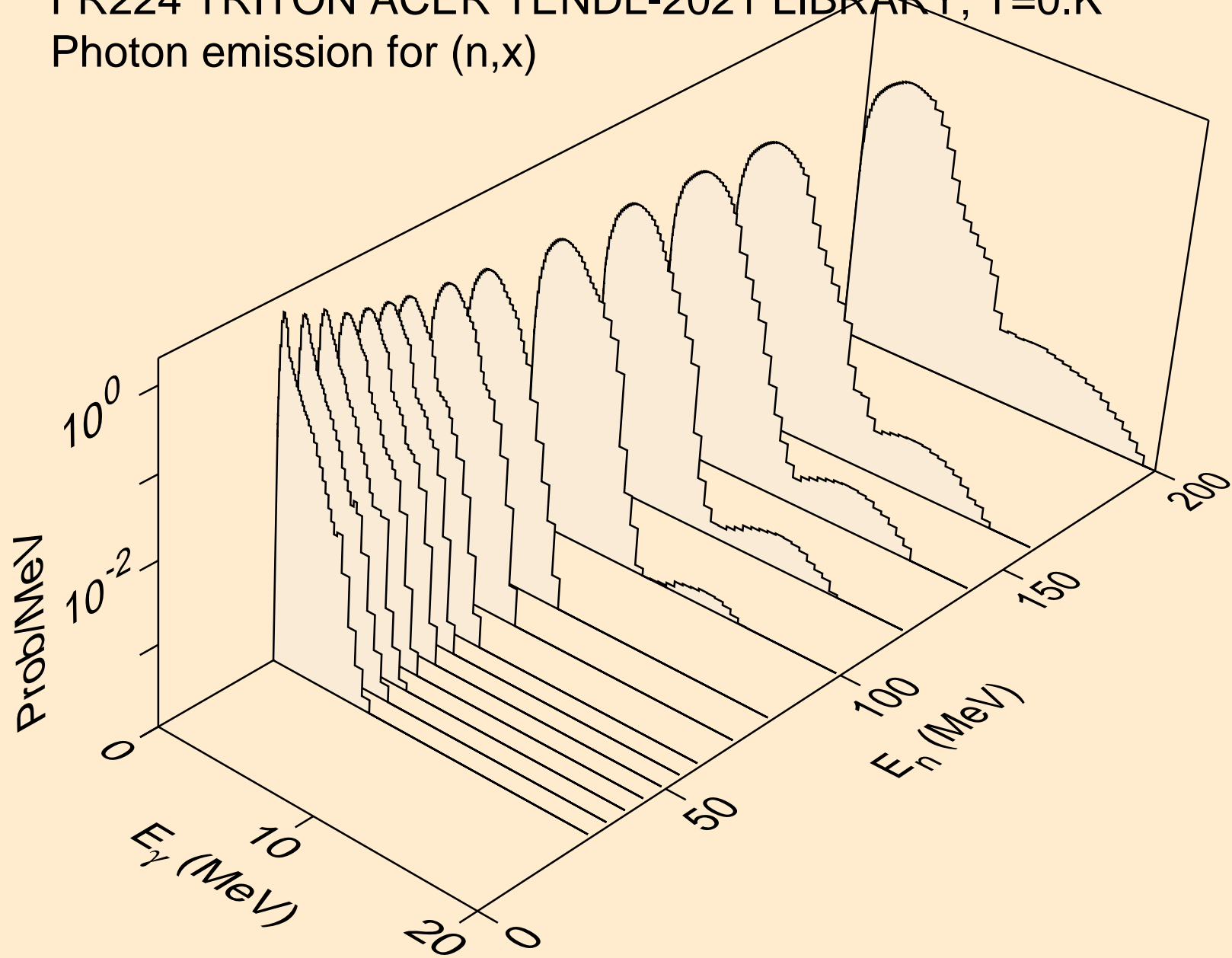



FR224 TRITON ACER TENDL-2021 LIBRARY; T=0.K  
Photon emission for (n,2nd)

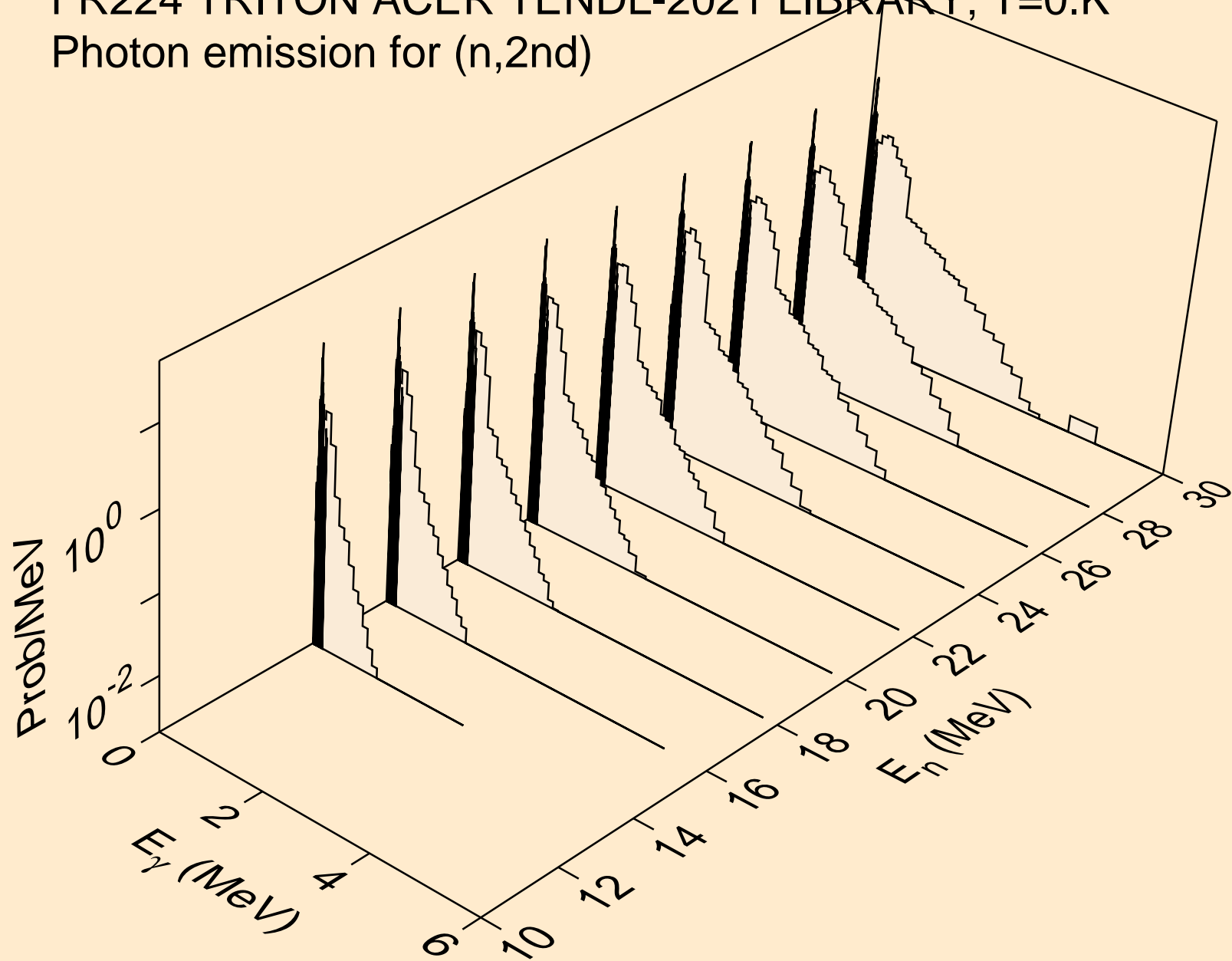

FR224 TRITON ACER TENDL-2021 LIBRARY; T=0.K  
Photon emission for (n,2n)

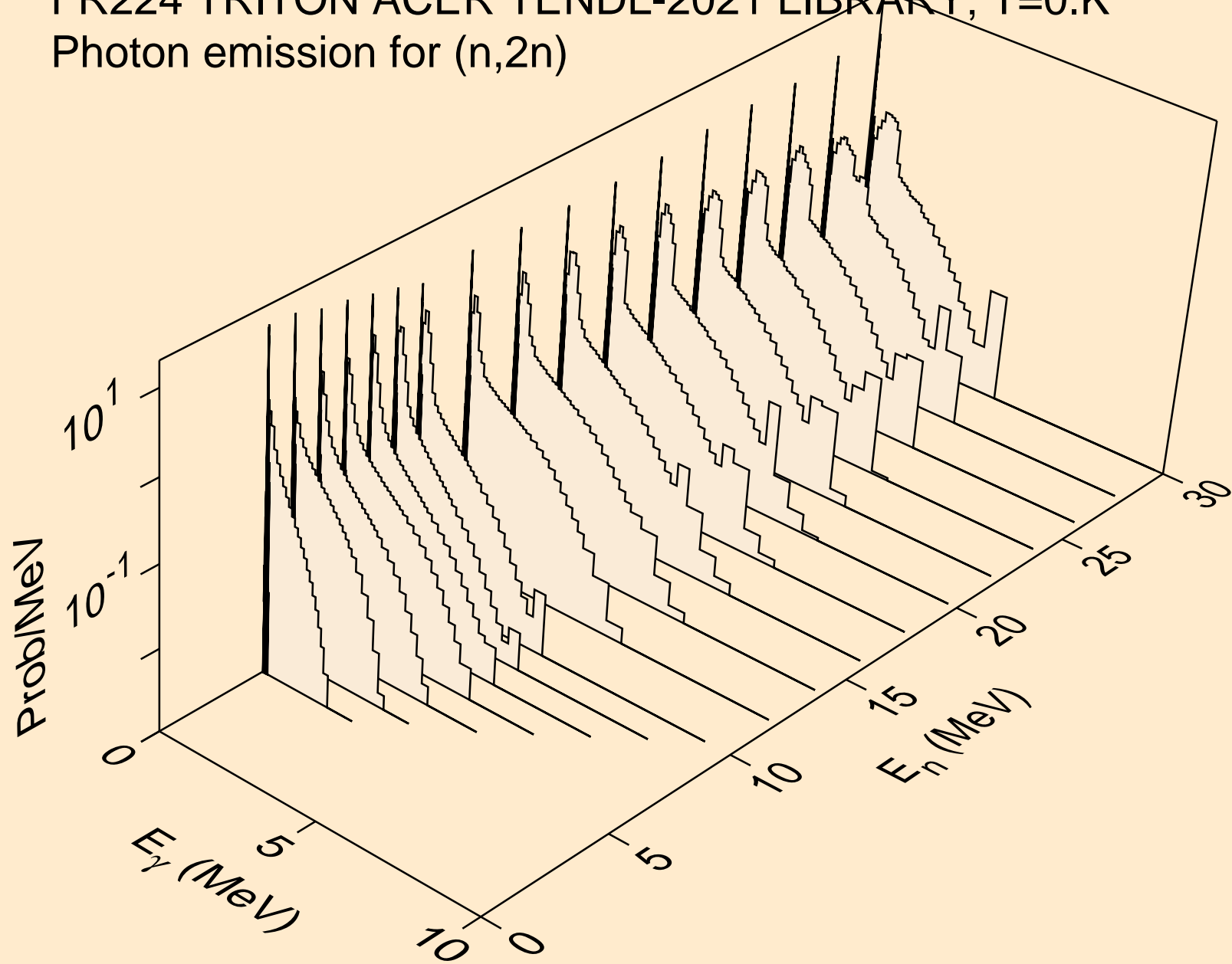

FR224 TRITON ACER TENDL-2021 LIBRARY; T=0.K  
Photon emission for (n,3n)

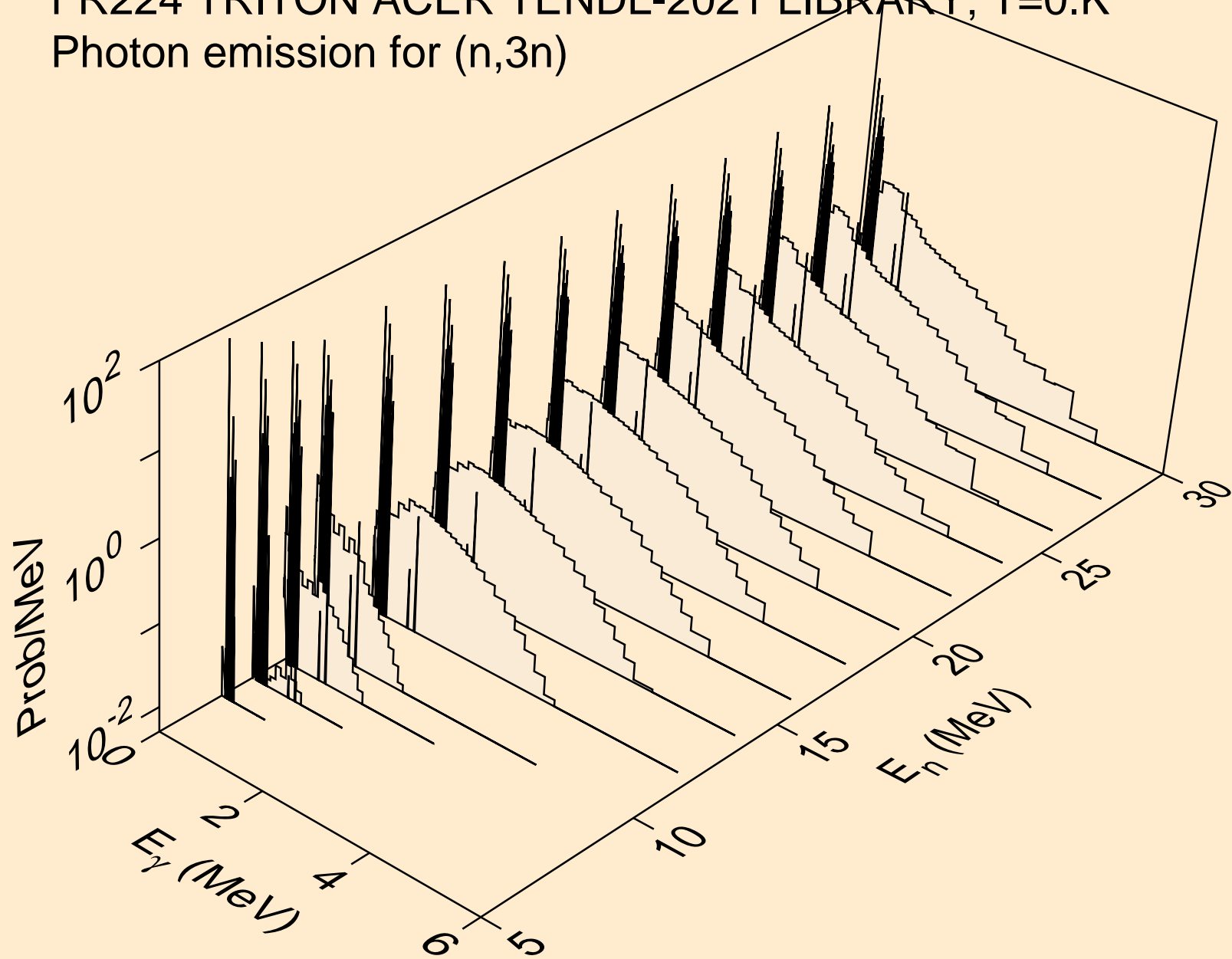

FR224 TRITON ACER TENDL-2021 LIBRARY; T=0.K  
Photon emission for (n,n\*)a

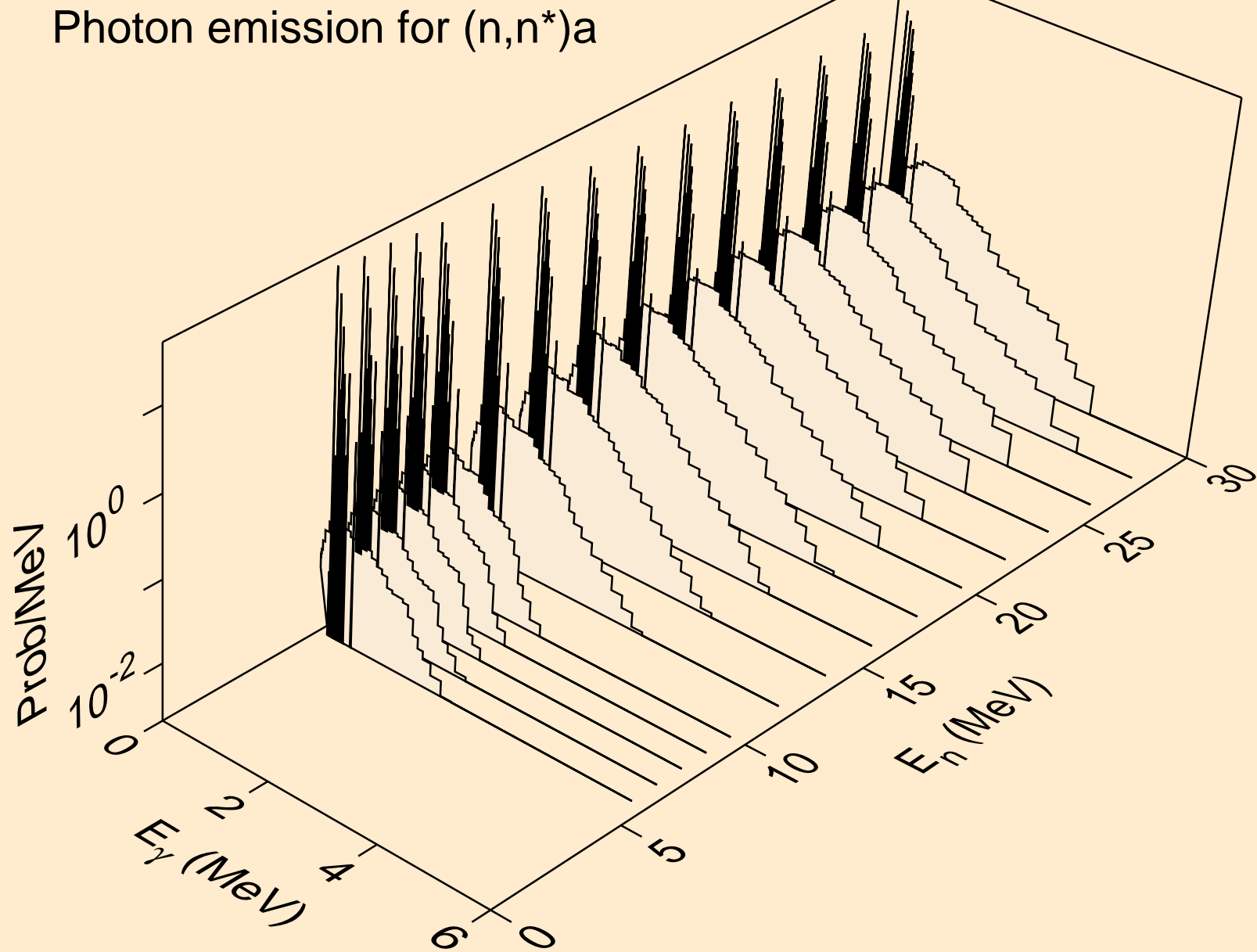

FR224 TRITON ACER TENDL-2021 LIBRARY; T=0.K  
Photon emission for (n,2n)a

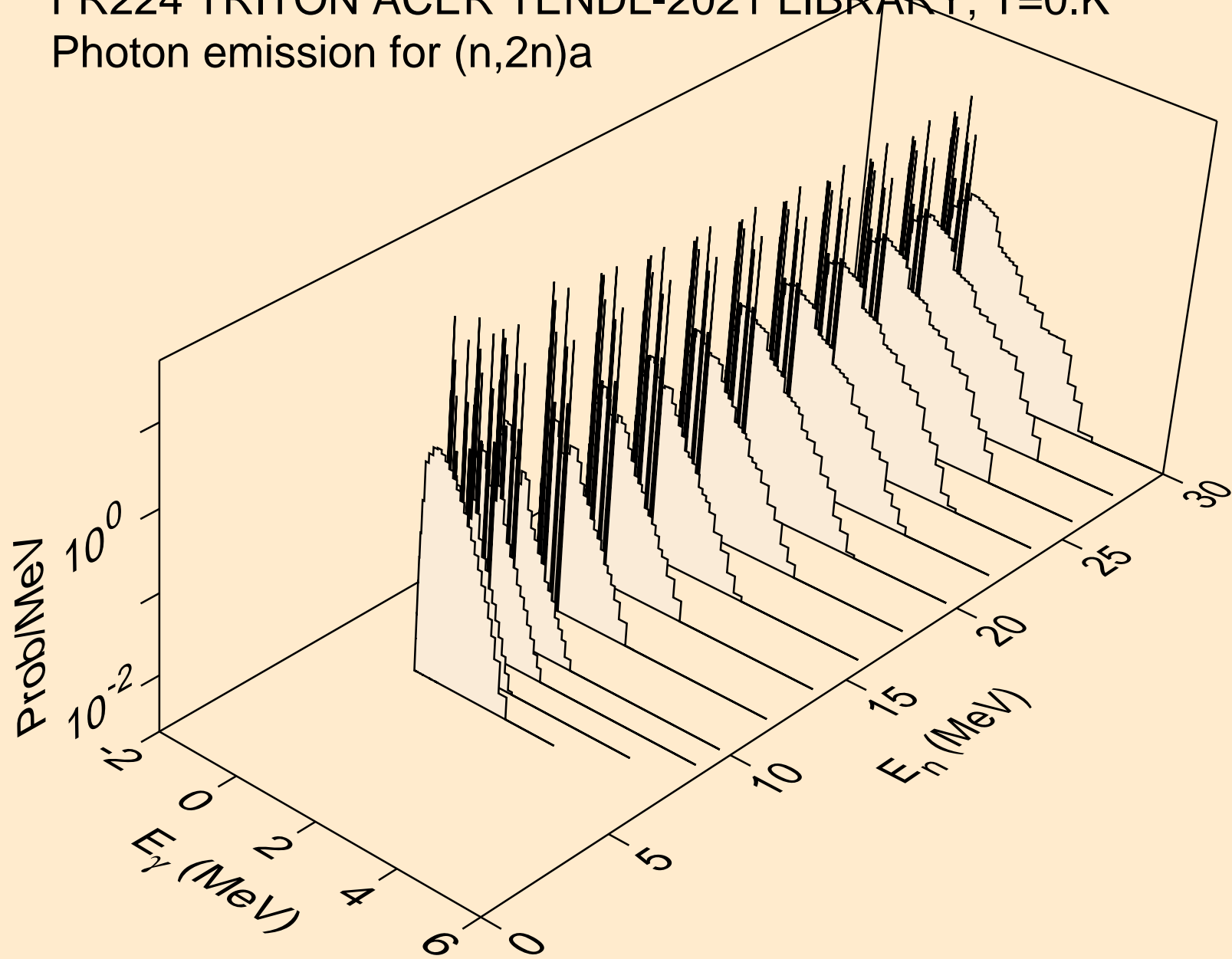

FR224 TRITON ACER TENDL-2021 LIBRARY; T=0.K  
Photon emission for (n,3n)a

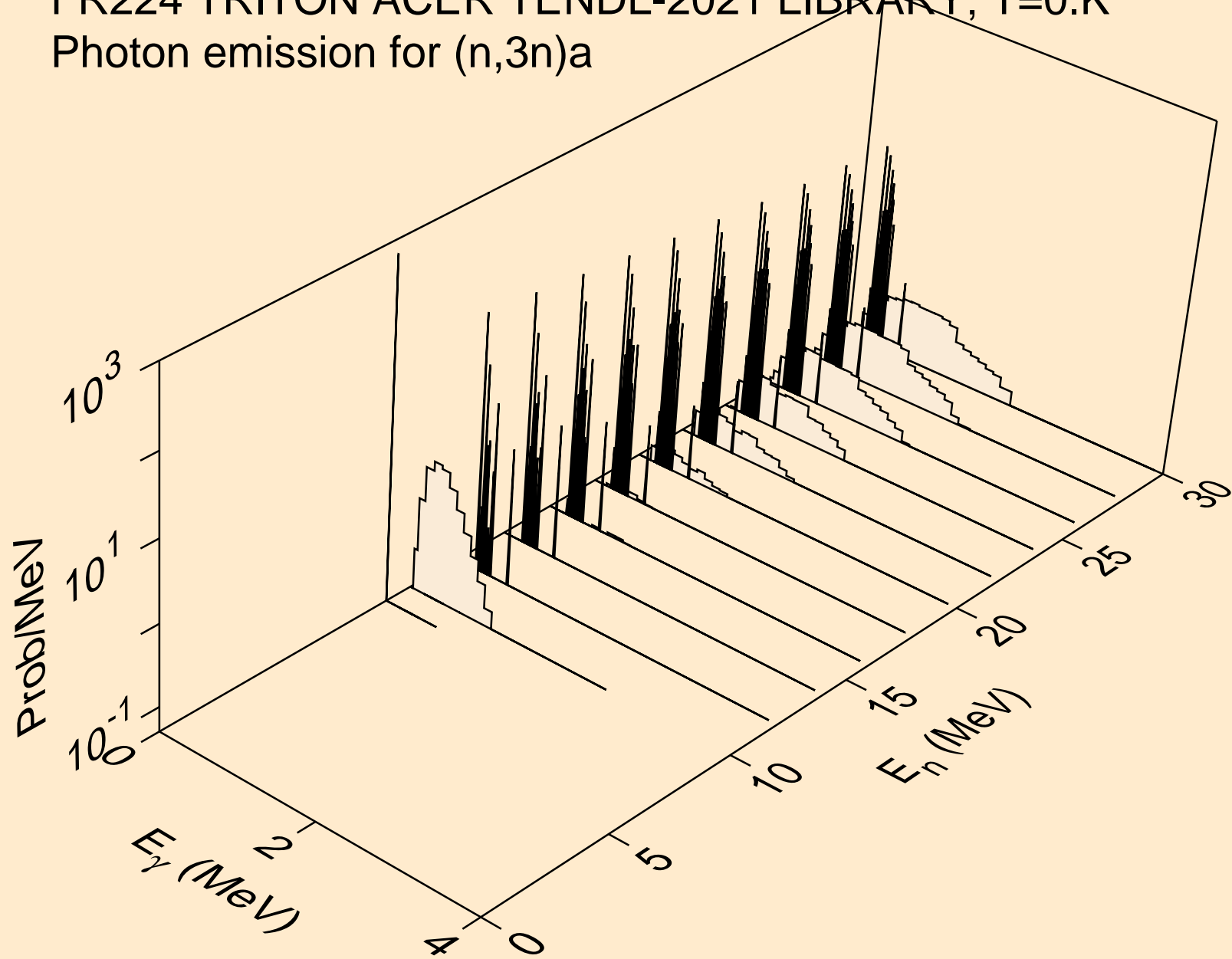

FR224 TRITON ACER TENDL-2021 LIBRARY; T=0.K  
Photon emission for (n,n\*)p

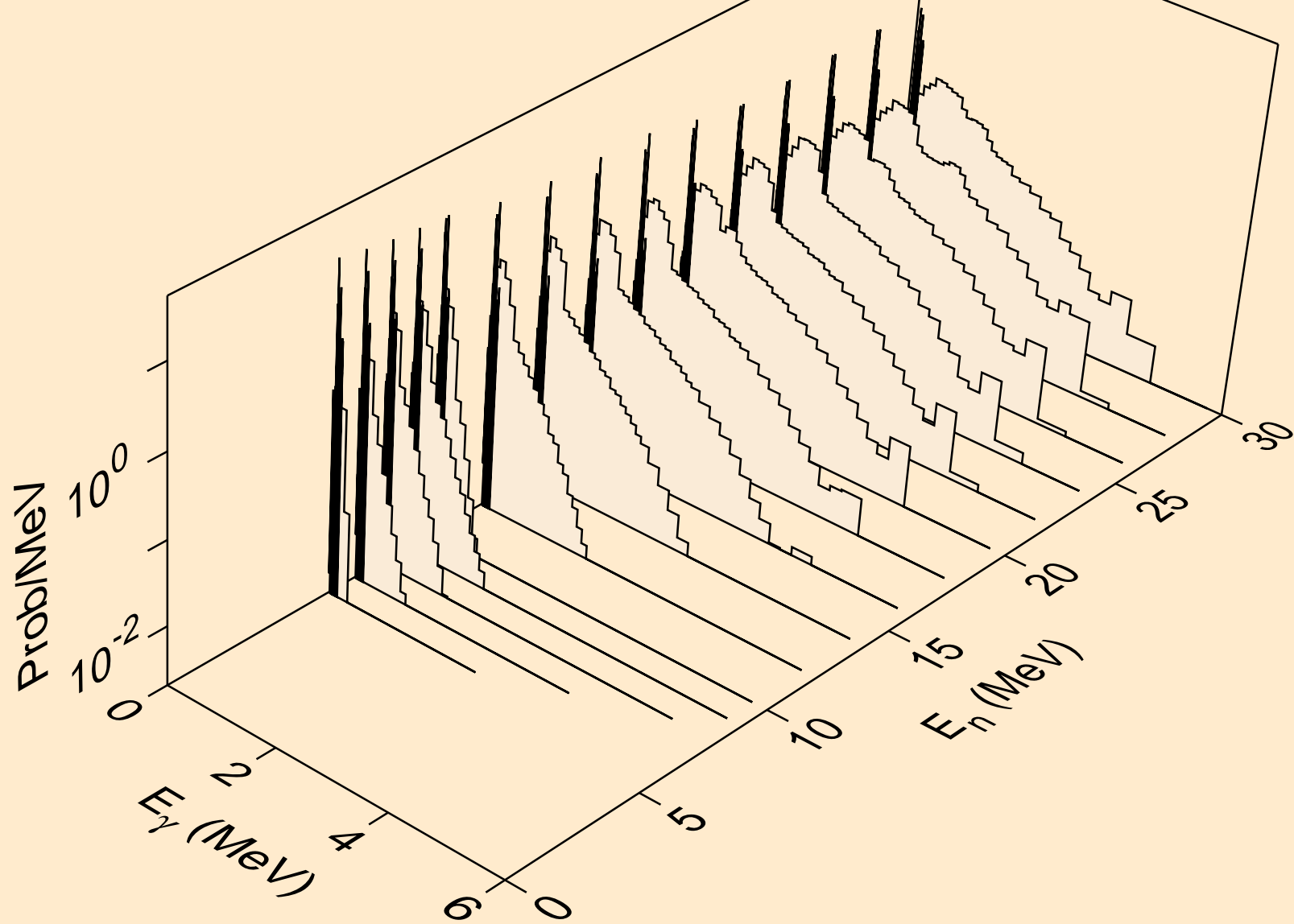

FR224 TRITON ACER TENDL-2021 LIBRARY; T=0.K  
Photon emission for (n,n\*)2a

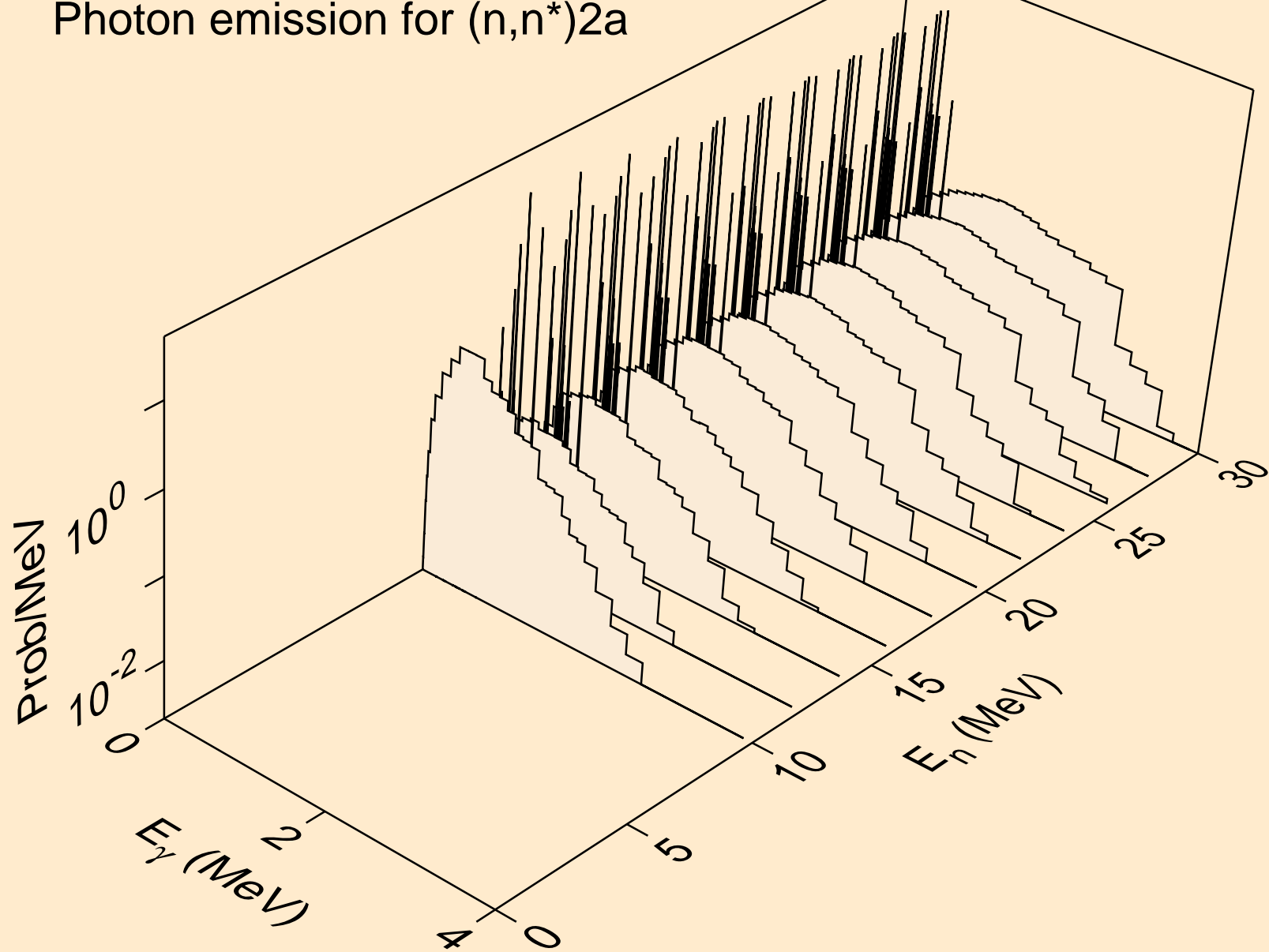



FR224 TRITON ACER TENDL-2021 LIBRARY; T=0.K  
Photon emission for (n,2n)2a

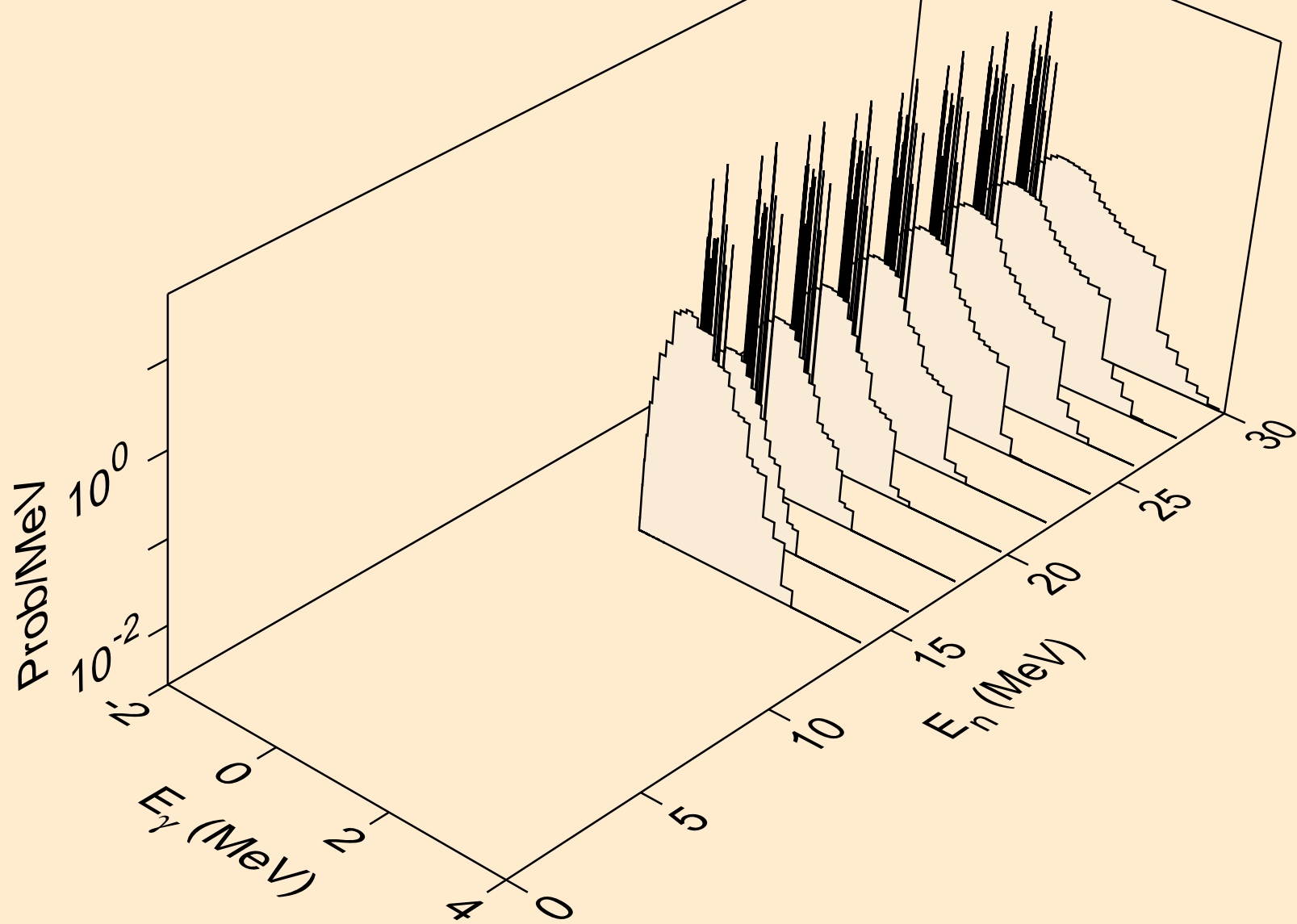

FR224 TRITON ACER TENDL-2021 LIBRARY; T=0.K  
Photon emission for (n,n\*)d

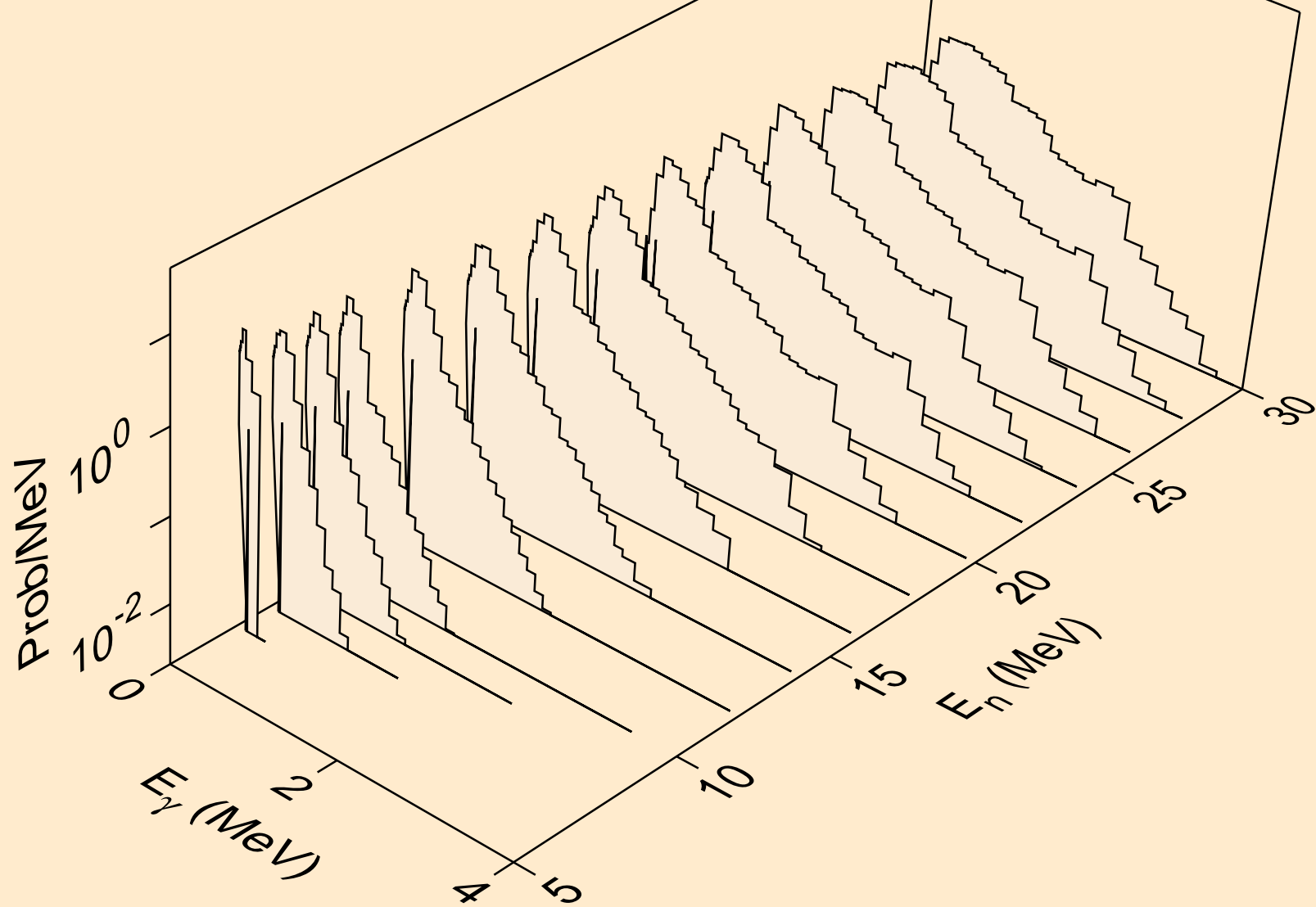

FR224 TRITON ACER TENDL-2021 LIBRARY; T=0.K  
Photon emission for (n,n\*)t

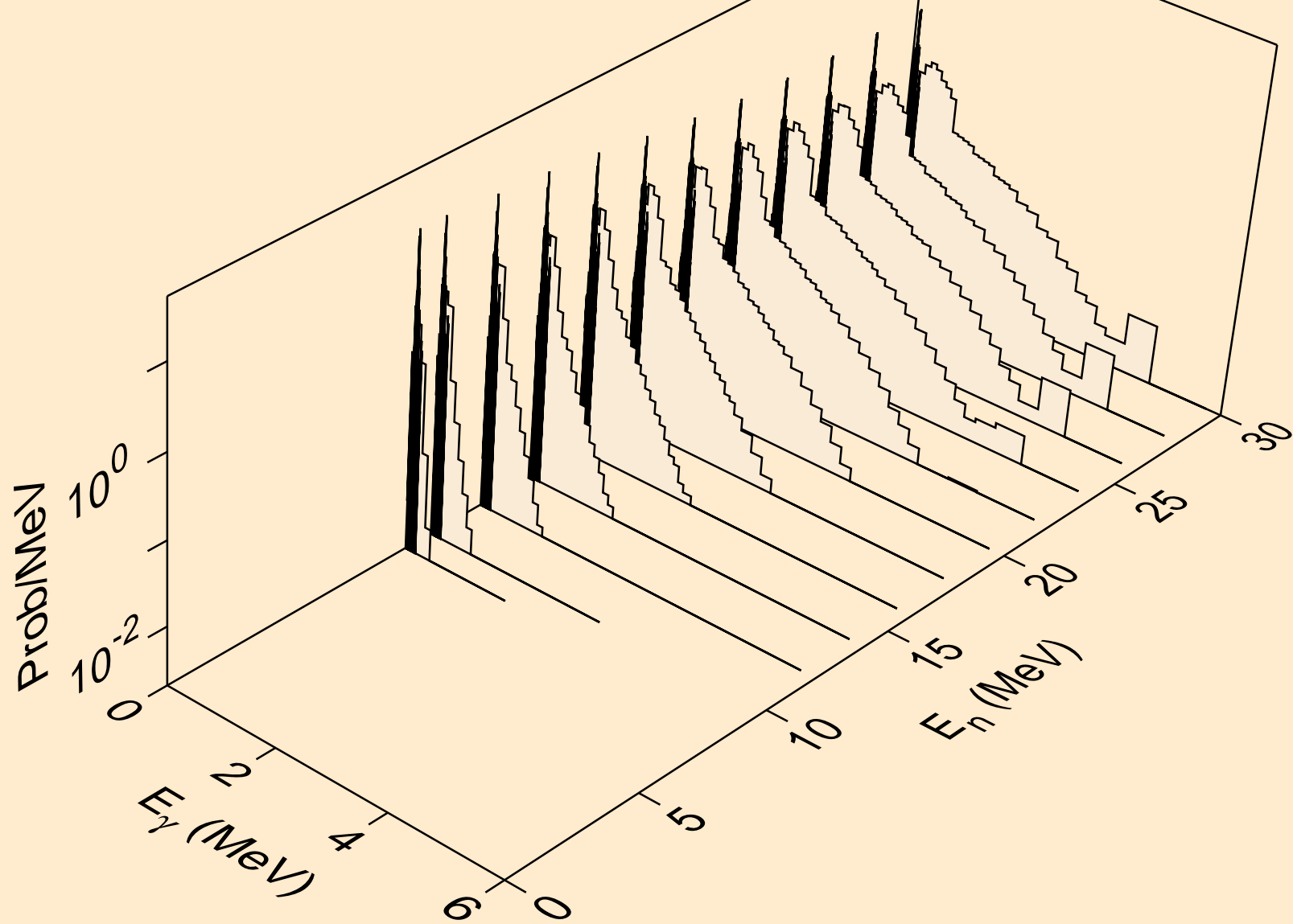

FR224 TRITON ACER TENDL-2021 LIBRARY; T=0.K  
Photon emission for (n,n\*)he3

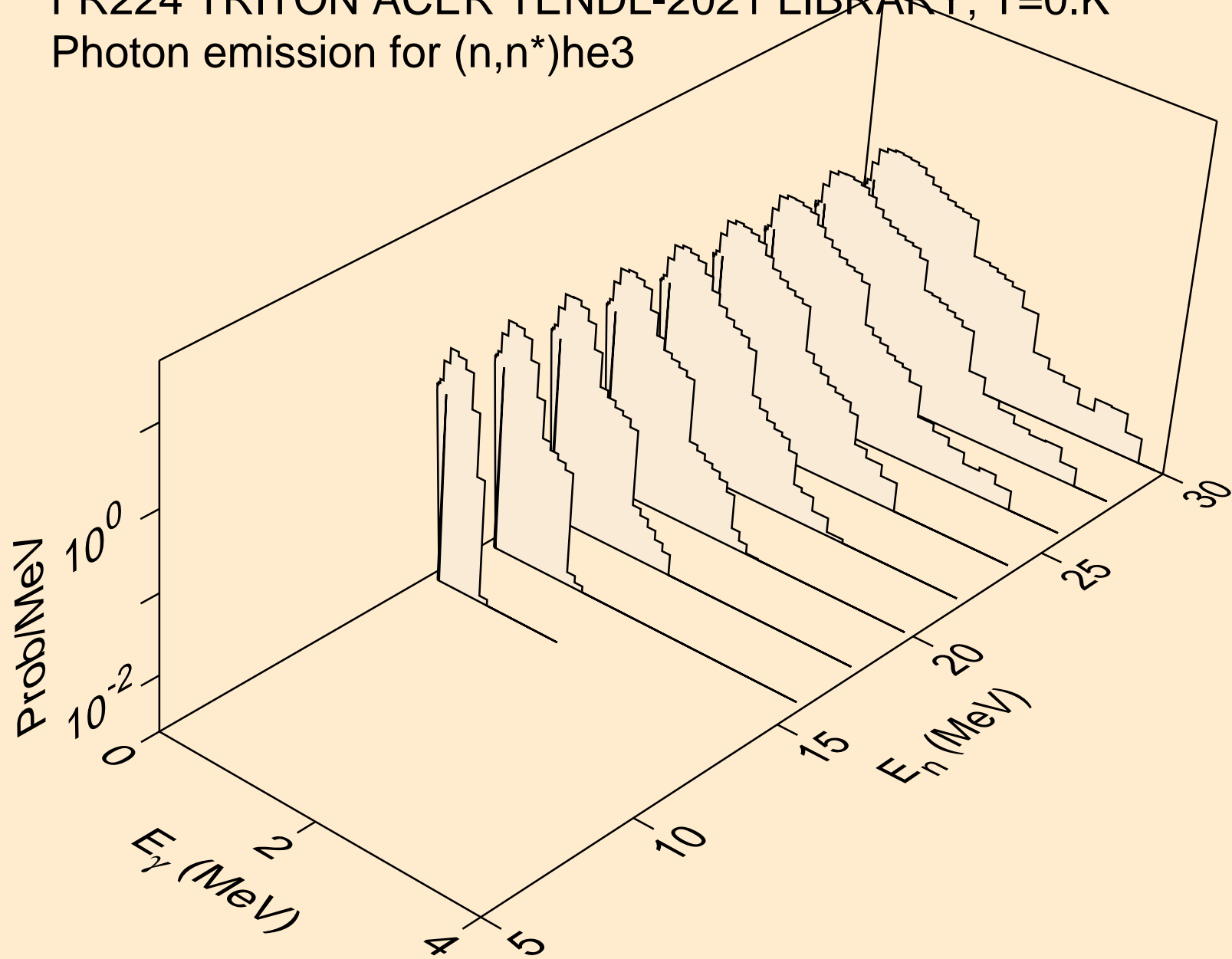

FR224 TRITON ACER TENDL-2021 LIBRARY; T=0.K  
Photon emission for (n,4n)

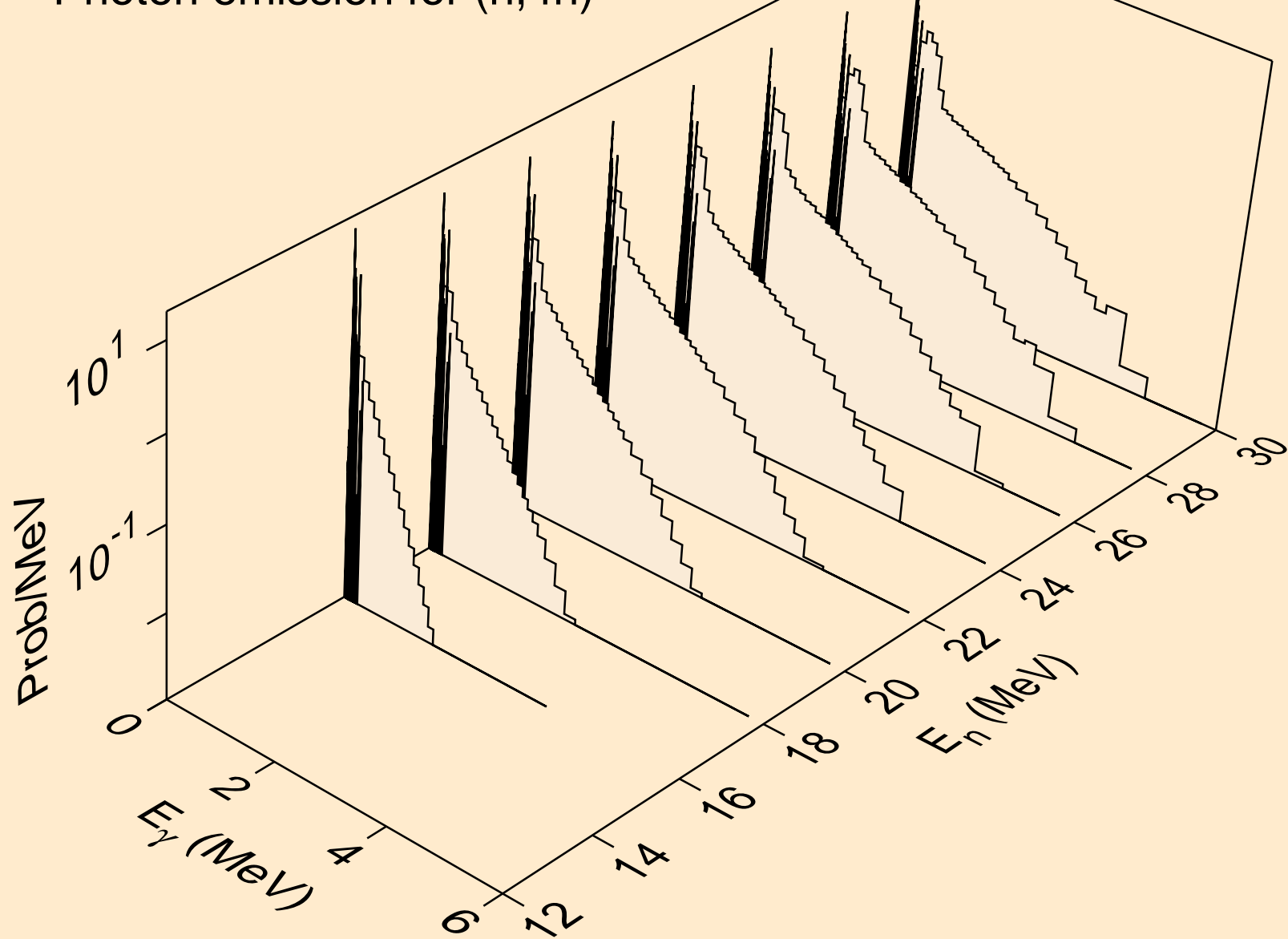

FR224 TRITON ACER TENDL-2021 LIBRARY; T=0.K  
Photon emission for (n,2np)

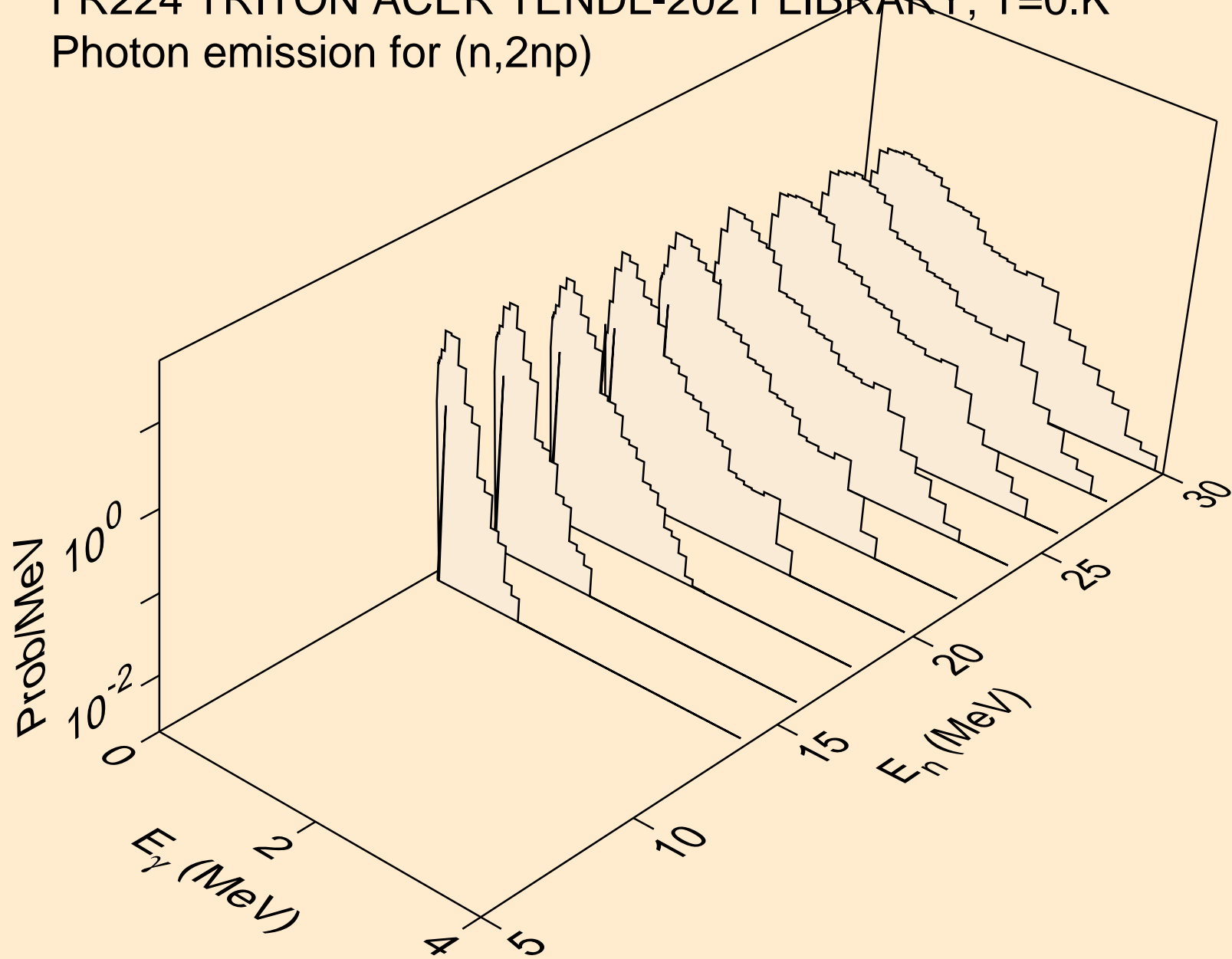

FR224 TRITON ACER TENDL-2021 LIBRARY; T=0.K  
Photon emission for (n,3np)

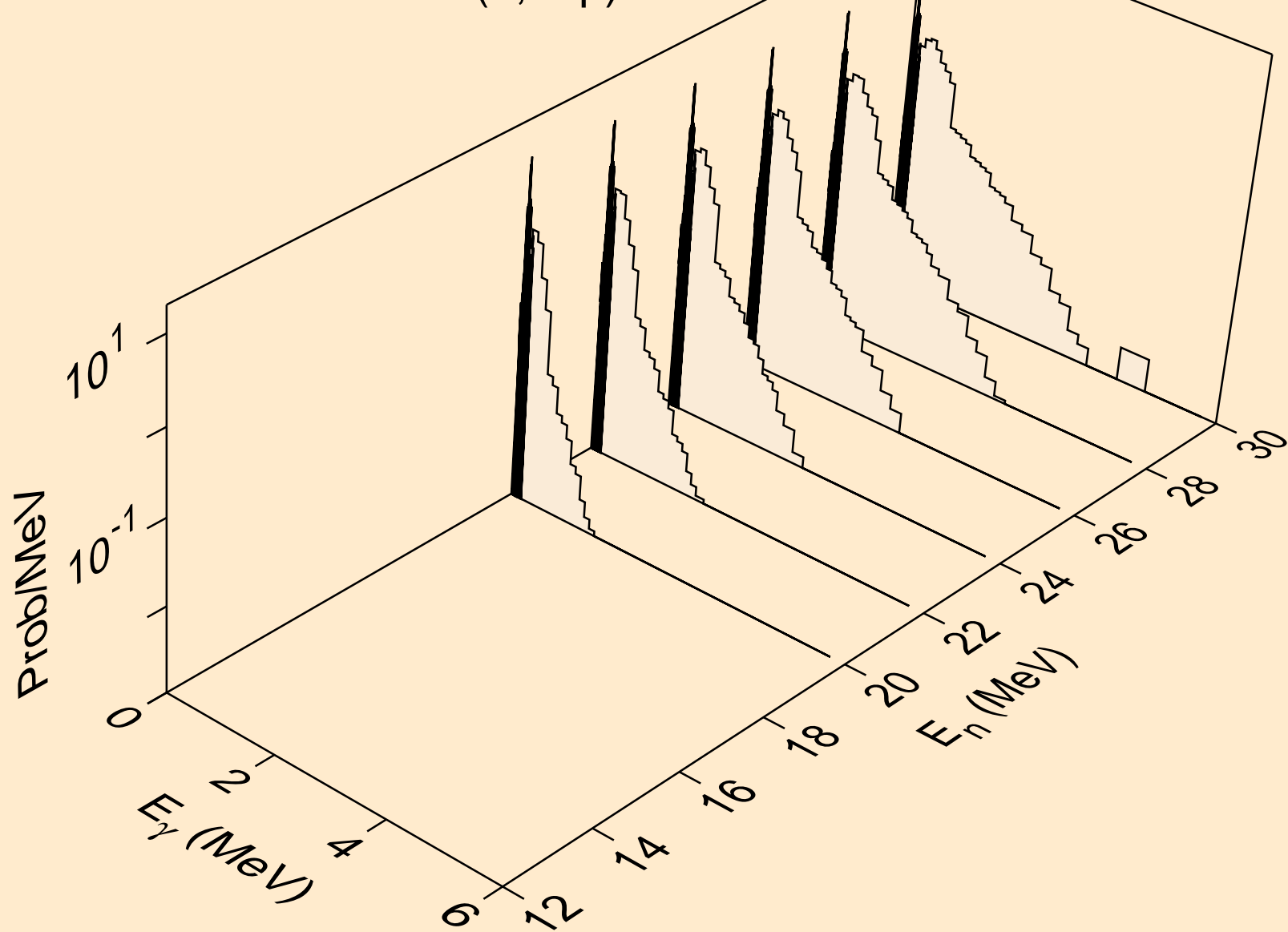

FR224 TRITON ACER TENDL-2021 LIBRARY; T=0.K  
Photon emission for (n,2np)

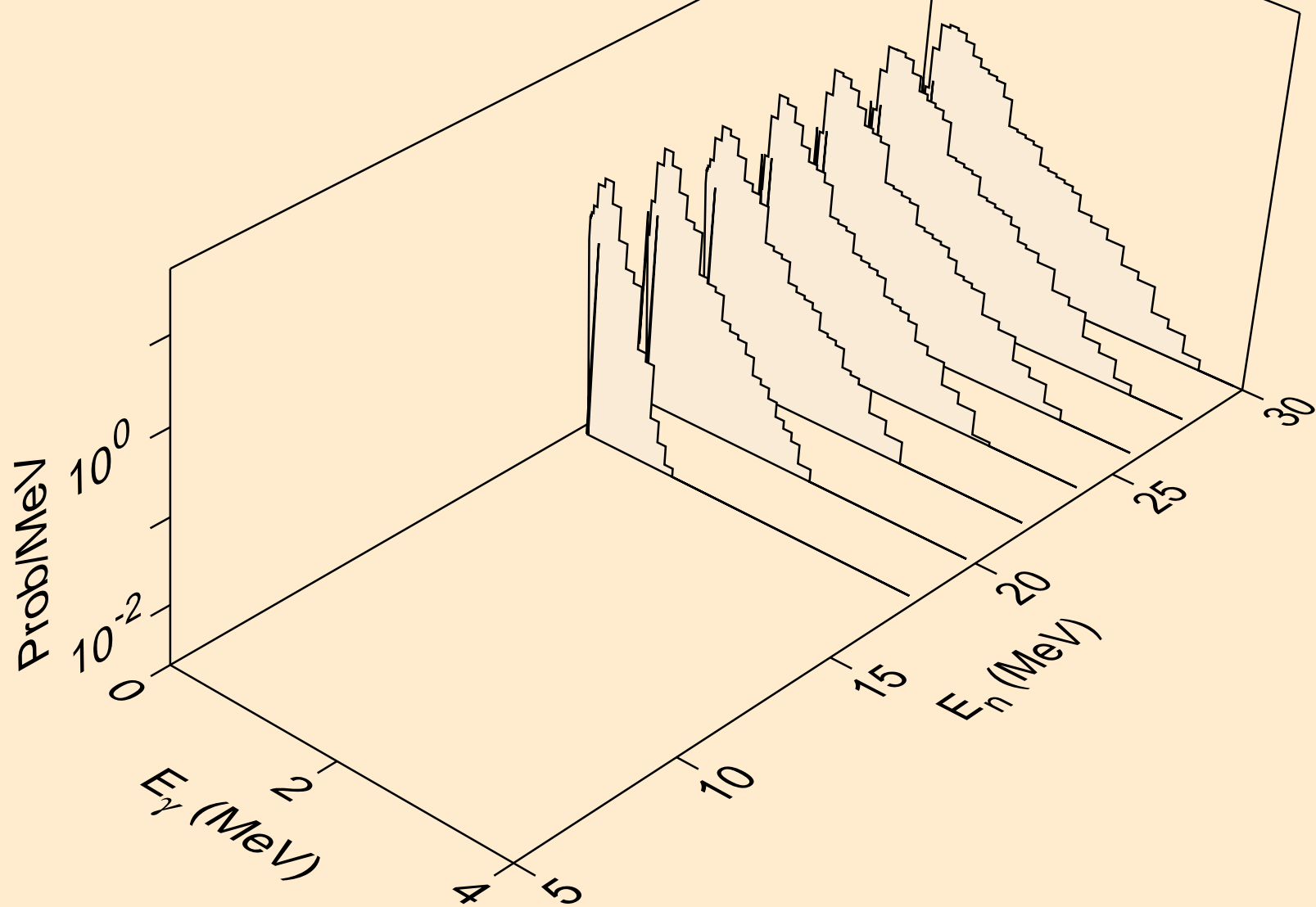



FR224 TRITON ACER TENDL-2021 LIBRARY; T=0.K  
Photon emission for (n,npa)

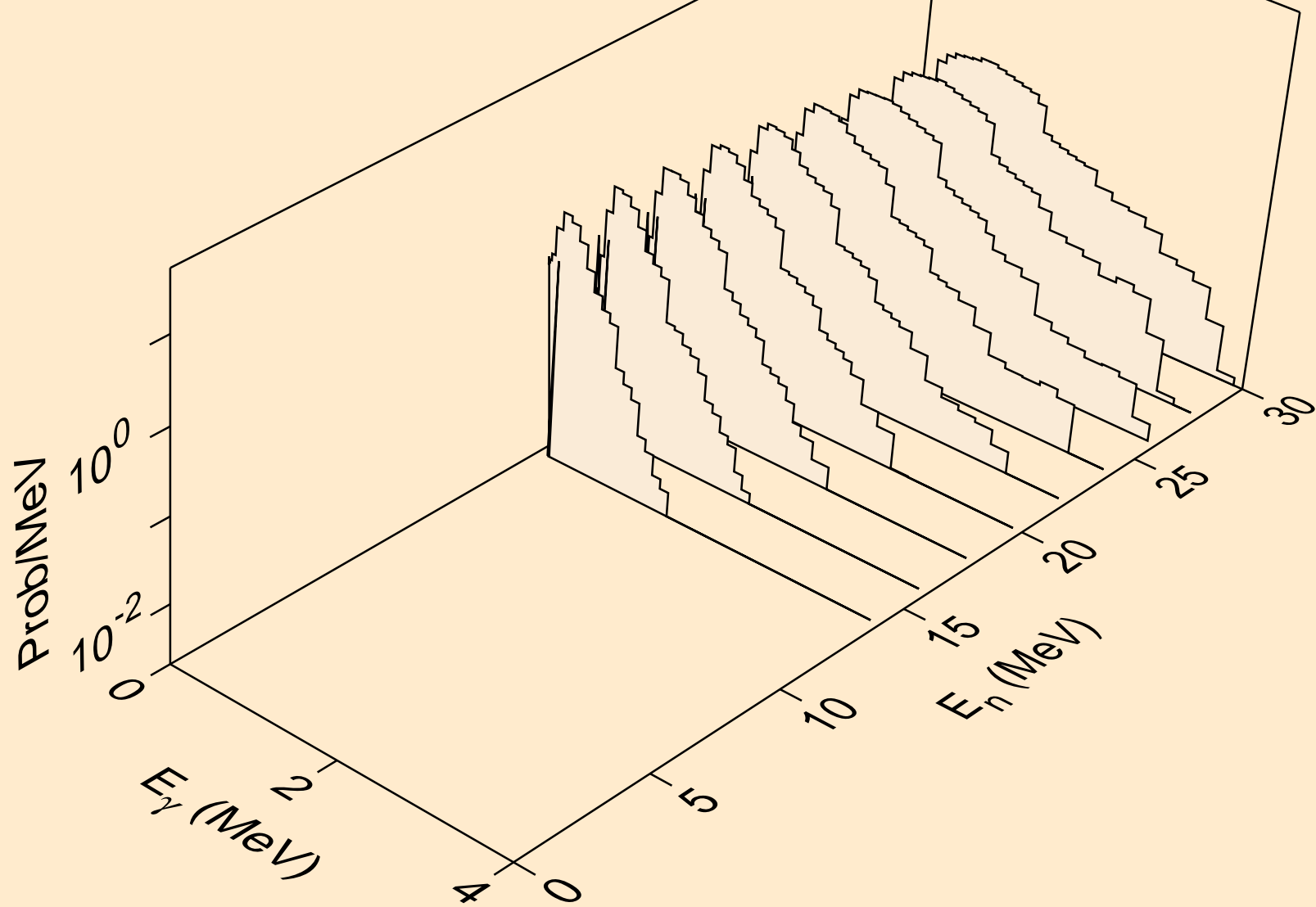

FR224 TRITON ACER TENDL-2021 LIBRARY; T=0.K  
Photon emission for (n,gma)

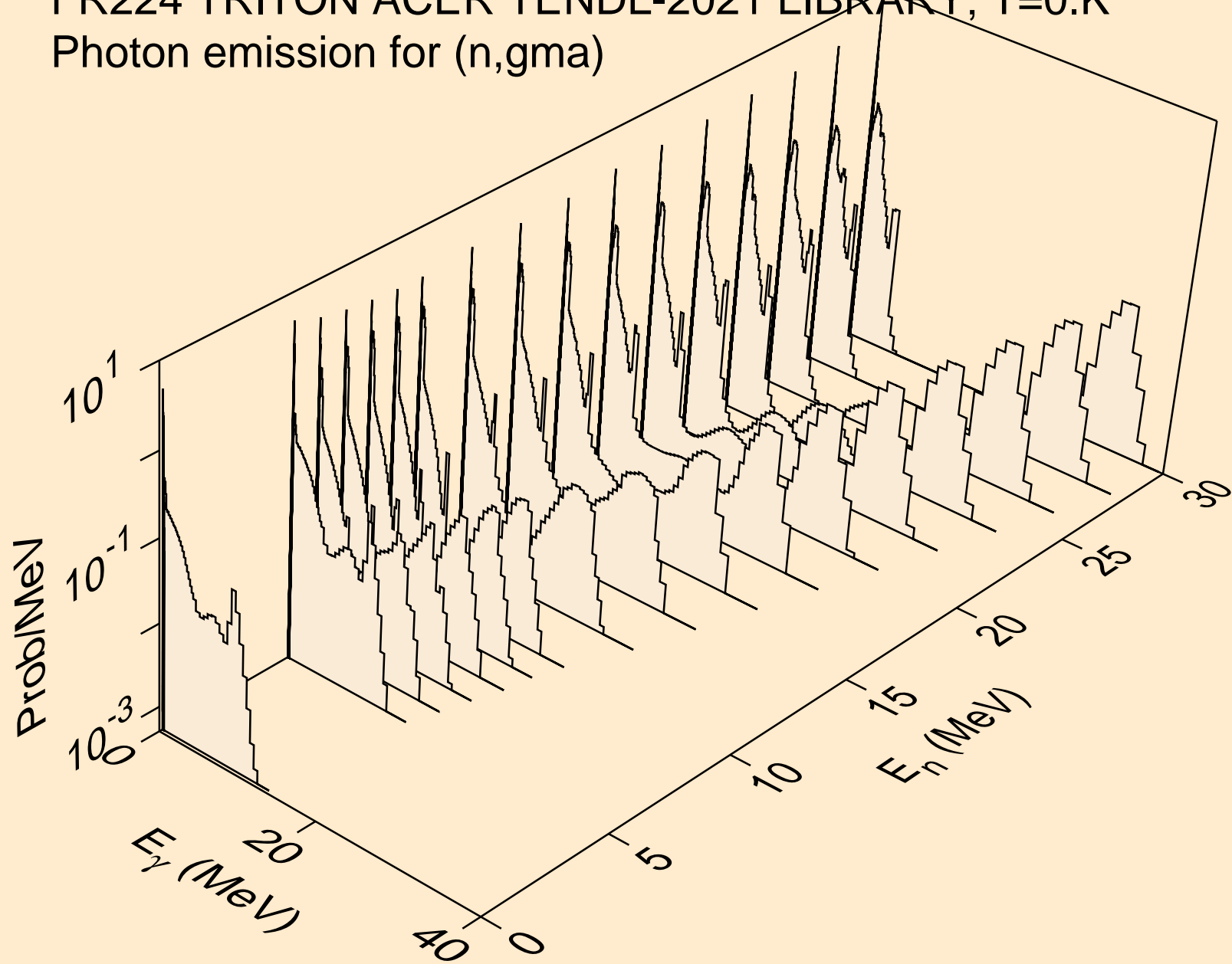

FR224 TRITON ACER TENDL-2021 LIBRARY; T=0.K  
Photon emission for (n,p)

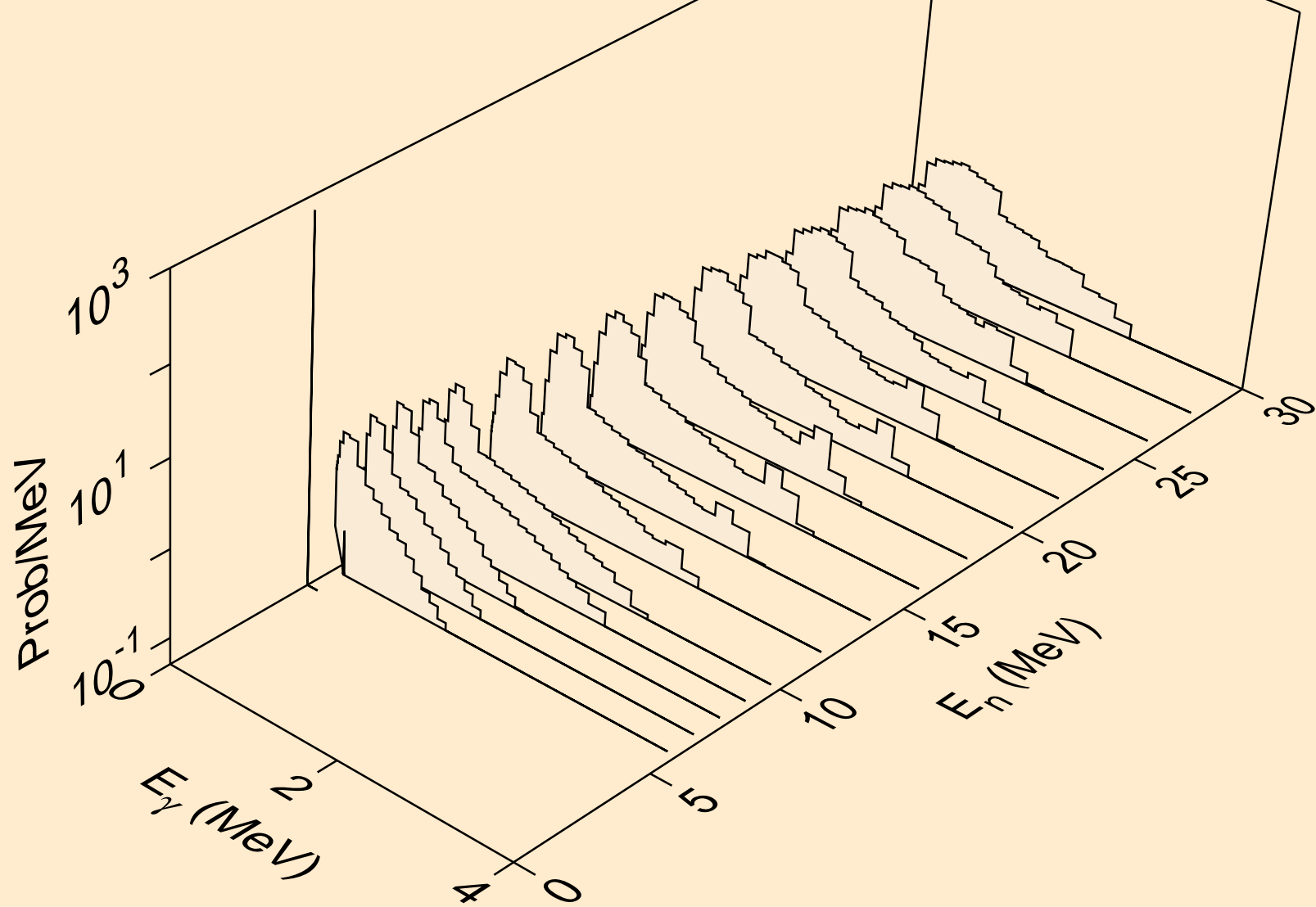

FR224 TRITON ACER TENDL-2021 LIBRARY; T=0.K  
Photon emission for (n,d)

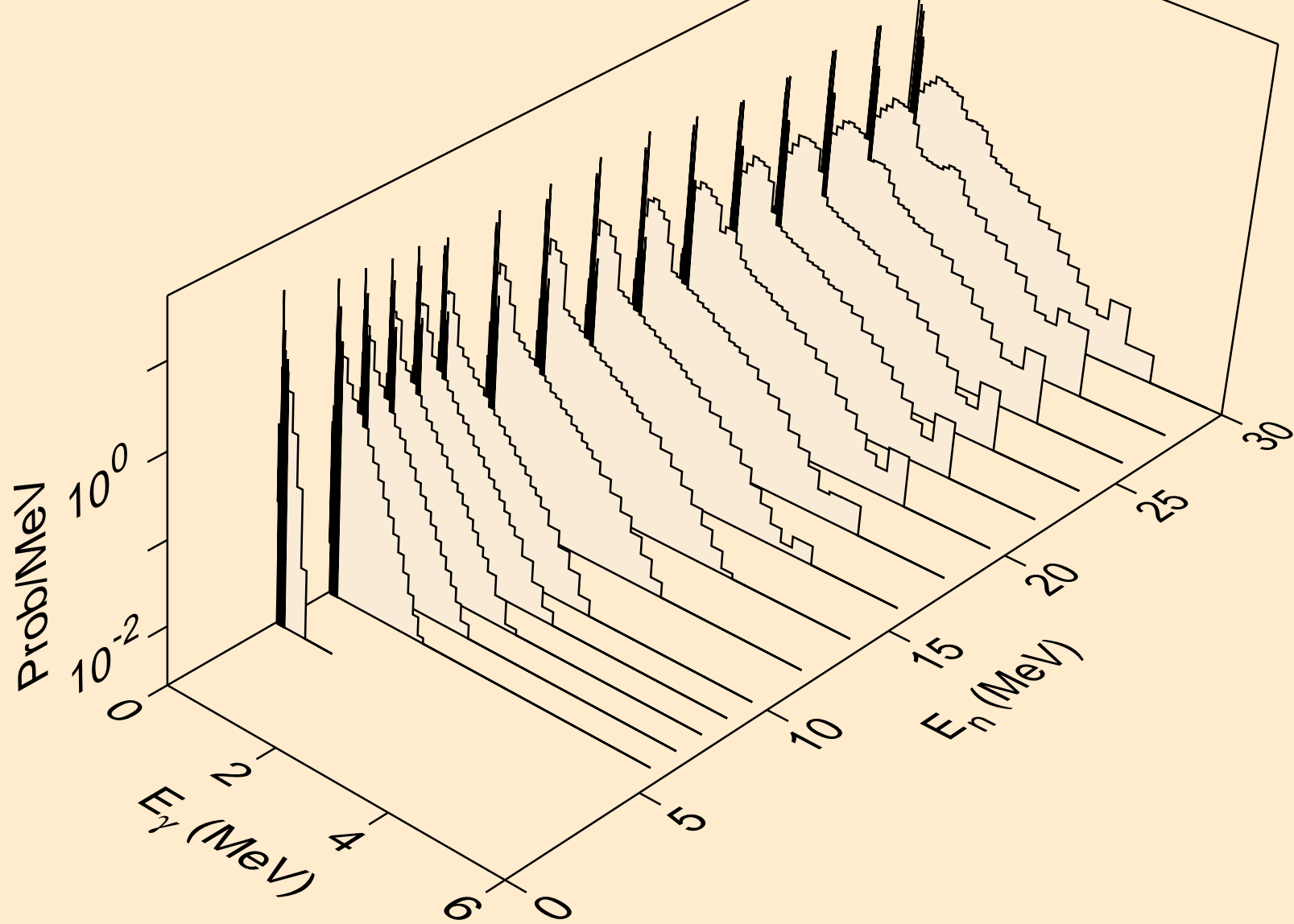

FR224 TRITON ACER TENDL-2021 LIBRARY; T=0.K  
Photon emission for inelastic

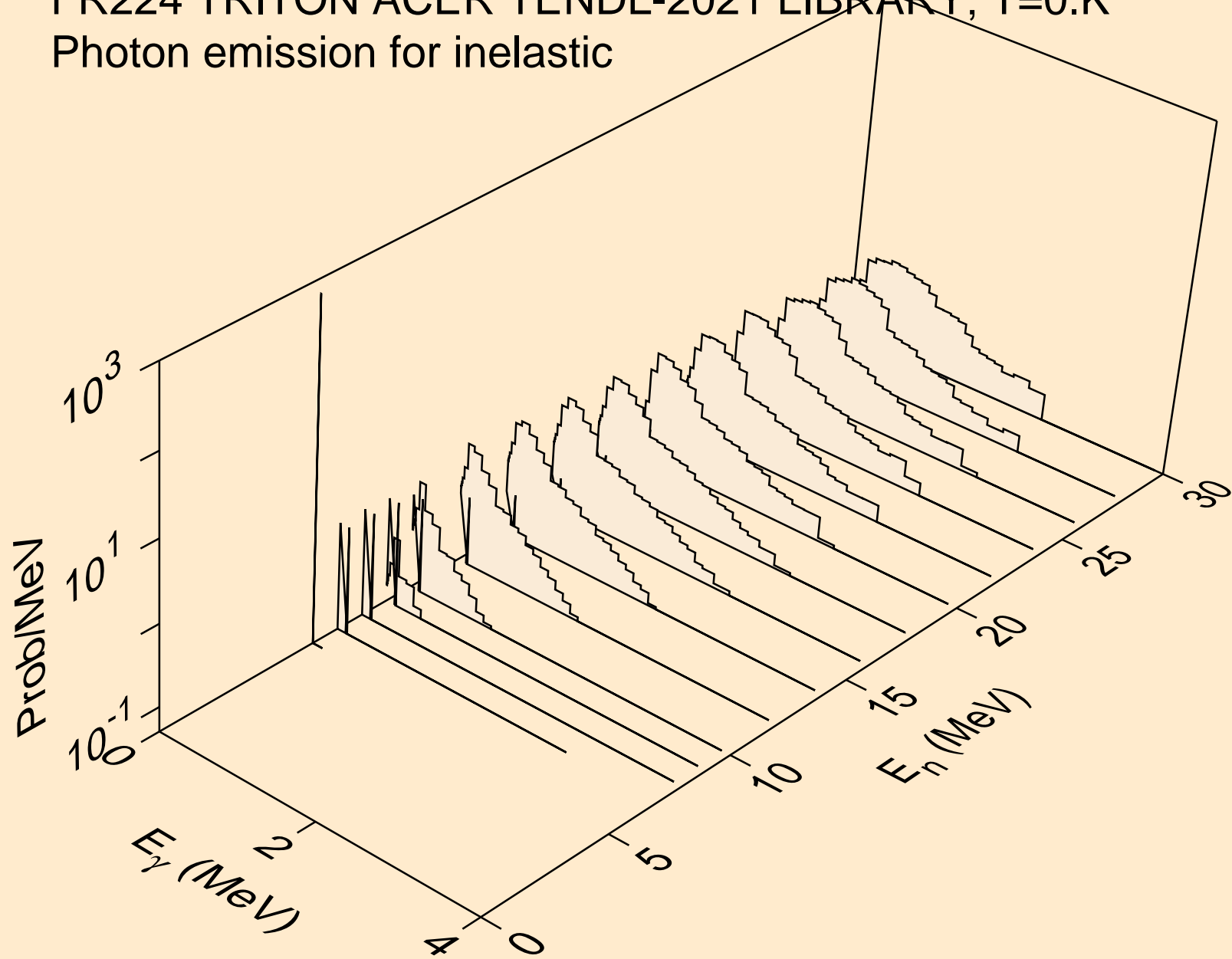

FR224 TRITON ACER TENDL-2021 LIBRARY; T=0.K  
Photon emission for (n,he3)

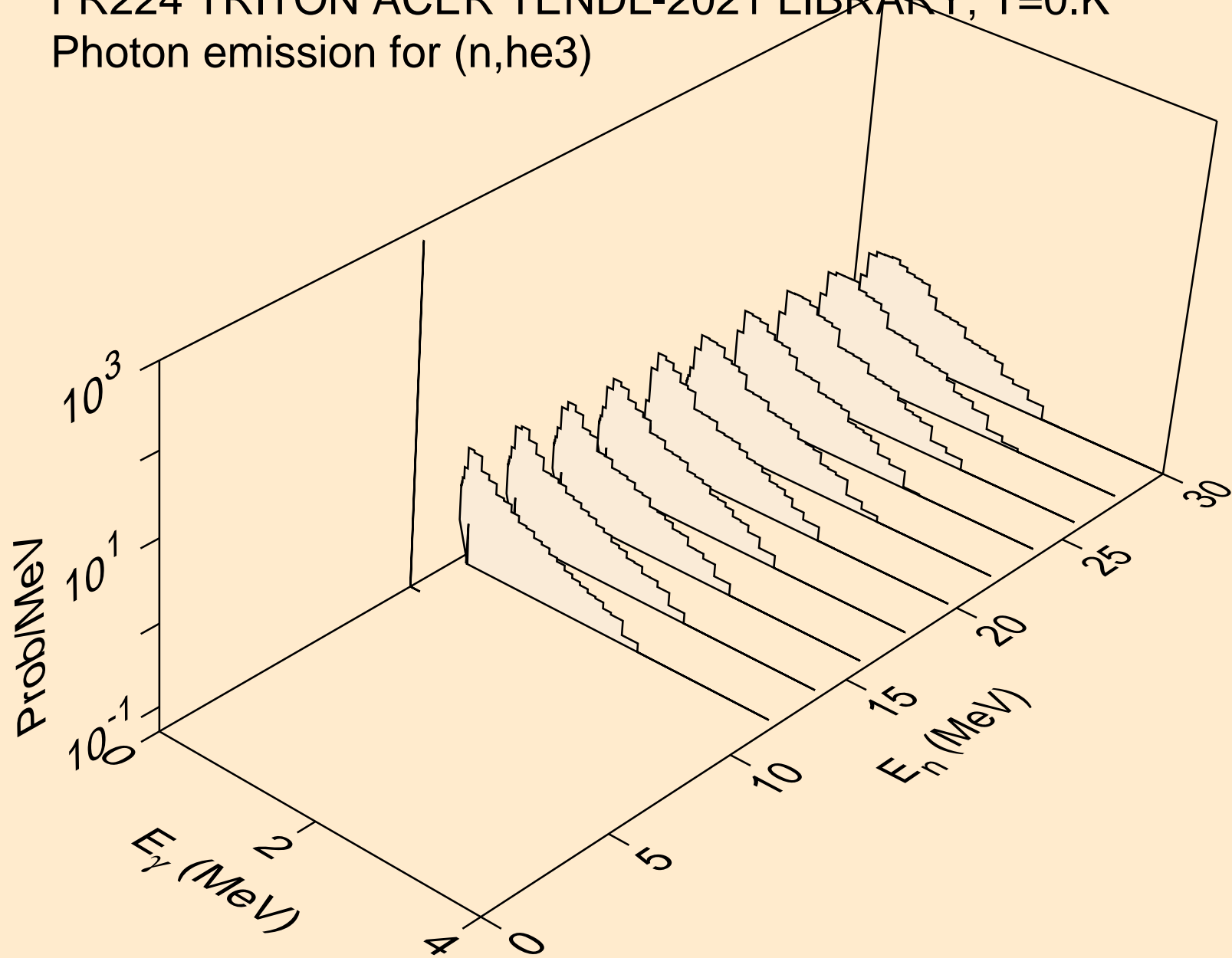

FR224 TRITON ACER TENDL-2021 LIBRARY; T=0.K  
Photon emission for (n,a)

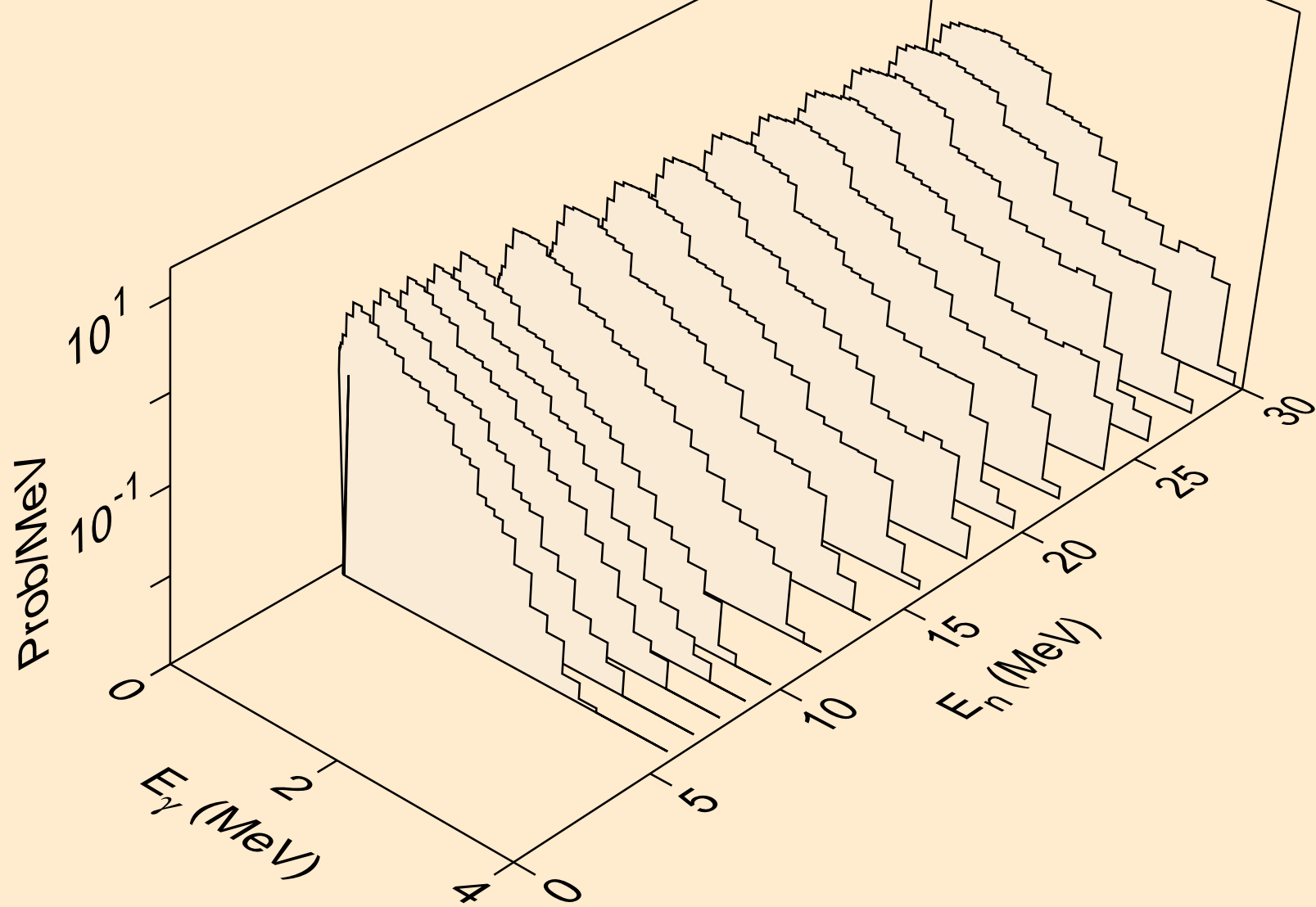

FR224 TRITON ACER TENDL-2021 LIBRARY; T=0.K  
Photon emission for (n,2a)

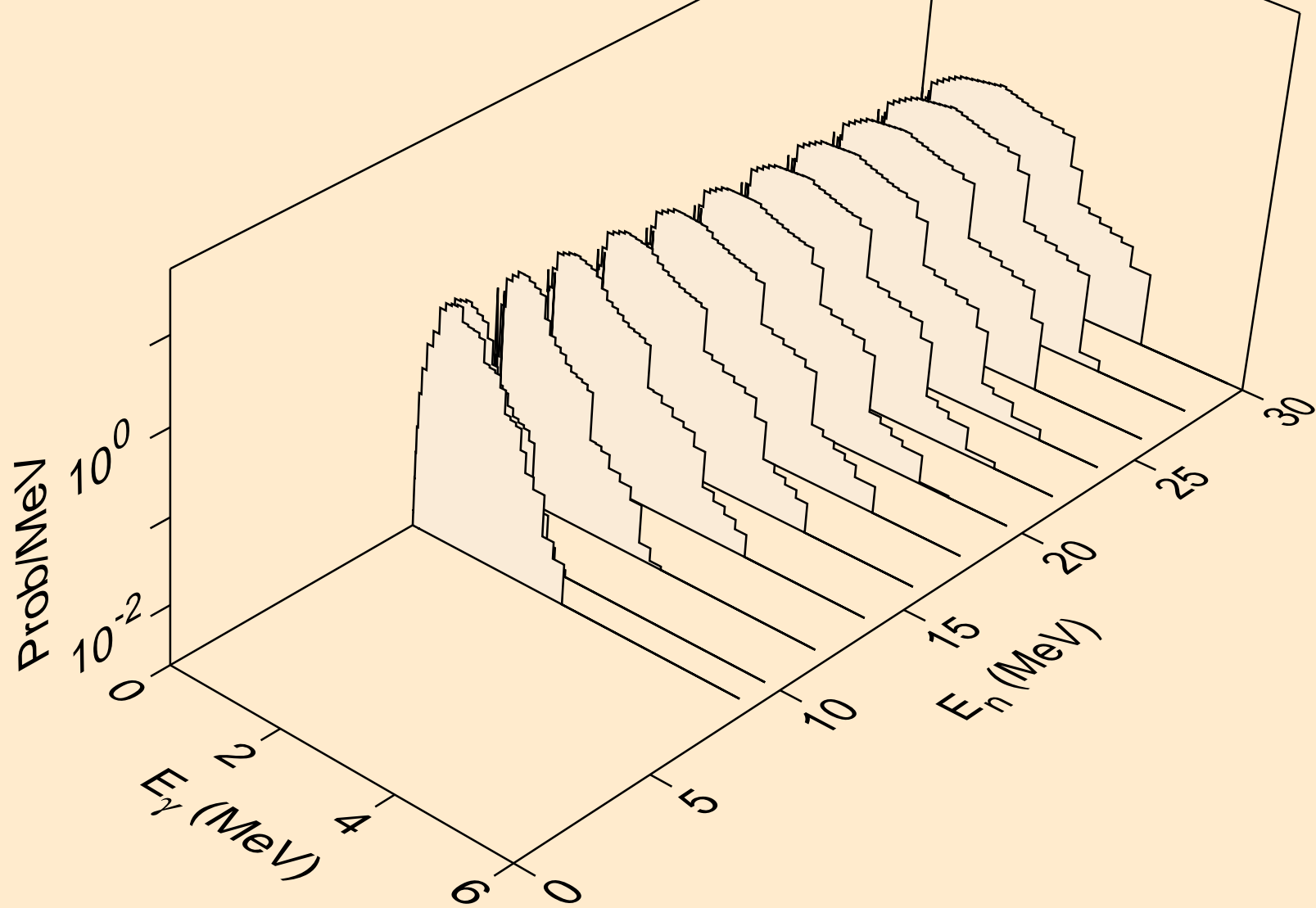



FR224 TRITON ACER TENDL-2021 LIBRARY; T=0.K  
Photon emission for (n,2p)

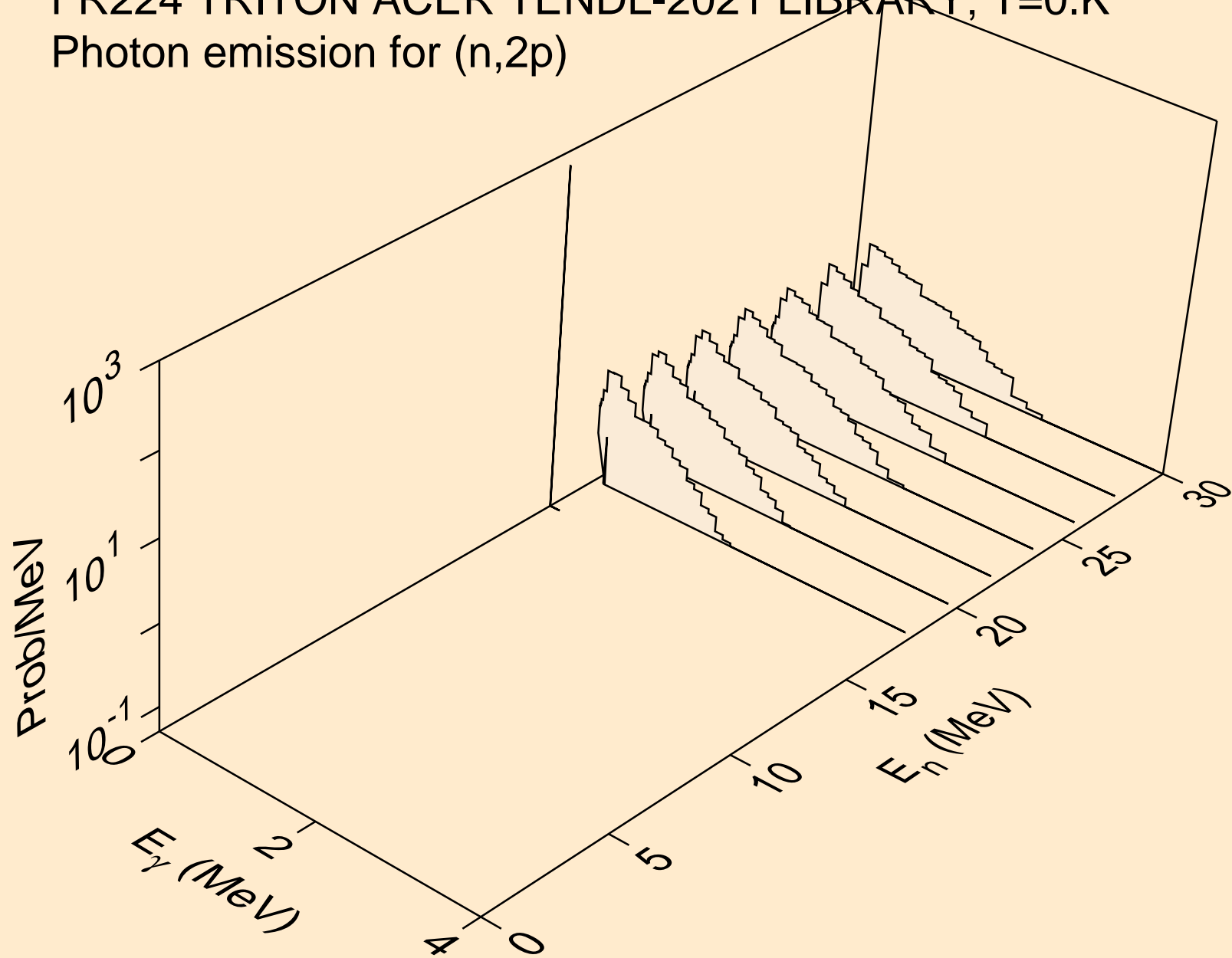

FR224 TRITON ACER TENDL-2021 LIBRARY; T=0.K  
Photon emission for (n,pa)

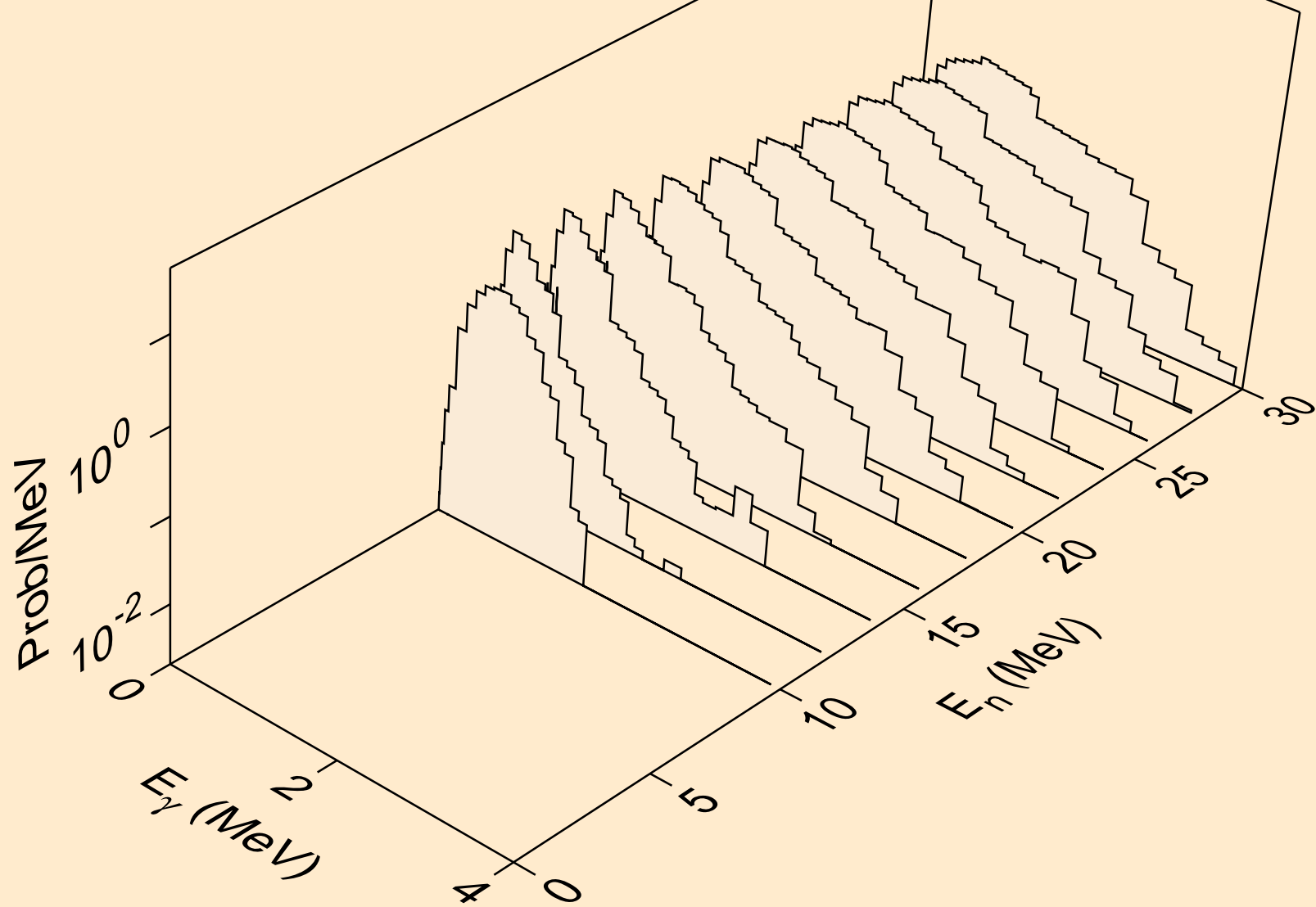

FR224 TRITON ACER TENDL-2021 LIBRARY; T=0.K  
Photon emission for (n,pd)

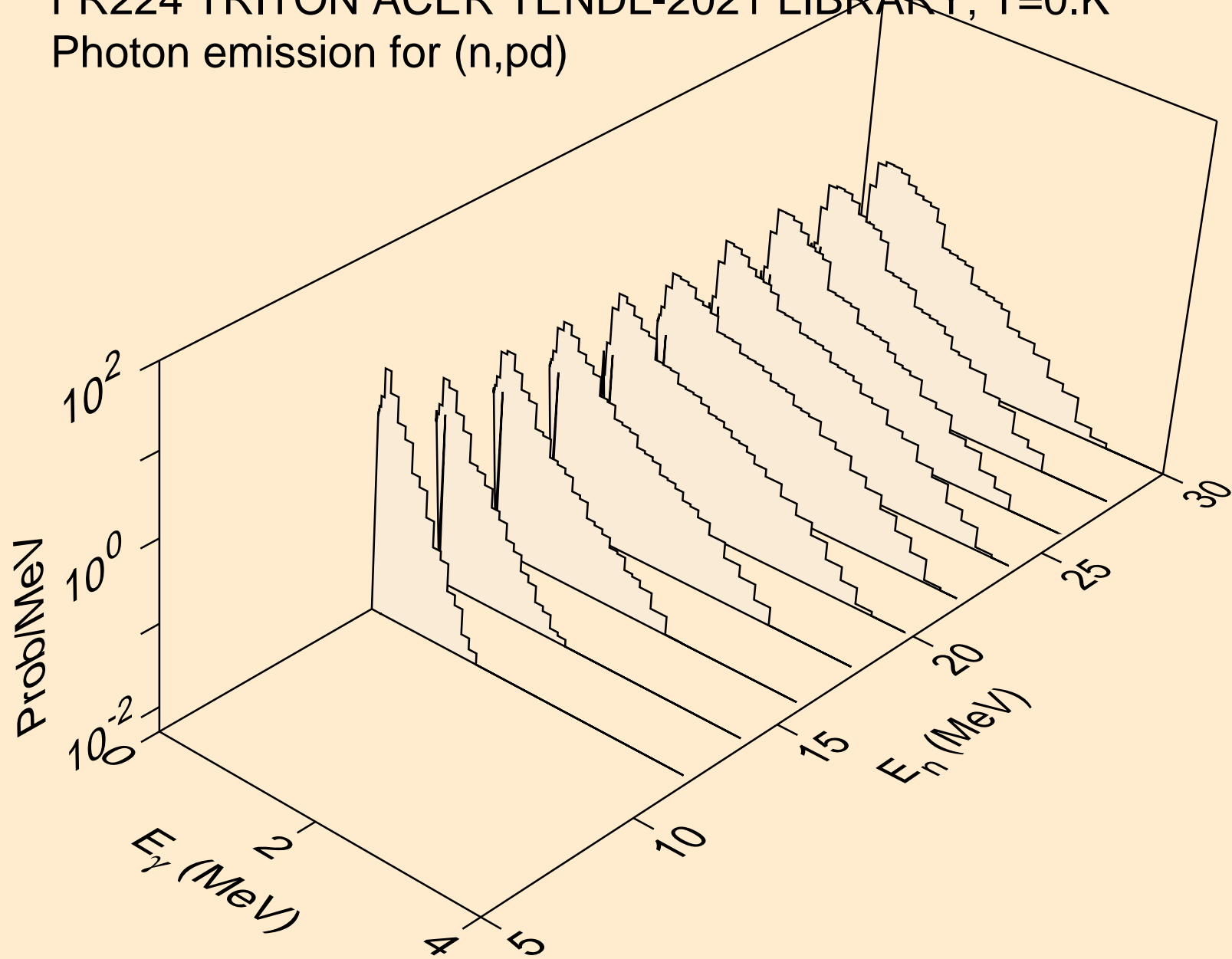

FR224 TRITON ACER TENDL-2021 LIBRARY; T=0.K  
Photon emission for (n,pt)

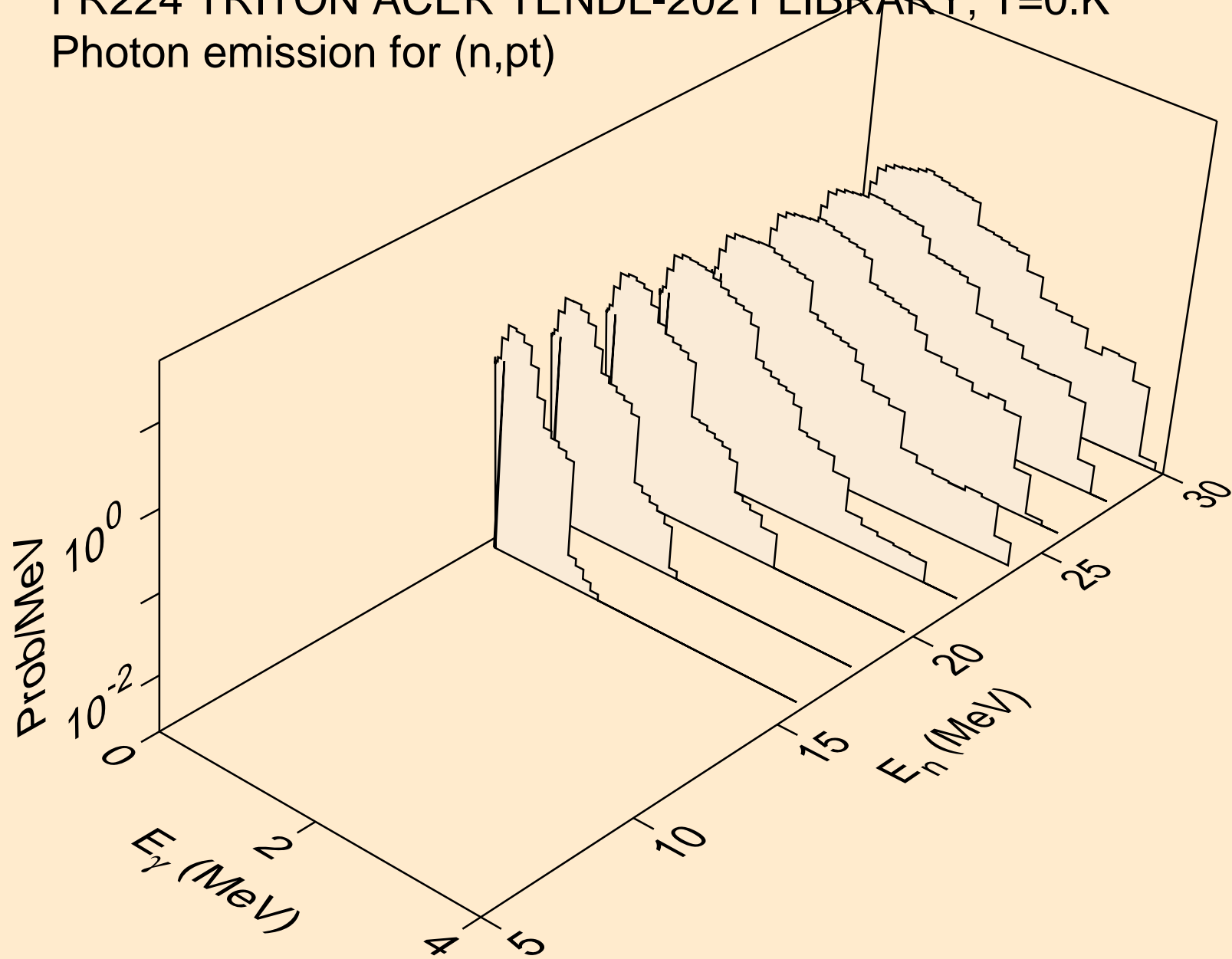

FR224 TRITON ACER TENDL-2021 LIBRARY; T=0.K  
Particle heating contributions

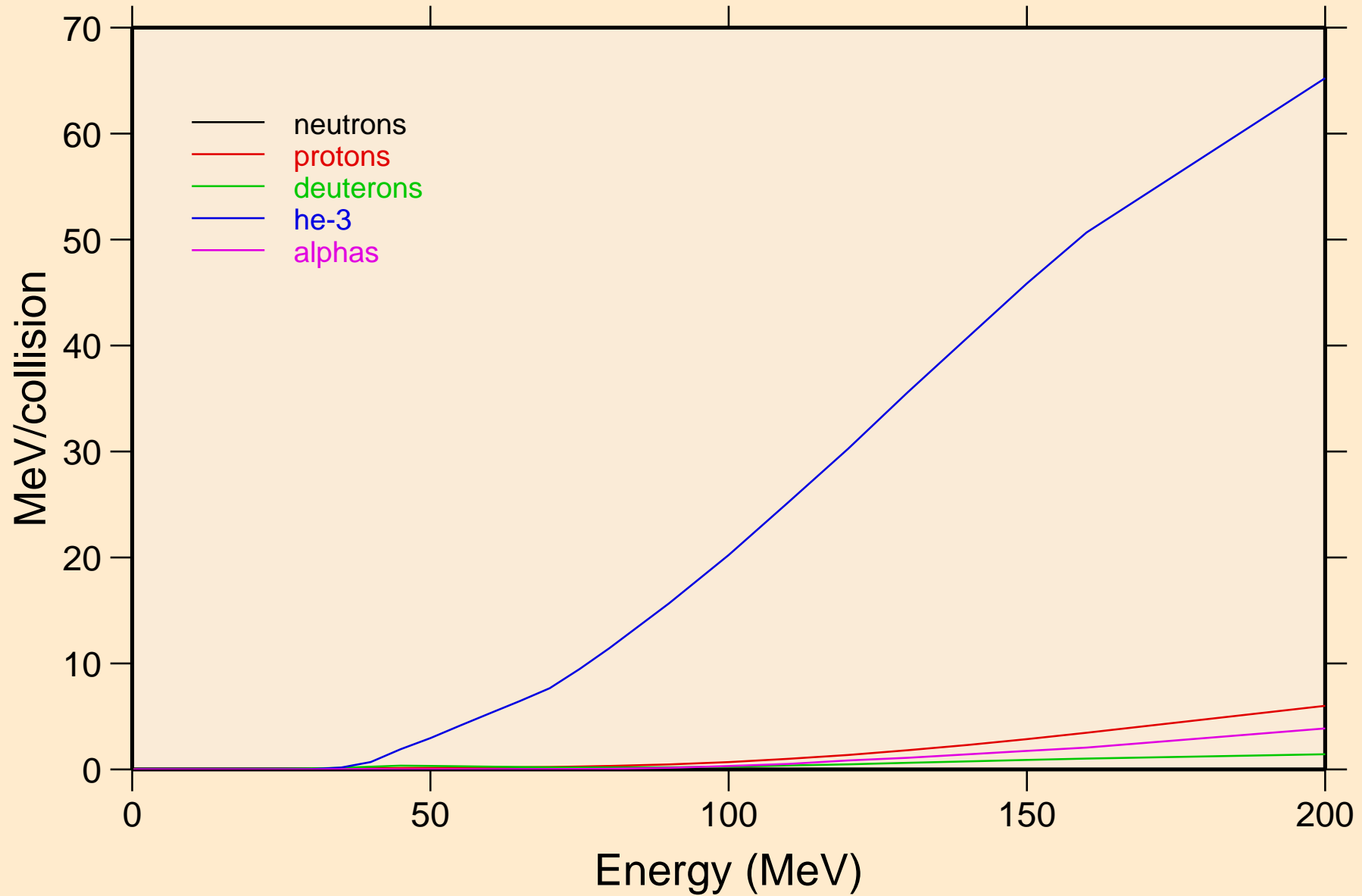

FR224 TRITON ACER TENDL-2021 LIBRARY; T=0.K  
Recoil Heating

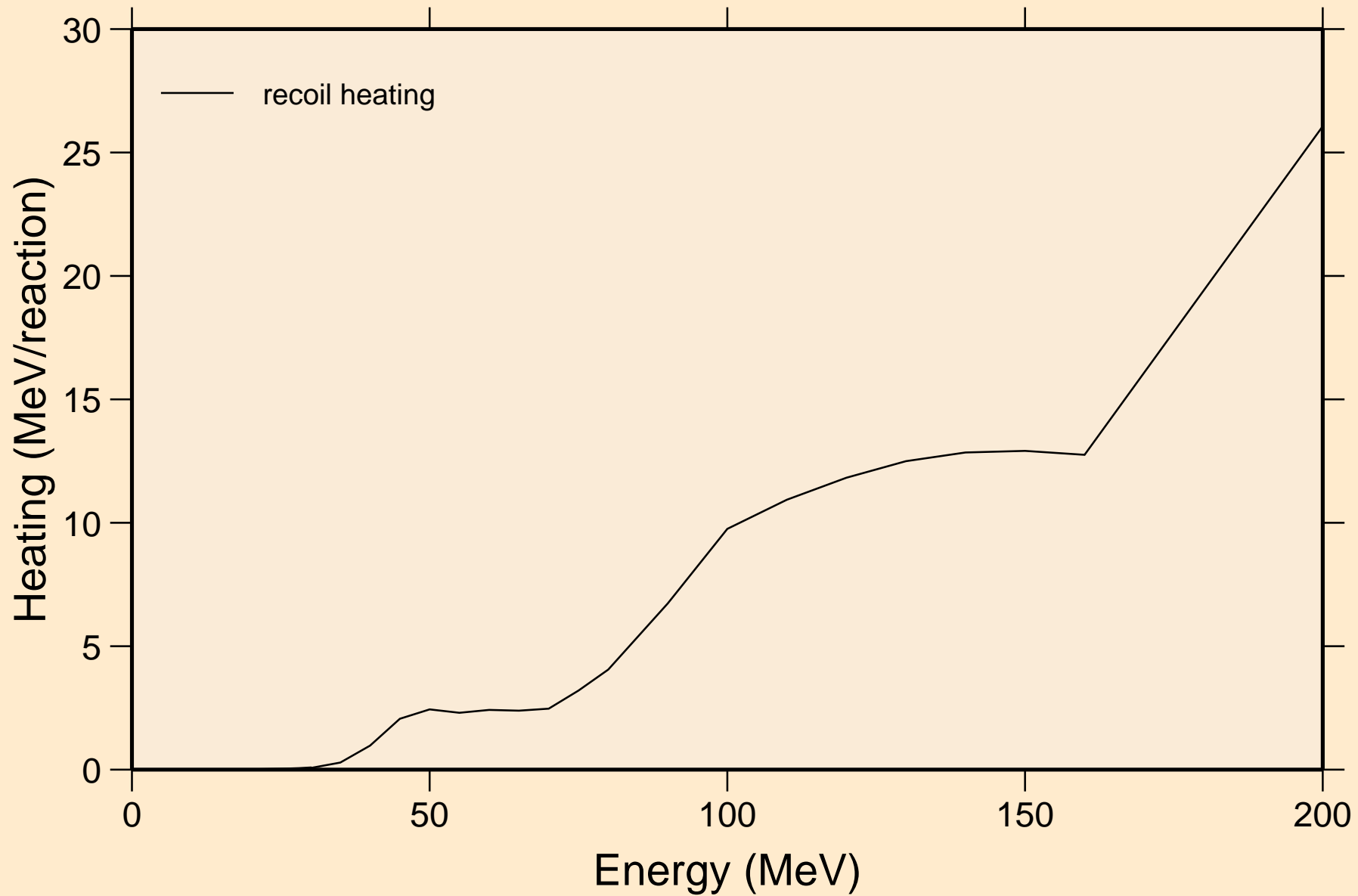

FR224 TRITON ACER TENDL-2021 LIBRARY; T=0.K  
Particle production cross sections

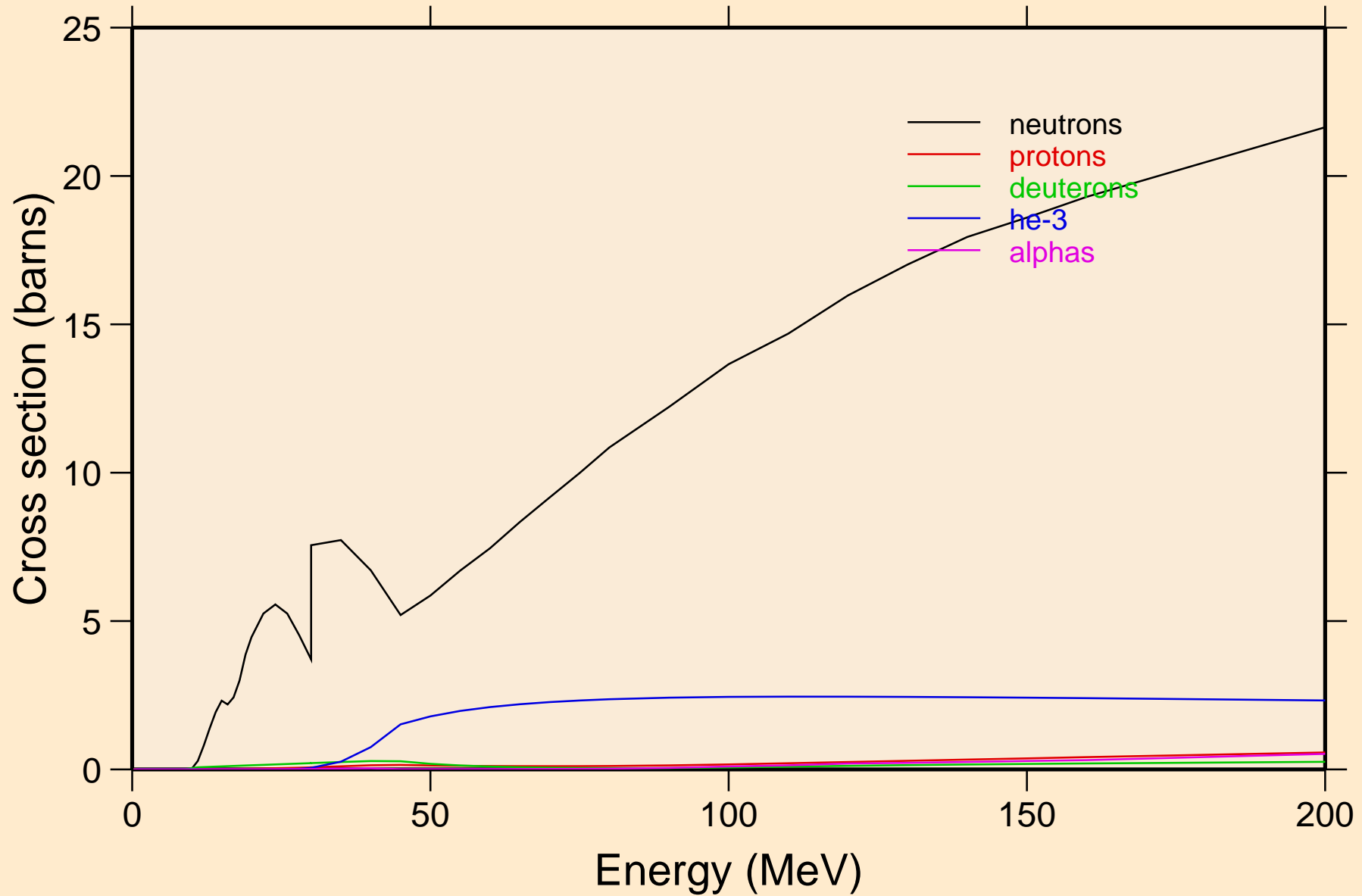

FR224 TRITON ACER TENDL-2021 LIBRARY; T=0.K  
neutrons from (t,n)

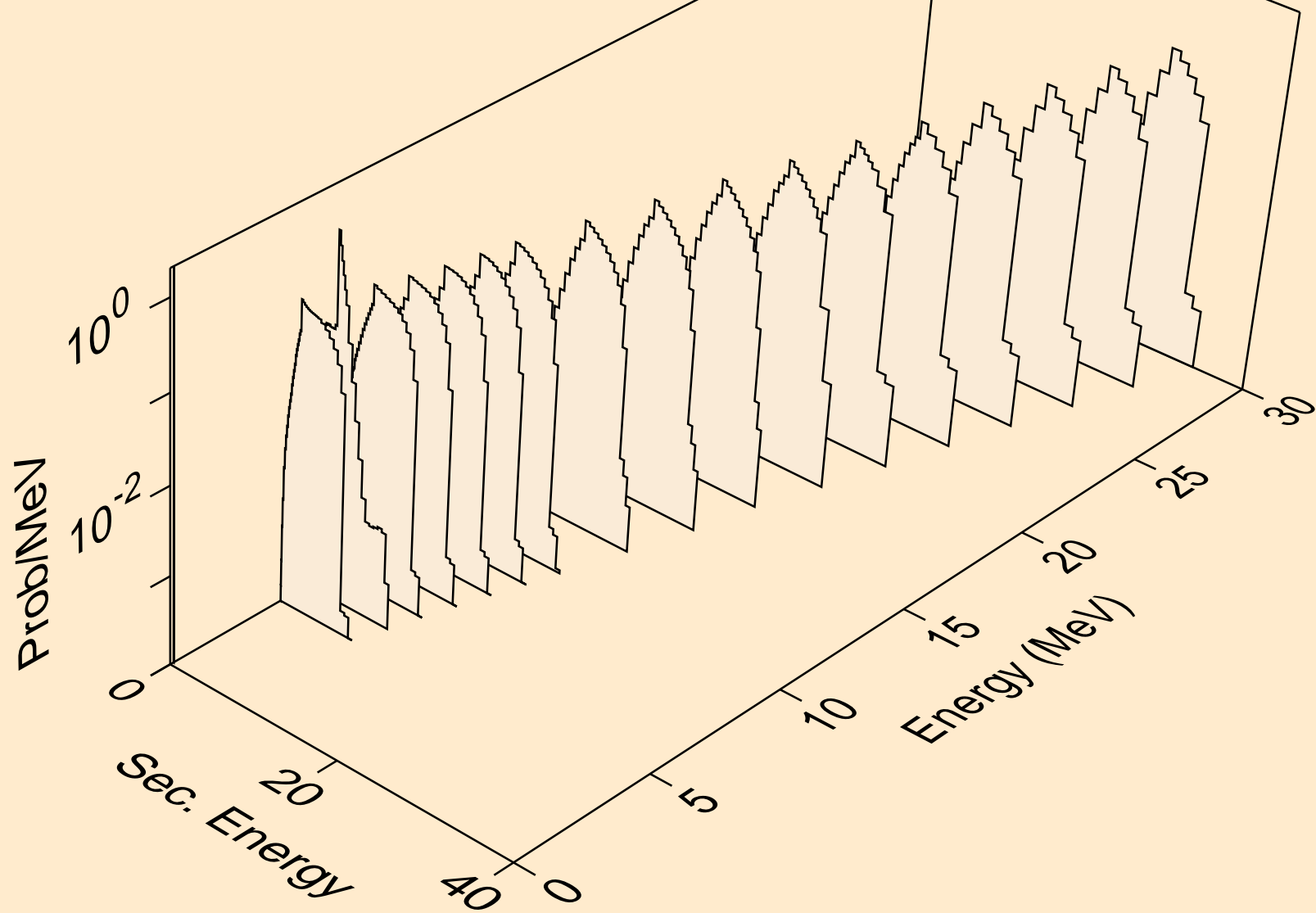



FR224 TRITON ACER TENDL-2021 LIBRARY; T=0.K  
neutrons from (t,x)

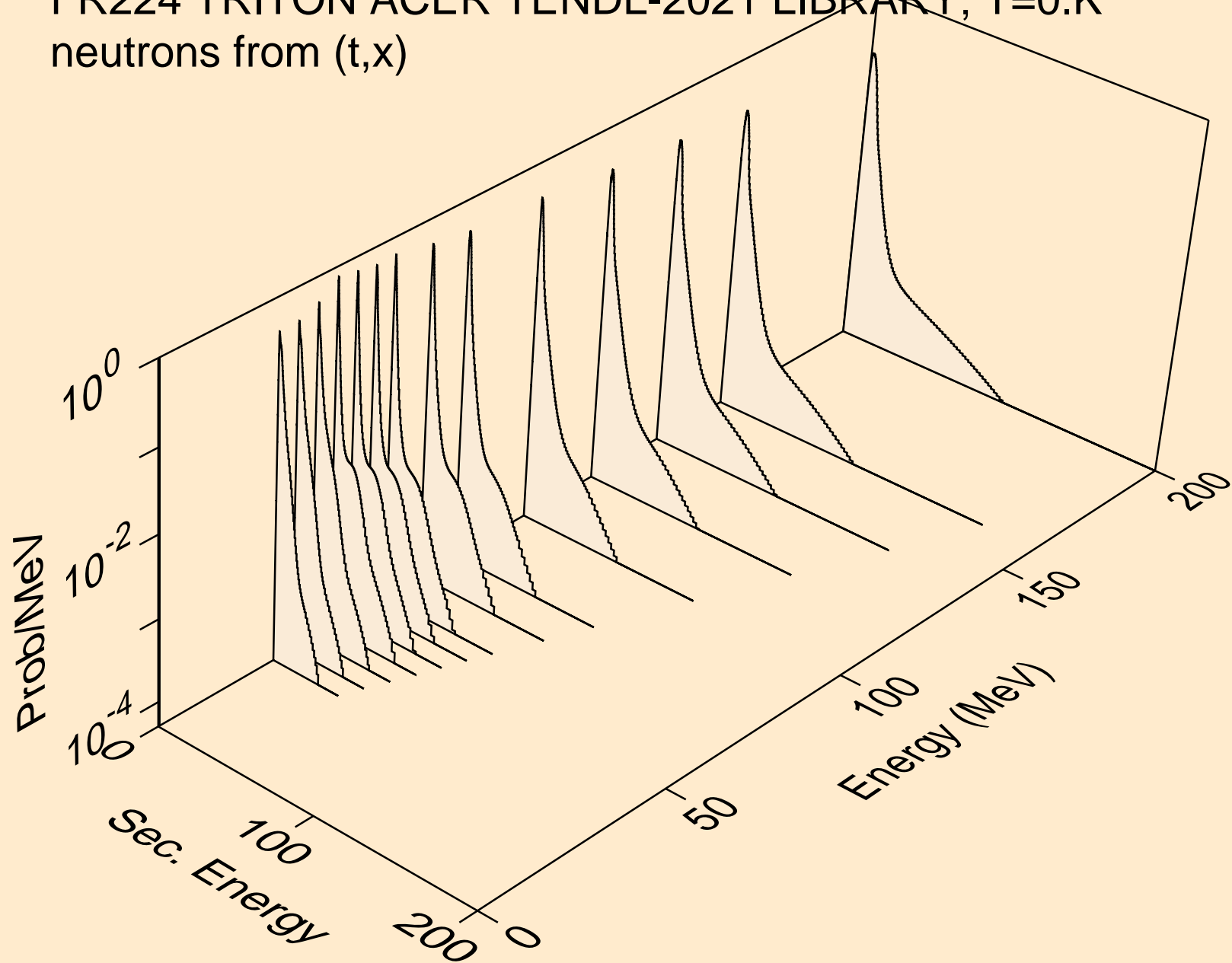

FR224 TRITON ACER TENDL-2021 LIBRARY; T=0.K  
neutrons from (t,2nd)

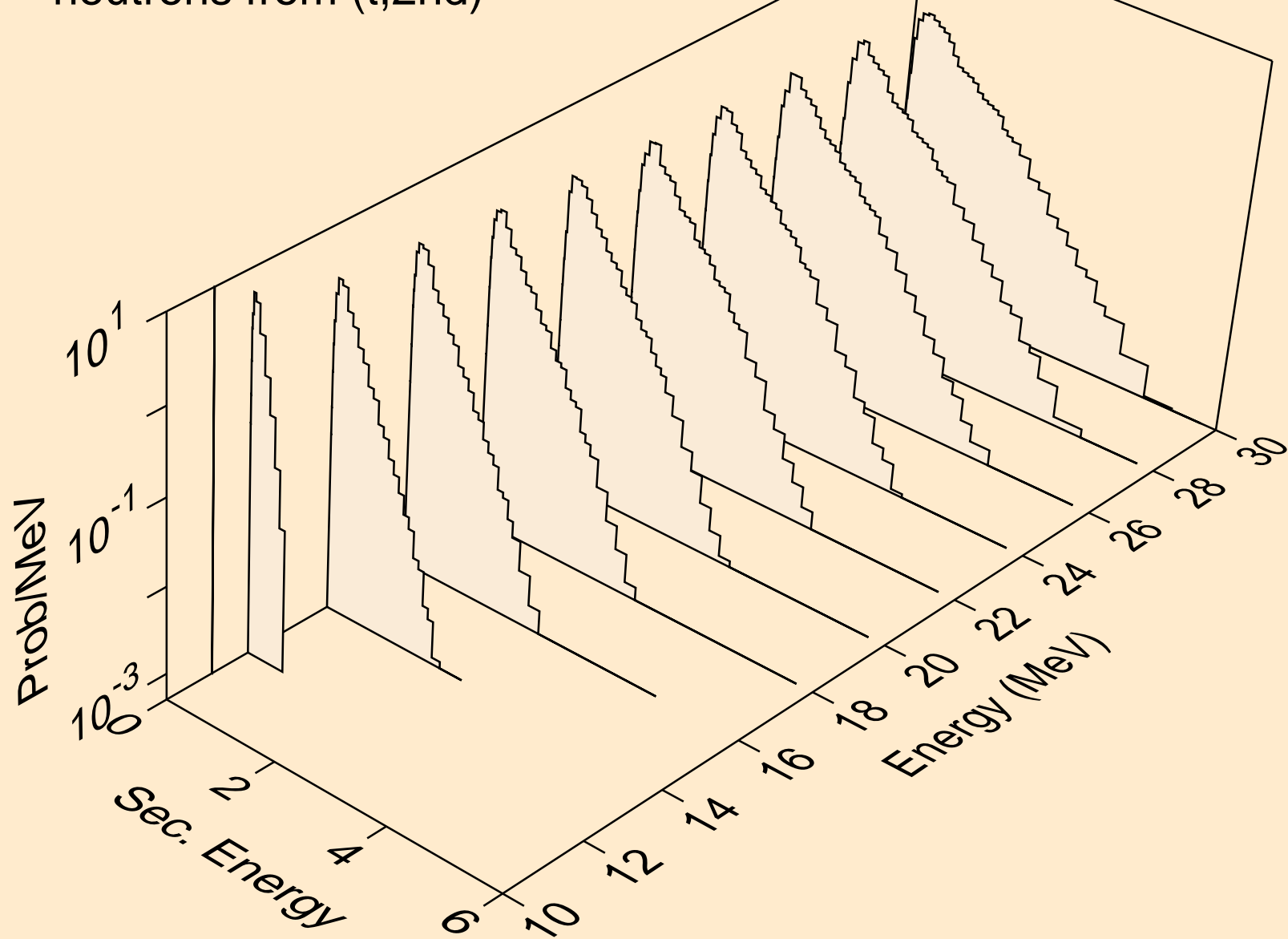

FR224 TRITON ACER TENDL-2021 LIBRARY; T=0.K  
neutrons from (t,2n)

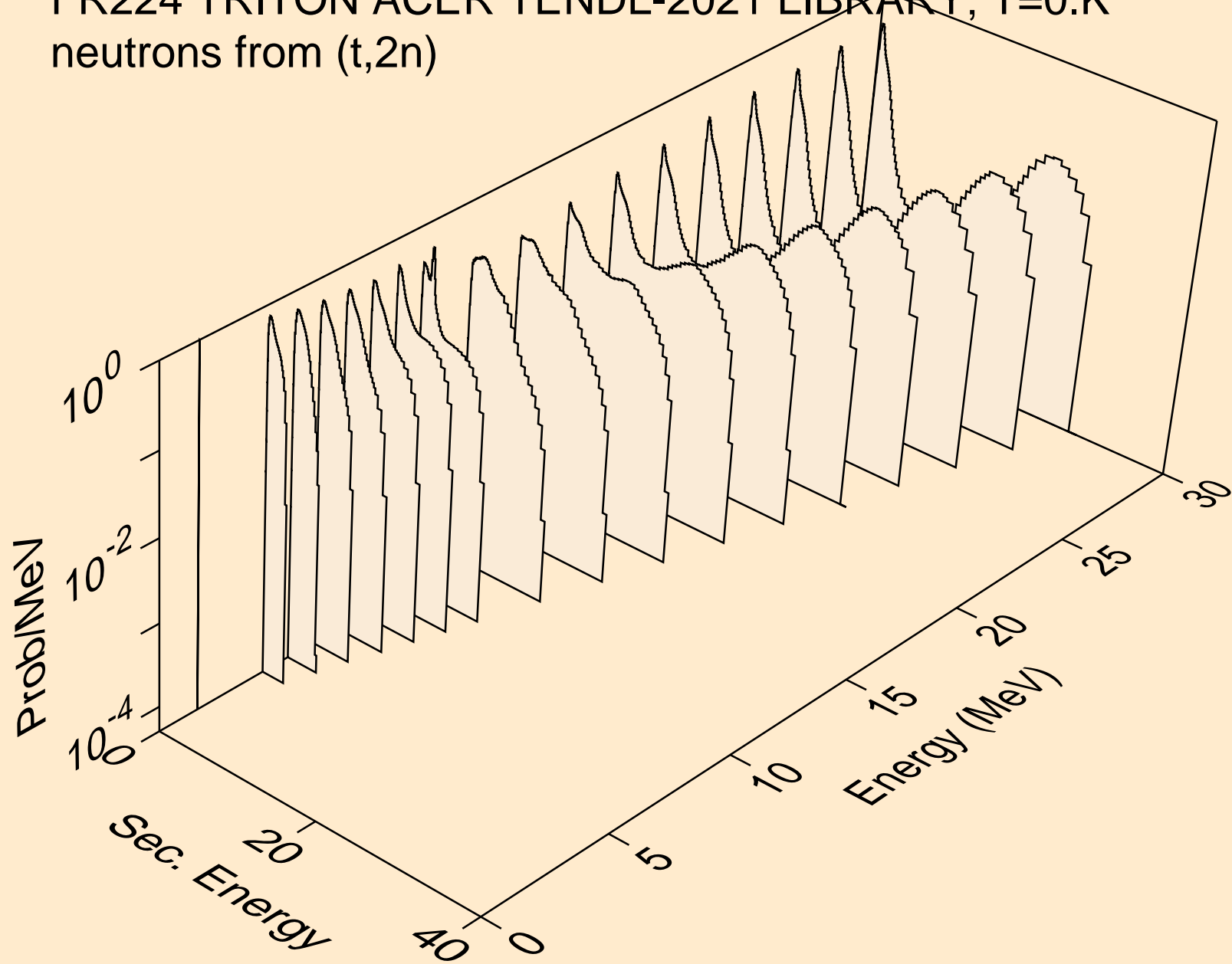

FR224 TRITON ACER TENDL-2021 LIBRARY; T=0.K  
neutrons from (t,3n)

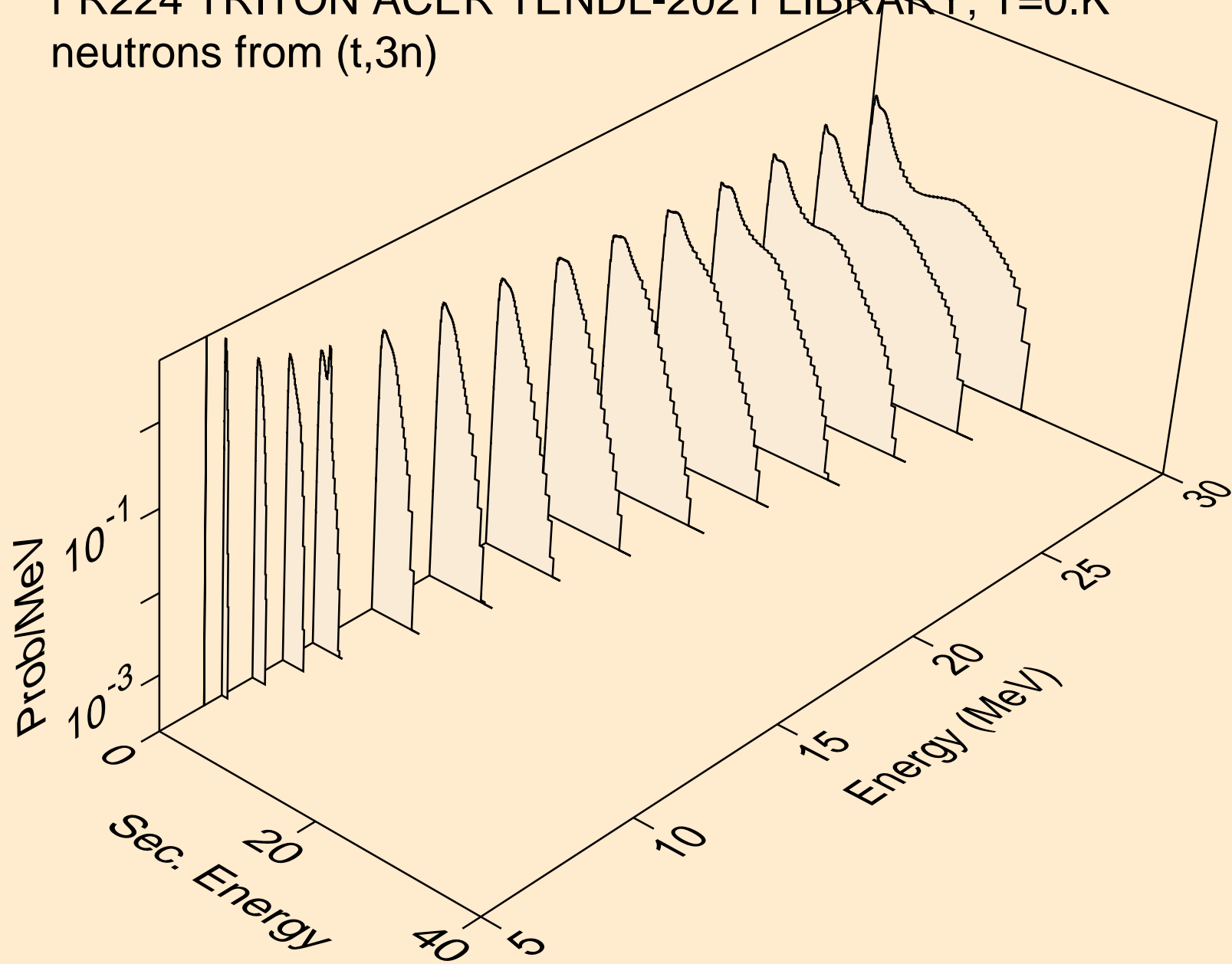

FR224 TRITON ACER TENDL-2021 LIBRARY; T=0.K  
neutrons from (t,n\*)a

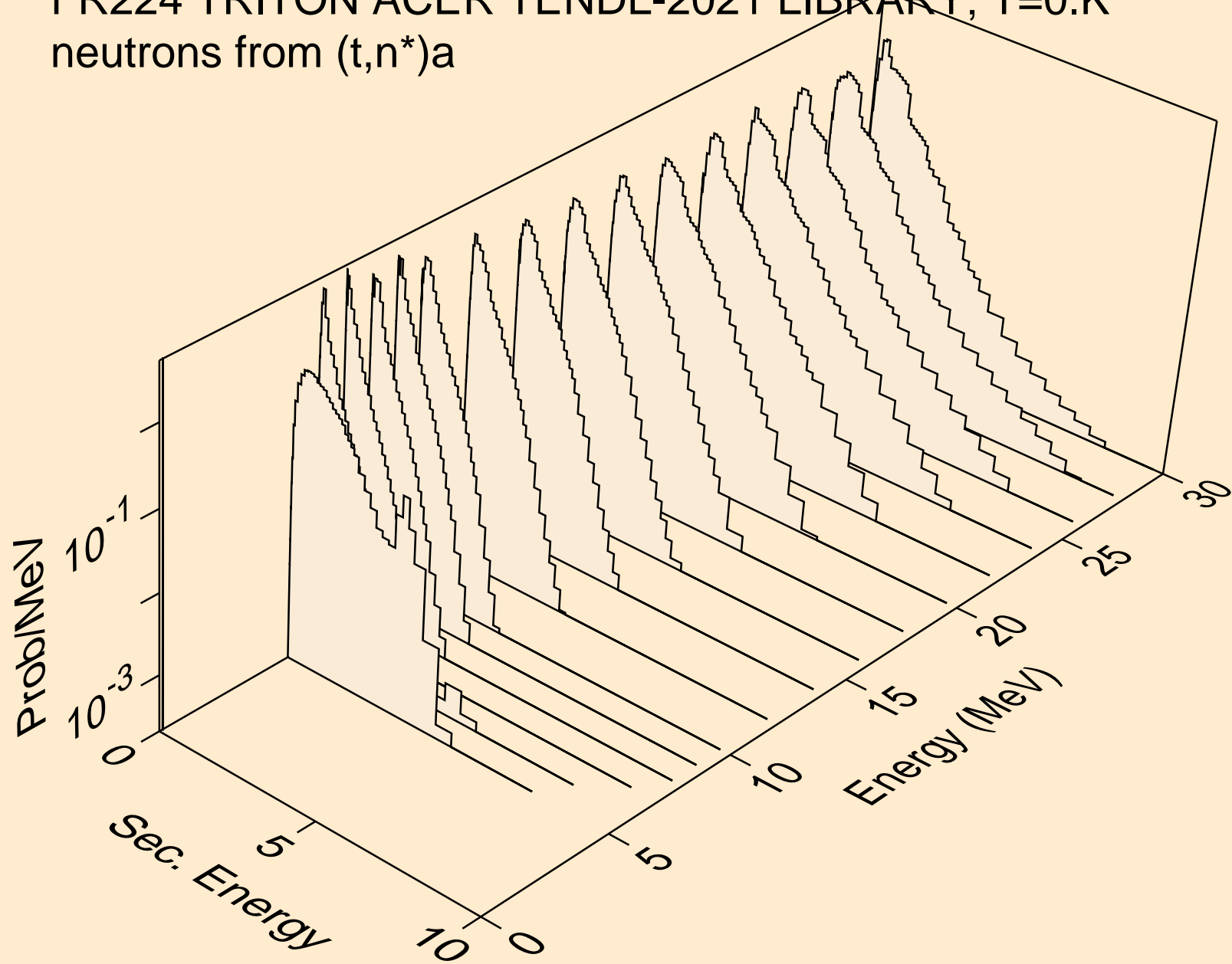

FR224 TRITON ACER TENDL-2021 LIBRARY; T=0.K  
neutrons from (t,2n)a

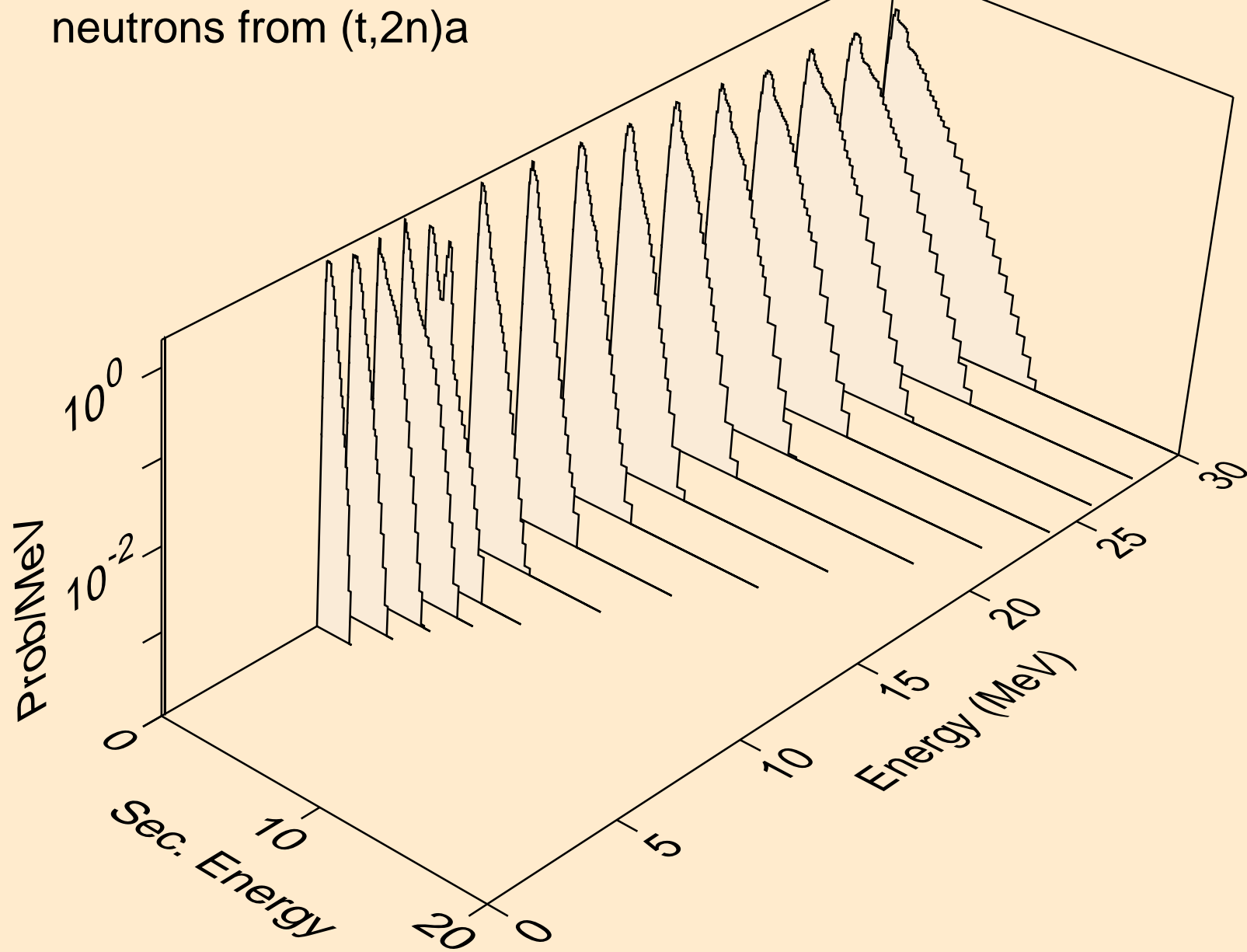

FR224 TRITON ACER TENDL-2021 LIBRARY; T=0.K  
neutrons from (t,3n)a

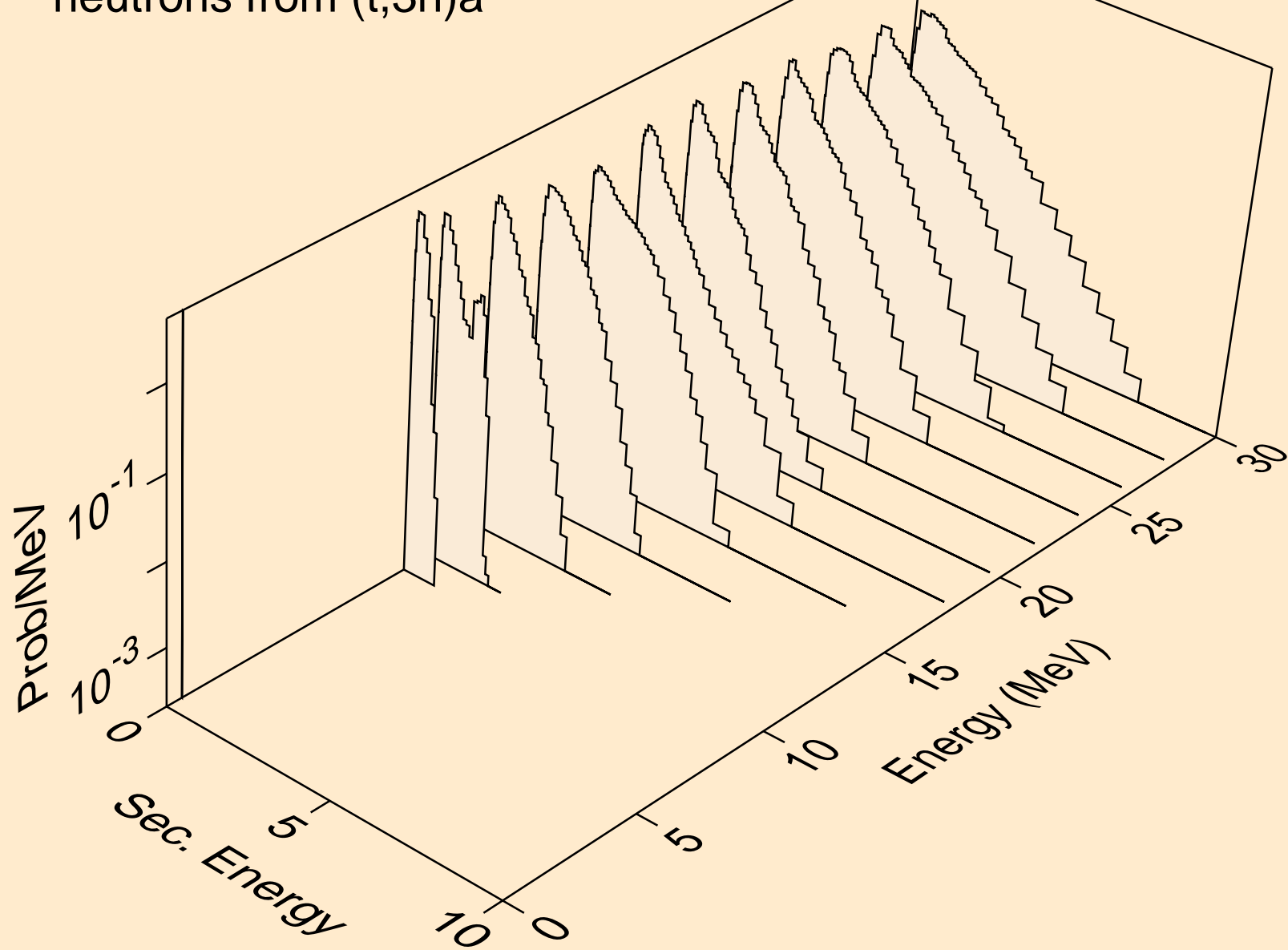

FR224 TRITON ACER TENDL-2021 LIBRARY; T=0.K  
neutrons from (t,n\*)p

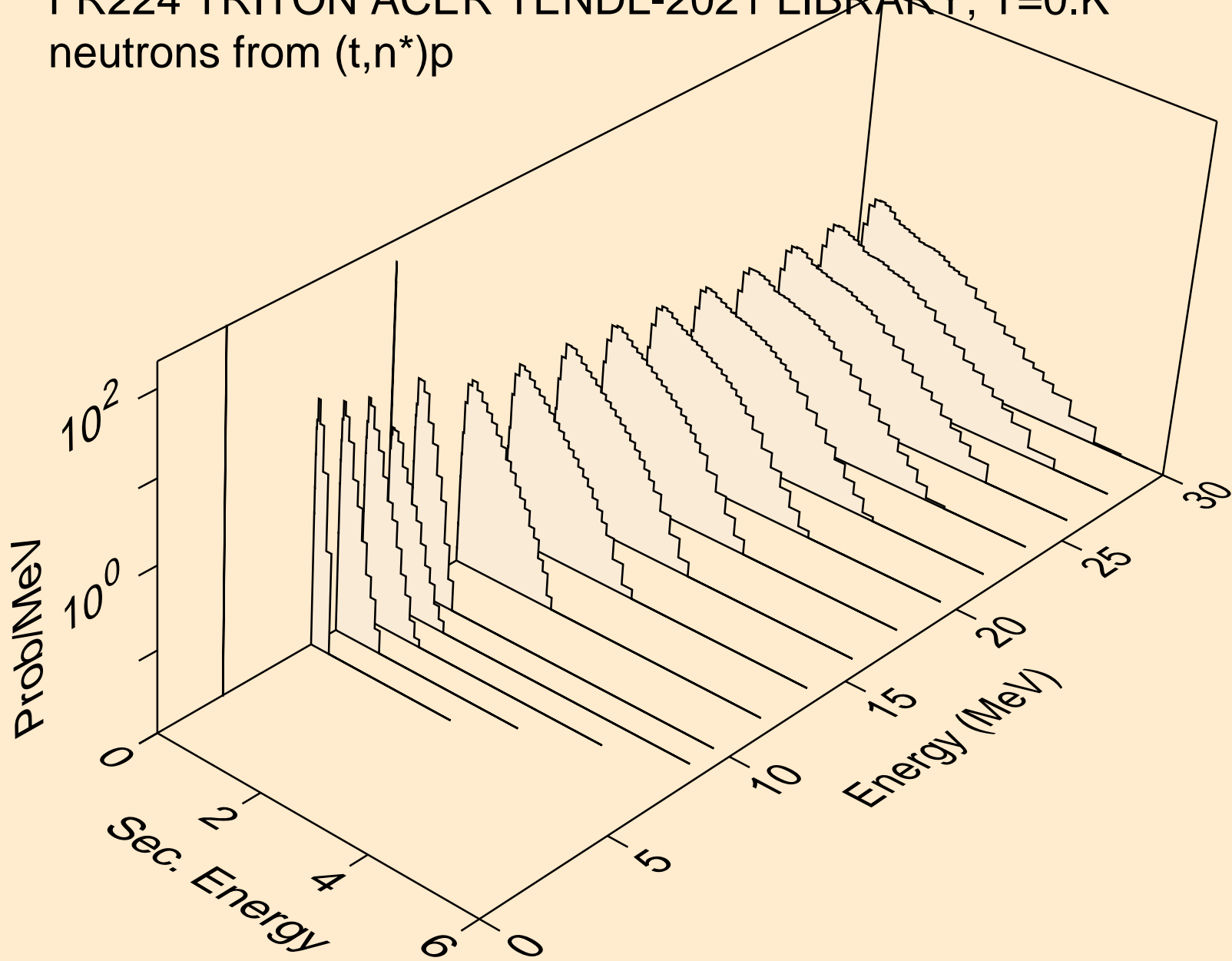



FR224 TRITON ACER TENDL-2021 LIBRARY; T=0.K  
neutrons from (t,n\*)2a

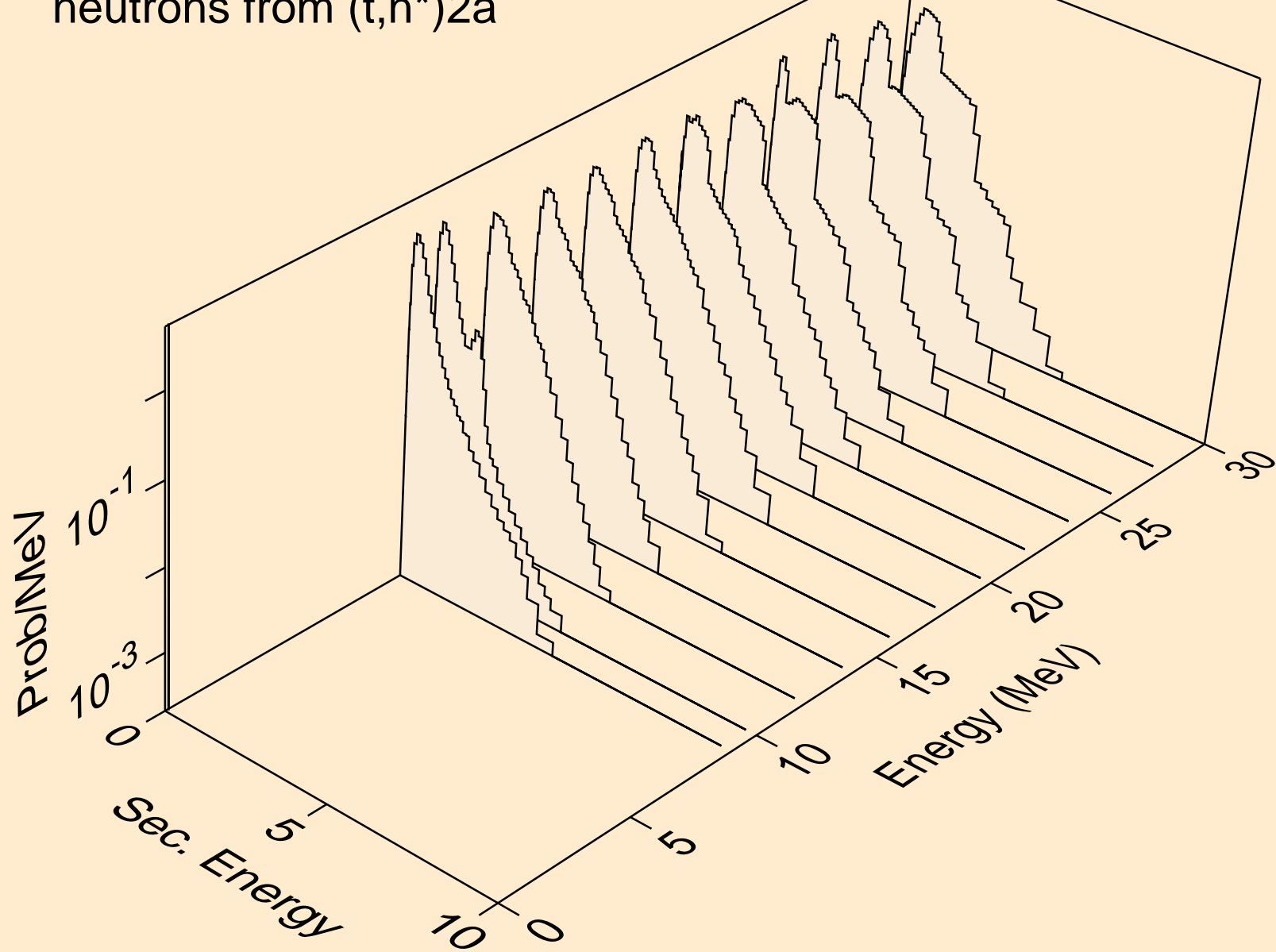

FR224 TRITON ACER TENDL-2021 LIBRARY; T=0.K  
neutrons from (t,2n)2a

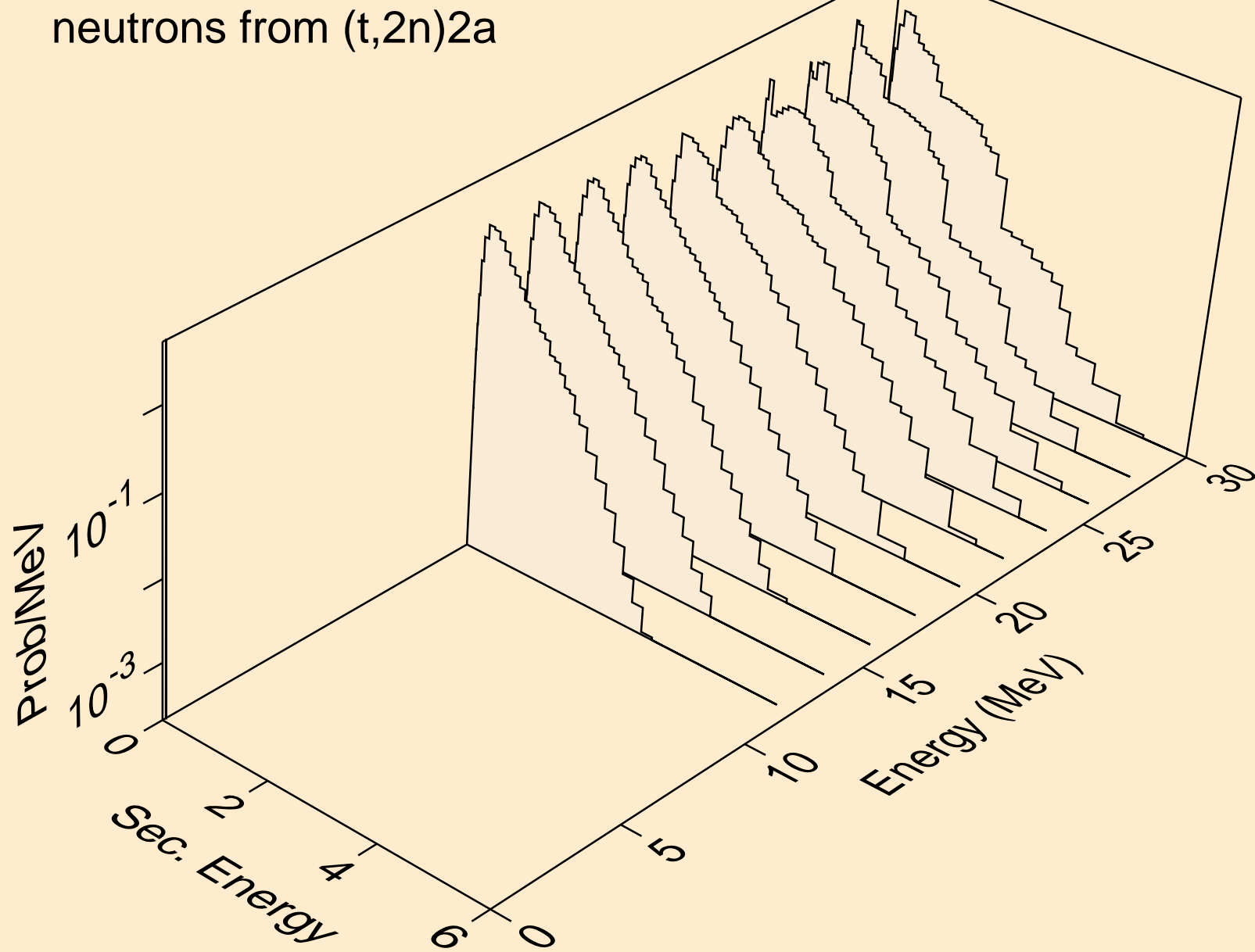

FR224 TRITON ACER TENDL-2021 LIBRARY; T=0.K  
neutrons from (t,n\*)d

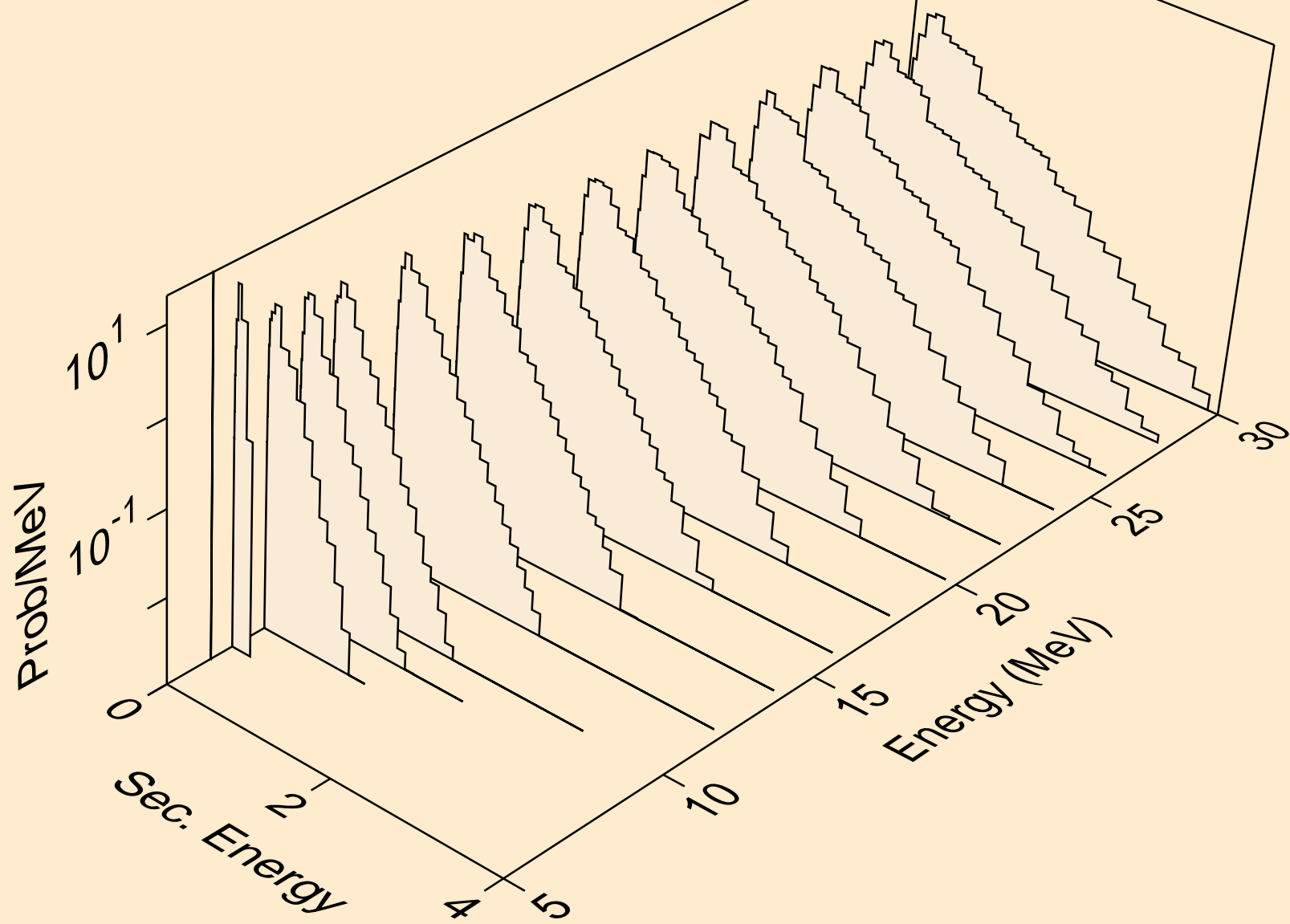

FR224 TRITON ACER TENDL-2021 LIBRARY; T=0.K  
neutrons from (t,n\*)t

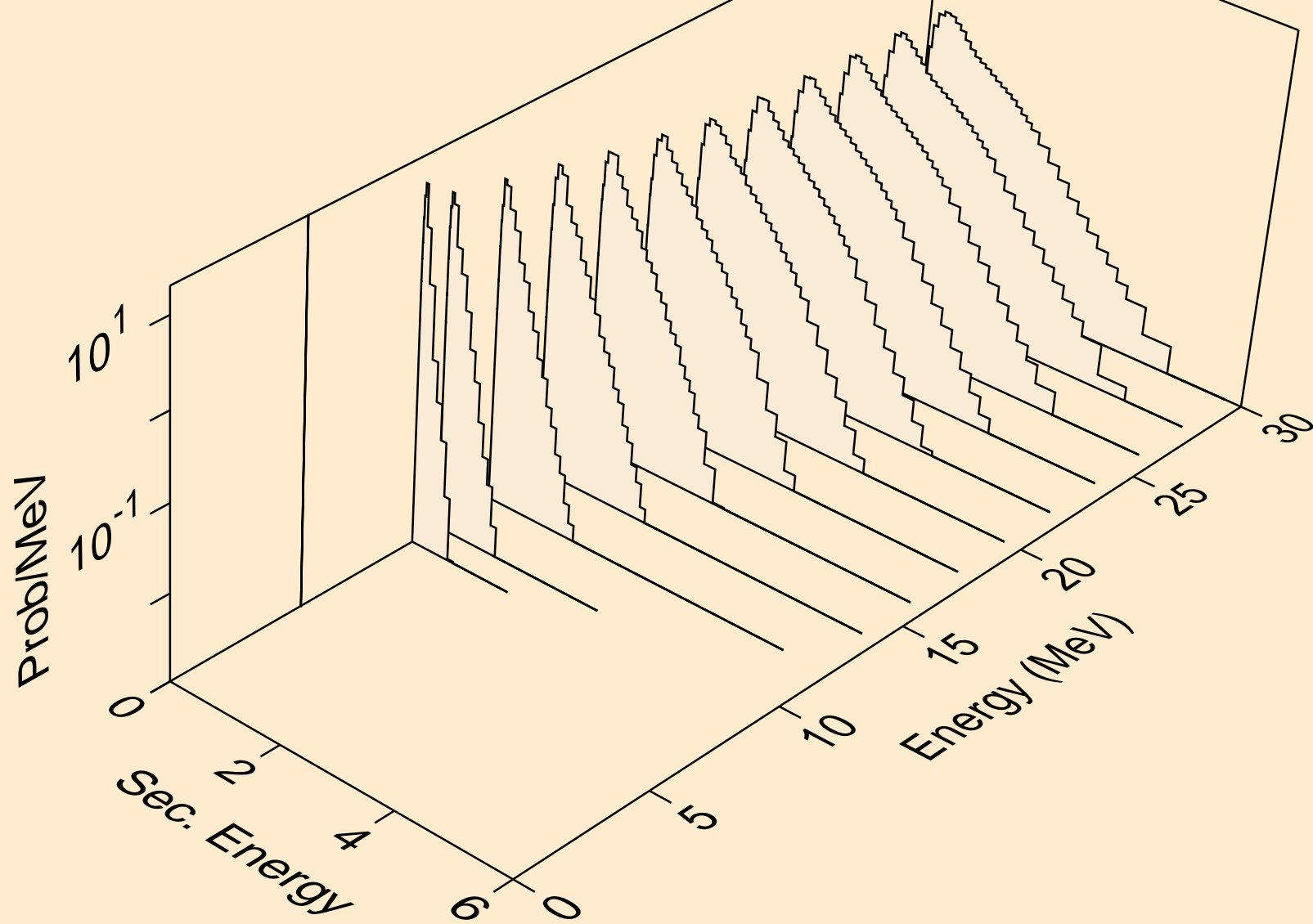

FR224 TRITON ACER TENDL-2021 LIBRARY; T=0.K  
neutrons from (t,n\*)he3

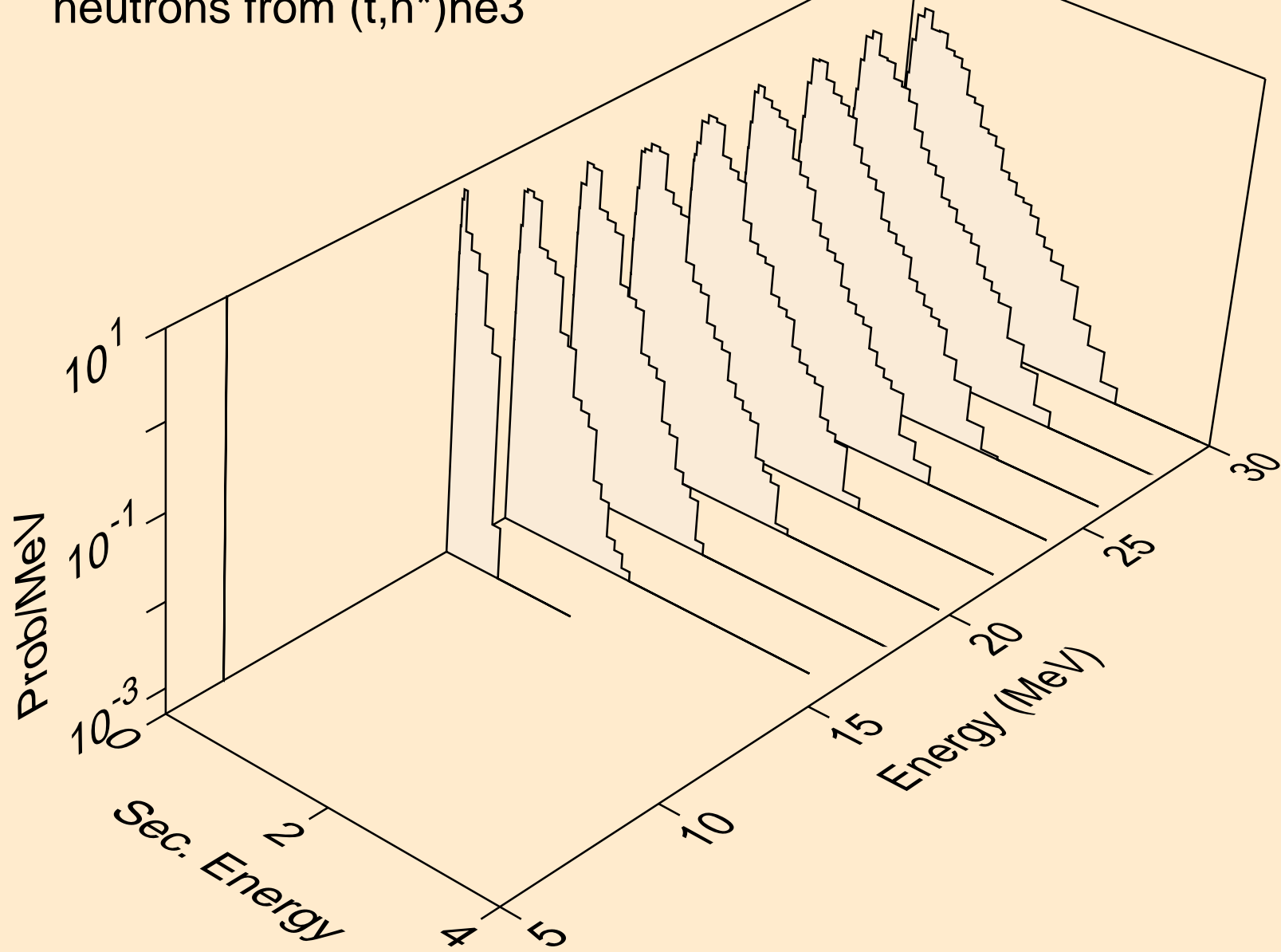

FR224 TRITON ACER TENDL-2021 LIBRARY; T=0.K  
neutrons from (t,4n)

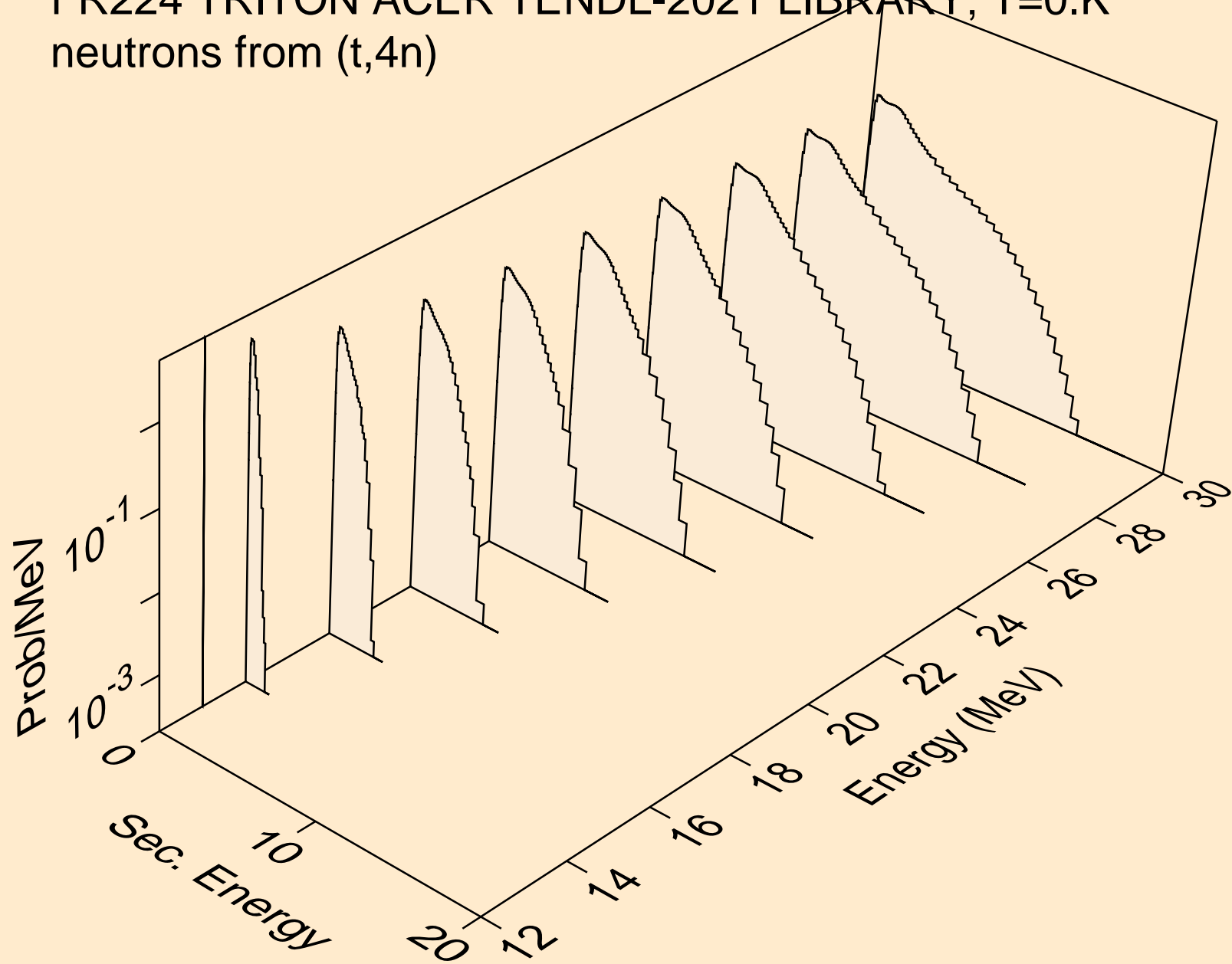

FR224 TRITON ACER TENDL-2021 LIBRARY; T=0.K  
neutrons from (t,2np)

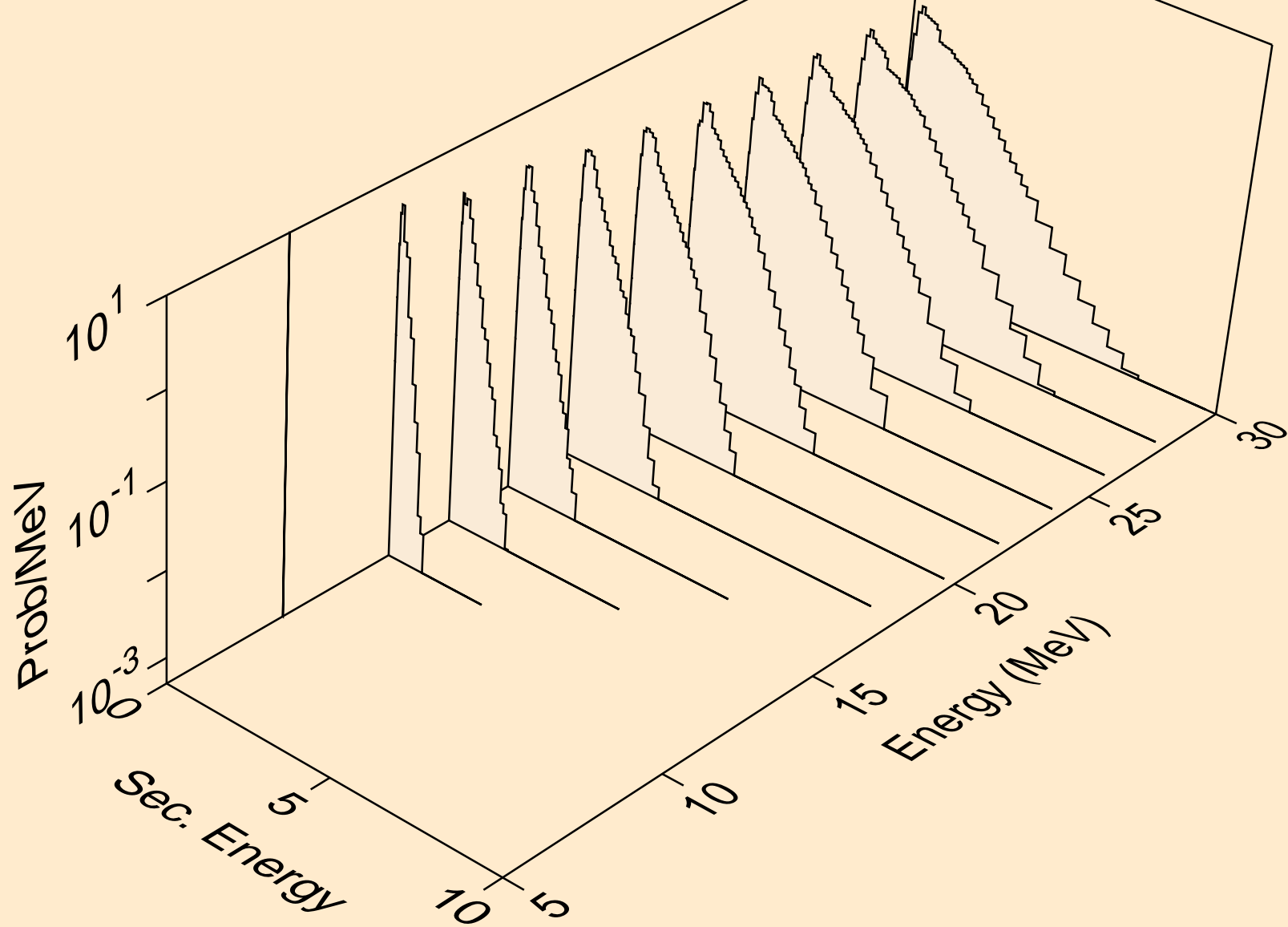

FR224 TRITON ACER TENDL-2021 LIBRARY; T=0.K  
neutrons from (t,3np)

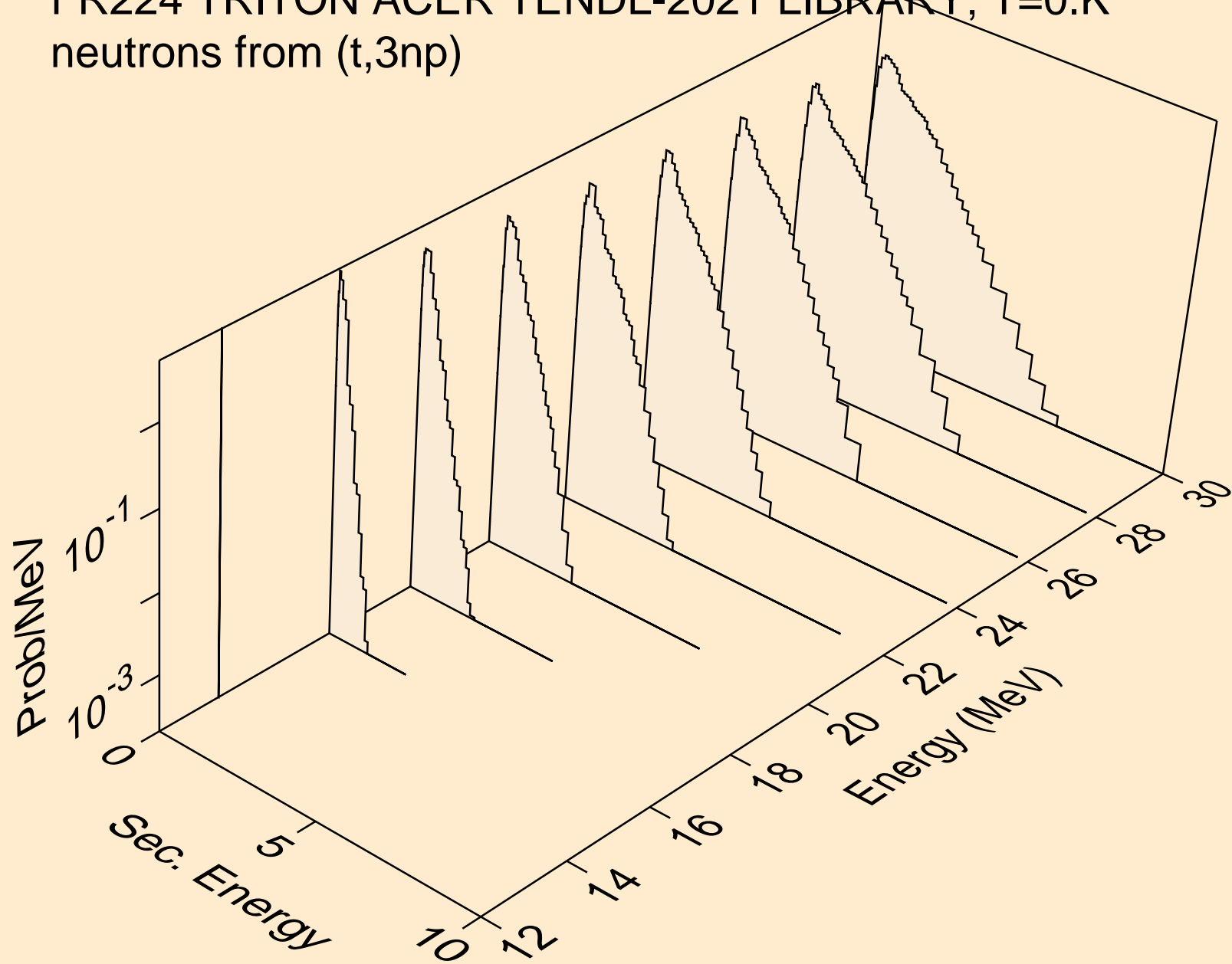



FR224 TRITON ACER TENDL-2021 LIBRARY; T=0.K  
neutrons from (t,2np)

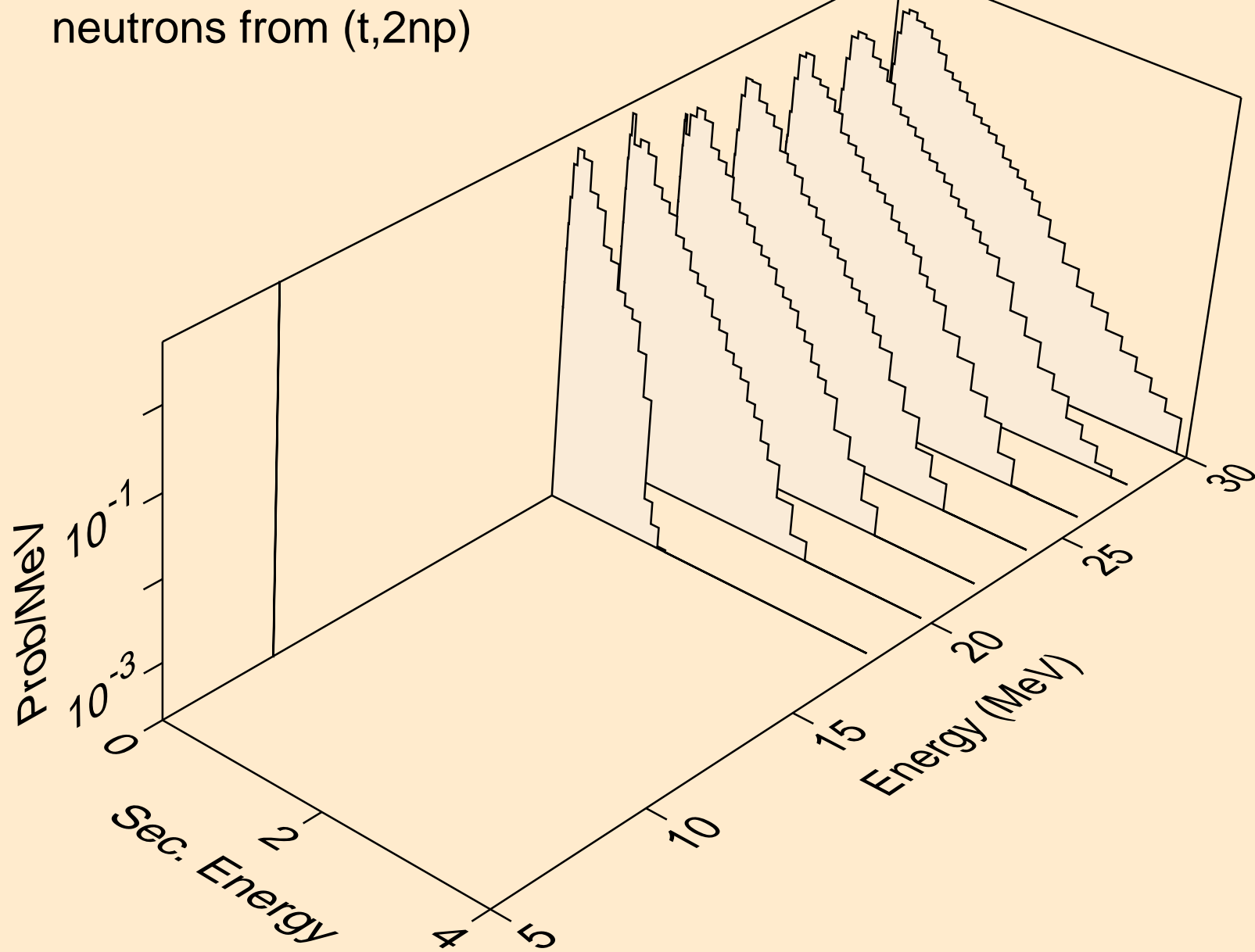

FR224 TRITON ACER TENDL-2021 LIBRARY; T=0.K  
neutrons from (t,npa)

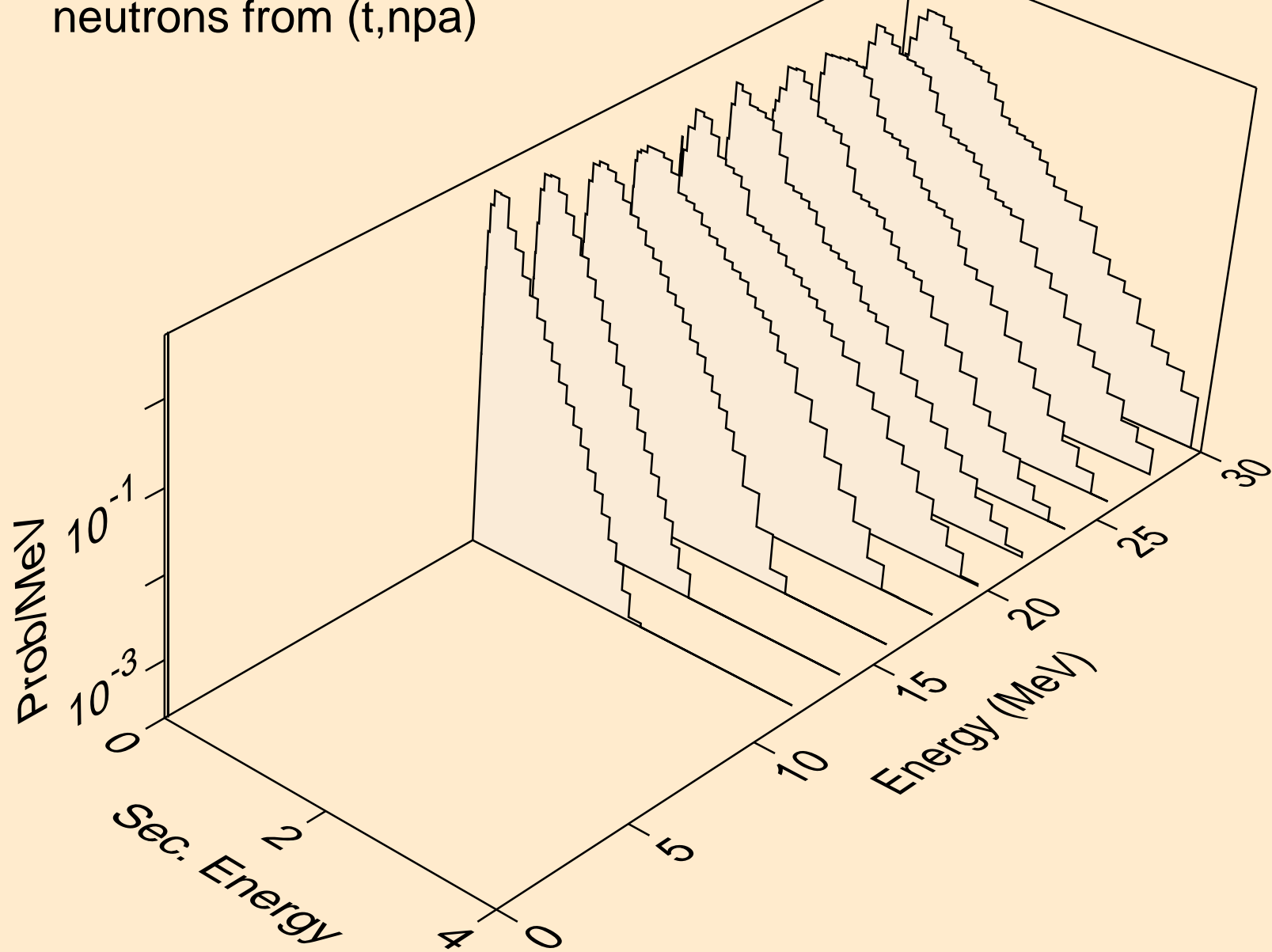

FR224 TRITON ACER TENDL-2021 LIBRARY; T=0.K  
protons from (t,x)

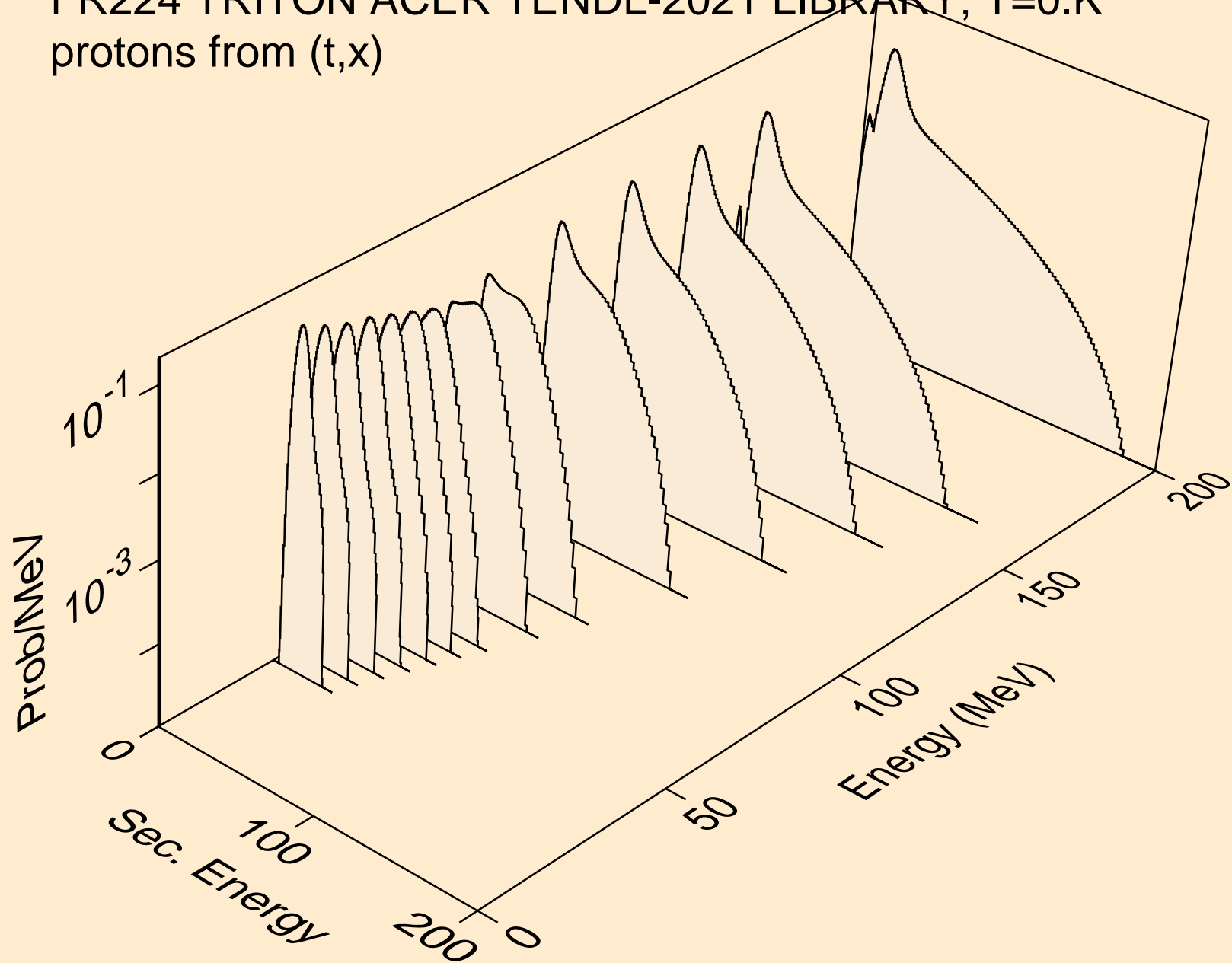

FR224 TRITON ACER TENDL-2021 LIBRARY; T=0.K  
protons from (t,n\*)p

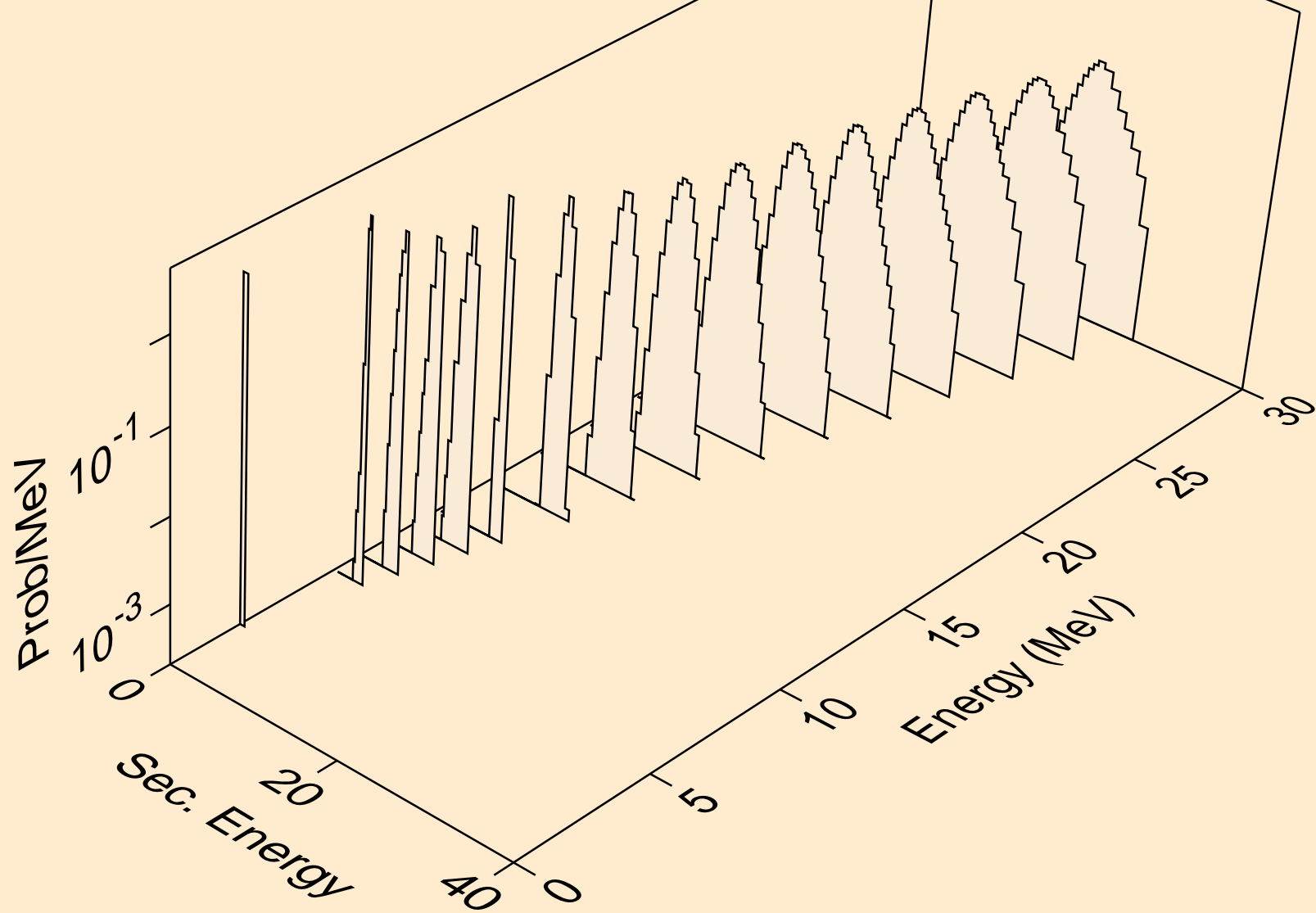

FR224 TRITON ACER TENDL-2021 LIBRARY; T=0.K  
protons from (t,2np)

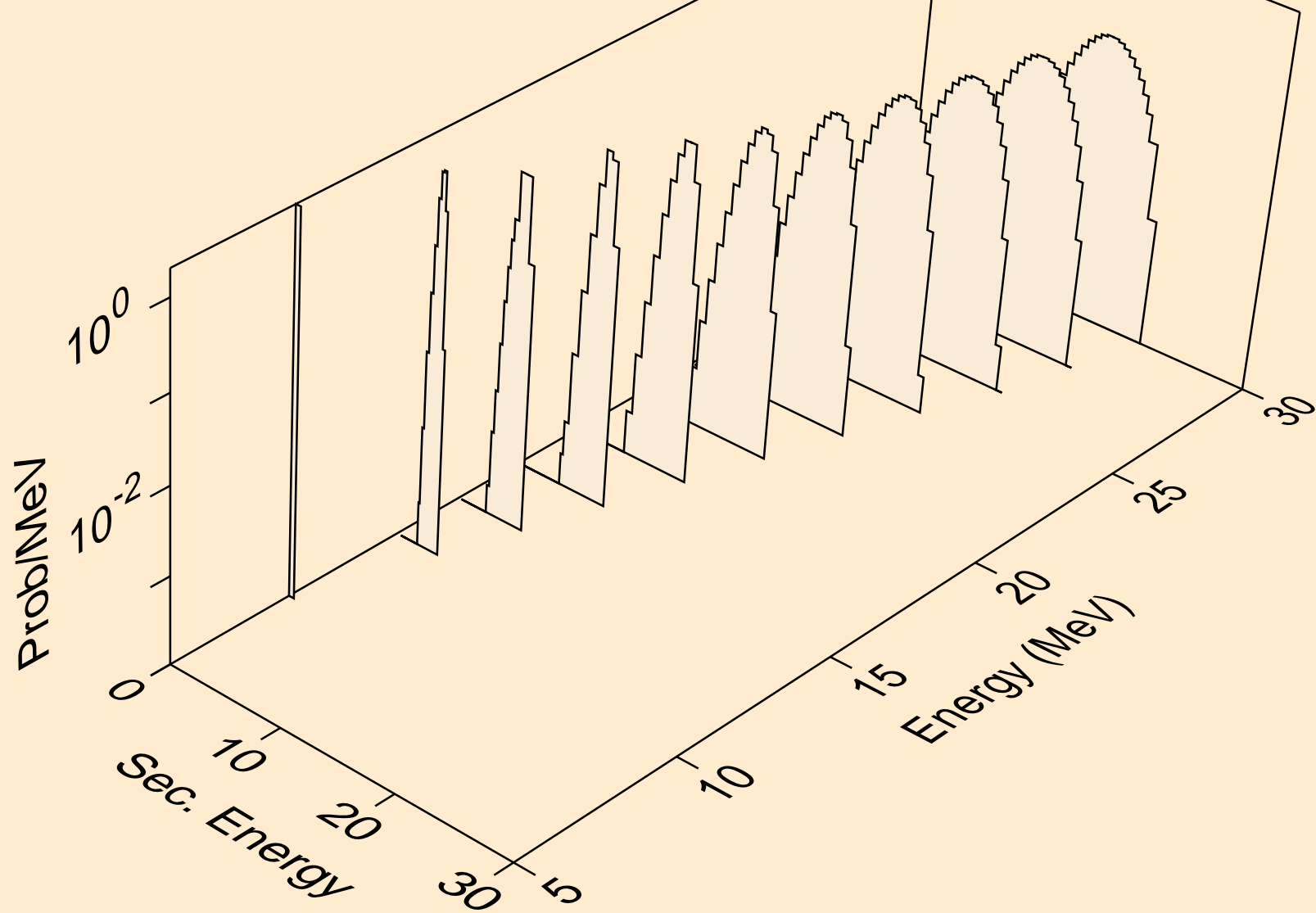

FR224 TRITON ACER TENDL-2021 LIBRARY; T=0.K  
protons from (t,3np)

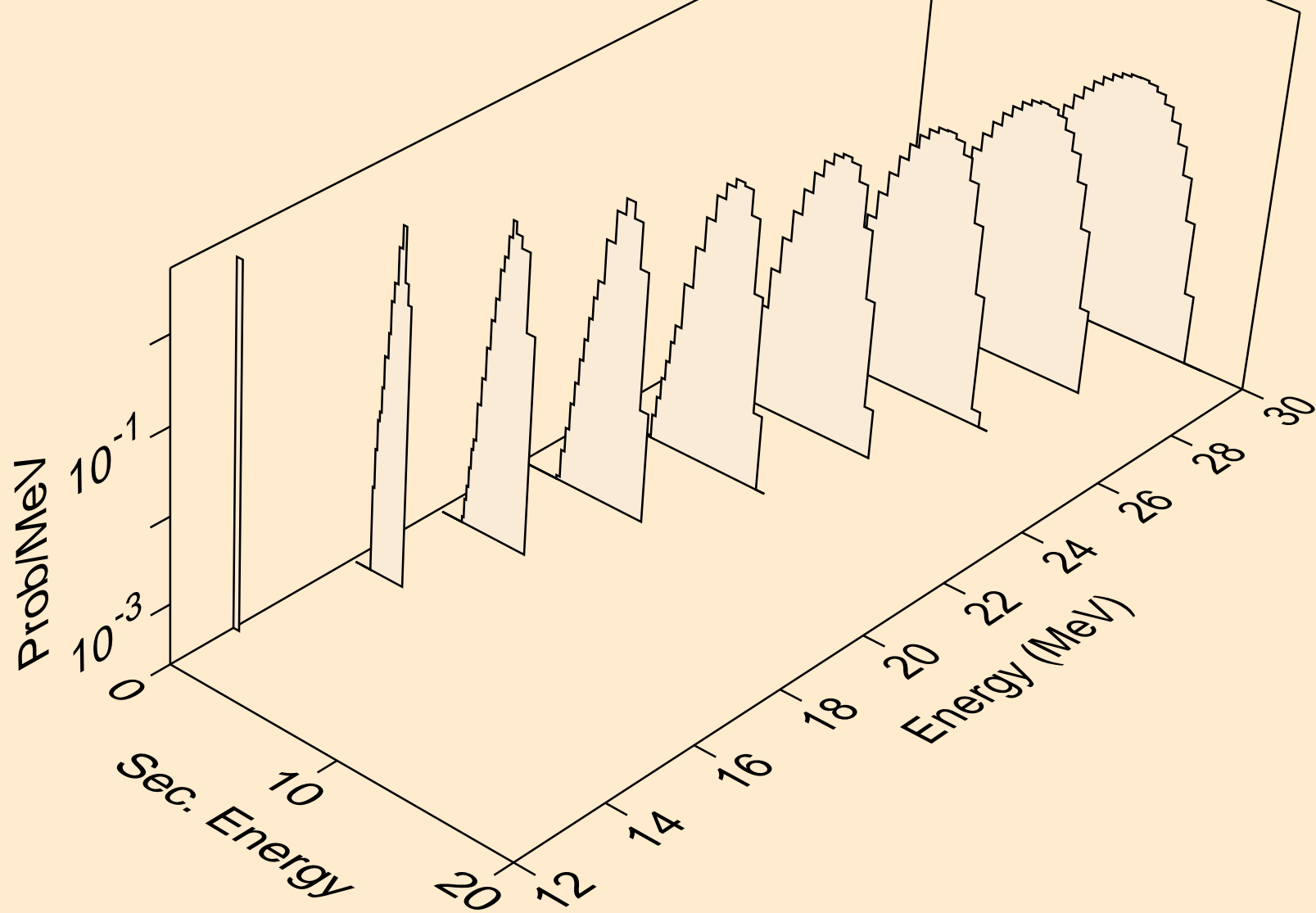

FR224 TRITON ACER TENDL-2021 LIBRARY; T=0.K  
protons from (t,2np)

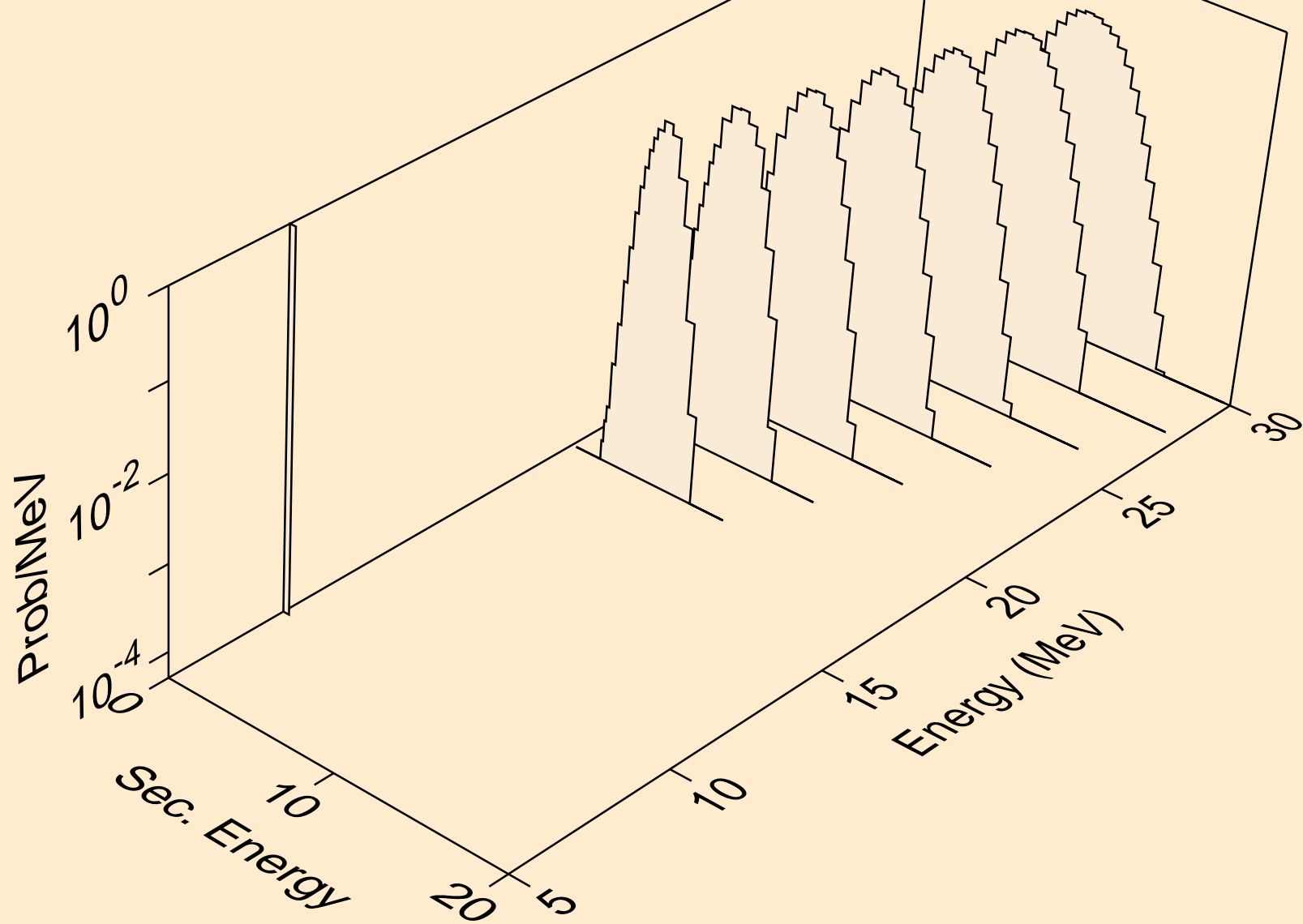

FR224 TRITON ACER TENDL-2021 LIBRARY; T=0.K  
protons from (t,npa)

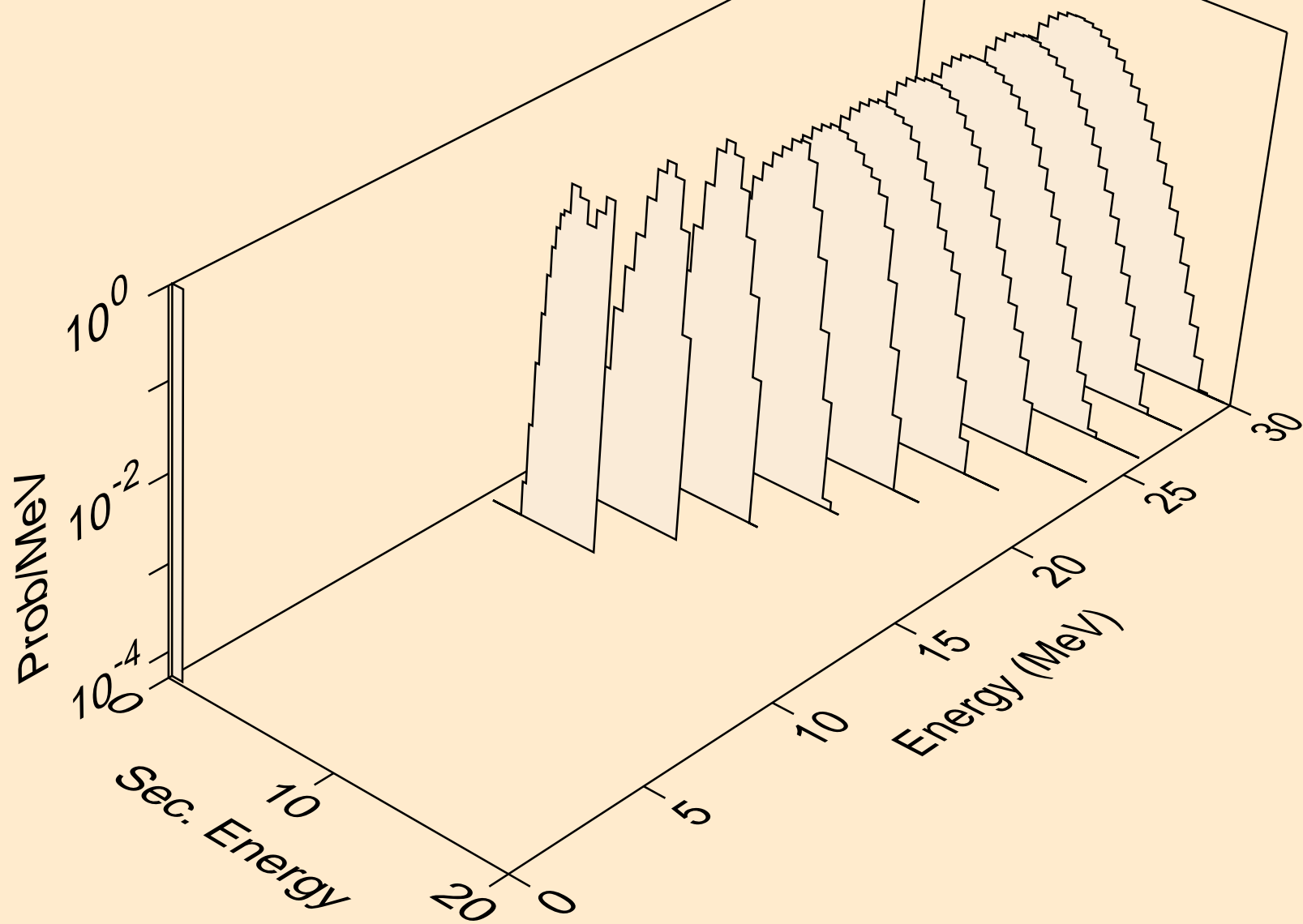



FR224 TRITON ACER TENDL-2021 LIBRARY; T=0.K  
protons from (t,p)

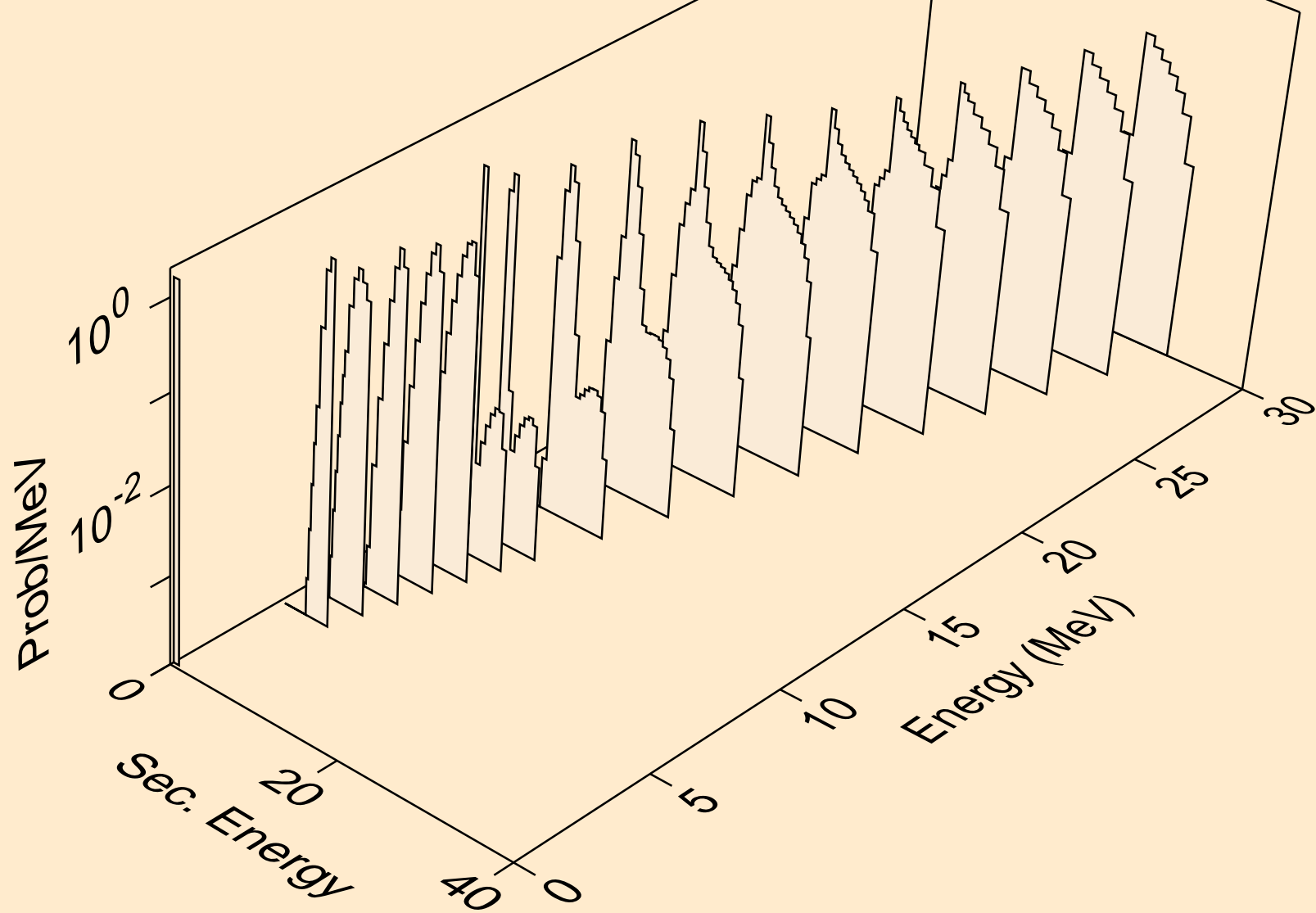

FR224 TRITON ACER TENDL-2021 LIBRARY; T=0.K  
protons from (t,2p)

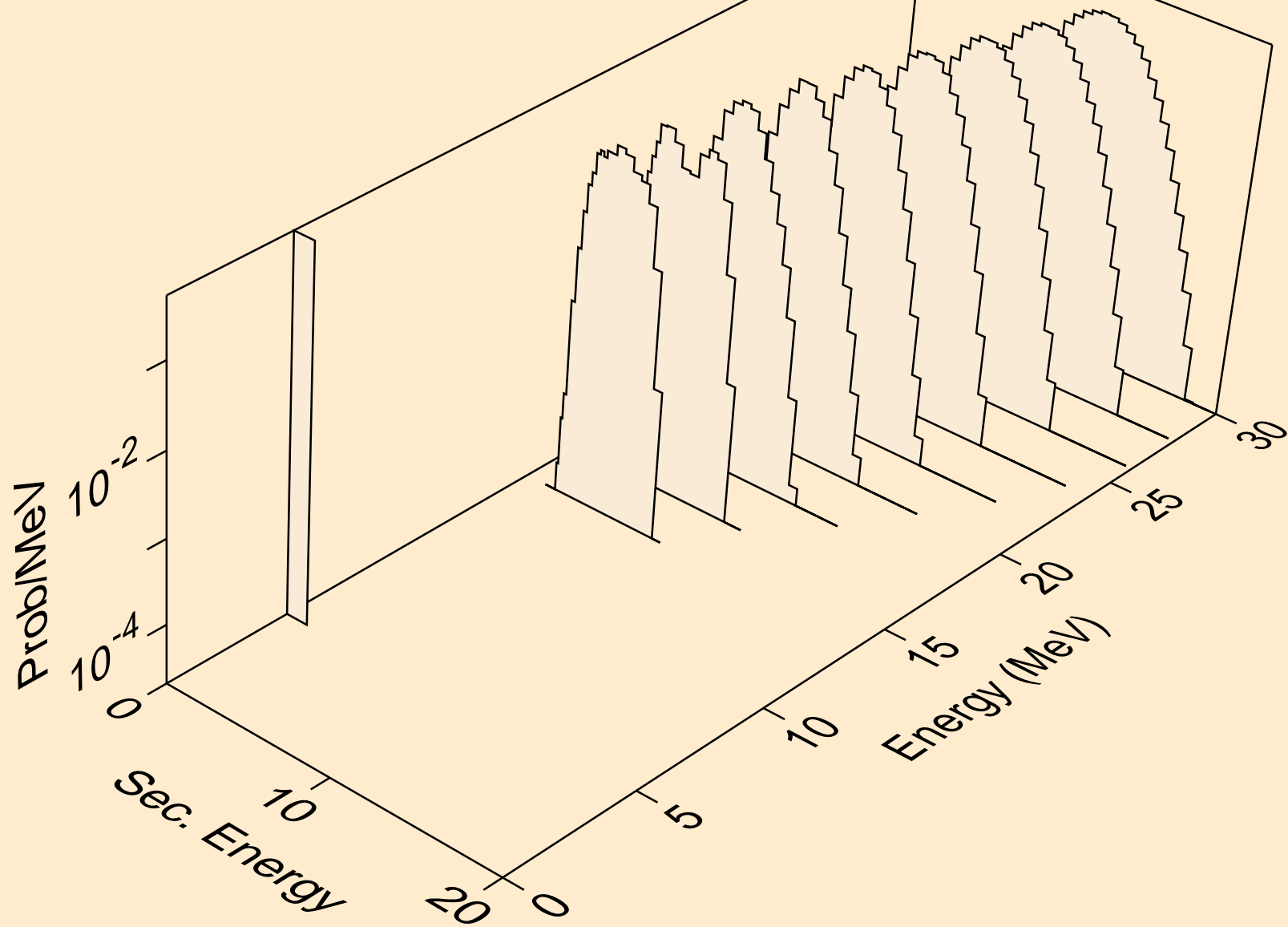

FR224 TRITON ACER TENDL-2021 LIBRARY; T=0.K  
protons from (t,pa)

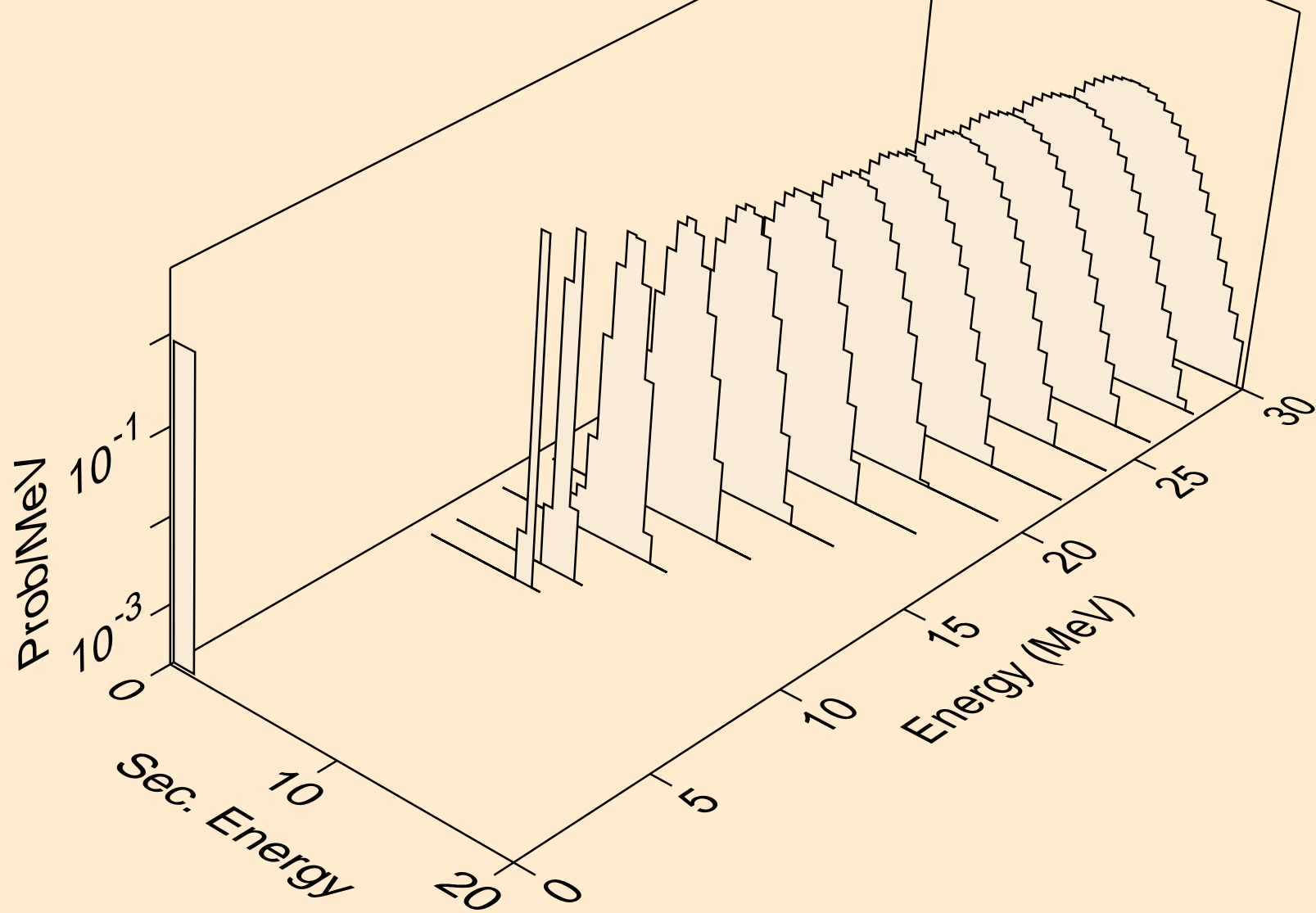

FR224 TRITON ACER TENDL-2021 LIBRARY; T=0.K  
protons from (t,pd)

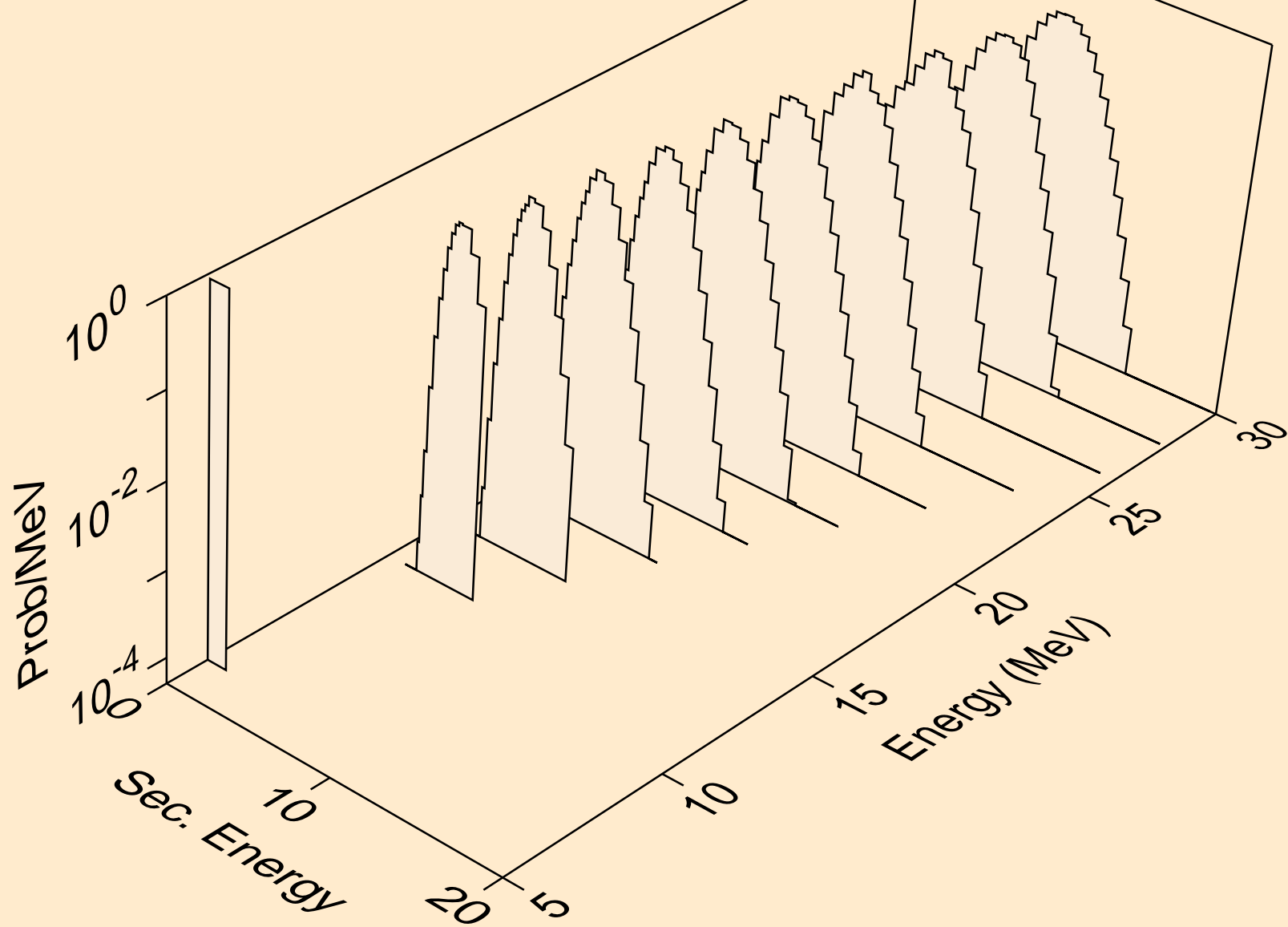

FR224 TRITON ACER TENDL-2021 LIBRARY; T=0.K  
protons from (t,pt)

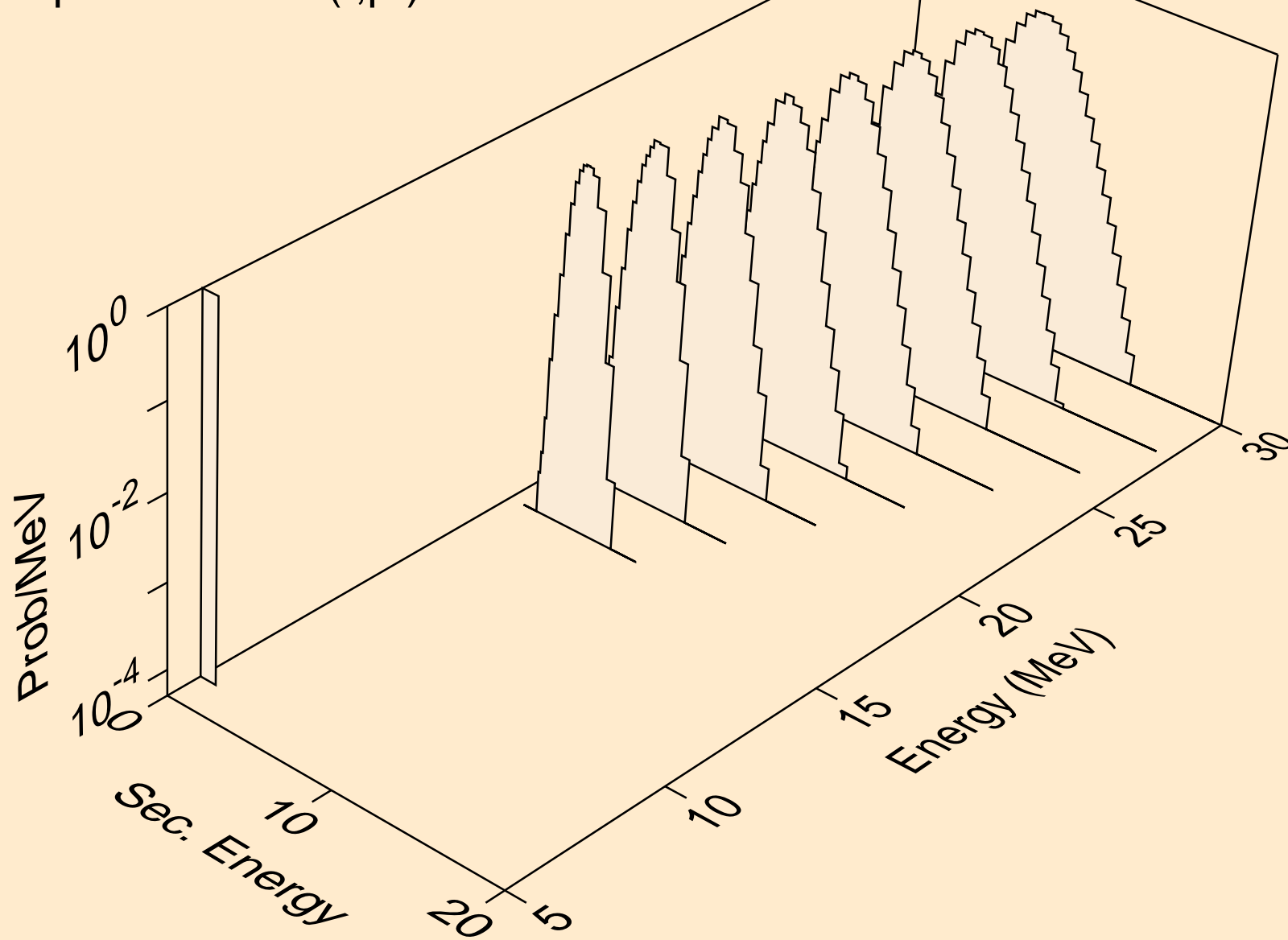

FR224 TRITON ACER TENDL-2021 LIBRARY; T=0.K  
deuterons from (t,x)

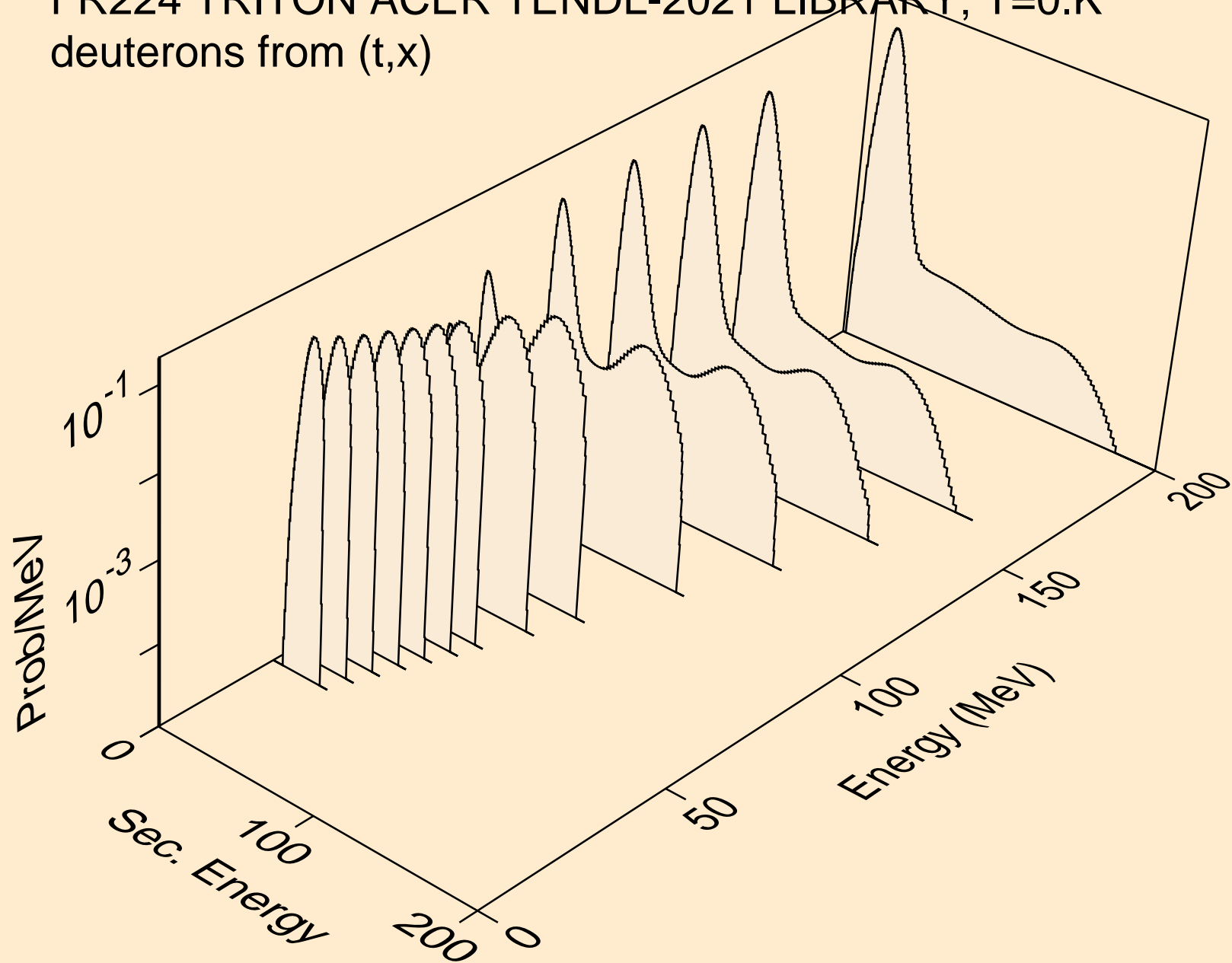

FR224 TRITON ACER TENDL-2021 LIBRARY; T=0.K  
deuterons from (t,2nd)

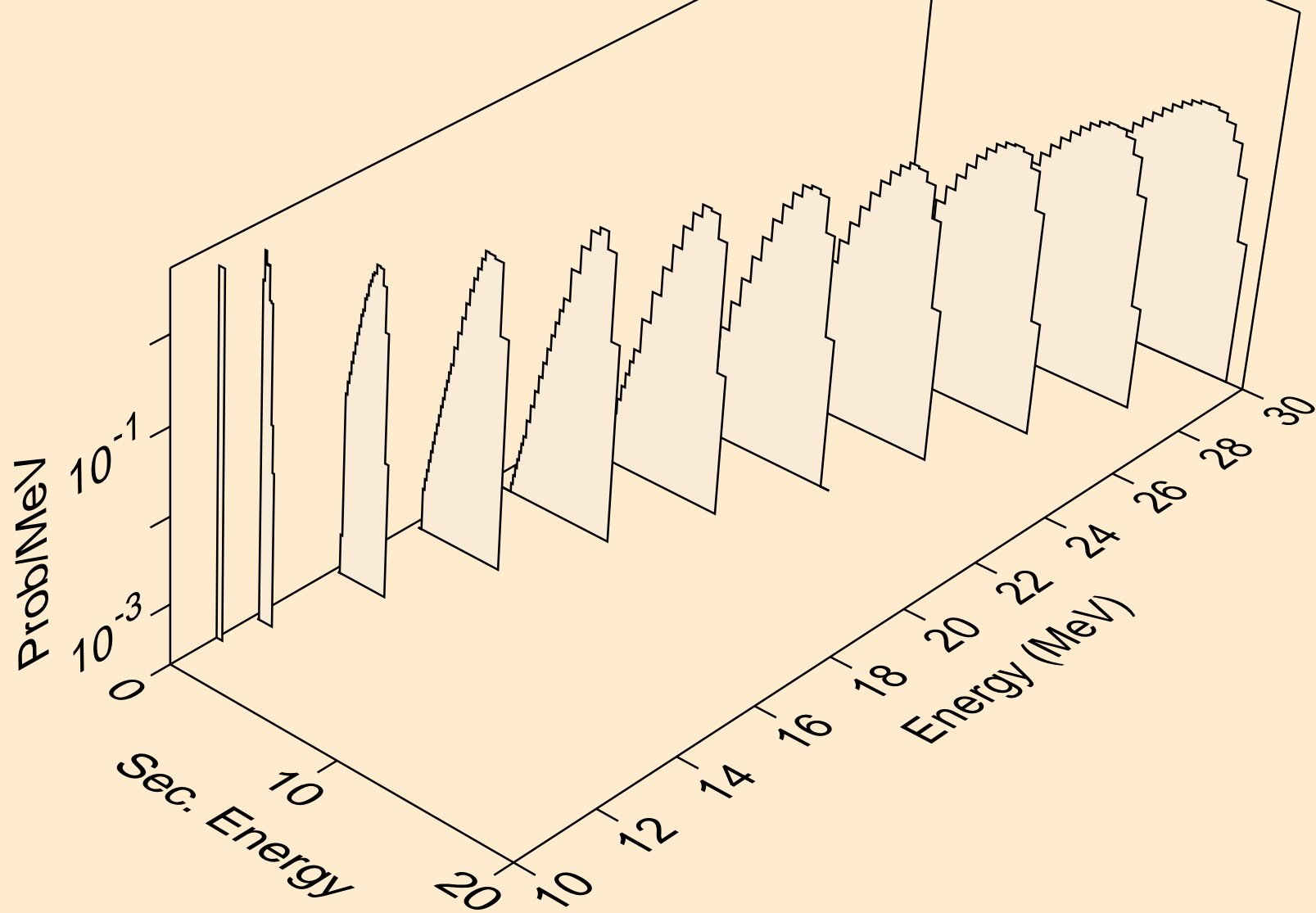

FR224 TRITON ACER TENDL-2021 LIBRARY; T=0.K  
deuterons from (t,n\*)d

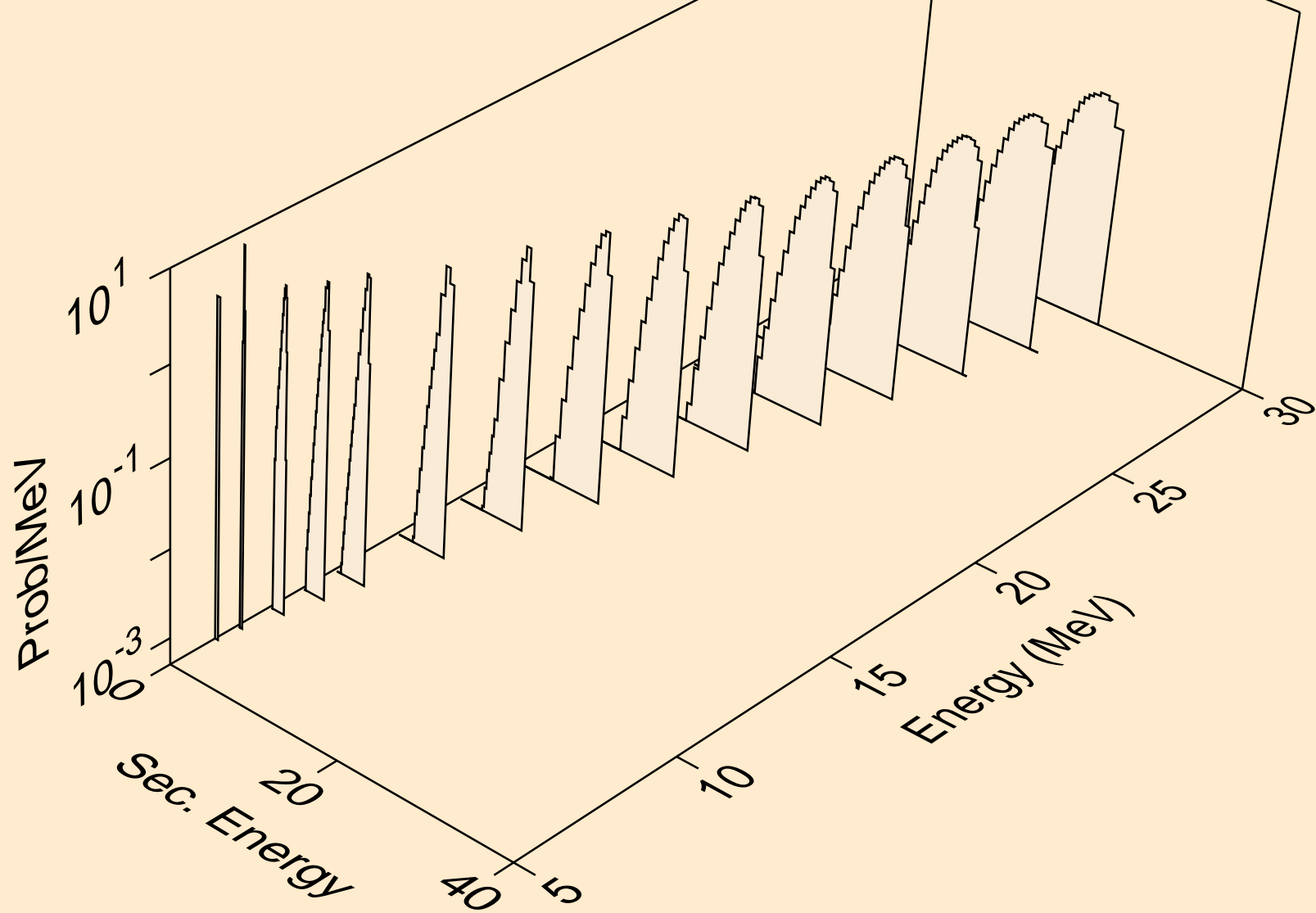



FR224 TRITON ACER TENDL-2021 LIBRARY; T=0.K  
deuterons from (t,d)

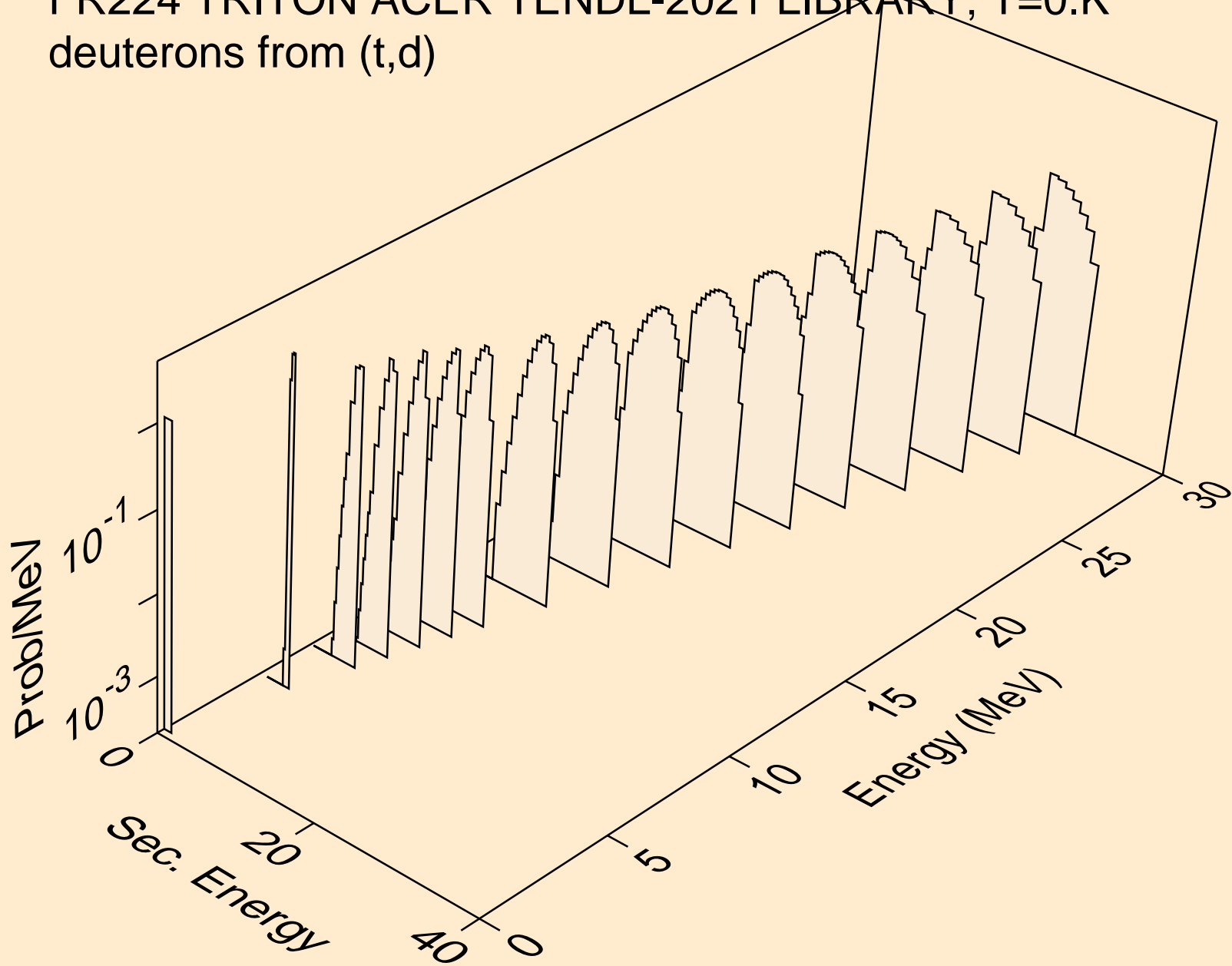

FR224 TRITON ACER TENDL-2021 LIBRARY; T=0.K  
deuterons from (t,pd)

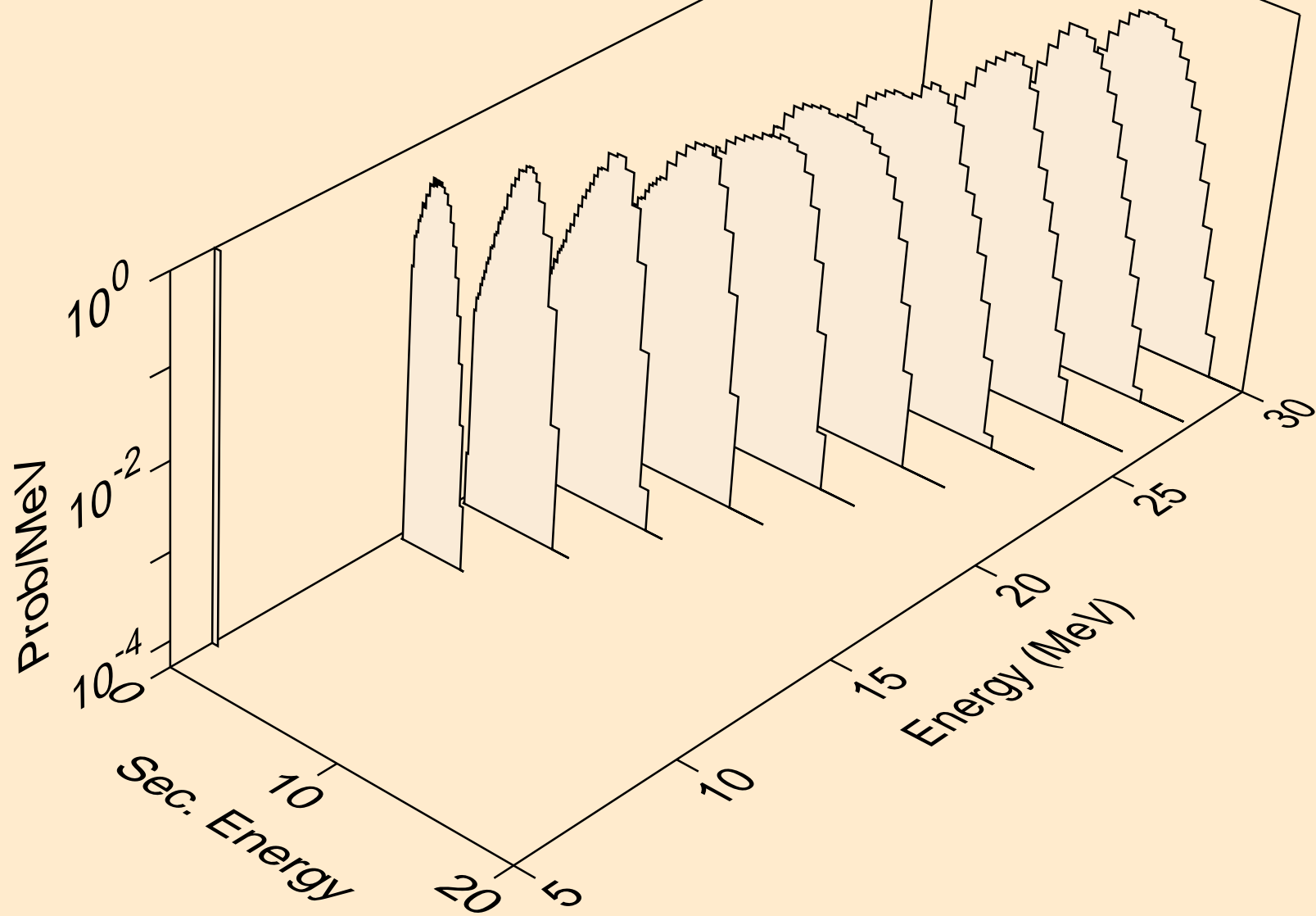

FR224 TRITON ACER TENDL-2021 LIBRARY; T=0.K  
he3s from (t,x)

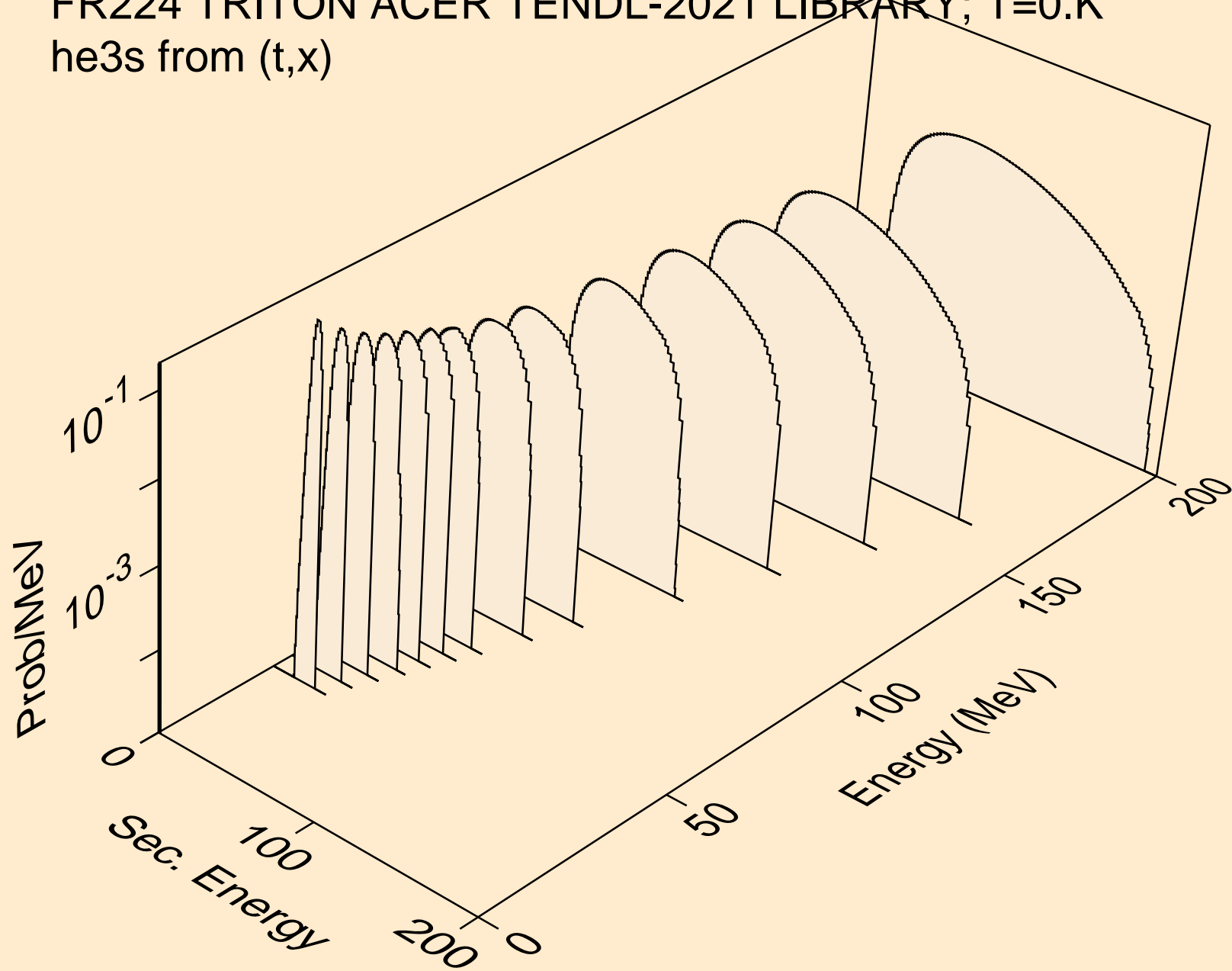

FR224 TRITON ACER TENDL-2021 LIBRARY; T=0.K  
he3s from (t,n\*)he3

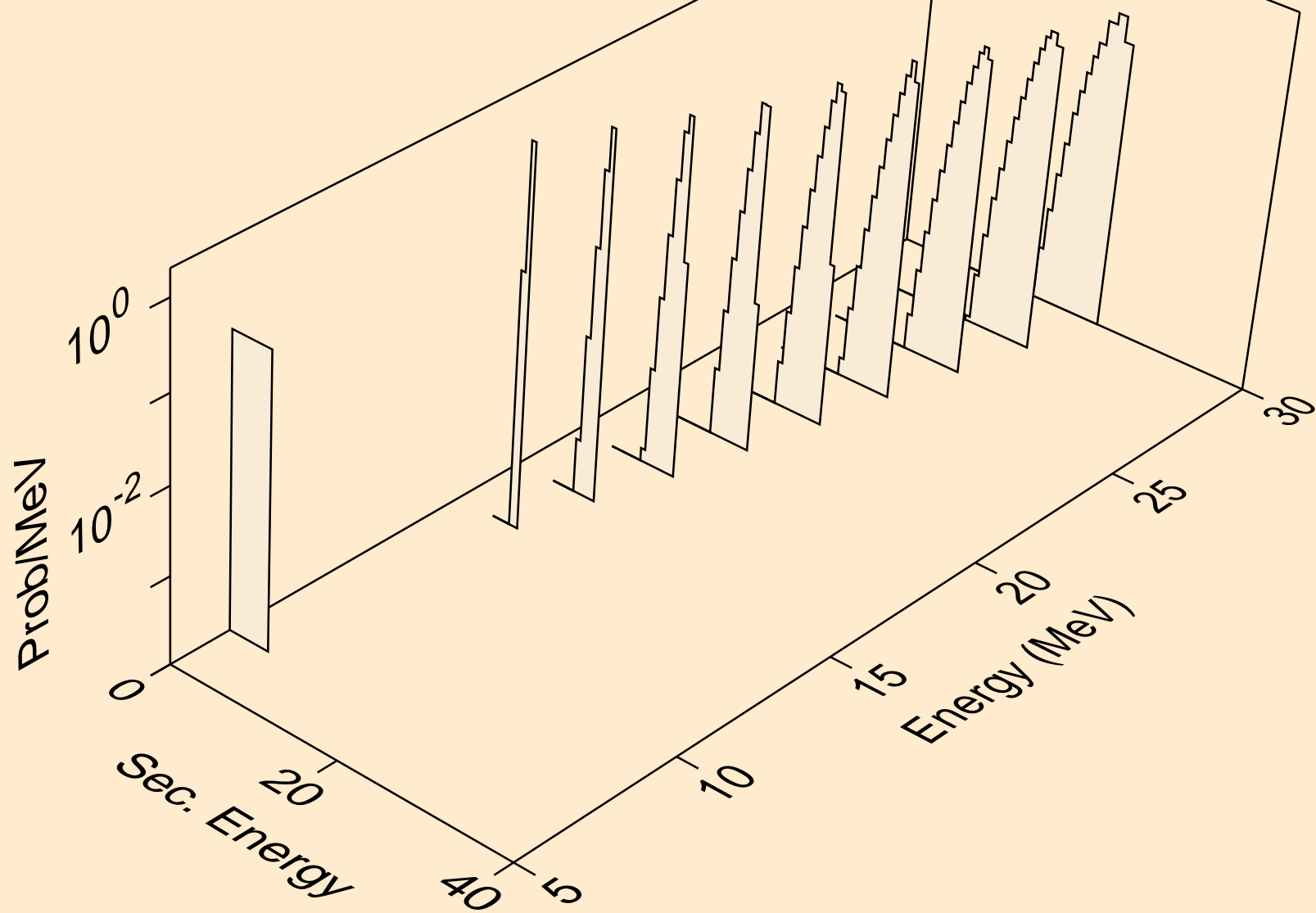

FR224 TRITON ACER TENDL-2021 LIBRARY; T=0.K  
he3s from (t,he3)

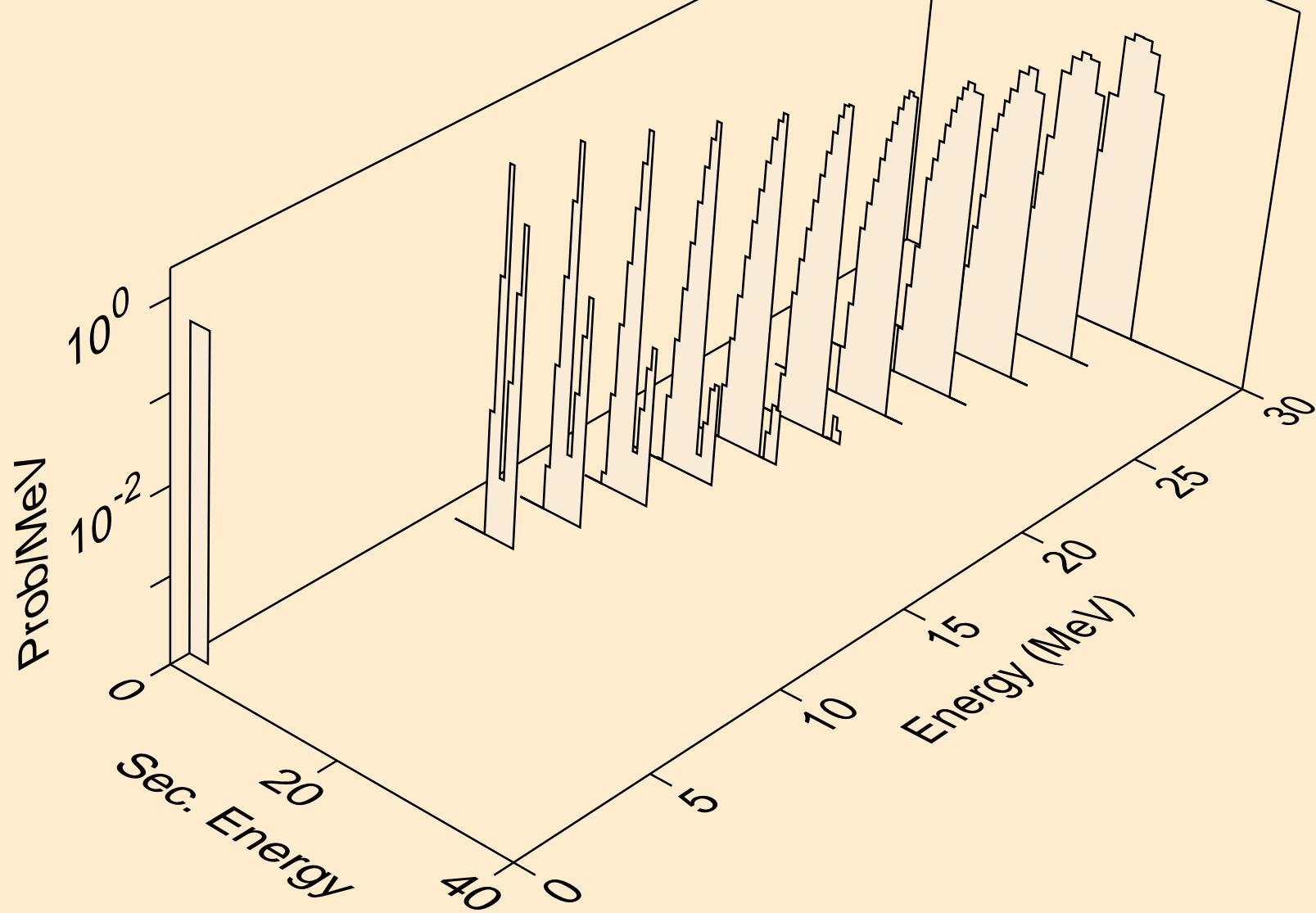

FR224 TRITON ACER TENDL-2021 LIBRARY; T=0.K  
alphas from (t,x)

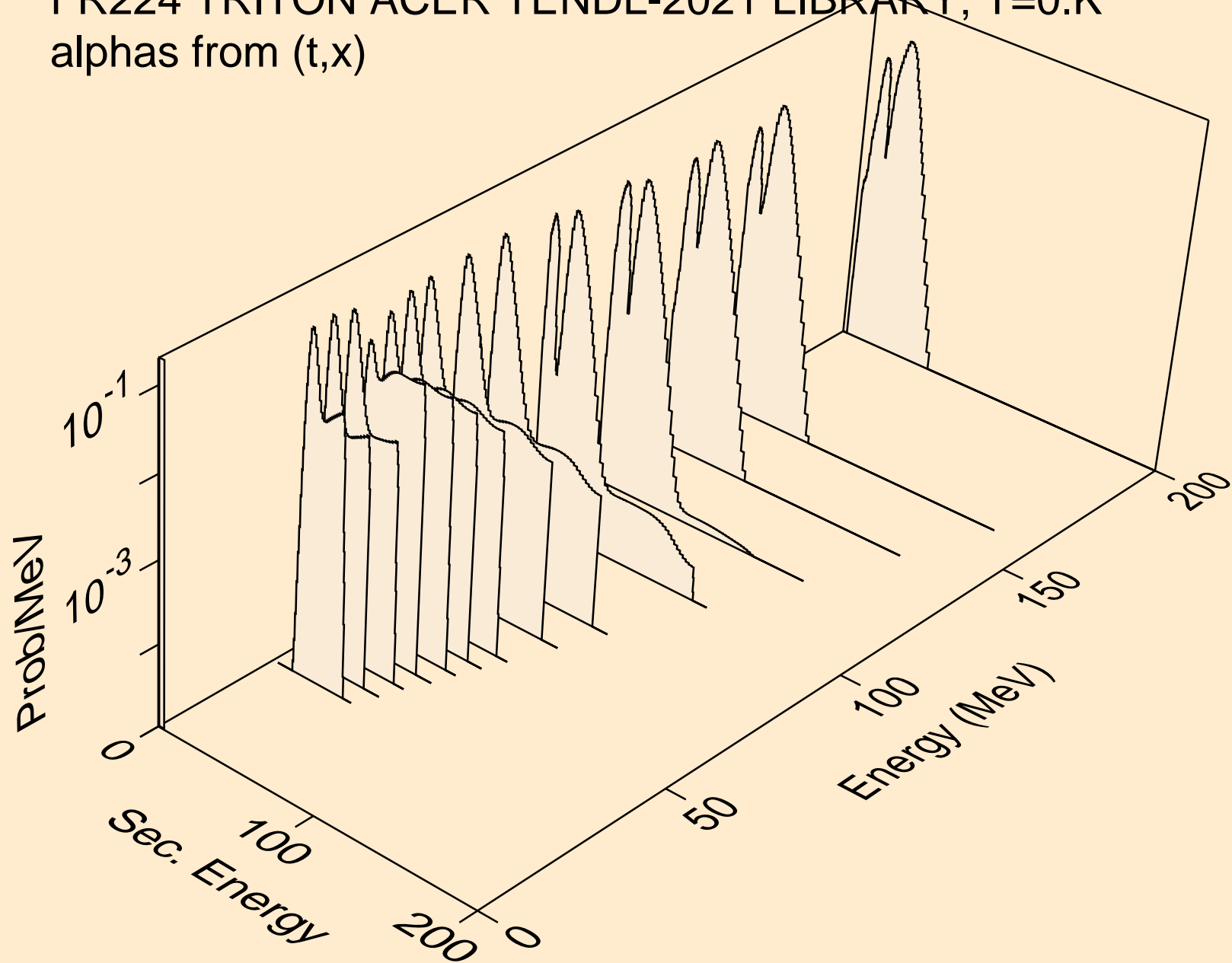

FR224 TRITON ACER TENDL-2021 LIBRARY; T=0.K  
alphas from (t,n\*)a

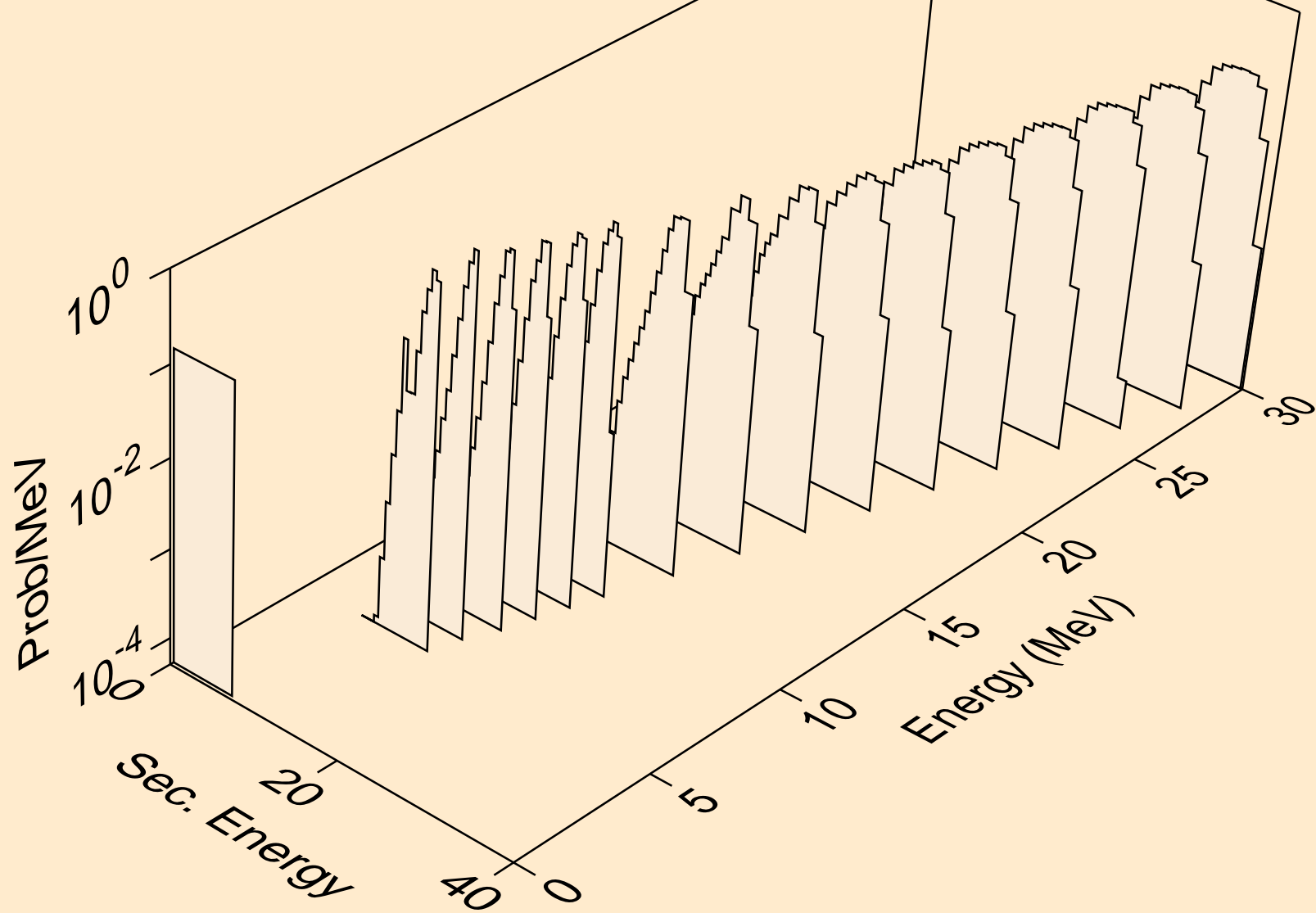

FR224 TRITON ACER TENDL-2021 LIBRARY; T=0.K  
alphas from (t,2n)a

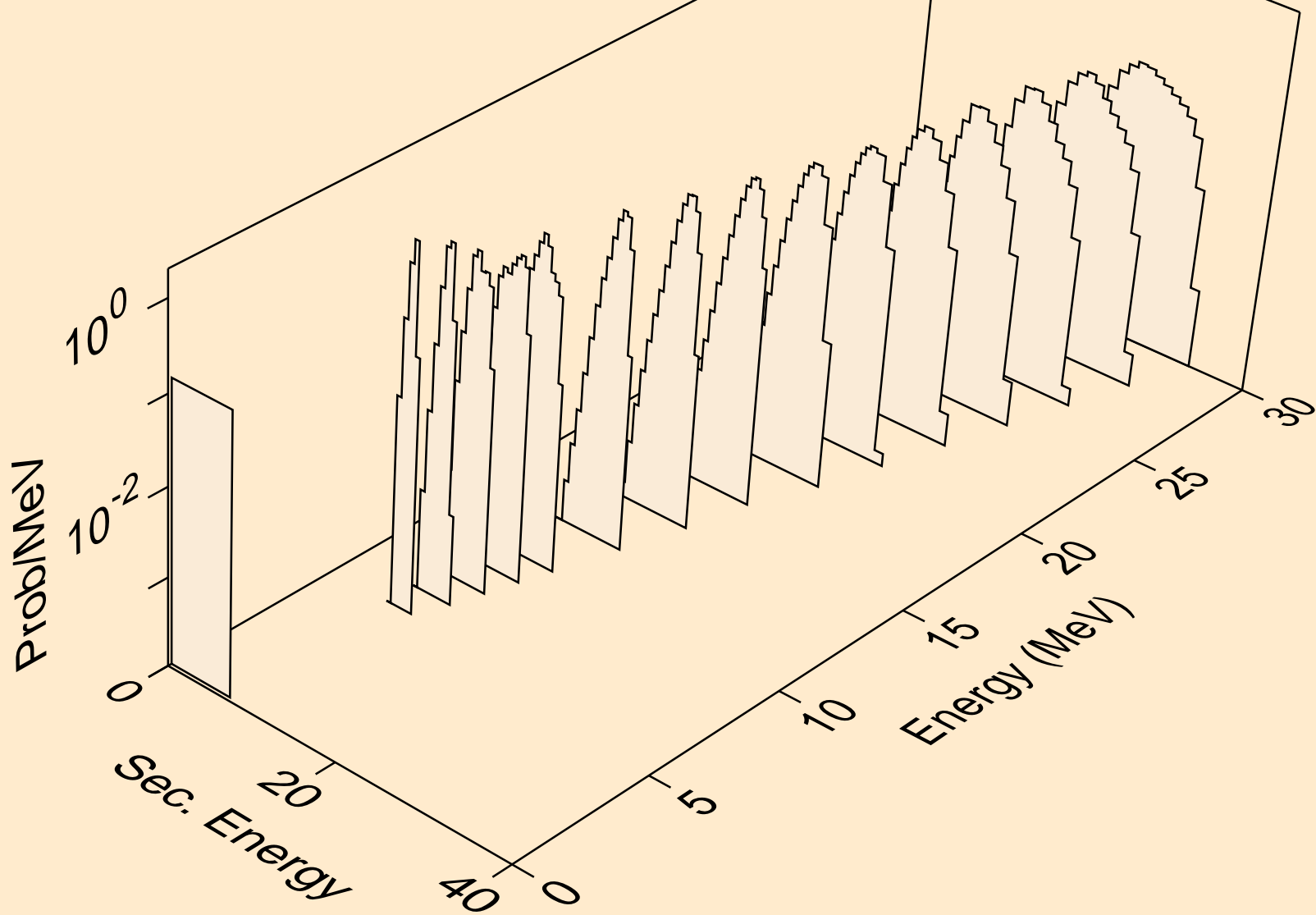



FR224 TRITON ACER TENDL-2021 LIBRARY; T=0.K  
alphas from (t,3n)a

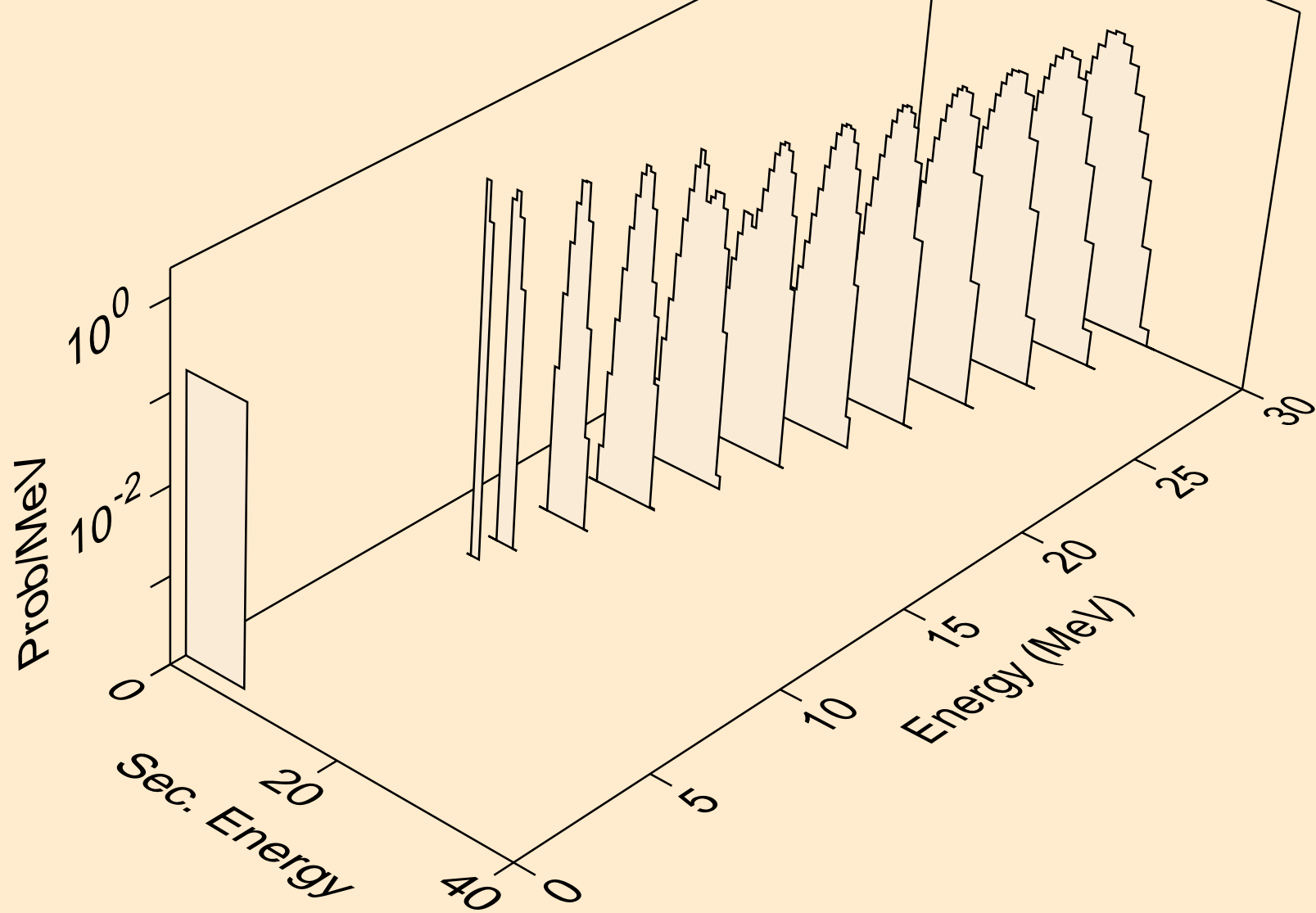

FR224 TRITON ACER TENDL-2021 LIBRARY; T=0.K  
alphas from (t,n\*)2a

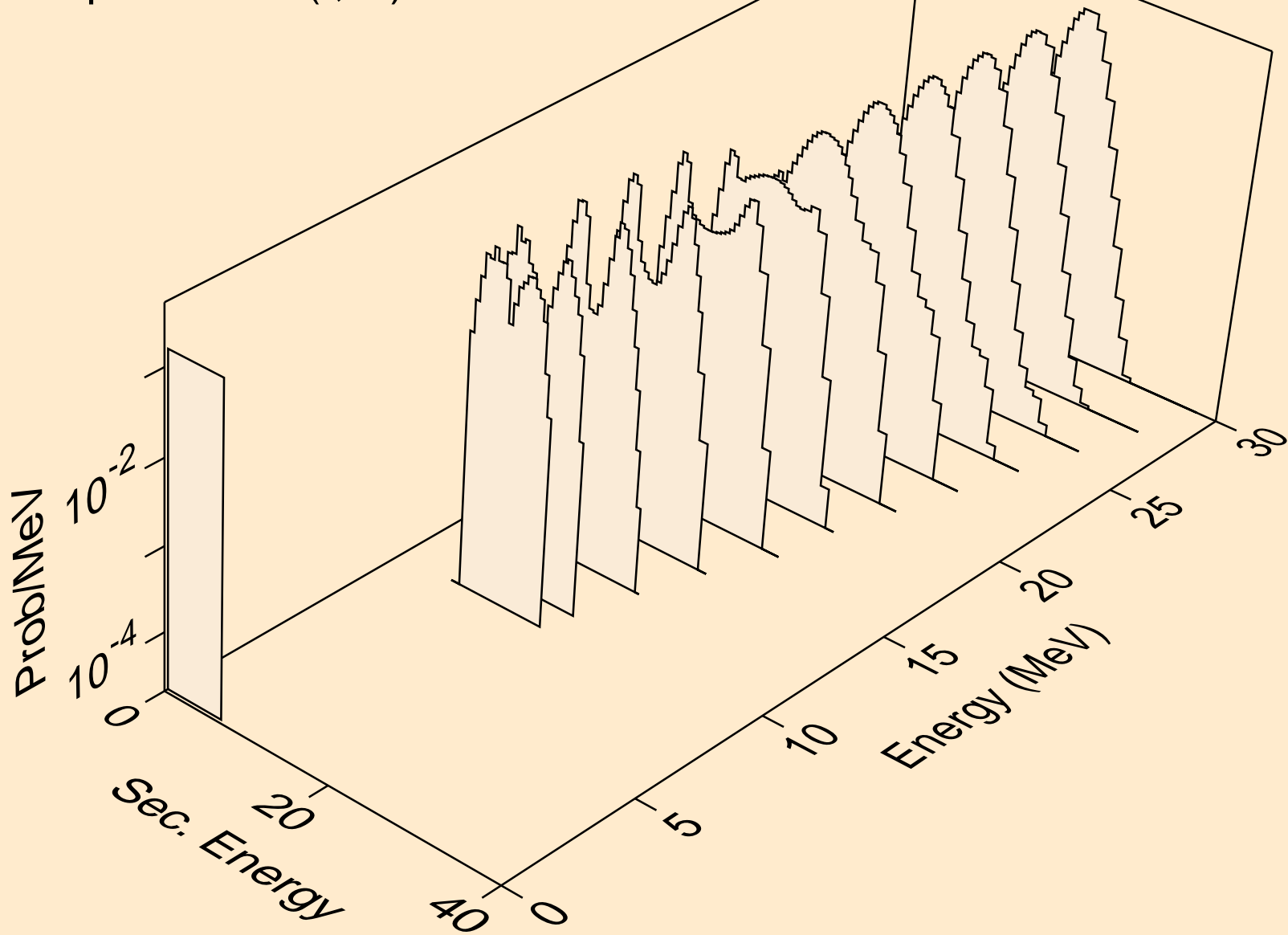

FR224 TRITON ACER TENDL-2021 LIBRARY; T=0.K  
alphas from (t,2n)2a

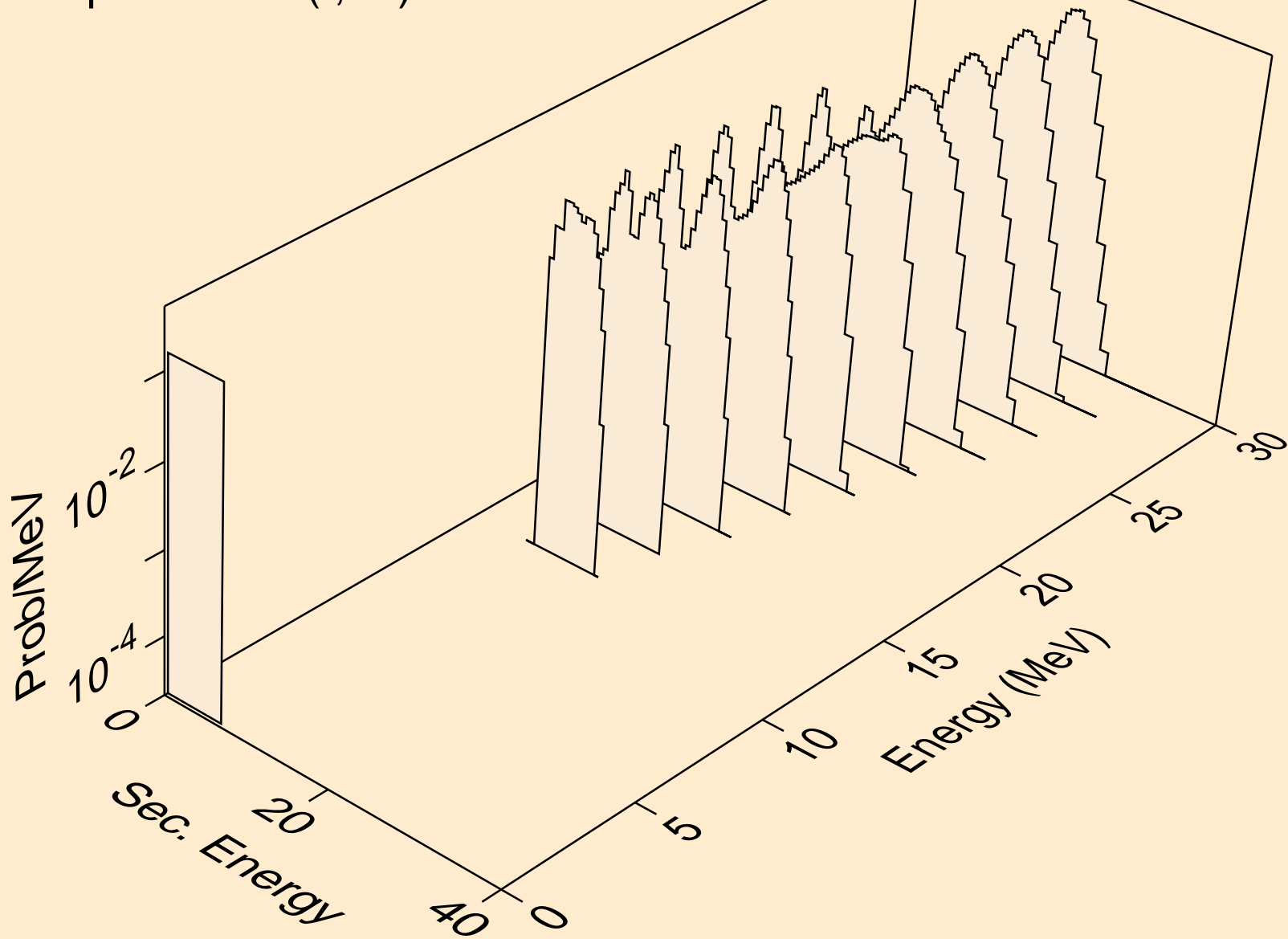

FR224 TRITON ACER TENDL-2021 LIBRARY; T=0.K  
alphas from (t,npa)

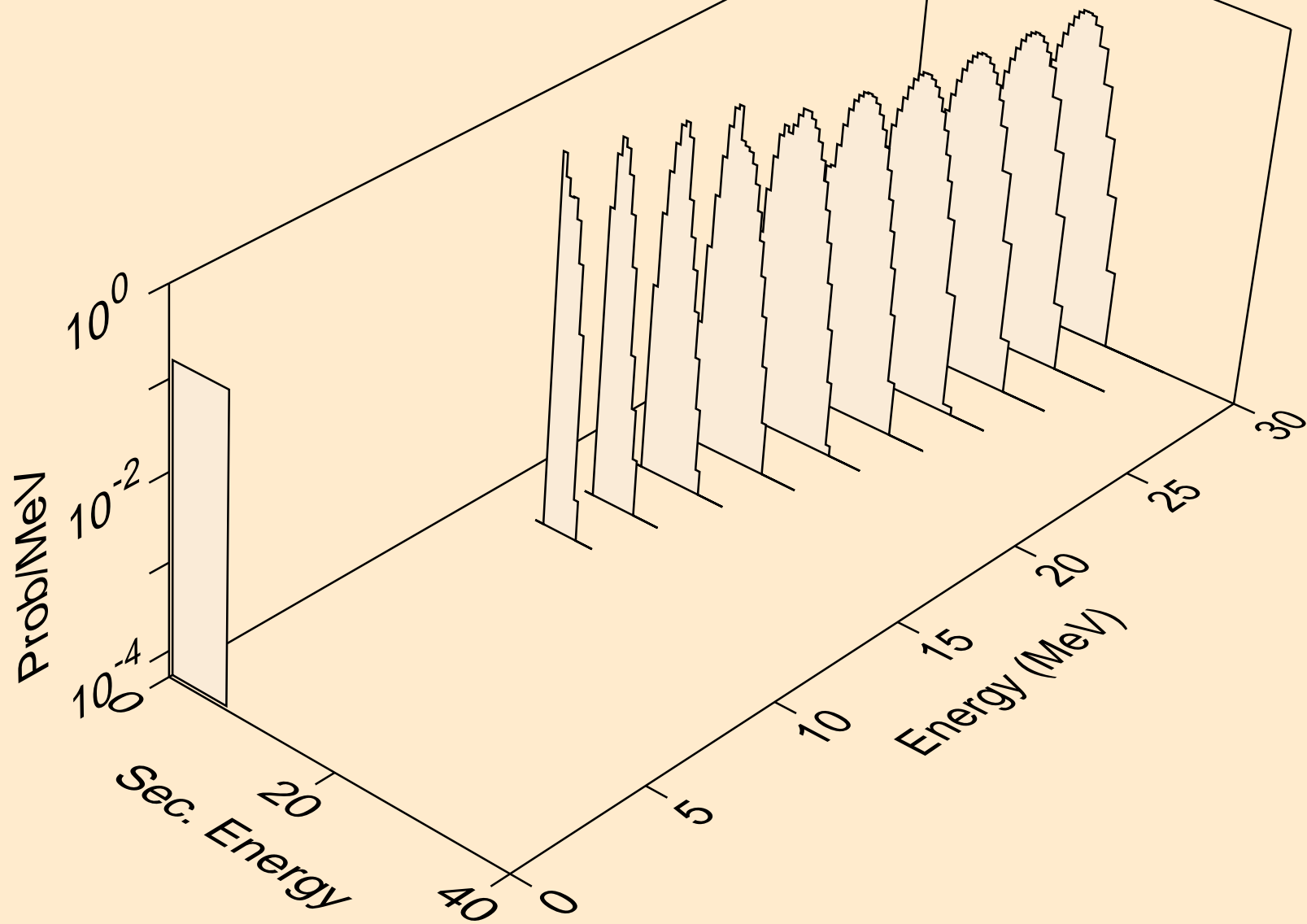

FR224 TRITON ACER TENDL-2021 LIBRARY; T=0.K  
alphas from (t,a)

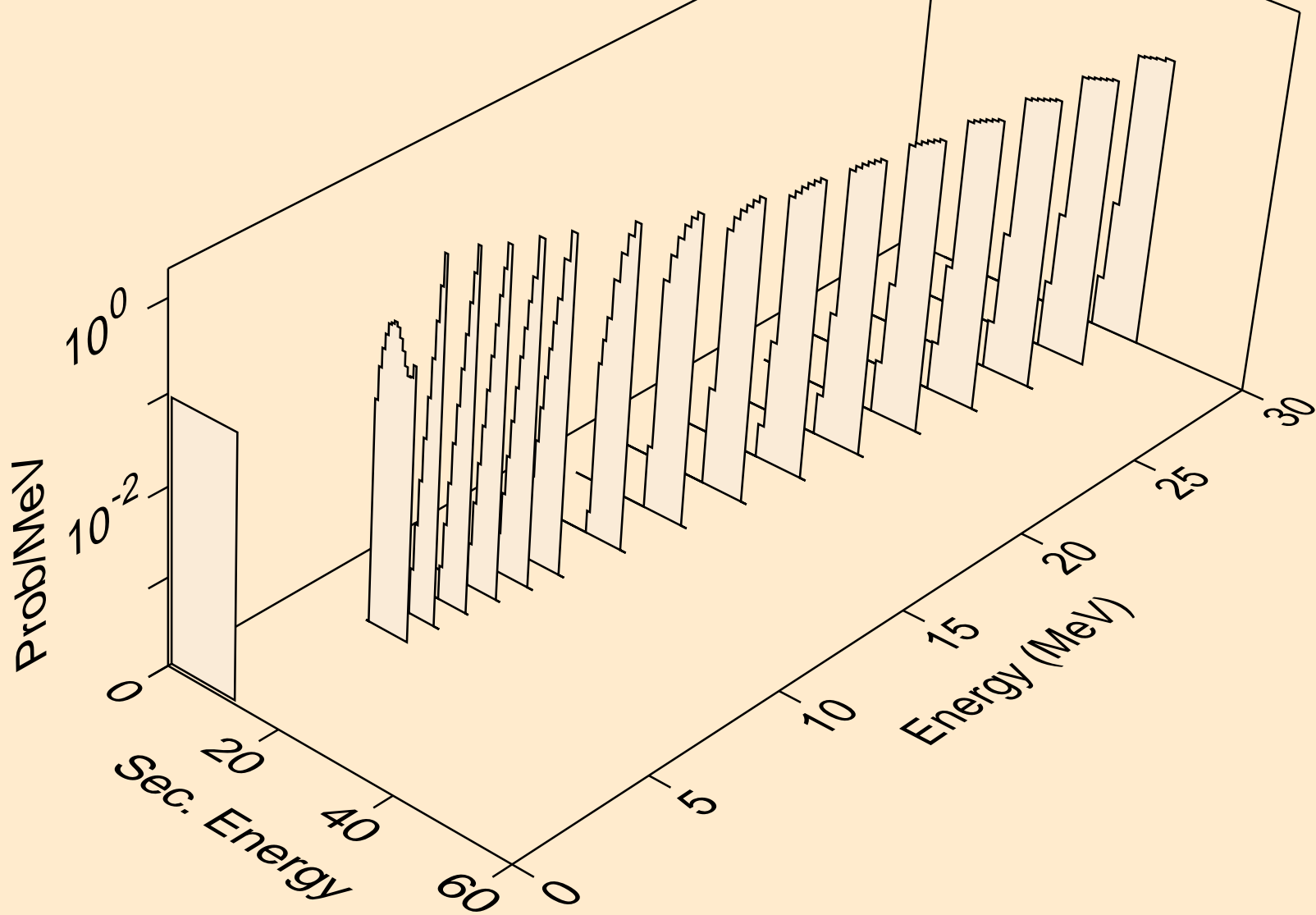

FR224 TRITON ACER TENDL-2021 LIBRARY; T=0.K  
alphas from (t,2a)

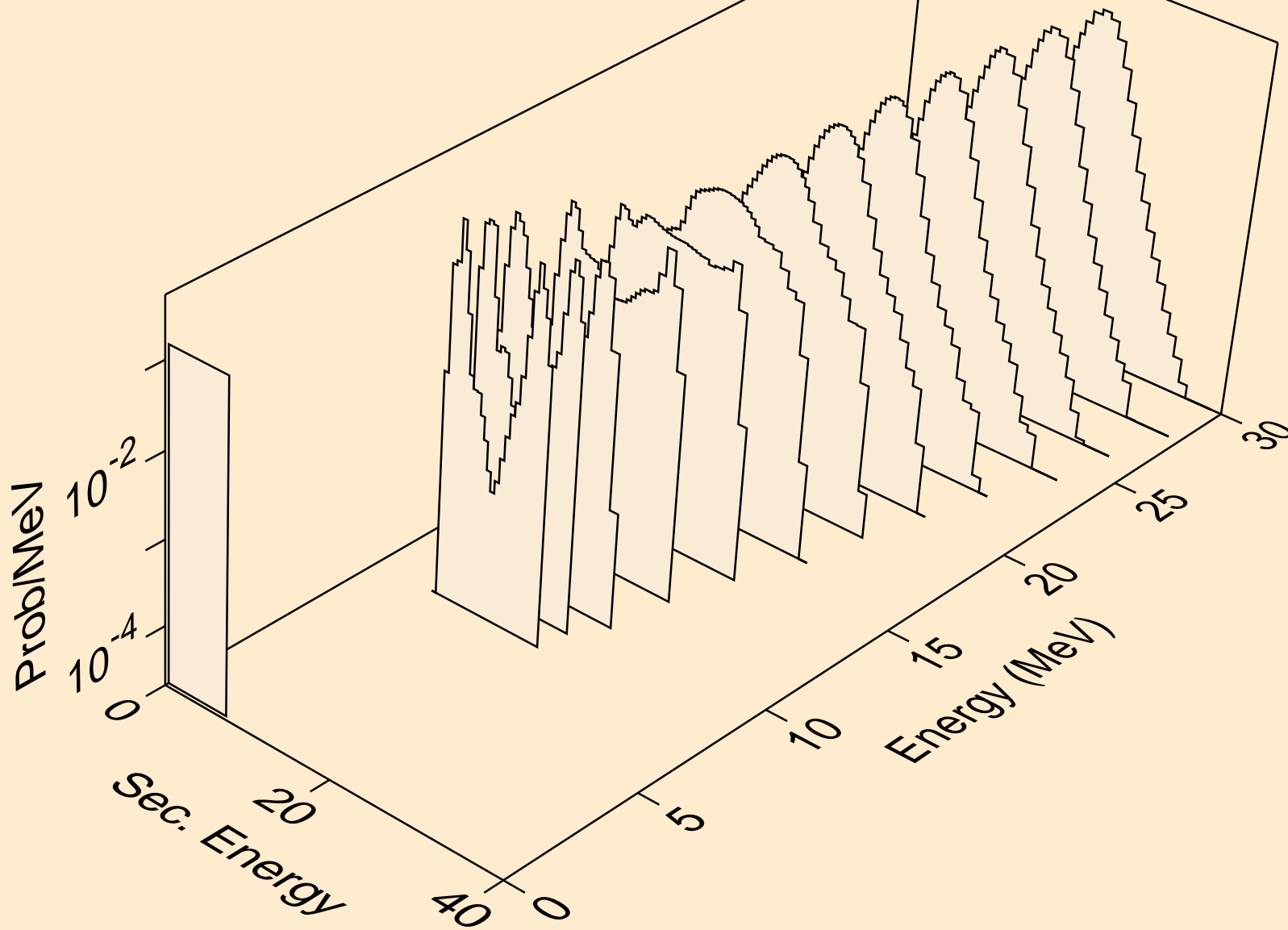

FR224 TRITON ACER TENDL-2021 LIBRARY; T=0.K  
alphas from (t,pa)

