

FR231 TRITON ACER TENDL-2021 LIBRARY; T=0.K  
Principal cross sections

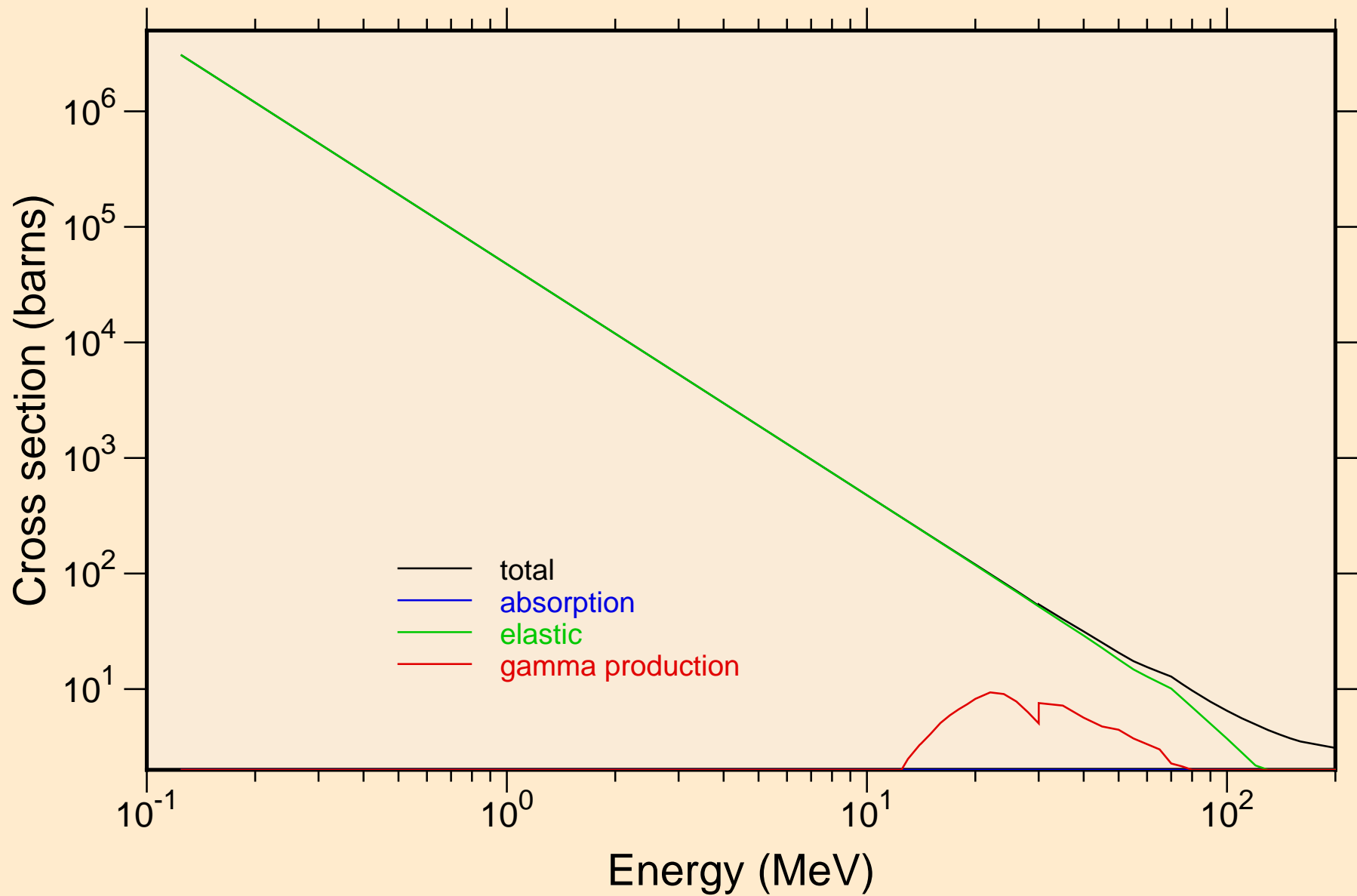

FR231 TRITON ACER TENDL-2021 LIBRARY; T=0.K

Heating

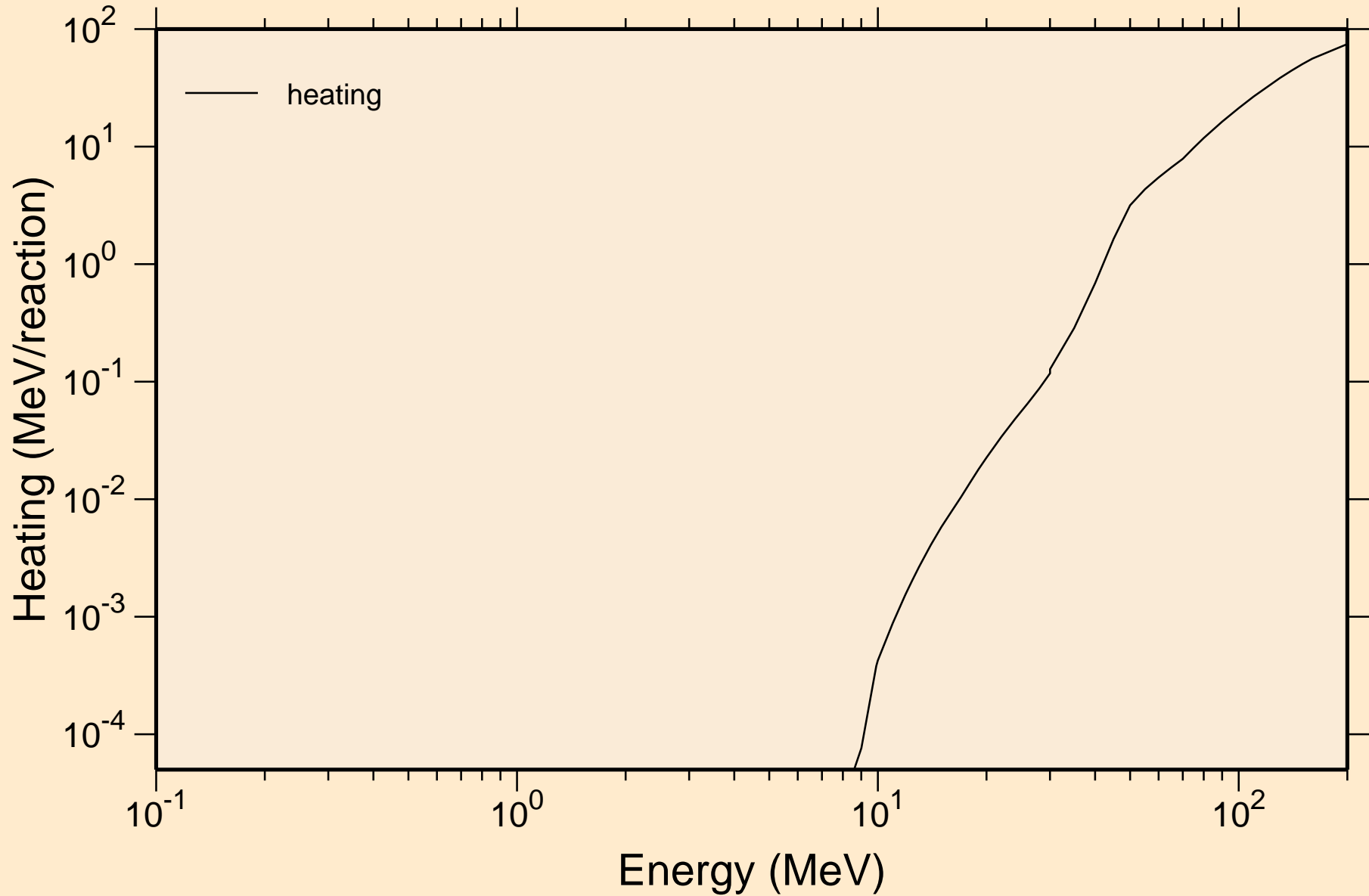

# FR231 TRITON ACER TENDL-2021 LIBRARY; T=0.K

## Principal cross sections

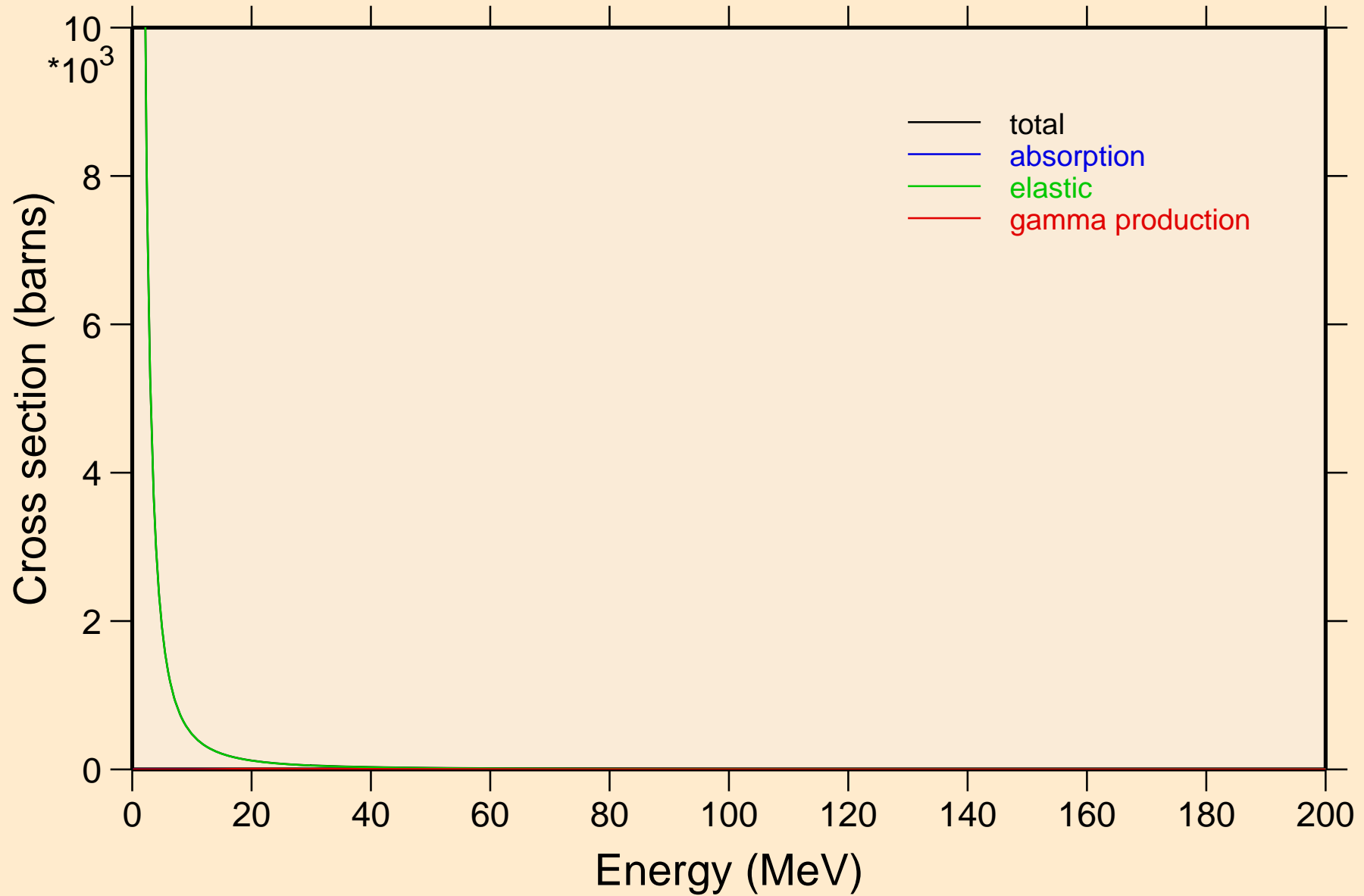

FR231 TRITON ACER TENDL-2021 LIBRARY; T=0.K

Heating

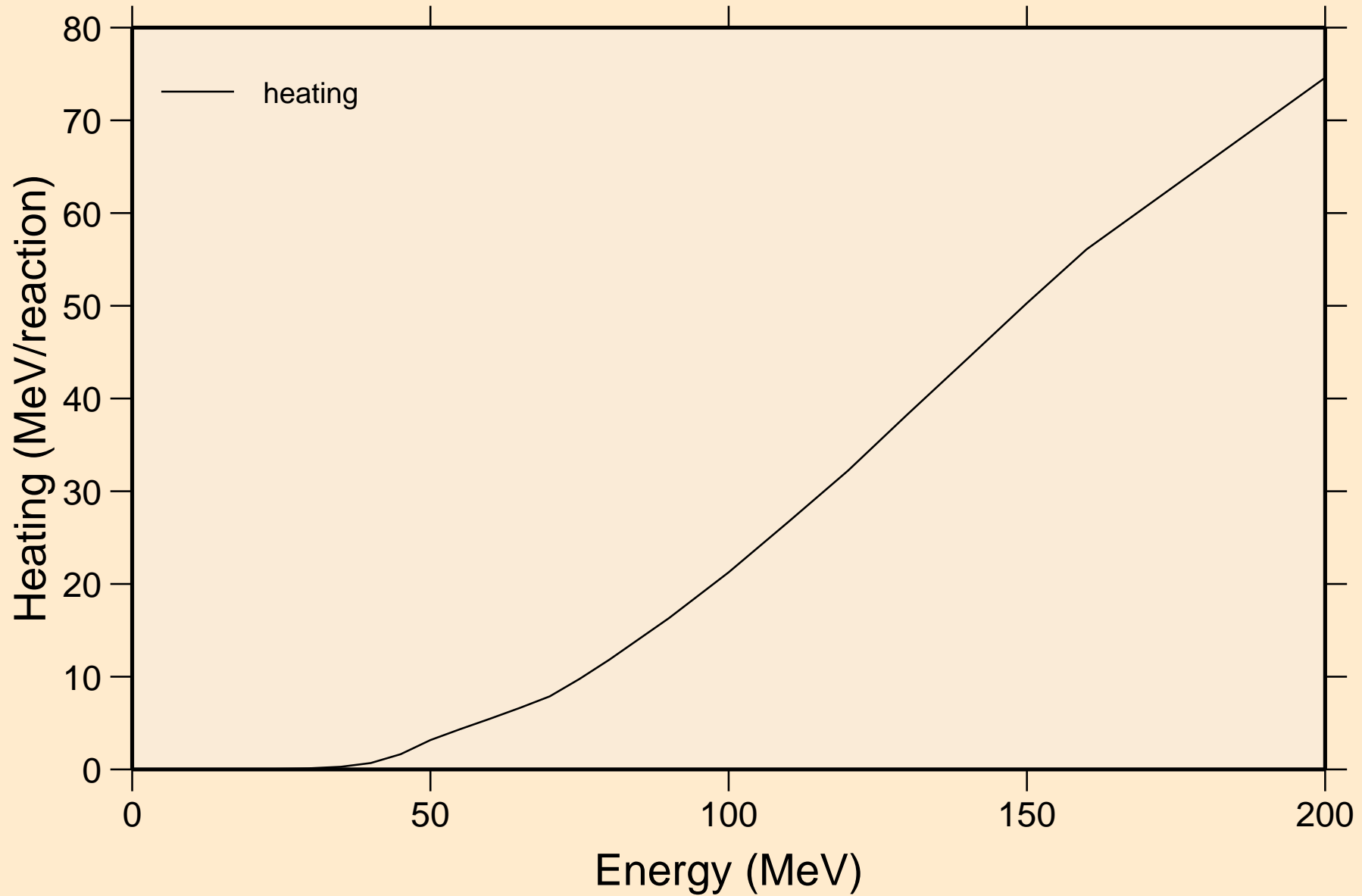

FR231 TRITON ACER TENDL-2021 LIBRARY; T=0.K  
Threshold reactions

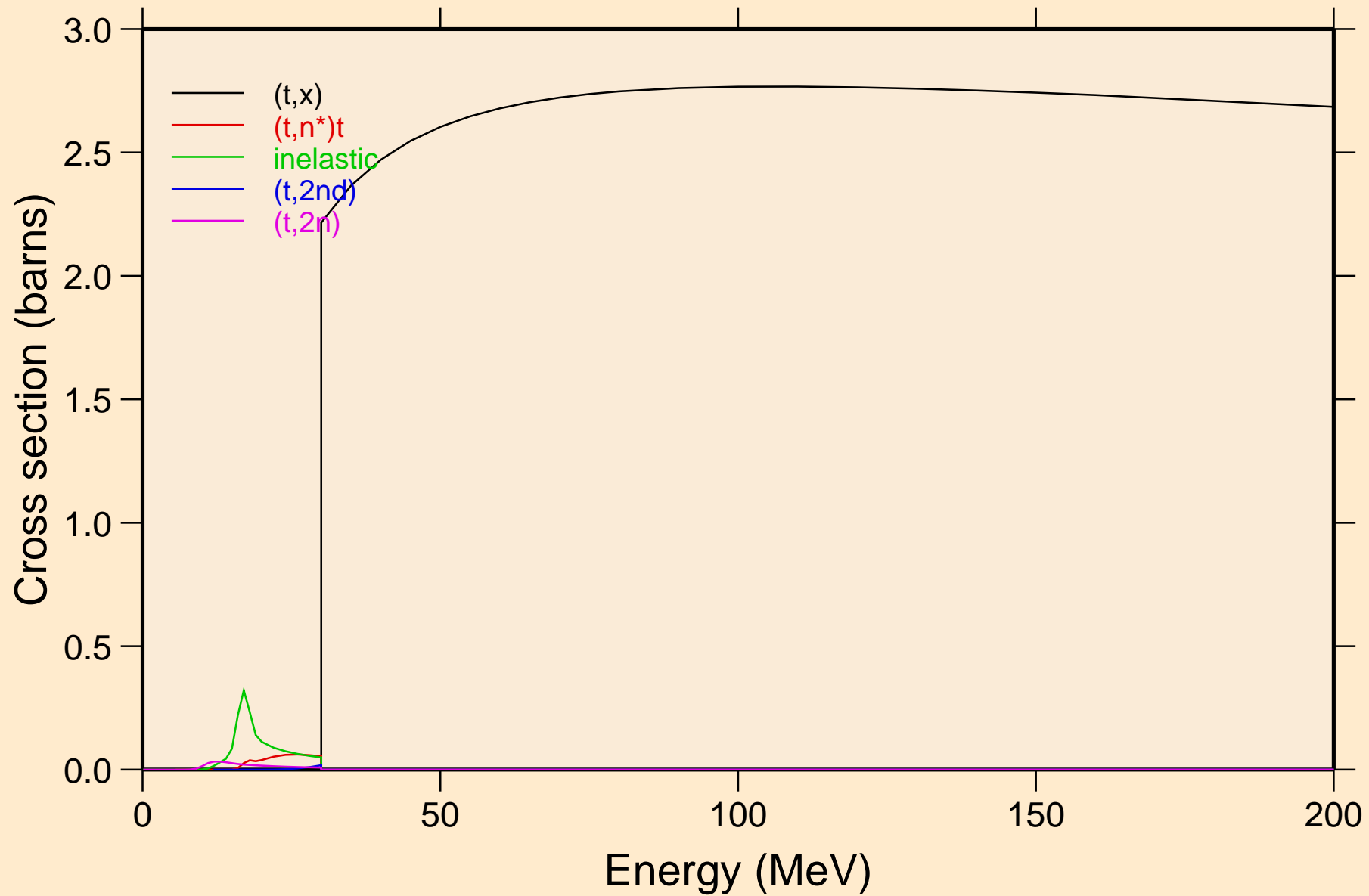

FR231 TRITON ACER TENDL-2021 LIBRARY; T=0.K  
Threshold reactions

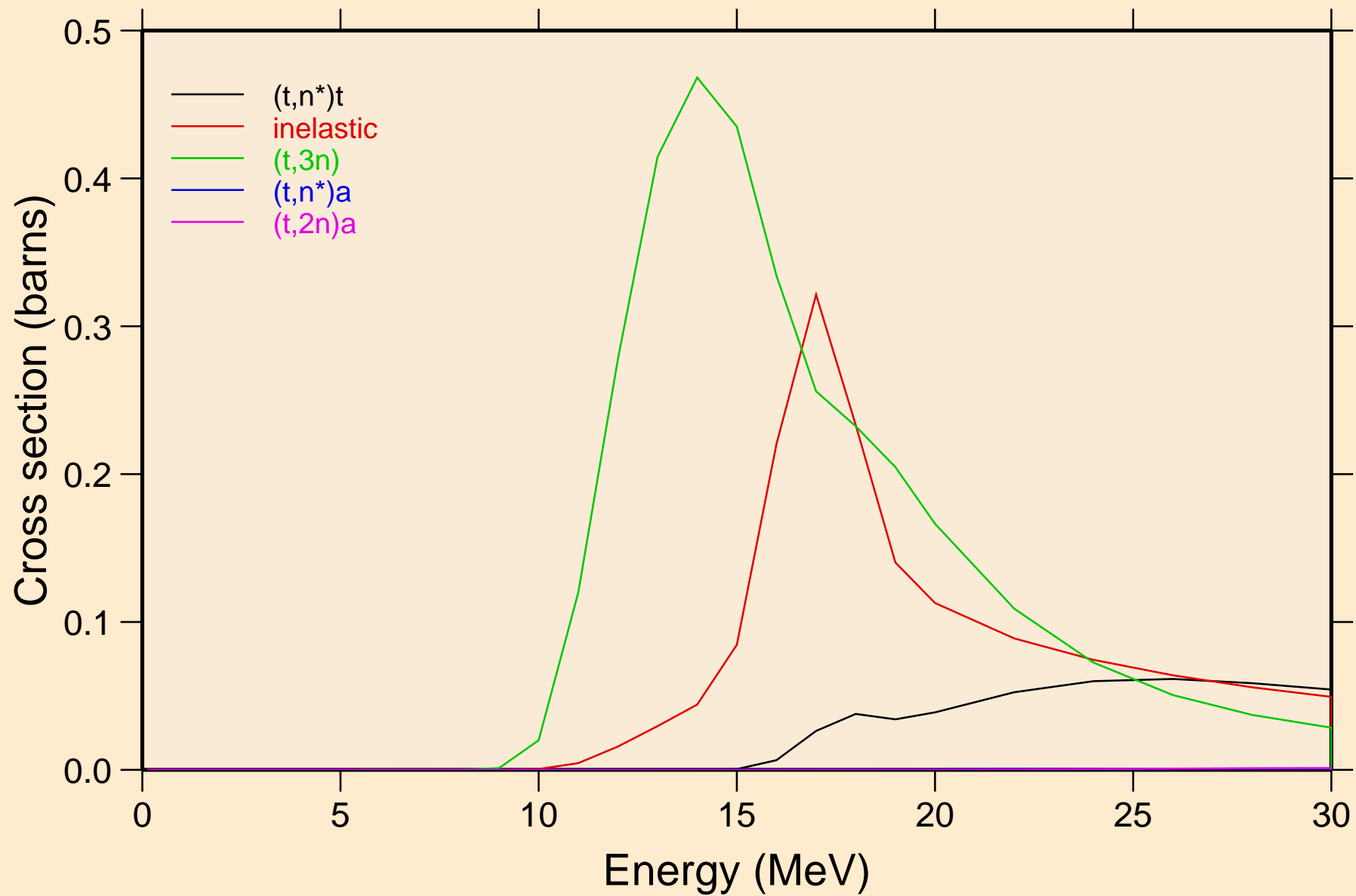

FR231 TRITON ACER TENDL-2021 LIBRARY; T=0.K  
Threshold reactions

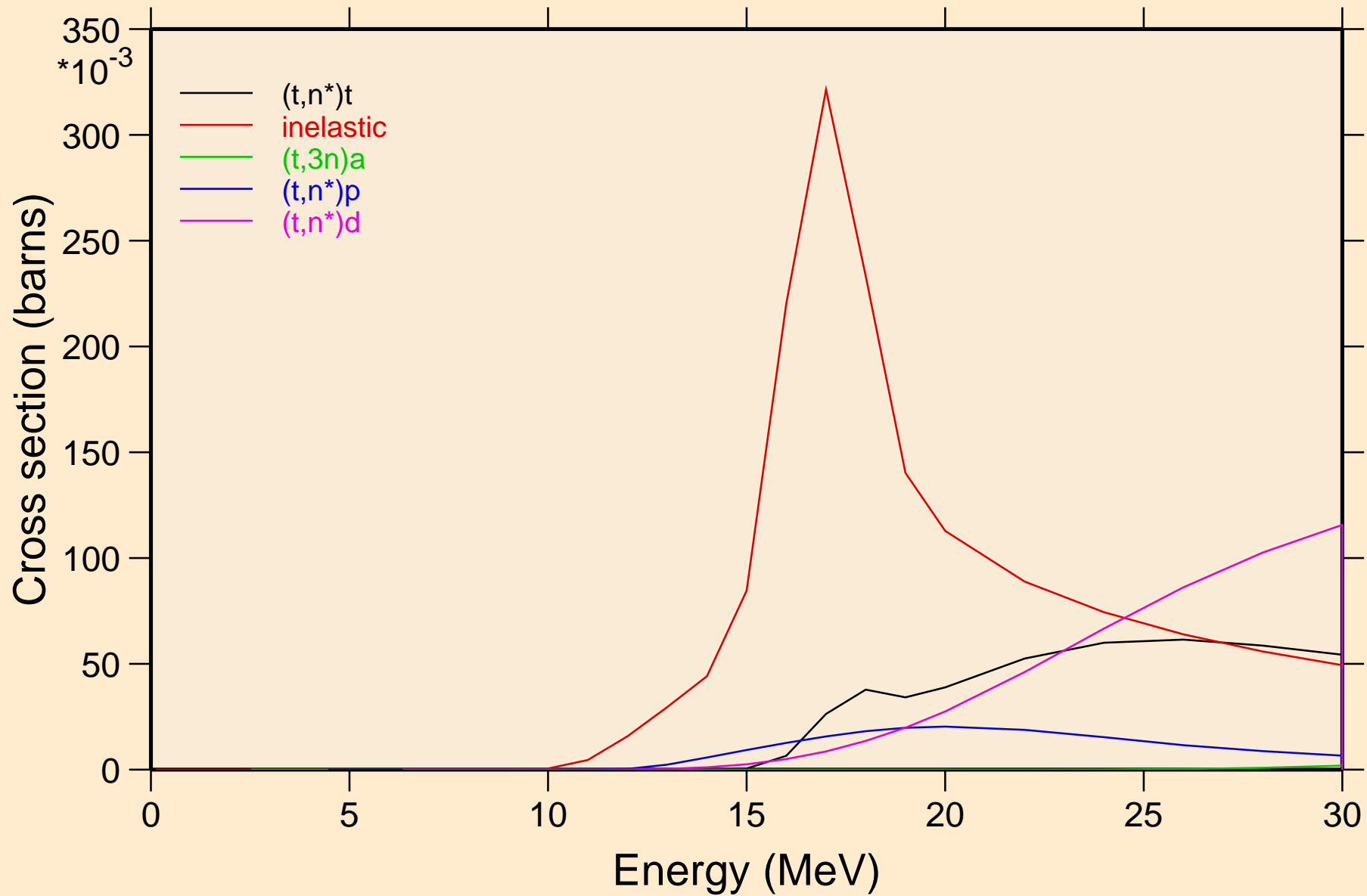

FR231 TRITON ACER TENDL-2021 LIBRARY; T=0.K  
Threshold reactions

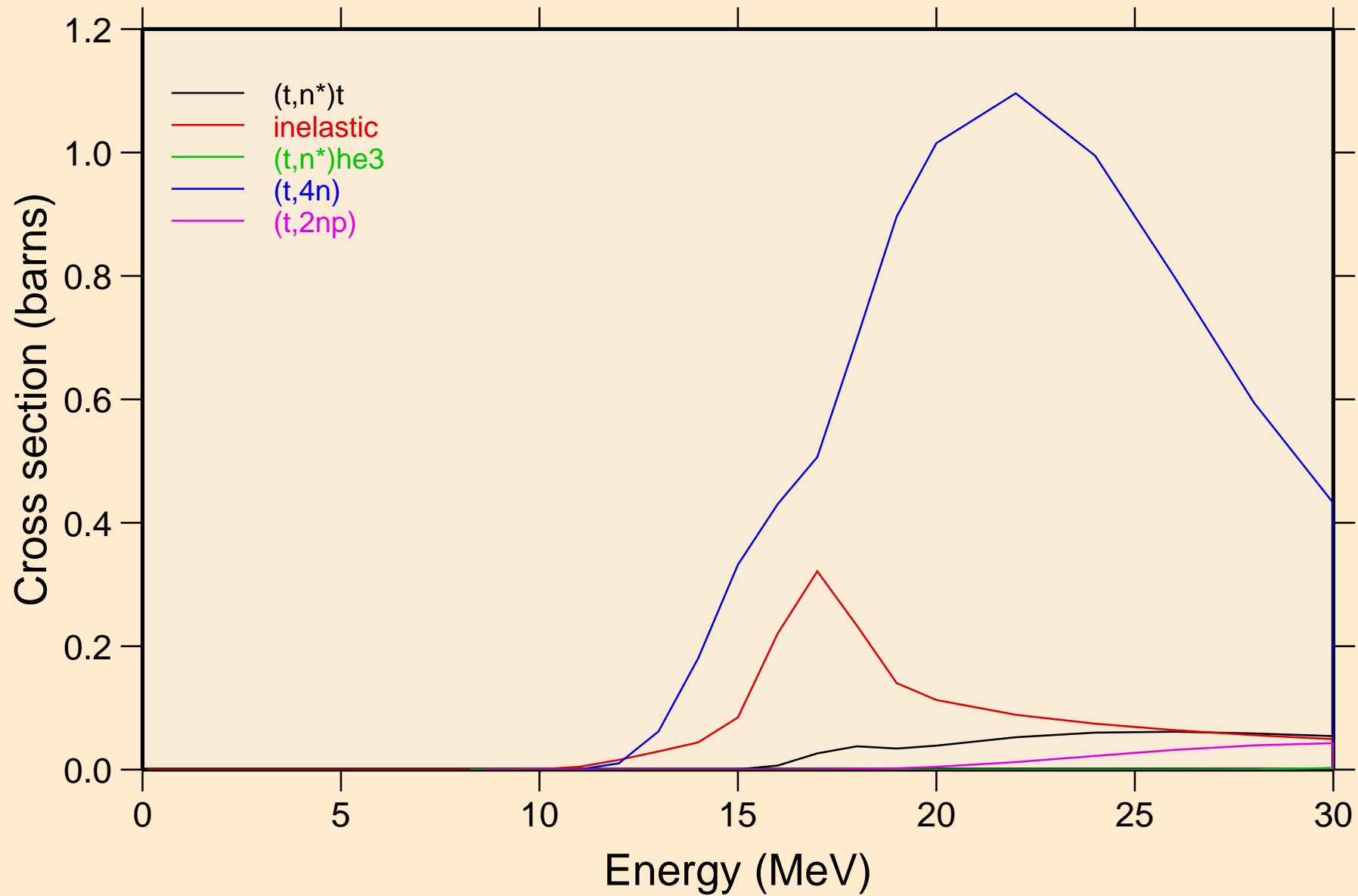



FR231 TRITON ACER TENDL-2021 LIBRARY; T=0.K  
Threshold reactions

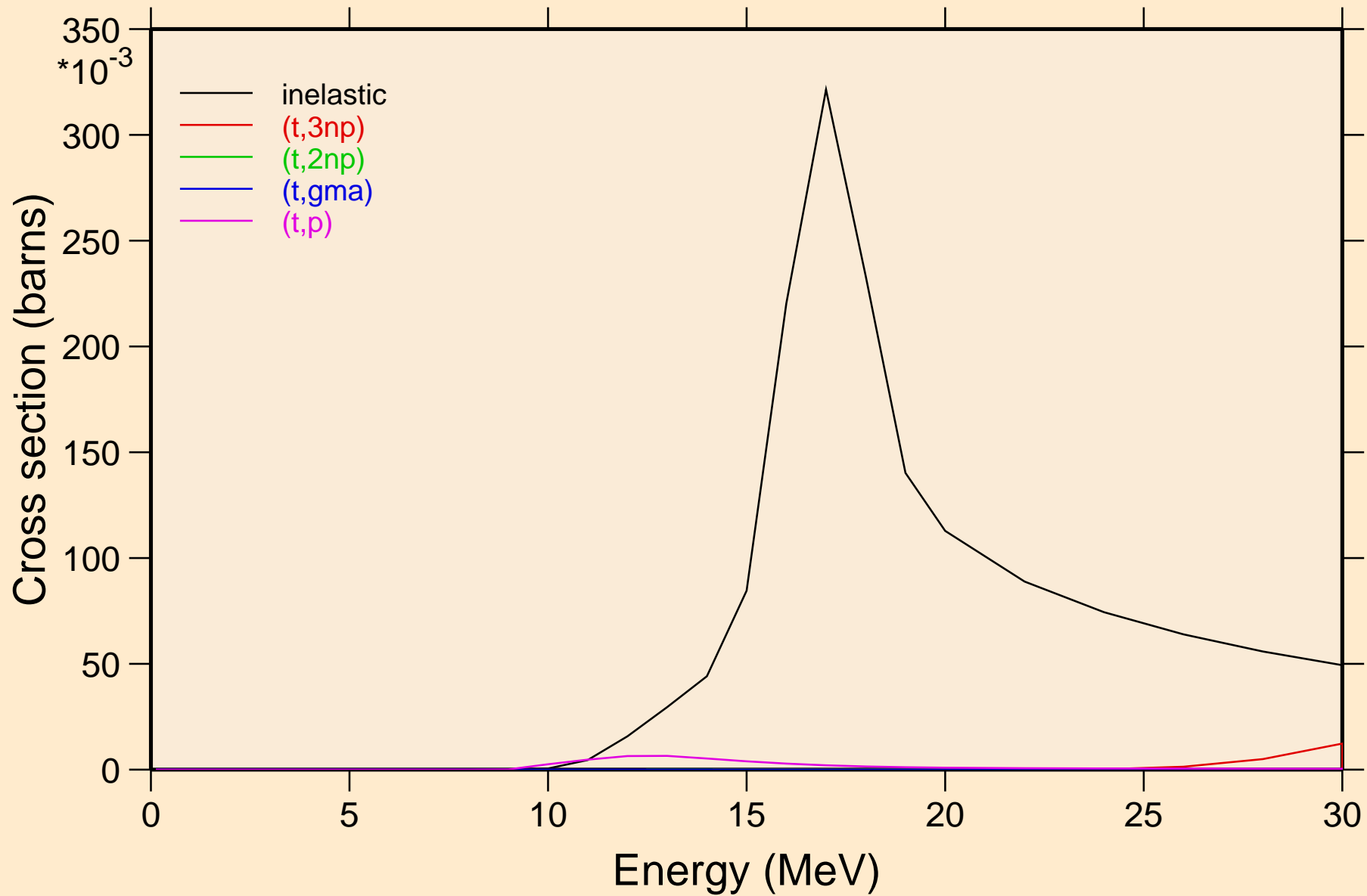

FR231 TRITON ACER TENDL-2021 LIBRARY; T=0.K  
Threshold reactions

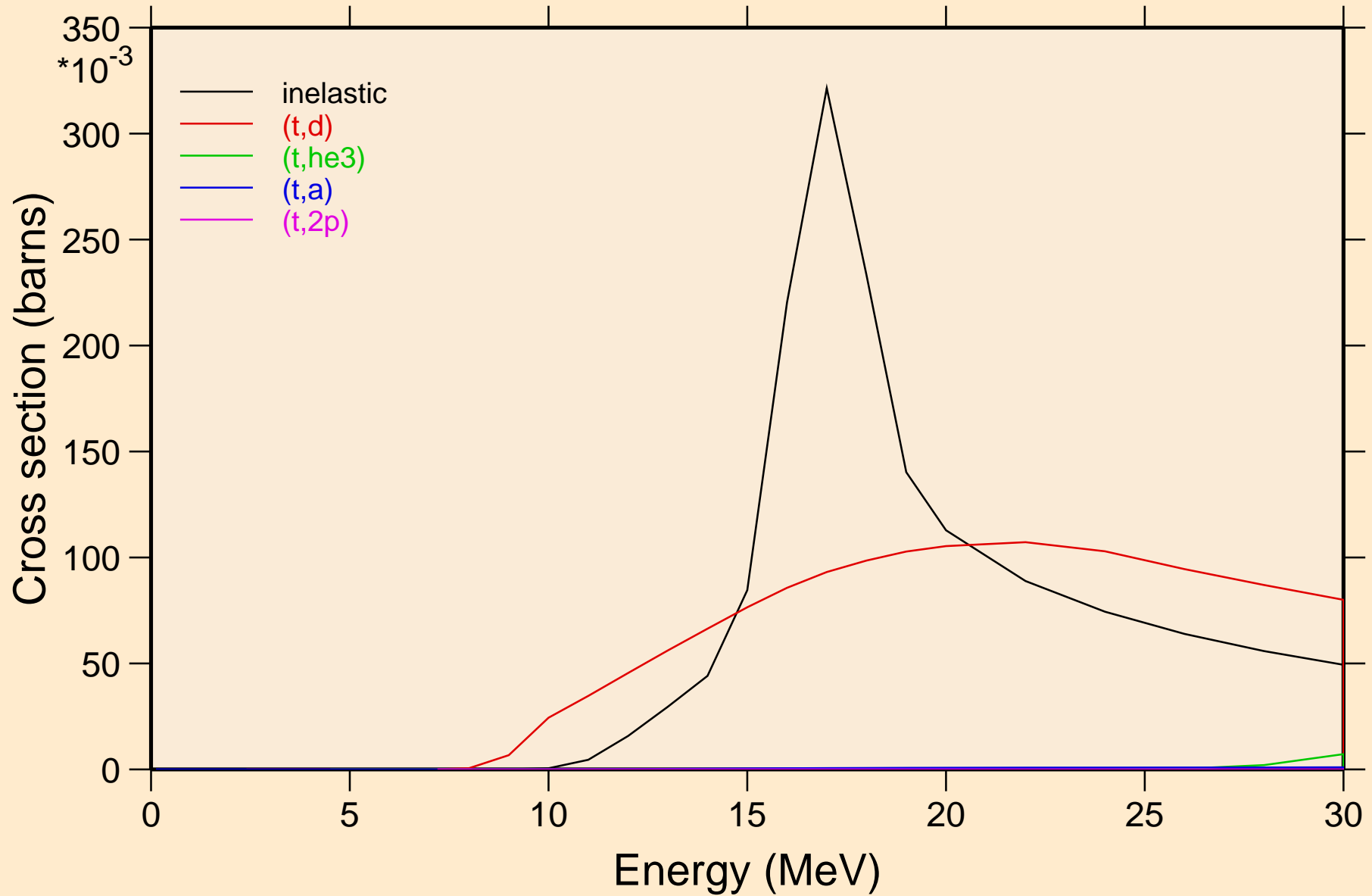

FR231 TRITON ACER TENDL-2021 LIBRARY; T=0.K  
angular distribution for elastic

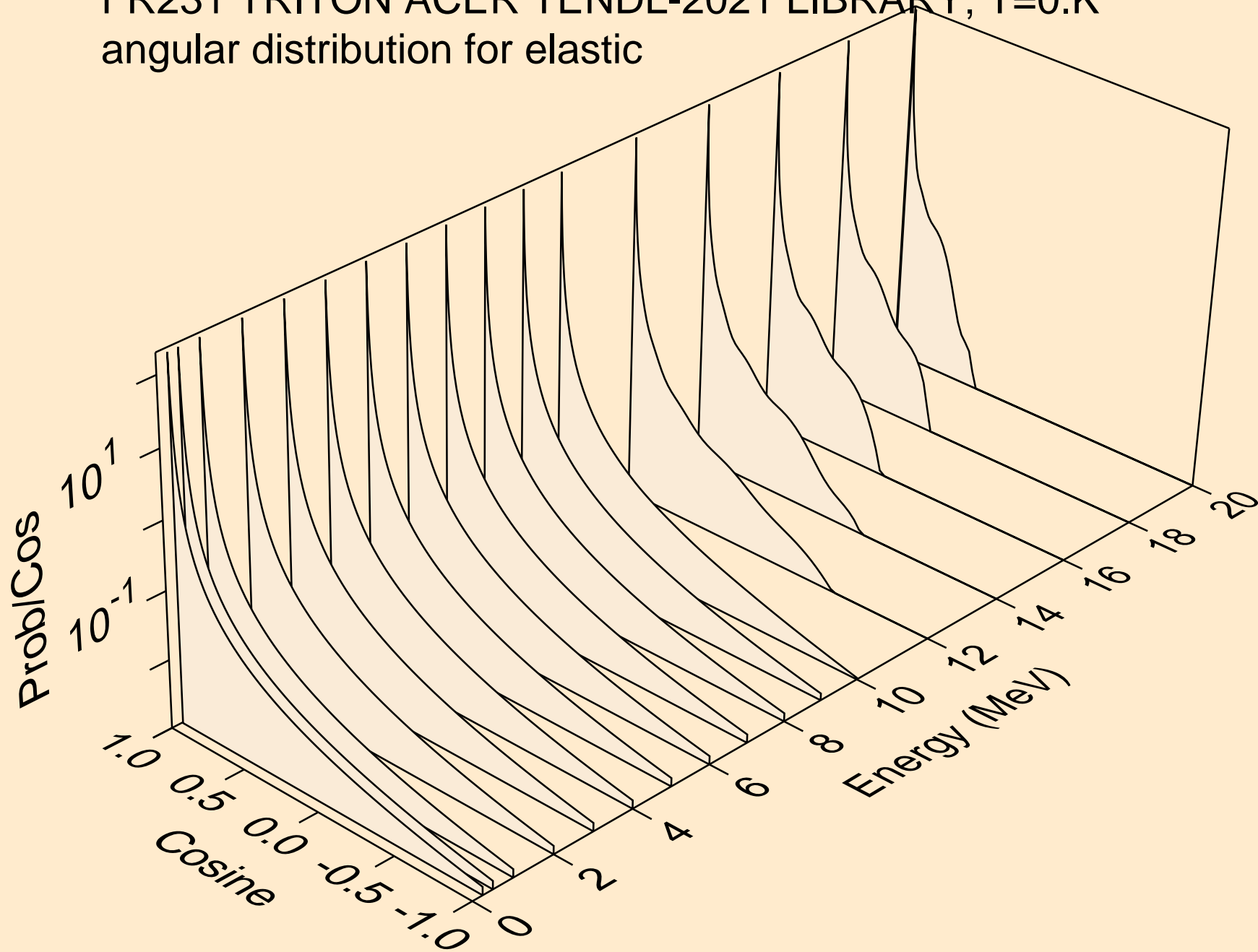

FR231 TRITON ACER TENDL-2021 LIBRARY; T=0.K  
angular distribution for elastic

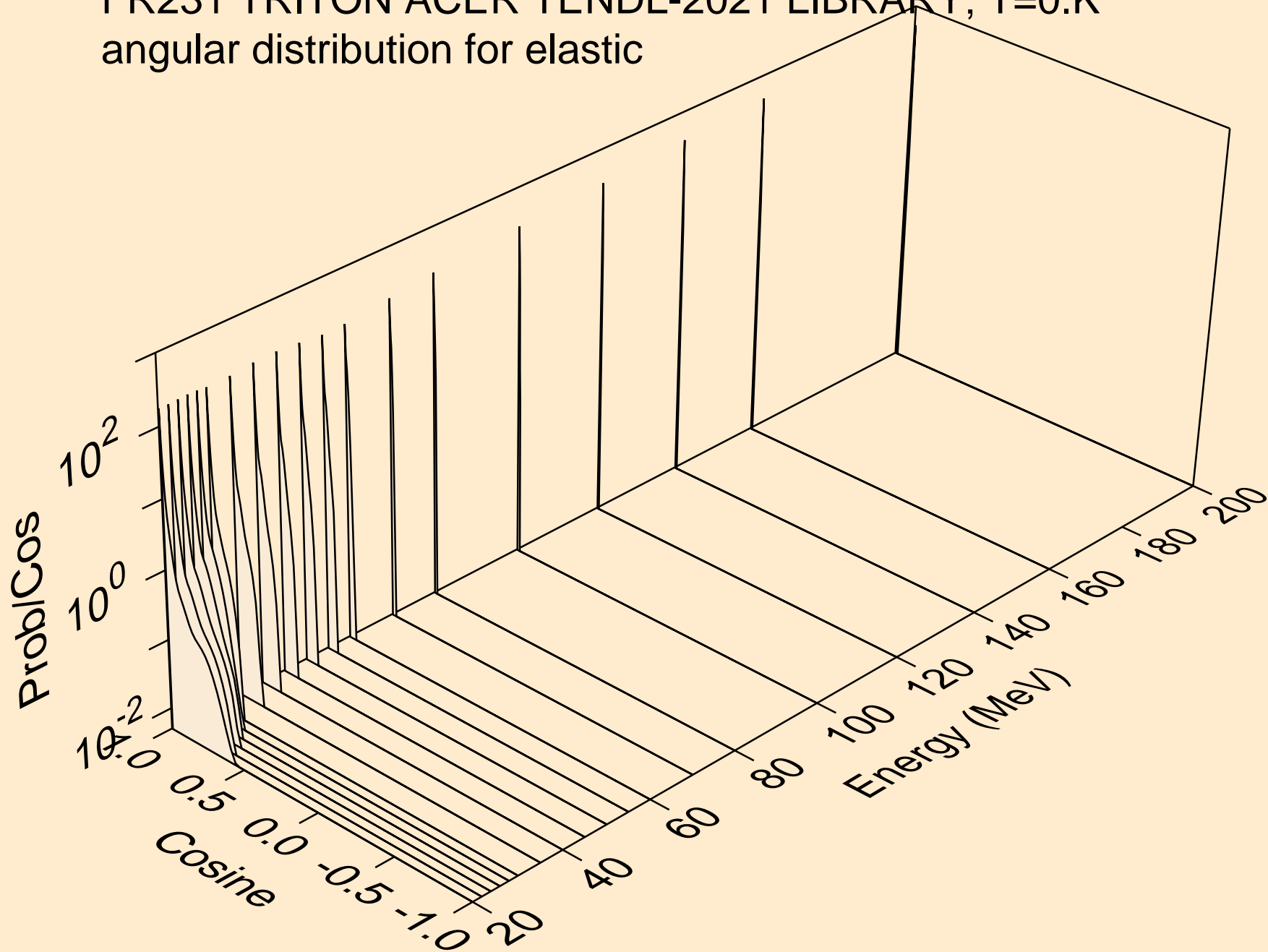

FR231 TRITON ACER TENDL-2021 LIBRARY; T=0.K  
Triton emission for (t,x)

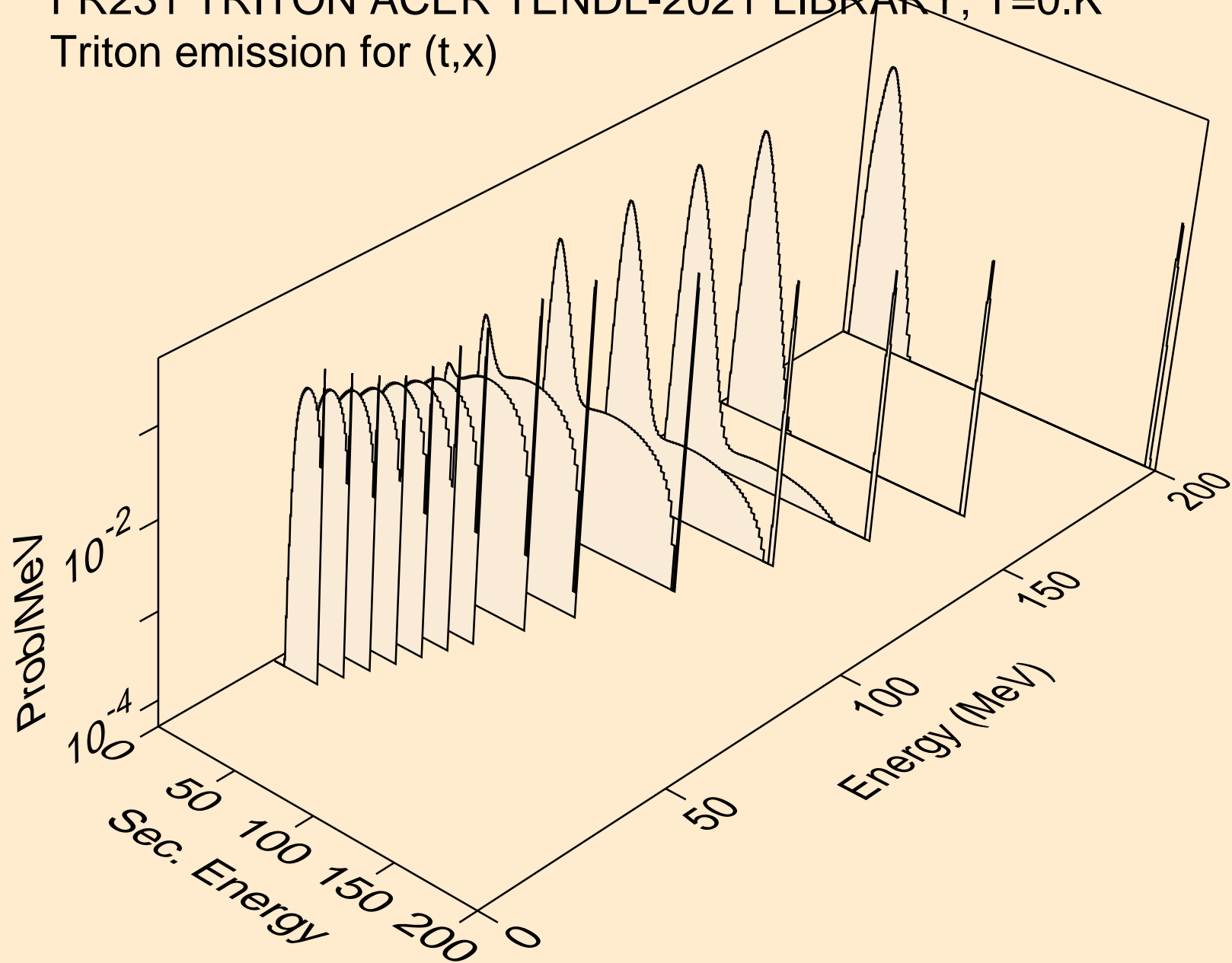

FR231 TRITON ACER TENDL-2021 LIBRARY; T=0.K  
Triton emission for (t,n\*)t

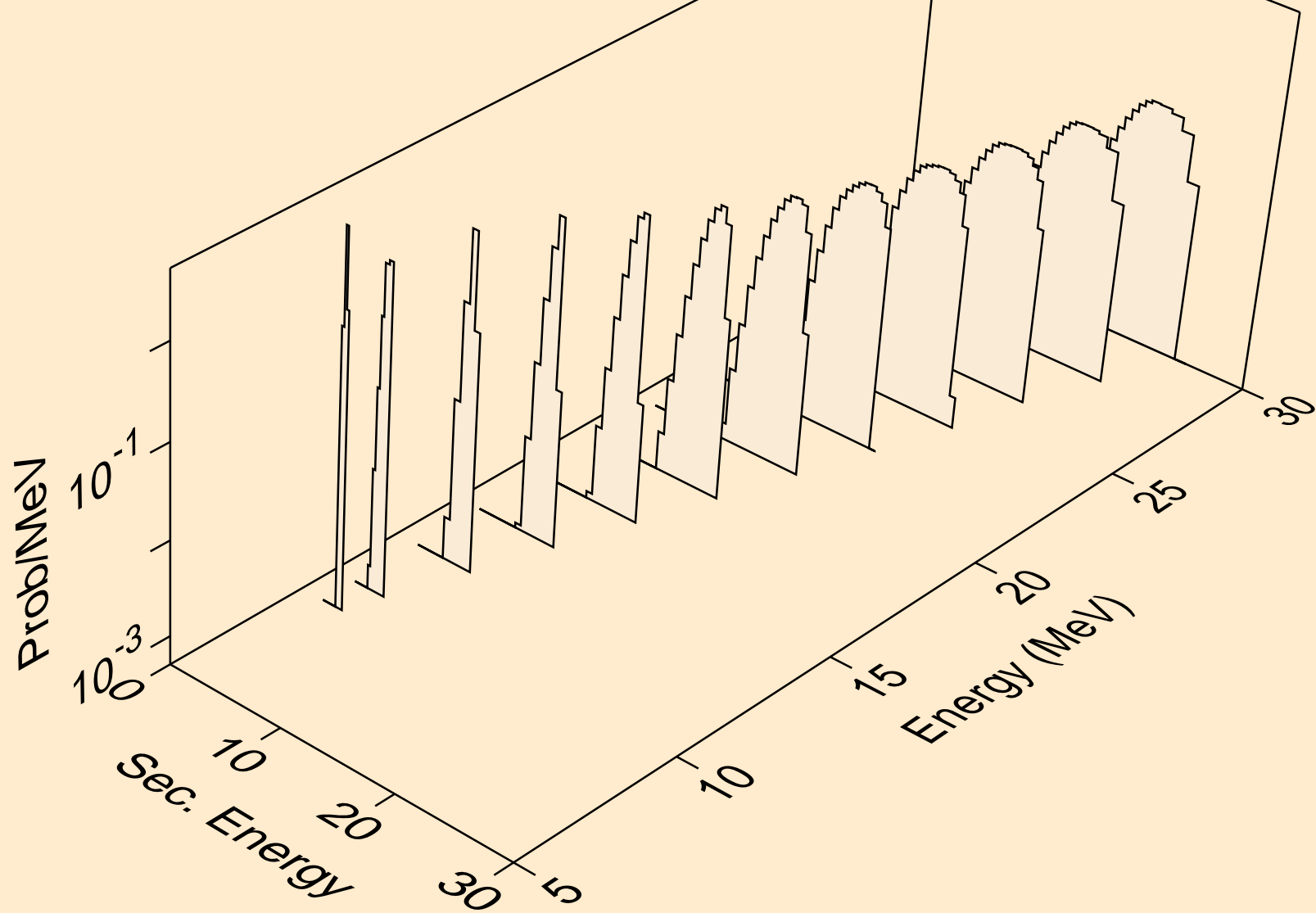

FR231 TRITON ACER TENDL-2021 LIBRARY; T=0.K  
Triton emission for inelastic

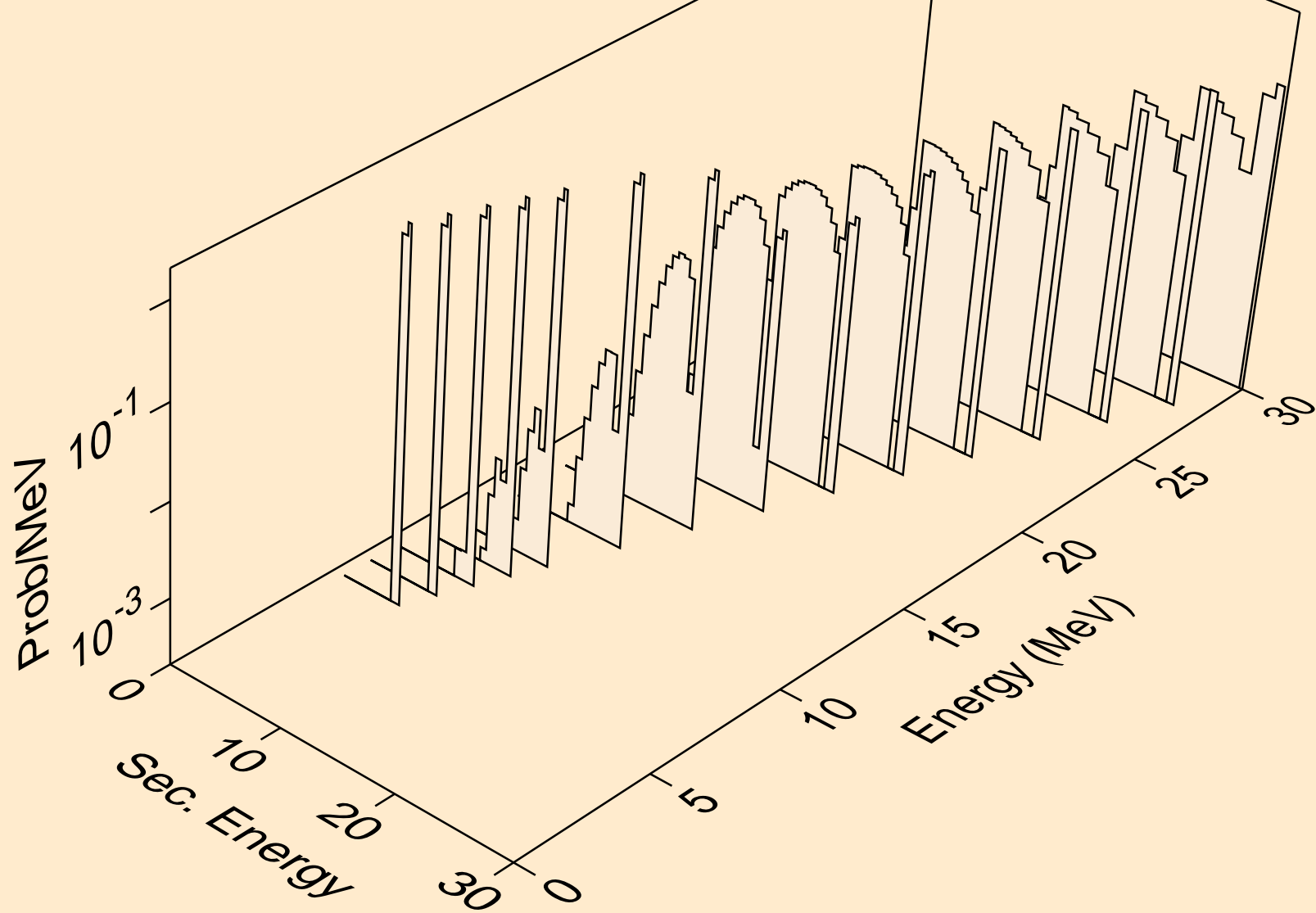

FR231 TRITON ACER TENDL-2021 LIBRARY; T=0.K  
Photon emission for (z,n)

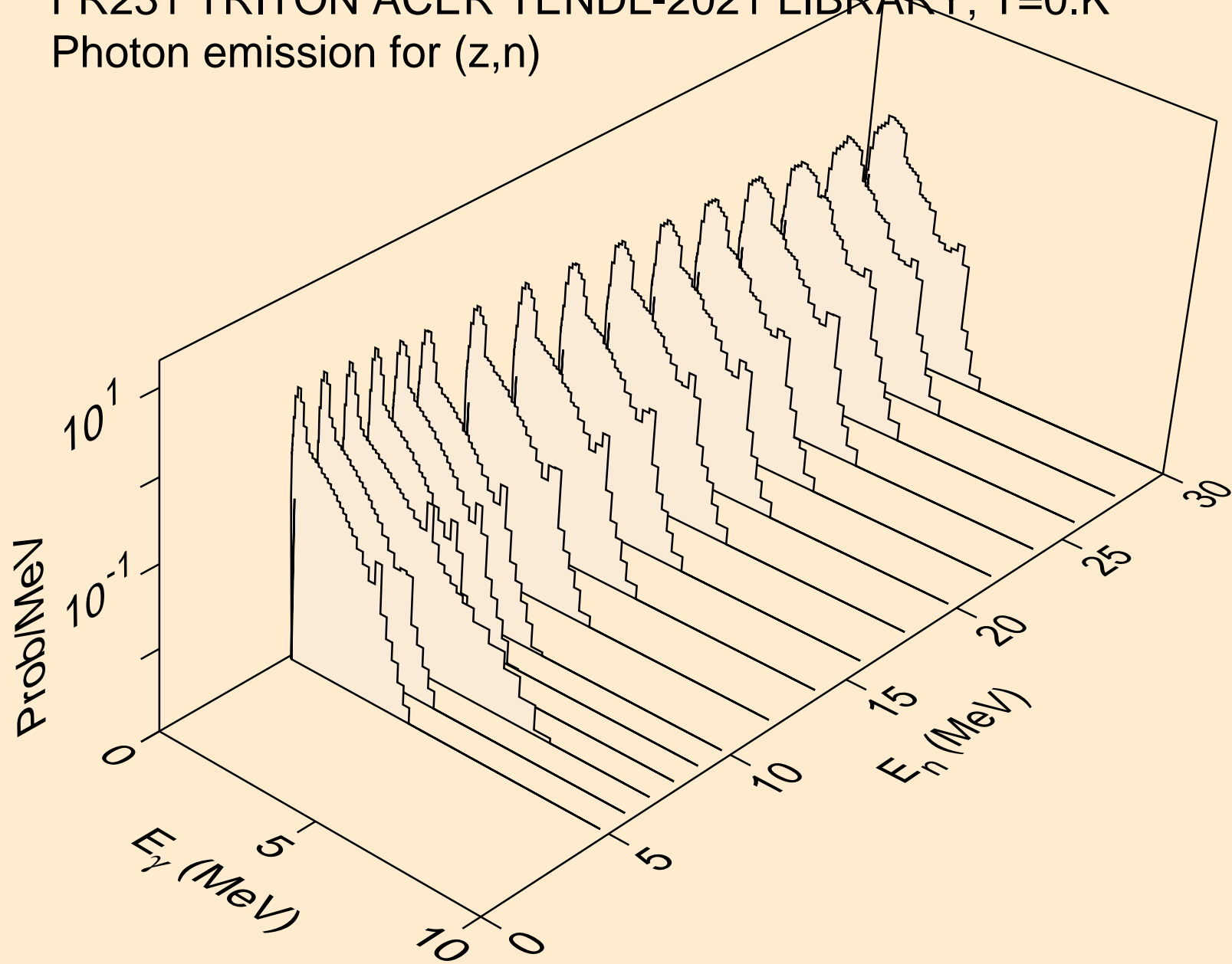



FR231 TRITON ACER TENDL-2021 LIBRARY; T=0.K  
Photon emission for (n,x)

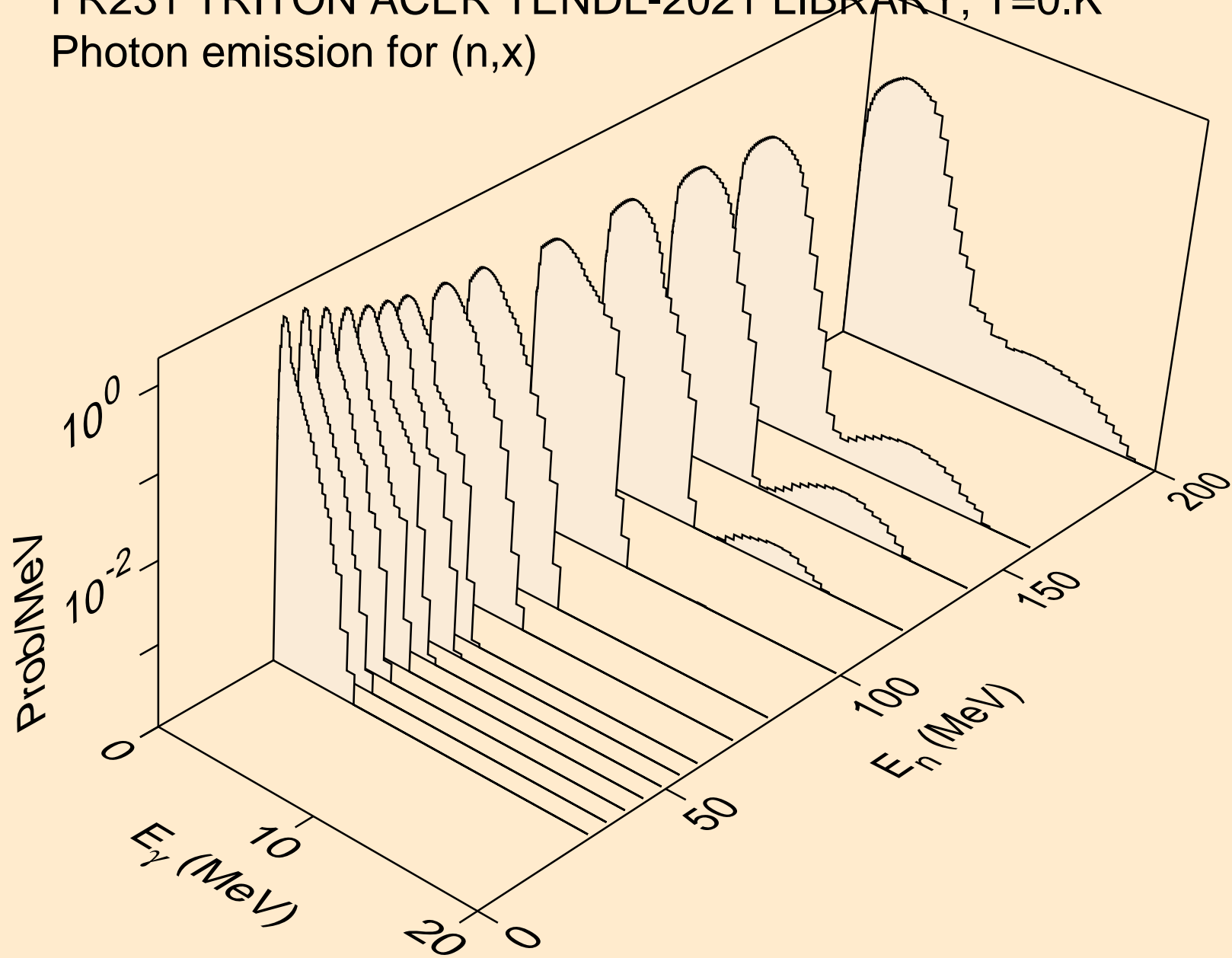

FR231 TRITON ACER TENDL-2021 LIBRARY; T=0.K  
Photon emission for (n,2nd)

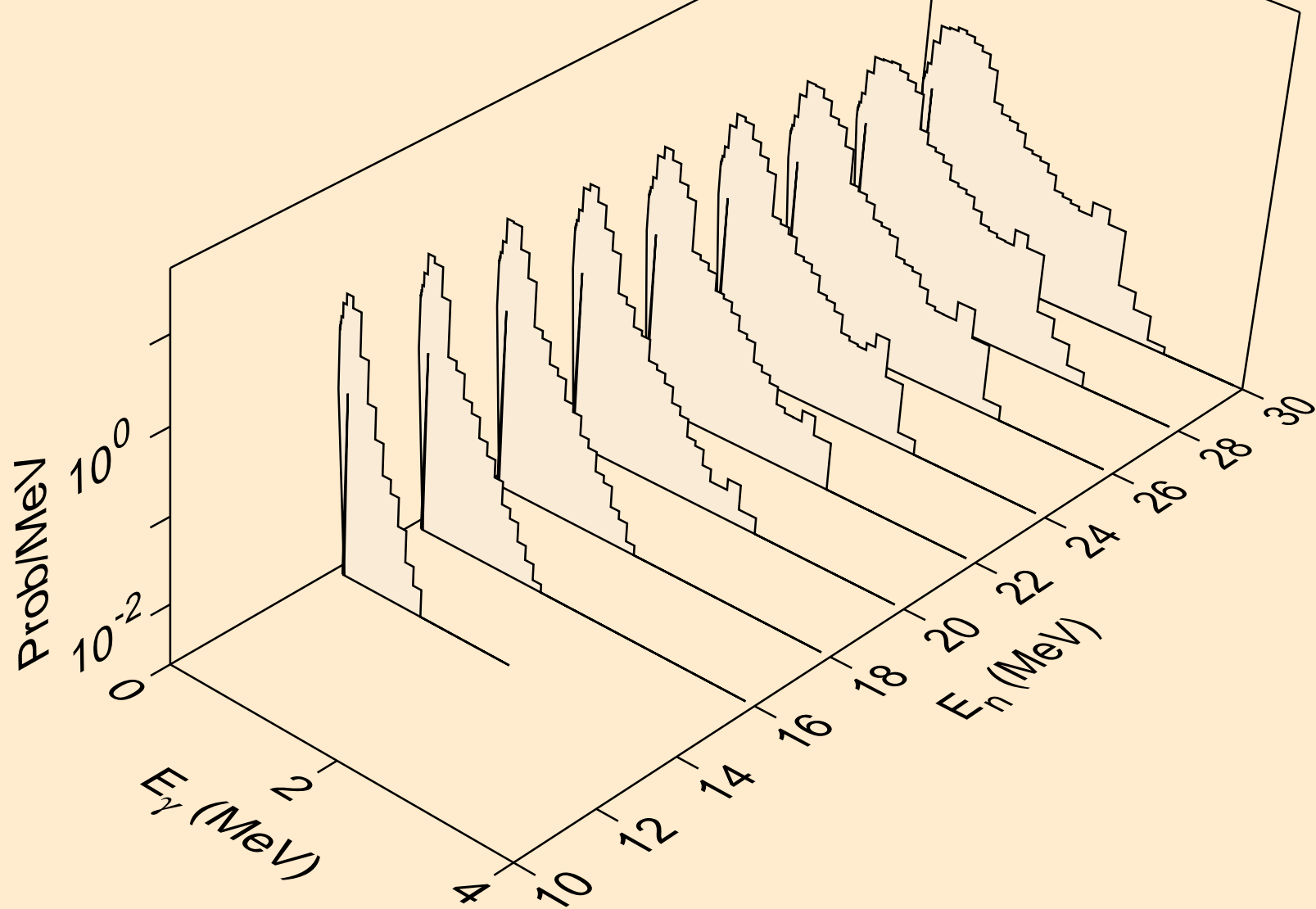

FR231 TRITON ACER TENDL-2021 LIBRARY; T=0.K  
Photon emission for (n,2n)

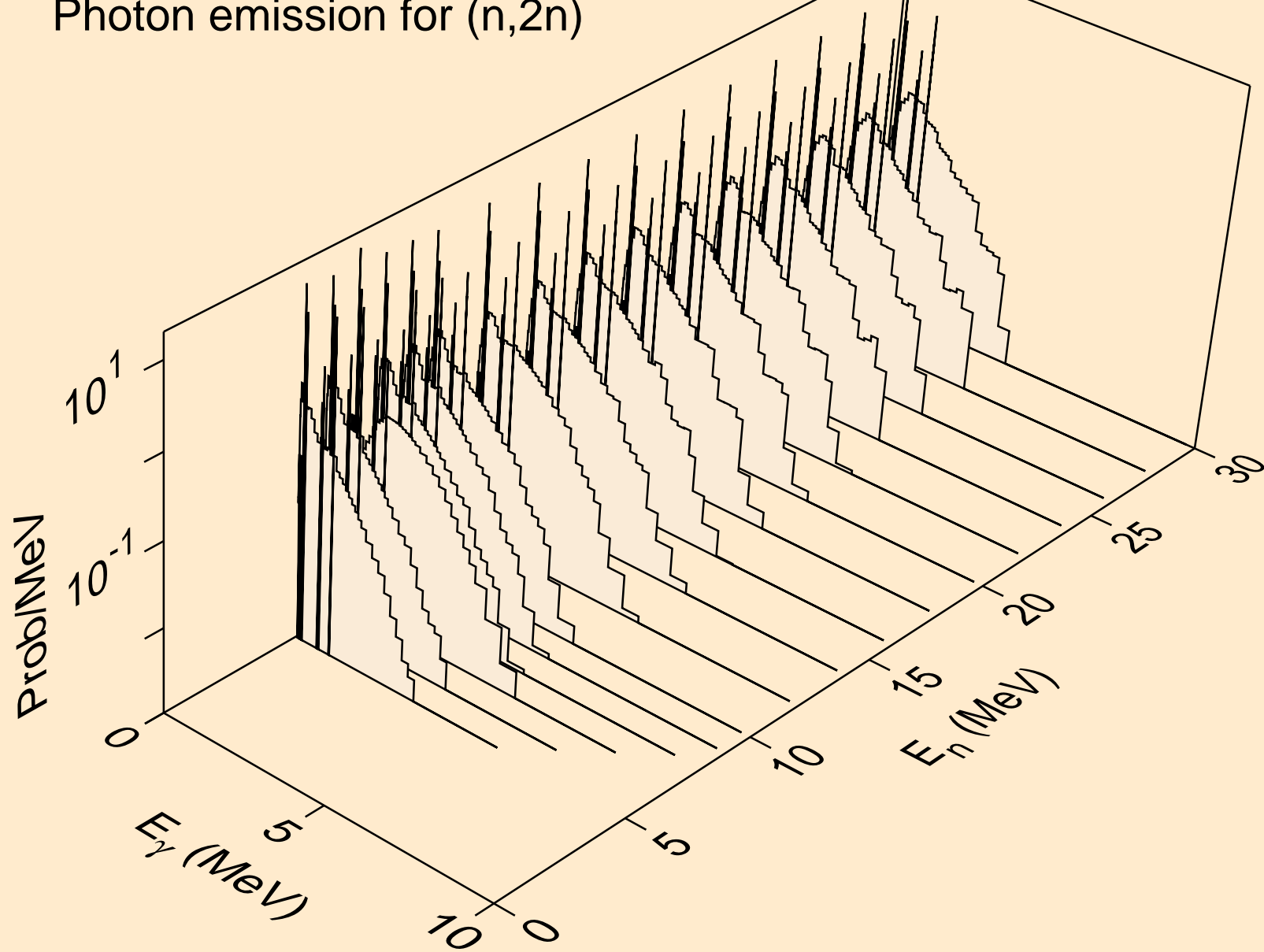

FR231 TRITON ACER TENDL-2021 LIBRARY; T=0.K  
Photon emission for (n,3n)

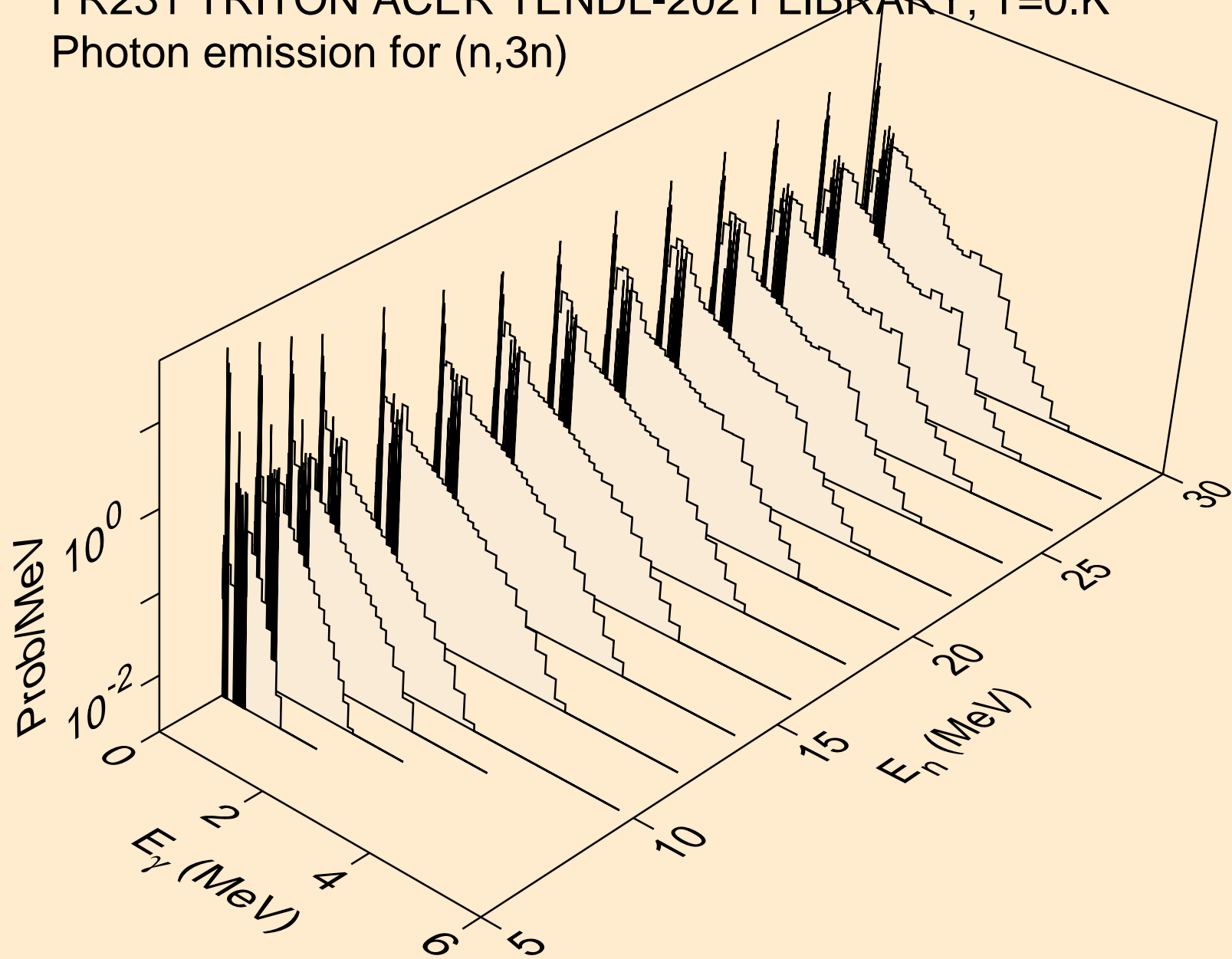

FR231 TRITON ACER TENDL-2021 LIBRARY; T=0.K  
Photon emission for (n,n\*)a

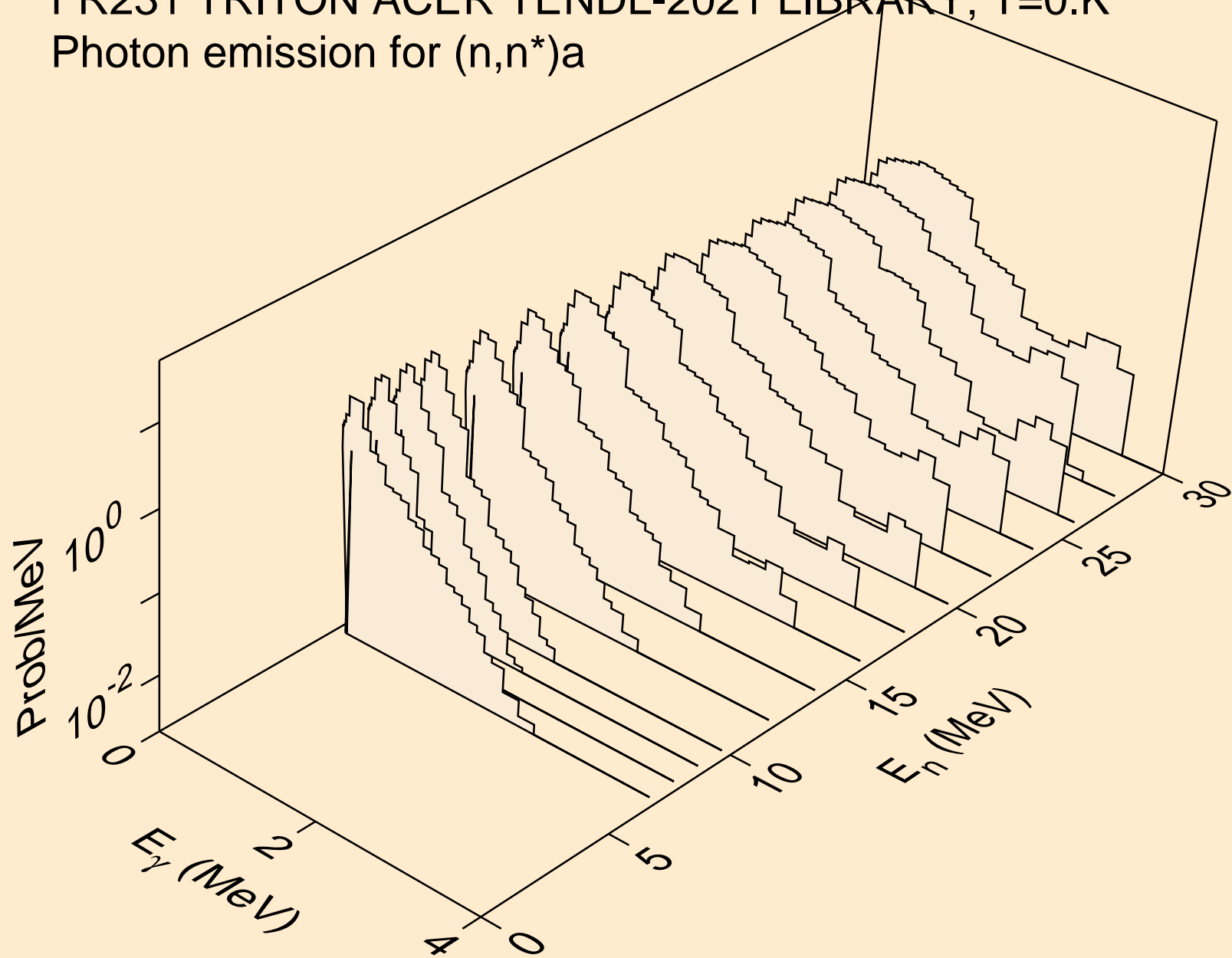

FR231 TRITON ACER TENDL-2021 LIBRARY; T=0.K  
Photon emission for (n,2n)a

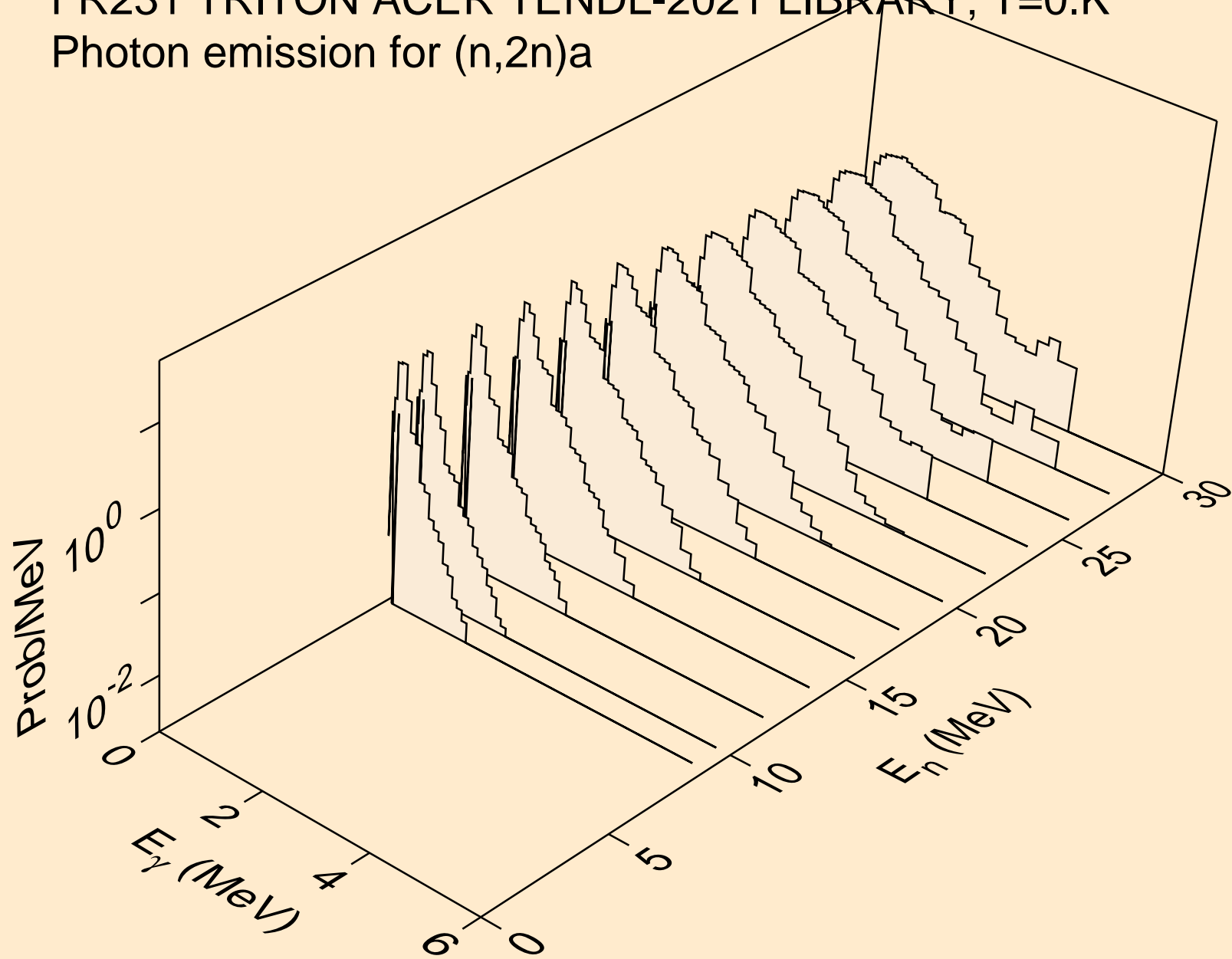

FR231 TRITON ACER TENDL-2021 LIBRARY; T=0.K  
Photon emission for (n,3n)a

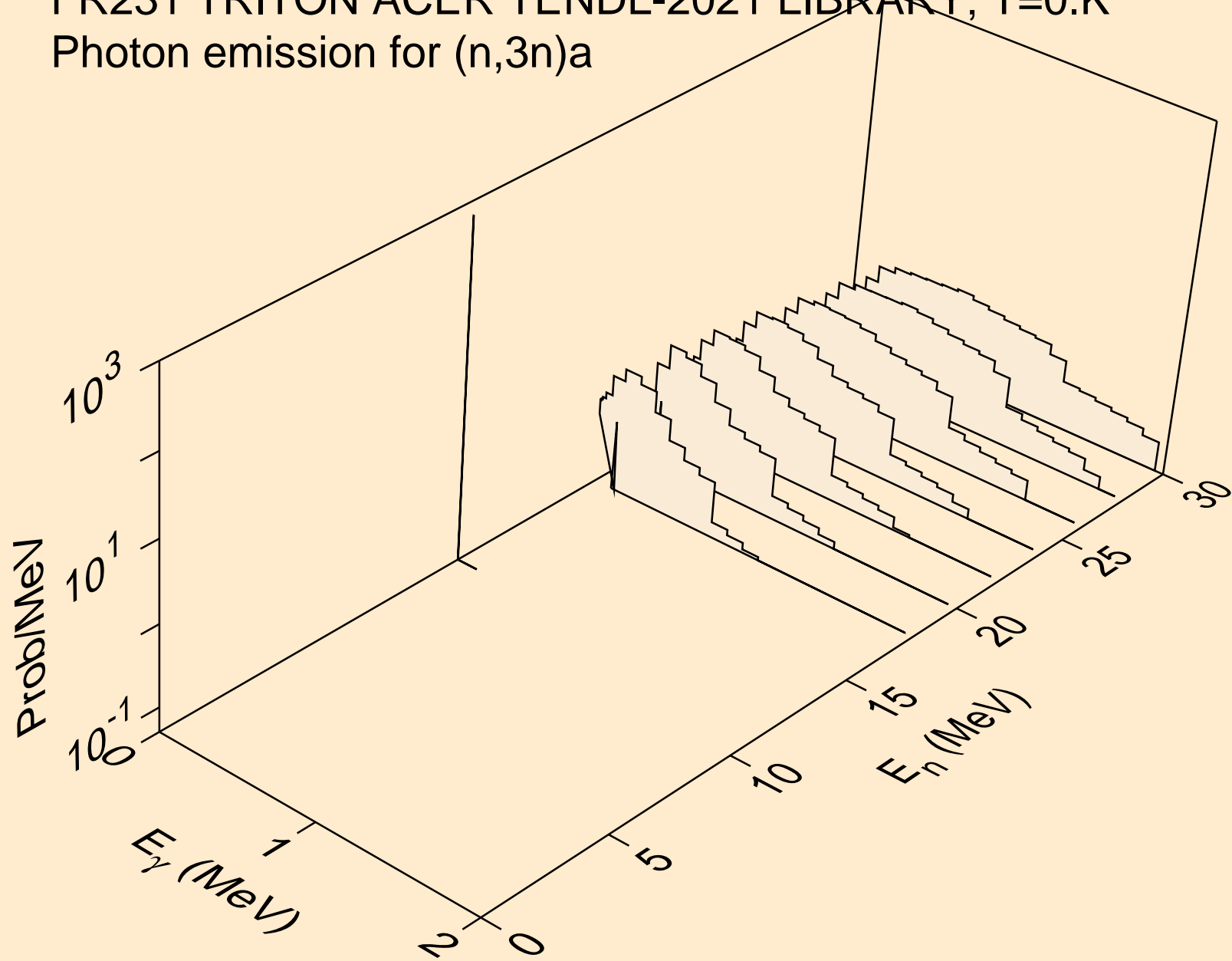

FR231 TRITON ACER TENDL-2021 LIBRARY; T=0.K  
Photon emission for (n,n\*)p

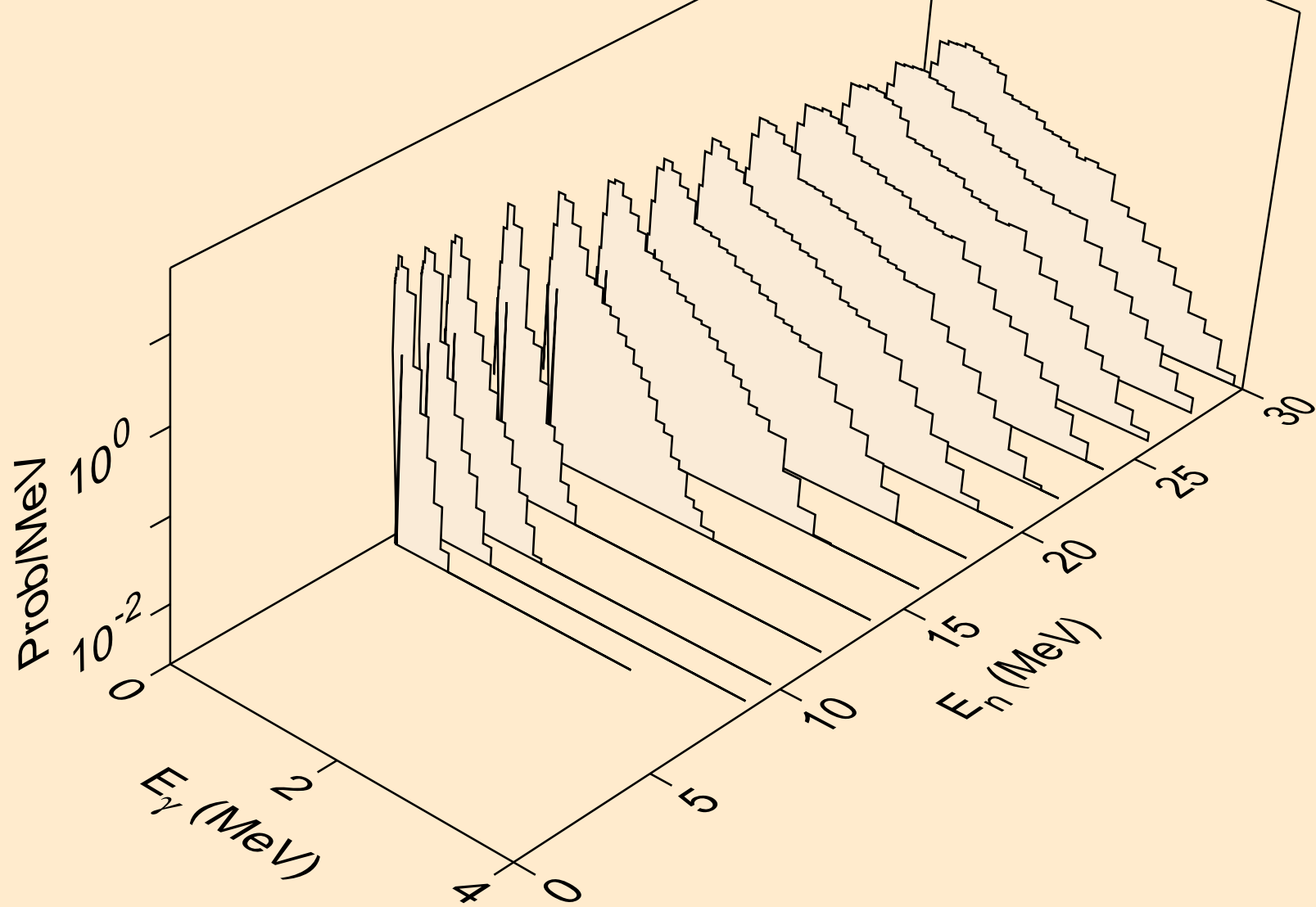



FR231 TRITON ACER TENDL-2021 LIBRARY; T=0.K  
Photon emission for (n,n\*)d

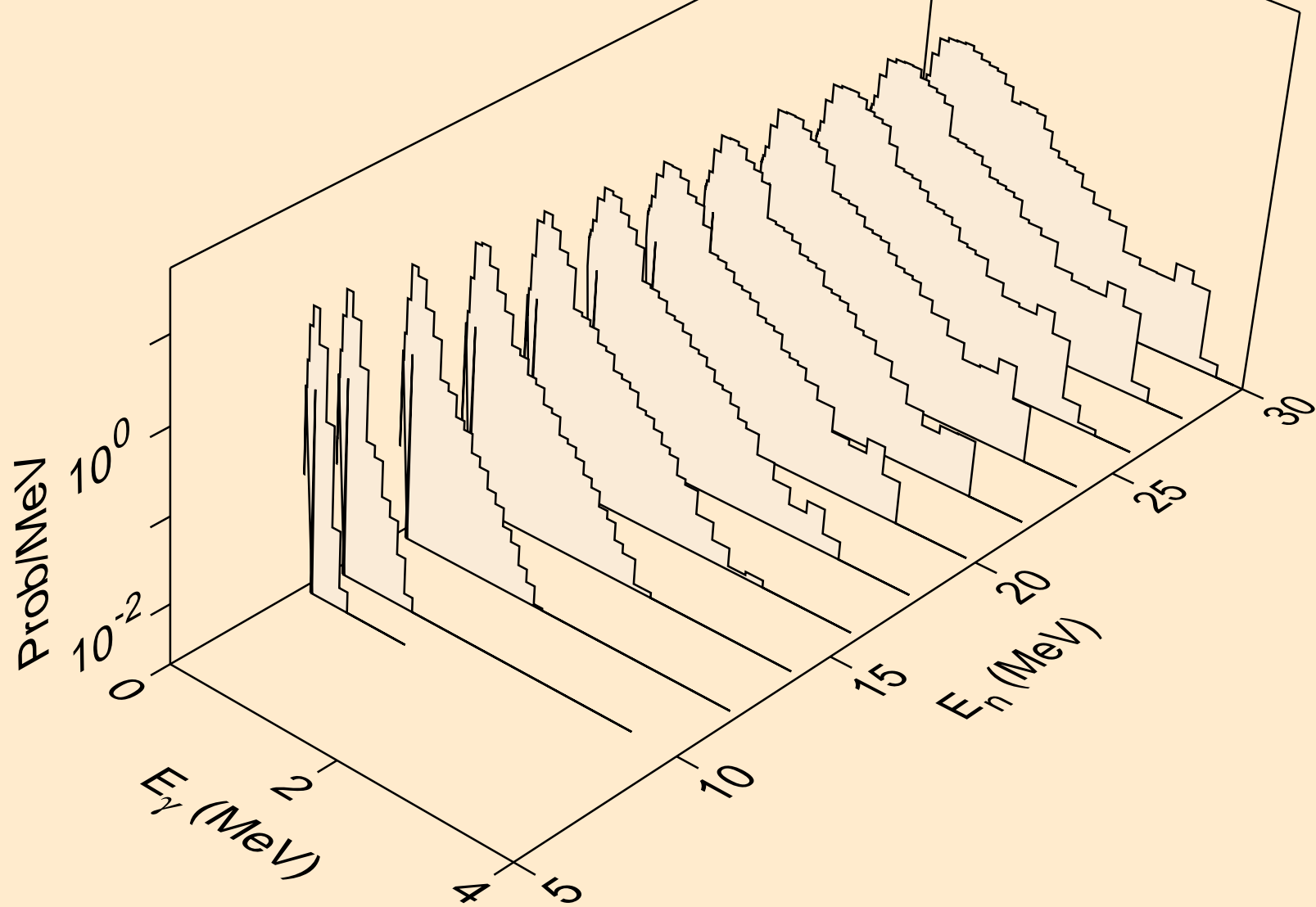

FR231 TRITON ACER TENDL-2021 LIBRARY; T=0.K  
Photon emission for (n,n\*)t

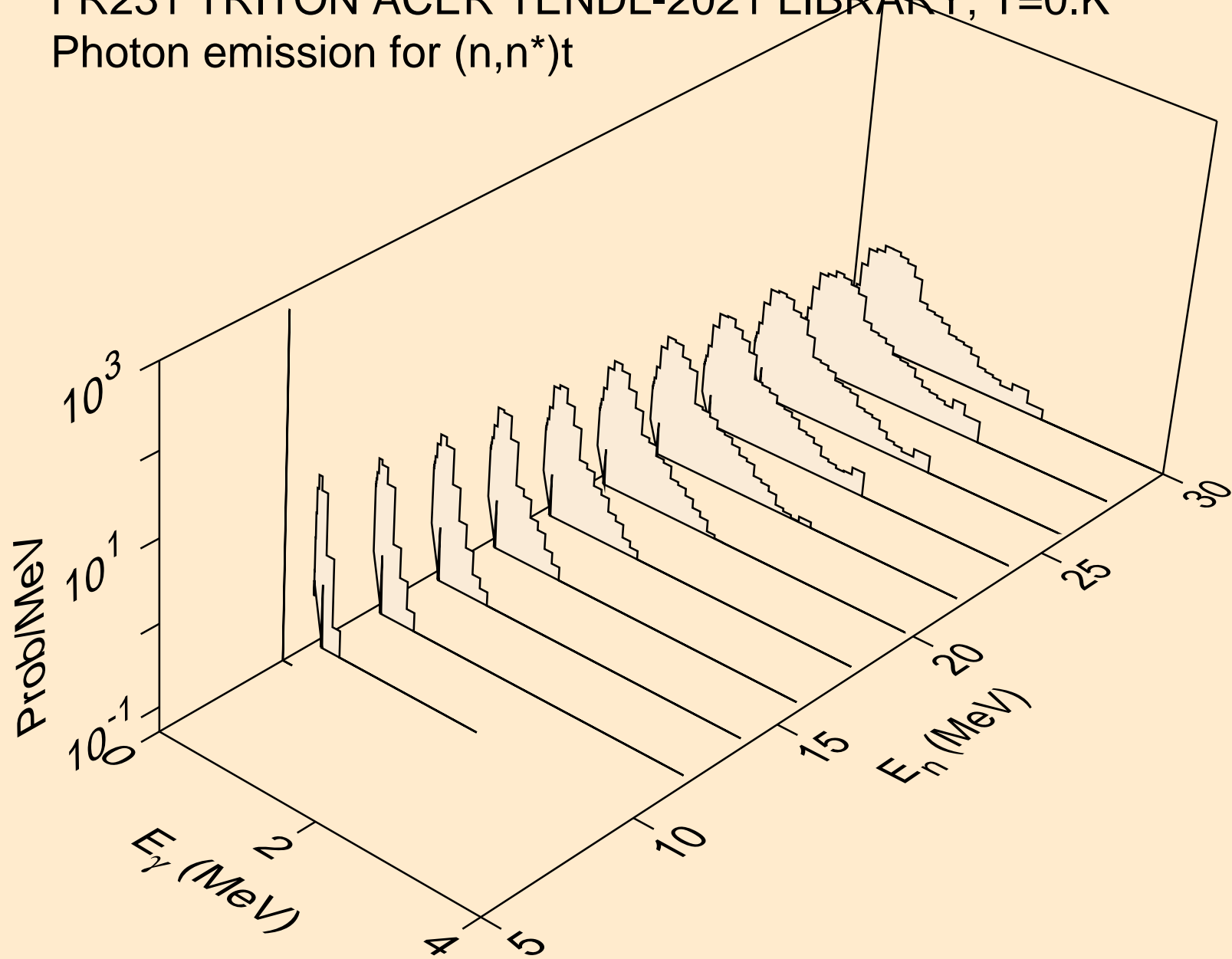

FR231 TRITON ACER TENDL-2021 LIBRARY; T=0.K  
Photon emission for (n,n\*)he3

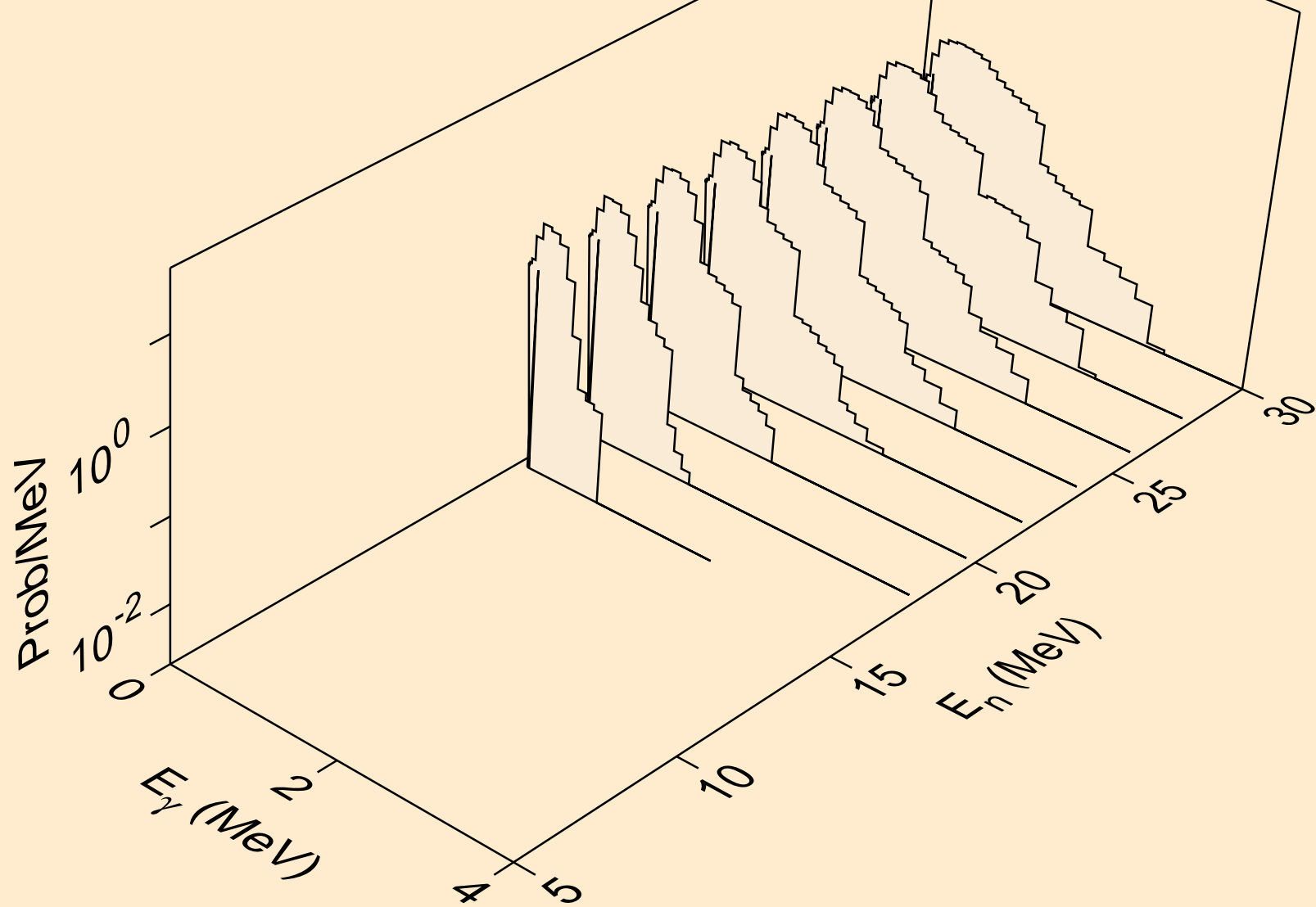

FR231 TRITON ACER TENDL-2021 LIBRARY; T=0.K  
Photon emission for (n,4n)

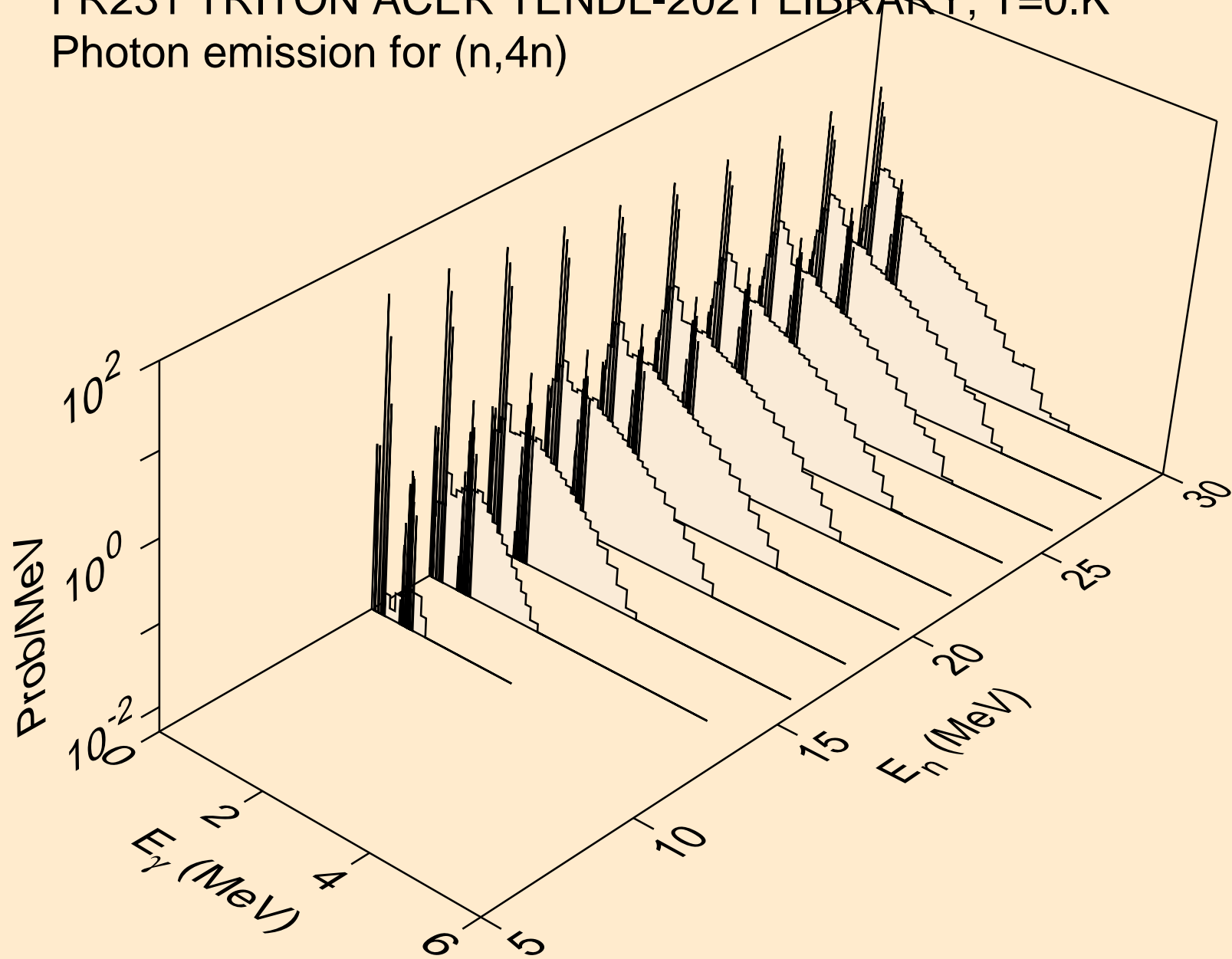

FR231 TRITON ACER TENDL-2021 LIBRARY; T=0.K  
Photon emission for (n,2np)

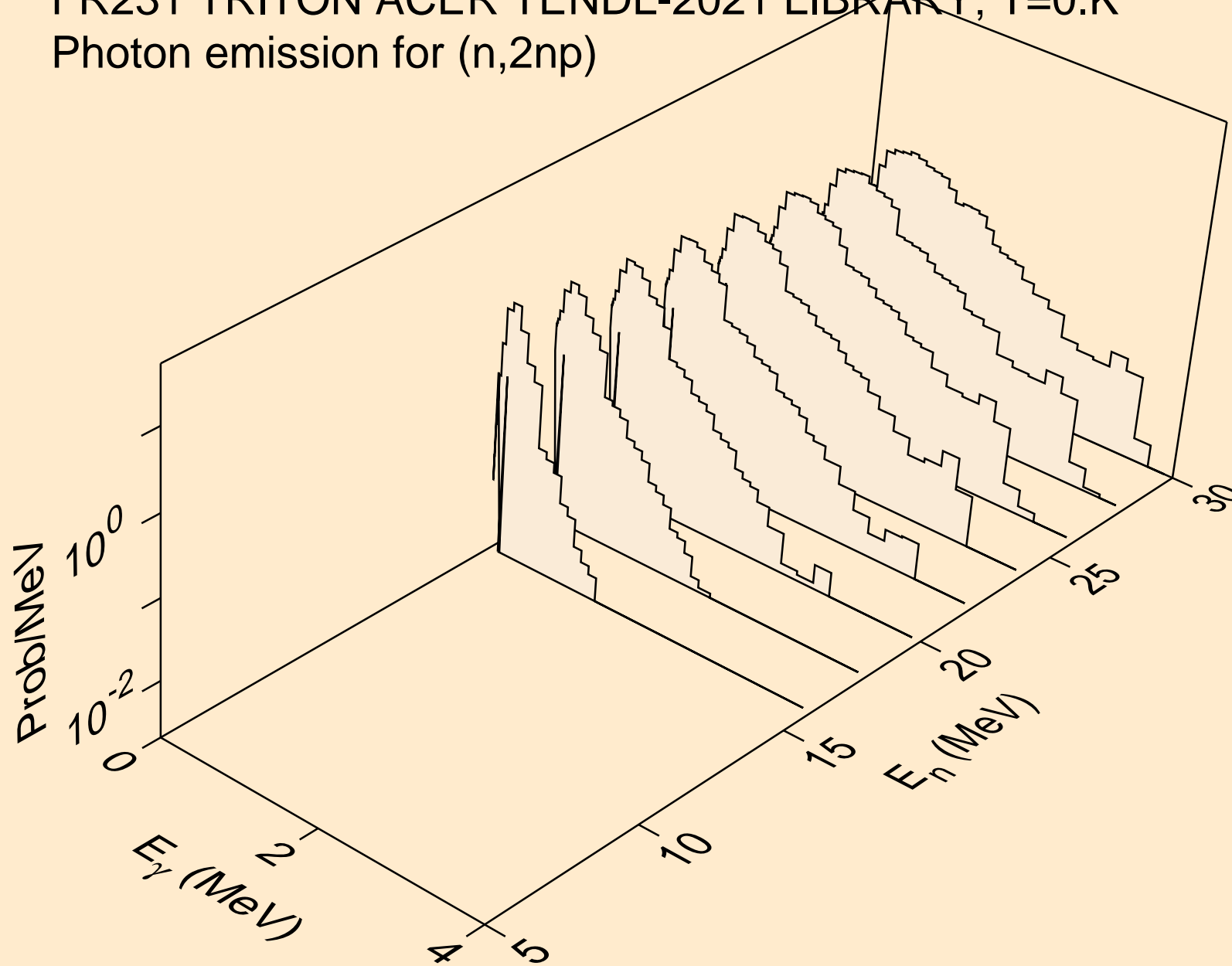

FR231 TRITON ACER TENDL-2021 LIBRARY; T=0.K  
Photon emission for (n,3np)

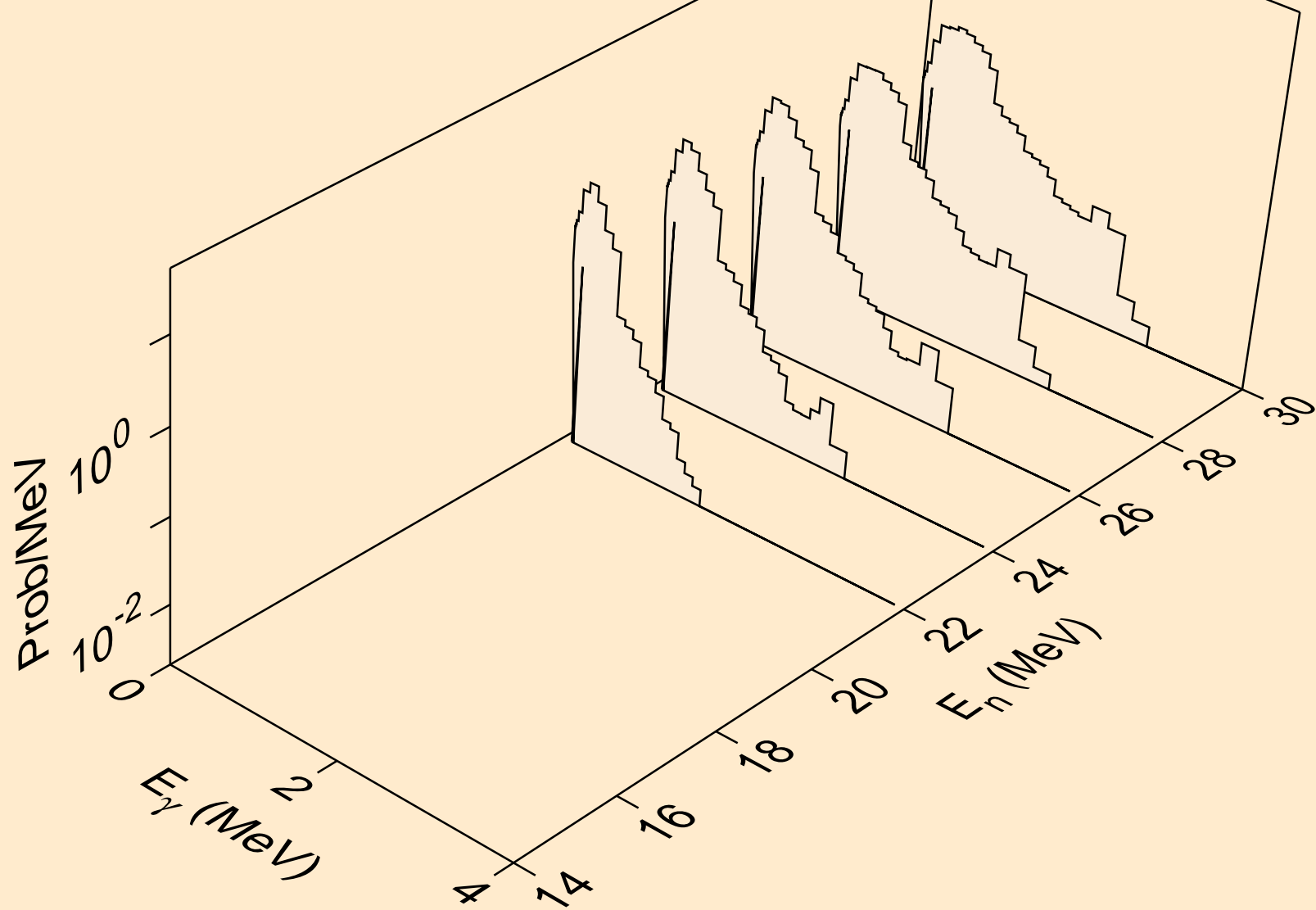

FR231 TRITON ACER TENDL-2021 LIBRARY; T=0.K  
Photon emission for (n,2np)

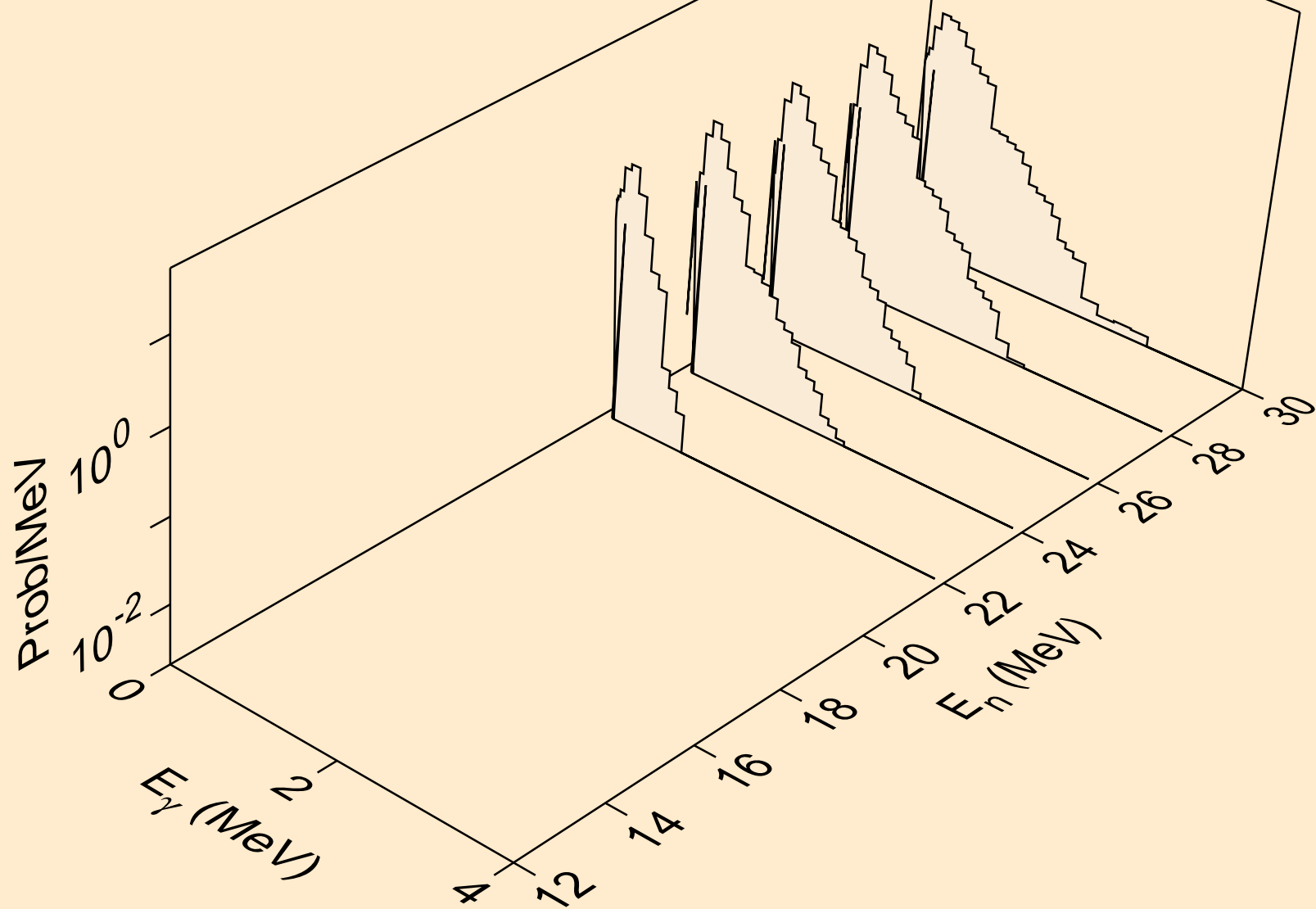

FR231 TRITON ACER TENDL-2021 LIBRARY; T=0.K  
Photon emission for (n,gma)

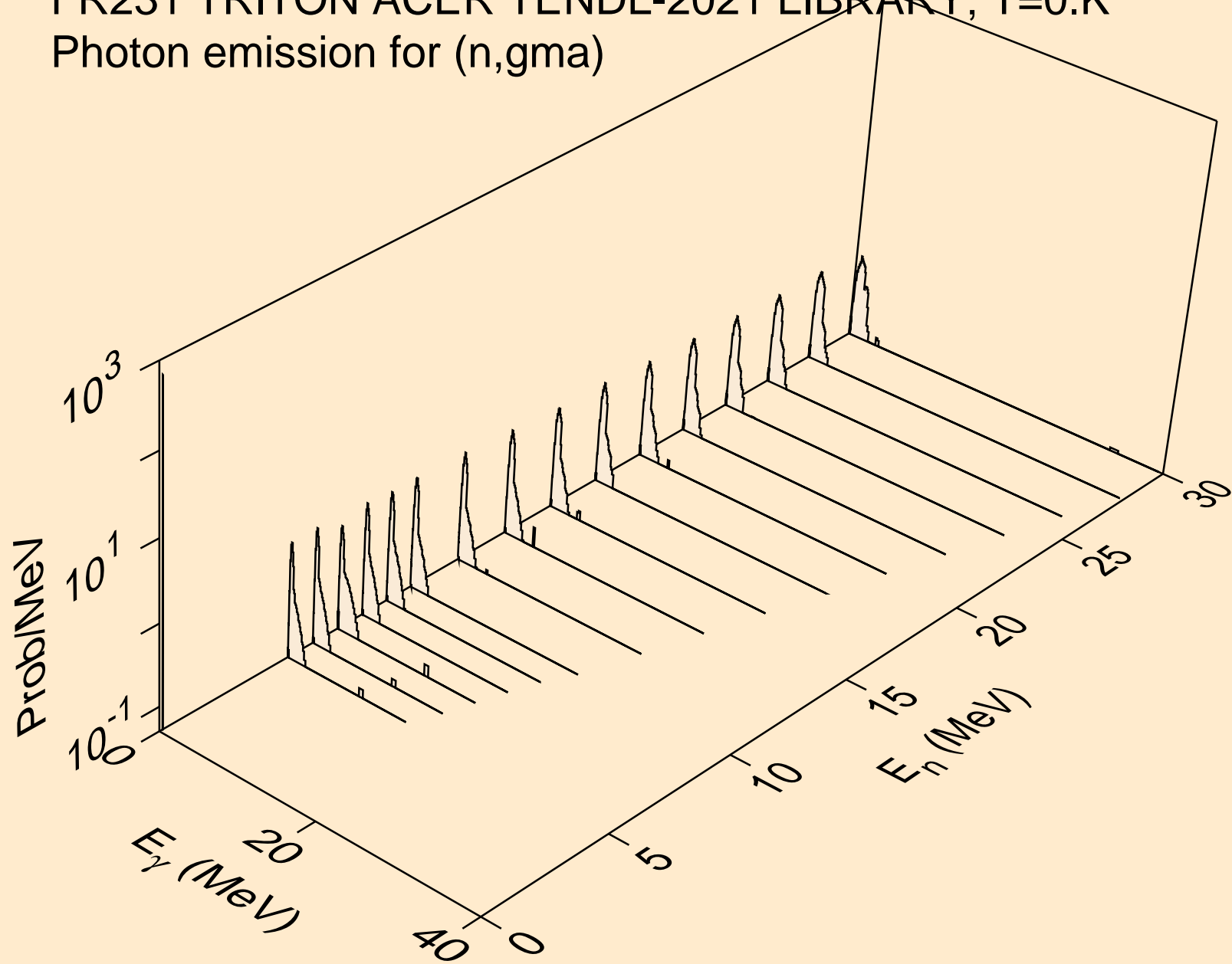



FR231 TRITON ACER TENDL-2021 LIBRARY; T=0.K  
Photon emission for (n,p)

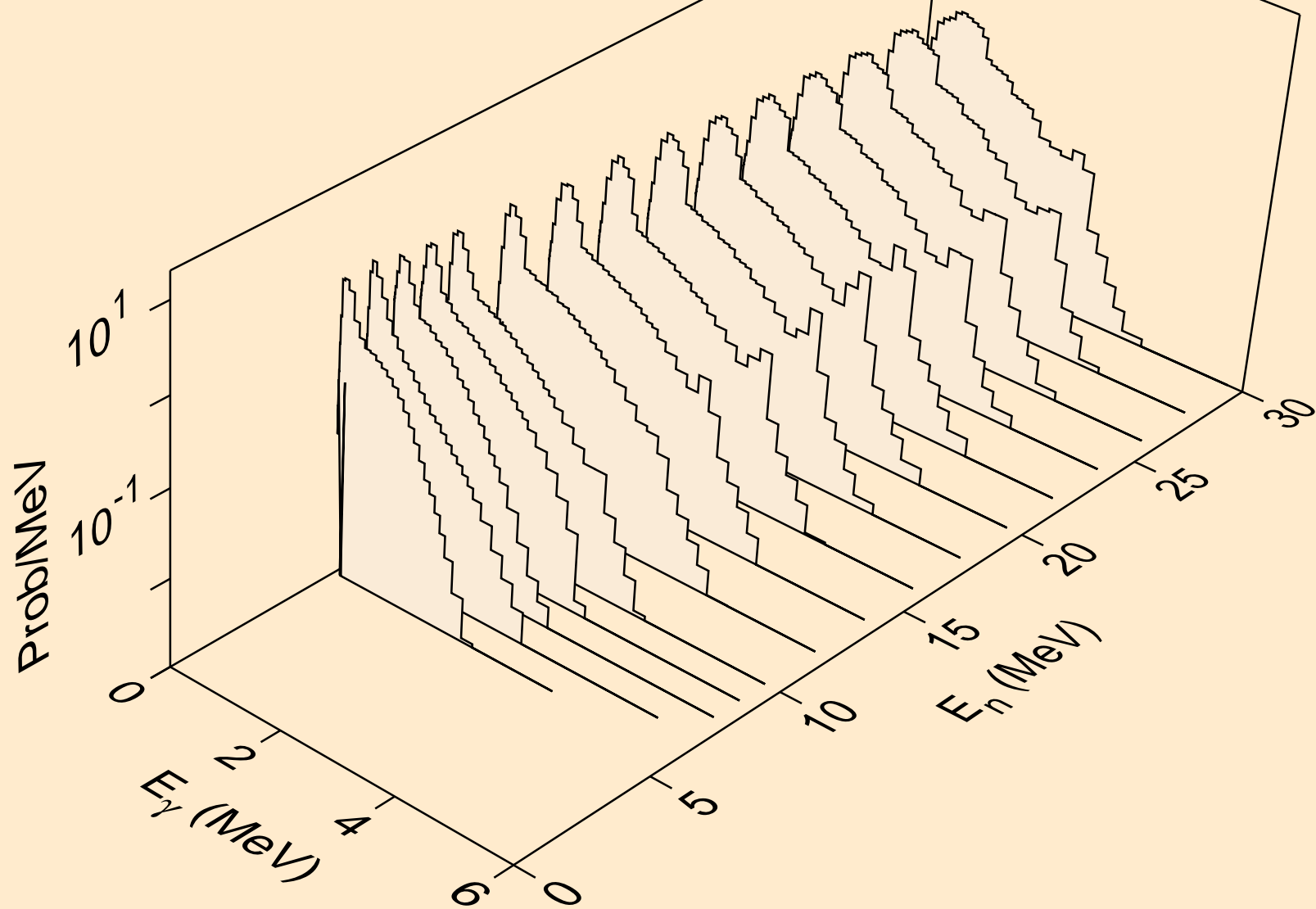

FR231 TRITON ACER TENDL-2021 LIBRARY; T=0.K  
Photon emission for (n,d)

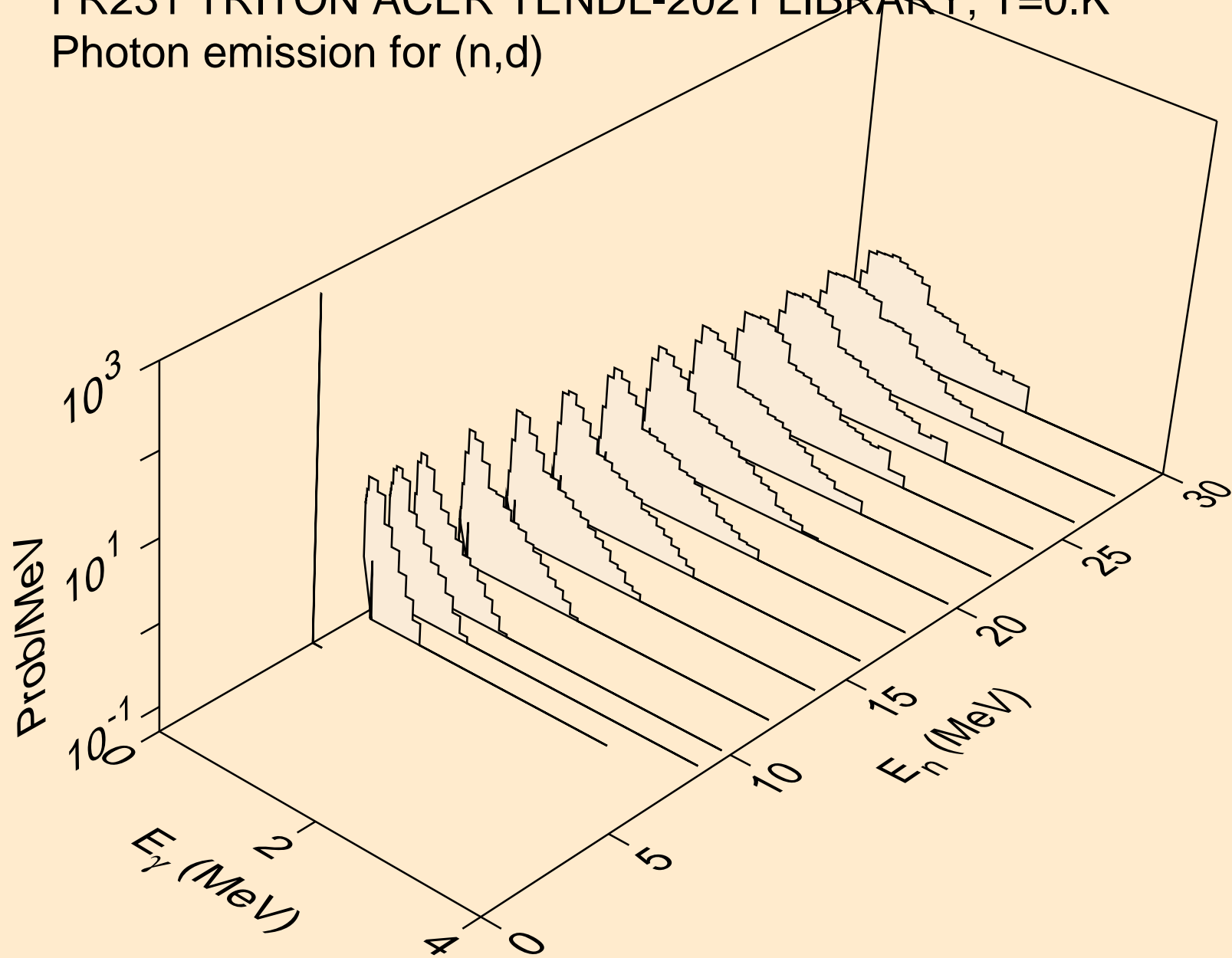

FR231 TRITON ACER TENDL-2021 LIBRARY; T=0.K  
Photon emission for inelastic

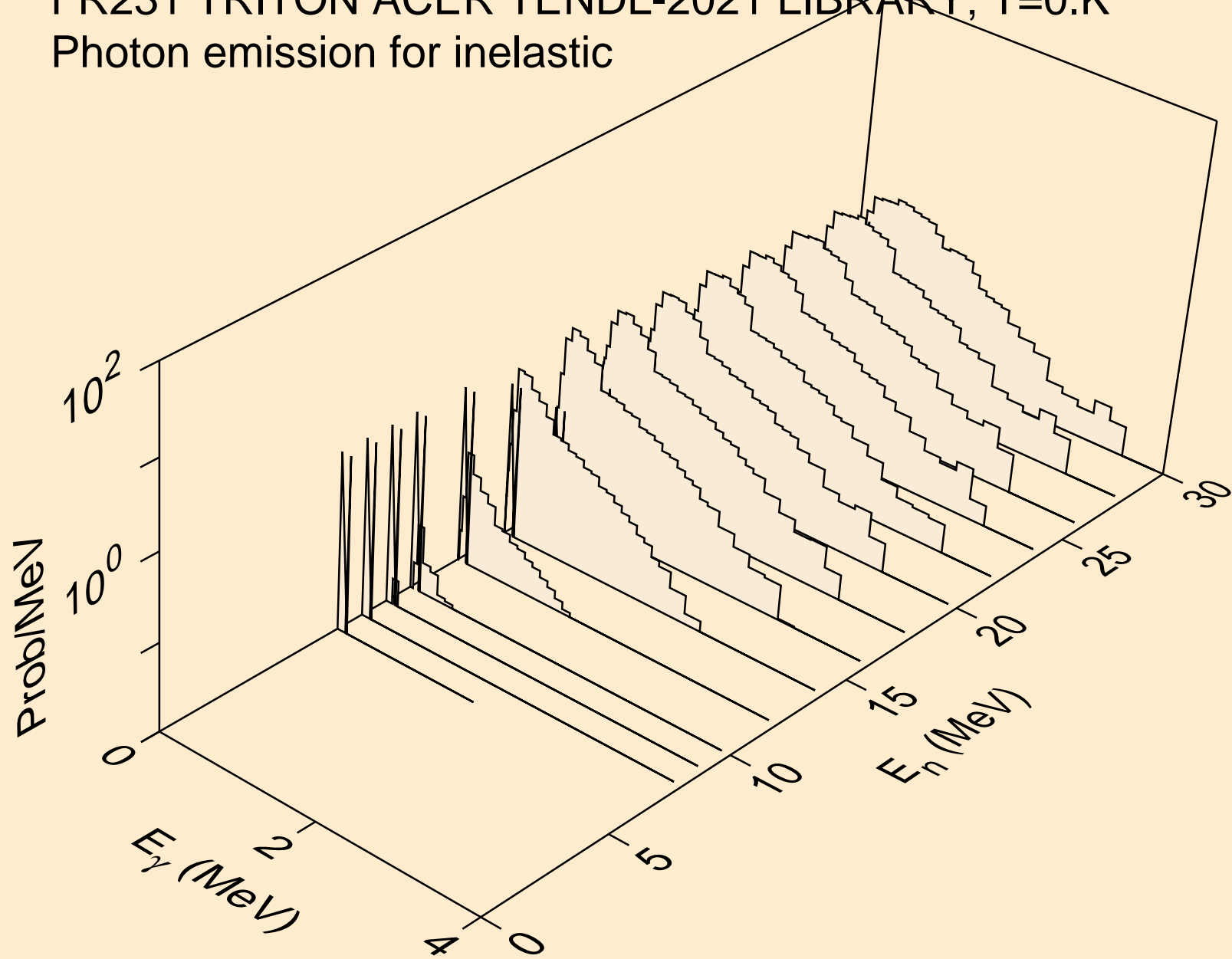

FR231 TRITON ACER TENDL-2021 LIBRARY; T=0.K  
Photon emission for (n,he3)

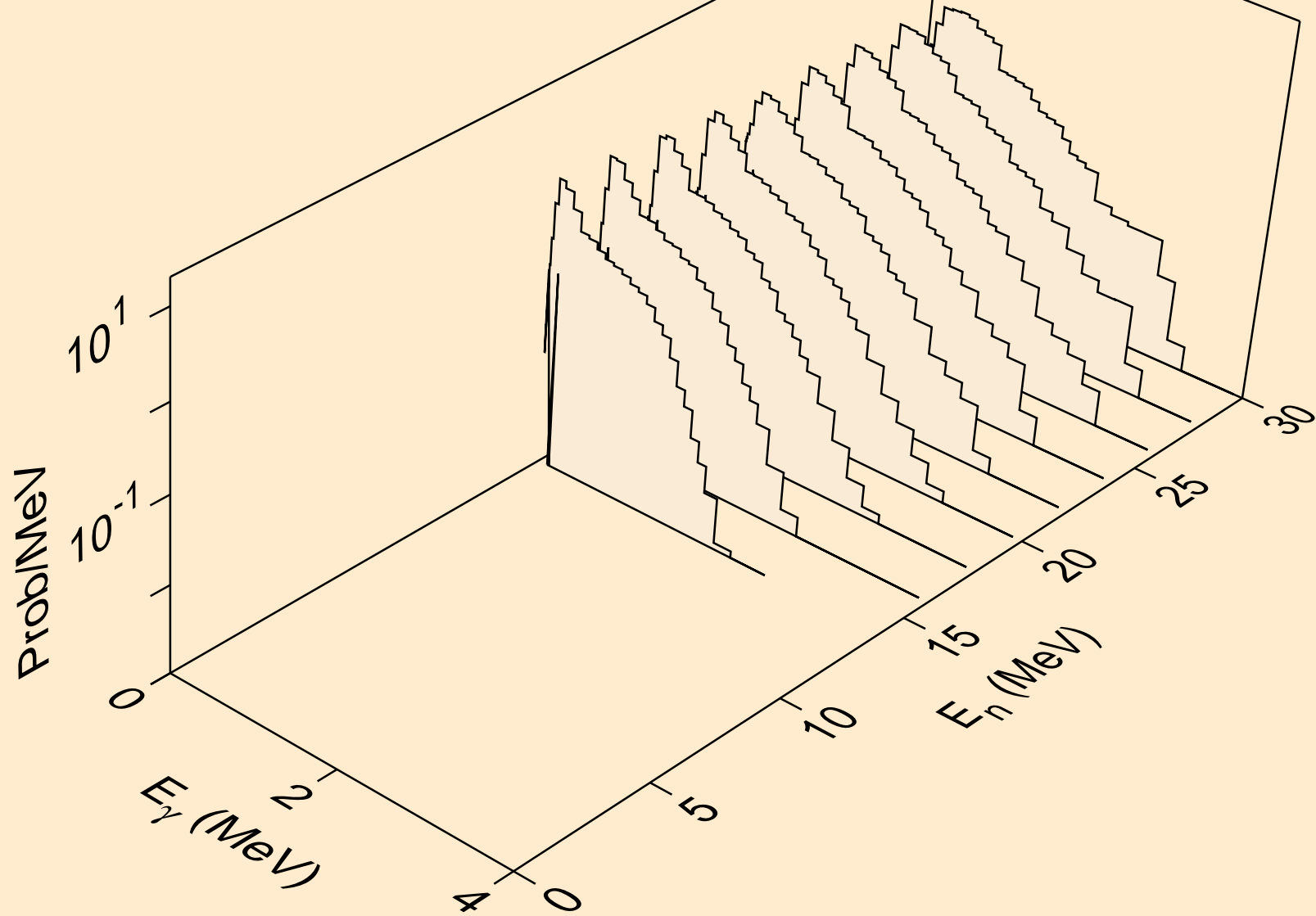

FR231 TRITON ACER TENDL-2021 LIBRARY; T=0.K  
Photon emission for (n,a)

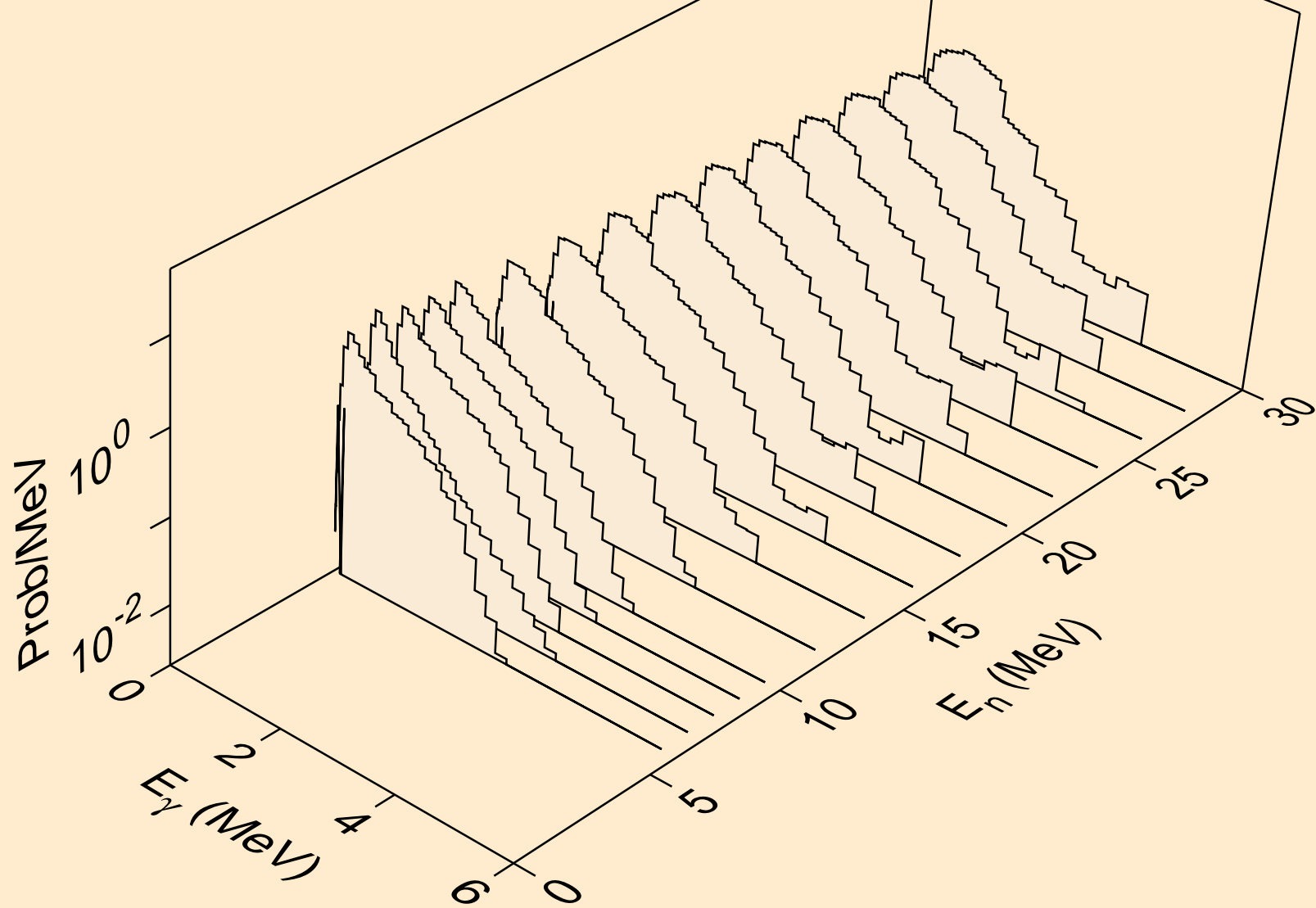

FR231 TRITON ACER TENDL-2021 LIBRARY; T=0.K  
Photon emission for (n,2p)

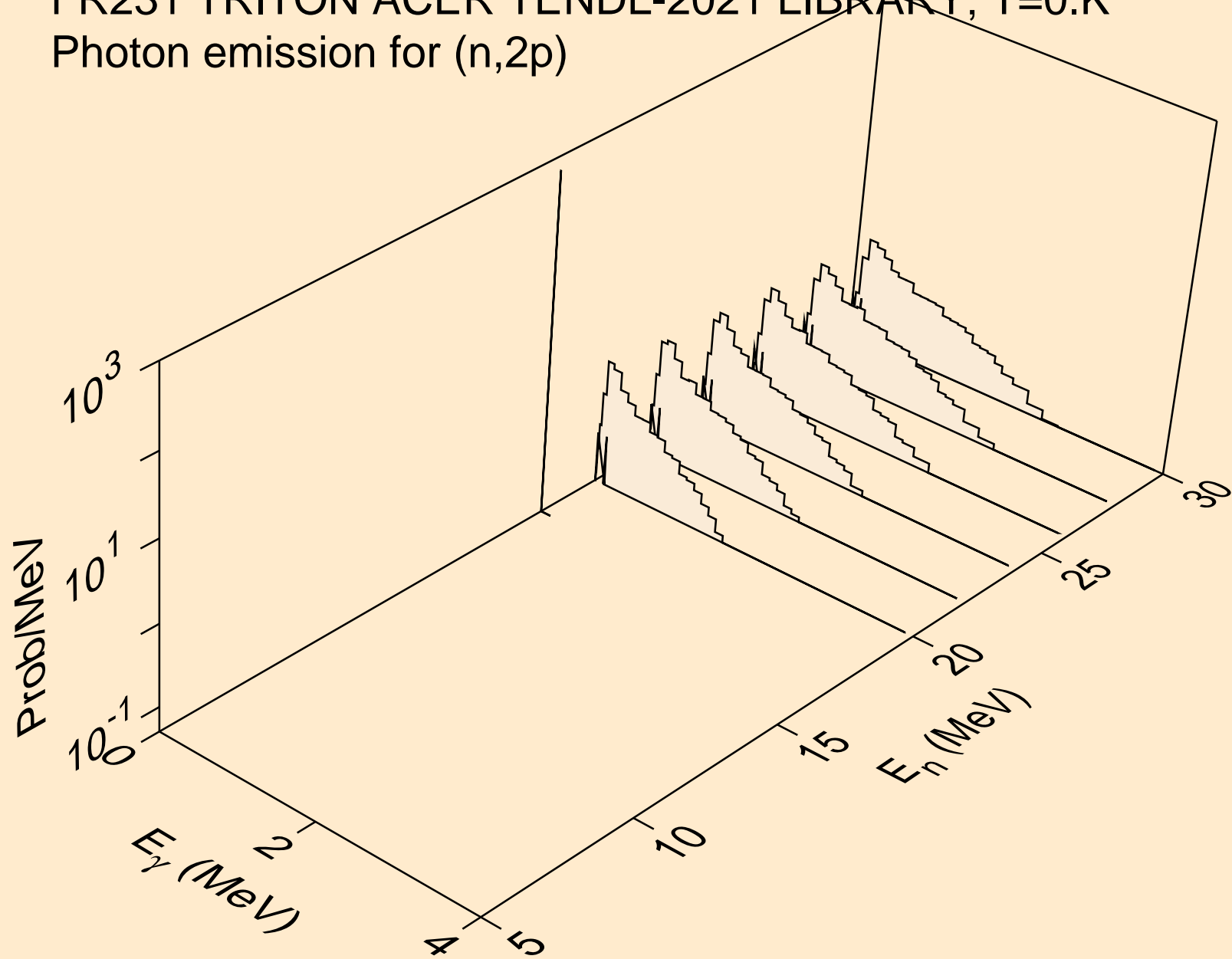

FR231 TRITON ACER TENDL-2021 LIBRARY; T=0.K  
Particle heating contributions

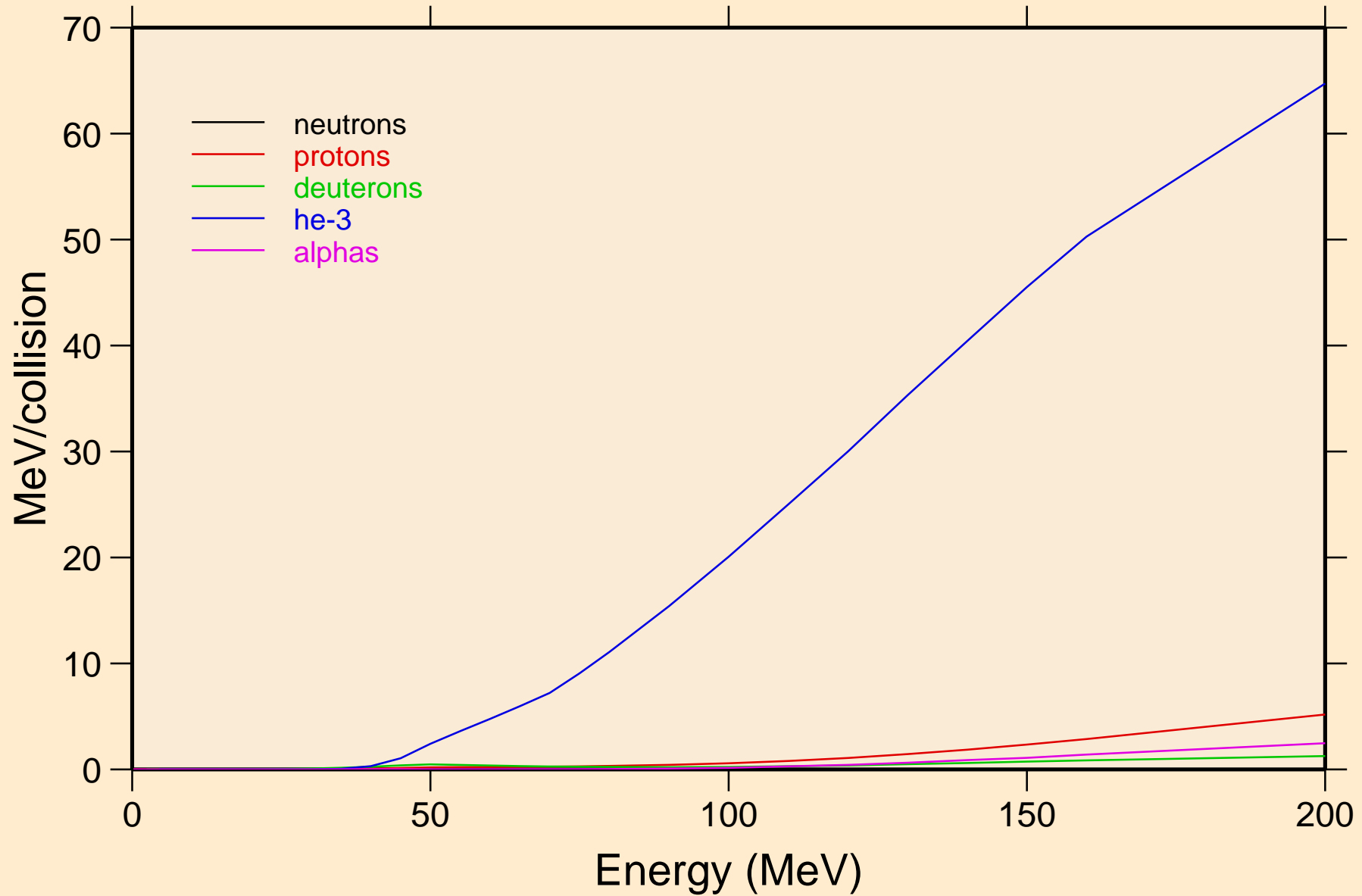

FR231 TRITON ACER TENDL-2021 LIBRARY; T=0.K  
Recoil Heating

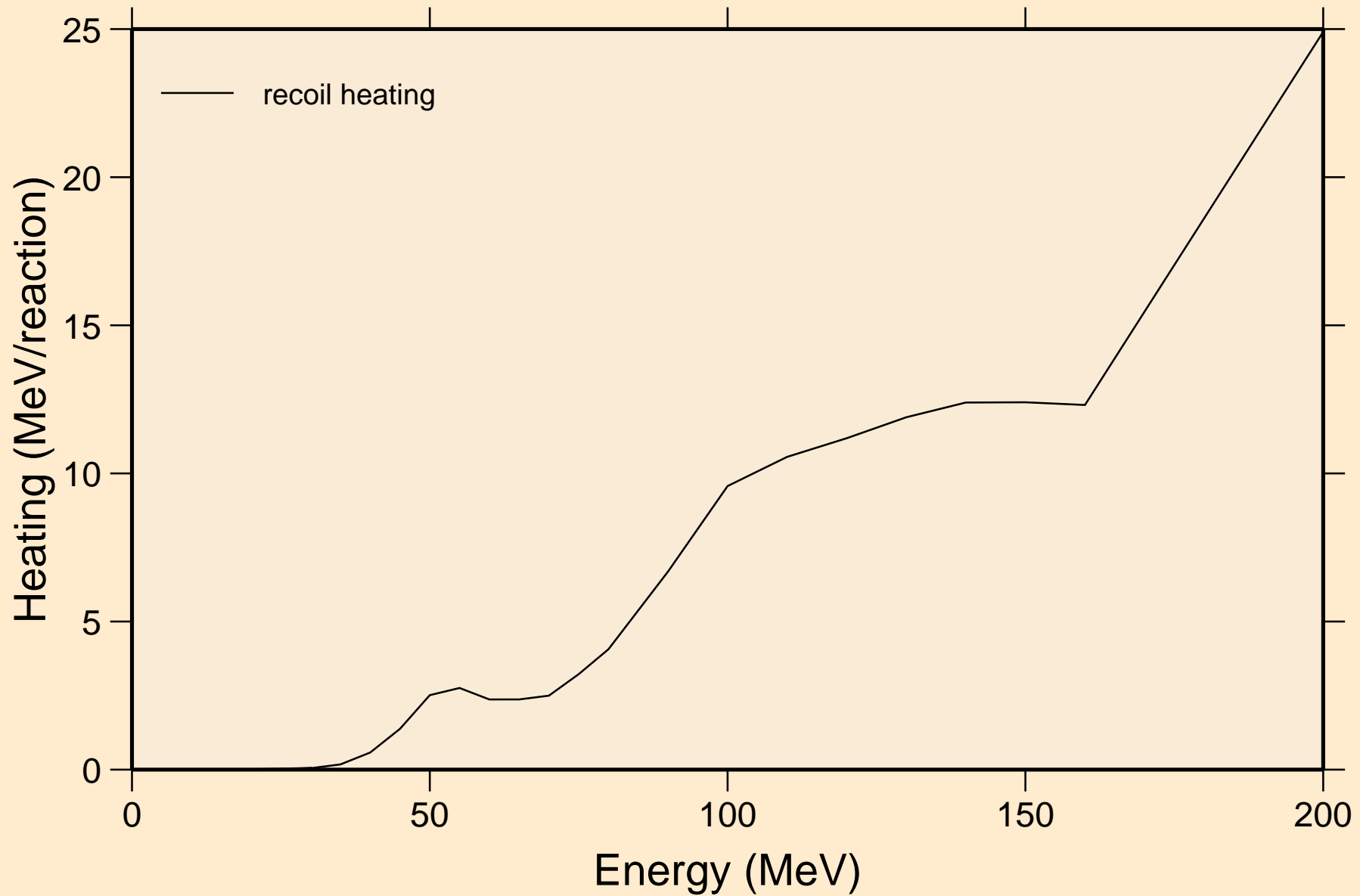



FR231 TRITON ACER TENDL-2021 LIBRARY; T=0.K  
Particle production cross sections

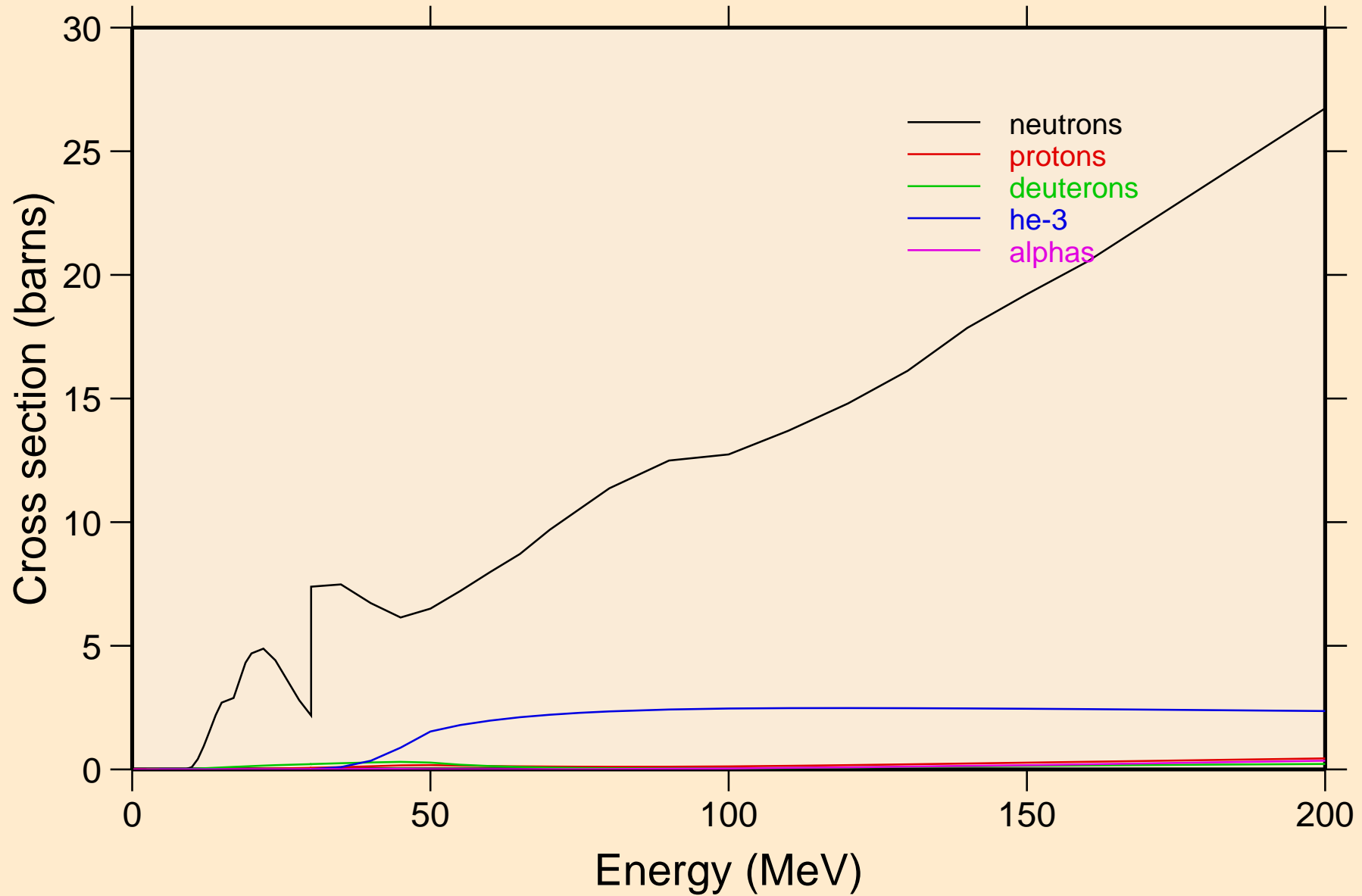

FR231 TRITON ACER TENDL-2021 LIBRARY; T=0.K  
neutrons from (t,n)

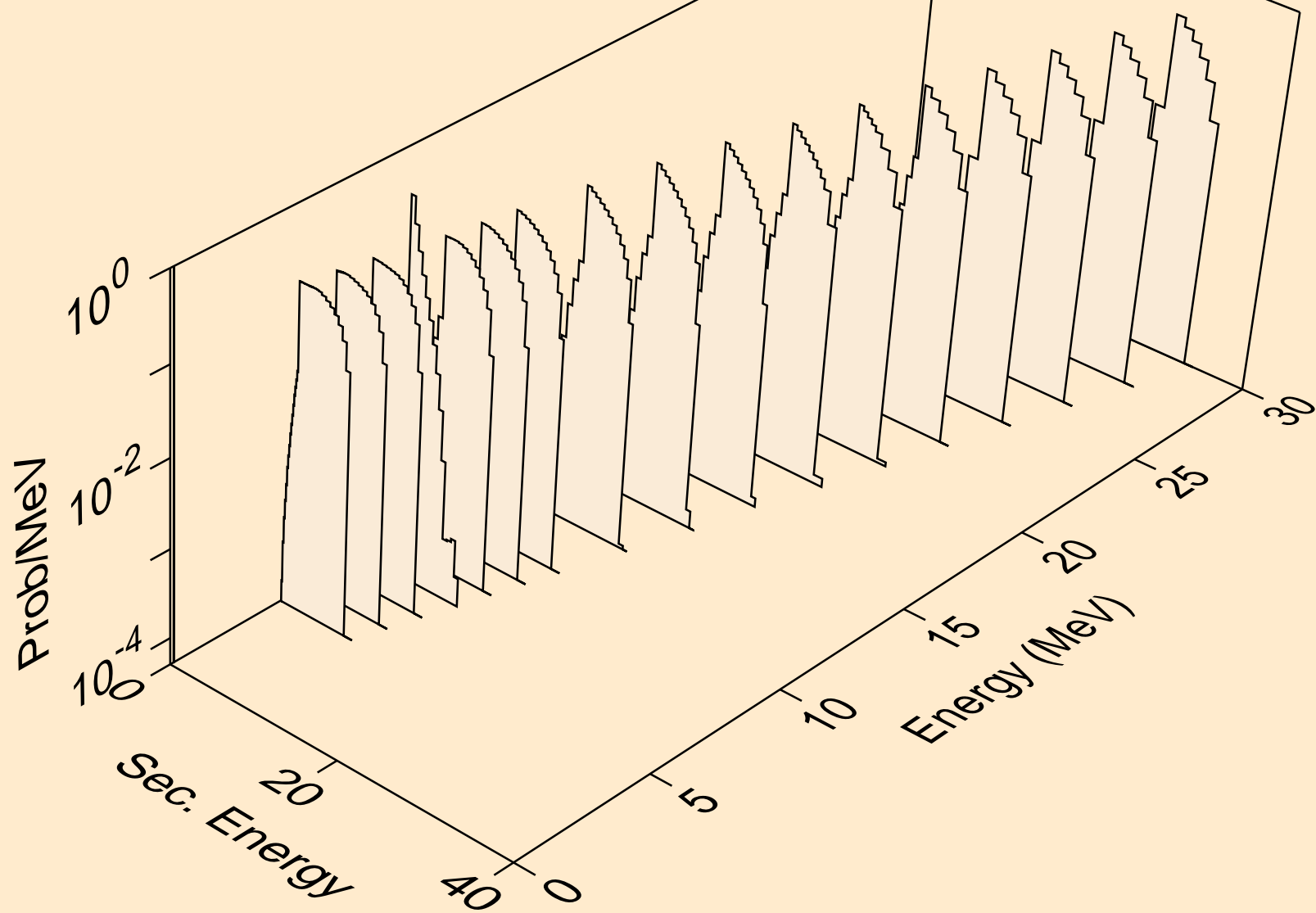

FR231 TRITON ACER TENDL-2021 LIBRARY; T=0.K  
neutrons from (t,x)

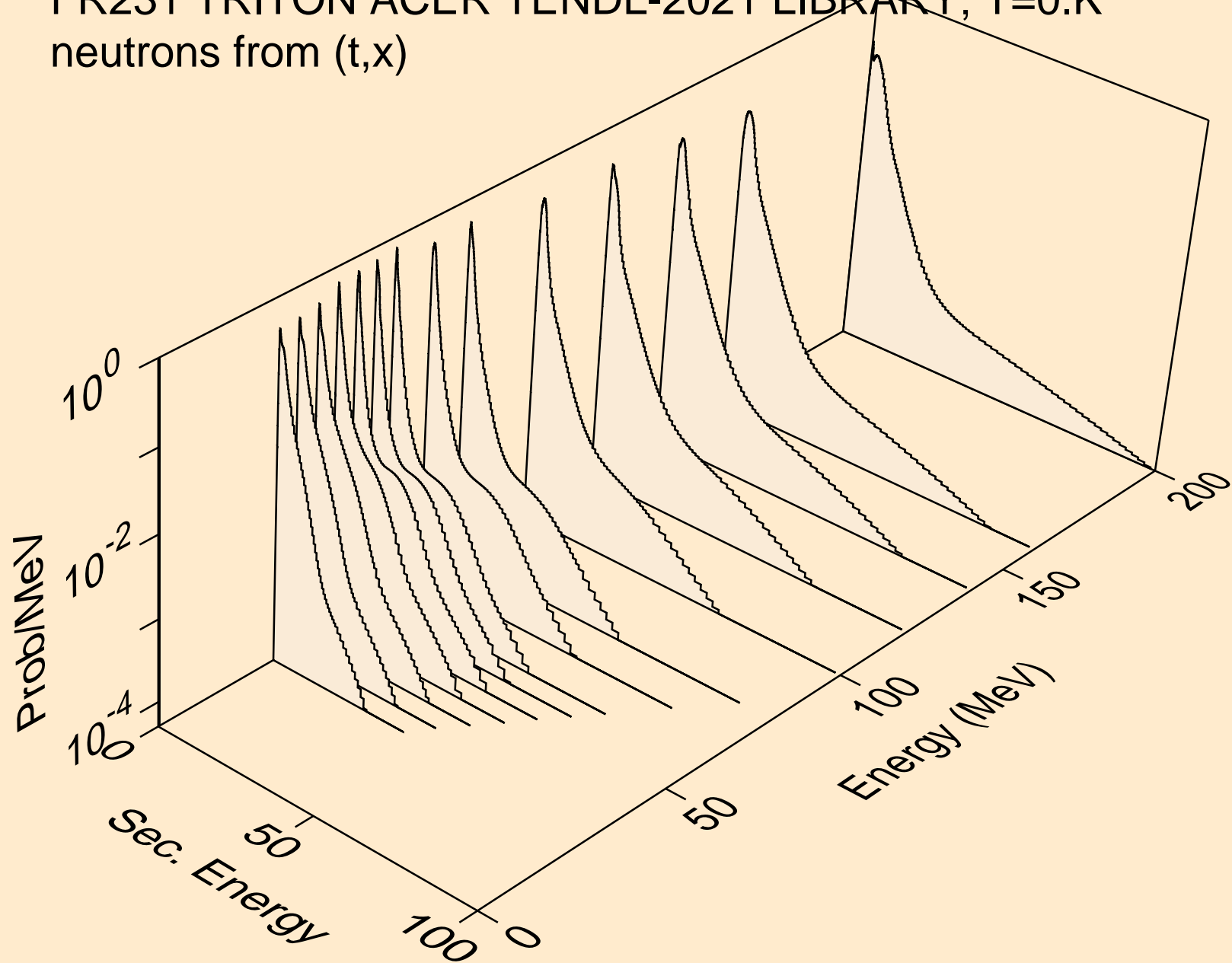

FR231 TRITON ACER TENDL-2021 LIBRARY; T=0.K  
neutrons from (t,2nd)

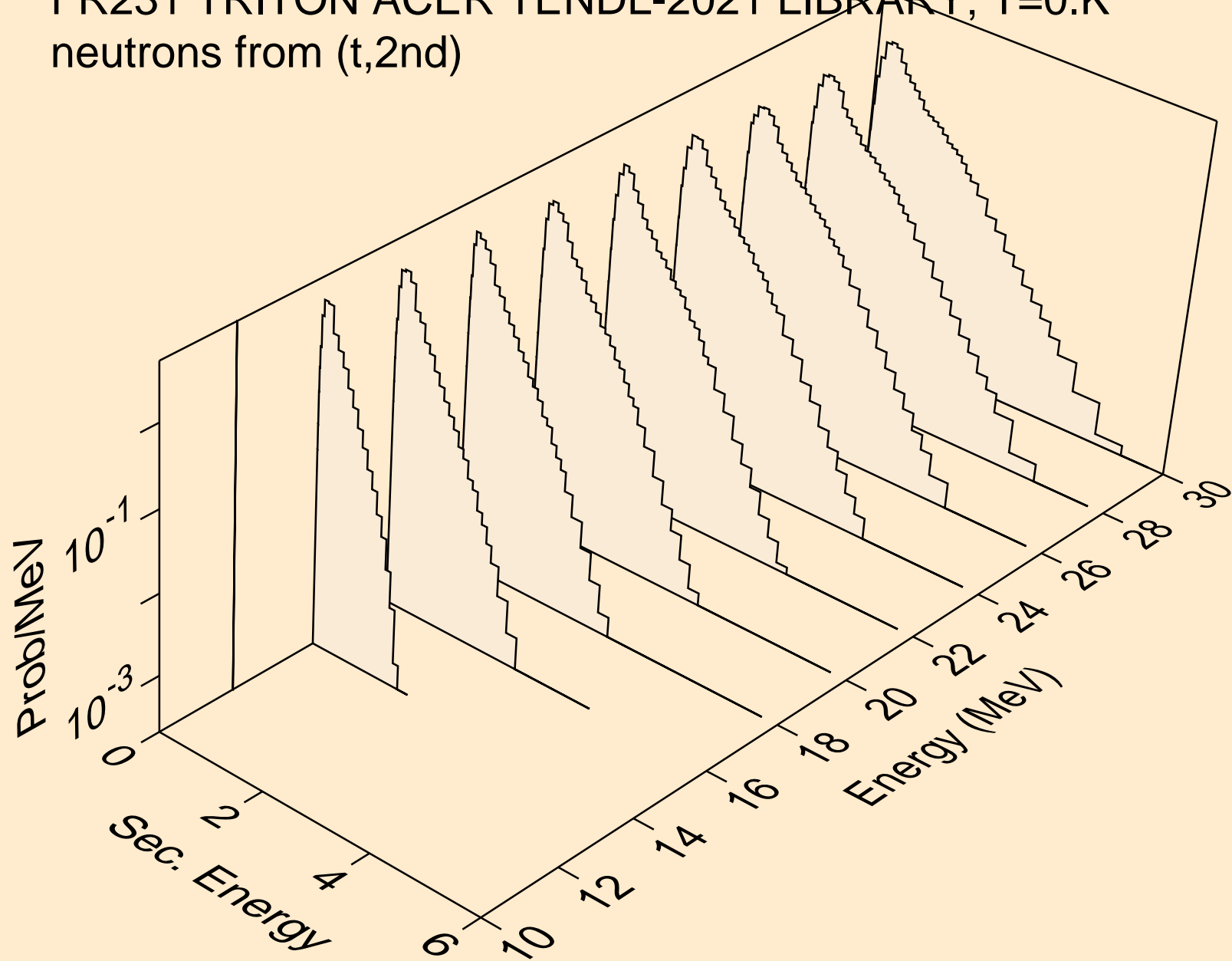

FR231 TRITON ACER TENDL-2021 LIBRARY; T=0.K  
neutrons from (t,2n)

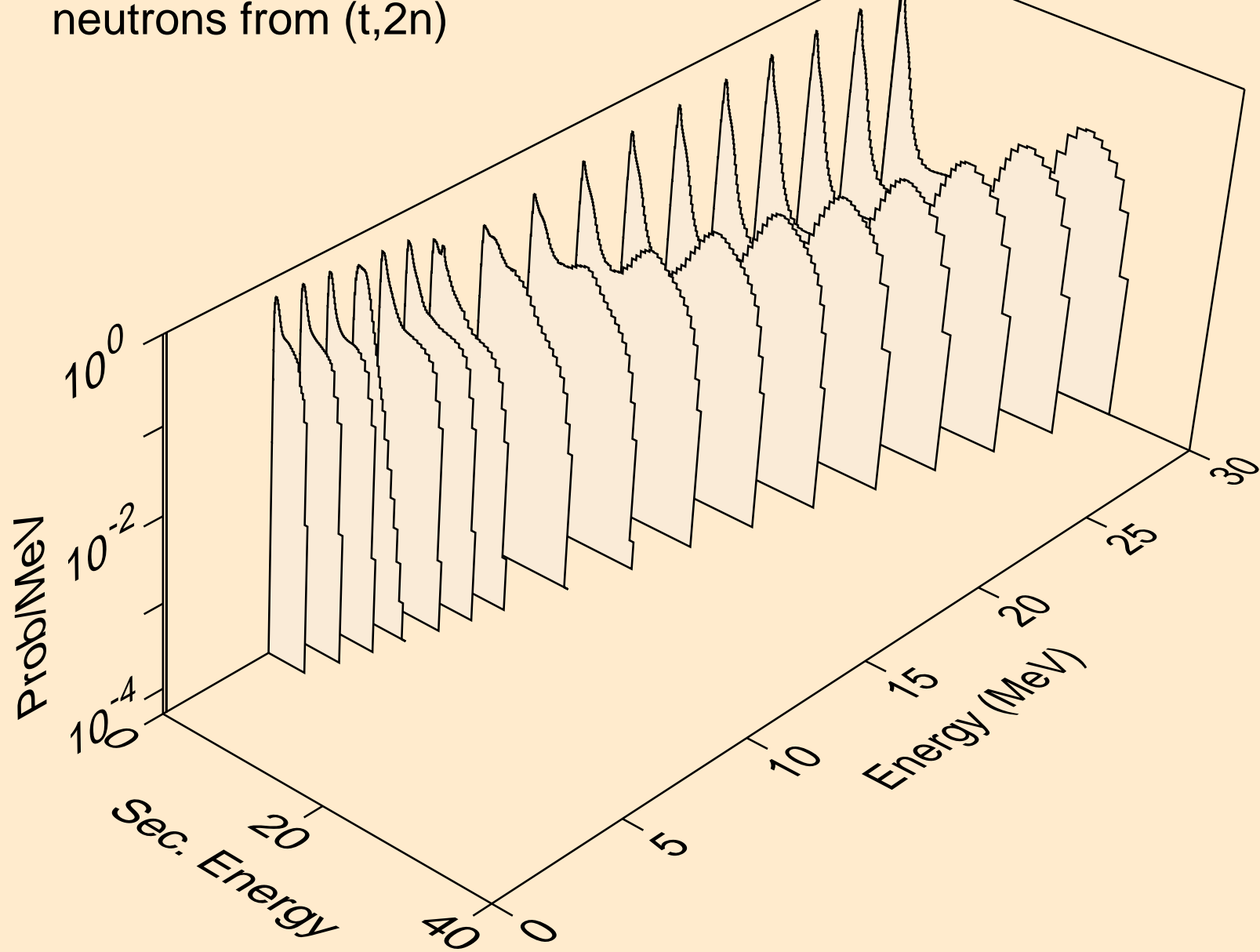

FR231 TRITON ACER TENDL-2021 LIBRARY; T=0.K  
neutrons from (t,3n)

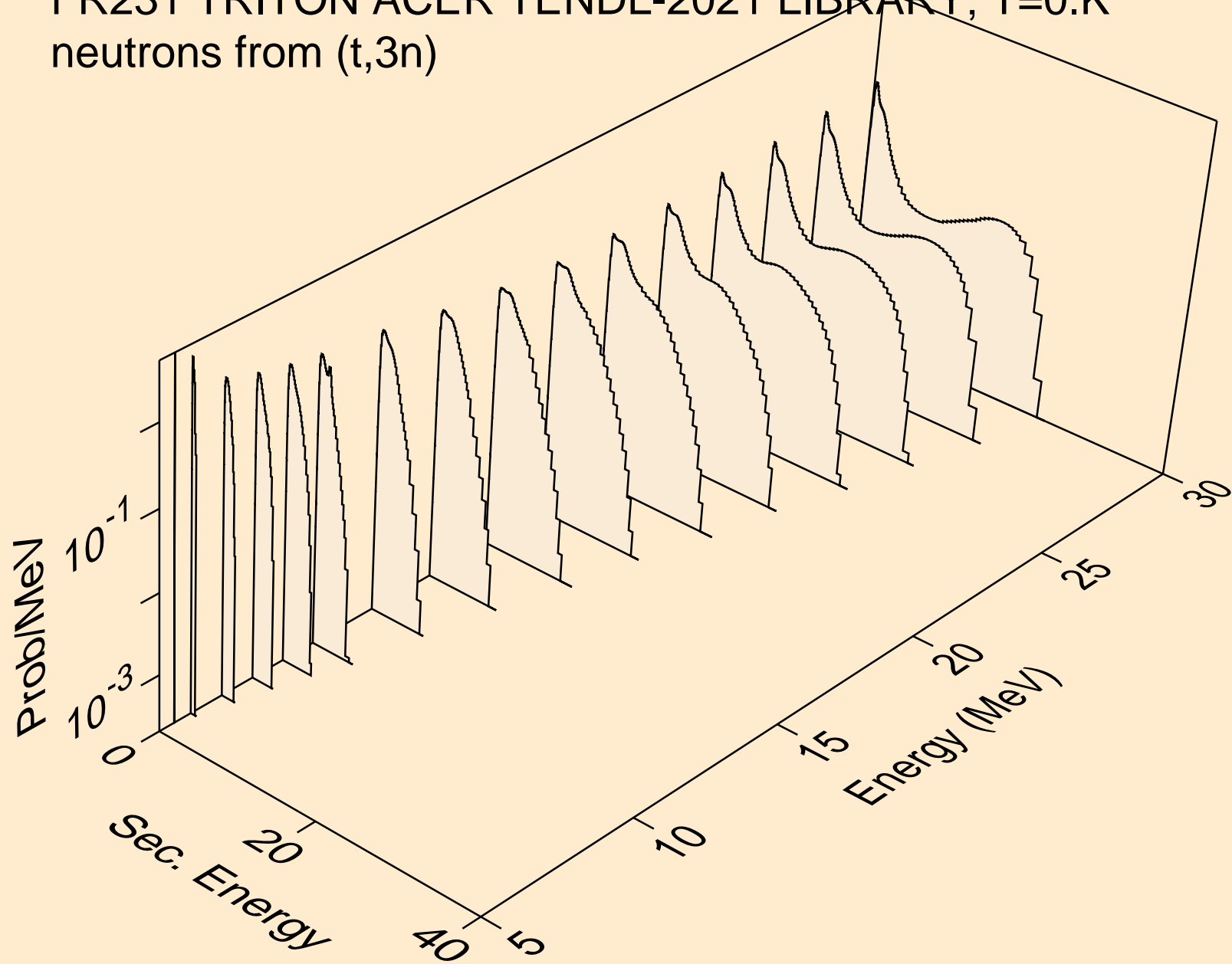

FR231 TRITON ACER TENDL-2021 LIBRARY; T=0.K  
neutrons from (t,n\*)a

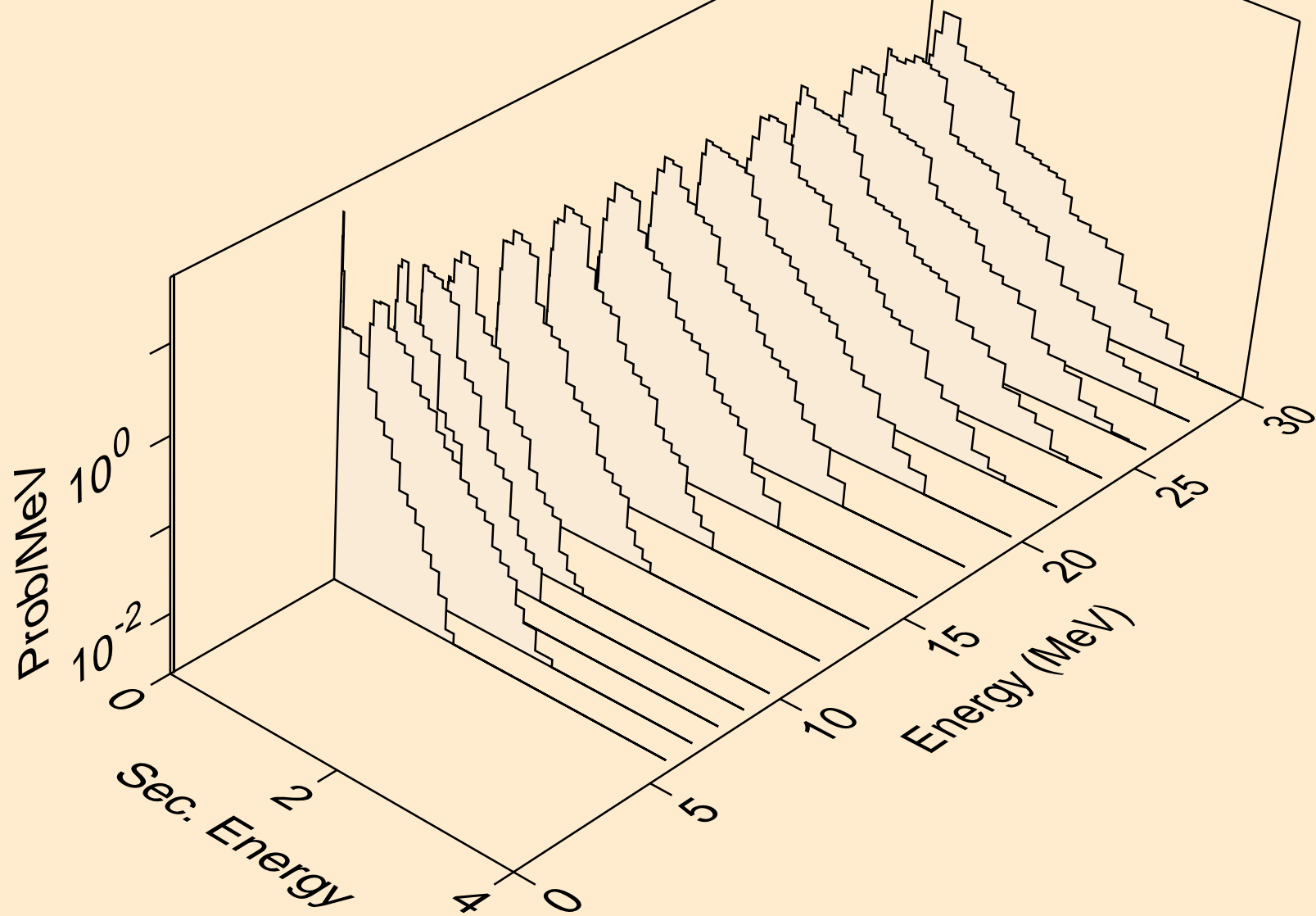

FR231 TRITON ACER TENDL-2021 LIBRARY; T=0.K  
neutrons from (t,2n)a

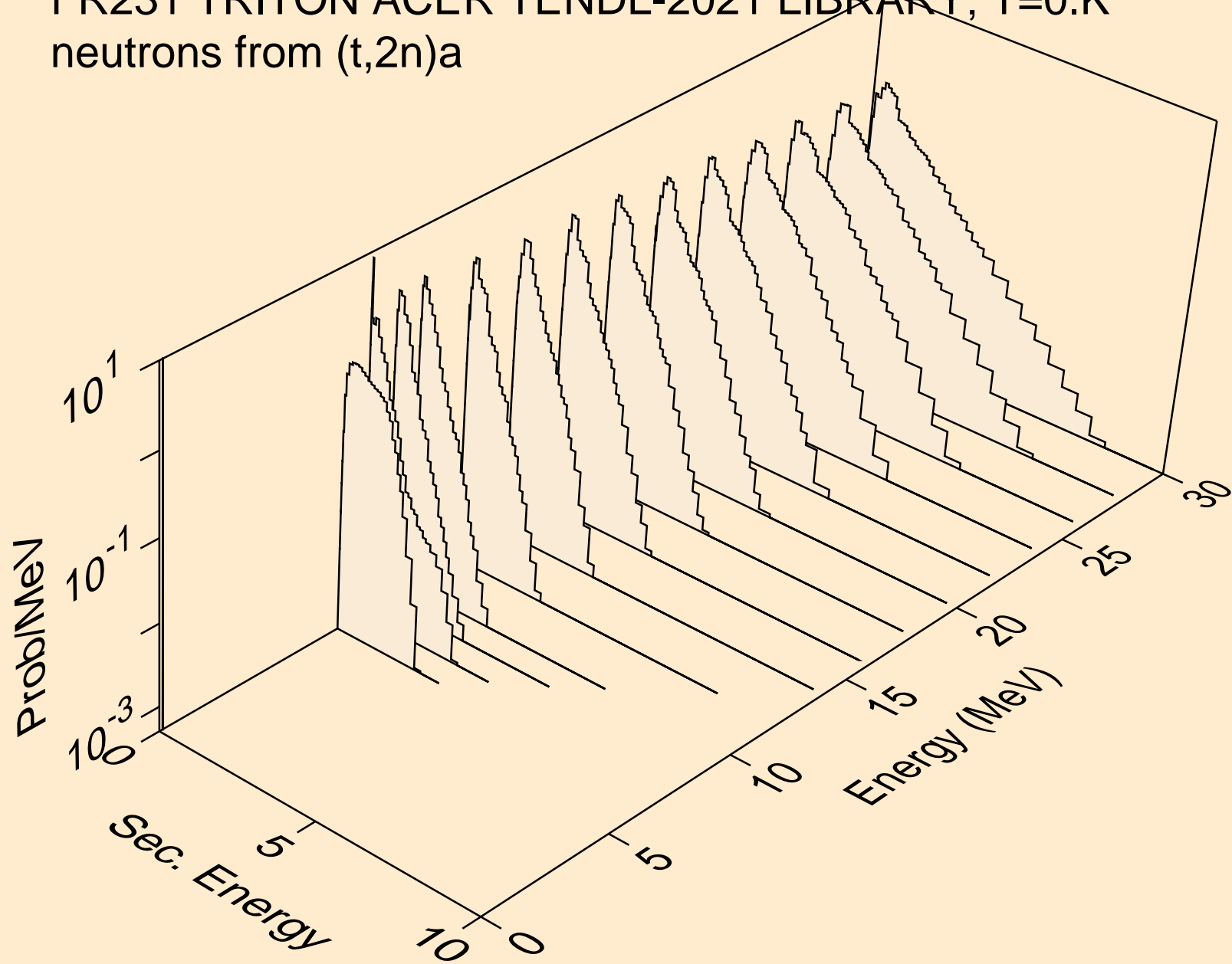



FR231 TRITON ACER TENDL-2021 LIBRARY; T=0.K  
neutrons from (t,3n)a

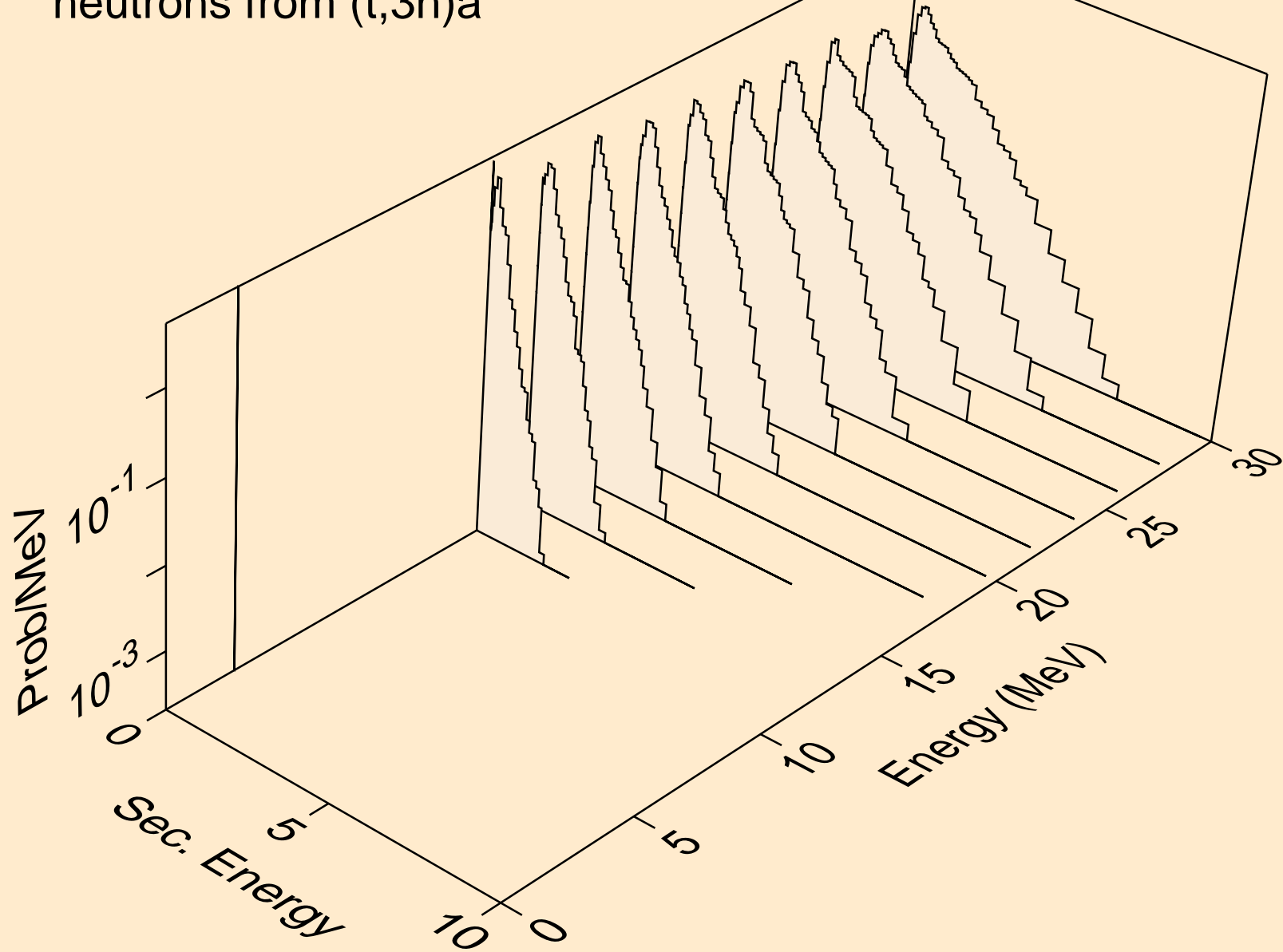

FR231 TRITON ACER TENDL-2021 LIBRARY; T=0.K  
neutrons from (t,n\*)p

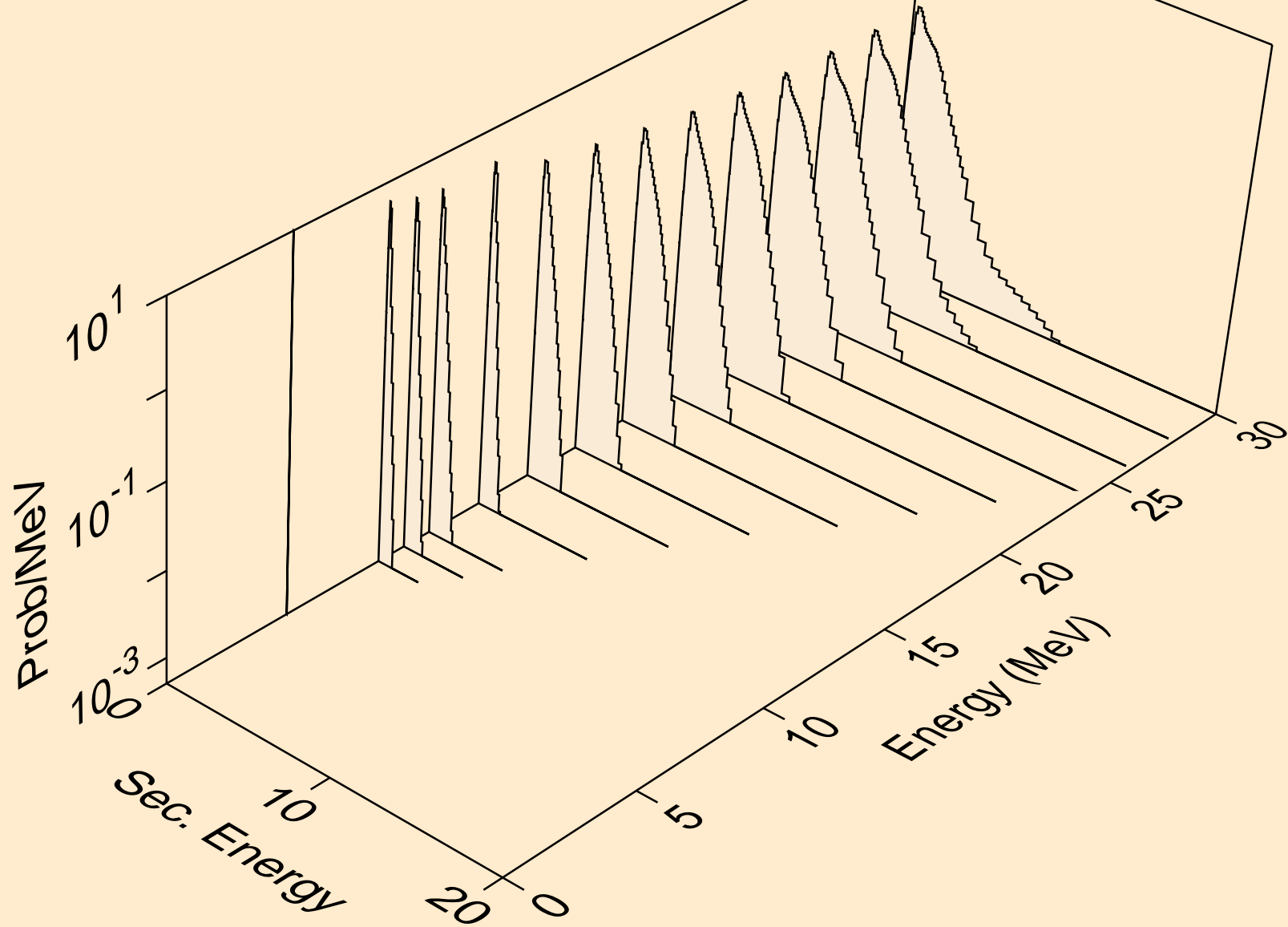

FR231 TRITON ACER TENDL-2021 LIBRARY; T=0.K  
neutrons from (t,n\*)d

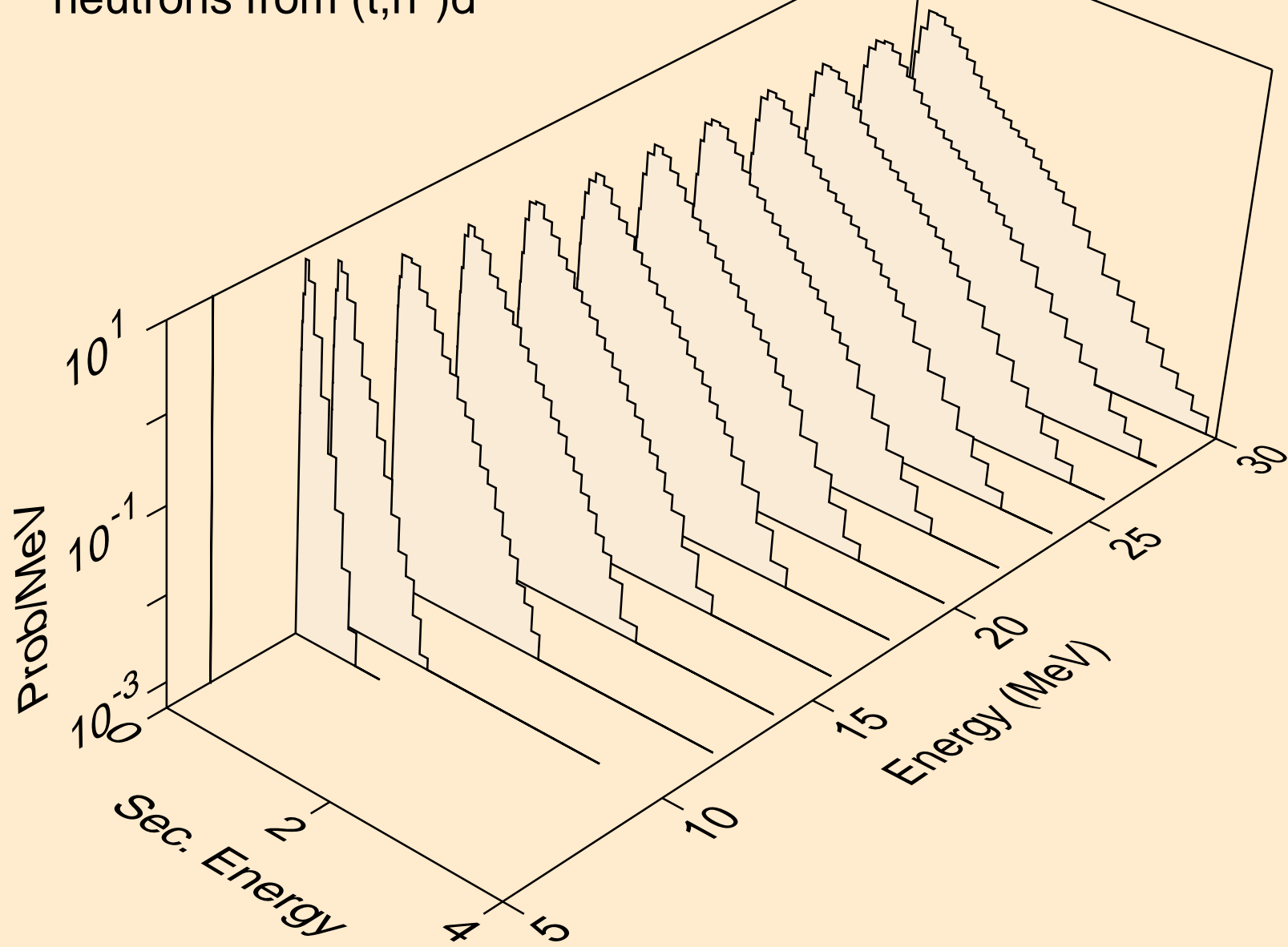

FR231 TRITON ACER TENDL-2021 LIBRARY; T=0.K  
neutrons from (t,n\*)t

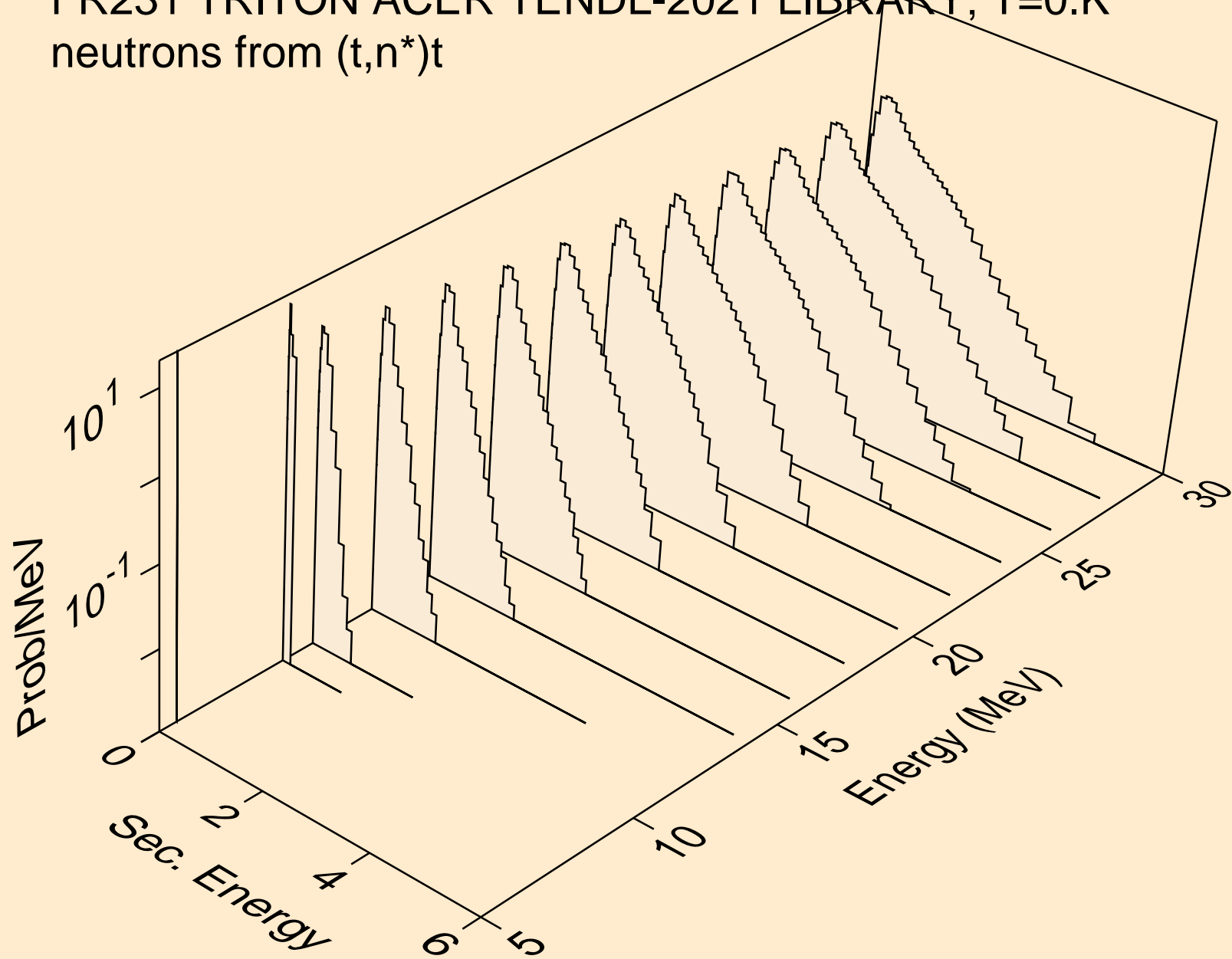

FR231 TRITON ACER TENDL-2021 LIBRARY; T=0.K  
neutrons from (t,n\*)he3

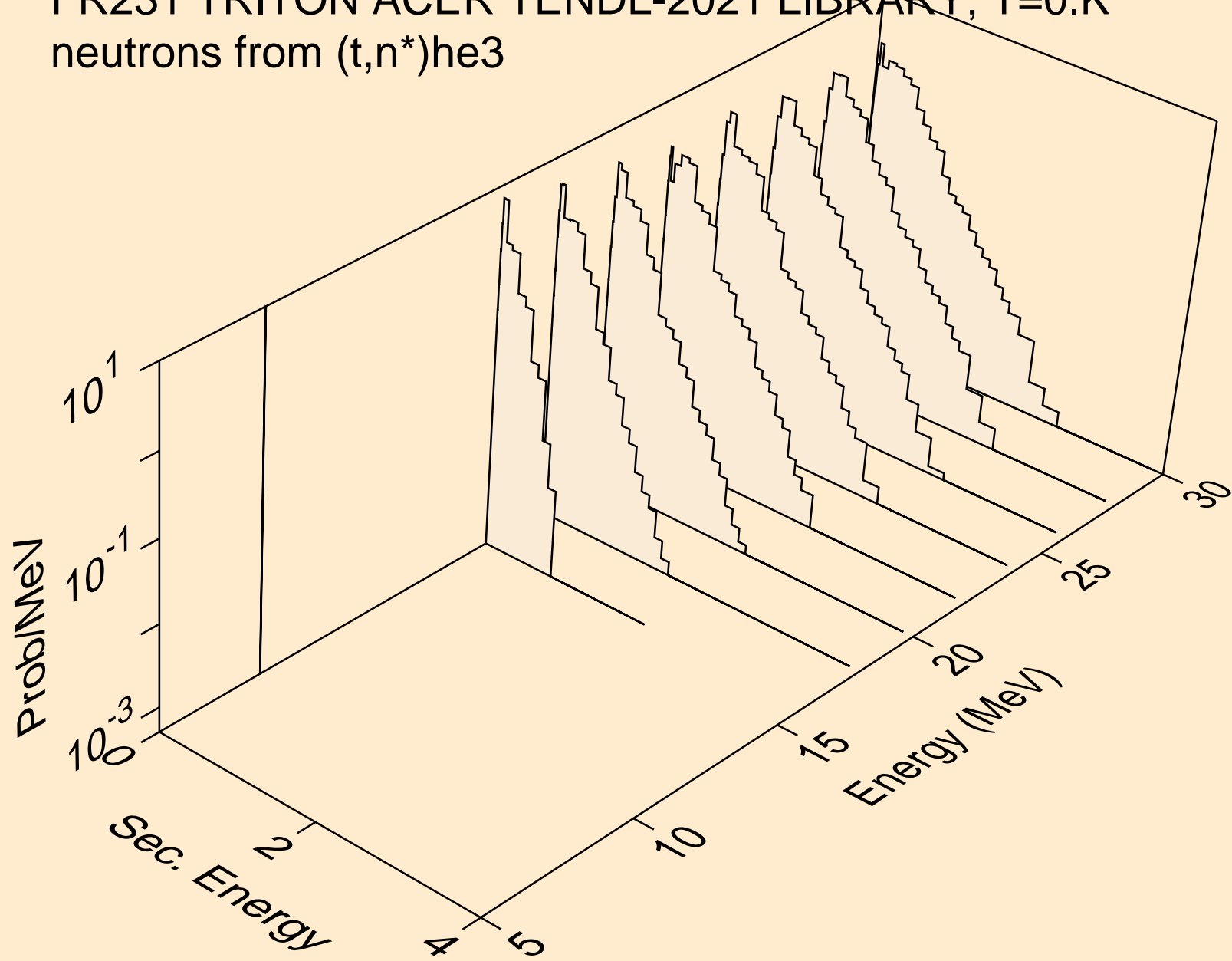

FR231 TRITON ACER TENDL-2021 LIBRARY; T=0.K  
neutrons from (t,4n)

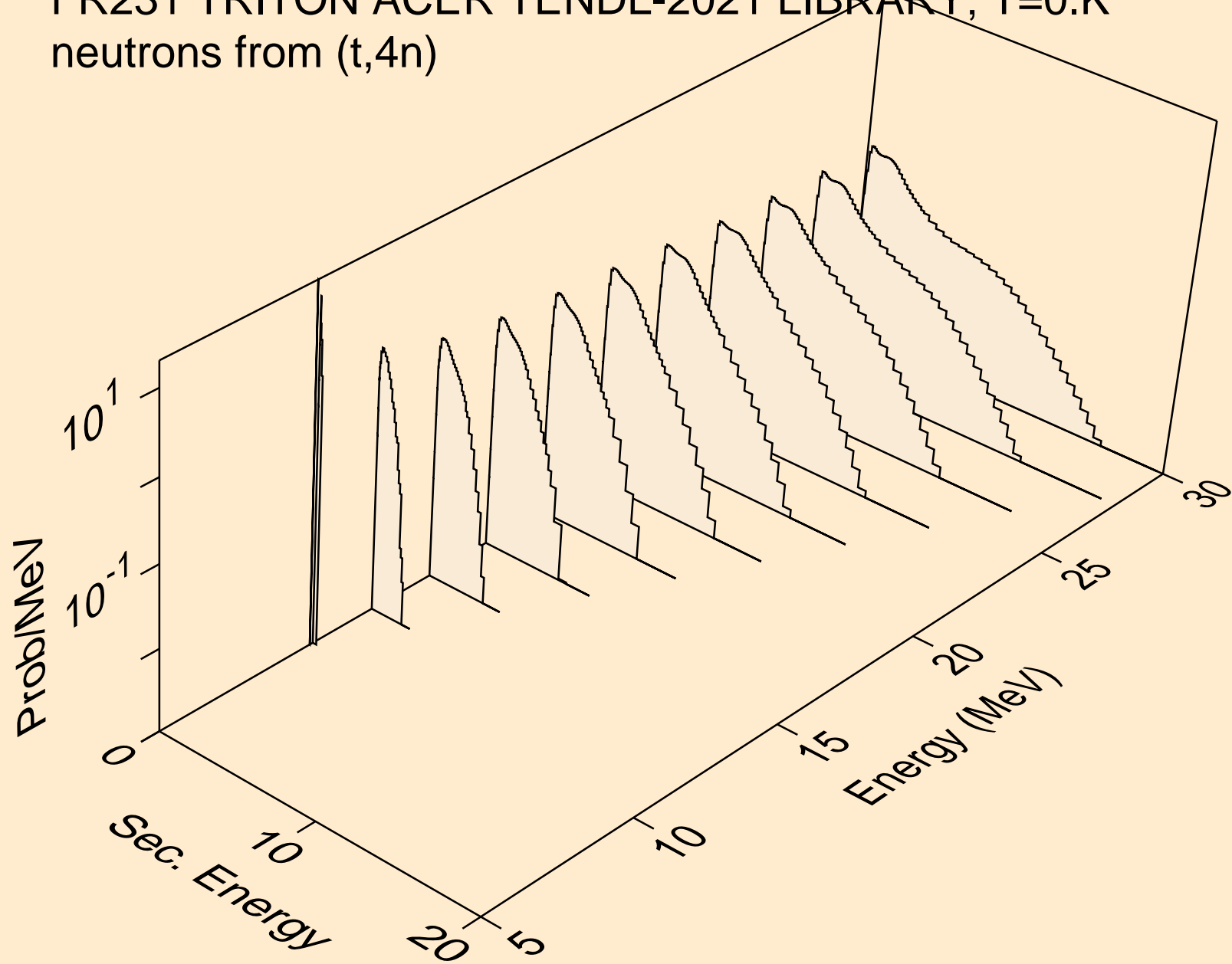

FR231 TRITON ACER TENDL-2021 LIBRARY; T=0.K  
neutrons from (t,2np)

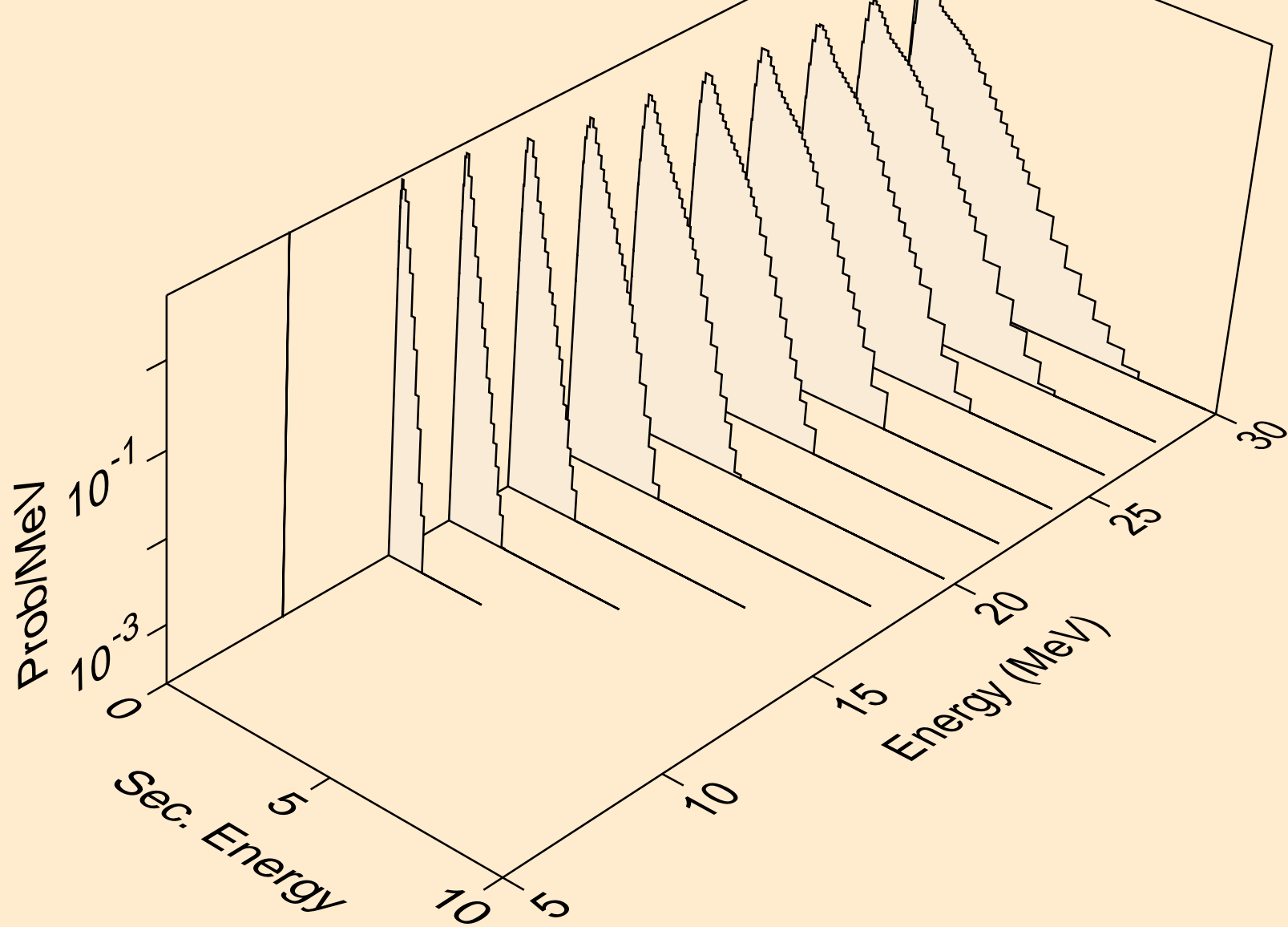

FR231 TRITON ACER TENDL-2021 LIBRARY; T=0.K  
neutrons from (t,3np)

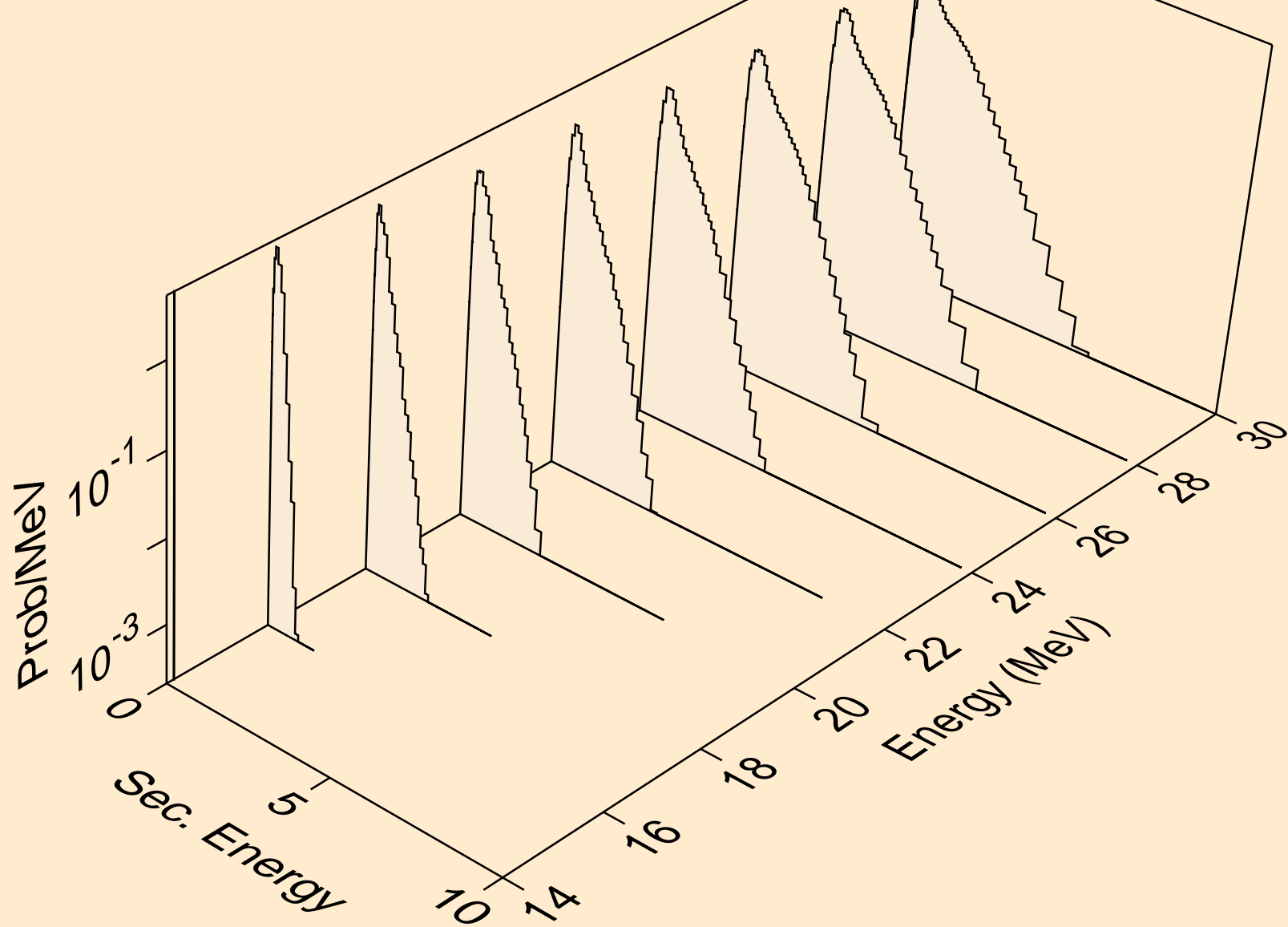



FR231 TRITON ACER TENDL-2021 LIBRARY; T=0.K  
neutrons from (t,2np)

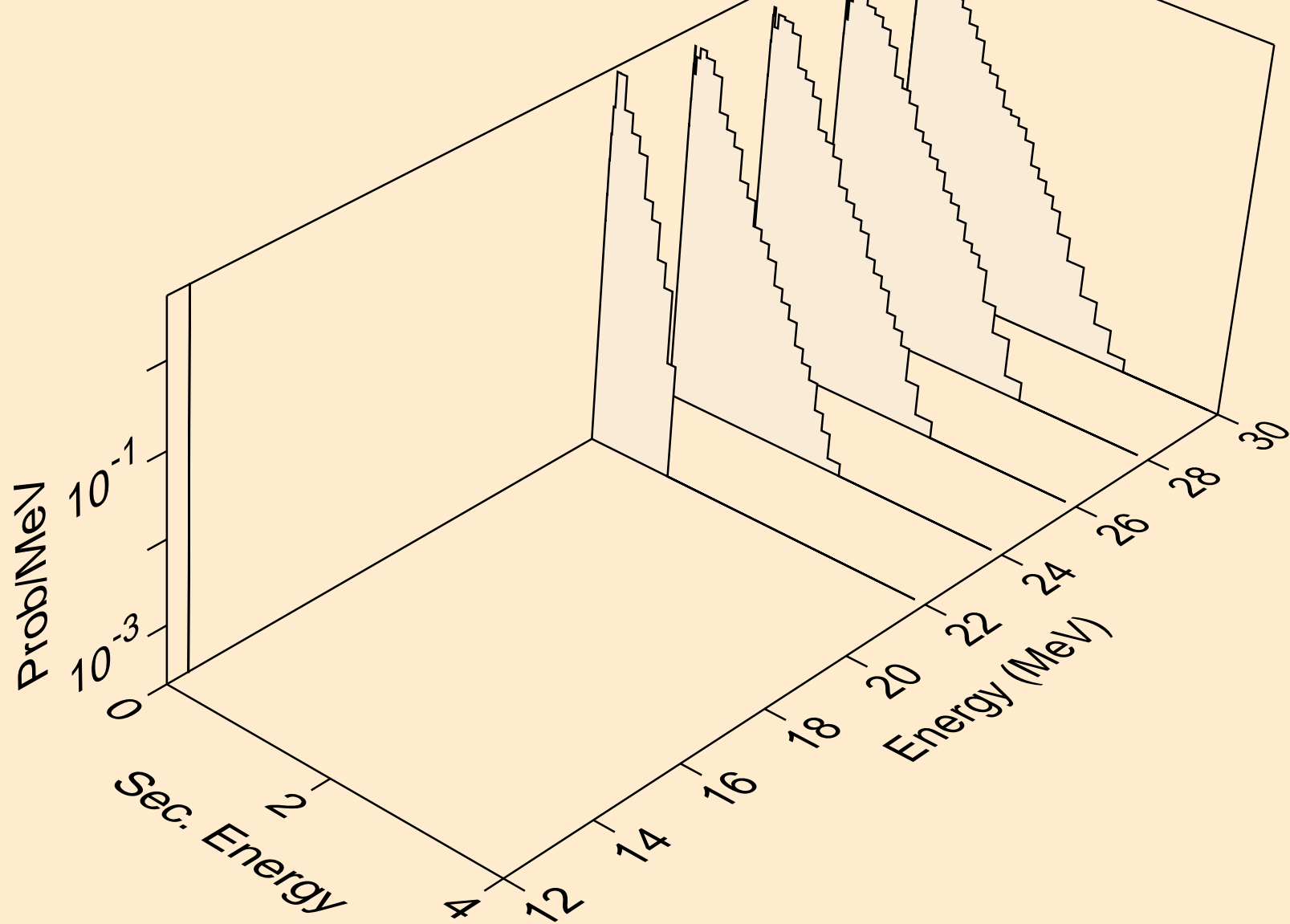

FR231 TRITON ACER TENDL-2021 LIBRARY; T=0.K  
protons from (t,x)

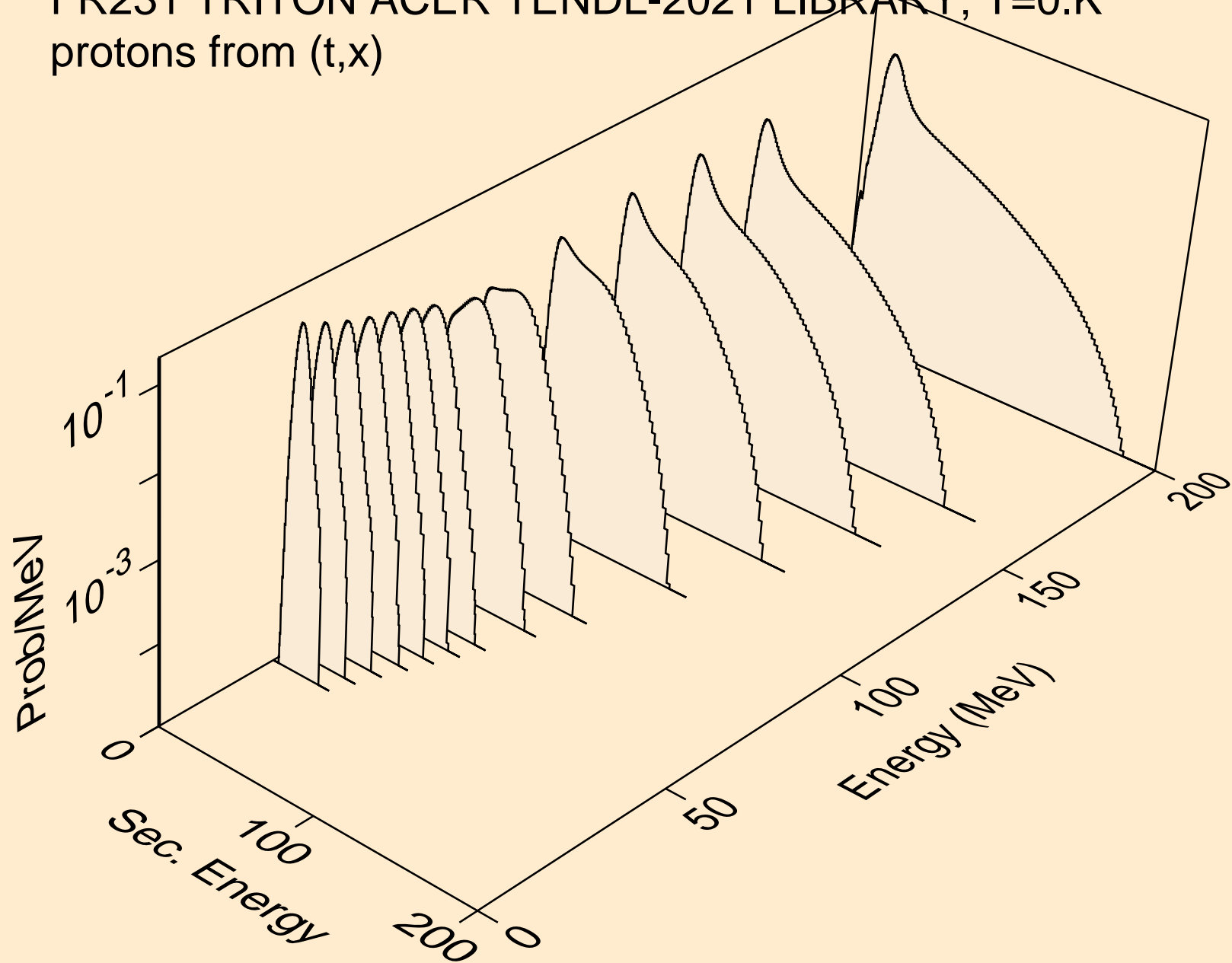

FR231 TRITON ACER TENDL-2021 LIBRARY; T=0.K  
protons from (t,n\*)p

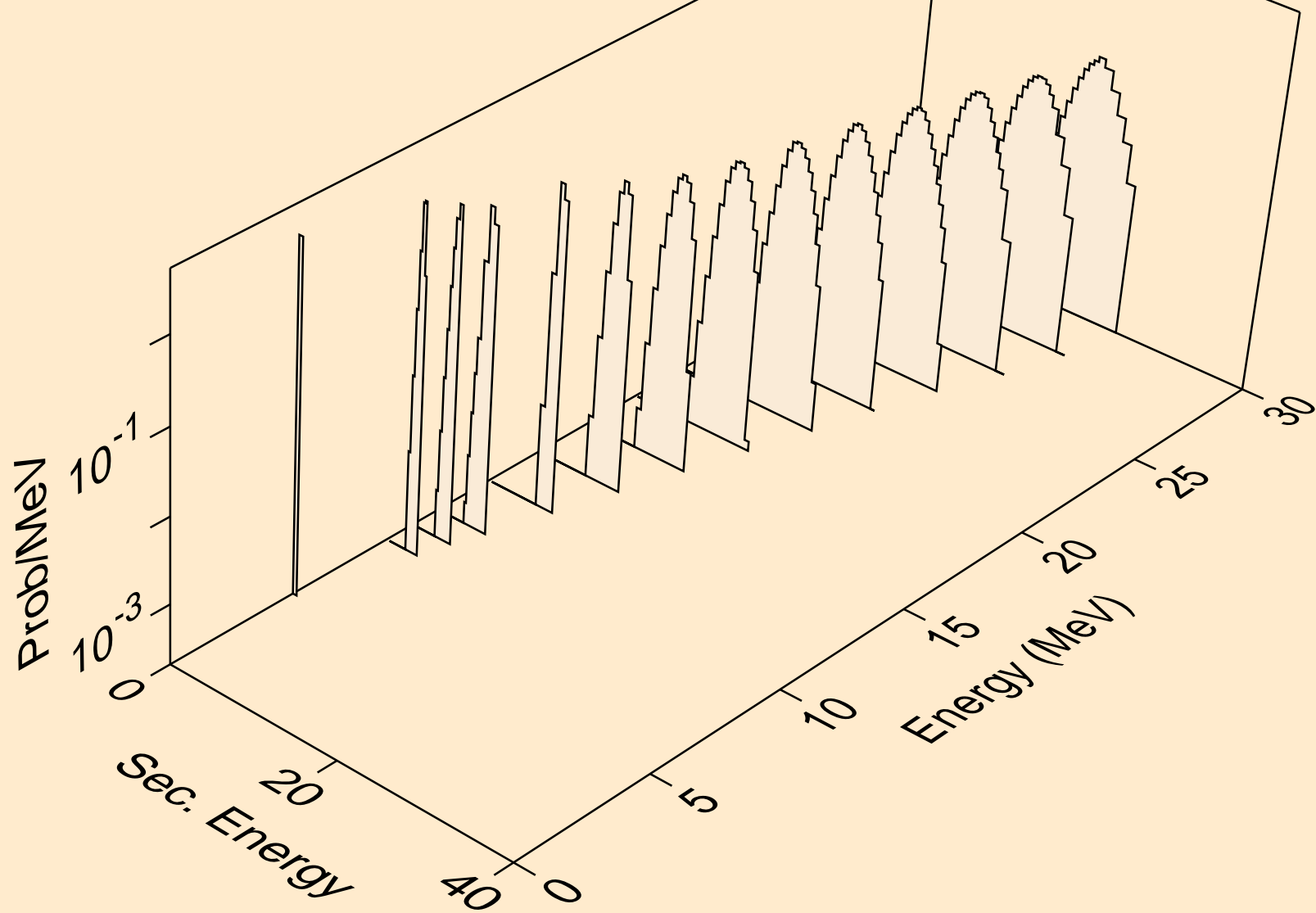

FR231 TRITON ACER TENDL-2021 LIBRARY; T=0.K  
protons from (t,2np)

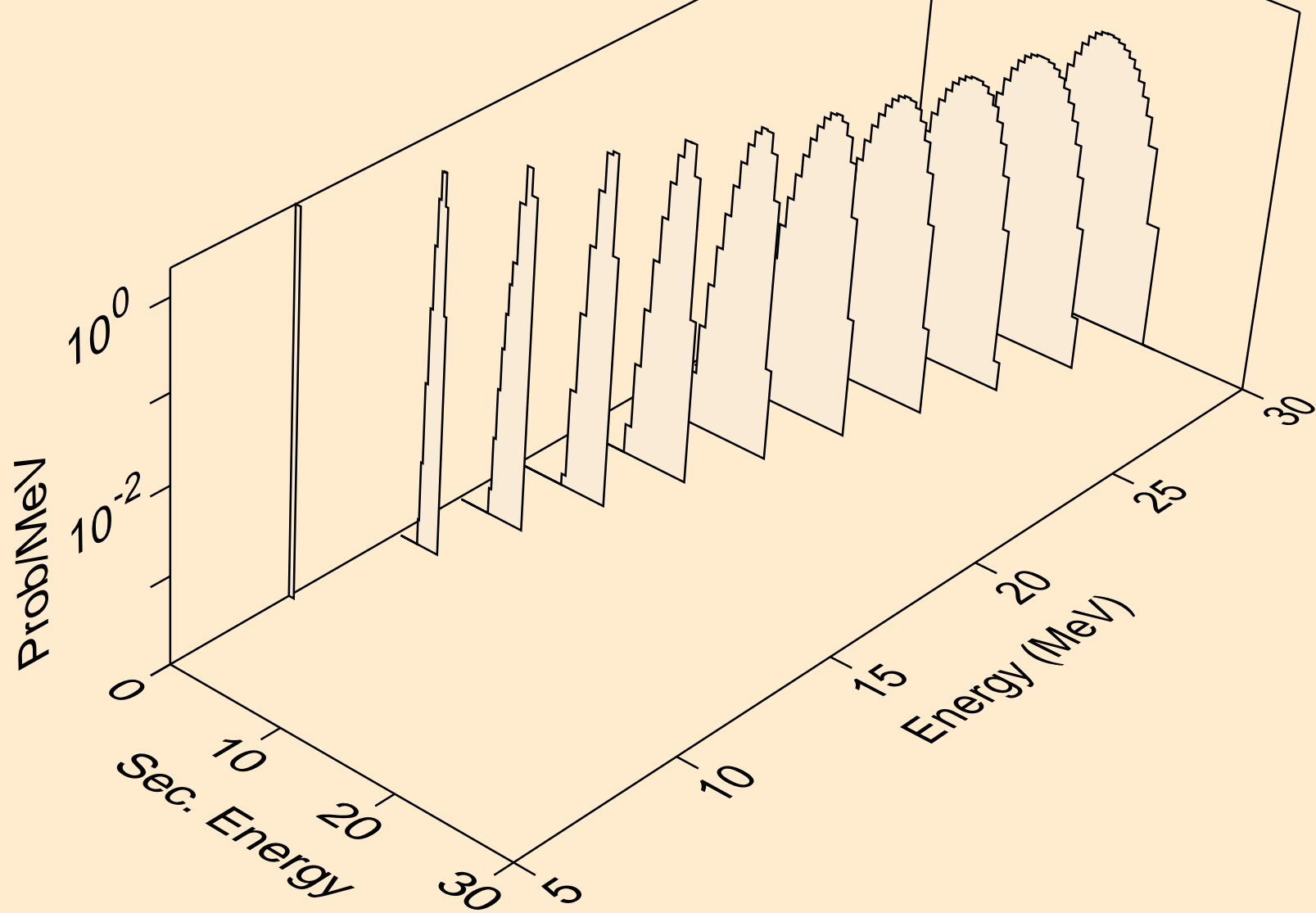

FR231 TRITON ACER TENDL-2021 LIBRARY; T=0.K  
protons from (t,3np)

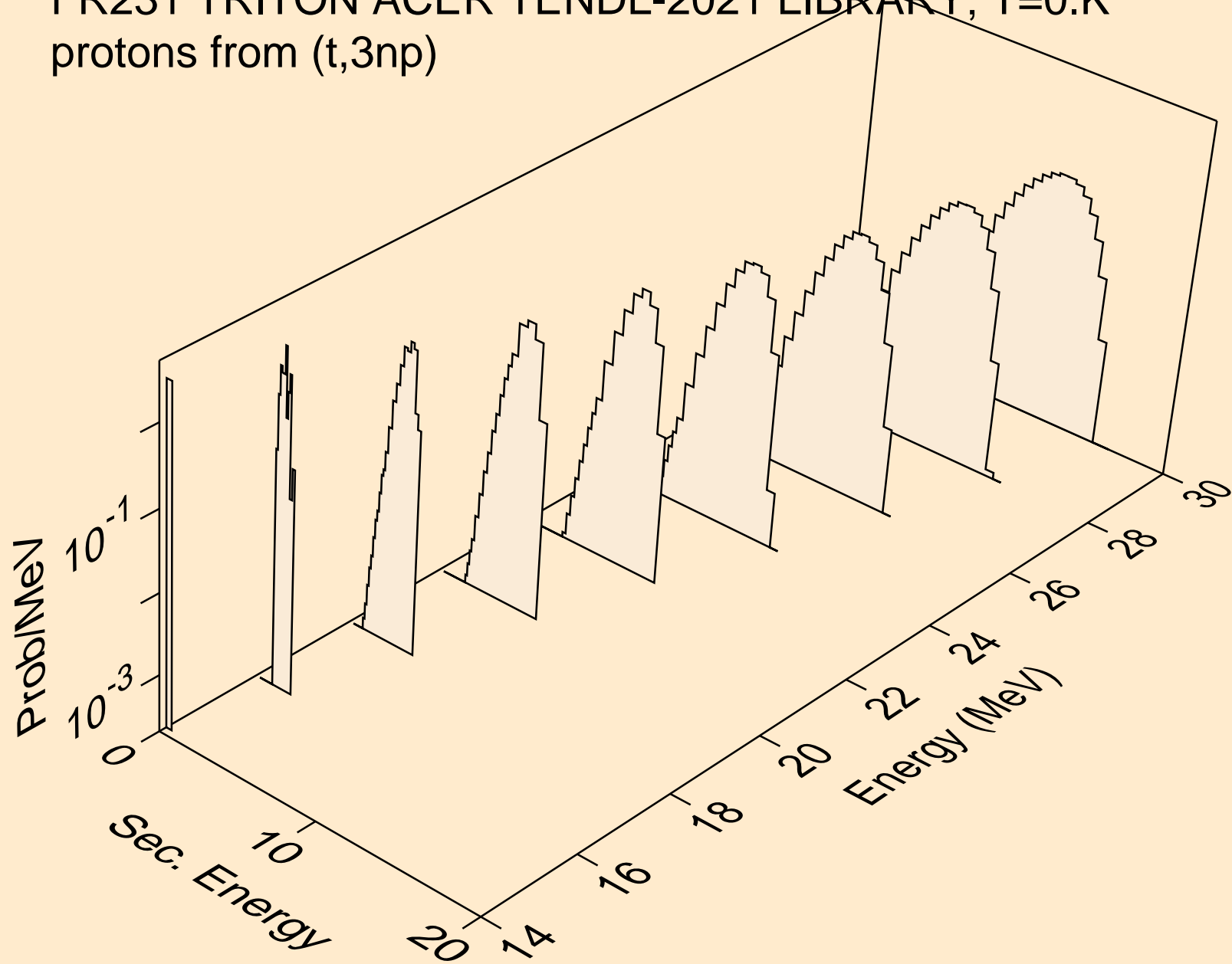

FR231 TRITON ACER TENDL-2021 LIBRARY; T=0.K  
protons from (t,2np)

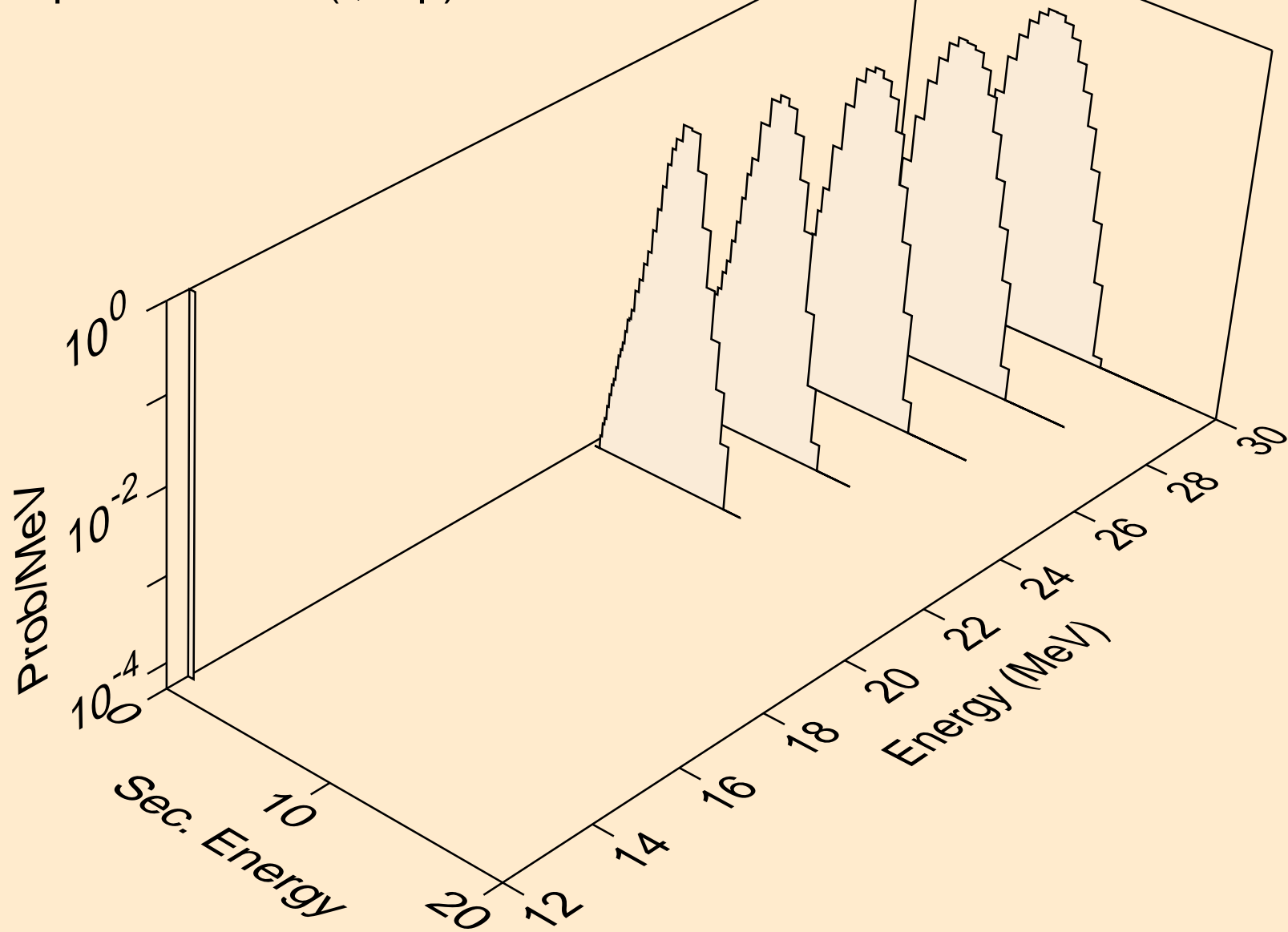

FR231 TRITON ACER TENDL-2021 LIBRARY; T=0.K  
protons from (t,p)

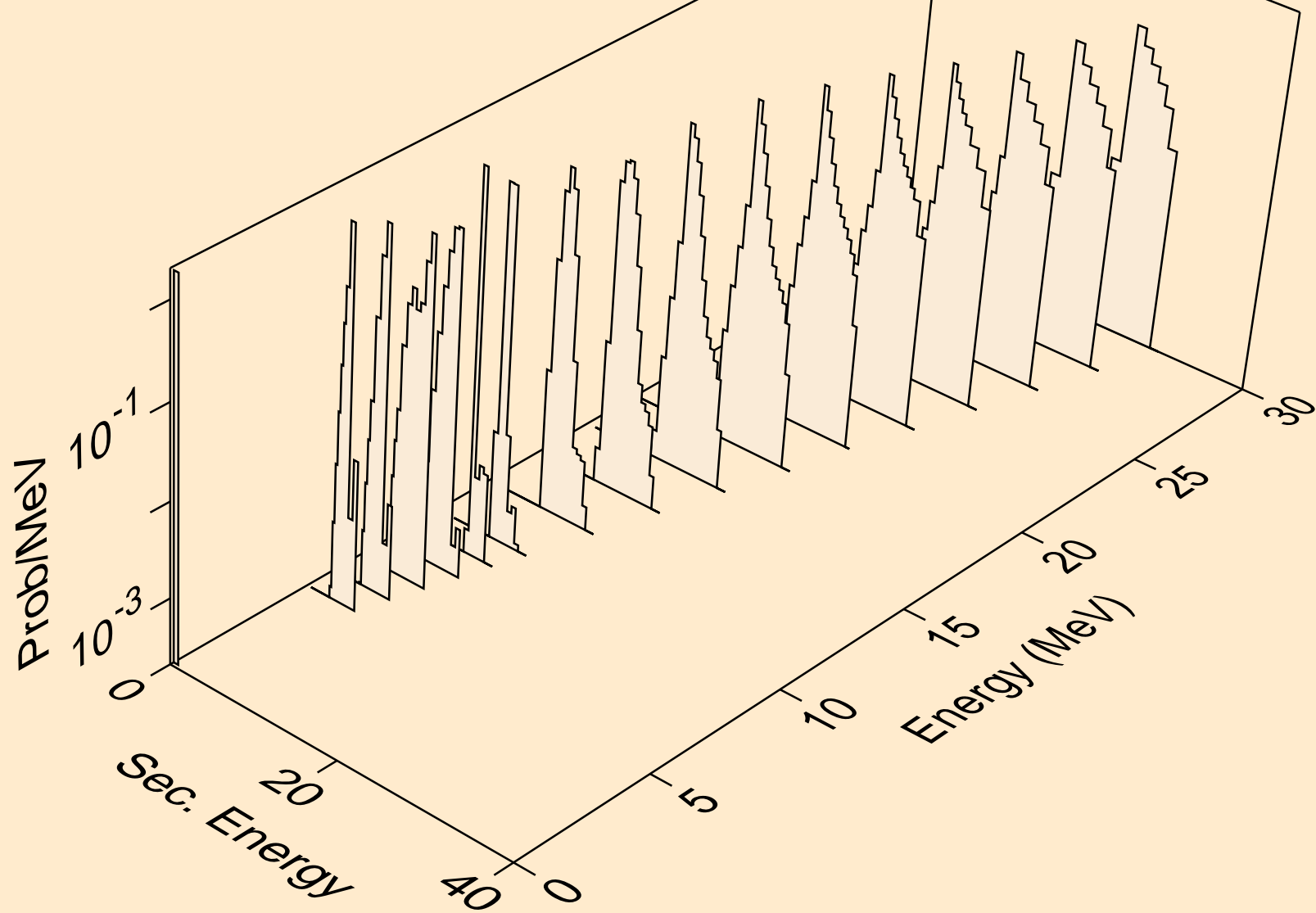

FR231 TRITON ACER TENDL-2021 LIBRARY; T=0.K  
protons from (t,2p)

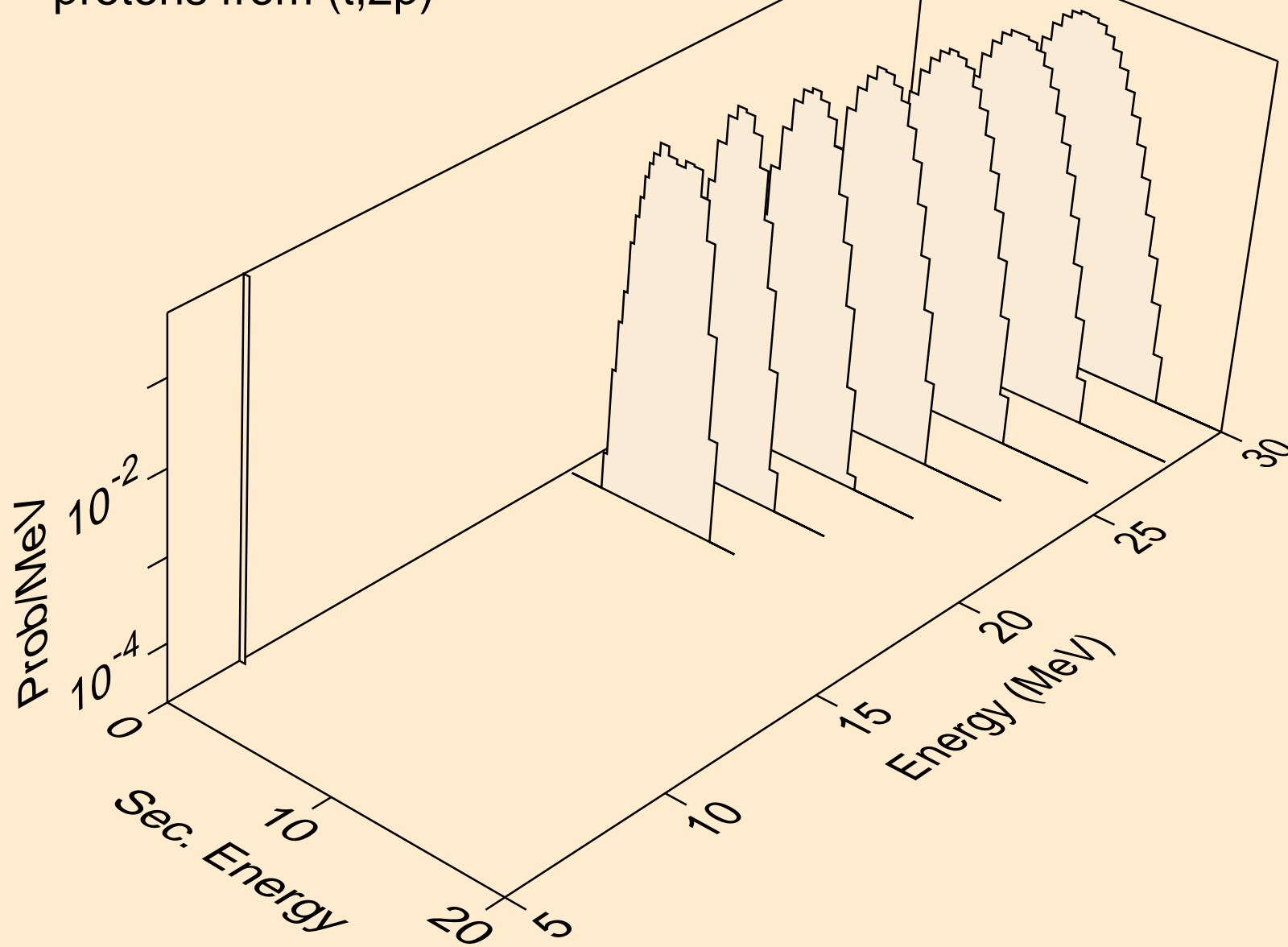



FR231 TRITON ACER TENDL-2021 LIBRARY; T=0.K  
deuterons from (t,x)

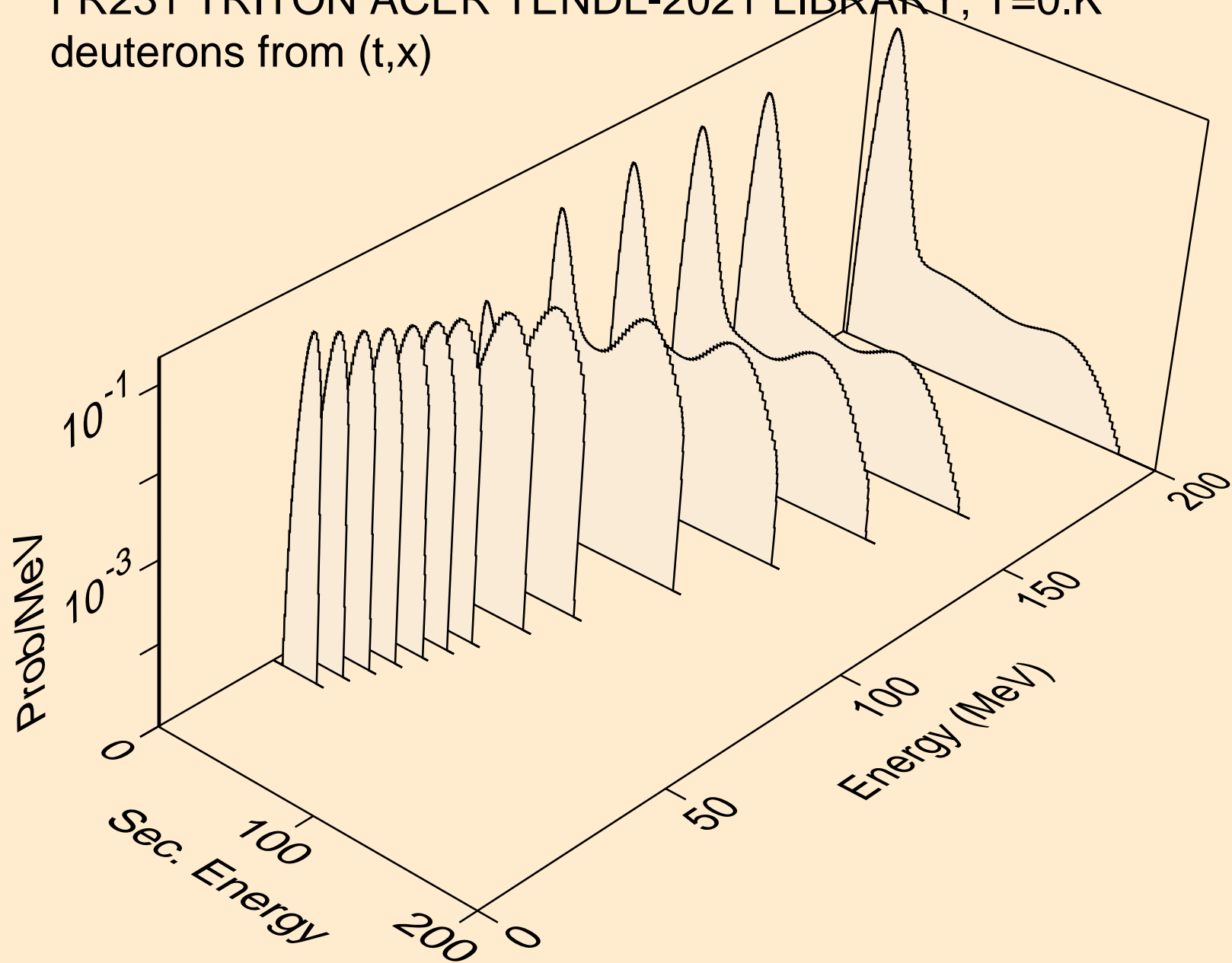

FR231 TRITON ACER TENDL-2021 LIBRARY; T=0.K  
deuterons from (t,2nd)

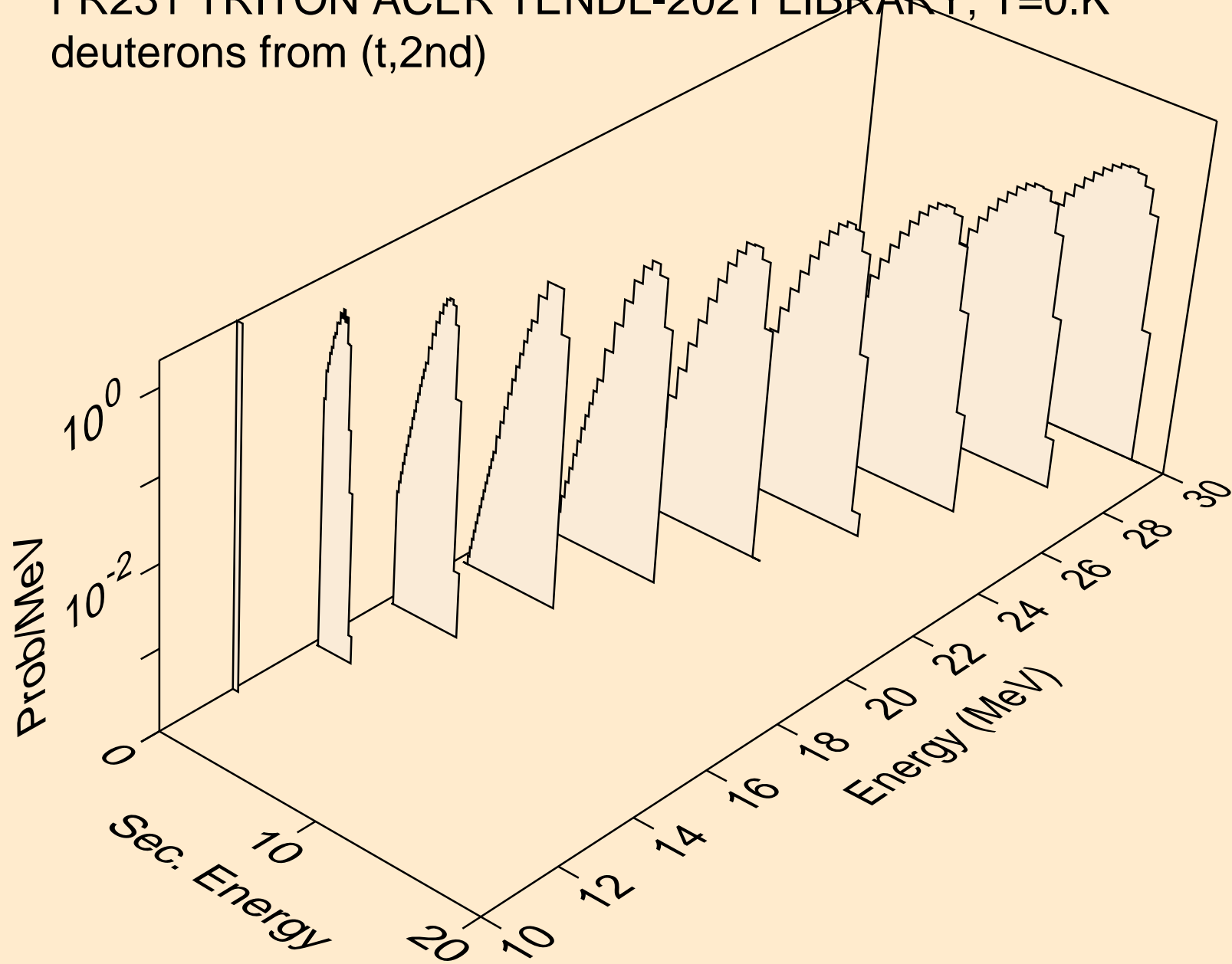

FR231 TRITON ACER TENDL-2021 LIBRARY; T=0.K  
deuterons from (t,n\*)d

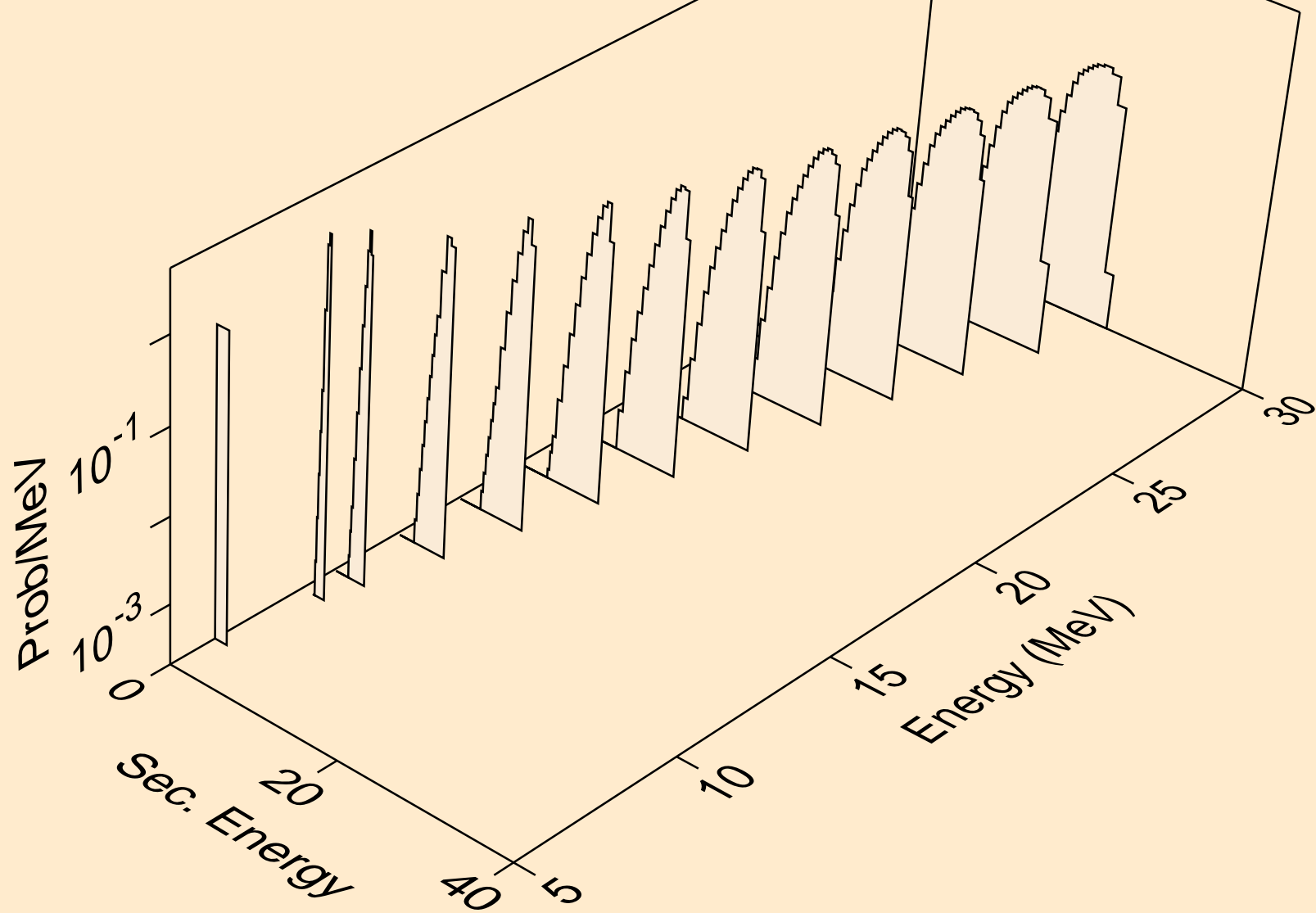

FR231 TRITON ACER TENDL-2021 LIBRARY; T=0.K  
deuterons from (t,d)

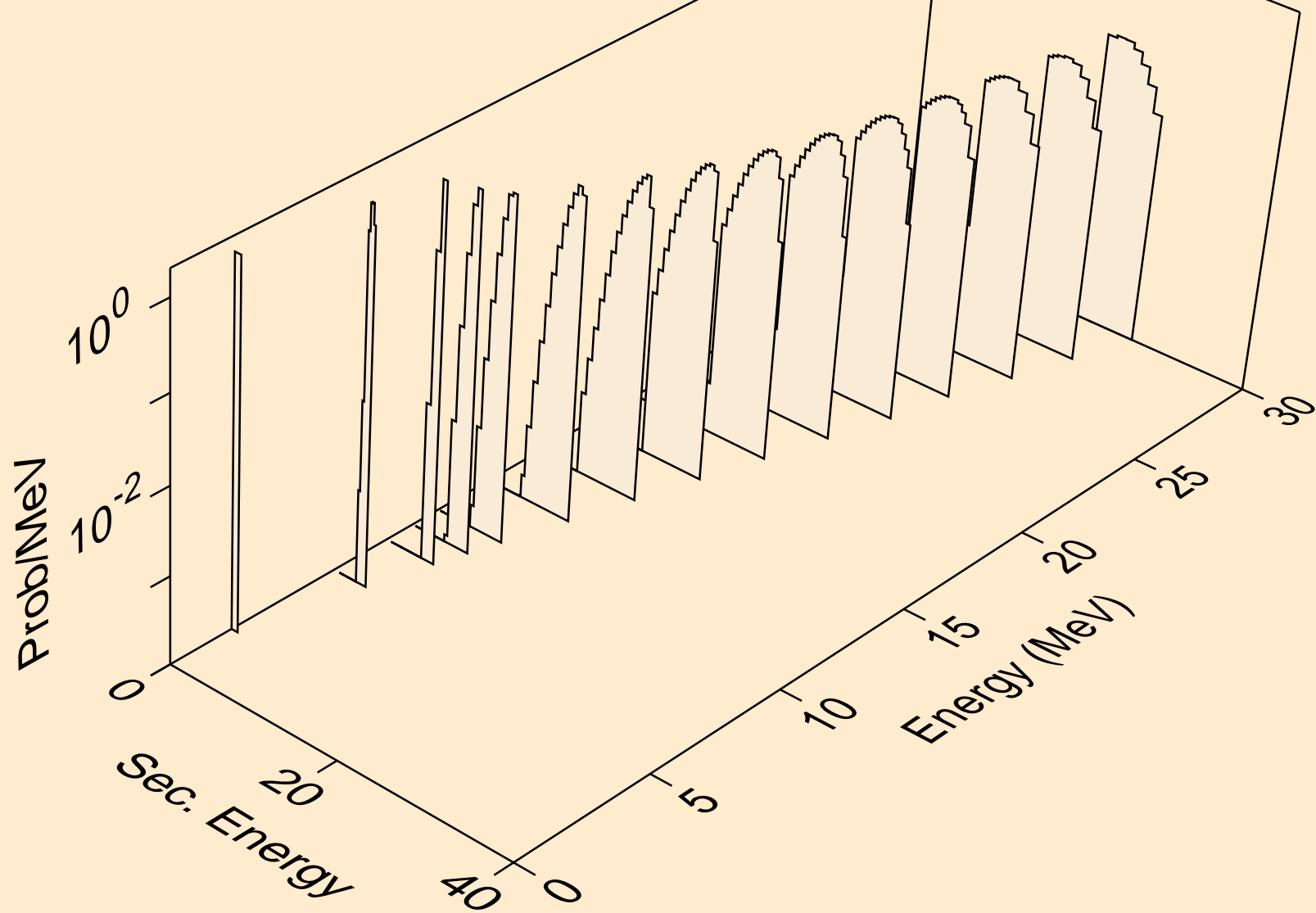

FR231 TRITON ACER TENDL-2021 LIBRARY; T=0.K  
he3s from (t,x)

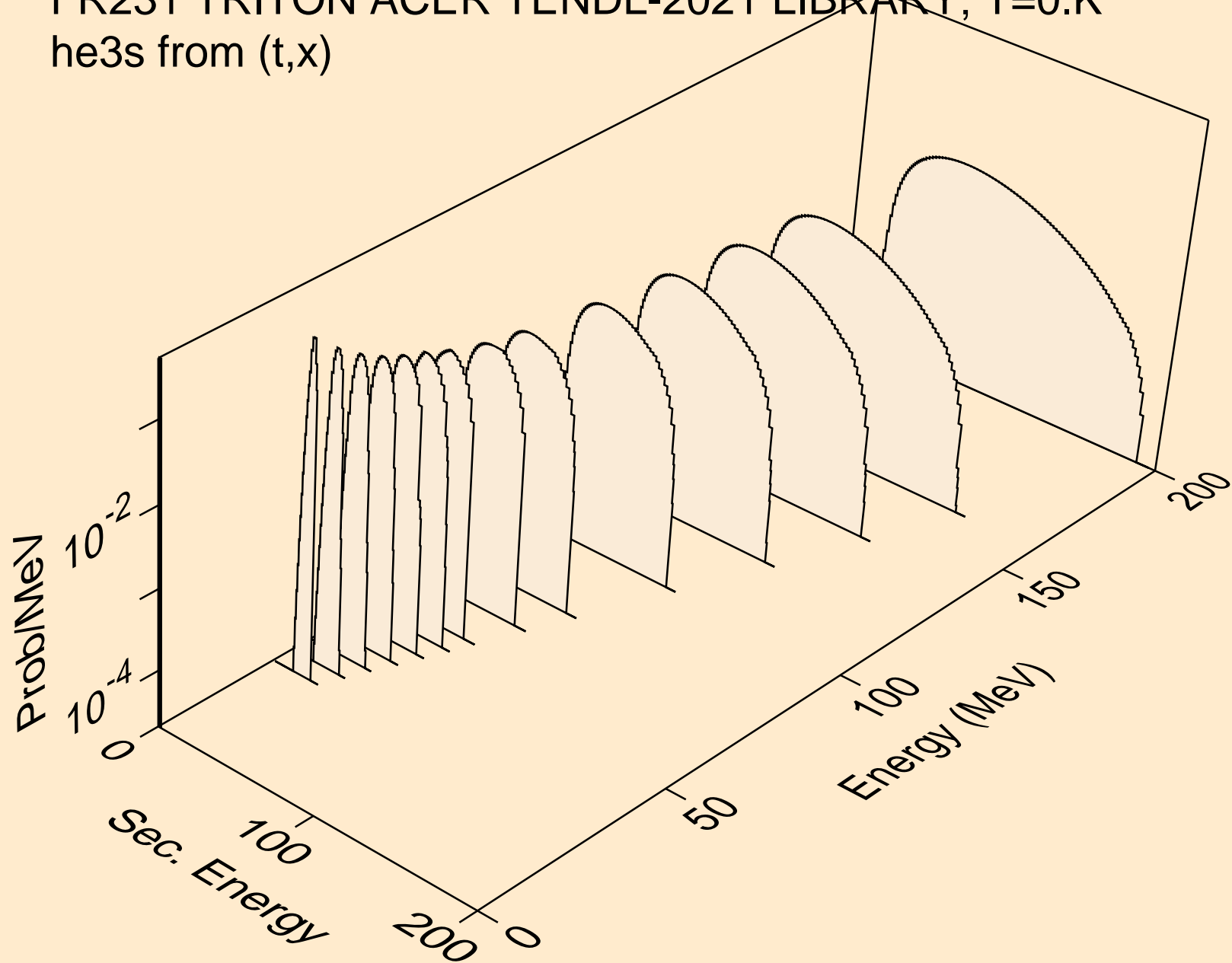

FR231 TRITON ACER TENDL-2021 LIBRARY; T=0.K  
he3s from (t,n\*)he3

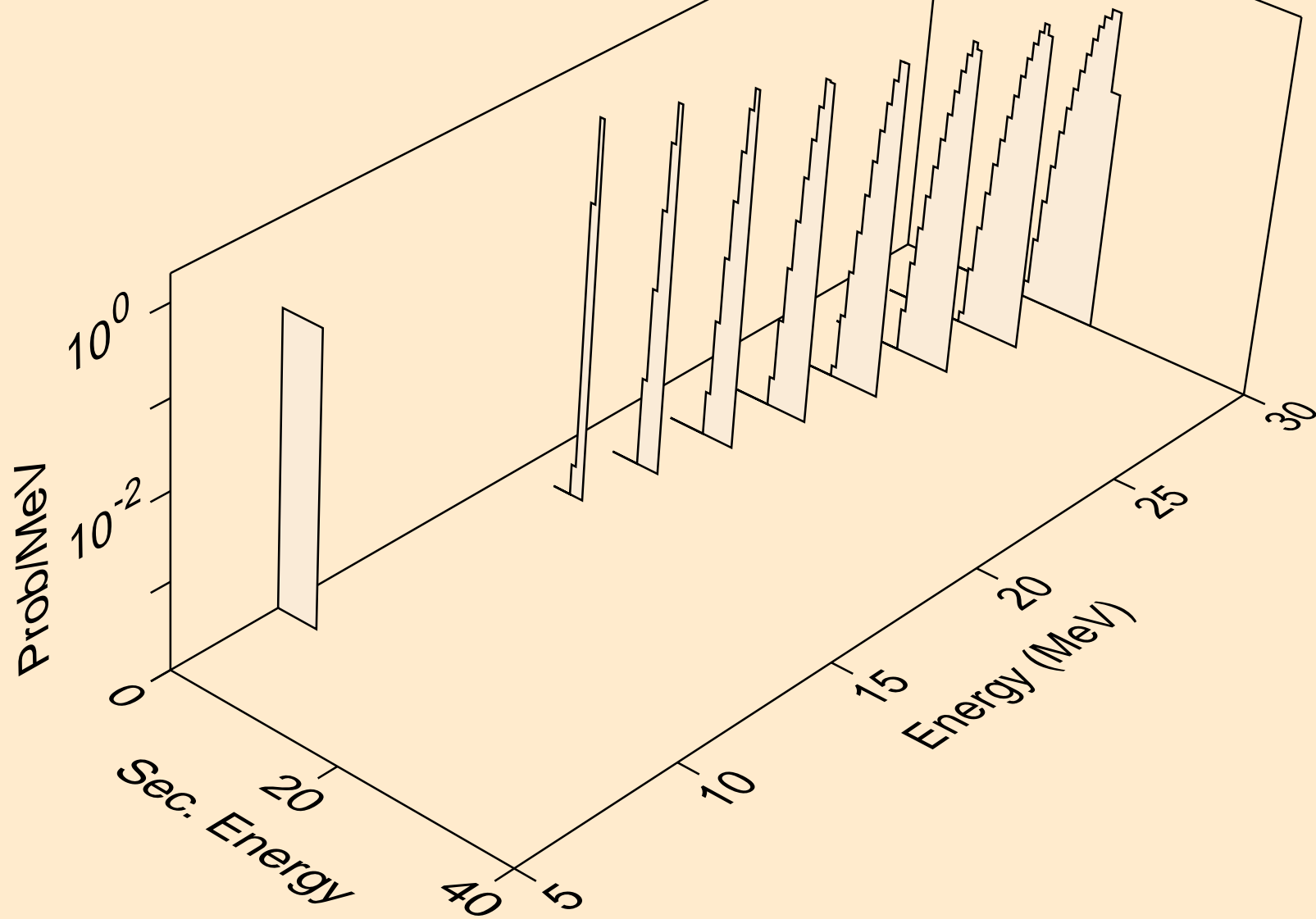

FR231 TRITON ACER TENDL-2021 LIBRARY; T=0.K  
he3s from (t,he3)

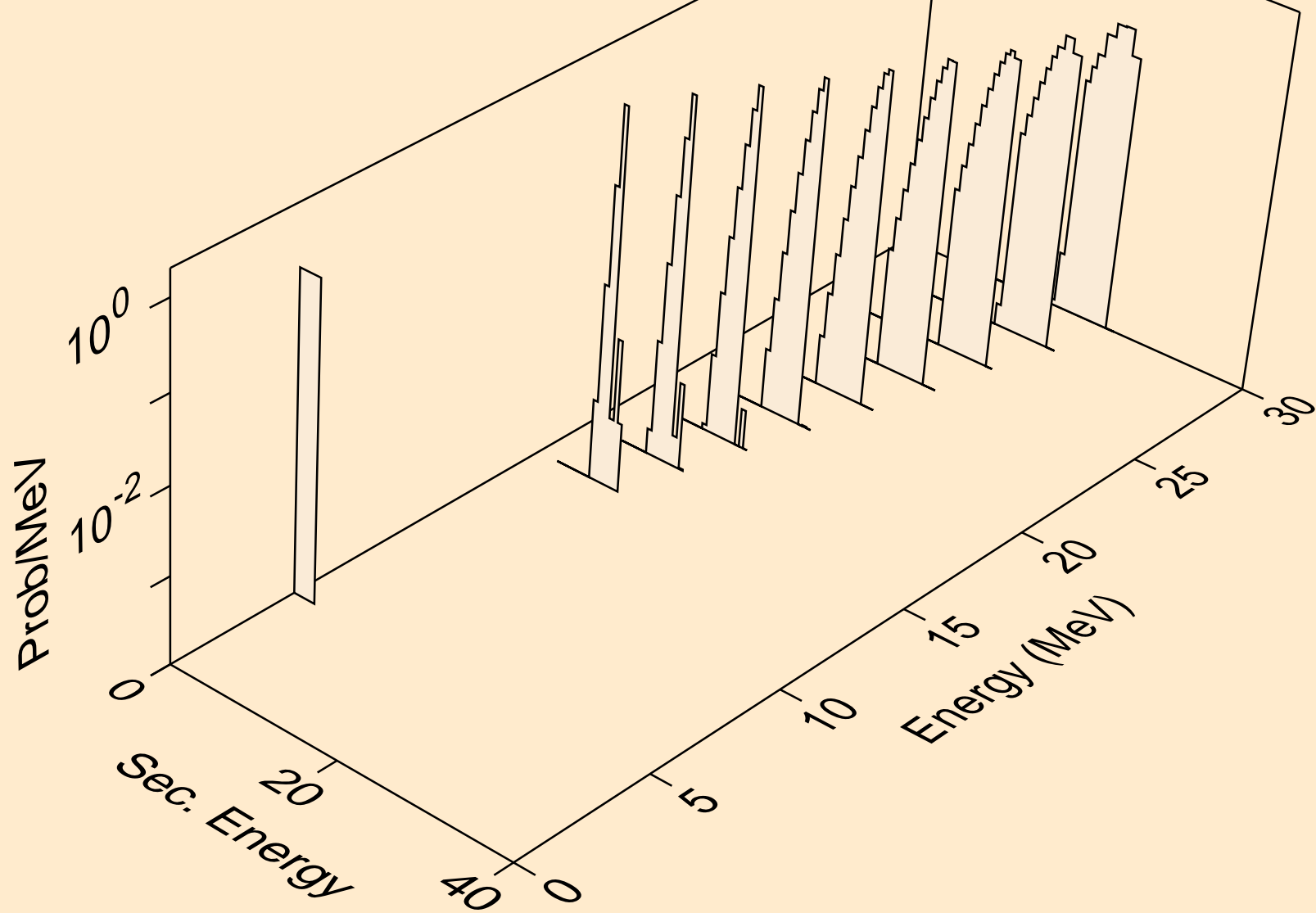

FR231 TRITON ACER TENDL-2021 LIBRARY; T=0.K  
alphas from (t,x)

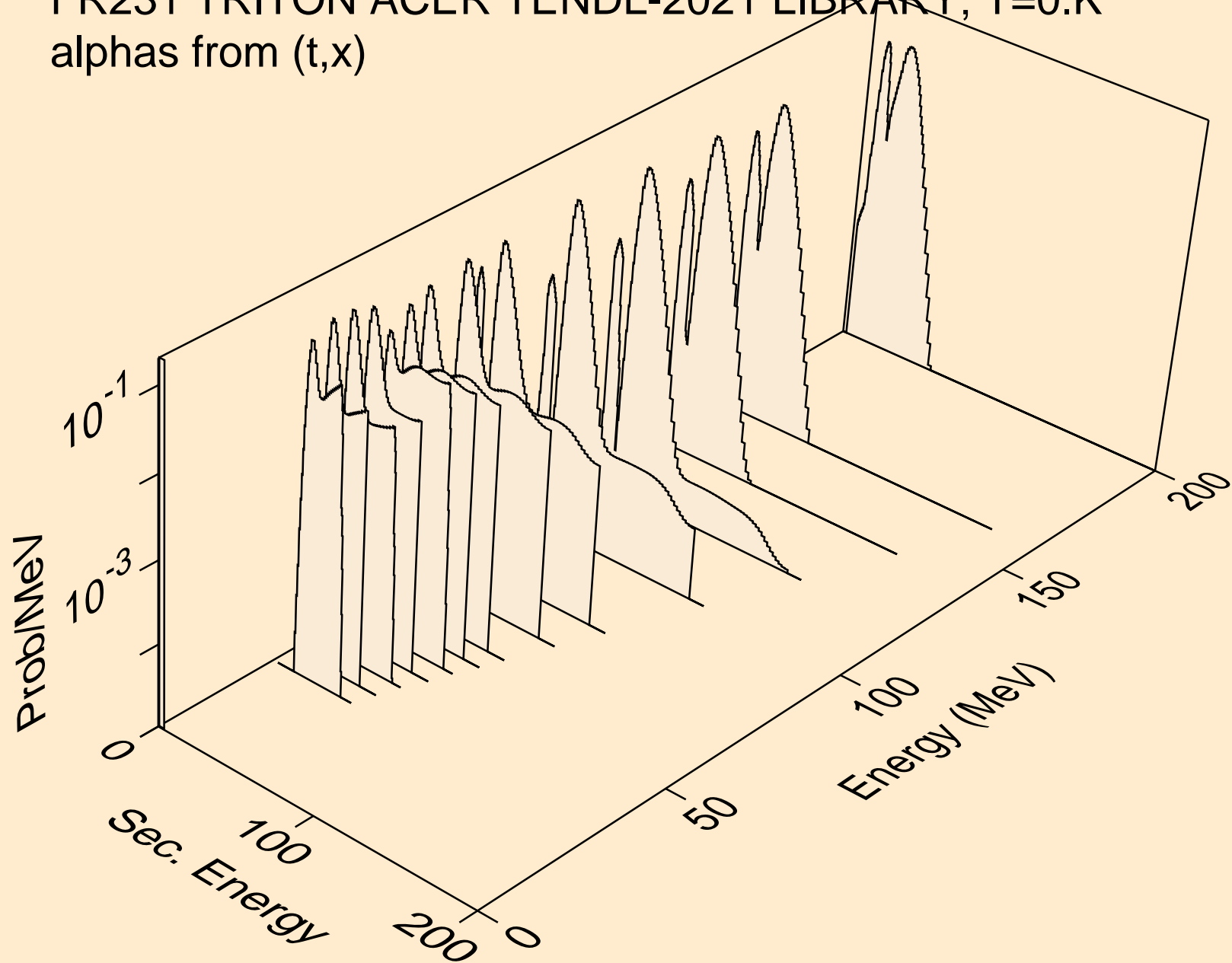



FR231 TRITON ACER TENDL-2021 LIBRARY; T=0.K  
alphas from (t,n\*)a

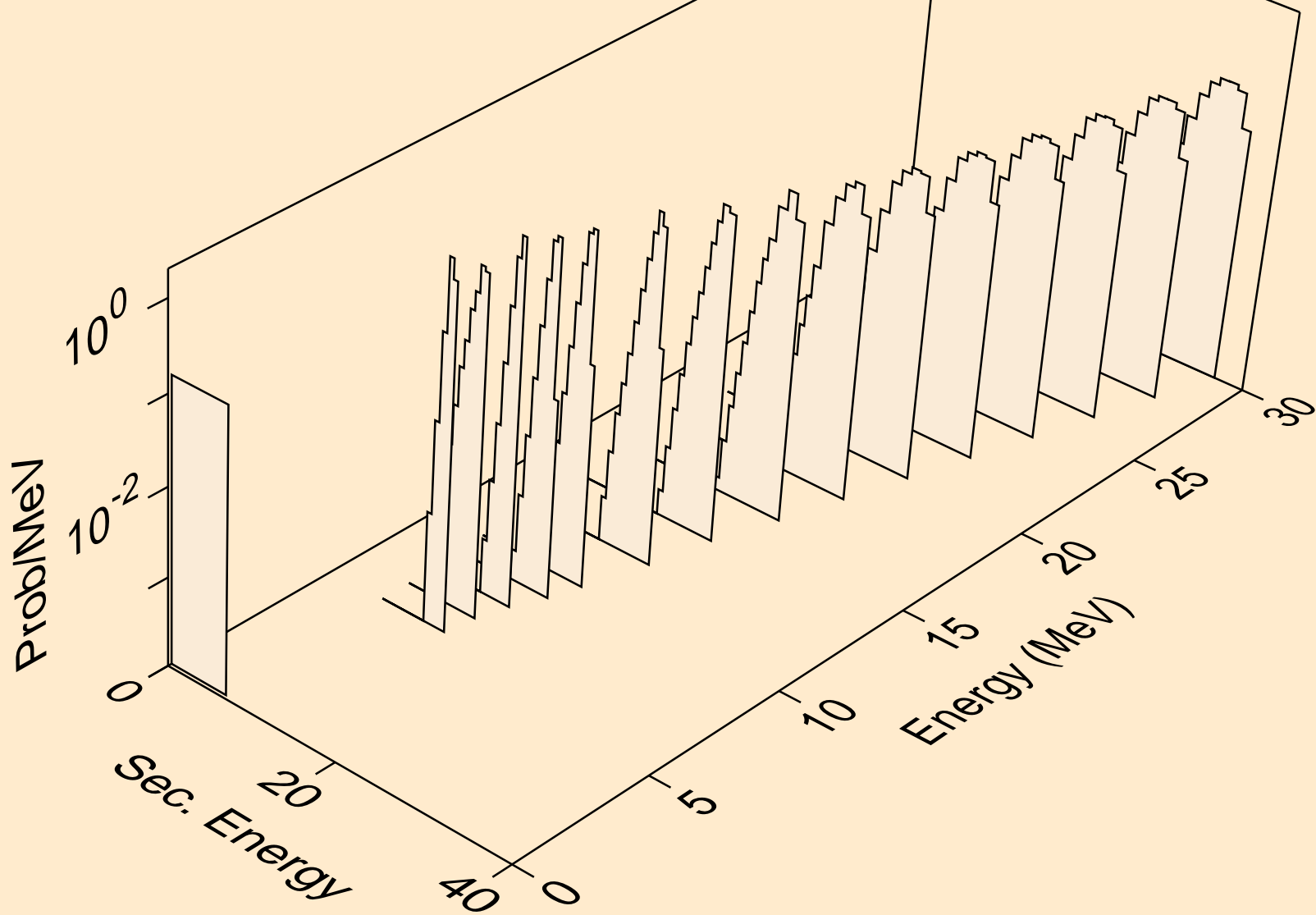

FR231 TRITON ACER TENDL-2021 LIBRARY; T=0.K  
alphas from (t,2n)a

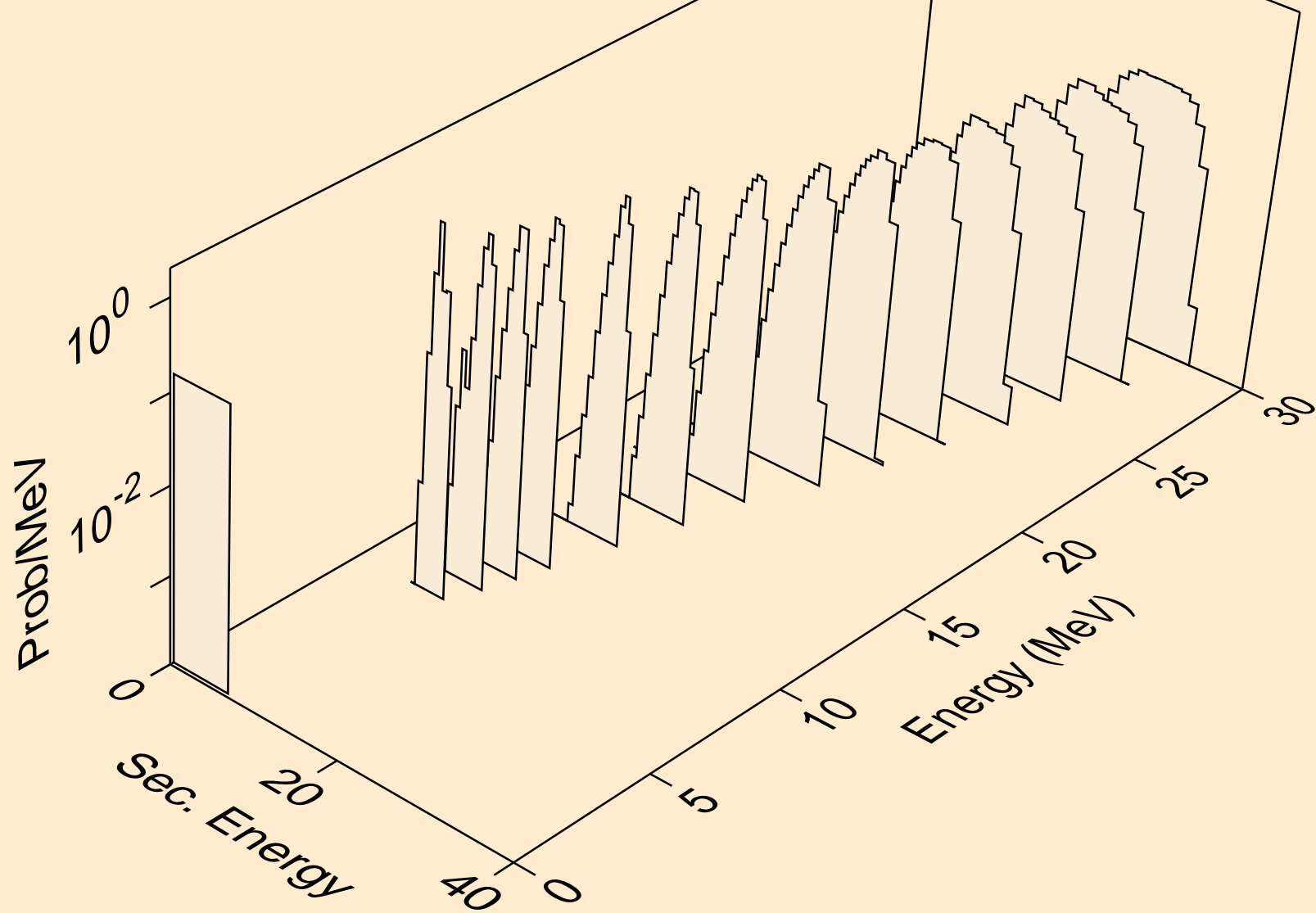

FR231 TRITON ACER TENDL-2021 LIBRARY; T=0.K  
alphas from (t,3n)a

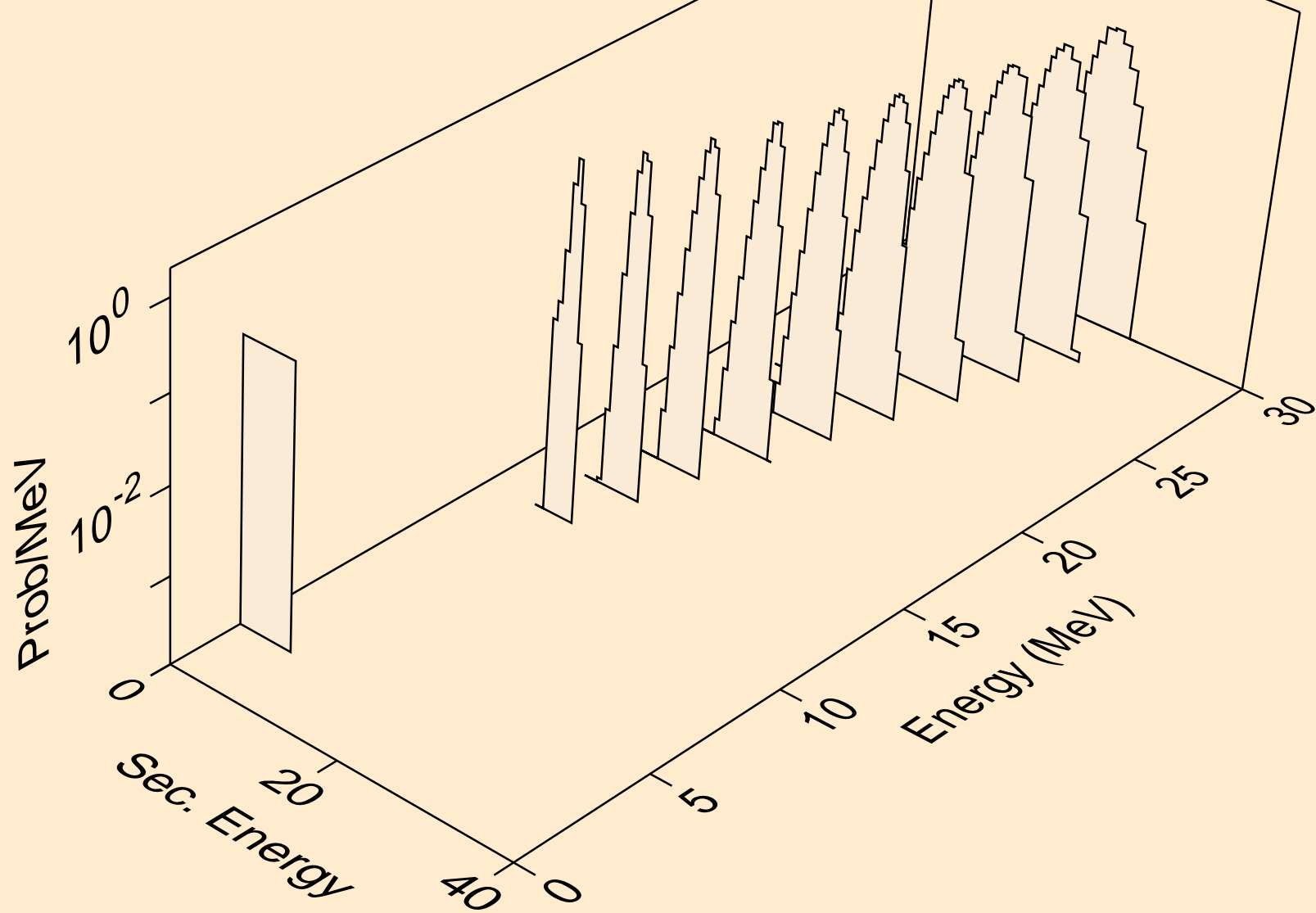

FR231 TRITON ACER TENDL-2021 LIBRARY; T=0.K  
alphas from (t,a)

