

IN127 TRITON ACER TENDL-2021 LIBRARY; T=0.K  
Principal cross sections

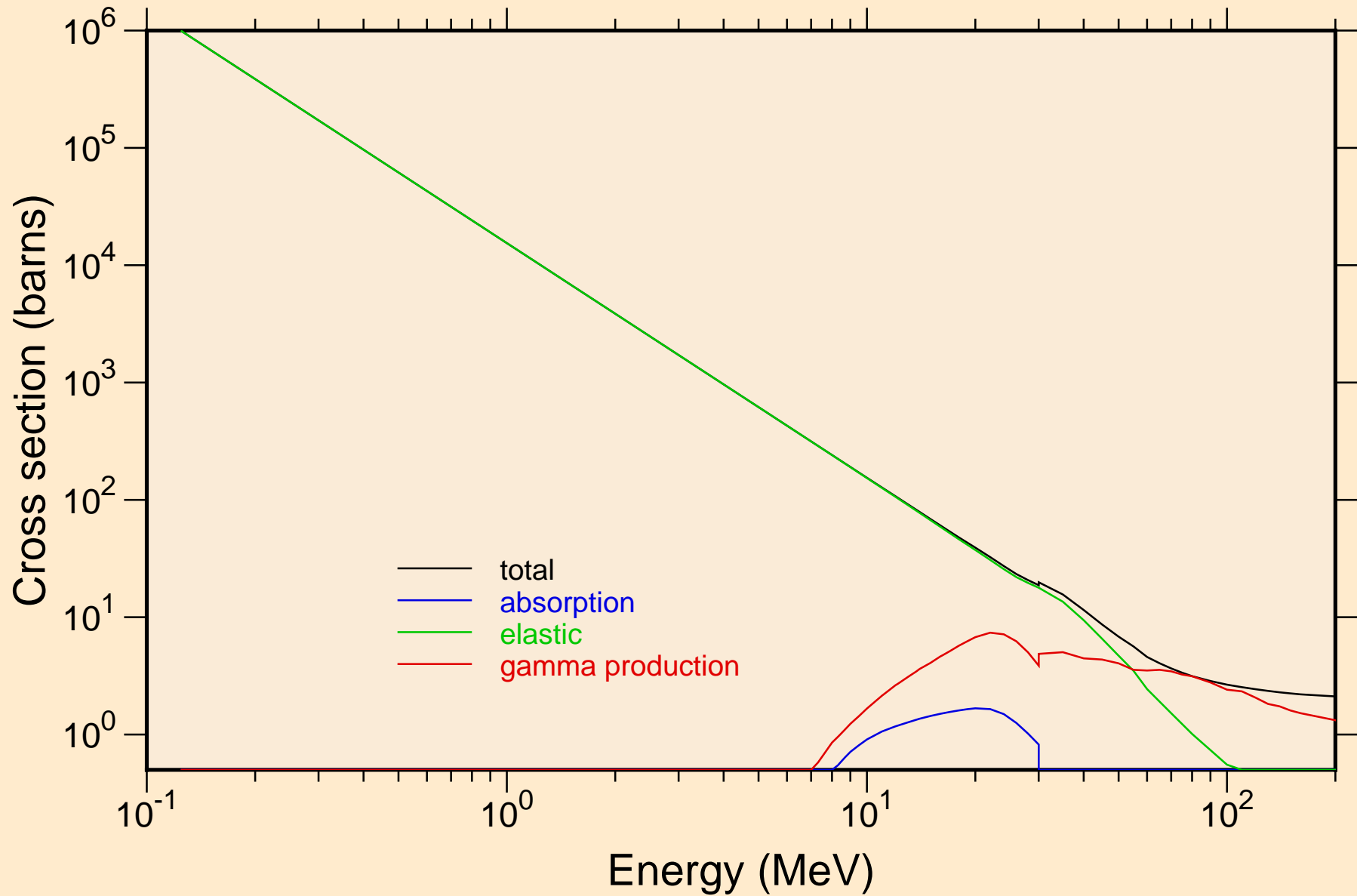

IN127 TRITON ACER TENDL-2021 LIBRARY; T=0.K

Heating

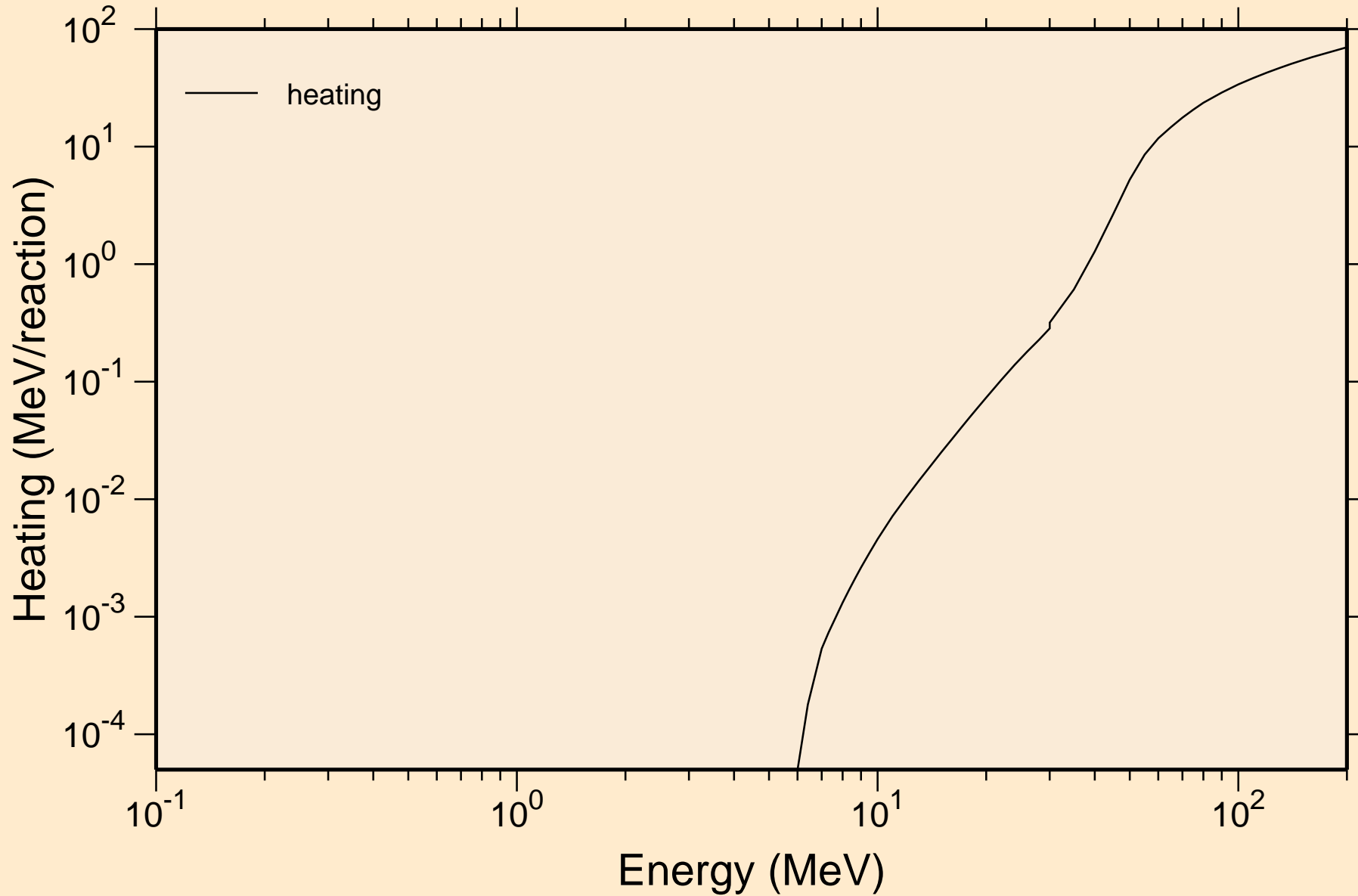

# IN127 TRITON ACER TENDL-2021 LIBRARY; T=0.K

## Principal cross sections

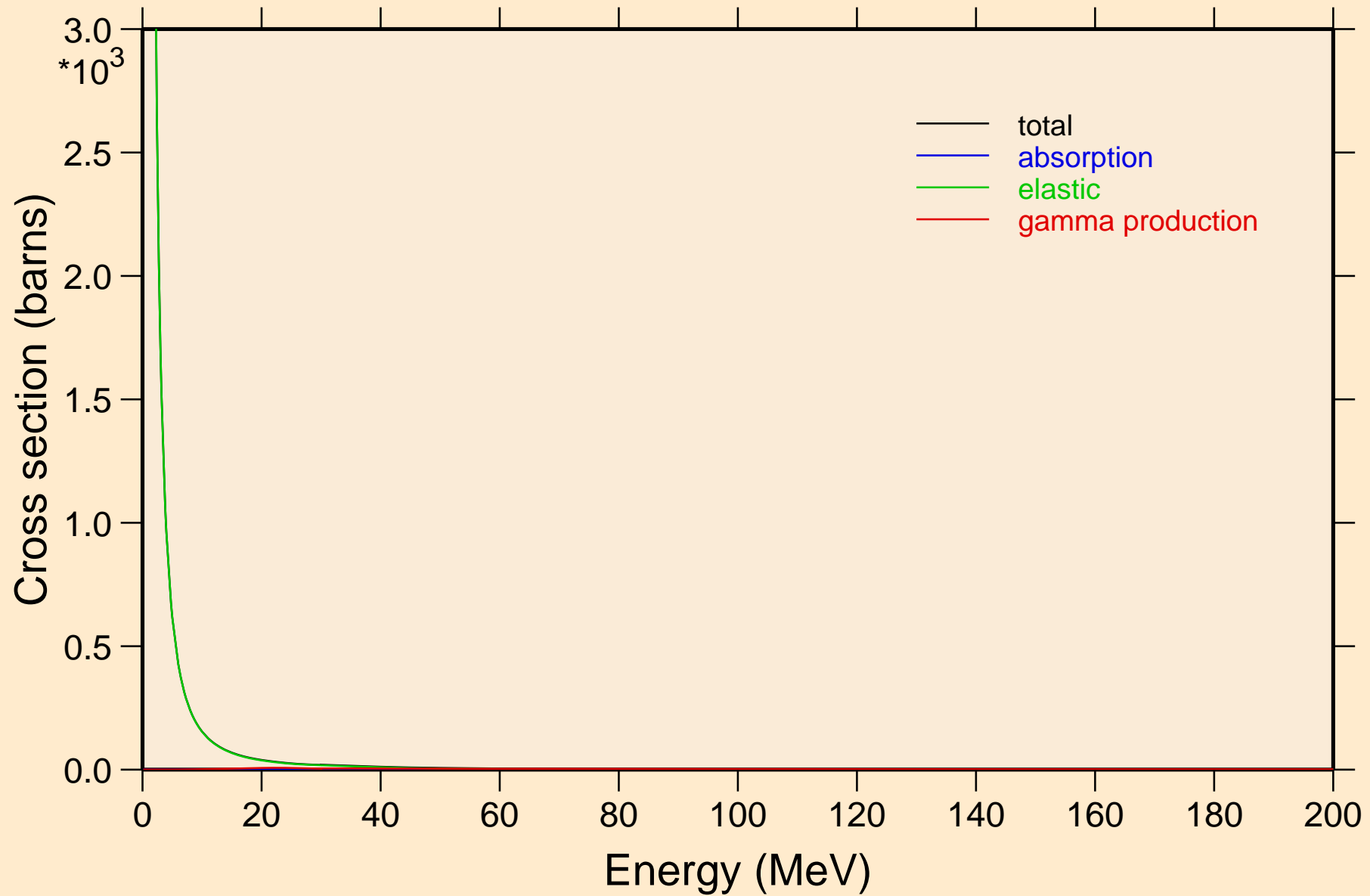

IN127 TRITON ACER TENDL-2021 LIBRARY; T=0.K

Heating

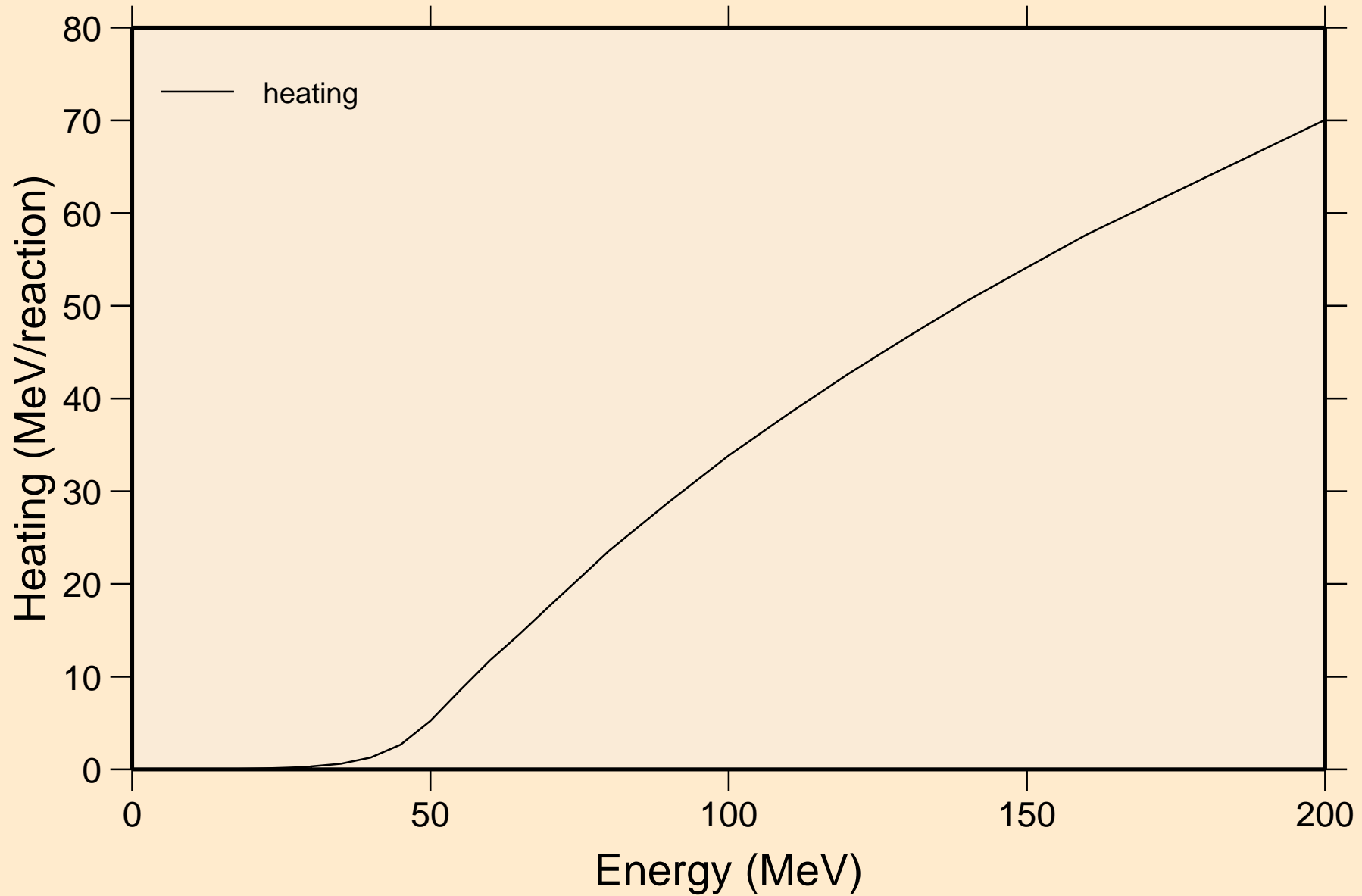

IN127 TRITON ACER TENDL-2021 LIBRARY; T=0.K  
Threshold reactions

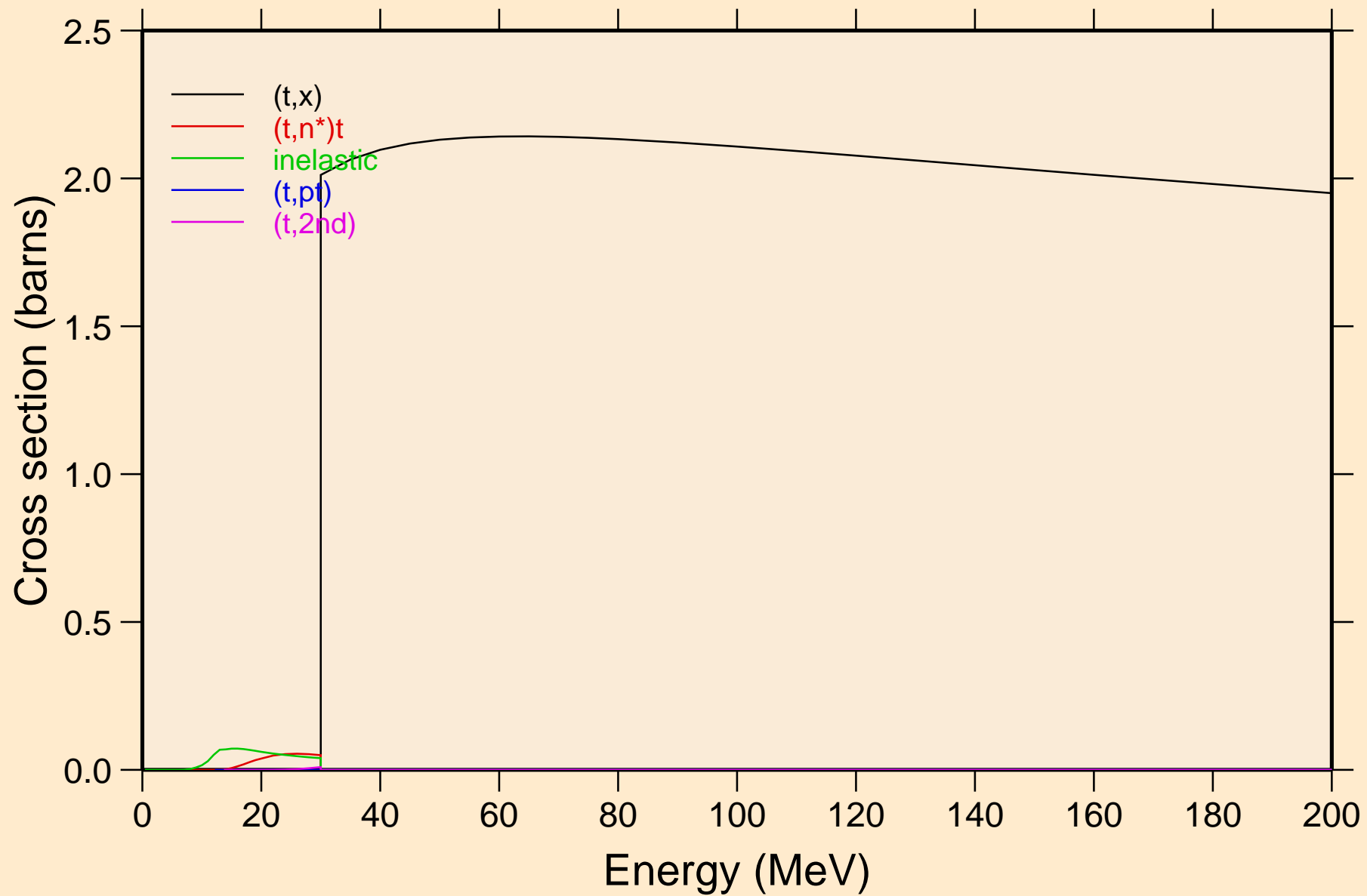

IN127 TRITON ACER TENDL-2021 LIBRARY; T=0.K  
Threshold reactions

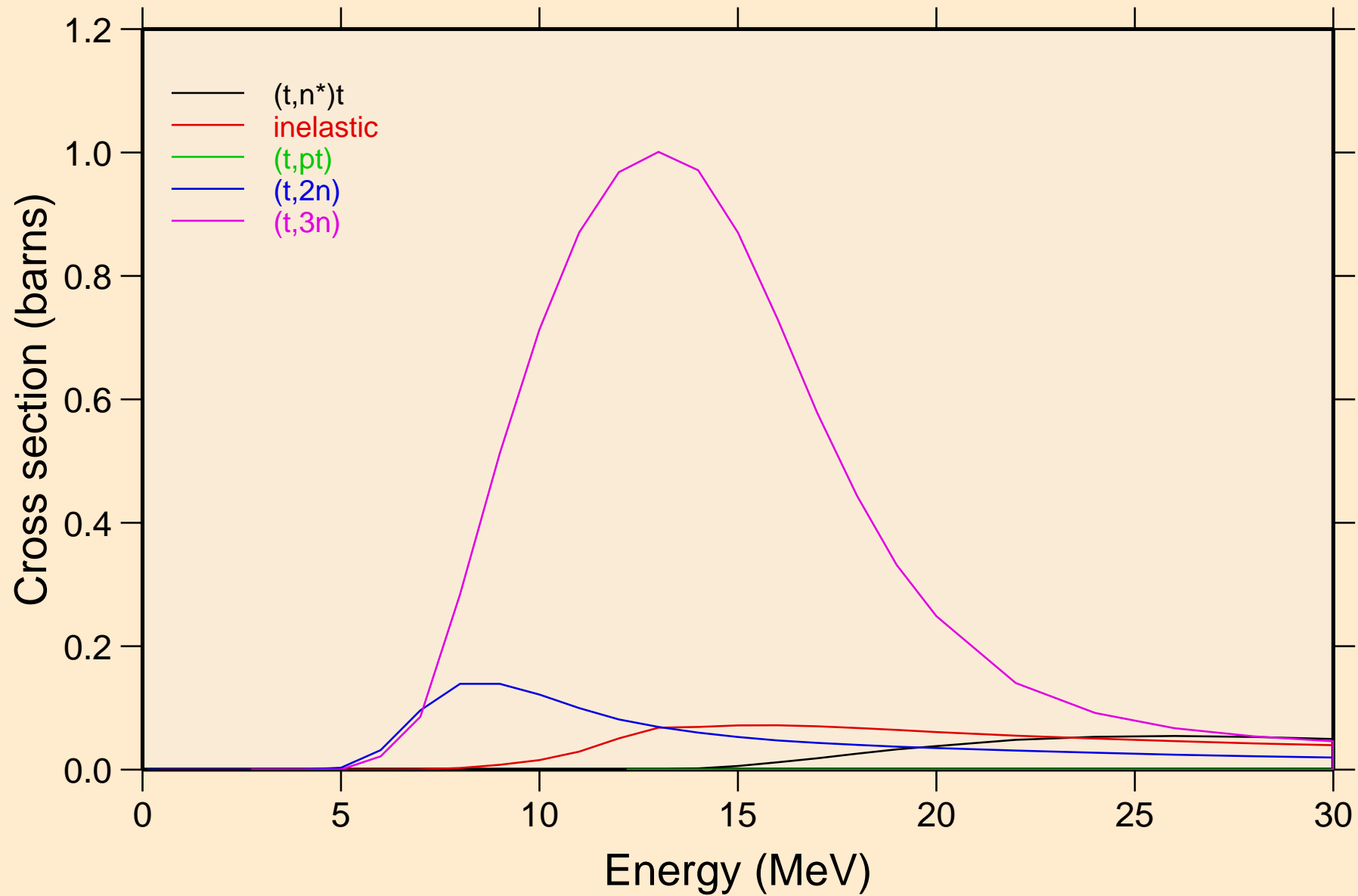

IN127 TRITON ACER TENDL-2021 LIBRARY; T=0.K  
Threshold reactions

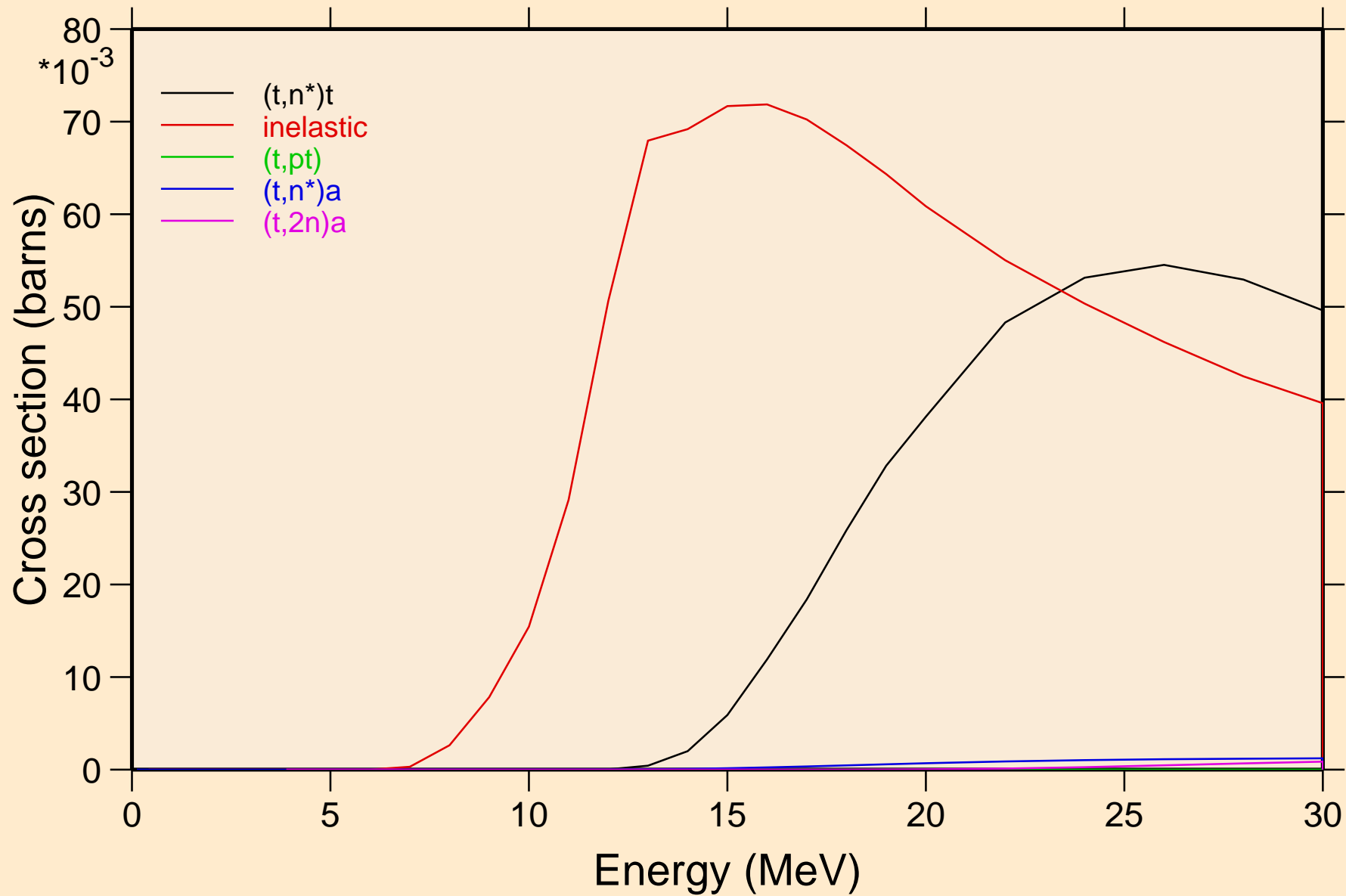

IN127 TRITON ACER TENDL-2021 LIBRARY; T=0.K  
Threshold reactions

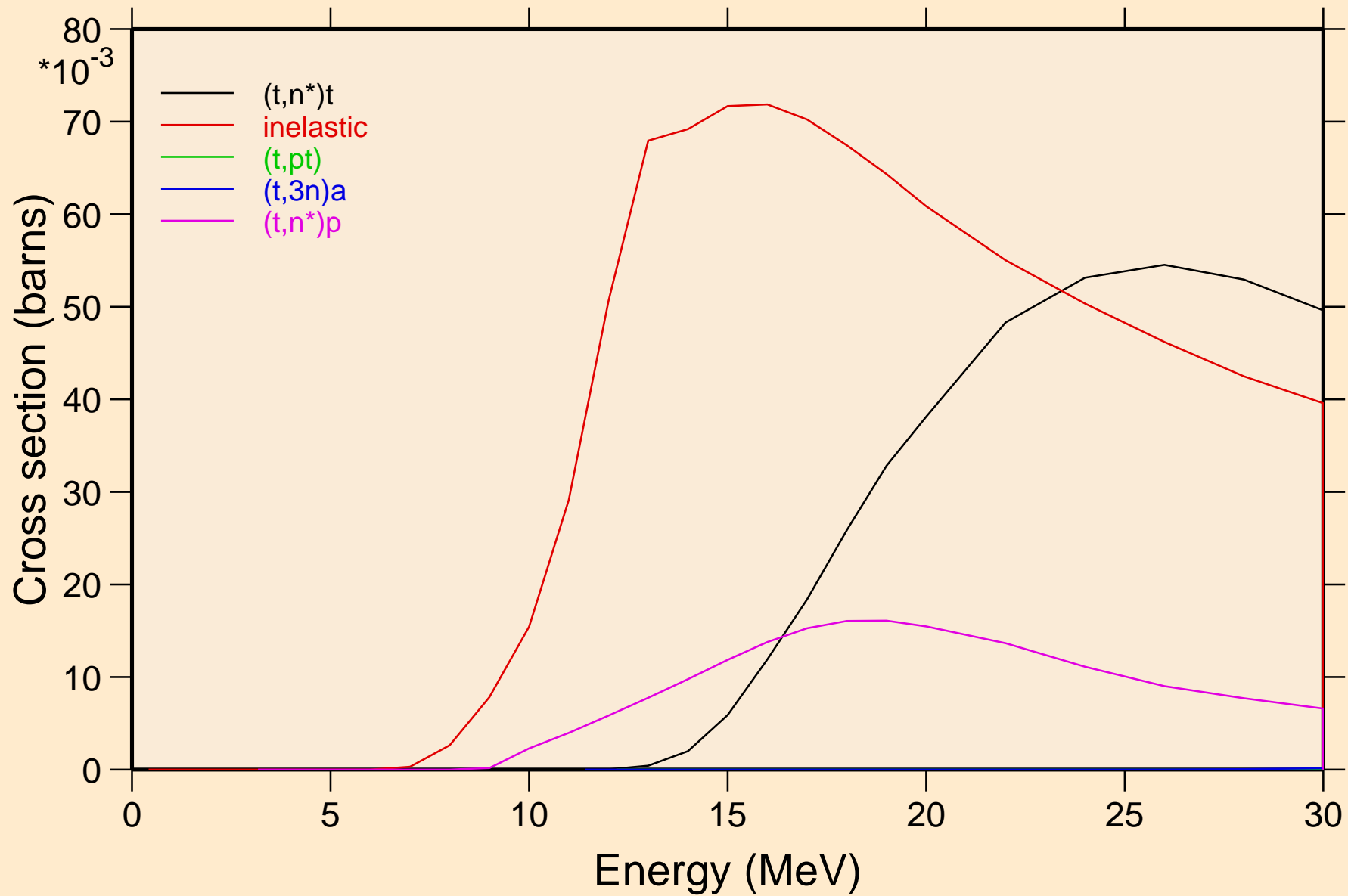



IN127 TRITON ACER TENDL-2021 LIBRARY; T=0.K  
Threshold reactions

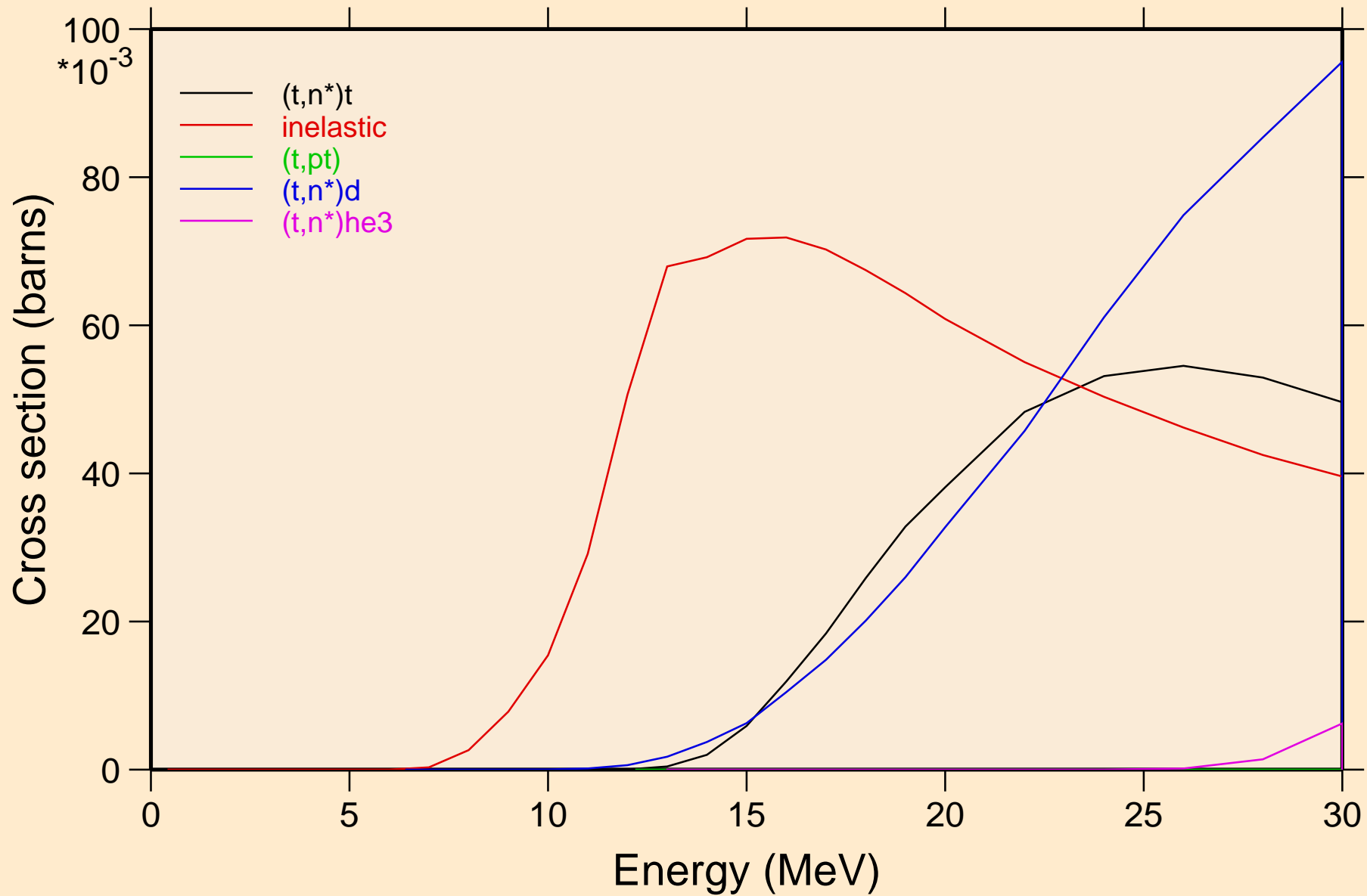

IN127 TRITON ACER TENDL-2021 LIBRARY; T=0.K  
Threshold reactions

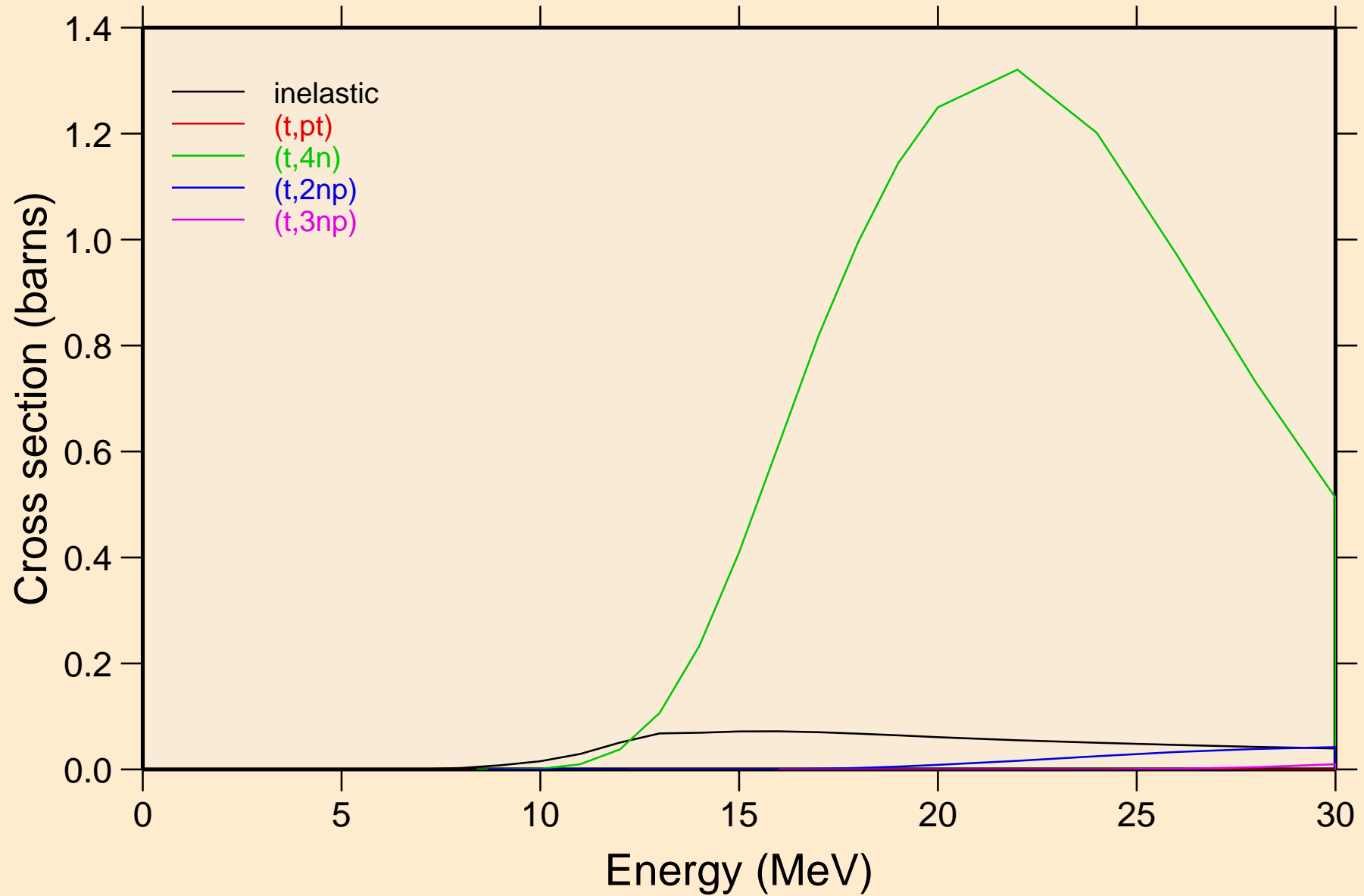

IN127 TRITON ACER TENDL-2021 LIBRARY; T=0.K  
Threshold reactions

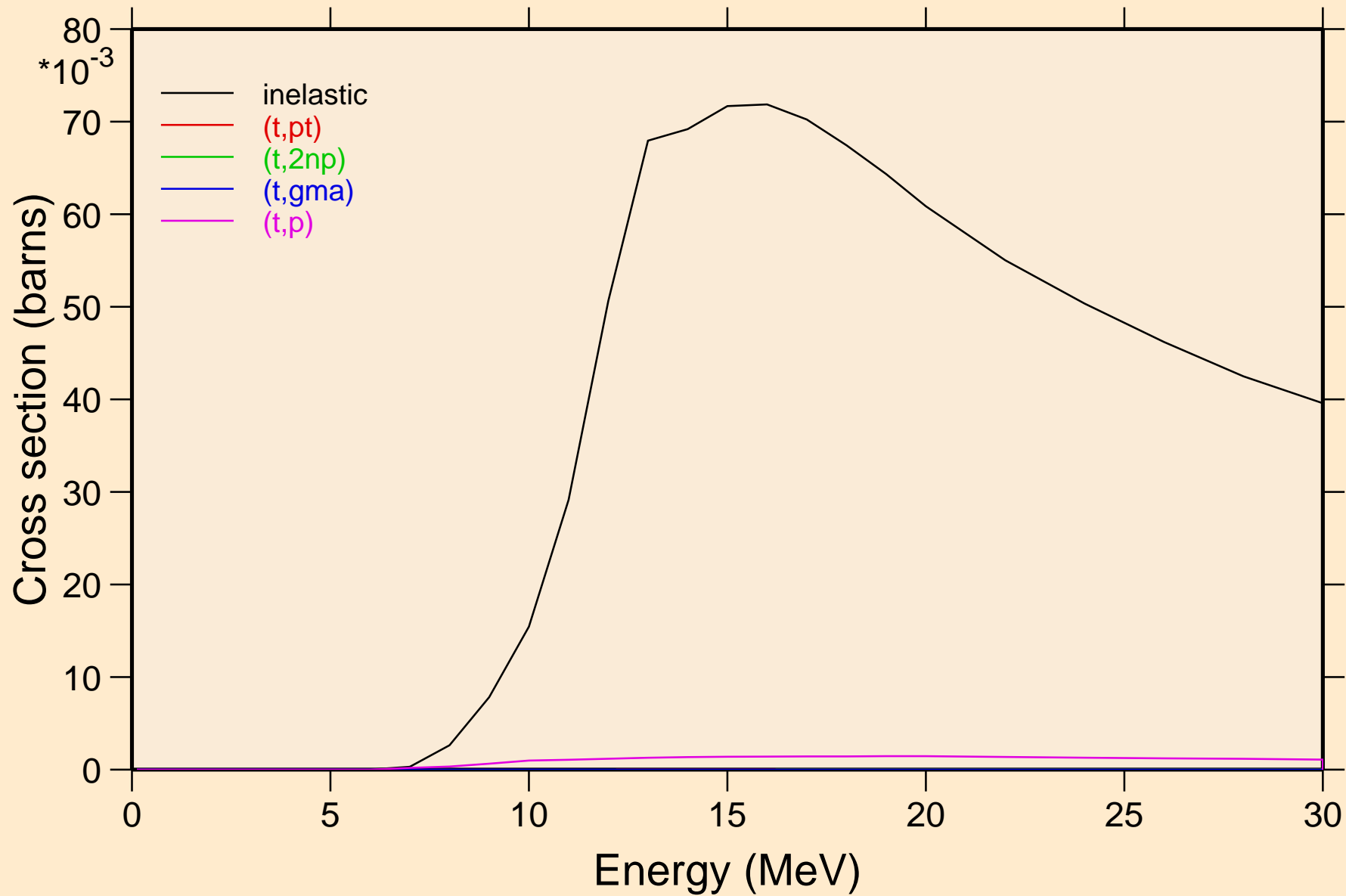

# IN127 TRITON ACER TENDL-2021 LIBRARY; T=0.K

## Threshold reactions

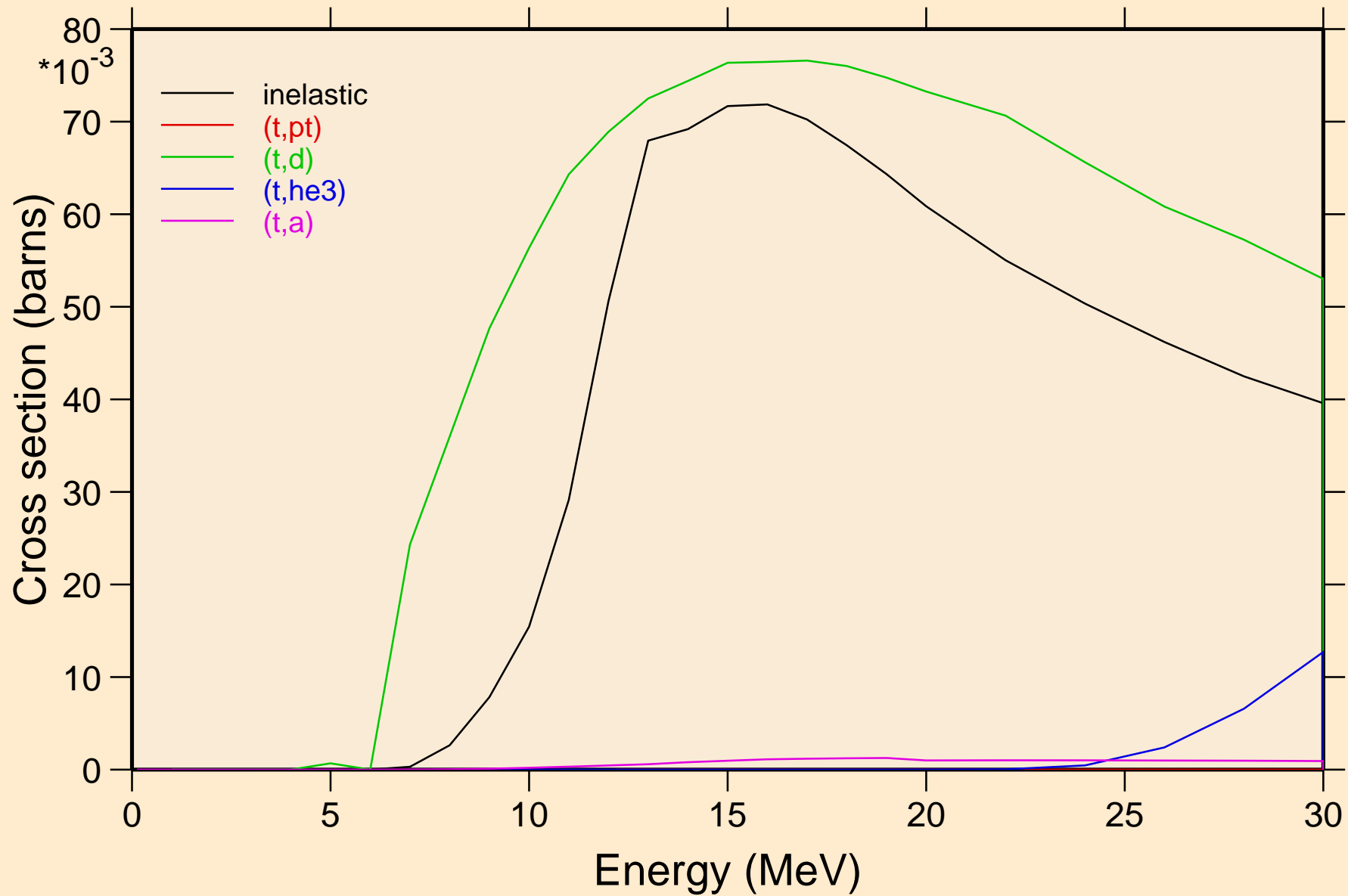

IN127 TRITON ACER TENDL-2021 LIBRARY; T=0.K  
Threshold reactions

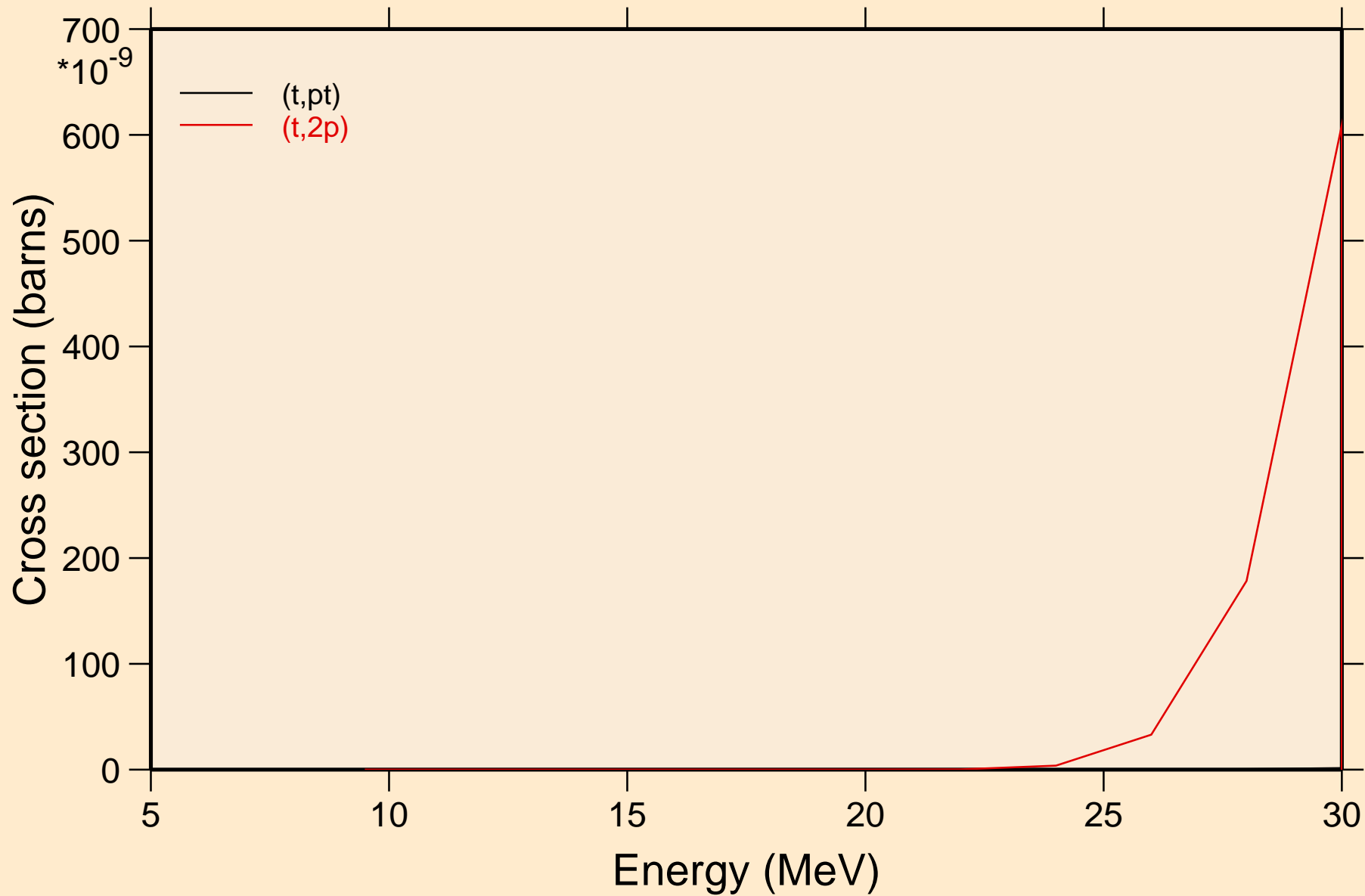

IN127 TRITON ACER TENDL-2021 LIBRARY; T=0.K  
Threshold reactions

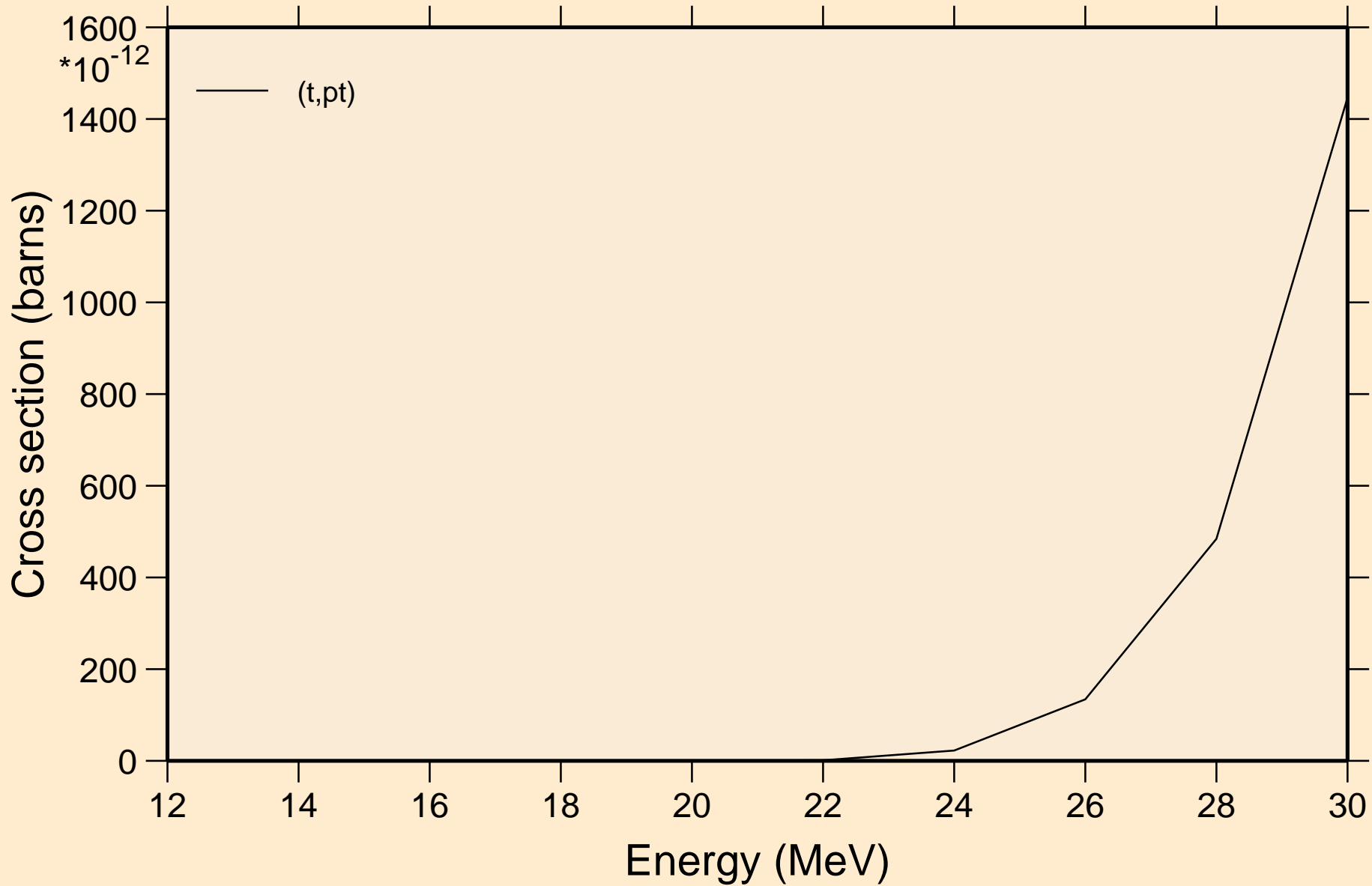

IN127 TRITON ACER TENDL-2021 LIBRARY; T=0.K  
angular distribution for elastic

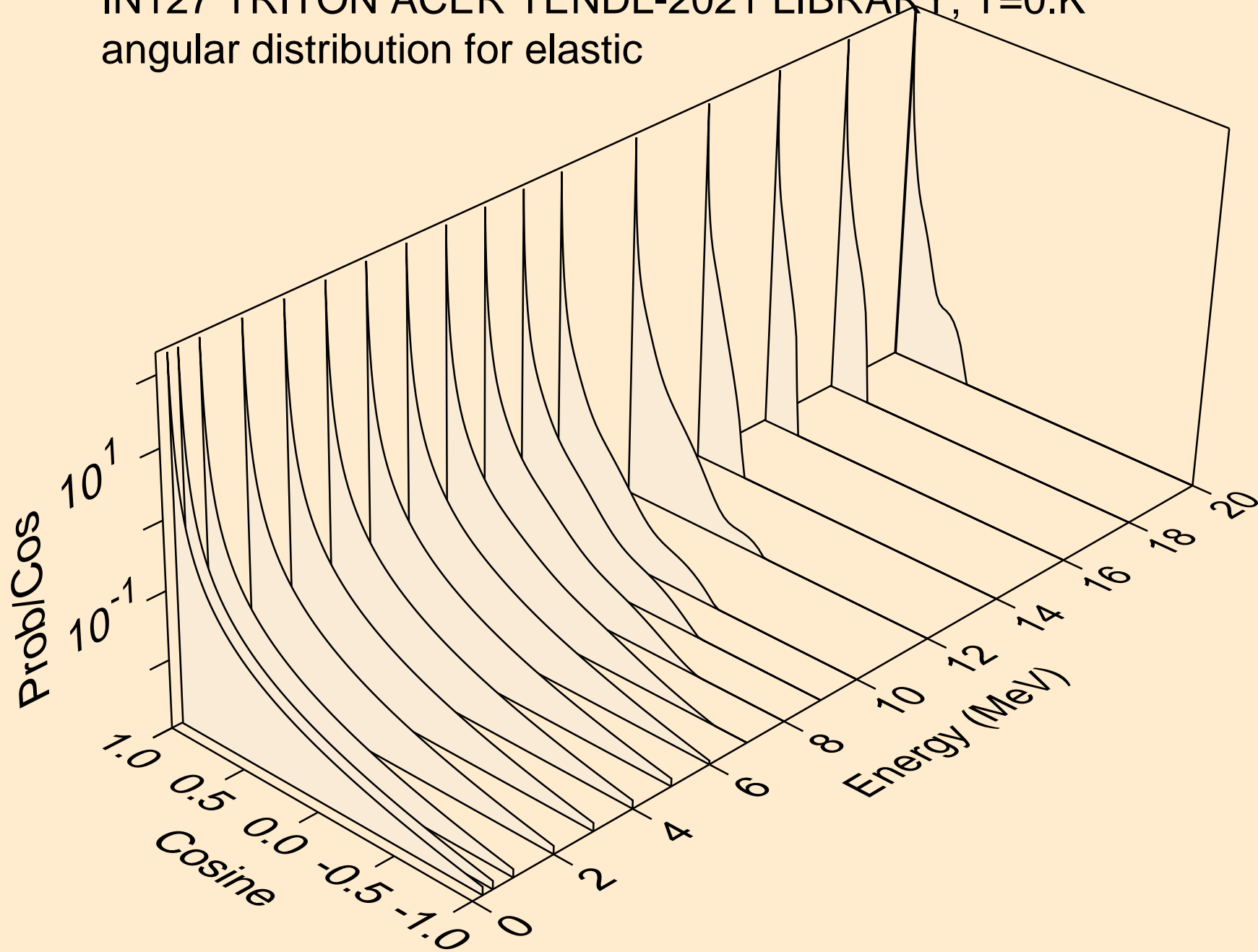

IN127 TRITON ACER TENDL-2021 LIBRARY; T=0.K  
angular distribution for elastic

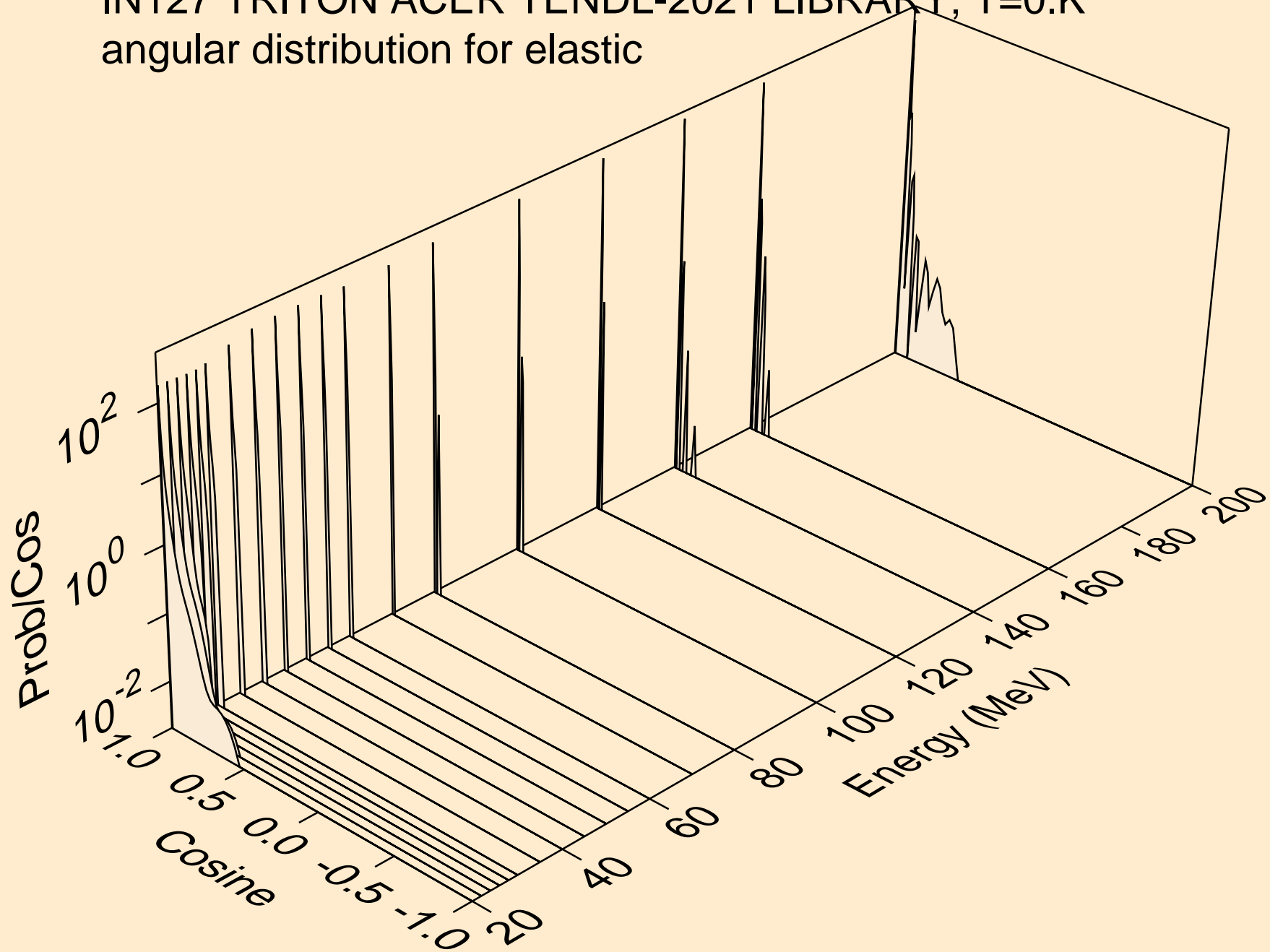



IN127 TRITON ACER TENDL-2021 LIBRARY; T=0.K  
Triton emission for (t,x)

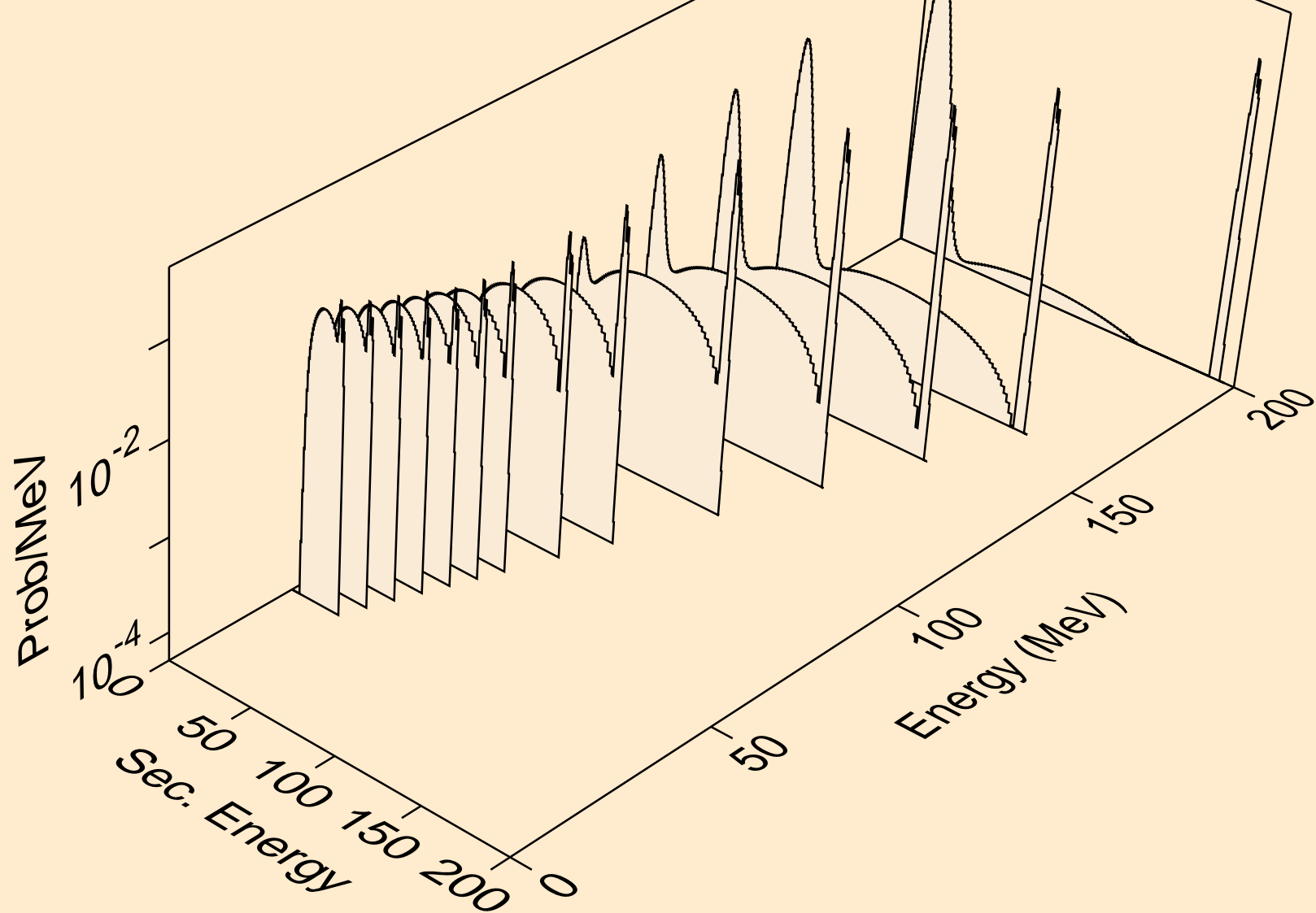

IN127 TRITON ACER TENDL-2021 LIBRARY; T=0.K  
Triton emission for (t,n\*)t

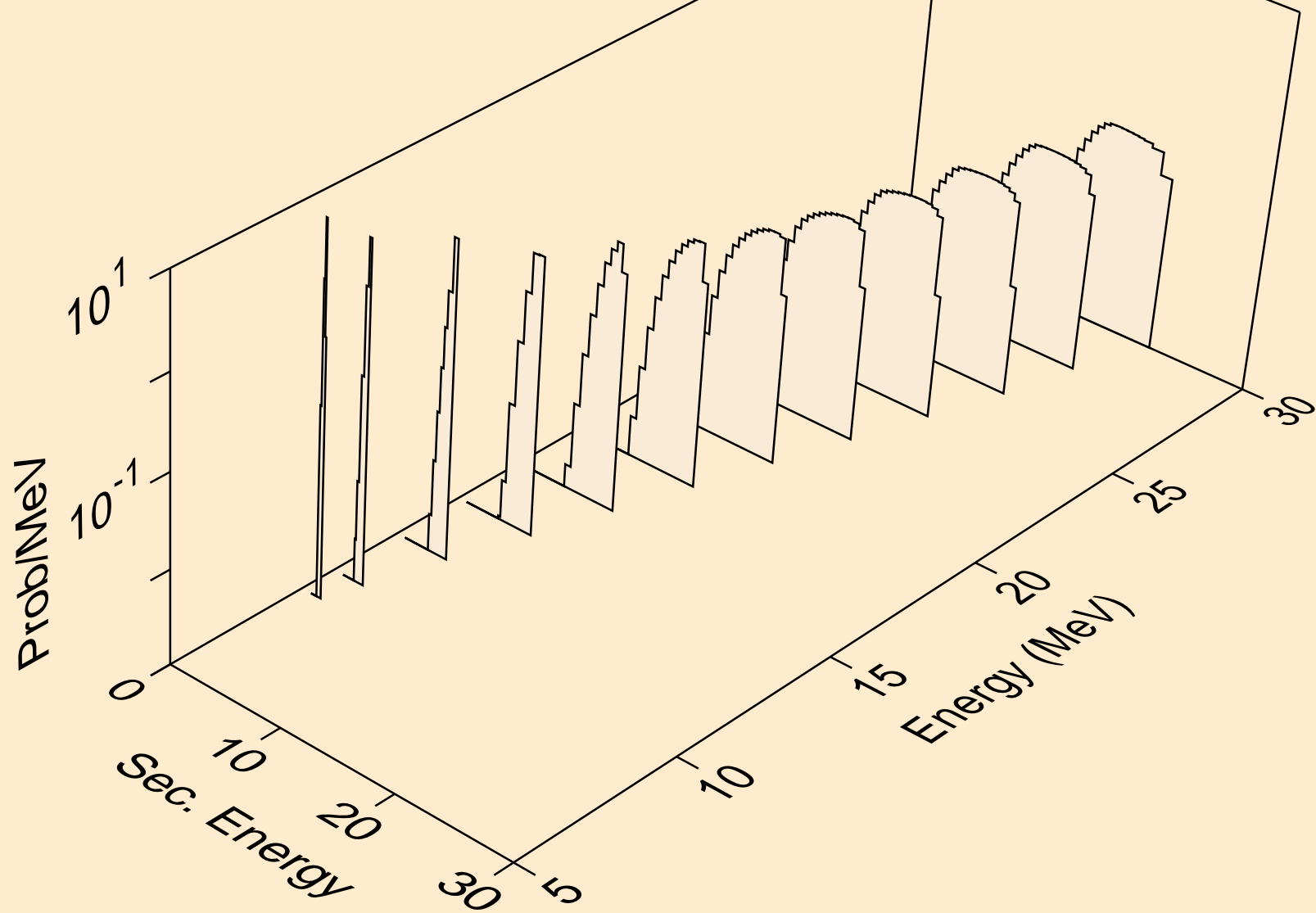

IN127 TRITON ACER TENDL-2021 LIBRARY; T=0.K  
Triton emission for inelastic

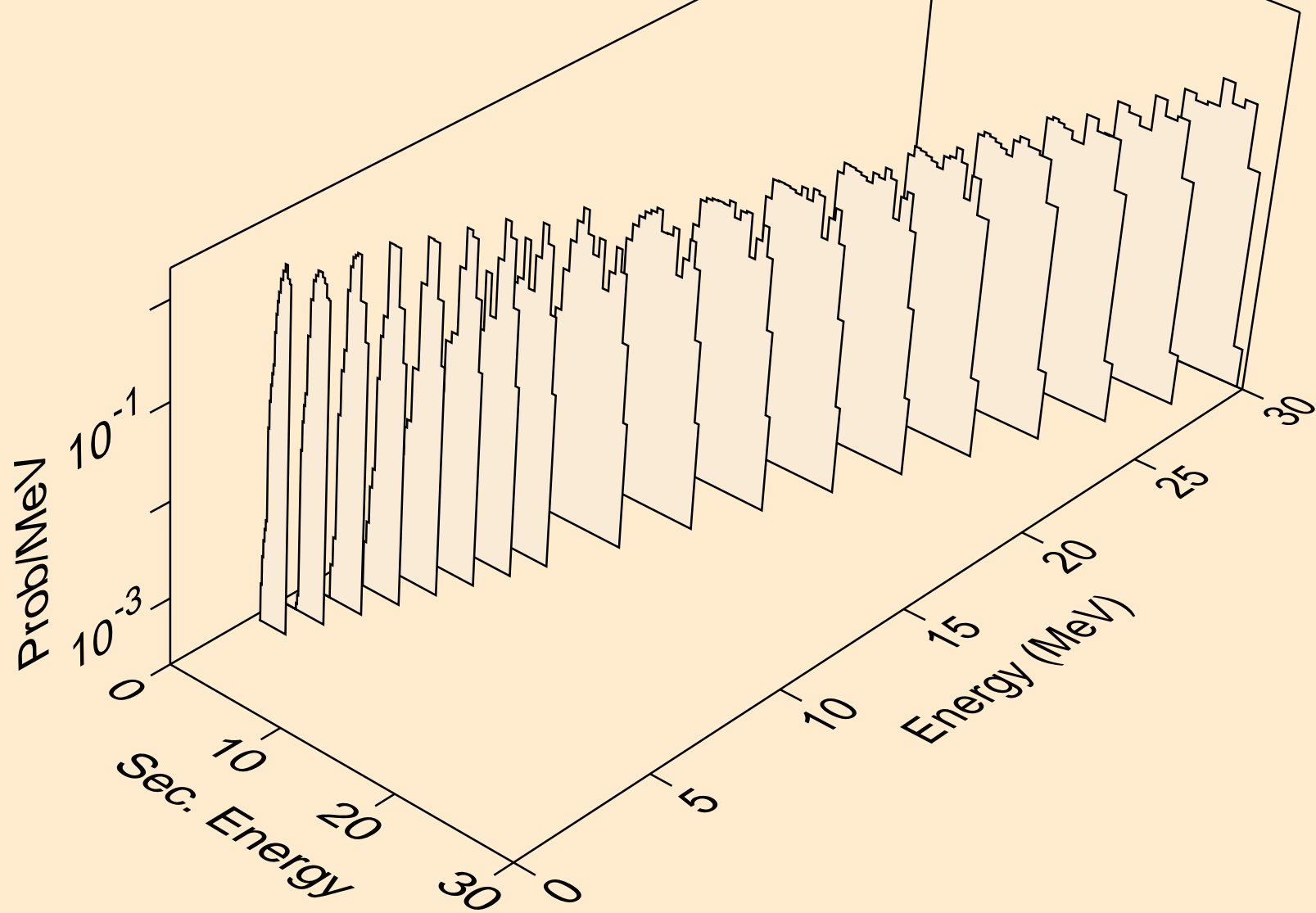

IN127 TRITON ACER TENDL-2021 LIBRARY; T=0.K  
Triton emission for (t,pt)

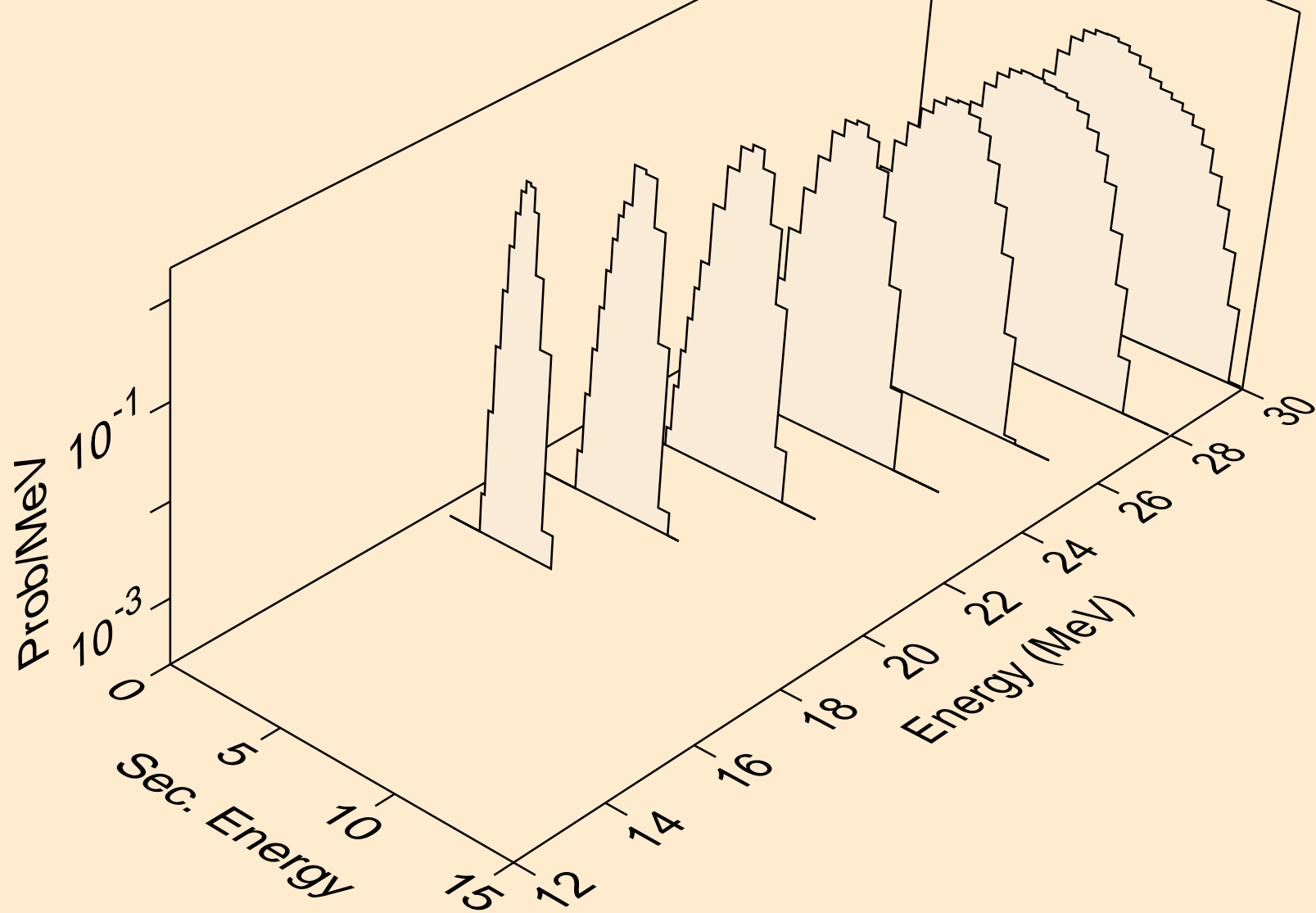

IN127 TRITON ACER TENDL-2021 LIBRARY; T=0.K  
Photon emission for (z,n)

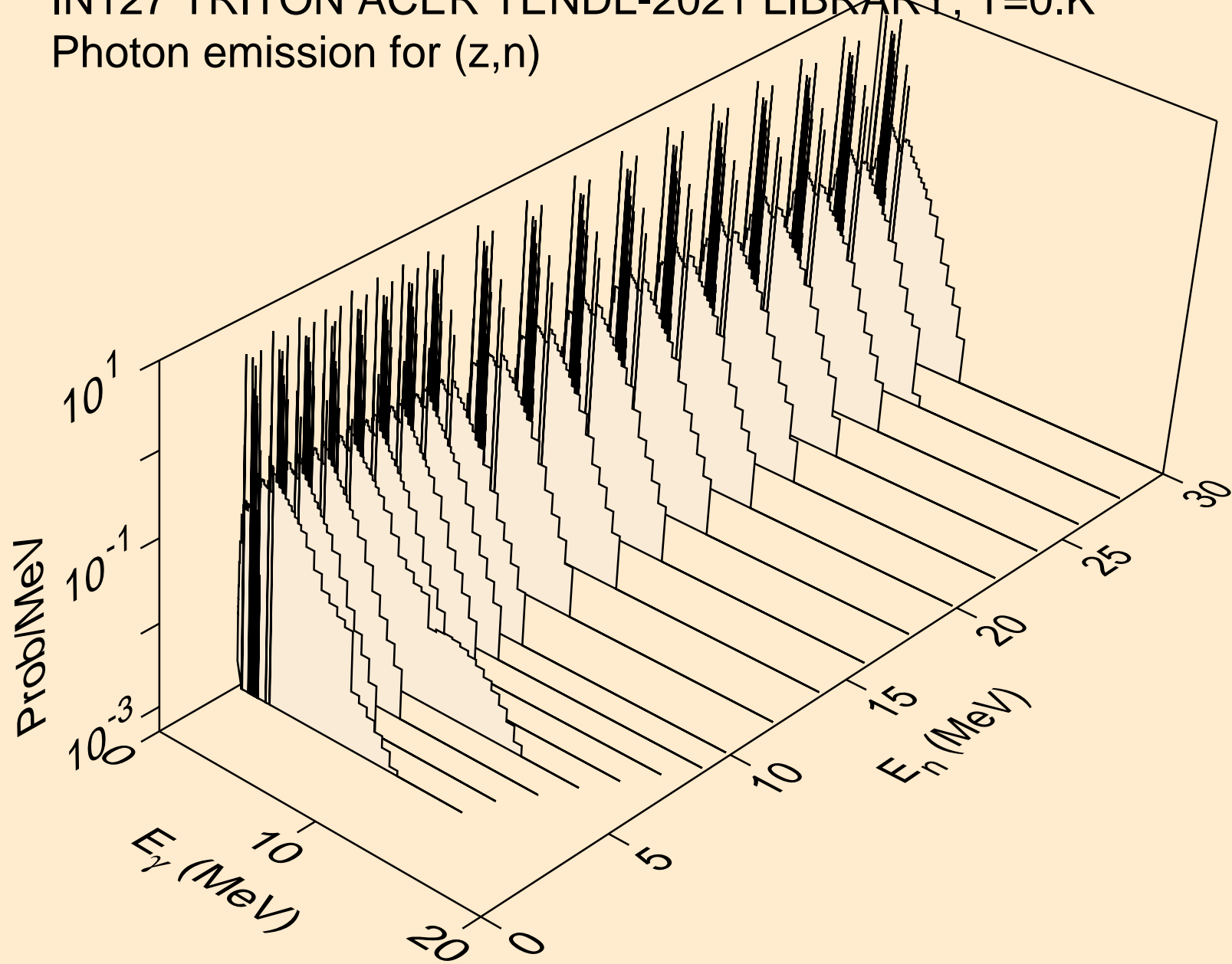

IN127 TRITON ACER TENDL-2021 LIBRARY; T=0.K  
Photon emission for (n,x)

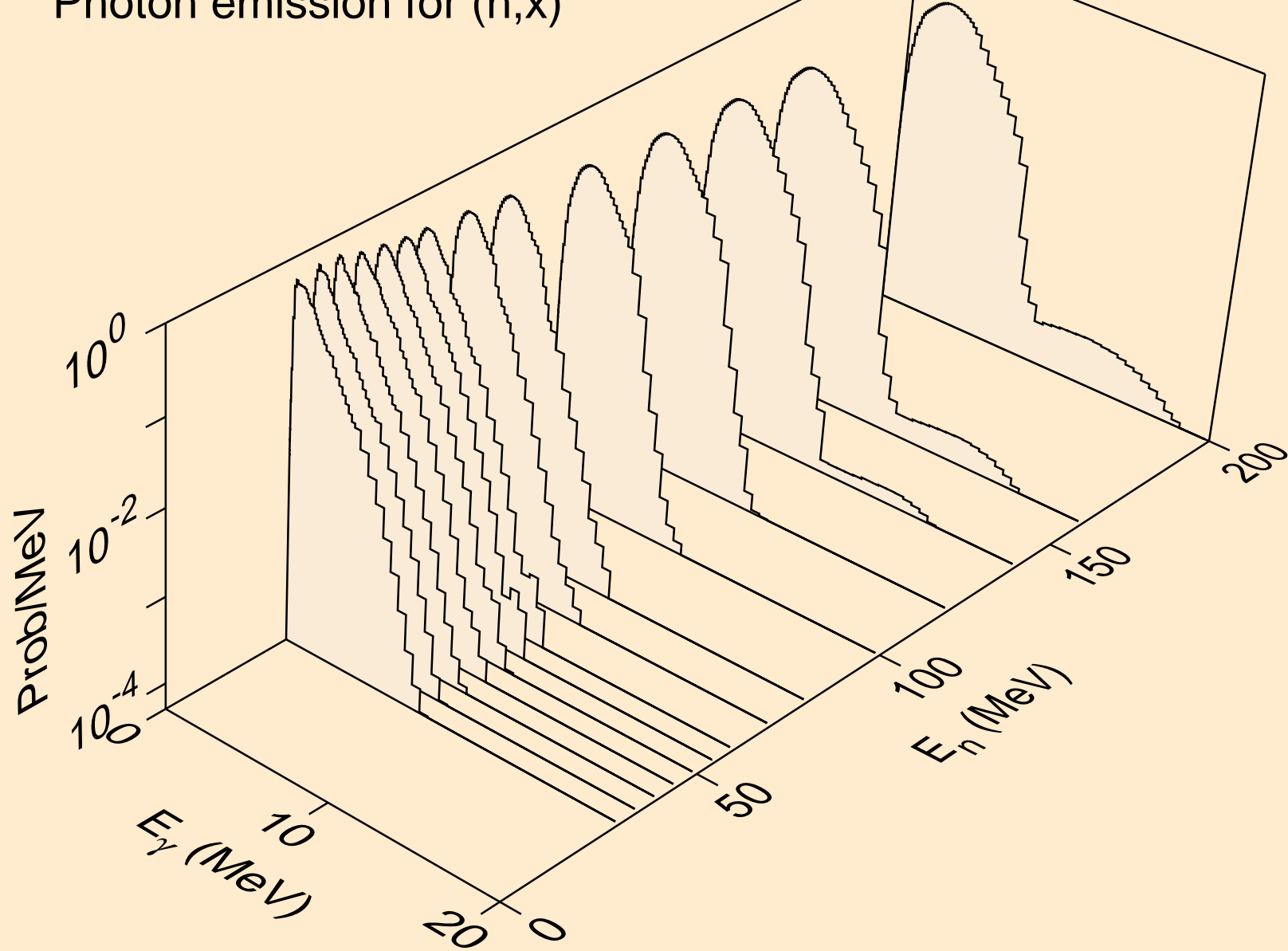

IN127 TRITON ACER TENDL-2021 LIBRARY; T=0.K  
Photon emission for (n,2nd)

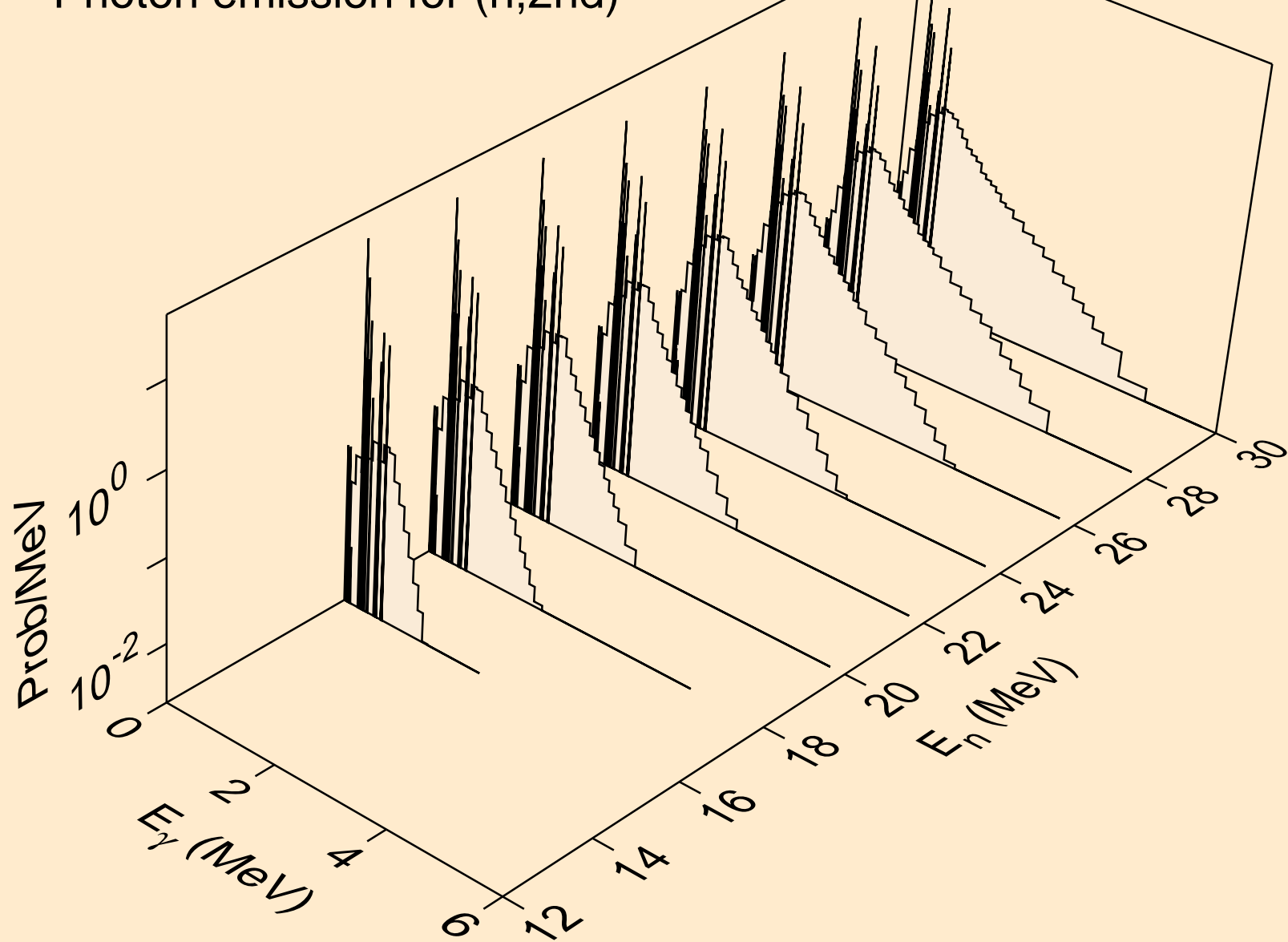

IN127 TRITON ACER TENDL-2021 LIBRARY; T=0.K  
Photon emission for (n,2n)

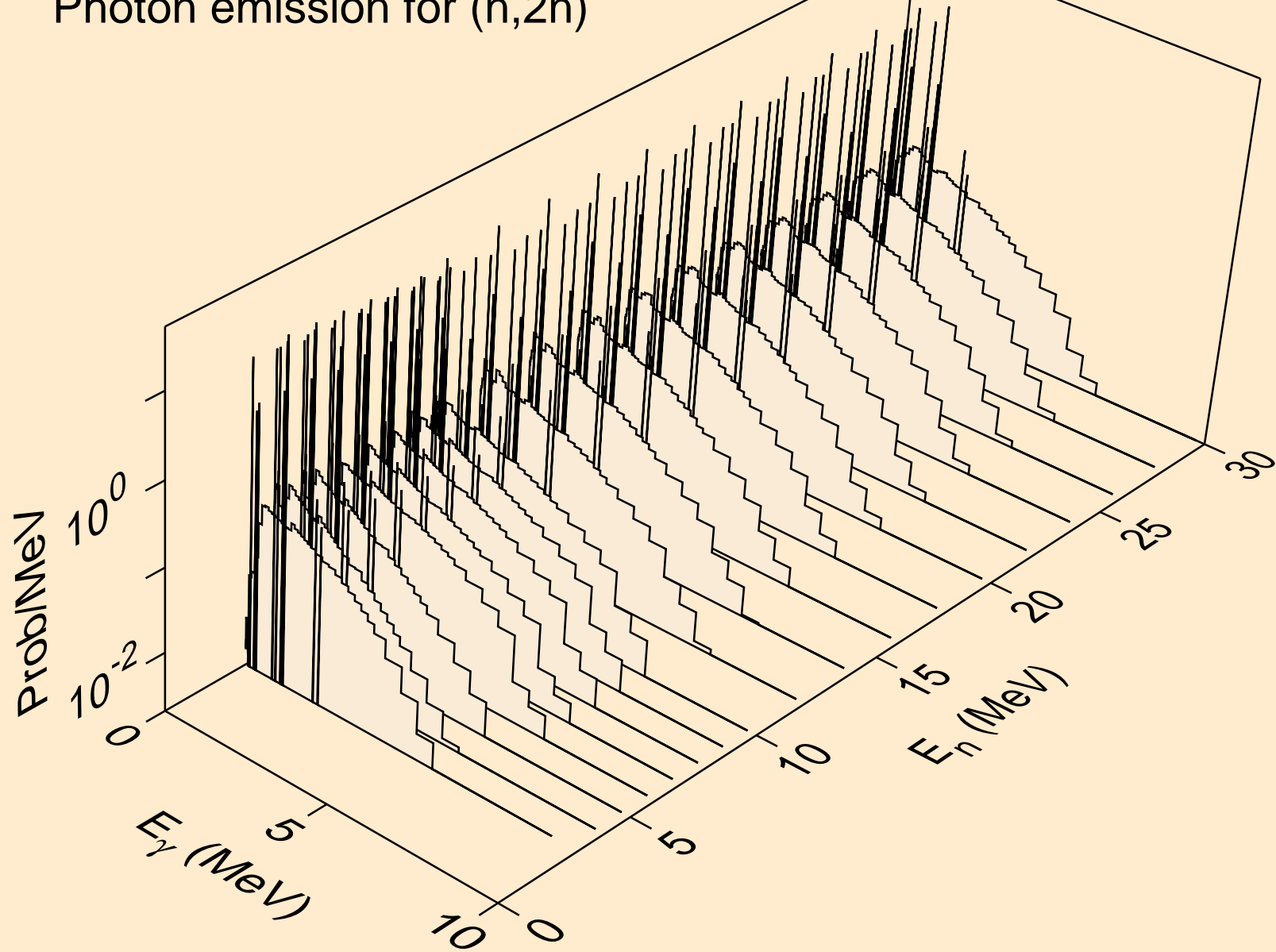



IN127 TRITON ACER TENDL-2021 LIBRARY; T=0.K  
Photon emission for (n,3n)

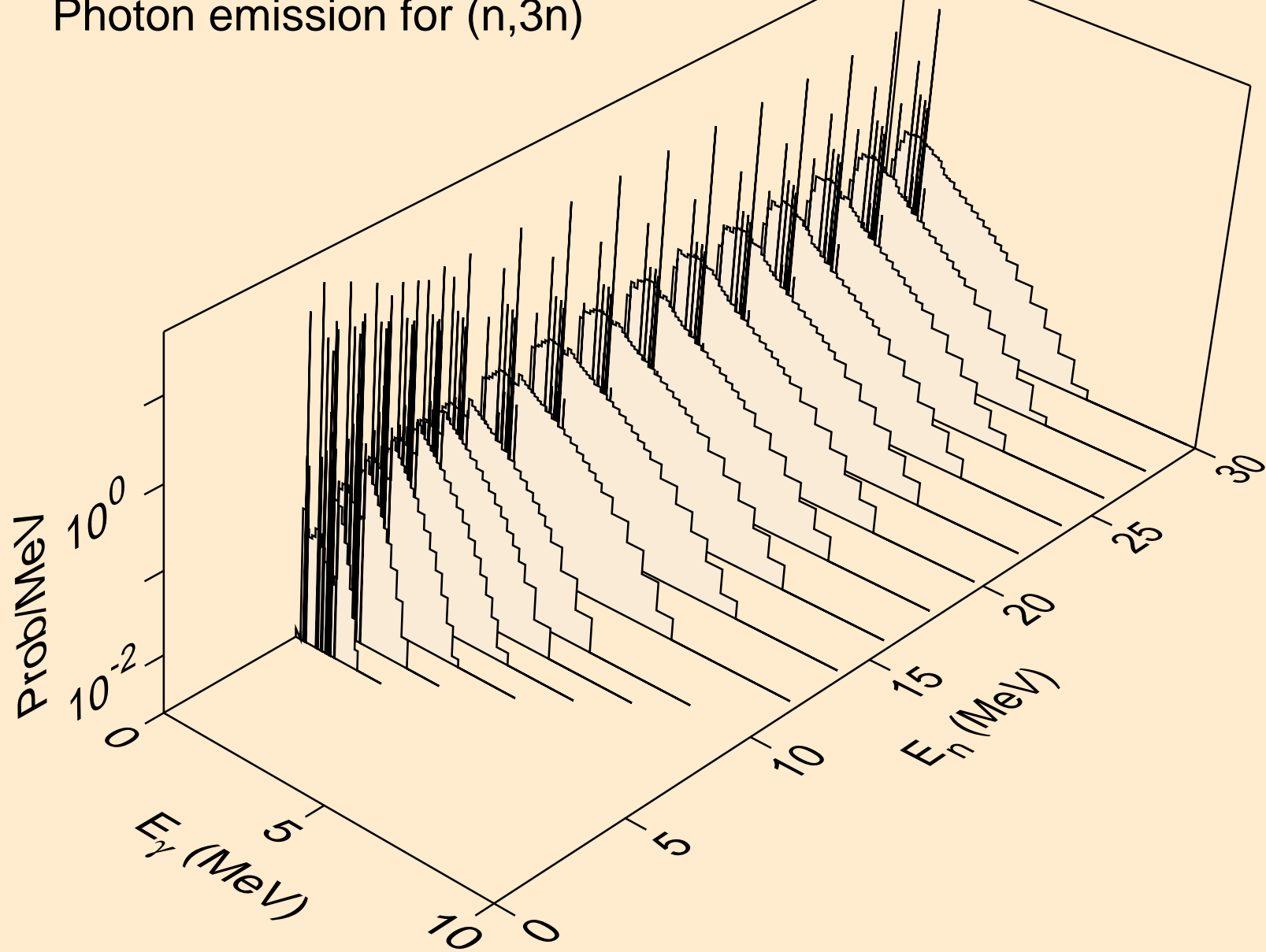

IN127 TRITON ACER TENDL-2021 LIBRARY; T=0.K  
Photon emission for (n,n\*)a

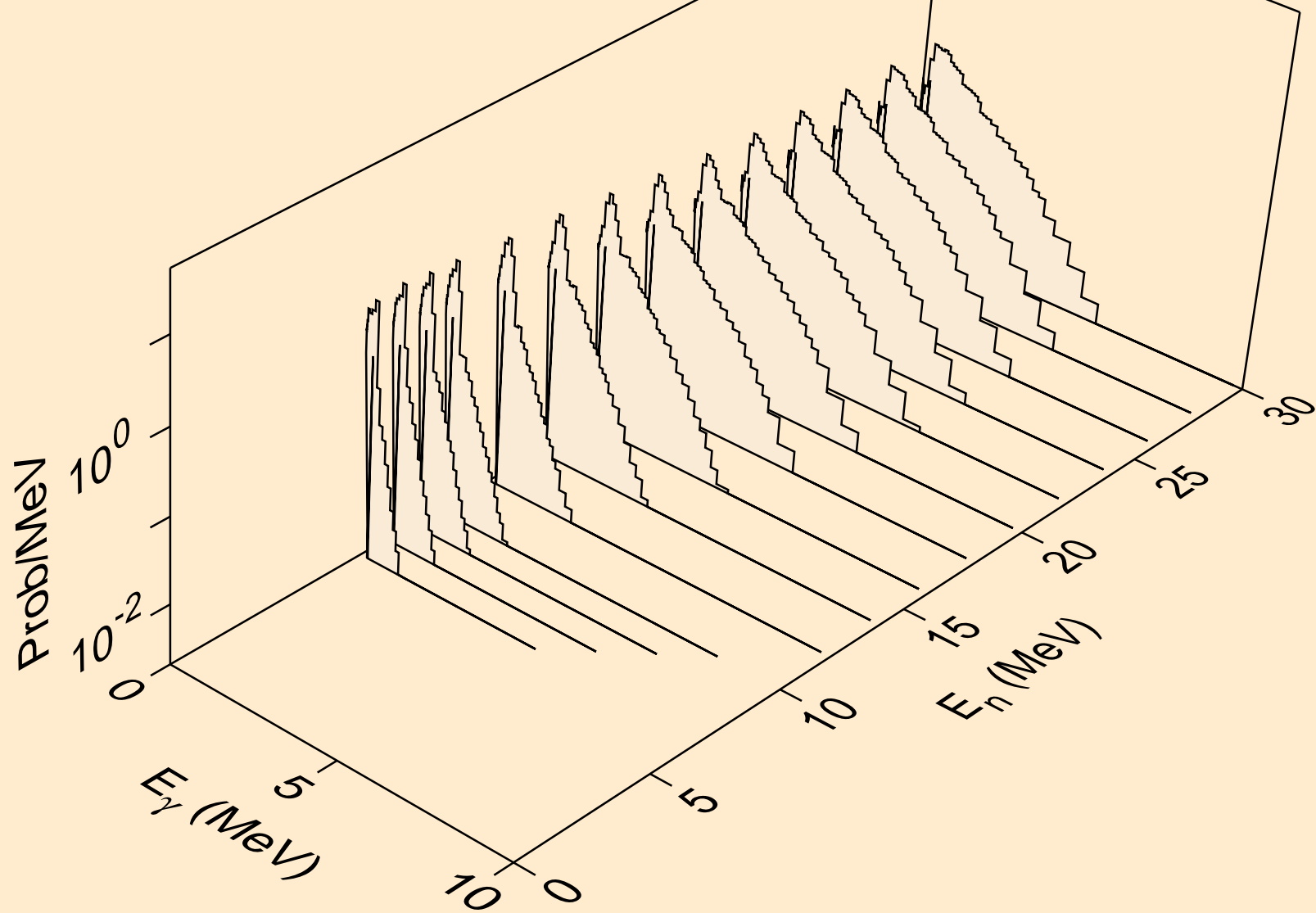

IN127 TRITON ACER TENDL-2021 LIBRARY; T=0.K  
Photon emission for (n,2n)a

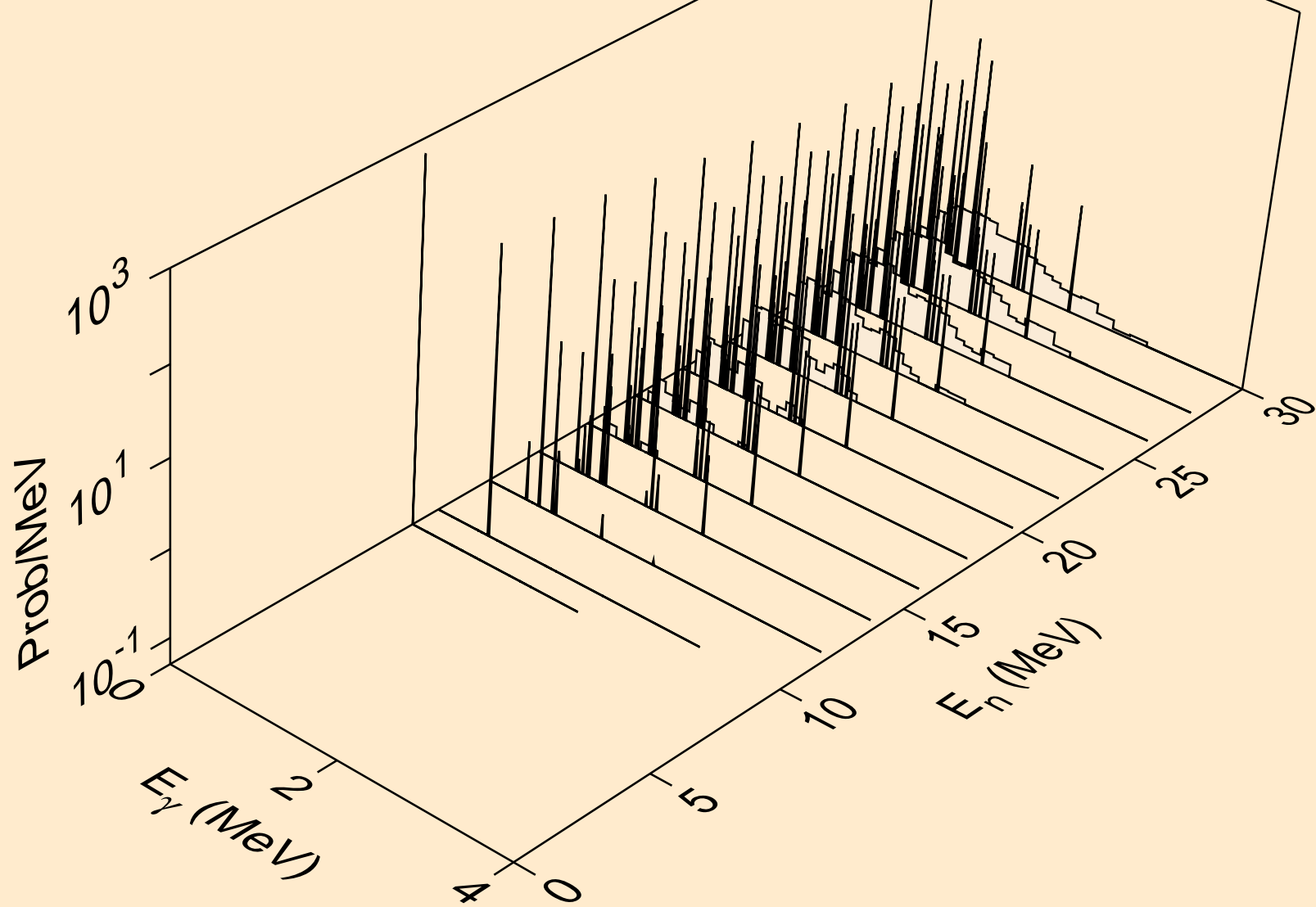

IN127 TRITON ACER TENDL-2021 LIBRARY; T=0.K  
Photon emission for (n,3n)a

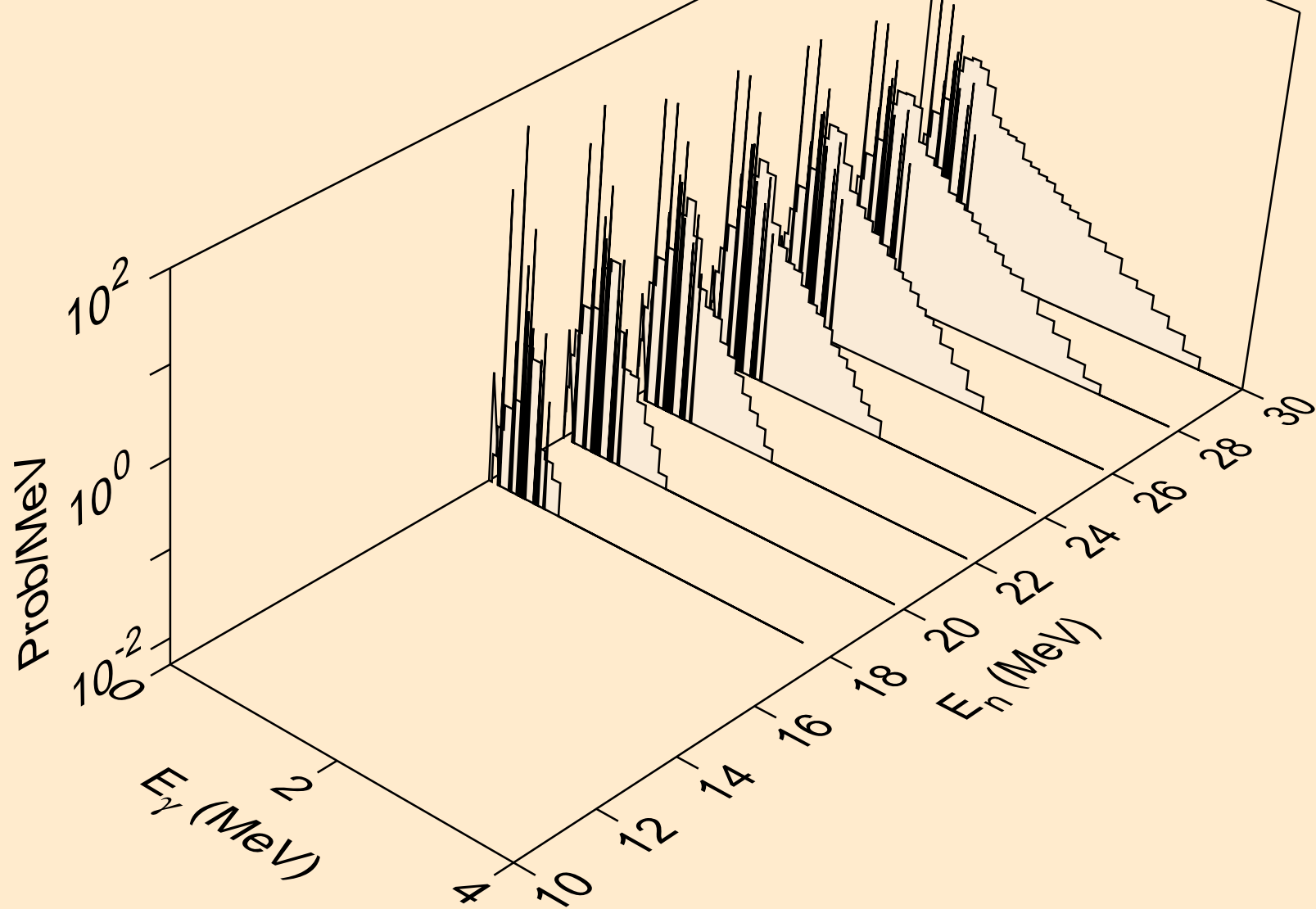

IN127 TRITON ACER TENDL-2021 LIBRARY; T=0.K  
Photon emission for (n,n\*)p

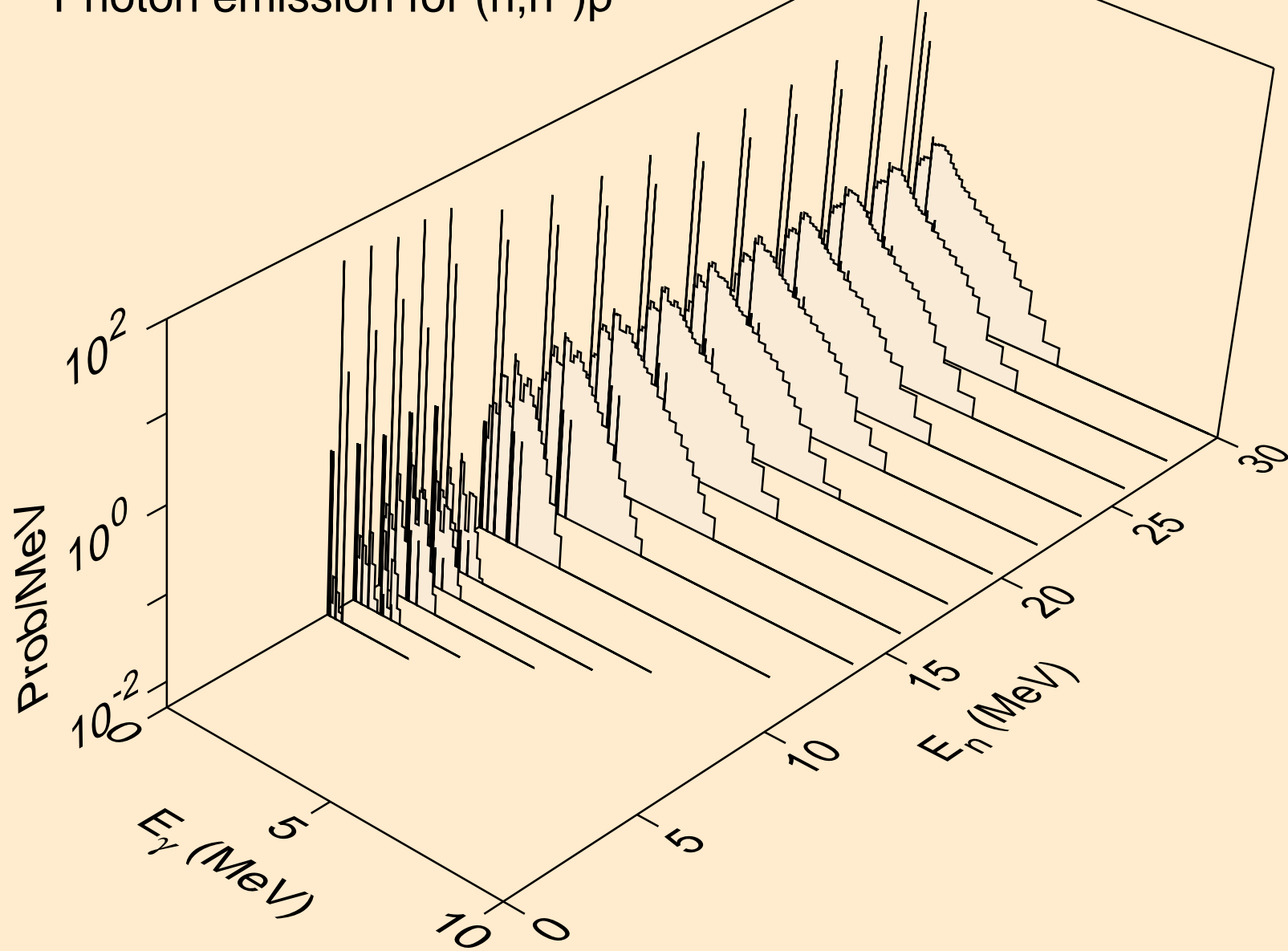

IN127 TRITON ACER TENDL-2021 LIBRARY; T=0.K  
Photon emission for (n,n\*)d

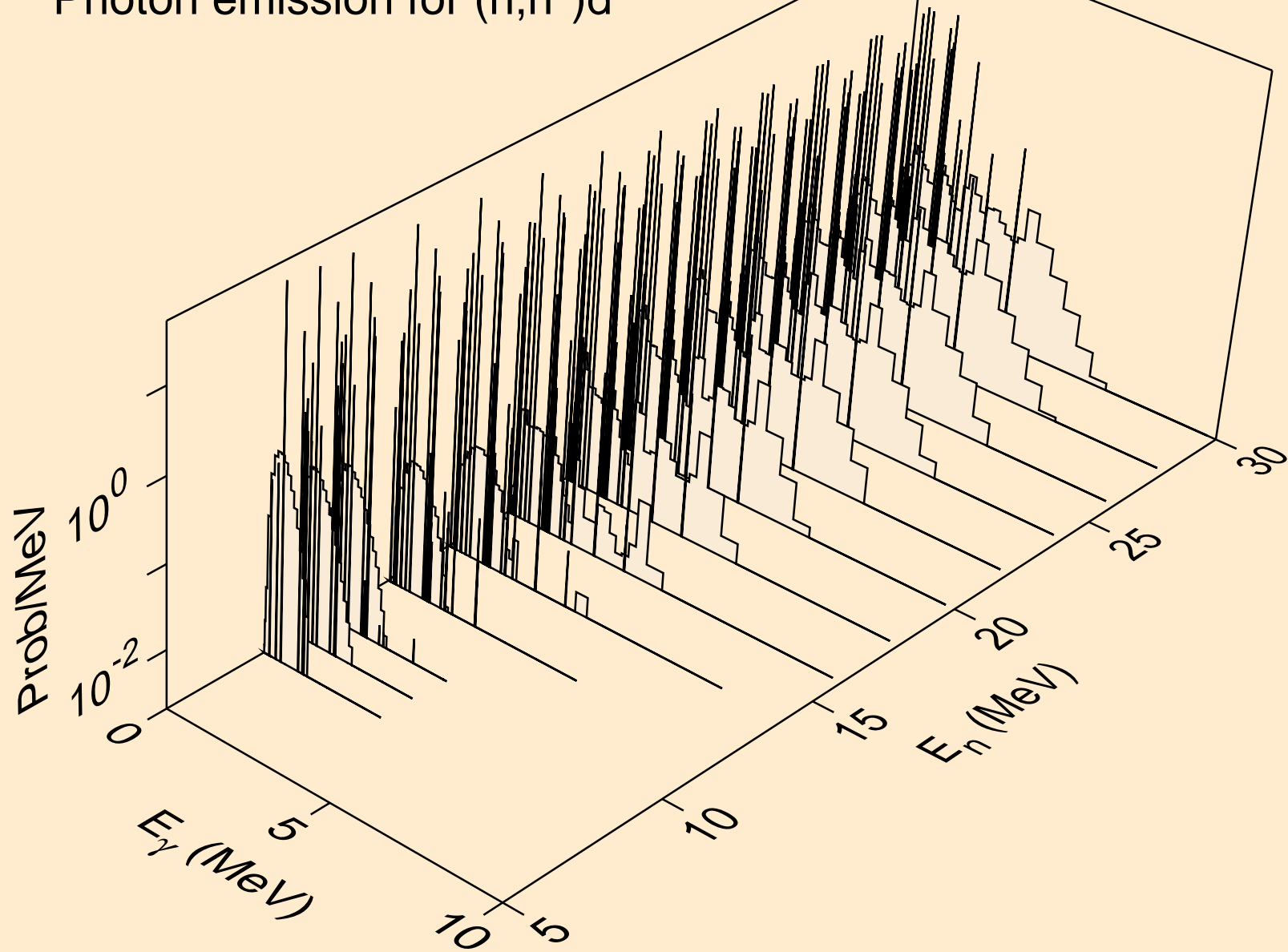

IN127 TRITON ACER TENDL-2021 LIBRARY; T=0.K  
Photon emission for (n,n\*)t

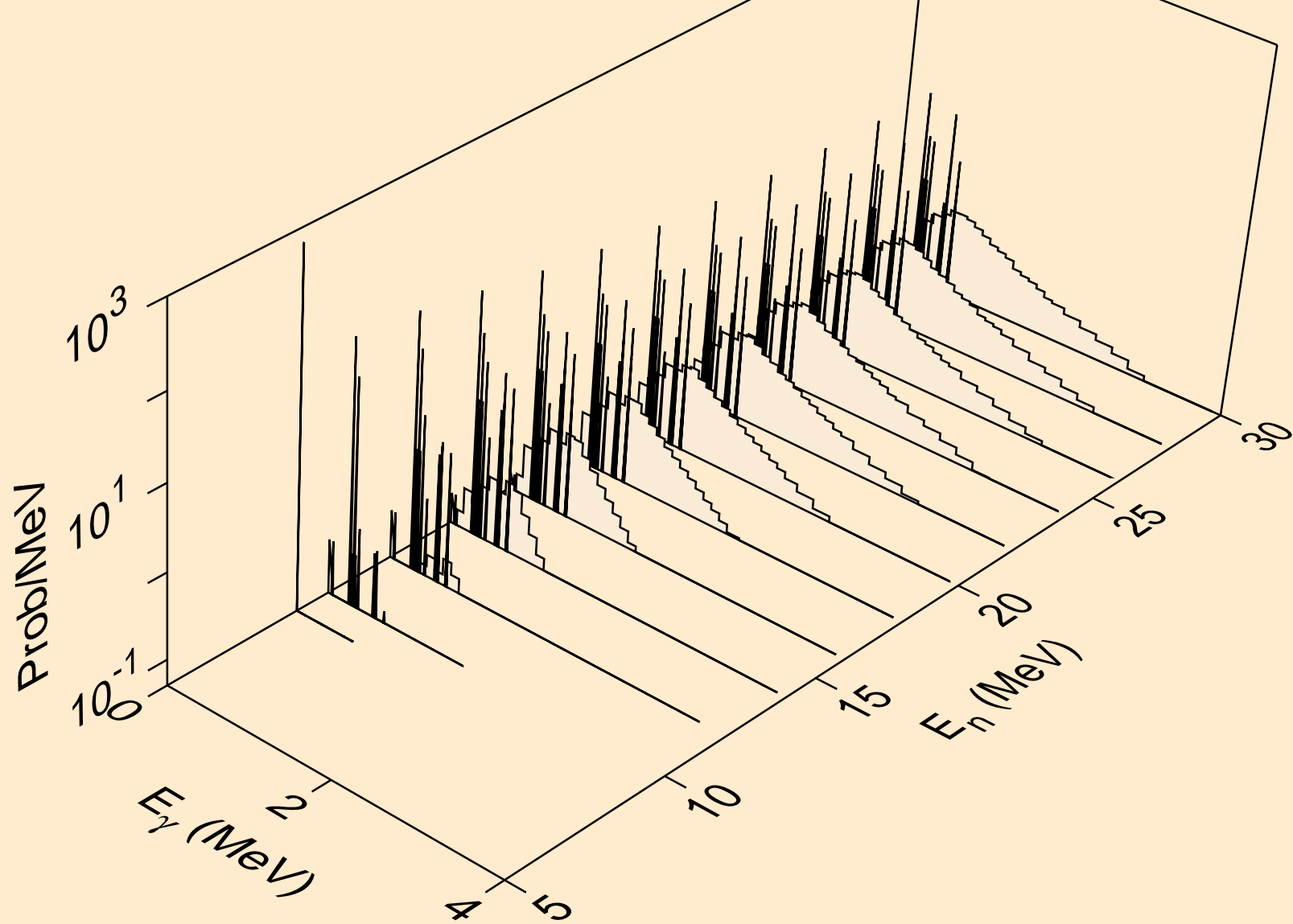

IN127 TRITON ACER TENDL-2021 LIBRARY; T=0.K  
Photon emission for (n,n\*)he3

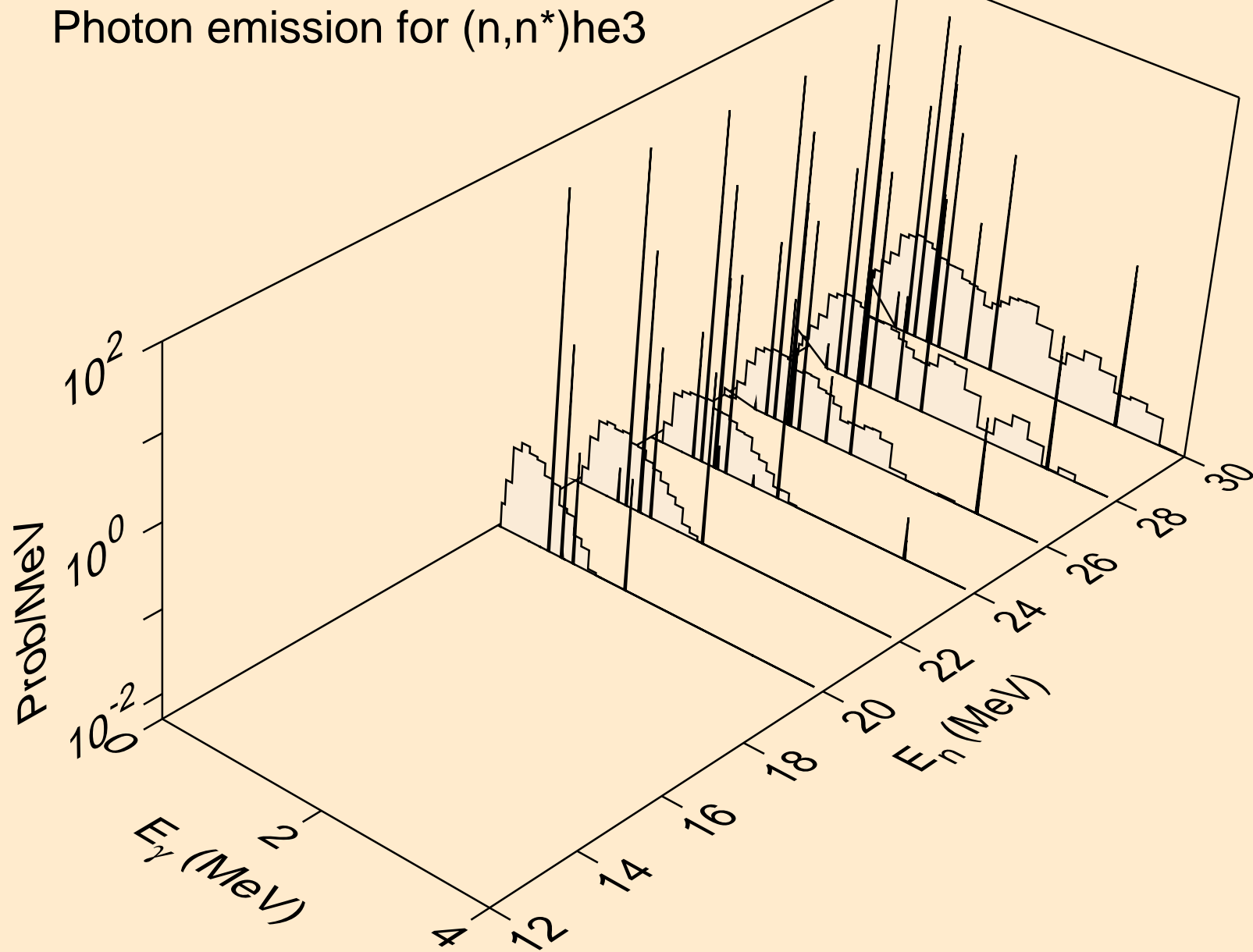



IN127 TRITON ACER TENDL-2021 LIBRARY; T=0.K  
Photon emission for (n,4n)

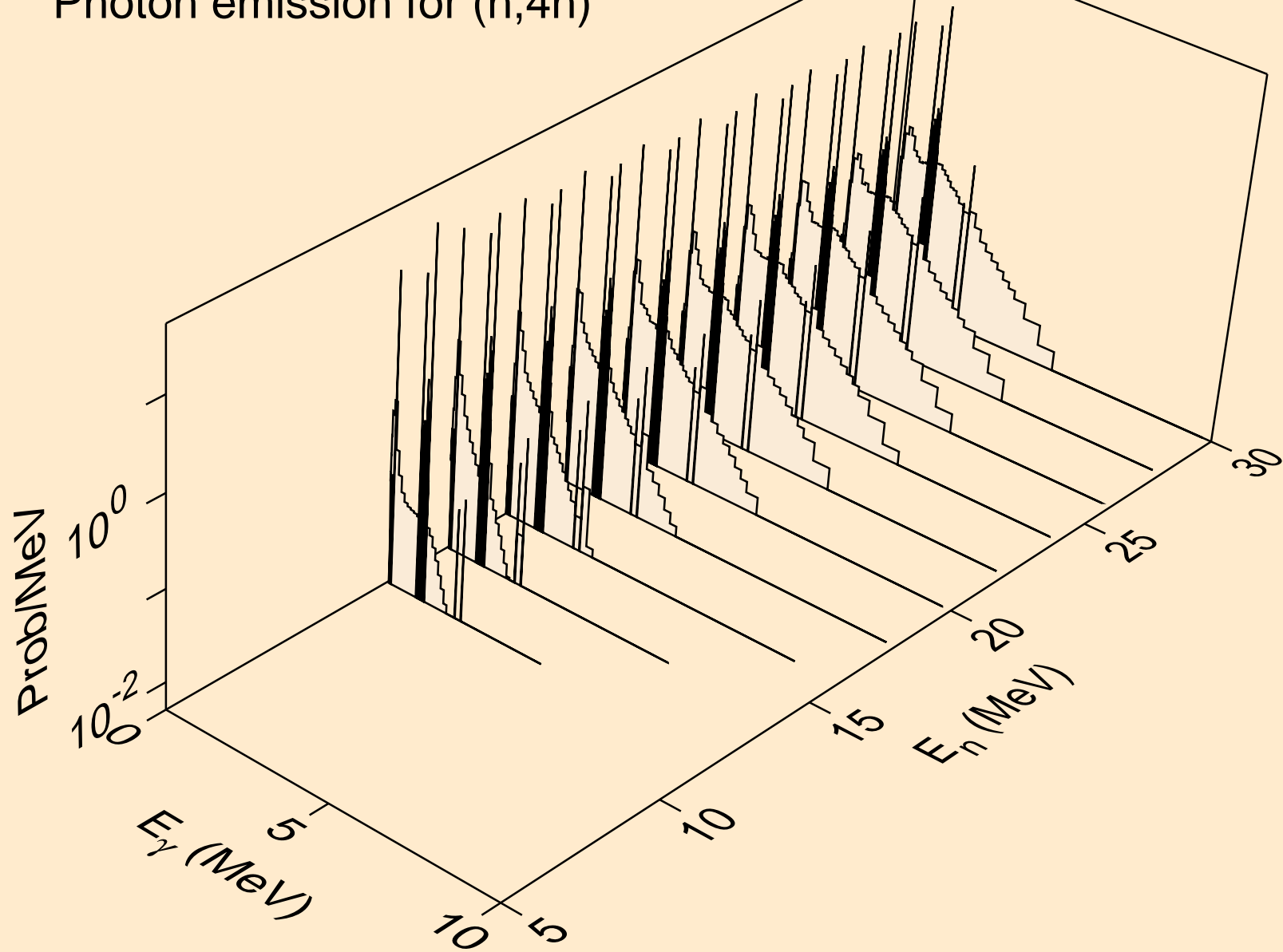

IN127 TRITON ACER TENDL-2021 LIBRARY; T=0.K  
Photon emission for (n,2np)

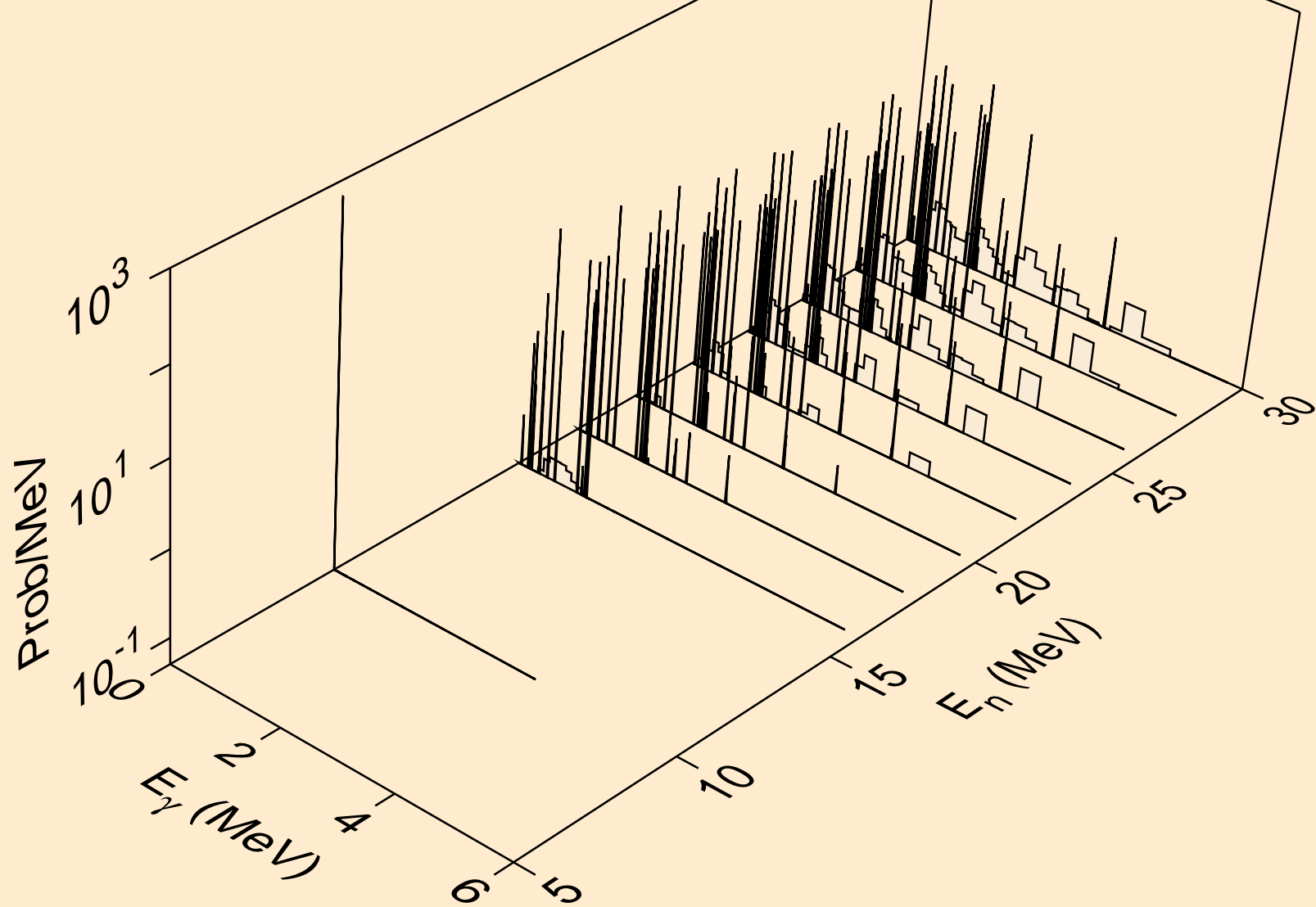

IN127 TRITON ACER TENDL-2021 LIBRARY; T=0.K  
Photon emission for (n,3np)

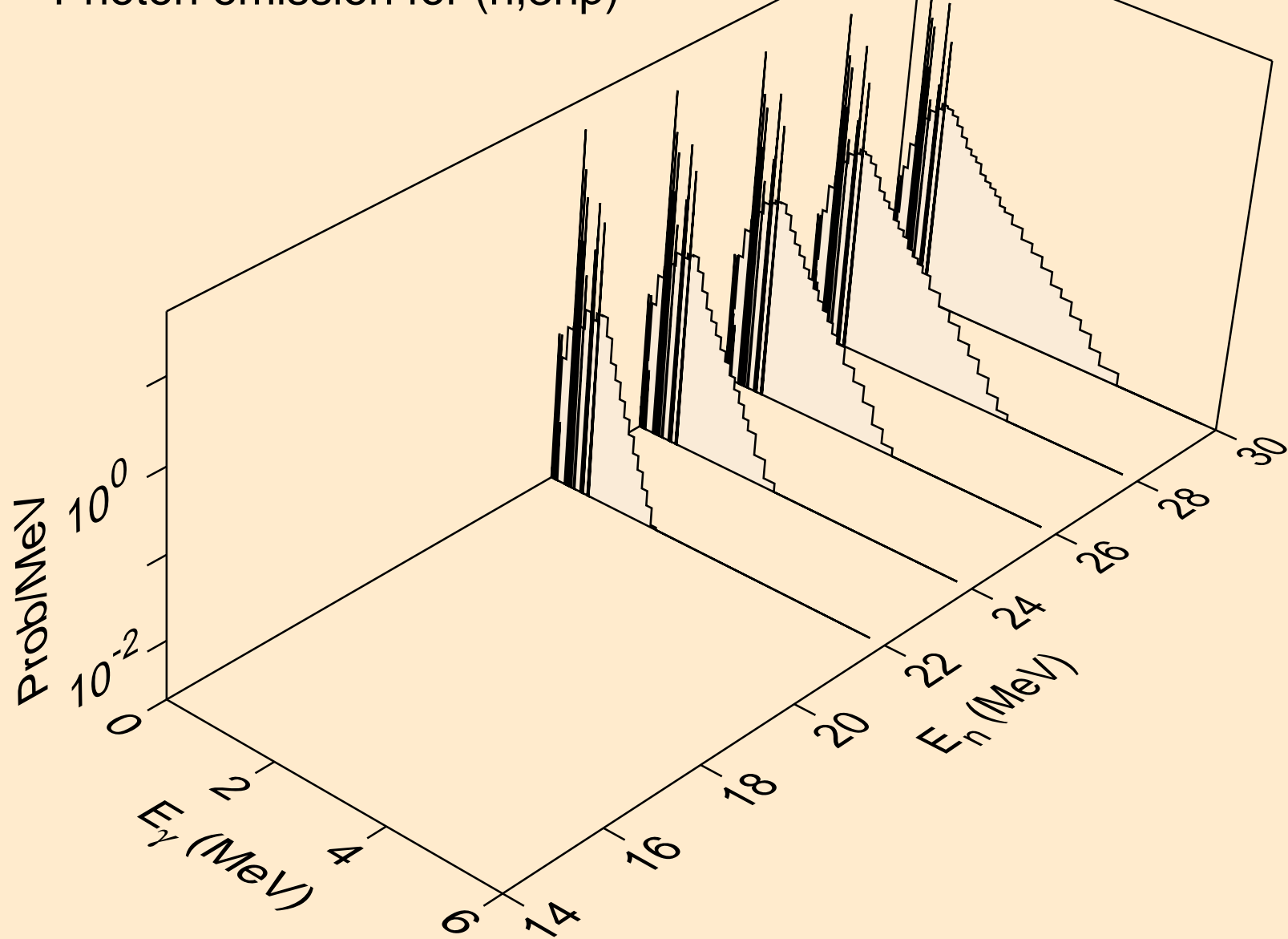

IN127 TRITON ACER TENDL-2021 LIBRARY; T=0.K  
Photon emission for (n,2np)

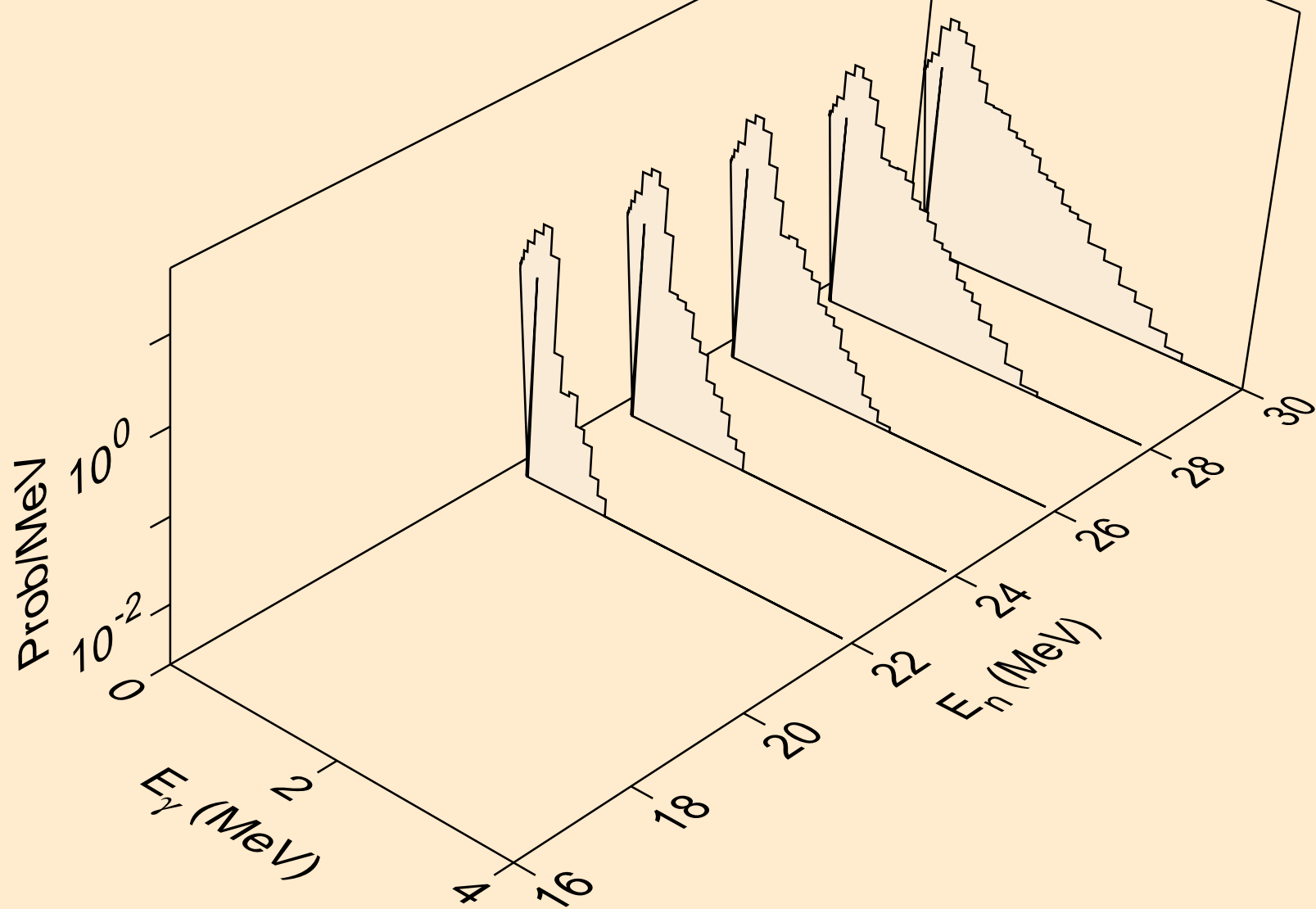

IN127 TRITON ACER TENDL-2021 LIBRARY; T=0.K  
Photon emission for (n,gma)

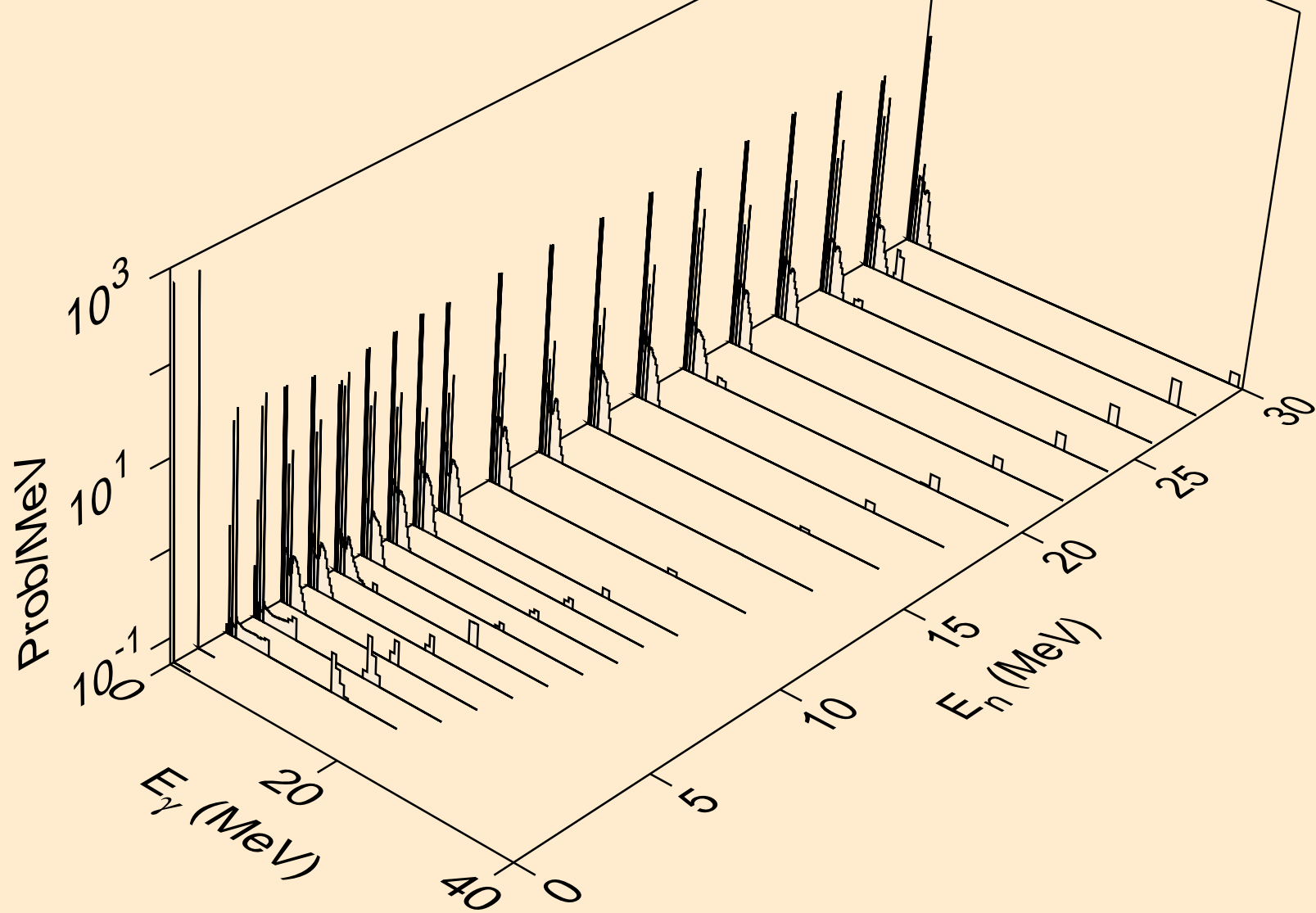

IN127 TRITON ACER TENDL-2021 LIBRARY; T=0.K  
Photon emission for (n,p)

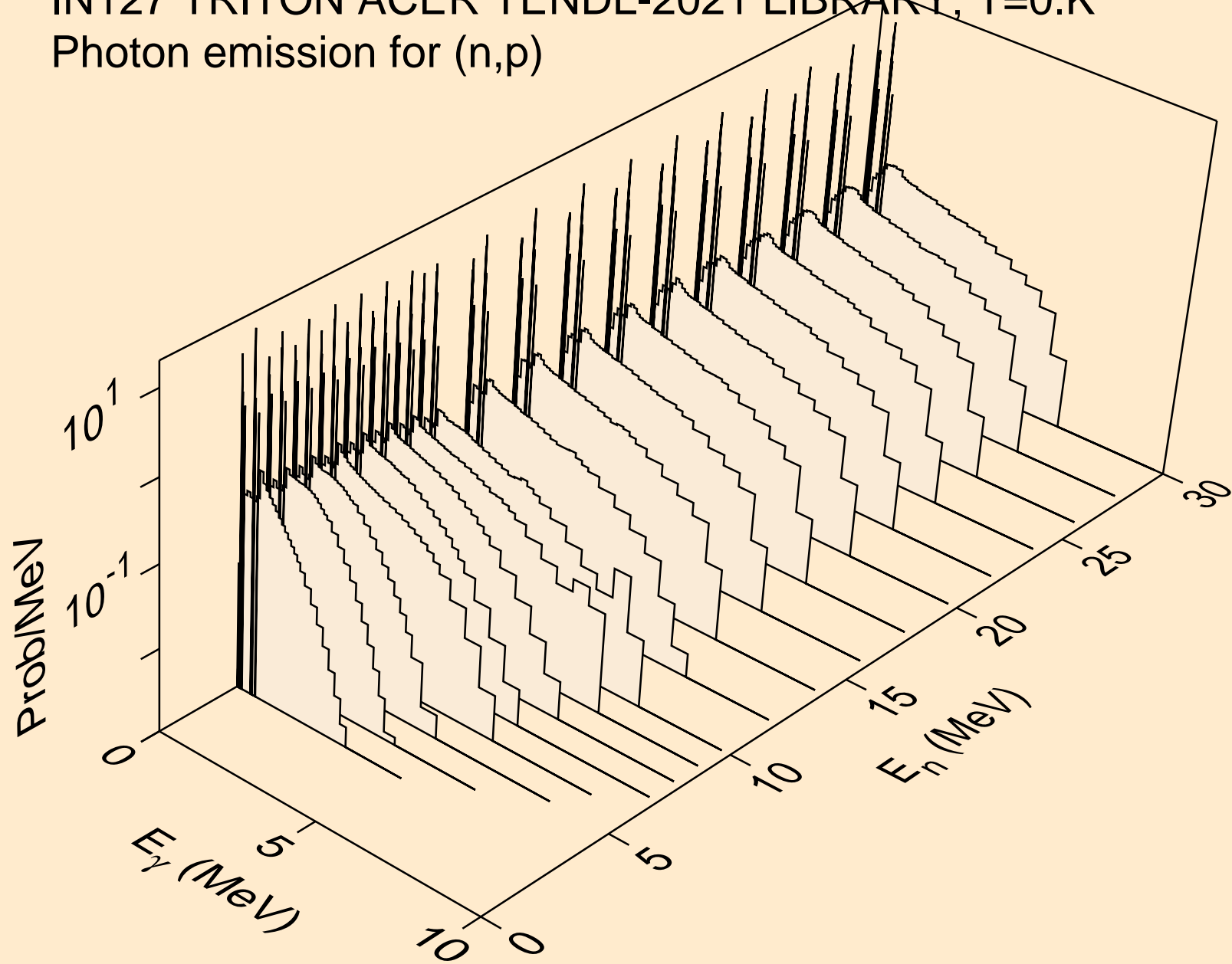

IN127 TRITON ACER TENDL-2021 LIBRARY; T=0.K  
Photon emission for (n,d)

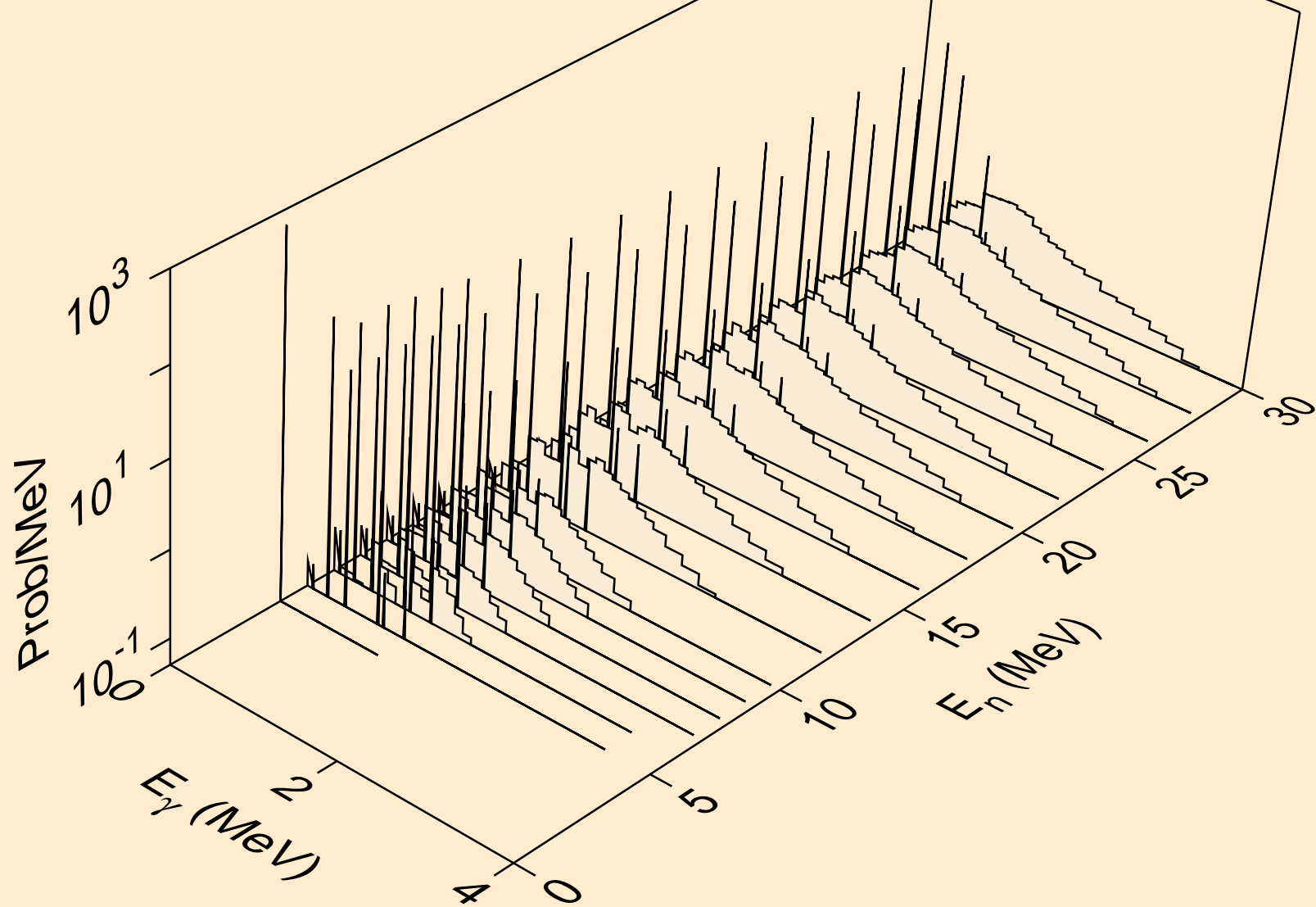

IN127 TRITON ACER TENDL-2021 LIBRARY; T=0.K  
Photon emission for inelastic

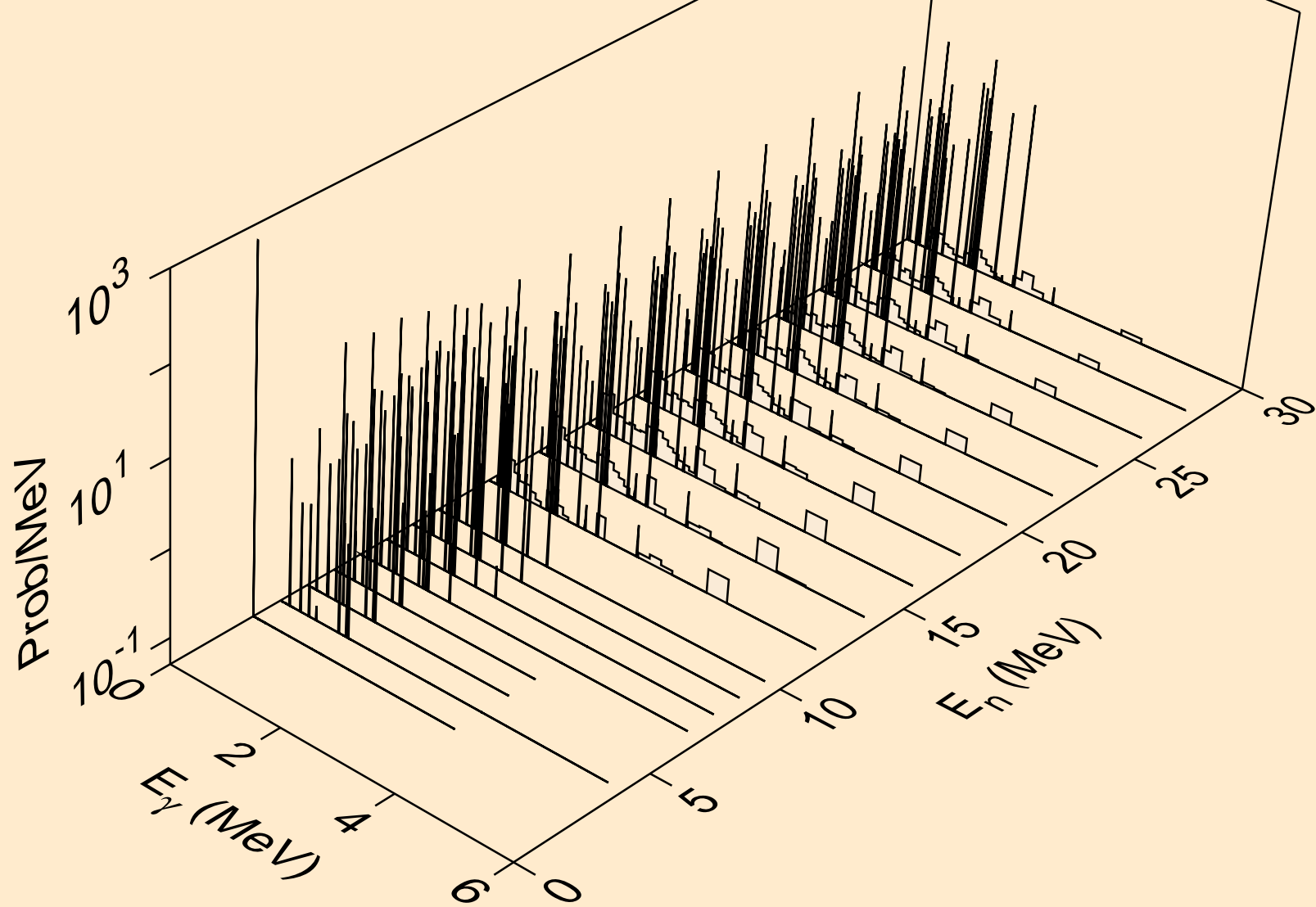



IN127 TRITON ACER TENDL-2021 LIBRARY; T=0.K  
Photon emission for (n,he3)

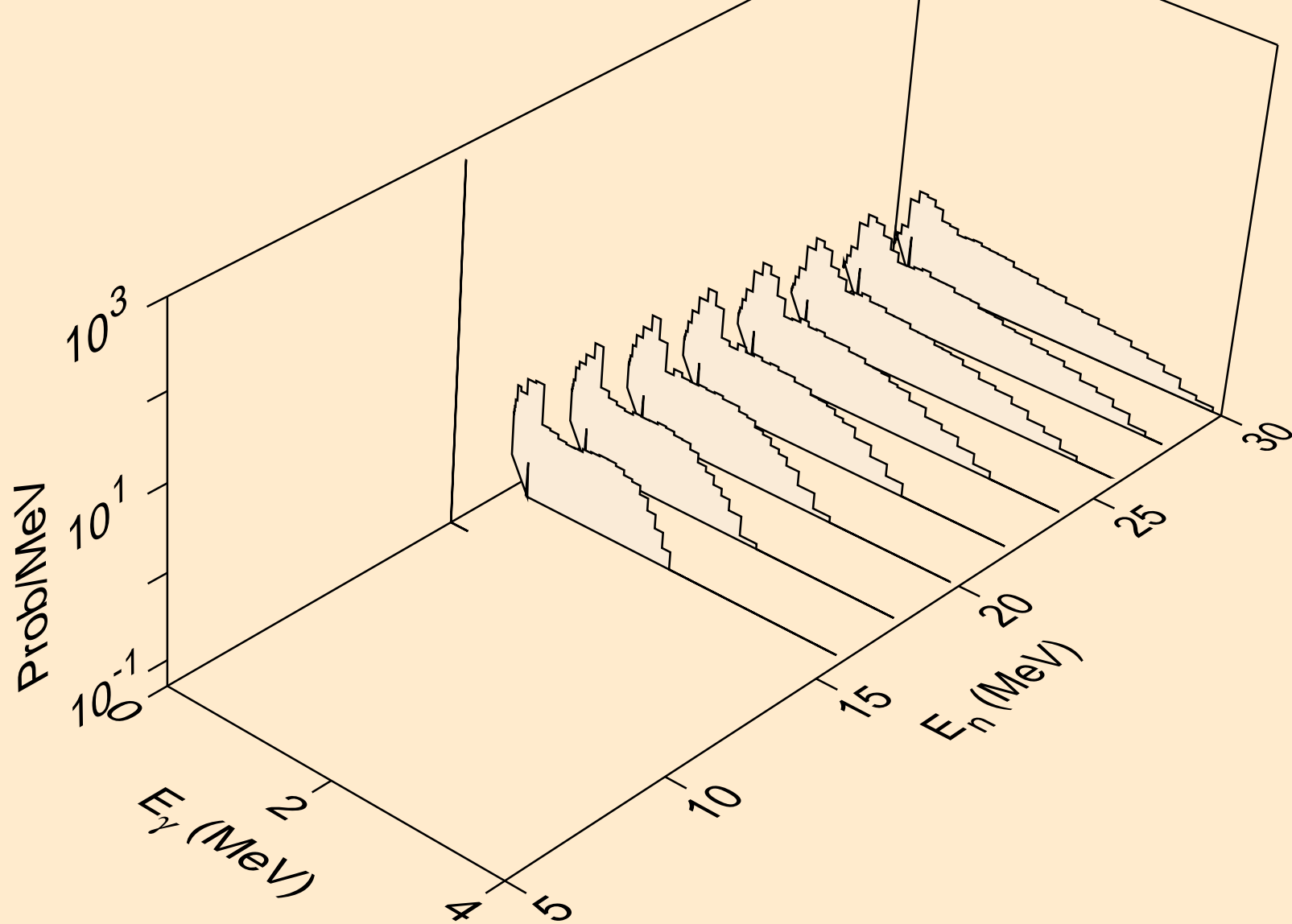

IN127 TRITON ACER TENDL-2021 LIBRARY; T=0.K  
Photon emission for (n,a)

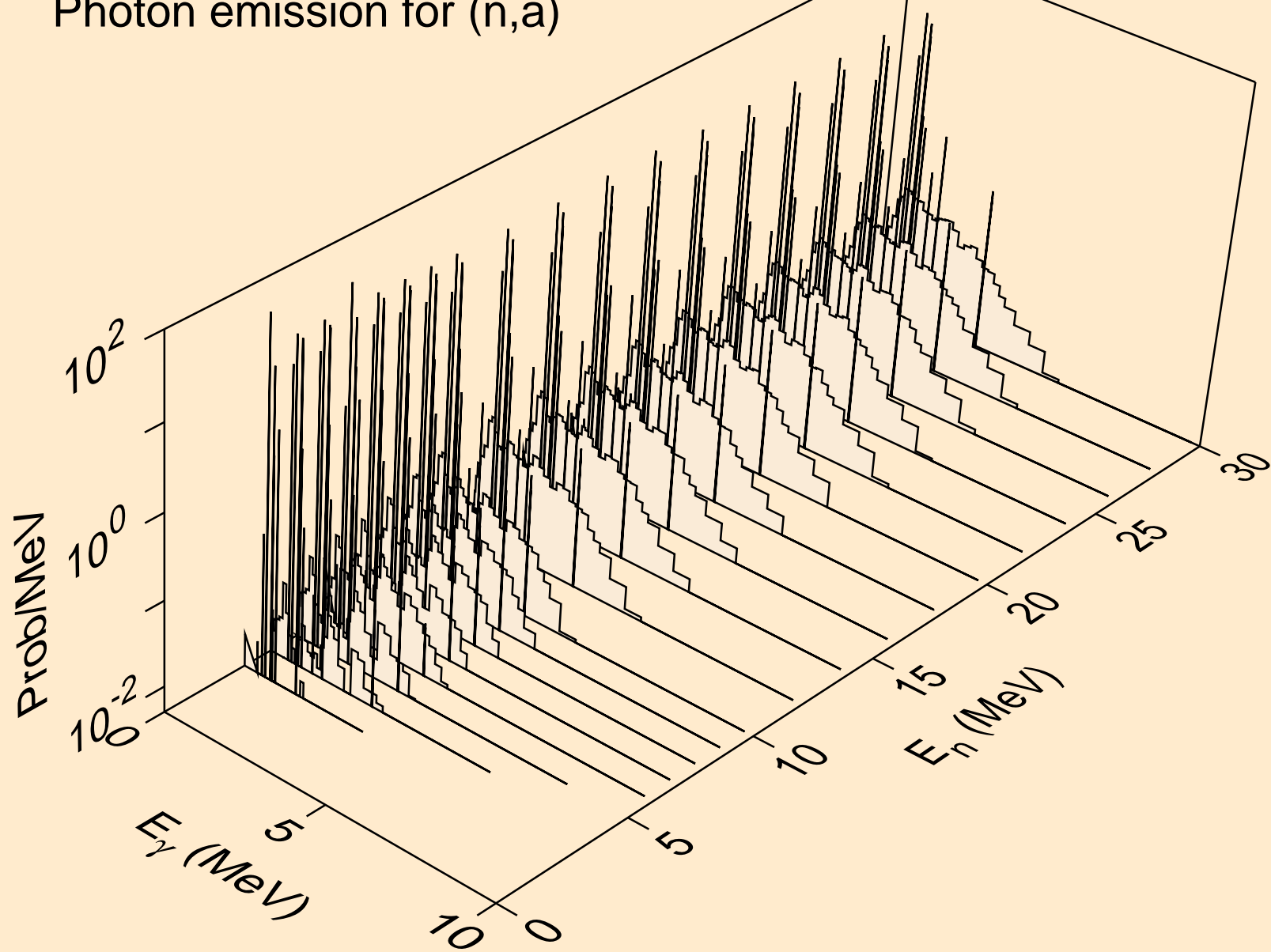

IN127 TRITON ACER TENDL-2021 LIBRARY; T=0.K  
Photon emission for (n,2p)

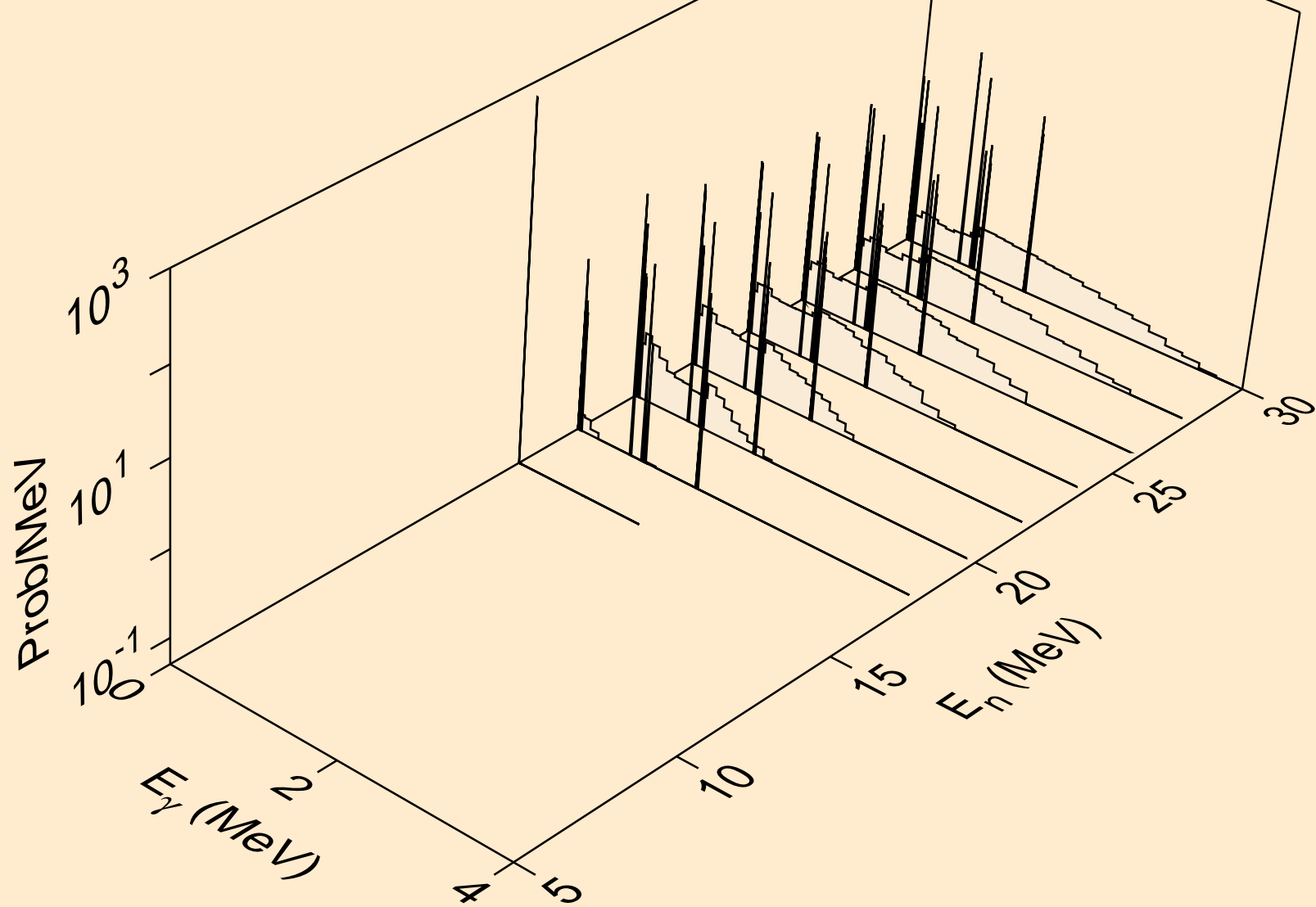

IN127 TRITON ACER TENDL-2021 LIBRARY; T=0.K  
Photon emission for (n,pt)

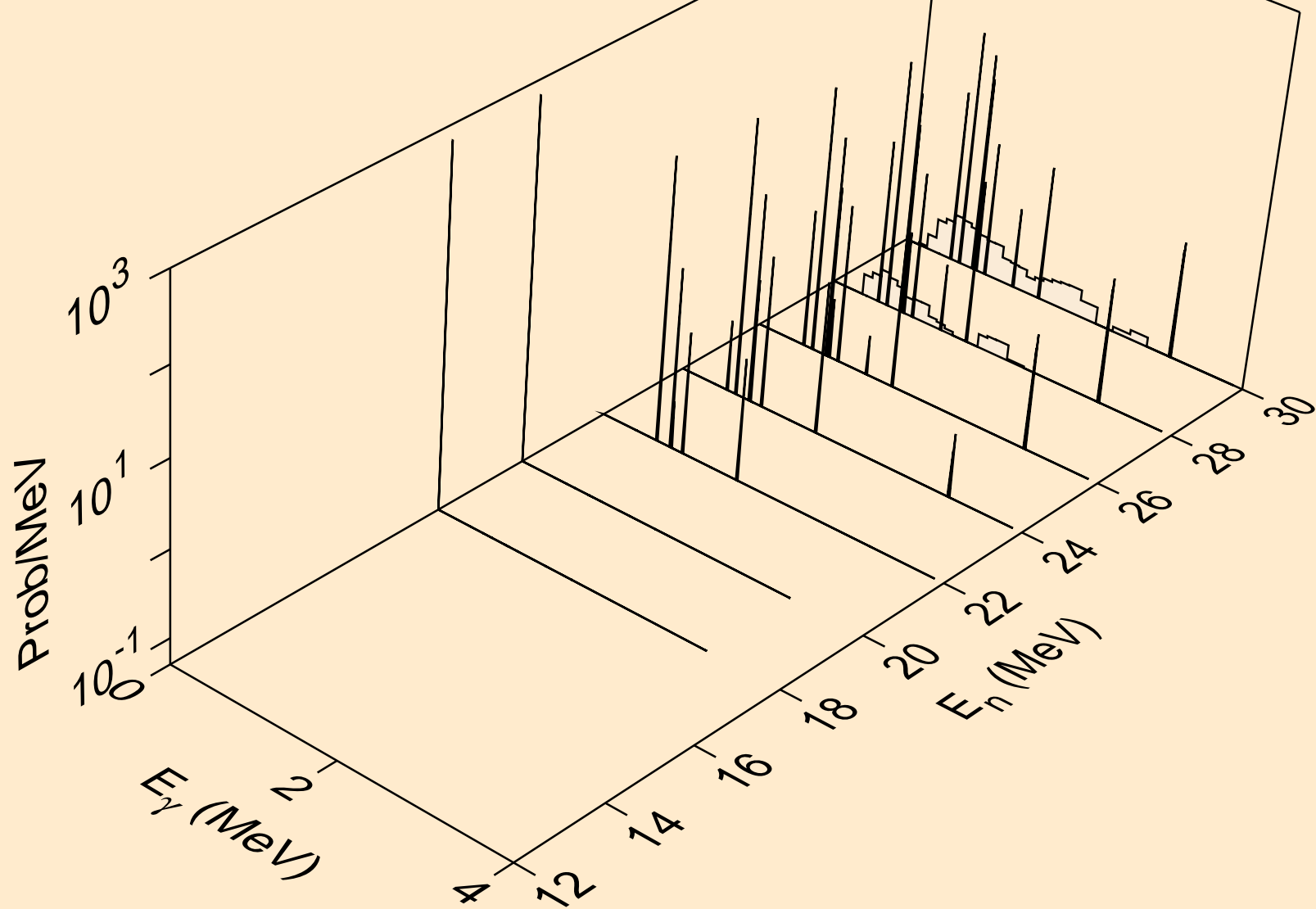

IN127 TRITON ACER TENDL-2021 LIBRARY; T=0.K  
Particle heating contributions

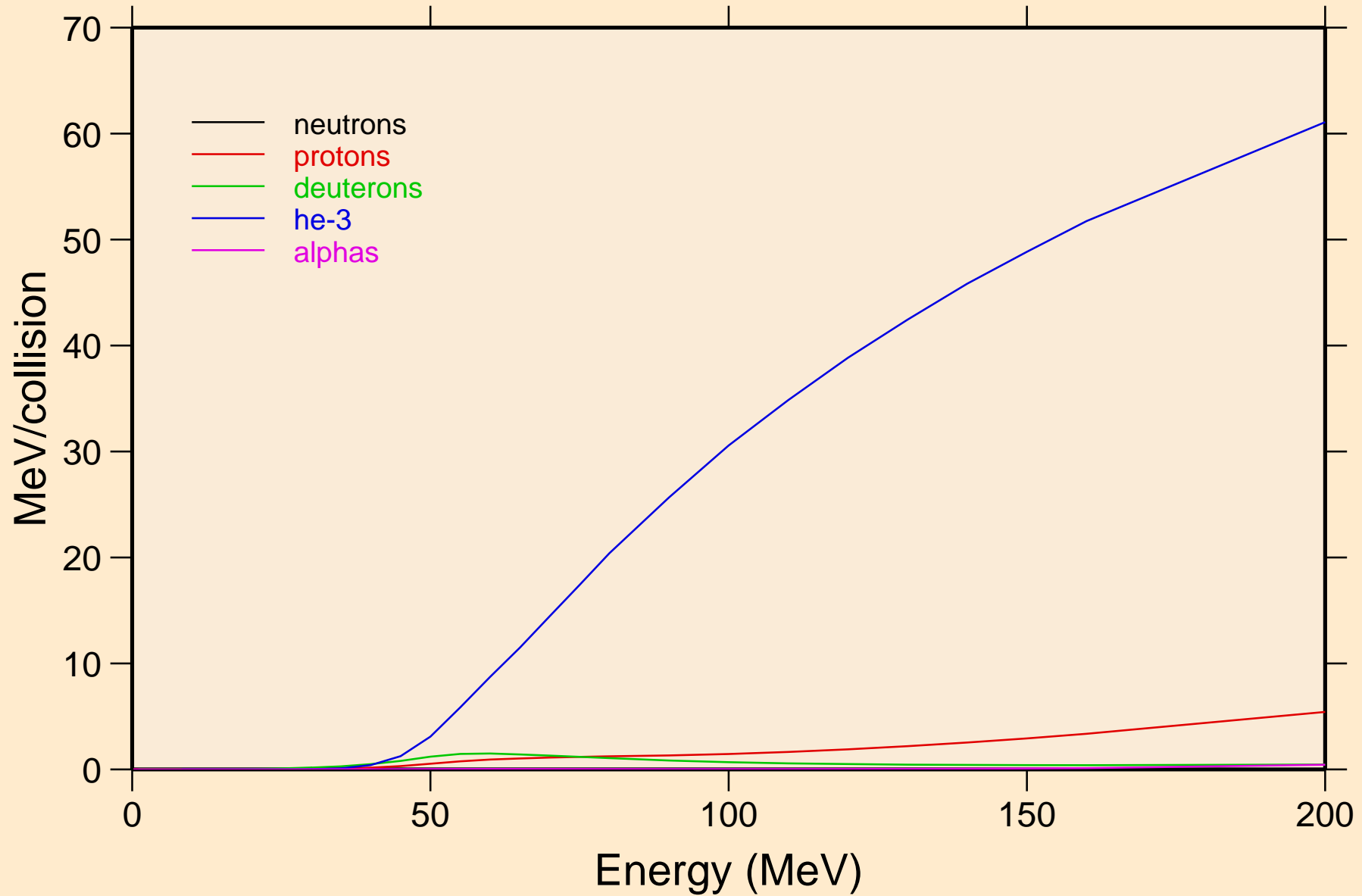

IN127 TRITON ACER TENDL-2021 LIBRARY; T=0.K  
Recoil Heating

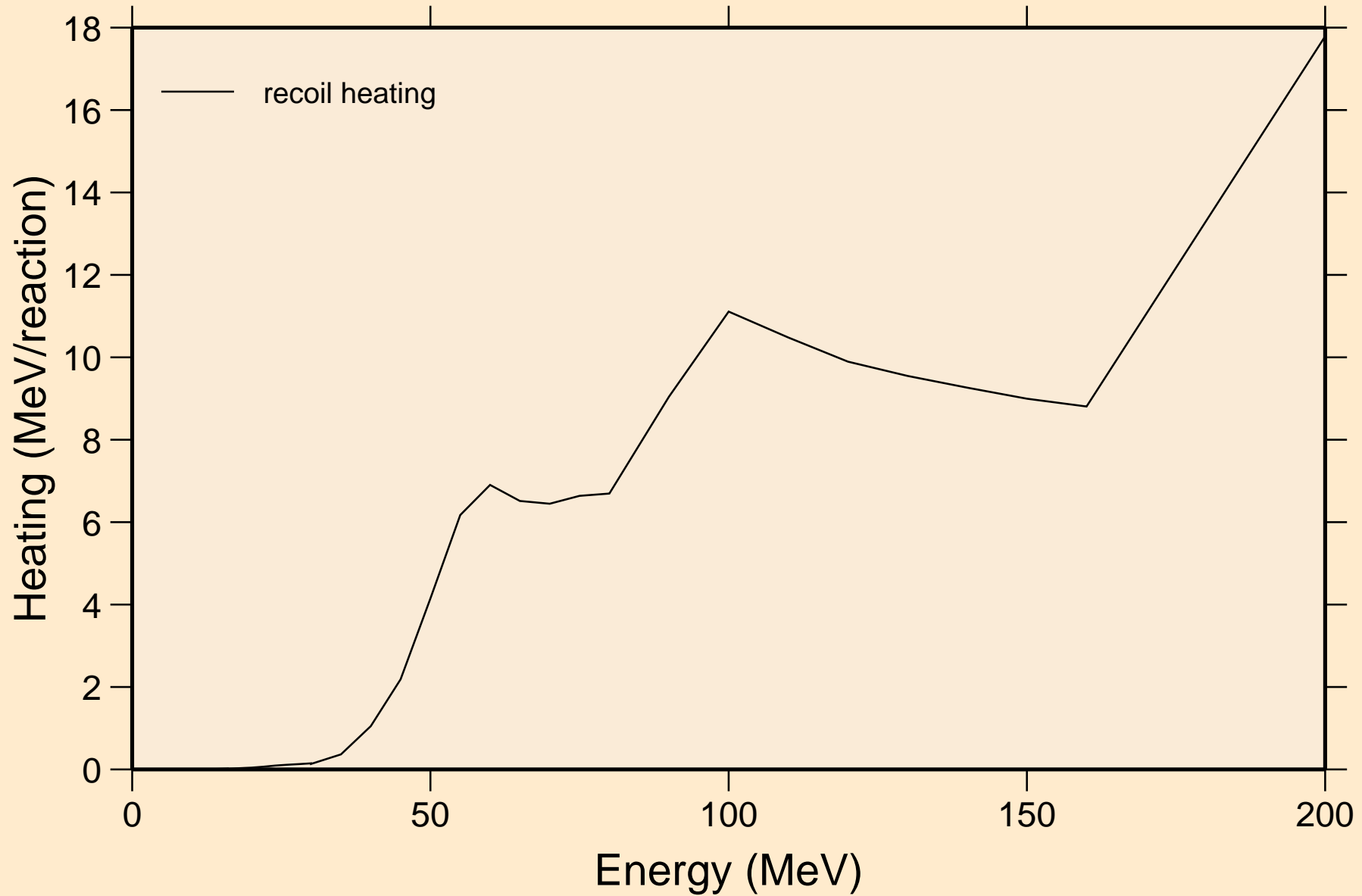

IN127 TRITON ACER TENDL-2021 LIBRARY; T=0.K  
Particle production cross sections

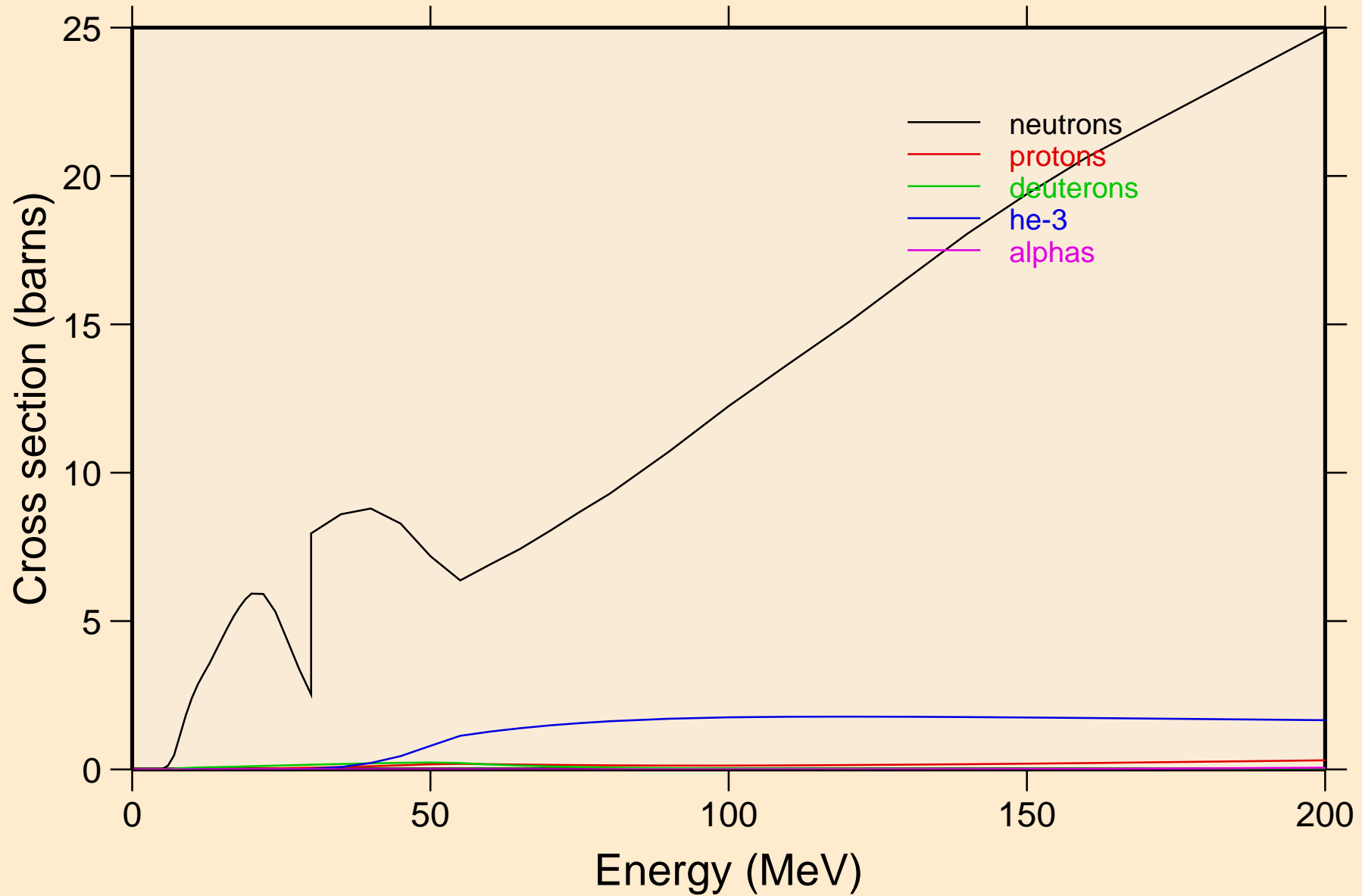

IN127 TRITON ACER TENDL-2021 LIBRARY; T=0.K  
neutrons from (t,n)

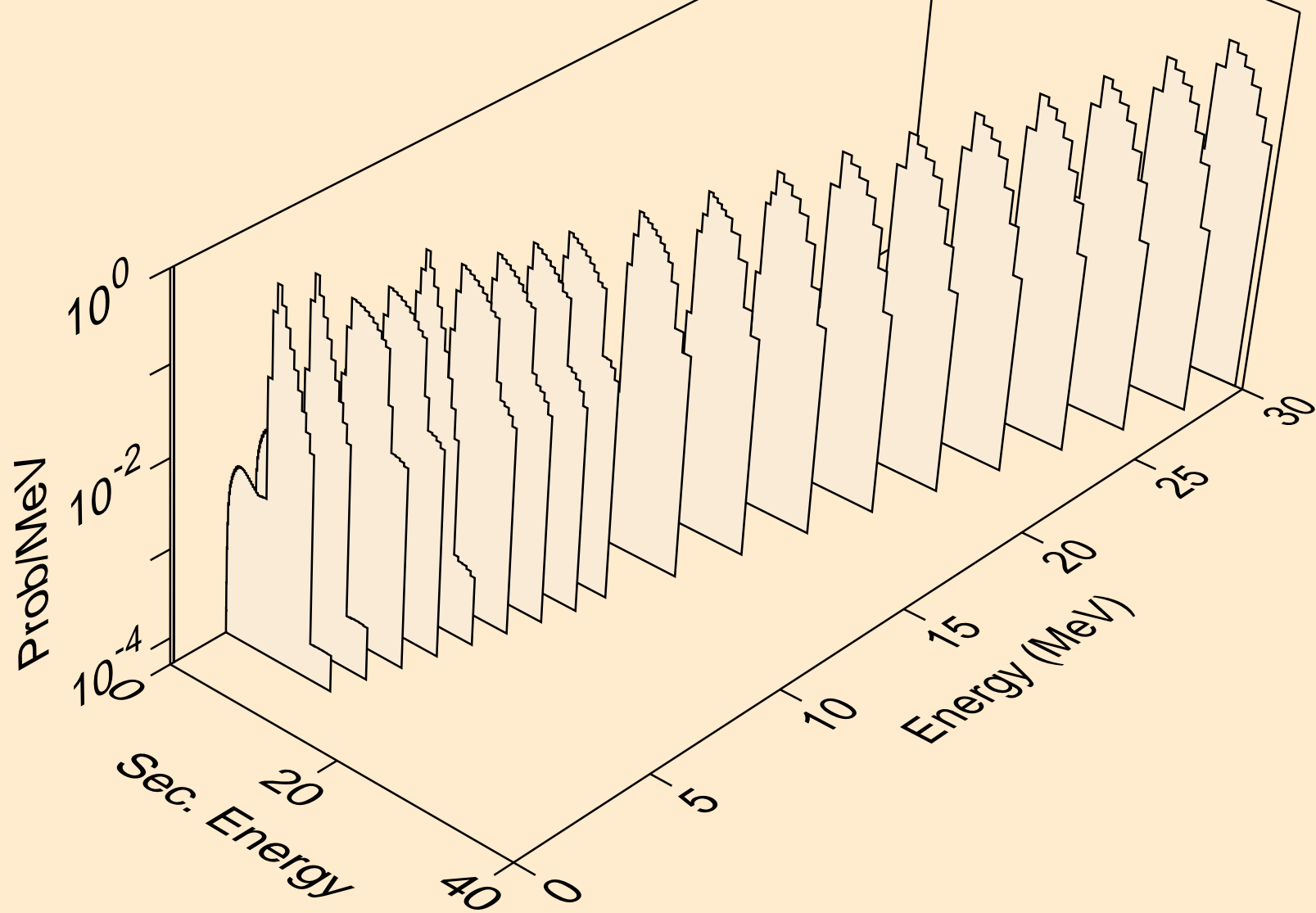



IN127 TRITON ACER TENDL-2021 LIBRARY; T=0.K  
neutrons from (t,x)

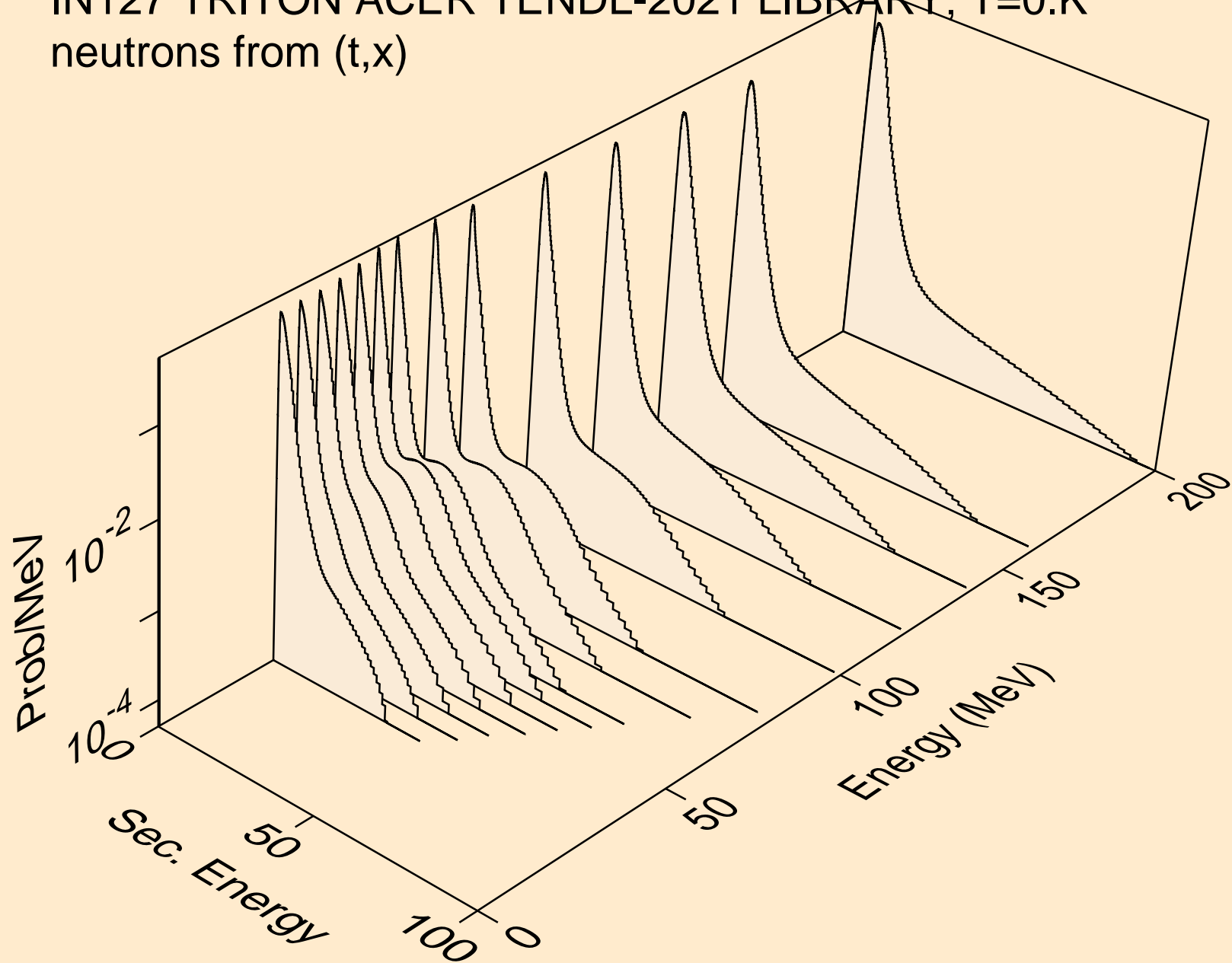

IN127 TRITON ACER TENDL-2021 LIBRARY; T=0.K  
neutrons from (t,2nd)

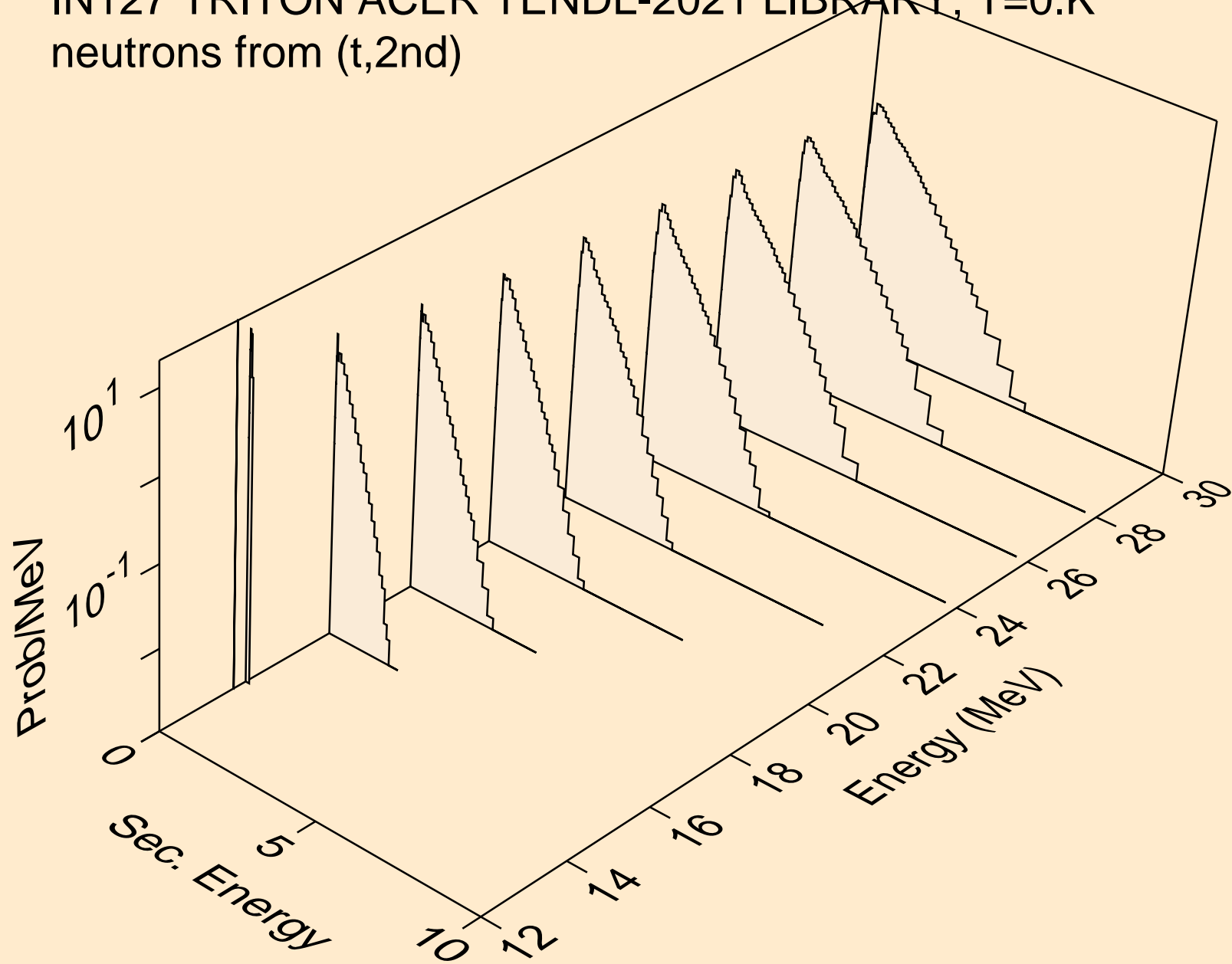

IN127 TRITON ACER TENDL-2021 LIBRARY; T=0.K  
neutrons from (t,2n)

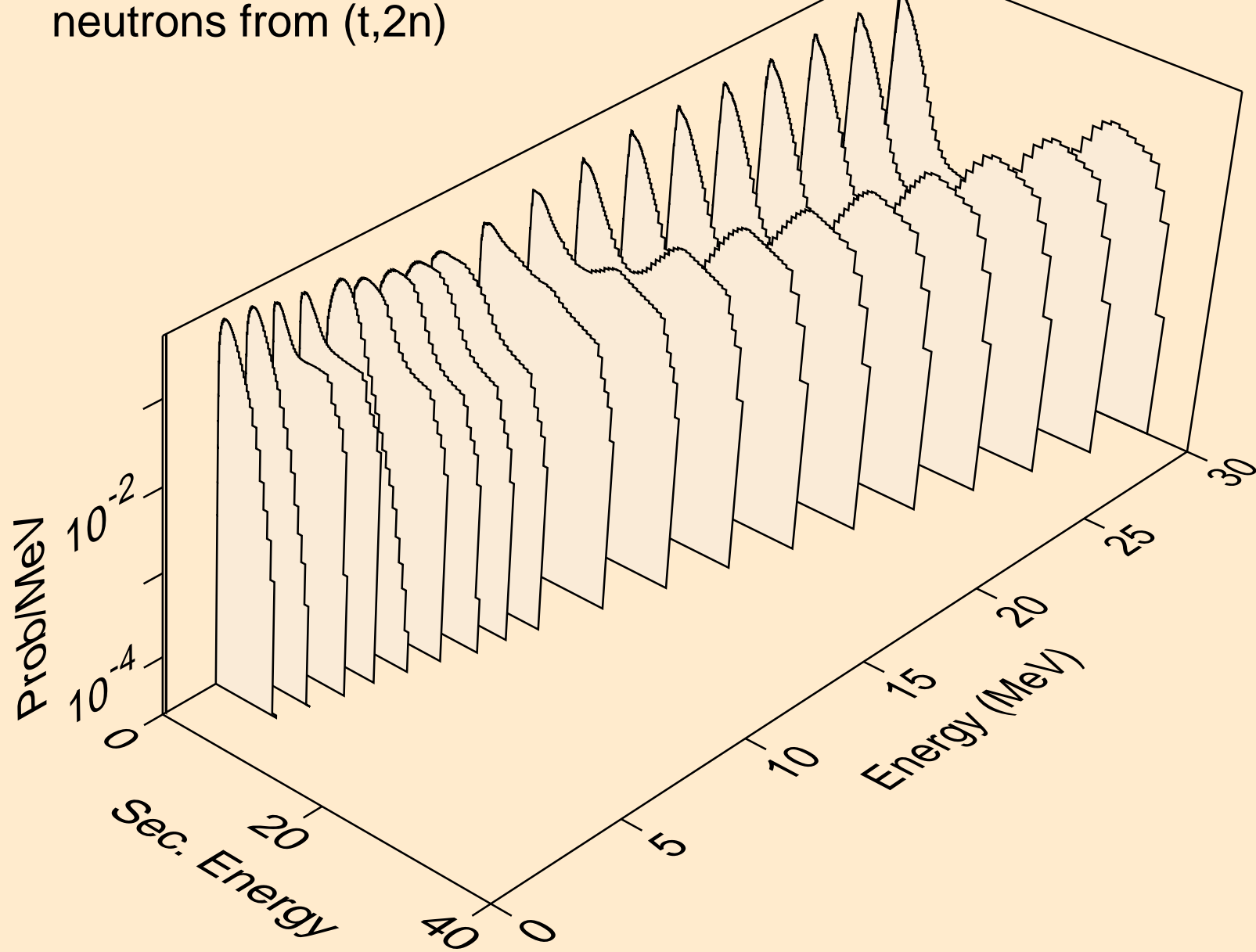

IN127 TRITON ACER TENDL-2021 LIBRARY; T=0.K  
neutrons from (t,3n)

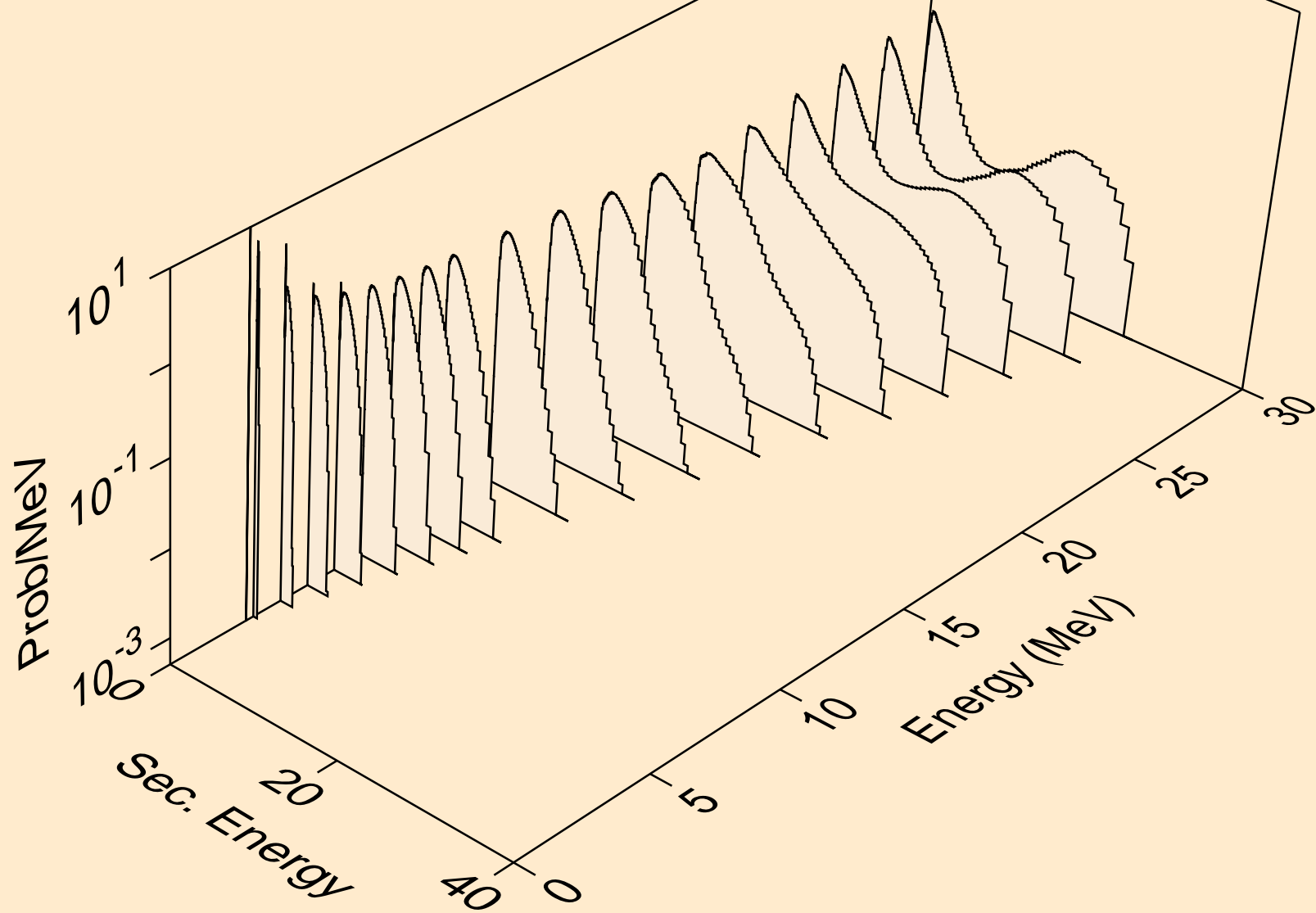

IN127 TRITON ACER TENDL-2021 LIBRARY; T=0.K  
neutrons from (t,n\*)a

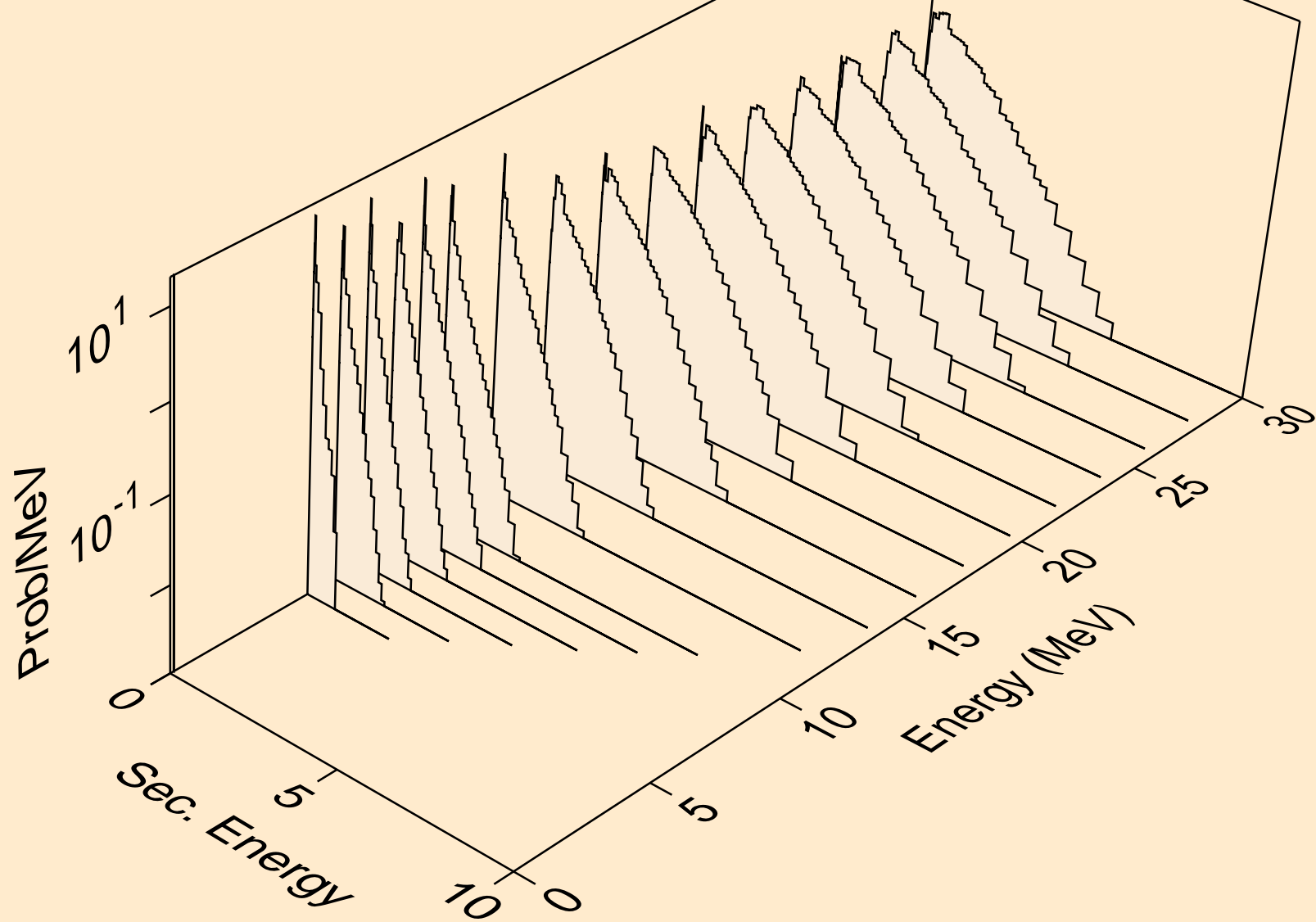

IN127 TRITON ACER TENDL-2021 LIBRARY; T=0.K  
neutrons from (t,2n)a

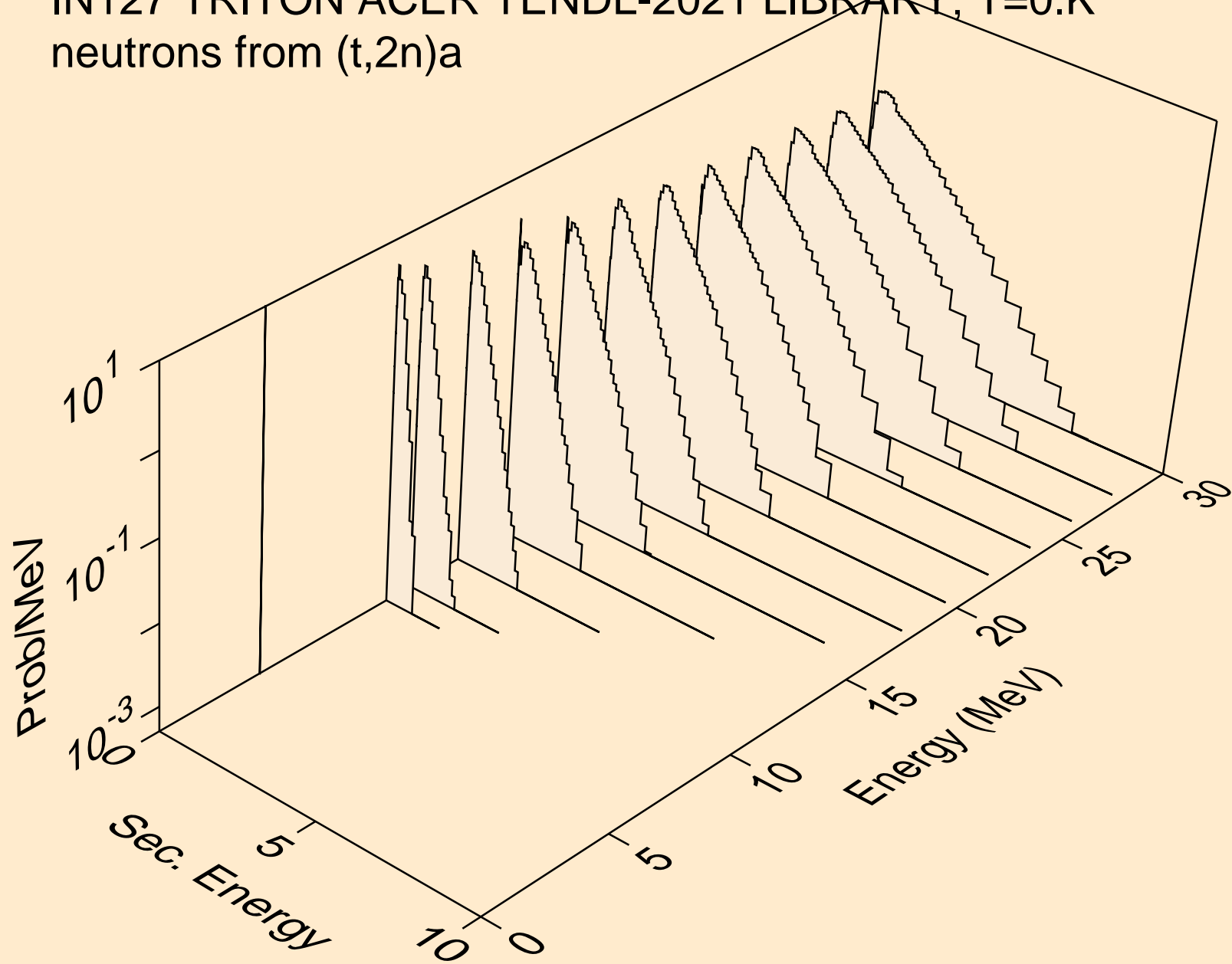

IN127 TRITON ACER TENDL-2021 LIBRARY; T=0.K  
neutrons from (t,3n)a

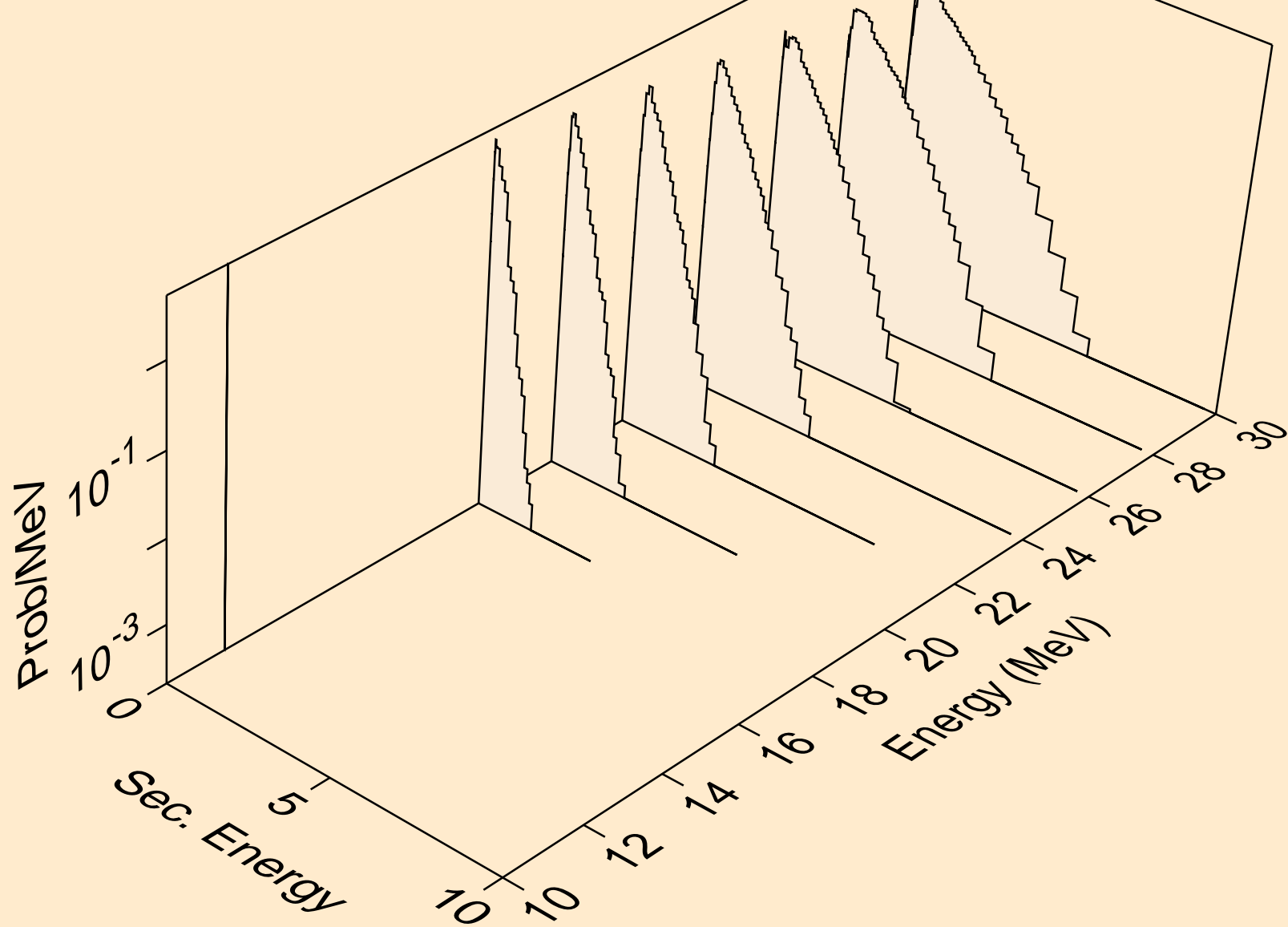

IN127 TRITON ACER TENDL-2021 LIBRARY; T=0.K  
neutrons from (t,n\*)p

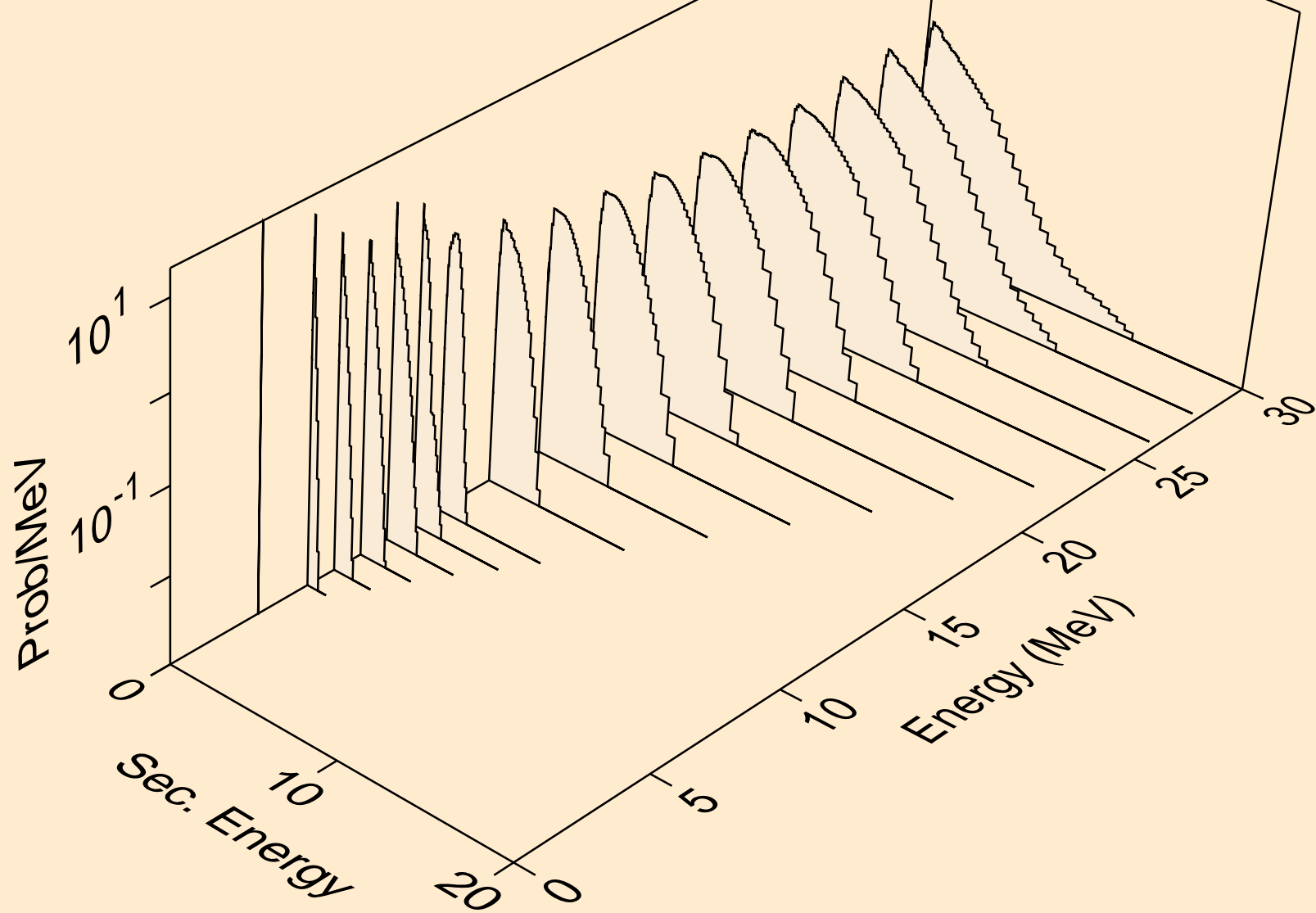



IN127 TRITON ACER TENDL-2021 LIBRARY; T=0.K  
neutrons from (t,n\*)d

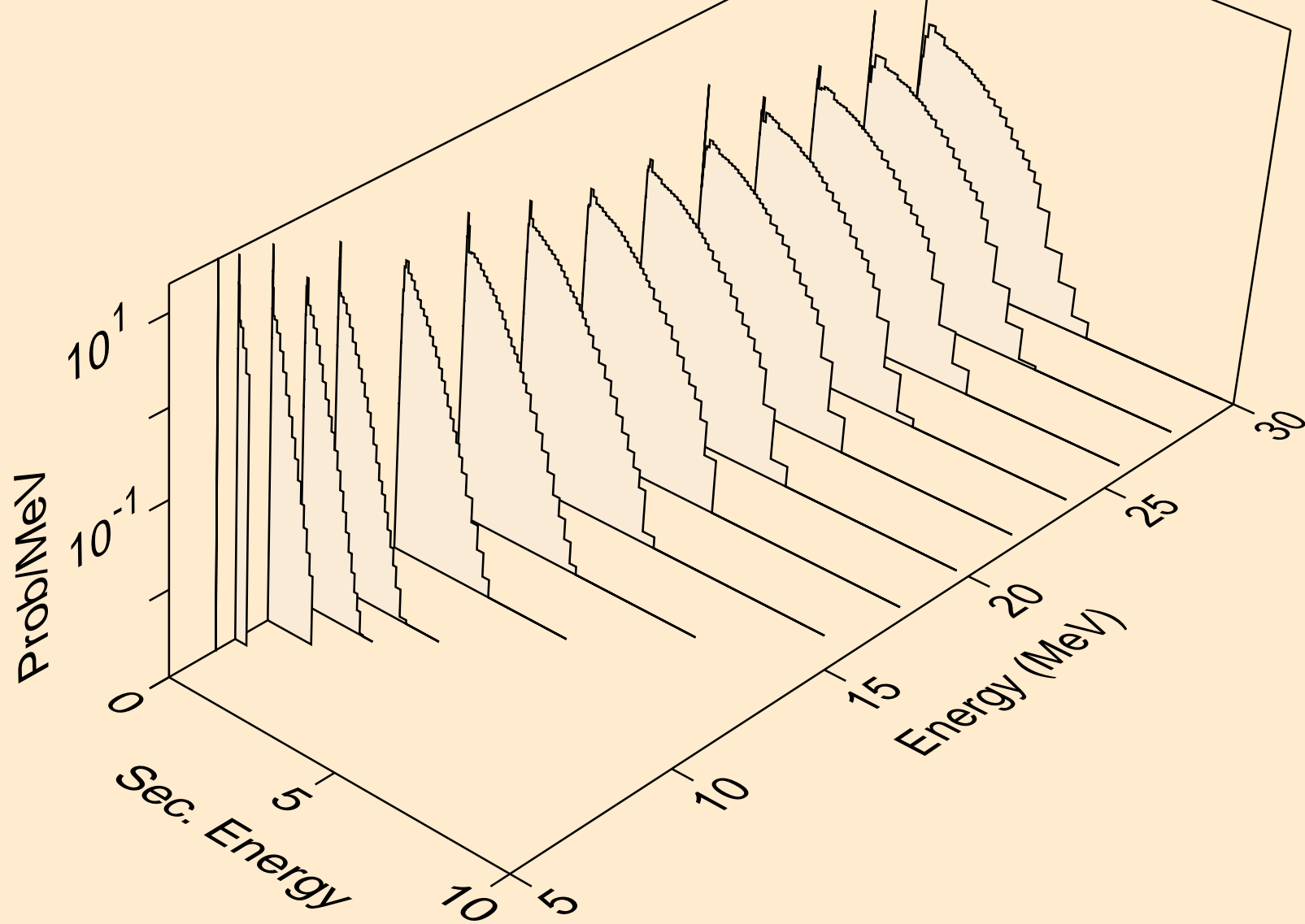

IN127 TRITON ACER TENDL-2021 LIBRARY; T=0.K  
neutrons from (t,n\*)t

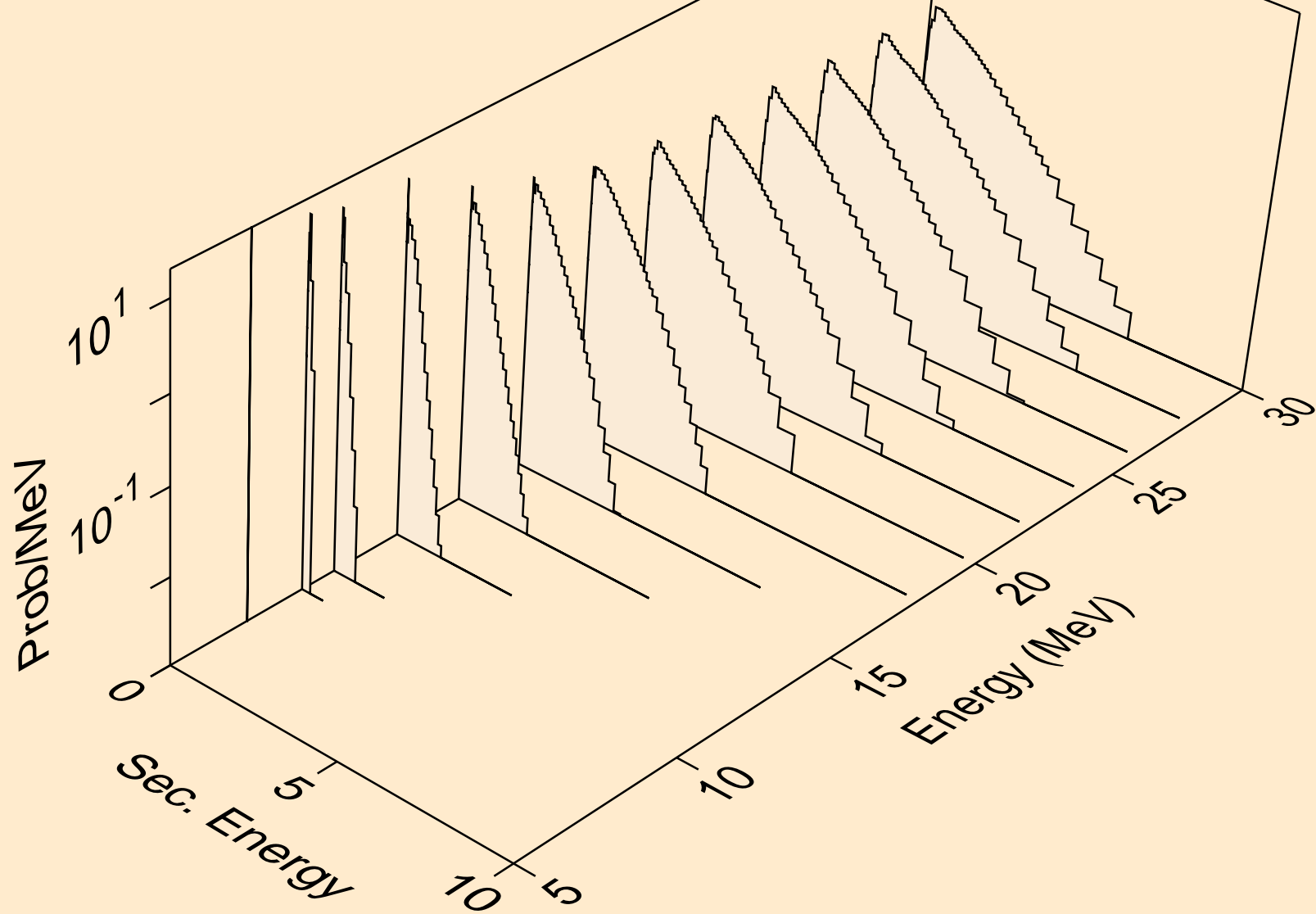

IN127 TRITON ACER TENDL-2021 LIBRARY; T=0.K  
neutrons from (t,n\*)he3

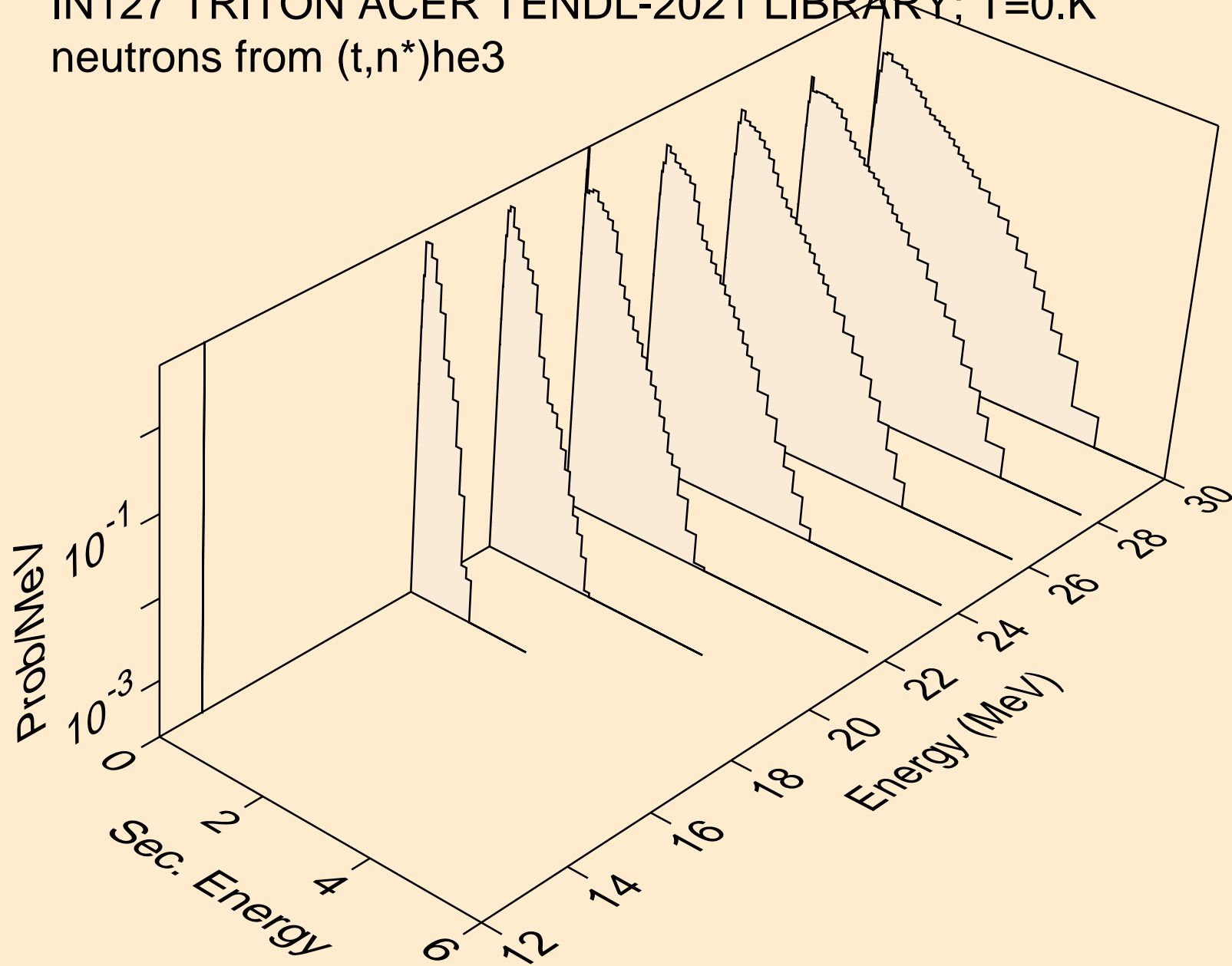

IN127 TRITON ACER TENDL-2021 LIBRARY; T=0.K  
neutrons from (t,4n)

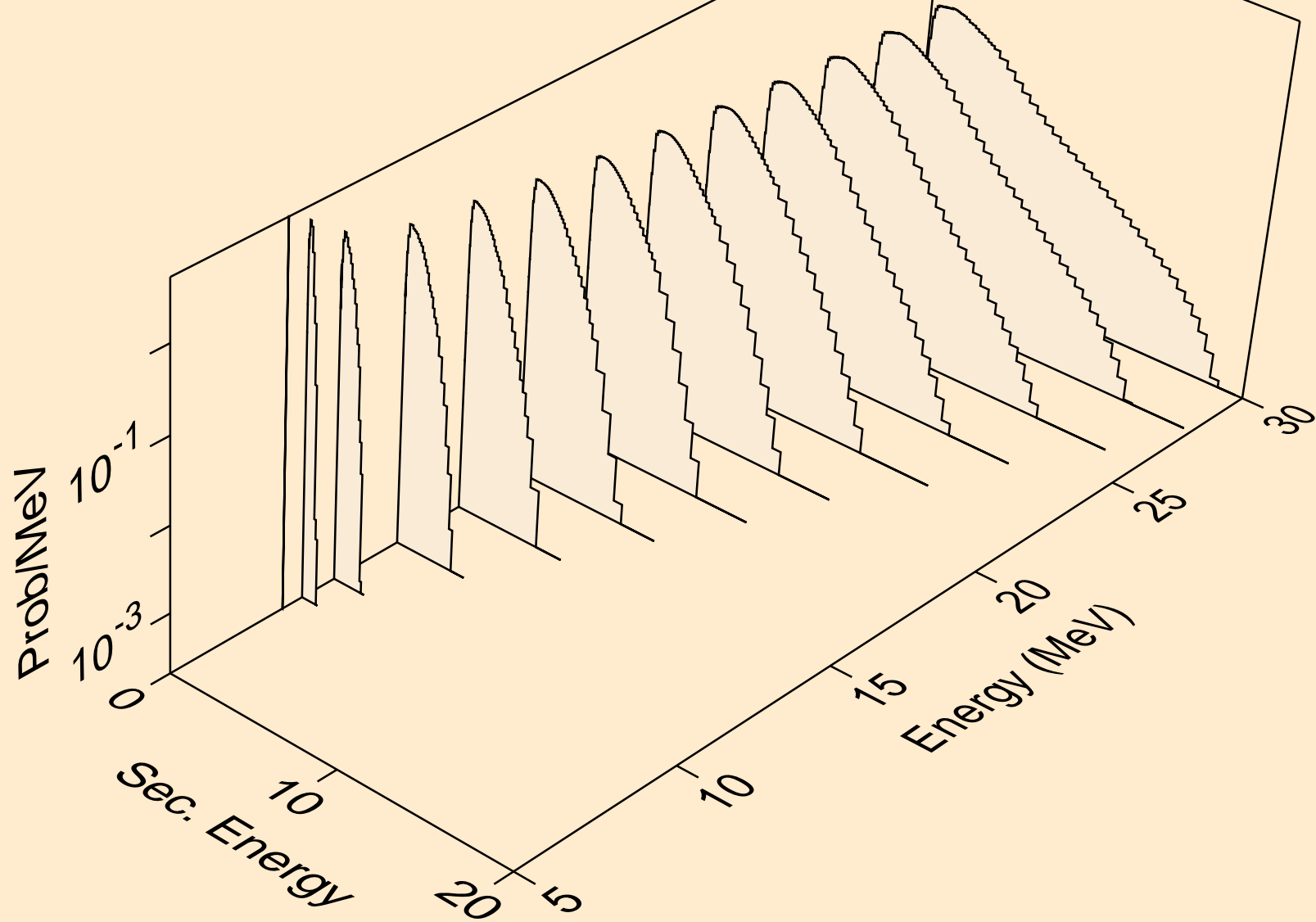

IN127 TRITON ACER TENDL-2021 LIBRARY; T=0.K  
neutrons from (t,2np)

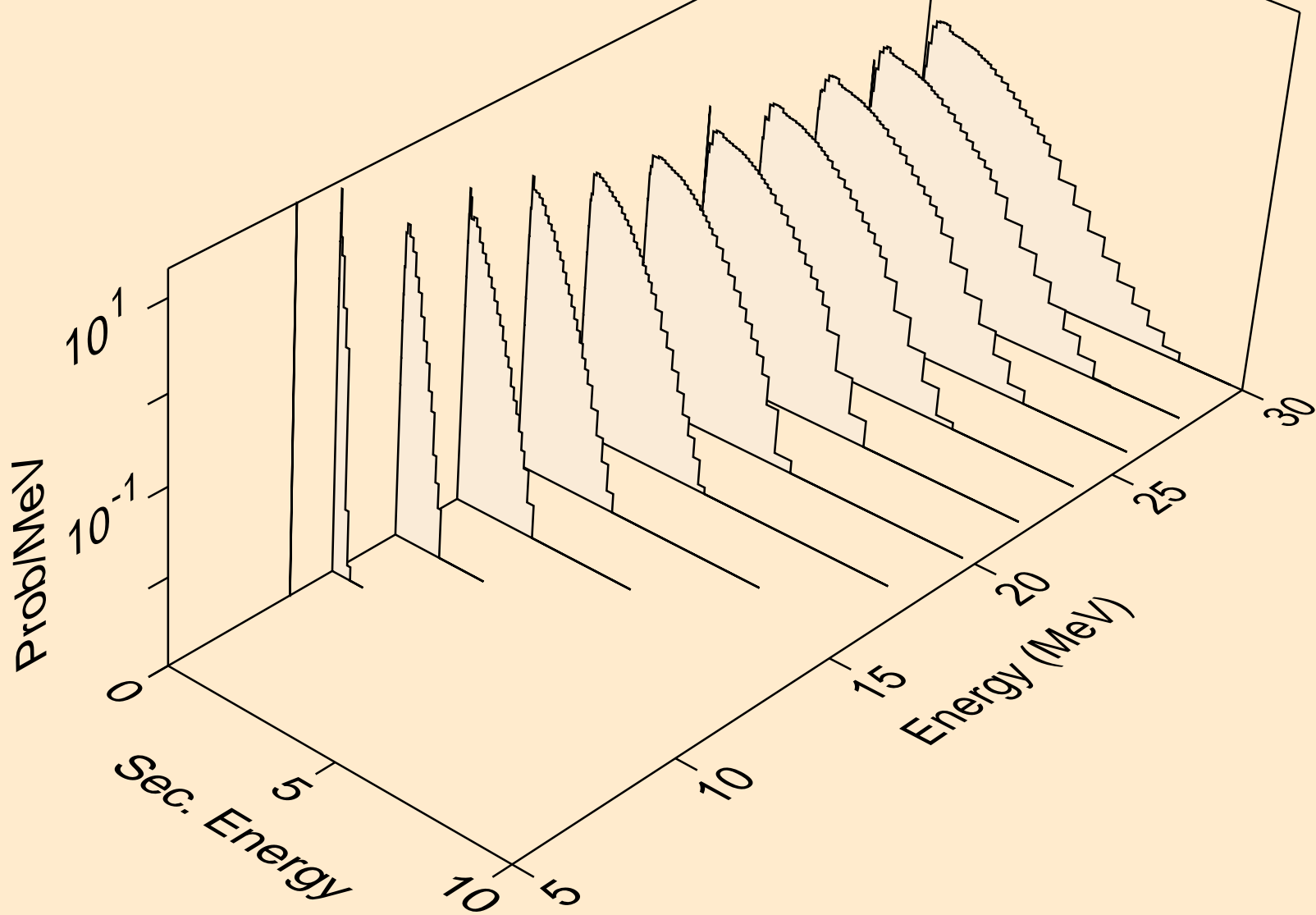

IN127 TRITON ACER TENDL-2021 LIBRARY; T=0.K  
neutrons from (t,3np)

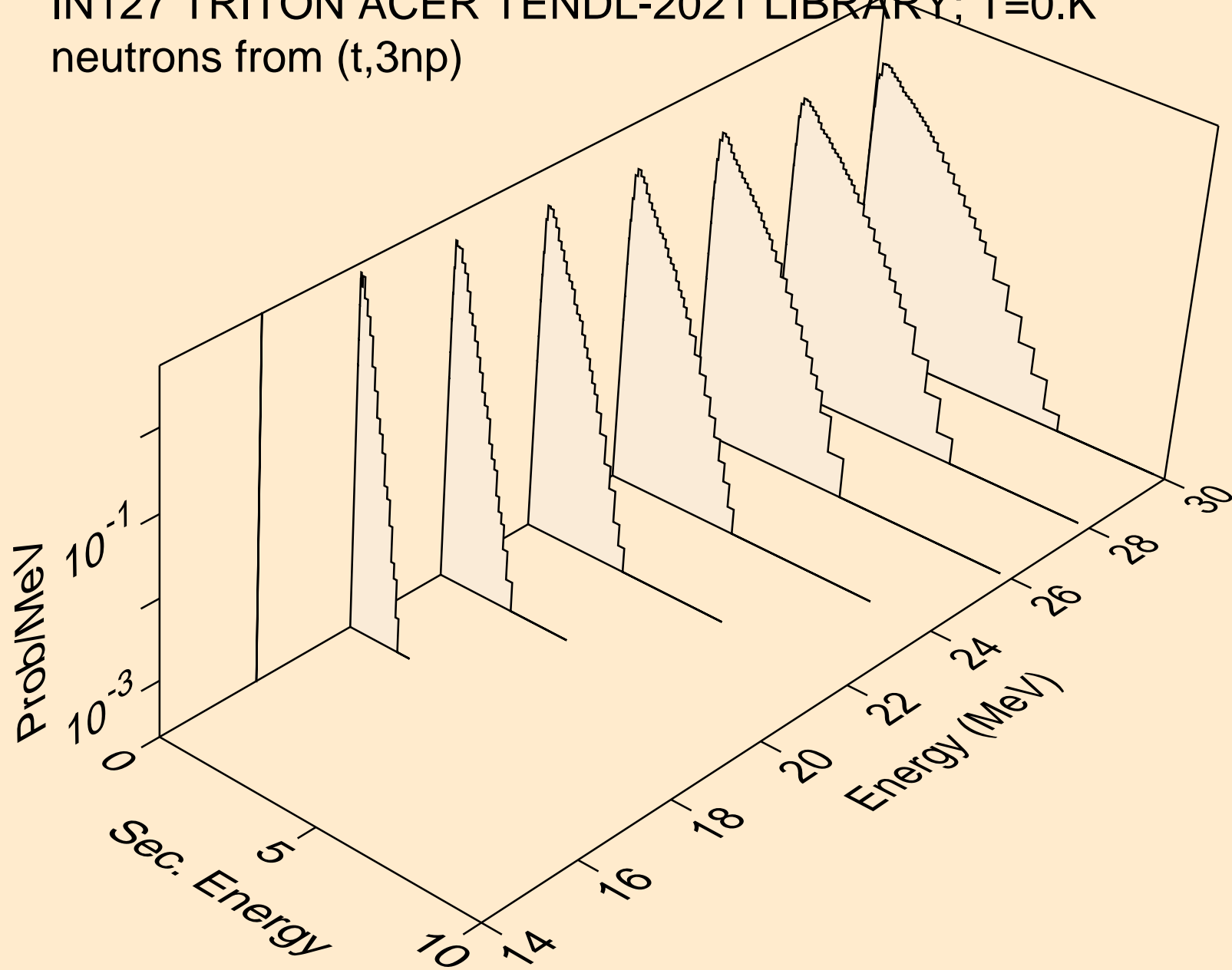

IN127 TRITON ACER TENDL-2021 LIBRARY; T=0.K  
neutrons from (t,2np)

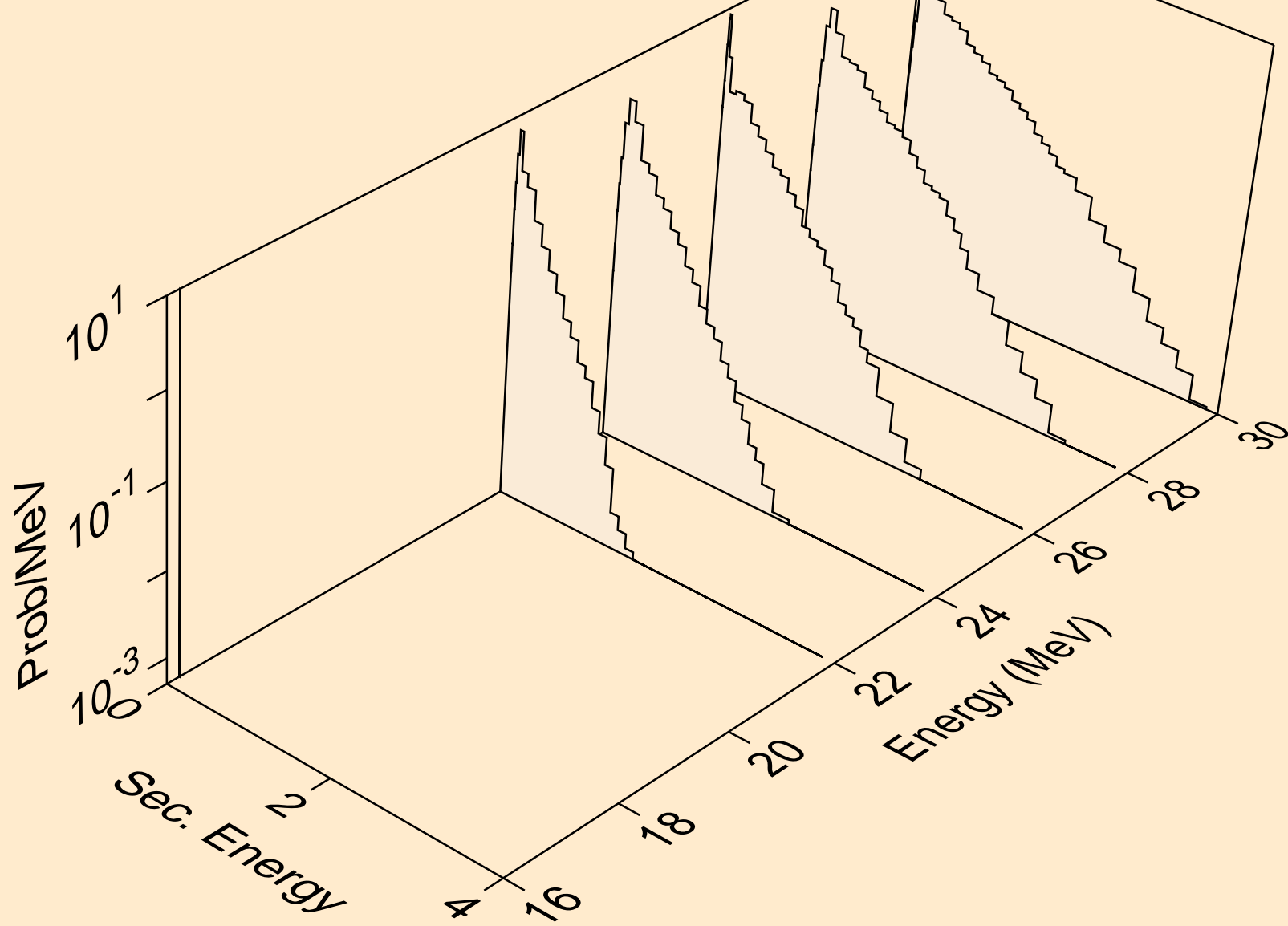

IN127 TRITON ACER TENDL-2021 LIBRARY; T=0.K  
protons from (t,x)

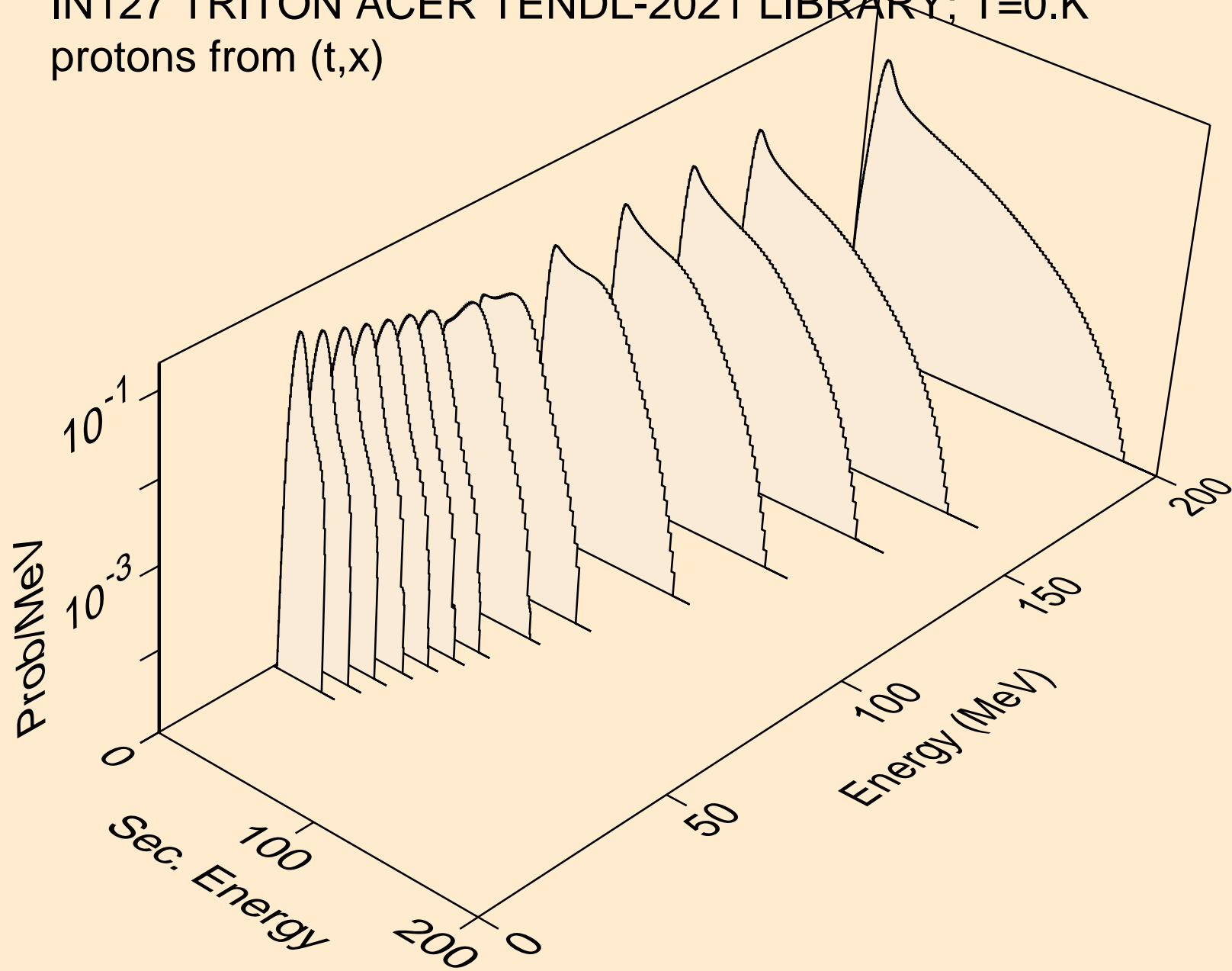



IN127 TRITON ACER TENDL-2021 LIBRARY; T=0.K  
protons from (t,n\*)p

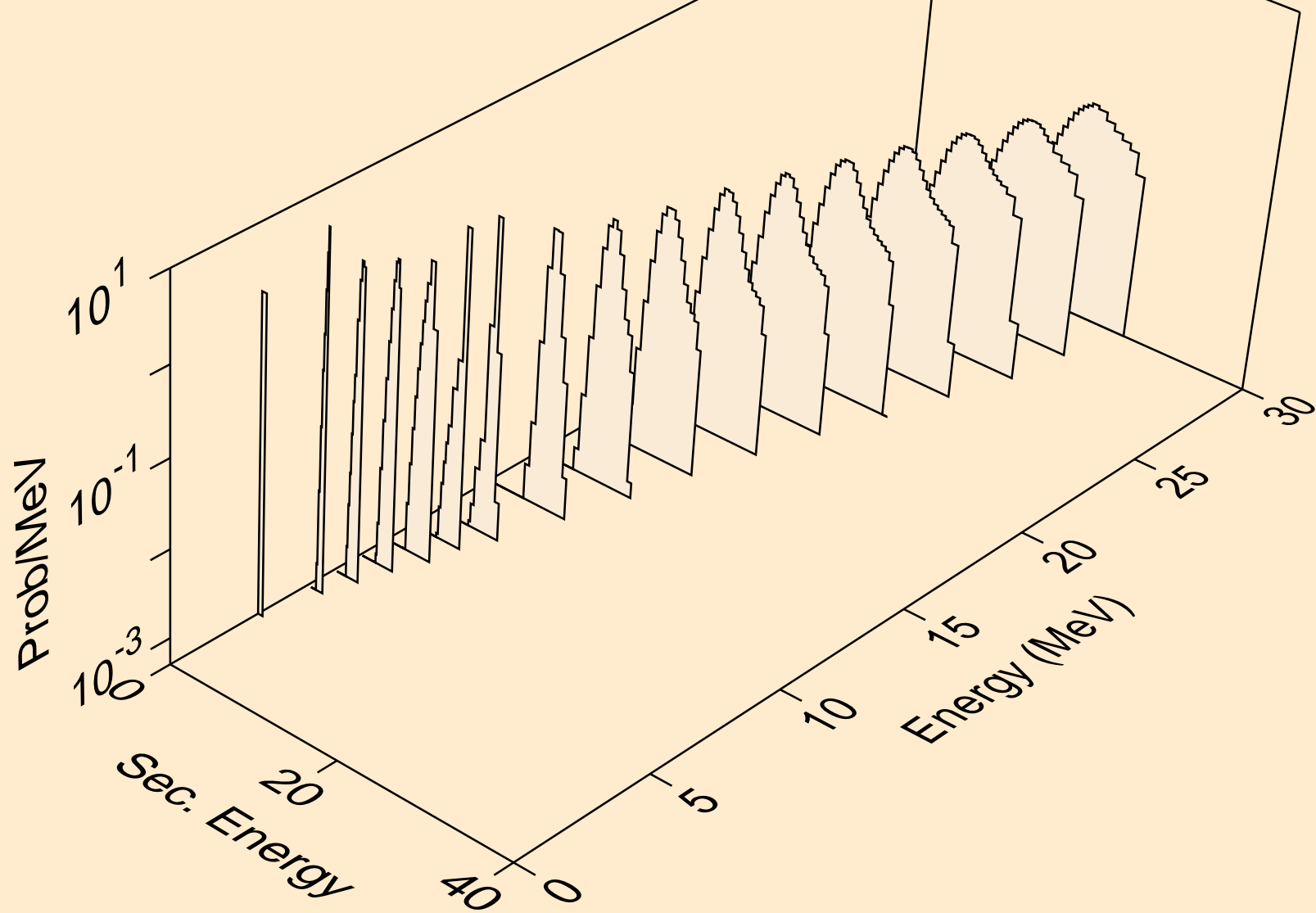

IN127 TRITON ACER TENDL-2021 LIBRARY; T=0.K  
protons from (t,2np)

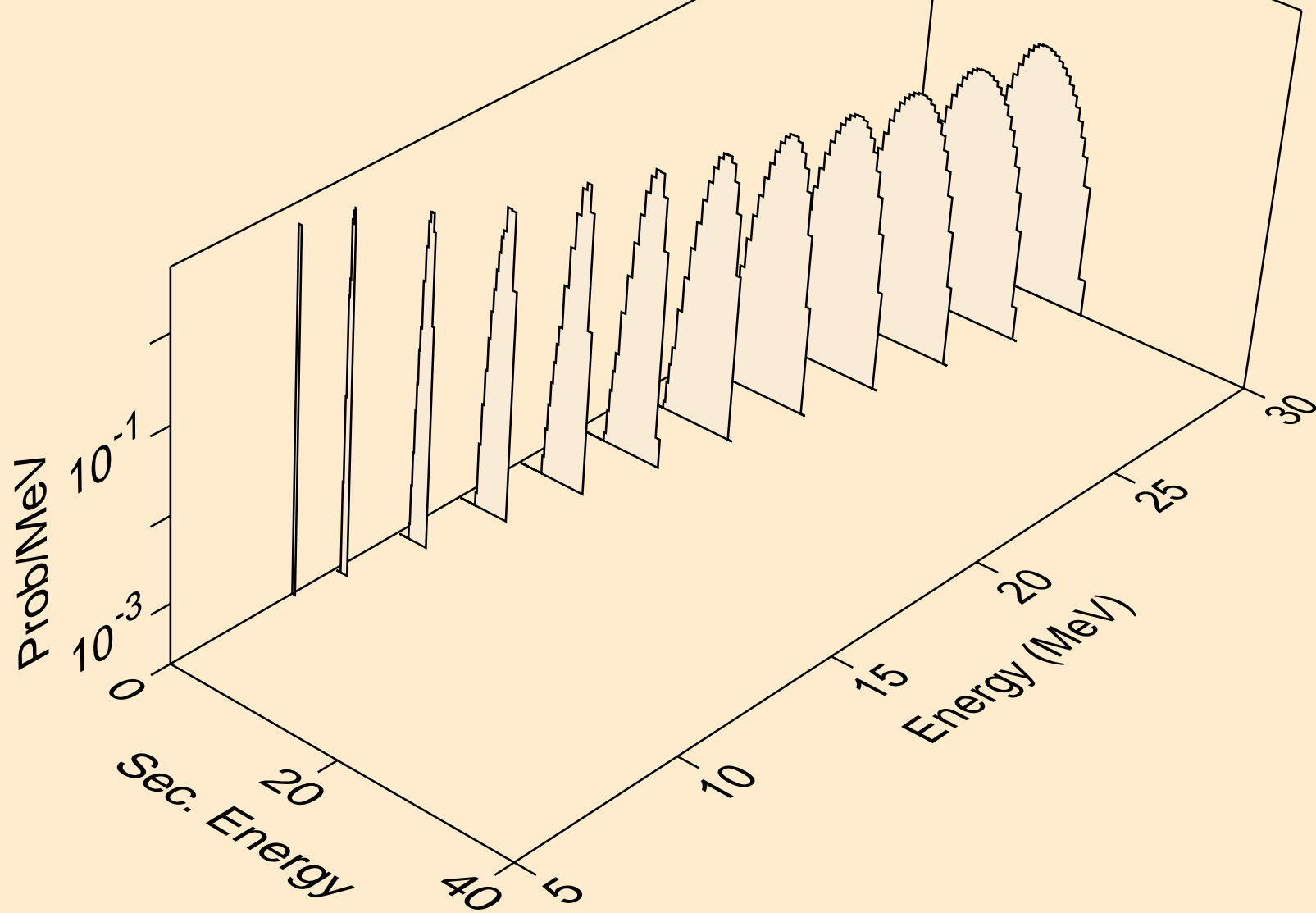

IN127 TRITON ACER TENDL-2021 LIBRARY; T=0.K  
protons from (t,3np)

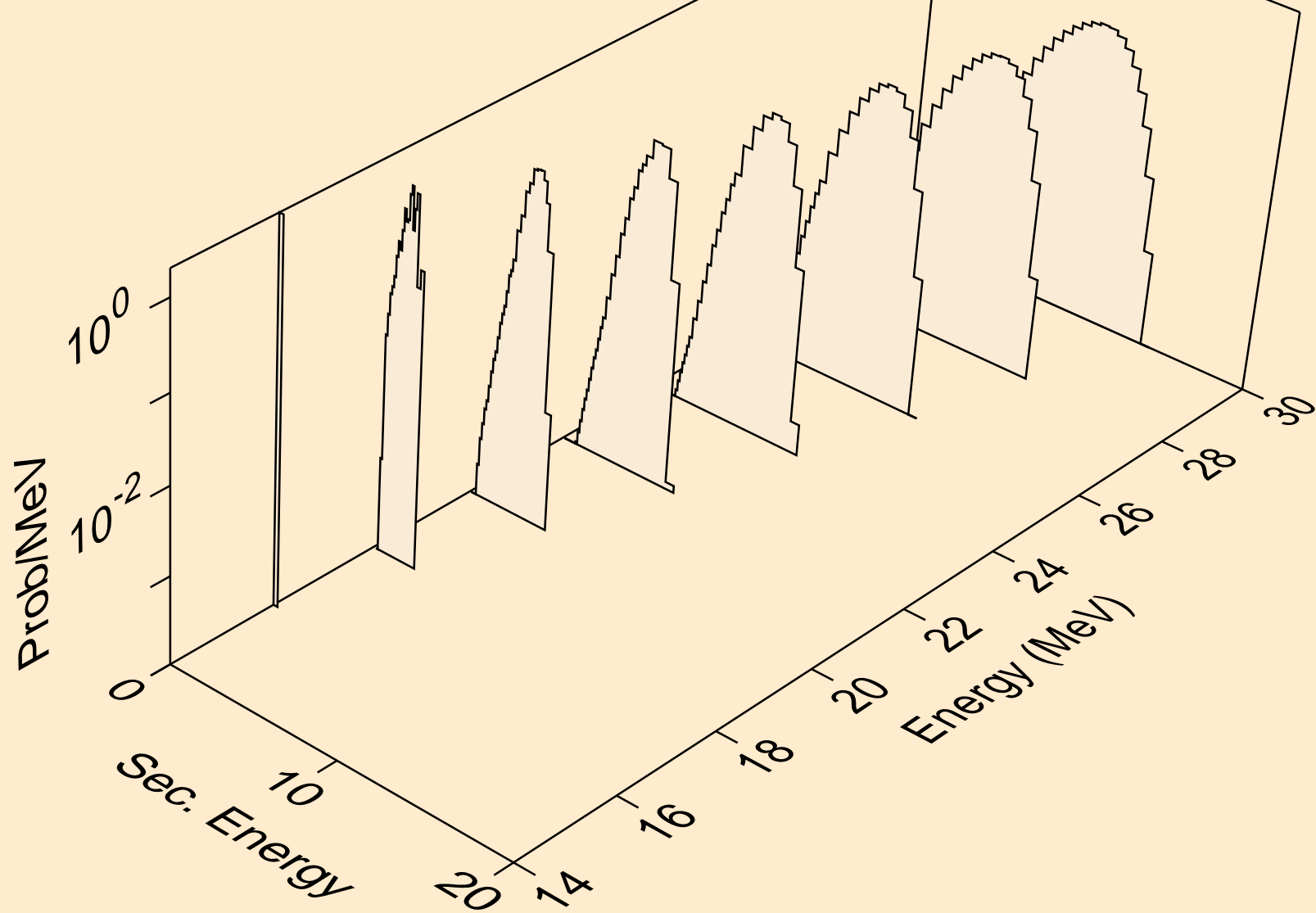

IN127 TRITON ACER TENDL-2021 LIBRARY; T=0.K  
protons from (t,2np)

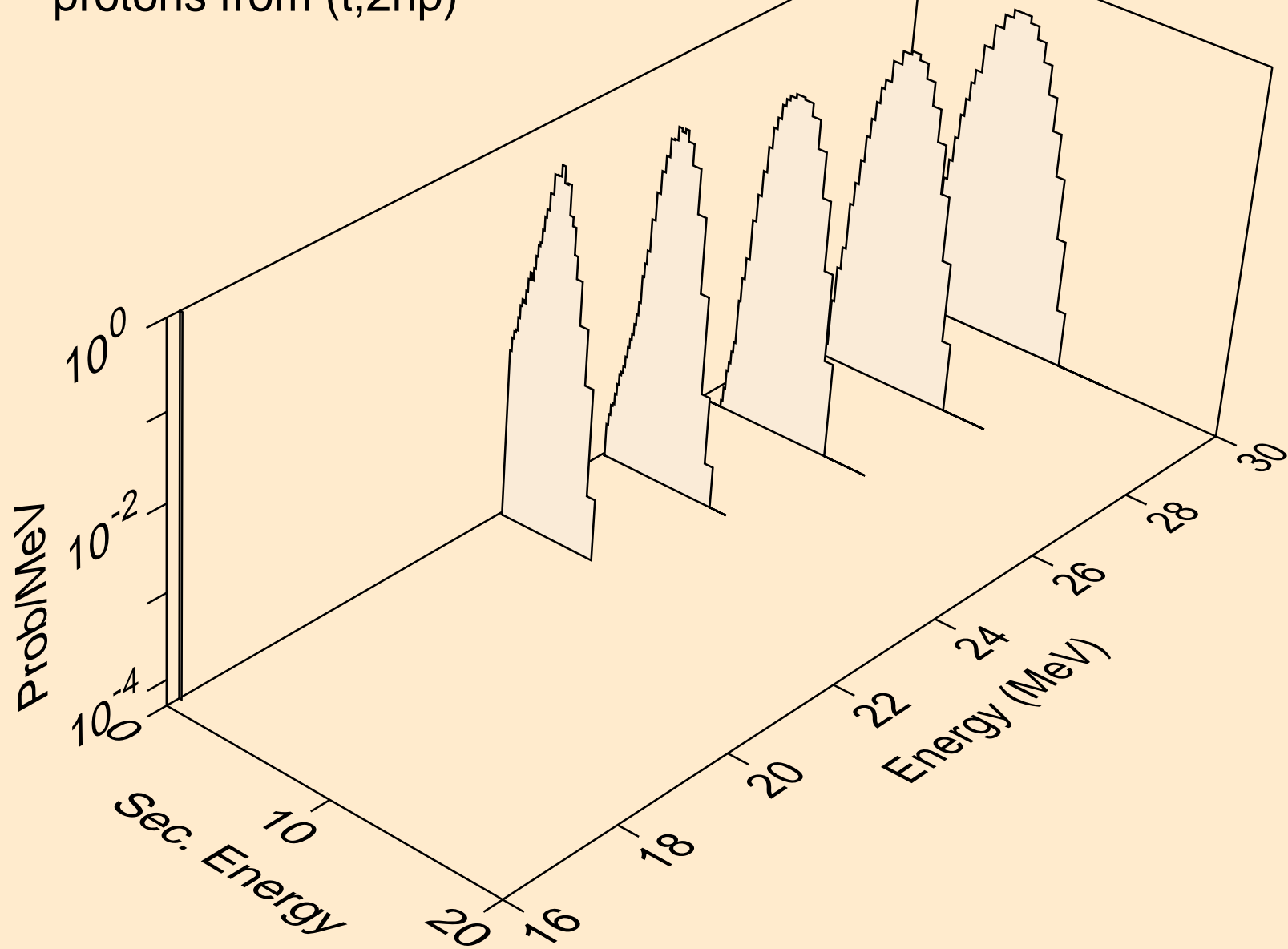

IN127 TRITON ACER TENDL-2021 LIBRARY; T=0.K  
protons from (t,p)

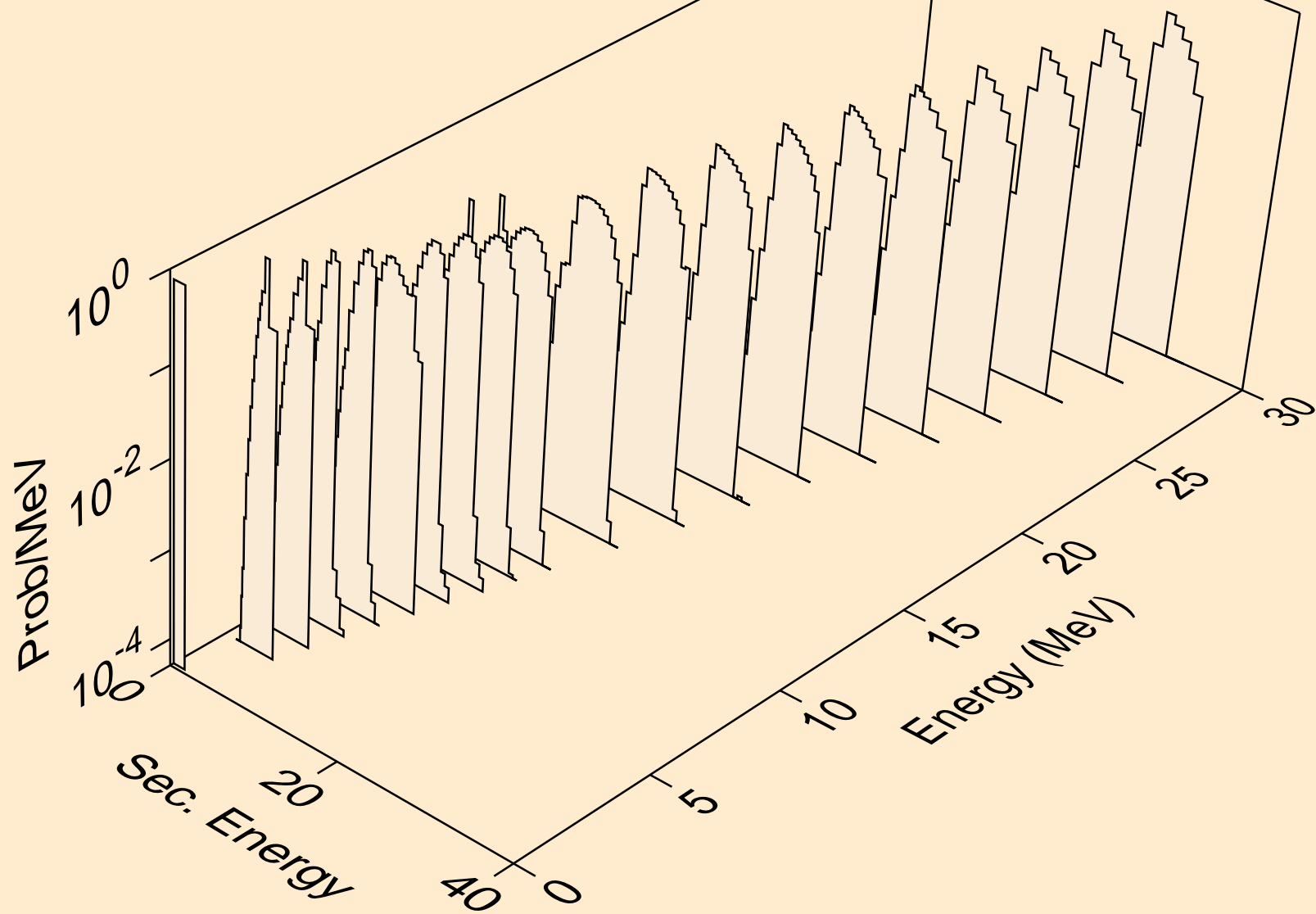

IN127 TRITON ACER TENDL-2021 LIBRARY; T=0.K  
protons from (t,2p)

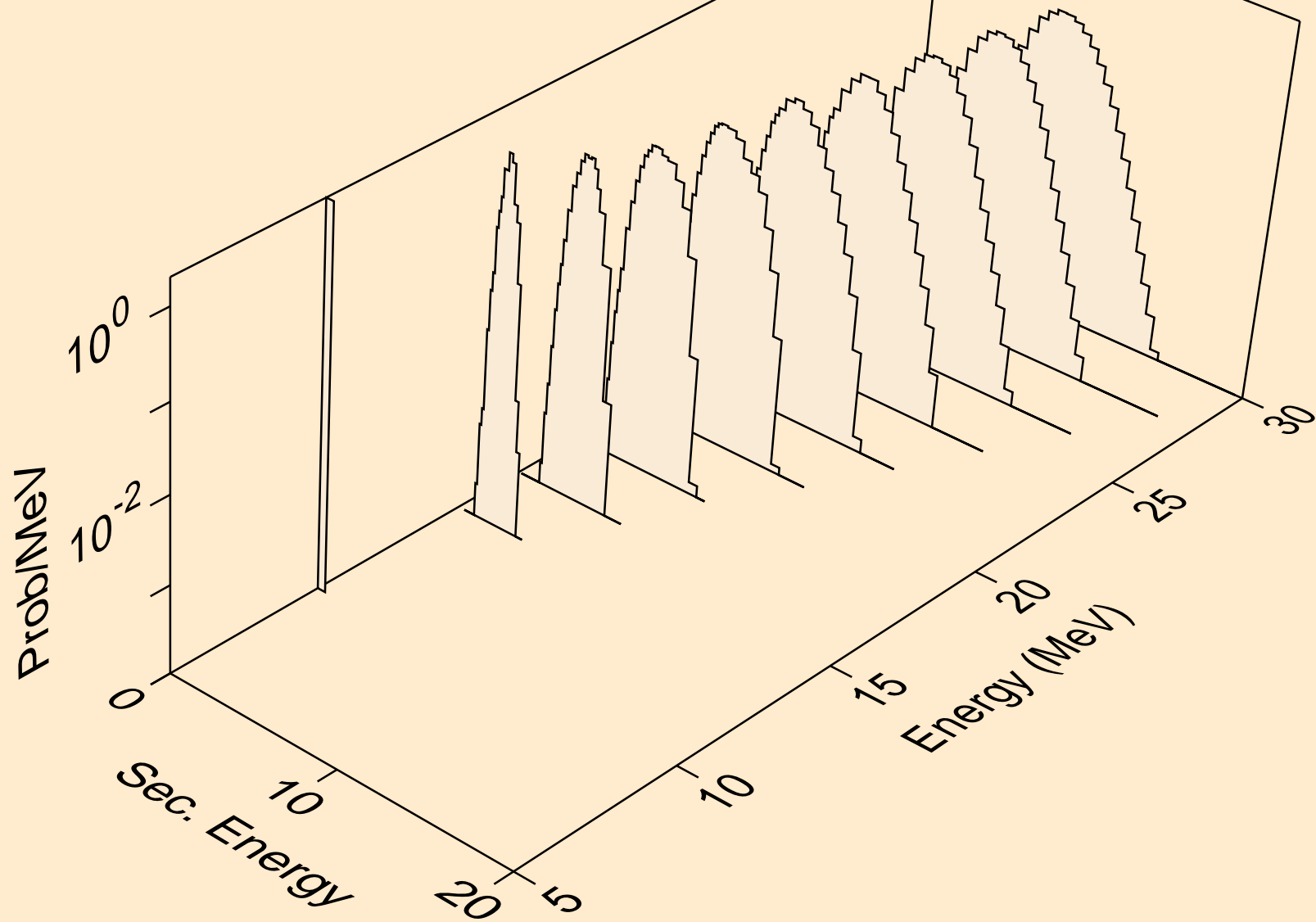

IN127 TRITON ACER TENDL-2021 LIBRARY; T=0.K  
protons from (t,pt)

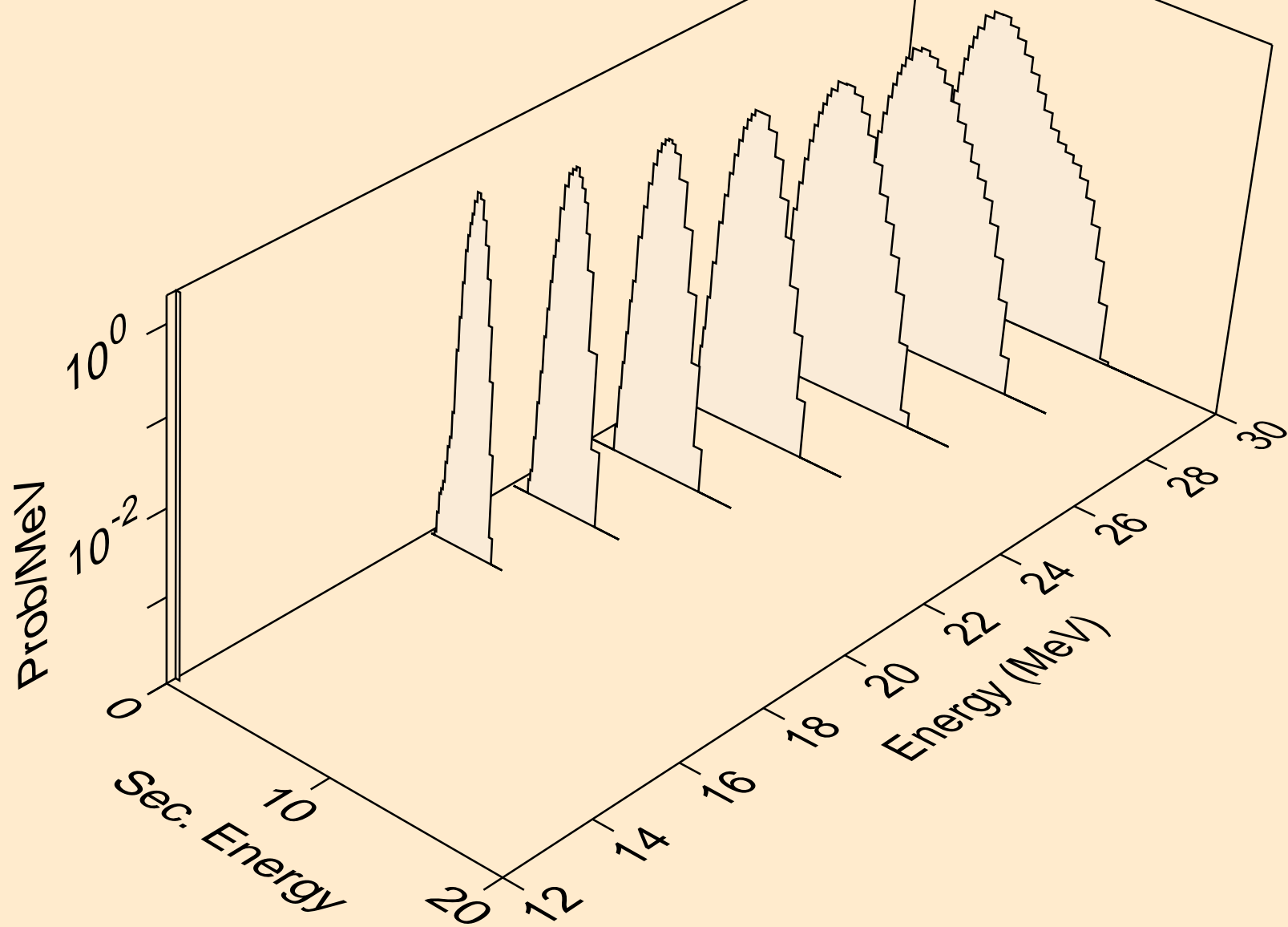

IN127 TRITON ACER TENDL-2021 LIBRARY; T=0.K  
deuterons from (t,x)

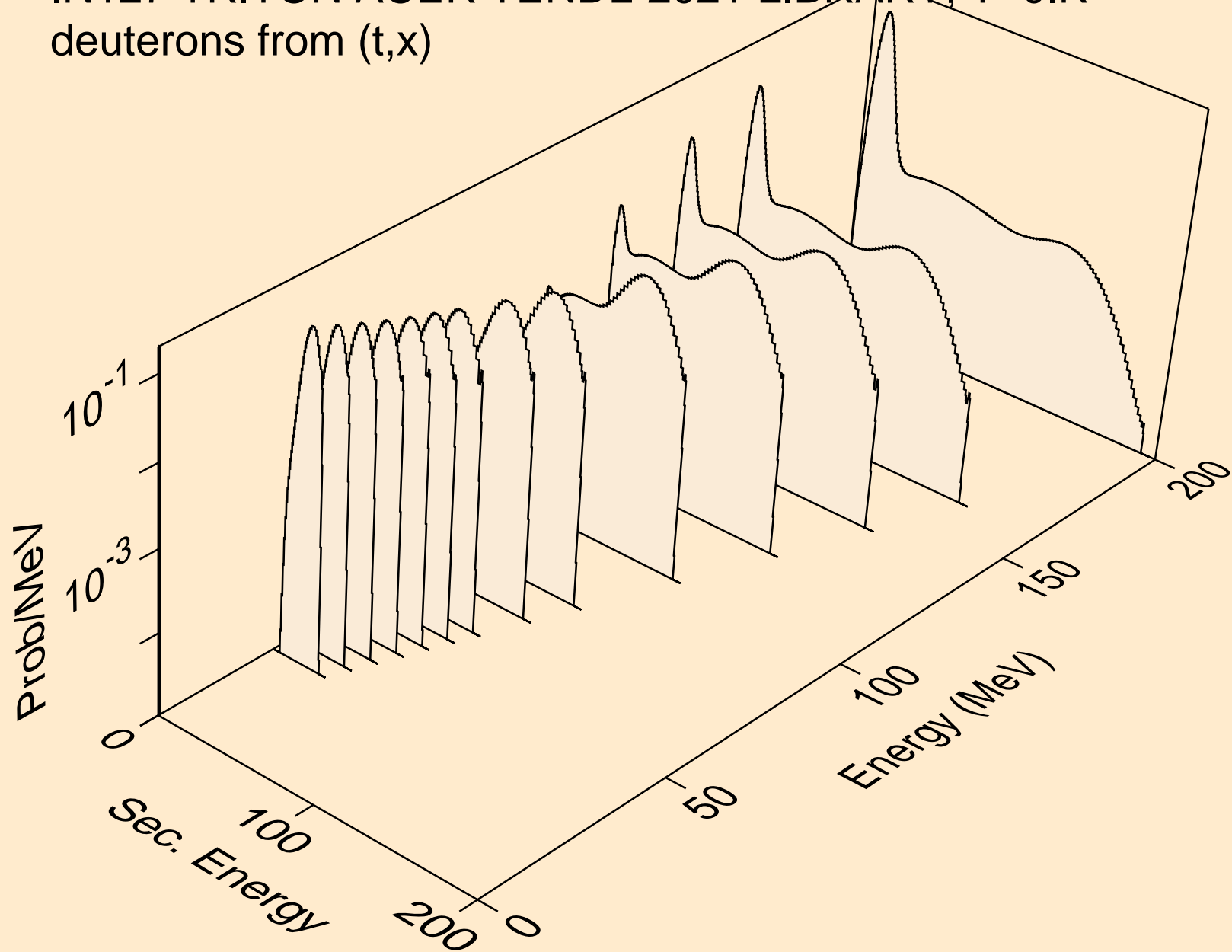



IN127 TRITON ACER TENDL-2021 LIBRARY; T=0.K  
deuterons from (t,2nd)

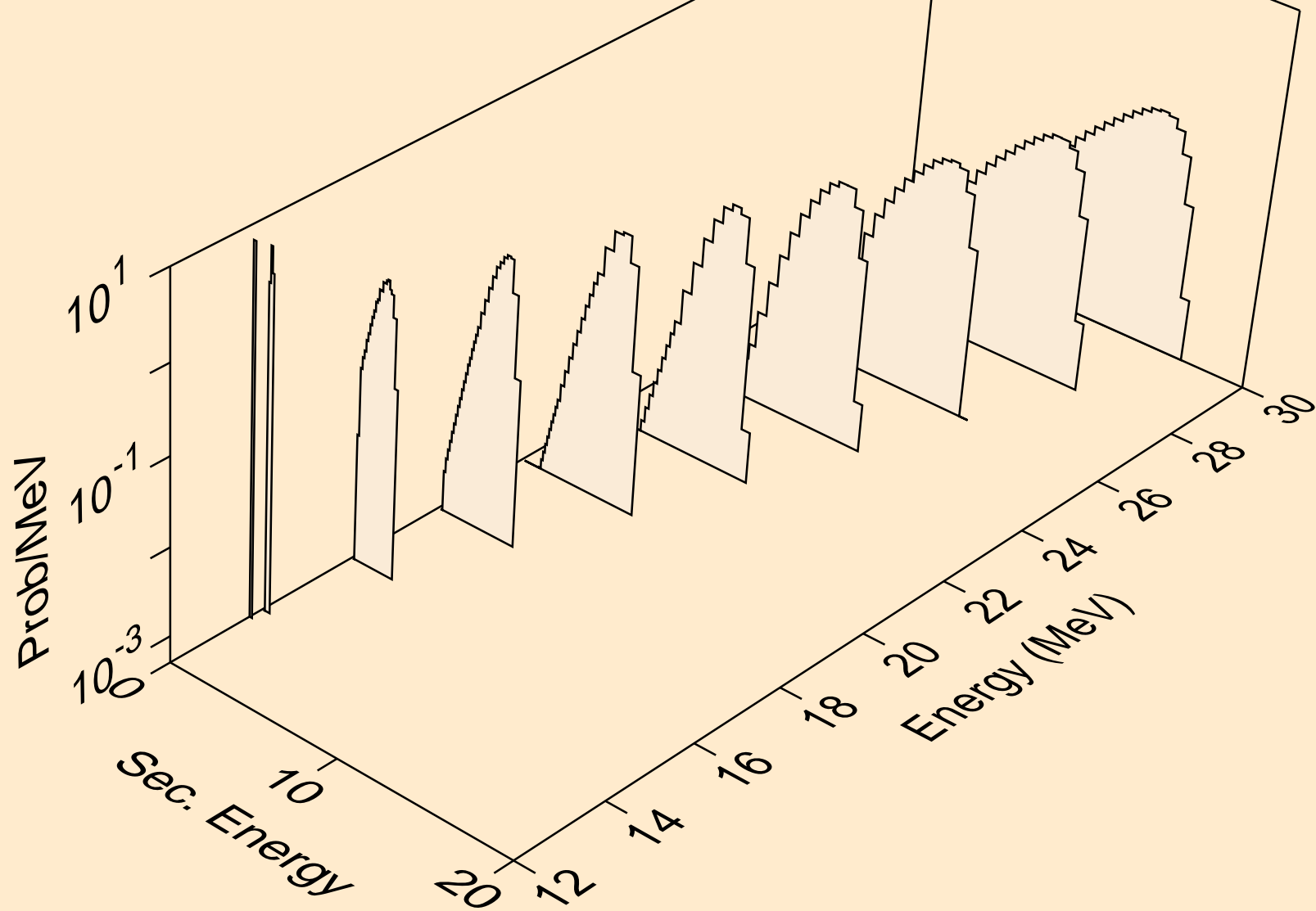

IN127 TRITON ACER TENDL-2021 LIBRARY; T=0.K  
deuterons from (t,n\*)d

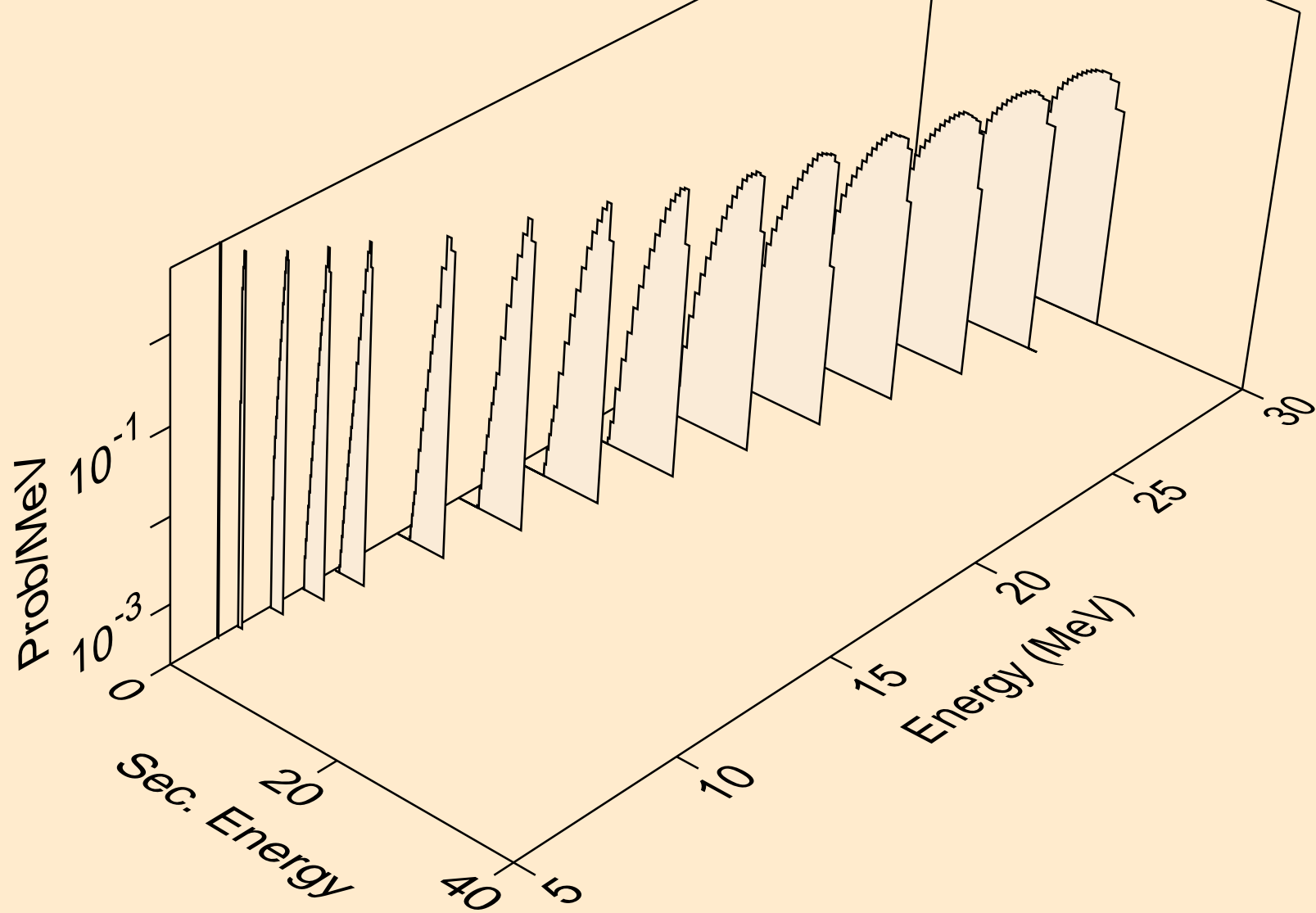

IN127 TRITON ACER TENDL-2021 LIBRARY; T=0.K  
deuterons from (t,d)

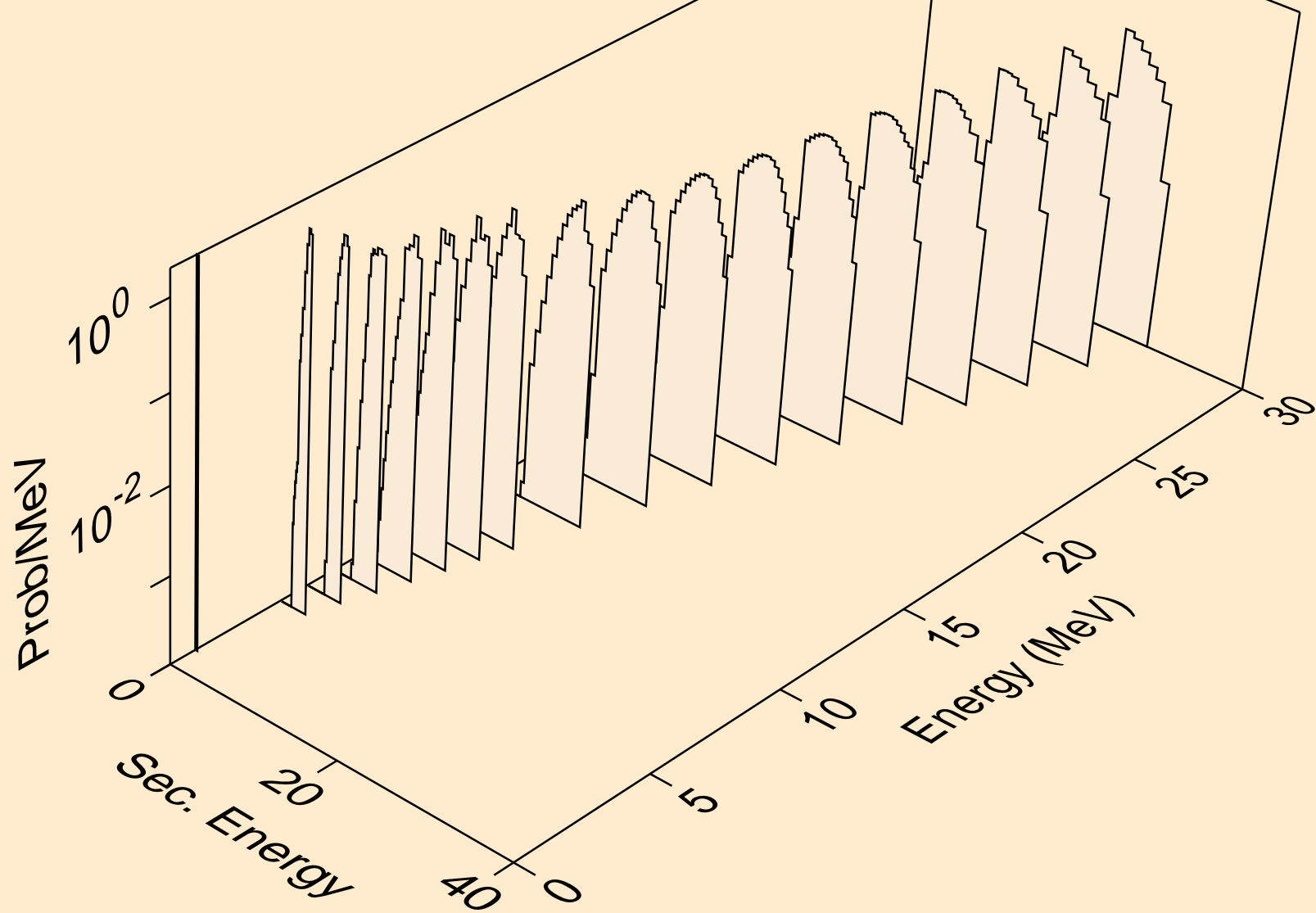

IN127 TRITON ACER TENDL-2021 LIBRARY; T=0.K  
he3s from (t,x)

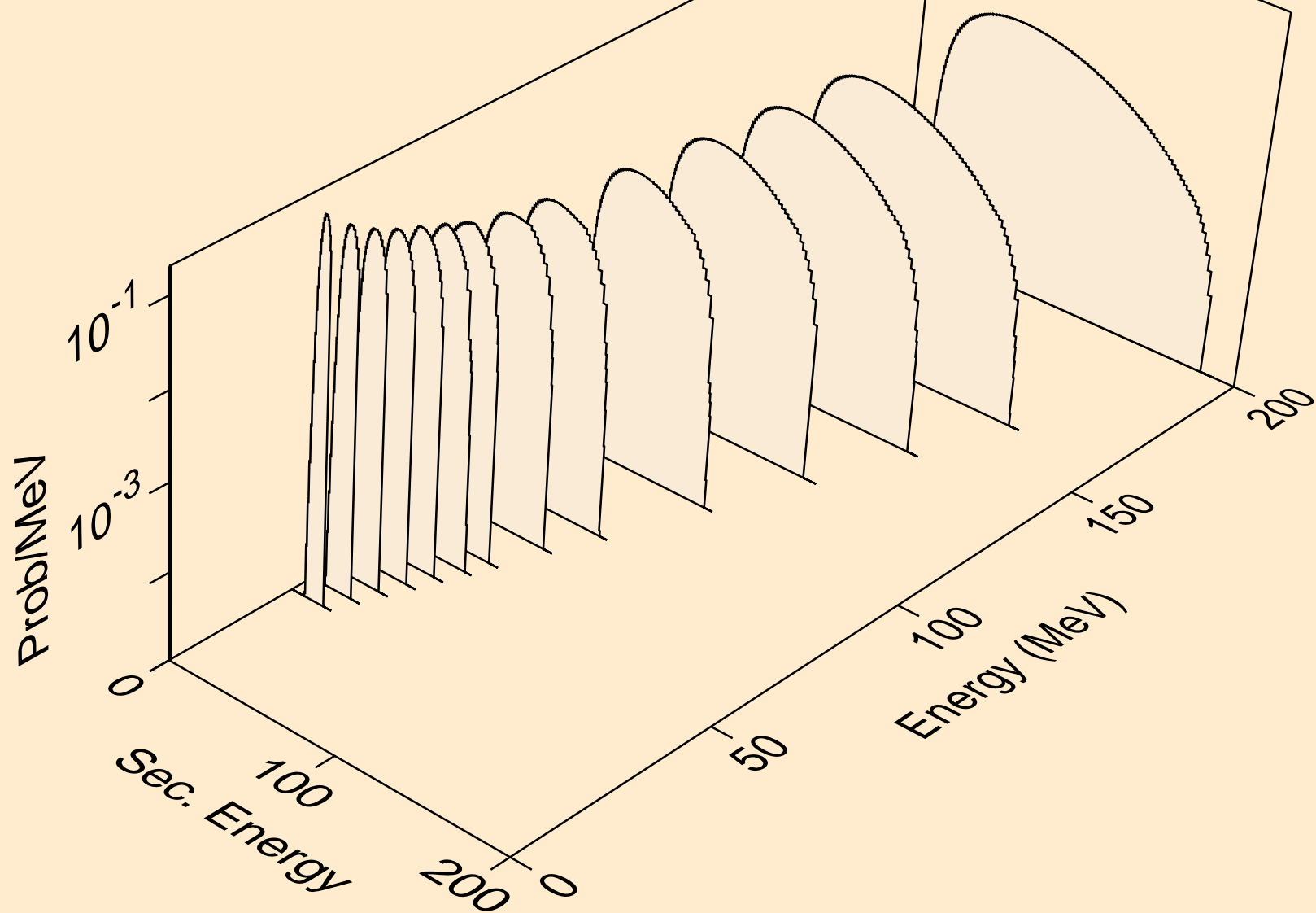

IN127 TRITON ACER TENDL-2021 LIBRARY; T=0.K  
he3s from (t,n\*)he3

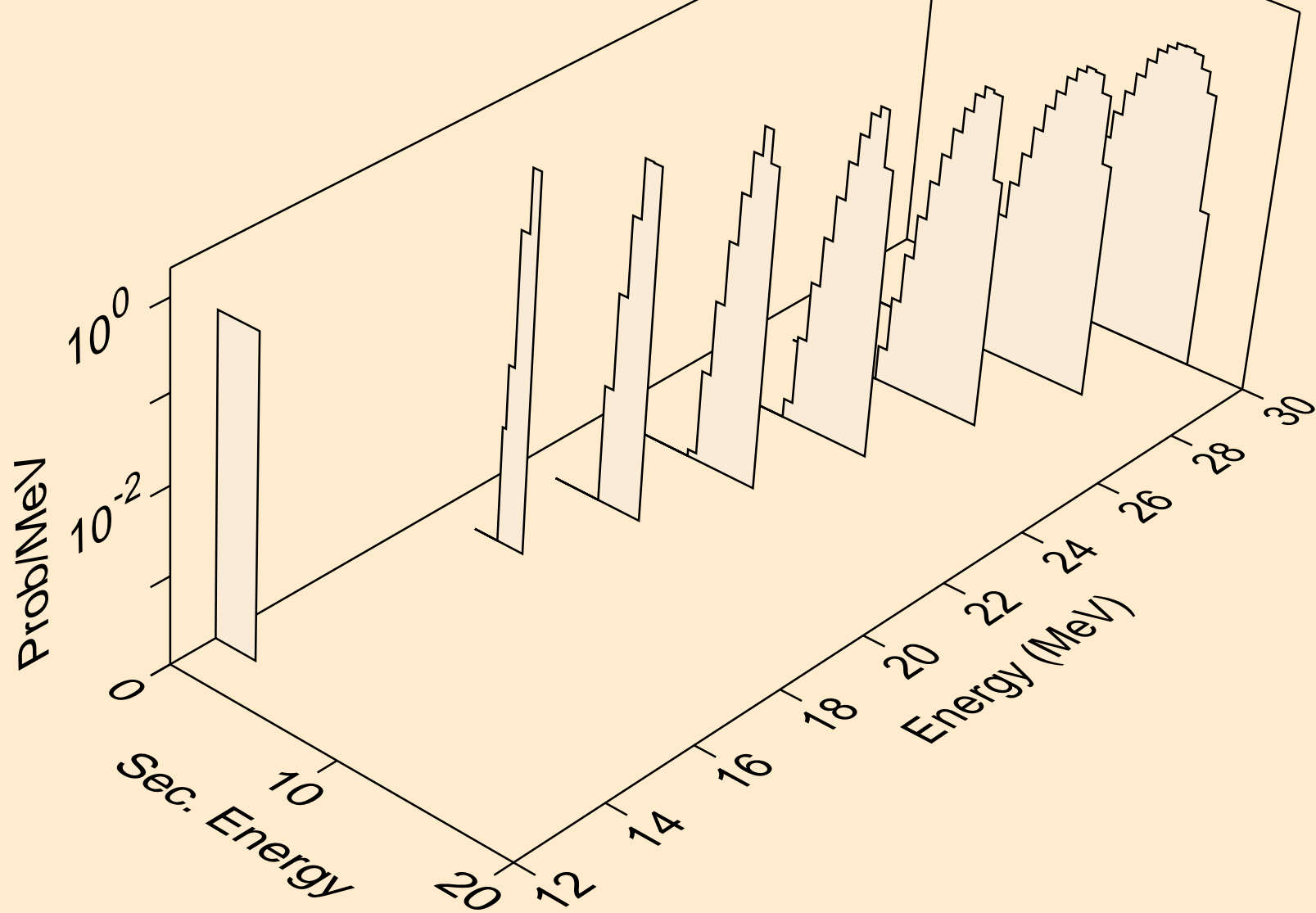

IN127 TRITON ACER TENDL-2021 LIBRARY; T=0.K  
he3s from (t,he3)

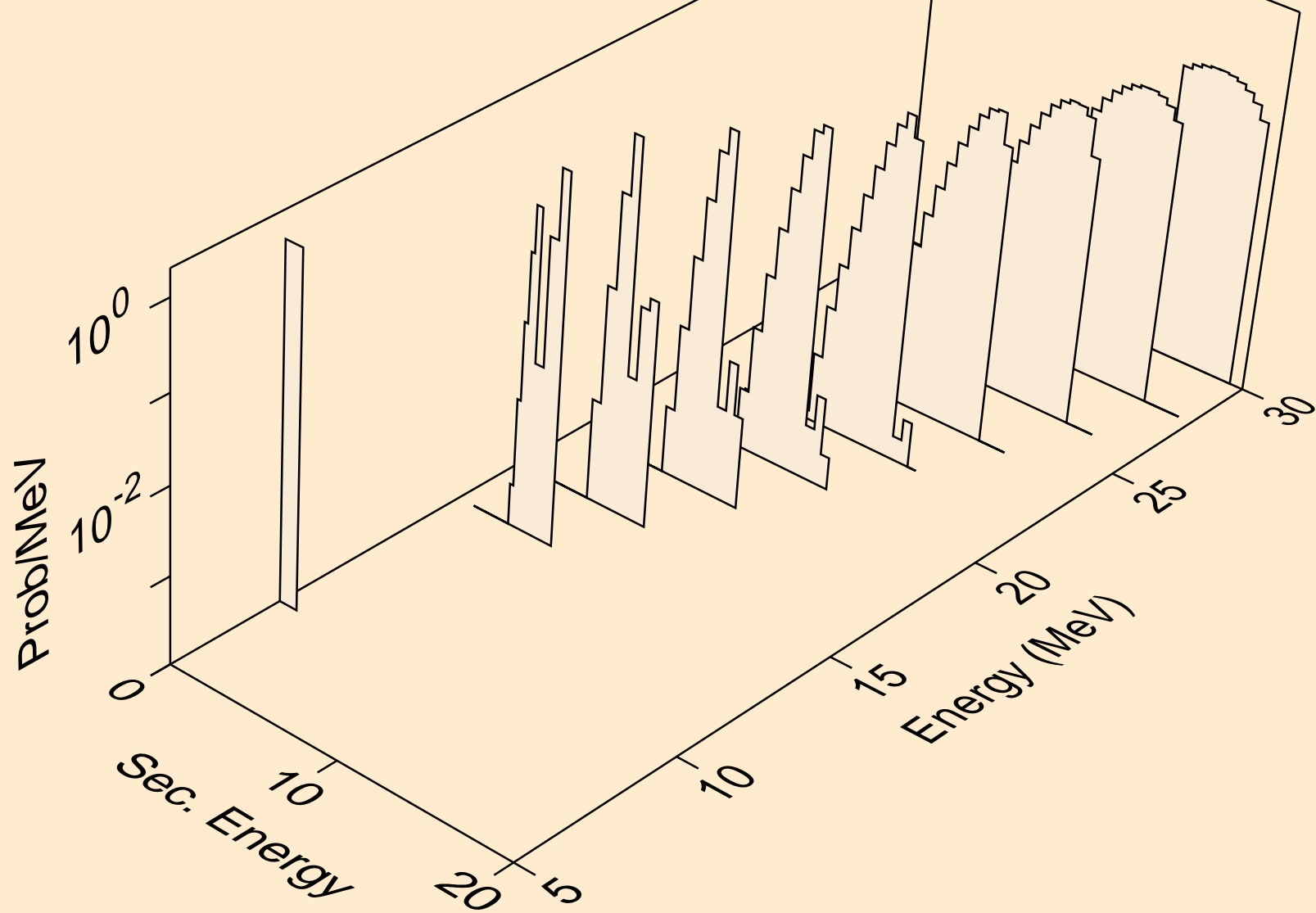

IN127 TRITON ACER TENDL-2021 LIBRARY; T=0.K  
alphas from (t,x)

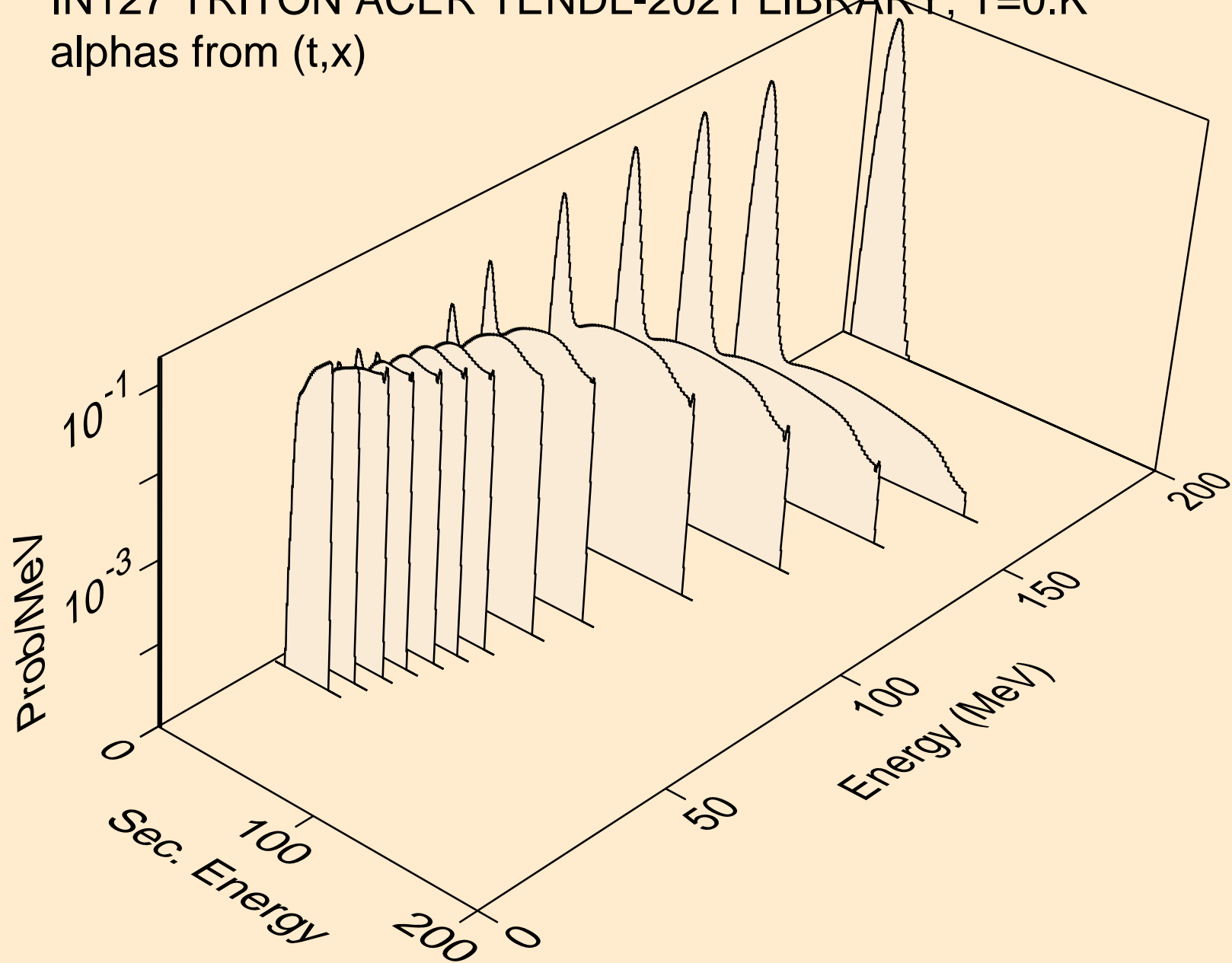

IN127 TRITON ACER TENDL-2021 LIBRARY; T=0.K  
alphas from (t,n\*)a

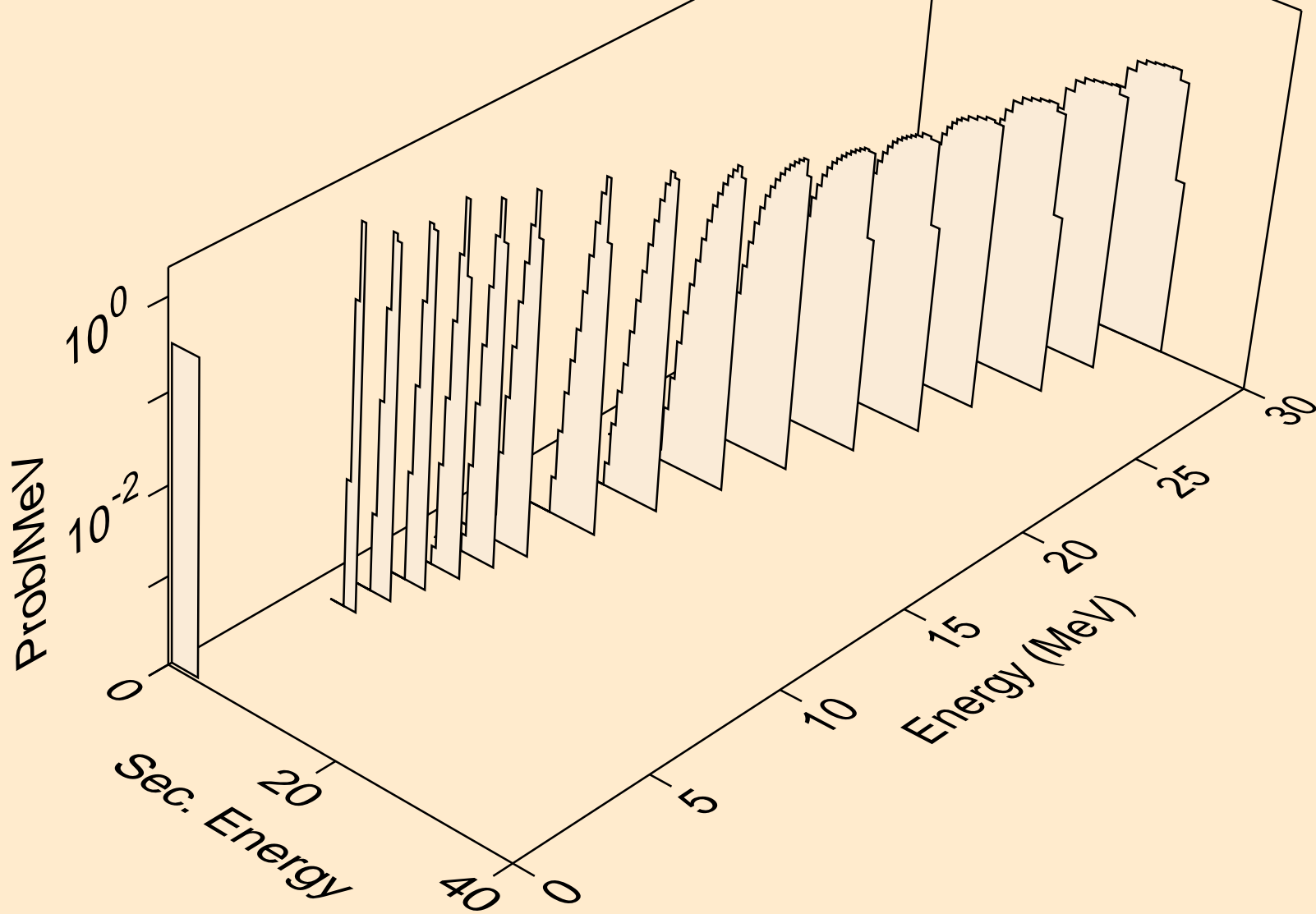



IN127 TRITON ACER TENDL-2021 LIBRARY; T=0.K  
alphas from (t,2n)a

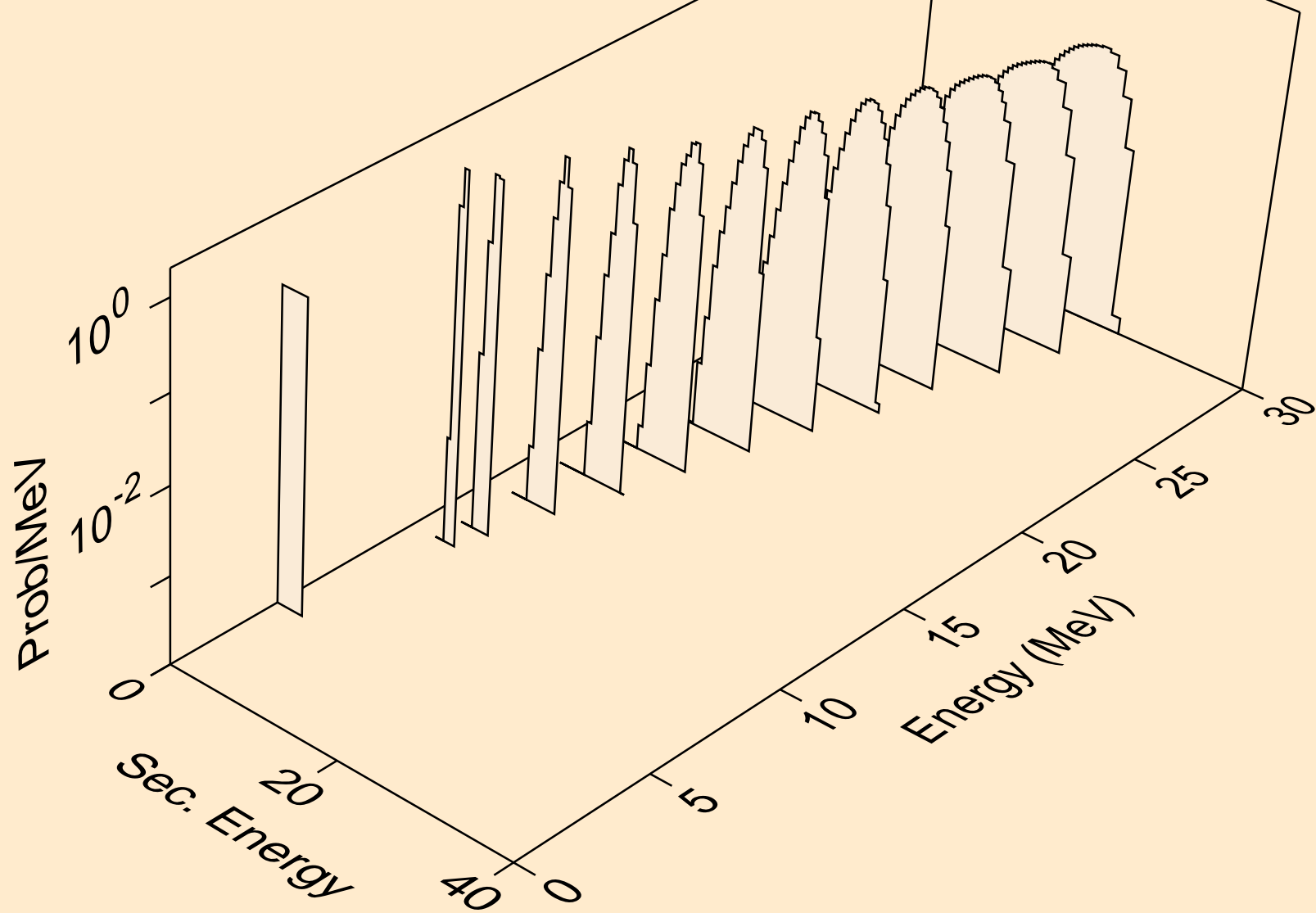

IN127 TRITON ACER TENDL-2021 LIBRARY; T=0.K  
alphas from (t,3n)a

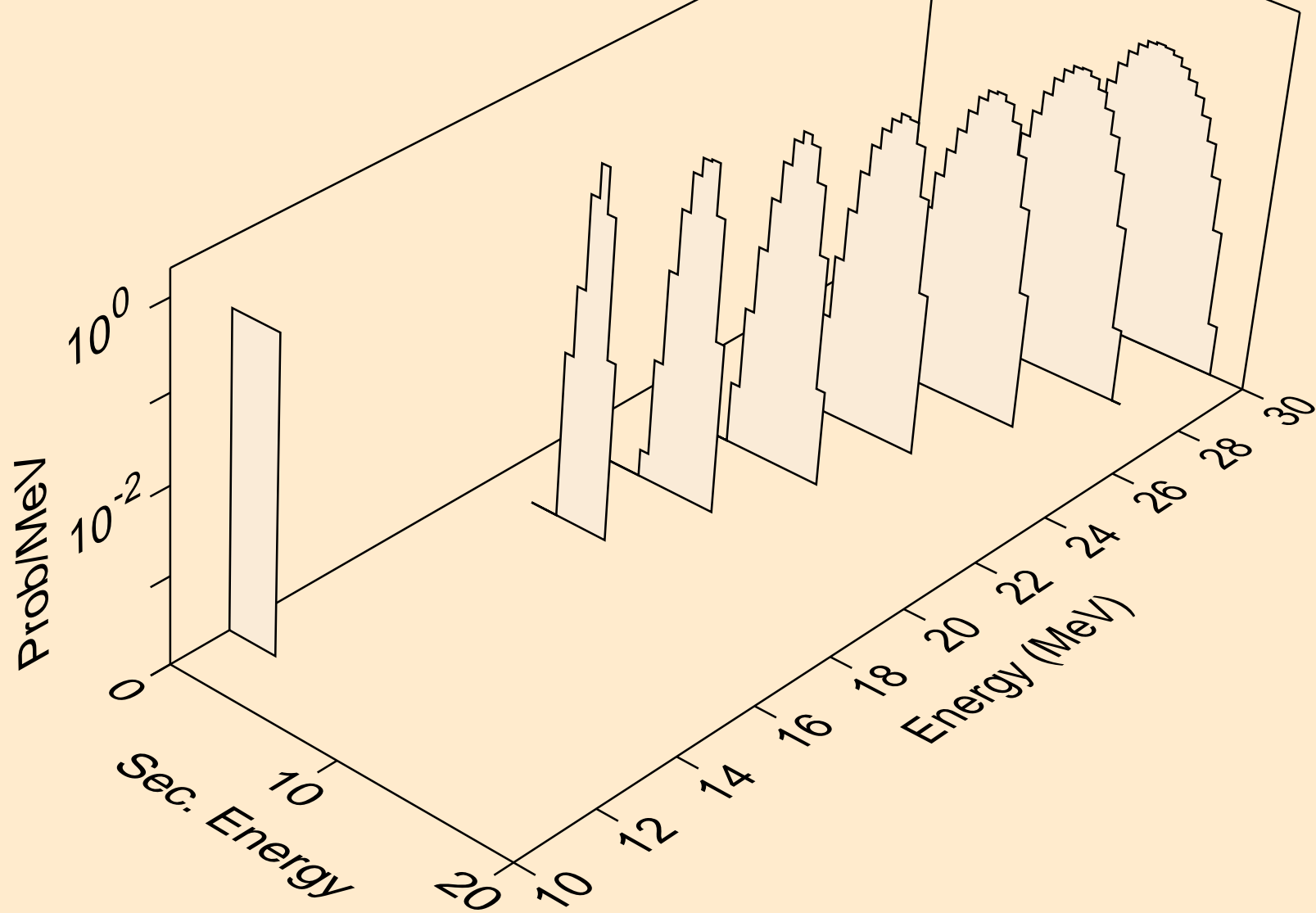

IN127 TRITON ACER TENDL-2021 LIBRARY; T=0.K  
alphas from (t,a)

