

IR172 TRITON ACER TENDL-2021 LIBRARY; T=0.K  
Principal cross sections

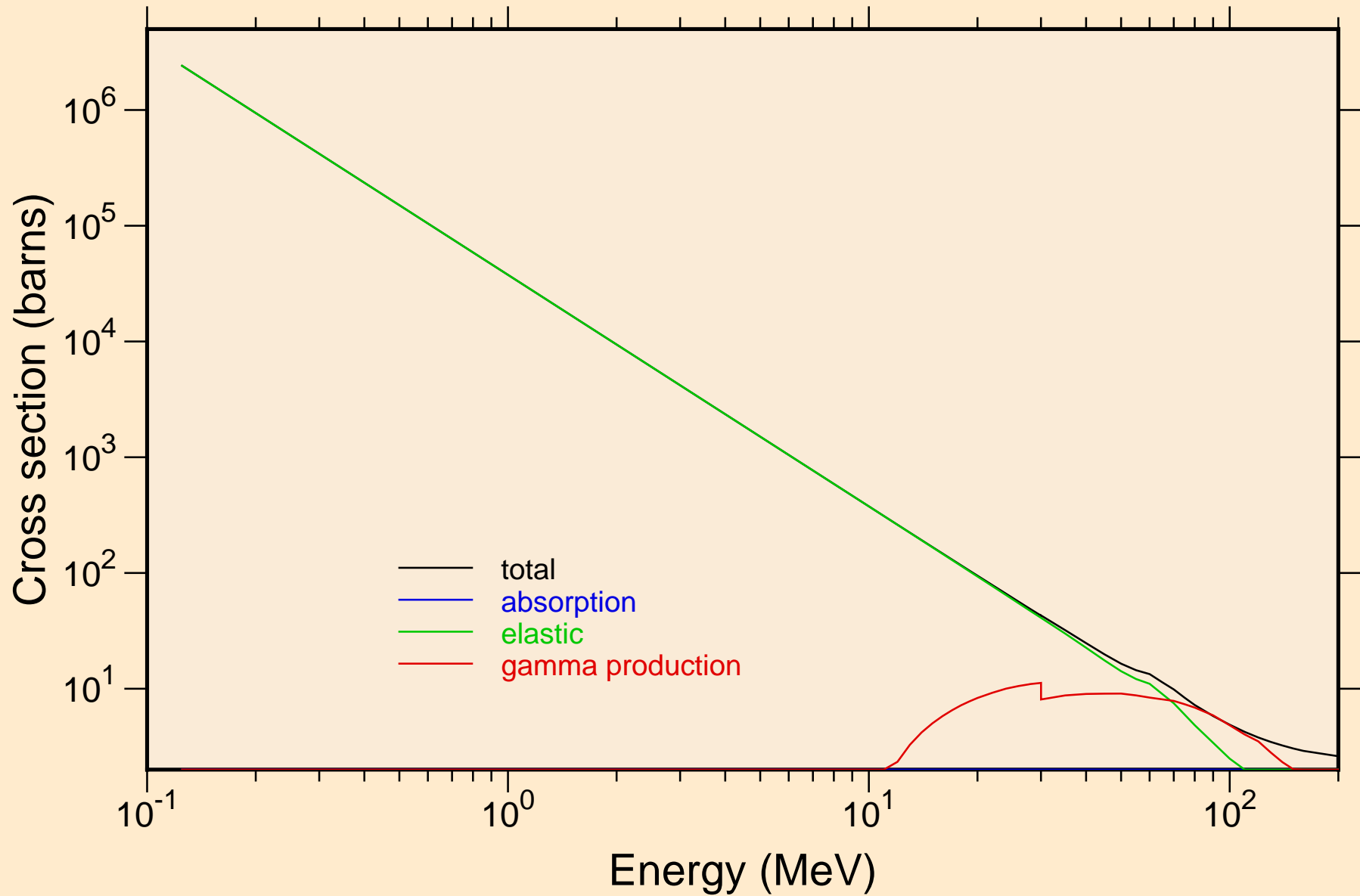

IR172 TRITON ACER TENDL-2021 LIBRARY; T=0.K  
Heating

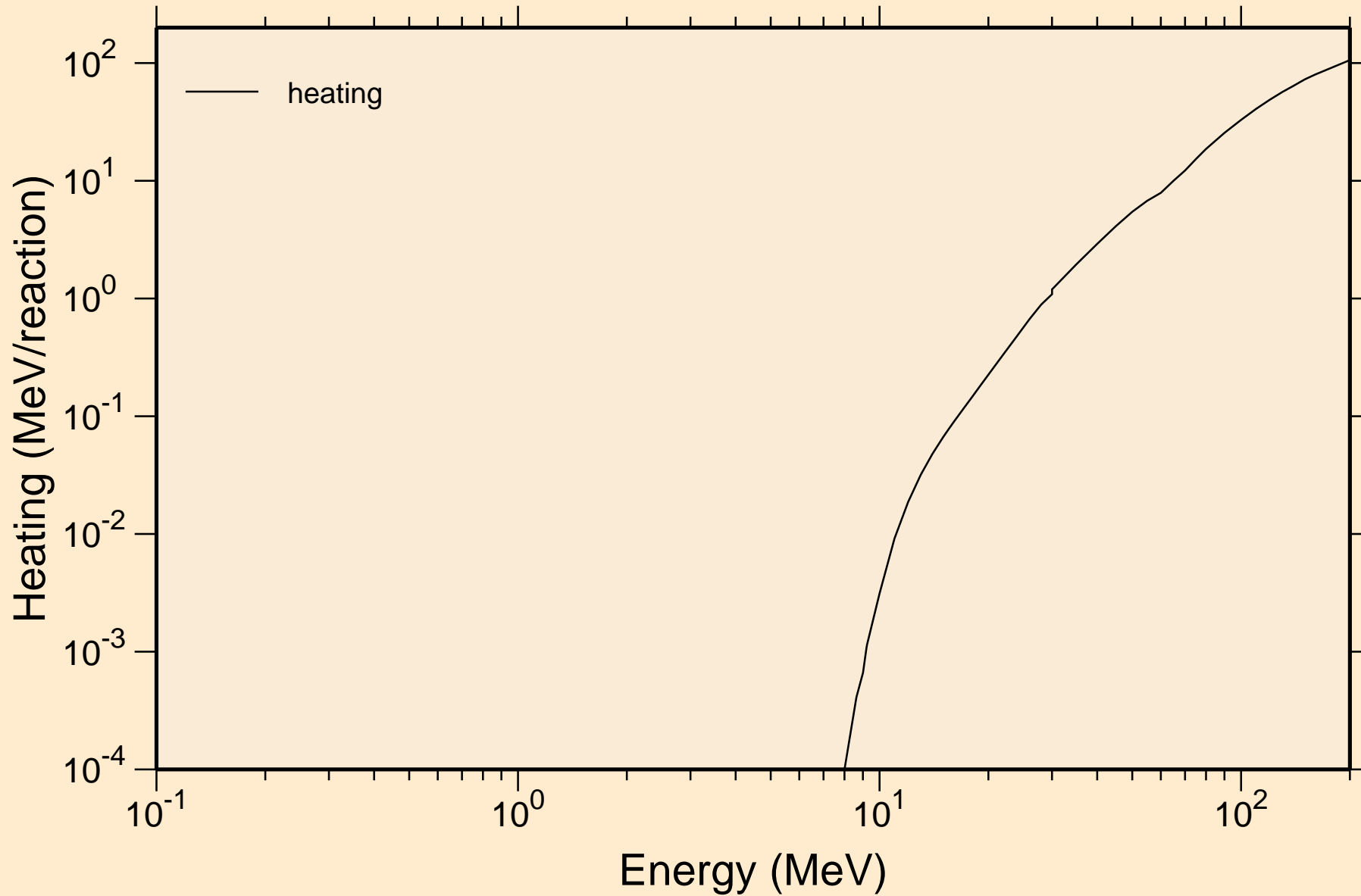

# IR172 TRITON ACER TENDL-2021 LIBRARY; T=0.K

## Principal cross sections

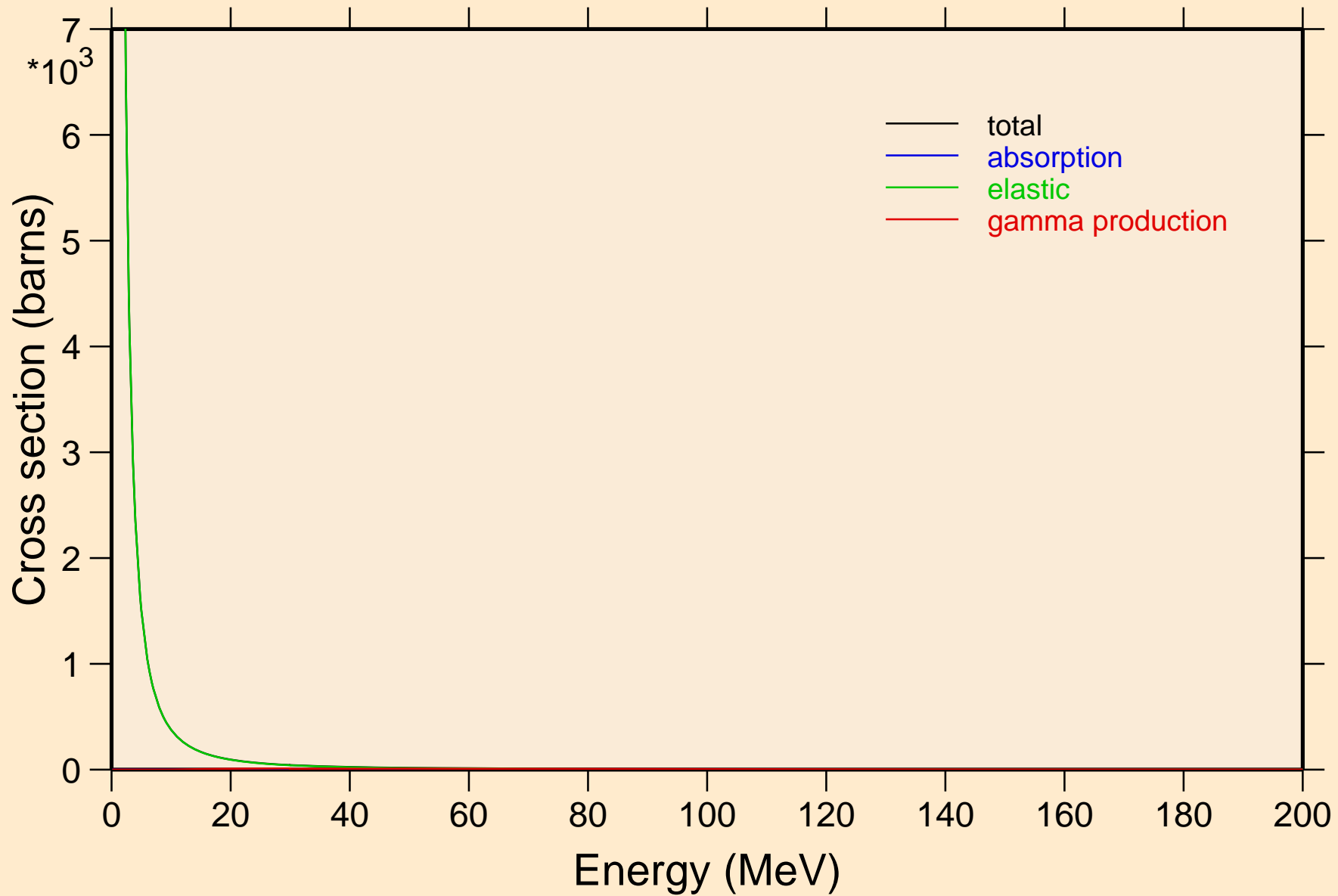

IR172 TRITON ACER TENDL-2021 LIBRARY; T=0.K

Heating

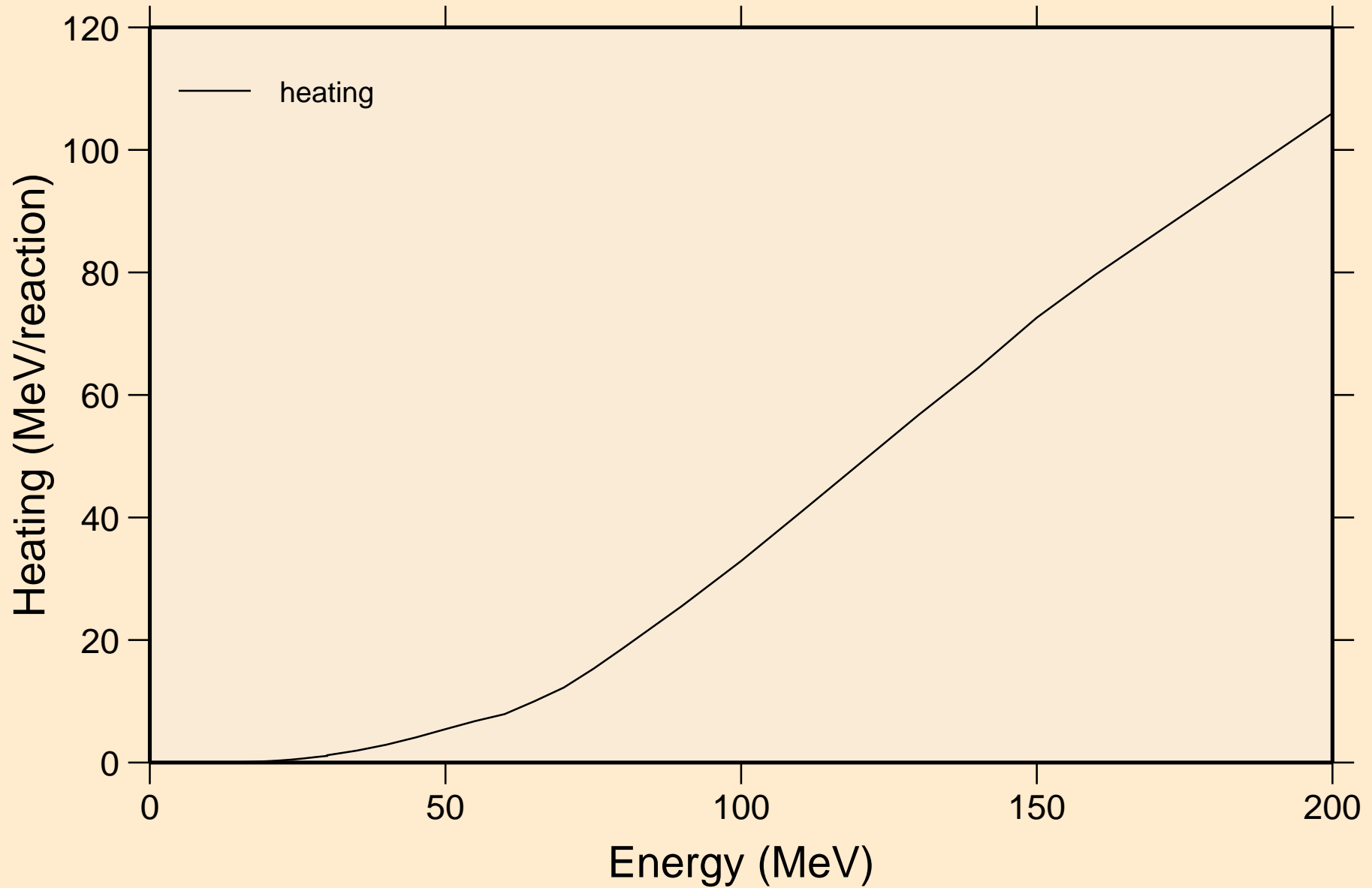

IR172 TRITON ACER TENDL-2021 LIBRARY; T=0.K  
Threshold reactions

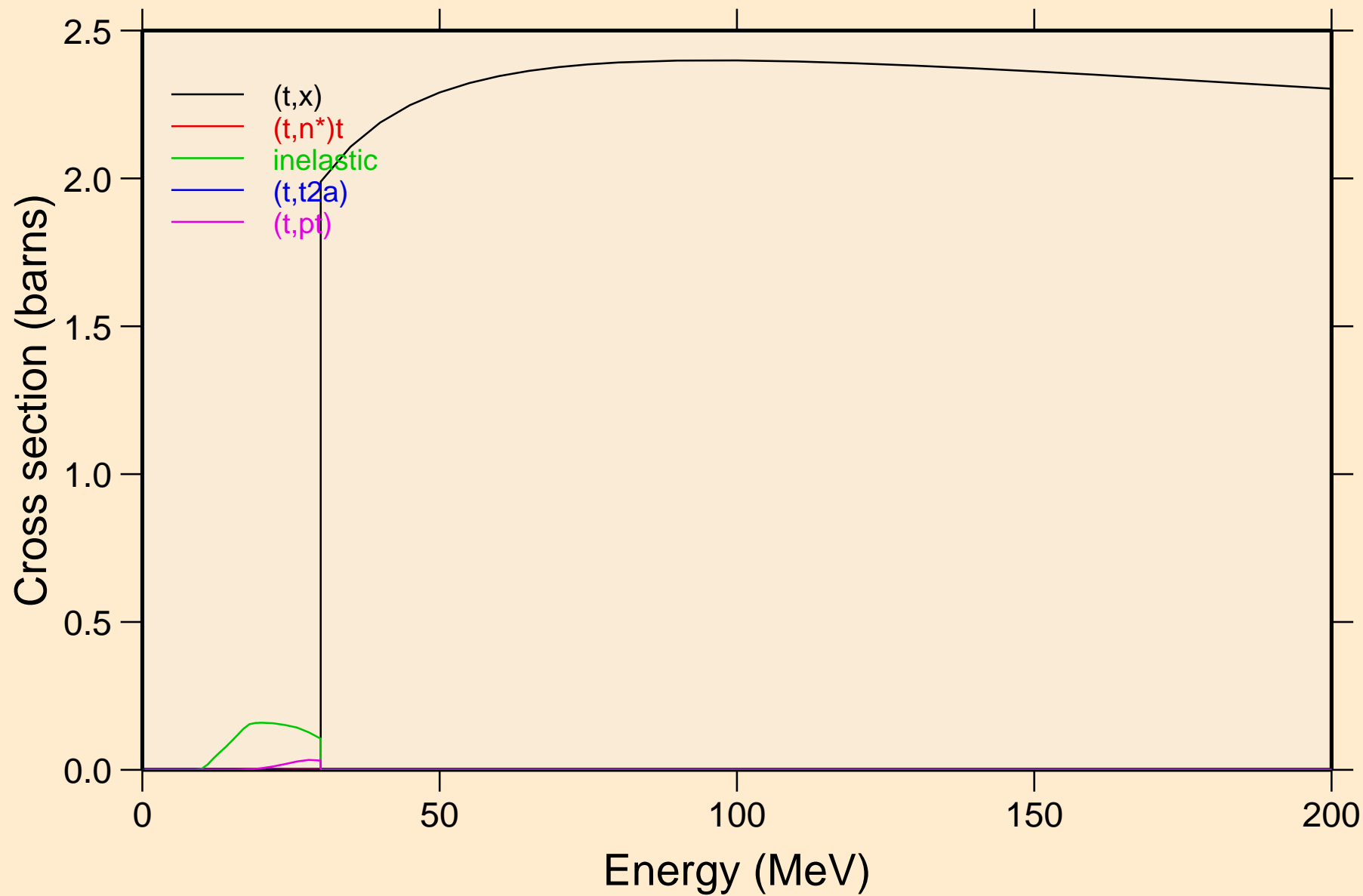

IR172 TRITON ACER TENDL-2021 LIBRARY; T=0.K  
Threshold reactions

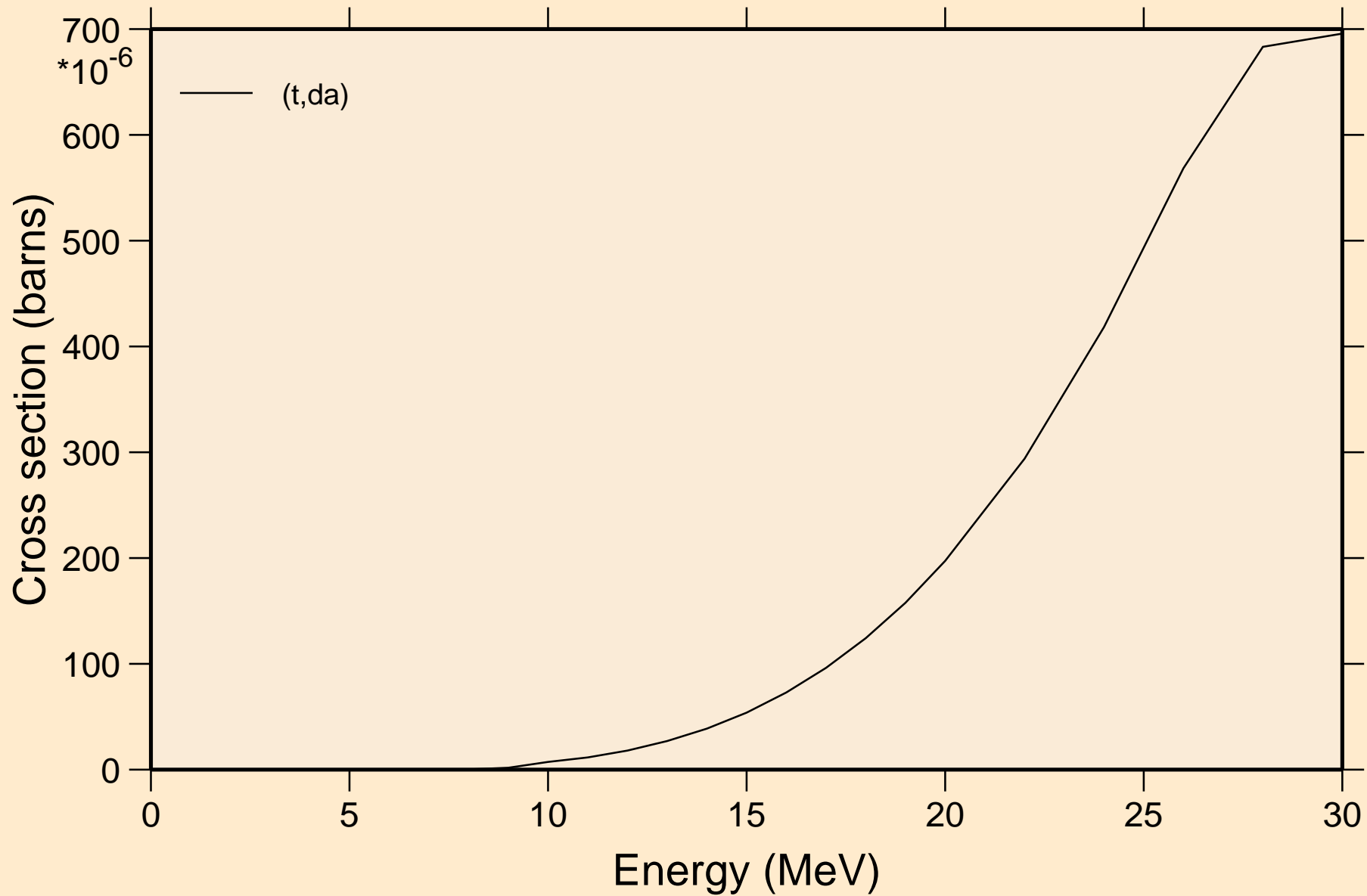

IR172 TRITON ACER TENDL-2021 LIBRARY; T=0.K  
angular distribution for elastic

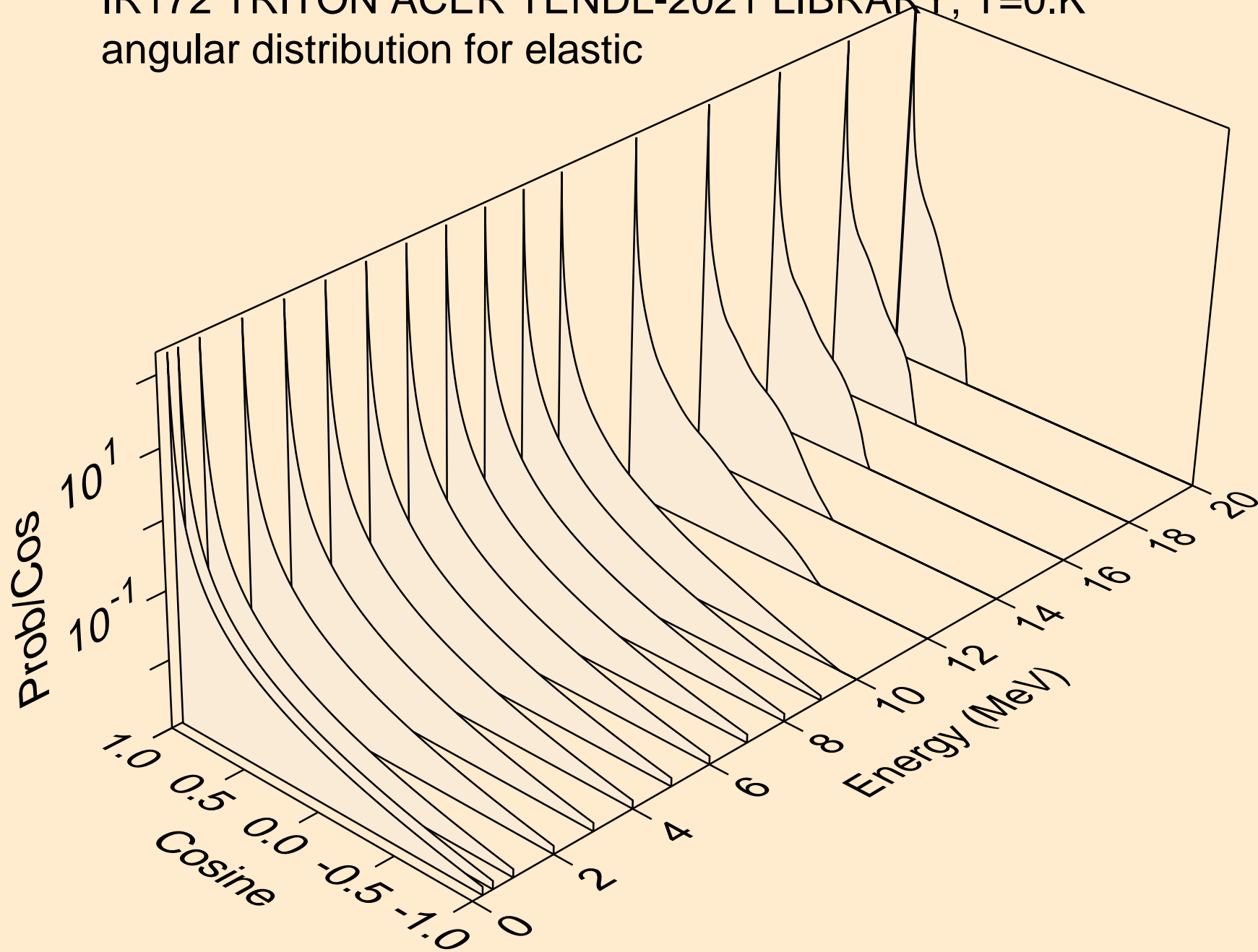

IR172 TRITON ACER TENDL-2021 LIBRARY; T=0.K  
angular distribution for elastic

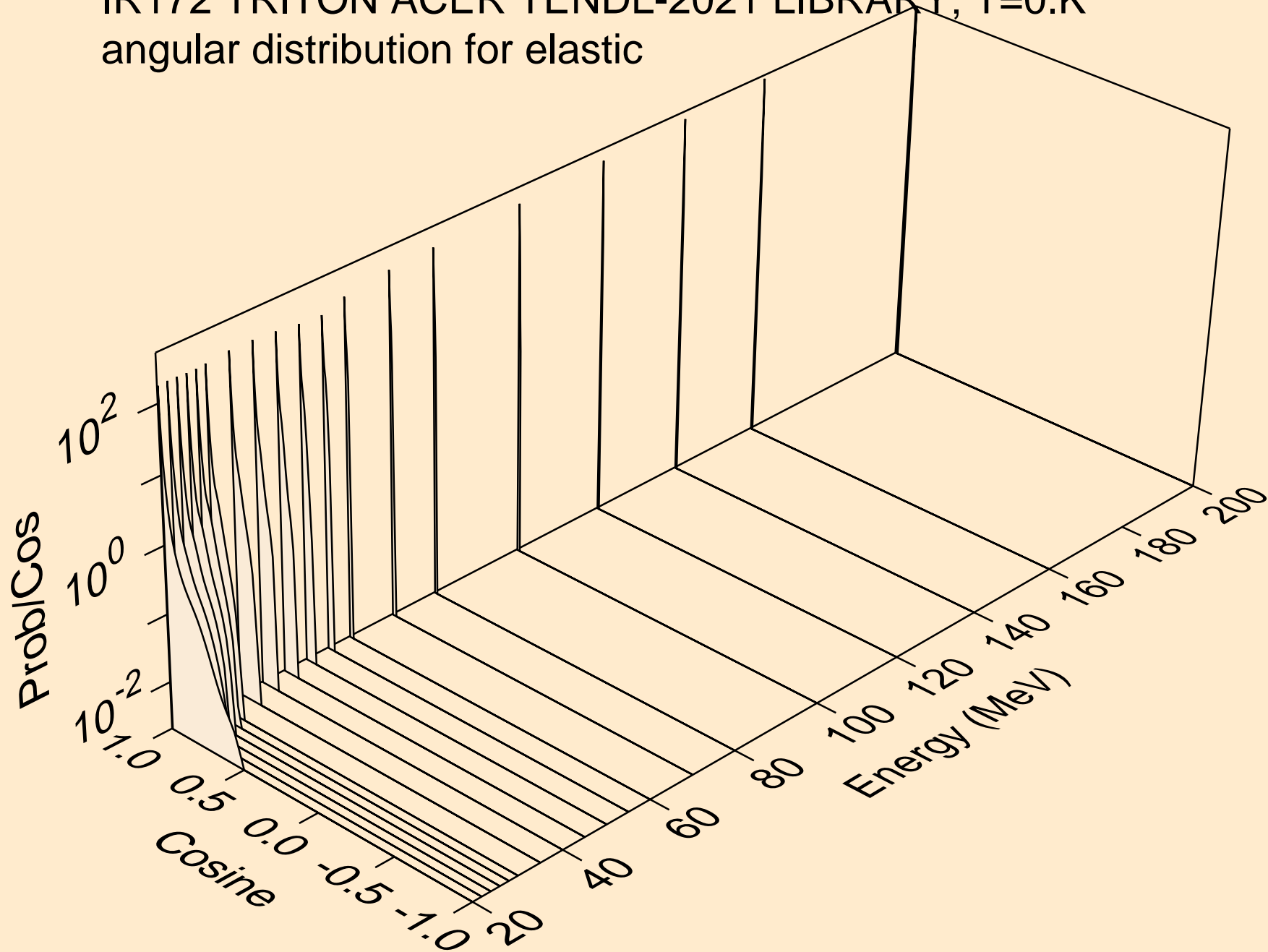



IR172 TRITON ACER TENDL-2021 LIBRARY; T=0.K  
Triton emission for (t,x)

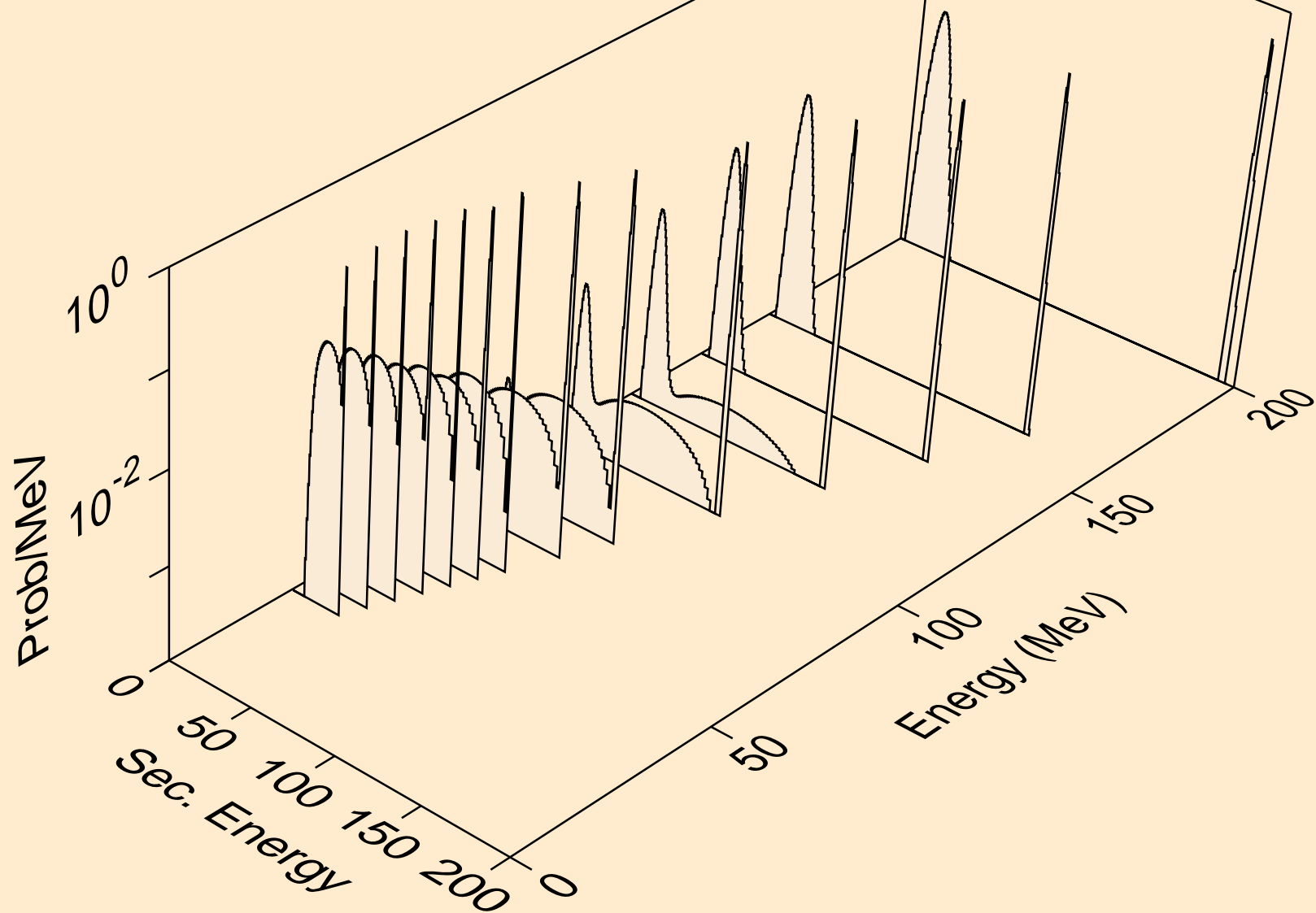

IR172 TRITON ACER TENDL-2021 LIBRARY; T=0.K  
Triton emission for (t,n\*)t

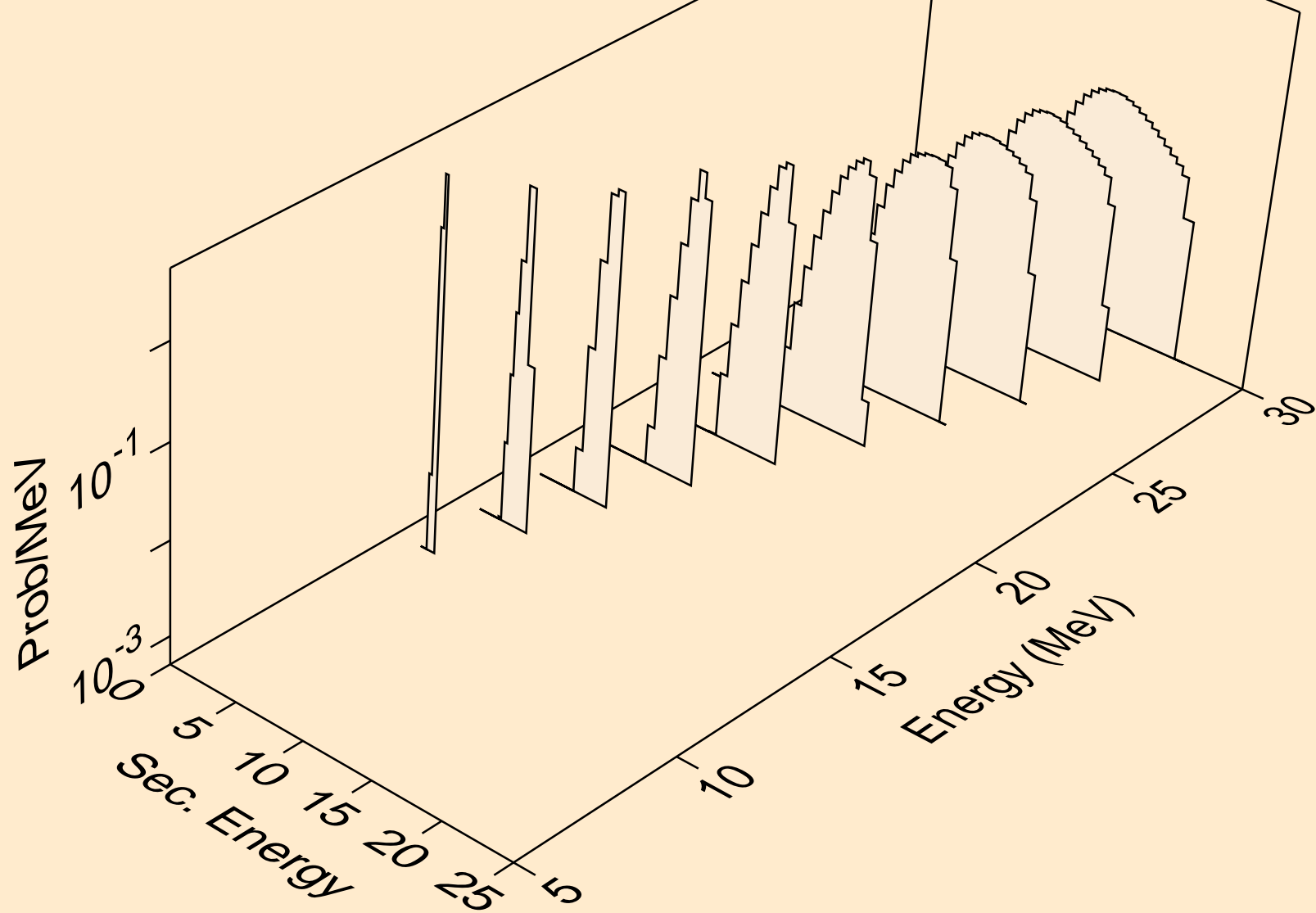

IR172 TRITON ACER TENDL-2021 LIBRARY; T=0.K  
Triton emission for inelastic

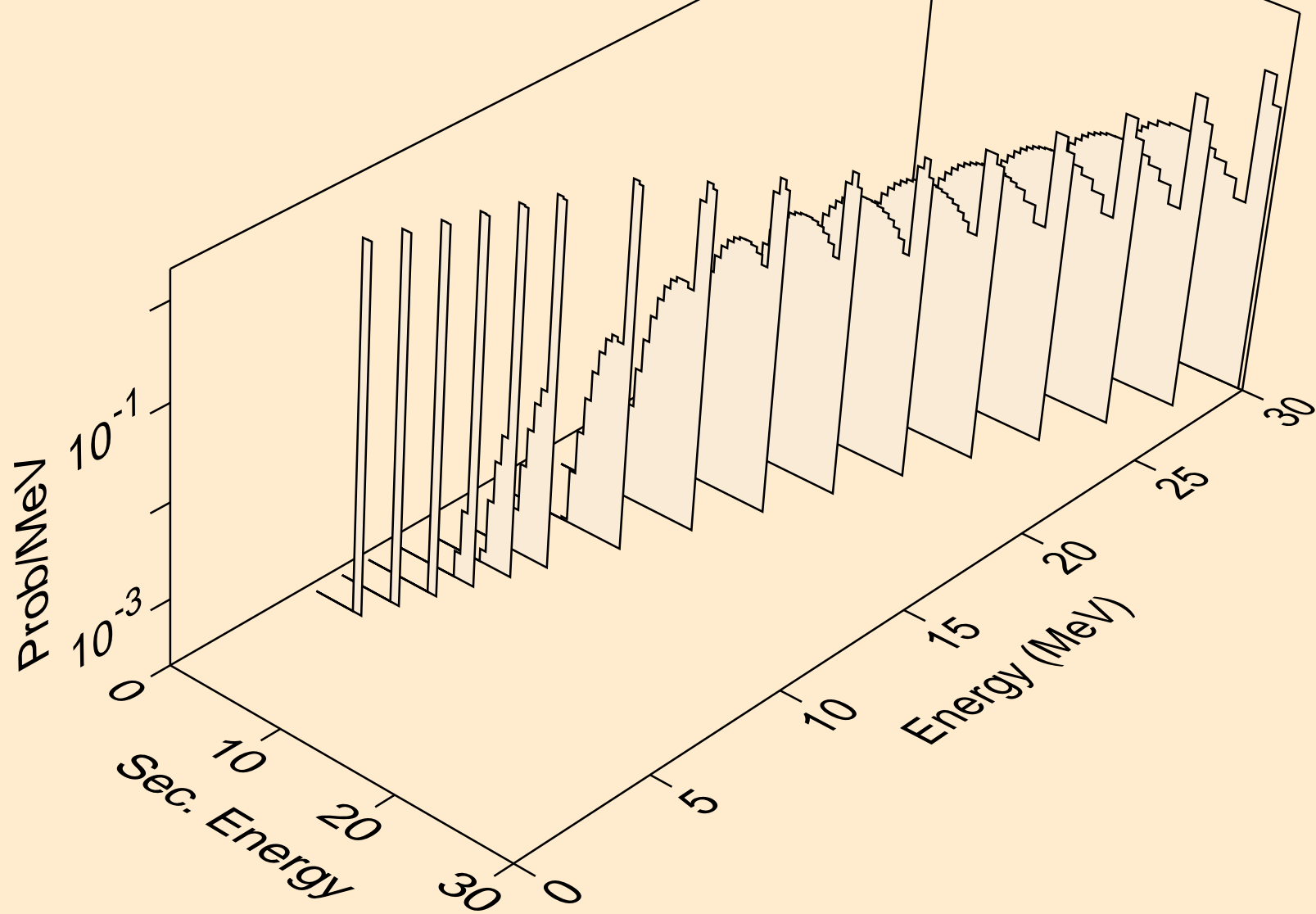

IR172 TRITON ACER TENDL-2021 LIBRARY; T=0.K  
Triton emission for (t,t2a)

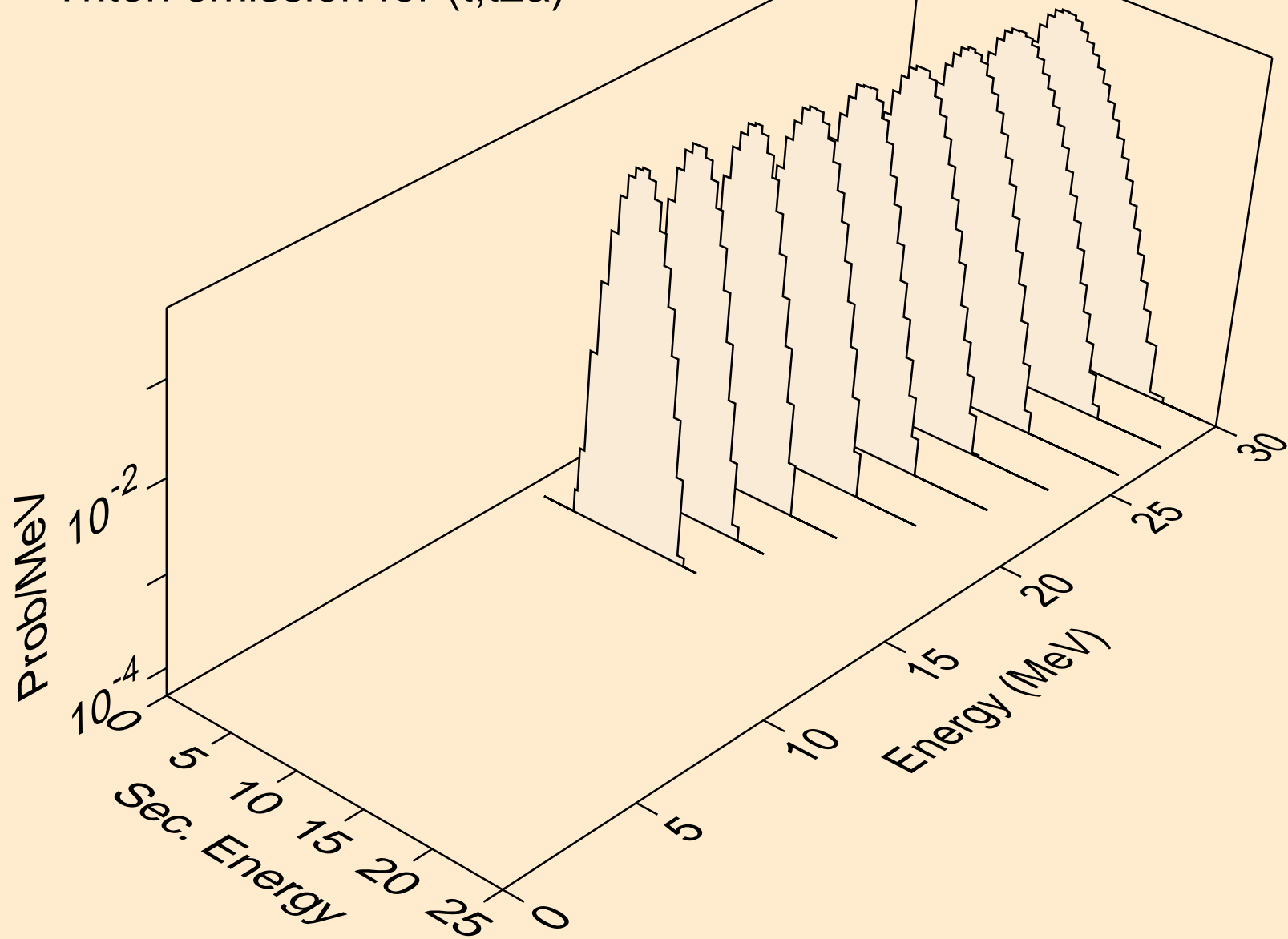

IR172 TRITON ACER TENDL-2021 LIBRARY; T=0.K  
Triton emission for (t,pt)

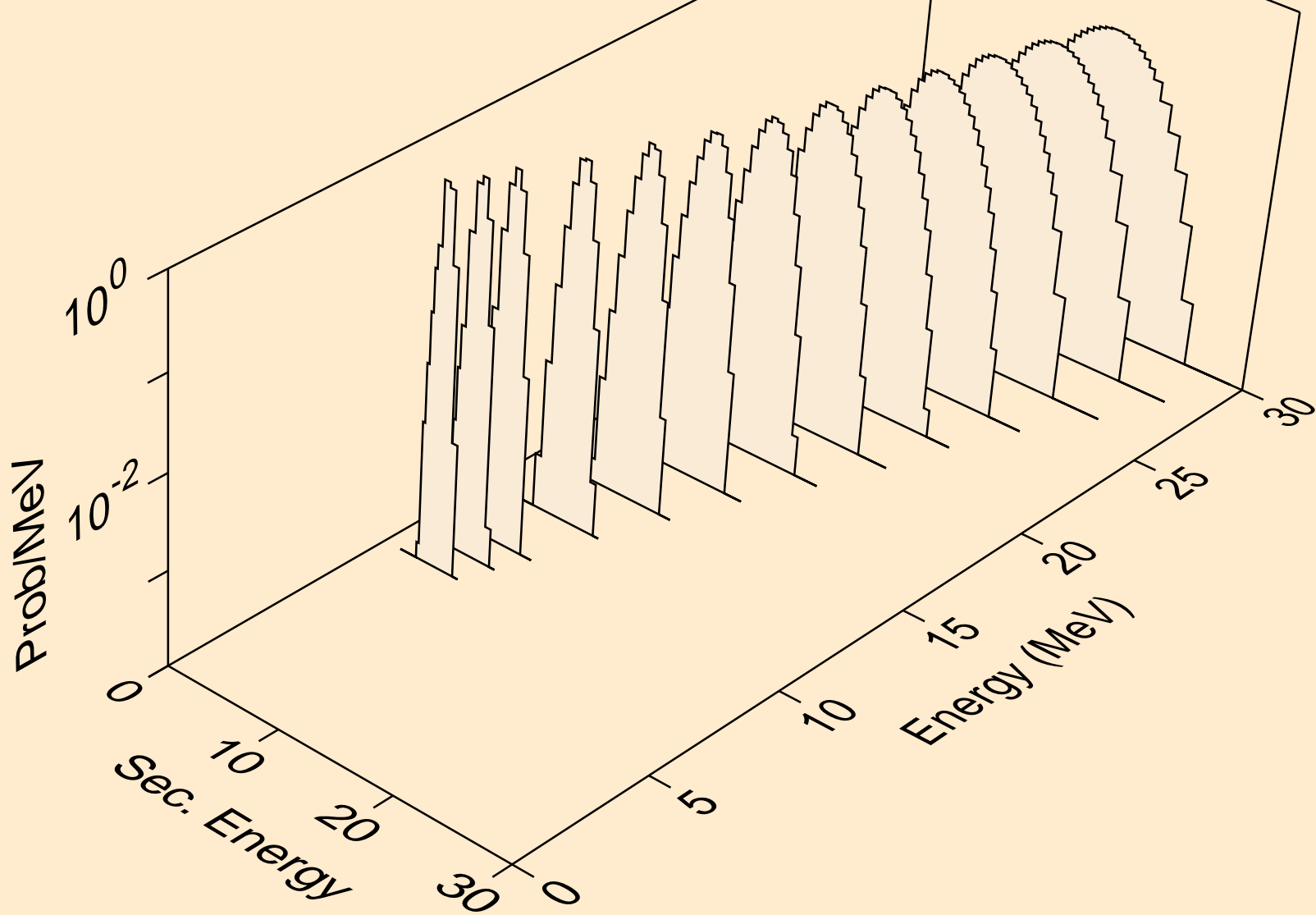

IR172 TRITON ACER TENDL-2021 LIBRARY; T=0.K  
Photon emission for (z,n)

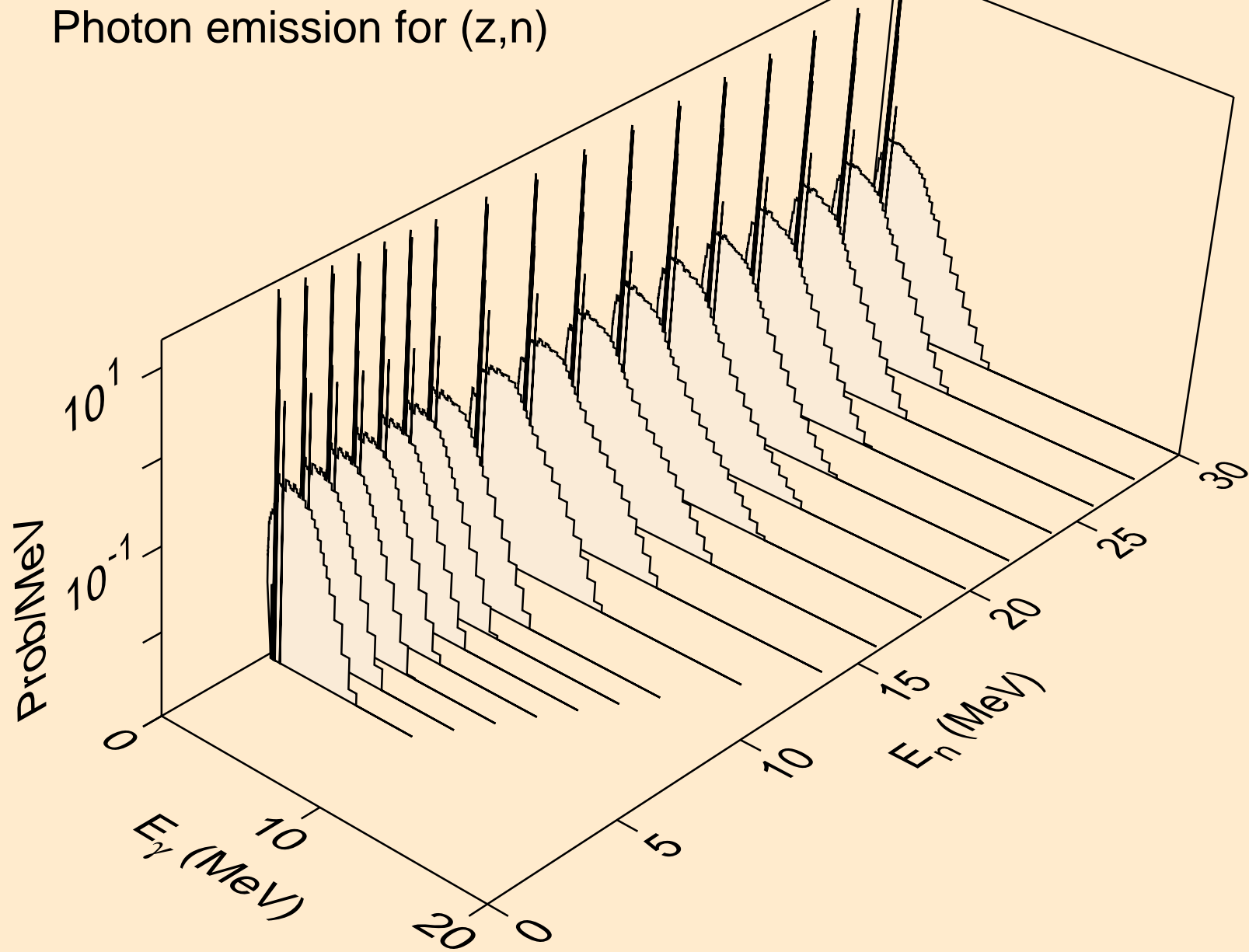

IR172 TRITON ACER TENDL-2021 LIBRARY; T=0.K  
Photon emission for (n,x)

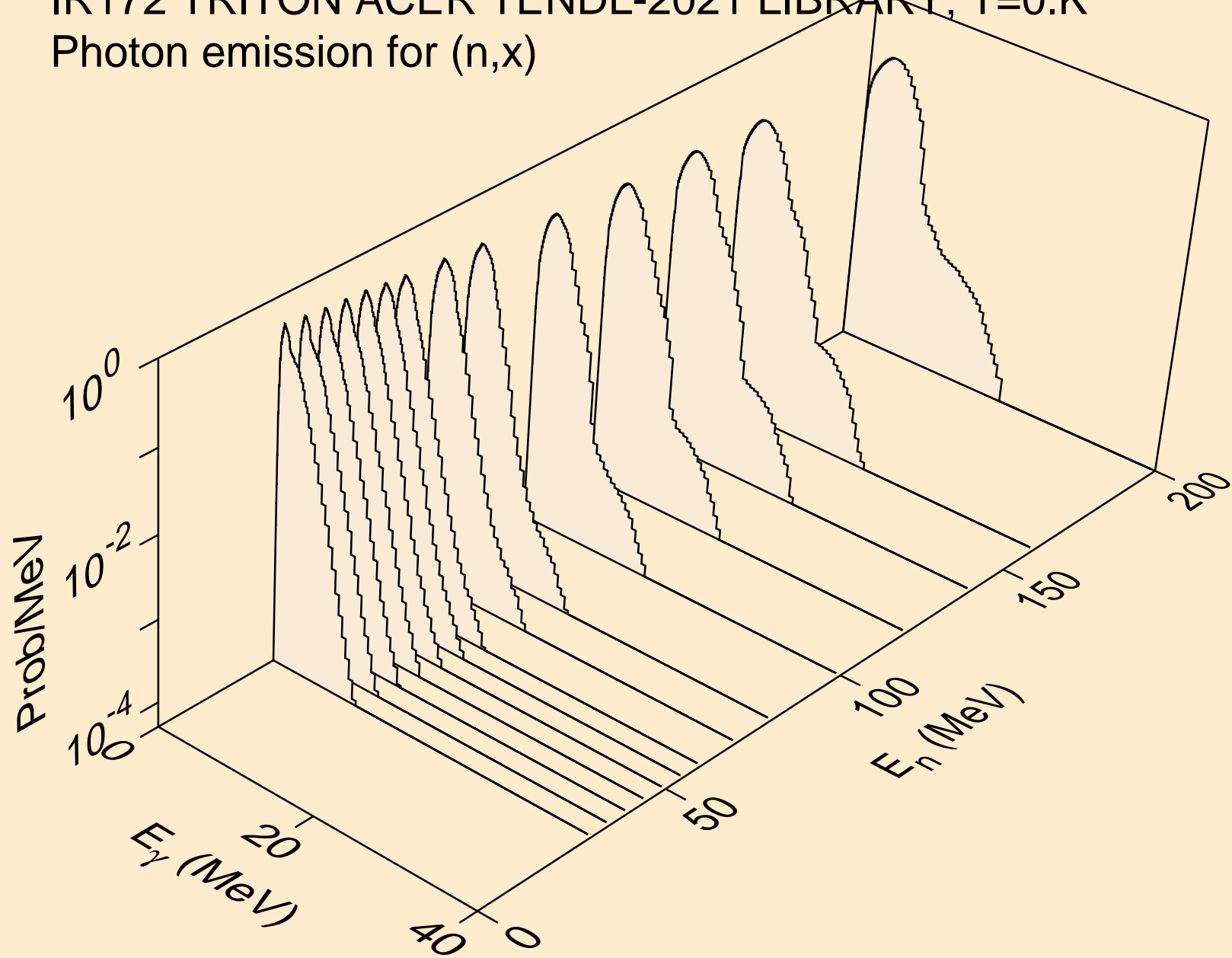

IR172 TRITON ACER TENDL-2021 LIBRARY; T=0.K  
Photon emission for (n,2nd)

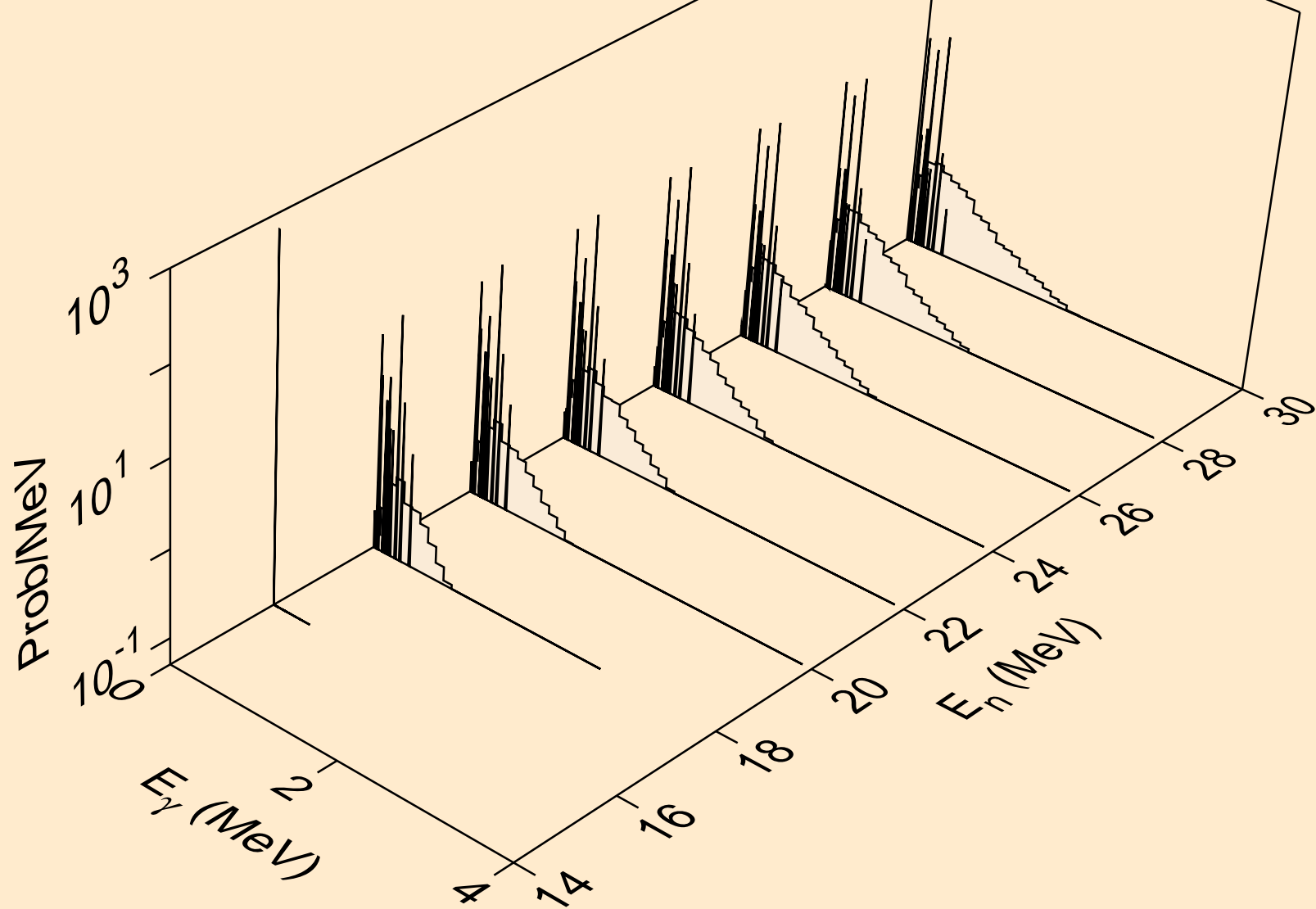



IR172 TRITON ACER TENDL-2021 LIBRARY; T=0.K  
Photon emission for (n,2n)

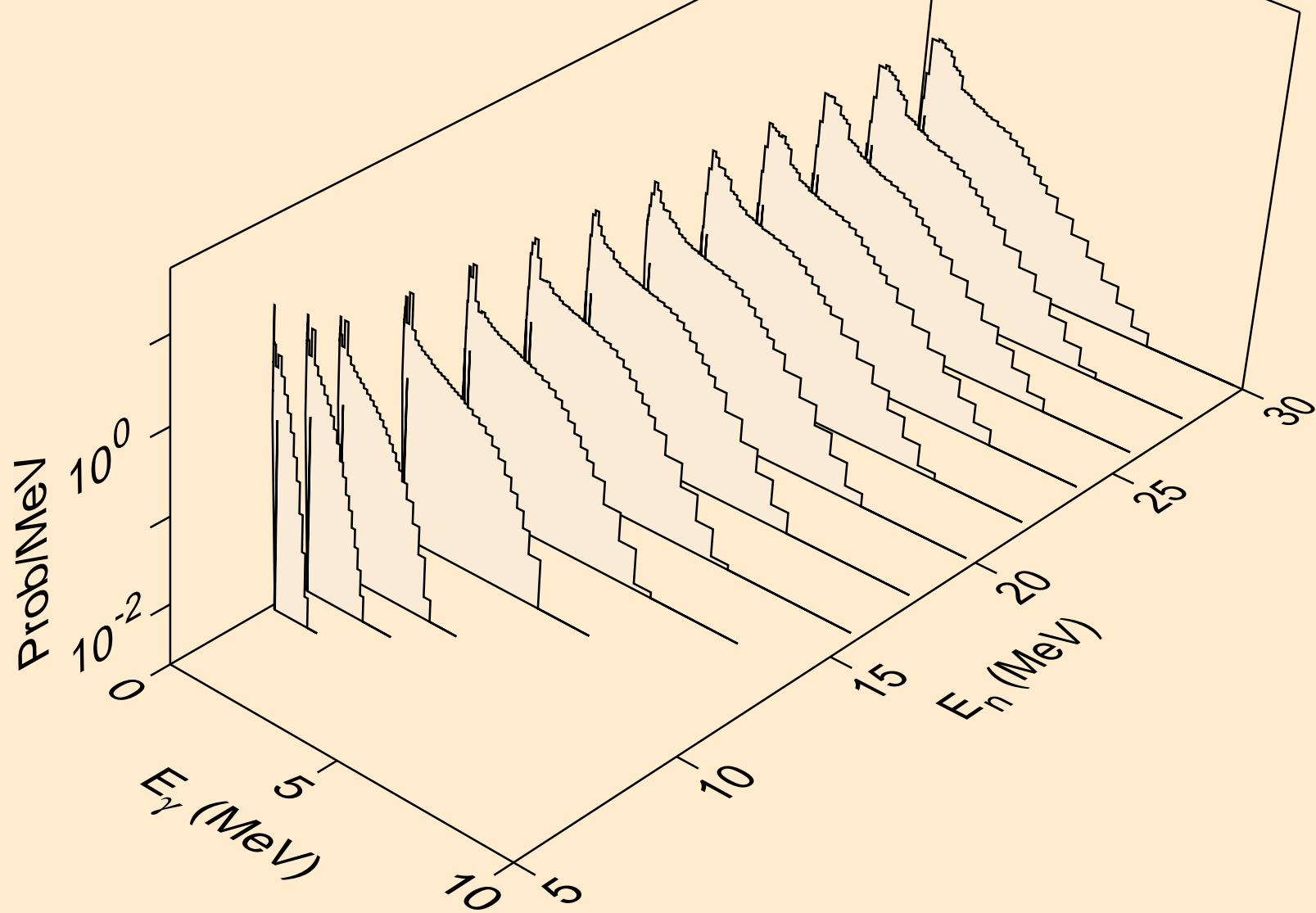

IR172 TRITON ACER TENDL-2021 LIBRARY; T=0.K  
Photon emission for (n,3n)

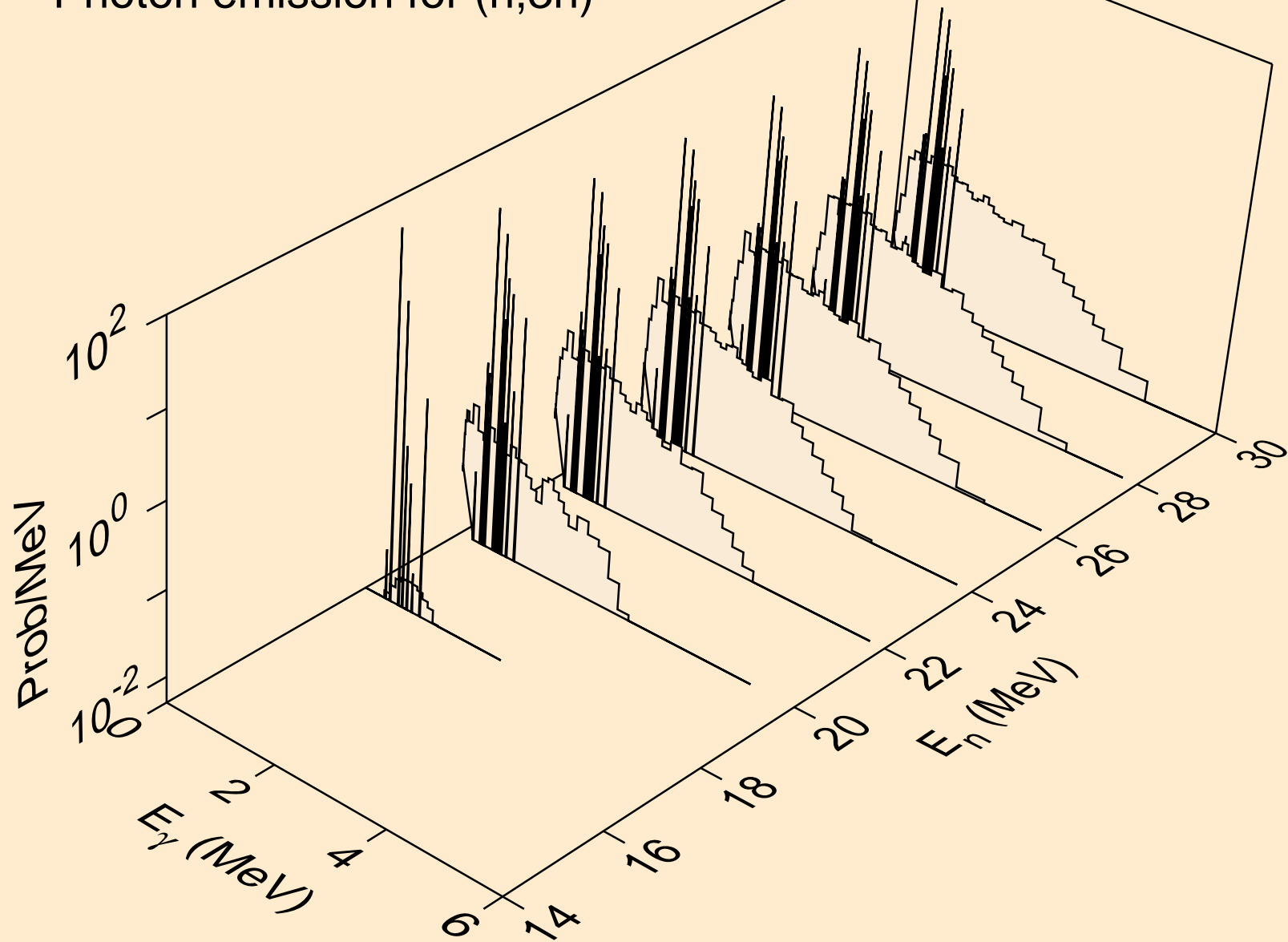

IR172 TRITON ACER TENDL-2021 LIBRARY; T=0.K  
Photon emission for (n,n\*)a

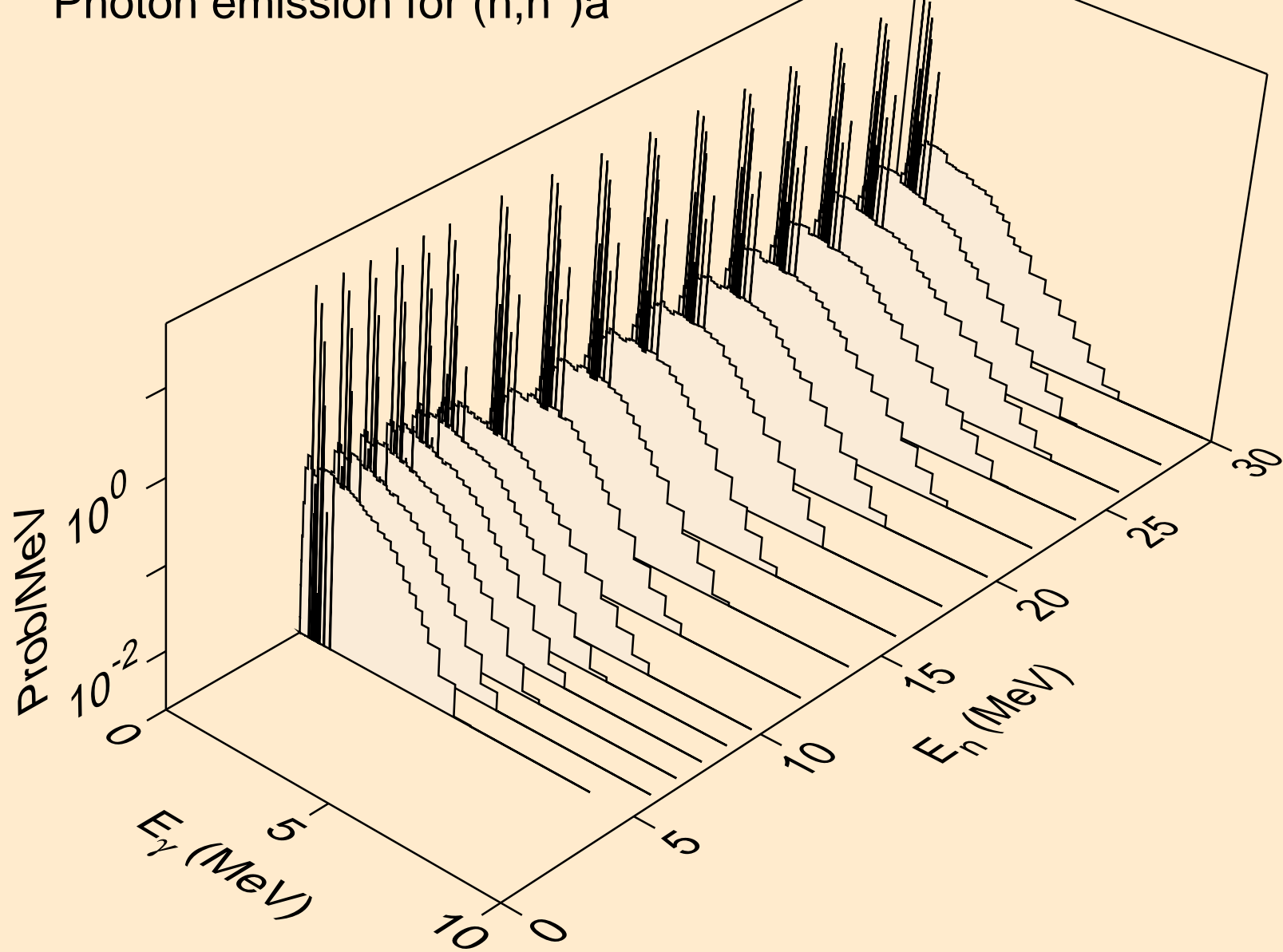

IR172 TRITON ACER TENDL-2021 LIBRARY; T=0.K  
Photon emission for (n,n\*)3a

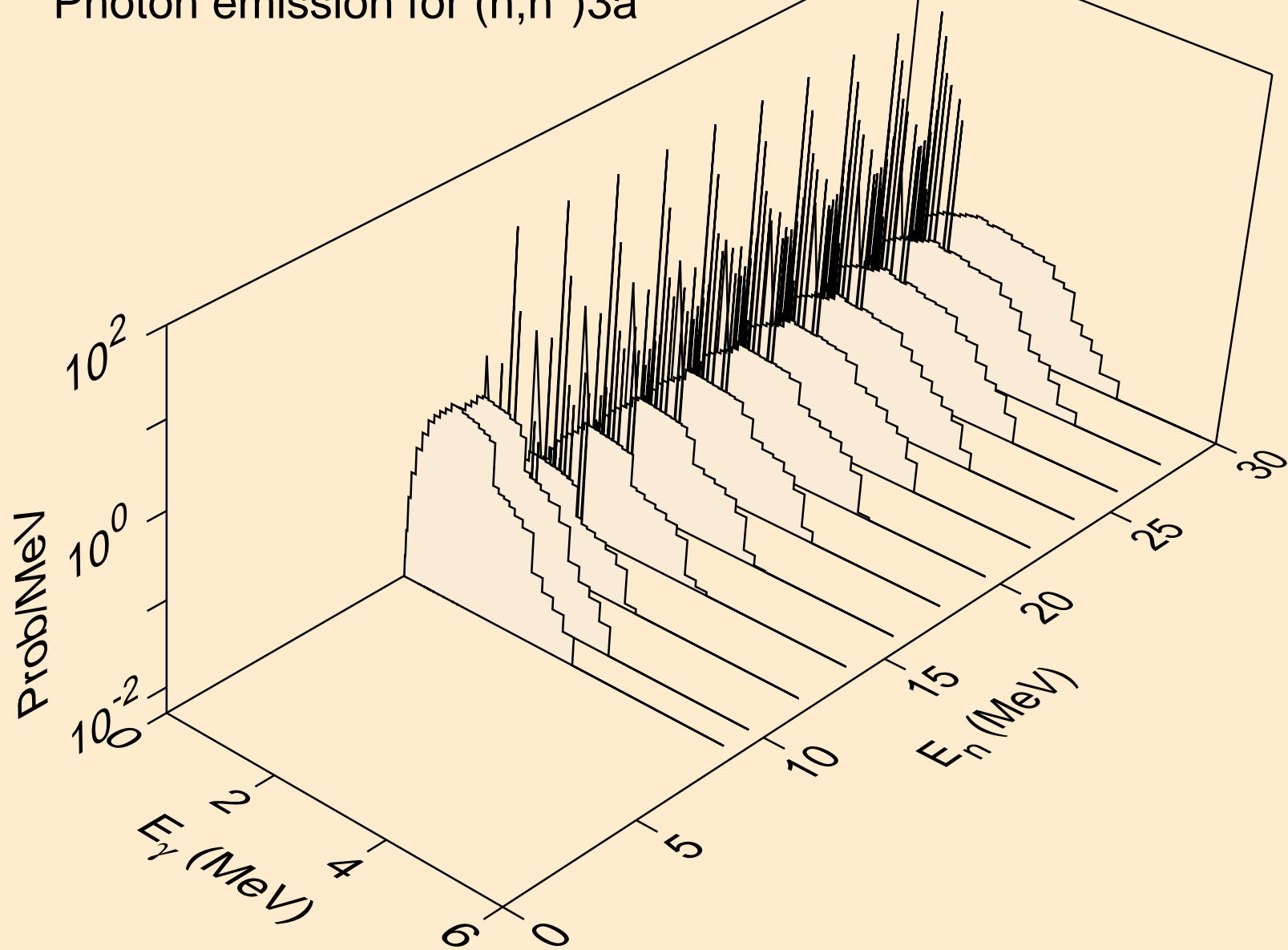

IR172 TRITON ACER TENDL-2021 LIBRARY; T=0.K  
Photon emission for (n,2n)a

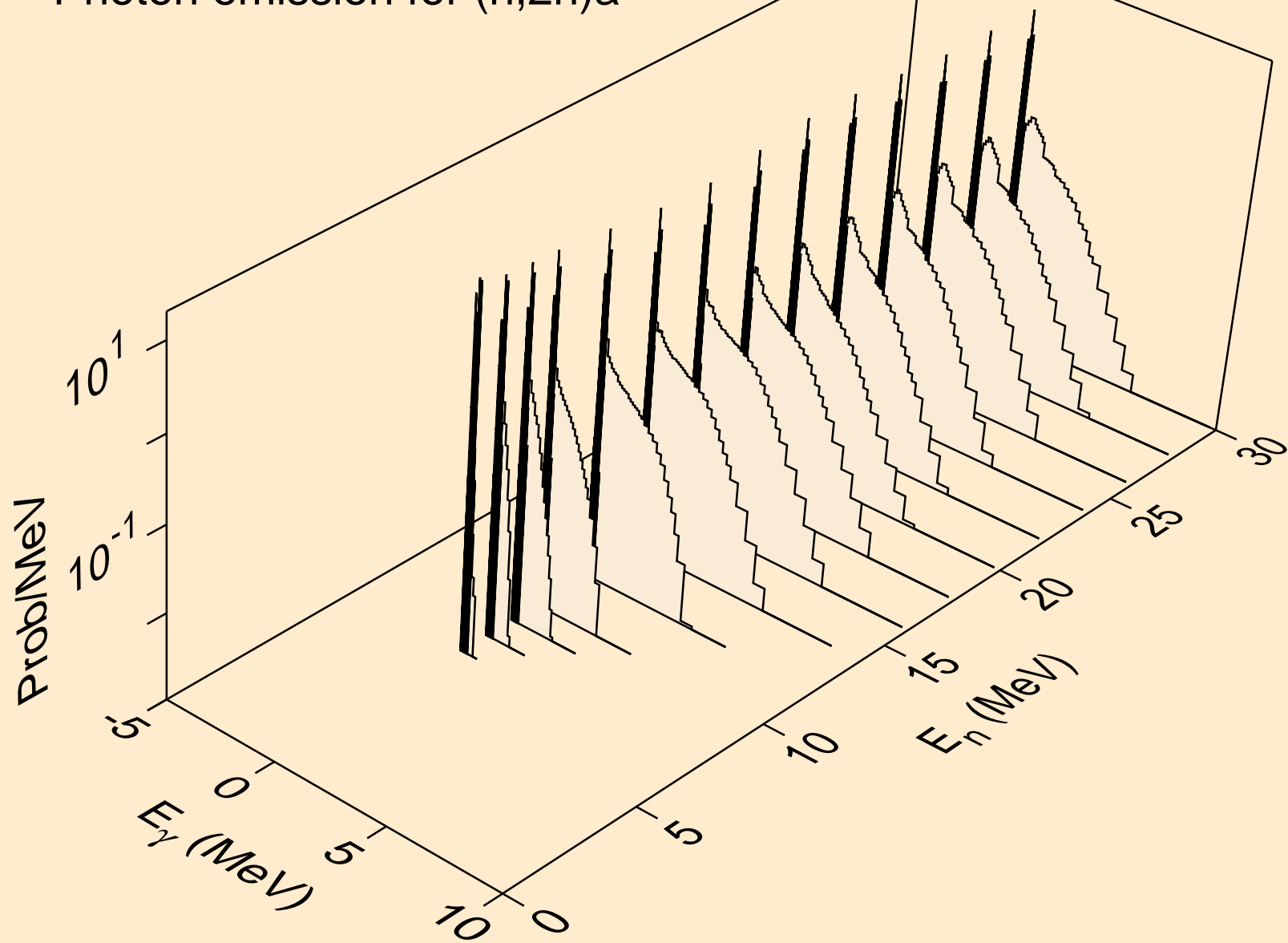

IR172 TRITON ACER TENDL-2021 LIBRARY; T=0.K  
Photon emission for (n,3n)a

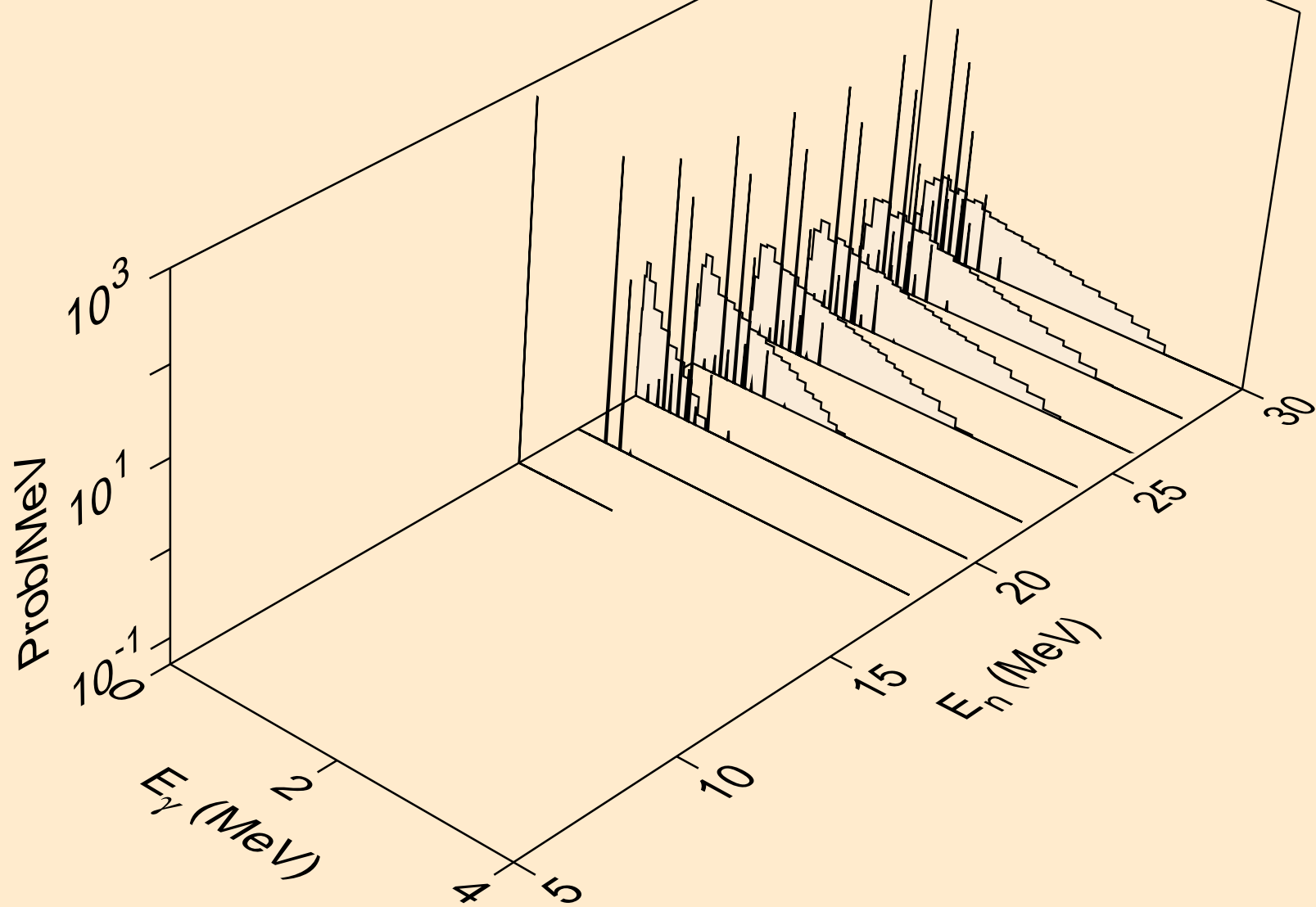

IR172 TRITON ACER TENDL-2021 LIBRARY; T=0.K  
Photon emission for (n,n\*)p

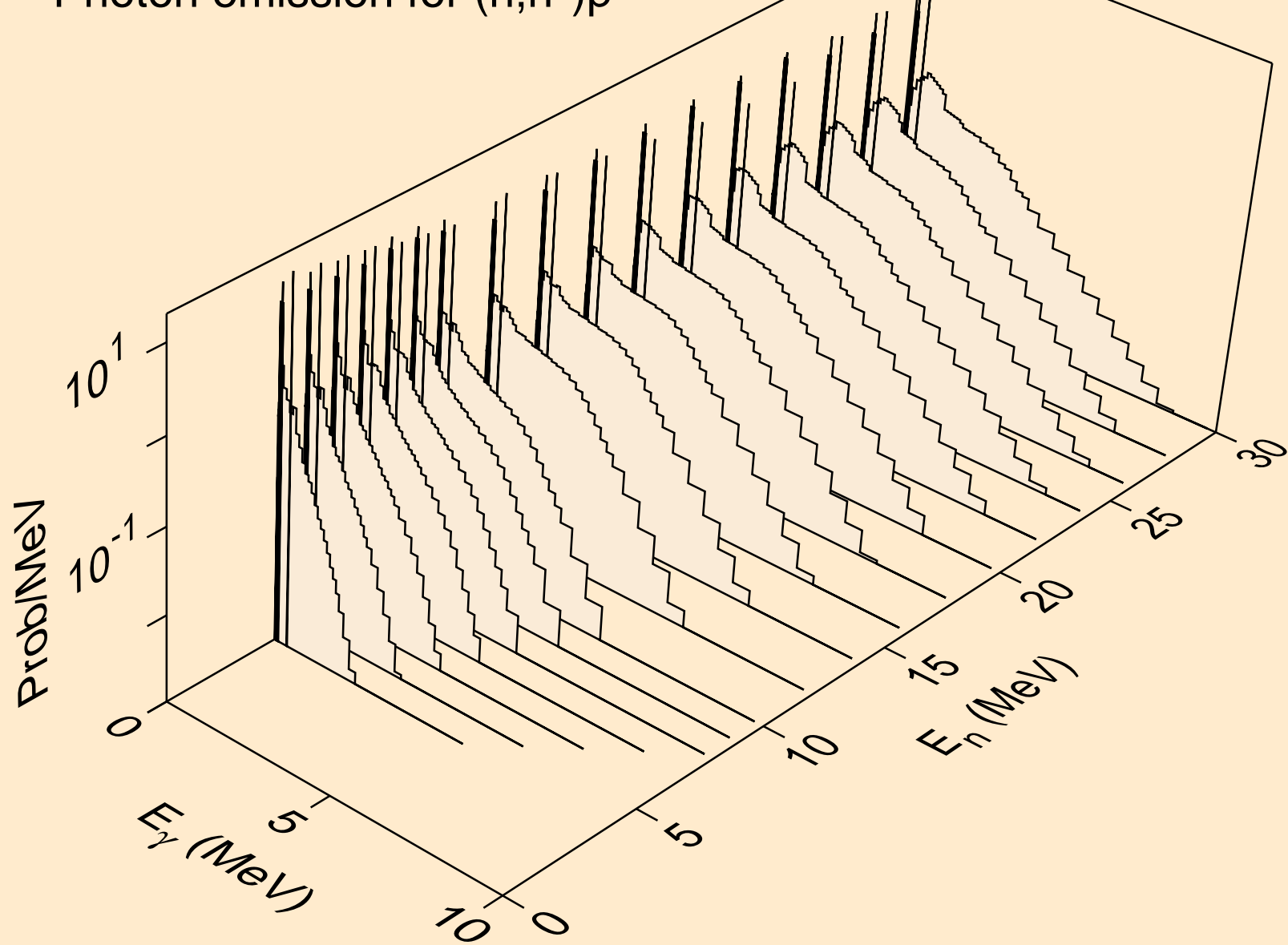

IR172 TRITON ACER TENDL-2021 LIBRARY; T=0.K  
Photon emission for (n,n\*)2a

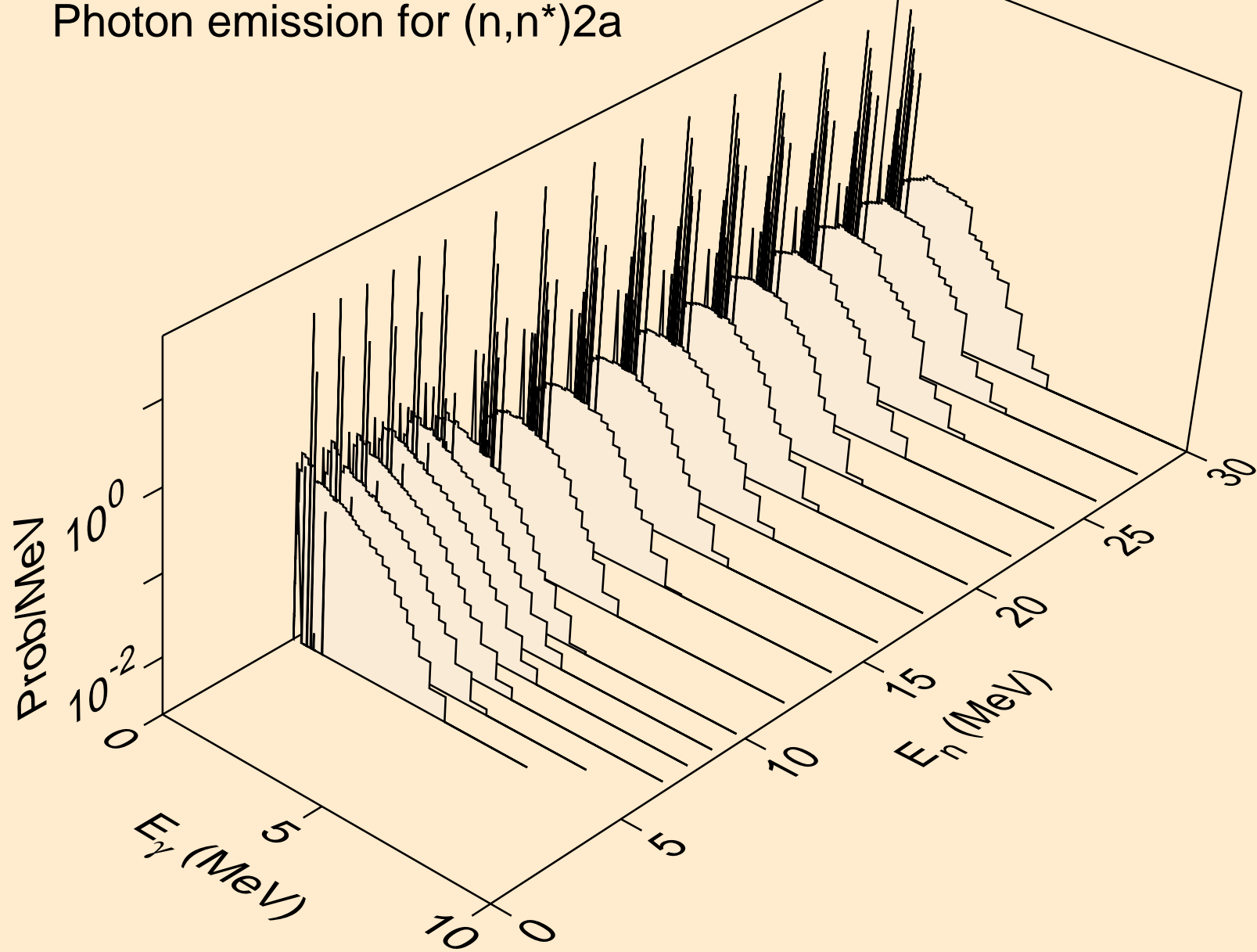



IR172 TRITON ACER TENDL-2021 LIBRARY; T=0.K  
Photon emission for (n,2n)2a

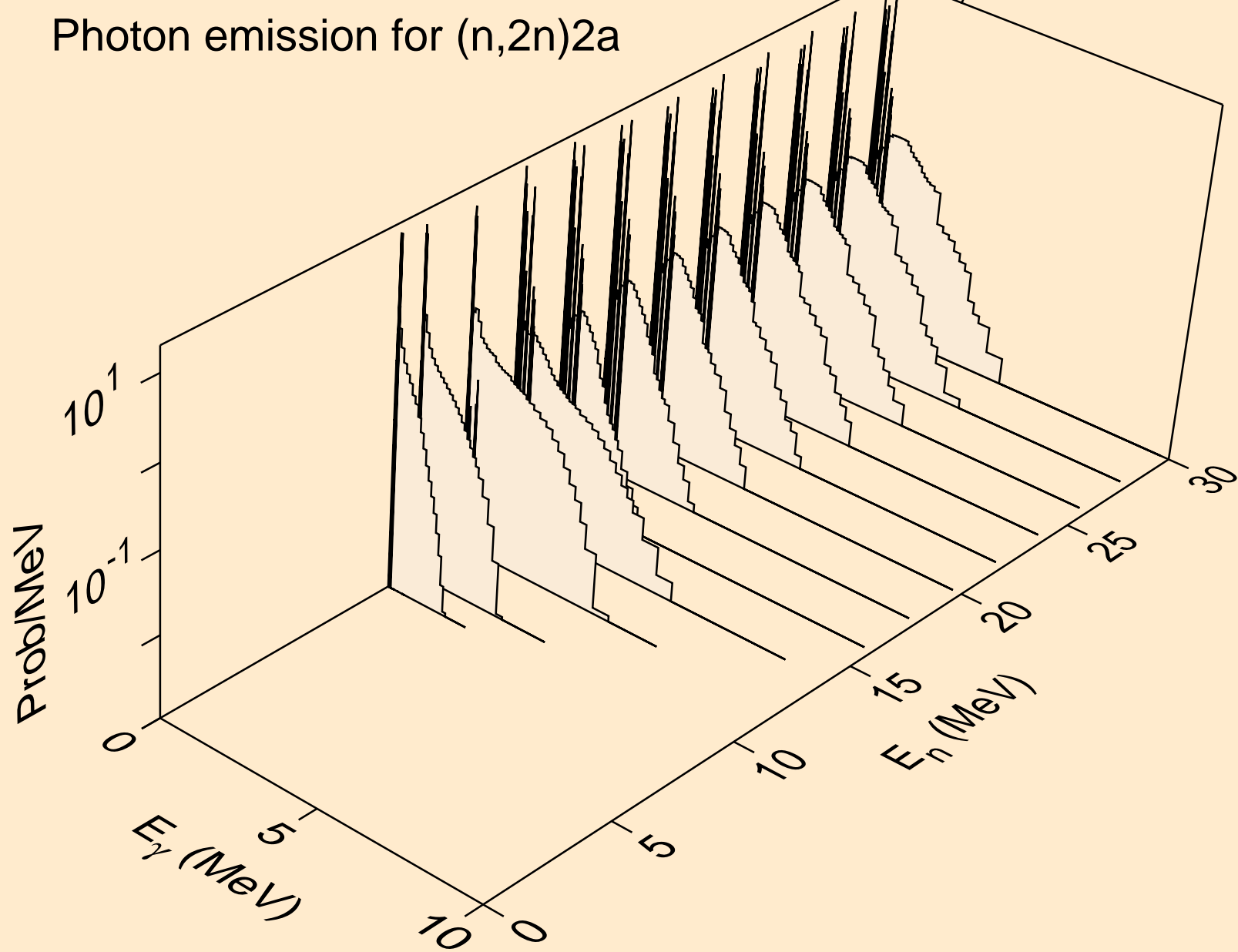

IR172 TRITON ACER TENDL-2021 LIBRARY; T=0.K  
Photon emission for (n,n\*)d

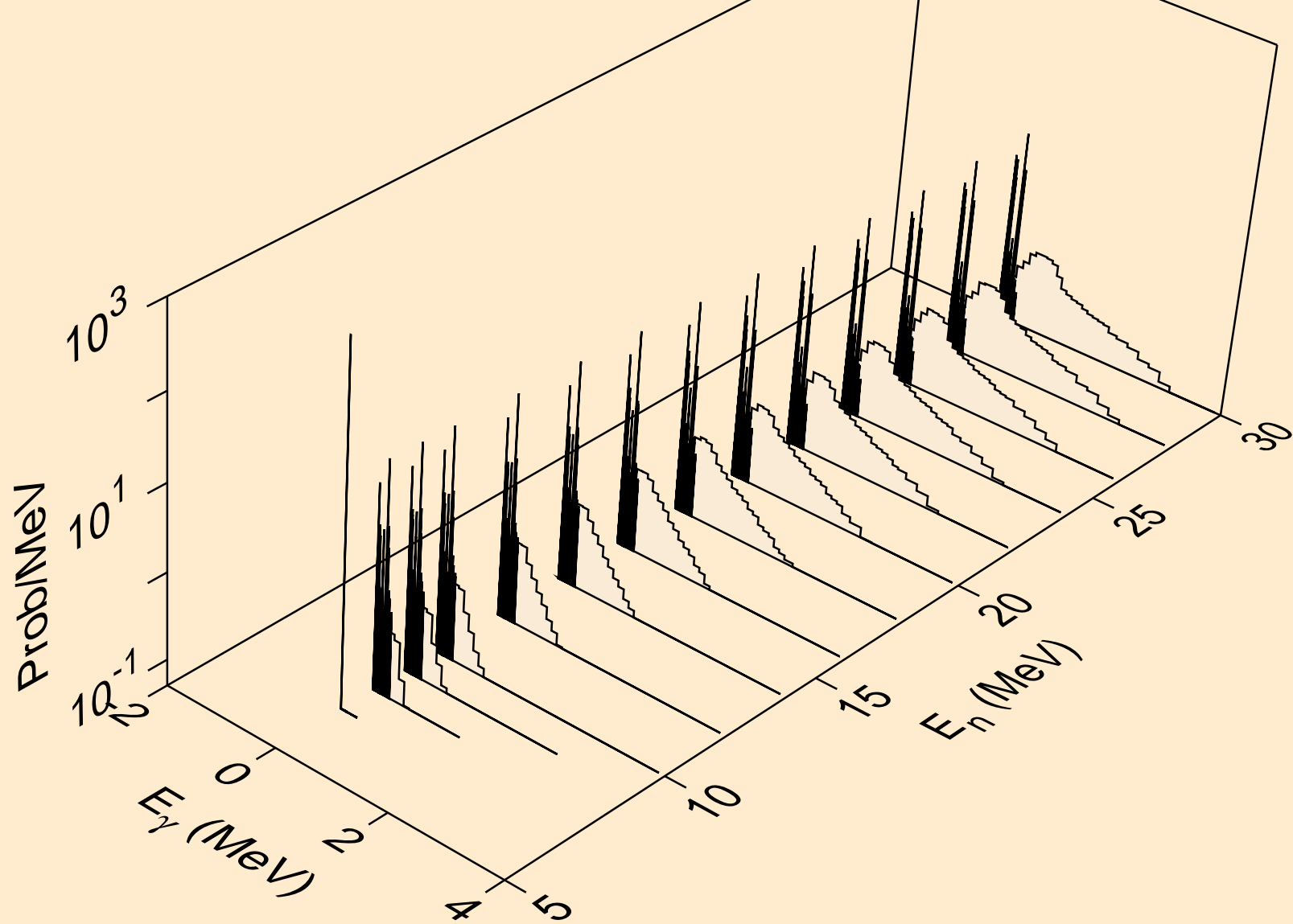

IR172 TRITON ACER TENDL-2021 LIBRARY; T=0.K  
Photon emission for (n,n\*)t

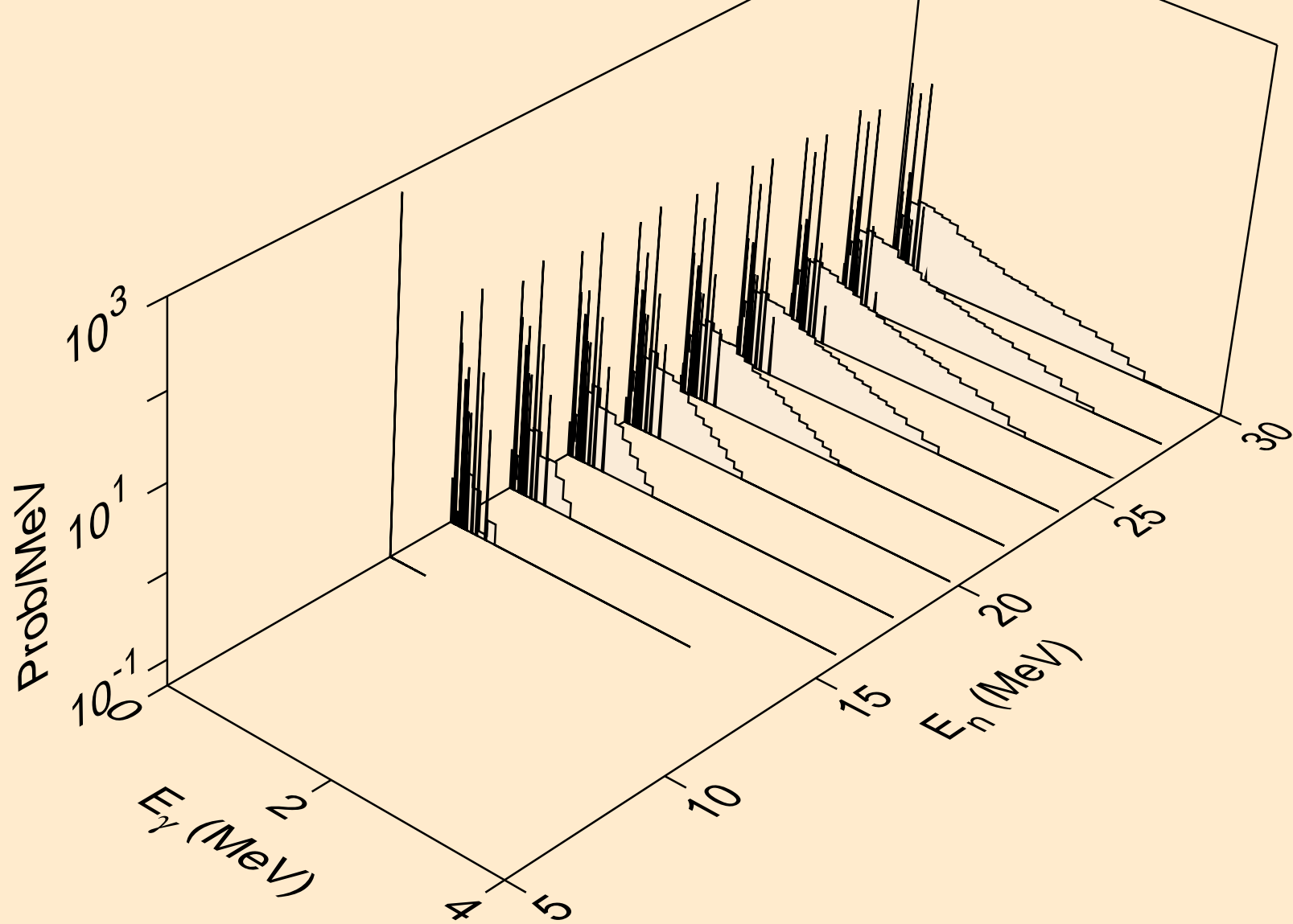

IR172 TRITON ACER TENDL-2021 LIBRARY; T=0.K  
Photon emission for (n,n\*)he3

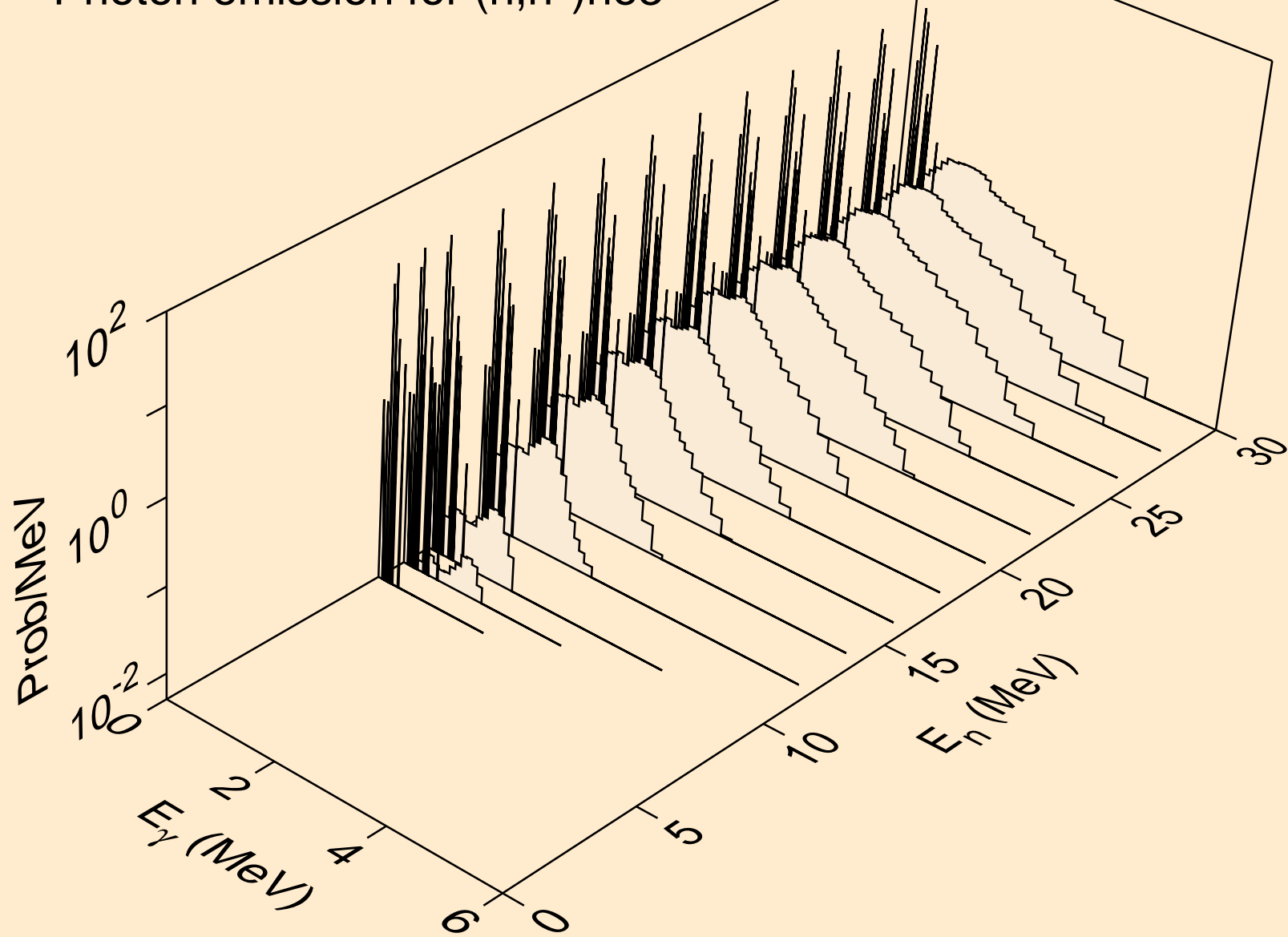

IR172 TRITON ACER TENDL-2021 LIBRARY; T=0.K  
Photon emission for (n,4n)

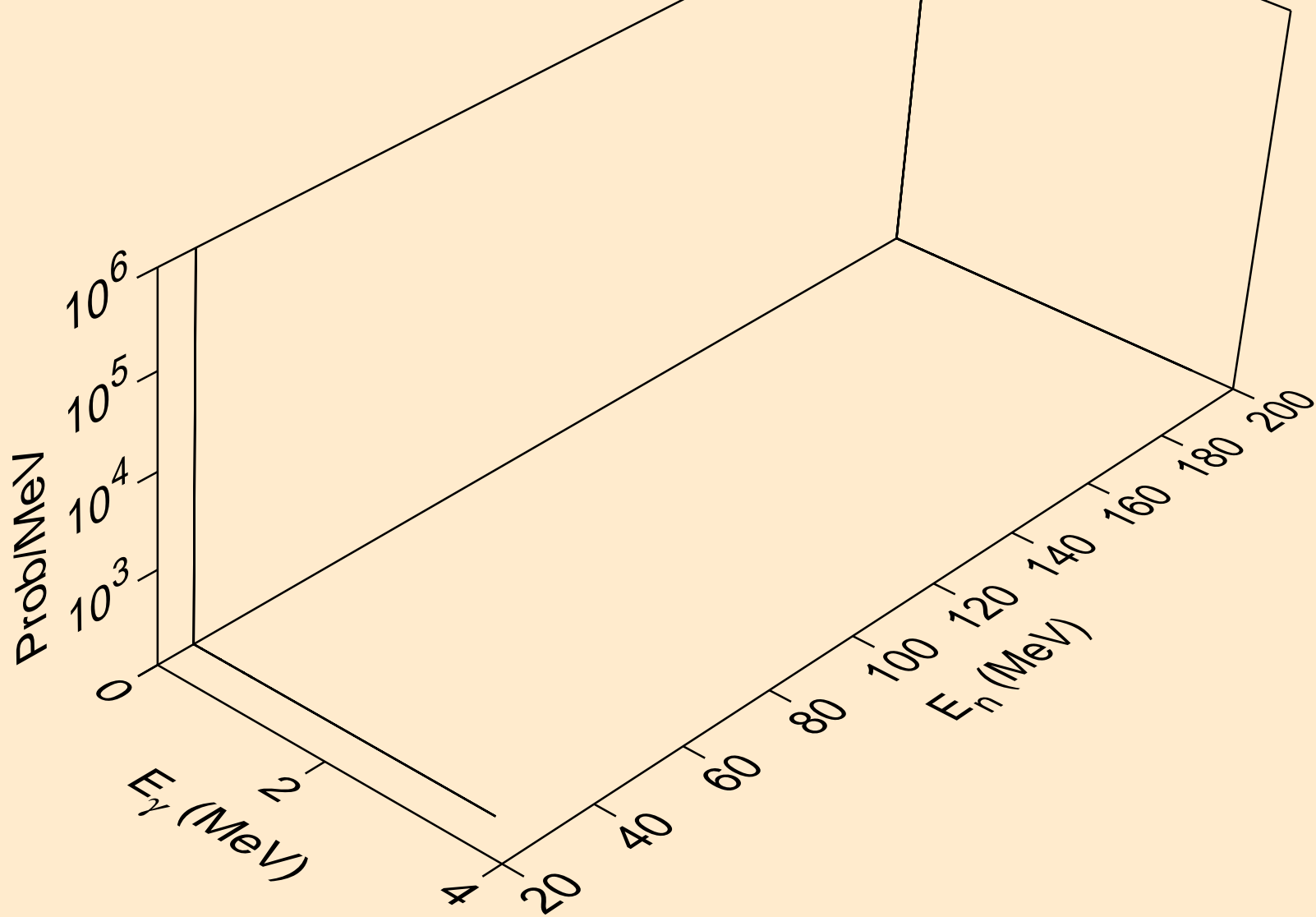

IR172 TRITON ACER TENDL-2021 LIBRARY; T=0.K  
Photon emission for (n,2np)

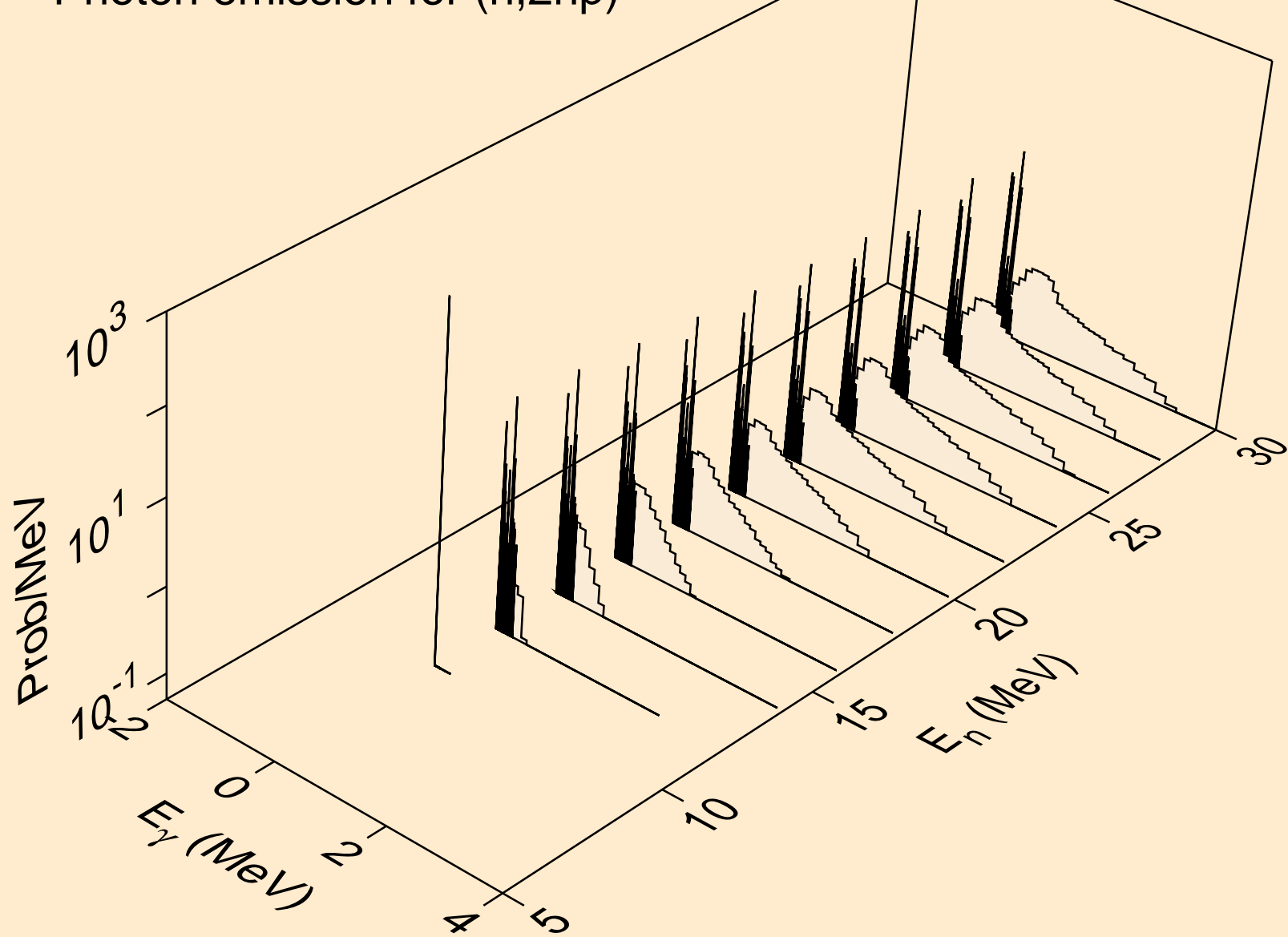

IR172 TRITON ACER TENDL-2021 LIBRARY; T=0.K  
Photon emission for (n,3np)

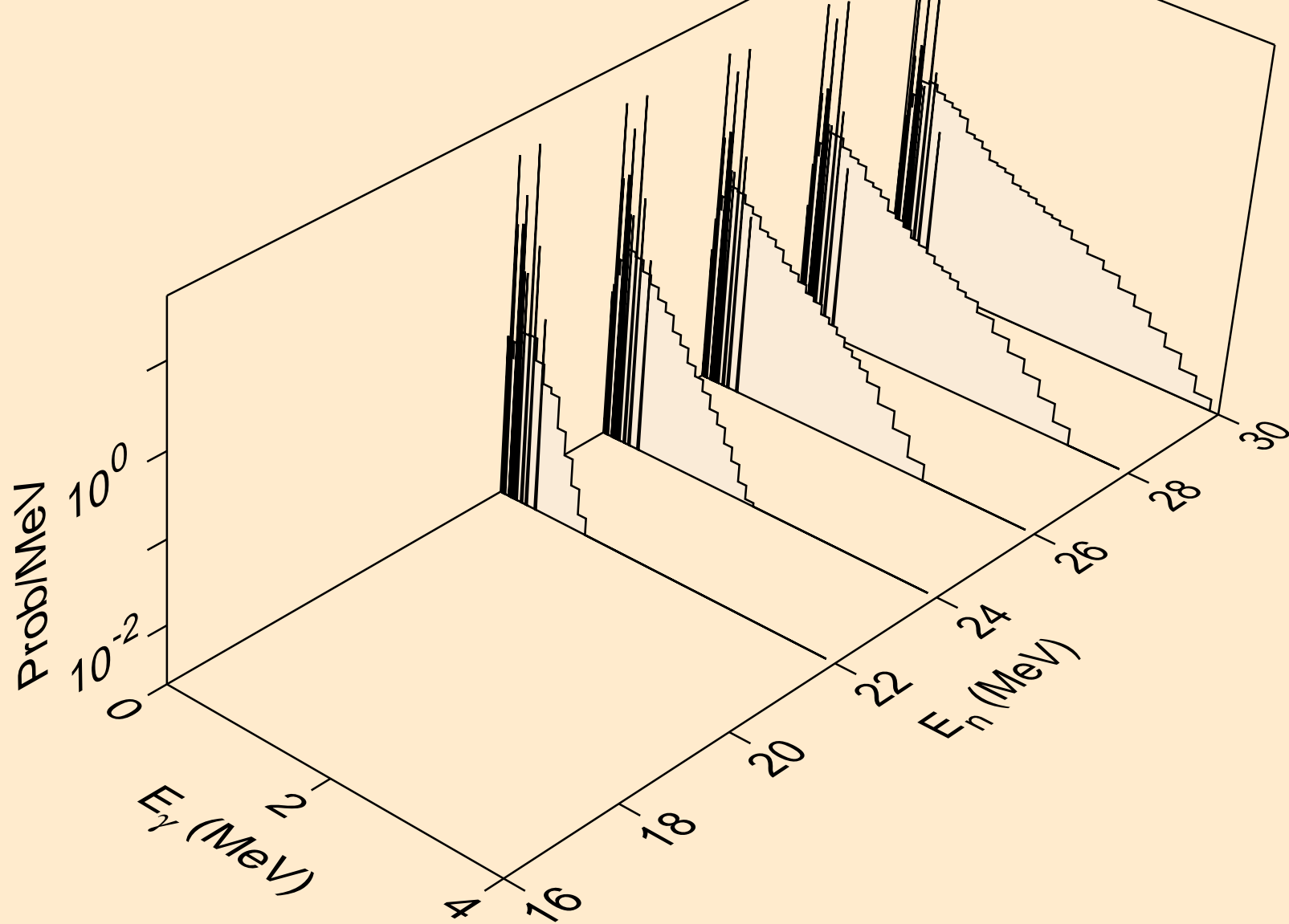

IR172 TRITON ACER TENDL-2021 LIBRARY; T=0.K  
Photon emission for (n,2np)

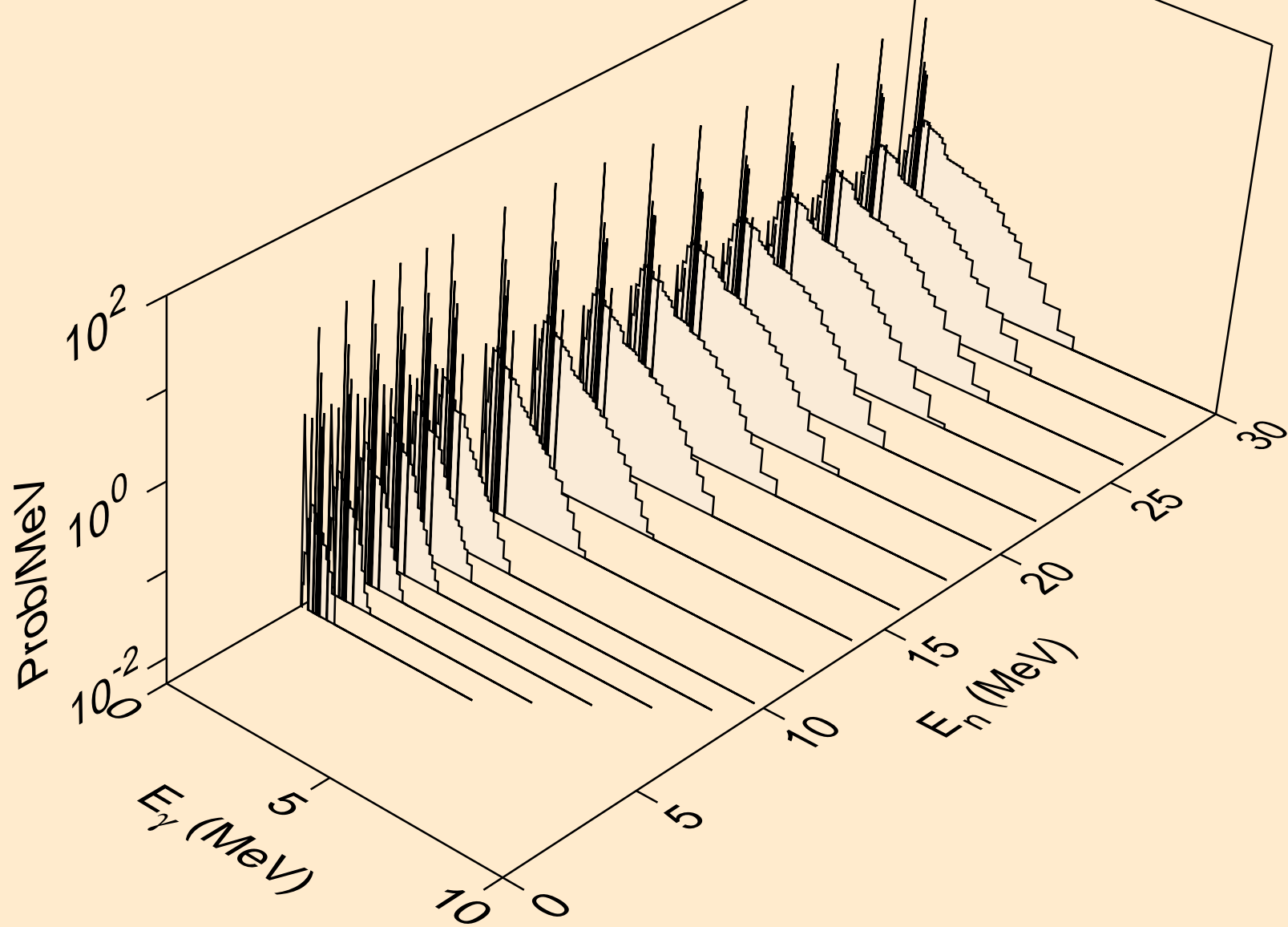



IR172 TRITON ACER TENDL-2021 LIBRARY; T=0.K  
Photon emission for (n,npa)

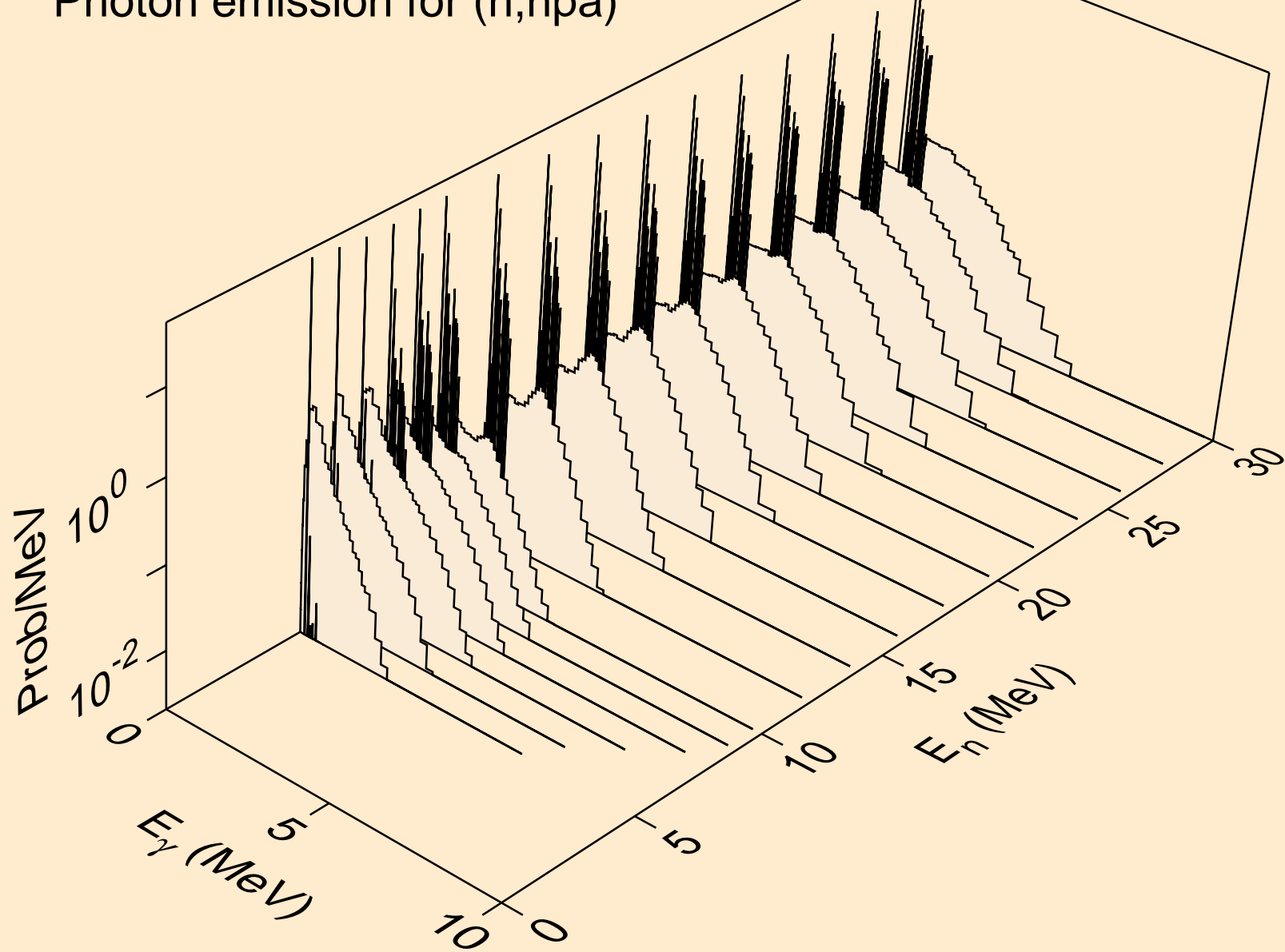

IR172 TRITON ACER TENDL-2021 LIBRARY; T=0.K  
Photon emission for (n,gma)

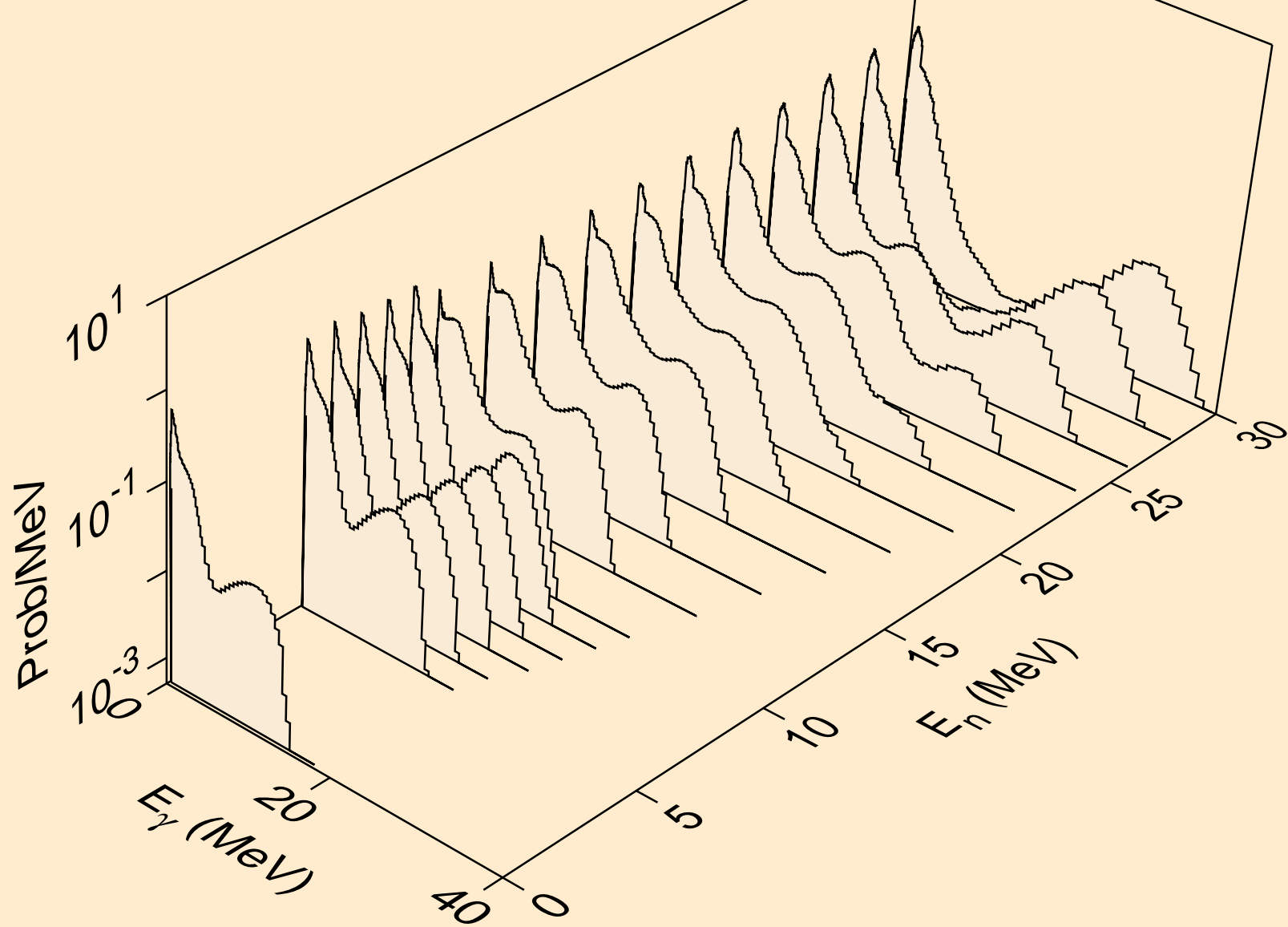

IR172 TRITON ACER TENDL-2021 LIBRARY; T=0.K  
Photon emission for (n,p)

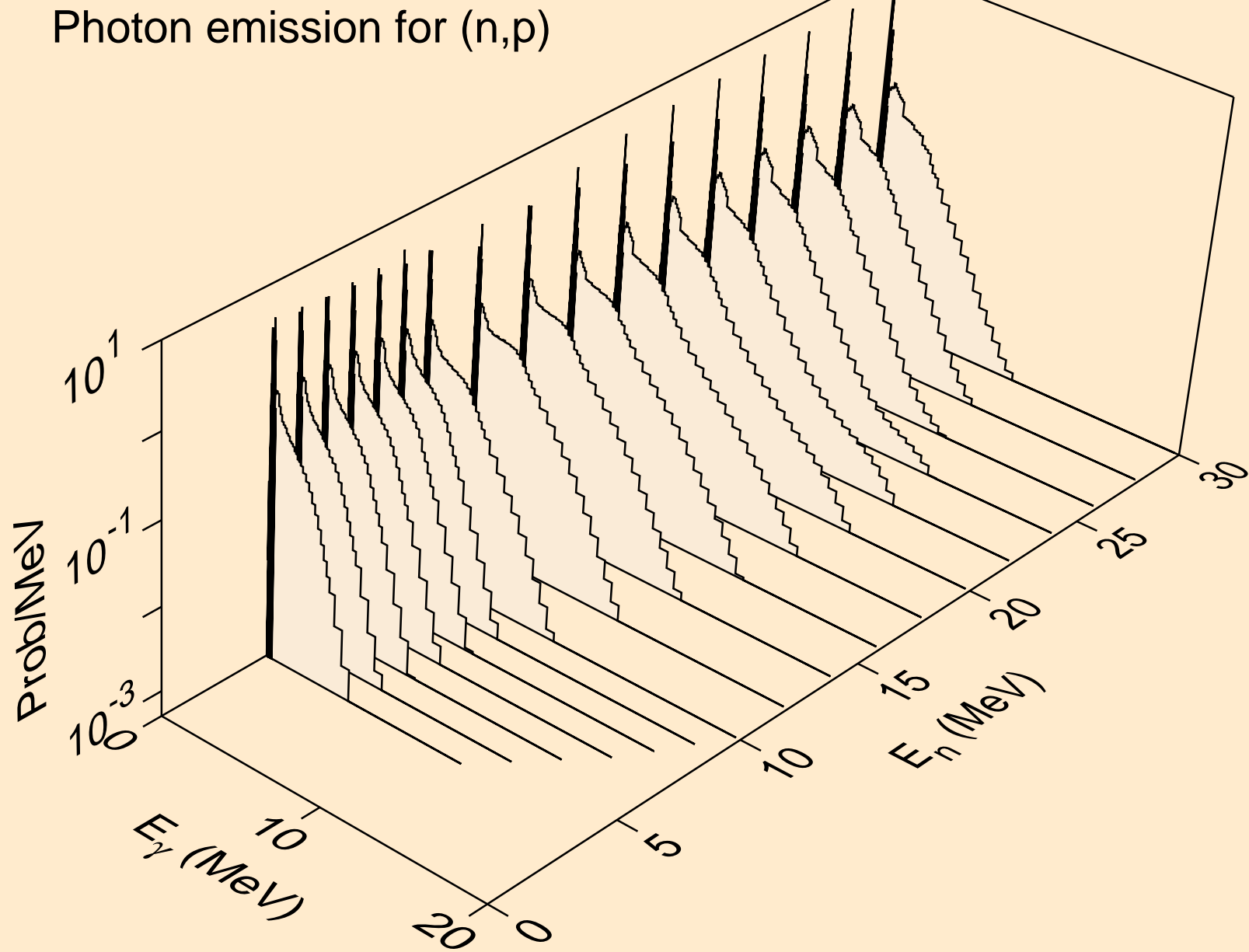

IR172 TRITON ACER TENDL-2021 LIBRARY; T=0.K  
Photon emission for (n,d)

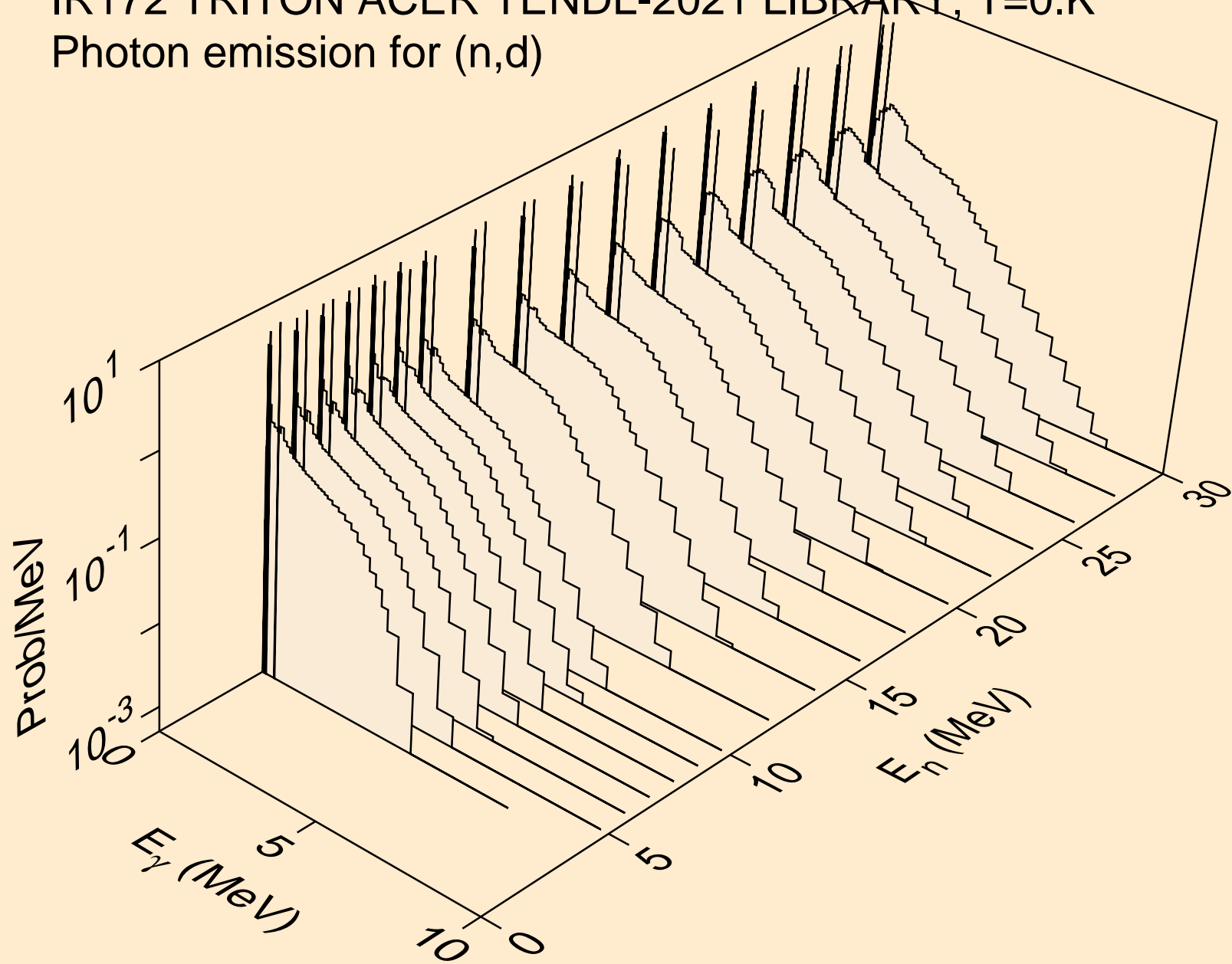

IR172 TRITON ACER TENDL-2021 LIBRARY; T=0.K  
Photon emission for inelastic

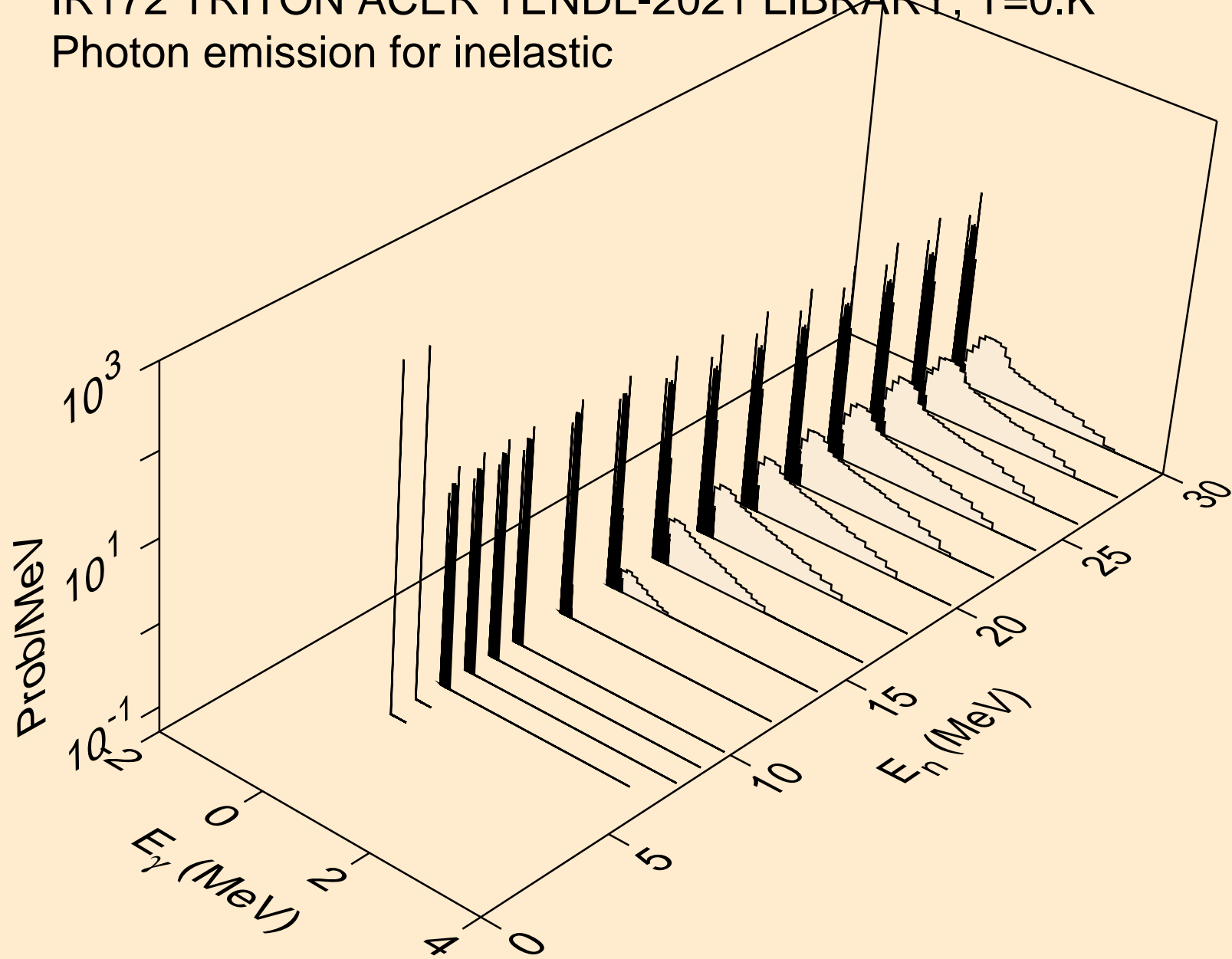

IR172 TRITON ACER TENDL-2021 LIBRARY; T=0.K  
Photon emission for (n,he3)

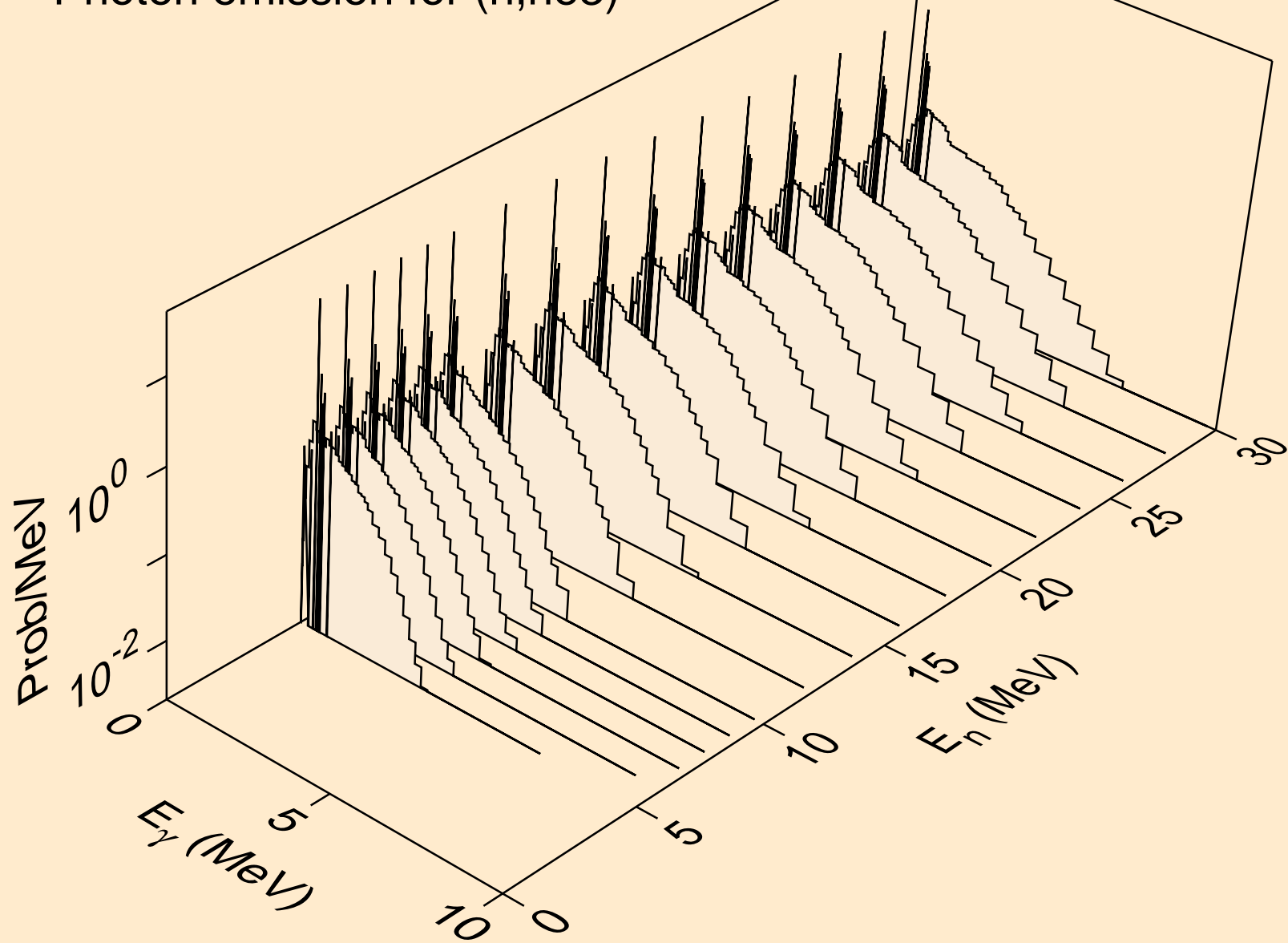

IR172 TRITON ACER TENDL-2021 LIBRARY; T=0.K  
Photon emission for (n,a)

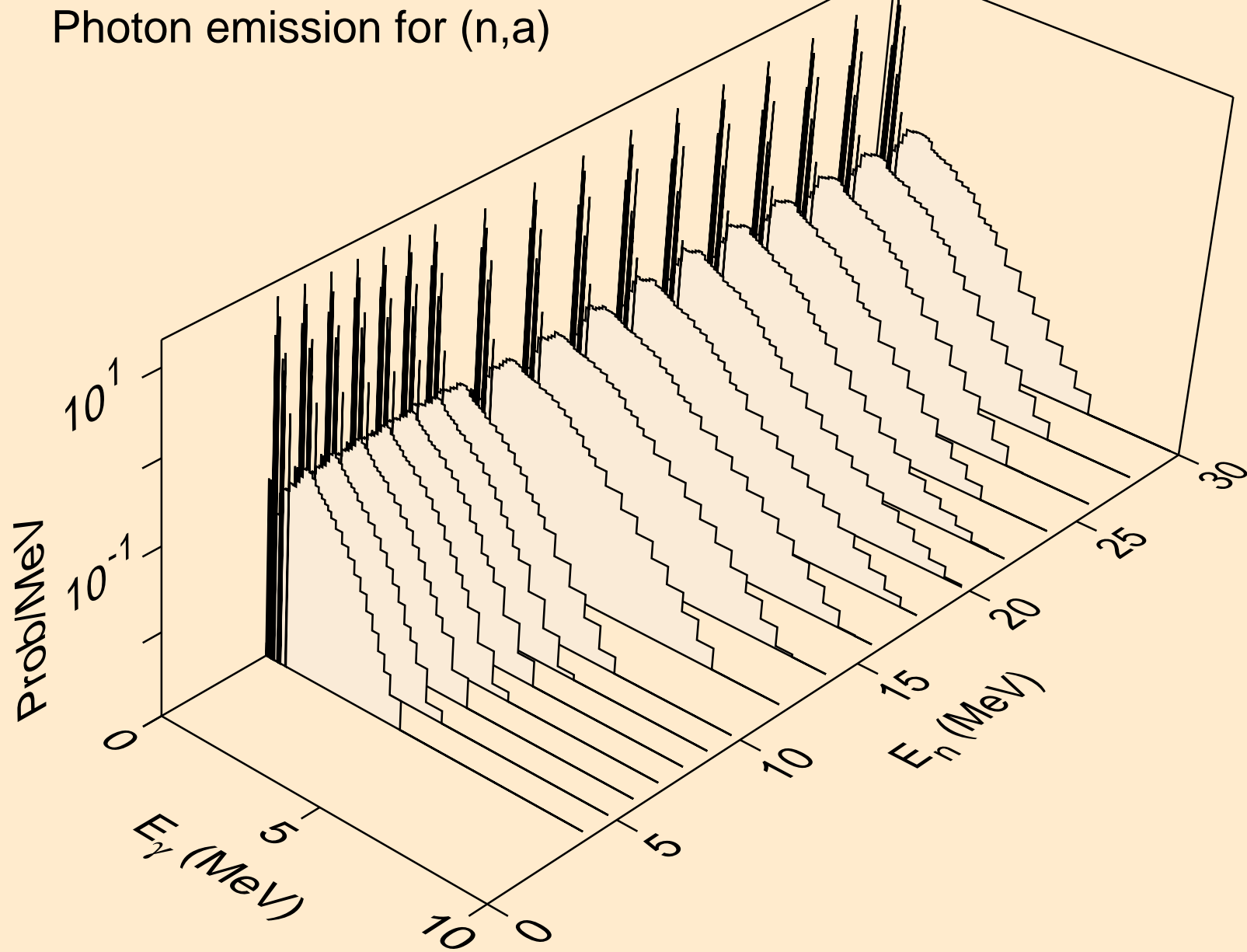

IR172 TRITON ACER TENDL-2021 LIBRARY; T=0.K  
Photon emission for (n,2a)

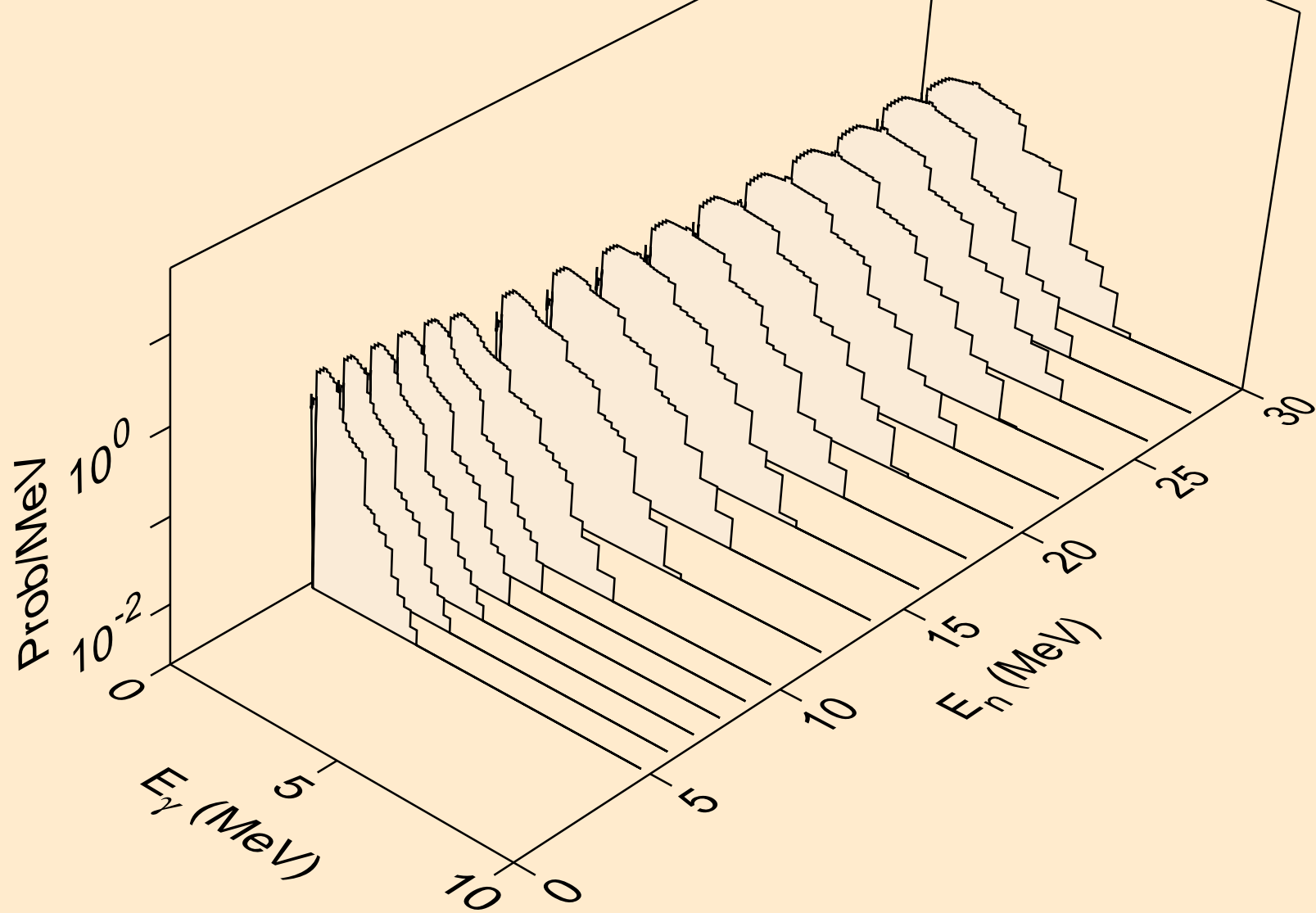



IR172 TRITON ACER TENDL-2021 LIBRARY; T=0.K  
Photon emission for (n,3a)

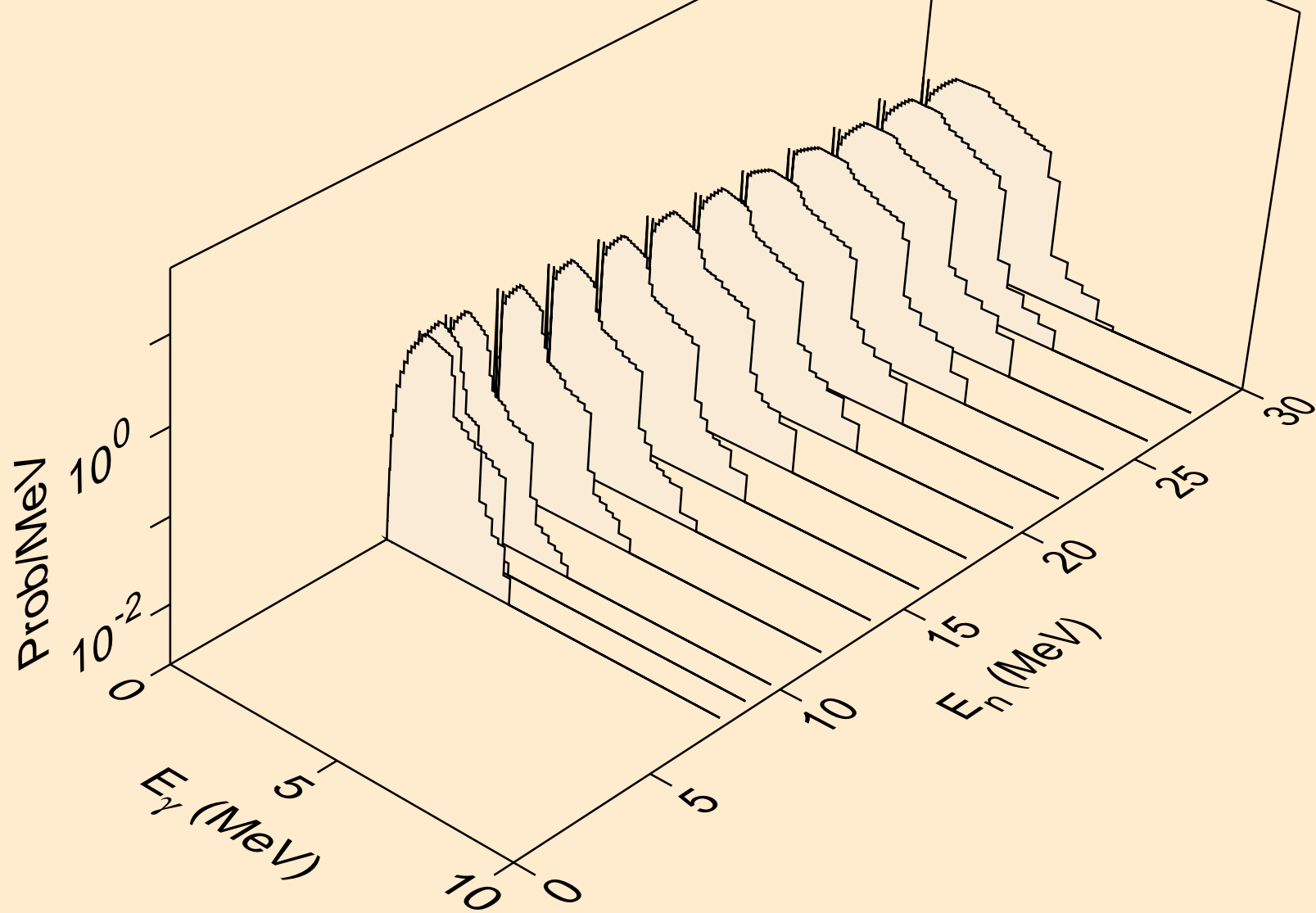

IR172 TRITON ACER TENDL-2021 LIBRARY; T=0.K  
Photon emission for (n,2p)

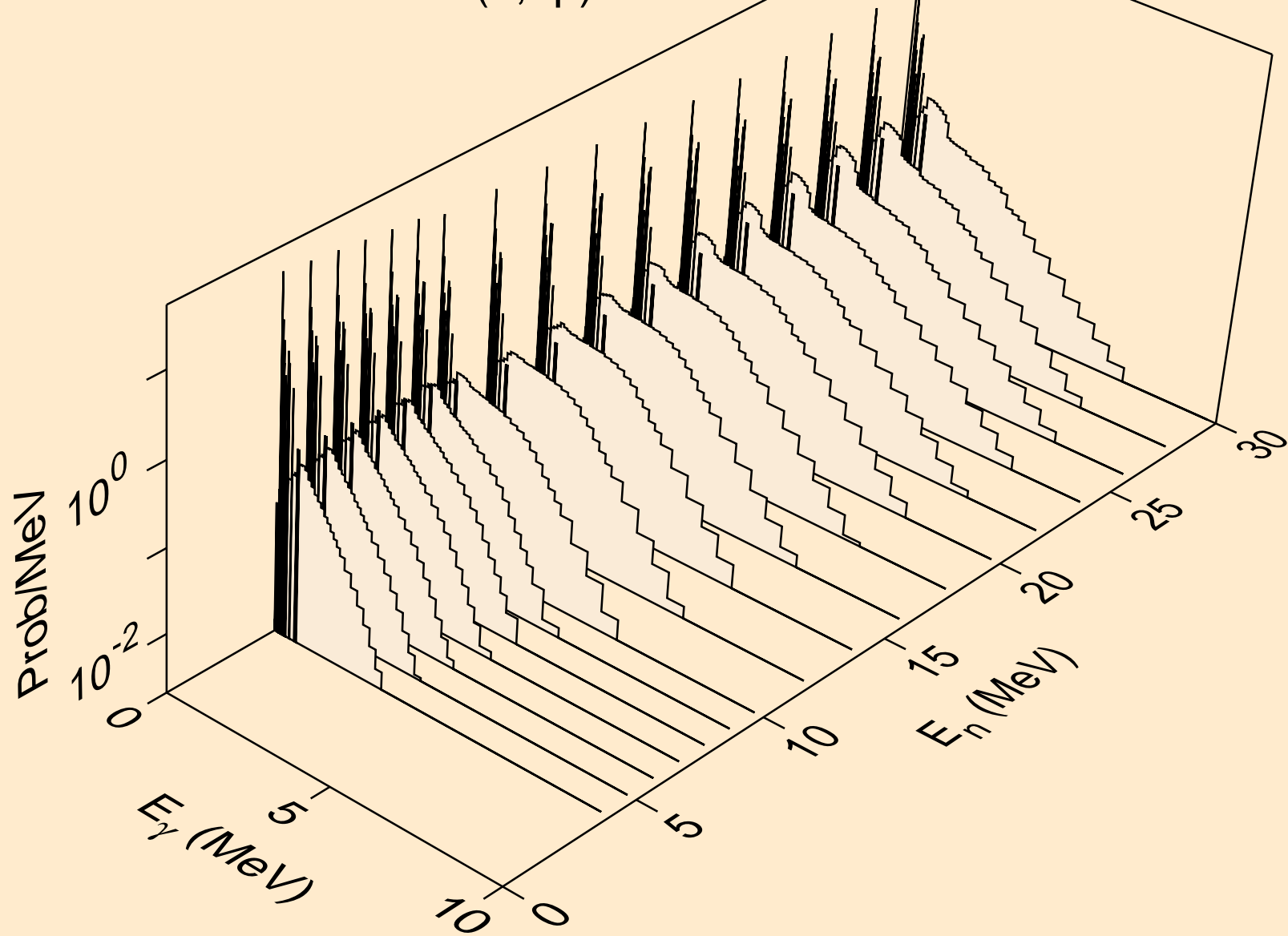

IR172 TRITON ACER TENDL-2021 LIBRARY; T=0.K  
Photon emission for (n,pa)

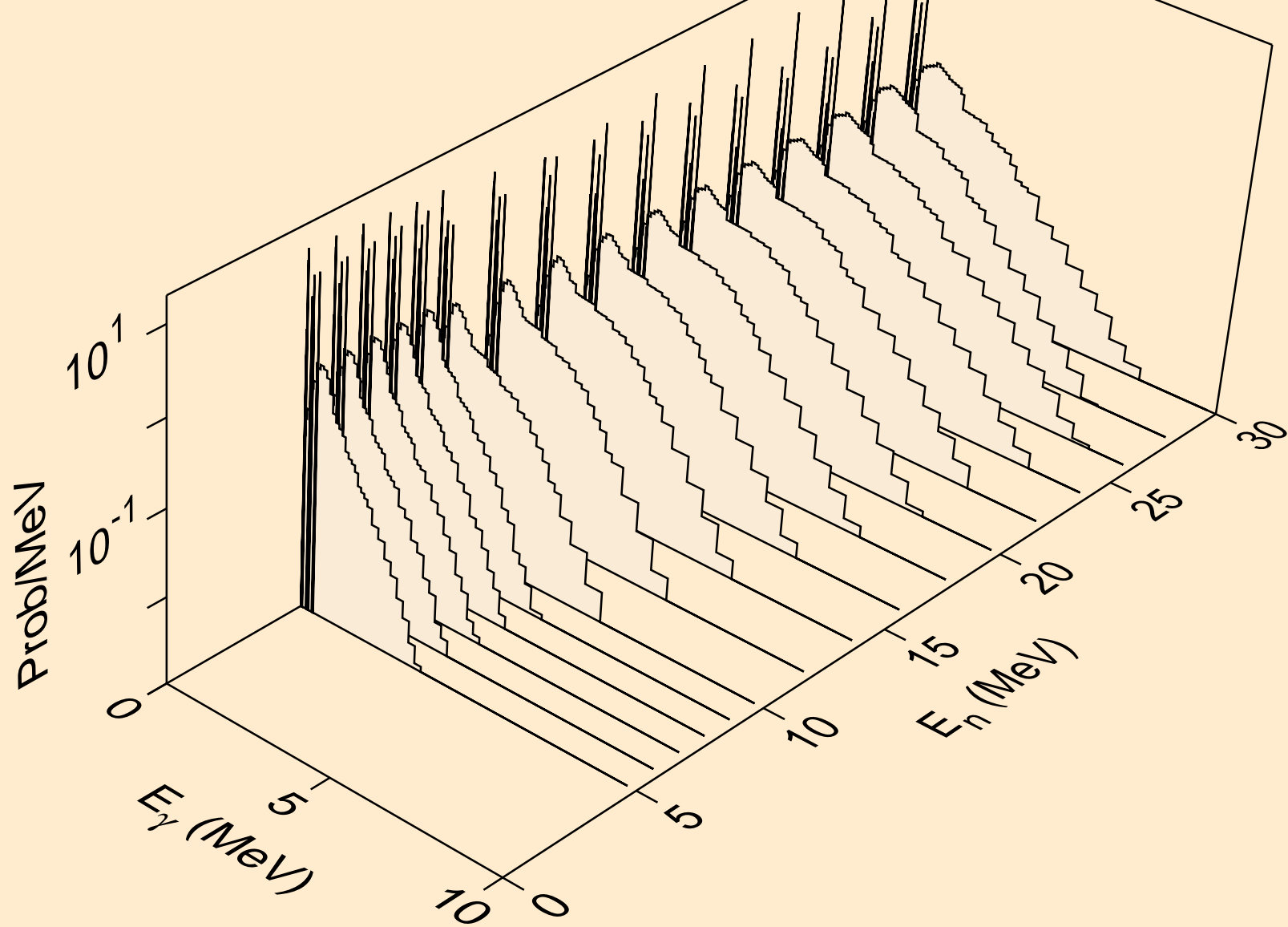

IR172 TRITON ACER TENDL-2021 LIBRARY; T=0.K  
Photon emission for (n,t2a)

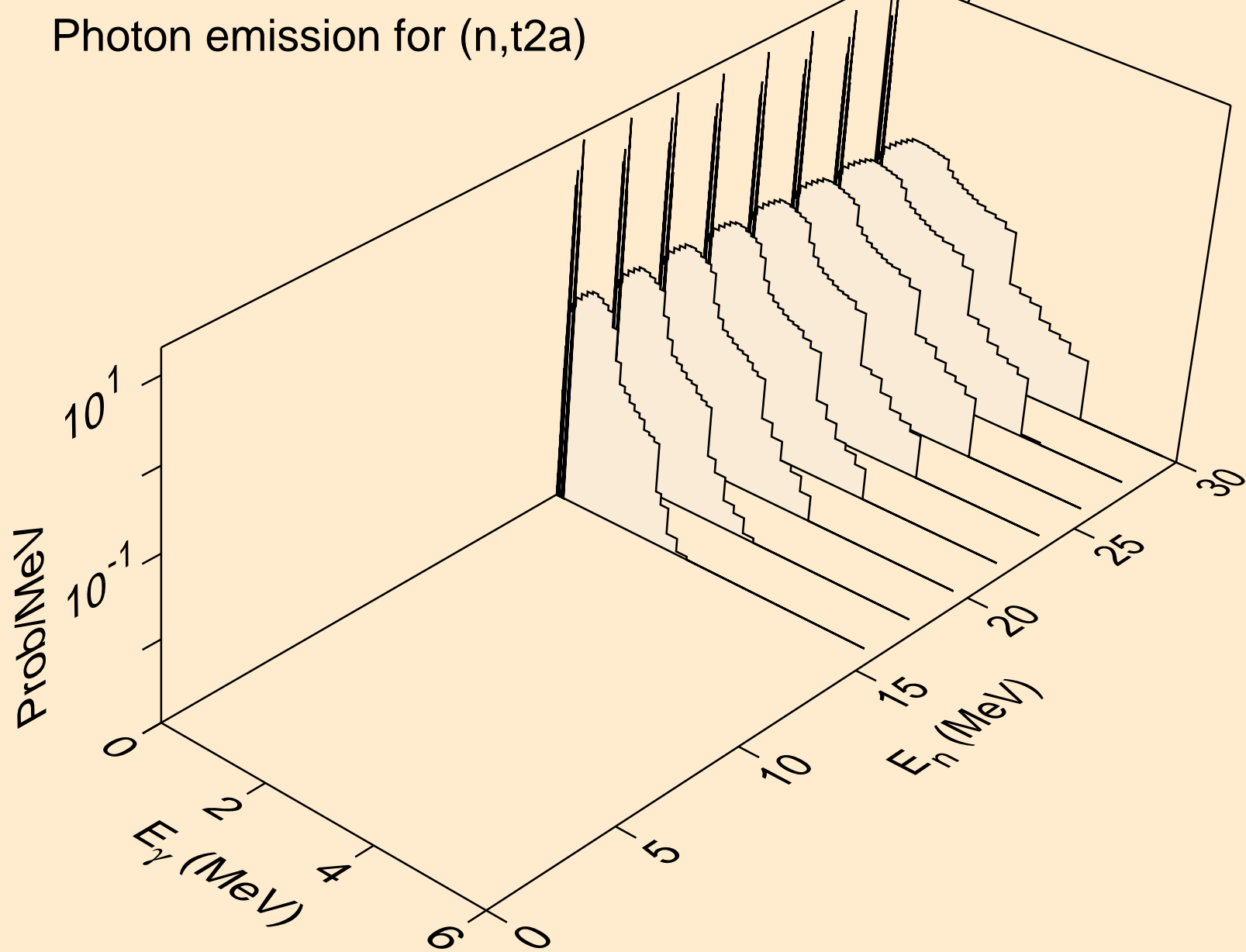

IR172 TRITON ACER TENDL-2021 LIBRARY; T=0.K  
Photon emission for (n,d2a)

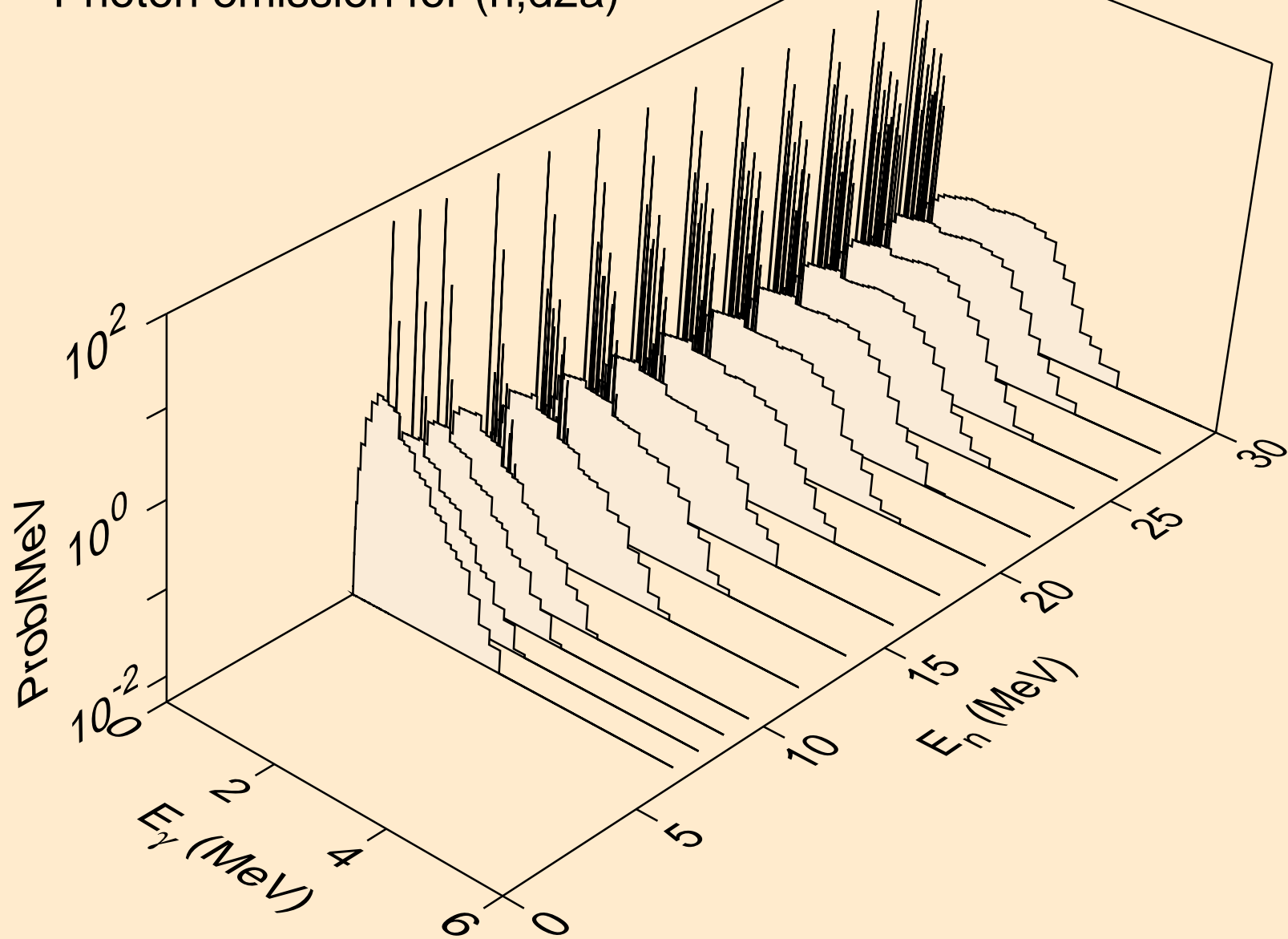

IR172 TRITON ACER TENDL-2021 LIBRARY; T=0.K  
Photon emission for (n,pd)

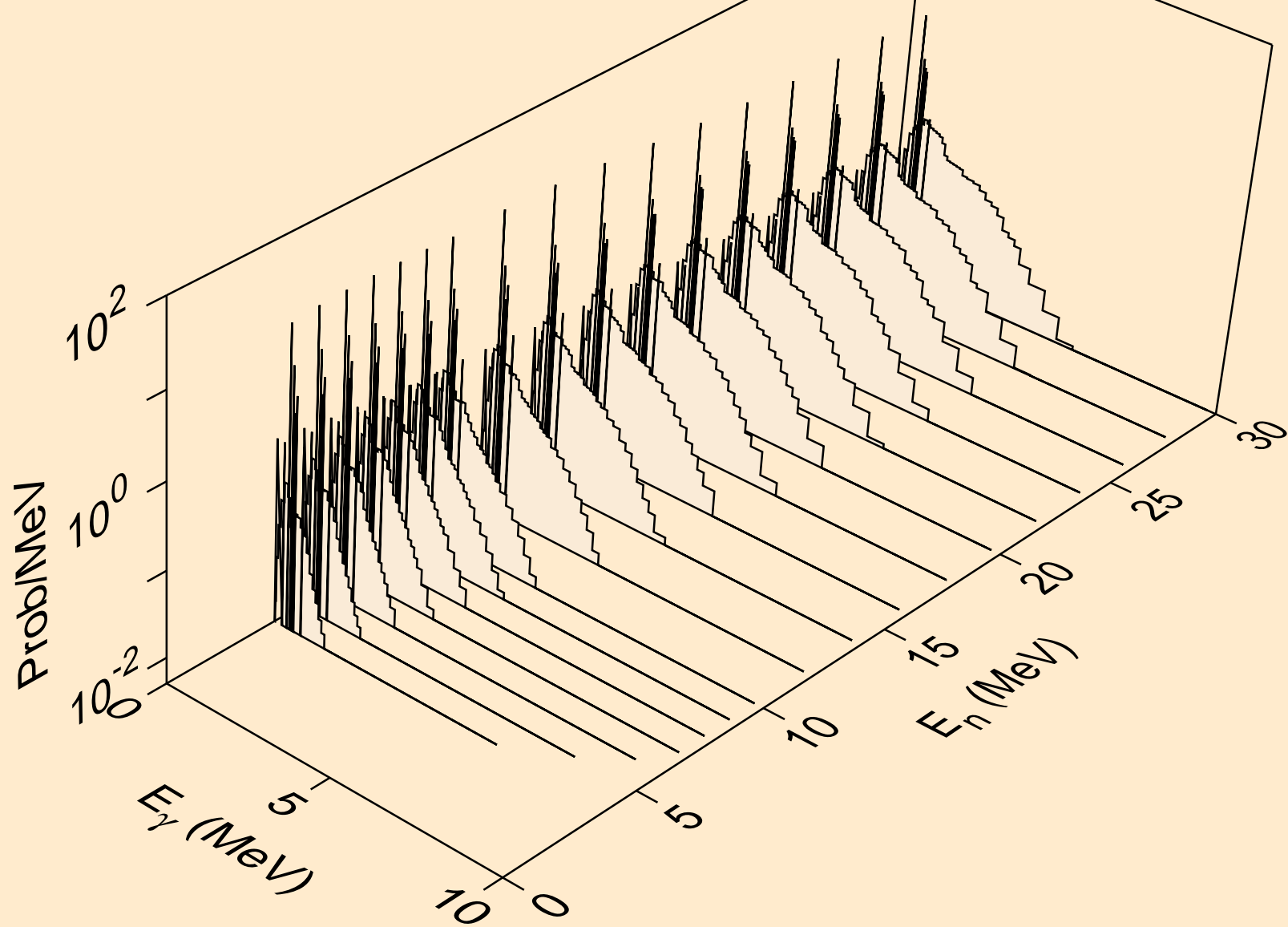

IR172 TRITON ACER TENDL-2021 LIBRARY; T=0.K  
Photon emission for (n,pt)

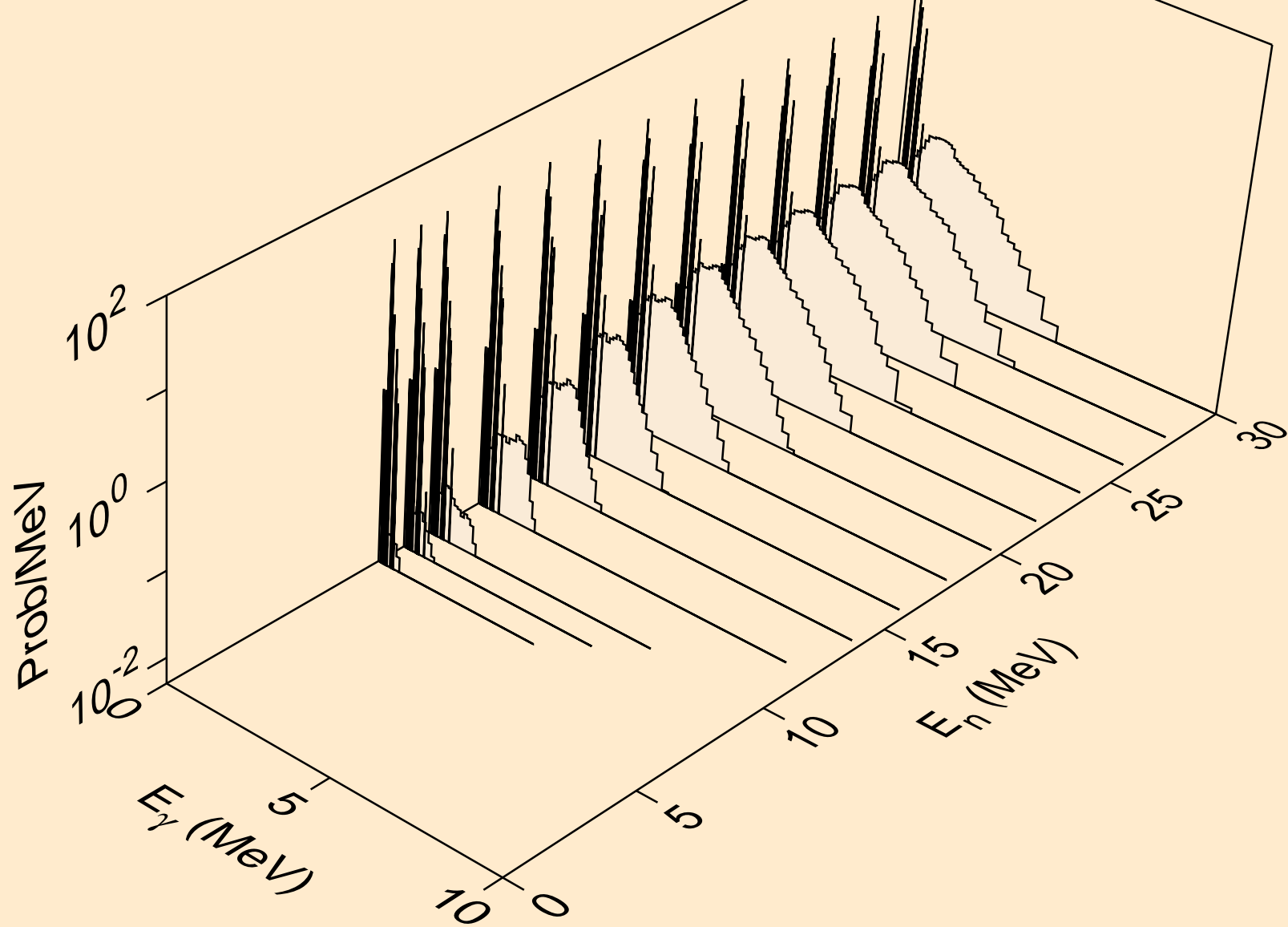

IR172 TRITON ACER TENDL-2021 LIBRARY; T=0.K  
Photon emission for (n,da)

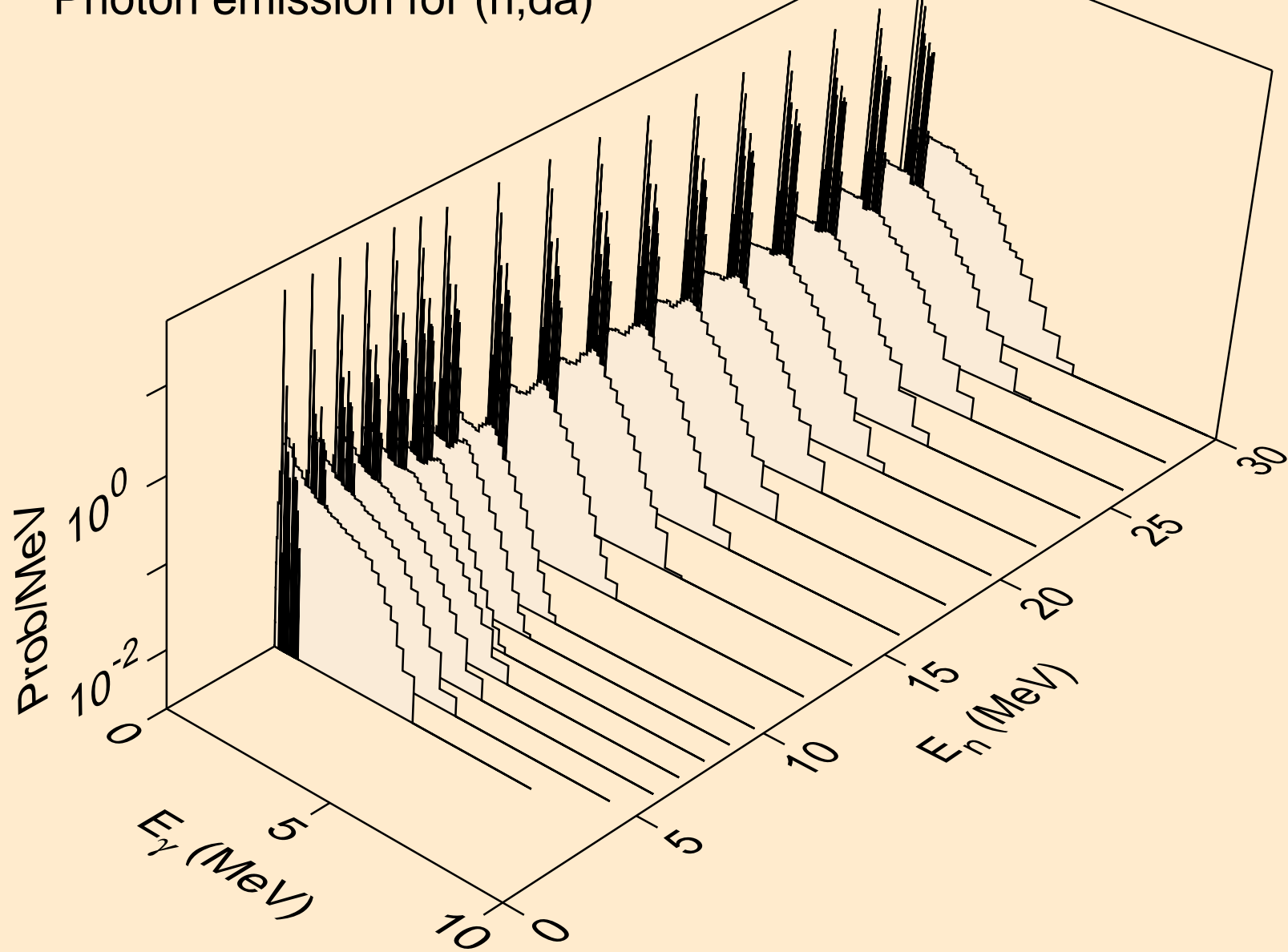



IR172 TRITON ACER TENDL-2021 LIBRARY; T=0.K  
Particle heating contributions

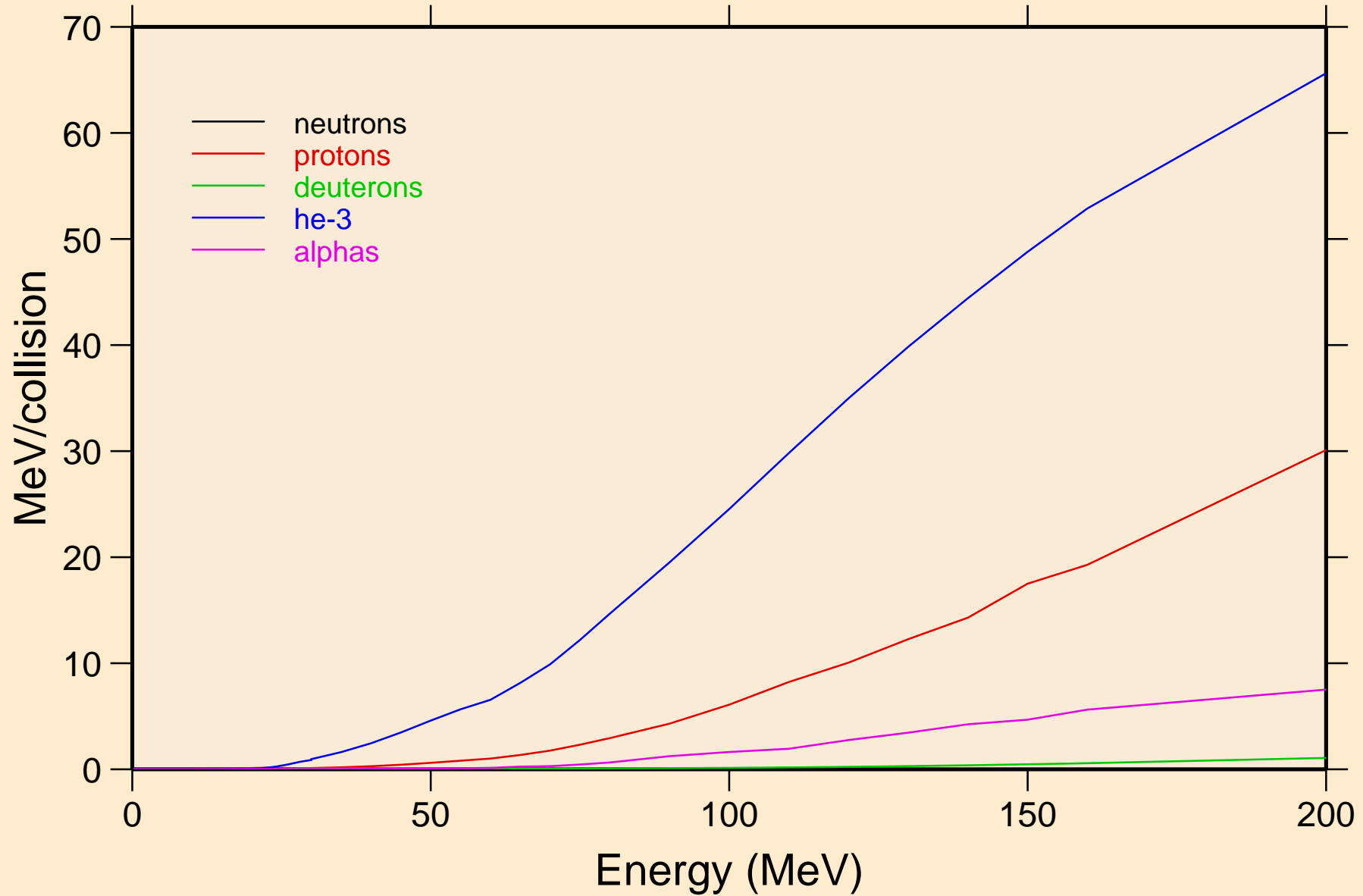

IR172 TRITON ACER TENDL-2021 LIBRARY; T=0.K  
Recoil Heating

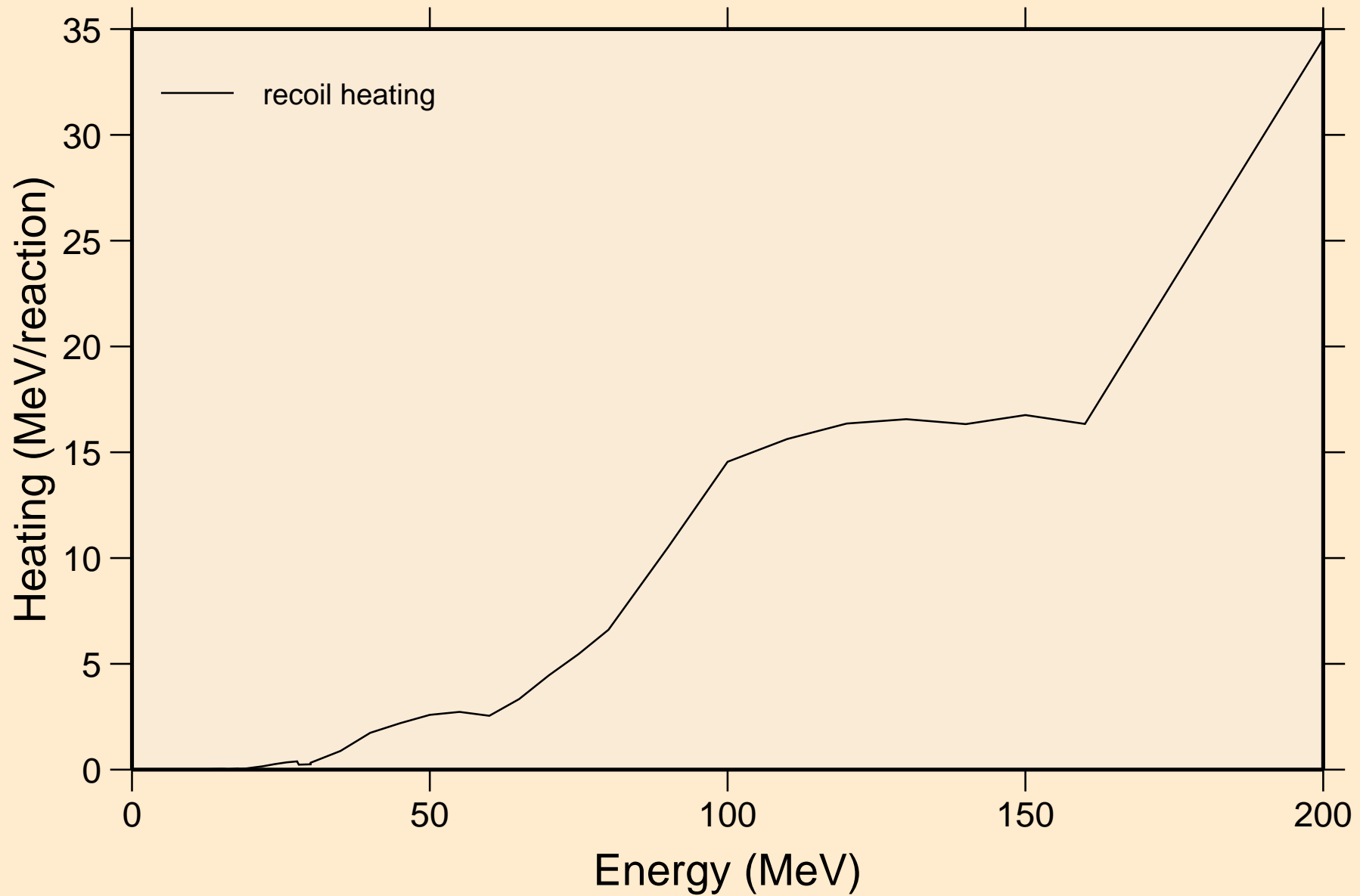

IR172 TRITON ACER TENDL-2021 LIBRARY; T=0.K  
Particle production cross sections

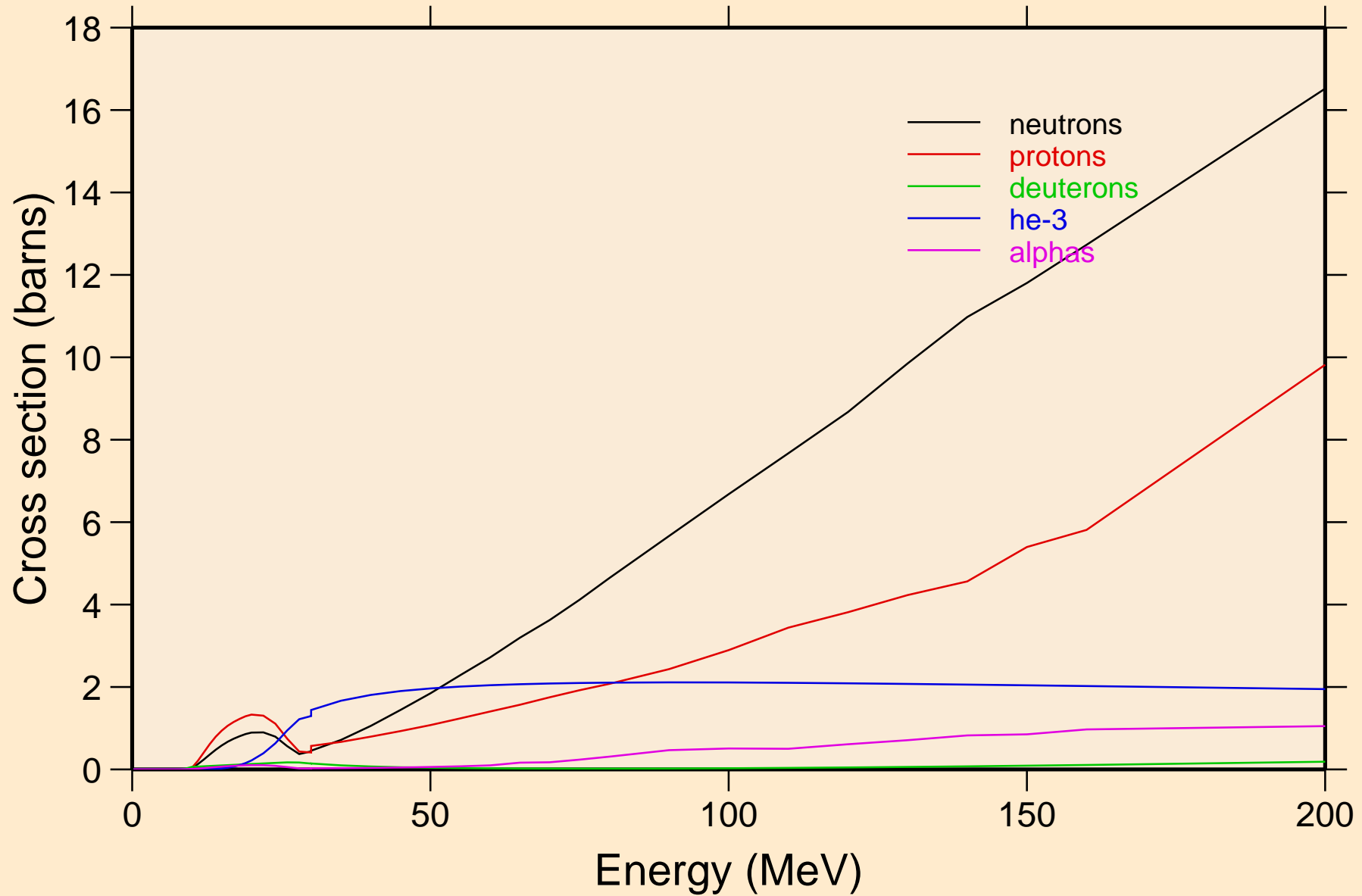

IR172 TRITON ACER TENDL-2021 LIBRARY; T=0.K  
neutrons from (t,n)

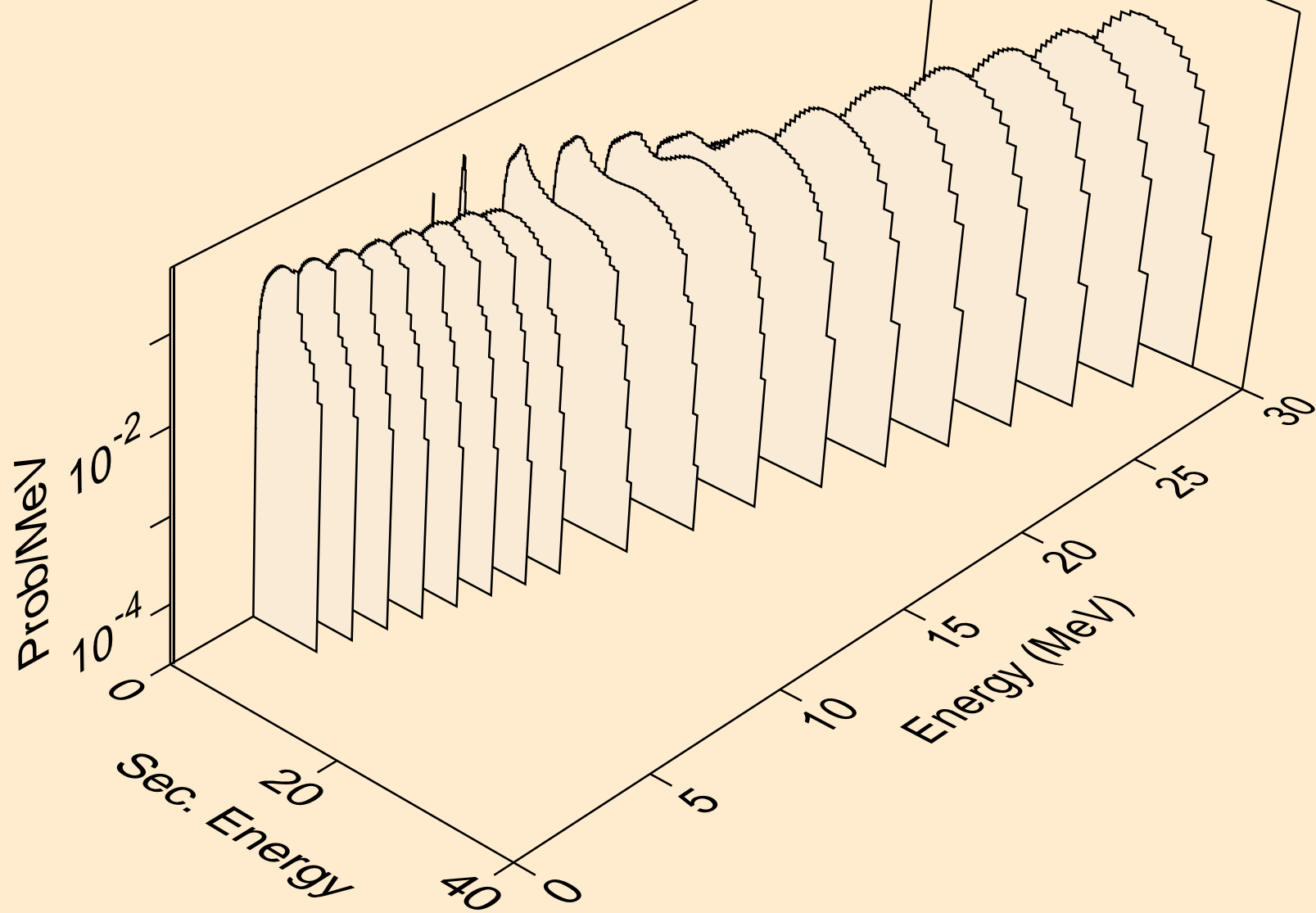

IR172 TRITON ACER TENDL-2021 LIBRARY; T=0.K  
neutrons from (t,x)

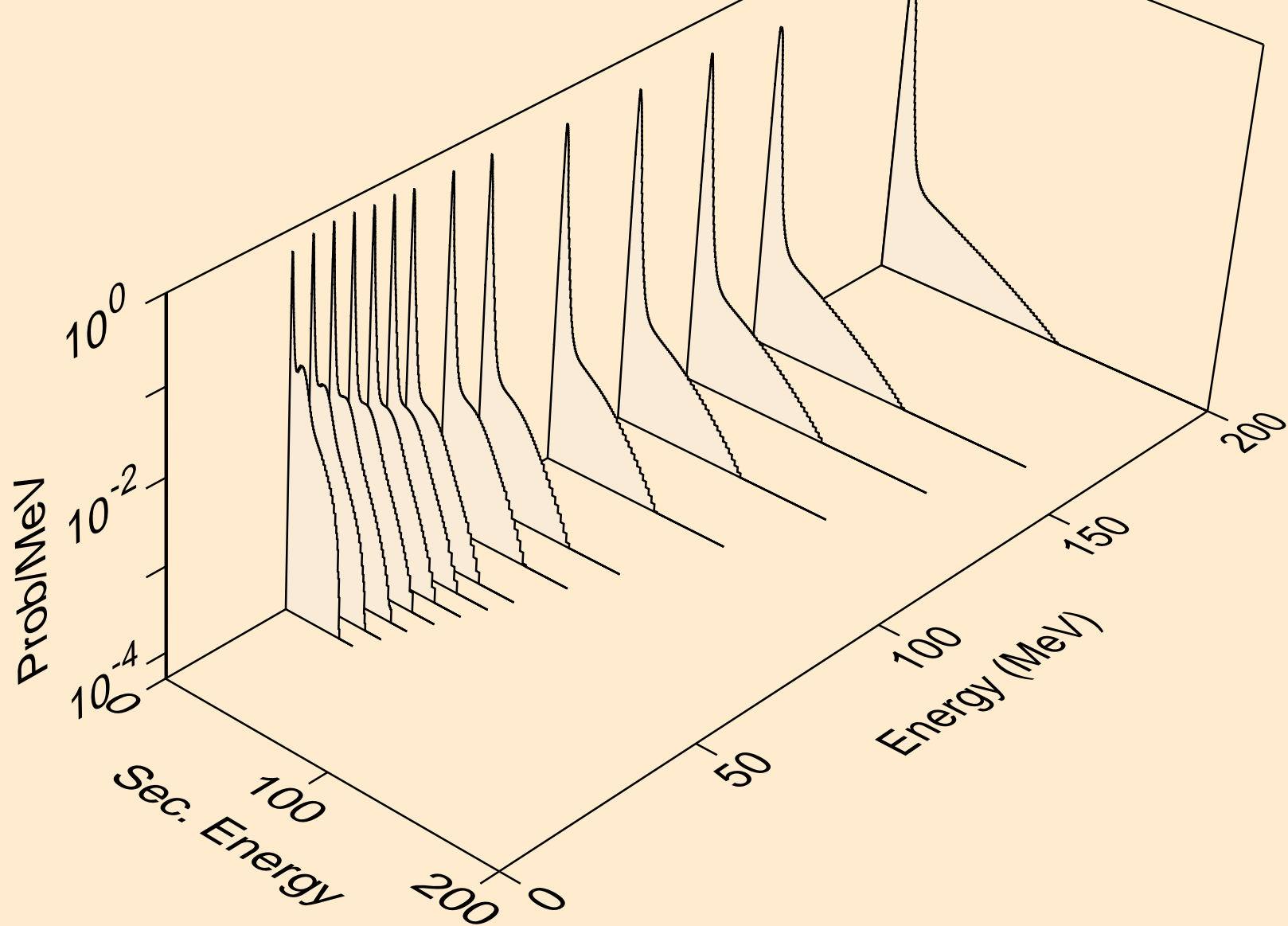

IR172 TRITON ACER TENDL-2021 LIBRARY; T=0.K  
neutrons from (t,2nd)

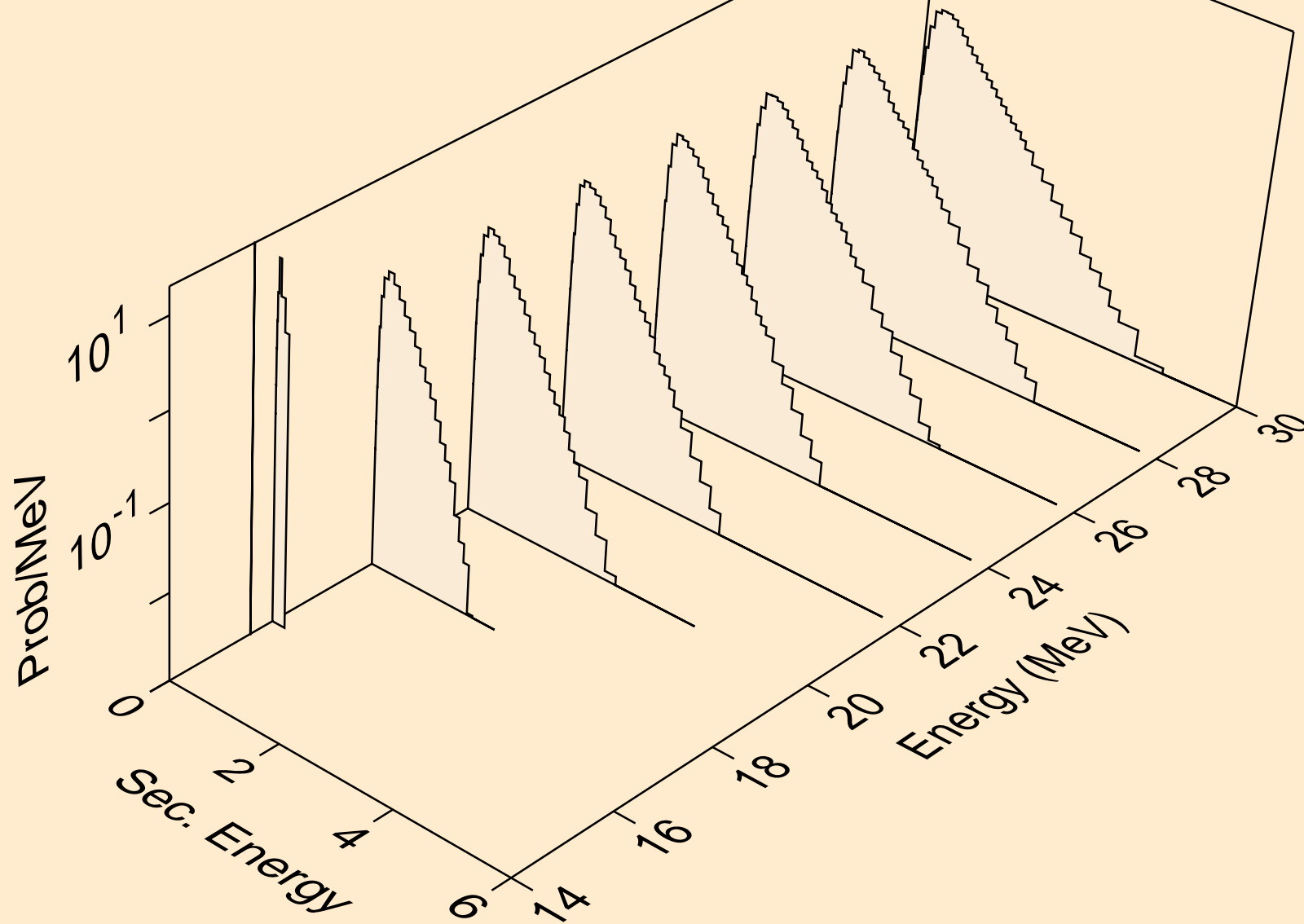

IR172 TRITON ACER TENDL-2021 LIBRARY; T=0.K  
neutrons from (t,2n)

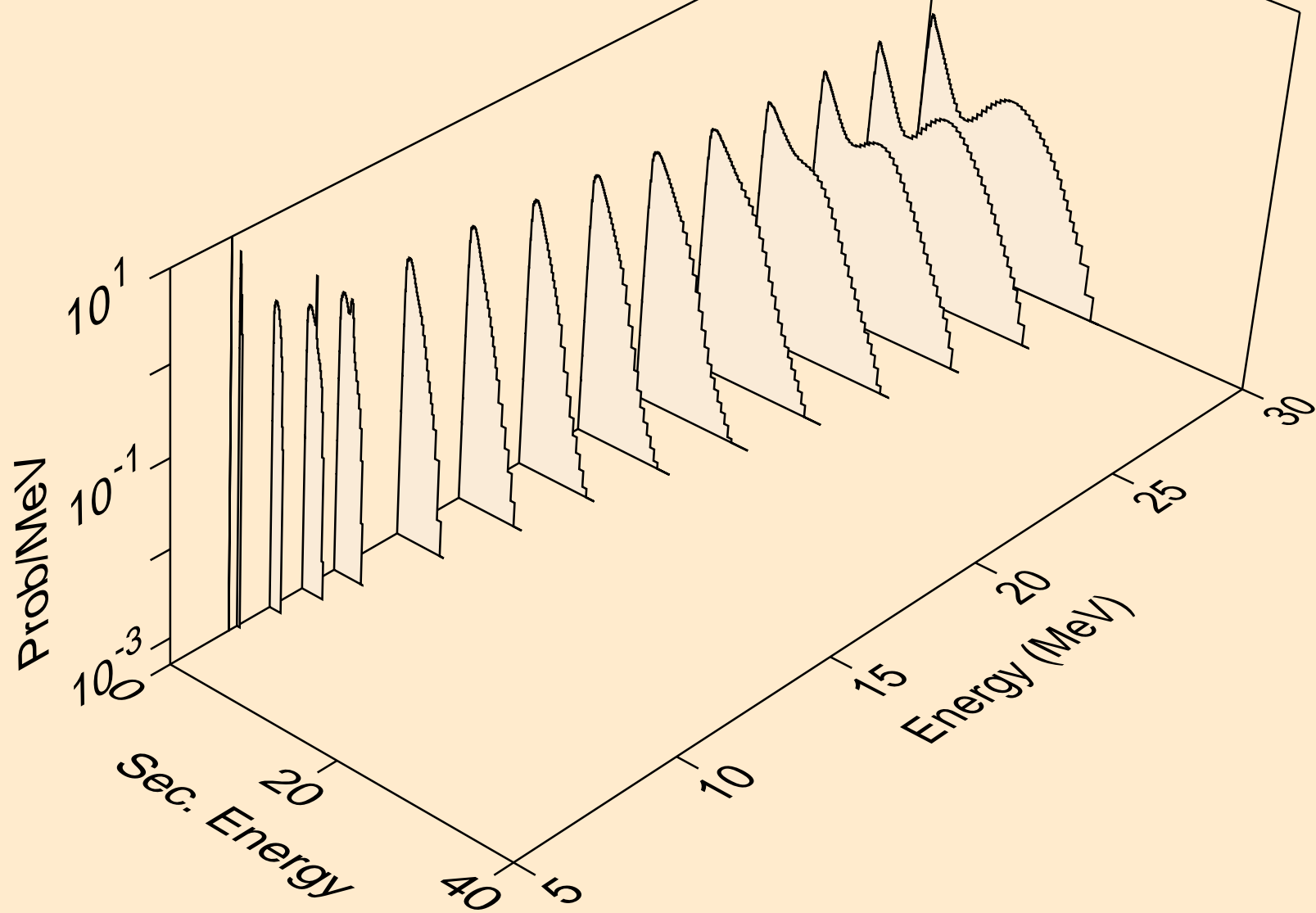

IR172 TRITON ACER TENDL-2021 LIBRARY; T=0.K  
neutrons from (t,3n)

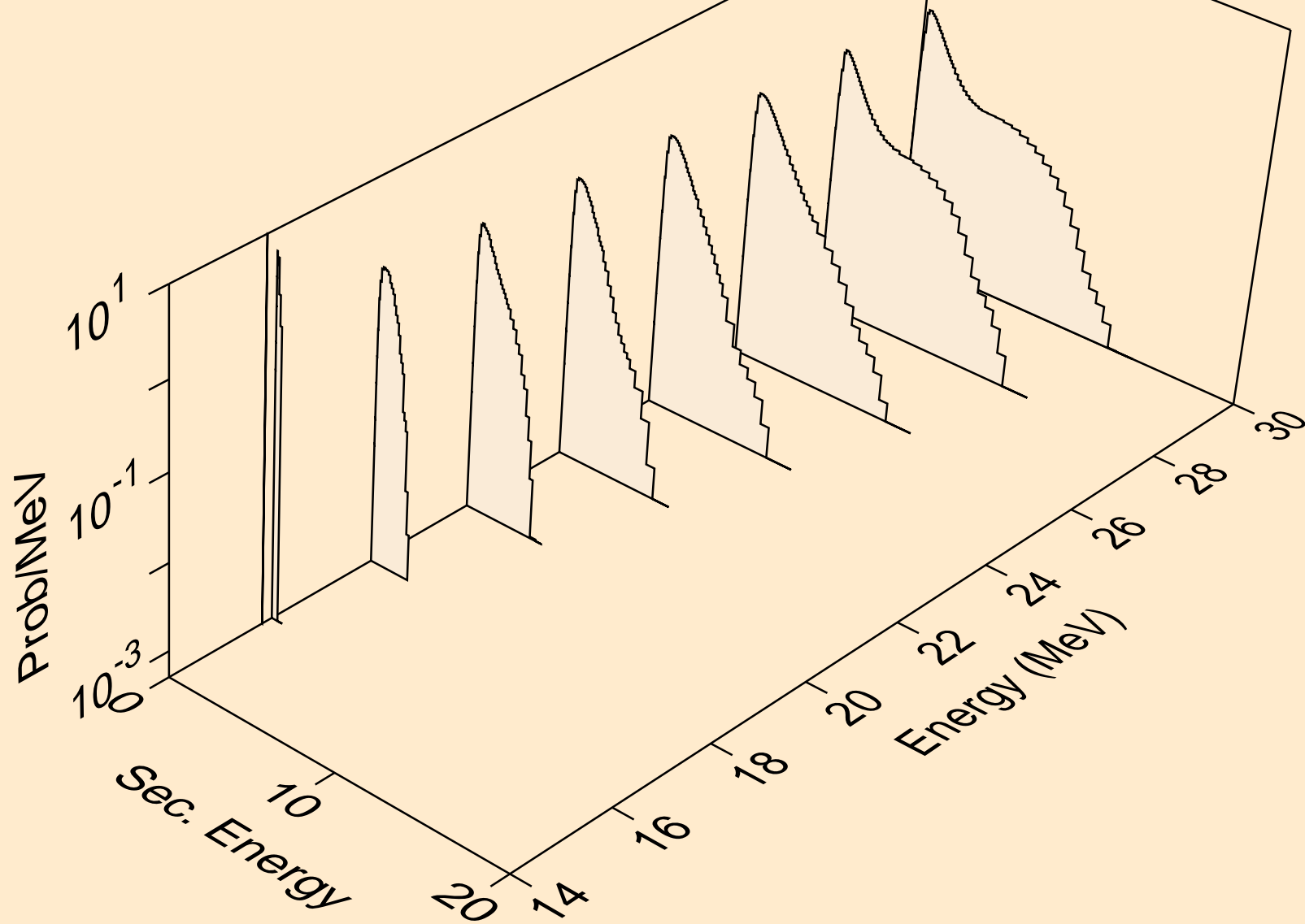



IR172 TRITON ACER TENDL-2021 LIBRARY; T=0.K  
neutrons from (t,n\*)a

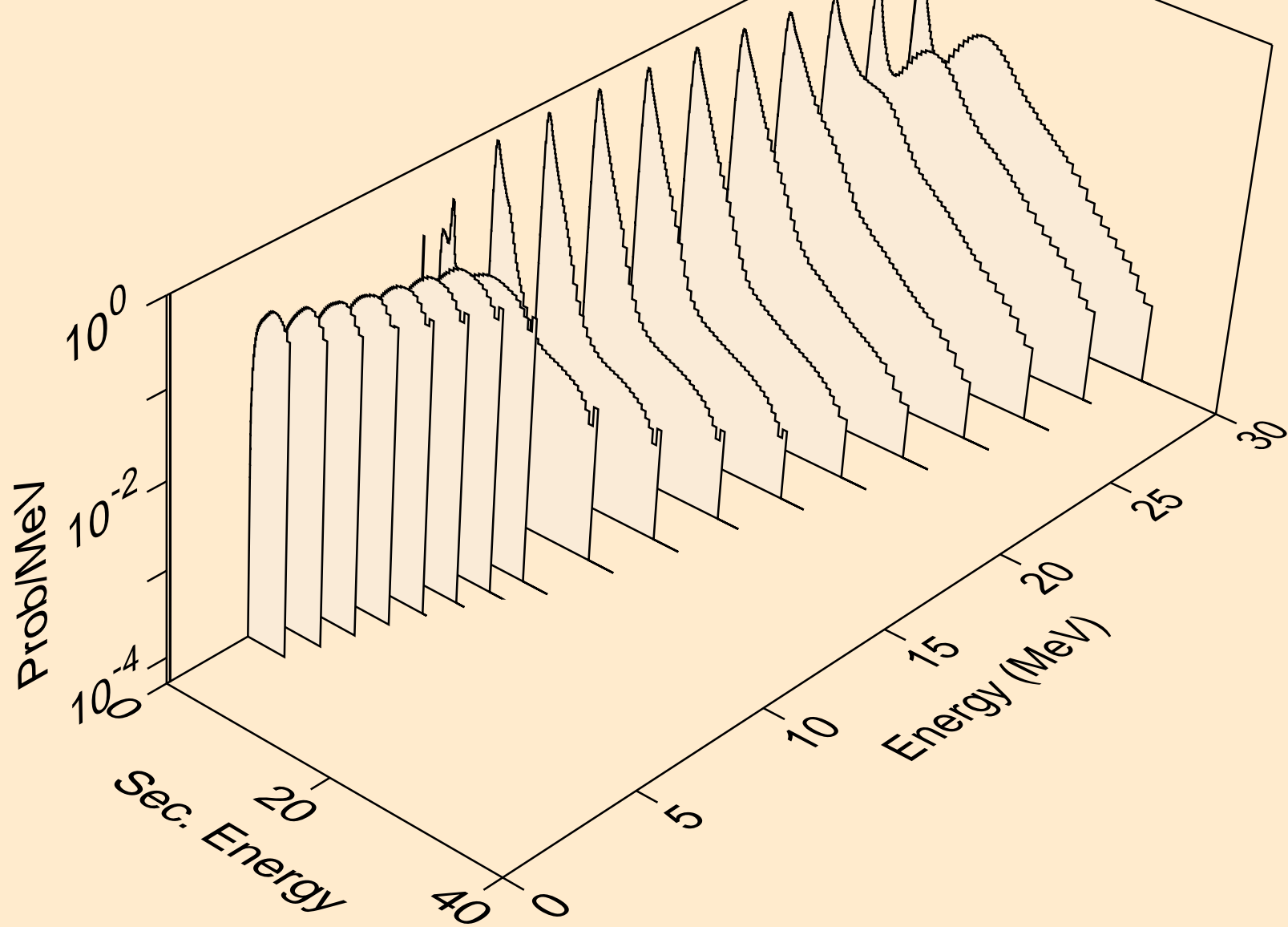

IR172 TRITON ACER TENDL-2021 LIBRARY; T=0.K  
neutrons from (t,n\*)3a

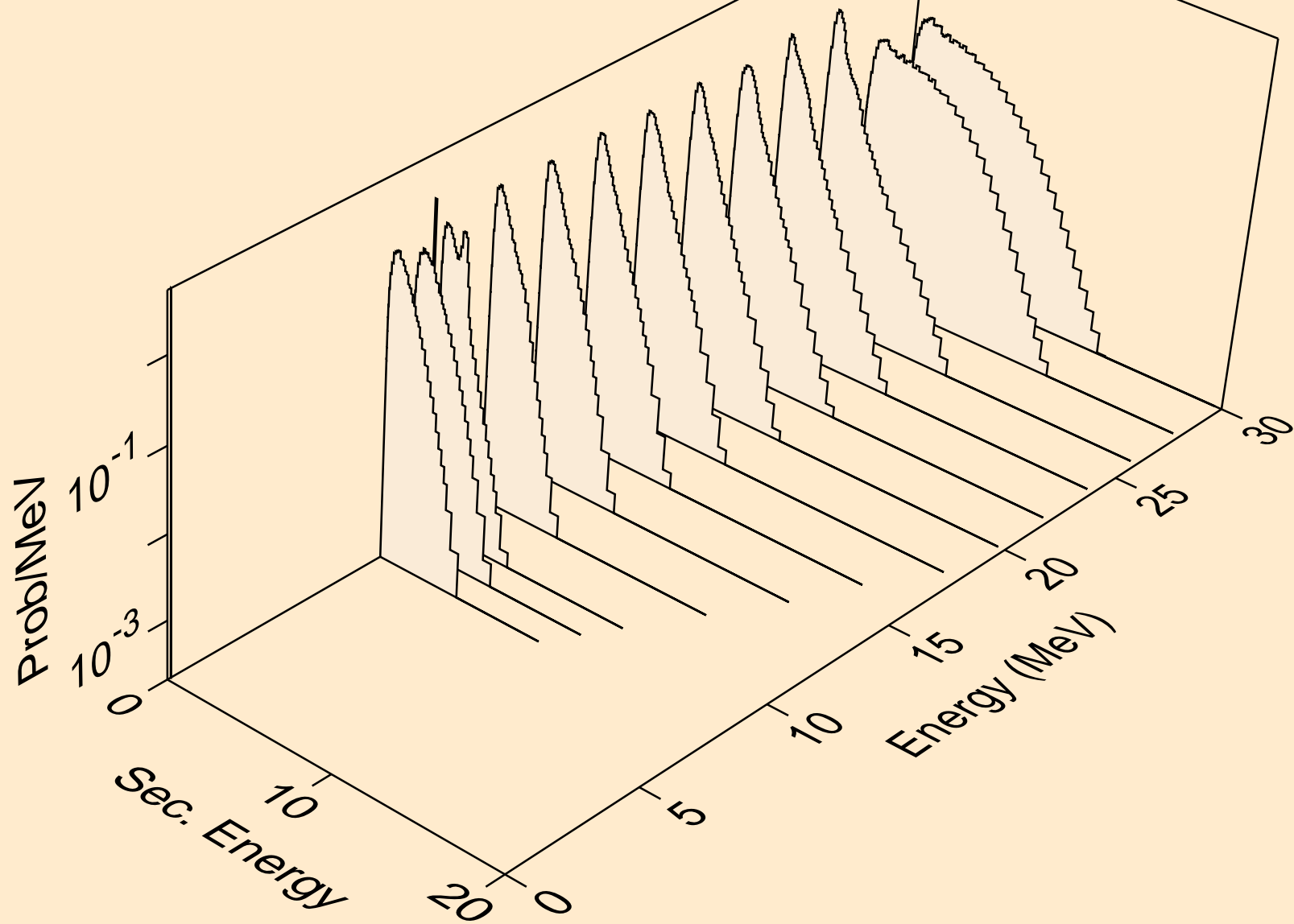

IR172 TRITON ACER TENDL-2021 LIBRARY; T=0.K  
neutrons from (t,2n)a

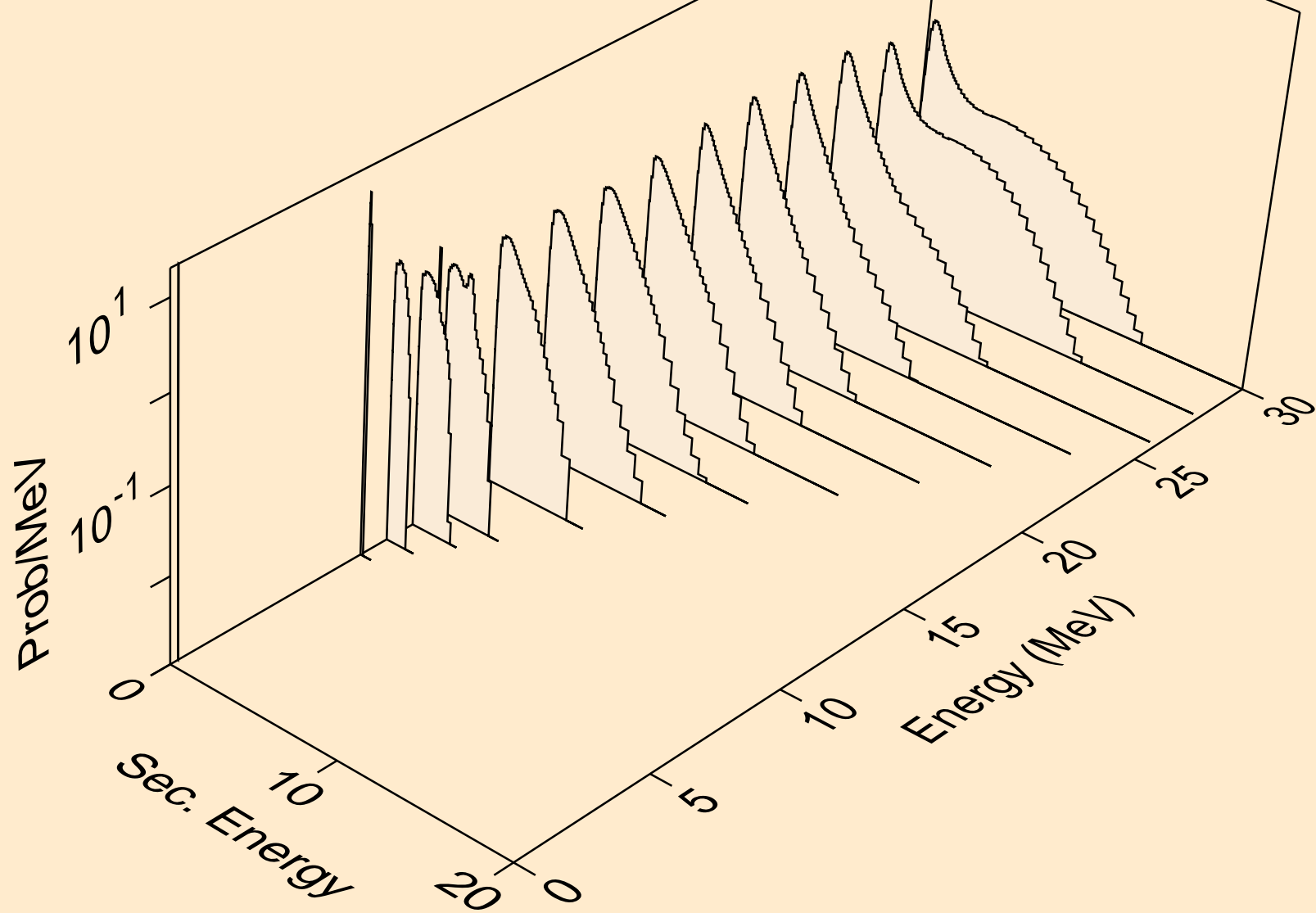

IR172 TRITON ACER TENDL-2021 LIBRARY; T=0.K  
neutrons from (t,3n)a

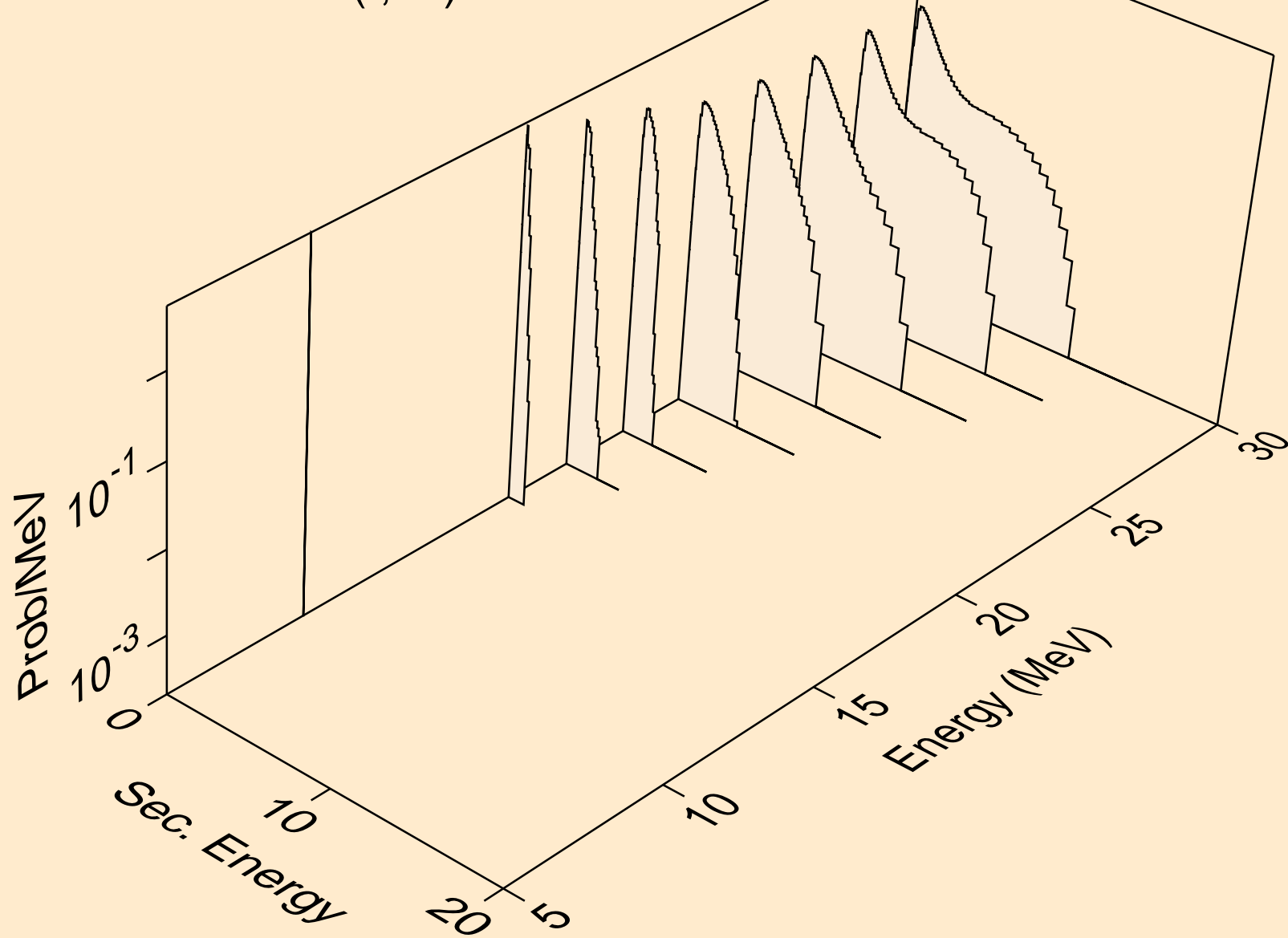

IR172 TRITON ACER TENDL-2021 LIBRARY; T=0.K  
neutrons from (t,n\*)p

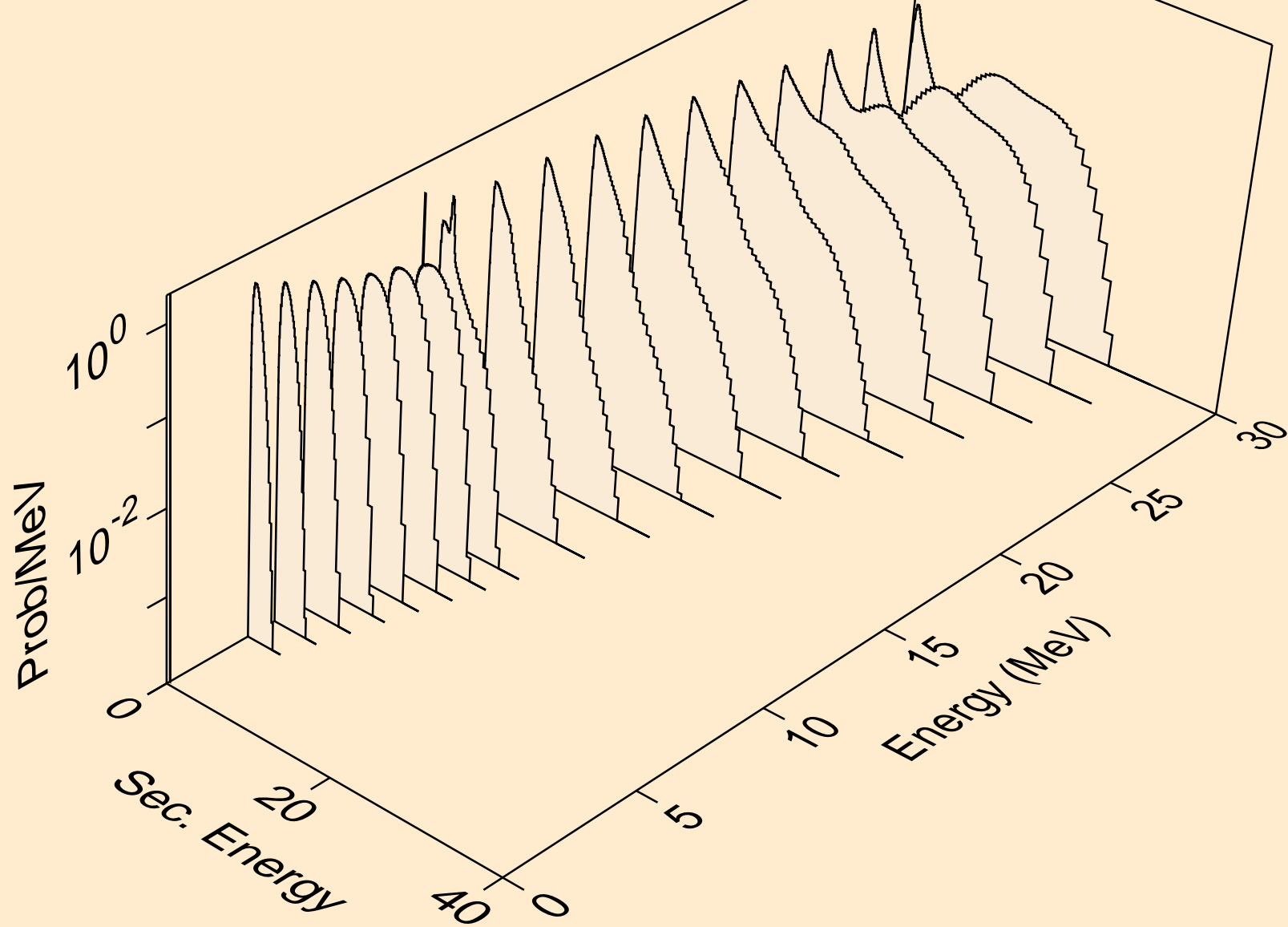

IR172 TRITON ACER TENDL-2021 LIBRARY; T=0.K  
neutrons from (t,n\*)2a

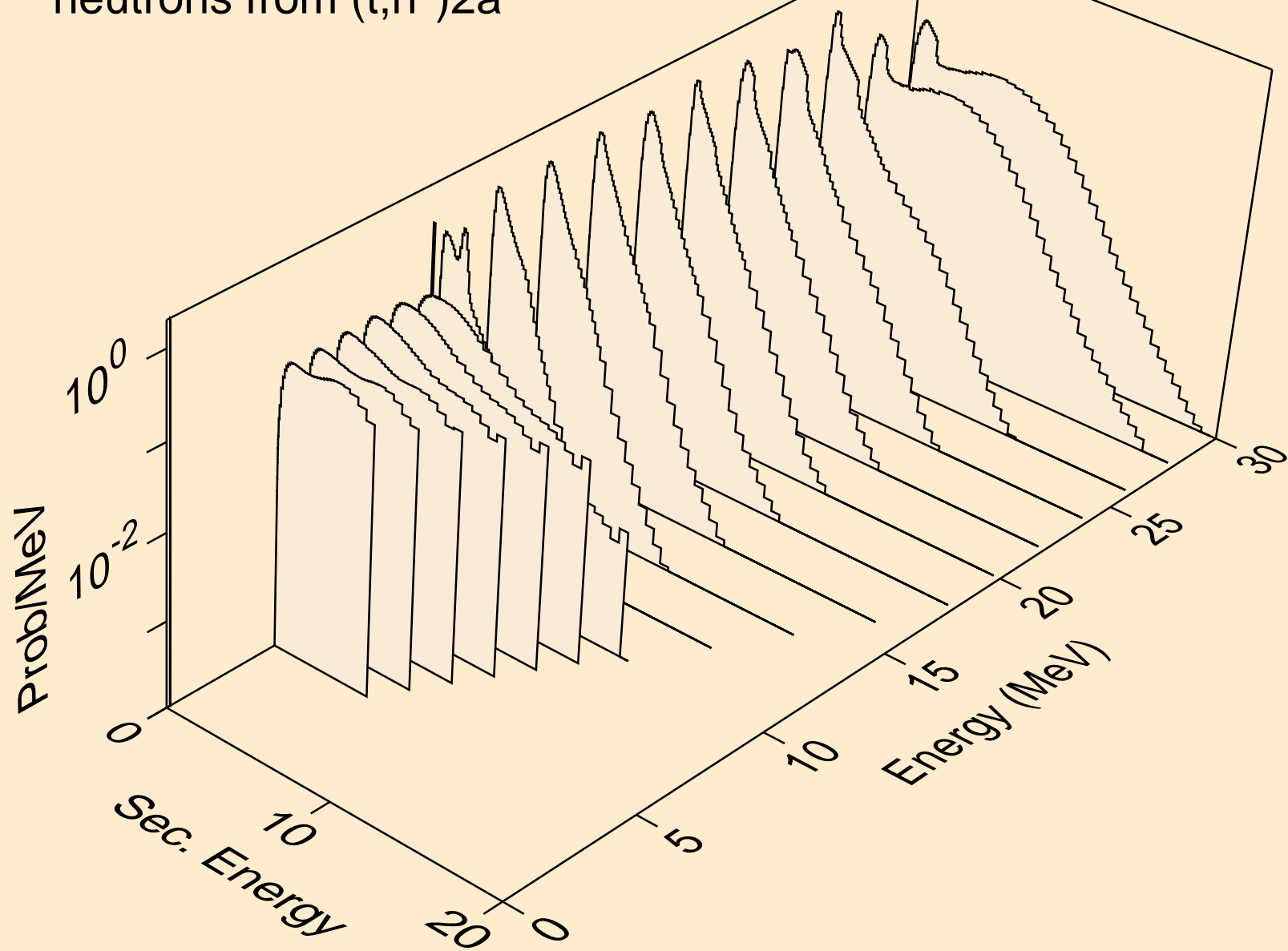

IR172 TRITON ACER TENDL-2021 LIBRARY; T=0.K  
neutrons from (t,2n)2a

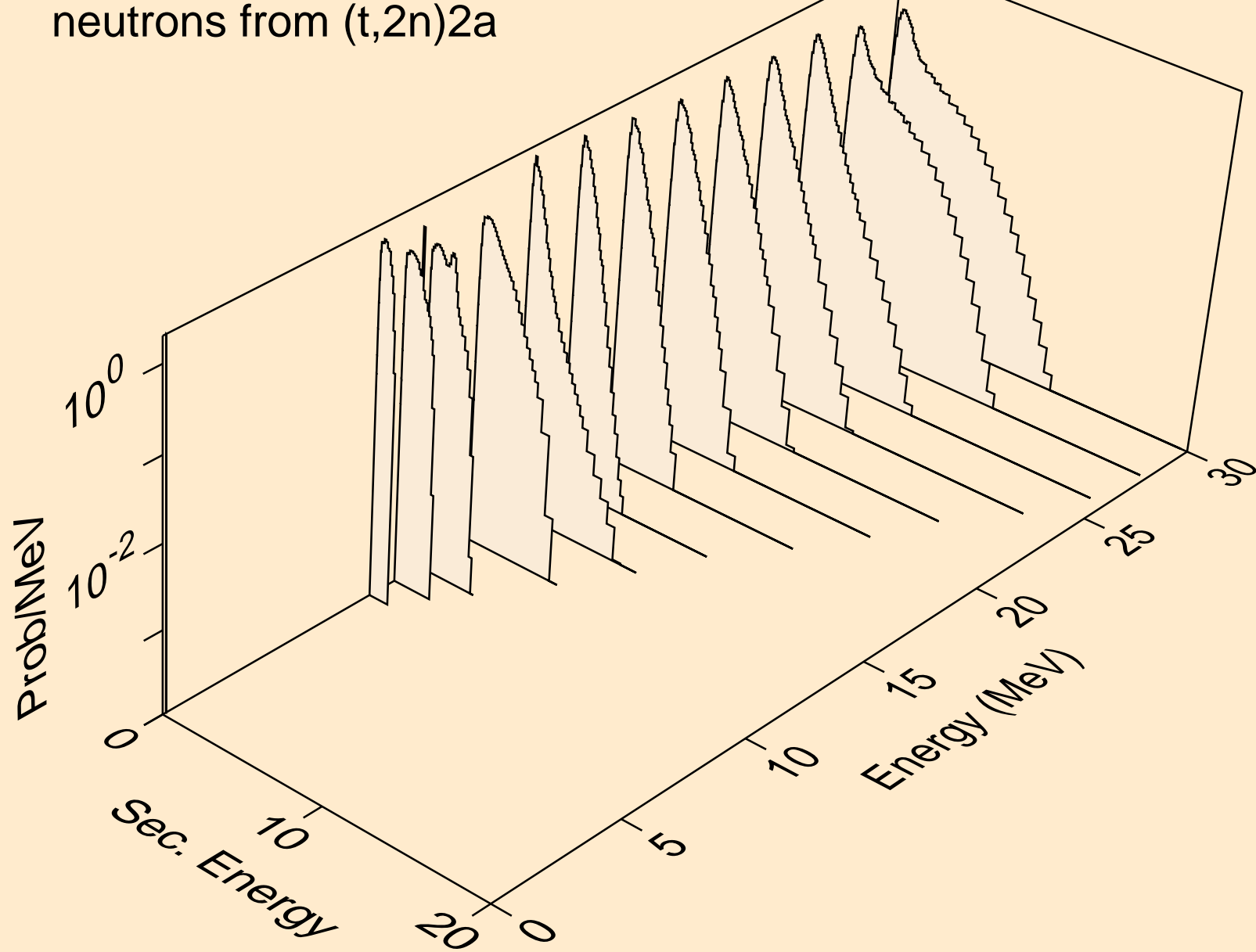

IR172 TRITON ACER TENDL-2021 LIBRARY; T=0.K  
neutrons from (t,n\*)d

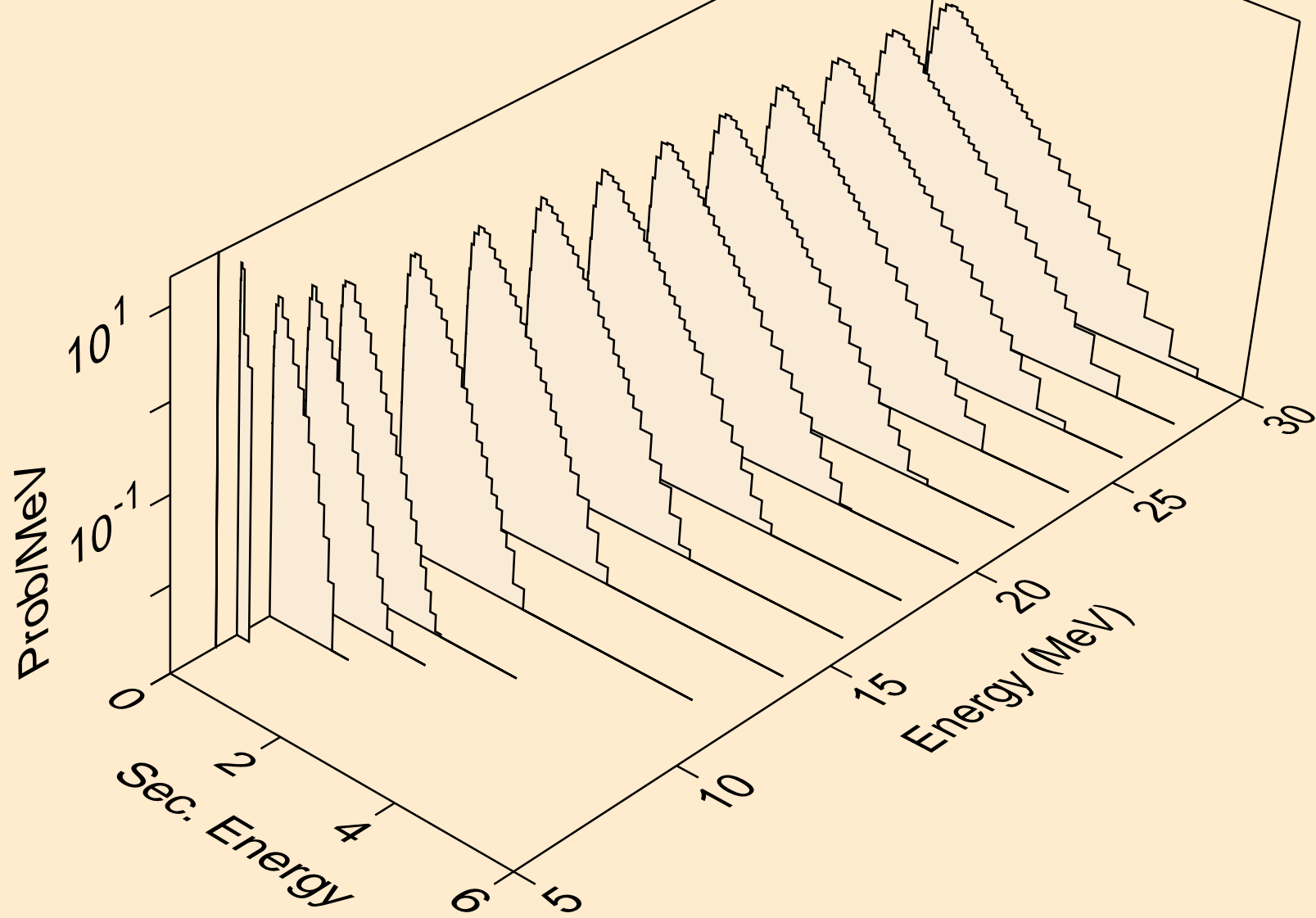



IR172 TRITON ACER TENDL-2021 LIBRARY; T=0.K  
neutrons from (t,n\*)t

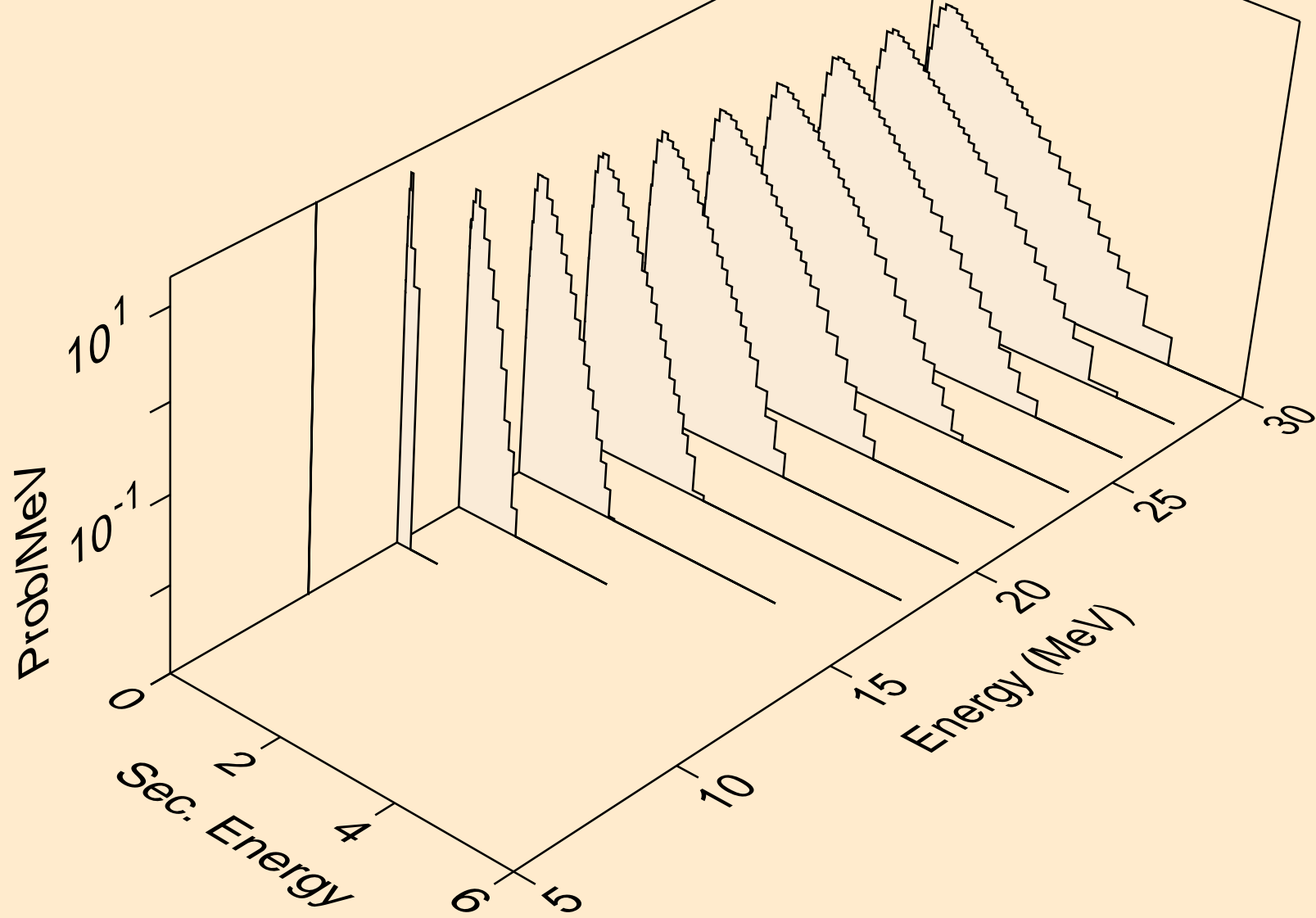

IR172 TRITON ACER TENDL-2021 LIBRARY; T=0.K  
neutrons from (t,n\*)he3

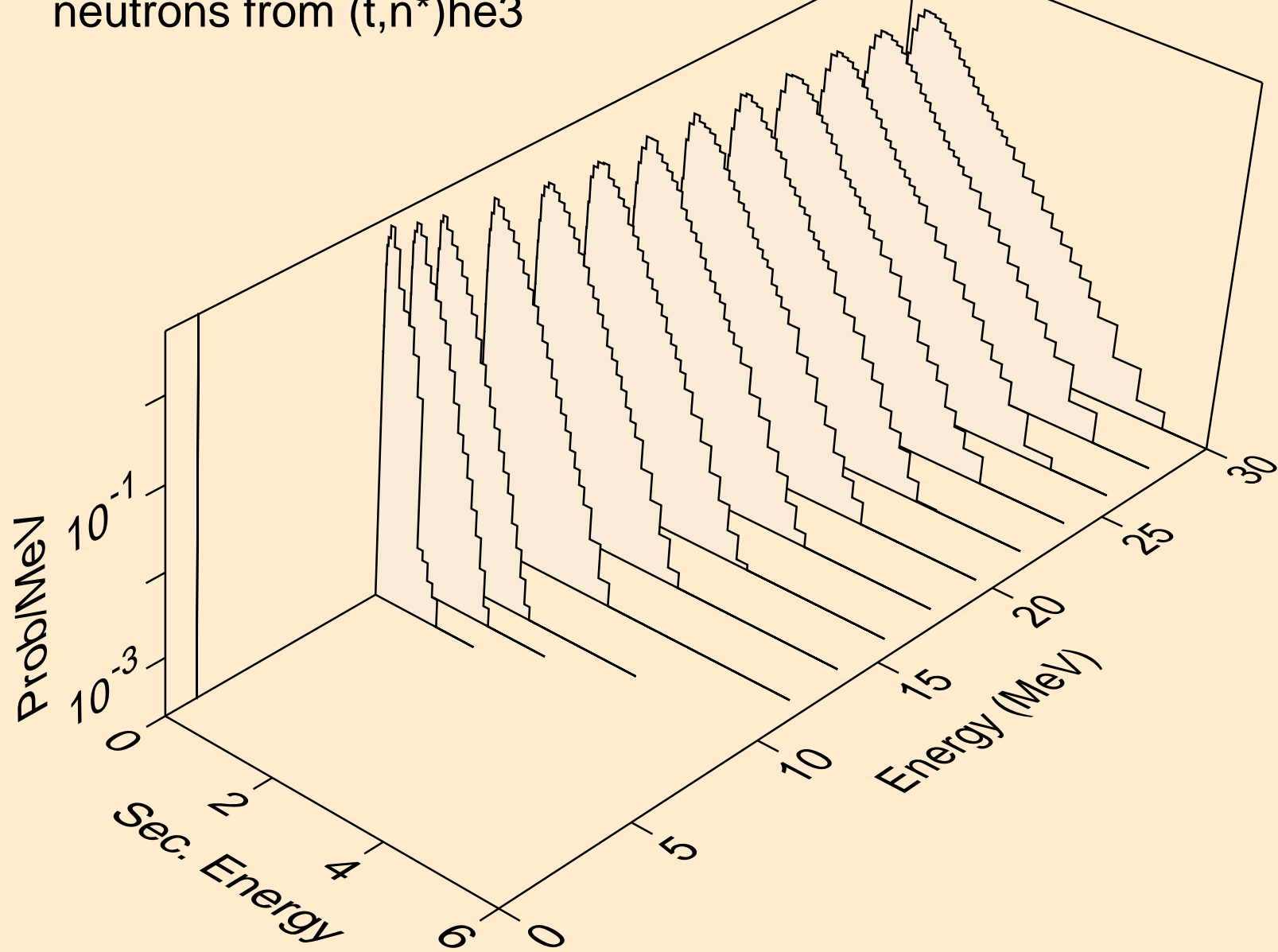

IR172 TRITON ACER TENDL-2021 LIBRARY; T=0.K  
neutrons from (t,4n)

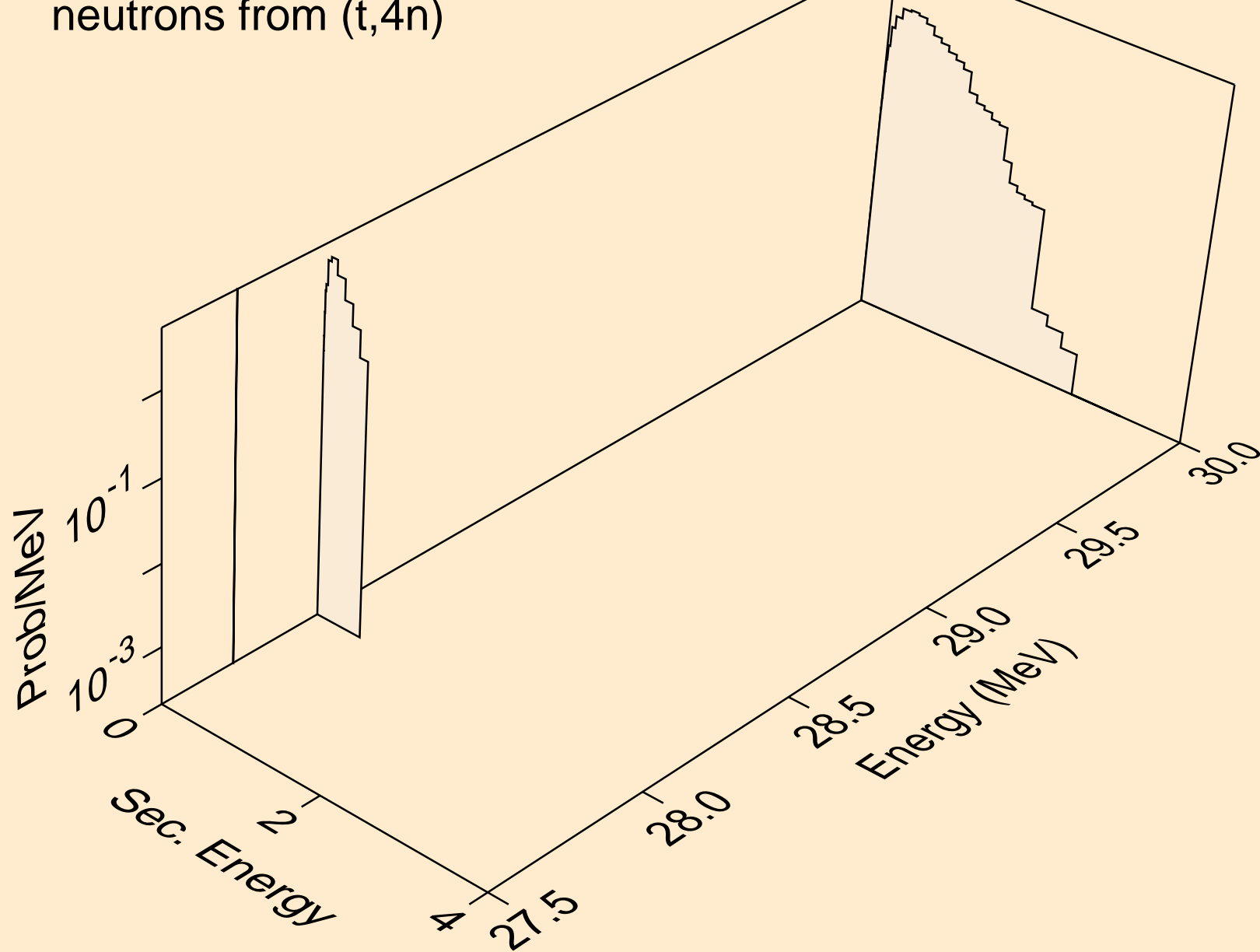

IR172 TRITON ACER TENDL-2021 LIBRARY; T=0.K  
neutrons from (t,2np)

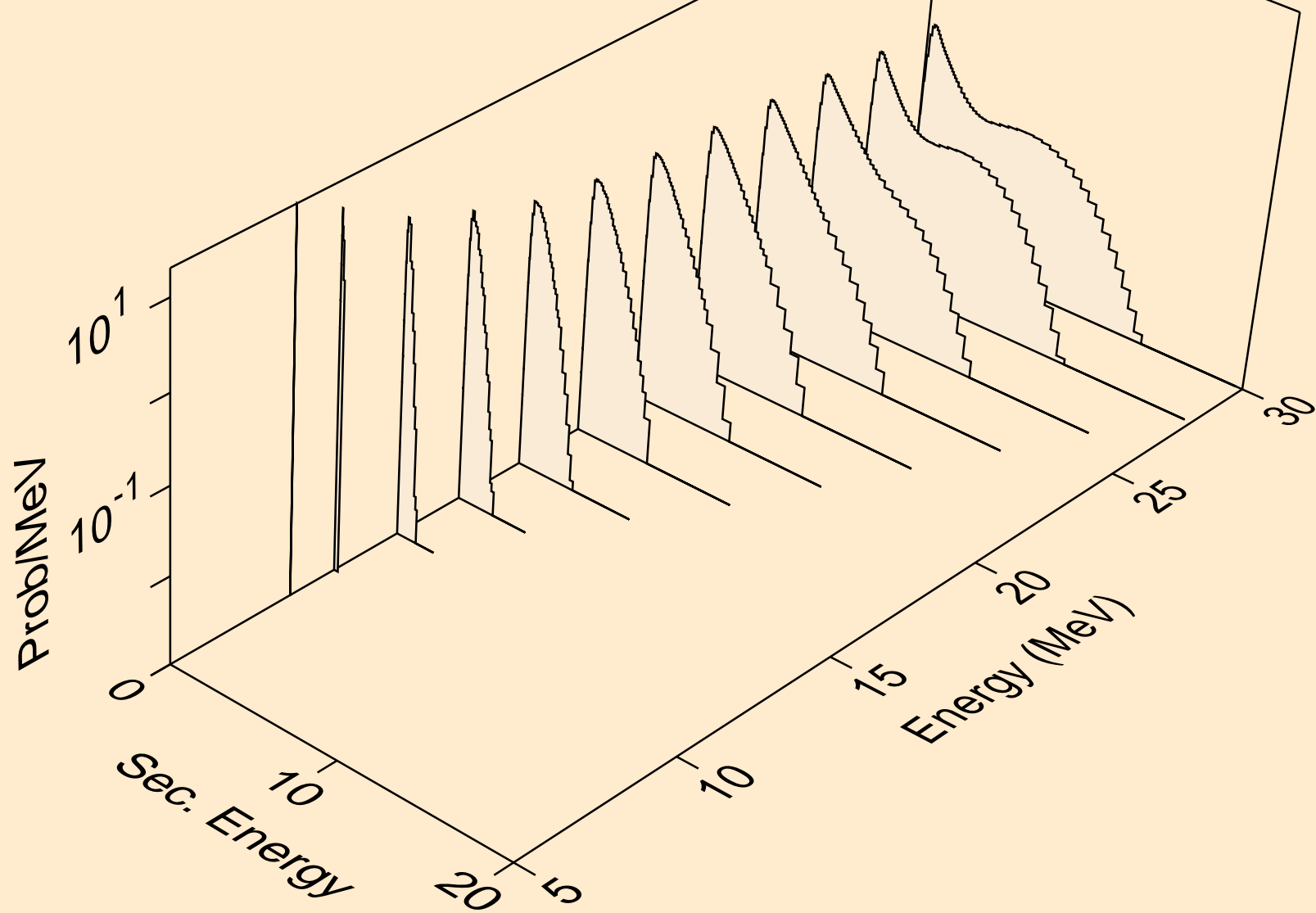

IR172 TRITON ACER TENDL-2021 LIBRARY; T=0.K  
neutrons from (t,3np)

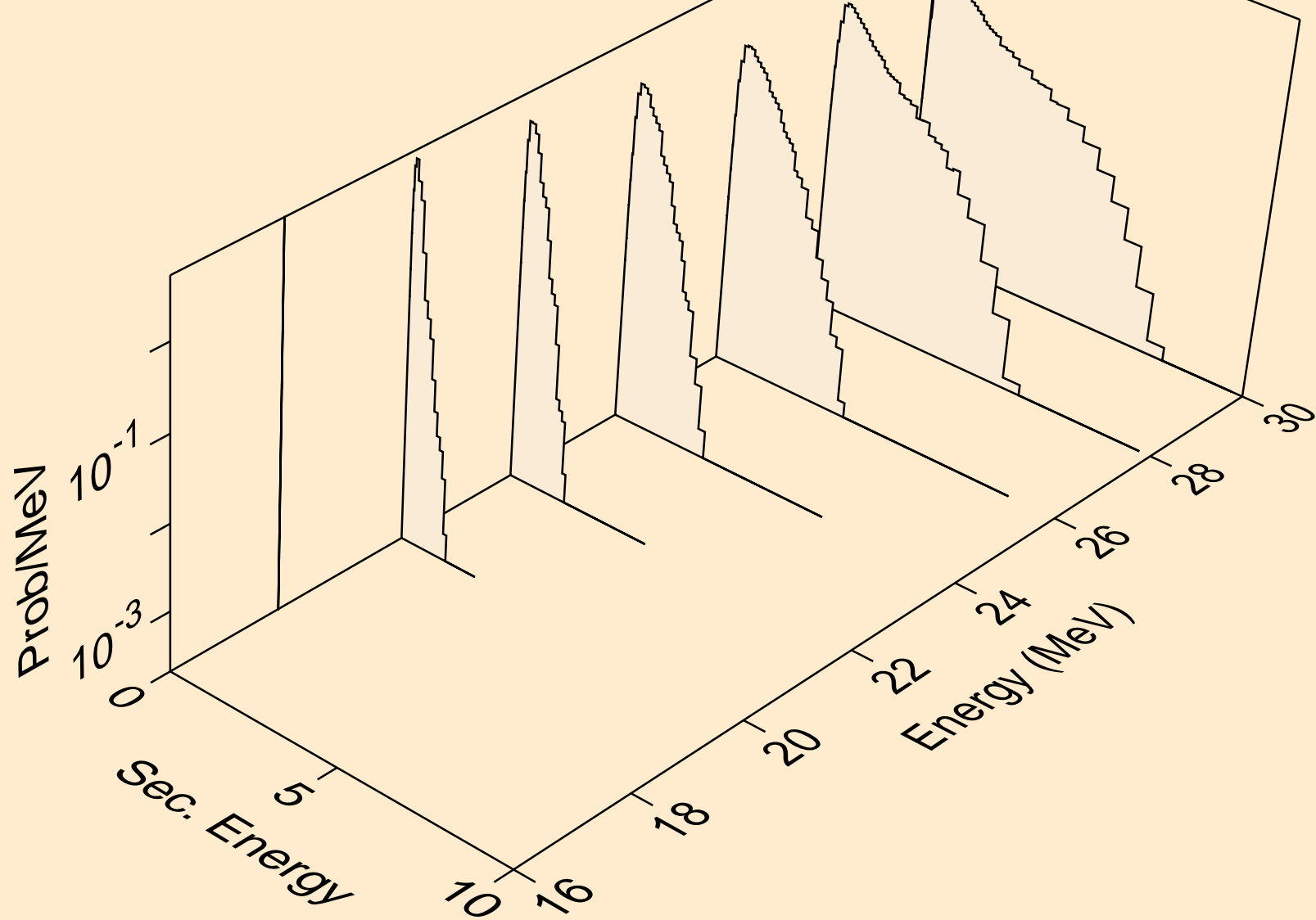

IR172 TRITON ACER TENDL-2021 LIBRARY; T=0.K  
neutrons from (t,2np)

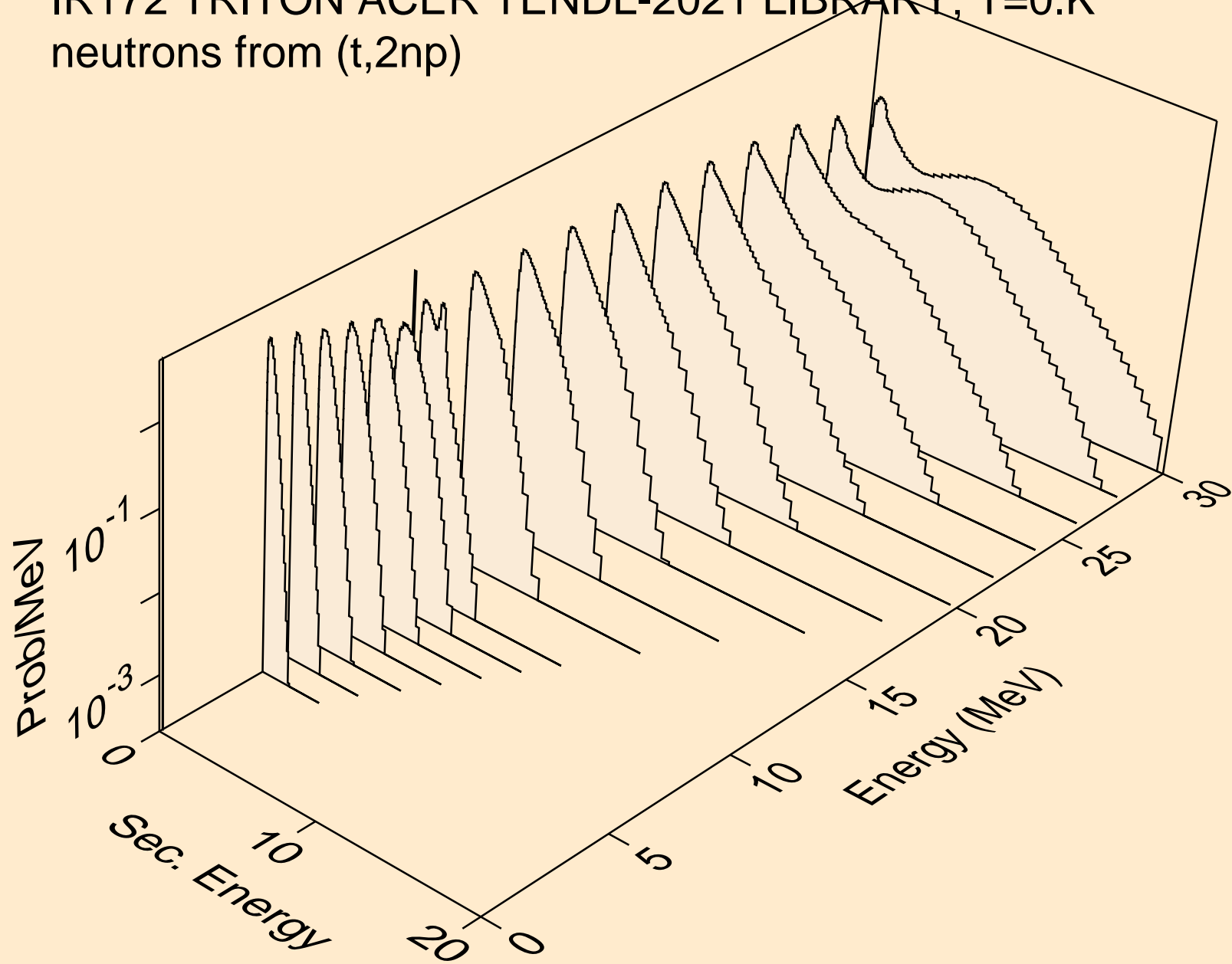

IR172 TRITON ACER TENDL-2021 LIBRARY; T=0.K  
neutrons from (t,npa)

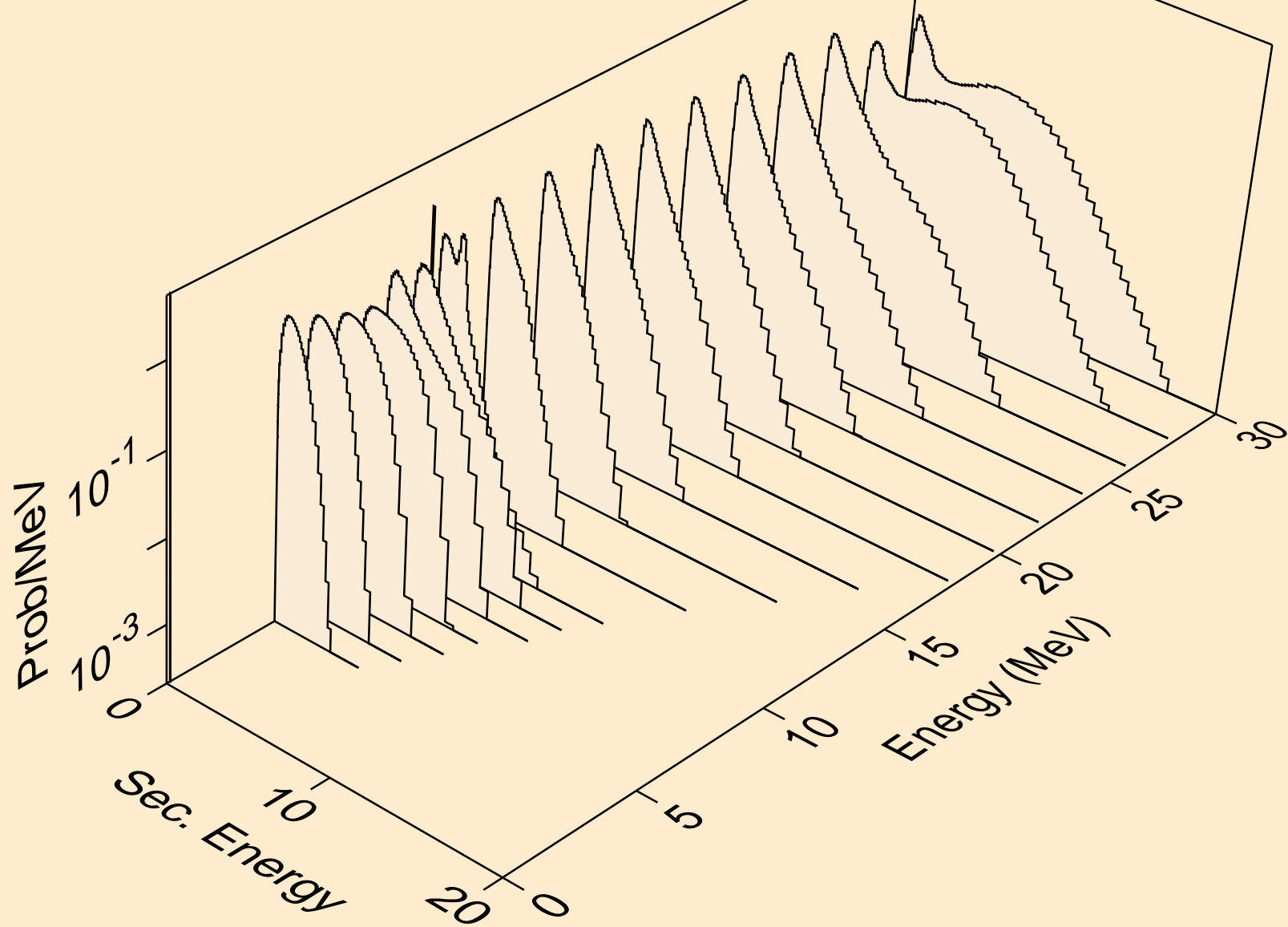

IR172 TRITON ACER TENDL-2021 LIBRARY; T=0.K  
protons from (t,x)

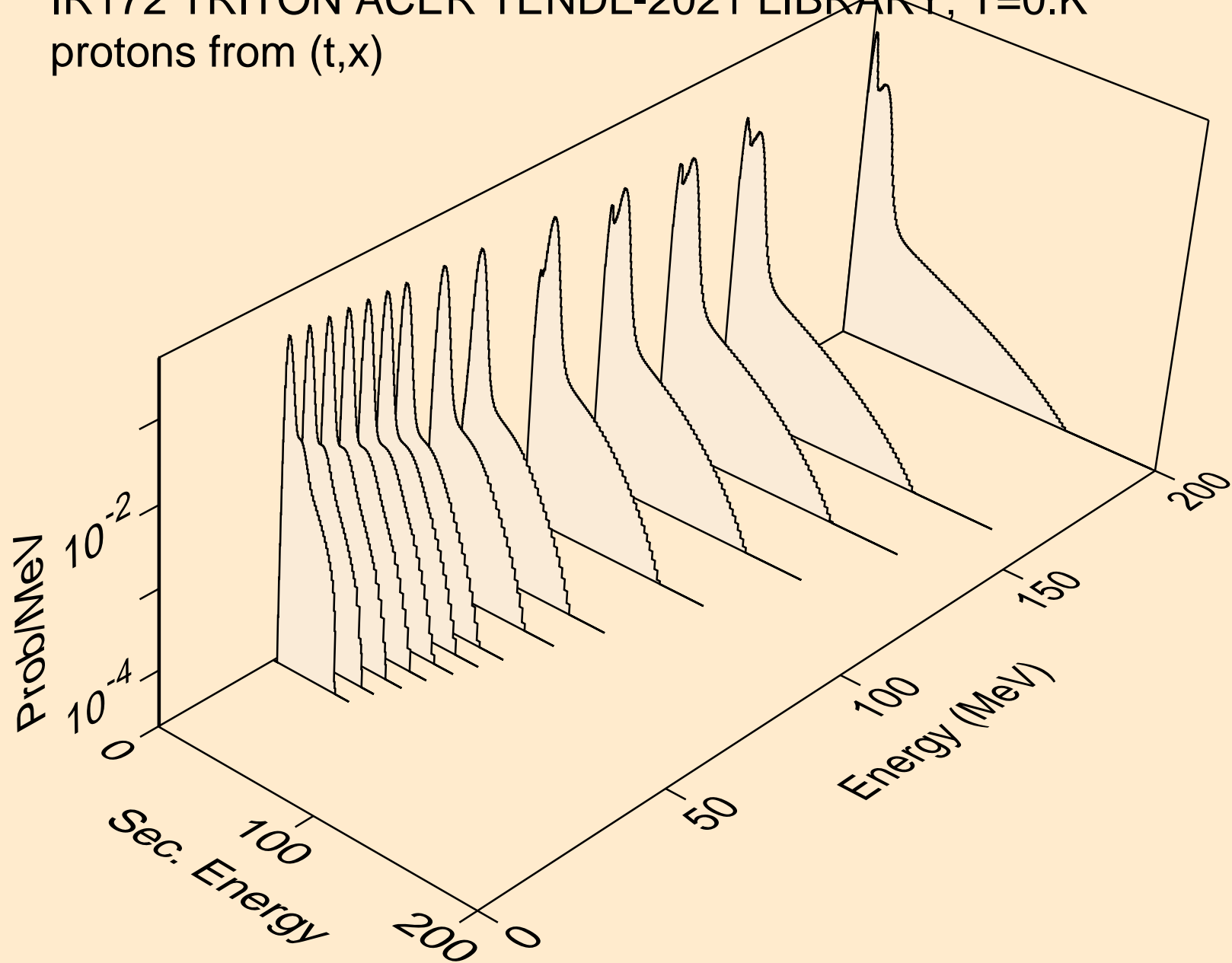



IR172 TRITON ACER TENDL-2021 LIBRARY; T=0.K  
protons from (t,n\*)p

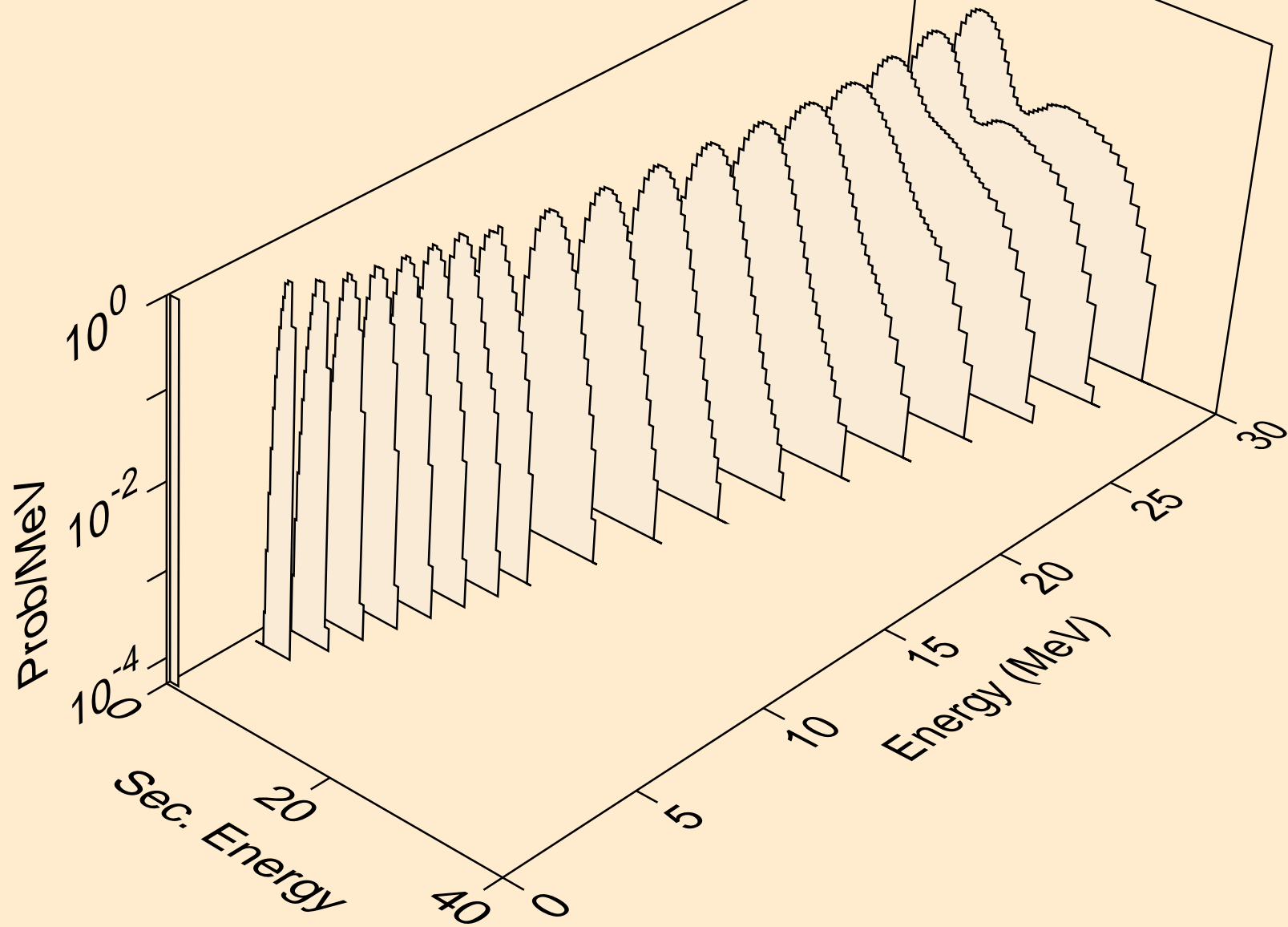

IR172 TRITON ACER TENDL-2021 LIBRARY; T=0.K  
protons from (t,2np)

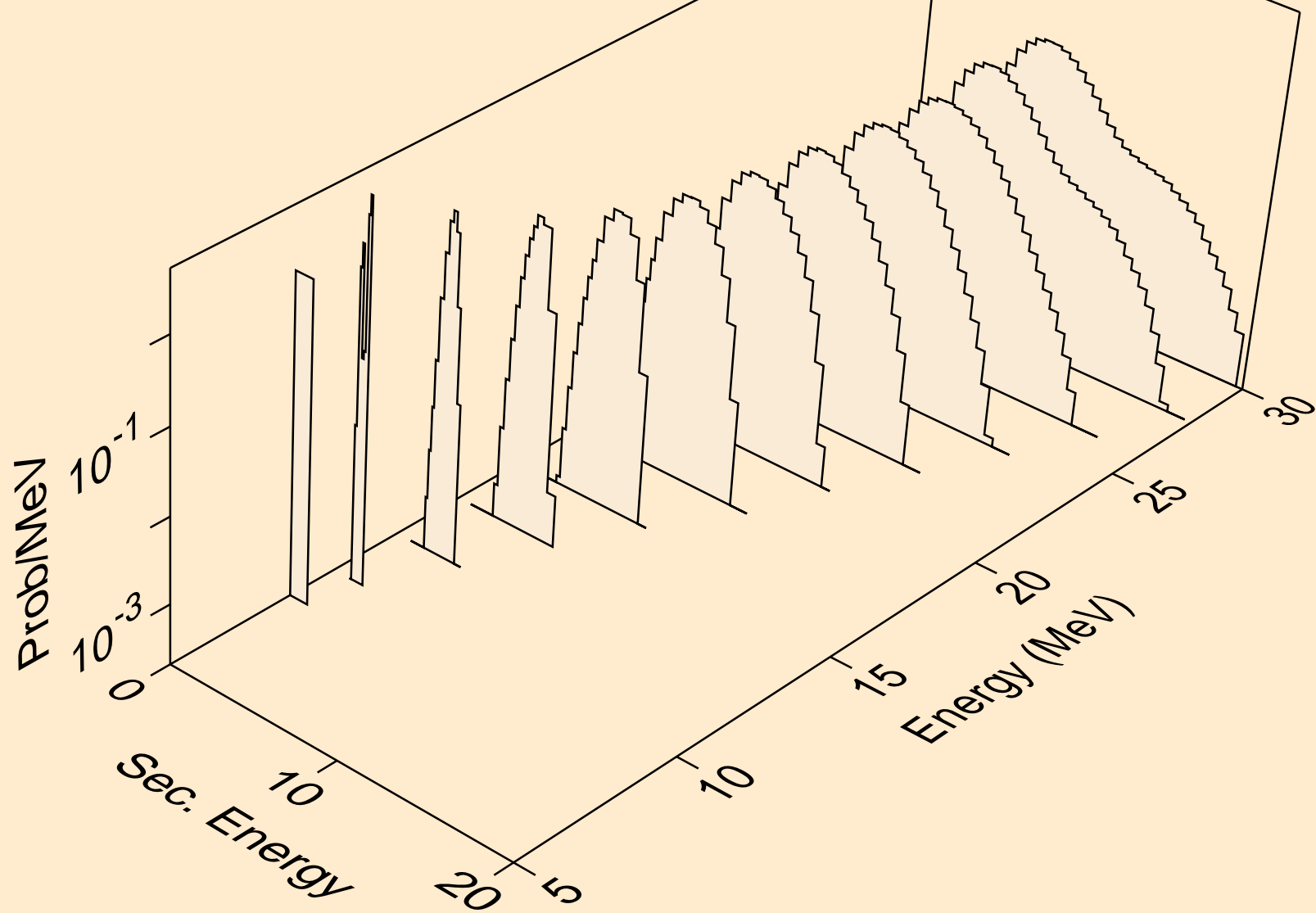

IR172 TRITON ACER TENDL-2021 LIBRARY; T=0.K  
protons from (t,3np)

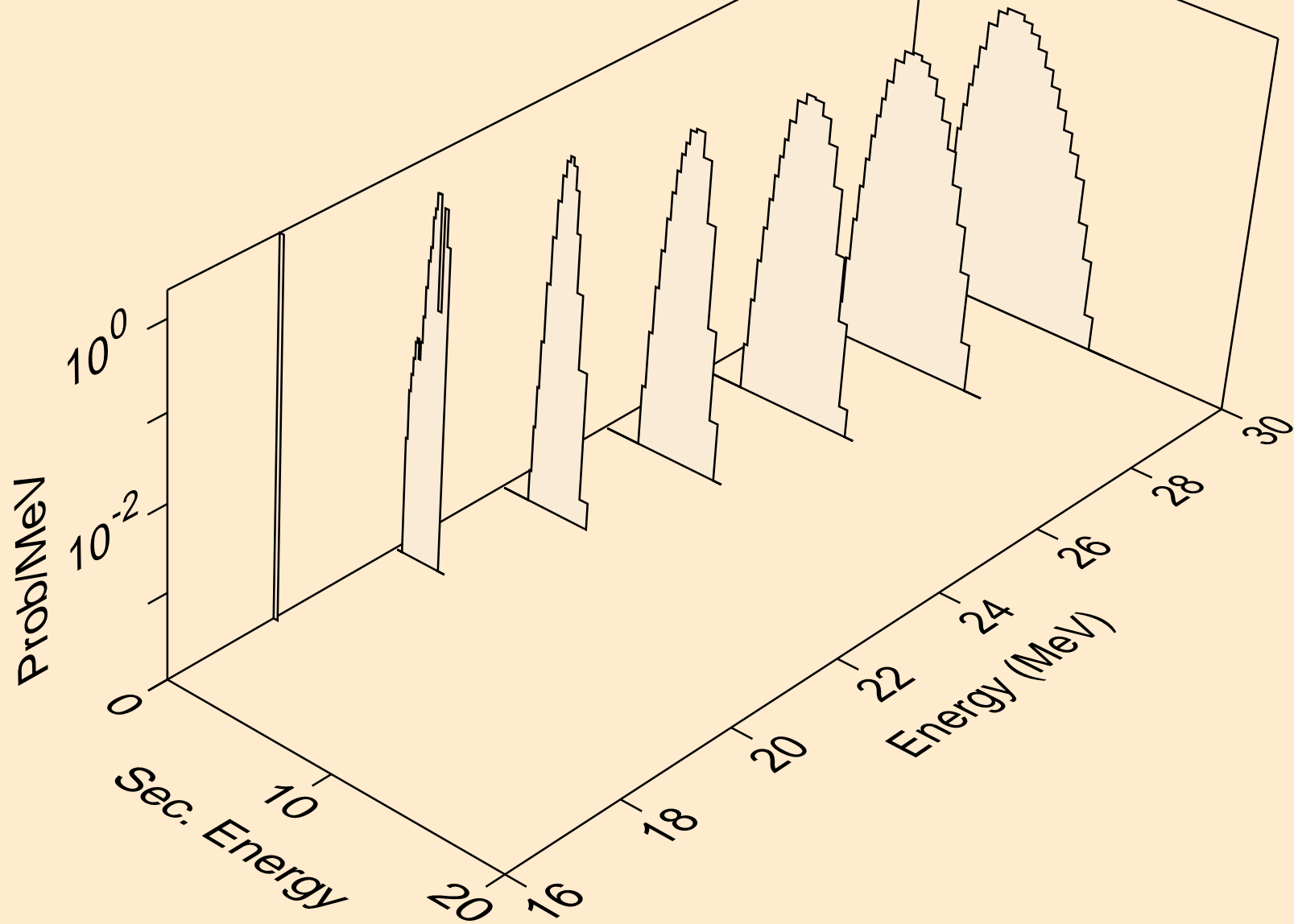

IR172 TRITON ACER TENDL-2021 LIBRARY; T=0.K  
protons from (t,2np)

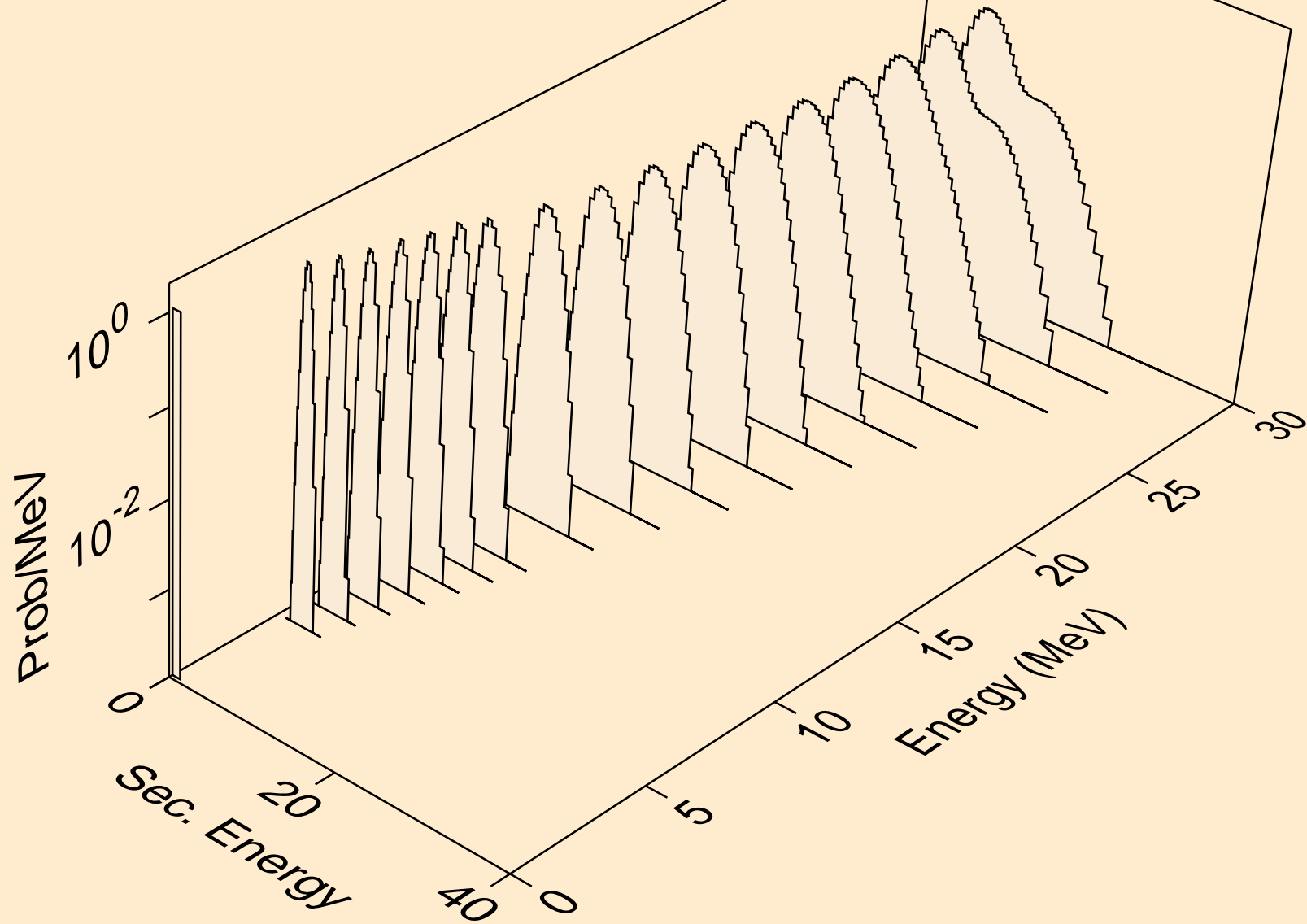

IR172 TRITON ACER TENDL-2021 LIBRARY; T=0.K  
protons from (t,npa)

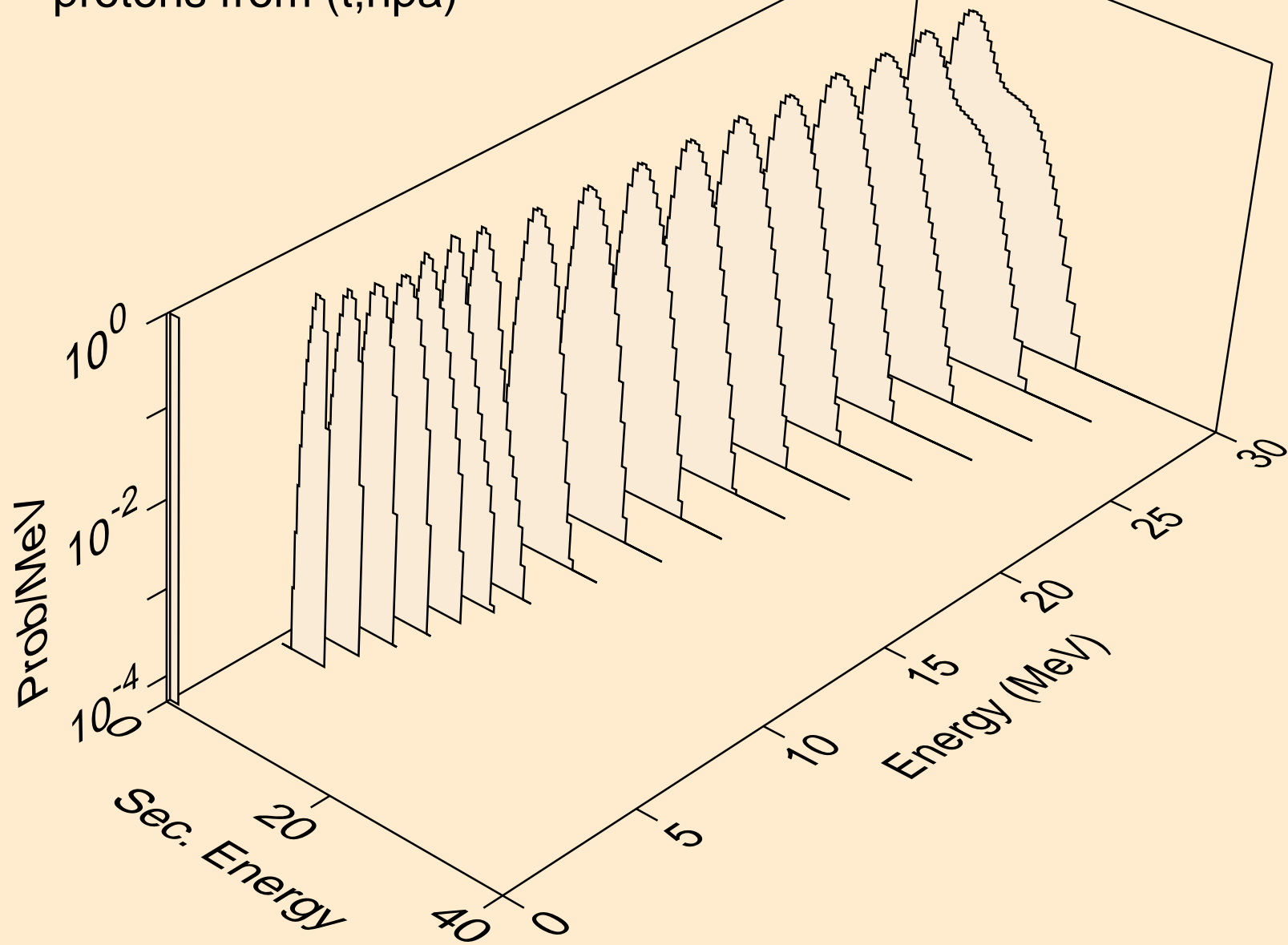

IR172 TRITON ACER TENDL-2021 LIBRARY; T=0.K  
protons from (t,p)

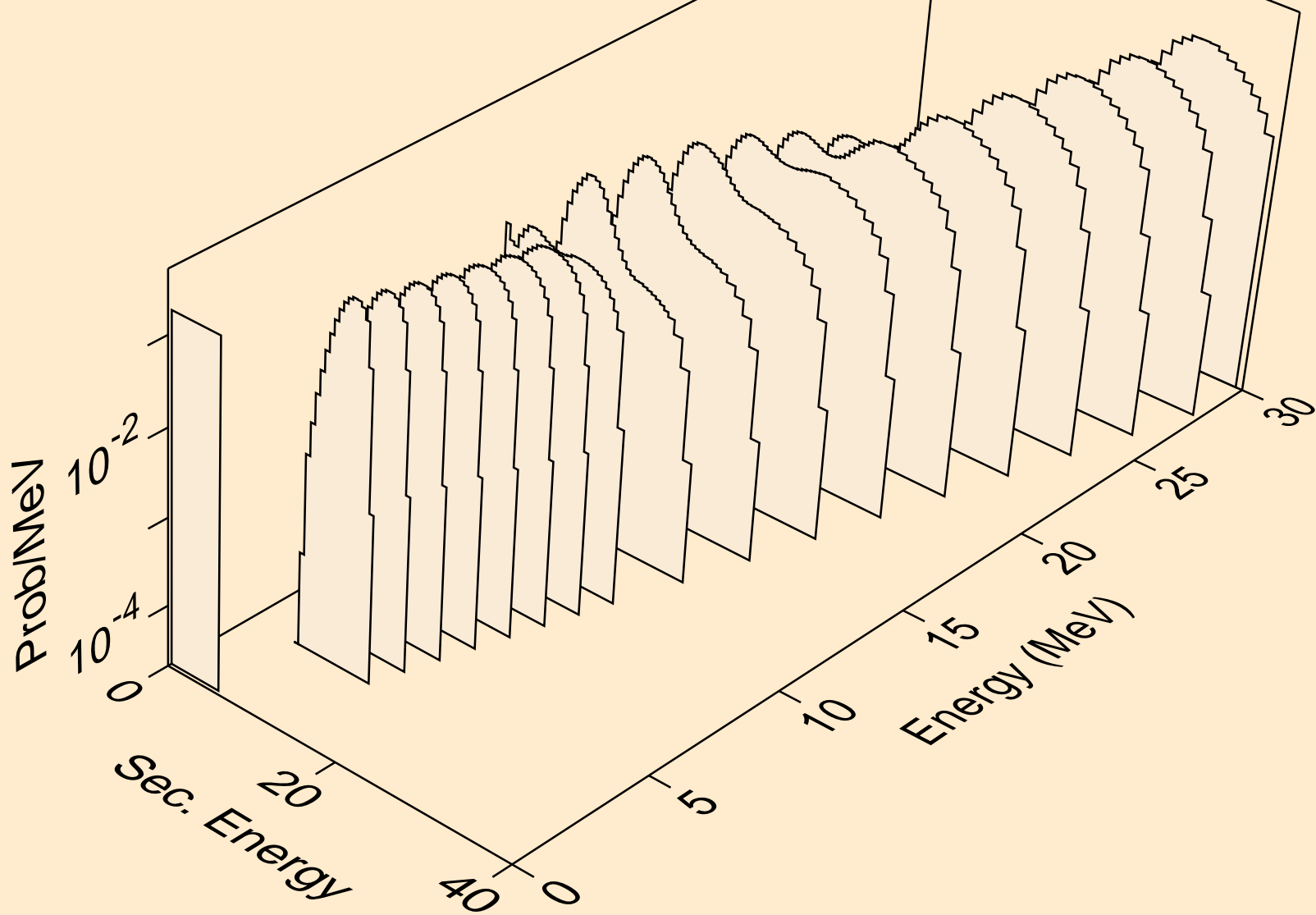

IR172 TRITON ACER TENDL-2021 LIBRARY; T=0.K  
protons from (t,2p)

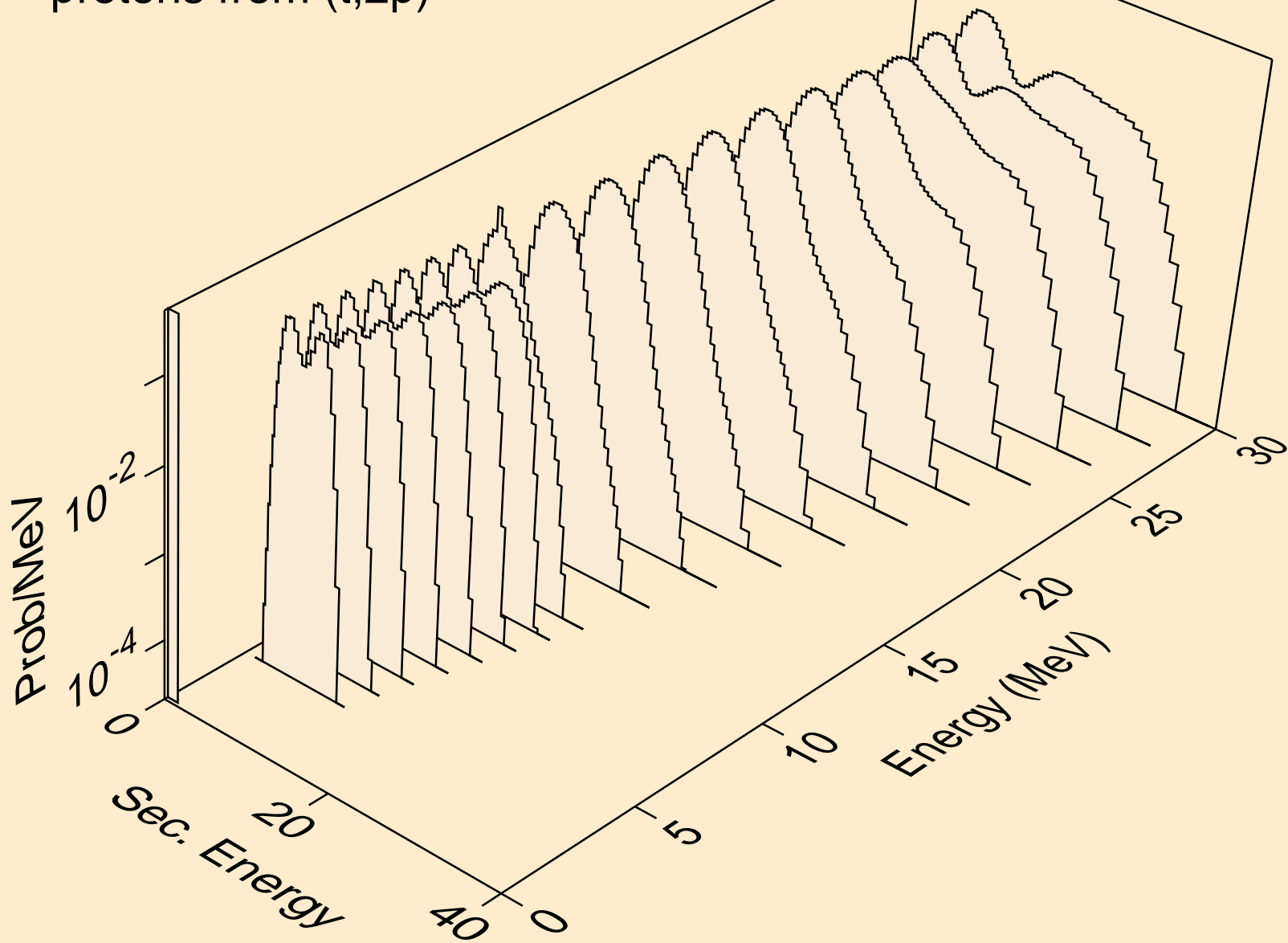

IR172 TRITON ACER TENDL-2021 LIBRARY; T=0.K  
protons from (t,pa)

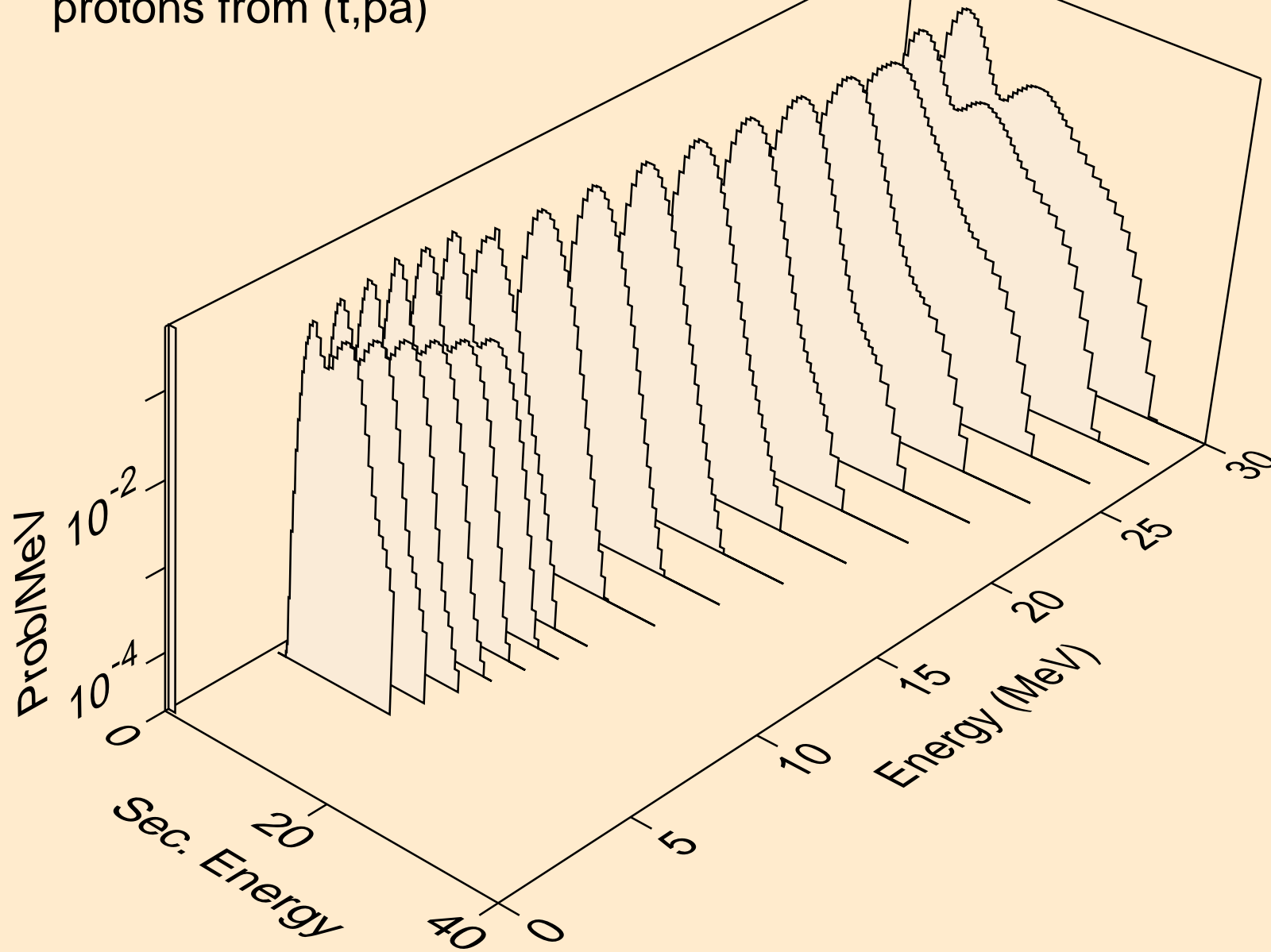



IR172 TRITON ACER TENDL-2021 LIBRARY; T=0.K  
protons from (t,pd)

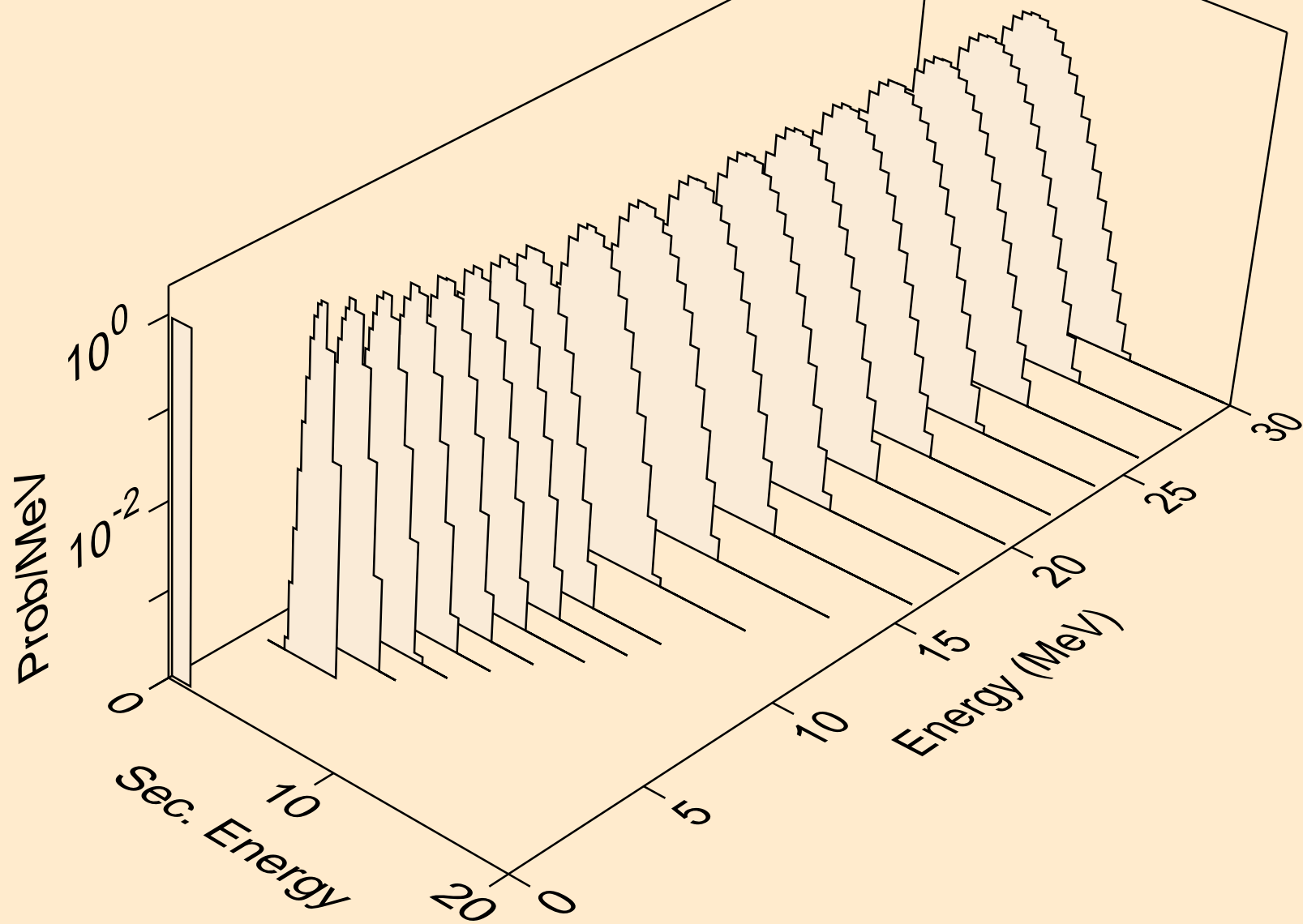

IR172 TRITON ACER TENDL-2021 LIBRARY; T=0.K  
protons from (t,pt)

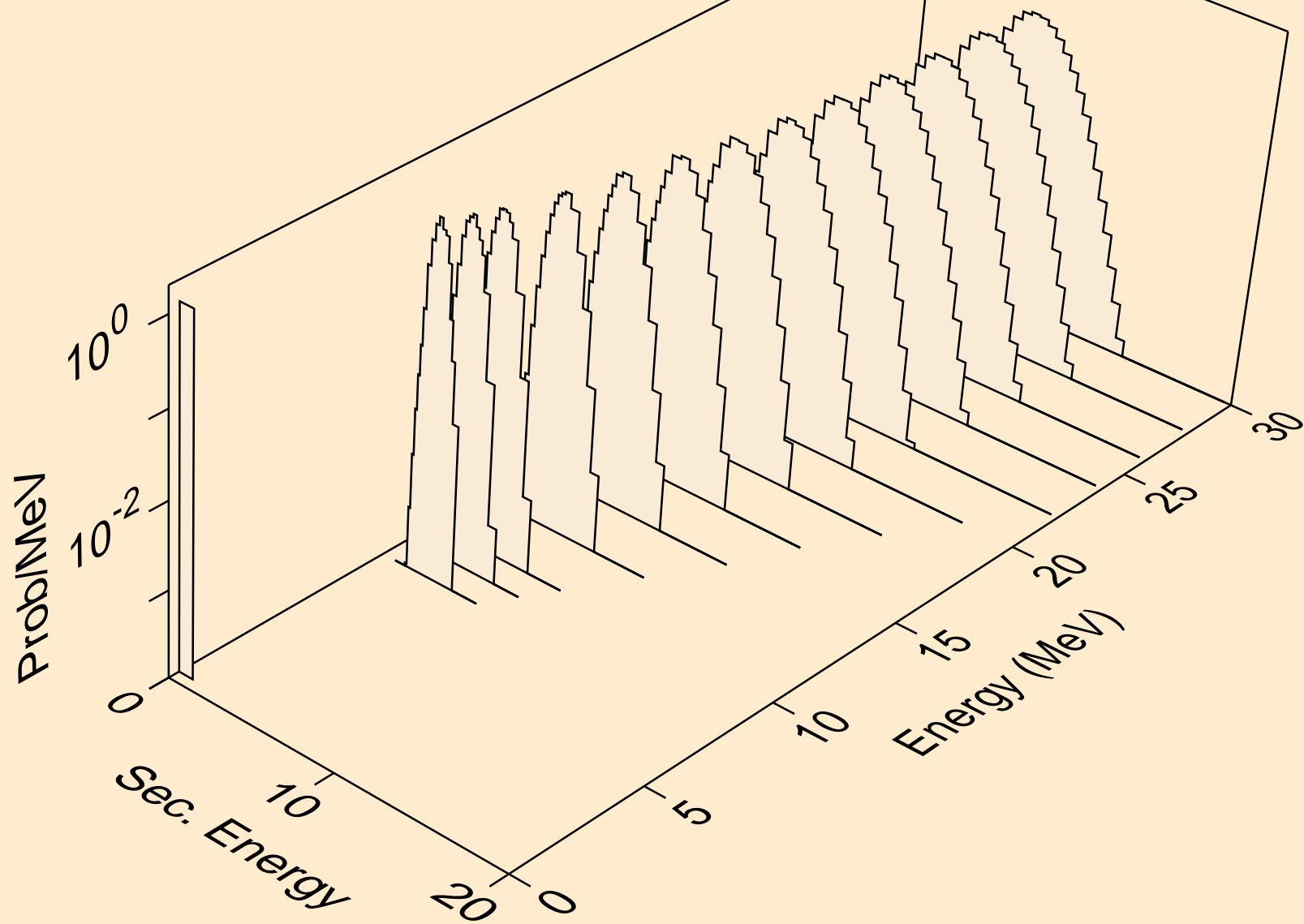

IR172 TRITON ACER TENDL-2021 LIBRARY; T=0.K  
deuterons from (t,x)

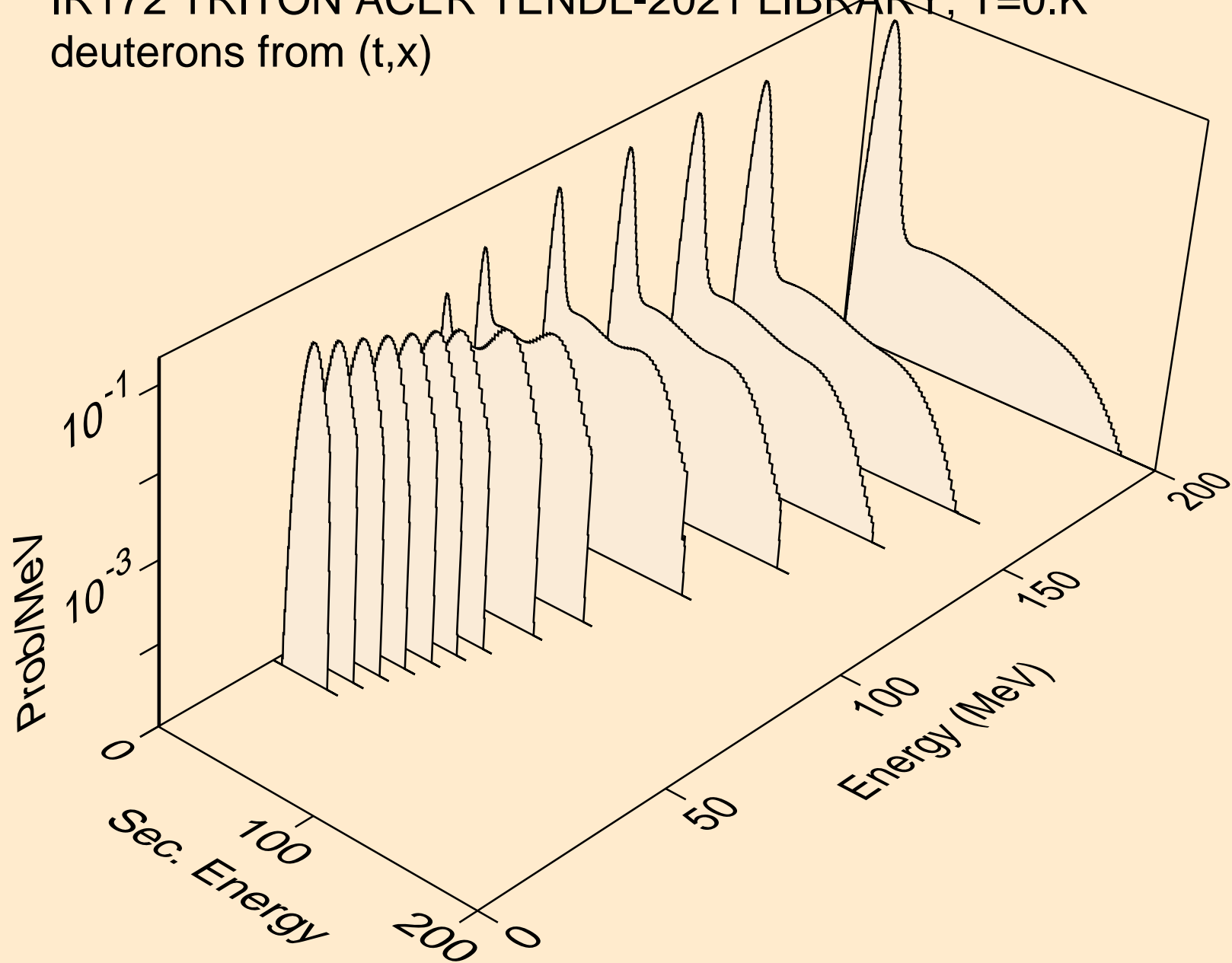

IR172 TRITON ACER TENDL-2021 LIBRARY; T=0.K  
deuterons from (t,2nd)

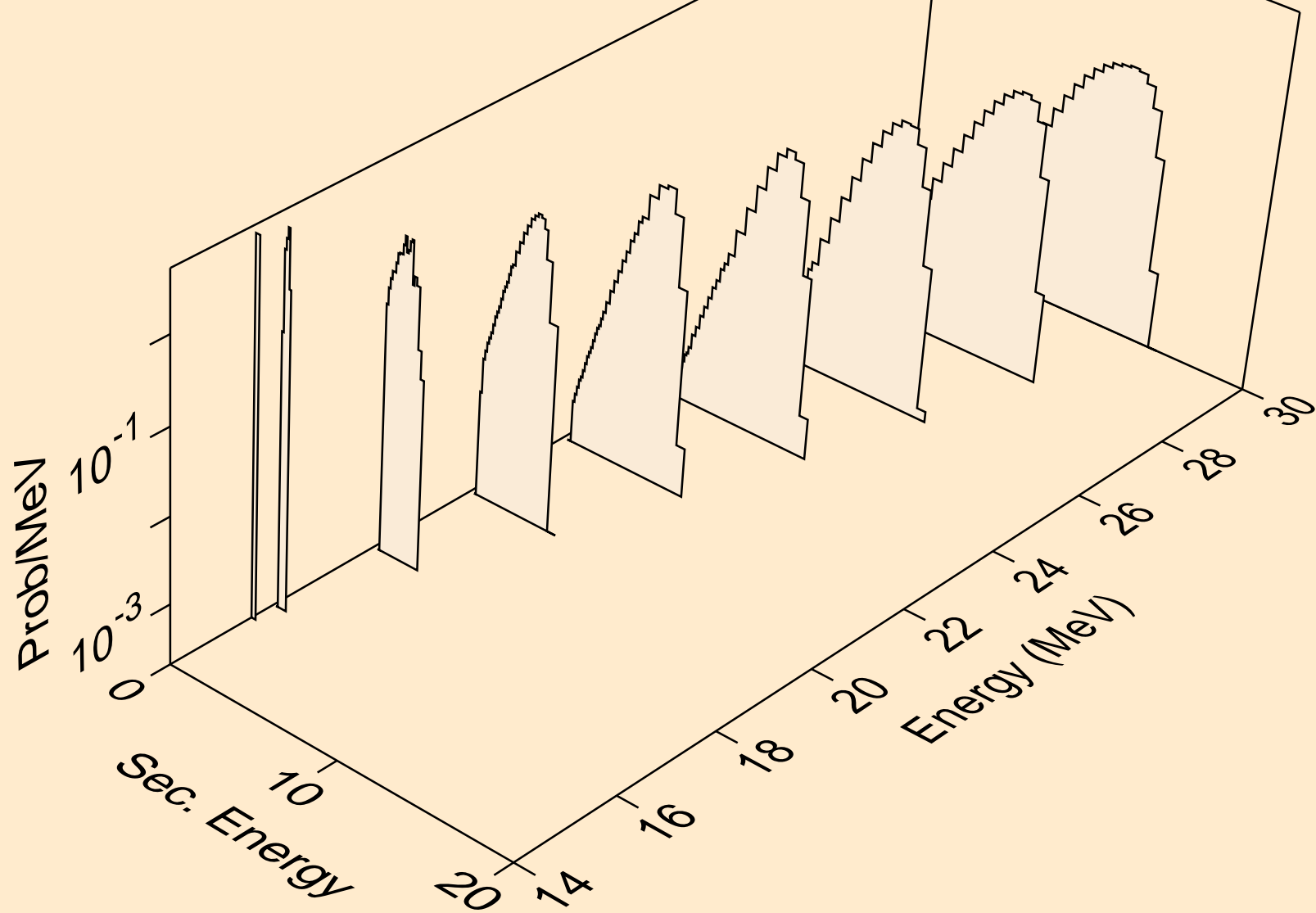

IR172 TRITON ACER TENDL-2021 LIBRARY; T=0.K  
deuterons from (t,n\*)d

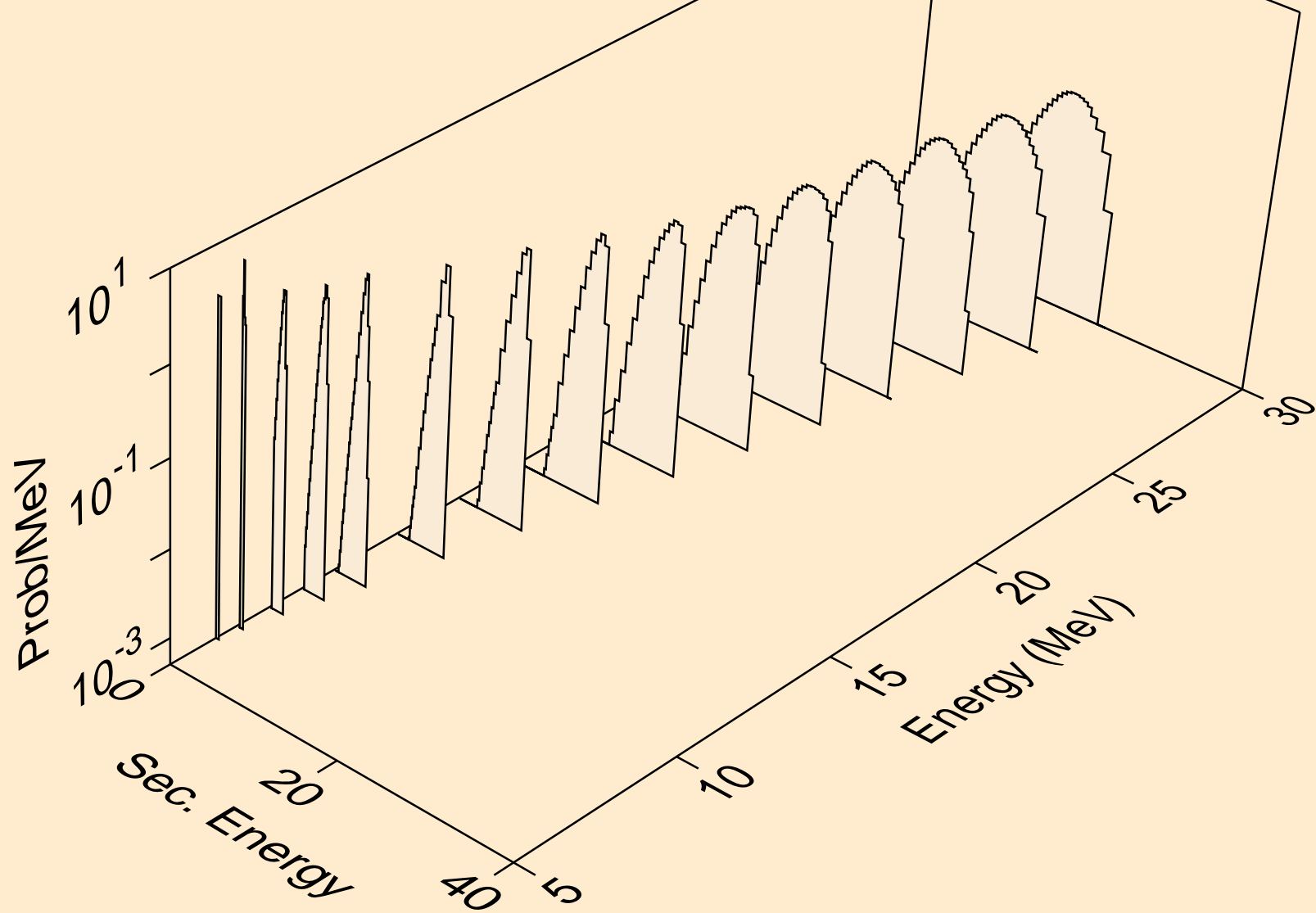

IR172 TRITON ACER TENDL-2021 LIBRARY; T=0.K  
deuterons from (t,d)

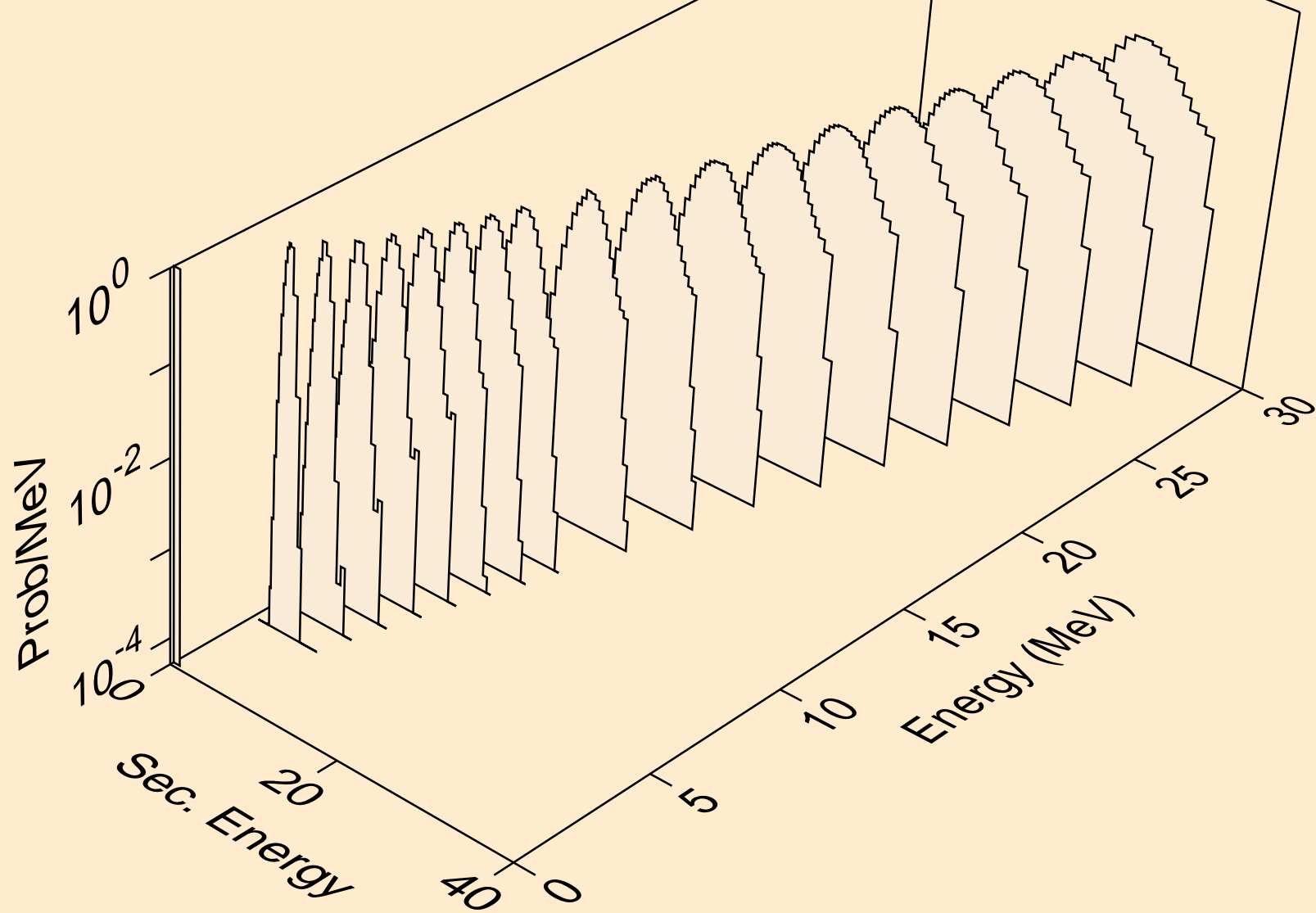

IR172 TRITON ACER TENDL-2021 LIBRARY; T=0.K  
deuterons from (t,d2a)

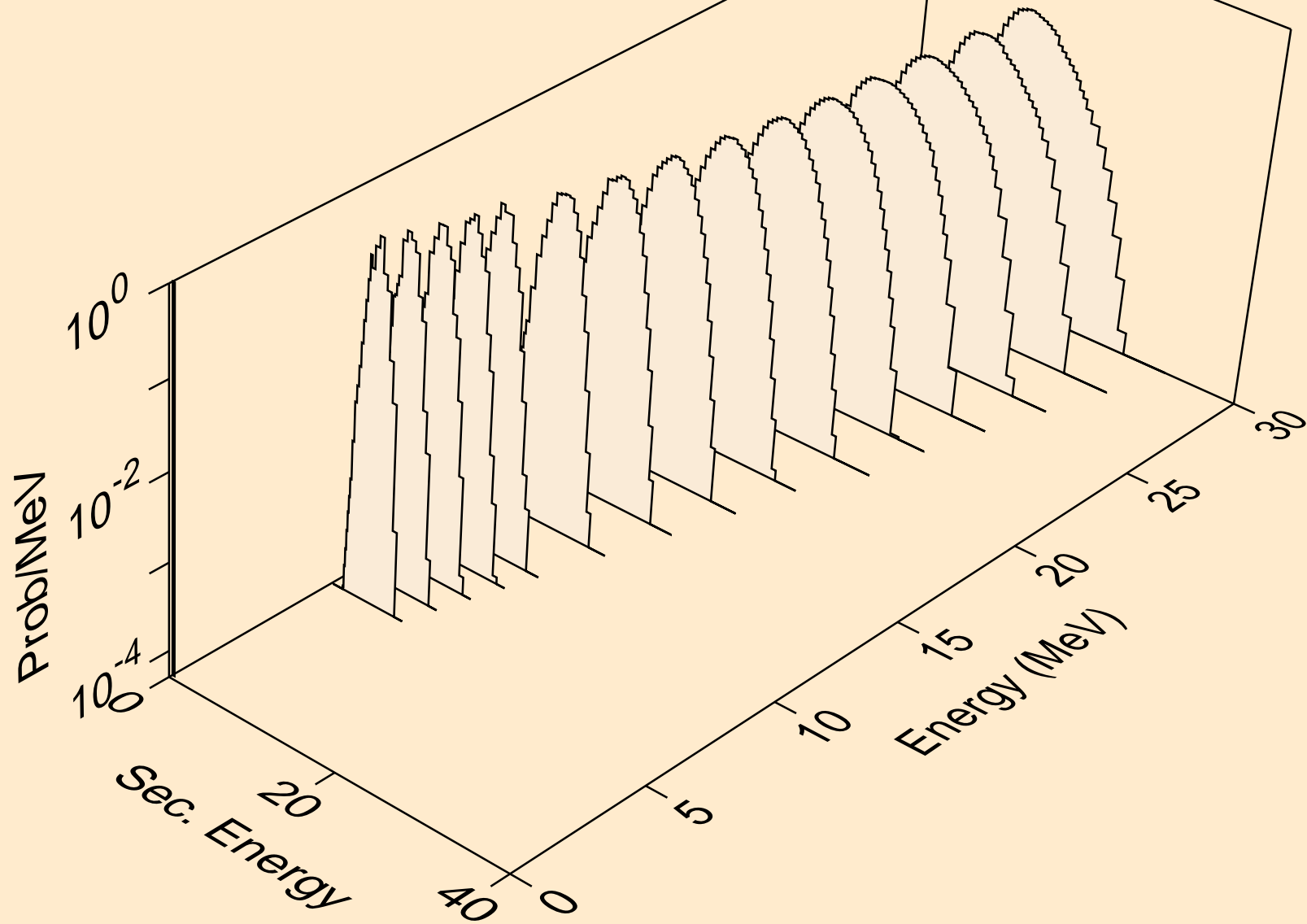

IR172 TRITON ACER TENDL-2021 LIBRARY; T=0.K  
deuterons from (t,pd)

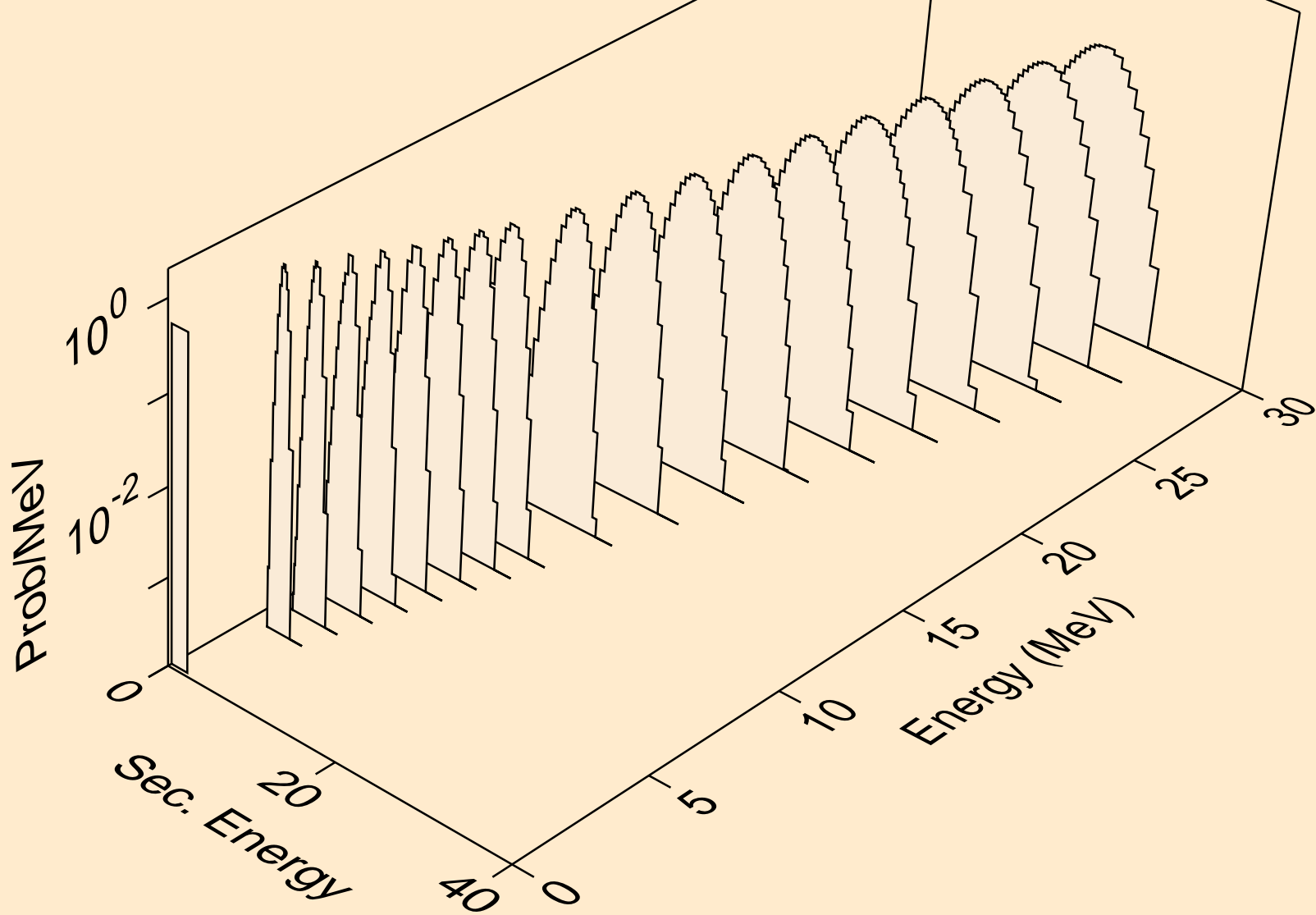



IR172 TRITON ACER TENDL-2021 LIBRARY; T=0.K  
deuterons from (t,da)

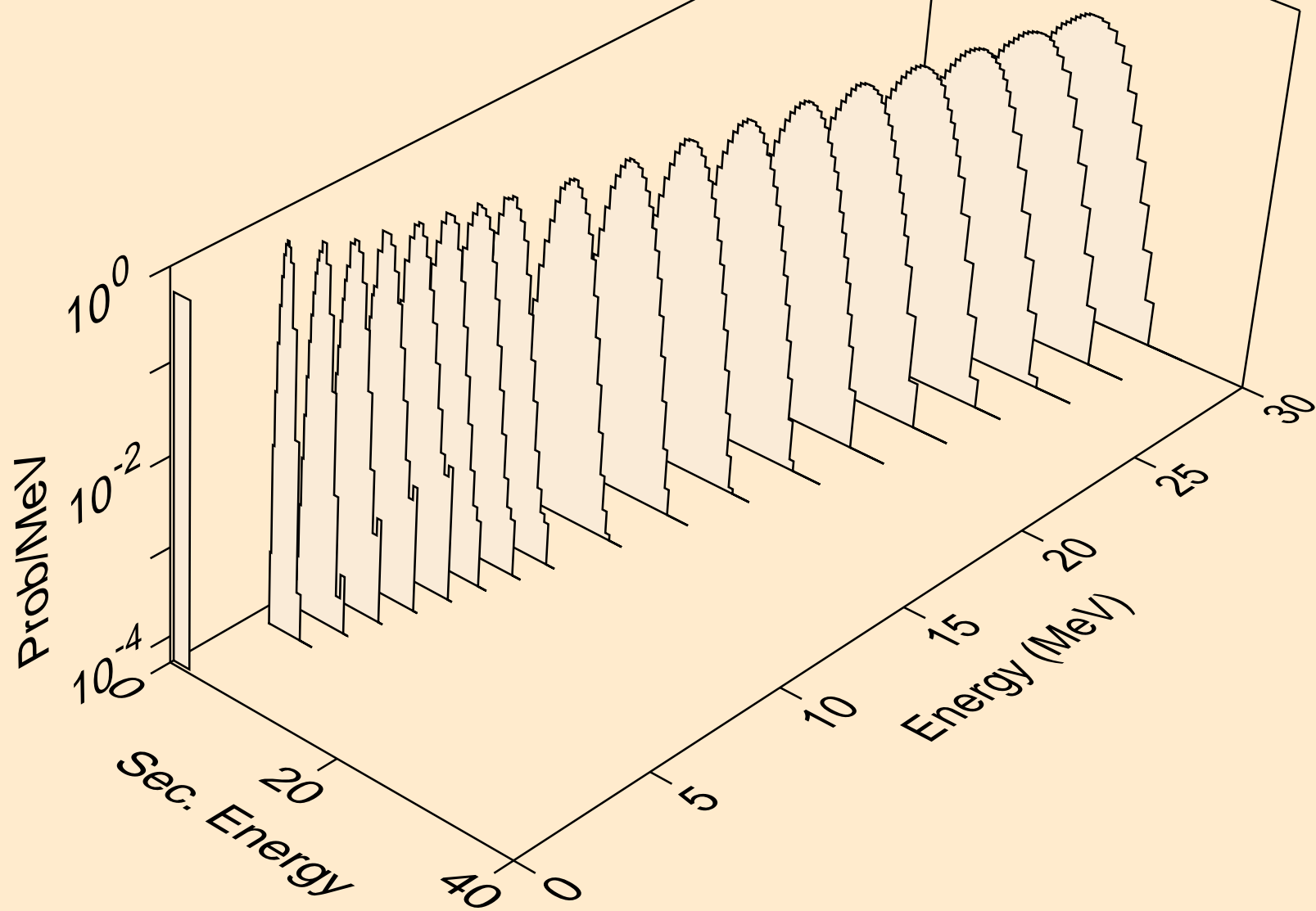

IR172 TRITON ACER TENDL-2021 LIBRARY; T=0.K  
he3s from (t,x)

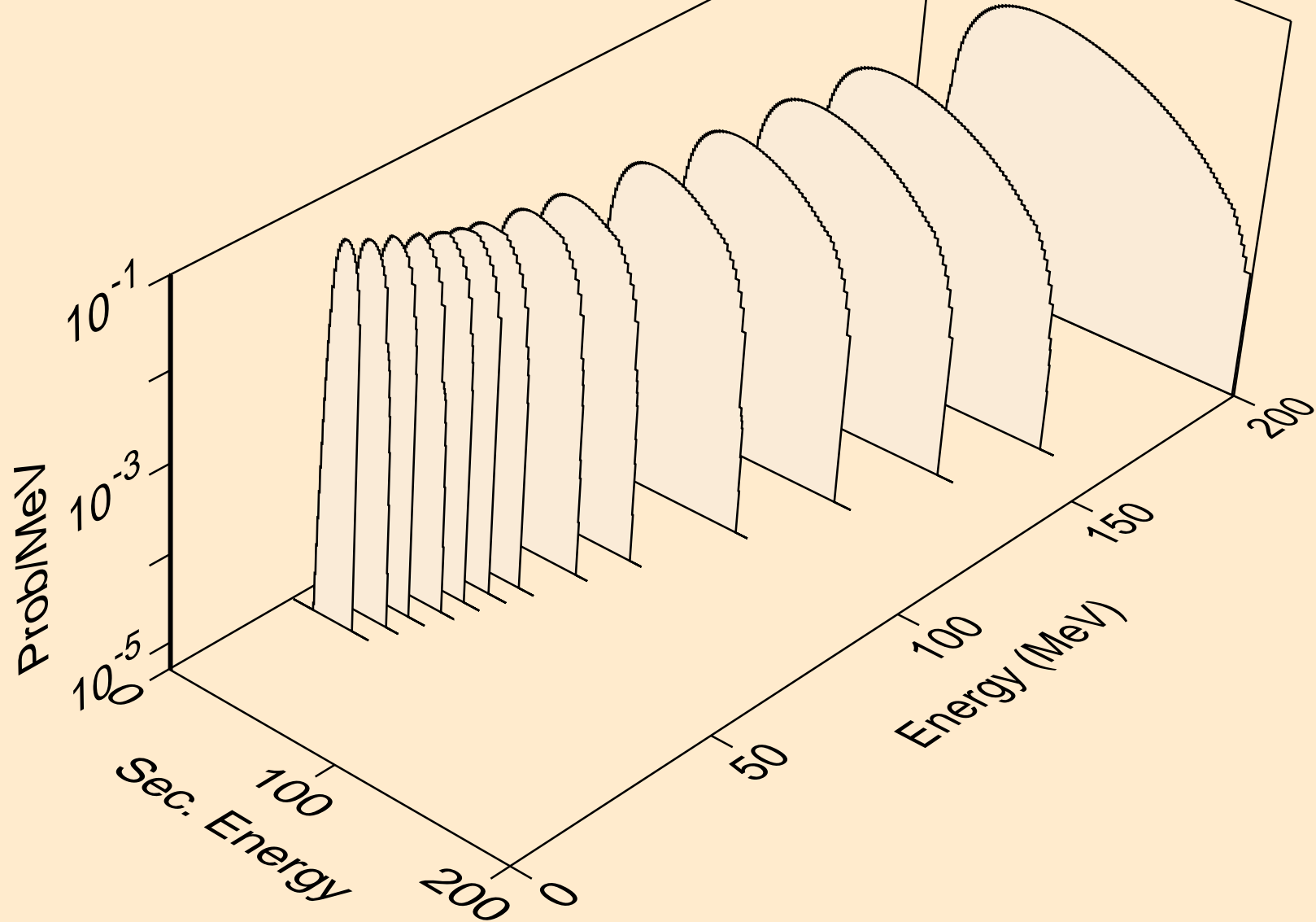

IR172 TRITON ACER TENDL-2021 LIBRARY; T=0.K  
he3s from (t,n\*)he3

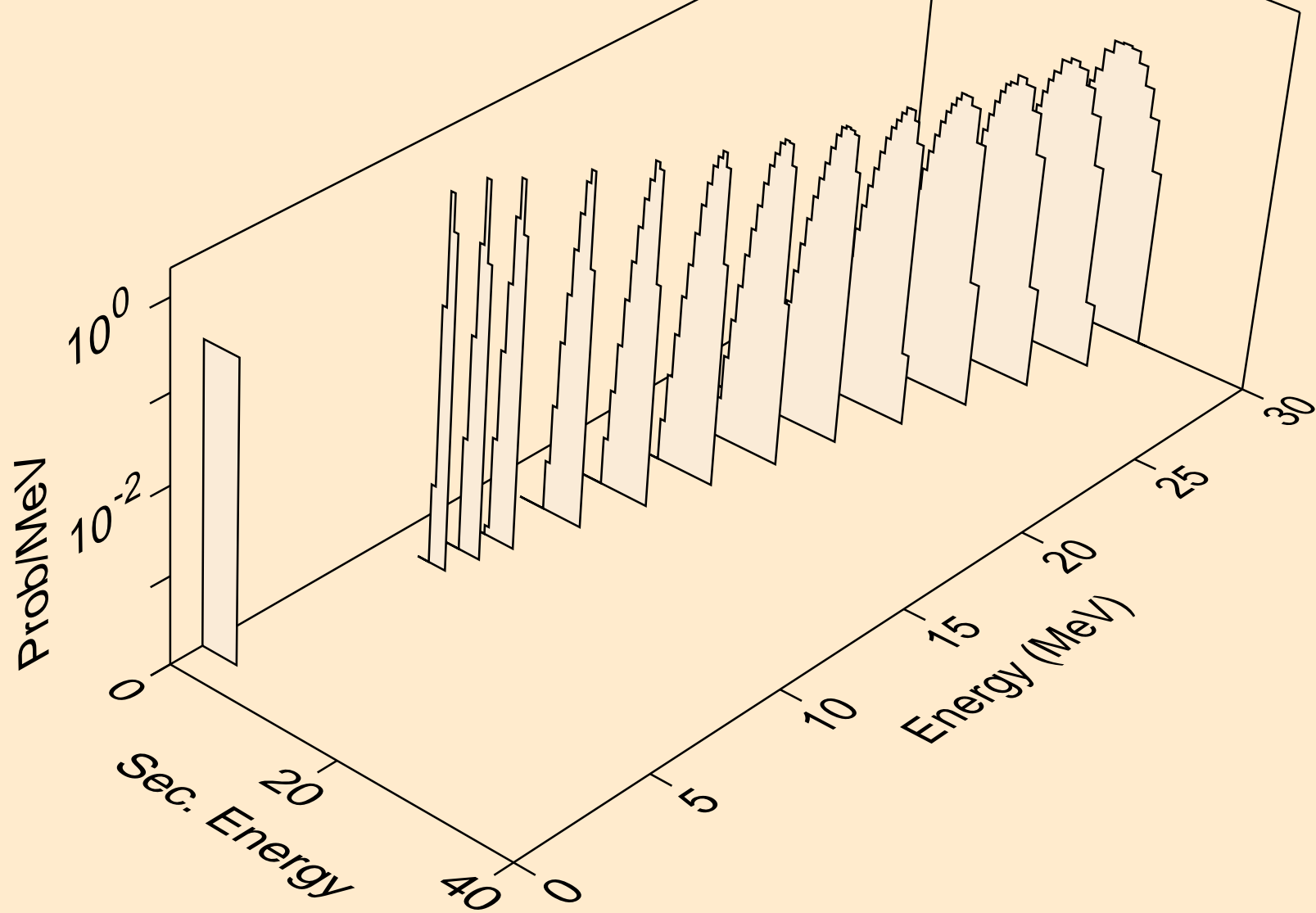

IR172 TRITON ACER TENDL-2021 LIBRARY; T=0.K  
he3s from (t,he3)

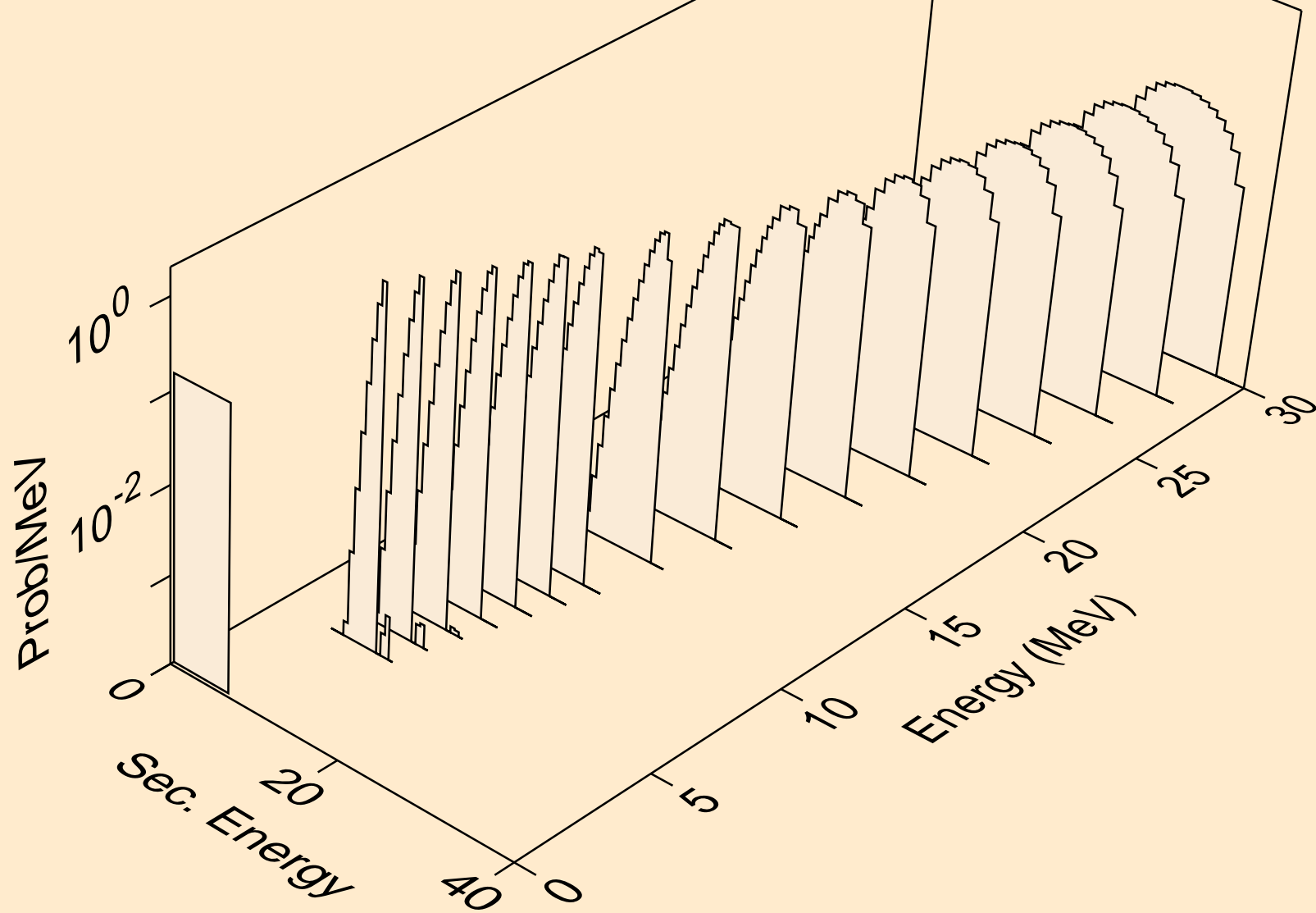

IR172 TRITON ACER TENDL-2021 LIBRARY; T=0.K  
alphas from (t,x)

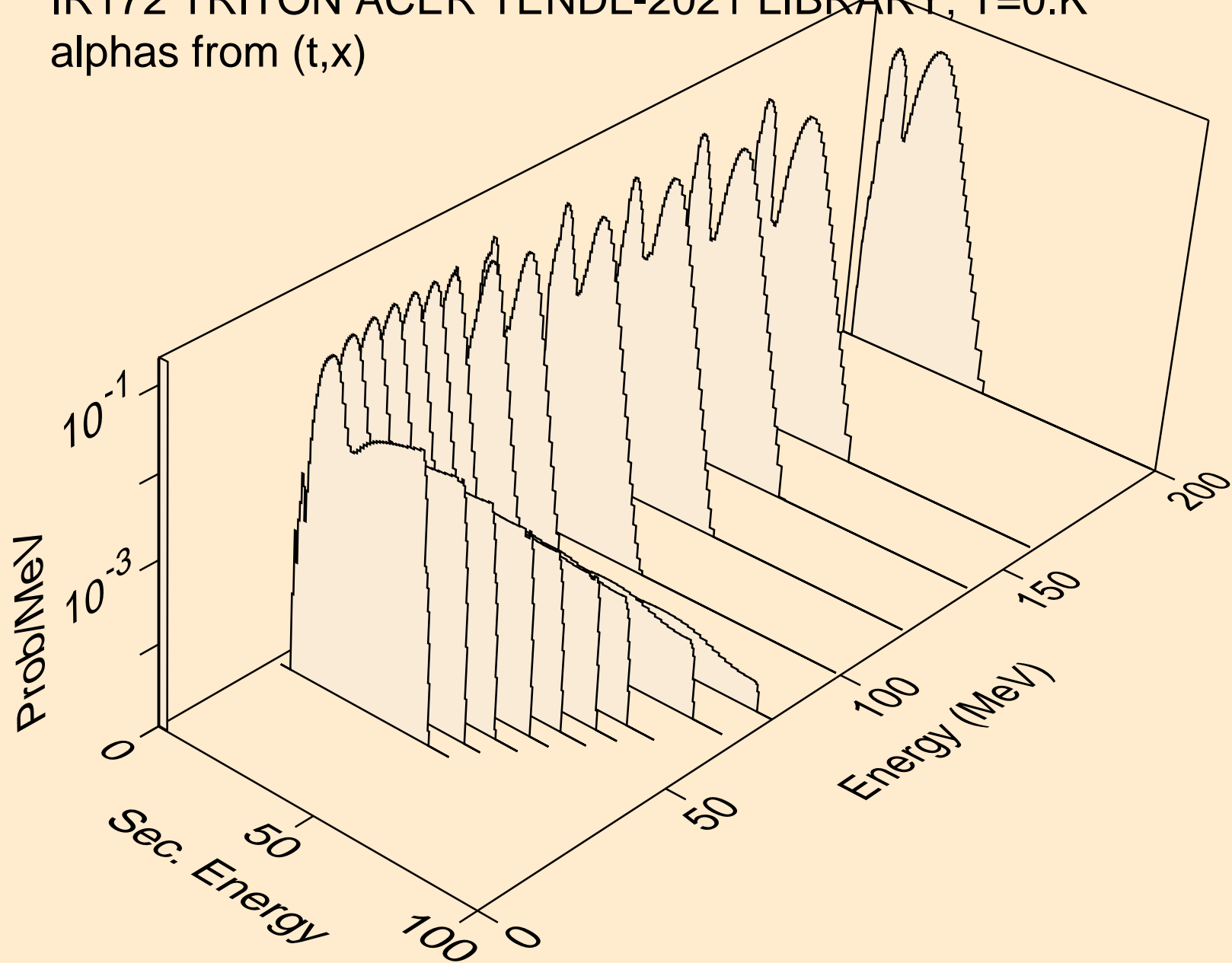

IR172 TRITON ACER TENDL-2021 LIBRARY; T=0.K  
alphas from (t,n\*)a

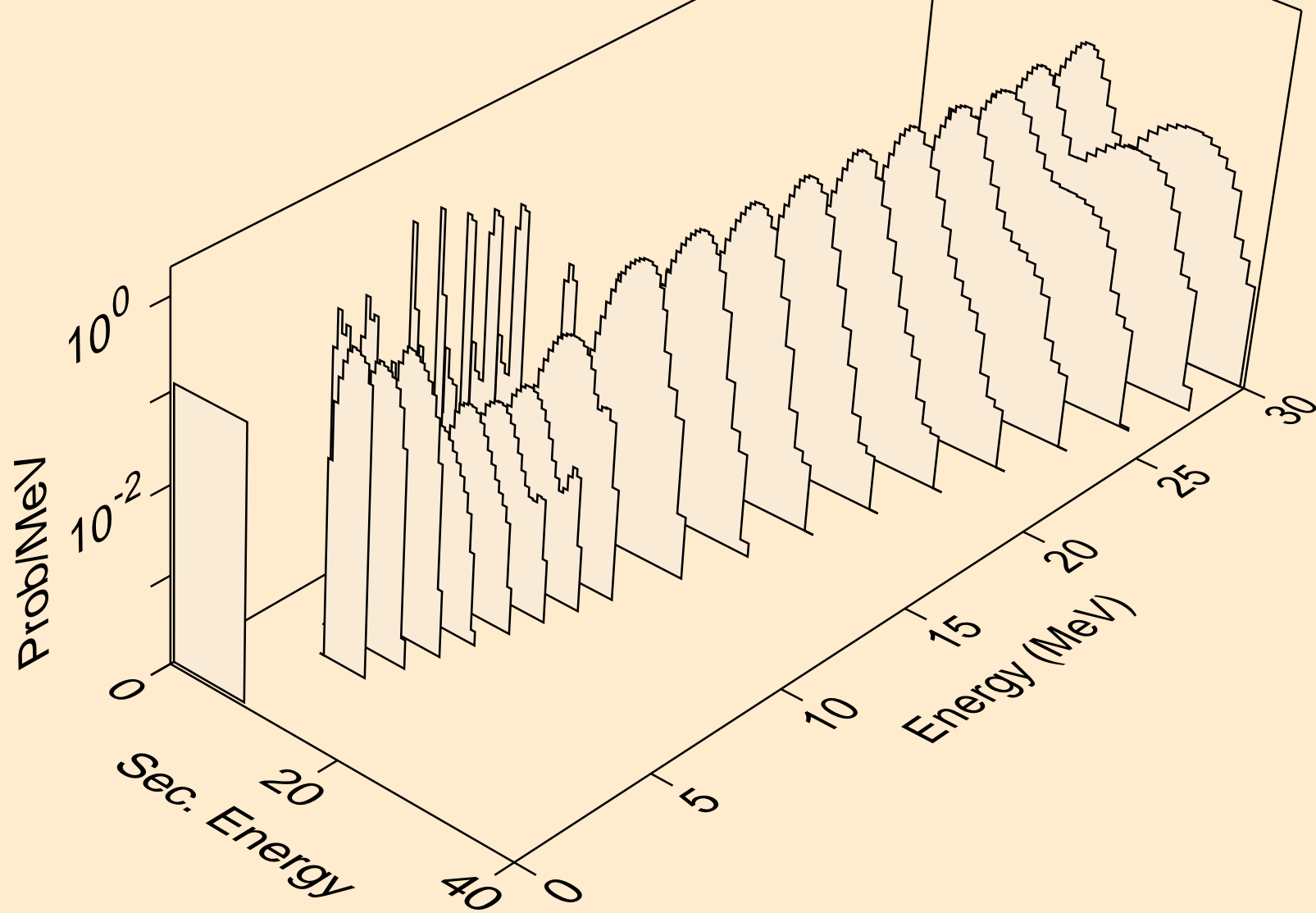

IR172 TRITON ACER TENDL-2021 LIBRARY; T=0.K  
alphas from (t,n\*)3a

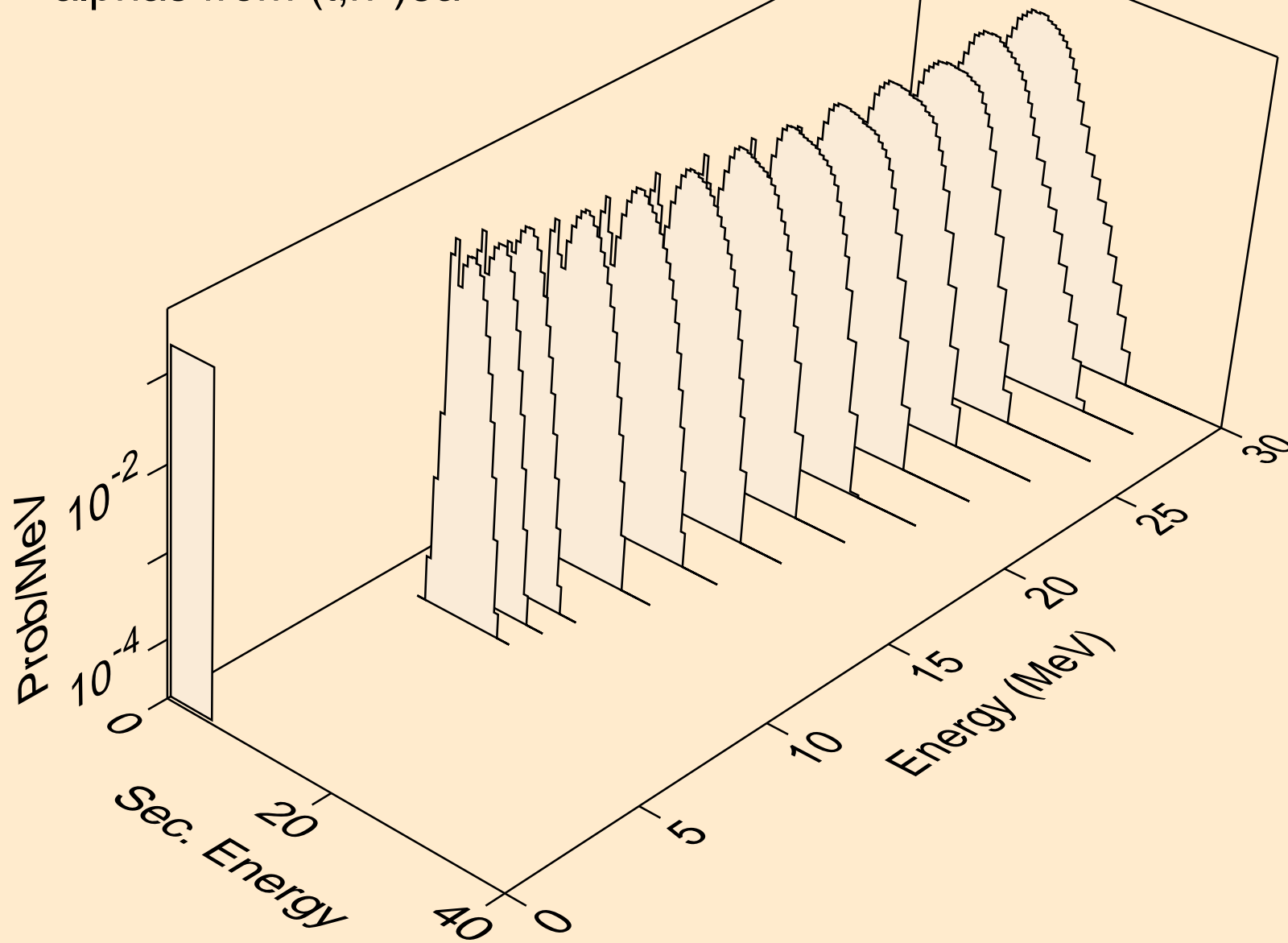

IR172 TRITON ACER TENDL-2021 LIBRARY; T=0.K  
alphas from (t,2n)a

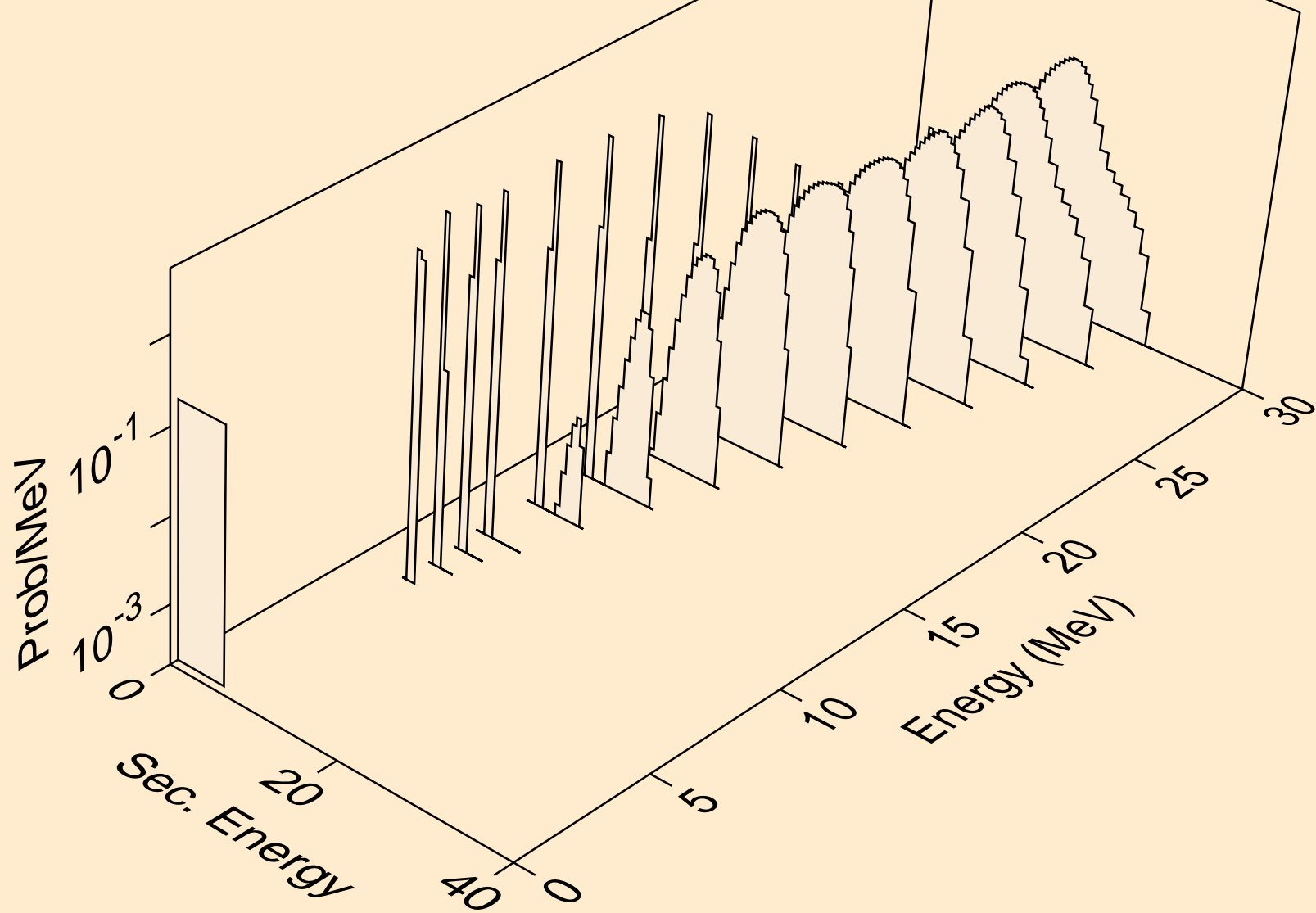



IR172 TRITON ACER TENDL-2021 LIBRARY; T=0.K  
alphas from (t,3n)a

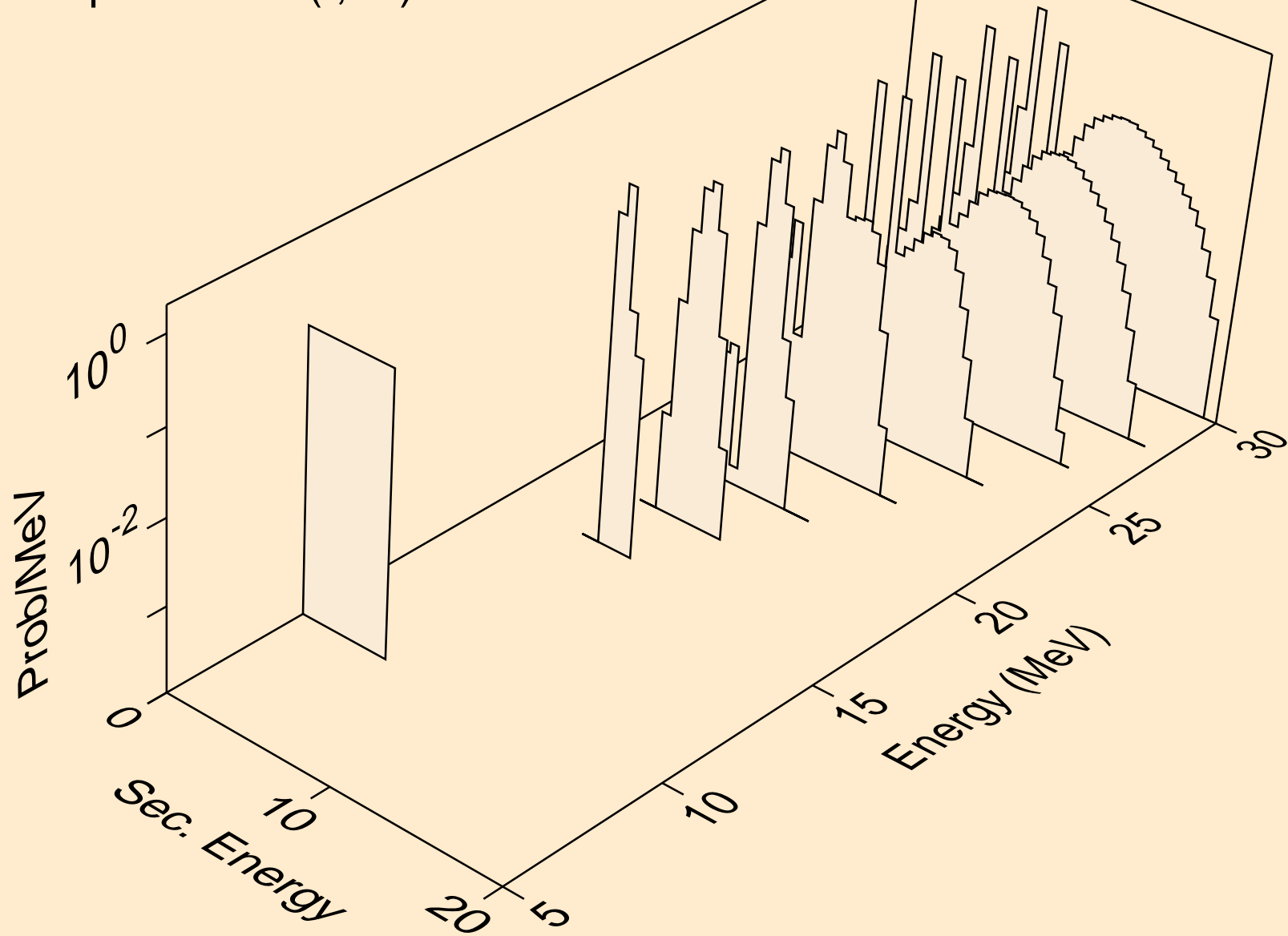

IR172 TRITON ACER TENDL-2021 LIBRARY; T=0.K  
alphas from (t,n\*)2a

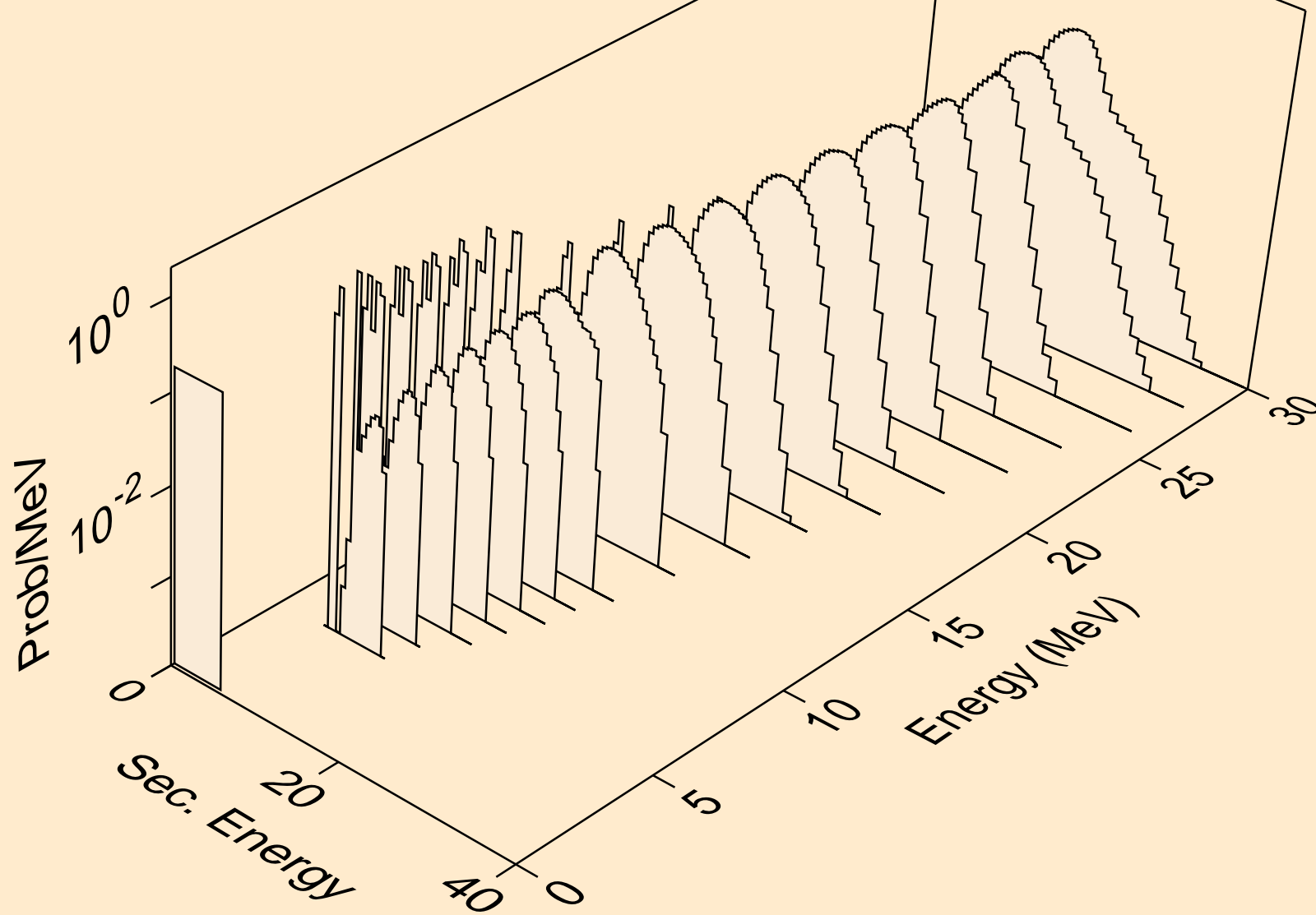

IR172 TRITON ACER TENDL-2021 LIBRARY; T=0.K  
alphas from (t,2n)2a

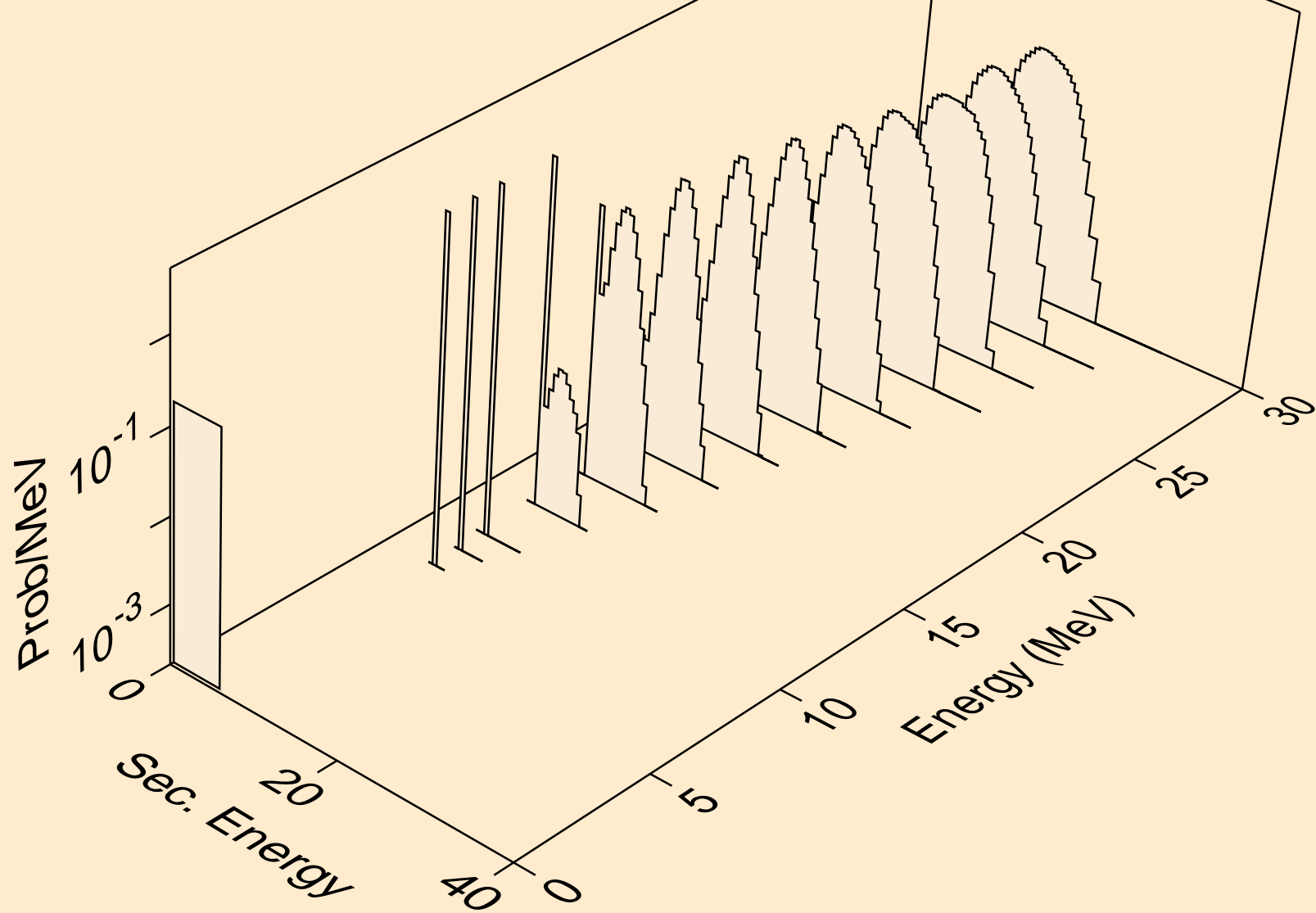

IR172 TRITON ACER TENDL-2021 LIBRARY; T=0.K  
alphas from (t,npa)

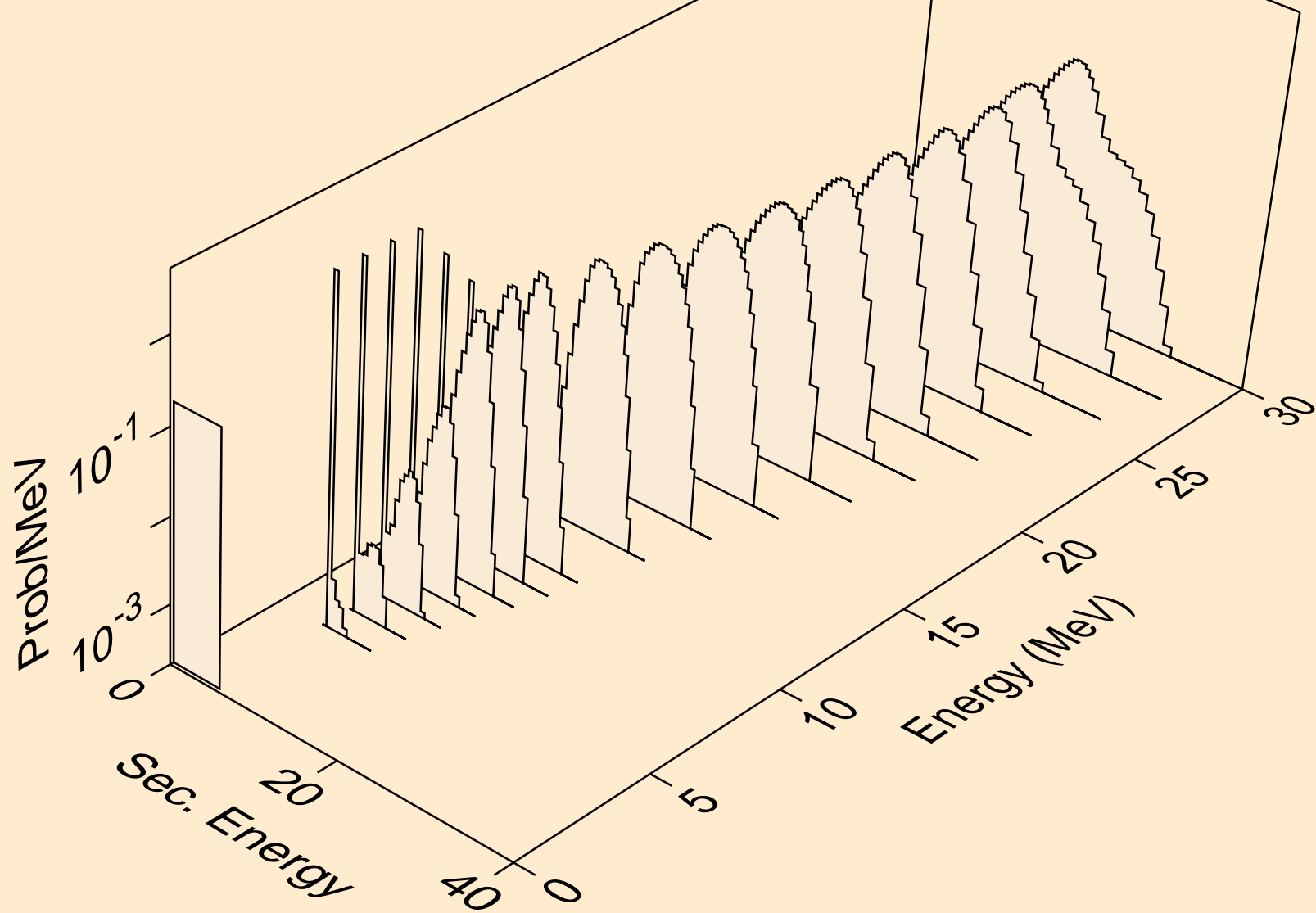

IR172 TRITON ACER TENDL-2021 LIBRARY; T=0.K  
alphas from (t,a)

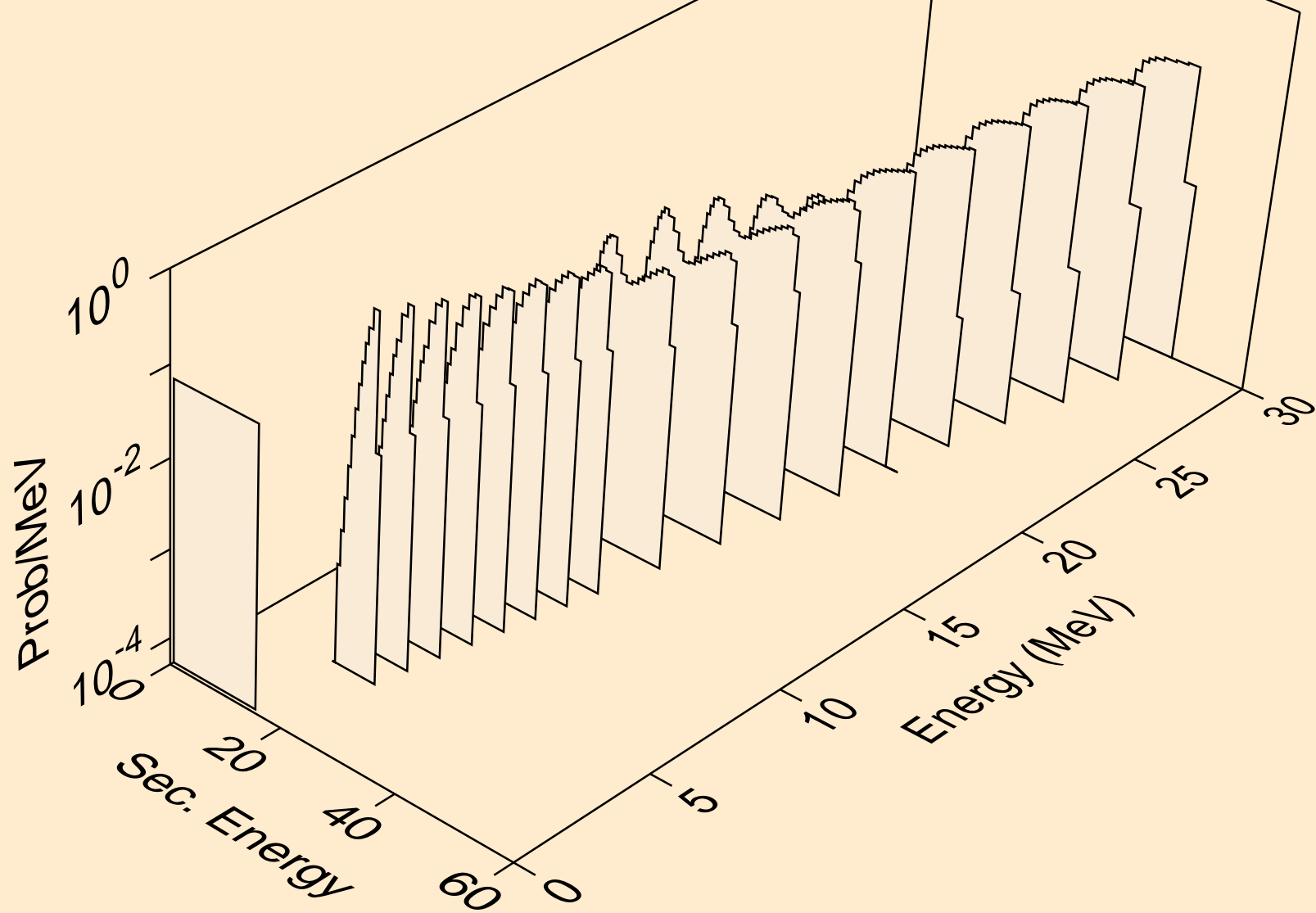

IR172 TRITON ACER TENDL-2021 LIBRARY; T=0.K  
alphas from (t,2a)

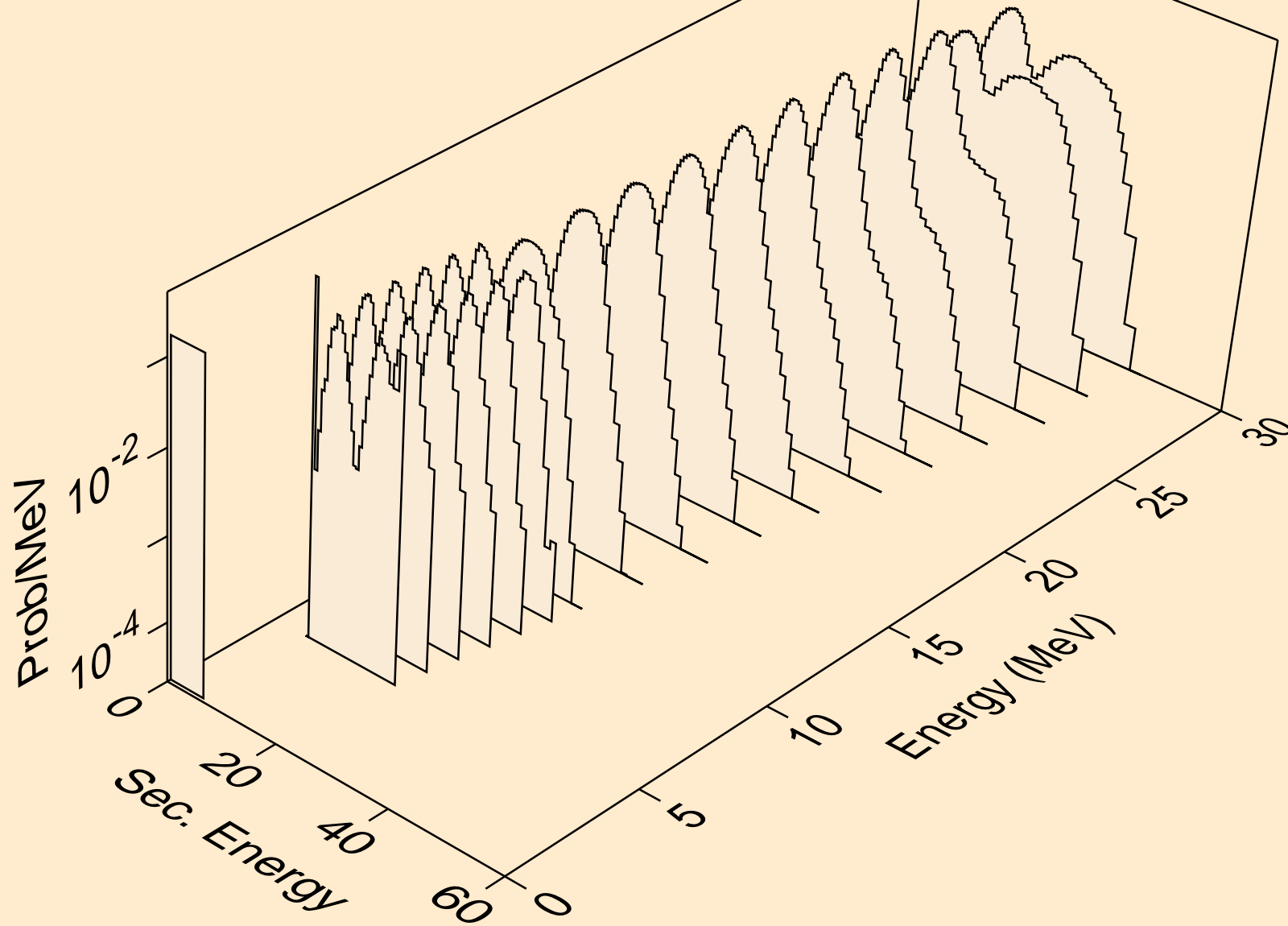

IR172 TRITON ACER TENDL-2021 LIBRARY; T=0.K  
alphas from (t,3a)

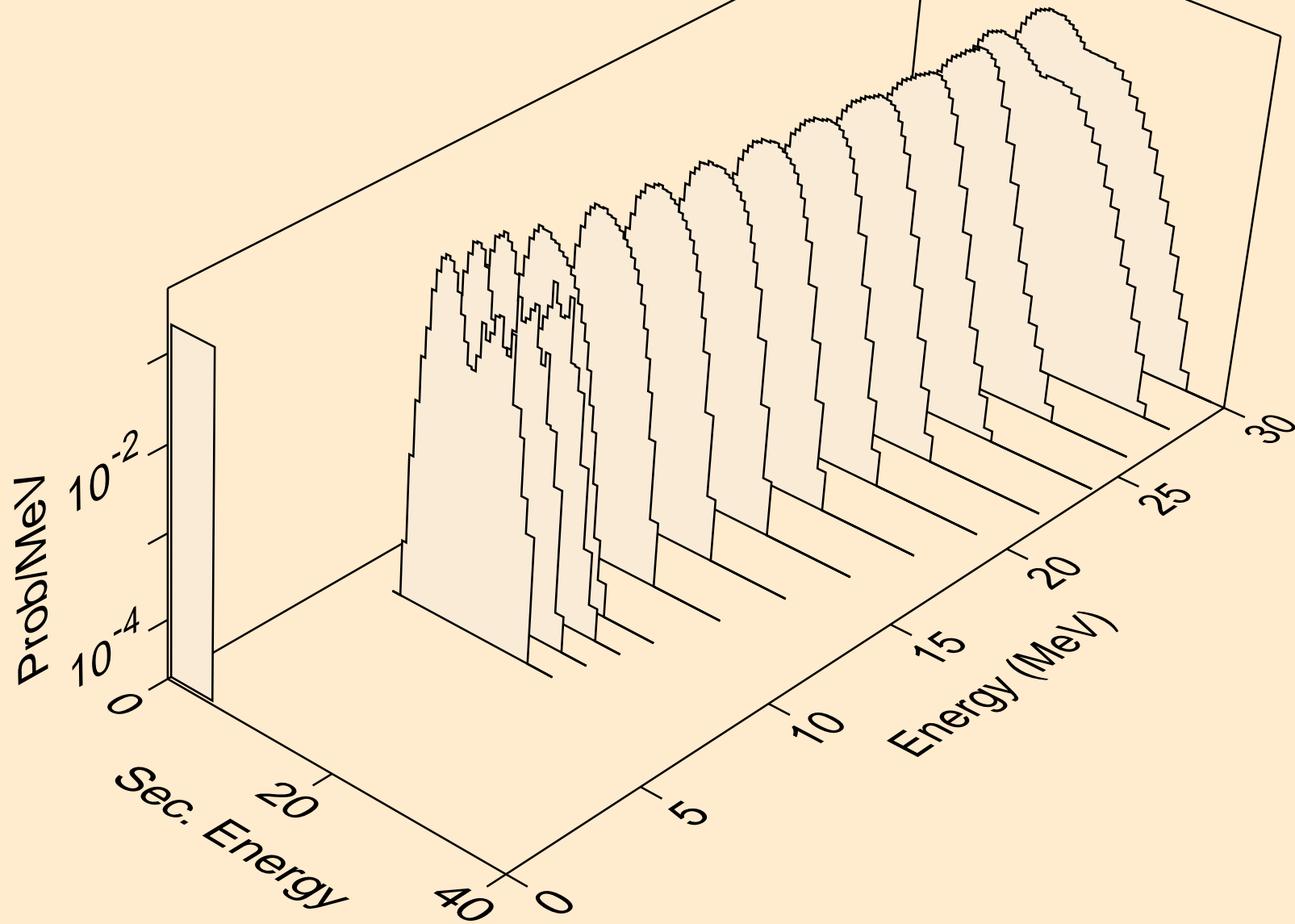

IR172 TRITON ACER TENDL-2021 LIBRARY; T=0.K  
alphas from (t,pa)

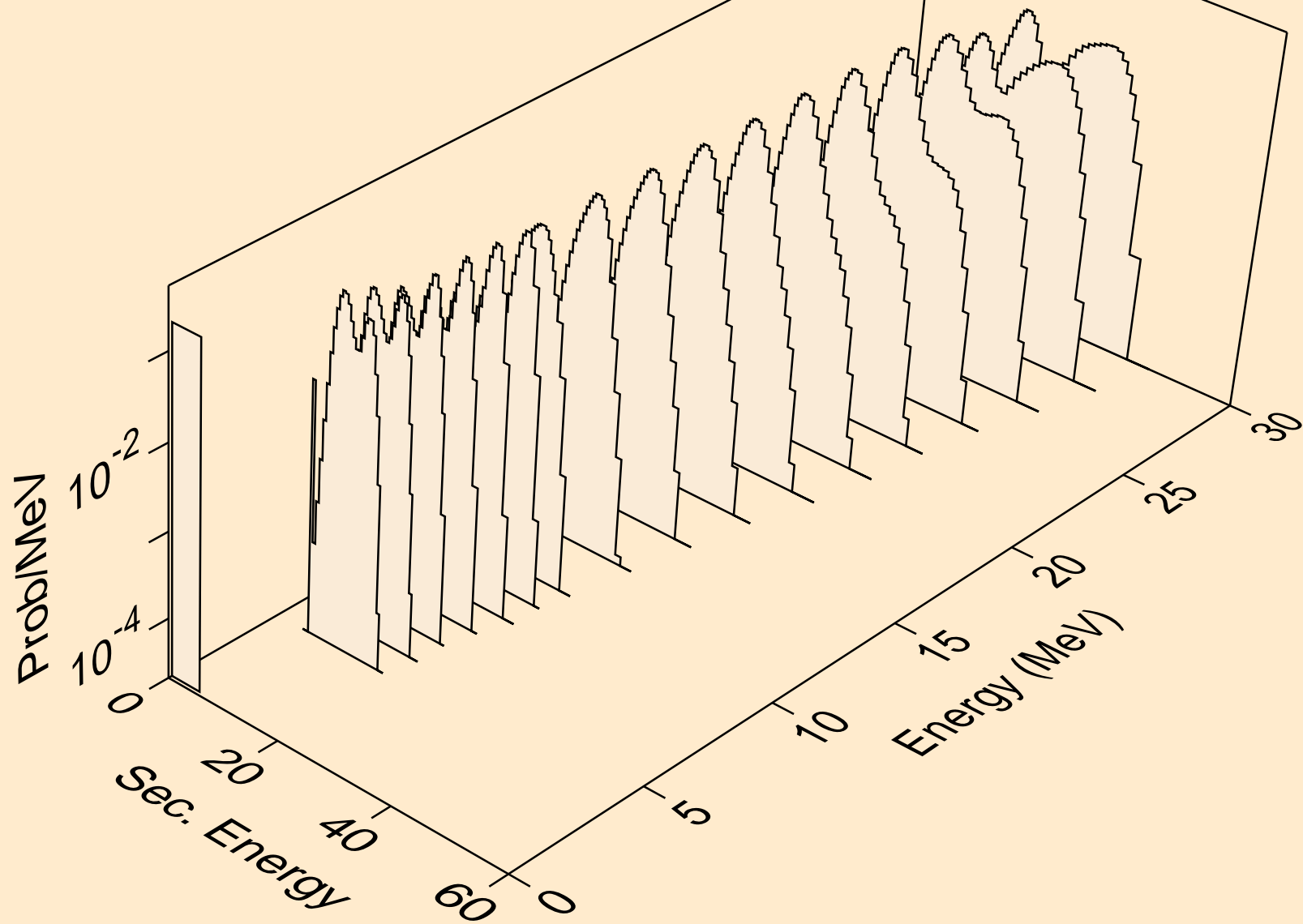



IR172 TRITON ACER TENDL-2021 LIBRARY; T=0.K  
alphas from (t,t2a)

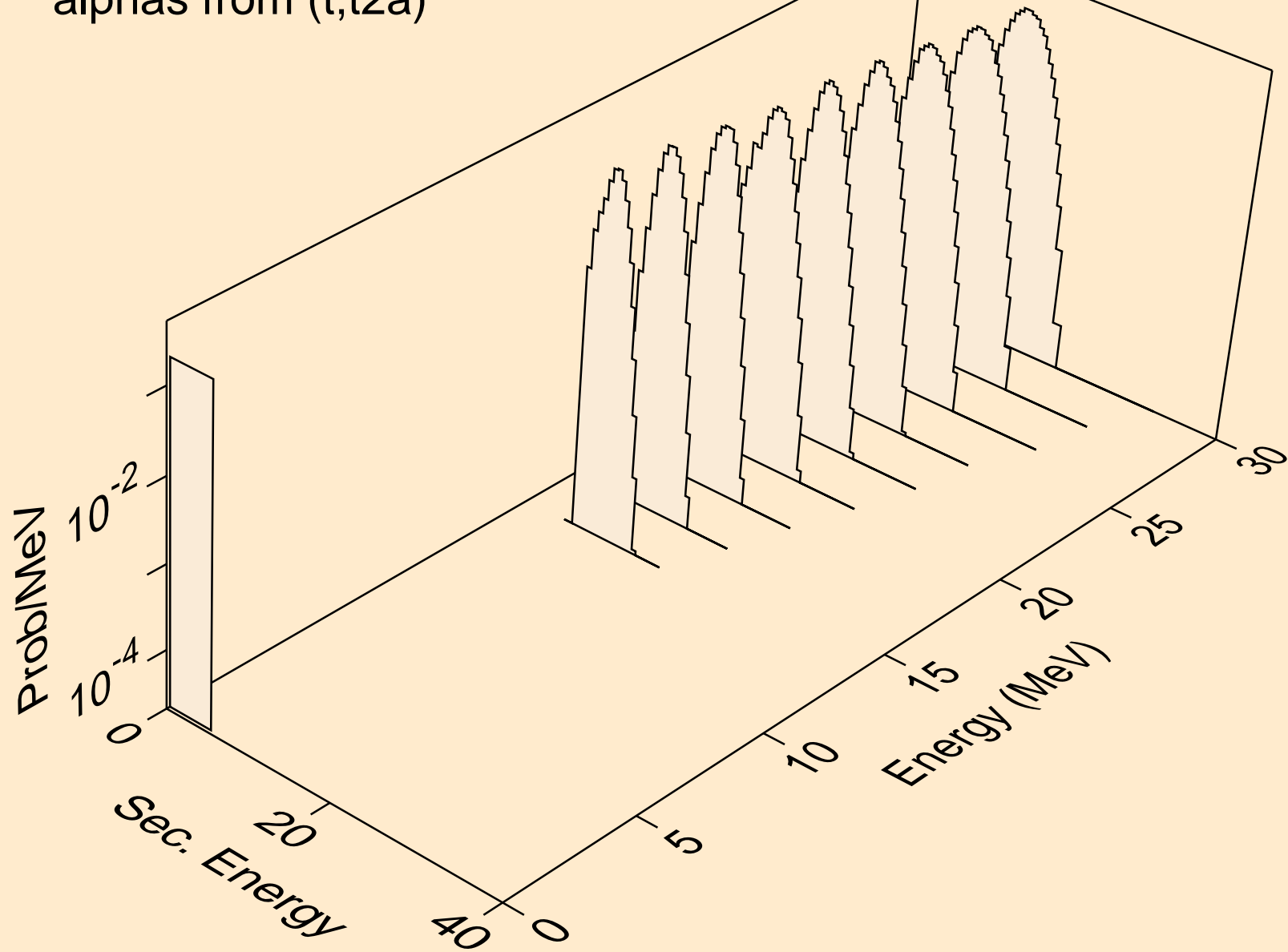

IR172 TRITON ACER TENDL-2021 LIBRARY; T=0.K  
alphas from (t,d2a)

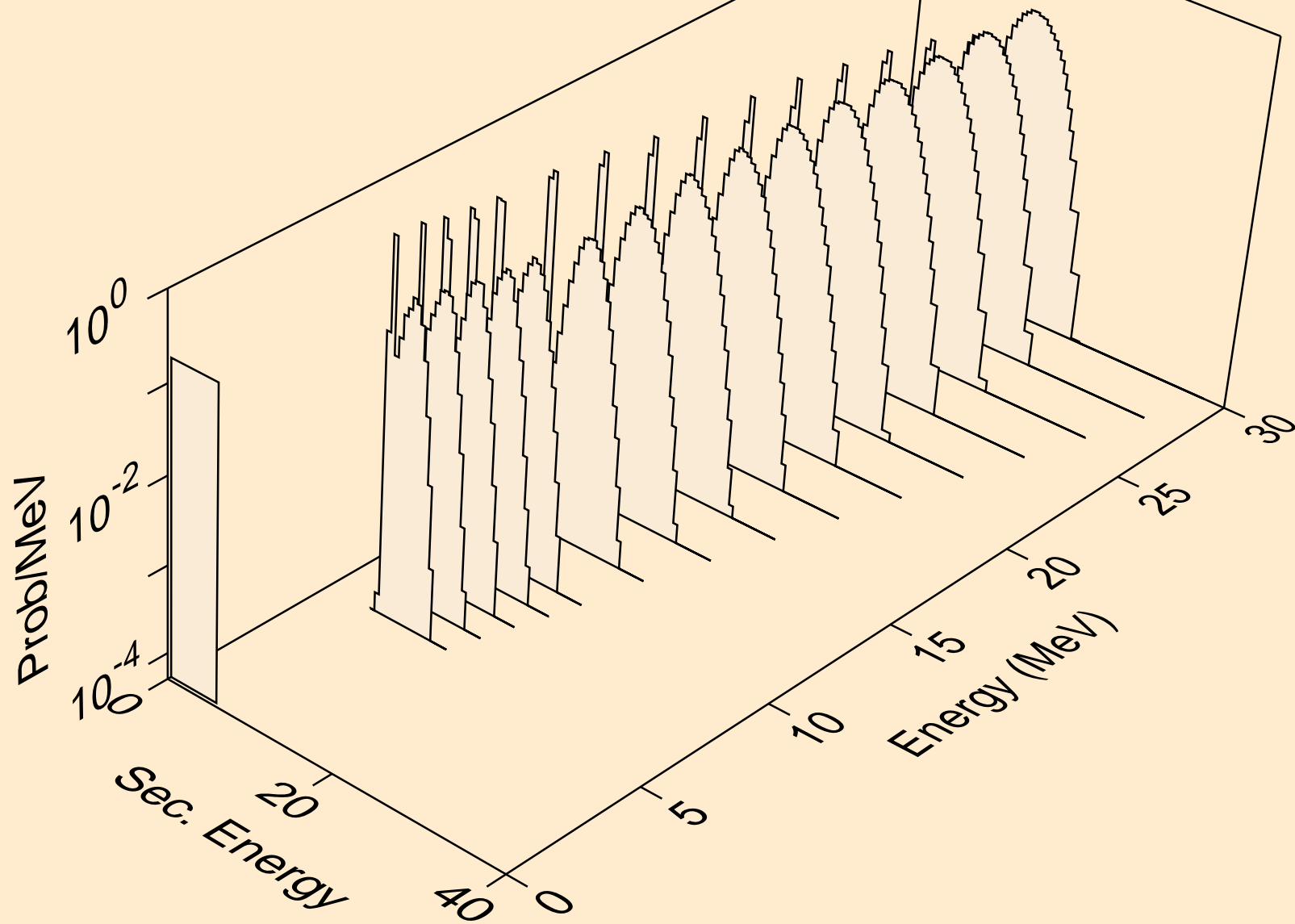

IR172 TRITON ACER TENDL-2021 LIBRARY; T=0.K  
alphas from (t,da)

