

IR197 TRITON ACER TENDL-2021 LIBRARY; T=0.K  
Principal cross sections

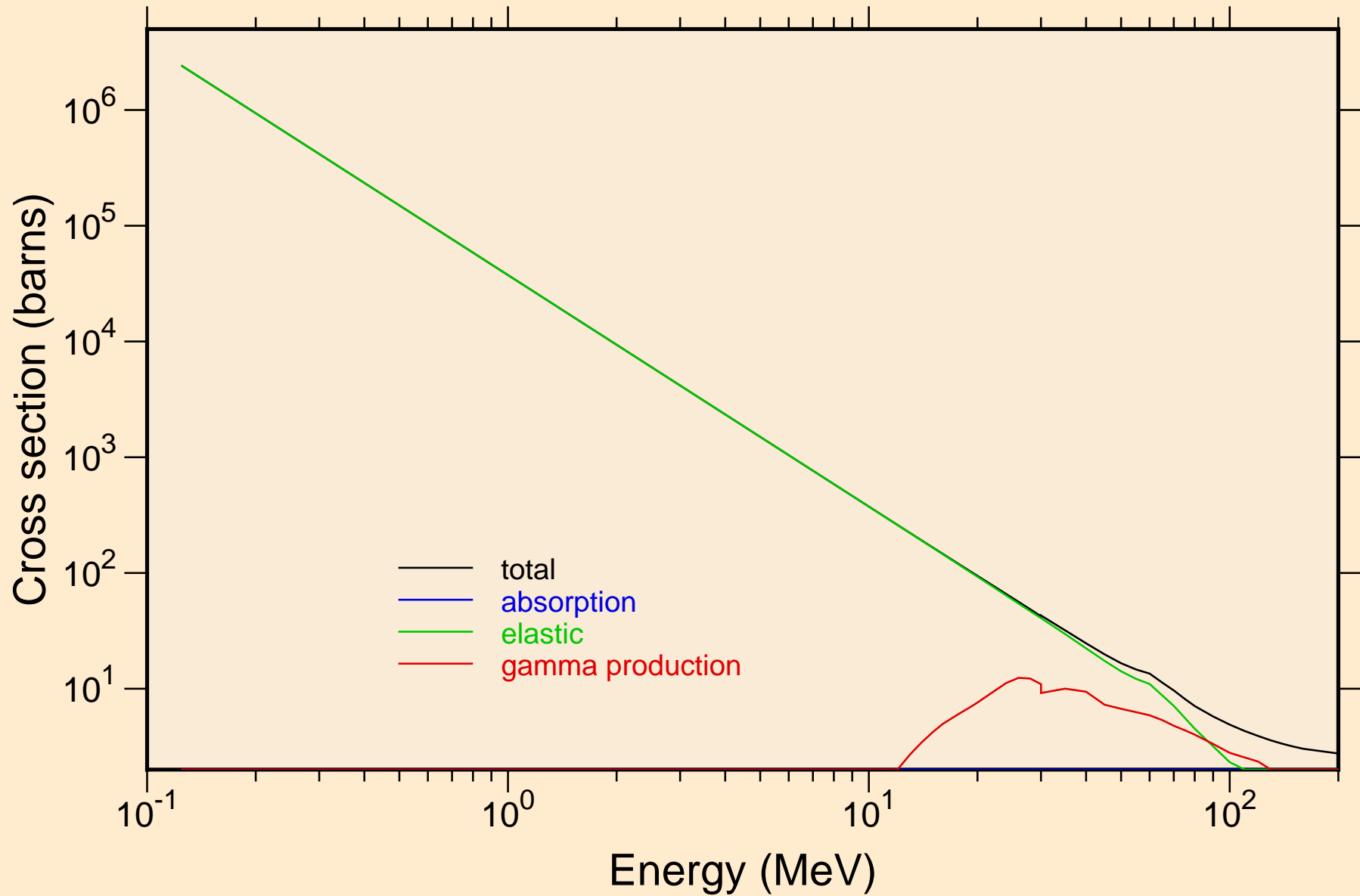

IR197 TRITON ACER TENDL-2021 LIBRARY; T=0.K

Heating

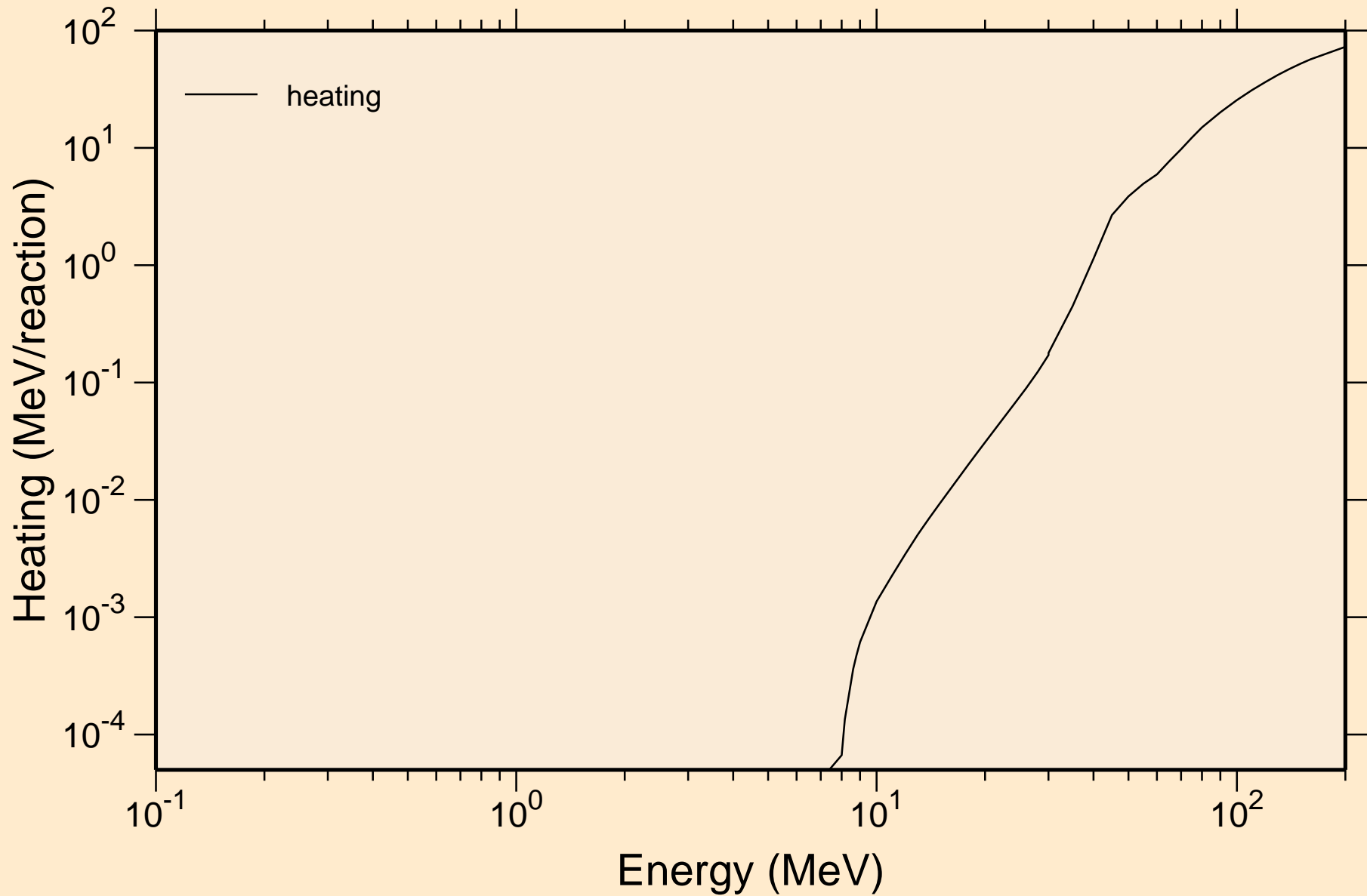

IR197 TRITON ACER TENDL-2021 LIBRARY; T=0.K

Principal cross sections

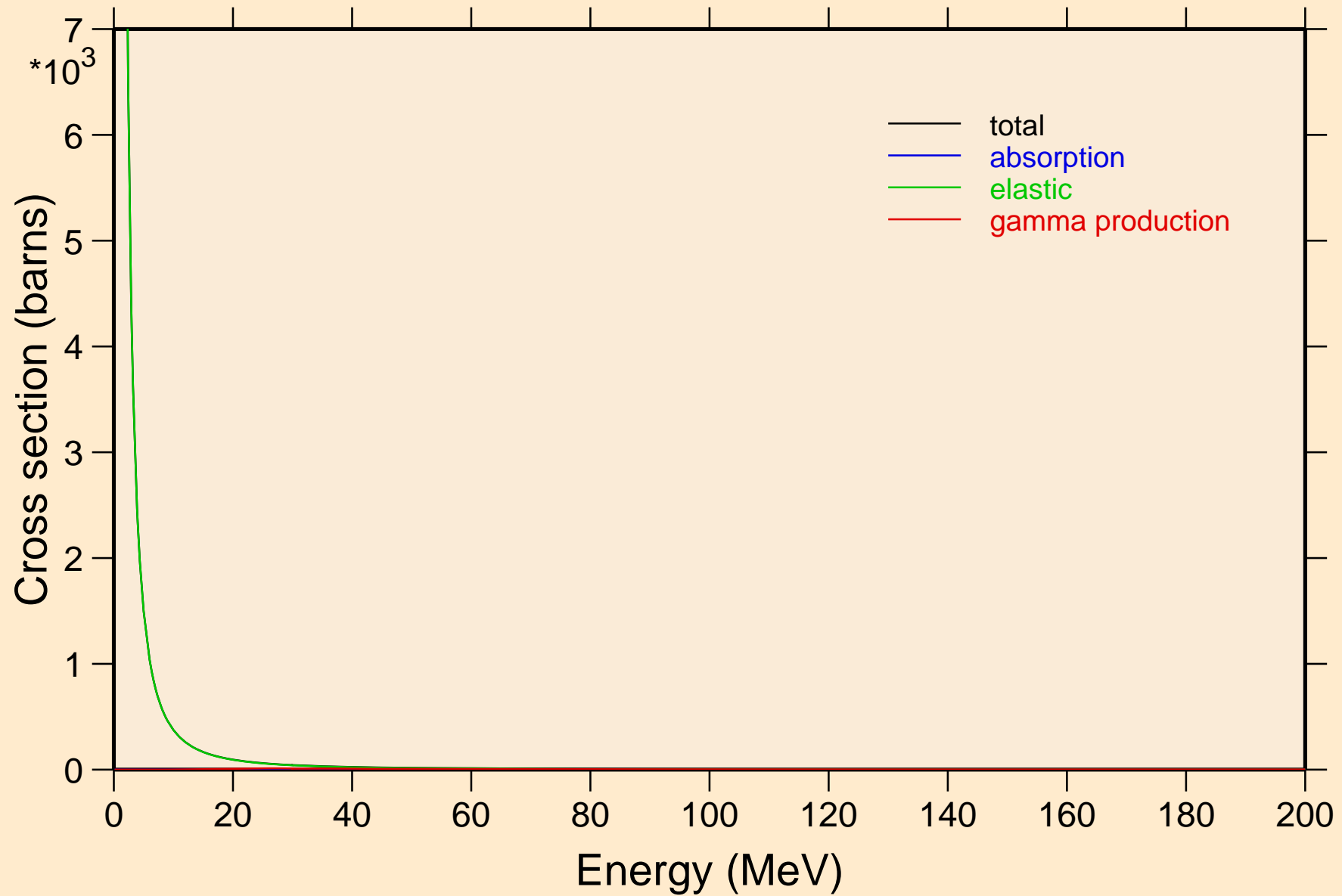

IR197 TRITON ACER TENDL-2021 LIBRARY; T=0.K

Heating

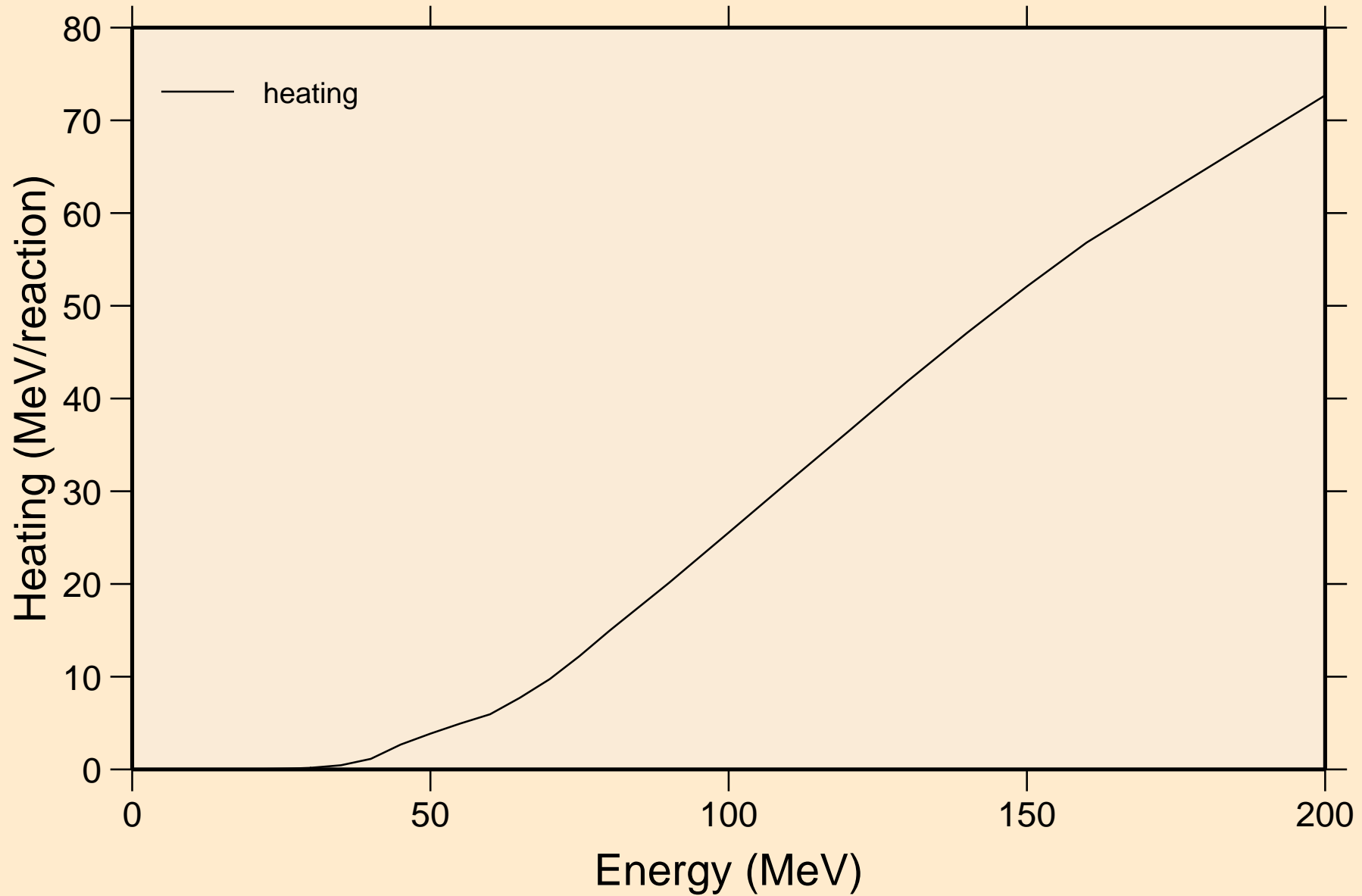

IR197 TRITON ACER TENDL-2021 LIBRARY; T=0.K  
Threshold reactions

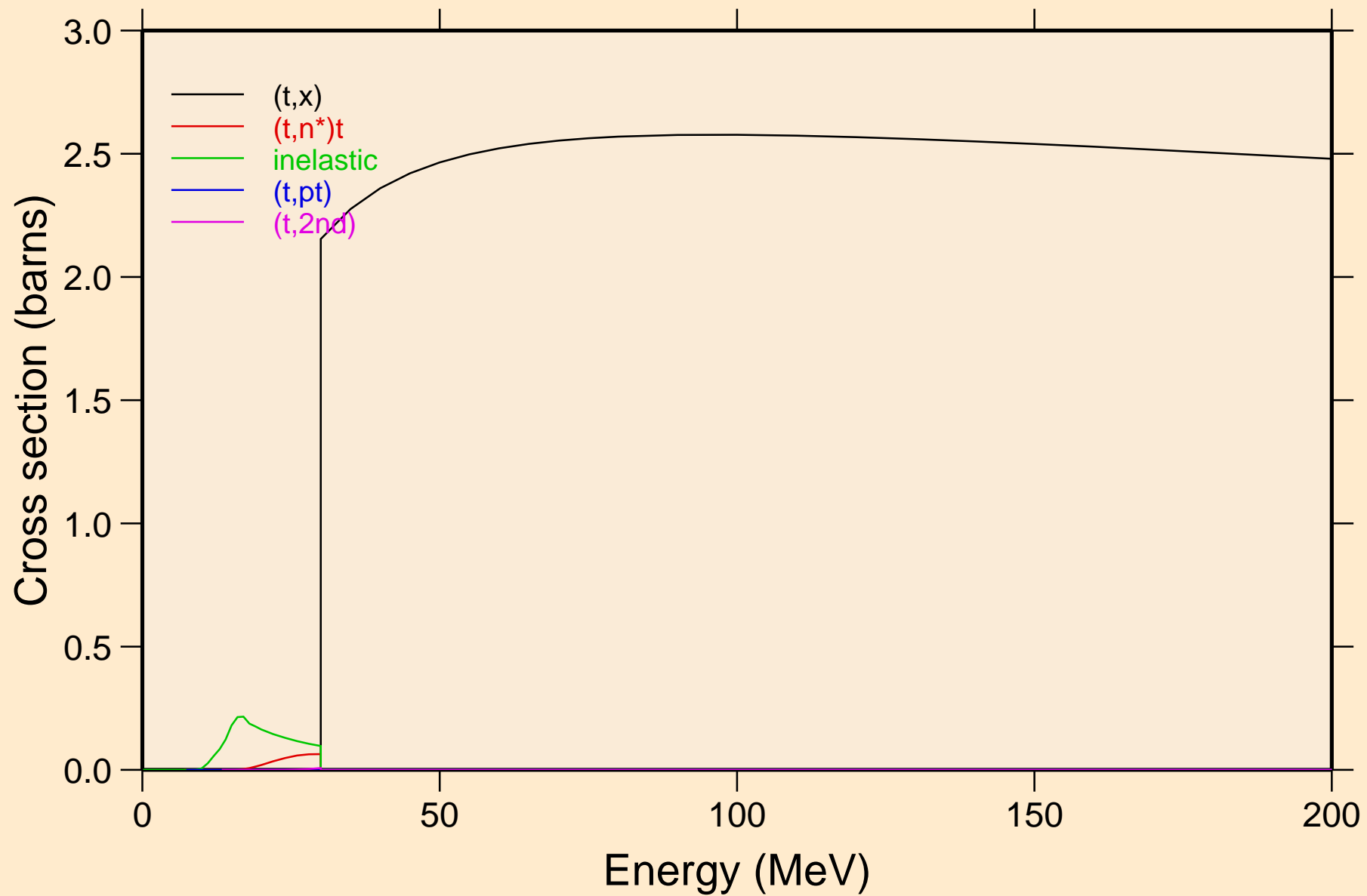

IR197 TRITON ACER TENDL-2021 LIBRARY; T=0.K  
Threshold reactions

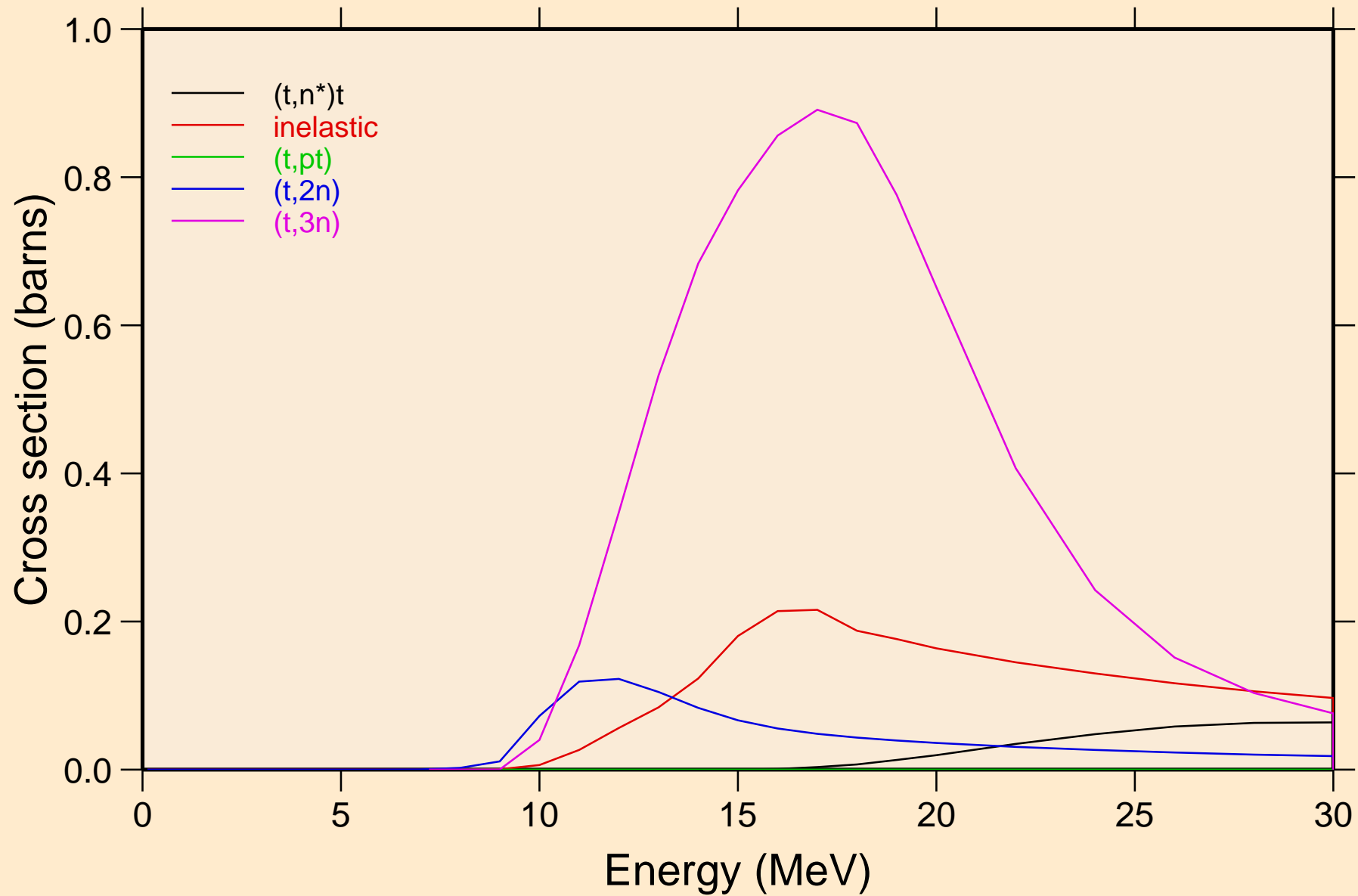

IR197 TRITON ACER TENDL-2021 LIBRARY; T=0.K  
Threshold reactions

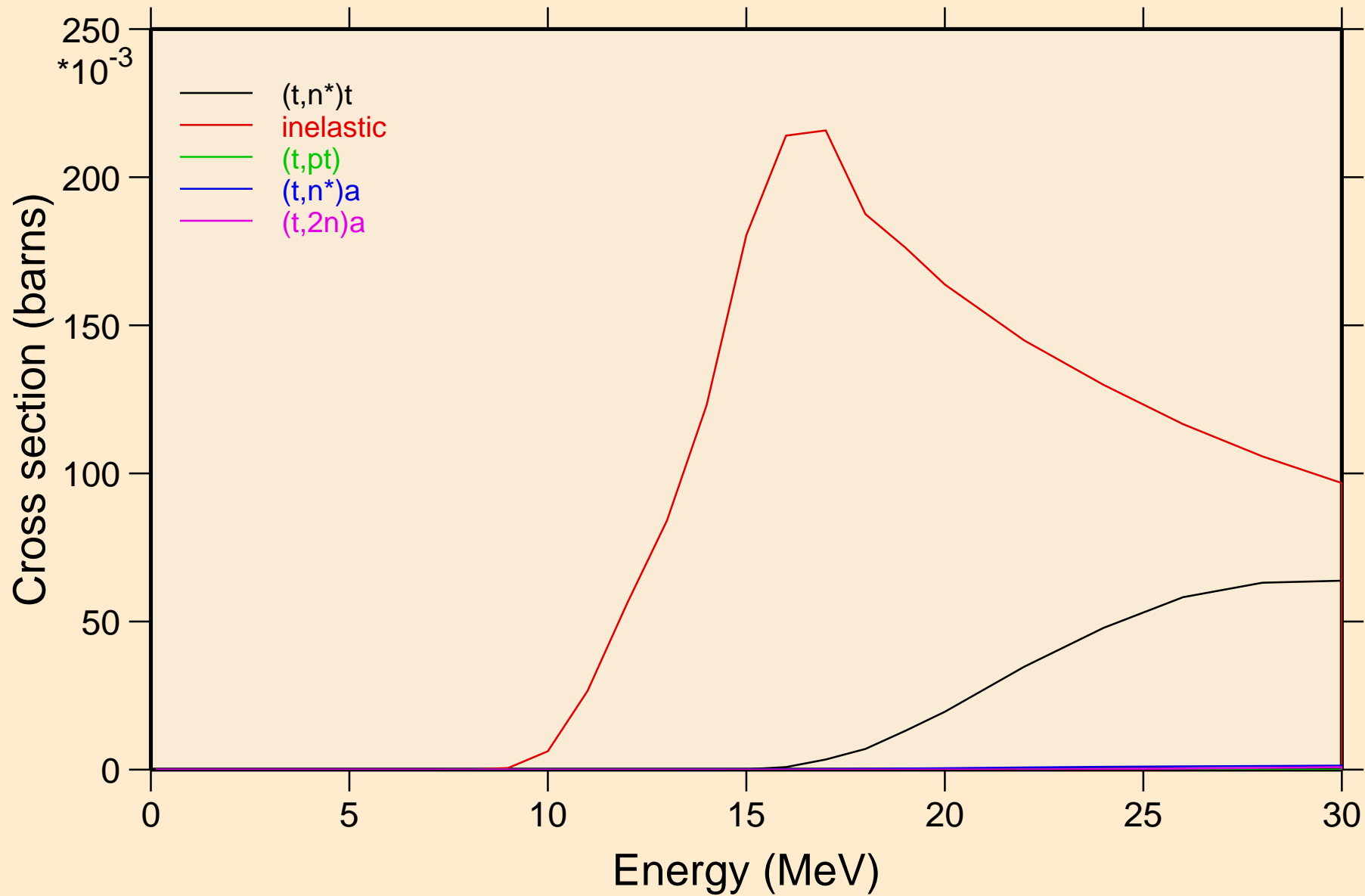

IR197 TRITON ACER TENDL-2021 LIBRARY; T=0.K  
Threshold reactions

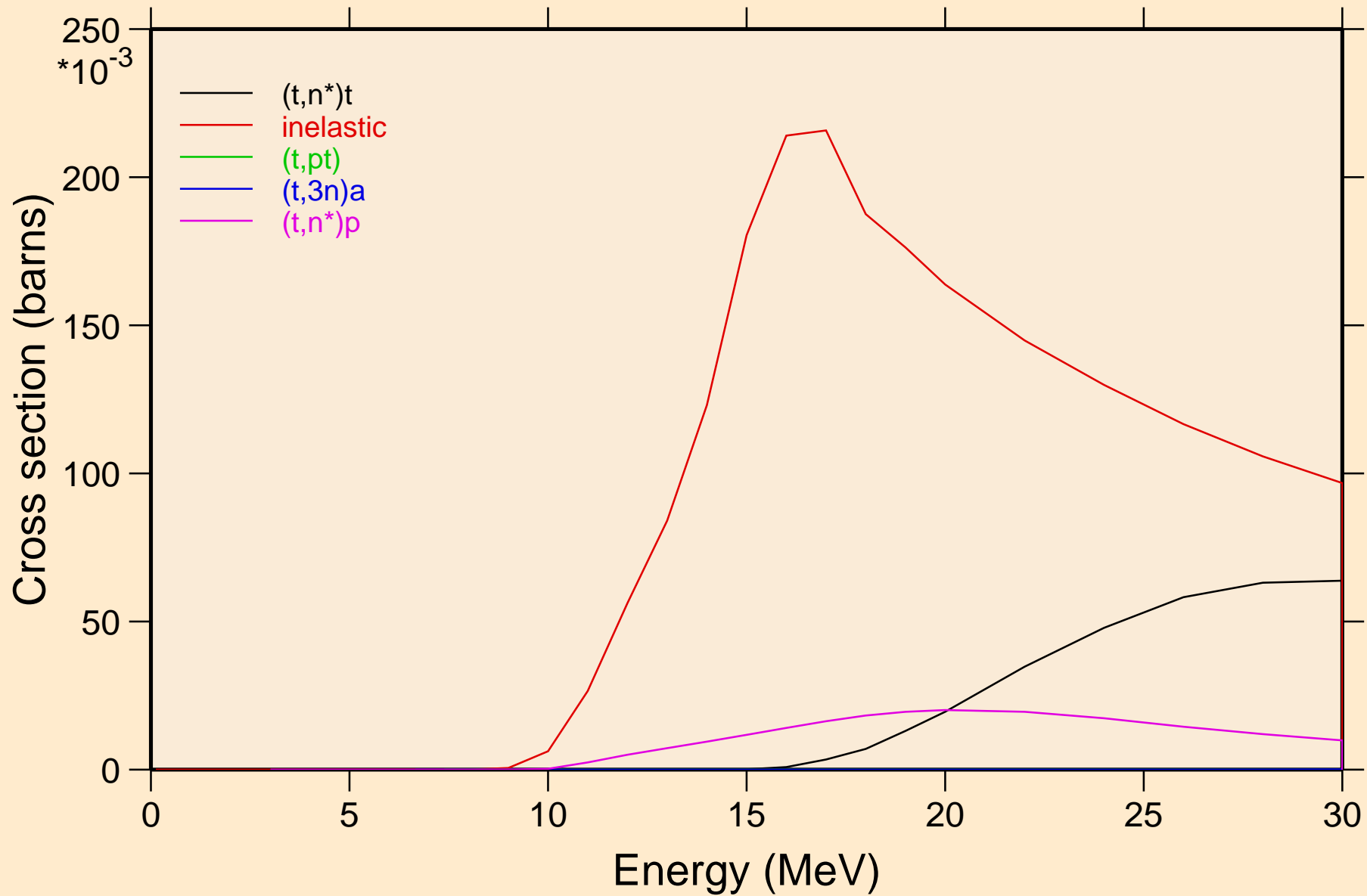



IR197 TRITON ACER TENDL-2021 LIBRARY; T=0.K  
Threshold reactions

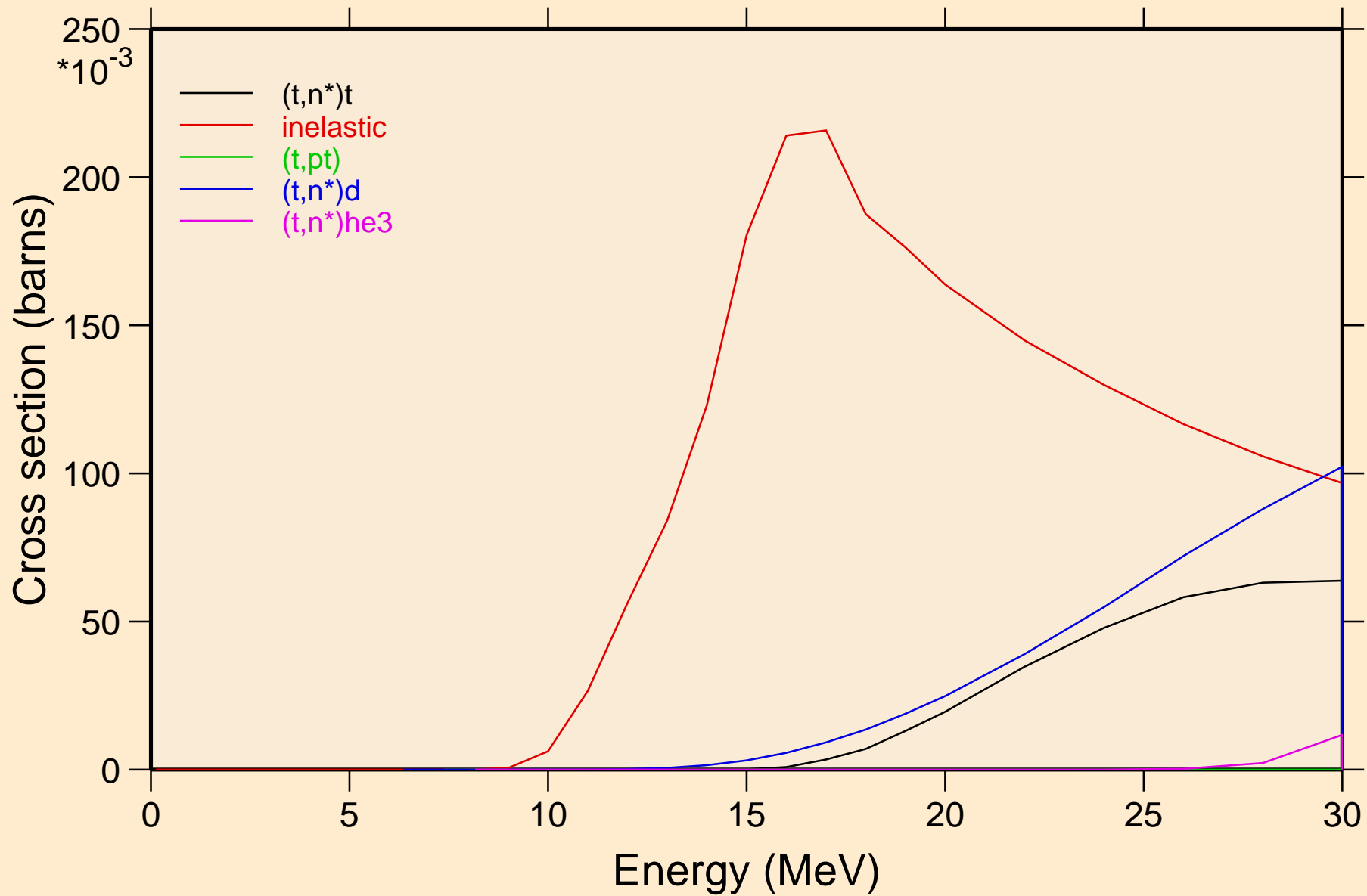

IR197 TRITON ACER TENDL-2021 LIBRARY; T=0.K  
Threshold reactions

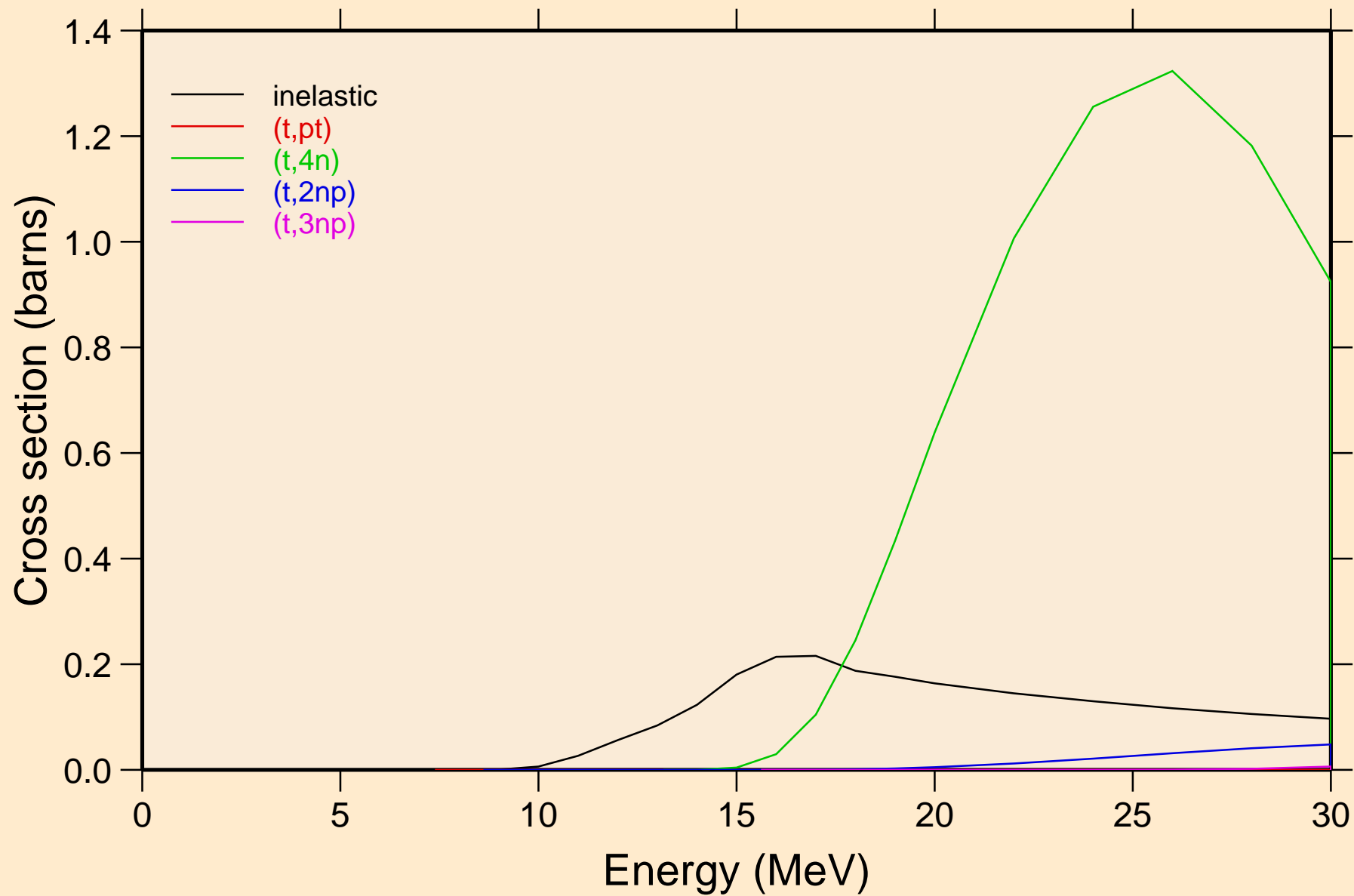

IR197 TRITON ACER TENDL-2021 LIBRARY; T=0.K  
Threshold reactions

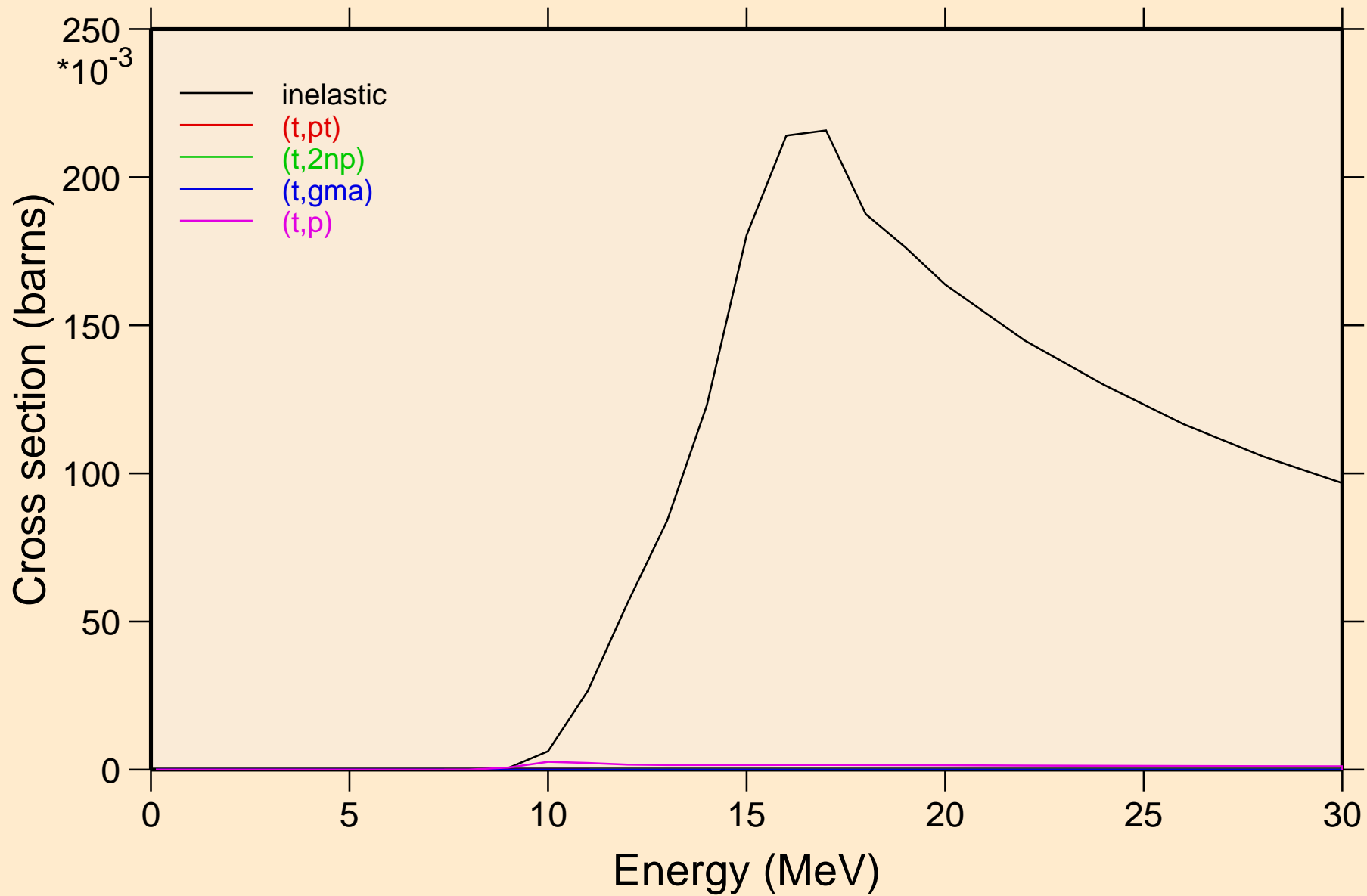

IR197 TRITON ACER TENDL-2021 LIBRARY; T=0.K  
Threshold reactions

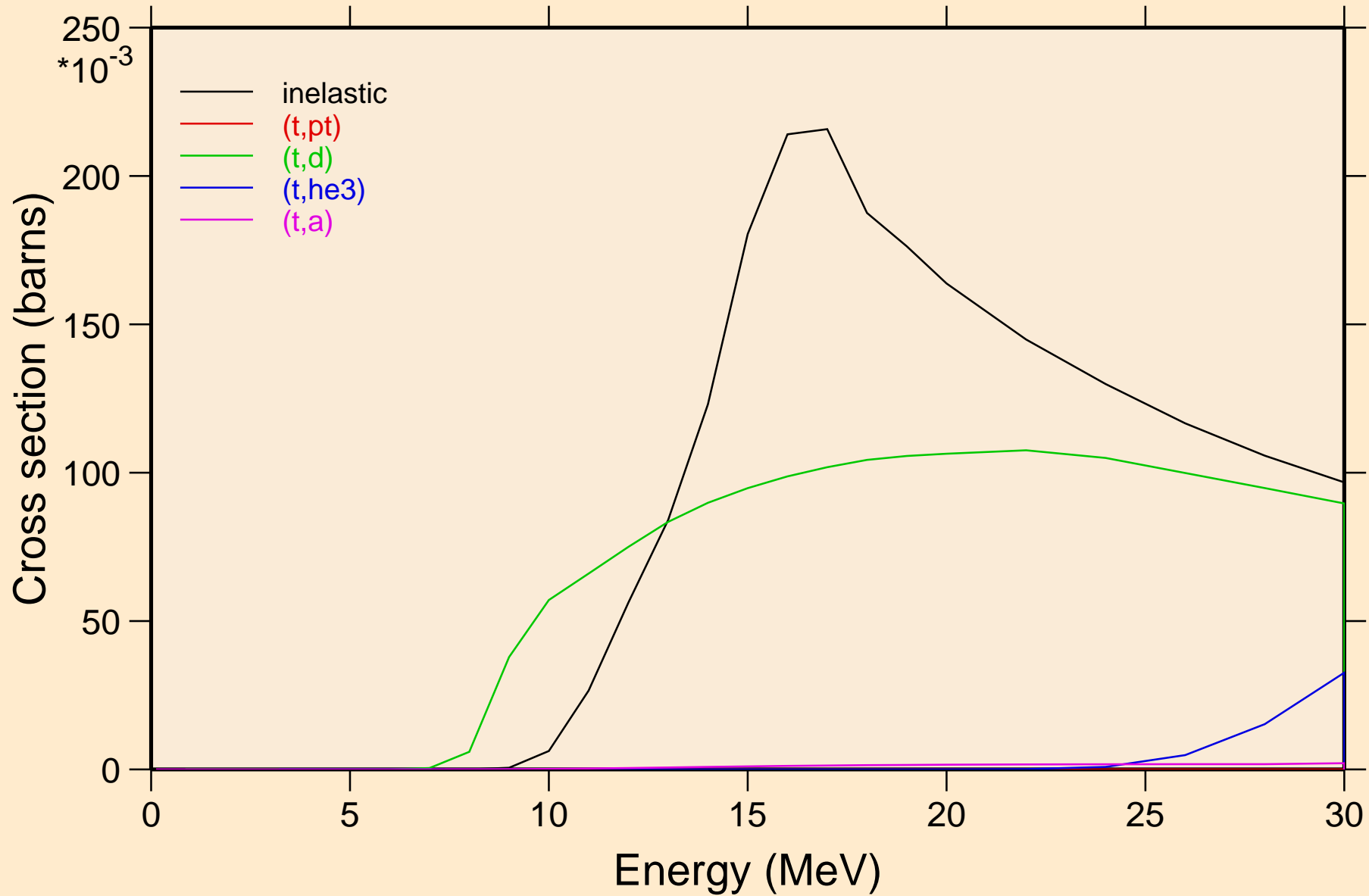

IR197 TRITON ACER TENDL-2021 LIBRARY; T=0.K  
Threshold reactions

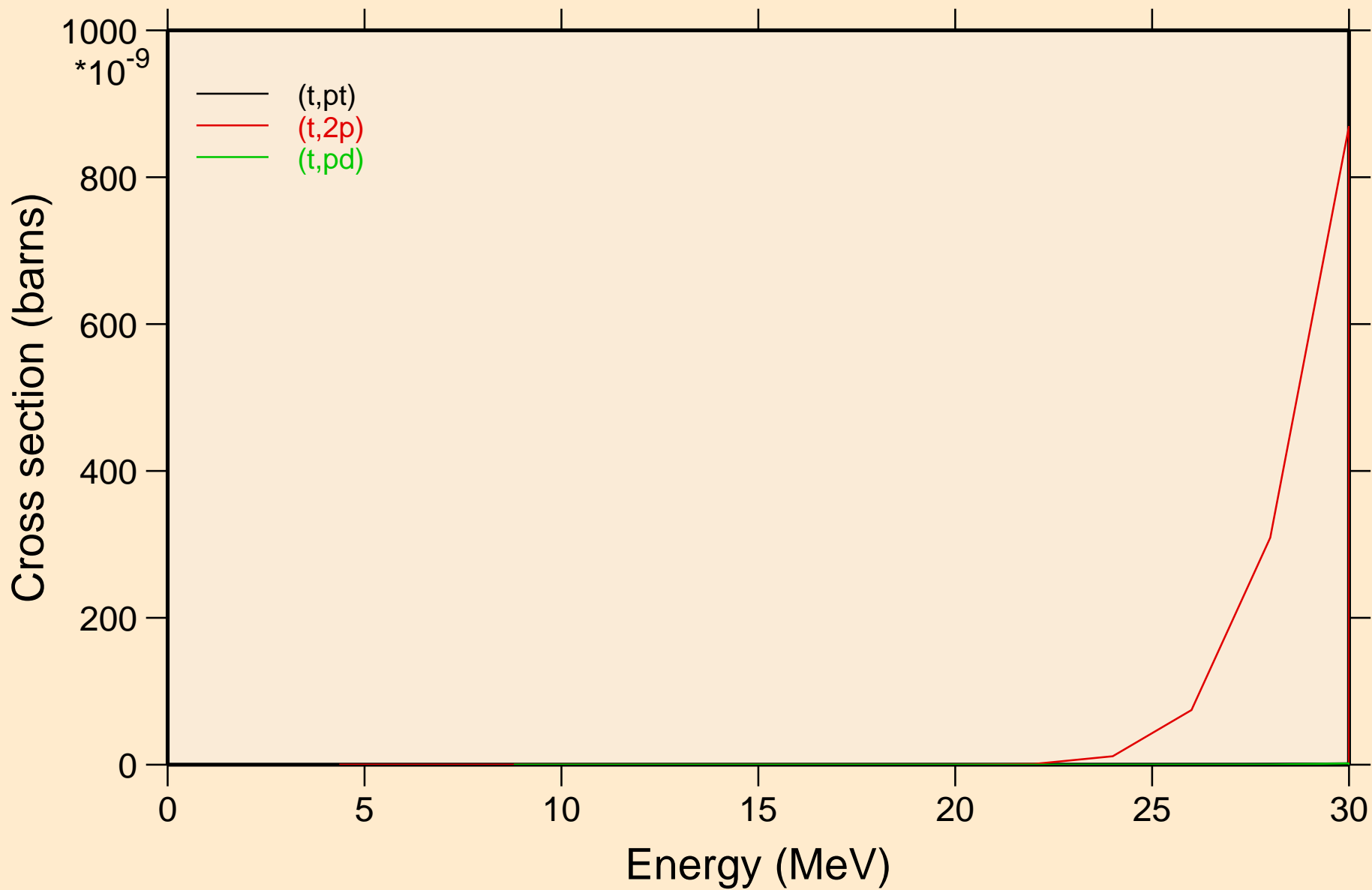

IR197 TRITON ACER TENDL-2021 LIBRARY; T=0.K  
Threshold reactions

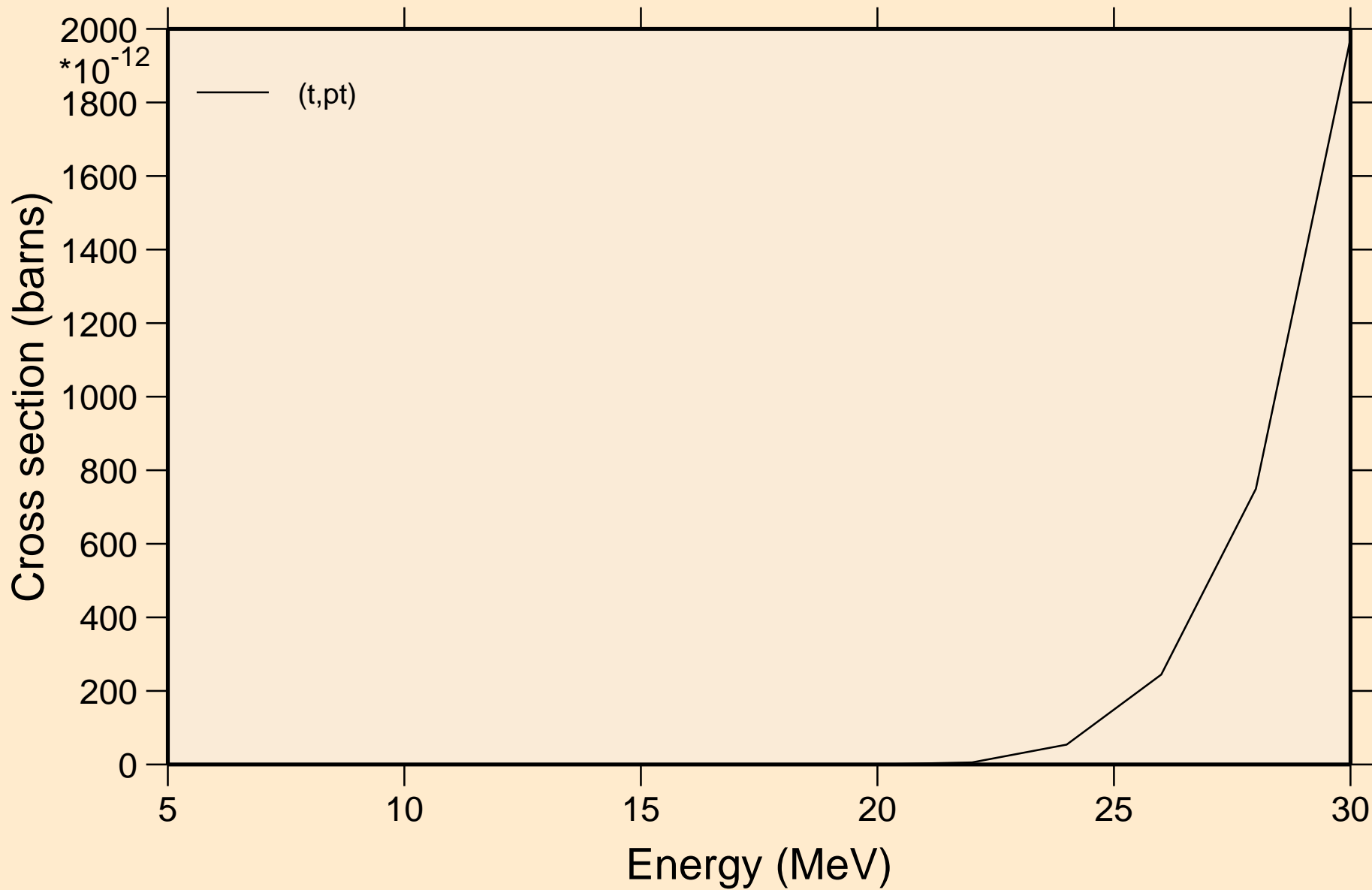

IR197 TRITON ACER TENDL-2021 LIBRARY; T=0.K  
angular distribution for elastic

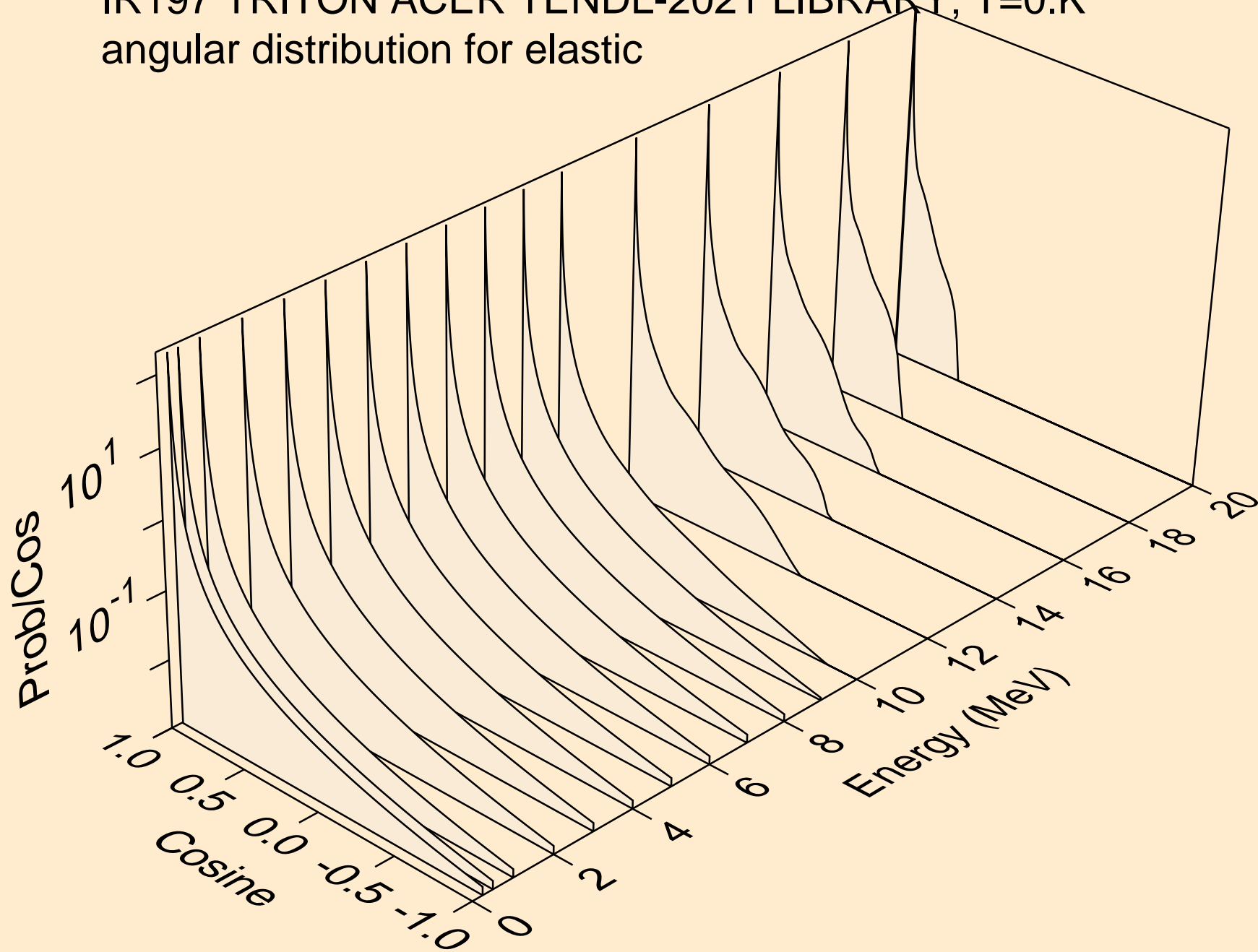

IR197 TRITON ACER TENDL-2021 LIBRARY; T=0.K  
angular distribution for elastic

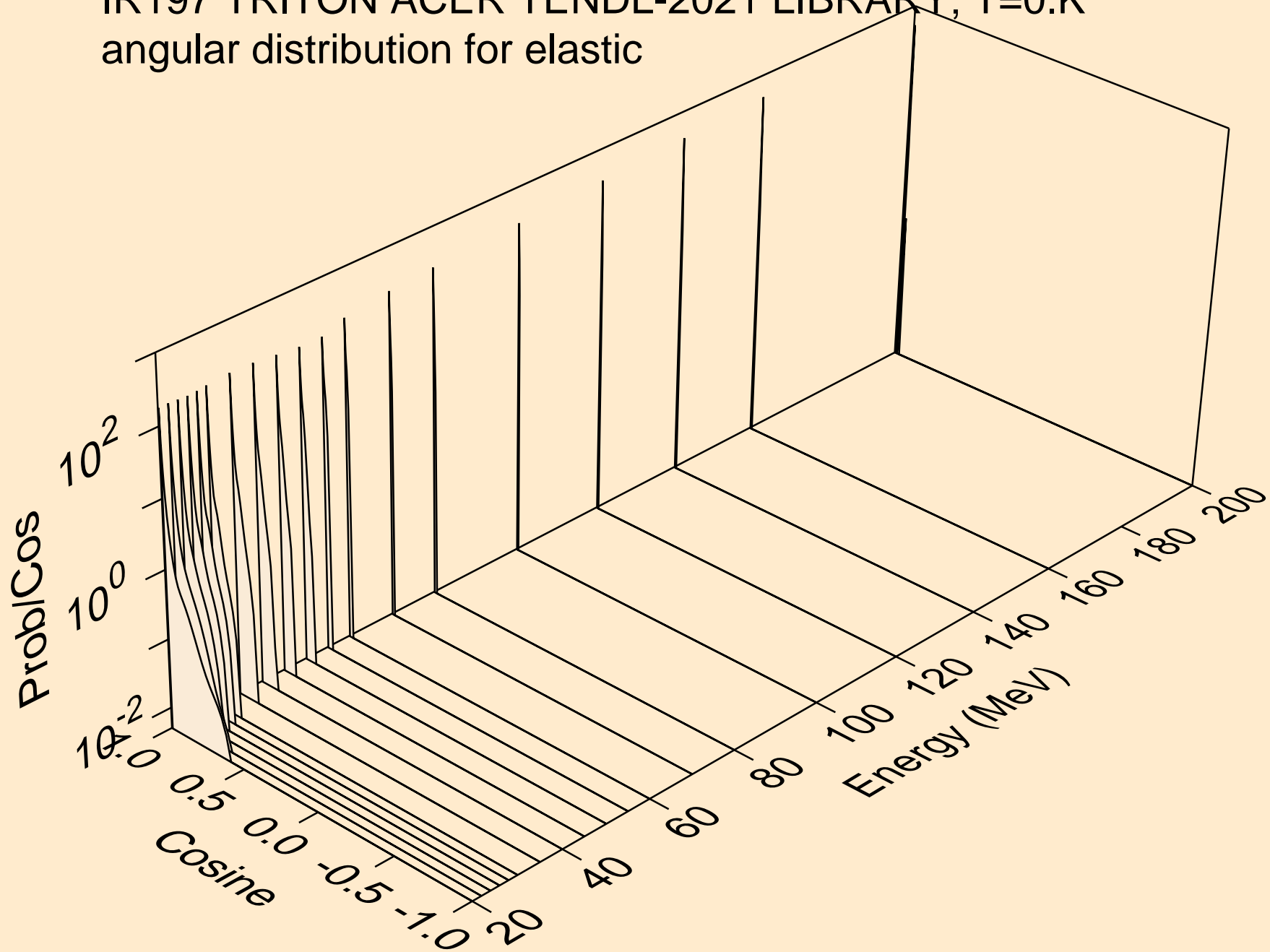



IR197 TRITON ACER TENDL-2021 LIBRARY; T=0.K  
Triton emission for (t,x)

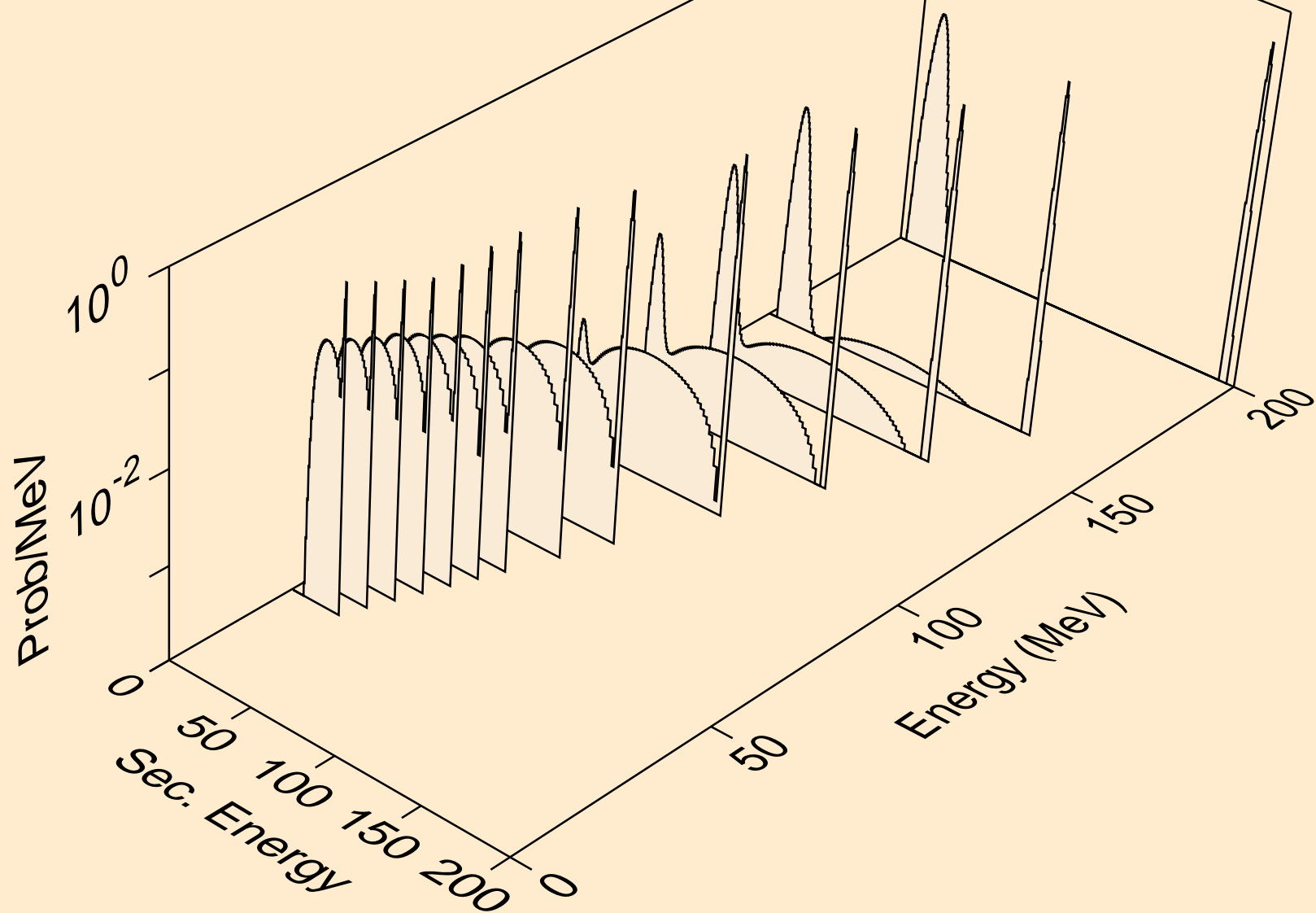

IR197 TRITON ACER TENDL-2021 LIBRARY; T=0.K  
Triton emission for (t,n\*)t

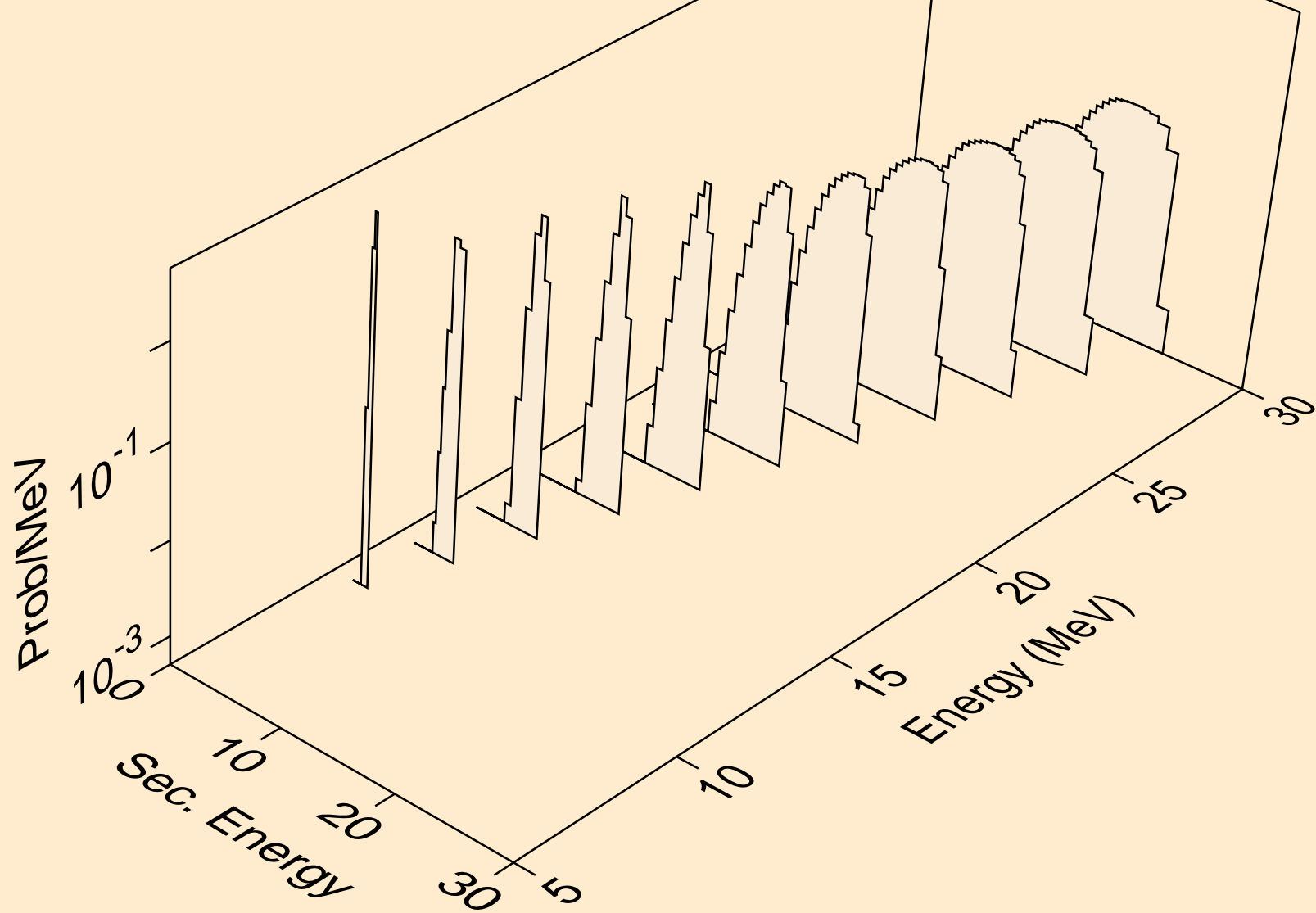

IR197 TRITON ACER TENDL-2021 LIBRARY; T=0.K  
Triton emission for inelastic

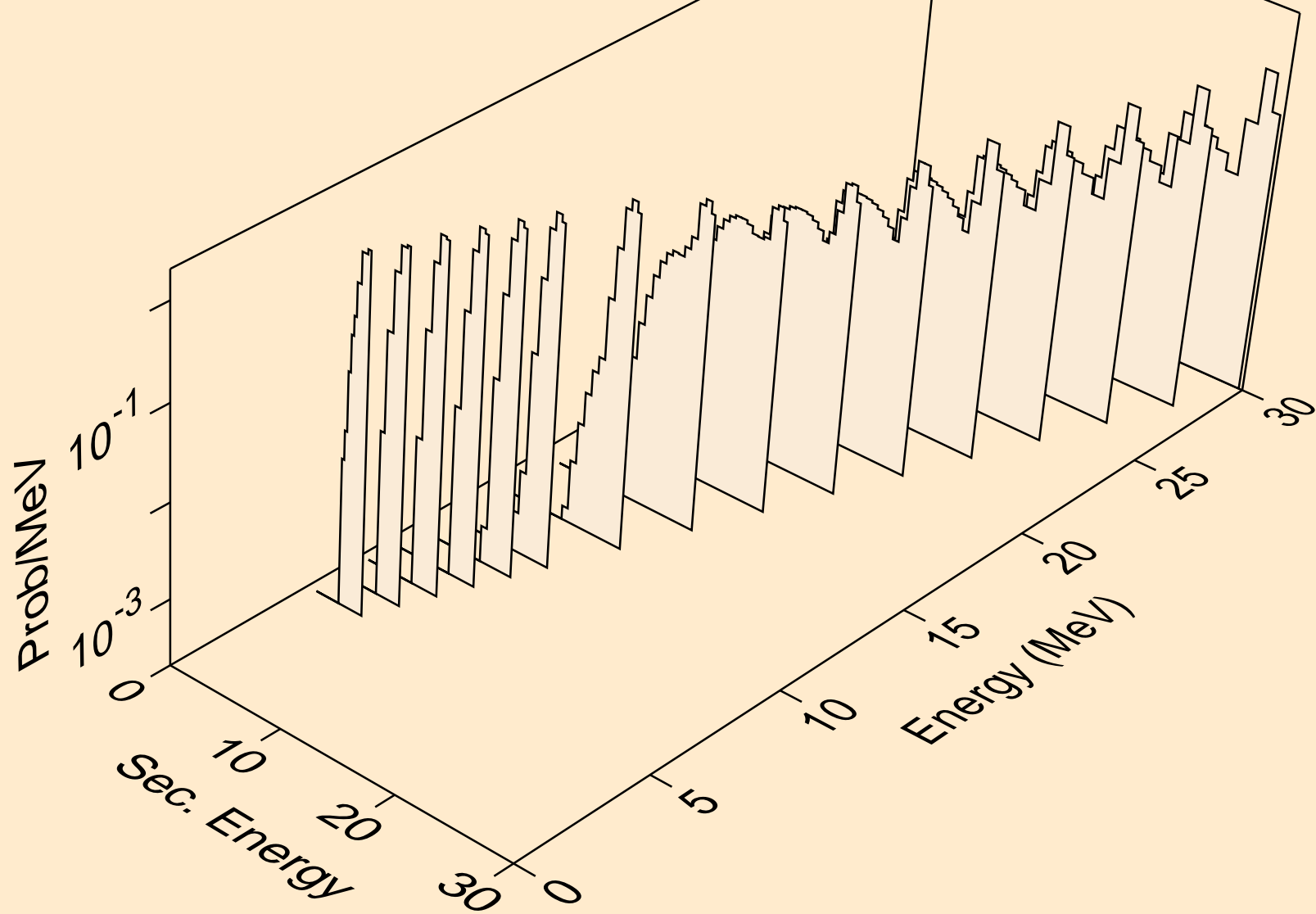

IR197 TRITON ACER TENDL-2021 LIBRARY; T=0.K  
Triton emission for (t,pt)

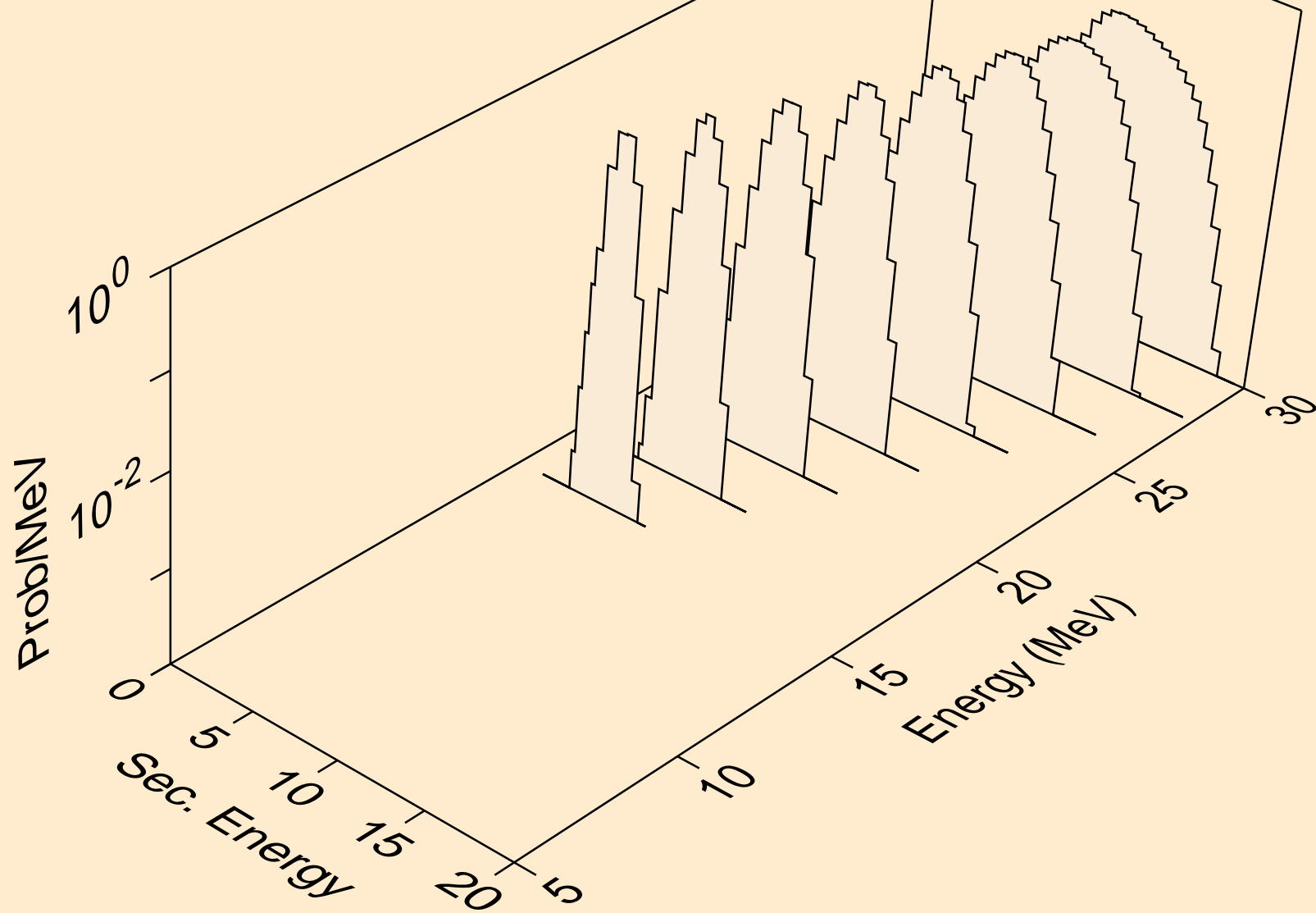

IR197 TRITON ACER TENDL-2021 LIBRARY; T=0.K  
Photon emission for (z,n)

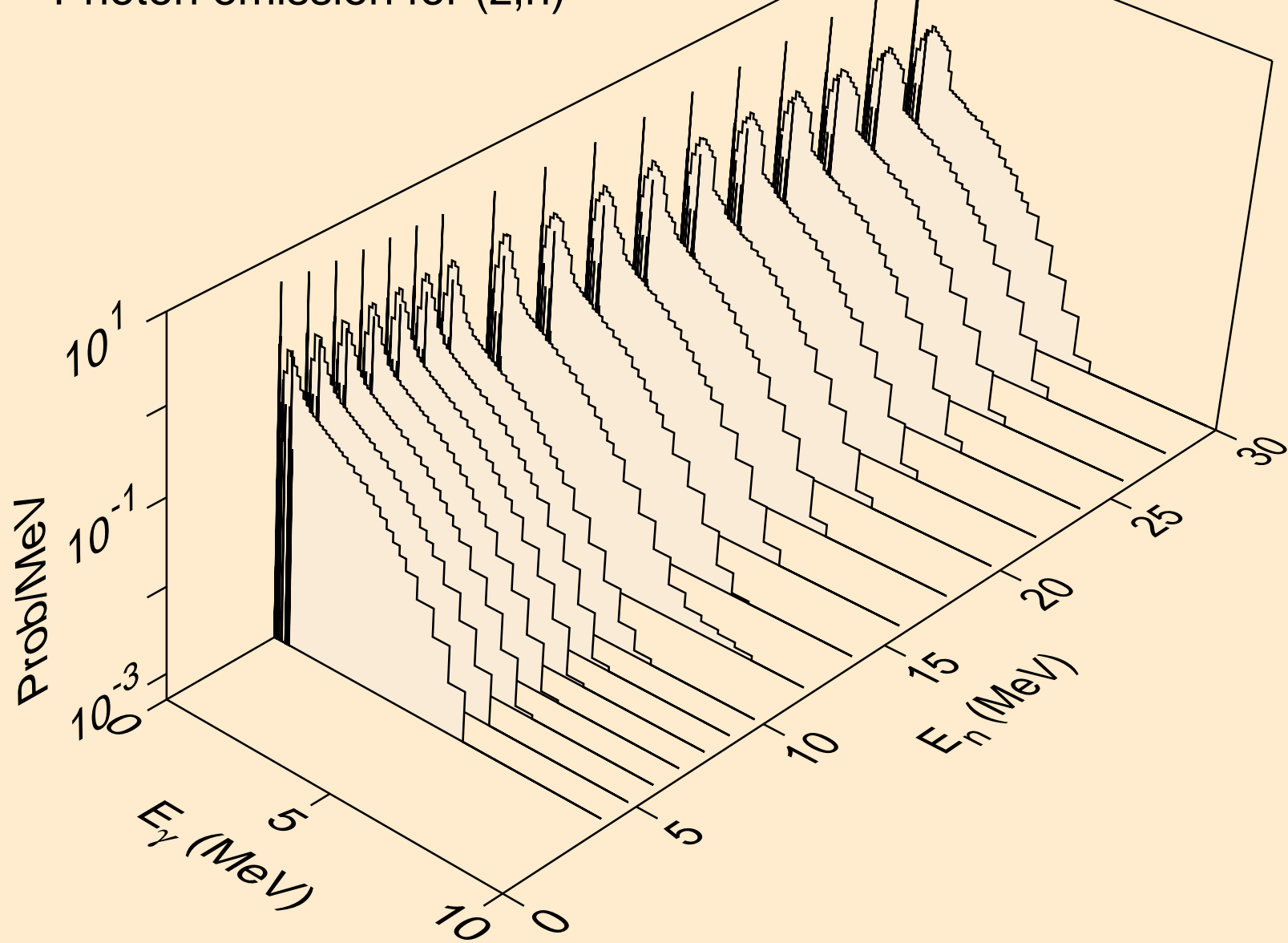

IR197 TRITON ACER TENDL-2021 LIBRARY; T=0.K  
Photon emission for (n,x)

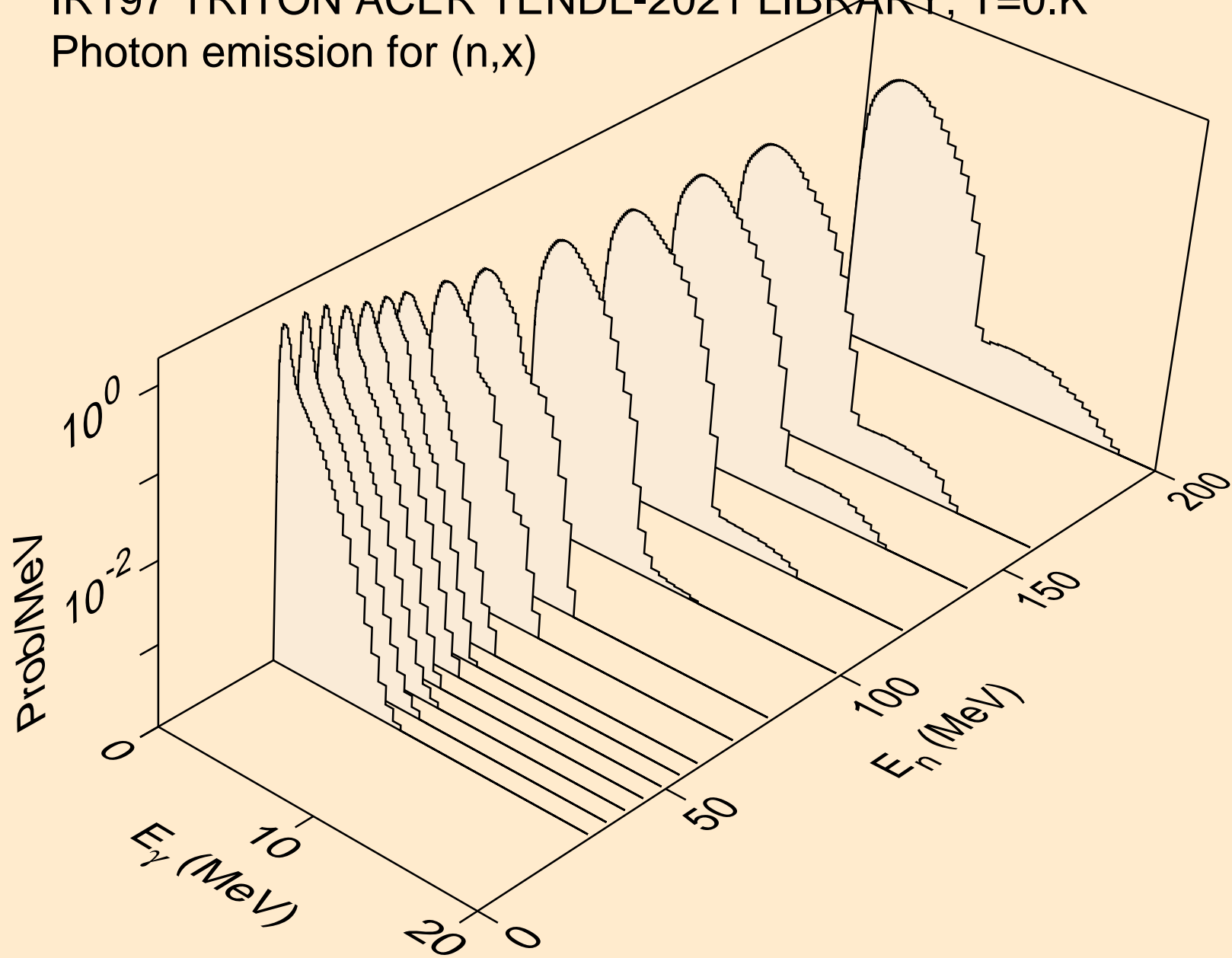

IR197 TRITON ACER TENDL-2021 LIBRARY; T=0.K  
Photon emission for (n,2nd)

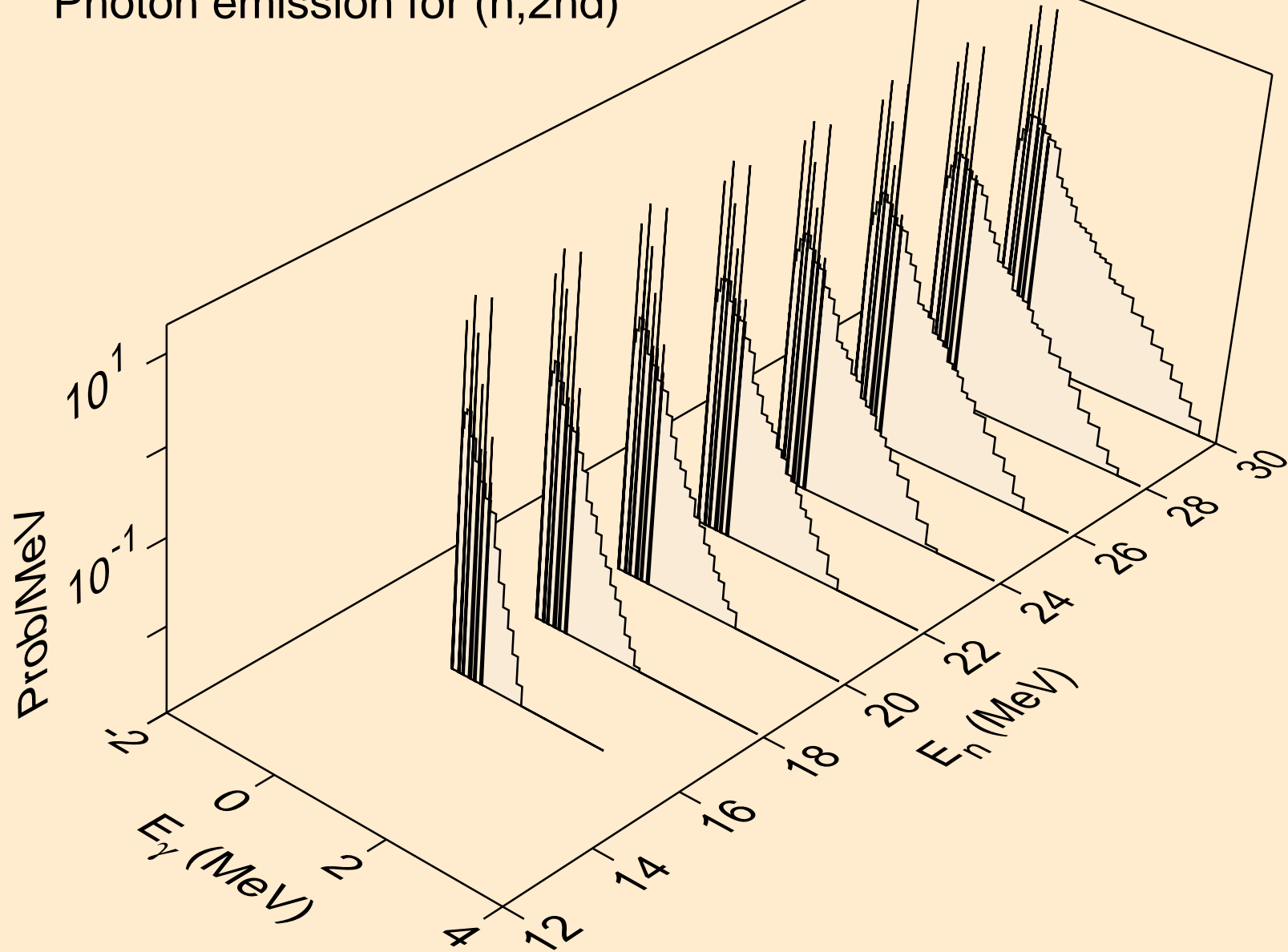

IR197 TRITON ACER TENDL-2021 LIBRARY; T=0.K  
Photon emission for (n,2n)

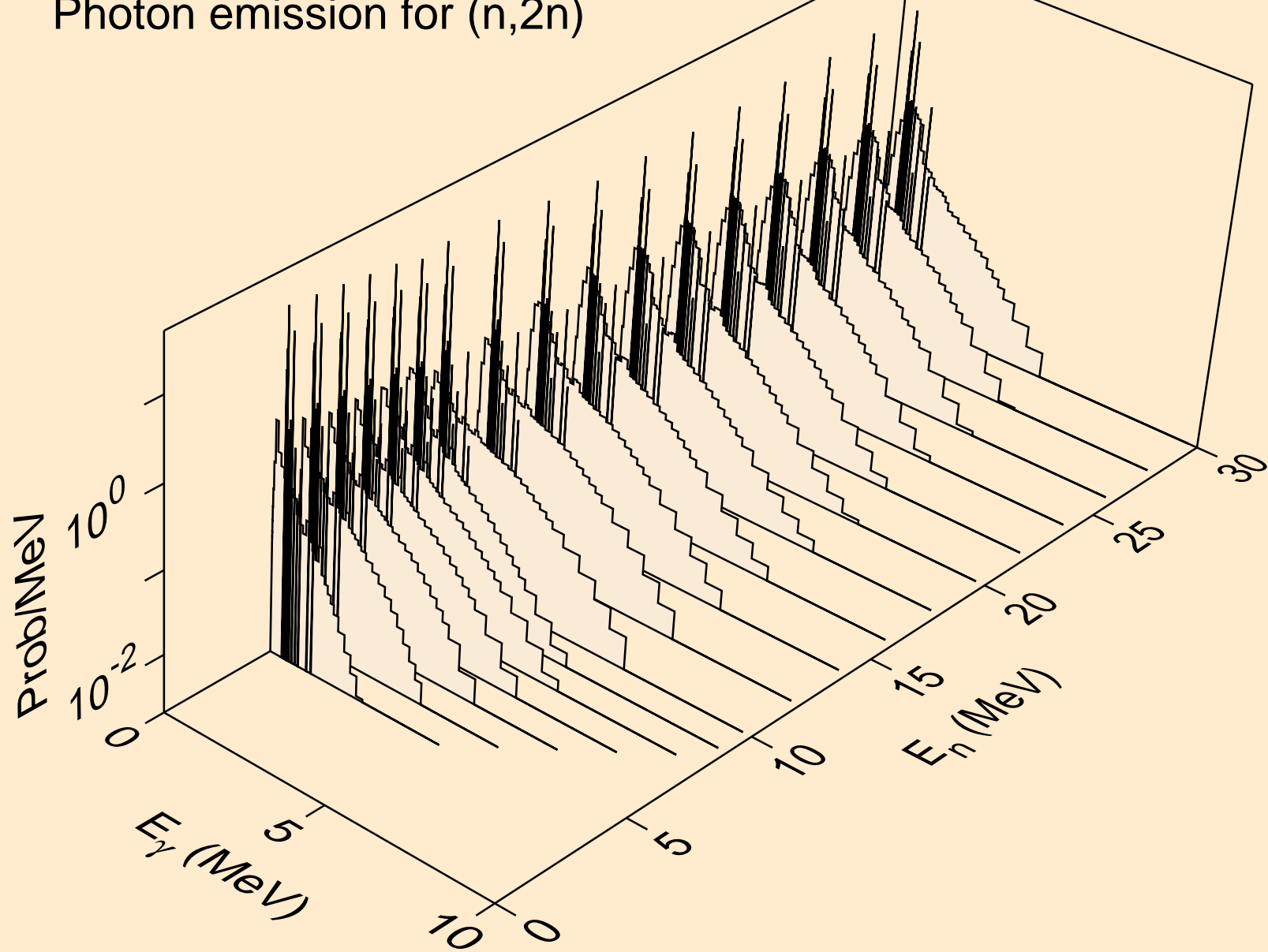



IR197 TRITON ACER TENDL-2021 LIBRARY; T=0.K  
Photon emission for (n,3n)

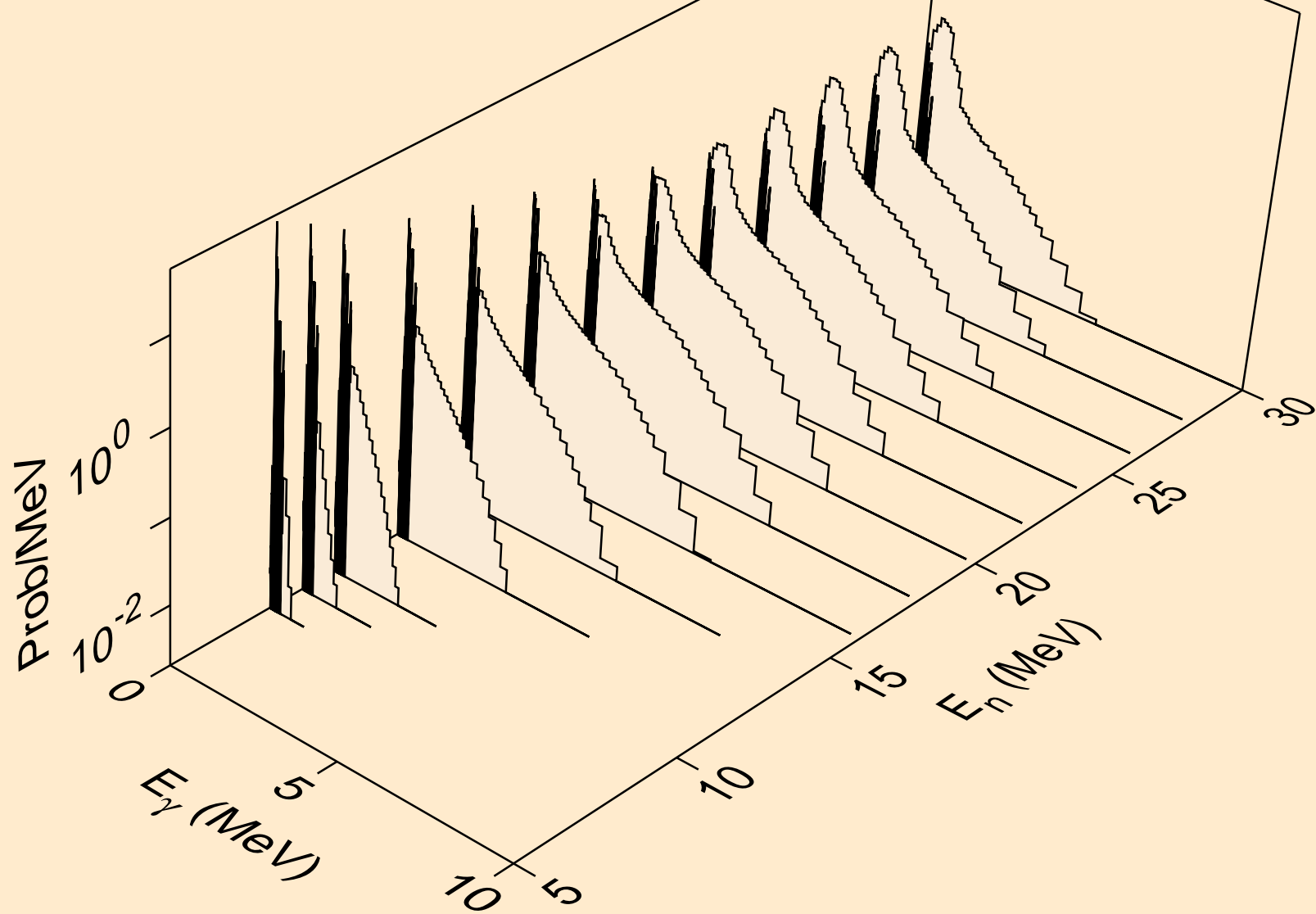

IR197 TRITON ACER TENDL-2021 LIBRARY; T=0.K  
Photon emission for (n,n\*)a

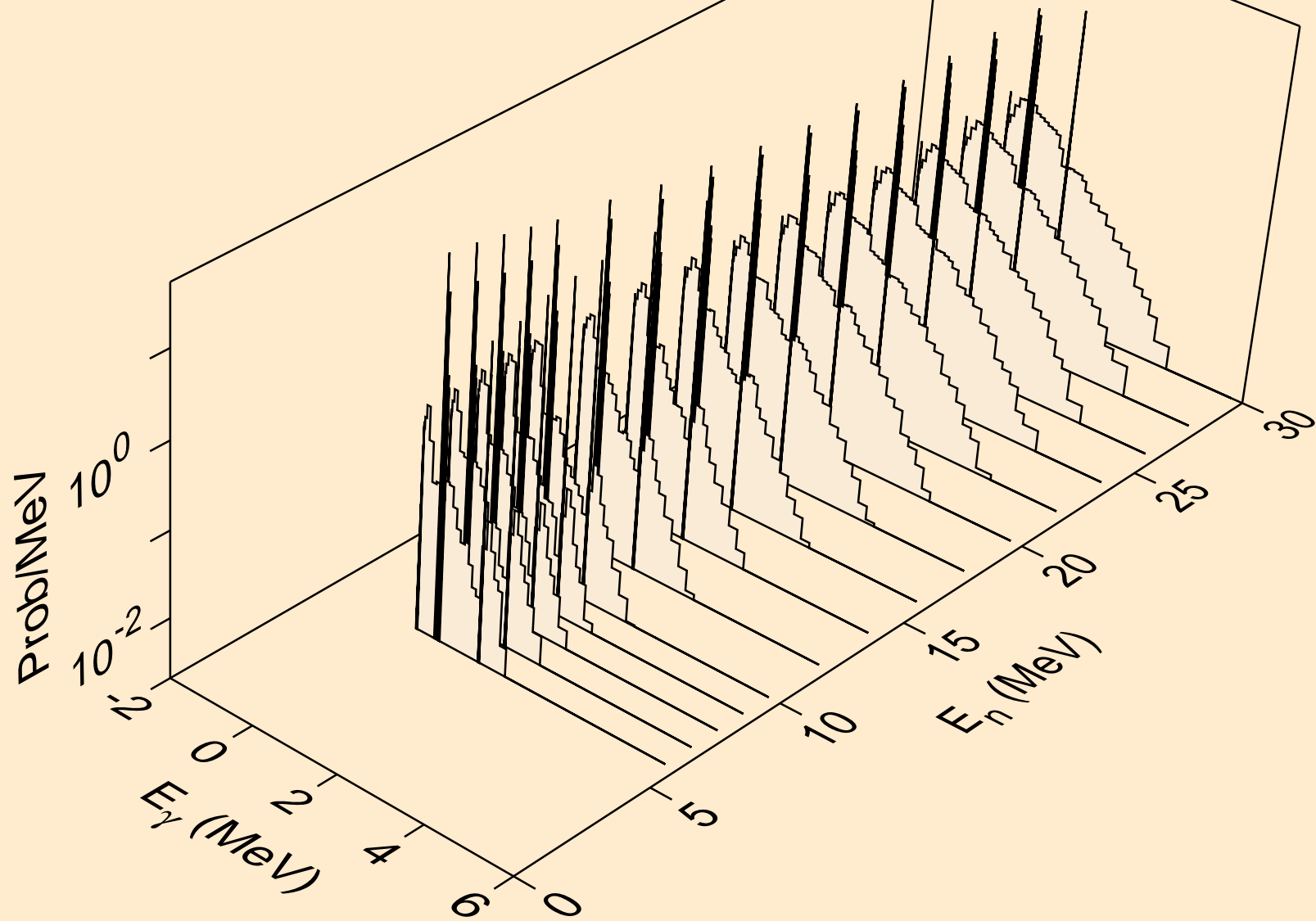

IR197 TRITON ACER TENDL-2021 LIBRARY; T=0.K  
Photon emission for (n,2n)a

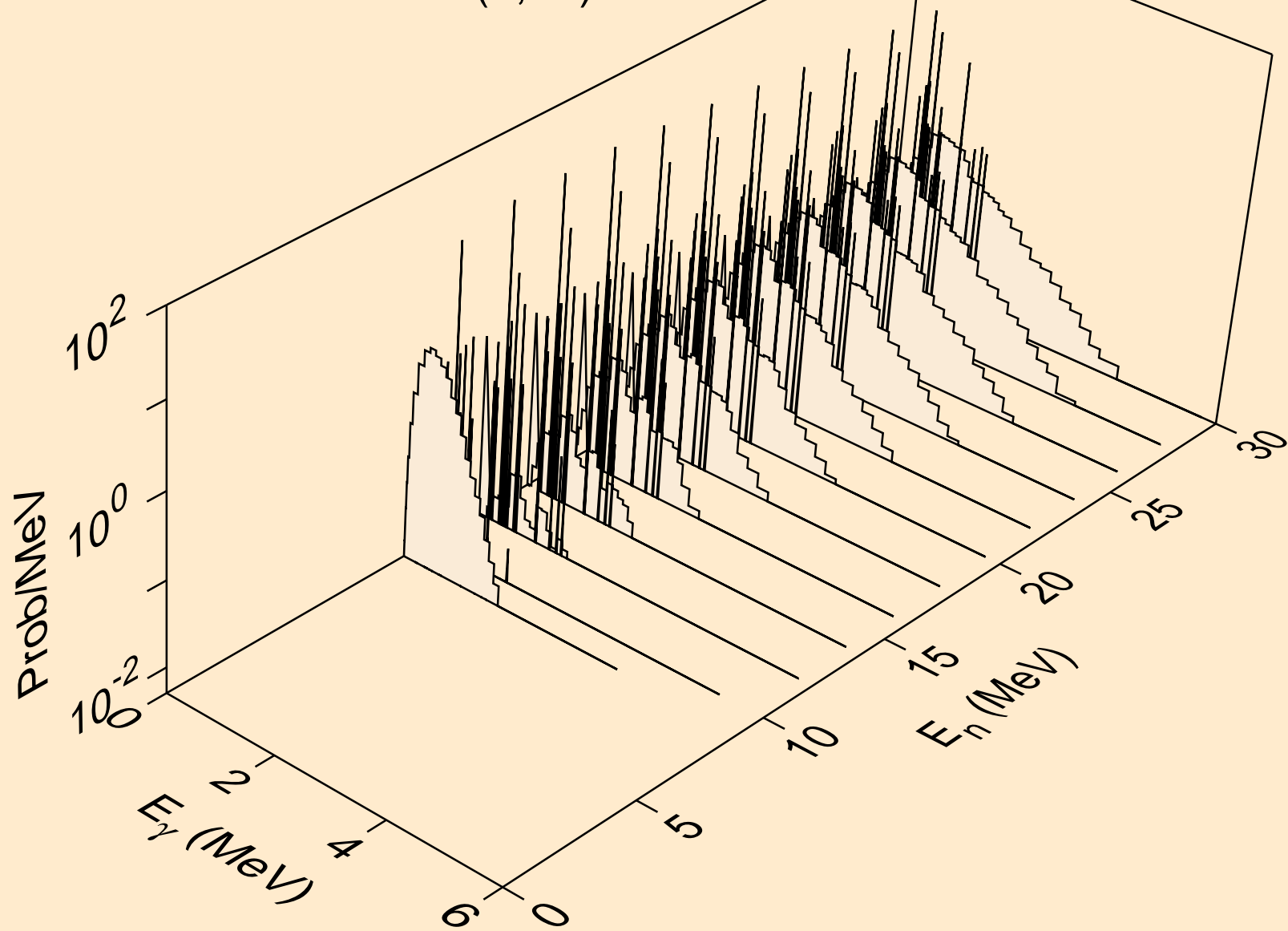

IR197 TRITON ACER TENDL-2021 LIBRARY; T=0.K  
Photon emission for (n,3n)a

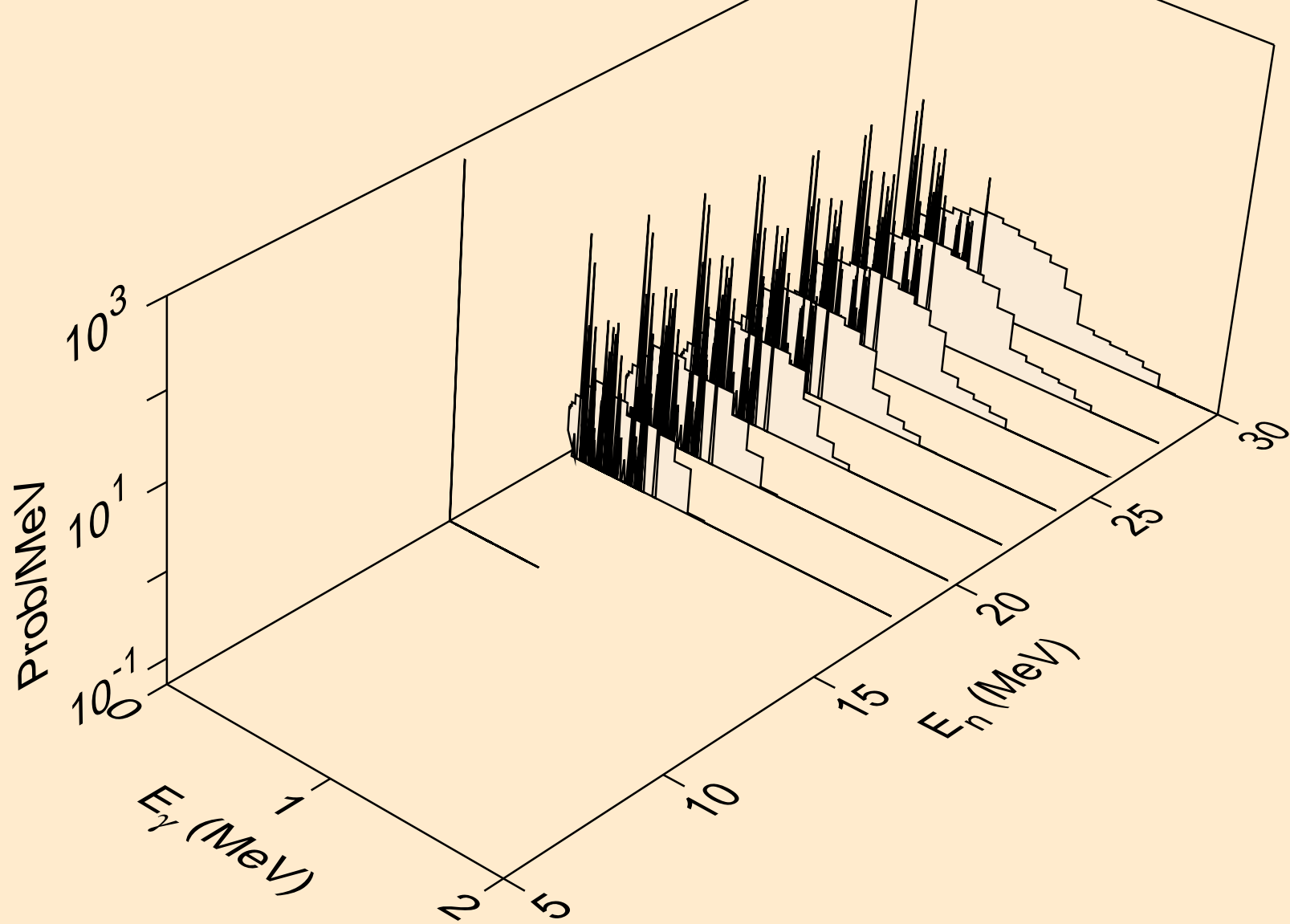

IR197 TRITON ACER TENDL-2021 LIBRARY; T=0.K  
Photon emission for (n,n\*)p

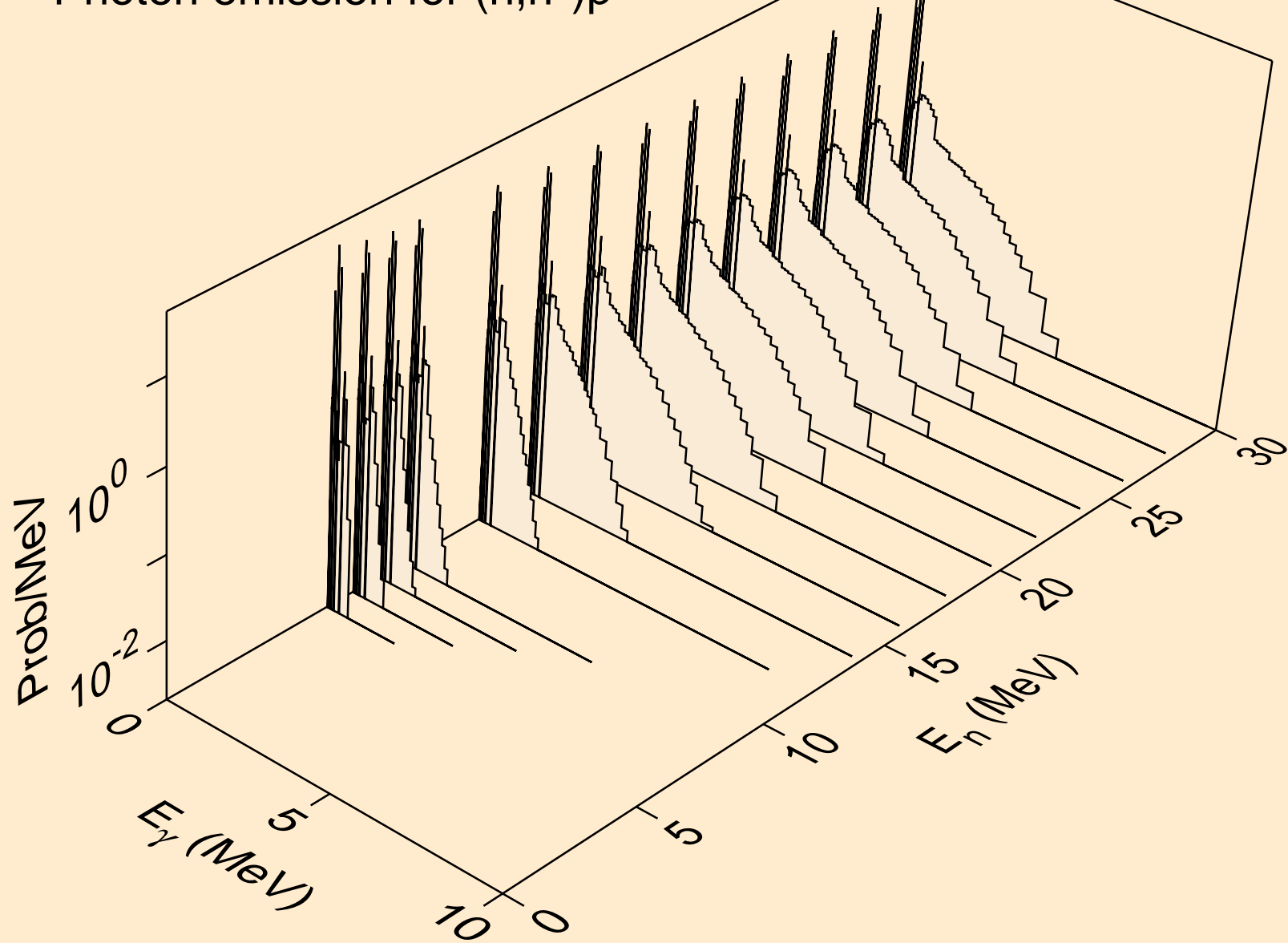

IR197 TRITON ACER TENDL-2021 LIBRARY; T=0.K  
Photon emission for (n,n\*)d

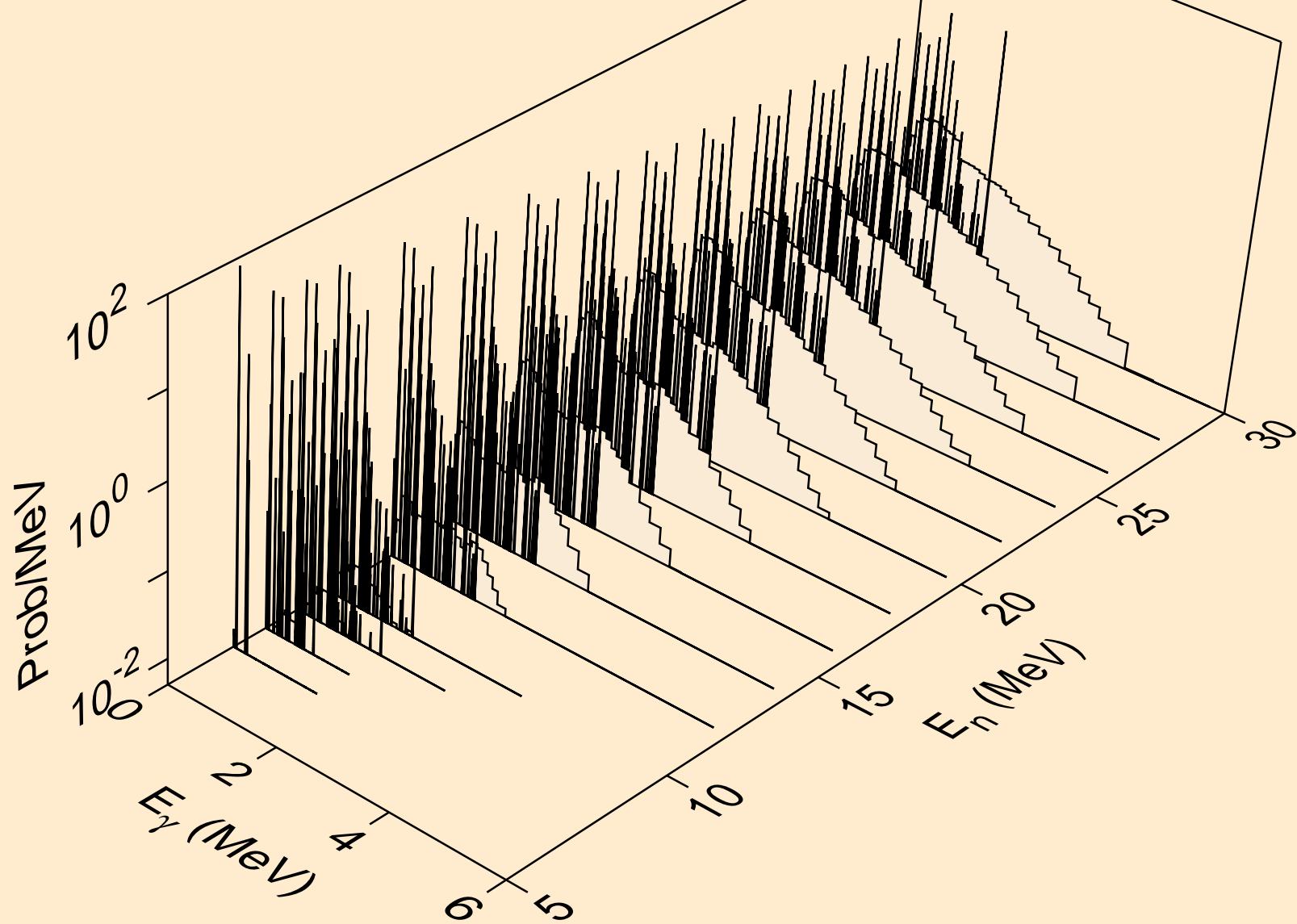

IR197 TRITON ACER TENDL-2021 LIBRARY; T=0.K  
Photon emission for (n,n\*)t

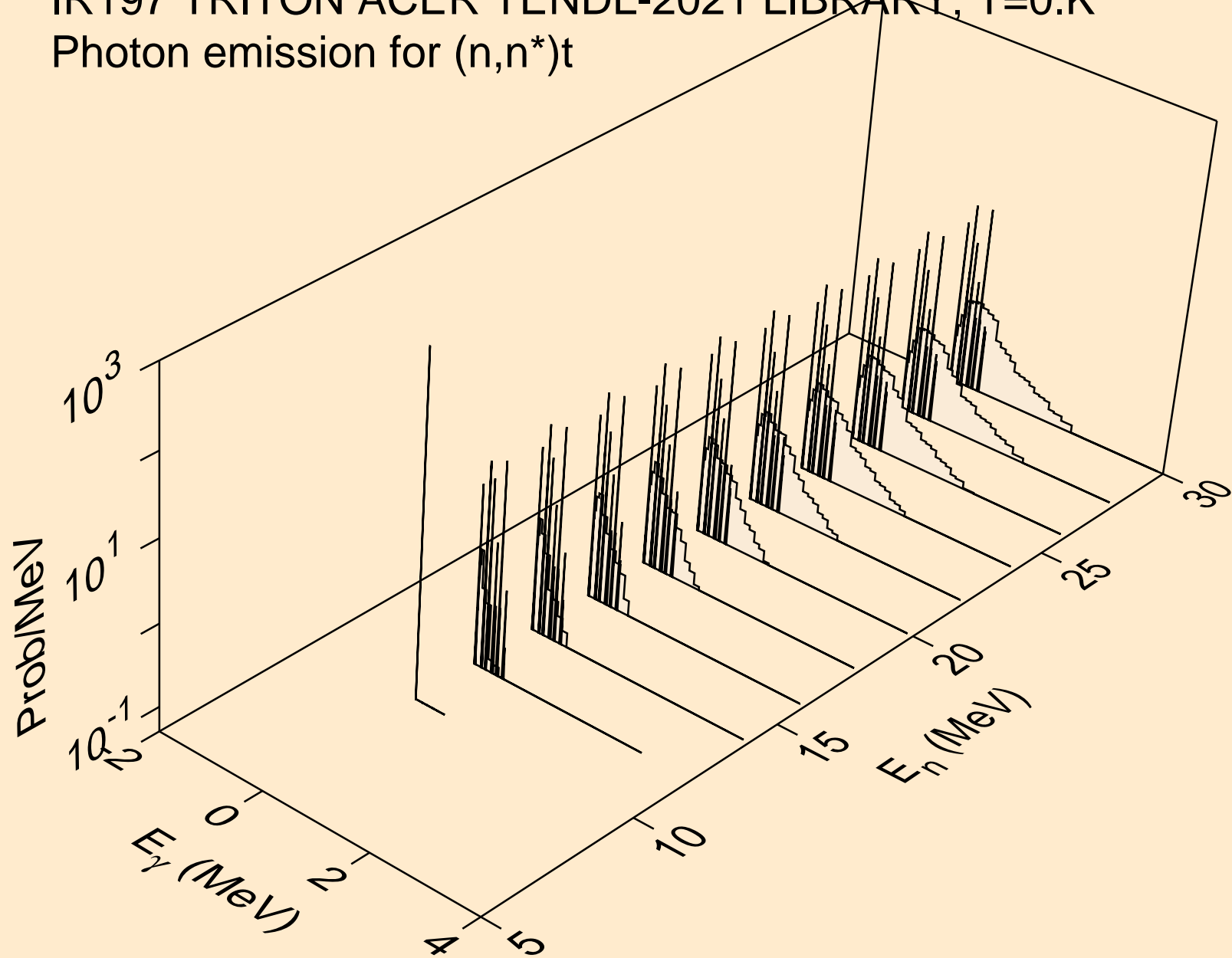

IR197 TRITON ACER TENDL-2021 LIBRARY; T=0.K  
Photon emission for (n,n\*)he3

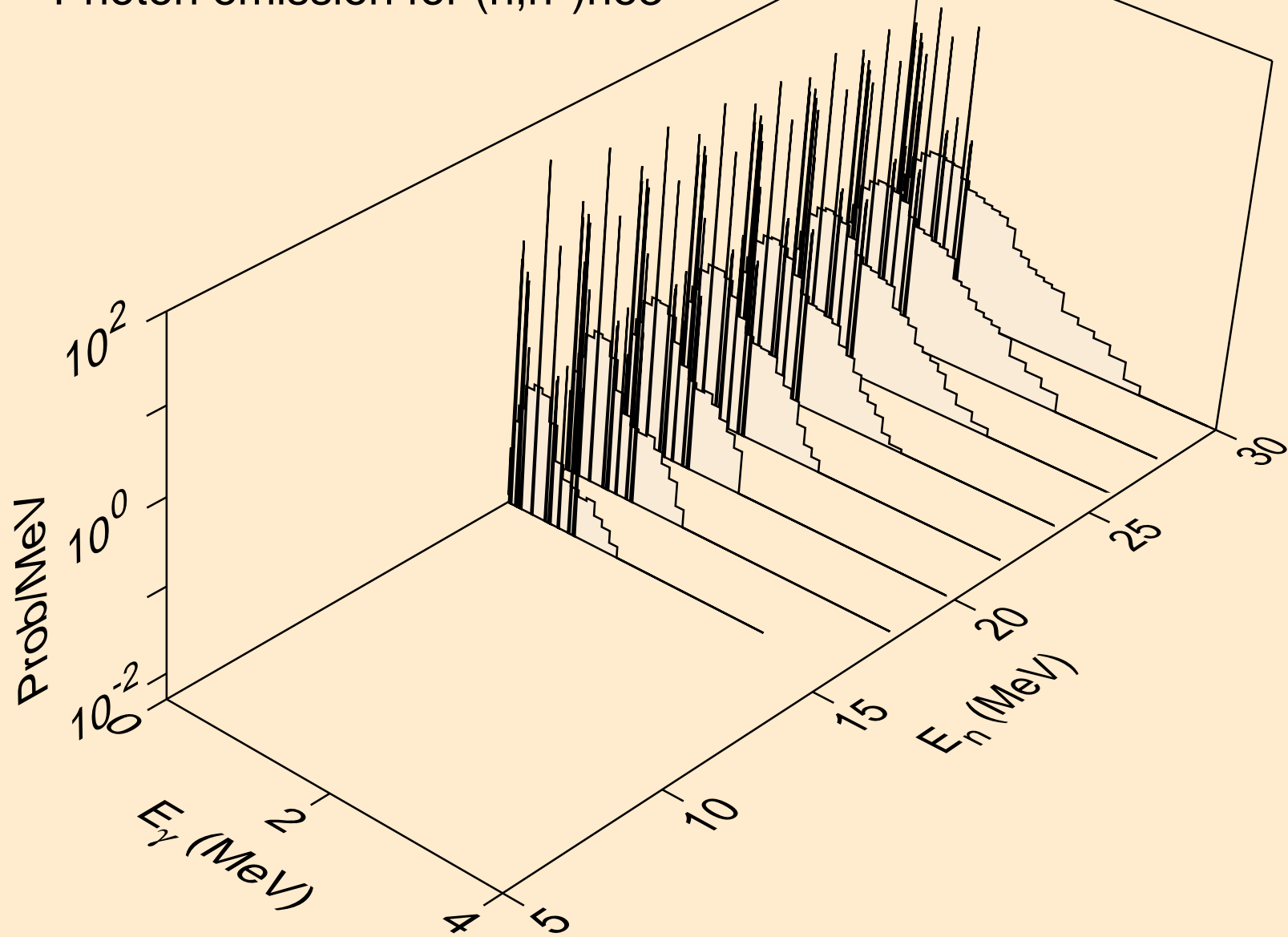



IR197 TRITON ACER TENDL-2021 LIBRARY; T=0.K  
Photon emission for (n,4n)

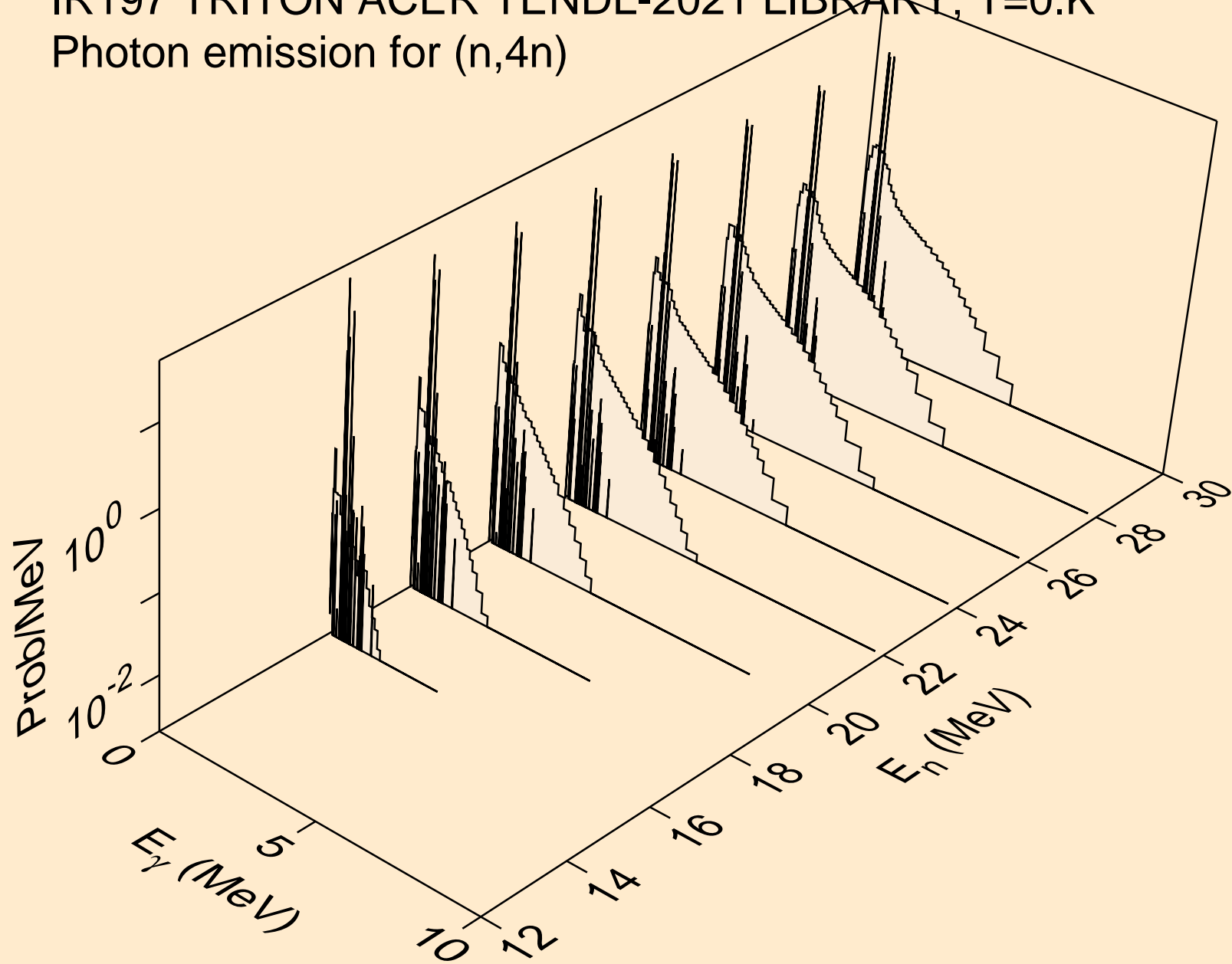

IR197 TRITON ACER TENDL-2021 LIBRARY; T=0.K  
Photon emission for (n,2np)

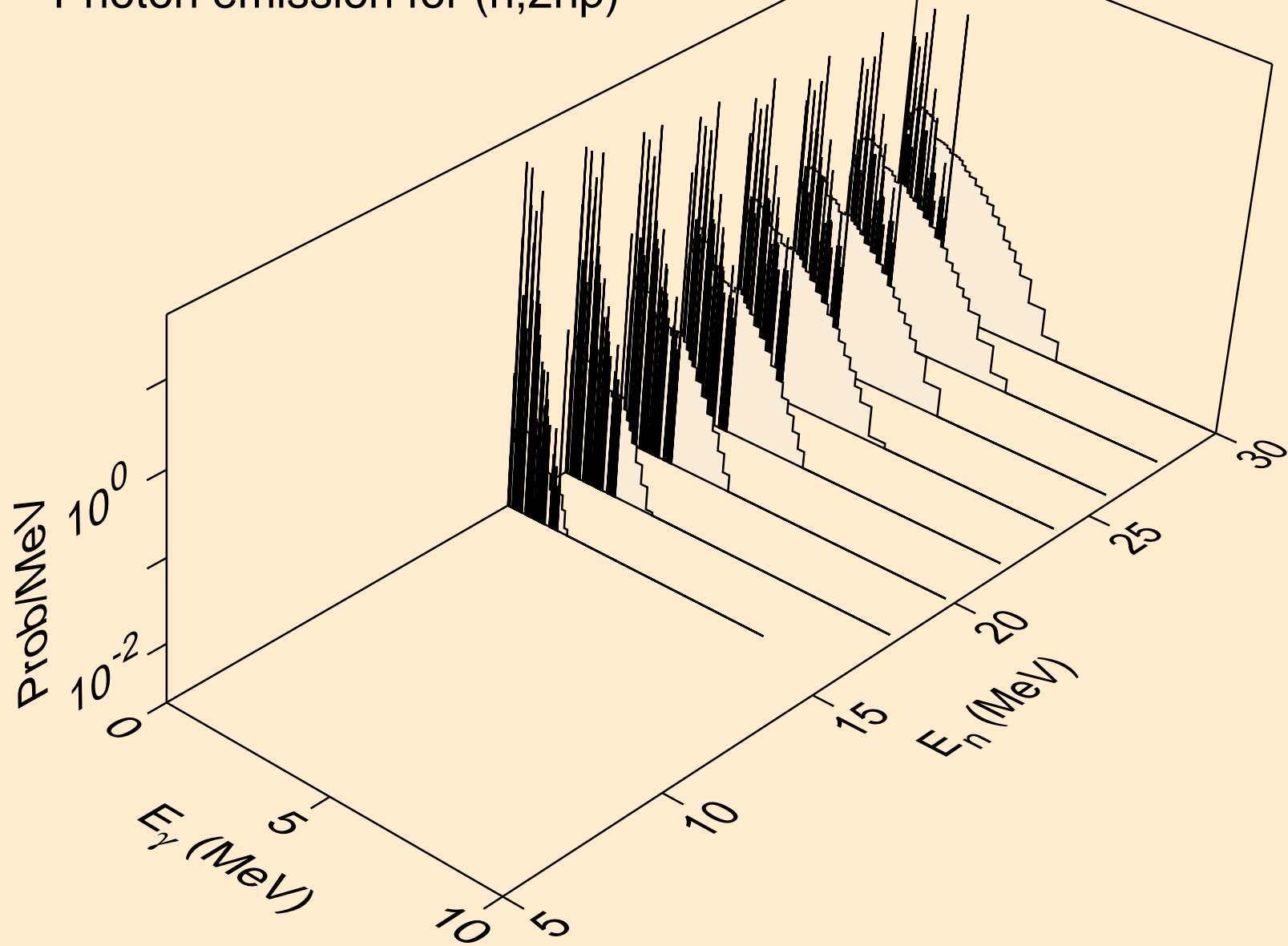

IR197 TRITON ACER TENDL-2021 LIBRARY; T=0.K  
Photon emission for (n,3np)

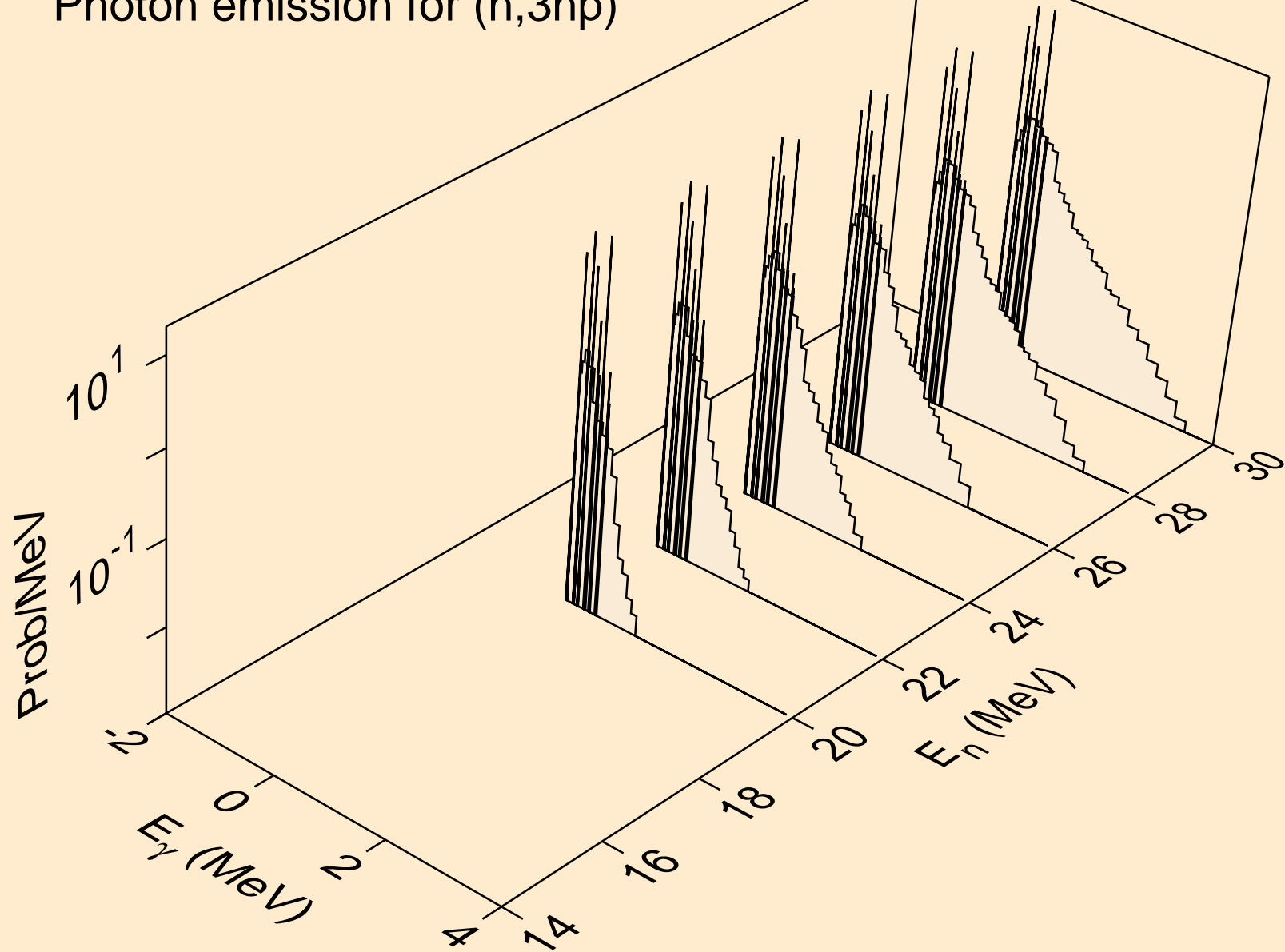

IR197 TRITON ACER TENDL-2021 LIBRARY; T=0.K  
Photon emission for (n,2np)

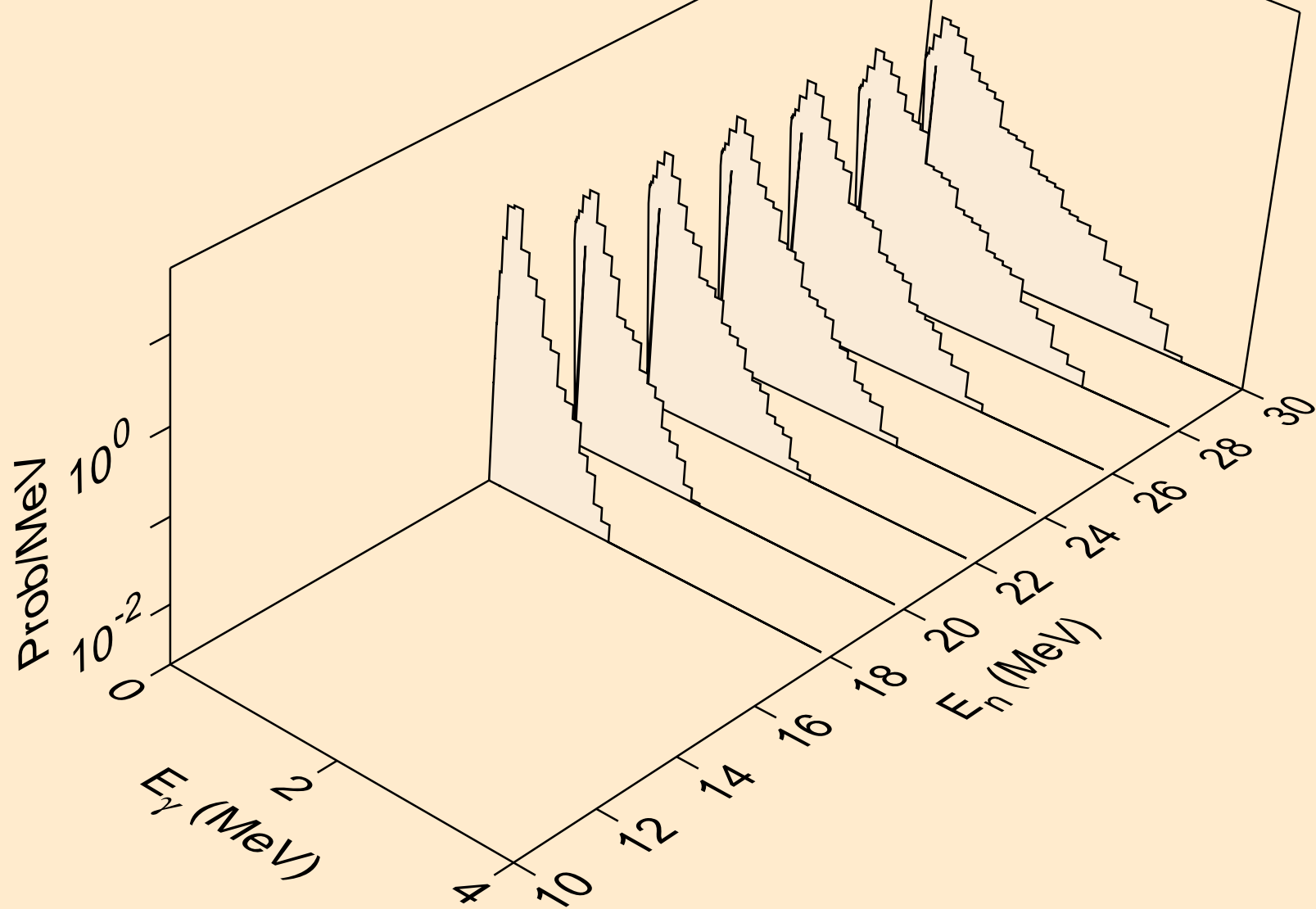

IR197 TRITON ACER TENDL-2021 LIBRARY; T=0.K  
Photon emission for (n,gma)

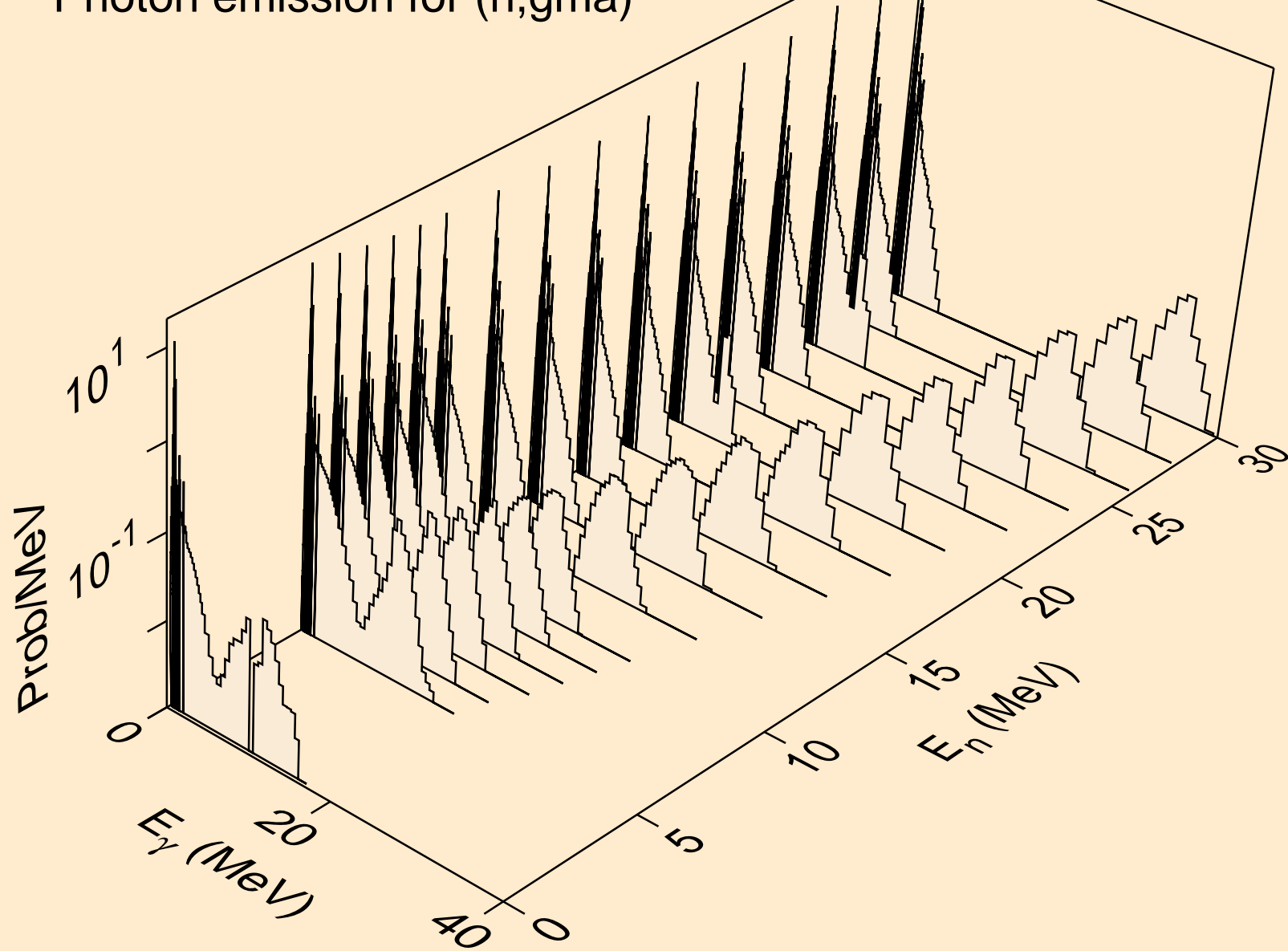

IR197 TRITON ACER TENDL-2021 LIBRARY; T=0.K  
Photon emission for (n,p)

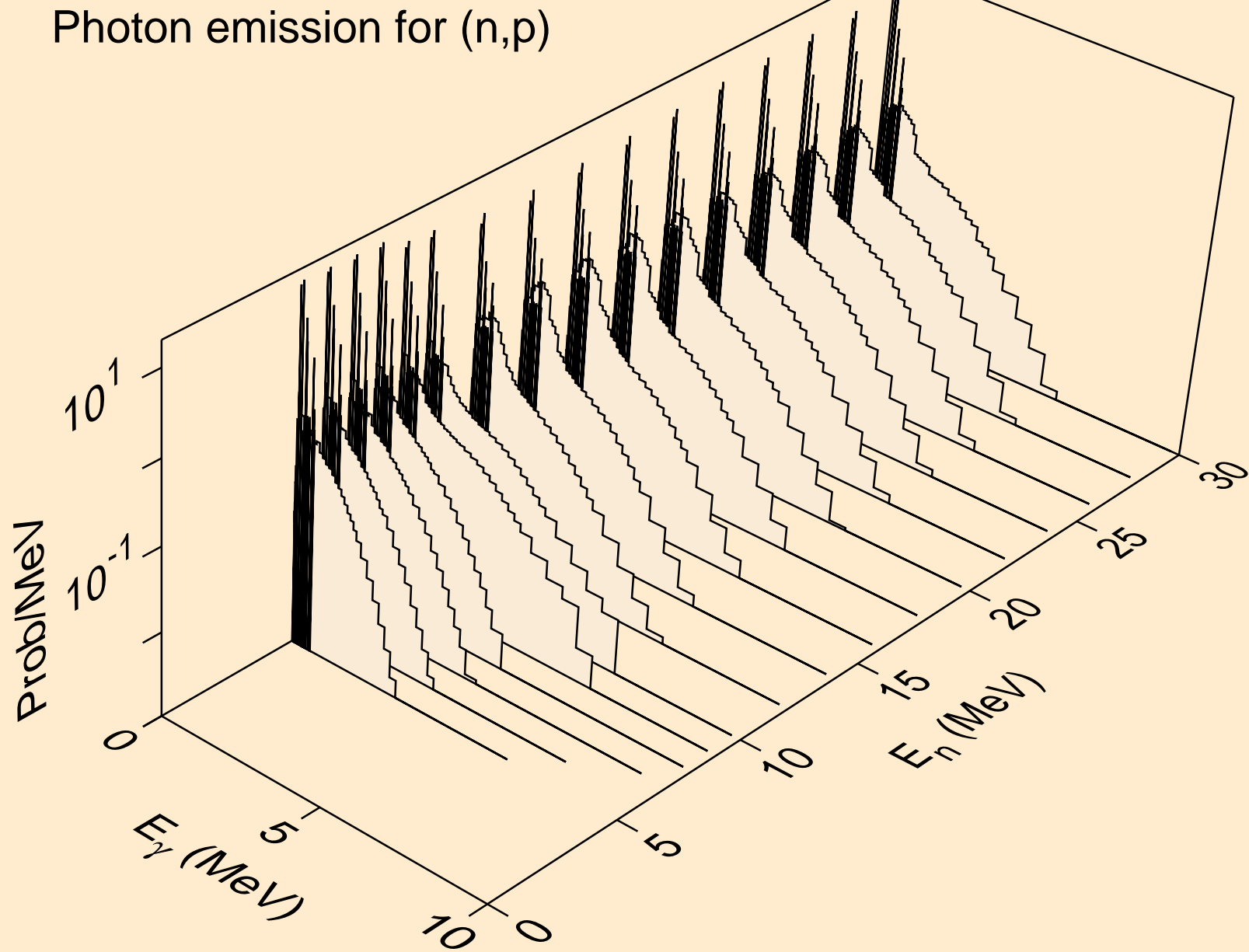

IR197 TRITON ACER TENDL-2021 LIBRARY; T=0.K  
Photon emission for (n,d)

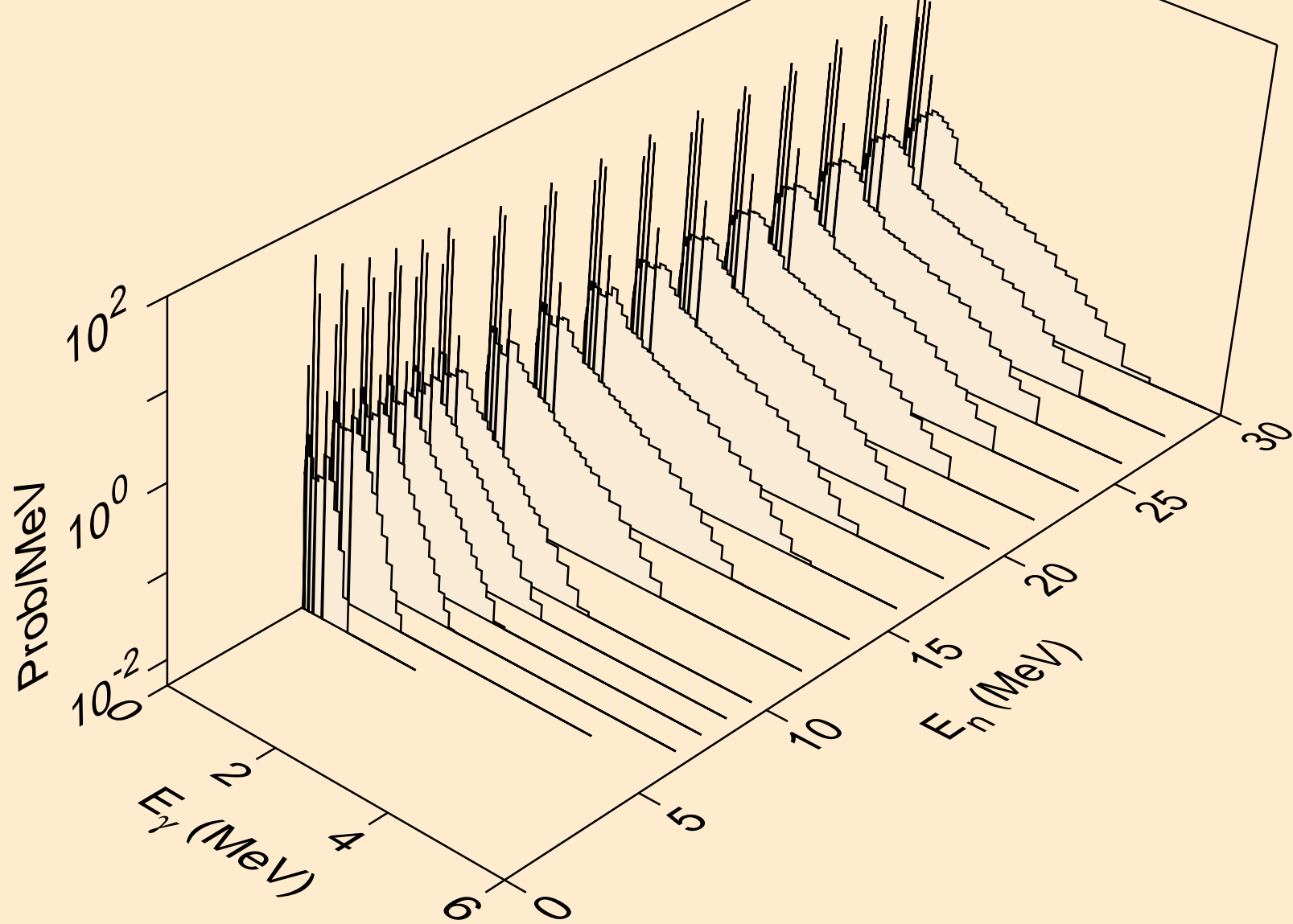

IR197 TRITON ACER TENDL-2021 LIBRARY; T=0.K  
Photon emission for inelastic

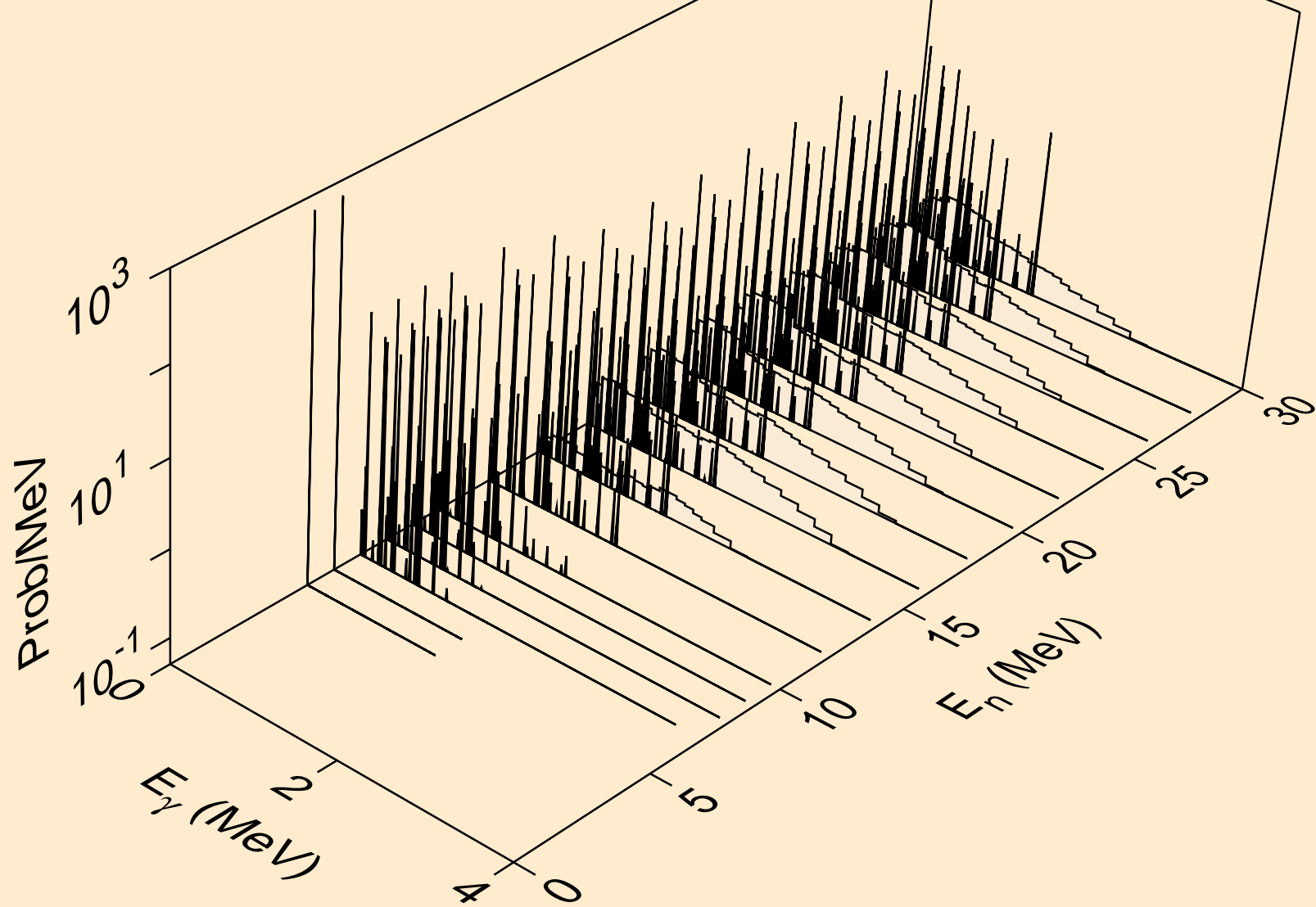



IR197 TRITON ACER TENDL-2021 LIBRARY; T=0.K  
Photon emission for (n,he3)

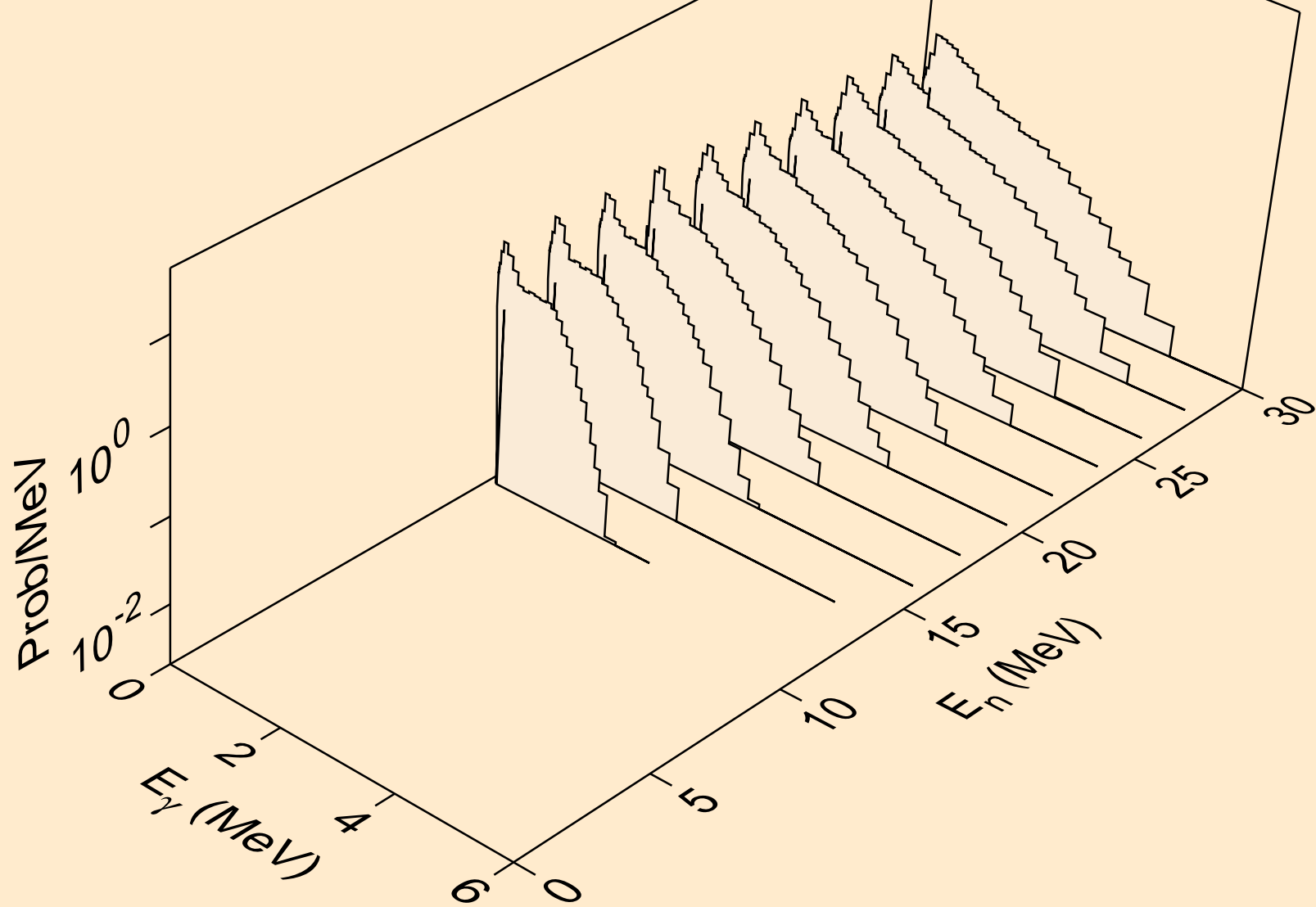

IR197 TRITON ACER TENDL-2021 LIBRARY; T=0.K  
Photon emission for (n,a)

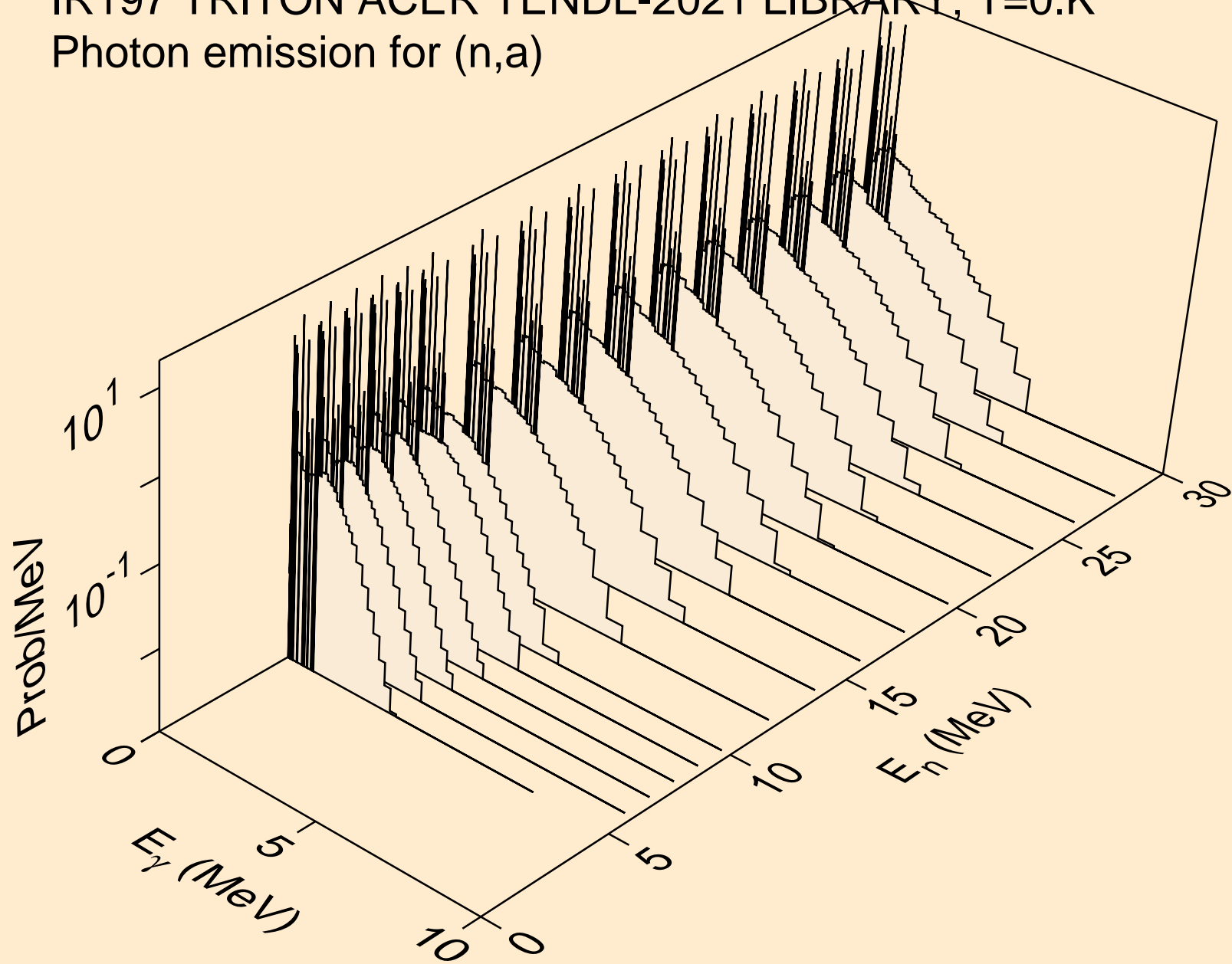

IR197 TRITON ACER TENDL-2021 LIBRARY; T=0.K  
Photon emission for (n,2p)

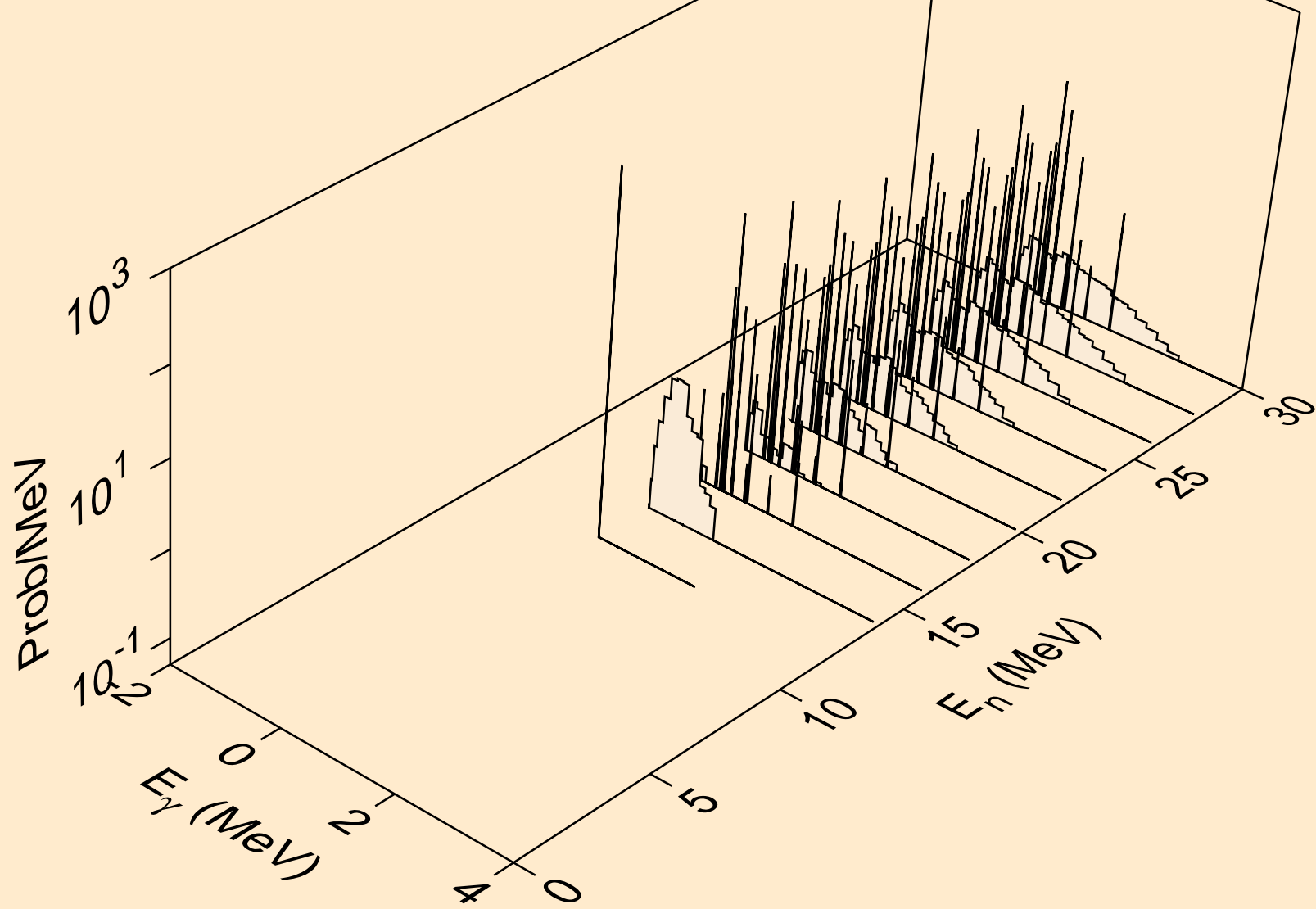

IR197 TRITON ACER TENDL-2021 LIBRARY; T=0.K  
Photon emission for (n,pd)

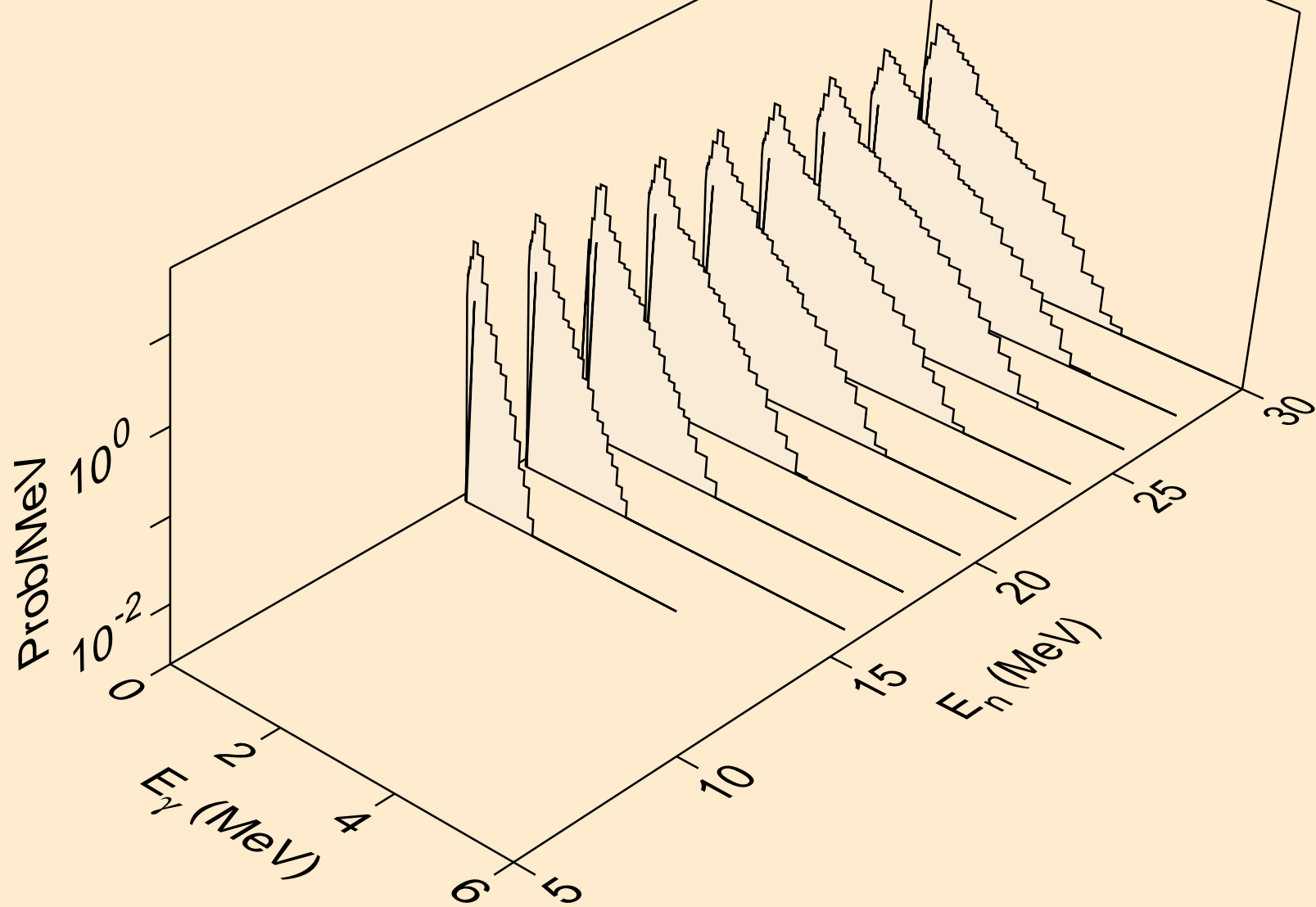

IR197 TRITON ACER TENDL-2021 LIBRARY; T=0.K  
Photon emission for (n,pt)

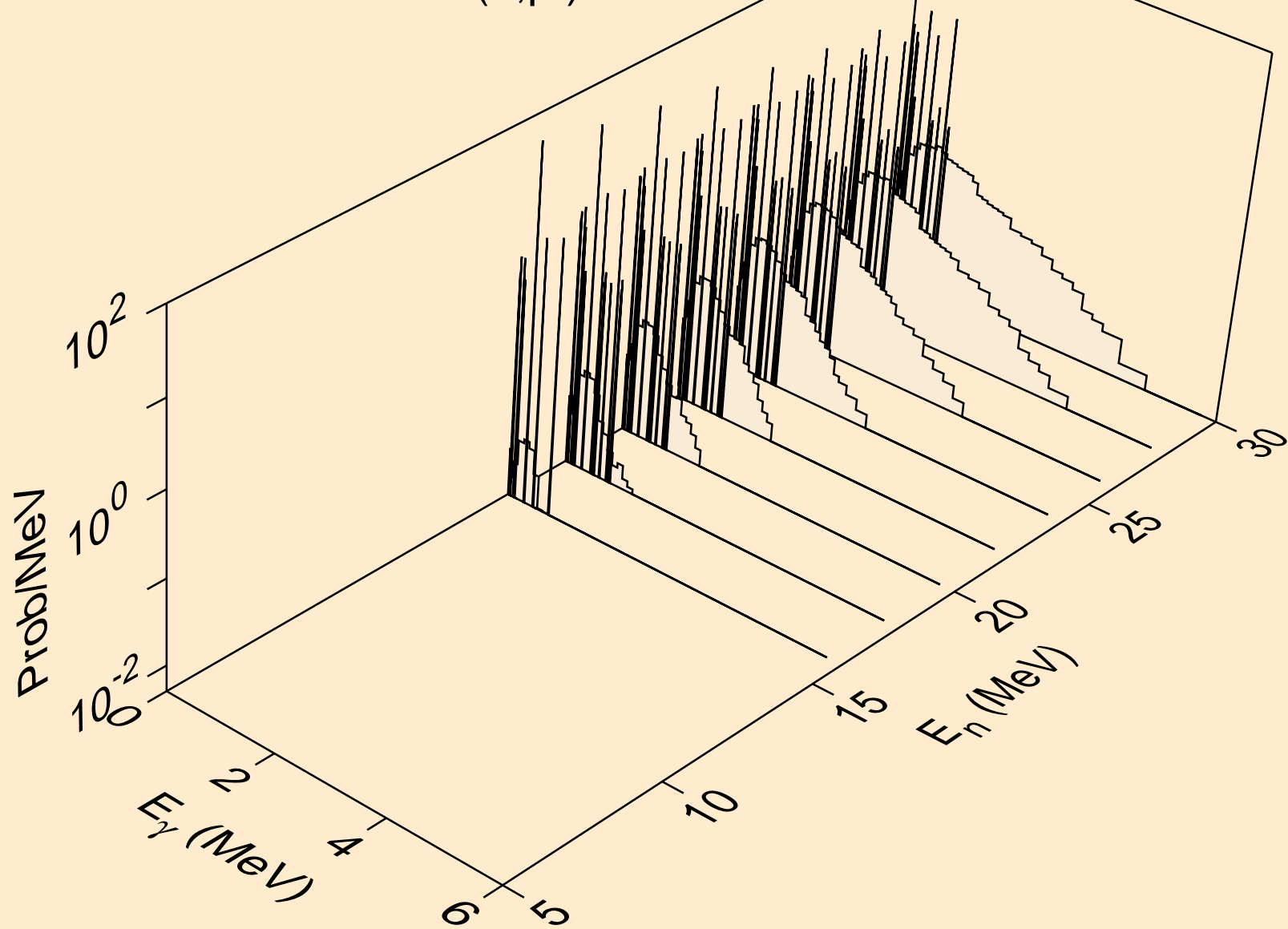

IR197 TRITON ACER TENDL-2021 LIBRARY; T=0.K  
Particle heating contributions

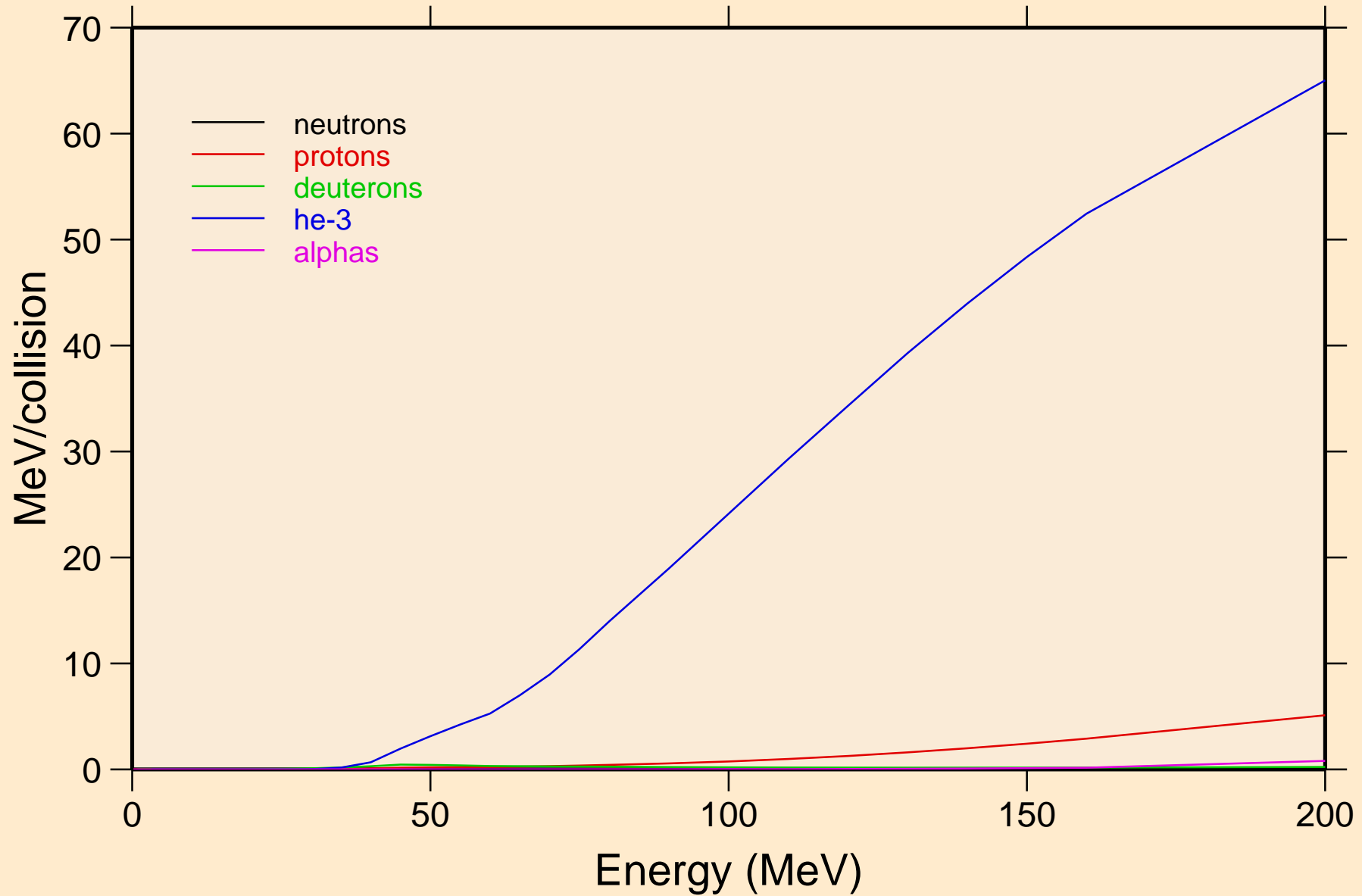

IR197 TRITON ACER TENDL-2021 LIBRARY; T=0.K  
Recoil Heating

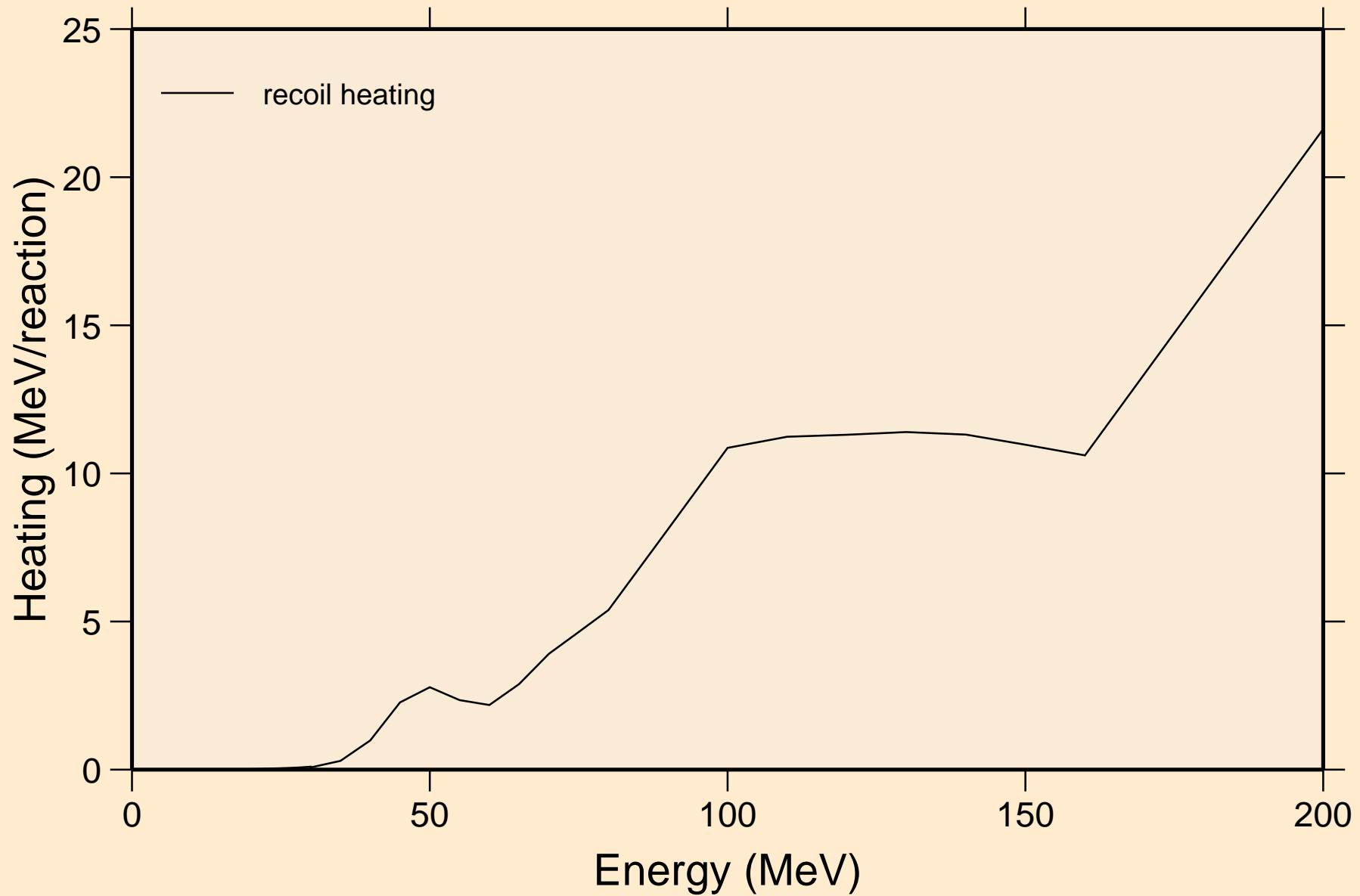

IR197 TRITON ACER TENDL-2021 LIBRARY; T=0.K  
Particle production cross sections

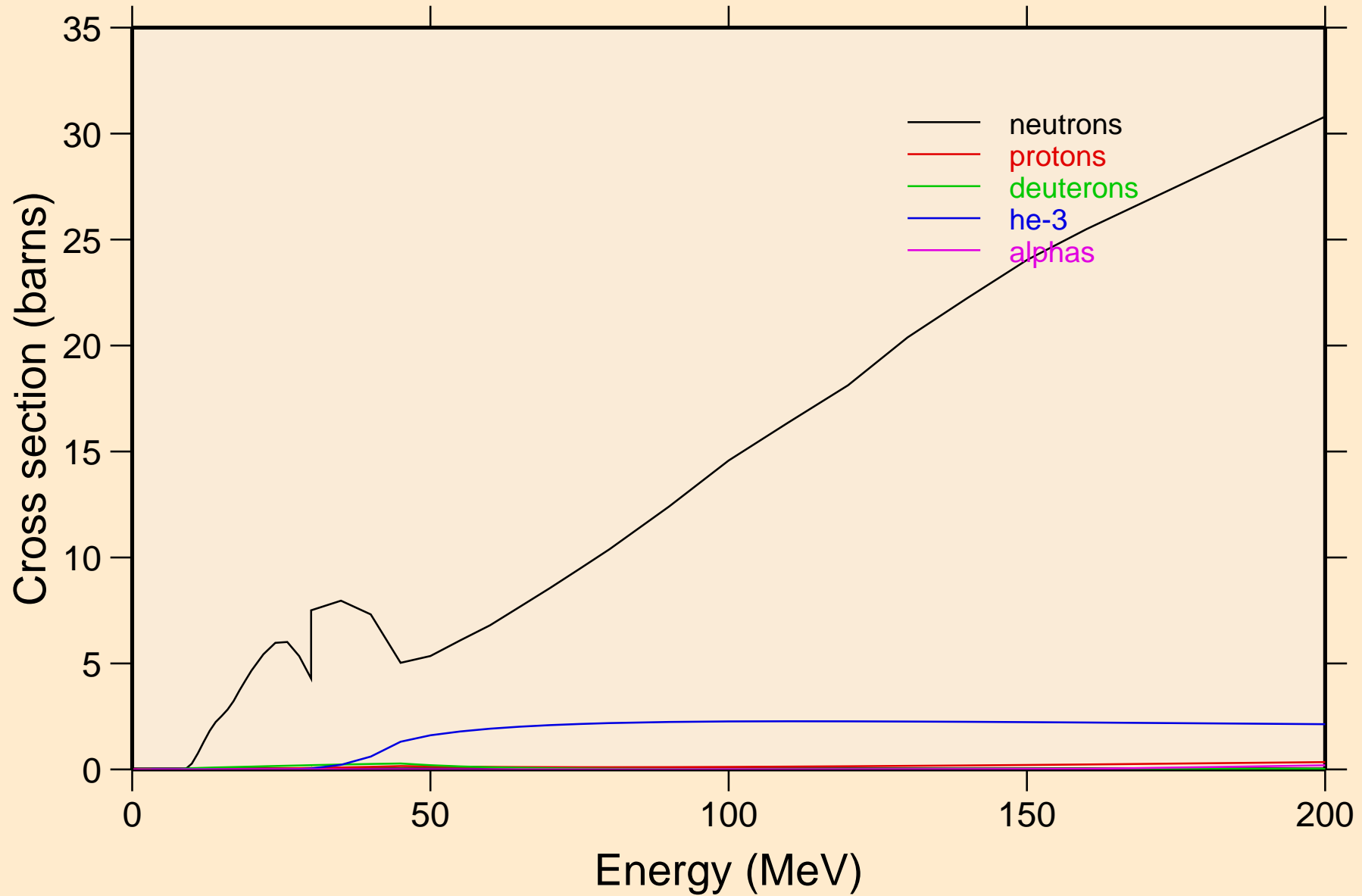



IR197 TRITON ACER TENDL-2021 LIBRARY; T=0.K  
neutrons from (t,n)

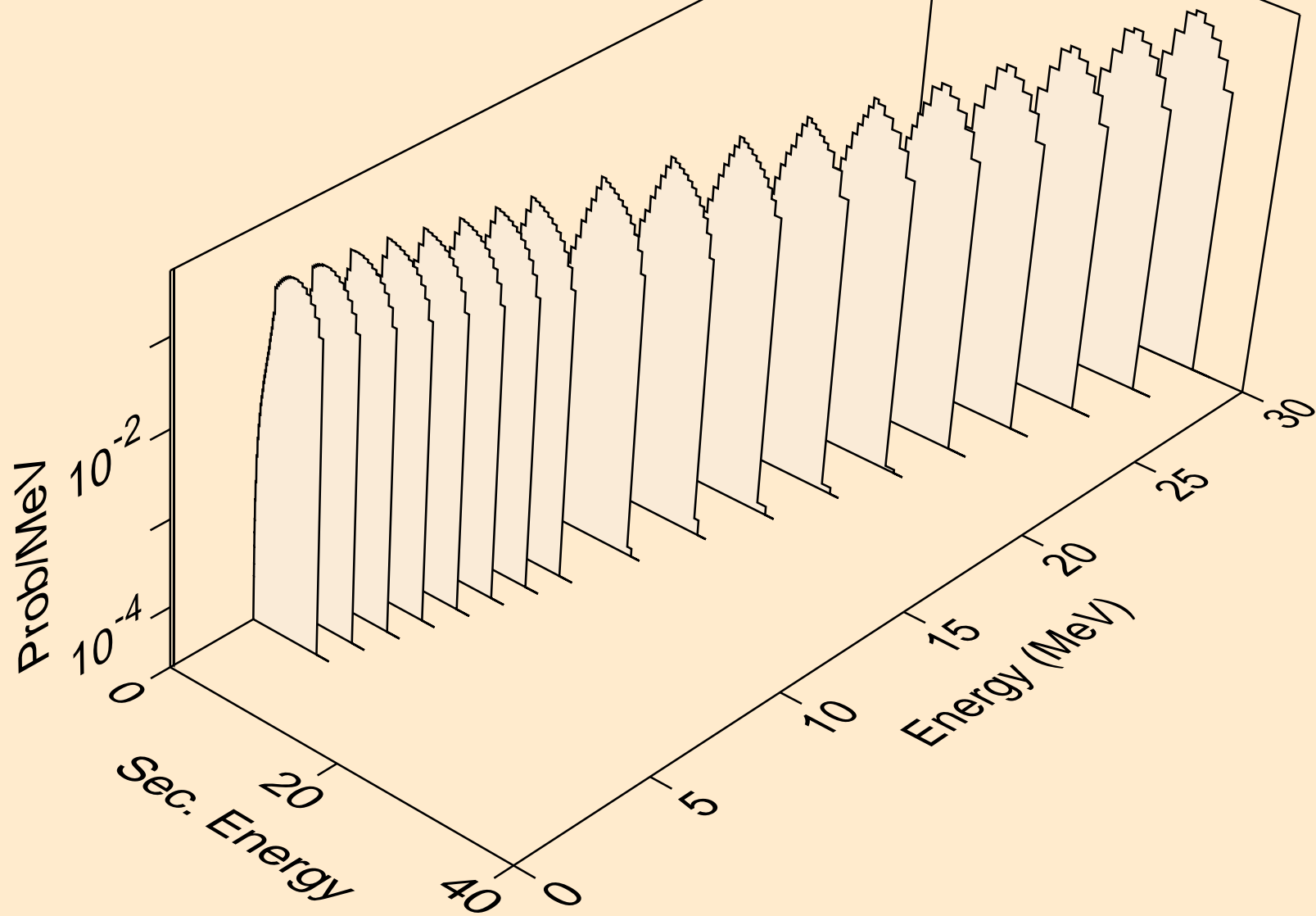

IR197 TRITON ACER TENDL-2021 LIBRARY; T=0.K  
neutrons from (t,x)

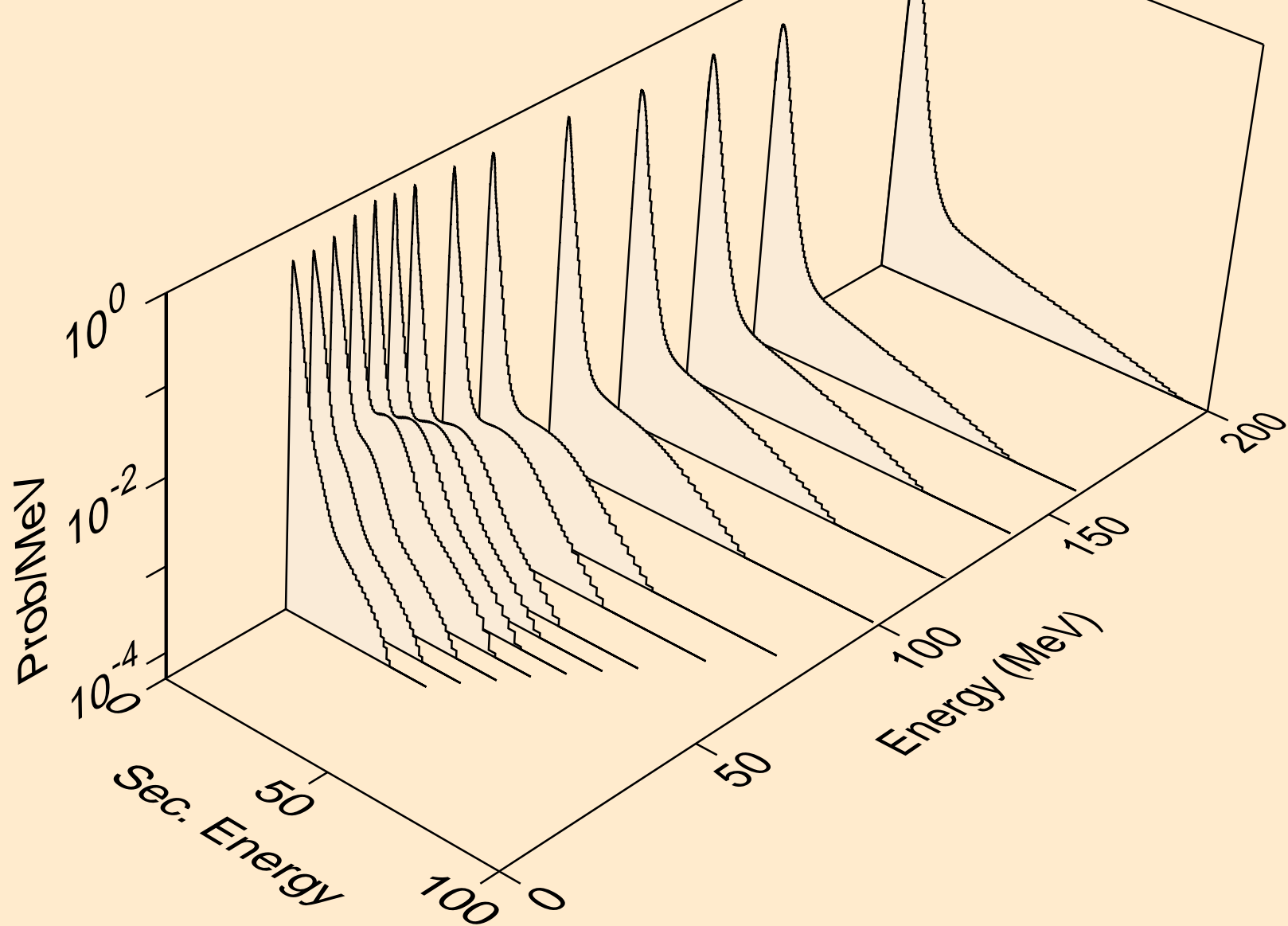

IR197 TRITON ACER TENDL-2021 LIBRARY; T=0.K  
neutrons from (t,2nd)

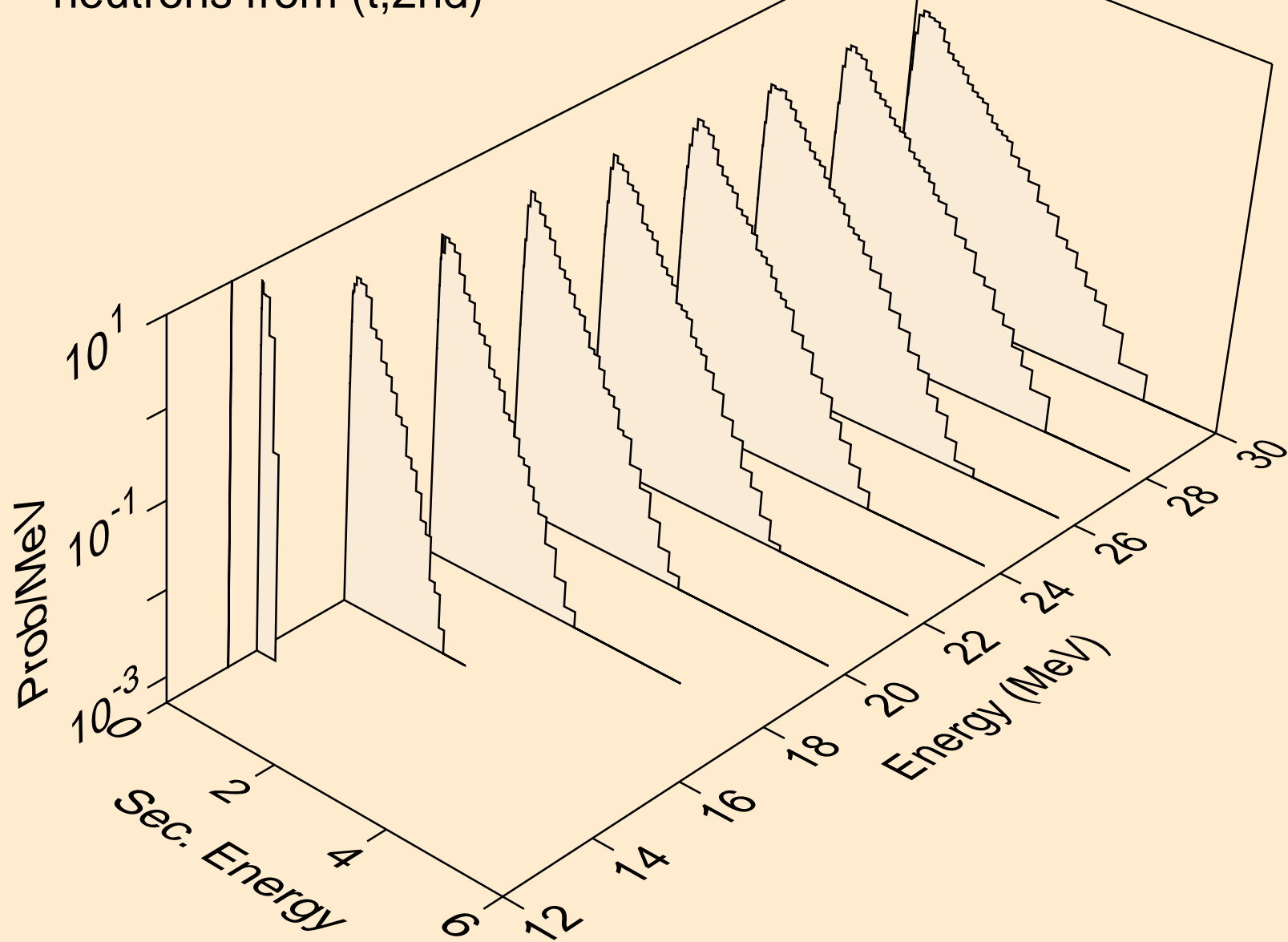

IR197 TRITON ACER TENDL-2021 LIBRARY; T=0.K  
neutrons from (t,2n)

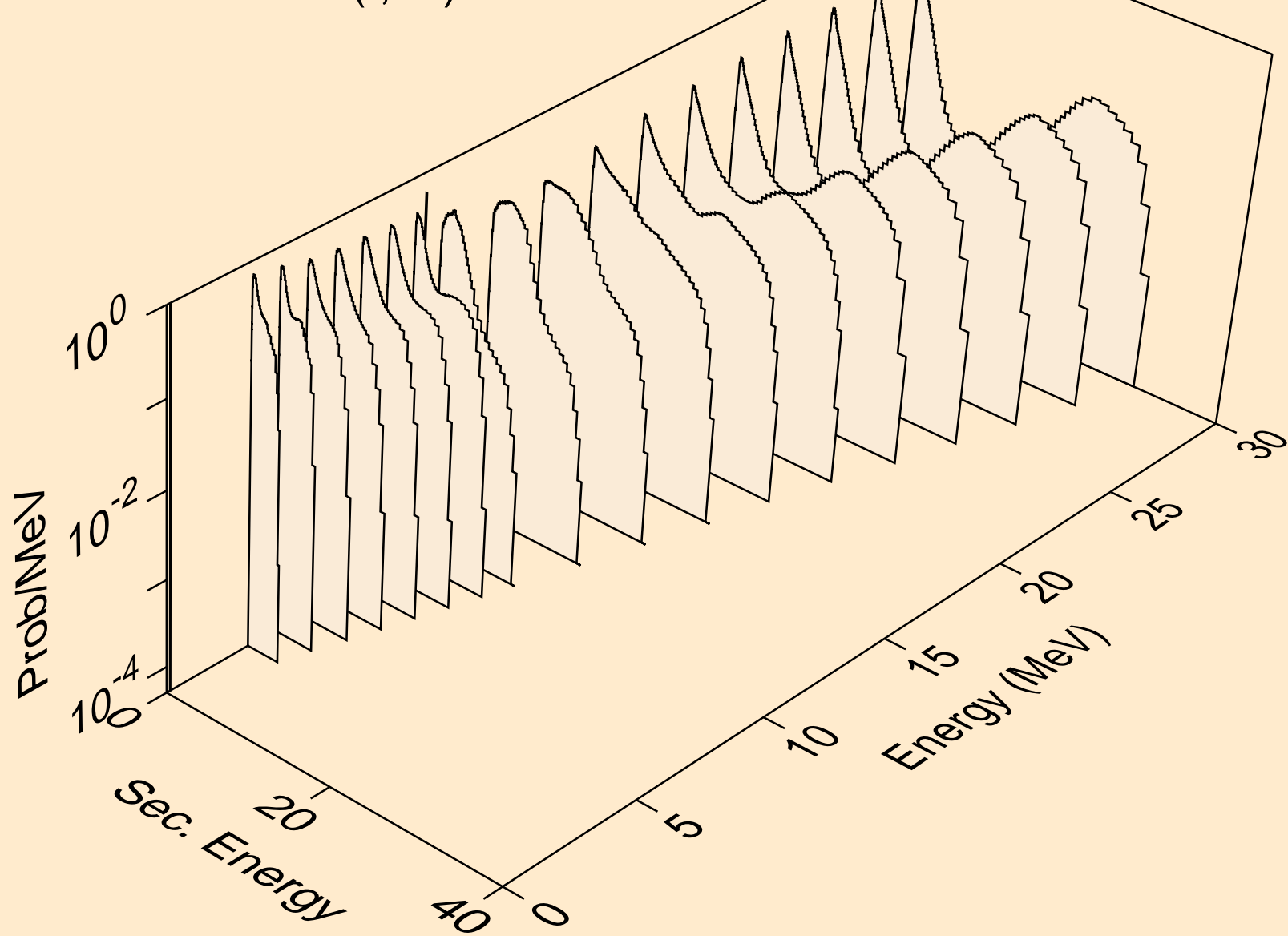

IR197 TRITON ACER TENDL-2021 LIBRARY; T=0.K  
neutrons from (t,3n)

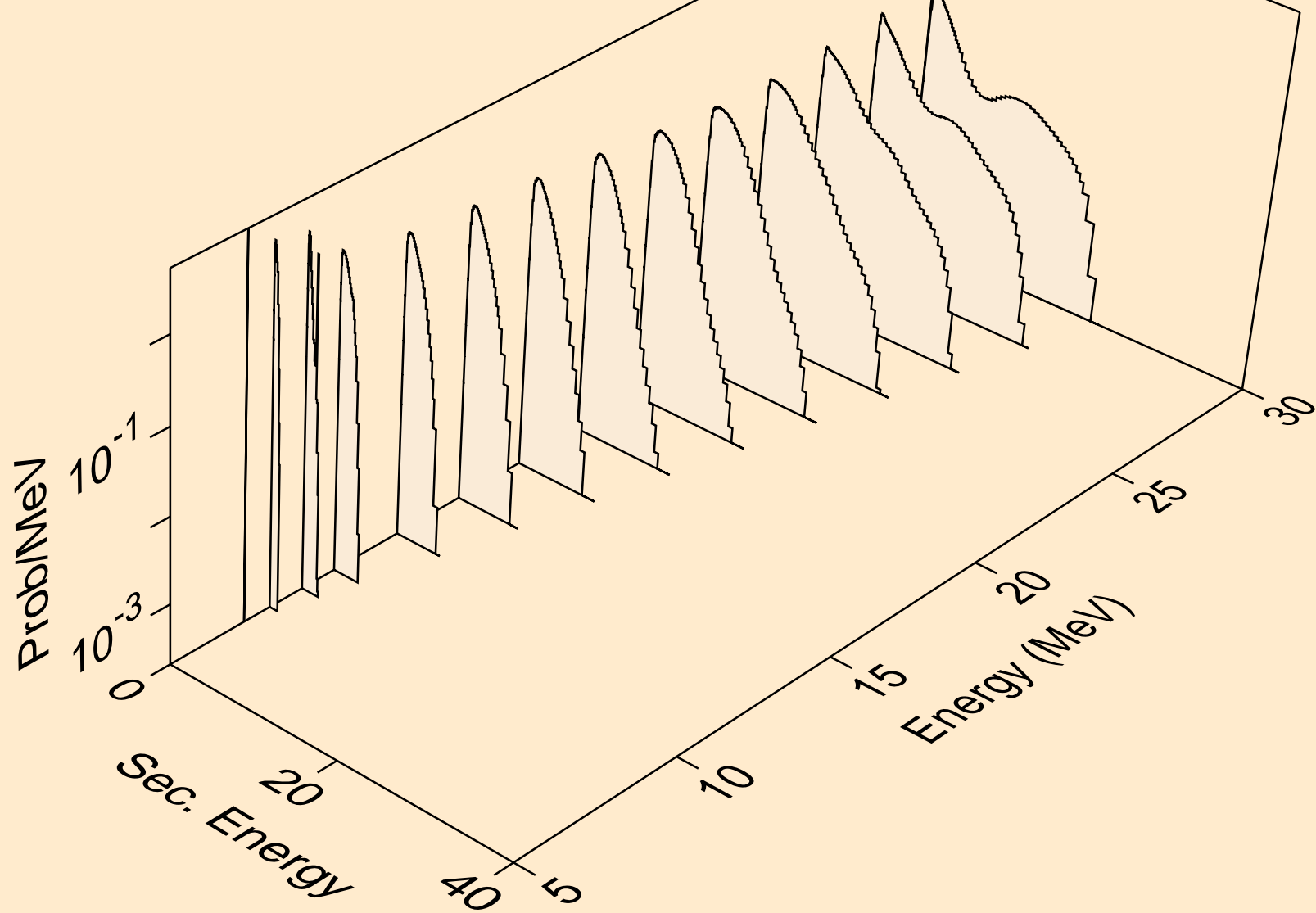

IR197 TRITON ACER TENDL-2021 LIBRARY; T=0.K  
neutrons from (t,n\*)a

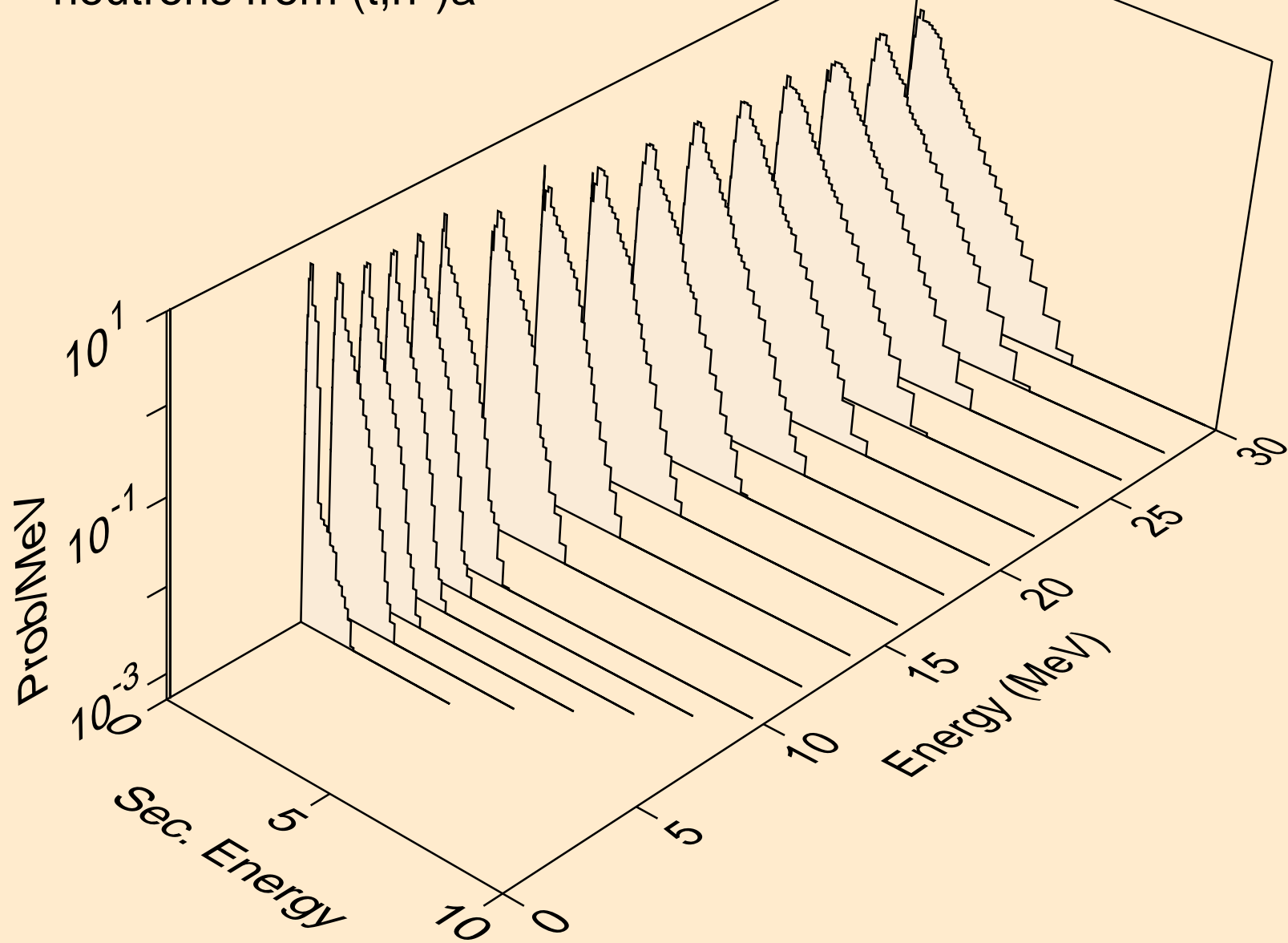

IR197 TRITON ACER TENDL-2021 LIBRARY; T=0.K  
neutrons from (t,2n)a

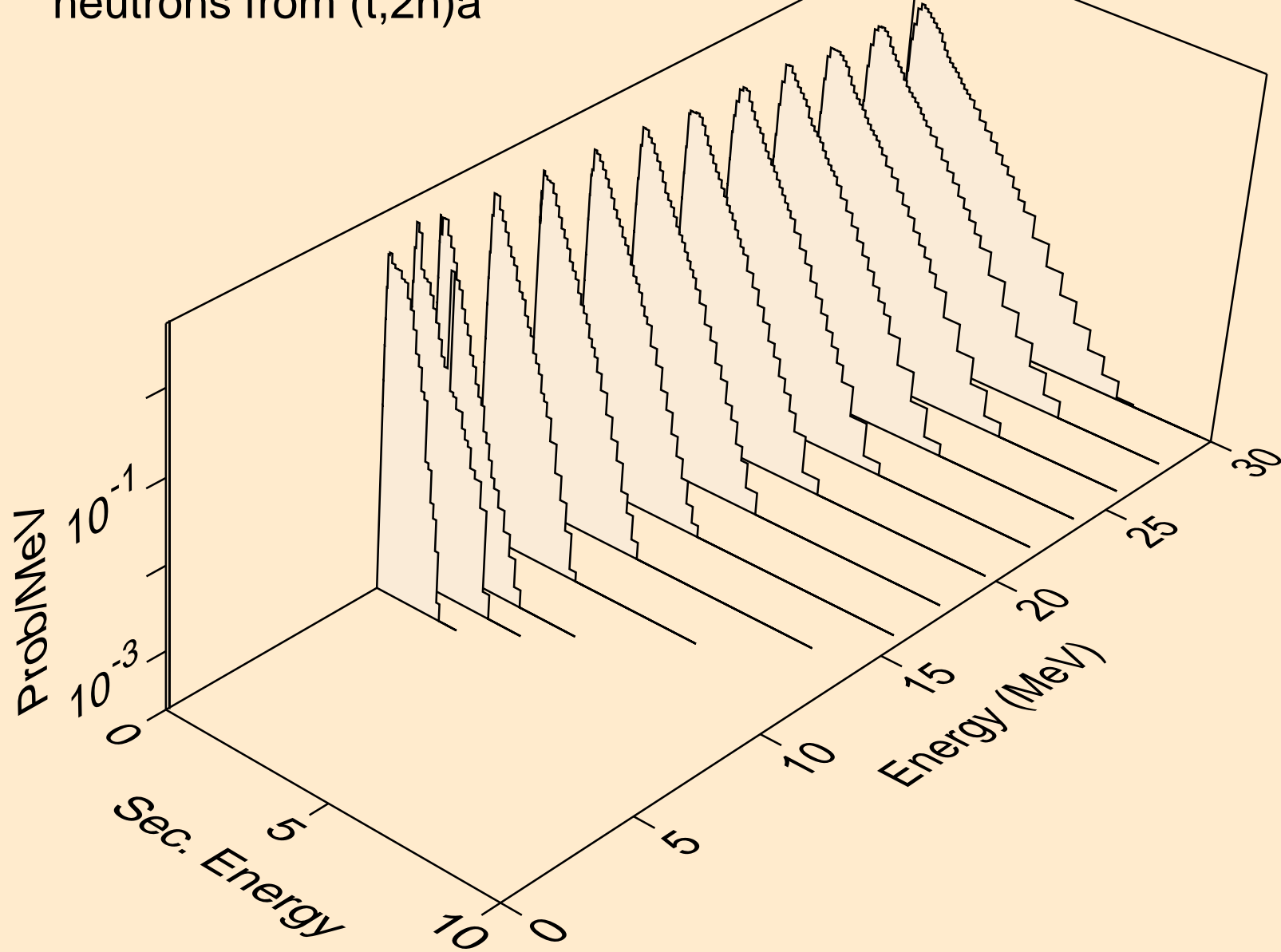

IR197 TRITON ACER TENDL-2021 LIBRARY; T=0.K  
neutrons from (t,3n)a

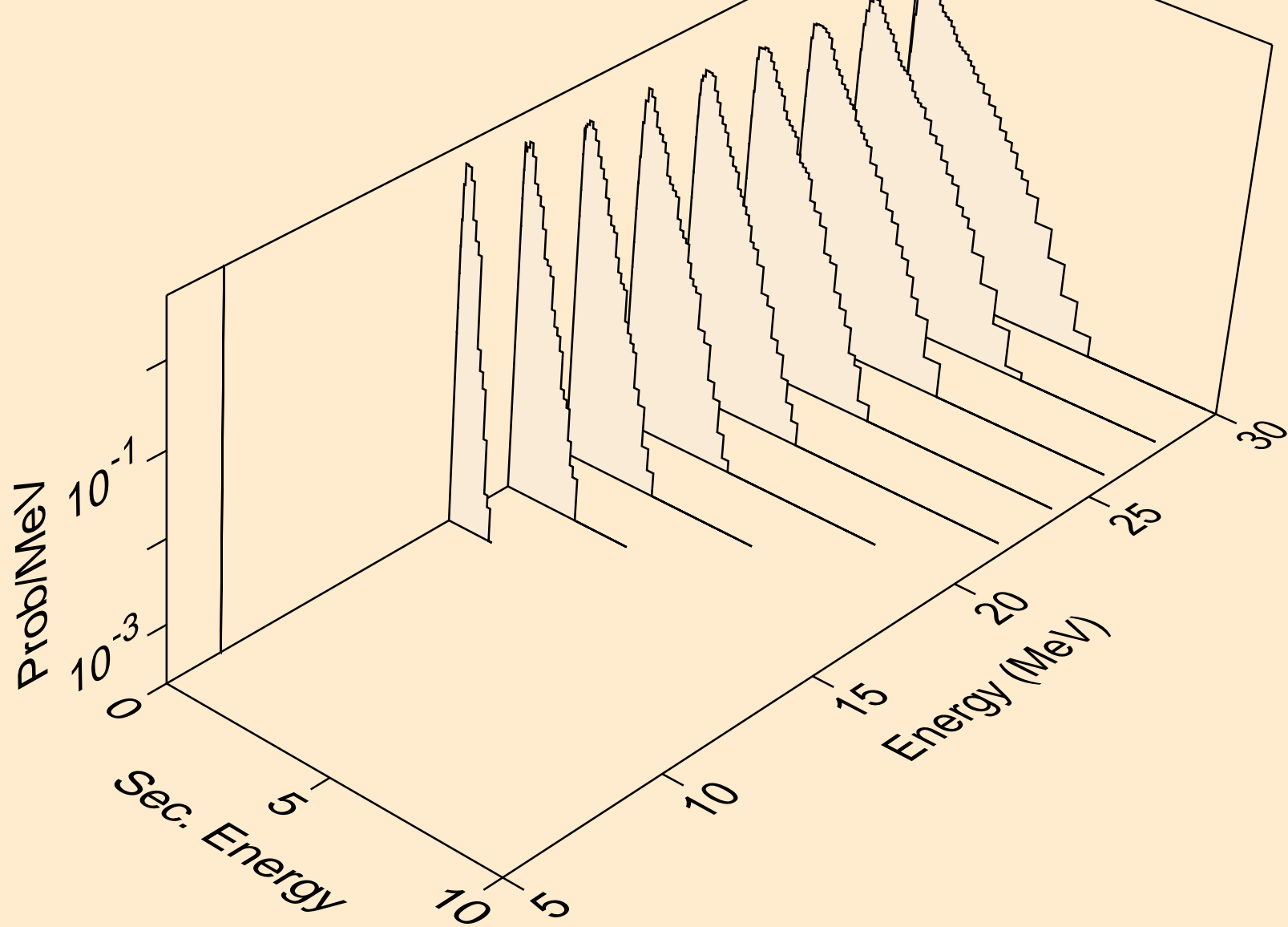



IR197 TRITON ACER TENDL-2021 LIBRARY; T=0.K  
neutrons from (t,n\*)p

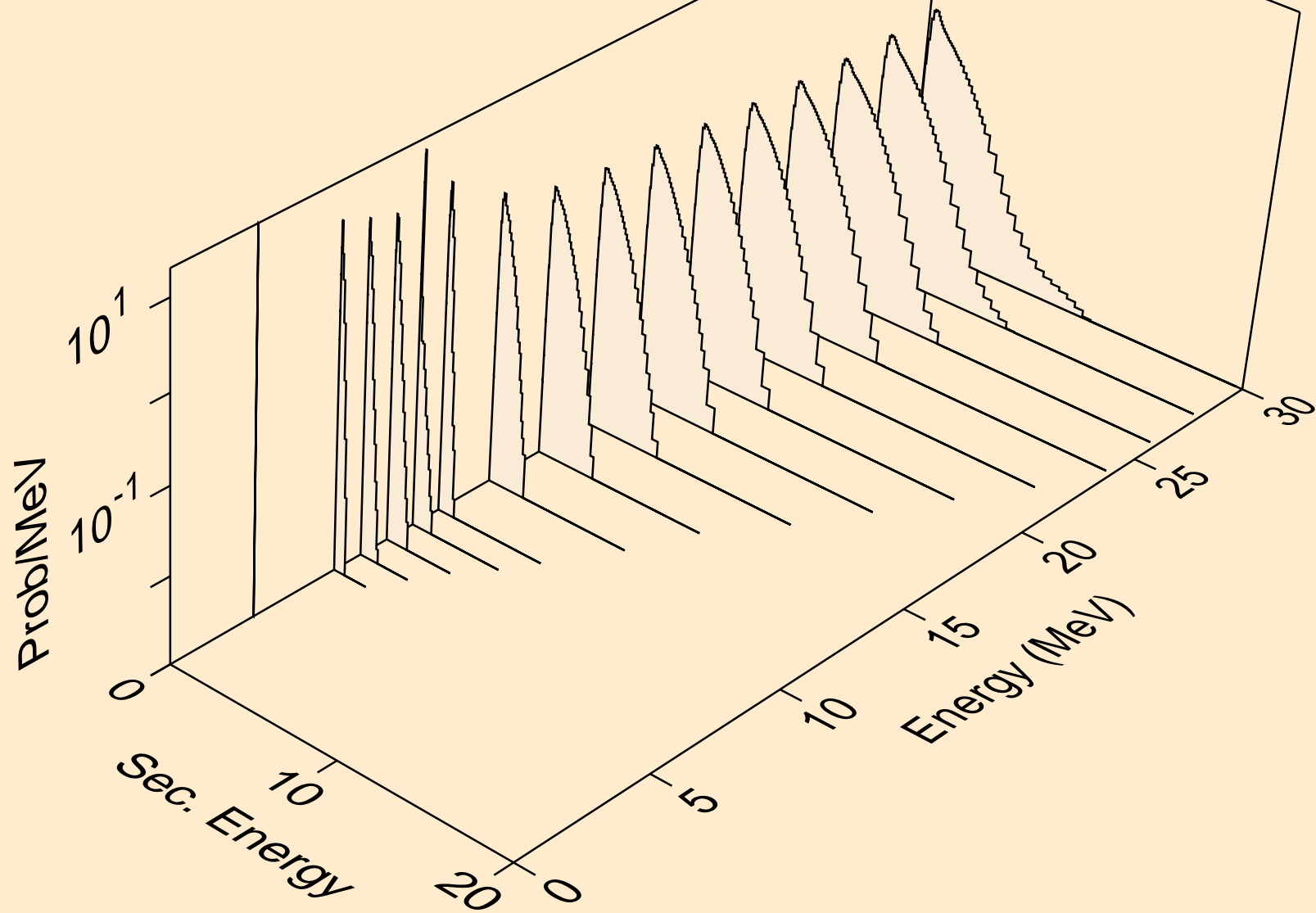

IR197 TRITON ACER TENDL-2021 LIBRARY; T=0.K  
neutrons from (t,n\*)d

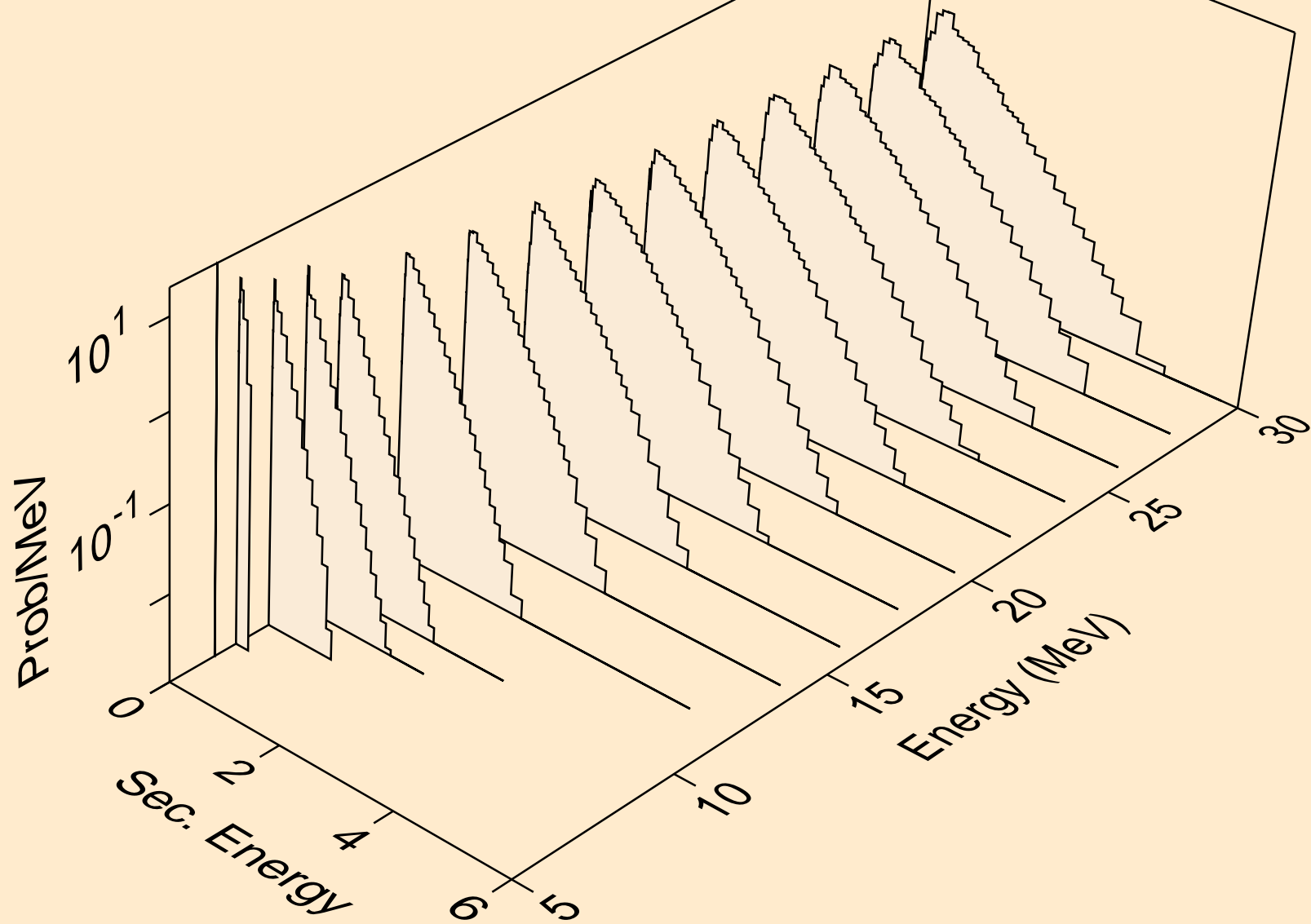

IR197 TRITON ACER TENDL-2021 LIBRARY; T=0.K  
neutrons from (t,n\*)t

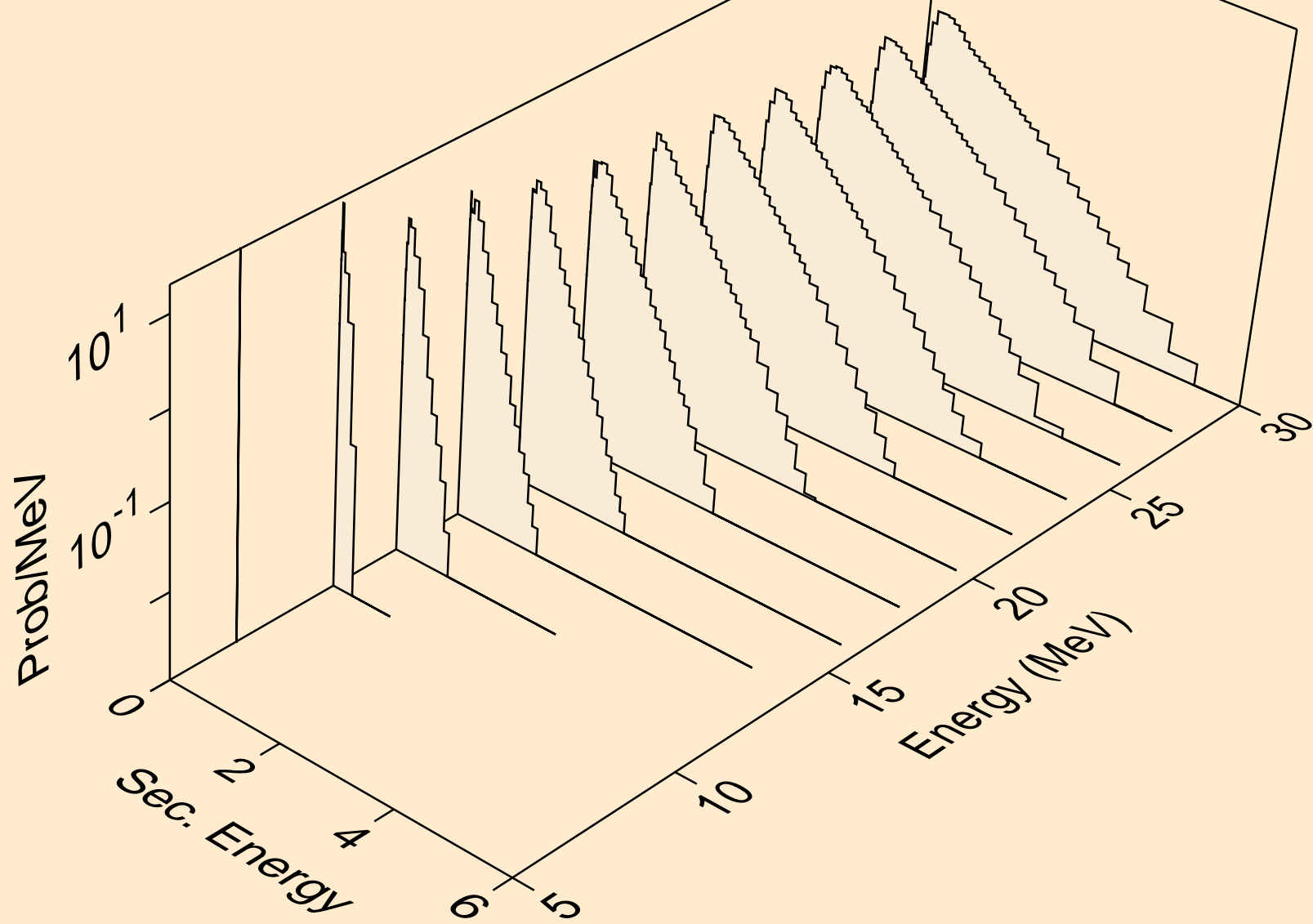

IR197 TRITON ACER TENDL-2021 LIBRARY; T=0.K  
neutrons from (t,n\*)he3

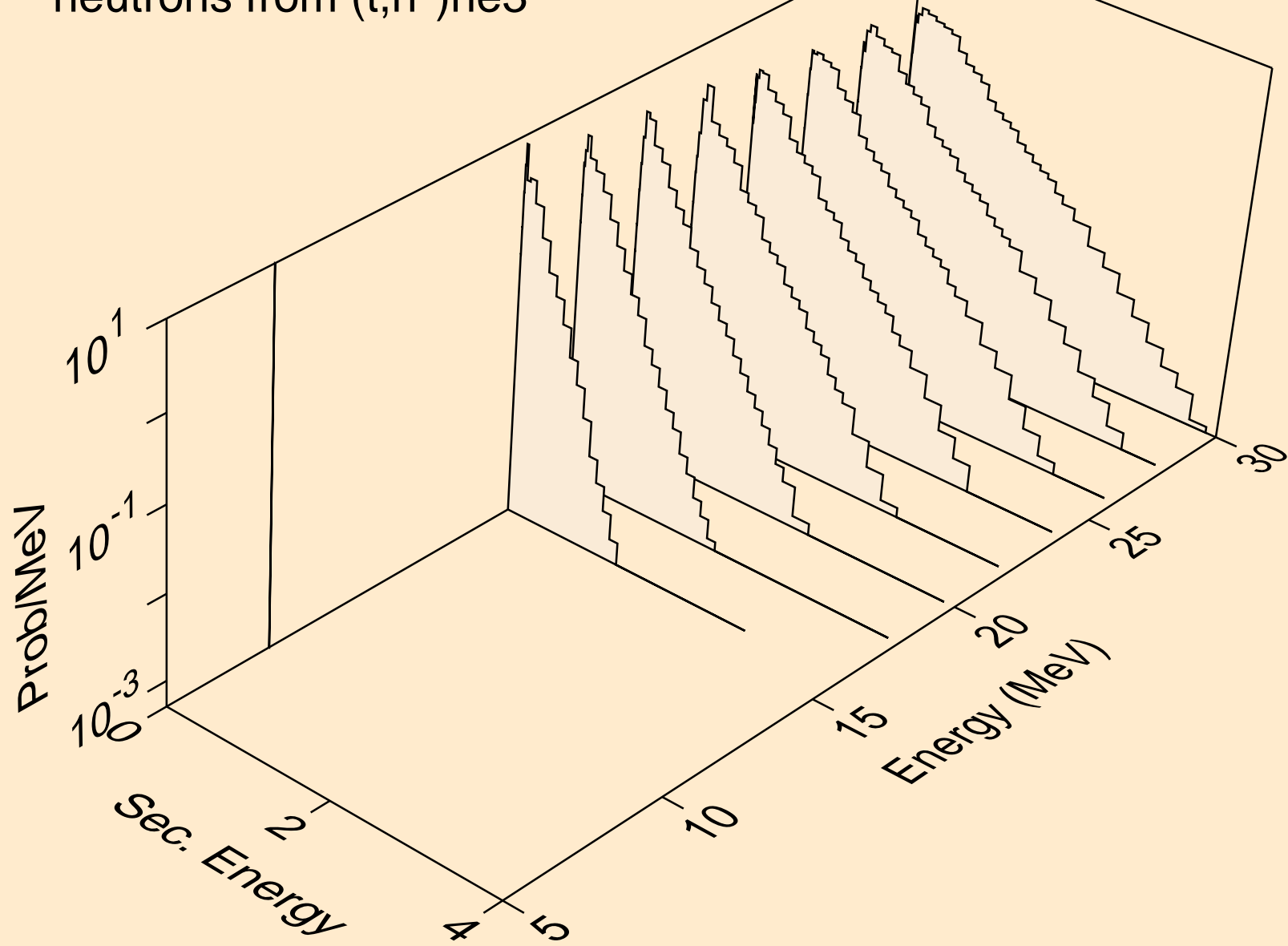

IR197 TRITON ACER TENDL-2021 LIBRARY; T=0.K  
neutrons from (t,4n)

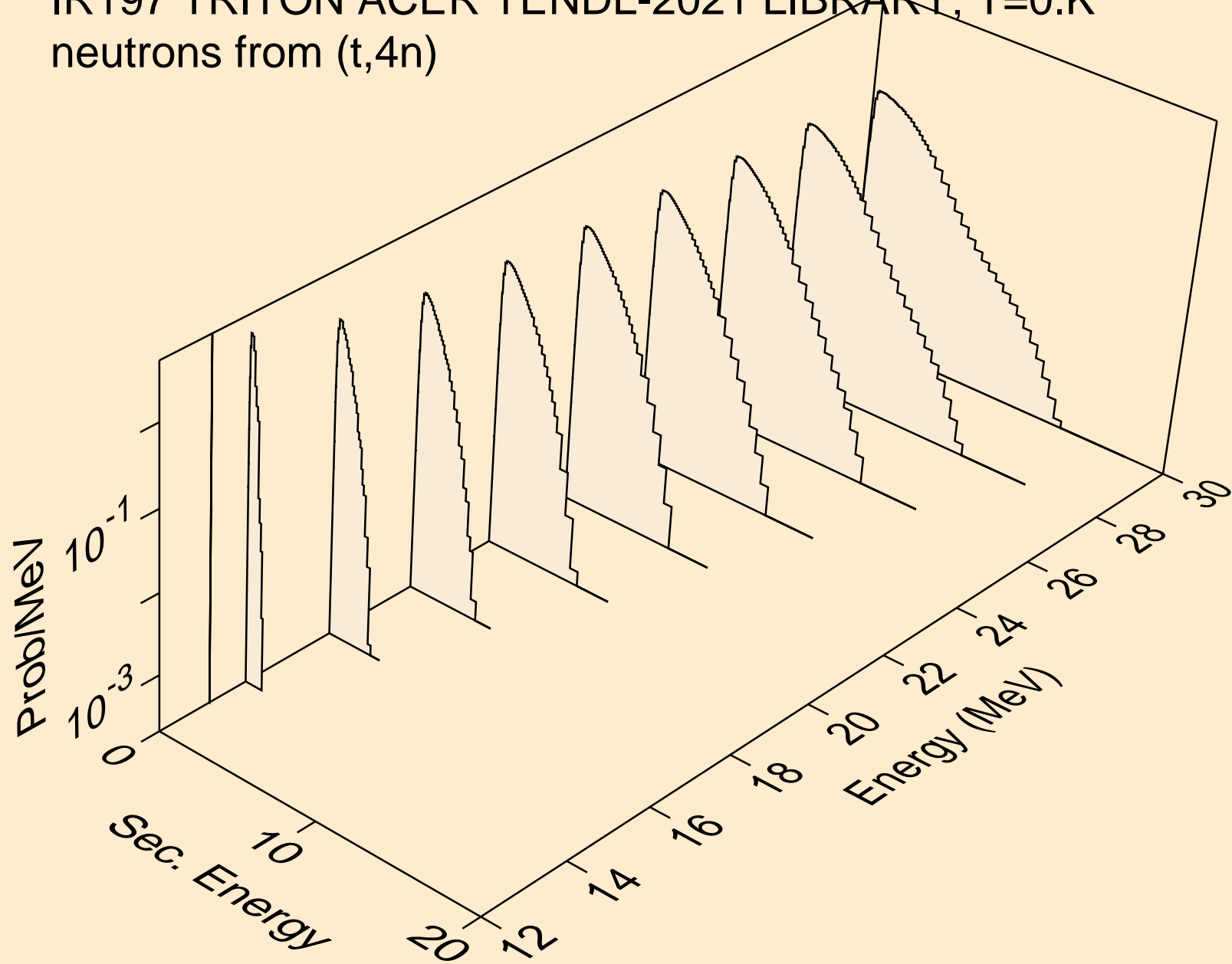

IR197 TRITON ACER TENDL-2021 LIBRARY; T=0.K  
neutrons from (t,2np)

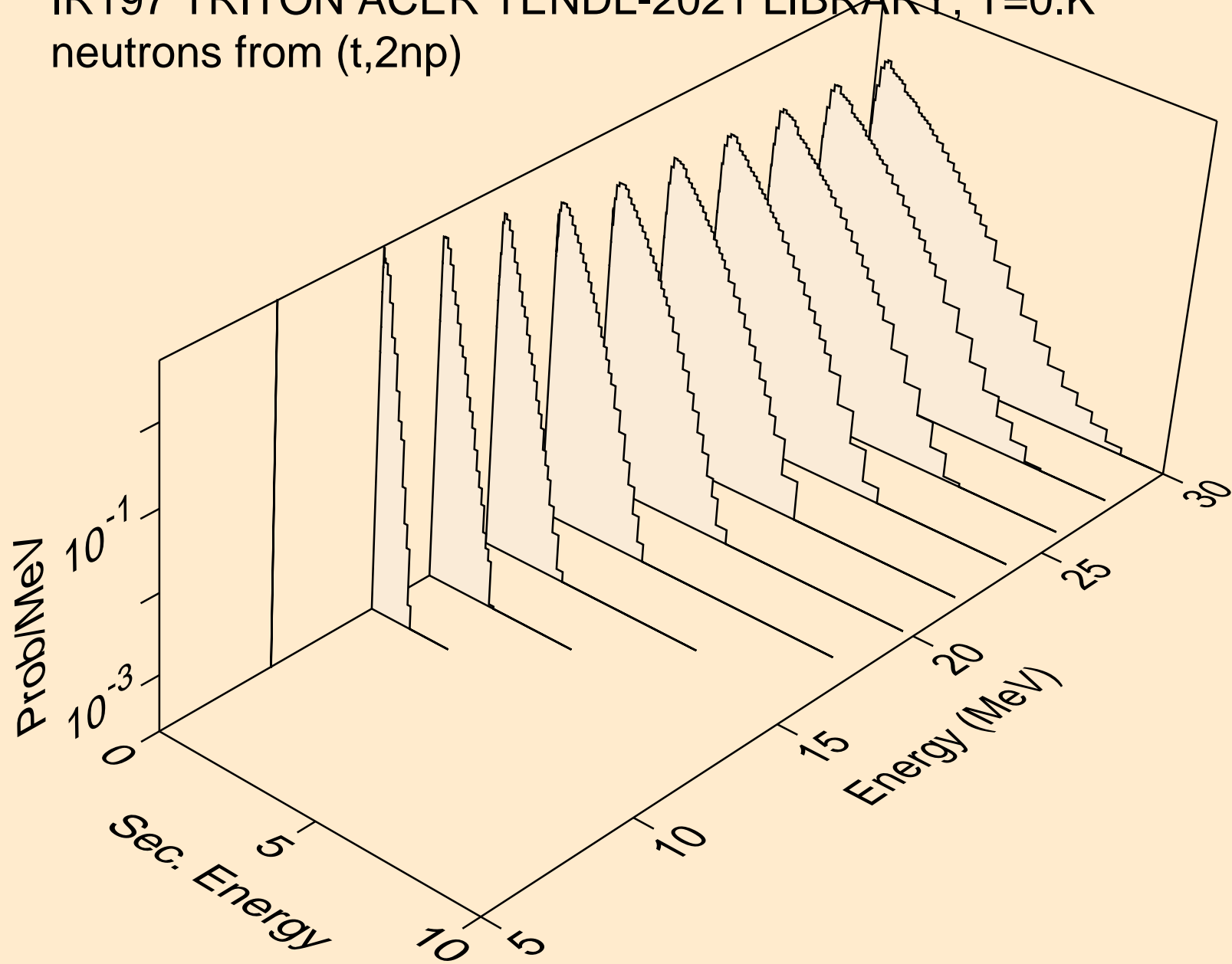

IR197 TRITON ACER TENDL-2021 LIBRARY; T=0.K  
neutrons from (t,3np)

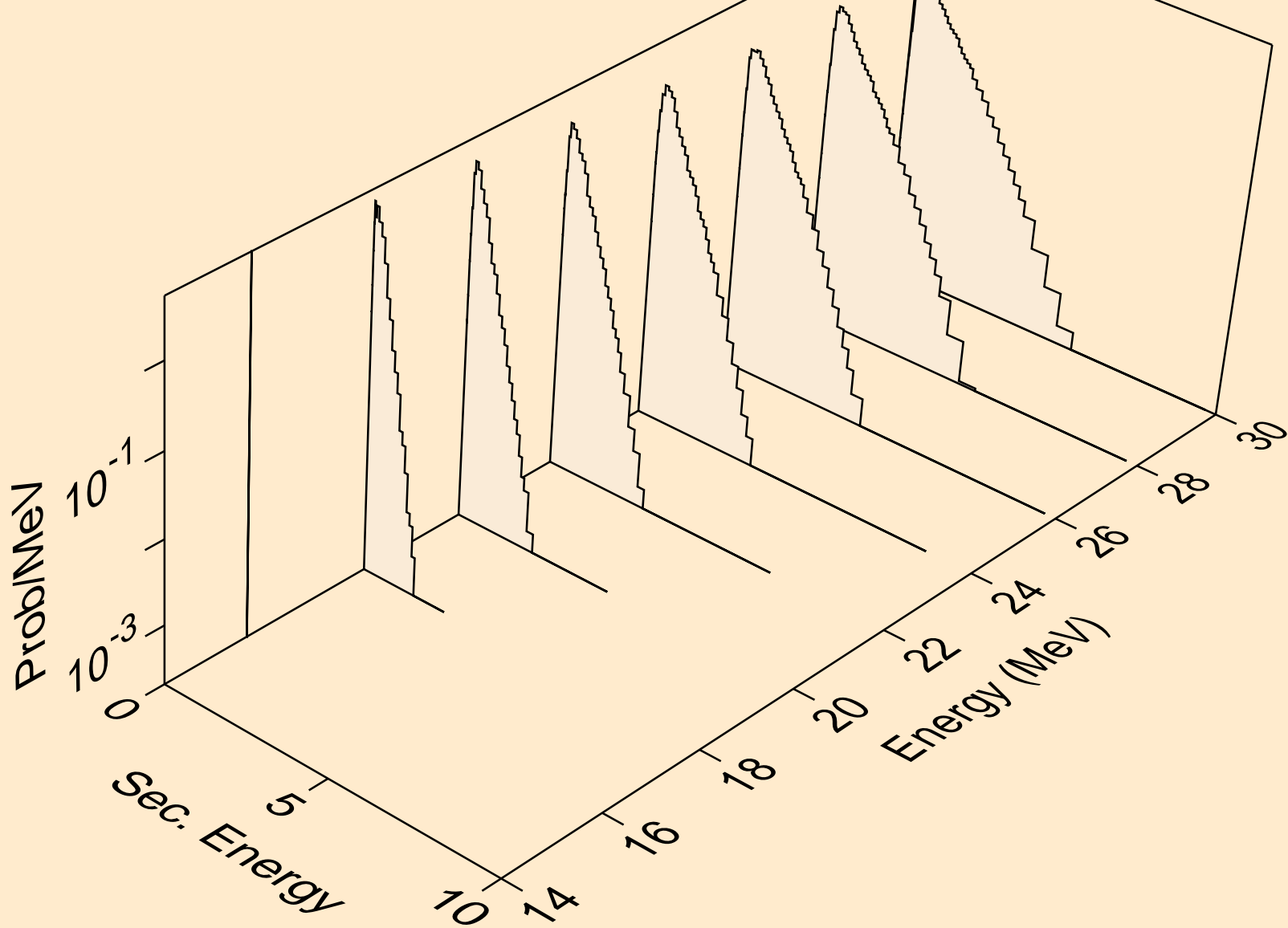

IR197 TRITON ACER TENDL-2021 LIBRARY; T=0.K  
neutrons from (t,2np)

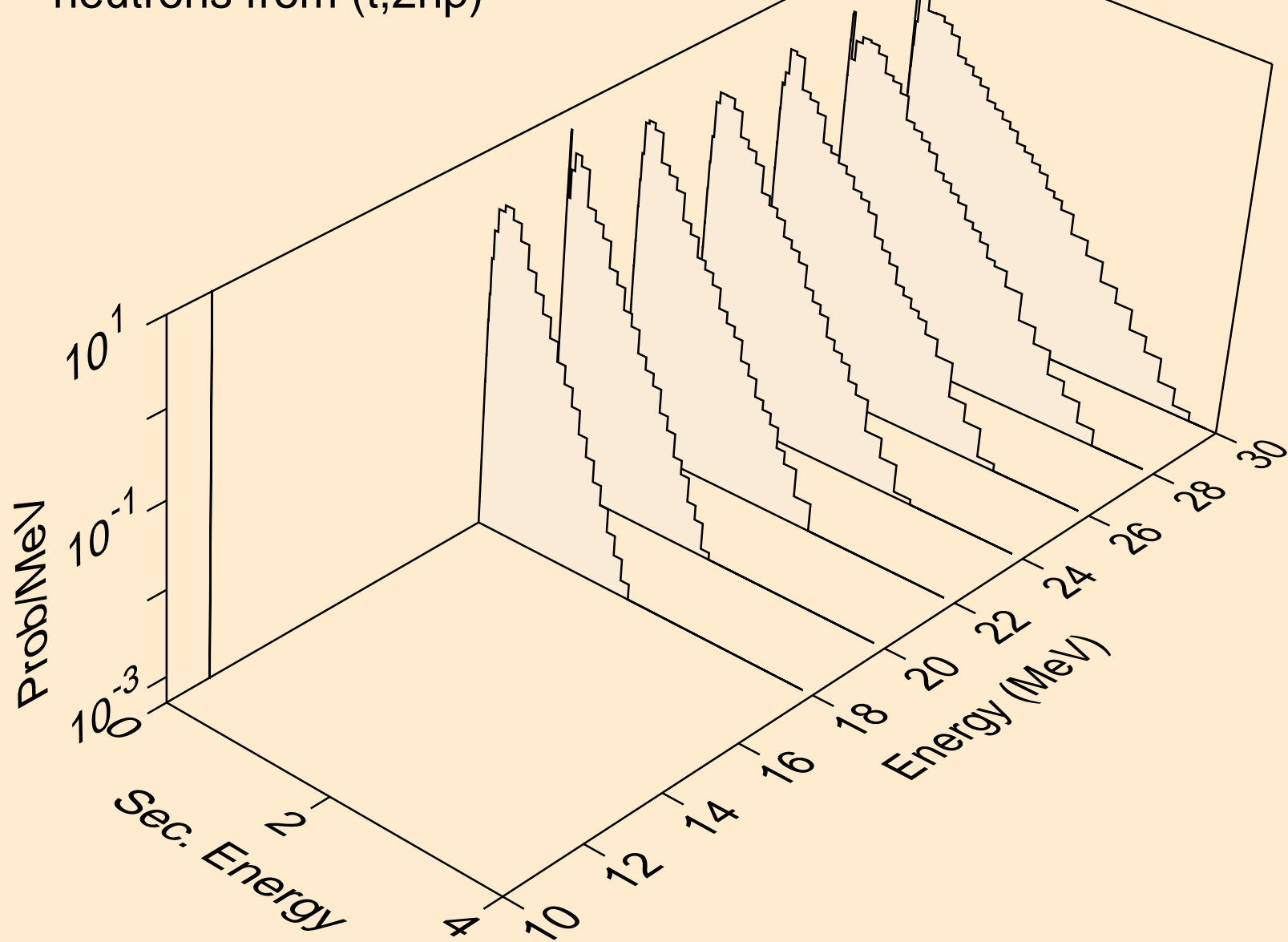



IR197 TRITON ACER TENDL-2021 LIBRARY; T=0.K  
protons from (t,x)

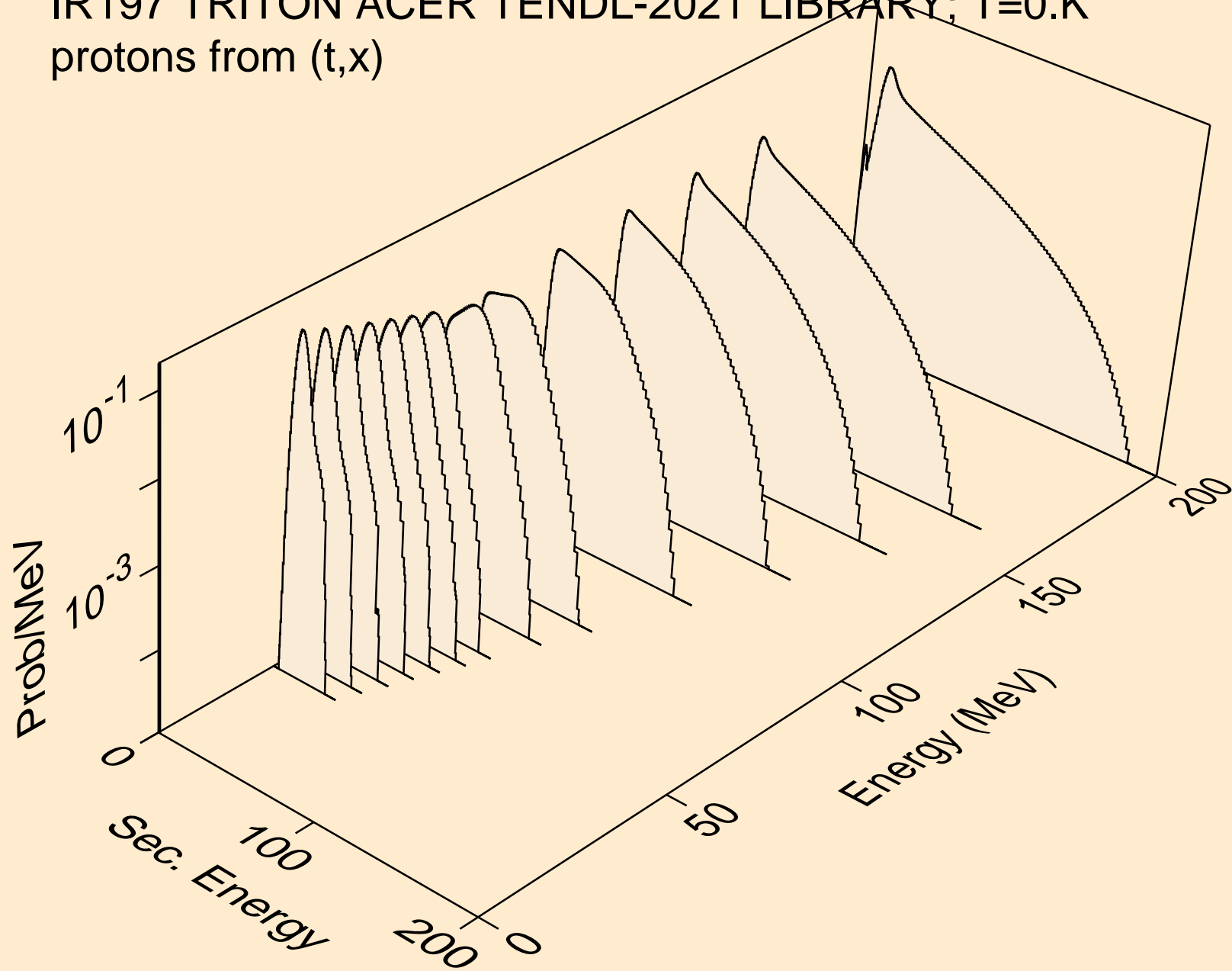

IR197 TRITON ACER TENDL-2021 LIBRARY; T=0.K  
protons from (t,n\*)p

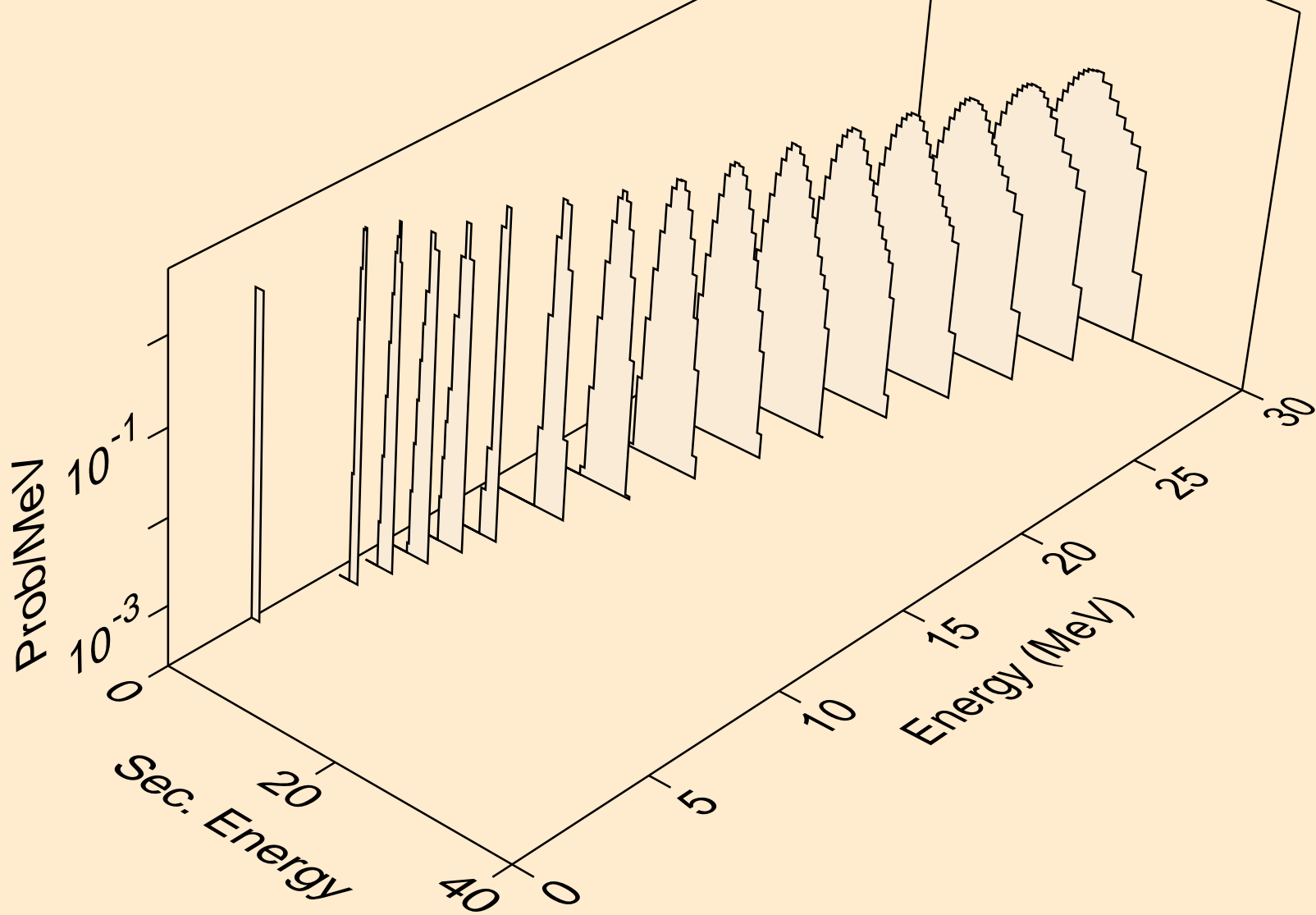

IR197 TRITON ACER TENDL-2021 LIBRARY; T=0.K  
protons from (t,2np)

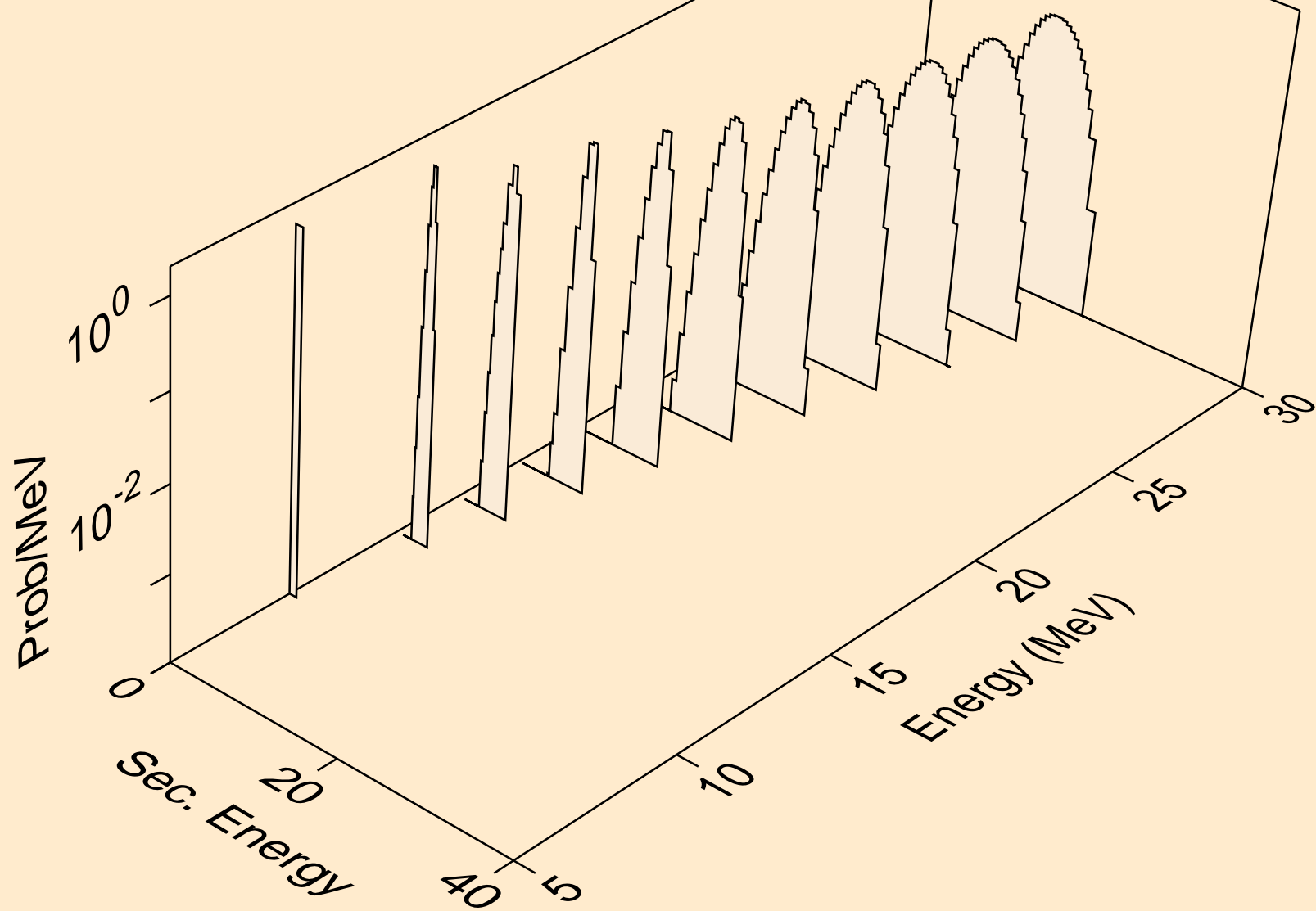

IR197 TRITON ACER TENDL-2021 LIBRARY; T=0.K  
protons from (t,3np)

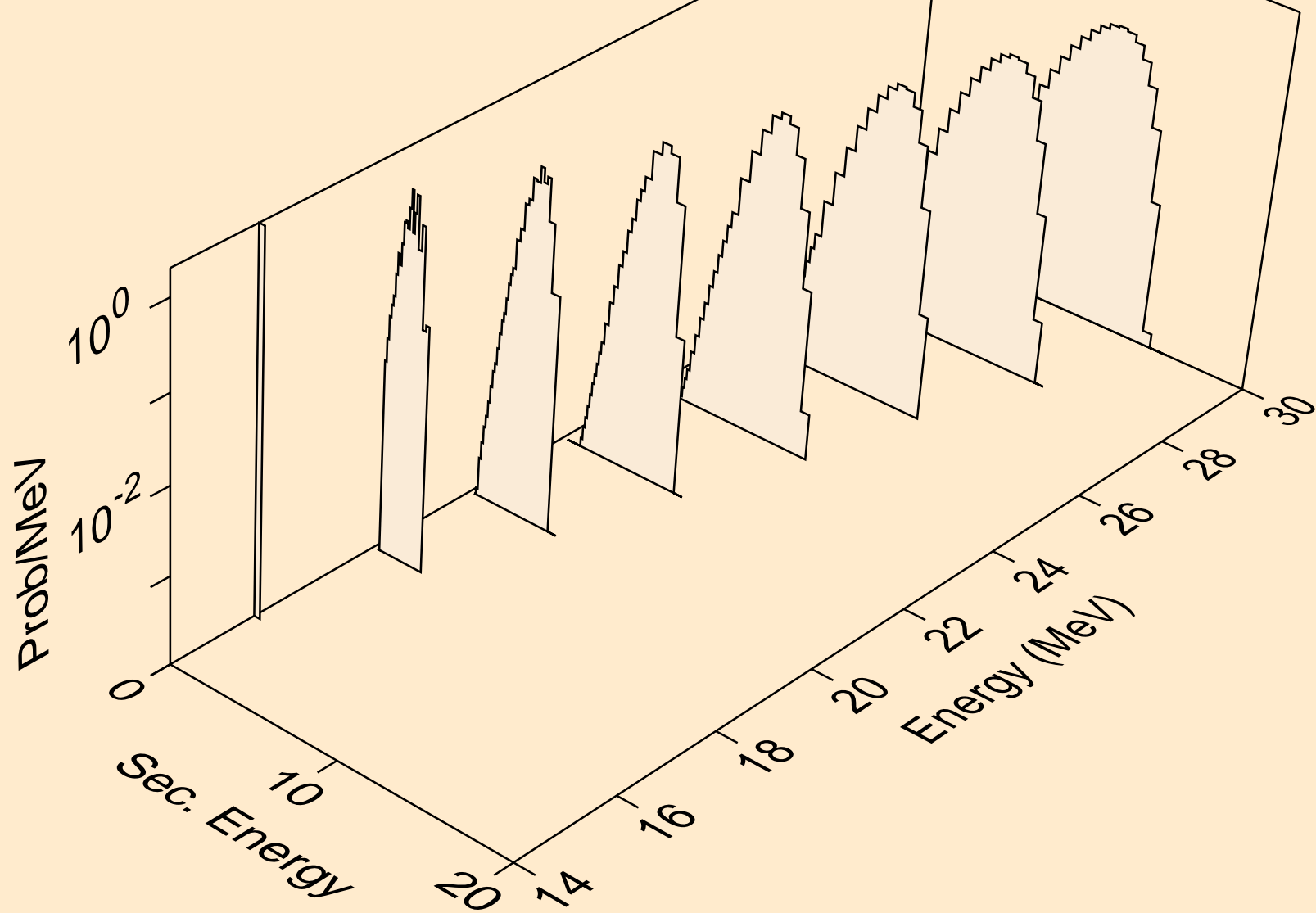

IR197 TRITON ACER TENDL-2021 LIBRARY; T=0.K  
protons from (t,2np)

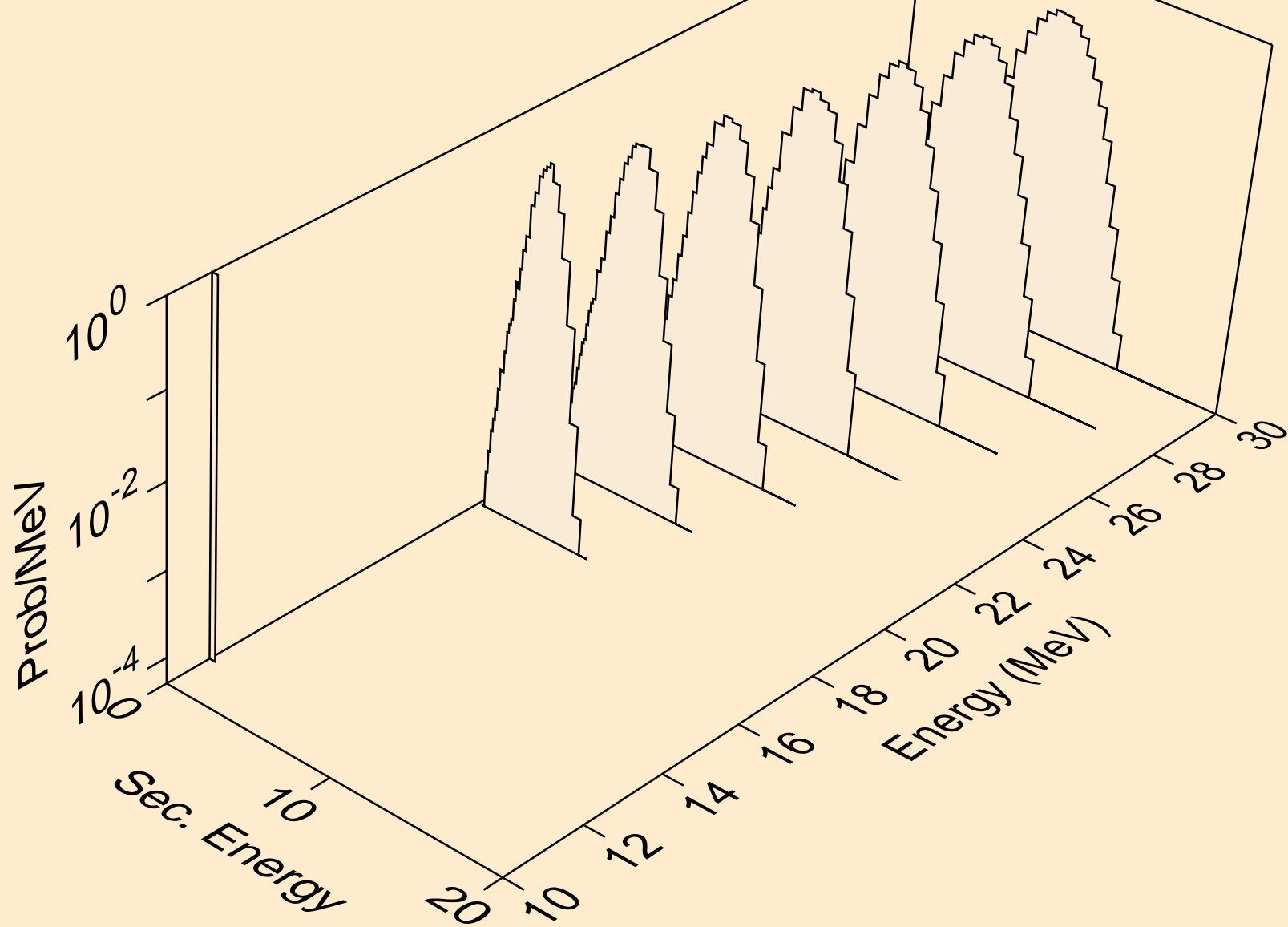

IR197 TRITON ACER TENDL-2021 LIBRARY; T=0.K  
protons from (t,p)

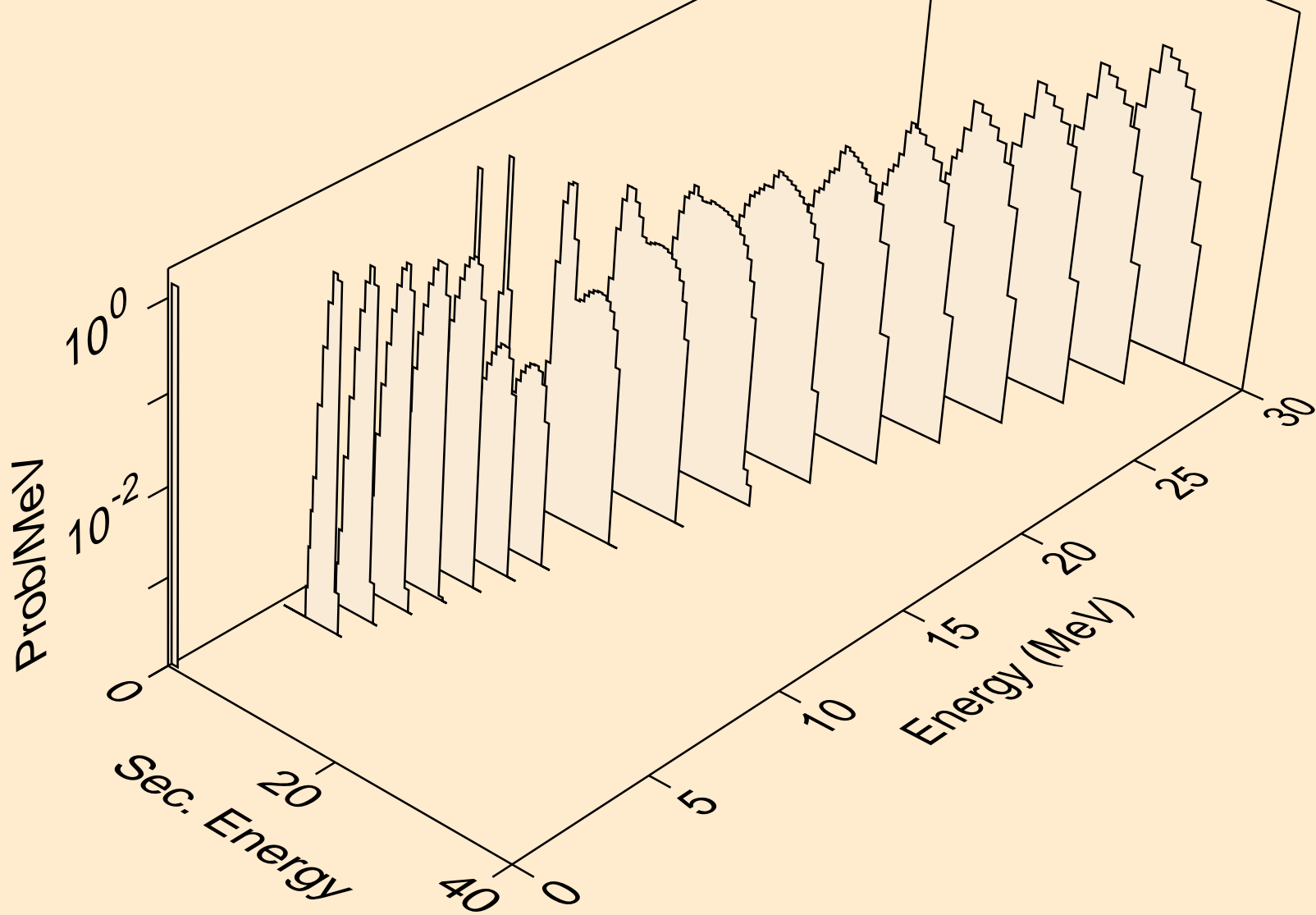

IR197 TRITON ACER TENDL-2021 LIBRARY; T=0.K  
protons from (t,2p)

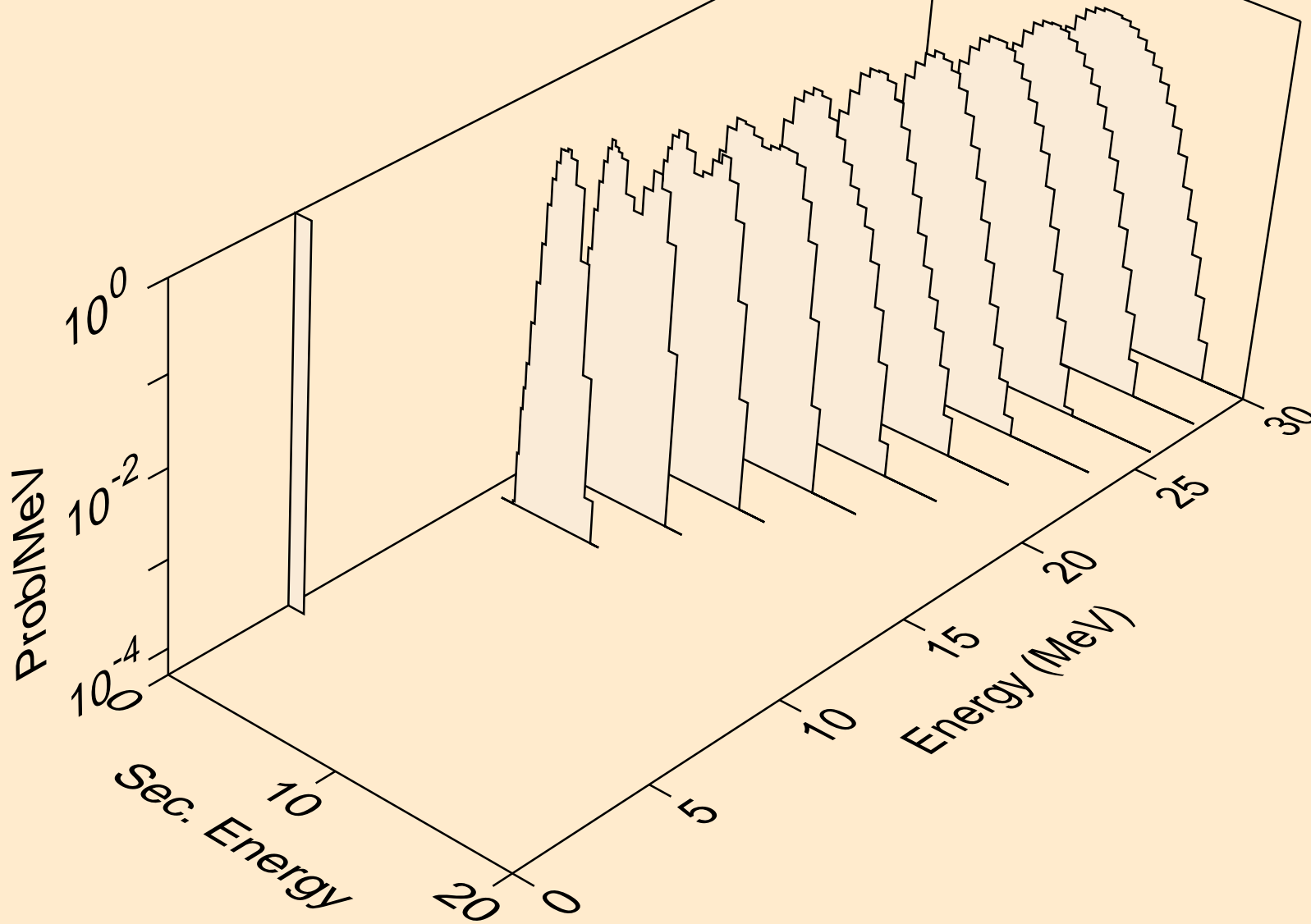

IR197 TRITON ACER TENDL-2021 LIBRARY; T=0.K  
protons from (t,pd)

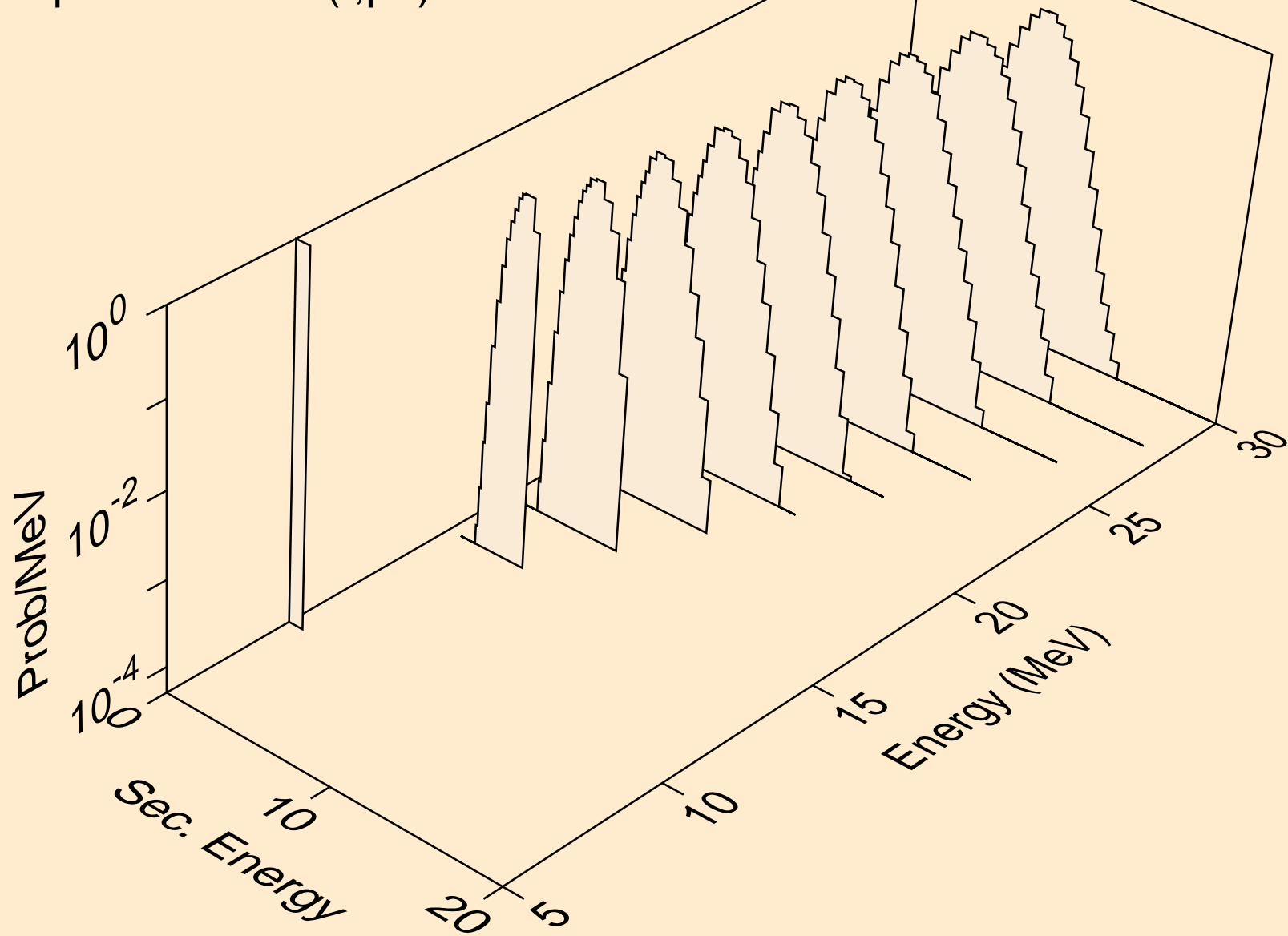



IR197 TRITON ACER TENDL-2021 LIBRARY; T=0.K  
protons from (t,pt)

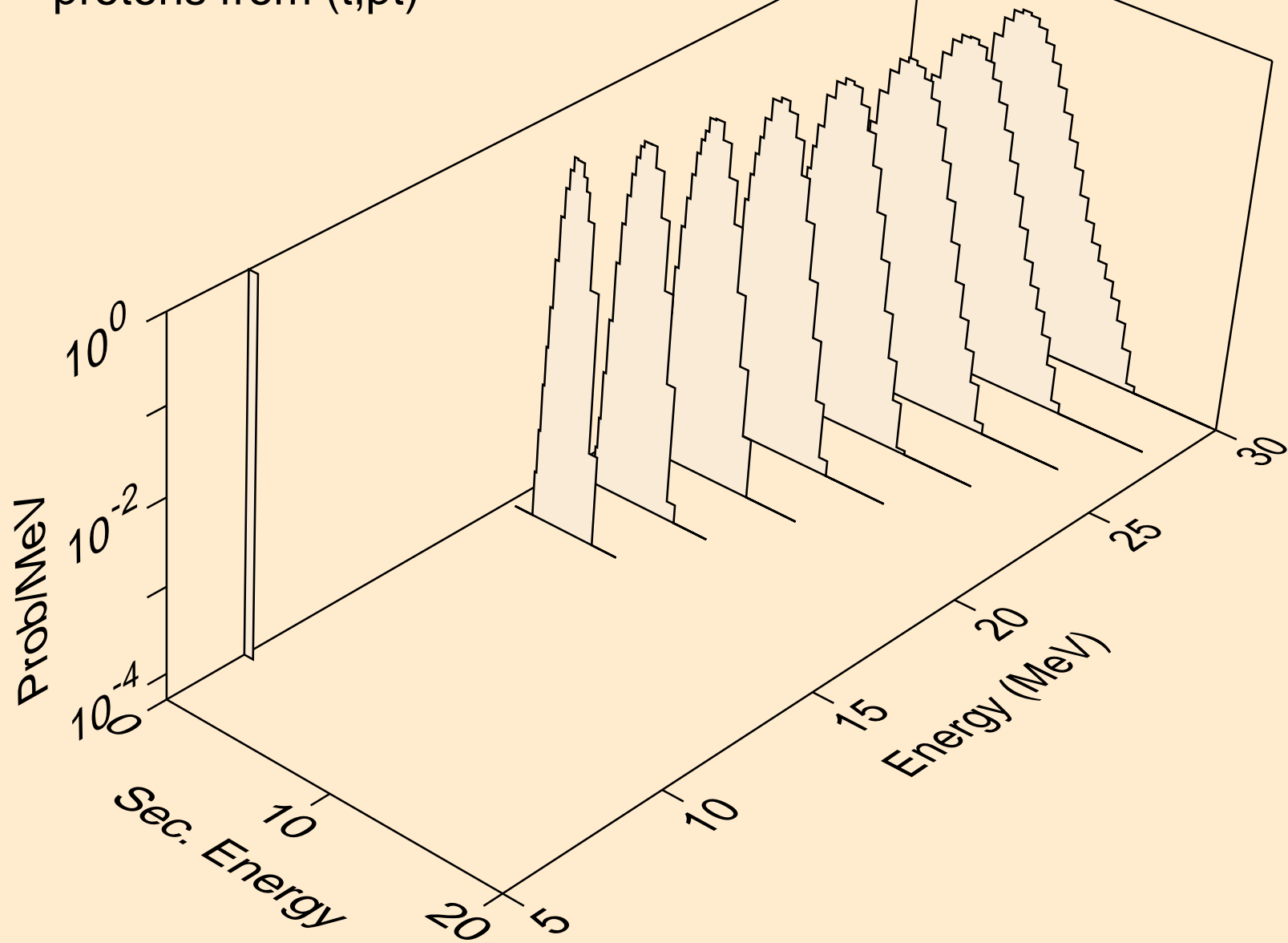

IR197 TRITON ACER TENDL-2021 LIBRARY; T=0.K  
deuterons from (t,x)

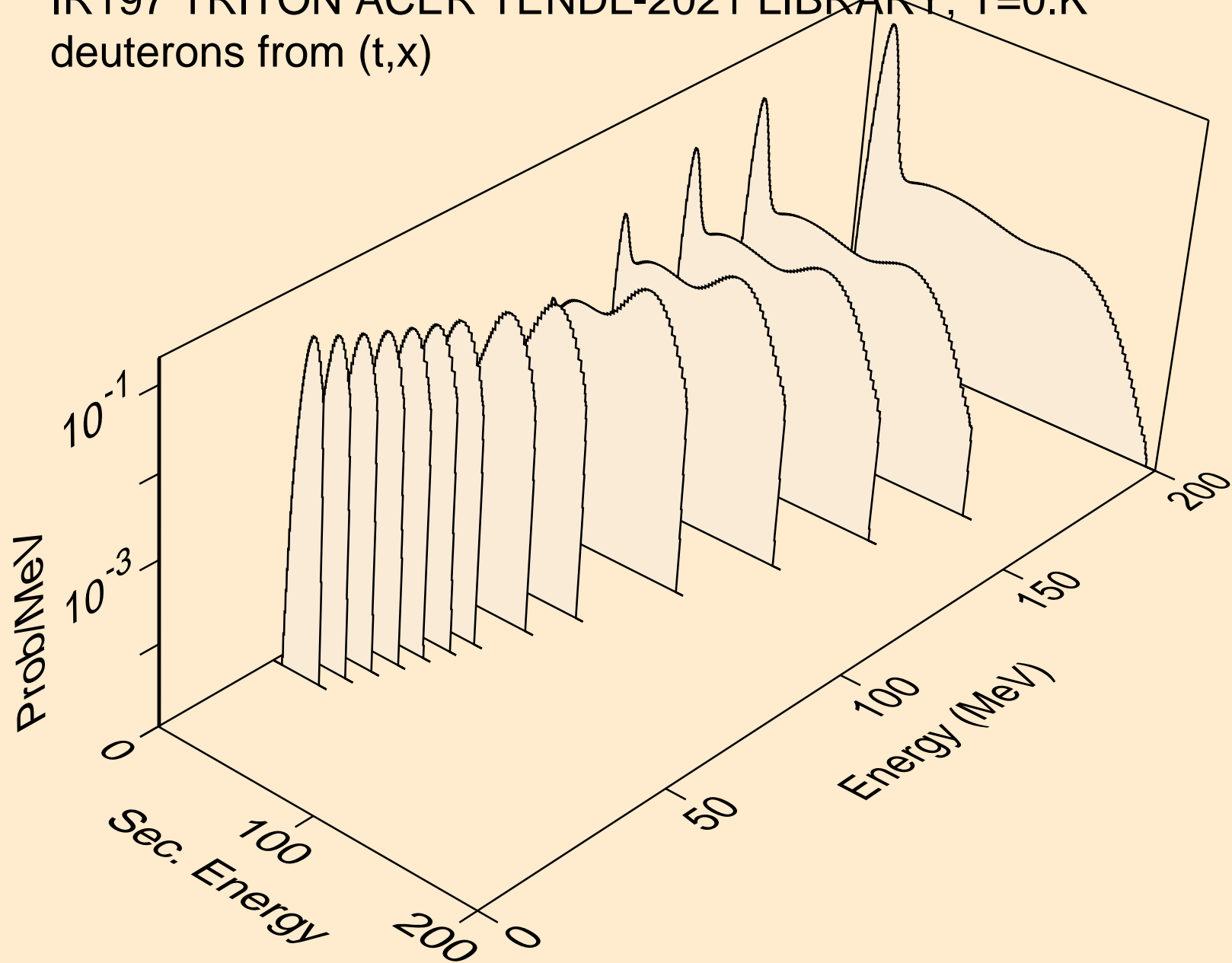

IR197 TRITON ACER TENDL-2021 LIBRARY; T=0.K  
deuterons from (t,2nd)

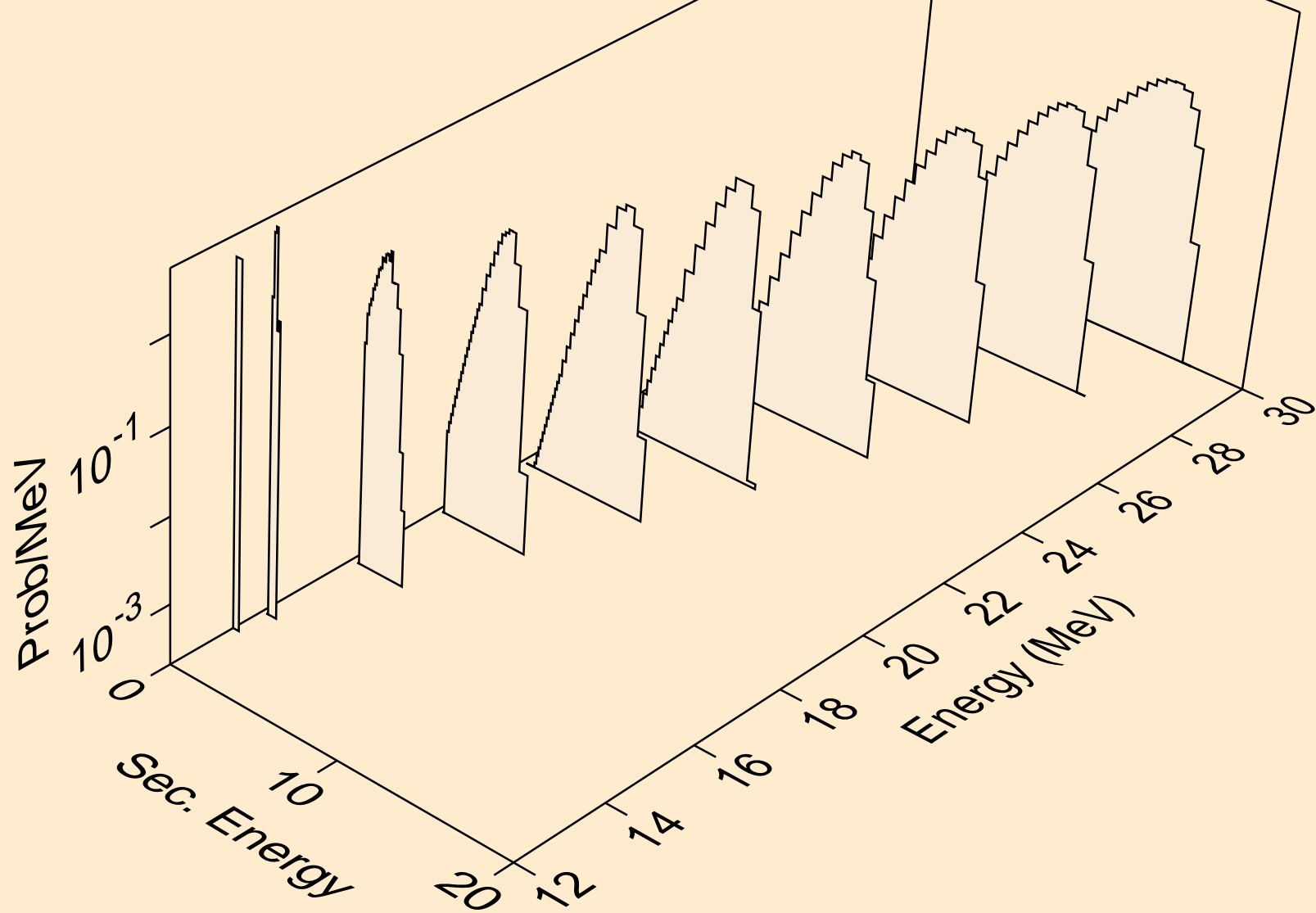

IR197 TRITON ACER TENDL-2021 LIBRARY; T=0.K  
deuterons from (t,n\*)d

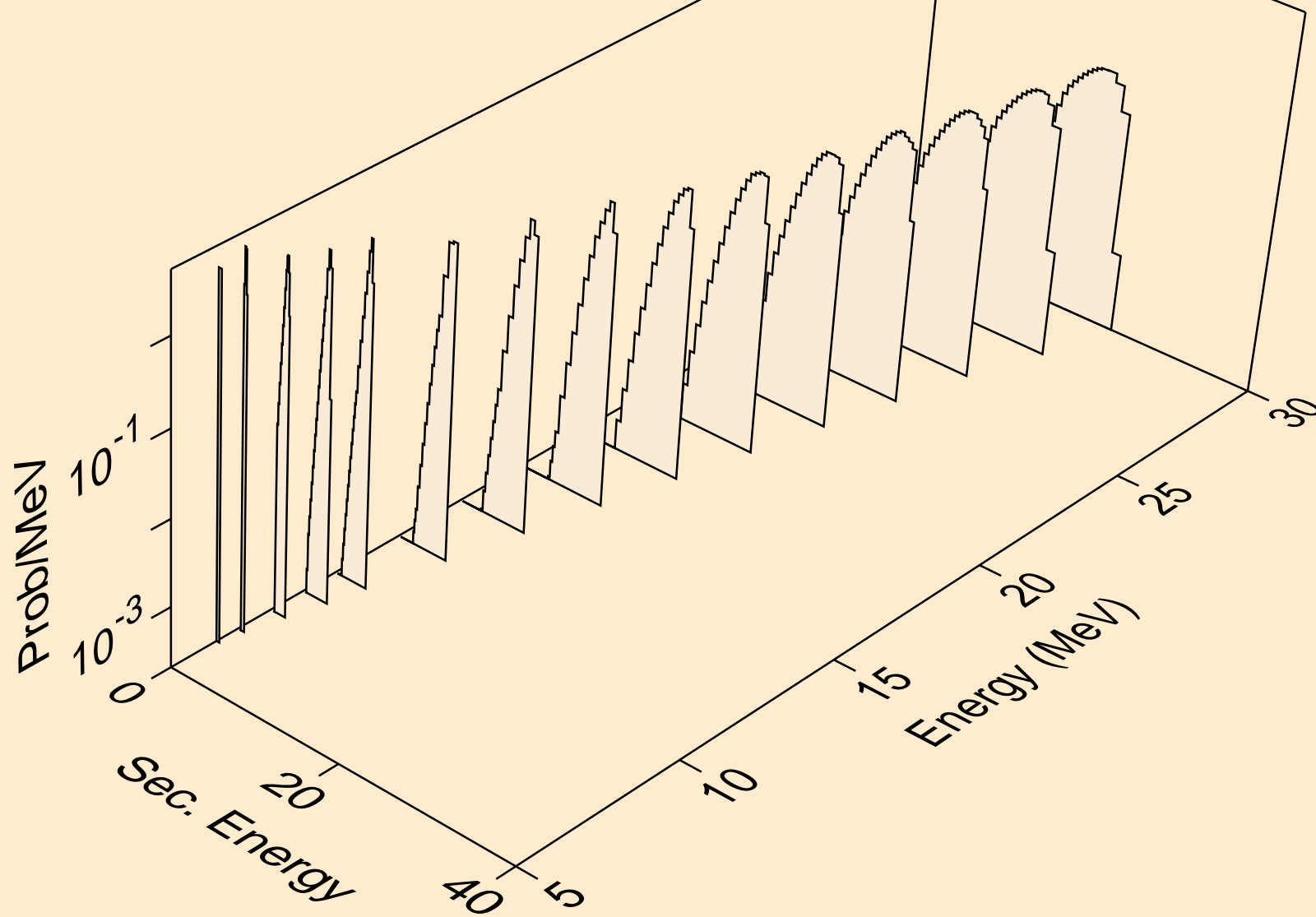

IR197 TRITON ACER TENDL-2021 LIBRARY; T=0.K  
deuterons from (t,d)

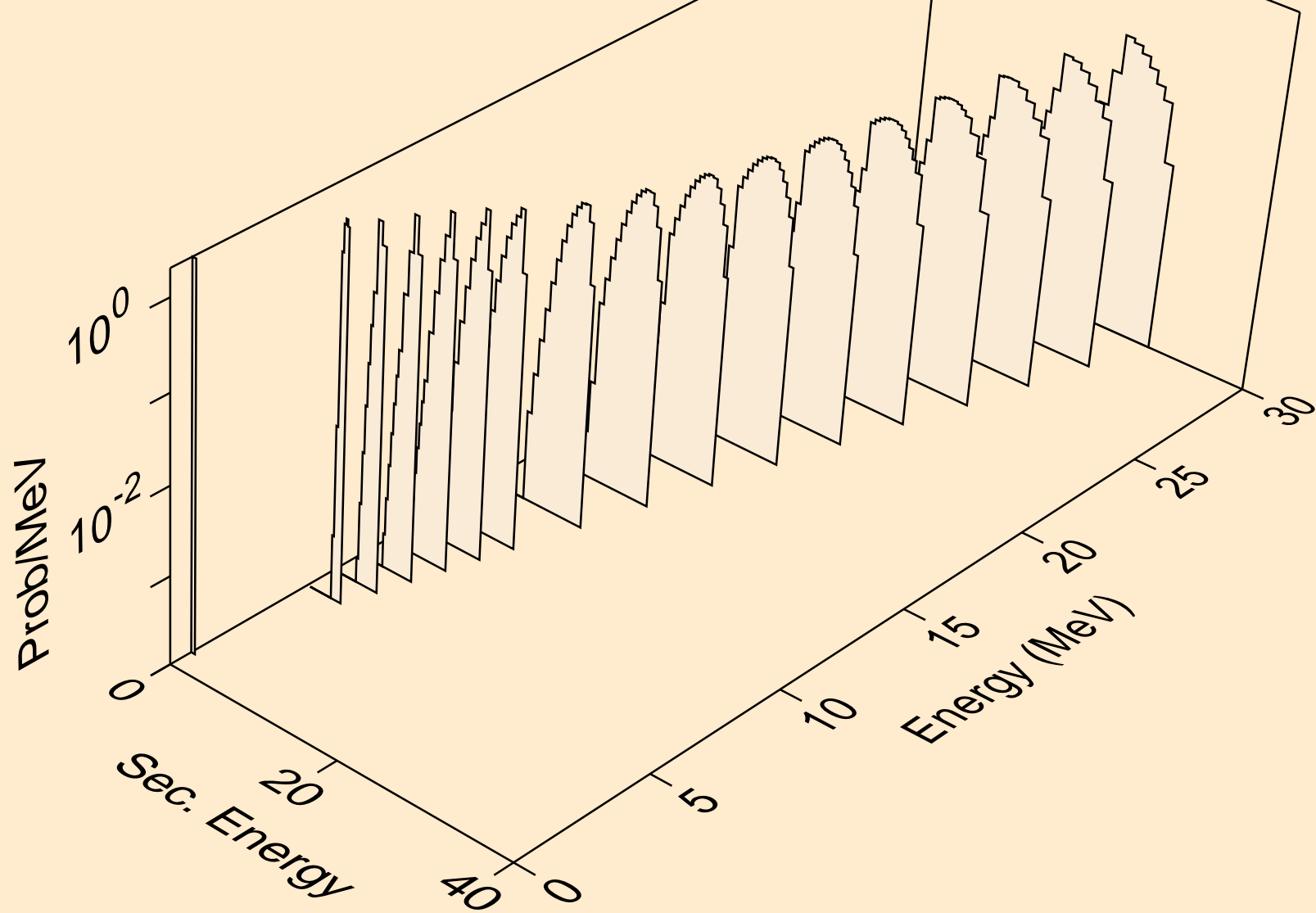

IR197 TRITON ACER TENDL-2021 LIBRARY; T=0.K  
deuterons from (t,pd)

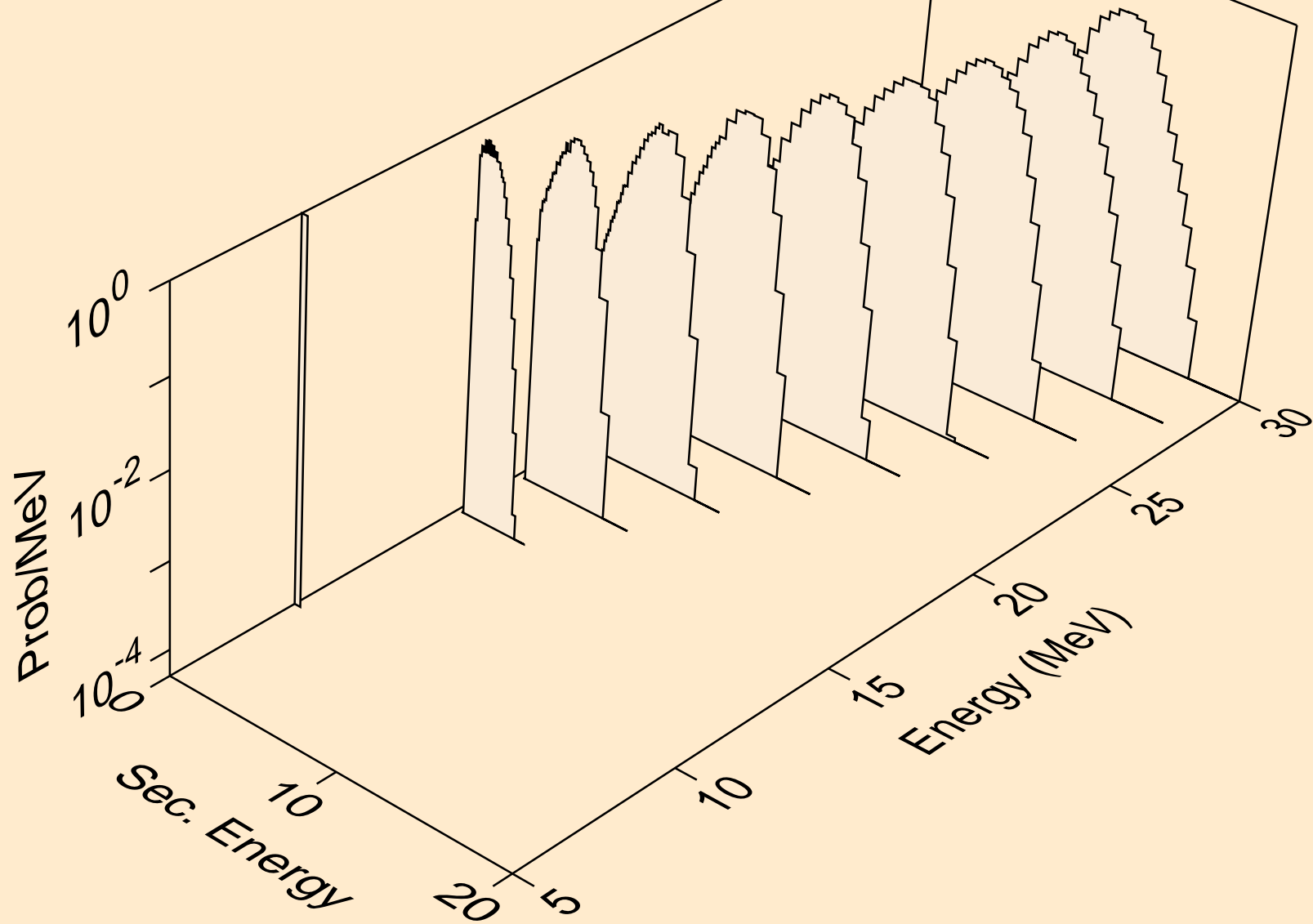

IR197 TRITON ACER TENDL-2021 LIBRARY; T=0.K  
he3s from (t,x)

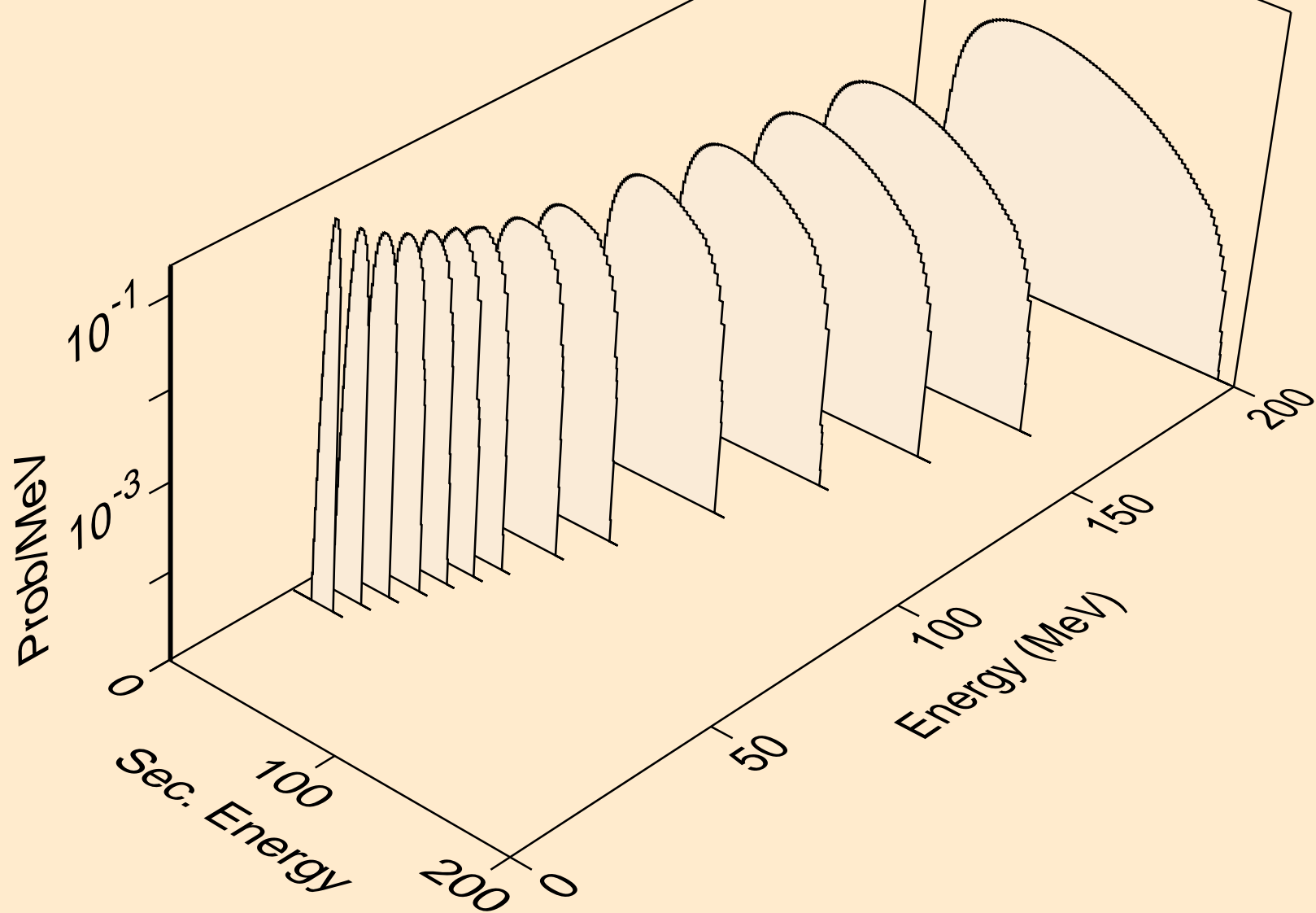

IR197 TRITON ACER TENDL-2021 LIBRARY; T=0.K  
he3s from (t,n\*)he3

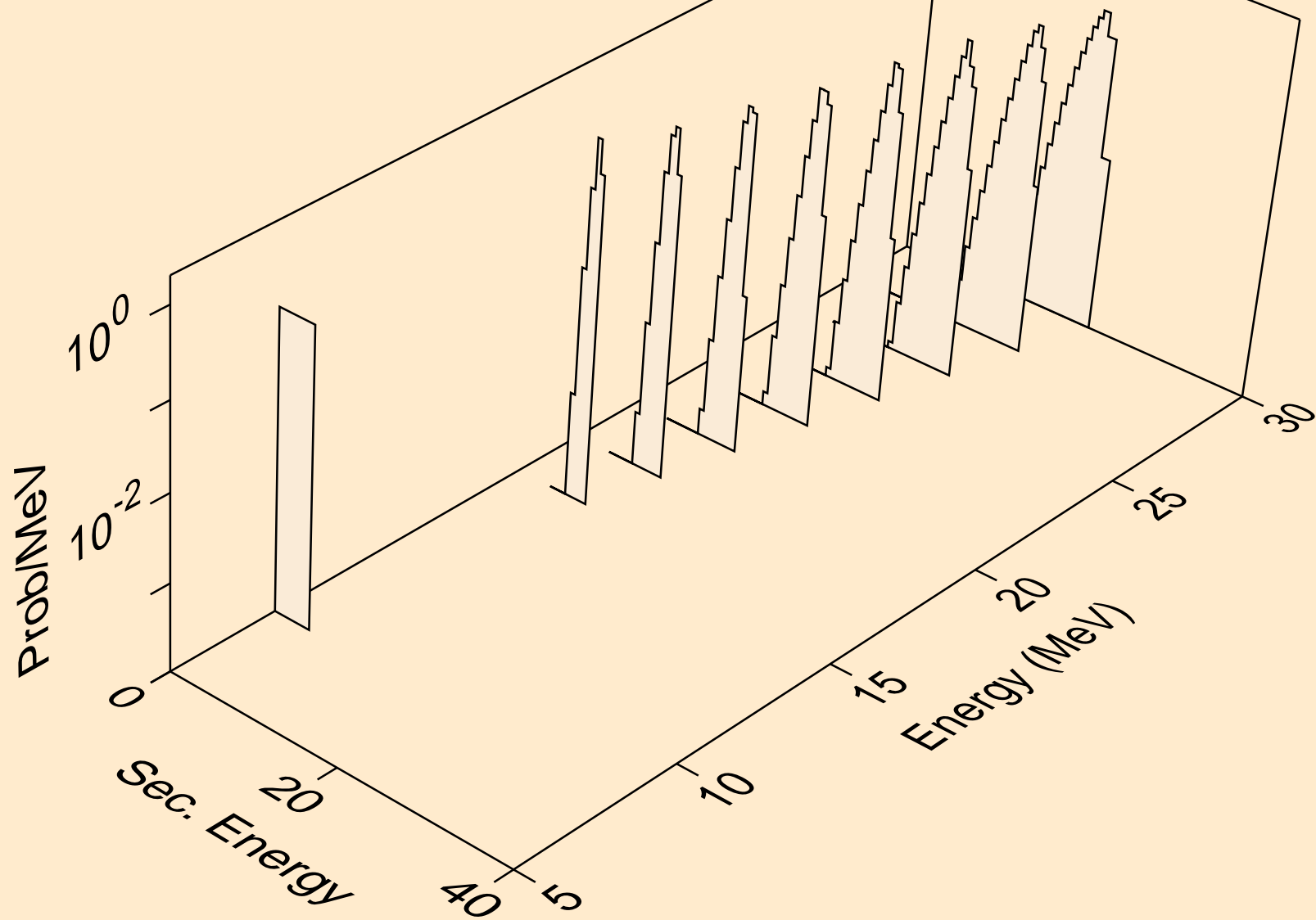



IR197 TRITON ACER TENDL-2021 LIBRARY; T=0.K  
he3s from (t,he3)

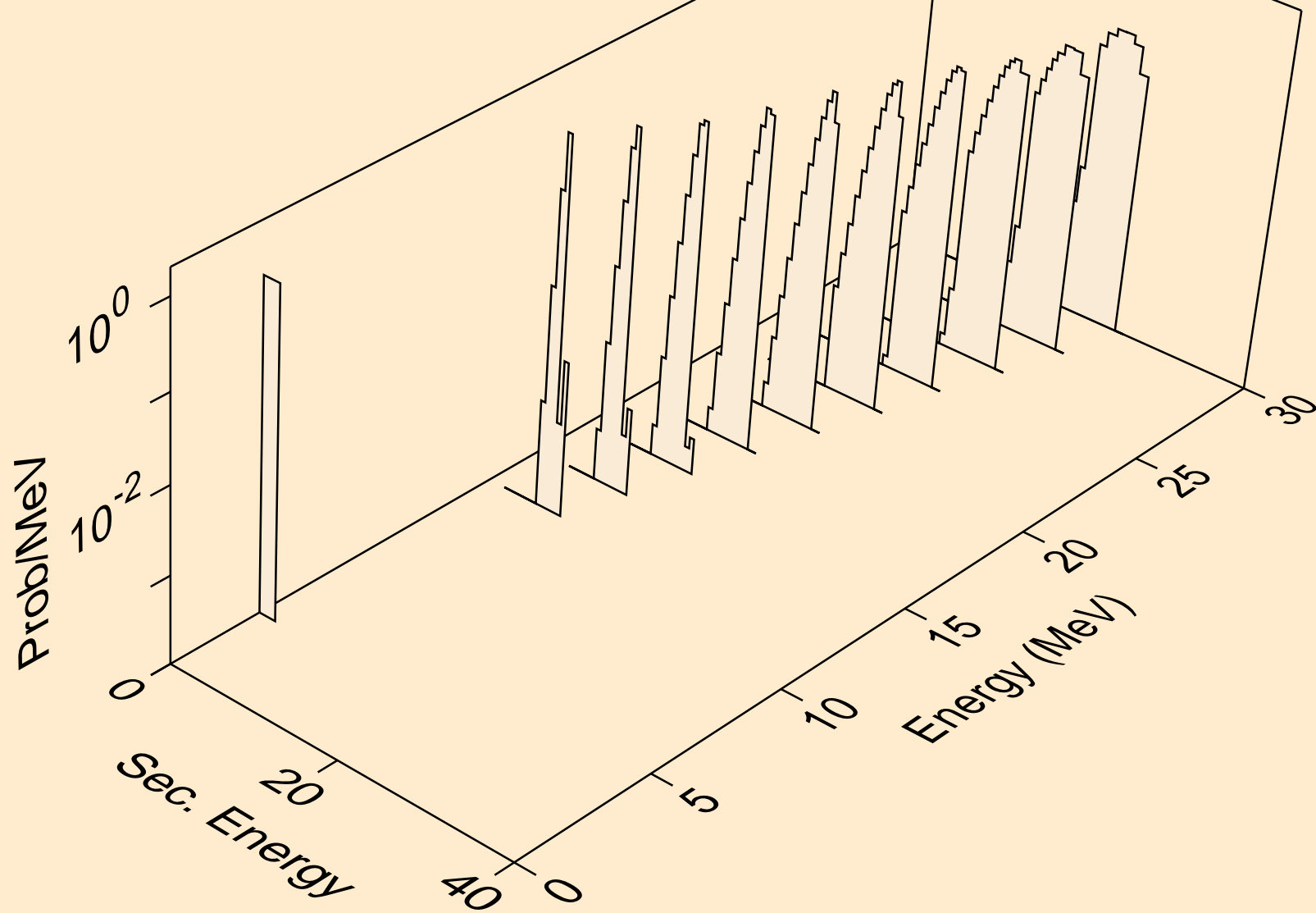

IR197 TRITON ACER TENDL-2021 LIBRARY; T=0.K  
alphas from (t,x)

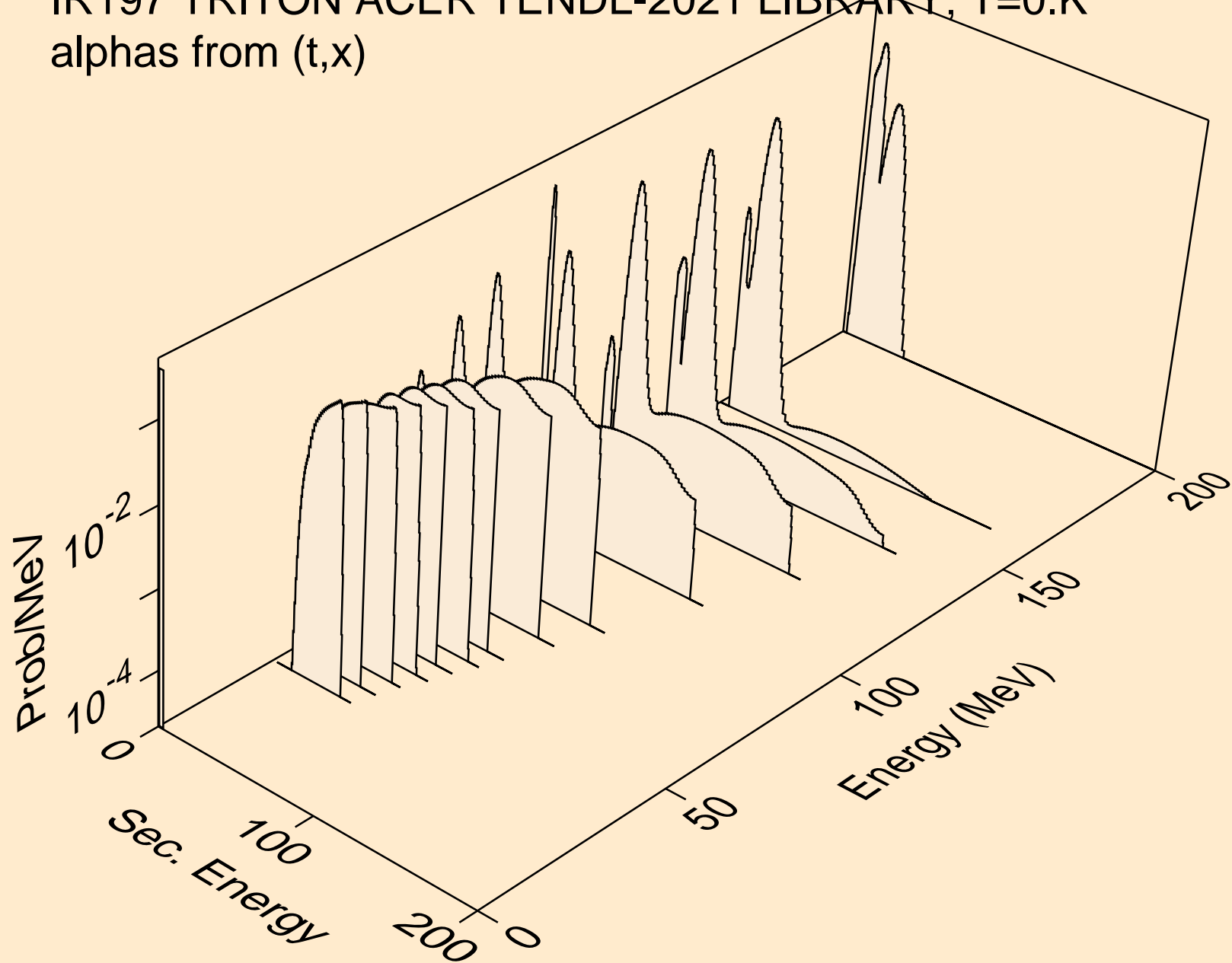

IR197 TRITON ACER TENDL-2021 LIBRARY; T=0.K  
alphas from (t,n\*)a

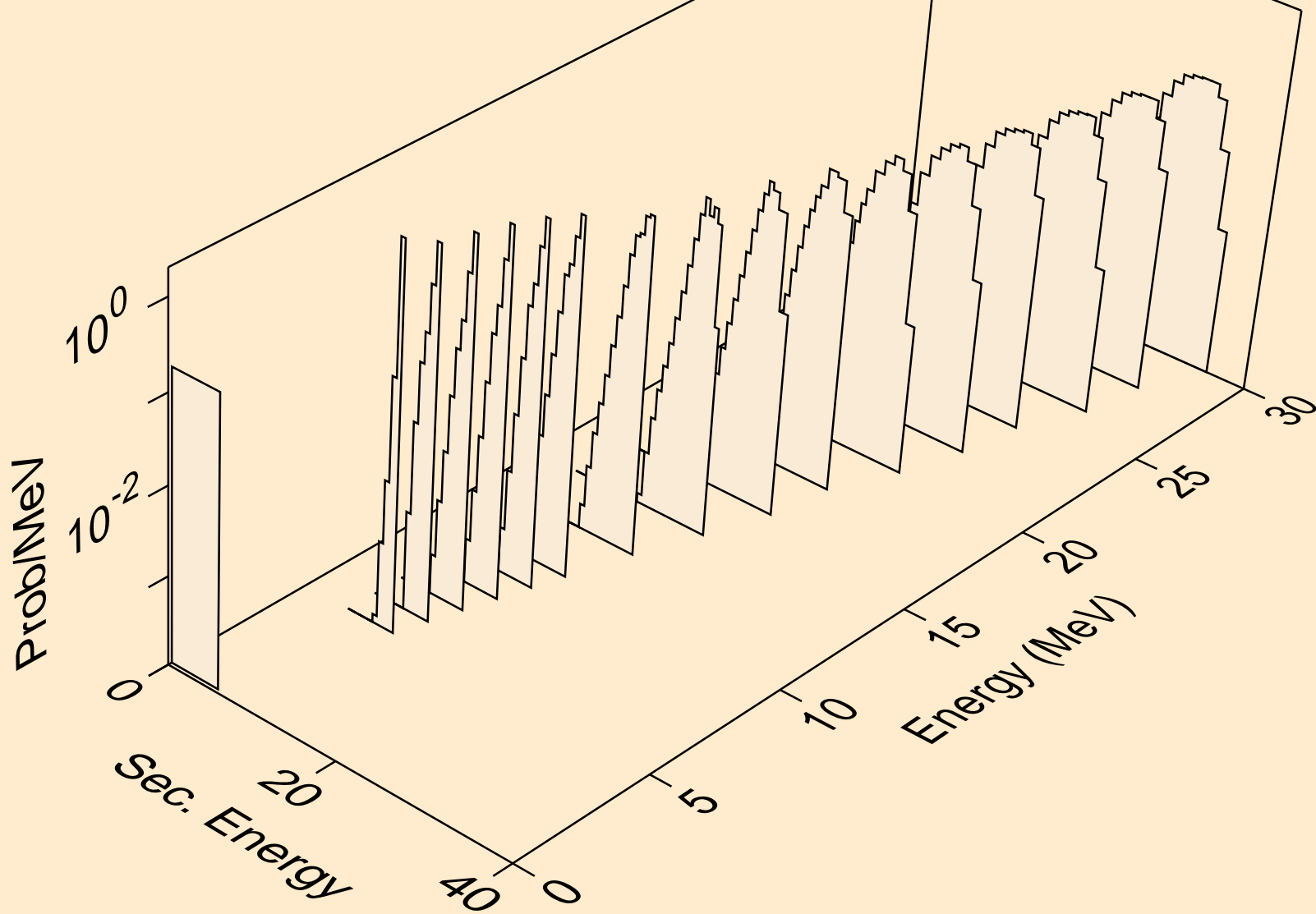

IR197 TRITON ACER TENDL-2021 LIBRARY; T=0.K  
alphas from (t,2n)a

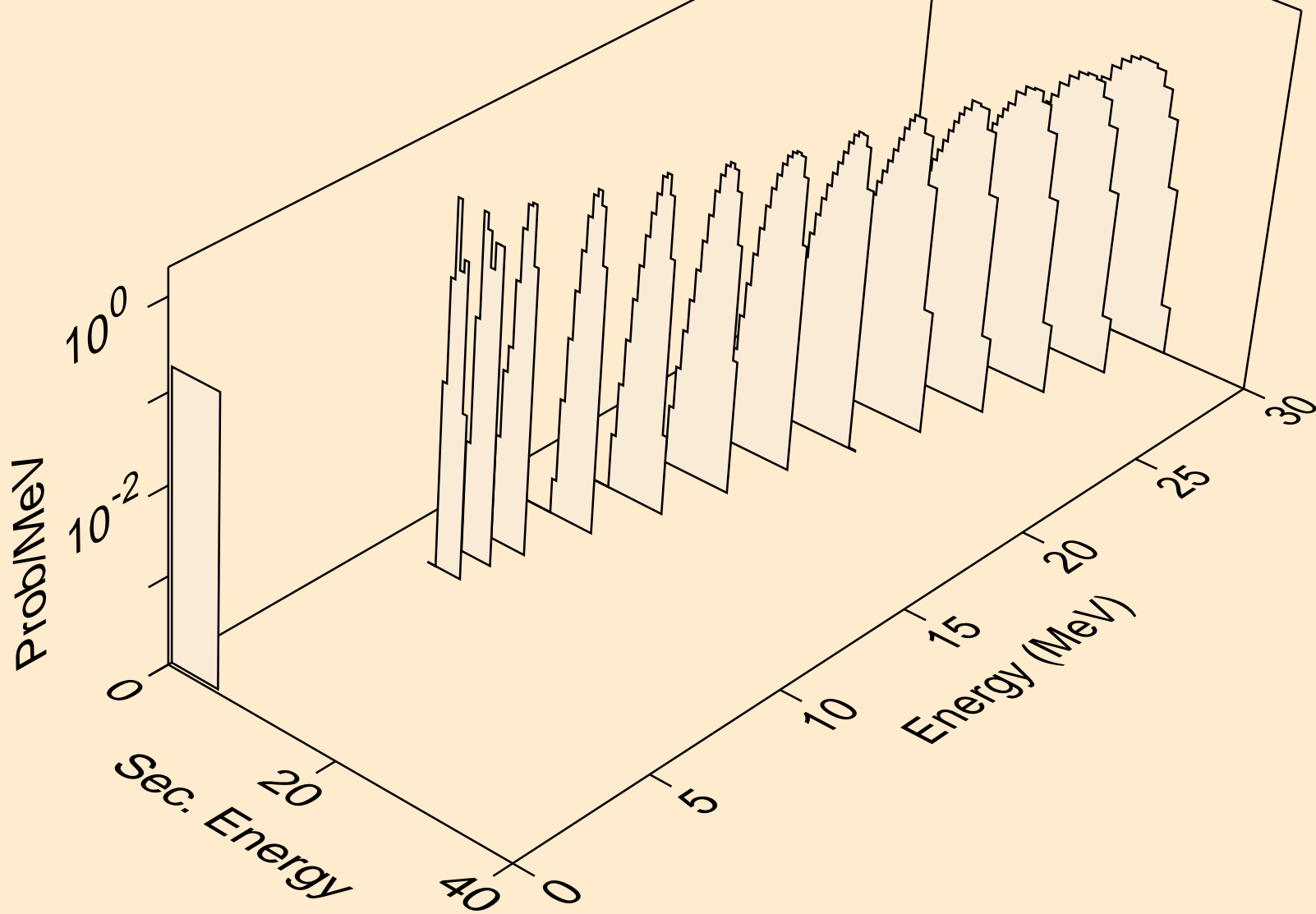

IR197 TRITON ACER TENDL-2021 LIBRARY; T=0.K  
alphas from (t,3n)a

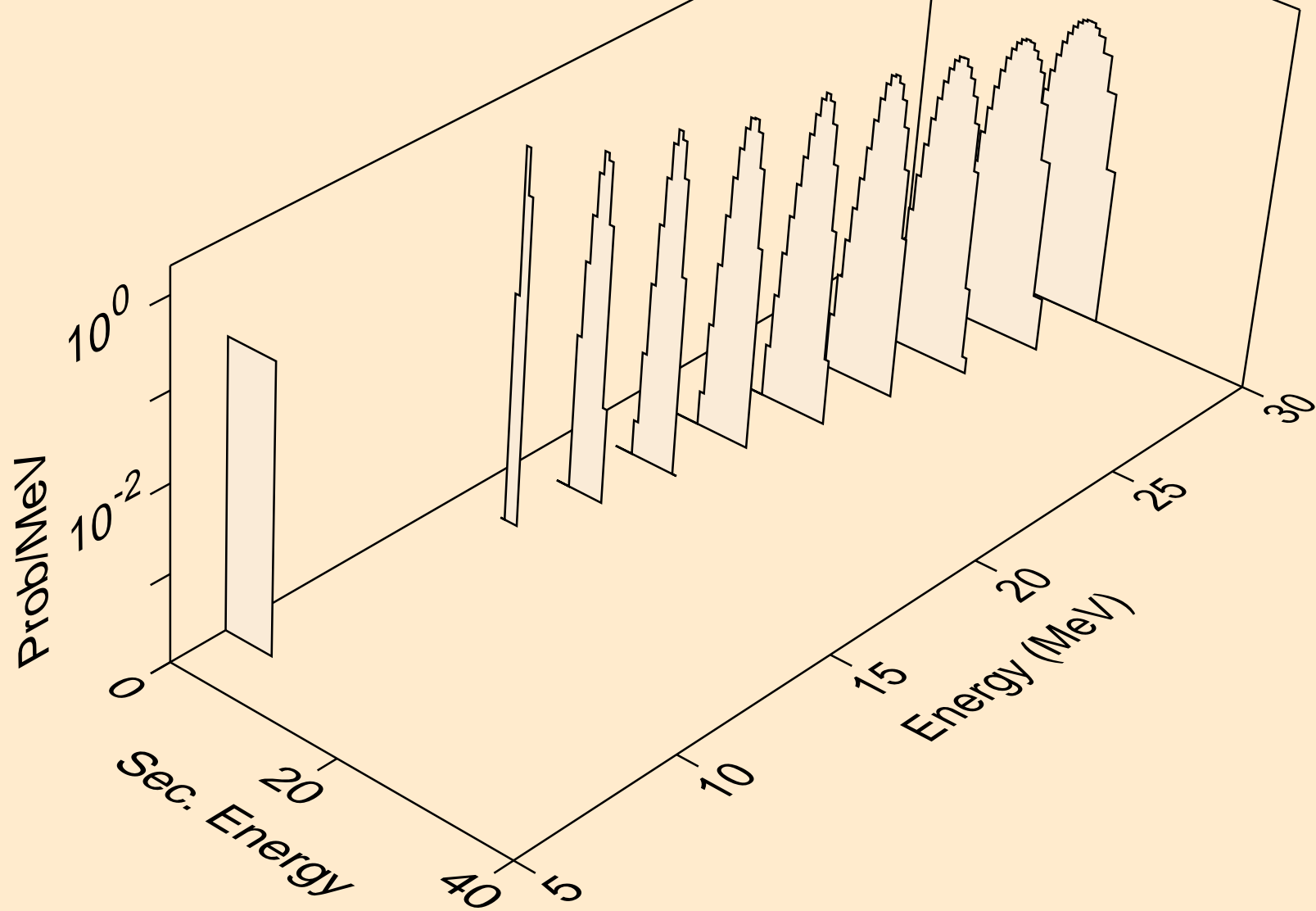

IR197 TRITON ACER TENDL-2021 LIBRARY; T=0.K  
alphas from (t,a)

