

LR258 TRITON ACER TENDL-2021 LIBRARY; T=0.K  
Principal cross sections

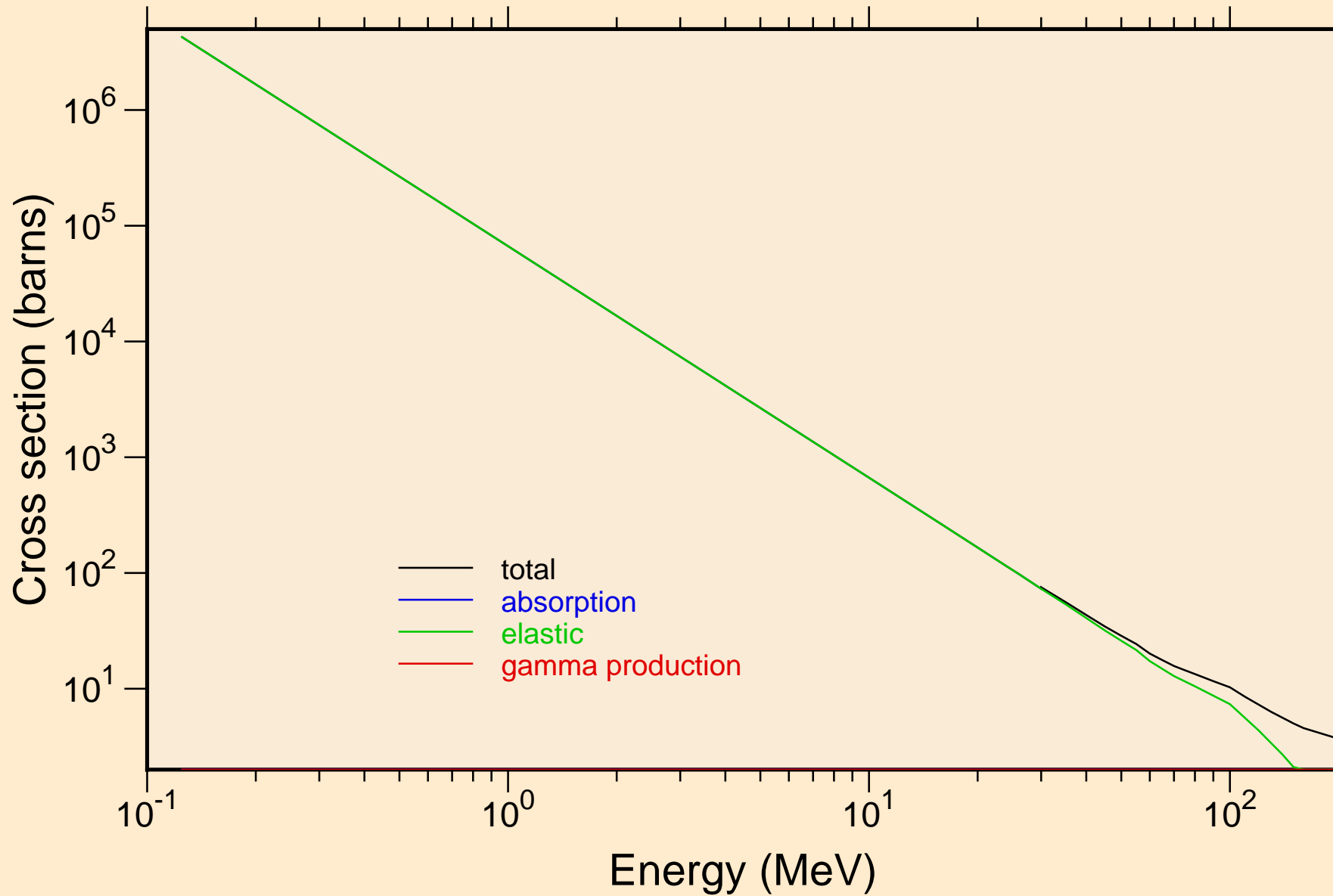

LR258 TRITON ACER TENDL-2021 LIBRARY; T=0.K

Heating

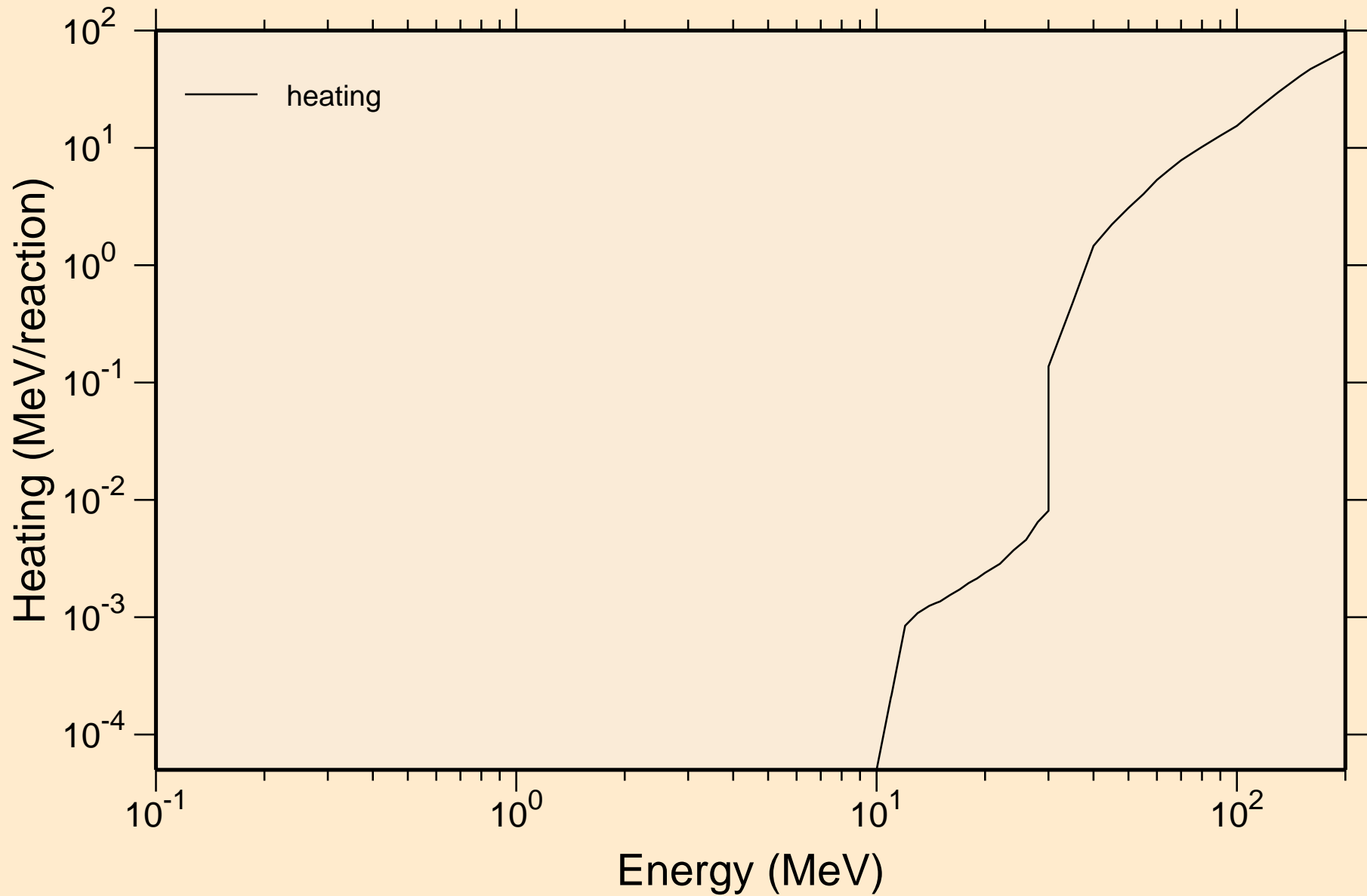

# LR258 TRITON ACER TENDL-2021 LIBRARY; T=0.K

## Principal cross sections

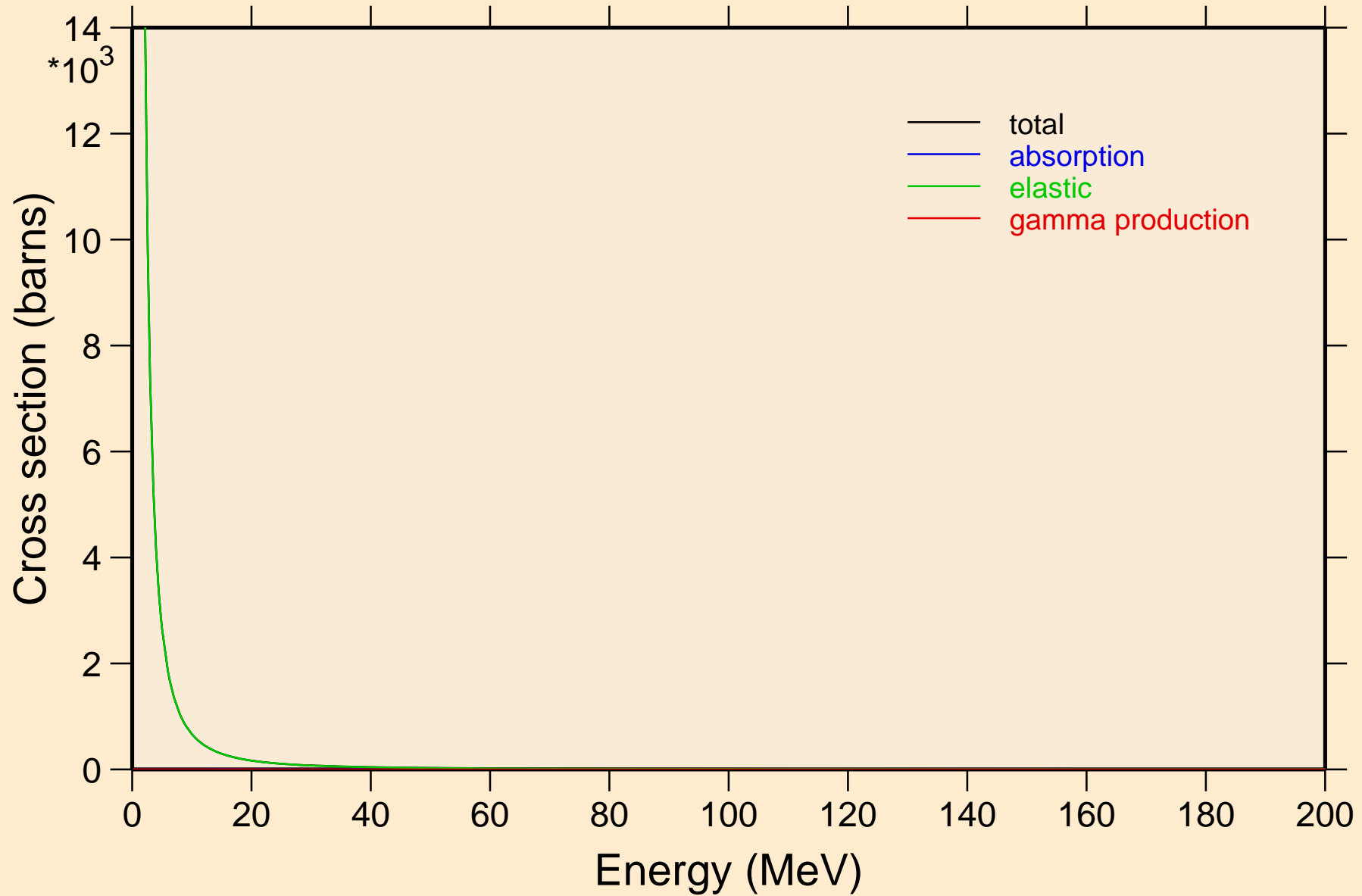

LR258 TRITON ACER TENDL-2021 LIBRARY; T=0.K

Heating

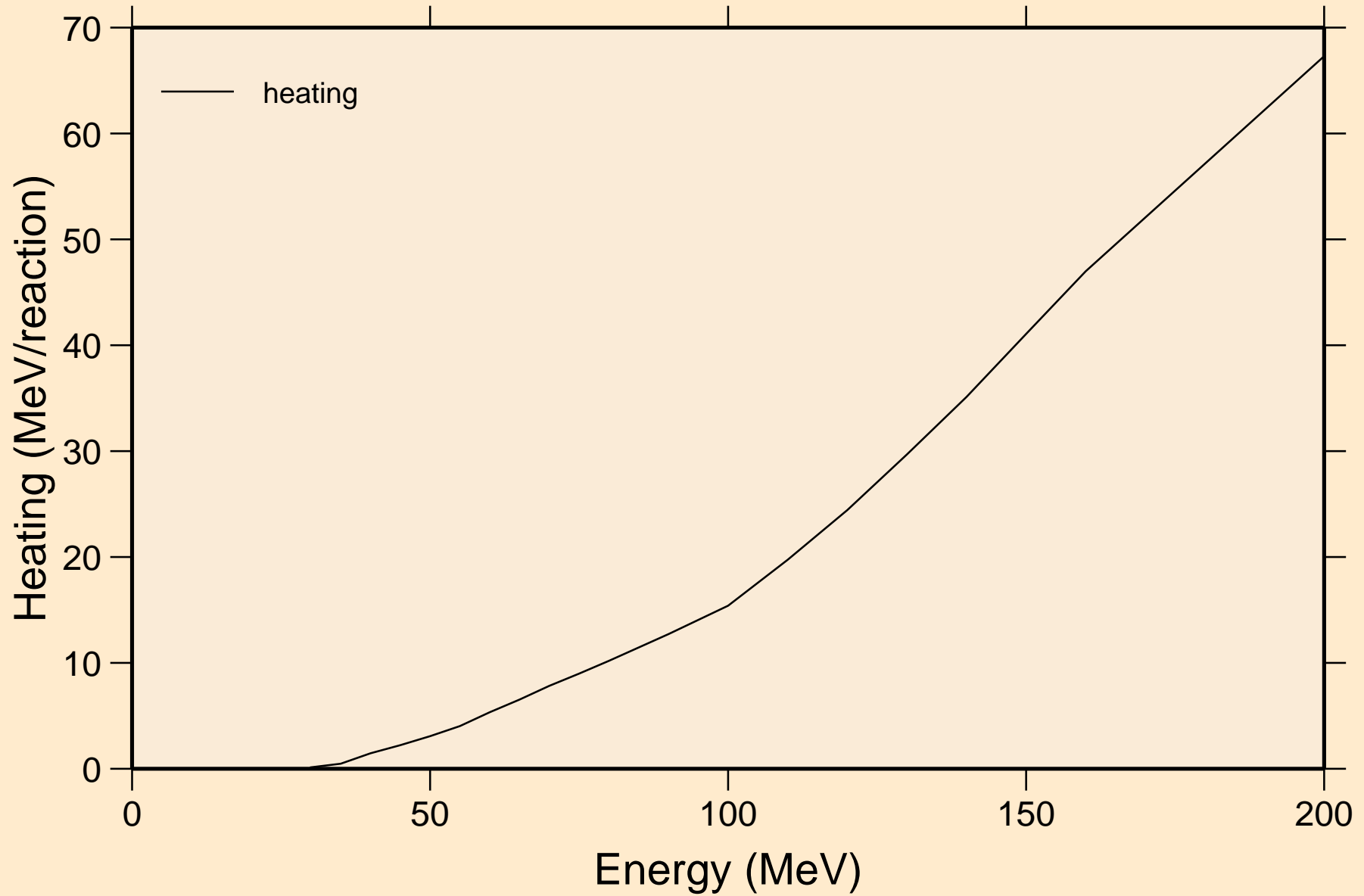

LR258 TRITON ACER TENDL-2021 LIBRARY; T=0.K  
Threshold reactions

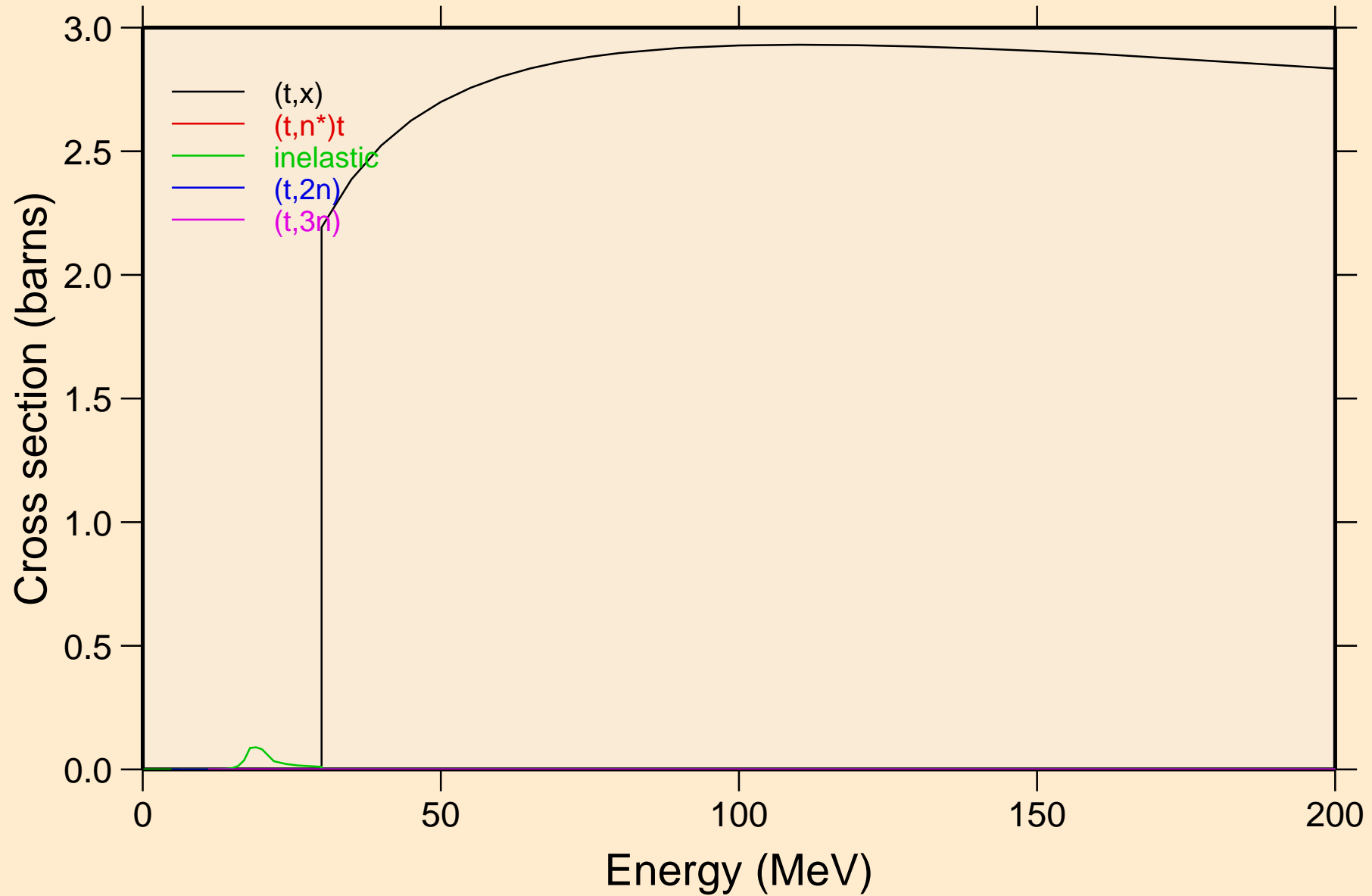

LR258 TRITON ACER TENDL-2021 LIBRARY; T=0.K  
Threshold reactions

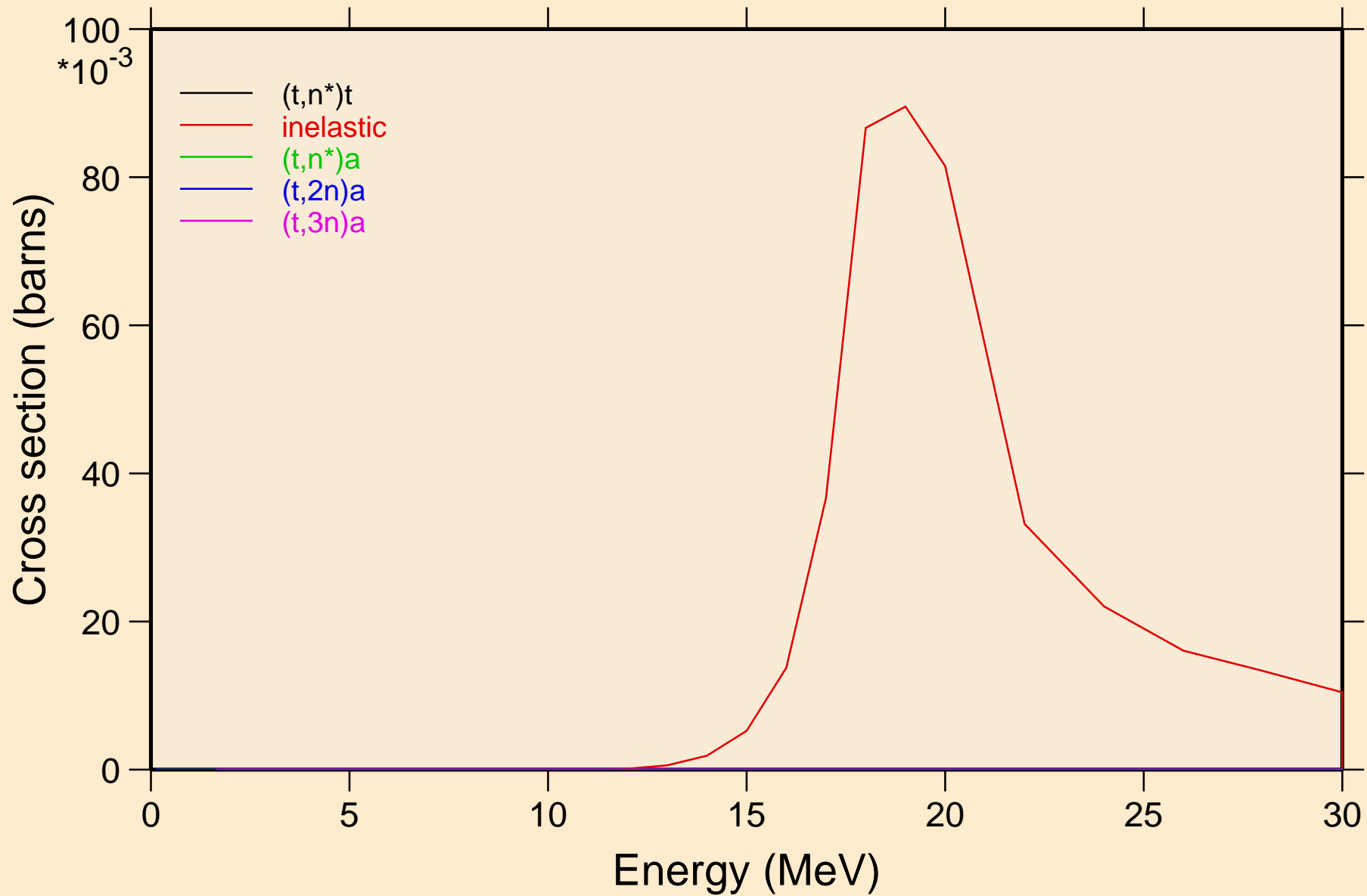

LR258 TRITON ACER TENDL-2021 LIBRARY; T=0.K  
Threshold reactions

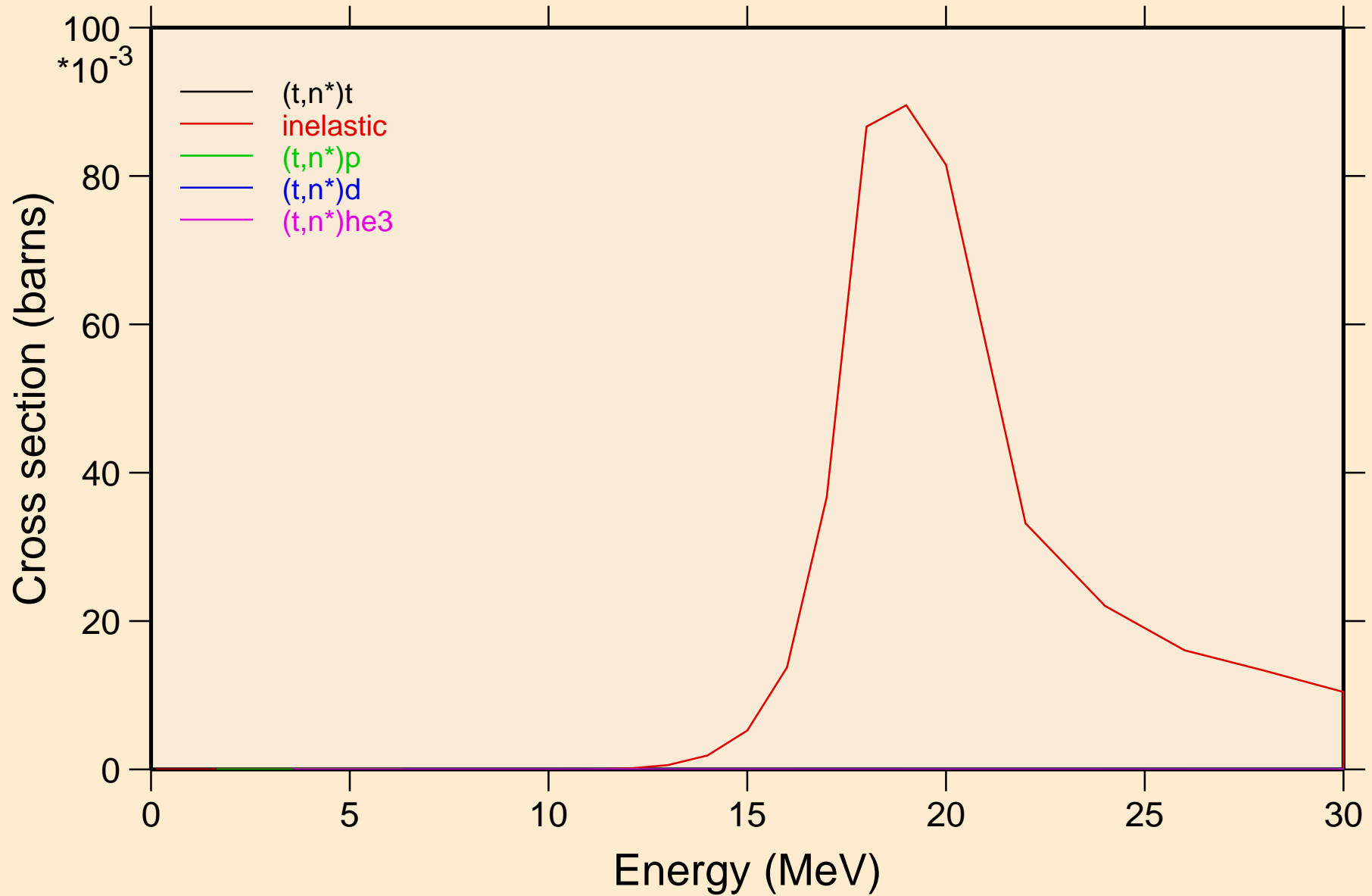

LR258 TRITON ACER TENDL-2021 LIBRARY; T=0.K  
Threshold reactions

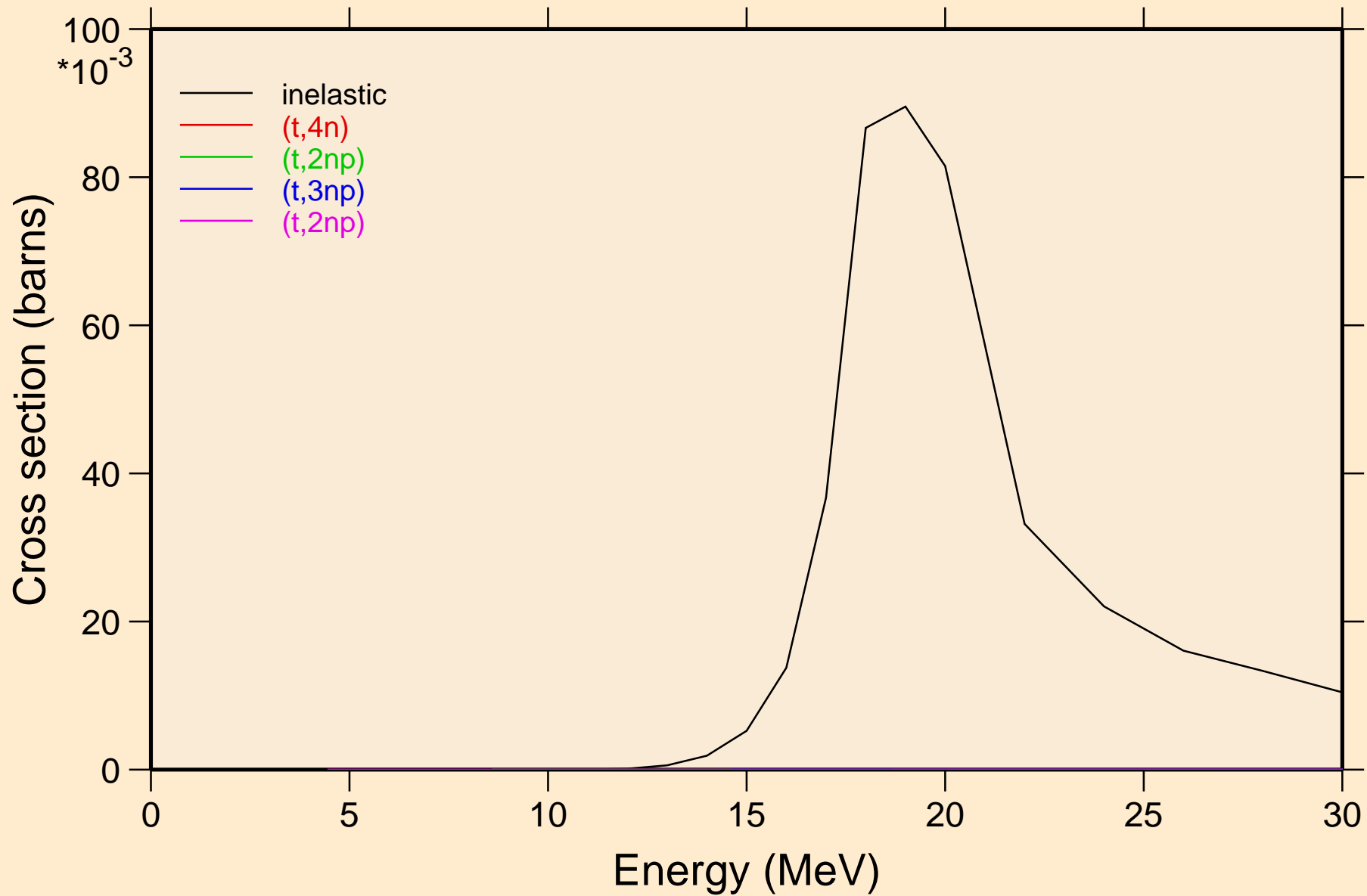



LR258 TRITON ACER TENDL-2021 LIBRARY; T=0.K  
Threshold reactions

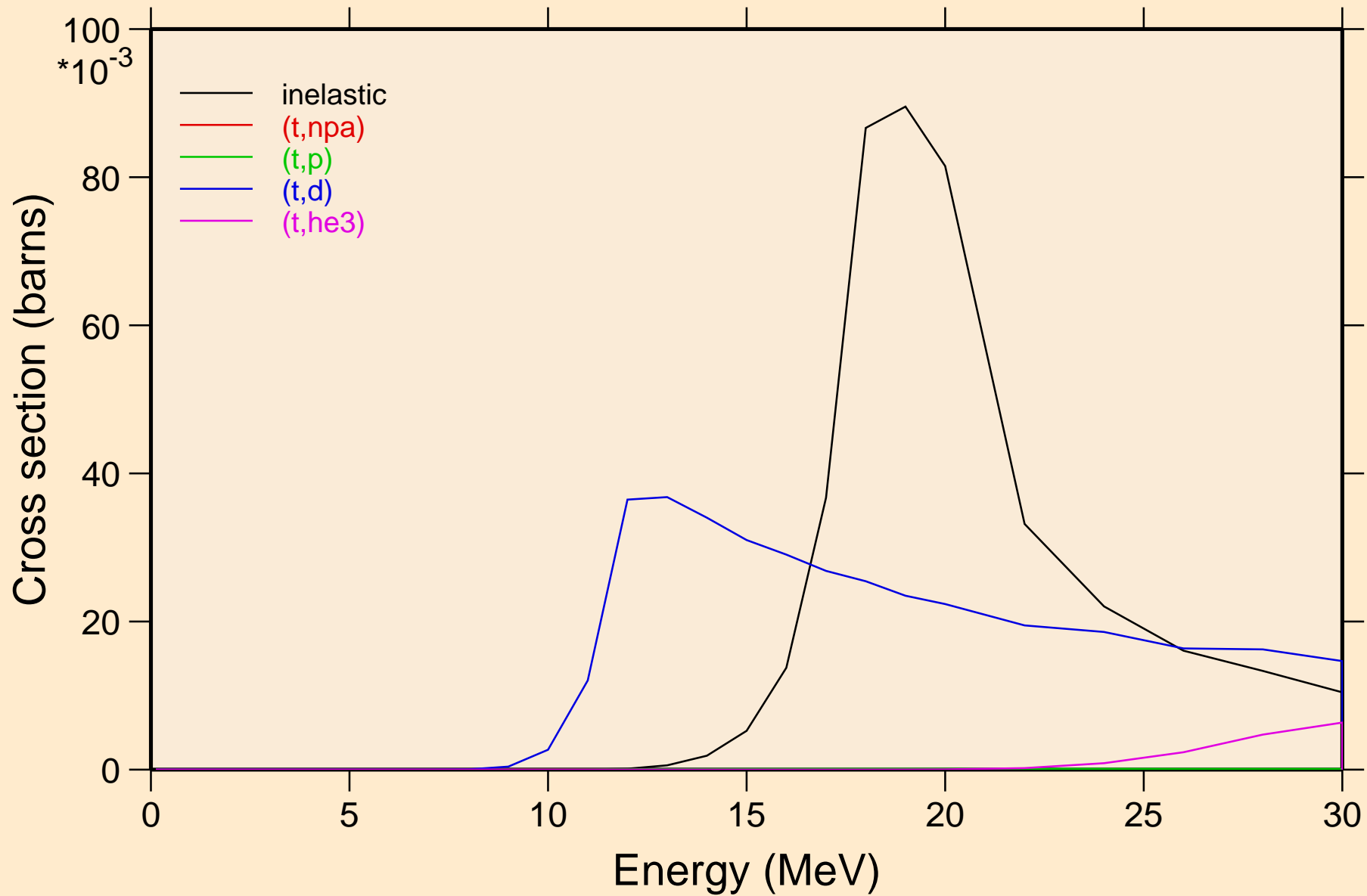

LR258 TRITON ACER TENDL-2021 LIBRARY; T=0.K  
Threshold reactions

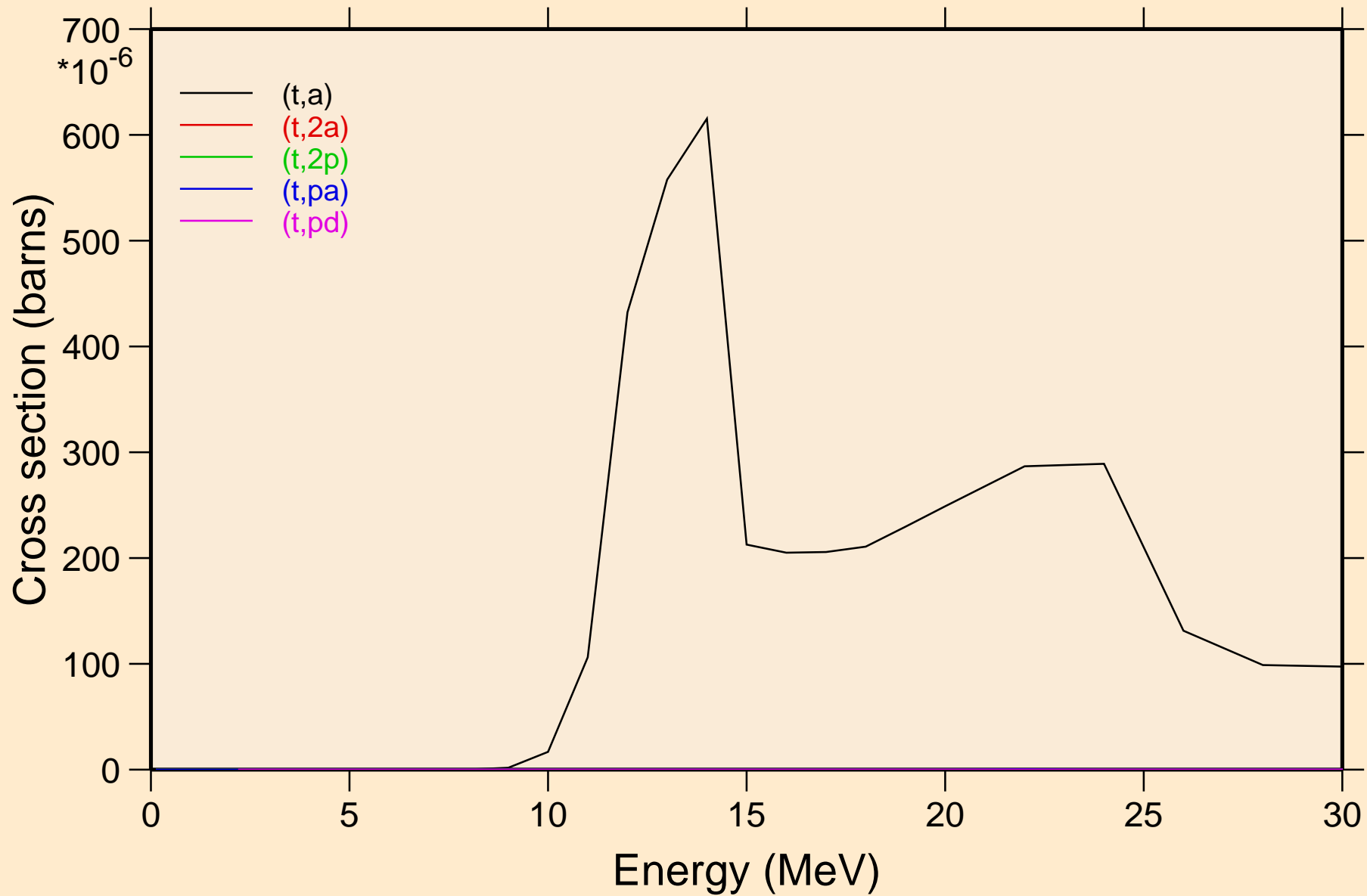

LR258 TRITON ACER TENDL-2021 LIBRARY; T=0.K  
Threshold reactions

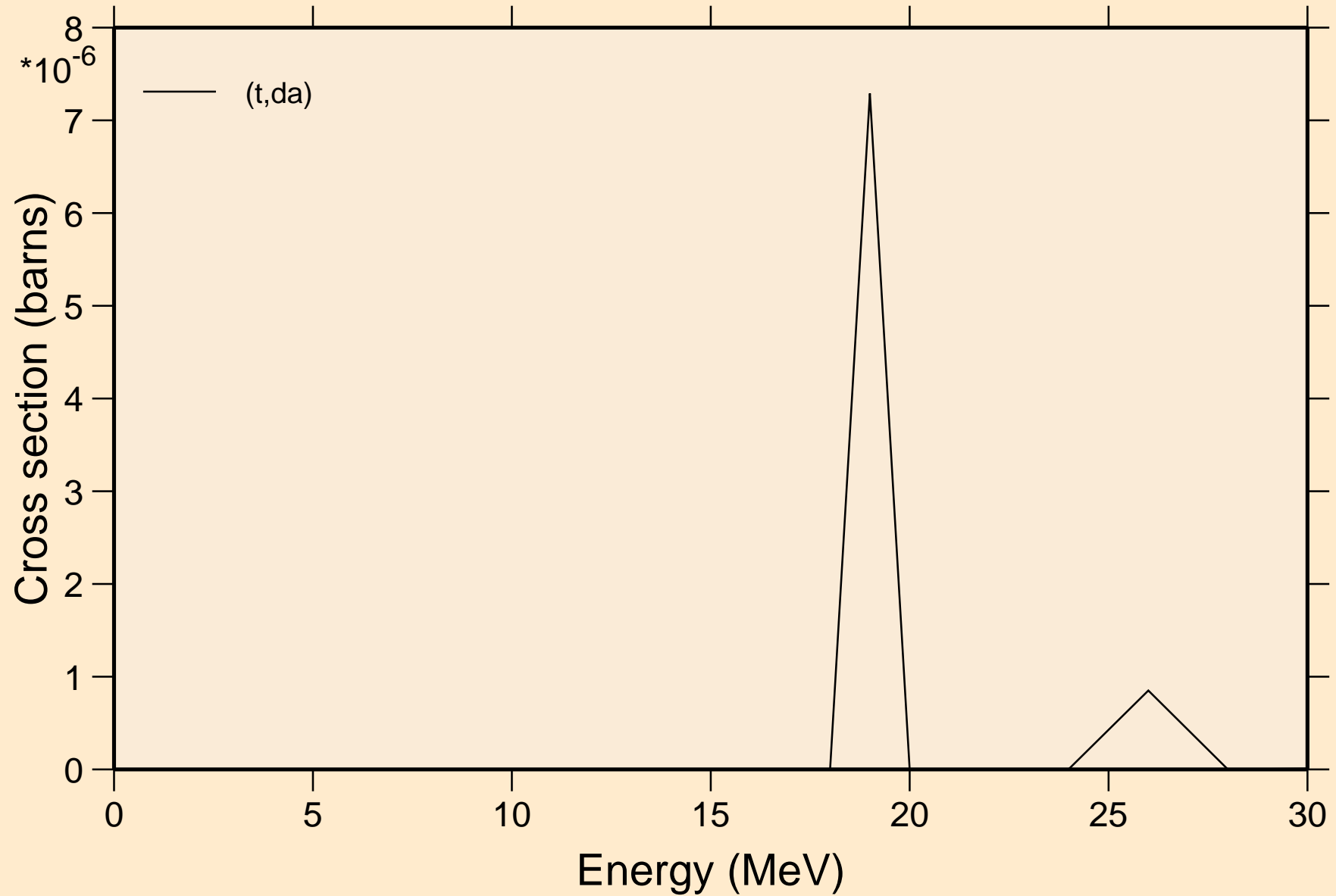

LR258 TRITON ACER TENDL-2021 LIBRARY; T=0.K  
angular distribution for elastic

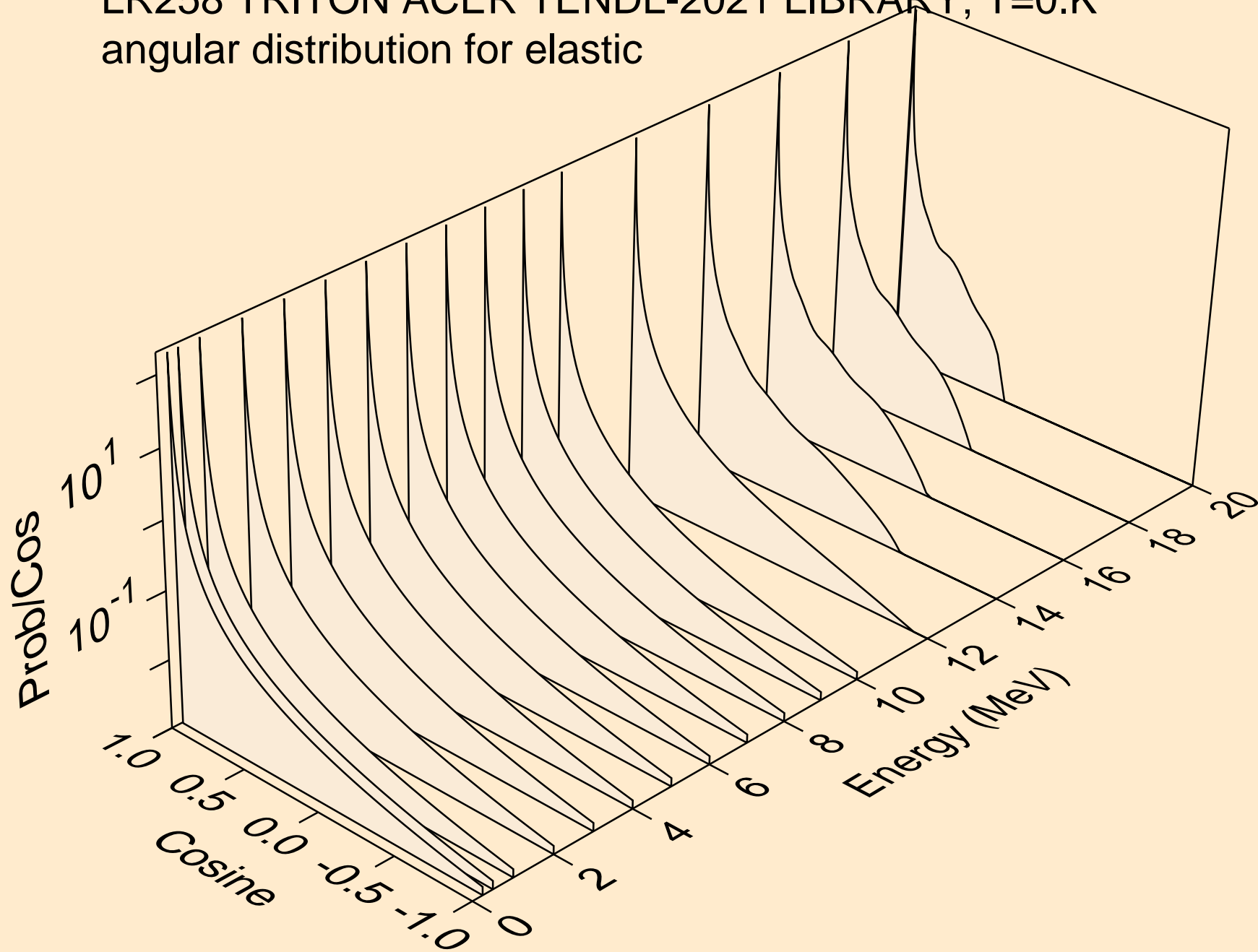

LR258 TRITON ACER TENDL-2021 LIBRARY; T=0.K  
angular distribution for elastic

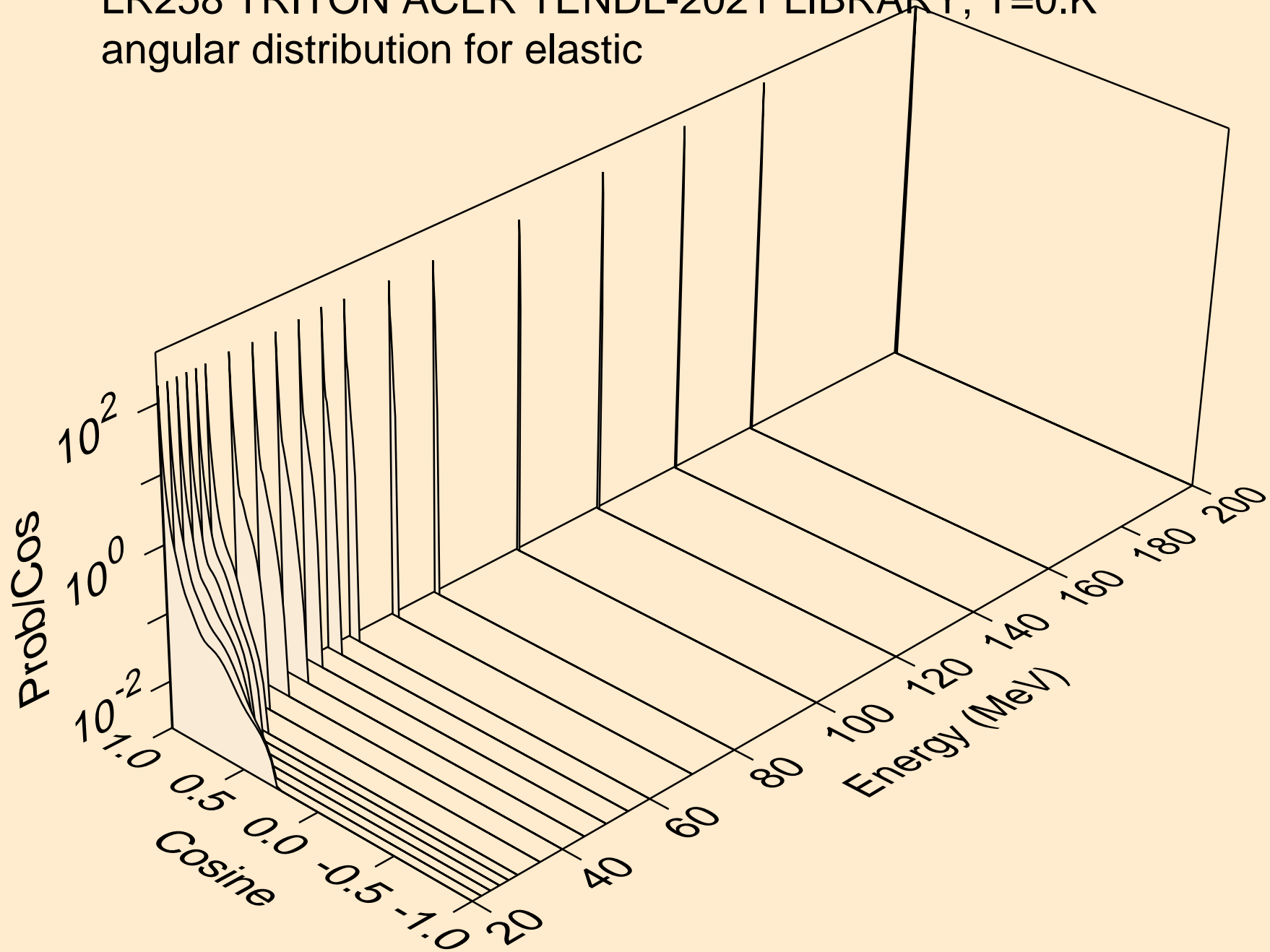

LR258 TRITON ACER TENDL-2021 LIBRARY; T=0.K  
Triton emission for (t,x)

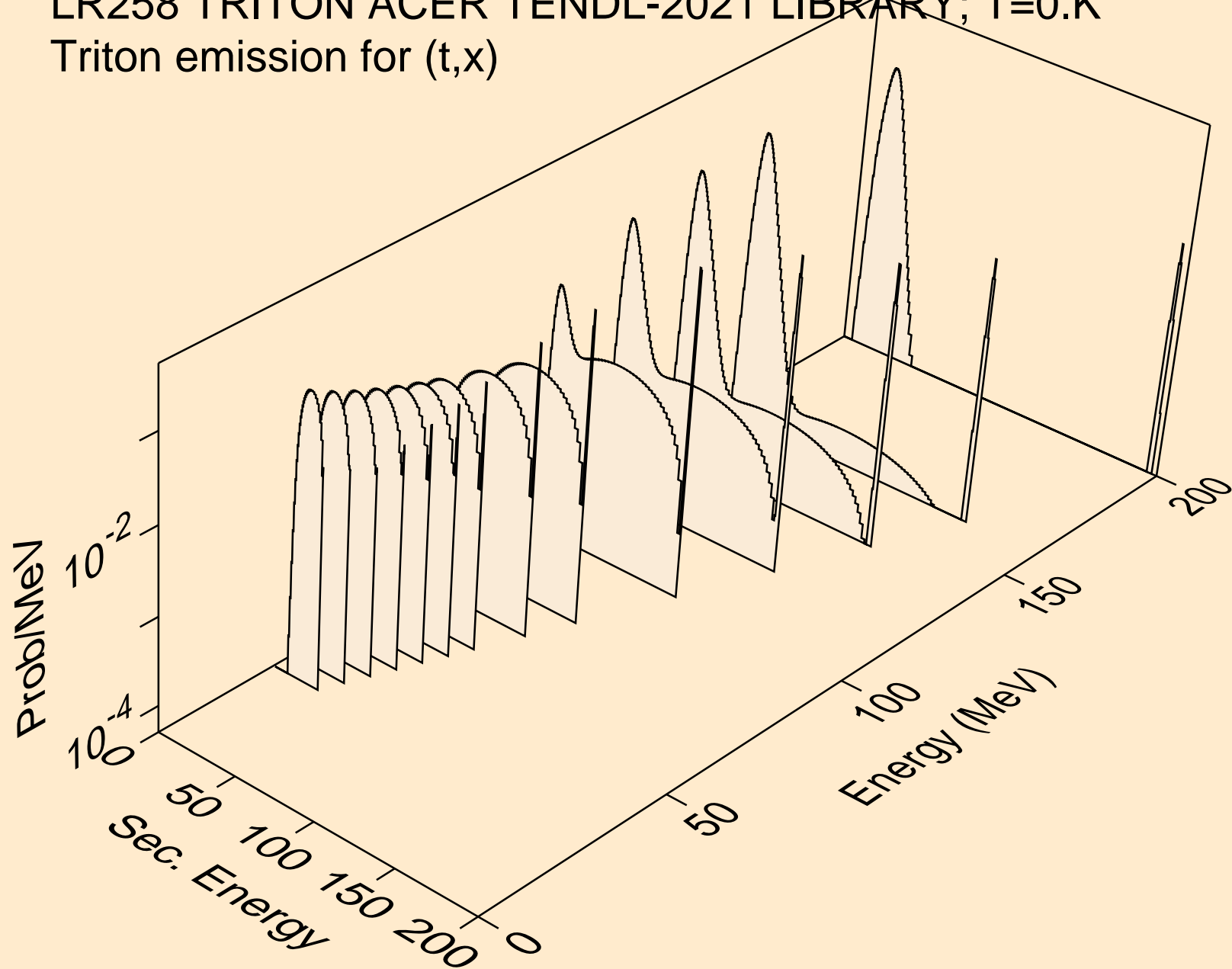

LR258 TRITON ACER TENDL-2021 LIBRARY; T=0.K  
Triton emission for (t,n\*)t

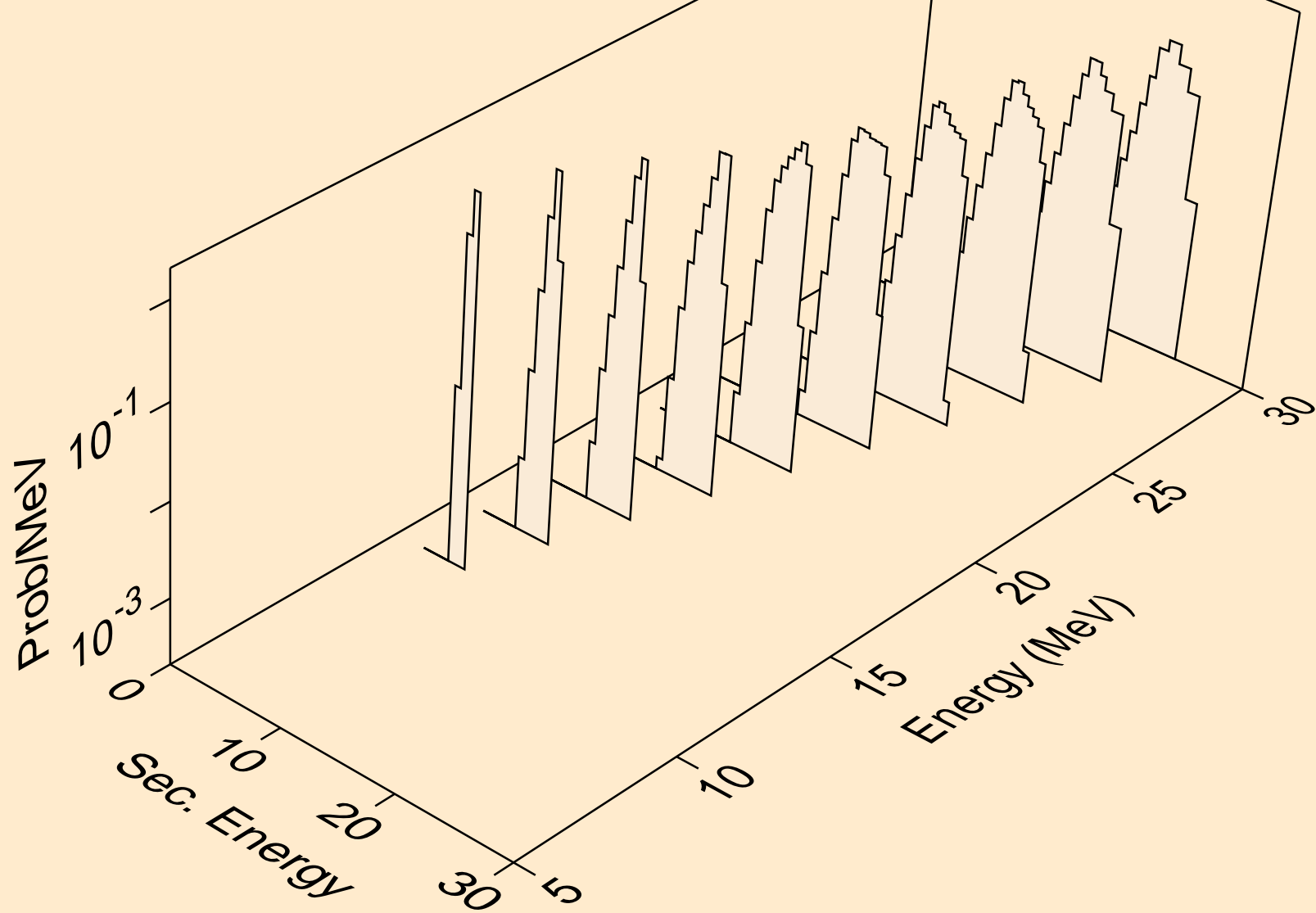

LR258 TRITON ACER TENDL-2021 LIBRARY; T=0.K  
Triton emission for inelastic

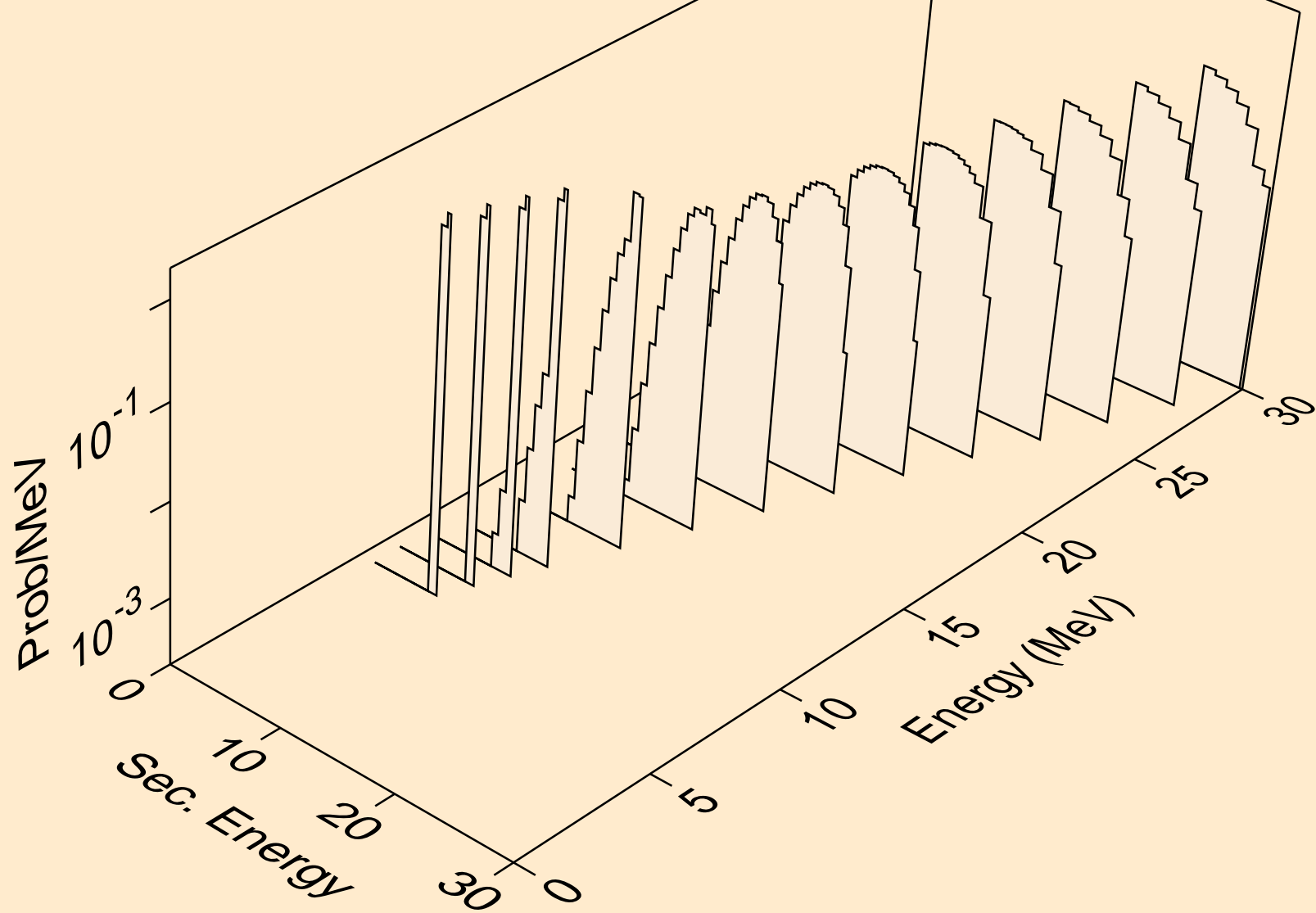



LR258 TRITON ACER TENDL-2021 LIBRARY; T=0.K  
Photon emission for (z,n)

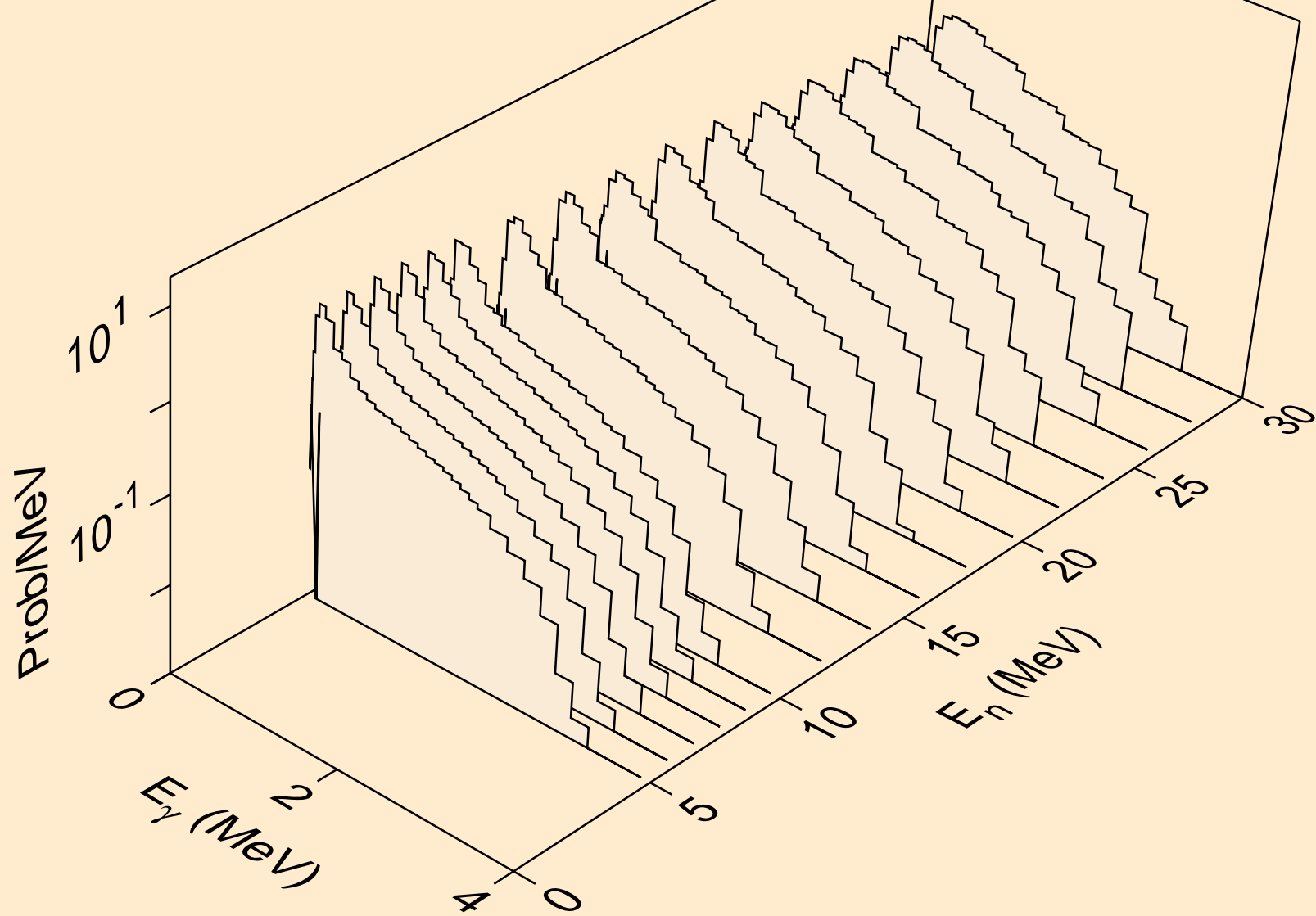

LR258 TRITON ACER TENDL-2021 LIBRARY; T=0.K  
Photon emission for (n,x)

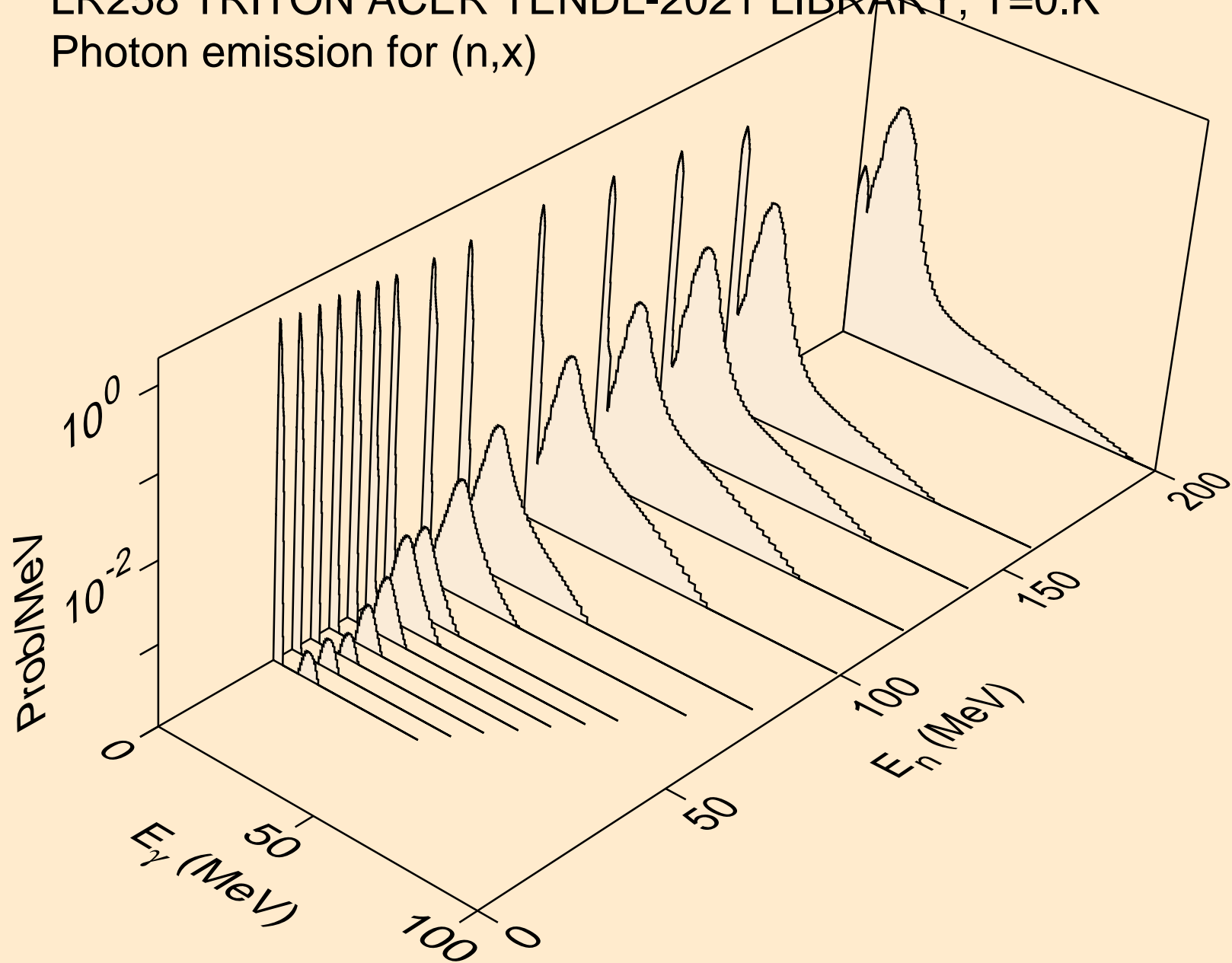

LR258 TRITON ACER TENDL-2021 LIBRARY; T=0.K  
Photon emission for (n,2n)

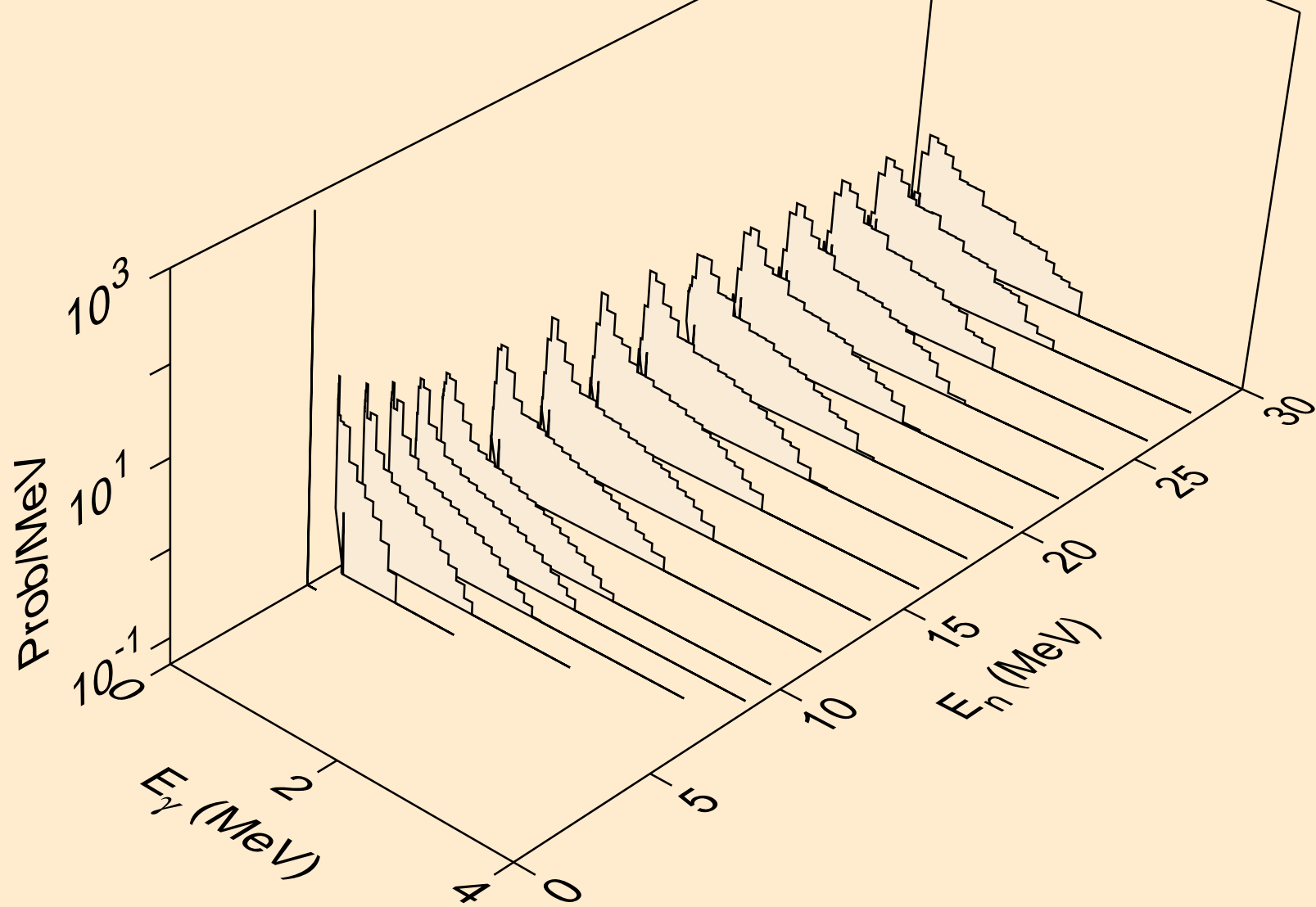

LR258 TRITON ACER TENDL-2021 LIBRARY; T=0.K  
Photon emission for (n,3n)

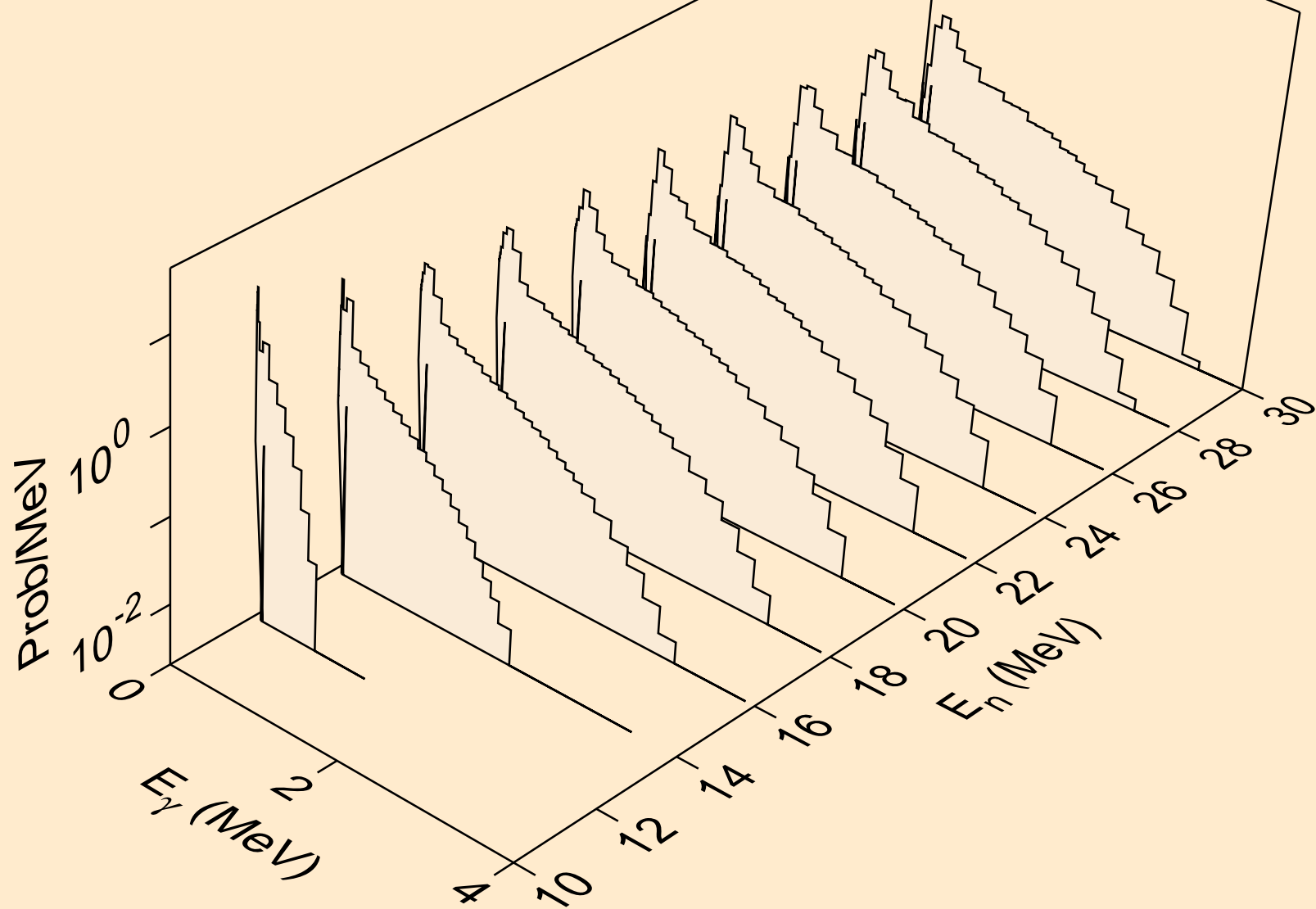

LR258 TRITON ACER TENDL-2021 LIBRARY; T=0.K  
Photon emission for (n,n\*)a

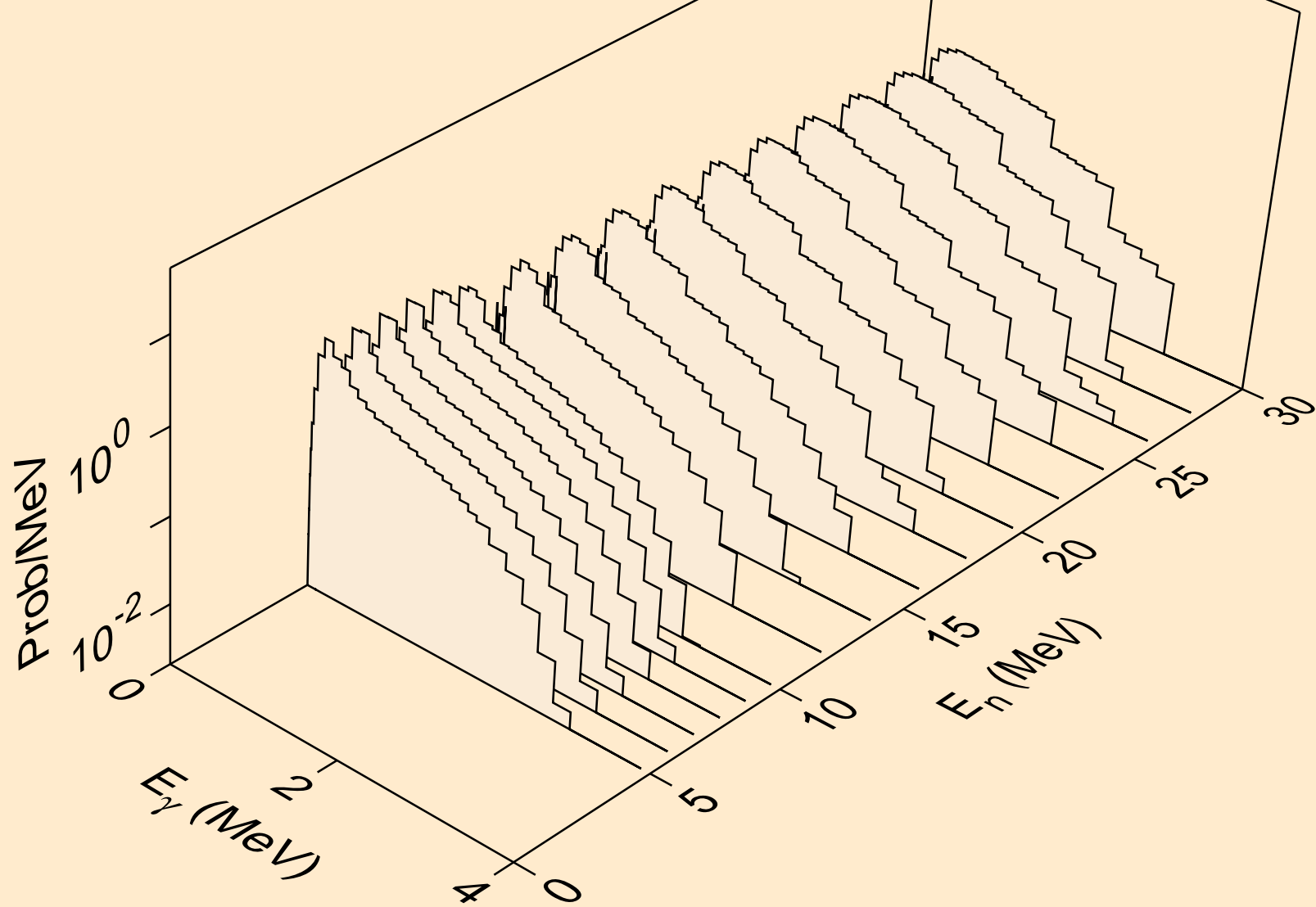

LR258 TRITON ACER TENDL-2021 LIBRARY; T=0.K  
Photon emission for (n,2n)a

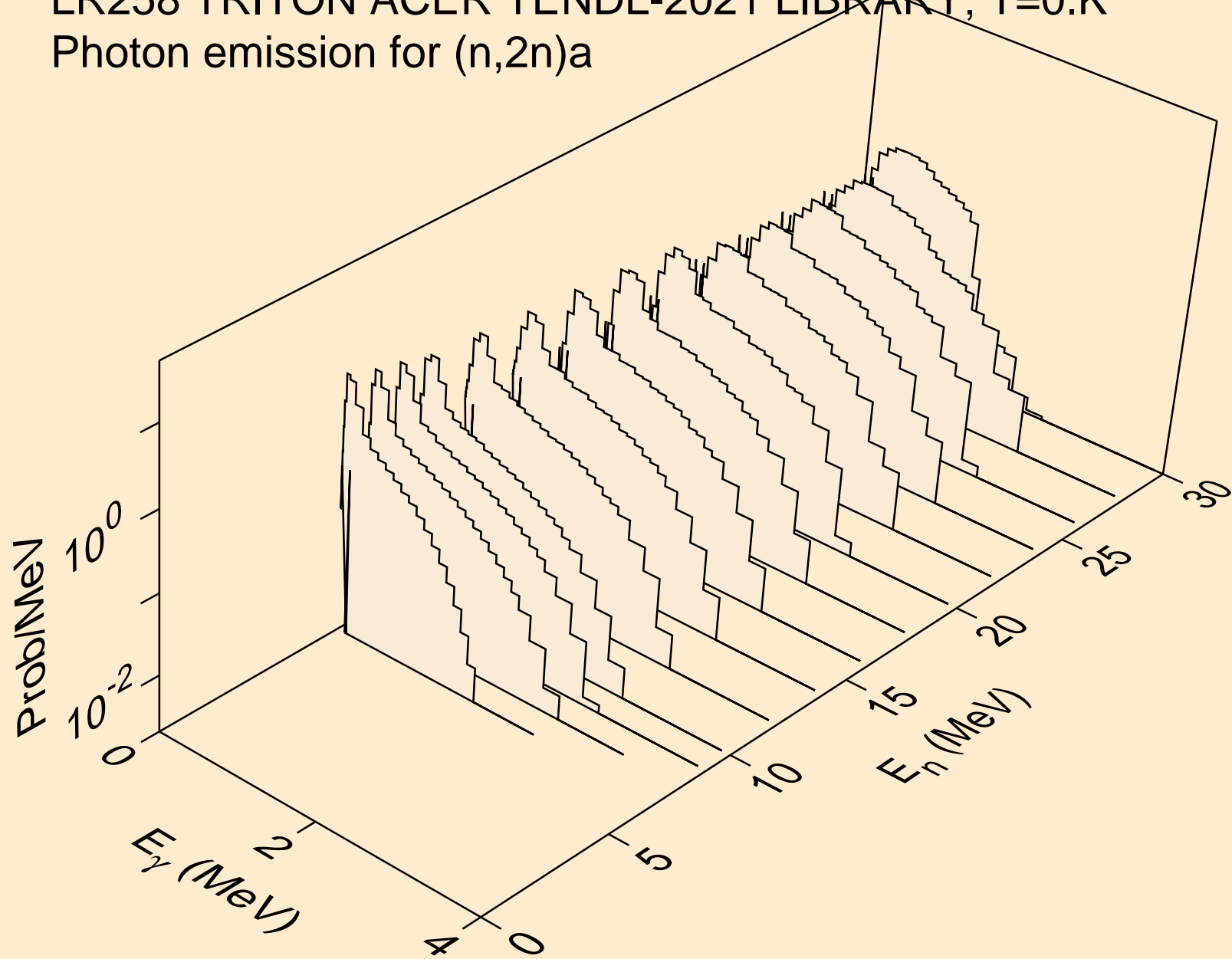

LR258 TRITON ACER TENDL-2021 LIBRARY; T=0.K  
Photon emission for (n,3n)a

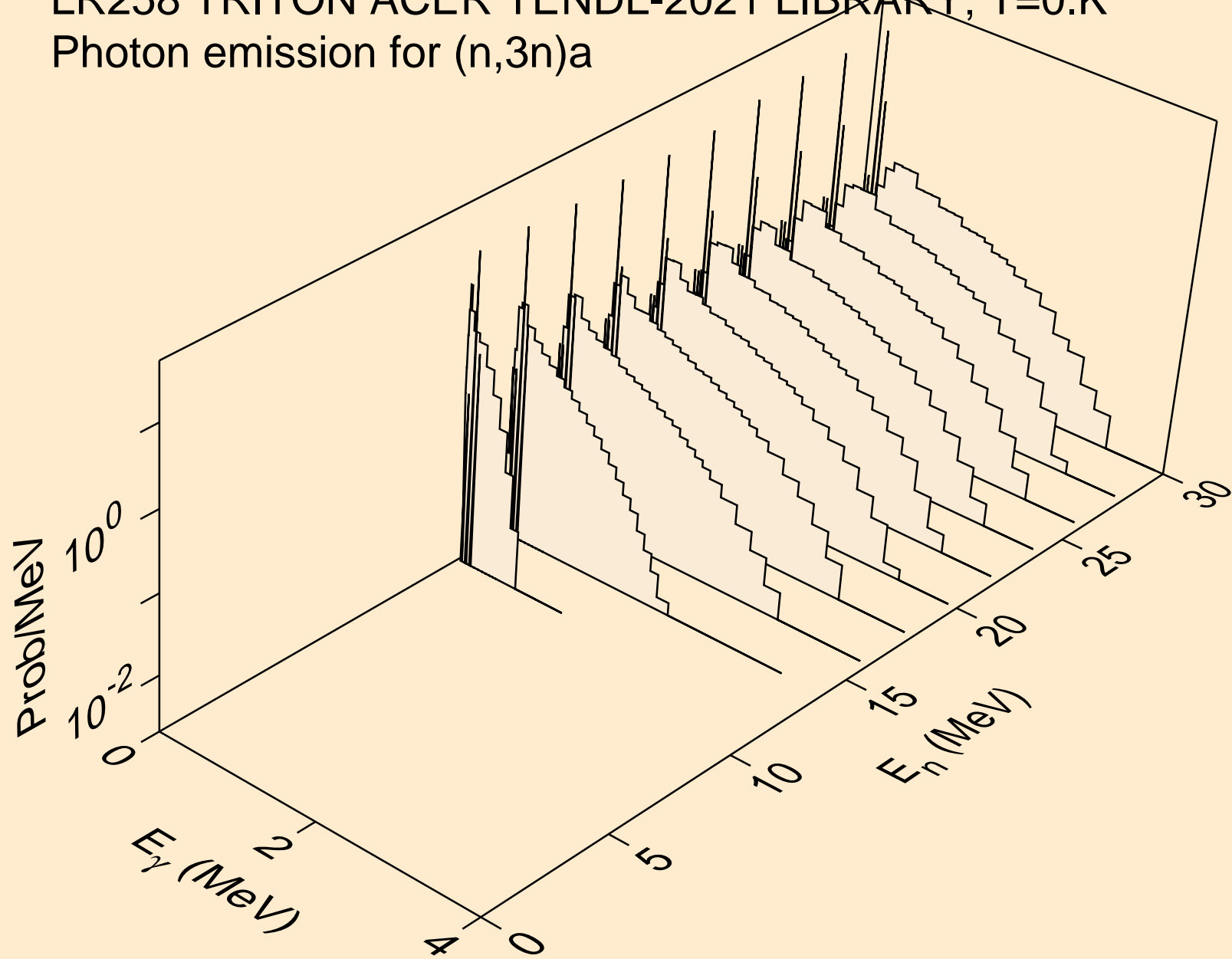

LR258 TRITON ACER TENDL-2021 LIBRARY; T=0.K  
Photon emission for (n,n\*)p

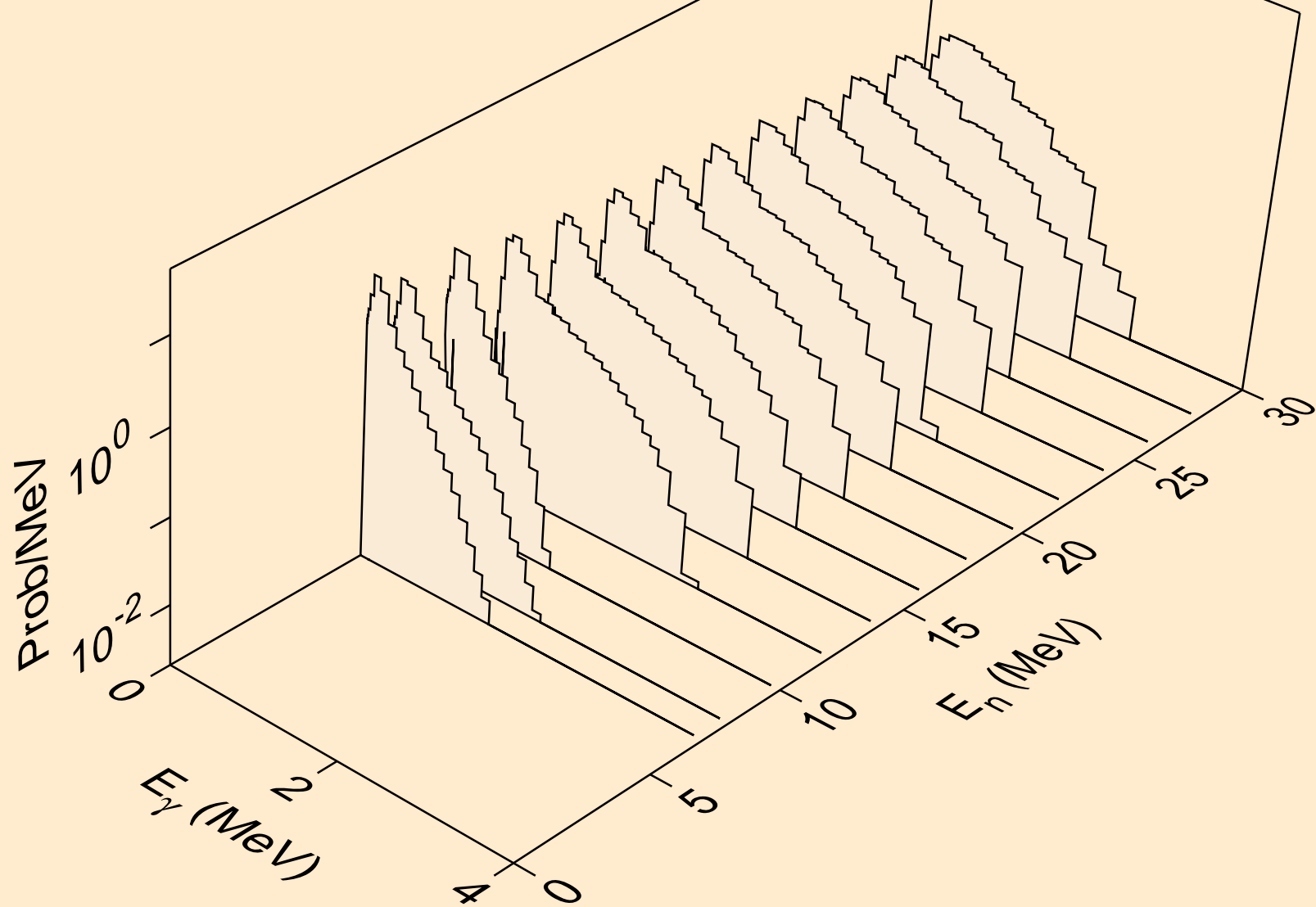



LR258 TRITON ACER TENDL-2021 LIBRARY; T=0.K  
Photon emission for (n,n\*)d

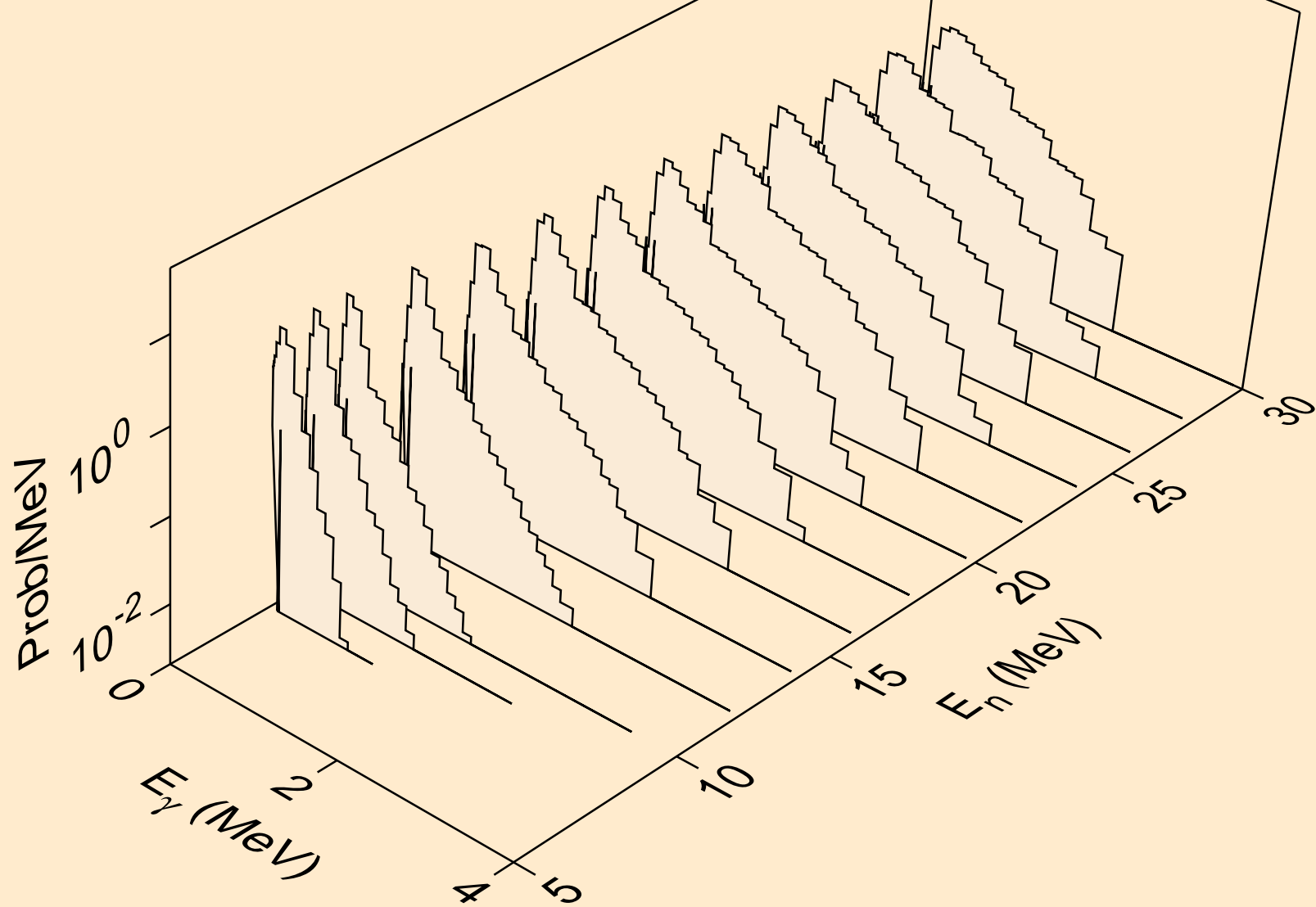

LR258 TRITON ACER TENDL-2021 LIBRARY; T=0.K  
Photon emission for (n,n\*)t

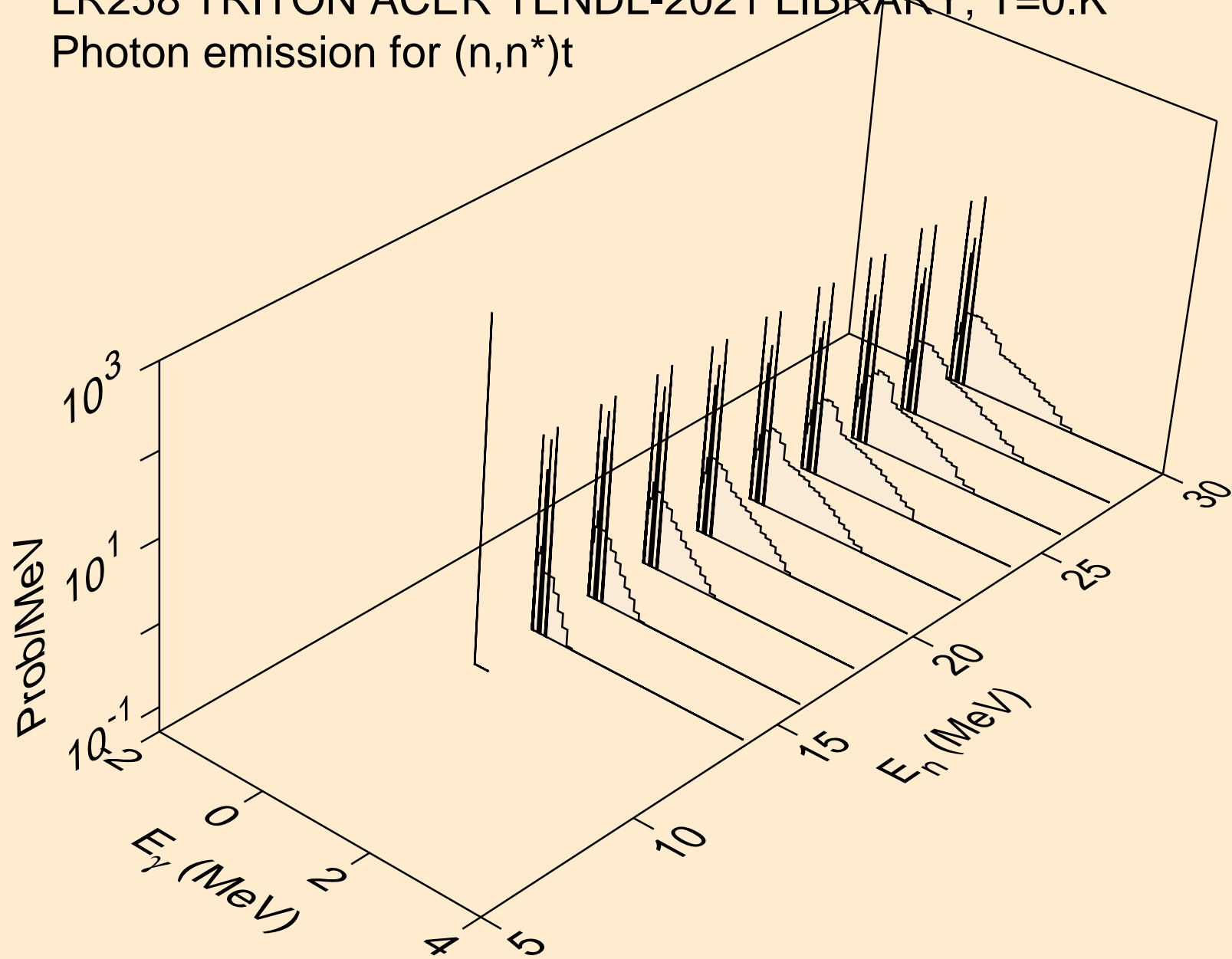

LR258 TRITON ACER TENDL-2021 LIBRARY; T=0.K  
Photon emission for (n,n\*)he3

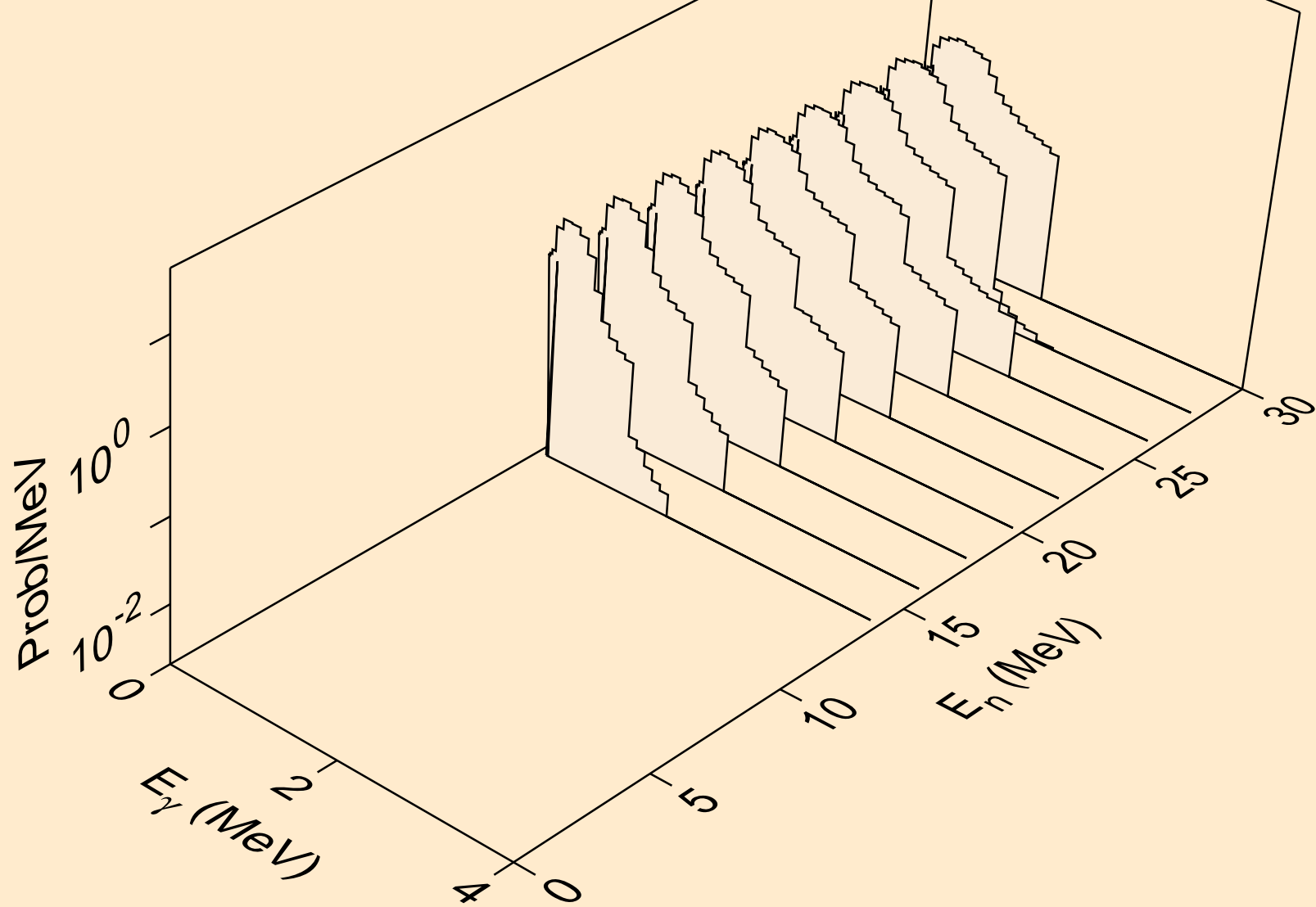

LR258 TRITON ACER TENDL-2021 LIBRARY; T=0.K  
Photon emission for (n,4n)

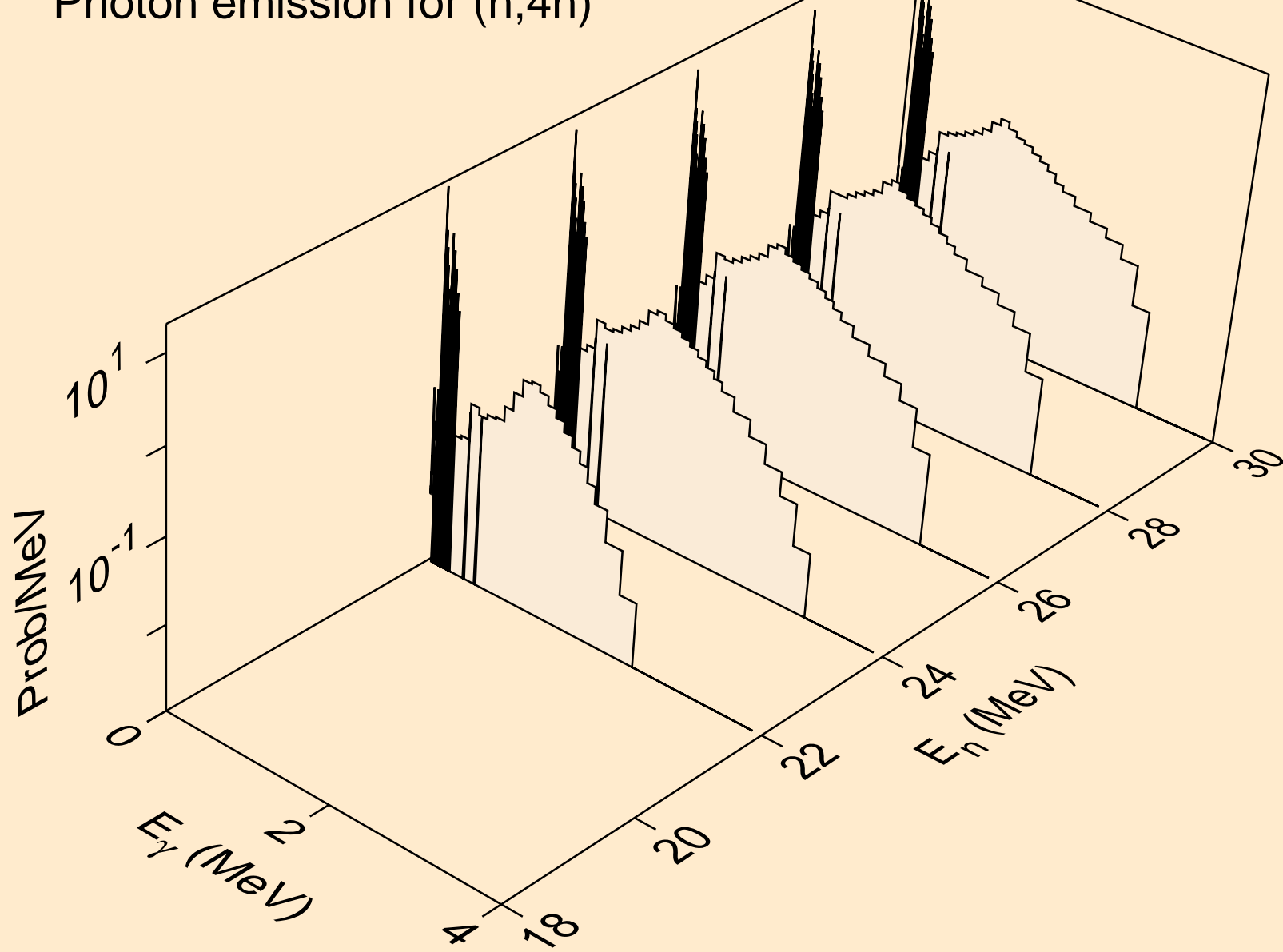

LR258 TRITON ACER TENDL-2021 LIBRARY; T=0.K  
Photon emission for (n,2np)

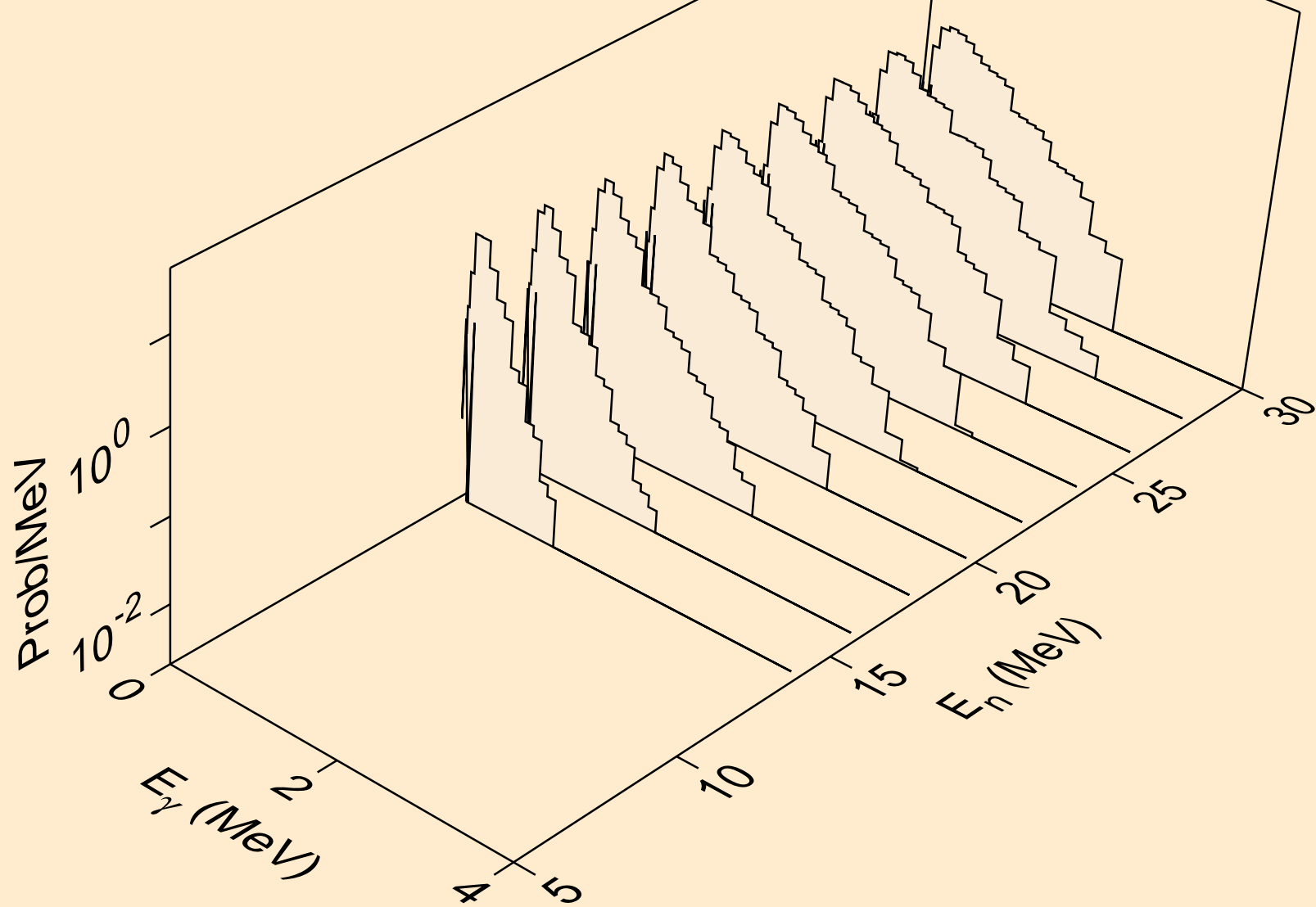

LR258 TRITON ACER TENDL-2021 LIBRARY; T=0.K  
Photon emission for (n,3np)

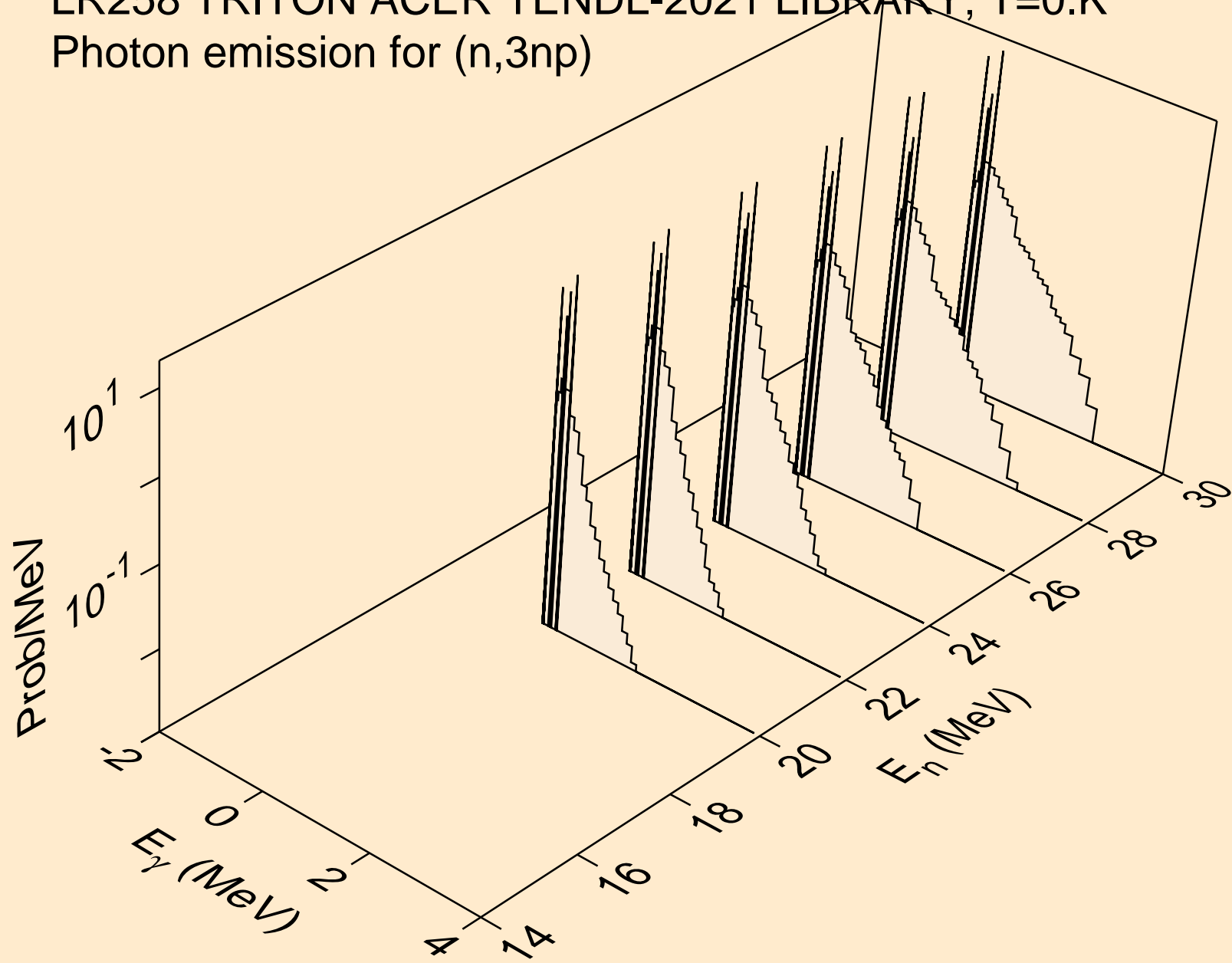

LR258 TRITON ACER TENDL-2021 LIBRARY; T=0.K  
Photon emission for (n,2np)

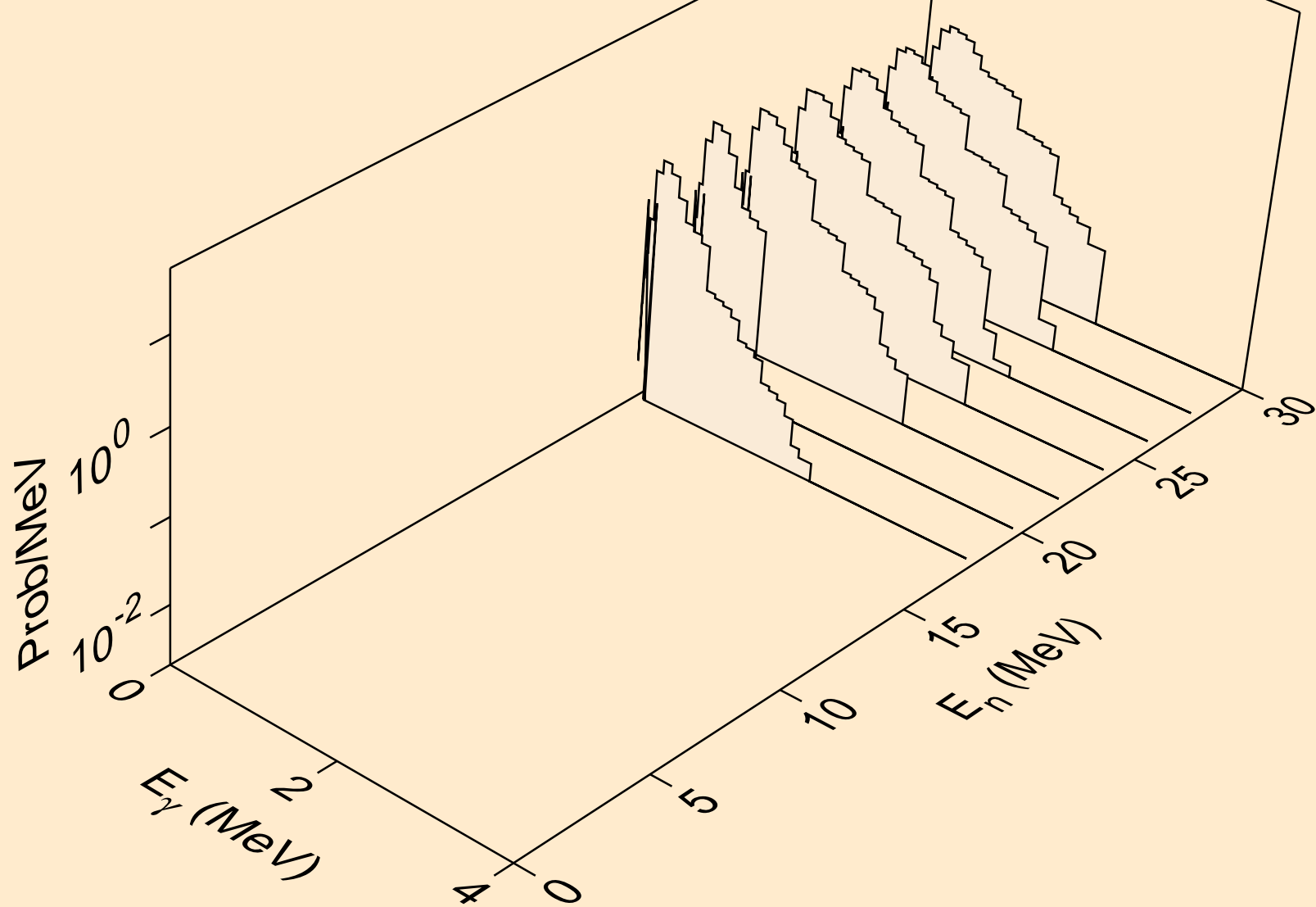

LR258 TRITON ACER TENDL-2021 LIBRARY; T=0.K  
Photon emission for (n,npa)

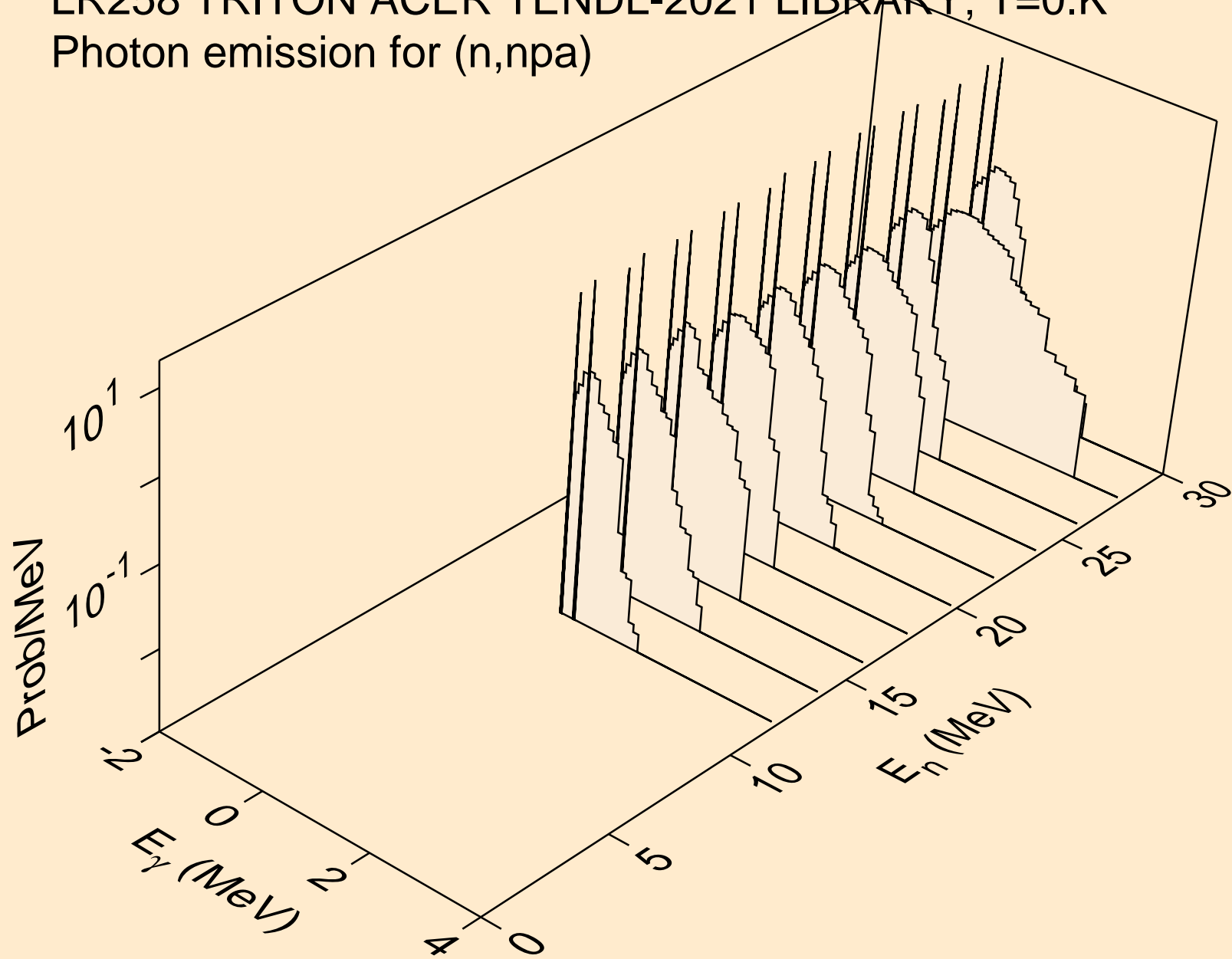



LR258 TRITON ACER TENDL-2021 LIBRARY; T=0.K  
Photon emission for (n,p)

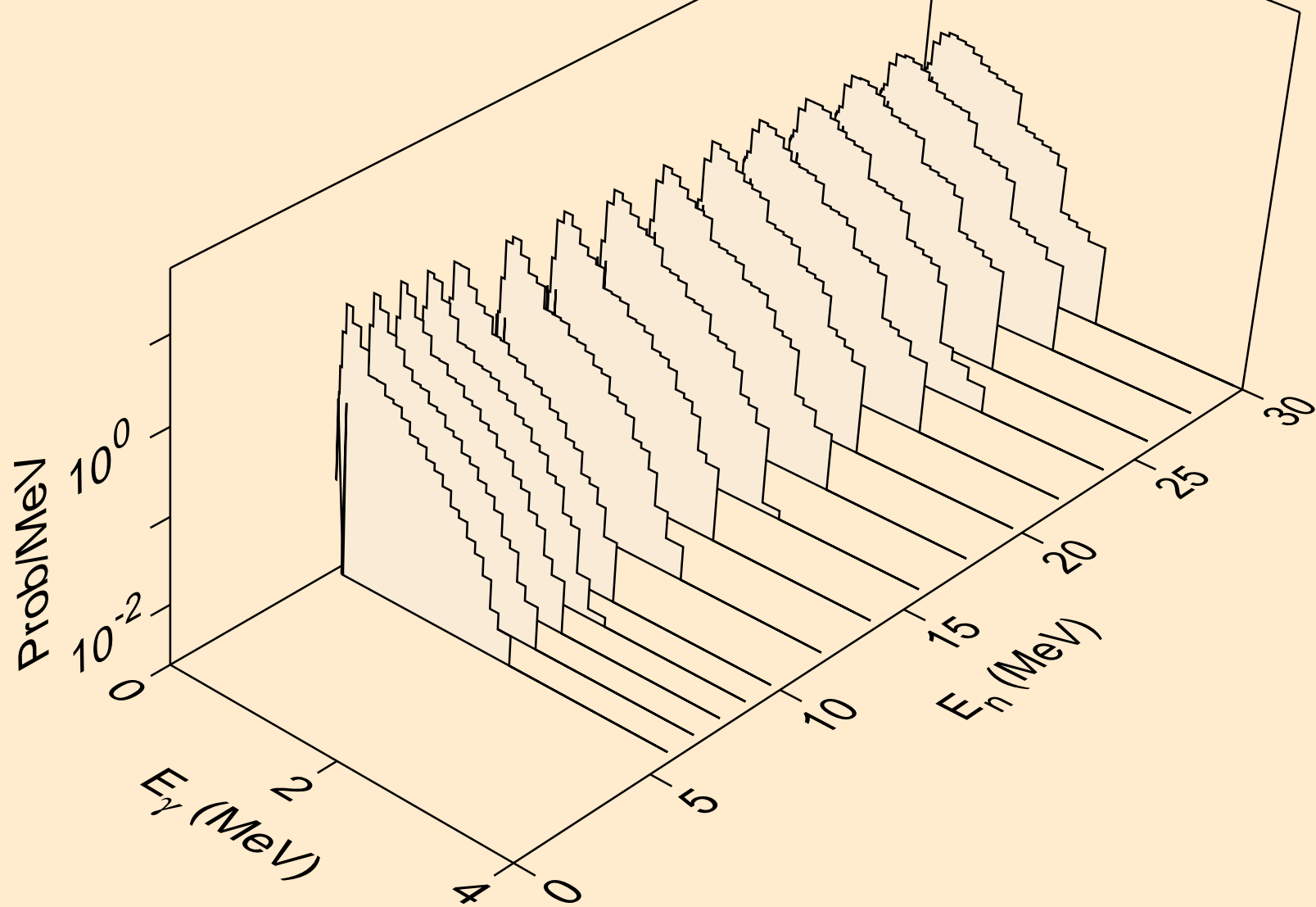

LR258 TRITON ACER TENDL-2021 LIBRARY; T=0.K  
Photon emission for (n,d)

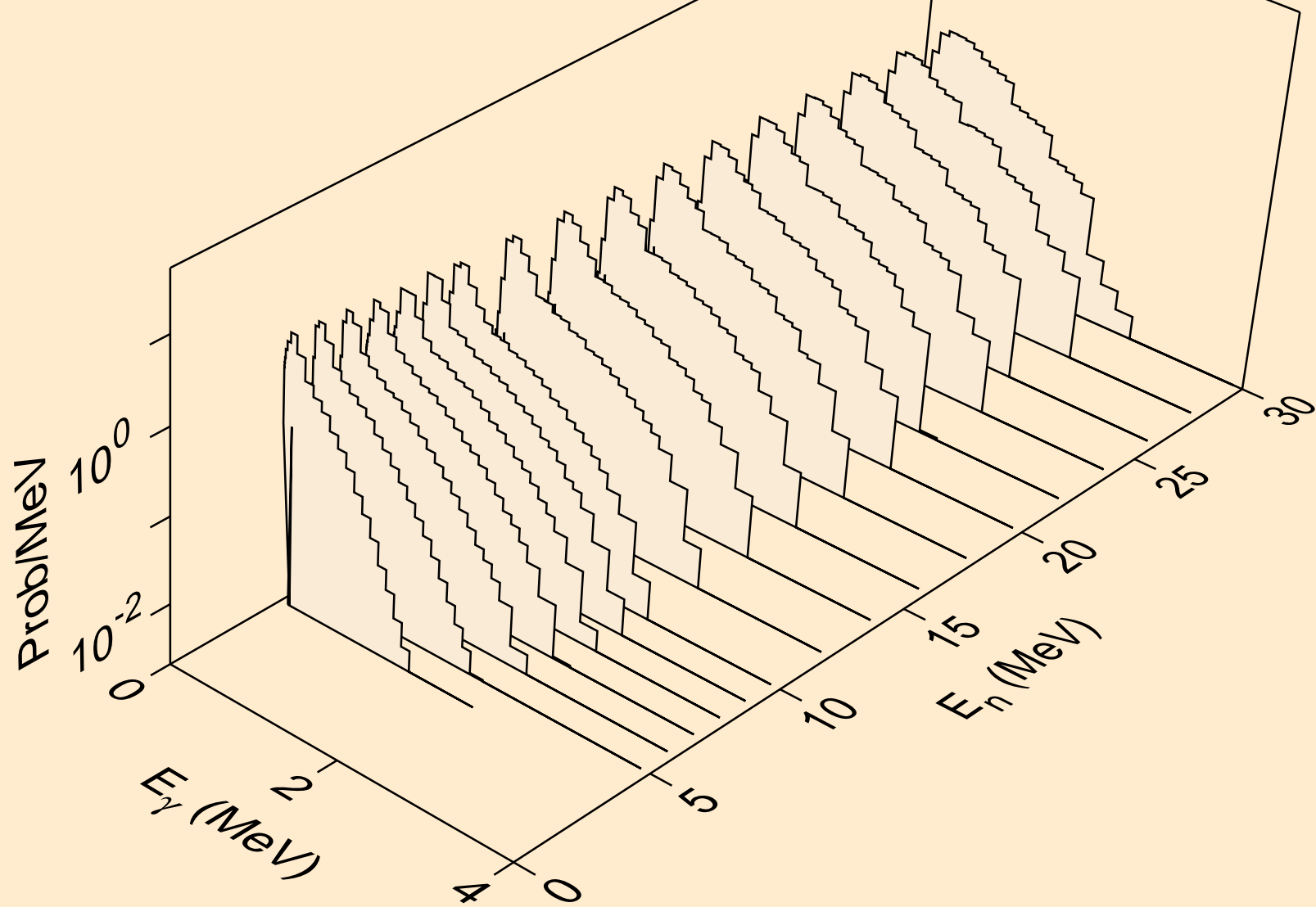

LR258 TRITON ACER TENDL-2021 LIBRARY; T=0.K  
Photon emission for inelastic

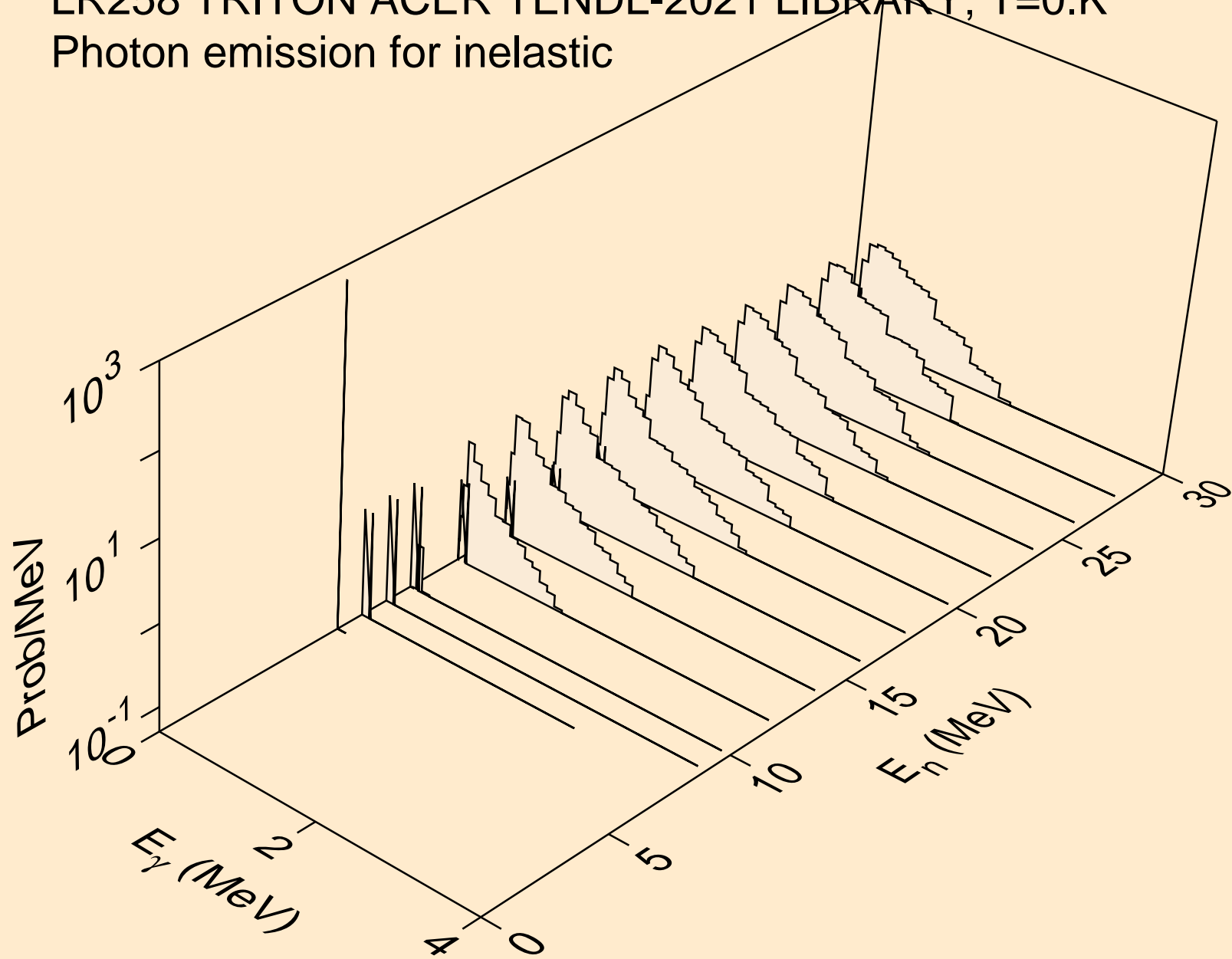

LR258 TRITON ACER TENDL-2021 LIBRARY; T=0.K  
Photon emission for (n,he3)

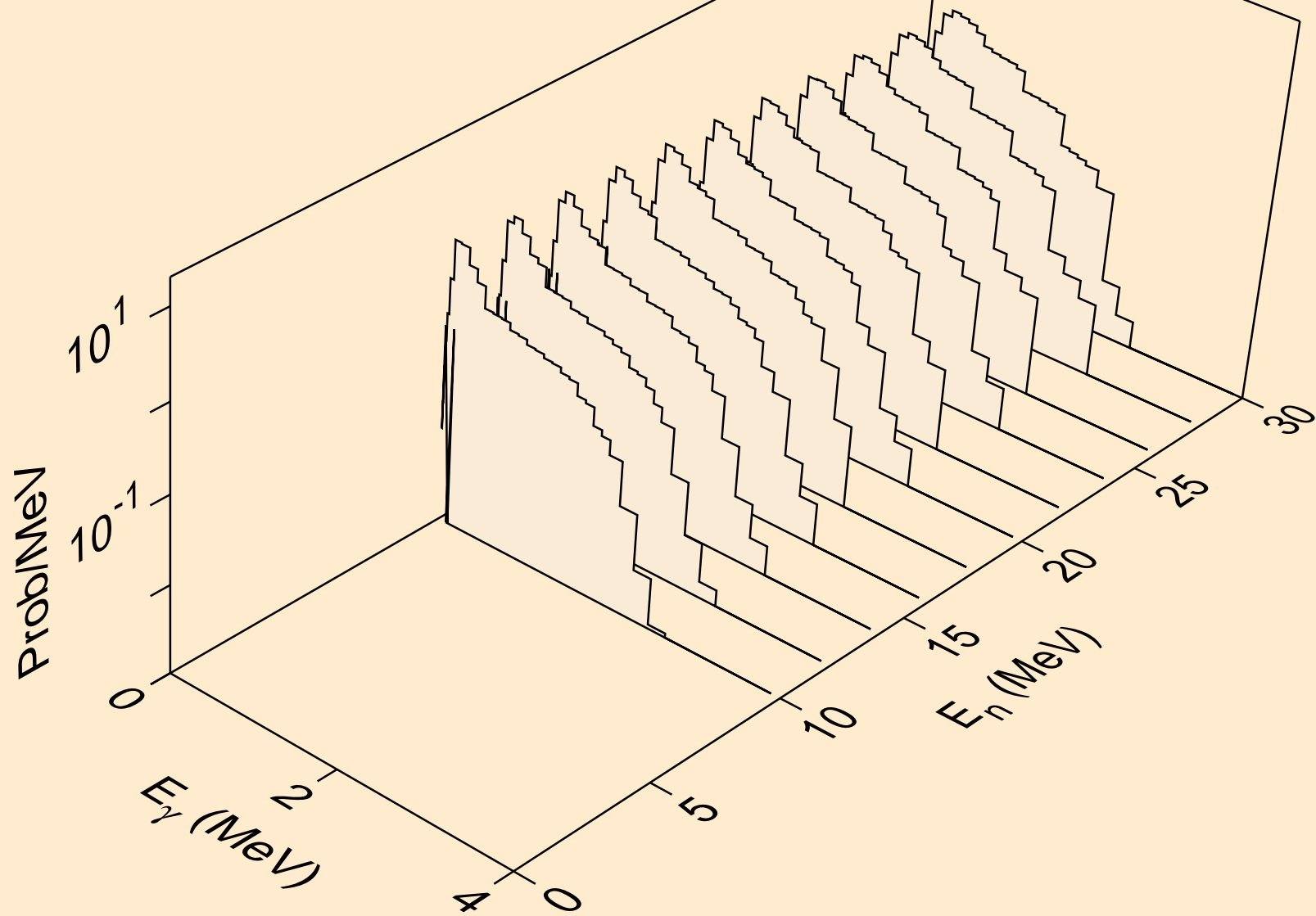

LR258 TRITON ACER TENDL-2021 LIBRARY; T=0.K  
Photon emission for (n,a)

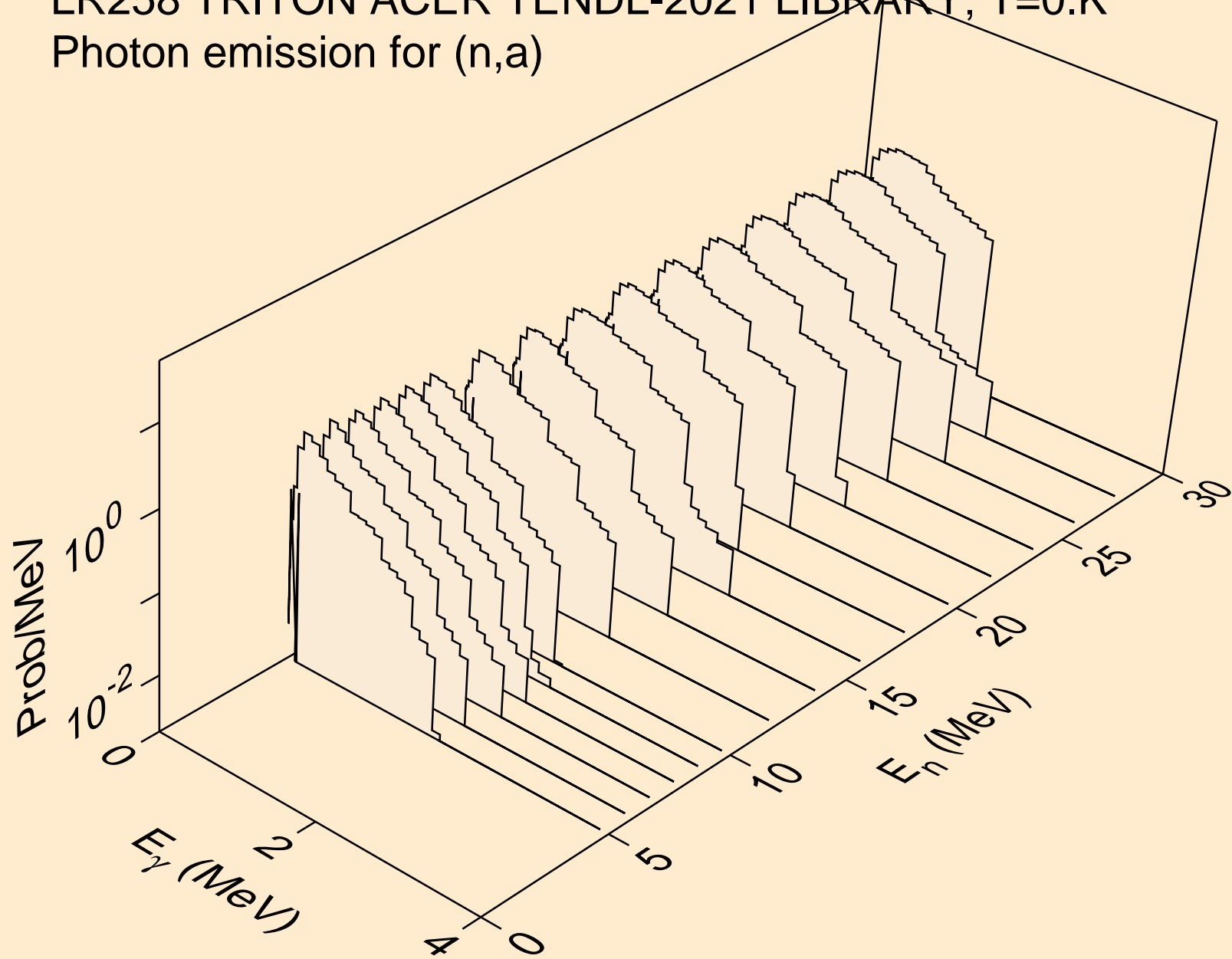

LR258 TRITON ACER TENDL-2021 LIBRARY; T=0.K  
Photon emission for (n,2a)

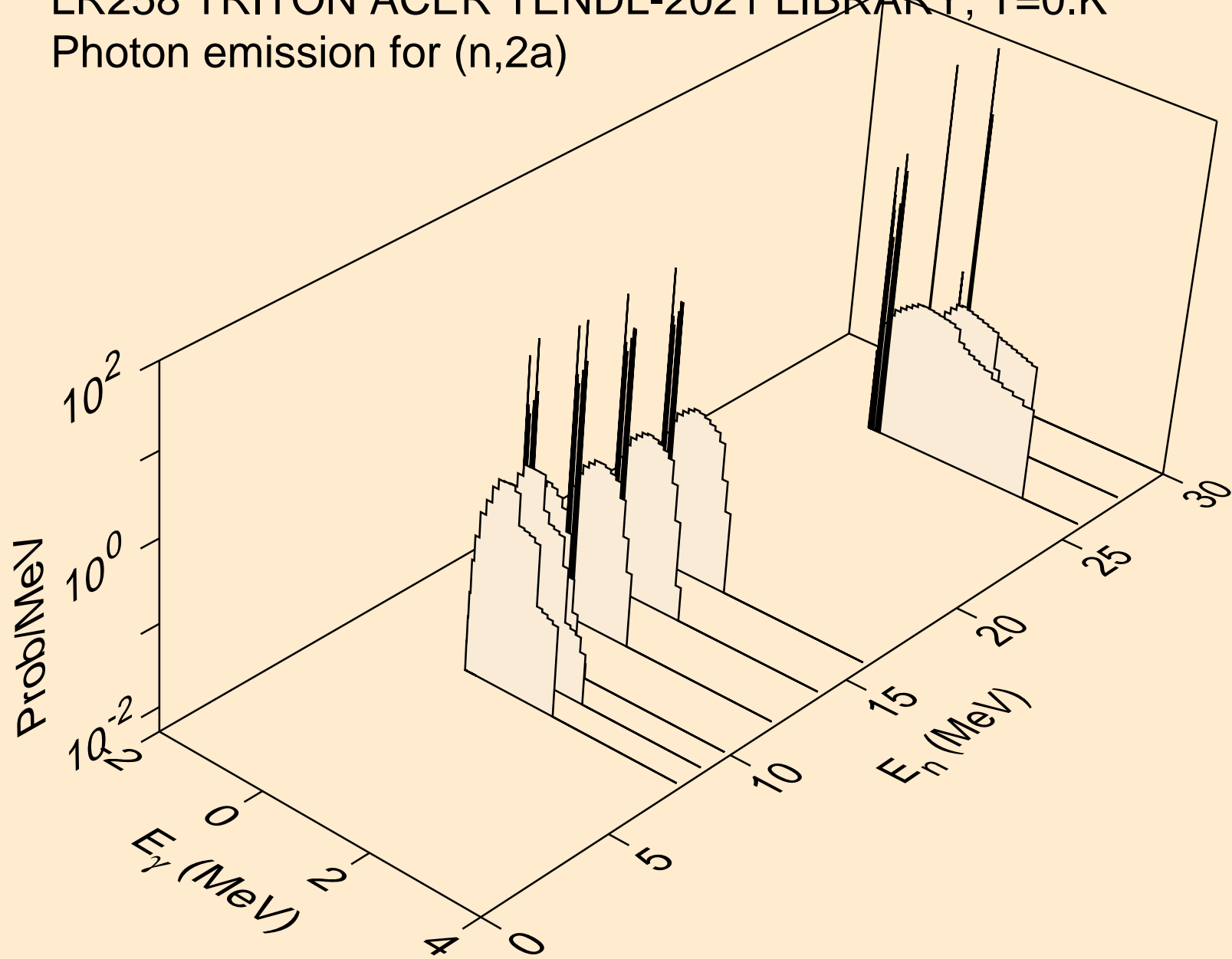

LR258 TRITON ACER TENDL-2021 LIBRARY; T=0.K  
Photon emission for (n,2p)

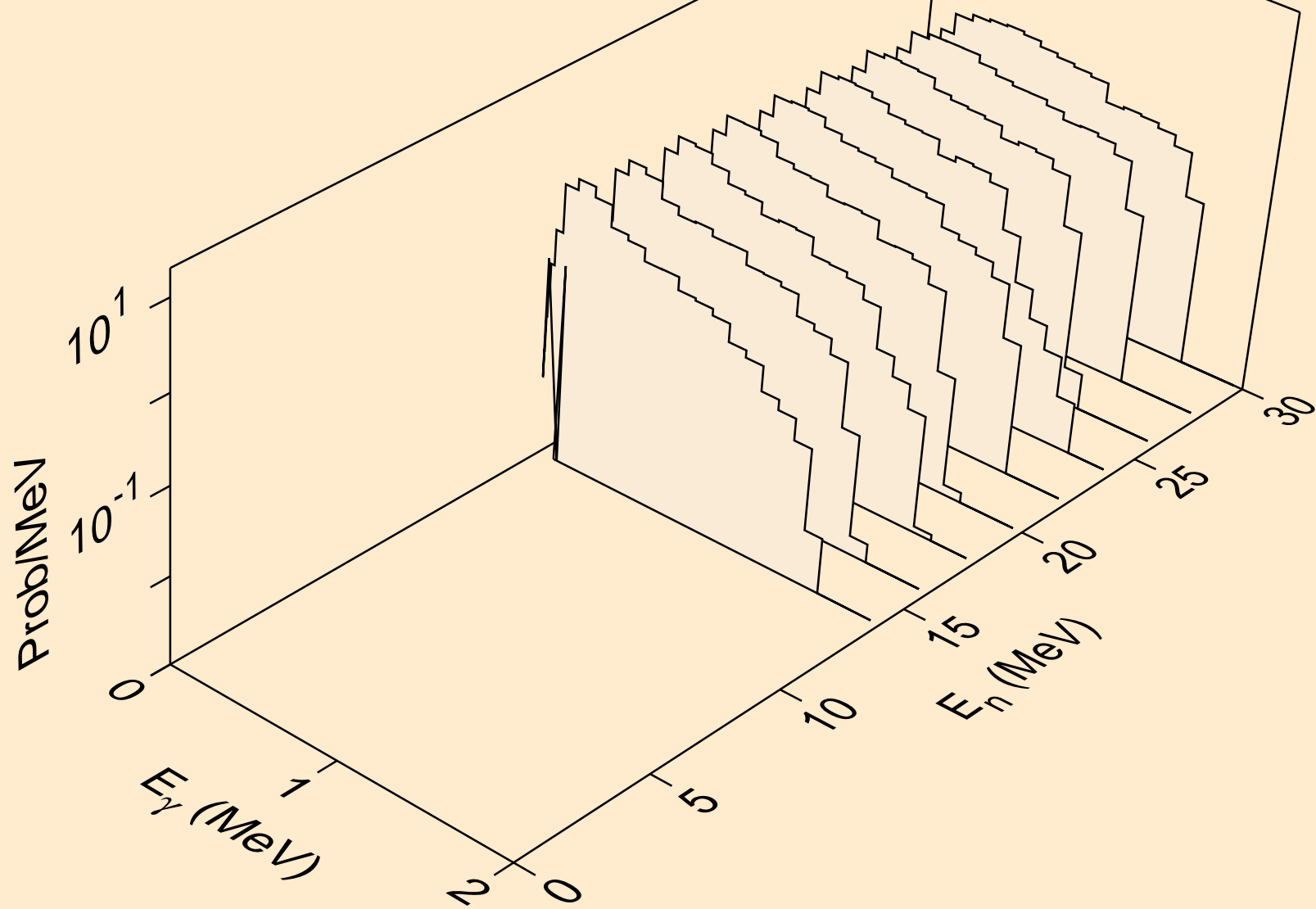

LR258 TRITON ACER TENDL-2021 LIBRARY; T=0.K  
Photon emission for (n,pa)

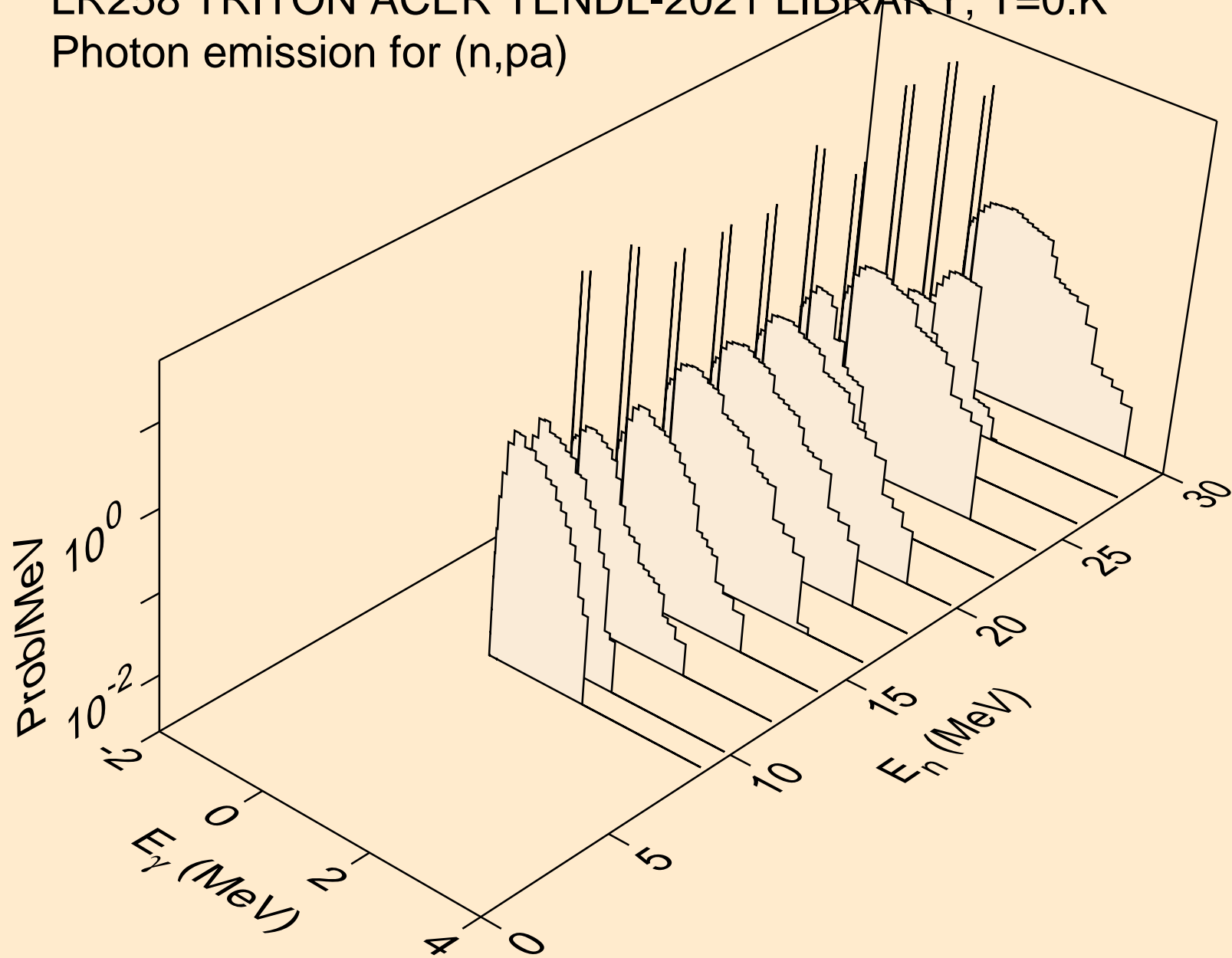



LR258 TRITON ACER TENDL-2021 LIBRARY; T=0.K  
Photon emission for (n,pd)

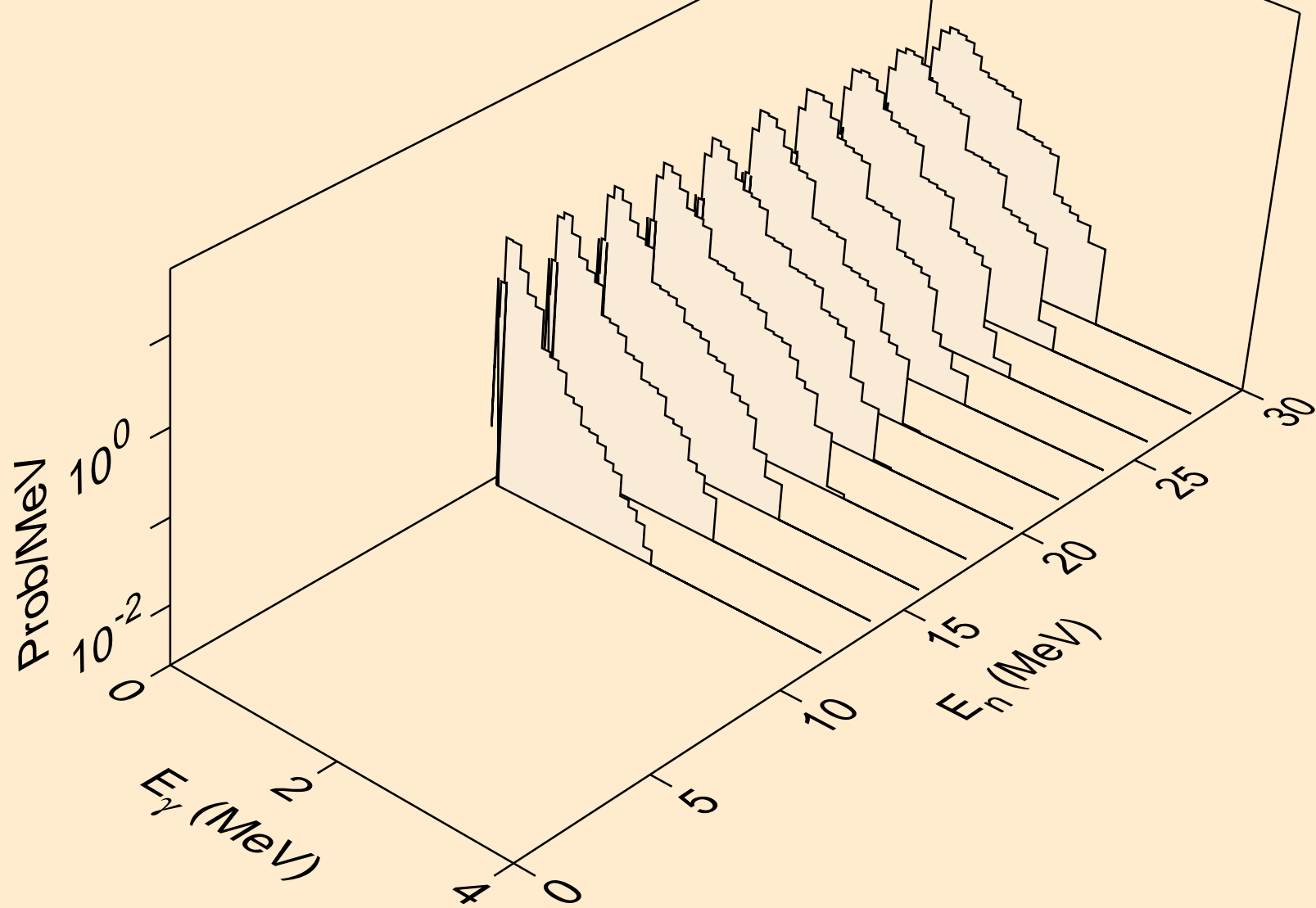

LR258 TRITON ACER TENDL-2021 LIBRARY; T=0.K  
Photon emission for (n,da)

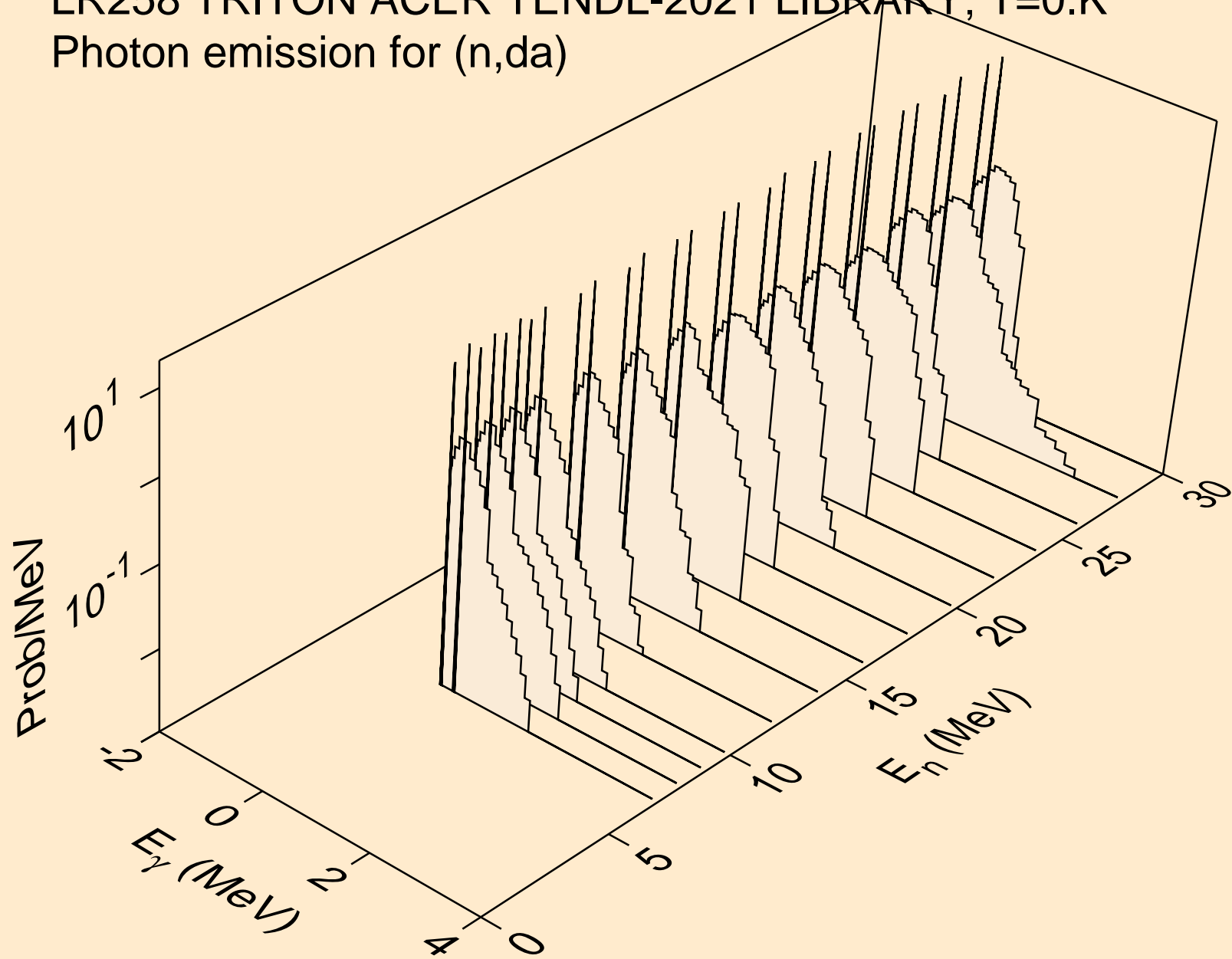

LR258 TRITON ACER TENDL-2021 LIBRARY; T=0.K  
Particle heating contributions

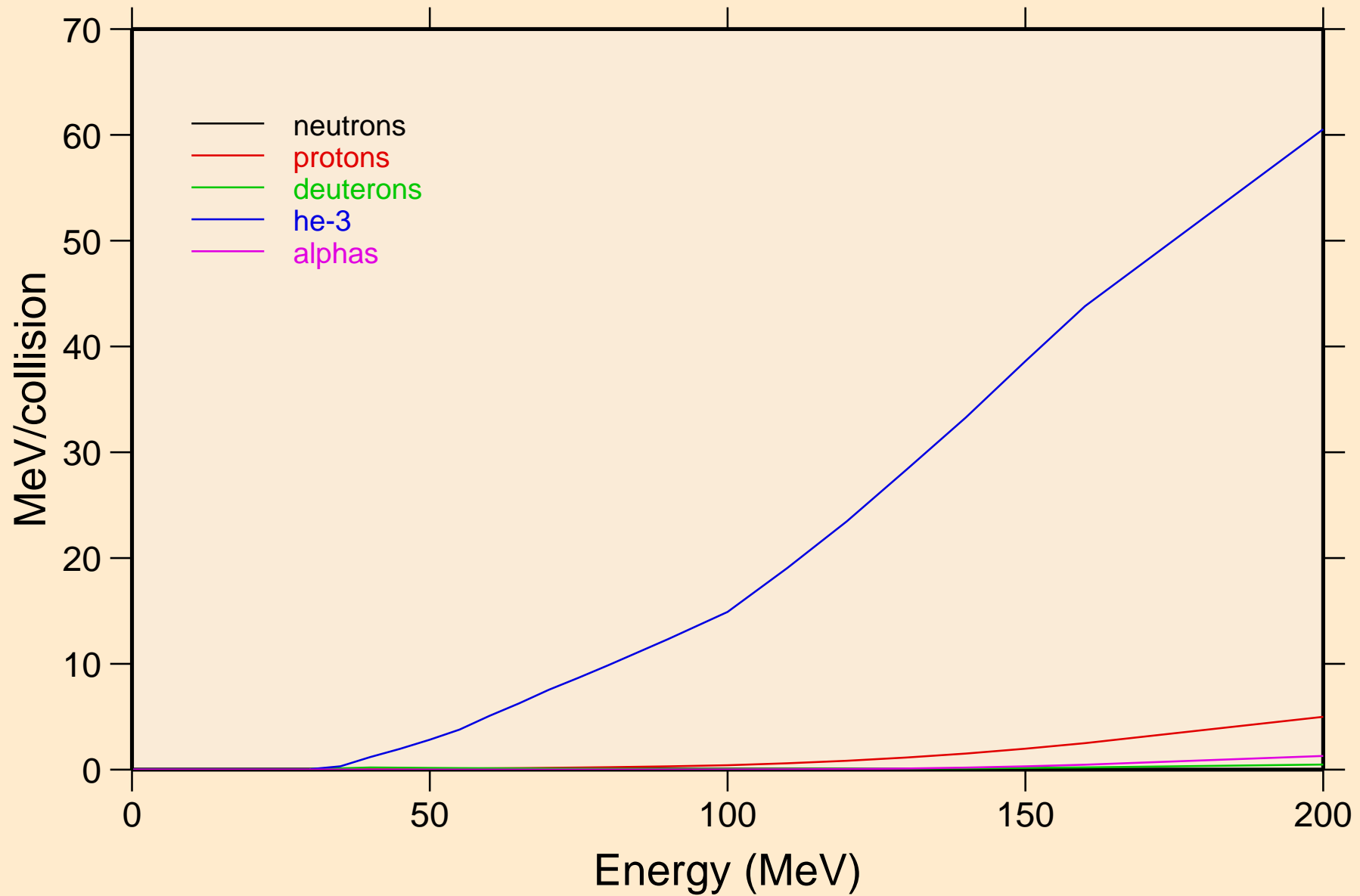

LR258 TRITON ACER TENDL-2021 LIBRARY; T=0.K  
Recoil Heating

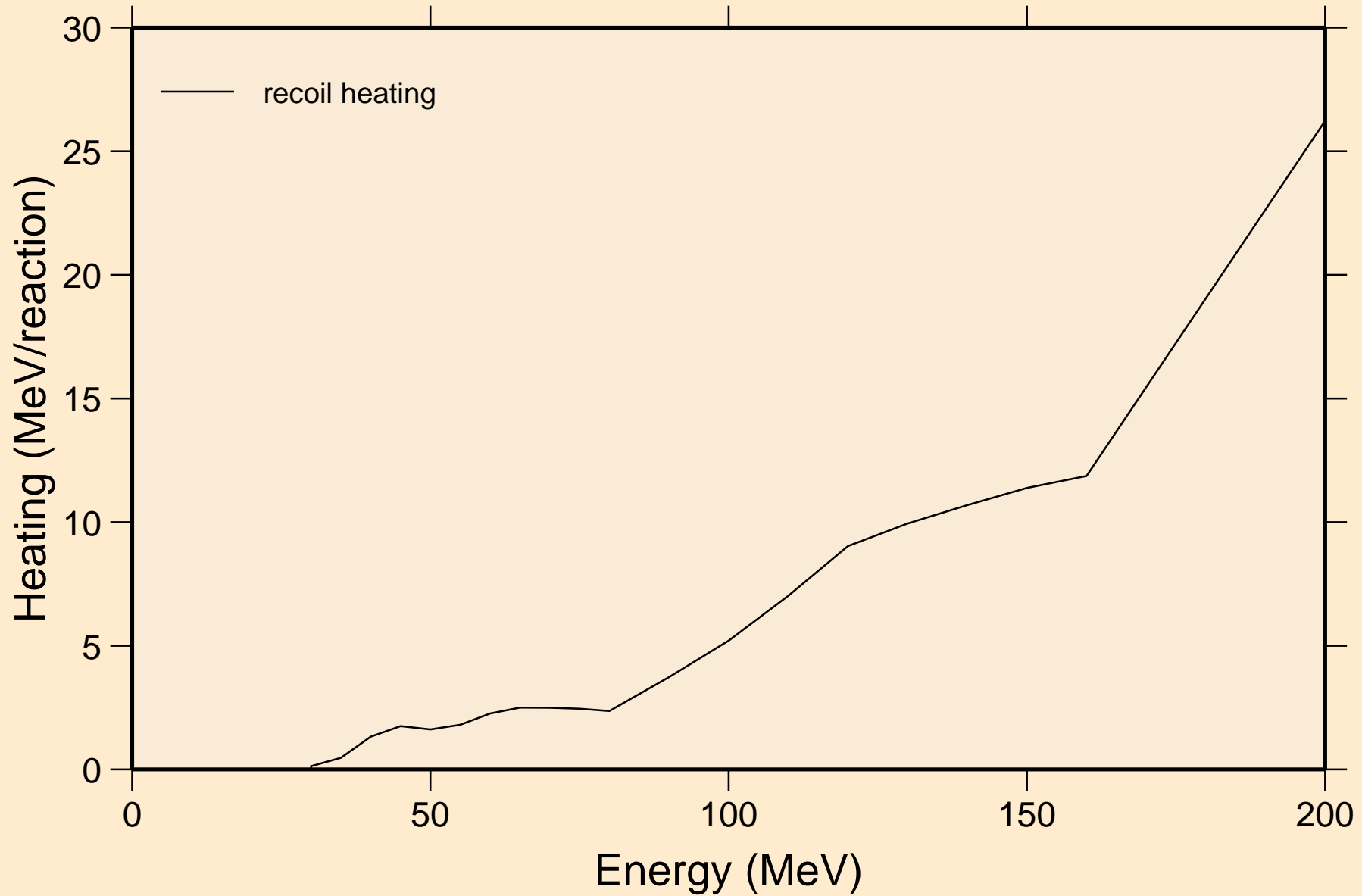

LR258 TRITON ACER TENDL-2021 LIBRARY; T=0.K  
Particle production cross sections

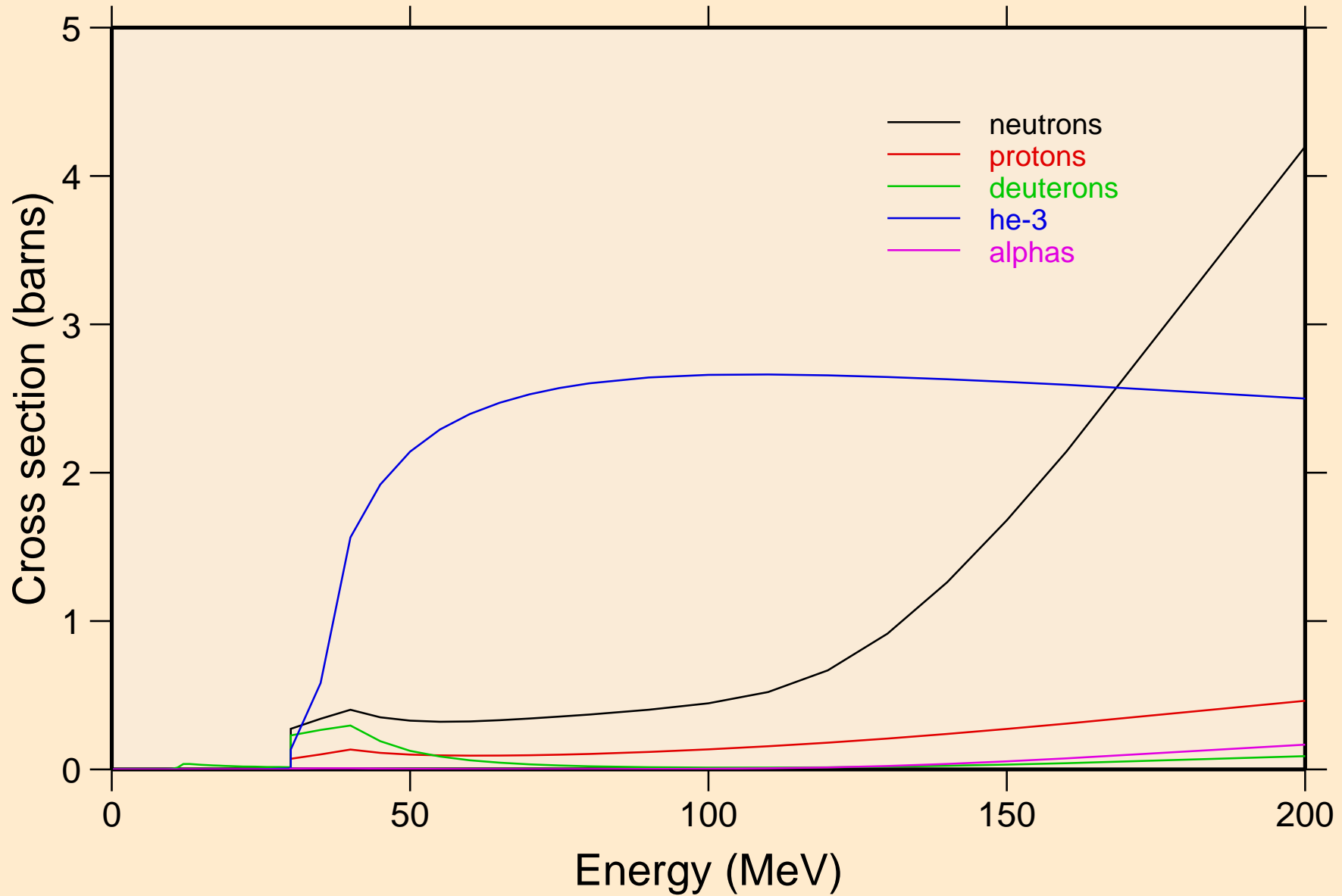

LR258 TRITON ACER TENDL-2021 LIBRARY; T=0.K  
neutrons from (t,n)

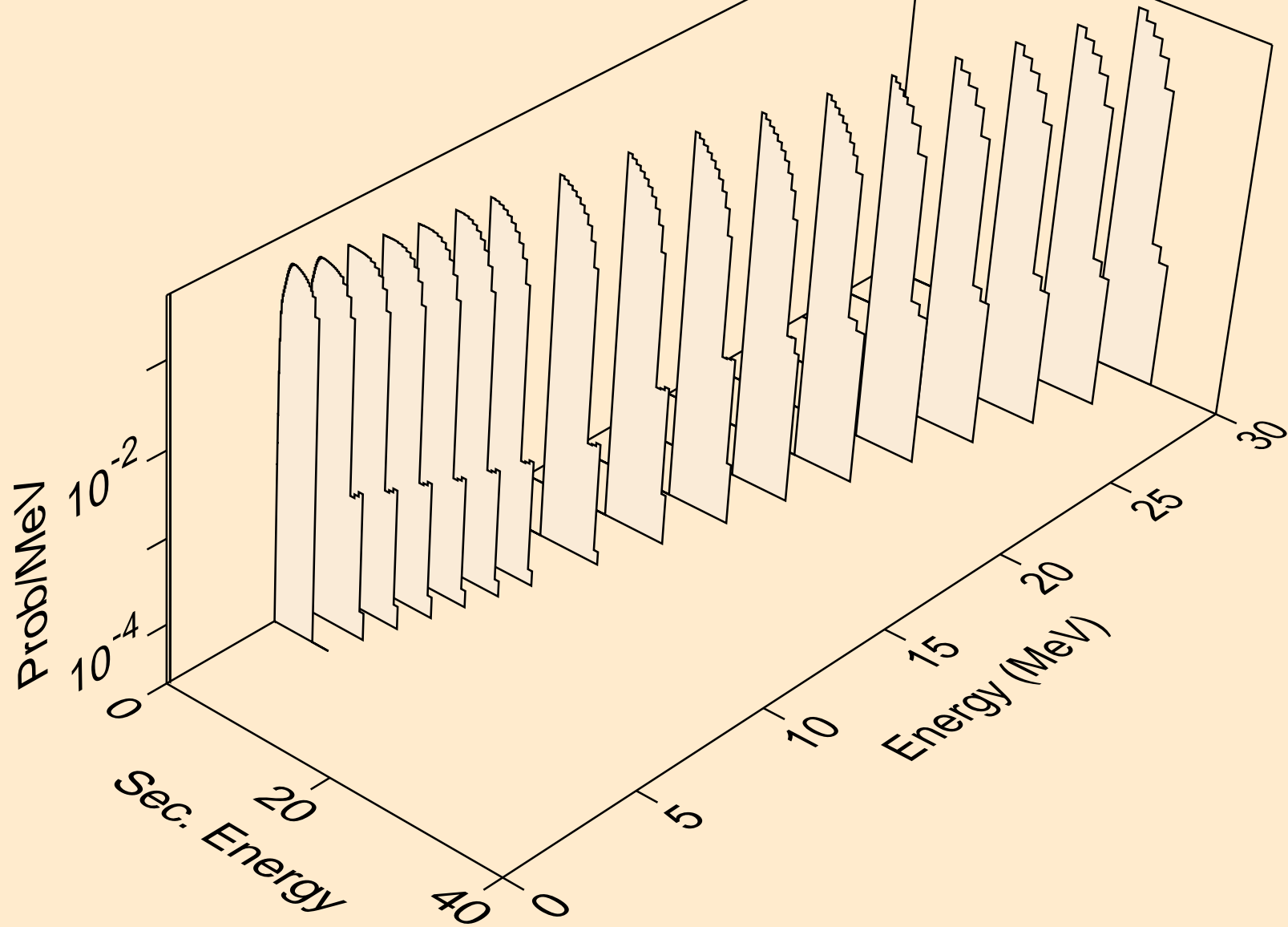

LR258 TRITON ACER TENDL-2021 LIBRARY; T=0.K  
neutrons from (t,x)

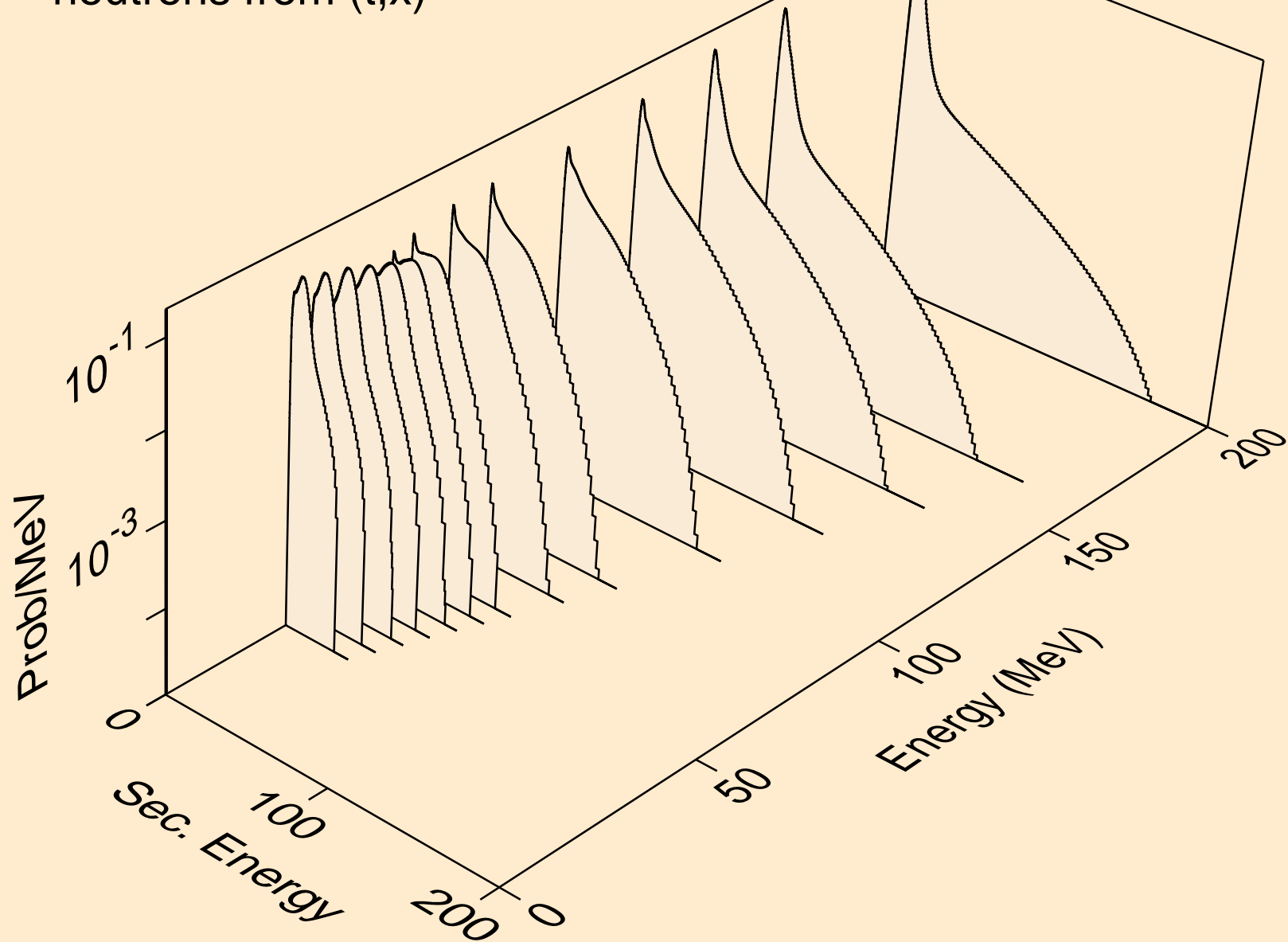

LR258 TRITON ACER TENDL-2021 LIBRARY; T=0.K  
neutrons from (t,2n)

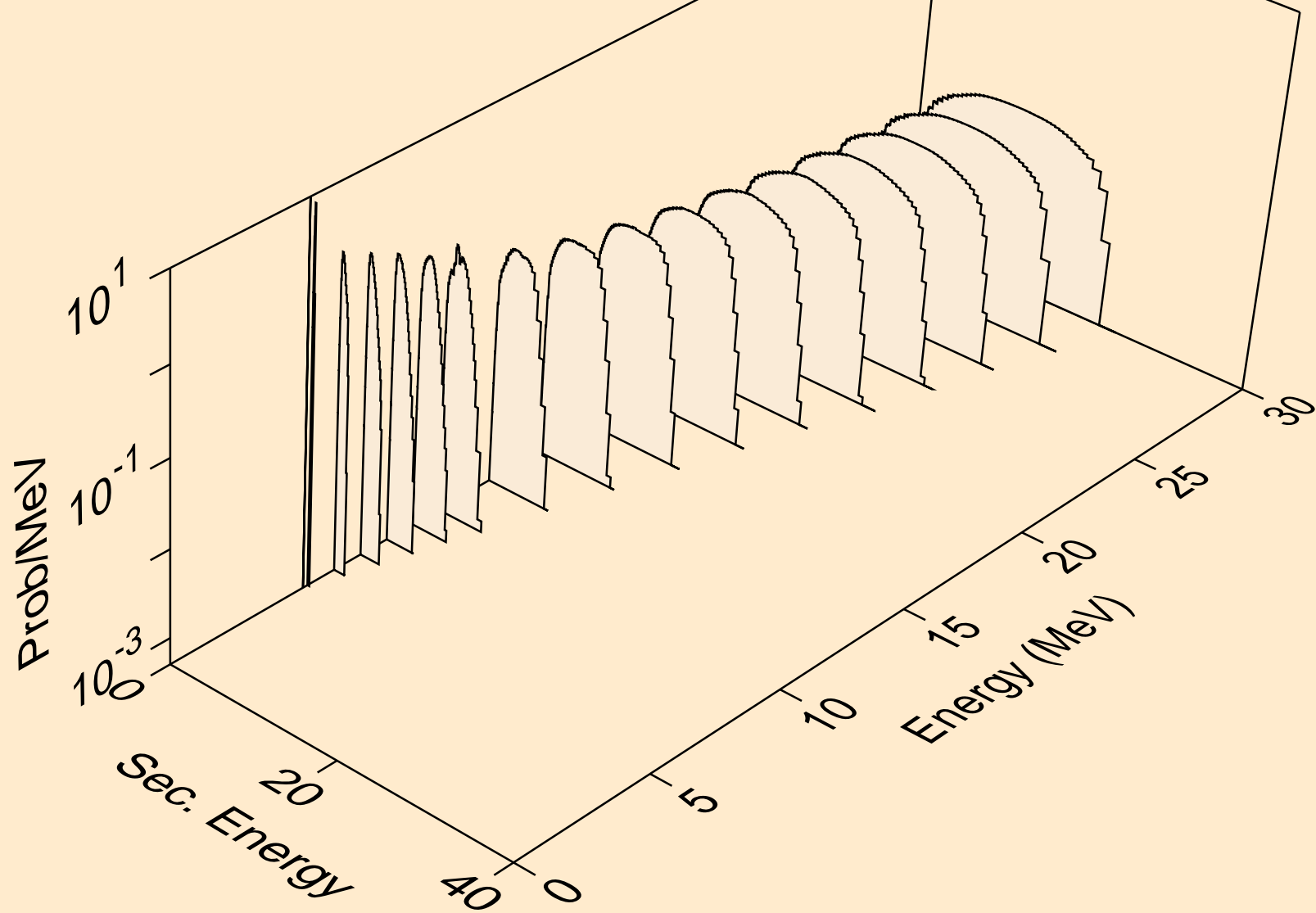



LR258 TRITON ACER TENDL-2021 LIBRARY; T=0.K  
neutrons from (t,3n)

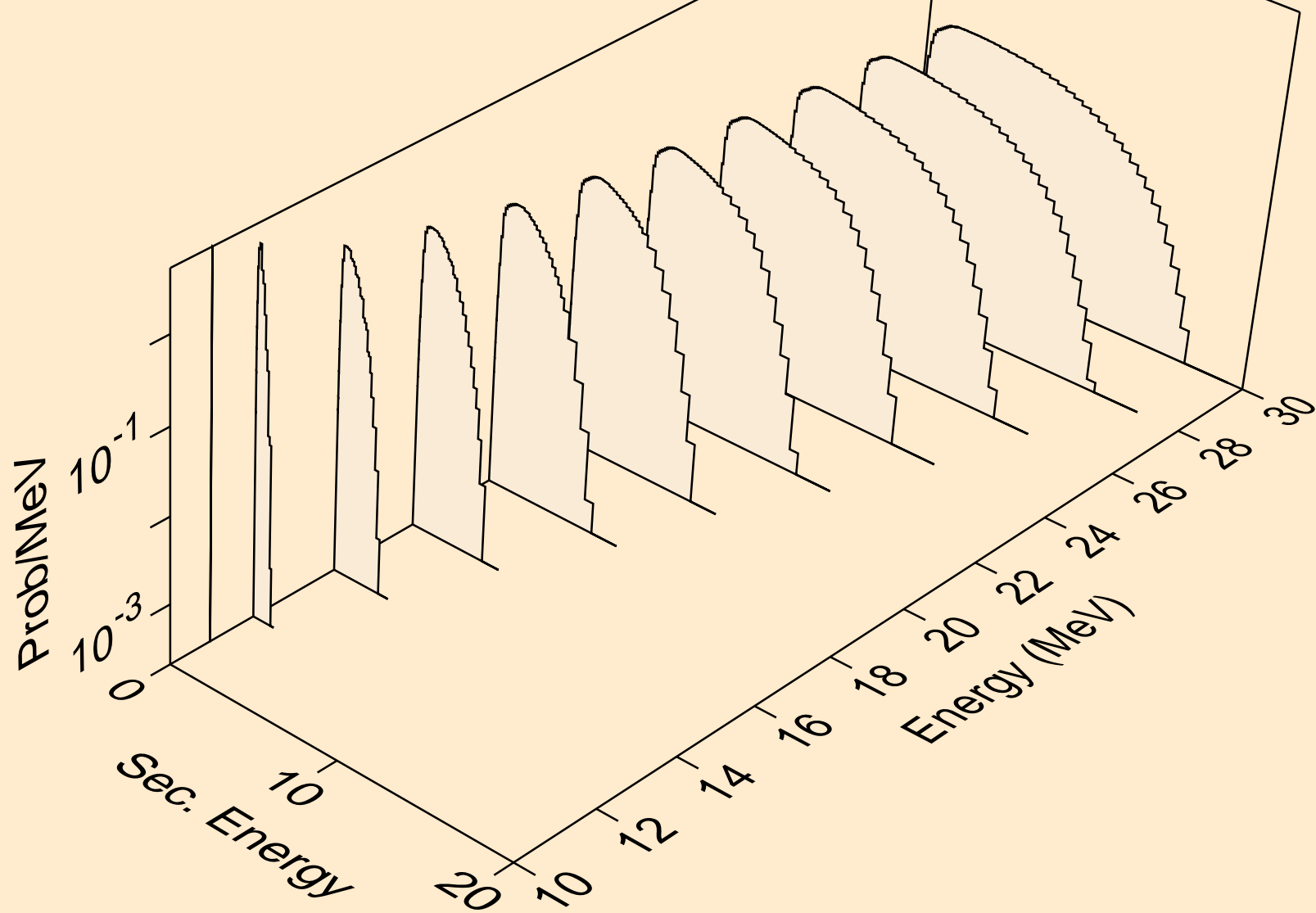

LR258 TRITON ACER TENDL-2021 LIBRARY; T=0.K  
neutrons from (t,n\*)a

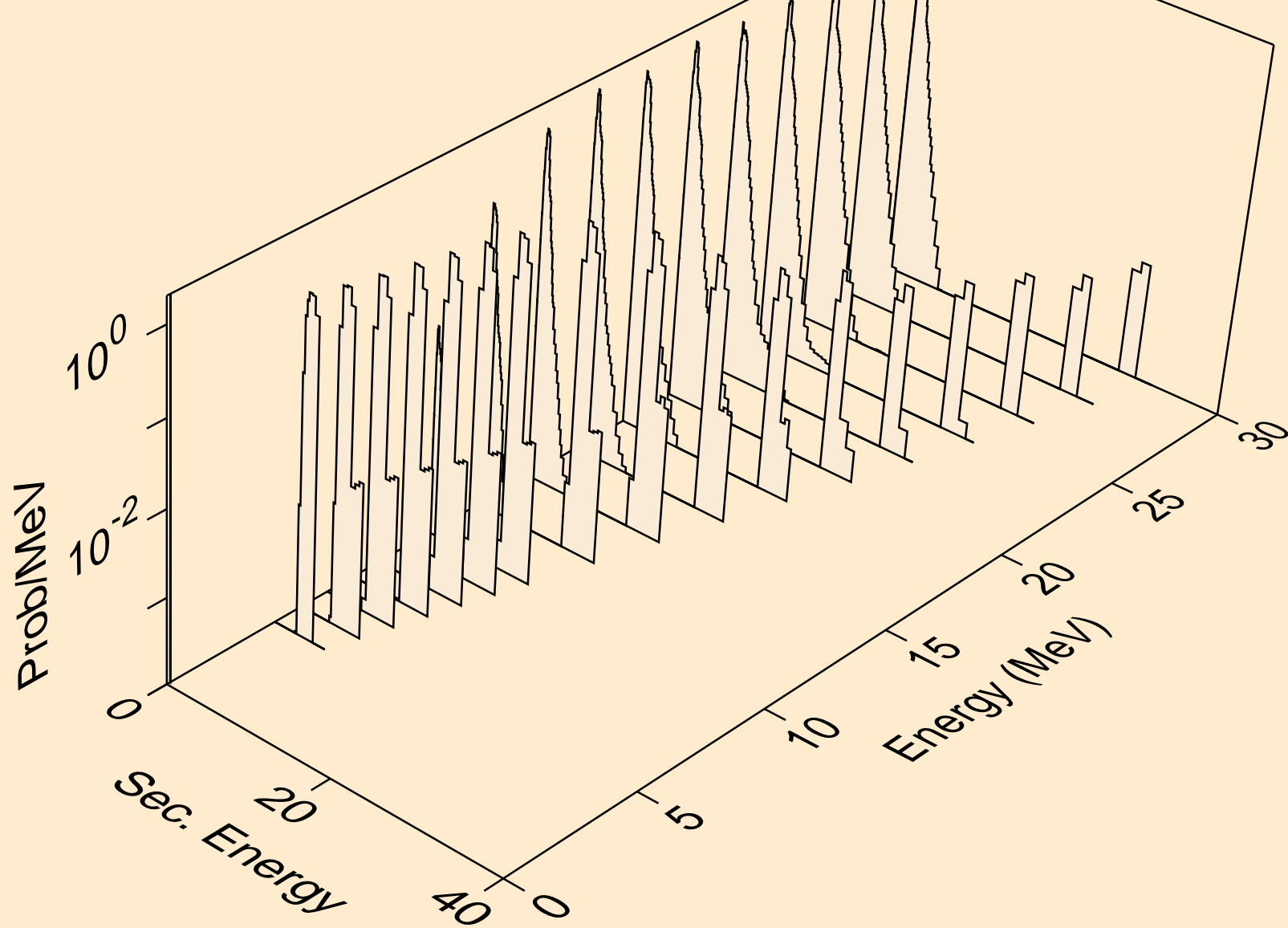

LR258 TRITON ACER TENDL-2021 LIBRARY; T=0.K  
neutrons from (t,2n)a

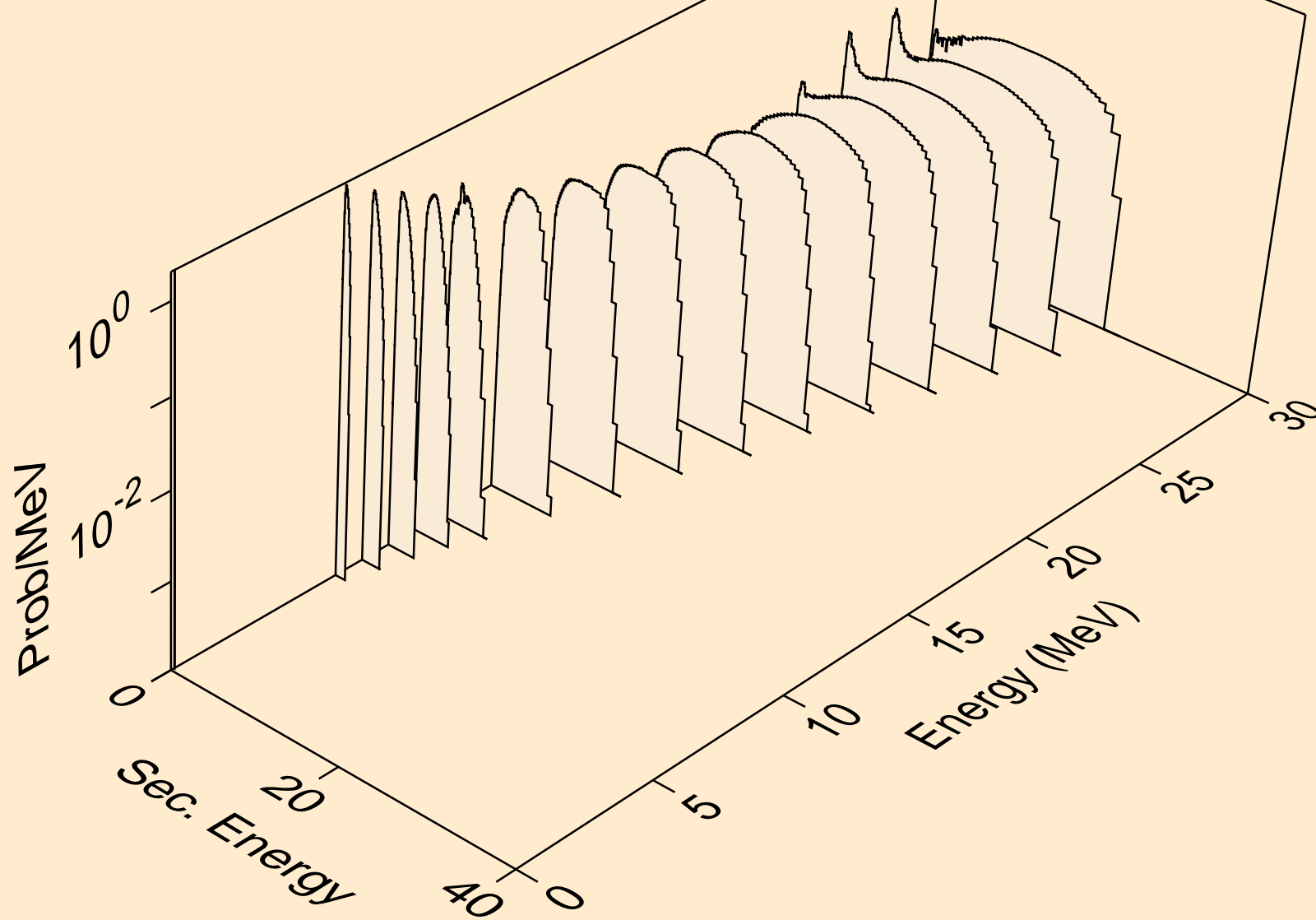

LR258 TRITON ACER TENDL-2021 LIBRARY; T=0.K  
neutrons from (t,3n)a

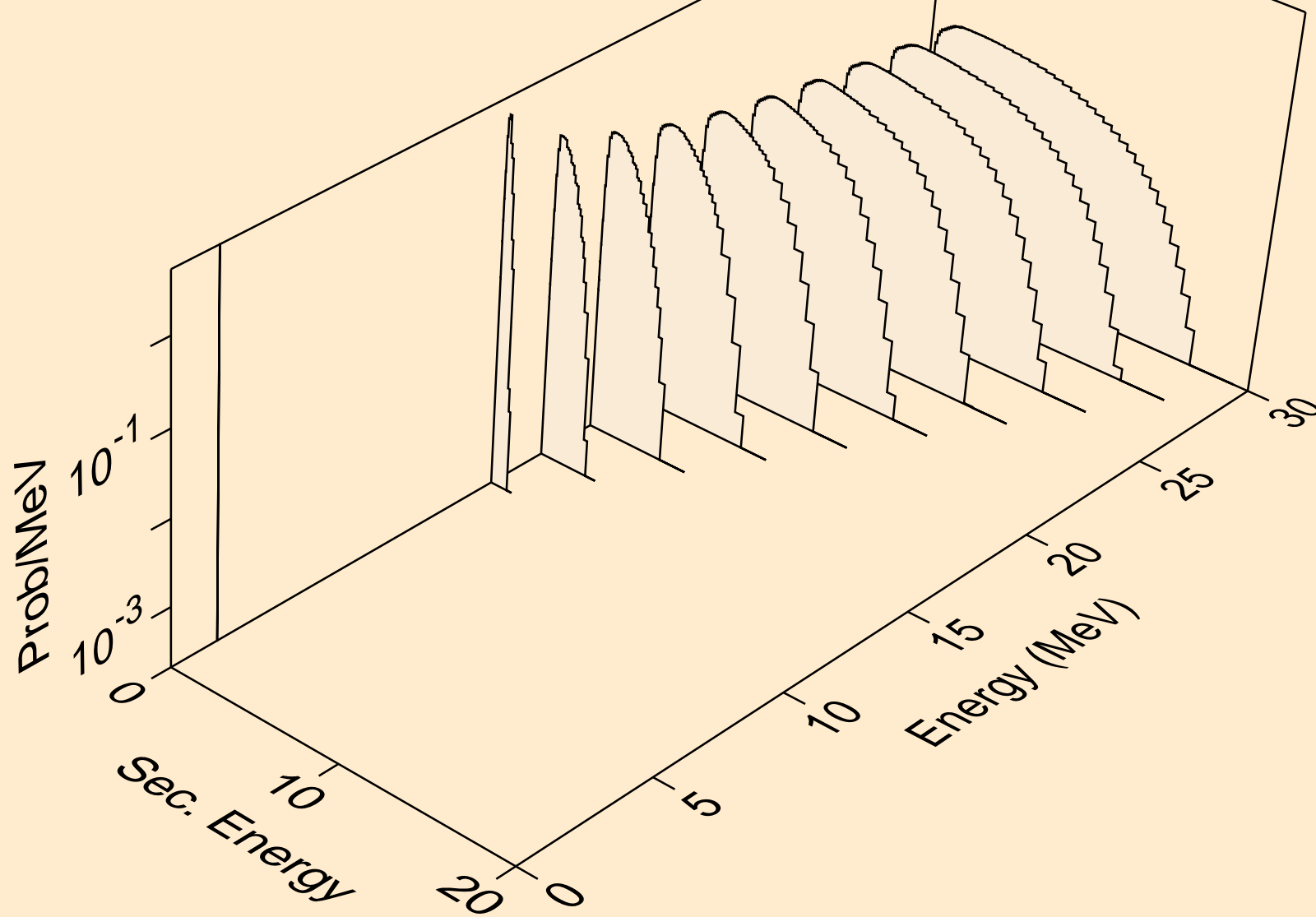

LR258 TRITON ACER TENDL-2021 LIBRARY; T=0.K  
neutrons from (t,n\*)p

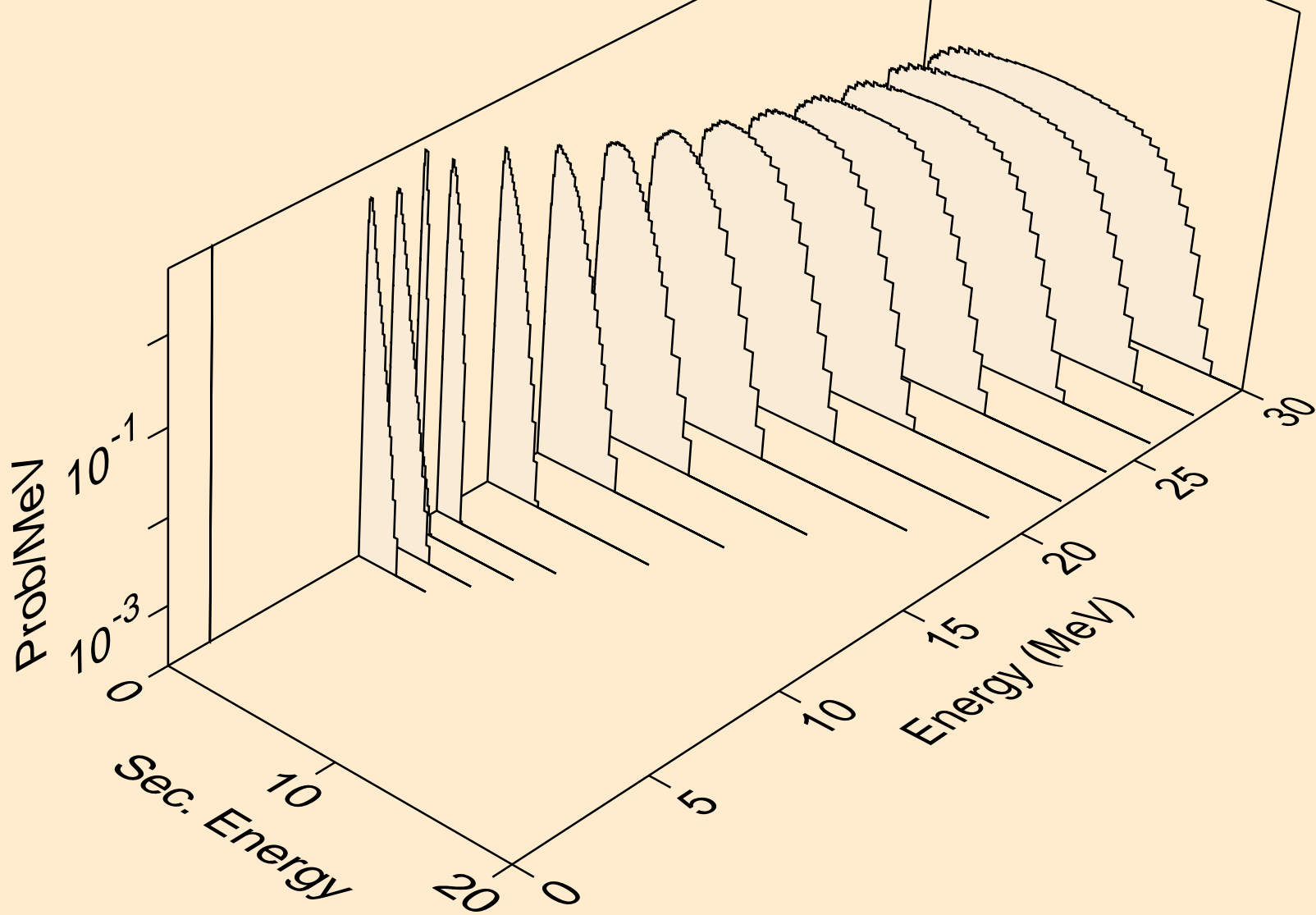

LR258 TRITON ACER TENDL-2021 LIBRARY; T=0.K  
neutrons from (t,n\*)d

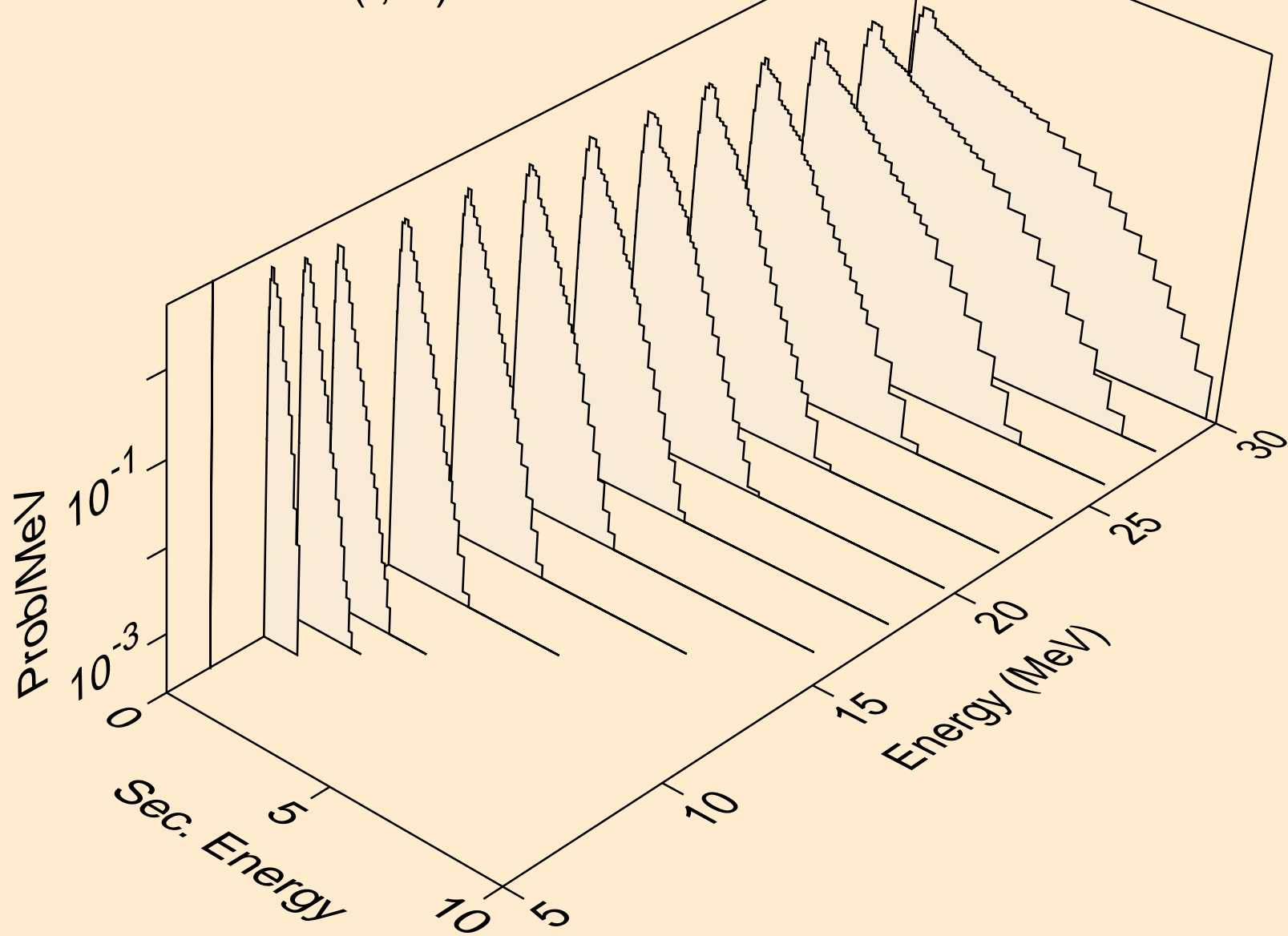

LR258 TRITON ACER TENDL-2021 LIBRARY; T=0.K  
neutrons from (t,n\*)t

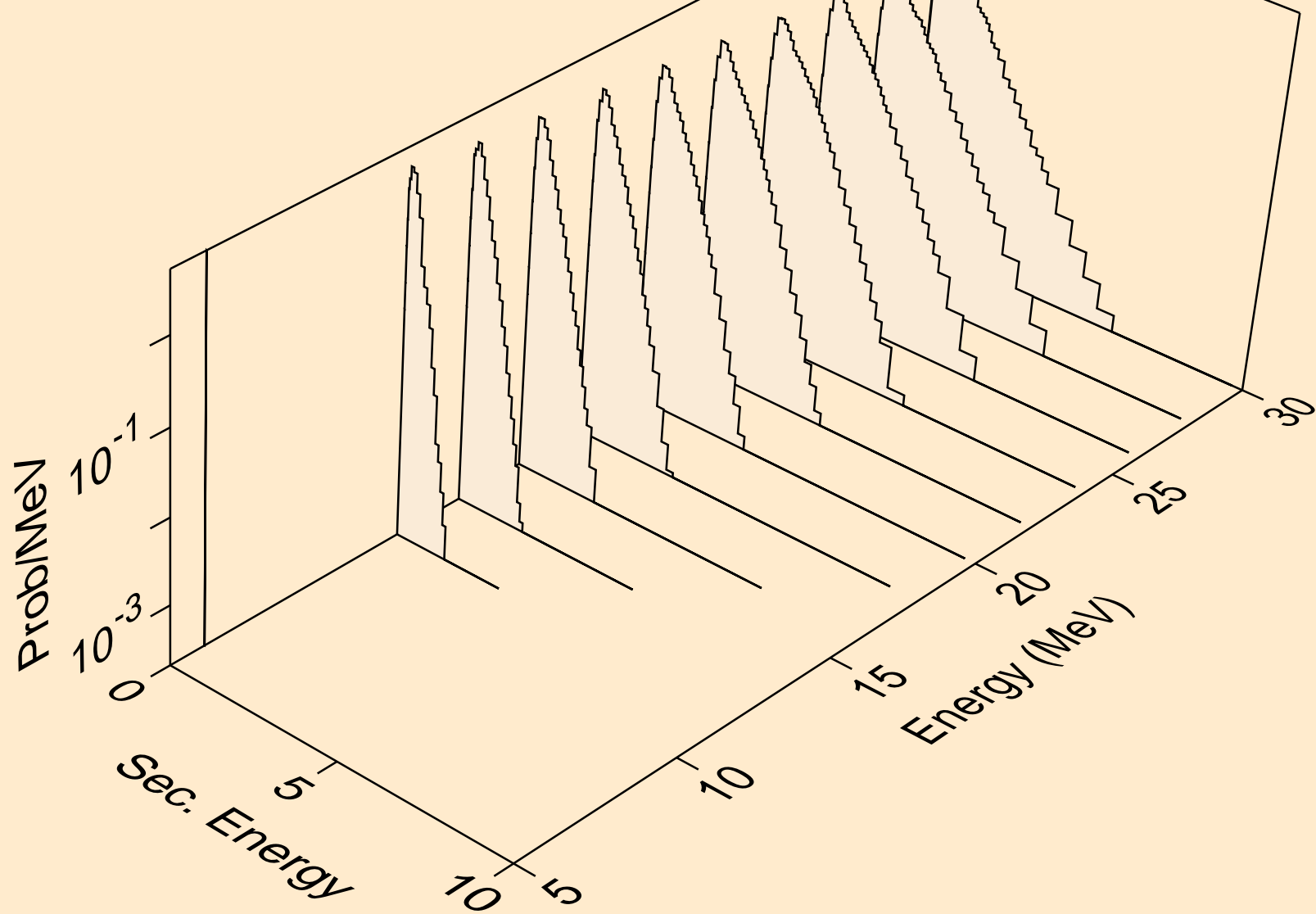

LR258 TRITON ACER TENDL-2021 LIBRARY; T=0.K  
neutrons from (t,n\*)he3

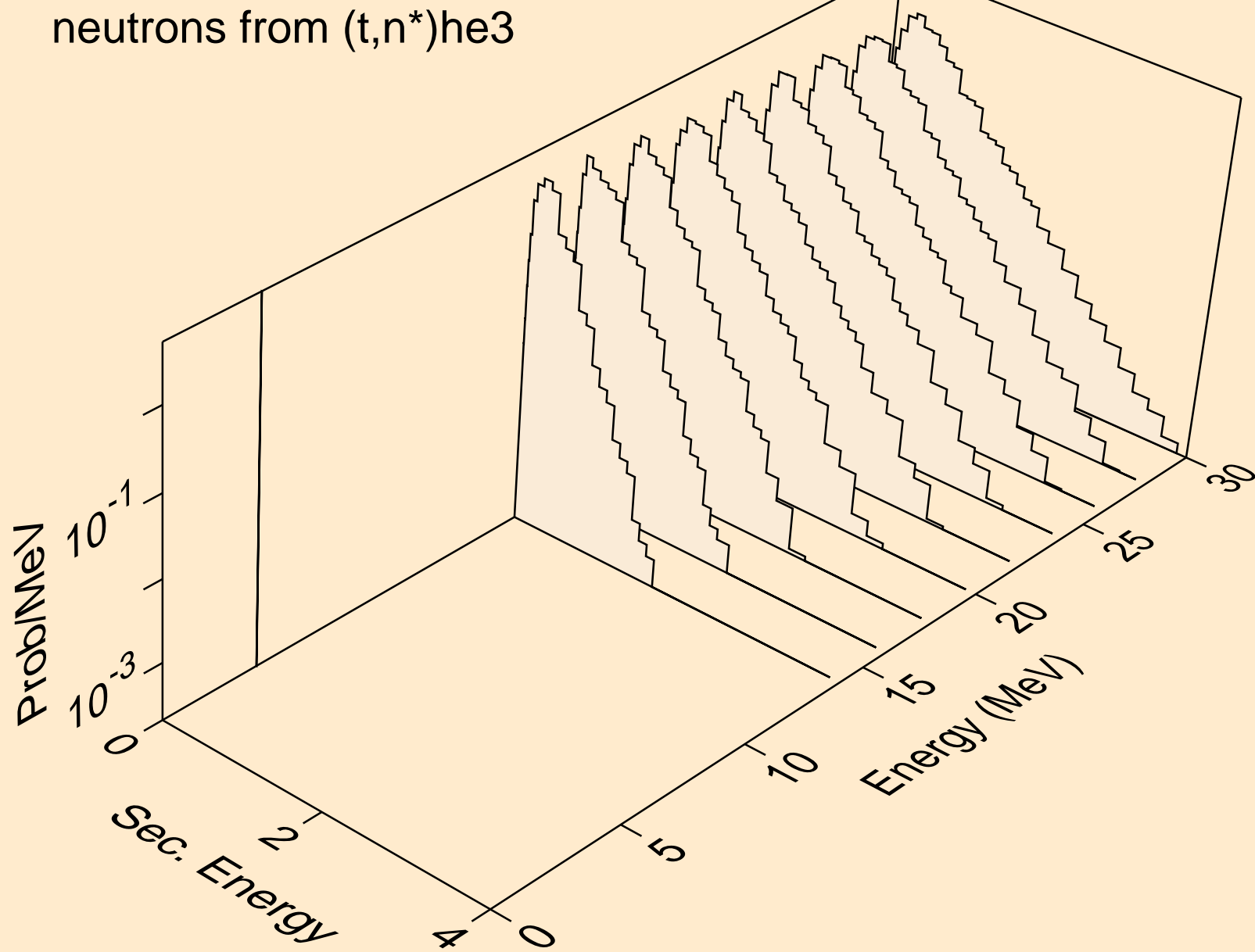



LR258 TRITON ACER TENDL-2021 LIBRARY; T=0.K  
neutrons from (t,4n)

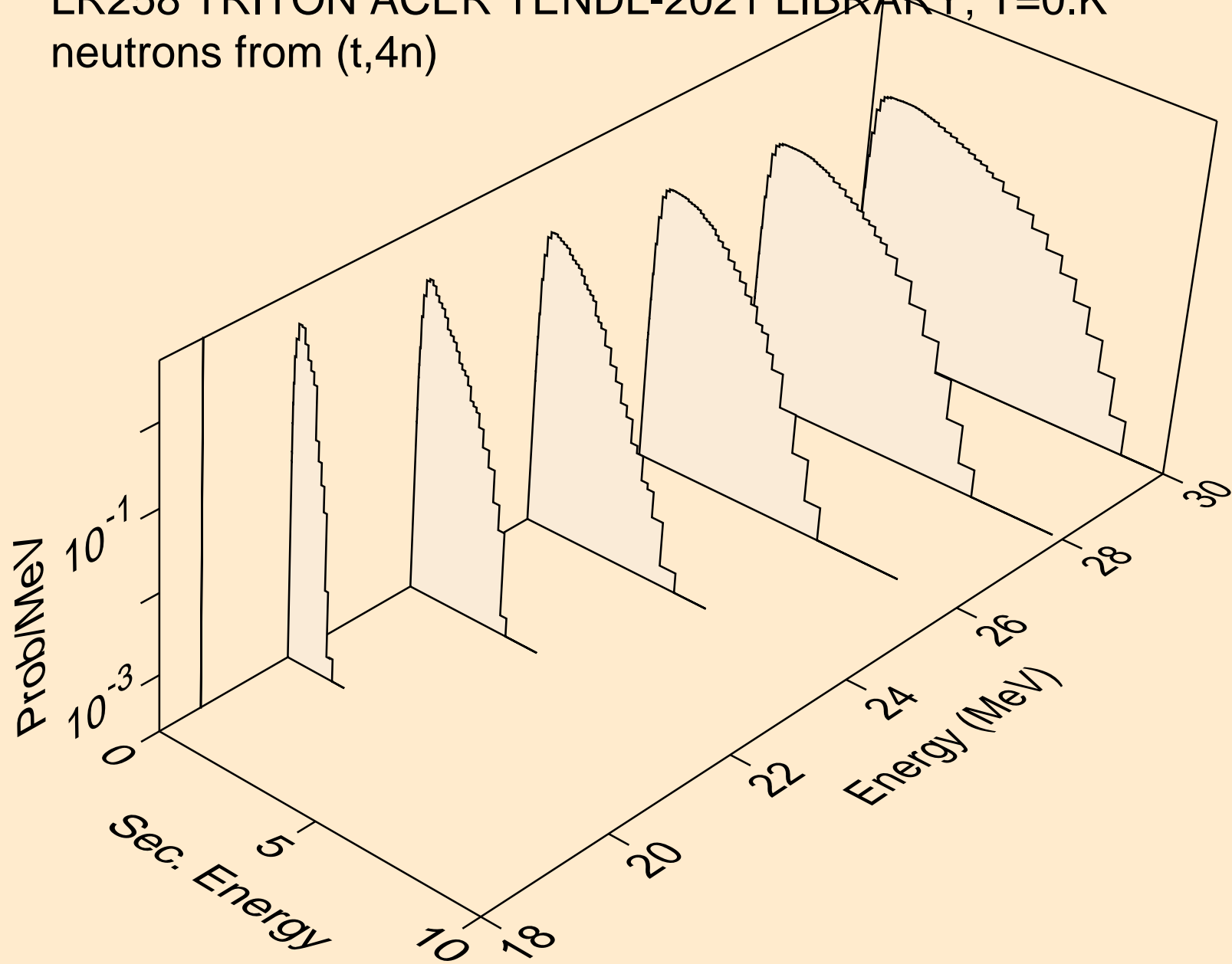

LR258 TRITON ACER TENDL-2021 LIBRARY; T=0.K  
neutrons from (t,2np)

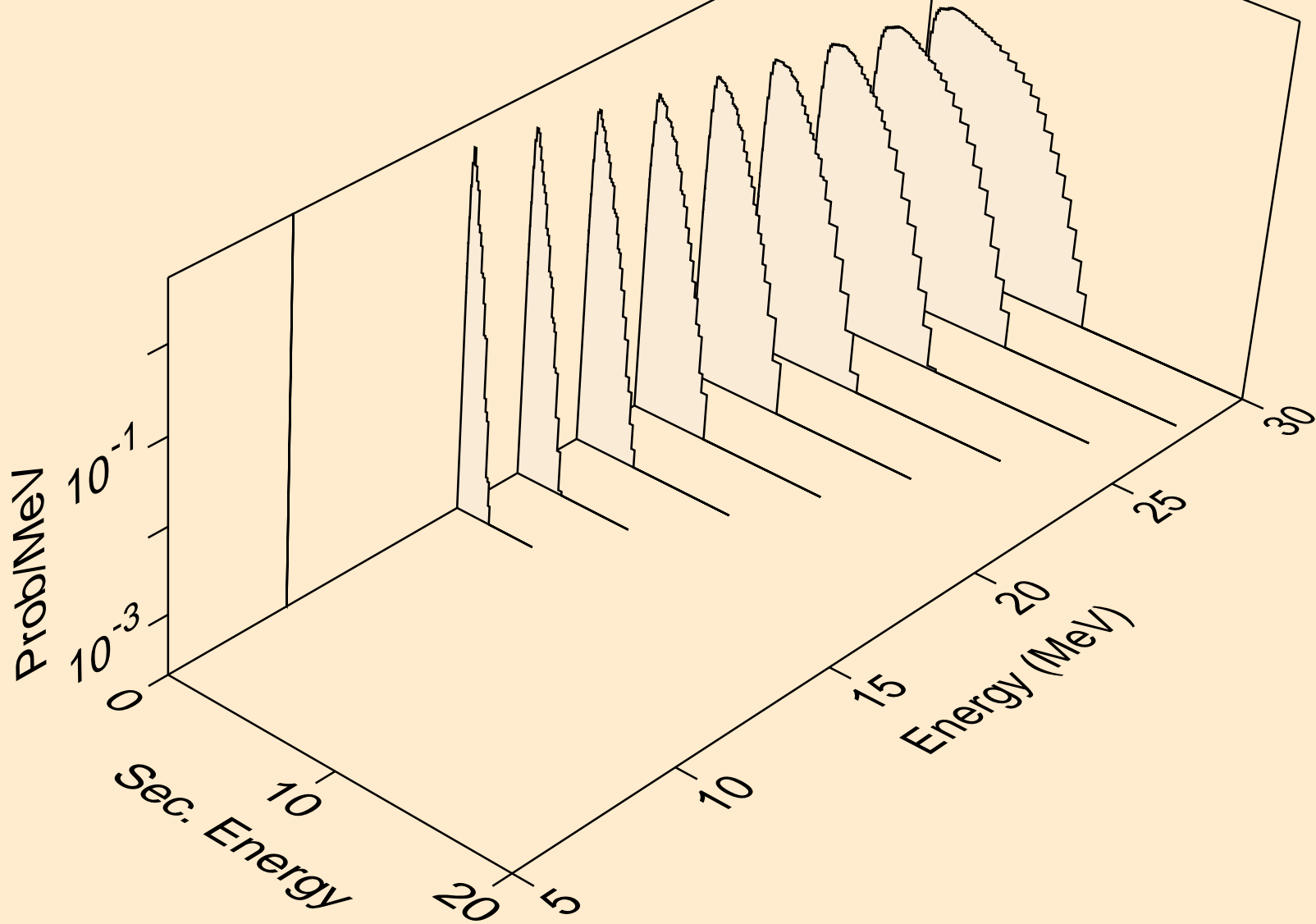

LR258 TRITON ACER TENDL-2021 LIBRARY; T=0.K  
neutrons from (t,3np)

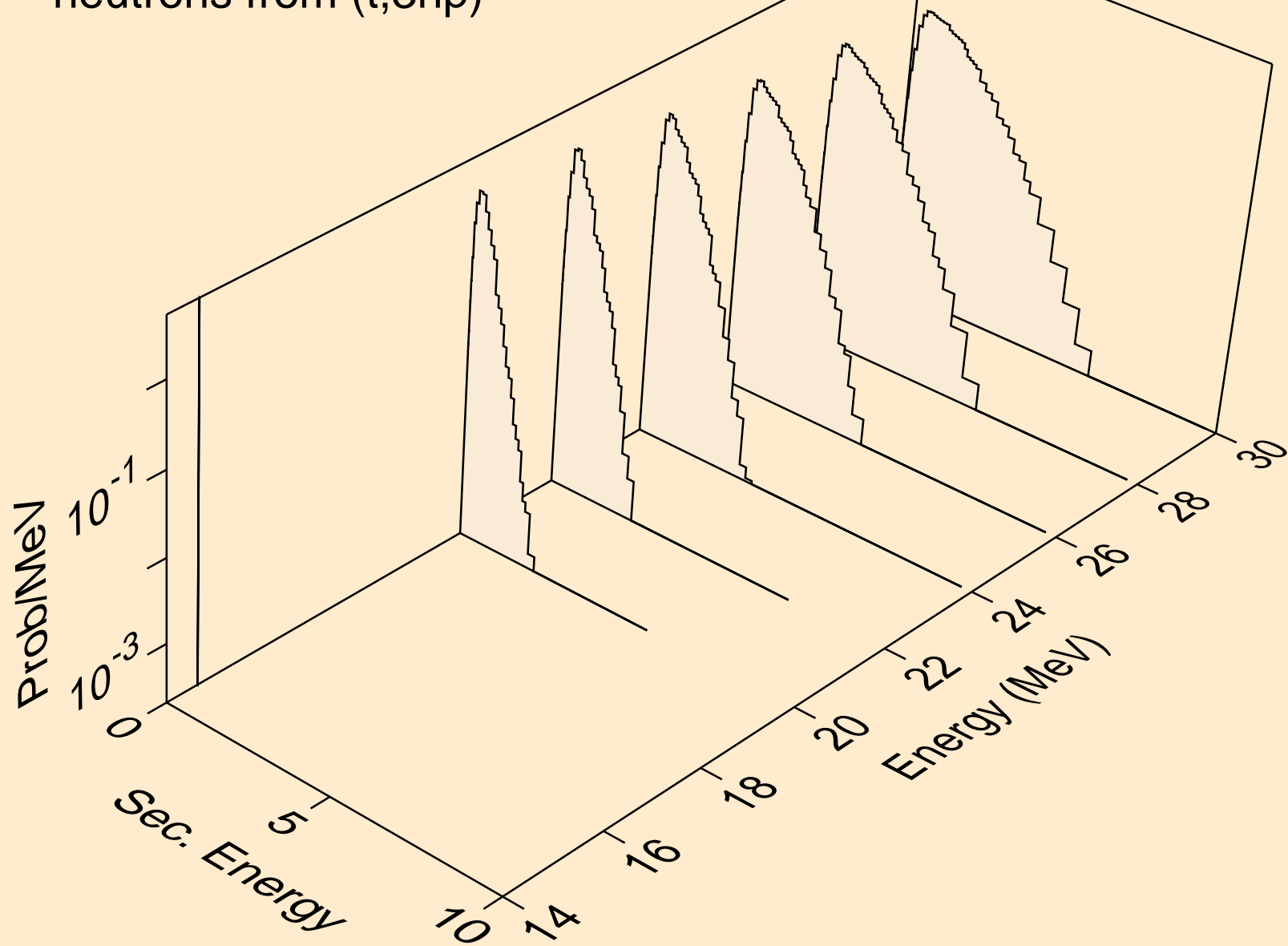

LR258 TRITON ACER TENDL-2021 LIBRARY; T=0.K  
neutrons from (t,2np)

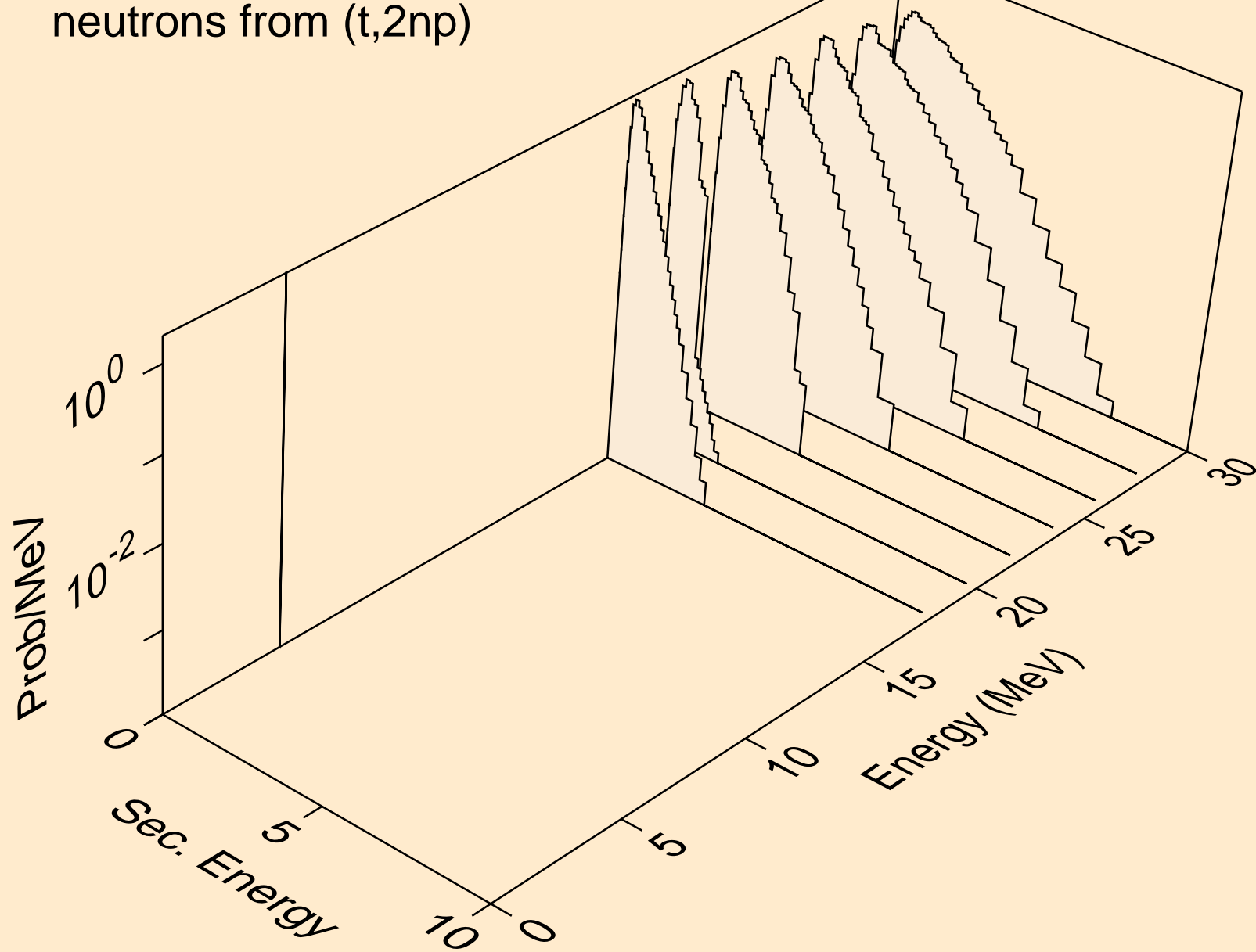

LR258 TRITON ACER TENDL-2021 LIBRARY; T=0.K  
neutrons from (t,npa)

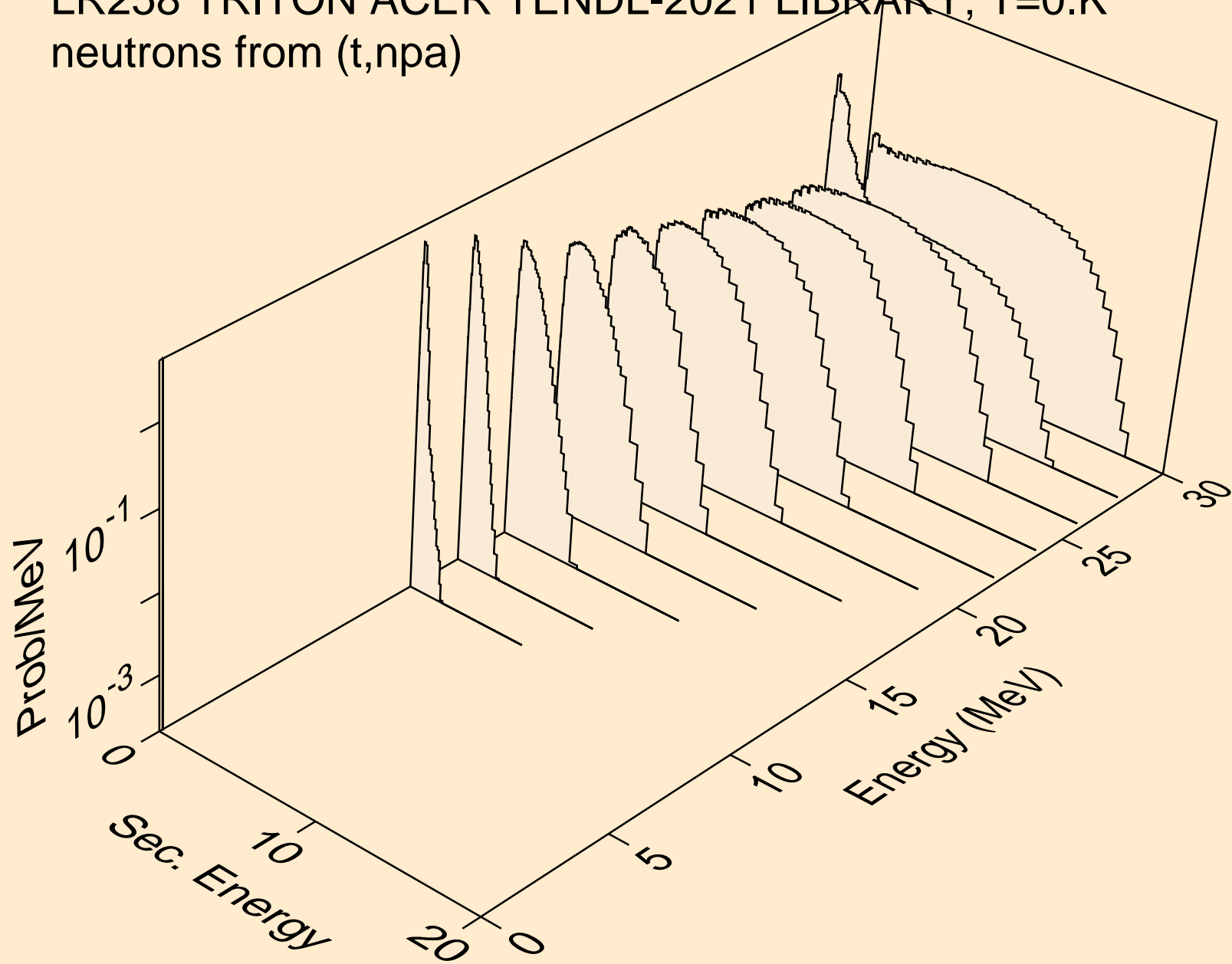

LR258 TRITON ACER TENDL-2021 LIBRARY; T=0.K  
protons from (t,x)

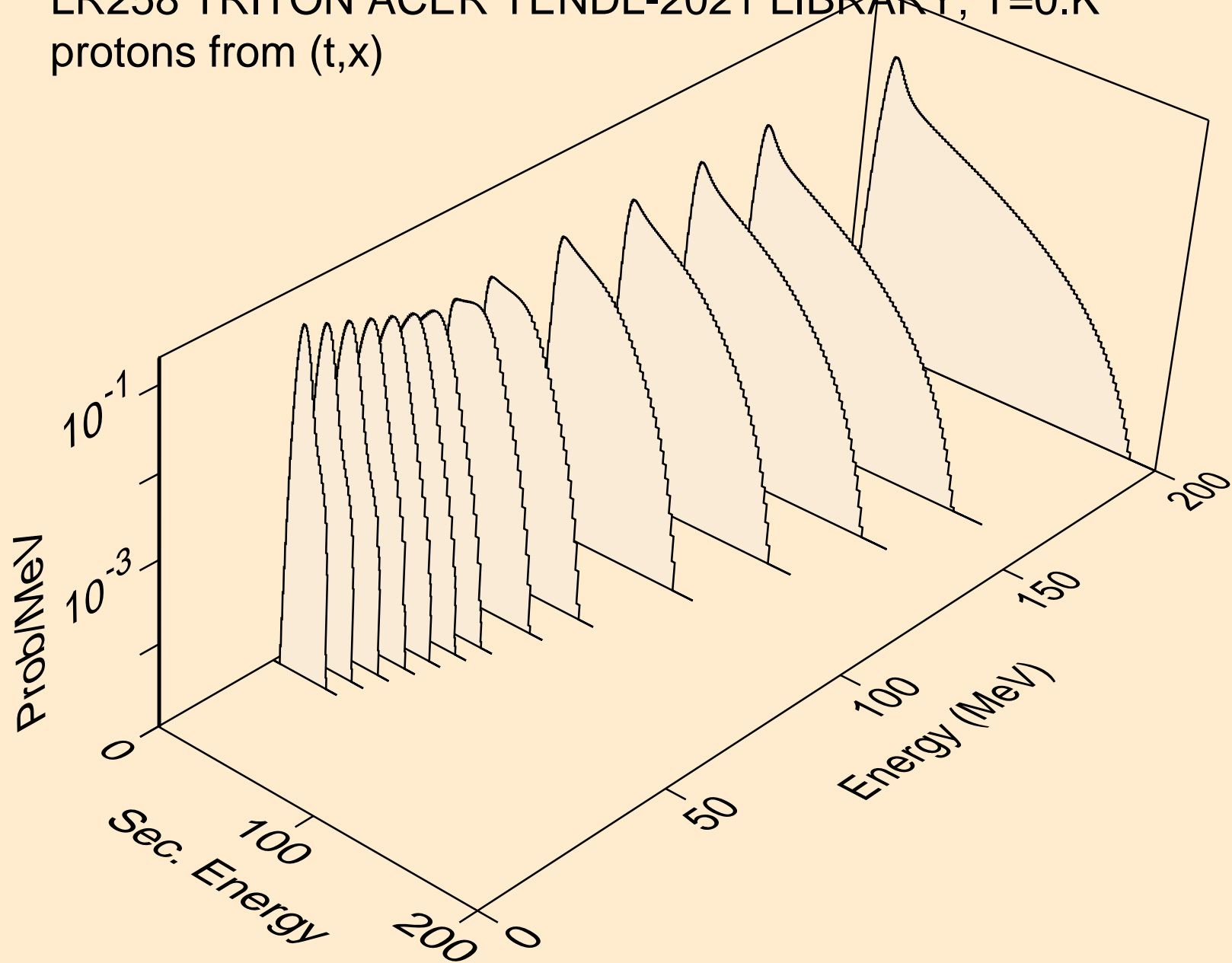

LR258 TRITON ACER TENDL-2021 LIBRARY; T=0.K  
protons from (t,n\*)p

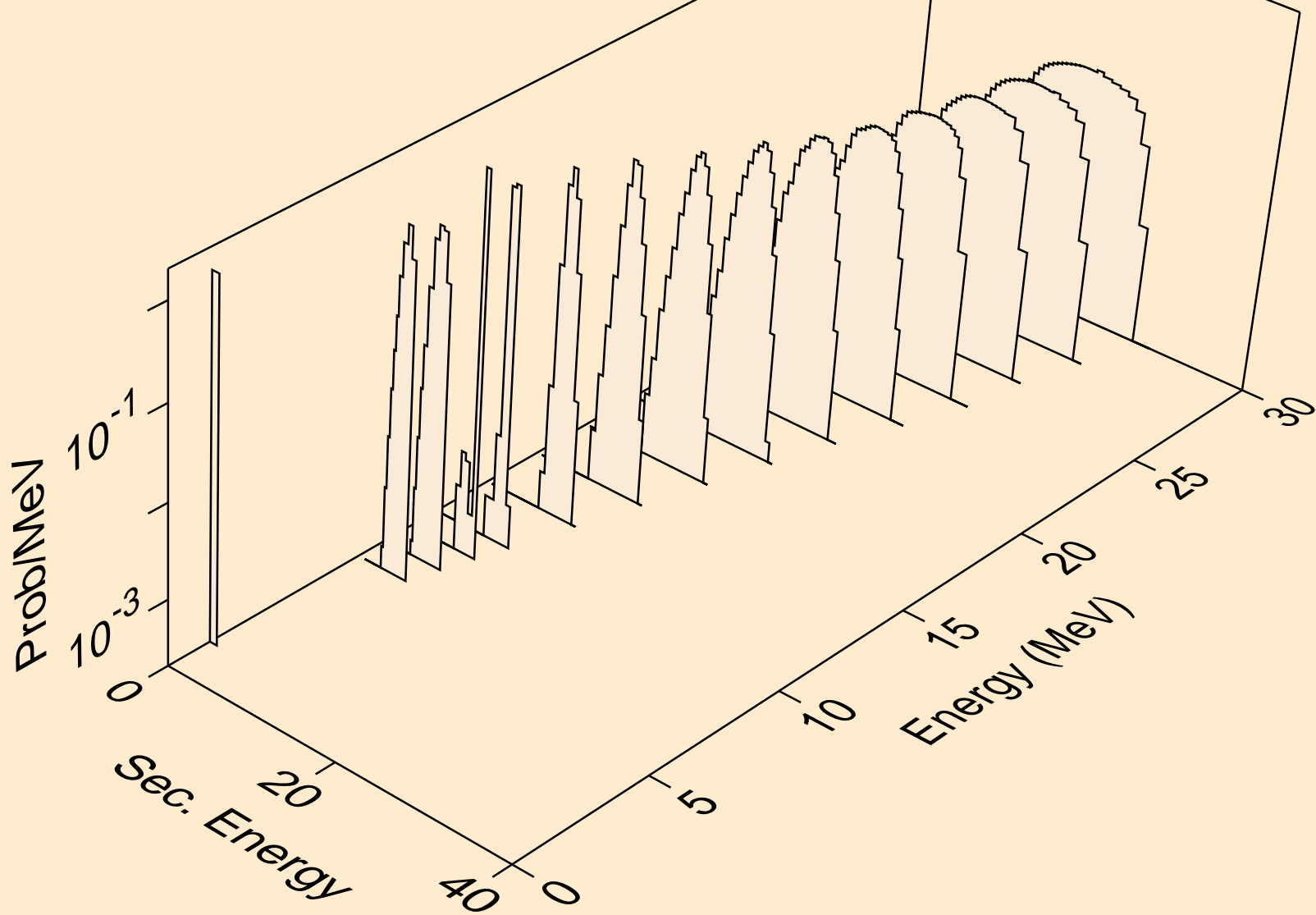

LR258 TRITON ACER TENDL-2021 LIBRARY; T=0.K  
protons from (t,2np)

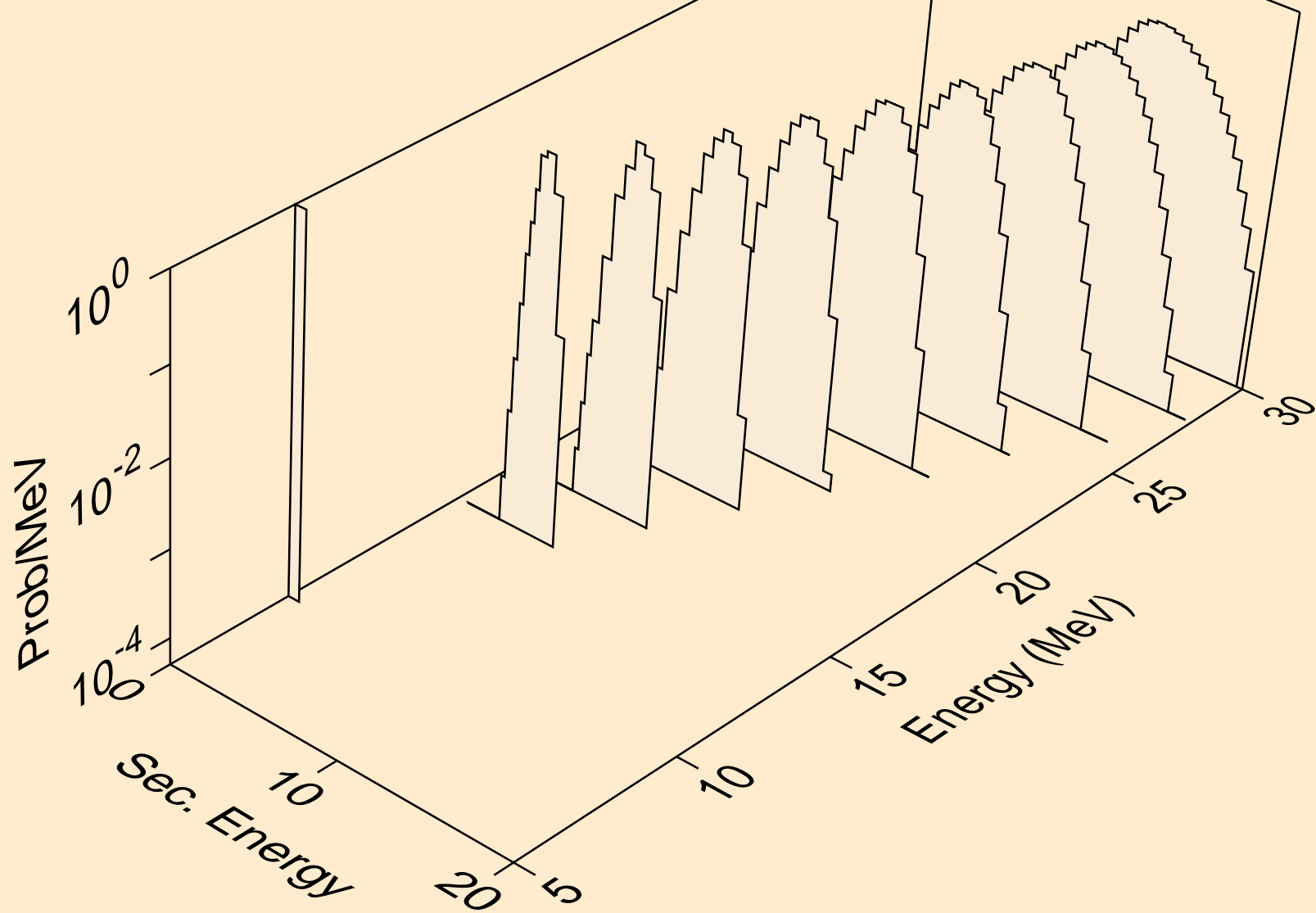



LR258 TRITON ACER TENDL-2021 LIBRARY; T=0.K  
protons from (t,3np)

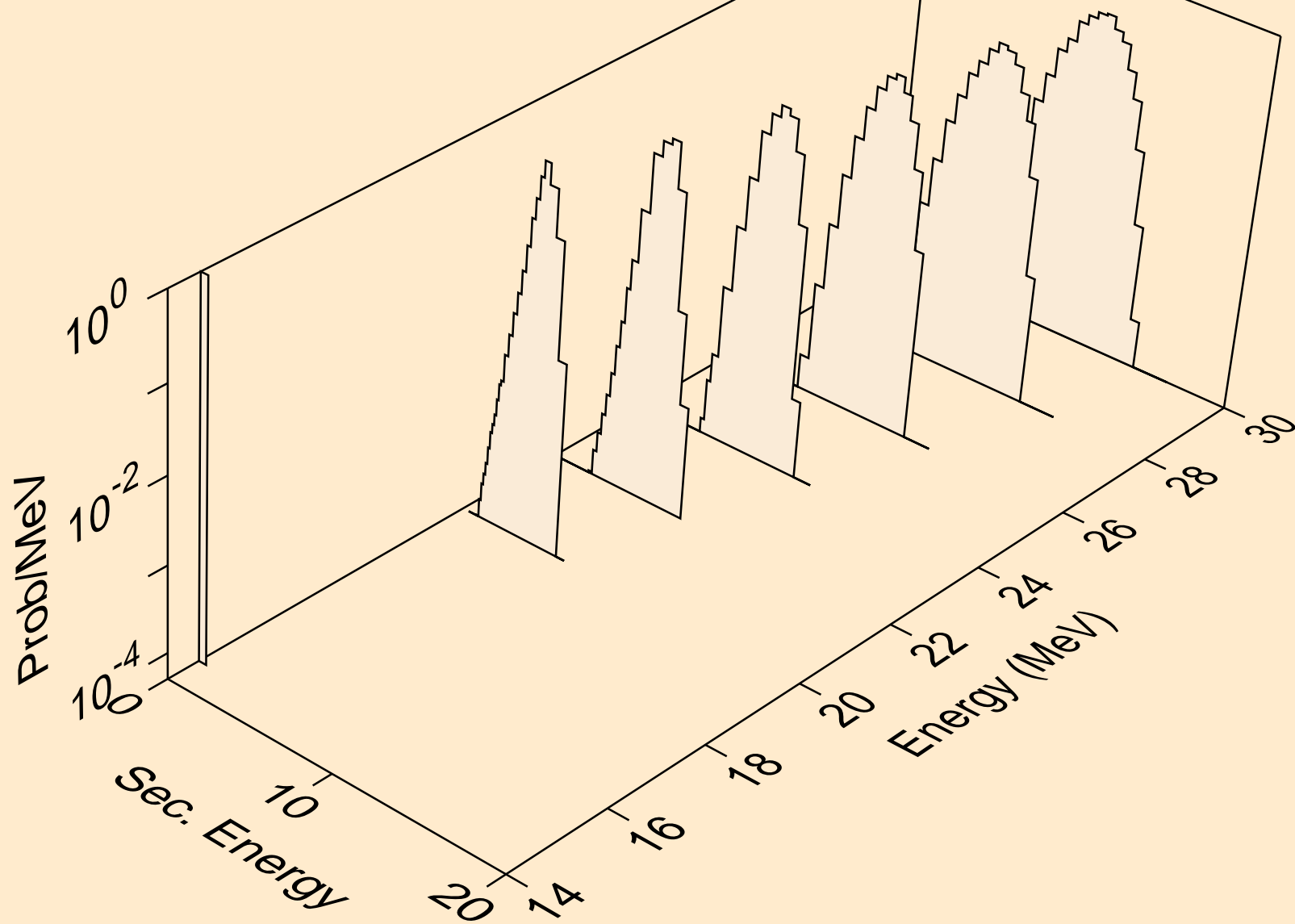

LR258 TRITON ACER TENDL-2021 LIBRARY; T=0.K  
protons from (t,2np)

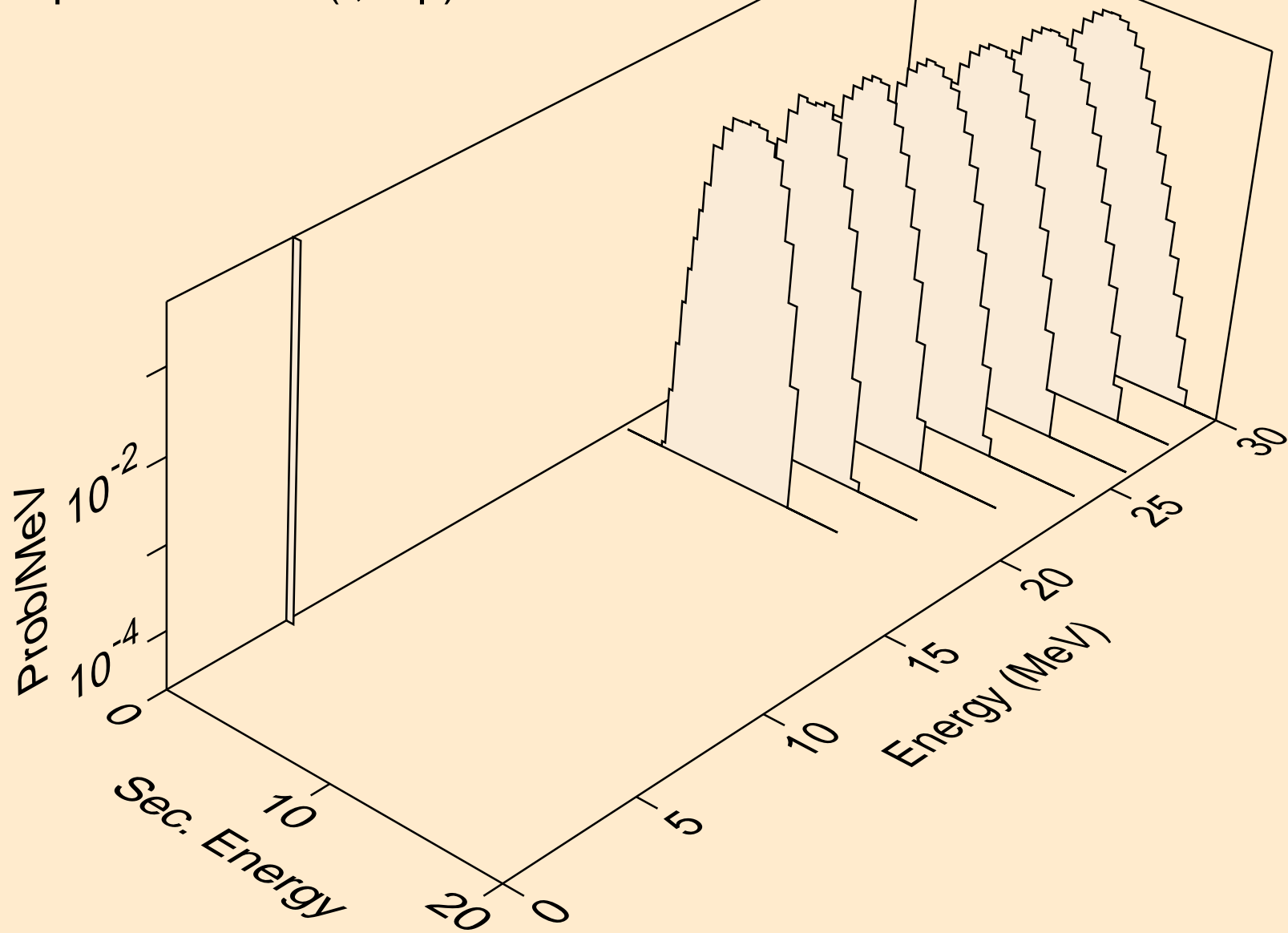

LR258 TRITON ACER TENDL-2021 LIBRARY; T=0.K  
protons from (t,npa)

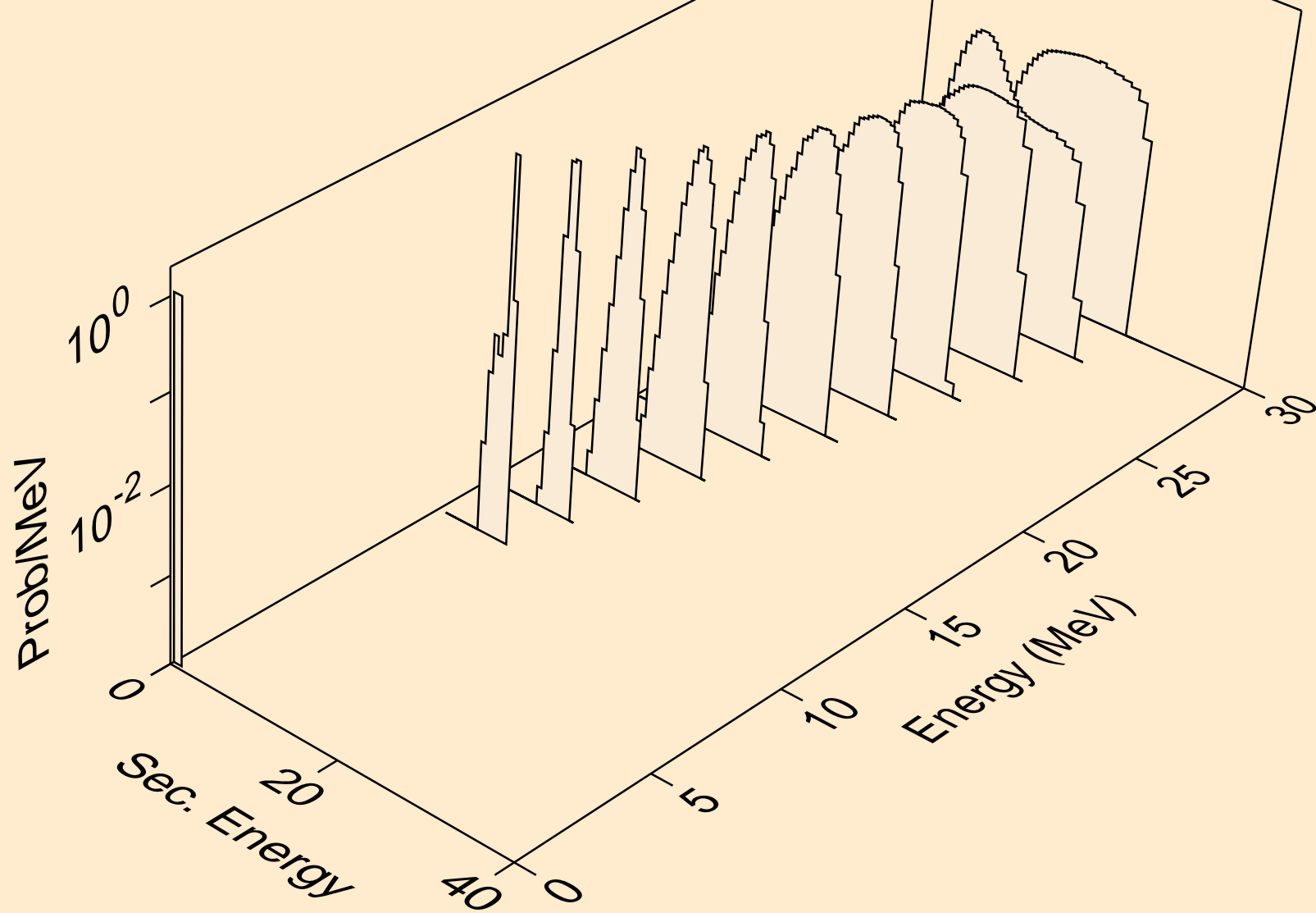

LR258 TRITON ACER TENDL-2021 LIBRARY; T=0.K  
protons from (t,p)

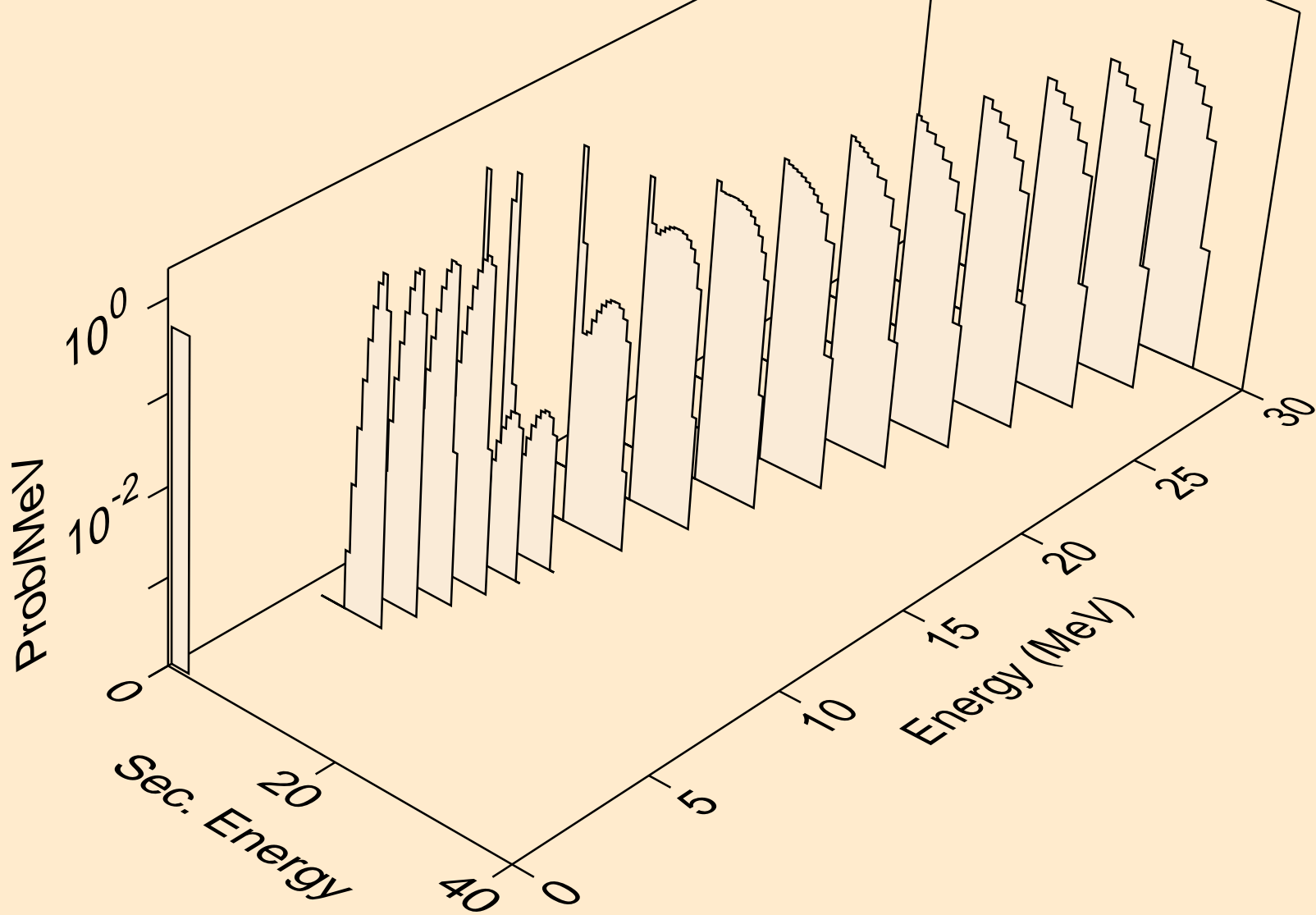

LR258 TRITON ACER TENDL-2021 LIBRARY; T=0.K  
protons from (t,2p)

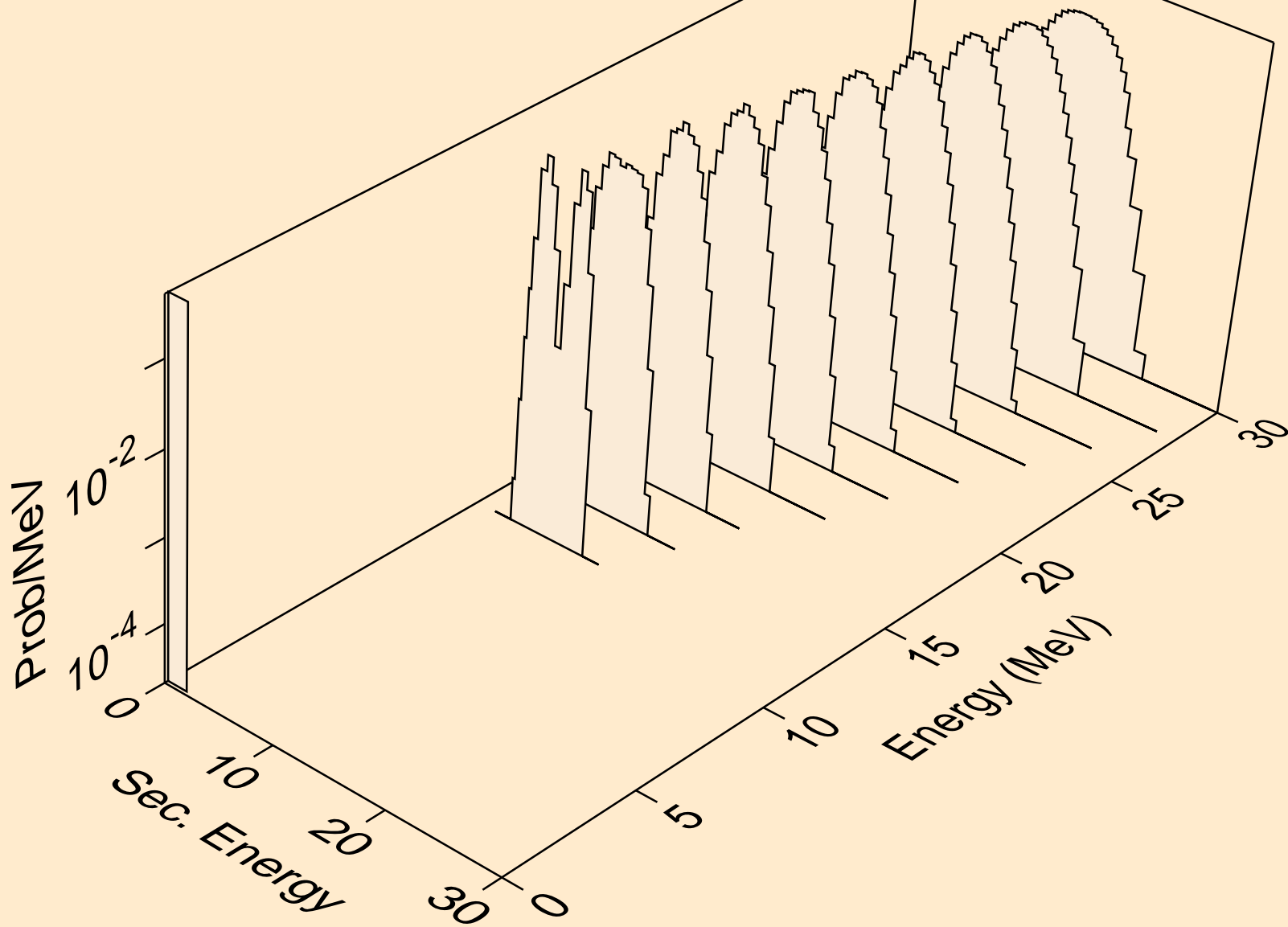

LR258 TRITON ACER TENDL-2021 LIBRARY; T=0.K  
protons from (t,pa)

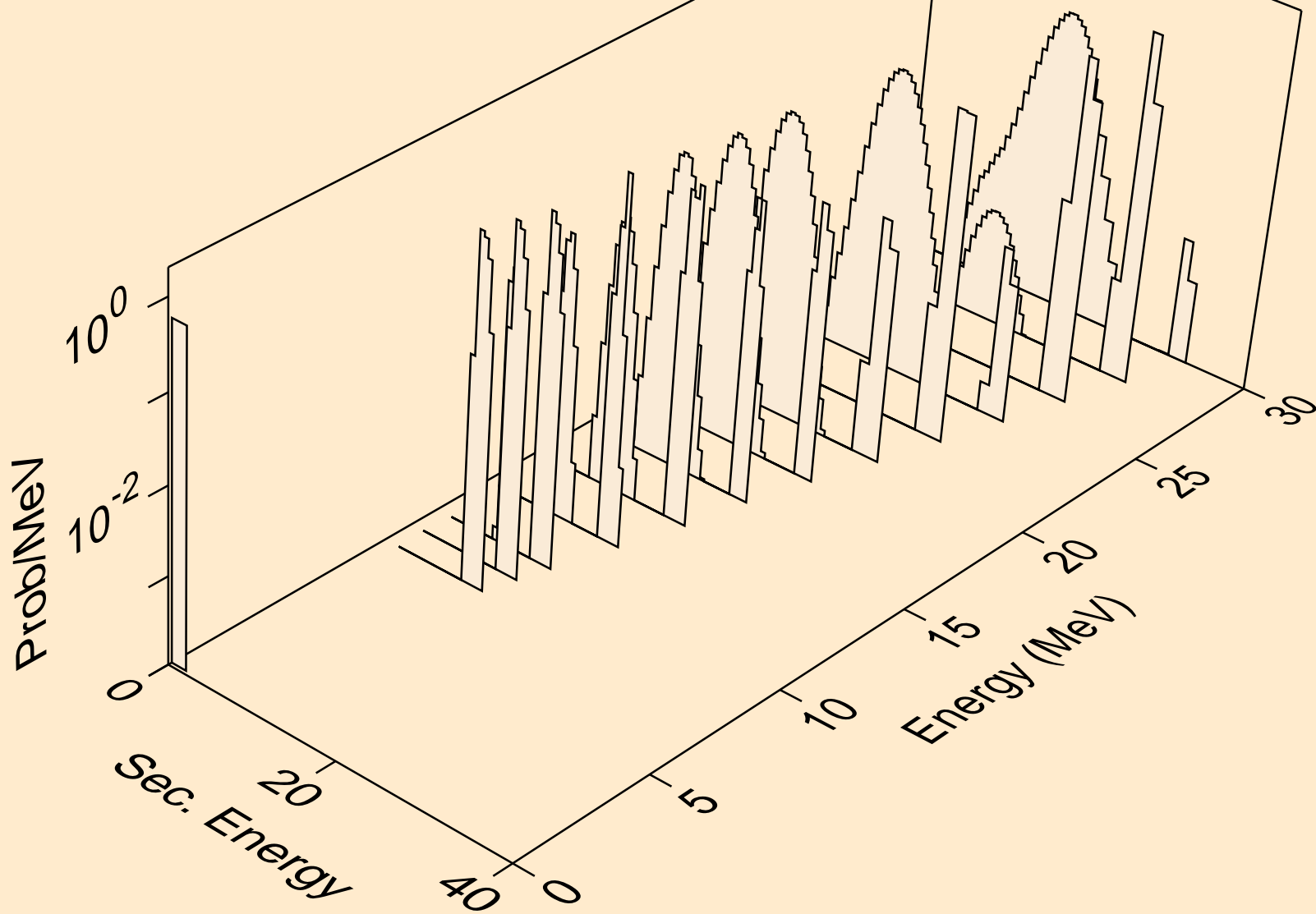

LR258 TRITON ACER TENDL-2021 LIBRARY; T=0.K  
protons from (t,pd)

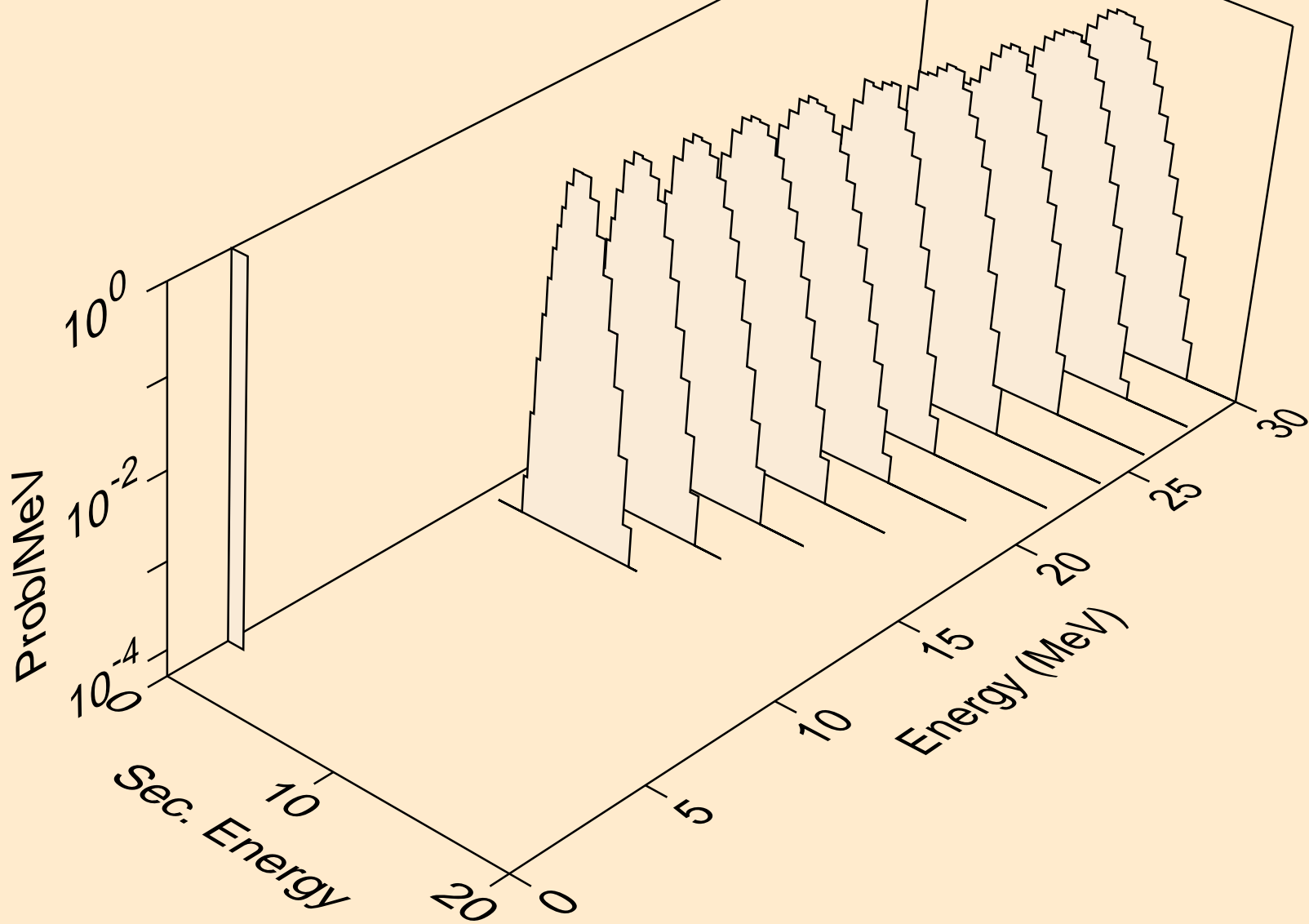

LR258 TRITON ACER TENDL-2021 LIBRARY; T=0.K  
deuterons from (t,x)

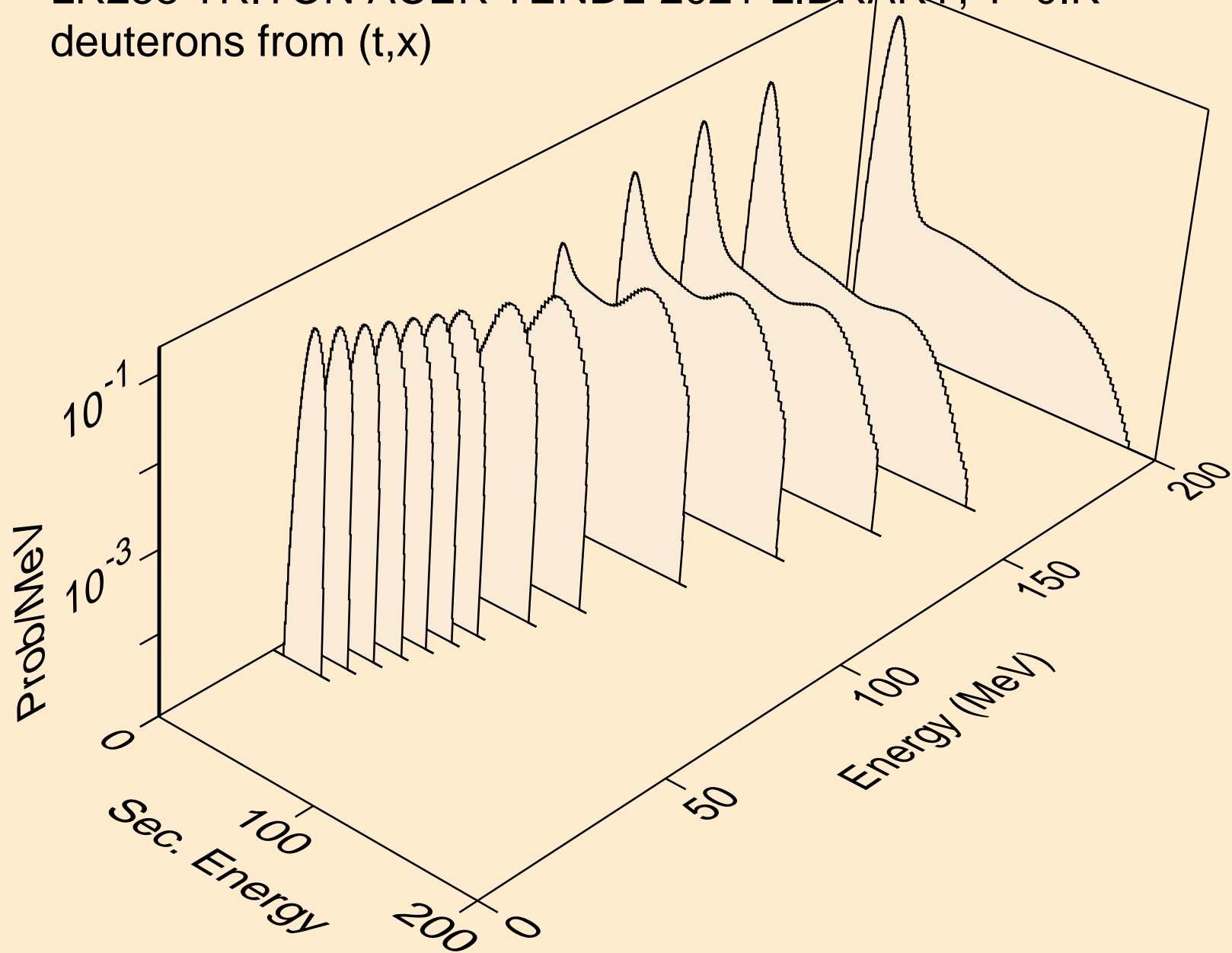



LR258 TRITON ACER TENDL-2021 LIBRARY; T=0.K  
deuterons from (t,n\*)d

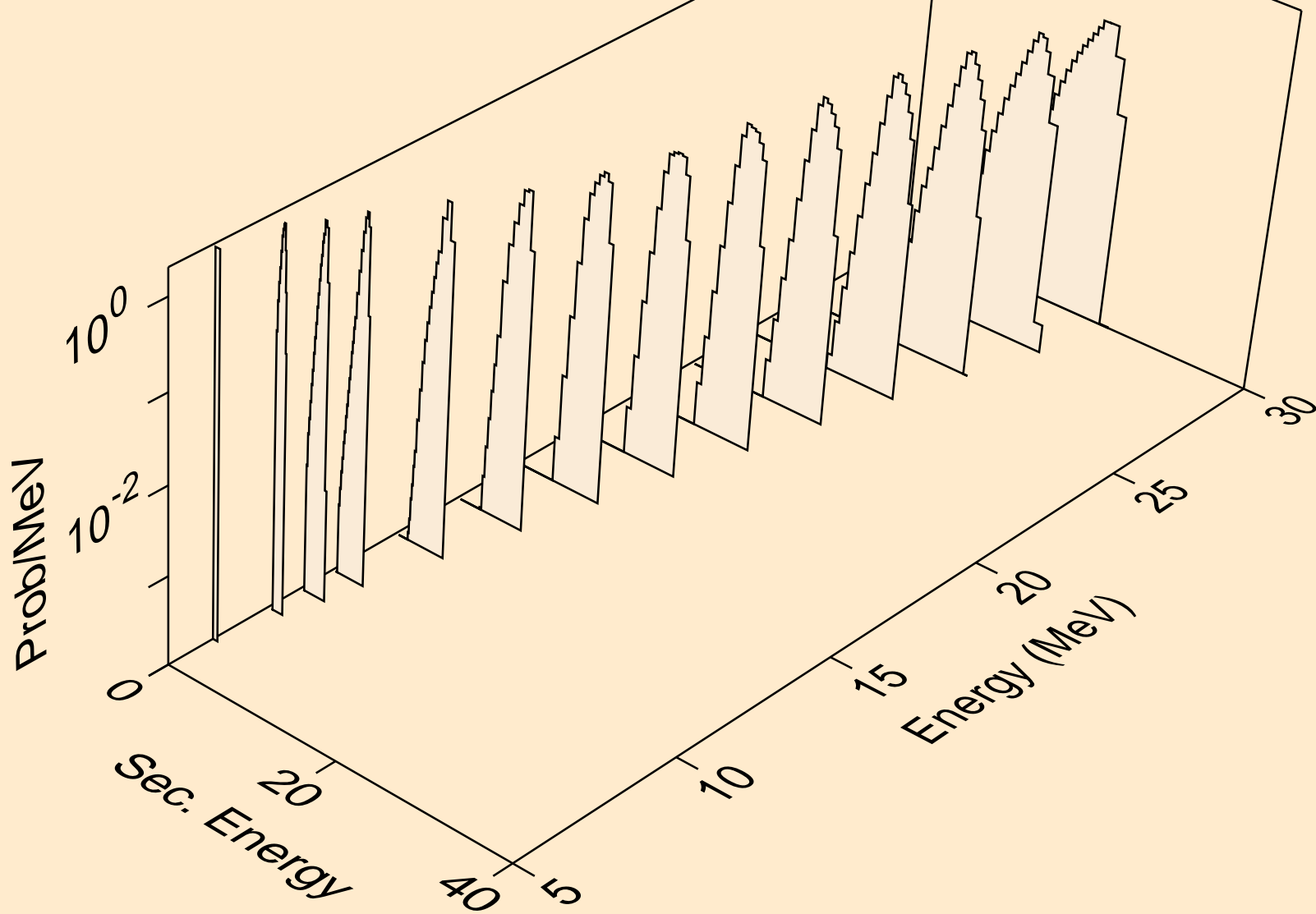

LR258 TRITON ACER TENDL-2021 LIBRARY; T=0.K  
deuterons from (t,d)

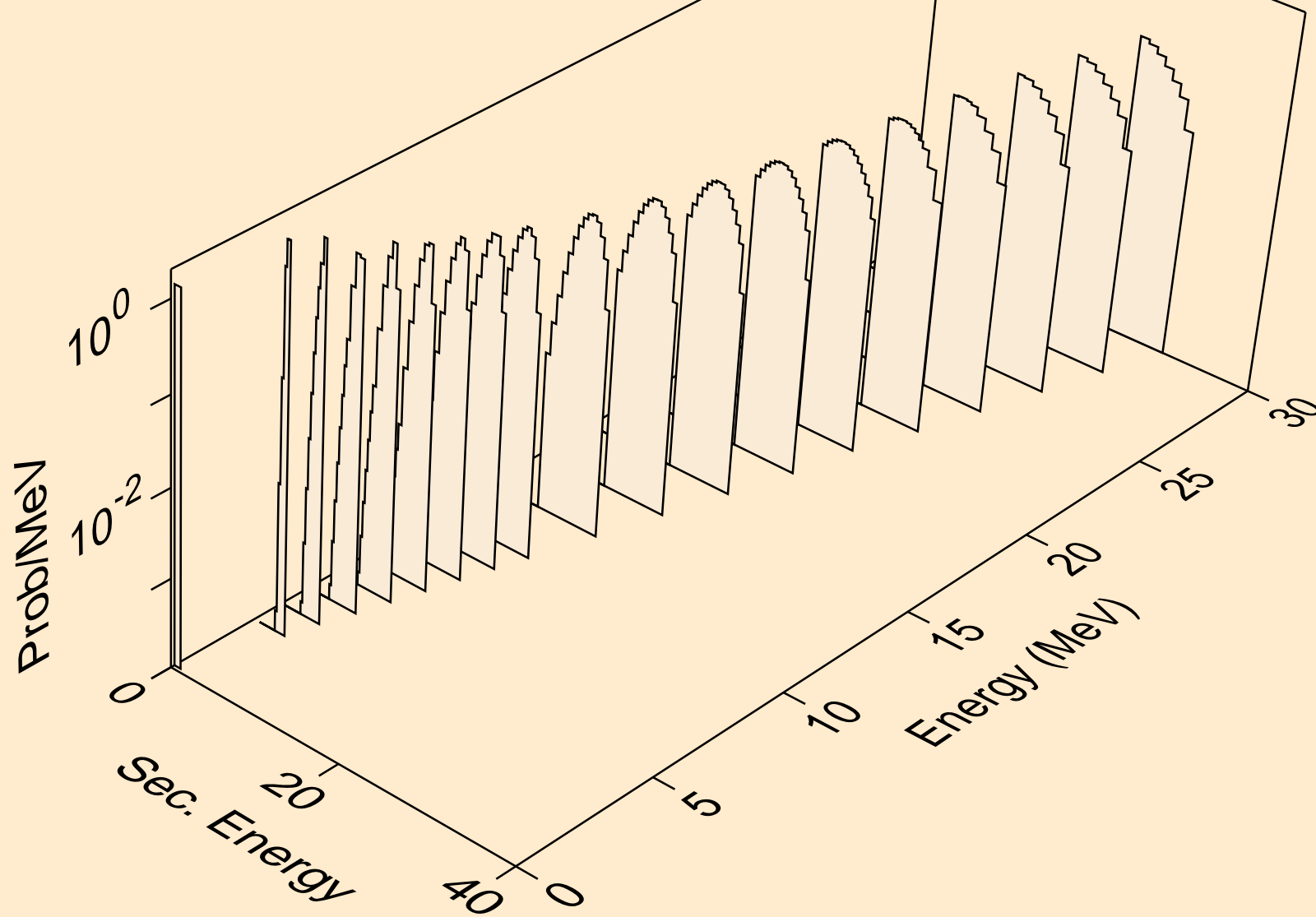

LR258 TRITON ACER TENDL-2021 LIBRARY; T=0.K  
deuterons from (t,pd)

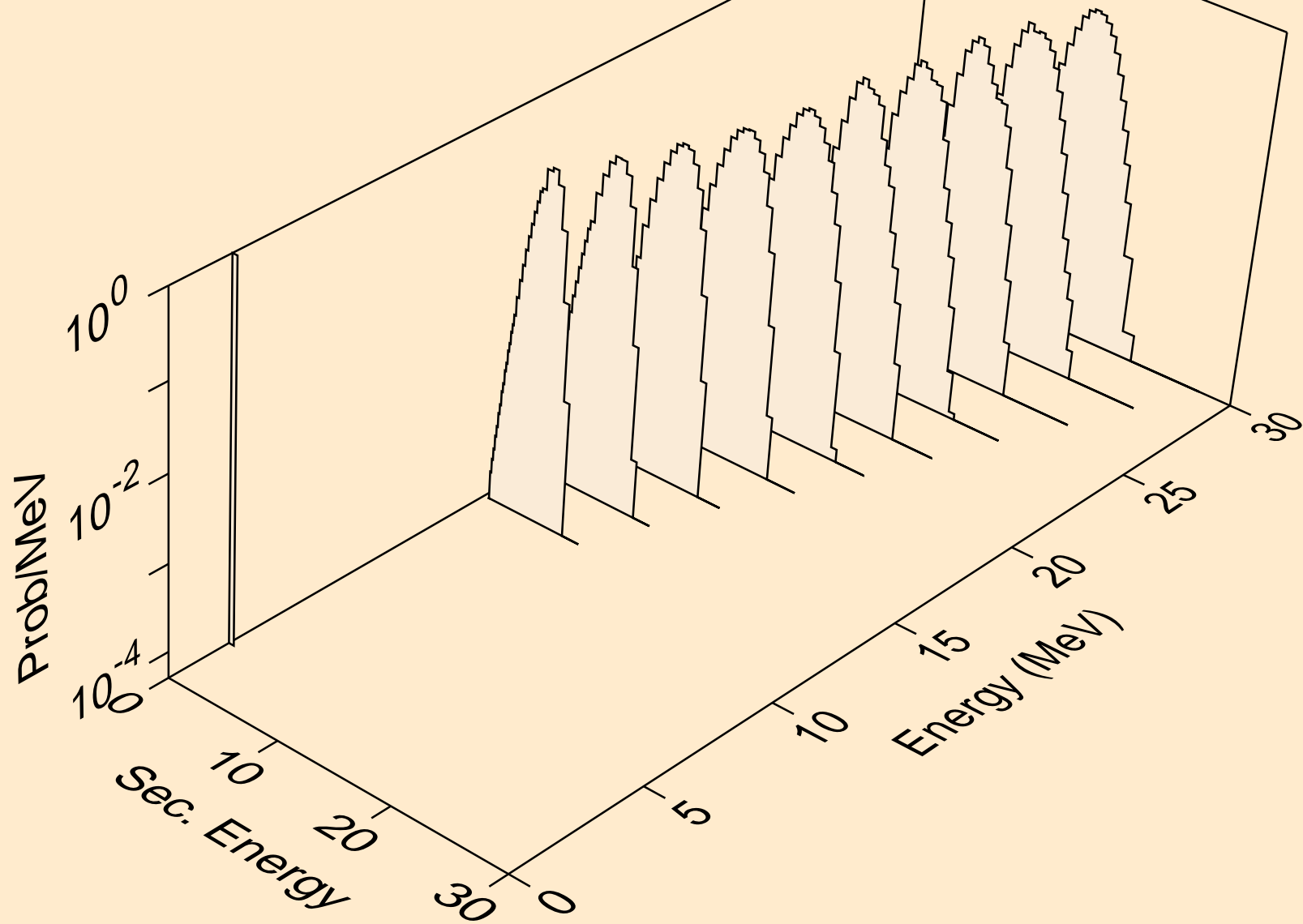

LR258 TRITON ACER TENDL-2021 LIBRARY; T=0.K  
deuterons from (t,da)

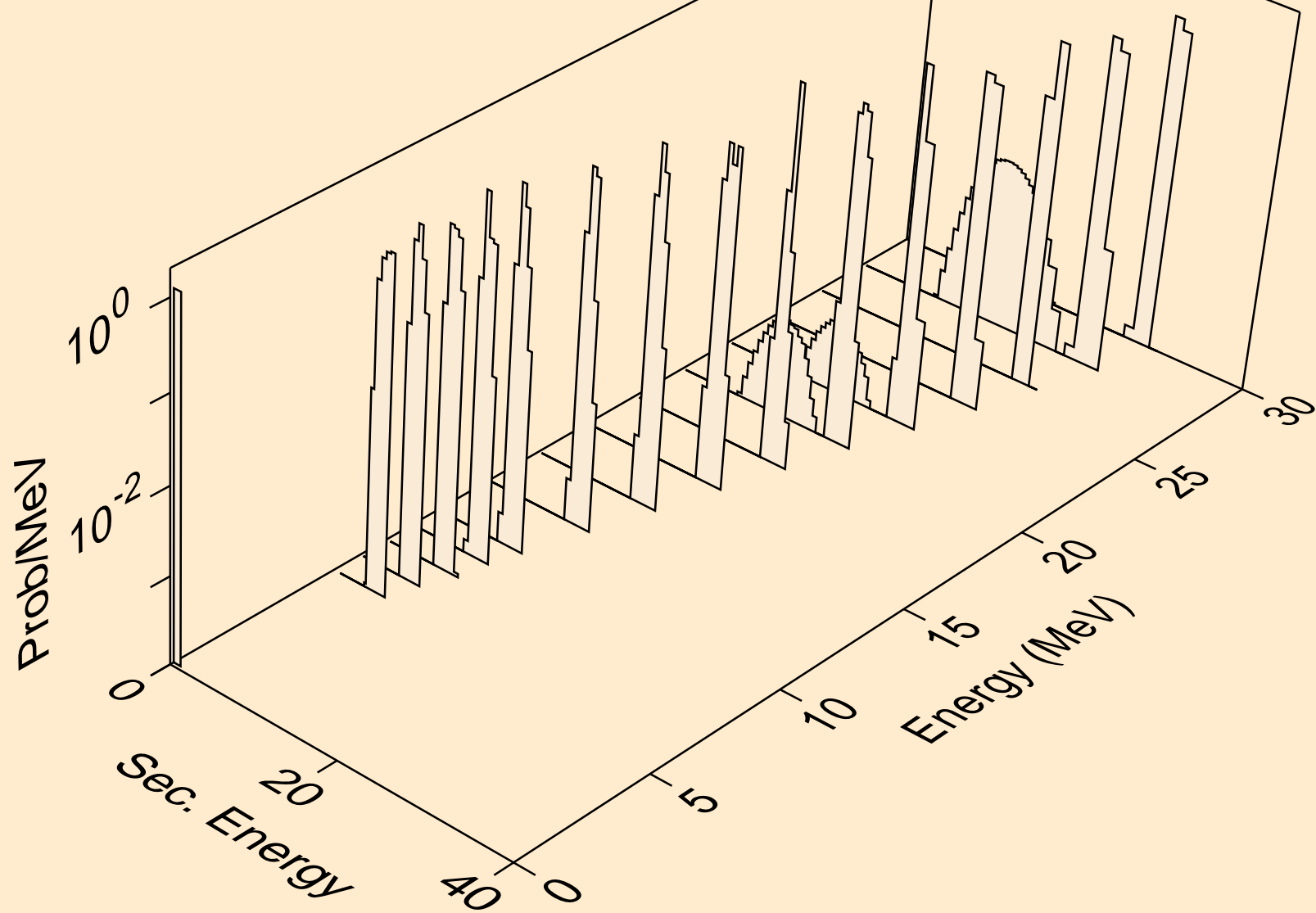

LR258 TRITON ACER TENDL-2021 LIBRARY; T=0.K  
he3s from (t,x)

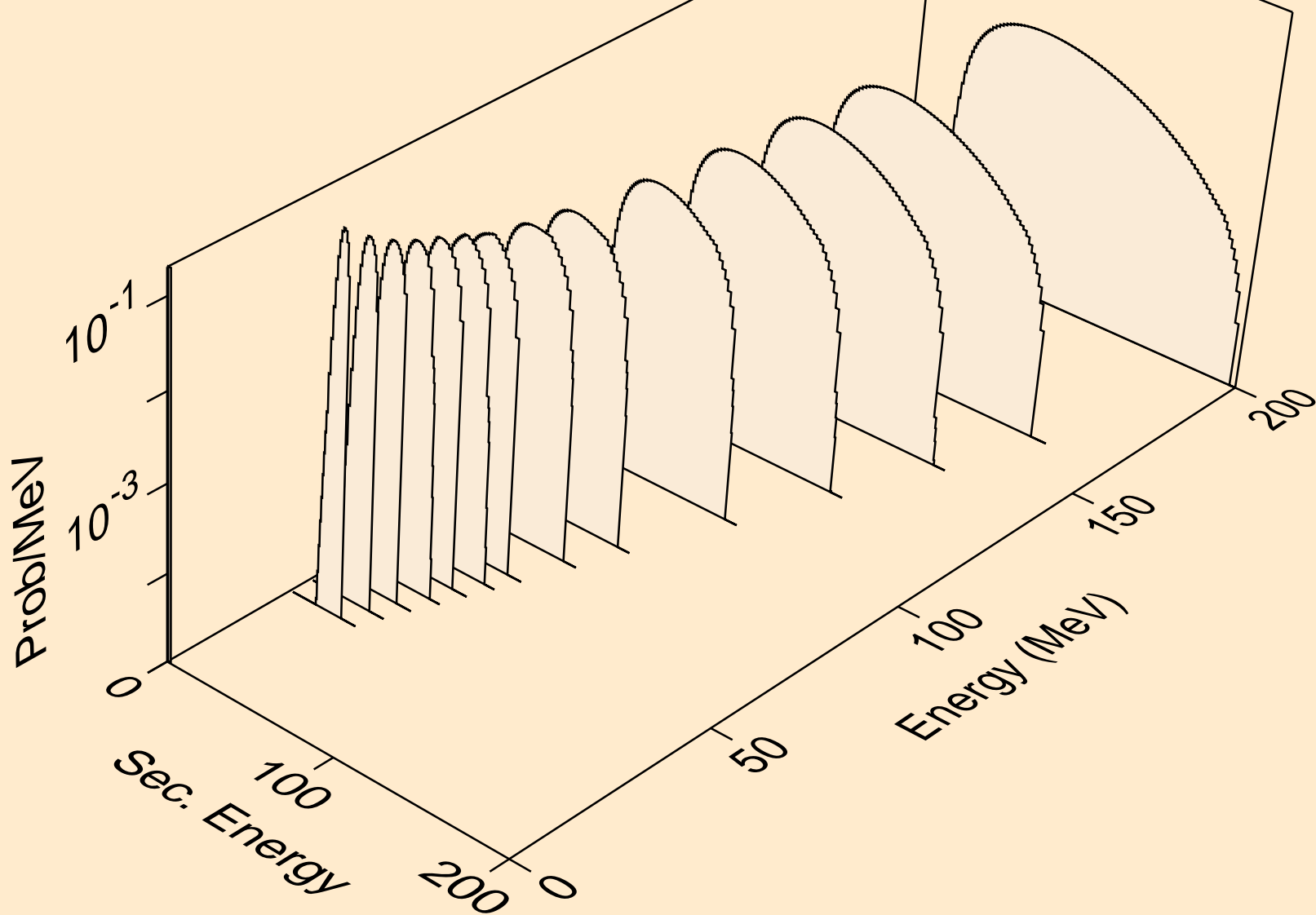

LR258 TRITON ACER TENDL-2021 LIBRARY; T=0.K  
he3s from (t,n\*)he3

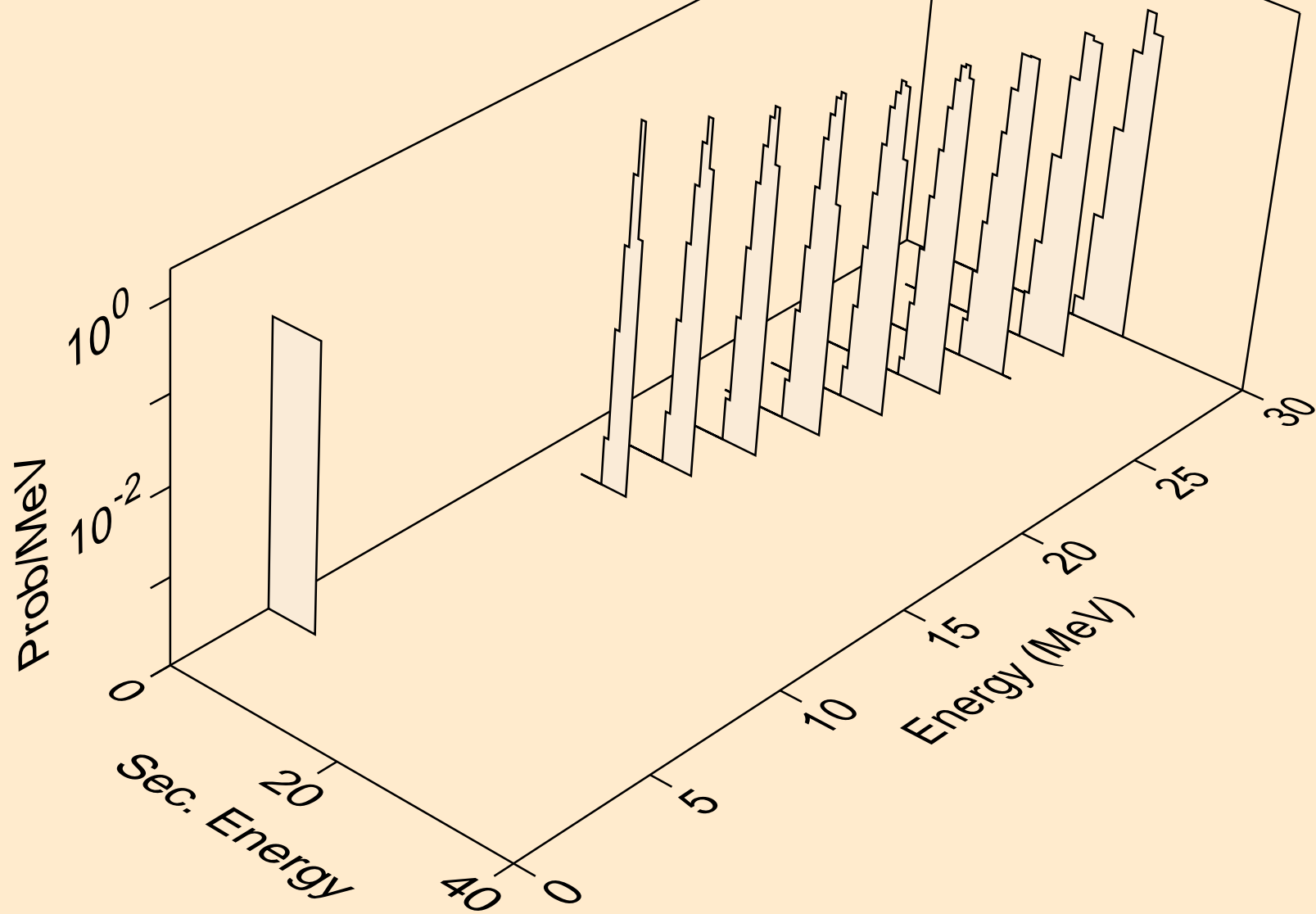

LR258 TRITON ACER TENDL-2021 LIBRARY; T=0.K  
he3s from (t,he3)

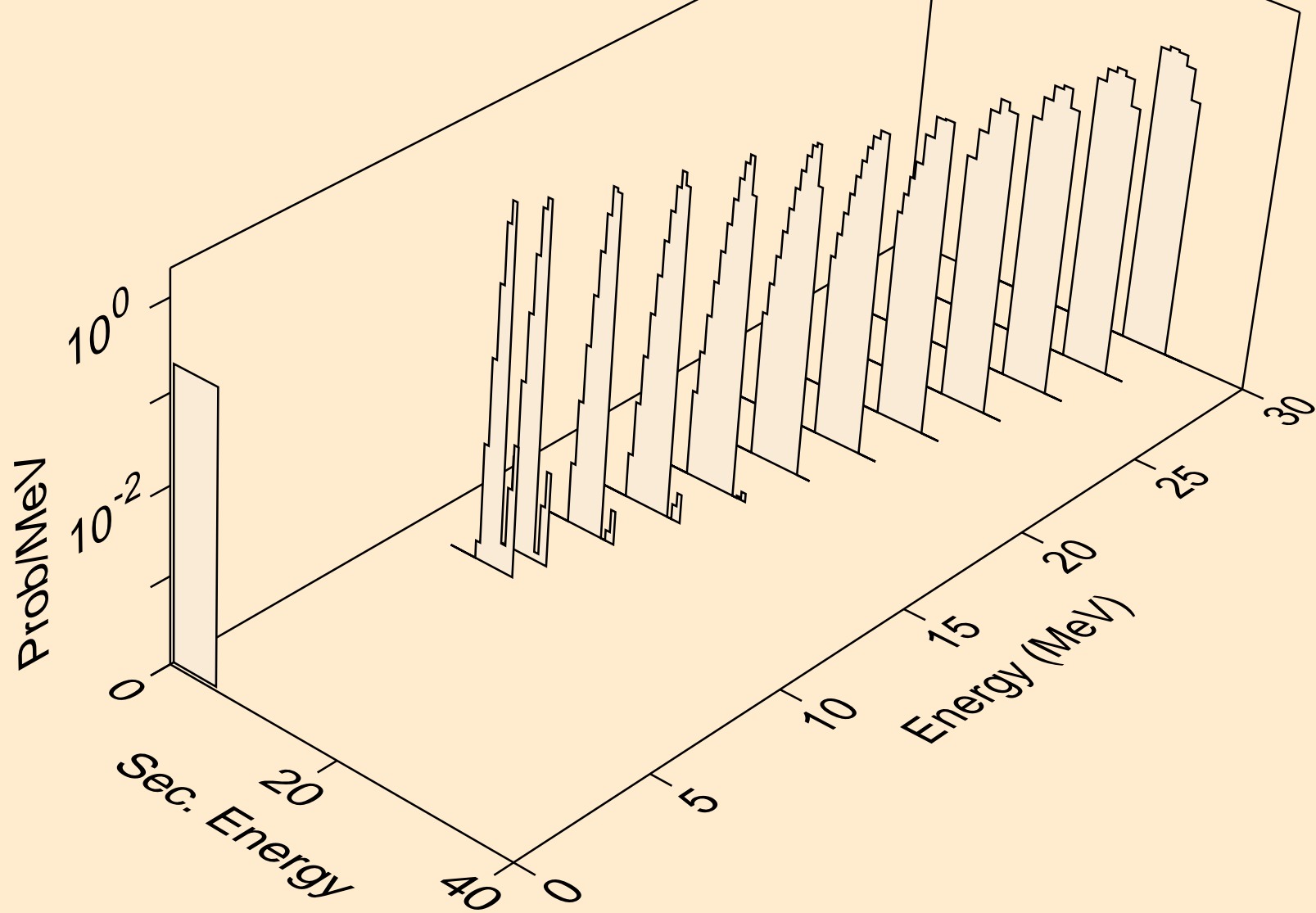

LR258 TRITON ACER TENDL-2021 LIBRARY; T=0.K  
alphas from (t,x)

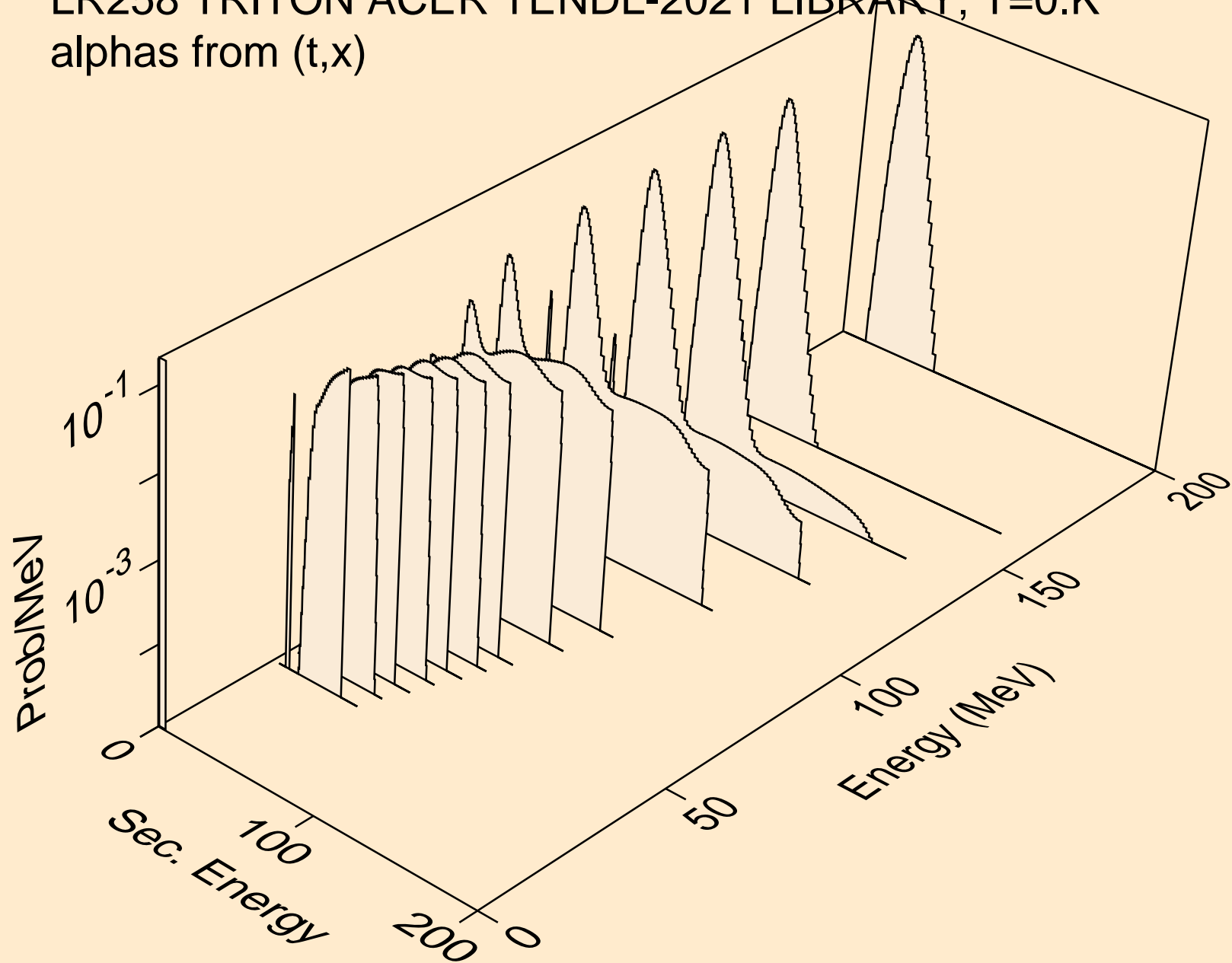



LR258 TRITON ACER TENDL-2021 LIBRARY; T=0.K  
alphas from (t,n\*)a

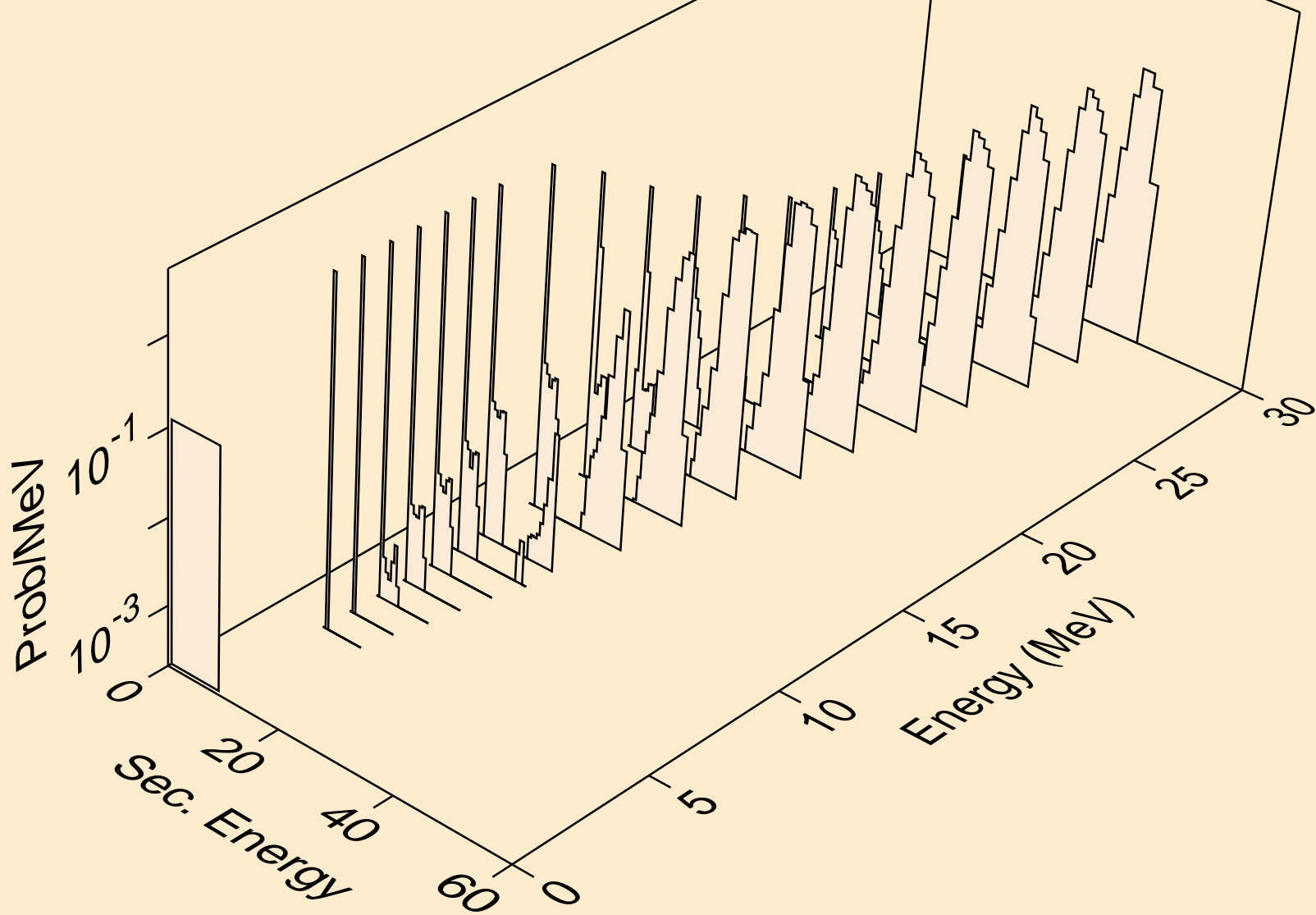

LR258 TRITON ACER TENDL-2021 LIBRARY; T=0.K  
alphas from (t,2n)a

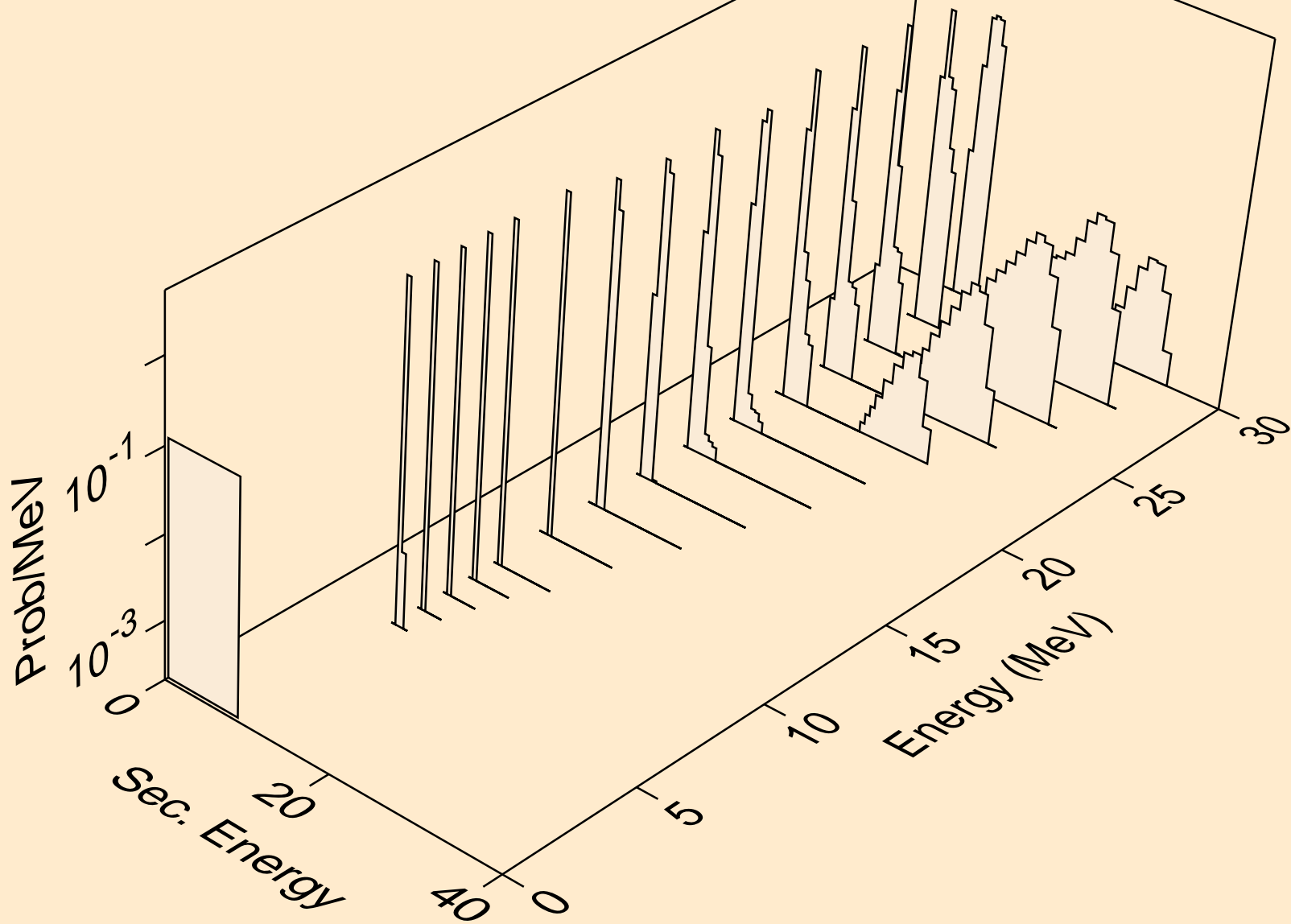

LR258 TRITON ACER TENDL-2021 LIBRARY; T=0.K  
alphas from (t,3n)a

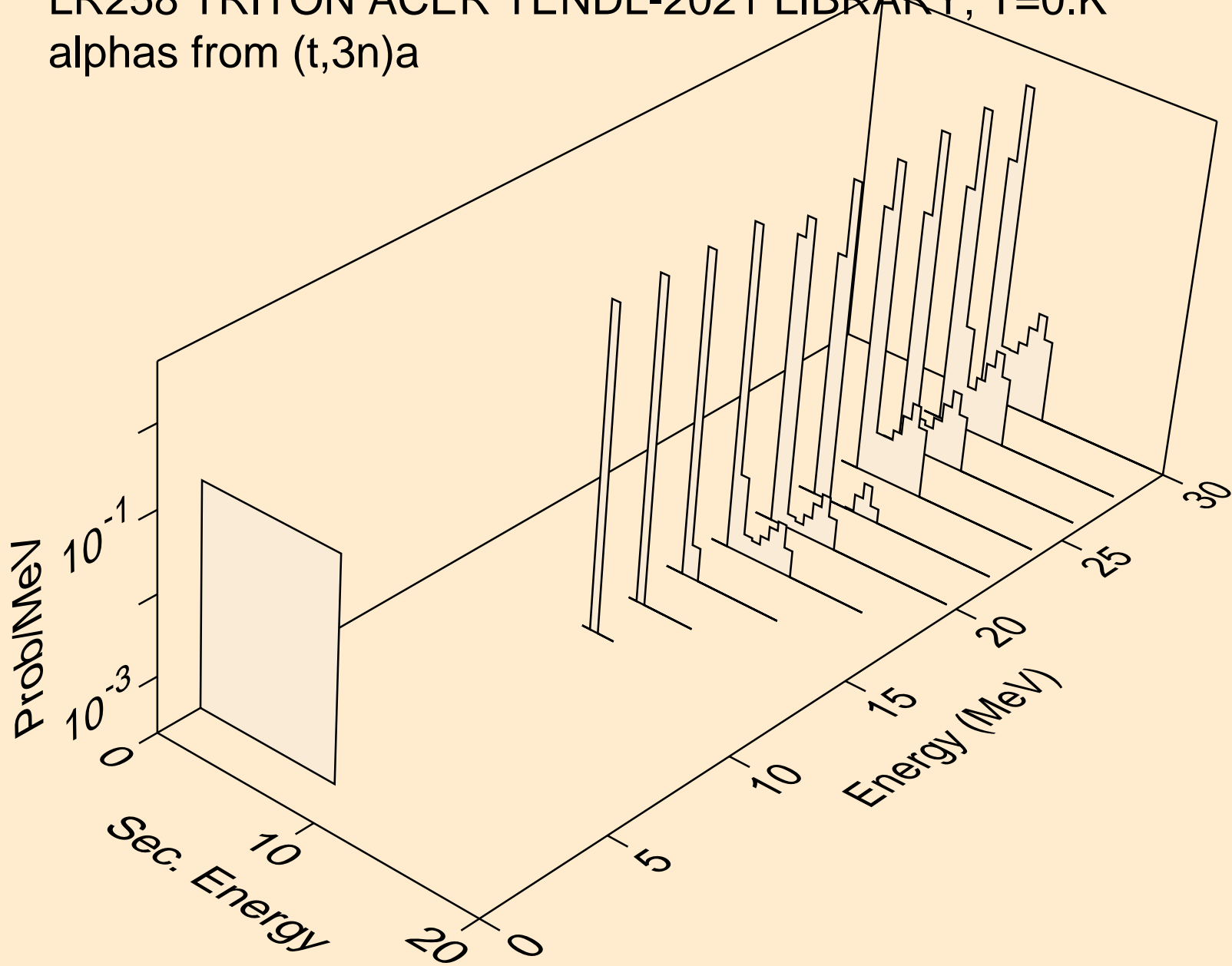

LR258 TRITON ACER TENDL-2021 LIBRARY; T=0.K  
alphas from (t,npa)

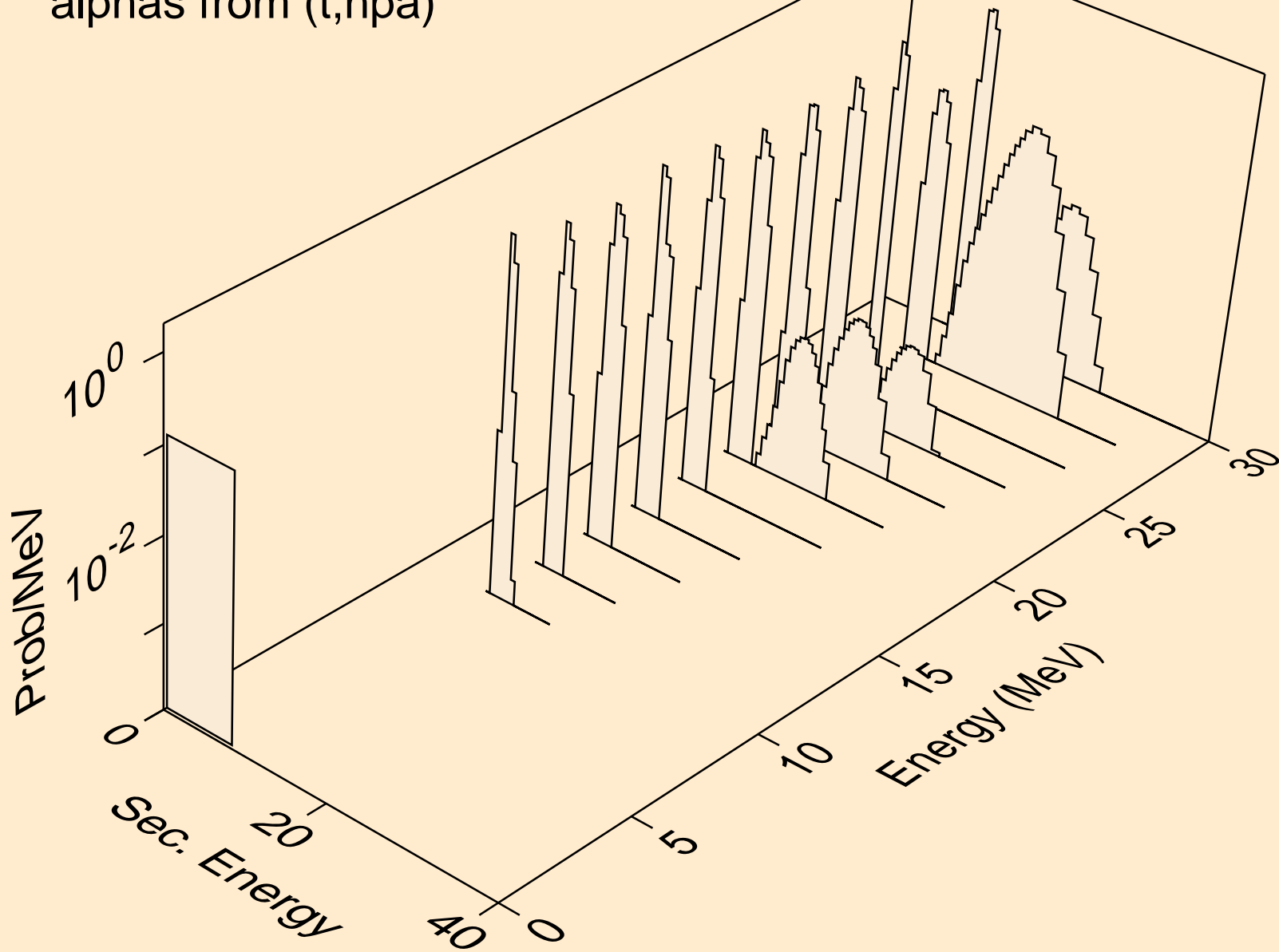

LR258 TRITON ACER TENDL-2021 LIBRARY; T=0.K  
alphas from (t,a)

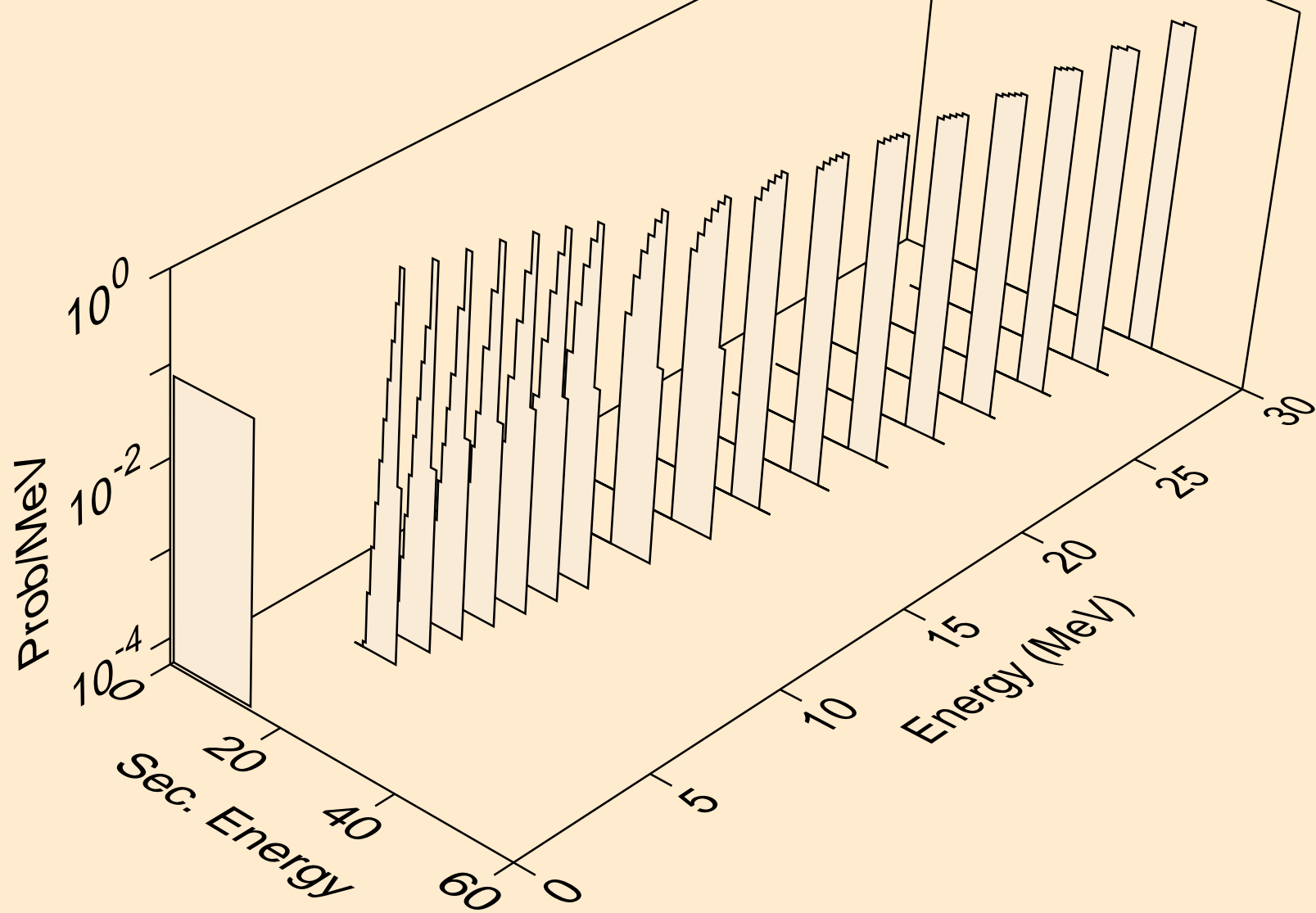

LR258 TRITON ACER TENDL-2021 LIBRARY; T=0.K  
alphas from (t,2a)

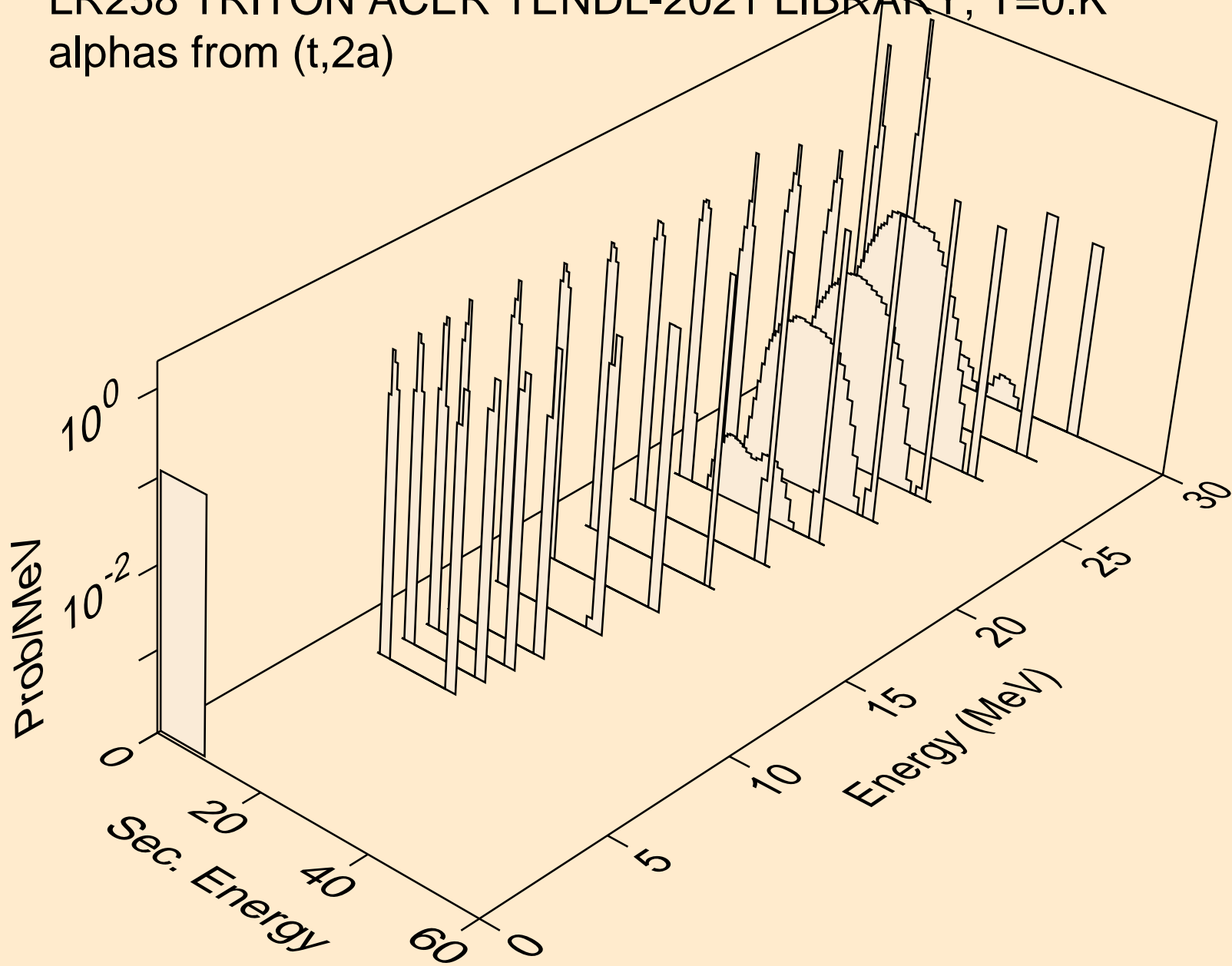

LR258 TRITON ACER TENDL-2021 LIBRARY; T=0.K  
alphas from (t,pa)

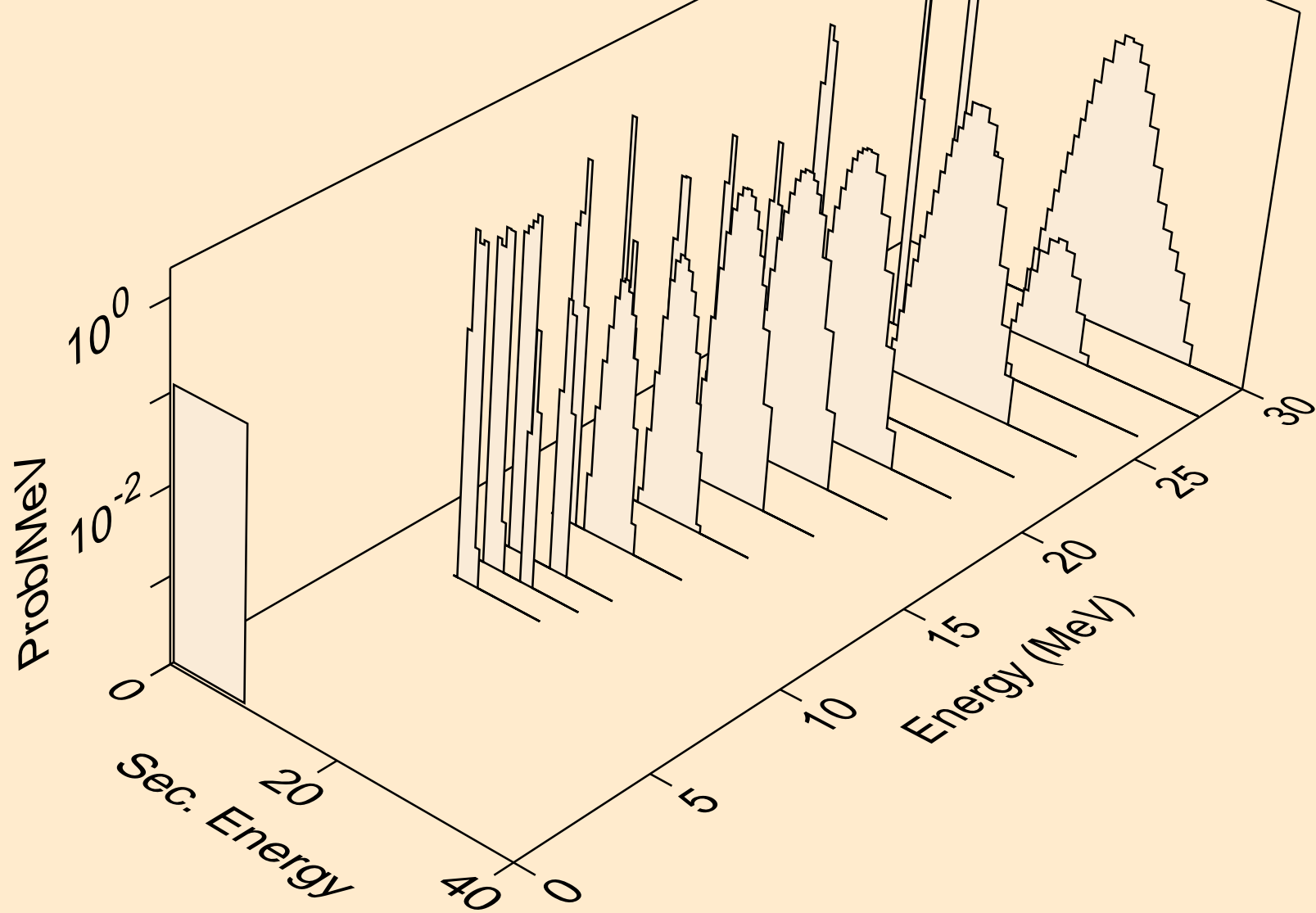

LR258 TRITON ACER TENDL-2021 LIBRARY; T=0.K  
alphas from (t,da)

