

LU169M TRITON ACER TENDL-2021 LIBRARY; T=0.K  
Principal cross sections

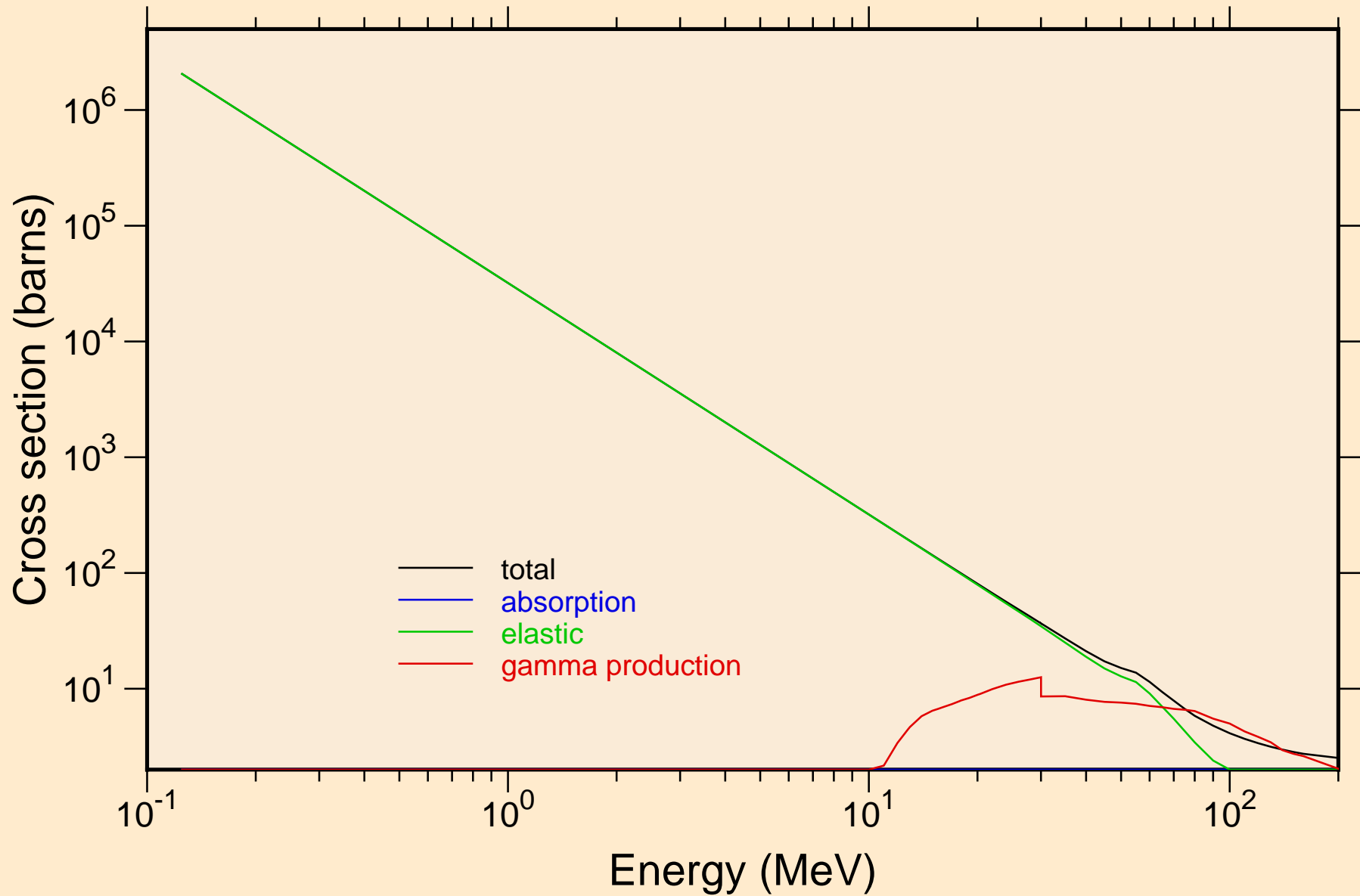

LU169M TRITON ACER TENDL-2021 LIBRARY; T=0.K

Heating

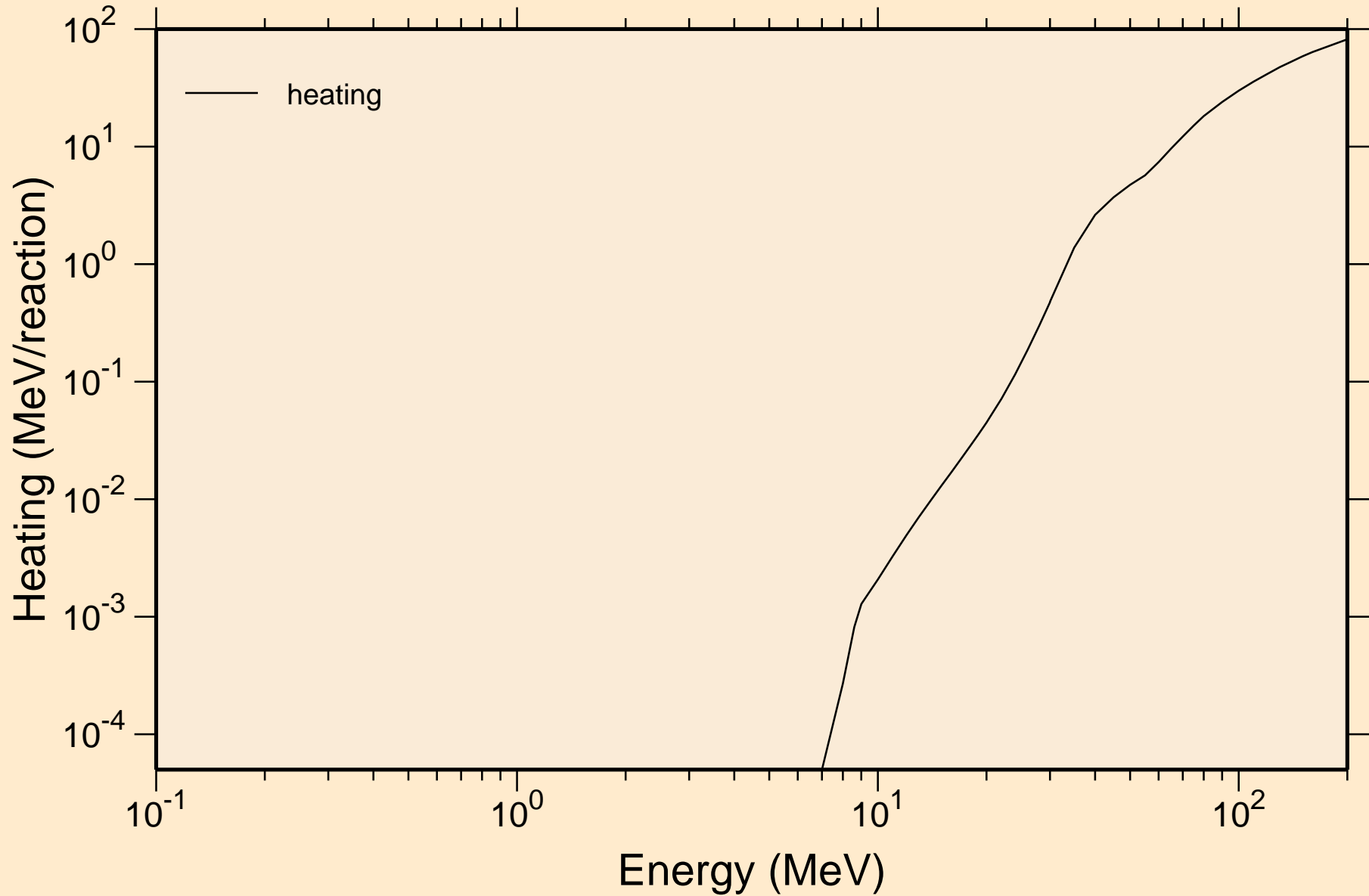

# LU169M TRITON ACER TENDL-2021 LIBRARY; T=0.K

## Principal cross sections

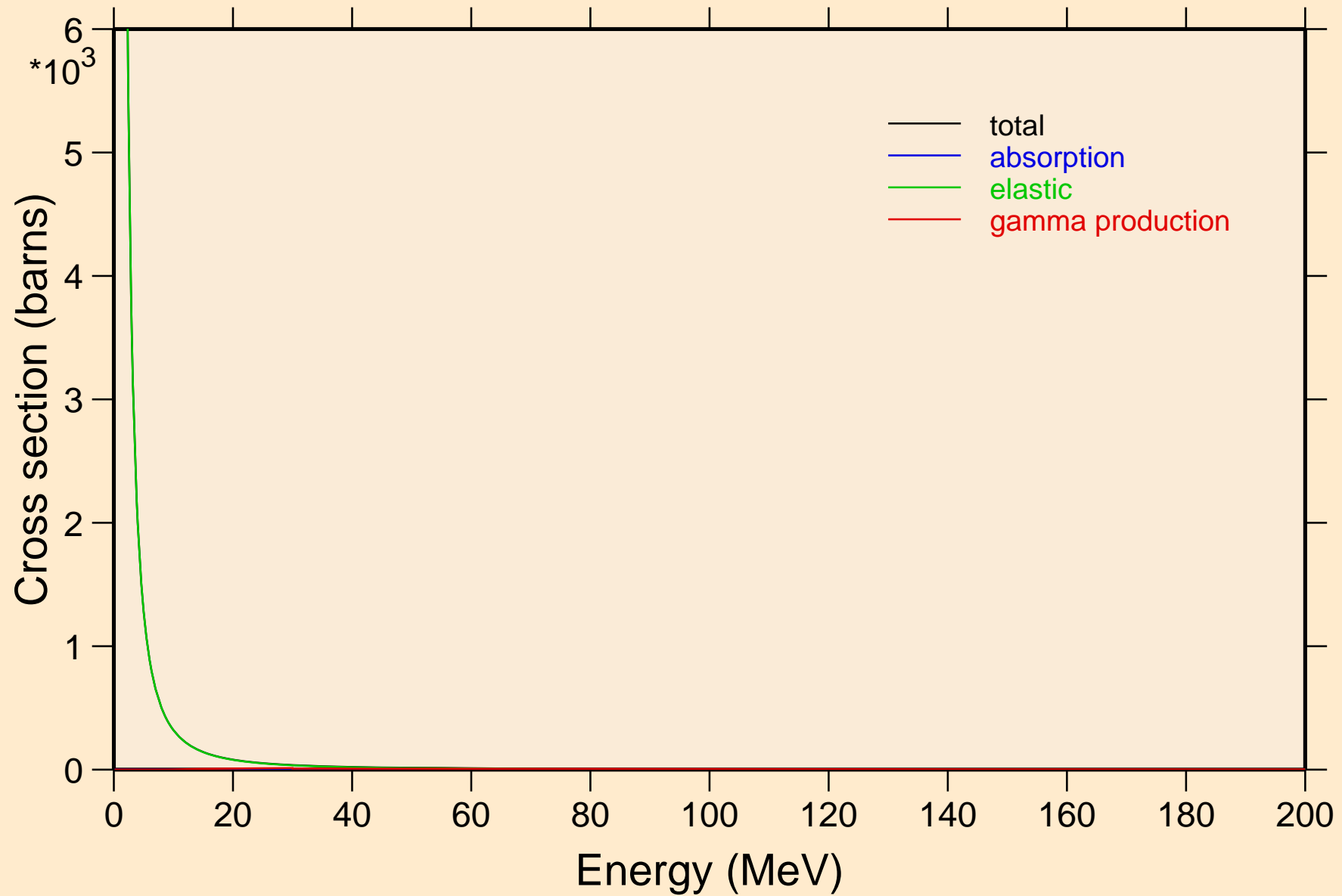

LU169M TRITON ACER TENDL-2021 LIBRARY; T=0.K  
Heating

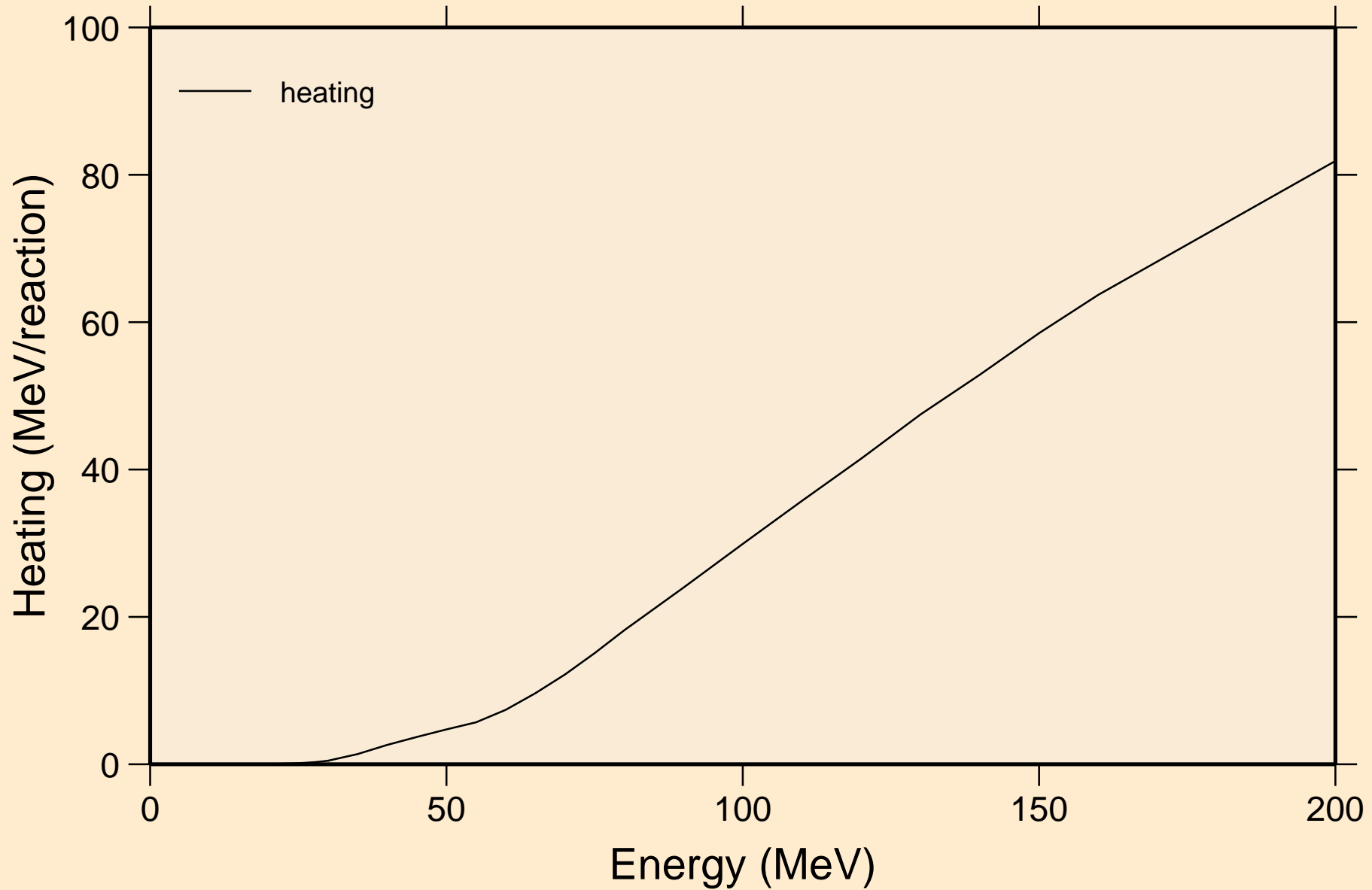

LU169M TRITON ACER TENDL-2021 LIBRARY; T=0.K  
Threshold reactions

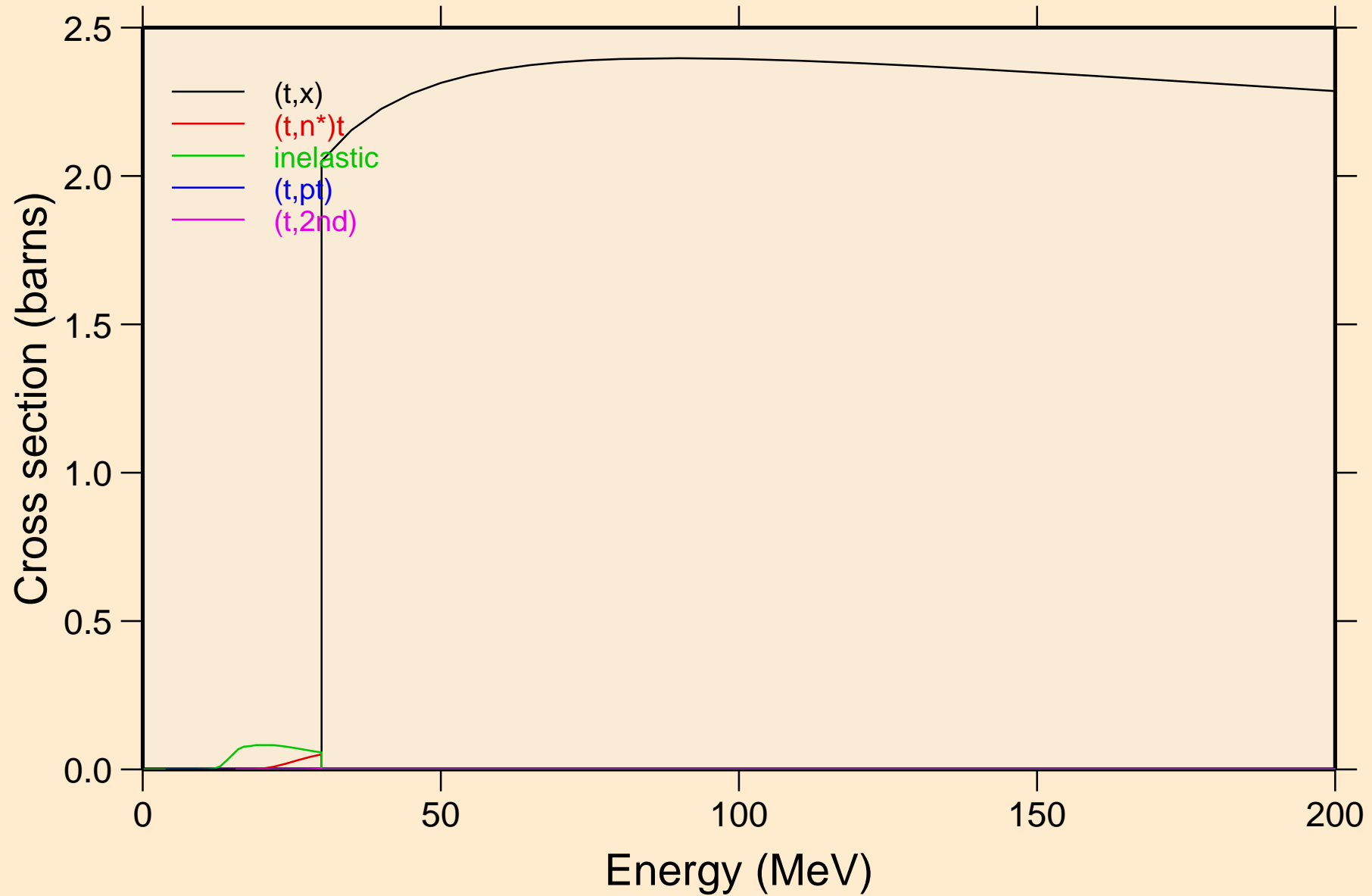

LU169M TRITON ACER TENDL-2021 LIBRARY; T=0.K  
Threshold reactions

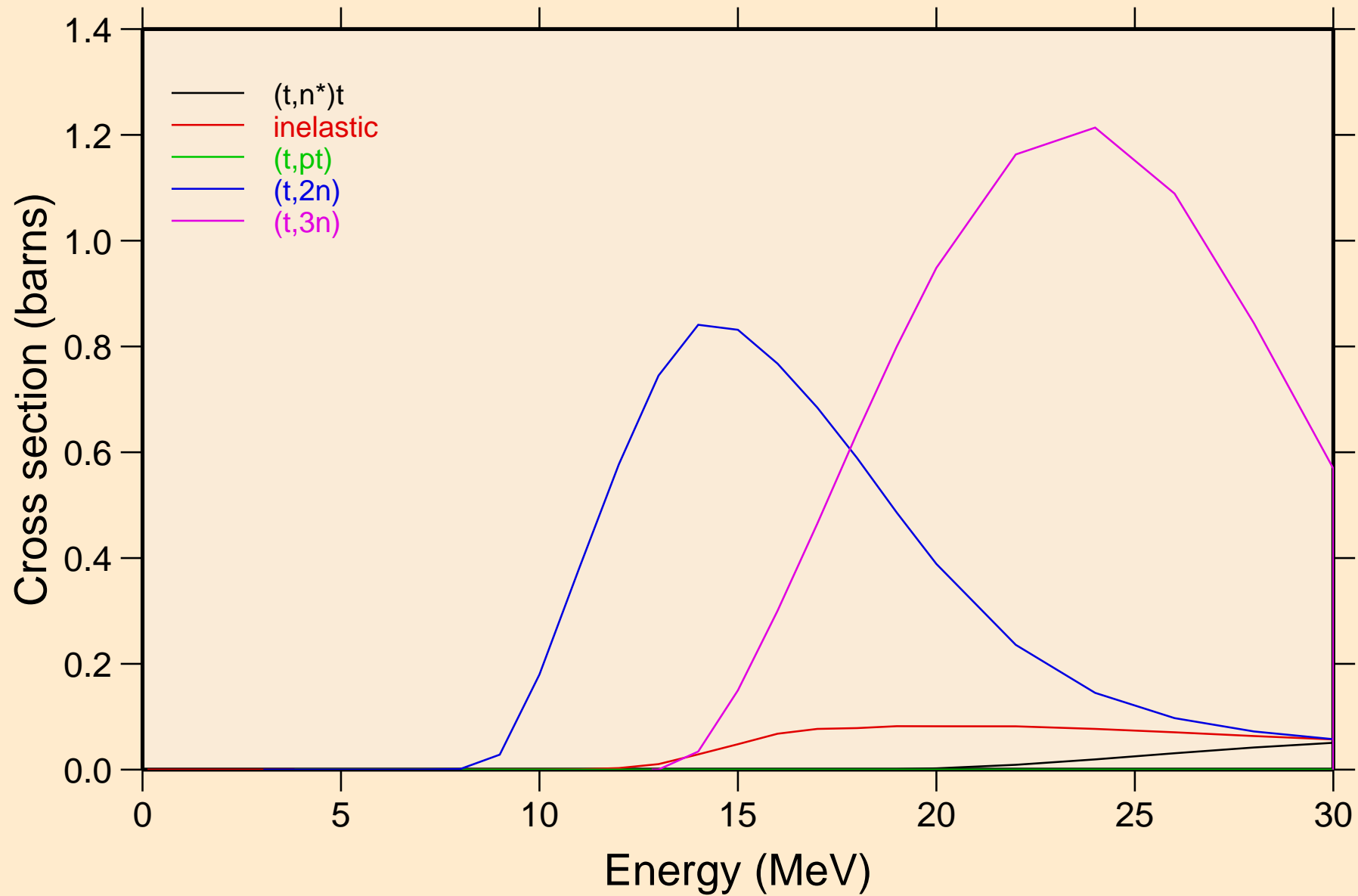

LU169M TRITON ACER TENDL-2021 LIBRARY; T=0.K  
Threshold reactions

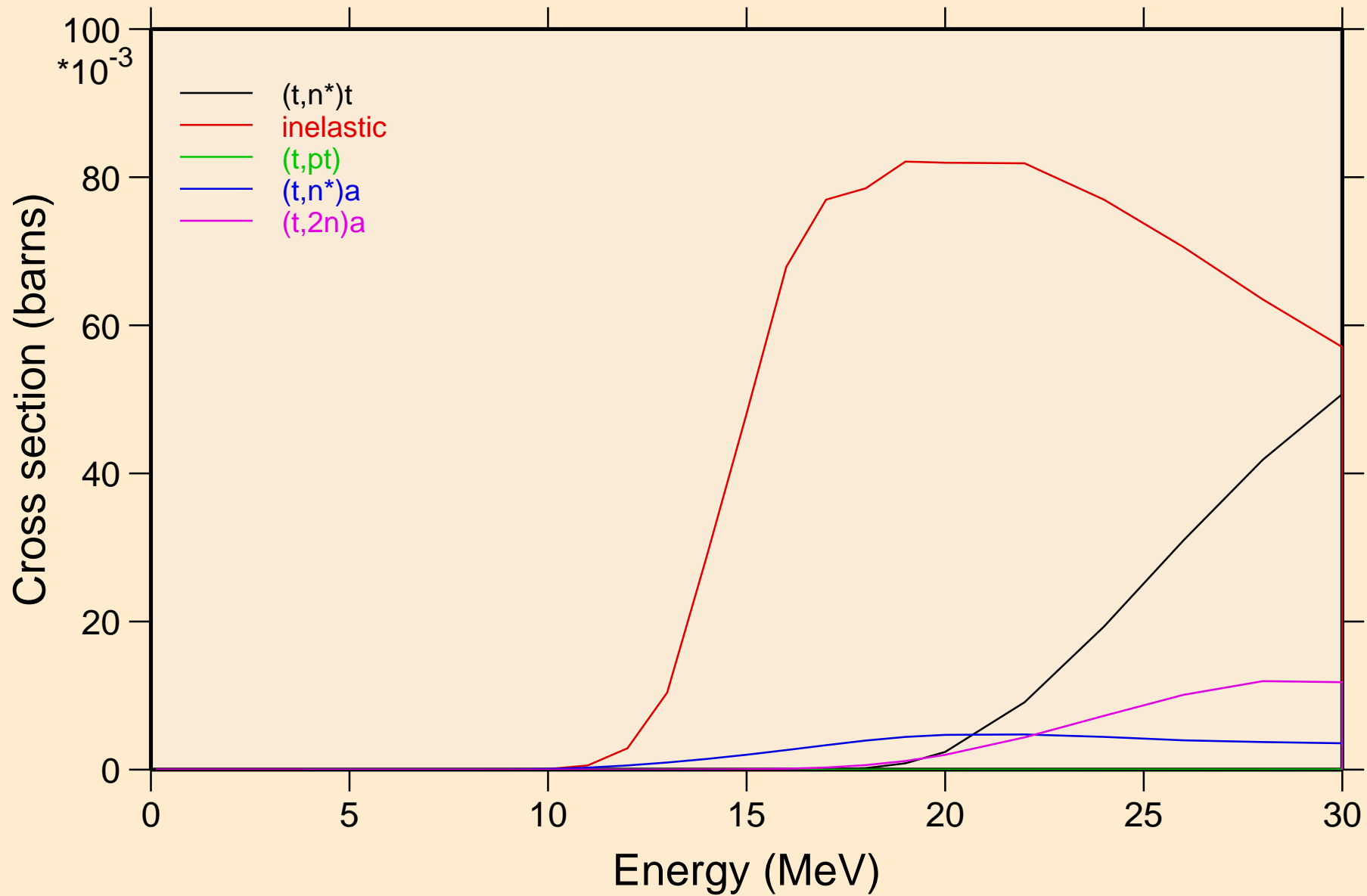

LU169M TRITON ACER TENDL-2021 LIBRARY; T=0.K  
Threshold reactions

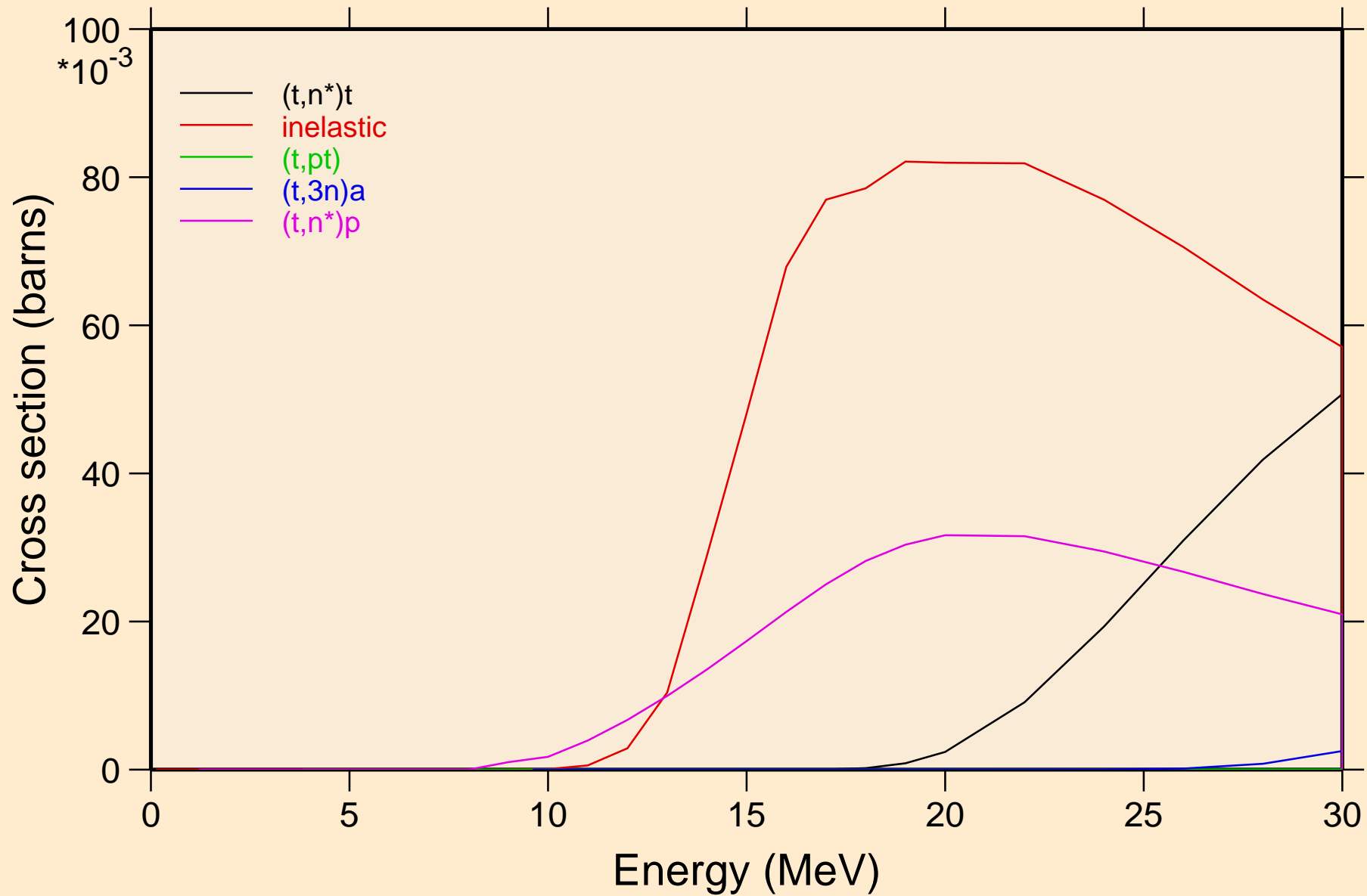



LU169M TRITON ACER TENDL-2021 LIBRARY; T=0.K  
Threshold reactions

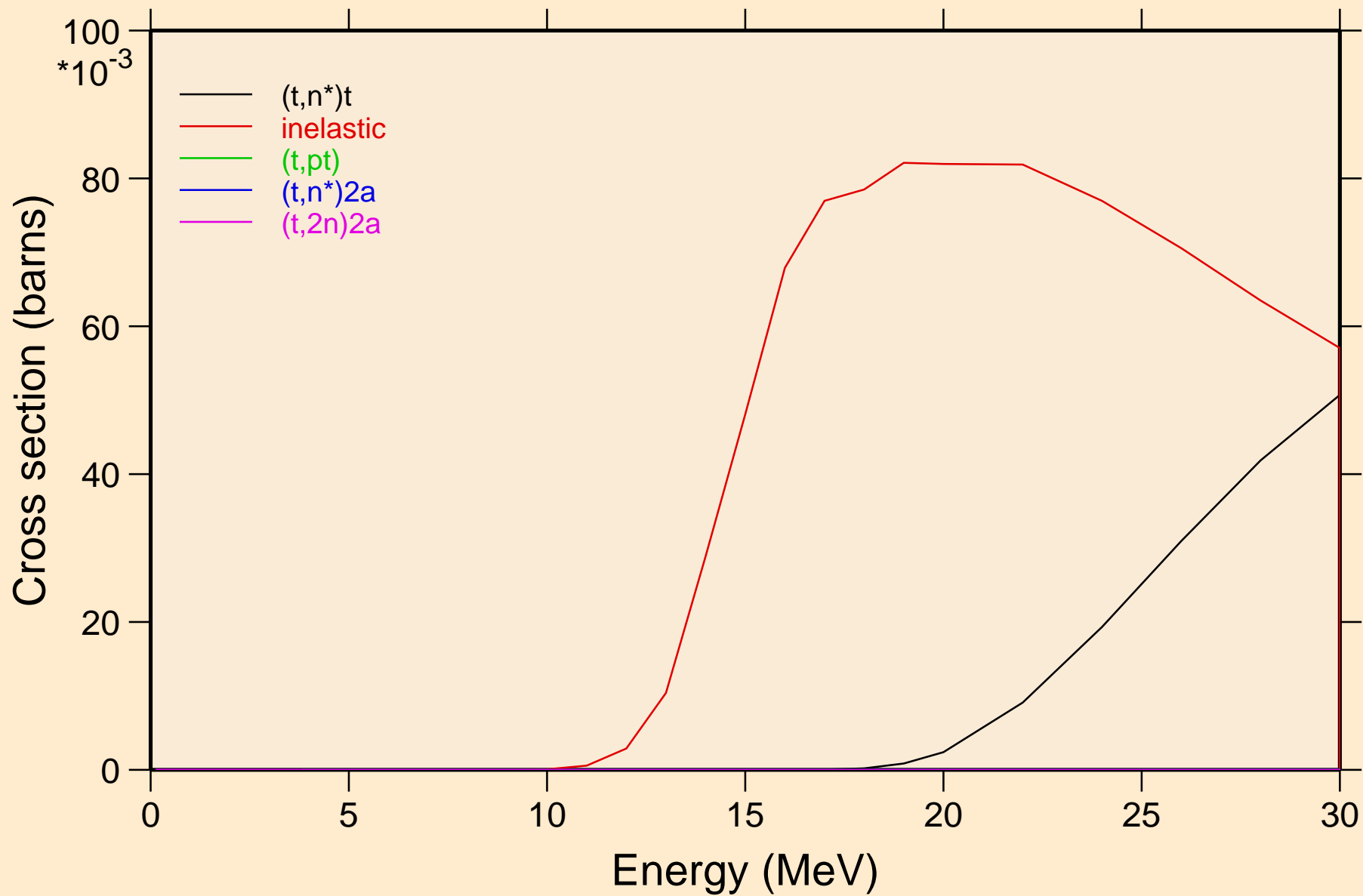

LU169M TRITON ACER TENDL-2021 LIBRARY; T=0.K  
Threshold reactions

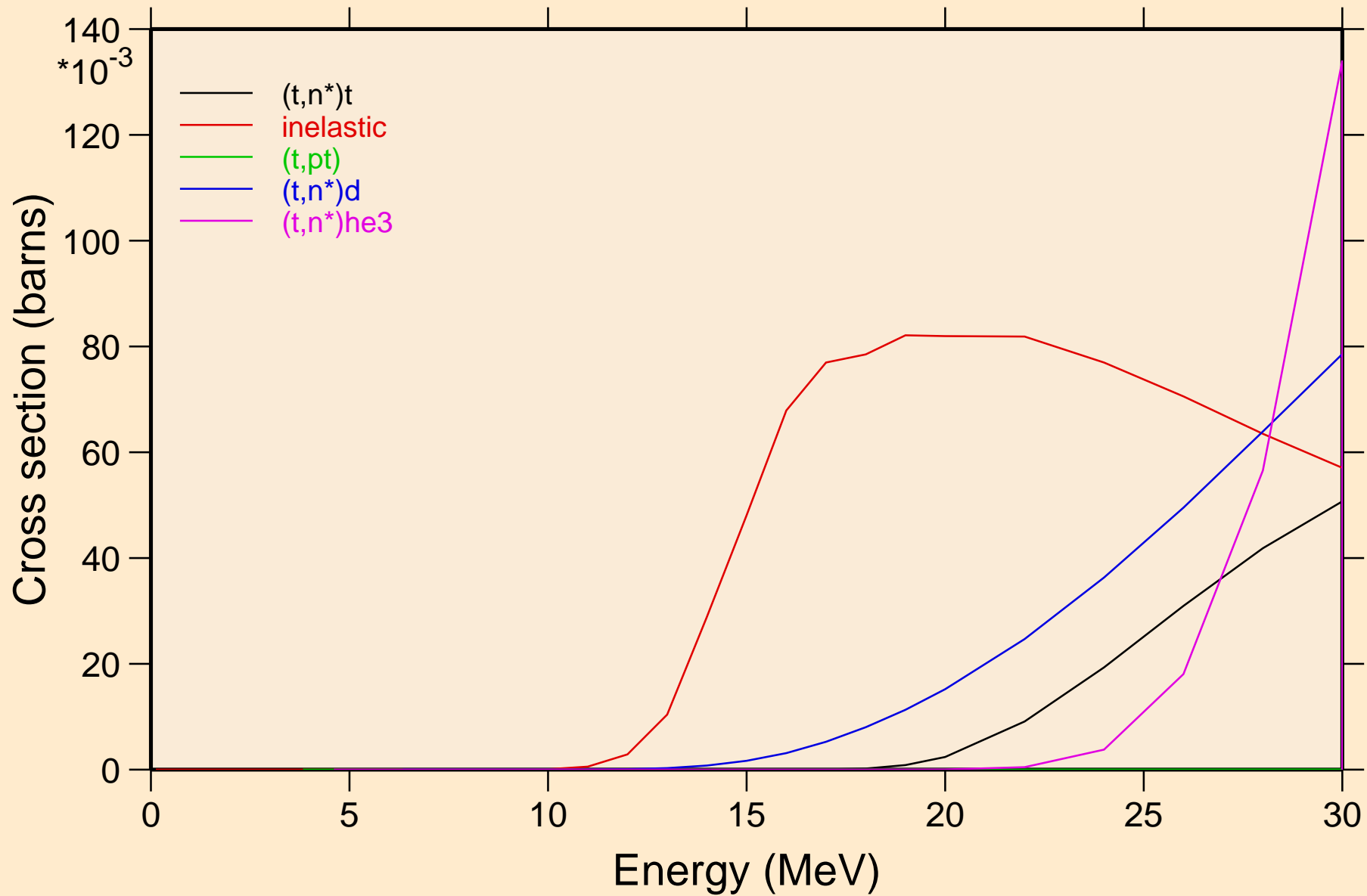

LU169M TRITON ACER TENDL-2021 LIBRARY; T=0.K  
Threshold reactions

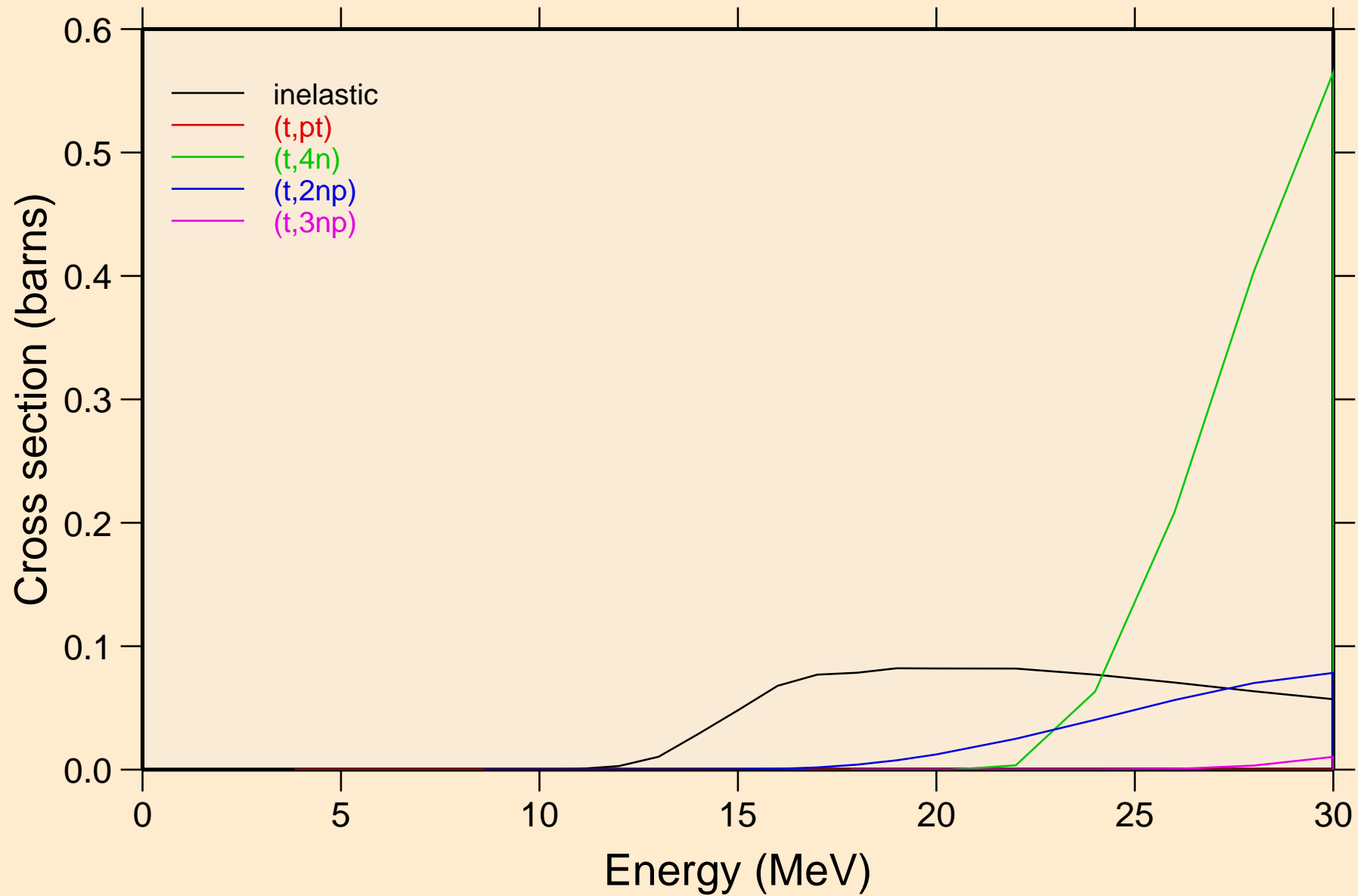

LU169M TRITON ACER TENDL-2021 LIBRARY; T=0.K  
Threshold reactions

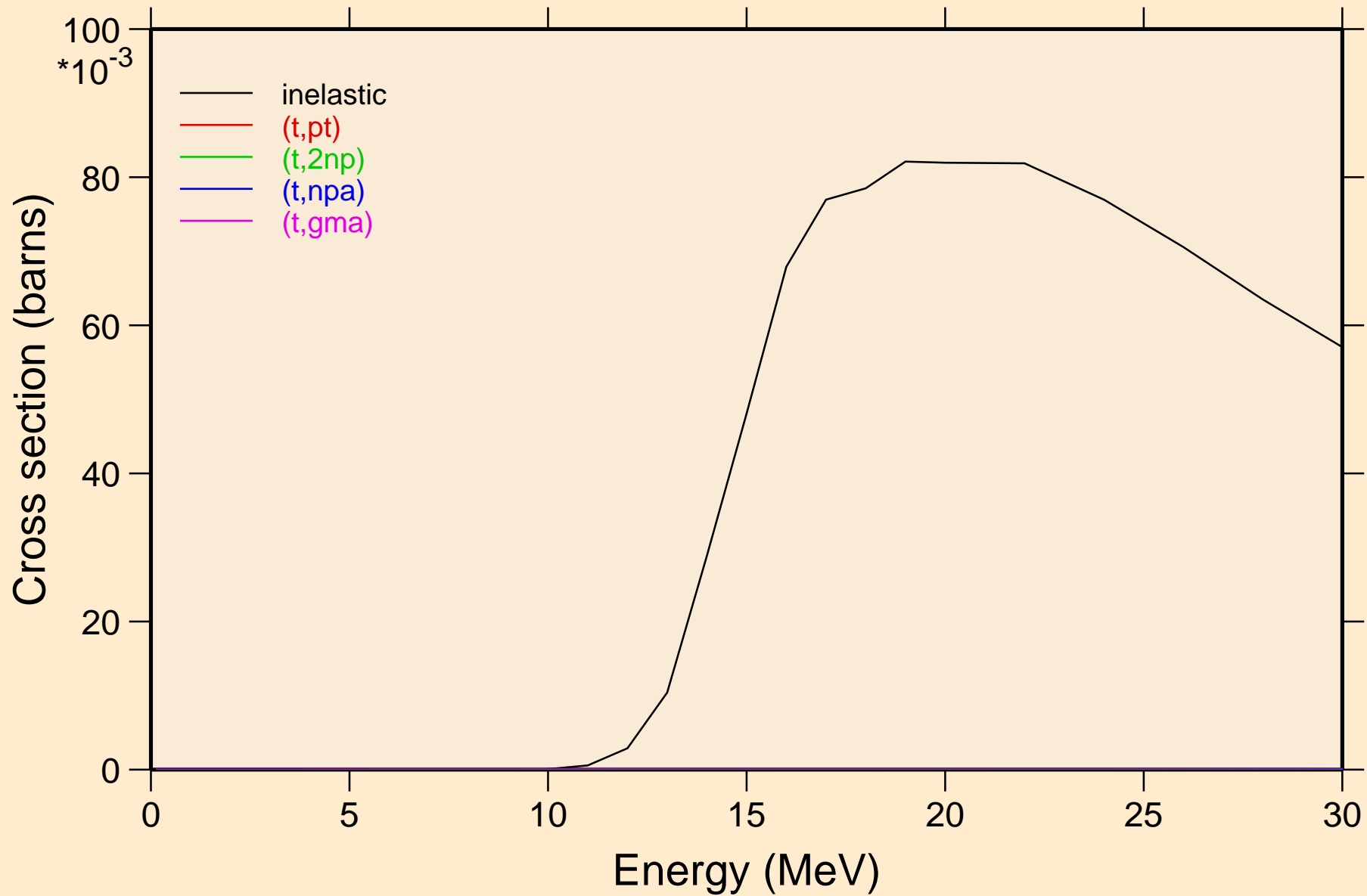

LU169M TRITON ACER TENDL-2021 LIBRARY; T=0.K  
Threshold reactions

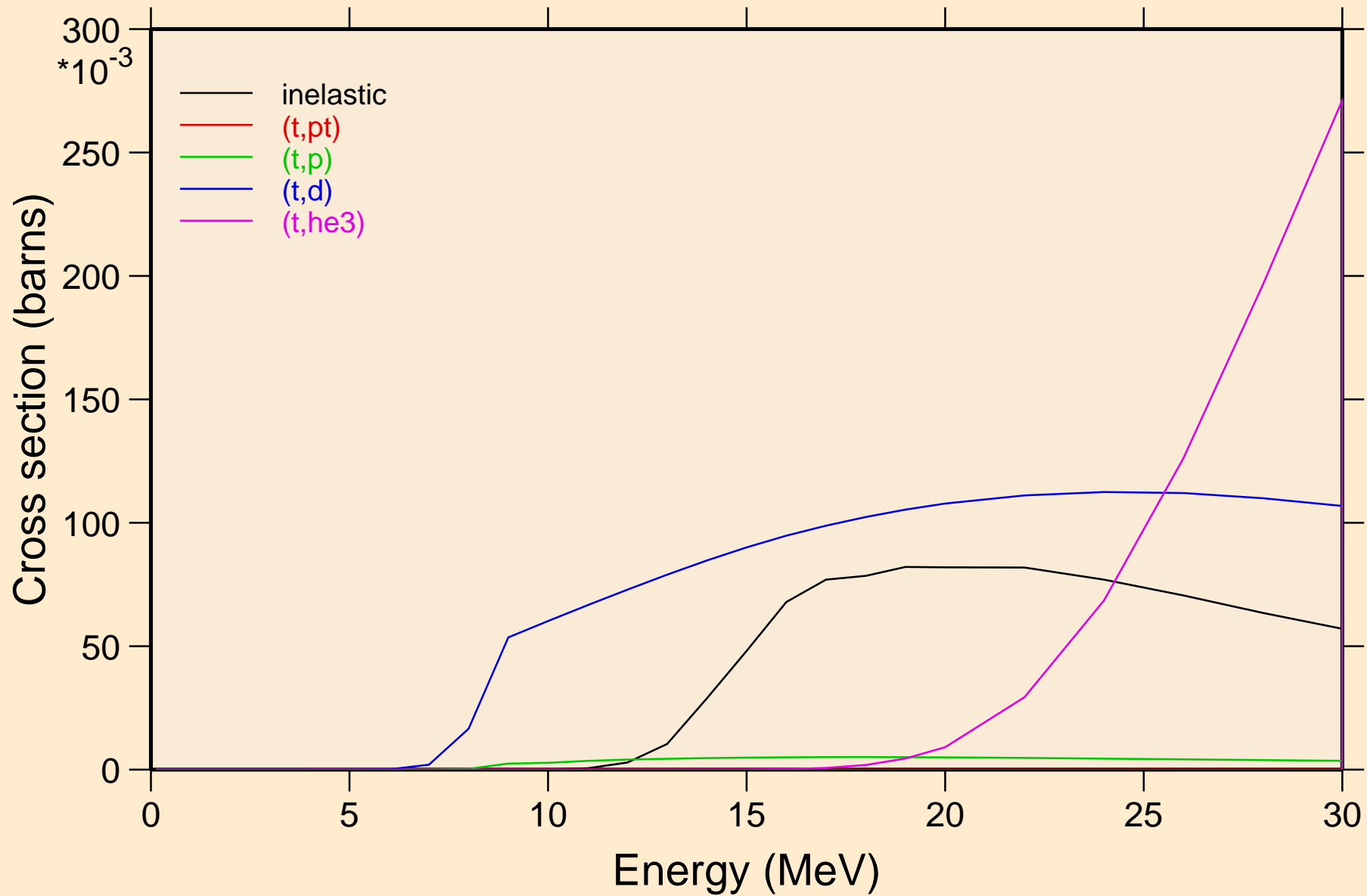

LU169M TRITON ACER TENDL-2021 LIBRARY; T=0.K  
Threshold reactions

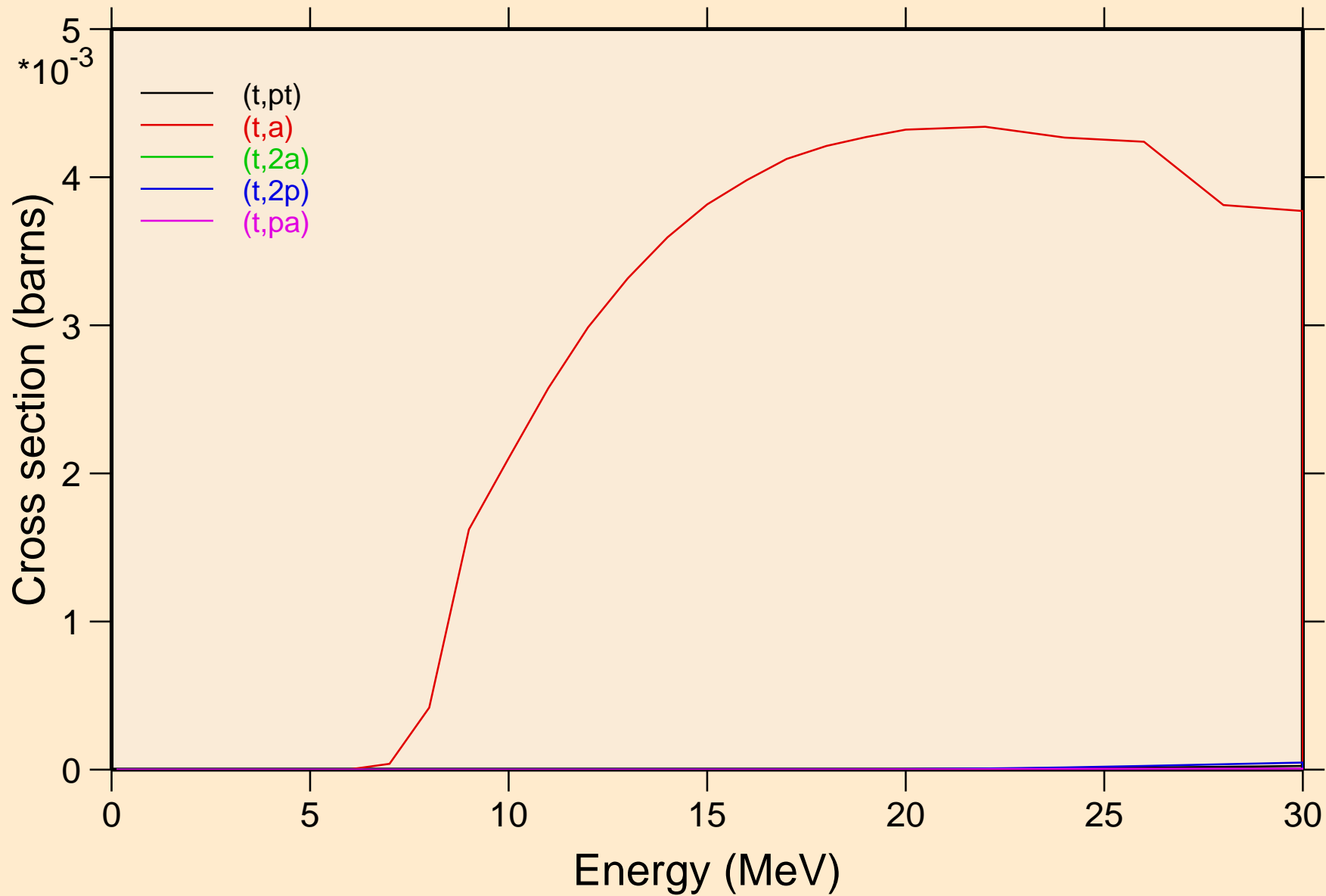

LU169M TRITON ACER TENDL-2021 LIBRARY; T=0.K  
Threshold reactions

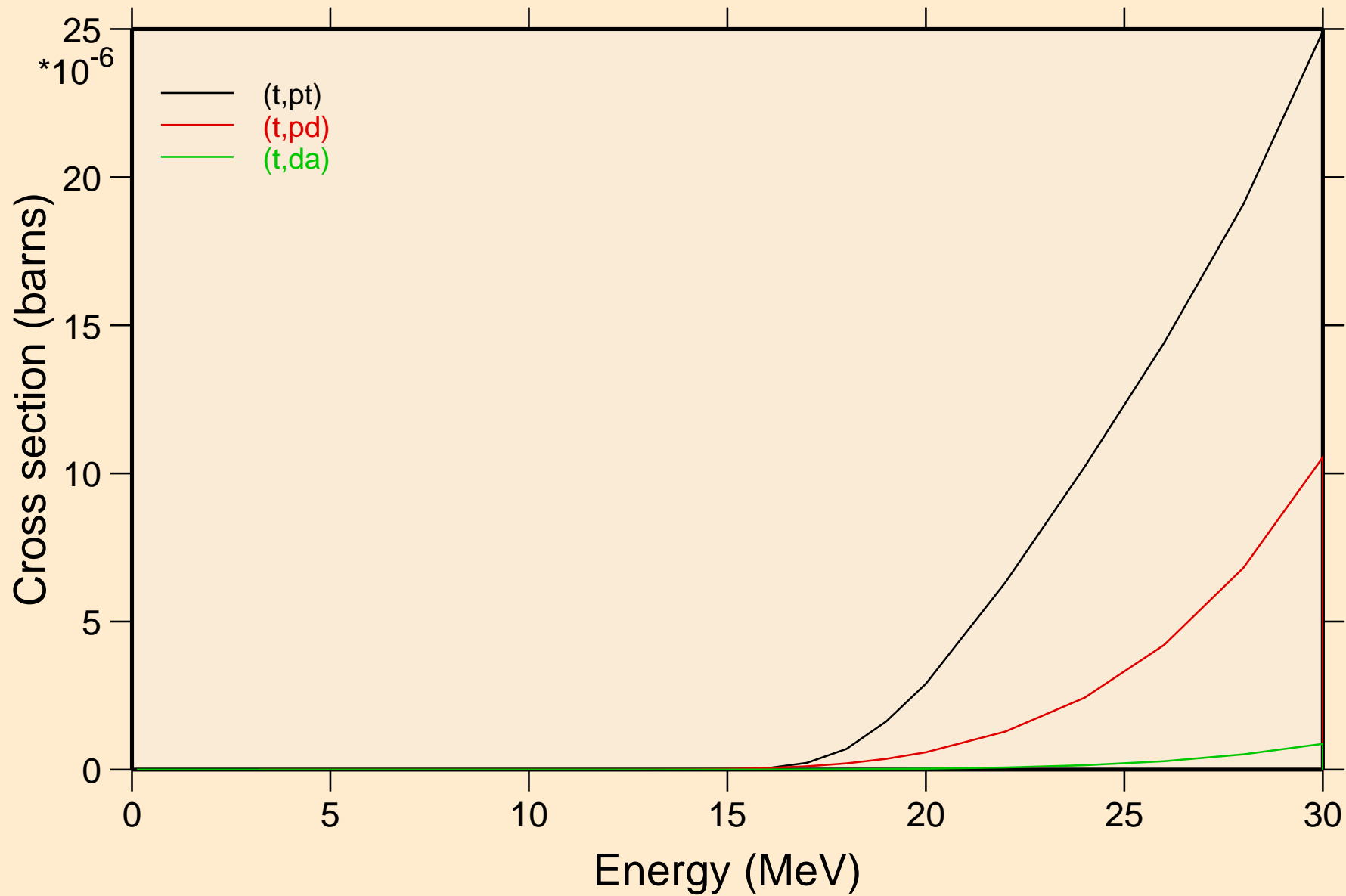

LU169M TRITON ACER TENDL-2021 LIBRARY; T=0.K  
angular distribution for elastic

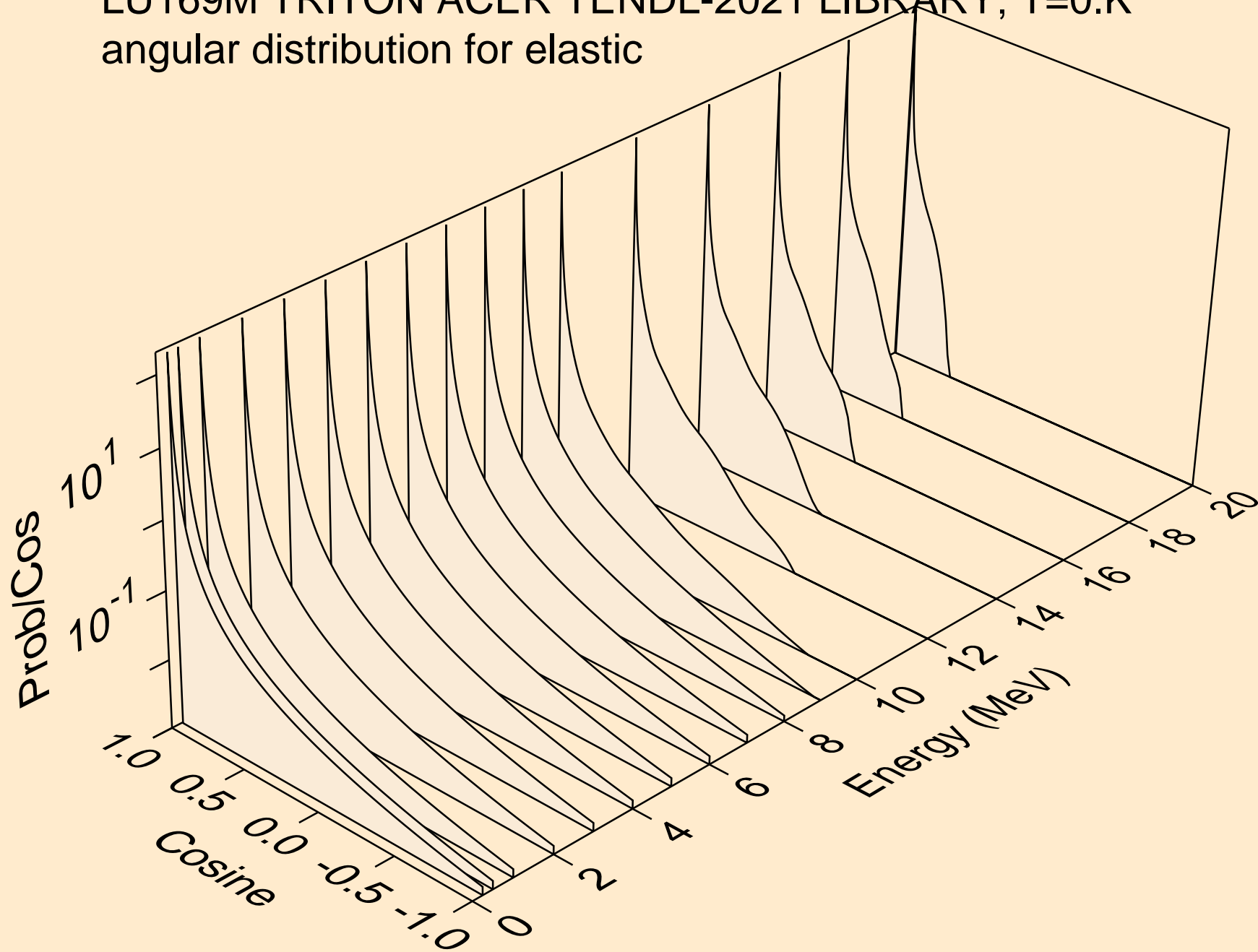



LU169M TRITON ACER TENDL-2021 LIBRARY; T=0.K  
angular distribution for elastic

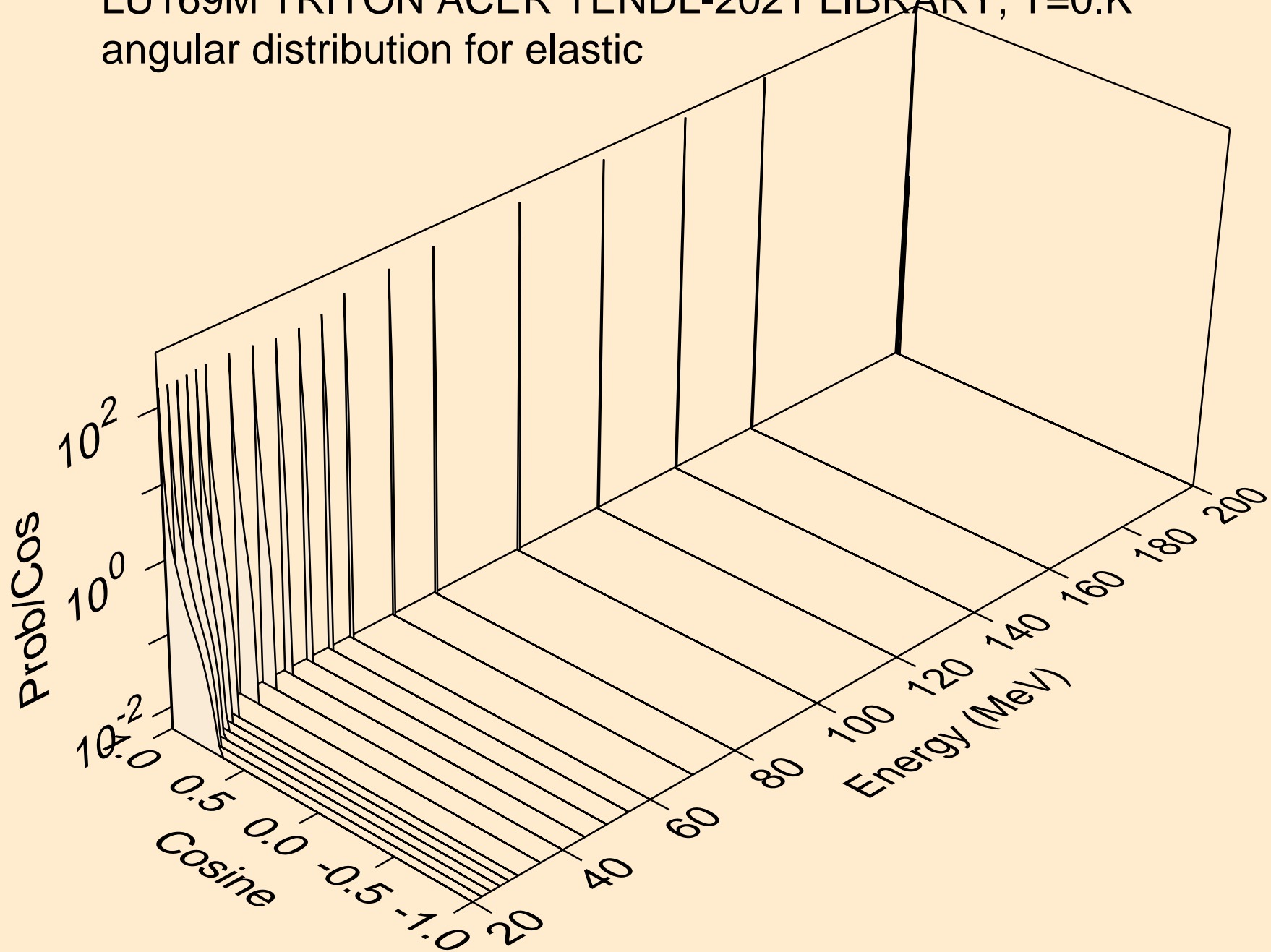

LU169M TRITON ACER TENDL-2021 LIBRARY; T=0.K  
Triton emission for (t,x)

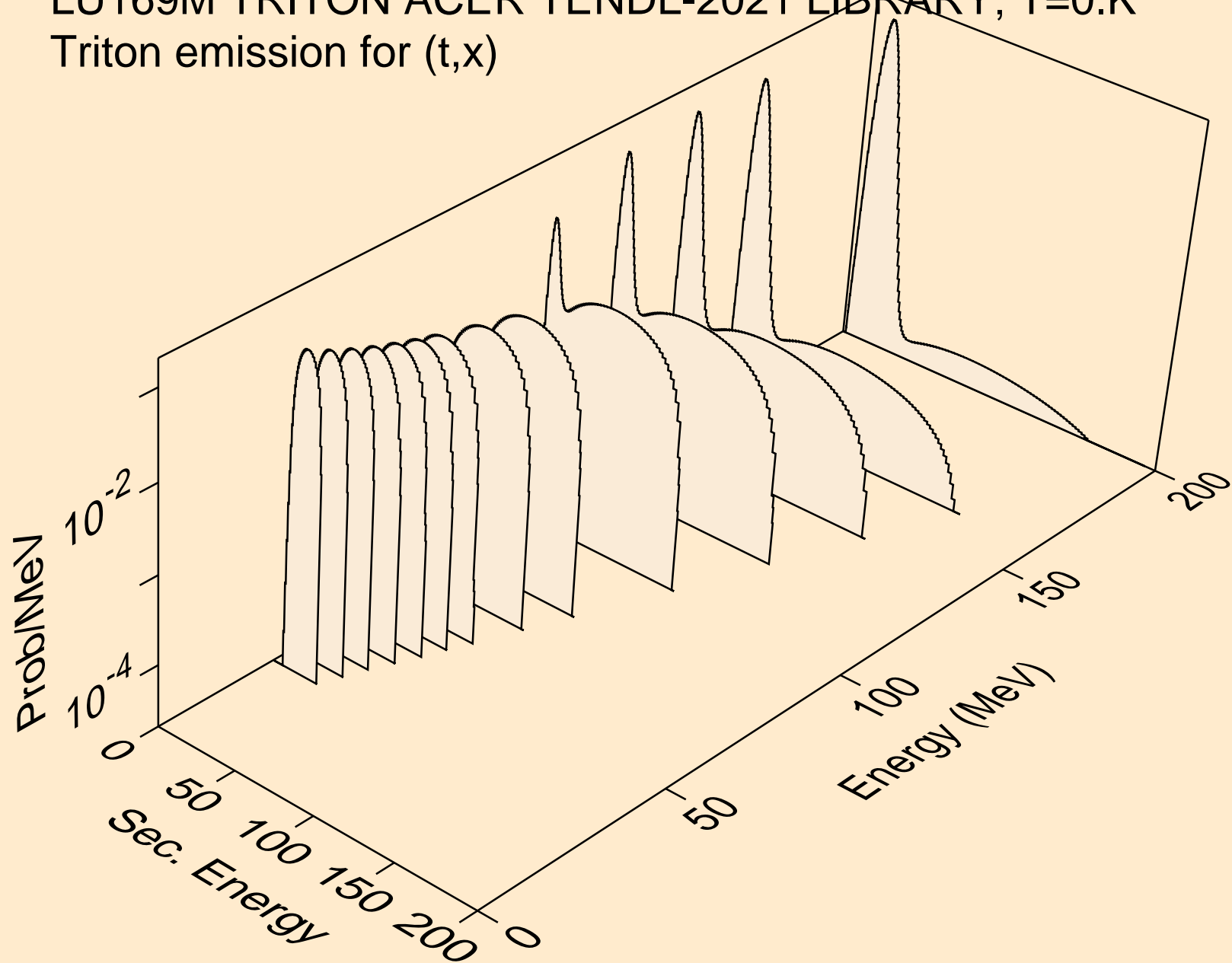

LU169M TRITON ACER TENDL-2021 LIBRARY; T=0.K  
Triton emission for (t,n\*)t

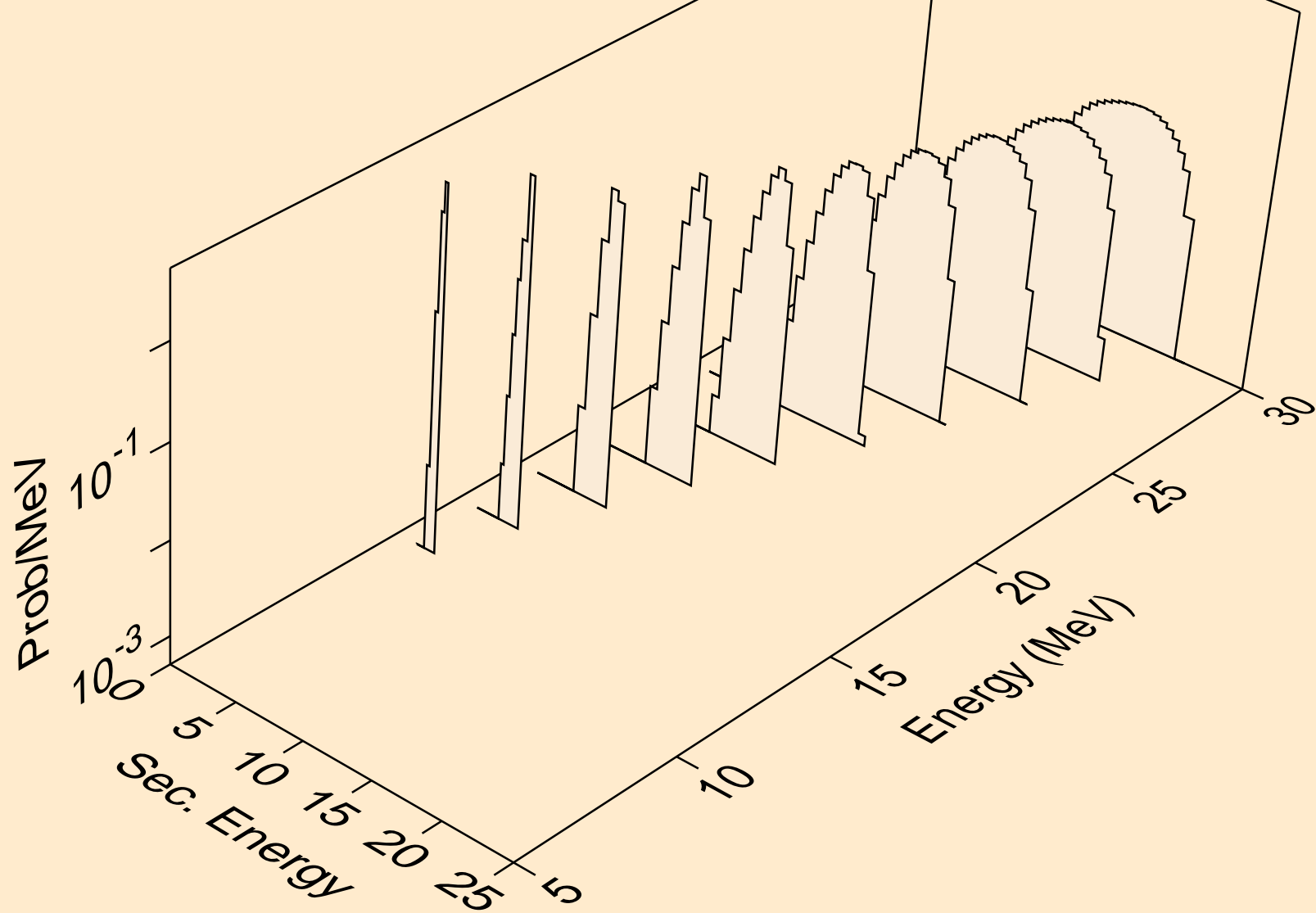

LU169M TRITON ACER TENDL-2021 LIBRARY; T=0.K  
Triton emission for inelastic

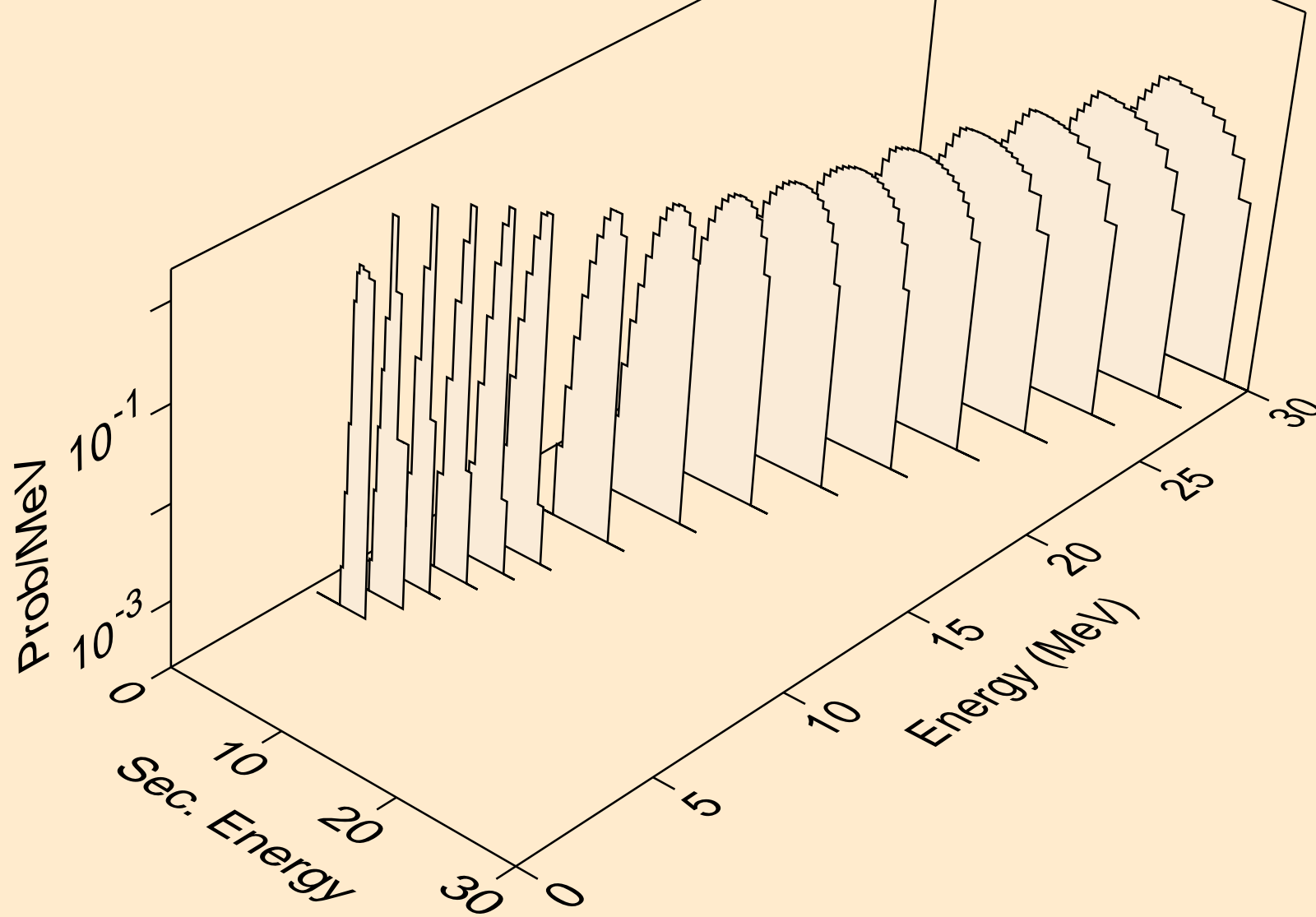

LU169M TRITON ACER TENDL-2021 LIBRARY; T=0.K  
Triton emission for (t,pt)

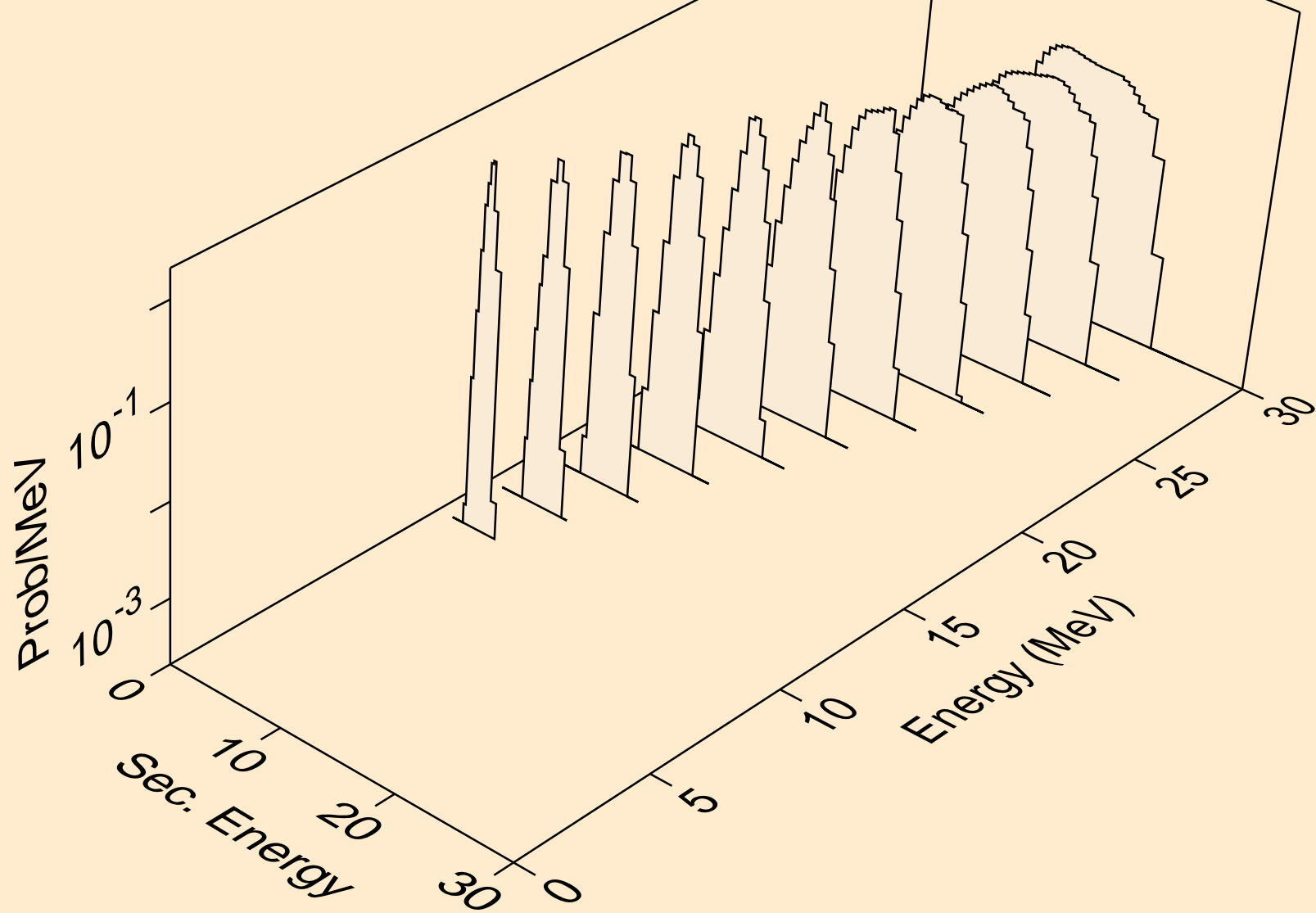

LU169M TRITON ACER TENDL-2021 LIBRARY; T=0.K  
Photon emission for (z,n)

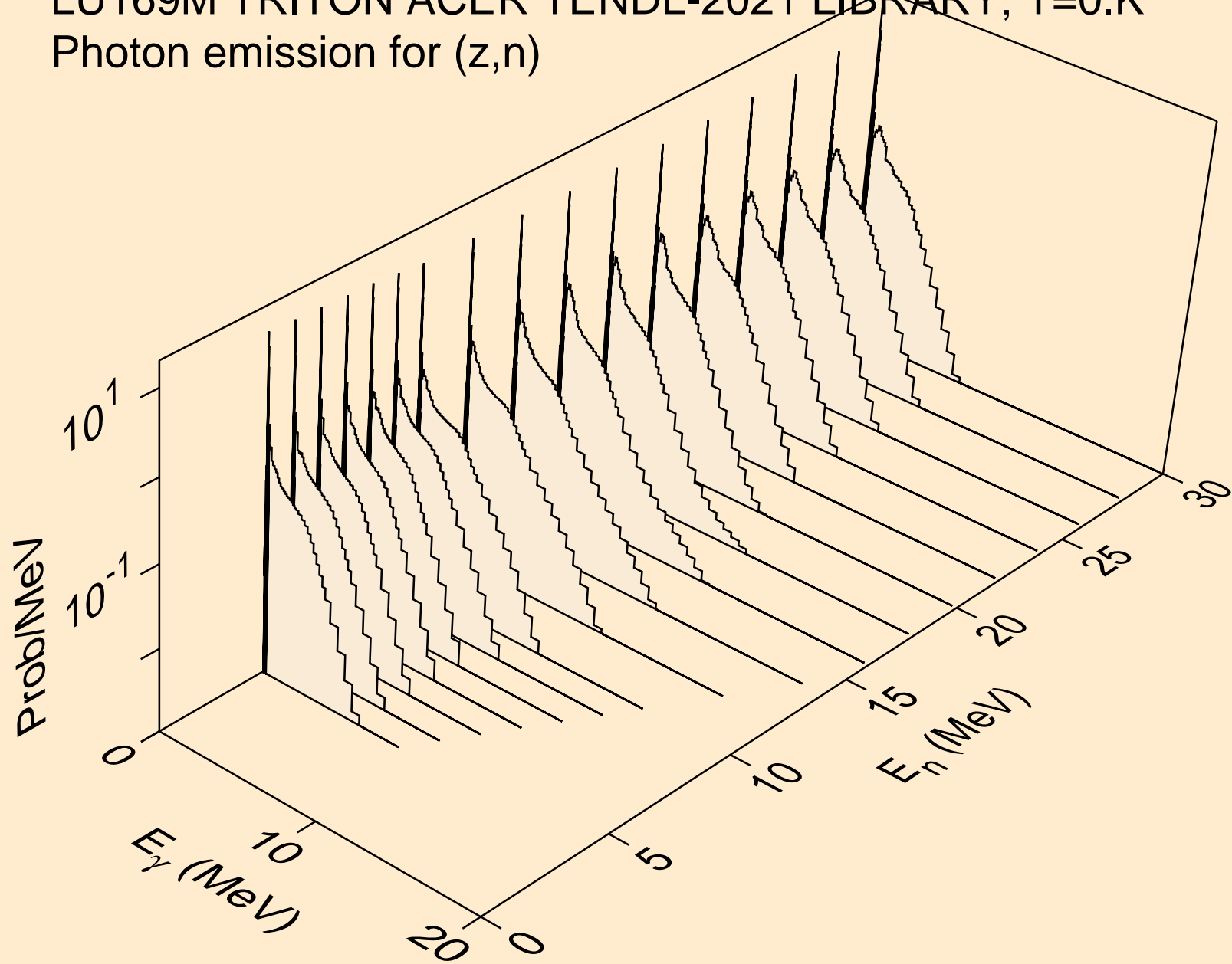

LU169M TRITON ACER TENDL-2021 LIBRARY; T=0.K  
Photon emission for (n,x)

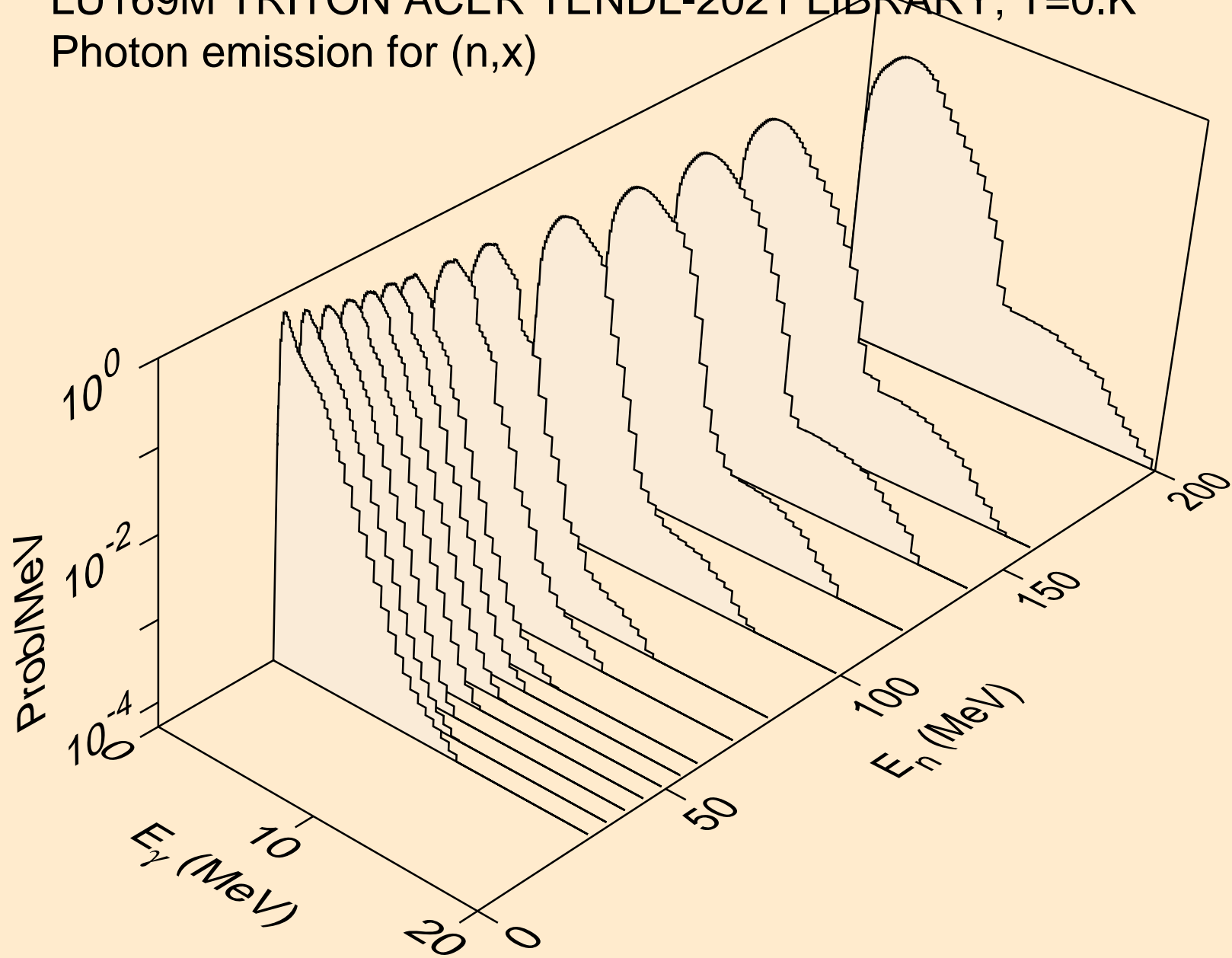

LU169M TRITON ACER TENDL-2021 LIBRARY; T=0.K  
Photon emission for (n,2nd)

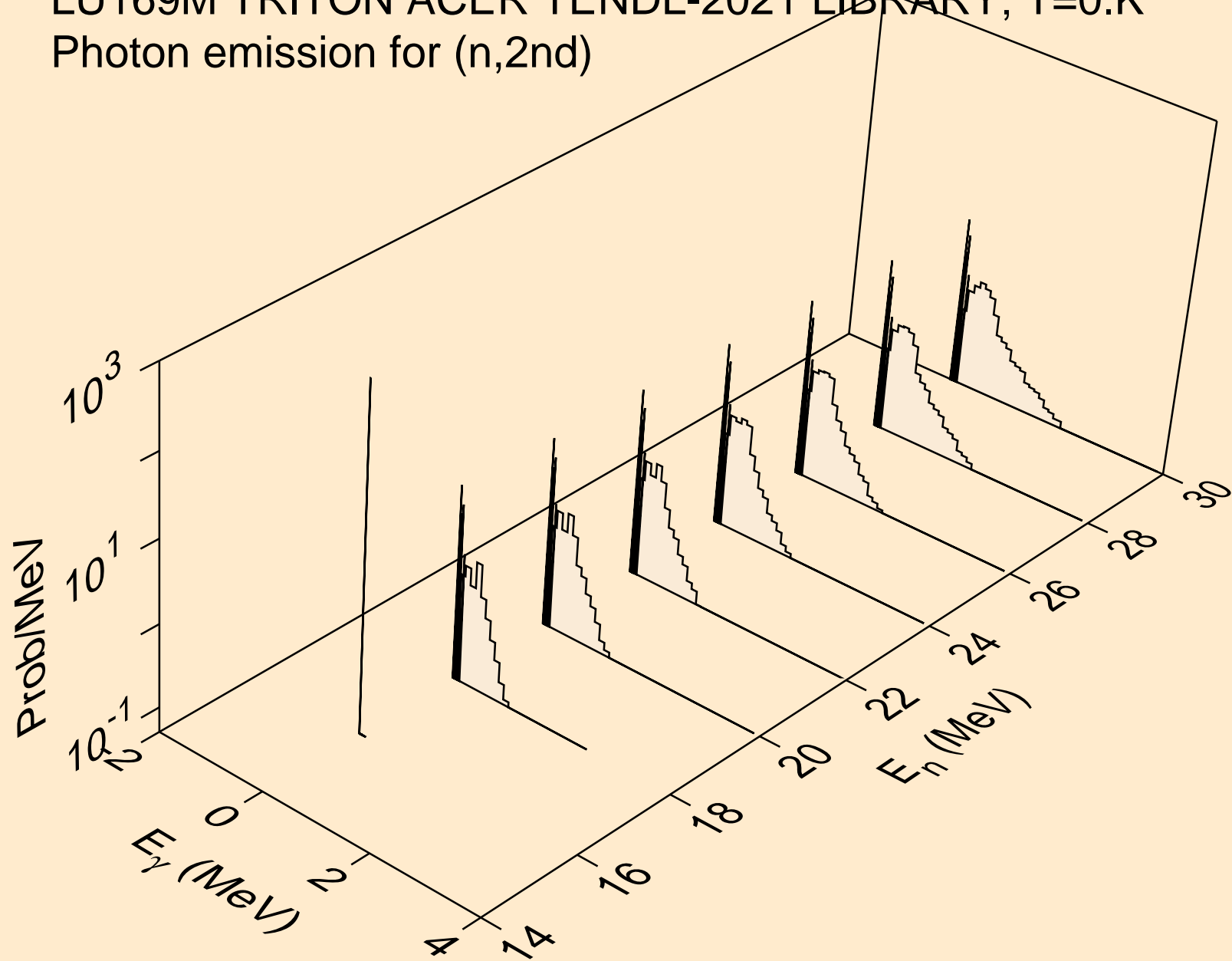



LU169M TRITON ACER TENDL-2021 LIBRARY; T=0.K  
Photon emission for (n,2n)

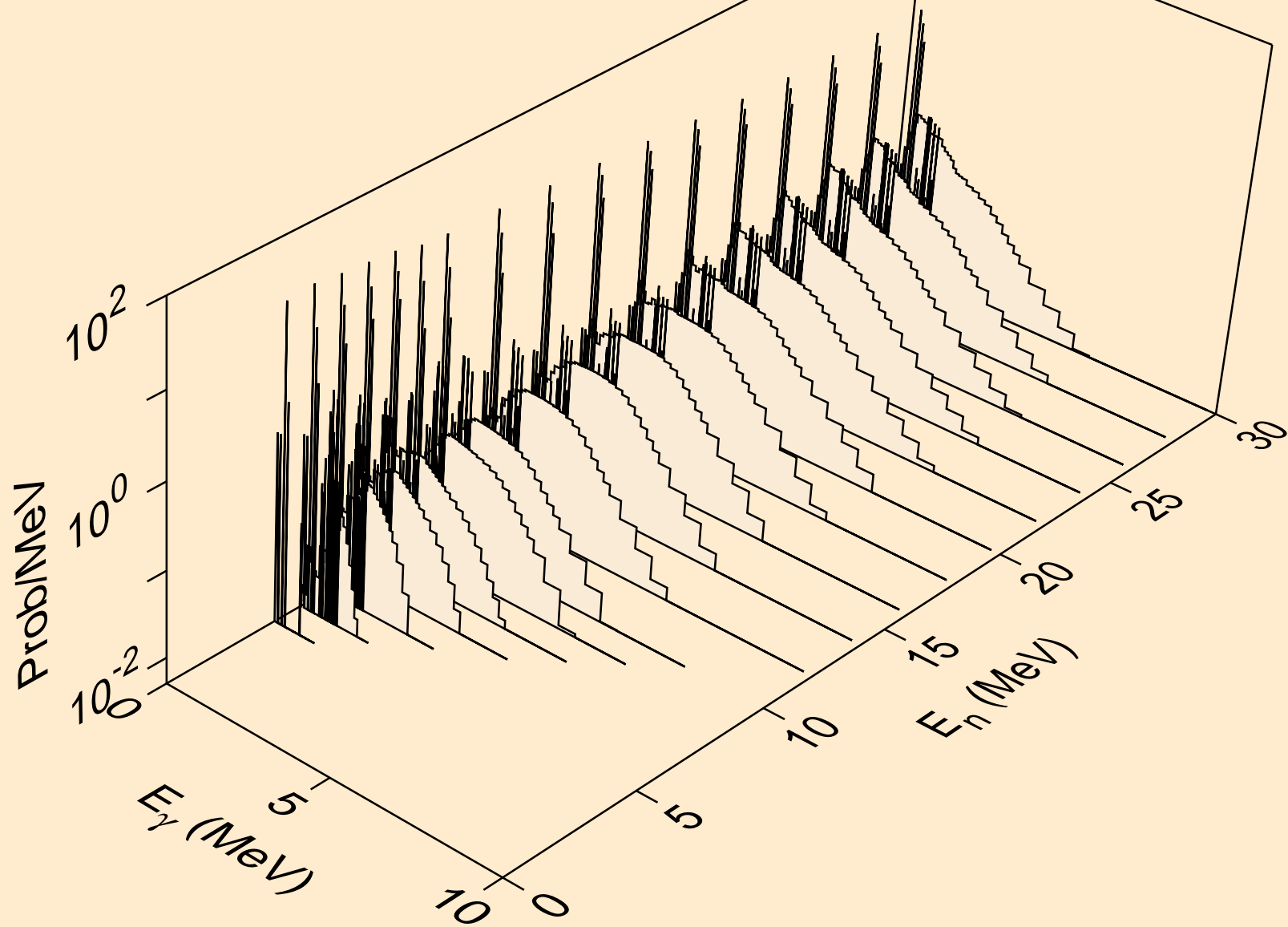

LU169M TRITON ACER TENDL-2021 LIBRARY; T=0.K  
Photon emission for (n,3n)

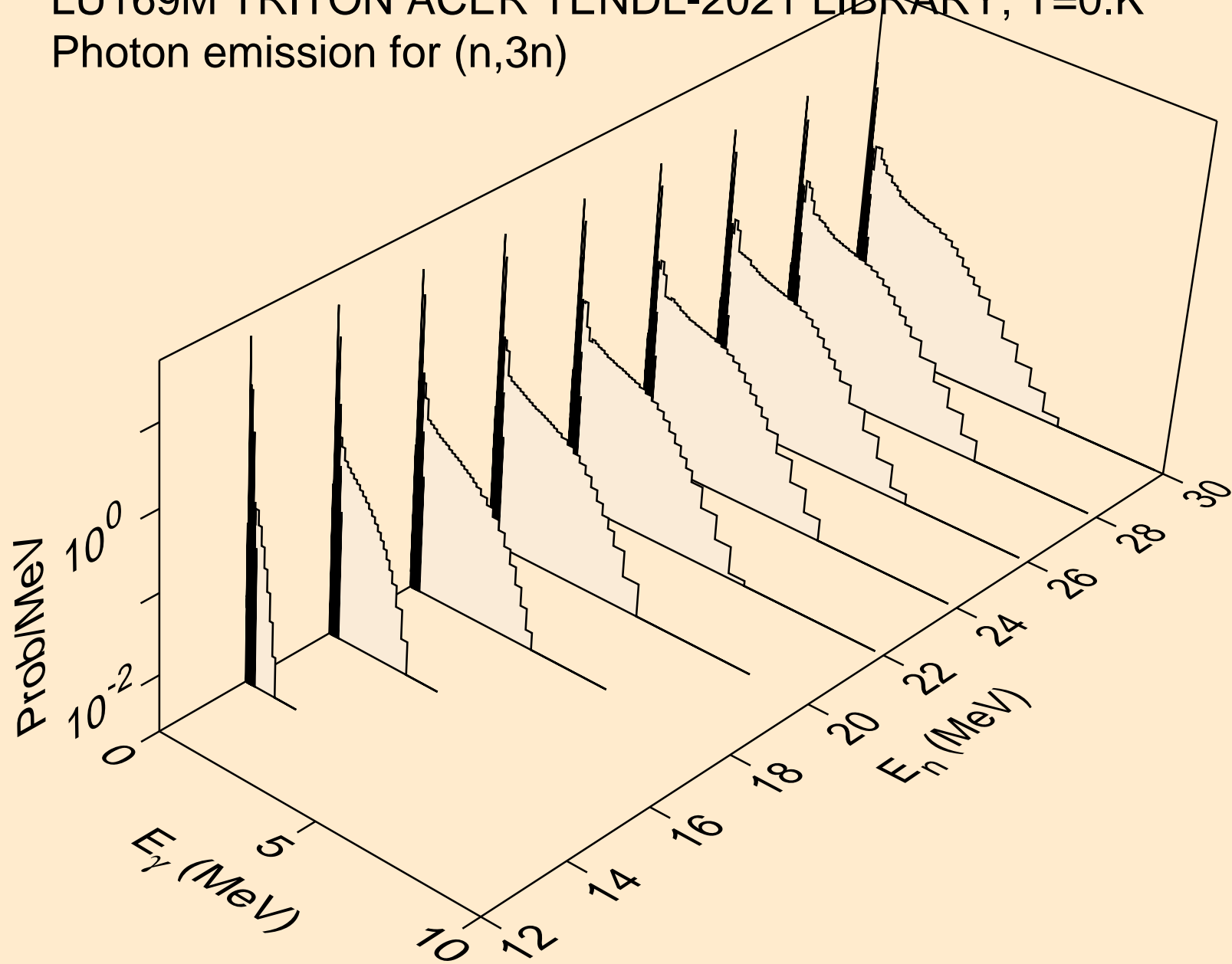

LU169M TRITON ACER TENDL-2021 LIBRARY; T=0.K  
Photon emission for (n,n\*)a

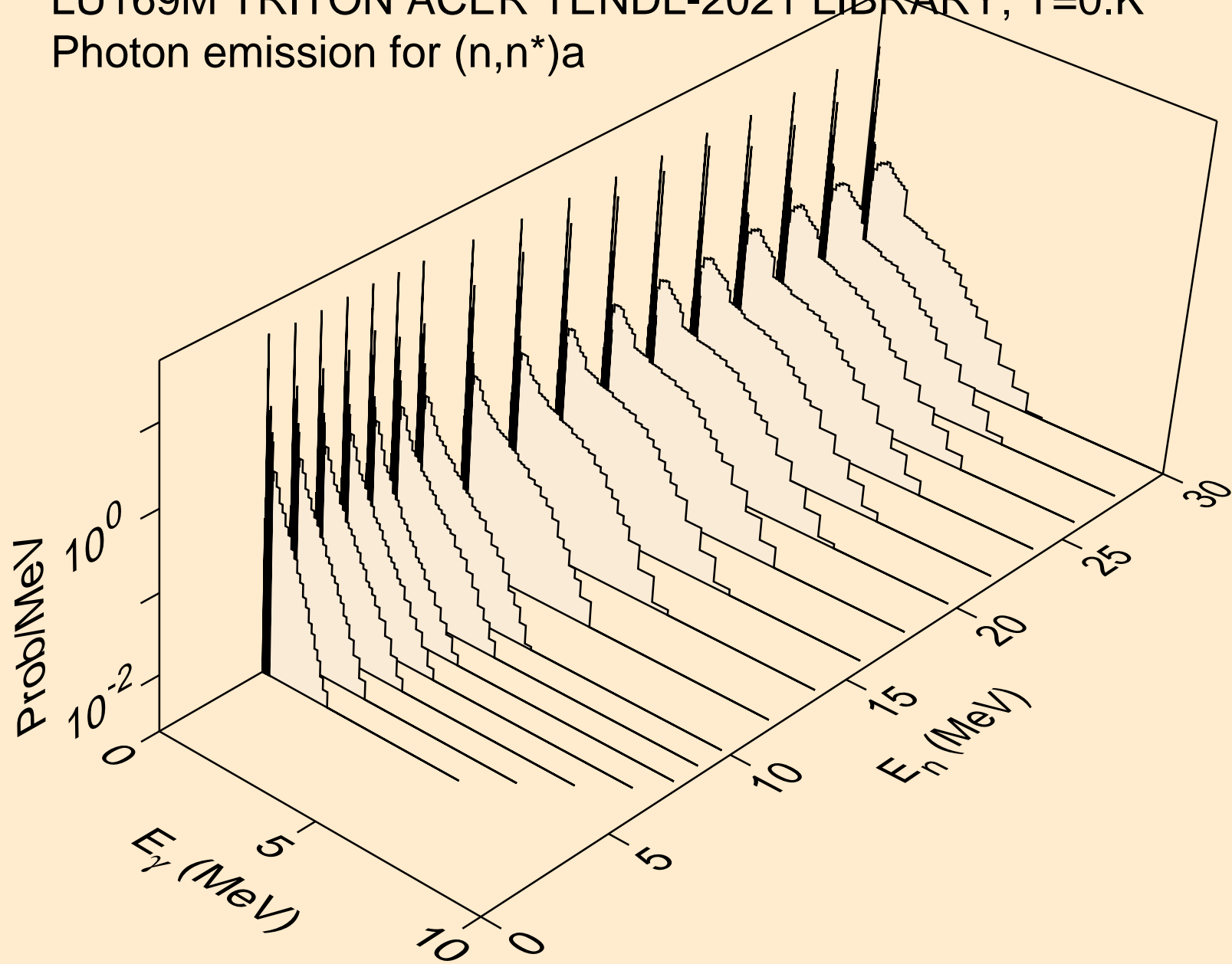

LU169M TRITON ACER TENDL-2021 LIBRARY; T=0.K  
Photon emission for (n,2n)a

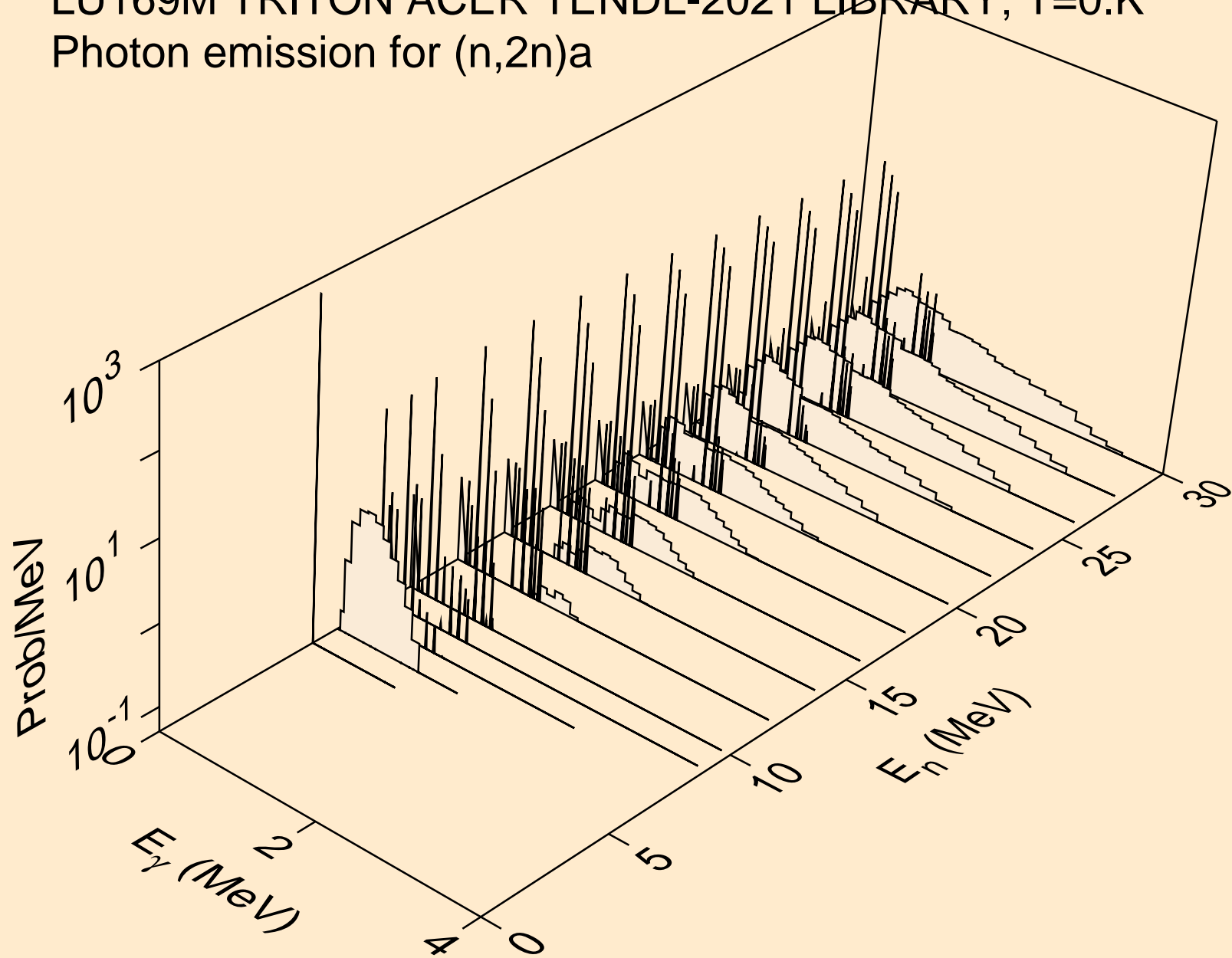

LU169M TRITON ACER TENDL-2021 LIBRARY; T=0.K  
Photon emission for (n,3n)a

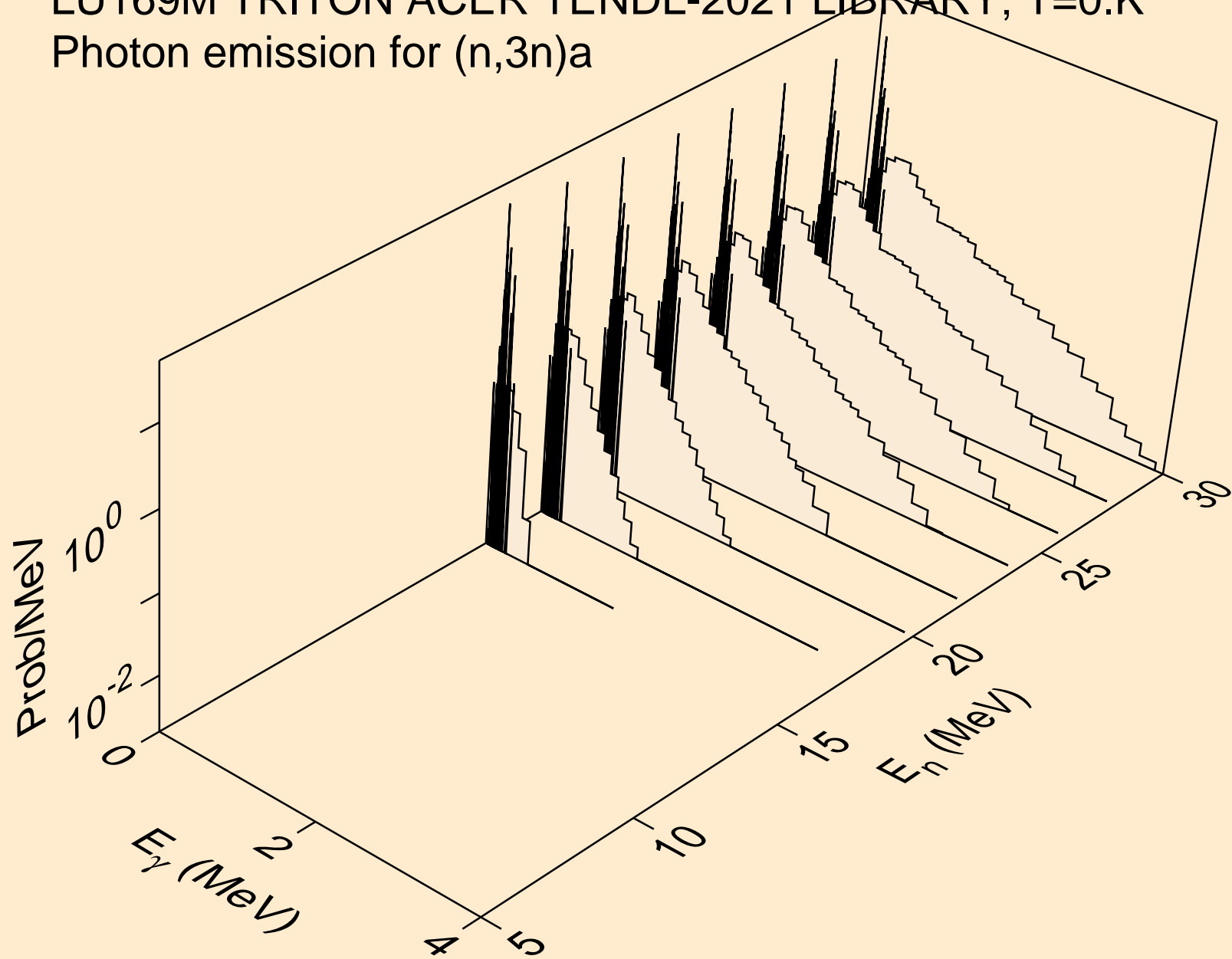

LU169M TRITON ACER TENDL-2021 LIBRARY; T=0.K  
Photon emission for (n,n\*)p

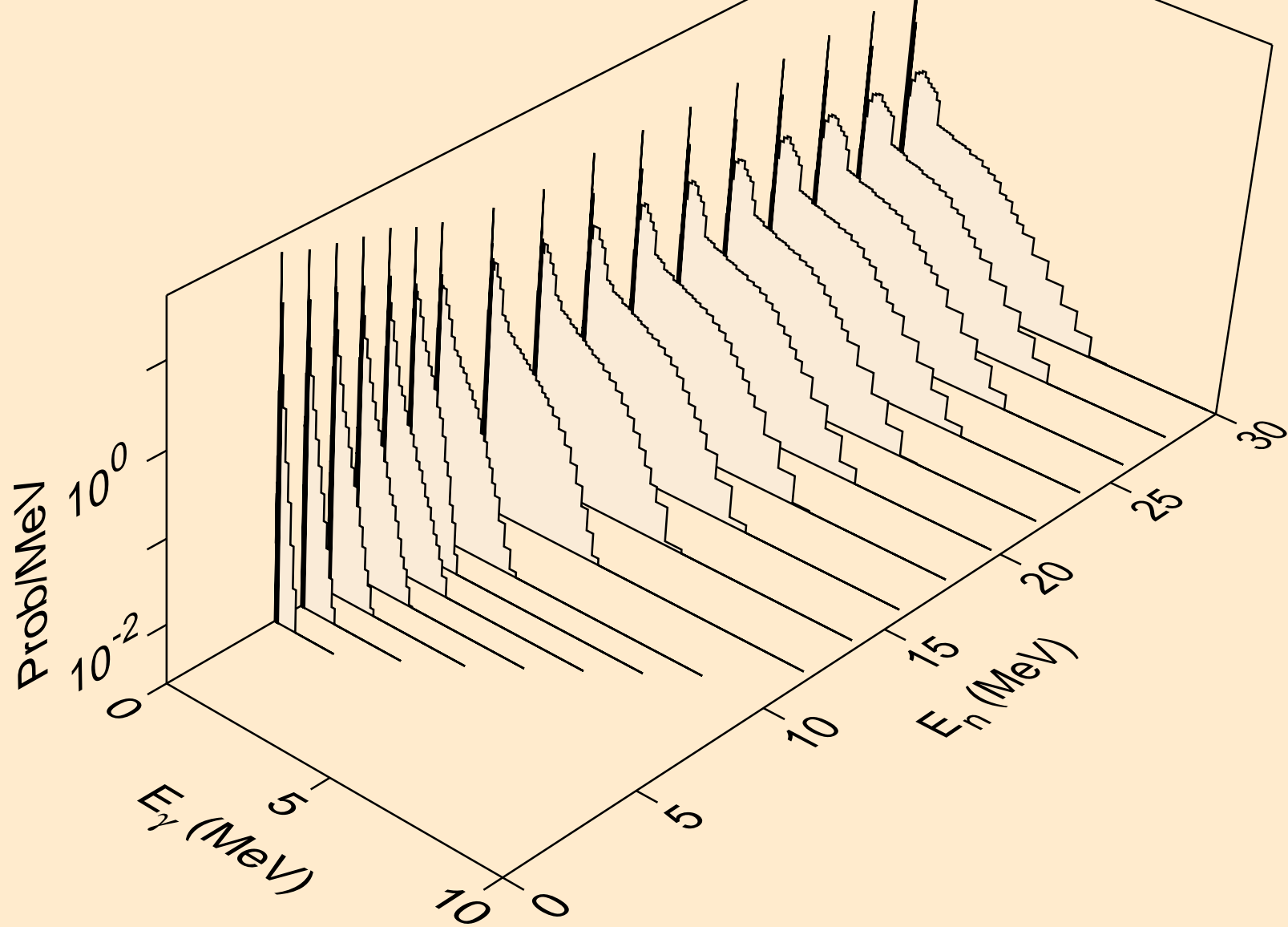

LU169M TRITON ACER TENDL-2021 LIBRARY; T=0.K  
Photon emission for (n,n\*)2a

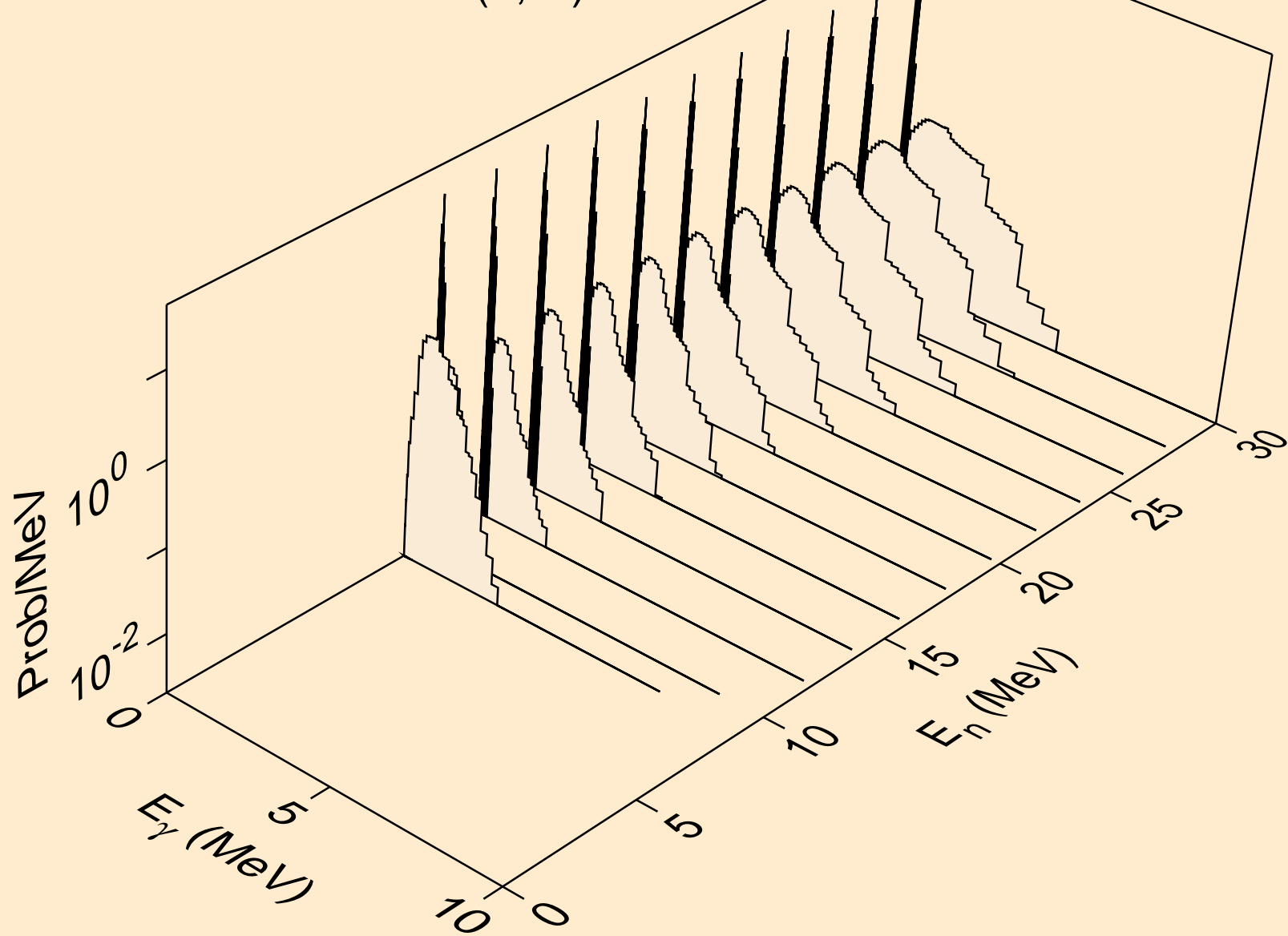

LU169M TRITON ACER TENDL-2021 LIBRARY; T=0.K  
Photon emission for (n,2n)2a

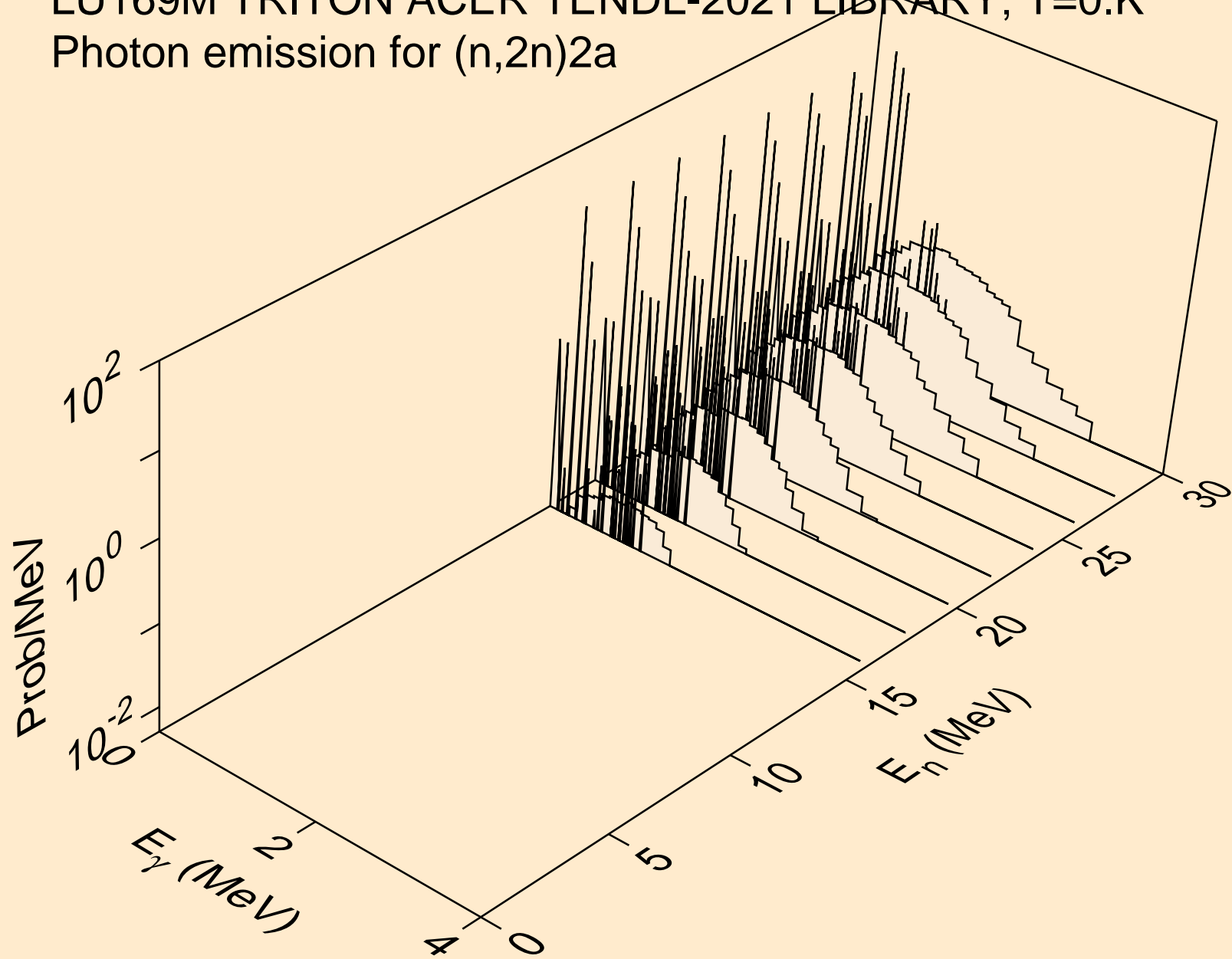



LU169M TRITON ACER TENDL-2021 LIBRARY; T=0.K  
Photon emission for (n,n\*)d

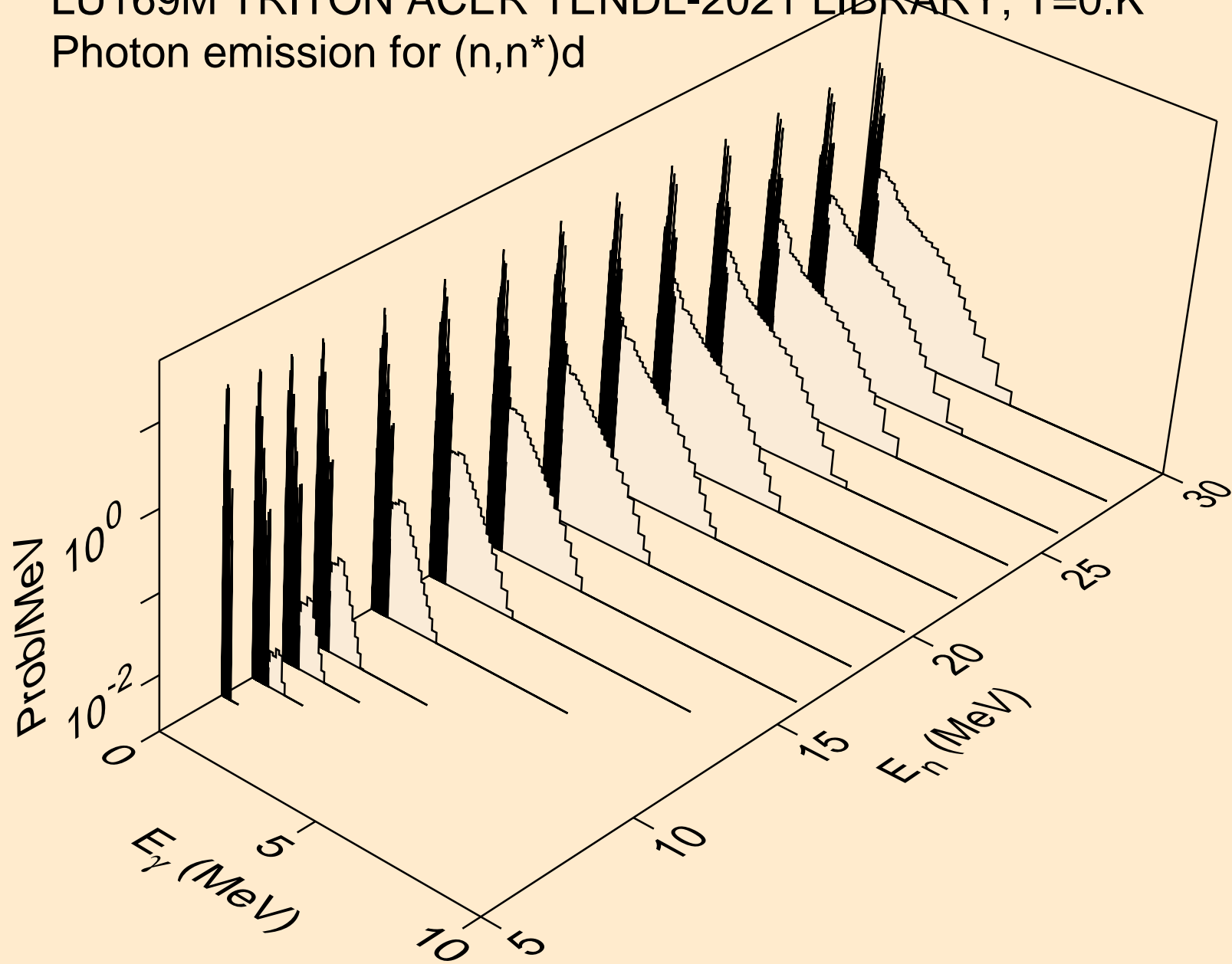

LU169M TRITON ACER TENDL-2021 LIBRARY; T=0.K  
Photon emission for (n,n\*)t

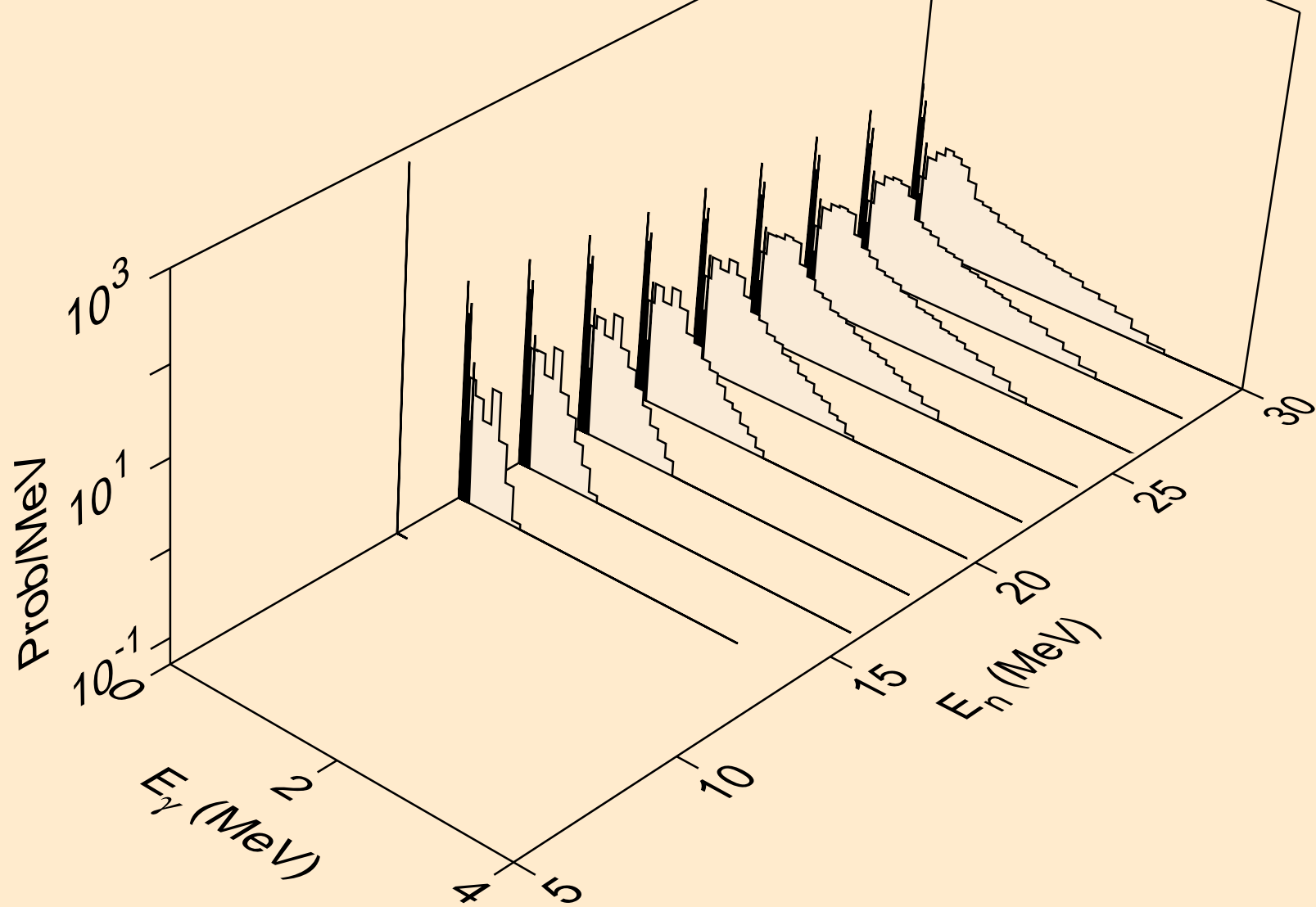

LU169M TRITON ACER TENDL-2021 LIBRARY; T=0.K  
Photon emission for (n,n\*)he3

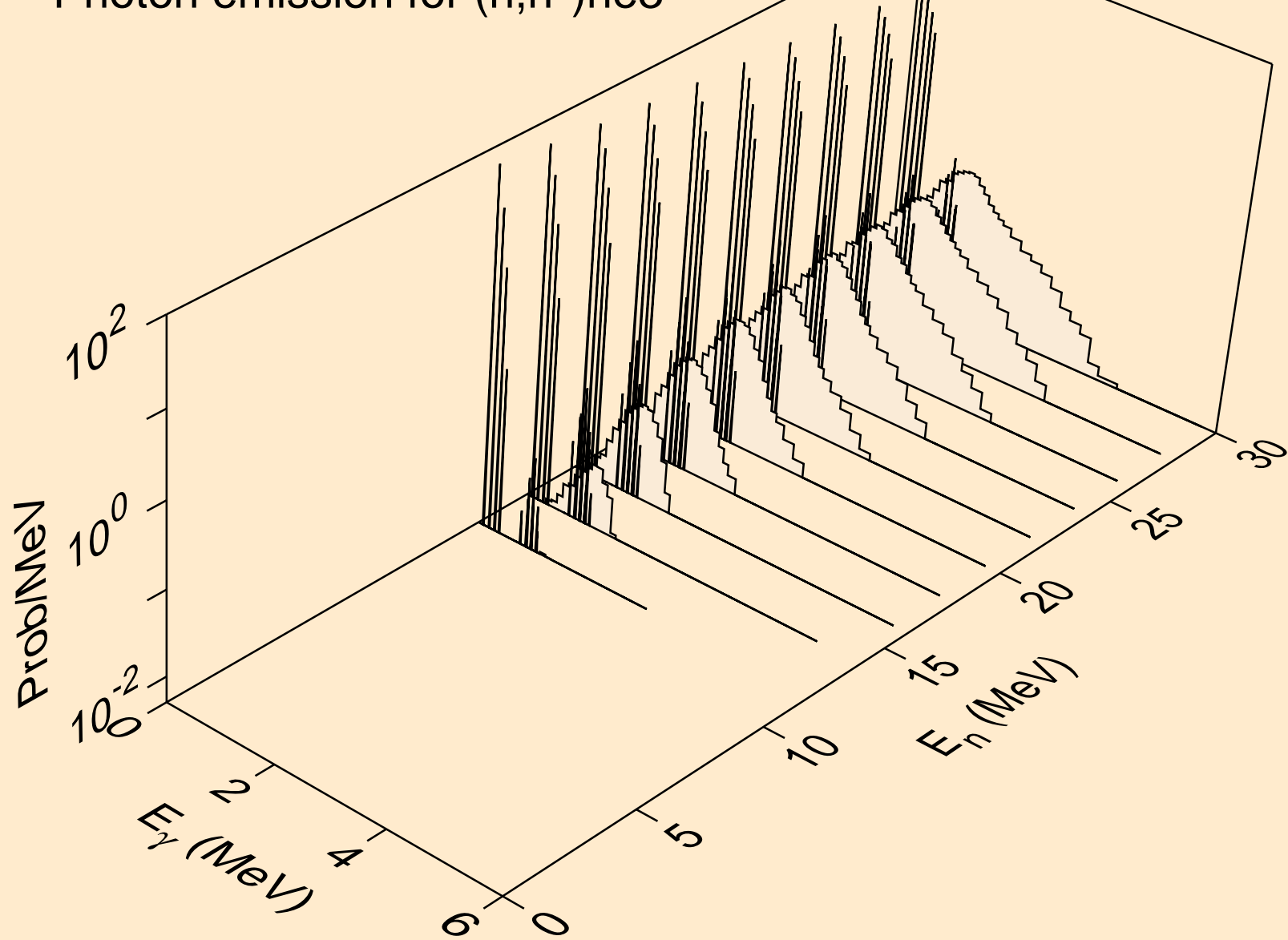

LU169M TRITON ACER TENDL-2021 LIBRARY; T=0.K  
Photon emission for (n,4n)

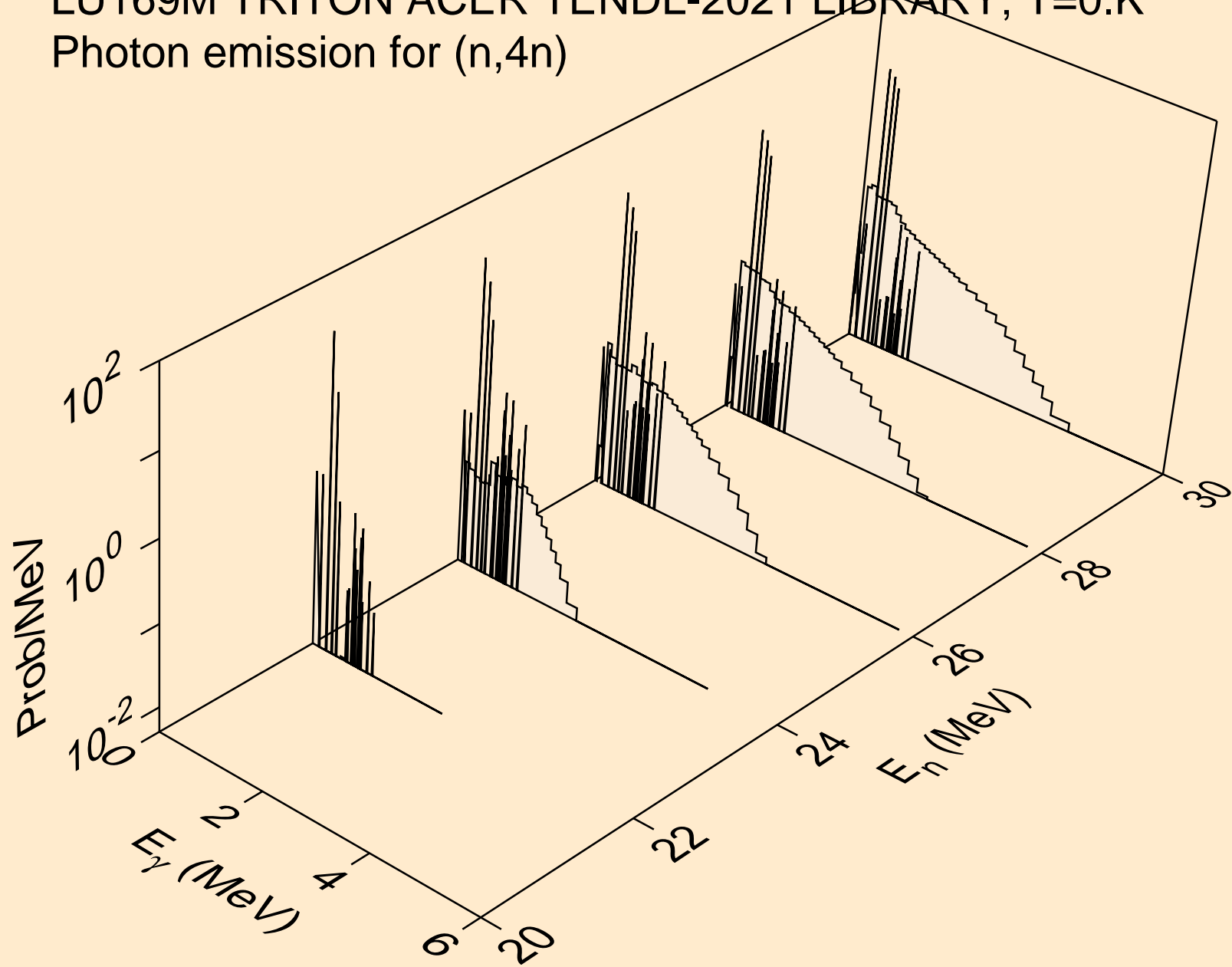

LU169M TRITON ACER TENDL-2021 LIBRARY; T=0.K  
Photon emission for (n,2np)

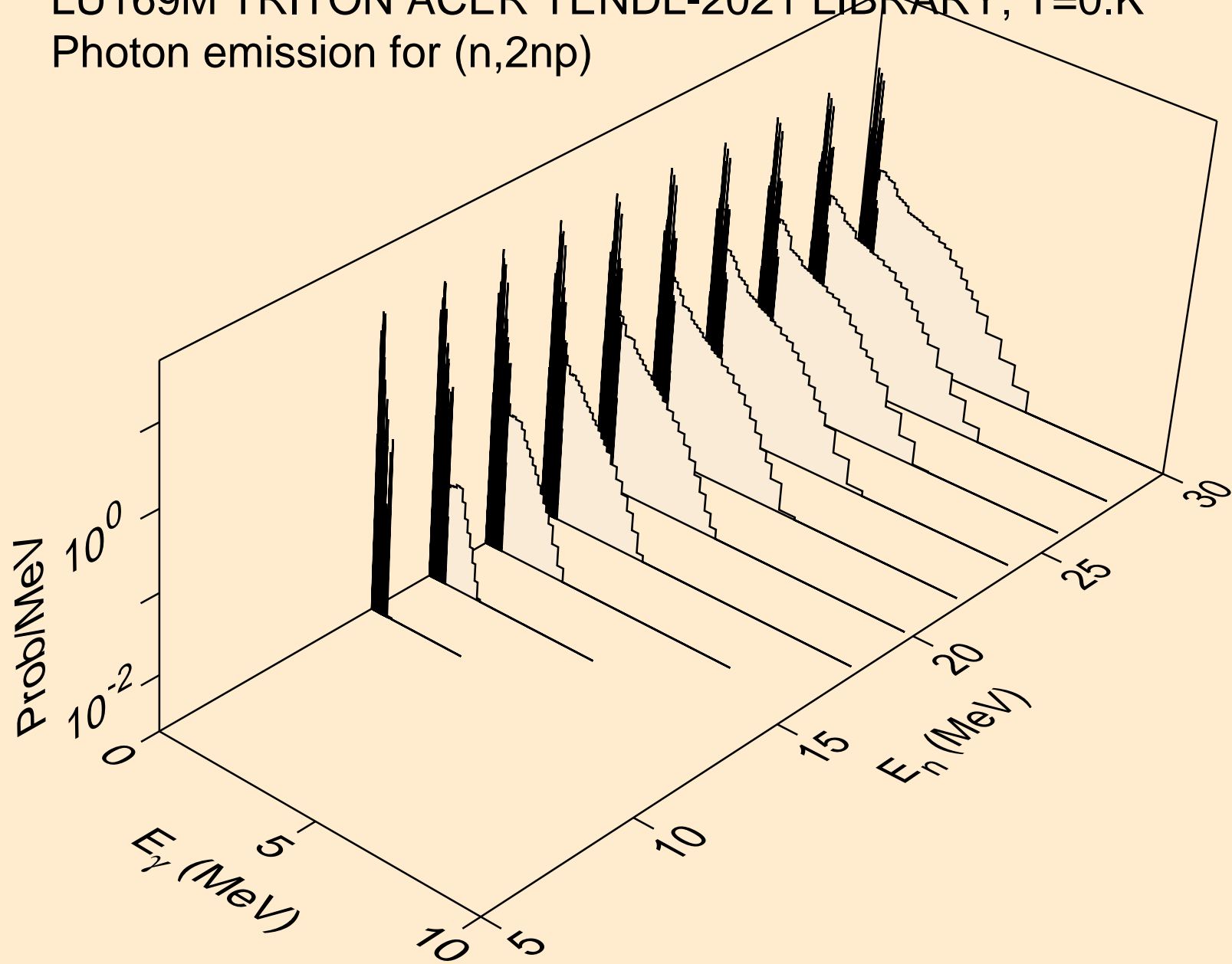

LU169M TRITON ACER TENDL-2021 LIBRARY; T=0.K  
Photon emission for (n,3np)

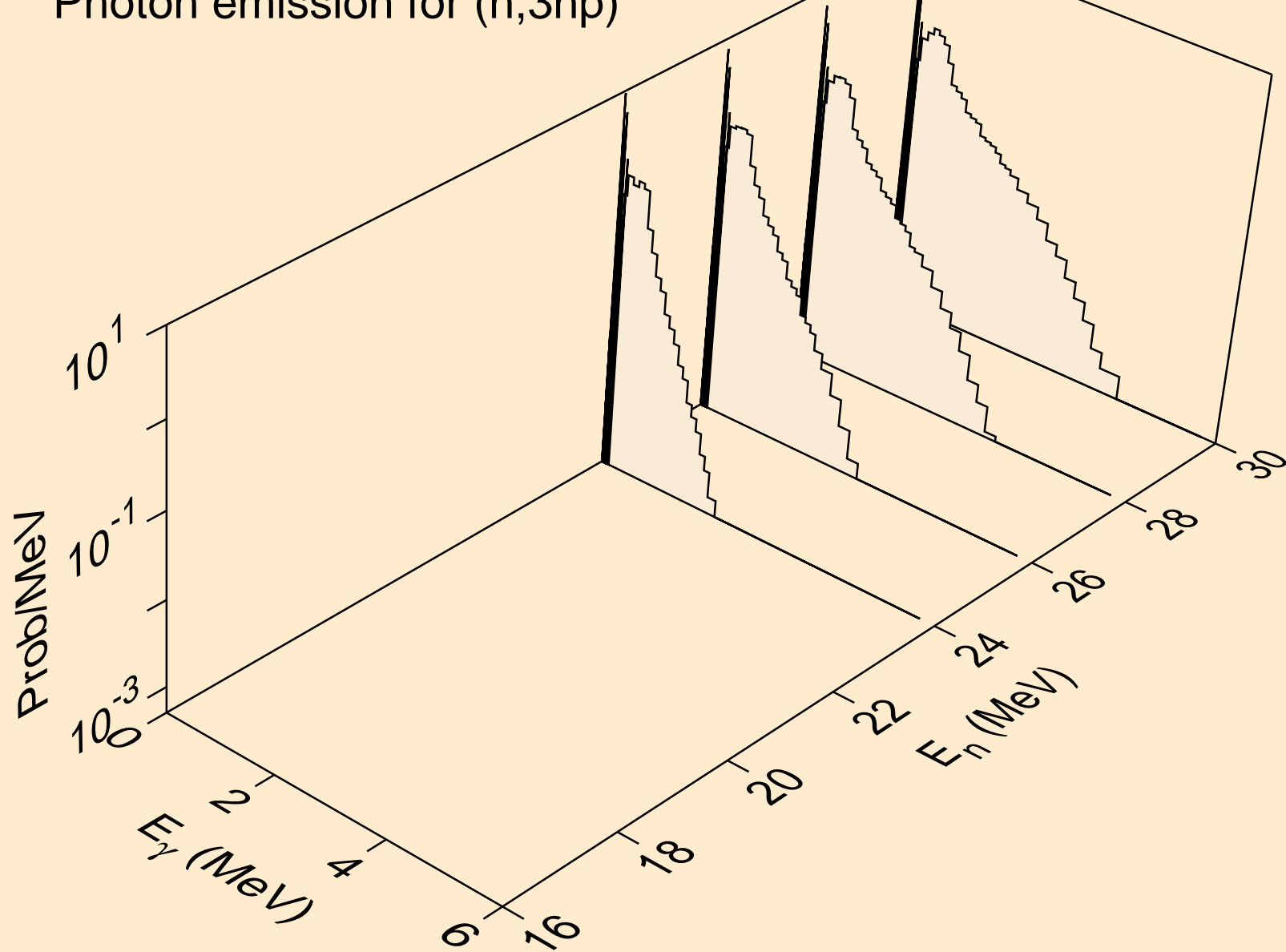

LU169M TRITON ACER TENDL-2021 LIBRARY; T=0.K  
Photon emission for (n,2np)

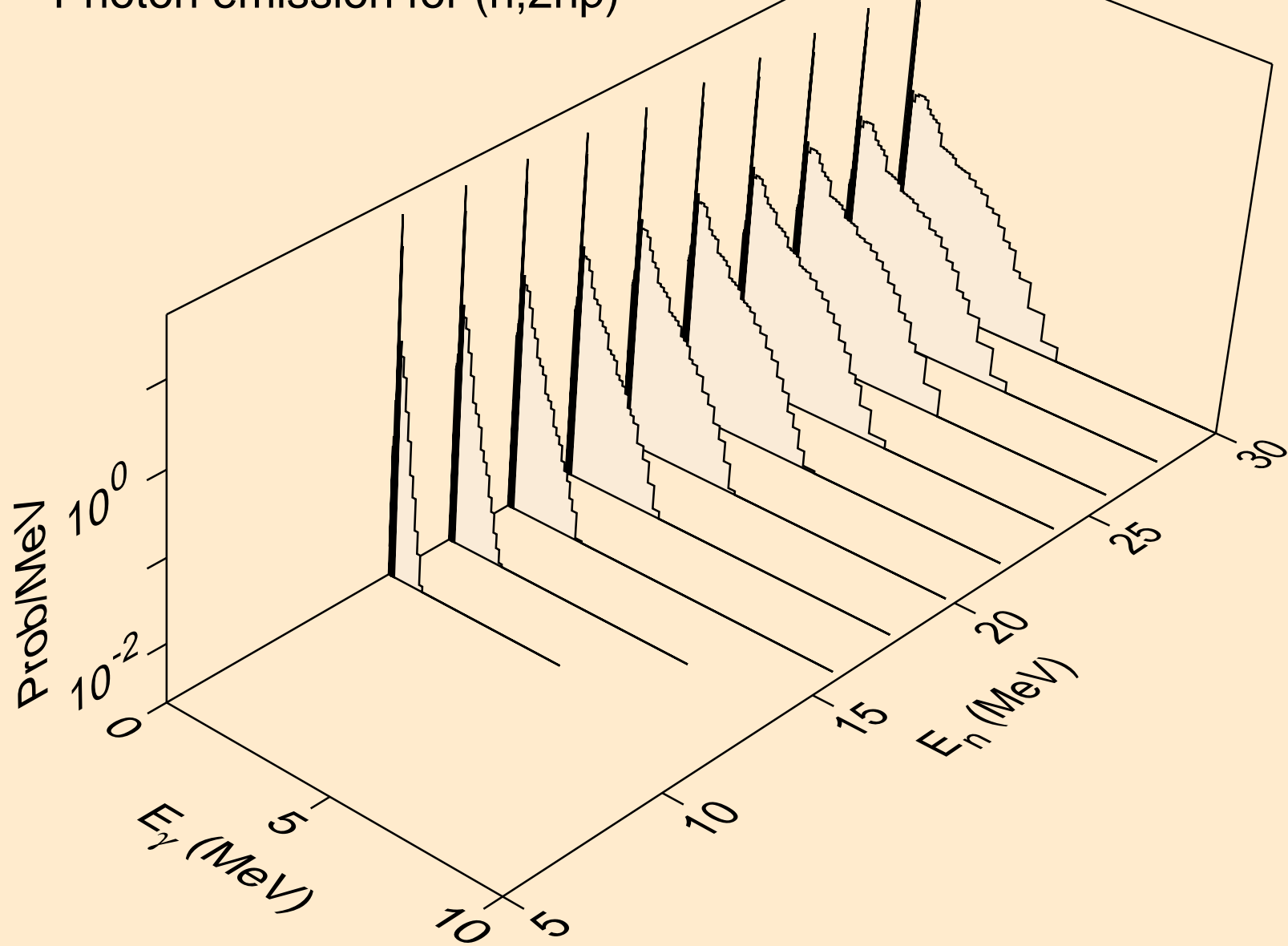

LU169M TRITON ACER TENDL-2021 LIBRARY; T=0.K  
Photon emission for (n,npa)

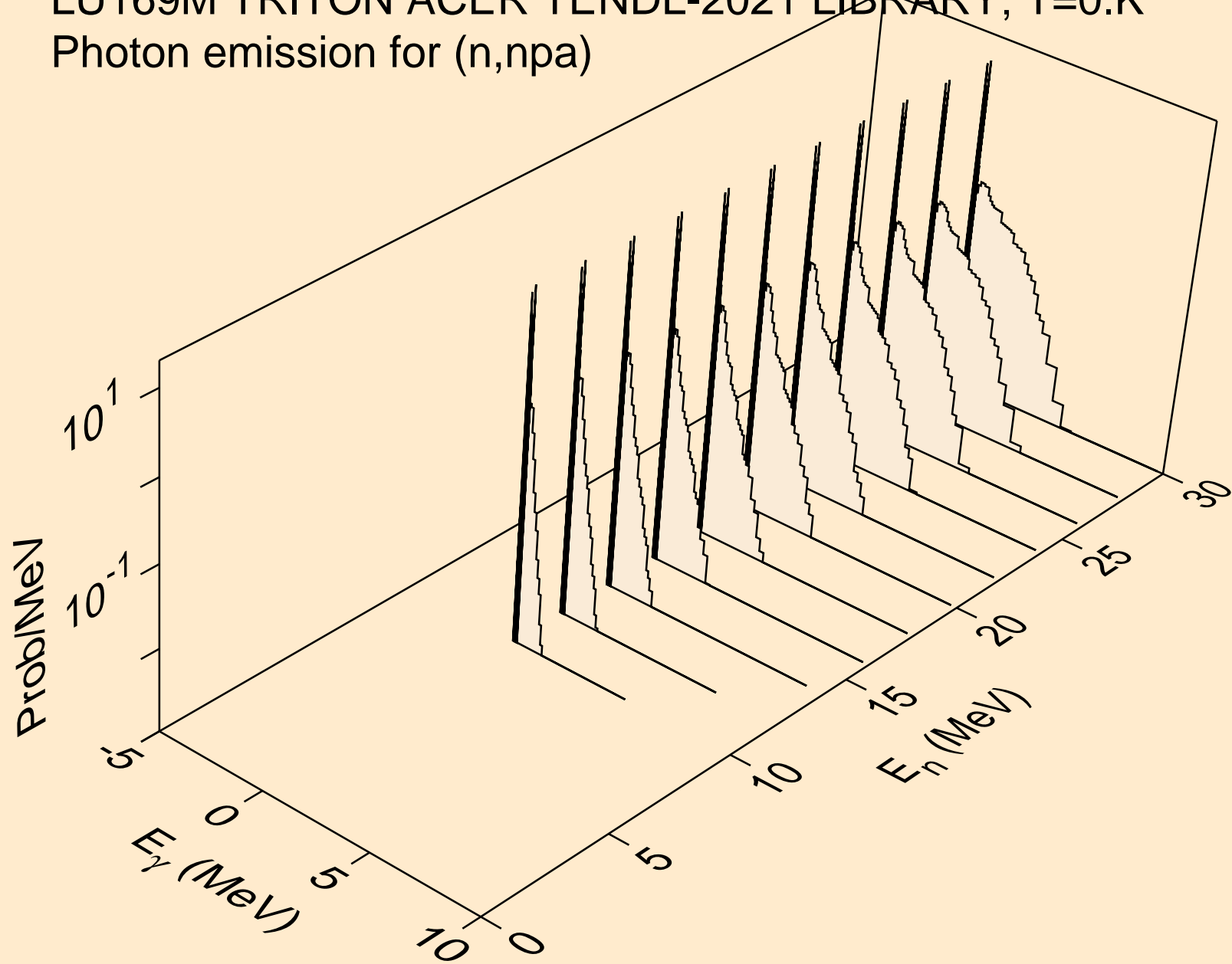



LU169M TRITON ACER TENDL-2021 LIBRARY; T=0.K  
Photon emission for (n,gma)

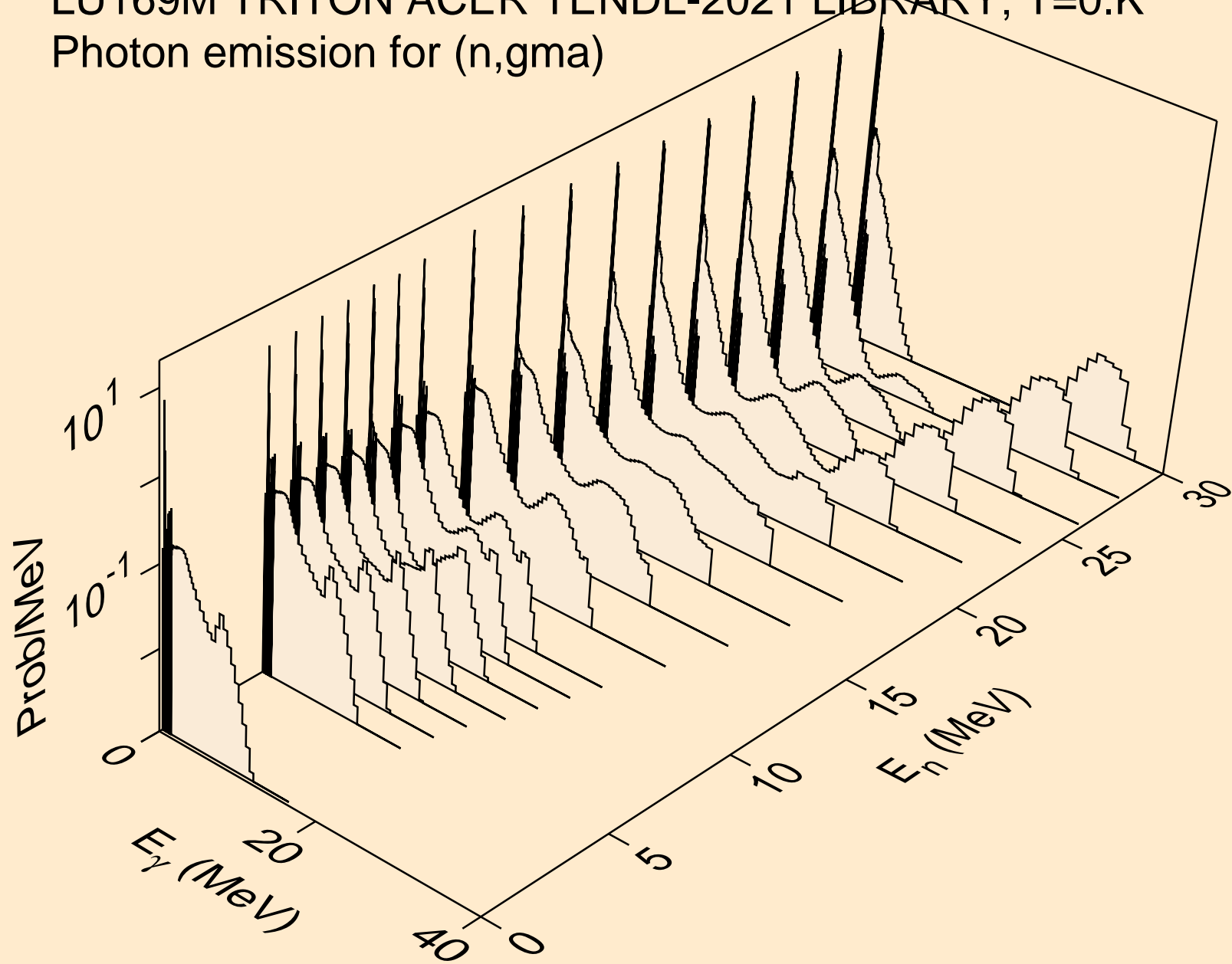

LU169M TRITON ACER TENDL-2021 LIBRARY; T=0.K  
Photon emission for (n,p)

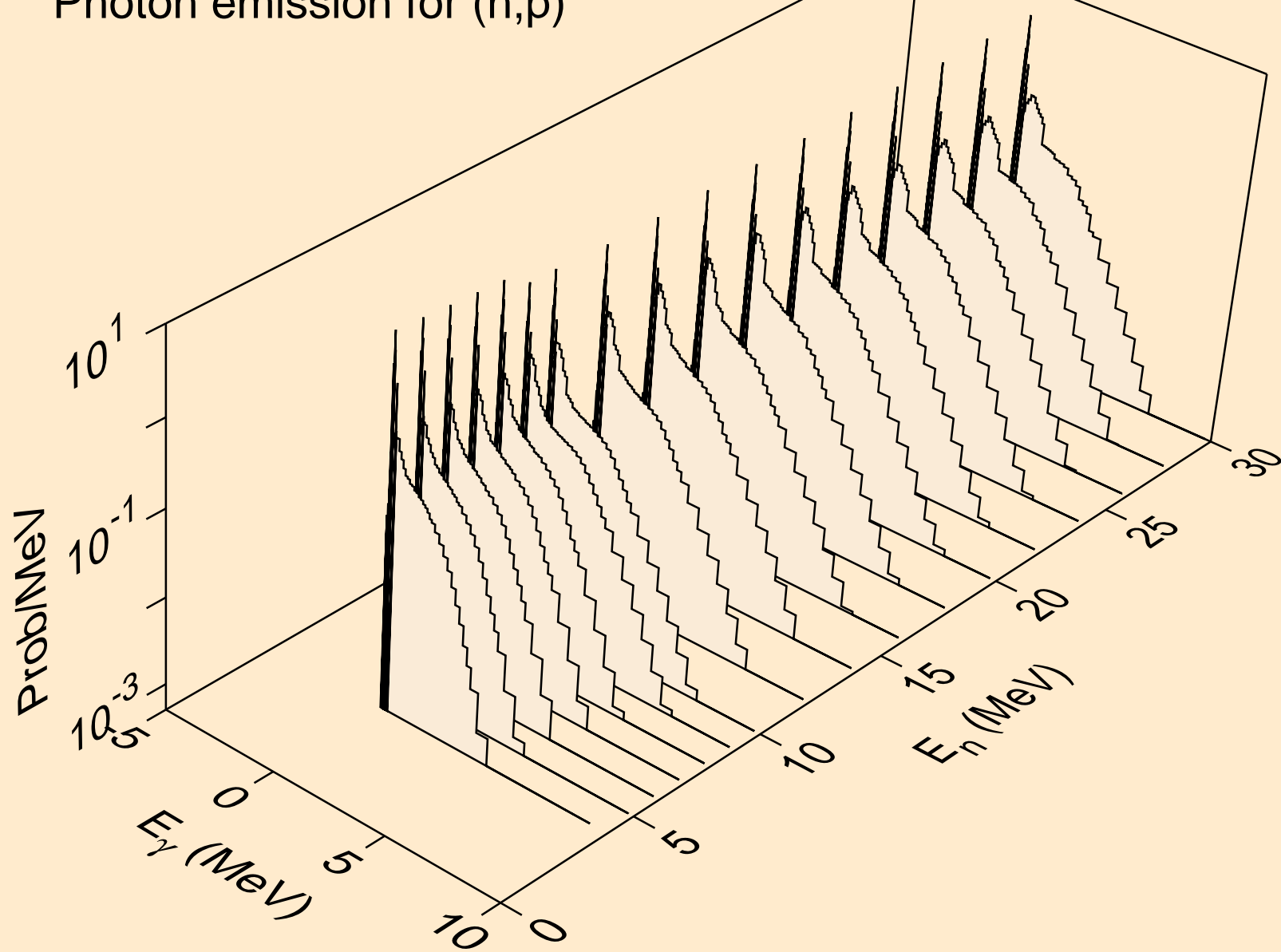

LU169M TRITON ACER TENDL-2021 LIBRARY; T=0.K  
Photon emission for (n,d)

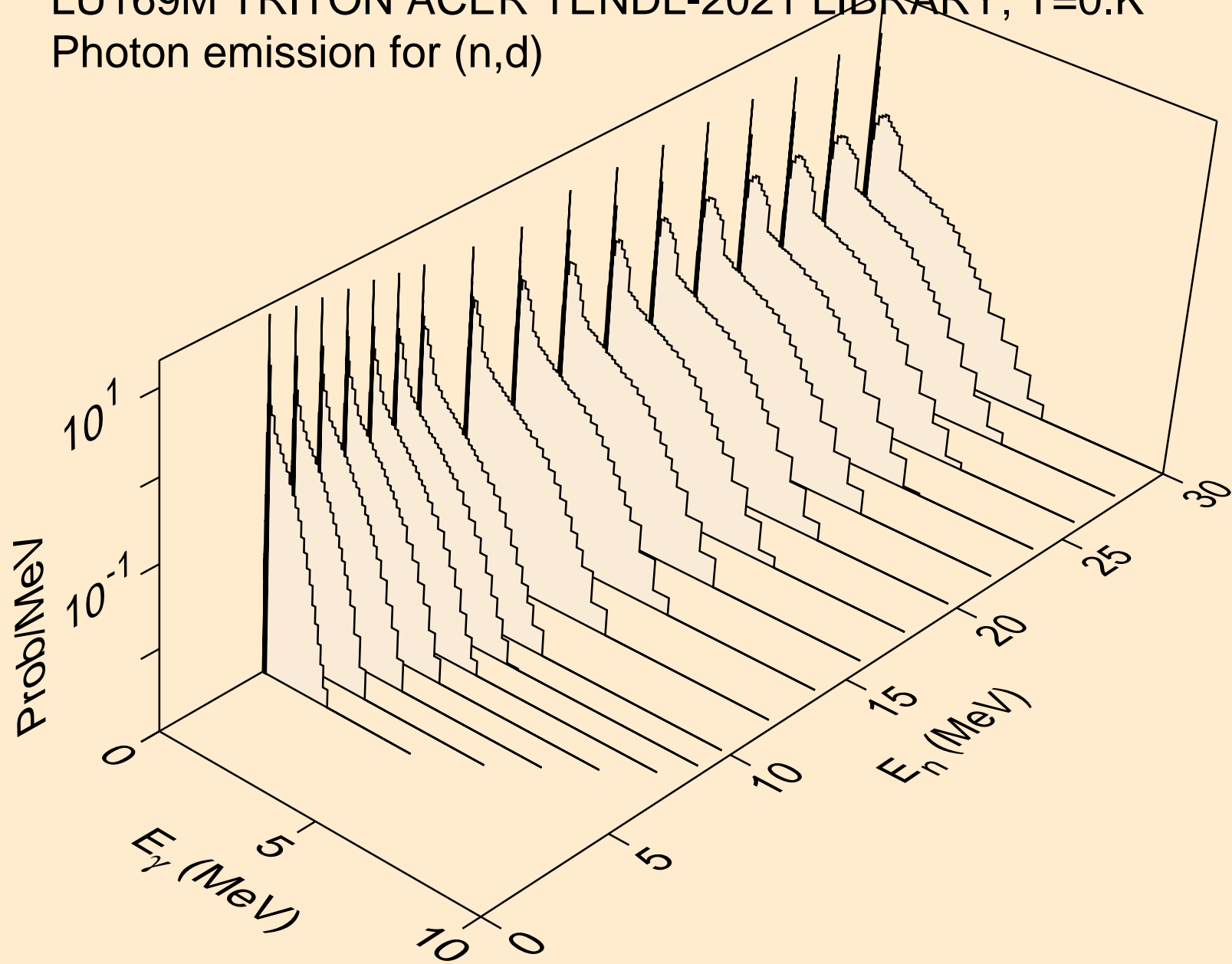

LU169M TRITON ACER TENDL-2021 LIBRARY; T=0.K  
Photon emission for inelastic

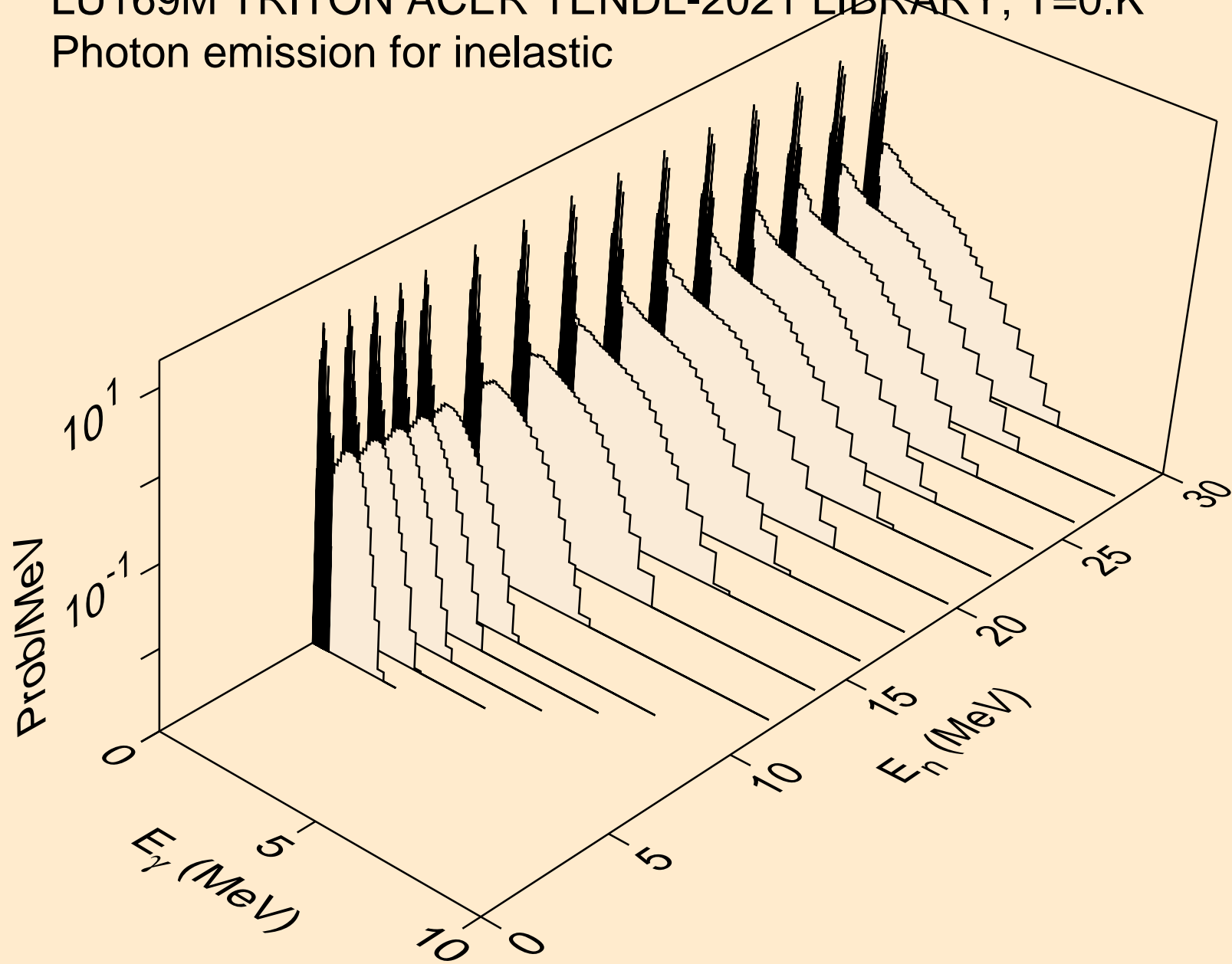

LU169M TRITON ACER TENDL-2021 LIBRARY; T=0.K  
Photon emission for (n,he3)

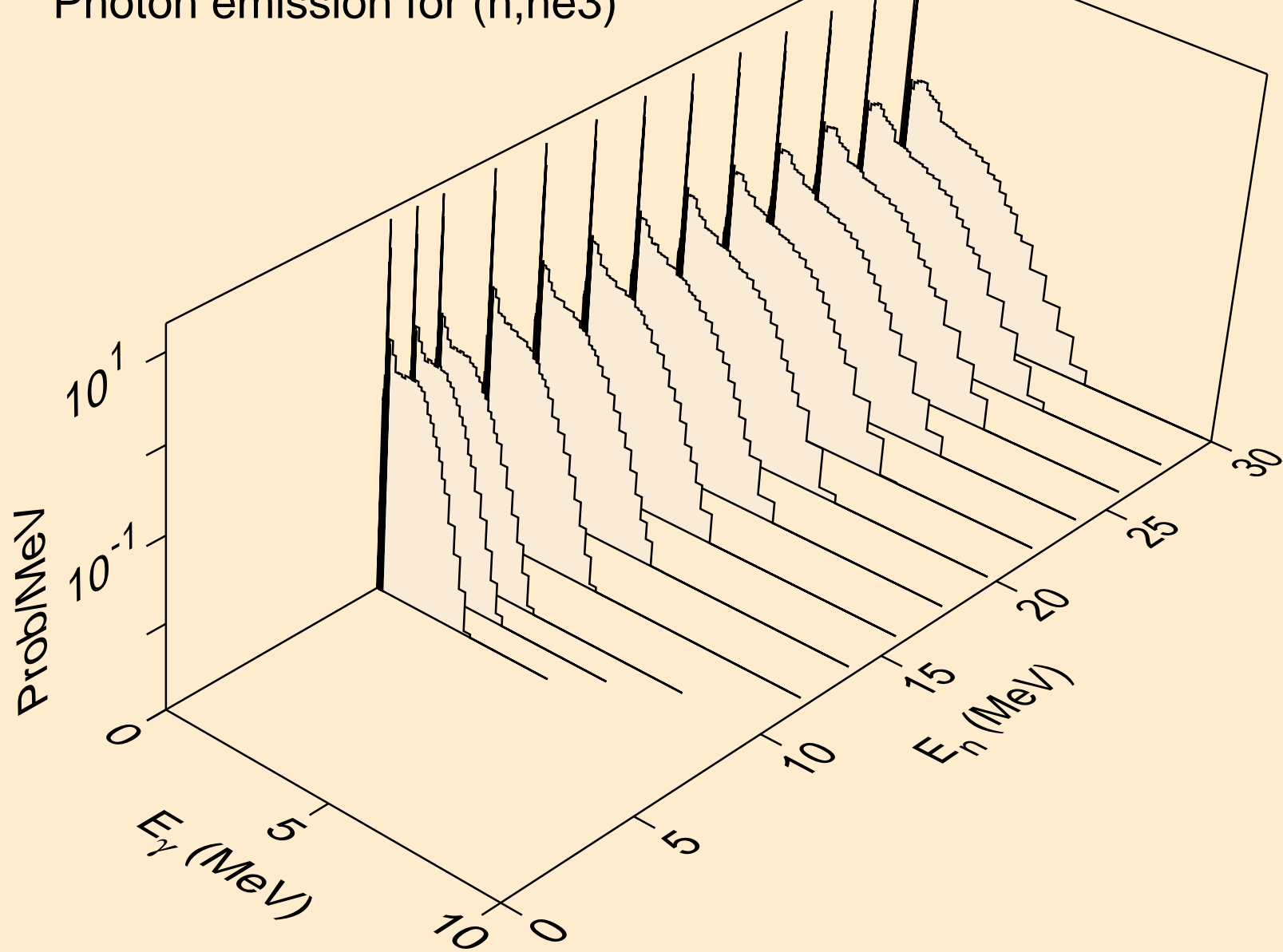

LU169M TRITON ACER TENDL-2021 LIBRARY; T=0.K  
Photon emission for (n,a)

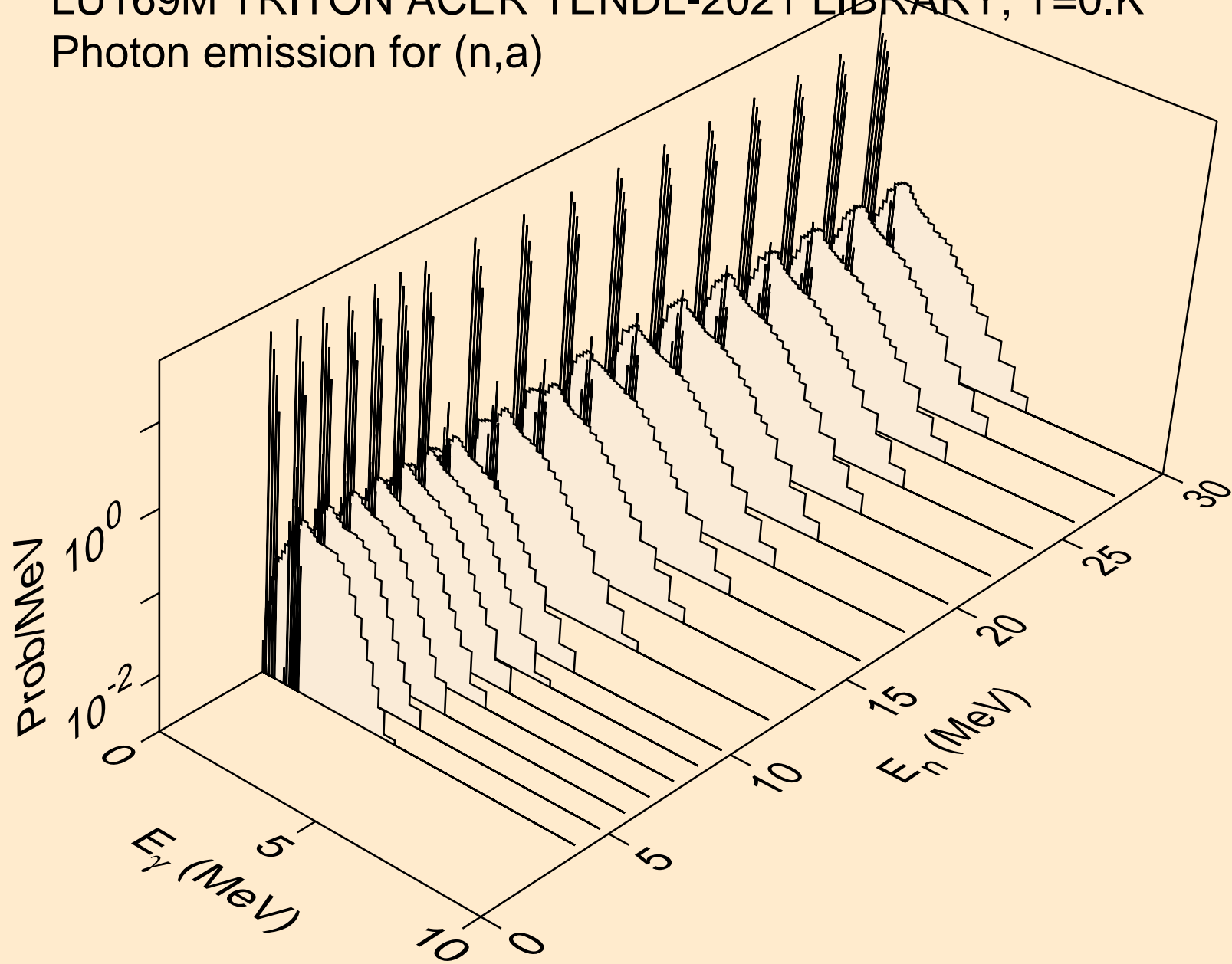

LU169M TRITON ACER TENDL-2021 LIBRARY; T=0.K  
Photon emission for (n,2a)

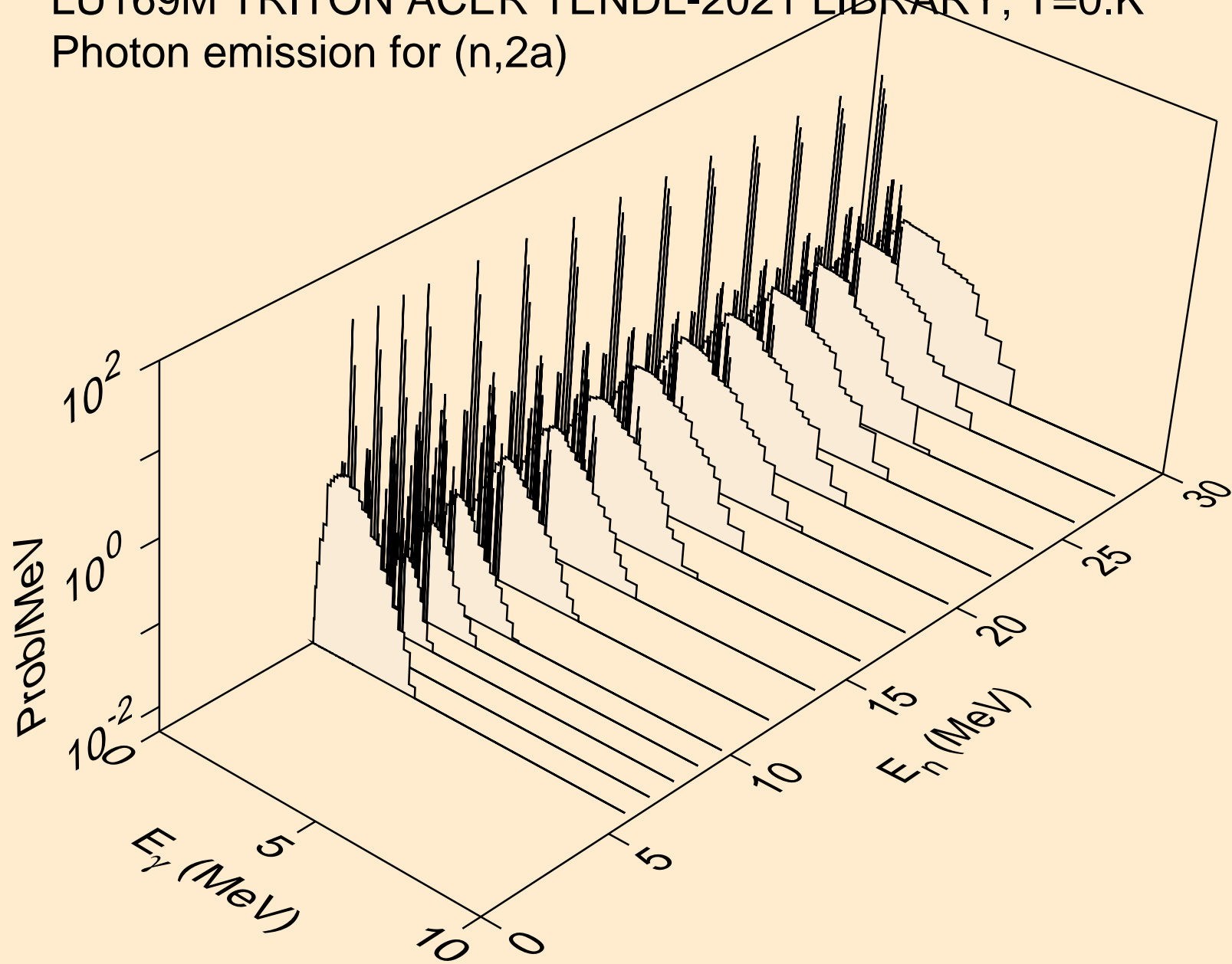

LU169M TRITON ACER TENDL-2021 LIBRARY; T=0.K  
Photon emission for (n,2p)

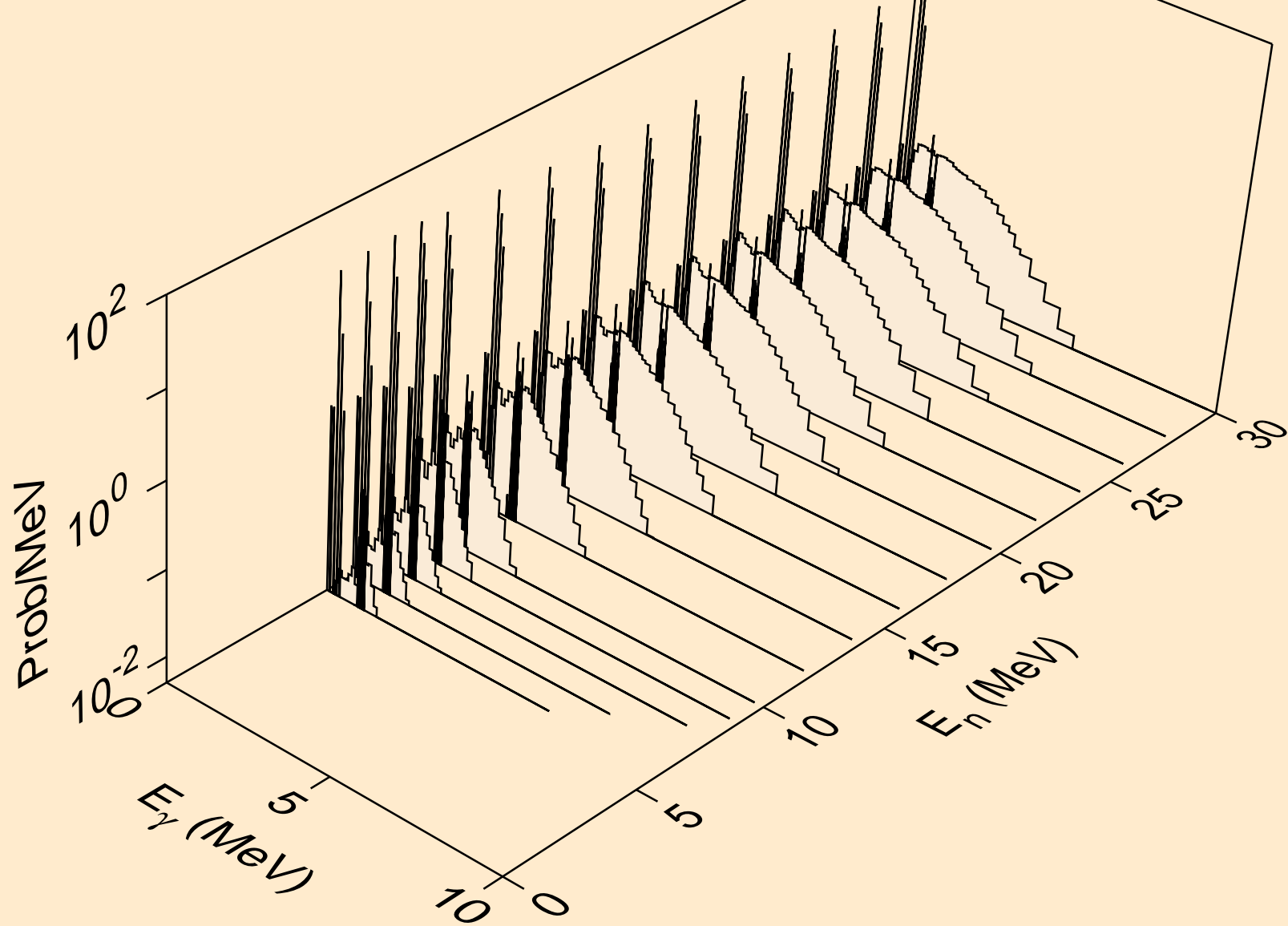



LU169M TRITON ACER TENDL-2021 LIBRARY; T=0.K  
Photon emission for (n,pa)

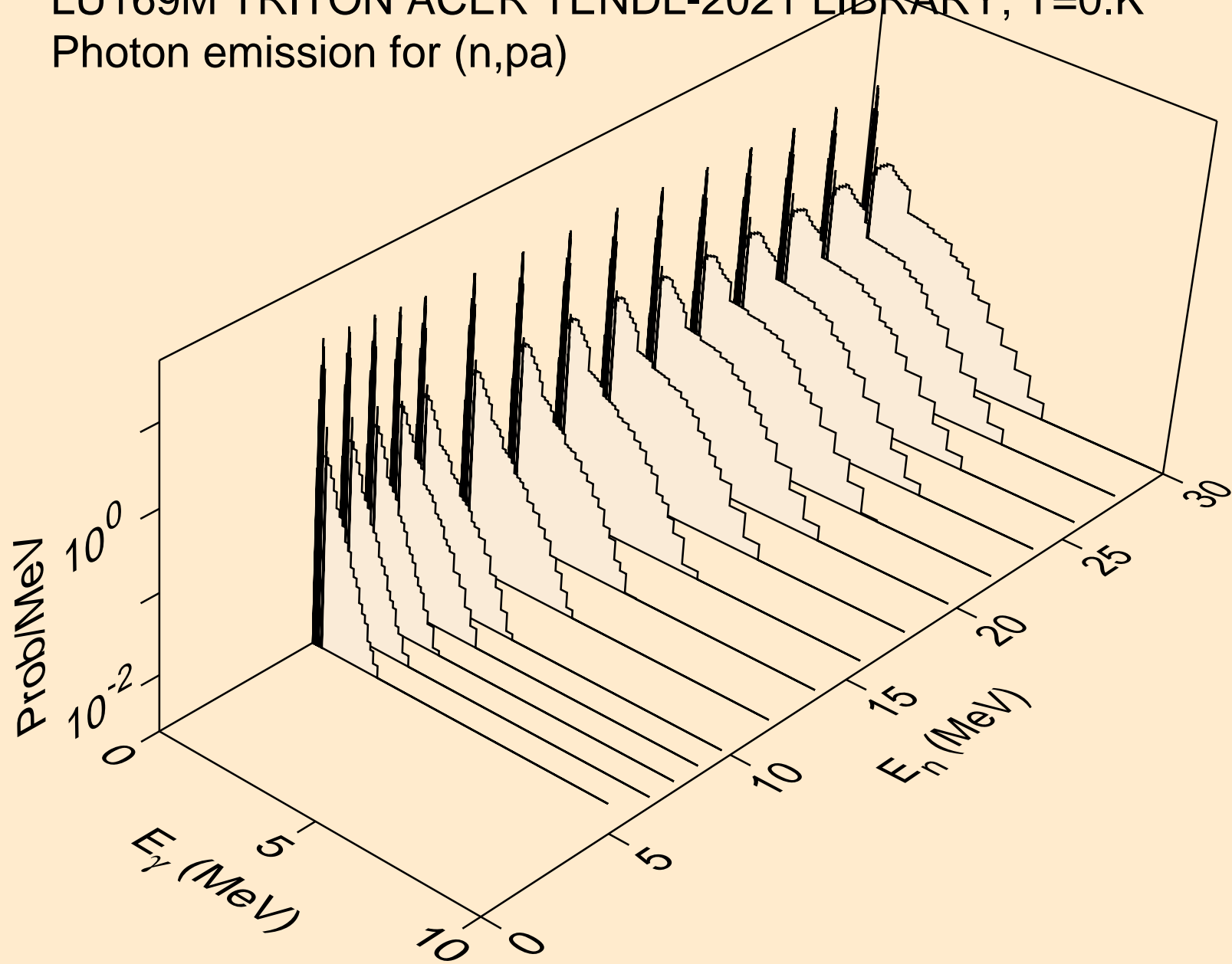

LU169M TRITON ACER TENDL-2021 LIBRARY; T=0.K  
Photon emission for (n,pd)

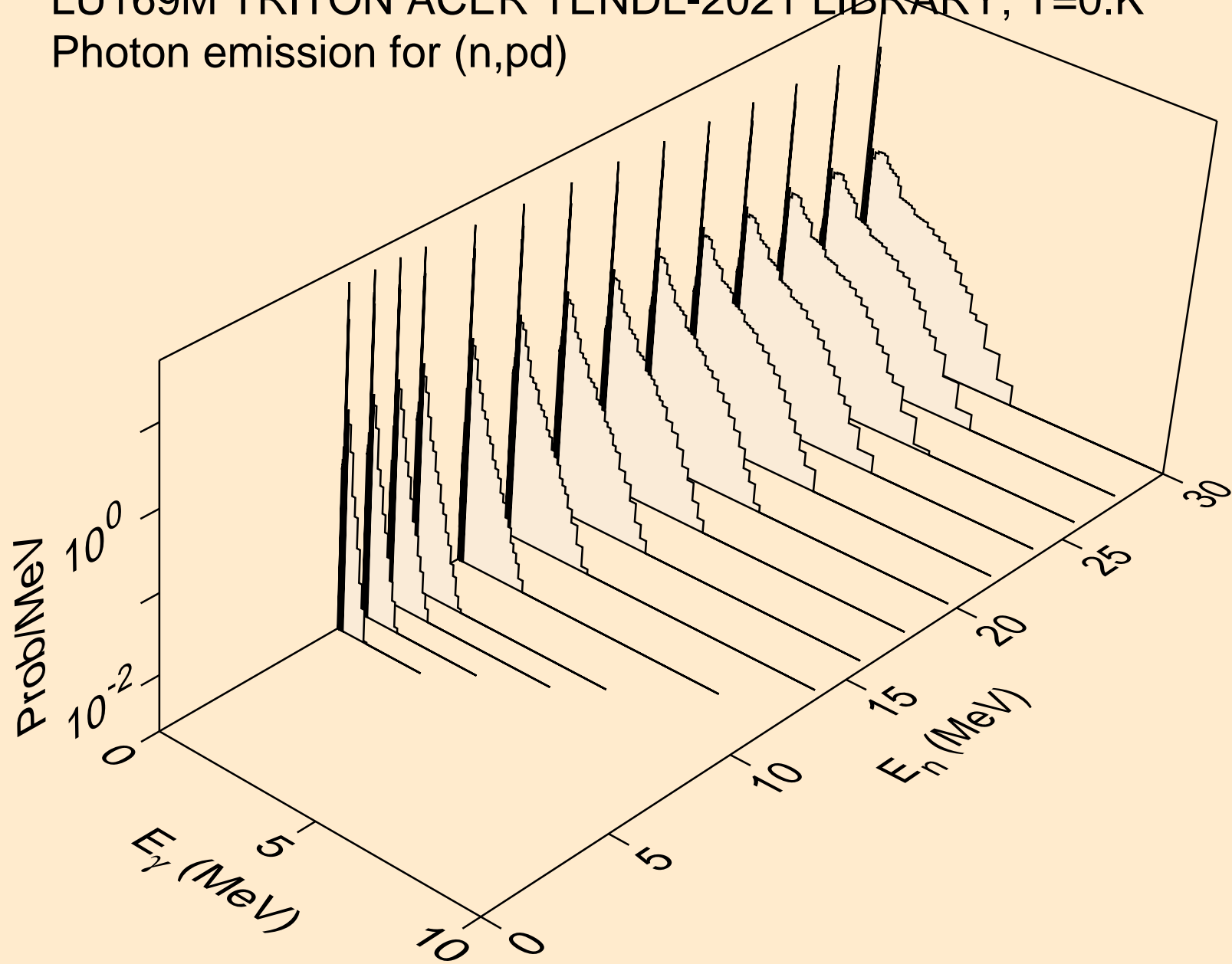

LU169M TRITON ACER TENDL-2021 LIBRARY; T=0.K  
Photon emission for (n,pt)

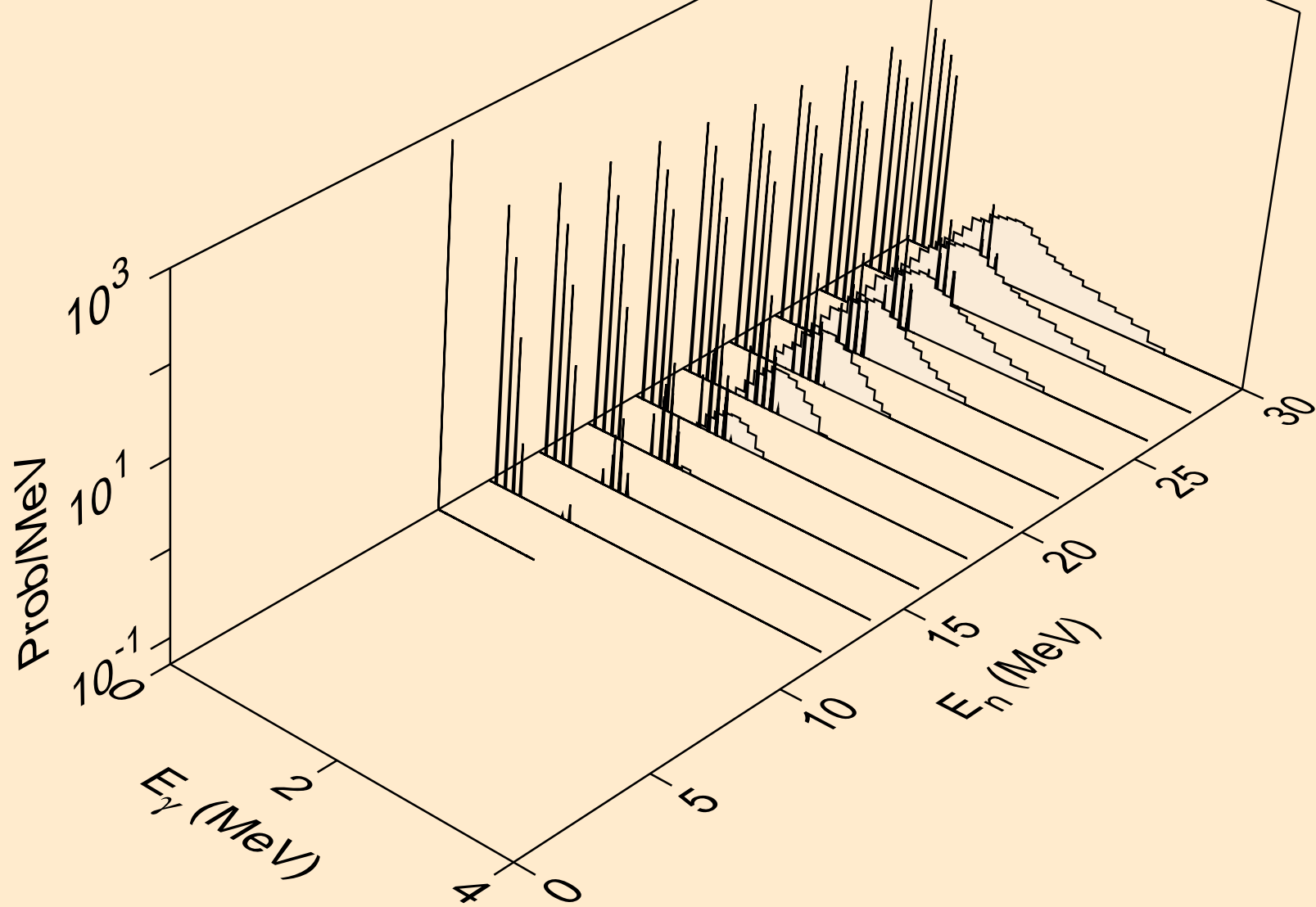

LU169M TRITON ACER TENDL-2021 LIBRARY; T=0.K  
Photon emission for (n,da)

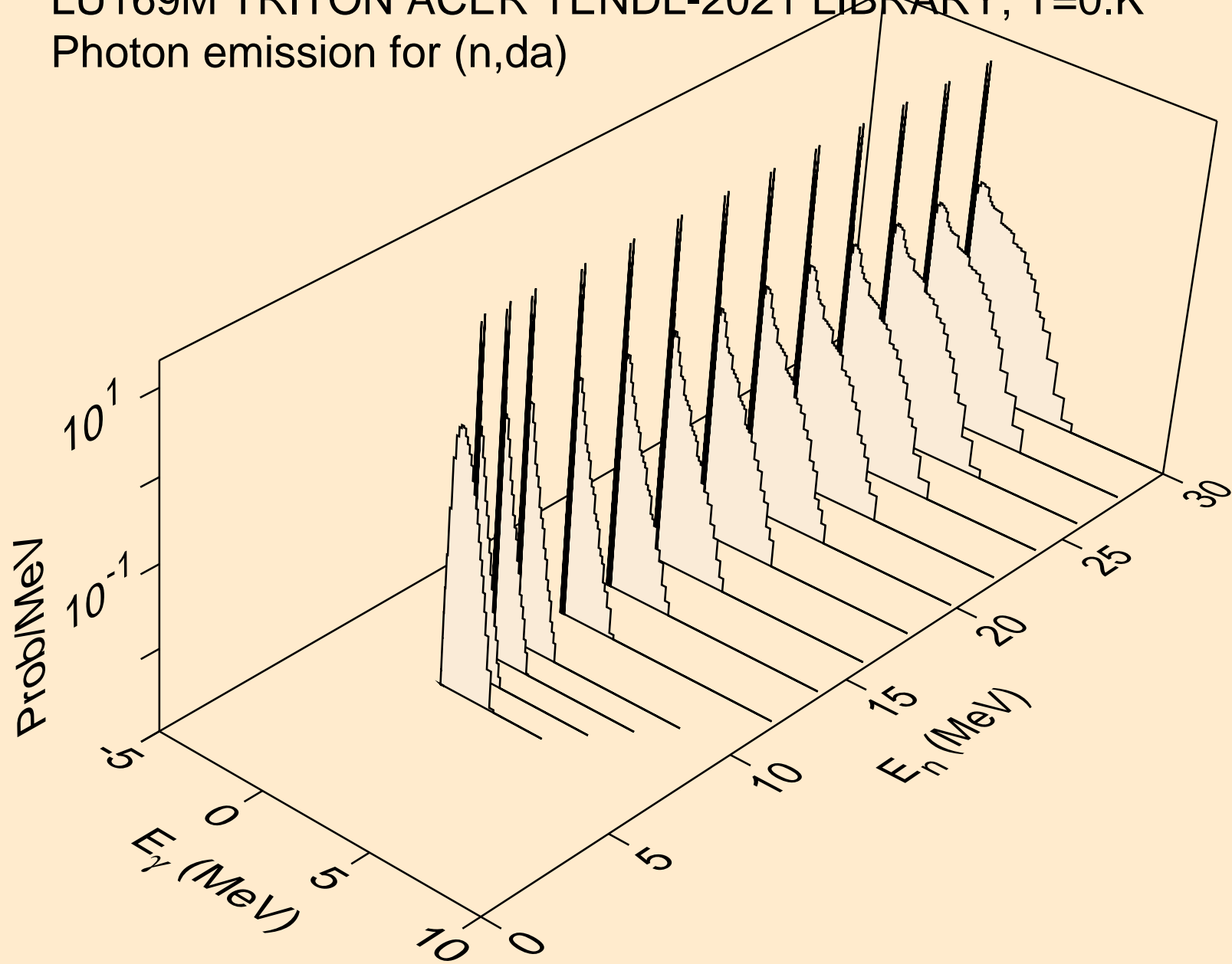

LU169M TRITON ACER TENDL-2021 LIBRARY; T=0.K  
Particle heating contributions

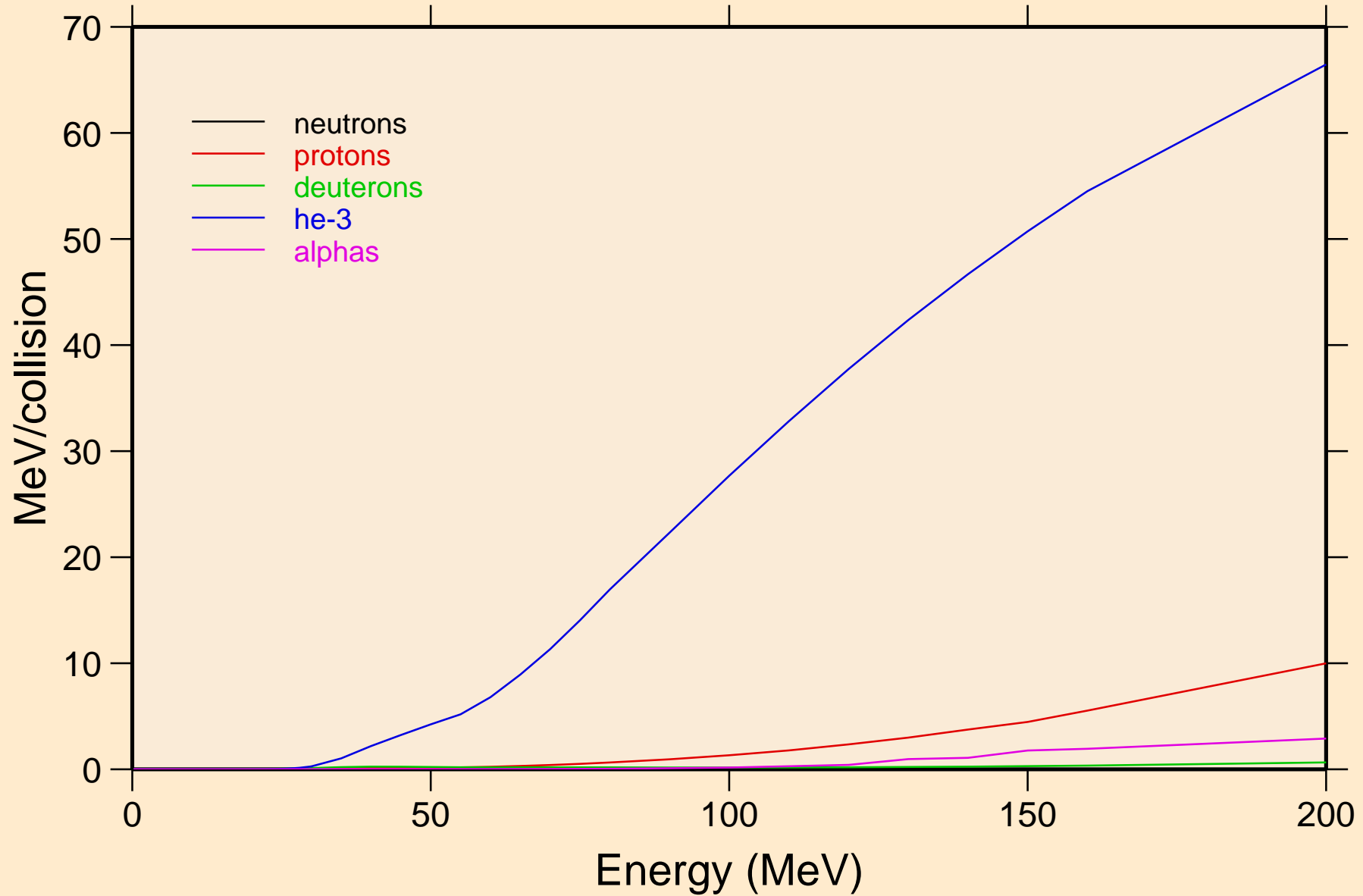

LU169M TRITON ACER TENDL-2021 LIBRARY; T=0.K  
Recoil Heating

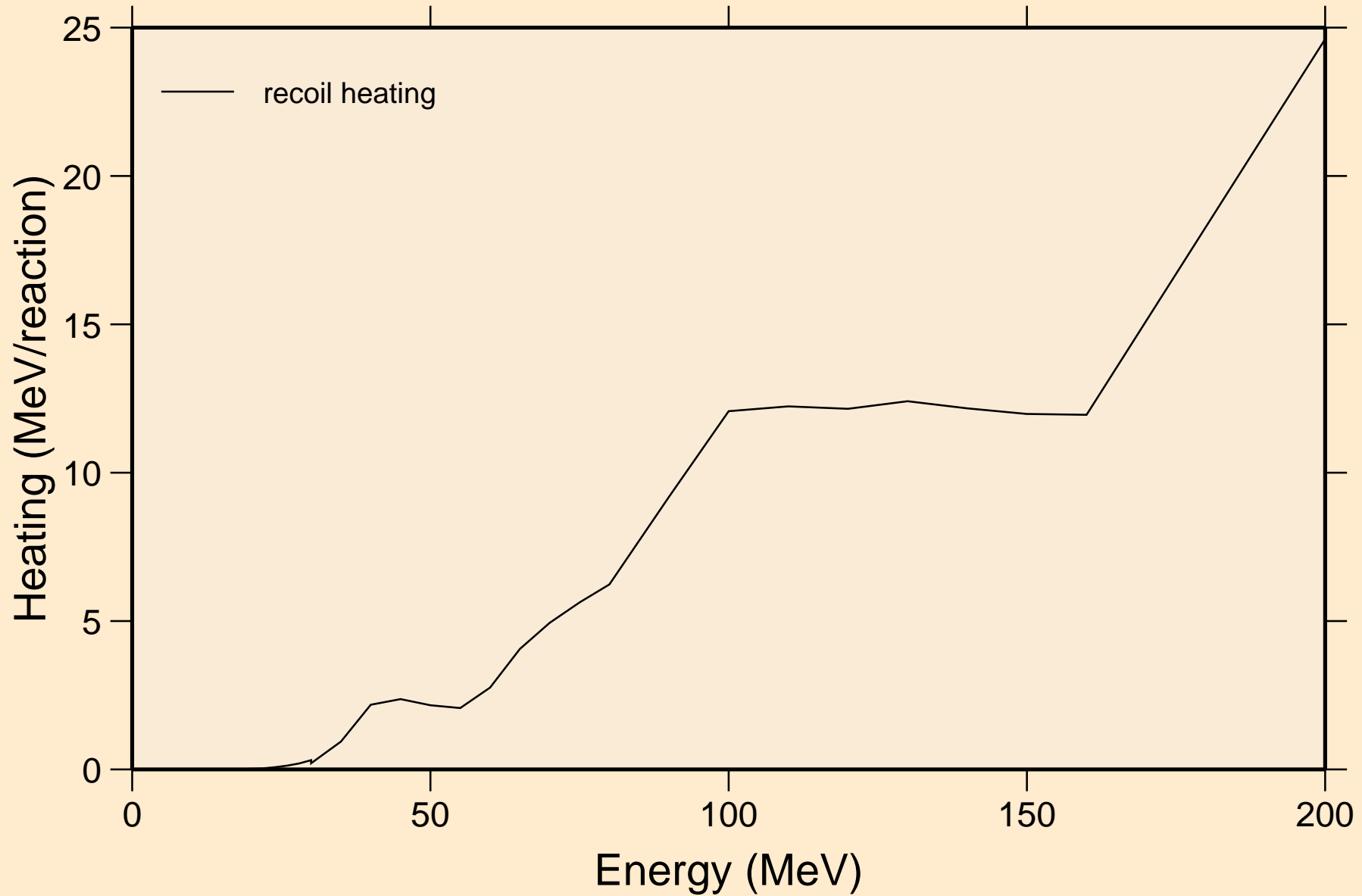

LU169M TRITON ACER TENDL-2021 LIBRARY; T=0.K  
Particle production cross sections

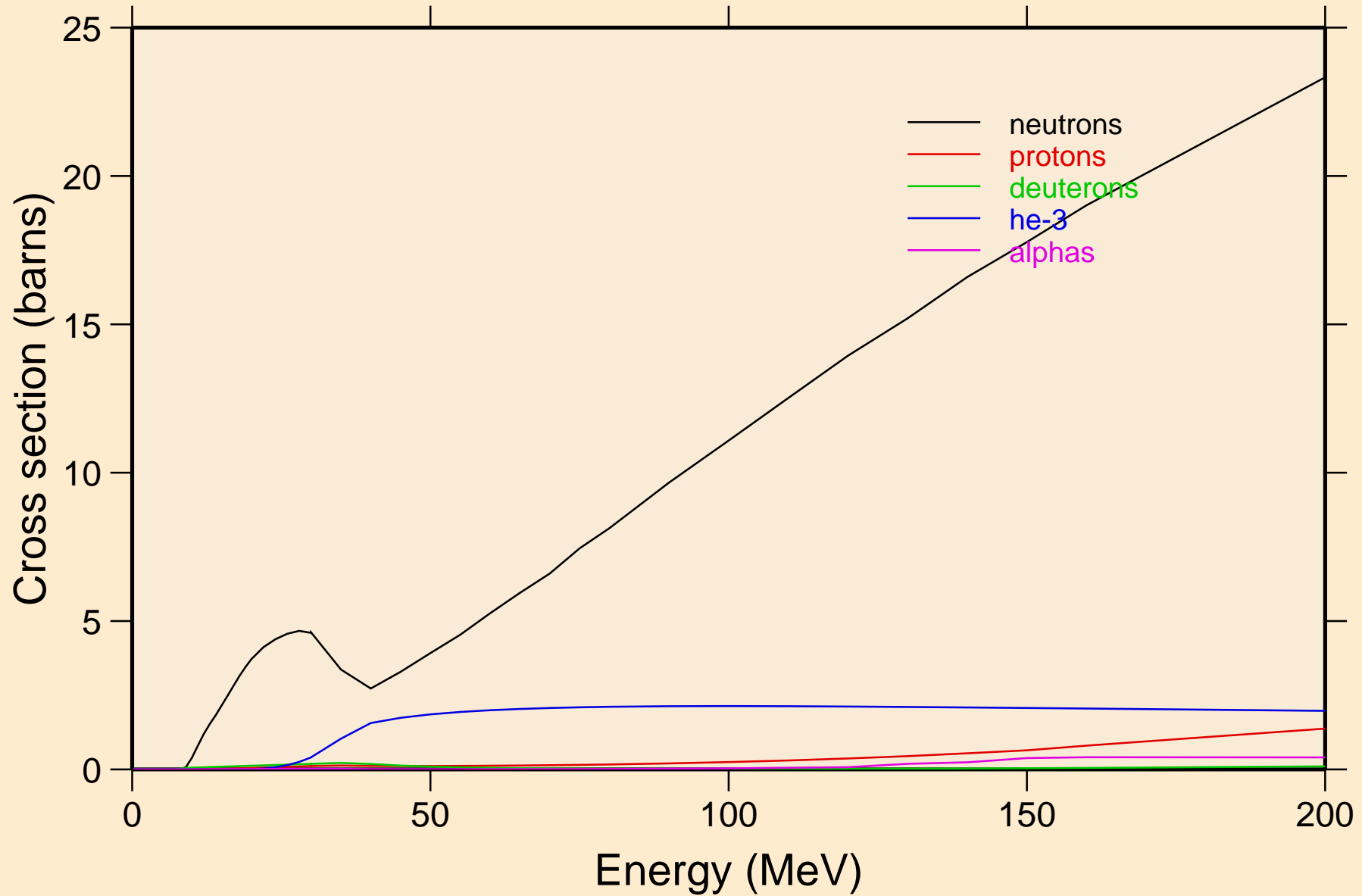

LU169M TRITON ACER TENDL-2021 LIBRARY; T=0.K  
neutrons from (t,n)

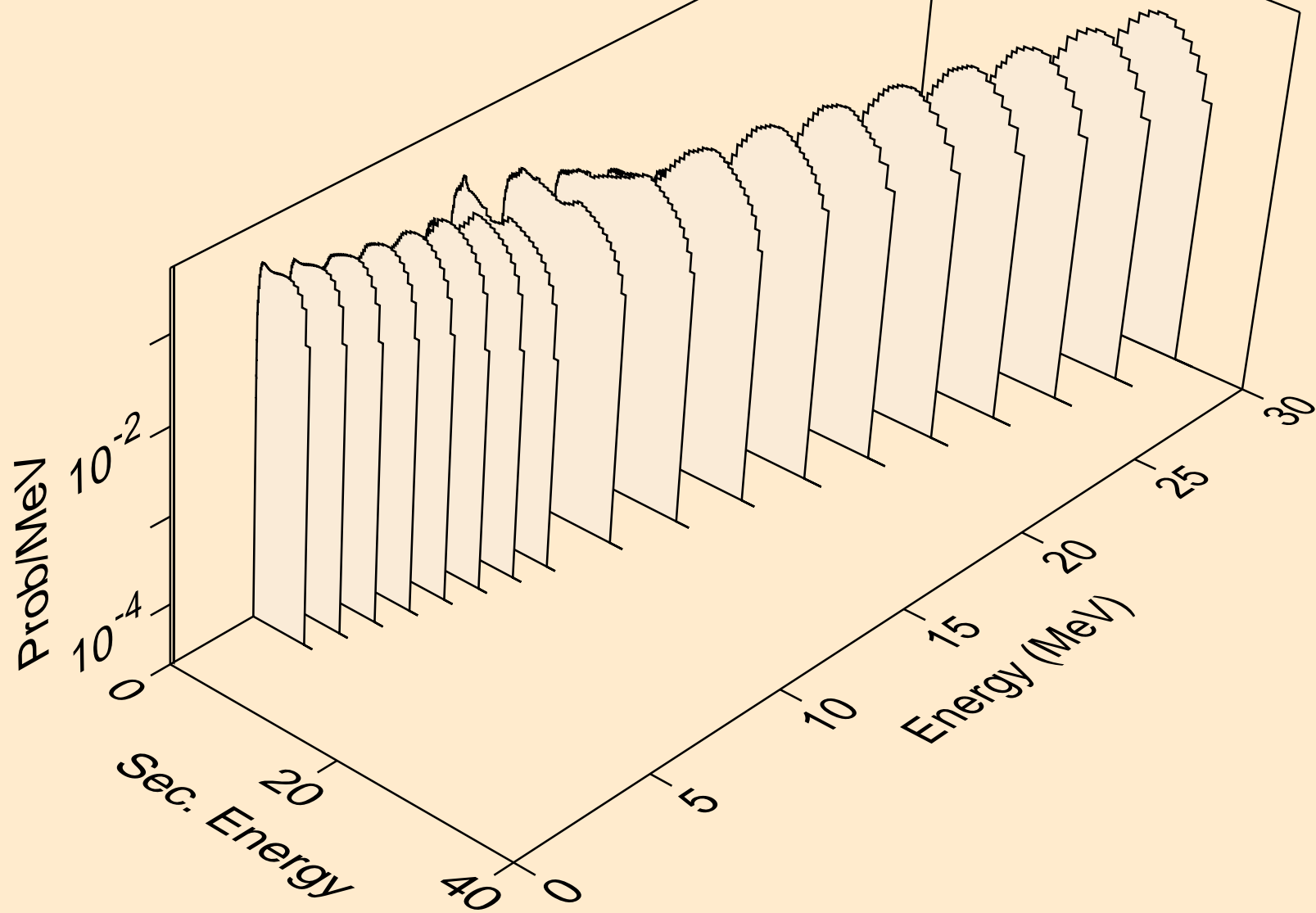



LU169M TRITON ACER TENDL-2021 LIBRARY; T=0.K  
neutrons from (t,x)

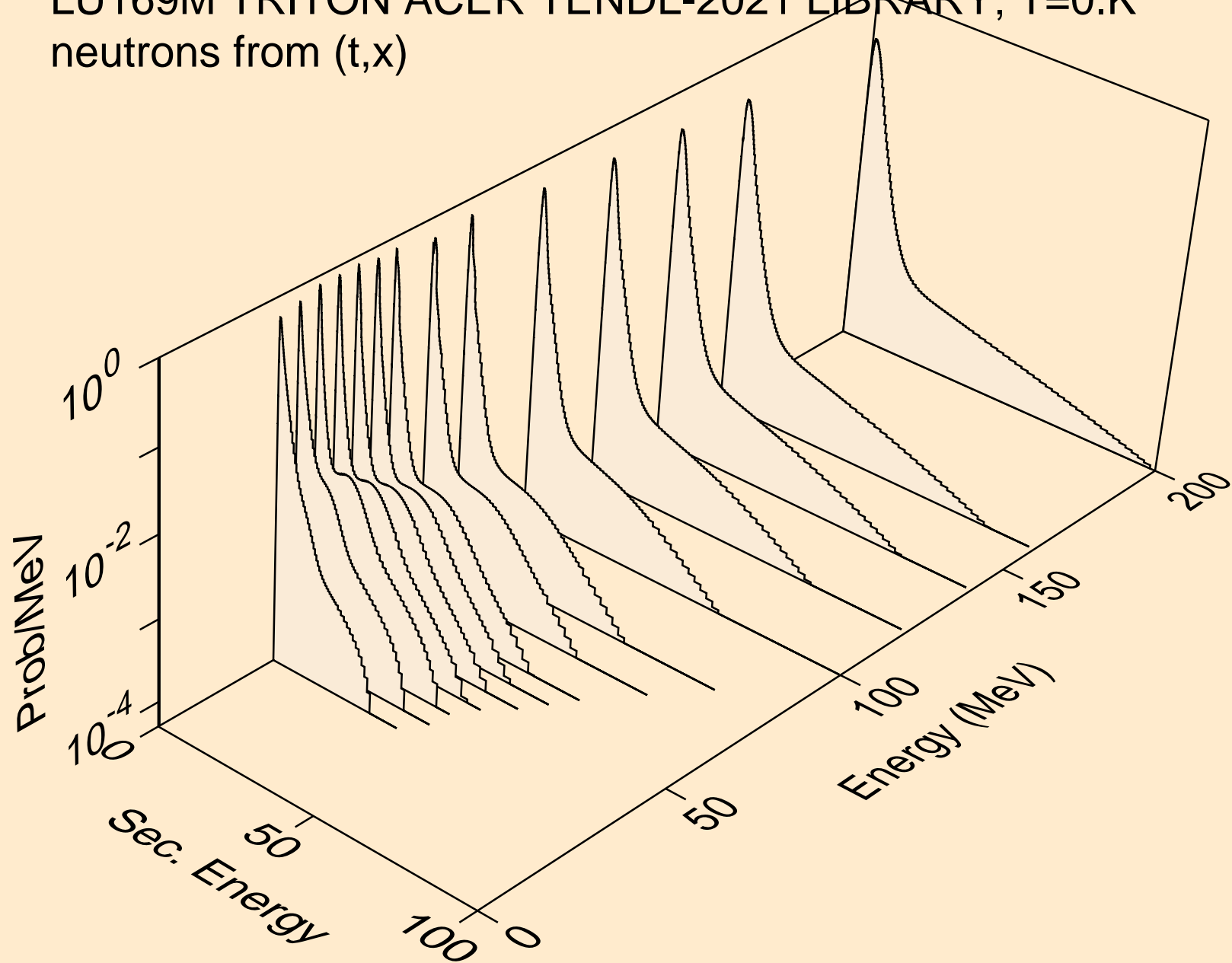

LU169M TRITON ACER TENDL-2021 LIBRARY; T=0.K  
neutrons from (t,2nd)

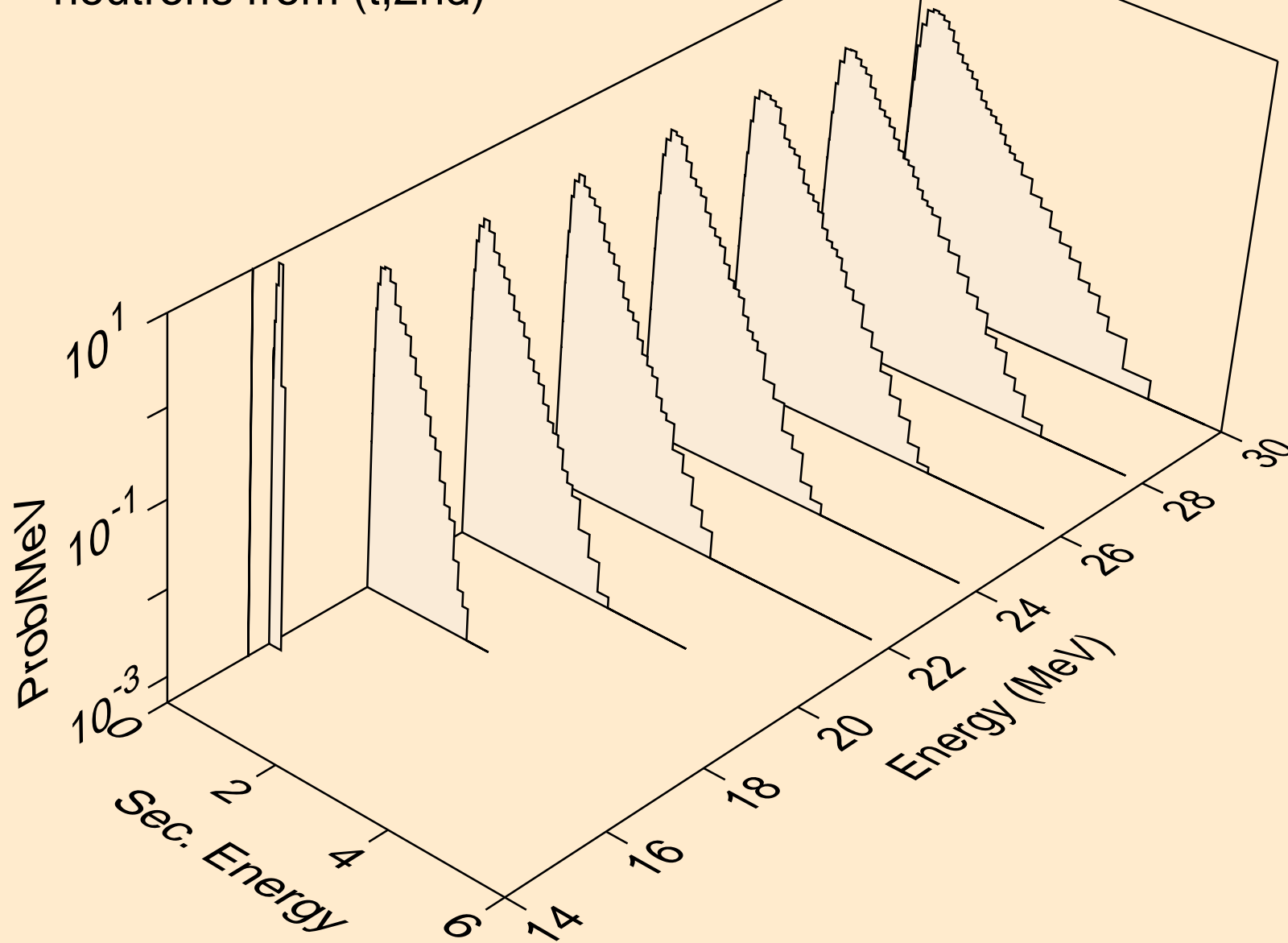

LU169M TRITON ACER TENDL-2021 LIBRARY; T=0.K  
neutrons from (t,2n)

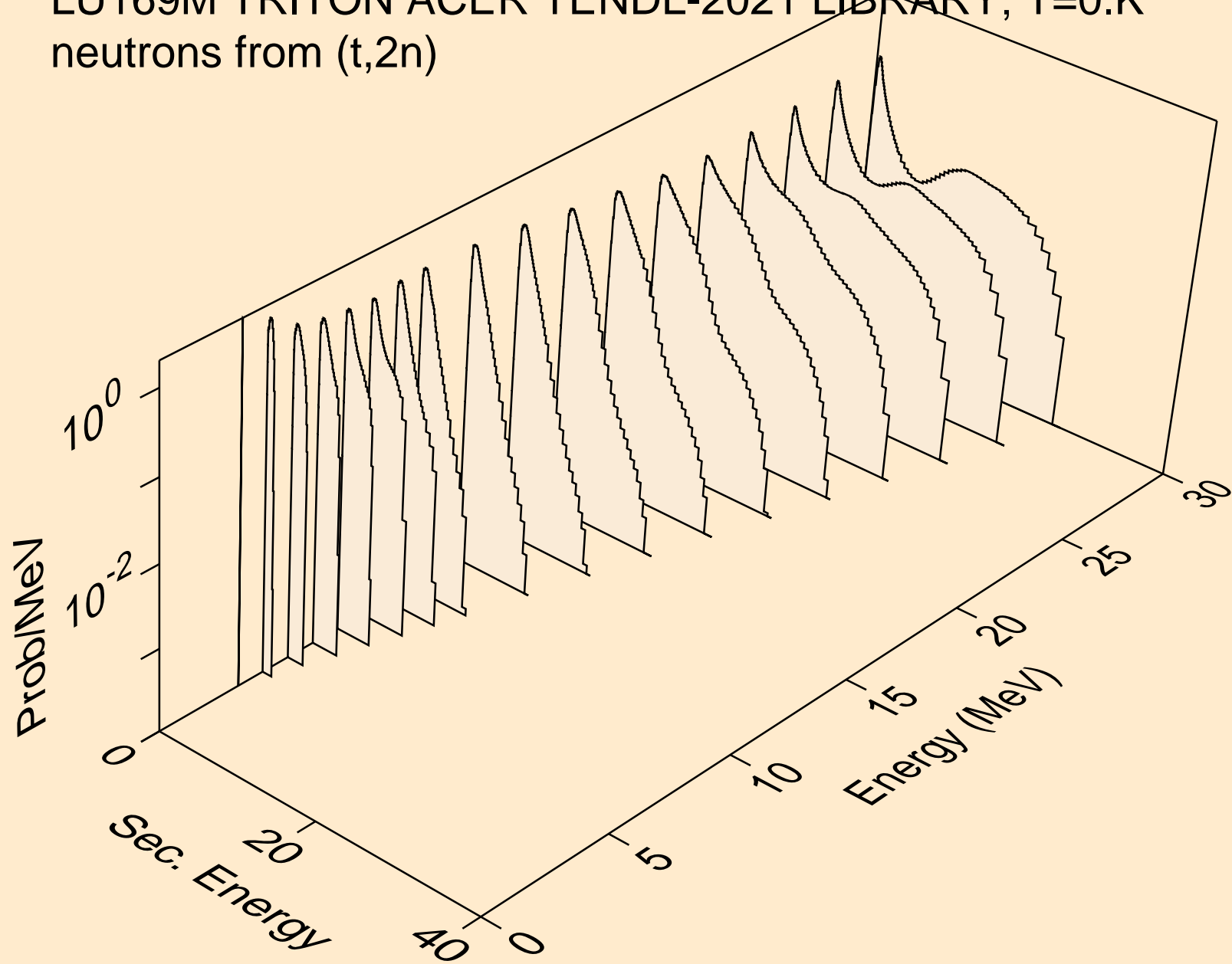

LU169M TRITON ACER TENDL-2021 LIBRARY; T=0.K  
neutrons from (t,3n)

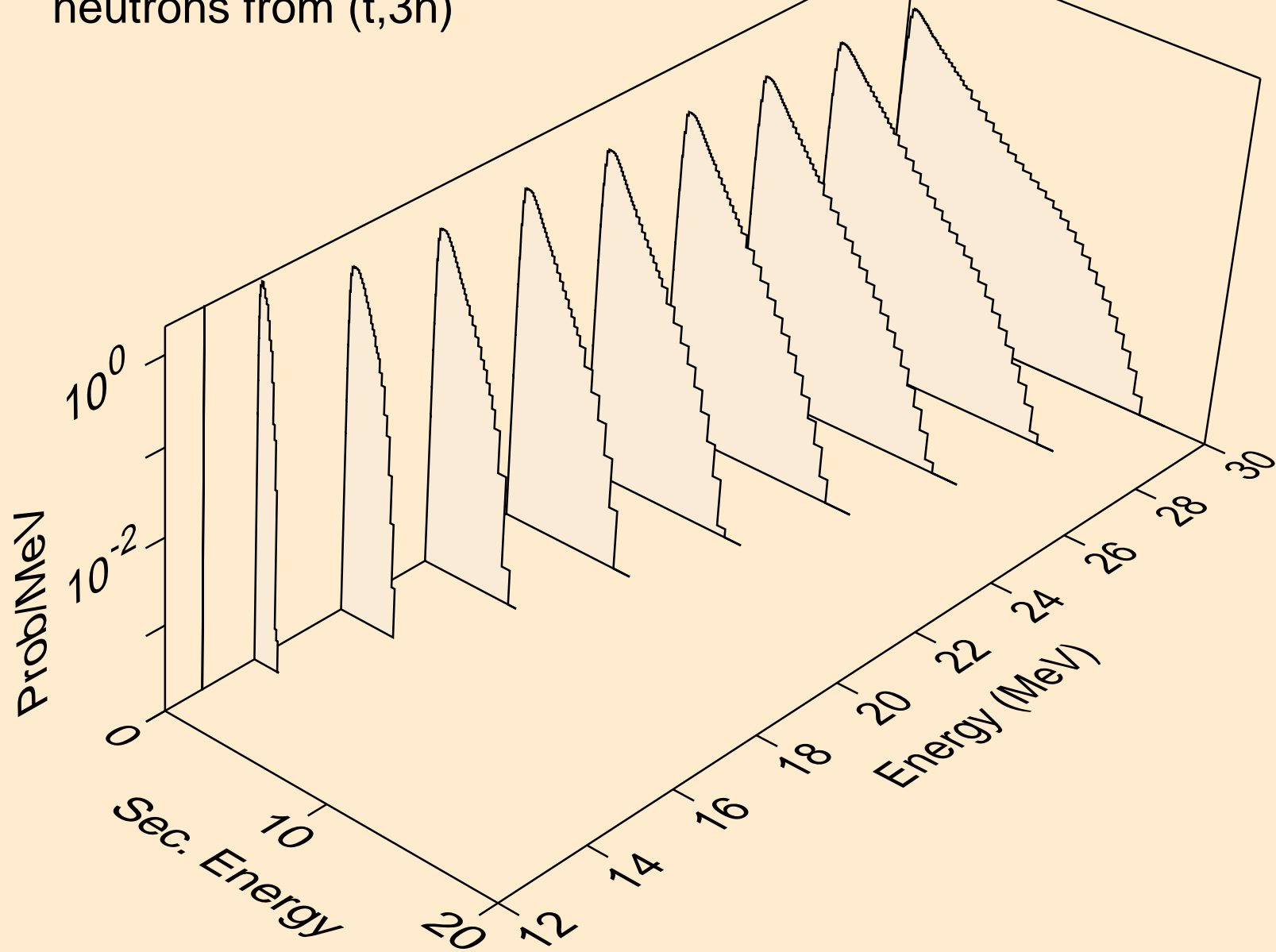

LU169M TRITON ACER TENDL-2021 LIBRARY; T=0.K  
neutrons from (t,n\*)a

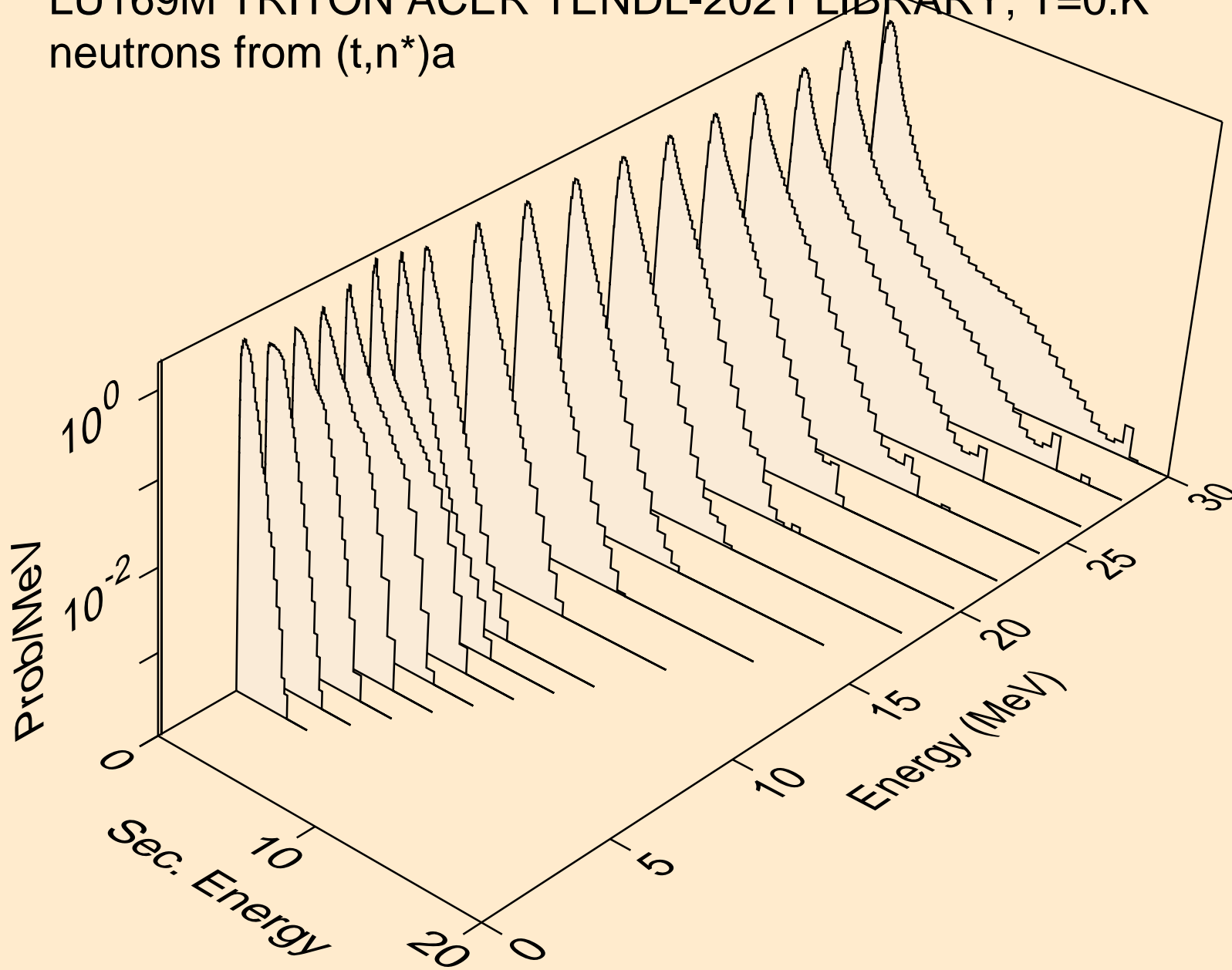

LU169M TRITON ACER TENDL-2021 LIBRARY; T=0.K  
neutrons from (t,2n)a

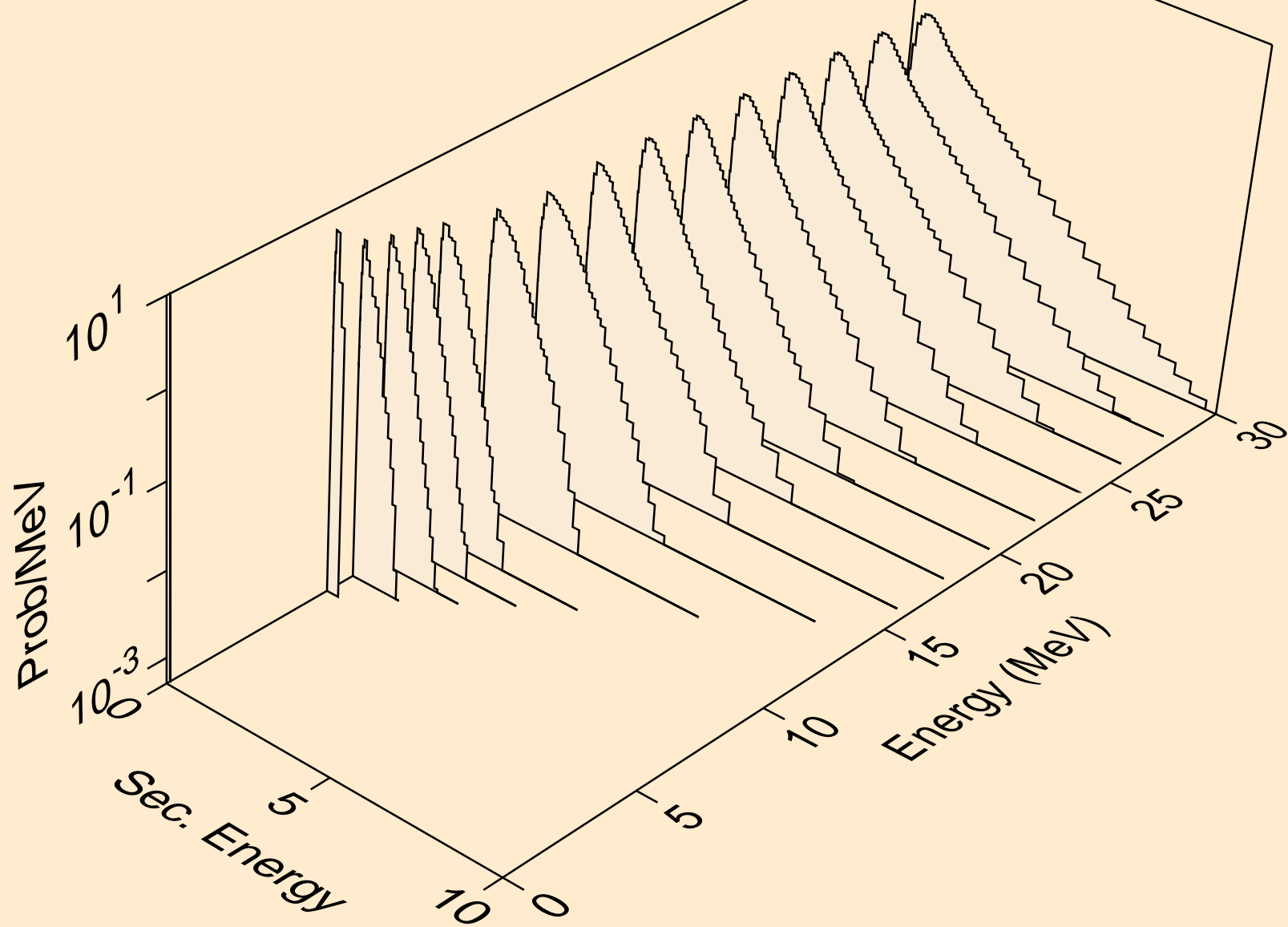

LU169M TRITON ACER TENDL-2021 LIBRARY; T=0.K  
neutrons from (t,3n)a

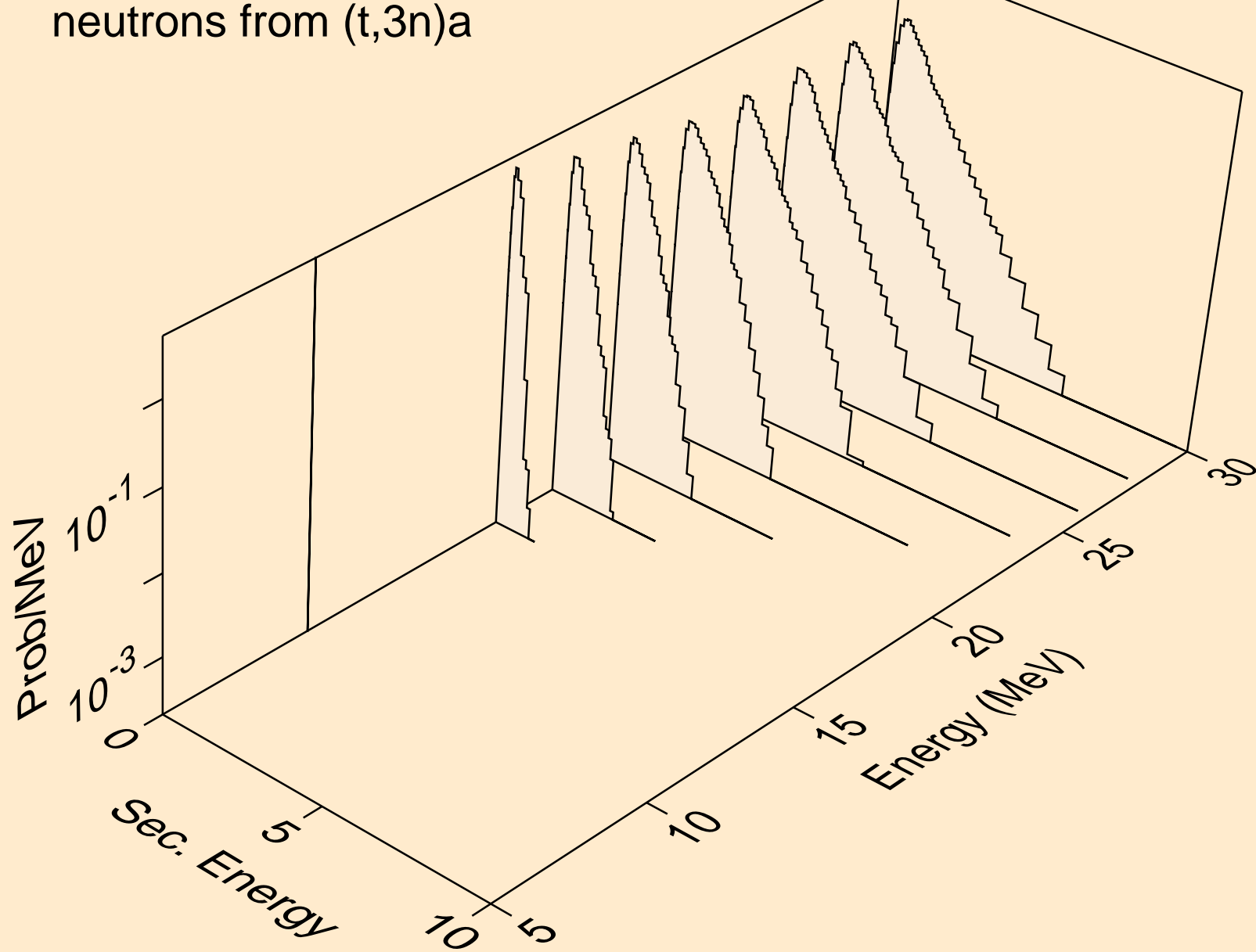

LU169M TRITON ACER TENDL-2021 LIBRARY; T=0.K  
neutrons from (t,n\*)p

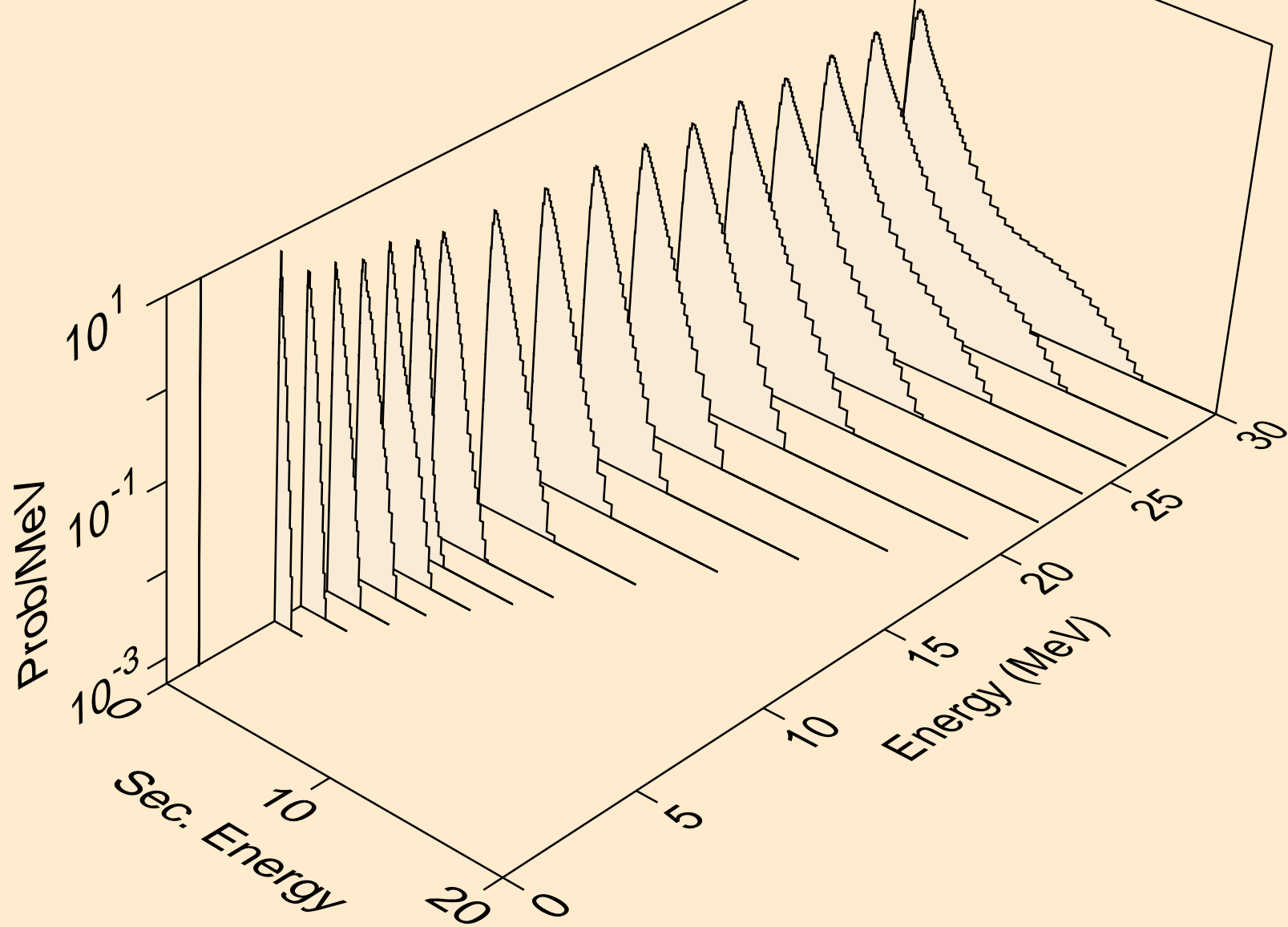



LU169M TRITON ACER TENDL-2021 LIBRARY; T=0.K  
neutrons from (t,n\*)2a

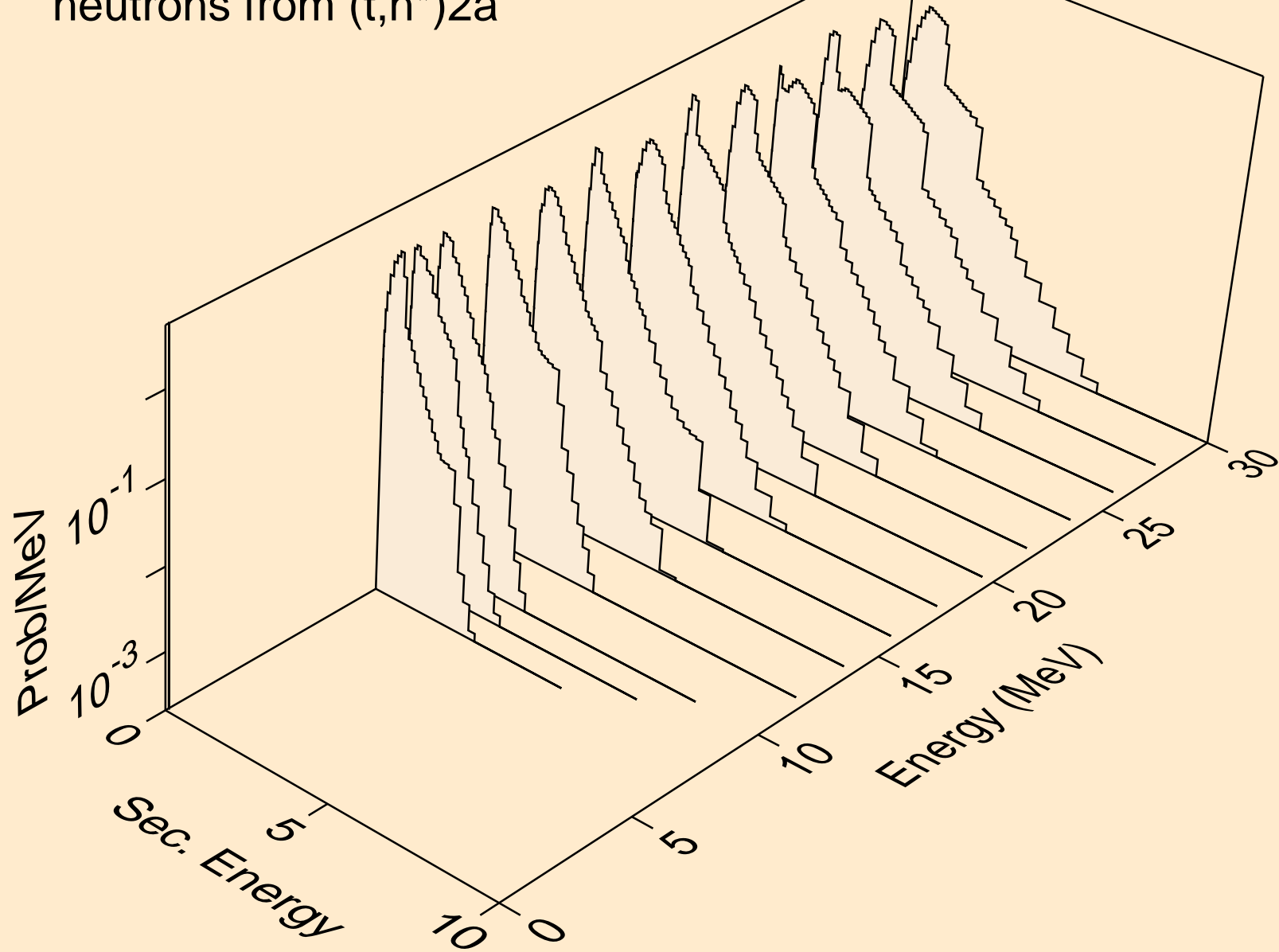

LU169M TRITON ACER TENDL-2021 LIBRARY; T=0.K  
neutrons from (t,2n)2a

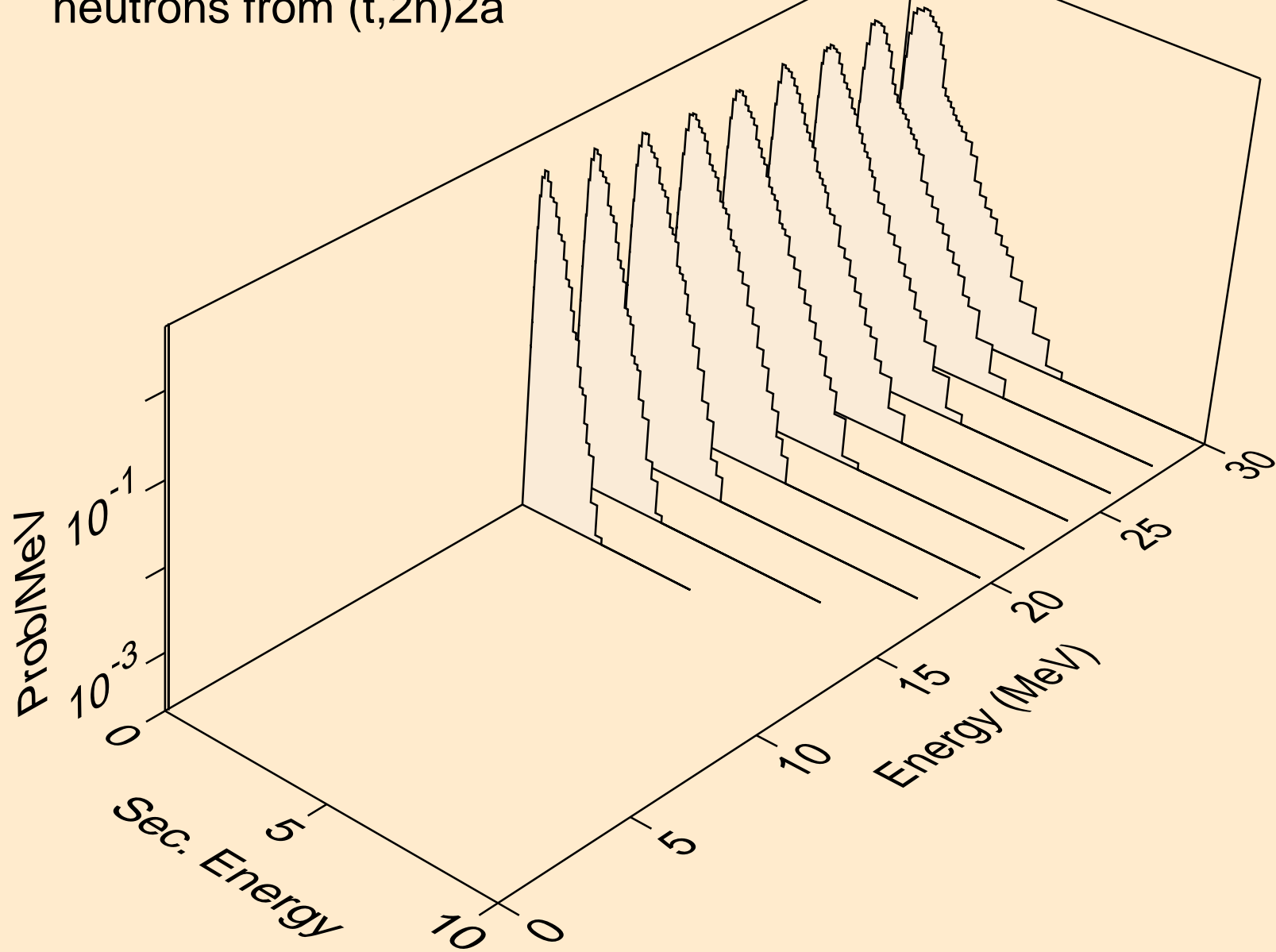

LU169M TRITON ACER TENDL-2021 LIBRARY; T=0.K  
neutrons from (t,n\*)d

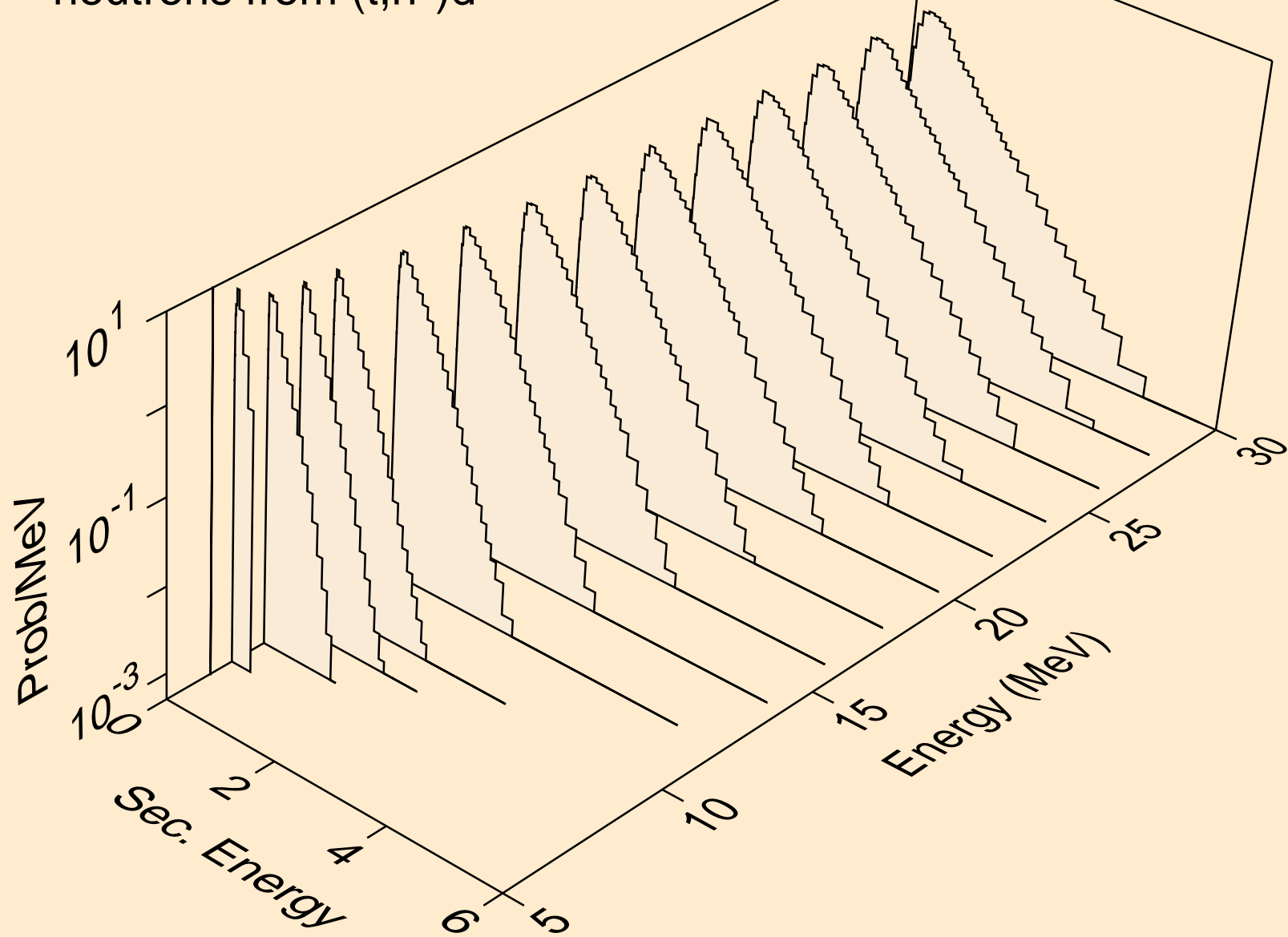

LU169M TRITON ACER TENDL-2021 LIBRARY; T=0.K  
neutrons from (t,n\*)t

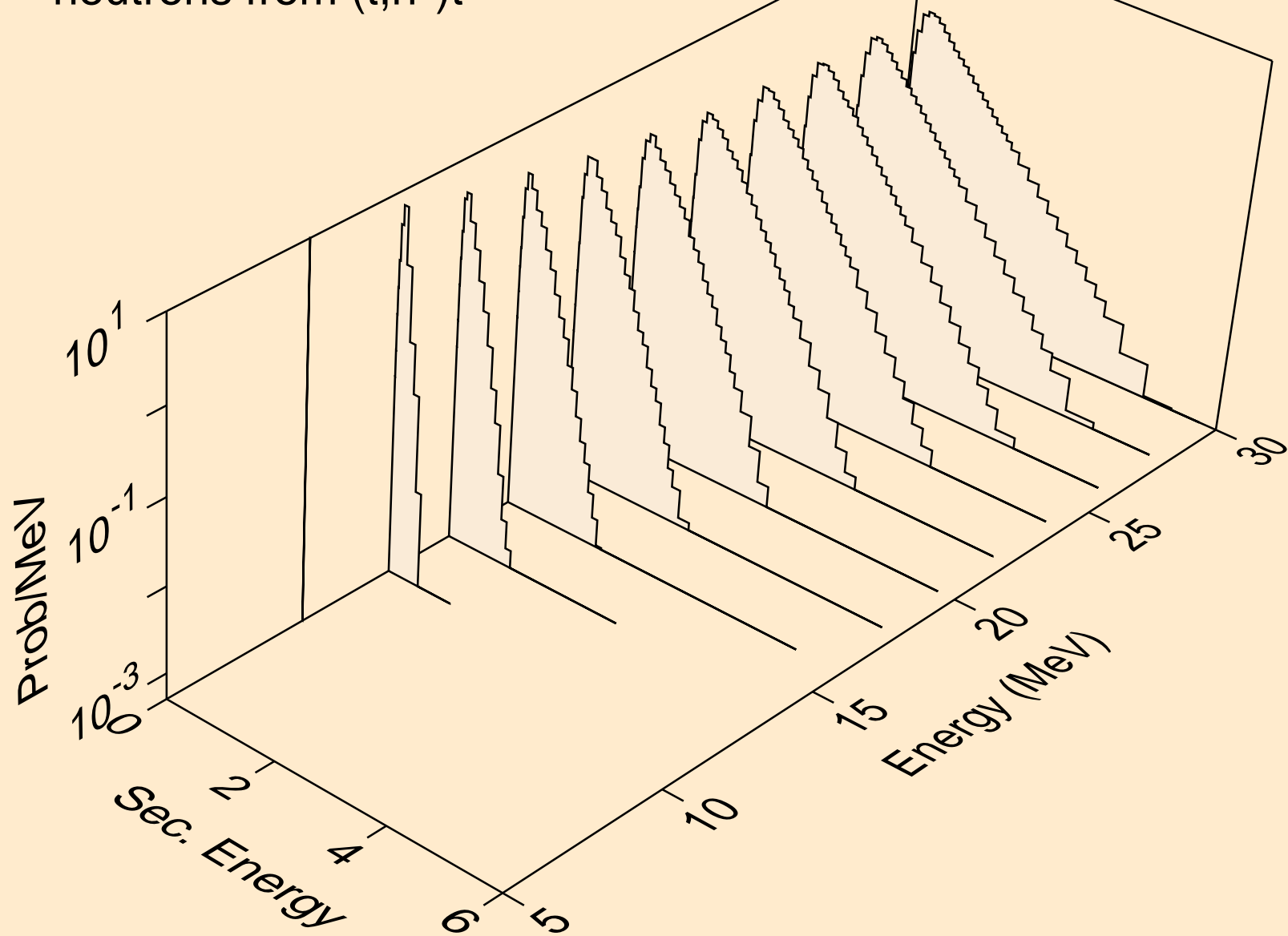

LU169M TRITON ACER TENDL-2021 LIBRARY; T=0.K  
neutrons from (t,n\*)he3

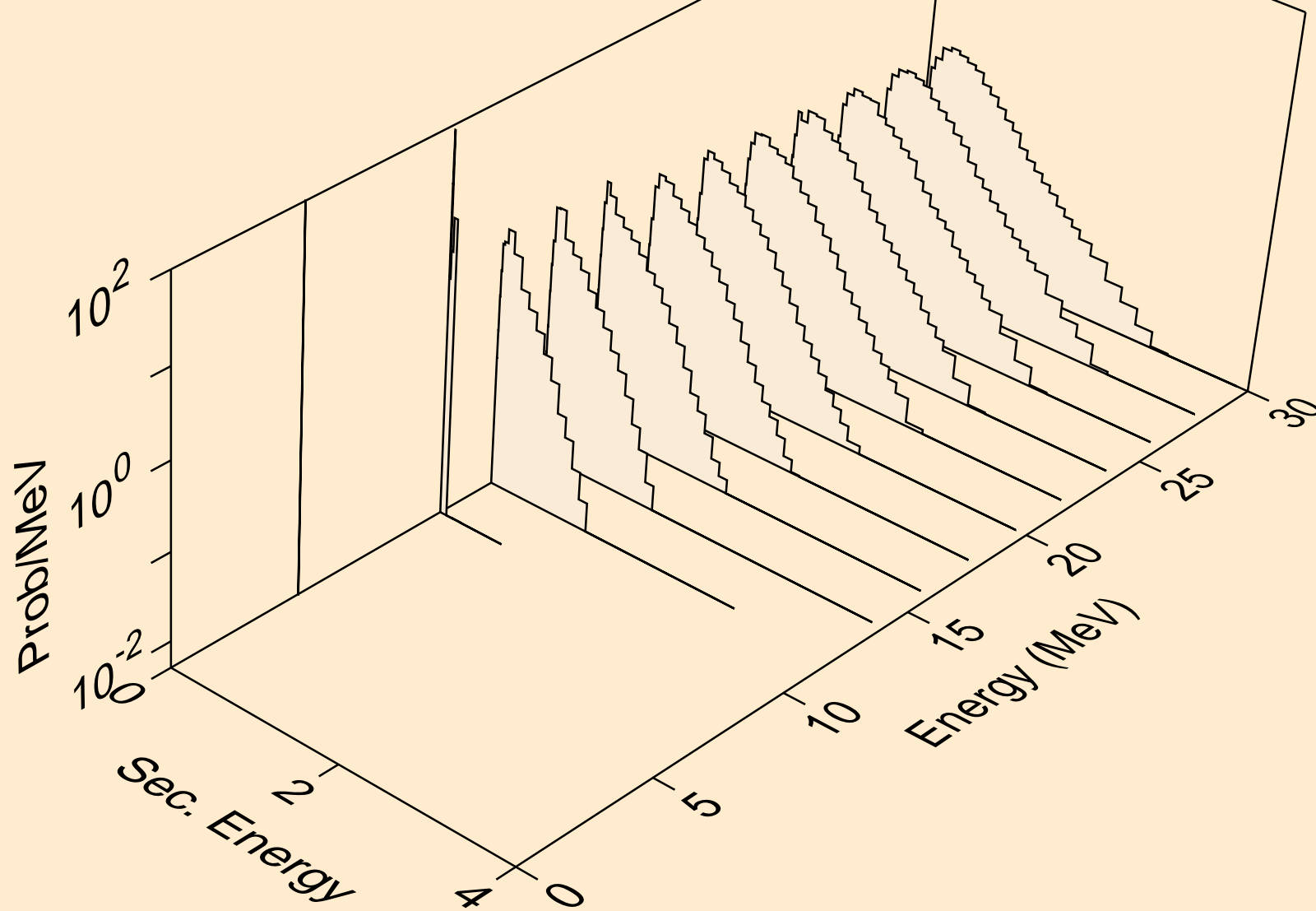

LU169M TRITON ACER TENDL-2021 LIBRARY; T=0.K  
neutrons from (t,4n)

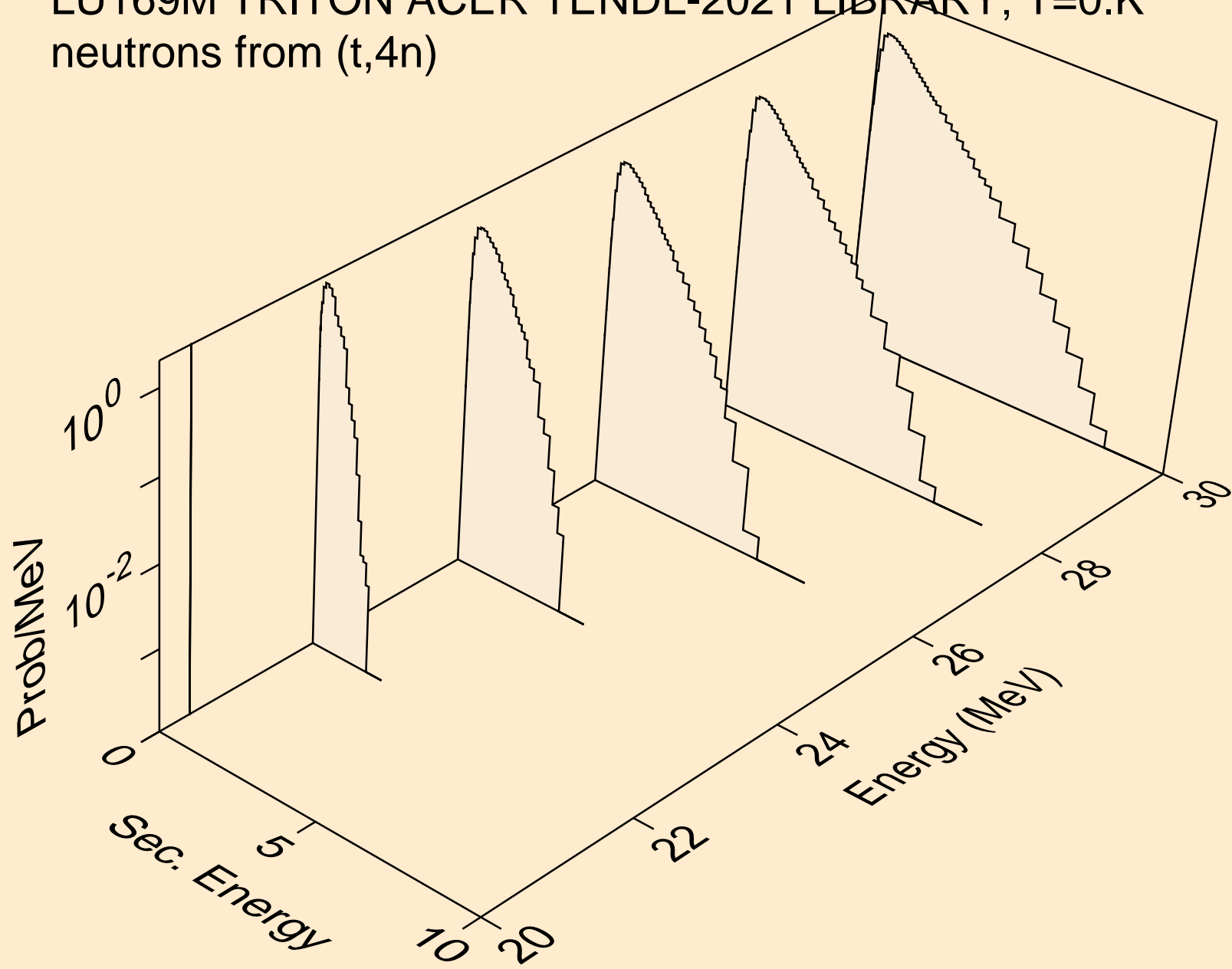

LU169M TRITON ACER TENDL-2021 LIBRARY; T=0.K  
neutrons from (t,2np)

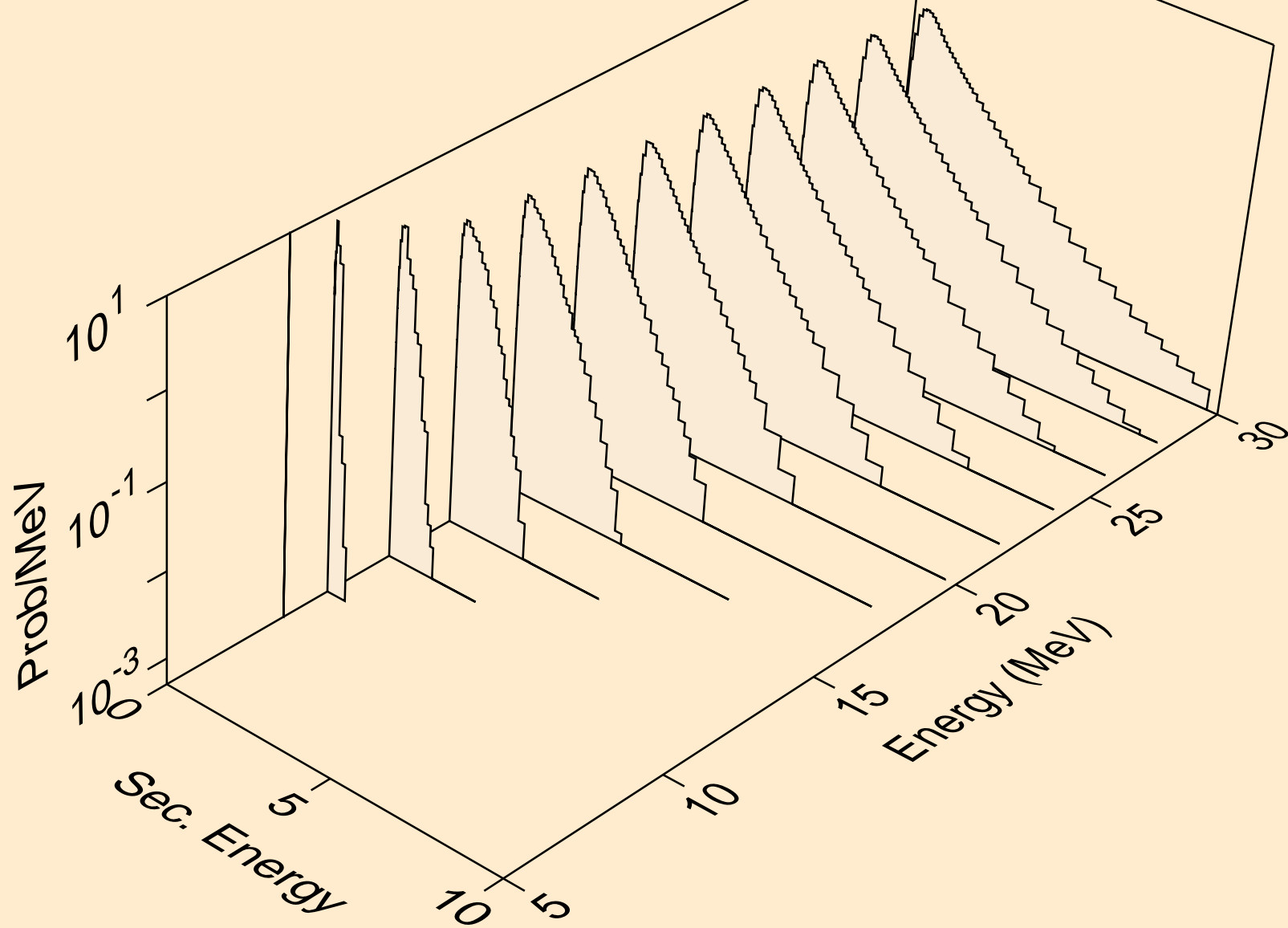

LU169M TRITON ACER TENDL-2021 LIBRARY; T=0.K  
neutrons from (t,3np)

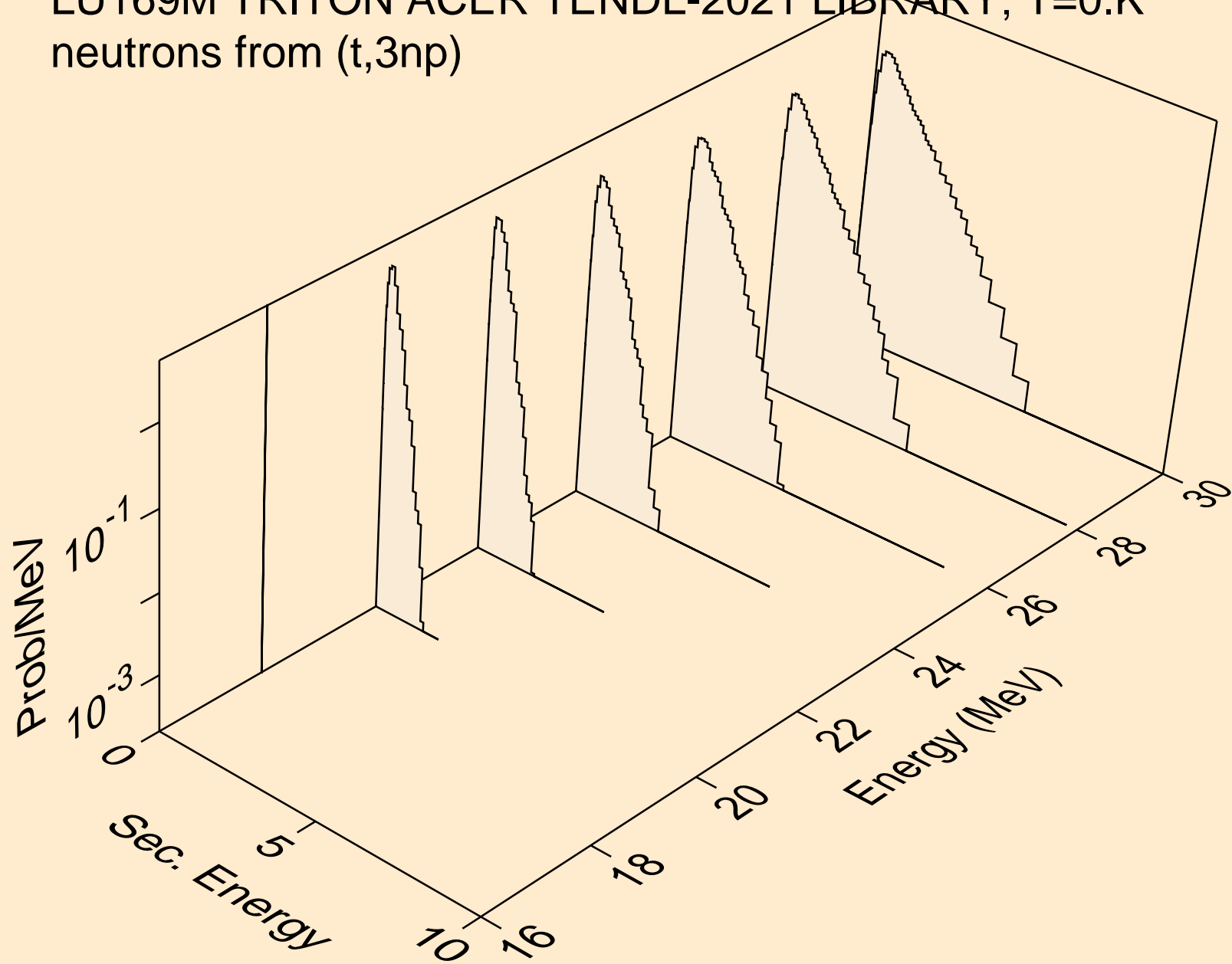



LU169M TRITON ACER TENDL-2021 LIBRARY; T=0.K  
neutrons from (t,2np)

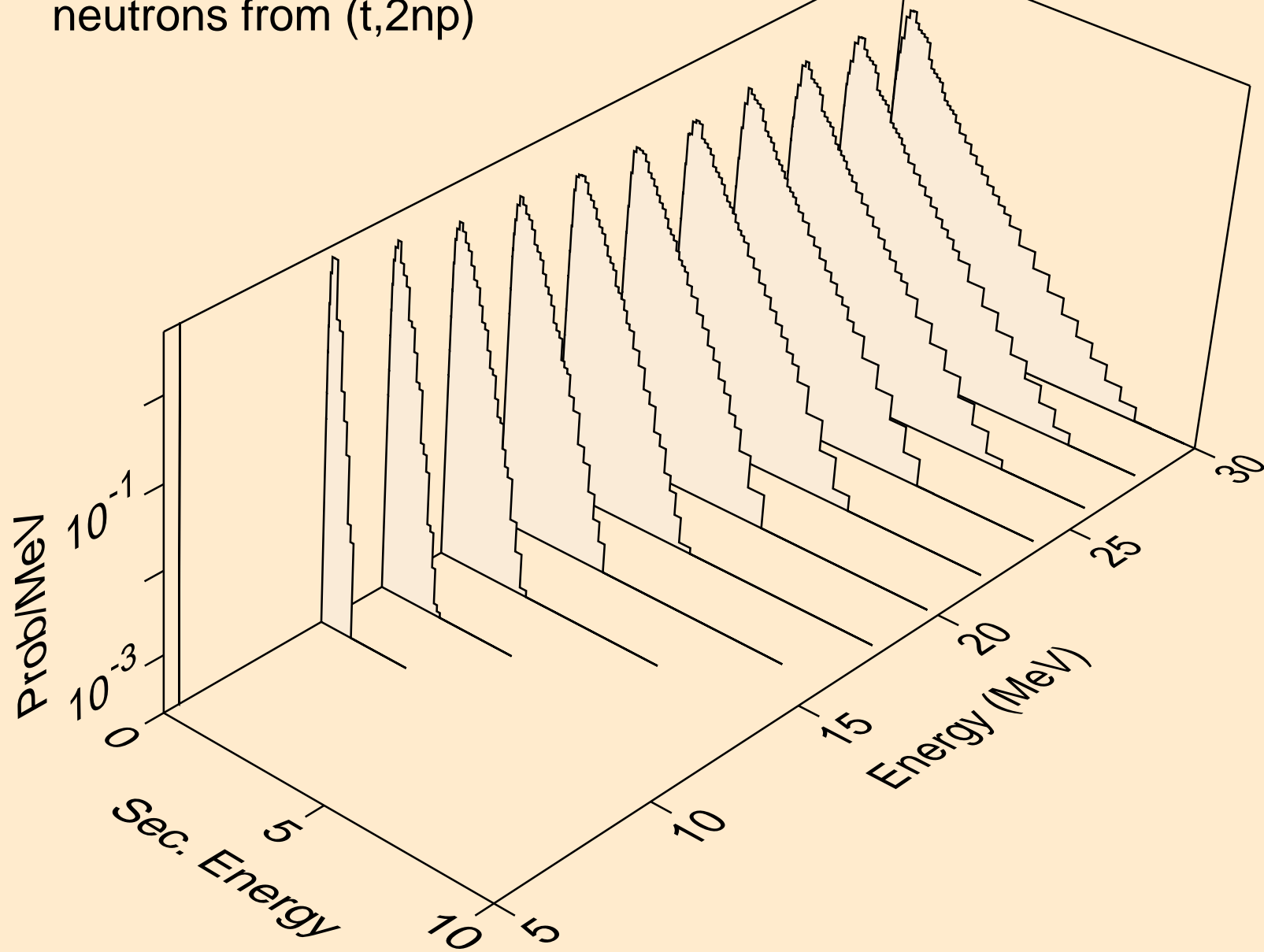

LU169M TRITON ACER TENDL-2021 LIBRARY; T=0.K  
neutrons from (t,npa)

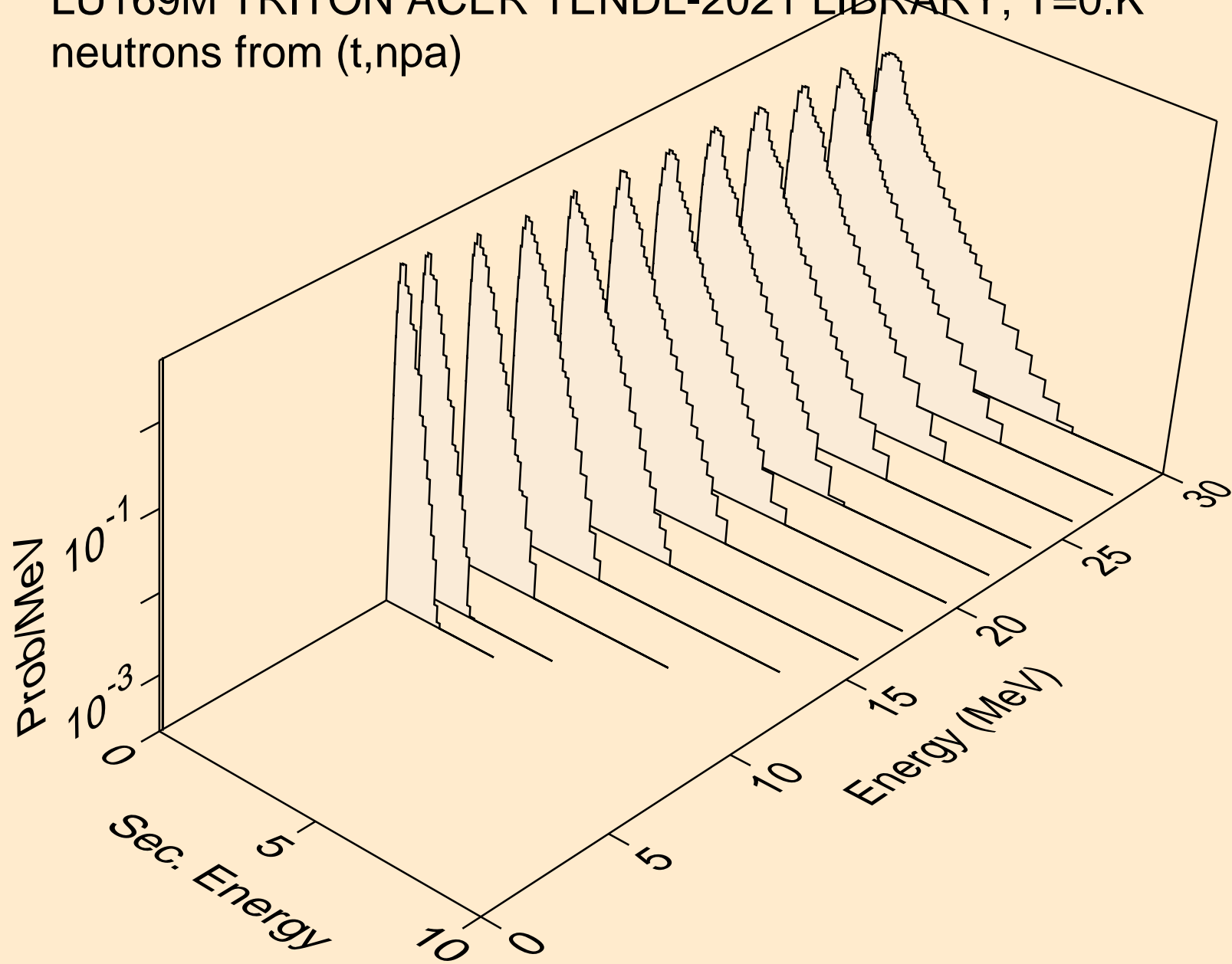

LU169M TRITON ACER TENDL-2021 LIBRARY; T=0.K  
protons from (t,x)

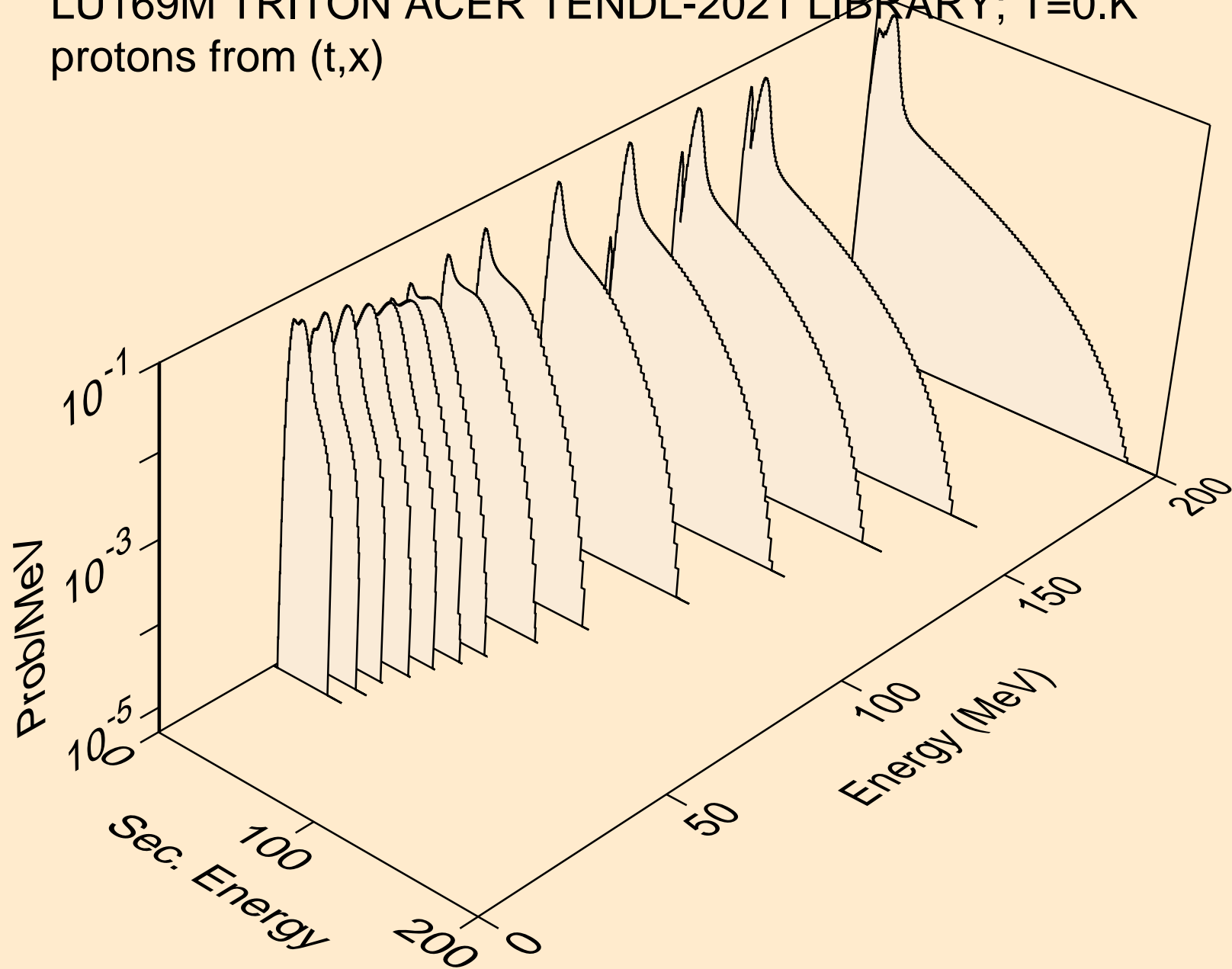

LU169M TRITON ACER TENDL-2021 LIBRARY; T=0.K  
protons from (t,n\*)p

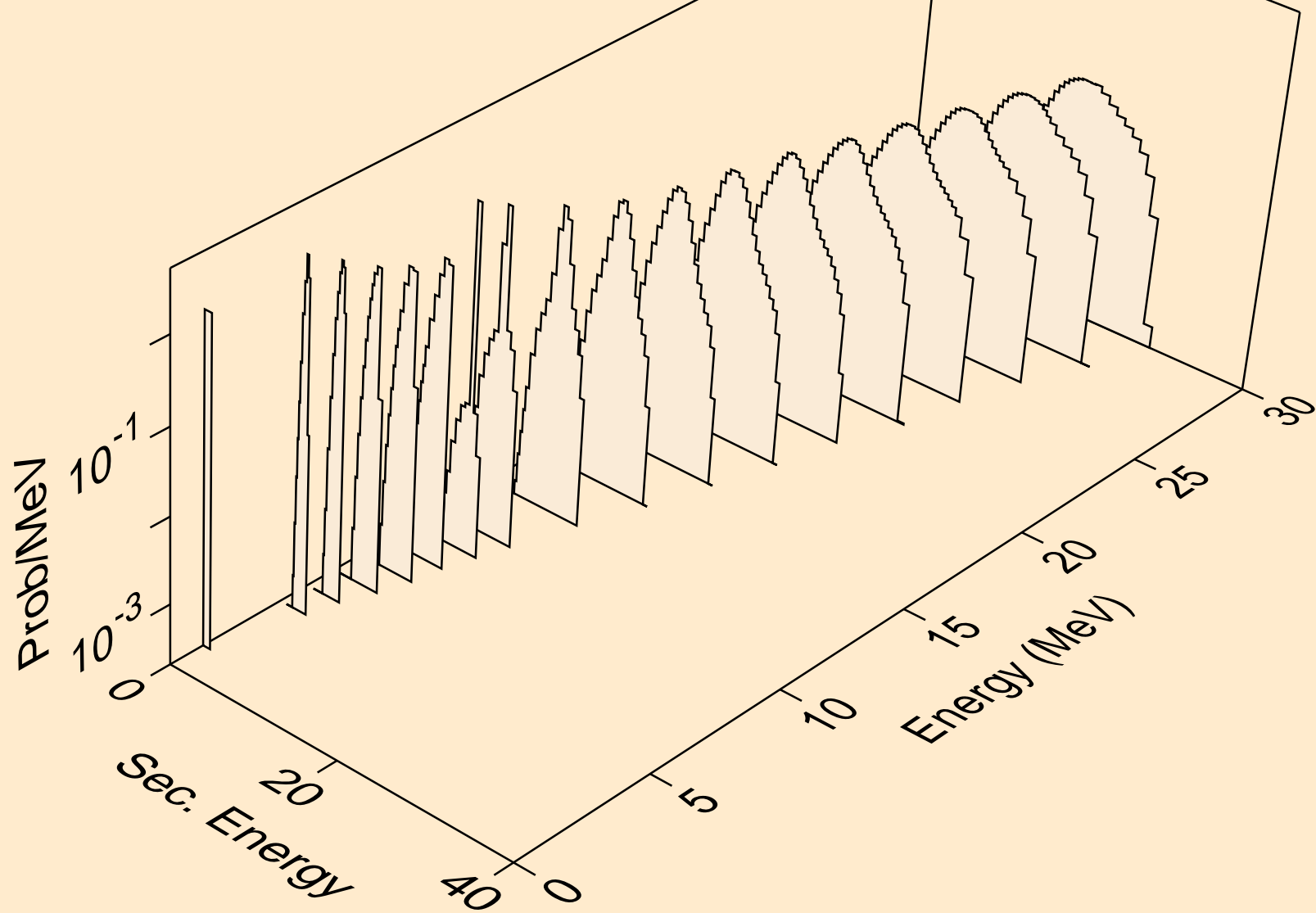

LU169M TRITON ACER TENDL-2021 LIBRARY; T=0.K  
protons from (t,2np)

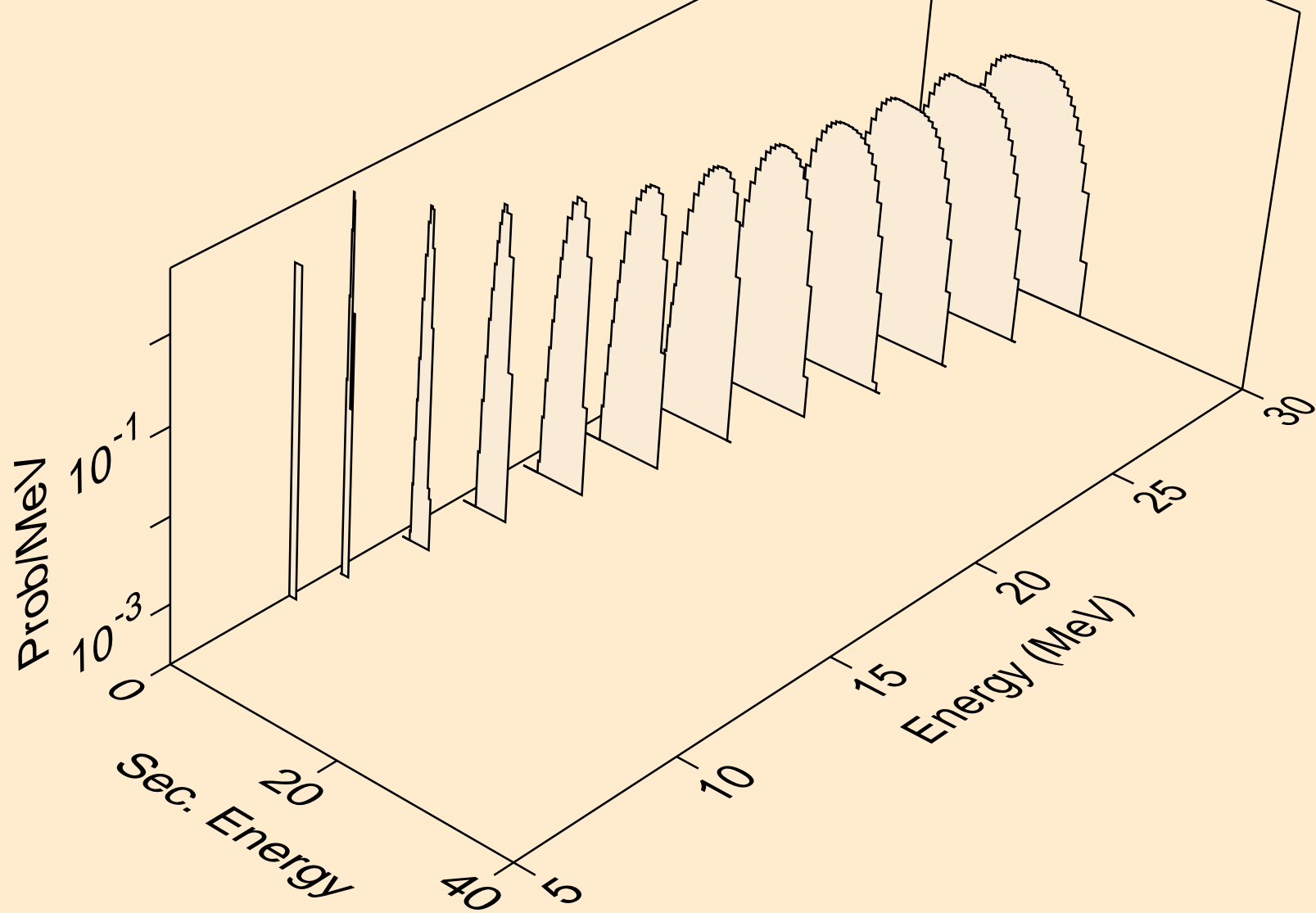

LU169M TRITON ACER TENDL-2021 LIBRARY; T=0.K  
protons from (t,3np)

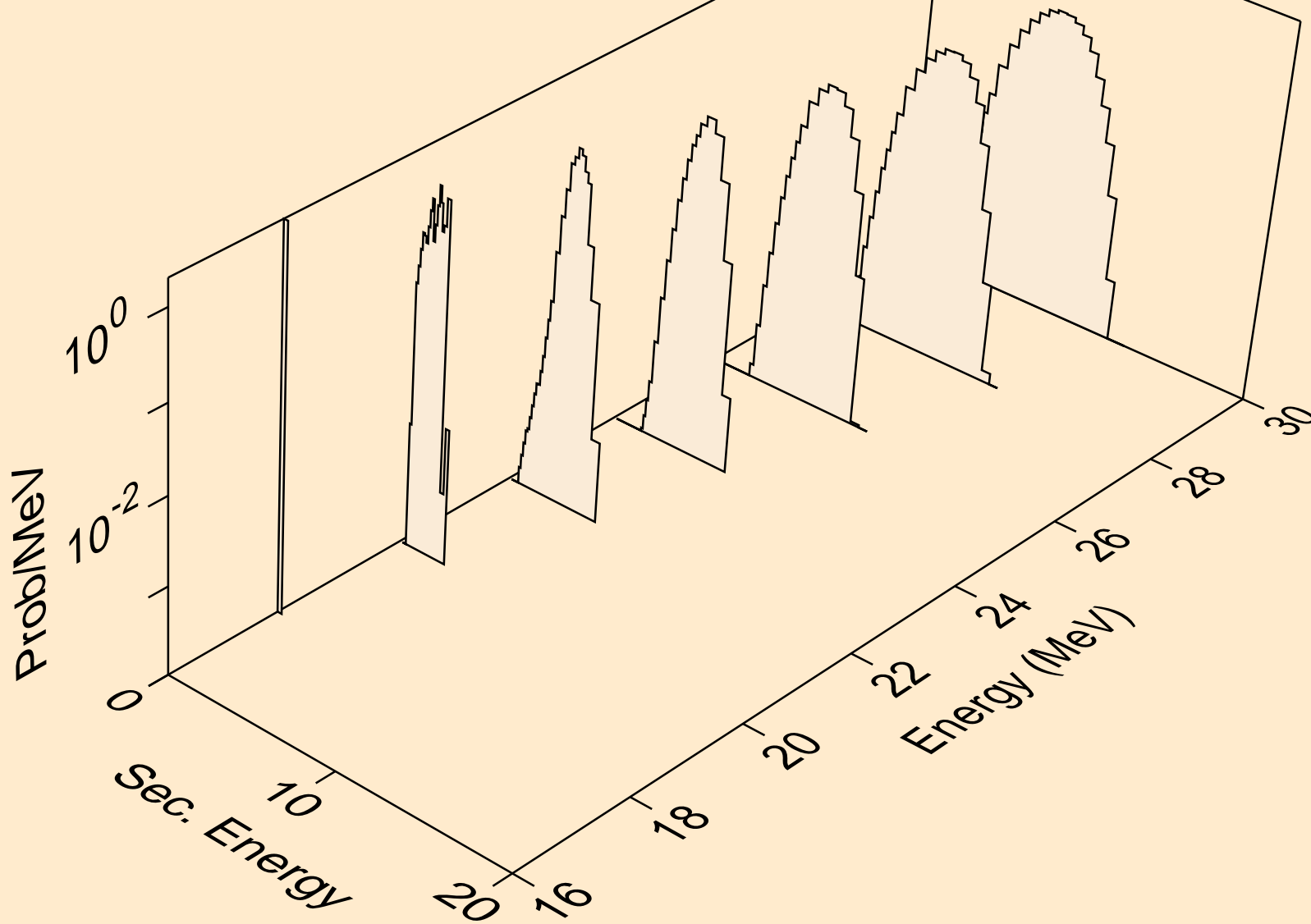

LU169M TRITON ACER TENDL-2021 LIBRARY; T=0.K  
protons from (t,2np)

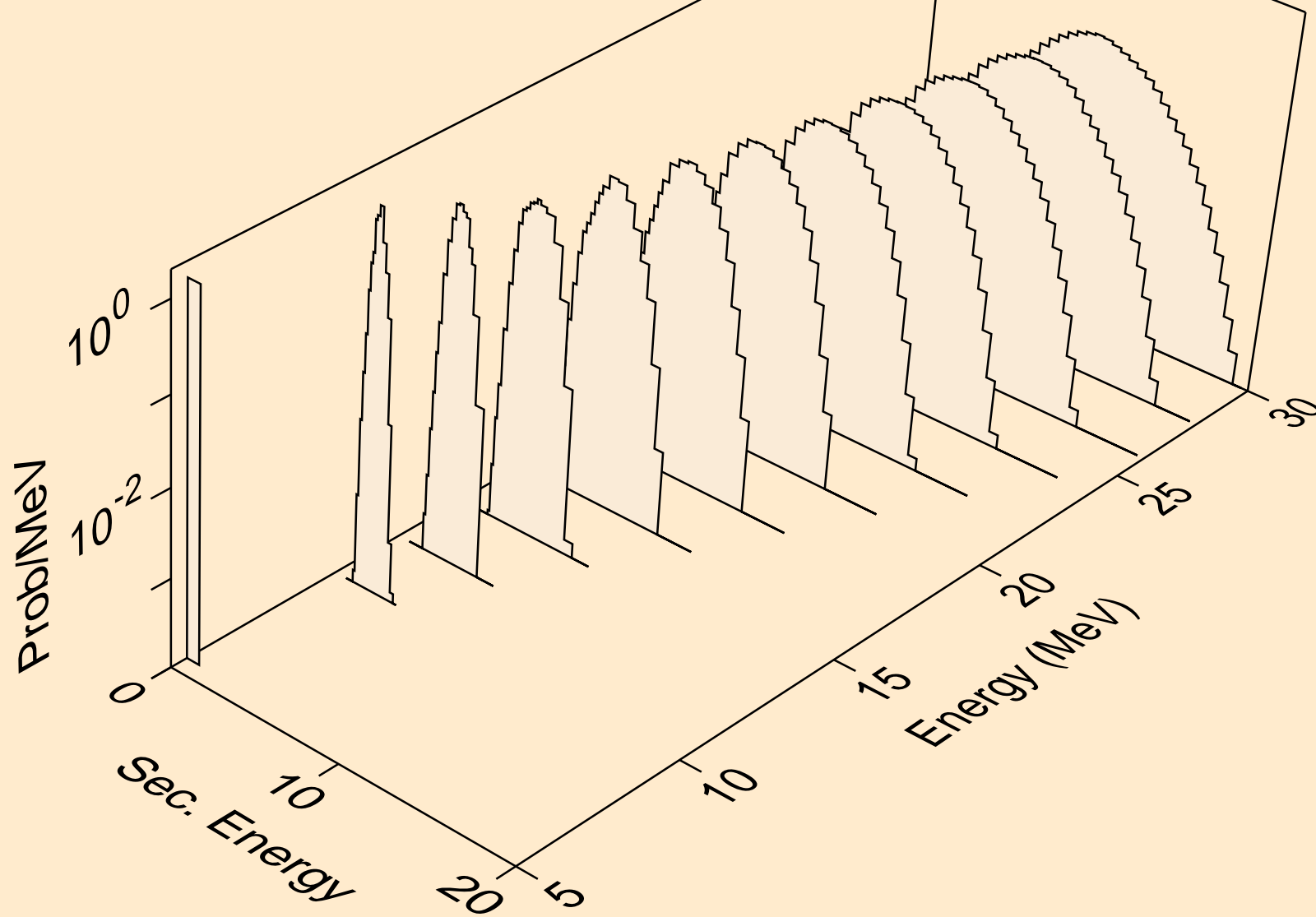

LU169M TRITON ACER TENDL-2021 LIBRARY; T=0.K  
protons from (t,npa)

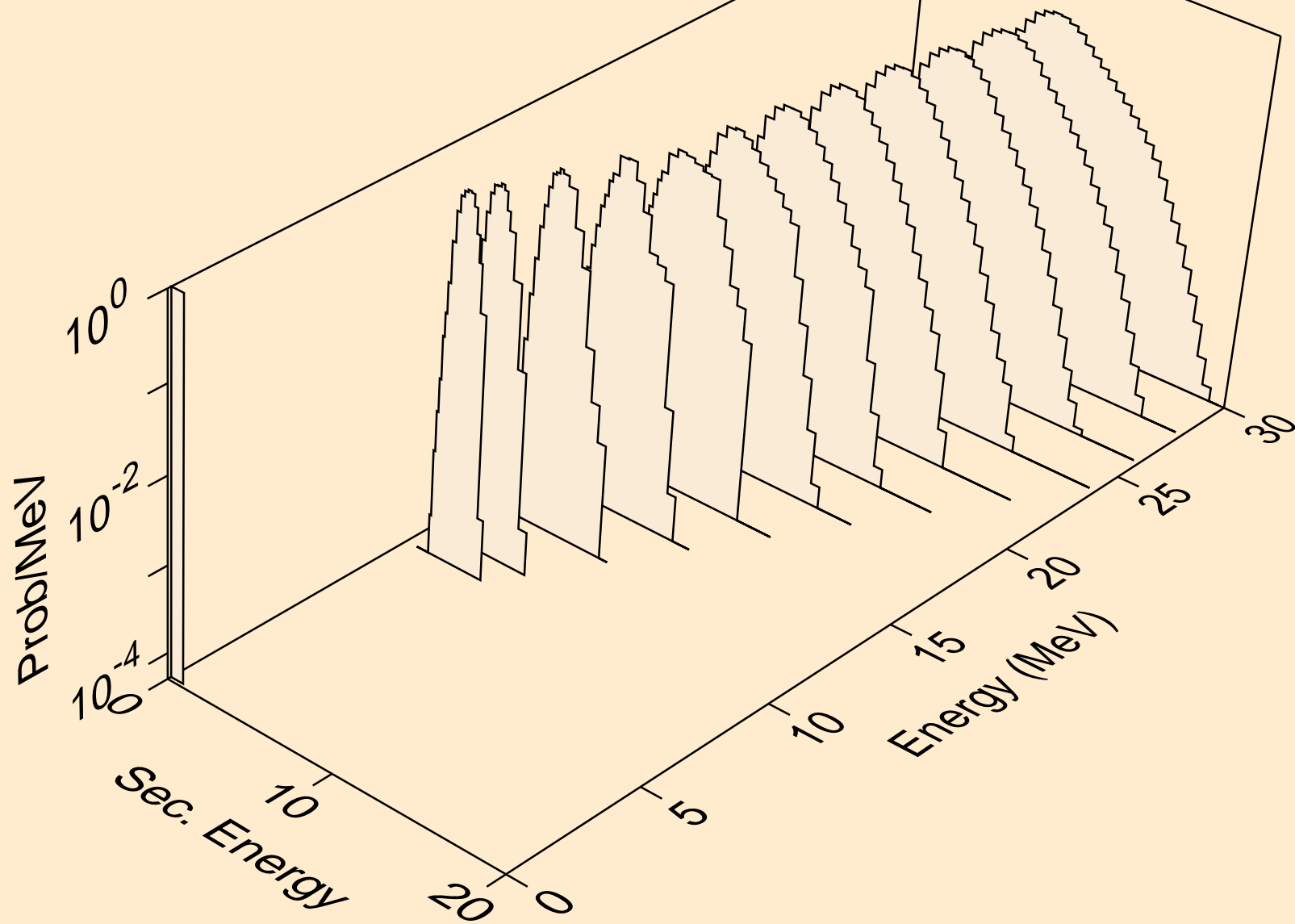



LU169M TRITON ACER TENDL-2021 LIBRARY; T=0.K  
protons from (t,p)

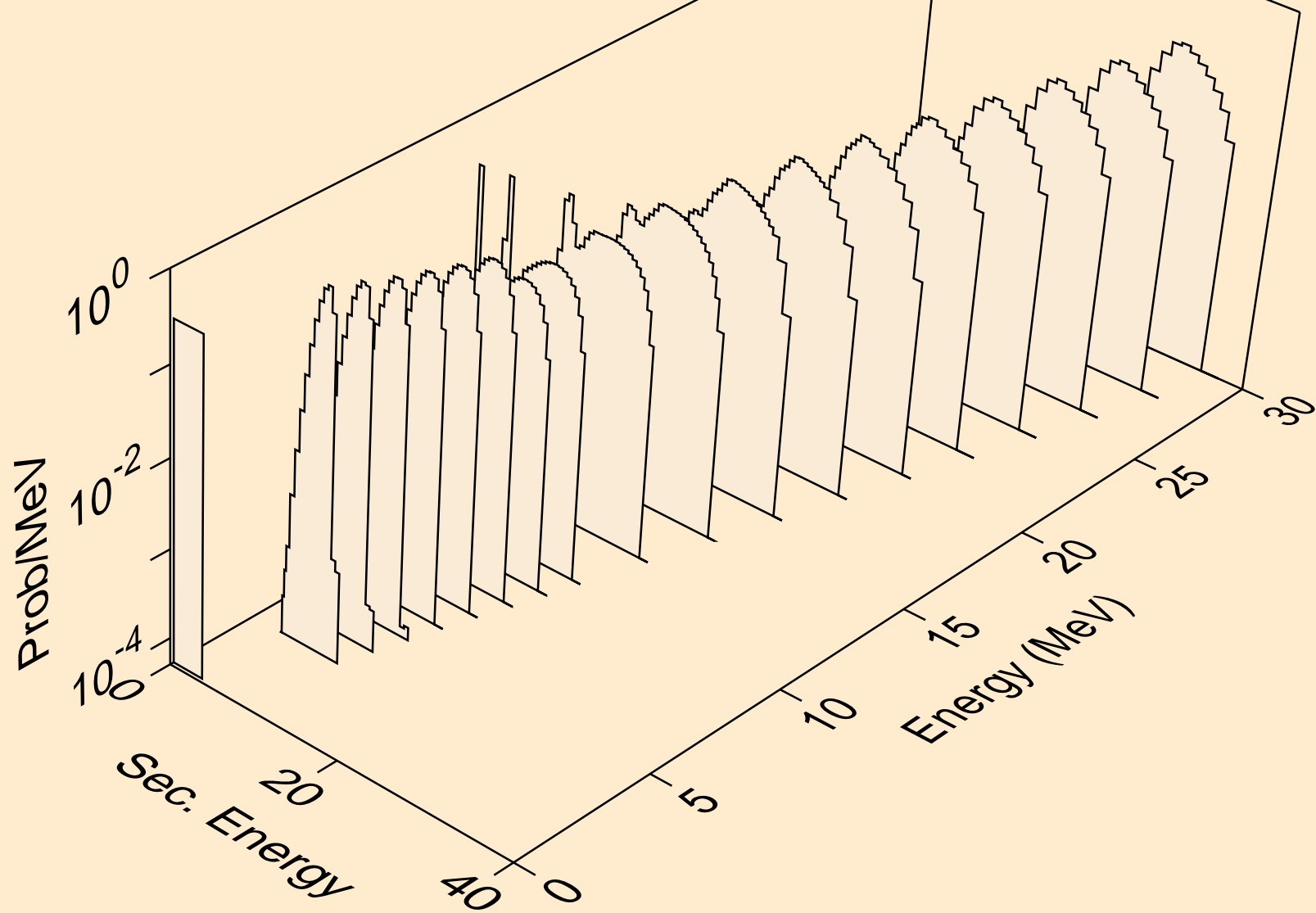

LU169M TRITON ACER TENDL-2021 LIBRARY; T=0.K  
protons from (t,2p)

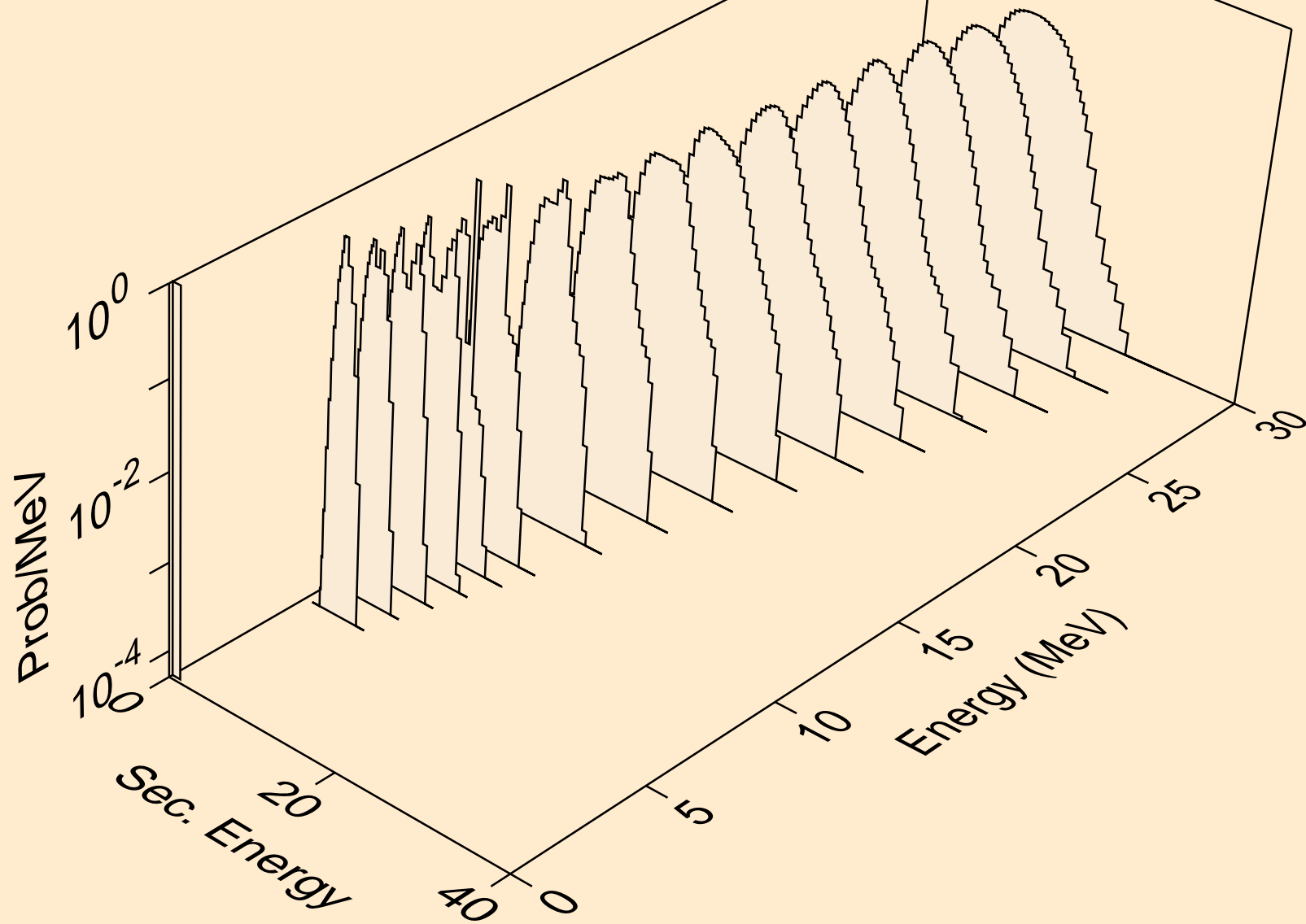

LU169M TRITON ACER TENDL-2021 LIBRARY; T=0.K  
protons from (t,pa)

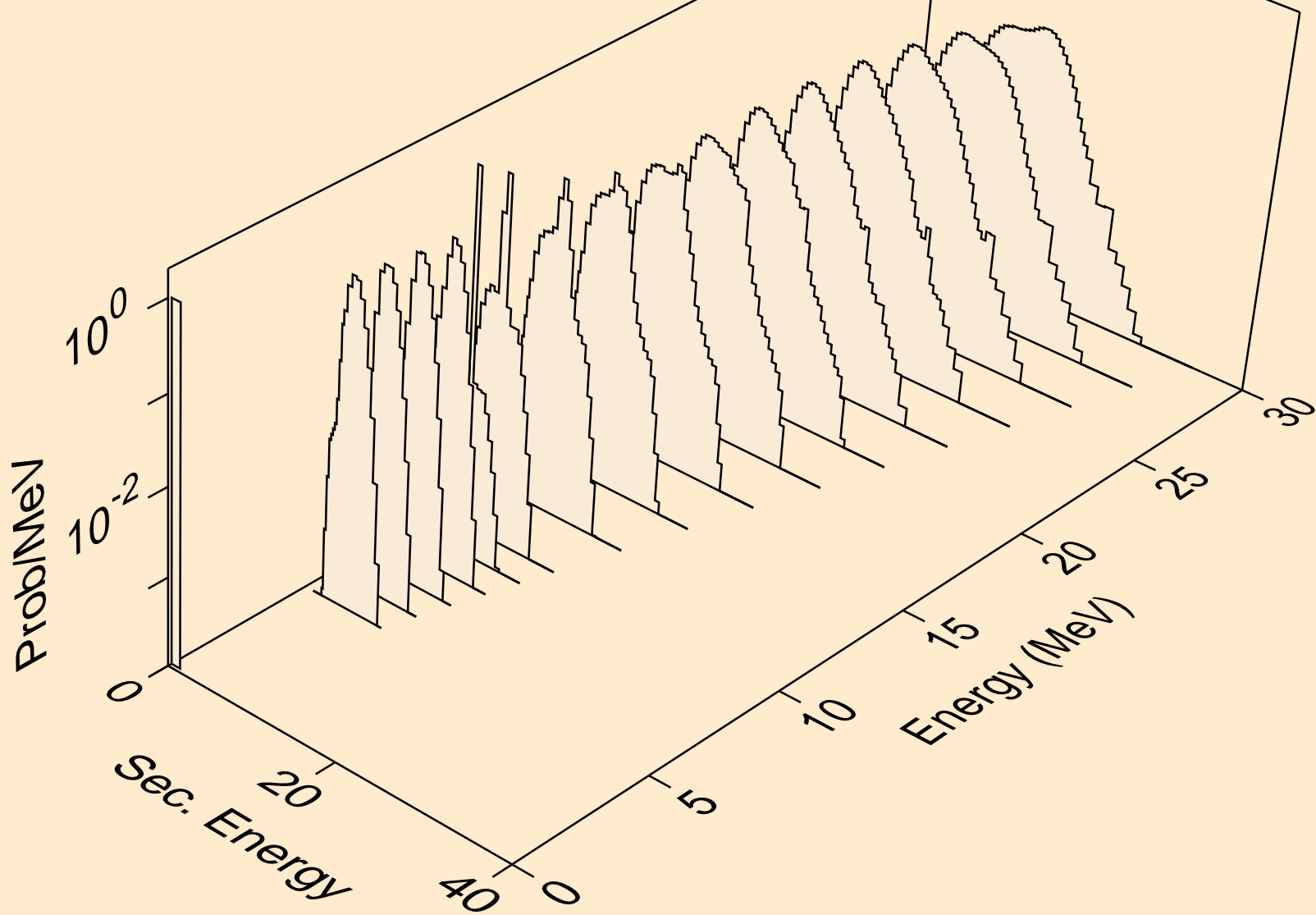

LU169M TRITON ACER TENDL-2021 LIBRARY; T=0.K  
protons from (t,pd)

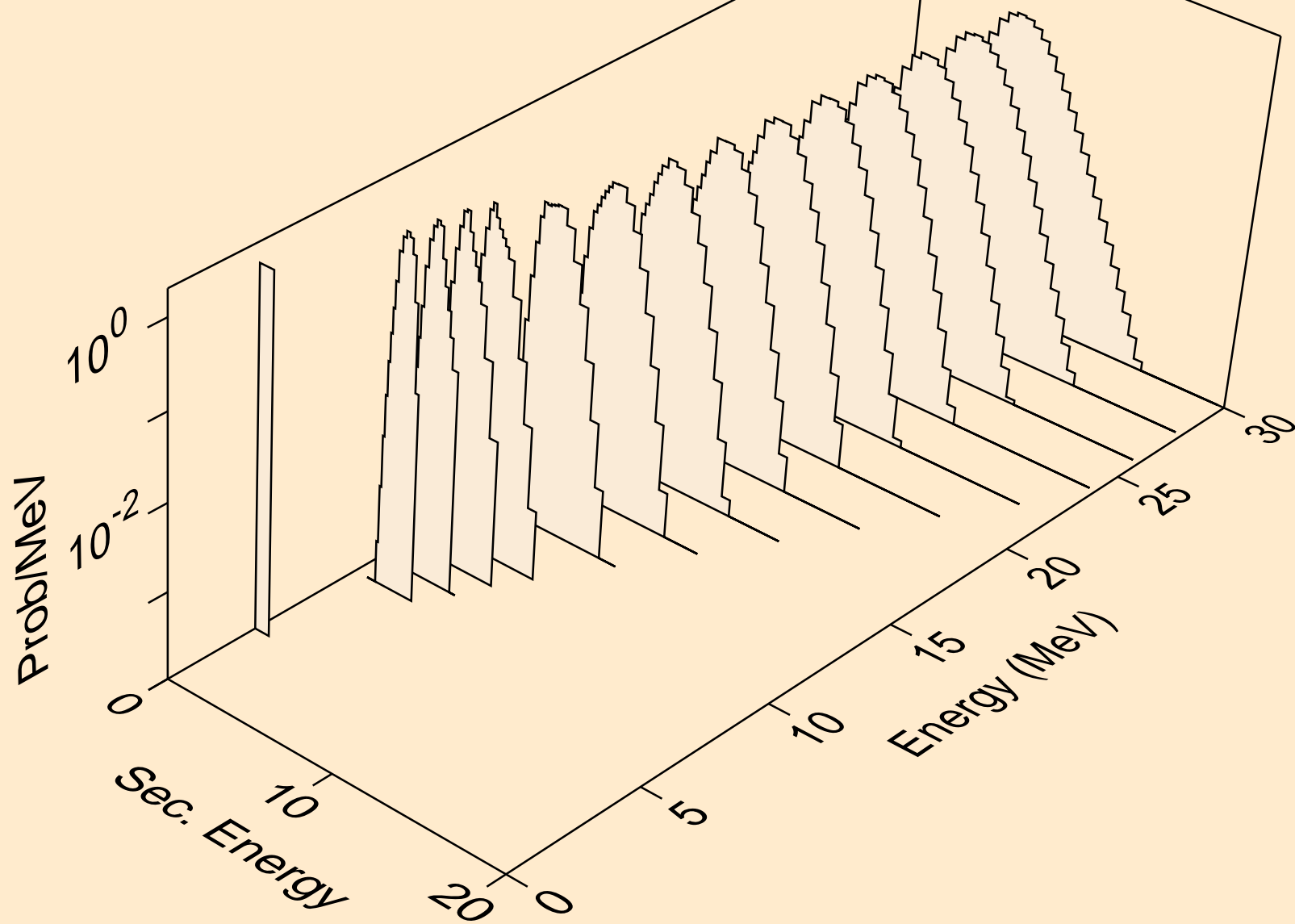

LU169M TRITON ACER TENDL-2021 LIBRARY; T=0.K  
protons from (t,pt)

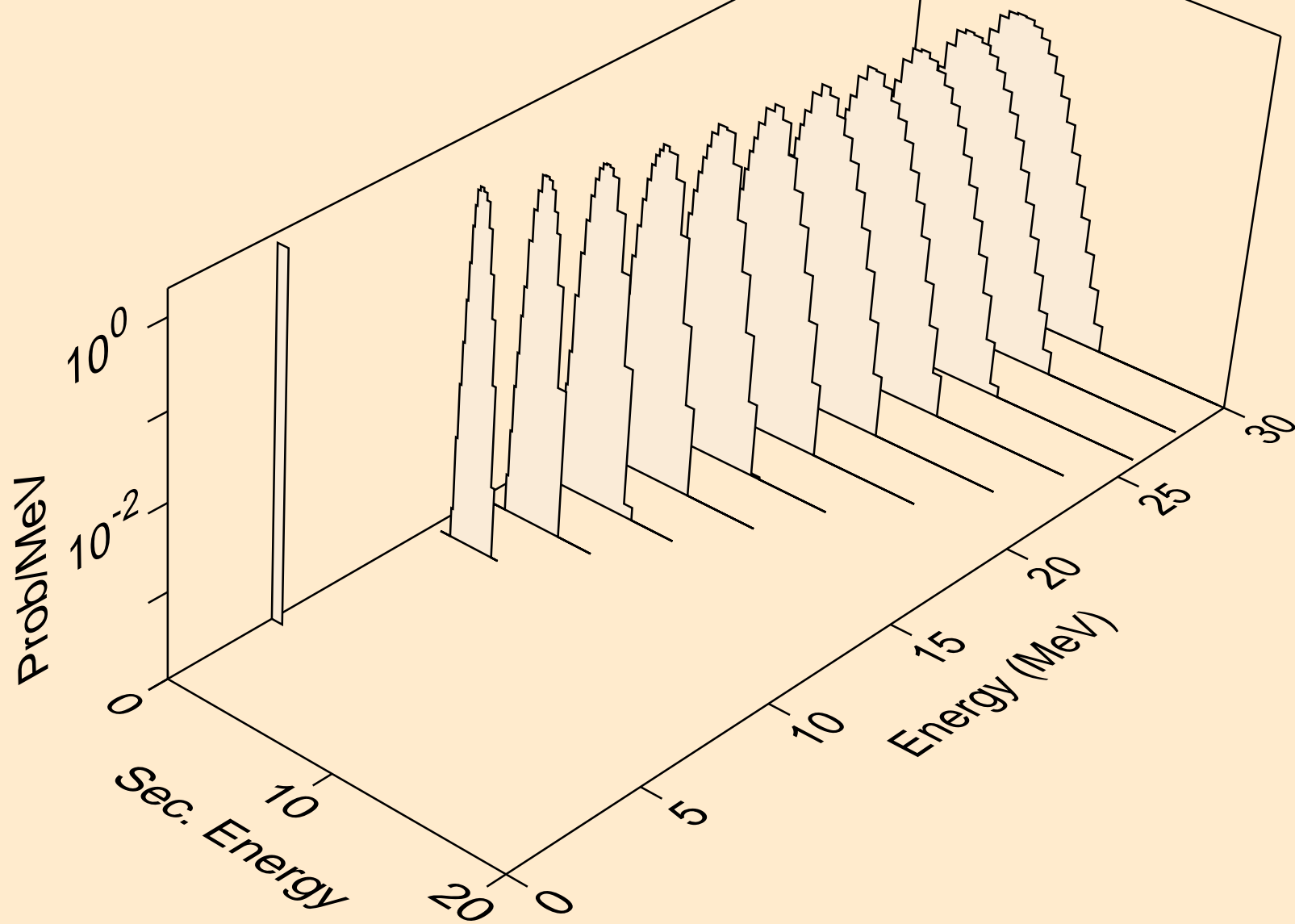

LU169M TRITON ACER TENDL-2021 LIBRARY; T=0.K  
deuterons from (t,x)

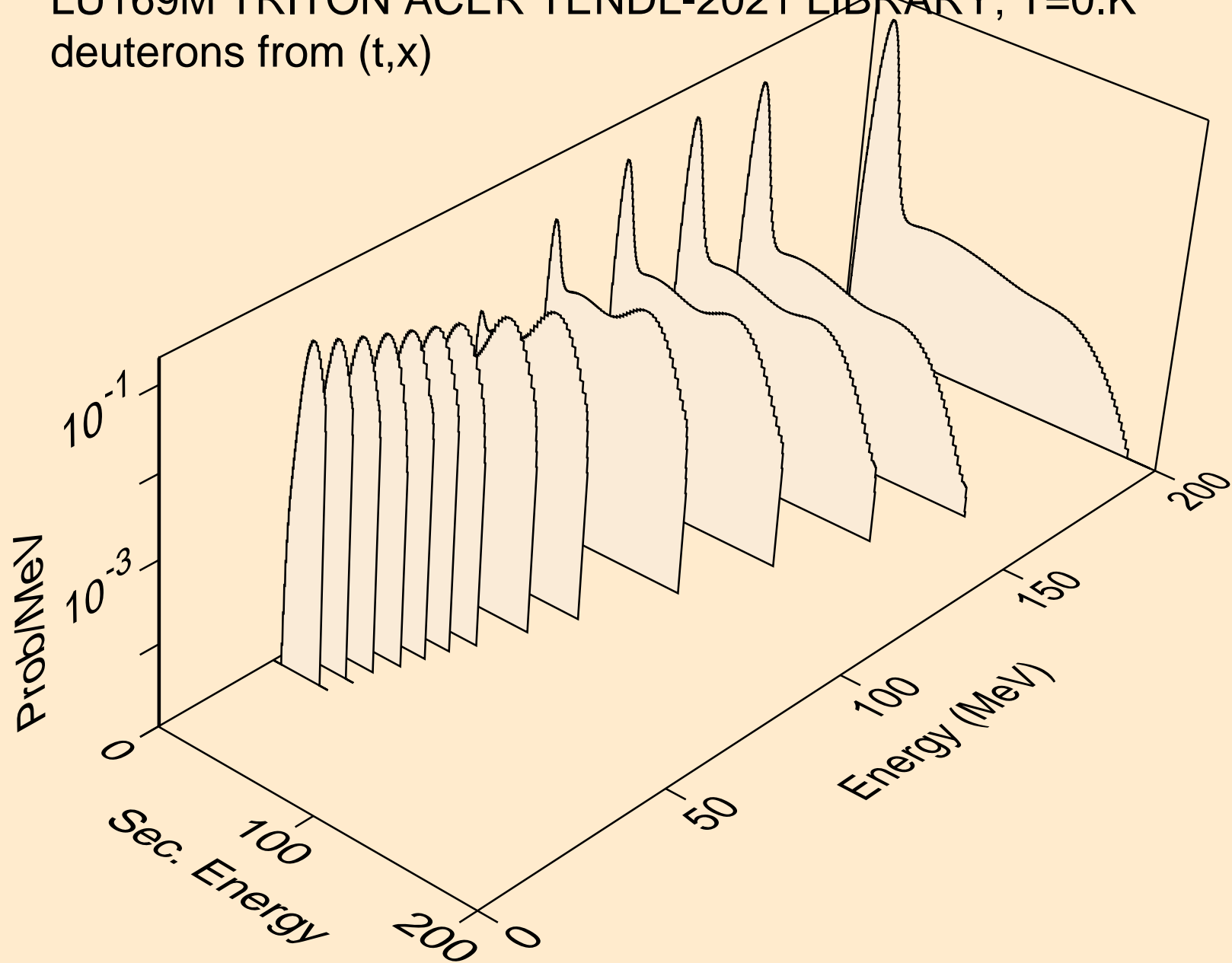

LU169M TRITON ACER TENDL-2021 LIBRARY; T=0.K  
deuterons from (t,2nd)

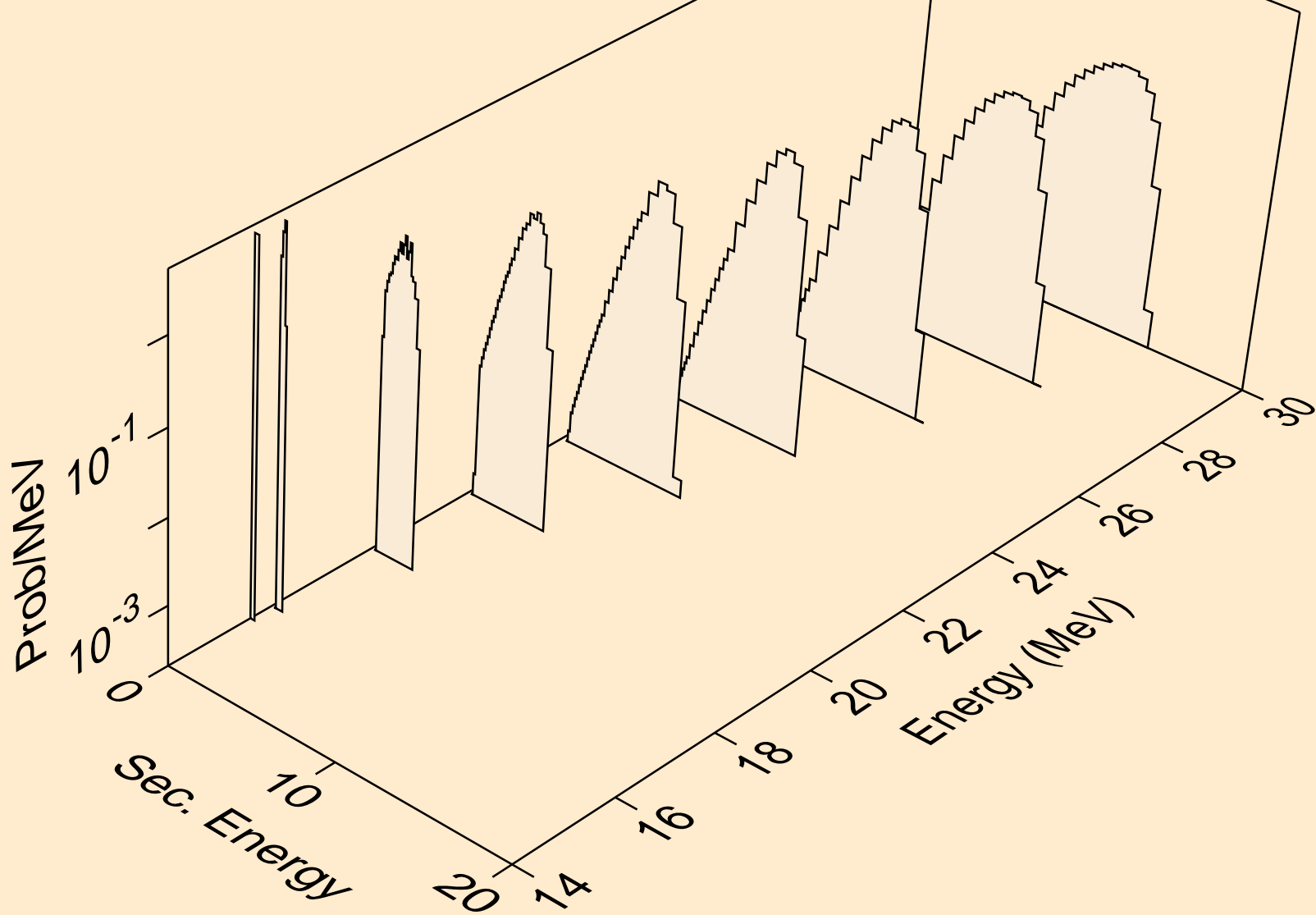

LU169M TRITON ACER TENDL-2021 LIBRARY; T=0.K  
deuterons from (t,n\*)d

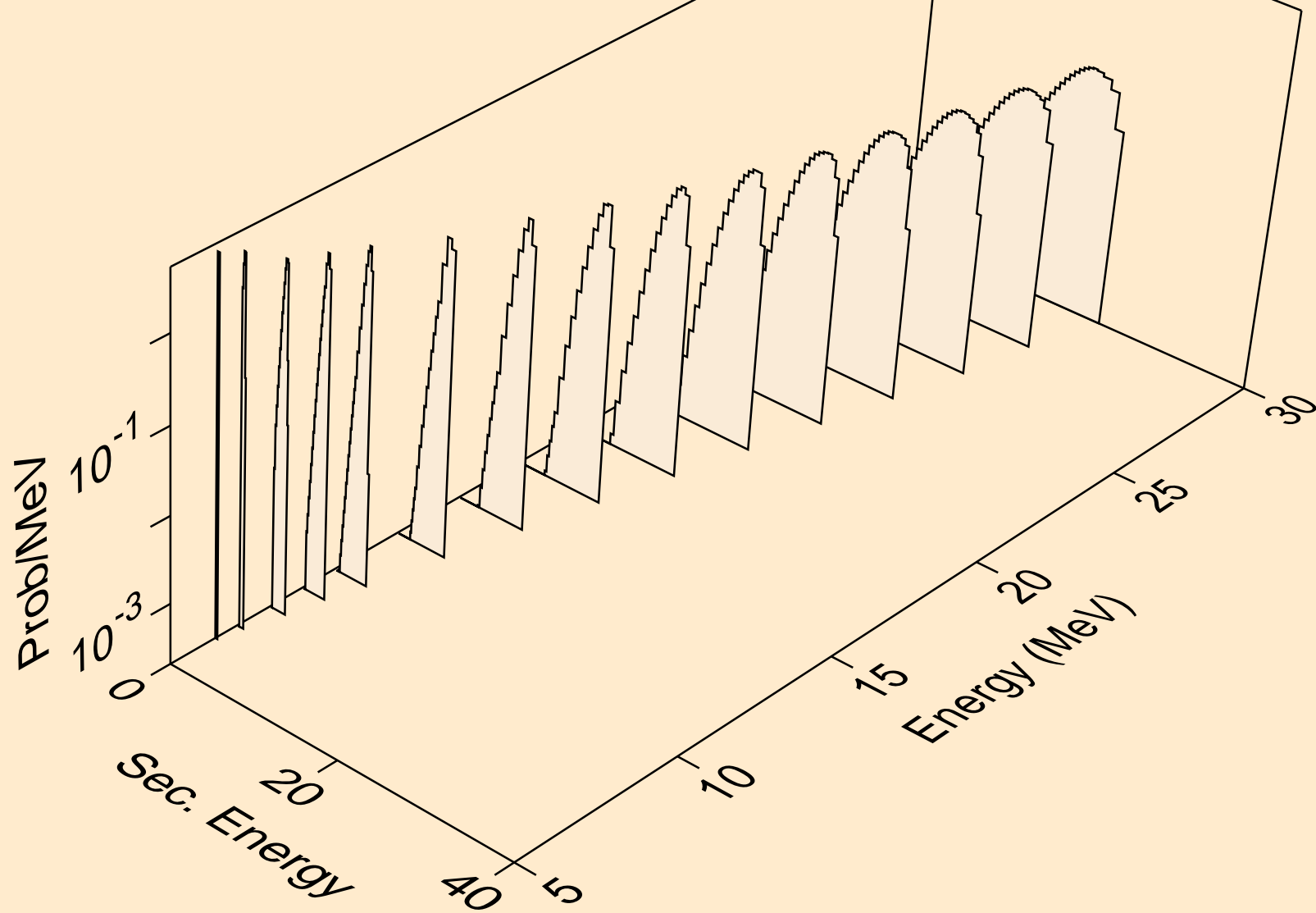



LU169M TRITON ACER TENDL-2021 LIBRARY; T=0.K  
deuterons from (t,d)

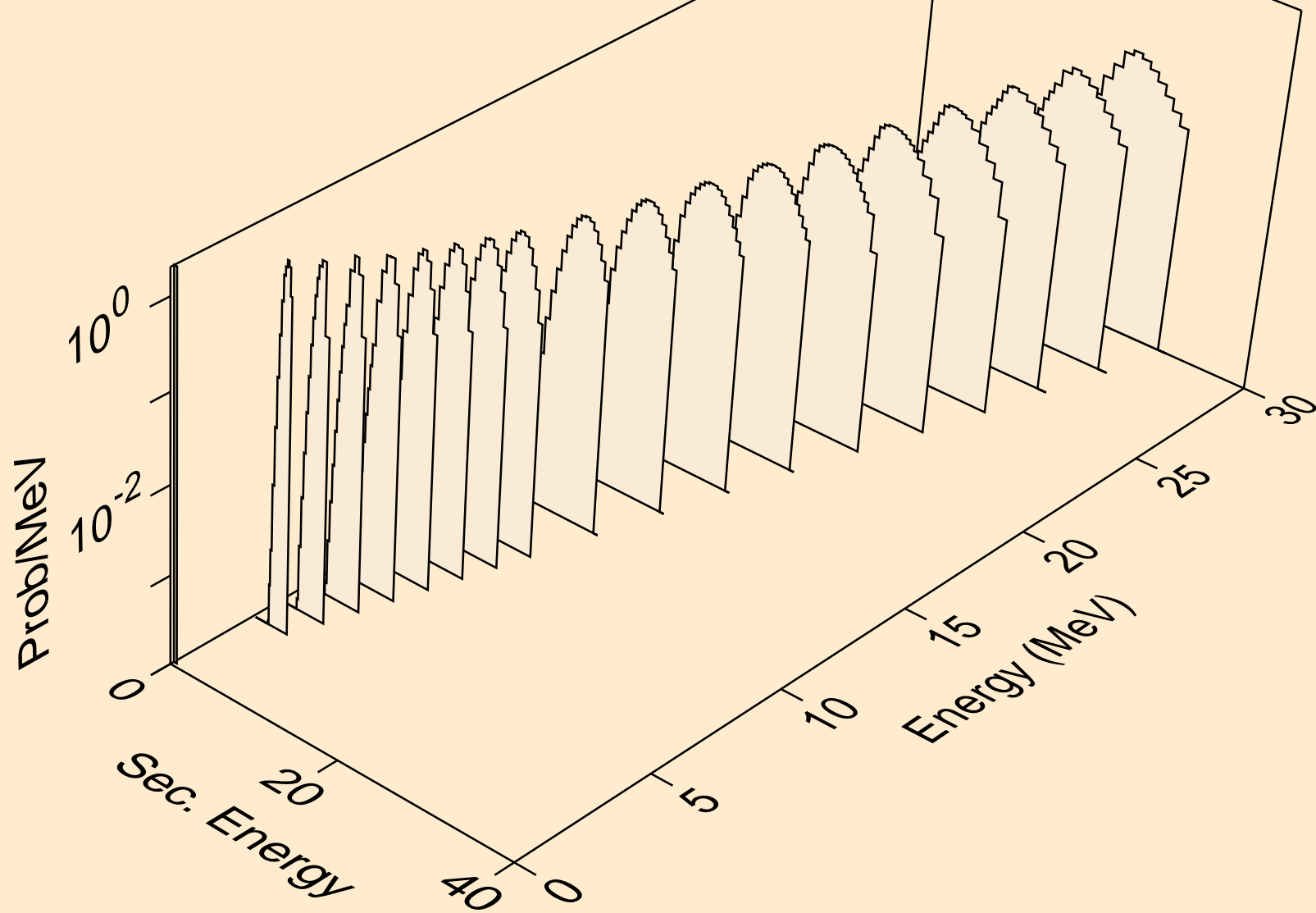

LU169M TRITON ACER TENDL-2021 LIBRARY; T=0.K  
deuterons from (t,pd)

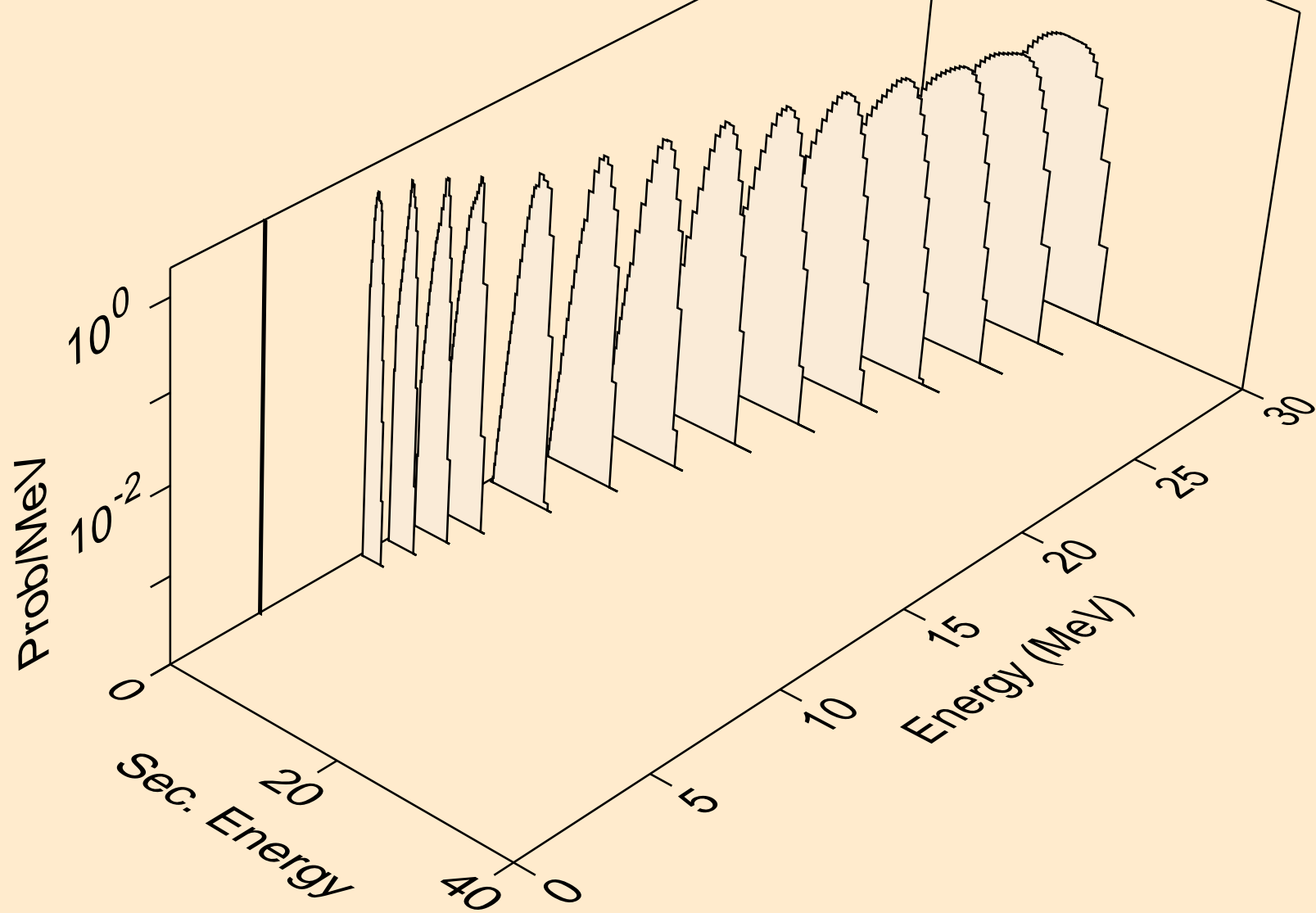

LU169M TRITON ACER TENDL-2021 LIBRARY; T=0.K  
deuterons from (t,da)

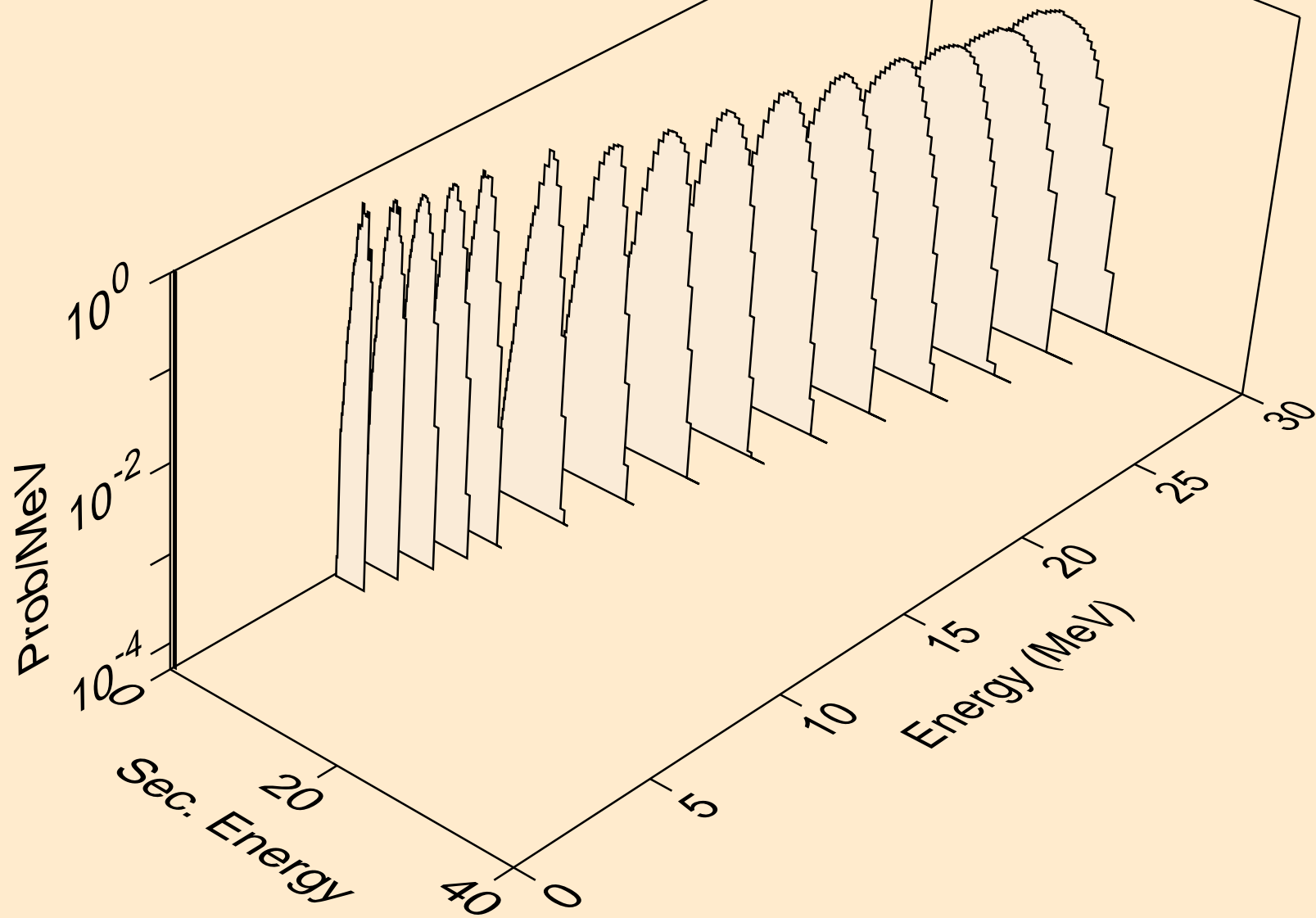

LU169M TRITON ACER TENDL-2021 LIBRARY; T=0.K  
he3s from (t,x)

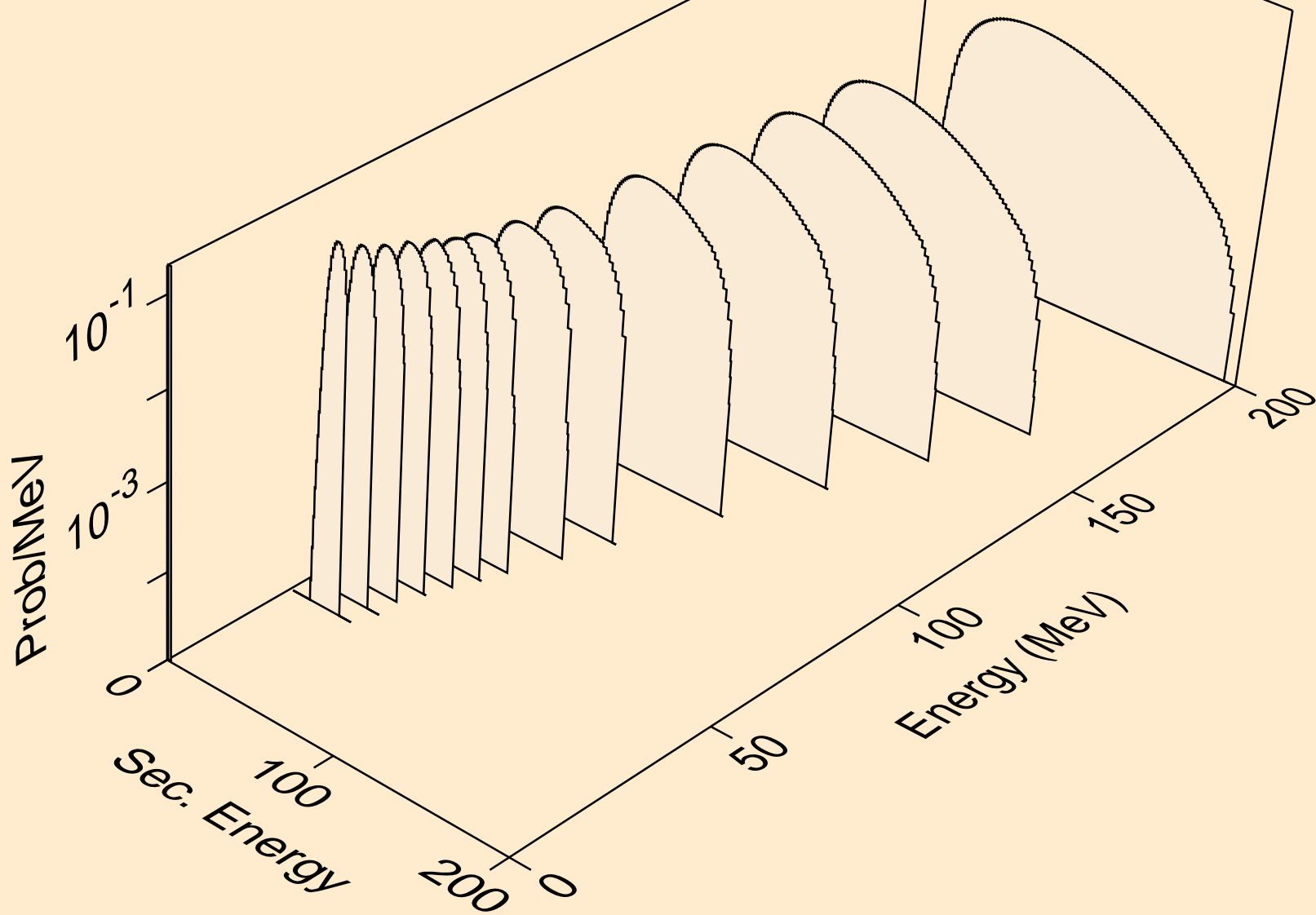

LU169M TRITON ACER TENDL-2021 LIBRARY; T=0.K  
he3s from (t,n\*)he3

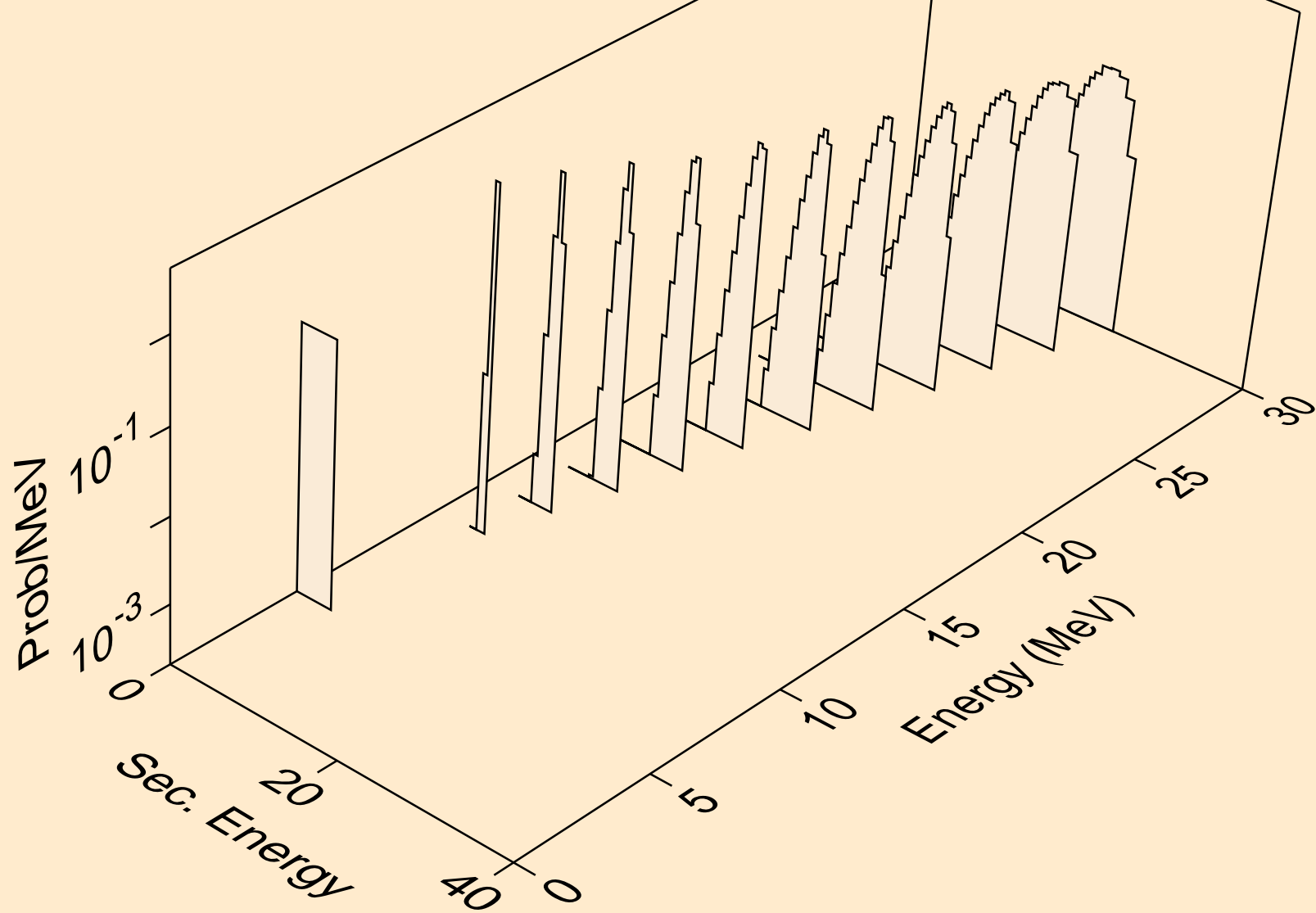

LU169M TRITON ACER TENDL-2021 LIBRARY; T=0.K  
he3s from (t,he3)

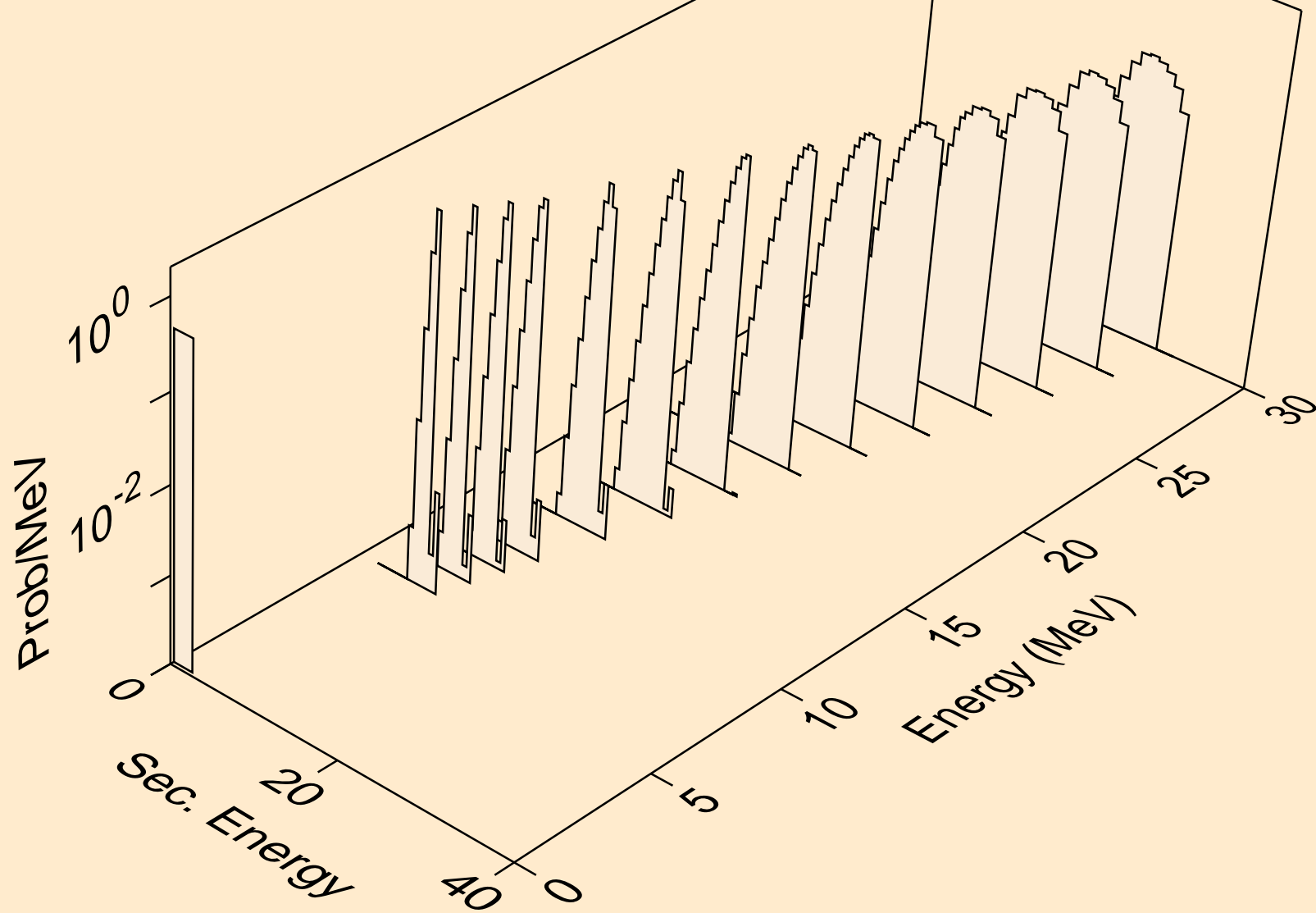

LU169M TRITON ACER TENDL-2021 LIBRARY; T=0.K  
alphas from (t,x)

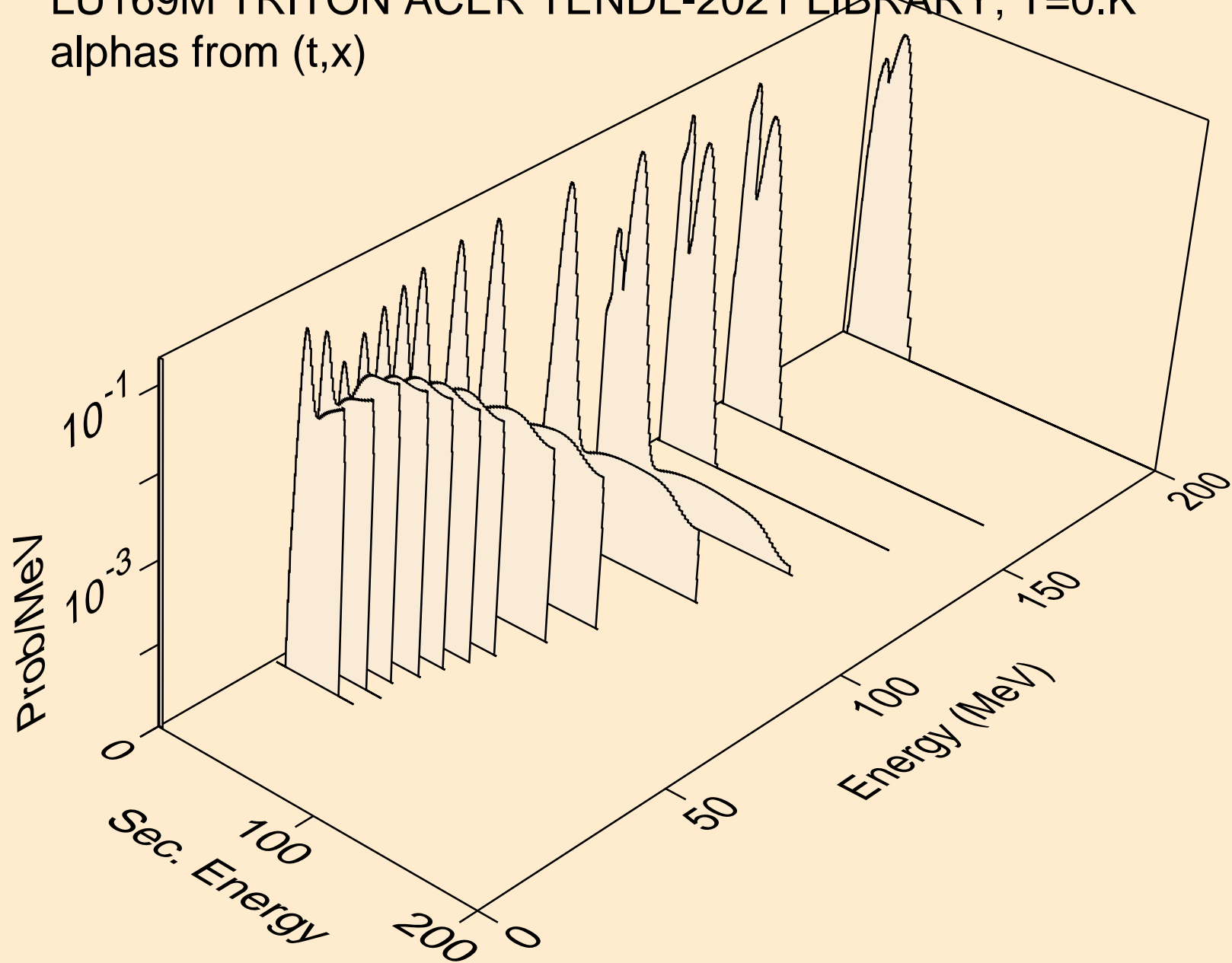

LU169M TRITON ACER TENDL-2021 LIBRARY; T=0.K  
alphas from (t,n\*)a

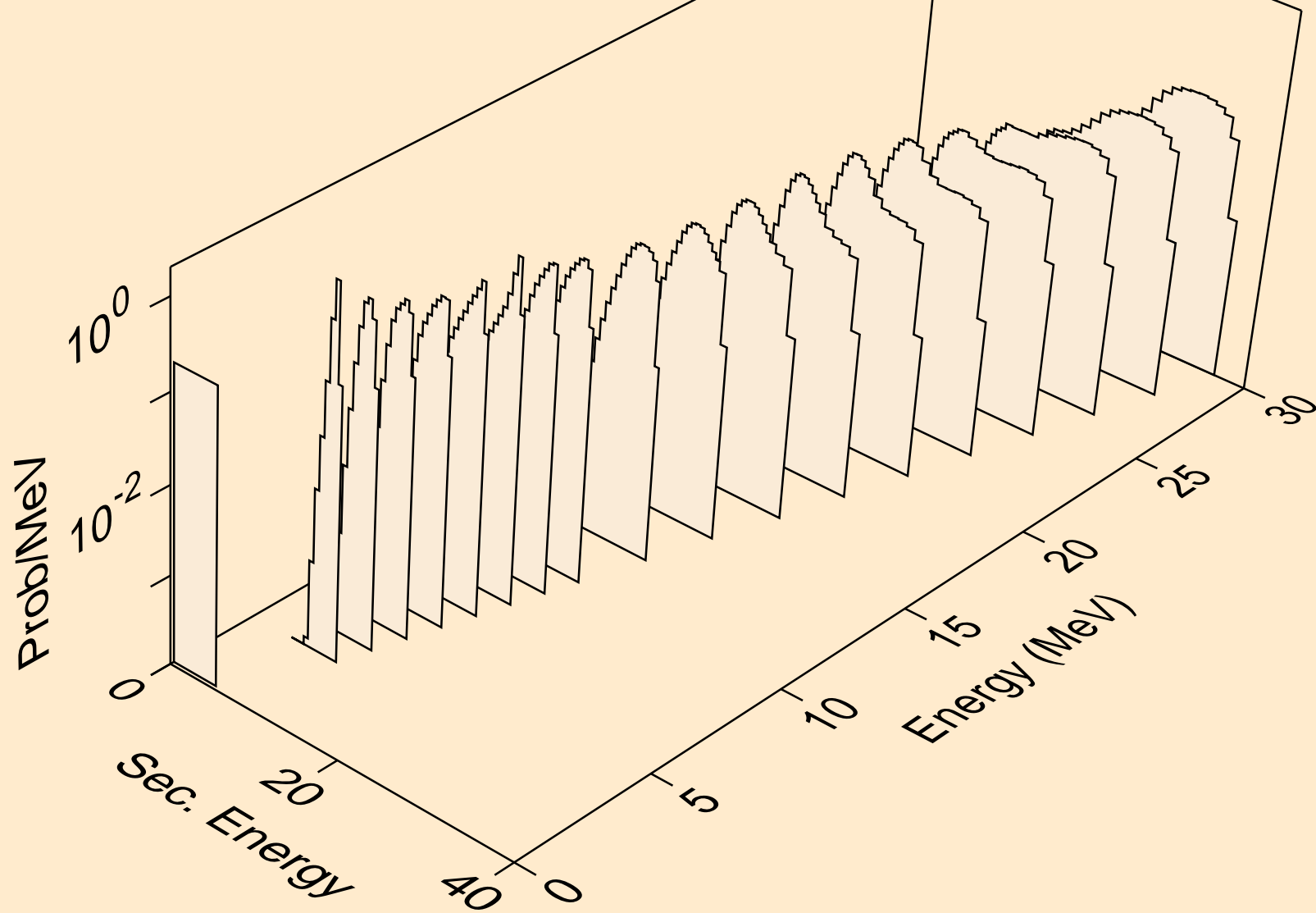



LU169M TRITON ACER TENDL-2021 LIBRARY; T=0.K  
alphas from (t,2n)a

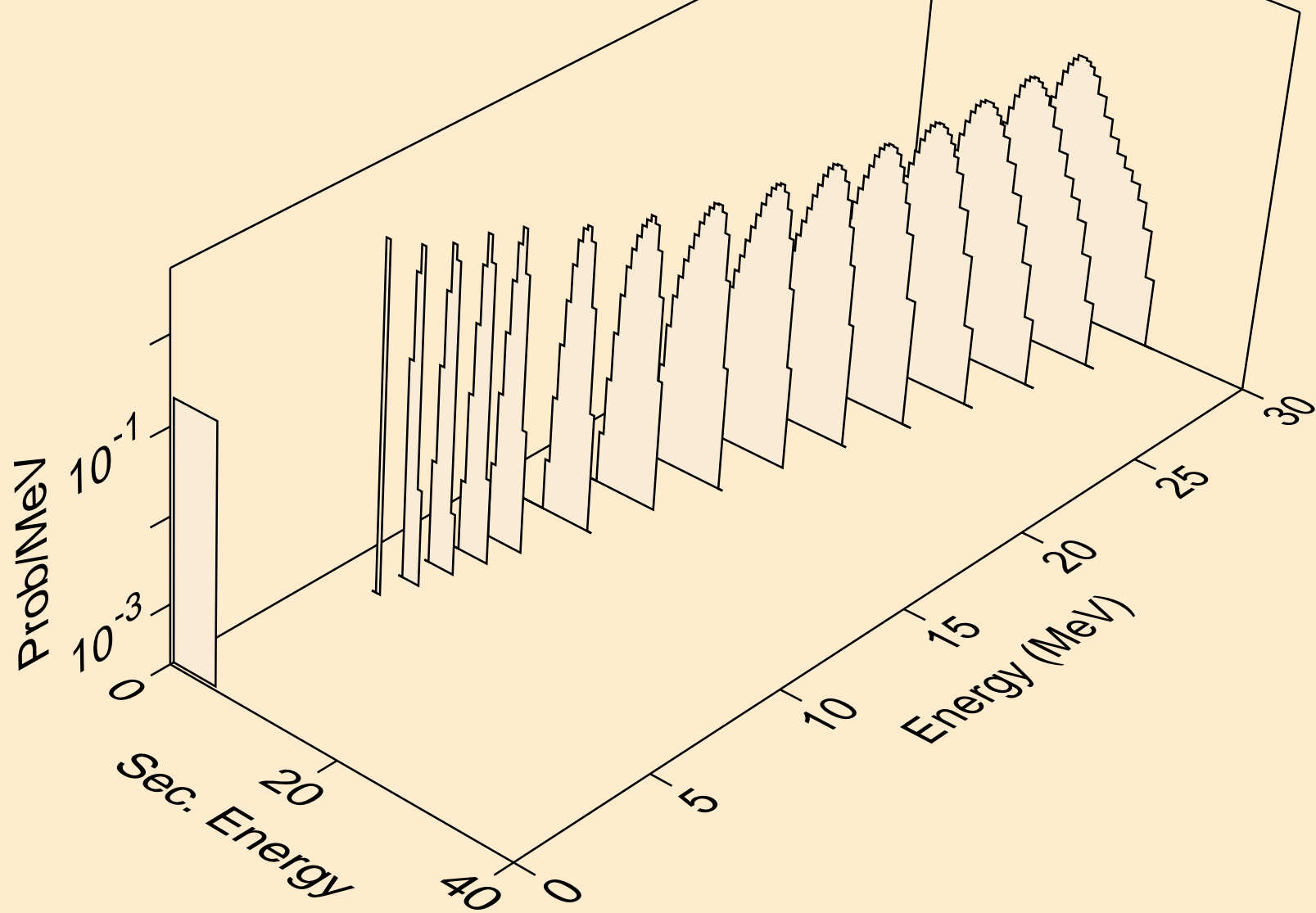

LU169M TRITON ACER TENDL-2021 LIBRARY; T=0.K  
alphas from (t,3n)a

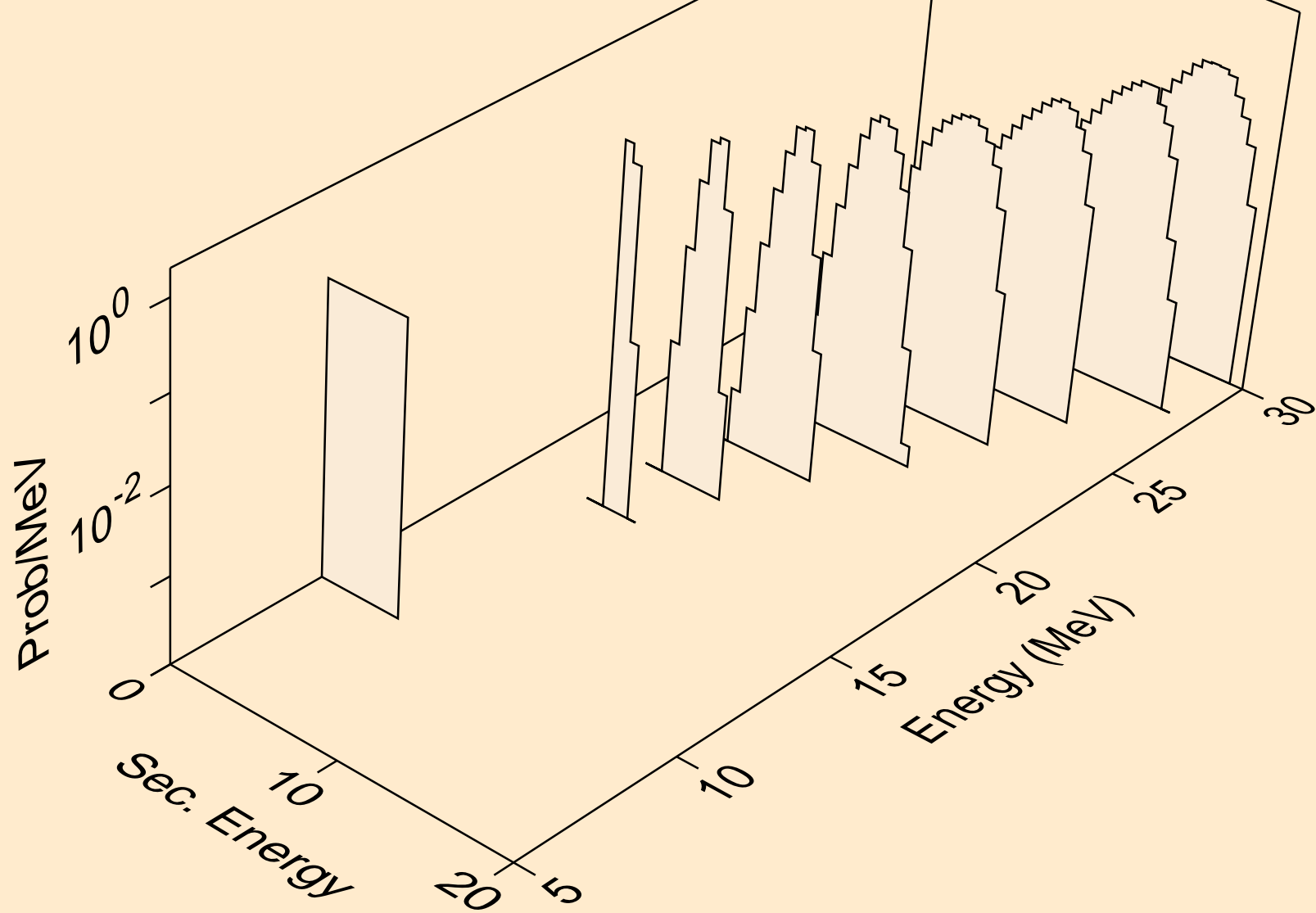

LU169M TRITON ACER TENDL-2021 LIBRARY; T=0.K  
alphas from (t,n\*)2a

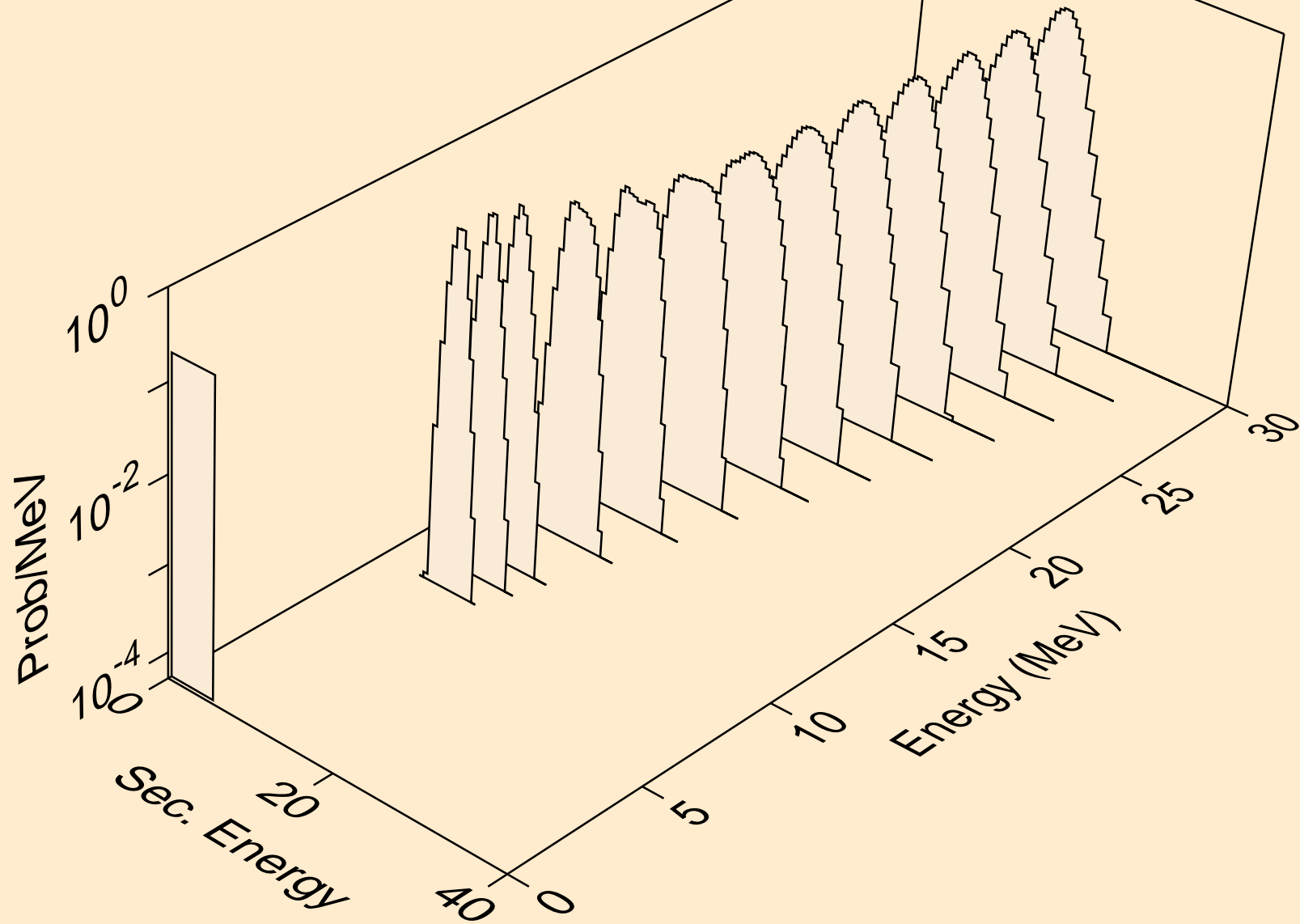

LU169M TRITON ACER TENDL-2021 LIBRARY; T=0.K  
alphas from (t,2n)2a

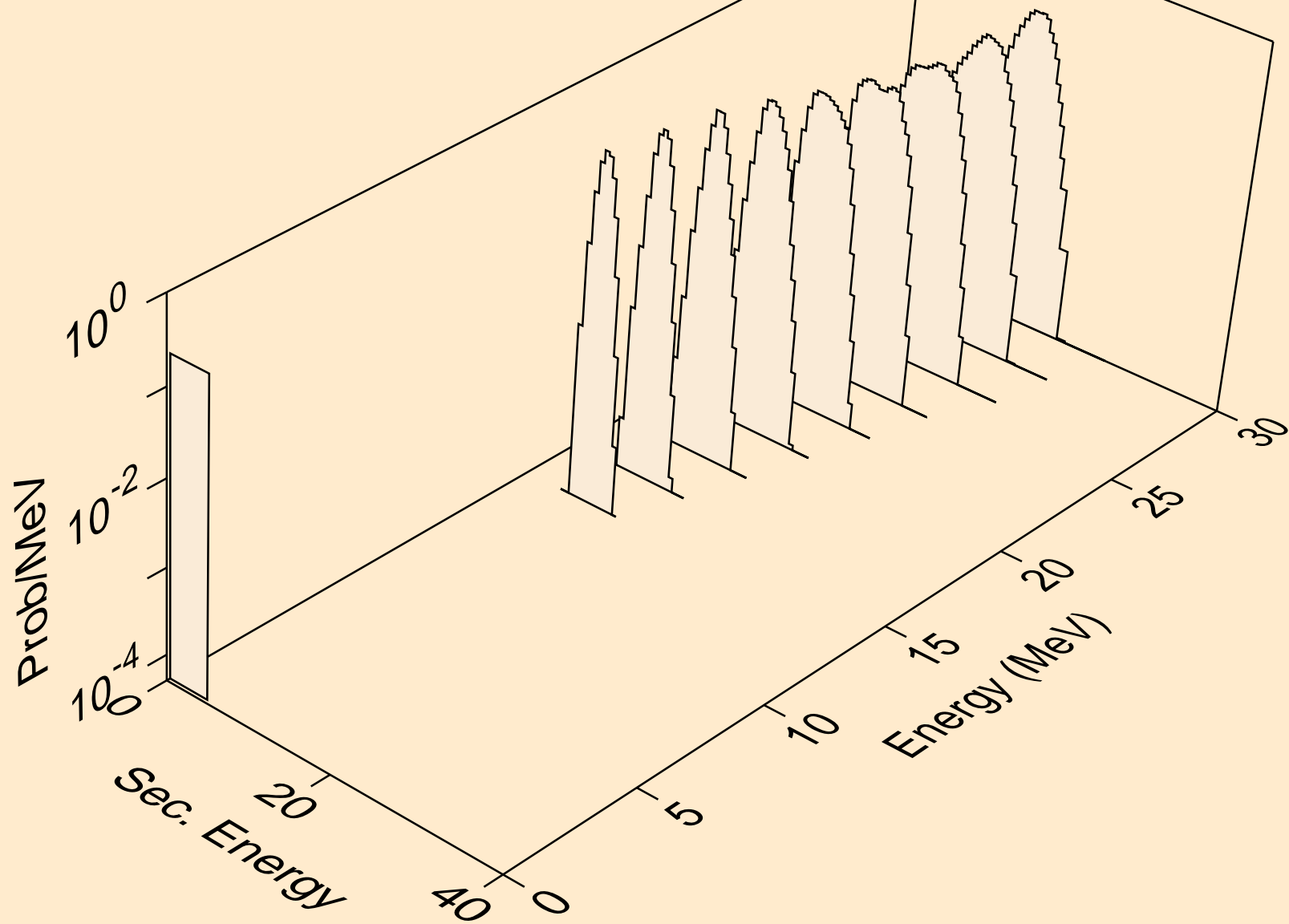

LU169M TRITON ACER TENDL-2021 LIBRARY; T=0.K  
alphas from (t,npa)

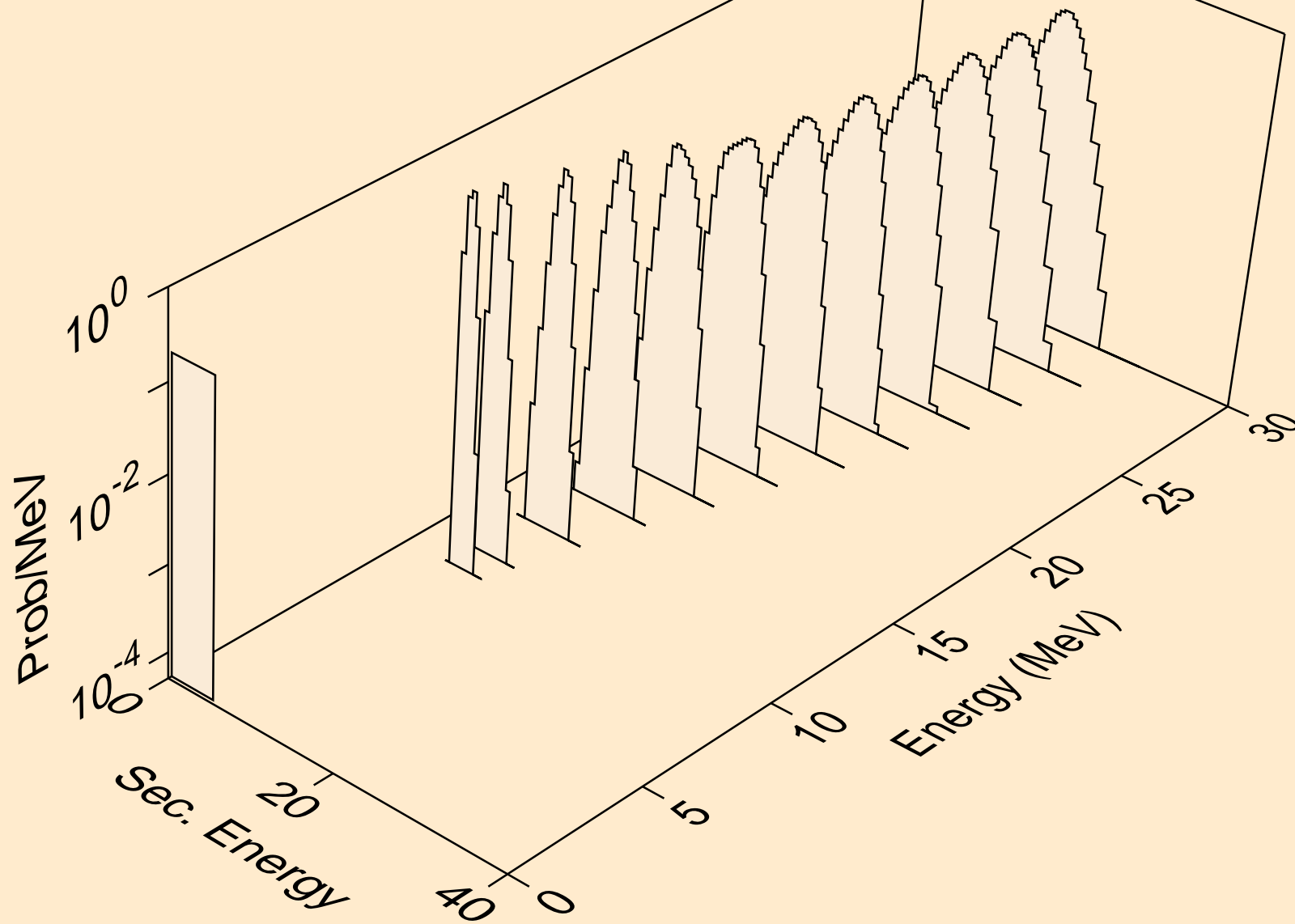

LU169M TRITON ACER TENDL-2021 LIBRARY; T=0.K  
alphas from (t,a)

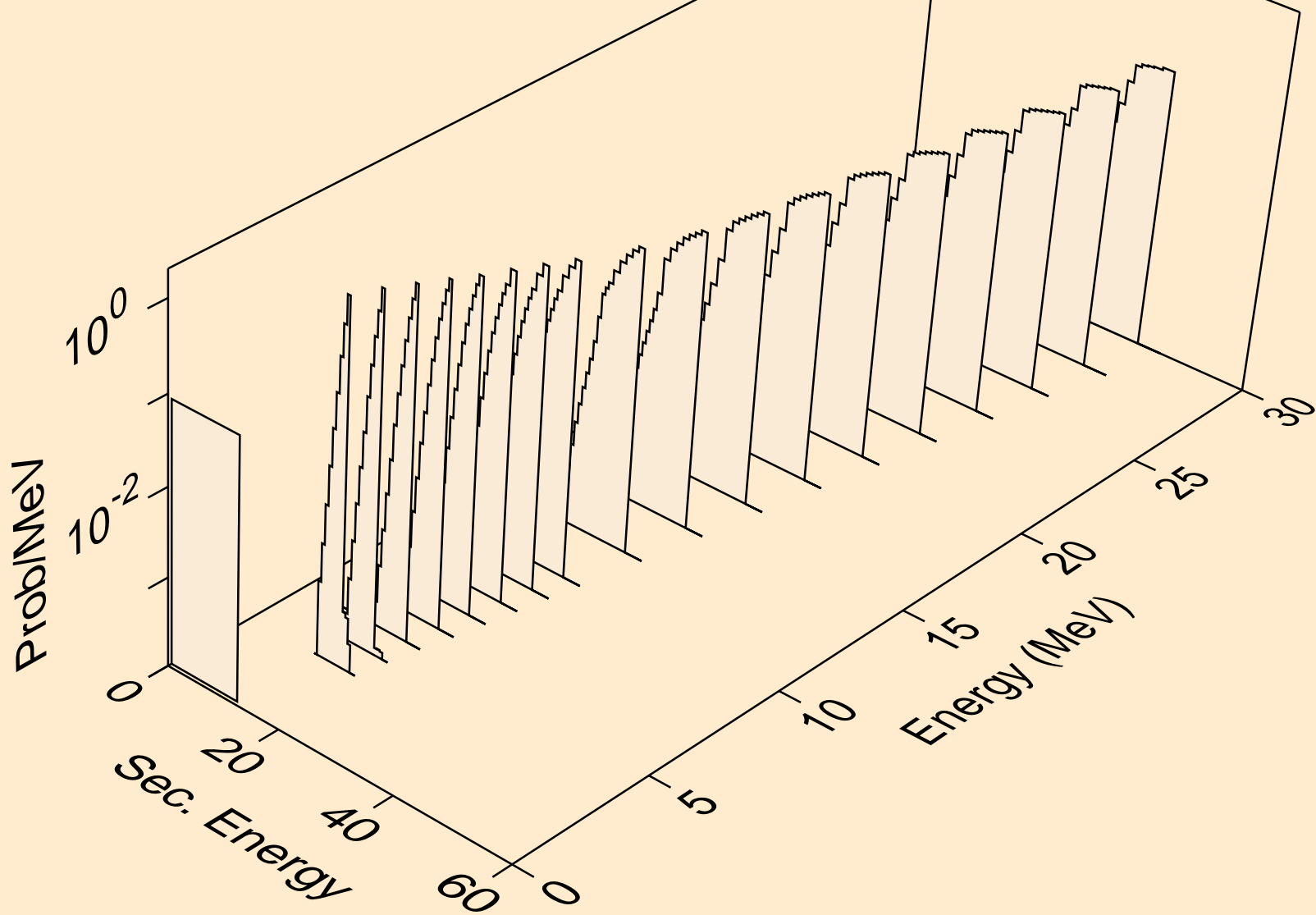

LU169M TRITON ACER TENDL-2021 LIBRARY; T=0.K  
alphas from (t,2a)

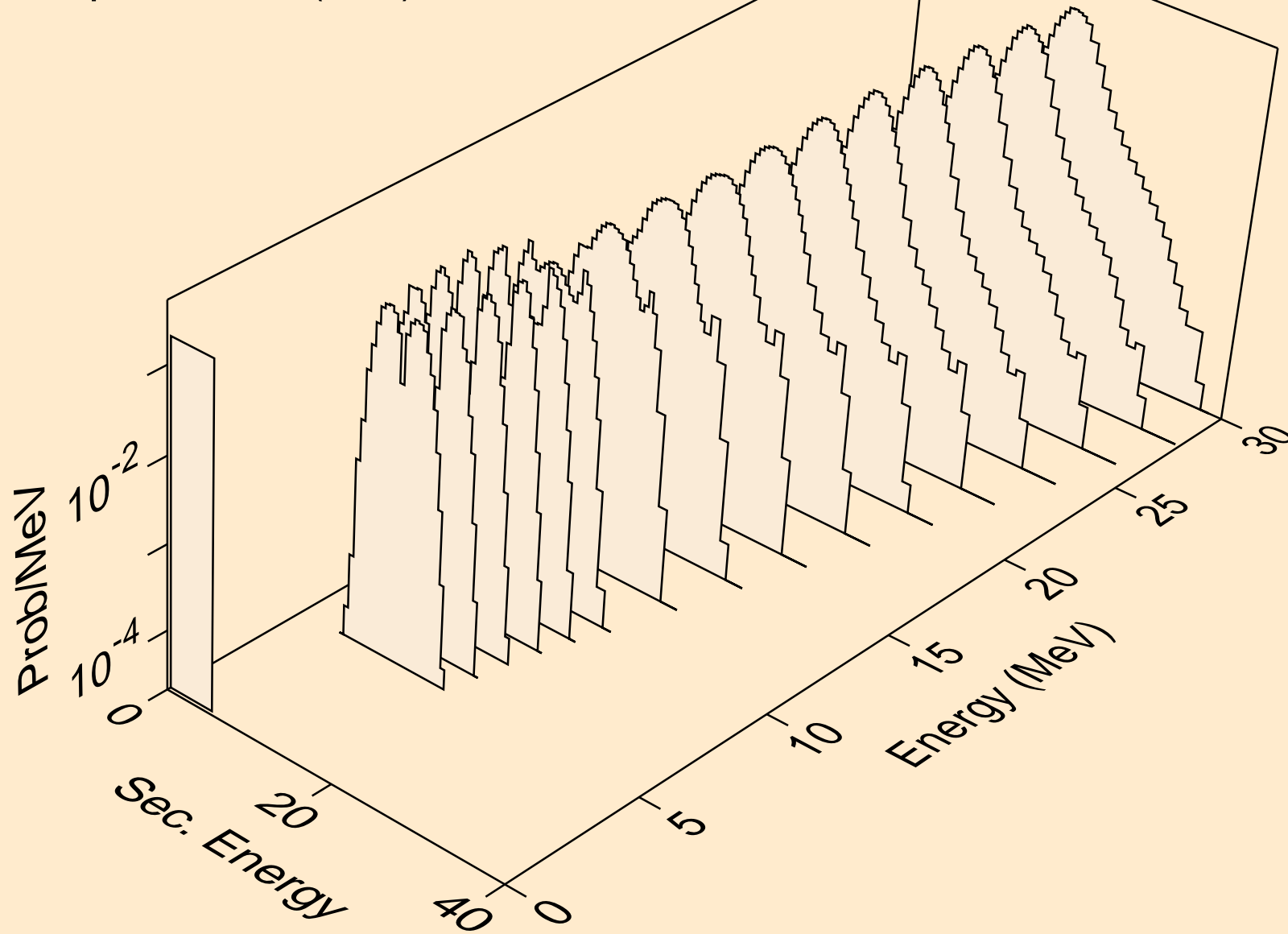

LU169M TRITON ACER TENDL-2021 LIBRARY; T=0.K  
alphas from (t,pa)

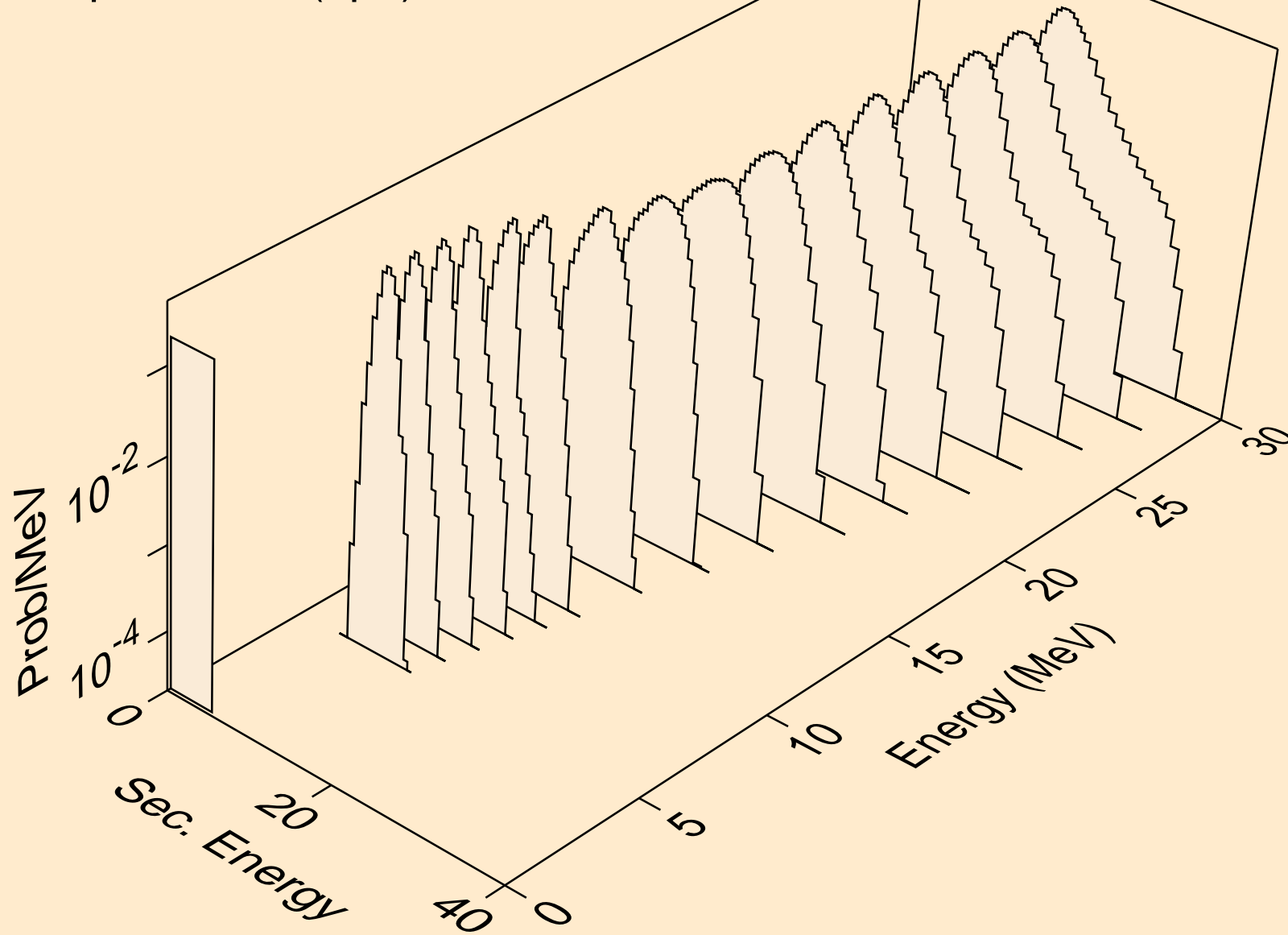



LU169M TRITON ACER TENDL-2021 LIBRARY; T=0.K  
alphas from (t,da)

