

LU179 TRITON ACER TENDL-2021 LIBRARY; T=0.K
Principal cross sections

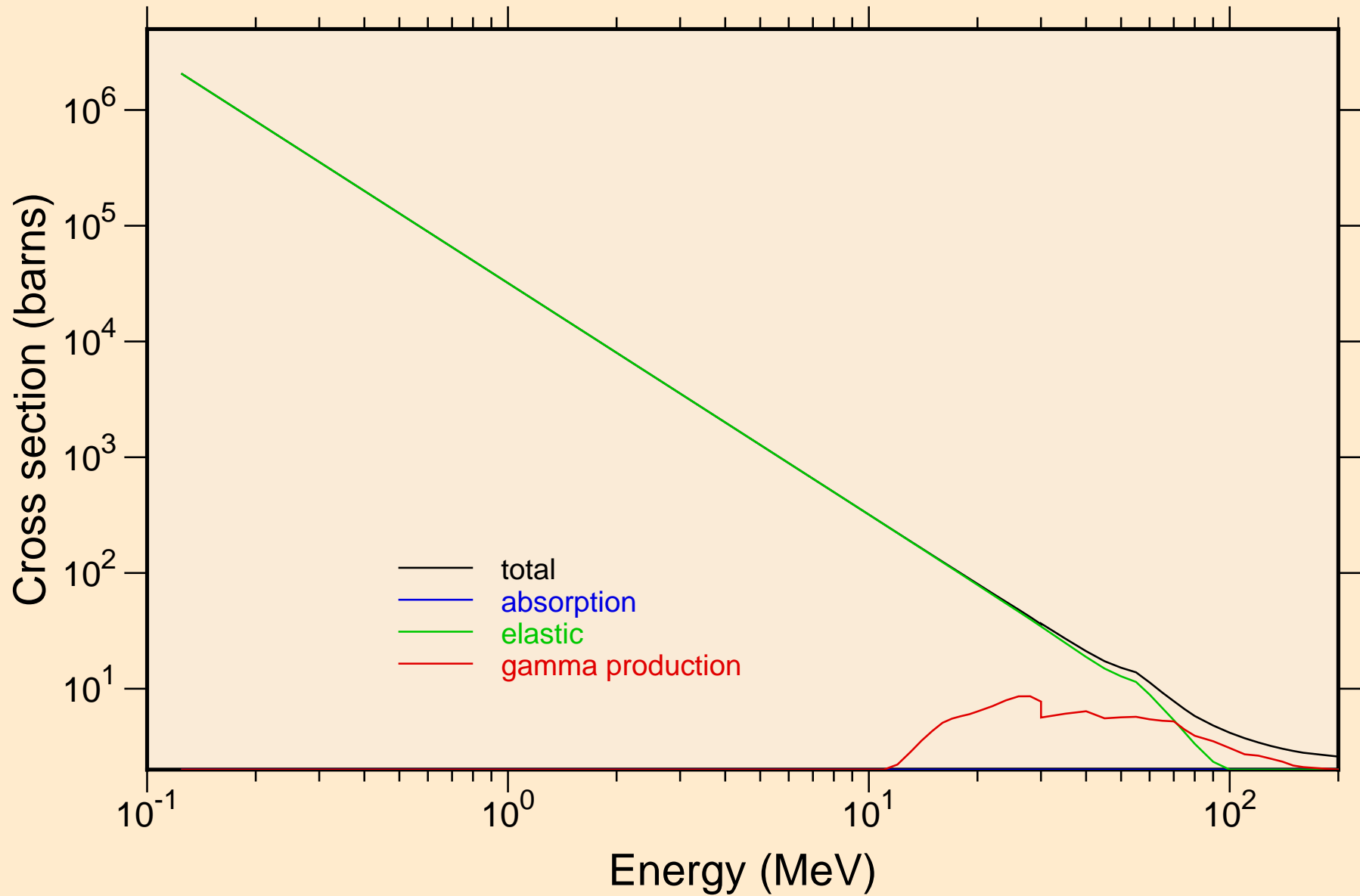

LU179 TRITON ACER TENDL-2021 LIBRARY; T=0.K

Heating

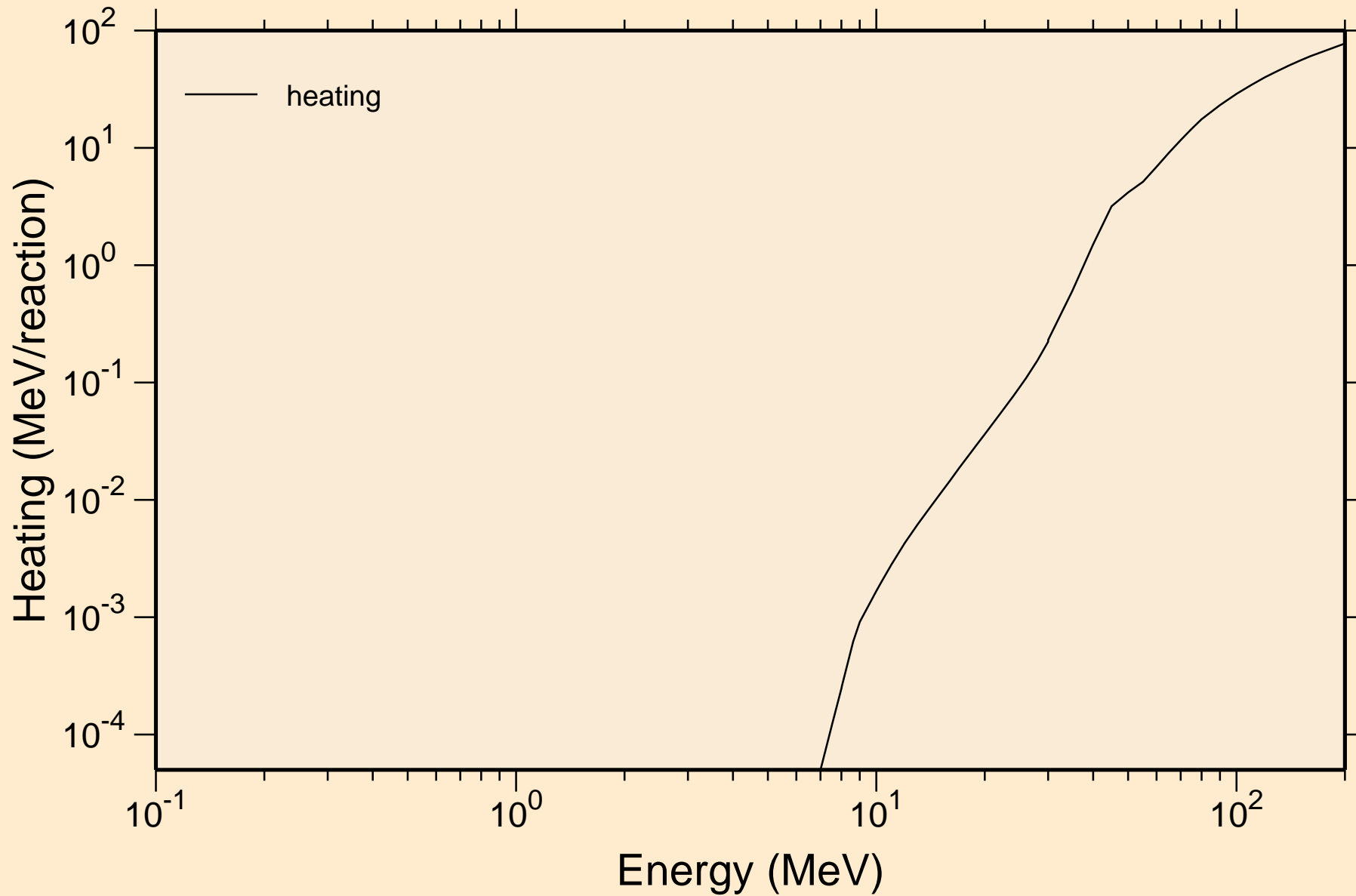

LU179 TRITON ACER TENDL-2021 LIBRARY; T=0.K

Principal cross sections

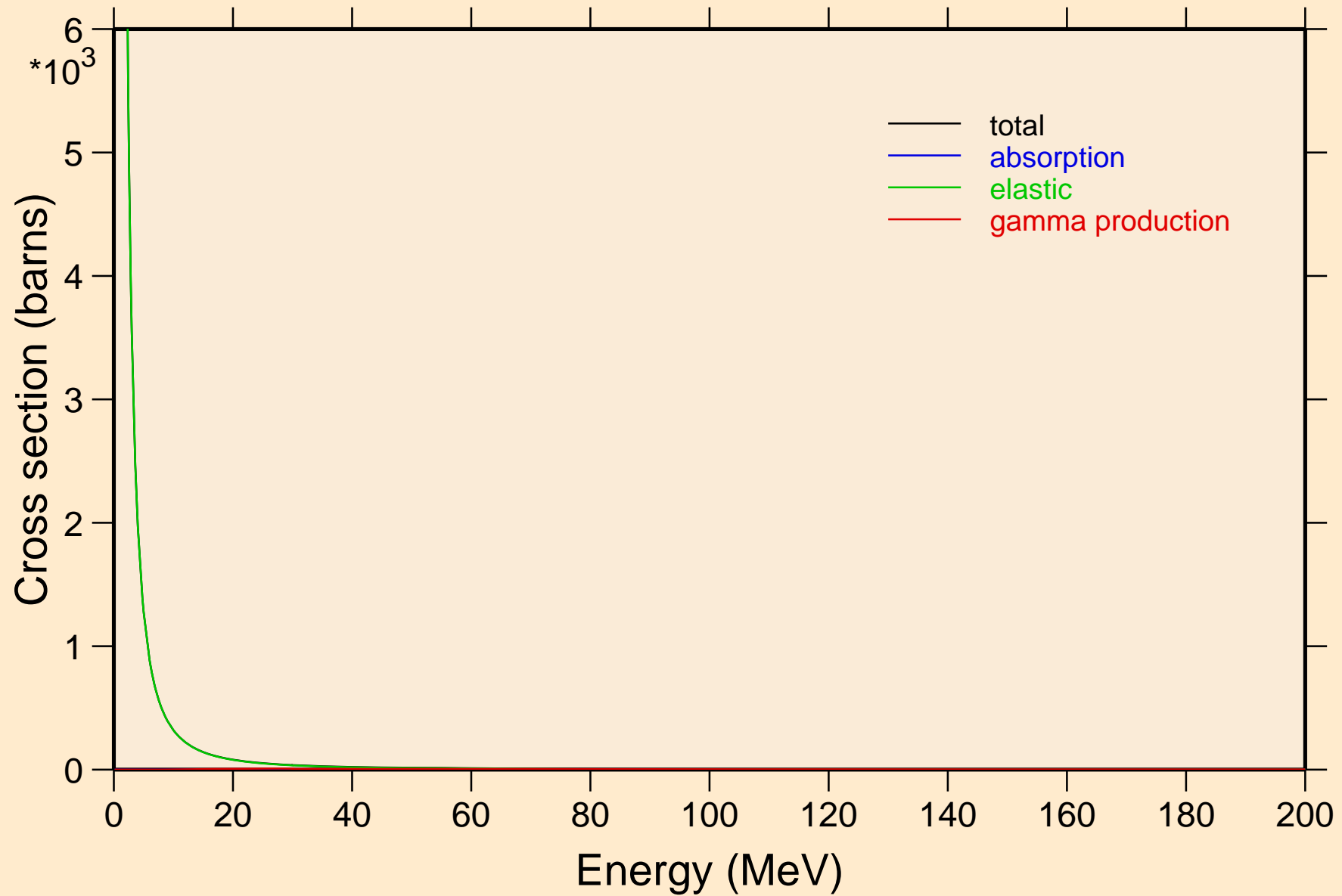

LU179 TRITON ACER TENDL-2021 LIBRARY; T=0.K

Heating

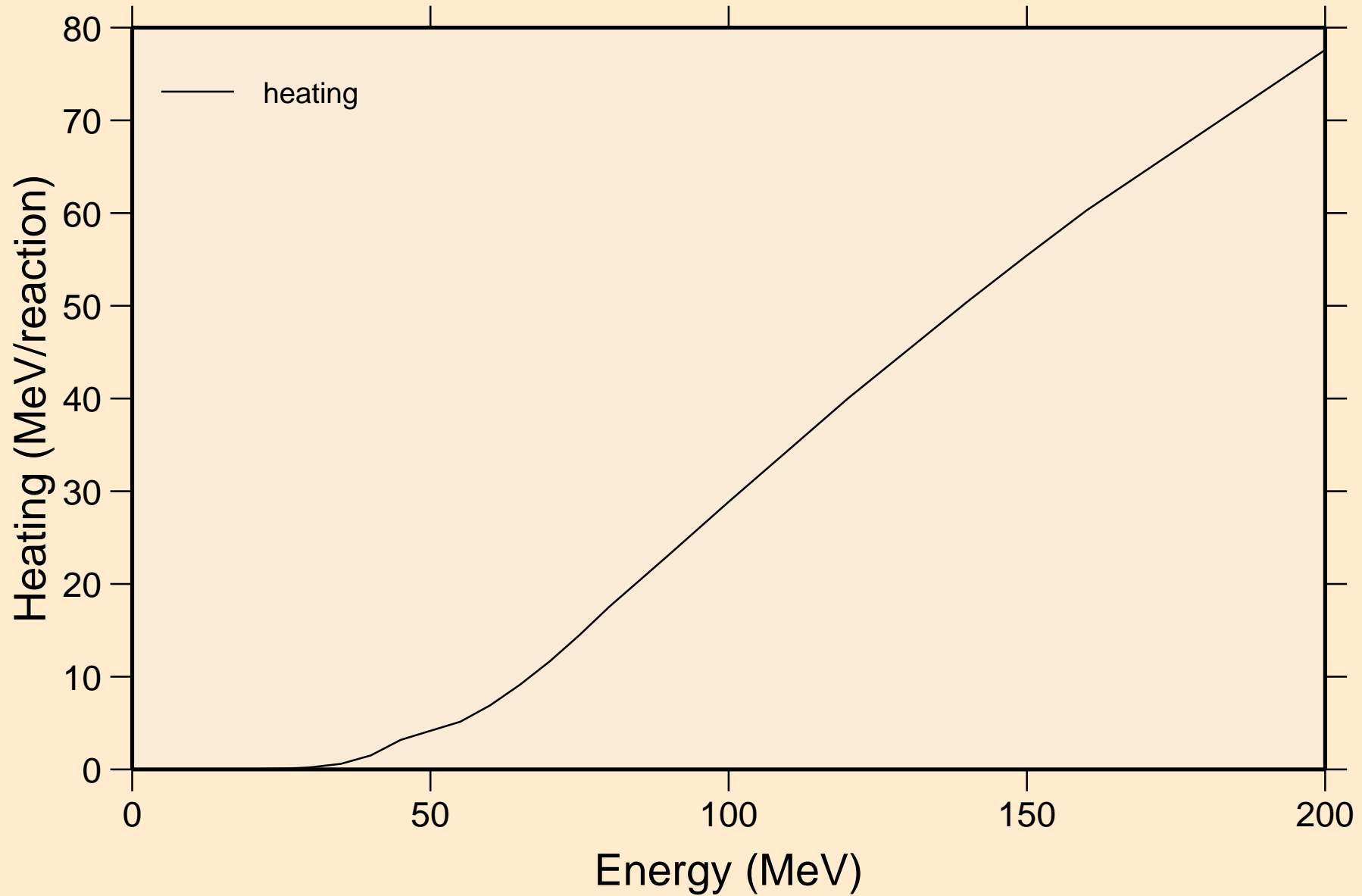

LU179 TRITON ACER TENDL-2021 LIBRARY; T=0.K
Threshold reactions

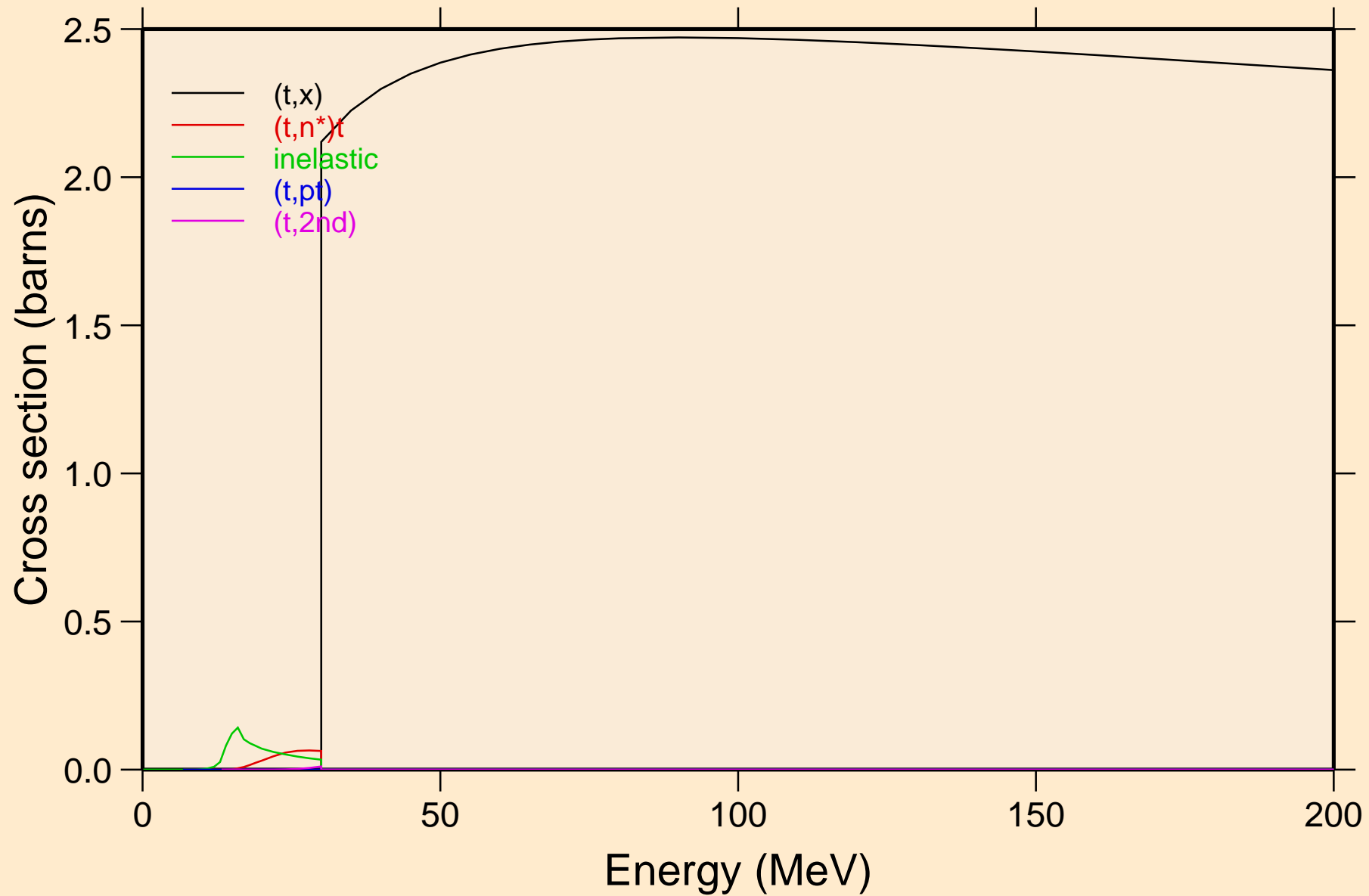

LU179 TRITON ACER TENDL-2021 LIBRARY; T=0.K
Threshold reactions

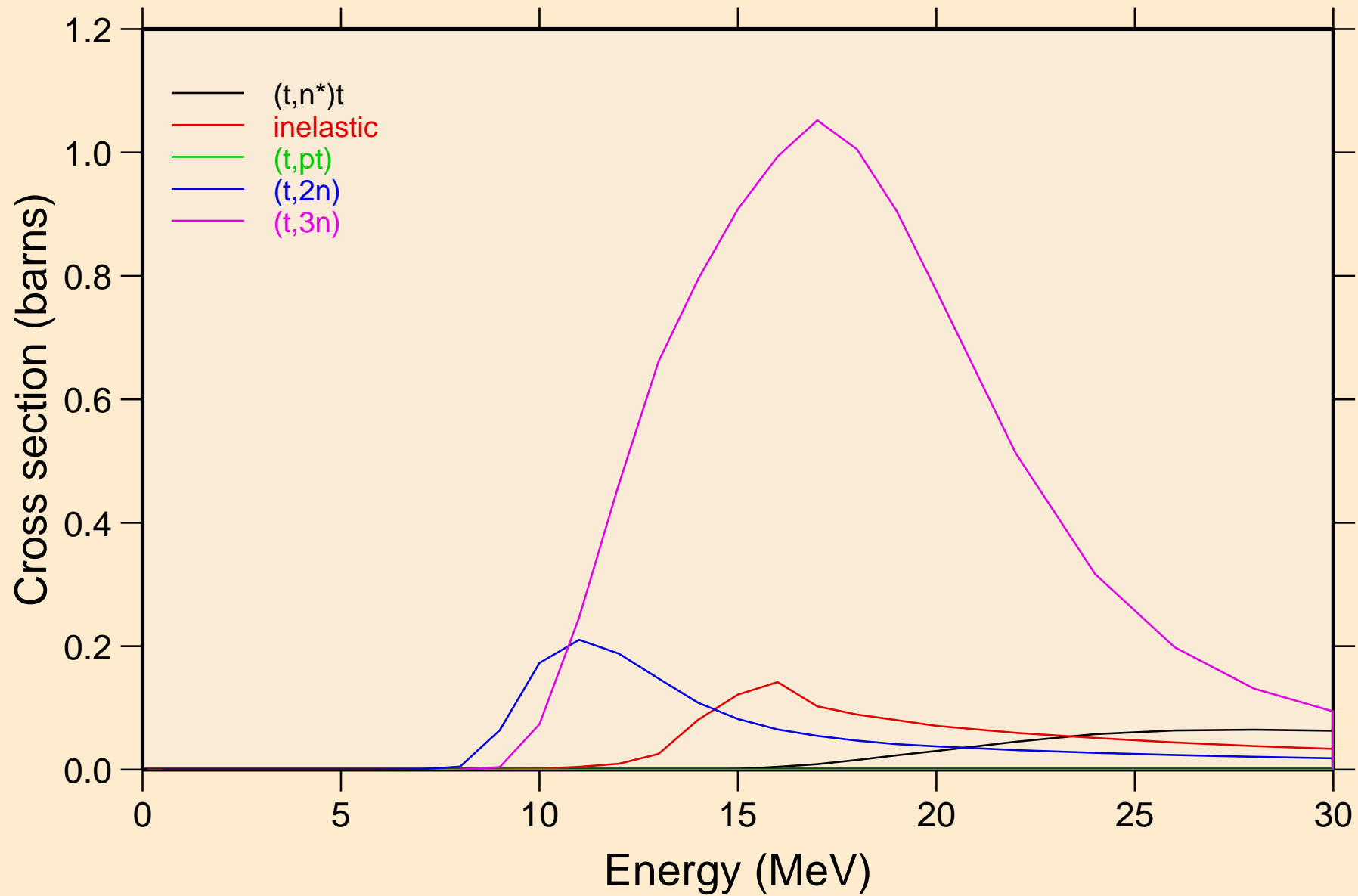

LU179 TRITON ACER TENDL-2021 LIBRARY; T=0.K
Threshold reactions

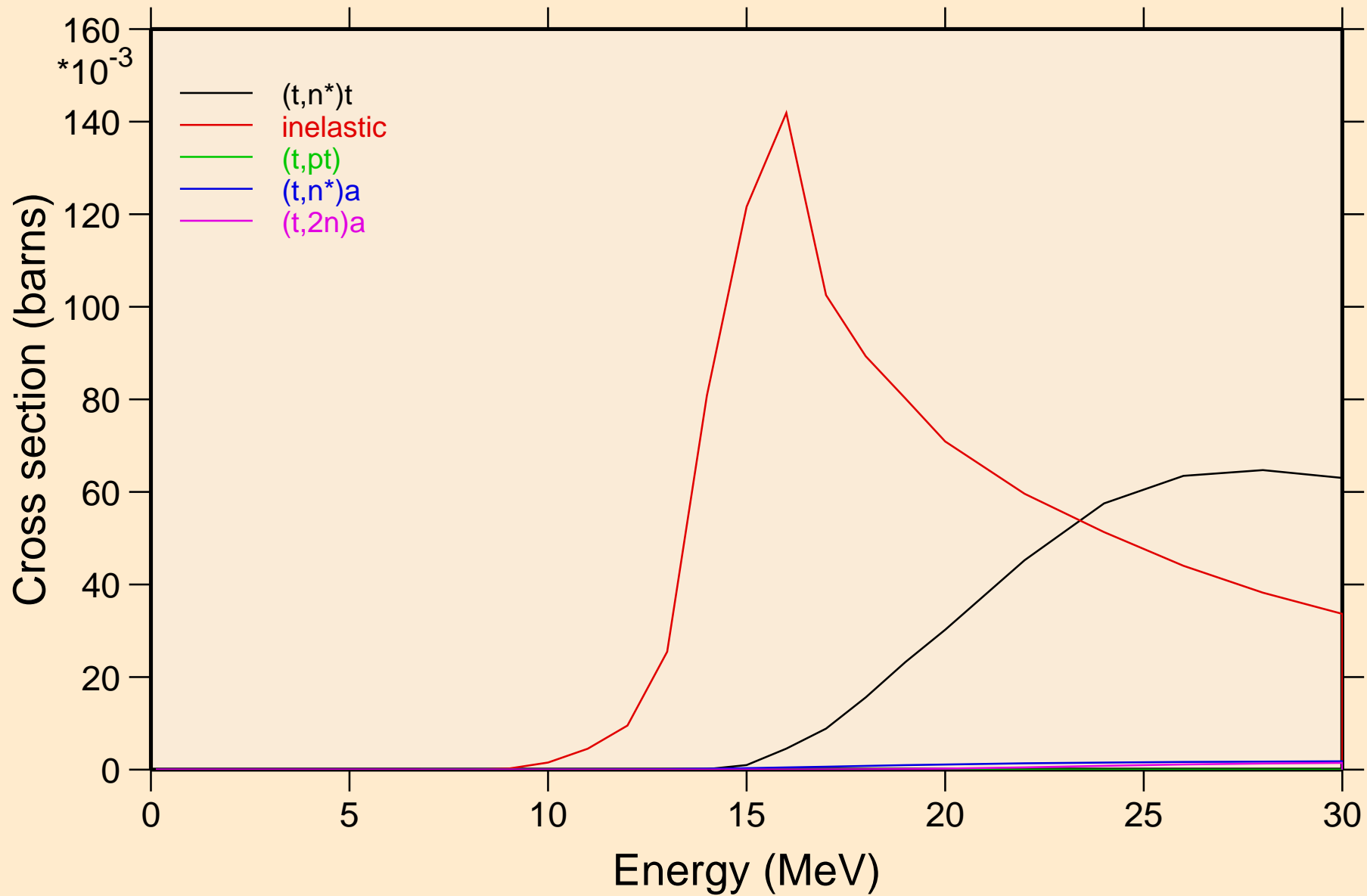

LU179 TRITON ACER TENDL-2021 LIBRARY; T=0.K
Threshold reactions

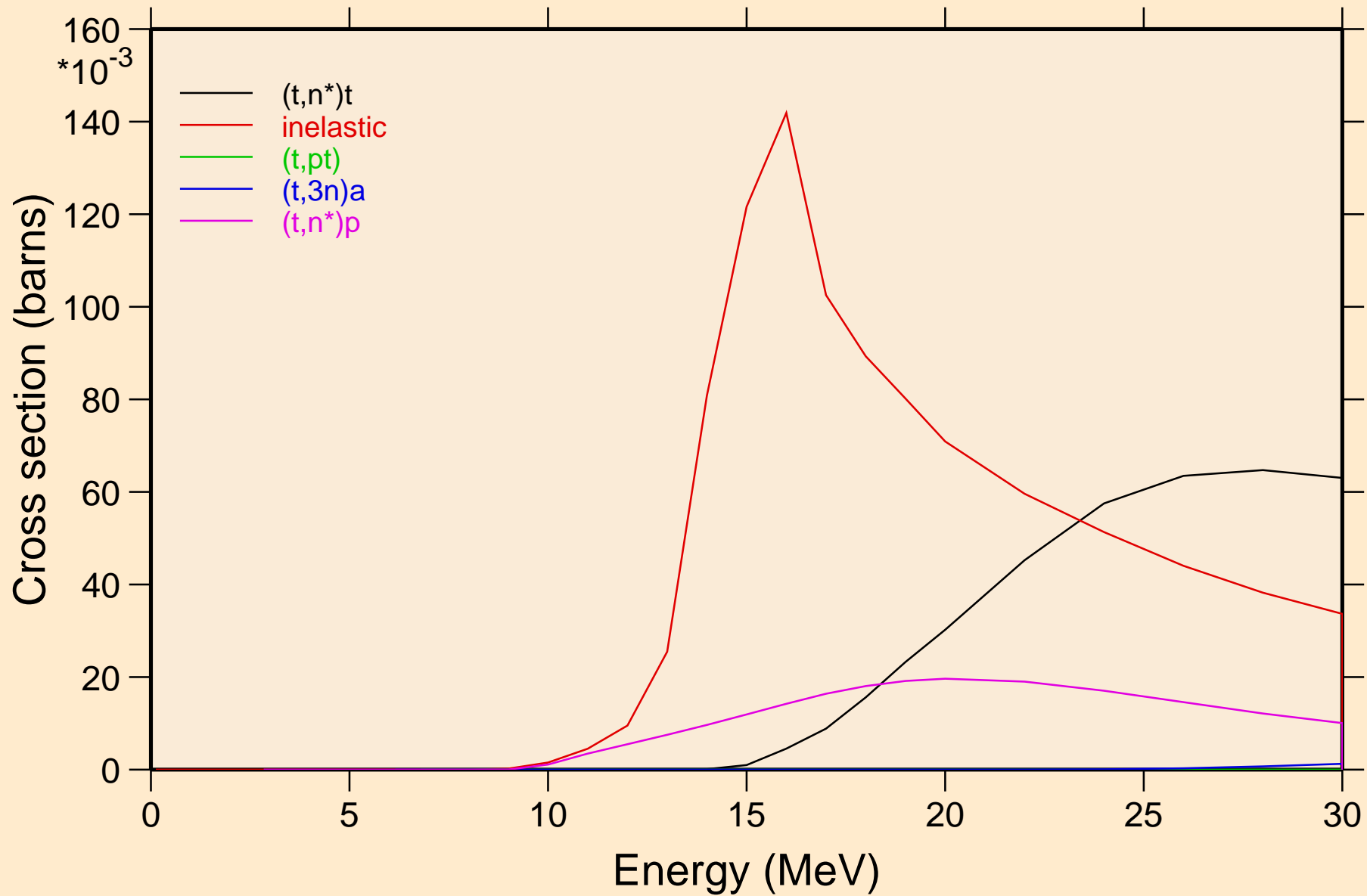

LU179 TRITON ACER TENDL-2021 LIBRARY; T=0.K
Threshold reactions

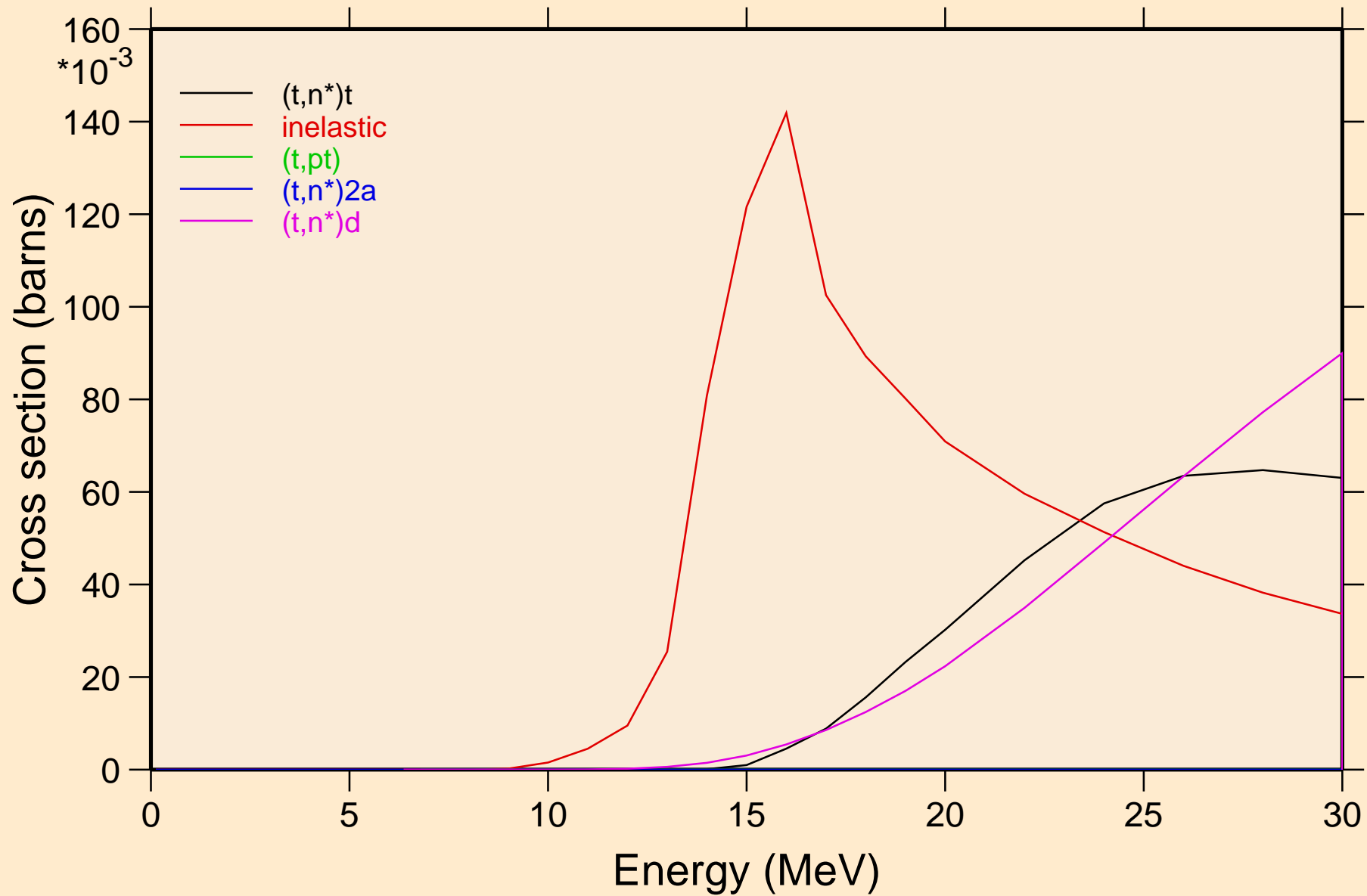

LU179 TRITON ACER TENDL-2021 LIBRARY; T=0.K
Threshold reactions

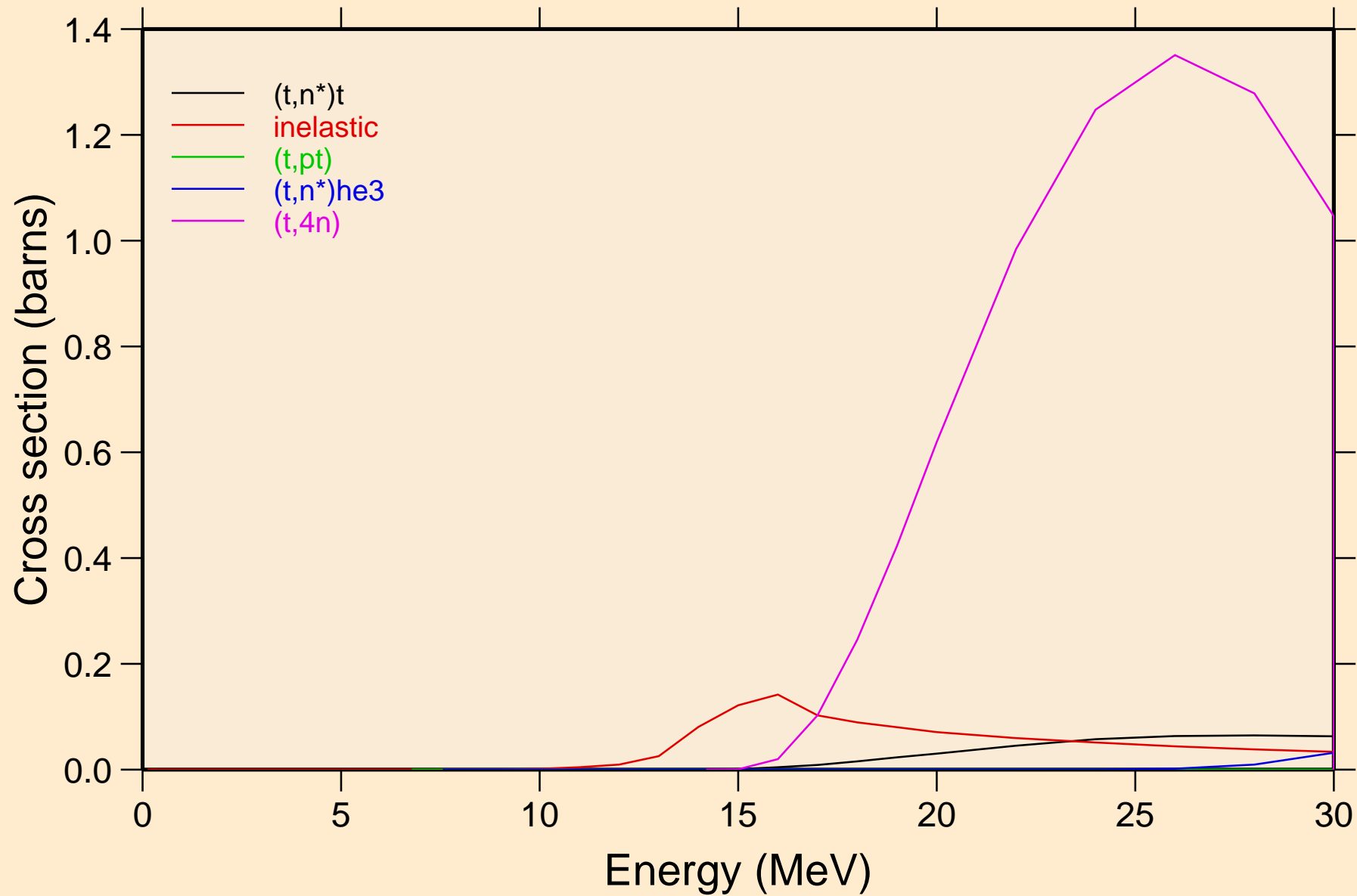

LU179 TRITON ACER TENDL-2021 LIBRARY; T=0.K
Threshold reactions

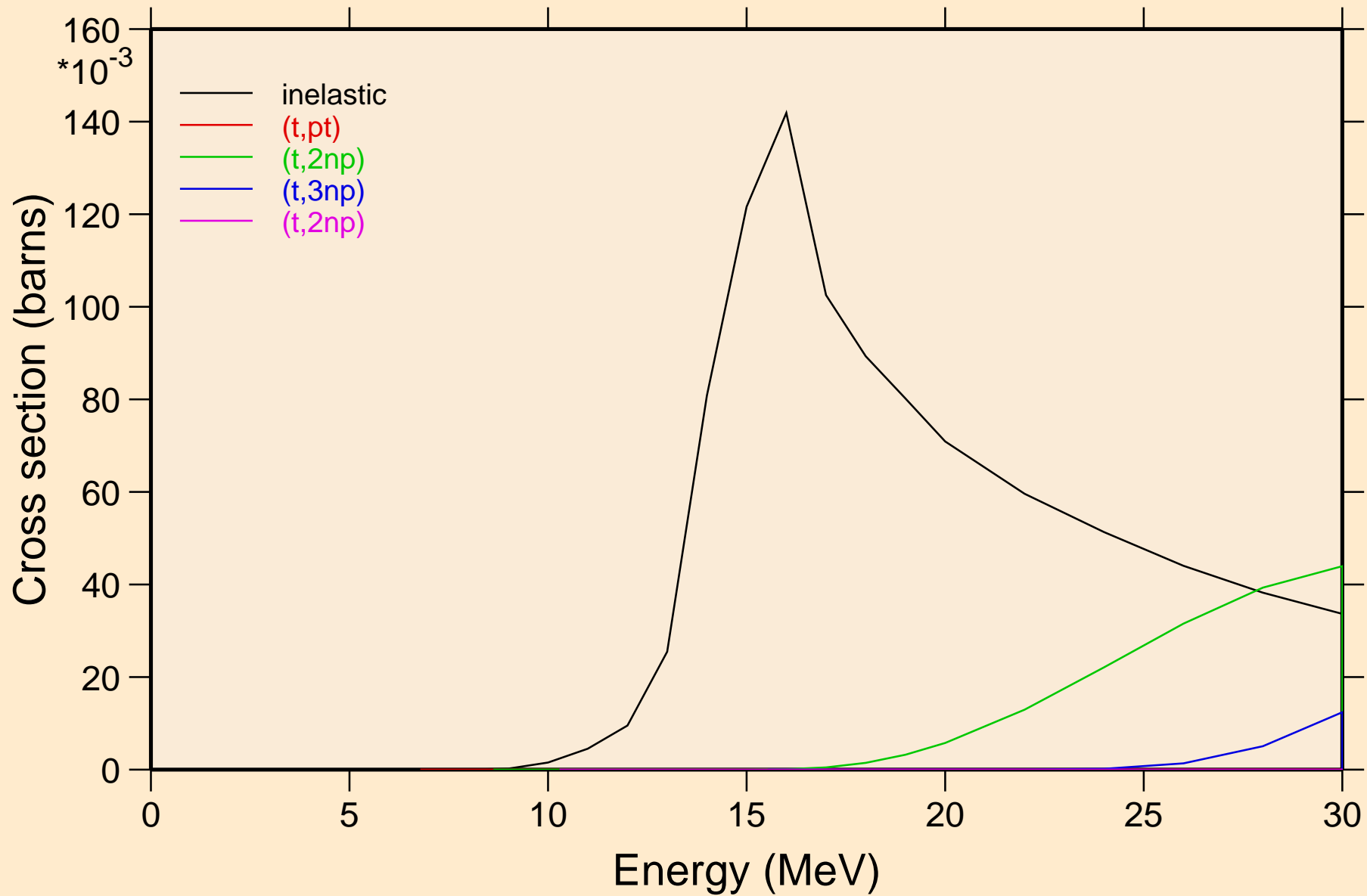

LU179 TRITON ACER TENDL-2021 LIBRARY; T=0.K
Threshold reactions

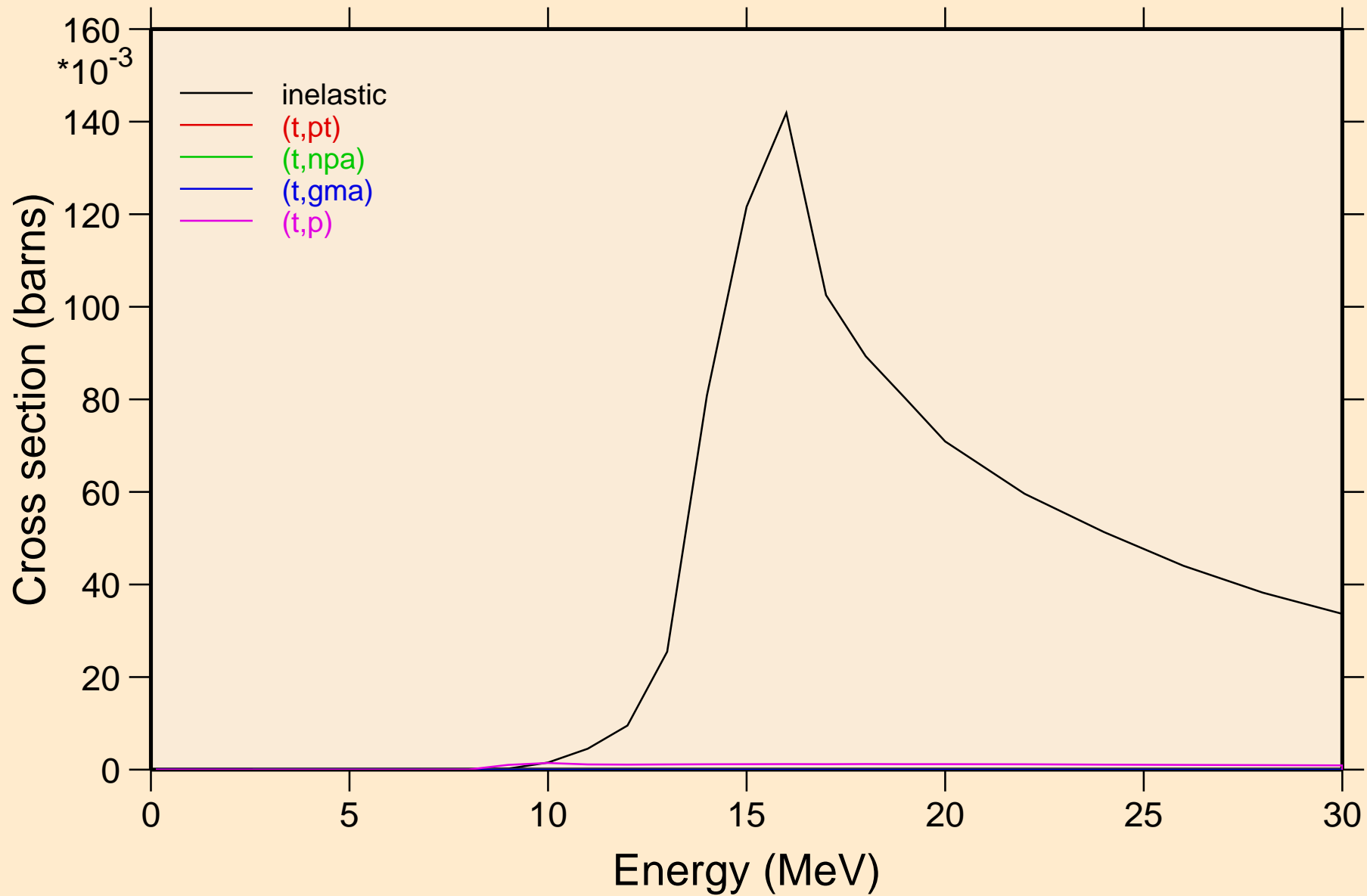

LU179 TRITON ACER TENDL-2021 LIBRARY; T=0.K
Threshold reactions

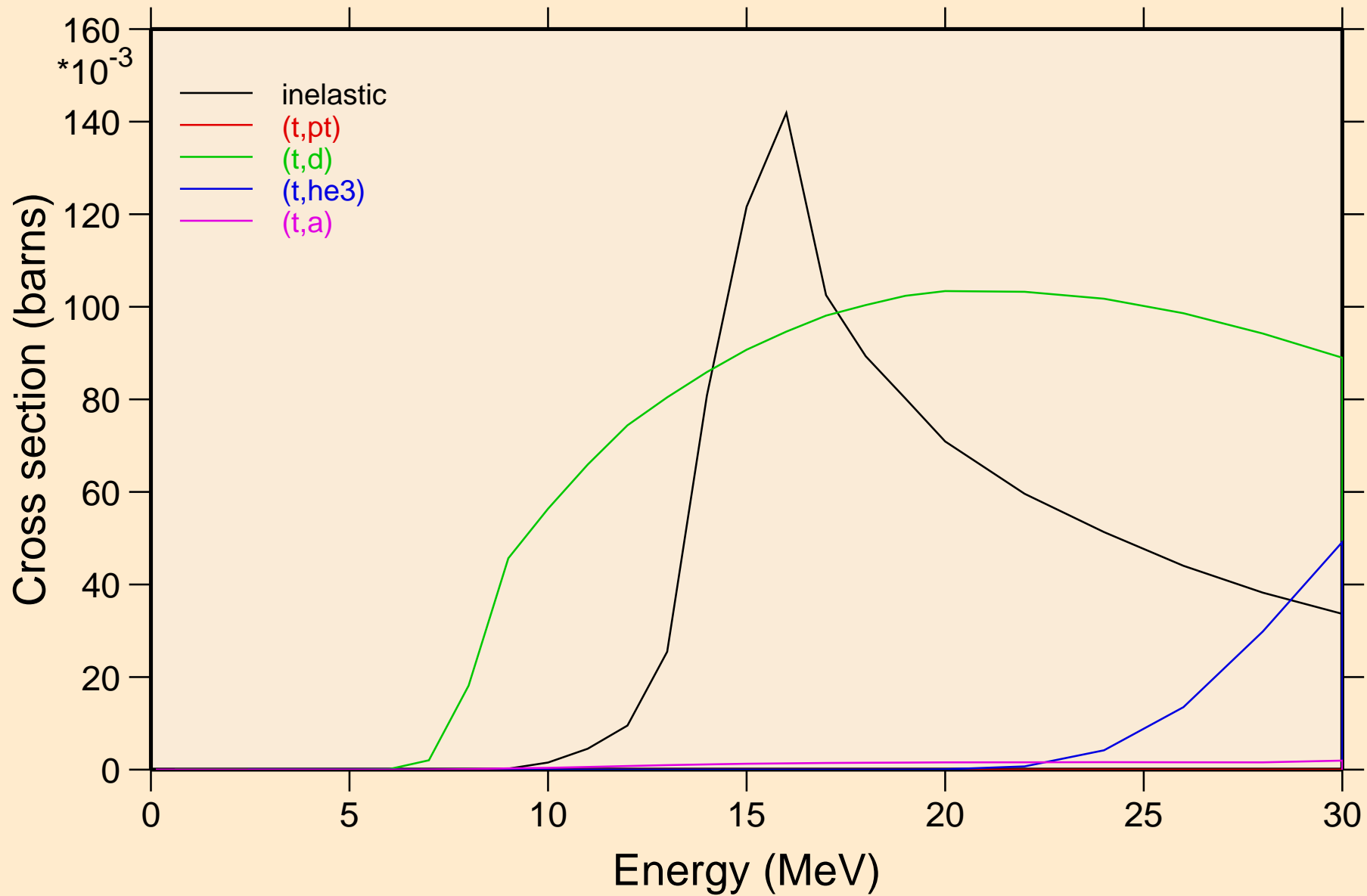

LU179 TRITON ACER TENDL-2021 LIBRARY; T=0.K
Threshold reactions

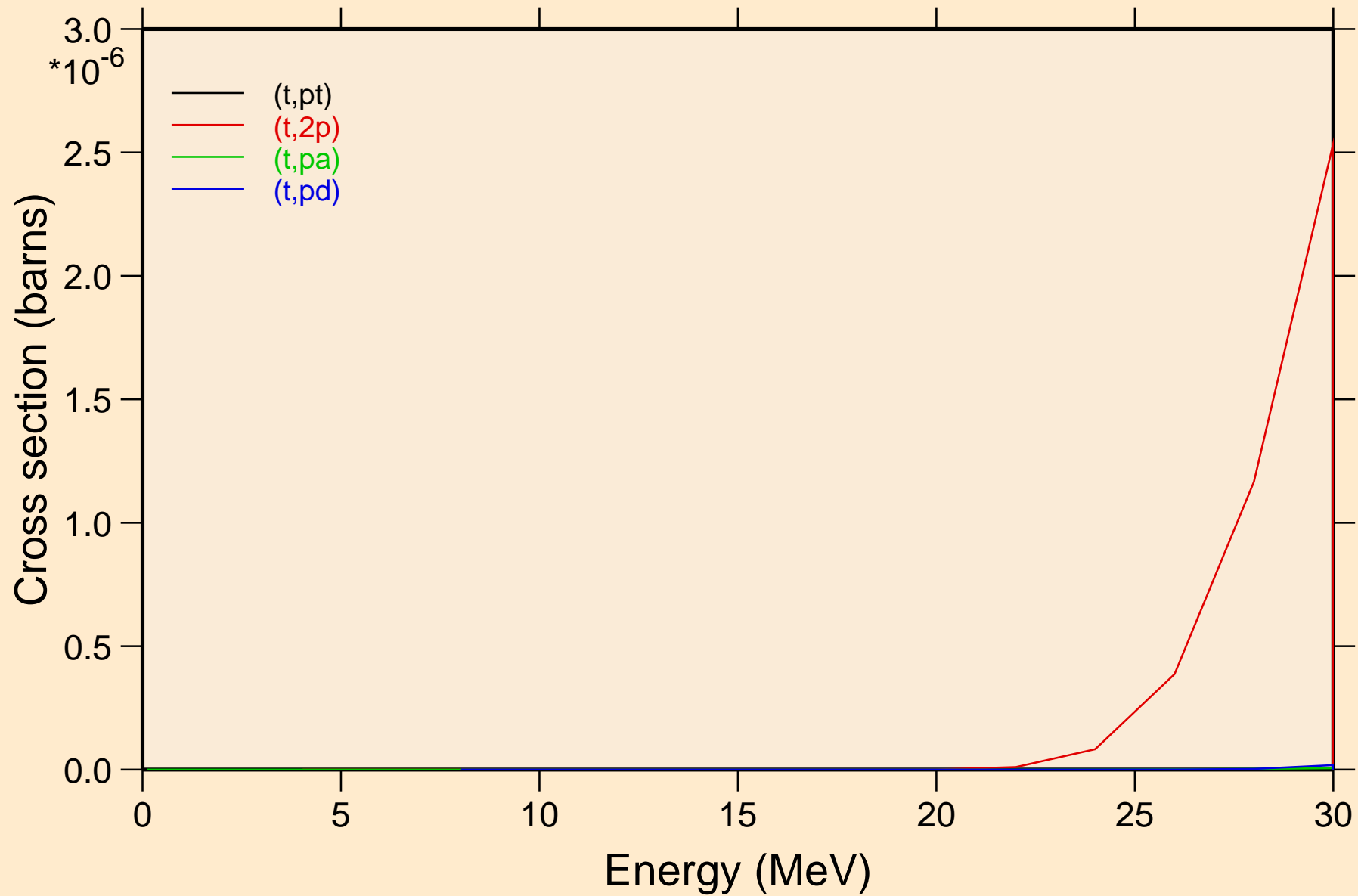

LU179 TRITON ACER TENDL-2021 LIBRARY; T=0.K
Threshold reactions

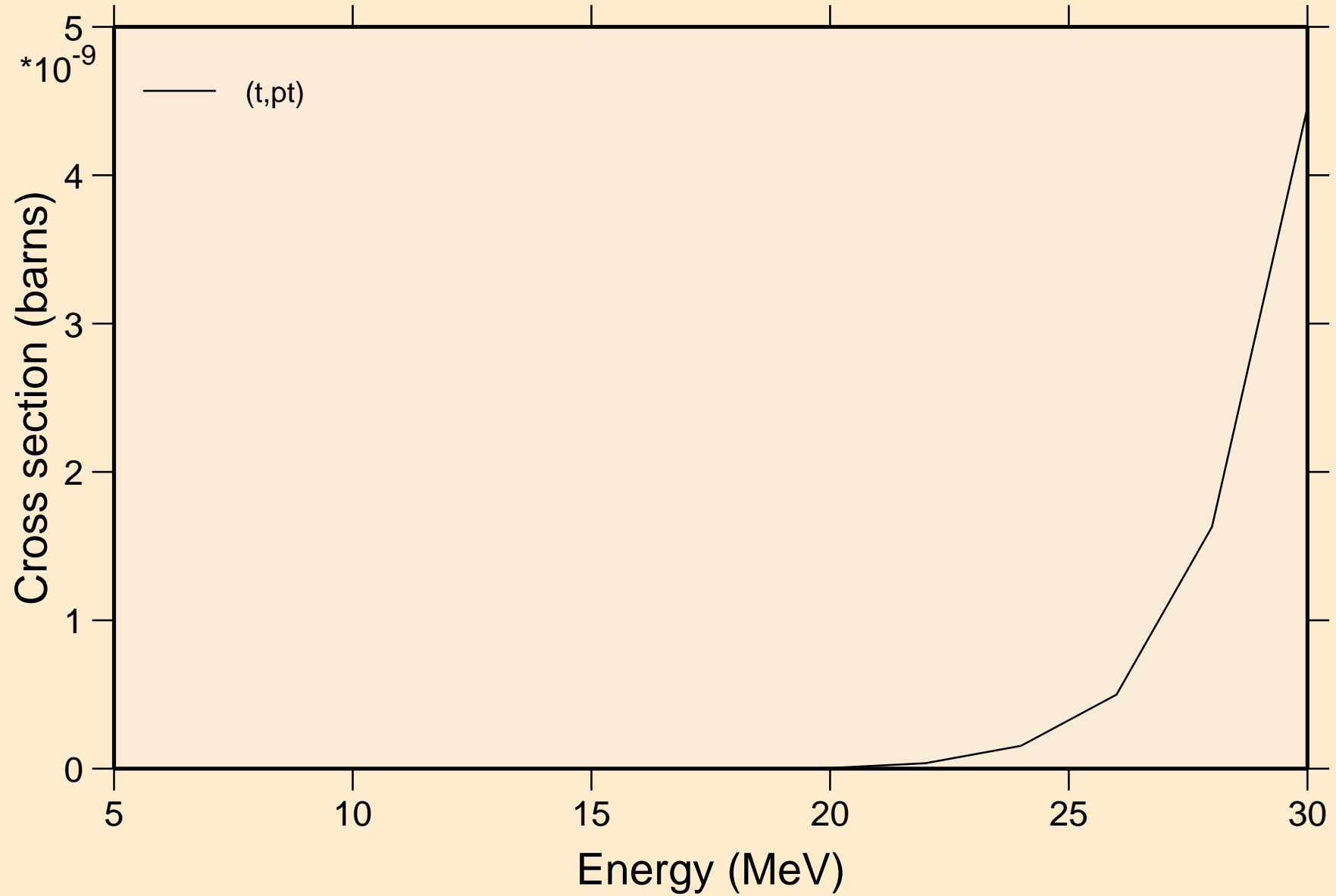

LU179 TRITON ACER TENDL-2021 LIBRARY; T=0.K
angular distribution for elastic

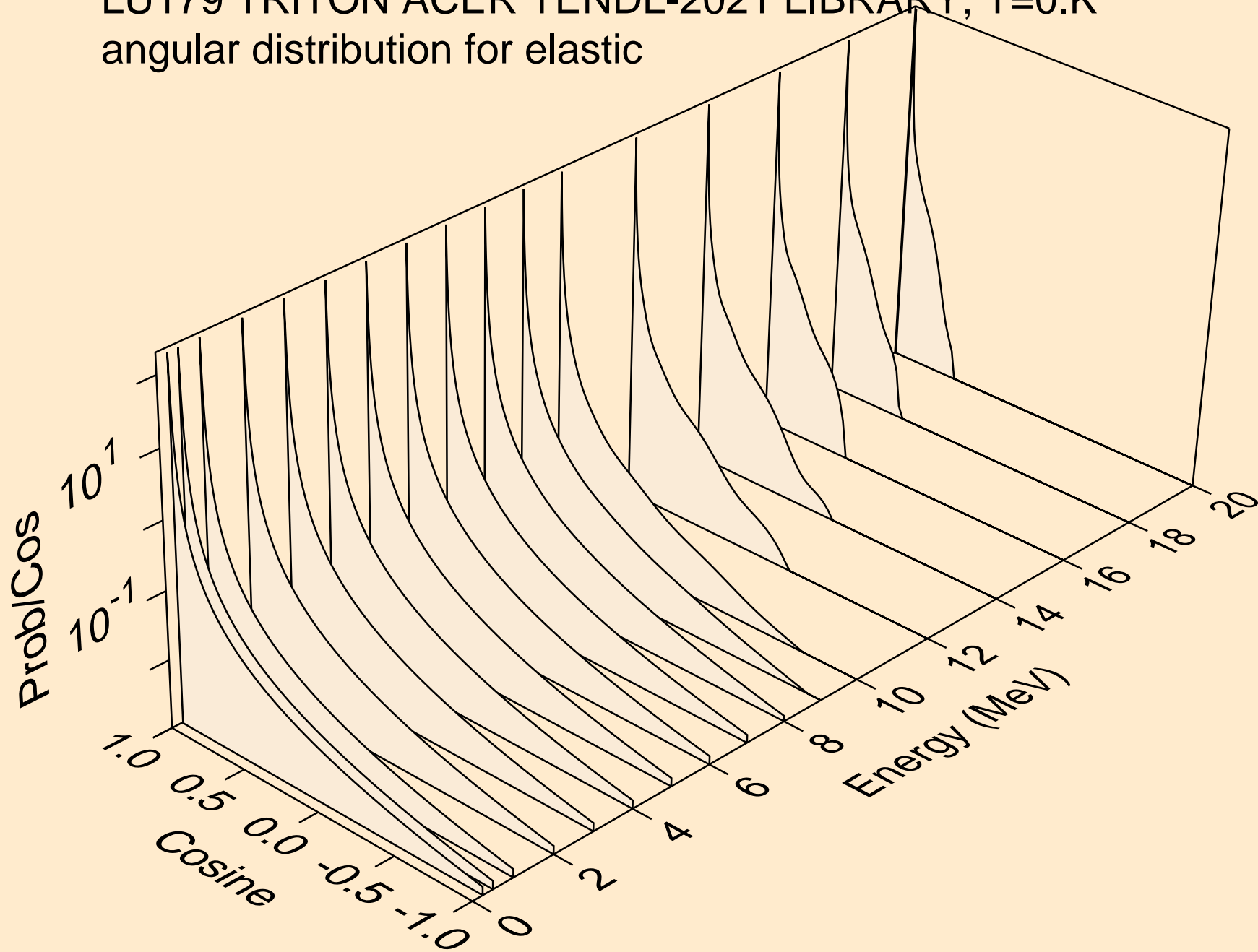

LU179 TRITON ACER TENDL-2021 LIBRARY; T=0.K
angular distribution for elastic

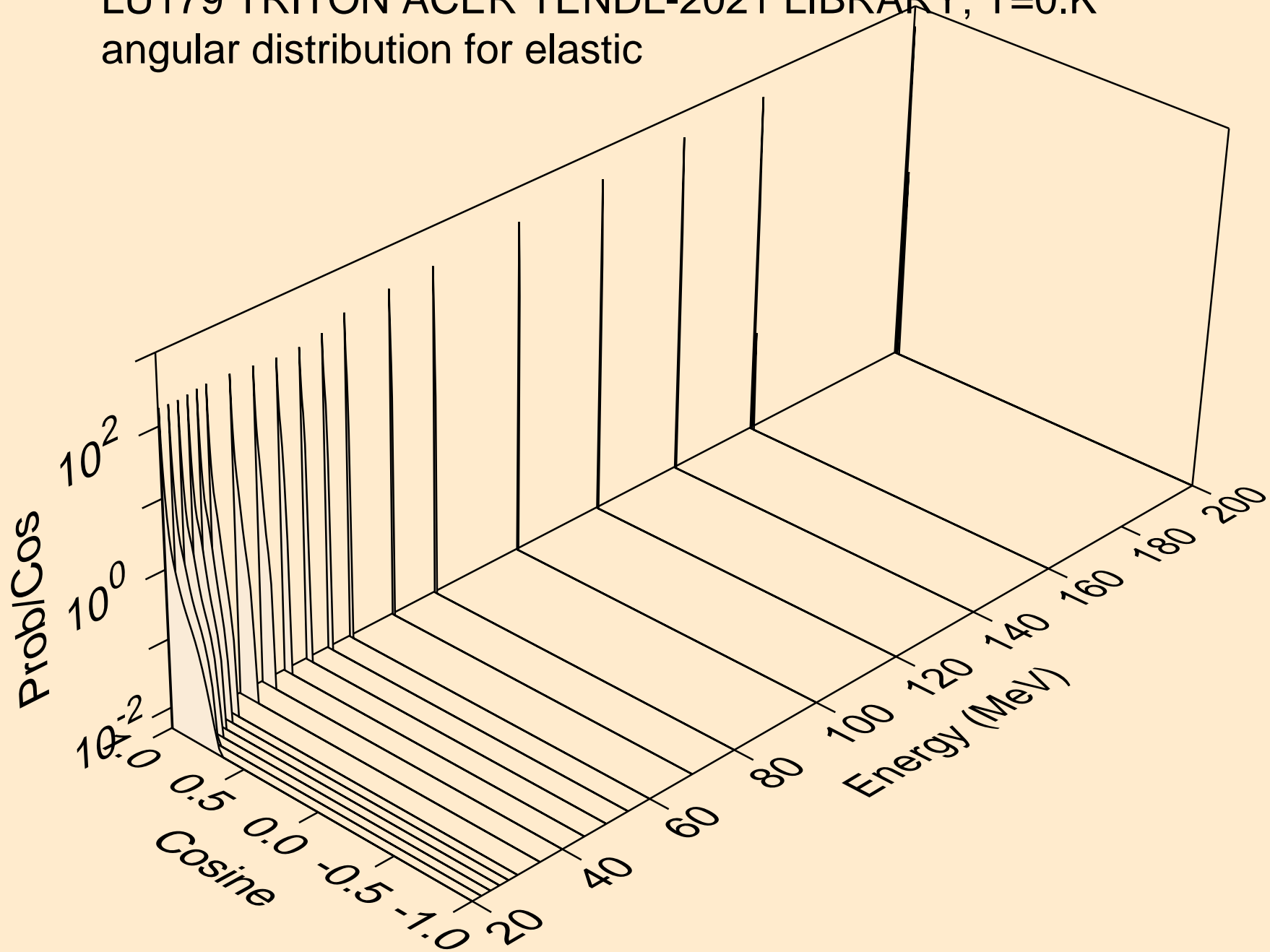

LU179 TRITON ACER TENDL-2021 LIBRARY; T=0.K
Triton emission for (t,x)

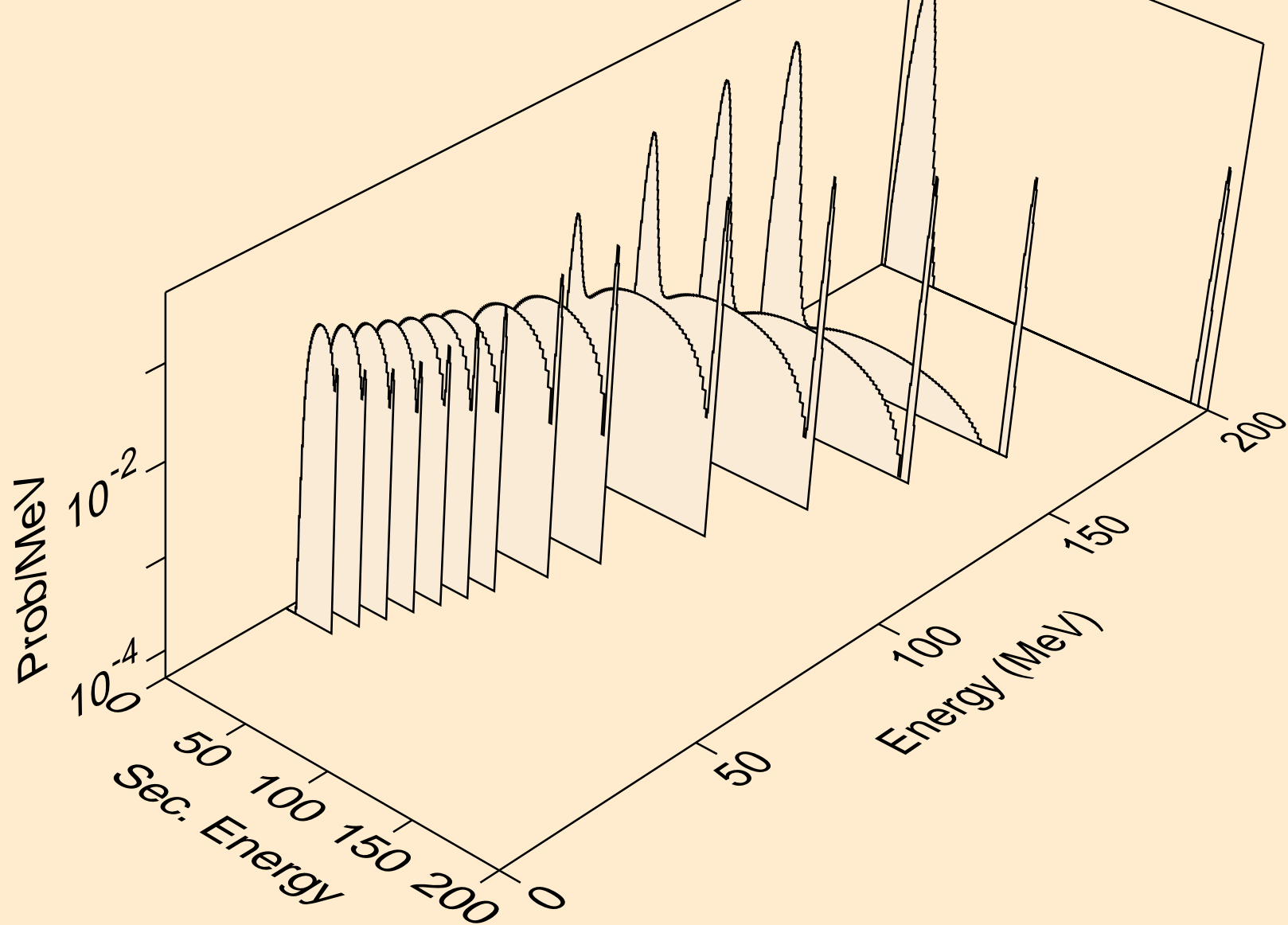

LU179 TRITON ACER TENDL-2021 LIBRARY; T=0.K
Triton emission for (t,n*)t

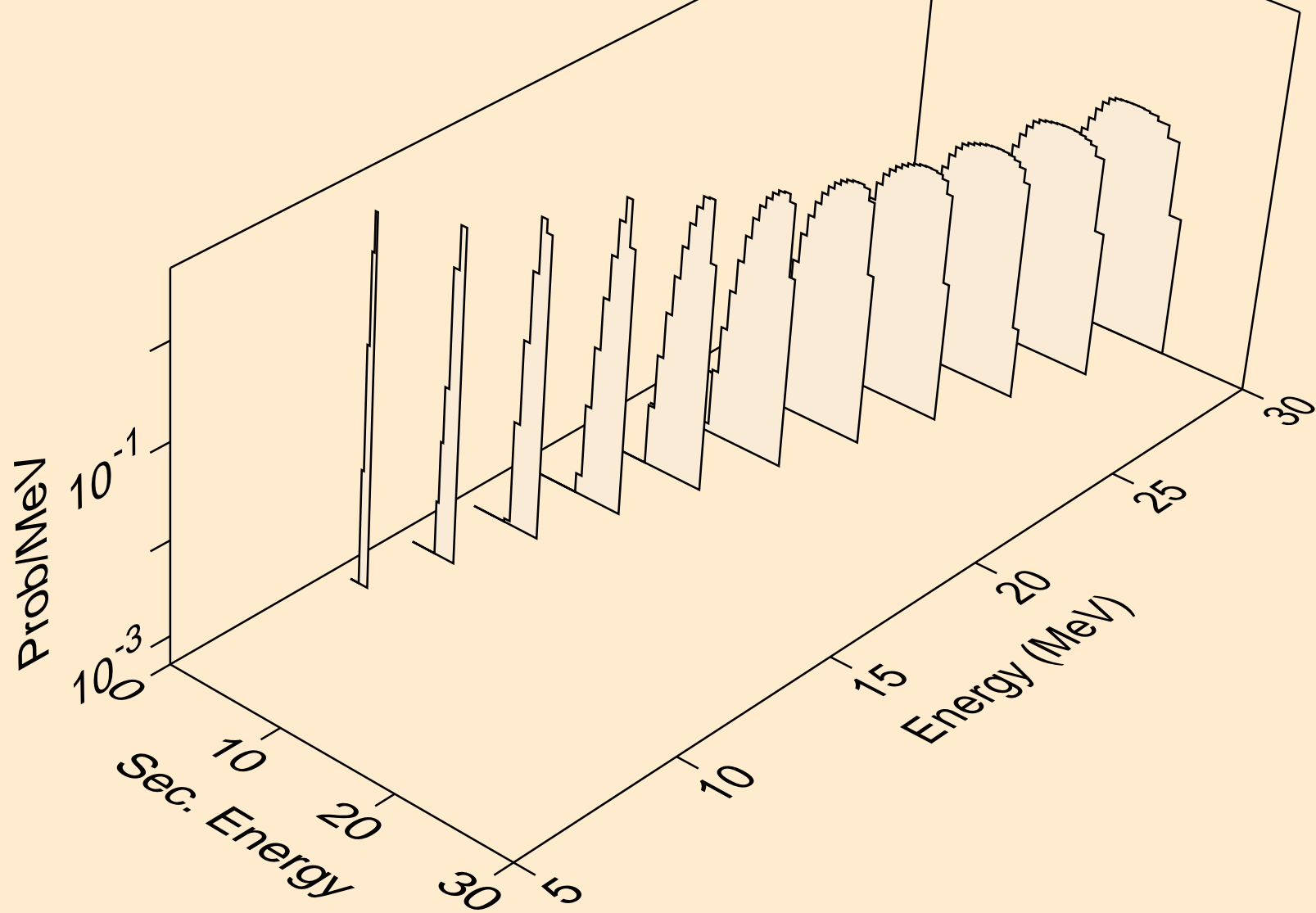

LU179 TRITON ACER TENDL-2021 LIBRARY; T=0.K
Triton emission for inelastic

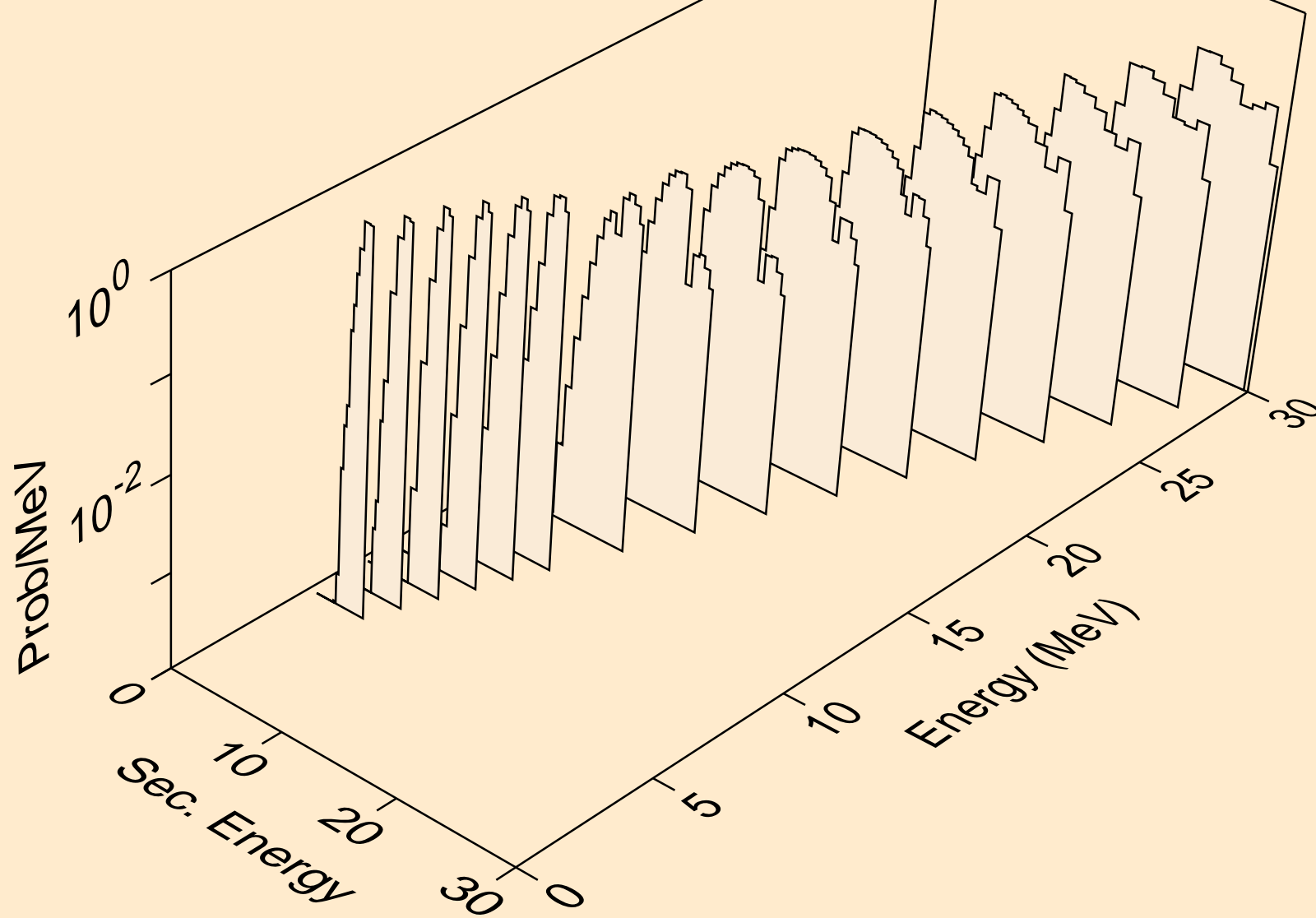

LU179 TRITON ACER TENDL-2021 LIBRARY; T=0.K
Triton emission for (t,pt)

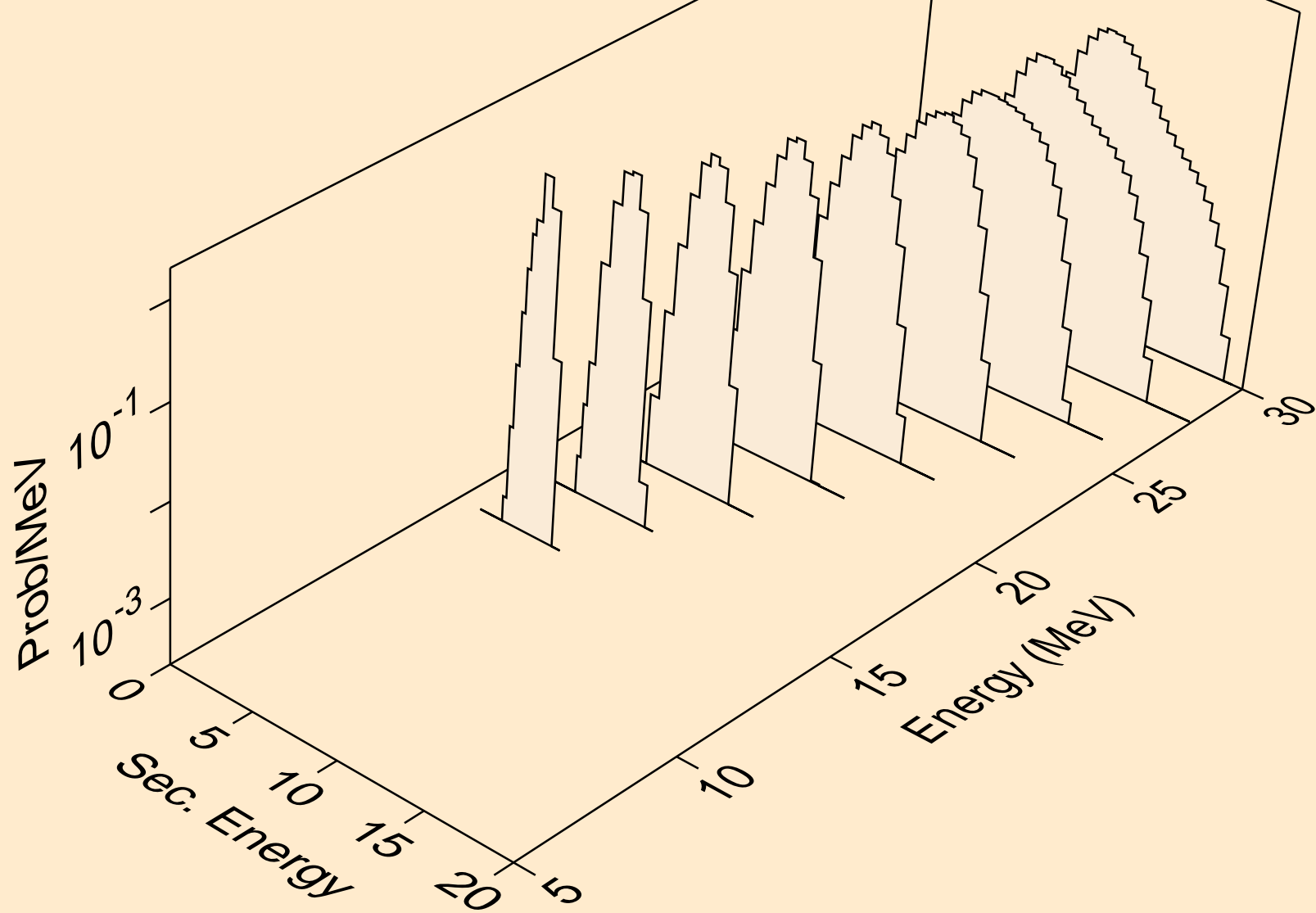

LU179 TRITON ACER TENDL-2021 LIBRARY; T=0.K
Photon emission for (z,n)

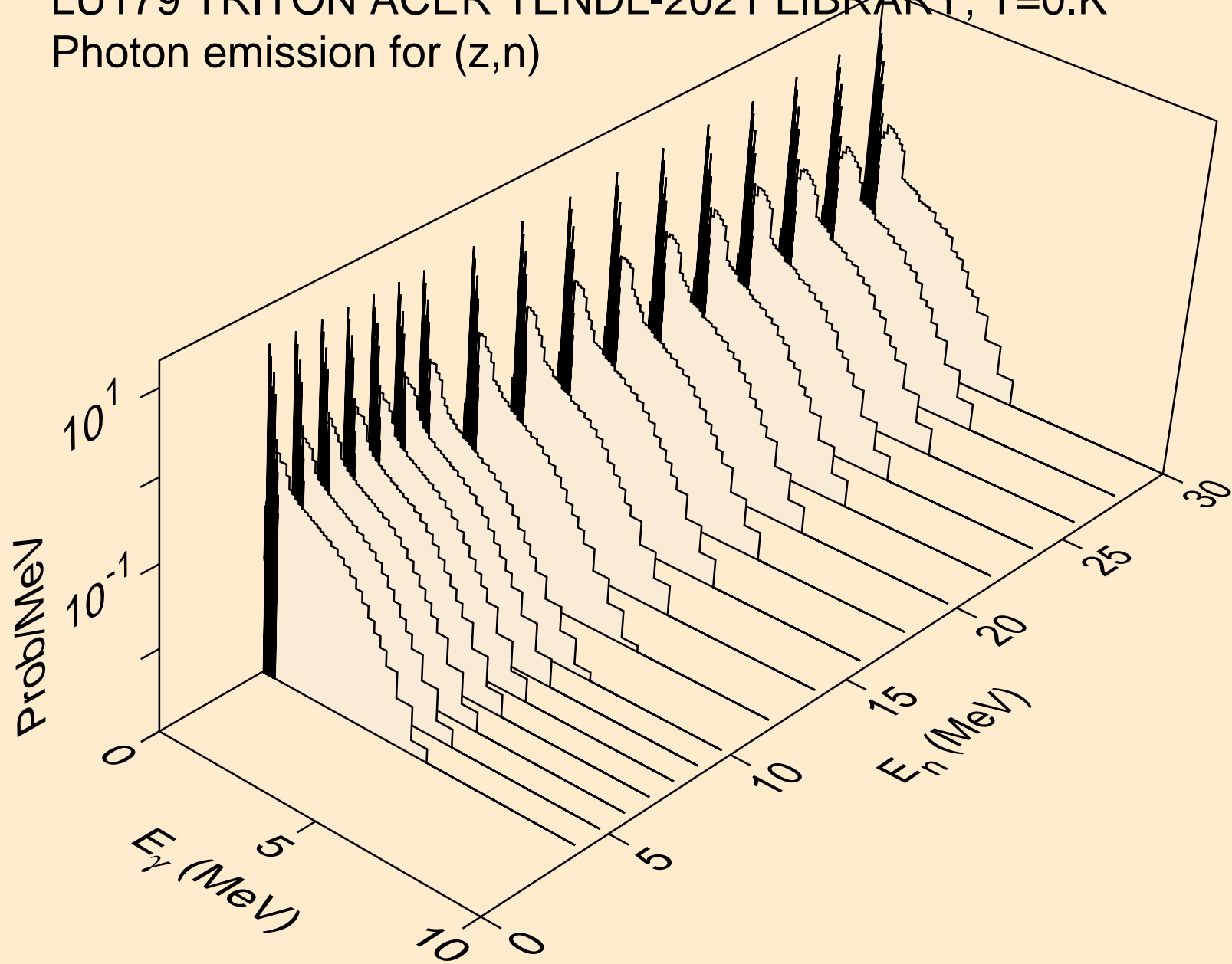

LU179 TRITON ACER TENDL-2021 LIBRARY; T=0.K
Photon emission for (n,x)

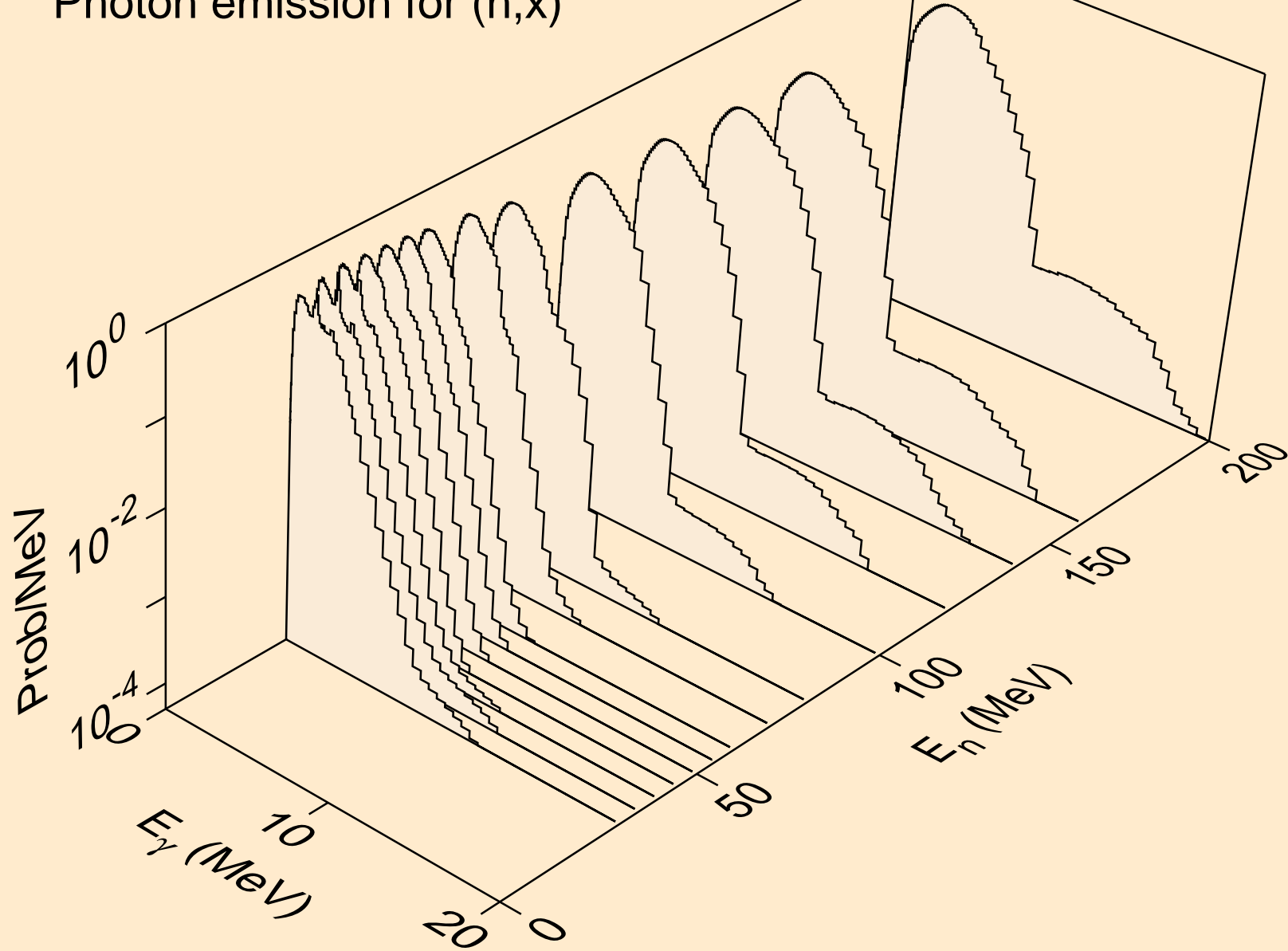

LU179 TRITON ACER TENDL-2021 LIBRARY; T=0.K
Photon emission for (n,2nd)

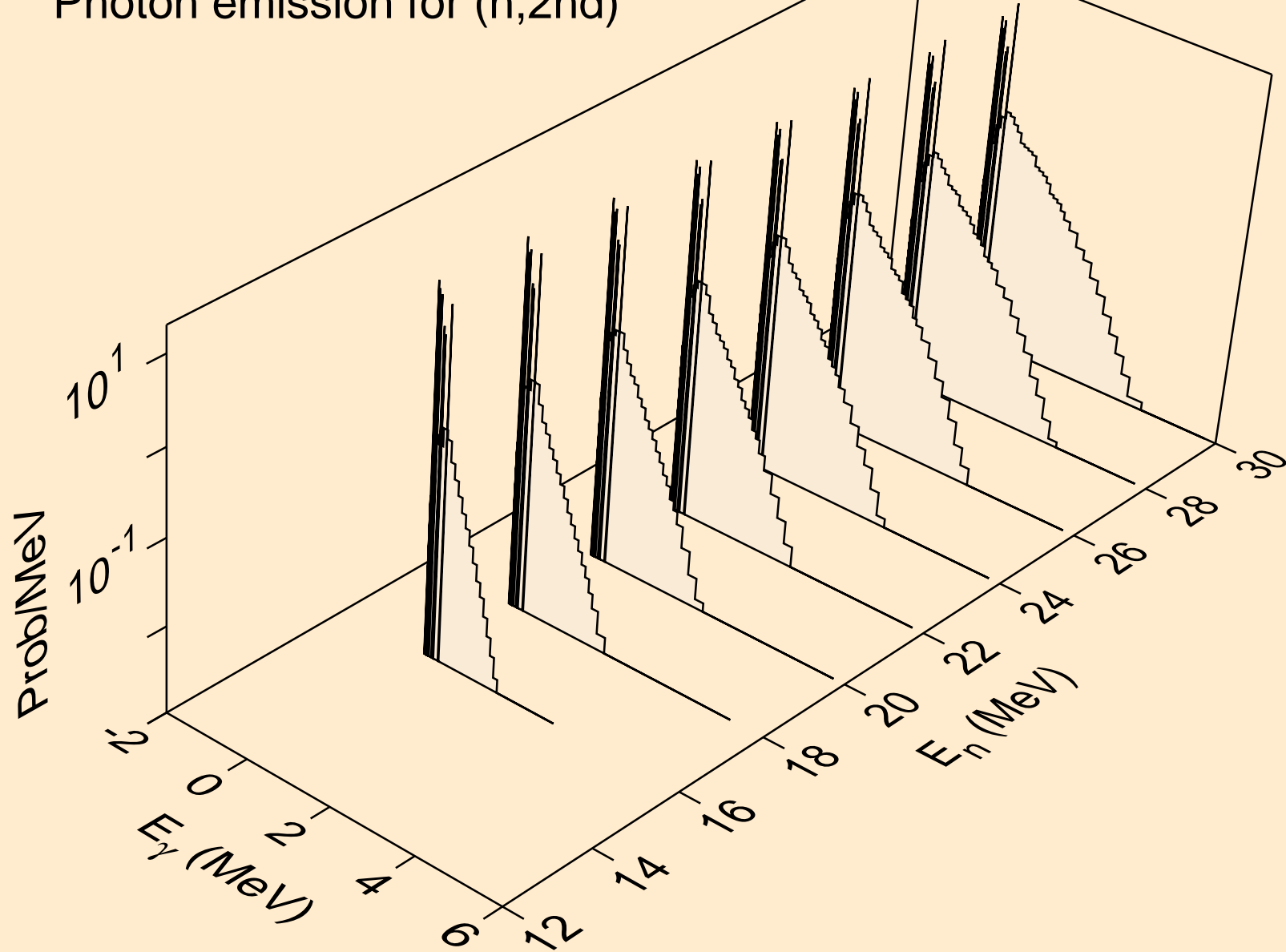

LU179 TRITON ACER TENDL-2021 LIBRARY; T=0.K
Photon emission for (n,2n)

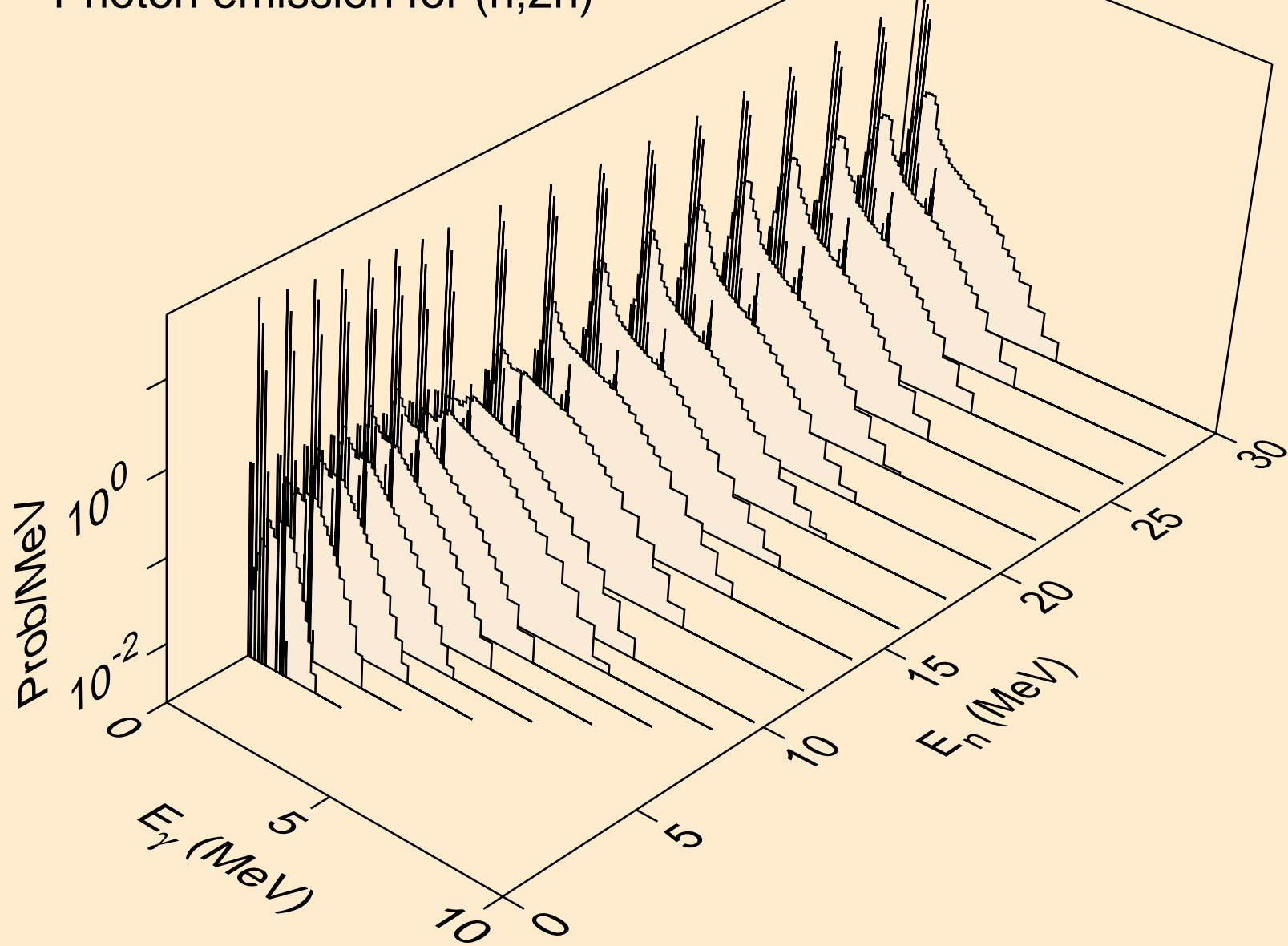

LU179 TRITON ACER TENDL-2021 LIBRARY; T=0.K
Photon emission for (n,3n)

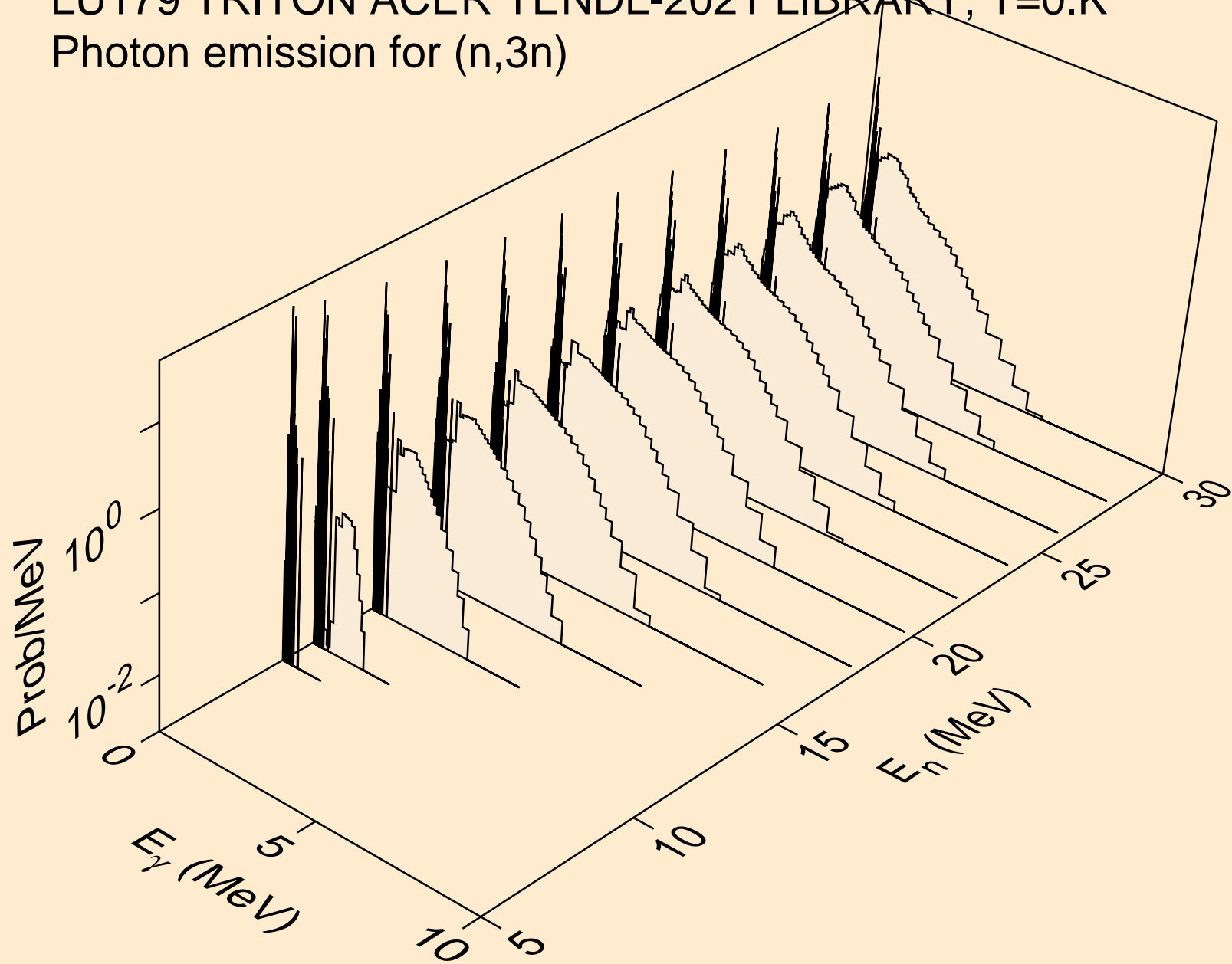

LU179 TRITON ACER TENDL-2021 LIBRARY; T=0.K
Photon emission for (n,n*)a

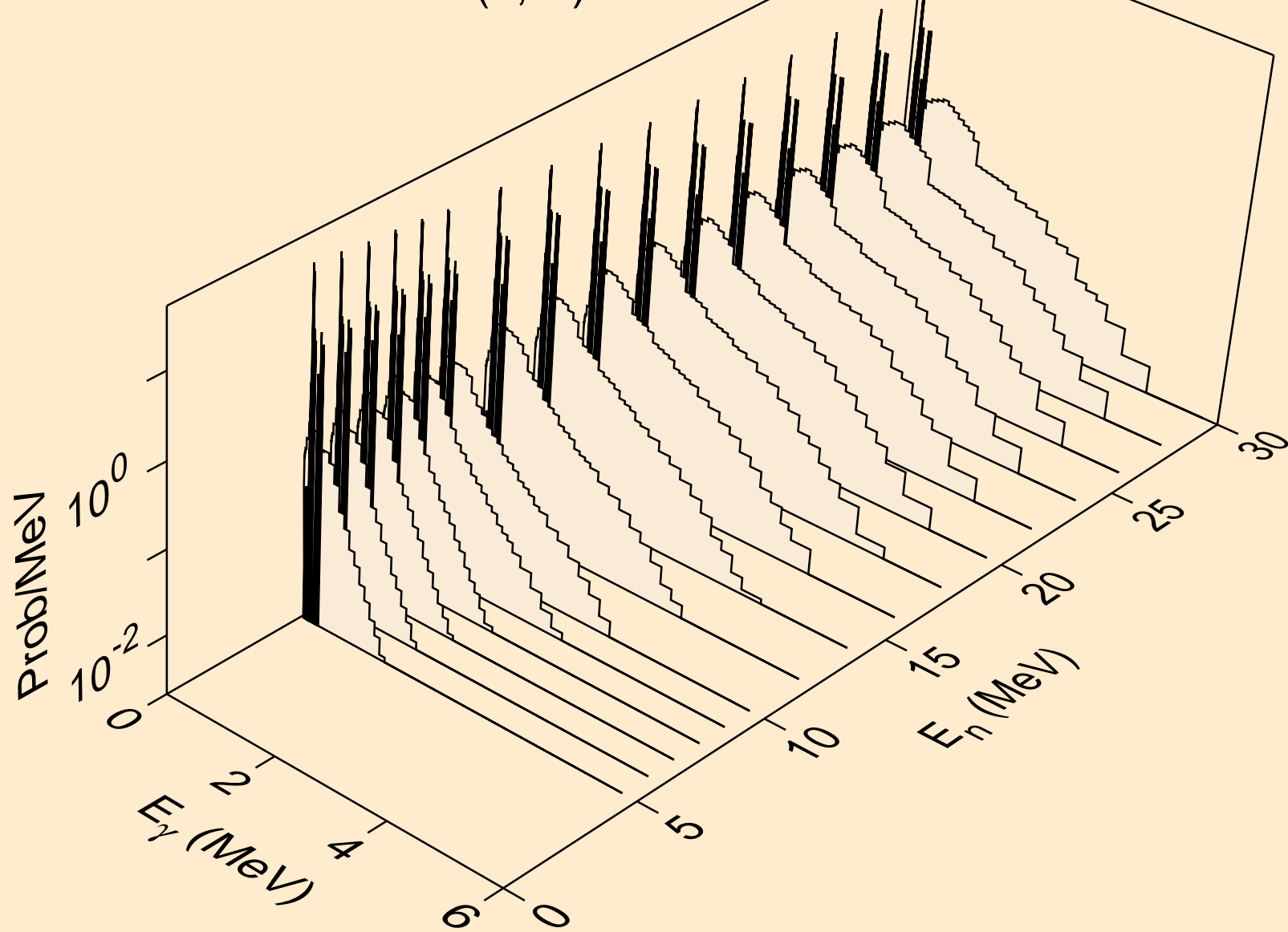

LU179 TRITON ACER TENDL-2021 LIBRARY; T=0.K
Photon emission for (n,2n)a

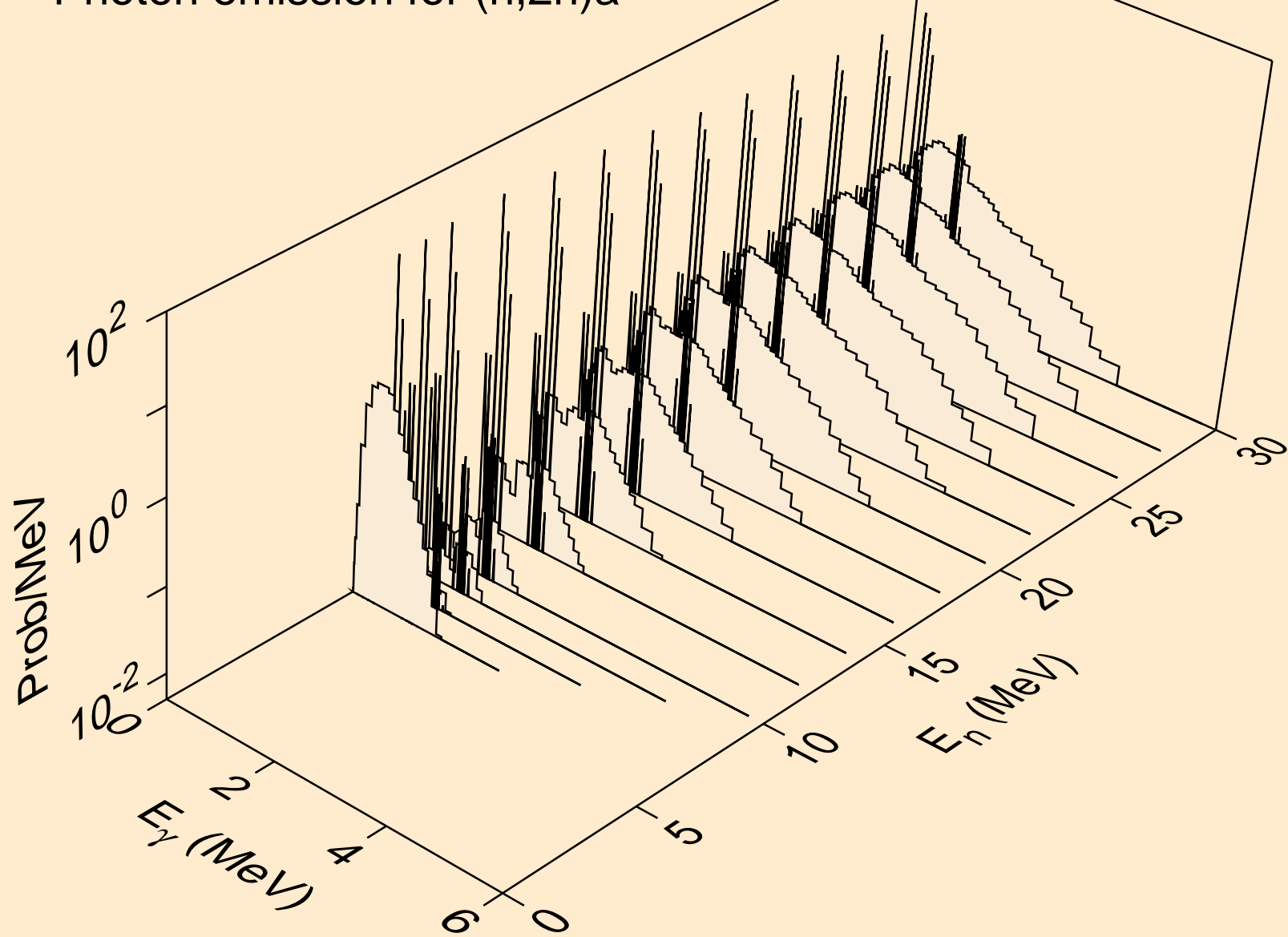

LU179 TRITON ACER TENDL-2021 LIBRARY; T=0.K
Photon emission for (n,3n)a

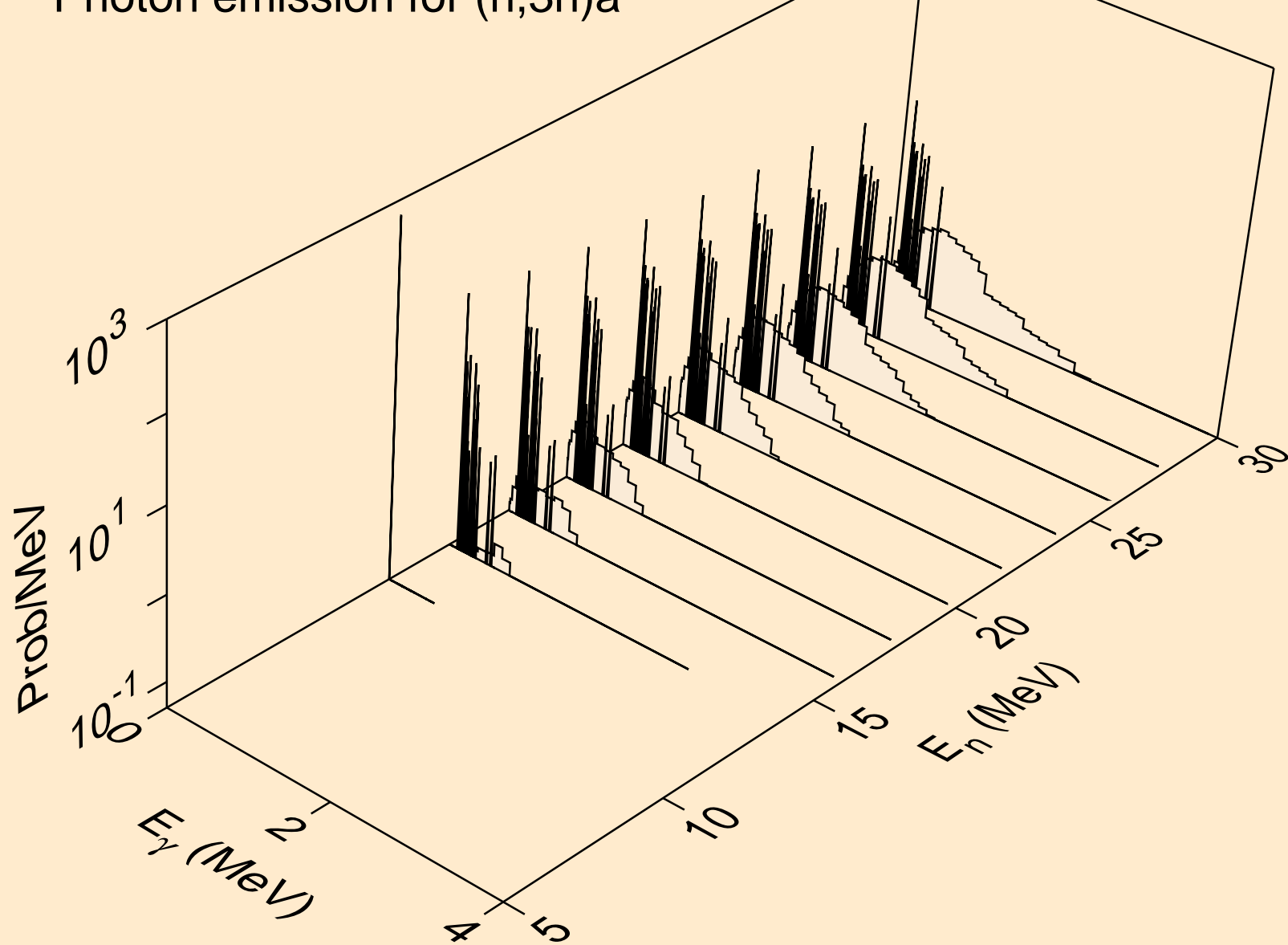

LU179 TRITON ACER TENDL-2021 LIBRARY; T=0.K
Photon emission for (n,n*)p

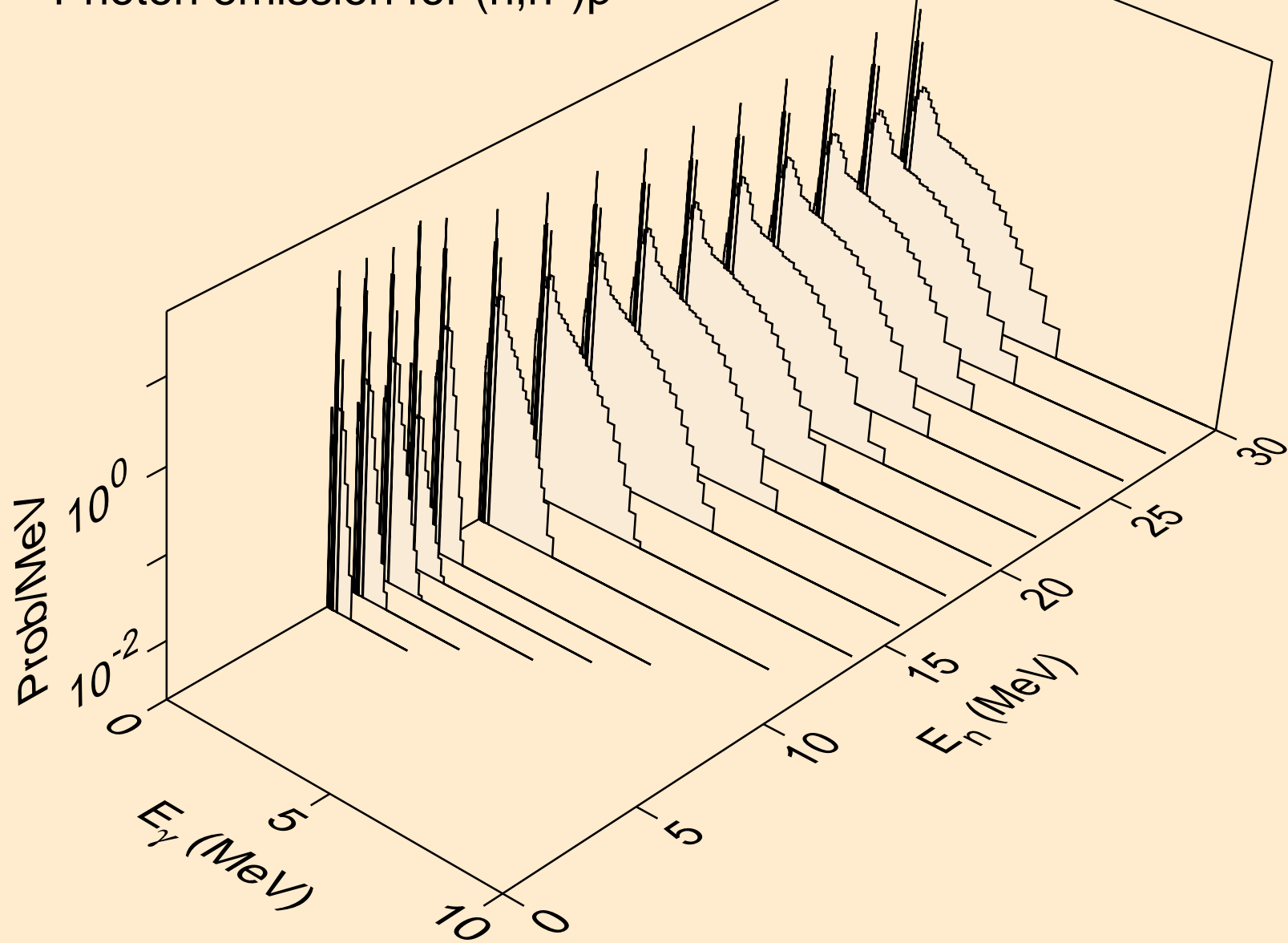

LU179 TRITON ACER TENDL-2021 LIBRARY; T=0.K
Photon emission for (n,n*)2a

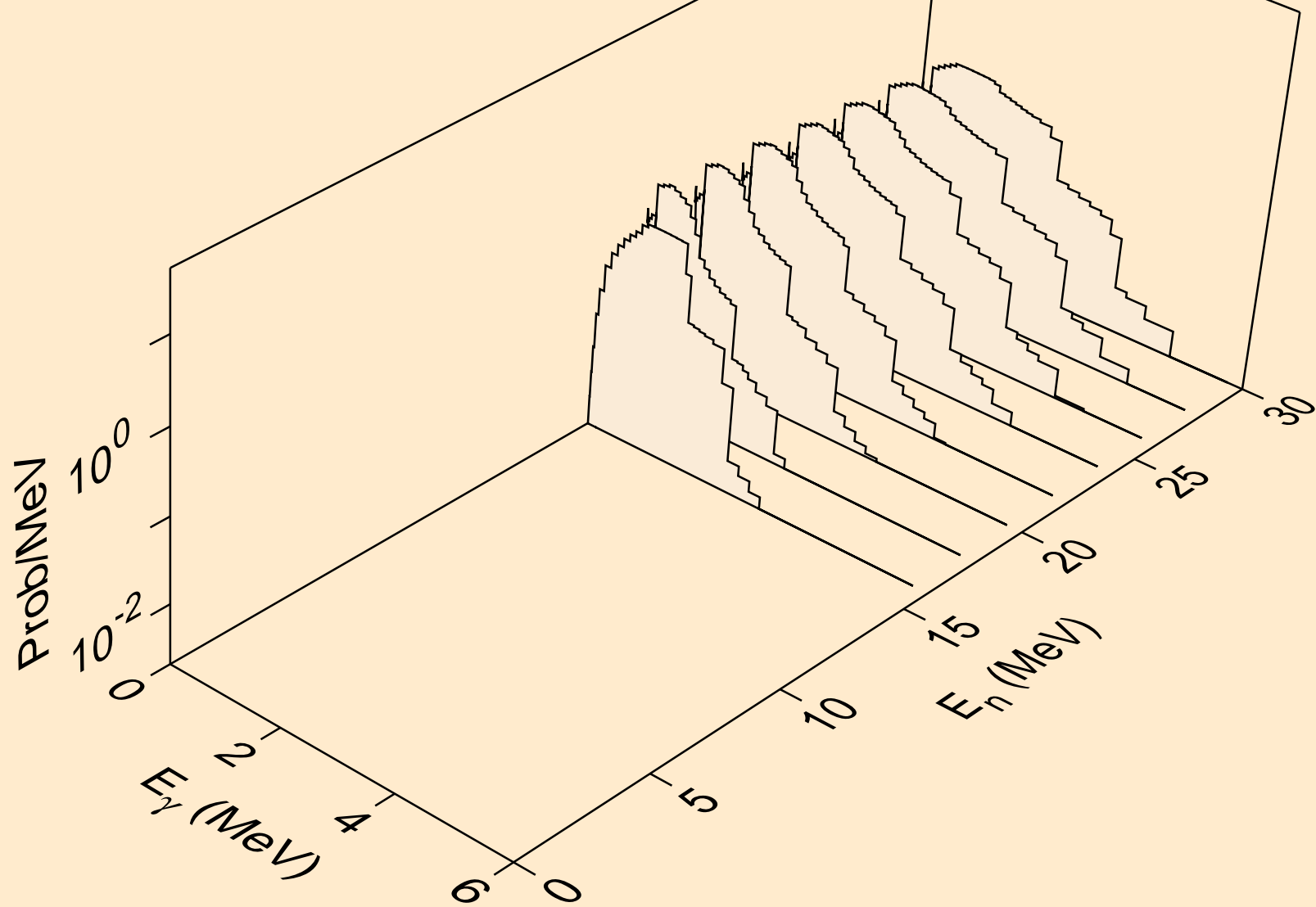

LU179 TRITON ACER TENDL-2021 LIBRARY; T=0.K
Photon emission for (n,n*)d

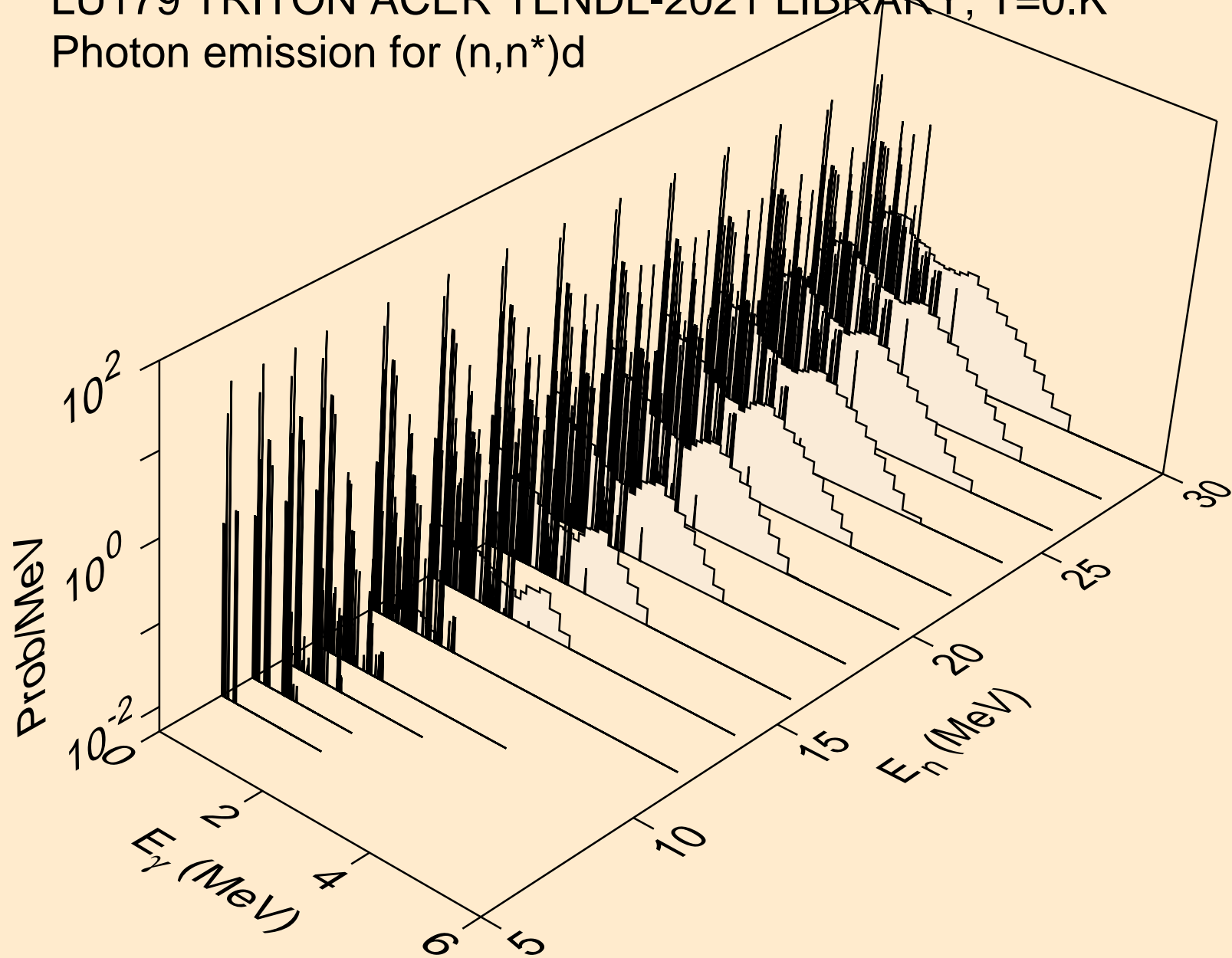

LU179 TRITON ACER TENDL-2021 LIBRARY; T=0.K
Photon emission for (n,n*)t

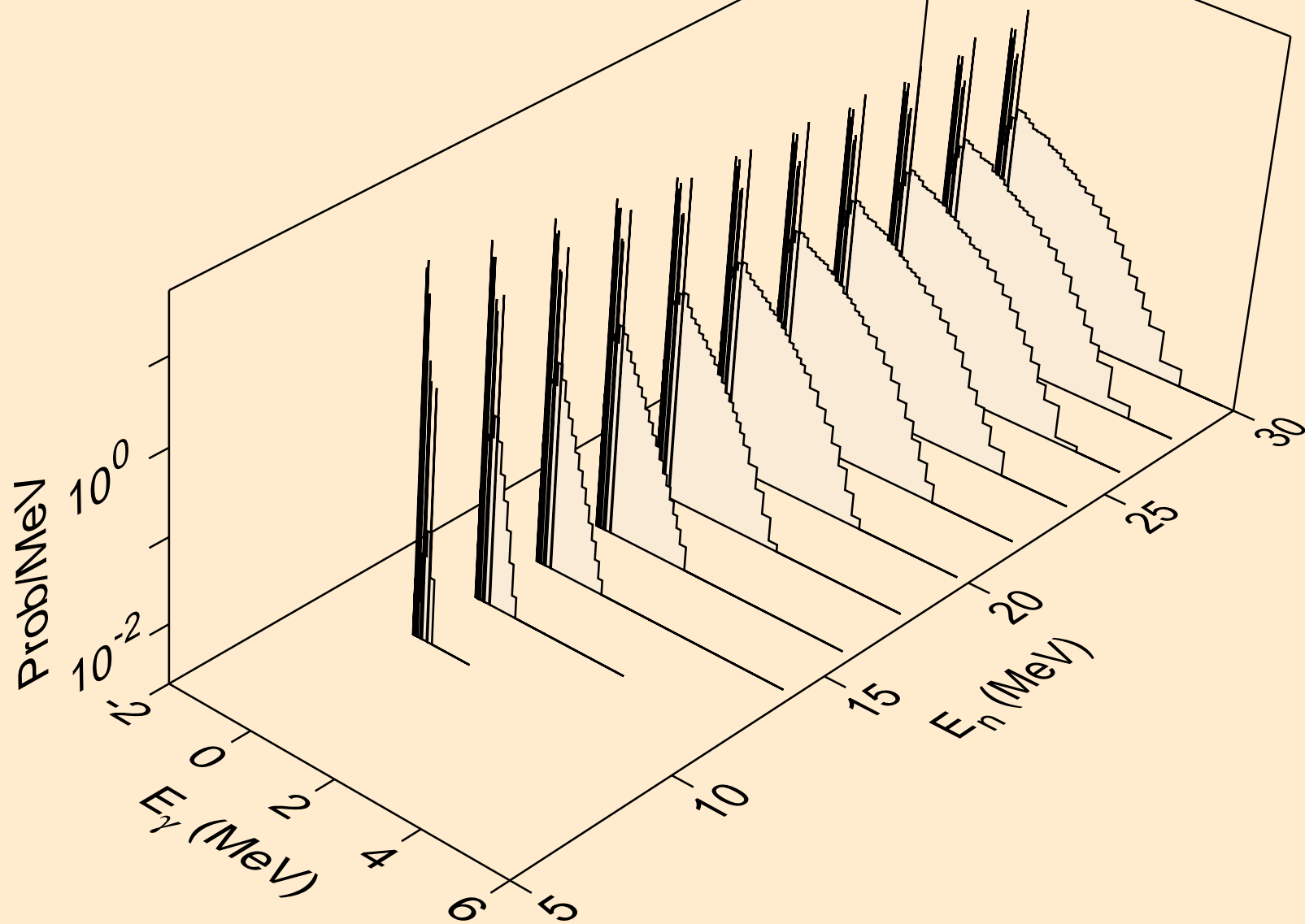

LU179 TRITON ACER TENDL-2021 LIBRARY; T=0.K
Photon emission for (n,n*)he3

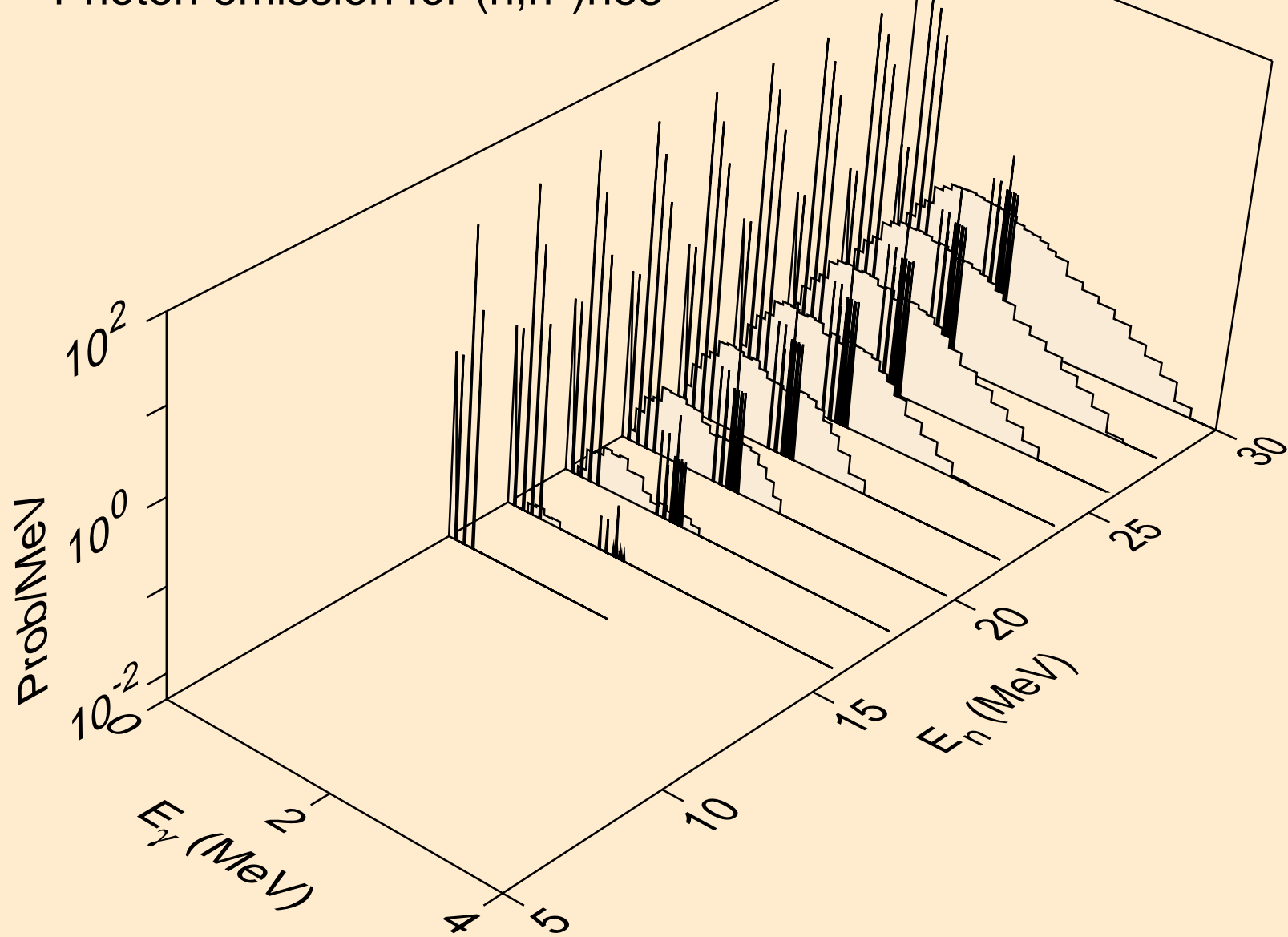

LU179 TRITON ACER TENDL-2021 LIBRARY; T=0.K
Photon emission for (n,4n)

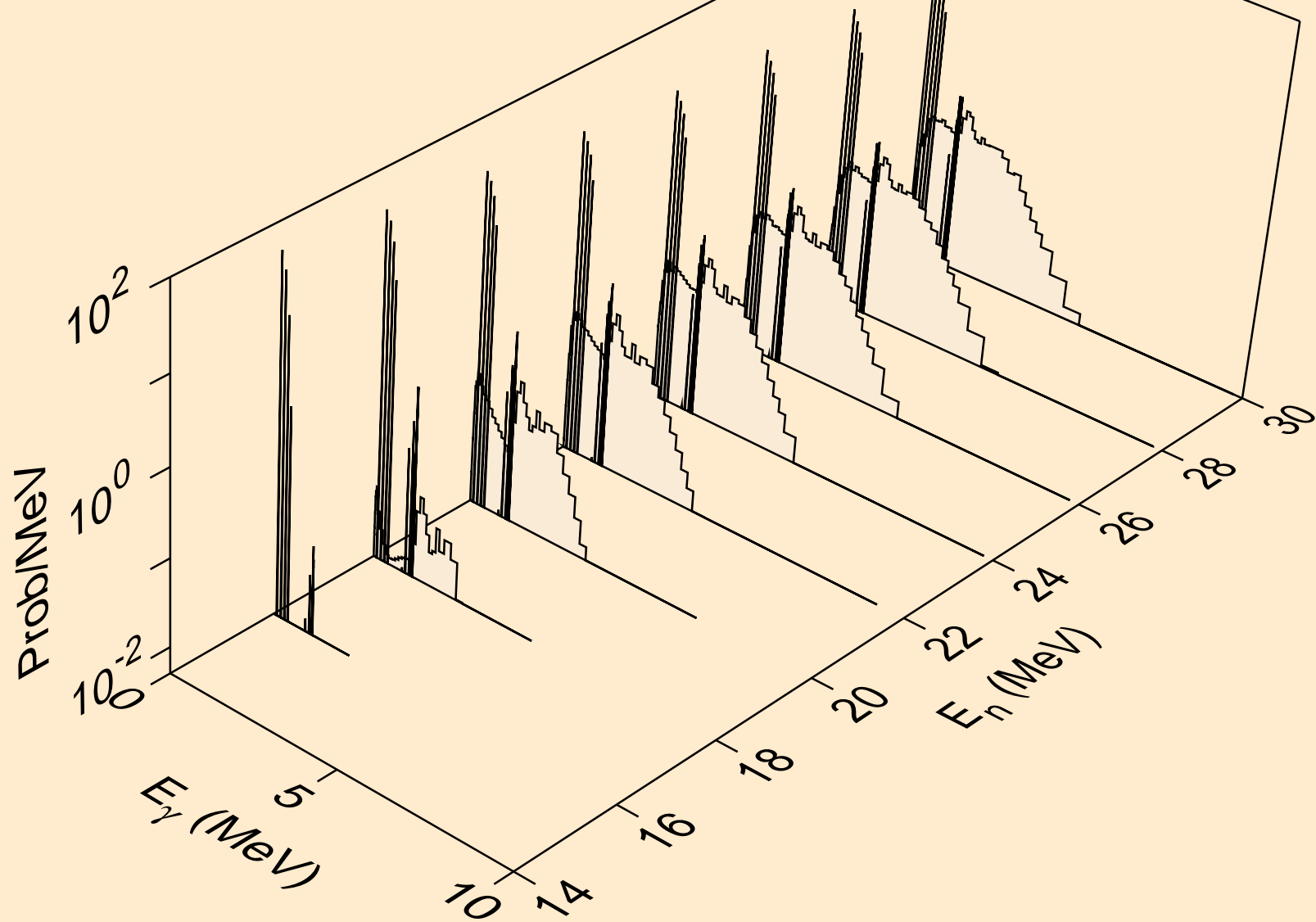

LU179 TRITON ACER TENDL-2021 LIBRARY; T=0.K
Photon emission for (n,2np)

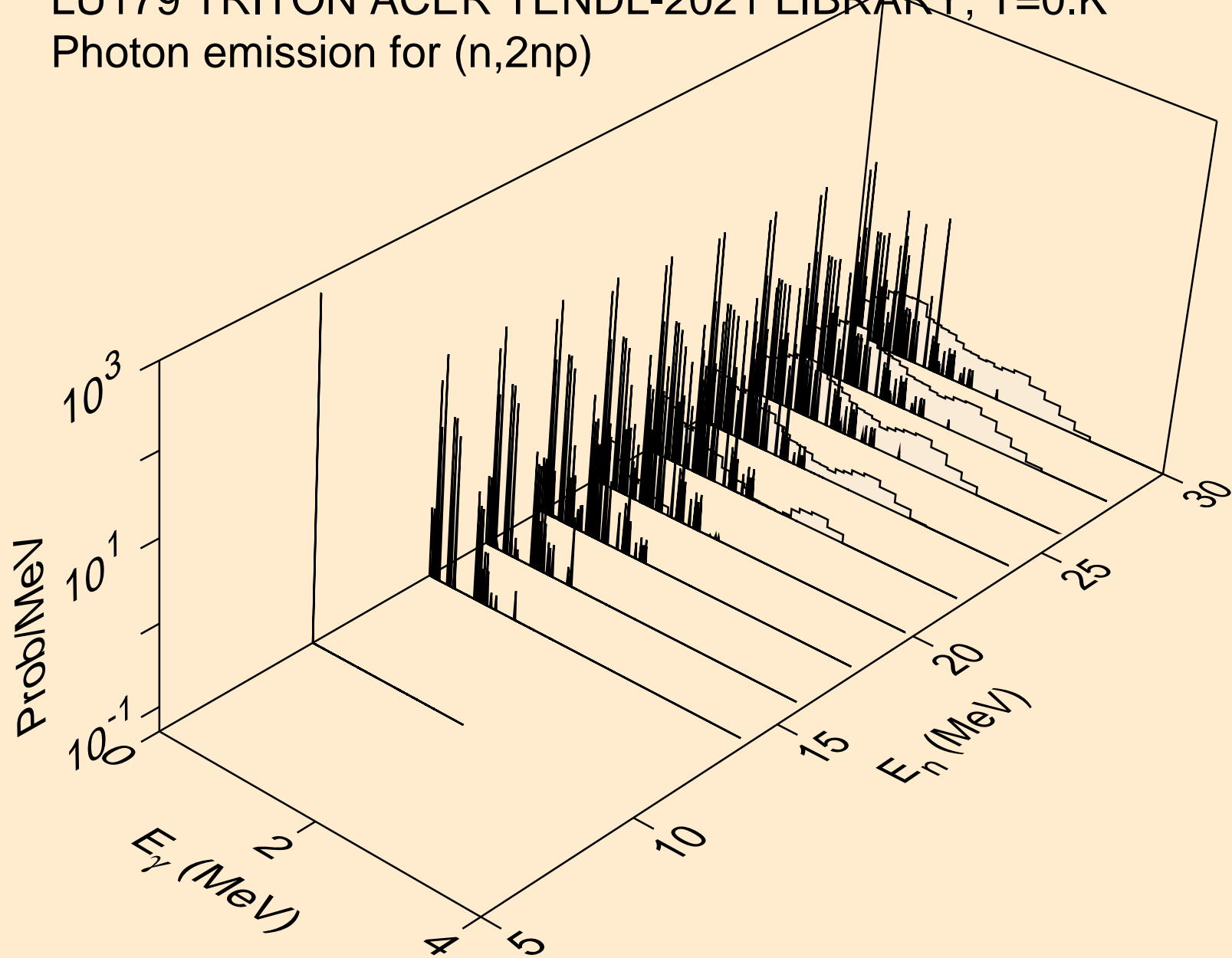

LU179 TRITON ACER TENDL-2021 LIBRARY; T=0.K
Photon emission for (n,3np)

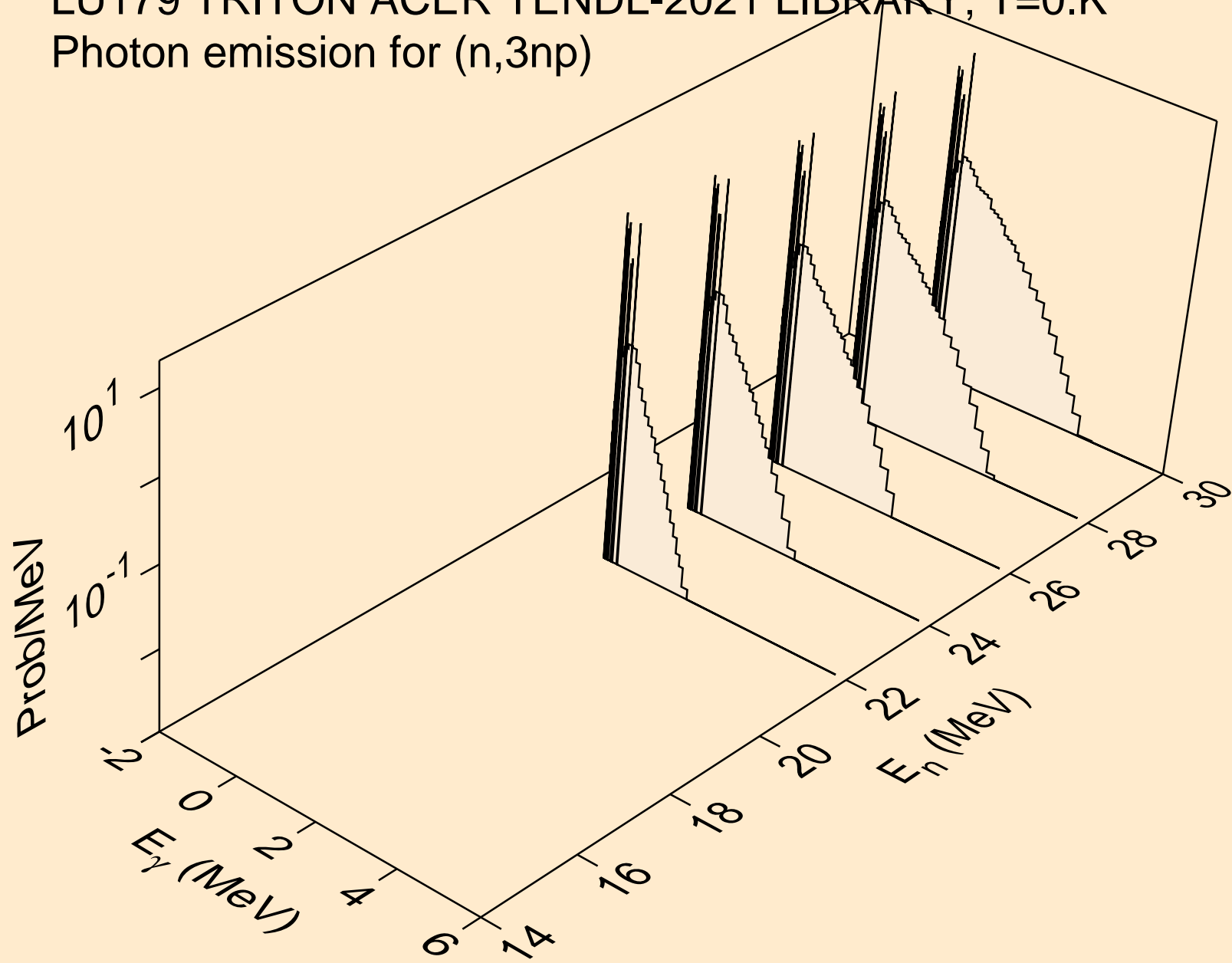

LU179 TRITON ACER TENDL-2021 LIBRARY; T=0.K
Photon emission for (n,2np)

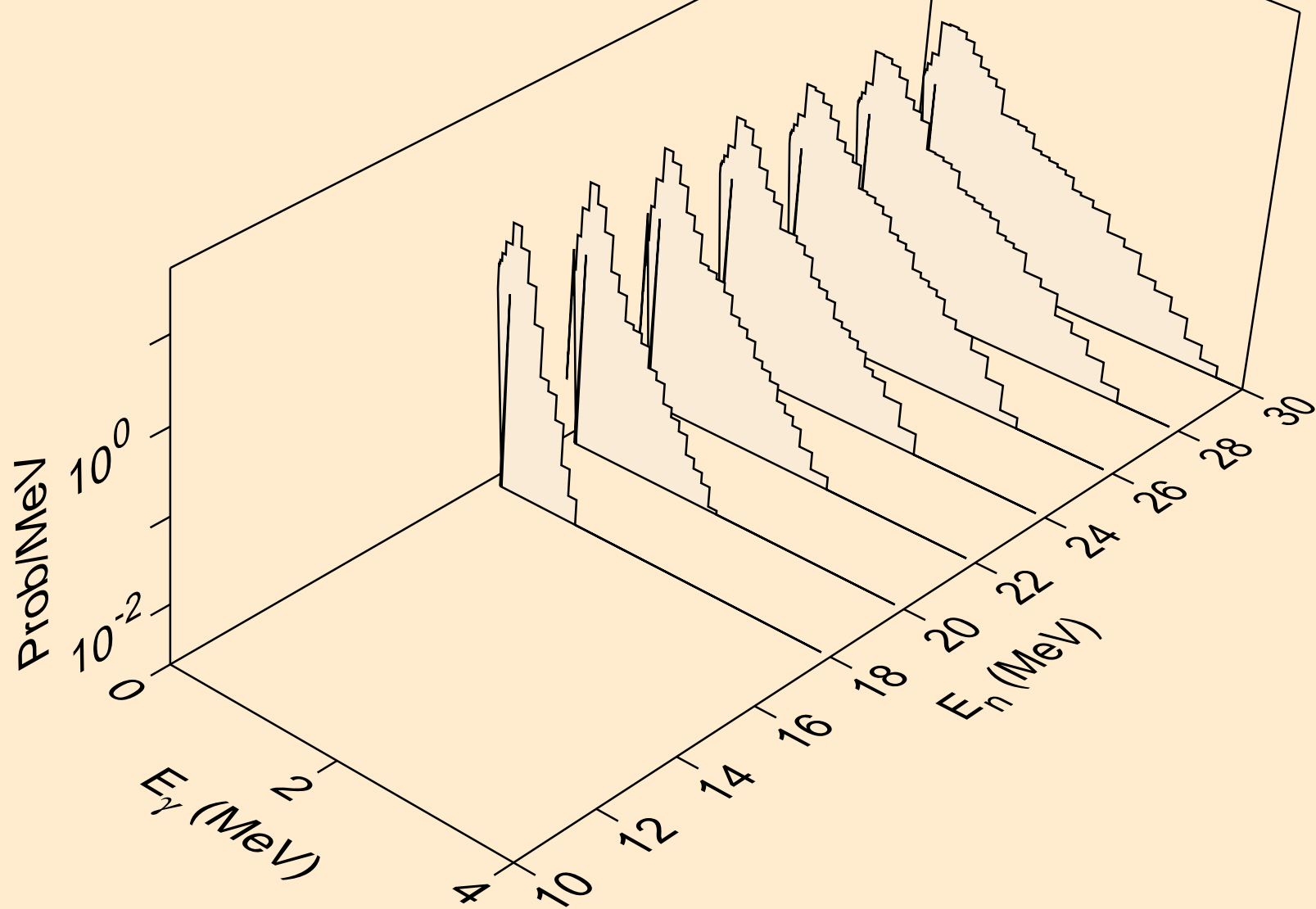

LU179 TRITON ACER TENDL-2021 LIBRARY; T=0.K
Photon emission for (n,npa)

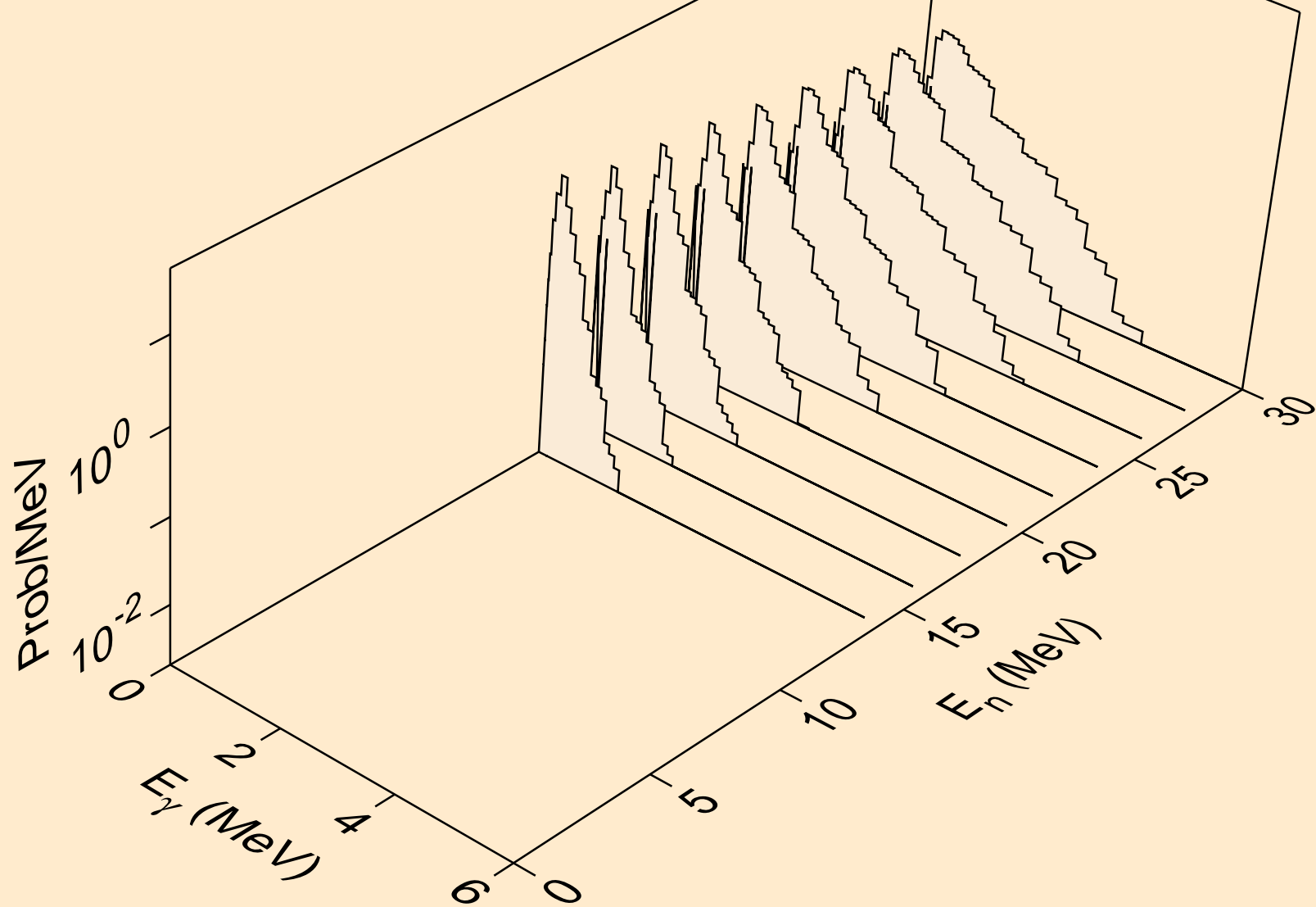

LU179 TRITON ACER TENDL-2021 LIBRARY; T=0.K
Photon emission for (n,gma)

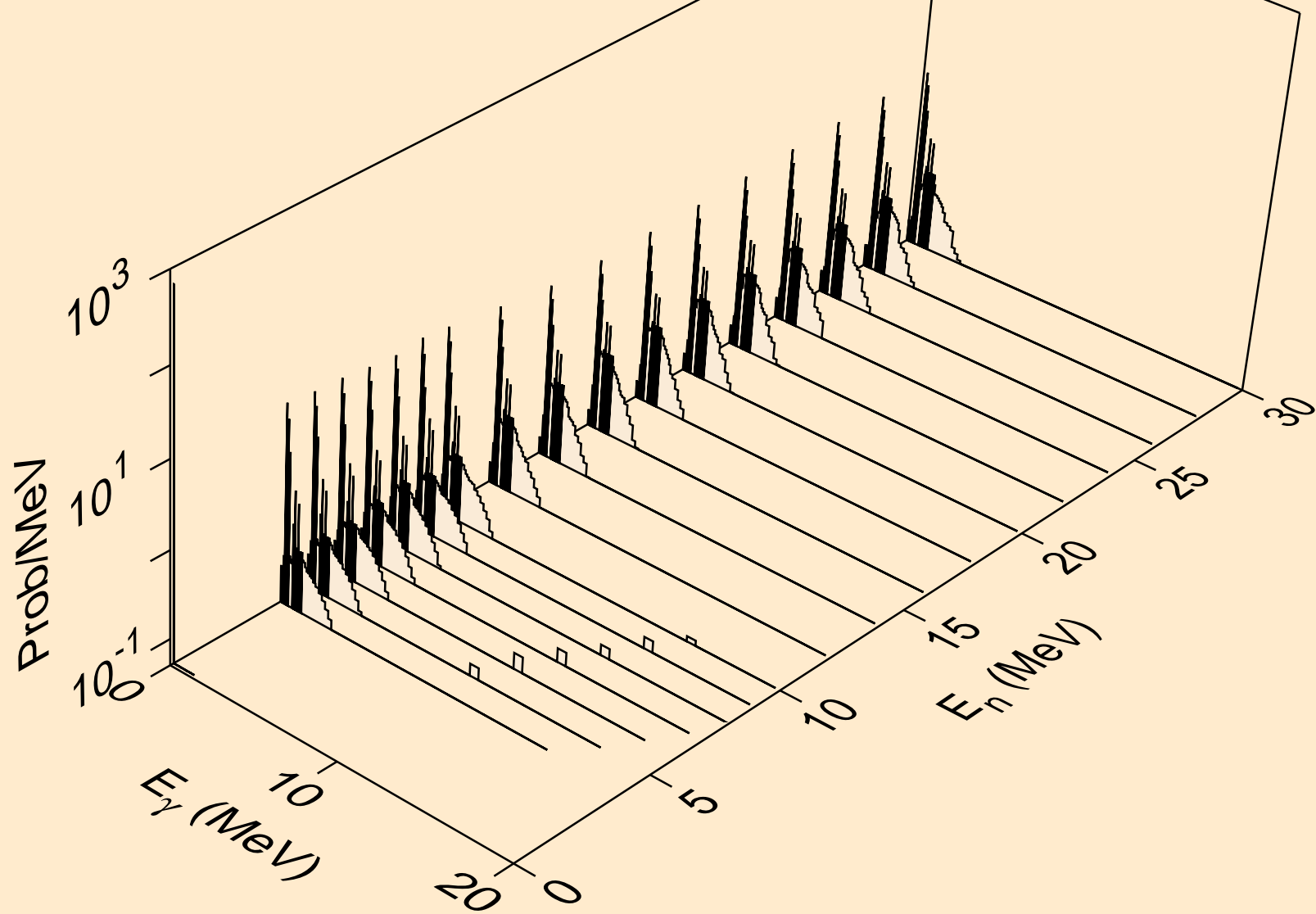

LU179 TRITON ACER TENDL-2021 LIBRARY; T=0.K
Photon emission for (n,p)

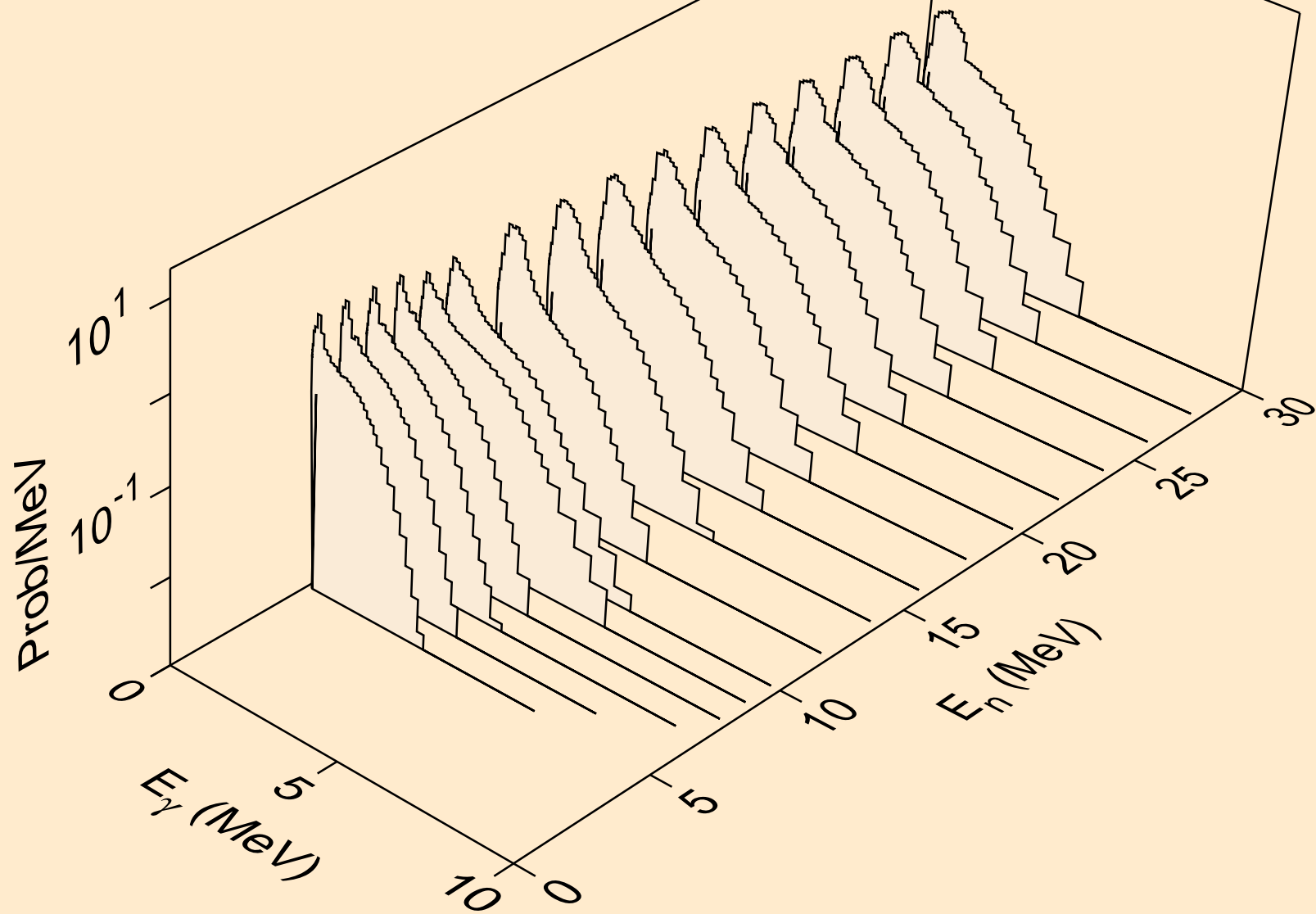

LU179 TRITON ACER TENDL-2021 LIBRARY; T=0.K
Photon emission for (n,d)

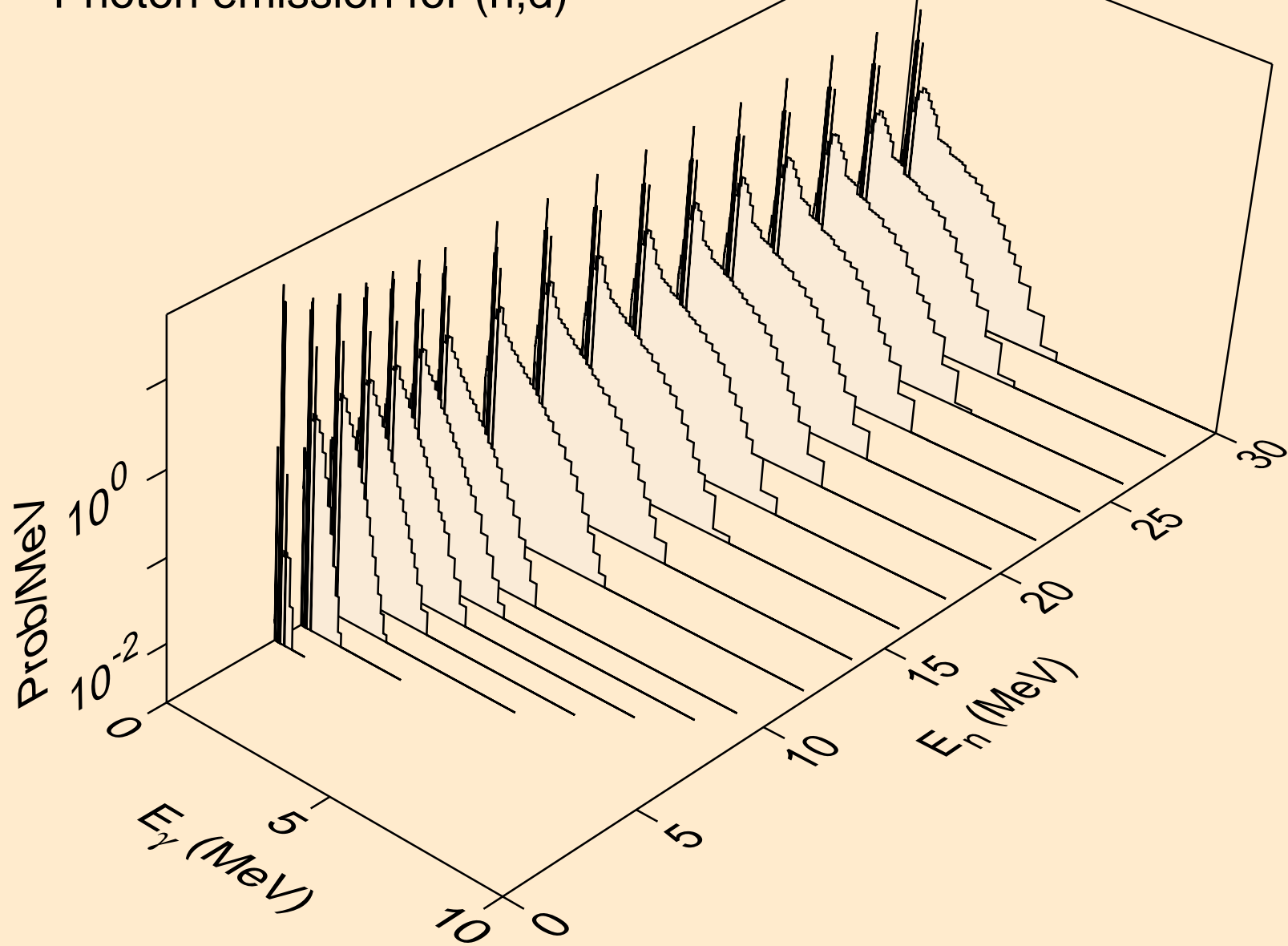

LU179 TRITON ACER TENDL-2021 LIBRARY; T=0.K
Photon emission for inelastic

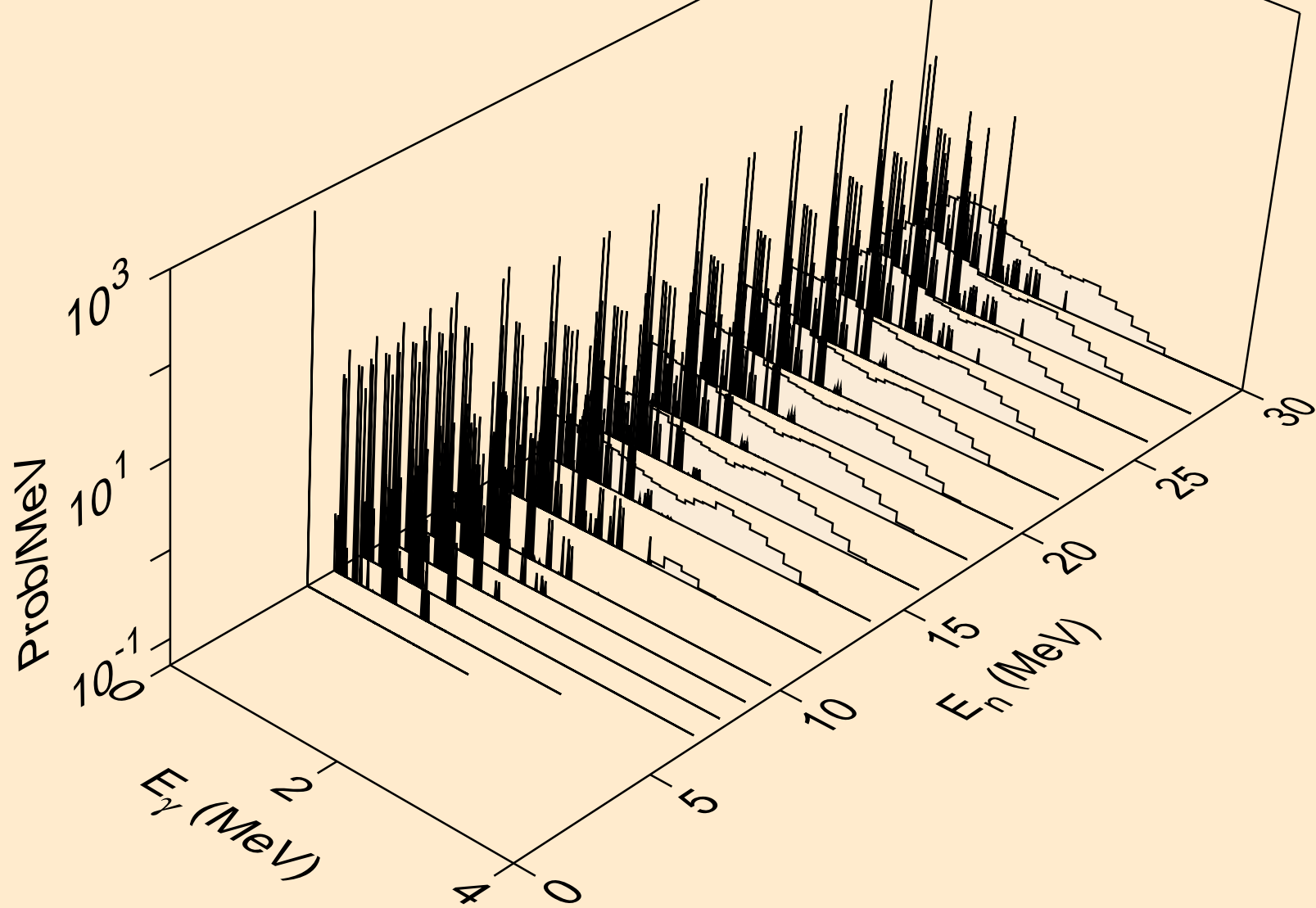

LU179 TRITON ACER TENDL-2021 LIBRARY; T=0.K
Photon emission for (n,he3)

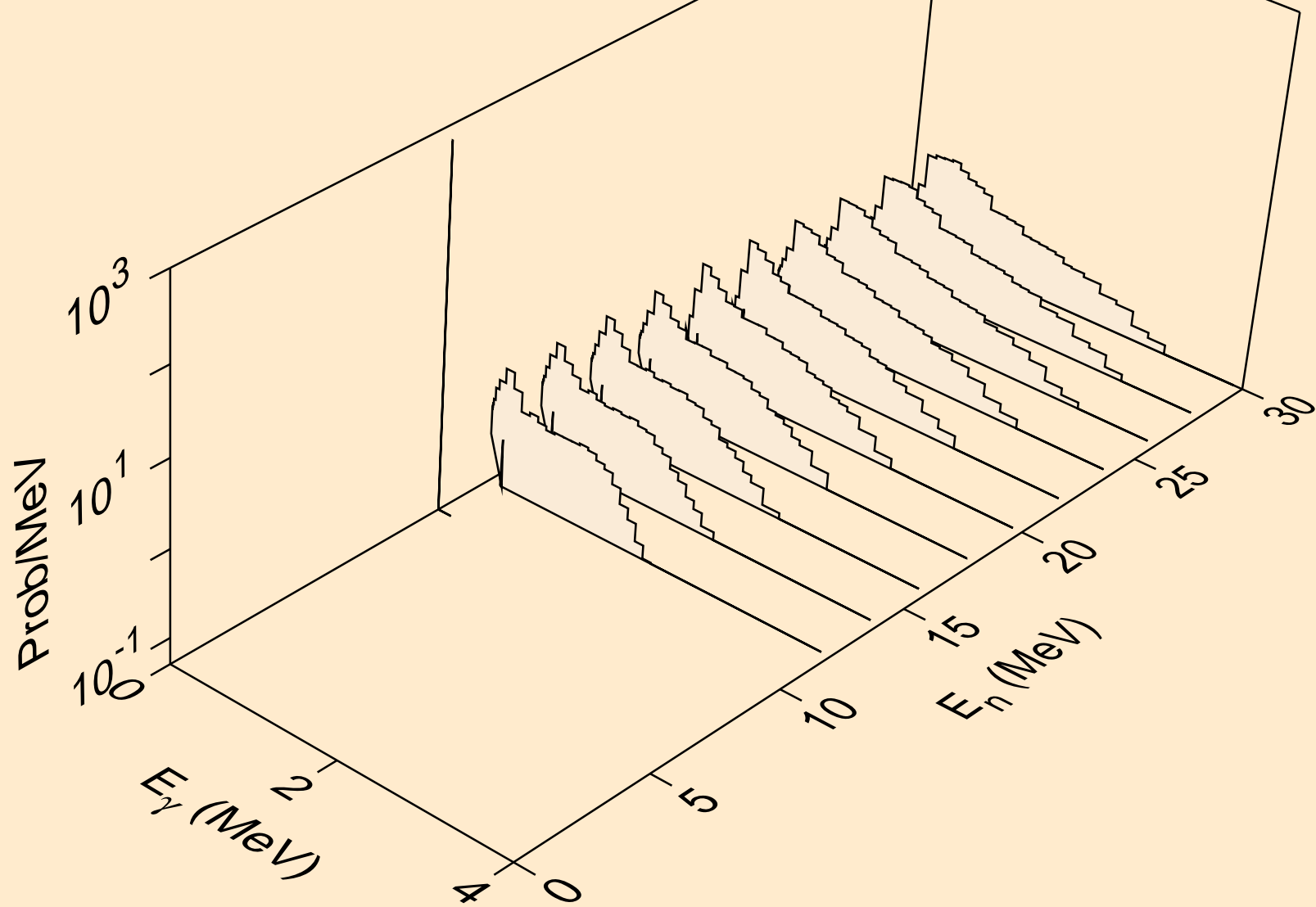

LU179 TRITON ACER TENDL-2021 LIBRARY; T=0.K
Photon emission for (n,a)

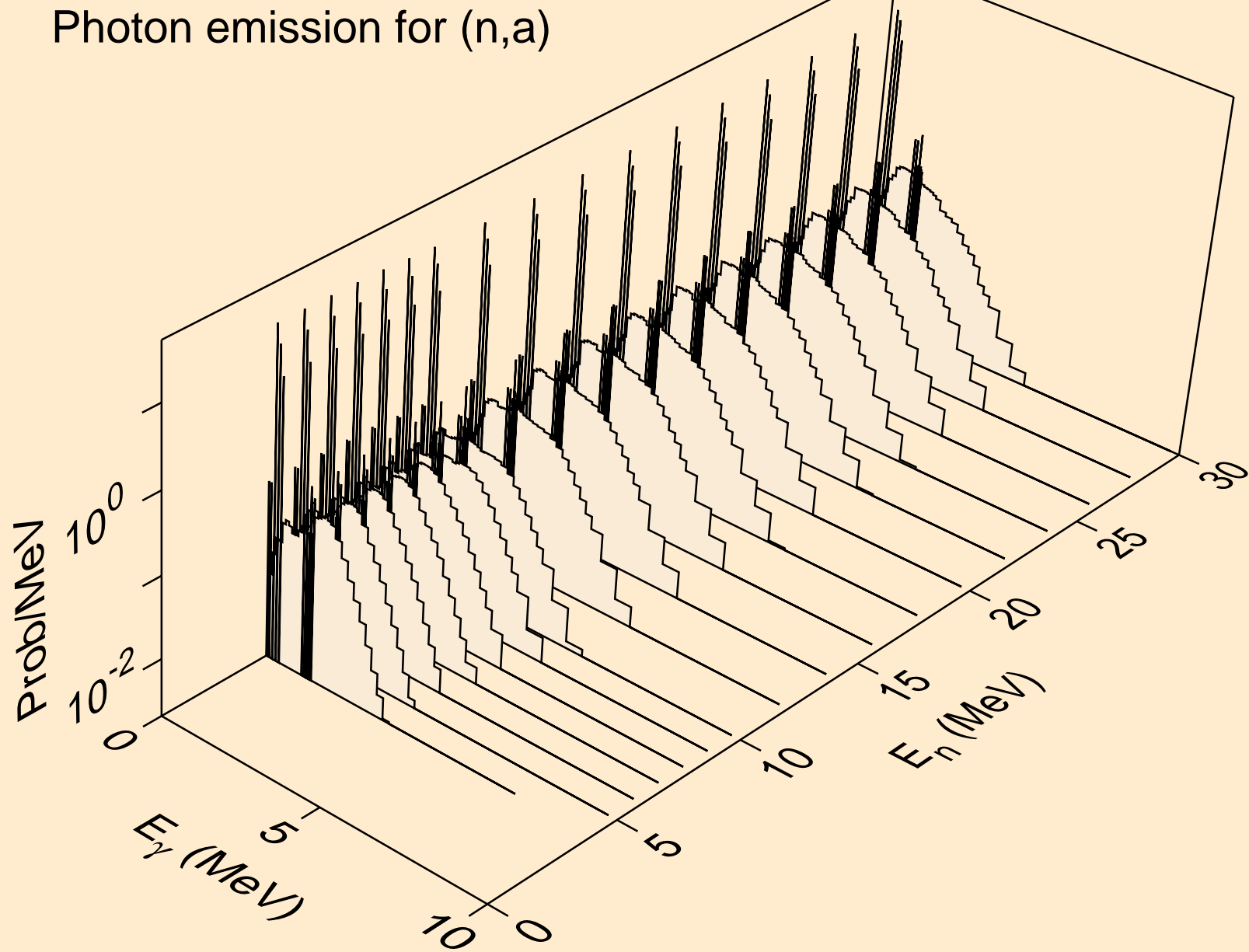

LU179 TRITON ACER TENDL-2021 LIBRARY; T=0.K
Photon emission for (n,2p)

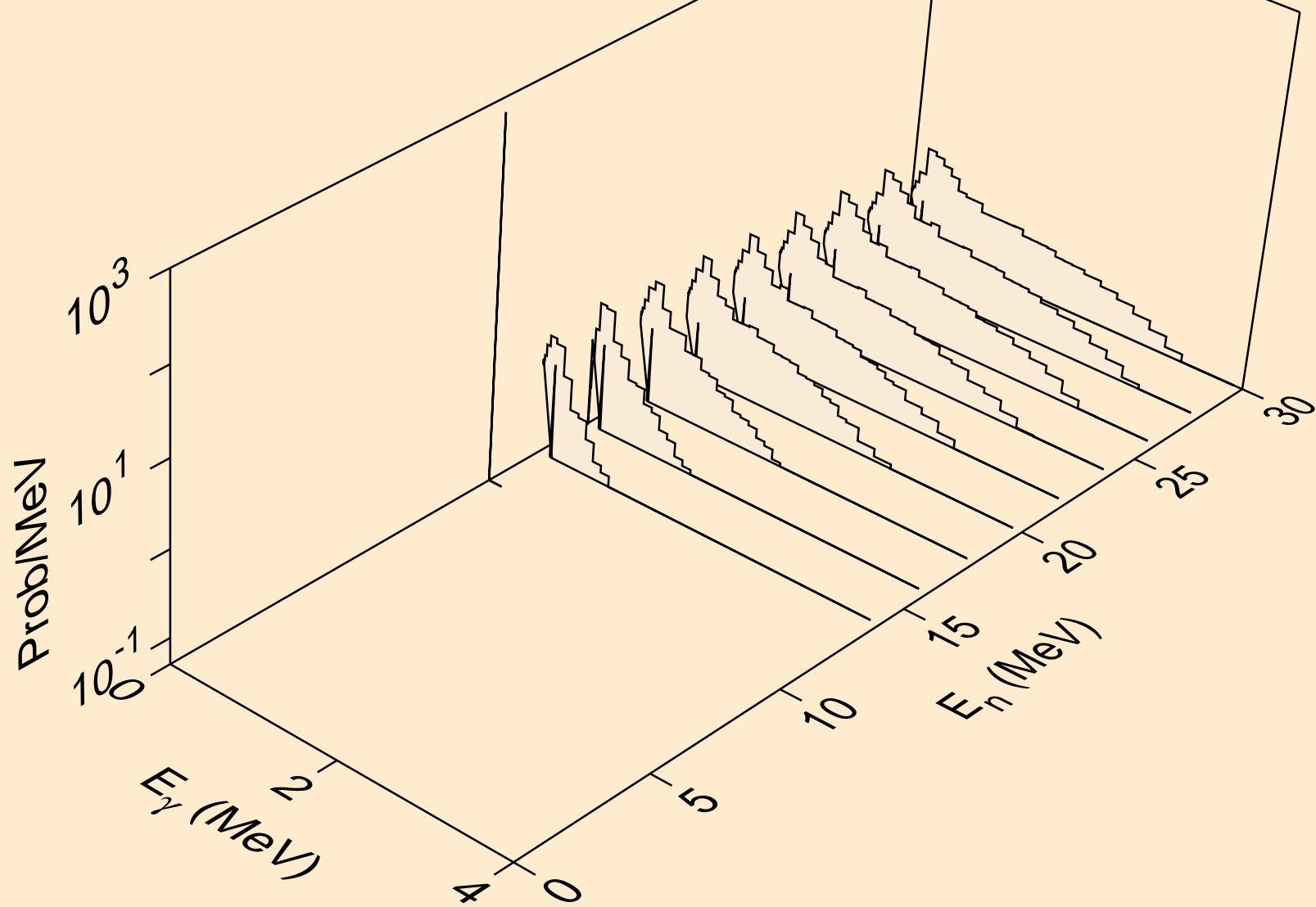

LU179 TRITON ACER TENDL-2021 LIBRARY; T=0.K
Photon emission for (n,pa)

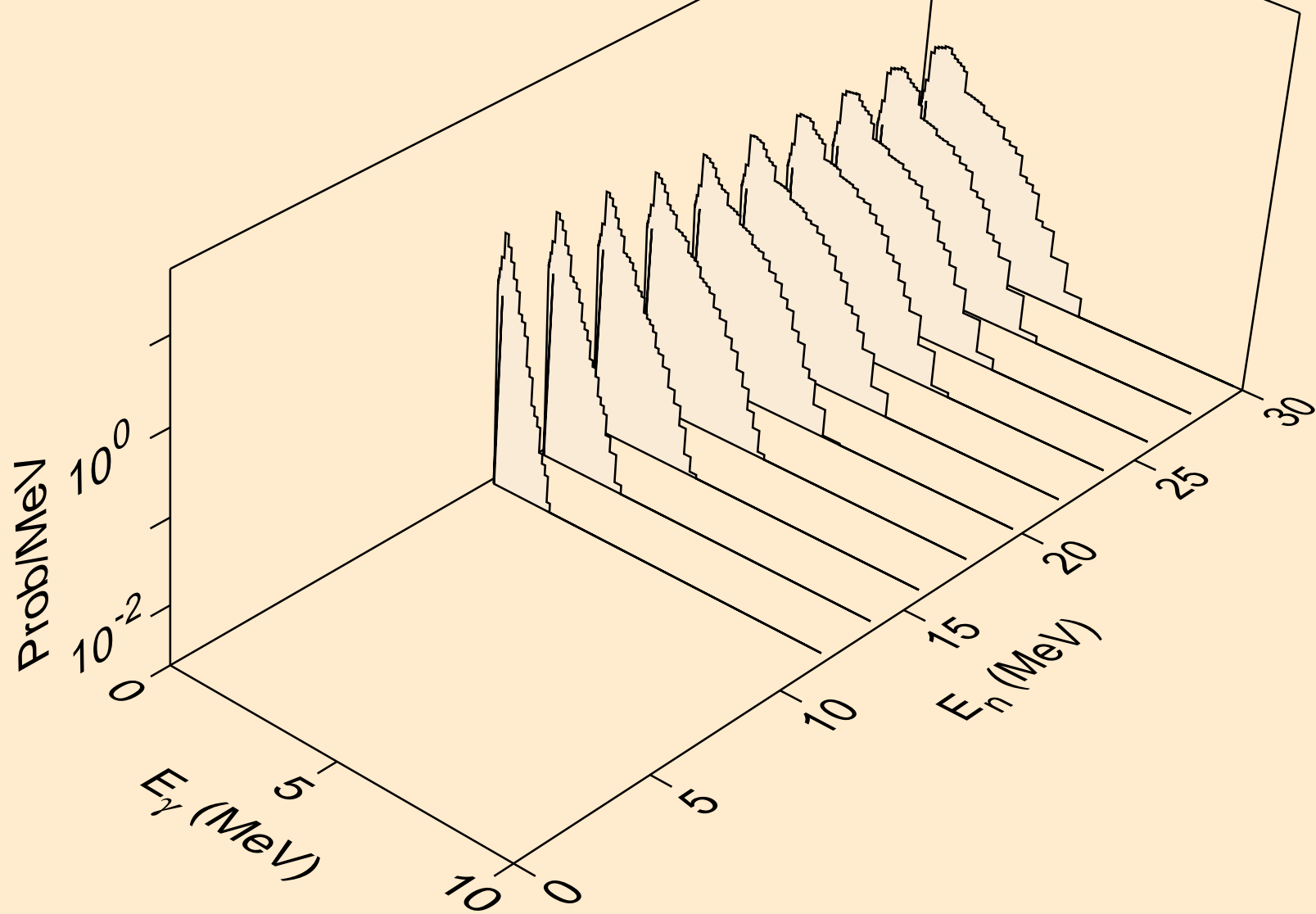

LU179 TRITON ACER TENDL-2021 LIBRARY; T=0.K
Photon emission for (n,pd)

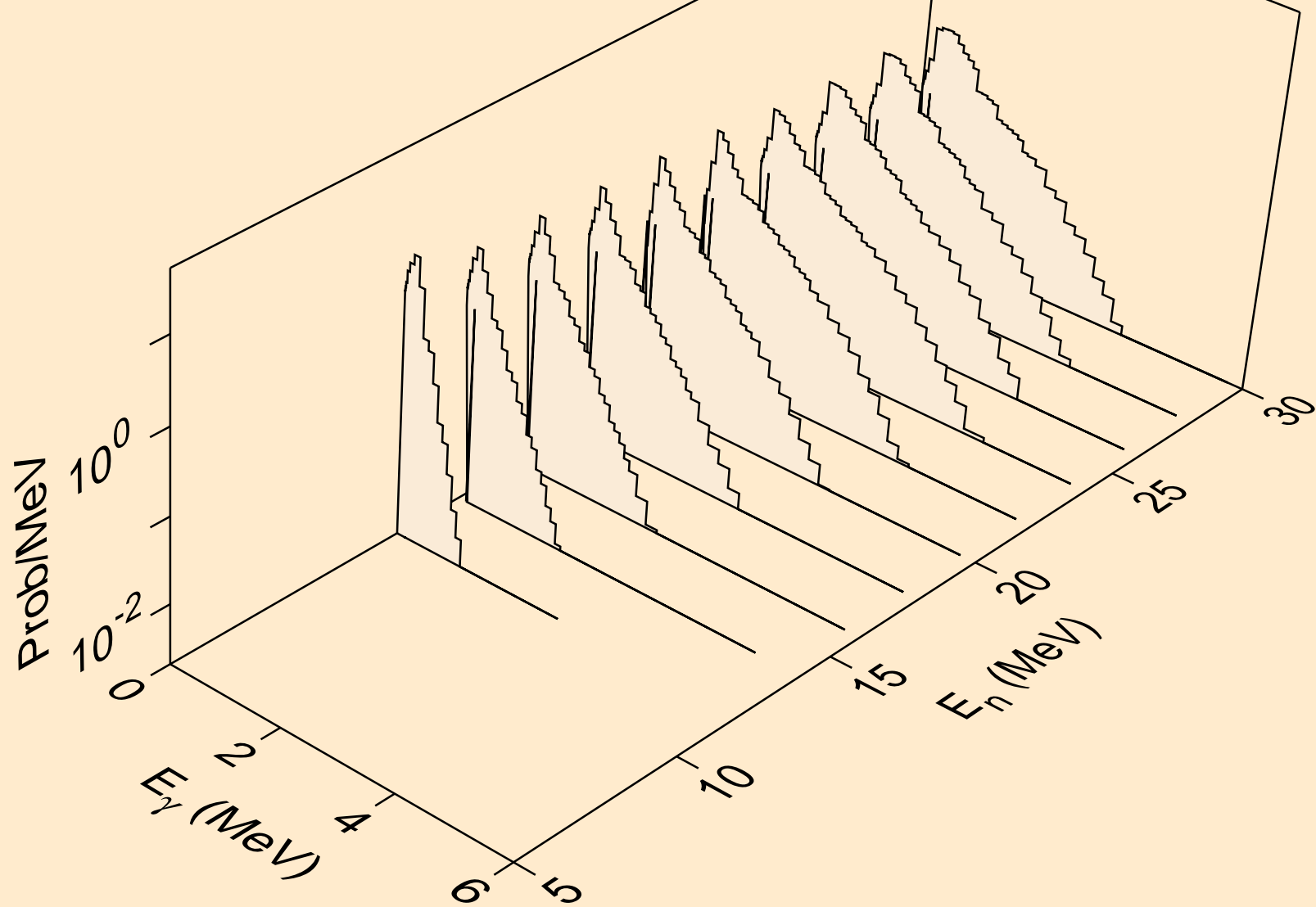

LU179 TRITON ACER TENDL-2021 LIBRARY; T=0.K
Photon emission for (n,pt)

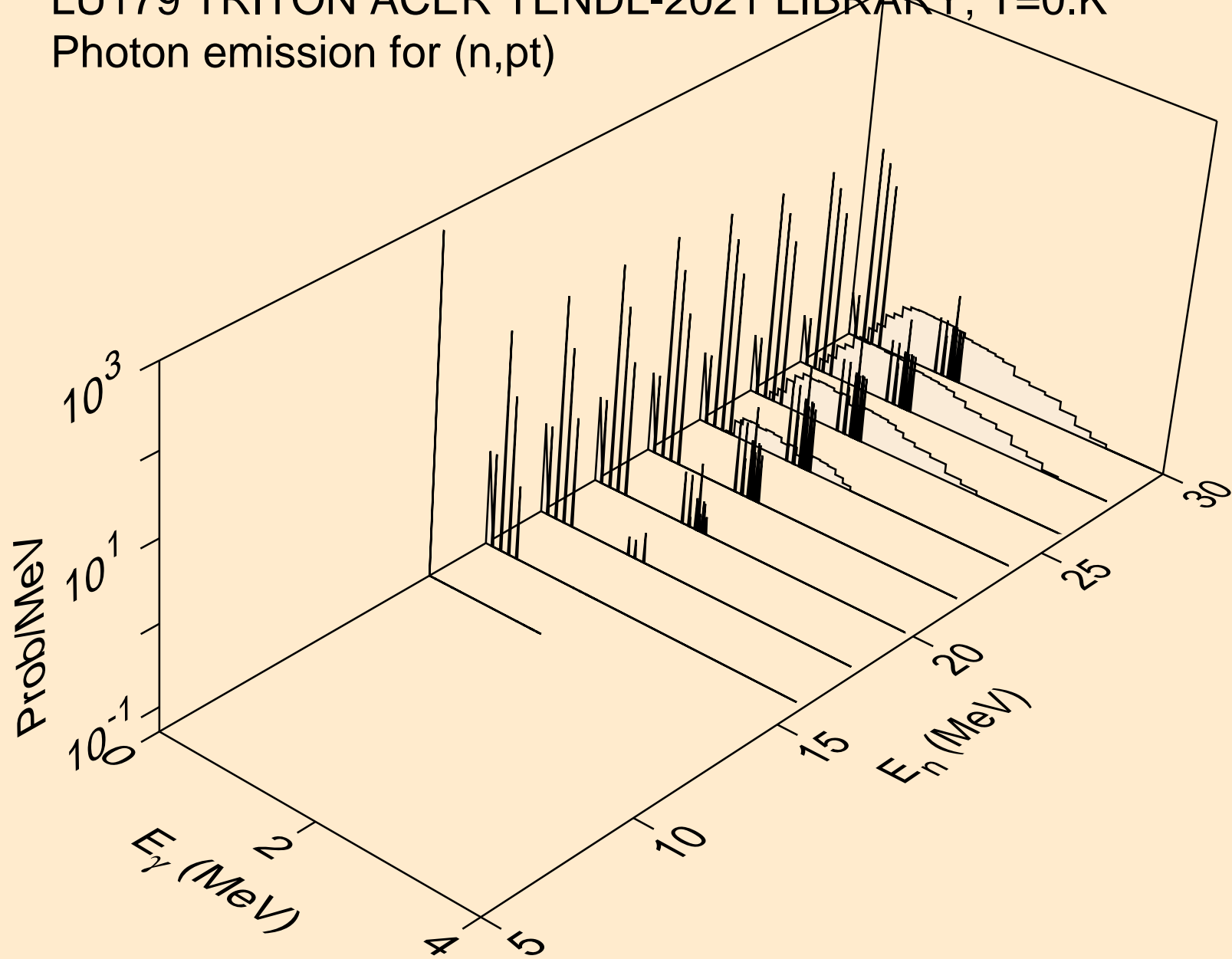

LU179 TRITON ACER TENDL-2021 LIBRARY; T=0.K
Particle heating contributions

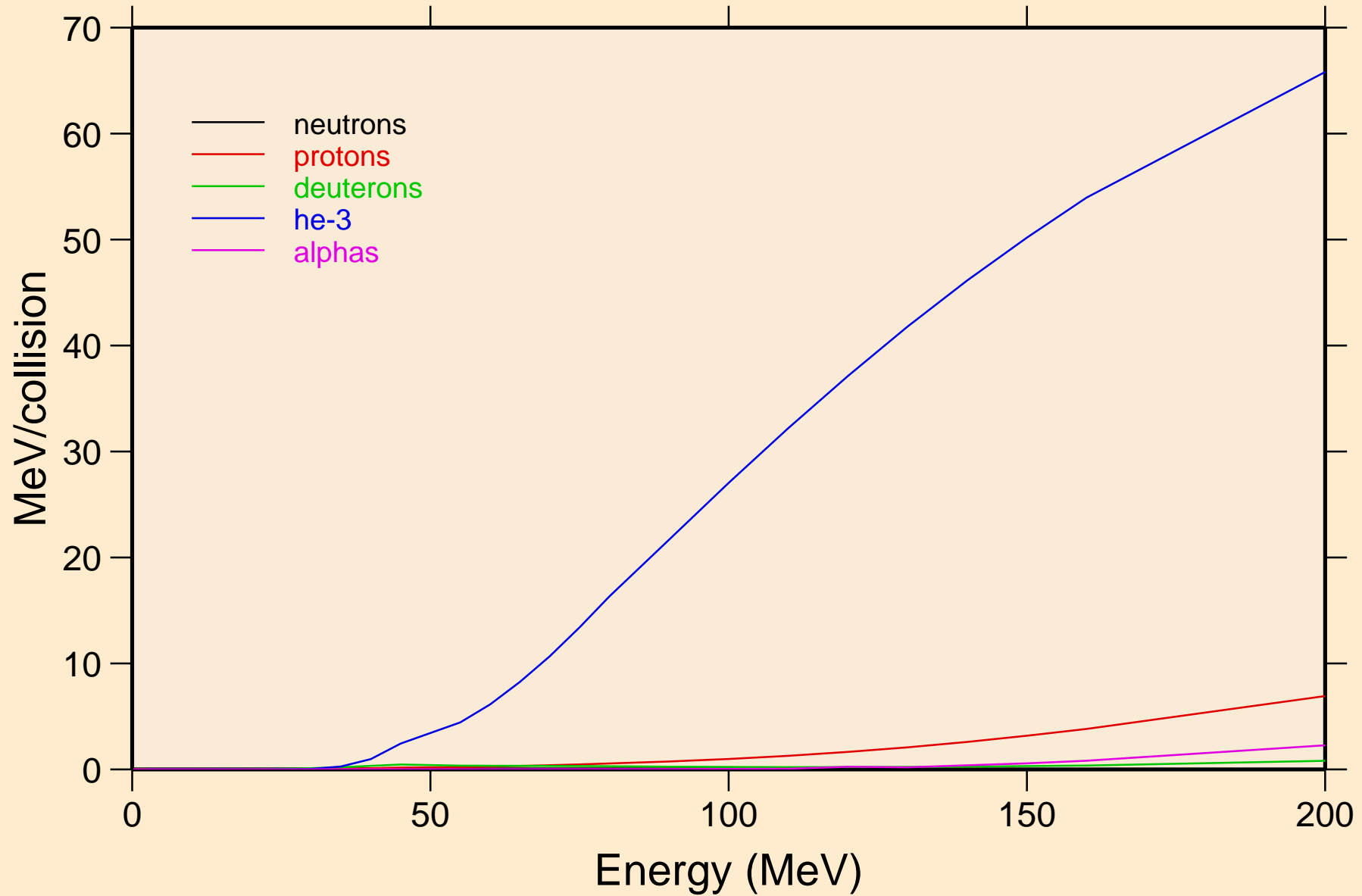

LU179 TRITON ACER TENDL-2021 LIBRARY; T=0.K
Recoil Heating

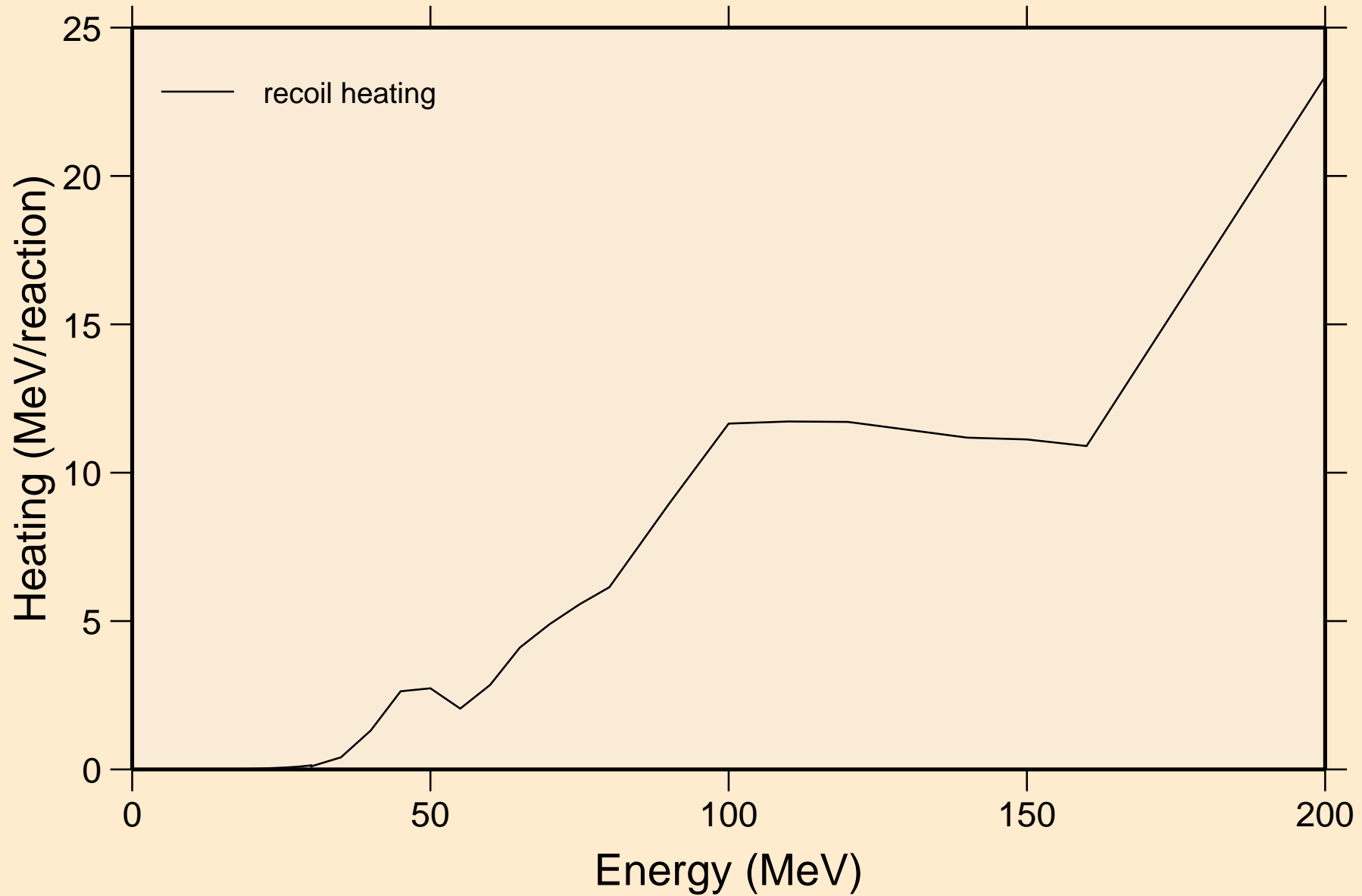

LU179 TRITON ACER TENDL-2021 LIBRARY; T=0.K
Particle production cross sections

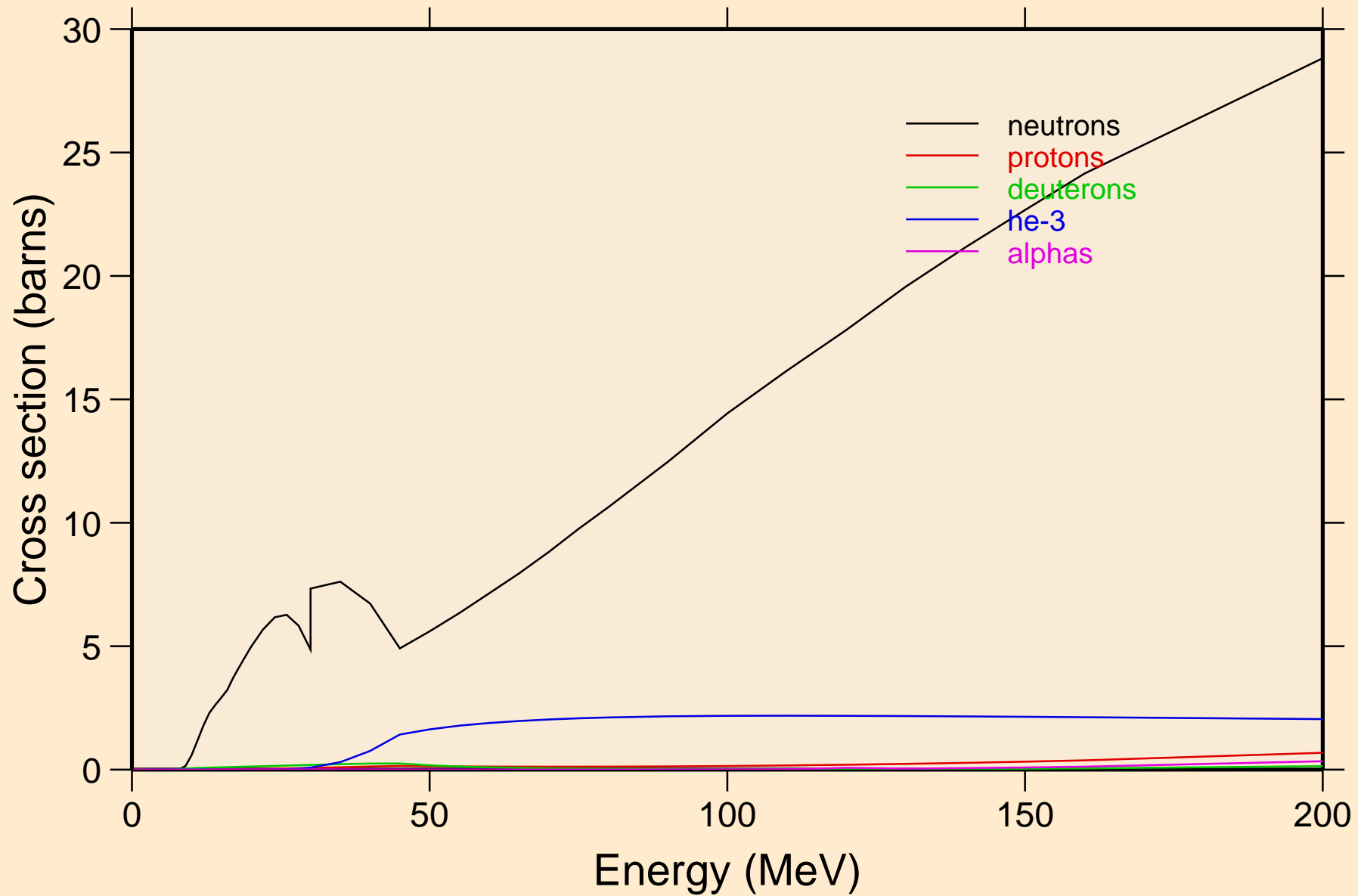

LU179 TRITON ACER TENDL-2021 LIBRARY; T=0.K
neutrons from (t,n)

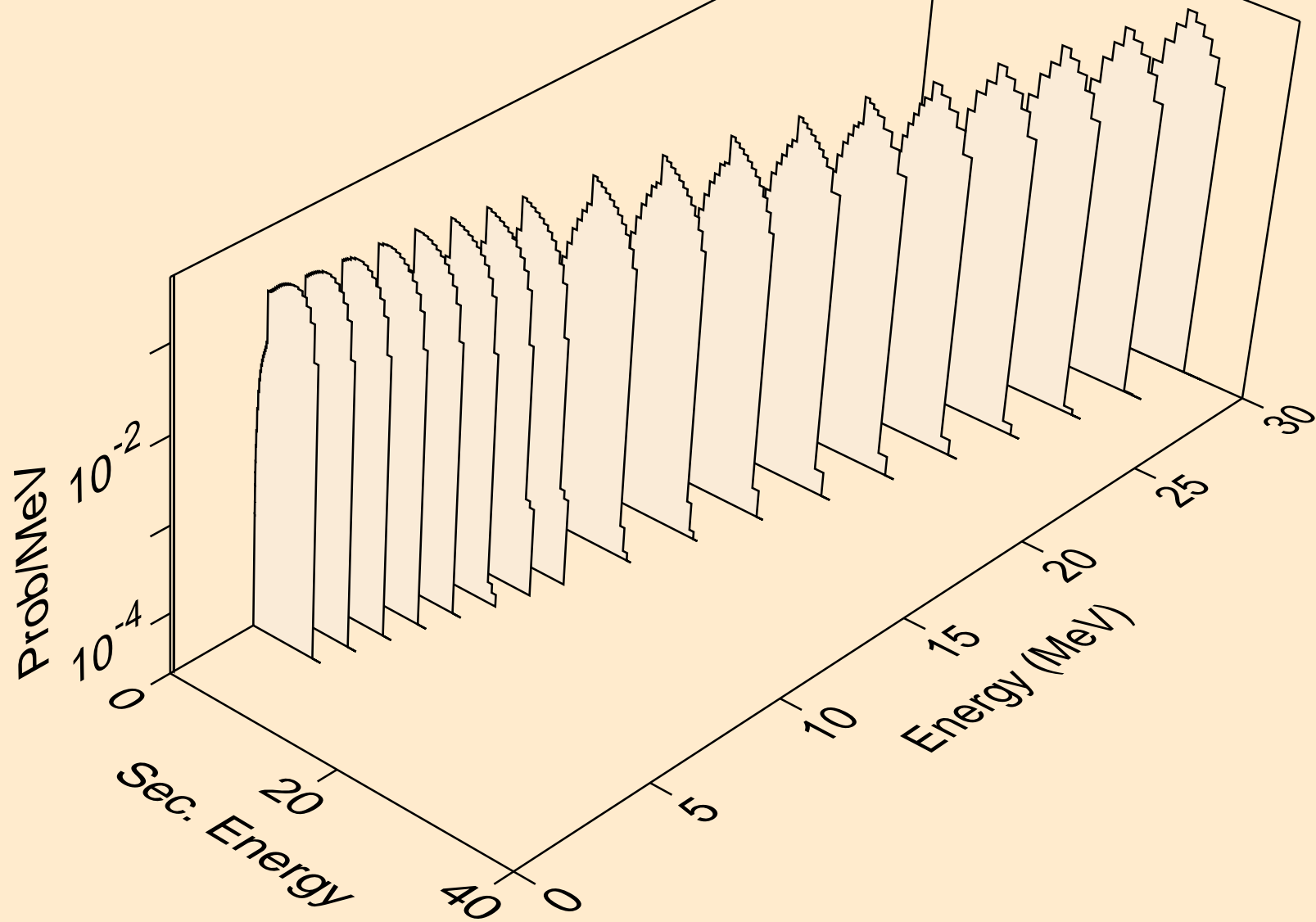

LU179 TRITON ACER TENDL-2021 LIBRARY; T=0.K
neutrons from (t,x)

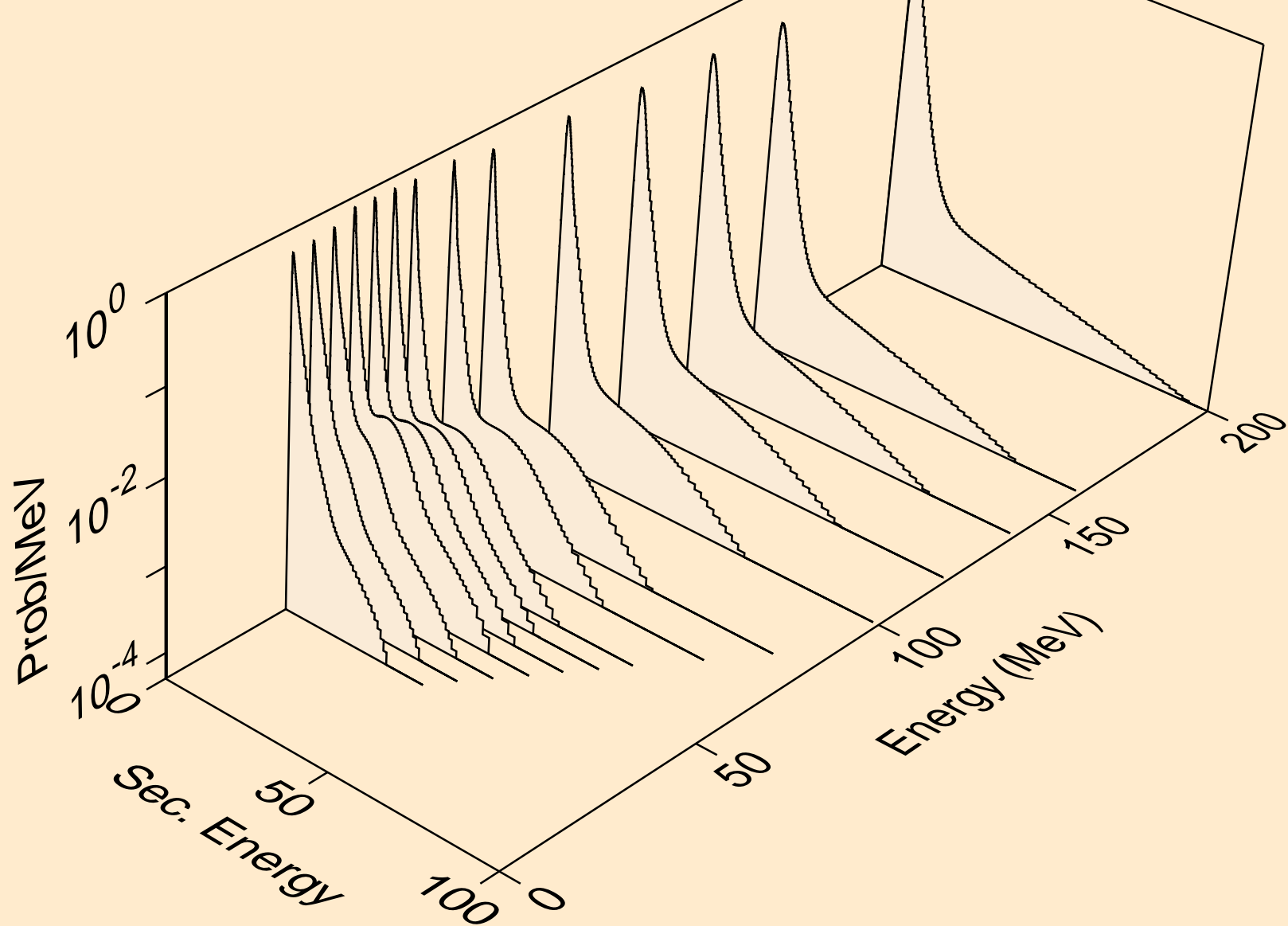

LU179 TRITON ACER TENDL-2021 LIBRARY; T=0.K
neutrons from (t,2nd)

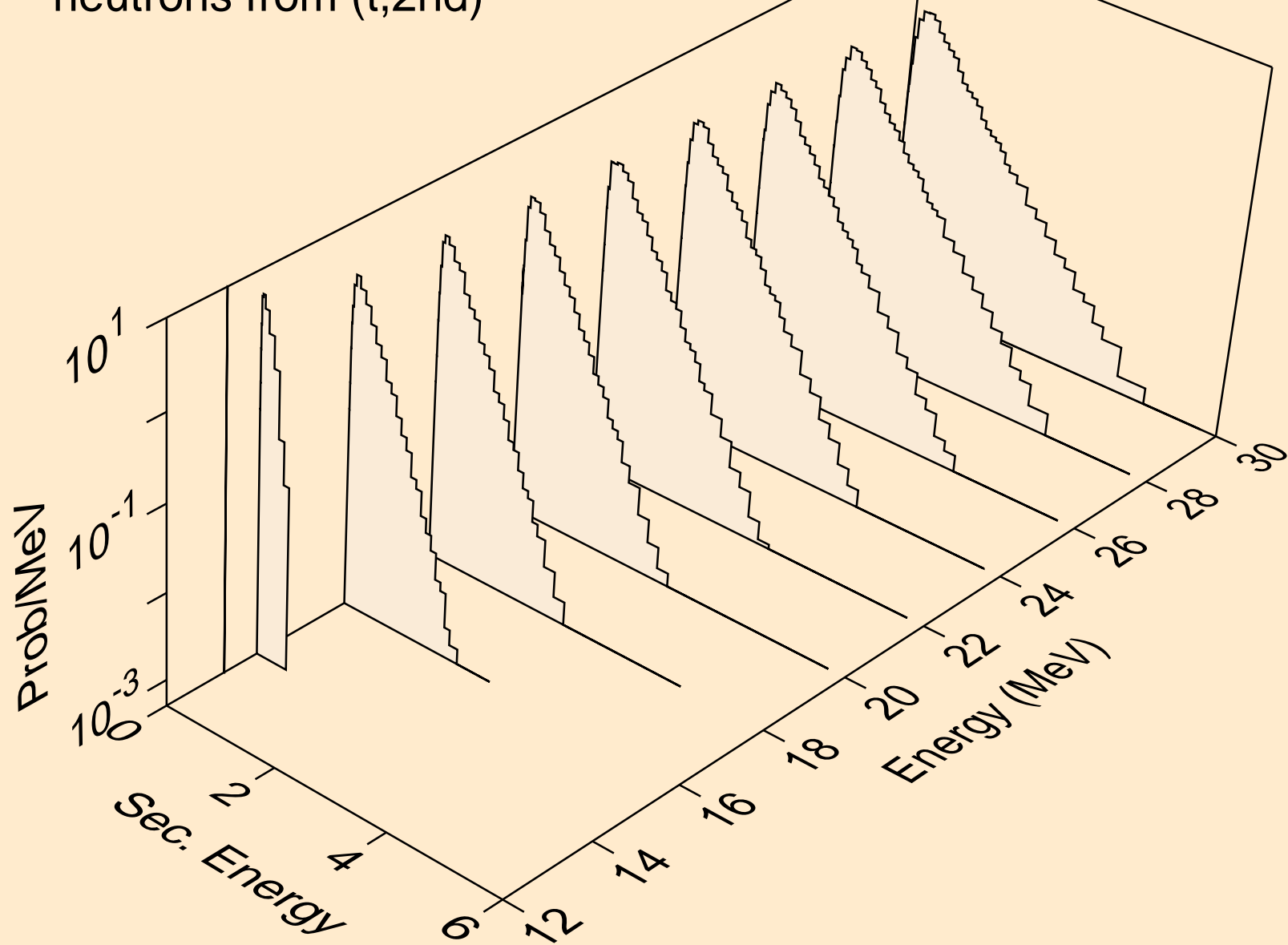

LU179 TRITON ACER TENDL-2021 LIBRARY; T=0.K
neutrons from (t,2n)

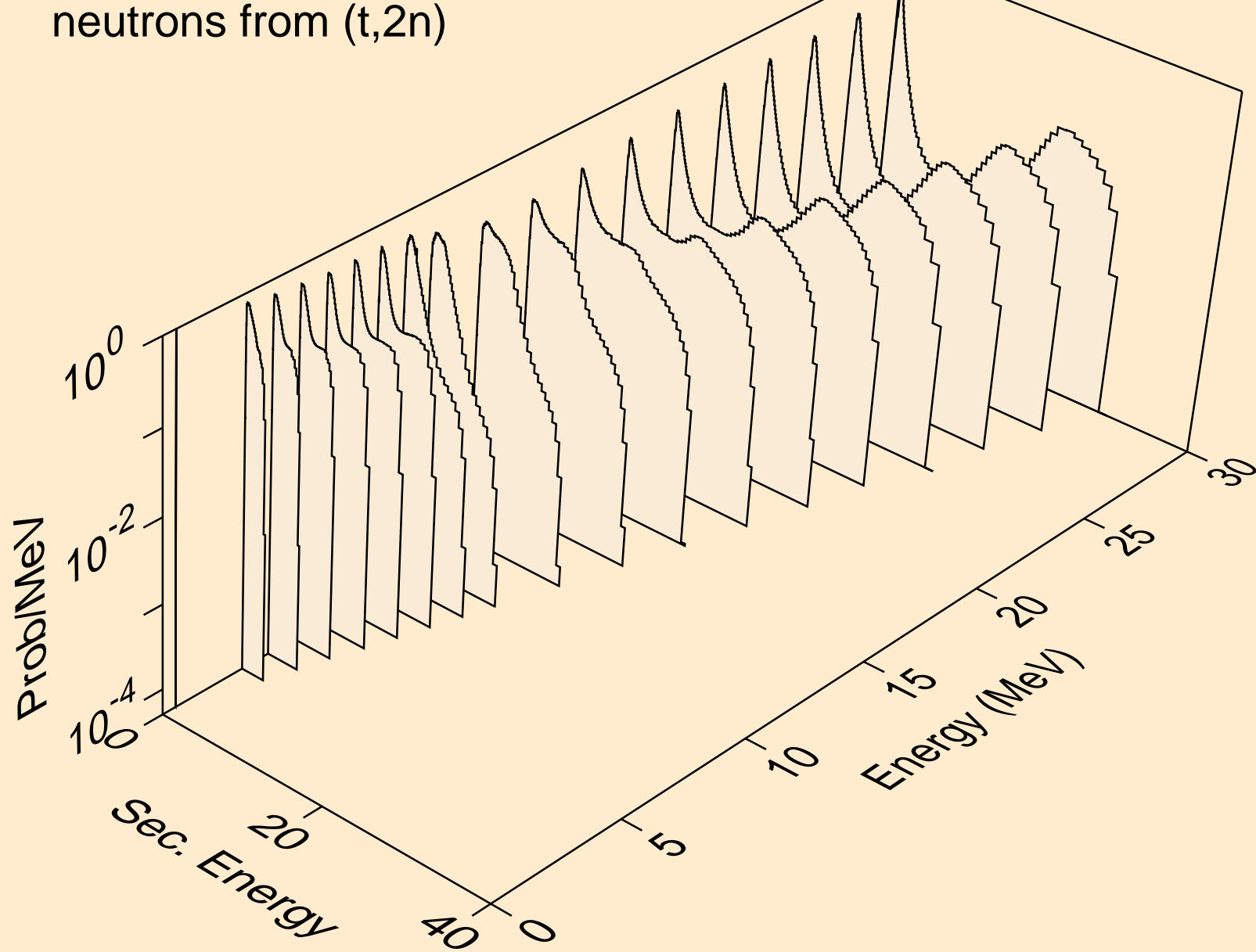

LU179 TRITON ACER TENDL-2021 LIBRARY; T=0.K
neutrons from (t,3n)

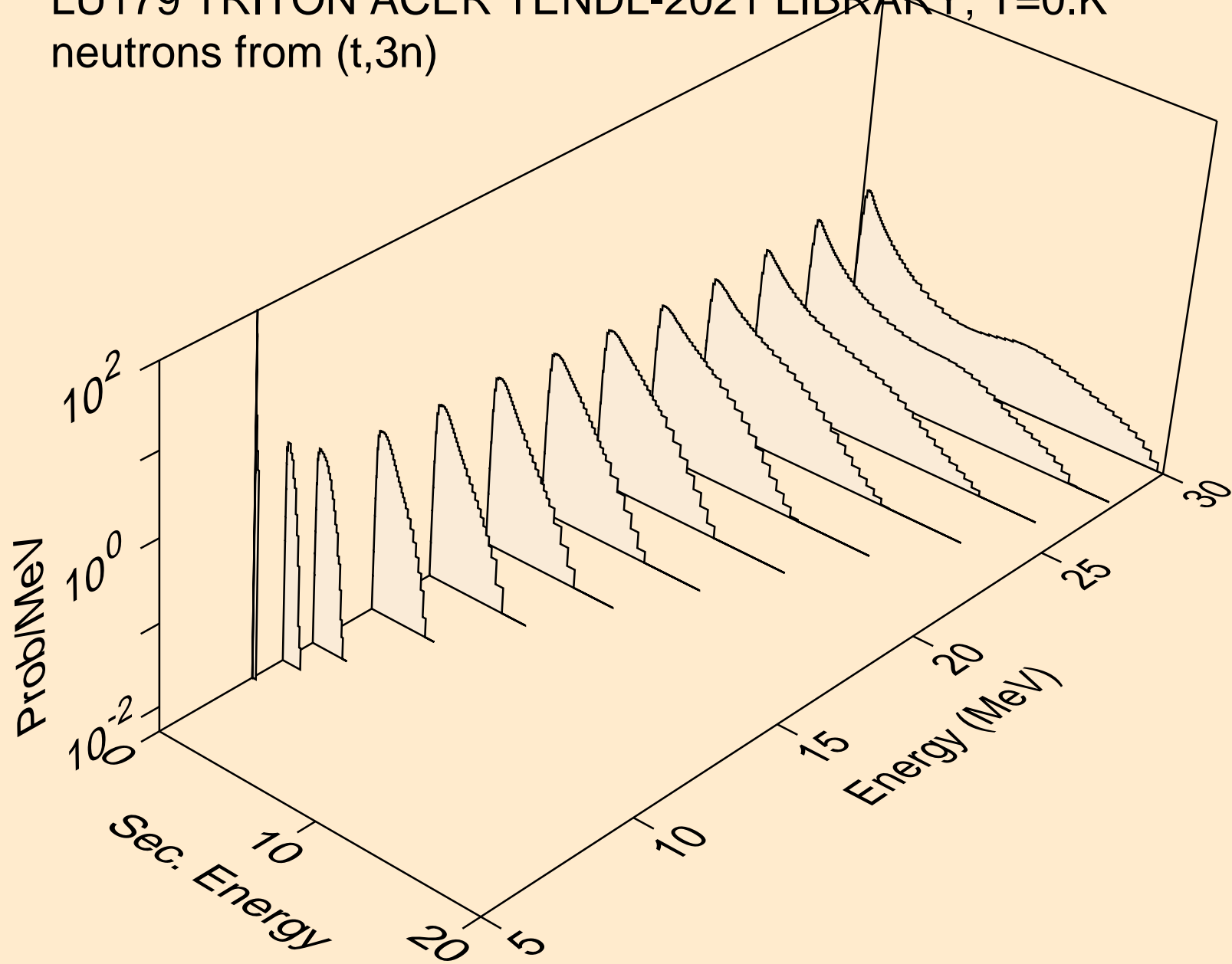

LU179 TRITON ACER TENDL-2021 LIBRARY; T=0.K
neutrons from (t,n*)a

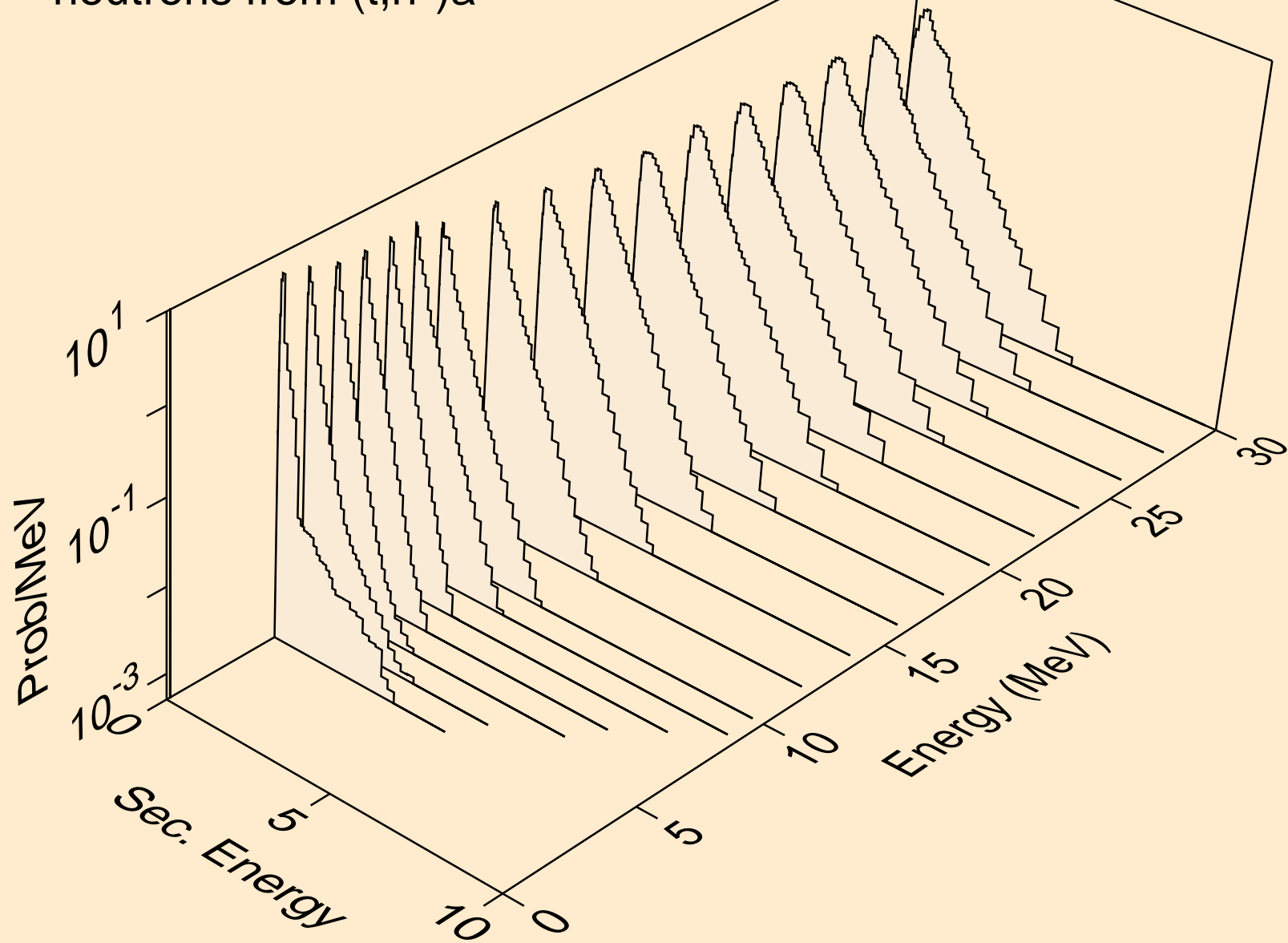

LU179 TRITON ACER TENDL-2021 LIBRARY; T=0.K
neutrons from (t,2n)a

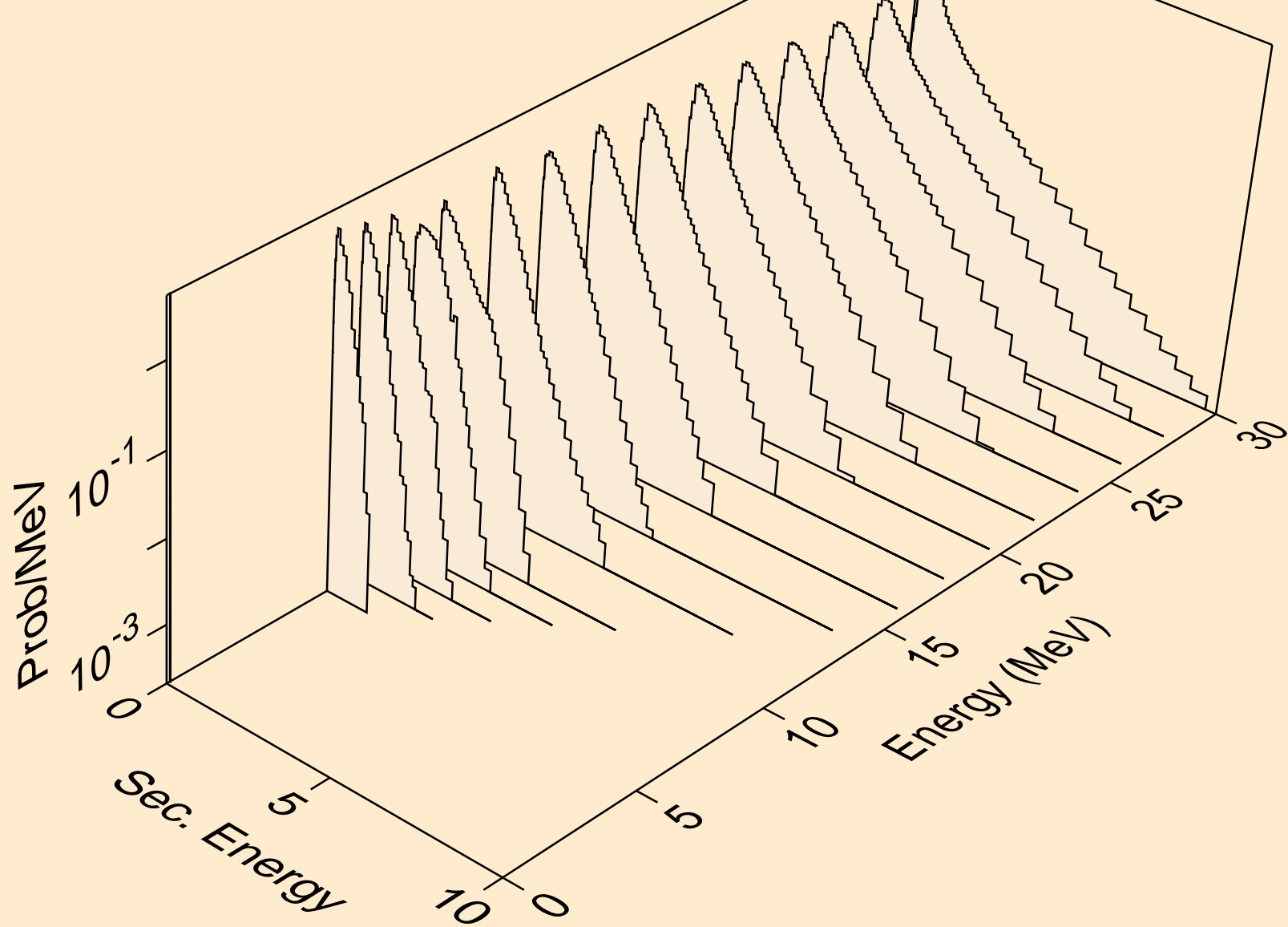

LU179 TRITON ACER TENDL-2021 LIBRARY; T=0.K
neutrons from (t,3n)a

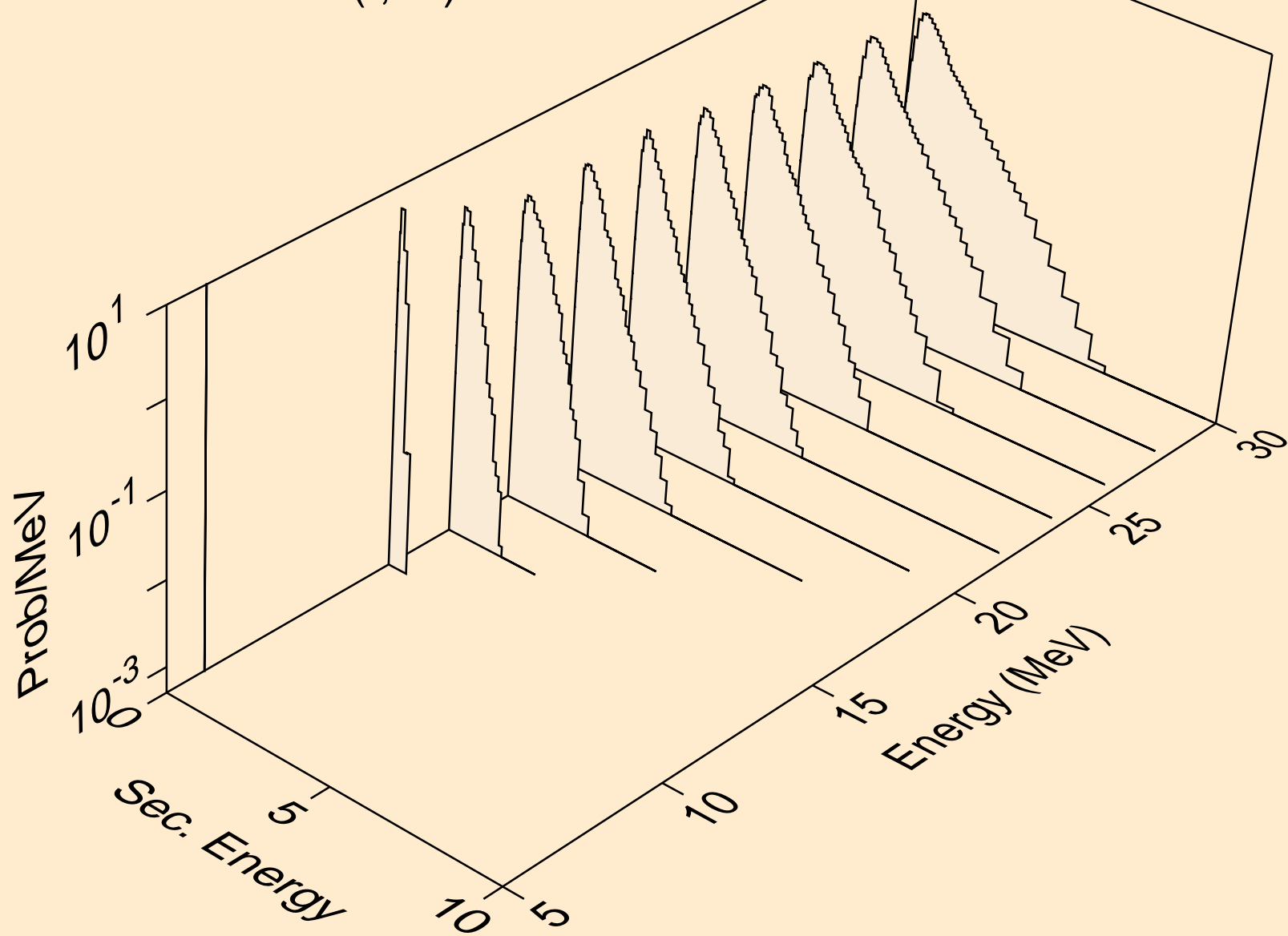

LU179 TRITON ACER TENDL-2021 LIBRARY; T=0.K
neutrons from (t,n*)p

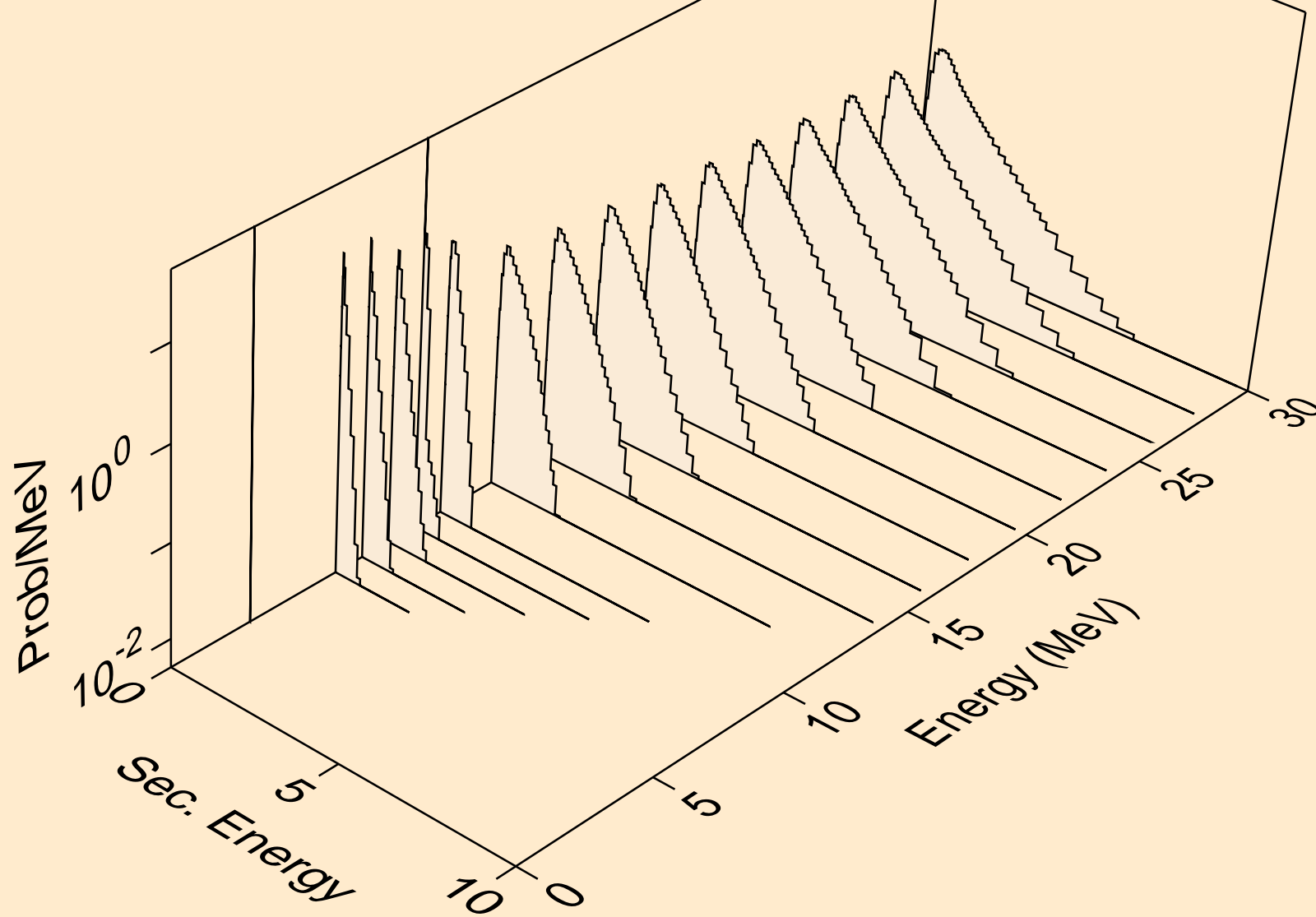

LU179 TRITON ACER TENDL-2021 LIBRARY; T=0.K
neutrons from (t,n*)2a

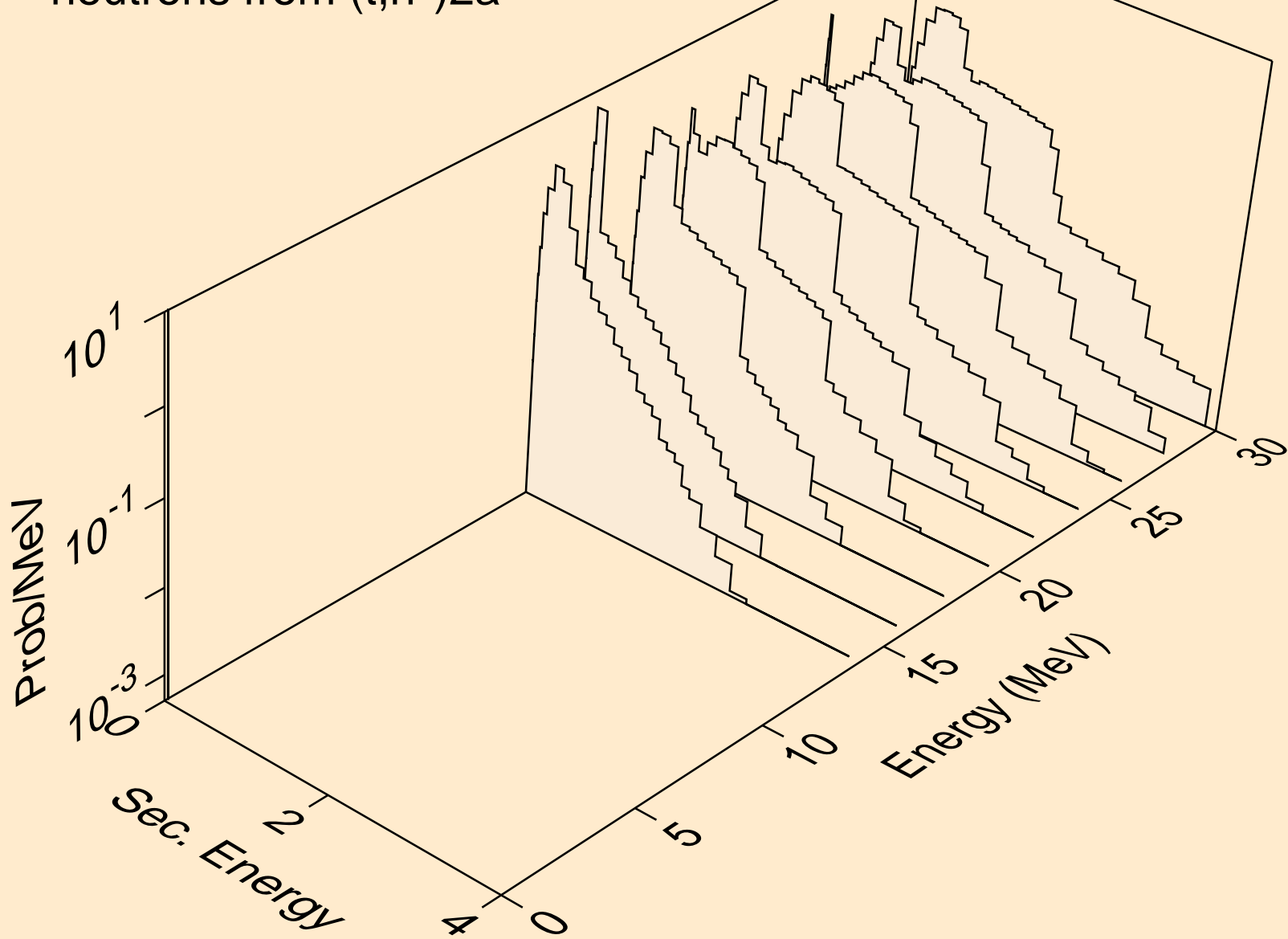

LU179 TRITON ACER TENDL-2021 LIBRARY; T=0.K
neutrons from (t,n*)d

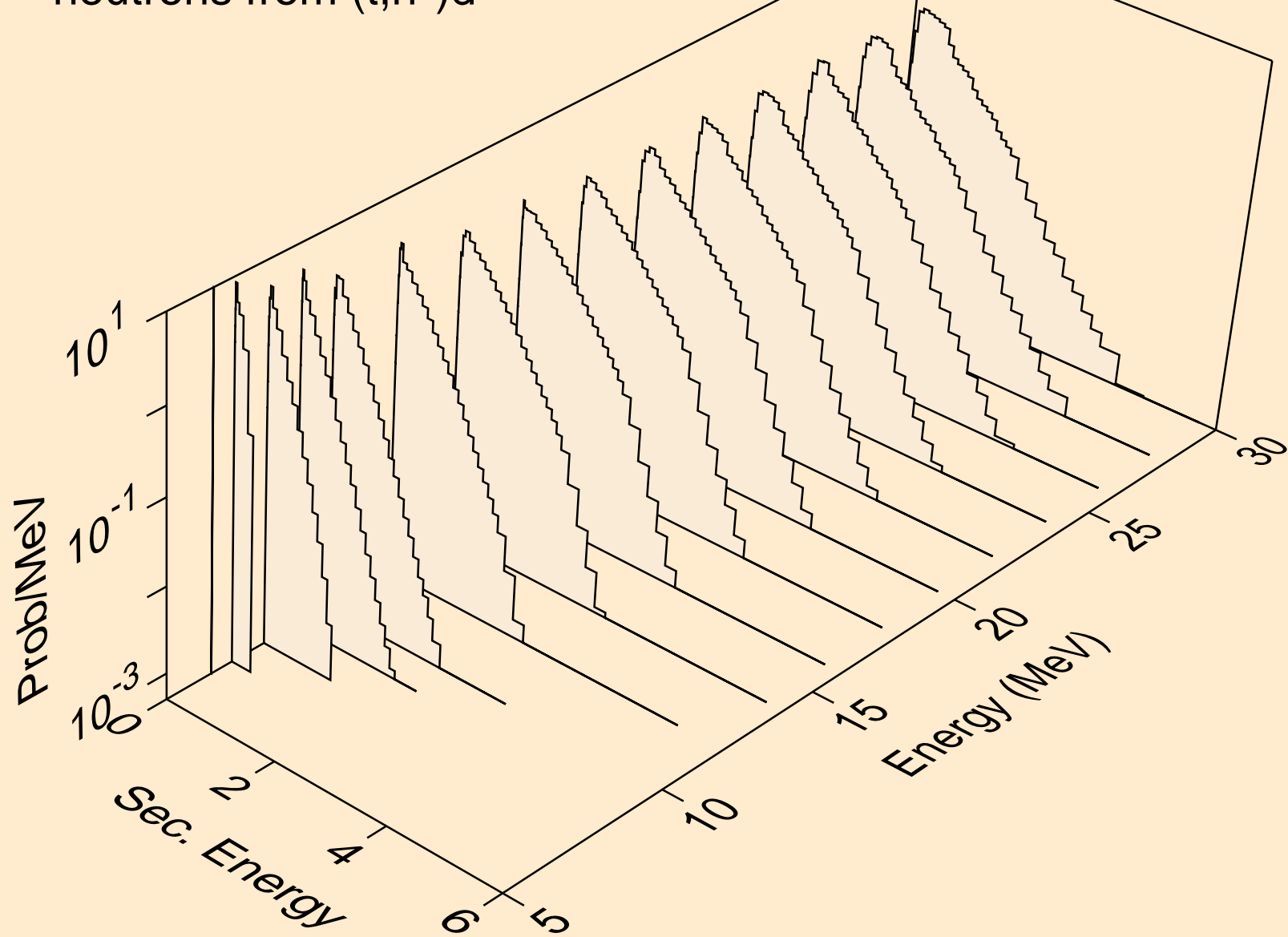

LU179 TRITON ACER TENDL-2021 LIBRARY; T=0.K
neutrons from (t,n*)t

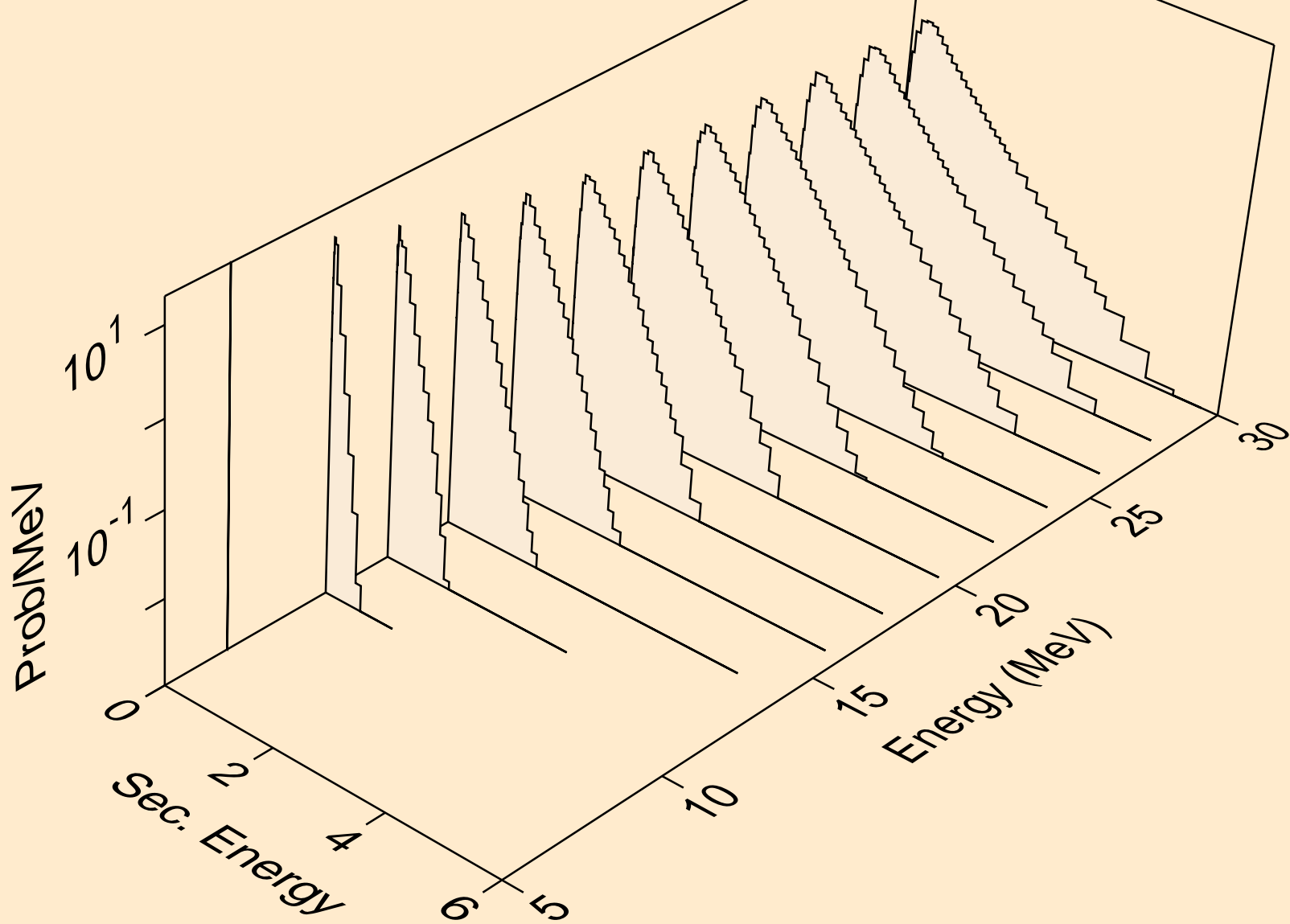

LU179 TRITON ACER TENDL-2021 LIBRARY; T=0.K
neutrons from (t,n*)he3

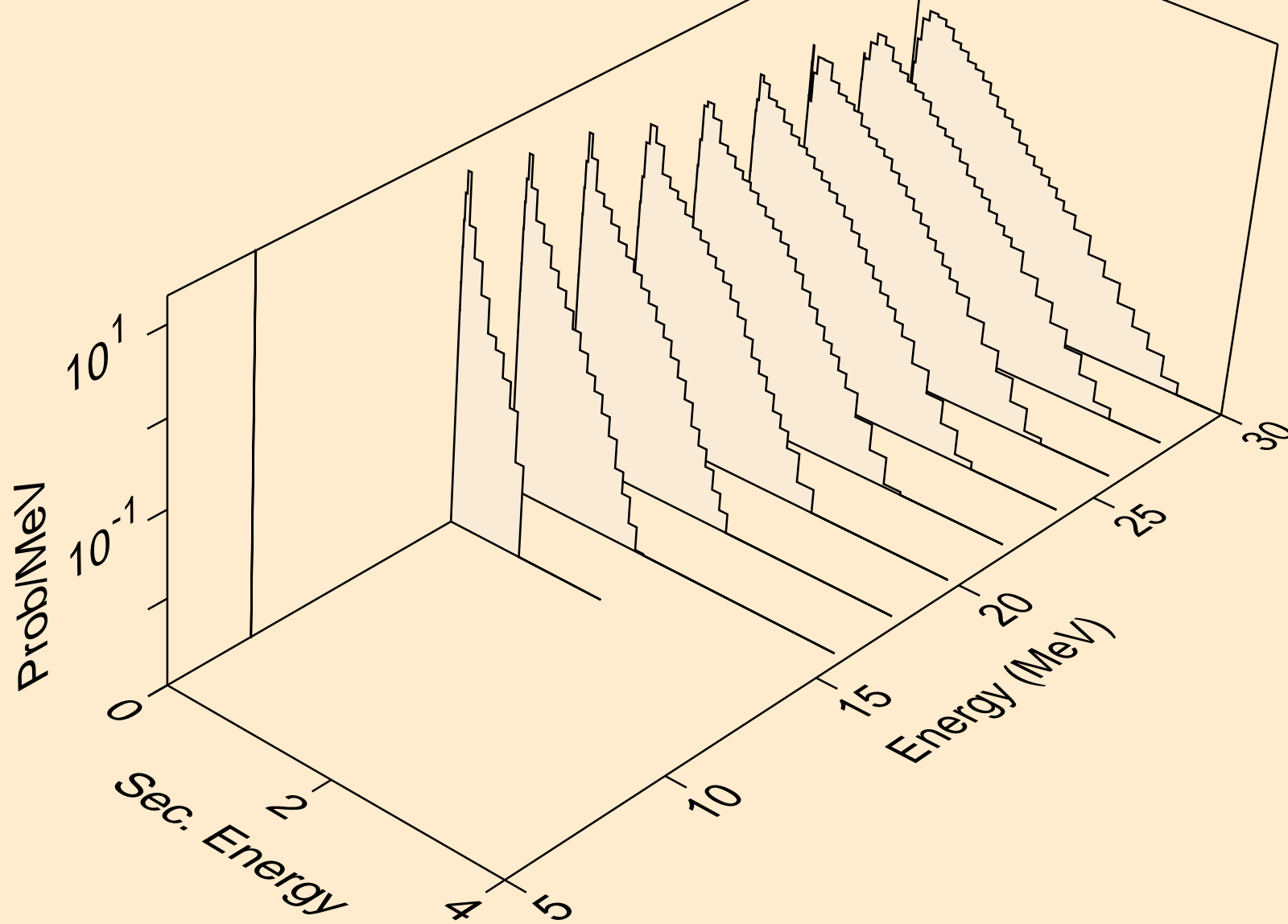

LU179 TRITON ACER TENDL-2021 LIBRARY; T=0.K
neutrons from (t,4n)

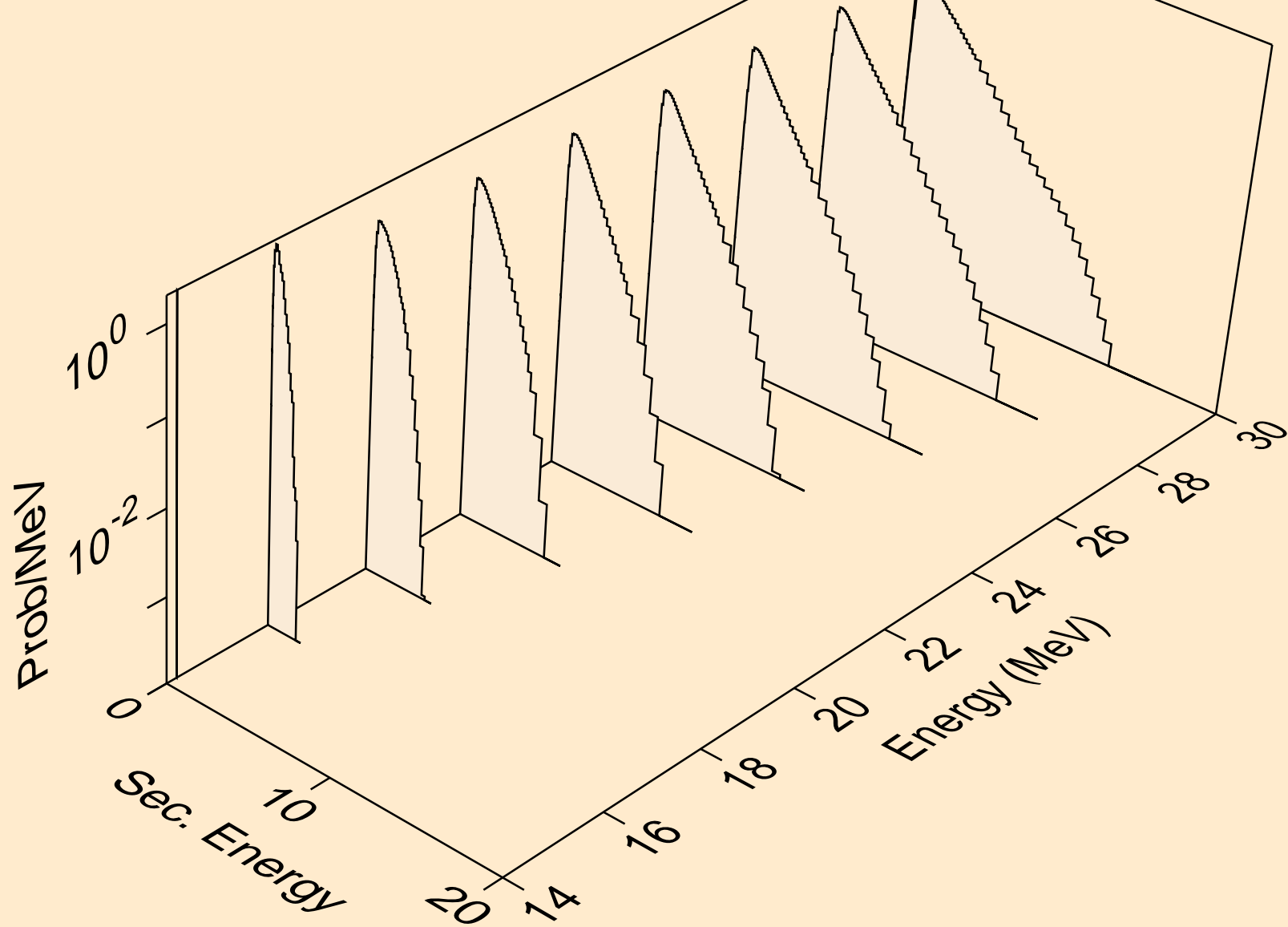

LU179 TRITON ACER TENDL-2021 LIBRARY; T=0.K
neutrons from (t,2np)

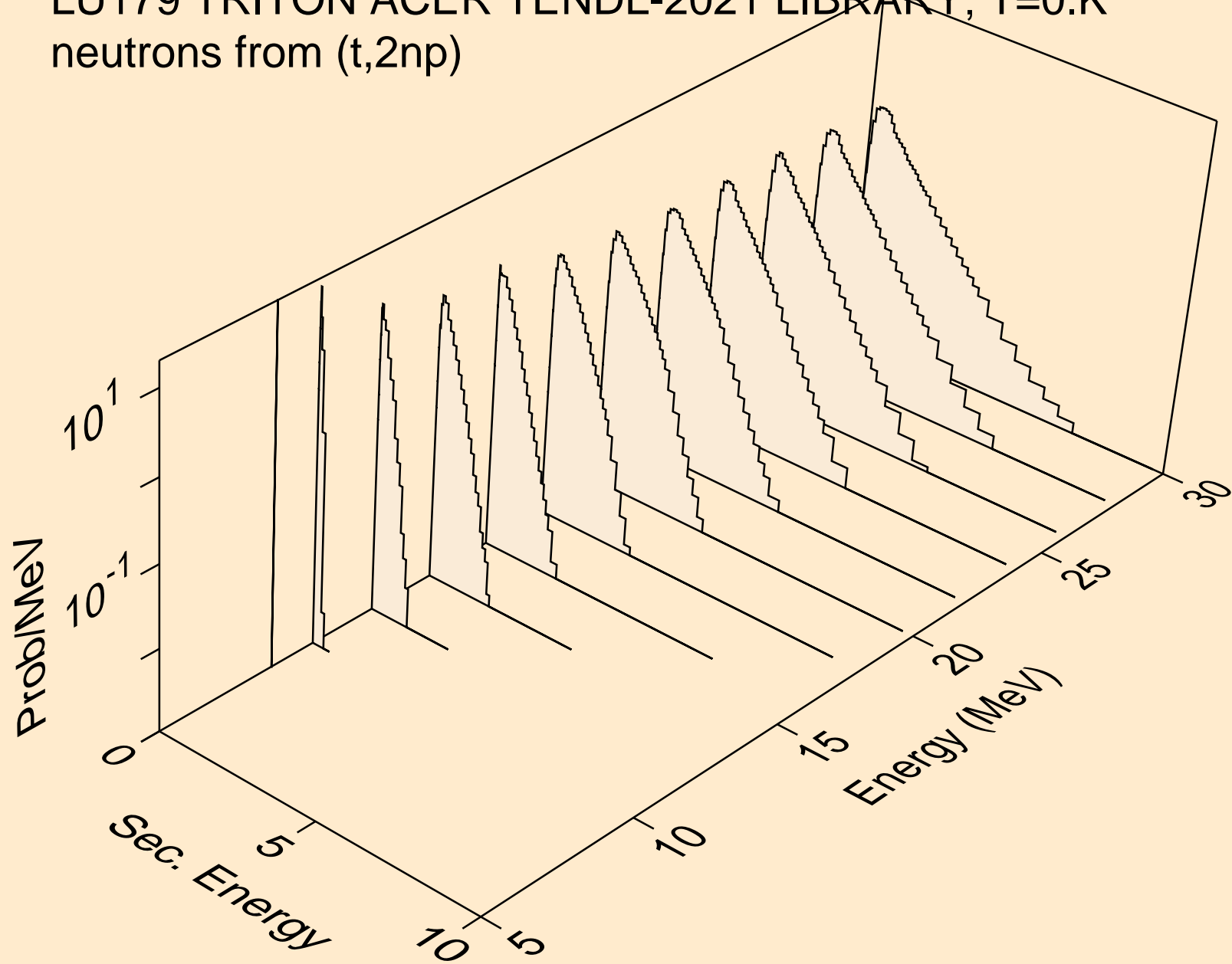

LU179 TRITON ACER TENDL-2021 LIBRARY; T=0.K
neutrons from (t,3np)

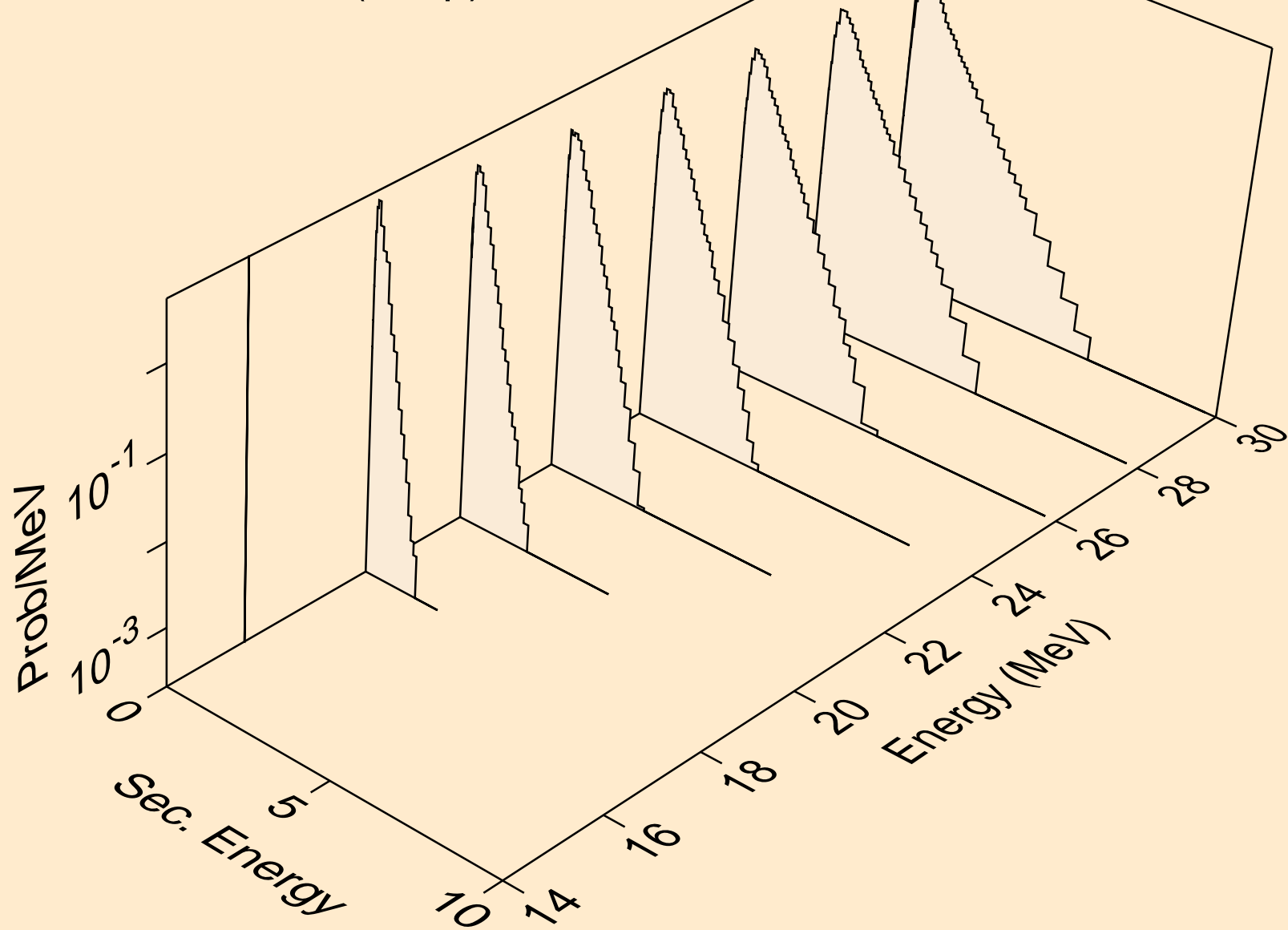

LU179 TRITON ACER TENDL-2021 LIBRARY; T=0.K
neutrons from (t,2np)

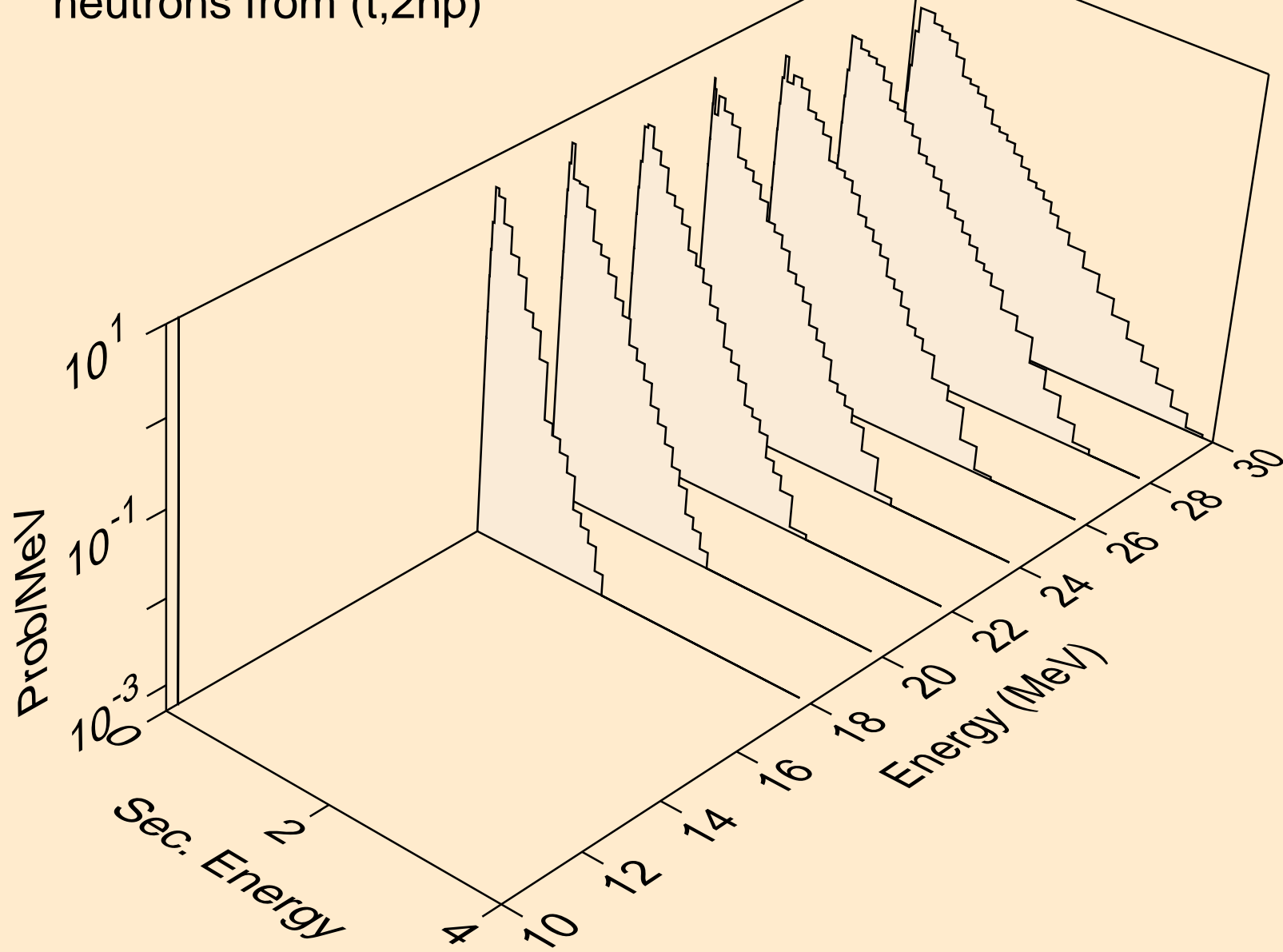

LU179 TRITON ACER TENDL-2021 LIBRARY; T=0.K
neutrons from (t,npa)

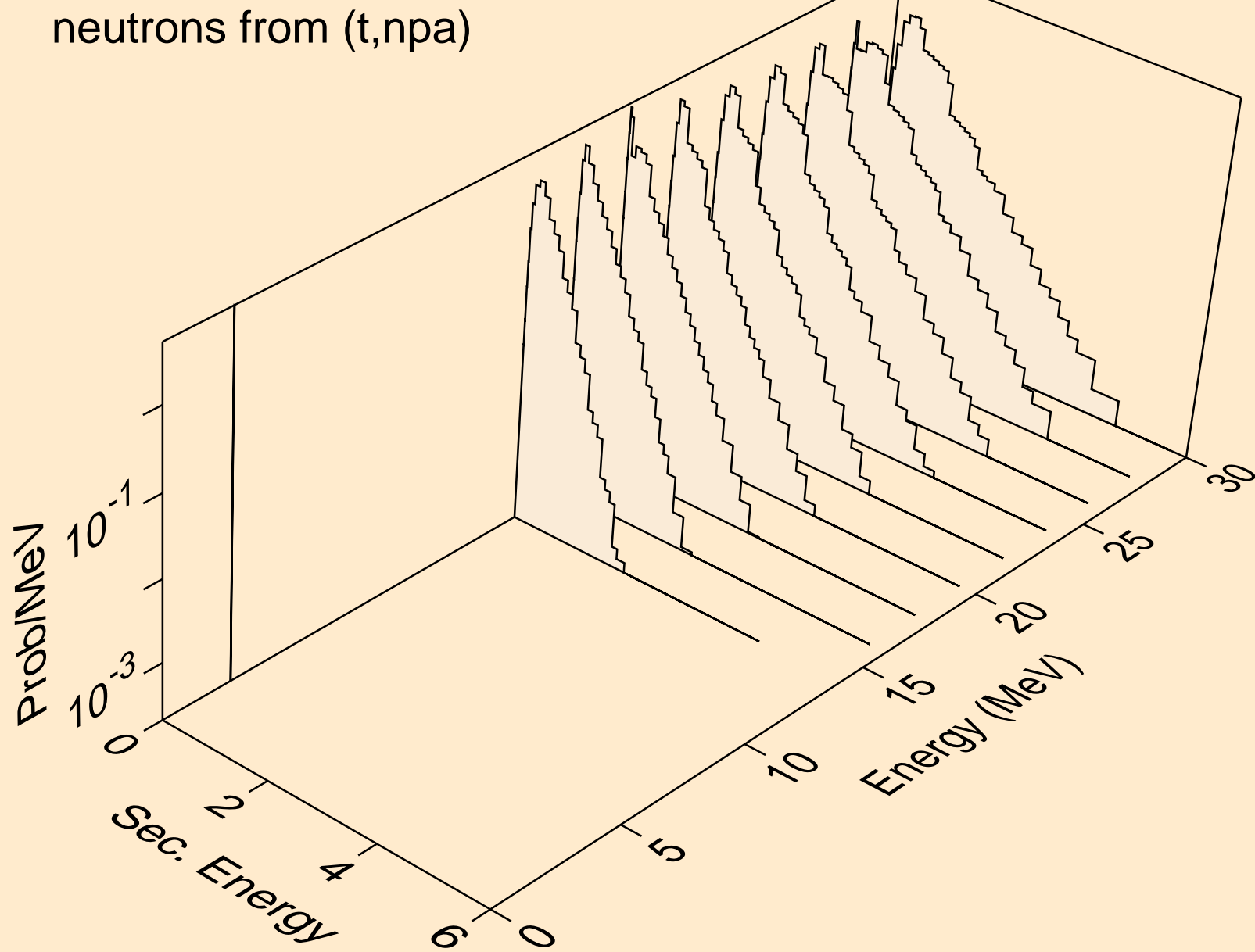

LU179 TRITON ACER TENDL-2021 LIBRARY; T=0.K
protons from (t,x)

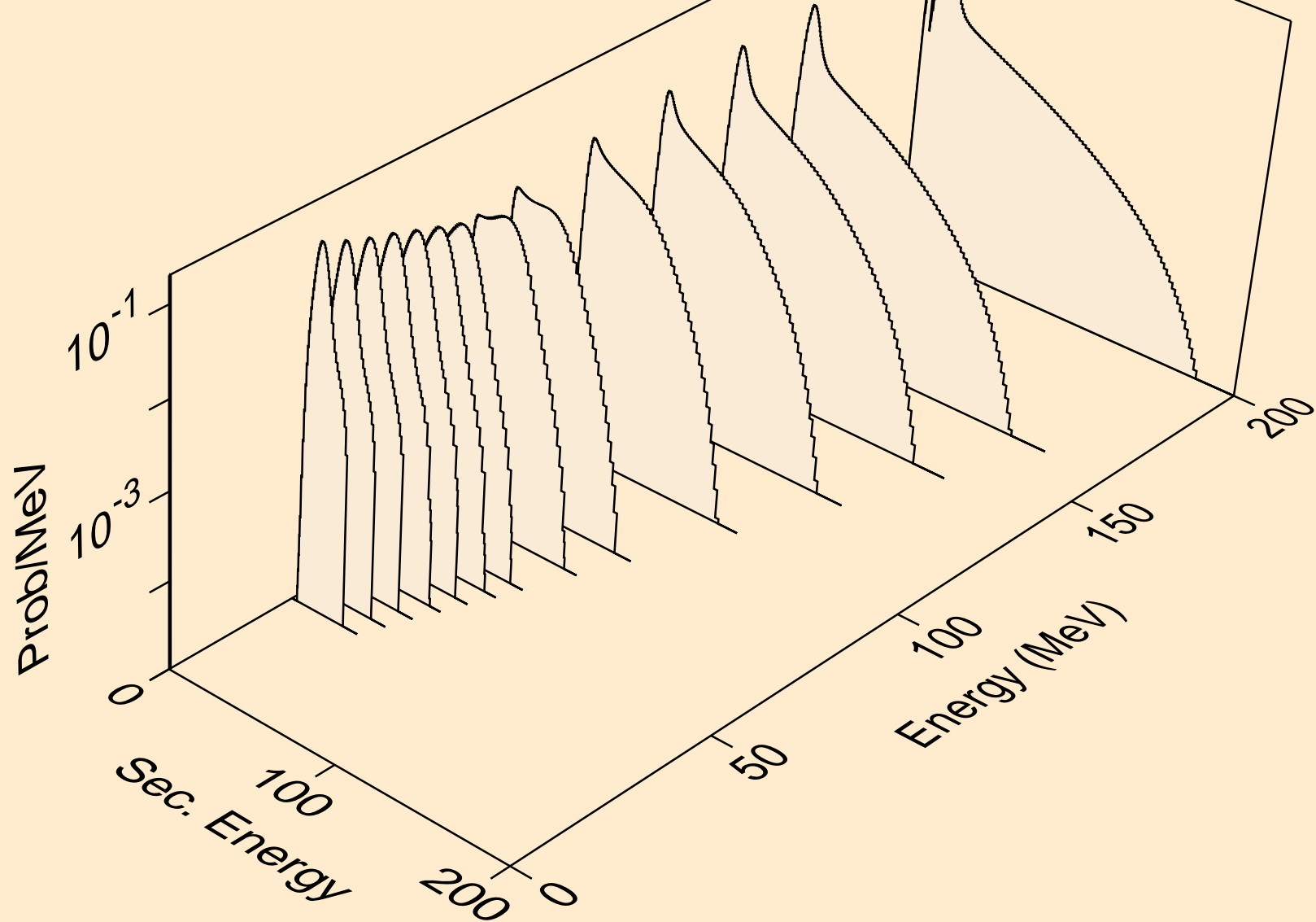

LU179 TRITON ACER TENDL-2021 LIBRARY; T=0.K
protons from (t,n*)p

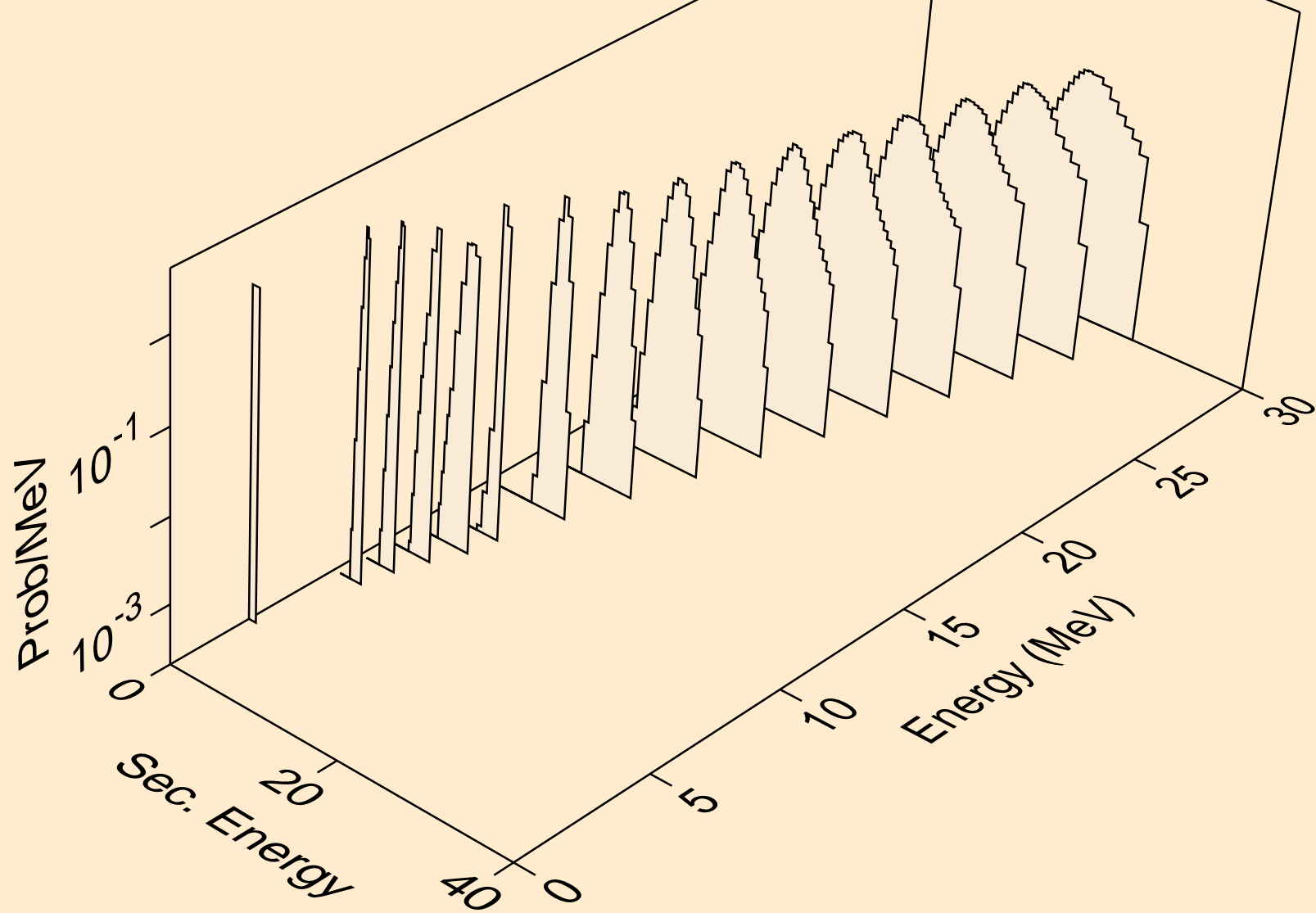

LU179 TRITON ACER TENDL-2021 LIBRARY; T=0.K
protons from (t,2np)

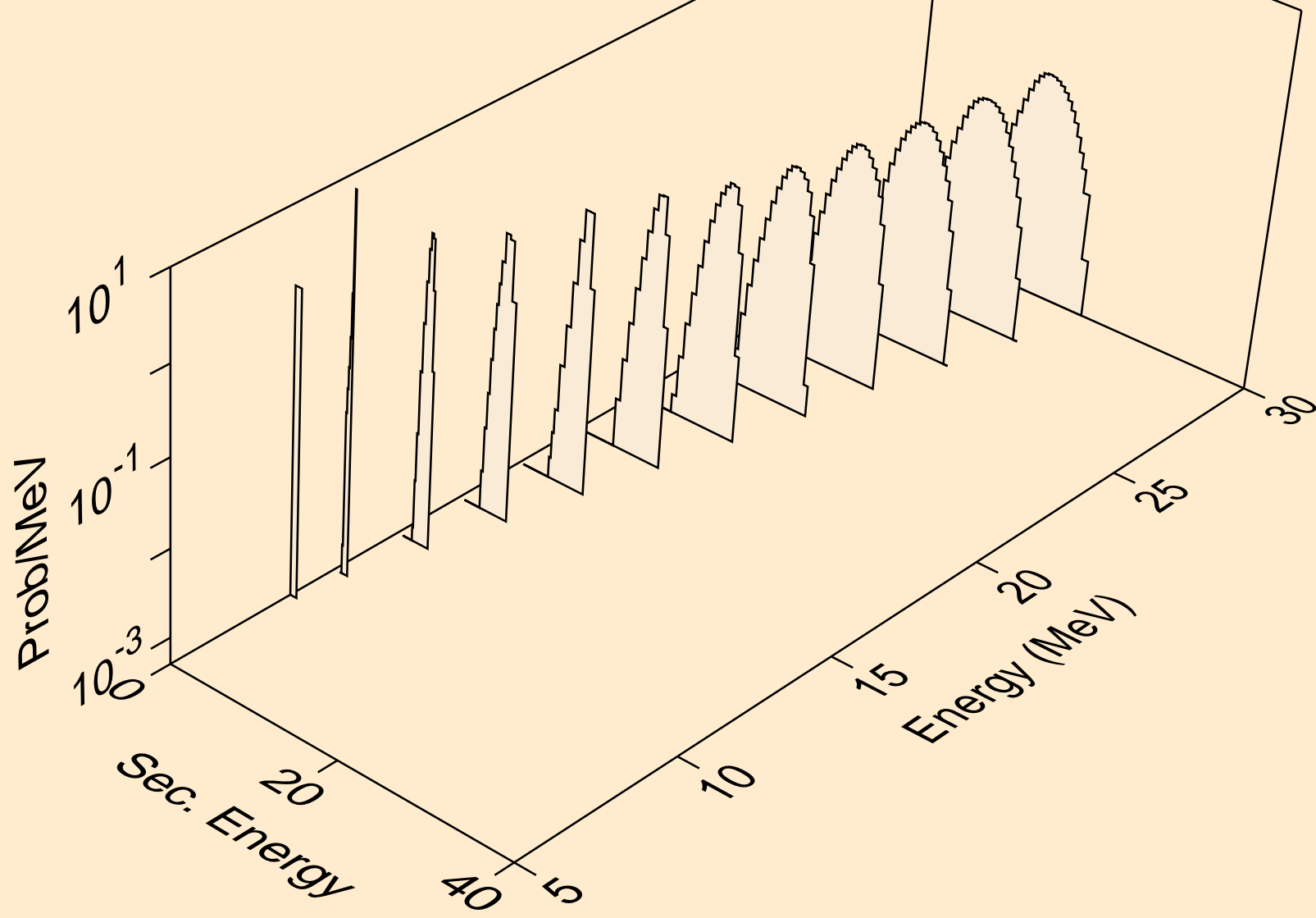

LU179 TRITON ACER TENDL-2021 LIBRARY; T=0.K
protons from (t,3np)

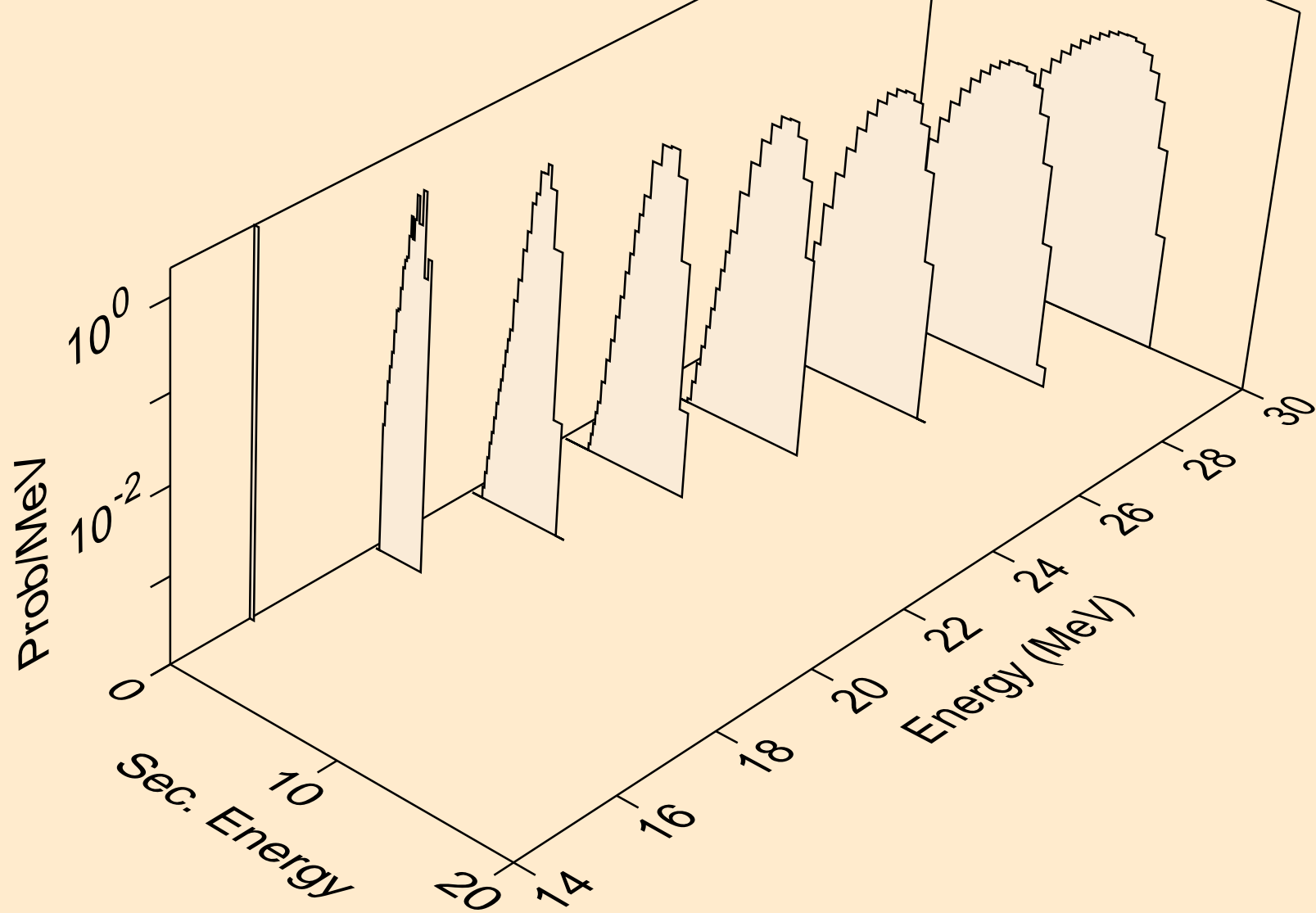

LU179 TRITON ACER TENDL-2021 LIBRARY; T=0.K
protons from (t,2np)

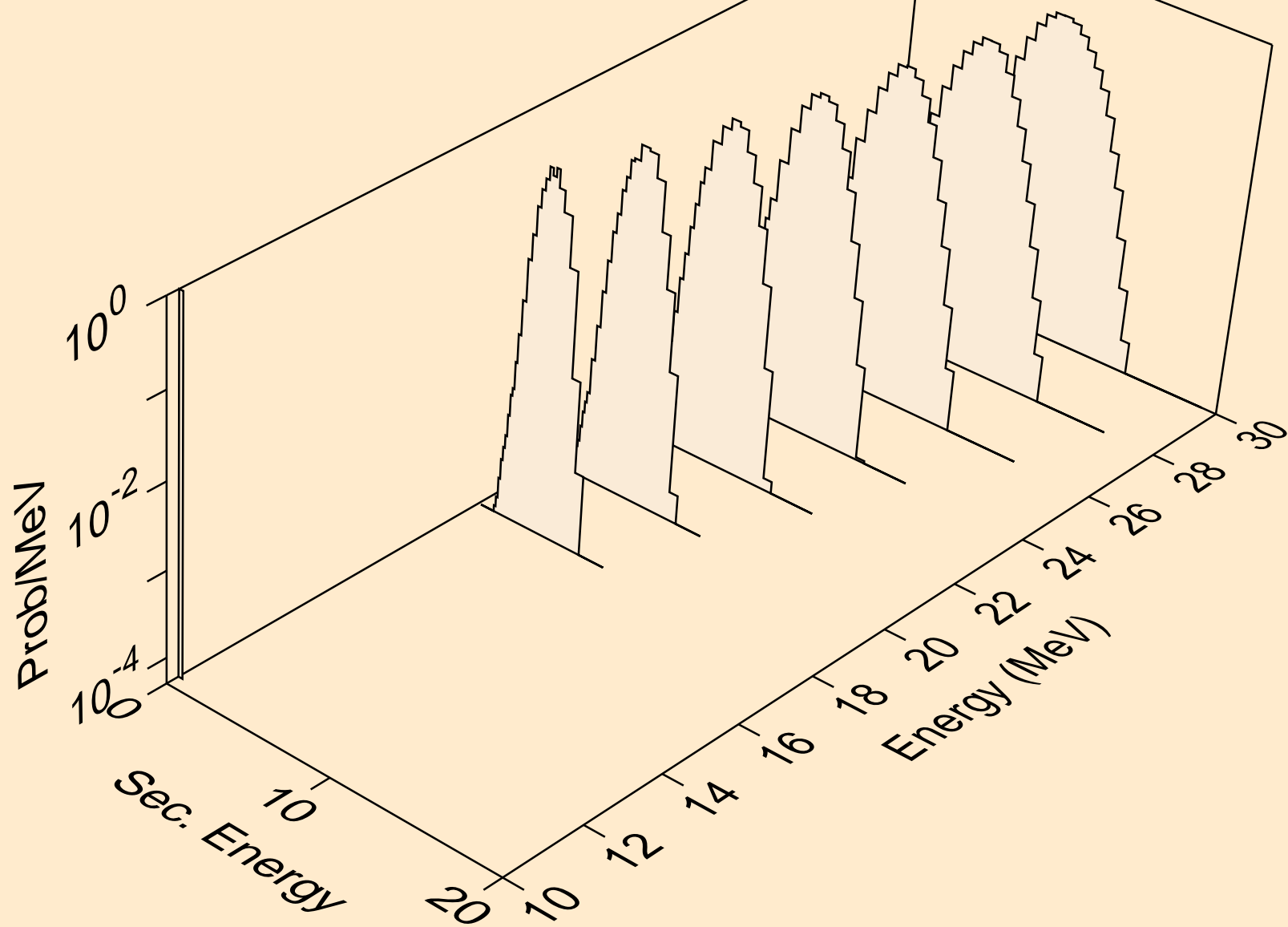

LU179 TRITON ACER TENDL-2021 LIBRARY; T=0.K
protons from (t,npa)

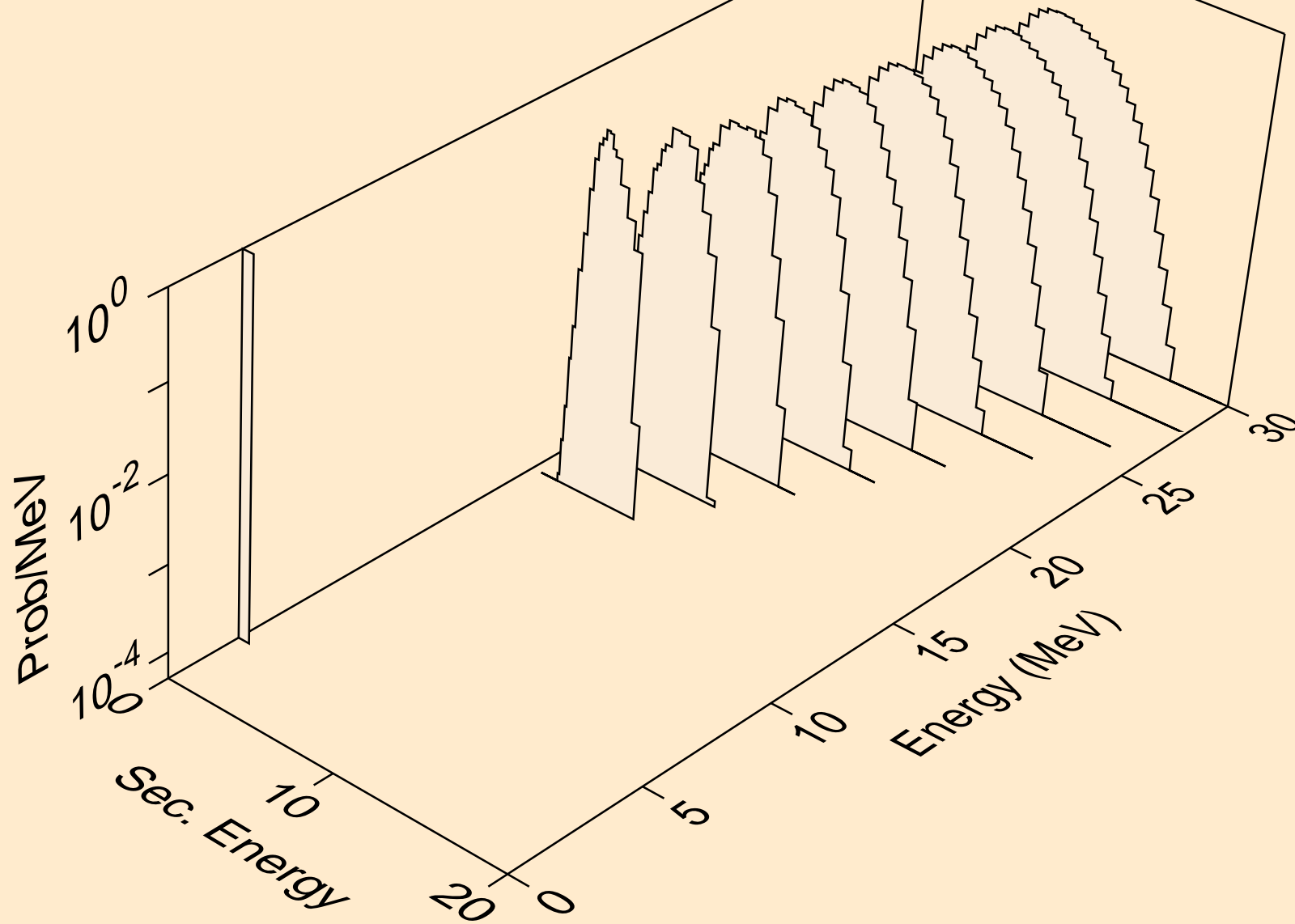

LU179 TRITON ACER TENDL-2021 LIBRARY; T=0.K
protons from (t,p)

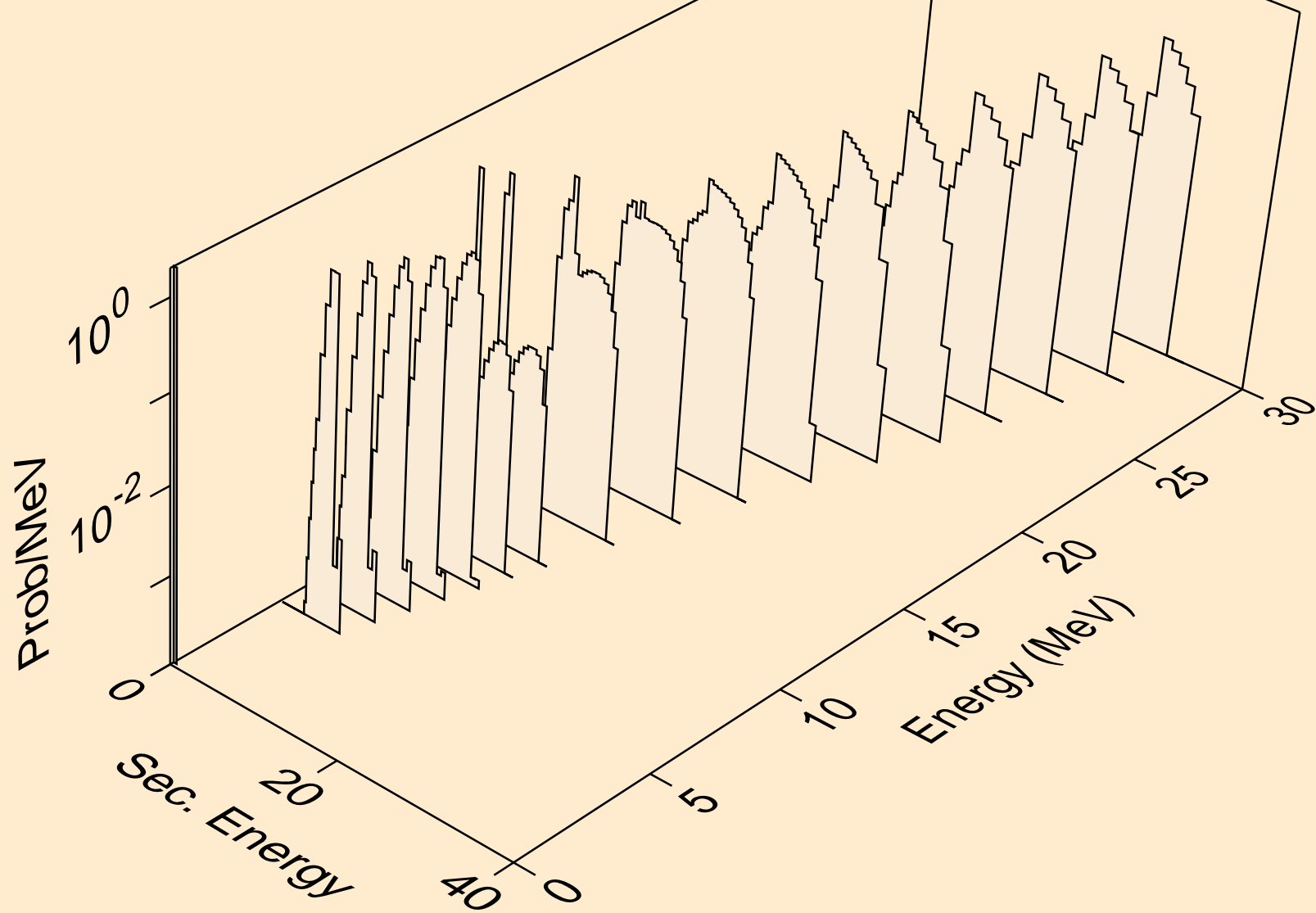

LU179 TRITON ACER TENDL-2021 LIBRARY; T=0.K
protons from (t,2p)

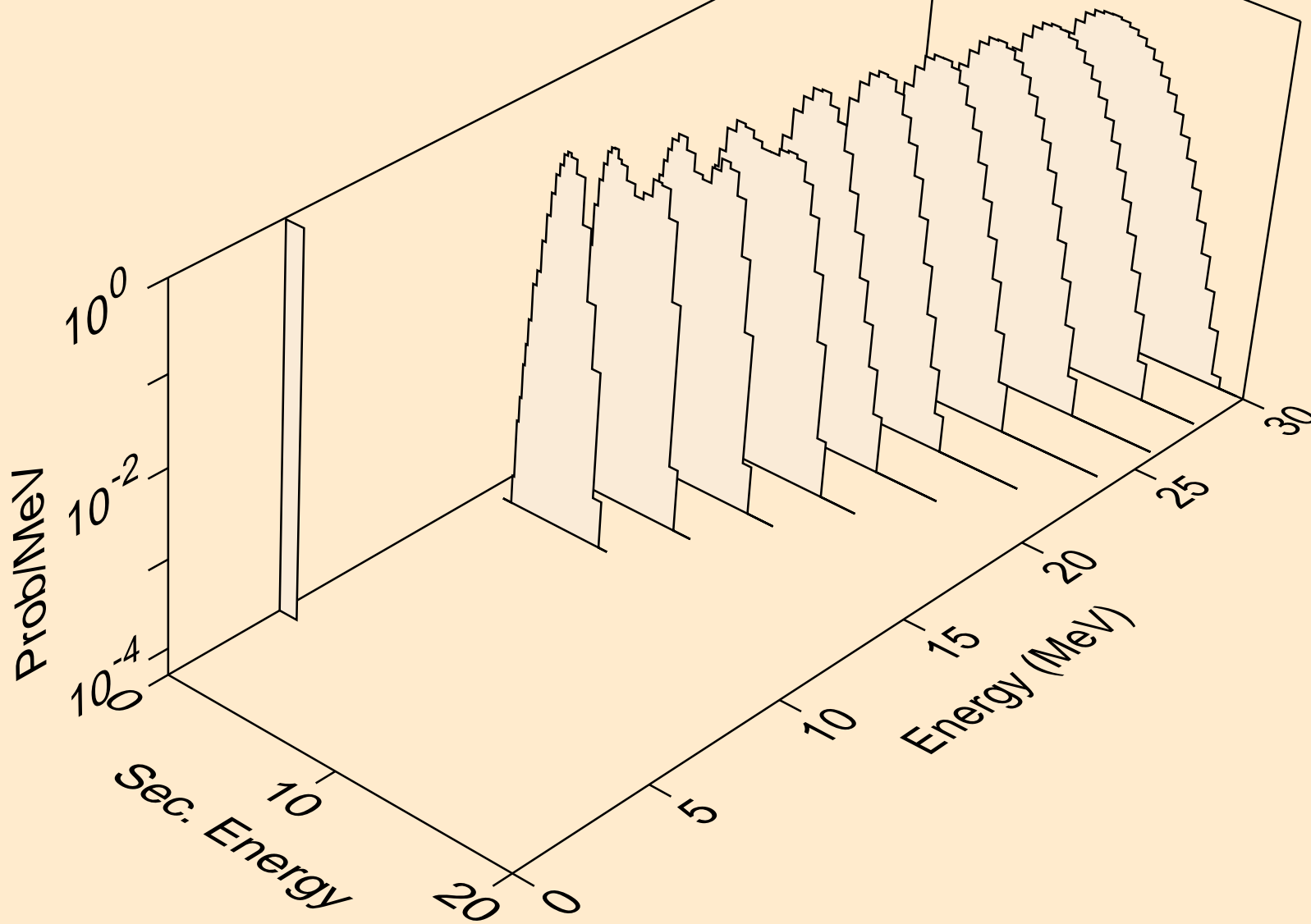

LU179 TRITON ACER TENDL-2021 LIBRARY; T=0.K
protons from (t,pa)

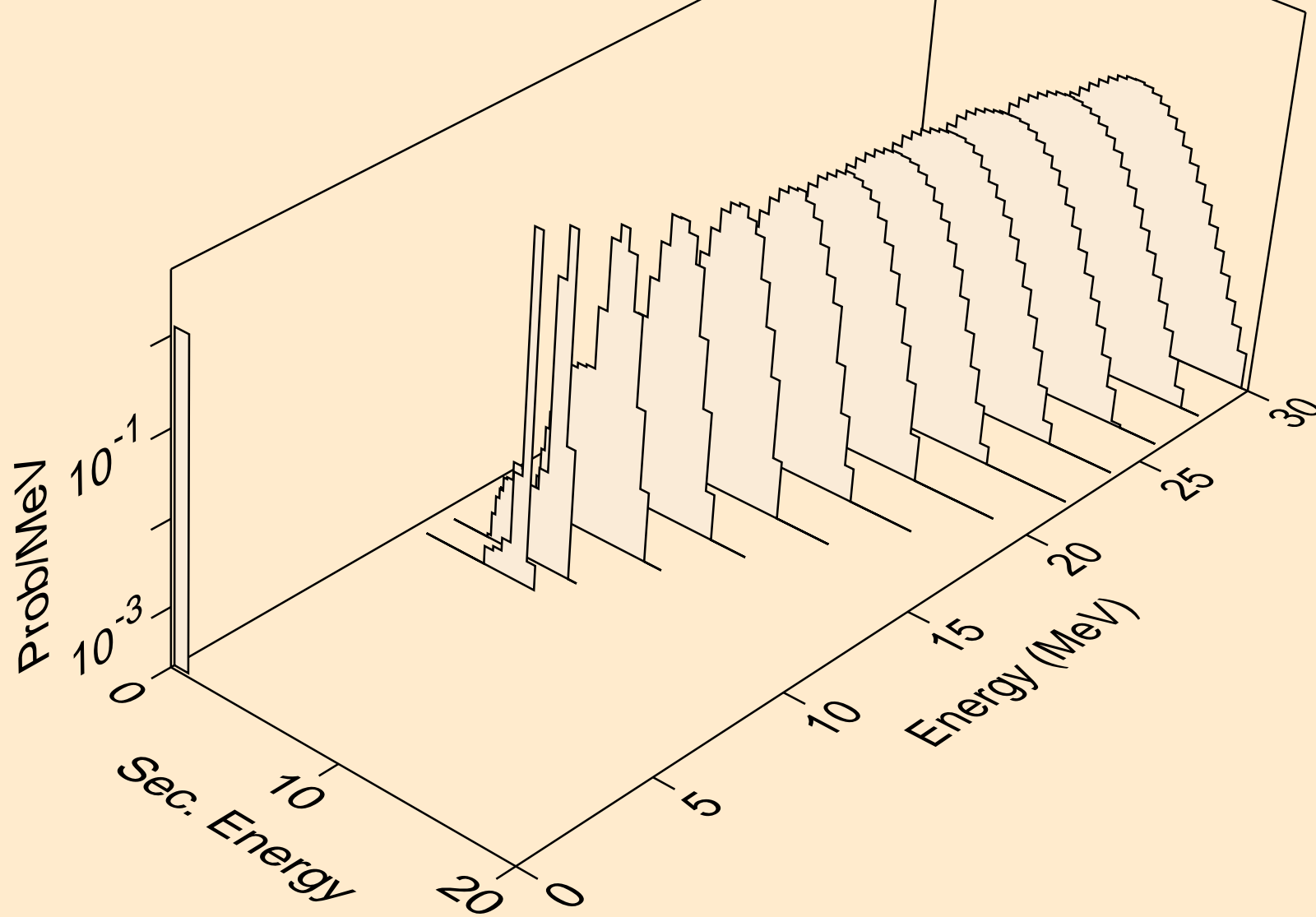

LU179 TRITON ACER TENDL-2021 LIBRARY; T=0.K
protons from (t,pd)

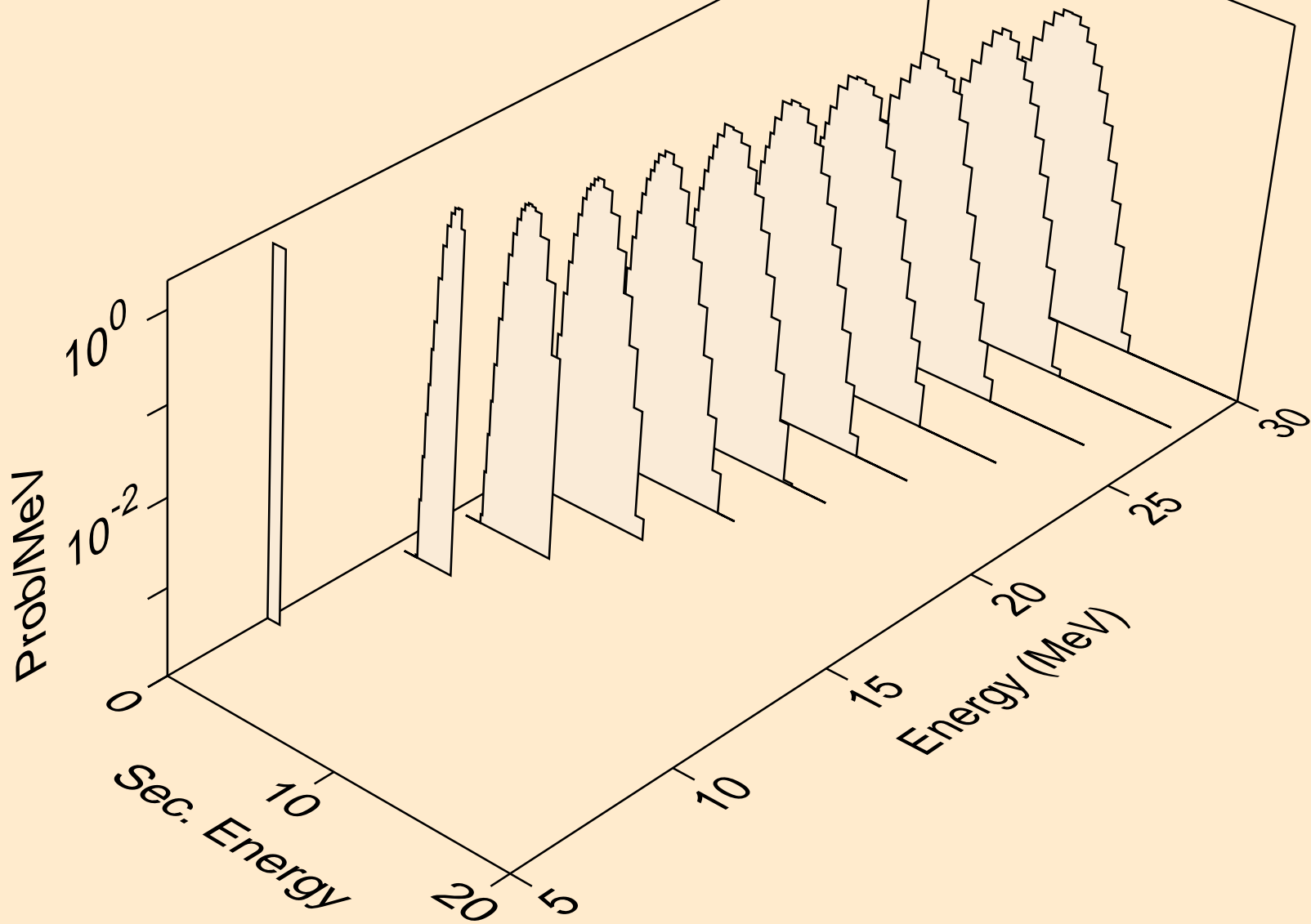

LU179 TRITON ACER TENDL-2021 LIBRARY; T=0.K
protons from (t,pt)

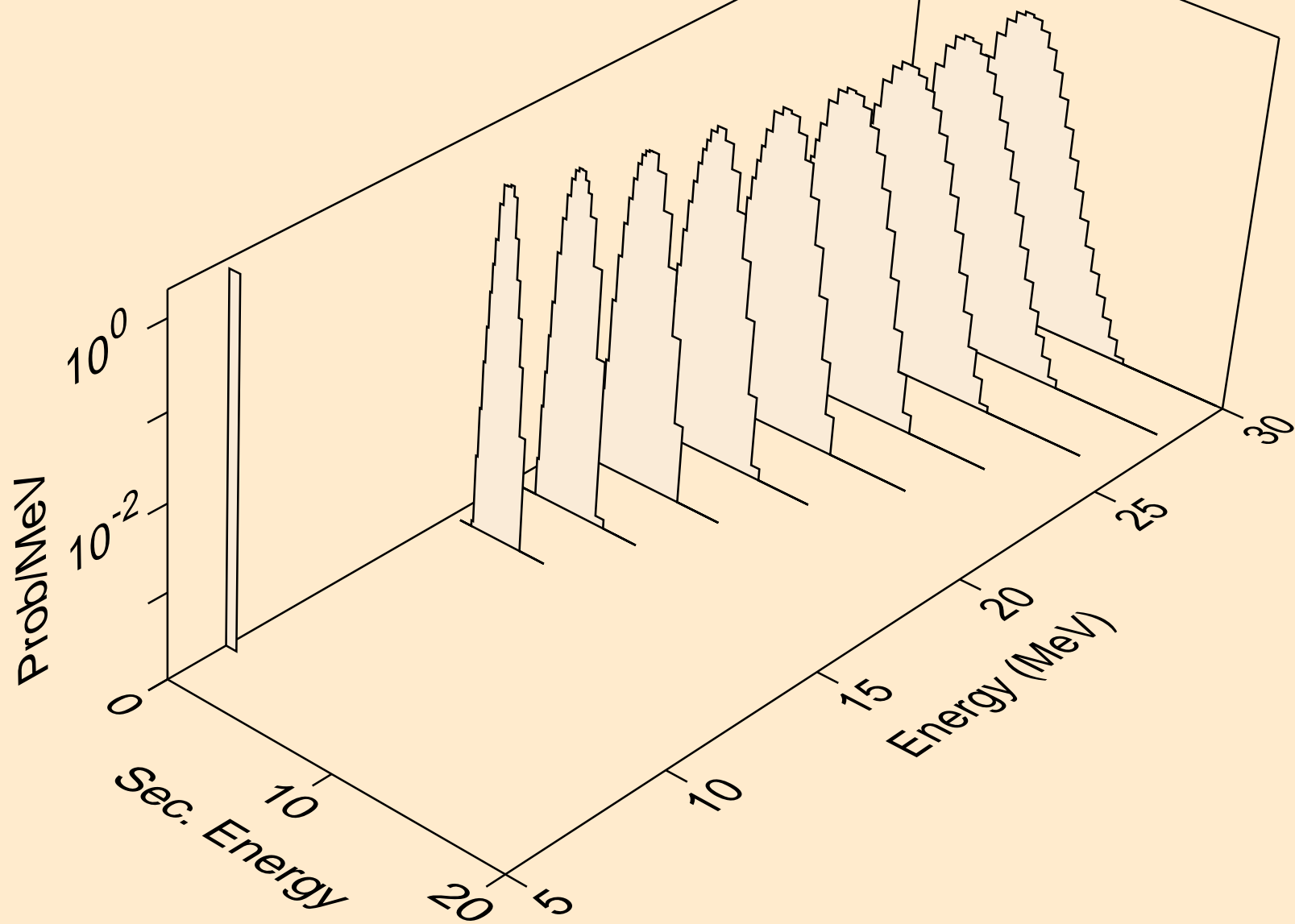

LU179 TRITON ACER TENDL-2021 LIBRARY; T=0.K
deuterons from (t,x)

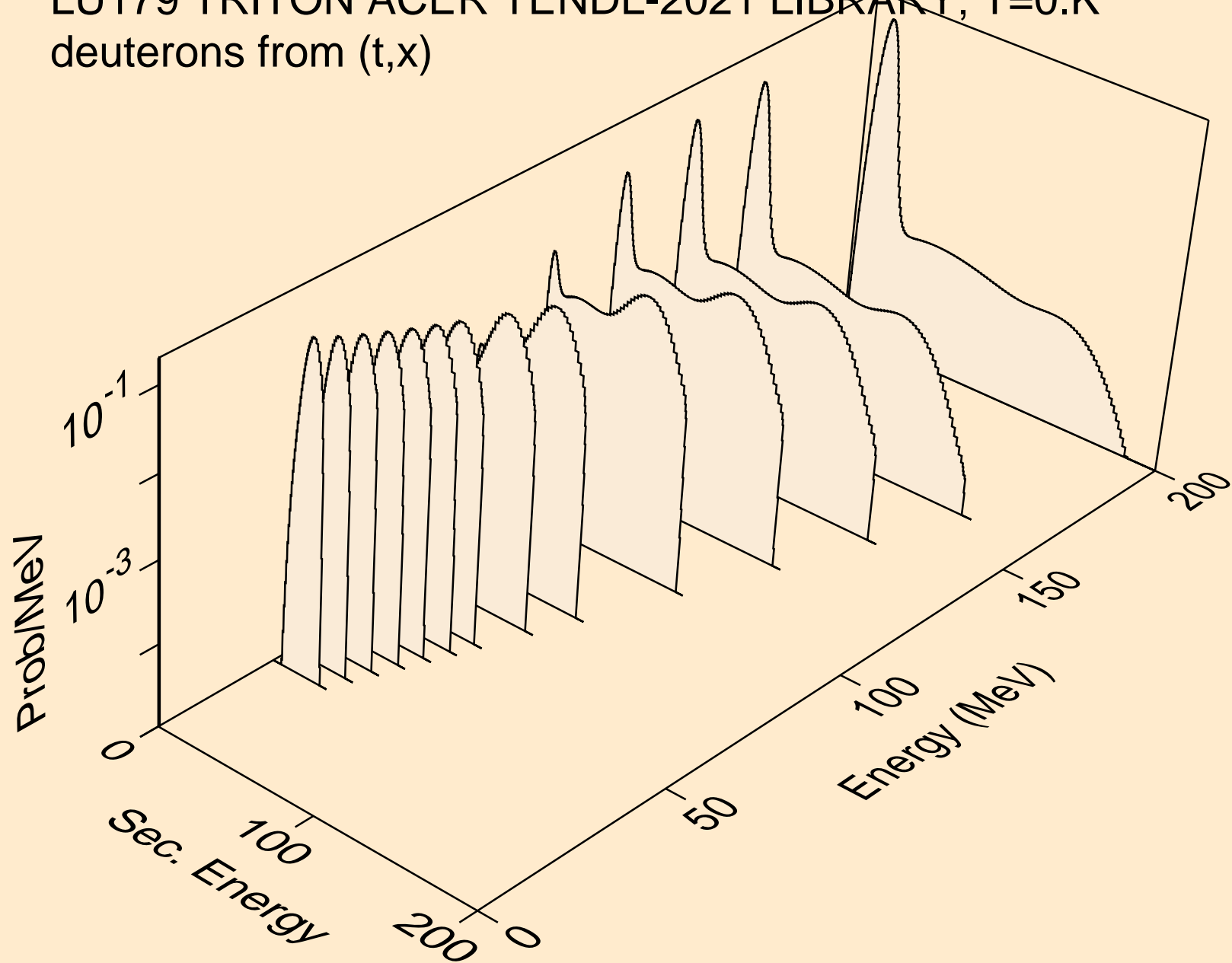

LU179 TRITON ACER TENDL-2021 LIBRARY; T=0.K
deuterons from (t,2nd)

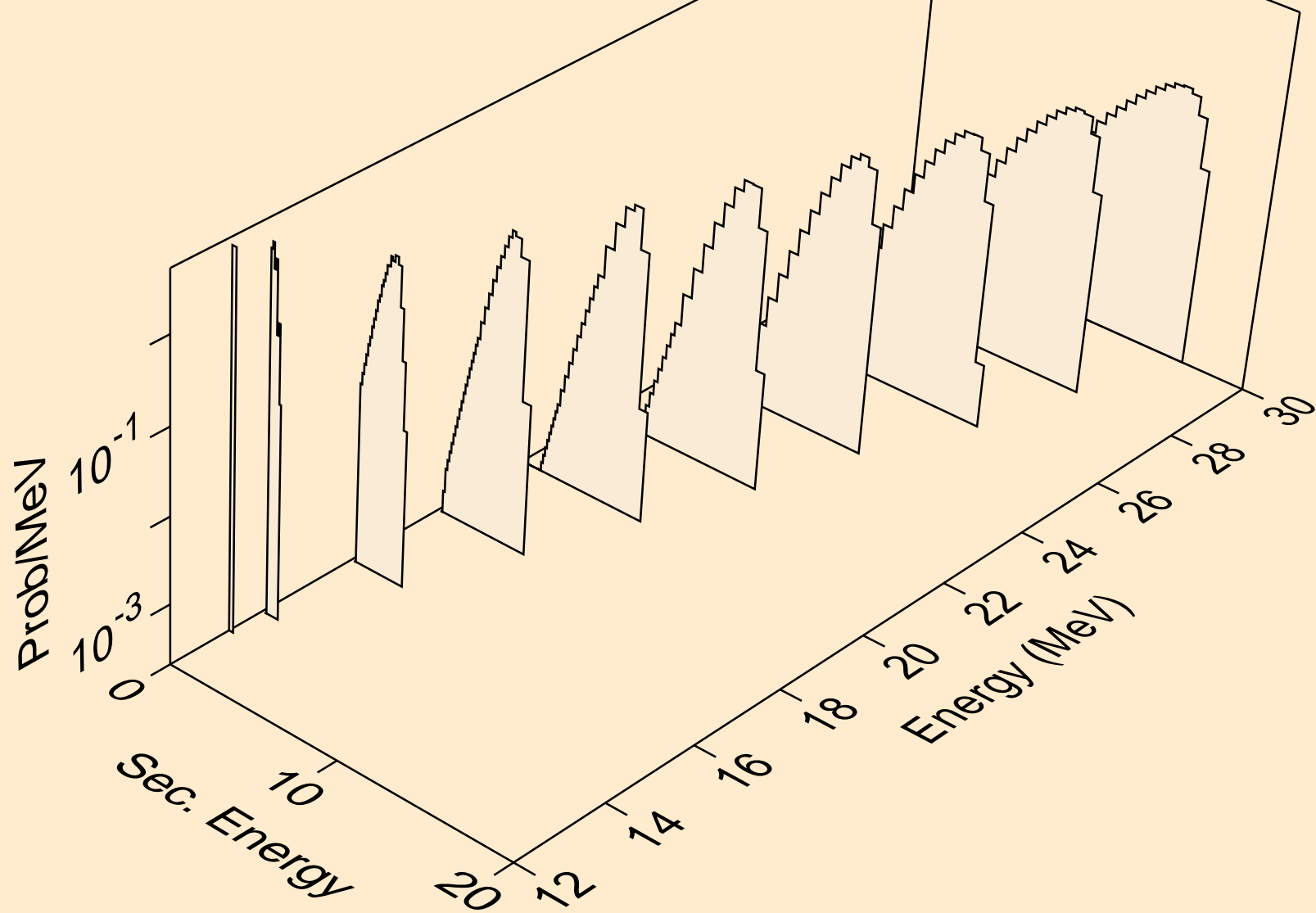

LU179 TRITON ACER TENDL-2021 LIBRARY; T=0.K
deuterons from (t,n*)d

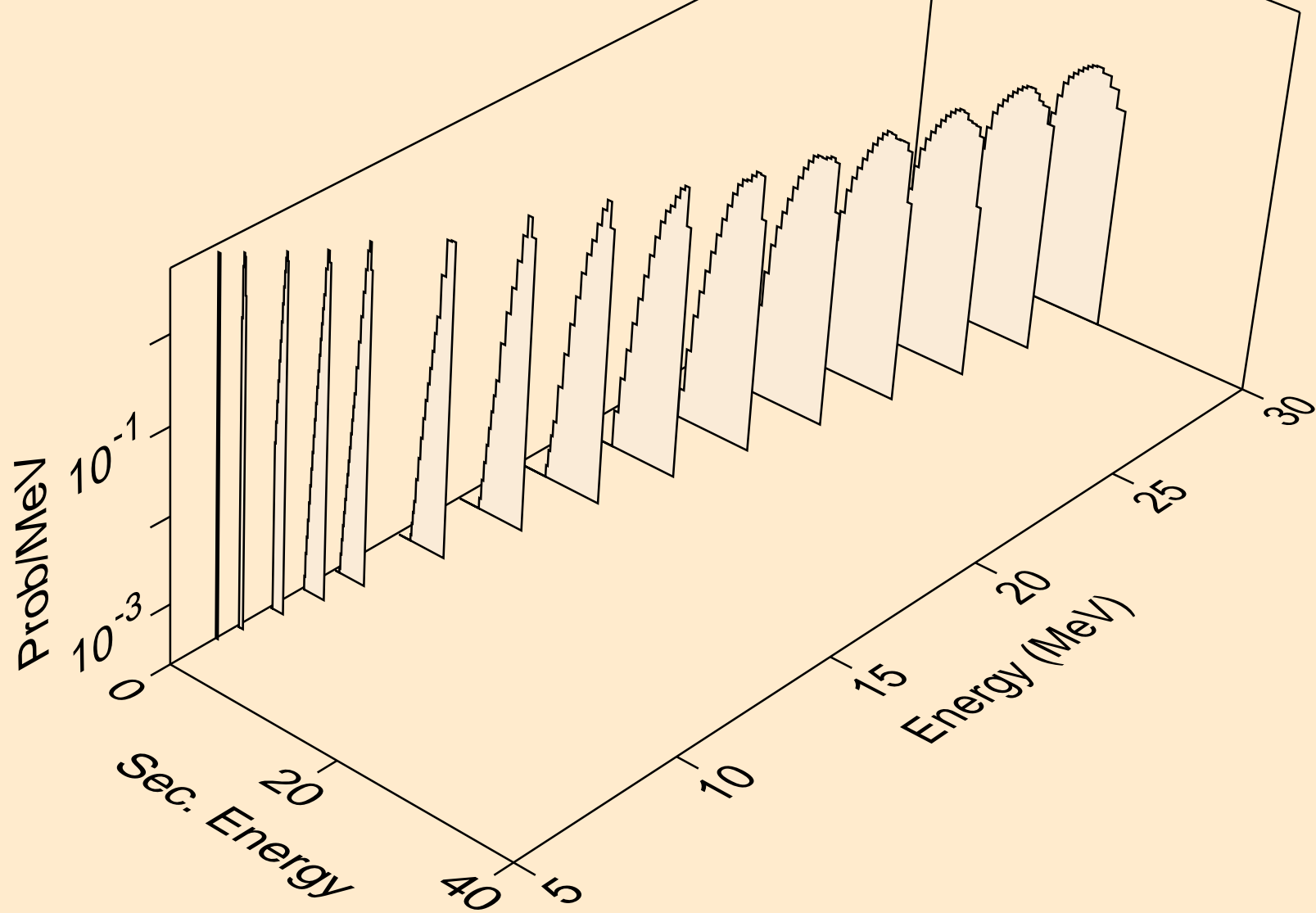

LU179 TRITON ACER TENDL-2021 LIBRARY; T=0.K
deuterons from (t,d)

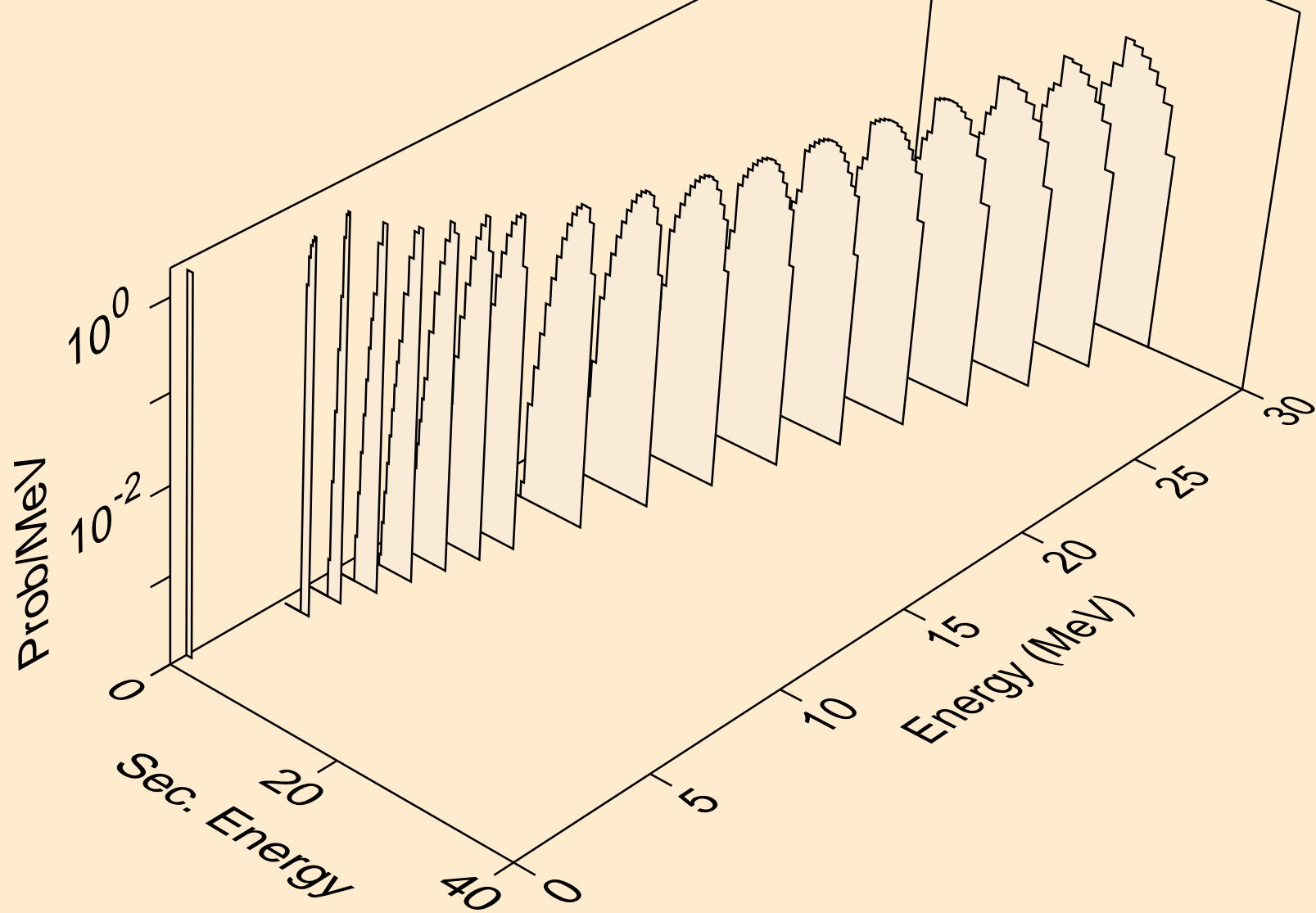

LU179 TRITON ACER TENDL-2021 LIBRARY; T=0.K
deuterons from (t,pd)

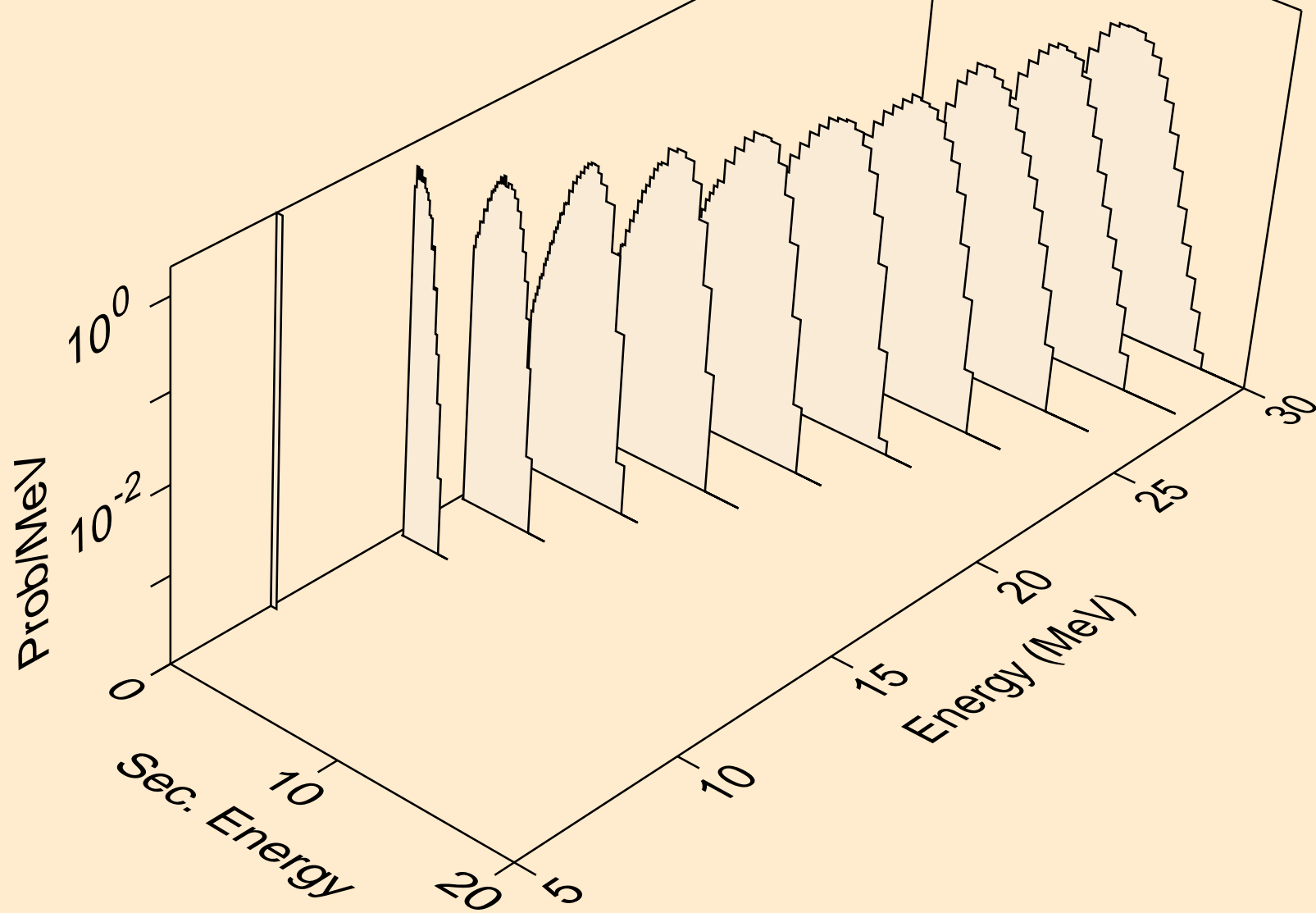

LU179 TRITON ACER TENDL-2021 LIBRARY; T=0.K
he3s from (t,x)

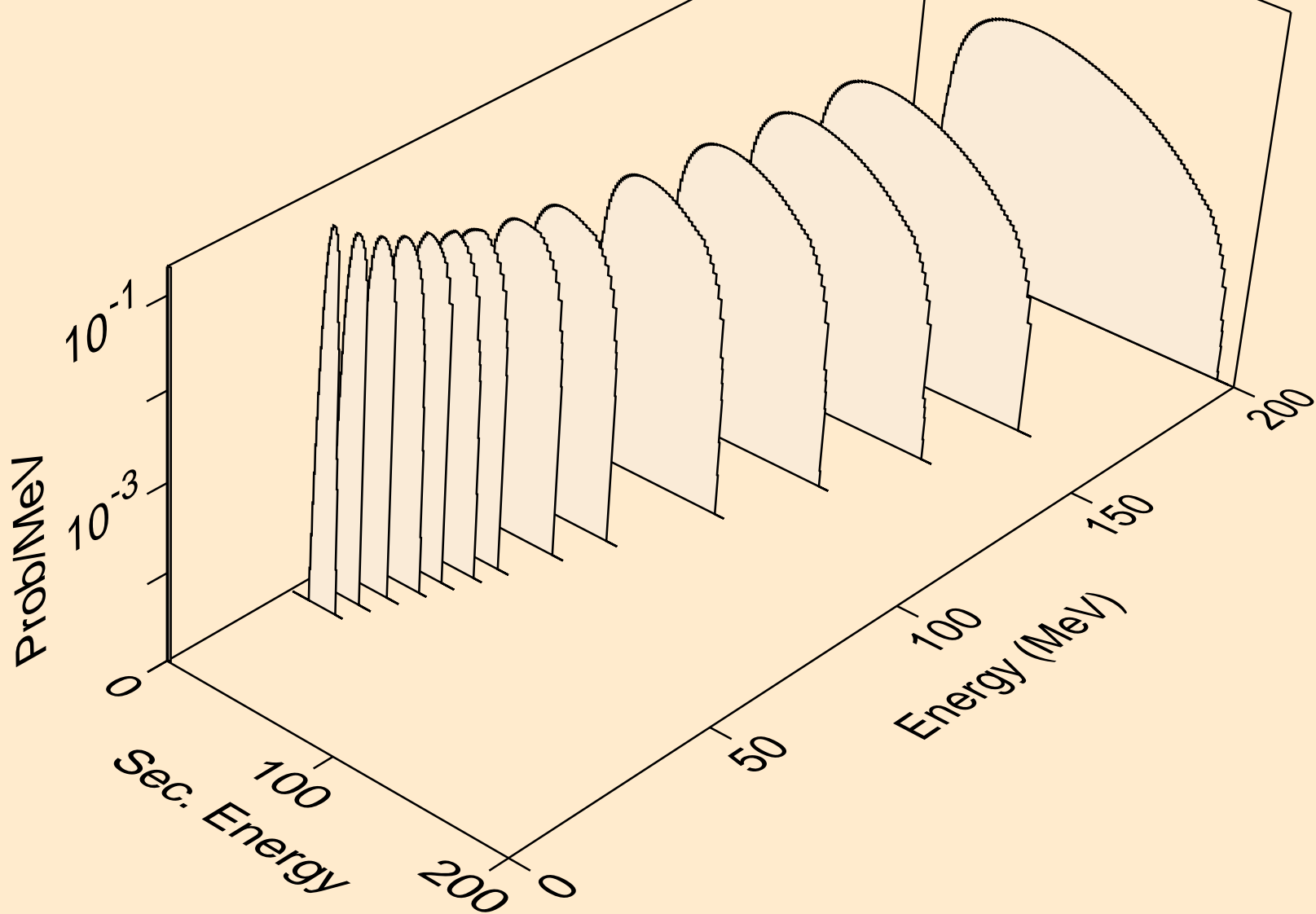

LU179 TRITON ACER TENDL-2021 LIBRARY; T=0.K
he3s from (t,n*)he3

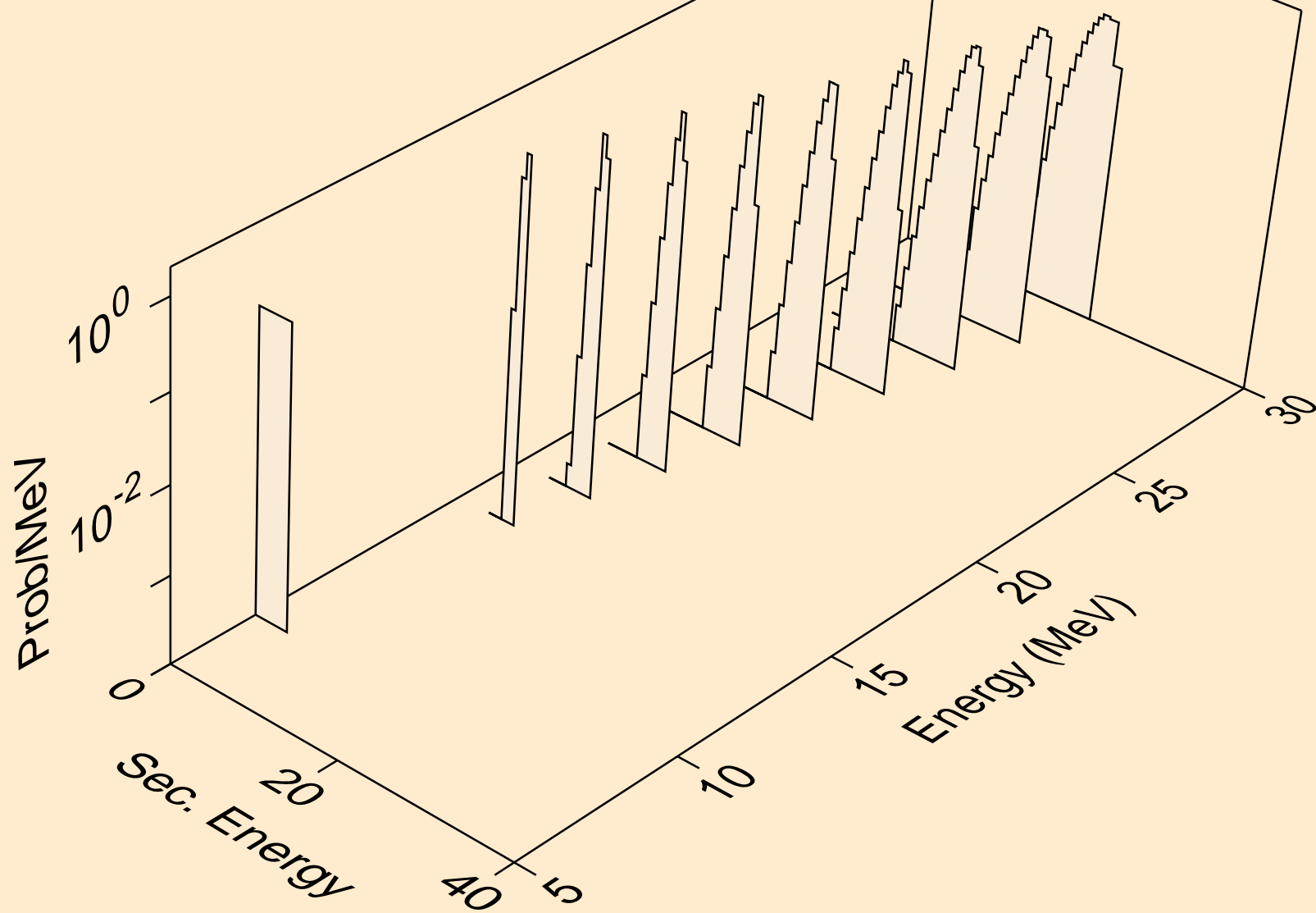

LU179 TRITON ACER TENDL-2021 LIBRARY; T=0.K
he3s from (t,he3)

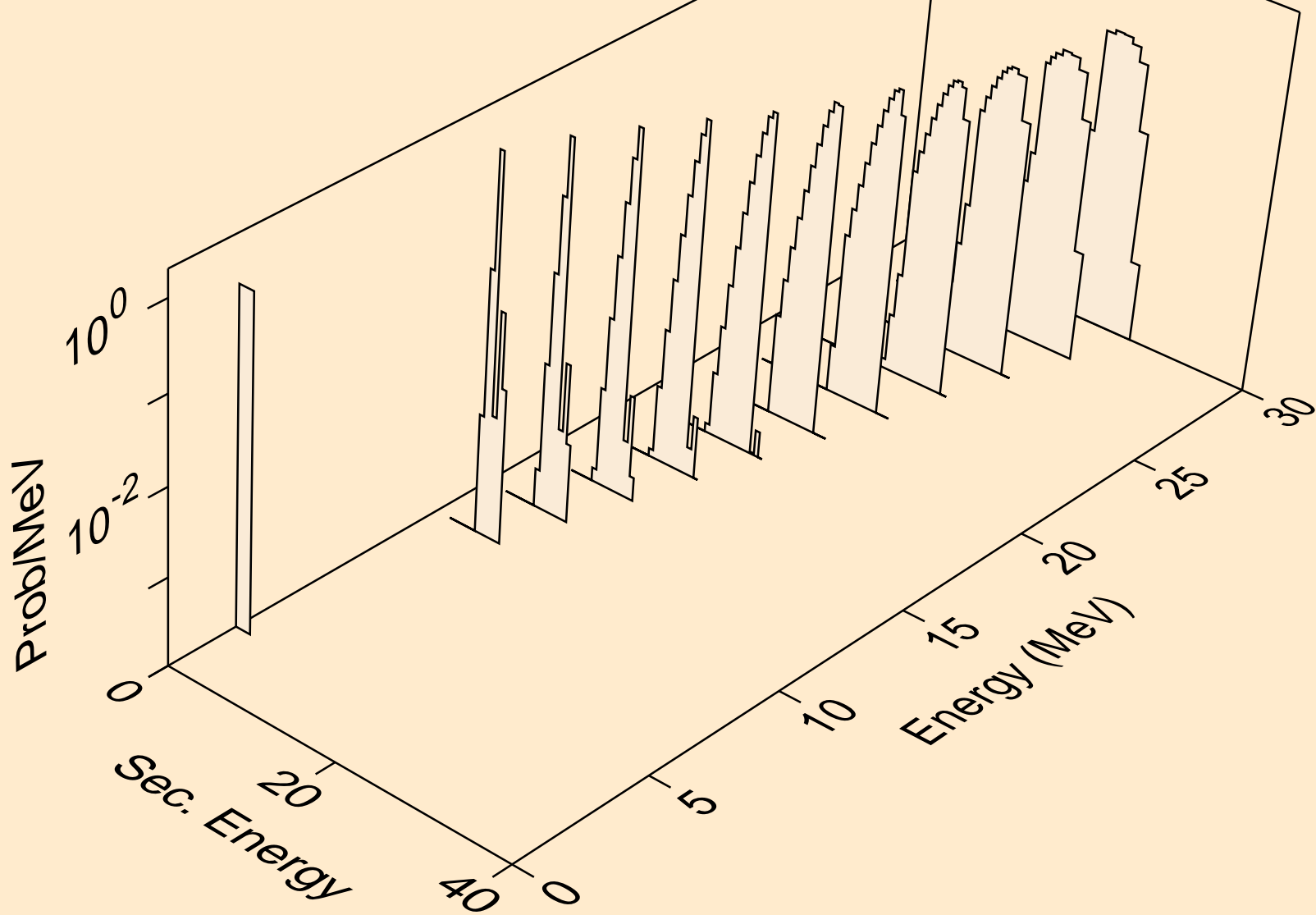

LU179 TRITON ACER TENDL-2021 LIBRARY; T=0.K
alphas from (t,x)

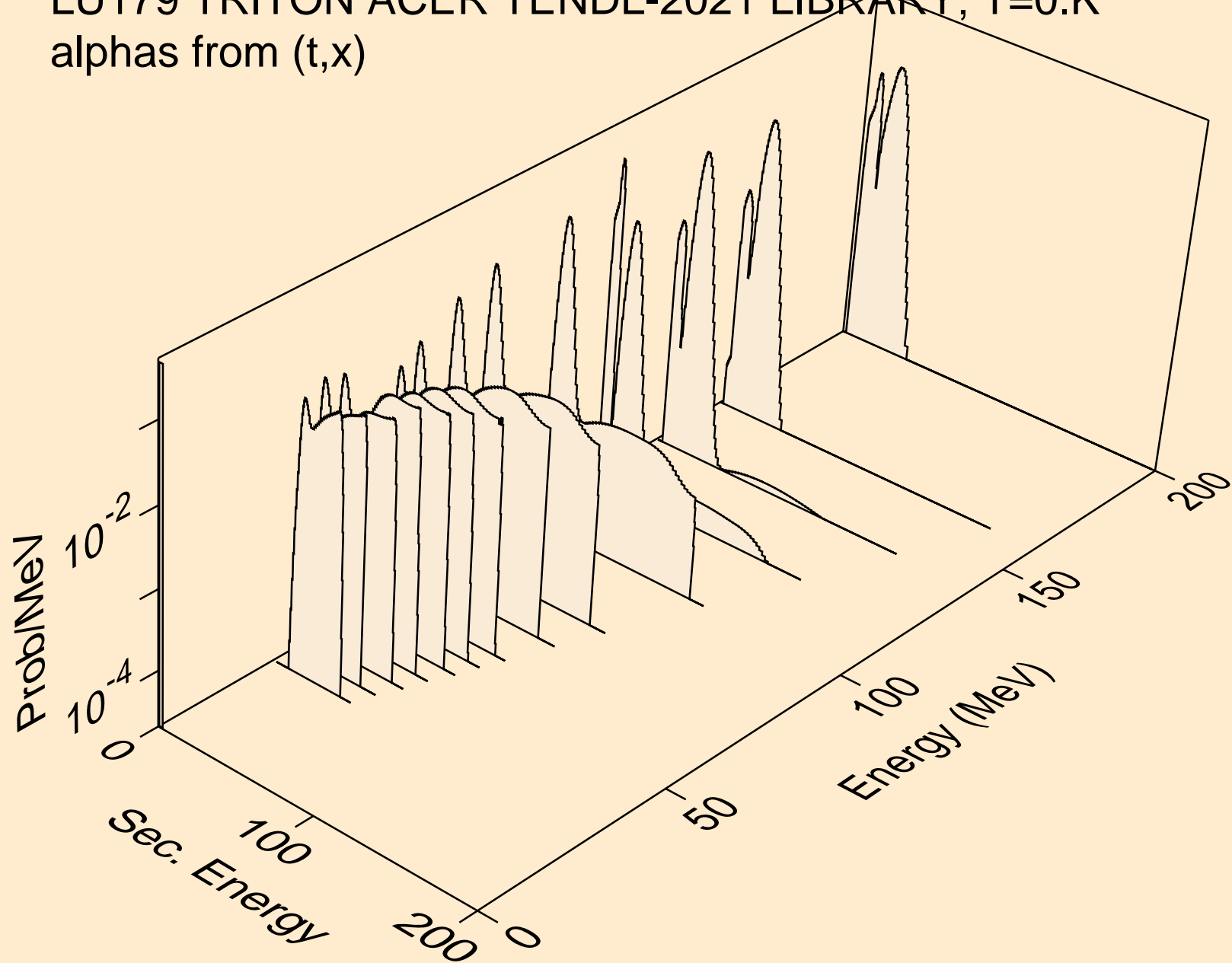

LU179 TRITON ACER TENDL-2021 LIBRARY; T=0.K
alphas from (t,n*)a

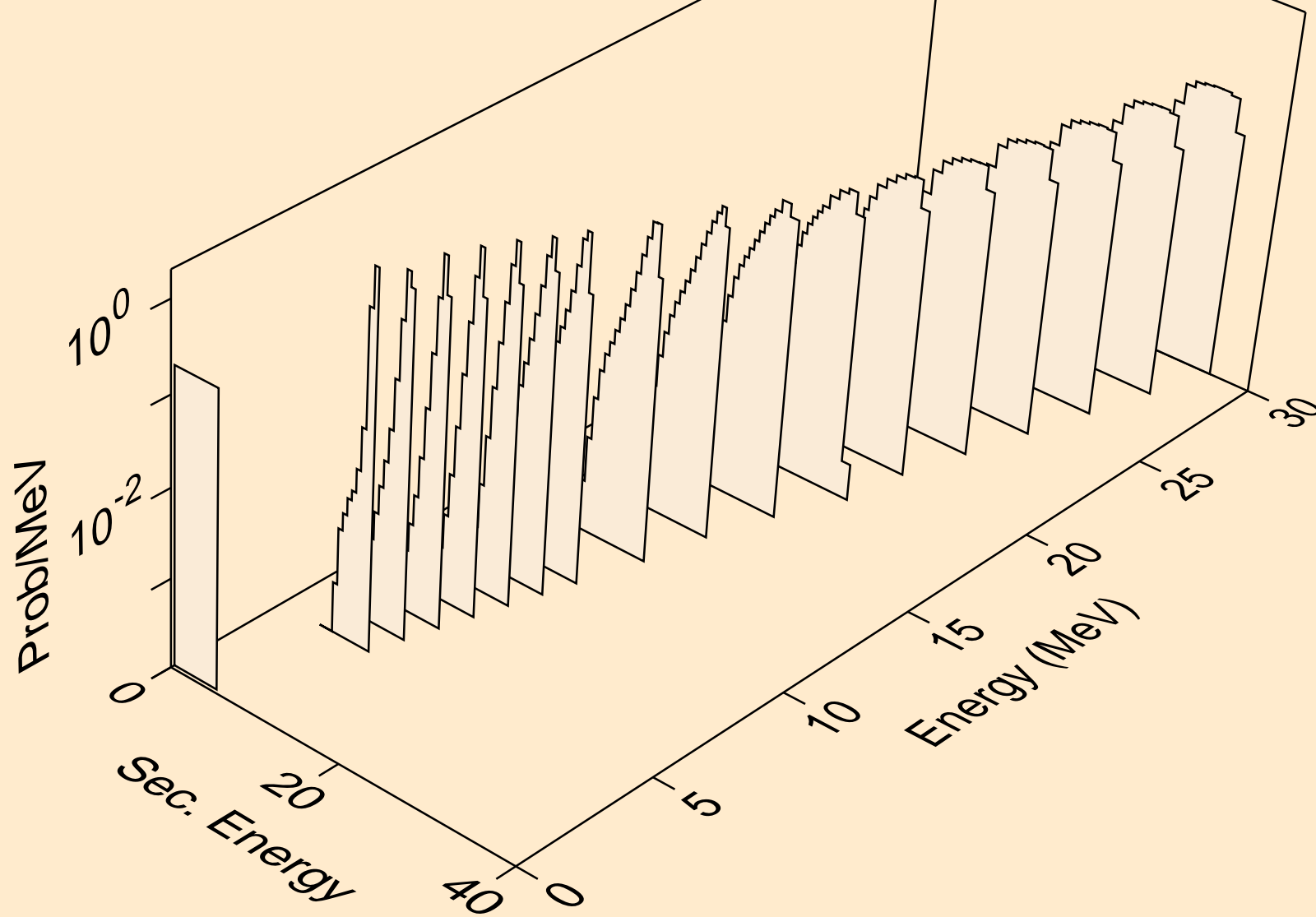

LU179 TRITON ACER TENDL-2021 LIBRARY; T=0.K
alphas from (t,2n)a

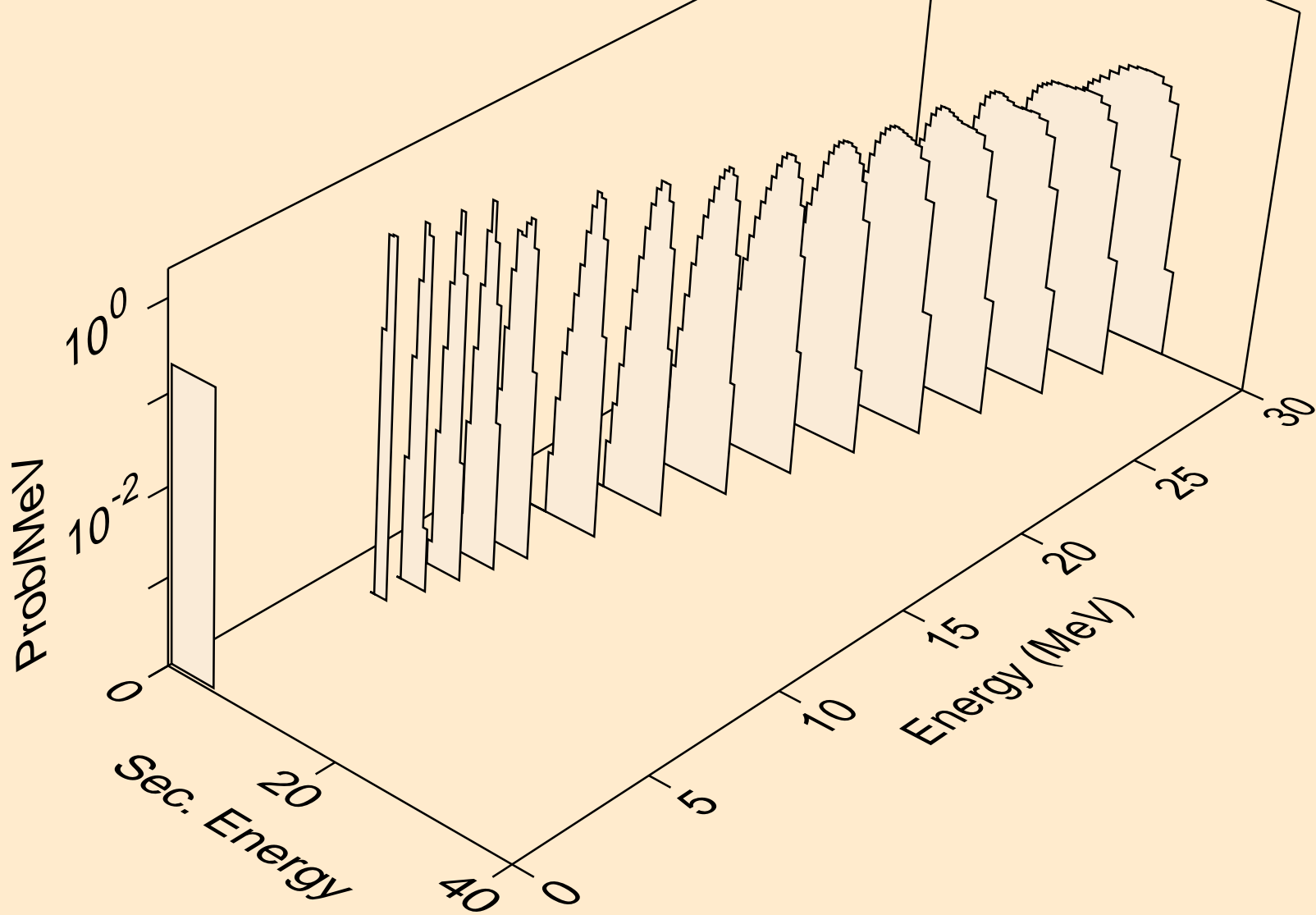

LU179 TRITON ACER TENDL-2021 LIBRARY; T=0.K
alphas from (t,3n)a

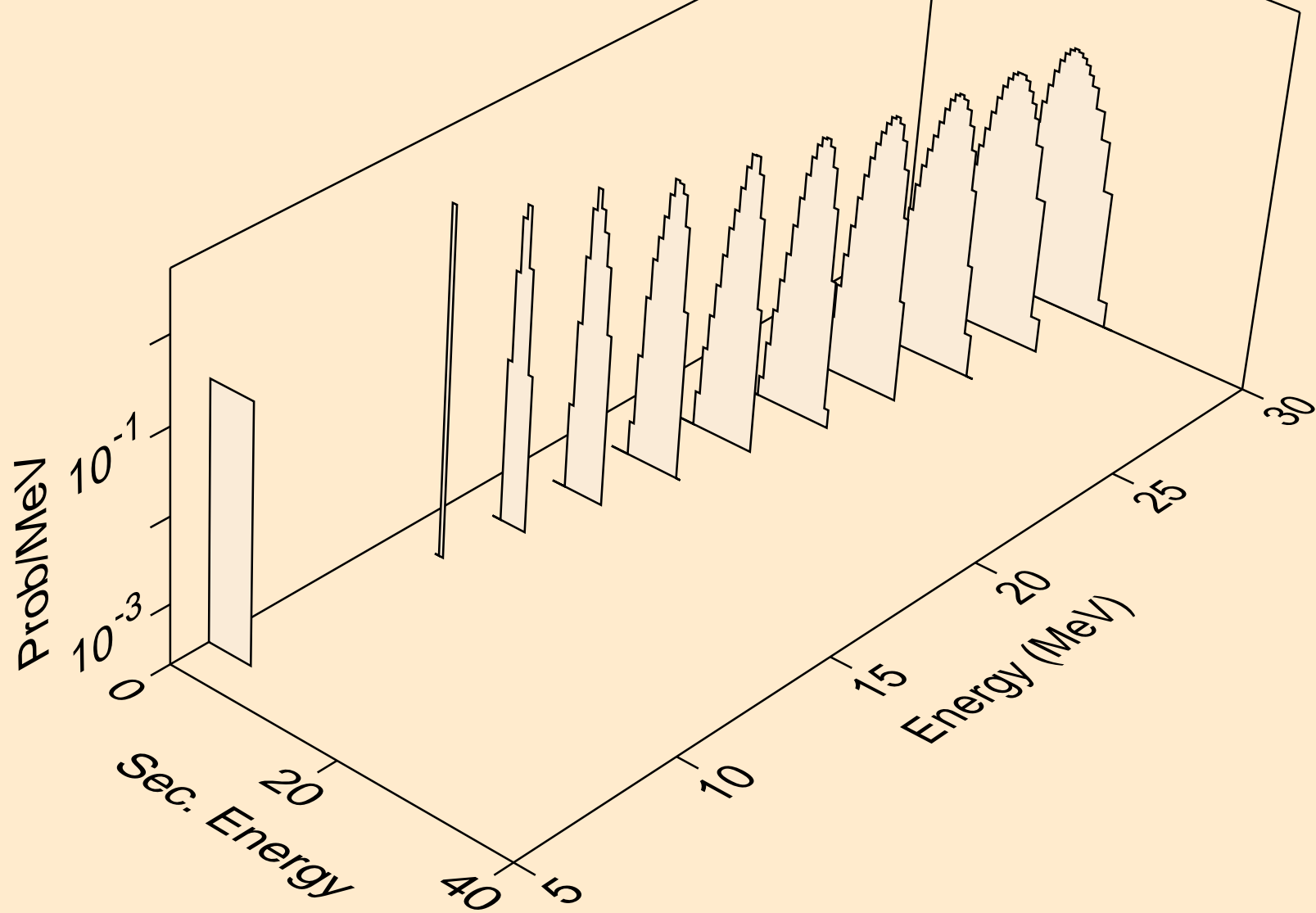

LU179 TRITON ACER TENDL-2021 LIBRARY; T=0.K
alphas from (t,n*)2a

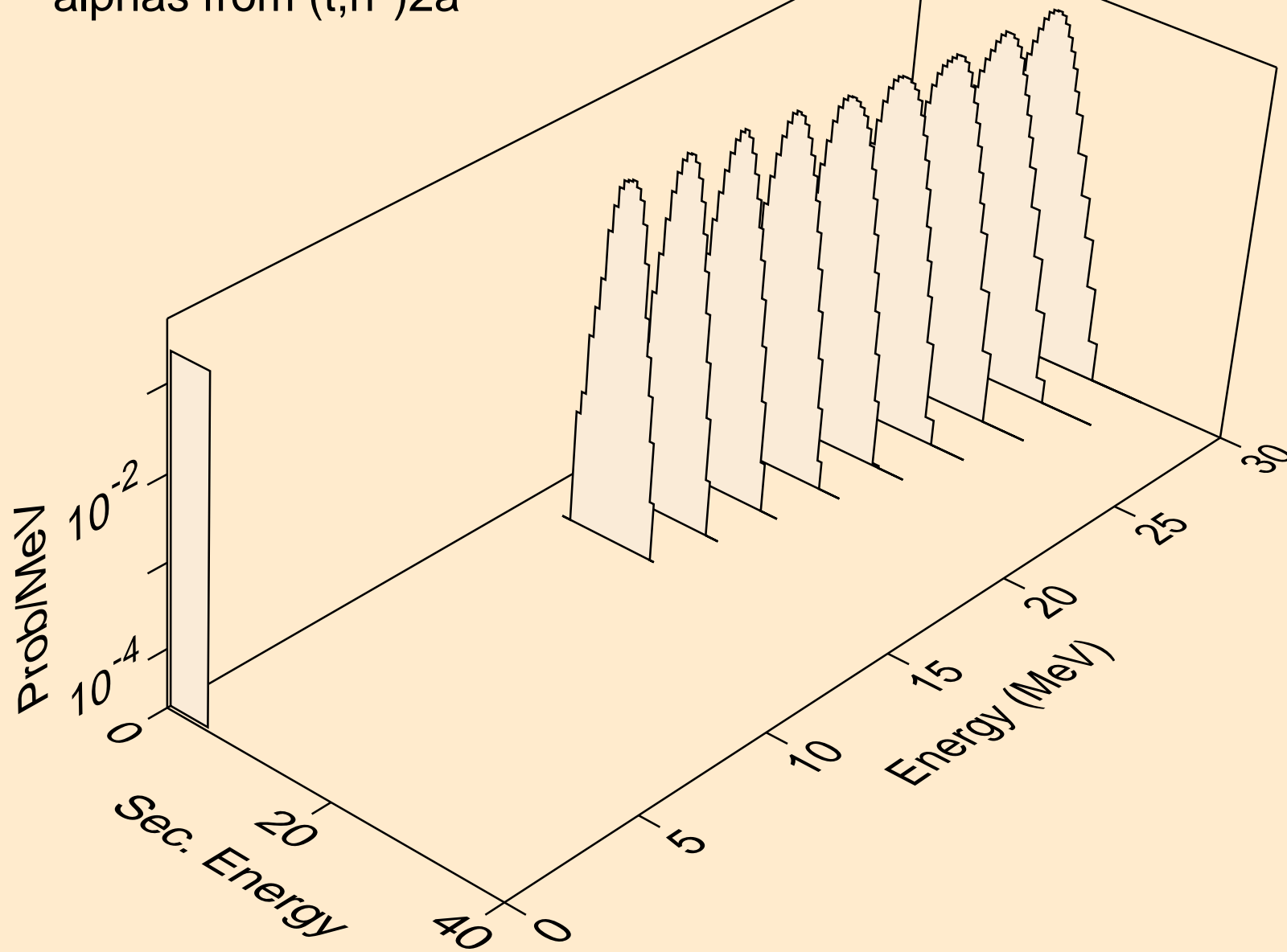

LU179 TRITON ACER TENDL-2021 LIBRARY; T=0.K
alphas from (t,npa)

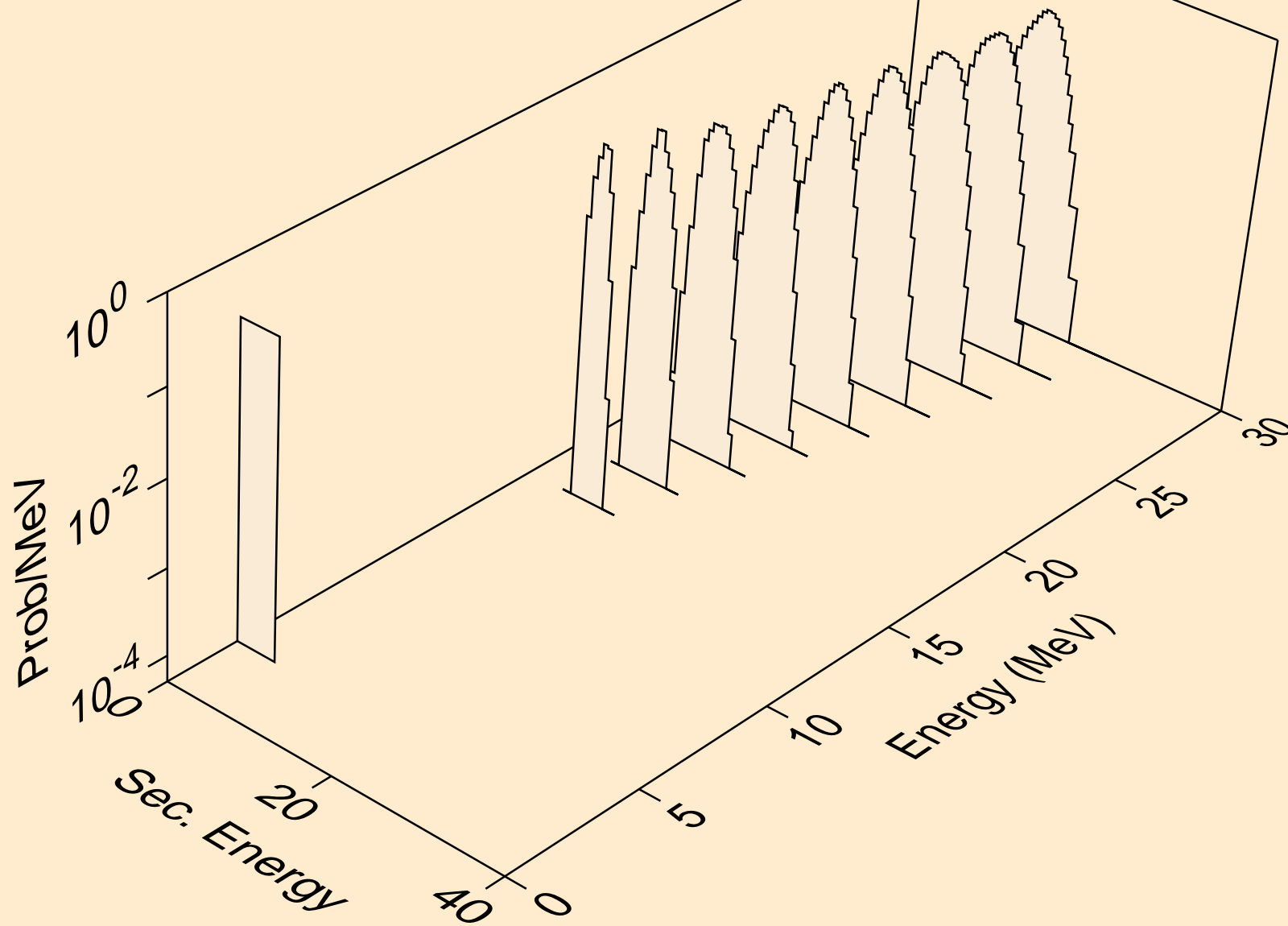

LU179 TRITON ACER TENDL-2021 LIBRARY; T=0.K
alphas from (t,a)

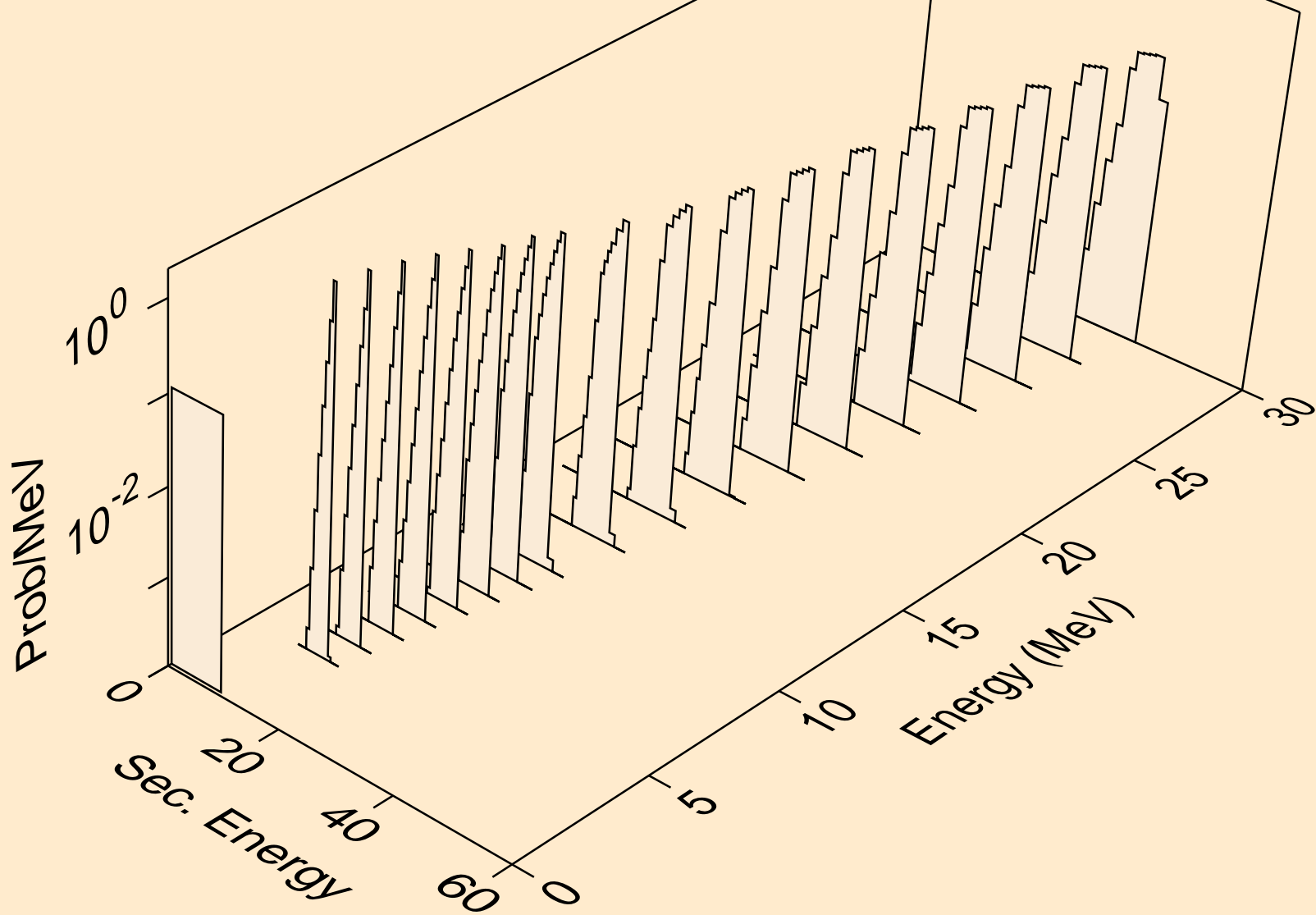

LU179 TRITON ACER TENDL-2021 LIBRARY; T=0.K
alphas from (t,pa)

