

# MO093M TRITON ACER TENDL-2021 LIBRARY; T=0.K

## Principal cross sections

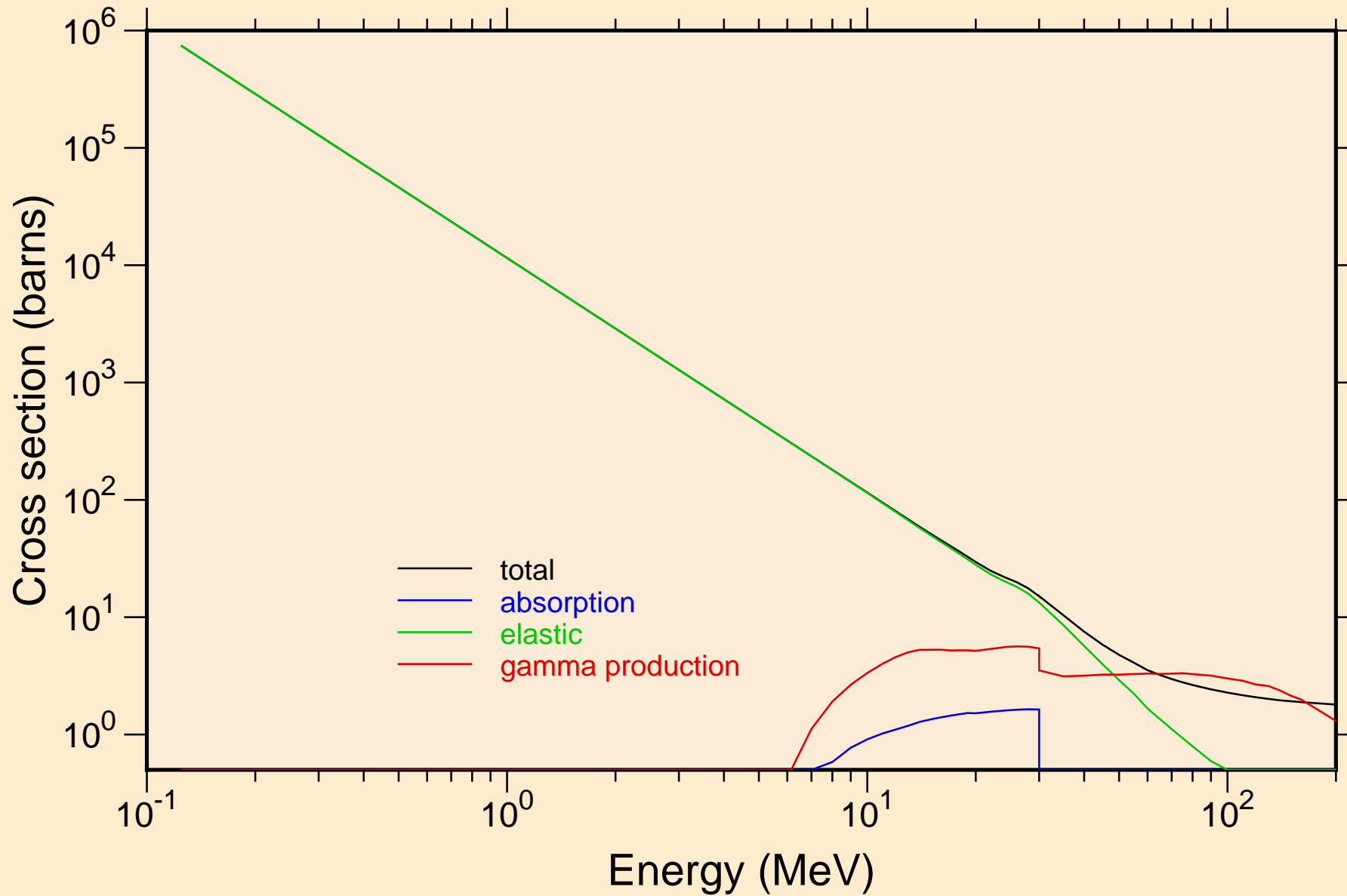

MO093M TRITON ACER TENDL-2021 LIBRARY; T=0.K

Heating

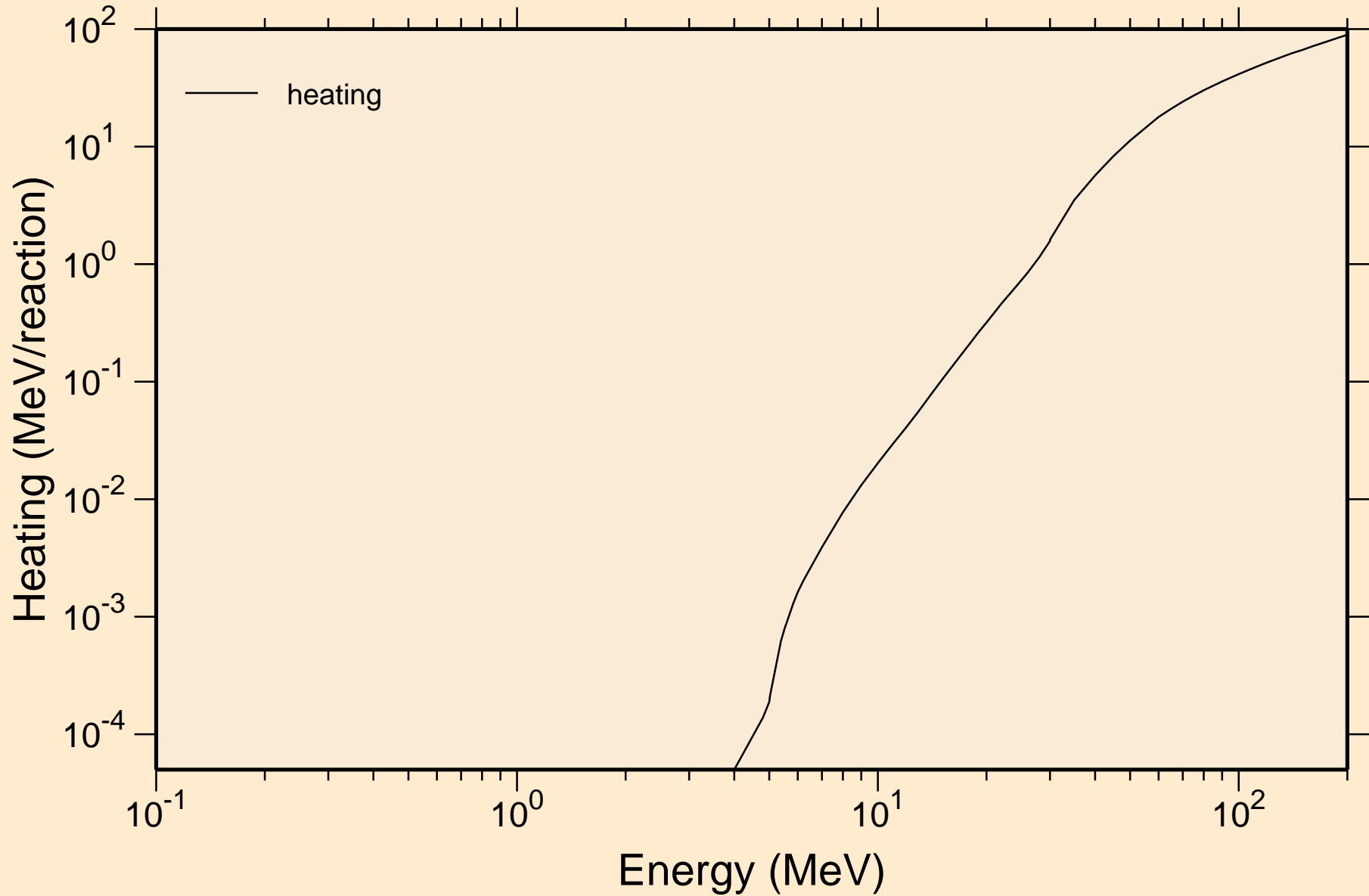

# MO093M TRITON ACER TENDL-2021 LIBRARY; T=0.K

## Principal cross sections

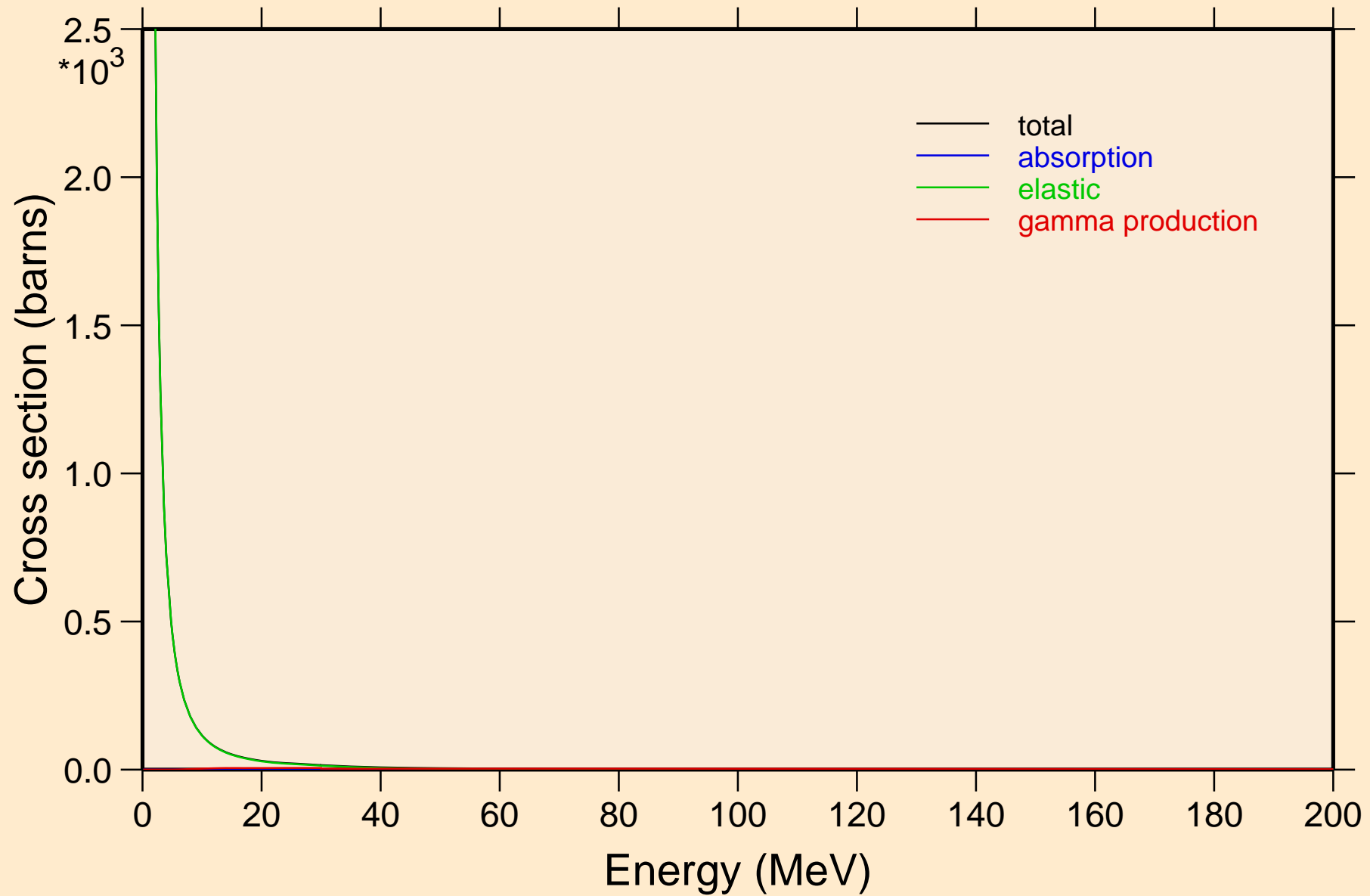

MO093M TRITON ACER TENDL-2021 LIBRARY; T=0.K

Heating

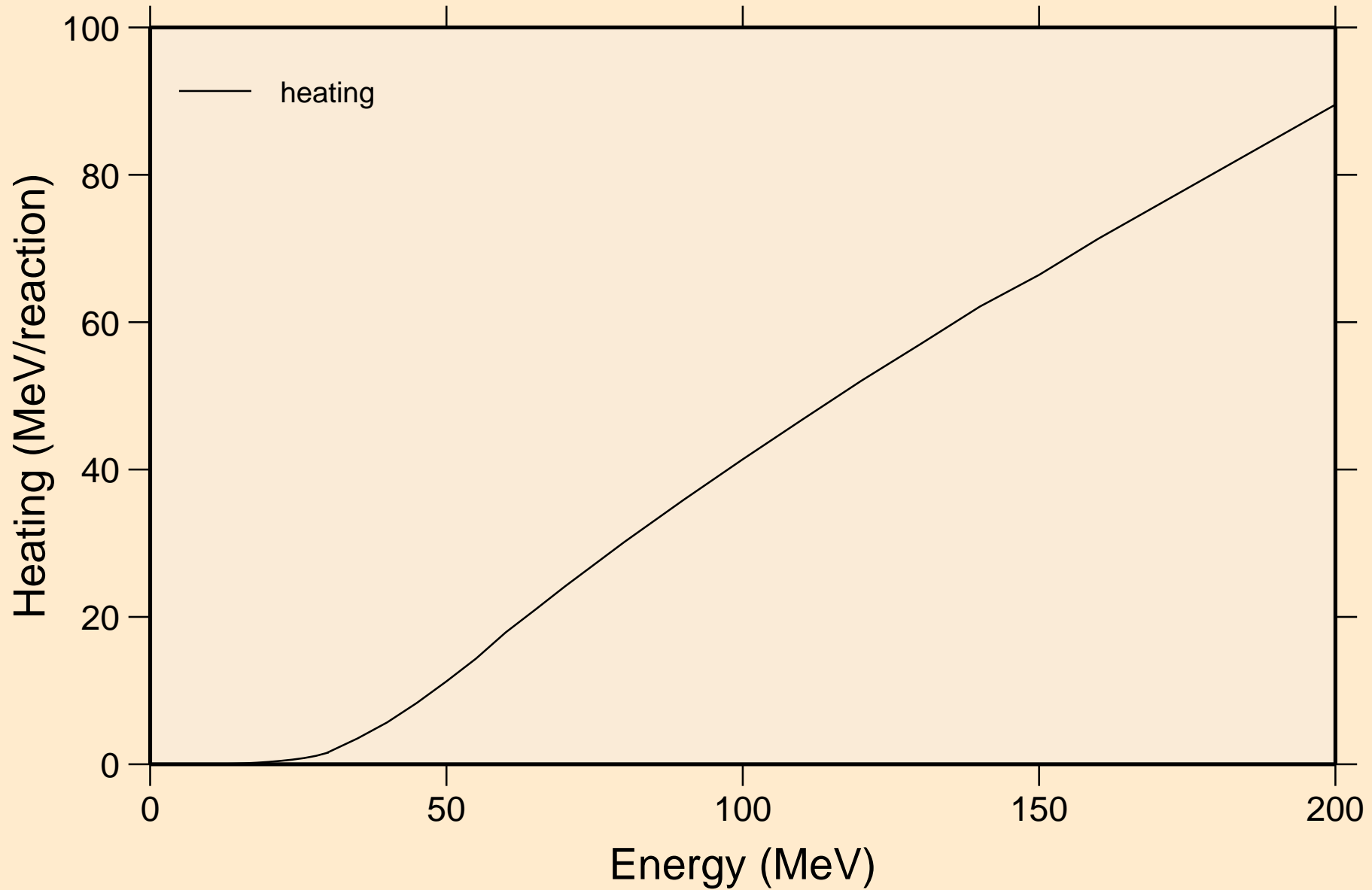

MO093M TRITON ACER TENDL-2021 LIBRARY; T=0.K  
Threshold reactions

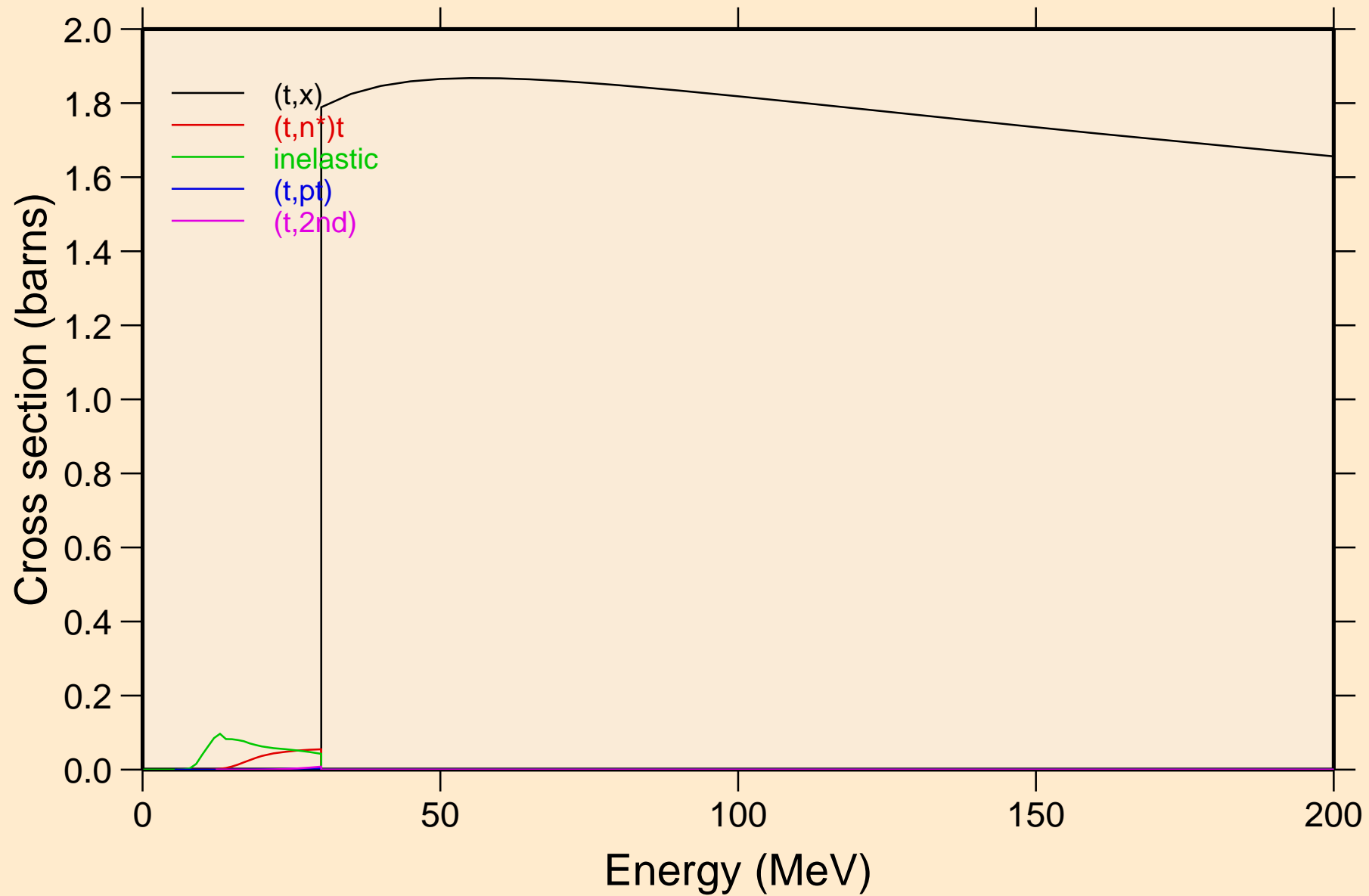

MO093M TRITON ACER TENDL-2021 LIBRARY; T=0.K  
Threshold reactions

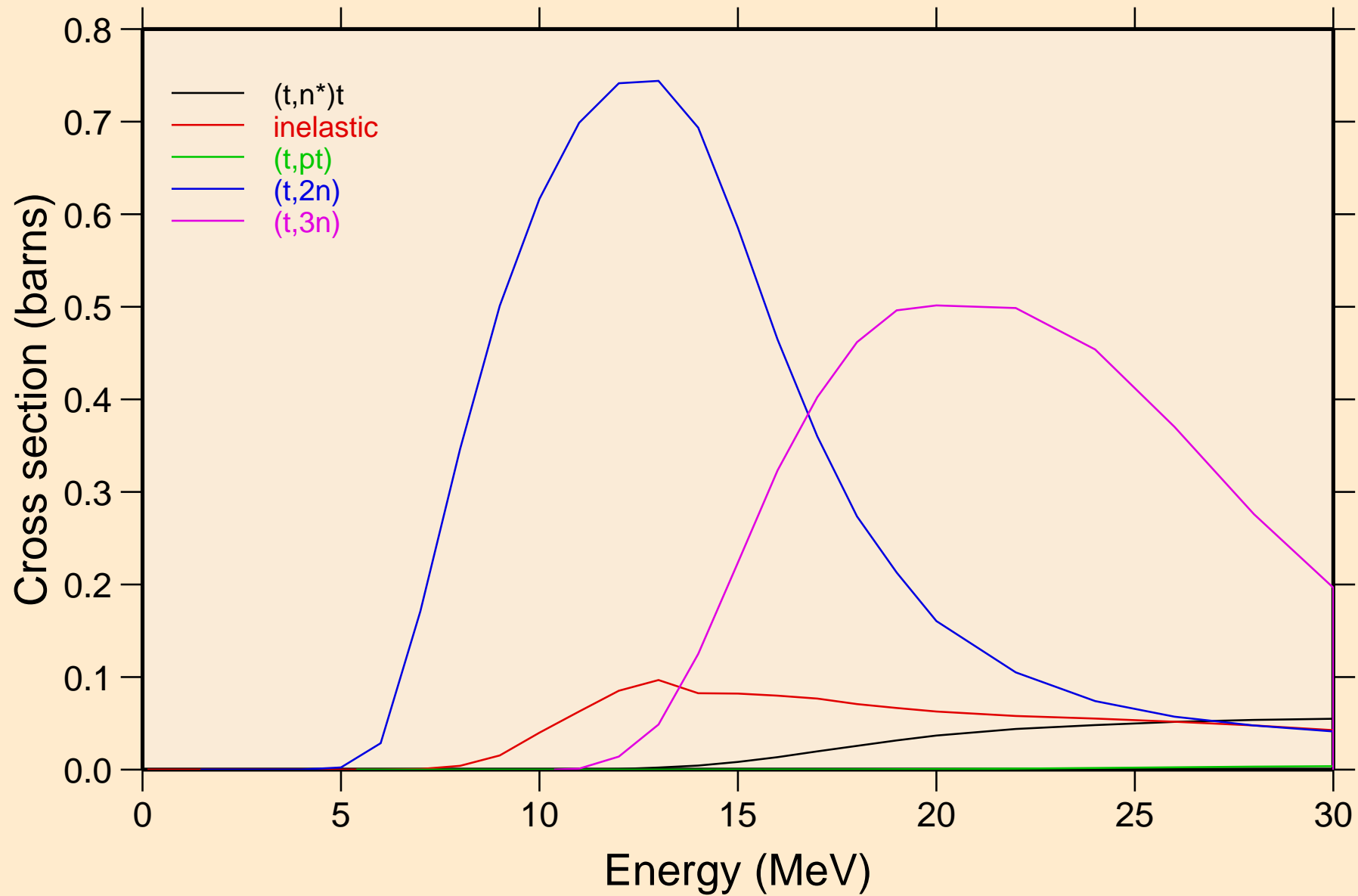

MO093M TRITON ACER TENDL-2021 LIBRARY; T=0.K  
Threshold reactions

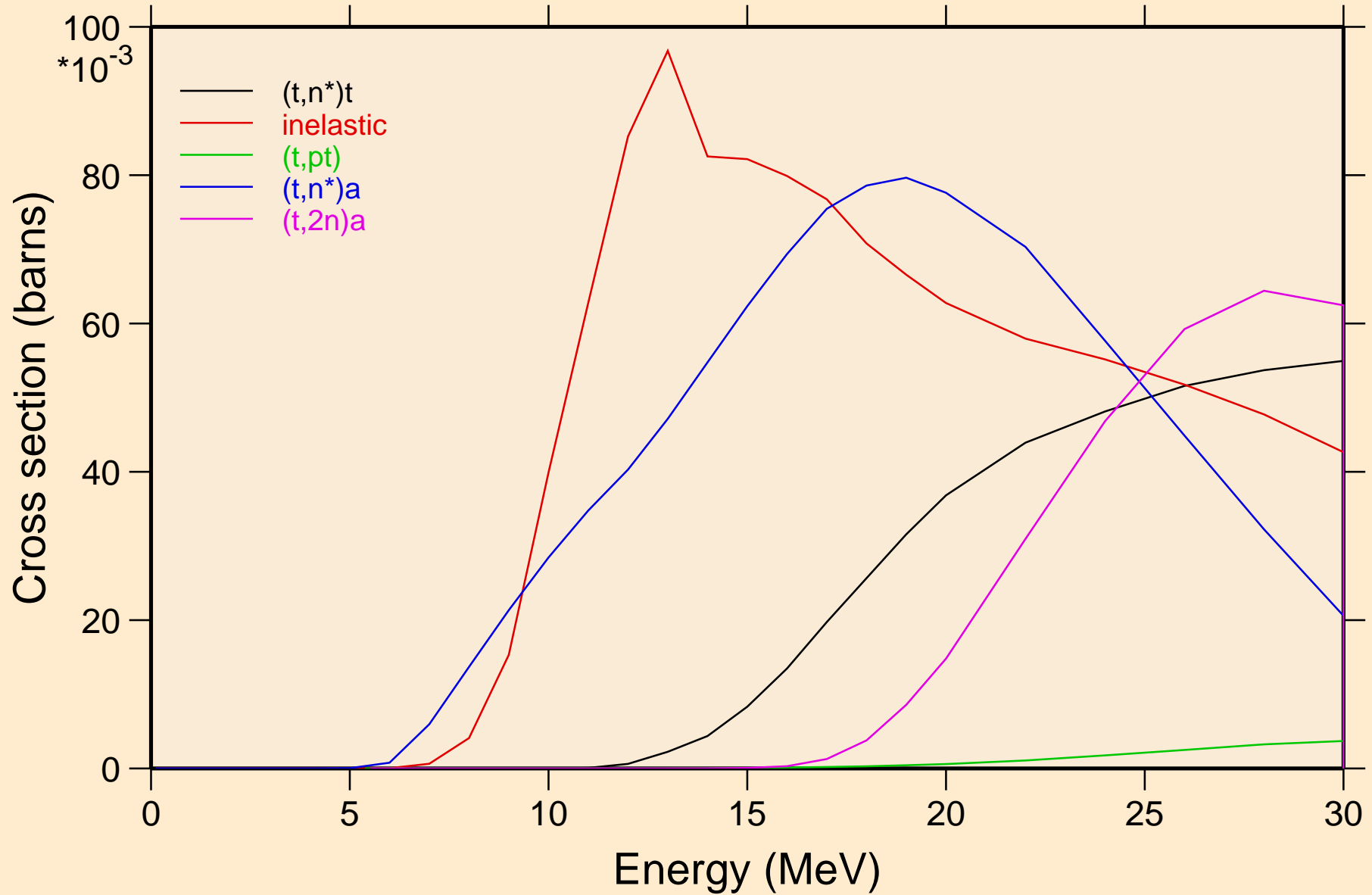

MO093M TRITON ACER TENDL-2021 LIBRARY; T=0.K  
Threshold reactions

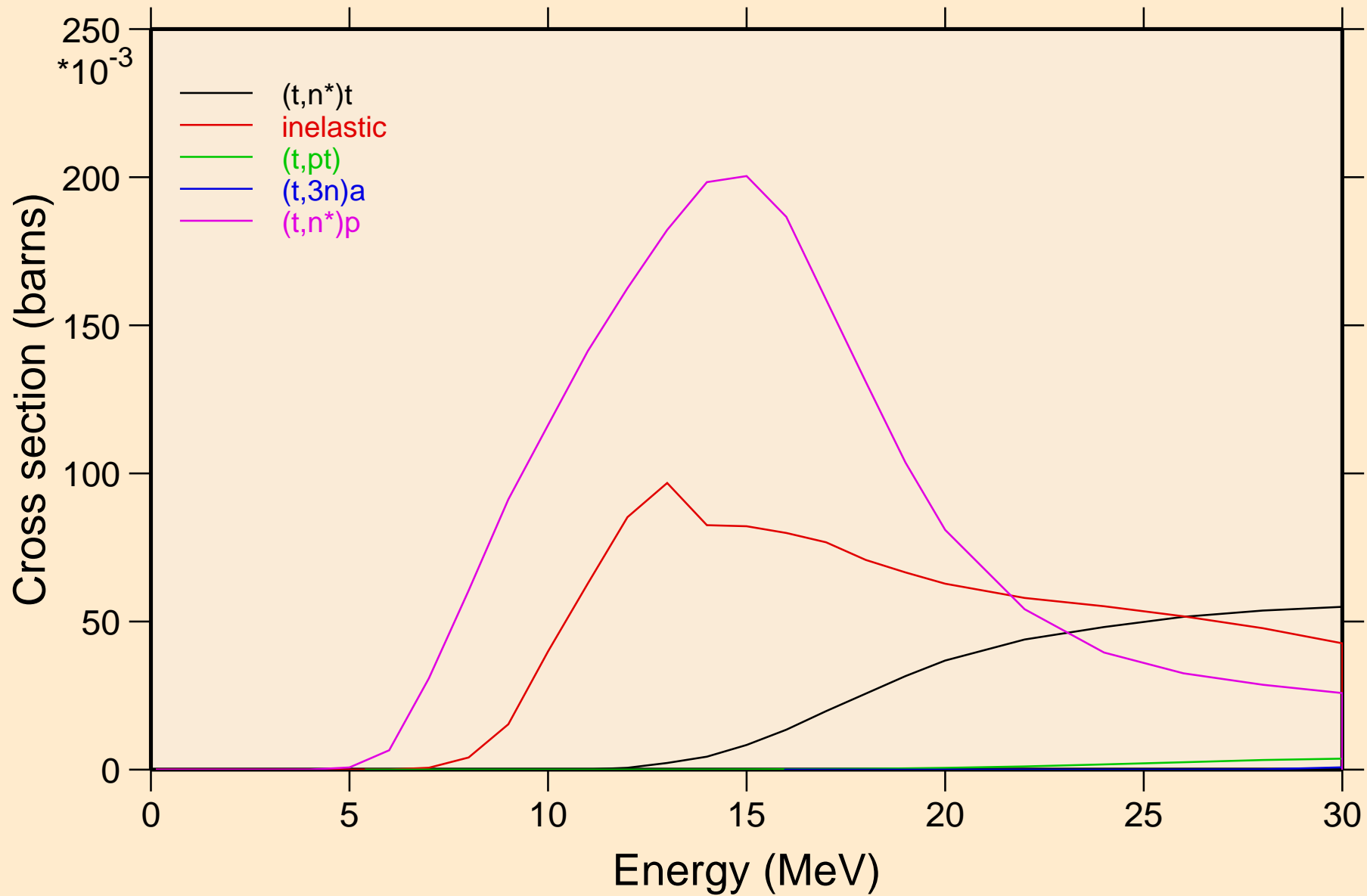



MO093M TRITON ACER TENDL-2021 LIBRARY; T=0.K  
Threshold reactions

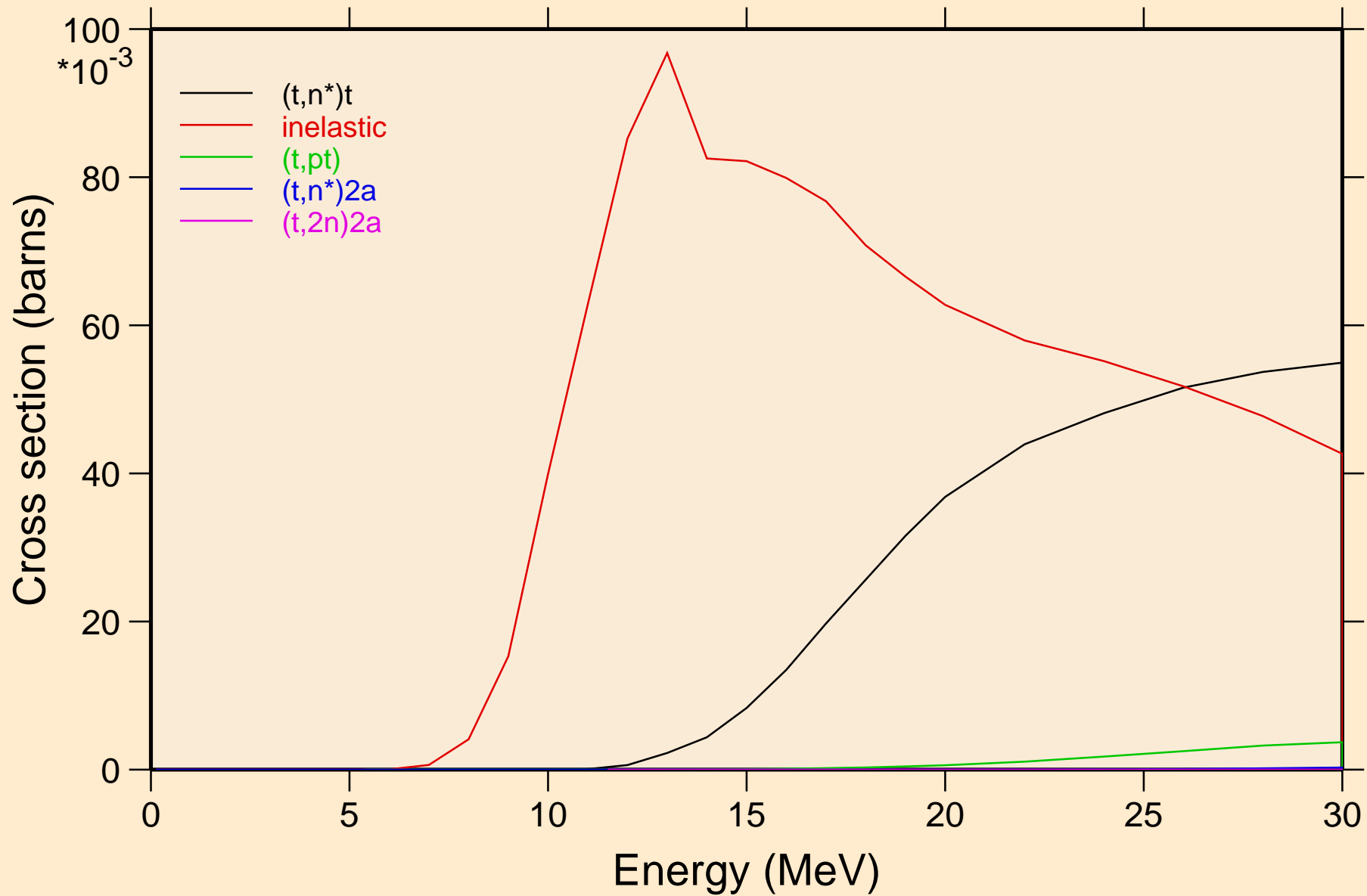

MO093M TRITON ACER TENDL-2021 LIBRARY; T=0.K  
Threshold reactions

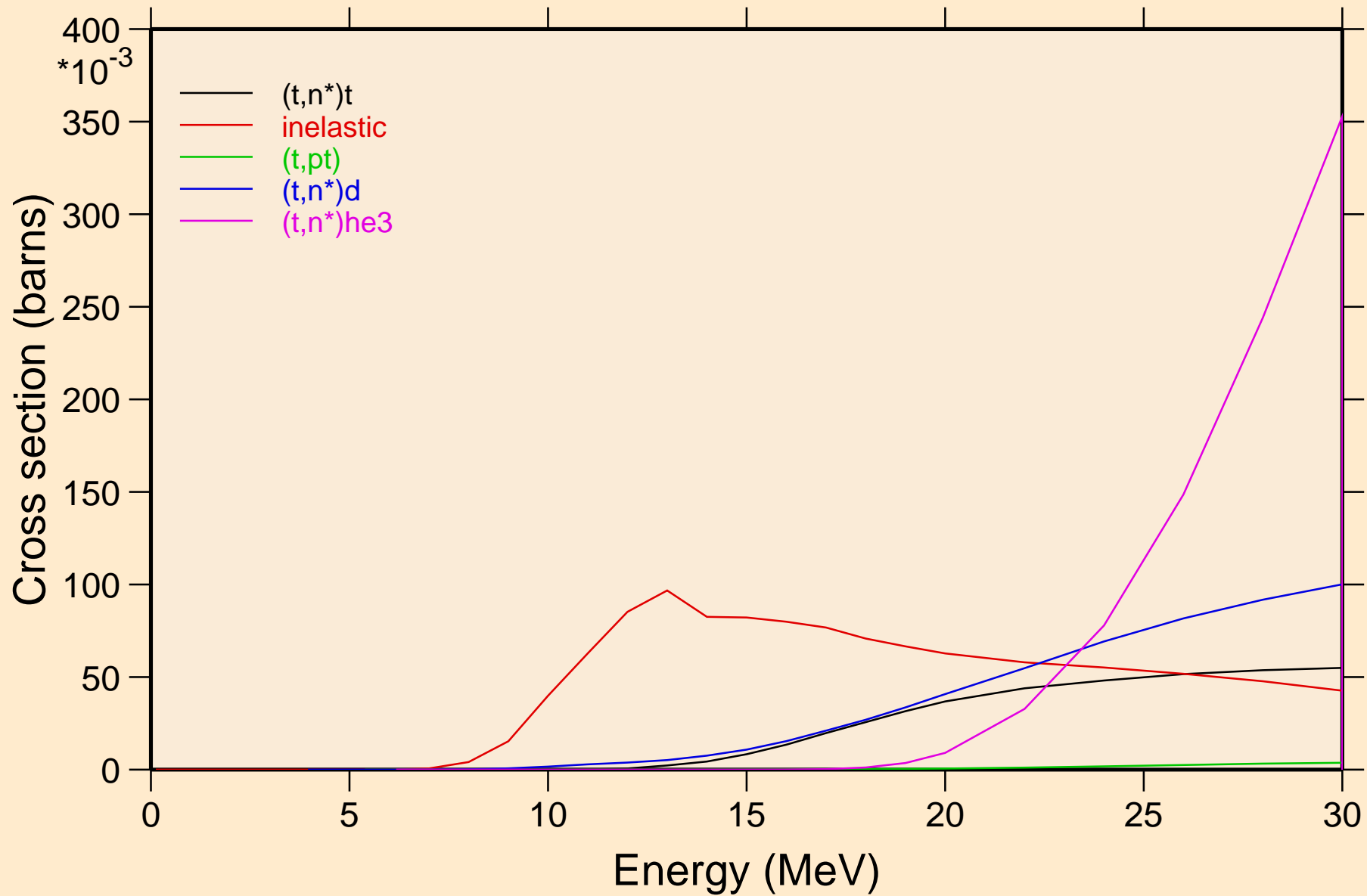

MO093M TRITON ACER TENDL-2021 LIBRARY; T=0.K  
Threshold reactions

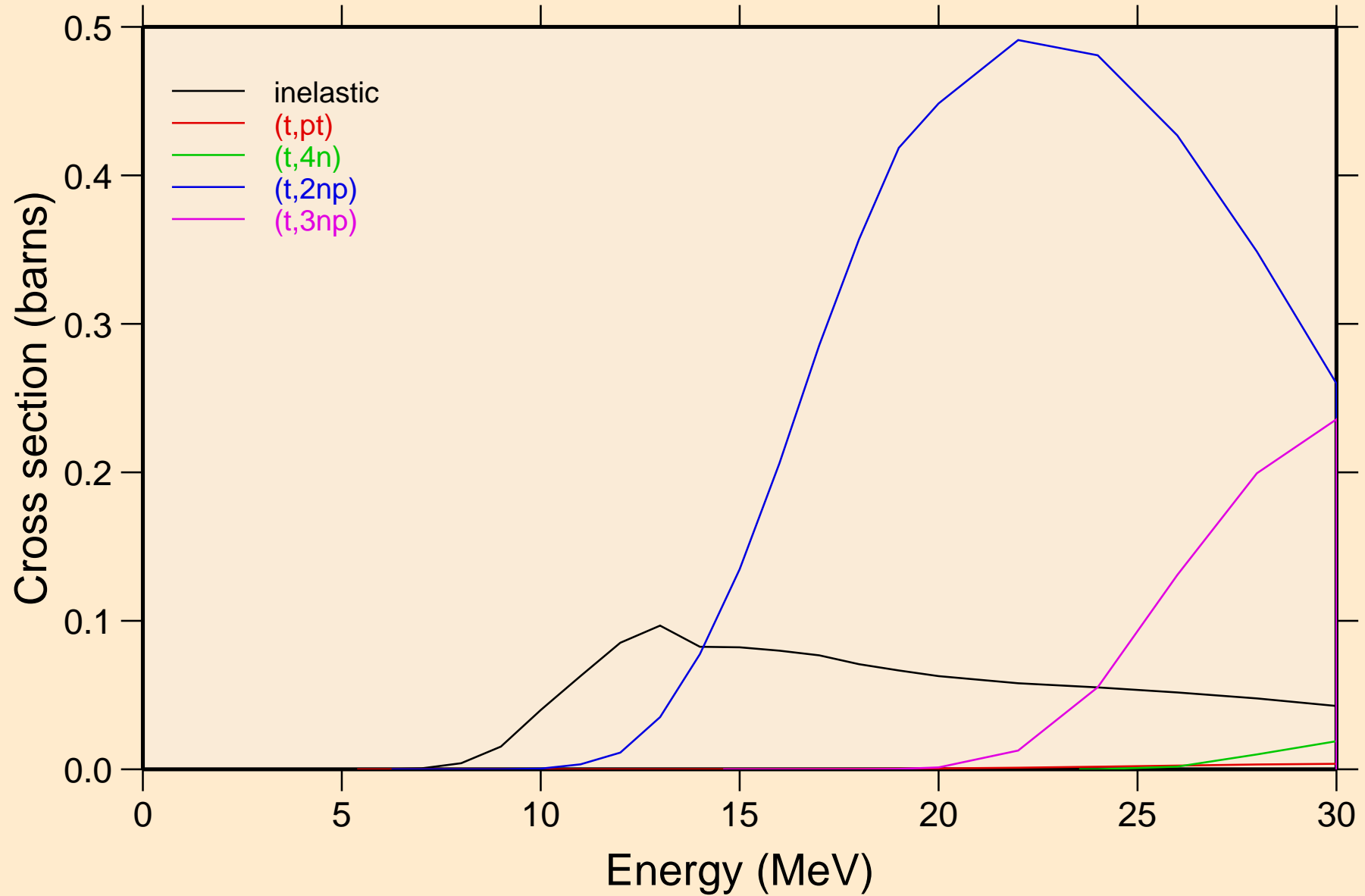

MO093M TRITON ACER TENDL-2021 LIBRARY; T=0.K  
Threshold reactions

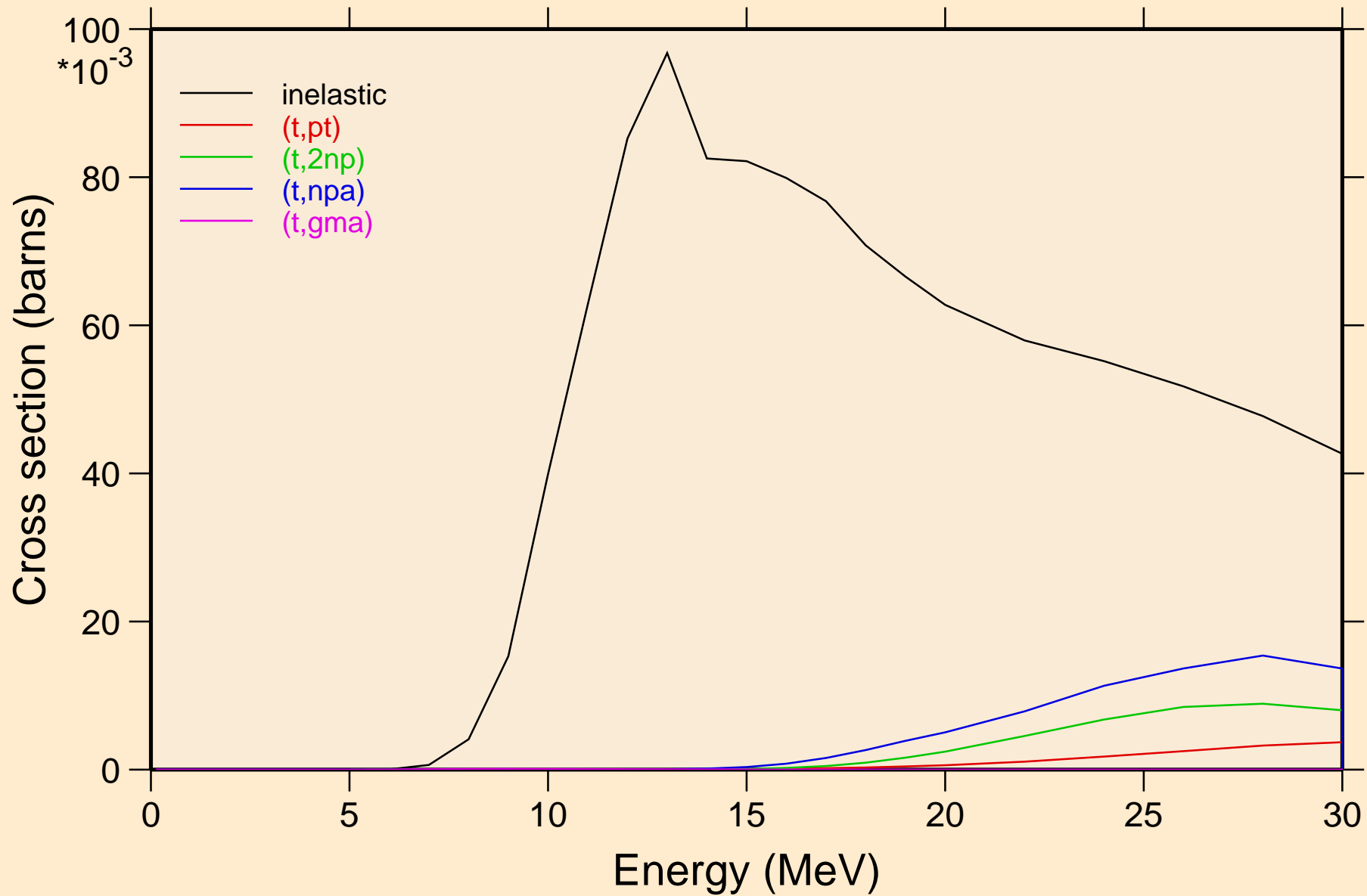

MO093M TRITON ACER TENDL-2021 LIBRARY; T=0.K  
Threshold reactions

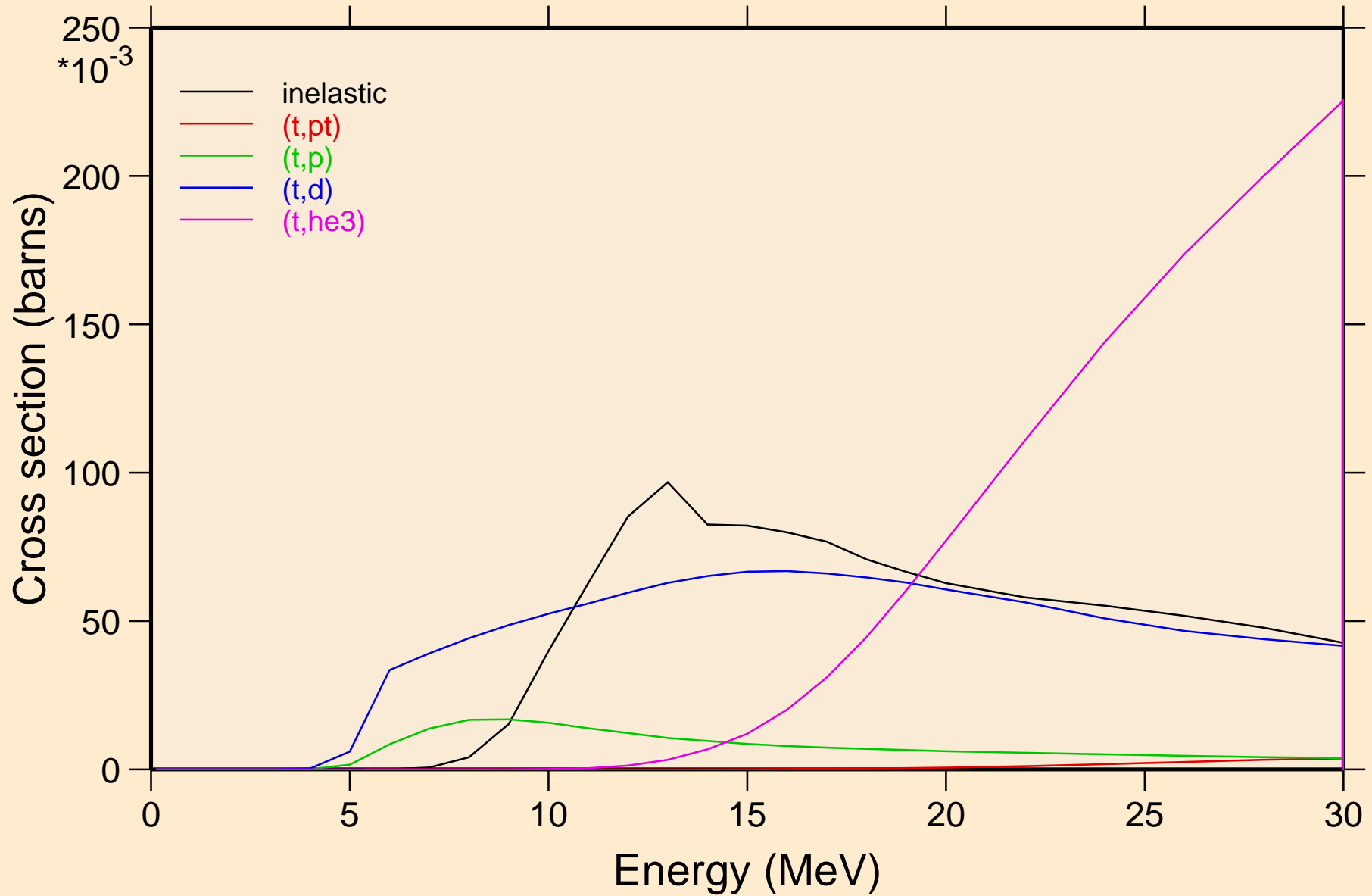

MO093M TRITON ACER TENDL-2021 LIBRARY; T=0.K  
Threshold reactions

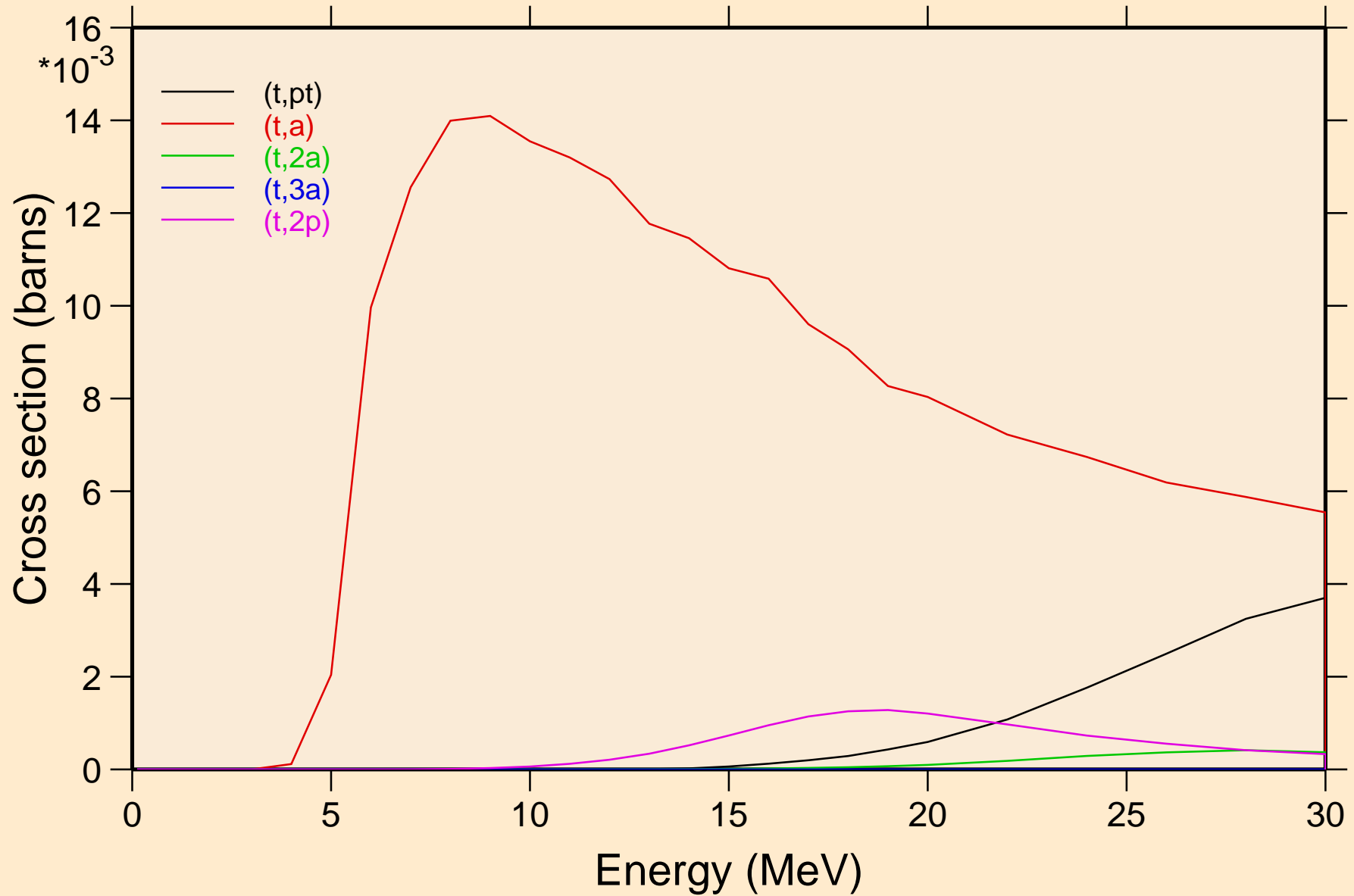

MO093M TRITON ACER TENDL-2021 LIBRARY; T=0.K  
Threshold reactions

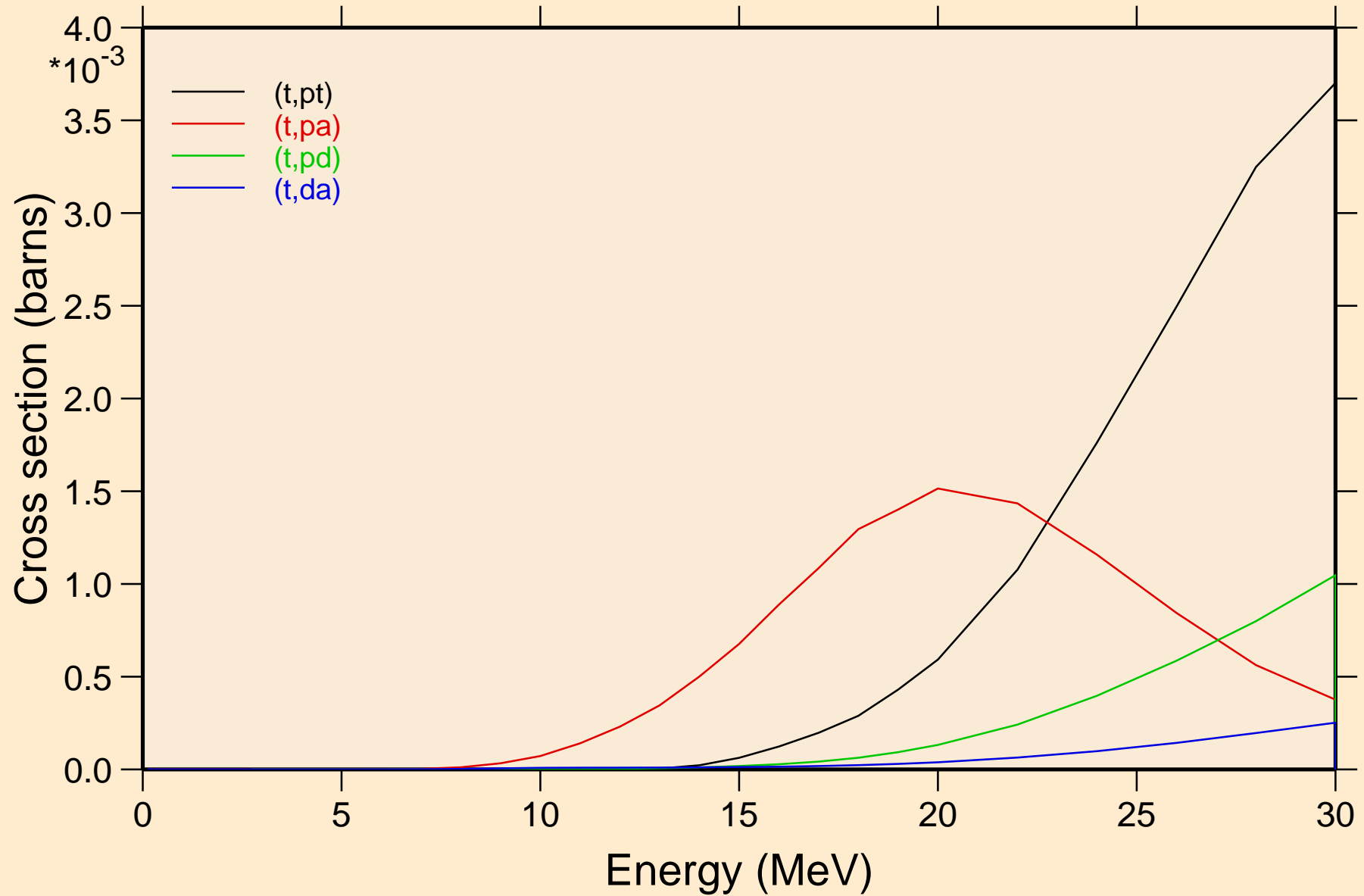

MO093M TRITON ACER TENDL-2021 LIBRARY; T=0.K  
angular distribution for elastic

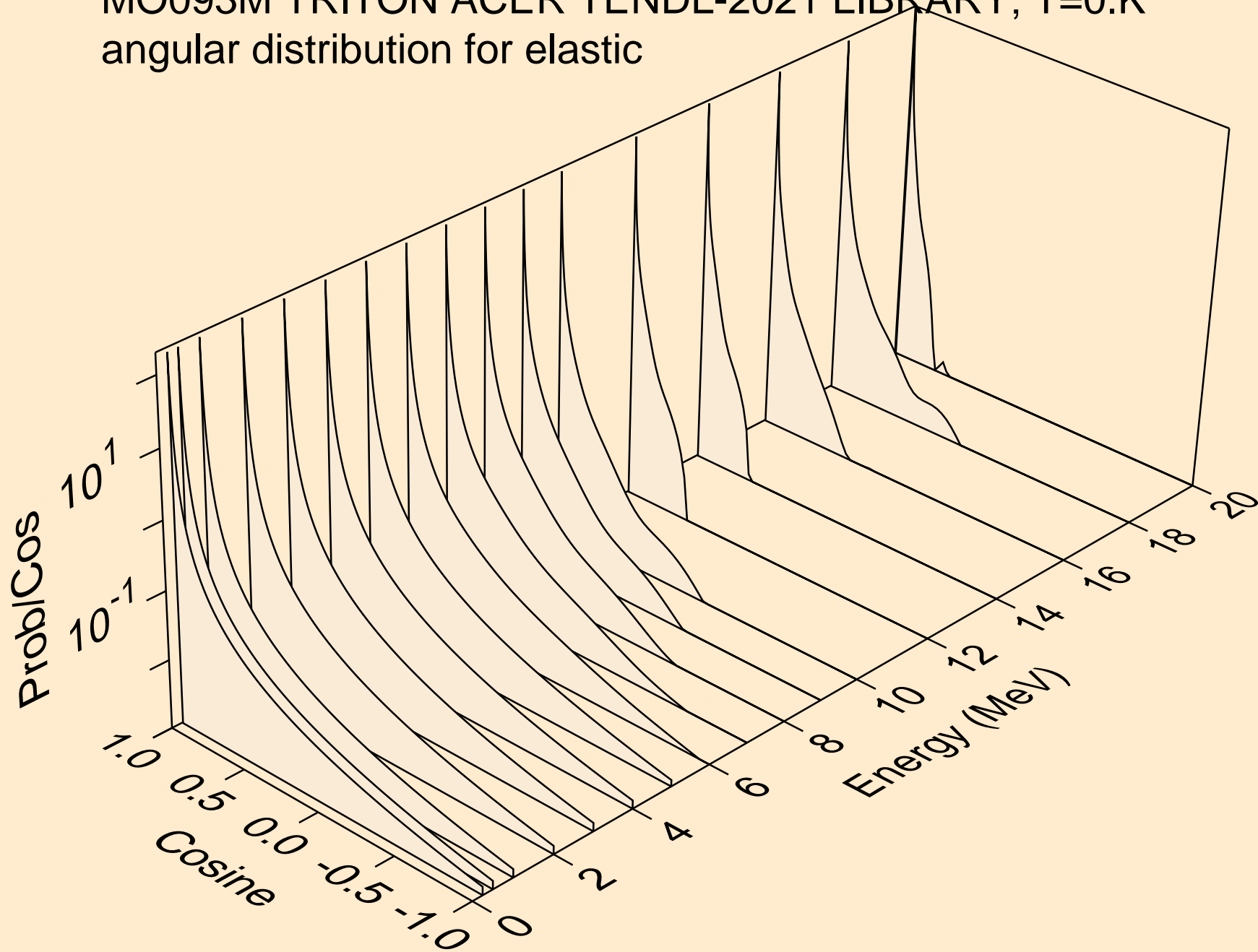



MO093M TRITON ACER TENDL-2021 LIBRARY; T=0.K  
angular distribution for elastic

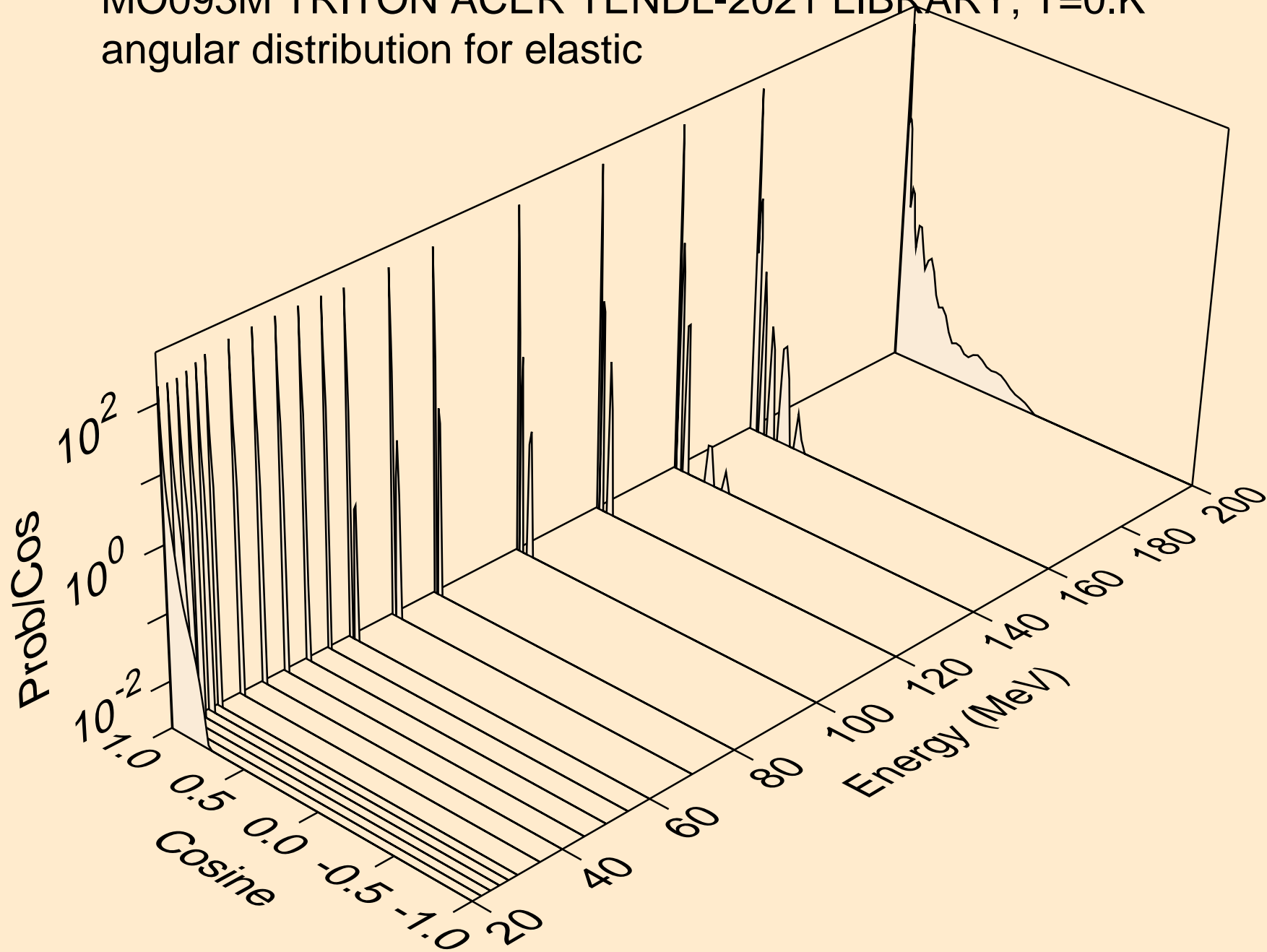

MO093M TRITON ACER TENDL-2021 LIBRARY; T=0.K  
Triton emission for (t,x)

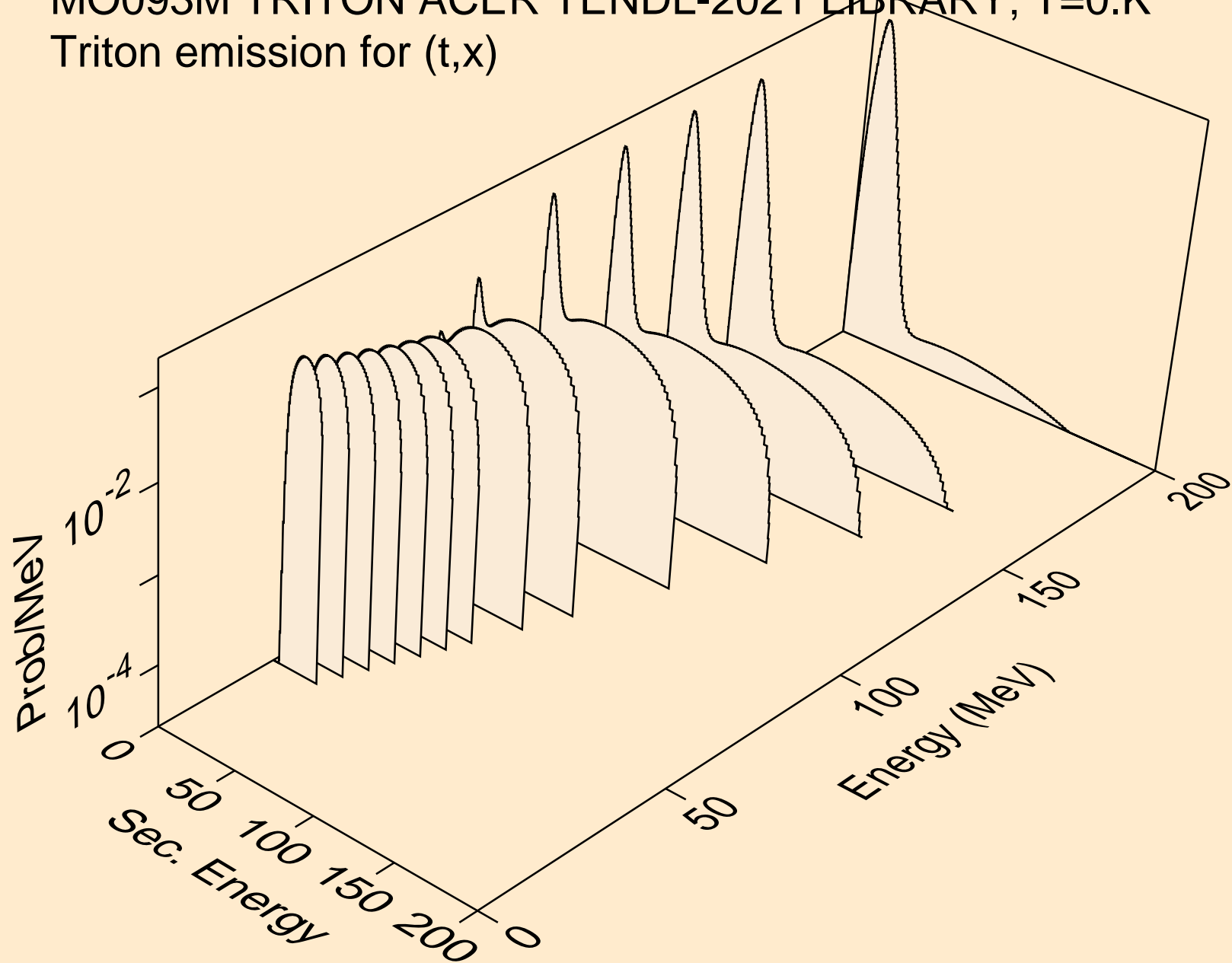

MO093M TRITON ACER TENDL-2021 LIBRARY; T=0.K  
Triton emission for (t,n\*)t

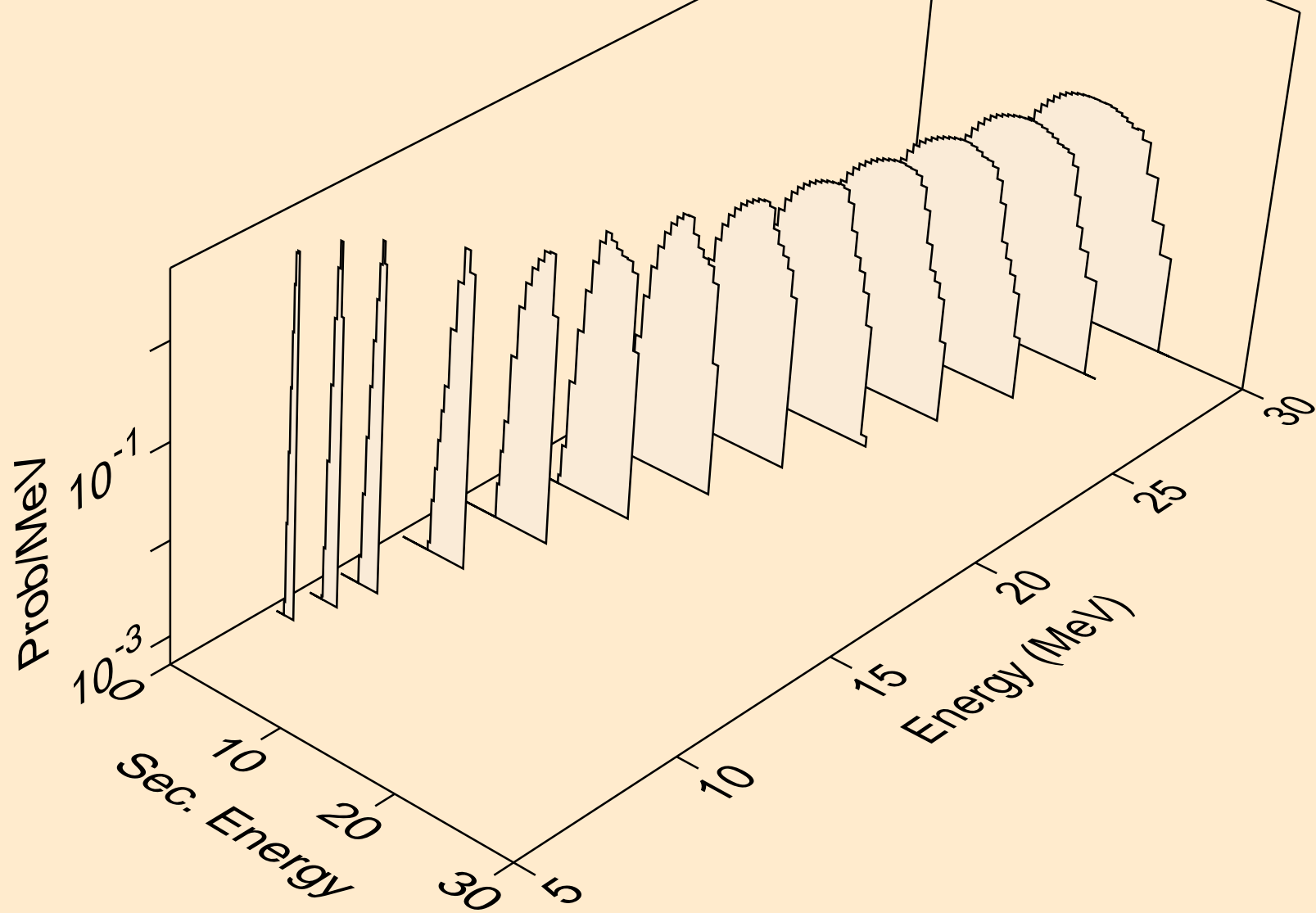

MO093M TRITON ACER TENDL-2021 LIBRARY; T=0.K  
Triton emission for inelastic

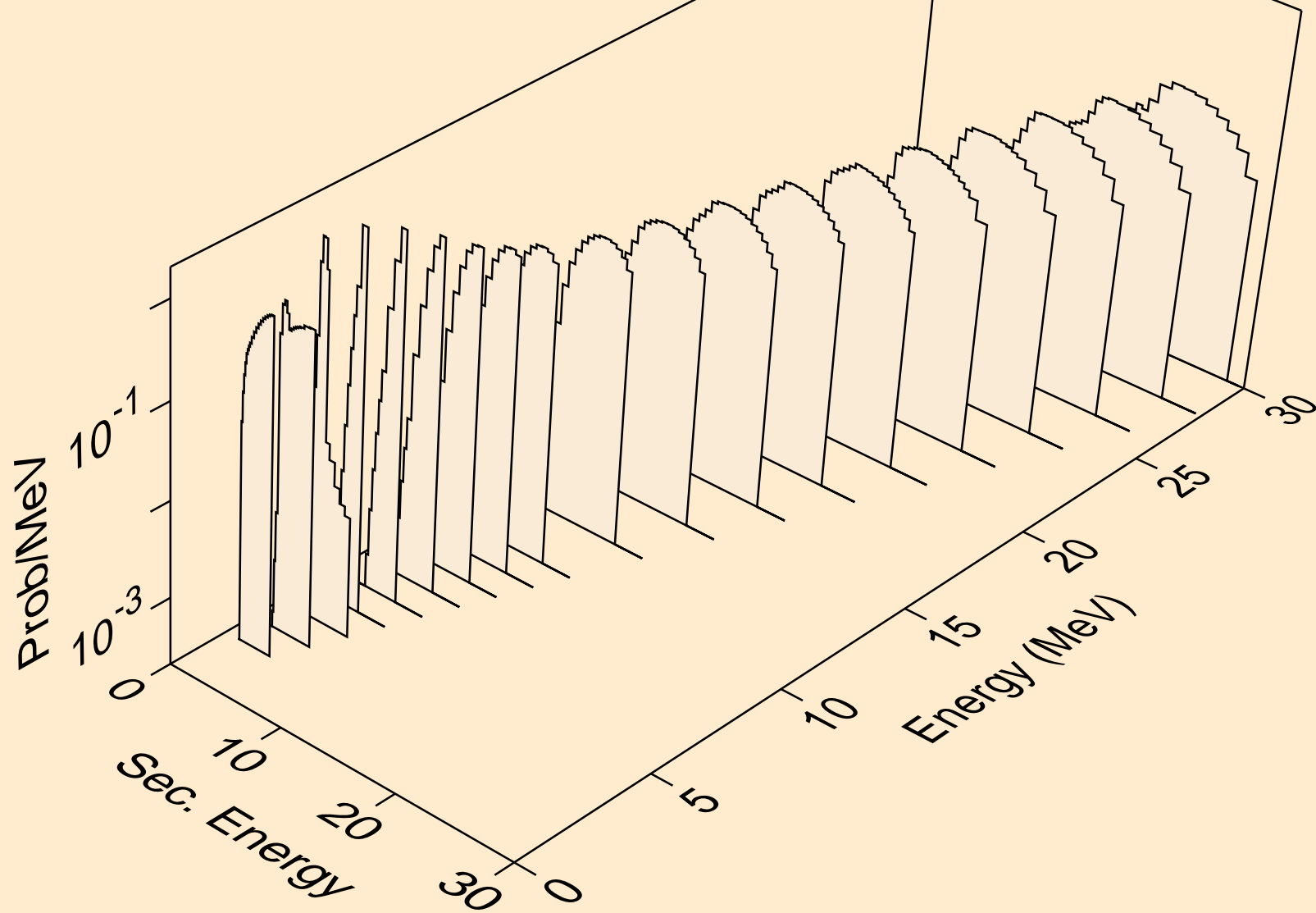

MO093M TRITON ACER TENDL-2021 LIBRARY; T=0.K  
Triton emission for (t,pt)

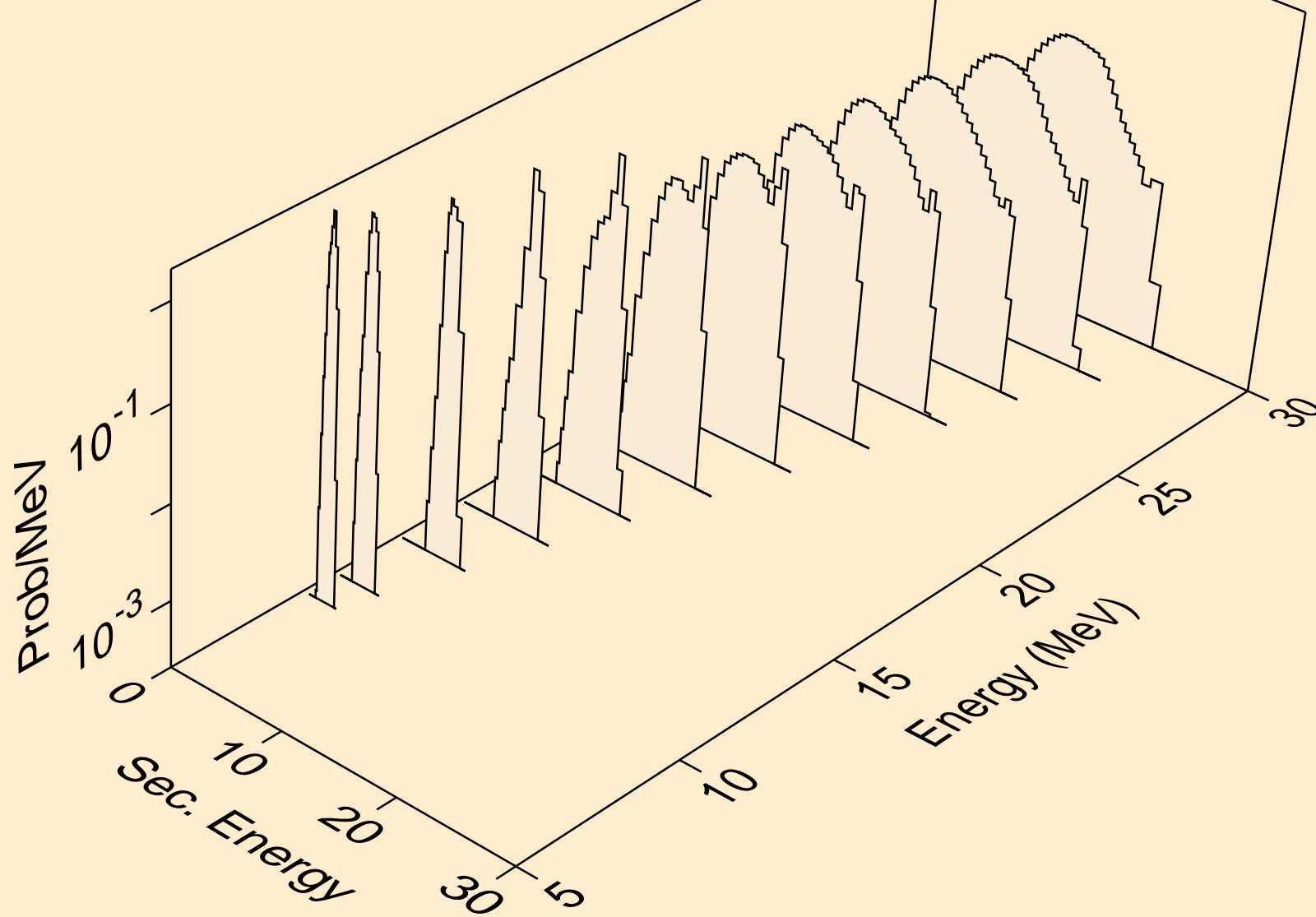

MO093M TRITON ACER TENDL-2021 LIBRARY; T=0.K  
Photon emission for (z,n)

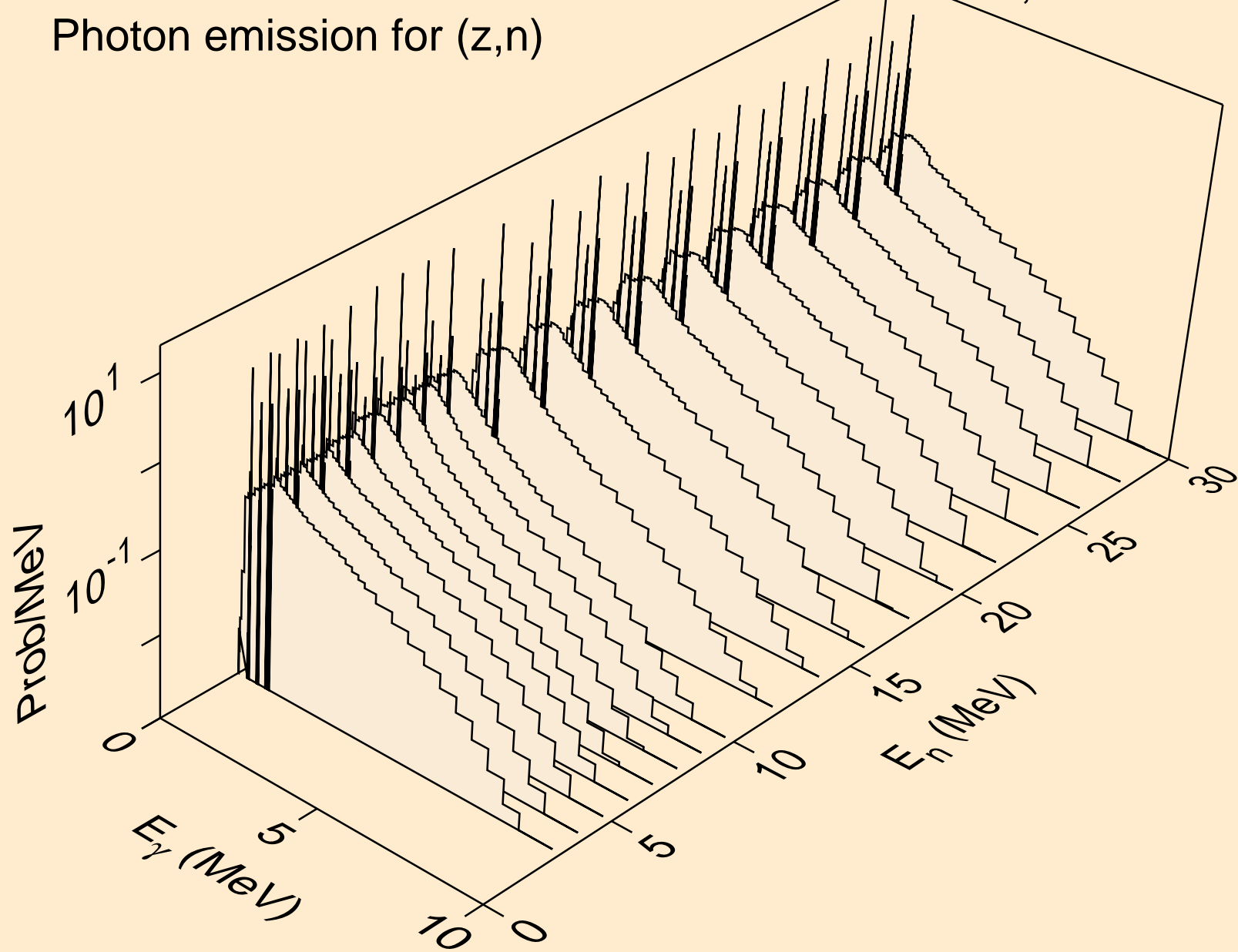

MO093M TRITON ACER TENDL-2021 LIBRARY; T=0.K  
Photon emission for (n,x)

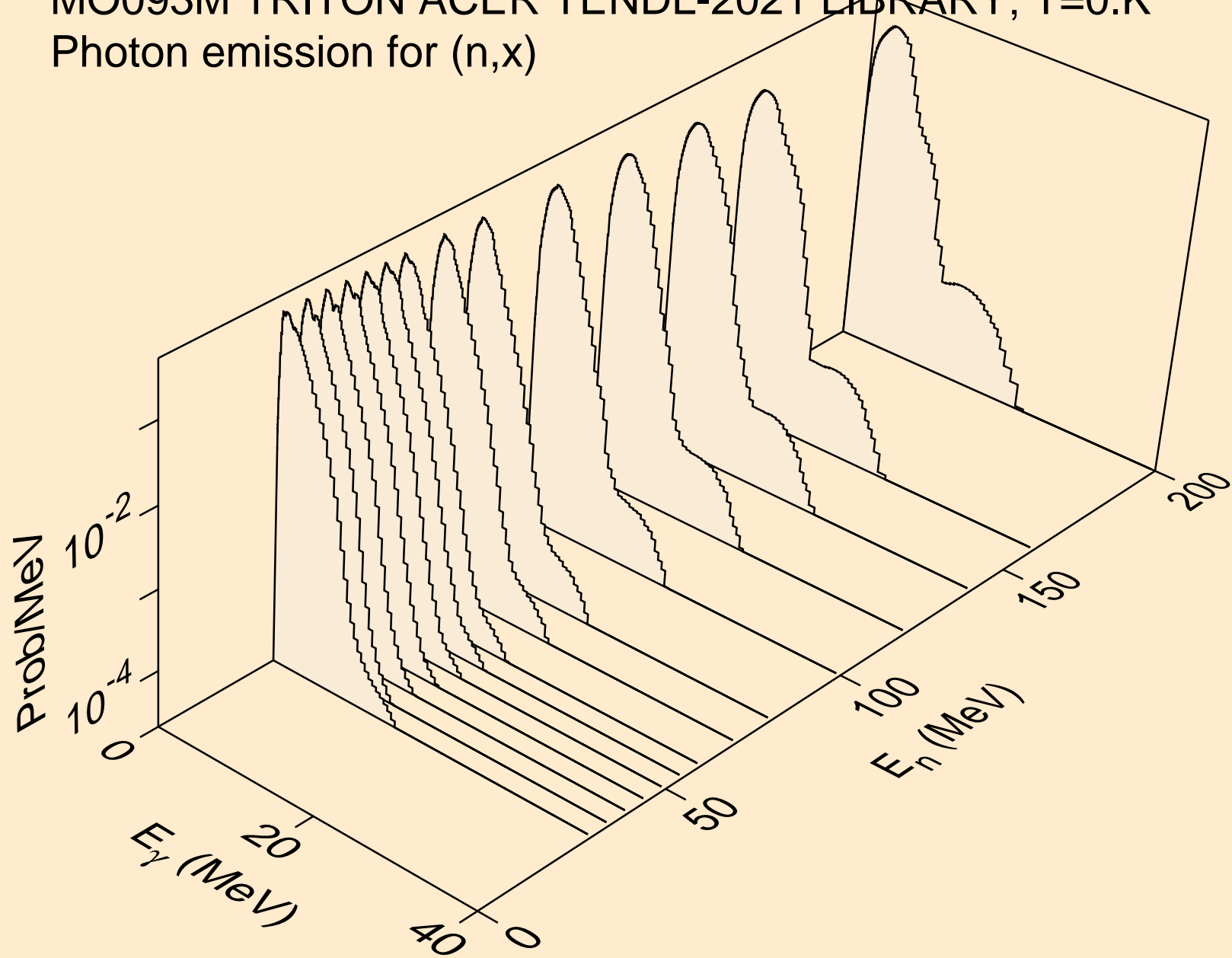

MO093M TRITON ACER TENDL-2021 LIBRARY; T=0.K  
Photon emission for (n,2nd)

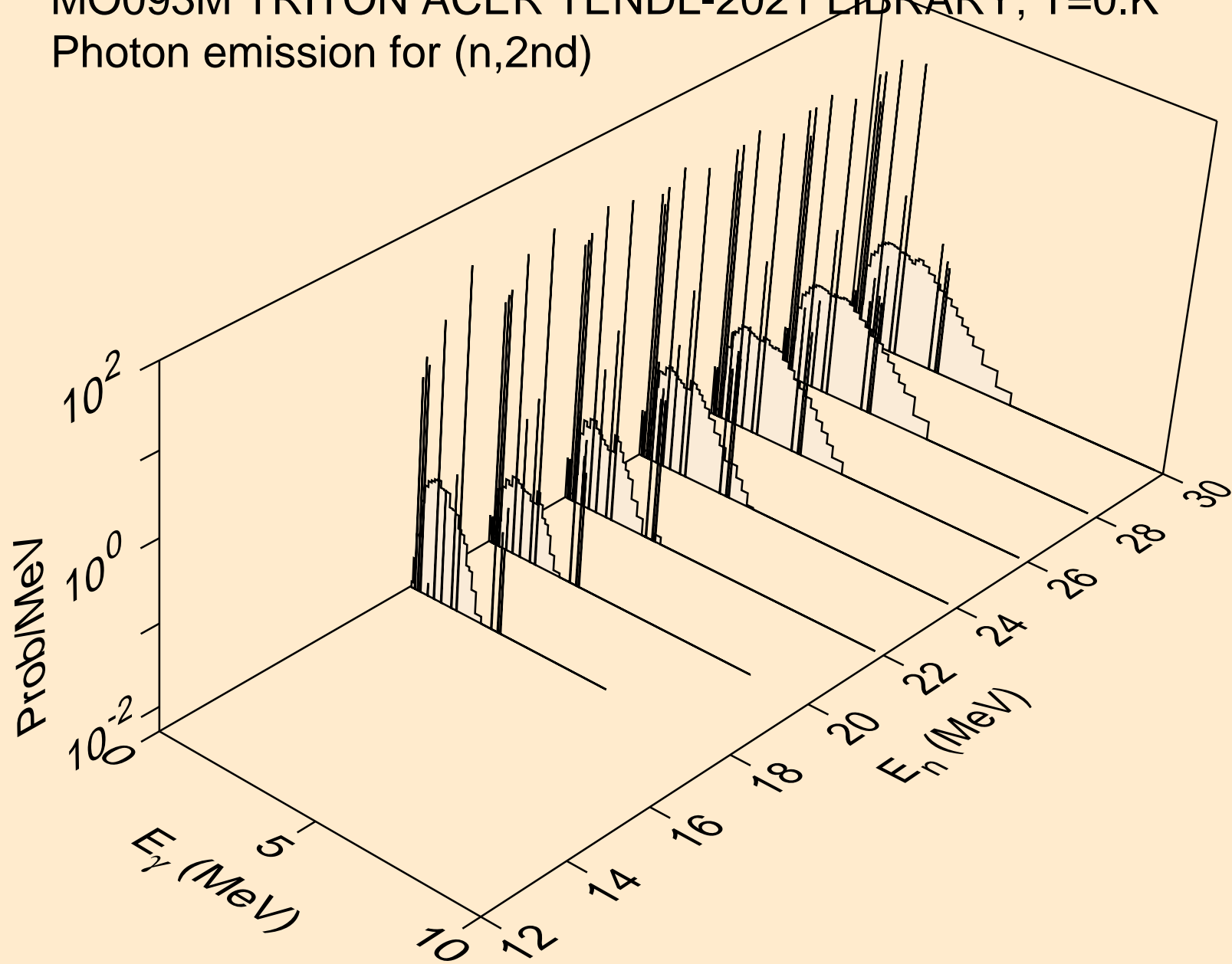



MO093M TRITON ACER TENDL-2021 LIBRARY; T=0.K  
Photon emission for (n,2n)

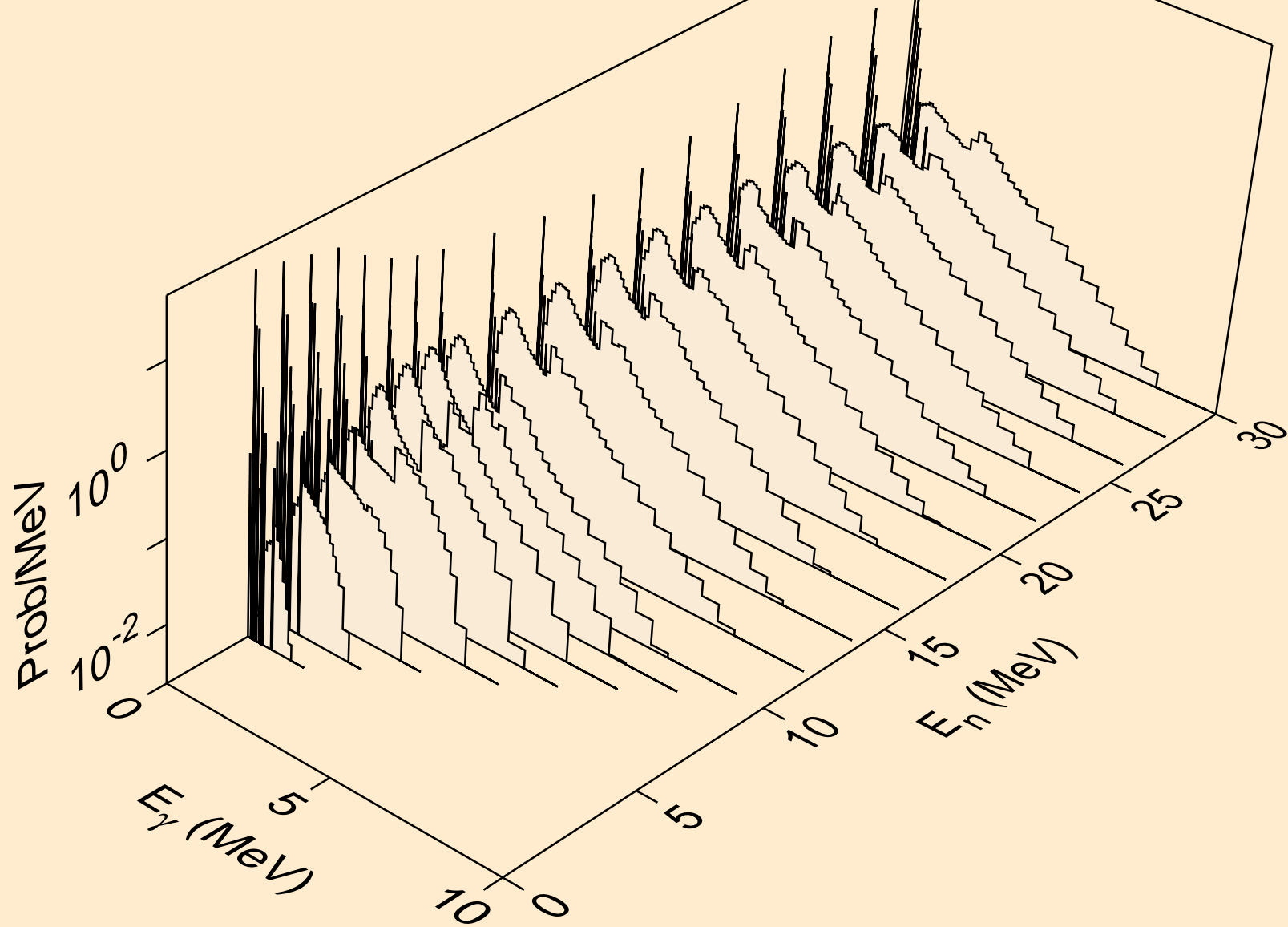

MO093M TRITON ACER TENDL-2021 LIBRARY; T=0.K  
Photon emission for (n,3n)

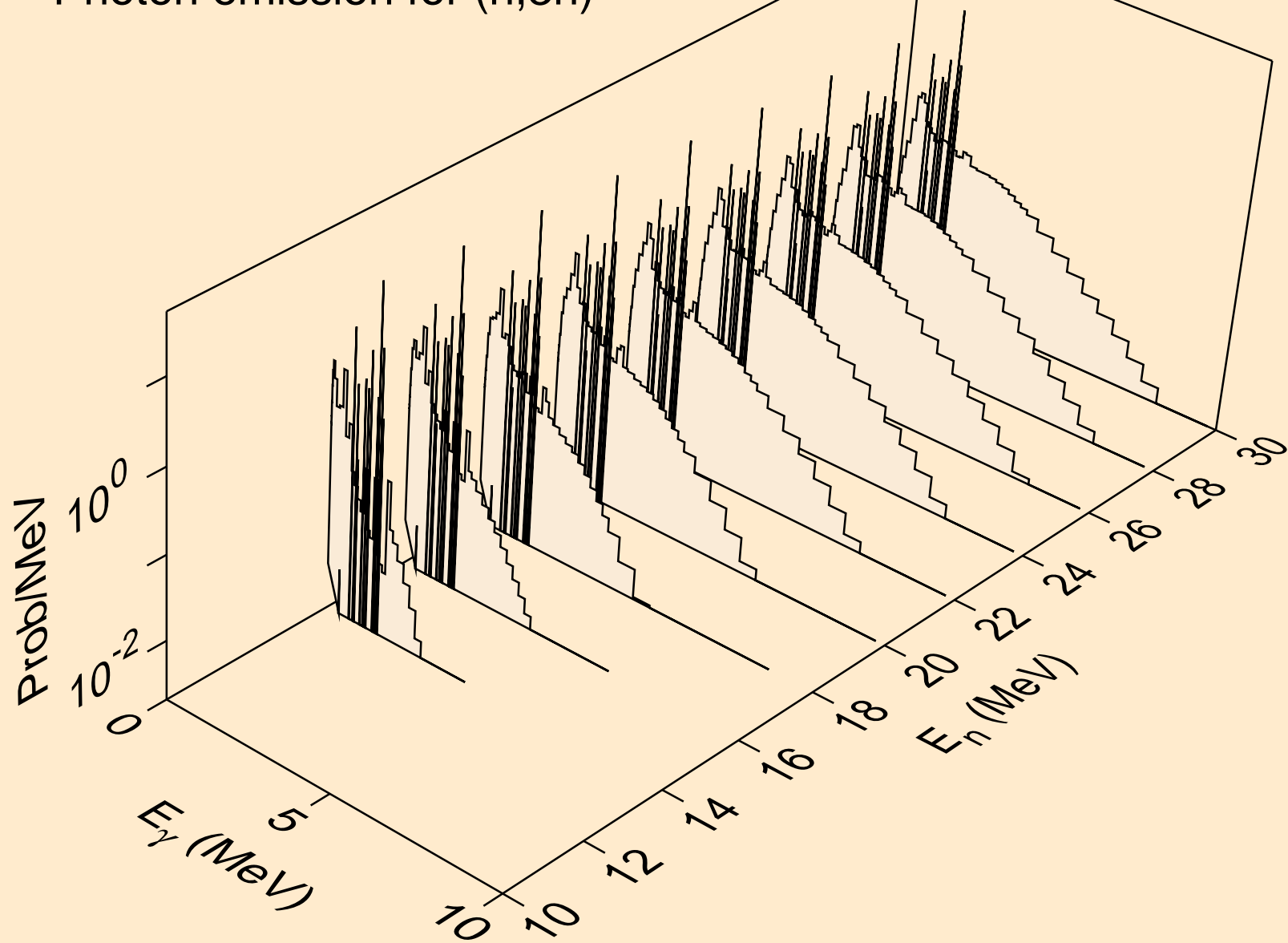

MO093M TRITON ACER TENDL-2021 LIBRARY; T=0.K  
Photon emission for (n,n\*)a

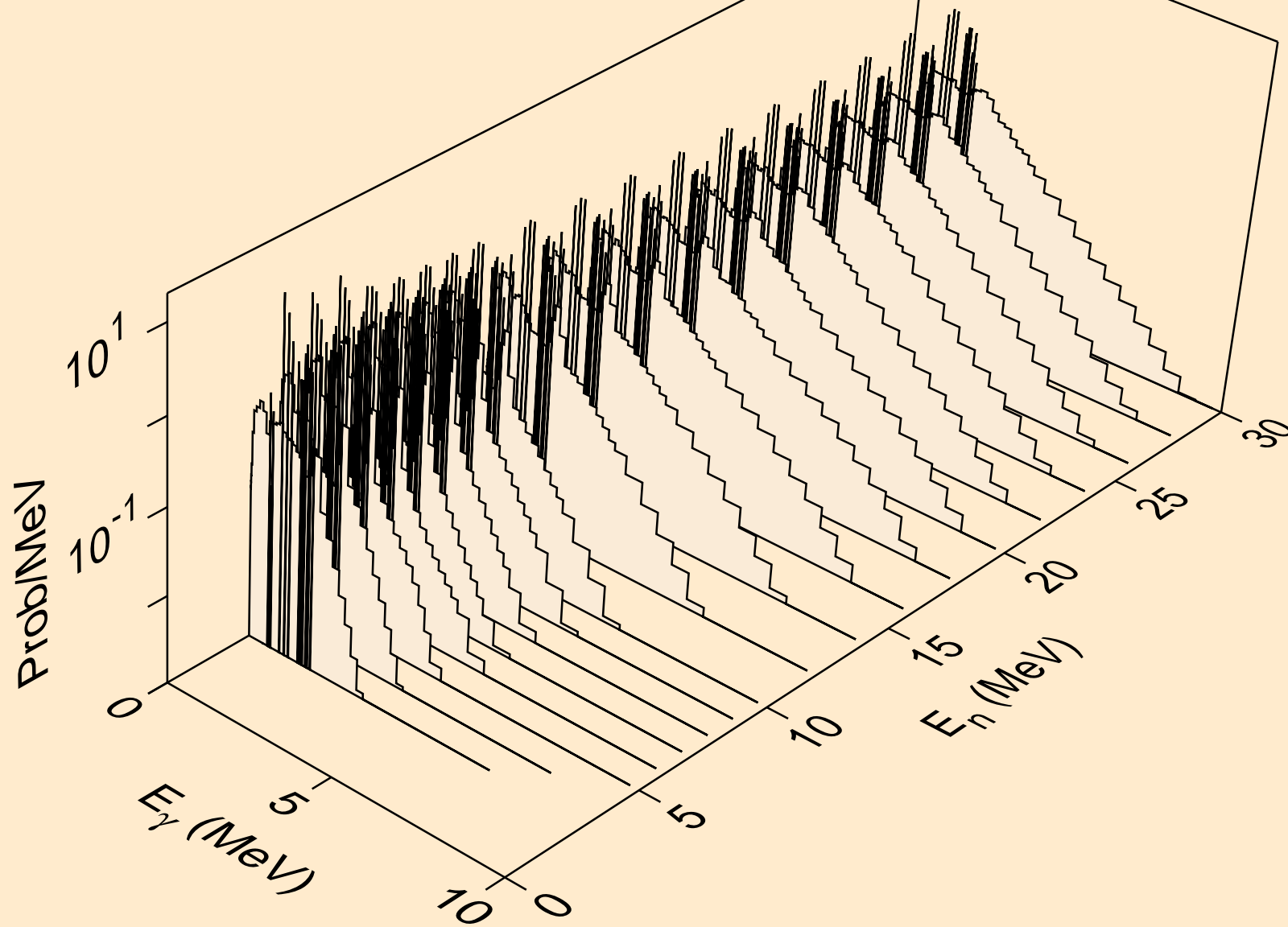

MO093M TRITON ACER TENDL-2021 LIBRARY; T=0.K  
Photon emission for (n,2n)a

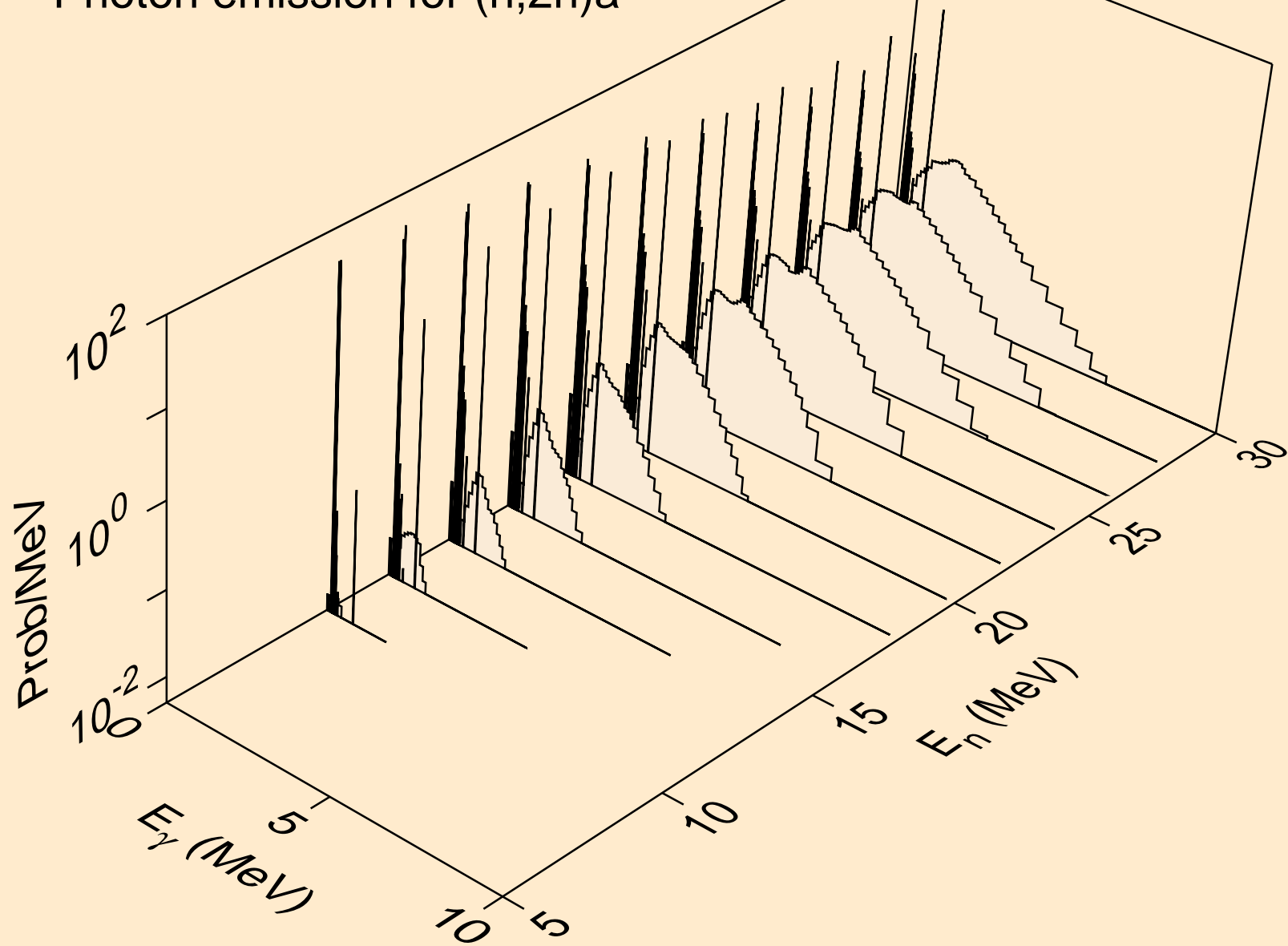

MO093M TRITON ACER TENDL-2021 LIBRARY; T=0.K  
Photon emission for (n,3n)a

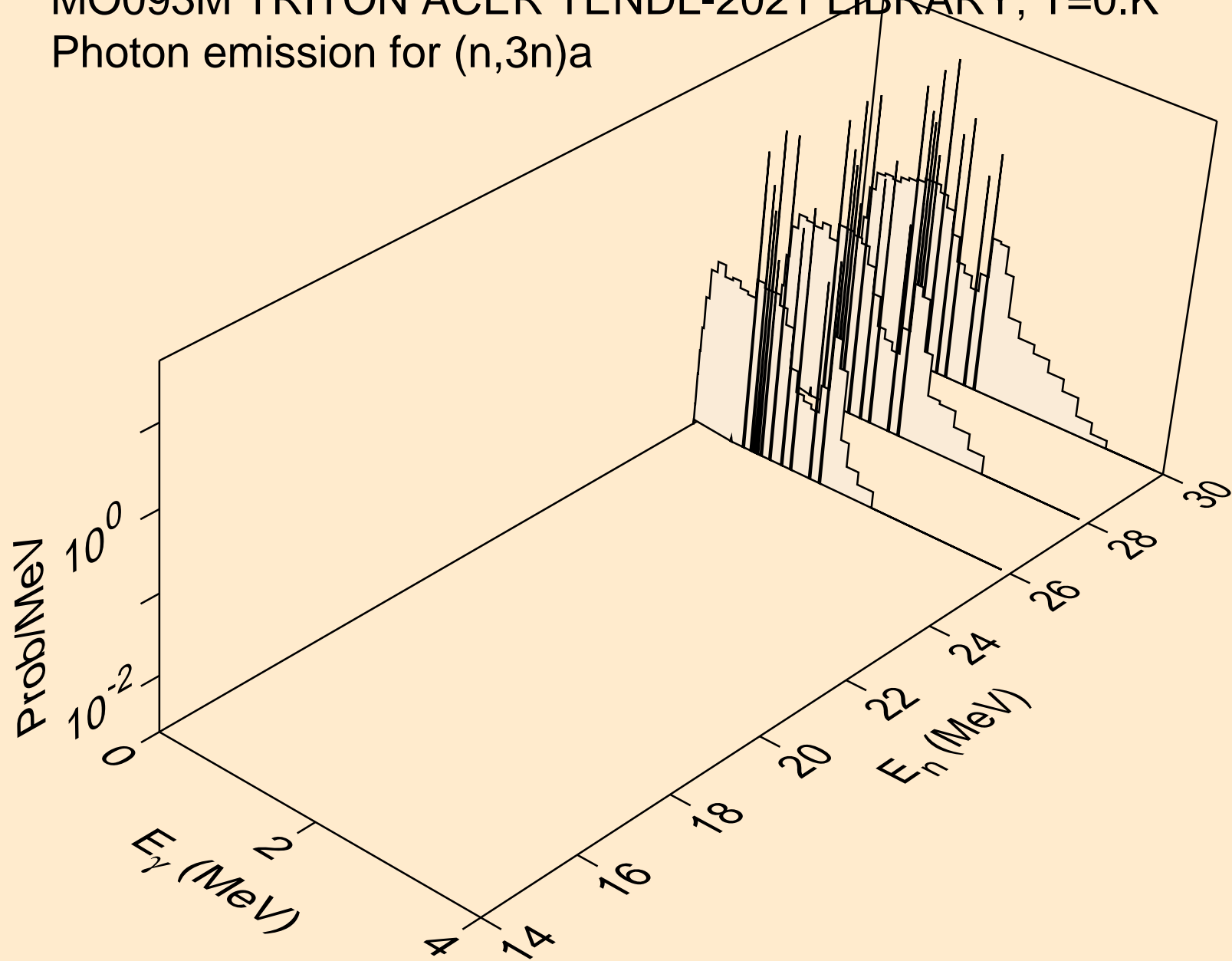

MO093M TRITON ACER TENDL-2021 LIBRARY; T=0.K  
Photon emission for (n,n\*)p

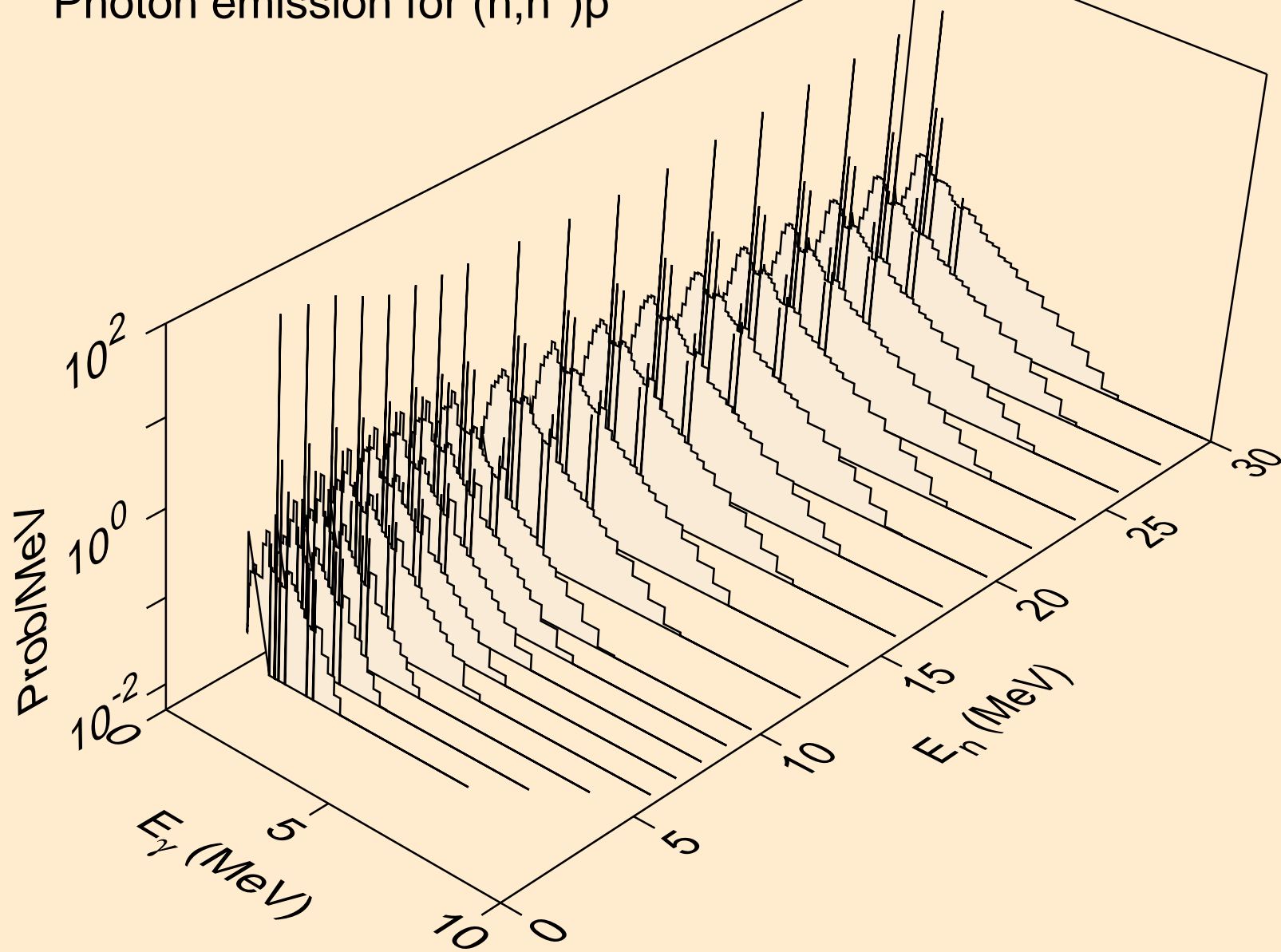

MO093M TRITON ACER TENDL-2021 LIBRARY; T=0.K  
Photon emission for (n,n\*)2a

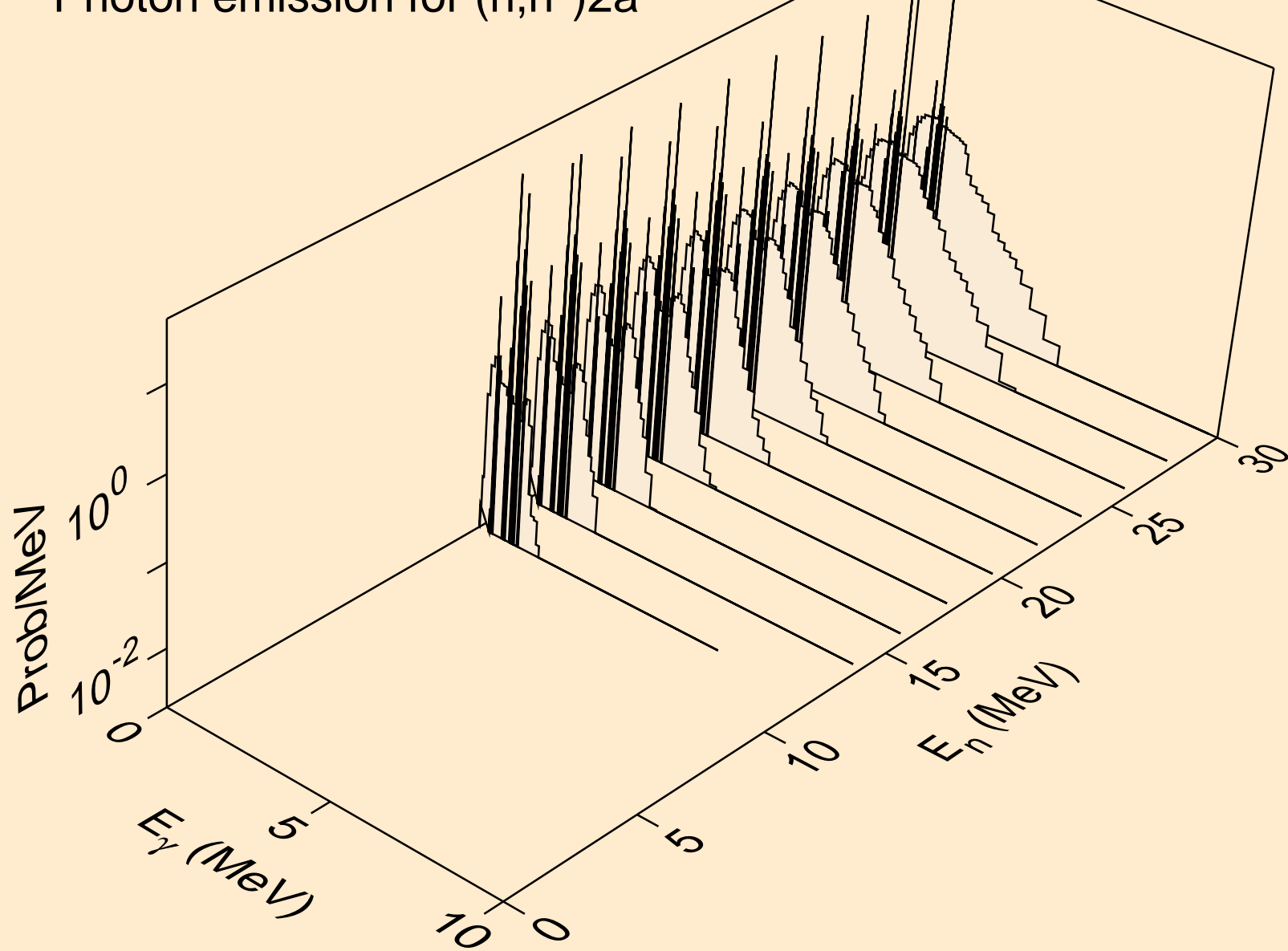

MO093M TRITON ACER TENDL-2021 LIBRARY; T=0.K  
Photon emission for (n,2n)2a

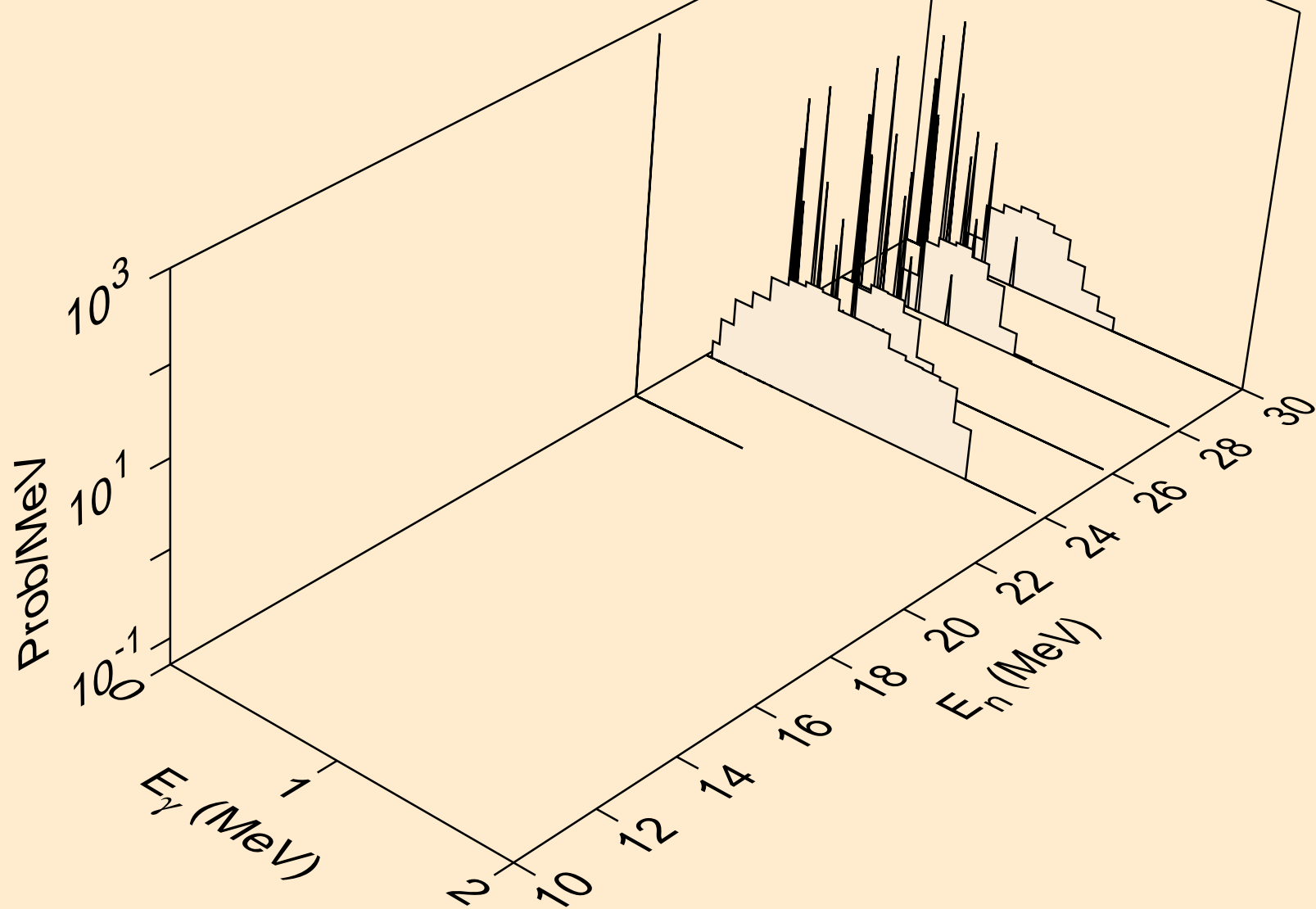



MO093M TRITON ACER TENDL-2021 LIBRARY; T=0.K  
Photon emission for (n,n\*)d

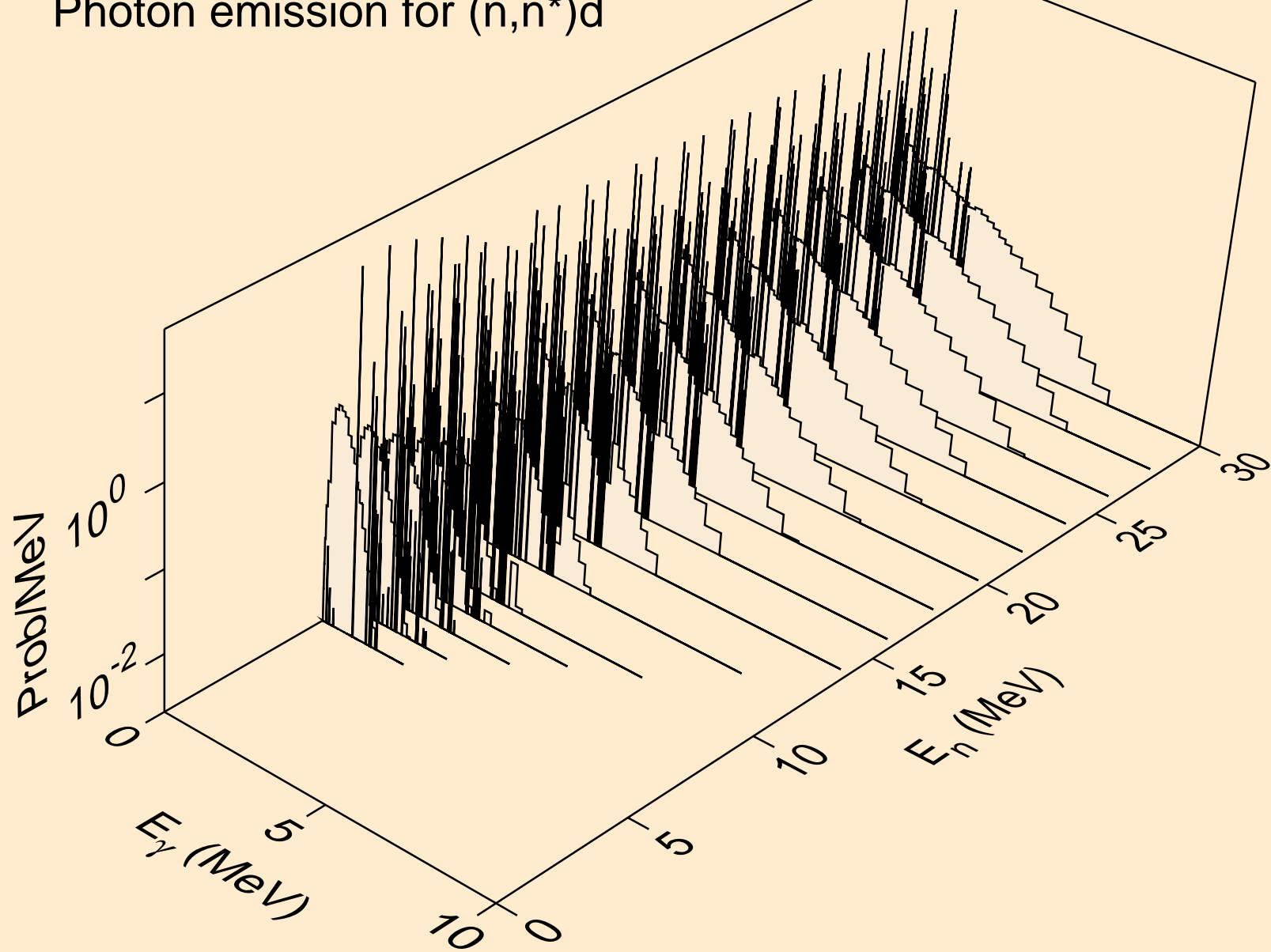

MO093M TRITON ACER TENDL-2021 LIBRARY; T=0.K  
Photon emission for (n,n\*)t

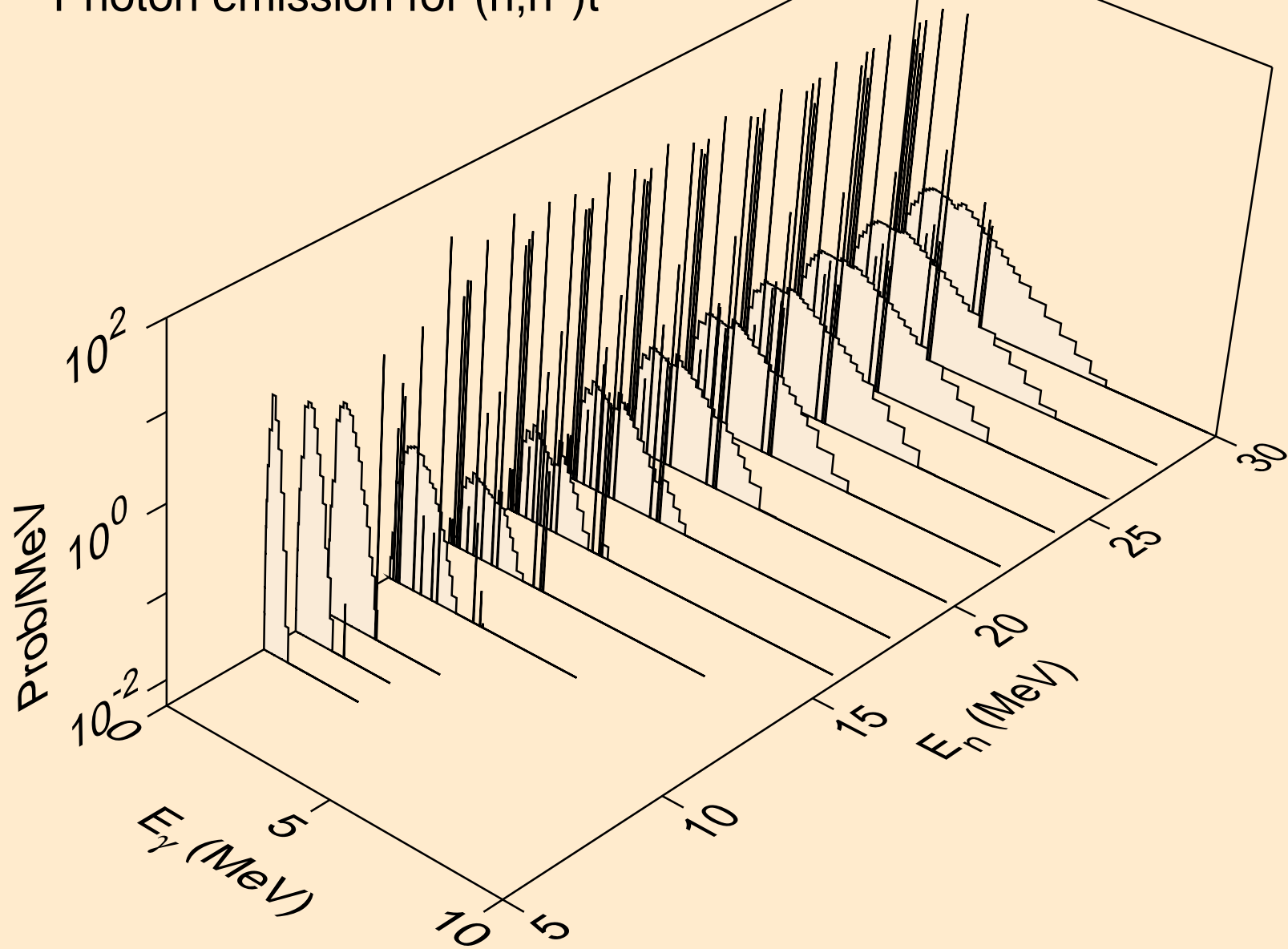

MO093M TRITON ACER TENDL-2021 LIBRARY; T=0.K  
Photon emission for (n,n\*)he3

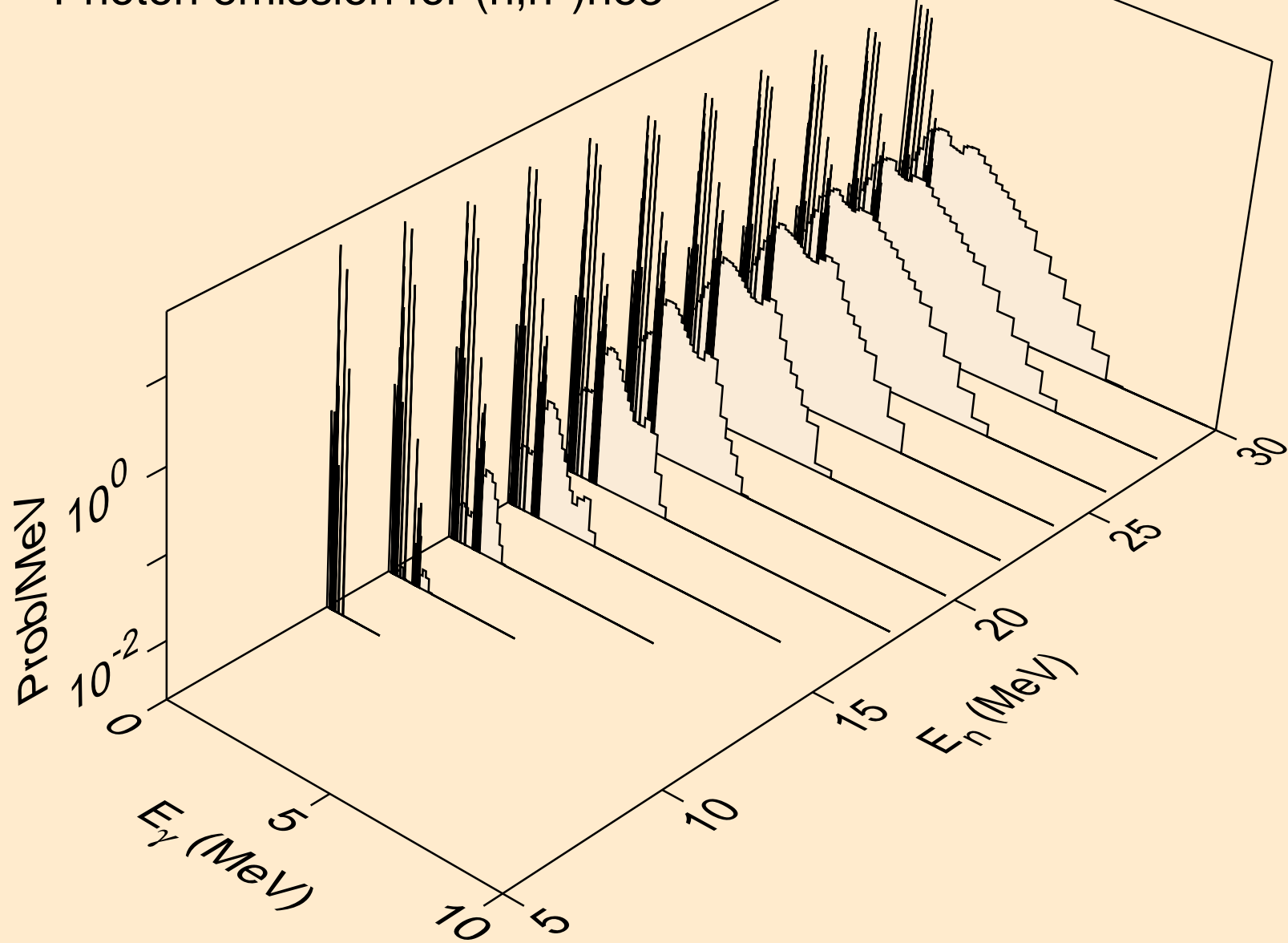

MO093M TRITON ACER TENDL-2021 LIBRARY; T=0.K  
Photon emission for (n,4n)

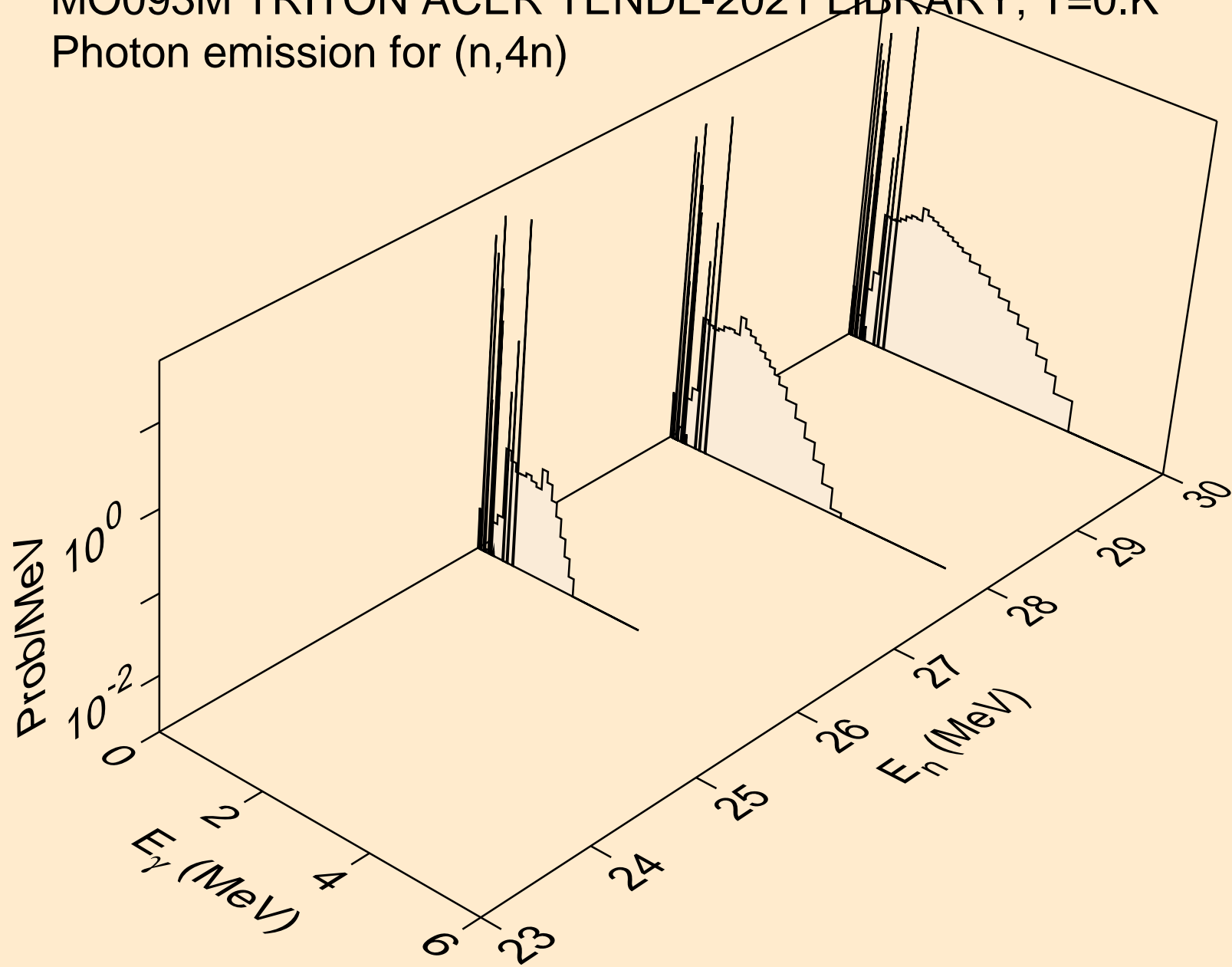

MO093M TRITON ACER TENDL-2021 LIBRARY; T=0.K  
Photon emission for (n,2np)

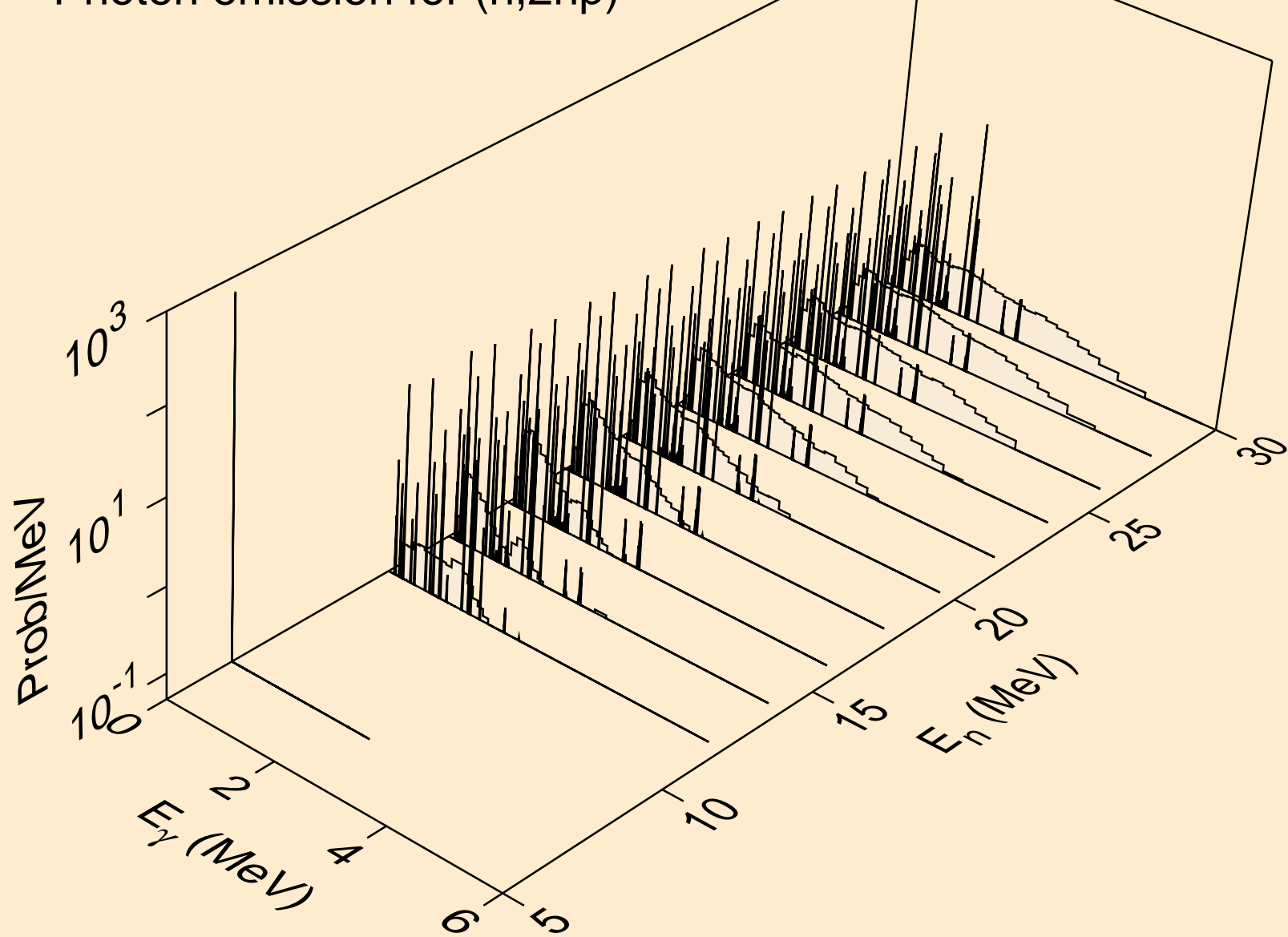

MO093M TRITON ACER TENDL-2021 LIBRARY; T=0.K  
Photon emission for (n,3np)

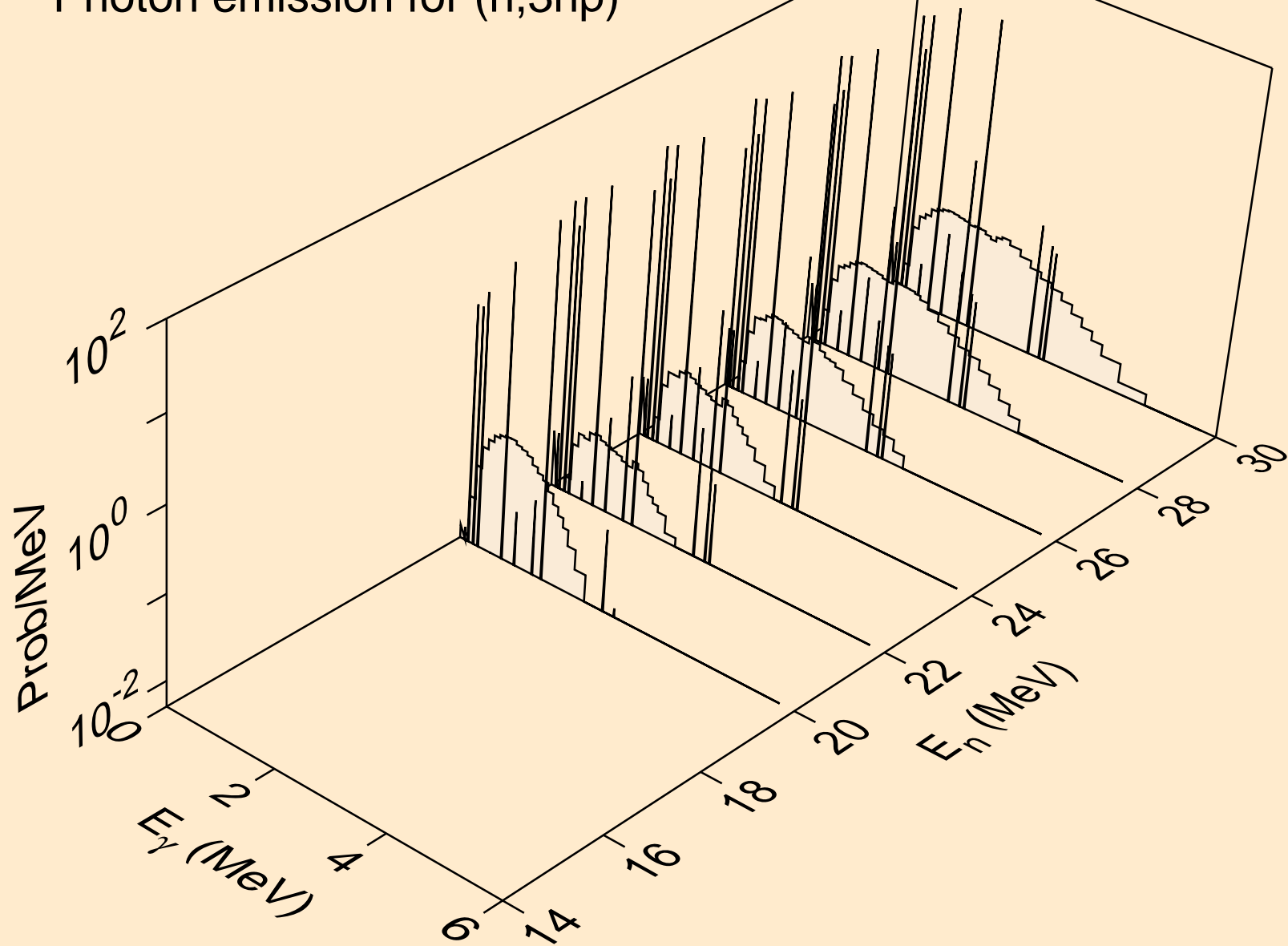

MO093M TRITON ACER TENDL-2021 LIBRARY; T=0.K  
Photon emission for (n,2np)

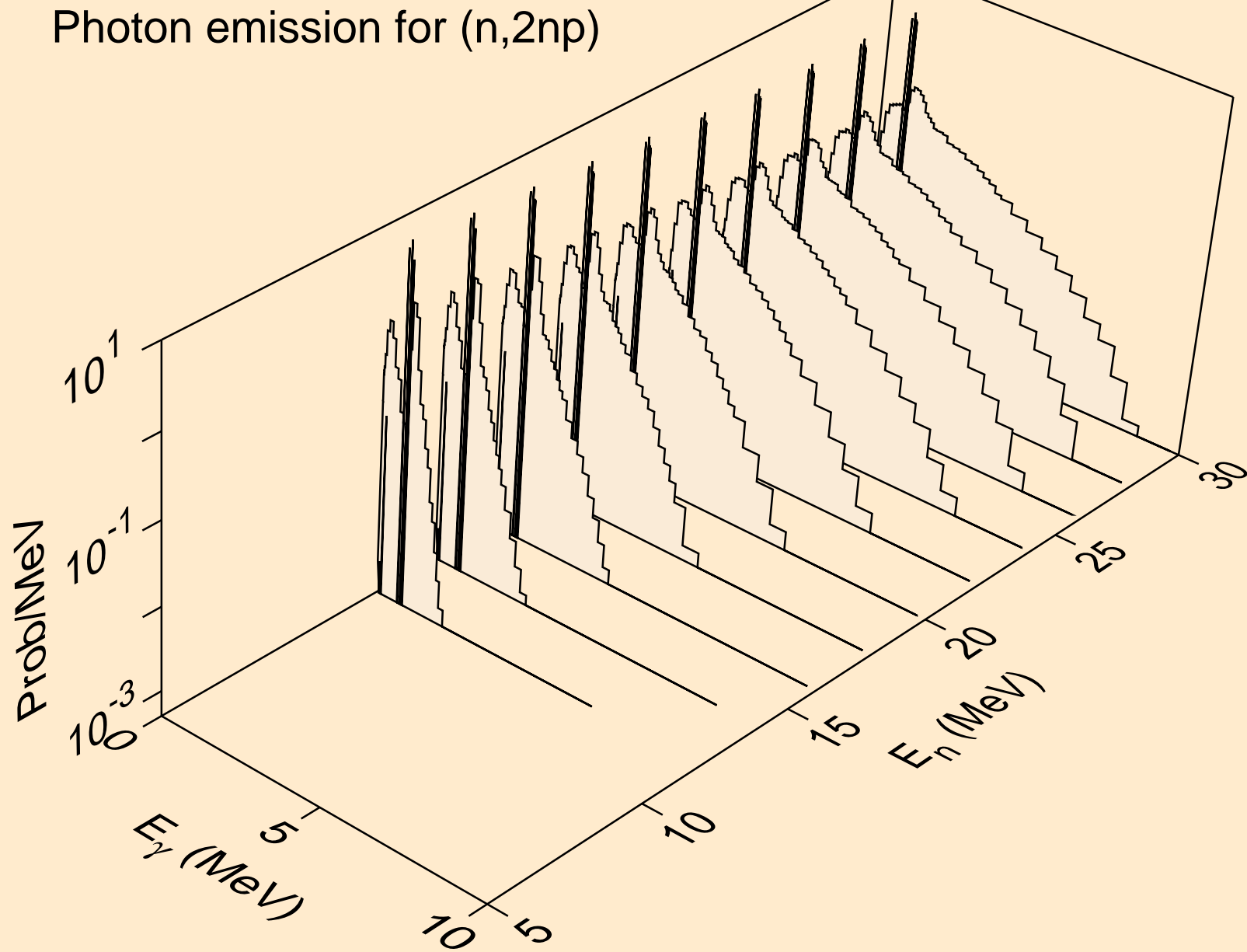

MO093M TRITON ACER TENDL-2021 LIBRARY; T=0.K  
Photon emission for (n,npa)

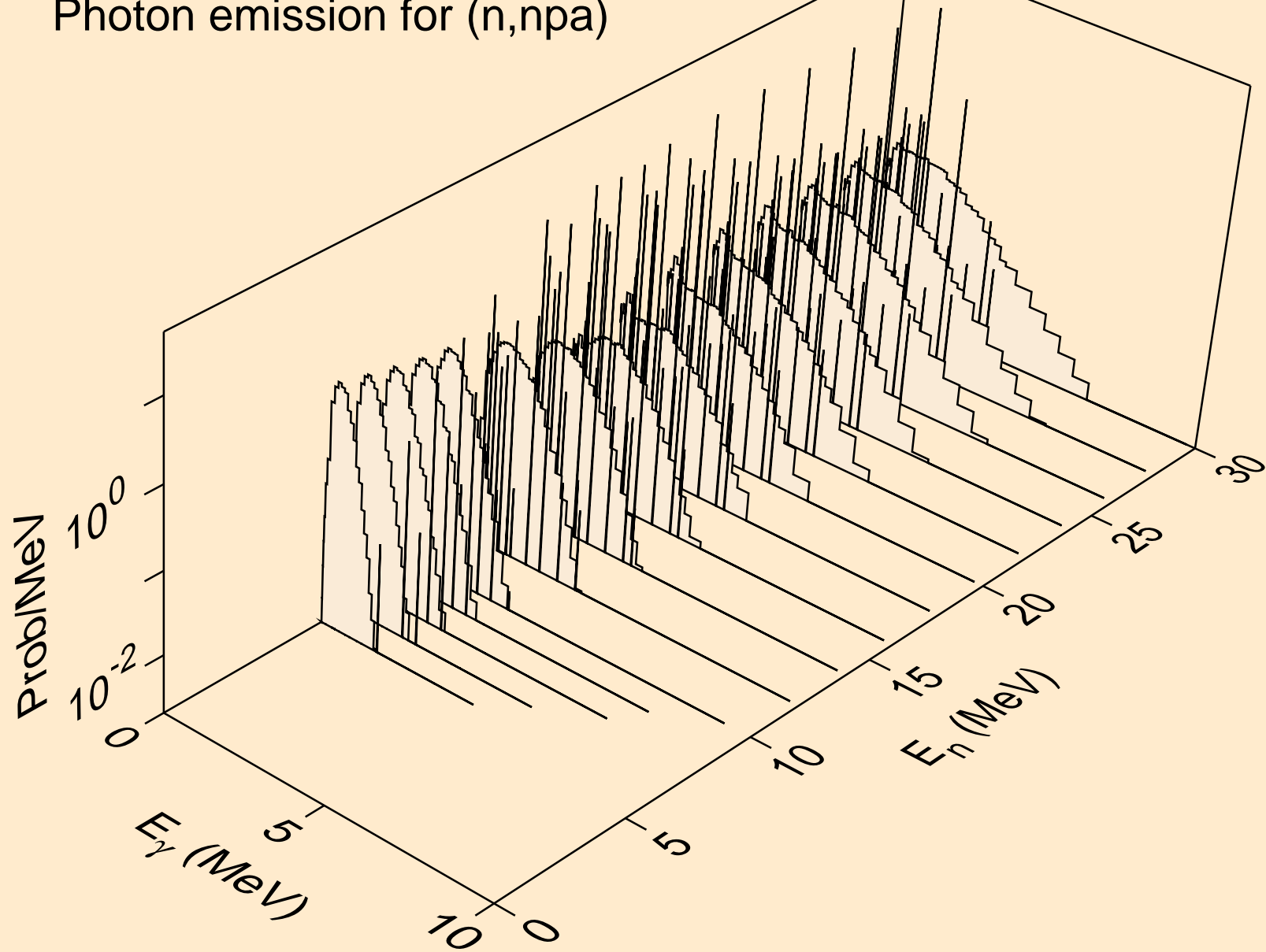



MO093M TRITON ACER TENDL-2021 LIBRARY; T=0.K  
Photon emission for (n,gma)

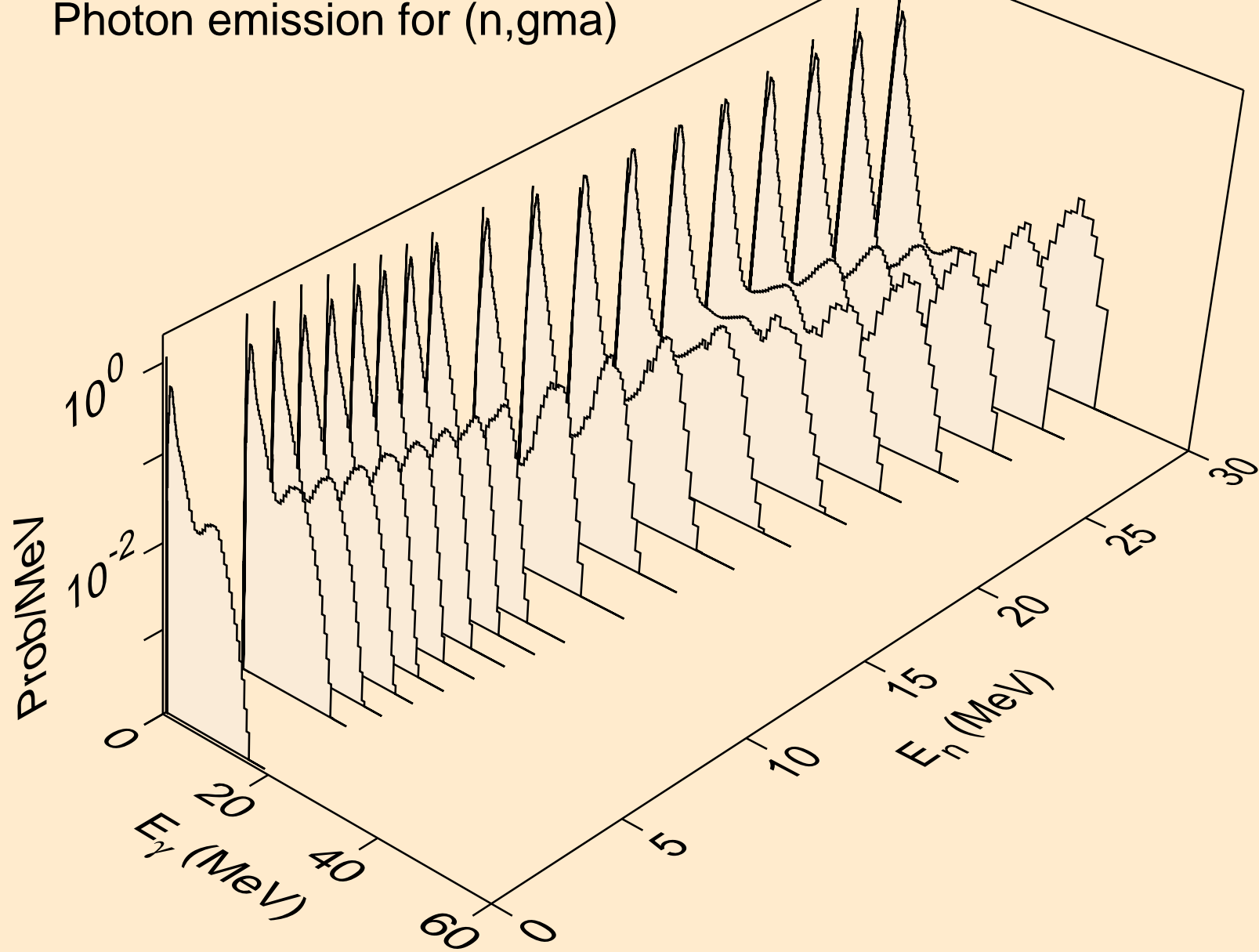

MO093M TRITON ACER TENDL-2021 LIBRARY; T=0.K  
Photon emission for (n,p)

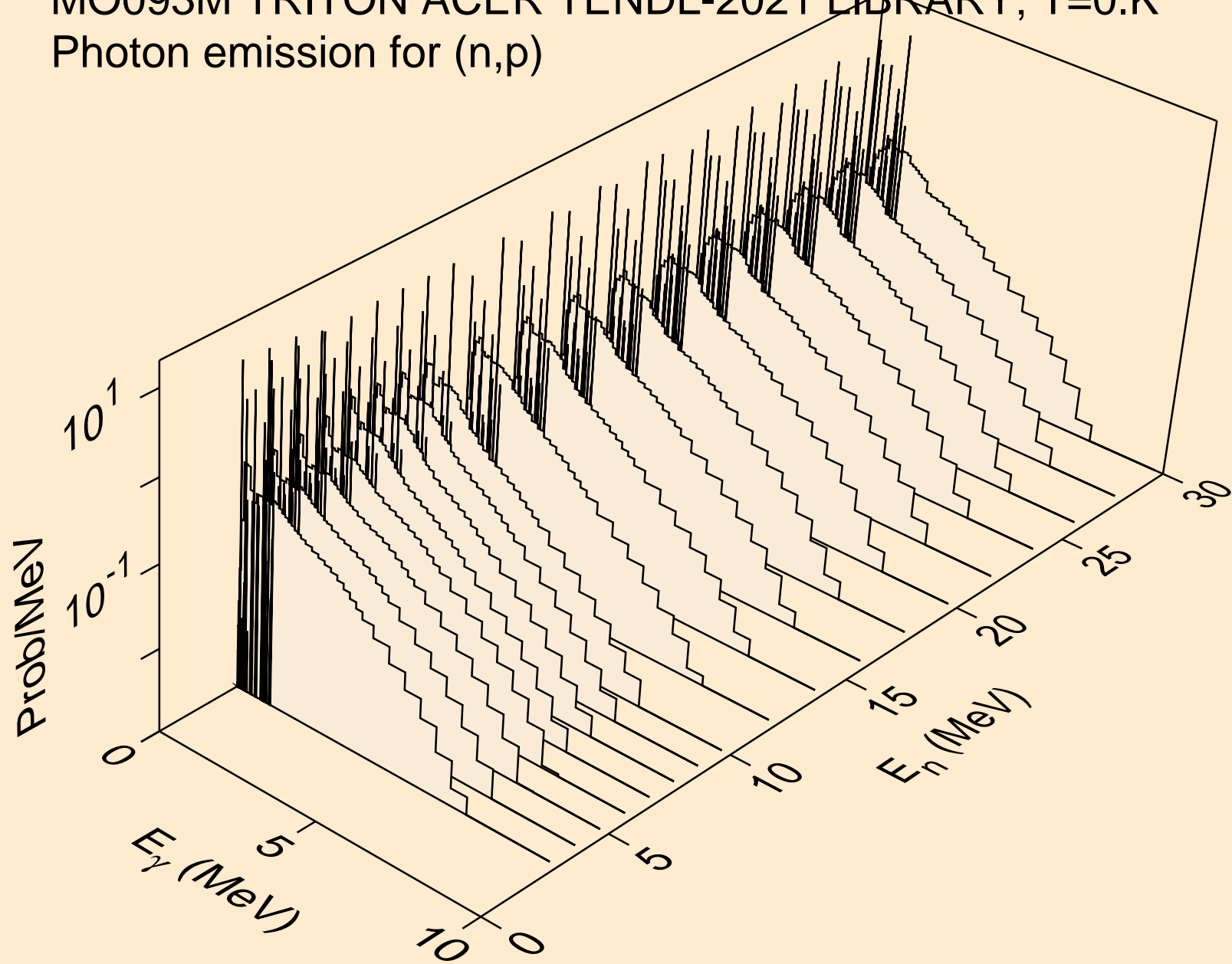

MO093M TRITON ACER TENDL-2021 LIBRARY; T=0.K  
Photon emission for (n,d)

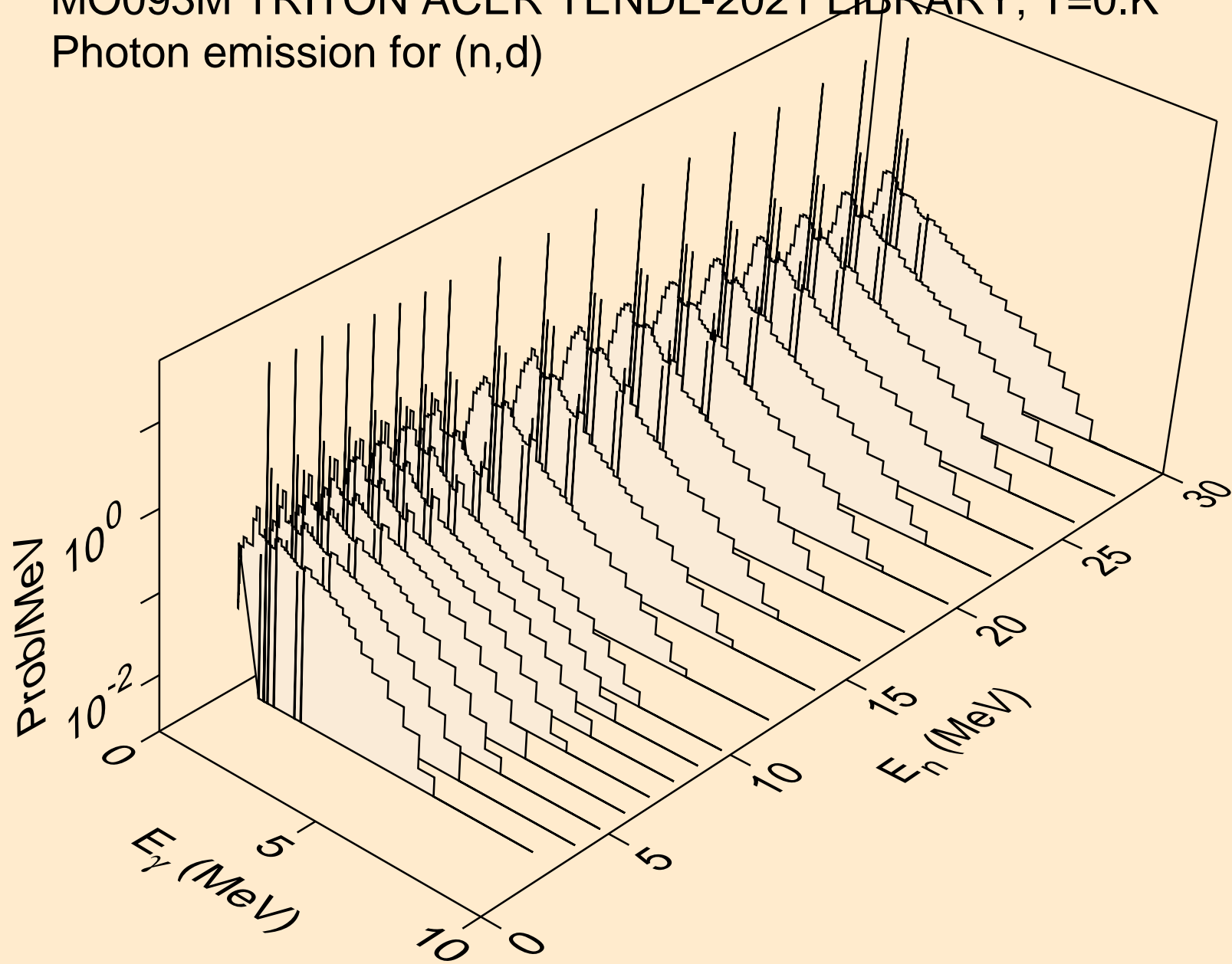

MO093M TRITON ACER TENDL-2021 LIBRARY; T=0.K  
Photon emission for inelastic

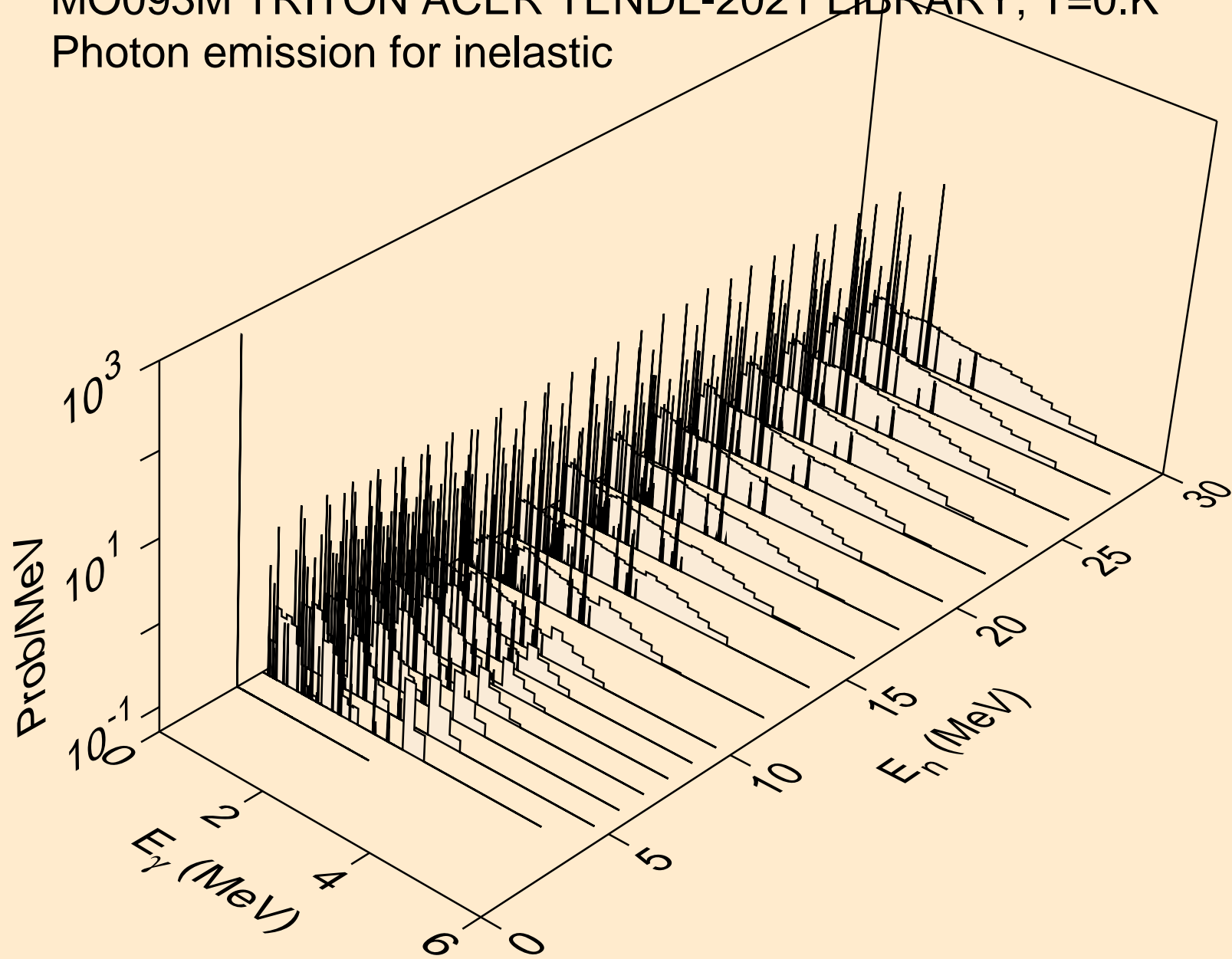

MO093M TRITON ACER TENDL-2021 LIBRARY; T=0.K  
Photon emission for (n,he3)

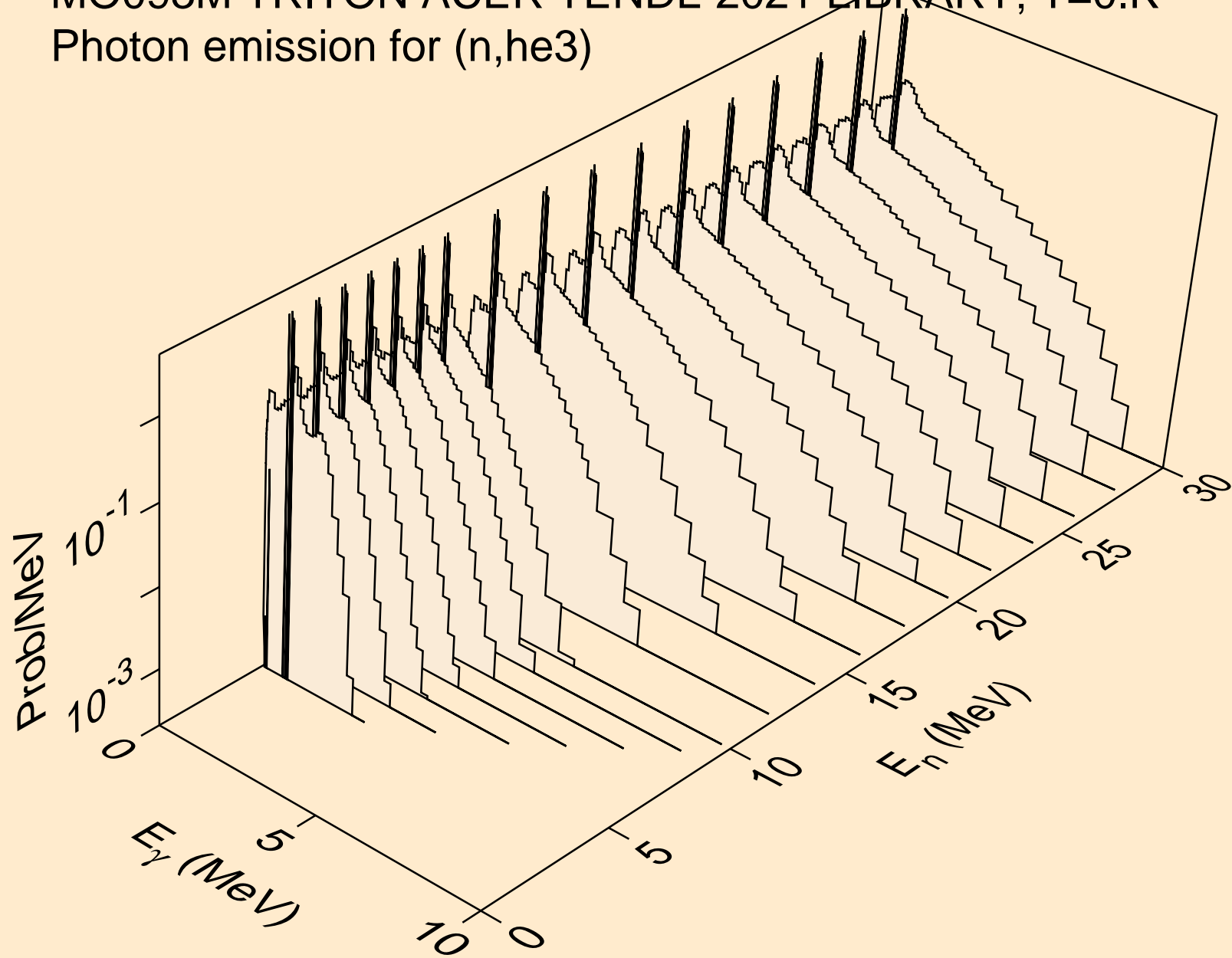

MO093M TRITON ACER TENDL-2021 LIBRARY; T=0.K  
Photon emission for (n,a)

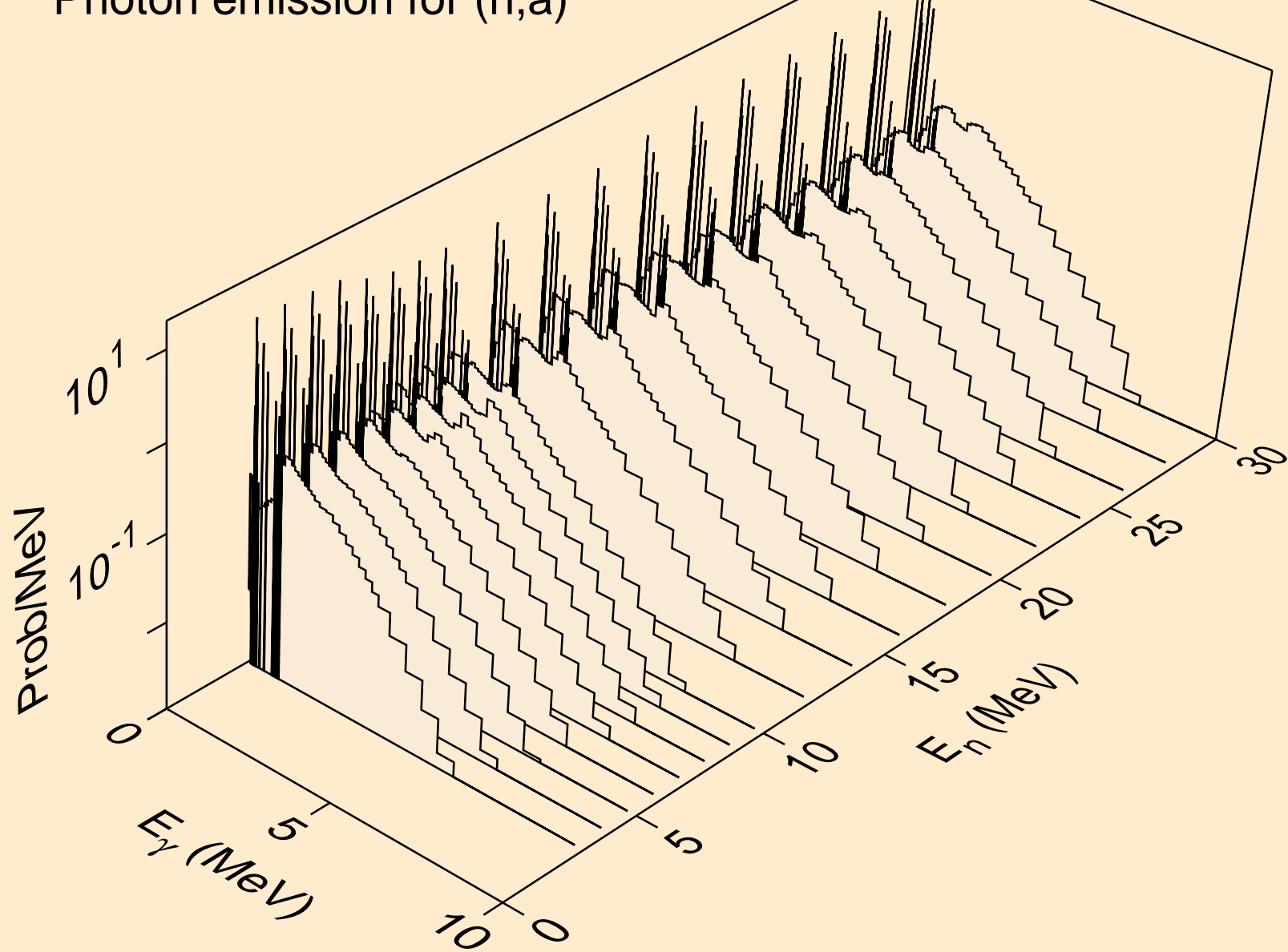

MO093M TRITON ACER TENDL-2021 LIBRARY; T=0.K  
Photon emission for (n,2a)

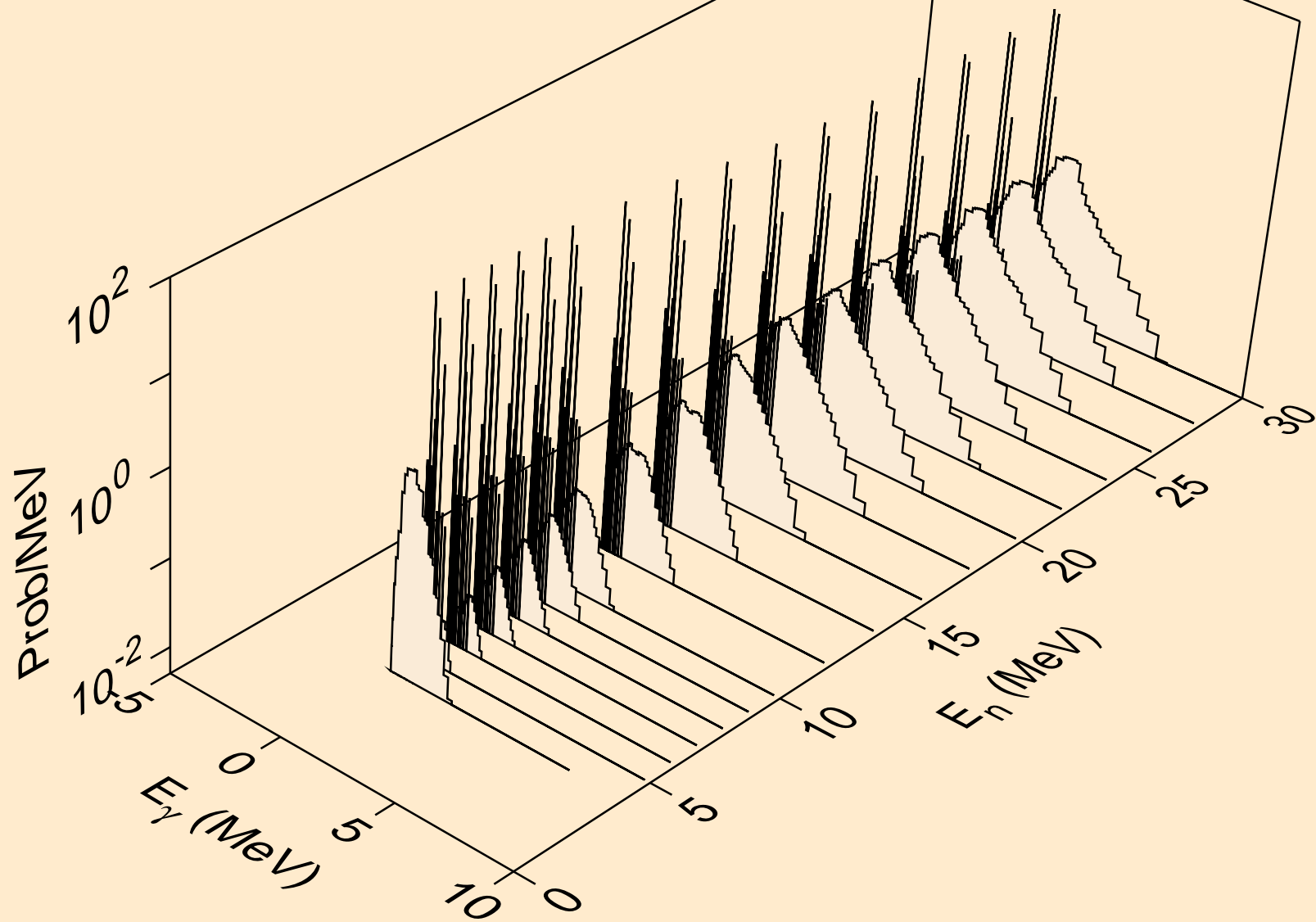

MO093M TRITON ACER TENDL-2021 LIBRARY; T=0.K  
Photon emission for (n,3a)

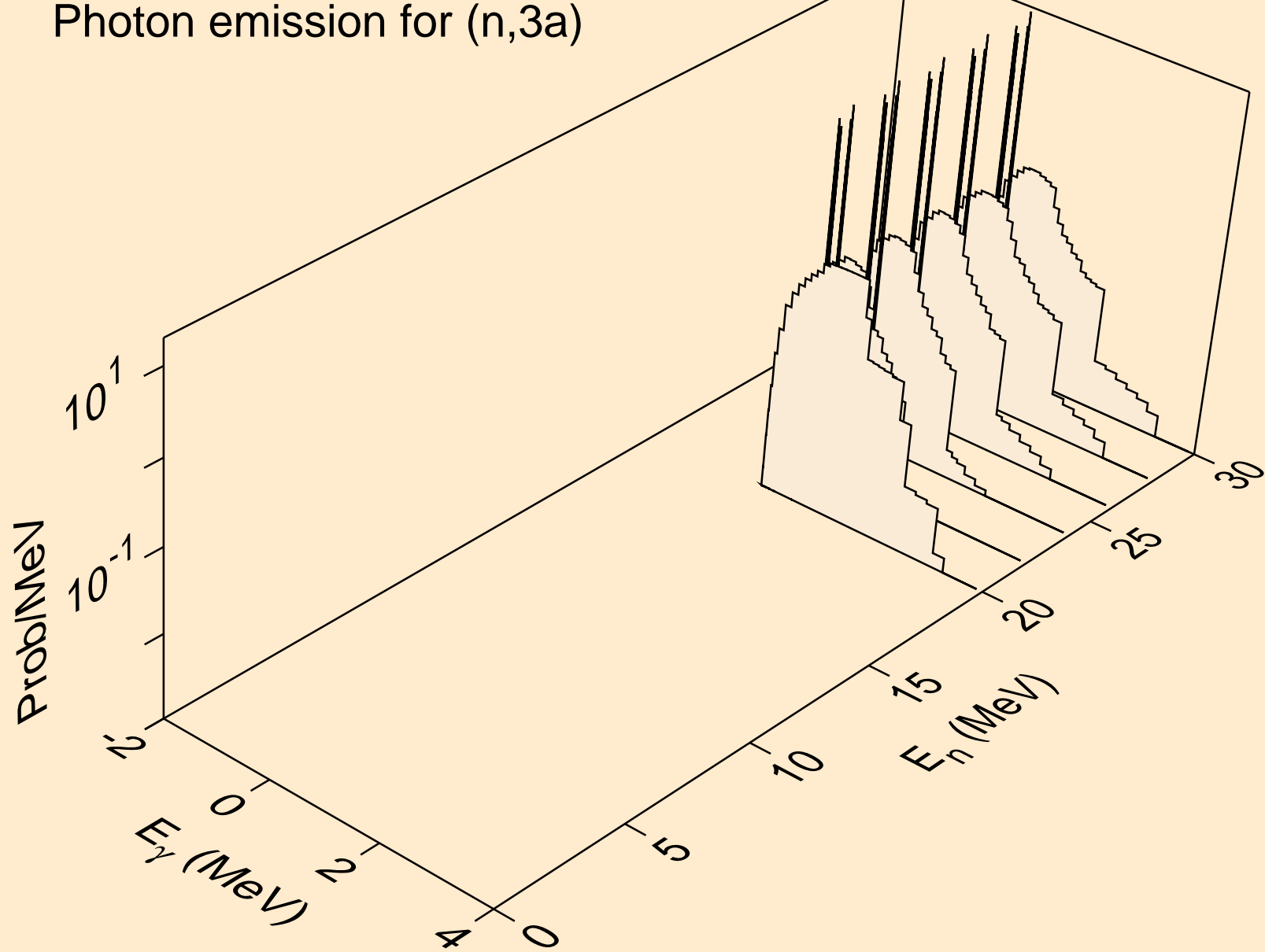



MO093M TRITON ACER TENDL-2021 LIBRARY; T=0.K  
Photon emission for (n,2p)

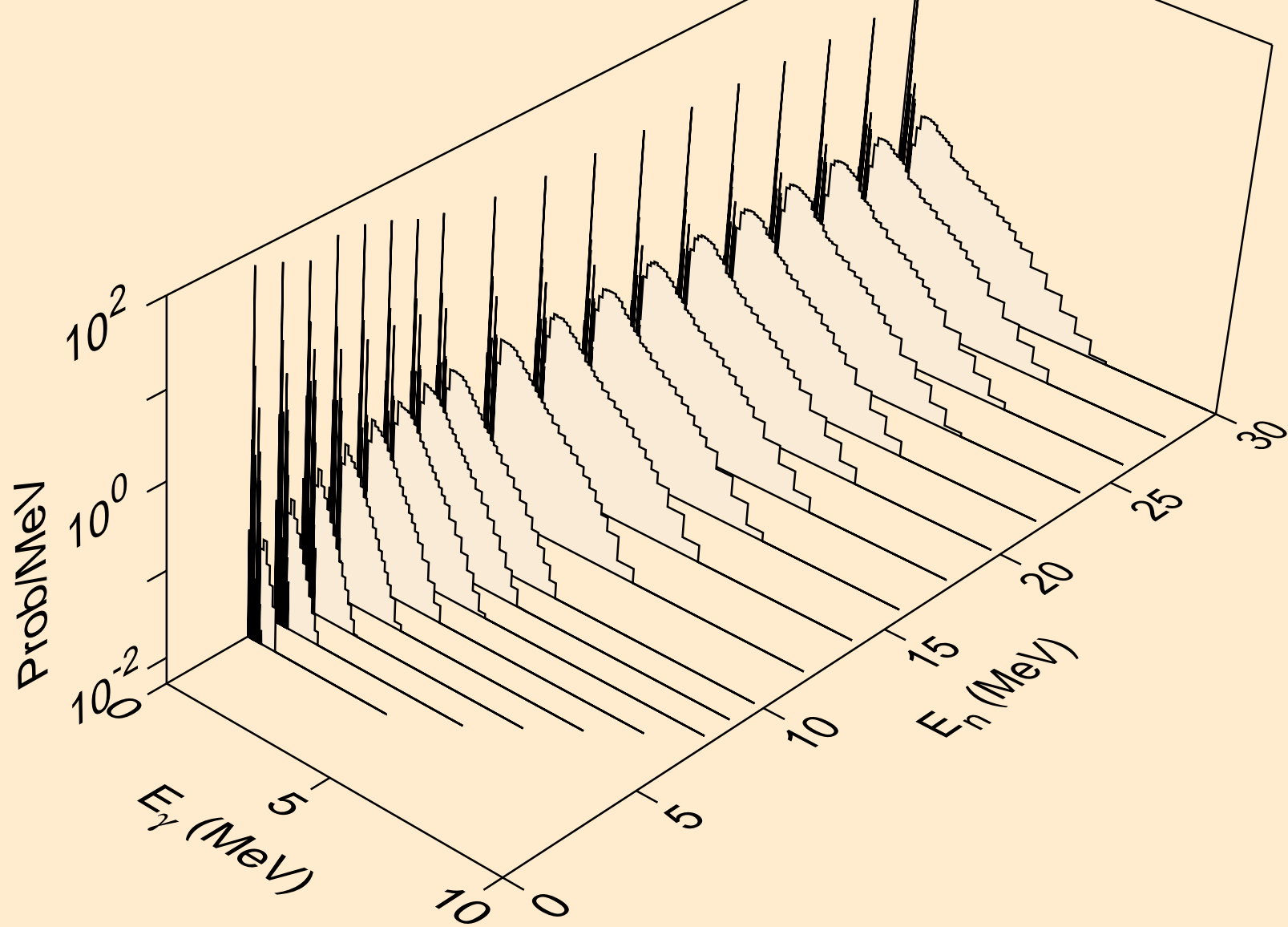

MO093M TRITON ACER TENDL-2021 LIBRARY; T=0.K  
Photon emission for (n,pa)

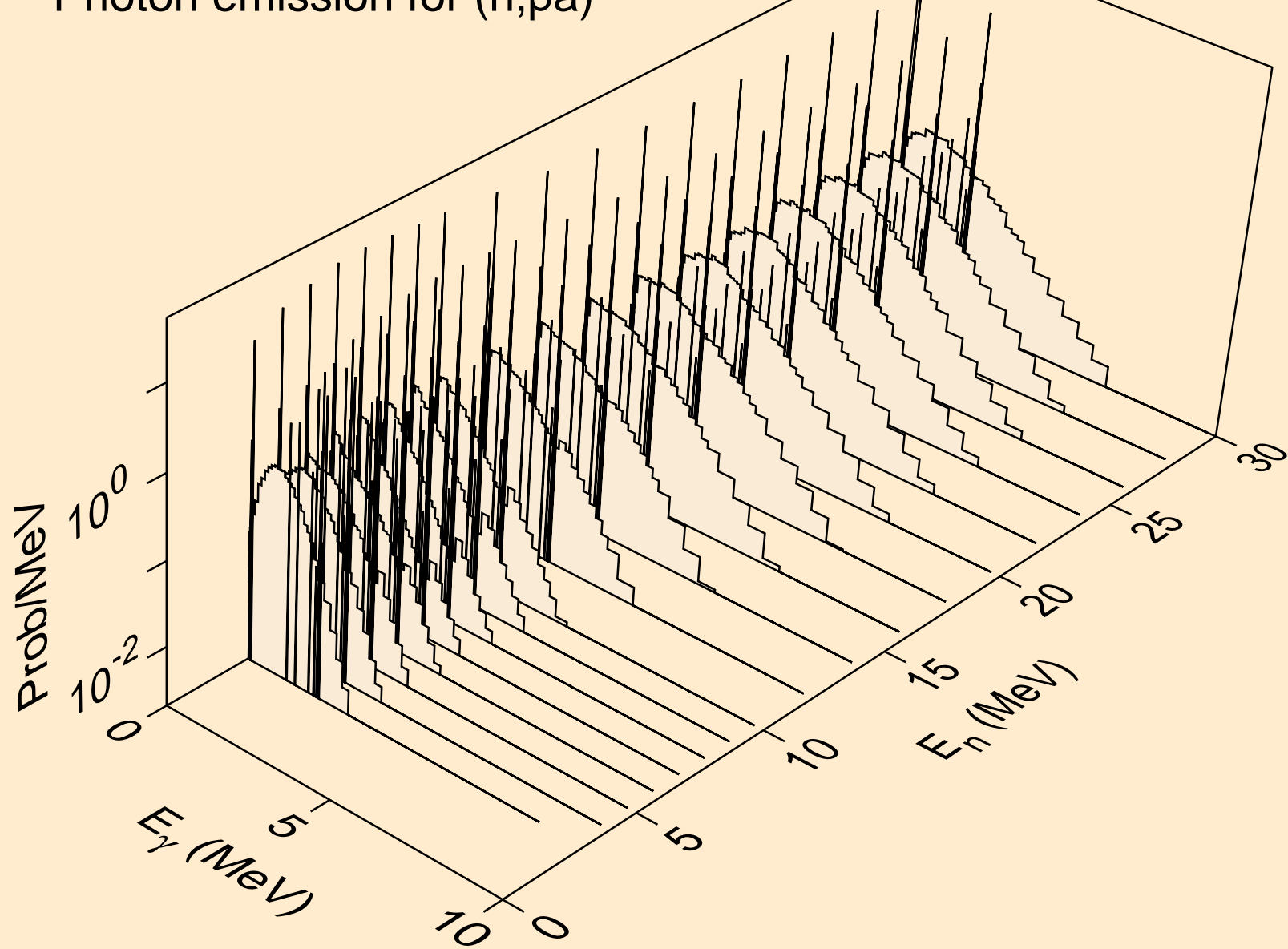

MO093M TRITON ACER TENDL-2021 LIBRARY; T=0.K  
Photon emission for (n,pd)

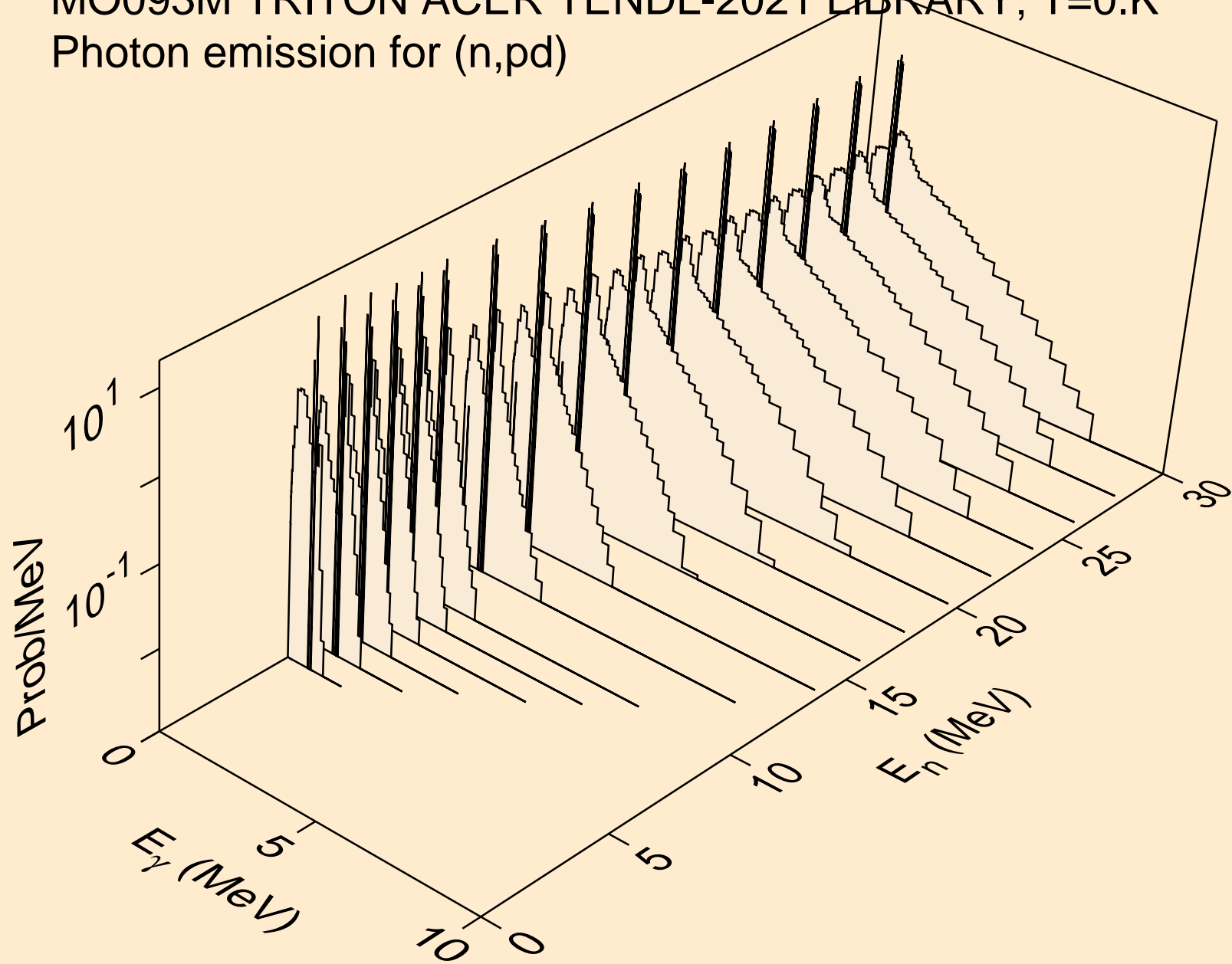

MO093M TRITON ACER TENDL-2021 LIBRARY; T=0.K  
Photon emission for (n,pt)

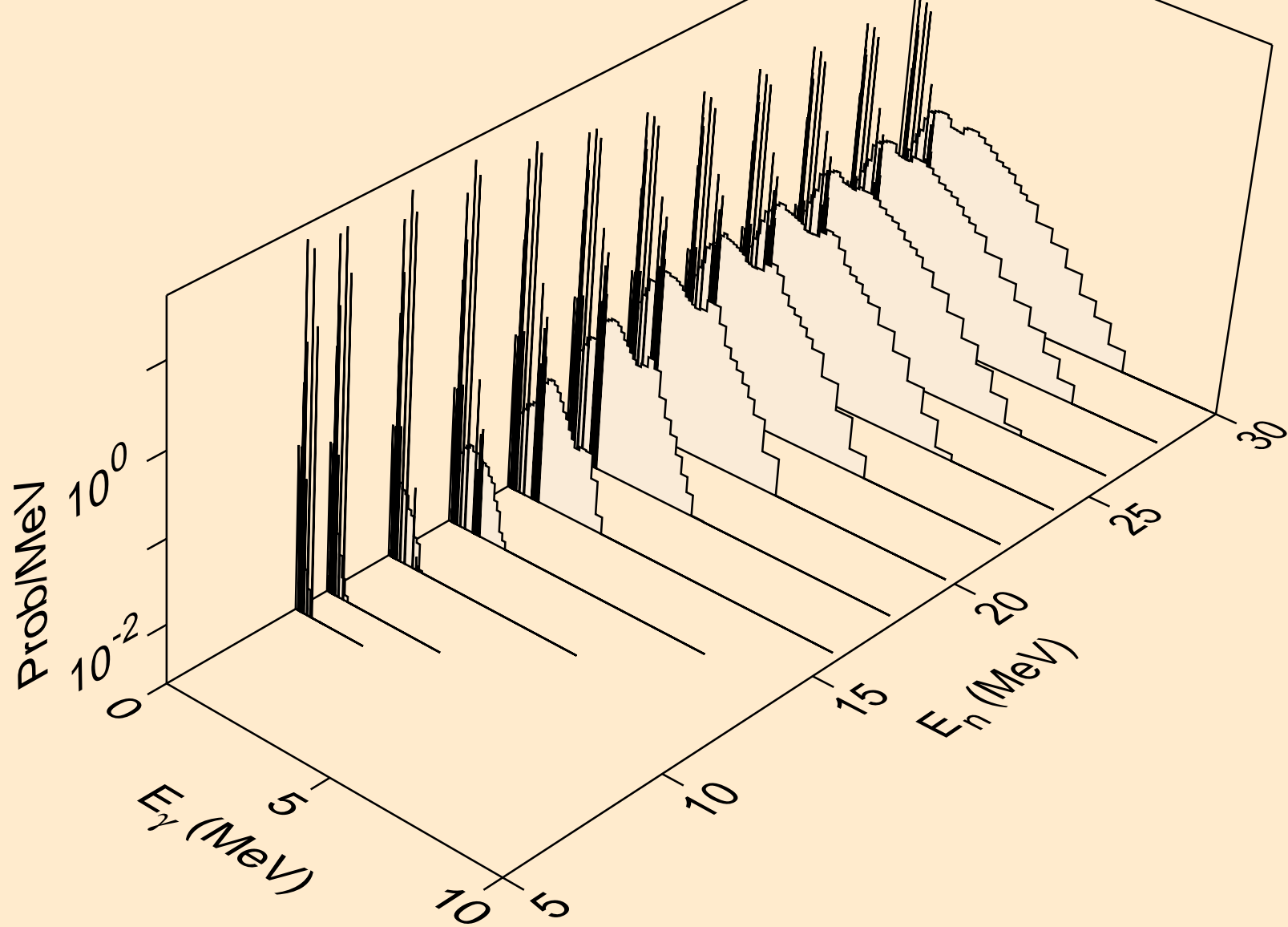

MO093M TRITON ACER TENDL-2021 LIBRARY; T=0.K  
Photon emission for (n,da)

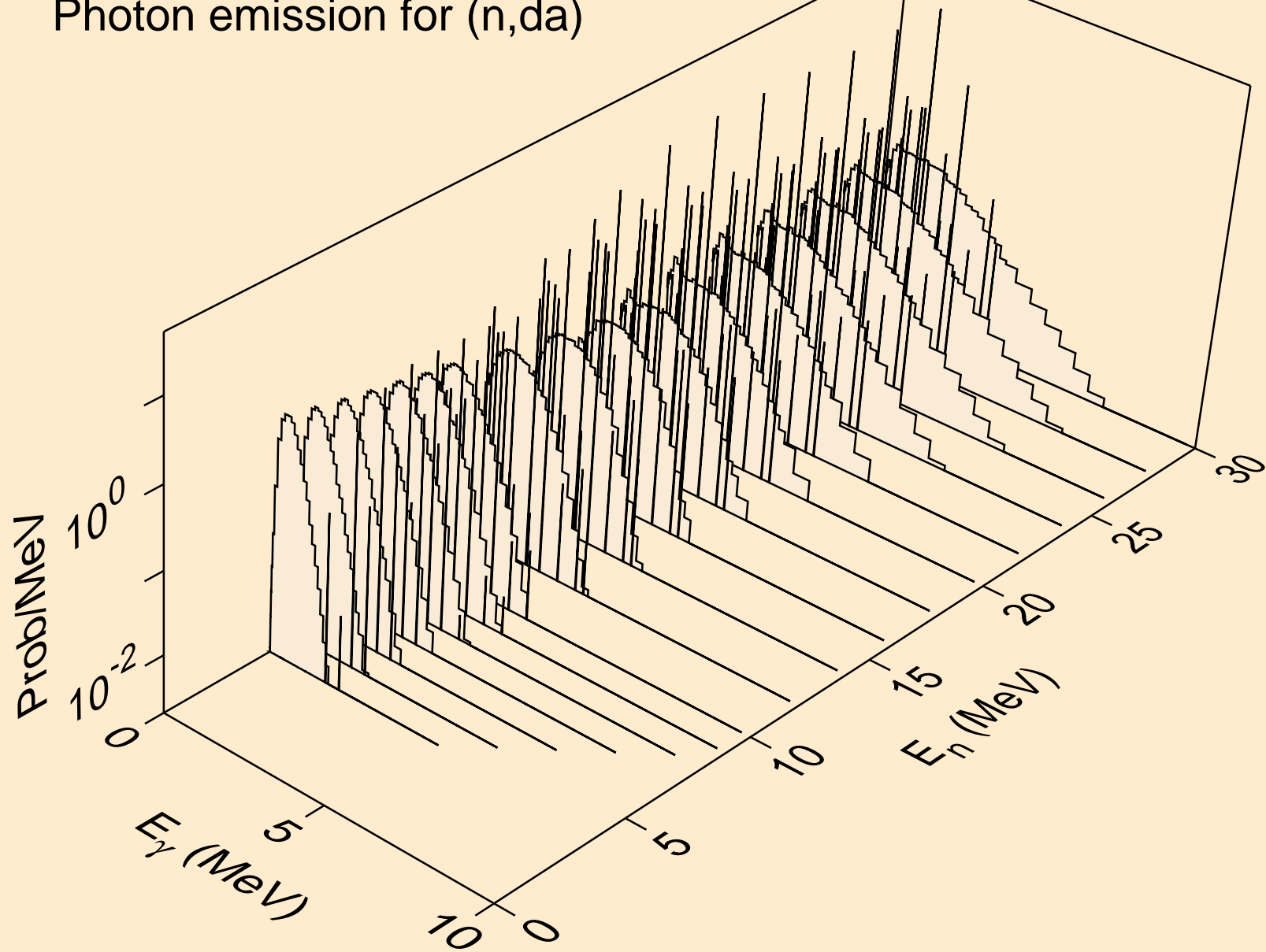

MO093M TRITON ACER TENDL-2021 LIBRARY; T=0.K  
Particle heating contributions

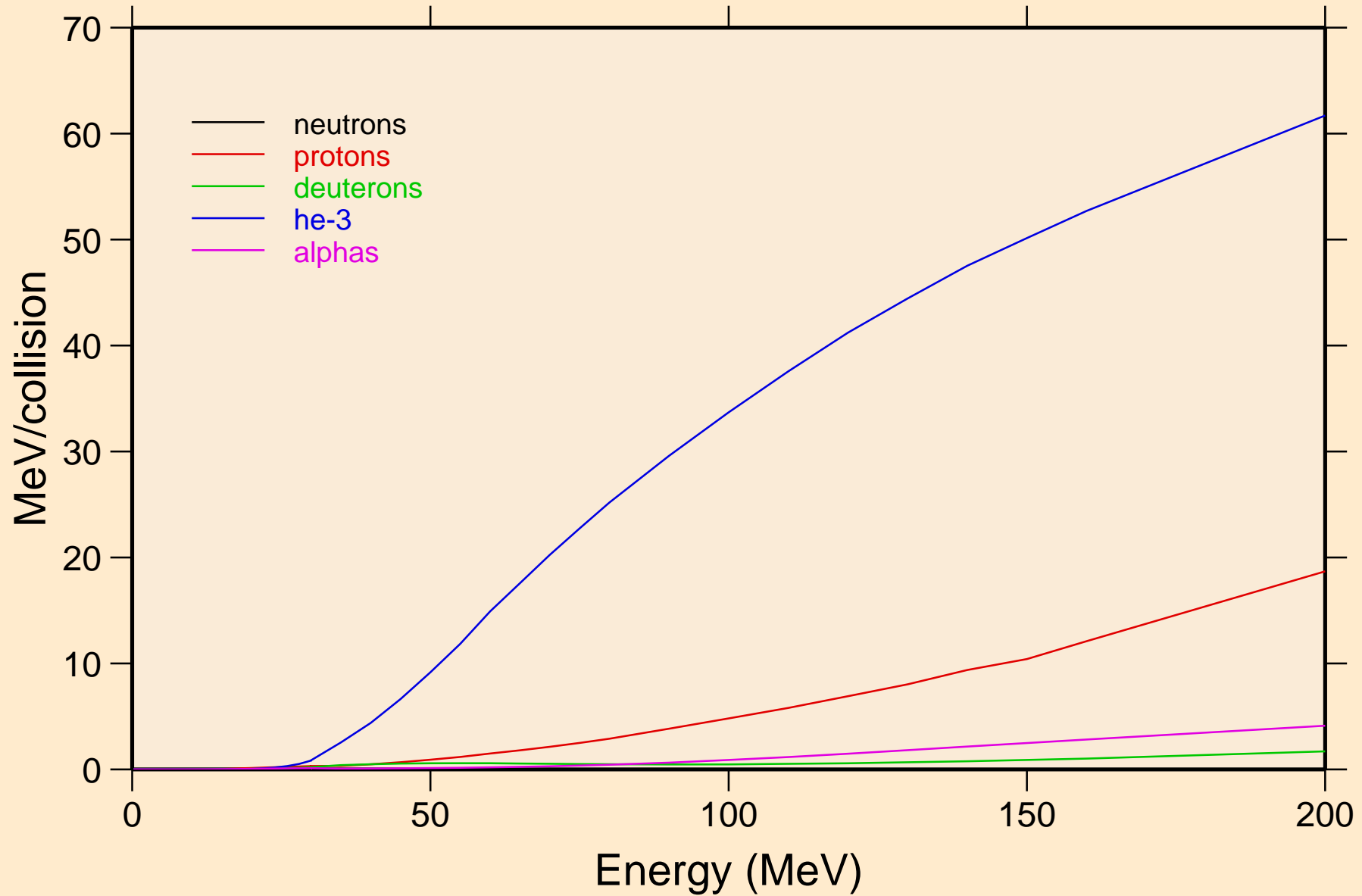

MO093M TRITON ACER TENDL-2021 LIBRARY; T=0.K

Recoil Heating

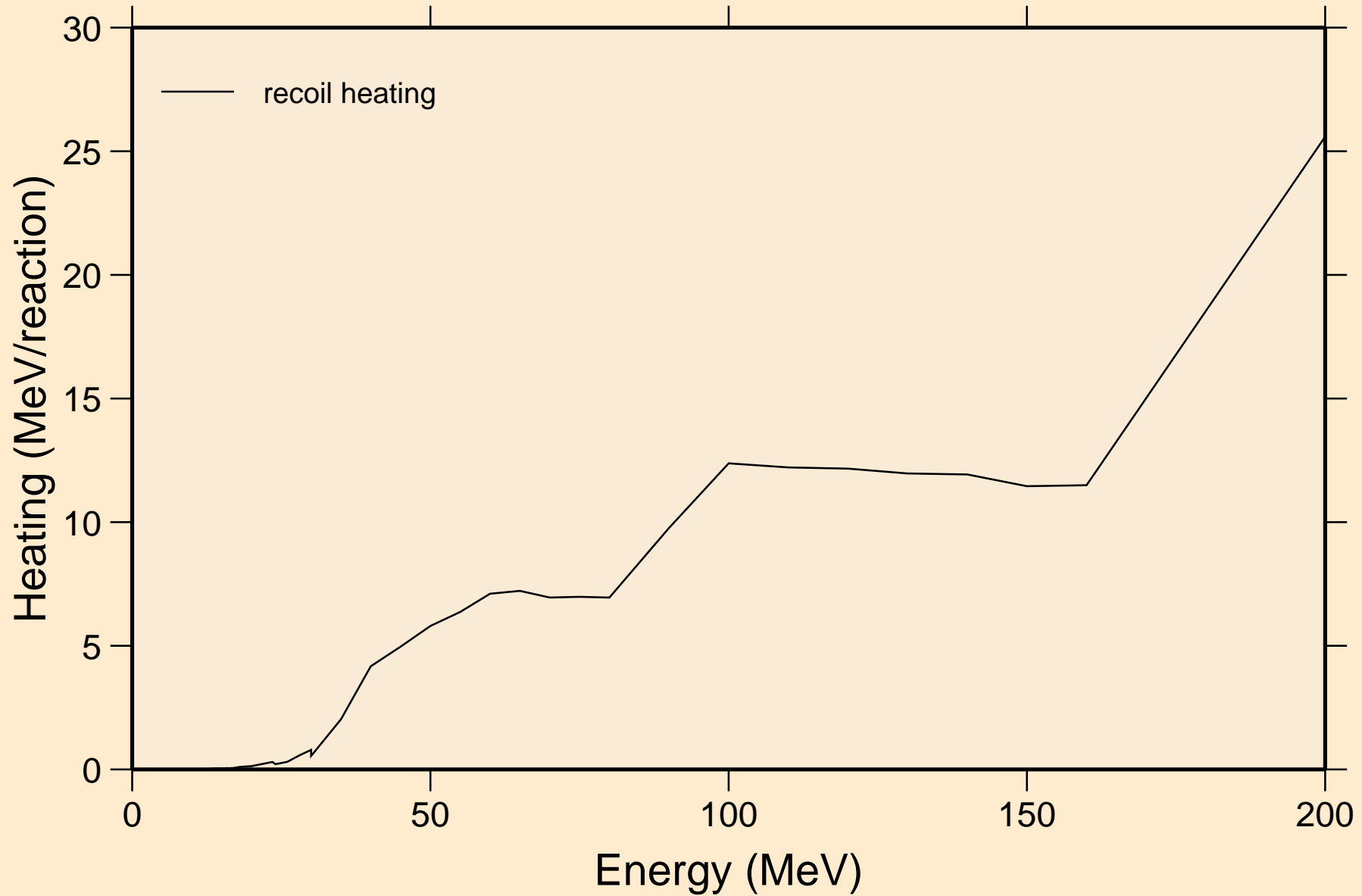

MO093M TRITON ACER TENDL-2021 LIBRARY; T=0.K  
Particle production cross sections

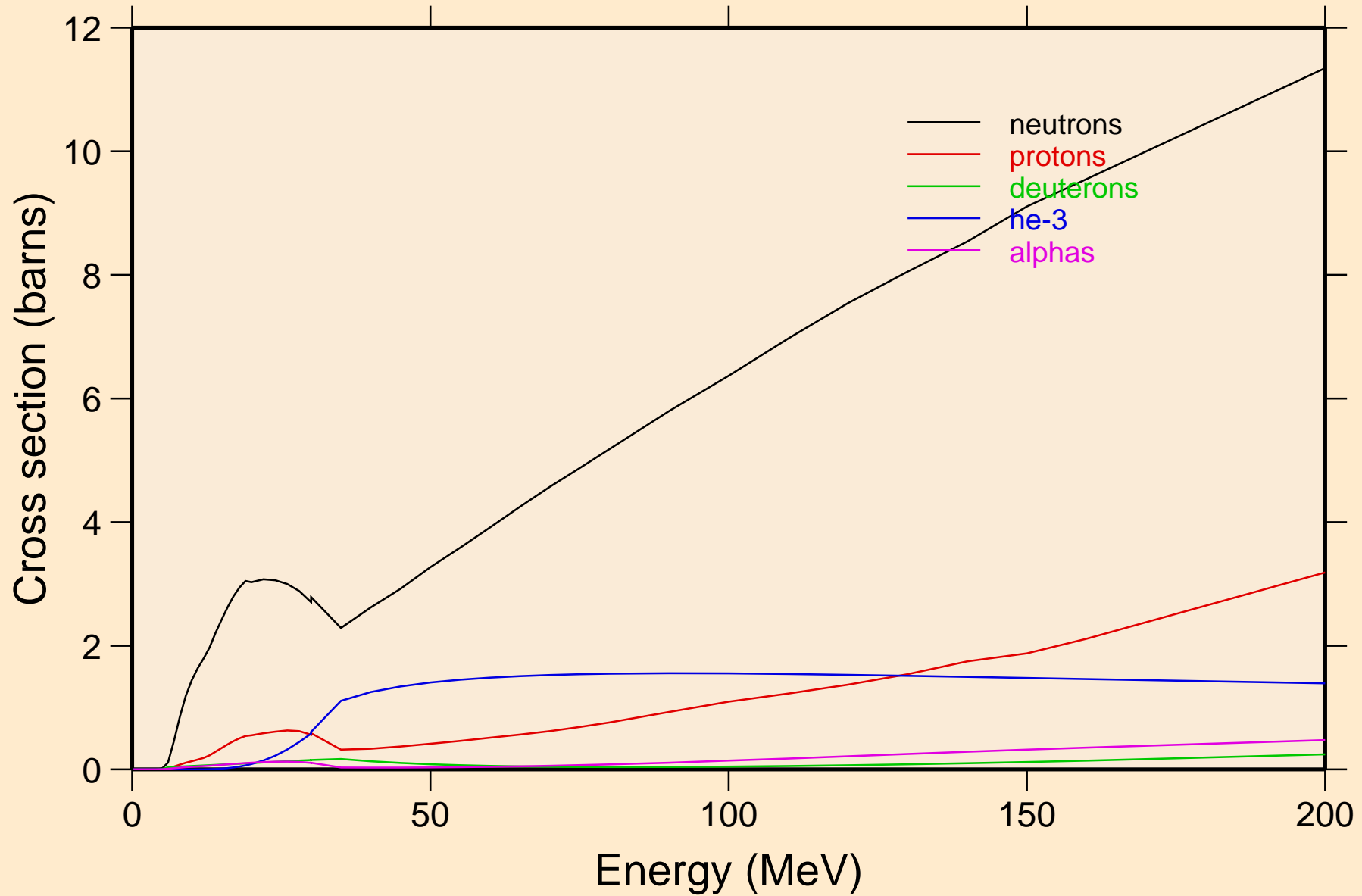



MO093M TRITON ACER TENDL-2021 LIBRARY; T=0.K  
neutrons from (t,n)

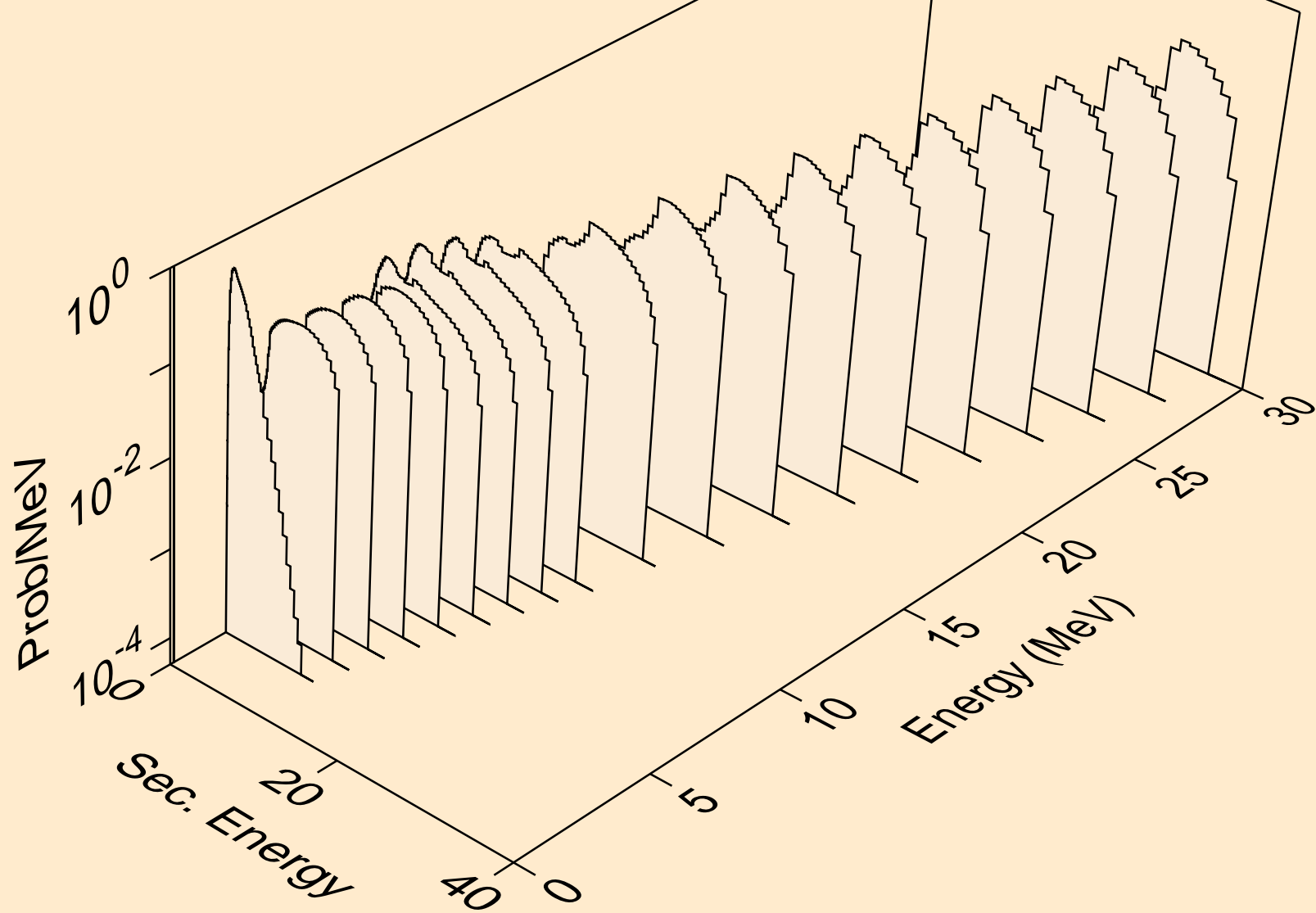

MO093M TRITON ACER TENDL-2021 LIBRARY; T=0.K  
neutrons from (t,x)

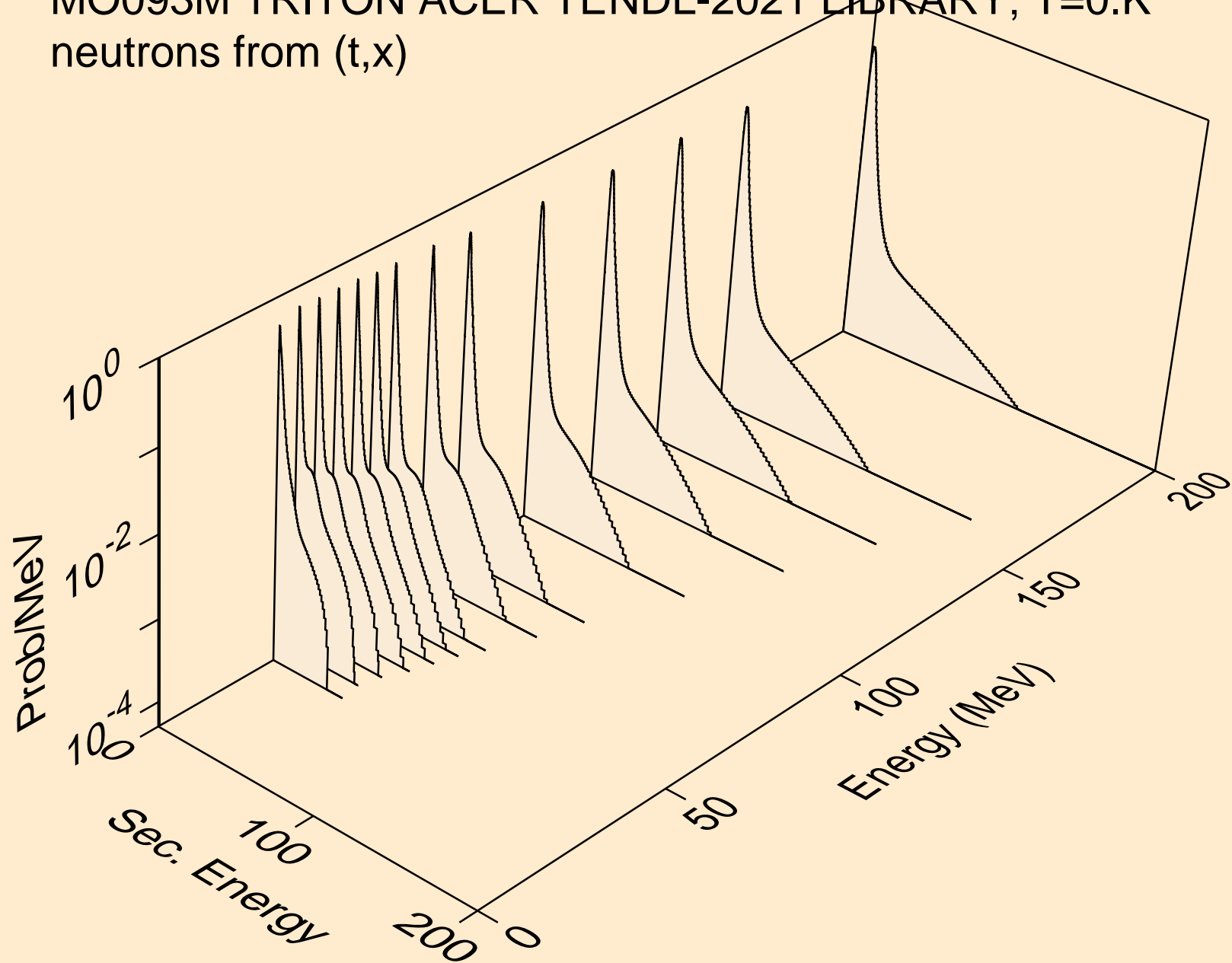

MO093M TRITON ACER TENDL-2021 LIBRARY; T=0.K  
neutrons from (t,2nd)

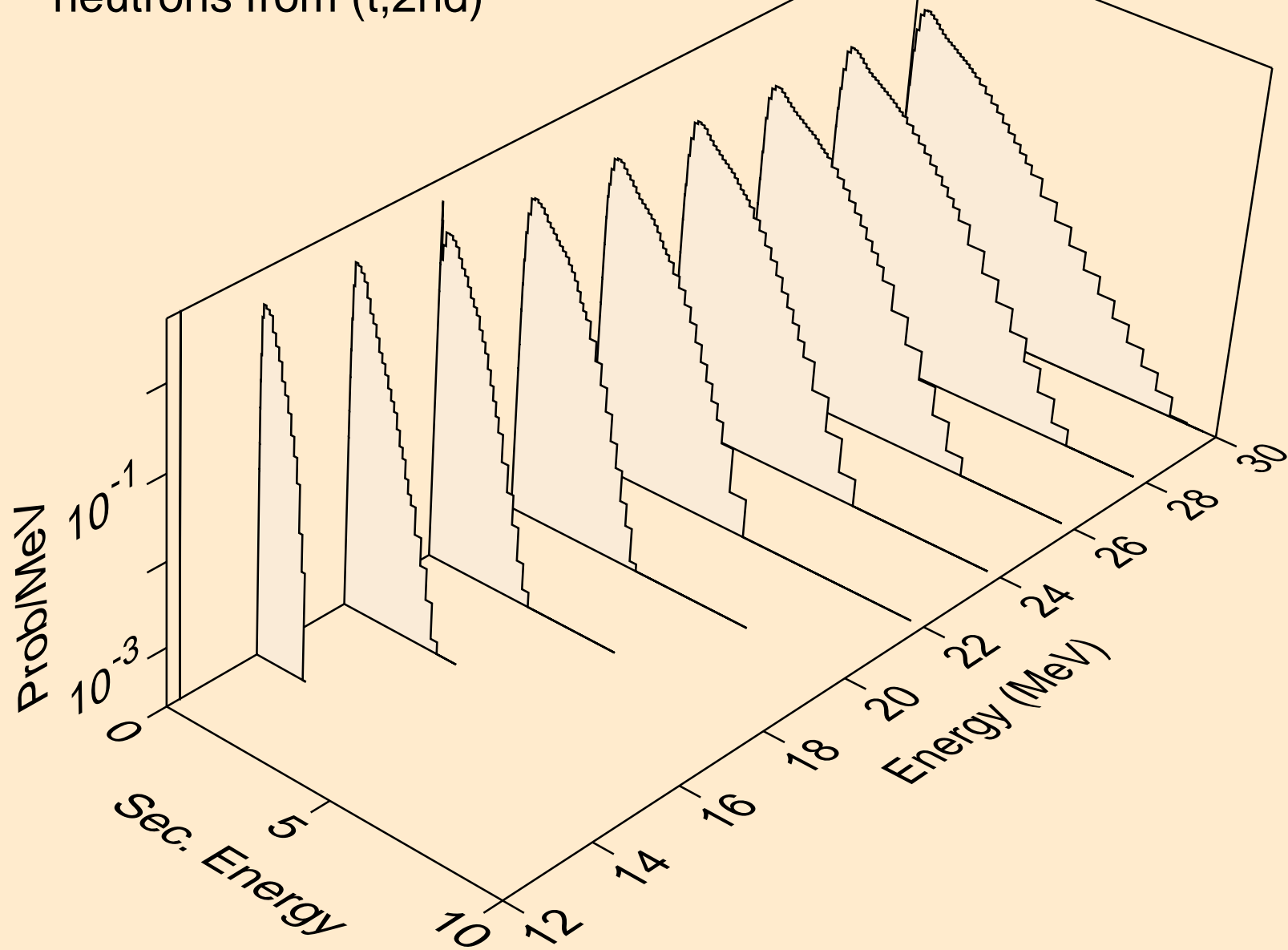

MO093M TRITON ACER TENDL-2021 LIBRARY; T=0.K  
neutrons from (t,2n)

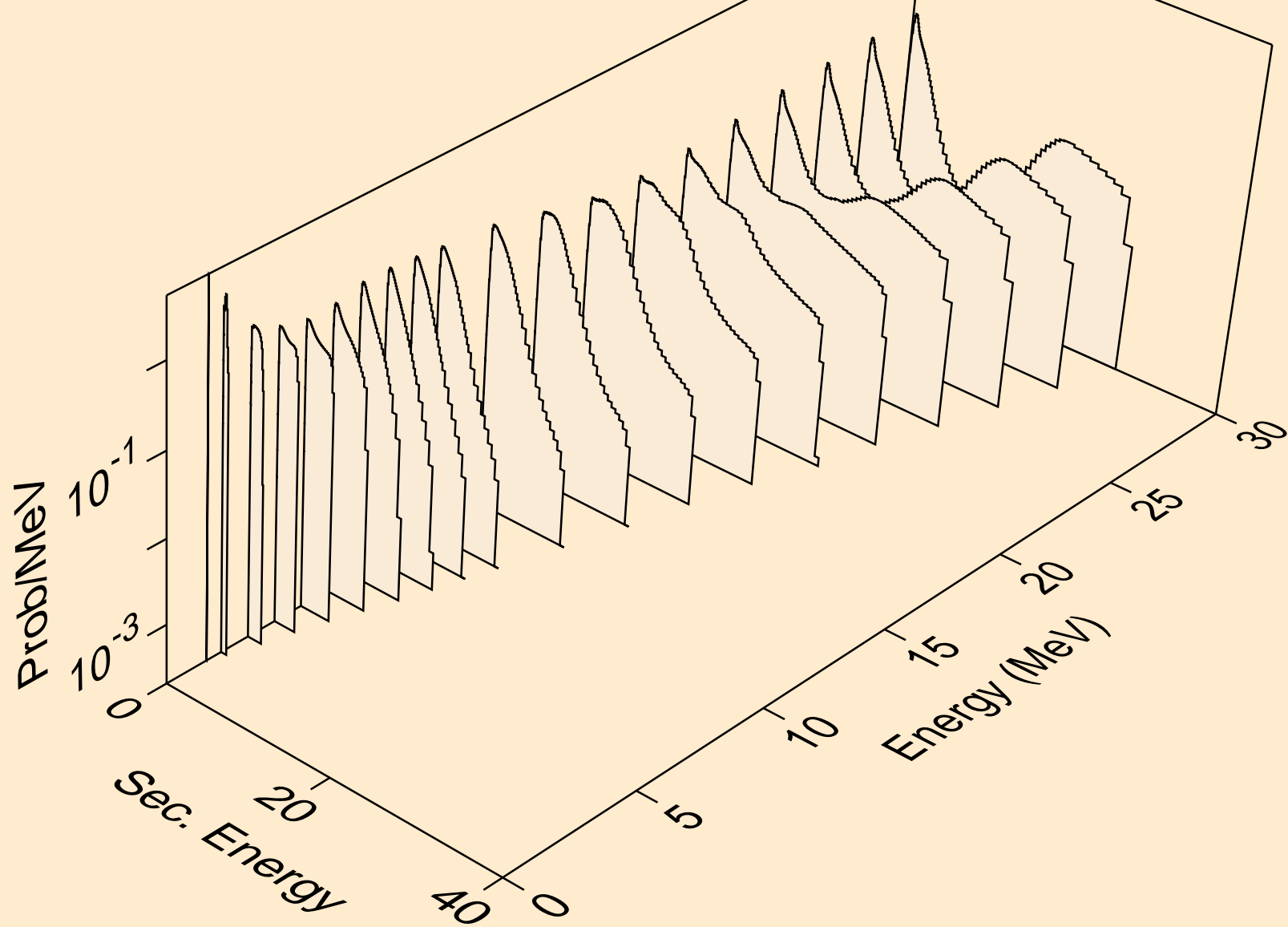

MO093M TRITON ACER TENDL-2021 LIBRARY; T=0.K  
neutrons from (t,3n)

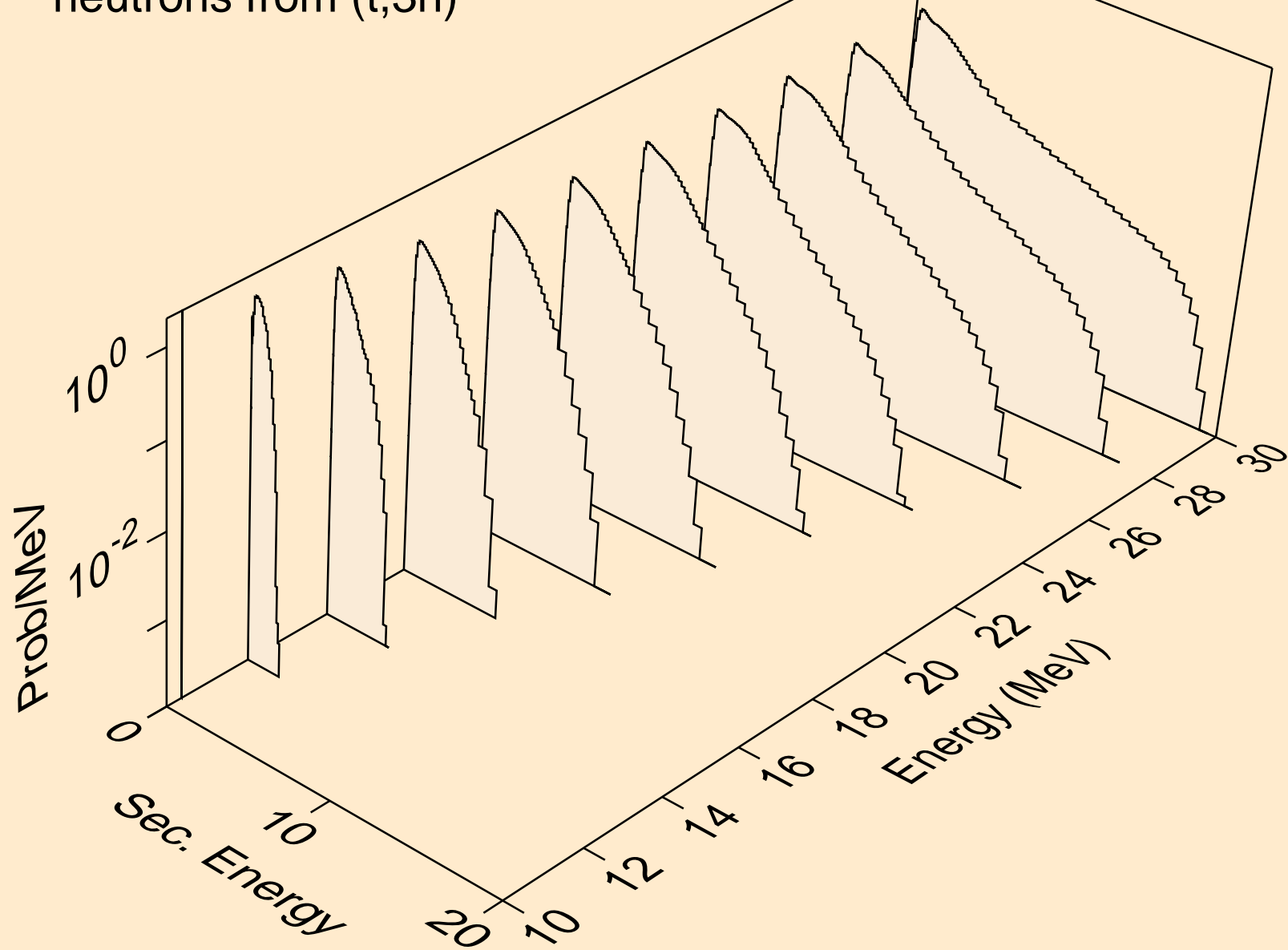

MO093M TRITON ACER TENDL-2021 LIBRARY; T=0.K  
neutrons from (t,n\*)a

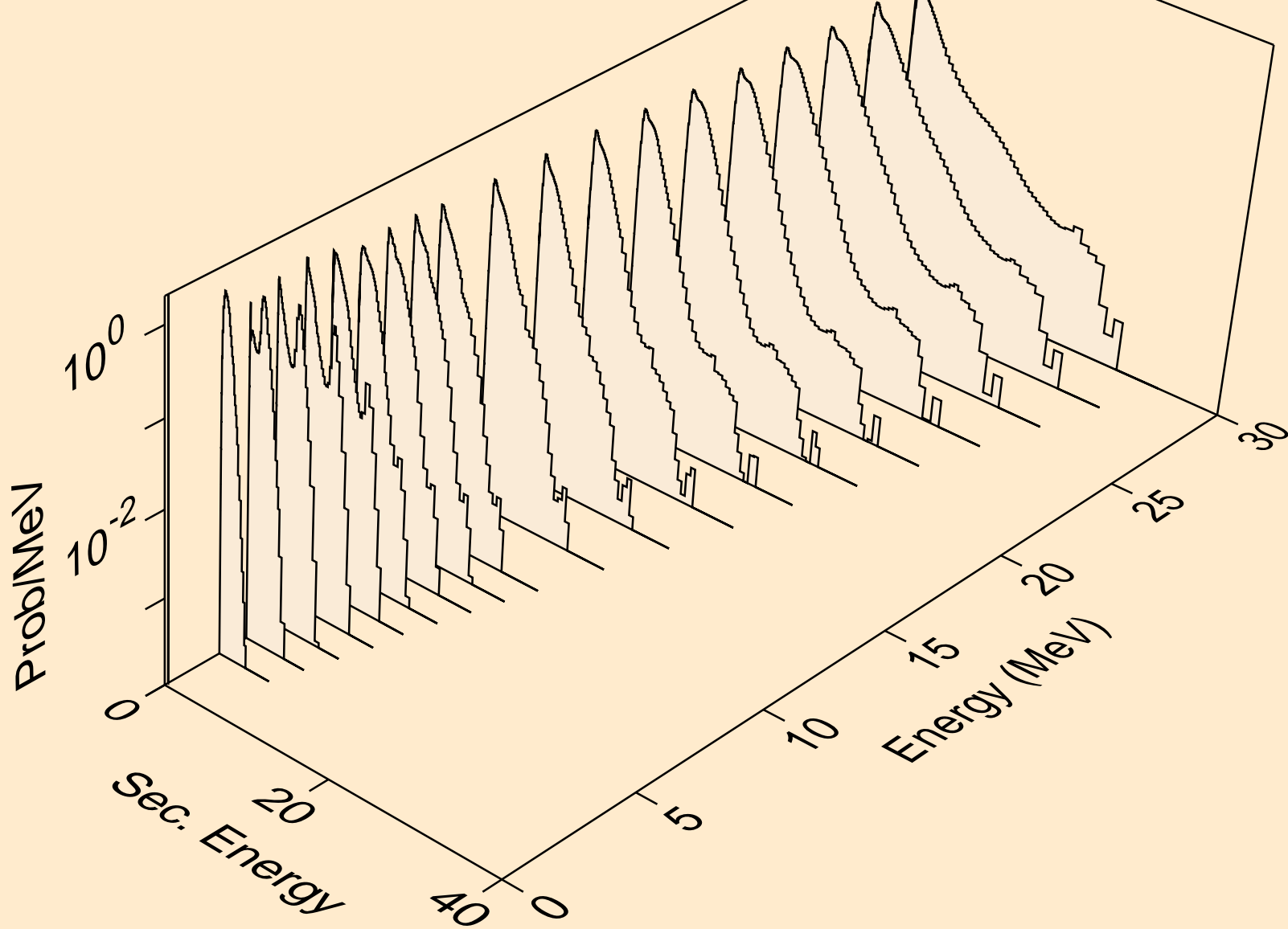

MO093M TRITON ACER TENDL-2021 LIBRARY; T=0.K  
neutrons from (t,2n)a

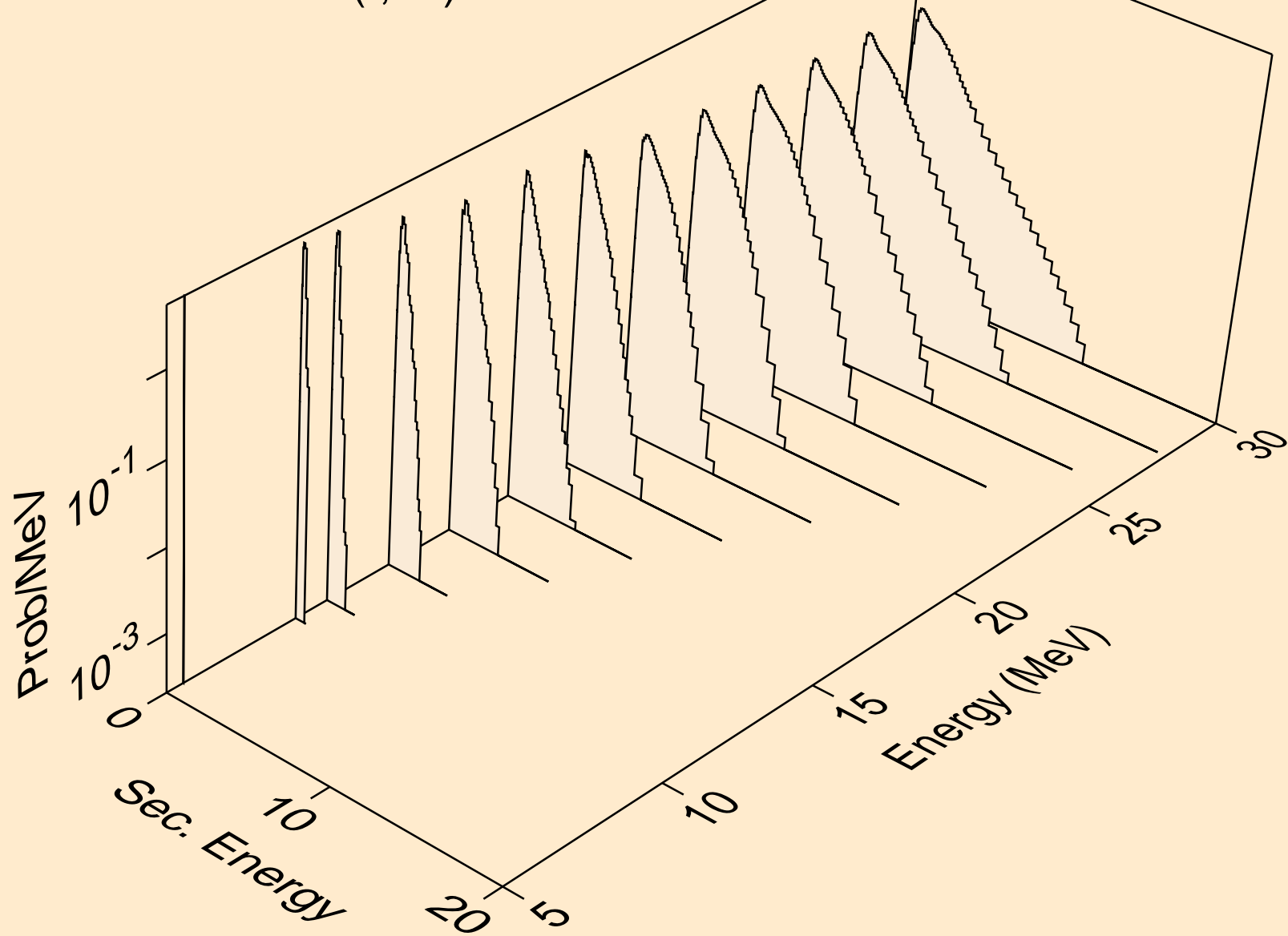

MO093M TRITON ACER TENDL-2021 LIBRARY; T=0.K  
neutrons from (t,3n)a

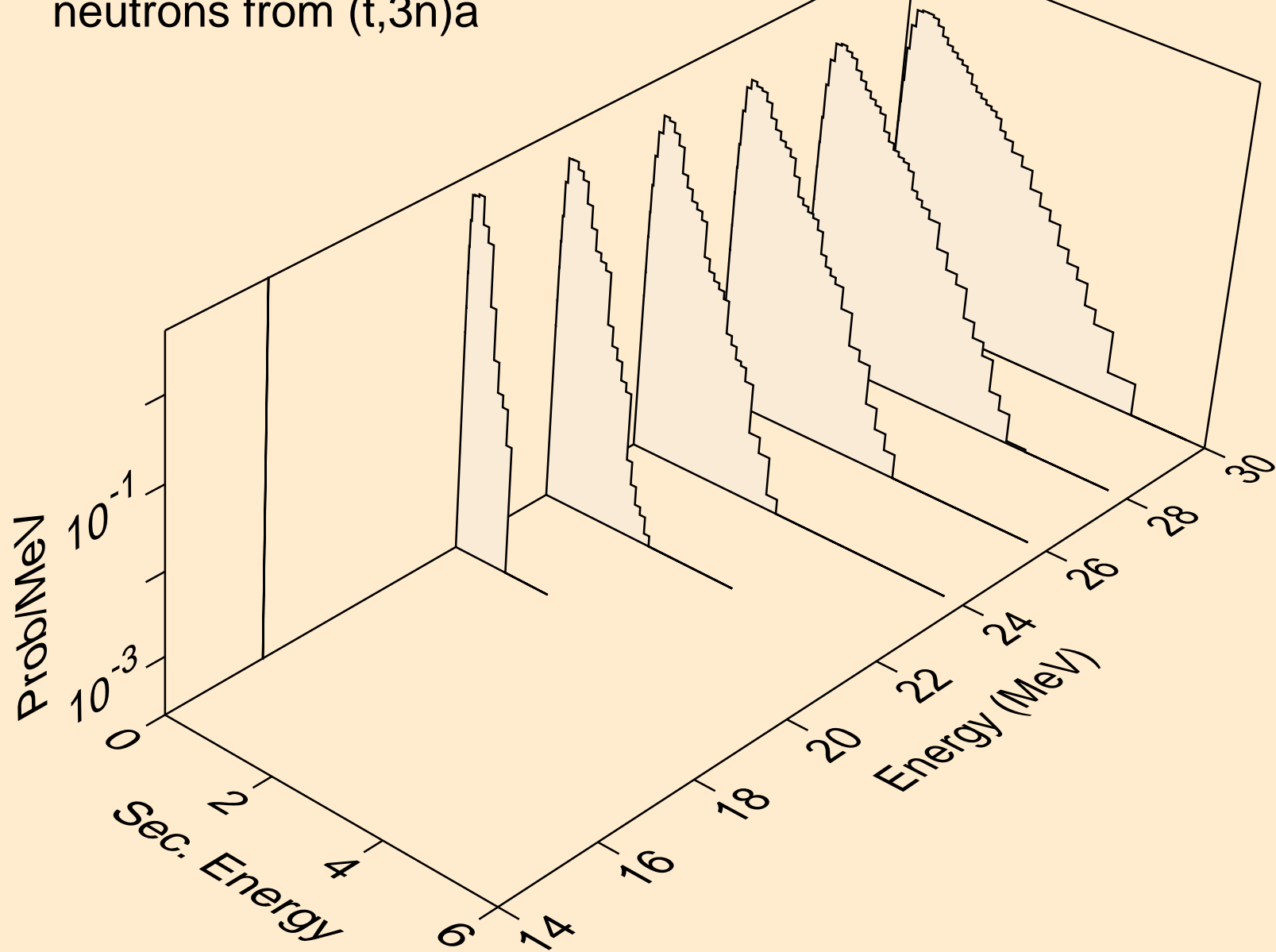



MO093M TRITON ACER TENDL-2021 LIBRARY; T=0.K  
neutrons from (t,n\*)p

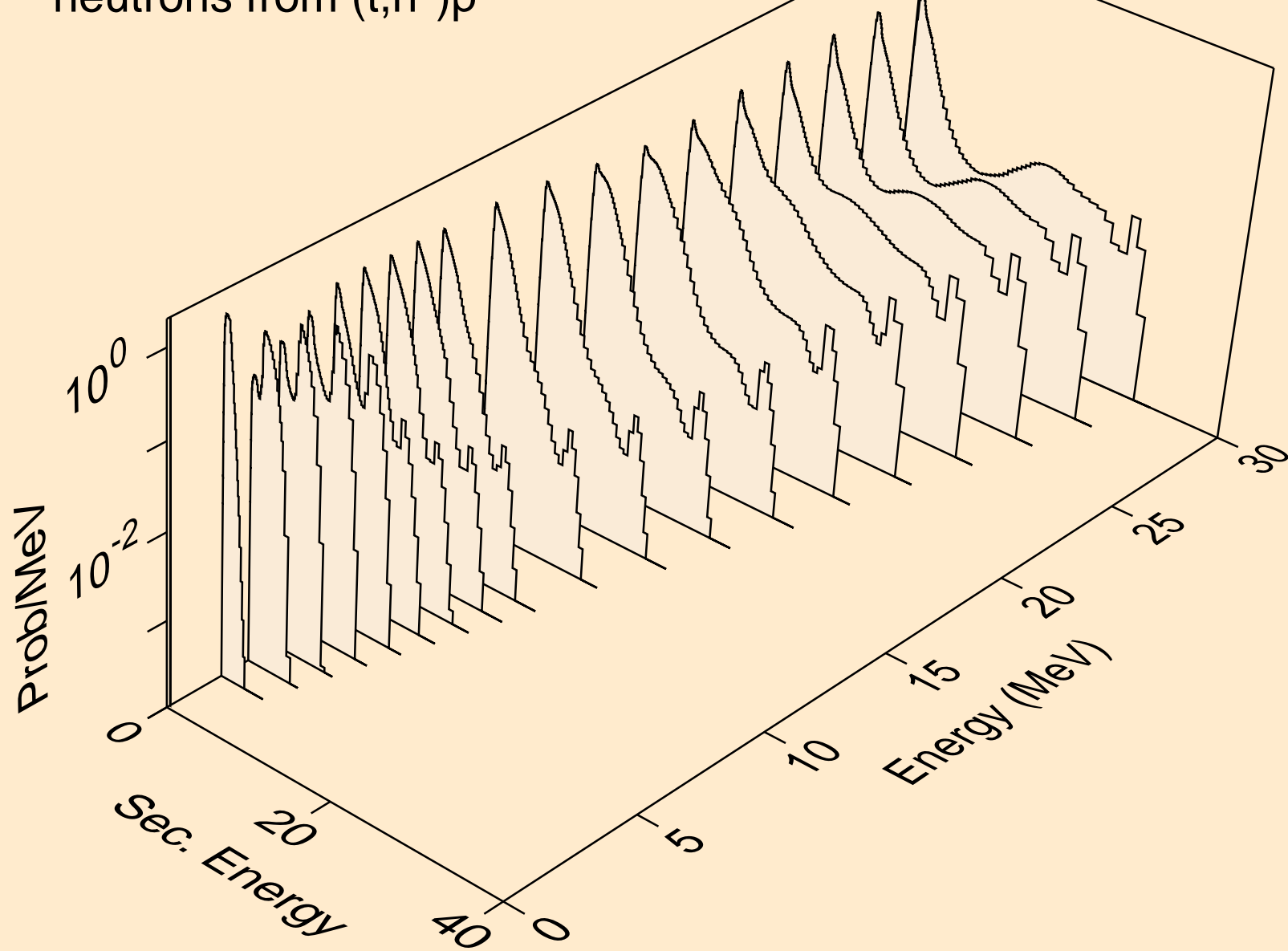

MO093M TRITON ACER TENDL-2021 LIBRARY; T=0.K  
neutrons from (t,n\*)2a

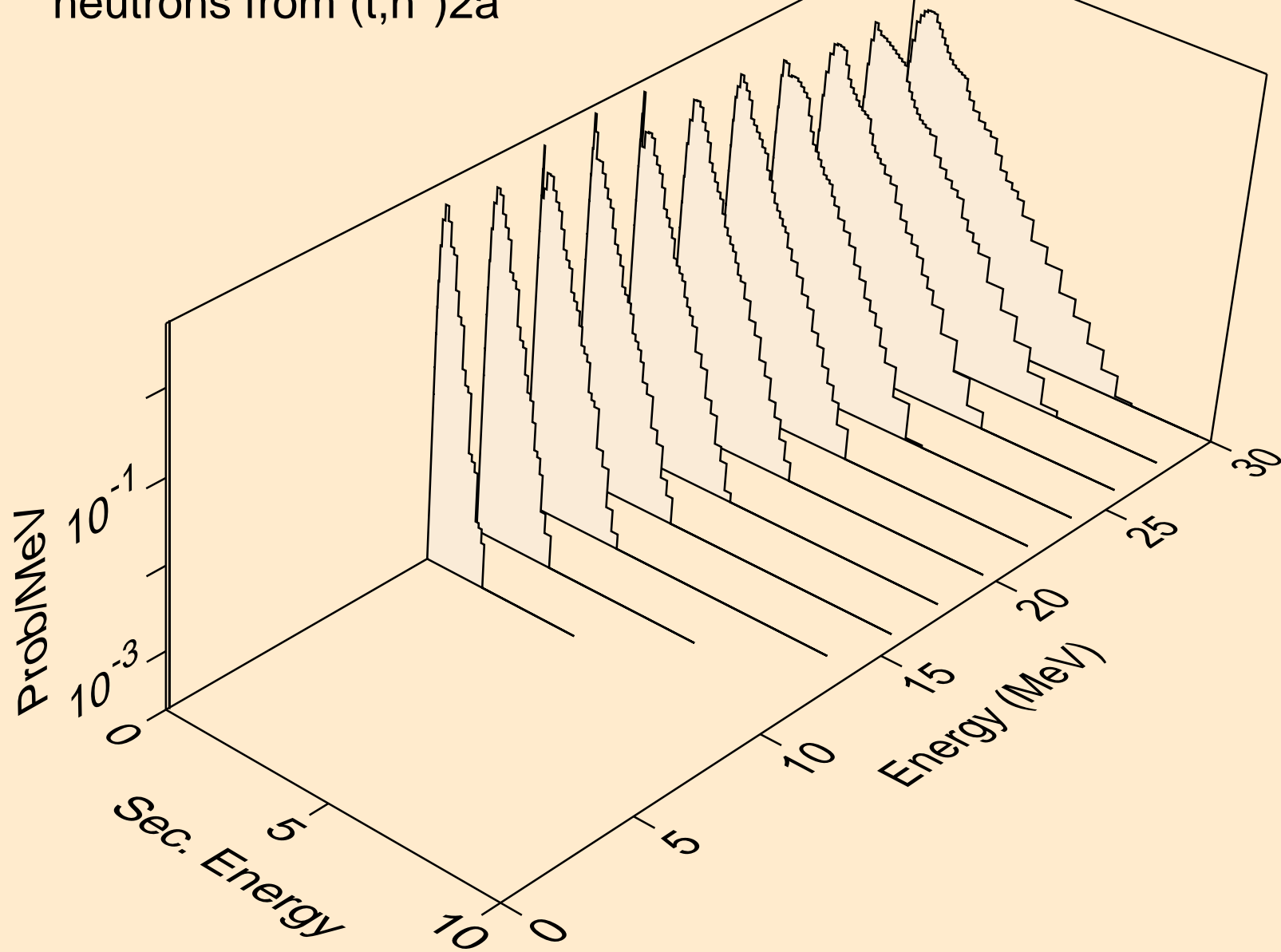

MO093M TRITON ACER TENDL-2021 LIBRARY; T=0.K  
neutrons from (t,2n)2a

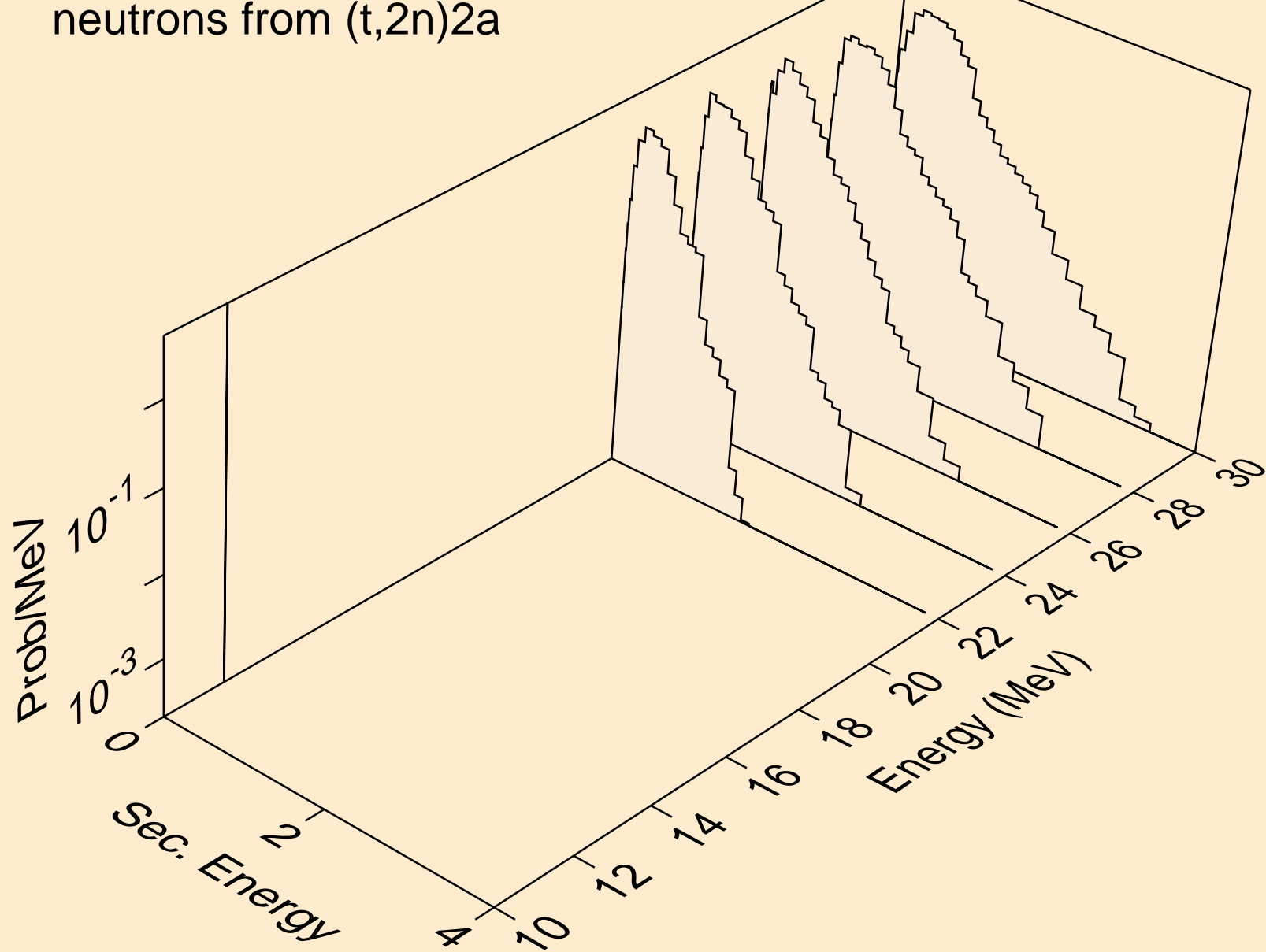

MO093M TRITON ACER TENDL-2021 LIBRARY; T=0.K  
neutrons from (t,n\*)d

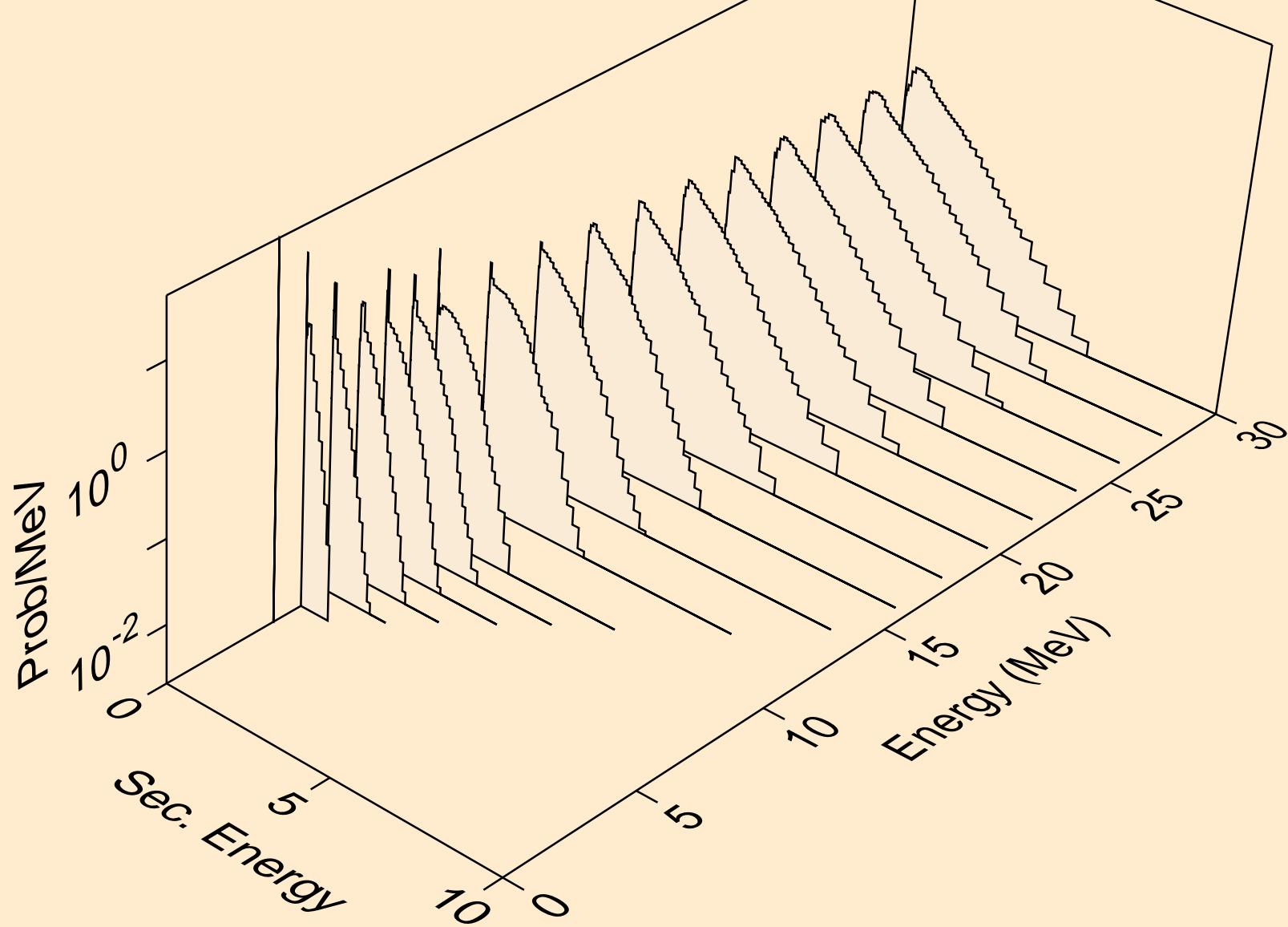

MO093M TRITON ACER TENDL-2021 LIBRARY; T=0.K  
neutrons from (t,n\*)t

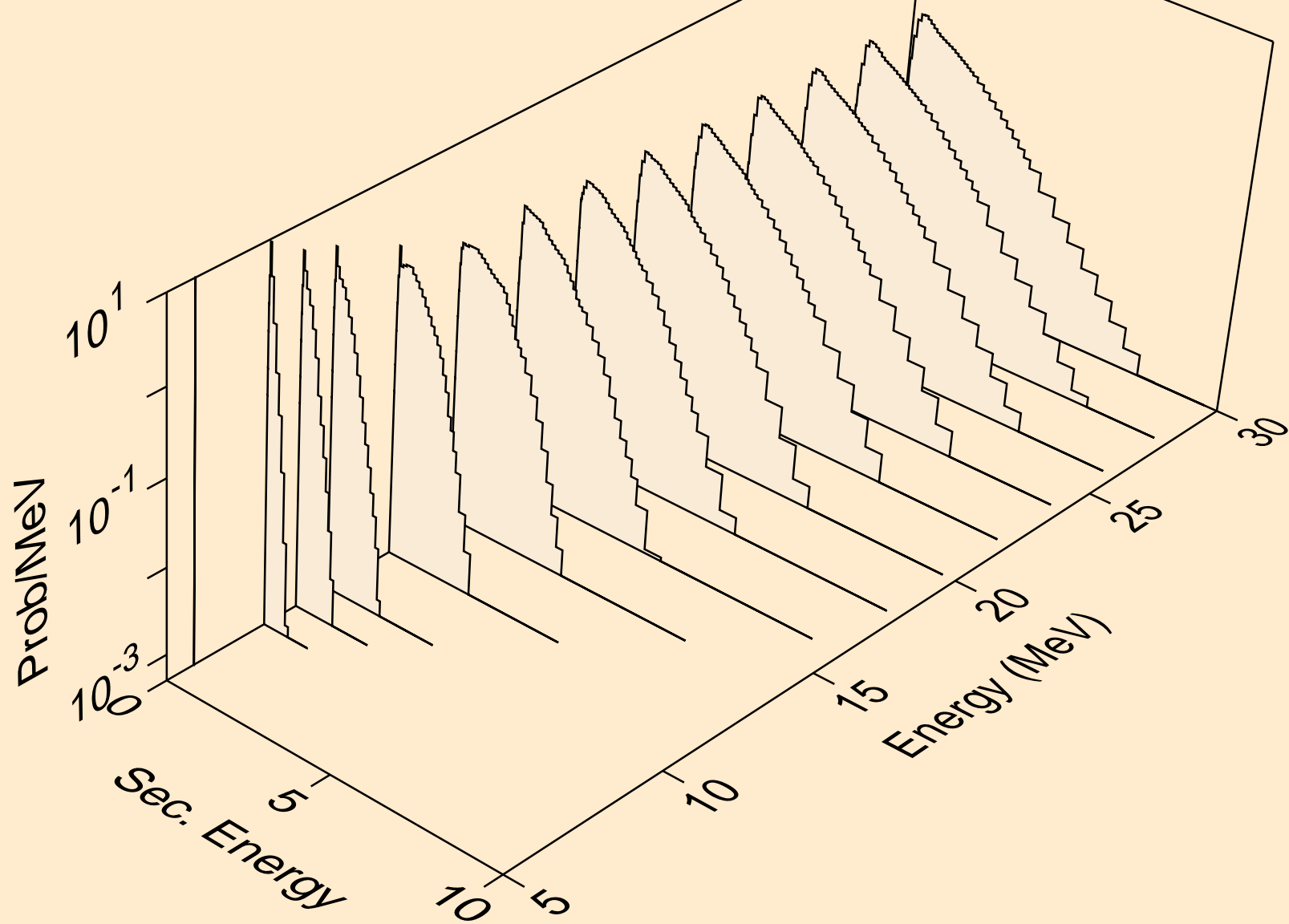

MO093M TRITON ACER TENDL-2021 LIBRARY; T=0.K  
neutrons from (t,n\*)he3

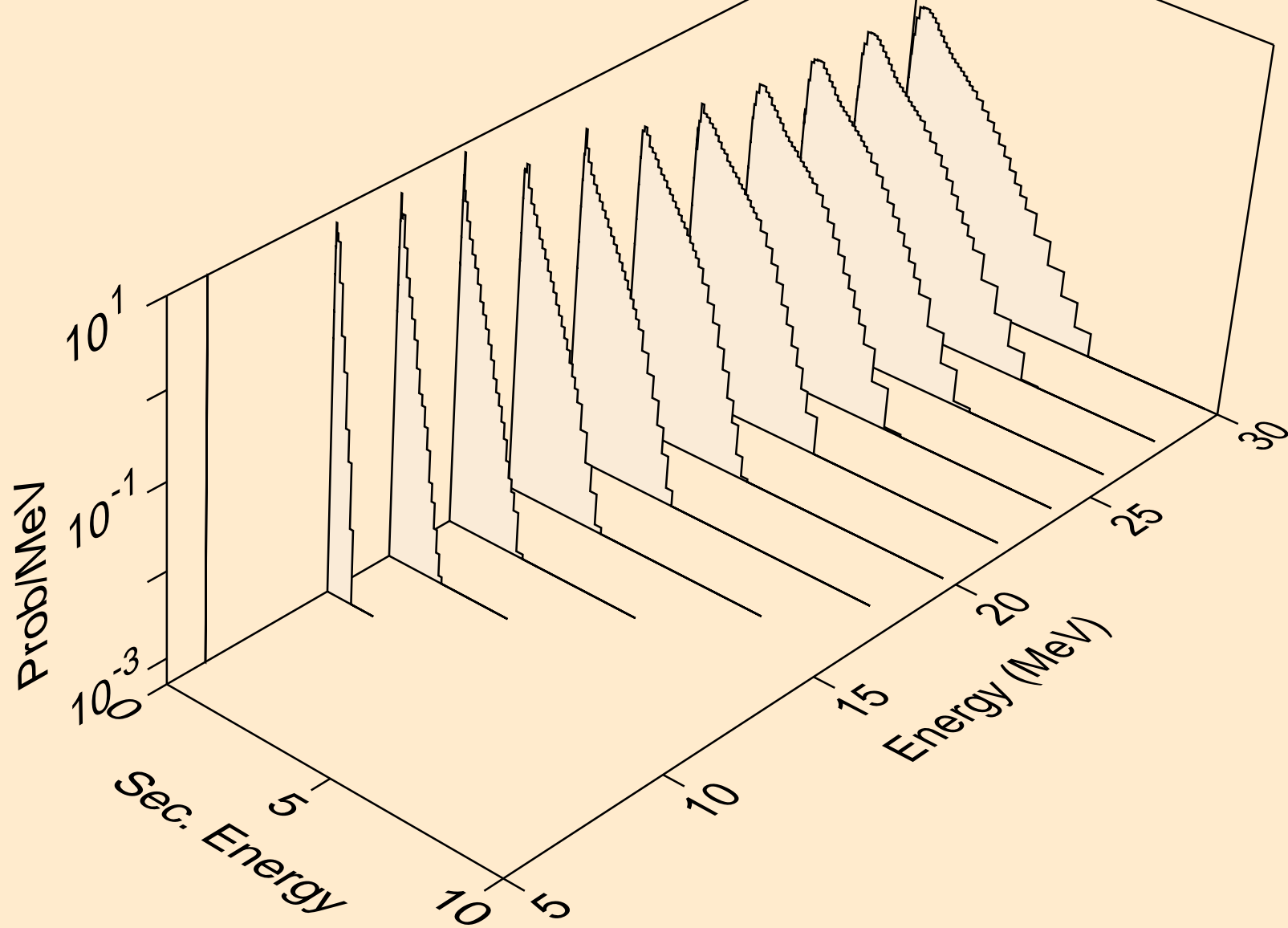

MO093M TRITON ACER TENDL-2021 LIBRARY; T=0.K  
neutrons from (t,4n)

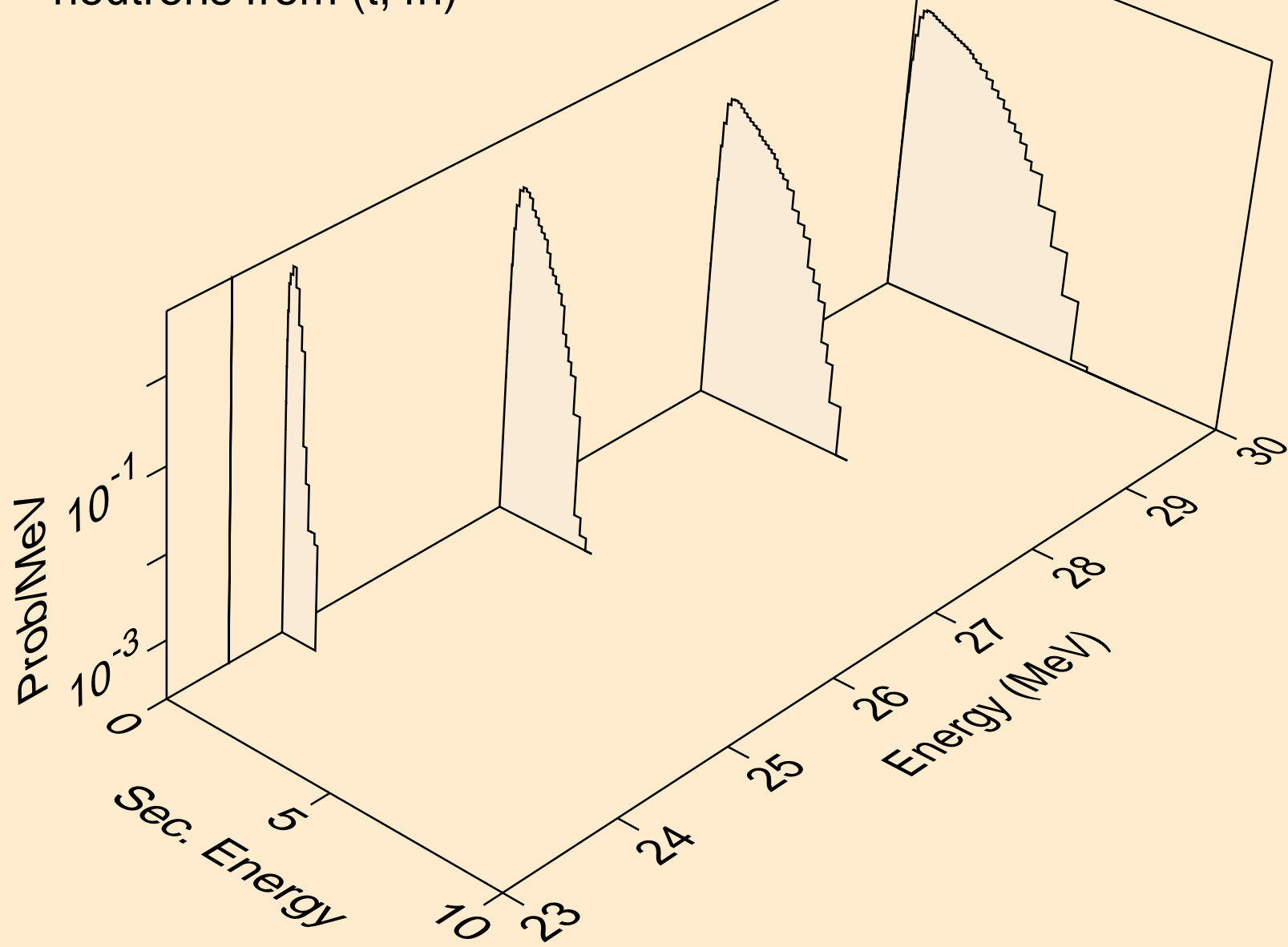

MO093M TRITON ACER TENDL-2021 LIBRARY; T=0.K  
neutrons from (t,2np)

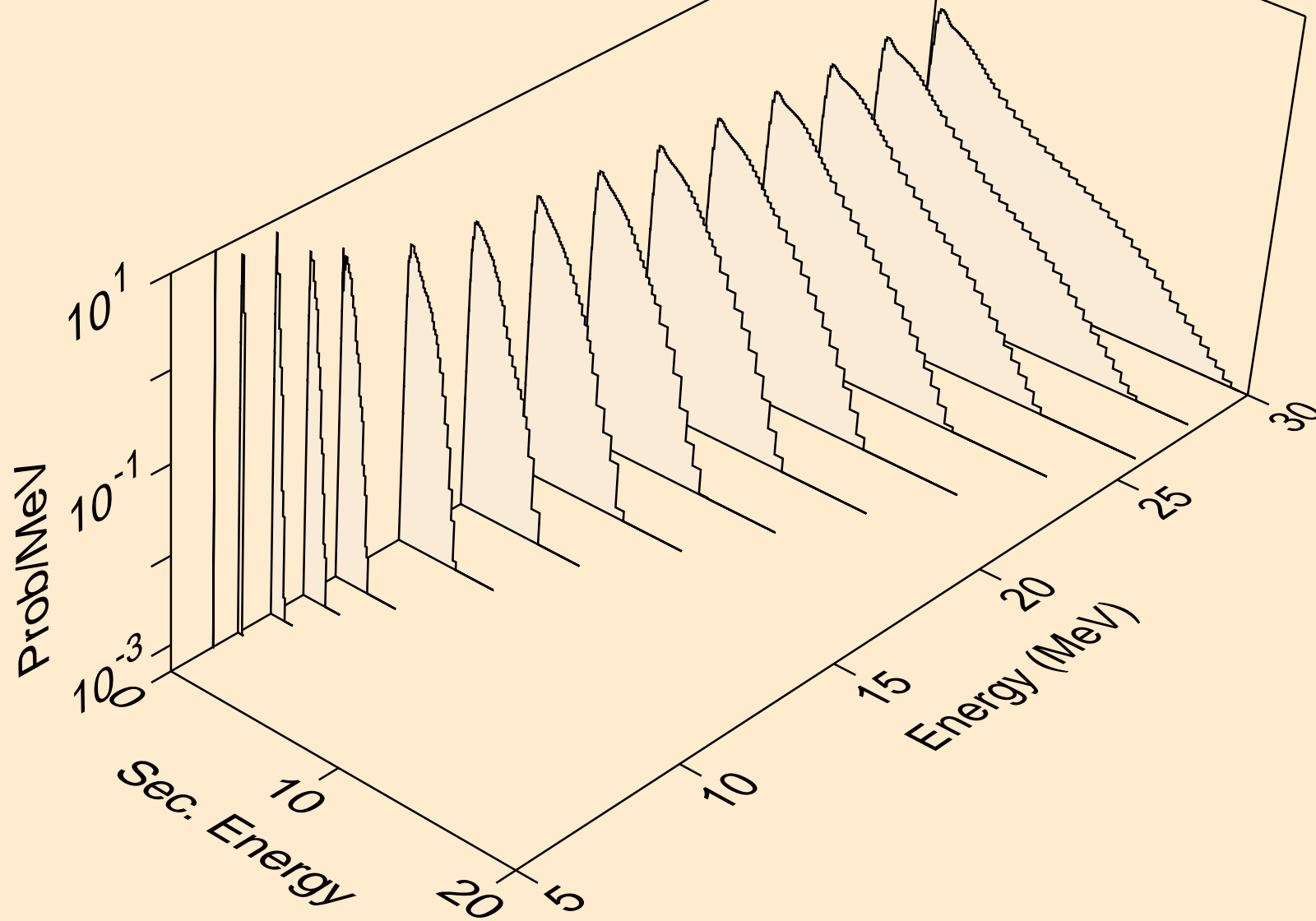



MO093M TRITON ACER TENDL-2021 LIBRARY; T=0.K  
neutrons from (t,3np)

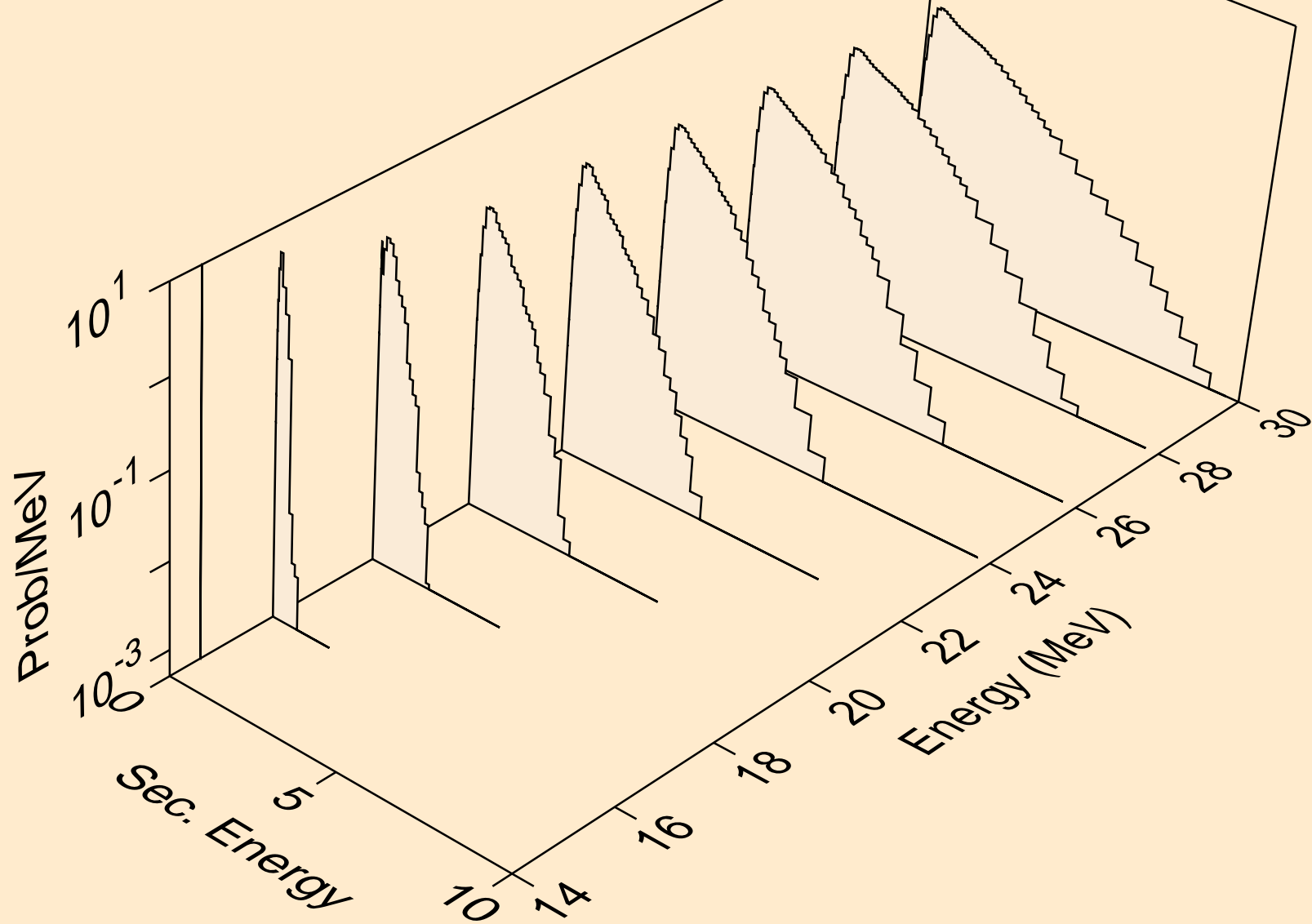

MO093M TRITON ACER TENDL-2021 LIBRARY; T=0.K  
neutrons from (t,2np)

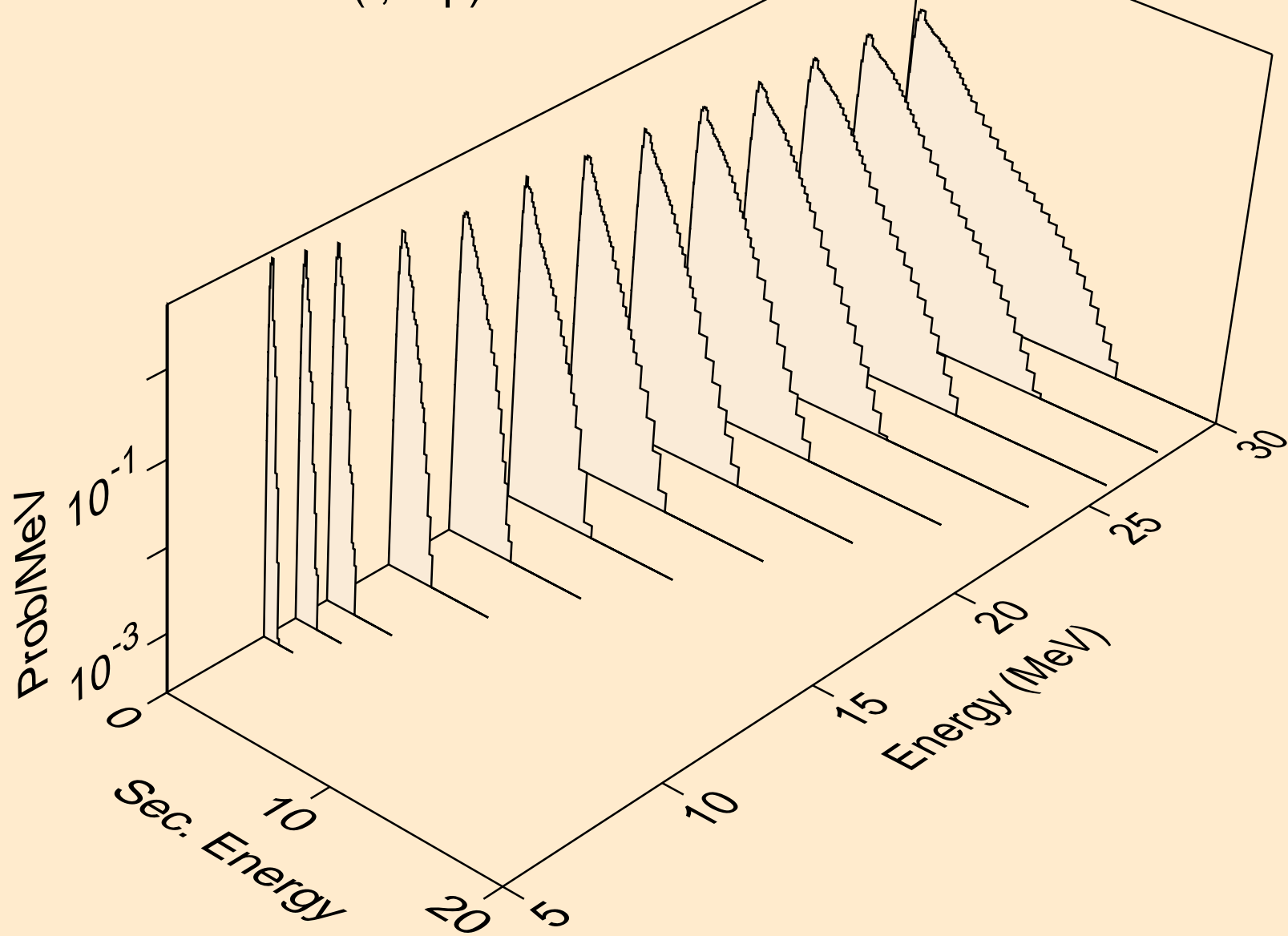

MO093M TRITON ACER TENDL-2021 LIBRARY; T=0.K  
neutrons from (t,npa)

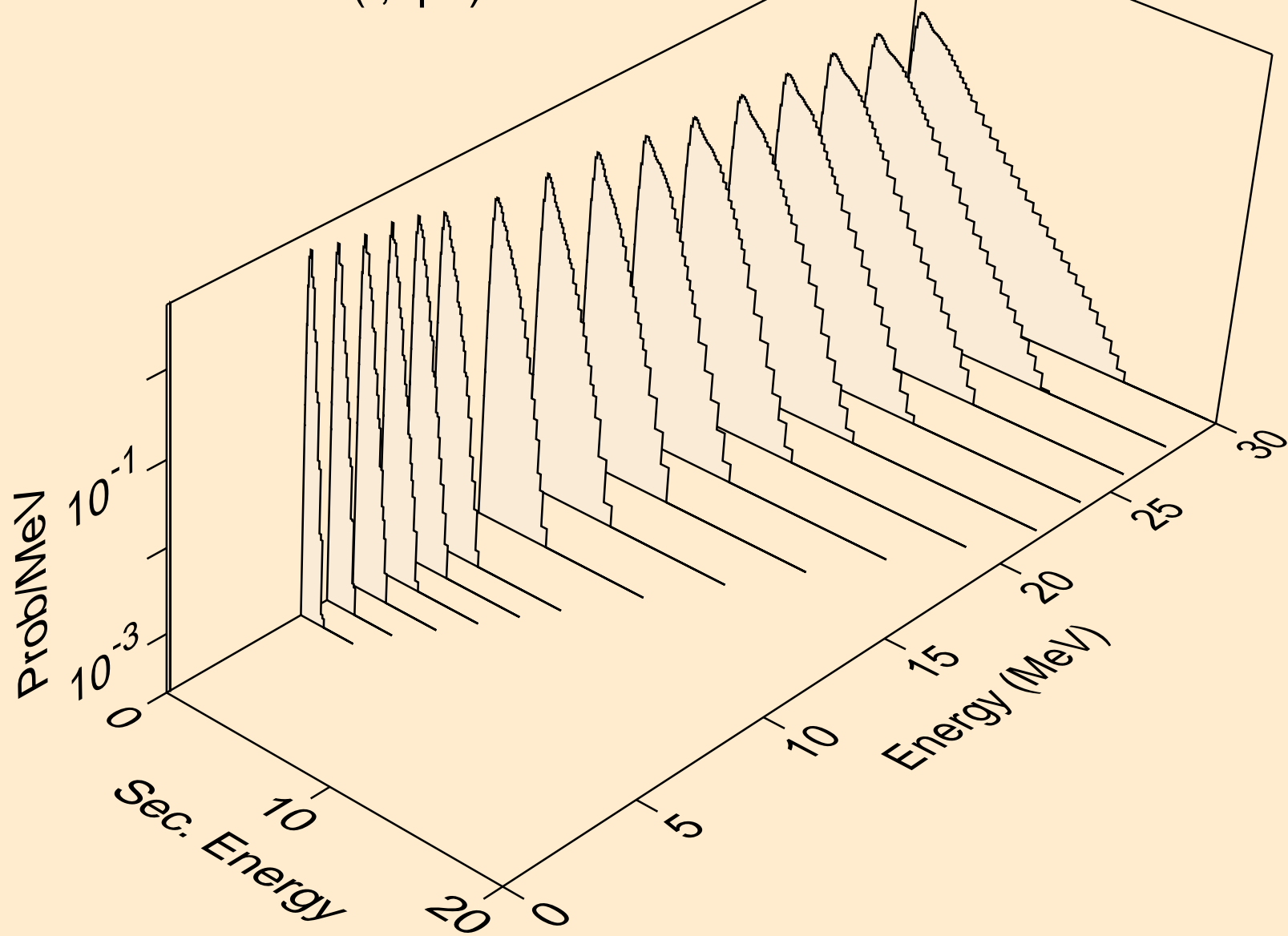

MO093M TRITON ACER TENDL-2021 LIBRARY; T=0.K  
protons from (t,x)

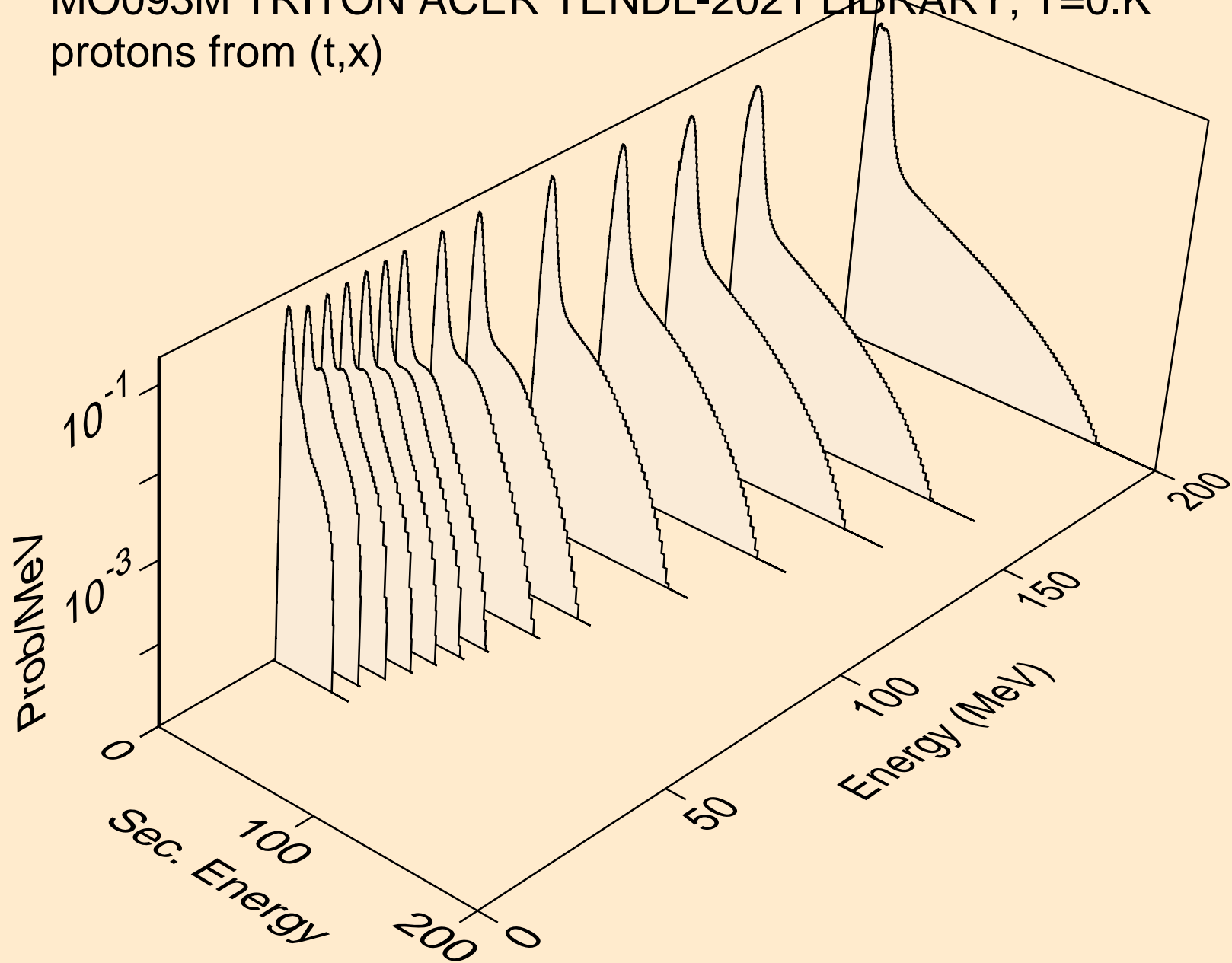

MO093M TRITON ACER TENDL-2021 LIBRARY; T=0.K  
protons from (t,n\*)p

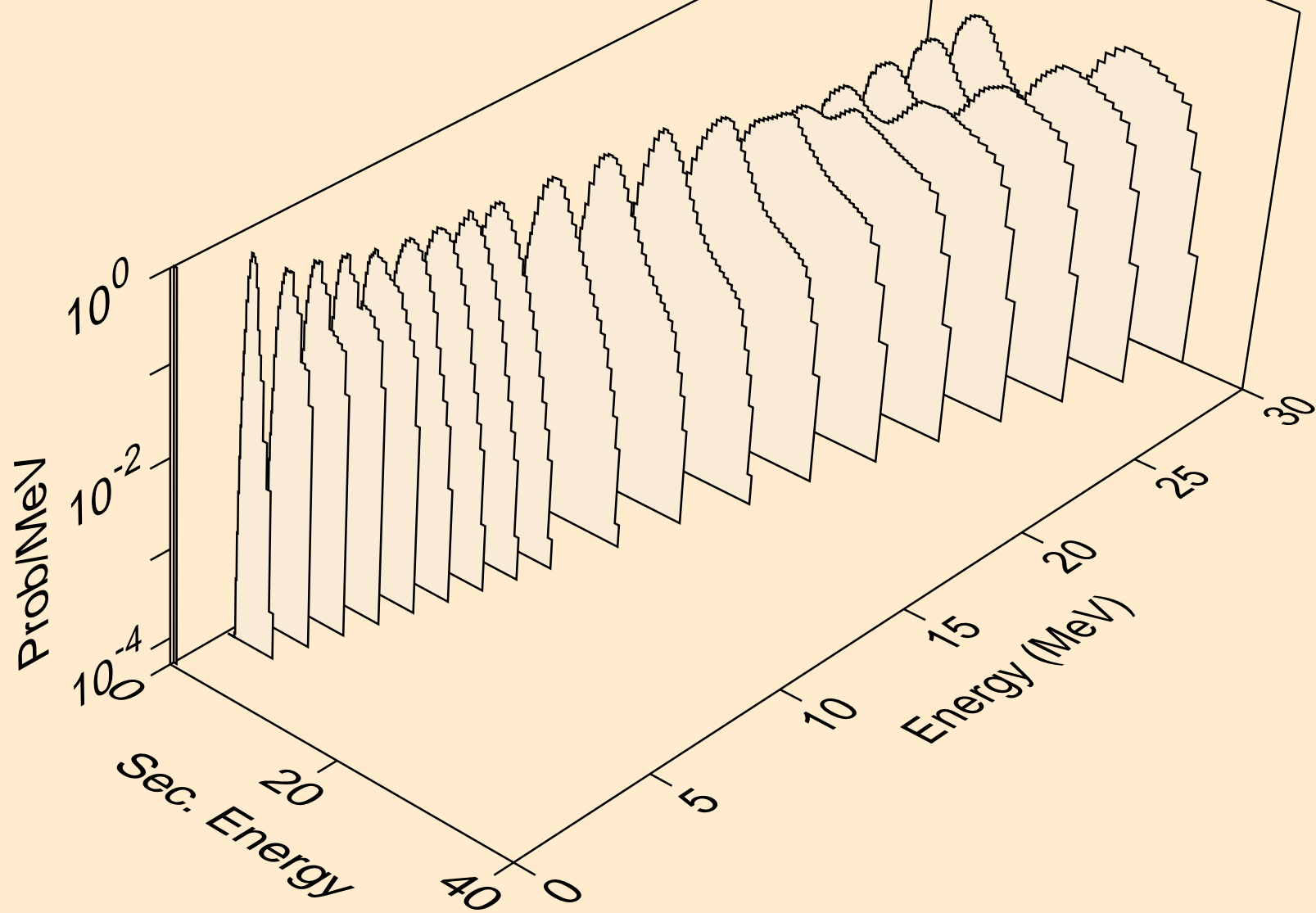

MO093M TRITON ACER TENDL-2021 LIBRARY; T=0.K  
protons from (t,2np)

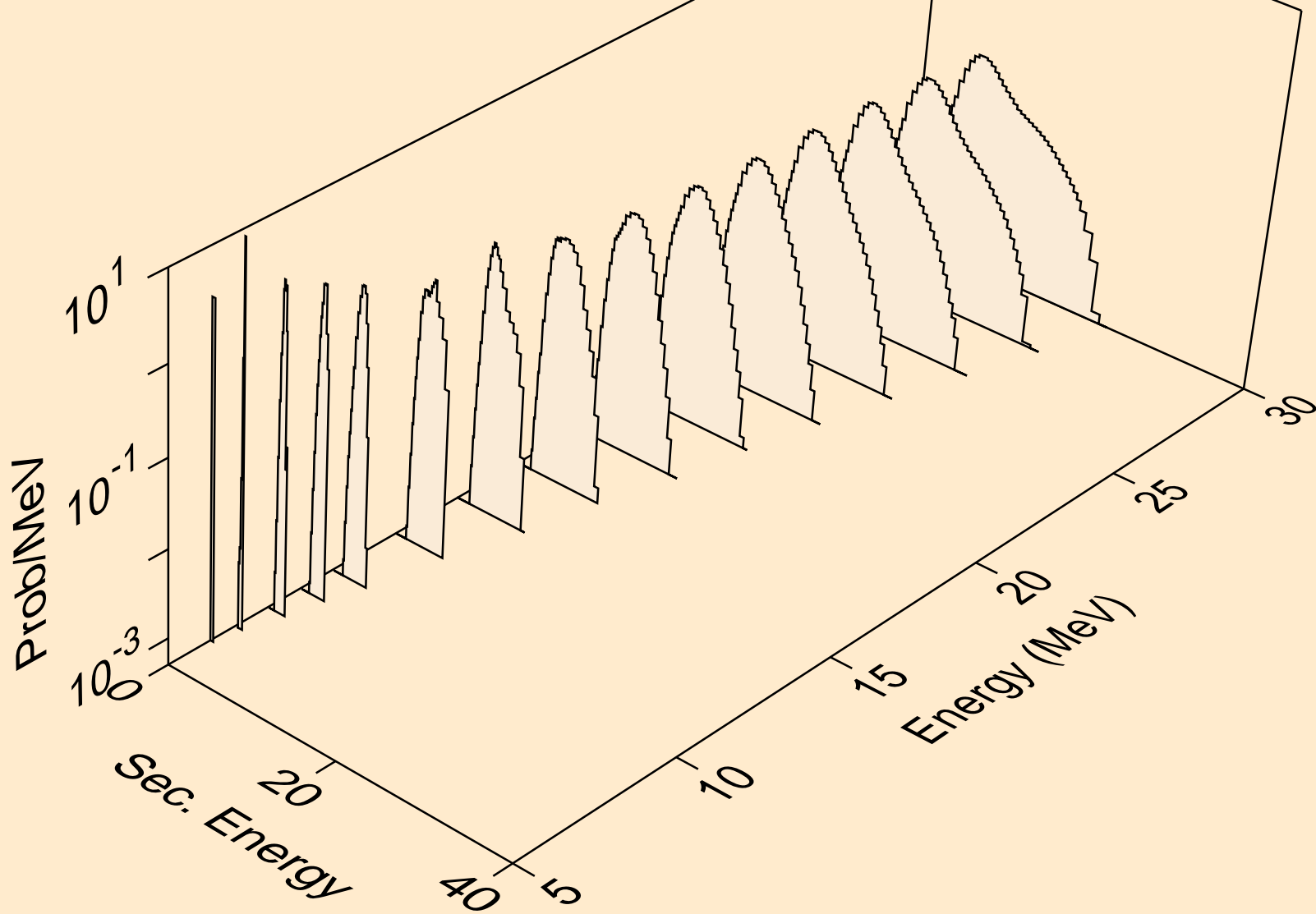

MO093M TRITON ACER TENDL-2021 LIBRARY; T=0.K  
protons from (t,3np)

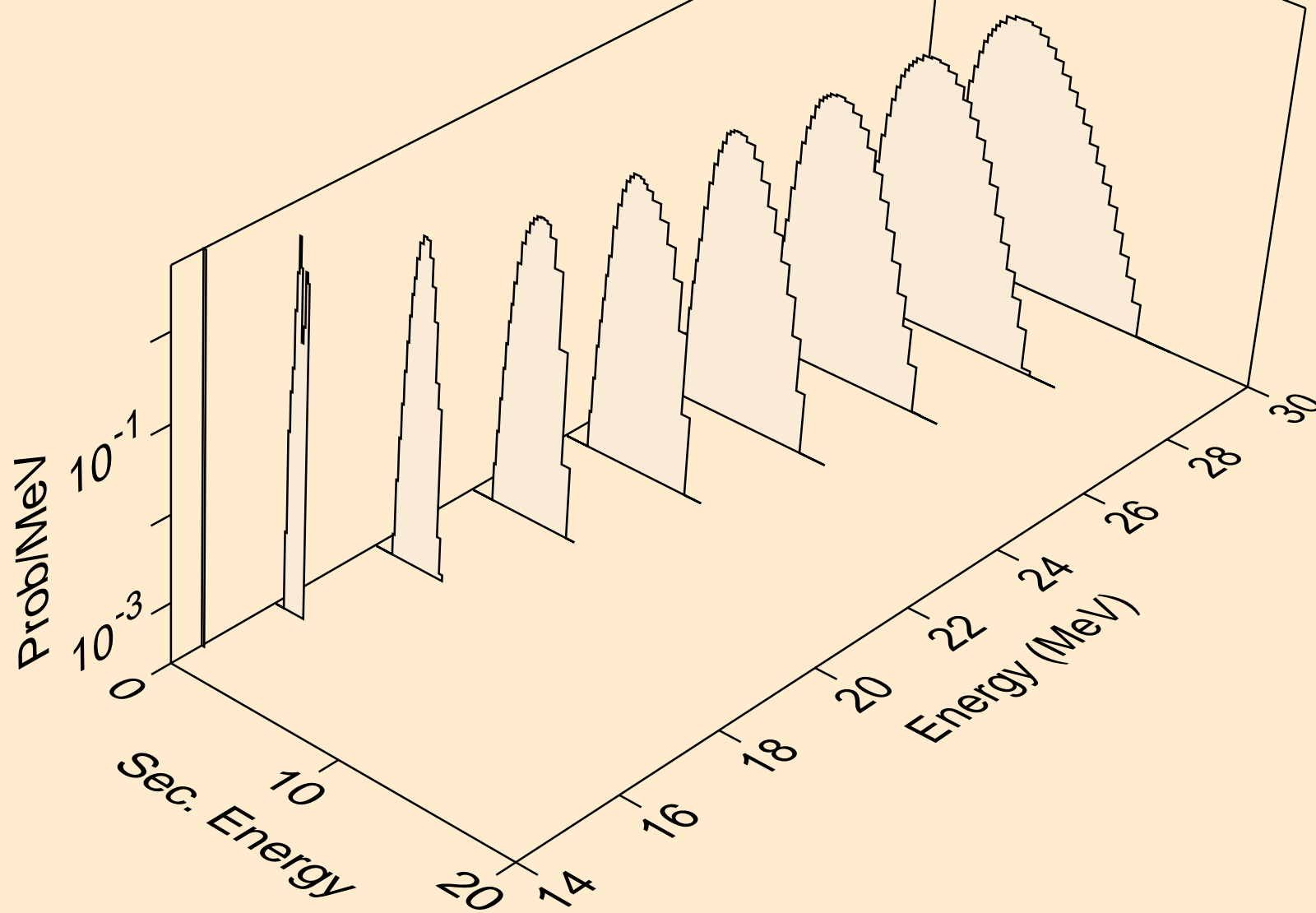

MO093M TRITON ACER TENDL-2021 LIBRARY; T=0.K  
protons from (t,2np)

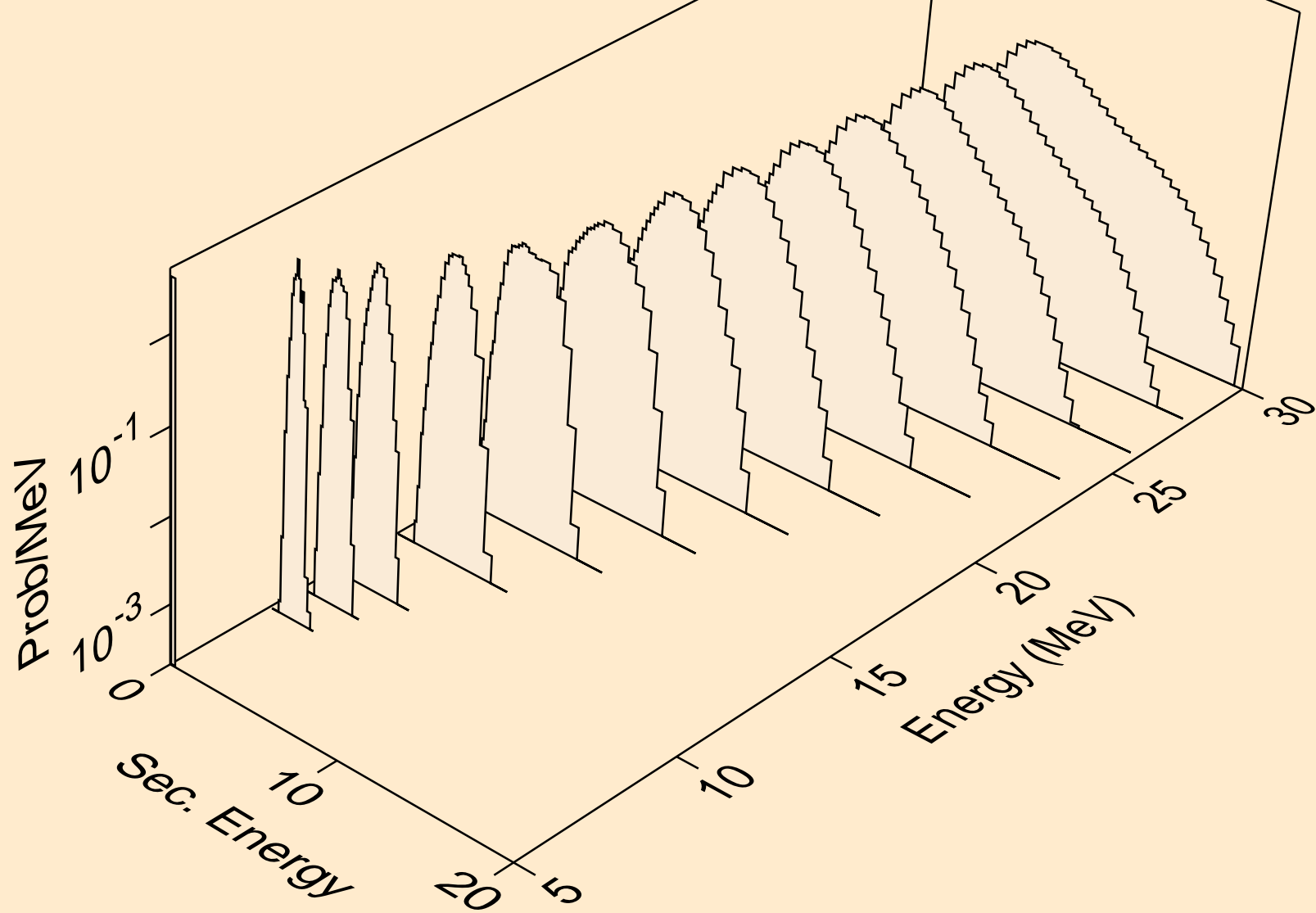



MO093M TRITON ACER TENDL-2021 LIBRARY; T=0.K  
protons from (t,npa)

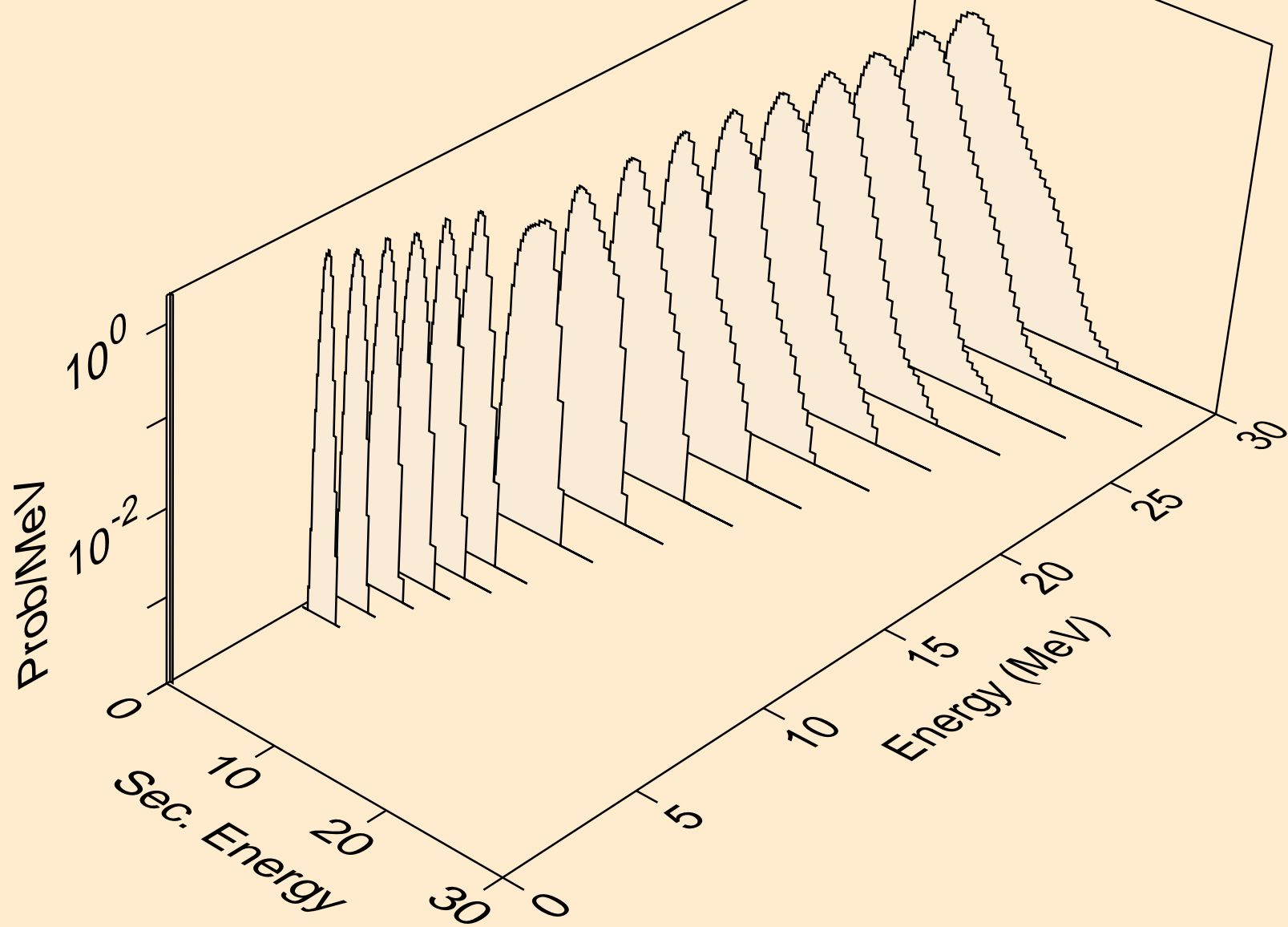

MO093M TRITON ACER TENDL-2021 LIBRARY; T=0.K  
protons from (t,p)

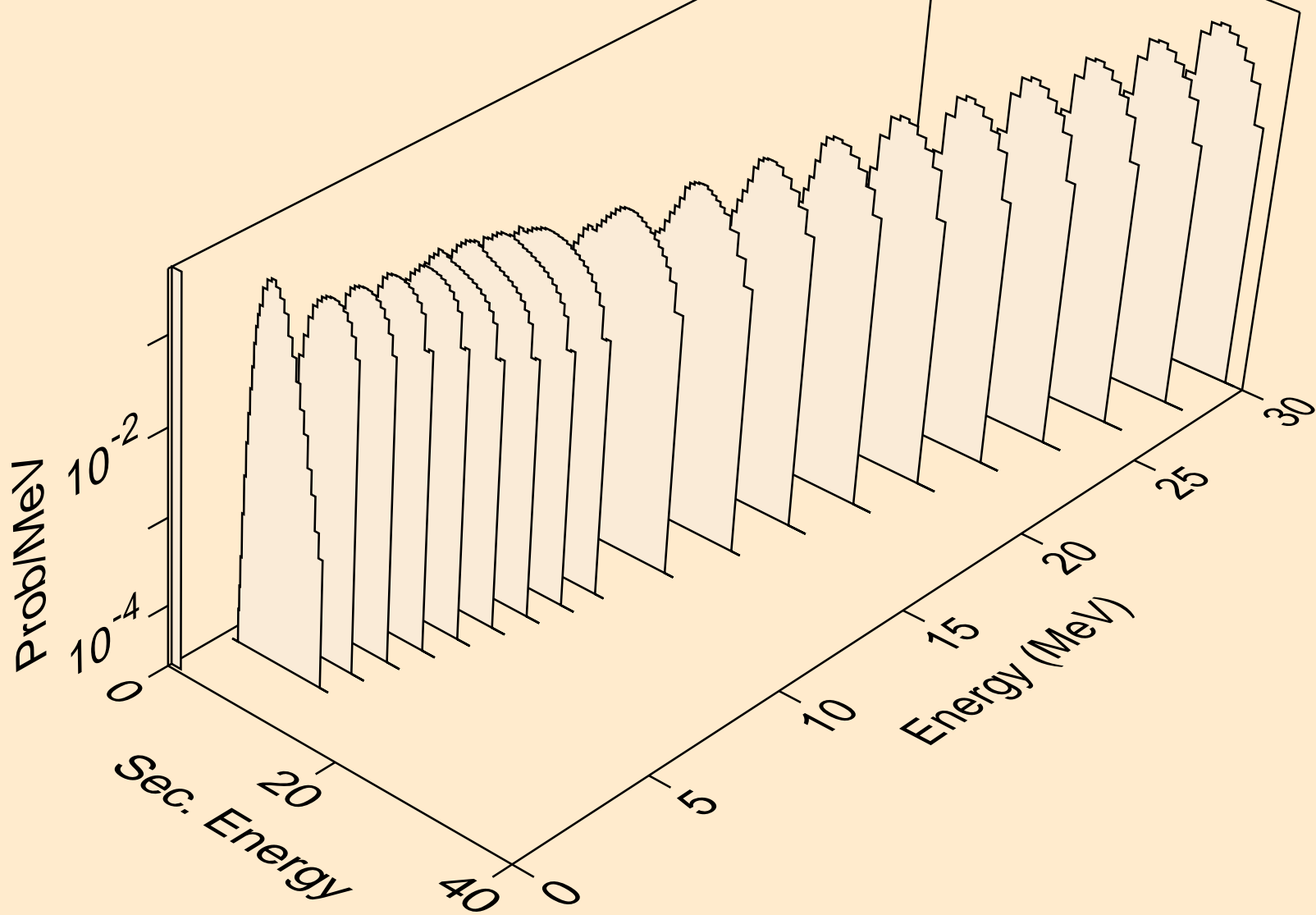

MO093M TRITON ACER TENDL-2021 LIBRARY; T=0.K  
protons from (t,2p)

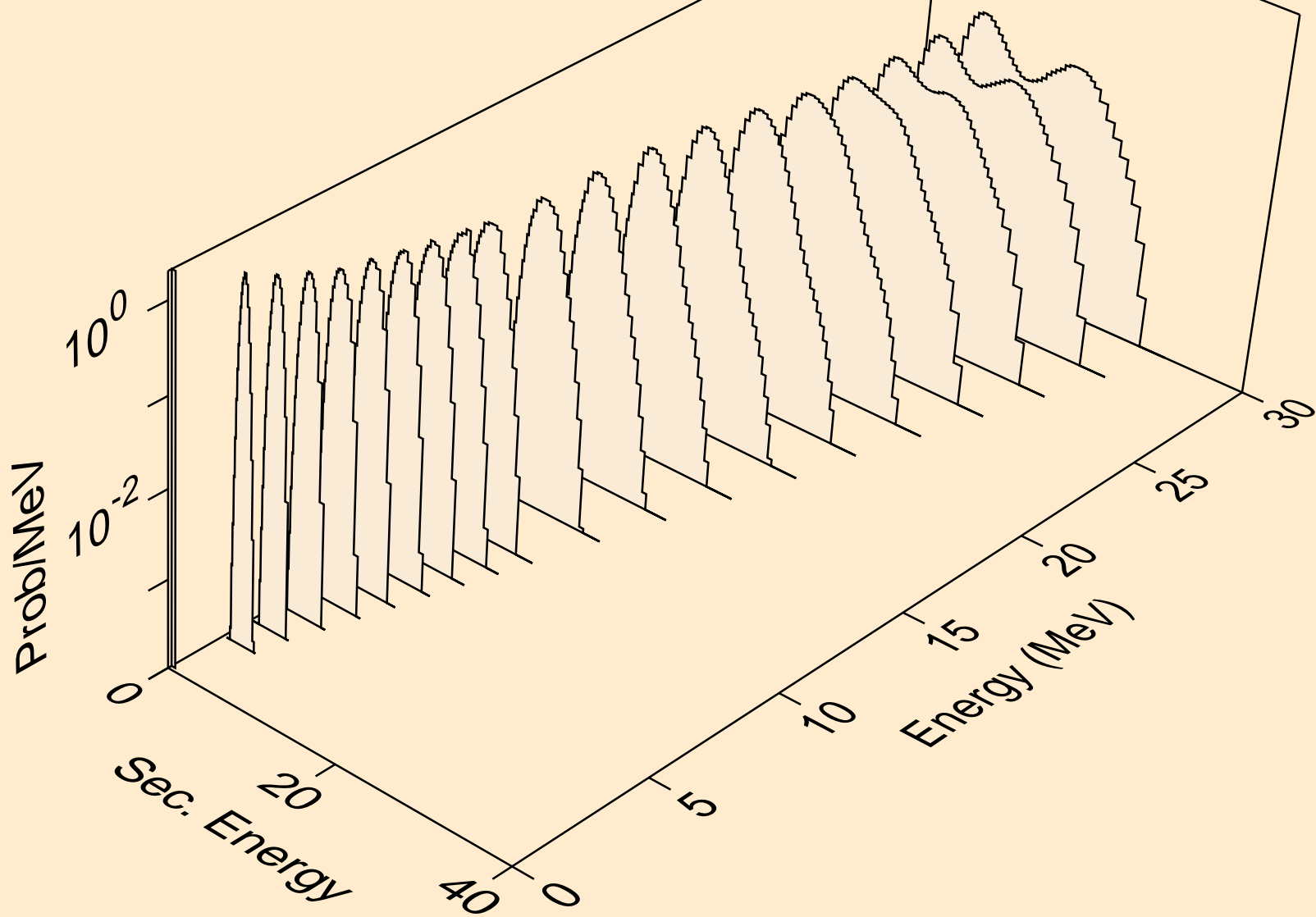

MO093M TRITON ACER TENDL-2021 LIBRARY; T=0.K  
protons from (t,pa)

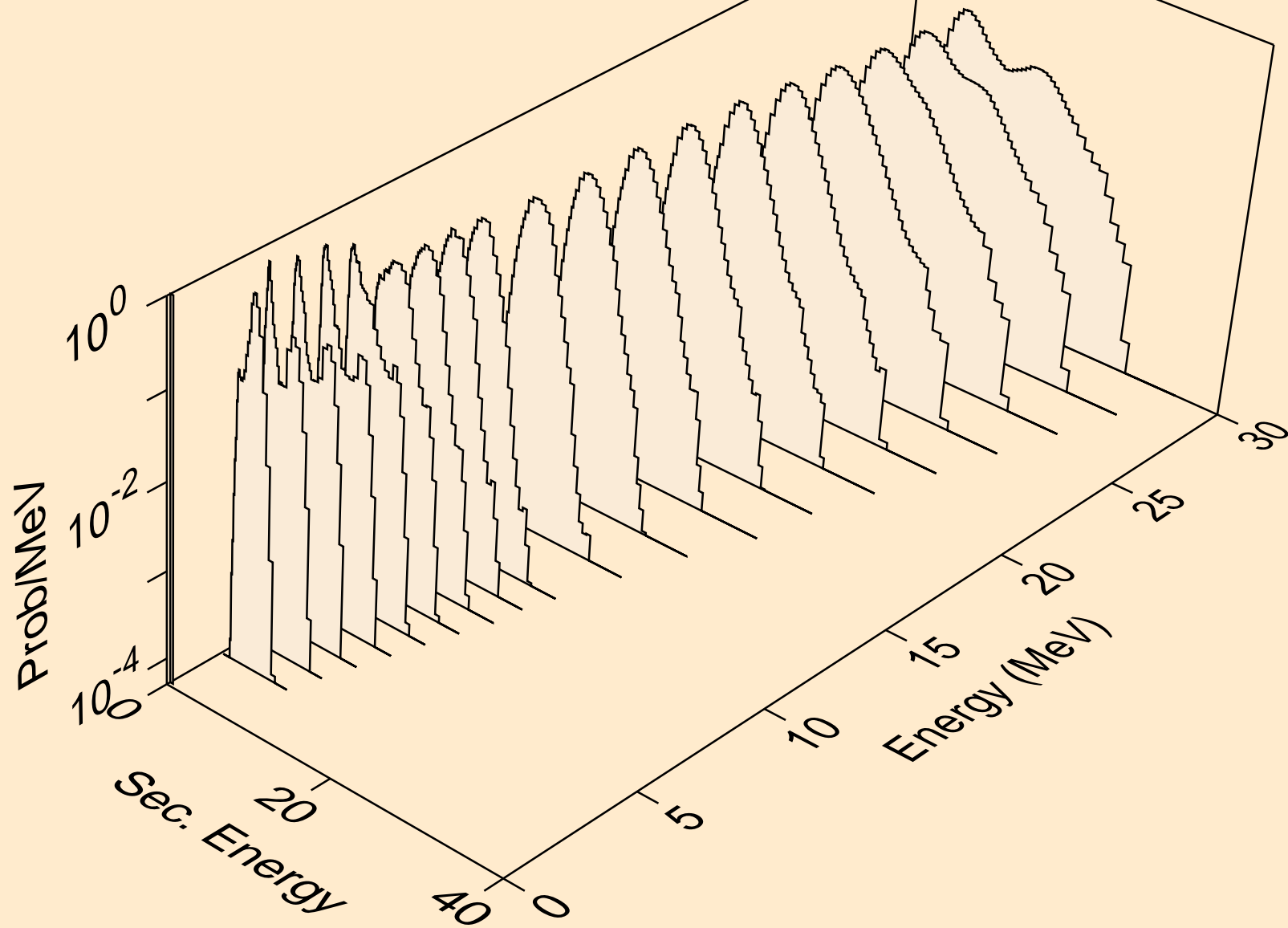

MO093M TRITON ACER TENDL-2021 LIBRARY; T=0.K  
protons from (t,pd)

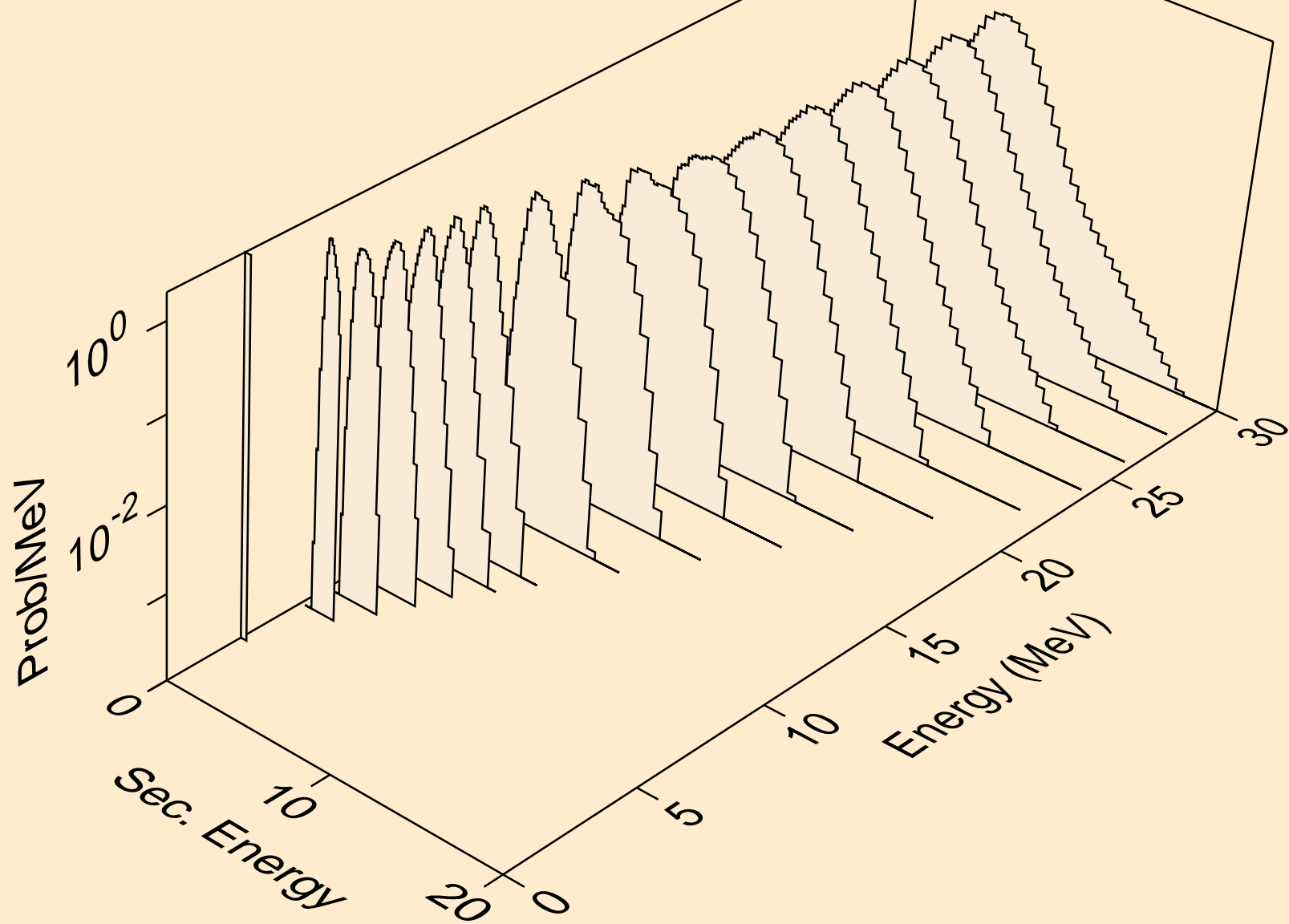

MO093M TRITON ACER TENDL-2021 LIBRARY; T=0.K  
protons from (t,pt)

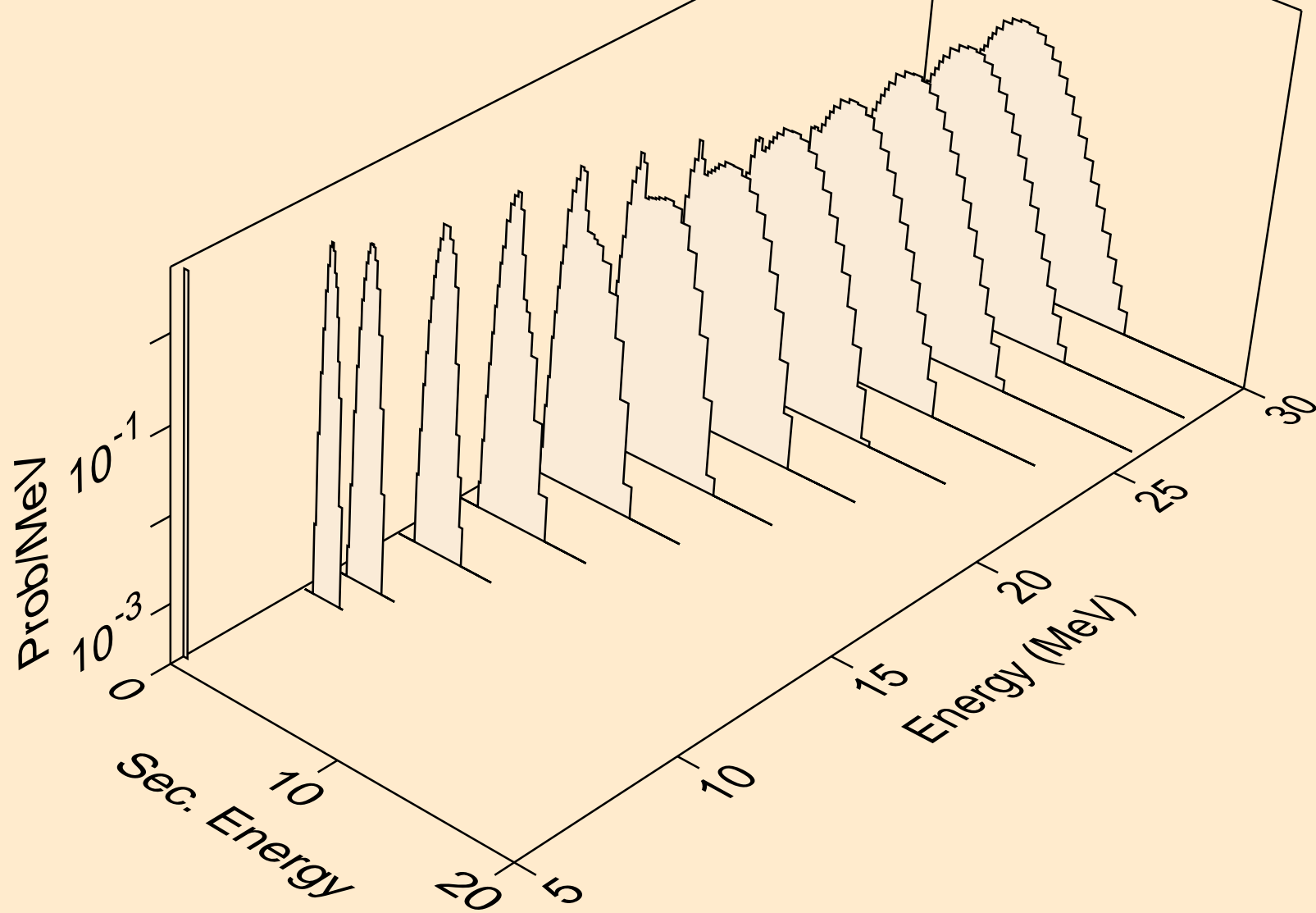

MO093M TRITON ACER TENDL-2021 LIBRARY; T=0.K  
deuterons from (t,x)

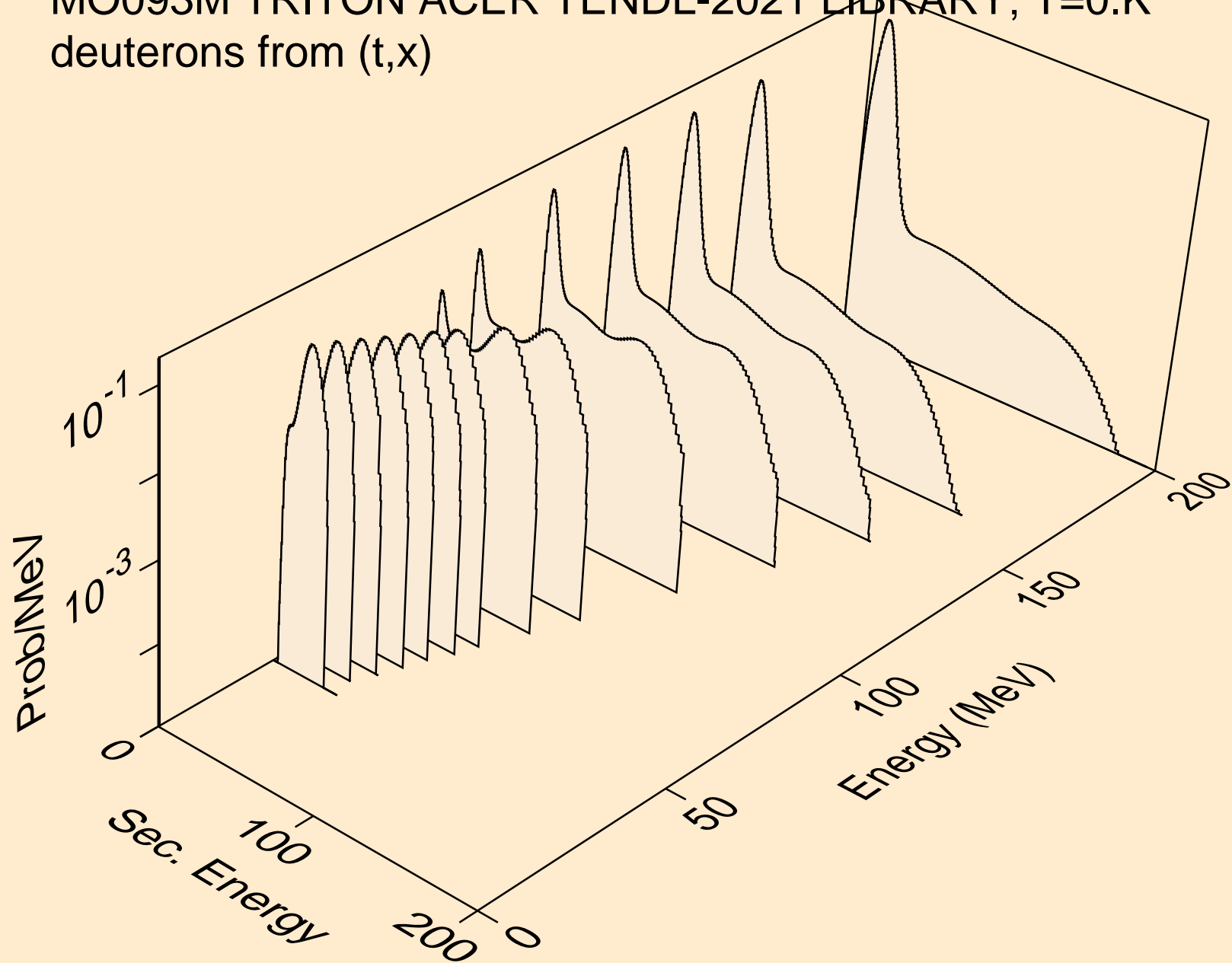

MO093M TRITON ACER TENDL-2021 LIBRARY; T=0.K  
deuterons from (t,2nd)

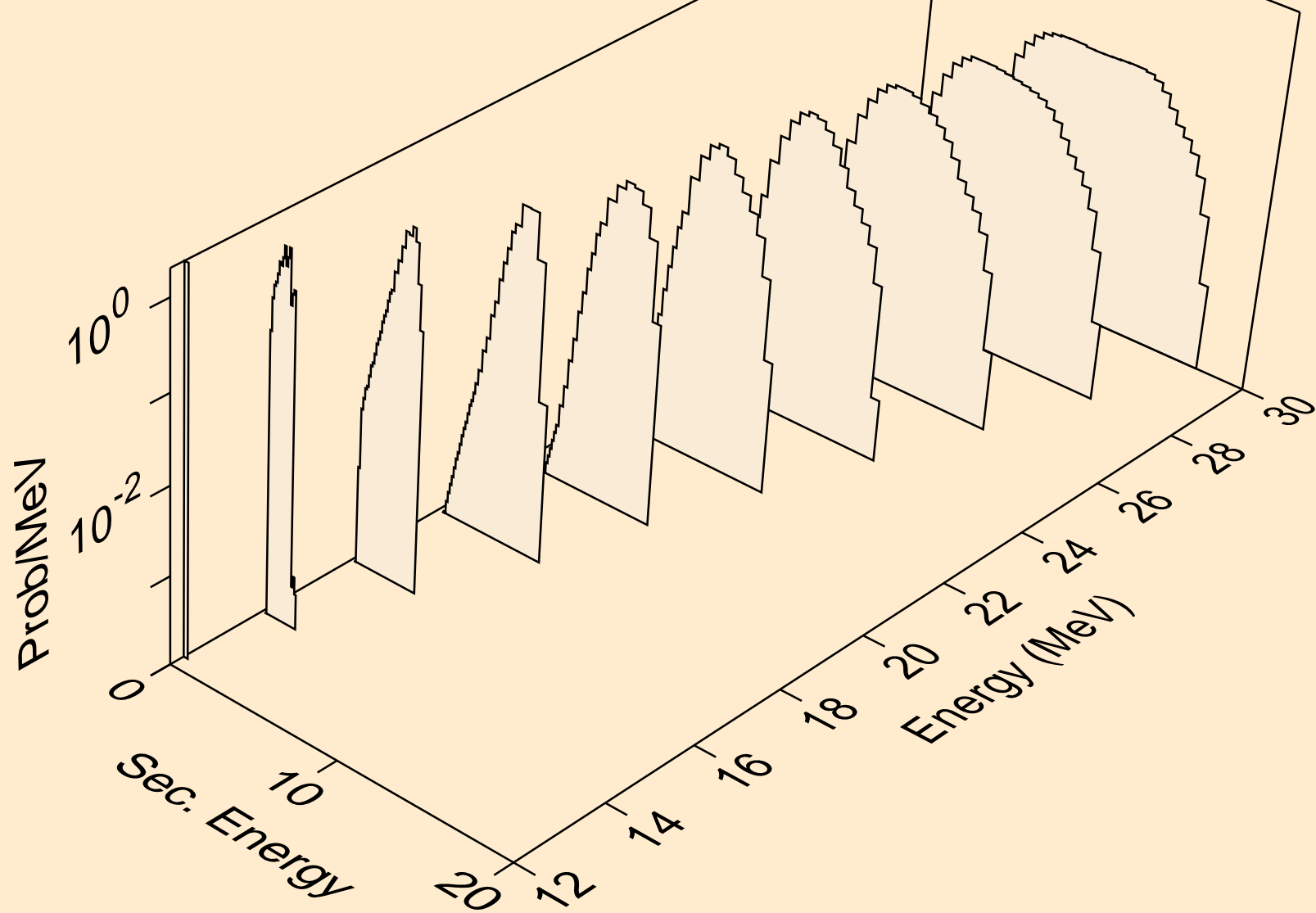



MO093M TRITON ACER TENDL-2021 LIBRARY; T=0.K  
deuterons from (t,n\*)d

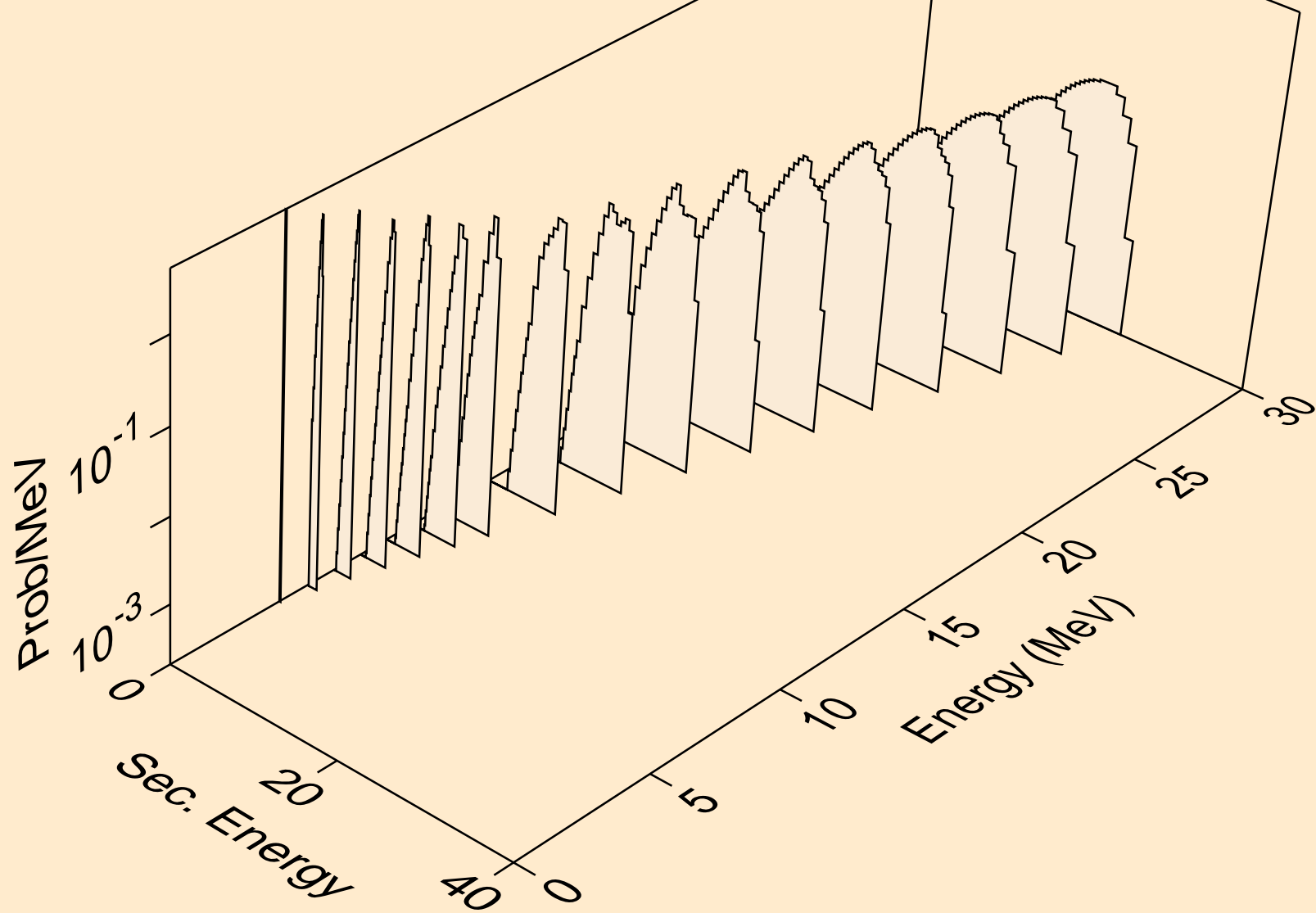

MO093M TRITON ACER TENDL-2021 LIBRARY; T=0.K  
deuterons from (t,d)

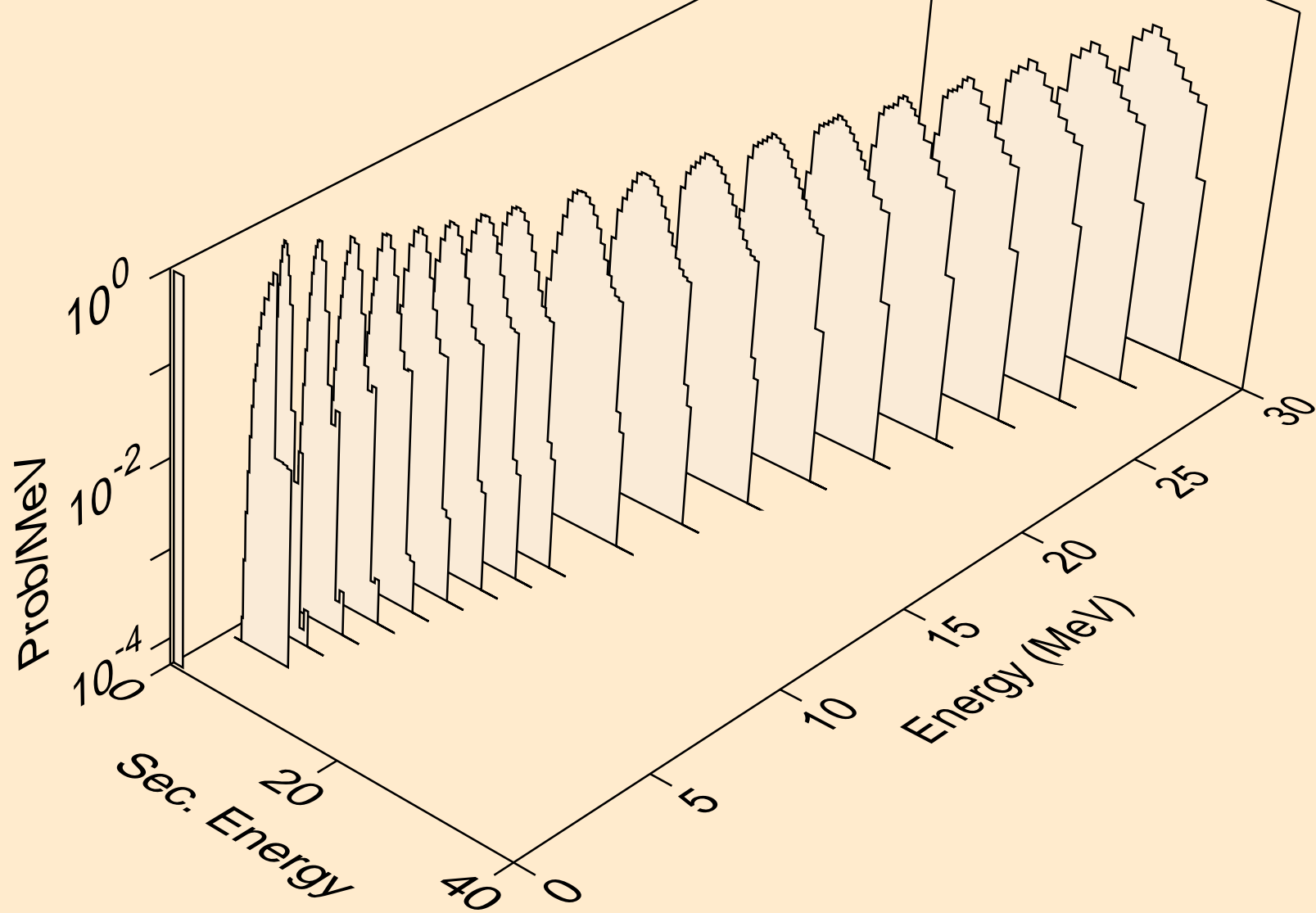

MO093M TRITON ACER TENDL-2021 LIBRARY; T=0.K  
deuterons from (t,pd)

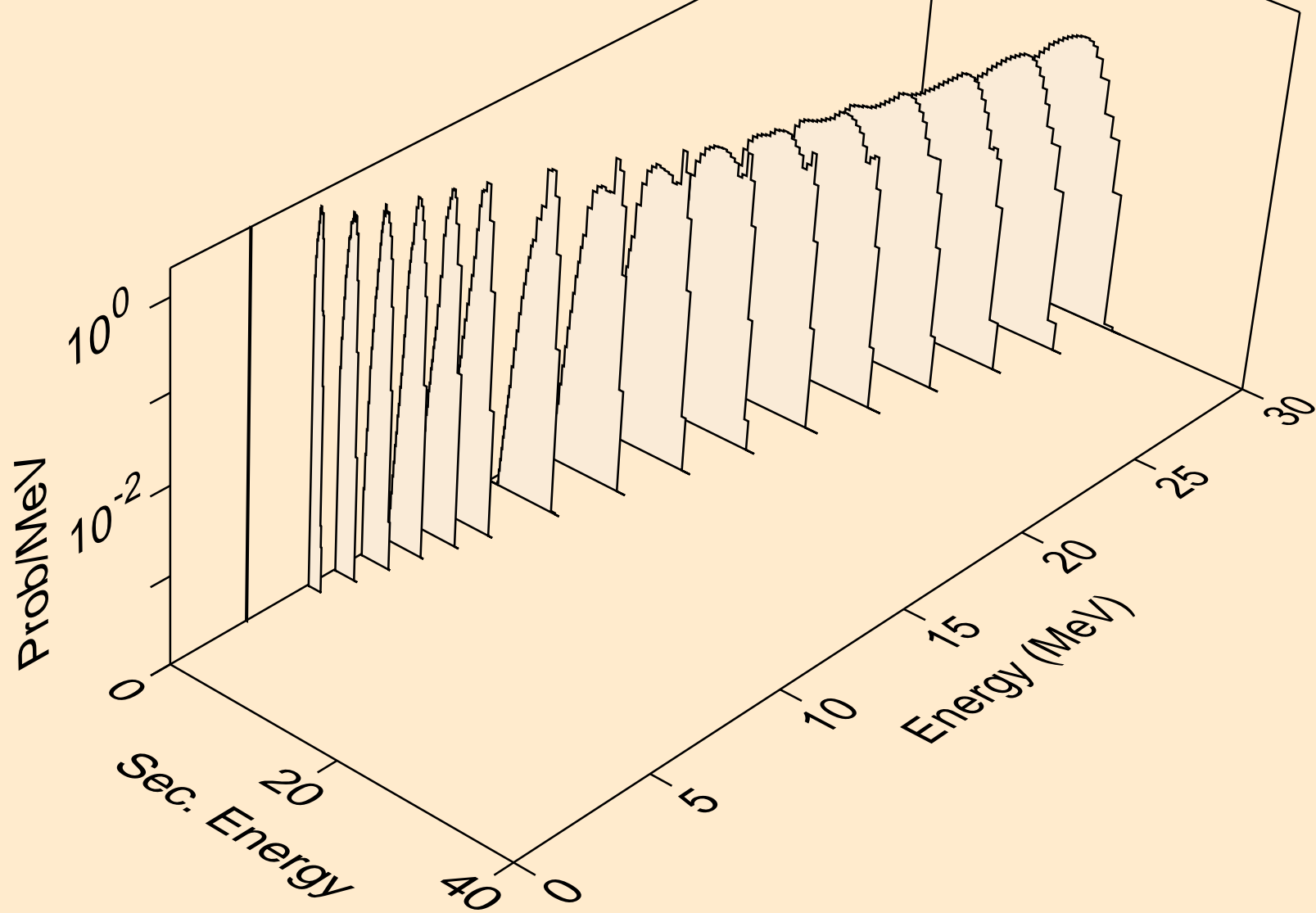

MO093M TRITON ACER TENDL-2021 LIBRARY; T=0.K  
deuterons from (t,da)

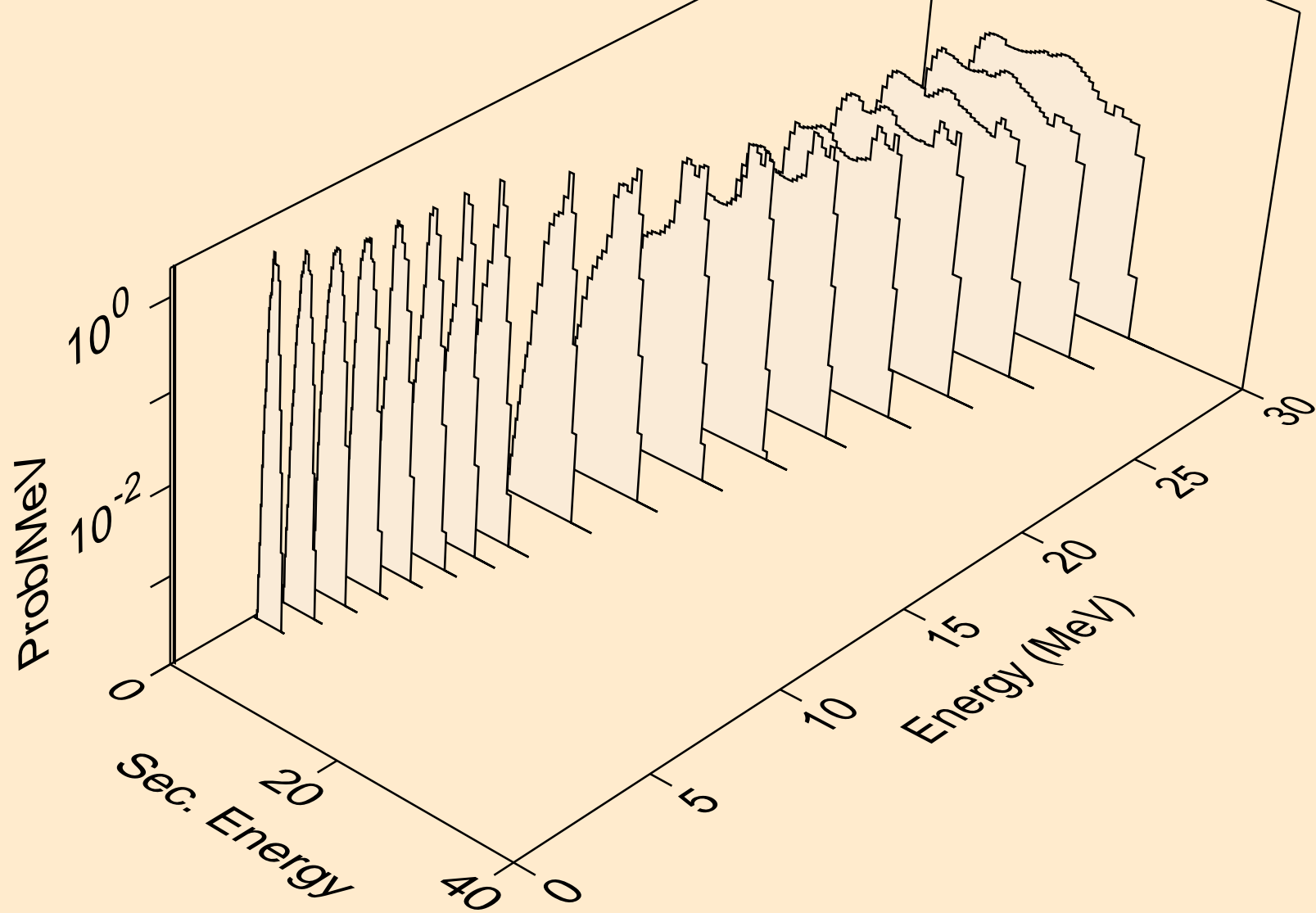

MO093M TRITON ACER TENDL-2021 LIBRARY; T=0.K  
he3s from (t,x)

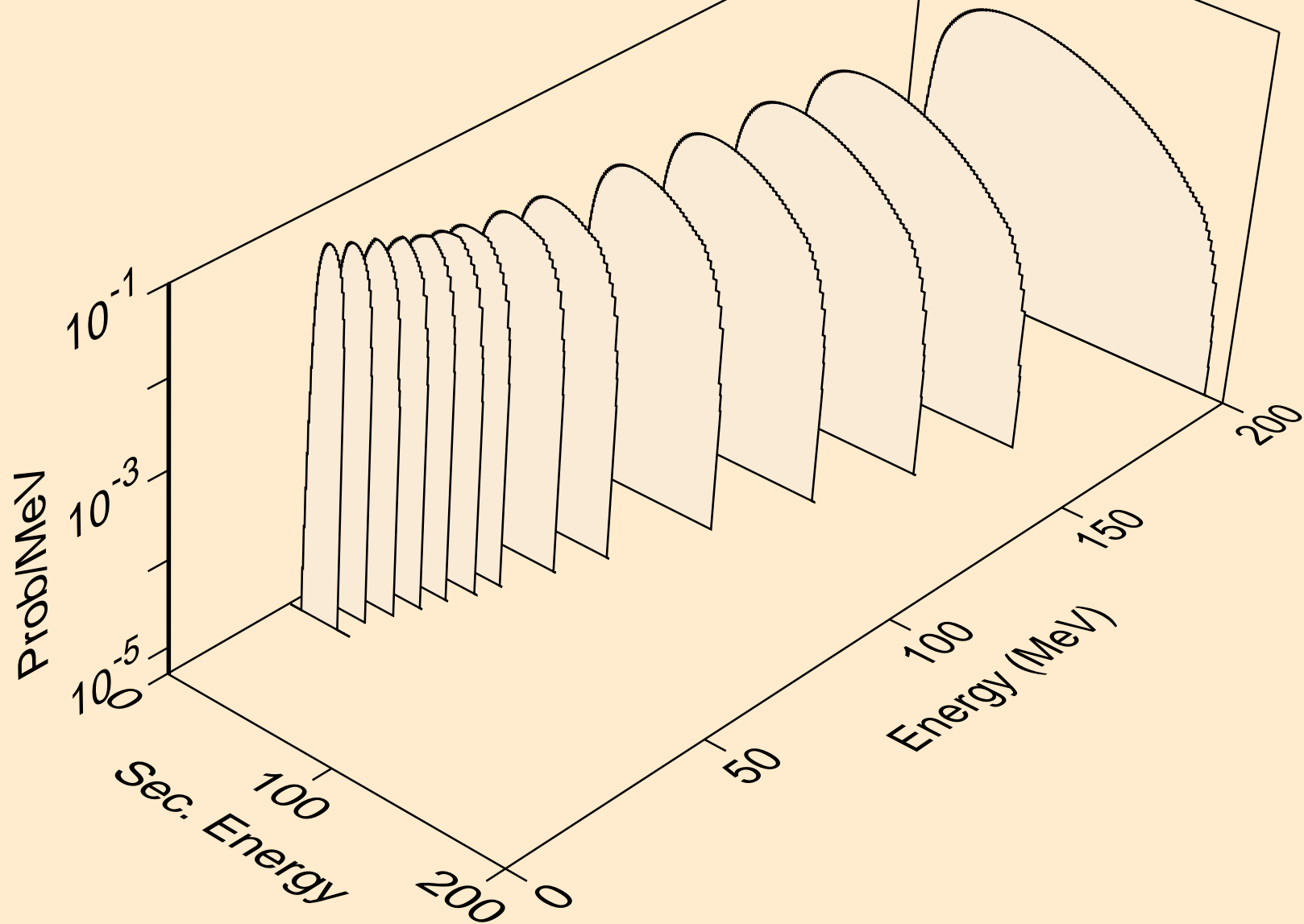

MO093M TRITON ACER TENDL-2021 LIBRARY; T=0.K  
he3s from (t,n\*)he3

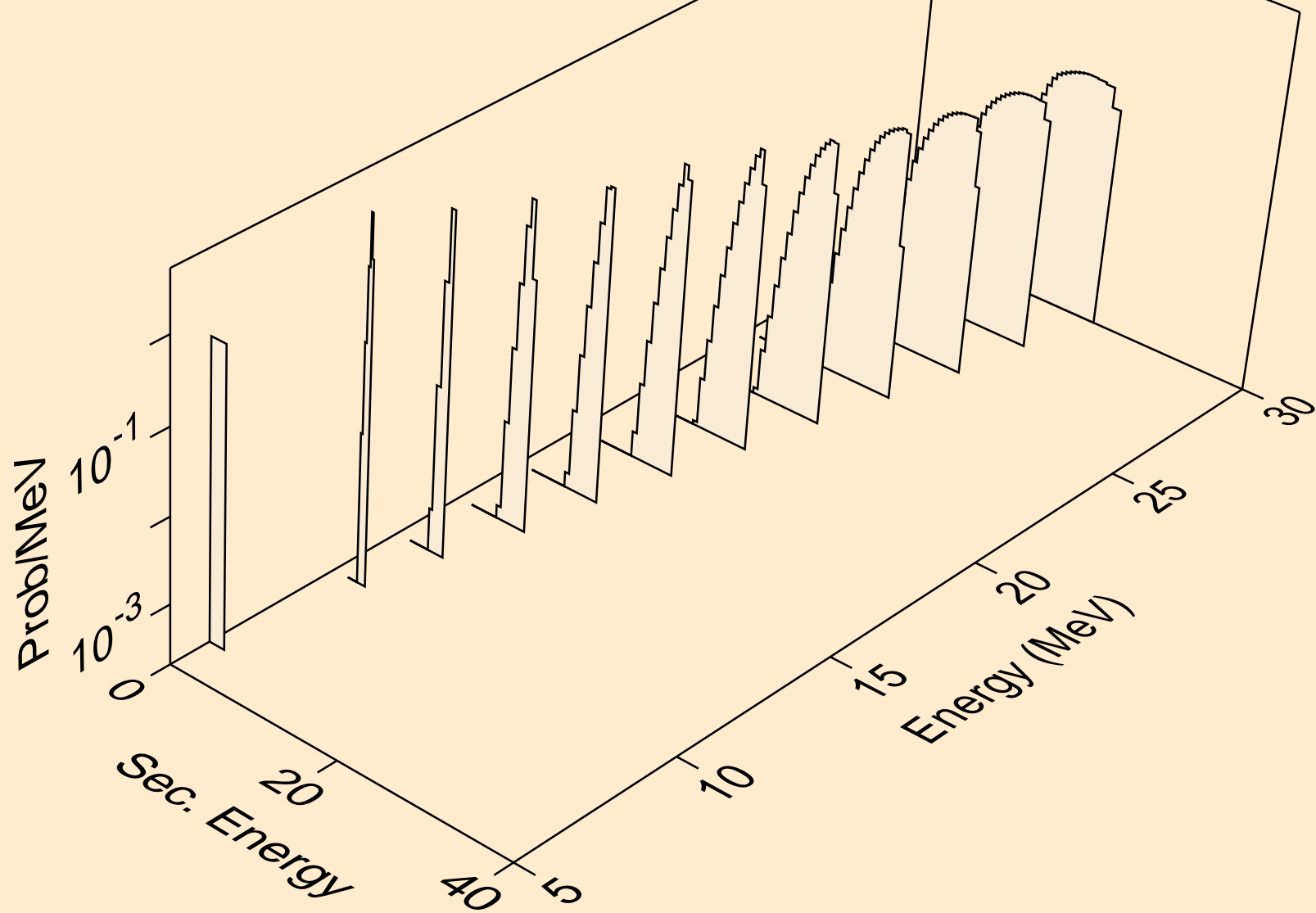

MO093M TRITON ACER TENDL-2021 LIBRARY; T=0.K  
he3s from (t,he3)

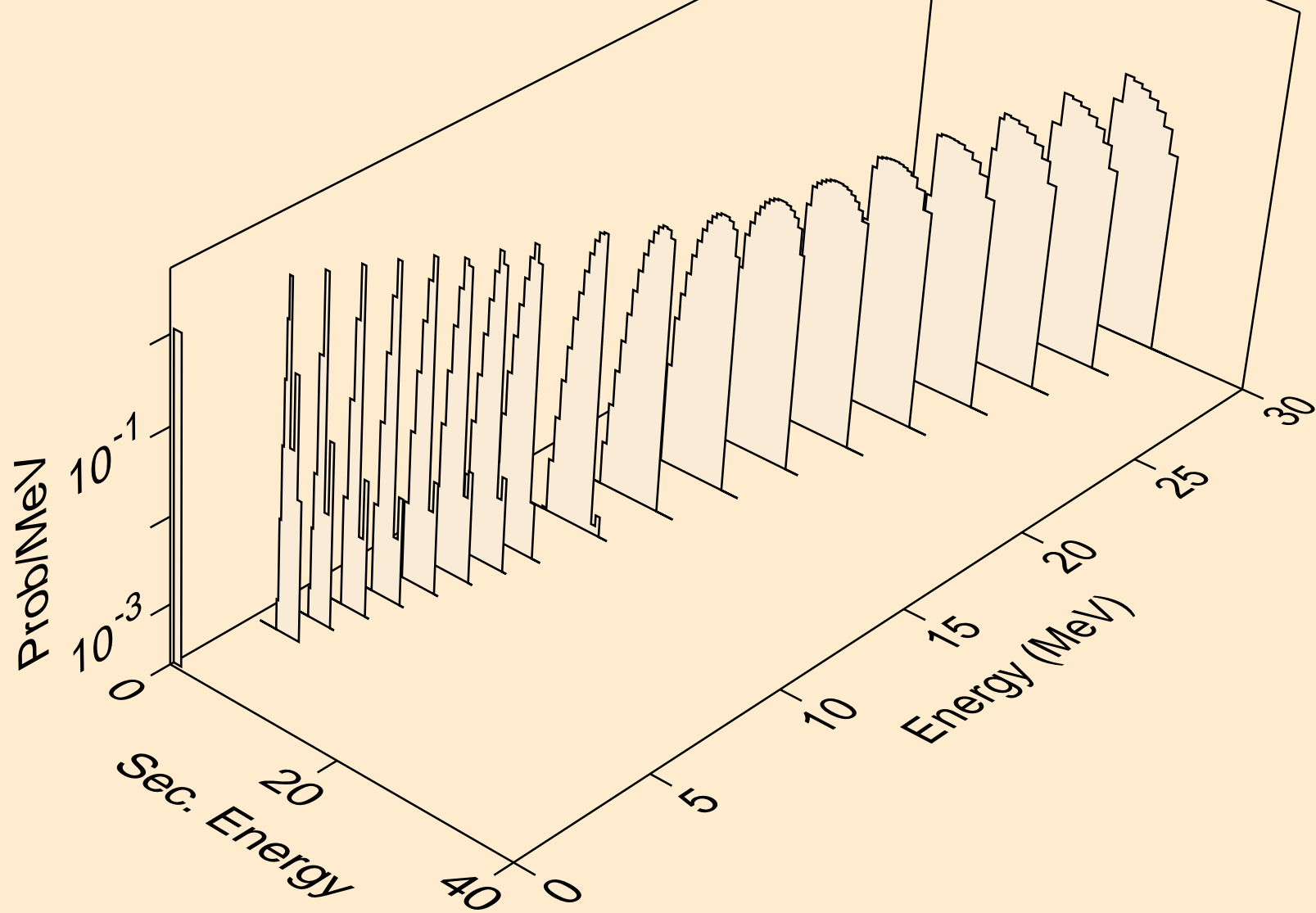

MO093M TRITON ACER TENDL-2021 LIBRARY; T=0.K  
alphas from (t,x)

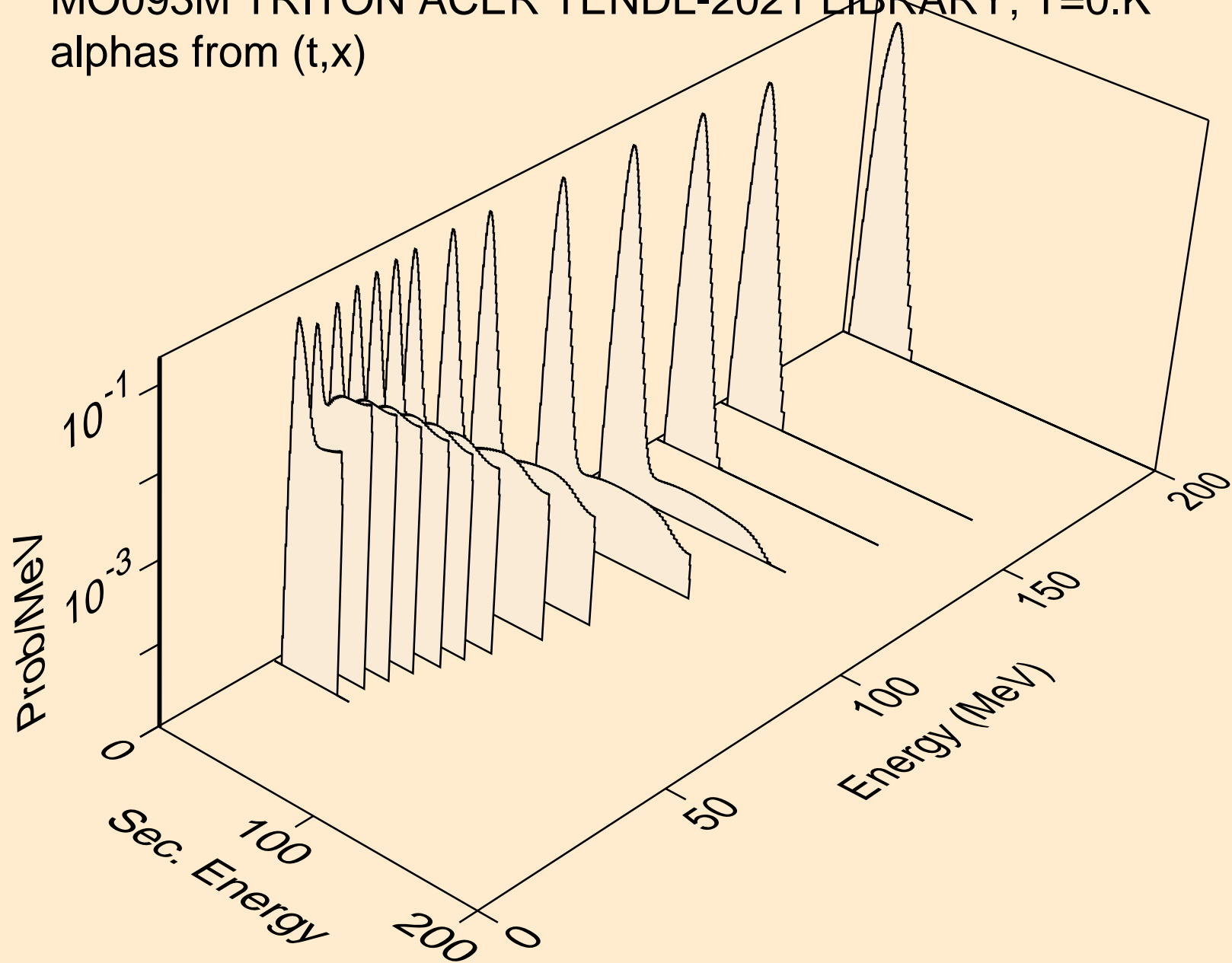



MO093M TRITON ACER TENDL-2021 LIBRARY; T=0.K  
alphas from (t,n\*)a

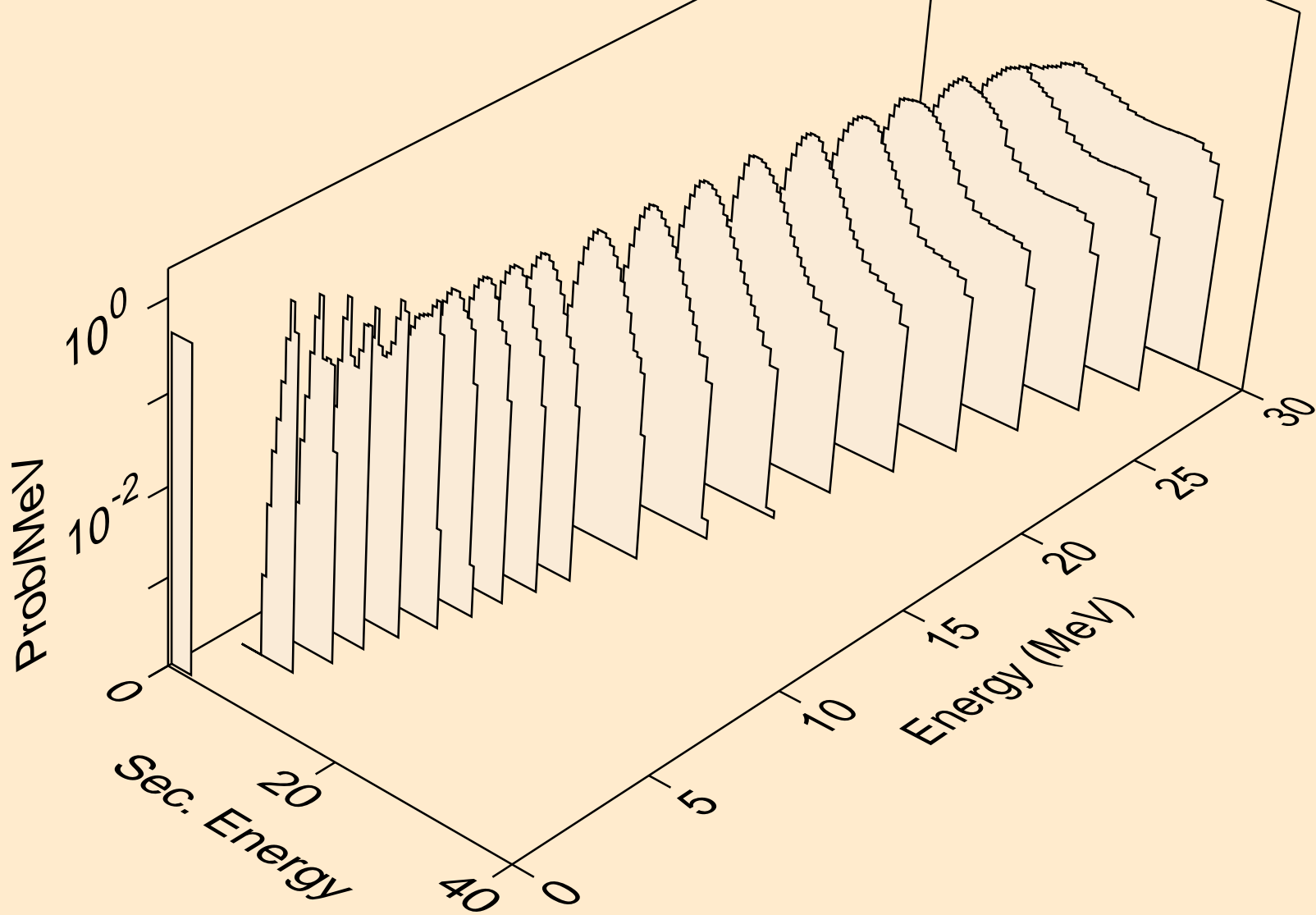

MO093M TRITON ACER TENDL-2021 LIBRARY; T=0.K  
alphas from (t,2n)a

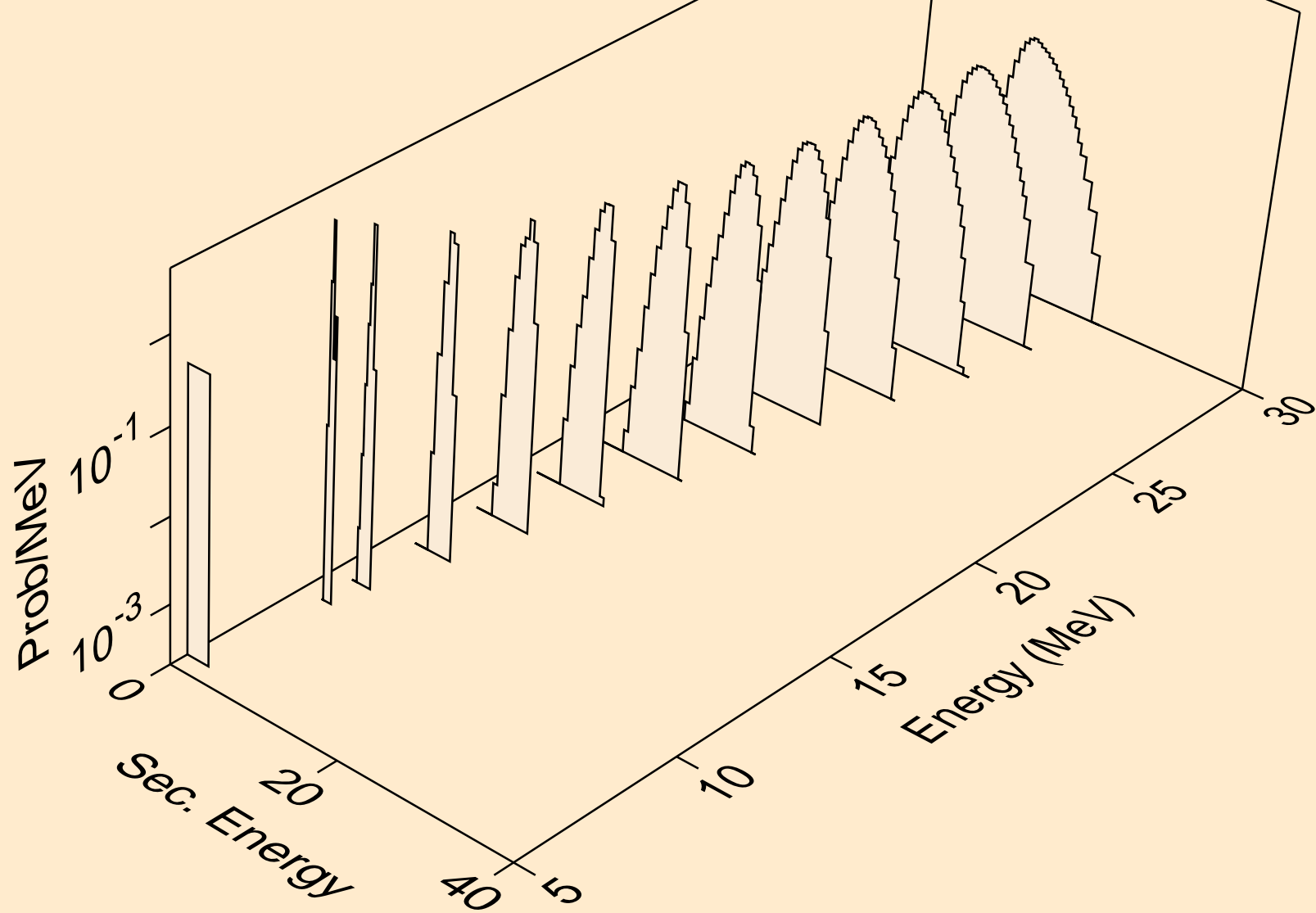

MO093M TRITON ACER TENDL-2021 LIBRARY; T=0.K  
alphas from (t,3n)a

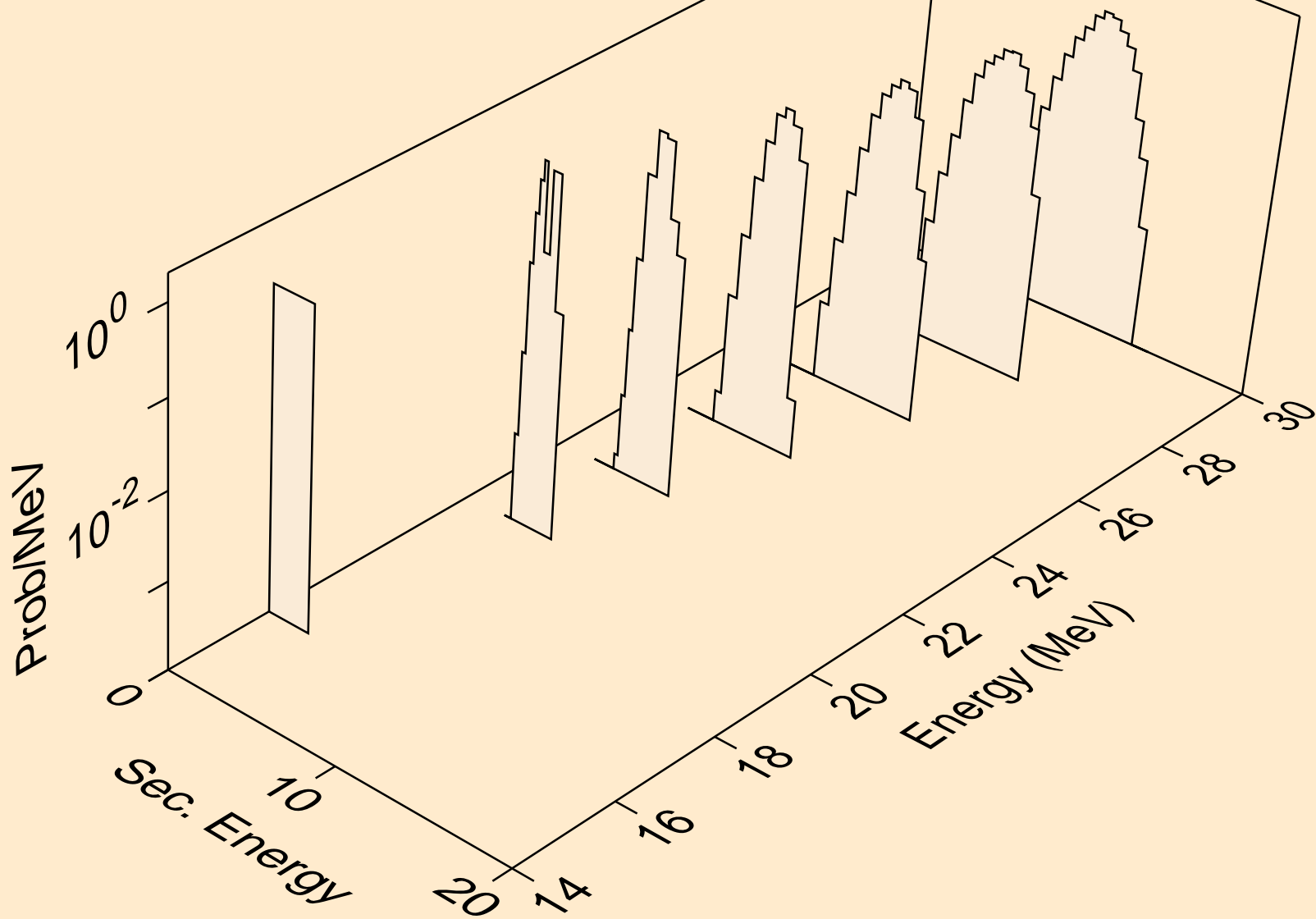

MO093M TRITON ACER TENDL-2021 LIBRARY; T=0.K  
alphas from (t,n\*)2a

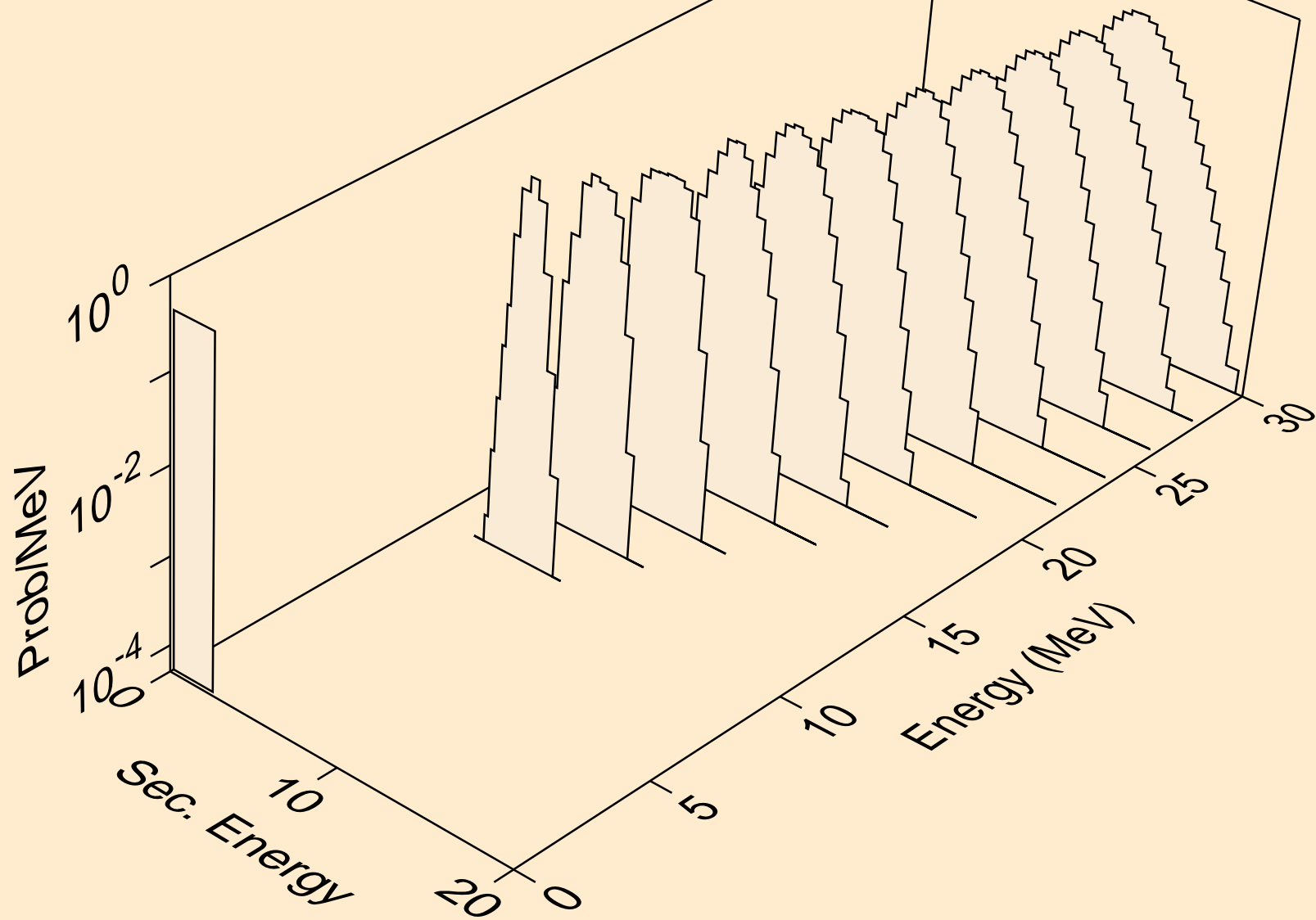

MO093M TRITON ACER TENDL-2021 LIBRARY; T=0.K  
alphas from (t,2n)2a

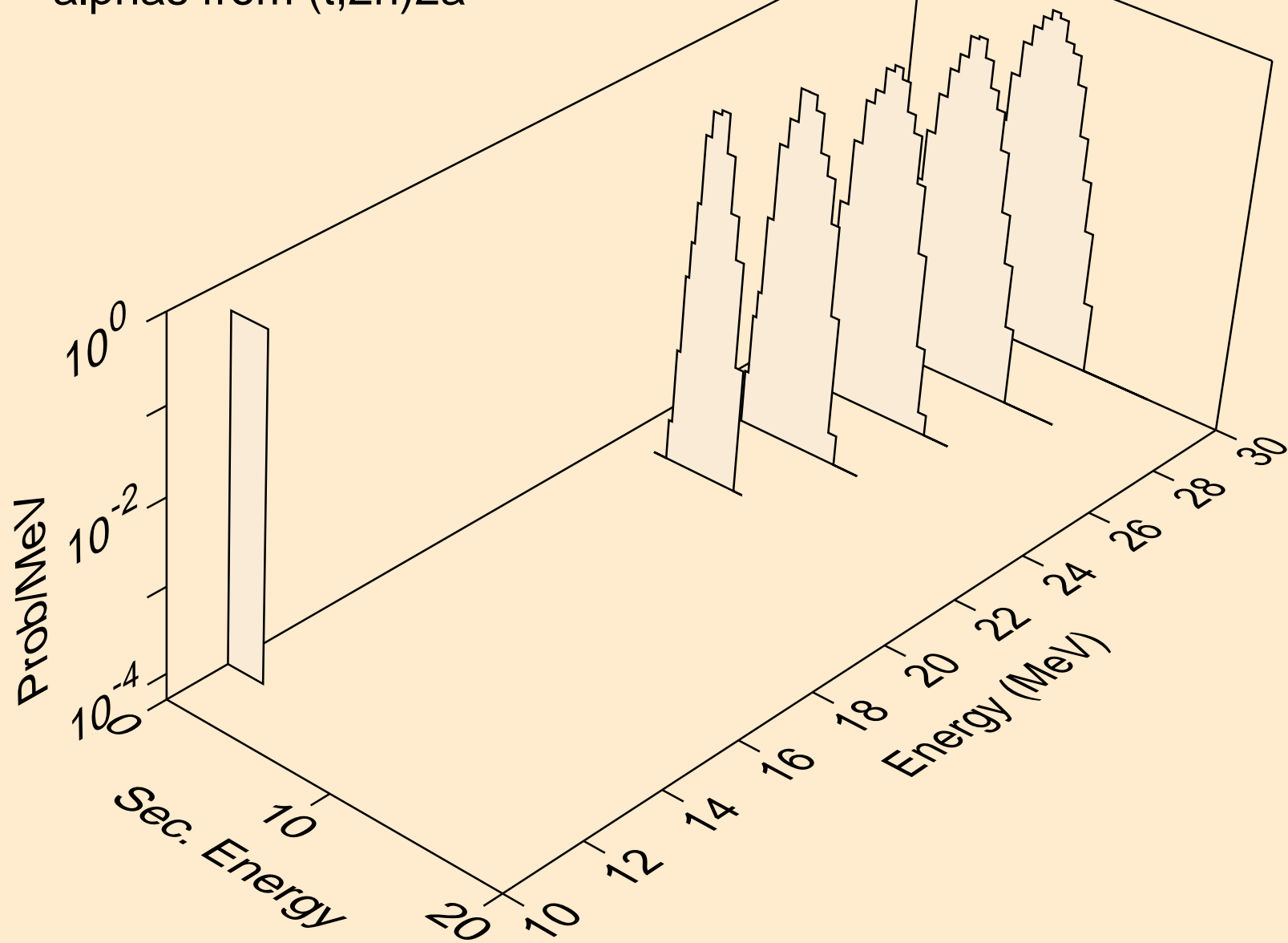

MO093M TRITON ACER TENDL-2021 LIBRARY; T=0.K  
alphas from (t,npa)

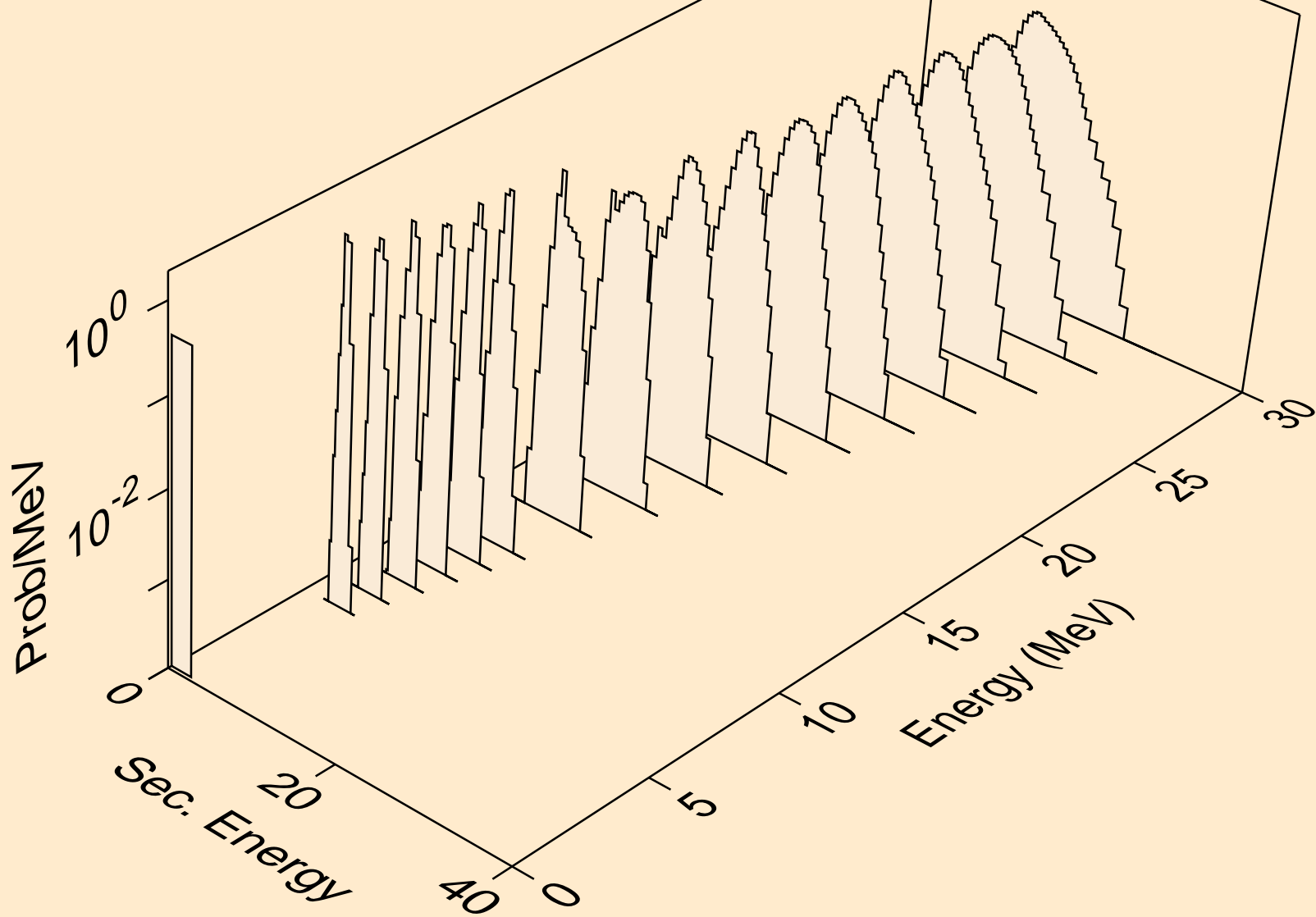

MO093M TRITON ACER TENDL-2021 LIBRARY; T=0.K  
alphas from (t,a)

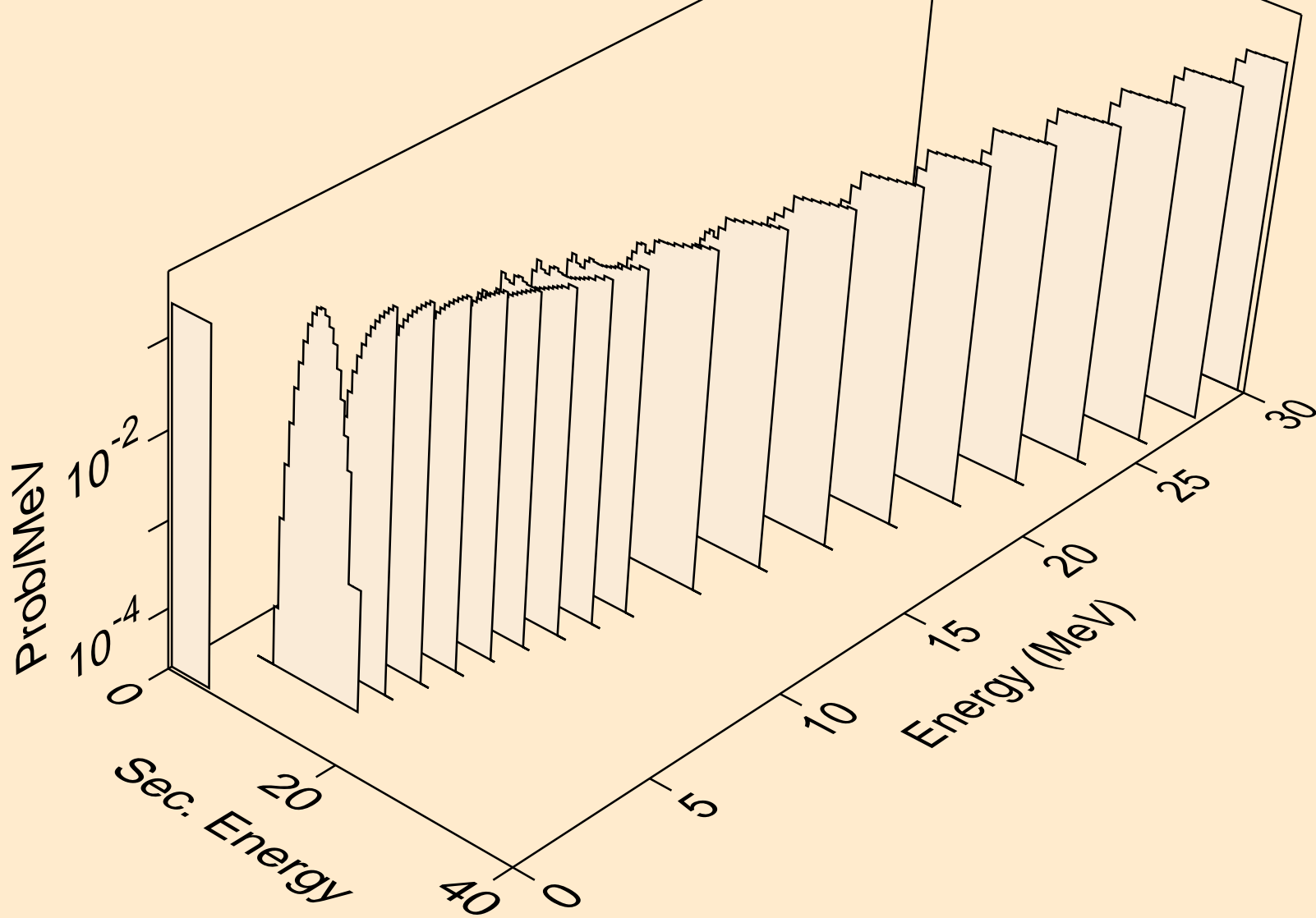

MO093M TRITON ACER TENDL-2021 LIBRARY; T=0.K  
alphas from (t,2a)

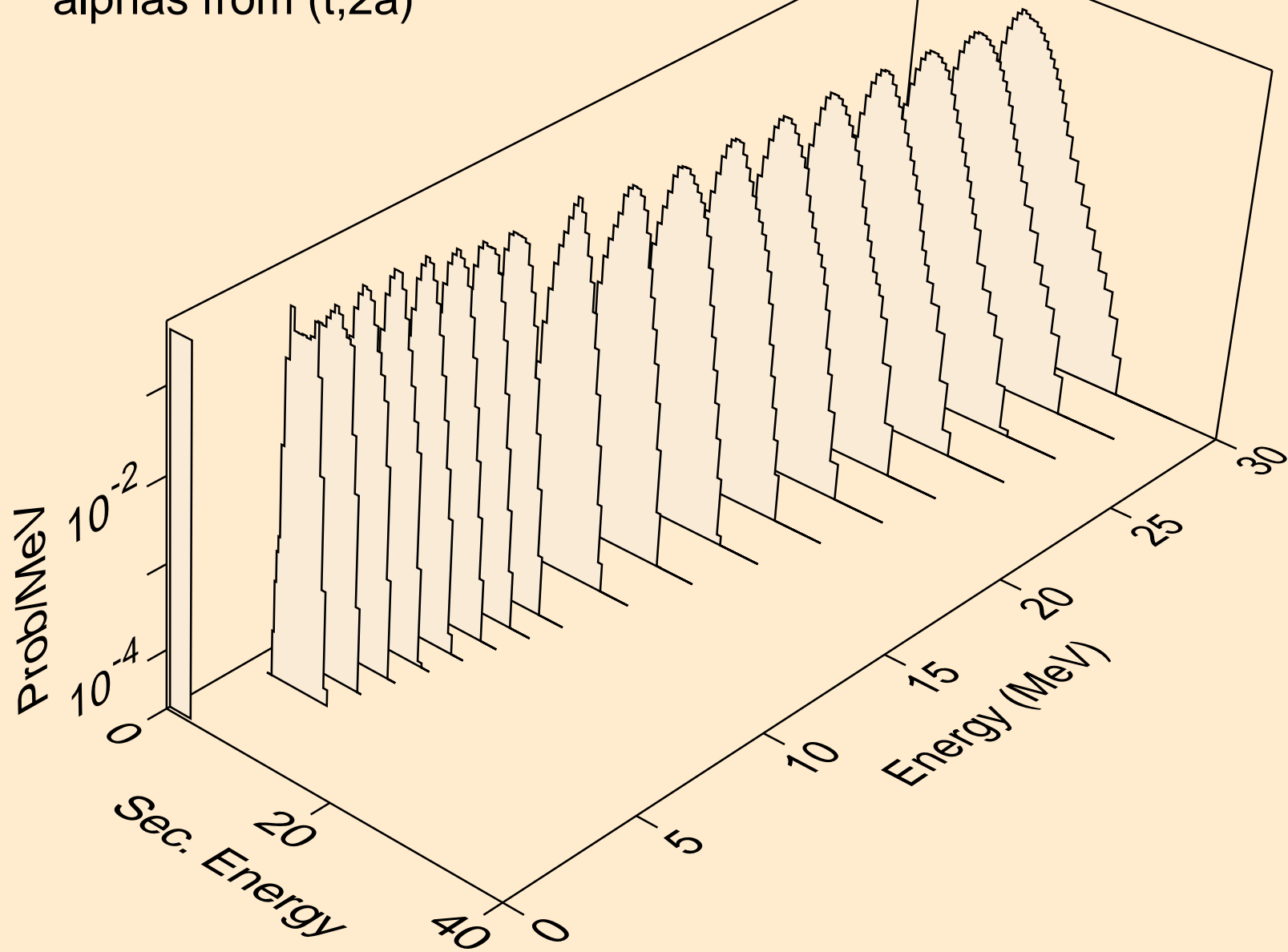



MO093M TRITON ACER TENDL-2021 LIBRARY; T=0.K  
alphas from (t,3a)

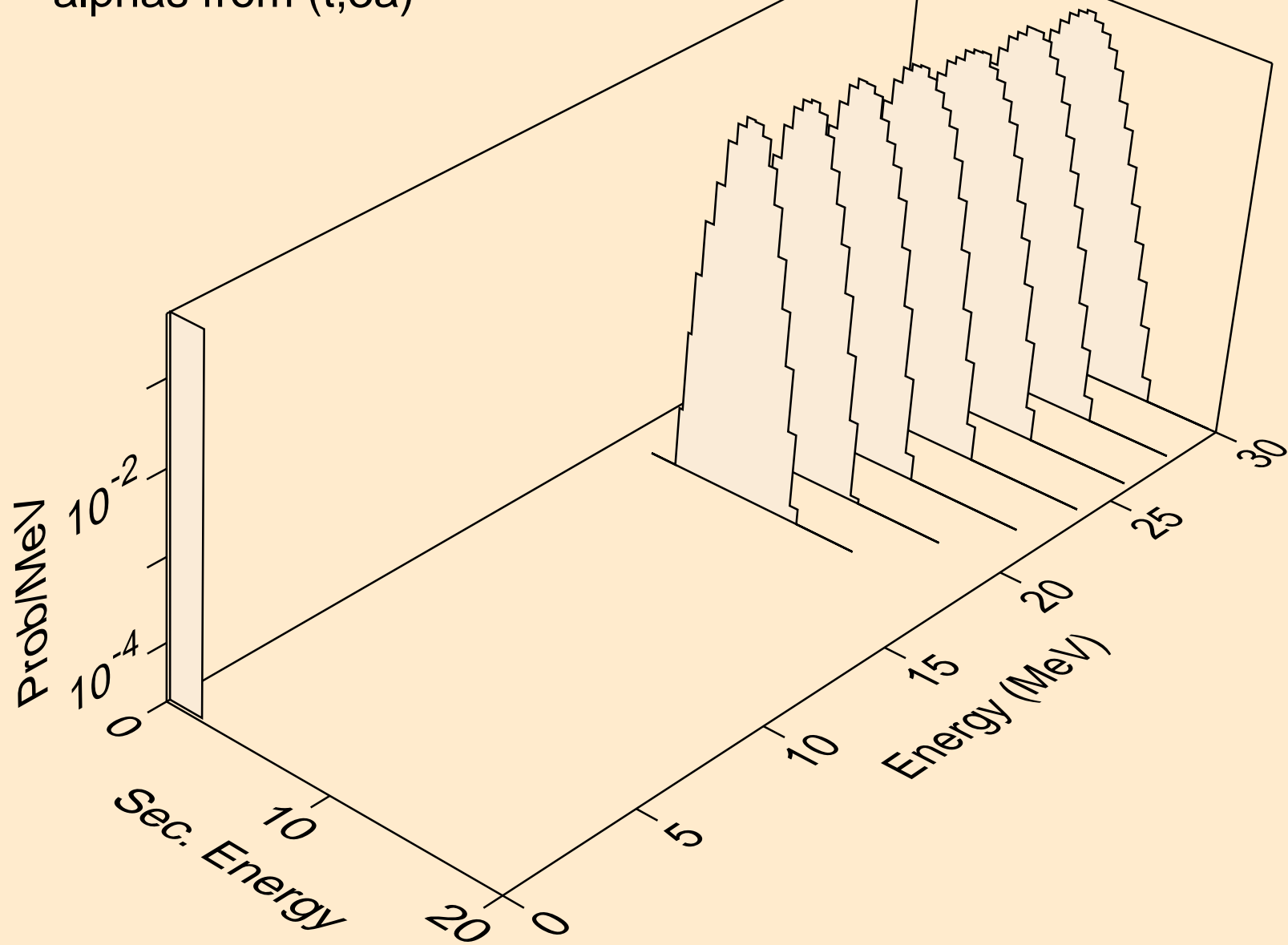

MO093M TRITON ACER TENDL-2021 LIBRARY; T=0.K  
alphas from (t,pa)

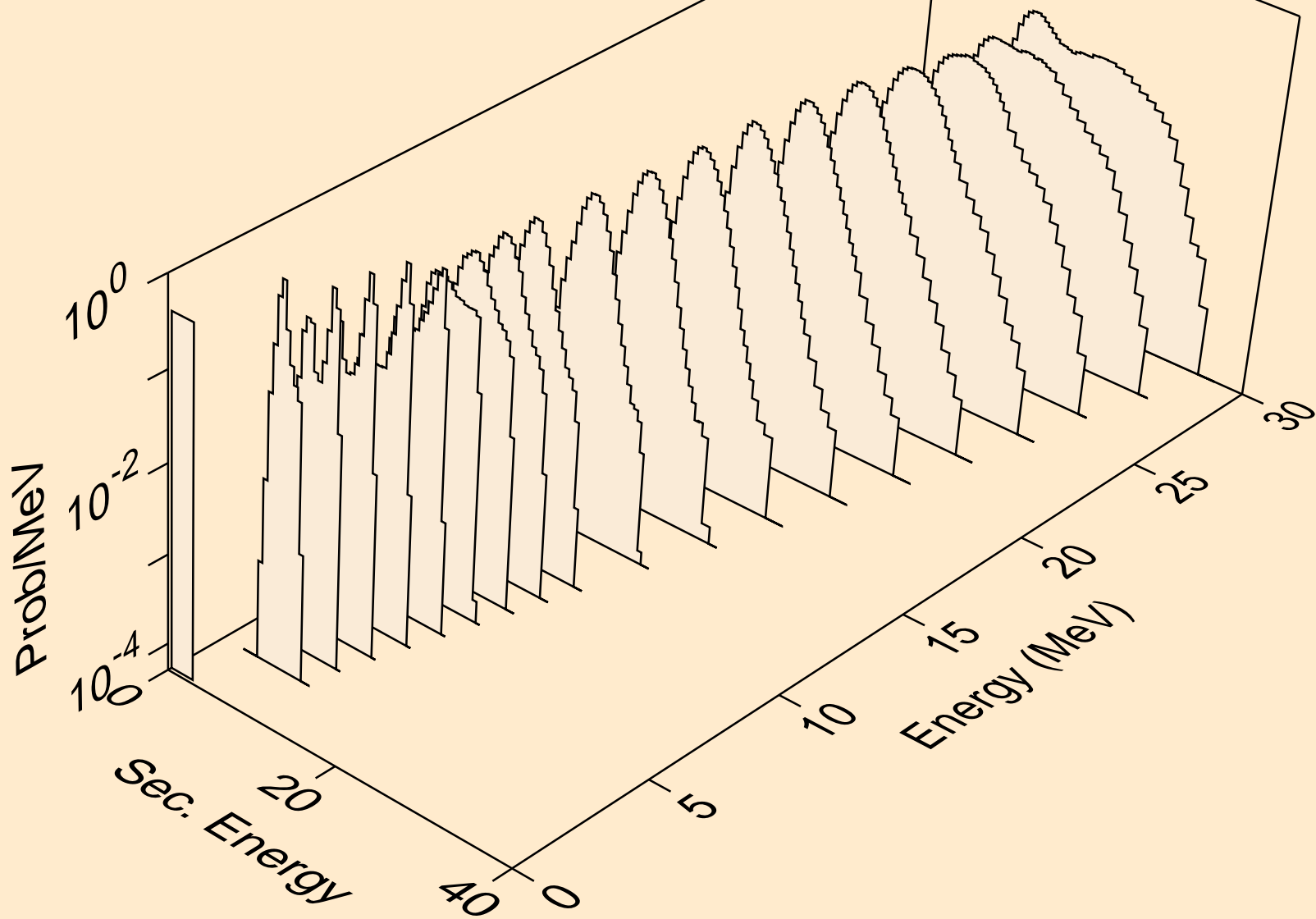

MO093M TRITON ACER TENDL-2021 LIBRARY; T=0.K  
alphas from (t,da)

