

NB084 TRITON ACER TENDL-2021 LIBRARY; T=0.K  
Principal cross sections

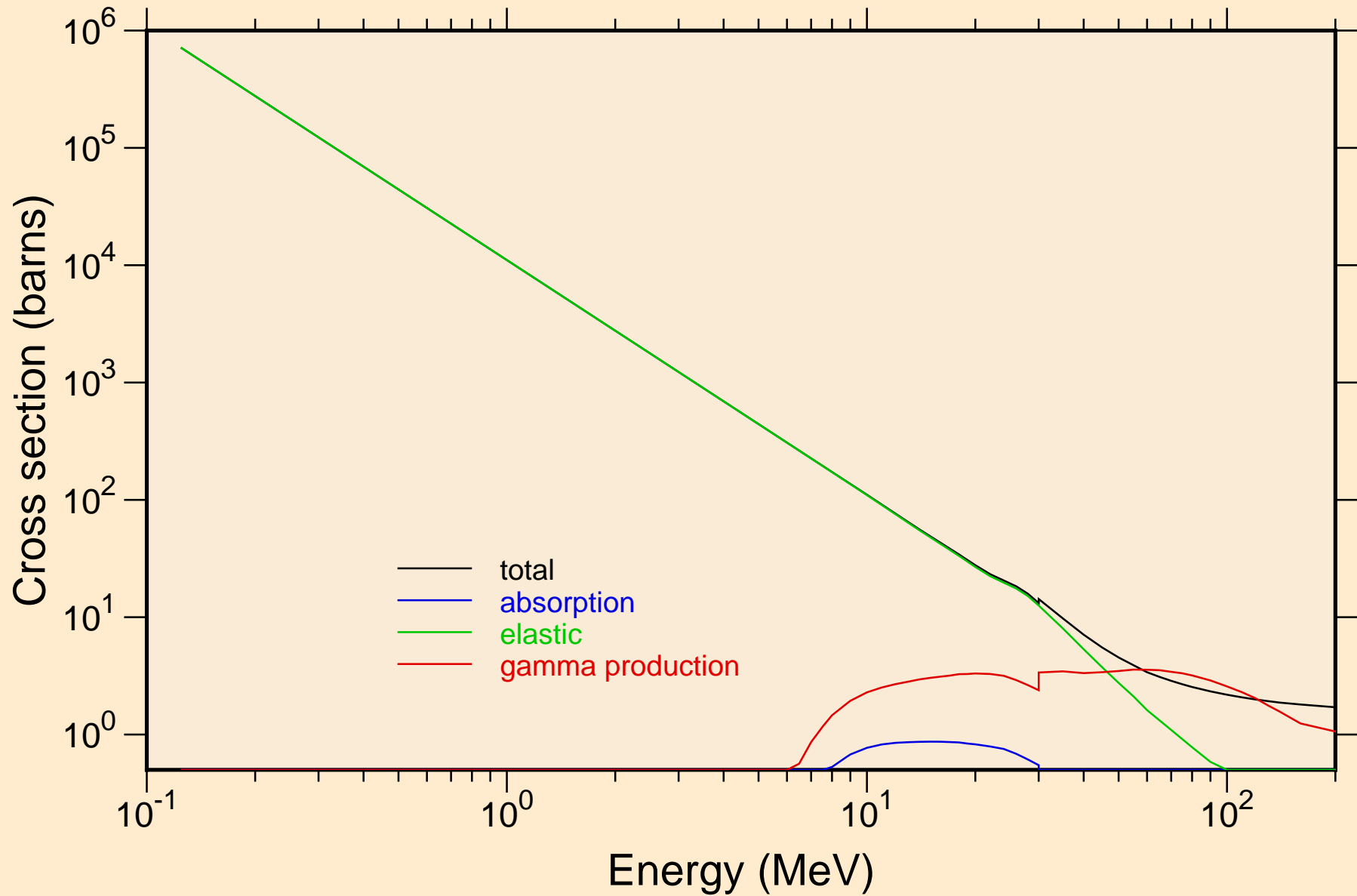

NB084 TRITON ACER TENDL-2021 LIBRARY; T=0.K  
Heating

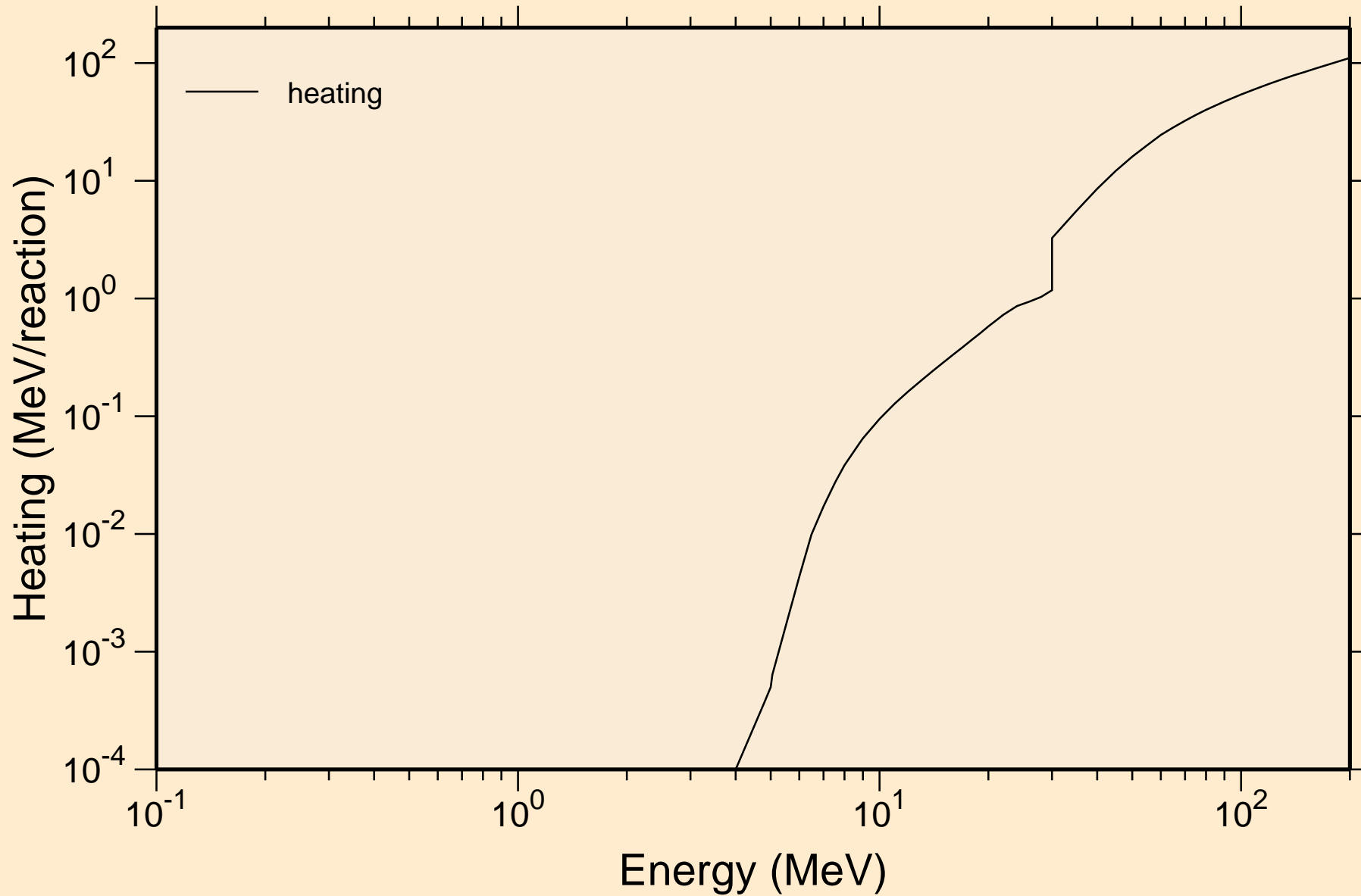

# NB084 TRITON ACER TENDL-2021 LIBRARY; T=0.K

## Principal cross sections

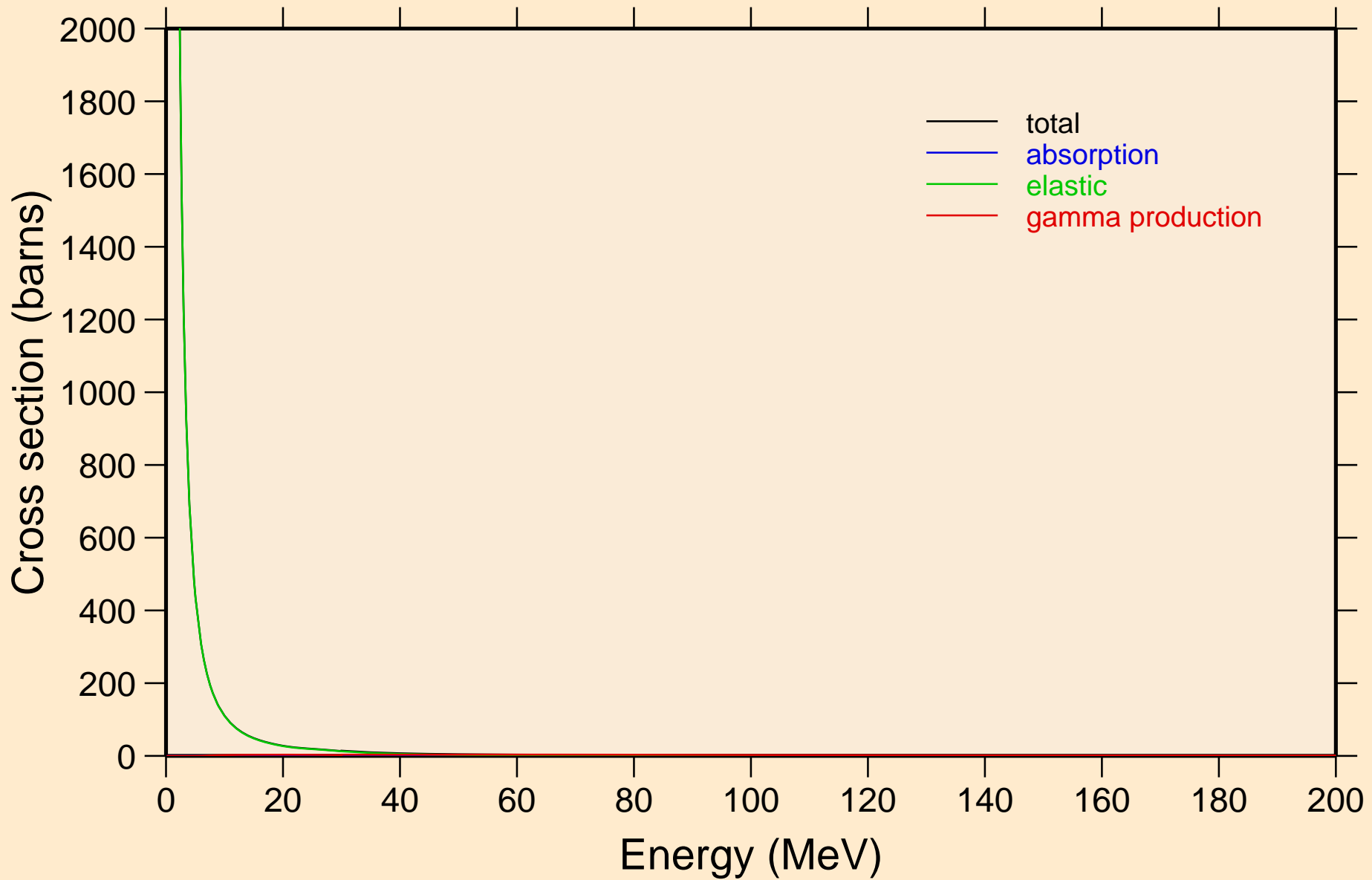

NB084 TRITON ACER TENDL-2021 LIBRARY; T=0.K

Heating

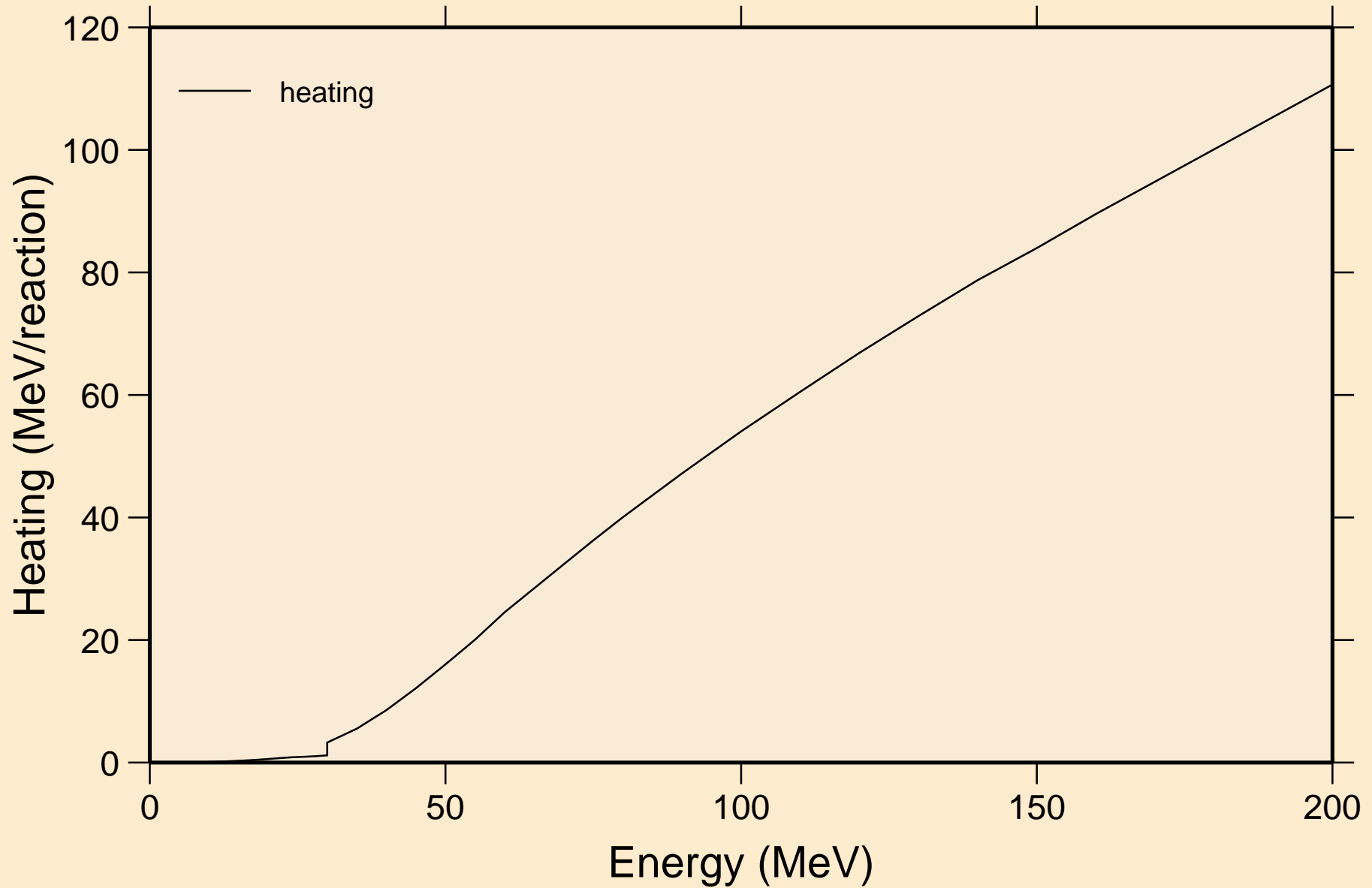

NB084 TRITON ACER TENDL-2021 LIBRARY; T=0.K  
Threshold reactions

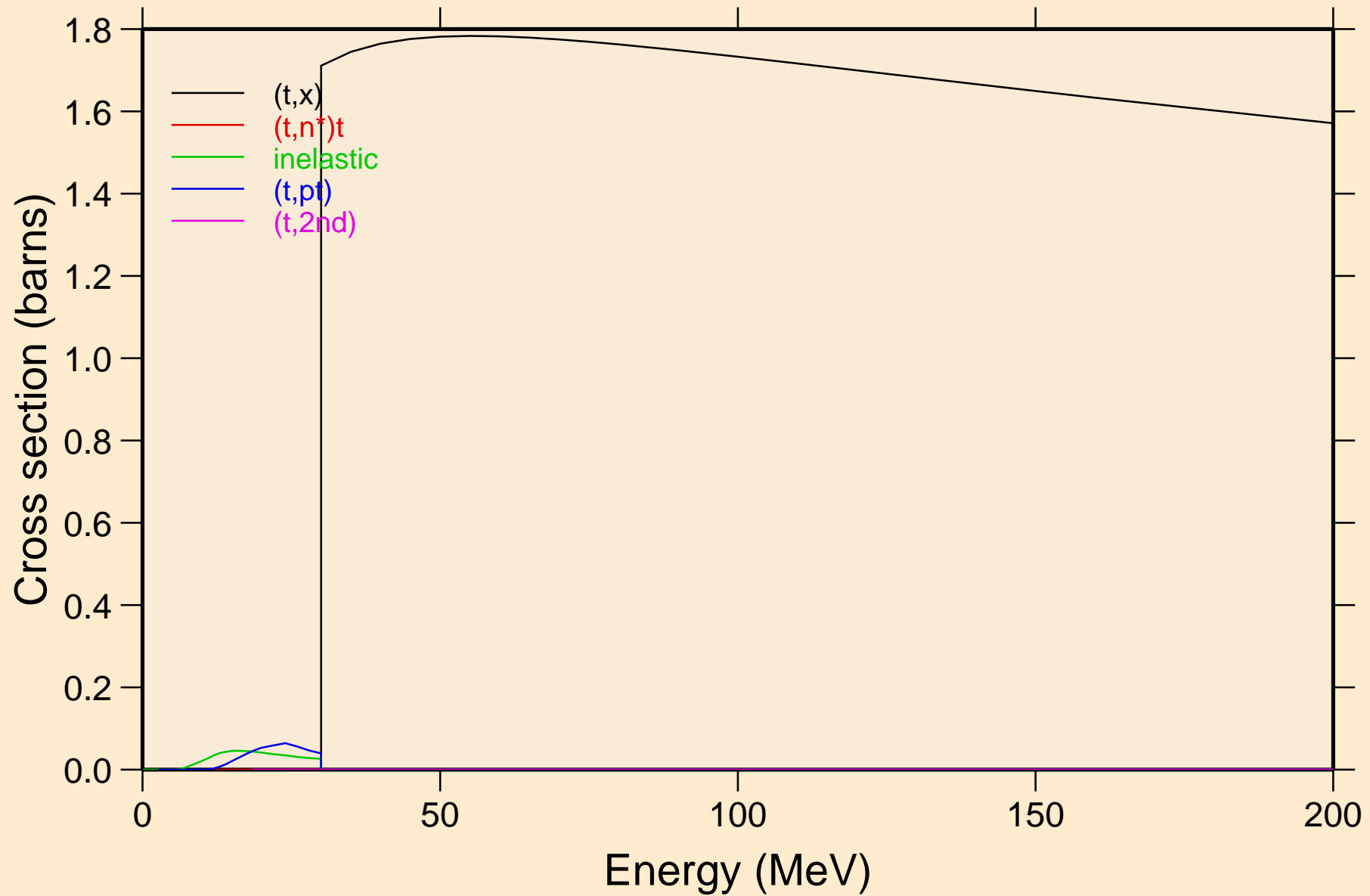

NB084 TRITON ACER TENDL-2021 LIBRARY; T=0.K  
Threshold reactions

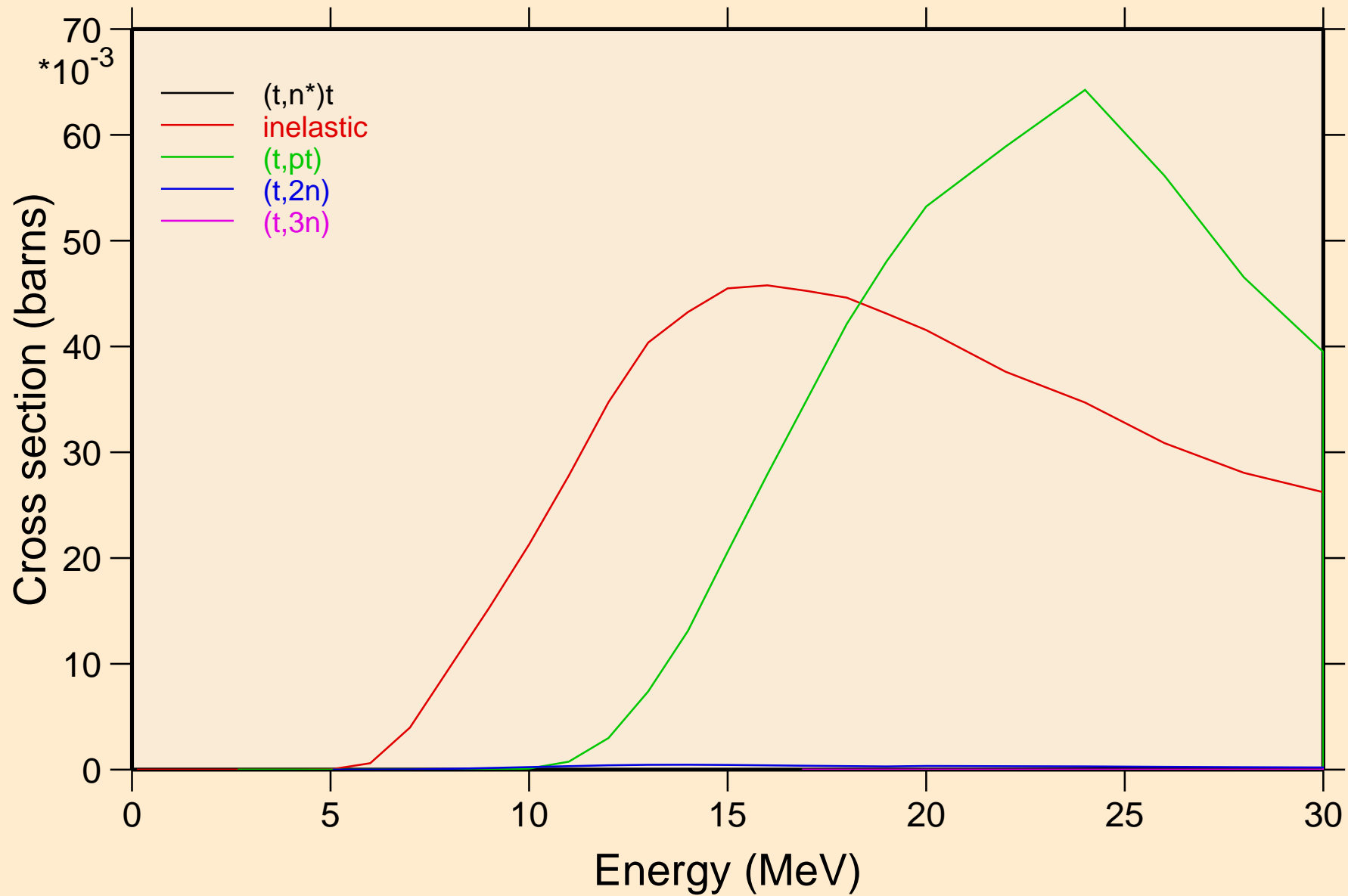

NB084 TRITON ACER TENDL-2021 LIBRARY; T=0.K  
Threshold reactions

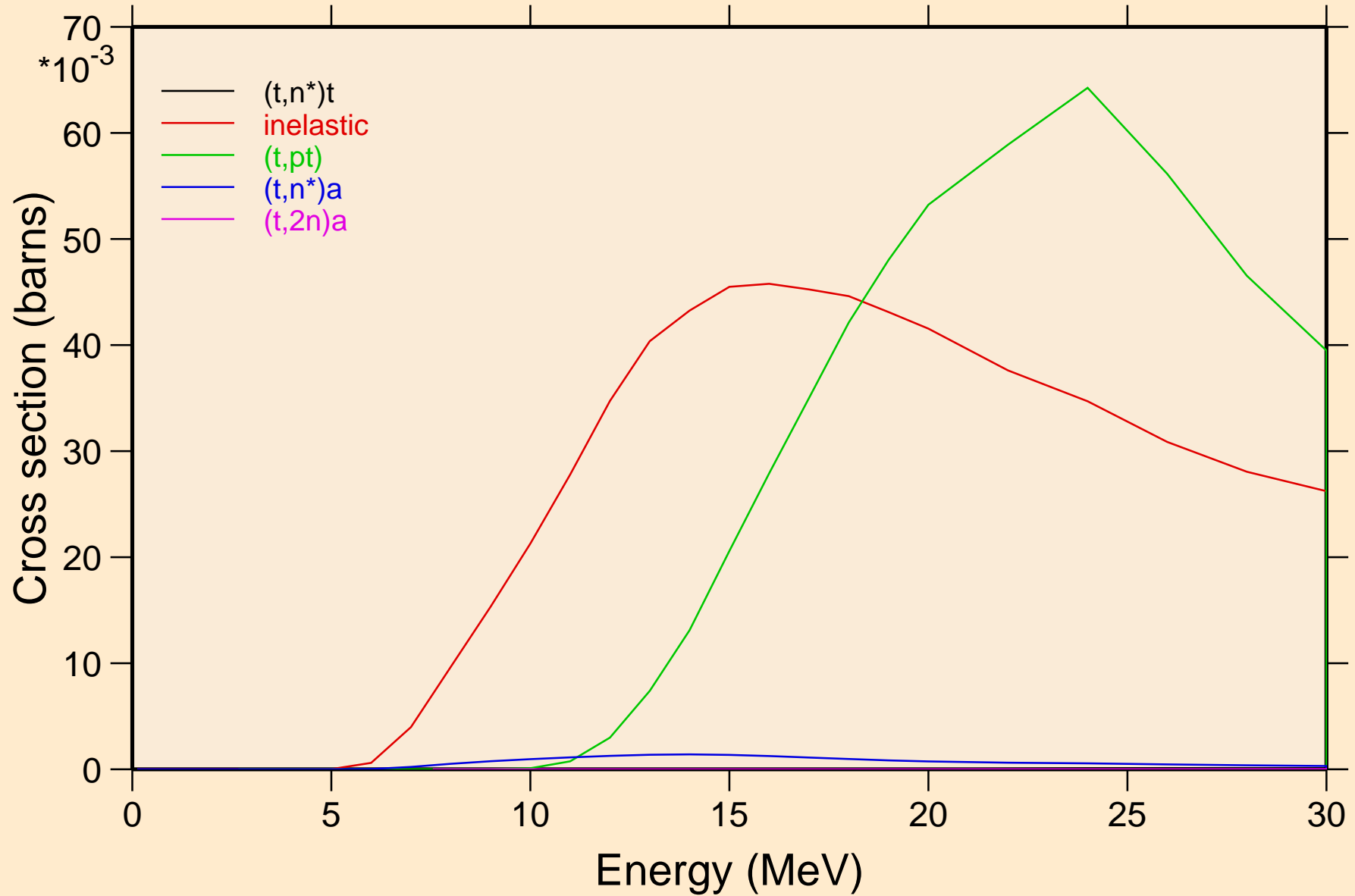

NB084 TRITON ACER TENDL-2021 LIBRARY; T=0.K  
Threshold reactions

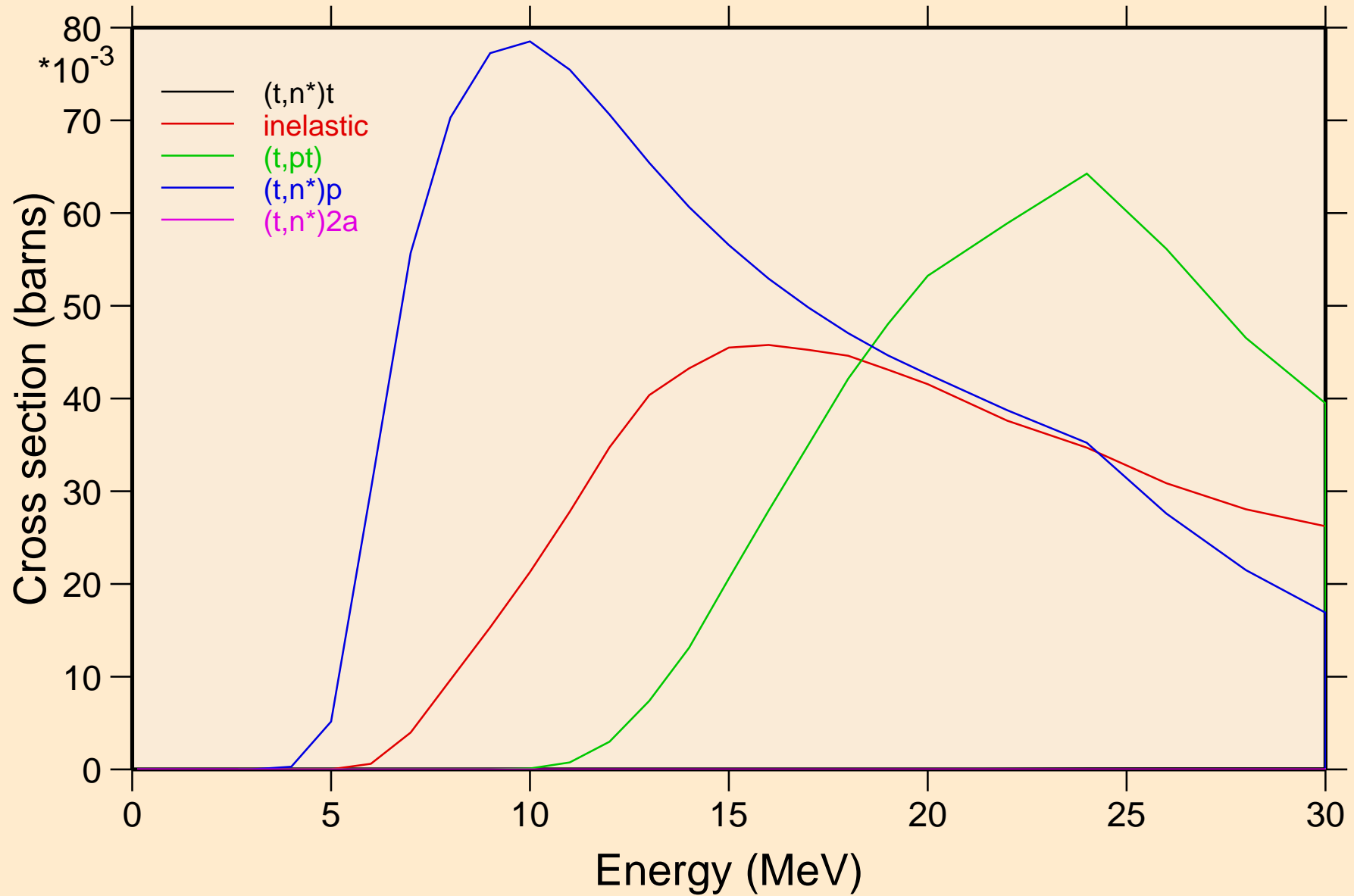



NB084 TRITON ACER TENDL-2021 LIBRARY; T=0.K  
Threshold reactions

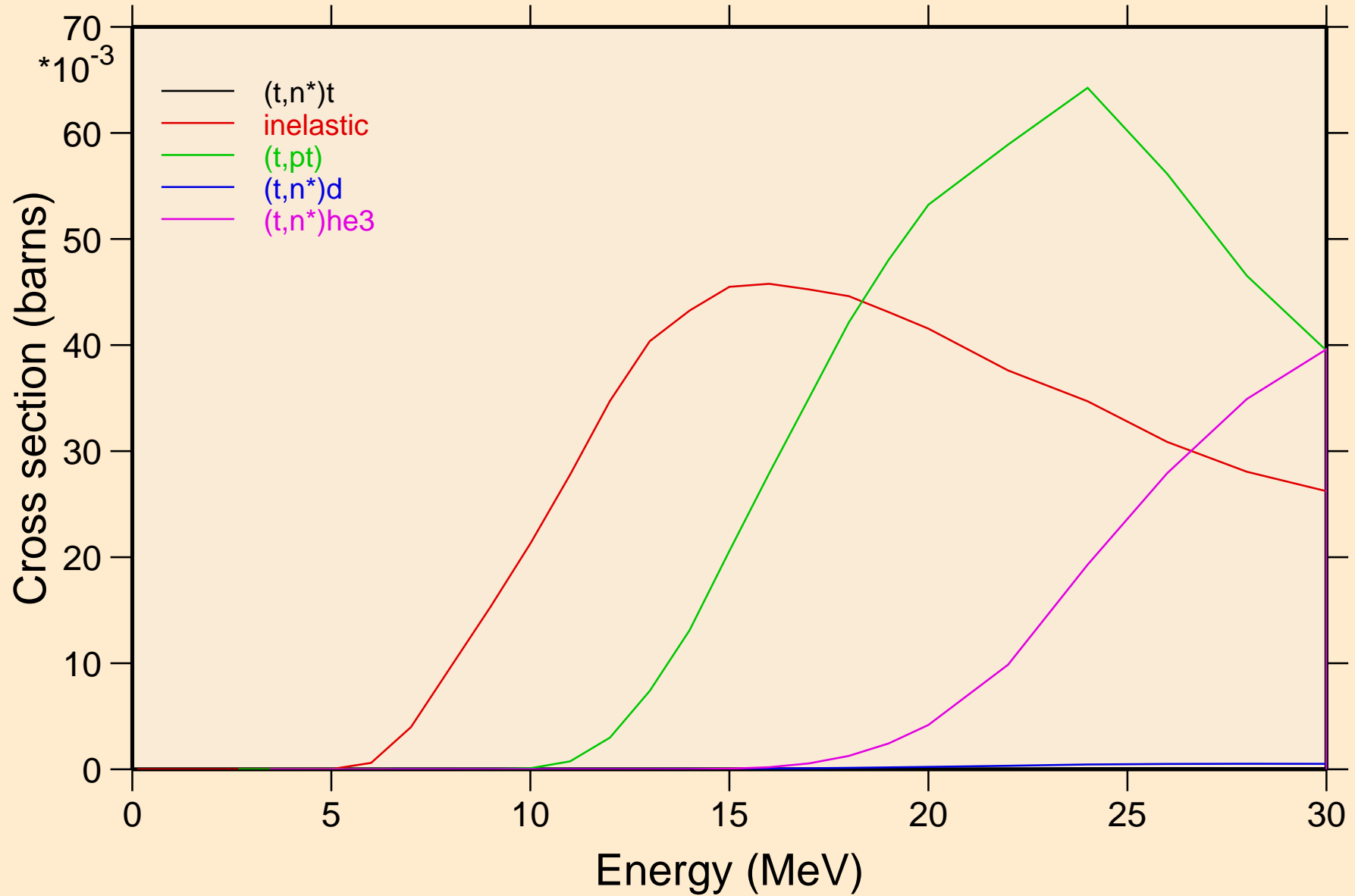

NB084 TRITON ACER TENDL-2021 LIBRARY; T=0.K  
Threshold reactions

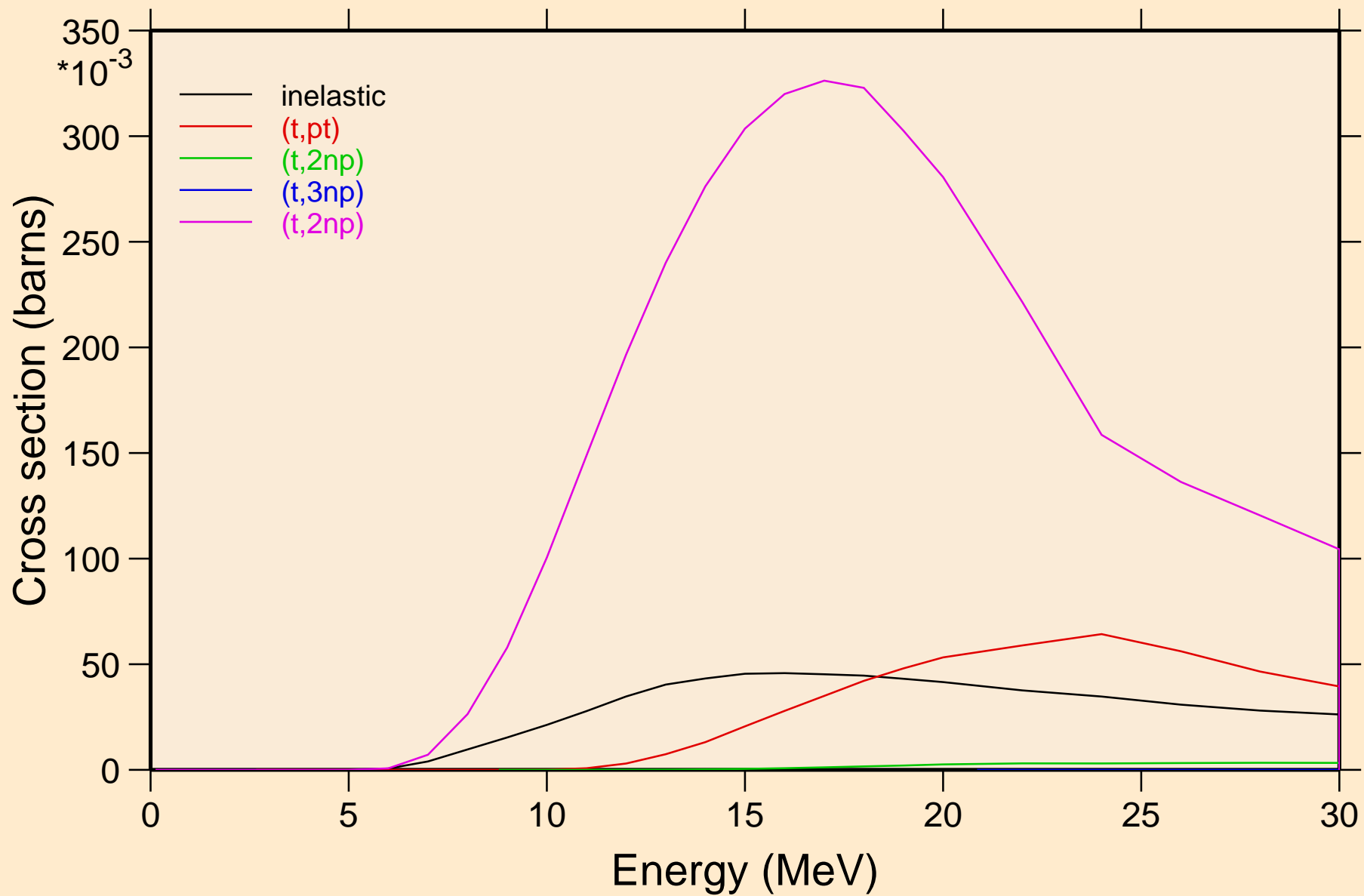

NB084 TRITON ACER TENDL-2021 LIBRARY; T=0.K  
Threshold reactions

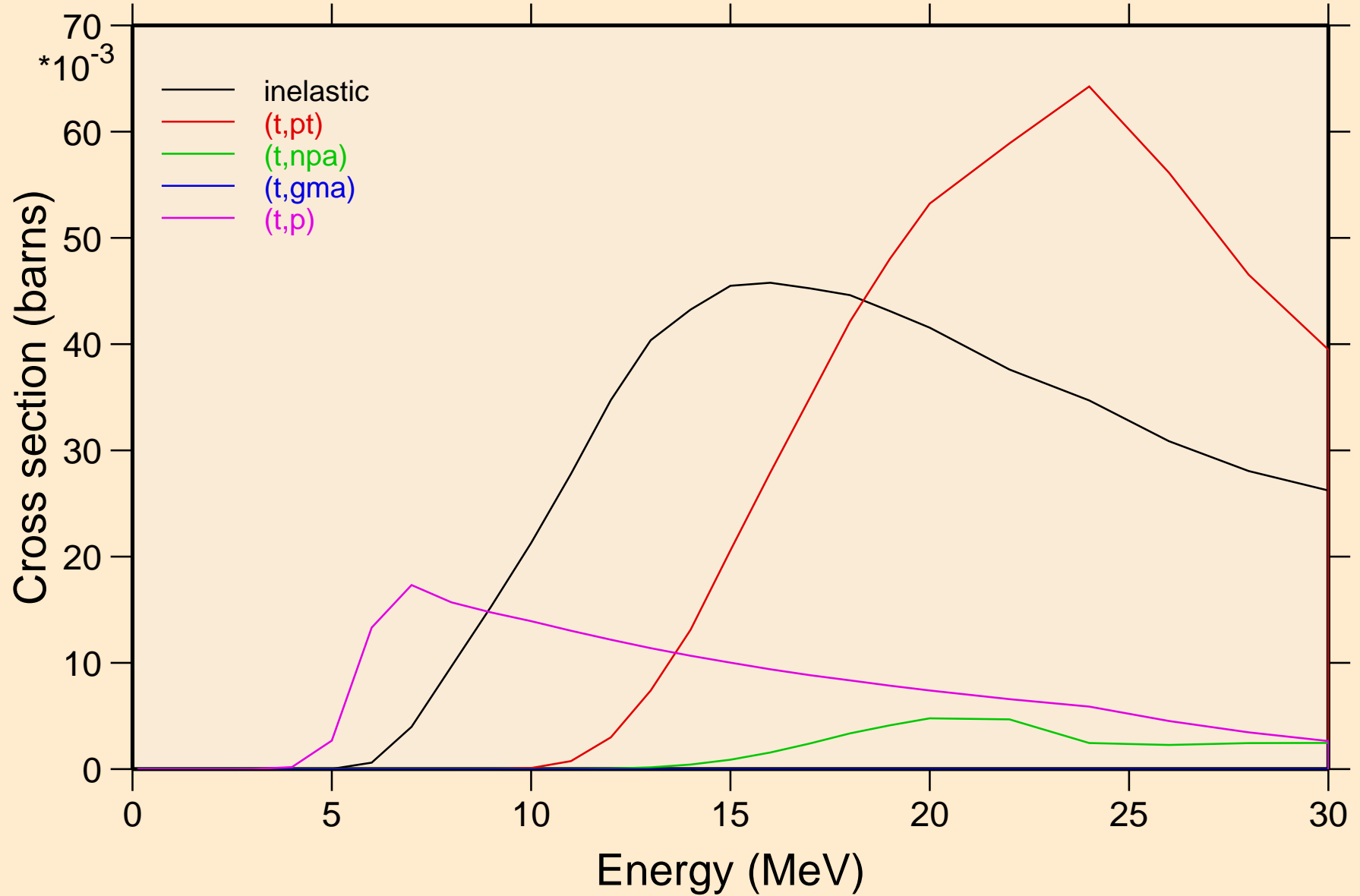

NB084 TRITON ACER TENDL-2021 LIBRARY; T=0.K  
Threshold reactions

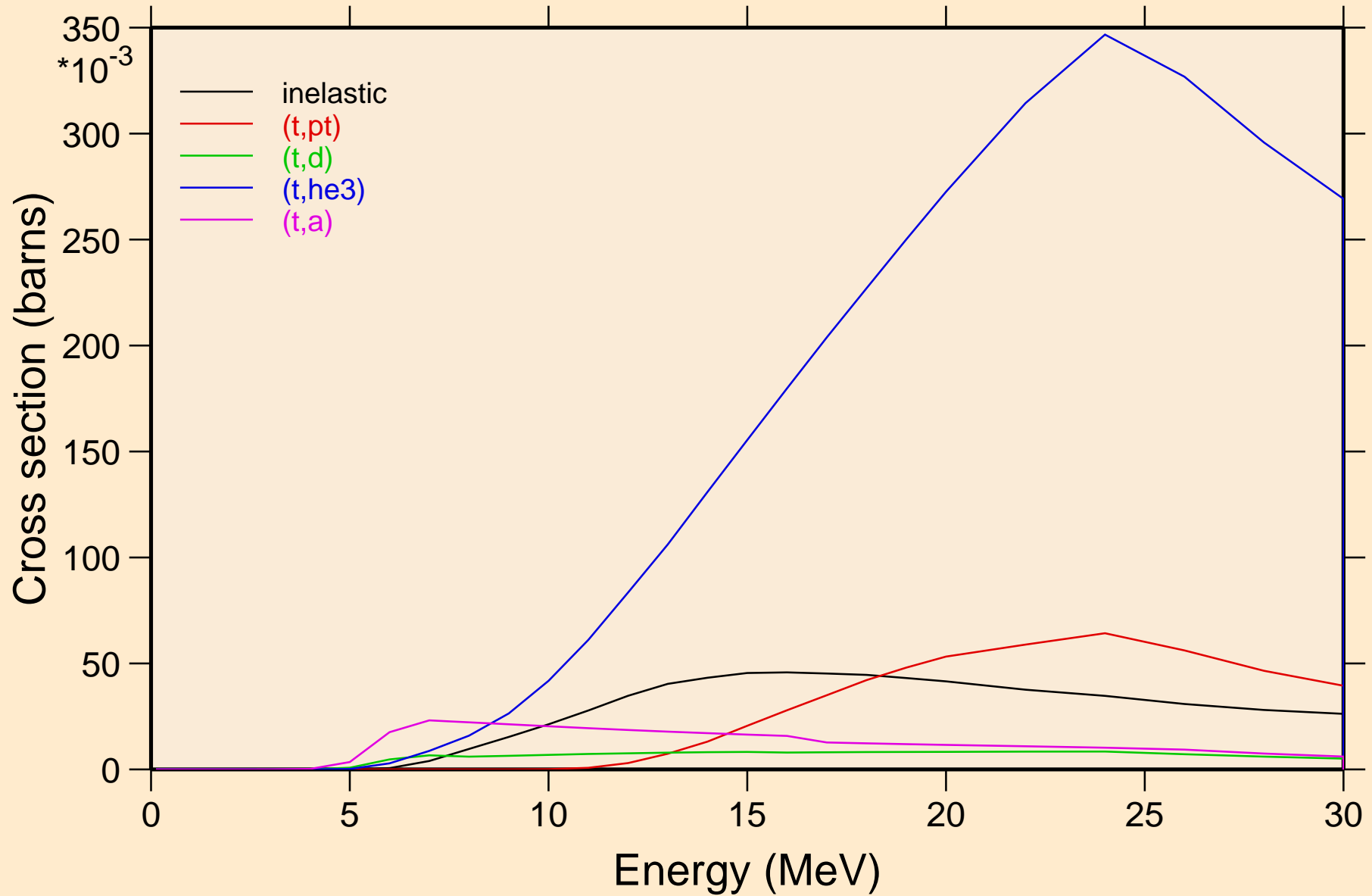

NB084 TRITON ACER TENDL-2021 LIBRARY; T=0.K  
Threshold reactions

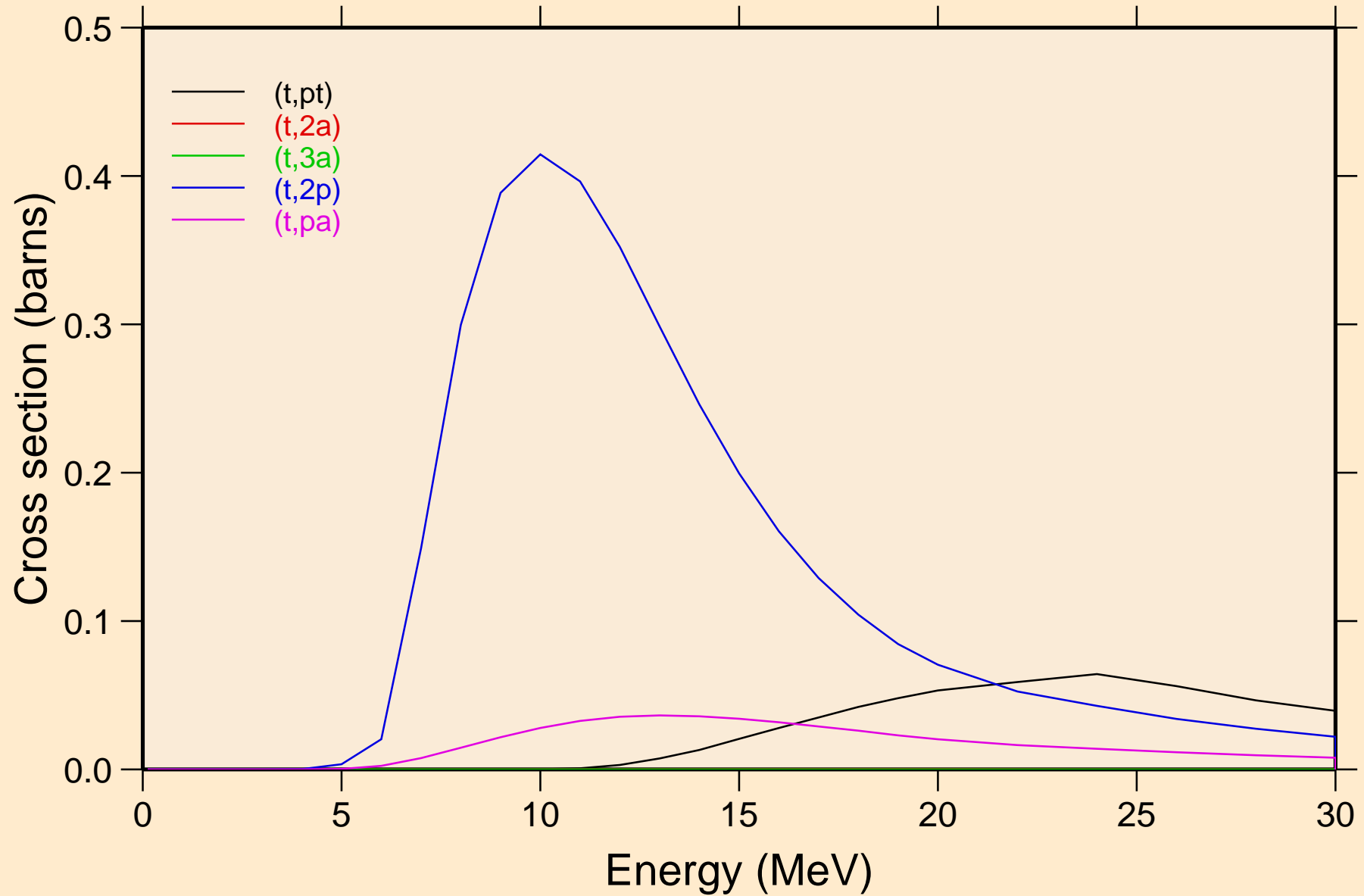

NB084 TRITON ACER TENDL-2021 LIBRARY; T=0.K  
Threshold reactions

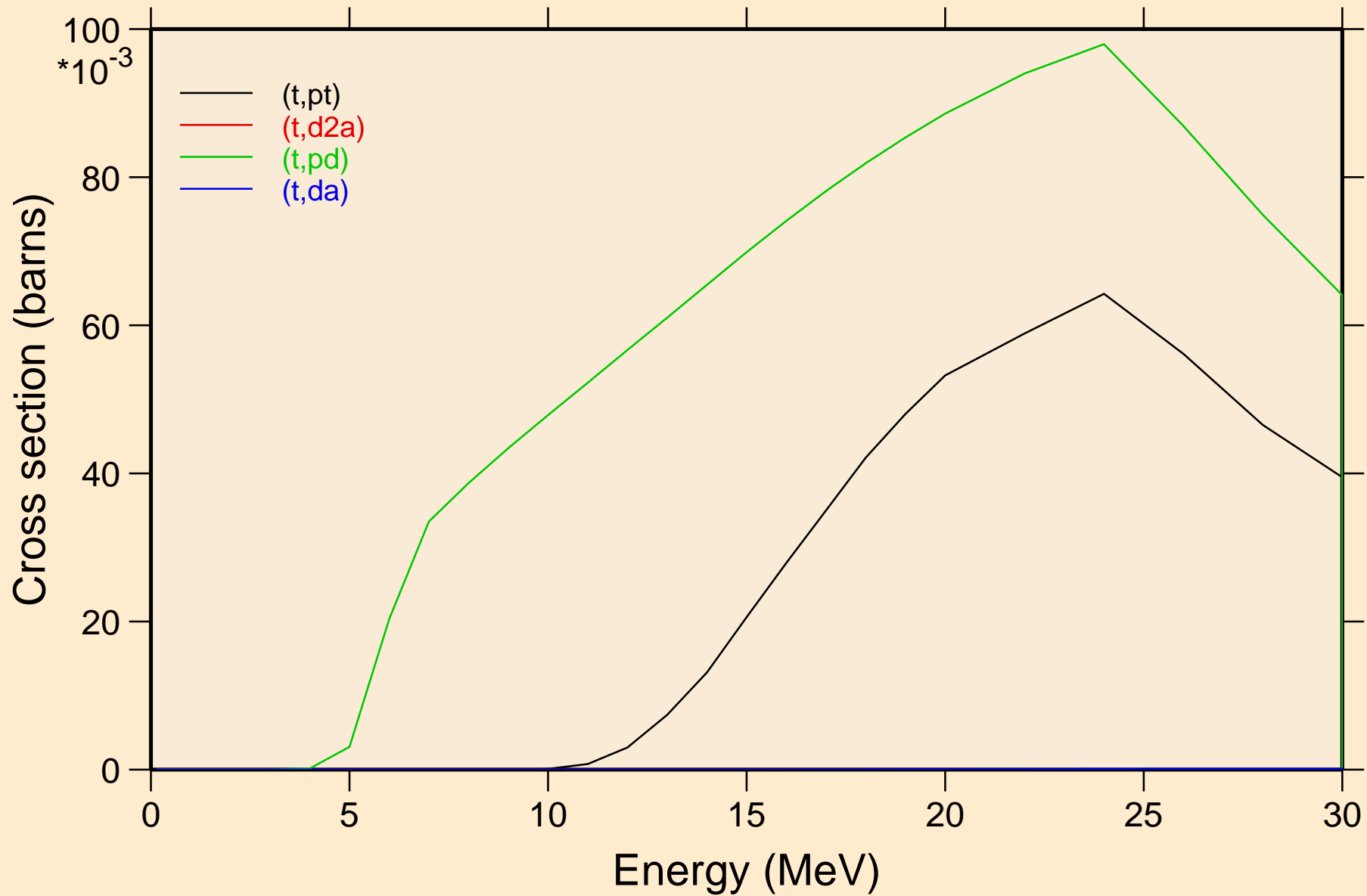

NB084 TRITON ACER TENDL-2021 LIBRARY; T=0.K  
angular distribution for elastic

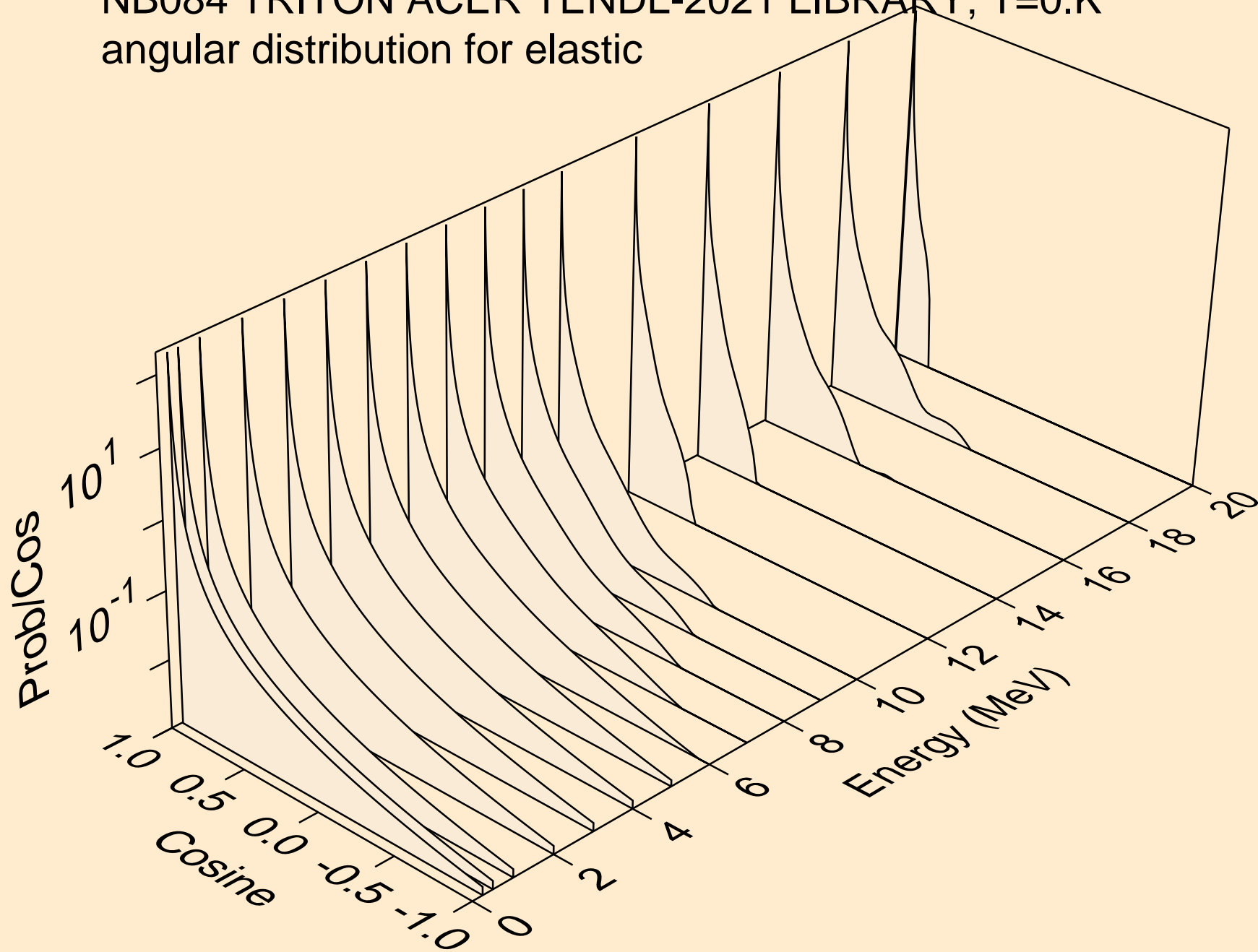

NB084 TRITON ACER TENDL-2021 LIBRARY; T=0.K  
angular distribution for elastic

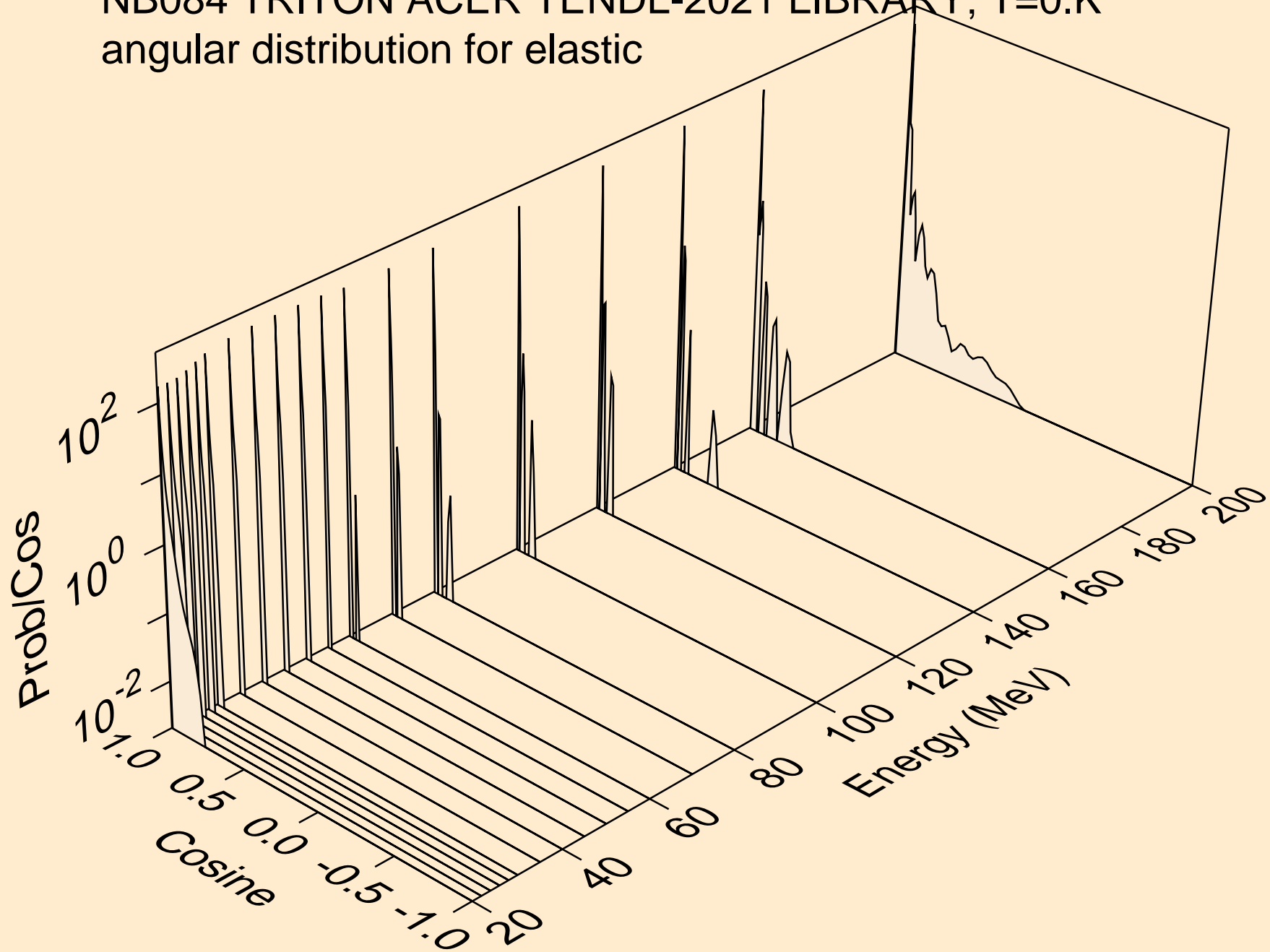



NB084 TRITON ACER TENDL-2021 LIBRARY; T=0.K  
Triton emission for (t,x)

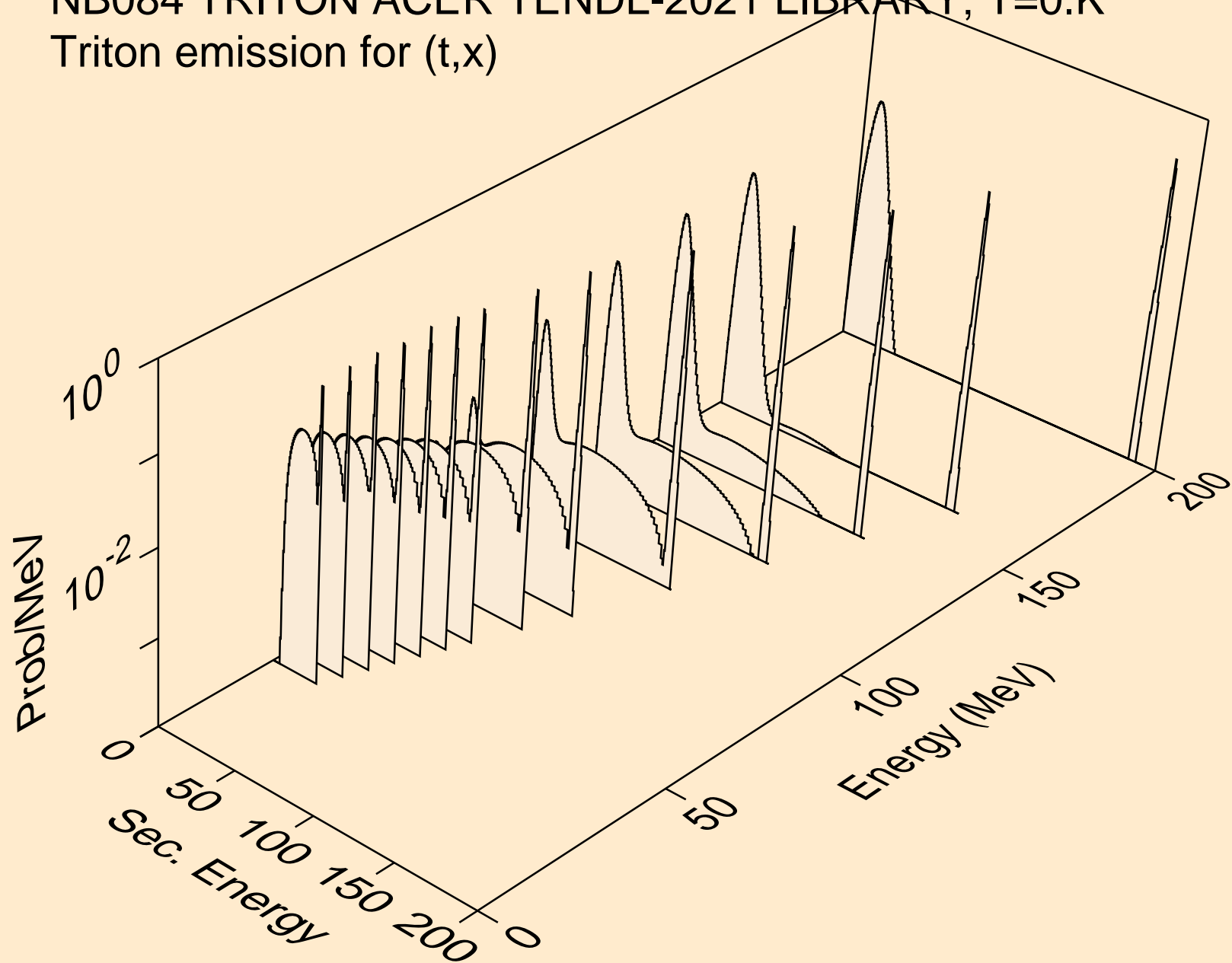

NB084 TRITON ACER TENDL-2021 LIBRARY; T=0.K  
Triton emission for (t,n\*)t

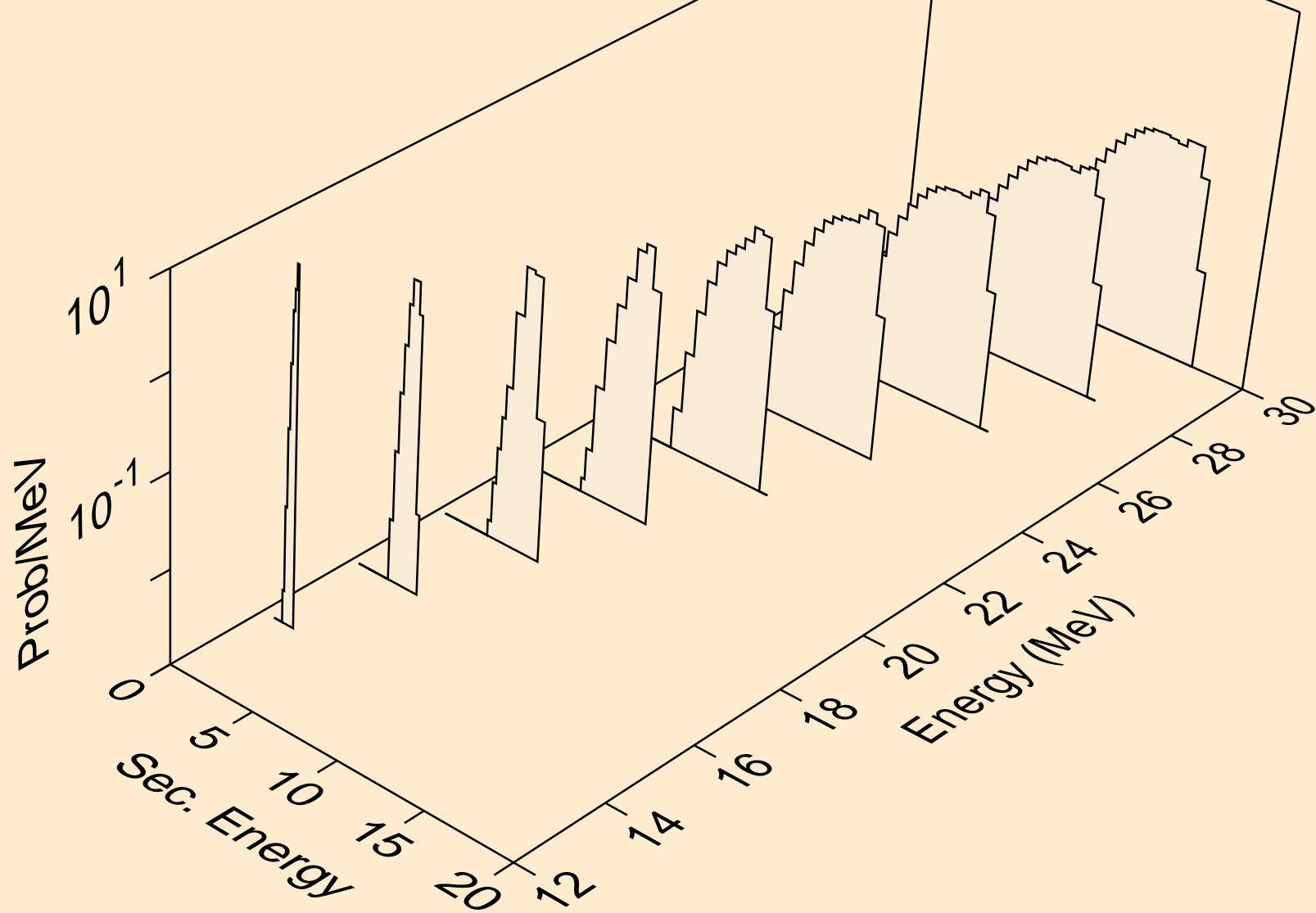

NB084 TRITON ACER TENDL-2021 LIBRARY; T=0.K  
Triton emission for inelastic

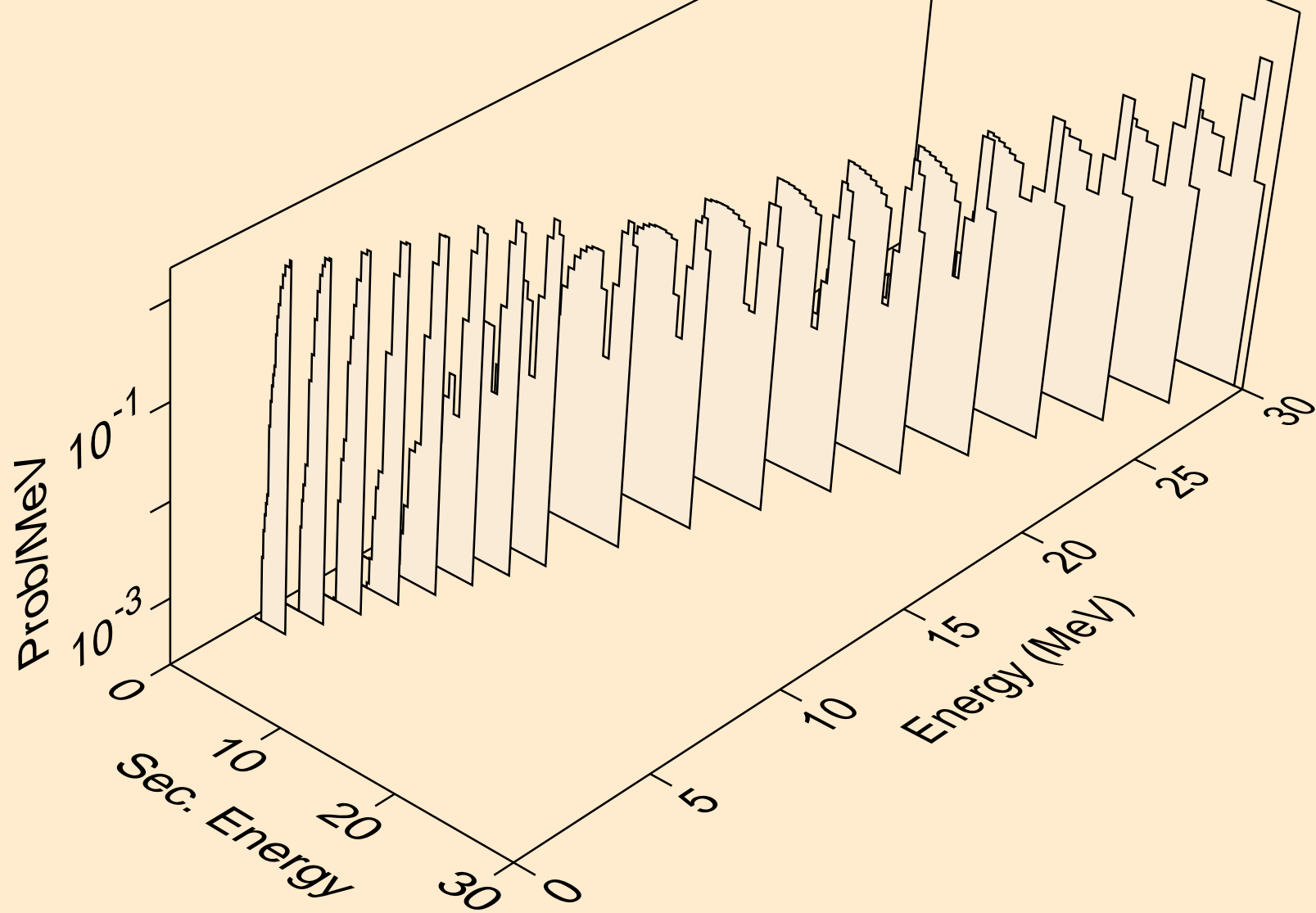

NB084 TRITON ACER TENDL-2021 LIBRARY; T=0.K  
Triton emission for (t,pt)

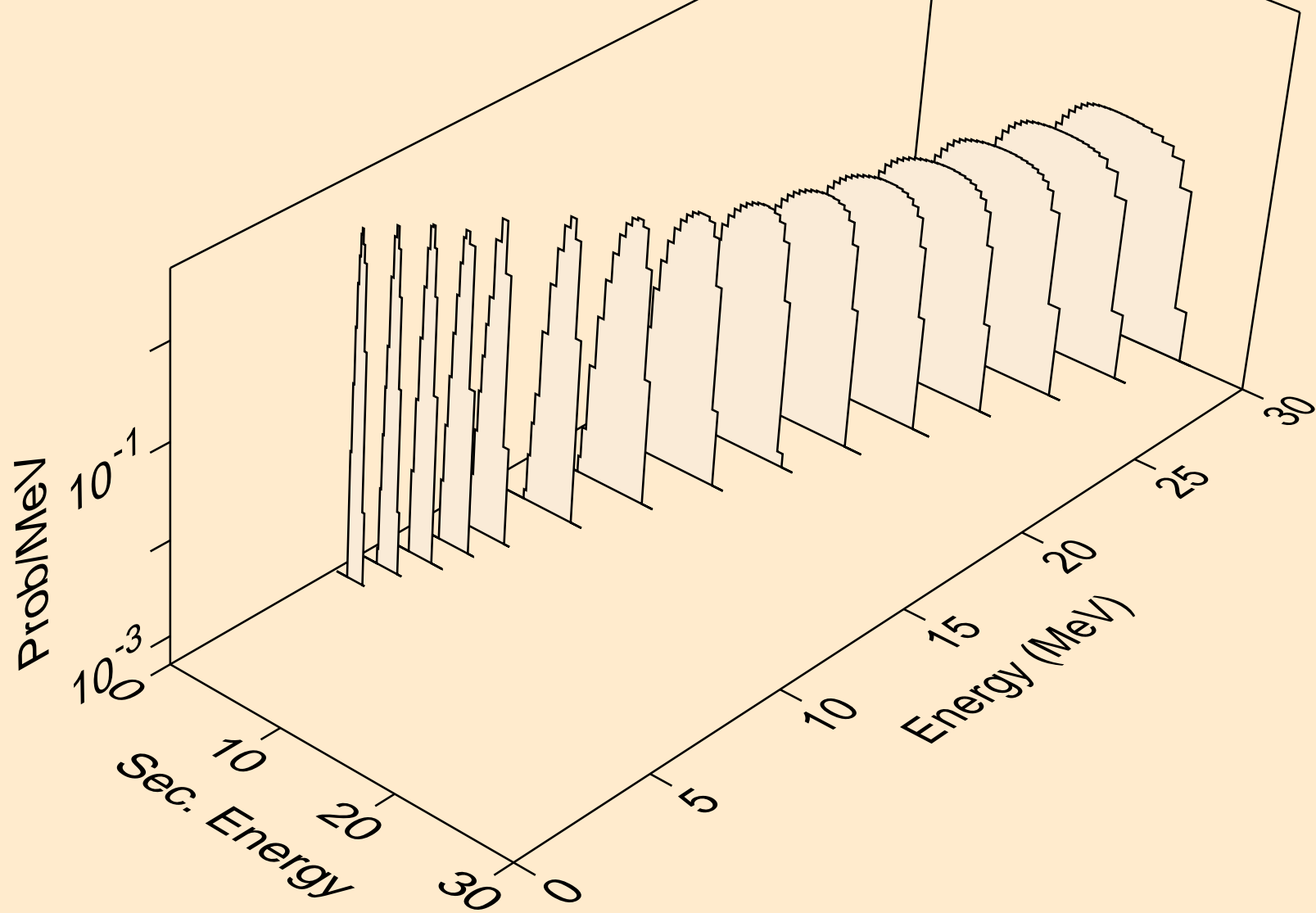

NB084 TRITON ACER TENDL-2021 LIBRARY; T=0.K  
Photon emission for (z,n)

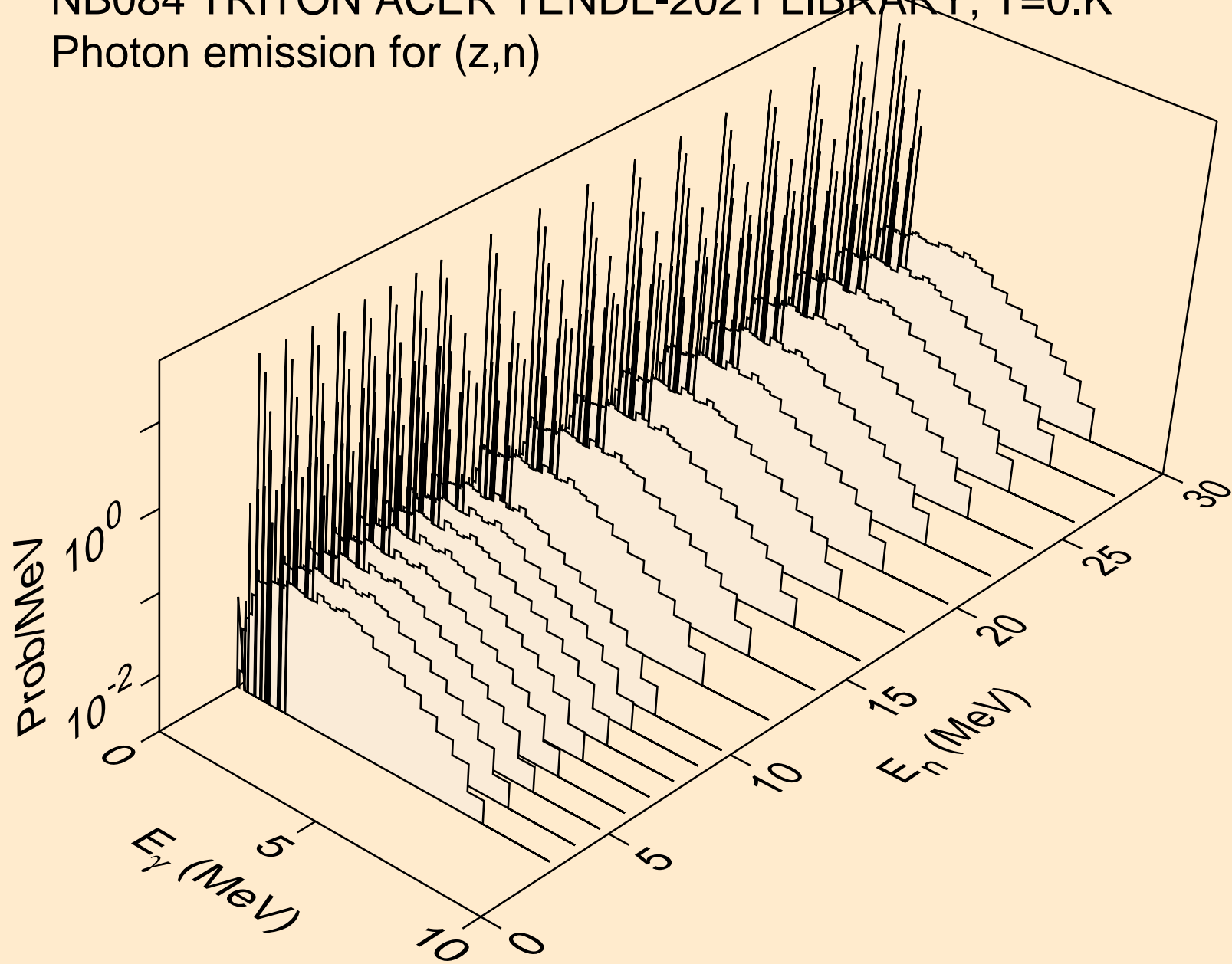

NB084 TRITON ACER TENDL-2021 LIBRARY; T=0.K  
Photon emission for (n,x)

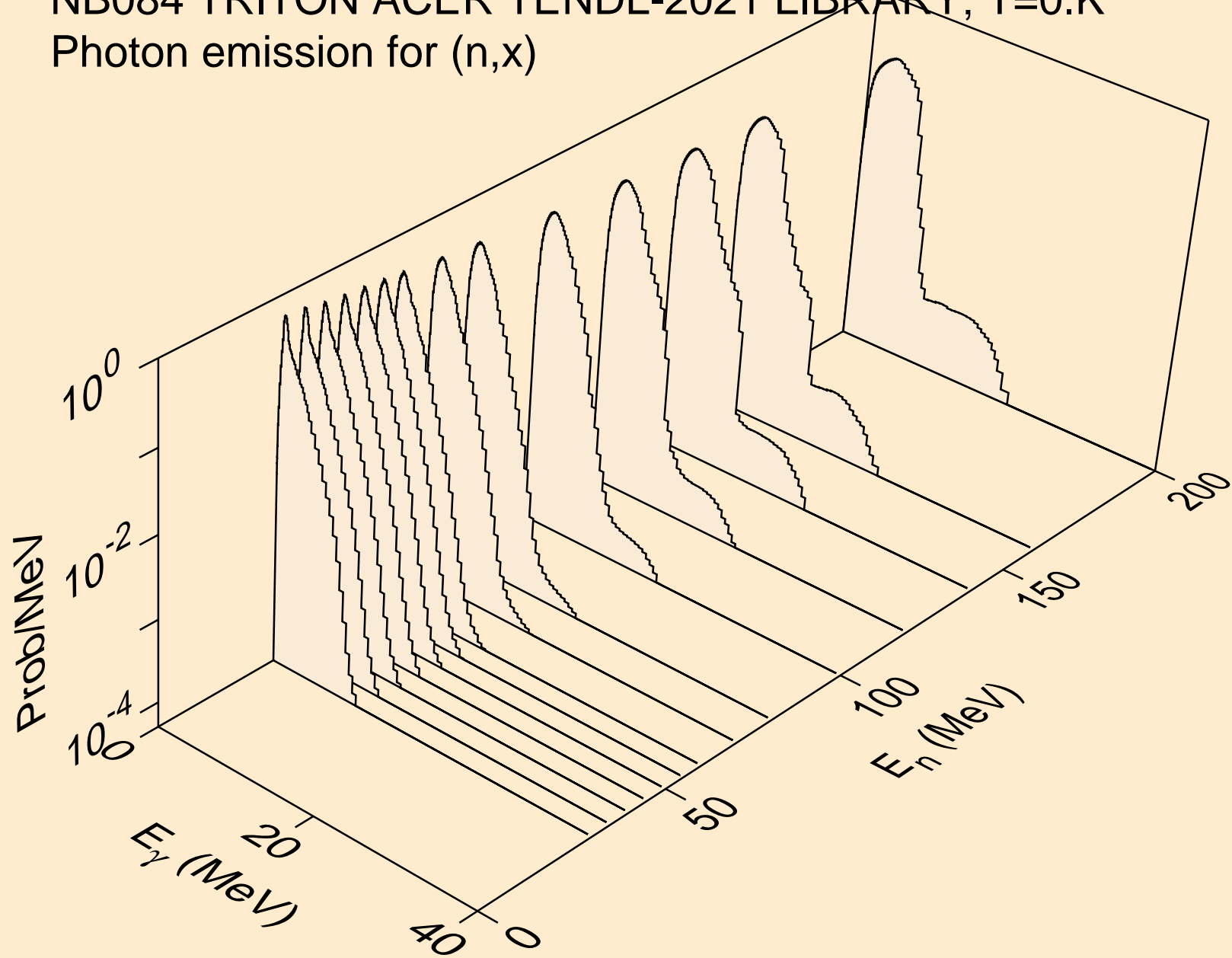

NB084 TRITON ACER TENDL-2021 LIBRARY; T=0.K  
Photon emission for (n,2nd)

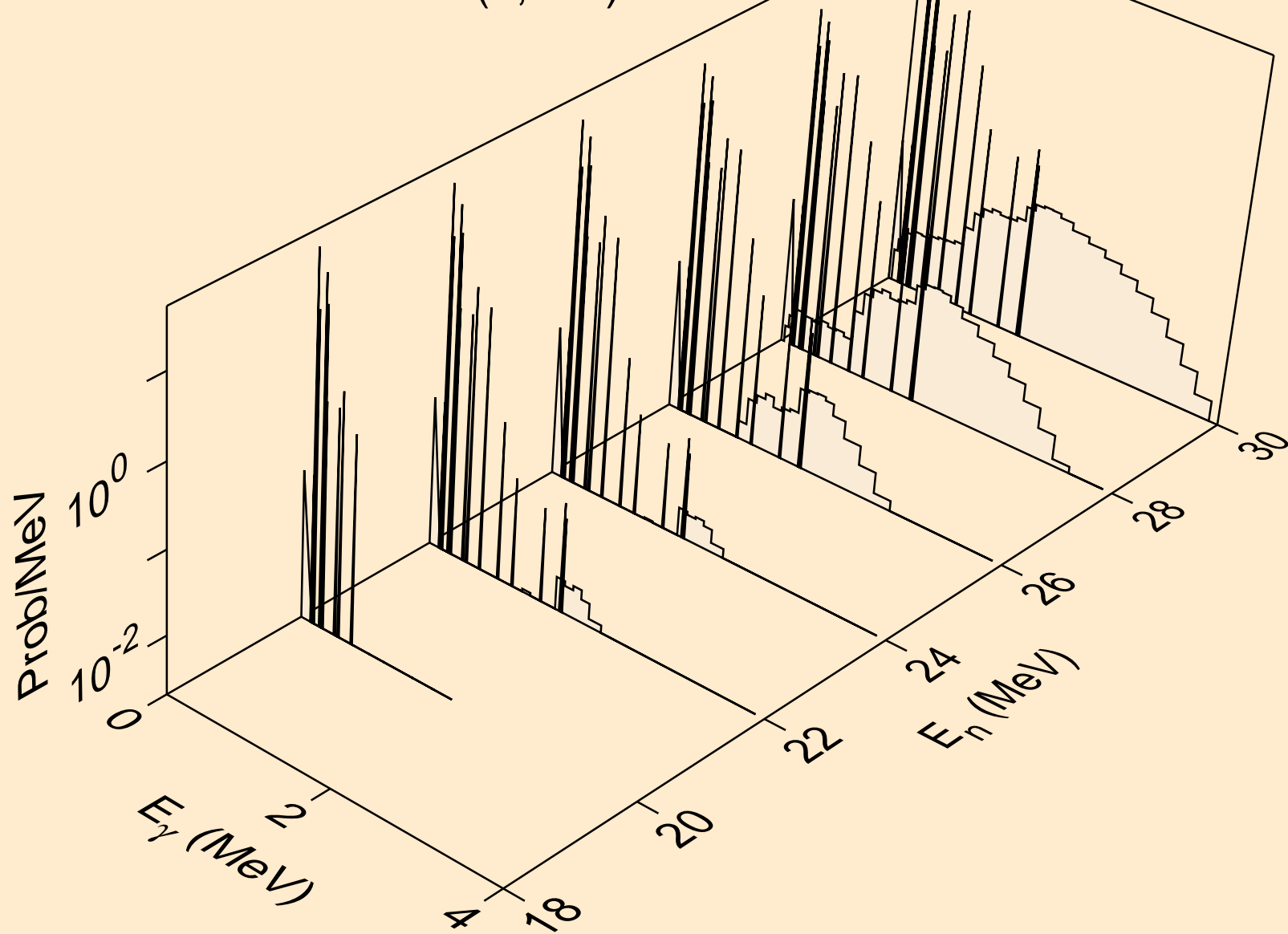

NB084 TRITON ACER TENDL-2021 LIBRARY; T=0.K  
Photon emission for (n,2n)

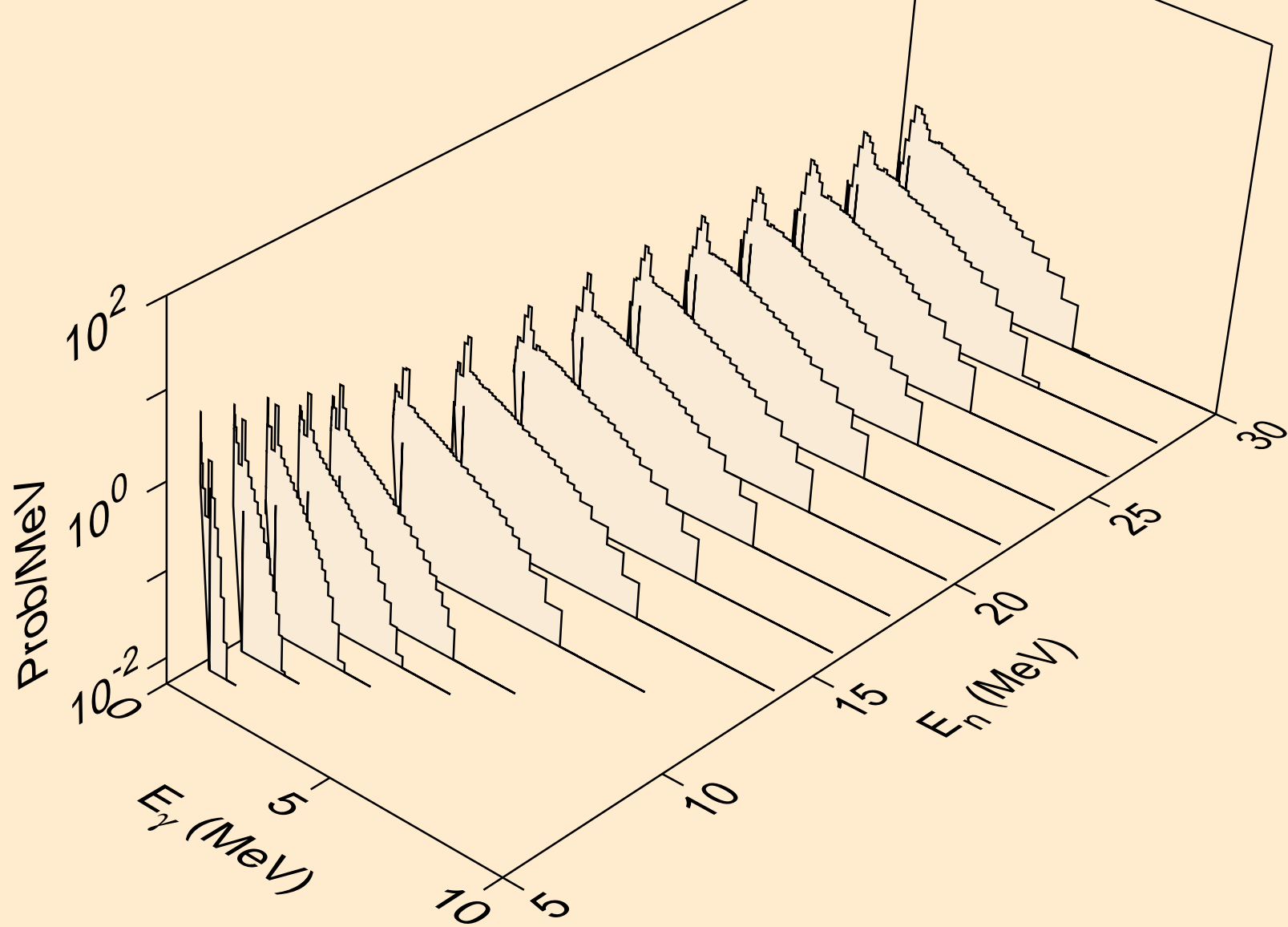



NB084 TRITON ACER TENDL-2021 LIBRARY; T=0.K  
Photon emission for (n,3n)

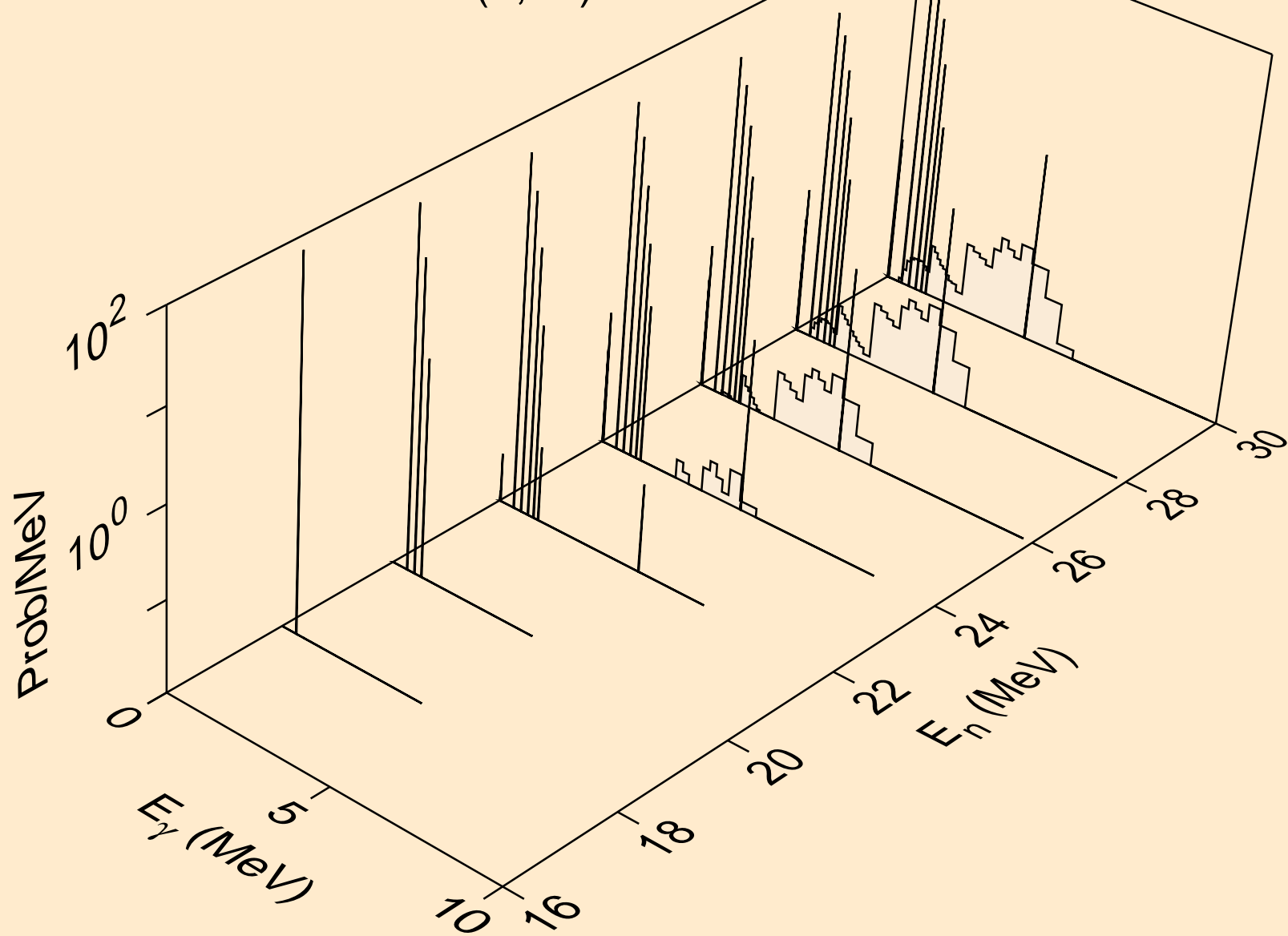

NB084 TRITON ACER TENDL-2021 LIBRARY; T=0.K  
Photon emission for (n,n\*)a

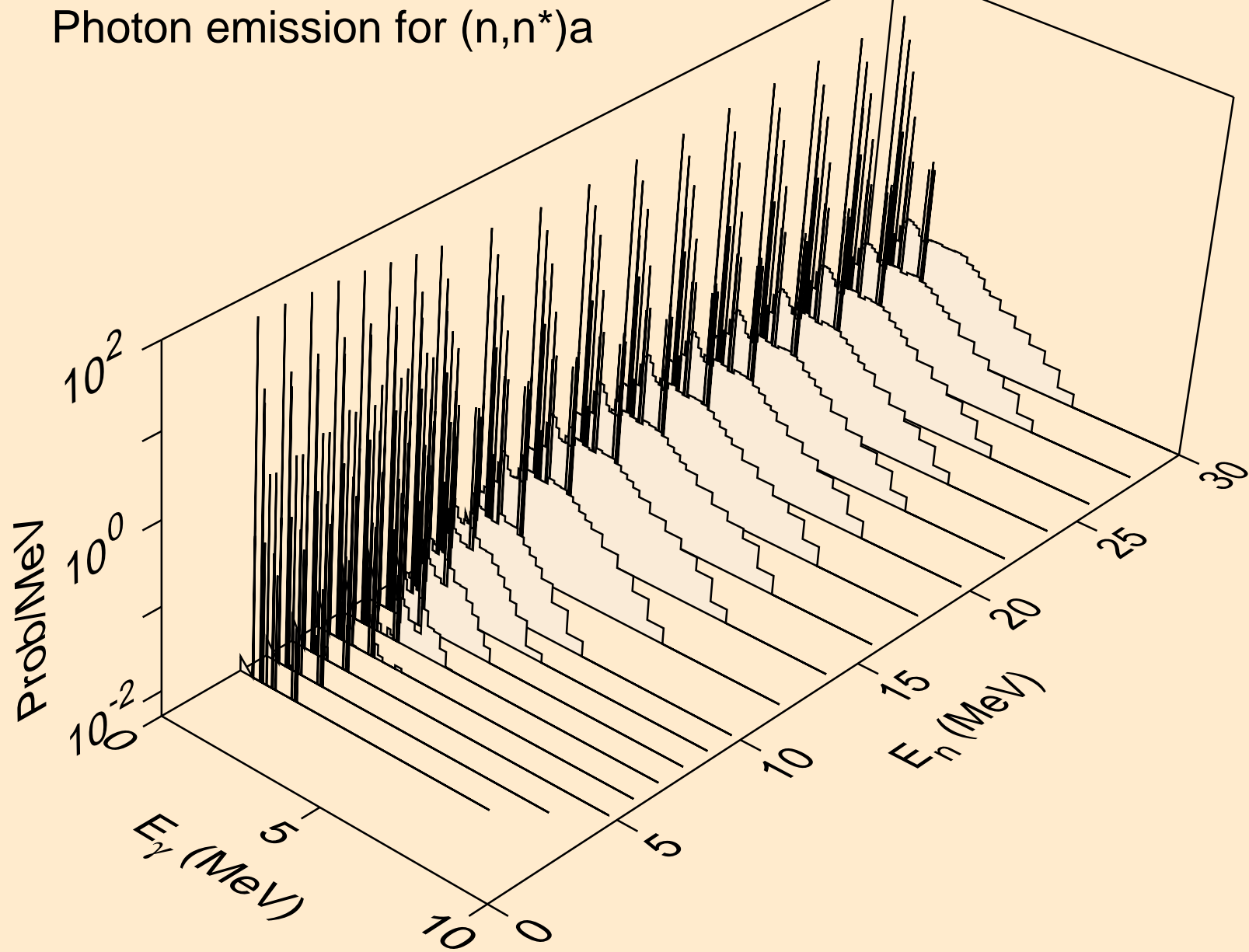

NB084 TRITON ACER TENDL-2021 LIBRARY; T=0.K  
Photon emission for (n,2n)a

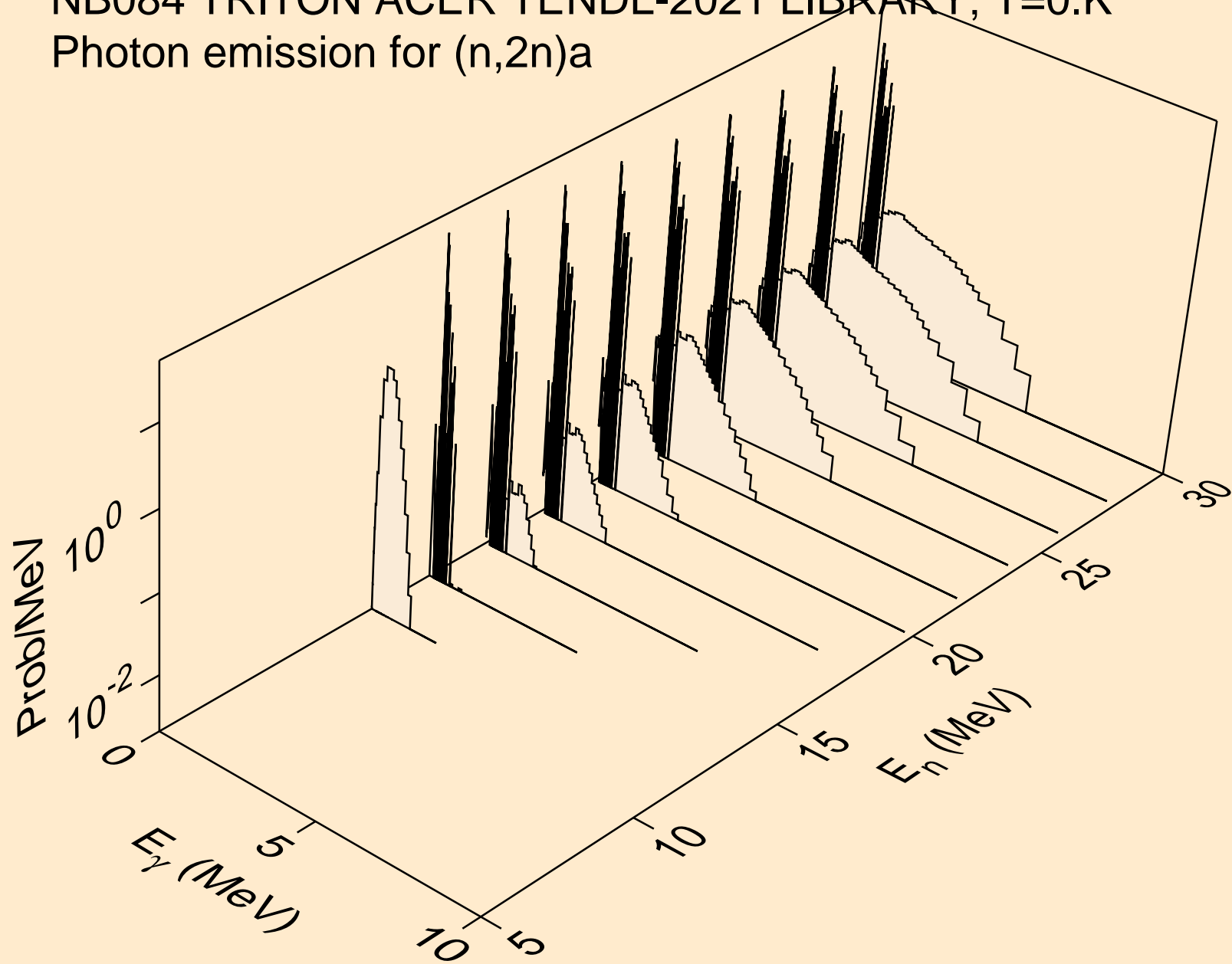

NB084 TRITON ACER TENDL-2021 LIBRARY; T=0.K  
Photon emission for (n,n\*)p

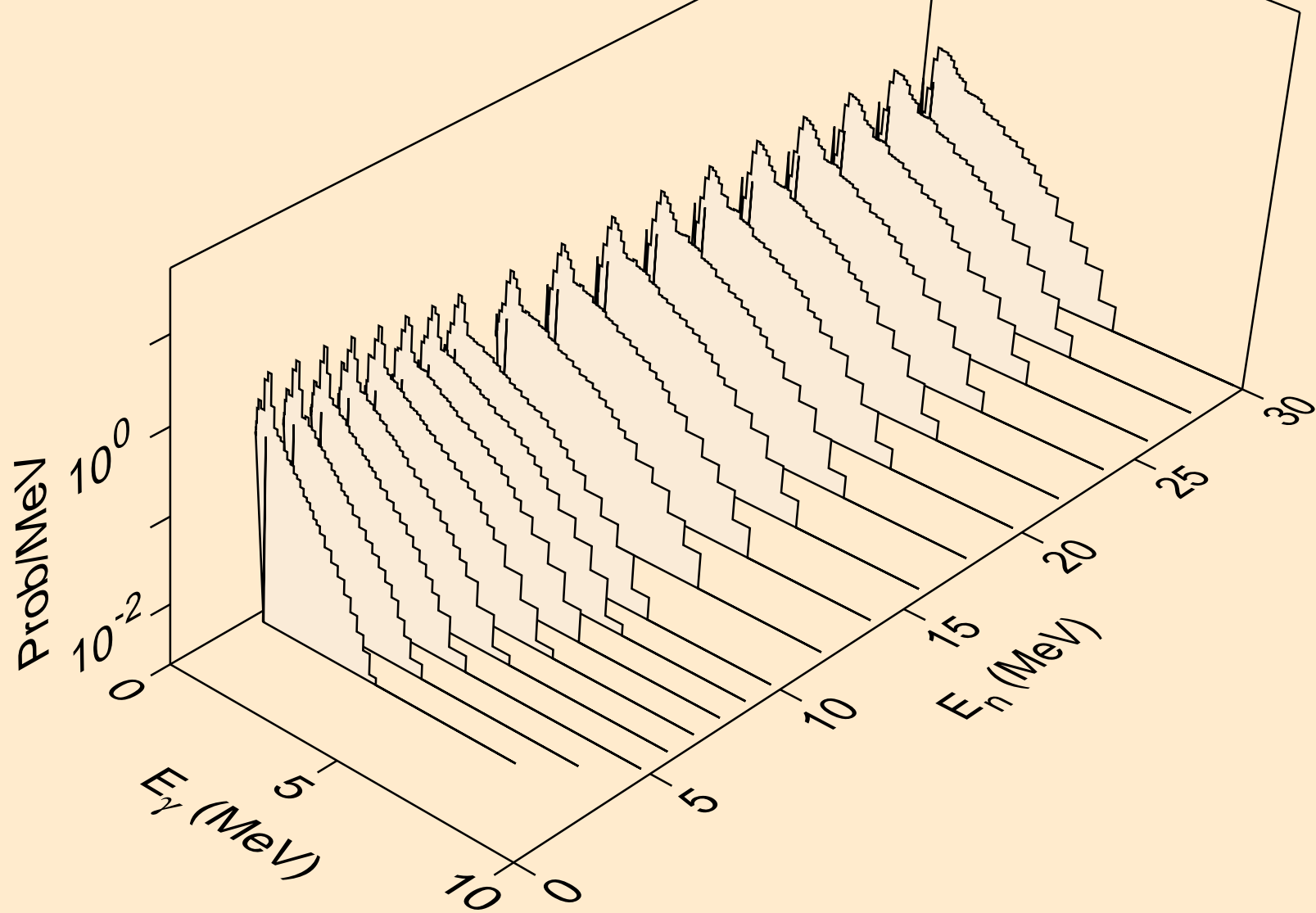

NB084 TRITON ACER TENDL-2021 LIBRARY; T=0.K  
Photon emission for (n,n\*)2a

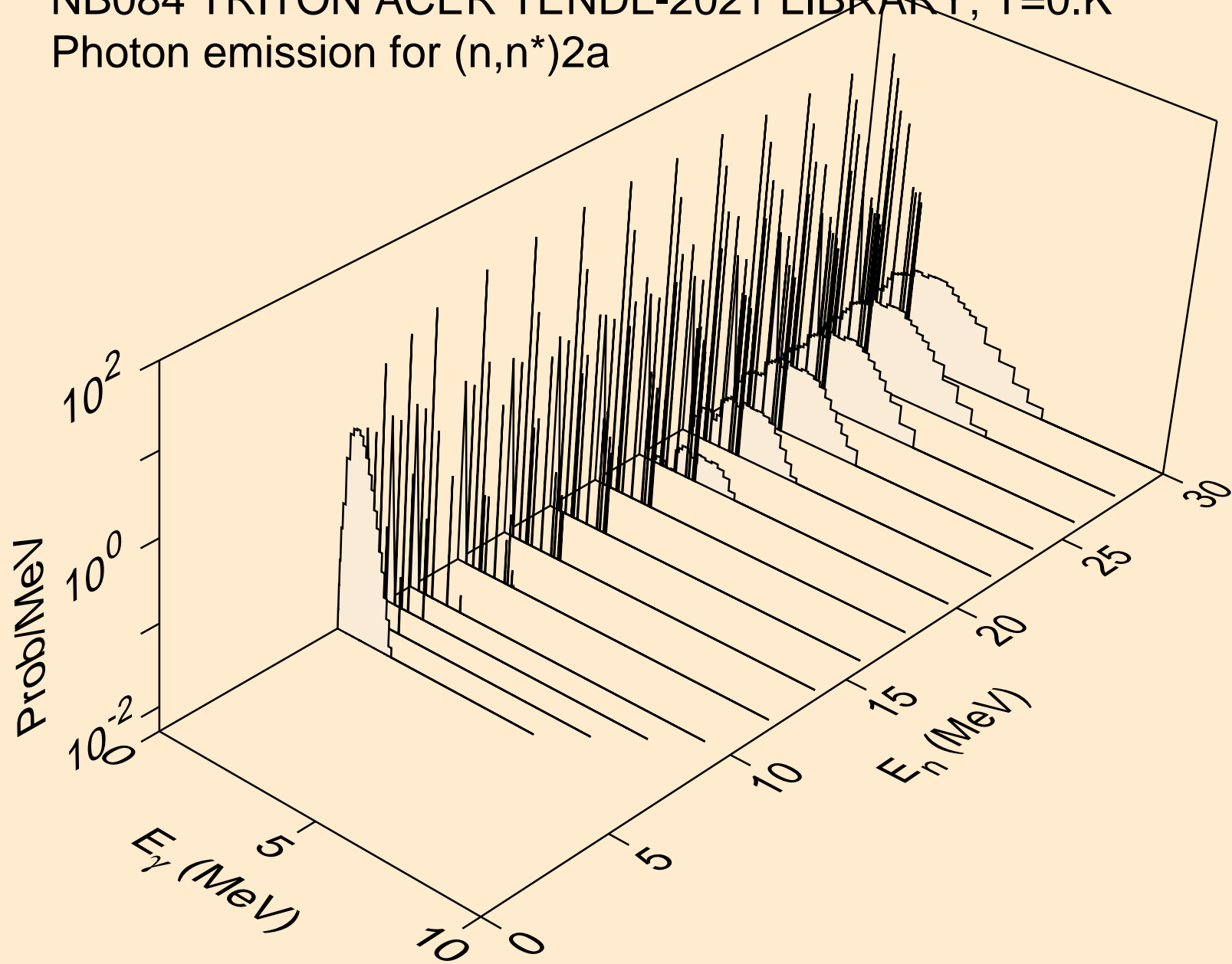

NB084 TRITON ACER TENDL-2021 LIBRARY; T=0.K  
Photon emission for (n,n\*)d

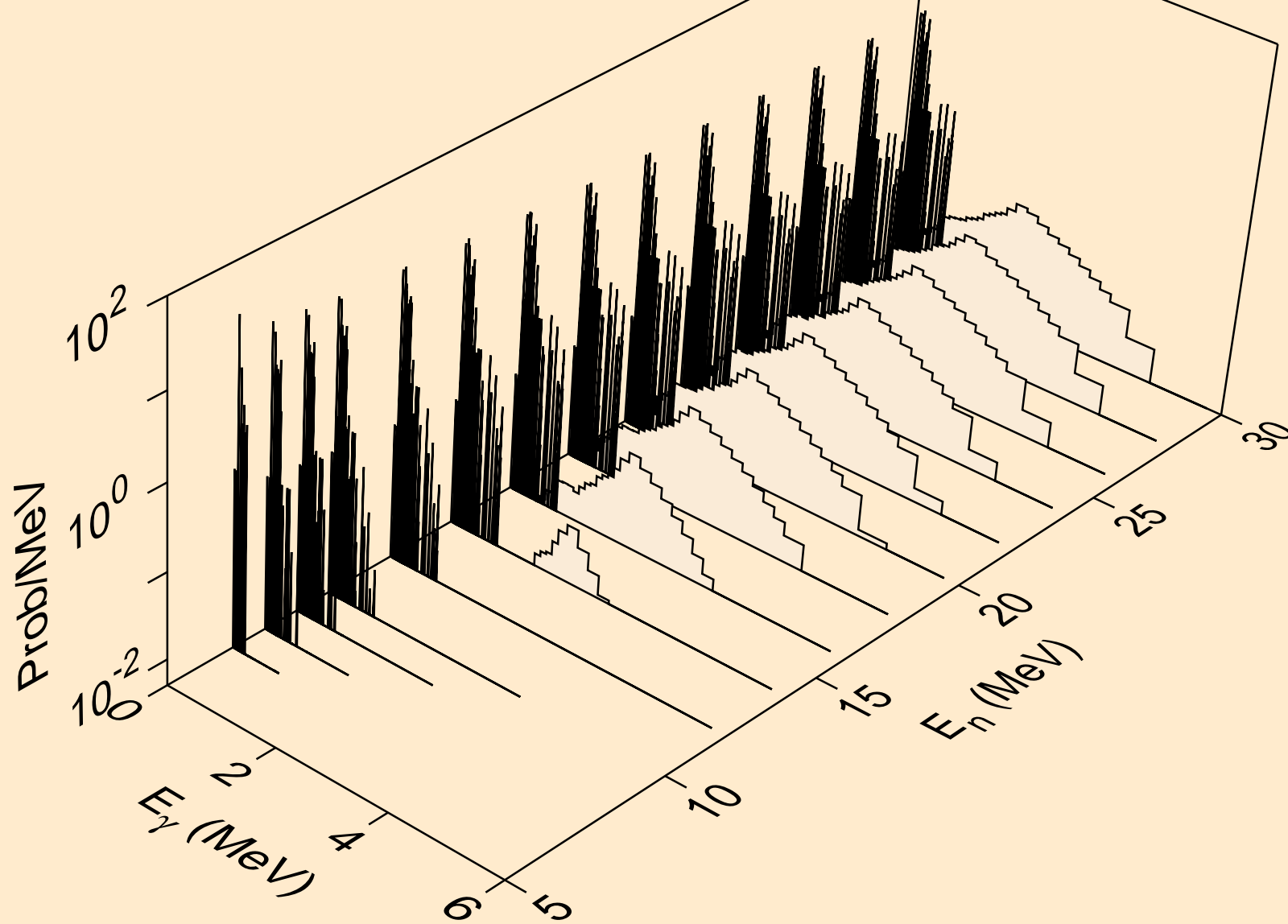

NB084 TRITON ACER TENDL-2021 LIBRARY; T=0.K  
Photon emission for (n,n\*)t

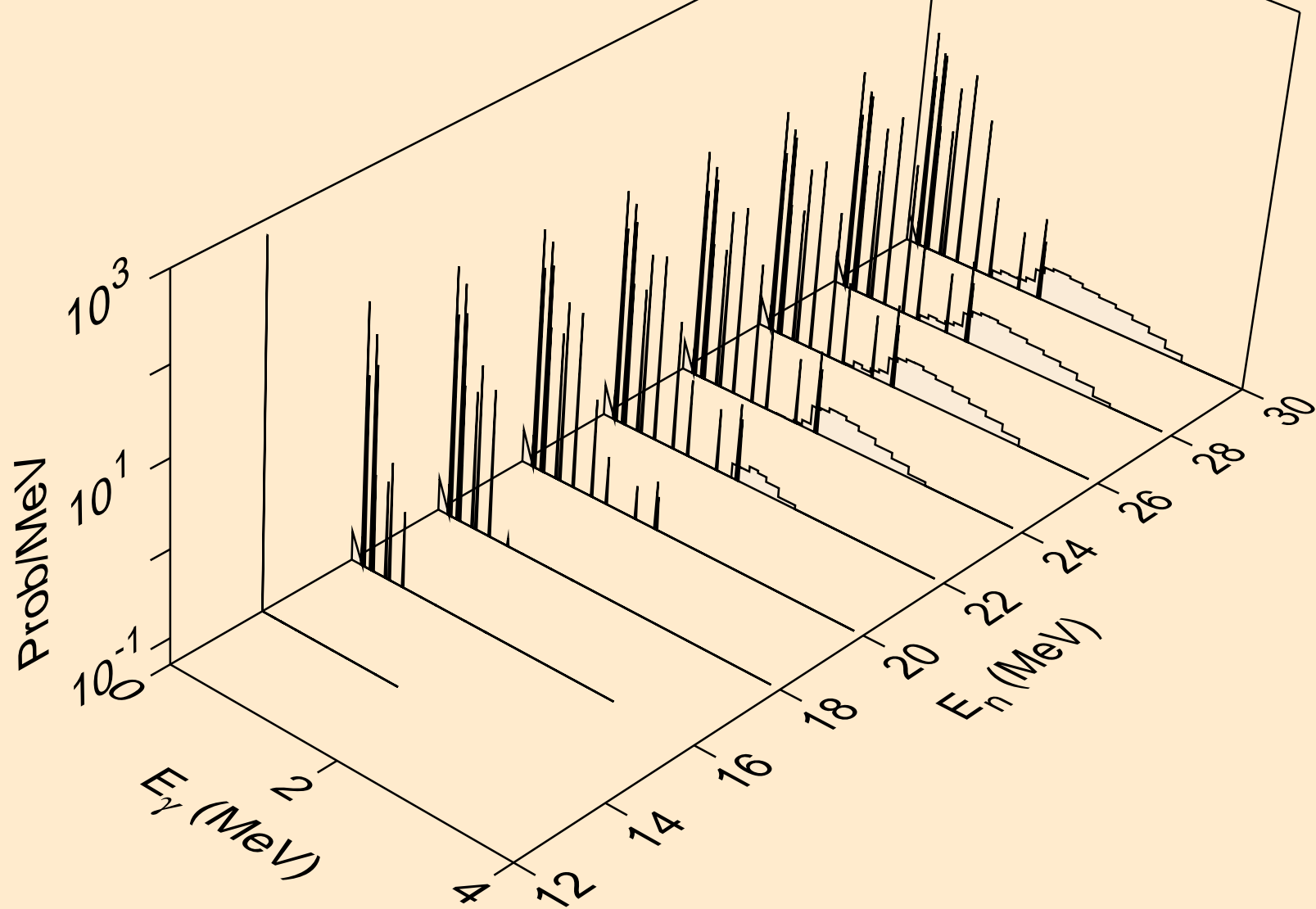

NB084 TRITON ACER TENDL-2021 LIBRARY; T=0.K  
Photon emission for (n,n\*)he3

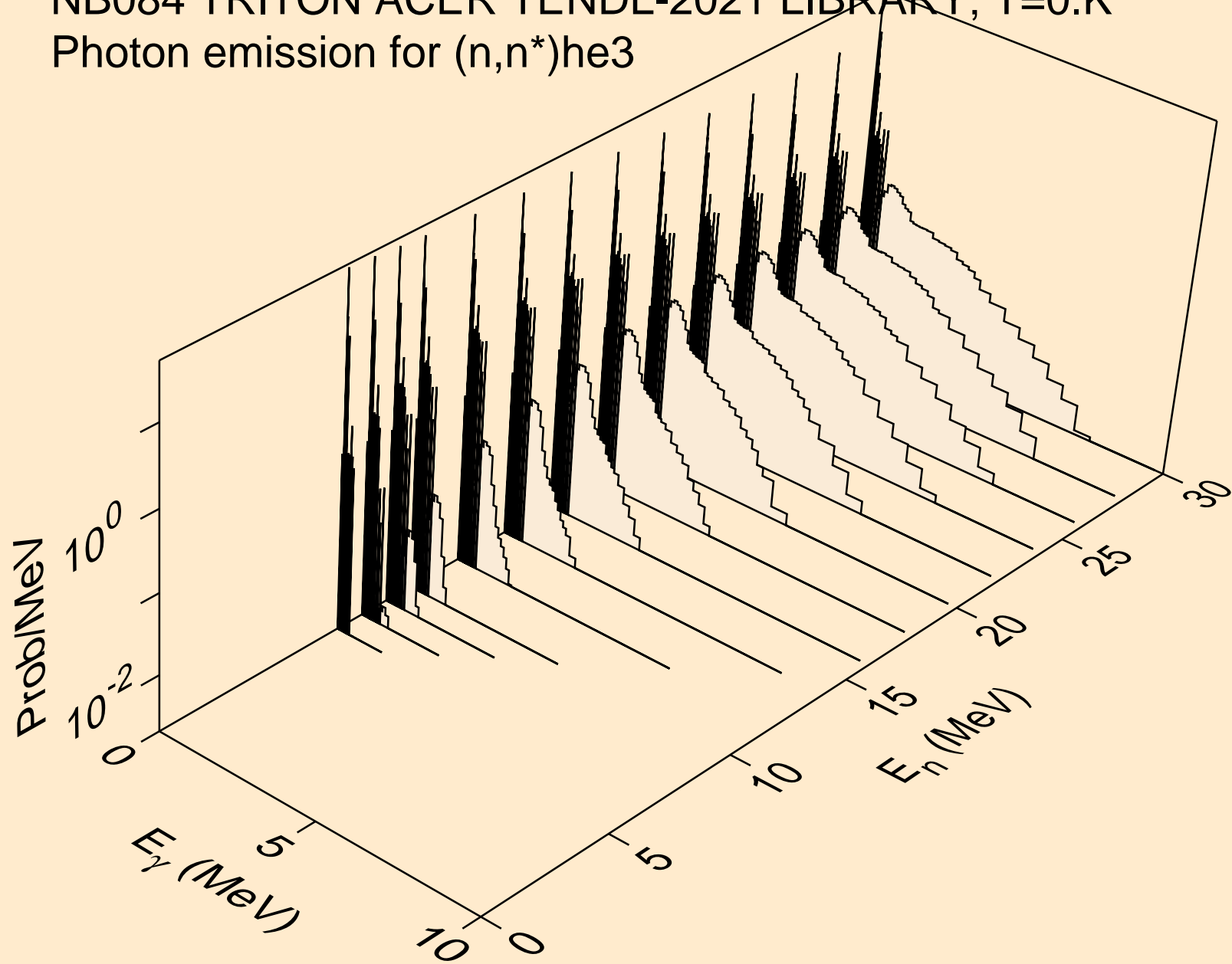



NB084 TRITON ACER TENDL-2021 LIBRARY; T=0.K  
Photon emission for (n,2np)

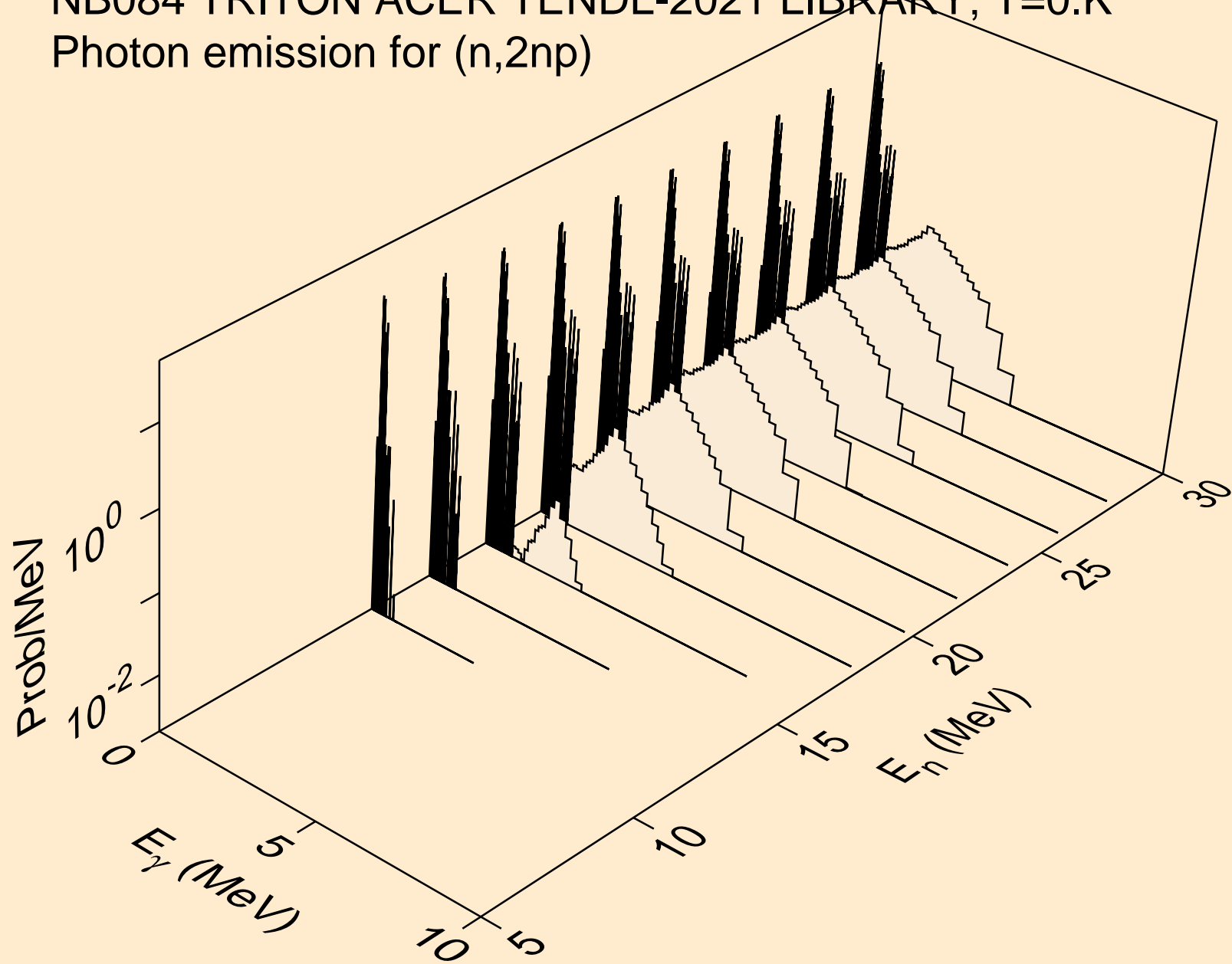

NB084 TRITON ACER TENDL-2021 LIBRARY; T=0.K  
Photon emission for (n,3np)

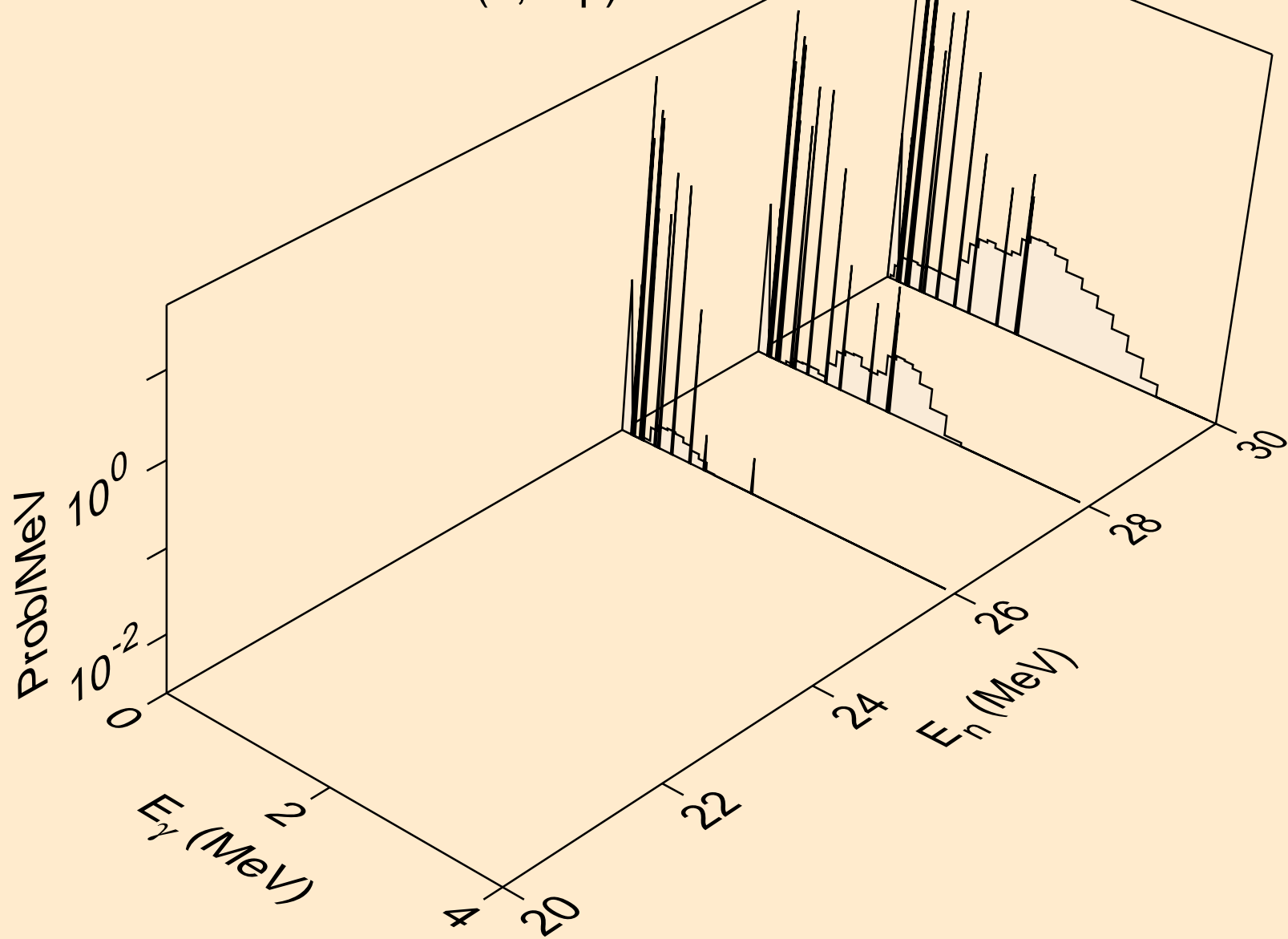

NB084 TRITON ACER TENDL-2021 LIBRARY; T=0.K  
Photon emission for (n,2np)

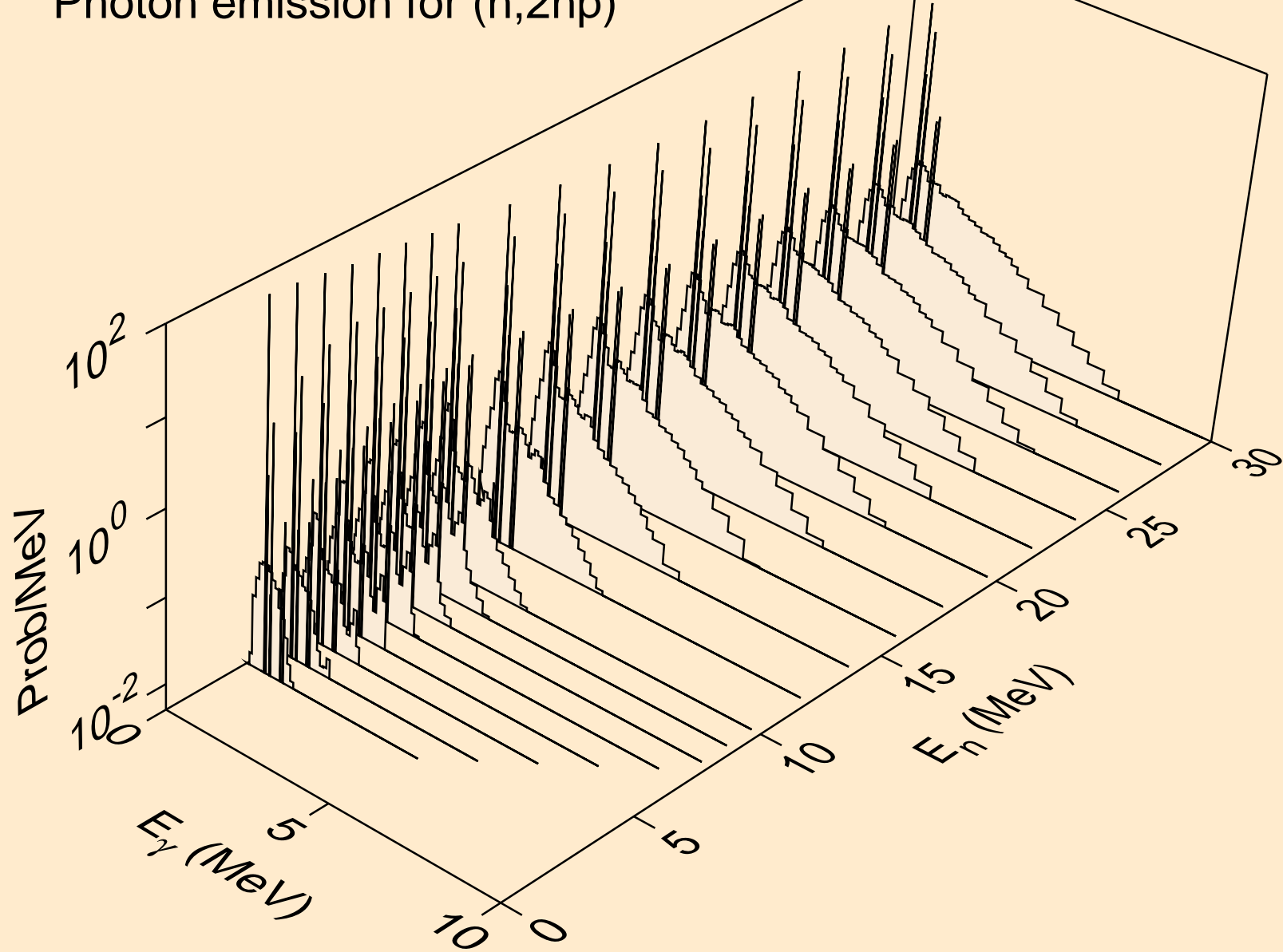

NB084 TRITON ACER TENDL-2021 LIBRARY; T=0.K  
Photon emission for (n,npa)

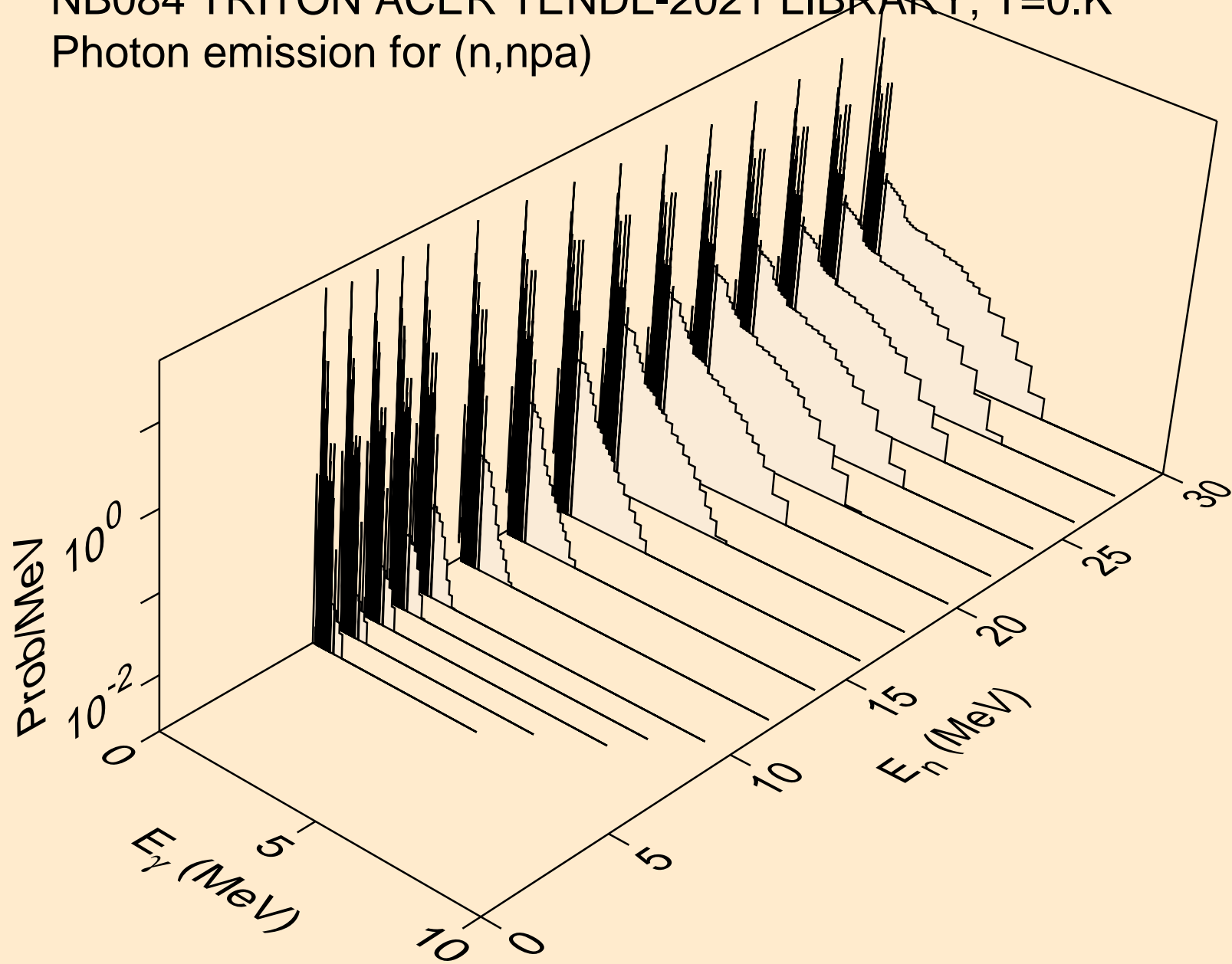

NB084 TRITON ACER TENDL-2021 LIBRARY; T=0.K  
Photon emission for (n,gma)

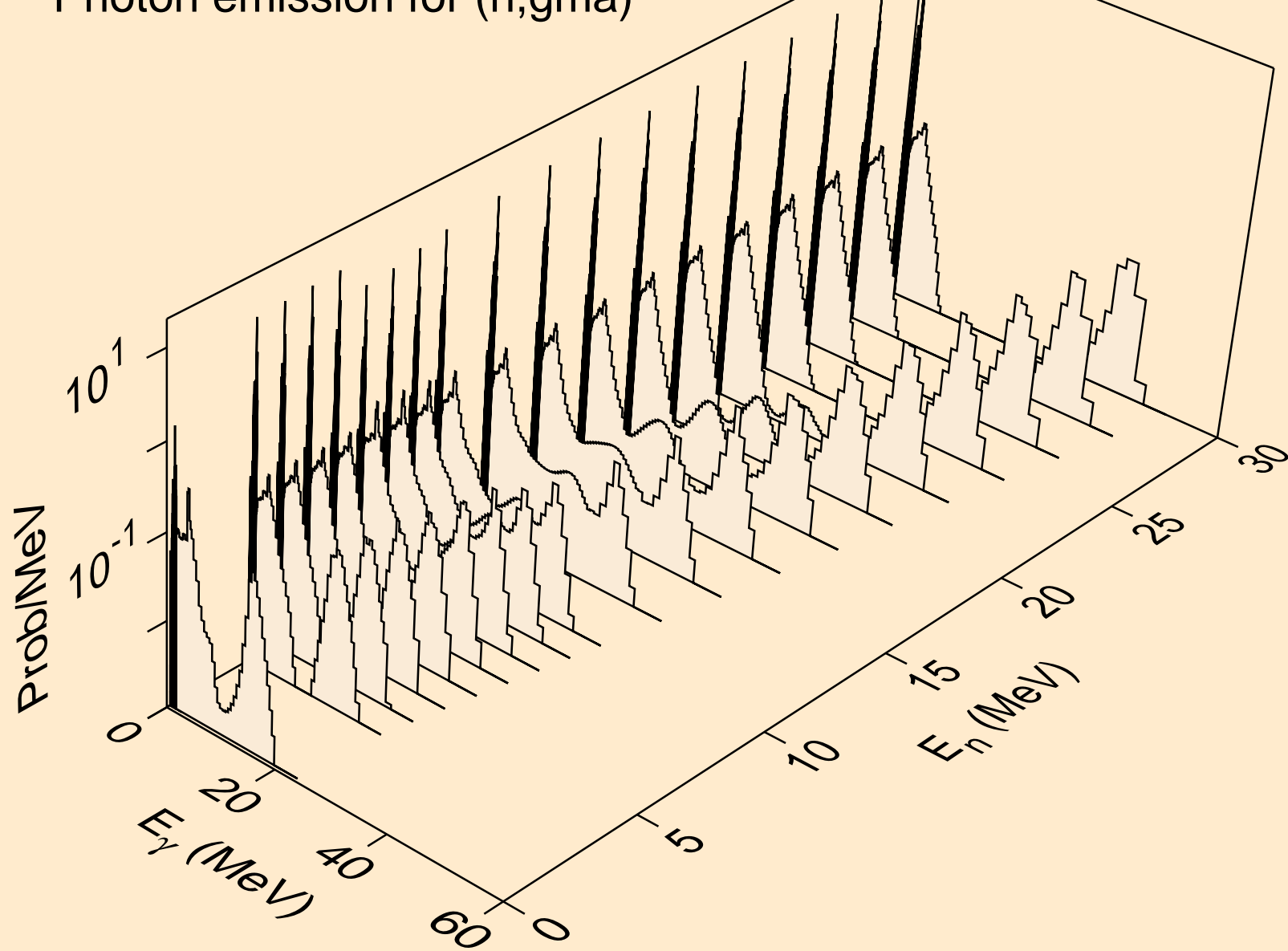

NB084 TRITON ACER TENDL-2021 LIBRARY; T=0.K  
Photon emission for (n,p)

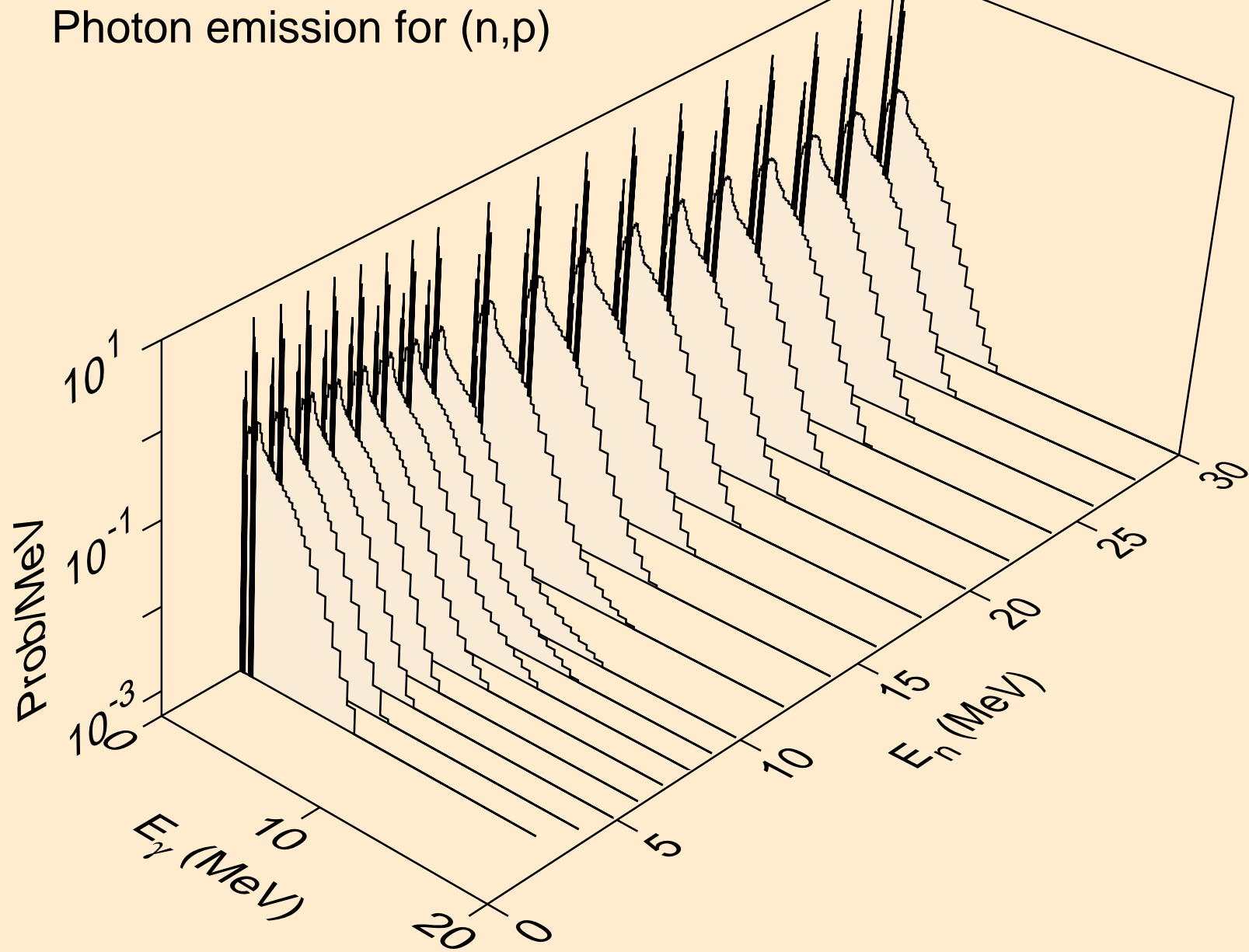

NB084 TRITON ACER TENDL-2021 LIBRARY; T=0.K  
Photon emission for (n,d)

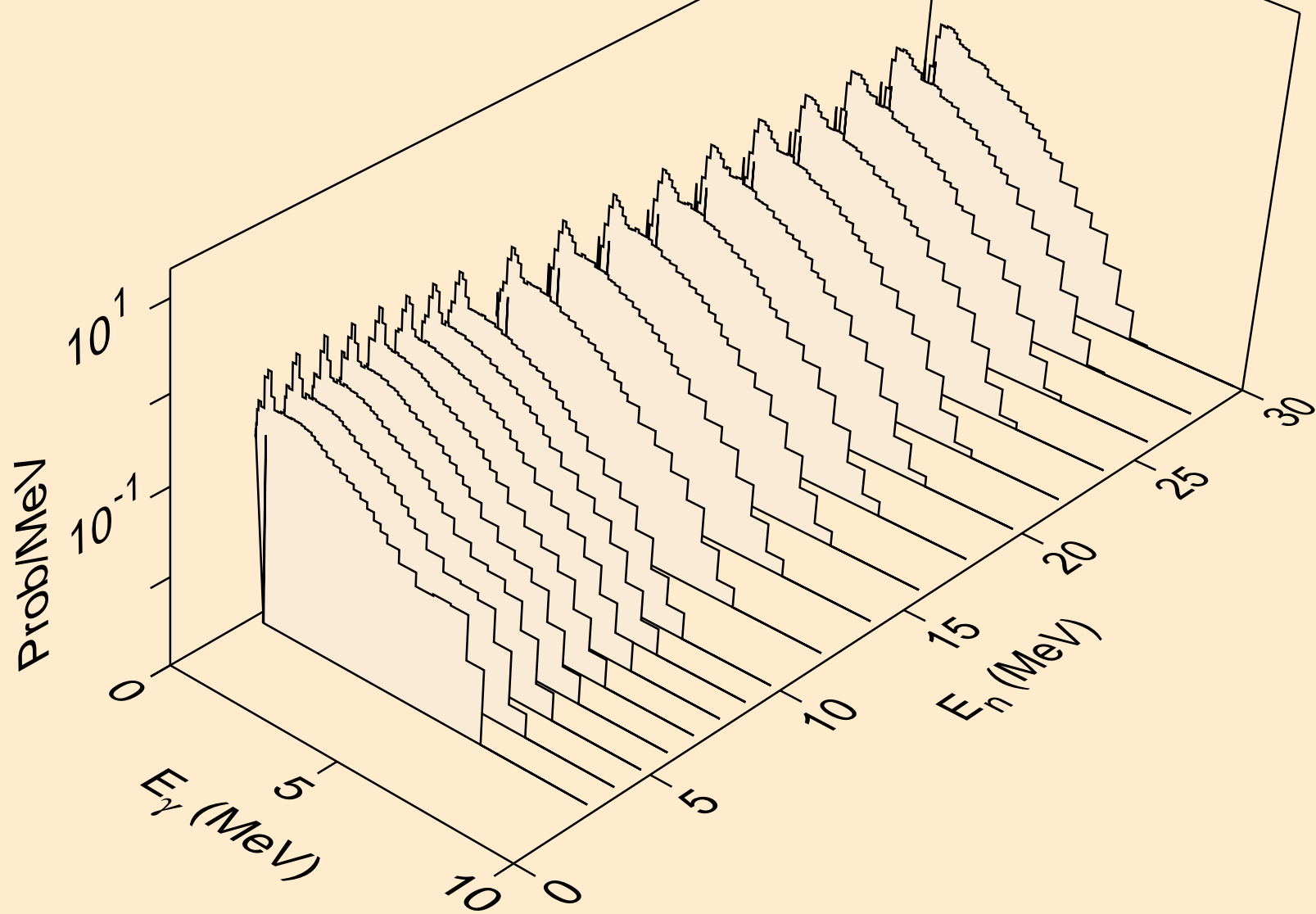

NB084 TRITON ACER TENDL-2021 LIBRARY; T=0.K  
Photon emission for inelastic

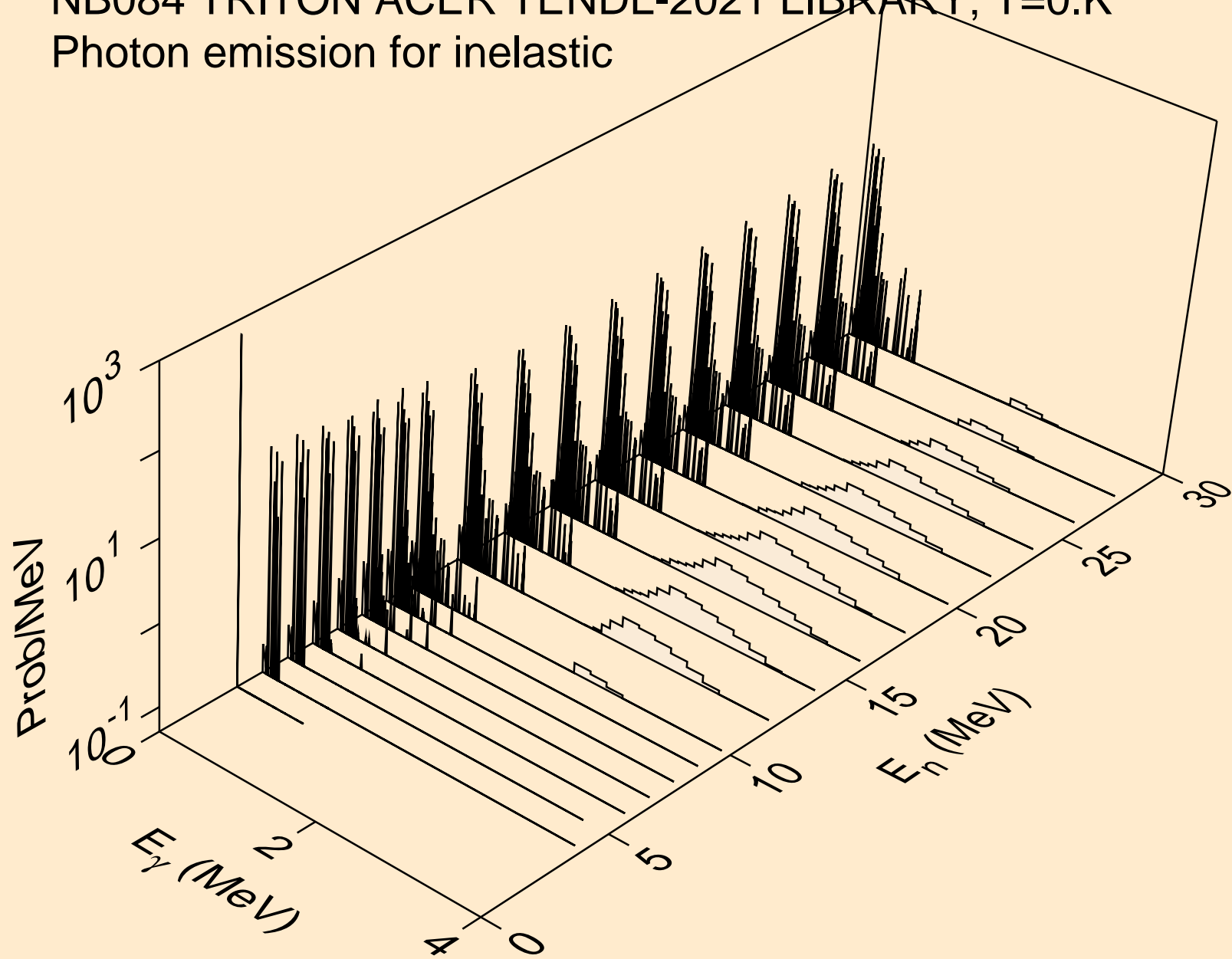



NB084 TRITON ACER TENDL-2021 LIBRARY; T=0.K  
Photon emission for (n,he3)

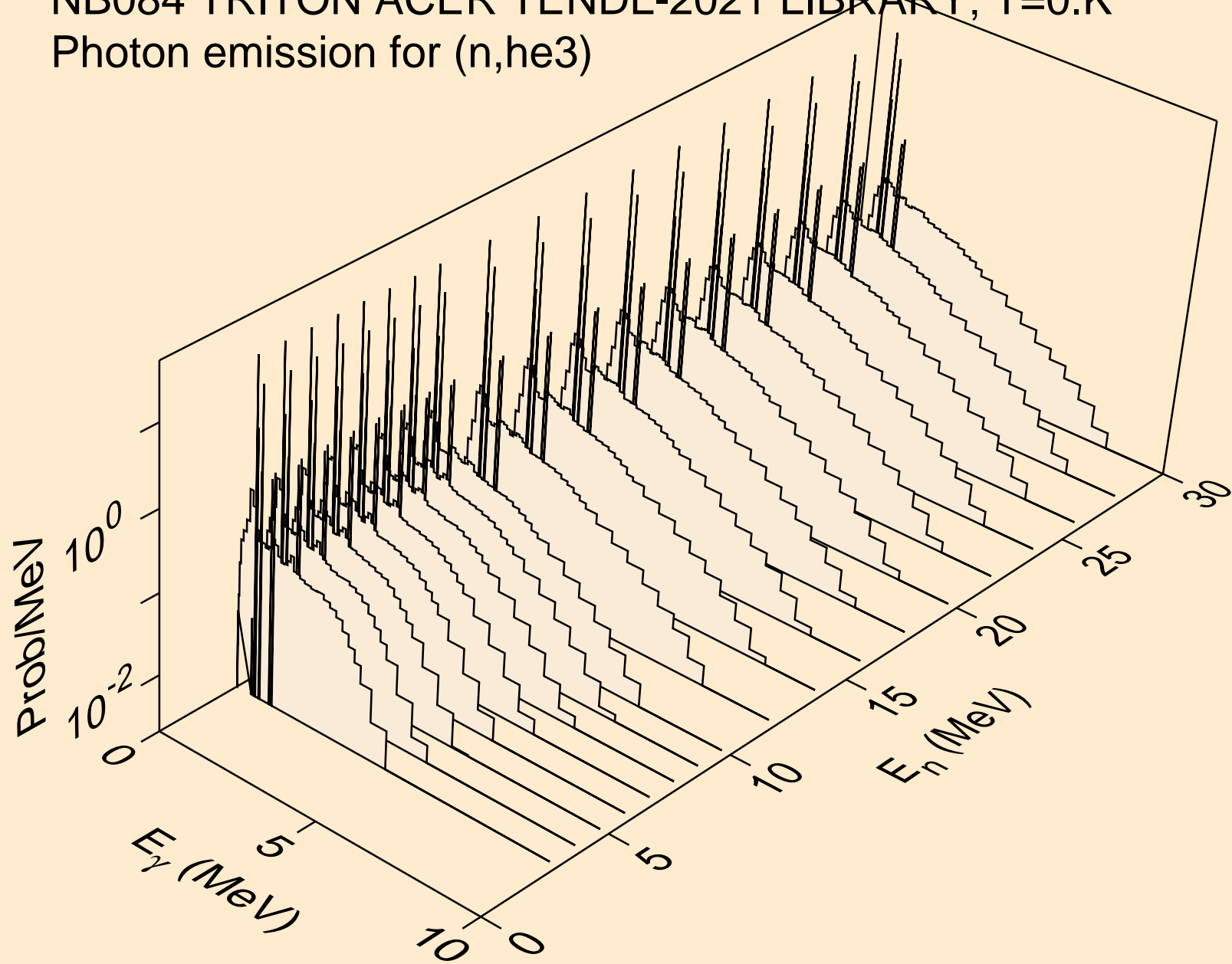

NB084 TRITON ACER TENDL-2021 LIBRARY; T=0.K  
Photon emission for (n,a)

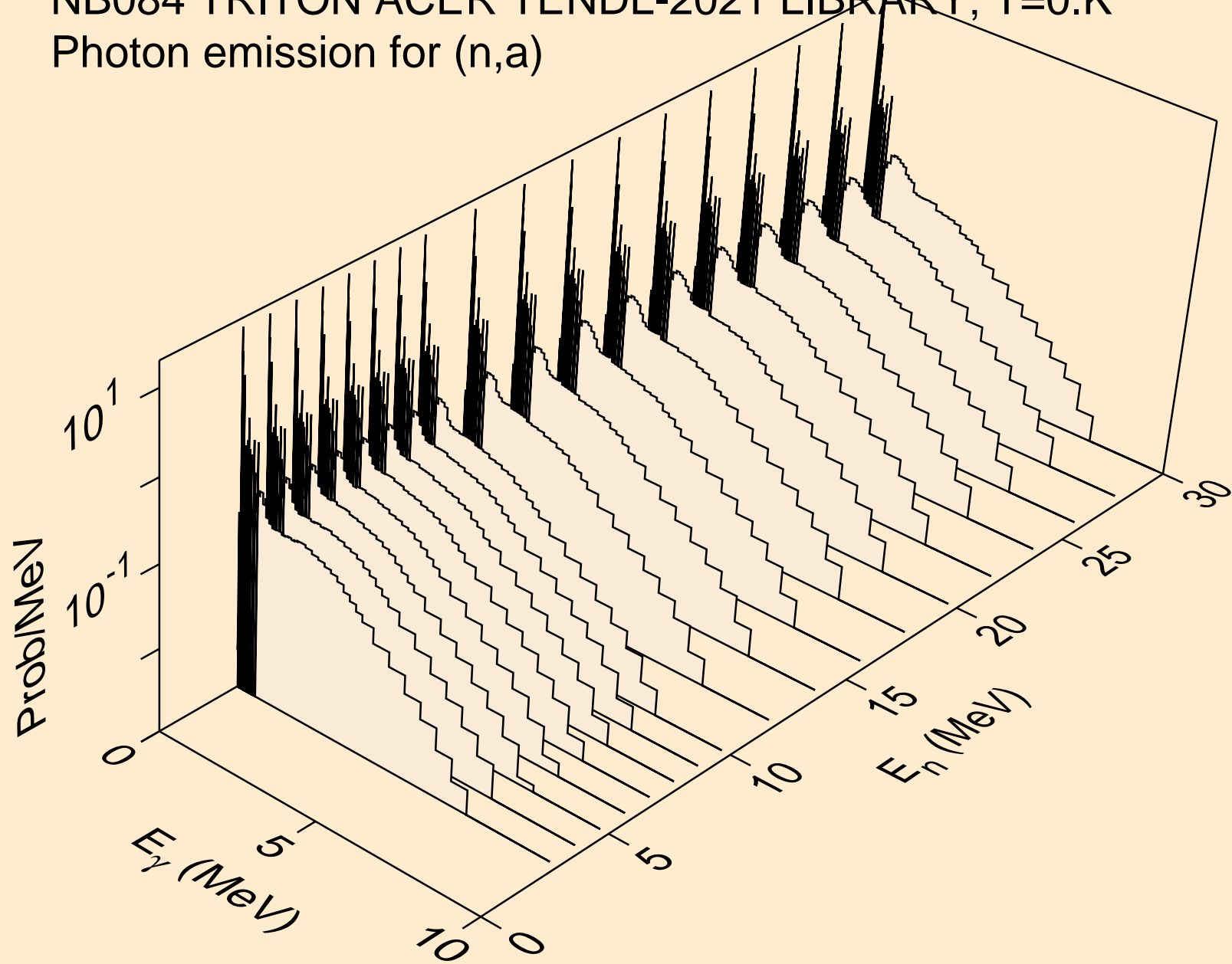

NB084 TRITON ACER TENDL-2021 LIBRARY; T=0.K  
Photon emission for (n,2a)

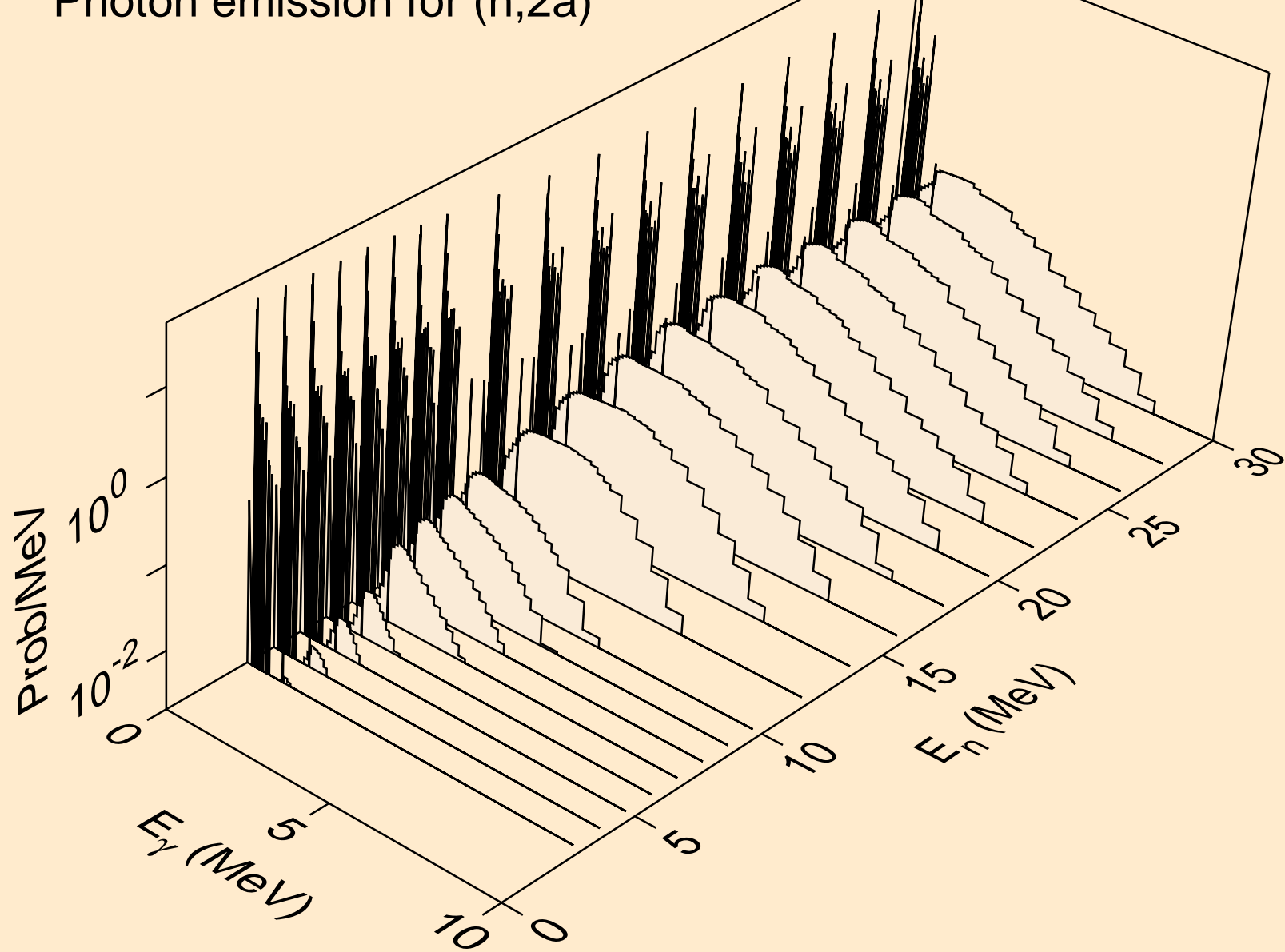

NB084 TRITON ACER TENDL-2021 LIBRARY; T=0.K  
Photon emission for (n,3a)

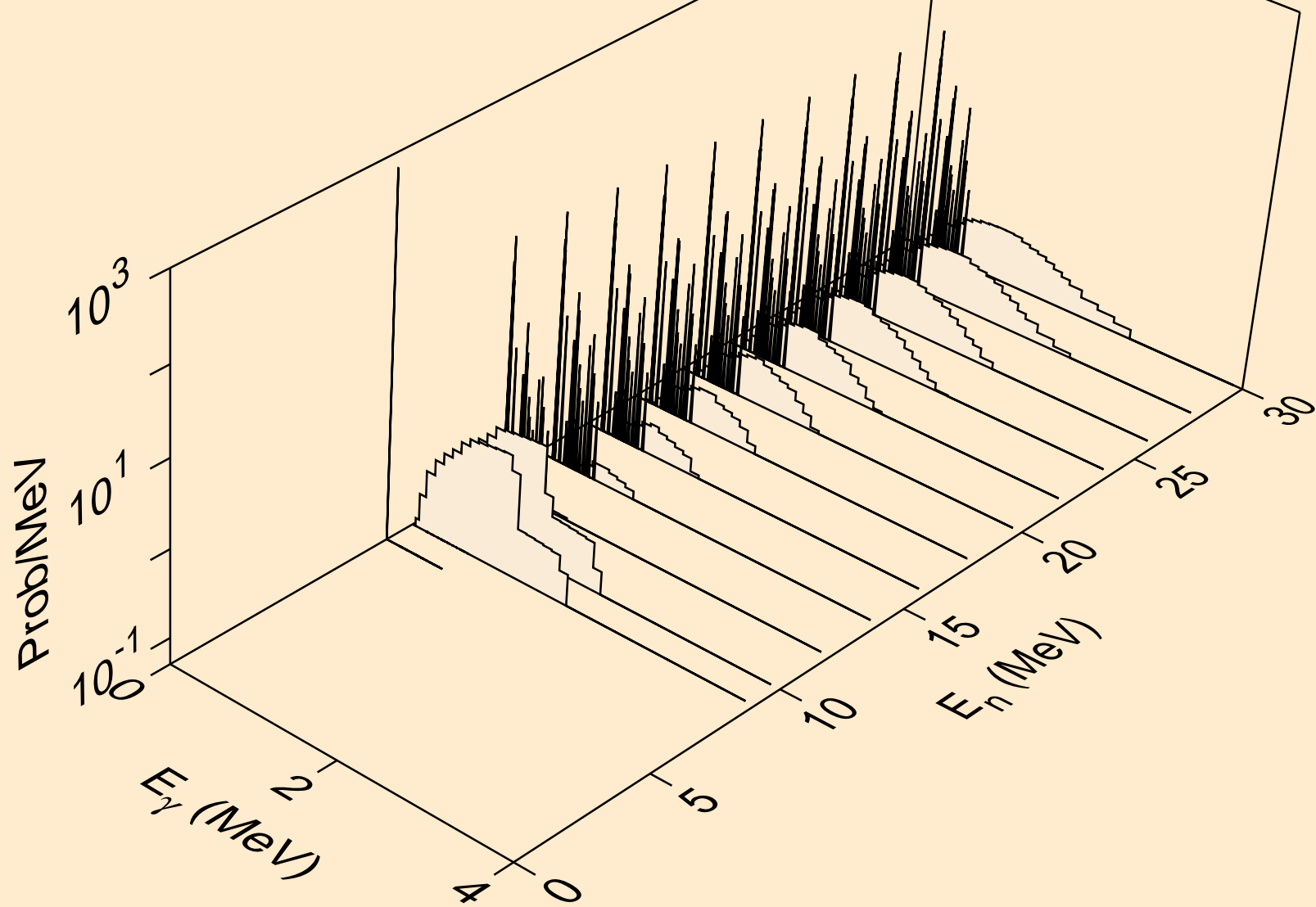

NB084 TRITON ACER TENDL-2021 LIBRARY; T=0.K  
Photon emission for (n,2p)

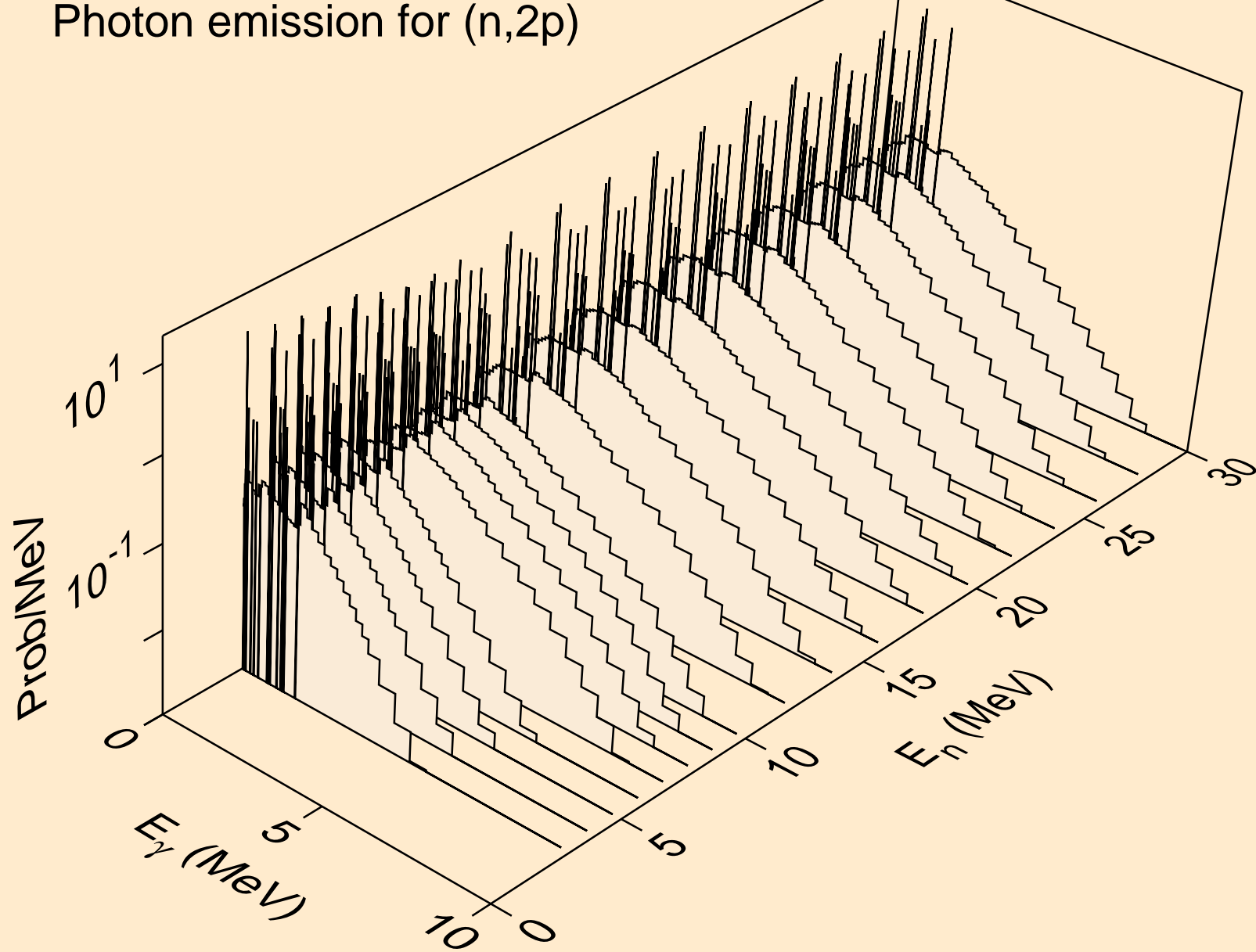

NB084 TRITON ACER TENDL-2021 LIBRARY; T=0.K  
Photon emission for (n,pa)

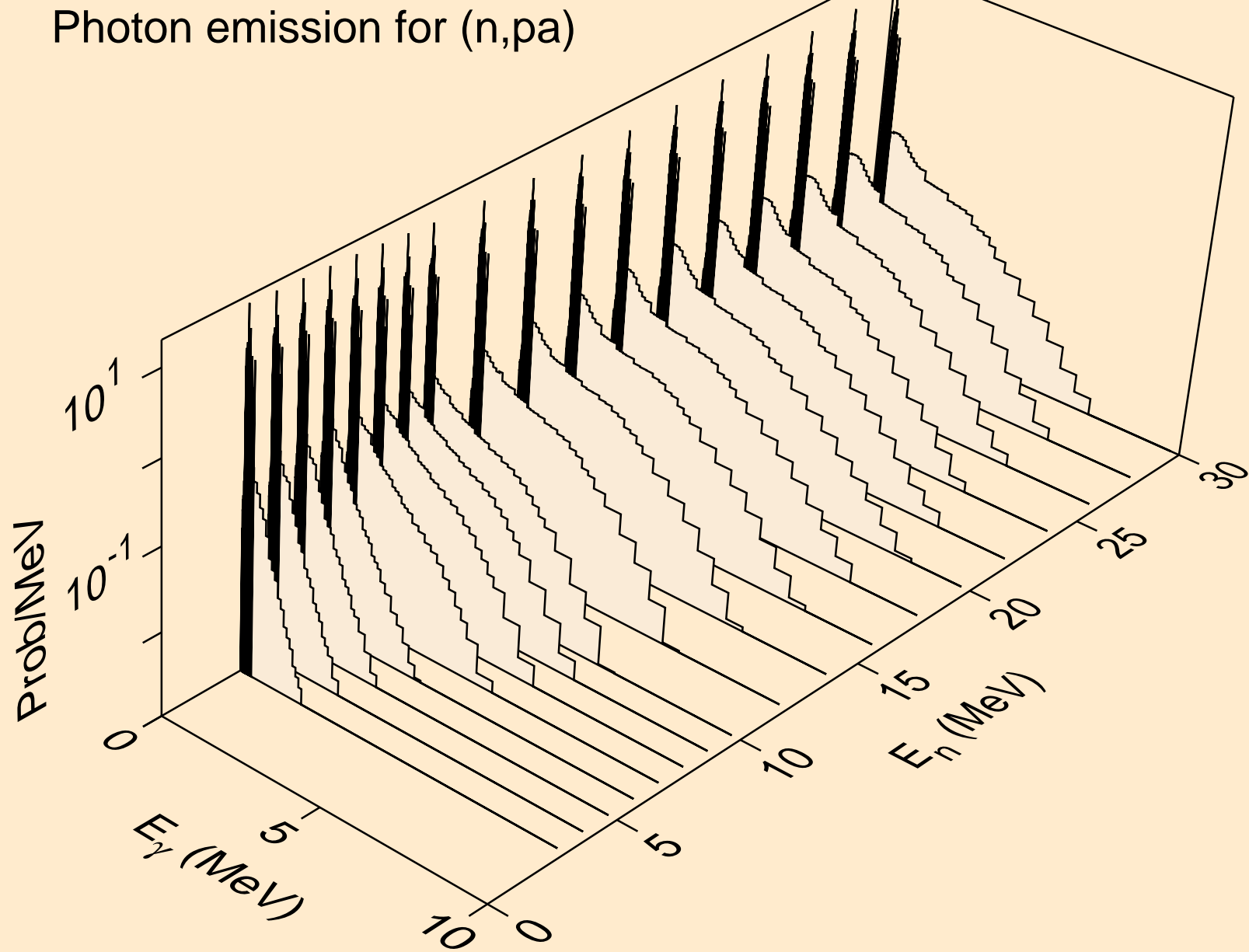

NB084 TRITON ACER TENDL-2021 LIBRARY; T=0.K  
Photon emission for (n,d2a)

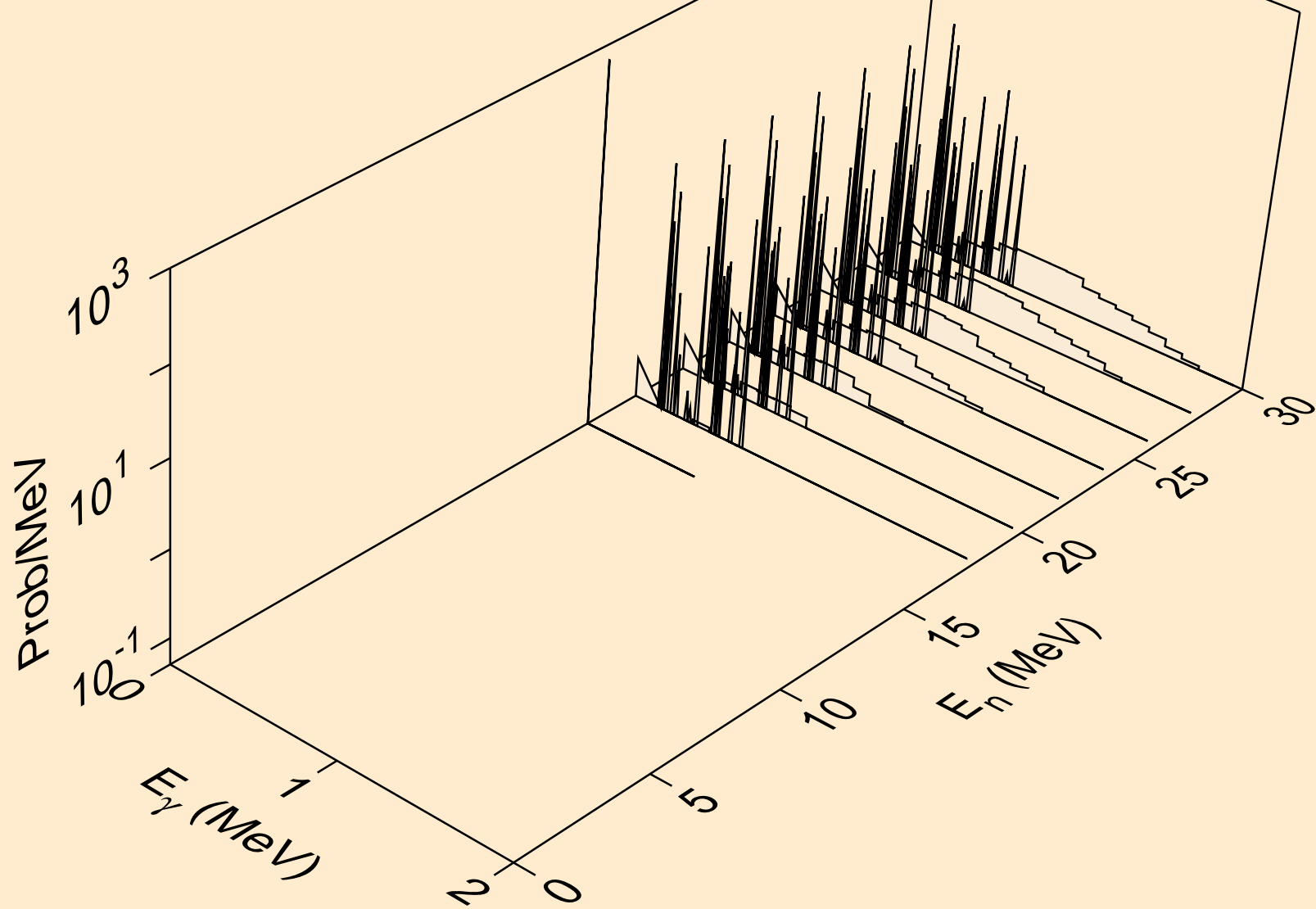

NB084 TRITON ACER TENDL-2021 LIBRARY; T=0.K  
Photon emission for (n,pd)

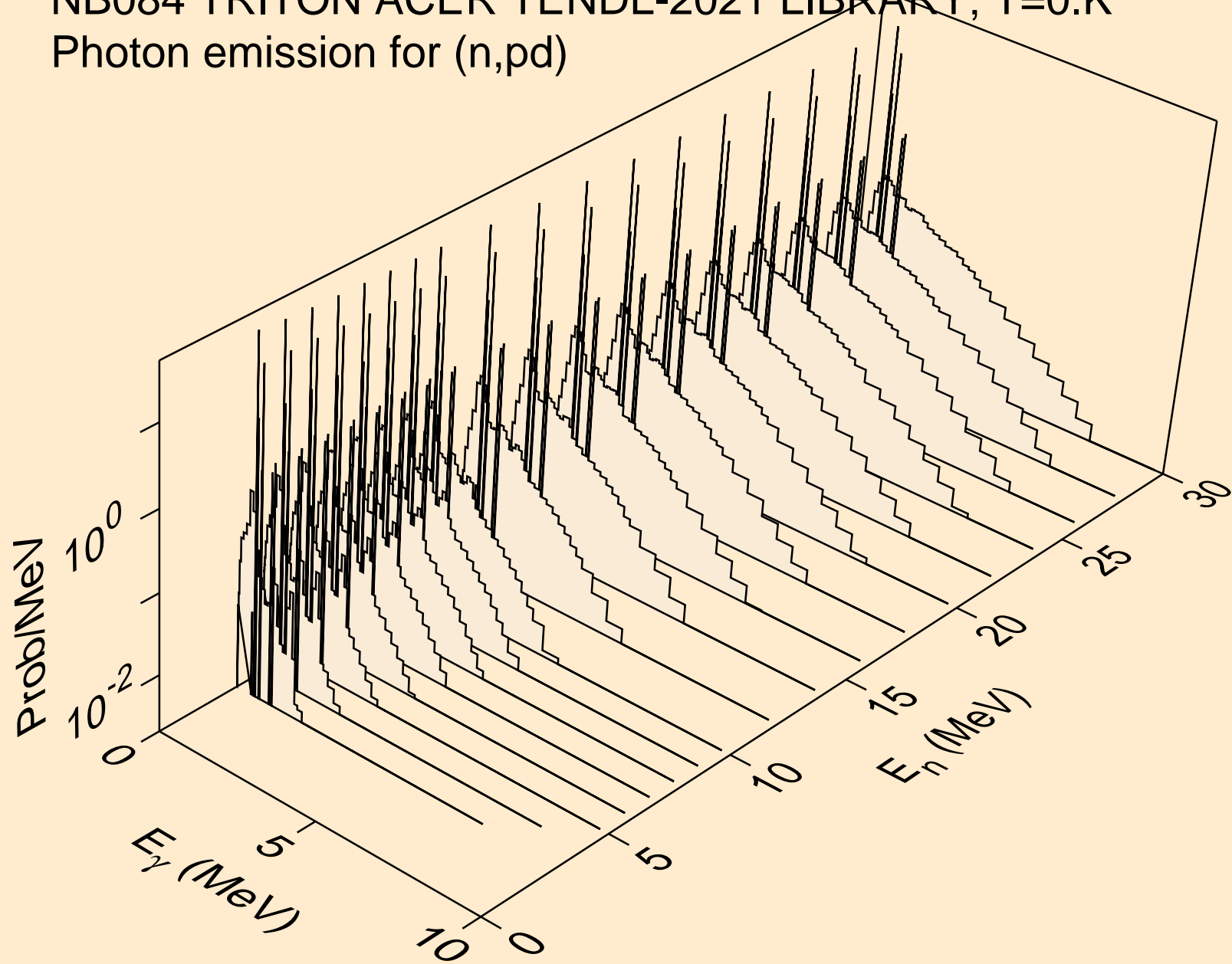



NB084 TRITON ACER TENDL-2021 LIBRARY; T=0.K  
Photon emission for (n,pt)

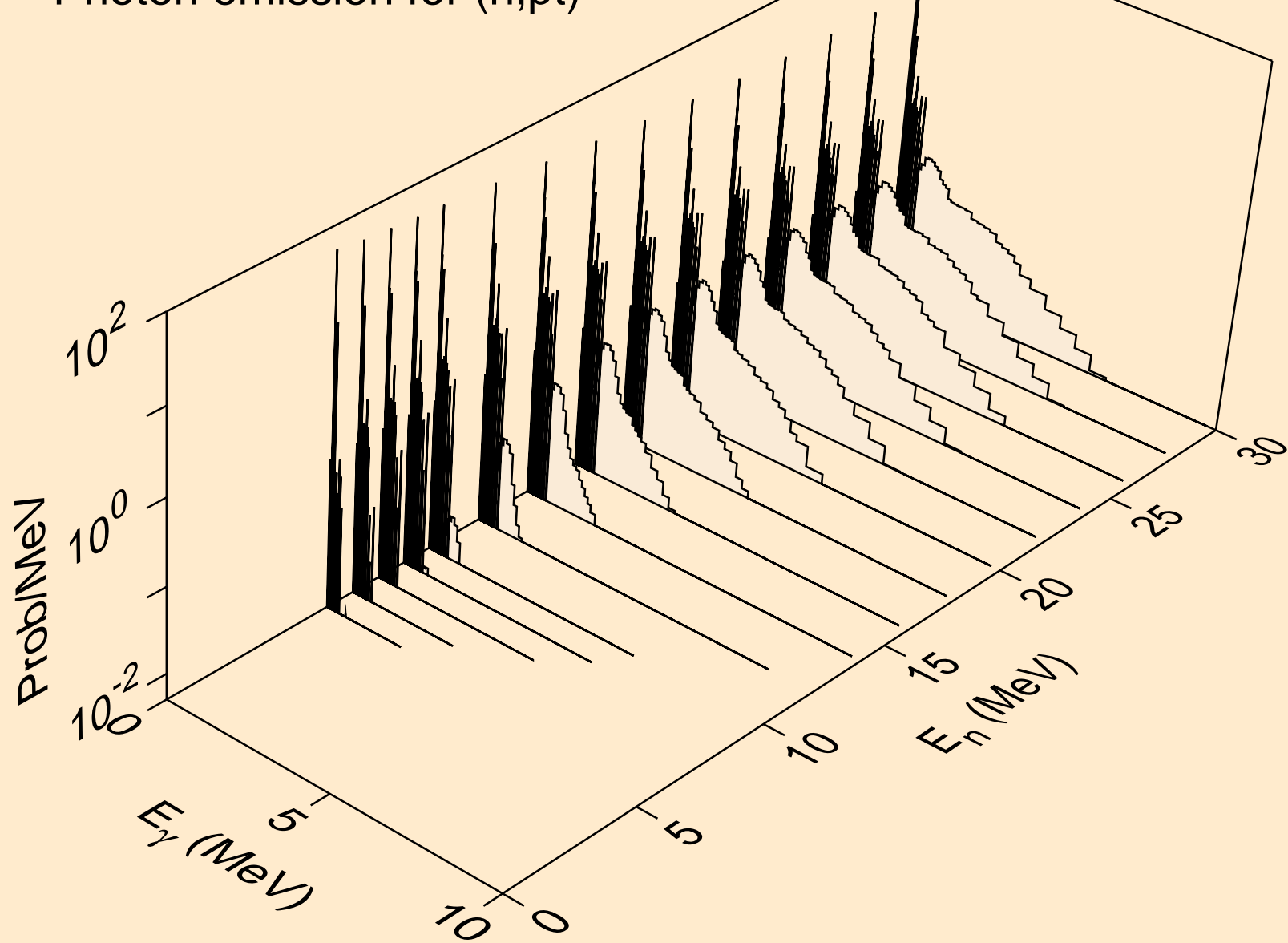

NB084 TRITON ACER TENDL-2021 LIBRARY; T=0.K  
Photon emission for (n,da)

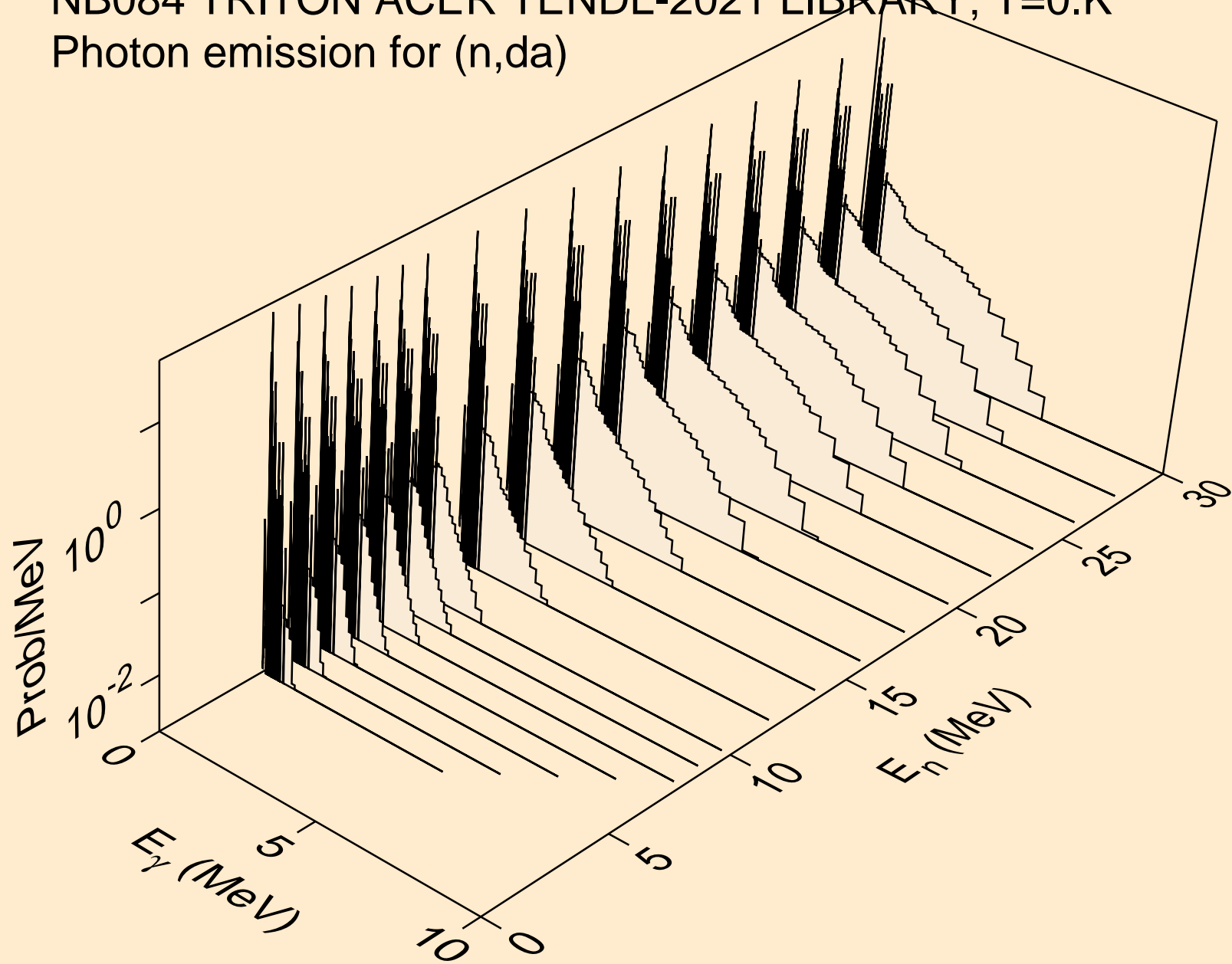

NB084 TRITON ACER TENDL-2021 LIBRARY; T=0.K  
Particle heating contributions

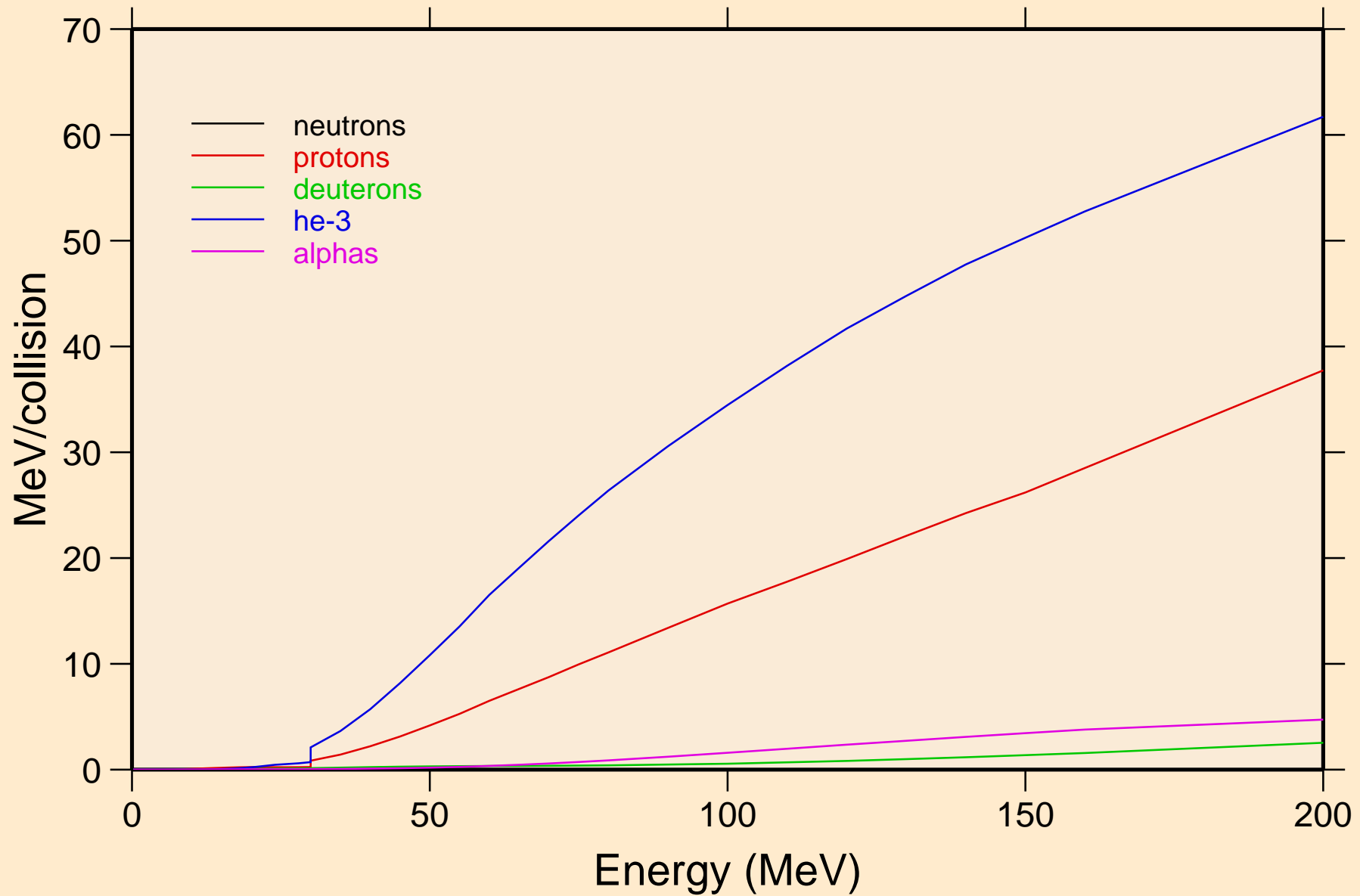

NB084 TRITON ACER TENDL-2021 LIBRARY; T=0.K  
Recoil Heating

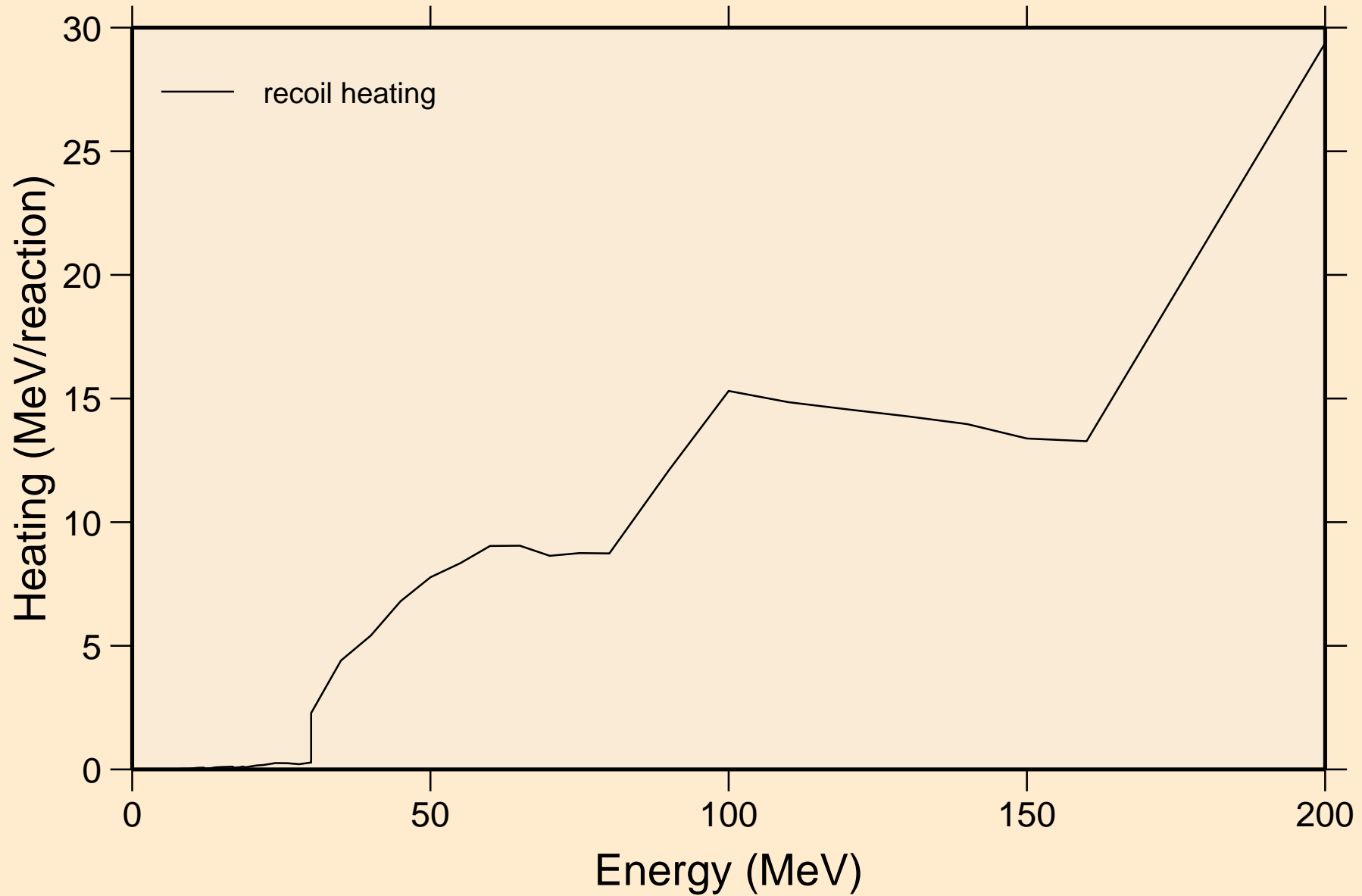

NB084 TRITON ACER TENDL-2021 LIBRARY; T=0.K  
Particle production cross sections

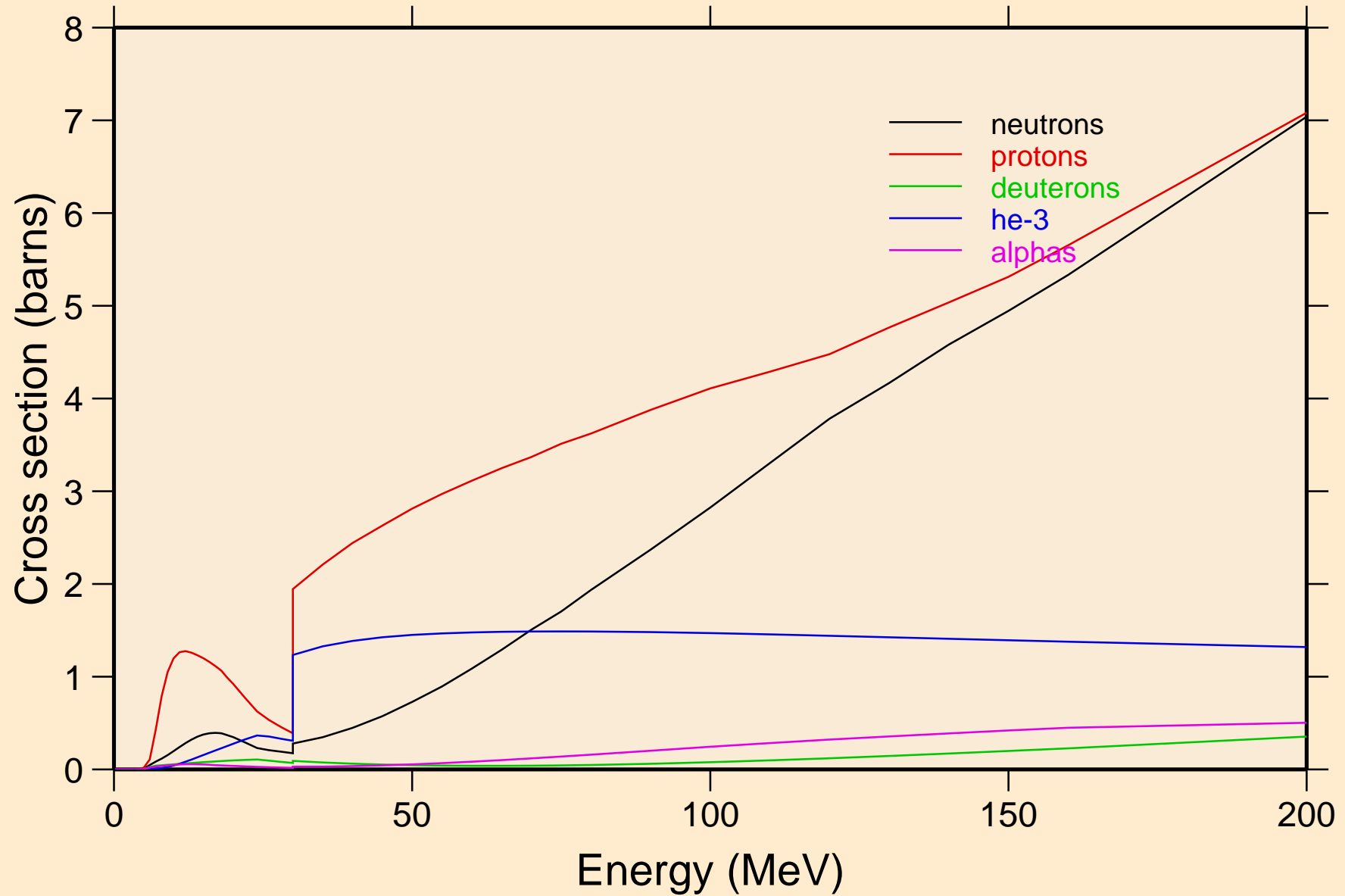

NB084 TRITON ACER TENDL-2021 LIBRARY; T=0.K  
neutrons from (t,n)

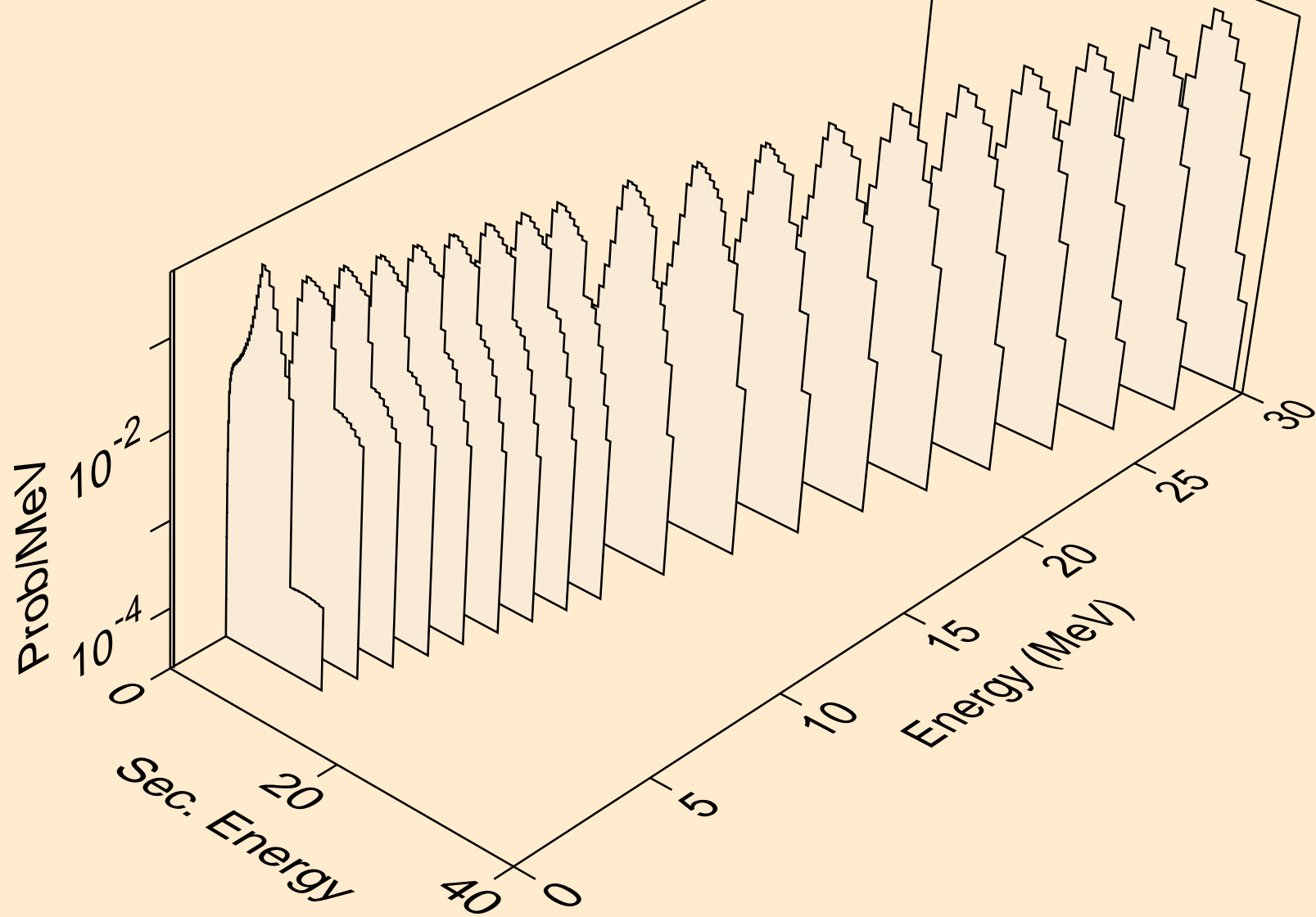

NB084 TRITON ACER TENDL-2021 LIBRARY; T=0.K  
neutrons from (t,x)

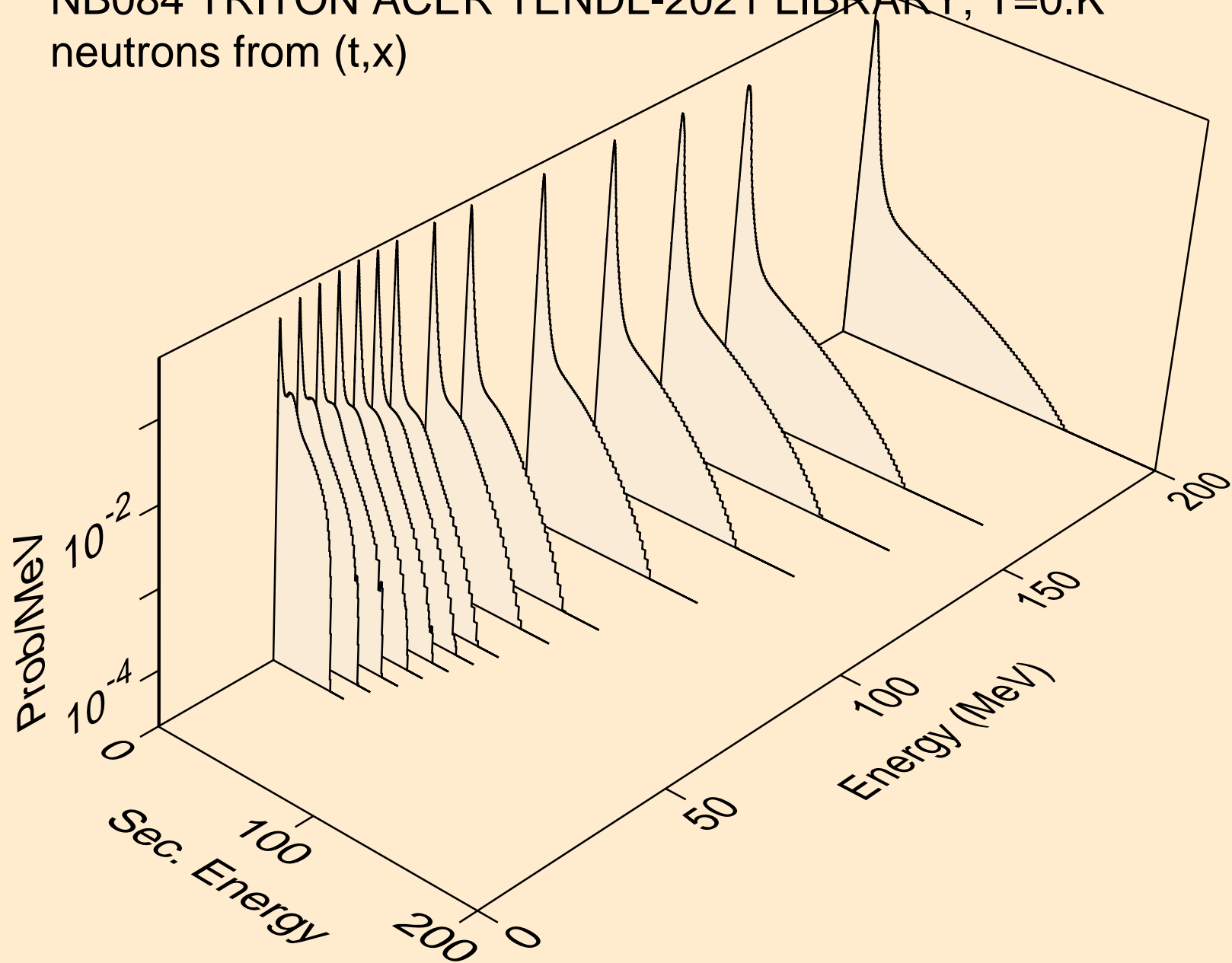

NB084 TRITON ACER TENDL-2021 LIBRARY; T=0.K  
neutrons from (t,2nd)

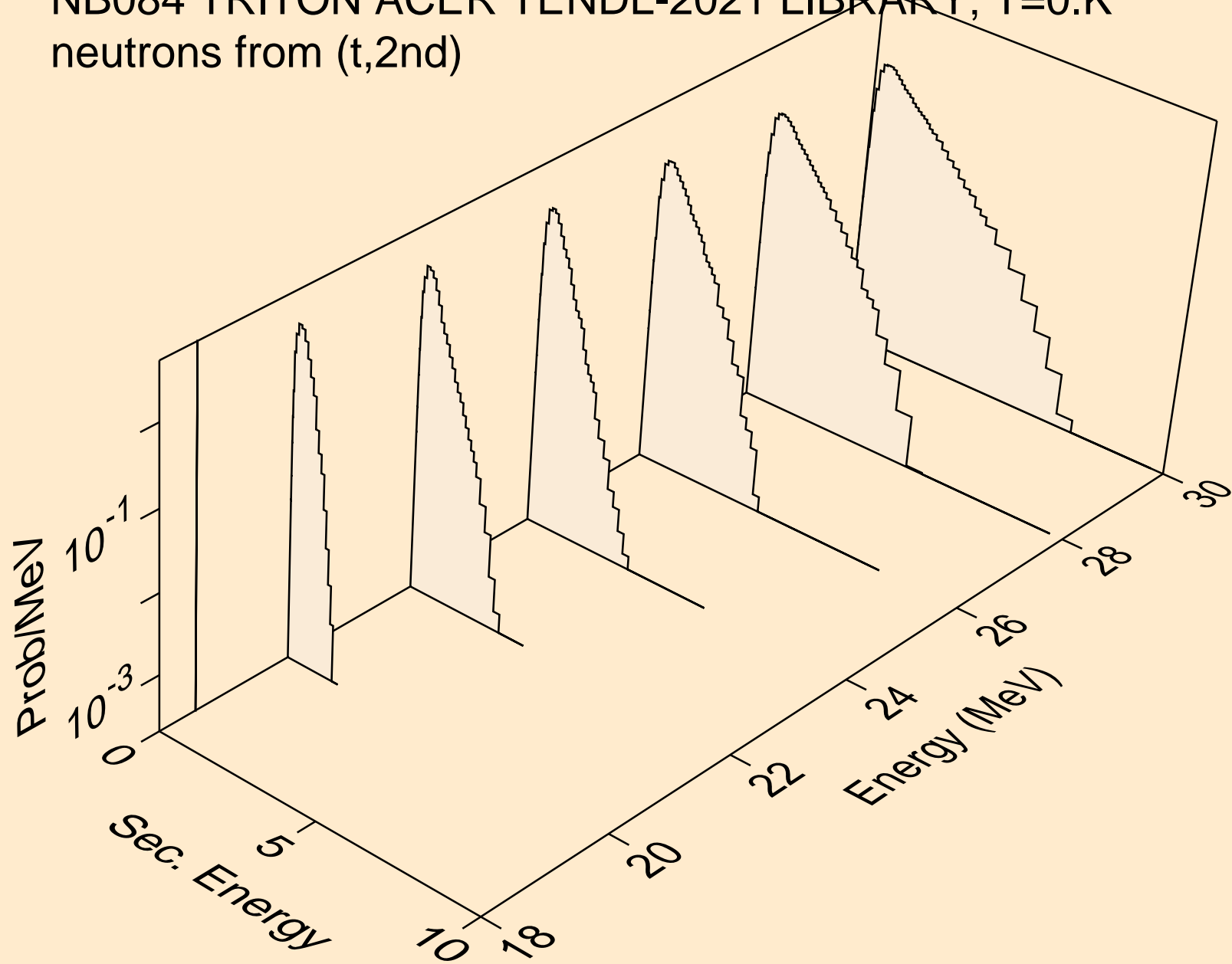



NB084 TRITON ACER TENDL-2021 LIBRARY; T=0.K  
neutrons from (t,2n)

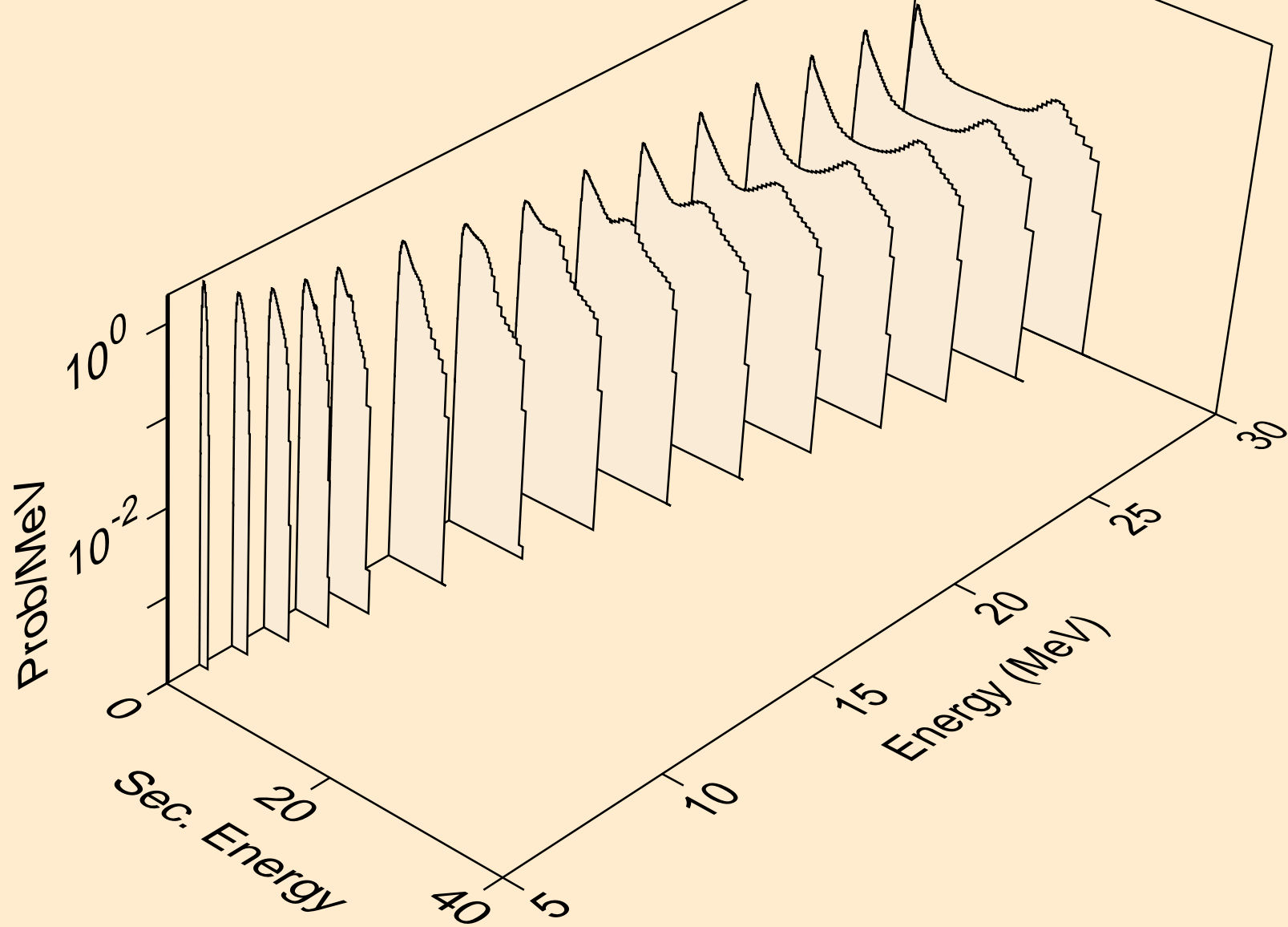

NB084 TRITON ACER TENDL-2021 LIBRARY; T=0.K  
neutrons from (t,3n)

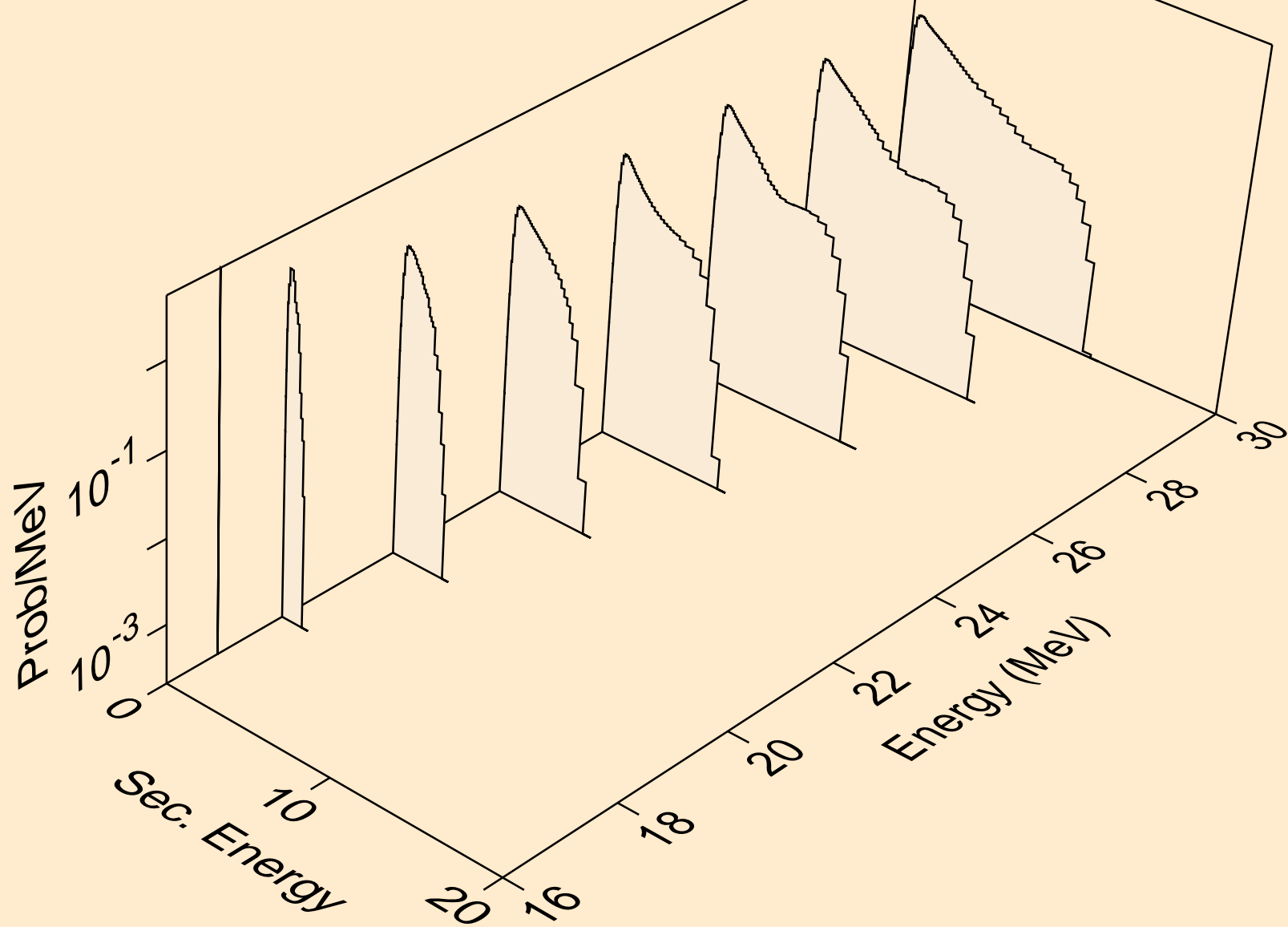

NB084 TRITON ACER TENDL-2021 LIBRARY; T=0.K  
neutrons from (t,n\*)a

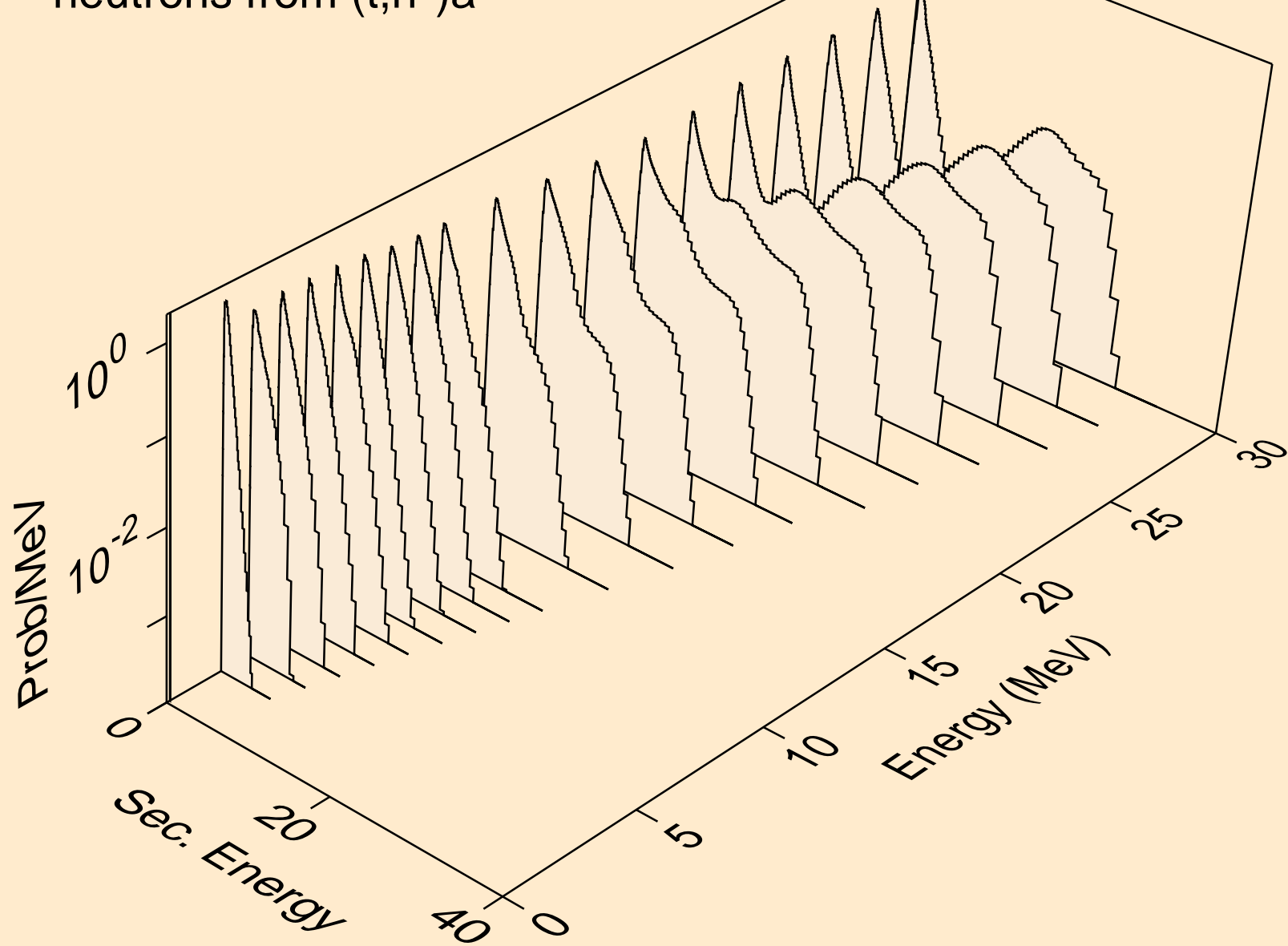

NB084 TRITON ACER TENDL-2021 LIBRARY; T=0.K  
neutrons from (t,2n)a

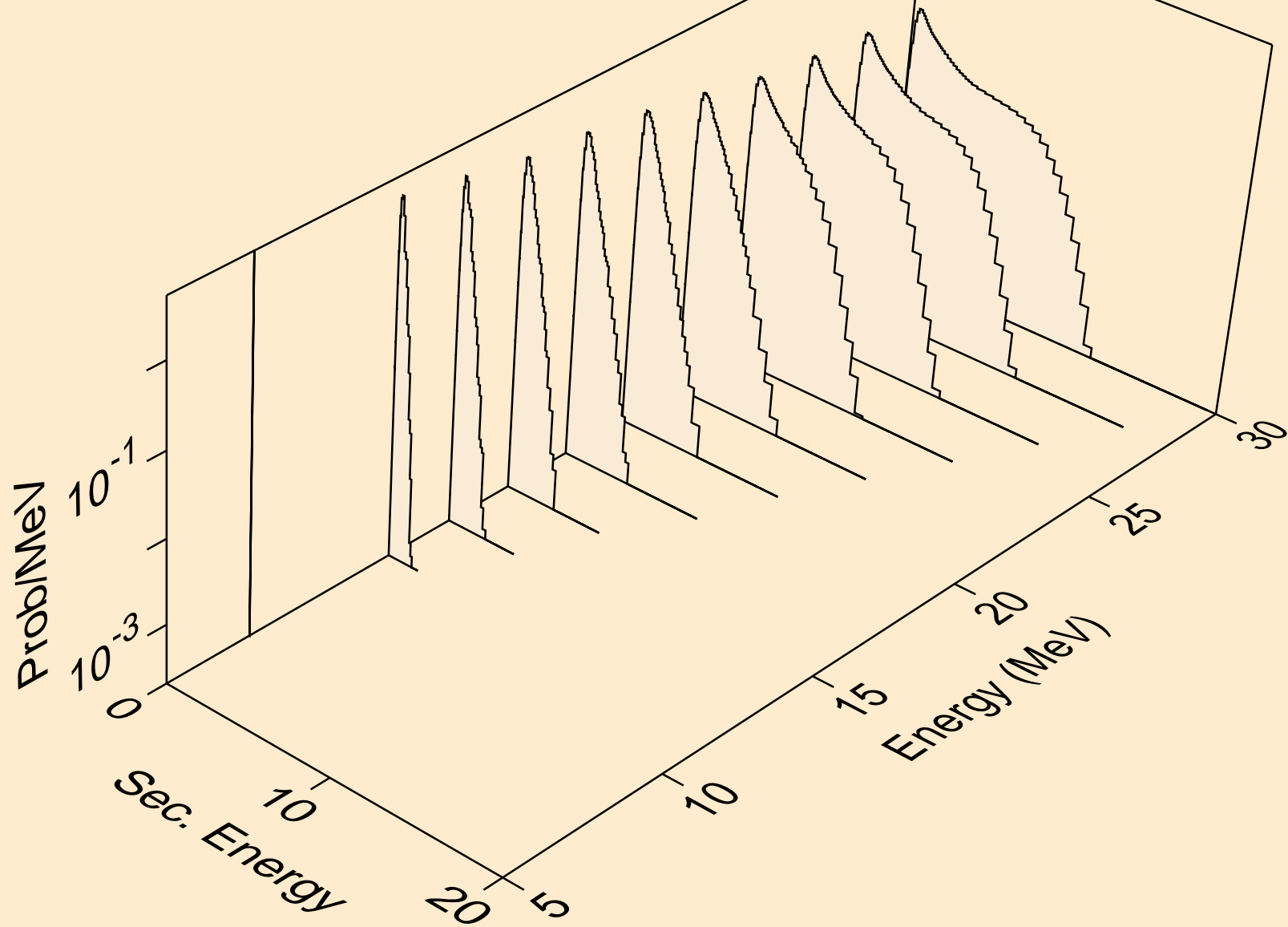

NB084 TRITON ACER TENDL-2021 LIBRARY; T=0.K  
neutrons from (t,n\*)p

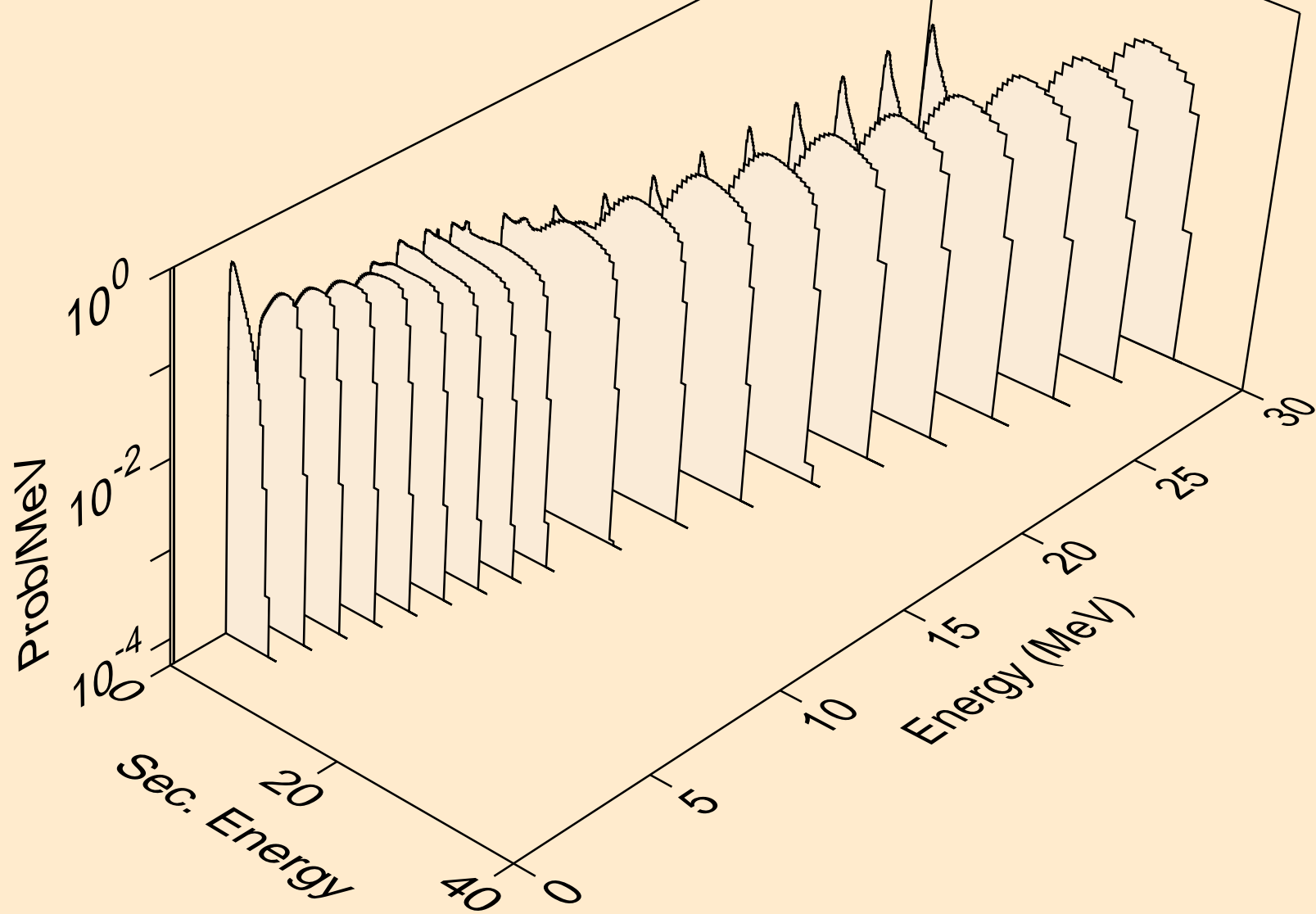

NB084 TRITON ACER TENDL-2021 LIBRARY; T=0.K  
neutrons from (t,n\*)2a

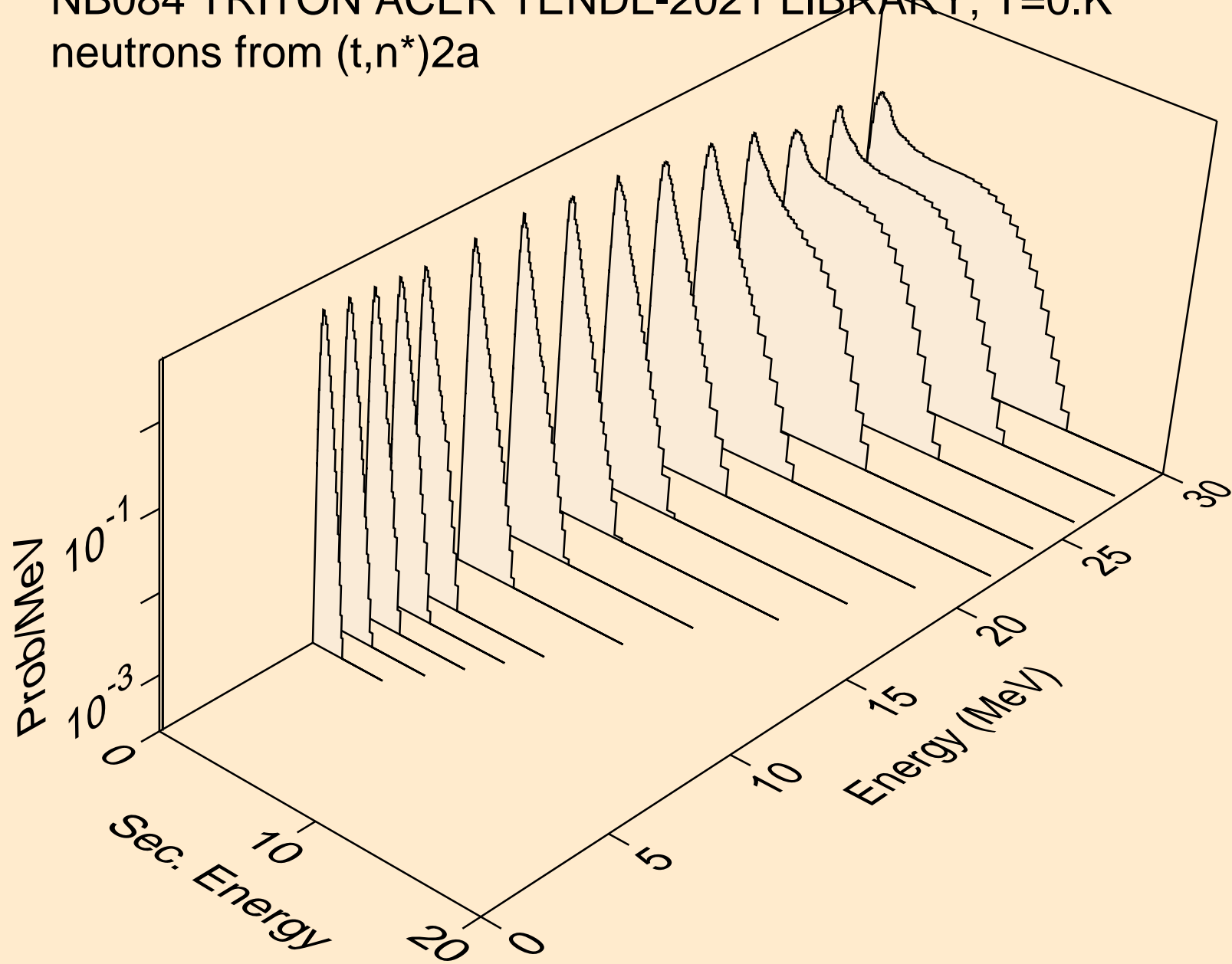

NB084 TRITON ACER TENDL-2021 LIBRARY; T=0.K  
neutrons from (t,n\*)d

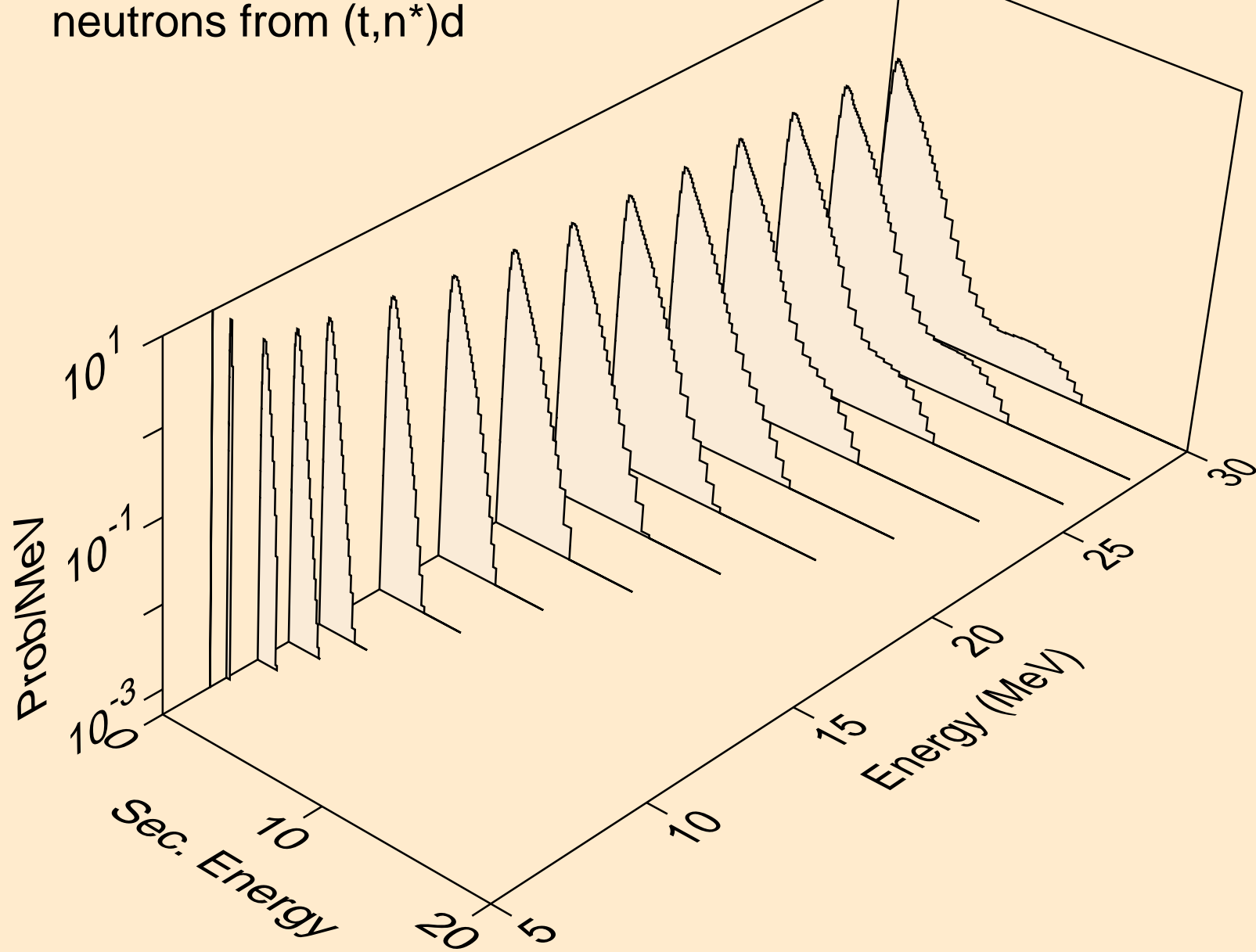

NB084 TRITON ACER TENDL-2021 LIBRARY; T=0.K  
neutrons from (t,n\*)t

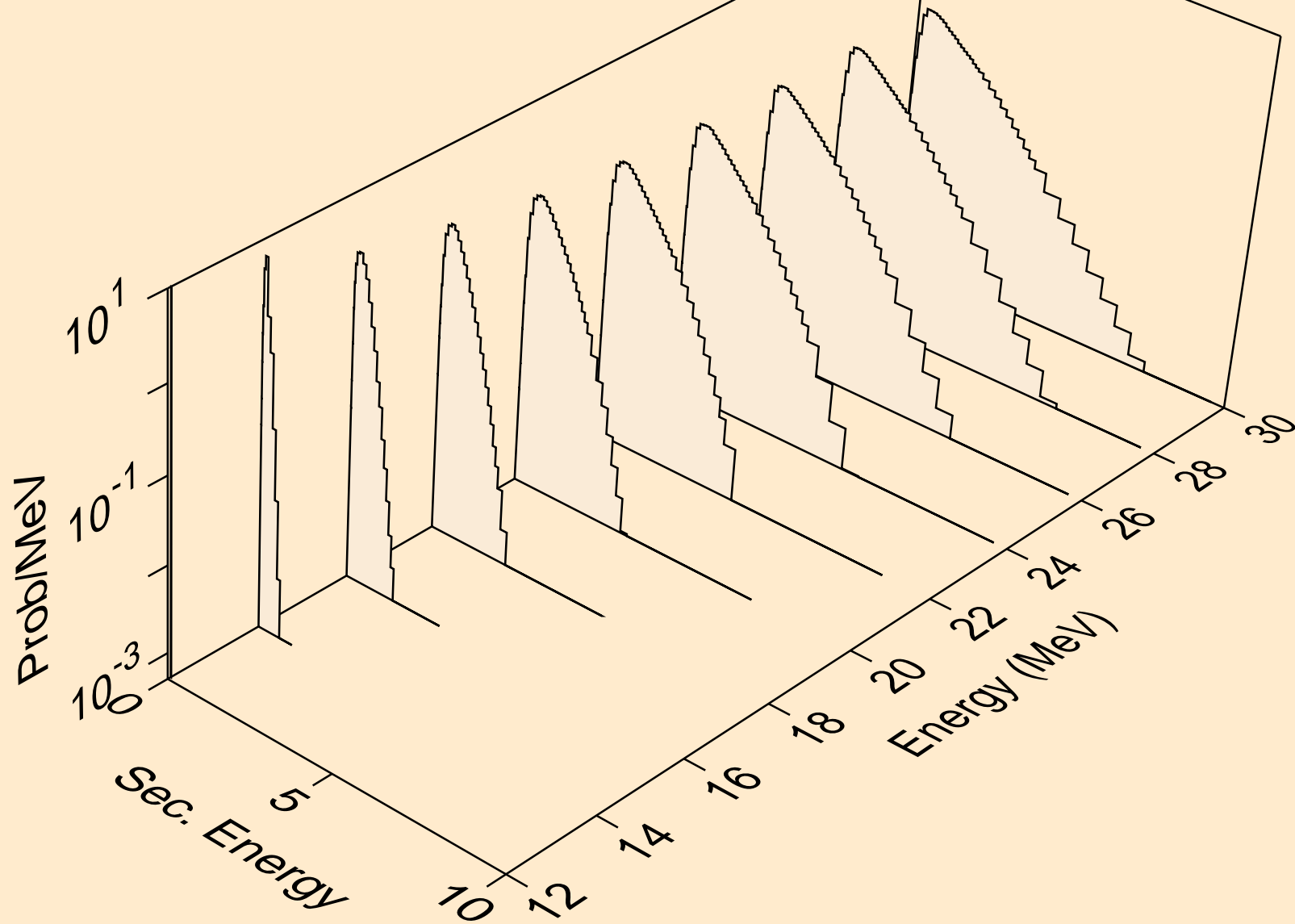



NB084 TRITON ACER TENDL-2021 LIBRARY; T=0.K  
neutrons from (t,n\*)he3

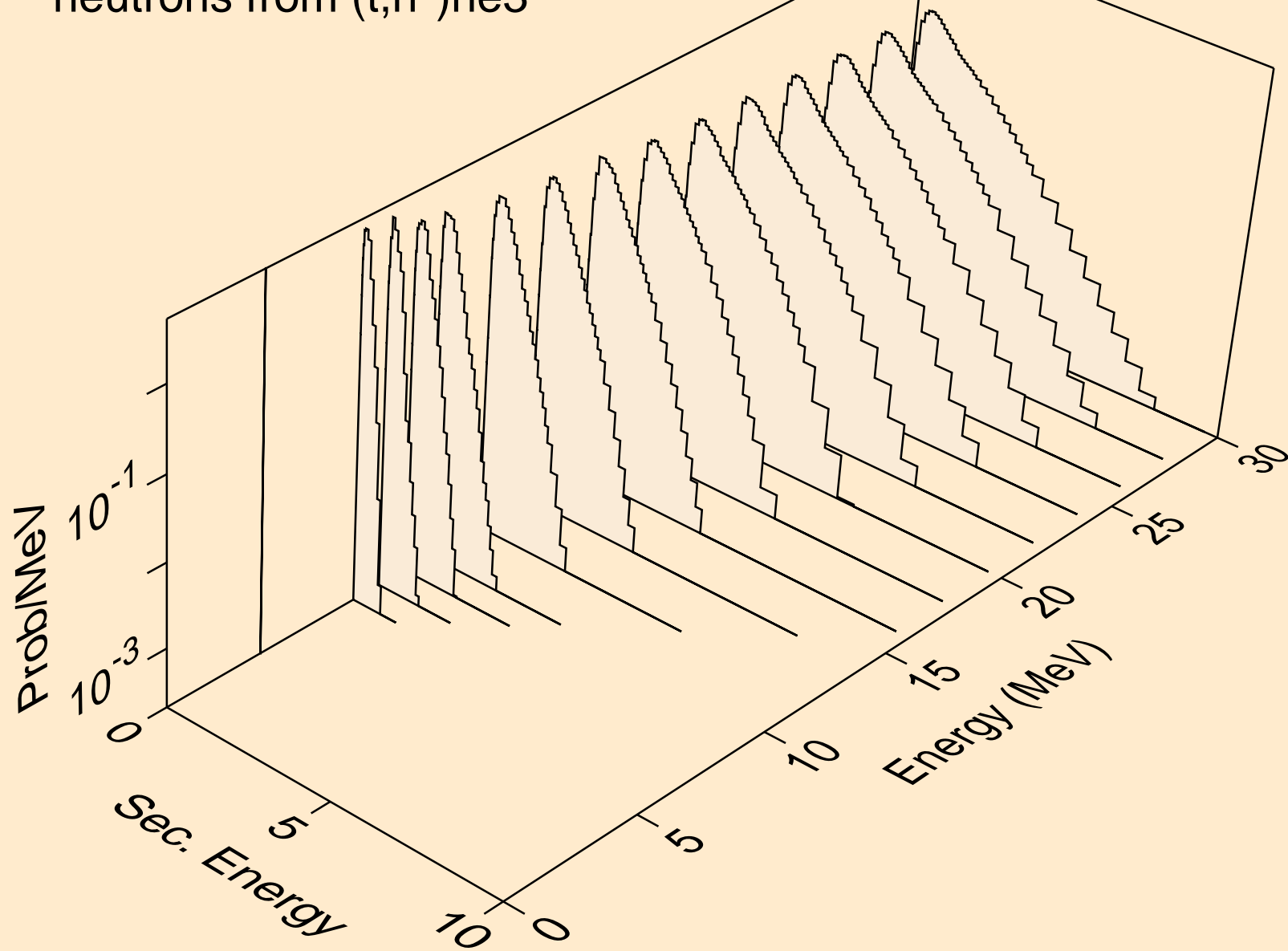

NB084 TRITON ACER TENDL-2021 LIBRARY; T=0.K  
neutrons from (t,2np)

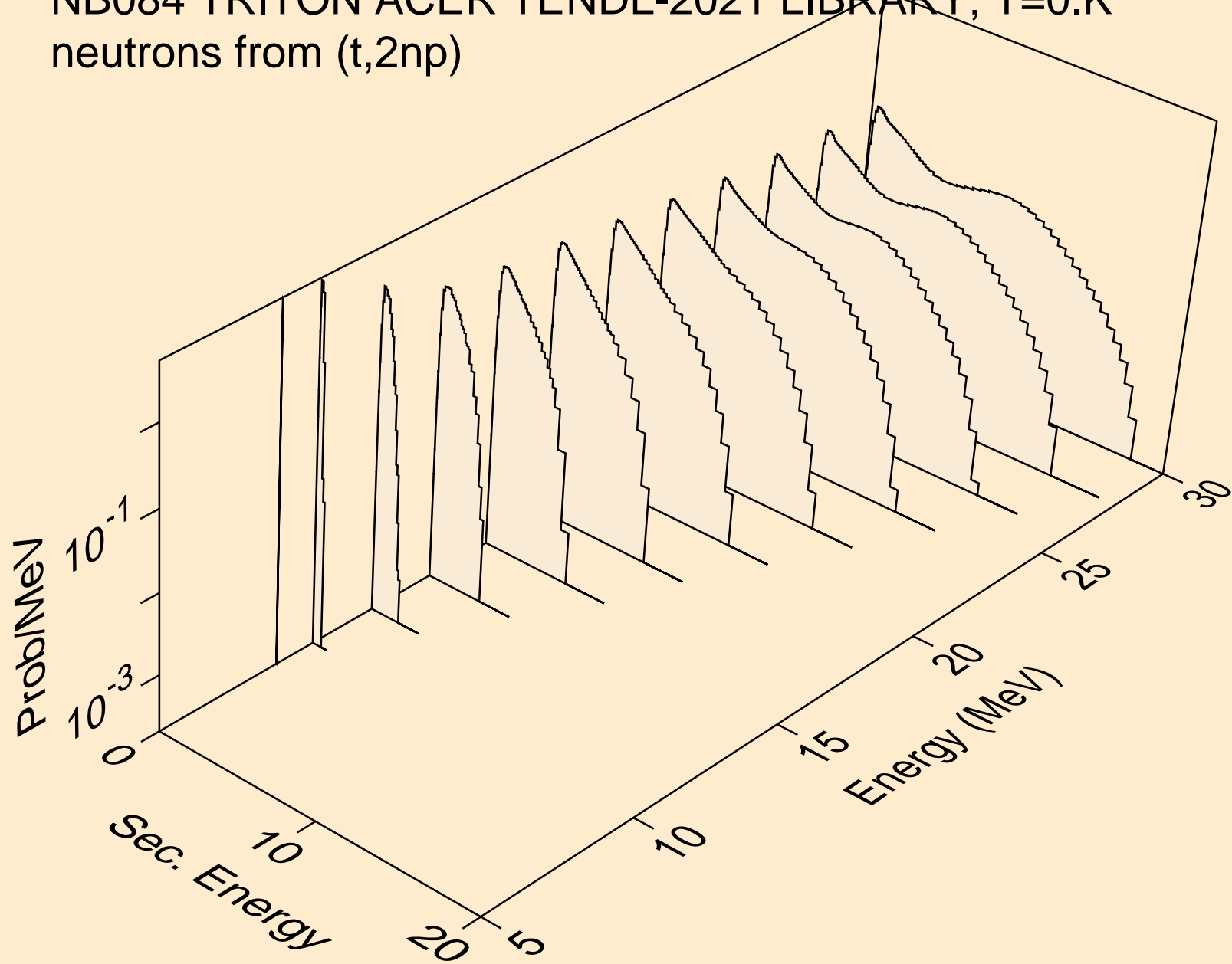

NB084 TRITON ACER TENDL-2021 LIBRARY; T=0.K  
neutrons from (t,3np)

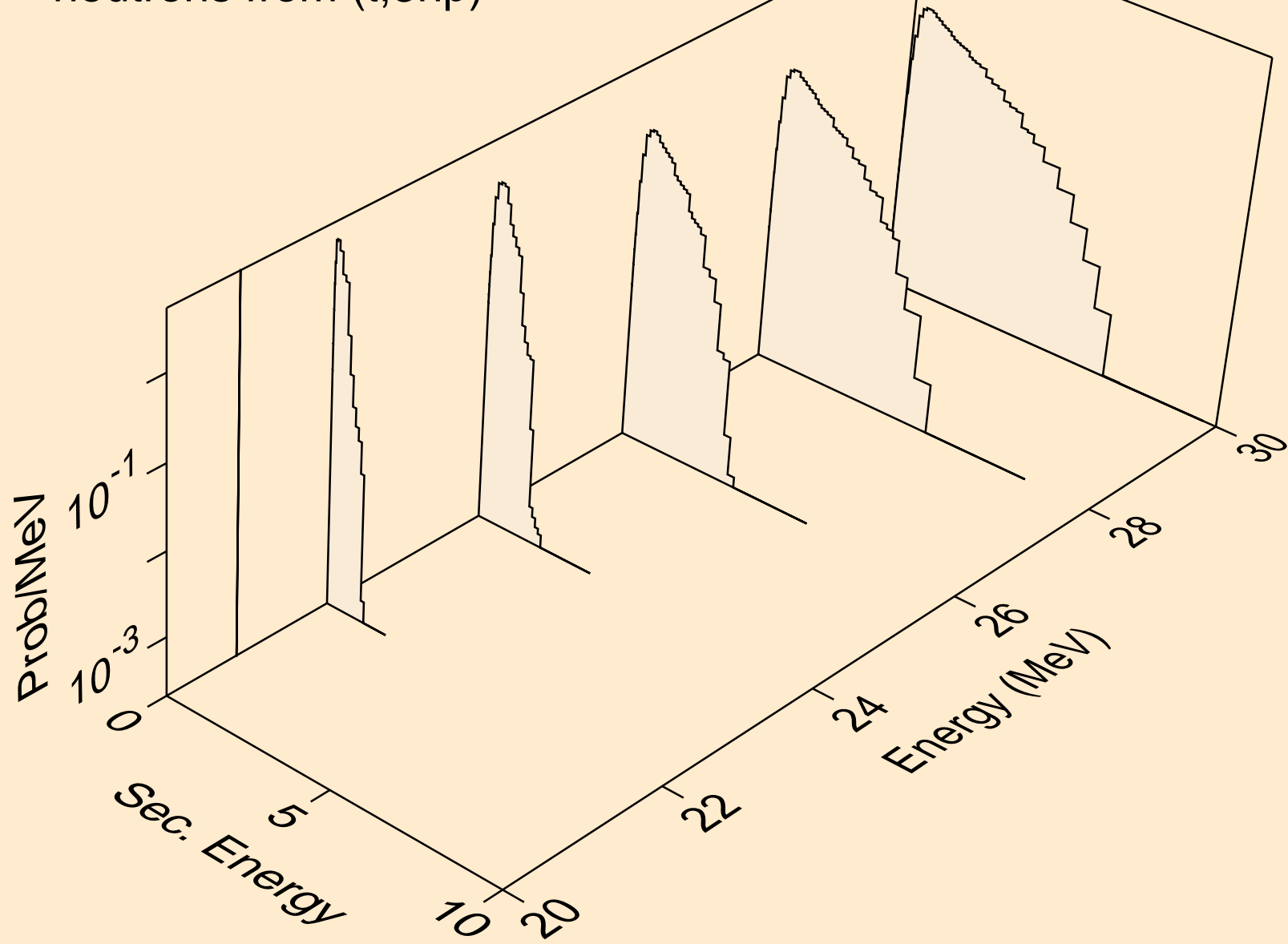

NB084 TRITON ACER TENDL-2021 LIBRARY; T=0.K  
neutrons from (t,2np)

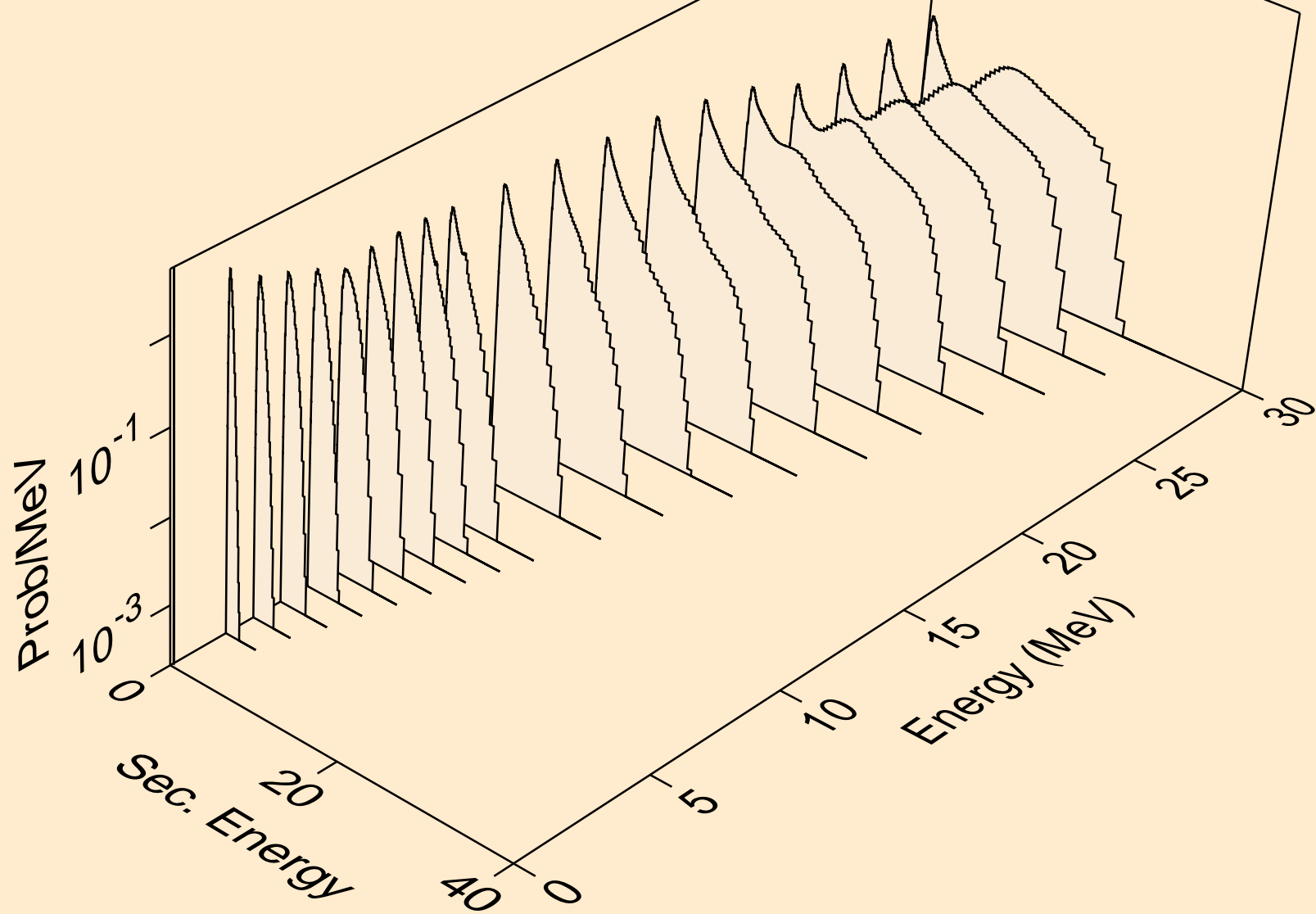

NB084 TRITON ACER TENDL-2021 LIBRARY; T=0.K  
neutrons from (t,npa)

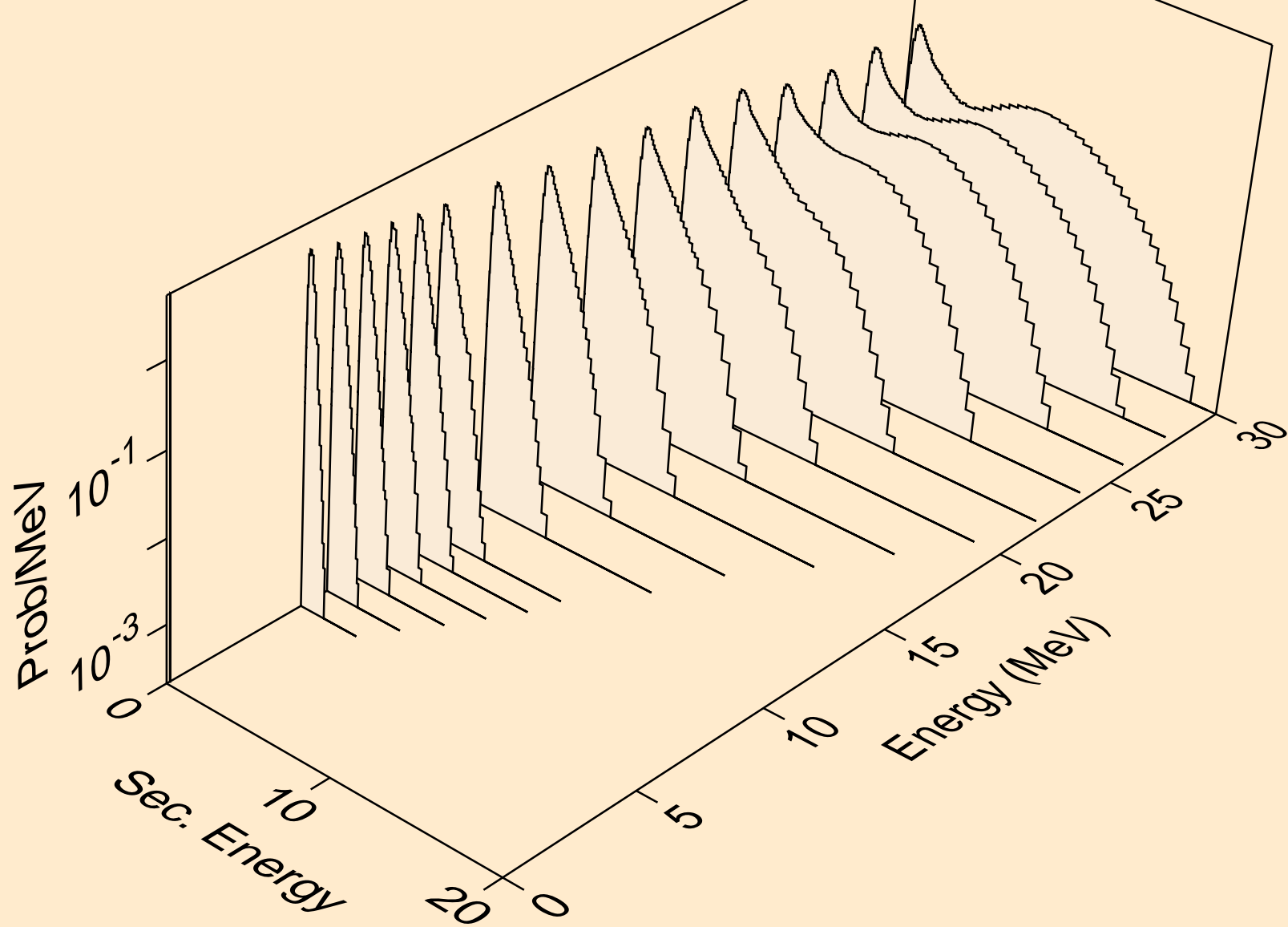

NB084 TRITON ACER TENDL-2021 LIBRARY; T=0.K  
protons from (t,x)

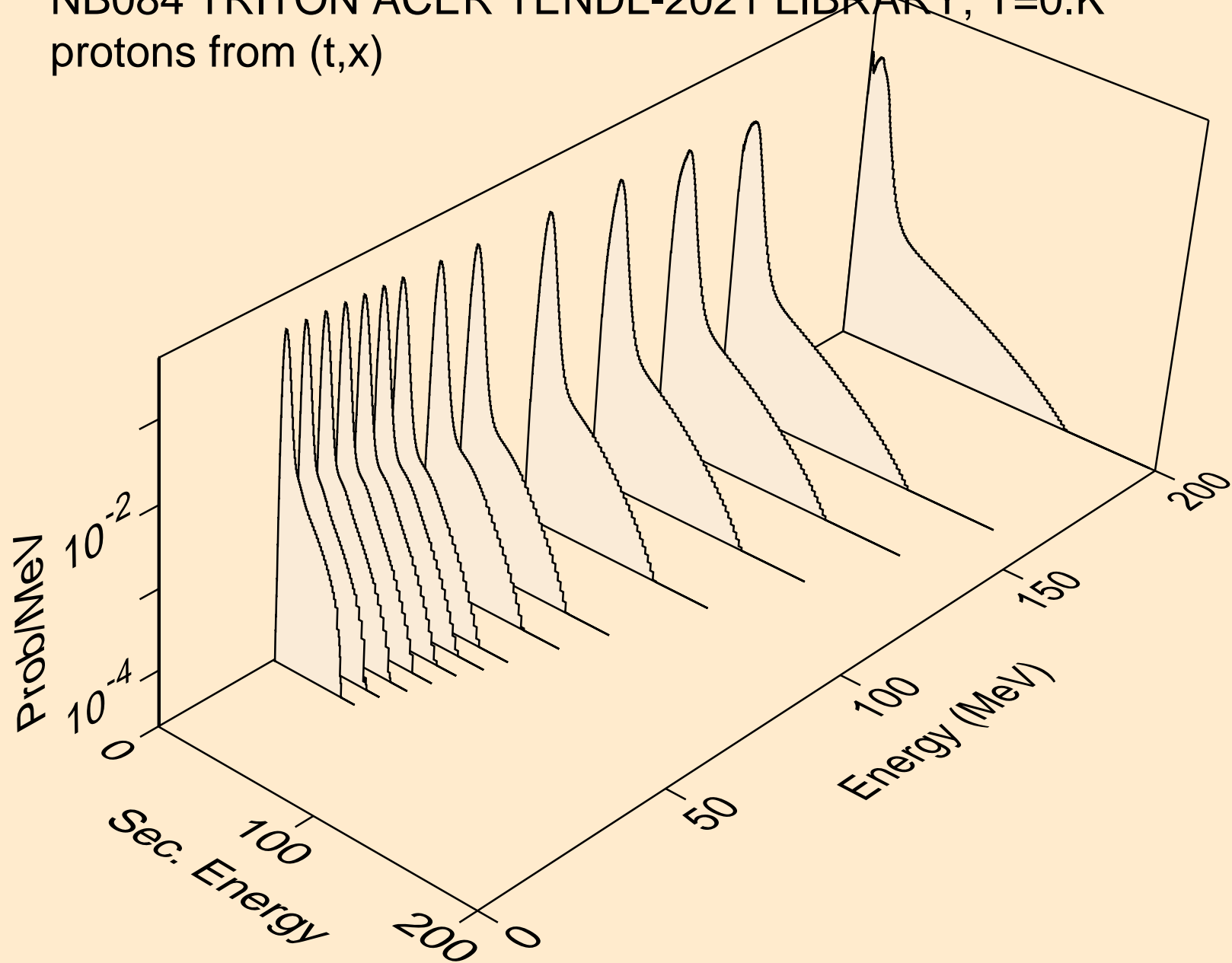

NB084 TRITON ACER TENDL-2021 LIBRARY; T=0.K  
protons from (t,n\*)p

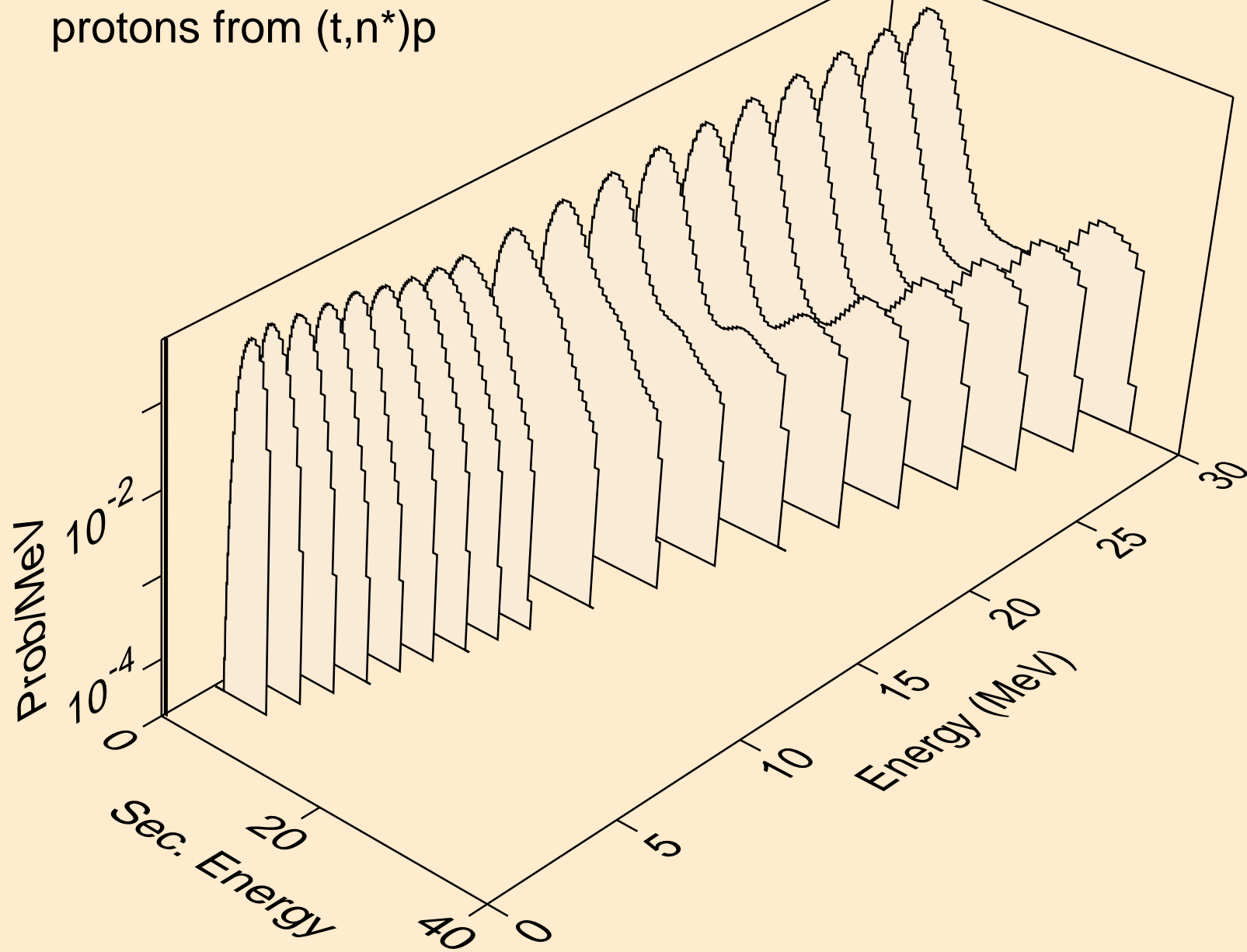

NB084 TRITON ACER TENDL-2021 LIBRARY; T=0.K  
protons from (t,2np)

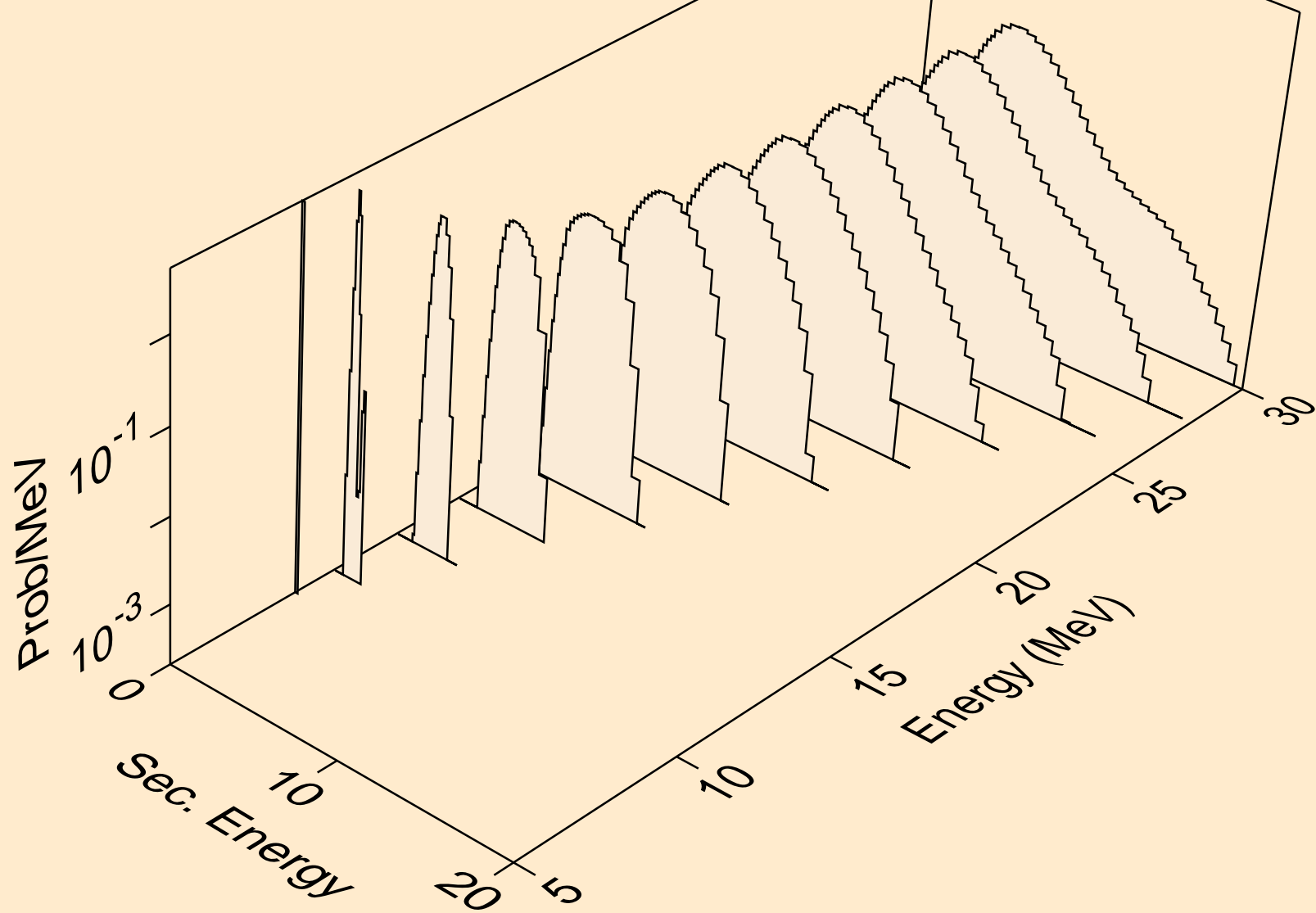



NB084 TRITON ACER TENDL-2021 LIBRARY; T=0.K  
protons from (t,3np)

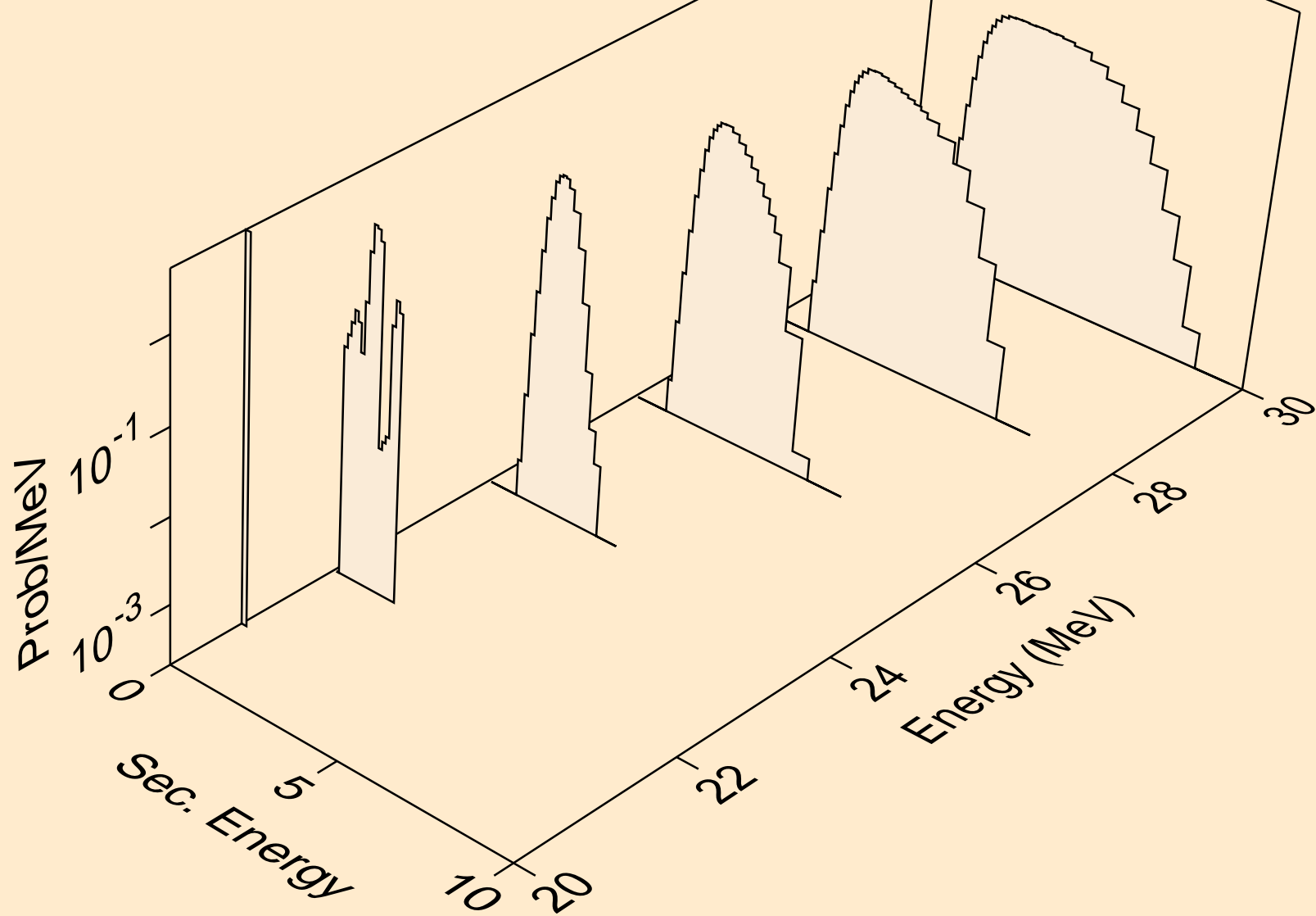

NB084 TRITON ACER TENDL-2021 LIBRARY; T=0.K  
protons from (t,2np)

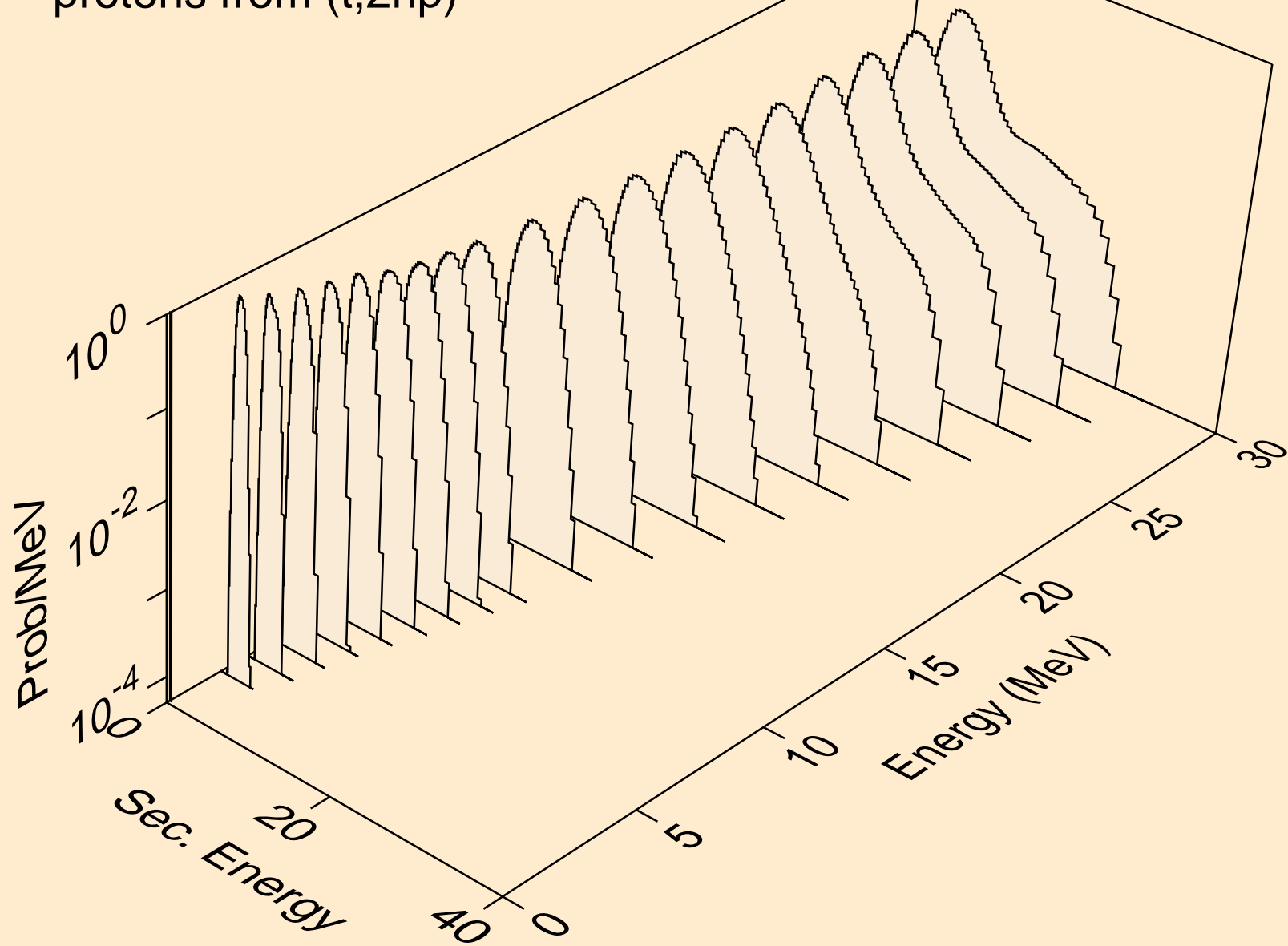

NB084 TRITON ACER TENDL-2021 LIBRARY; T=0.K  
protons from (t,npa)

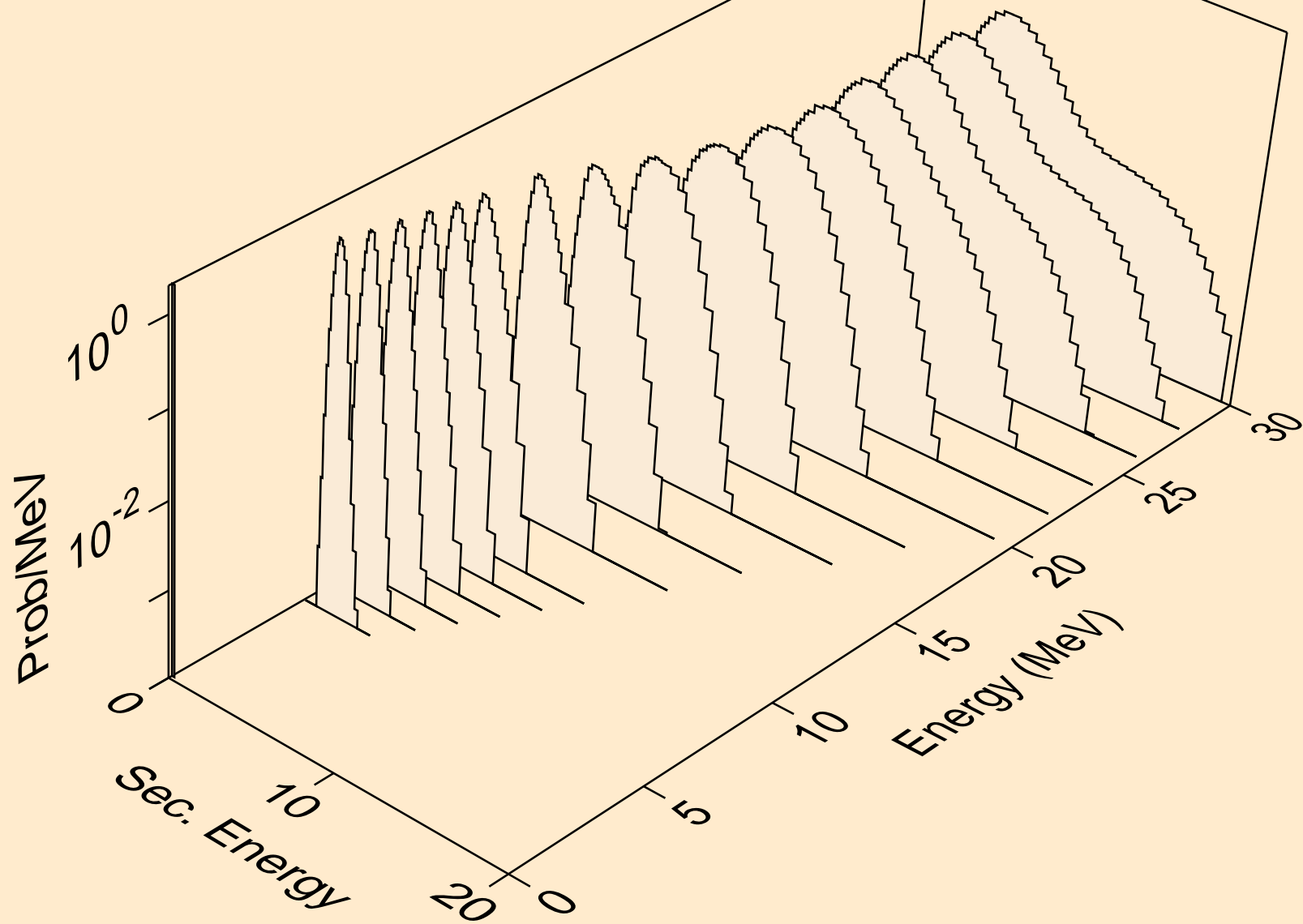

NB084 TRITON ACER TENDL-2021 LIBRARY; T=0.K  
protons from (t,p)

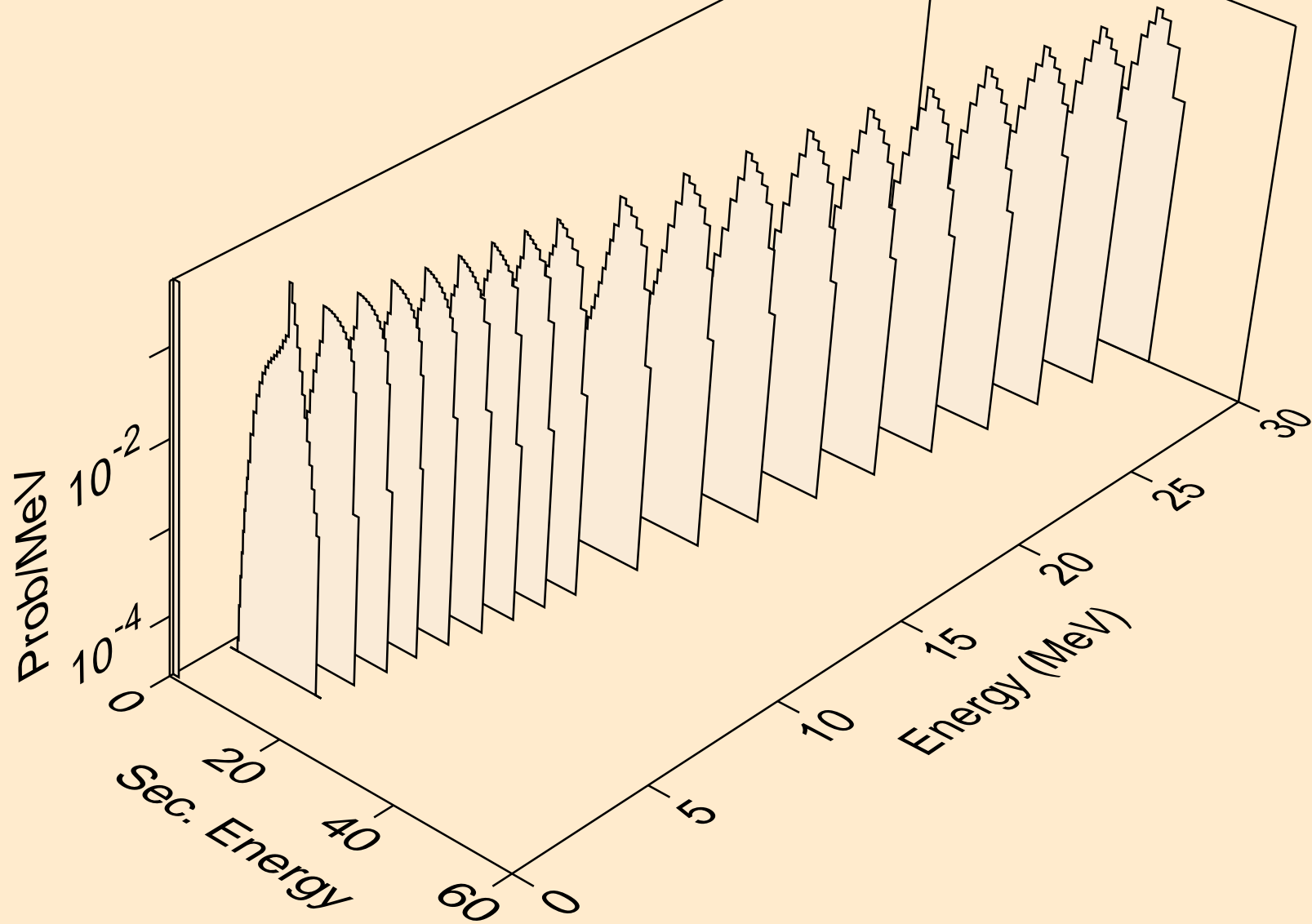

NB084 TRITON ACER TENDL-2021 LIBRARY; T=0.K  
protons from (t,2p)

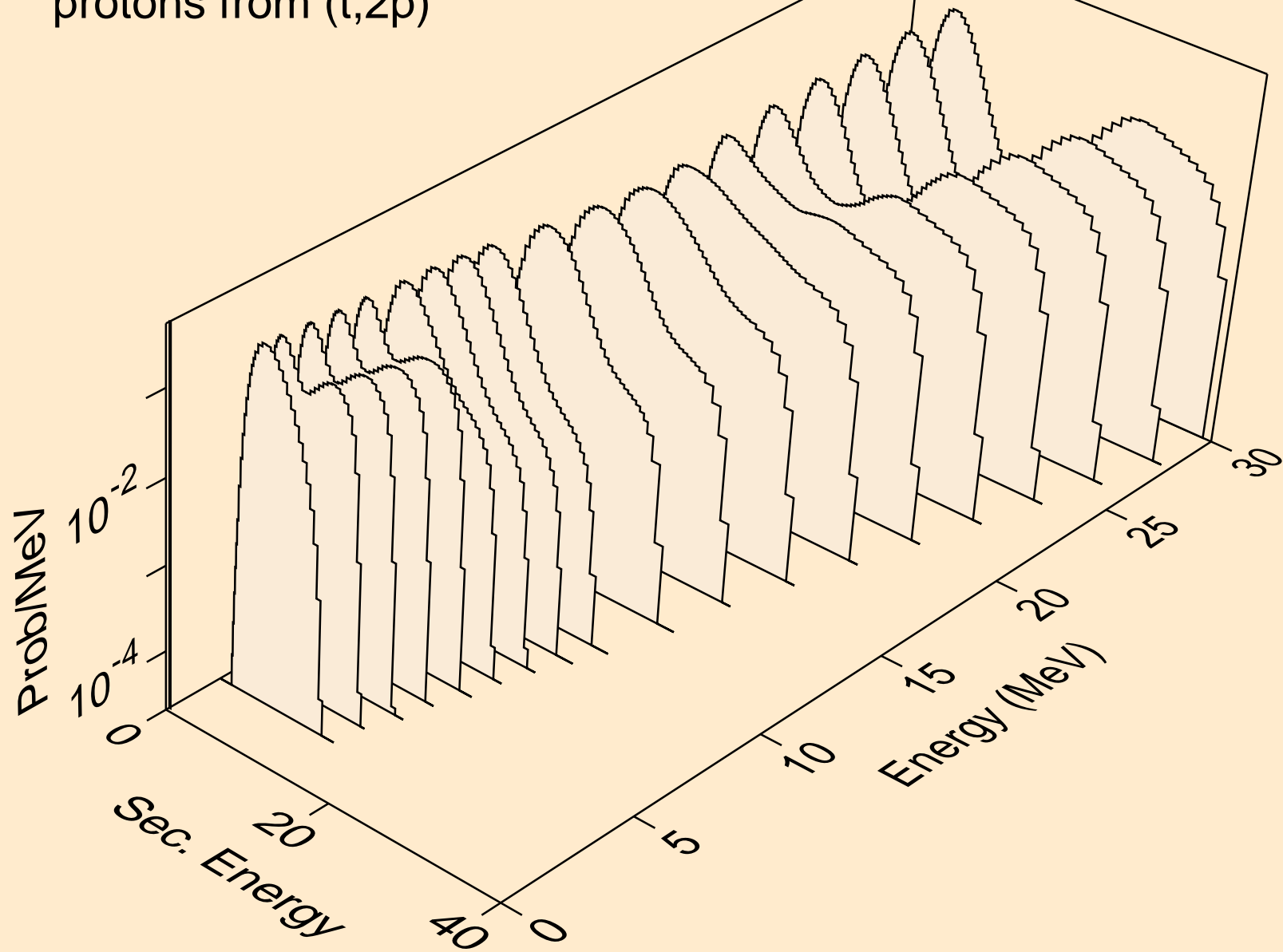

NB084 TRITON ACER TENDL-2021 LIBRARY; T=0.K  
protons from (t,pa)

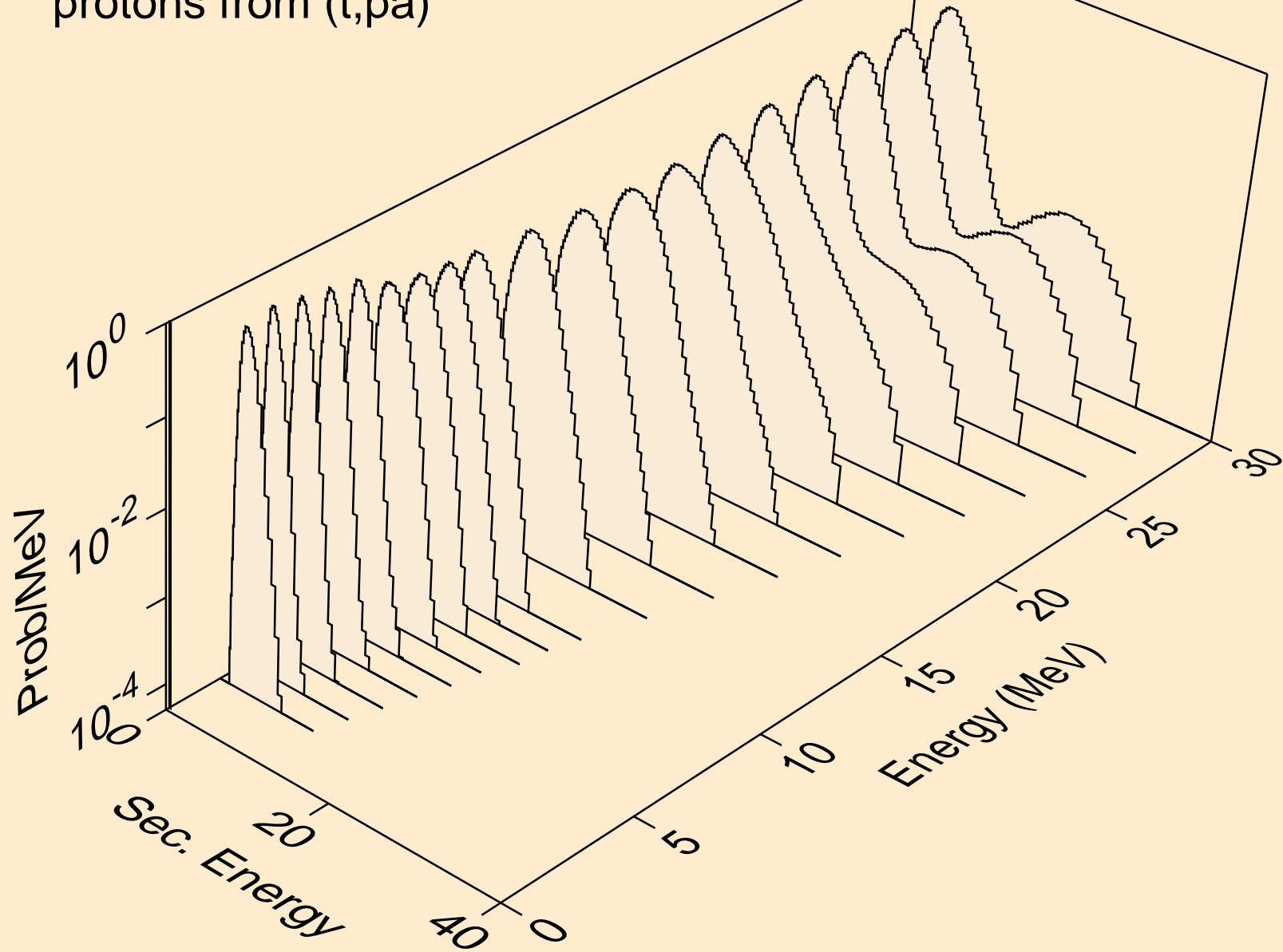

NB084 TRITON ACER TENDL-2021 LIBRARY; T=0.K  
protons from (t,pd)

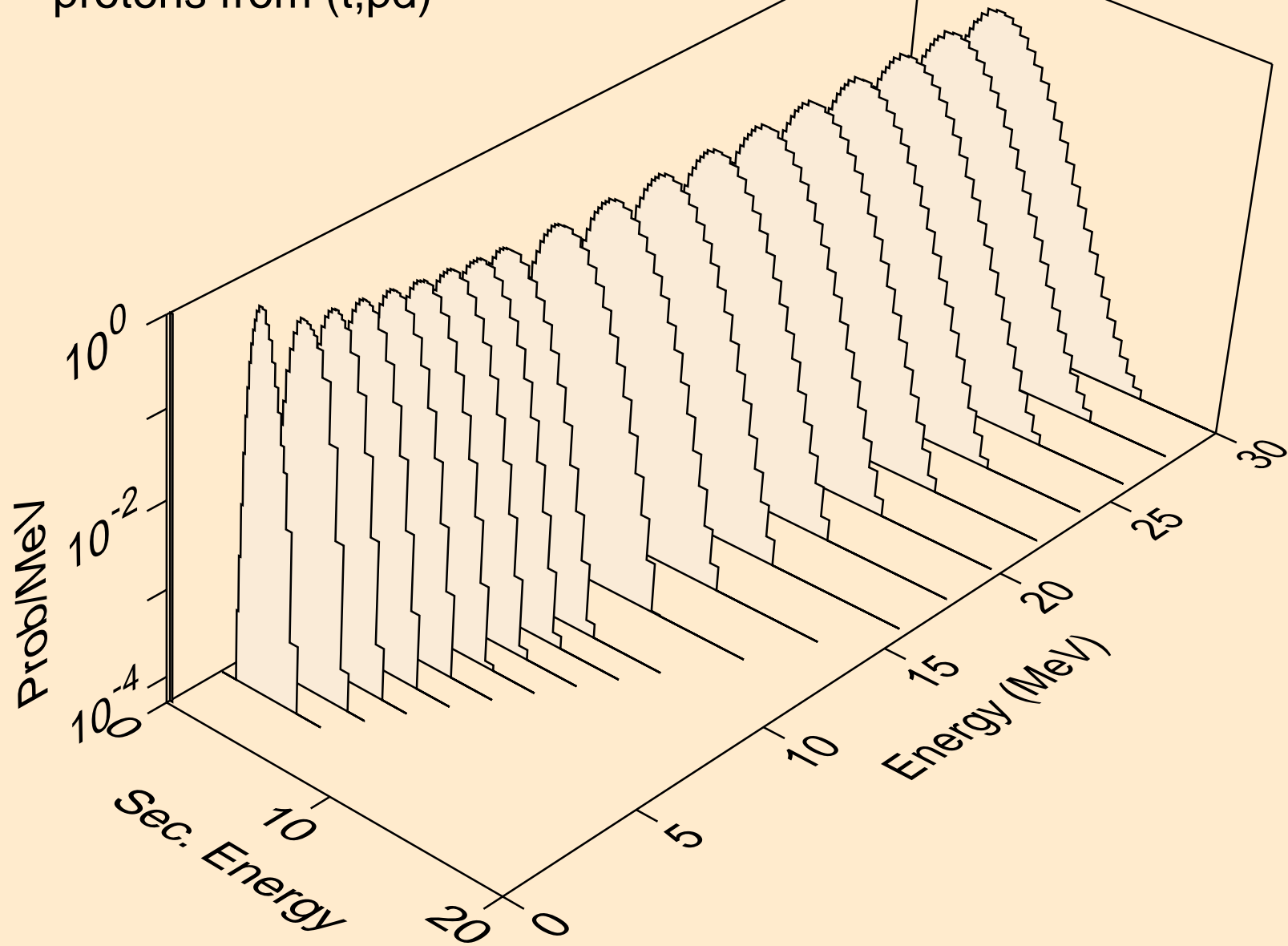

NB084 TRITON ACER TENDL-2021 LIBRARY; T=0.K  
protons from (t,pt)

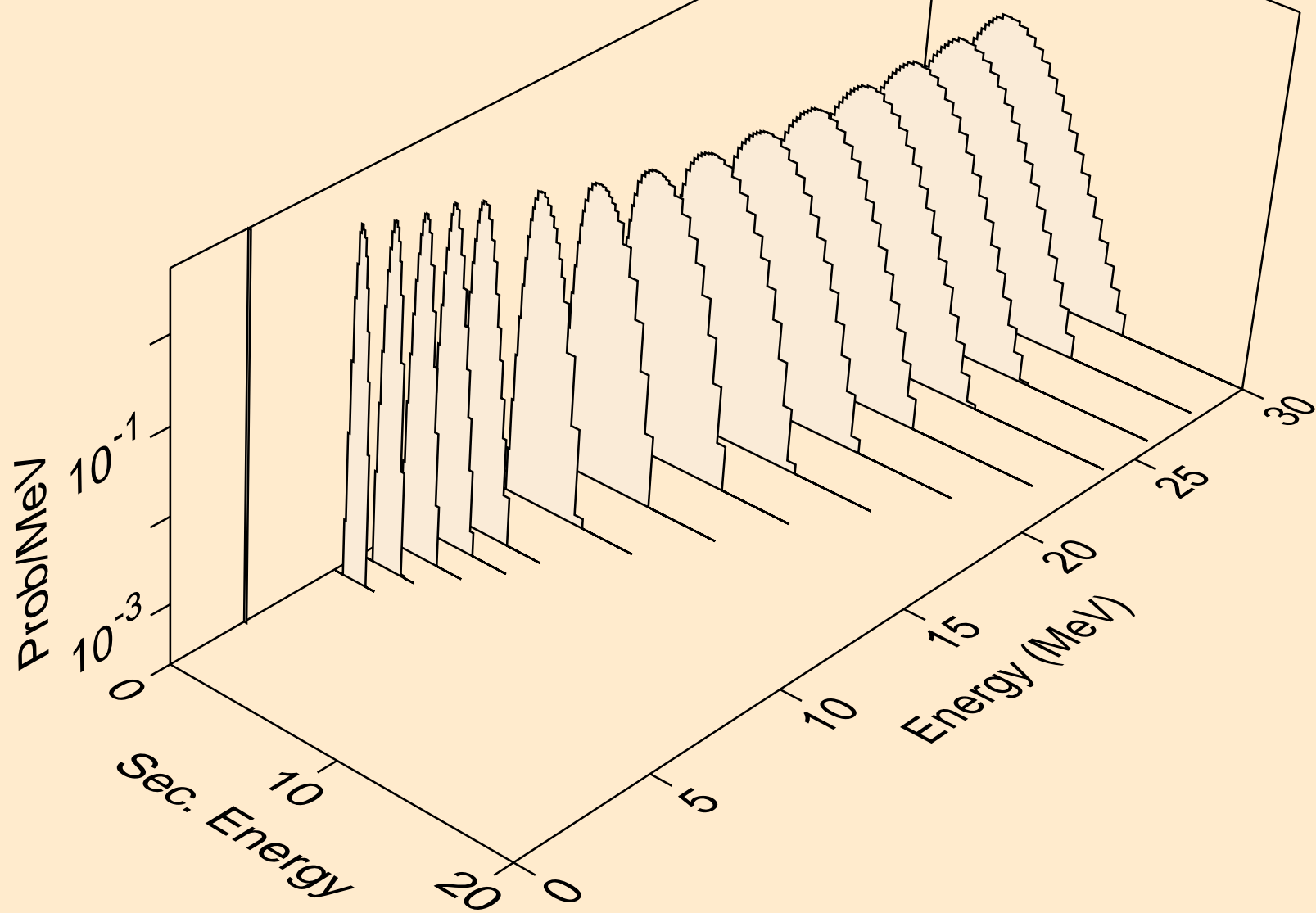



NB084 TRITON ACER TENDL-2021 LIBRARY; T=0.K  
deuterons from (t,x)

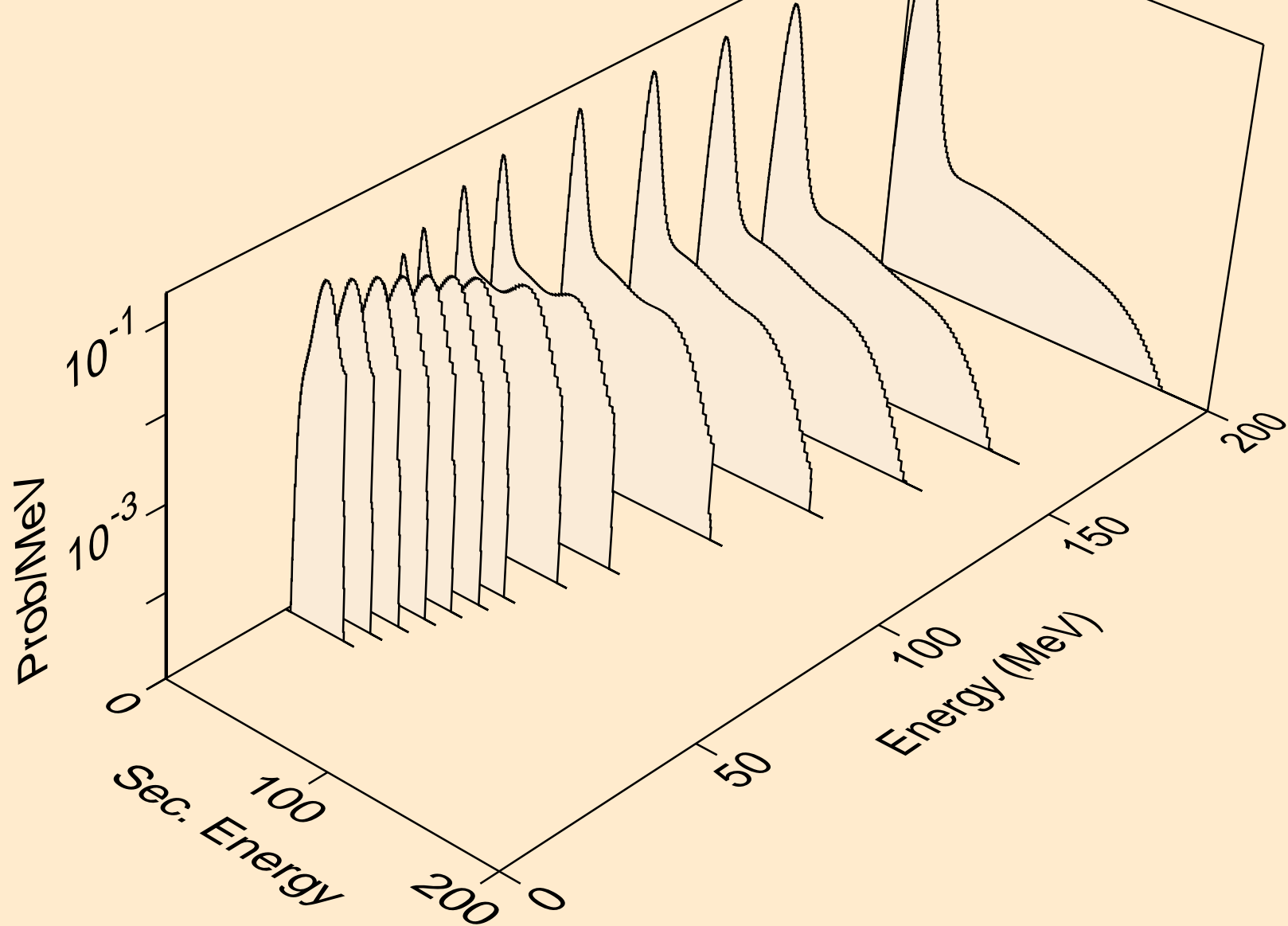

NB084 TRITON ACER TENDL-2021 LIBRARY; T=0.K  
deuterons from (t,2nd)

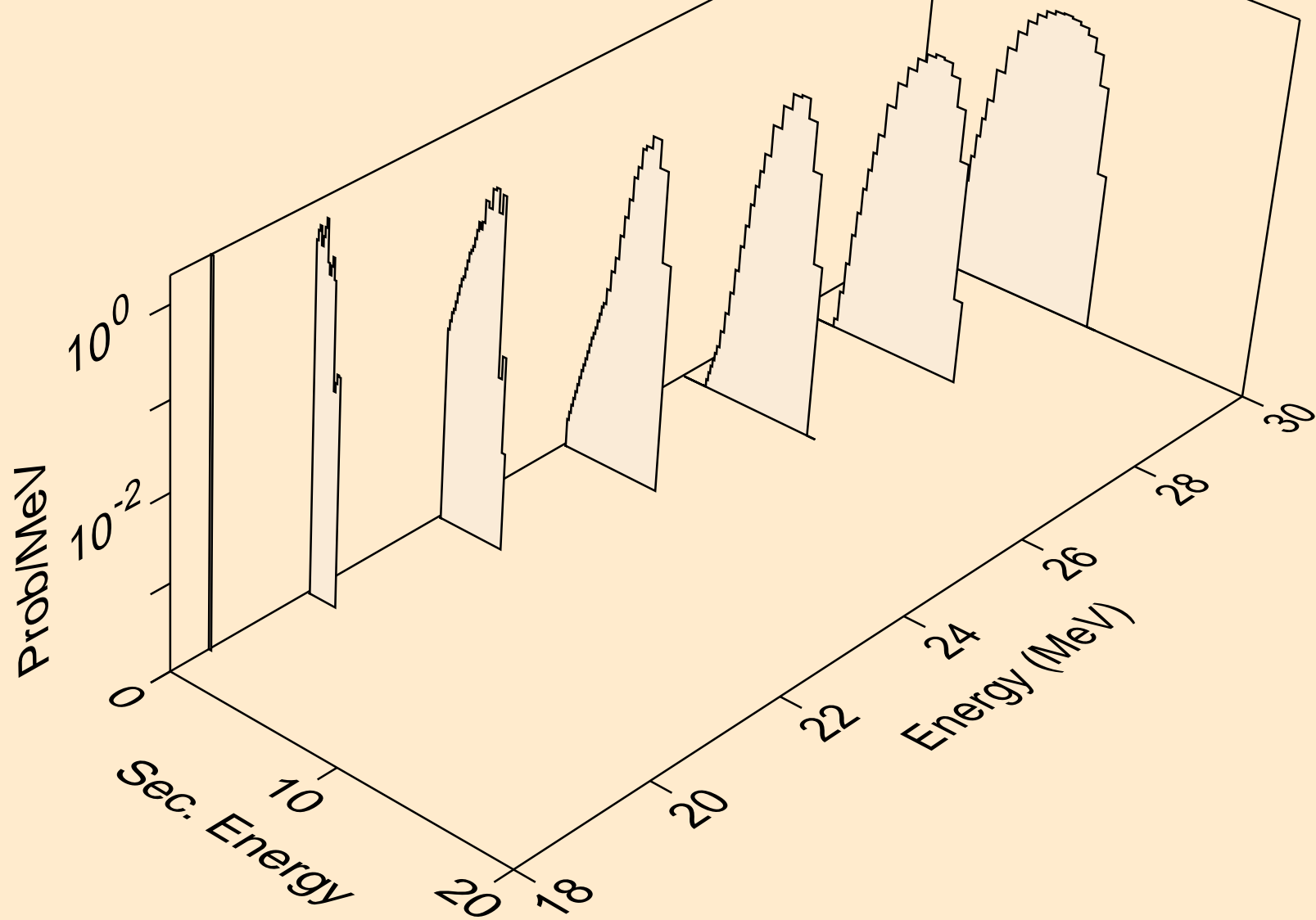

NB084 TRITON ACER TENDL-2021 LIBRARY; T=0.K  
deuterons from (t,n\*)d

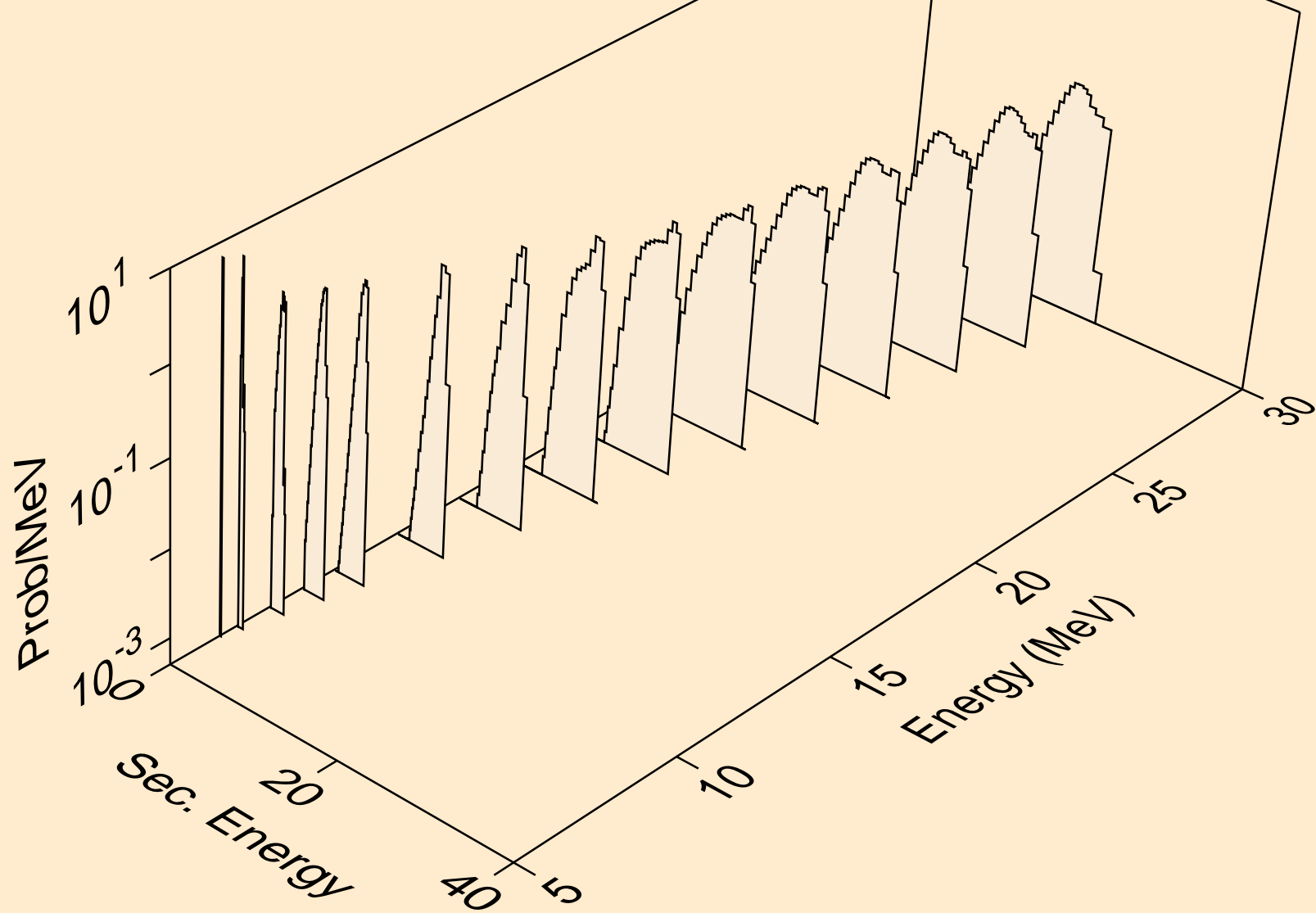

NB084 TRITON ACER TENDL-2021 LIBRARY; T=0.K  
deuterons from (t,d)

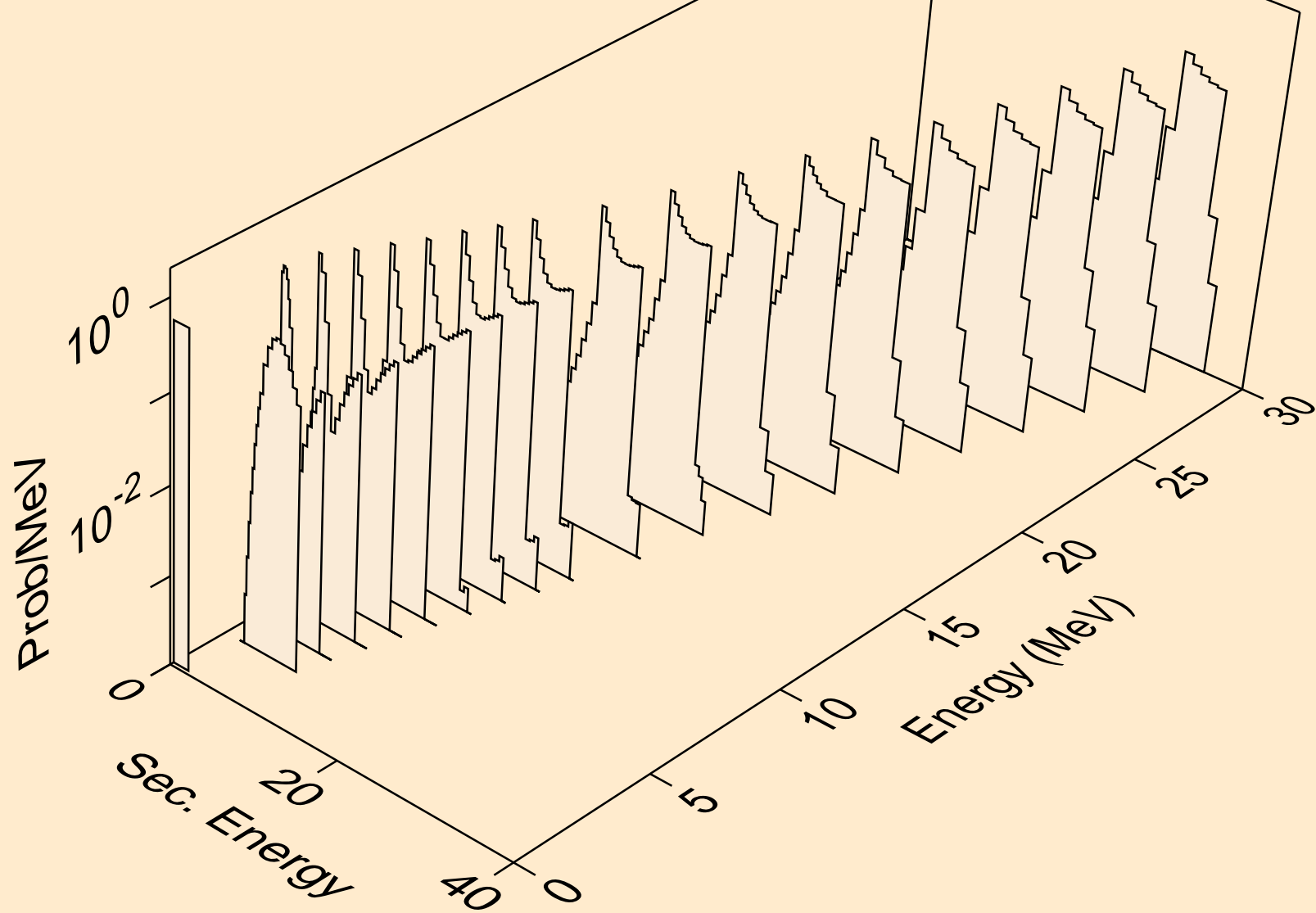

NB084 TRITON ACER TENDL-2021 LIBRARY; T=0.K  
deuterons from (t,d2a)

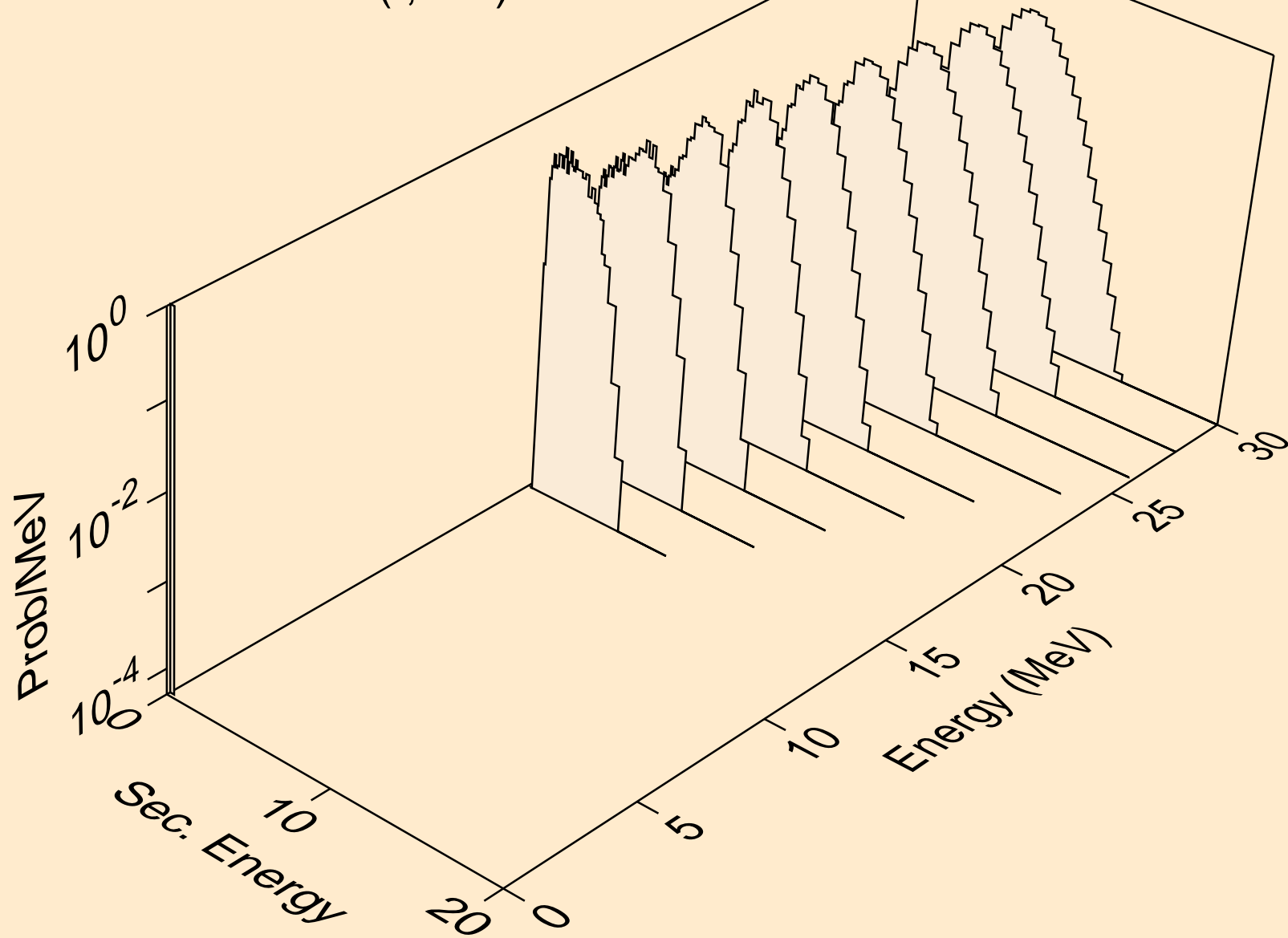

NB084 TRITON ACER TENDL-2021 LIBRARY; T=0.K  
deuterons from (t,pd)

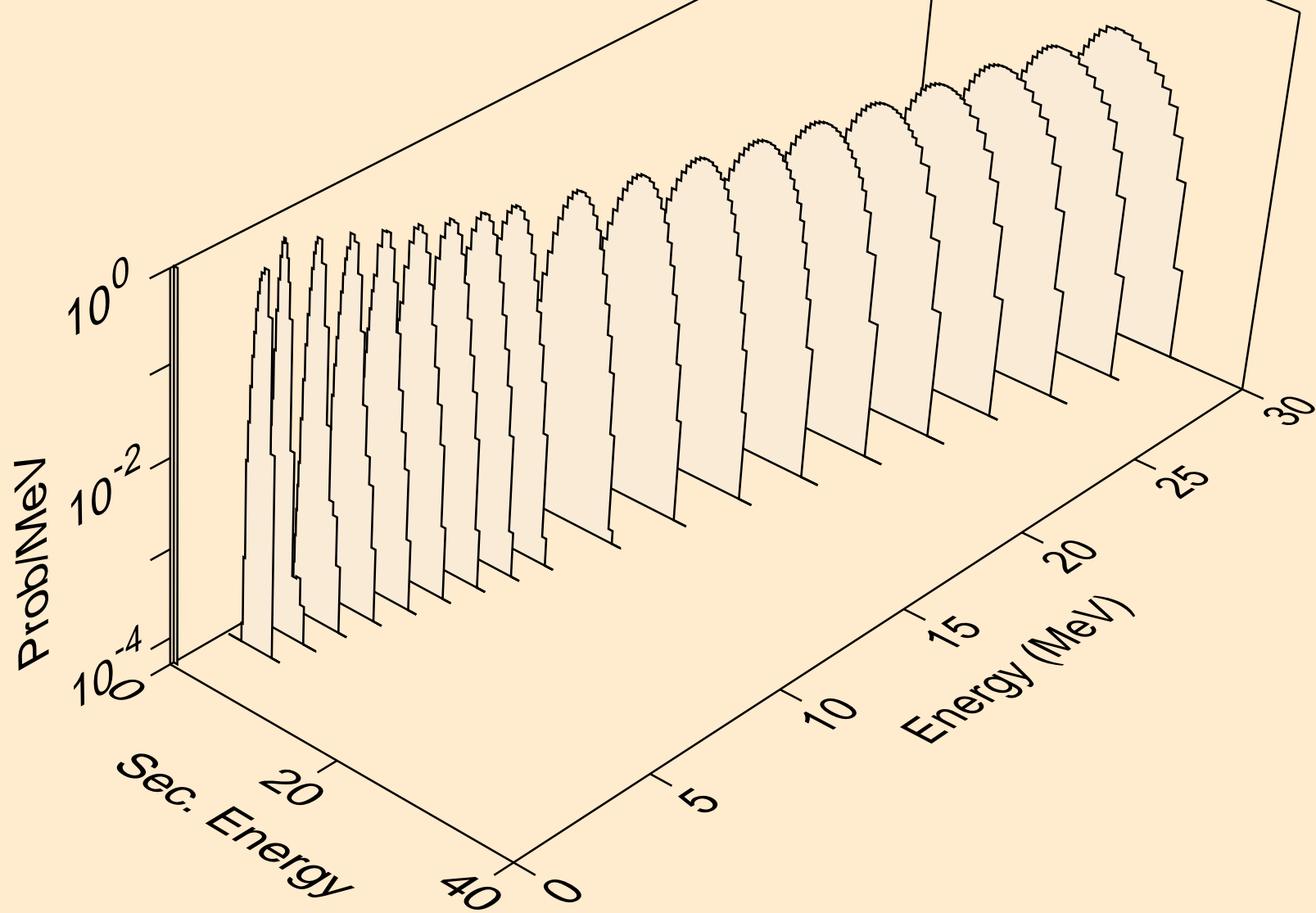

NB084 TRITON ACER TENDL-2021 LIBRARY; T=0.K  
deuterons from (t,da)

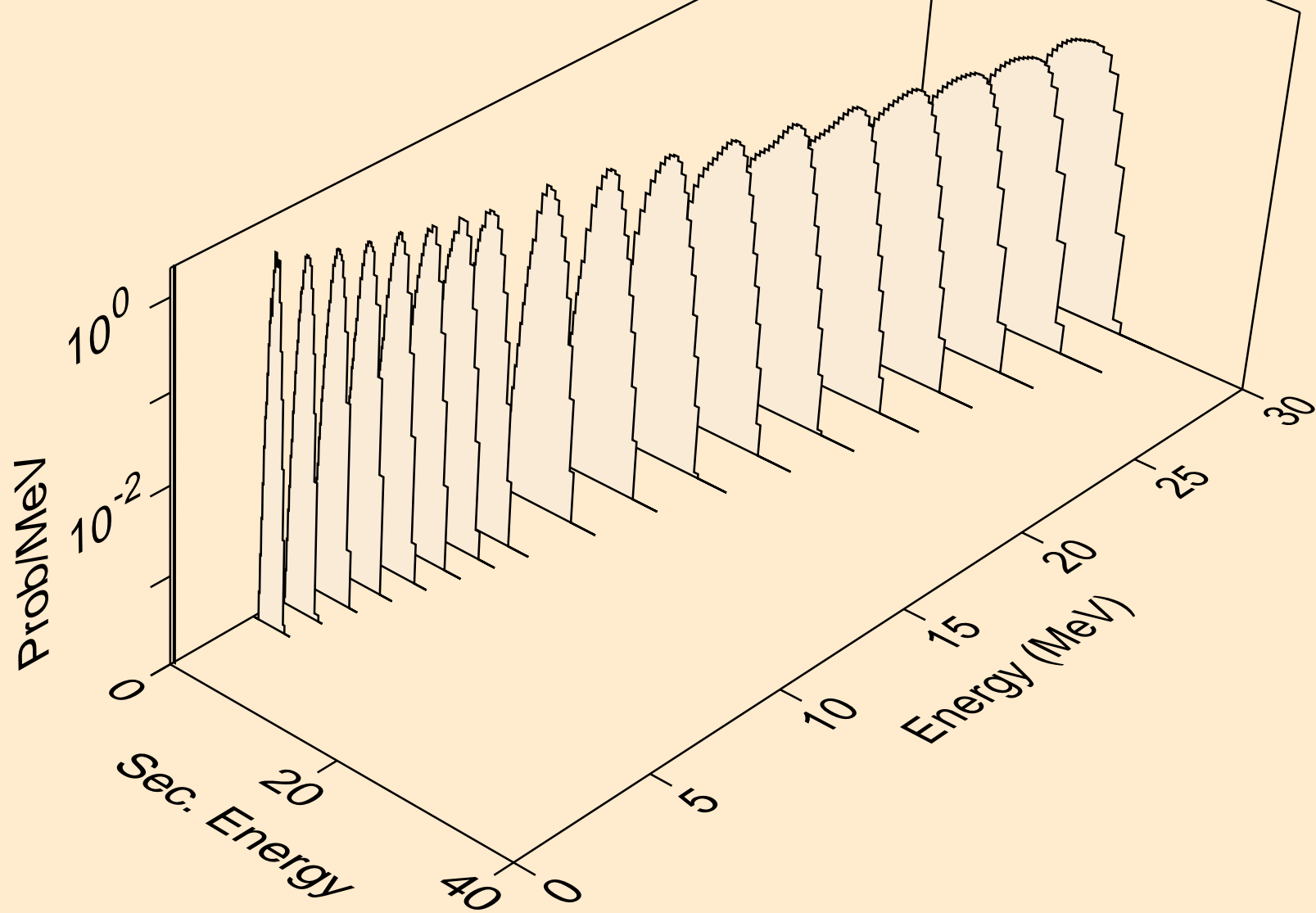

NB084 TRITON ACER TENDL-2021 LIBRARY; T=0.K  
he3s from (t,x)

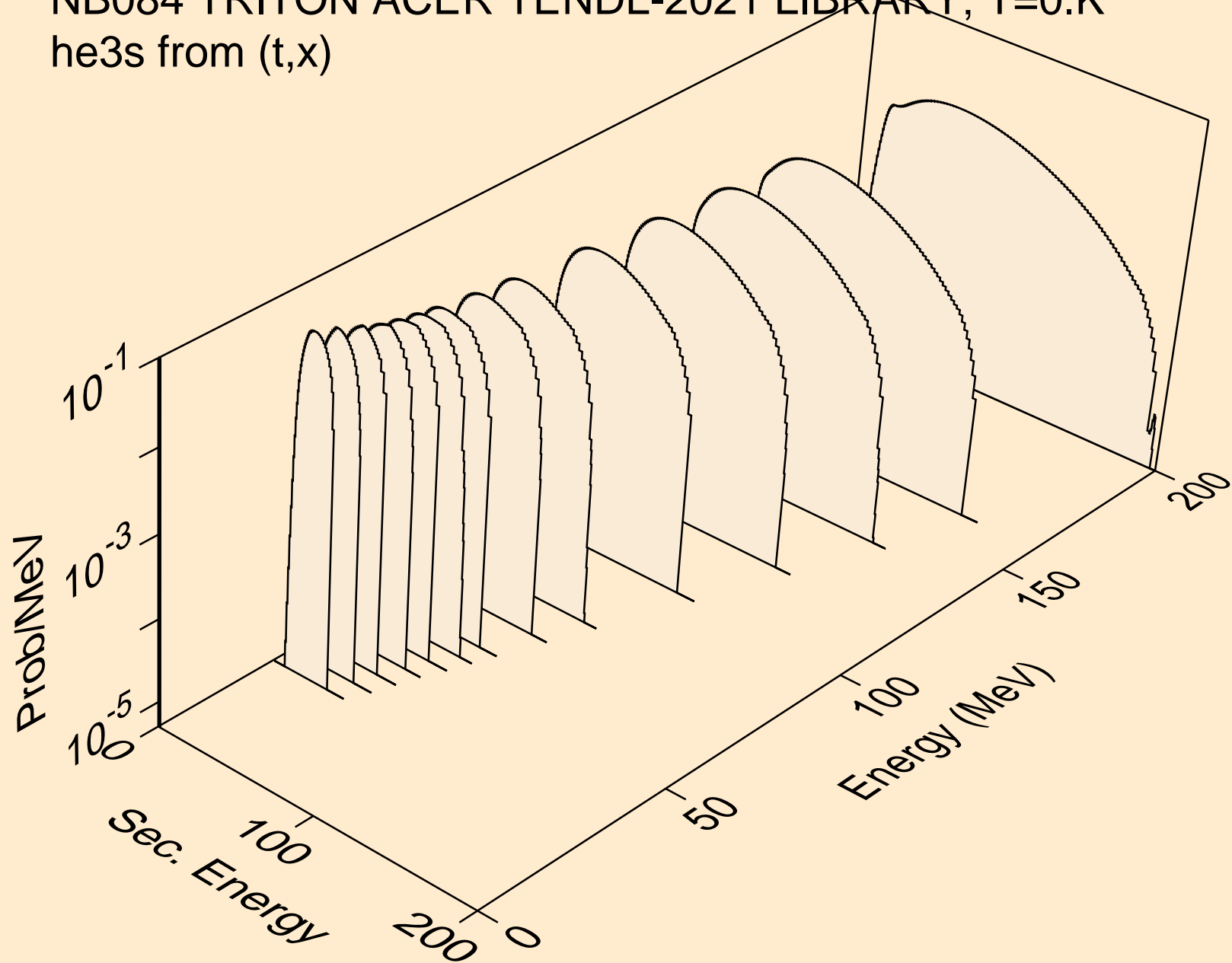



NB084 TRITON ACER TENDL-2021 LIBRARY; T=0.K  
he3s from (t,n\*)he3

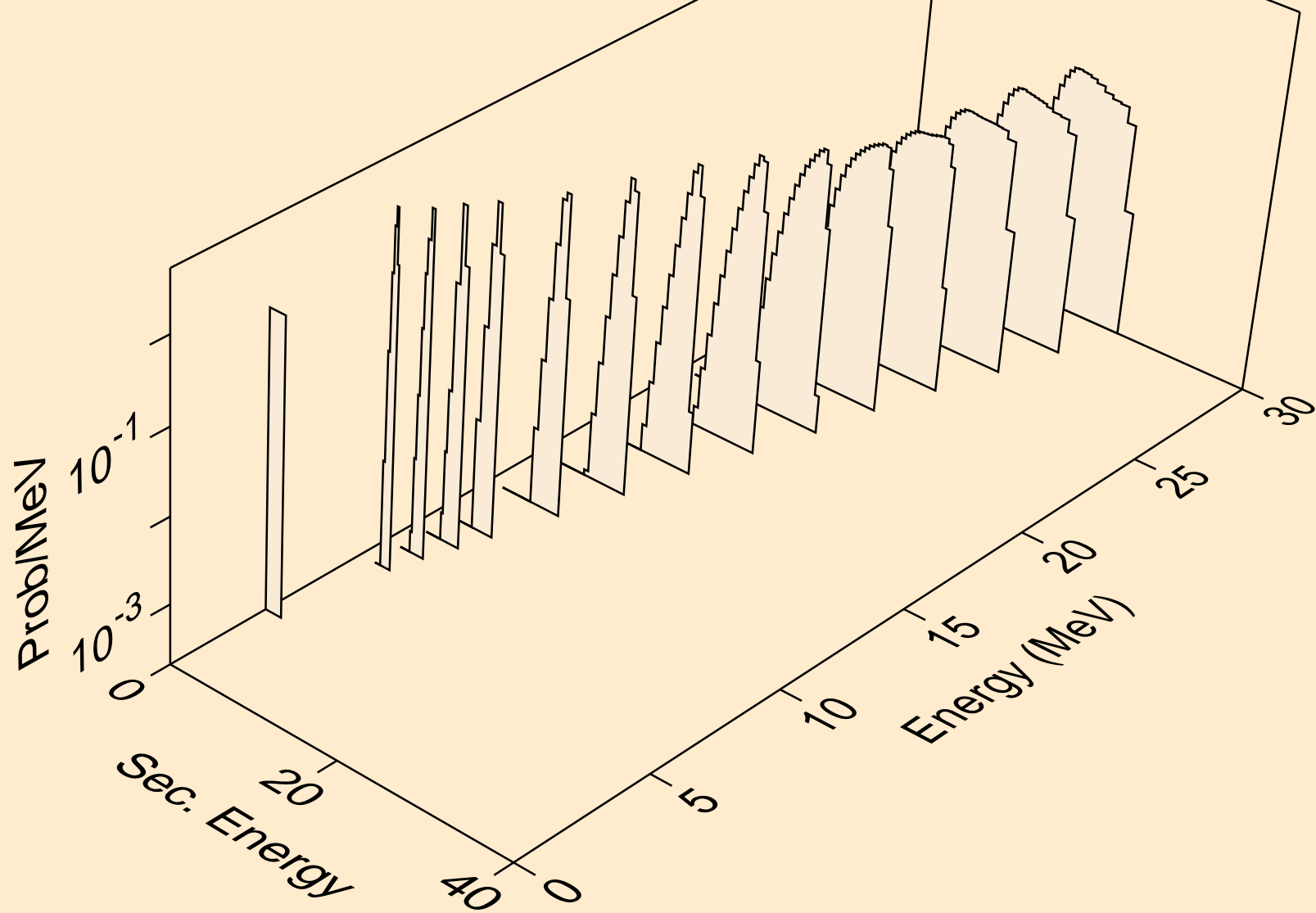

NB084 TRITON ACER TENDL-2021 LIBRARY; T=0.K  
he3s from (t,he3)

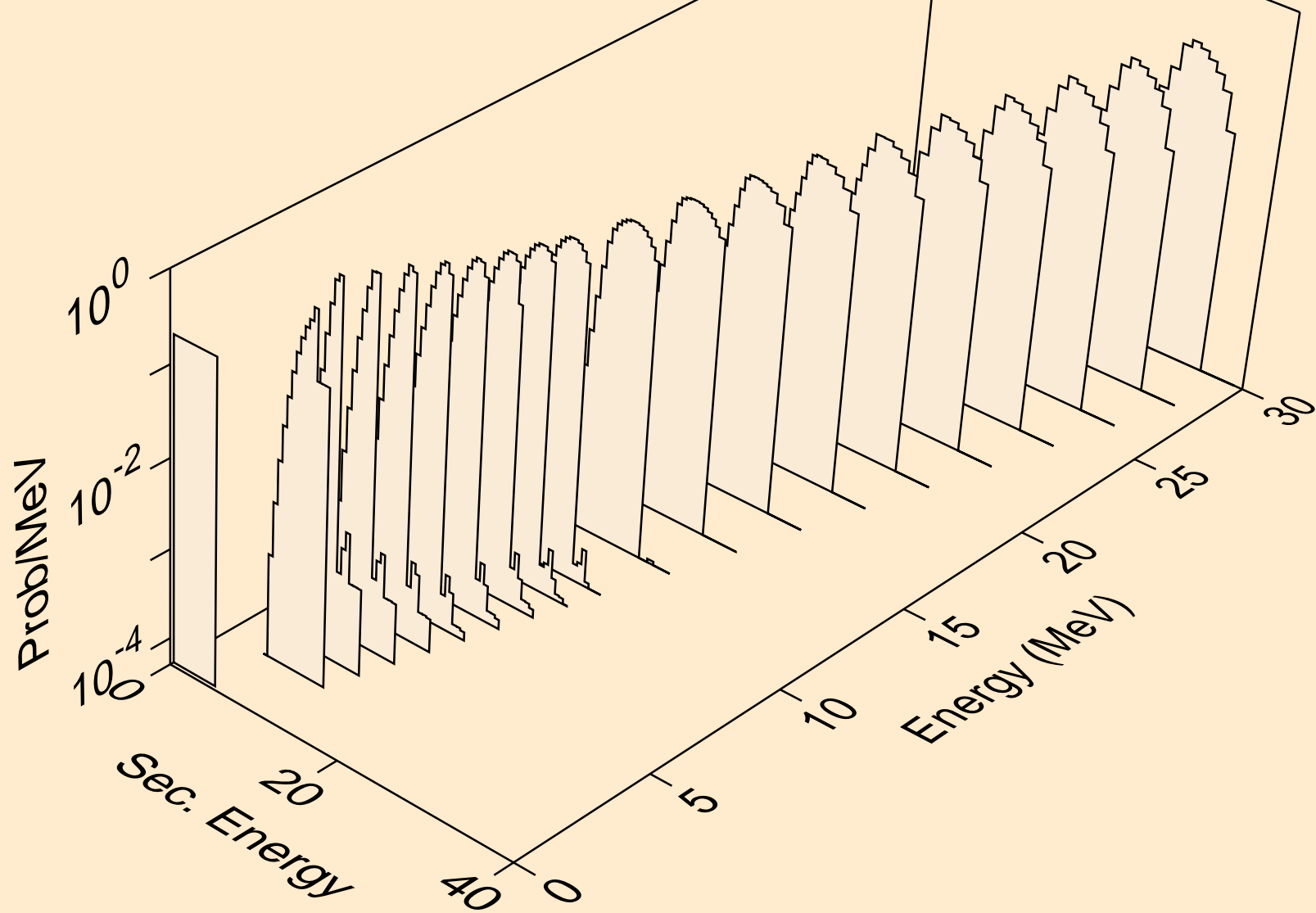

NB084 TRITON ACER TENDL-2021 LIBRARY; T=0.K  
alphas from (t,x)

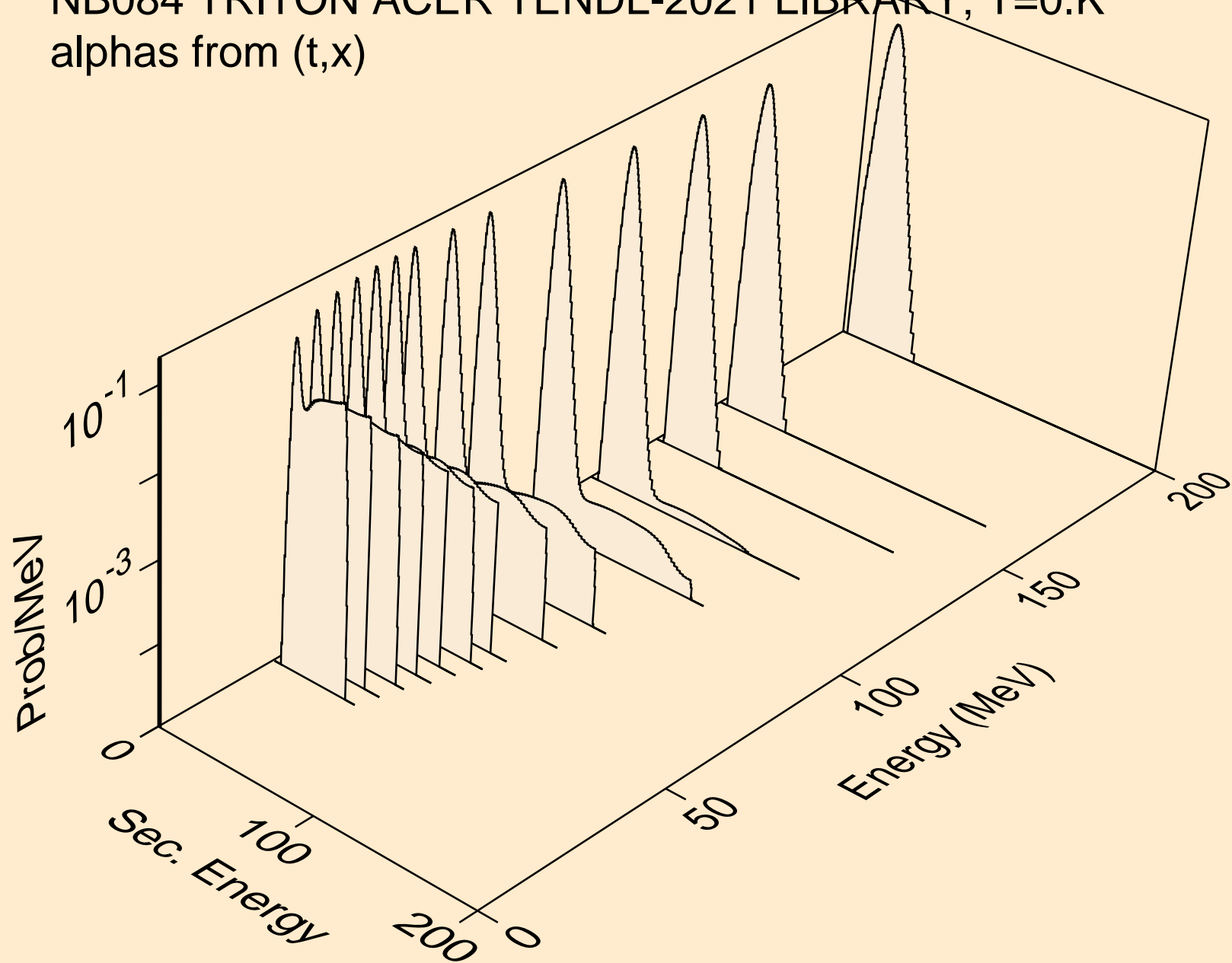

NB084 TRITON ACER TENDL-2021 LIBRARY; T=0.K  
alphas from (t,n\*)a

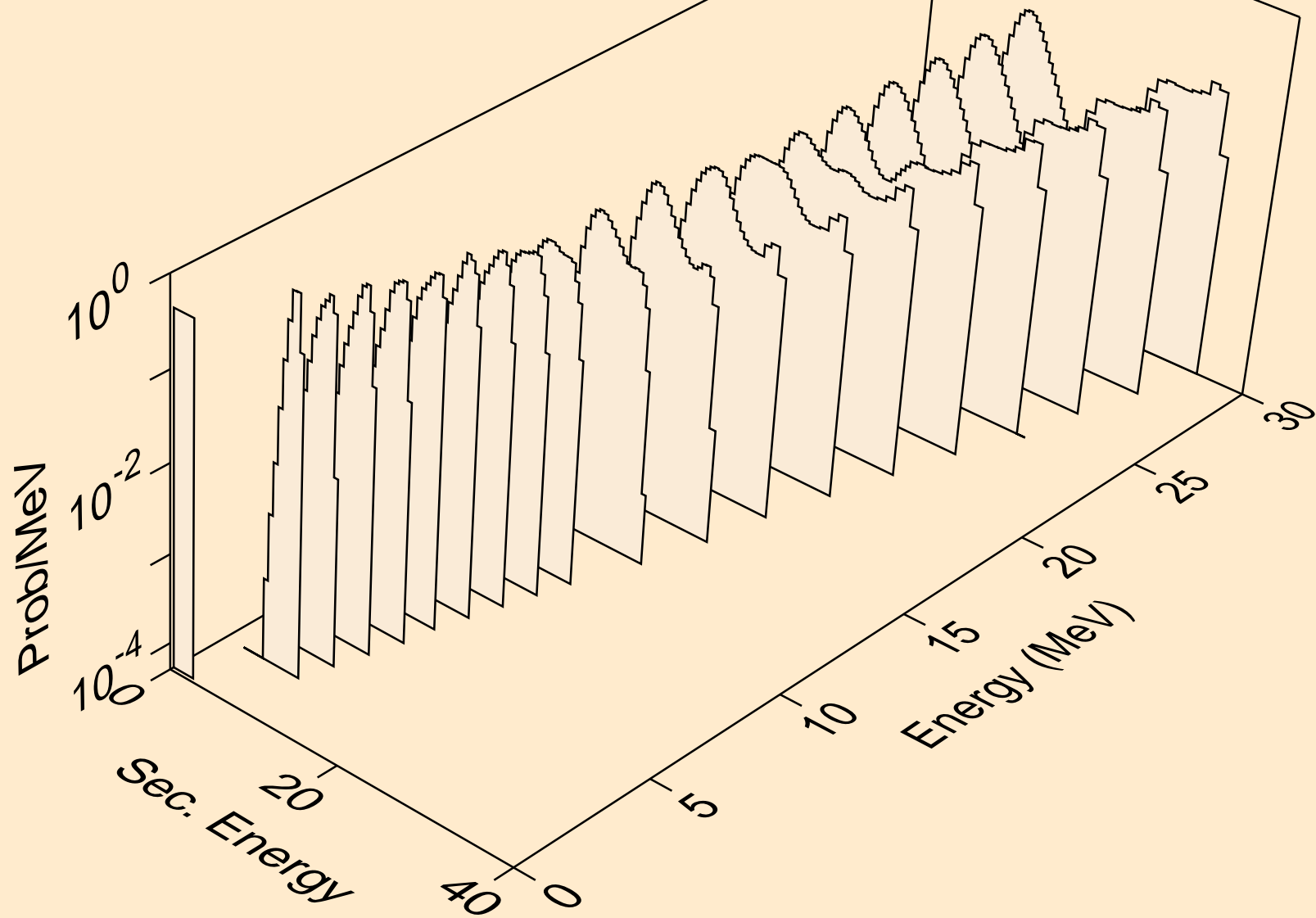

NB084 TRITON ACER TENDL-2021 LIBRARY; T=0.K  
alphas from (t,2n)a

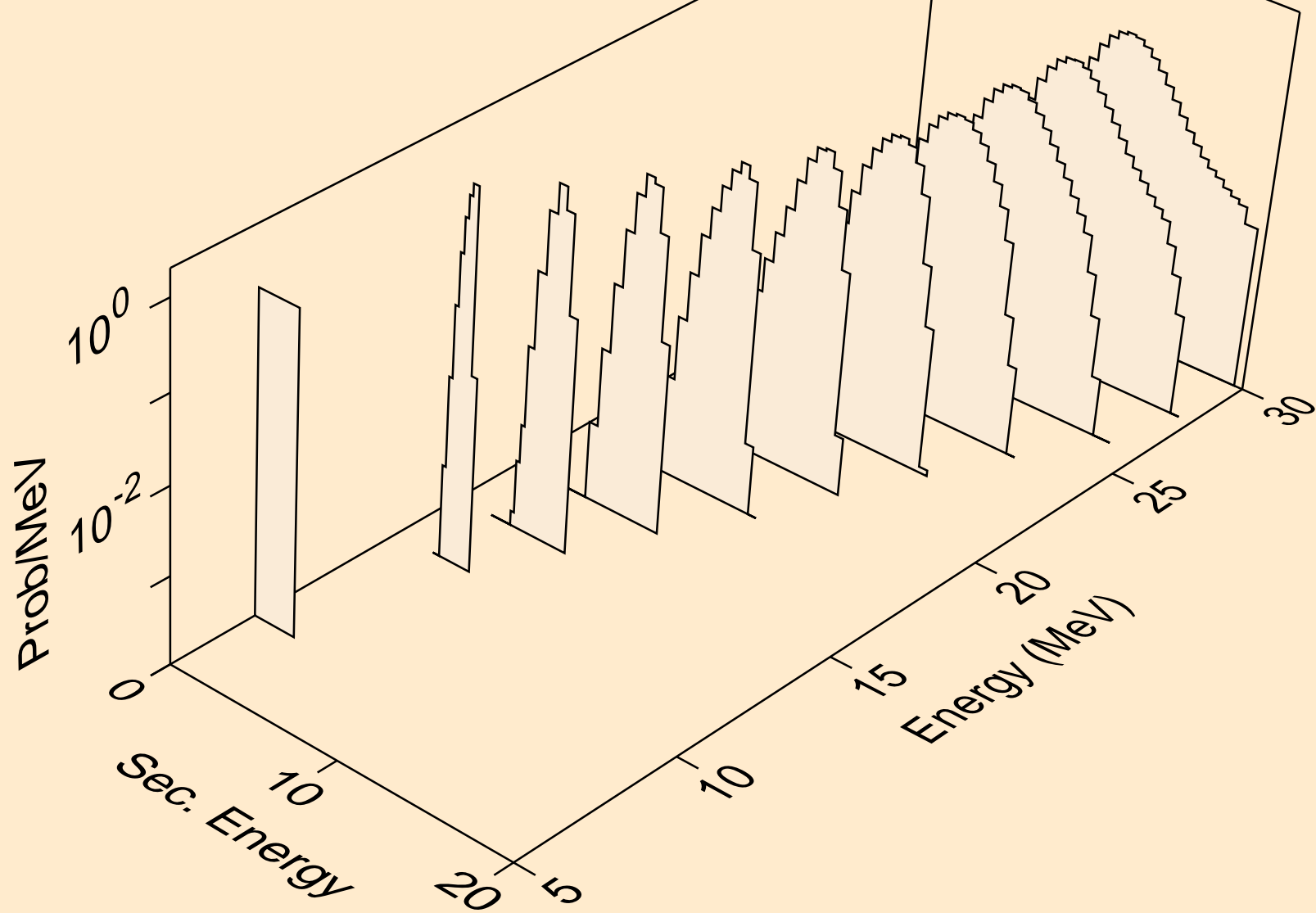

NB084 TRITON ACER TENDL-2021 LIBRARY; T=0.K  
alphas from (t,n\*)2a

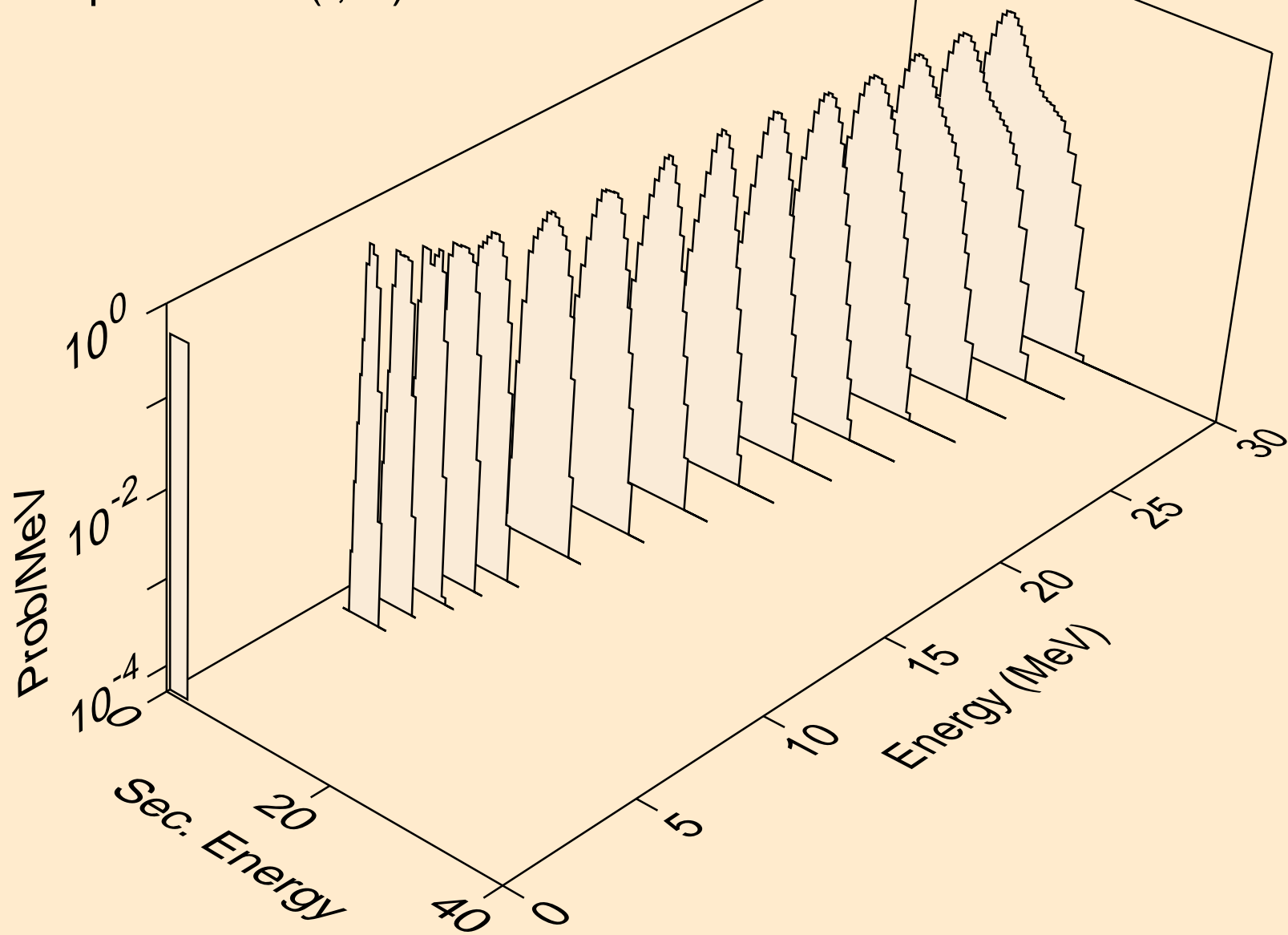

NB084 TRITON ACER TENDL-2021 LIBRARY; T=0.K  
alphas from (t,npa)

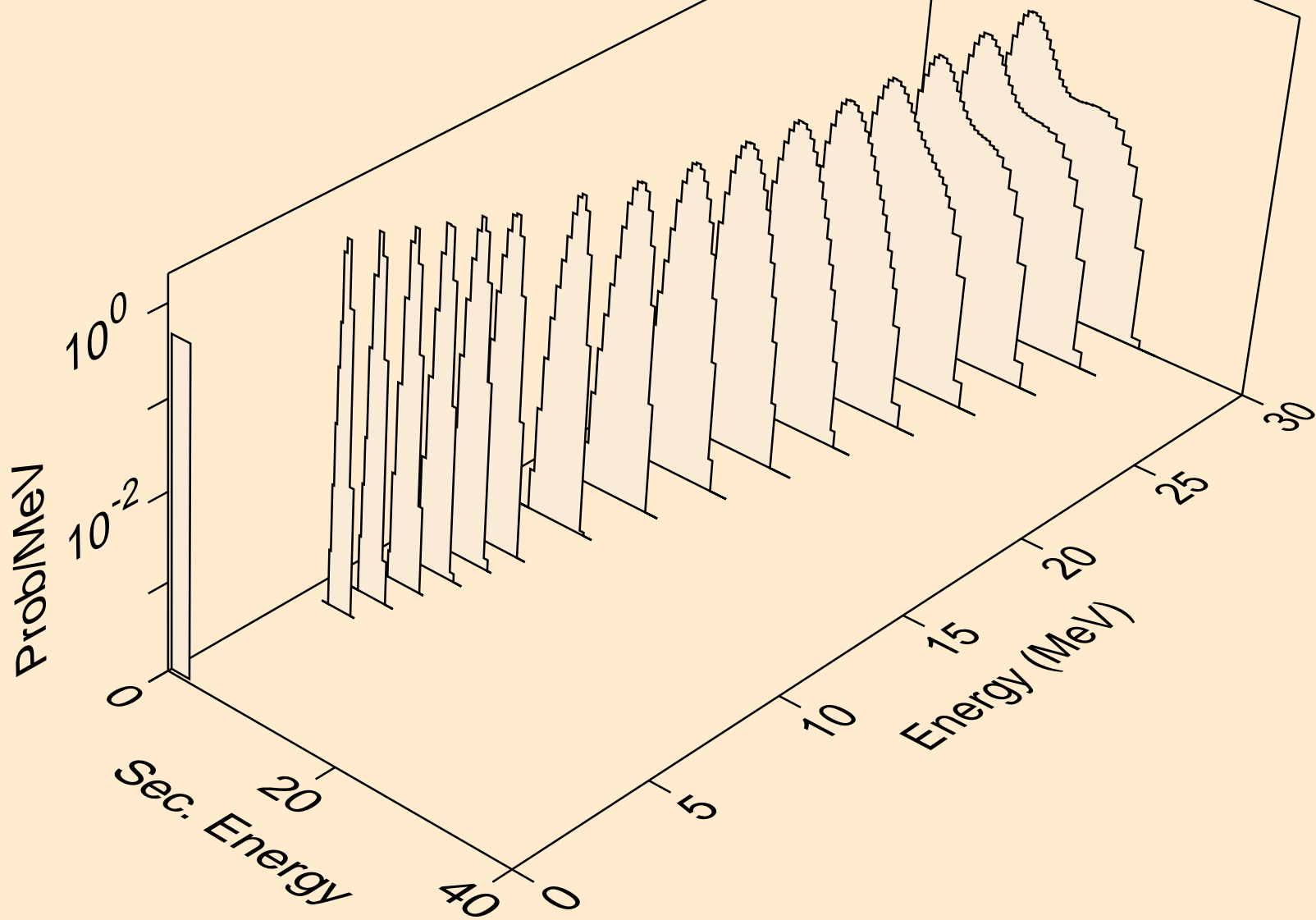

NB084 TRITON ACER TENDL-2021 LIBRARY; T=0.K  
alphas from (t,a)

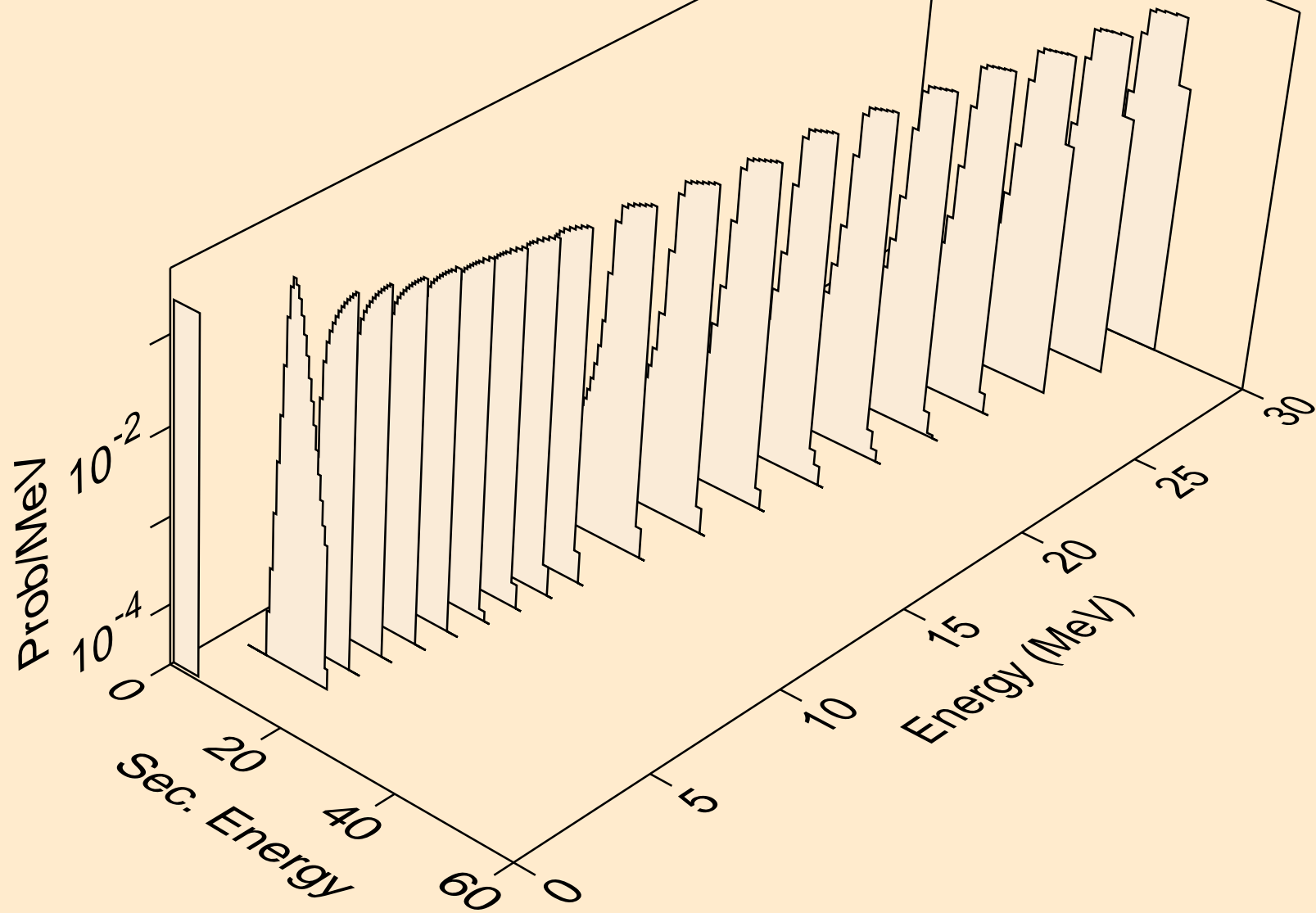



NB084 TRITON ACER TENDL-2021 LIBRARY; T=0.K  
alphas from (t,2a)

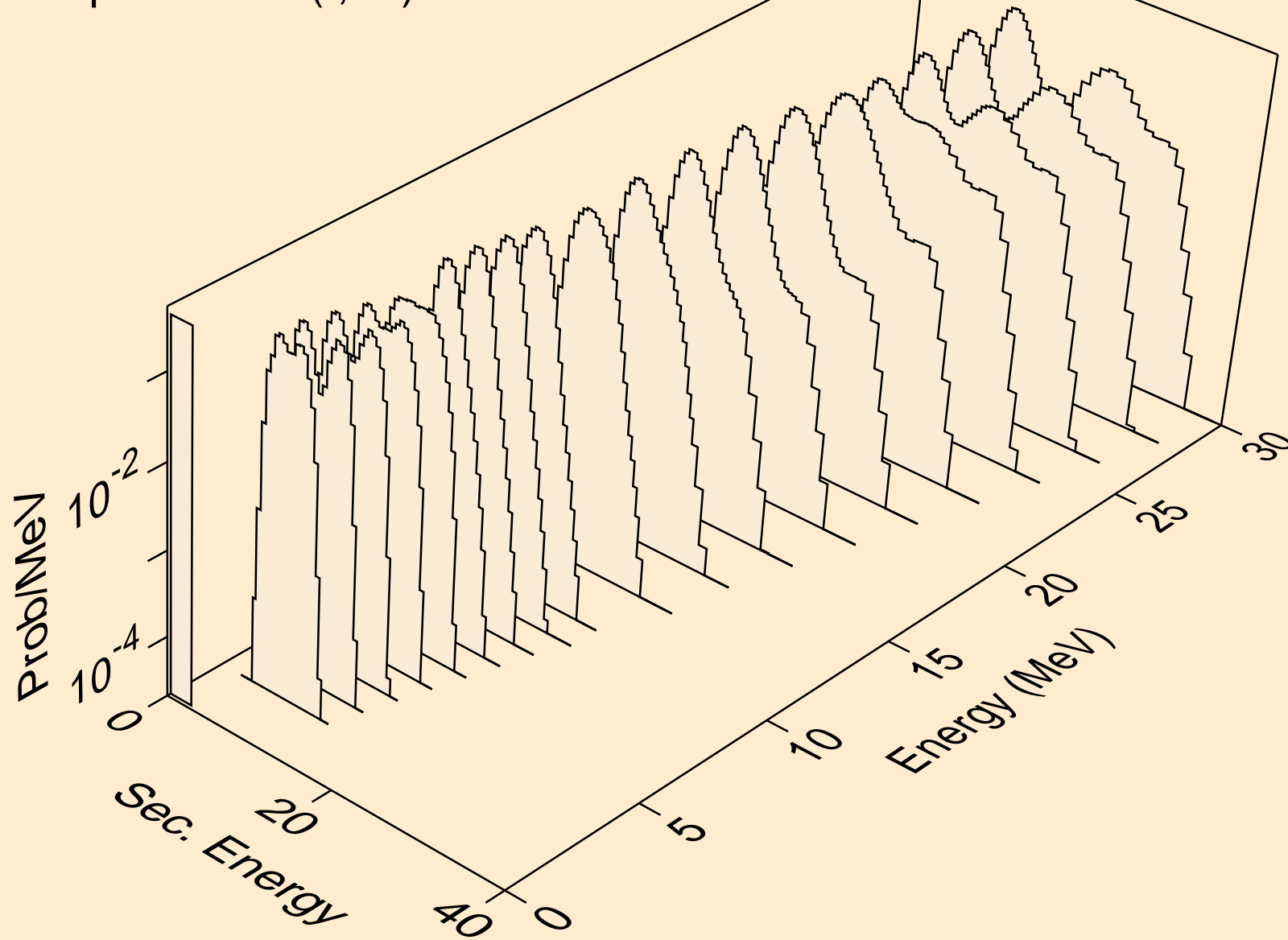

NB084 TRITON ACER TENDL-2021 LIBRARY; T=0.K  
alphas from (t,3a)

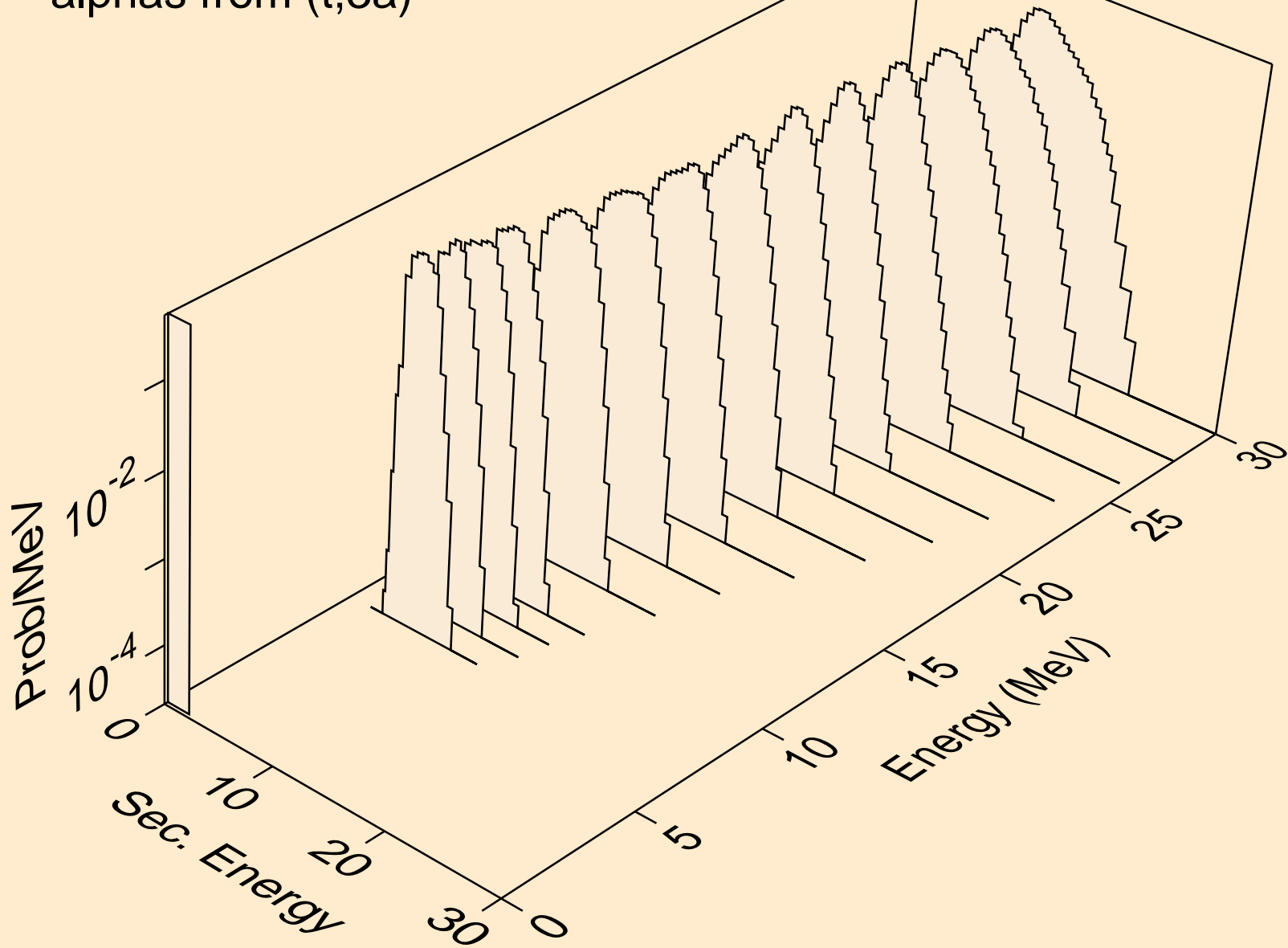

NB084 TRITON ACER TENDL-2021 LIBRARY; T=0.K  
alphas from (t,pa)

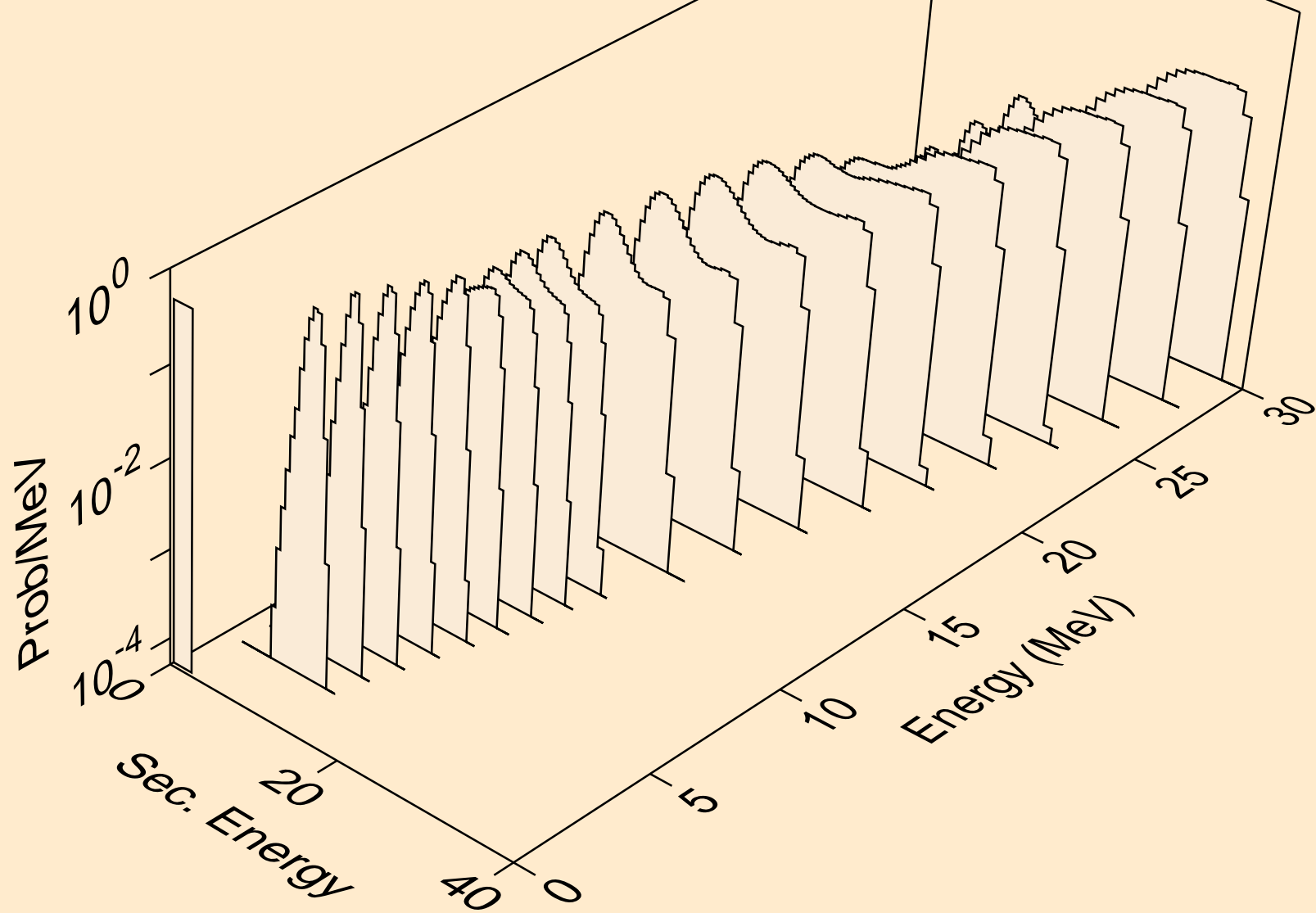

NB084 TRITON ACER TENDL-2021 LIBRARY; T=0.K  
alphas from (t,d2a)

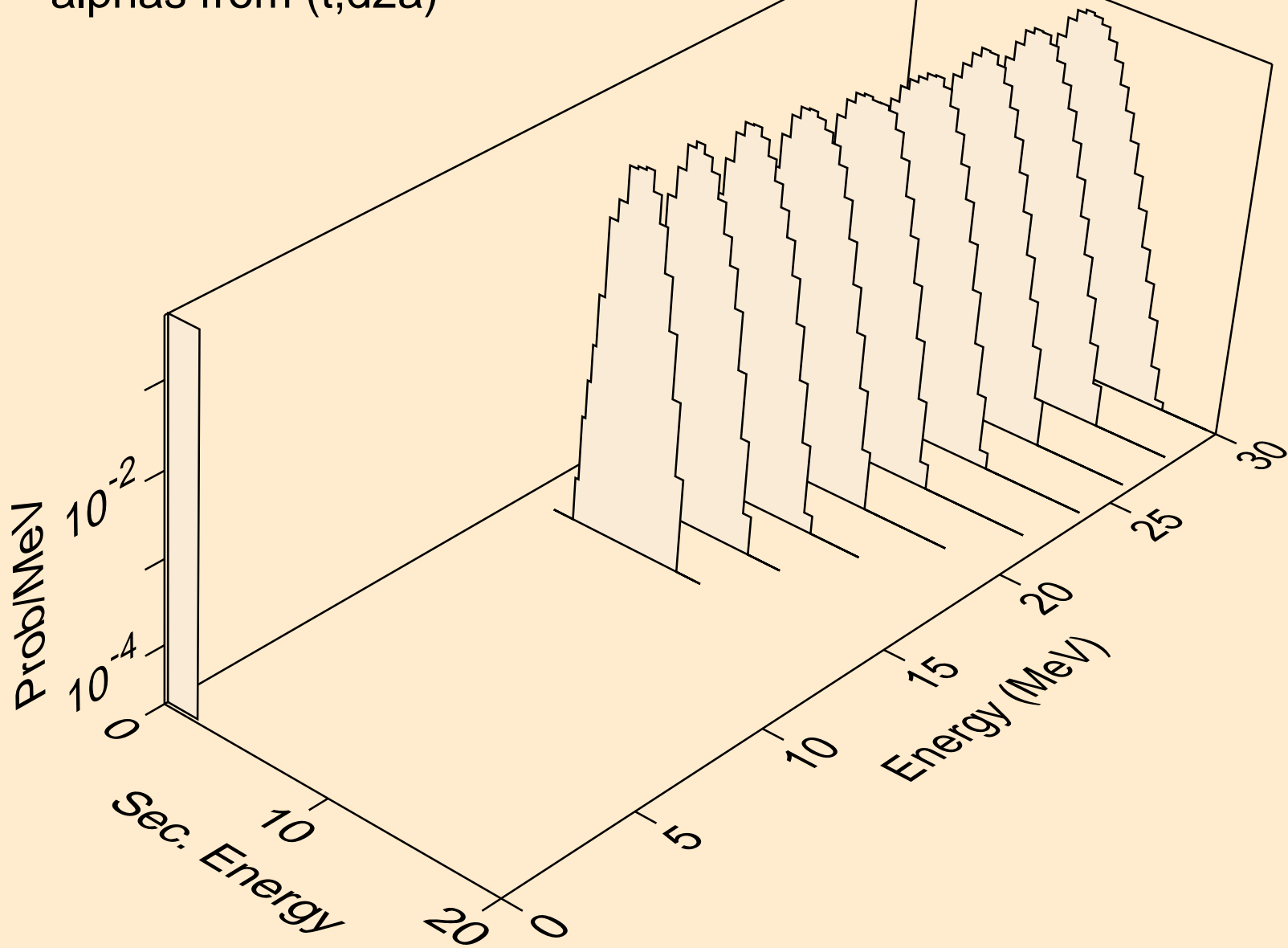

NB084 TRITON ACER TENDL-2021 LIBRARY; T=0.K  
alphas from (t,da)

