

NB106 TRITON ACER TENDL-2021 LIBRARY; T=0.K  
Principal cross sections

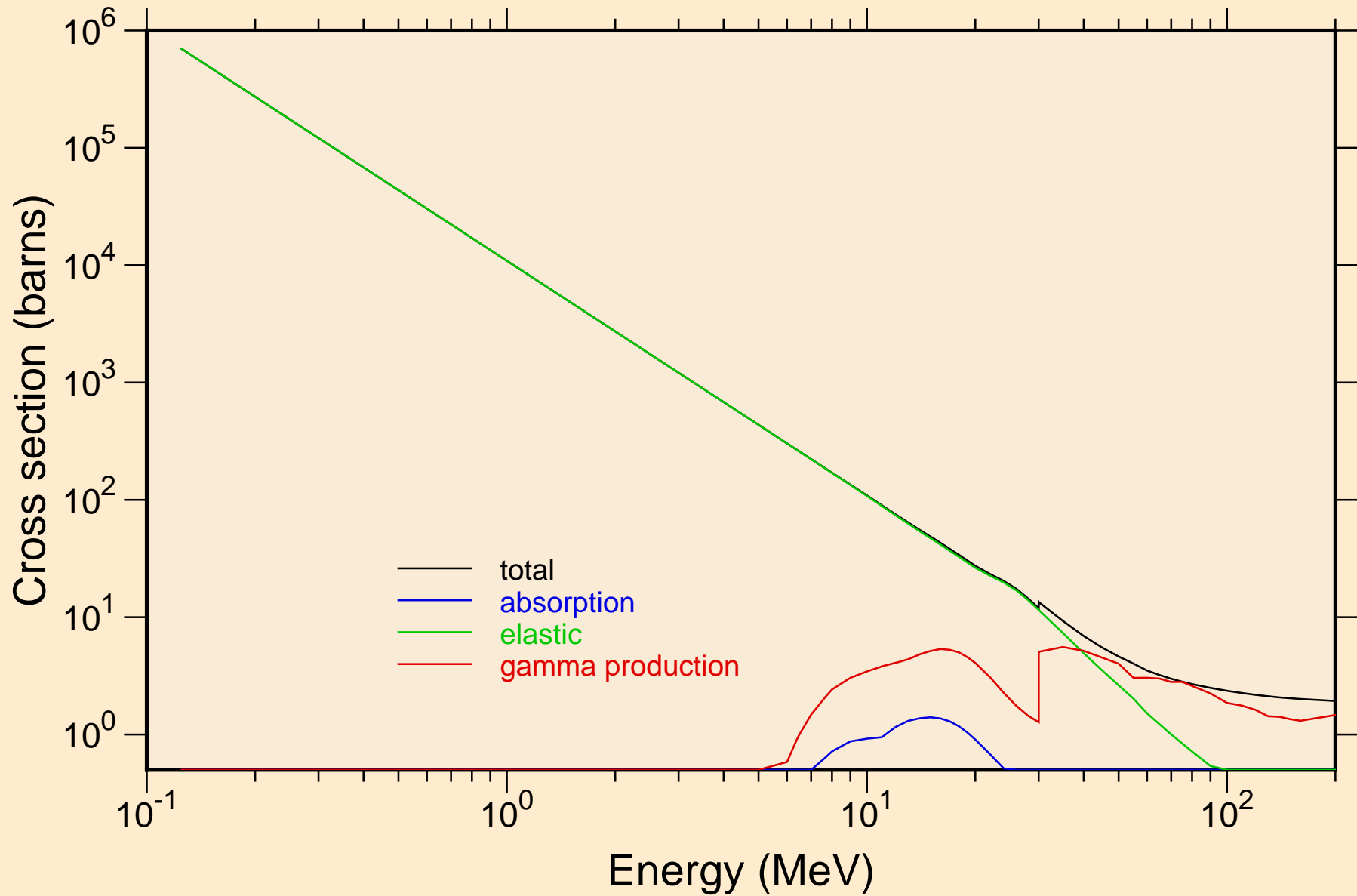

NB106 TRITON ACER TENDL-2021 LIBRARY; T=0.K

Heating

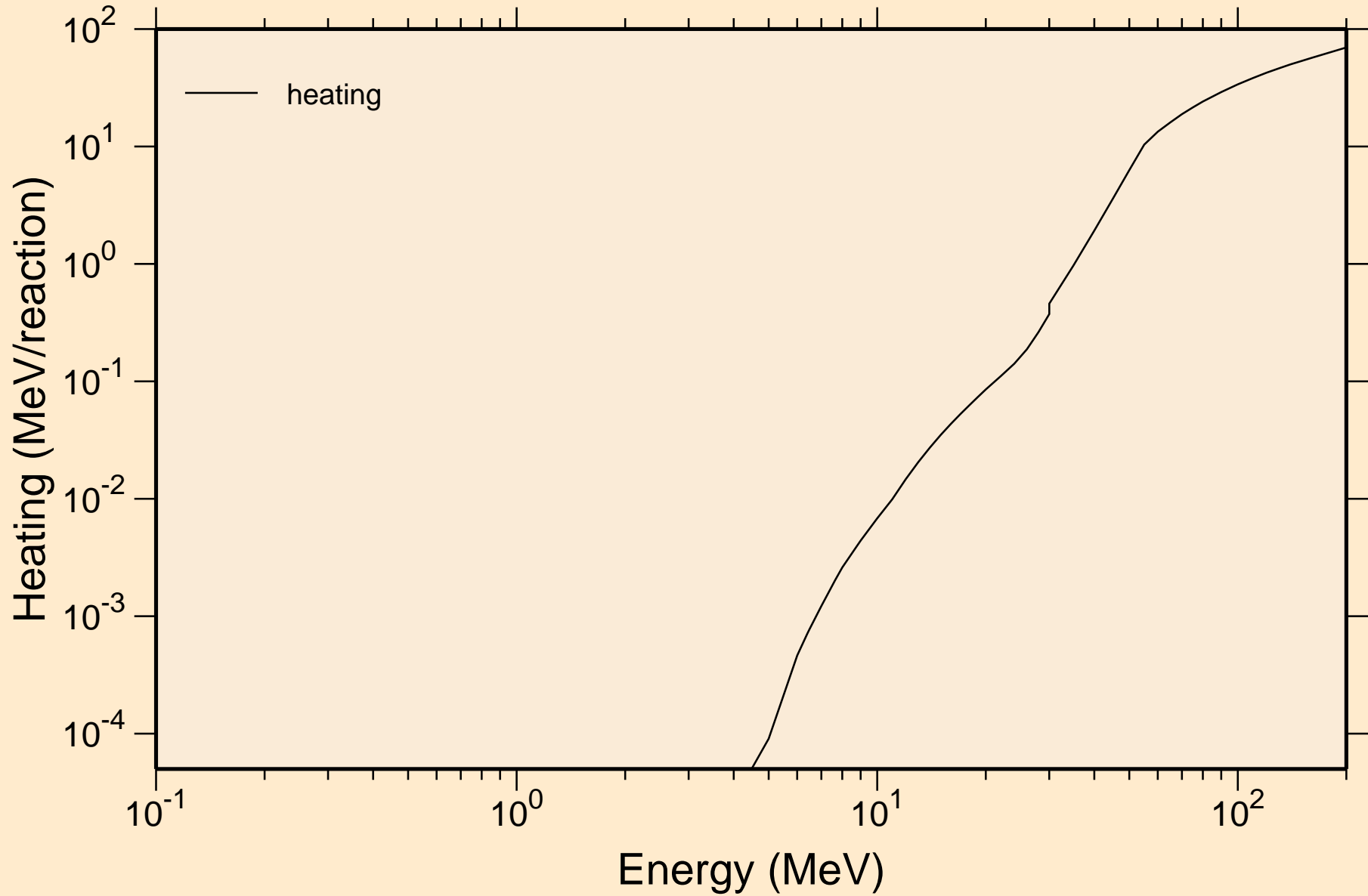

# NB106 TRITON ACER TENDL-2021 LIBRARY; T=0.K

## Principal cross sections

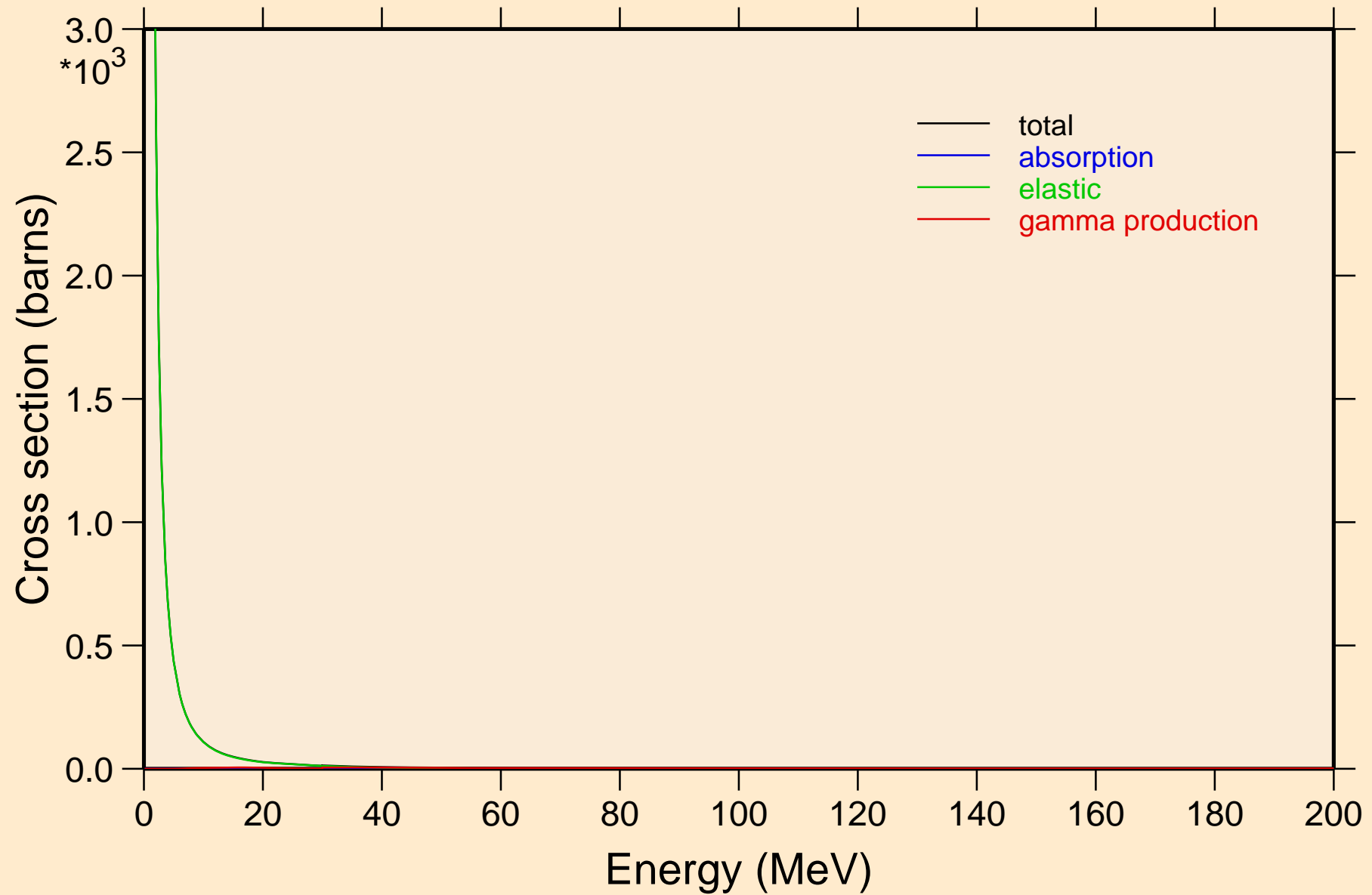

NB106 TRITON ACER TENDL-2021 LIBRARY; T=0.K

Heating

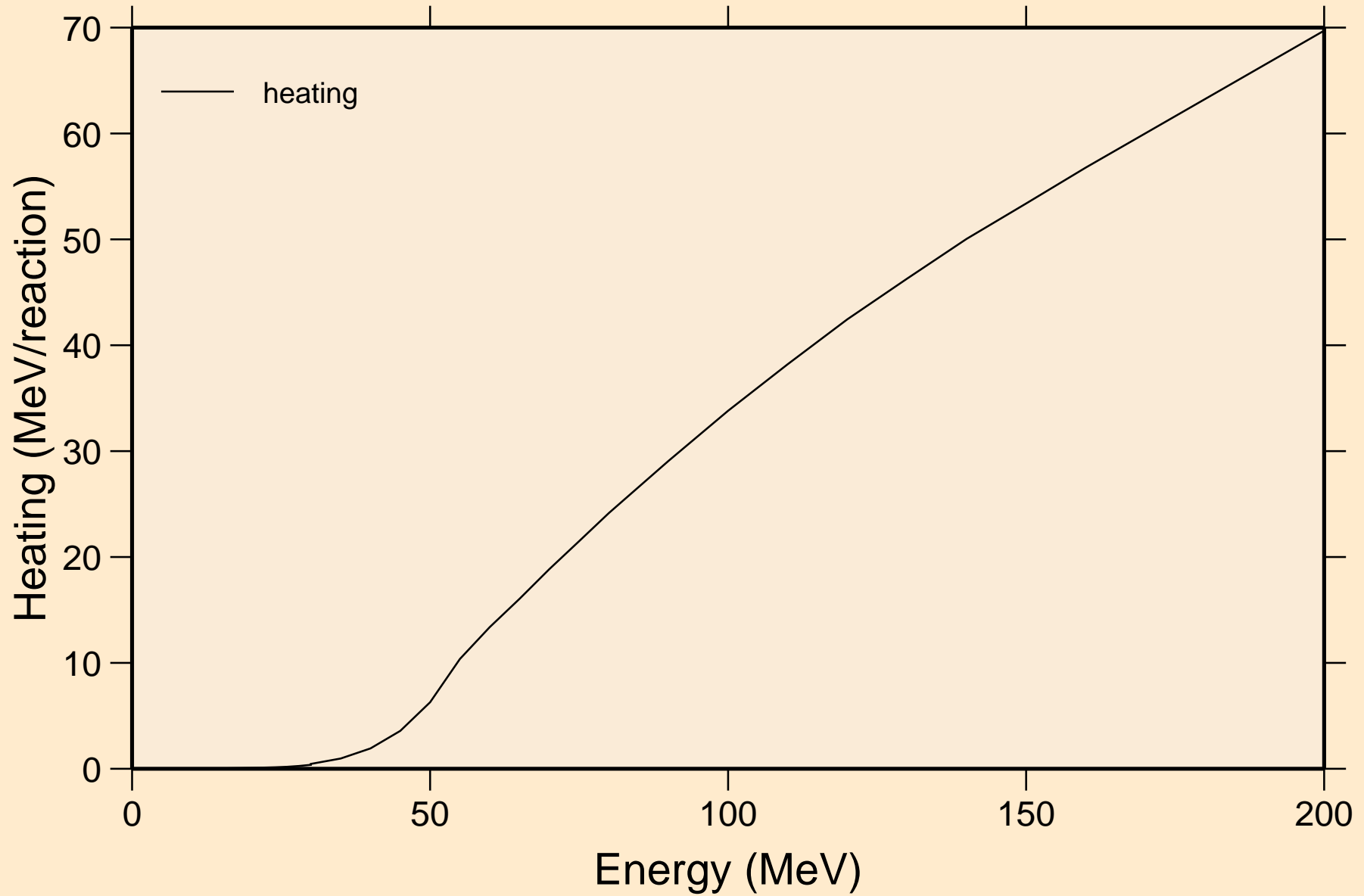

NB106 TRITON ACER TENDL-2021 LIBRARY; T=0.K  
Threshold reactions

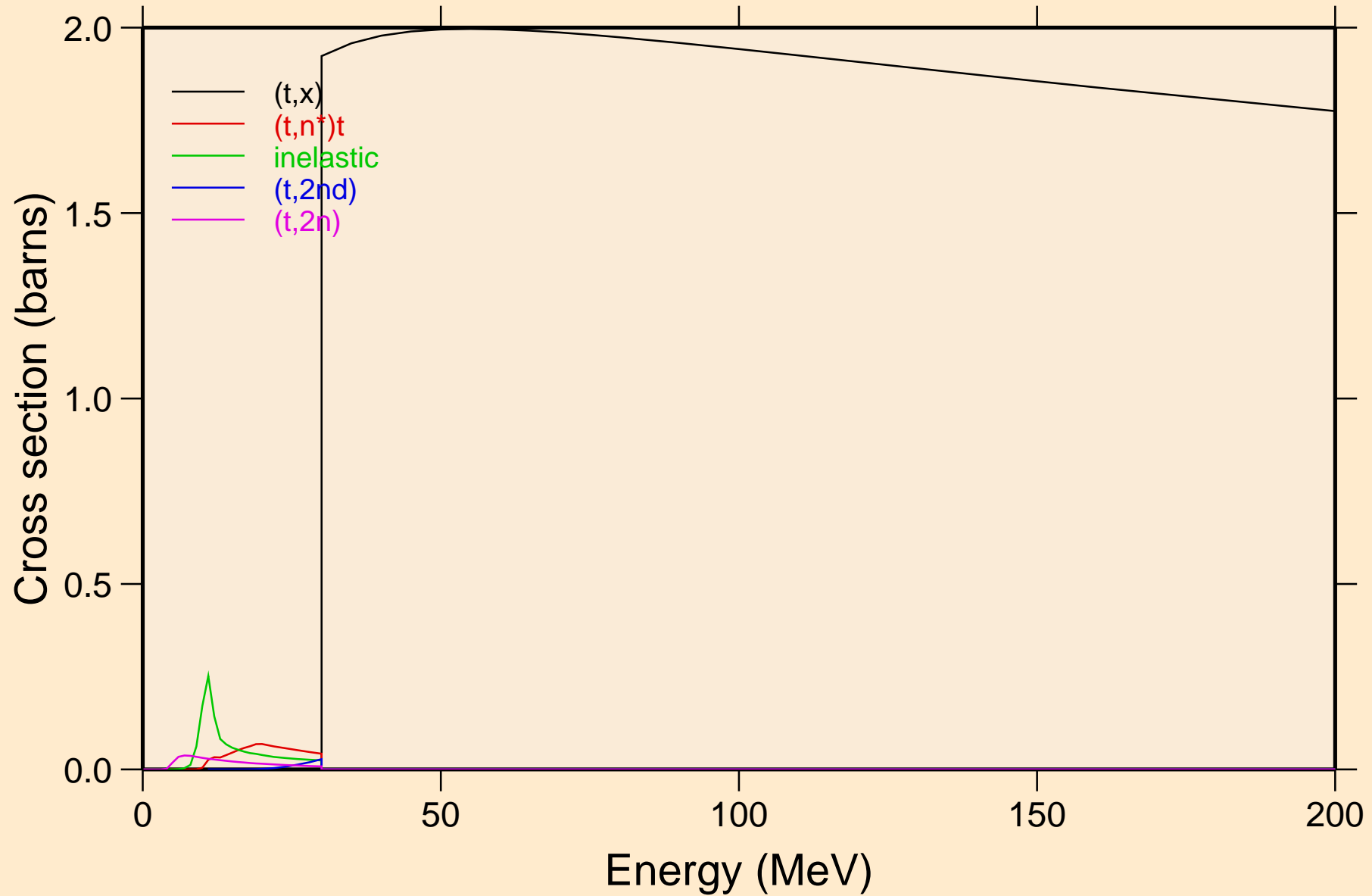

NB106 TRITON ACER TENDL-2021 LIBRARY; T=0.K  
Threshold reactions

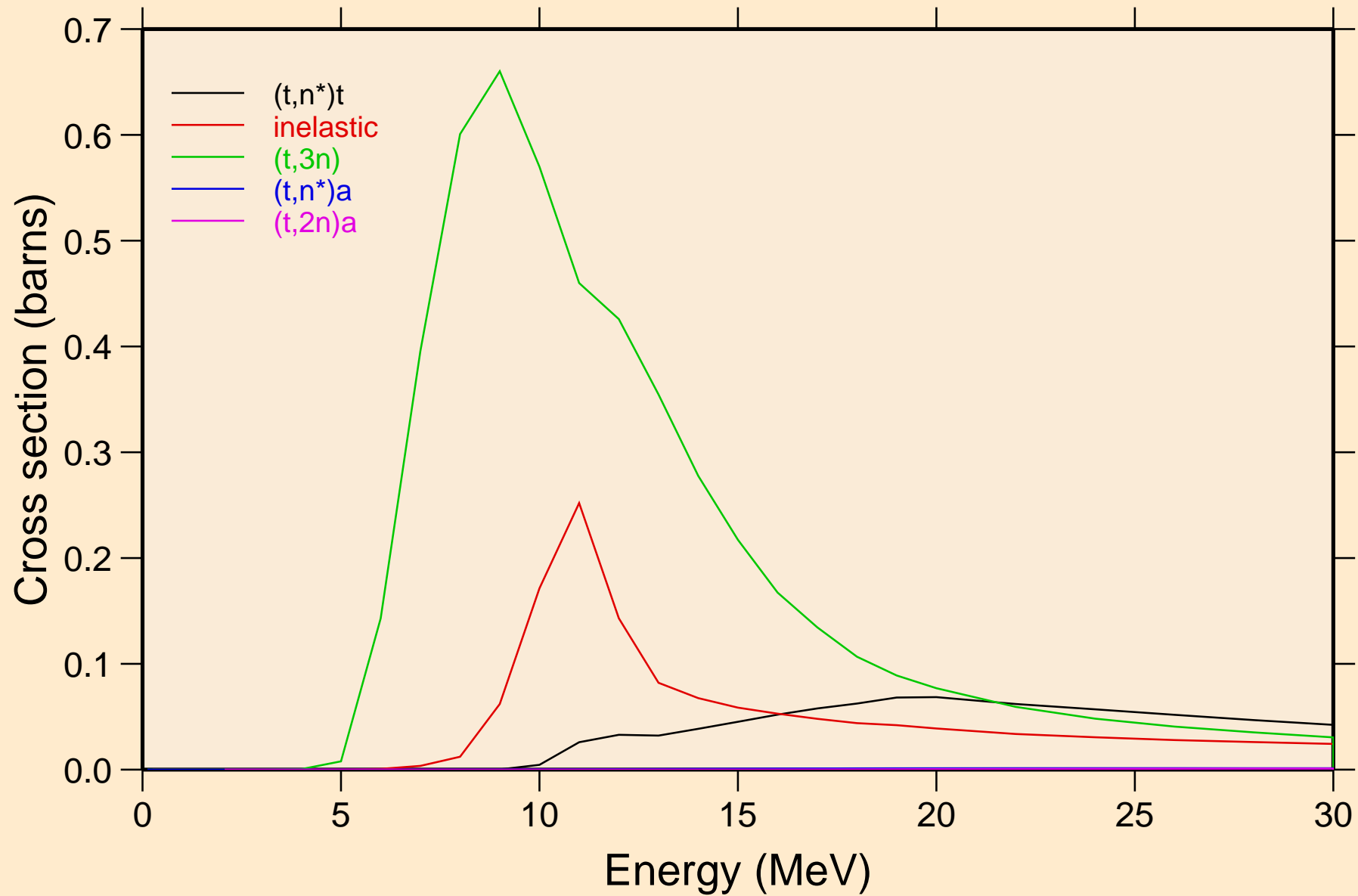

NB106 TRITON ACER TENDL-2021 LIBRARY; T=0.K  
Threshold reactions

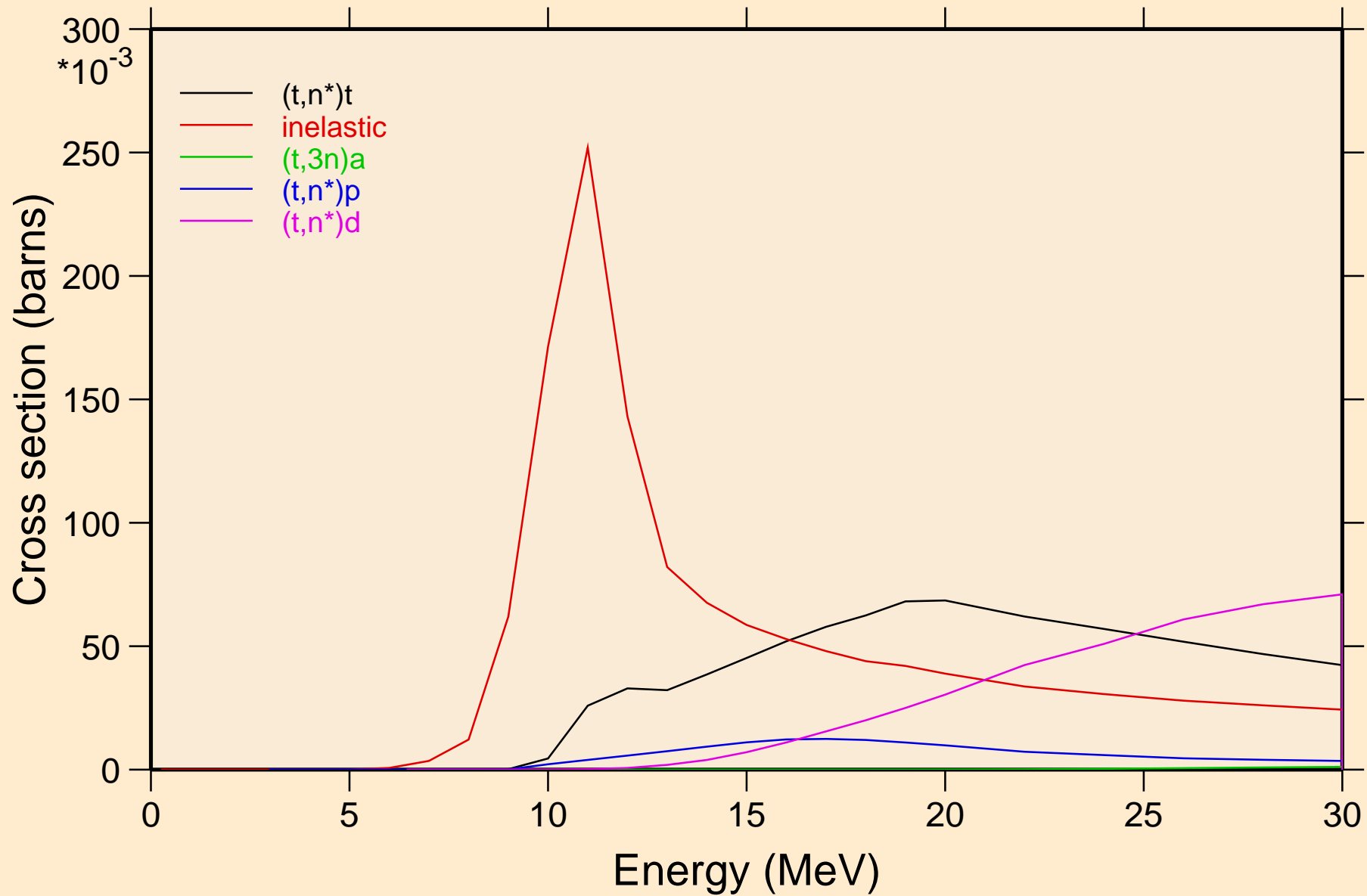

NB106 TRITON ACER TENDL-2021 LIBRARY; T=0.K  
Threshold reactions

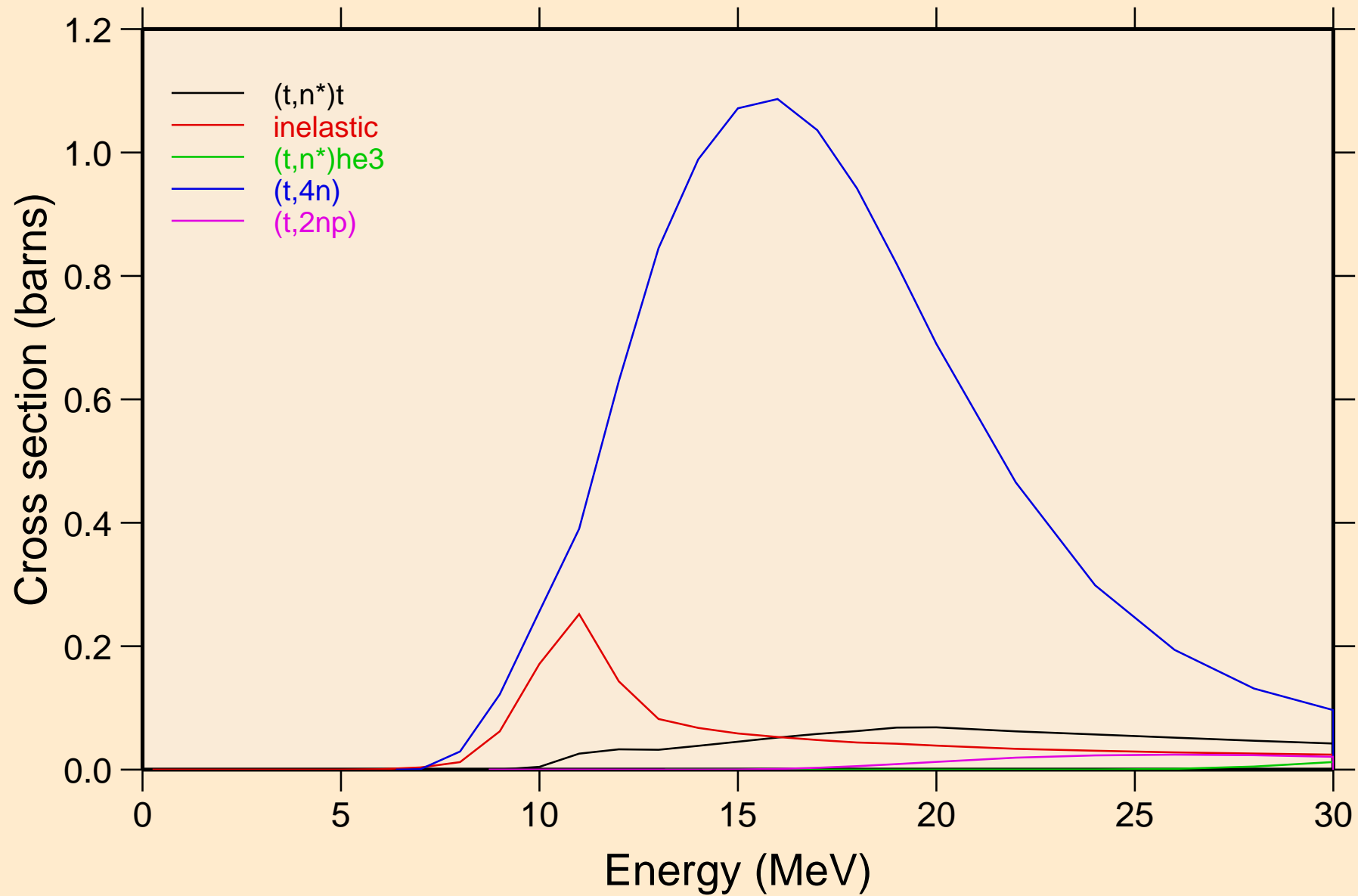



NB106 TRITON ACER TENDL-2021 LIBRARY; T=0.K  
Threshold reactions

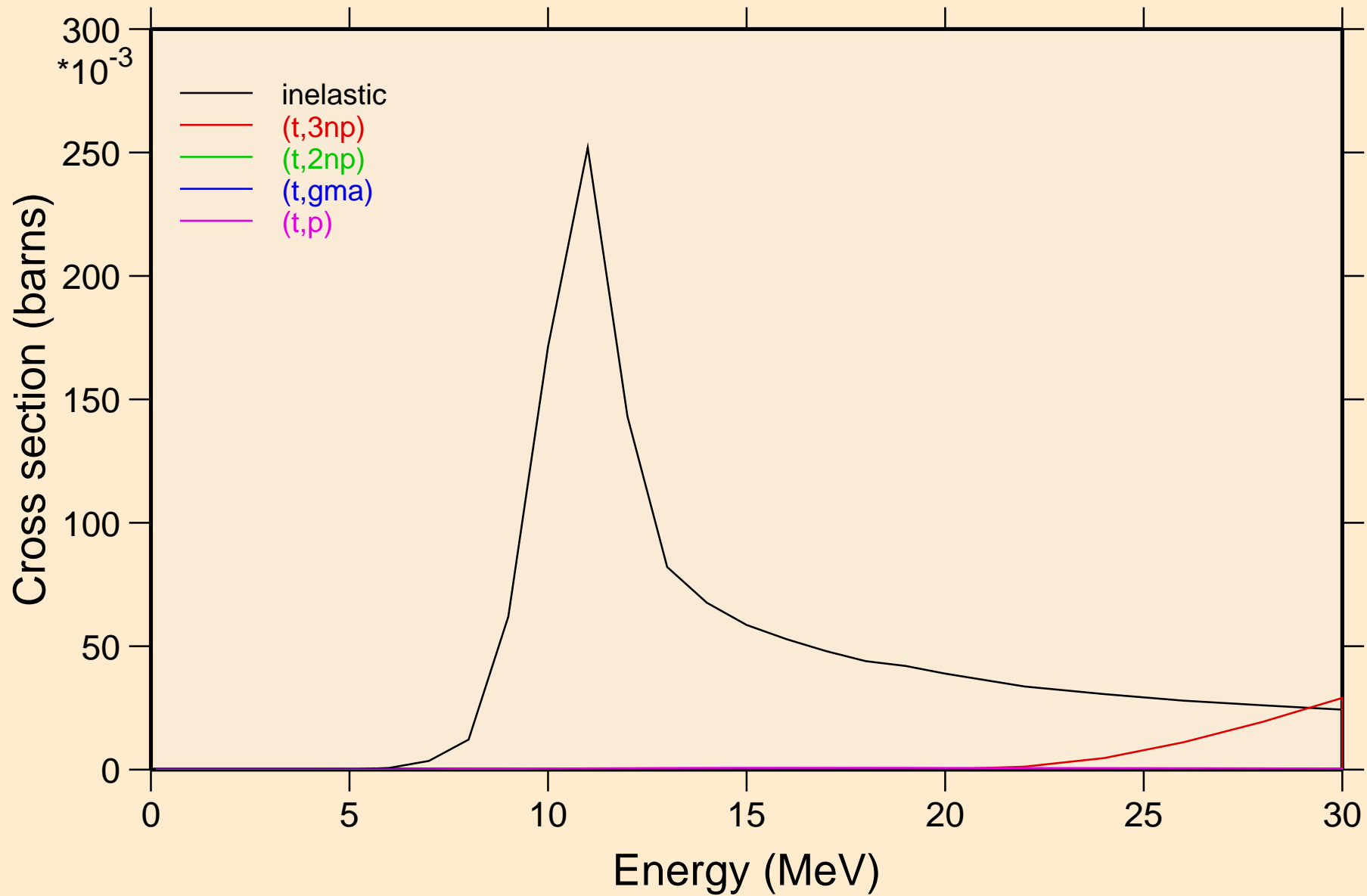

NB106 TRITON ACER TENDL-2021 LIBRARY; T=0.K  
Threshold reactions

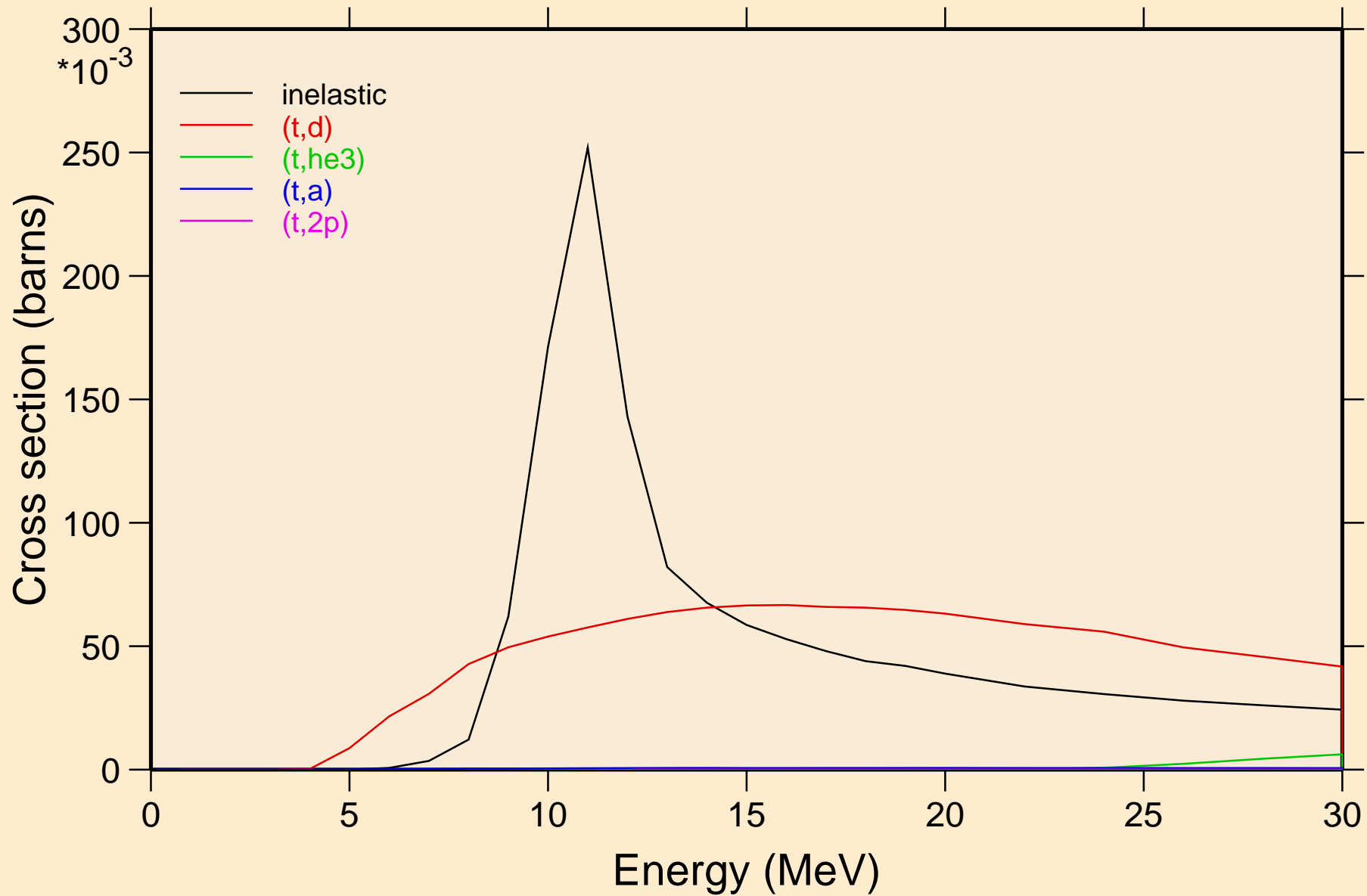

NB106 TRITON ACER TENDL-2021 LIBRARY; T=0.K  
Threshold reactions

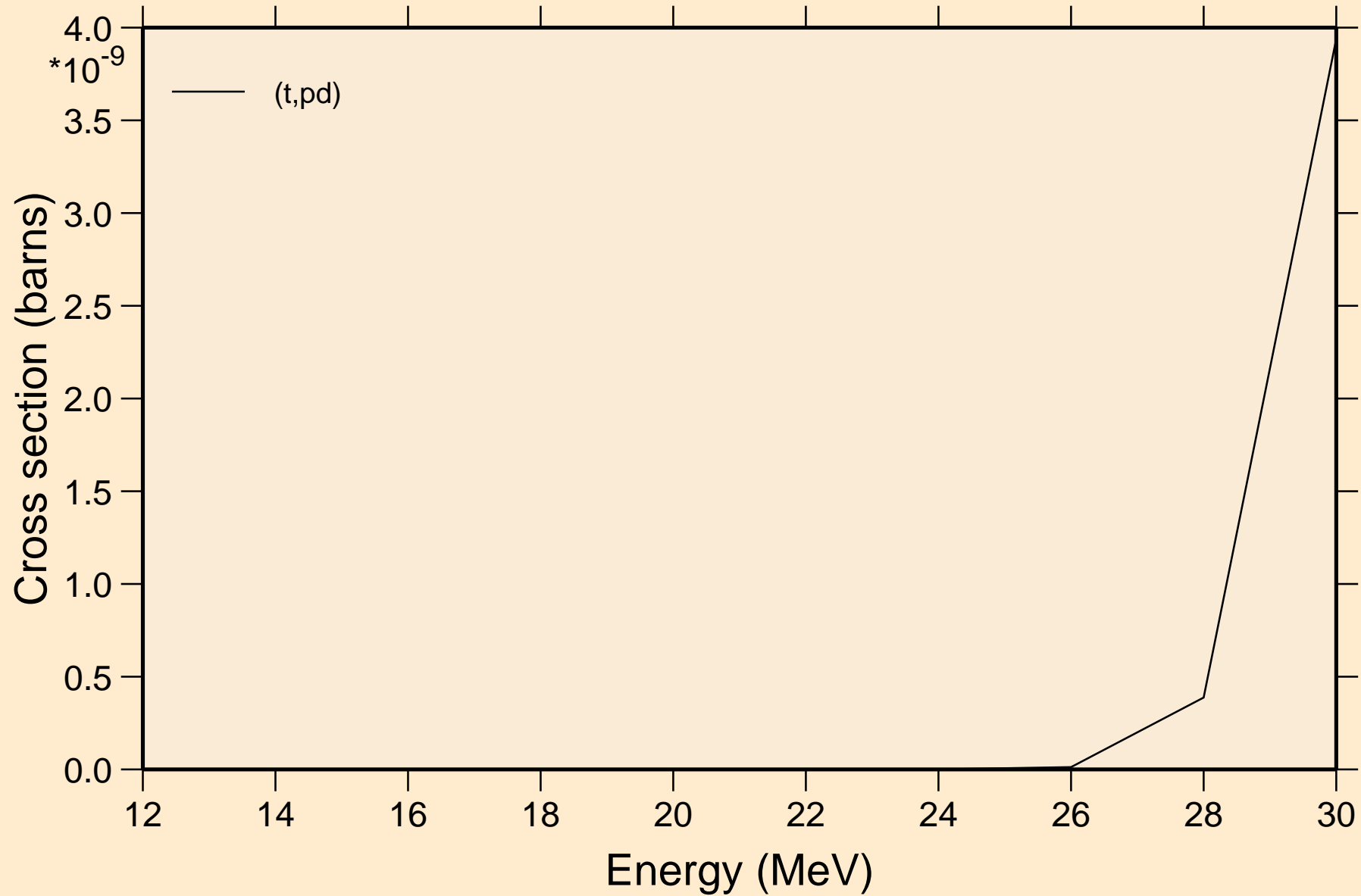

NB106 TRITON ACER TENDL-2021 LIBRARY; T=0.K  
angular distribution for elastic

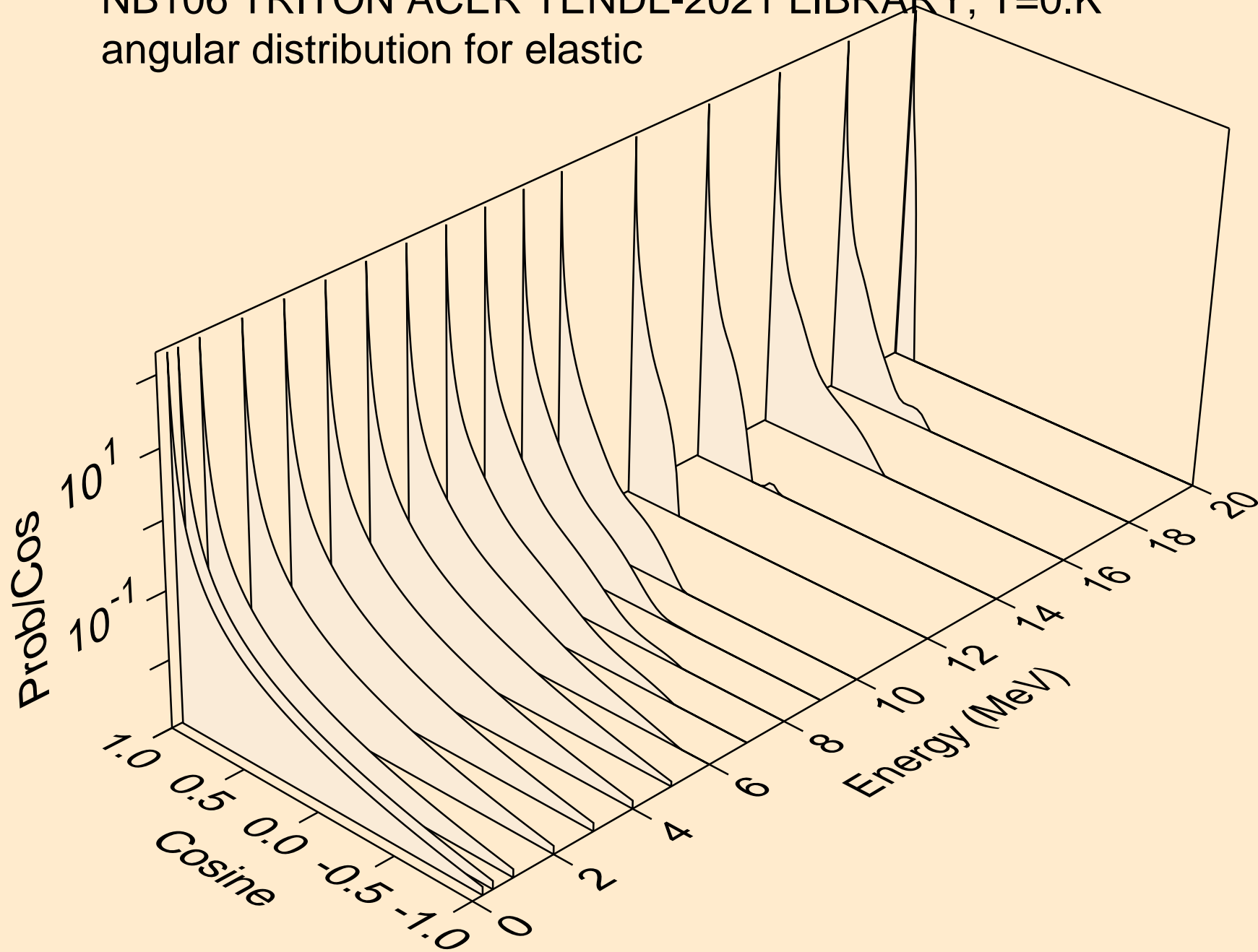

NB106 TRITON ACER TENDL-2021 LIBRARY; T=0.K  
angular distribution for elastic

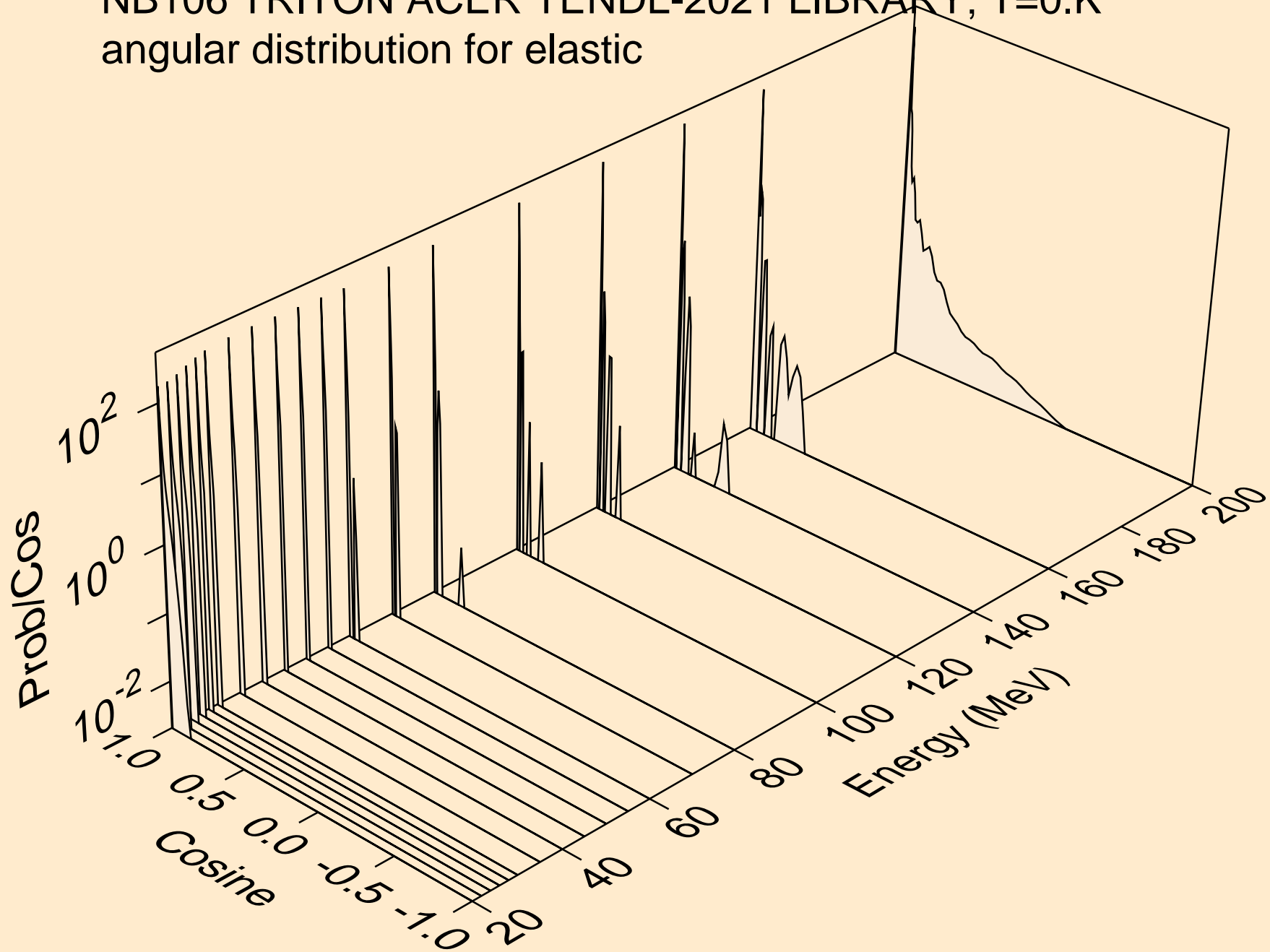

NB106 TRITON ACER TENDL-2021 LIBRARY; T=0.K  
Triton emission for (t,x)

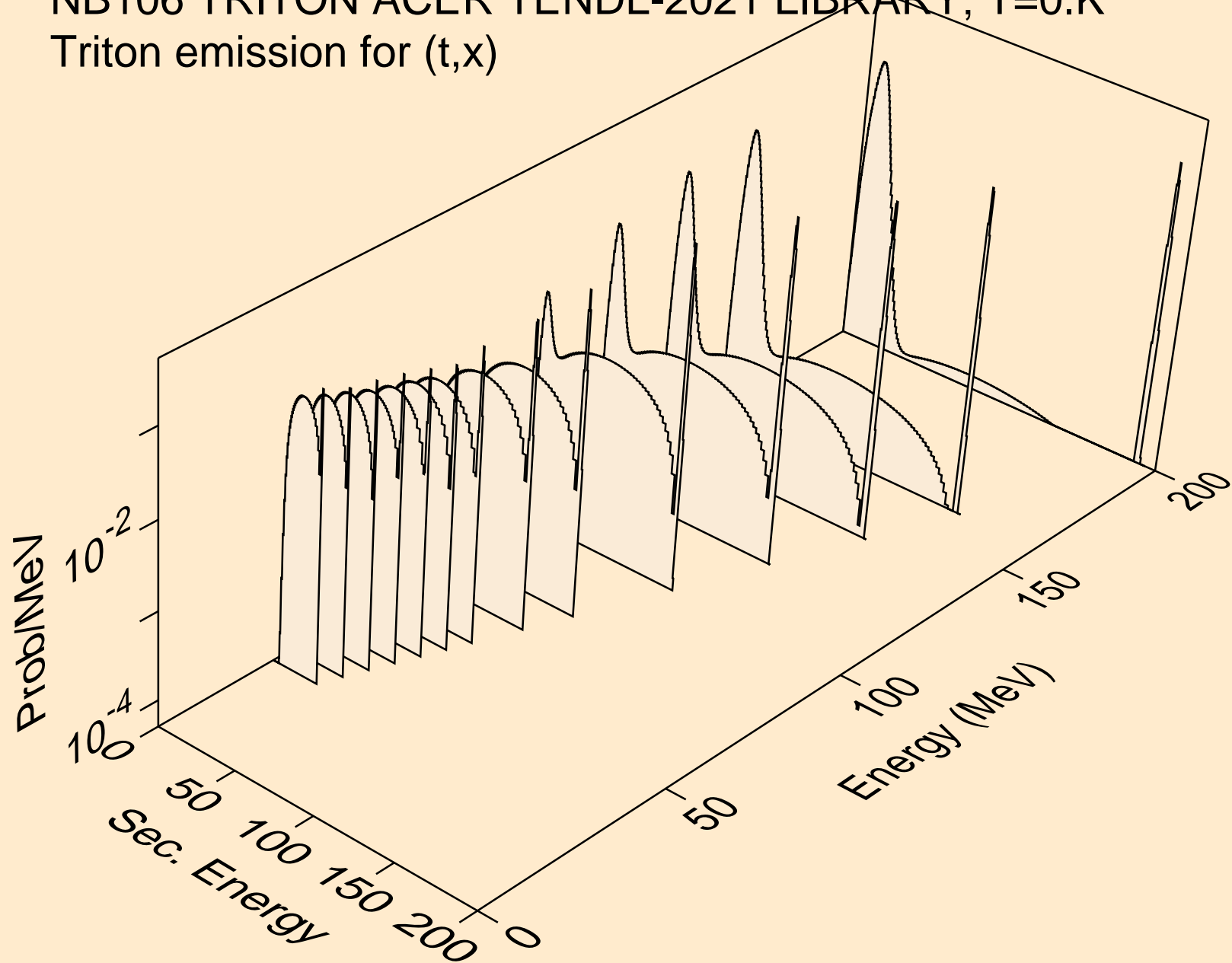

NB106 TRITON ACER TENDL-2021 LIBRARY; T=0.K  
Triton emission for (t,n\*)t

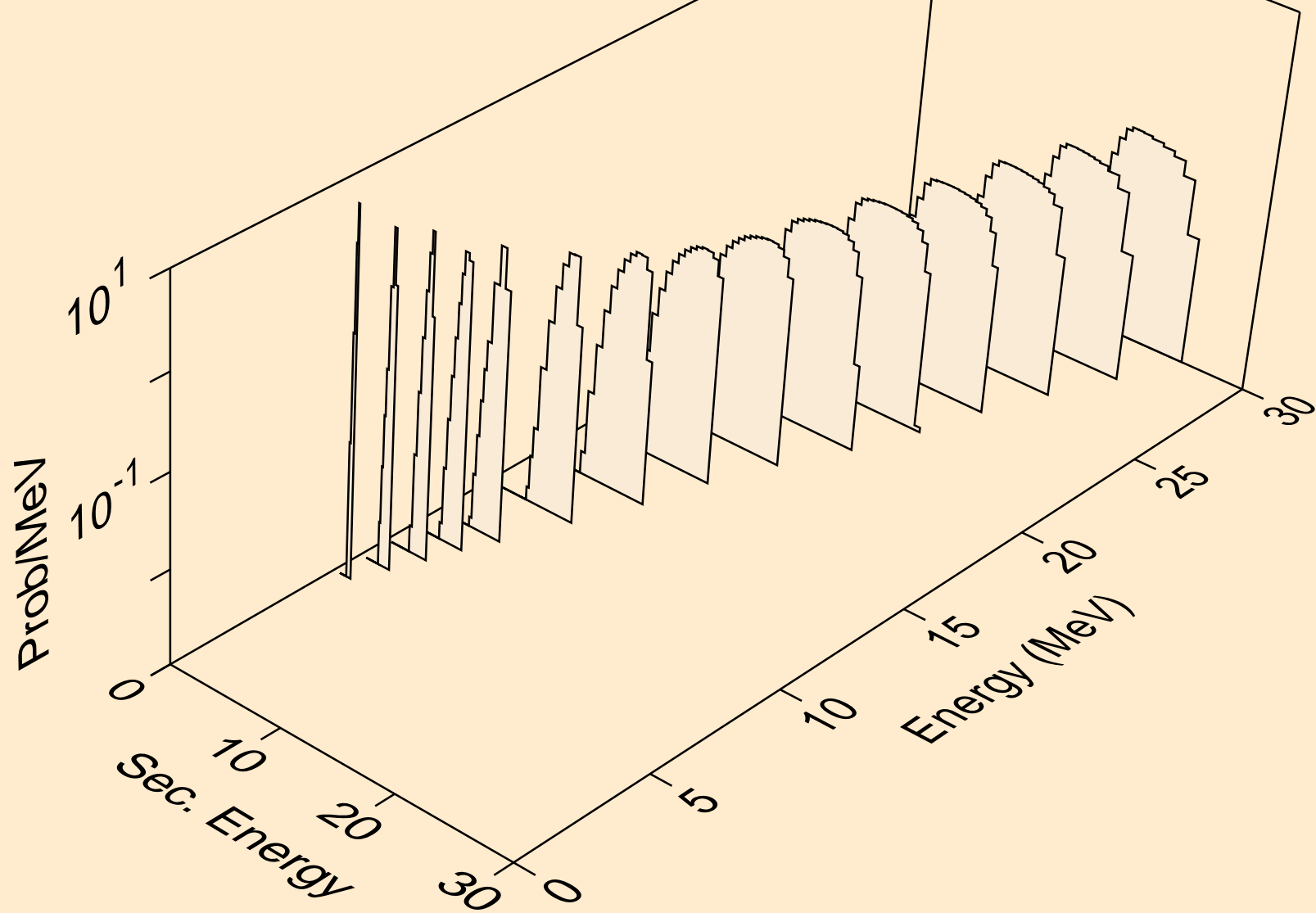

NB106 TRITON ACER TENDL-2021 LIBRARY; T=0.K  
Triton emission for inelastic

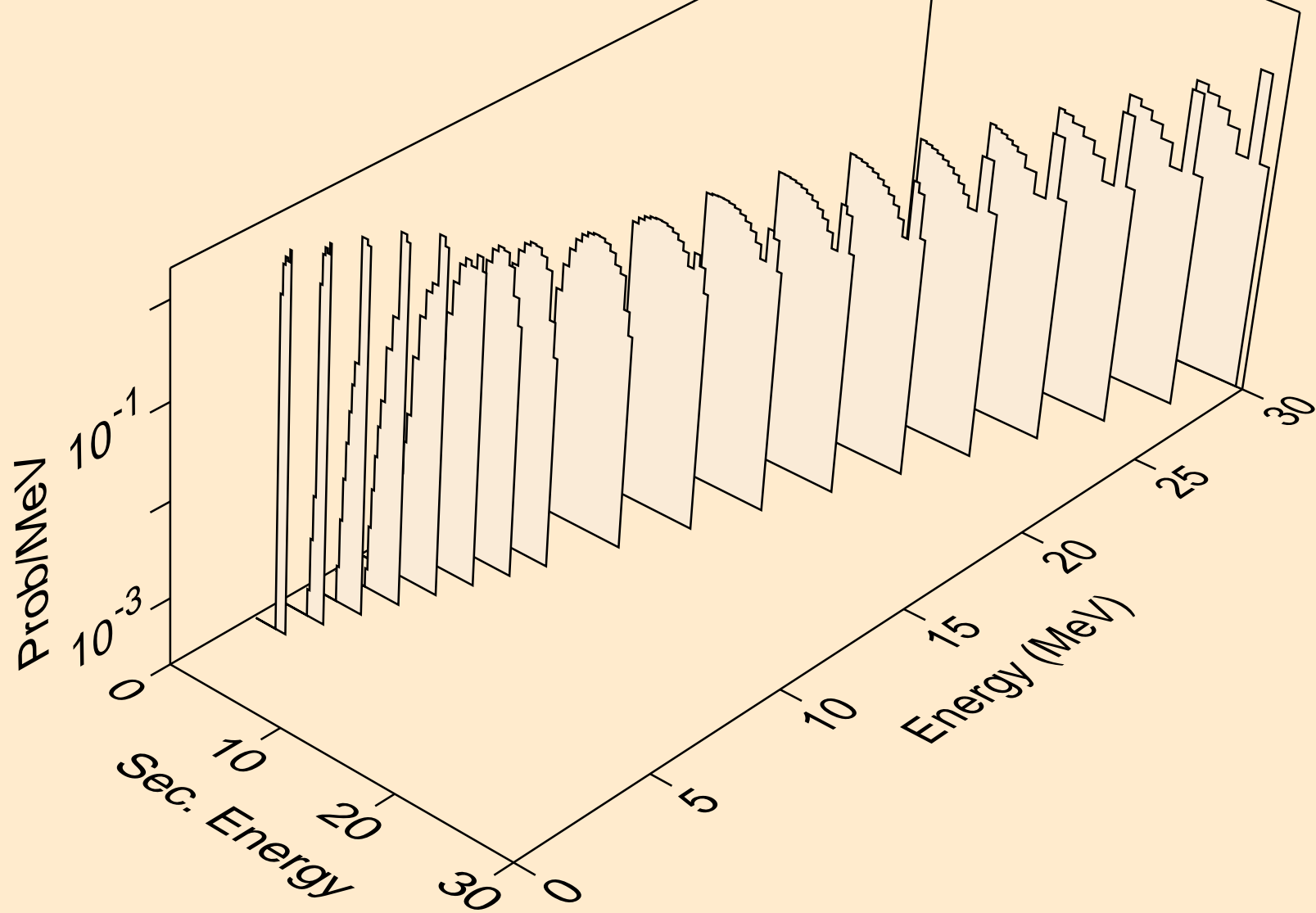



NB106 TRITON ACER TENDL-2021 LIBRARY; T=0.K  
Photon emission for (z,n)

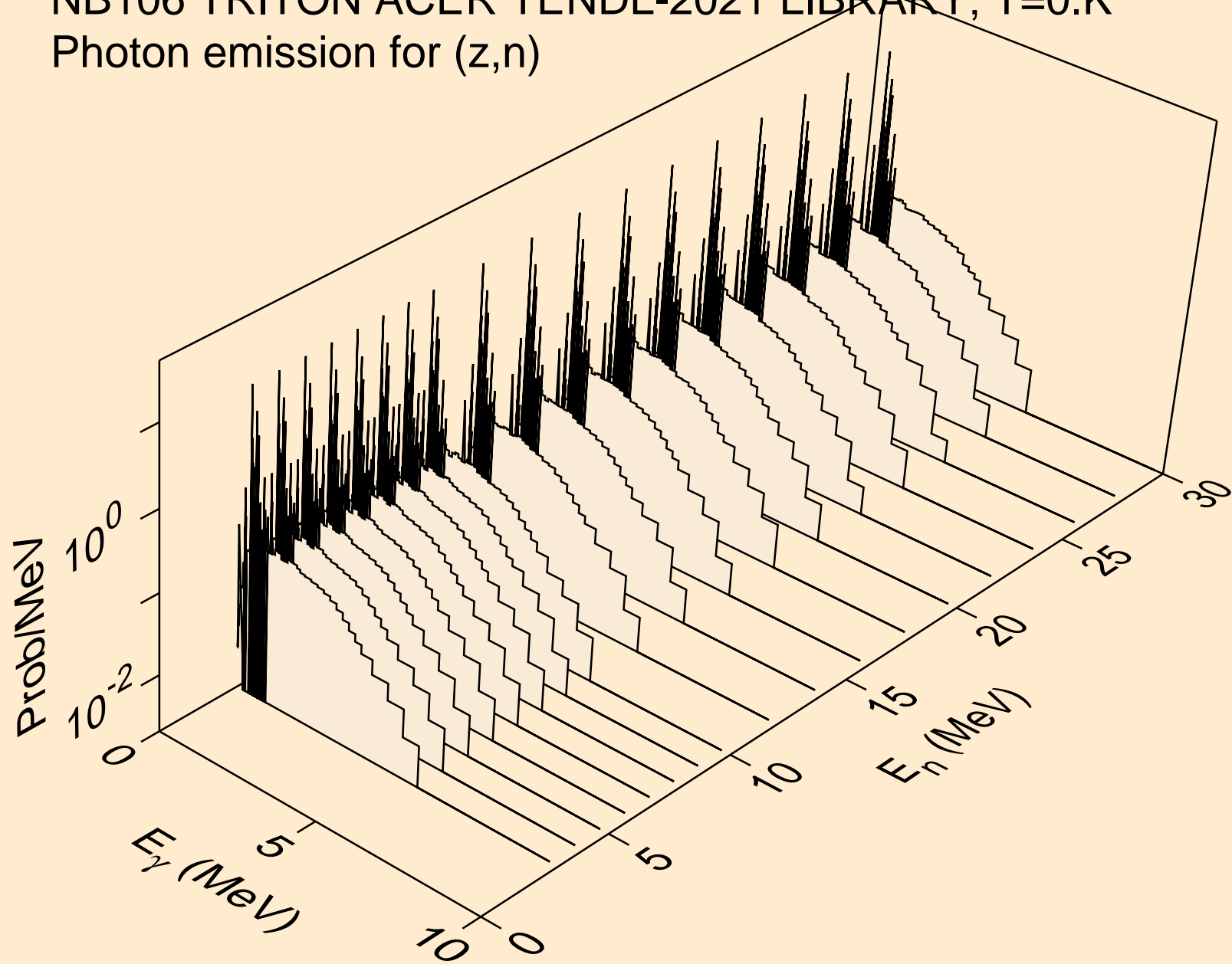

NB106 TRITON ACER TENDL-2021 LIBRARY; T=0.K  
Photon emission for (n,x)

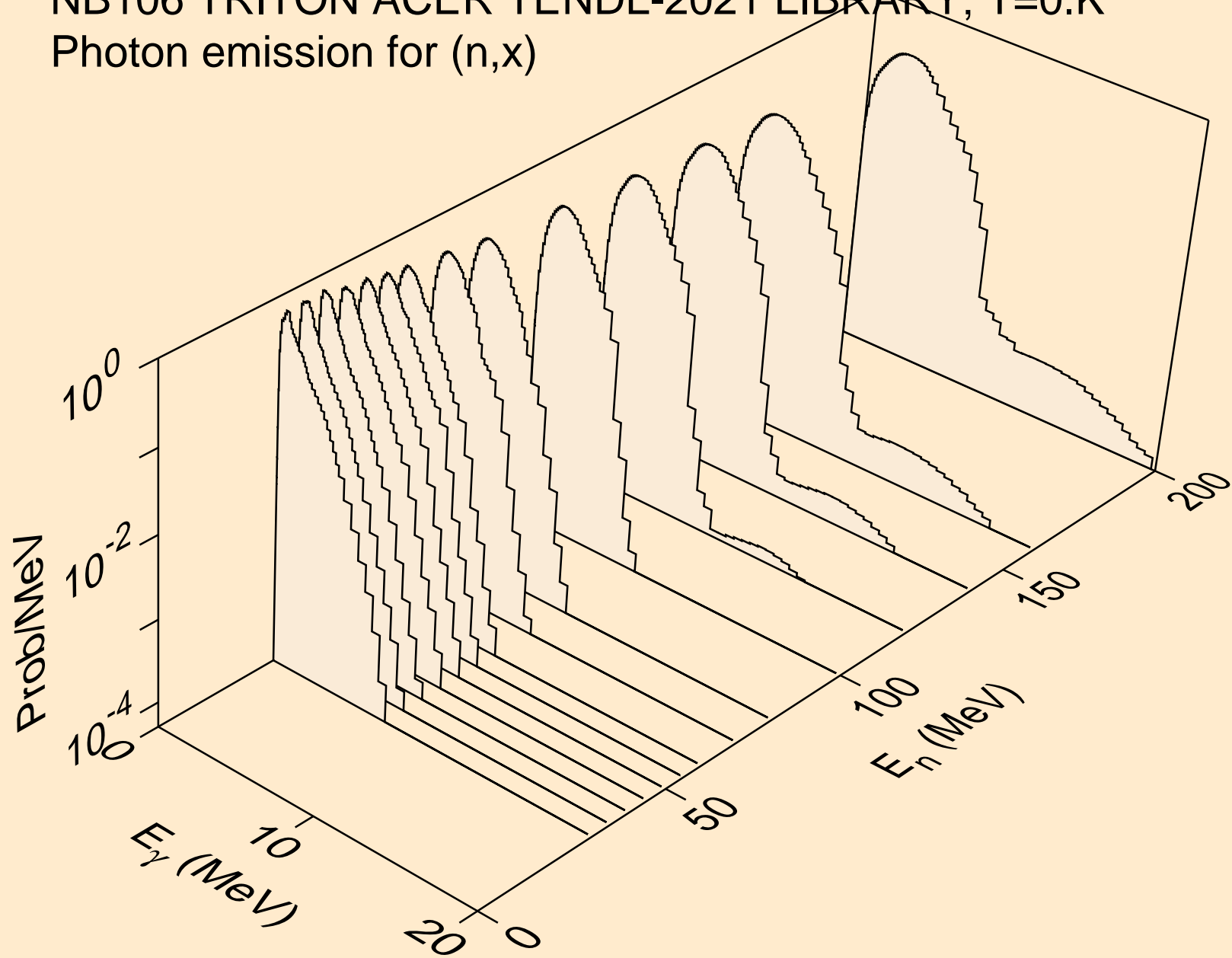

NB106 TRITON ACER TENDL-2021 LIBRARY; T=0.K  
Photon emission for (n,2nd)

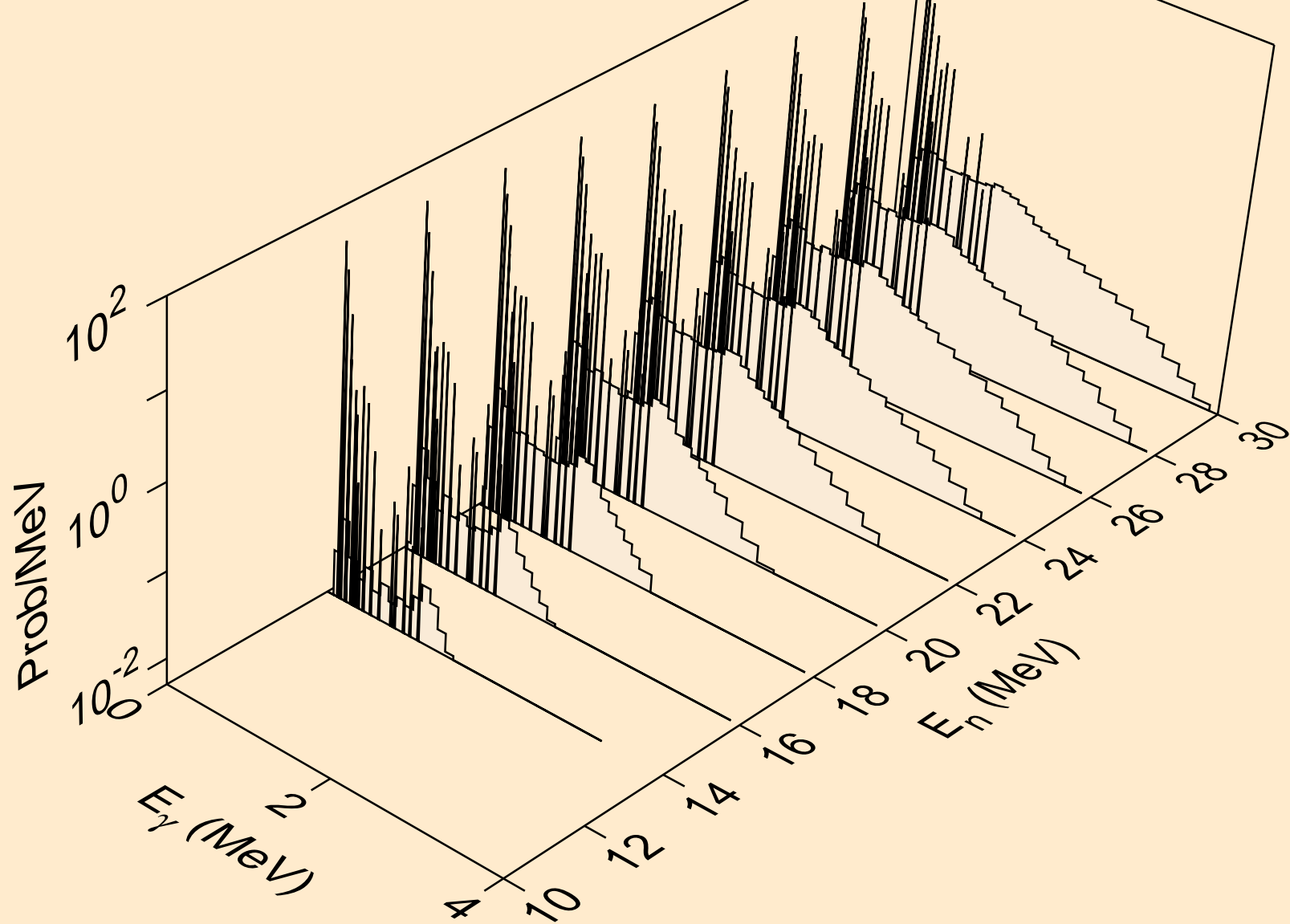

NB106 TRITON ACER TENDL-2021 LIBRARY; T=0.K  
Photon emission for (n,2n)

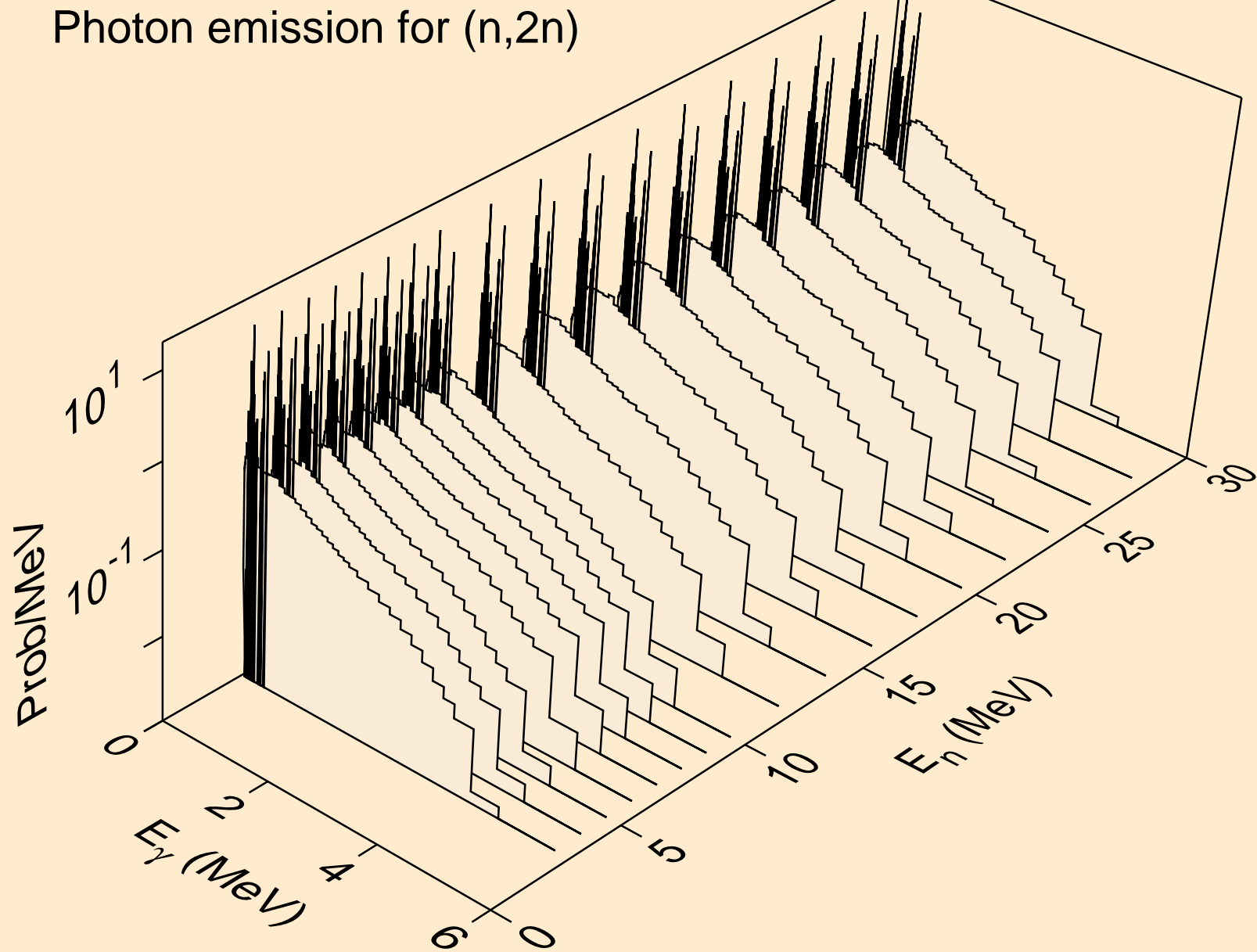

NB106 TRITON ACER TENDL-2021 LIBRARY; T=0.K  
Photon emission for (n,3n)

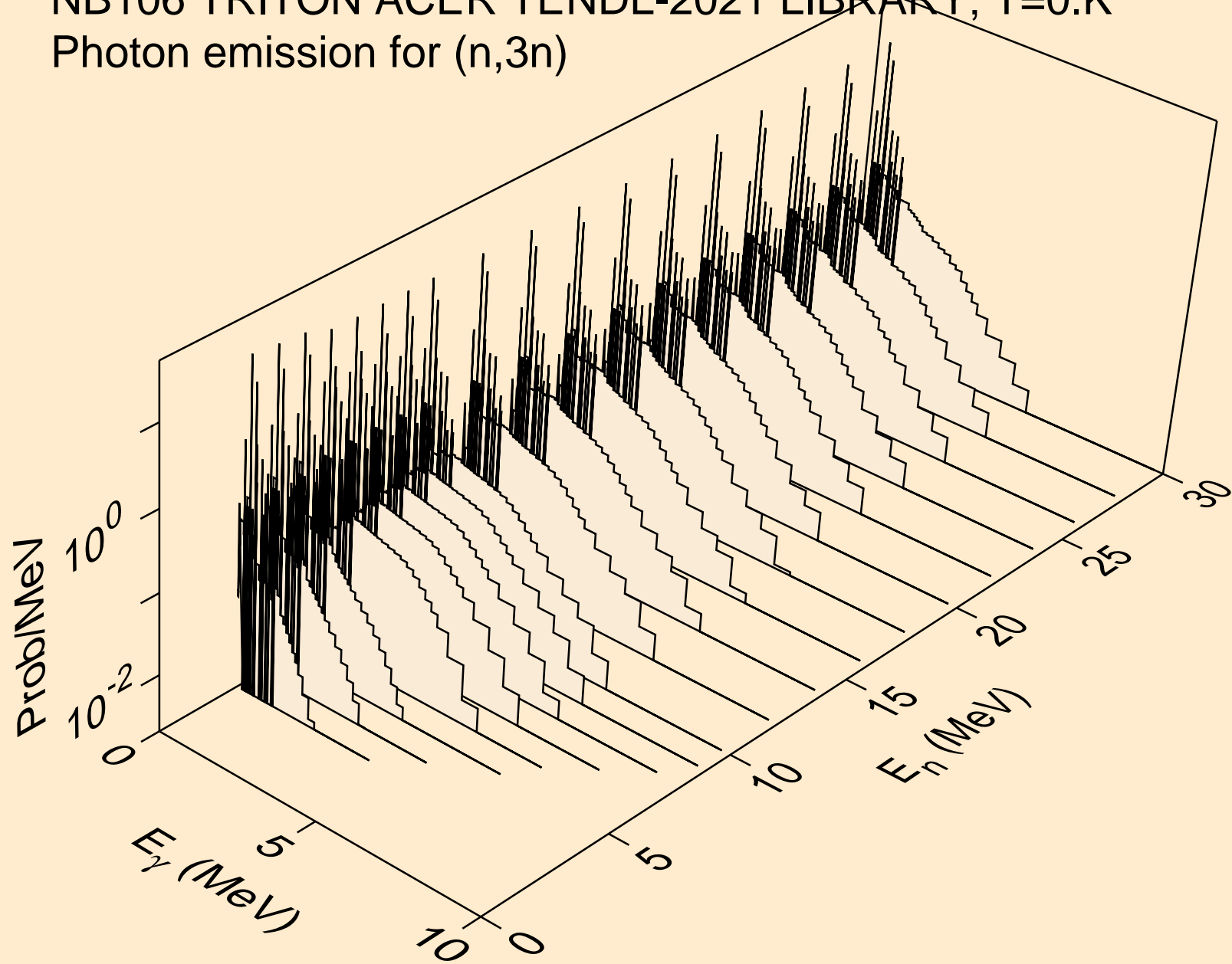

NB106 TRITON ACER TENDL-2021 LIBRARY; T=0.K  
Photon emission for (n,n\*)a

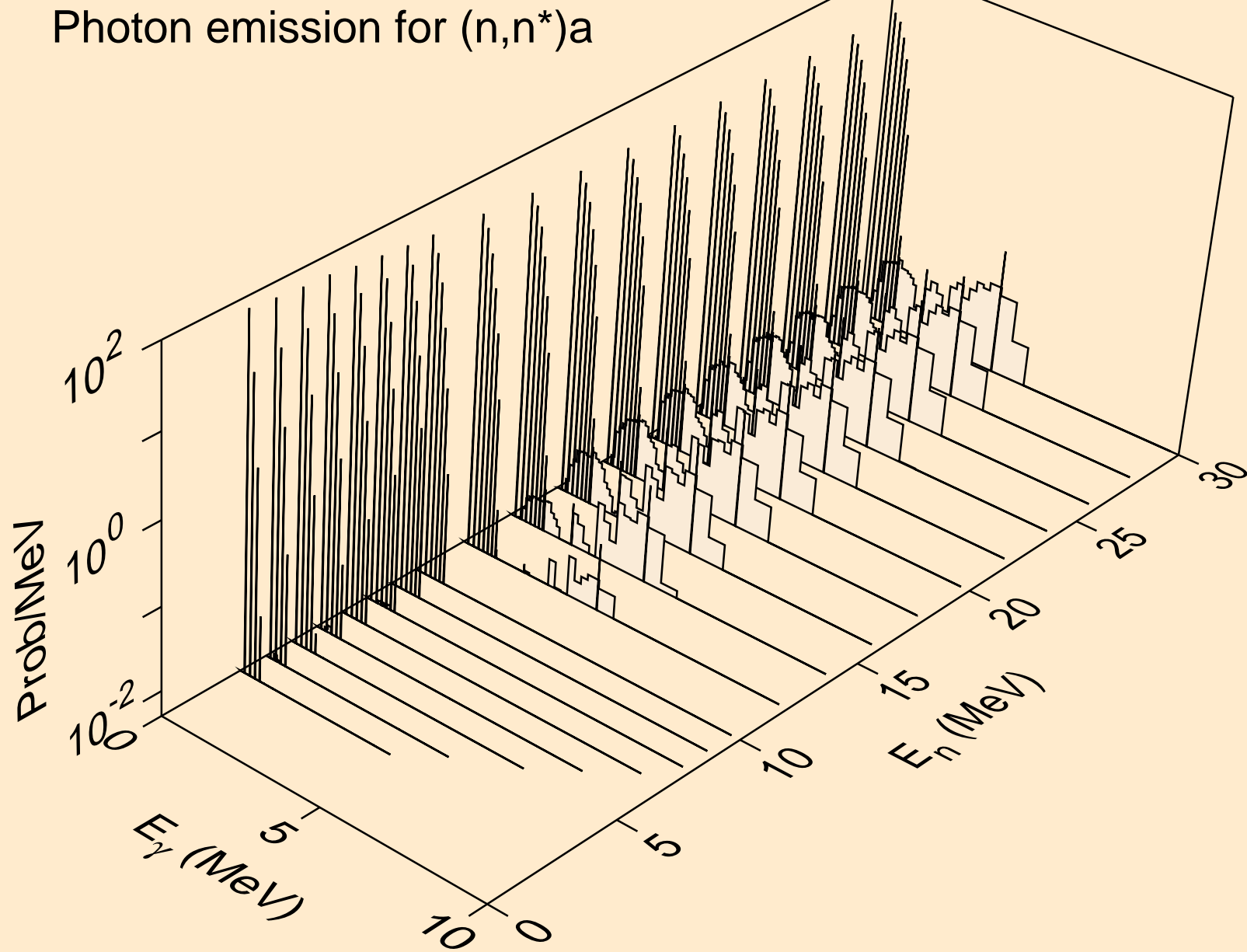

NB106 TRITON ACER TENDL-2021 LIBRARY; T=0.K  
Photon emission for (n,2n)a

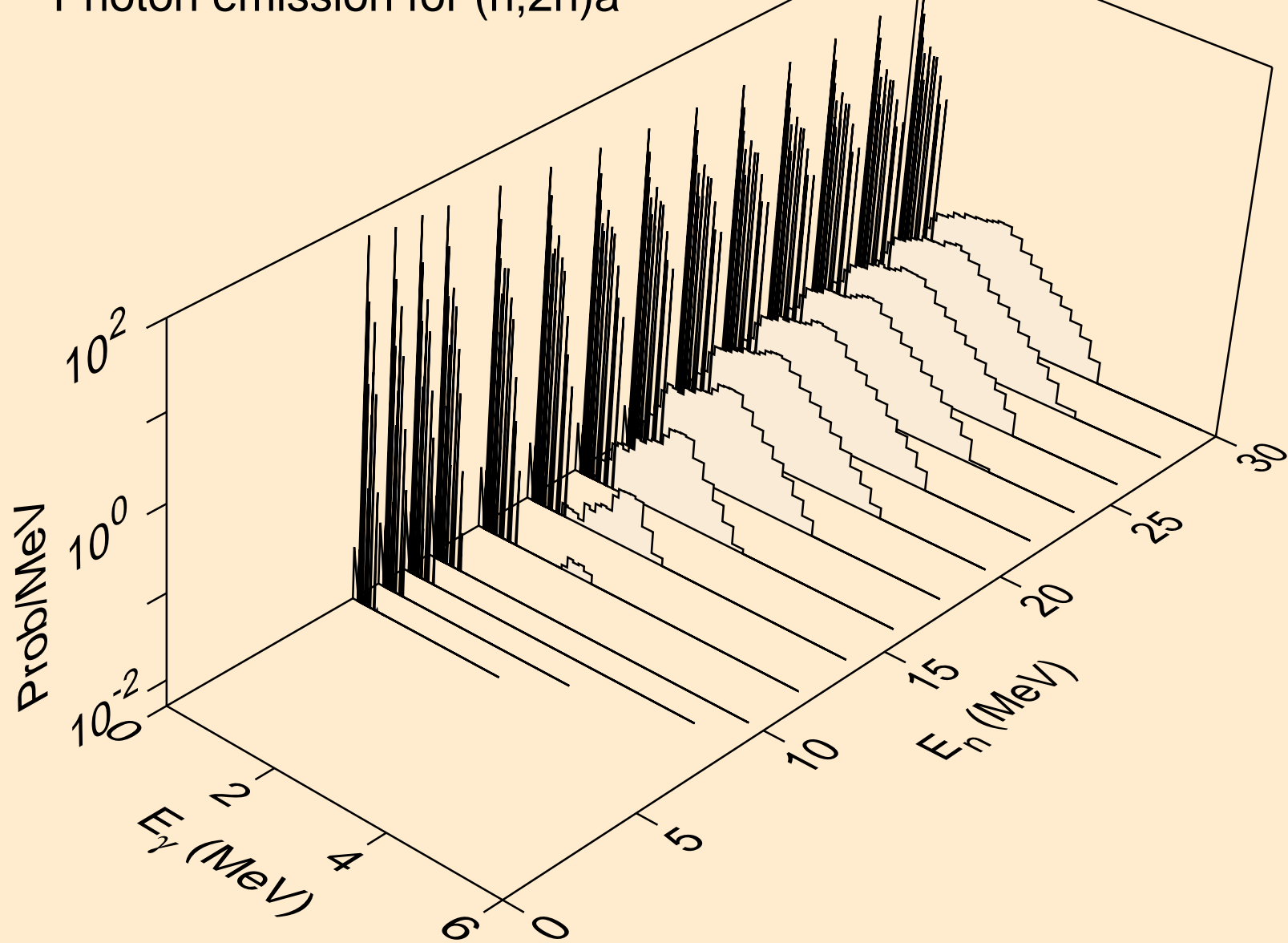

NB106 TRITON ACER TENDL-2021 LIBRARY; T=0.K  
Photon emission for (n,3n)a

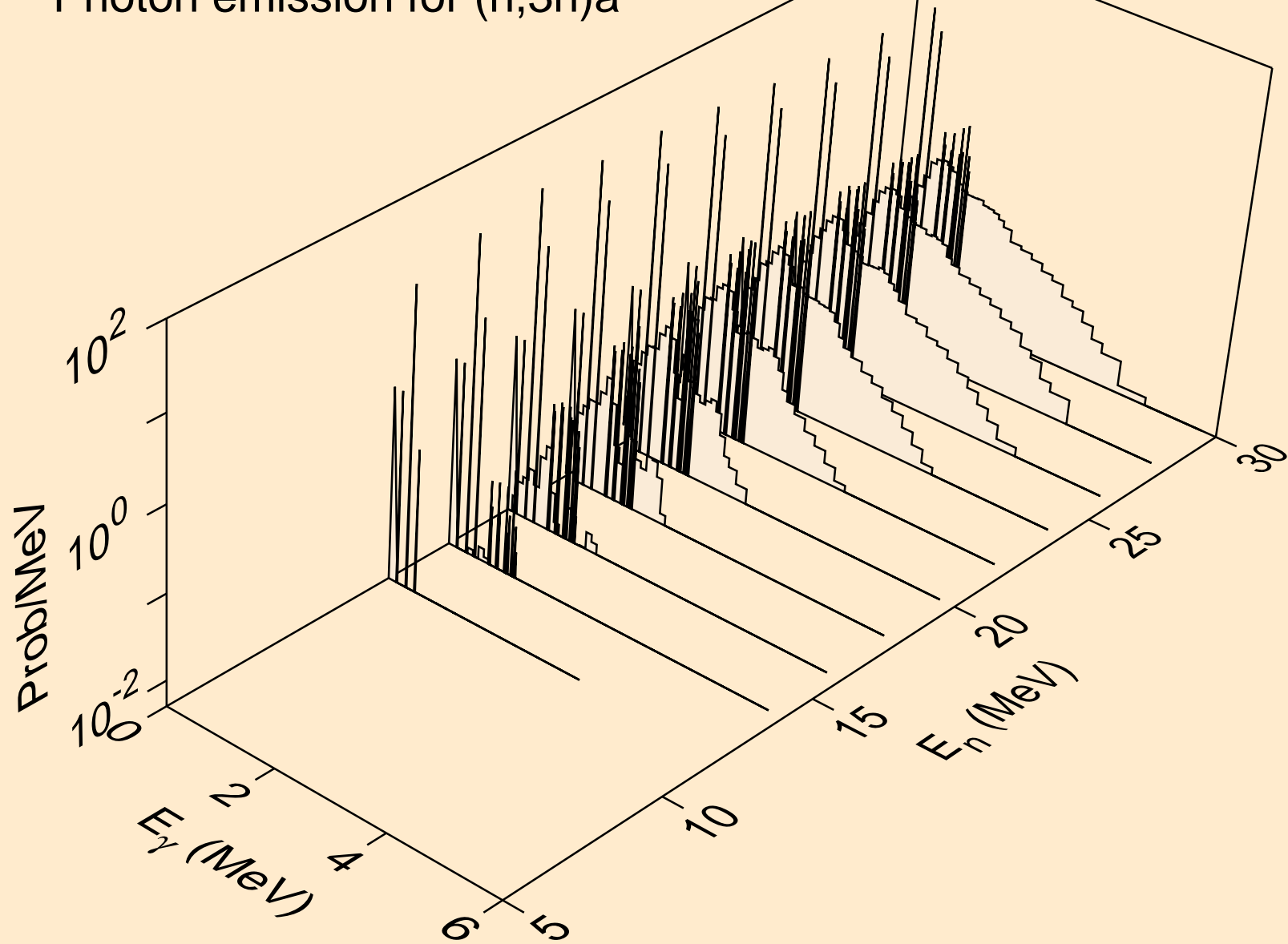



NB106 TRITON ACER TENDL-2021 LIBRARY; T=0.K  
Photon emission for (n,n\*)p

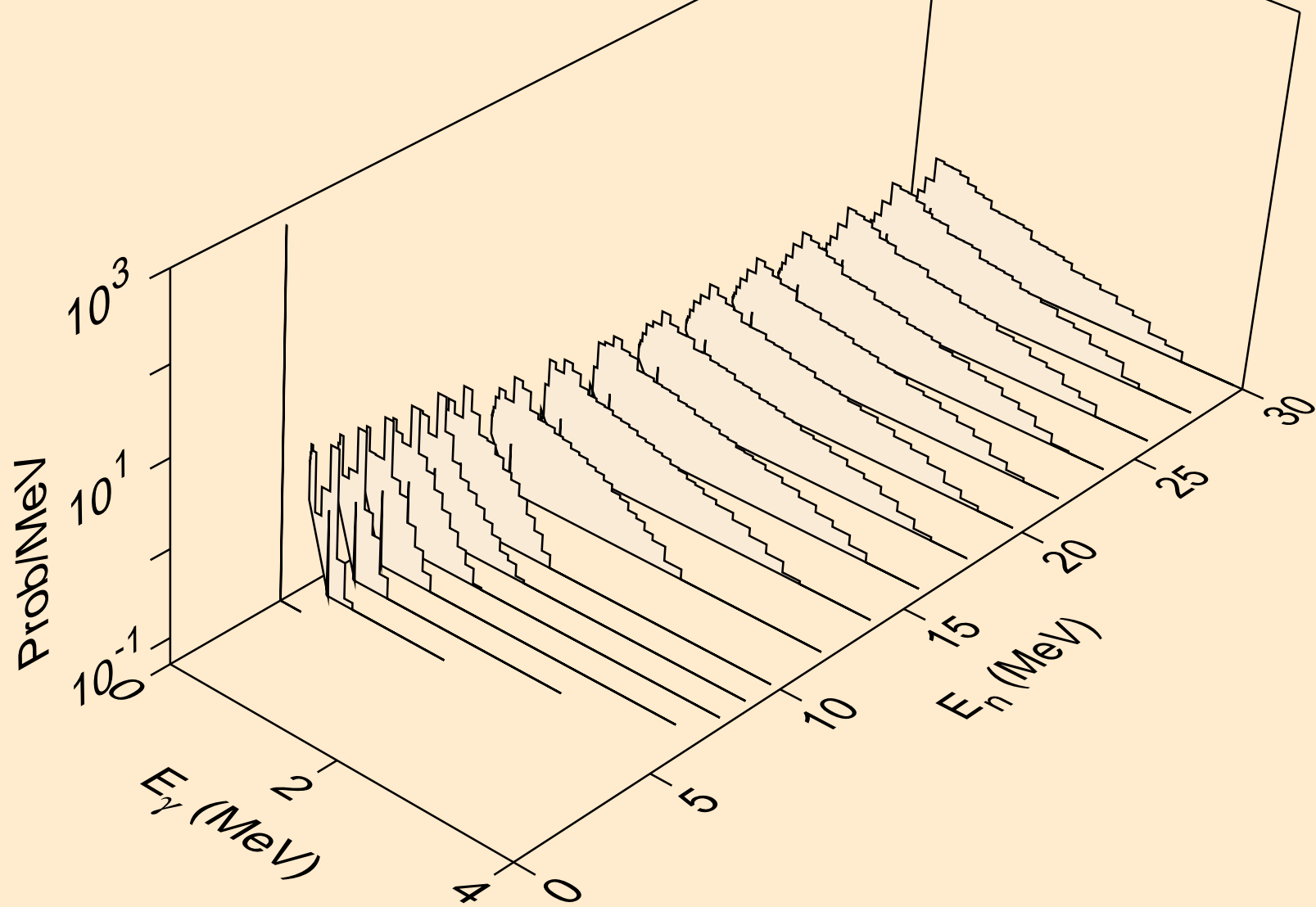

NB106 TRITON ACER TENDL-2021 LIBRARY; T=0.K  
Photon emission for (n,n\*)d

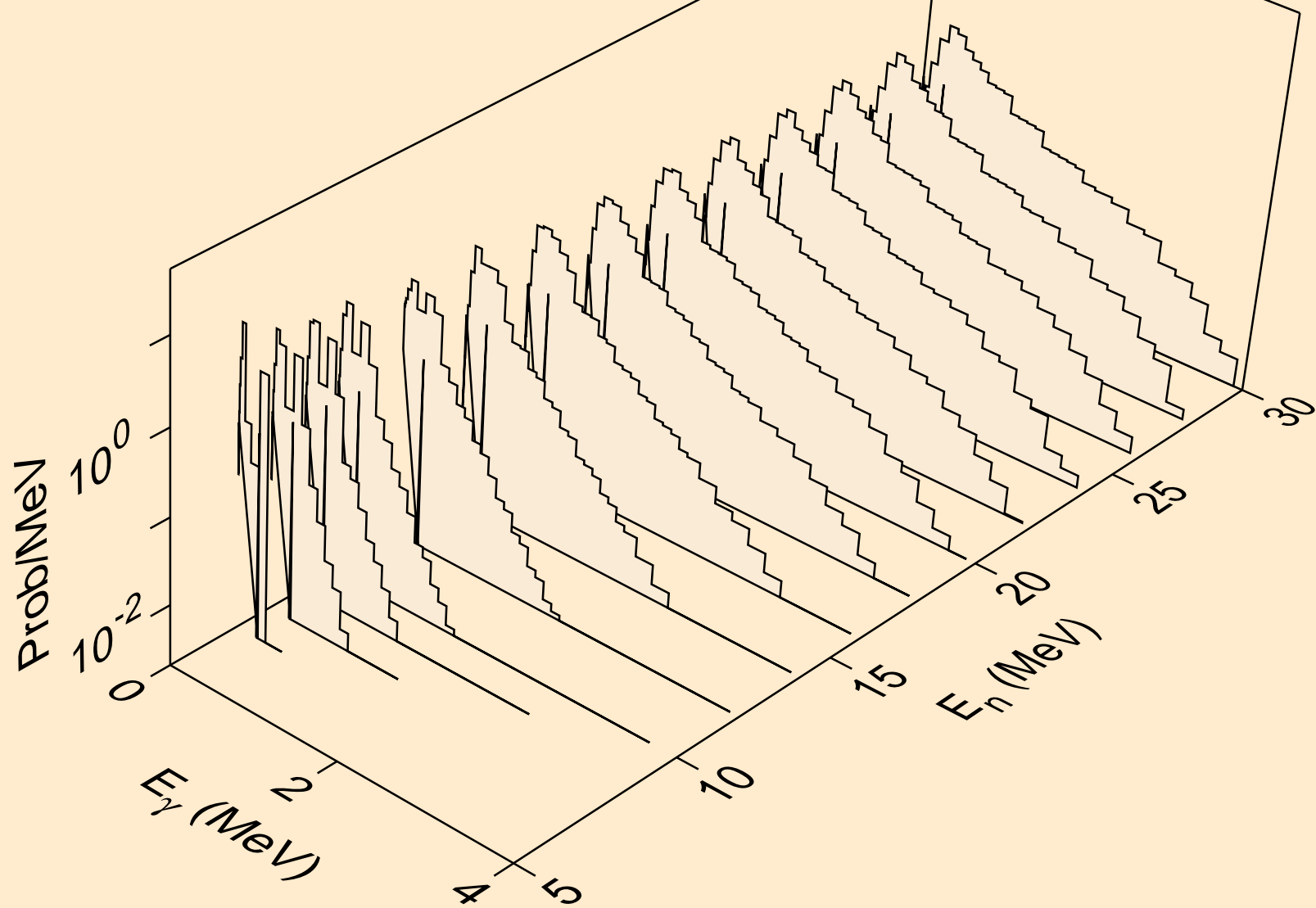

NB106 TRITON ACER TENDL-2021 LIBRARY; T=0.K  
Photon emission for (n,n\*)t

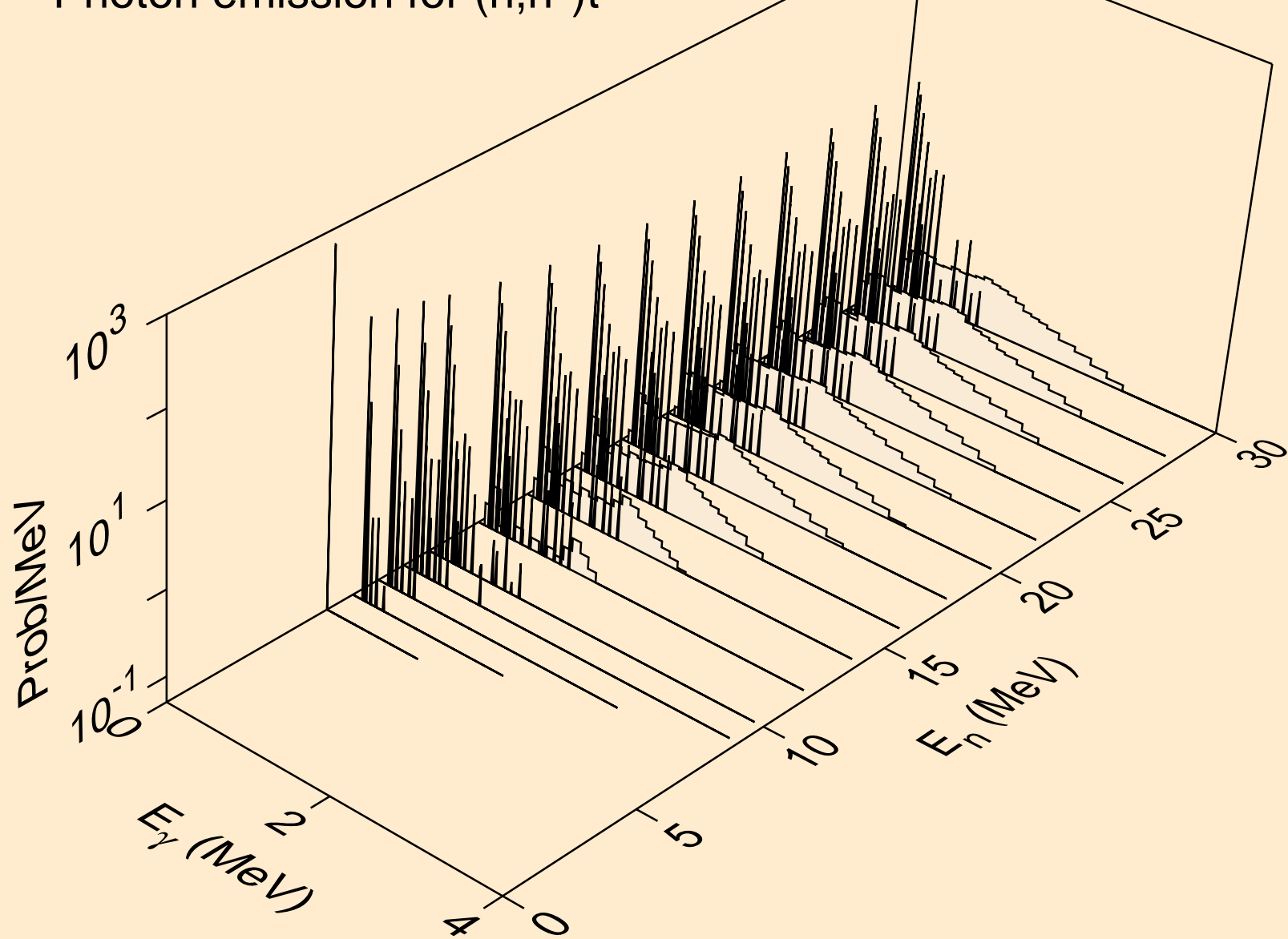

NB106 TRITON ACER TENDL-2021 LIBRARY; T=0.K  
Photon emission for (n,n\*)he3

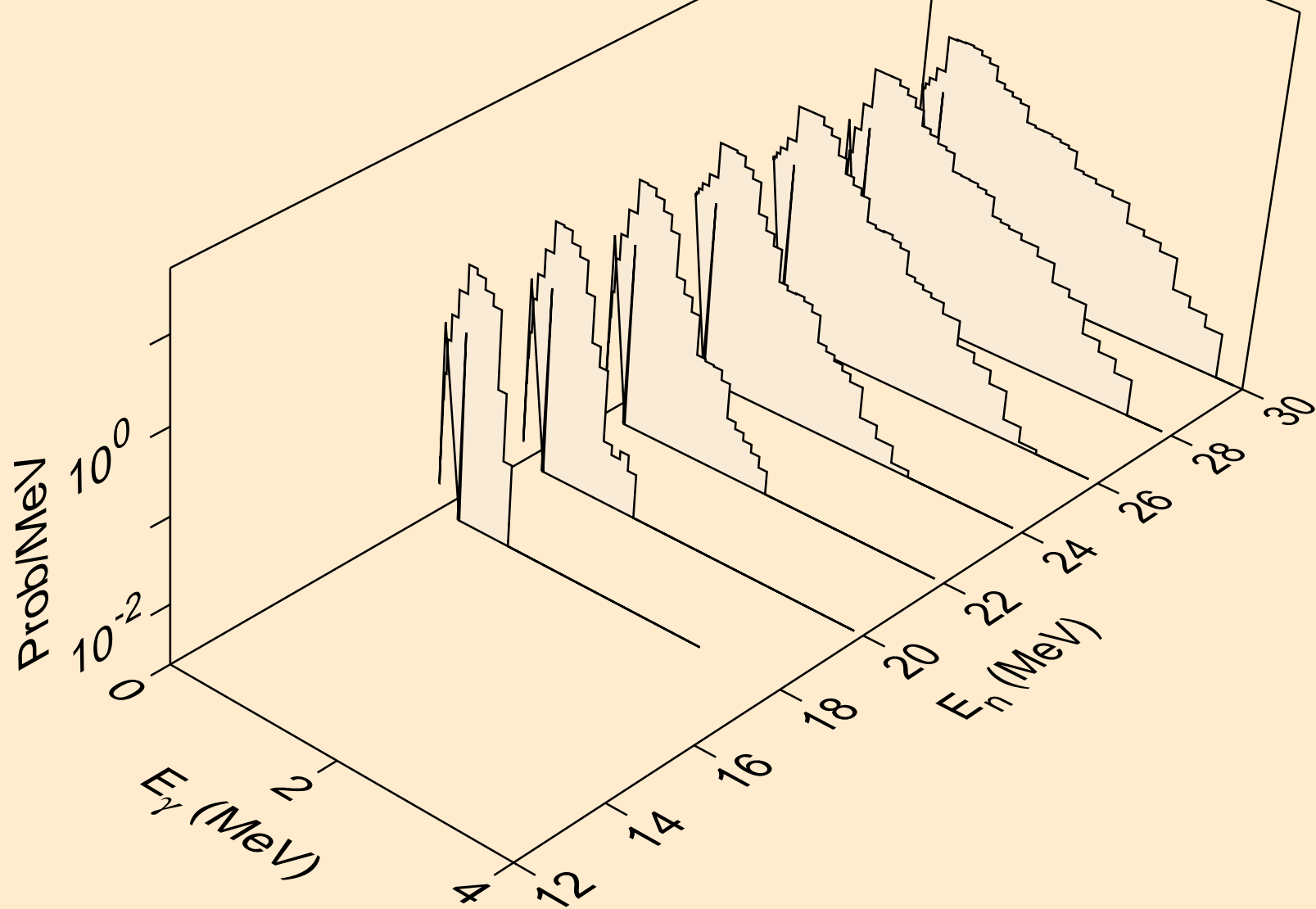

NB106 TRITON ACER TENDL-2021 LIBRARY; T=0.K  
Photon emission for (n,4n)

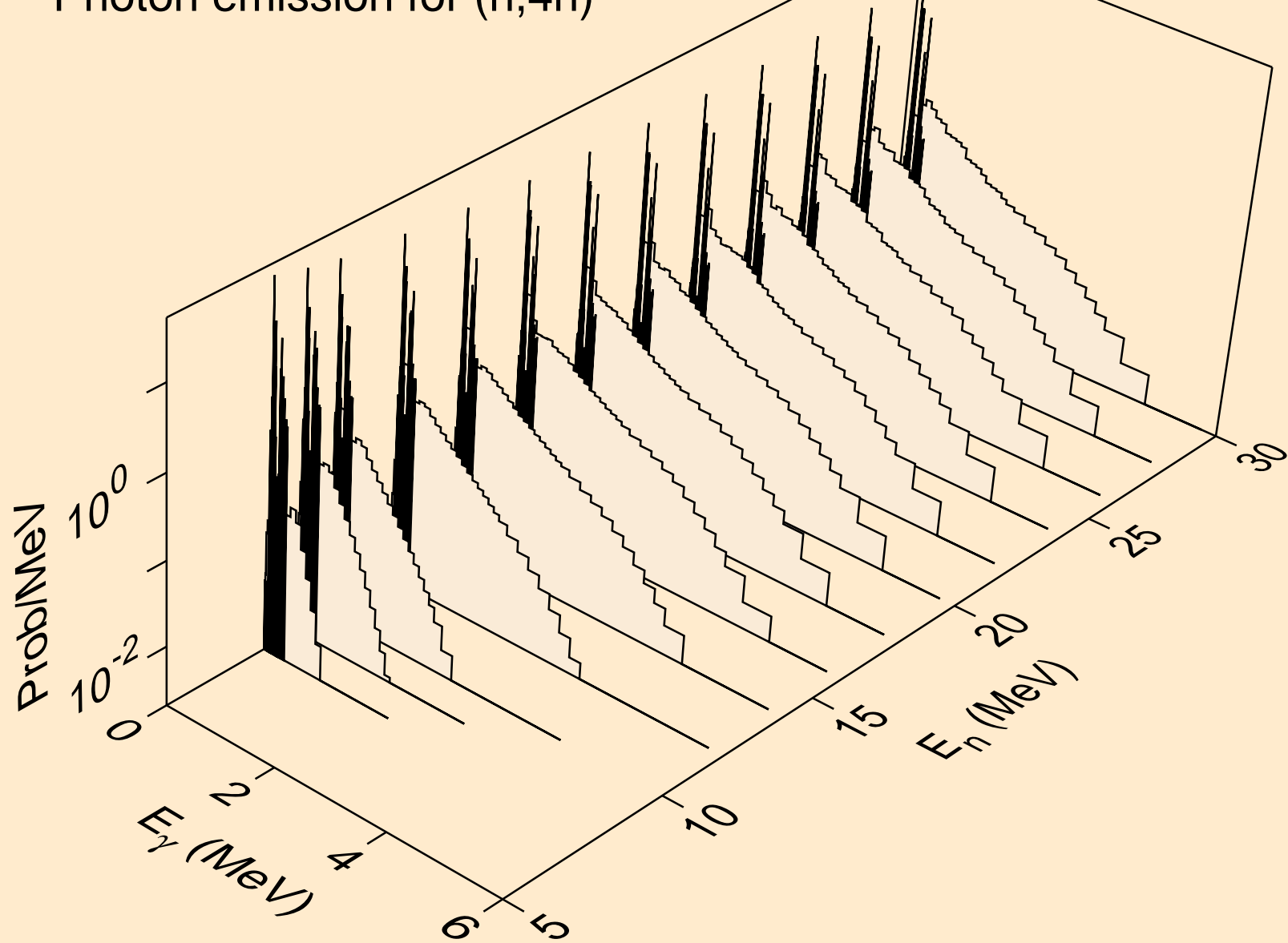

NB106 TRITON ACER TENDL-2021 LIBRARY; T=0.K  
Photon emission for (n,2np)

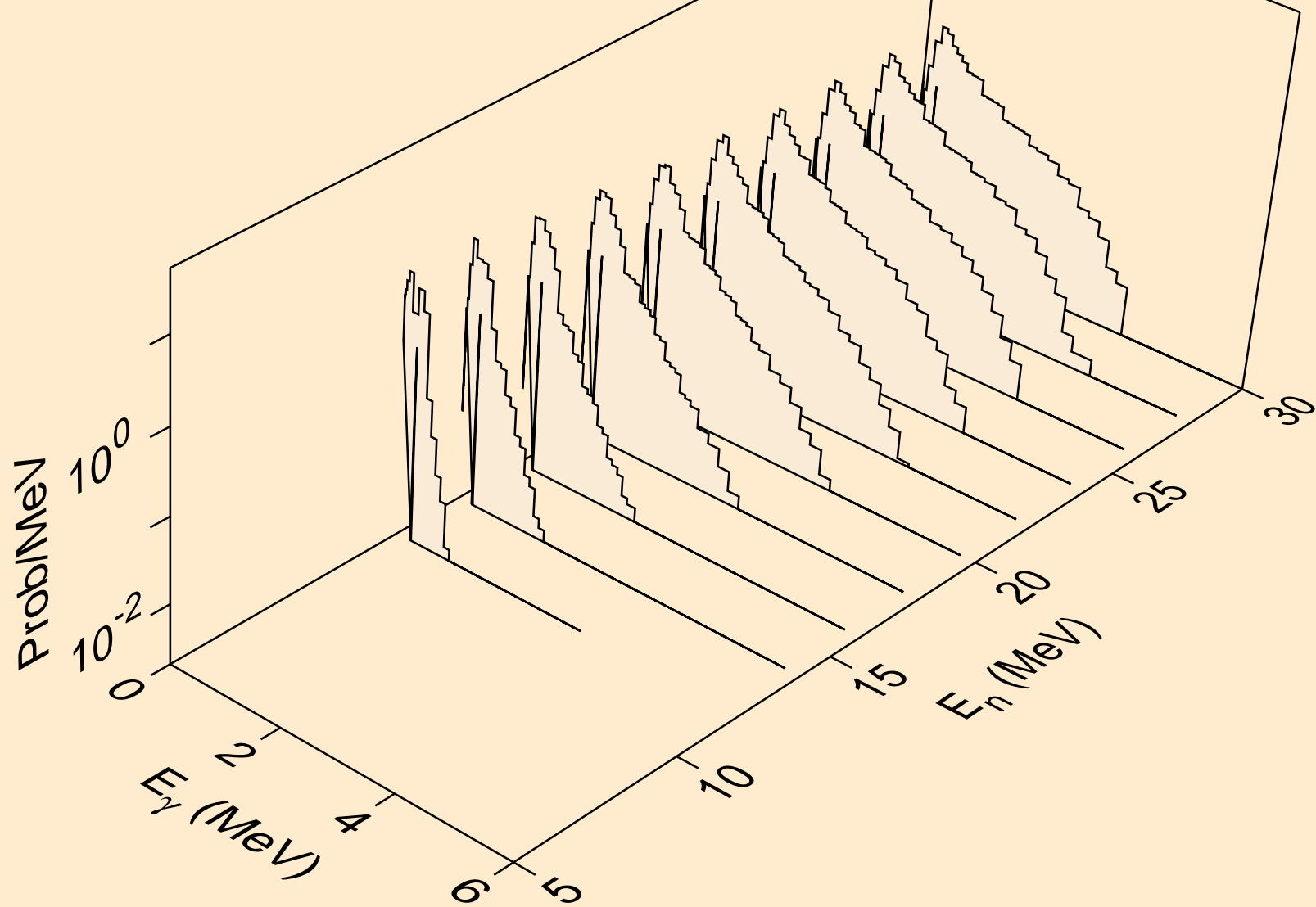

NB106 TRITON ACER TENDL-2021 LIBRARY; T=0.K  
Photon emission for (n,3np)

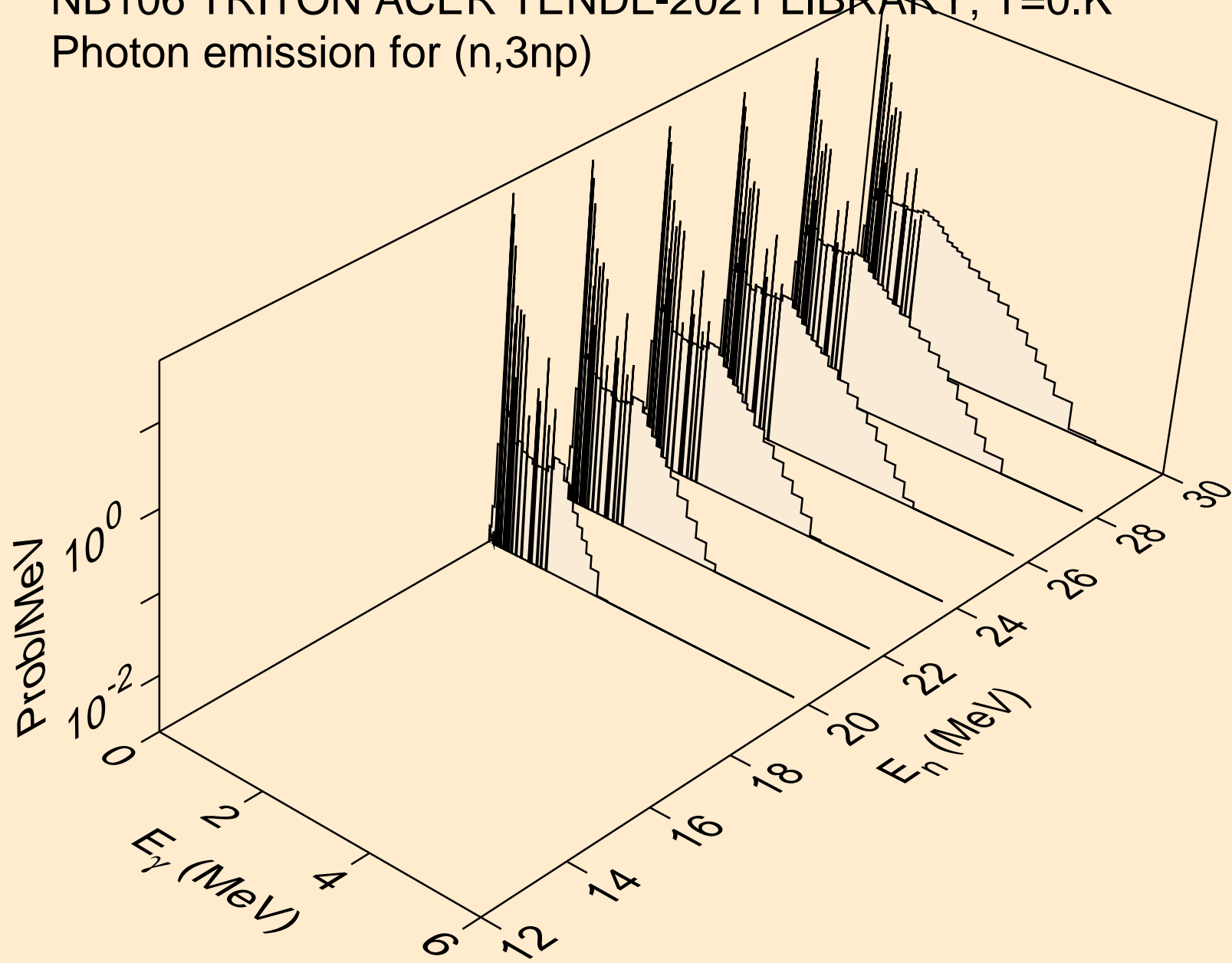

NB106 TRITON ACER TENDL-2021 LIBRARY; T=0.K  
Photon emission for (n,2np)

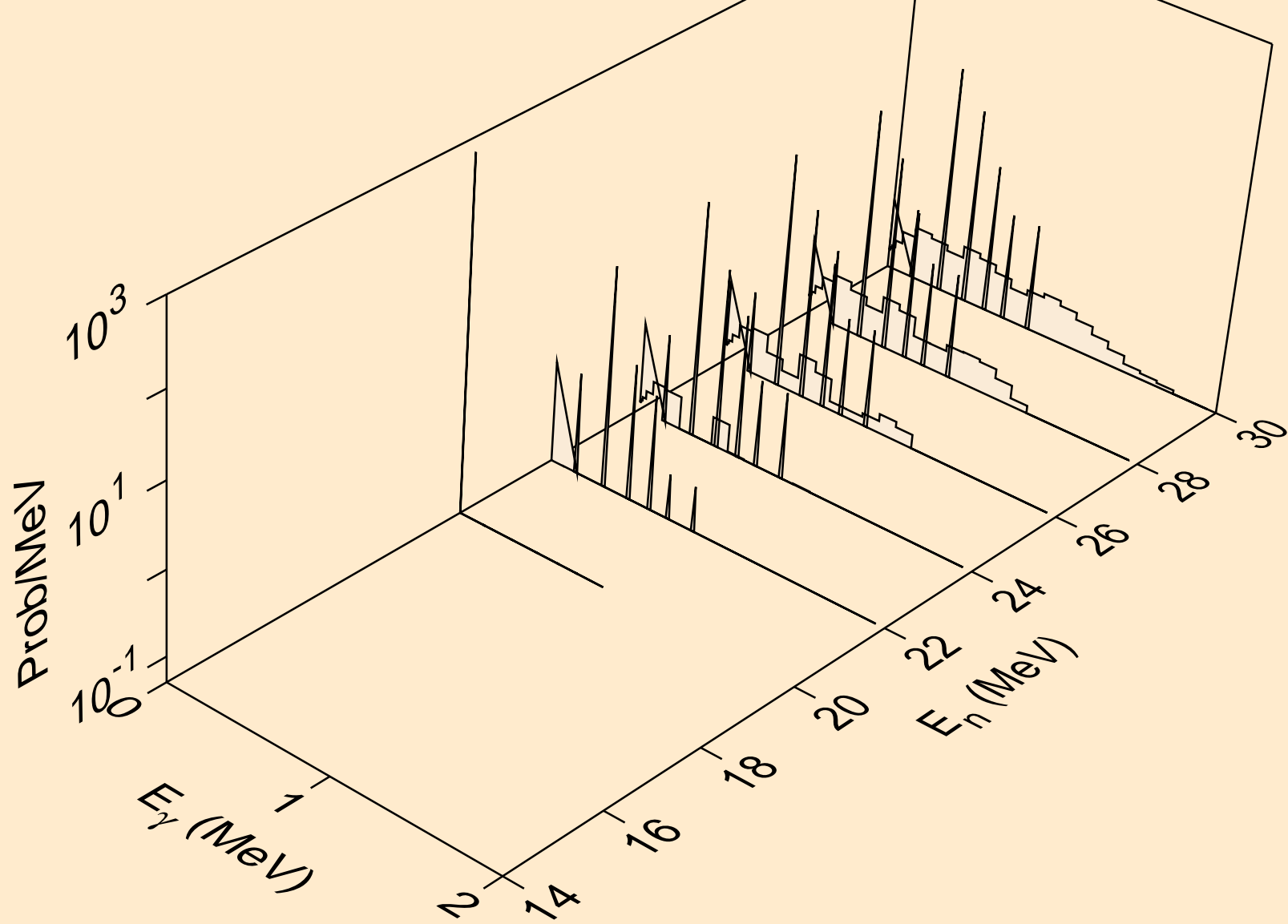



NB106 TRITON ACER TENDL-2021 LIBRARY; T=0.K  
Photon emission for (n,gma)

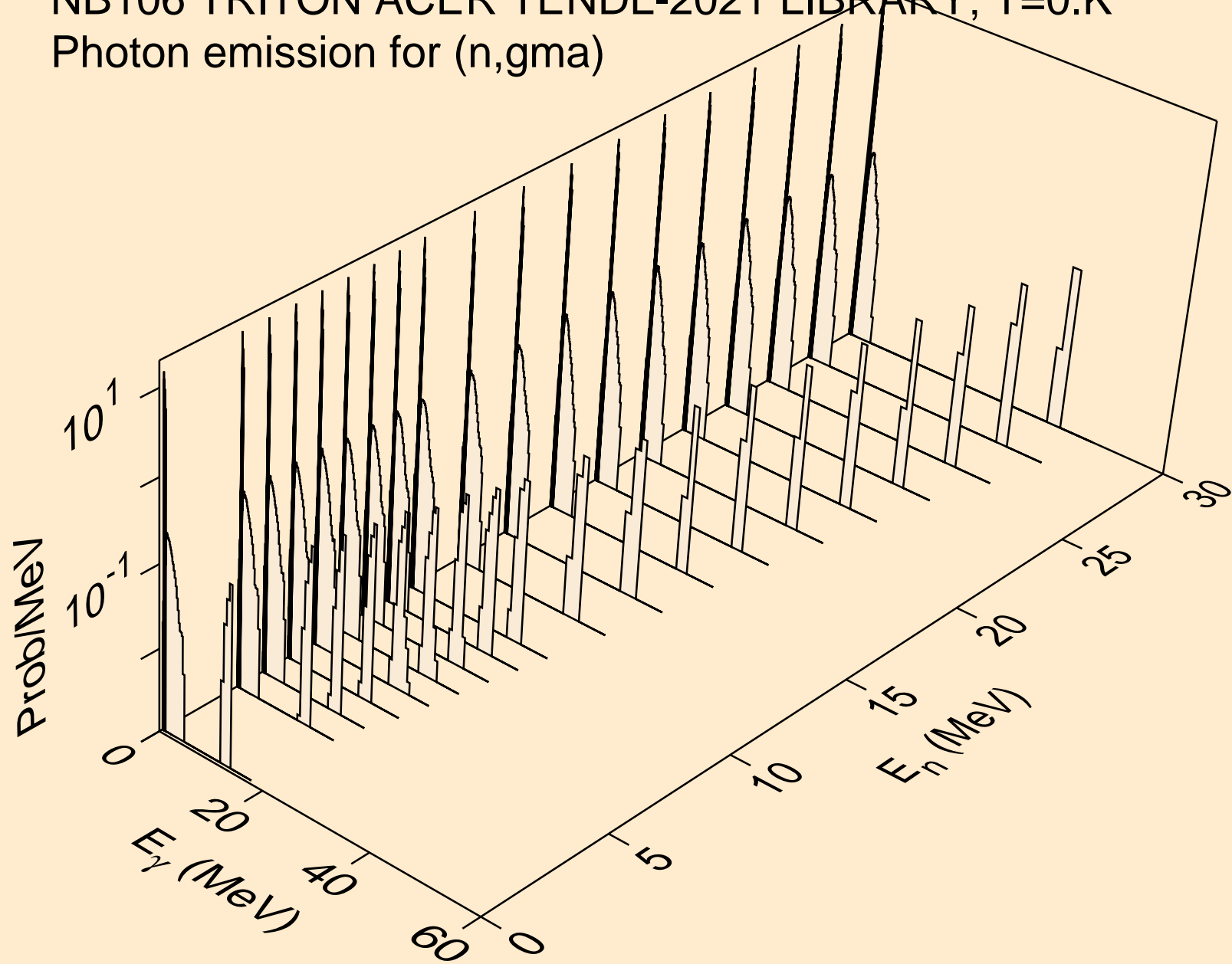

NB106 TRITON ACER TENDL-2021 LIBRARY; T=0.K  
Photon emission for (n,p)

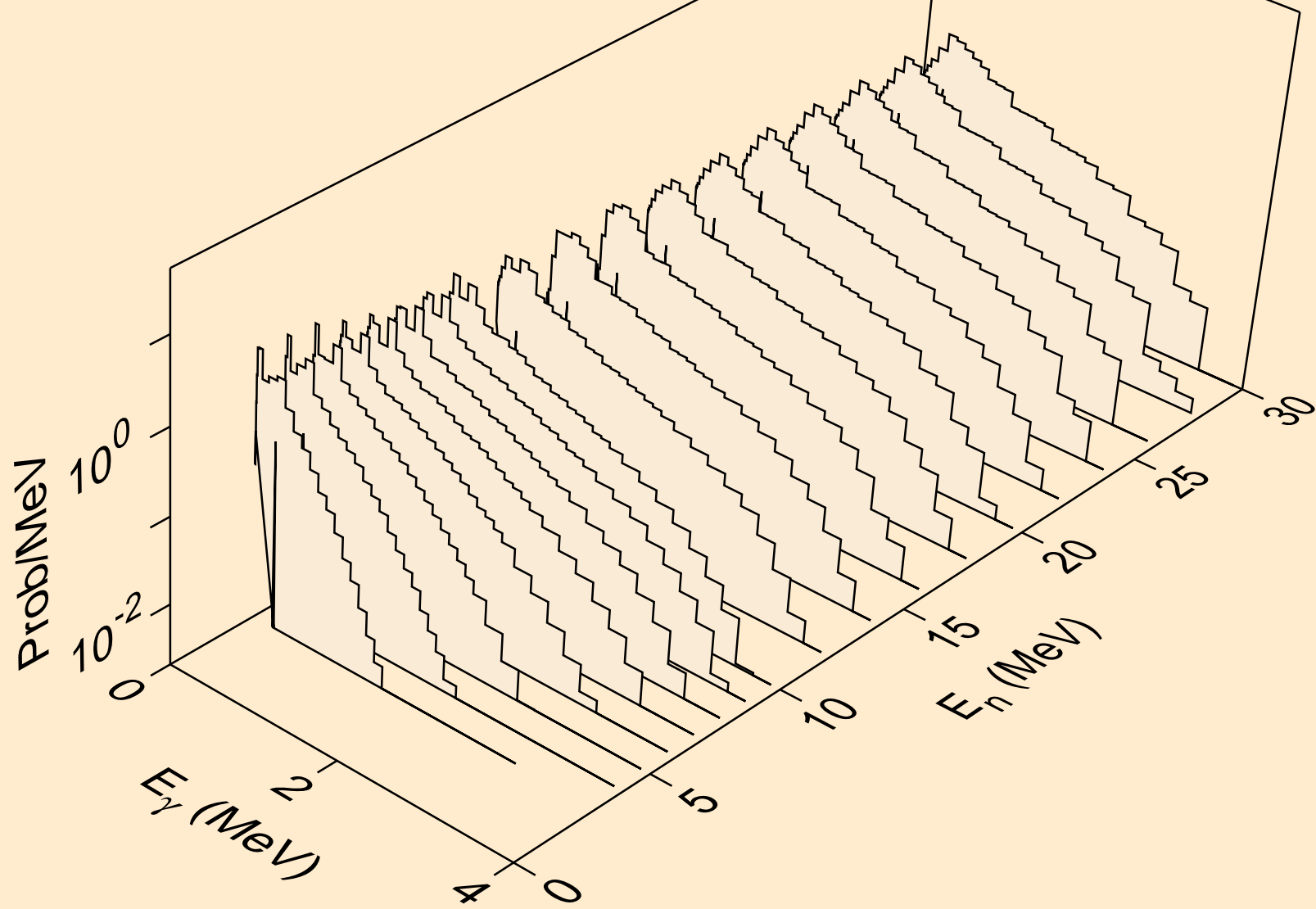

NB106 TRITON ACER TENDL-2021 LIBRARY; T=0.K  
Photon emission for (n,d)

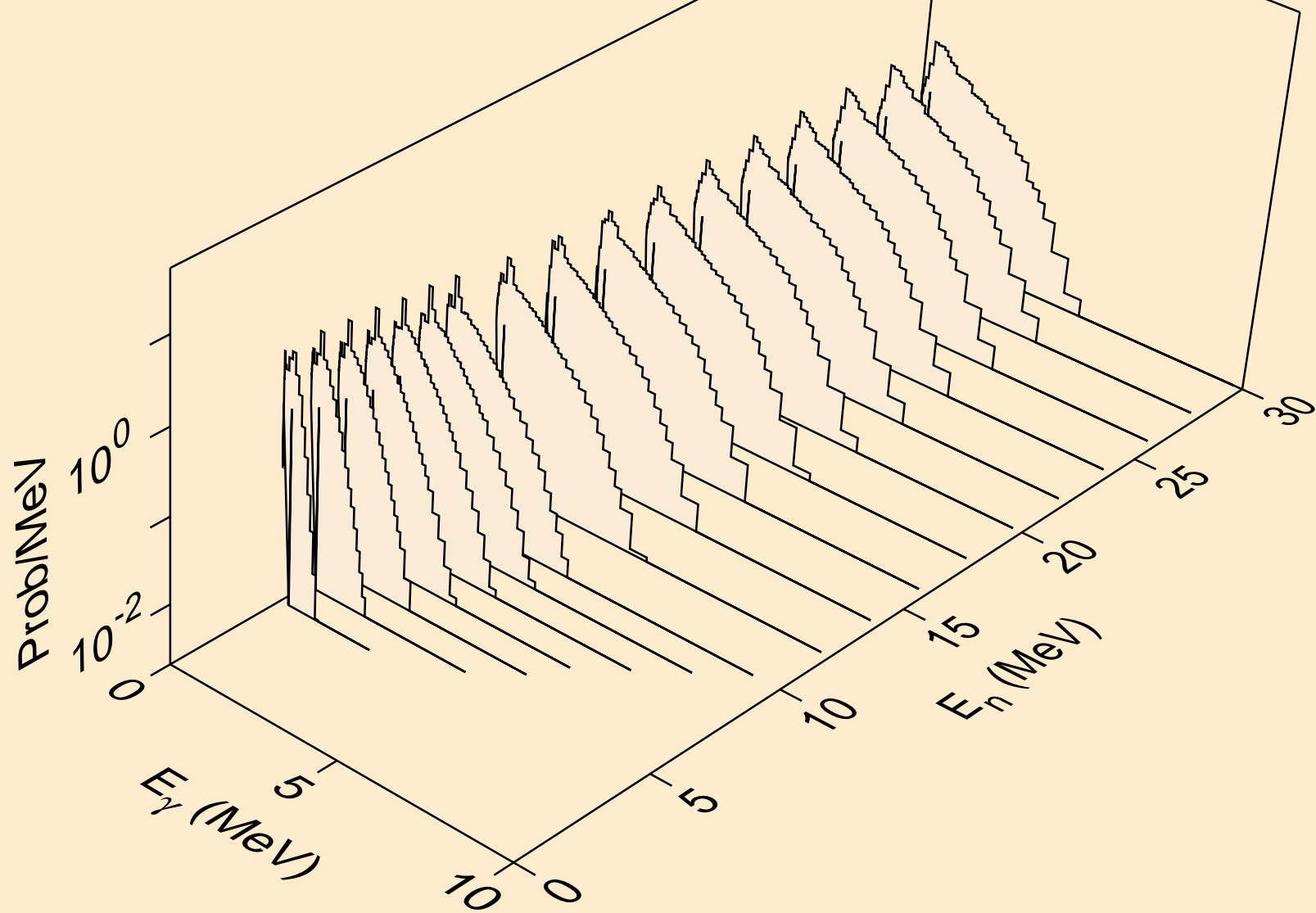

NB106 TRITON ACER TENDL-2021 LIBRARY; T=0.K  
Photon emission for inelastic

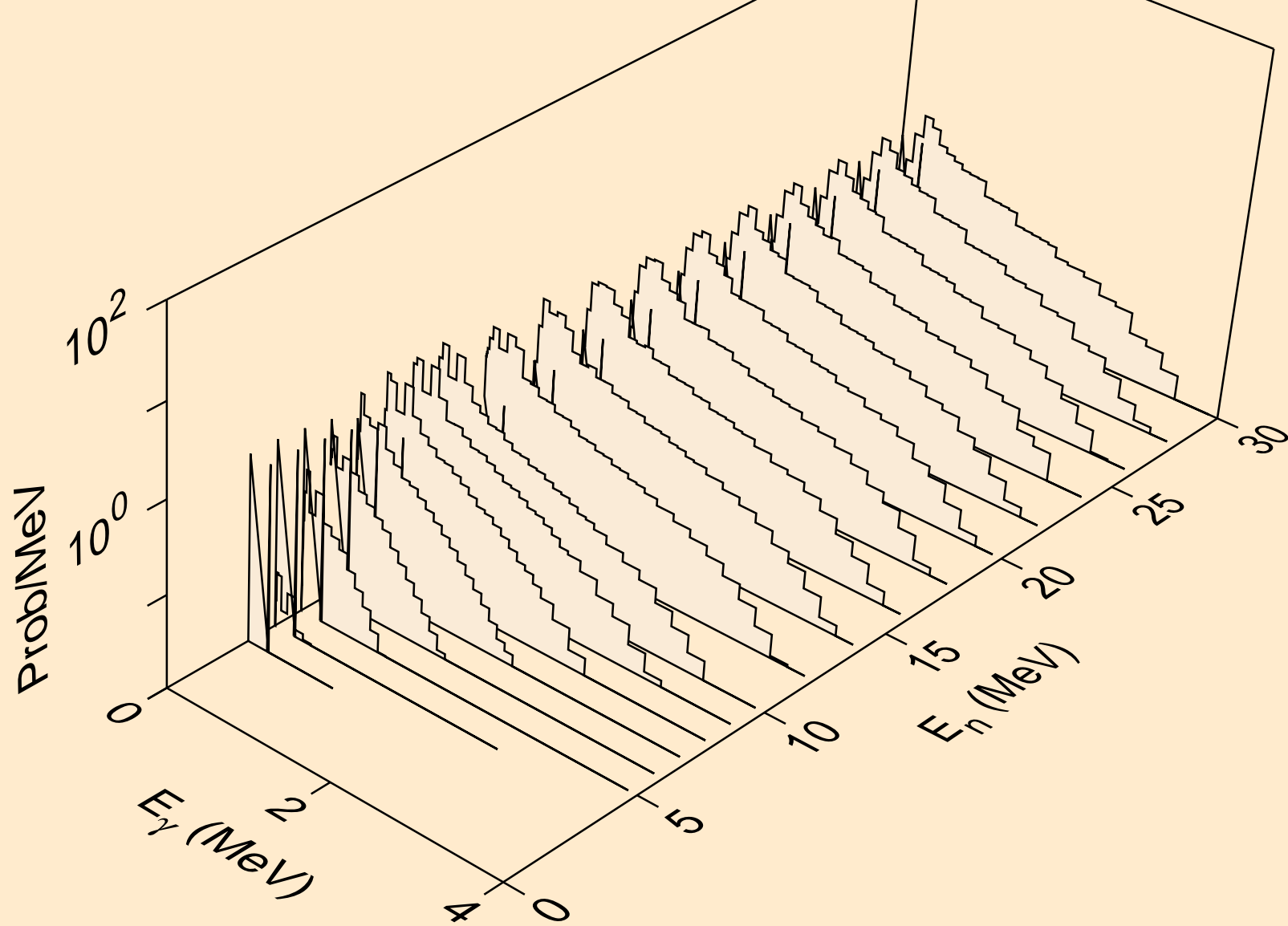

NB106 TRITON ACER TENDL-2021 LIBRARY; T=0.K  
Photon emission for (n,he3)

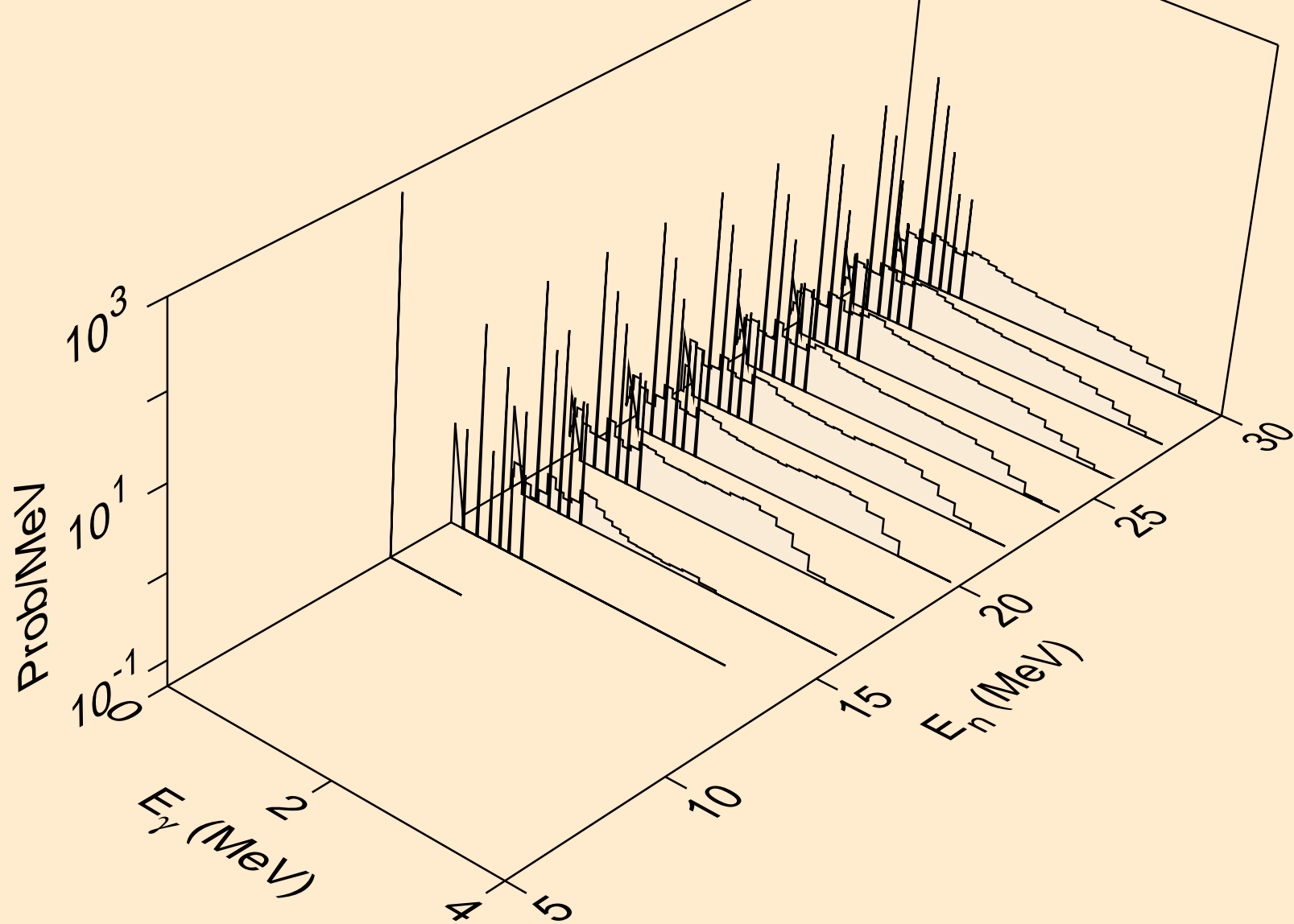

NB106 TRITON ACER TENDL-2021 LIBRARY; T=0.K  
Photon emission for (n,a)

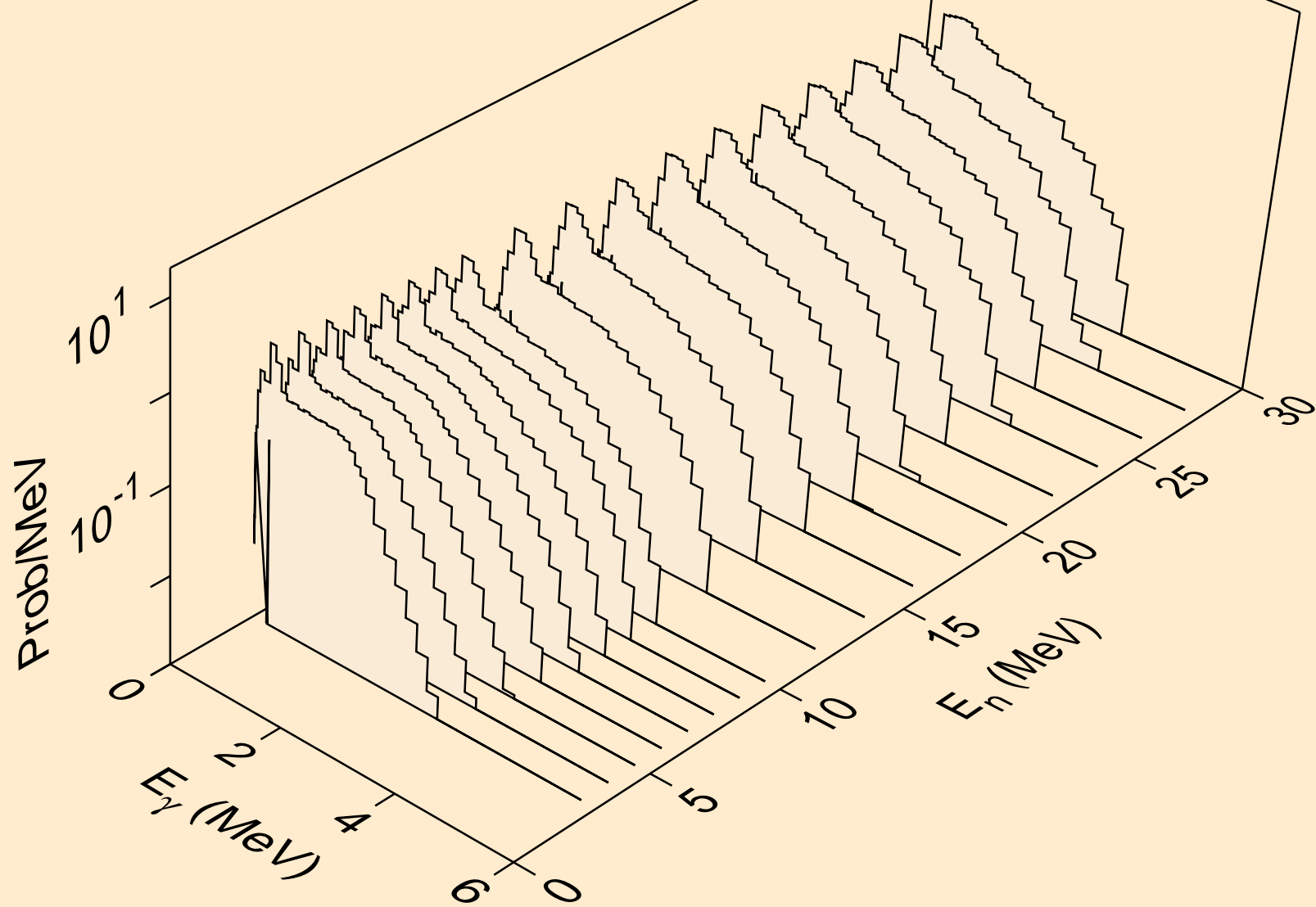

NB106 TRITON ACER TENDL-2021 LIBRARY; T=0.K  
Photon emission for (n,2p)

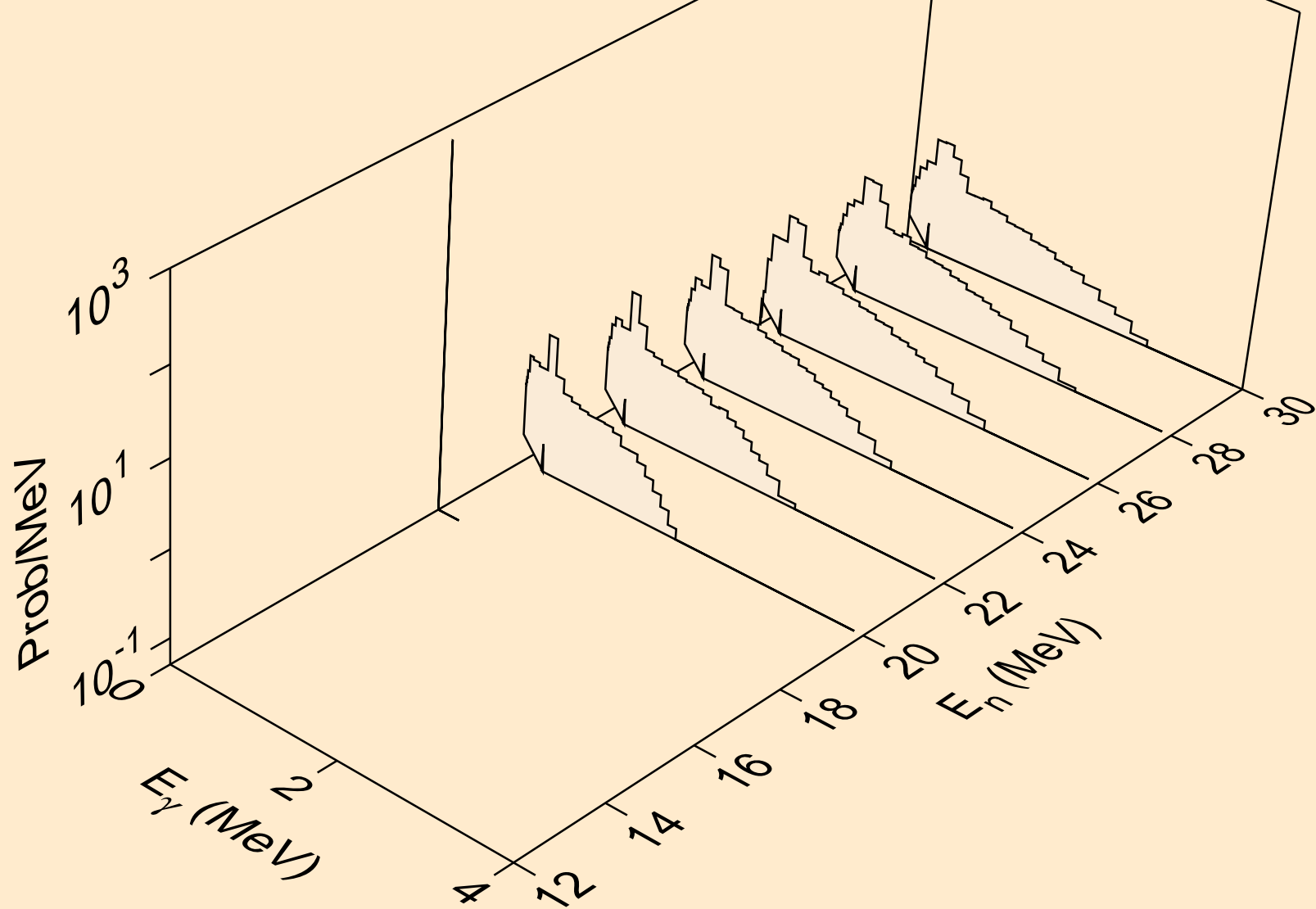

NB106 TRITON ACER TENDL-2021 LIBRARY; T=0.K  
Photon emission for (n,pd)

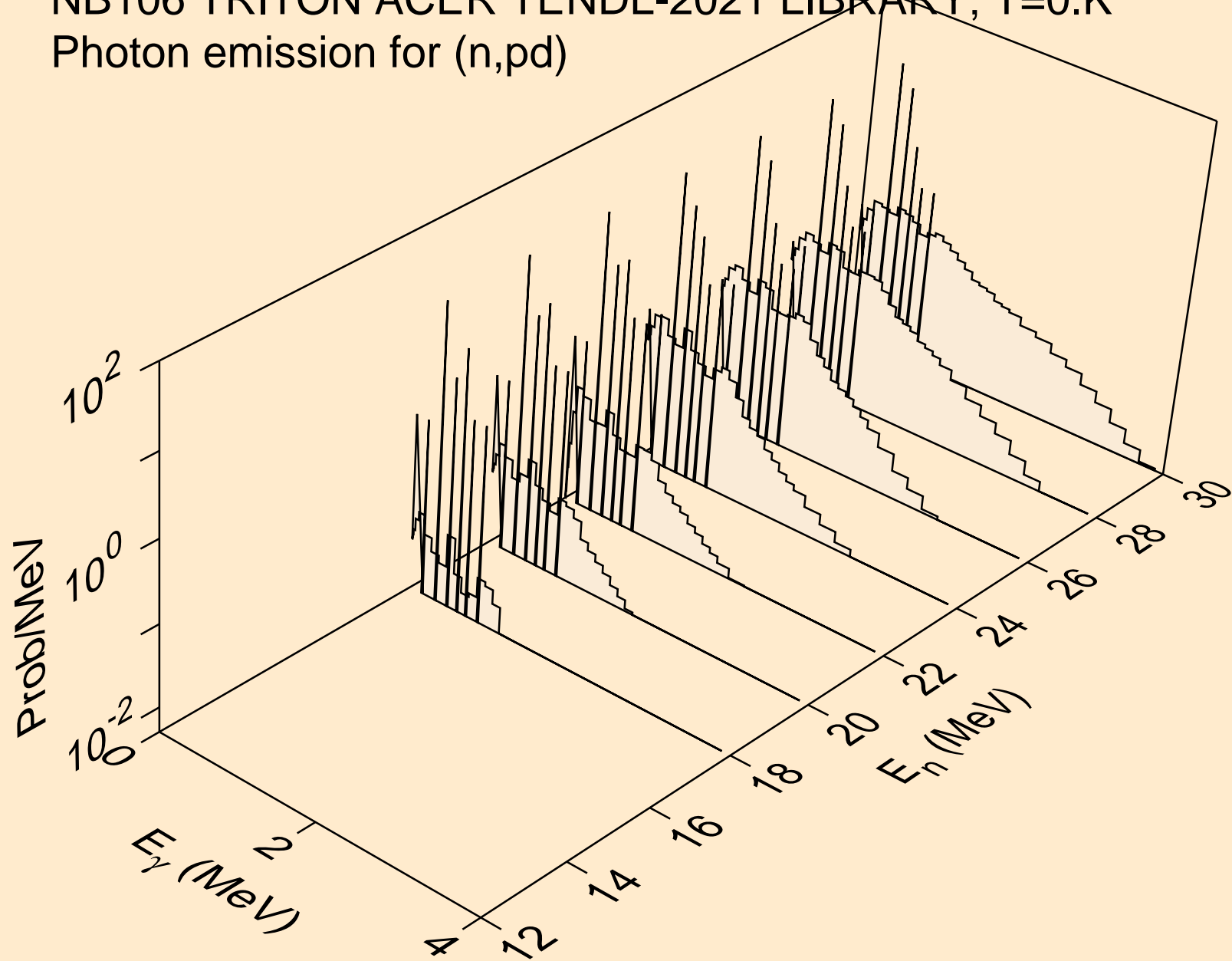



NB106 TRITON ACER TENDL-2021 LIBRARY; T=0.K  
Particle heating contributions

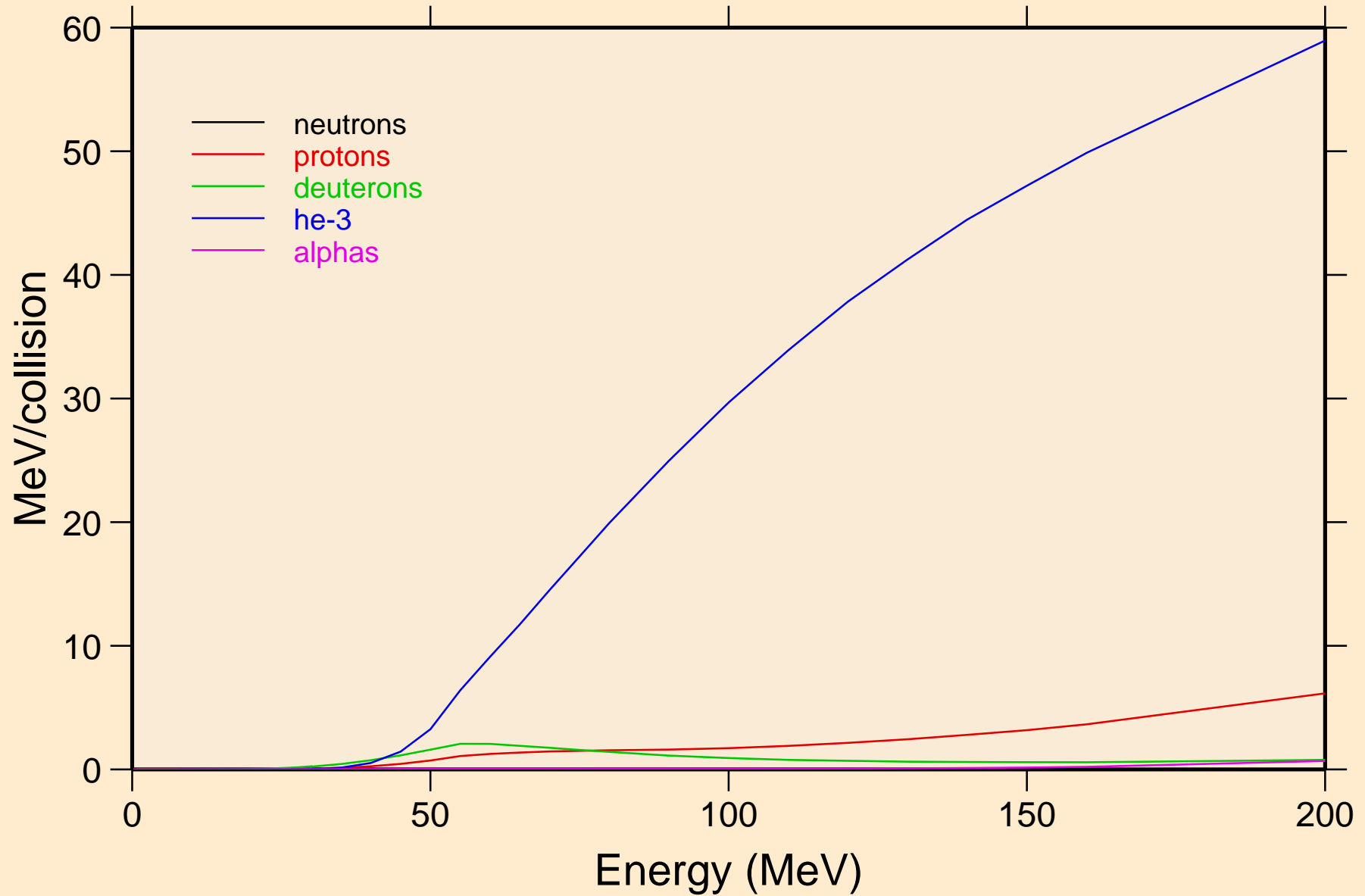

NB106 TRITON ACER TENDL-2021 LIBRARY; T=0.K  
Recoil Heating

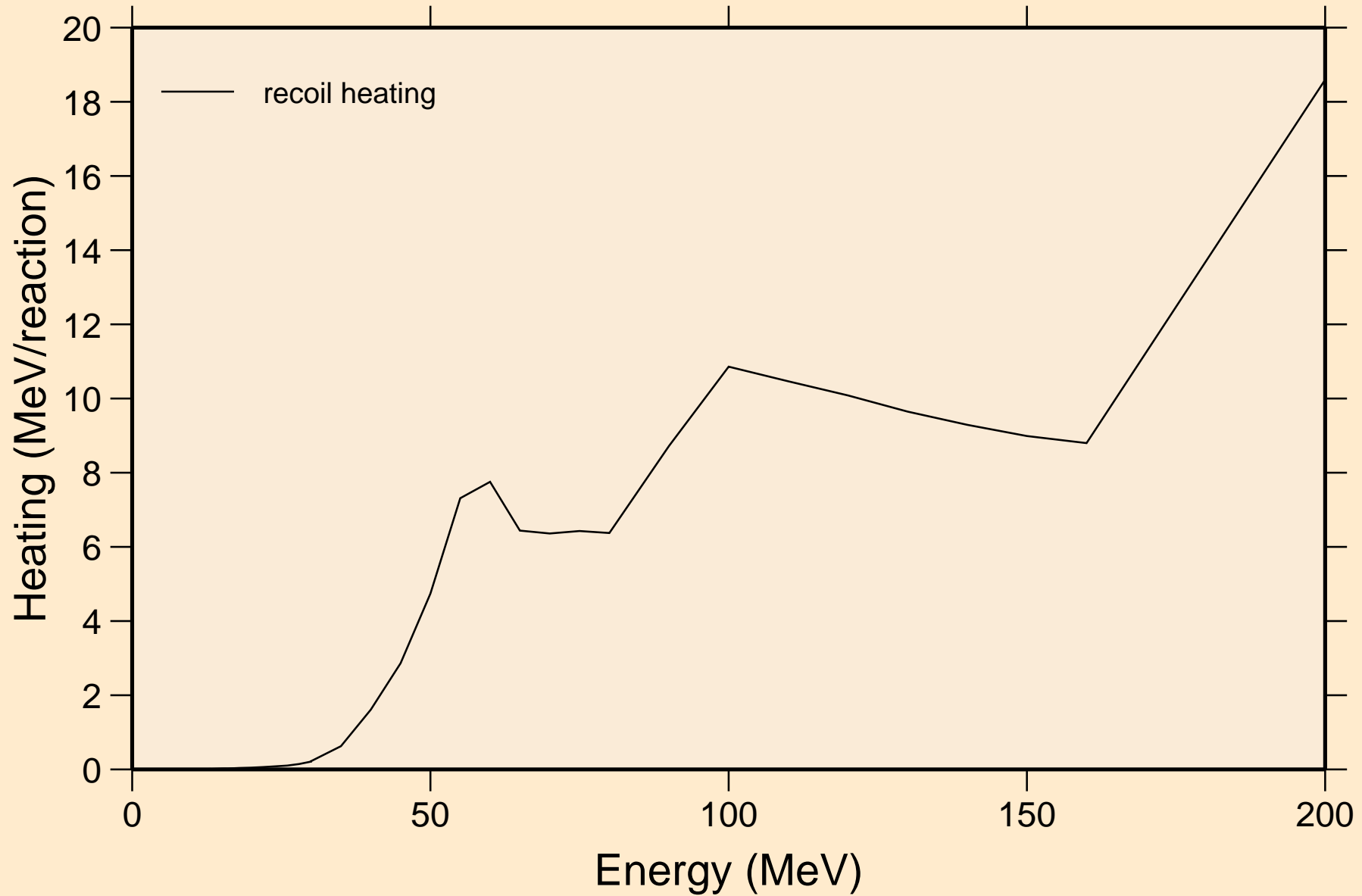

NB106 TRITON ACER TENDL-2021 LIBRARY; T=0.K  
Particle production cross sections

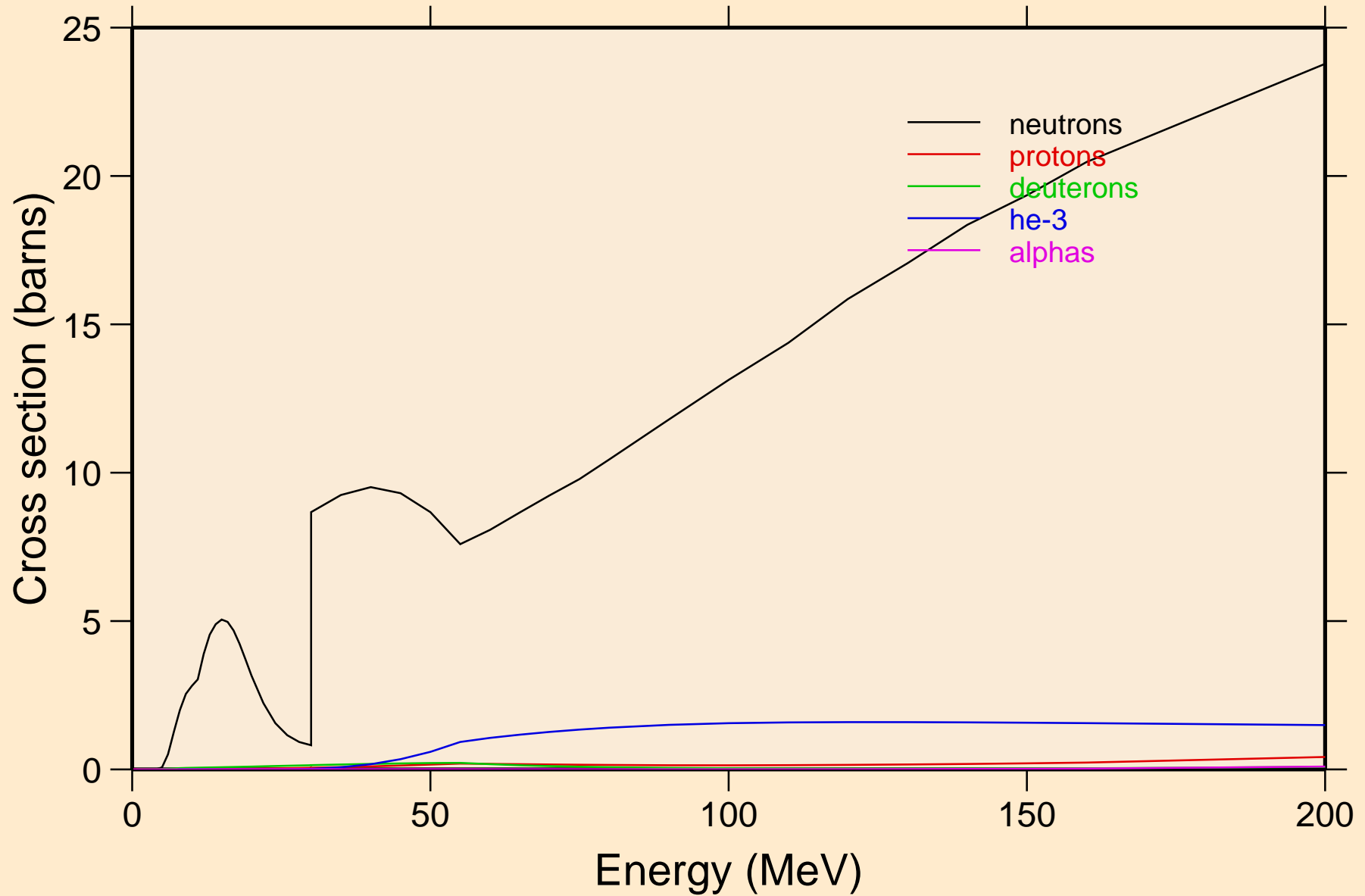

NB106 TRITON ACER TENDL-2021 LIBRARY; T=0.K  
neutrons from (t,n)

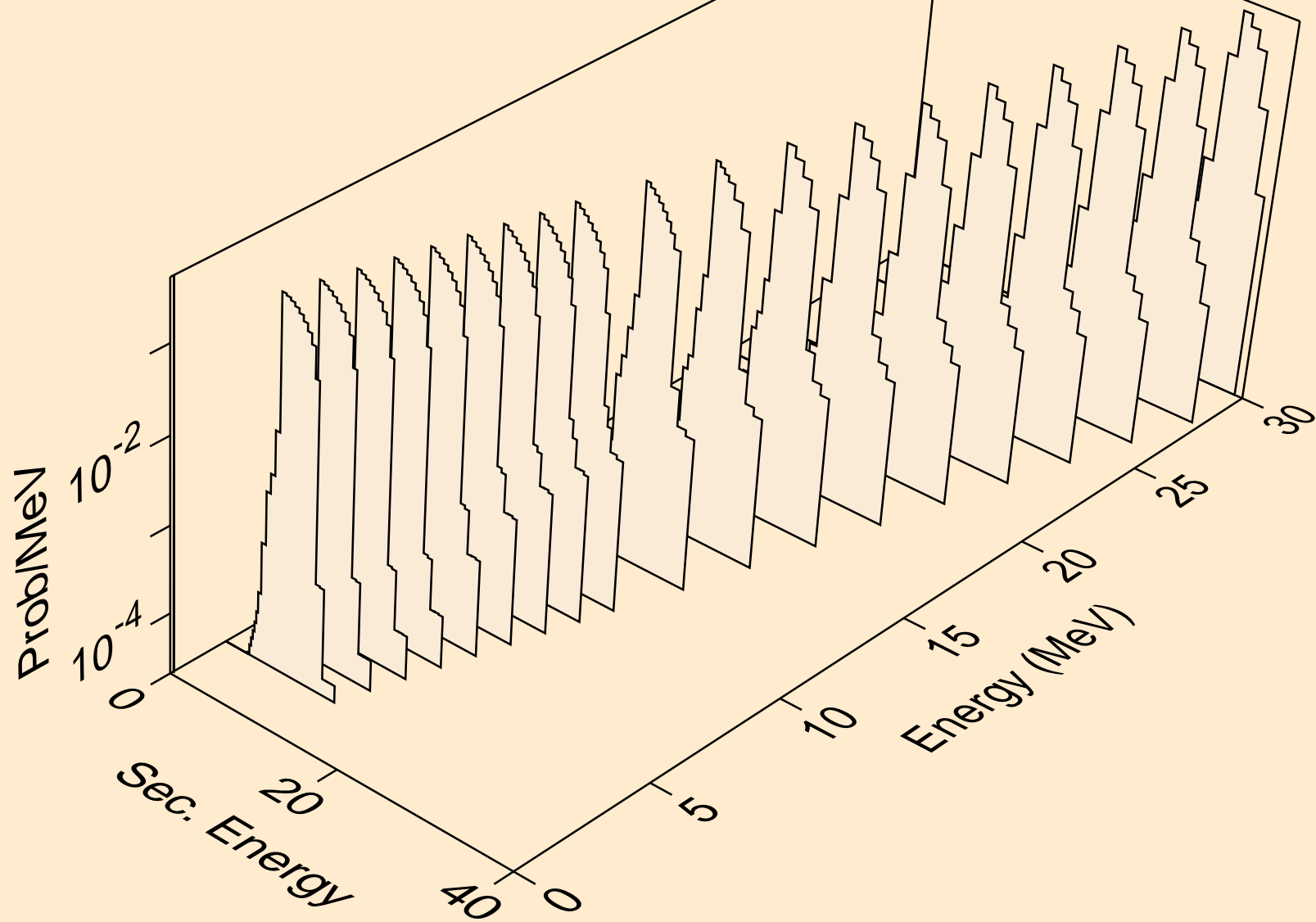

NB106 TRITON ACER TENDL-2021 LIBRARY; T=0.K  
neutrons from (t,x)

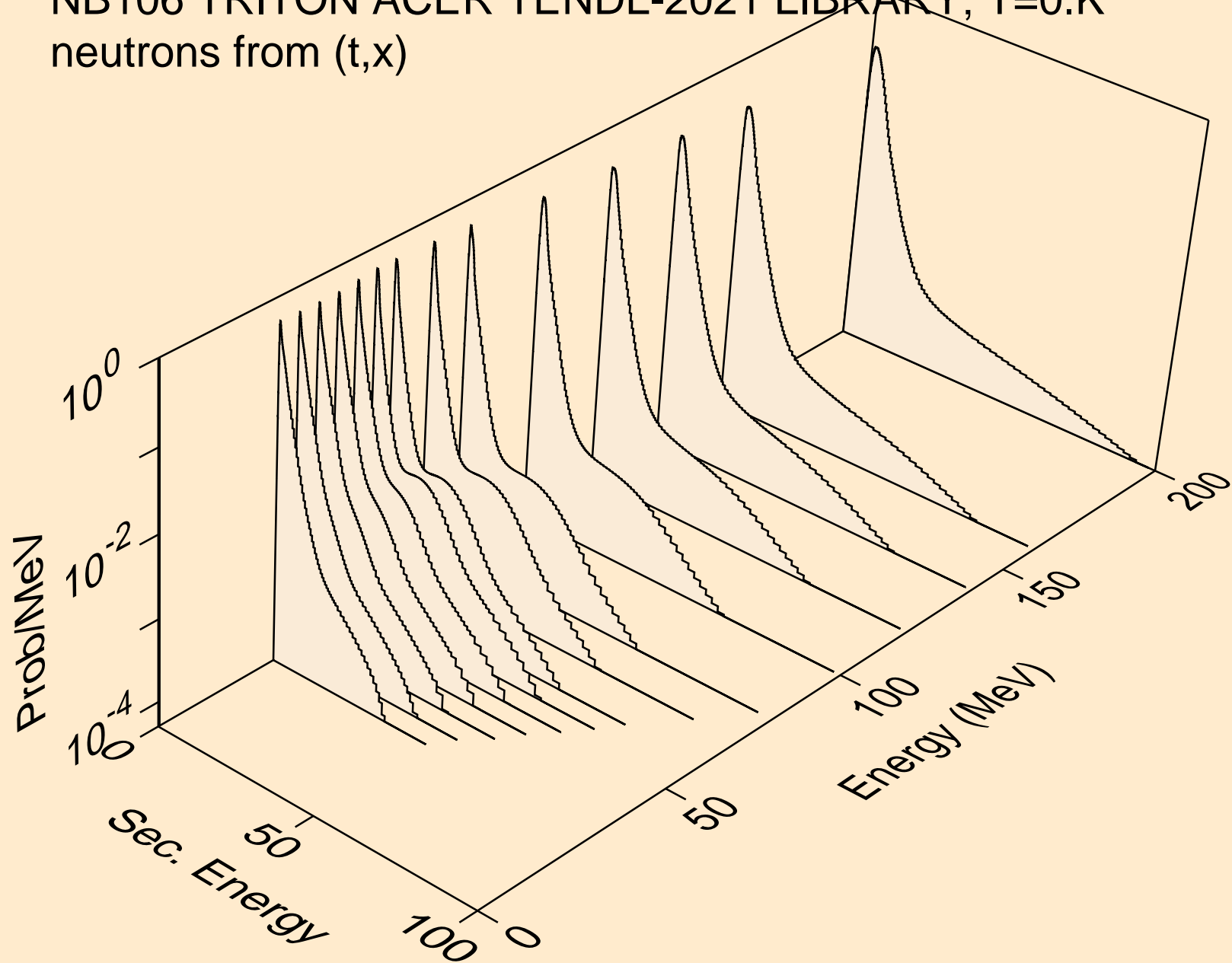

NB106 TRITON ACER TENDL-2021 LIBRARY; T=0.K  
neutrons from (t,2nd)

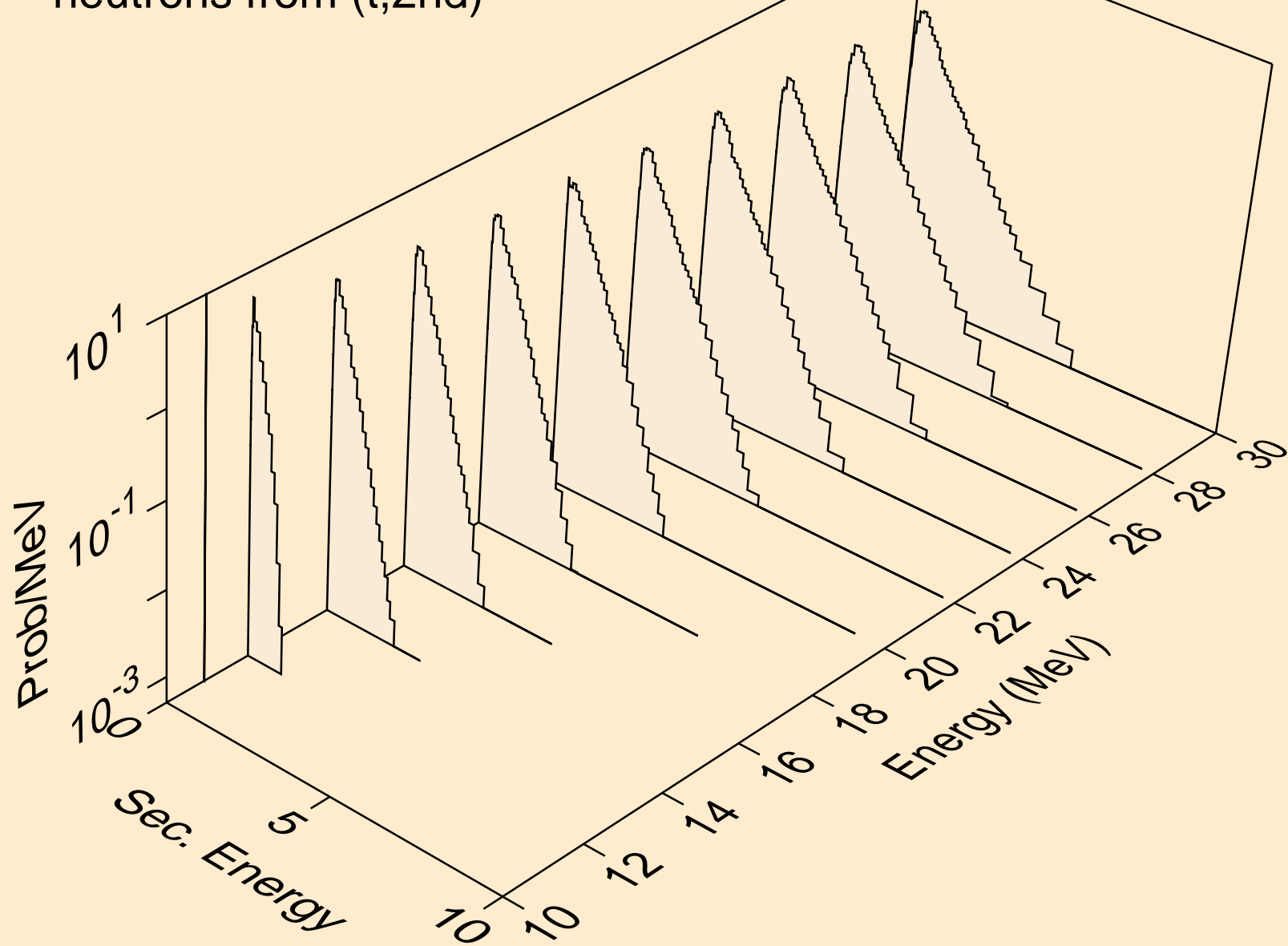

NB106 TRITON ACER TENDL-2021 LIBRARY; T=0.K  
neutrons from (t,2n)

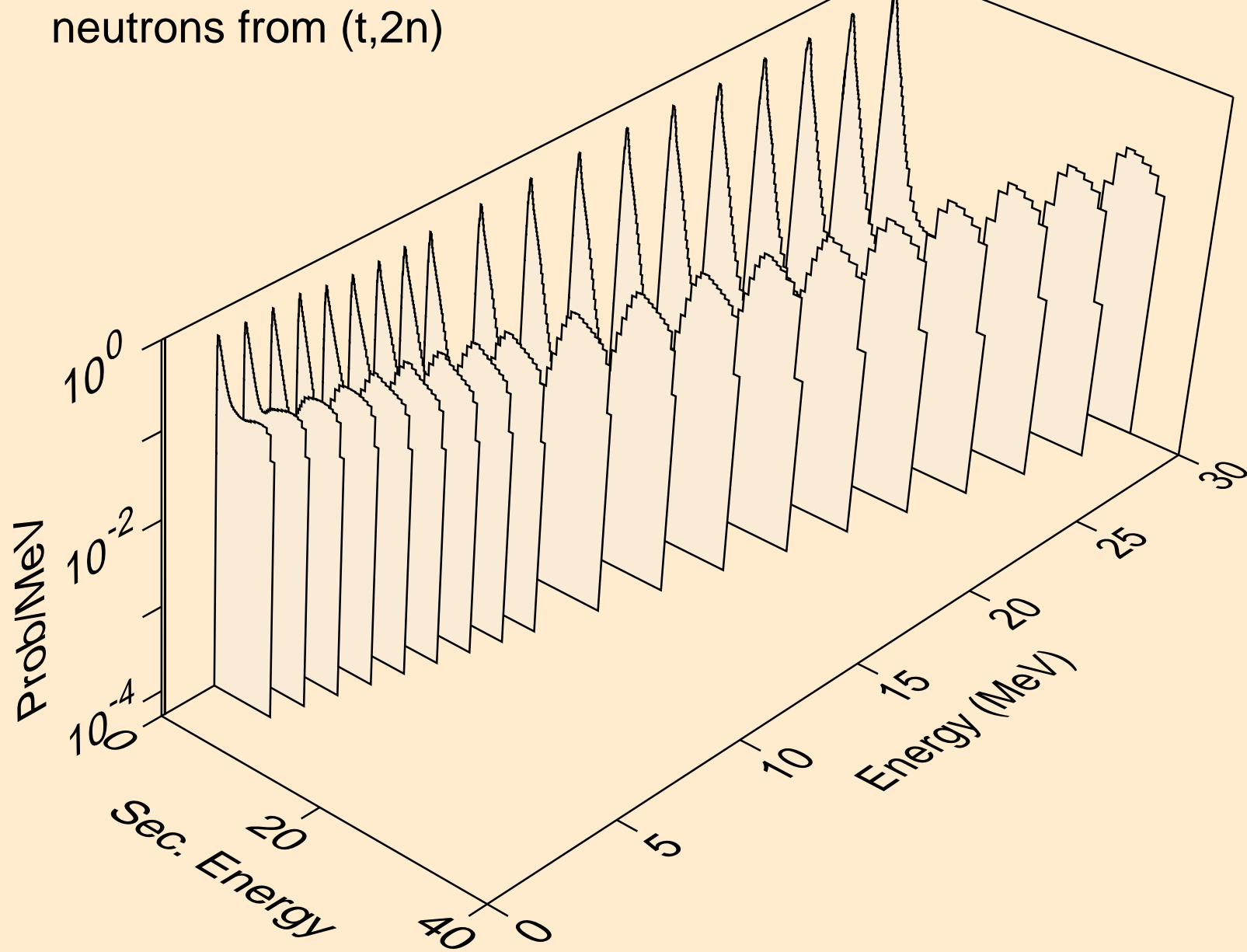

NB106 TRITON ACER TENDL-2021 LIBRARY; T=0.K  
neutrons from (t,3n)

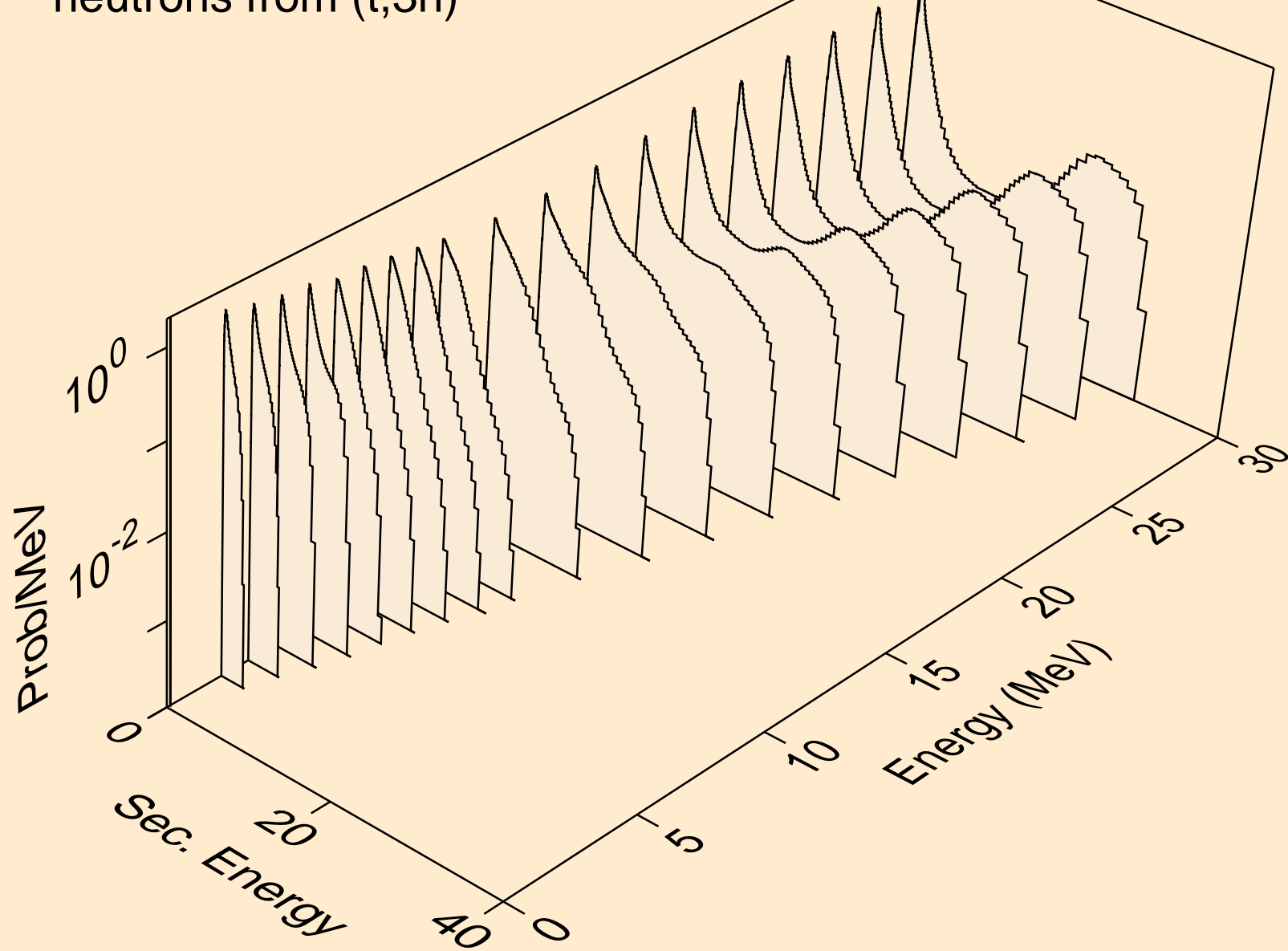



NB106 TRITON ACER TENDL-2021 LIBRARY; T=0.K  
neutrons from (t,n\*)a

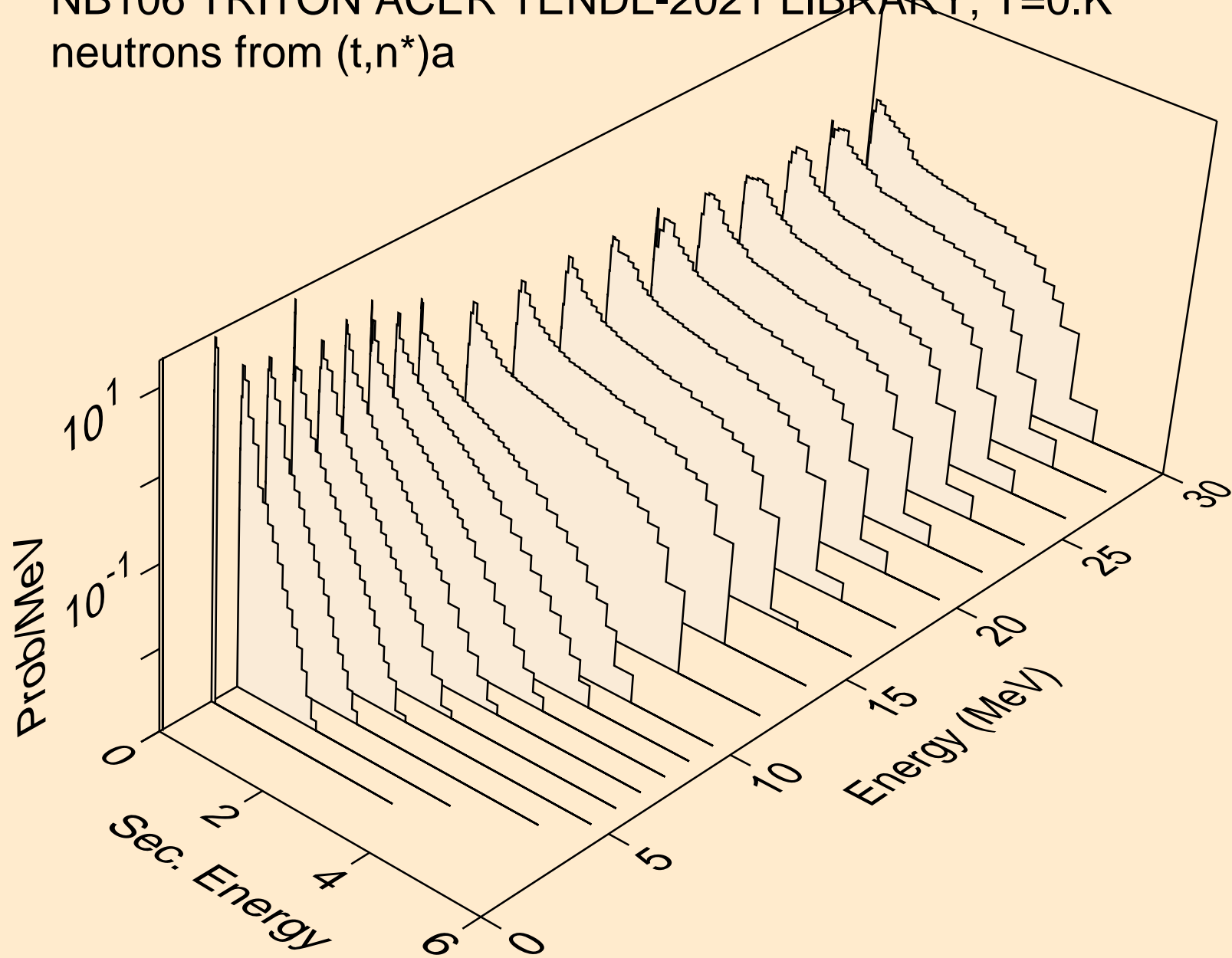

NB106 TRITON ACER TENDL-2021 LIBRARY; T=0.K  
neutrons from (t,2n)a

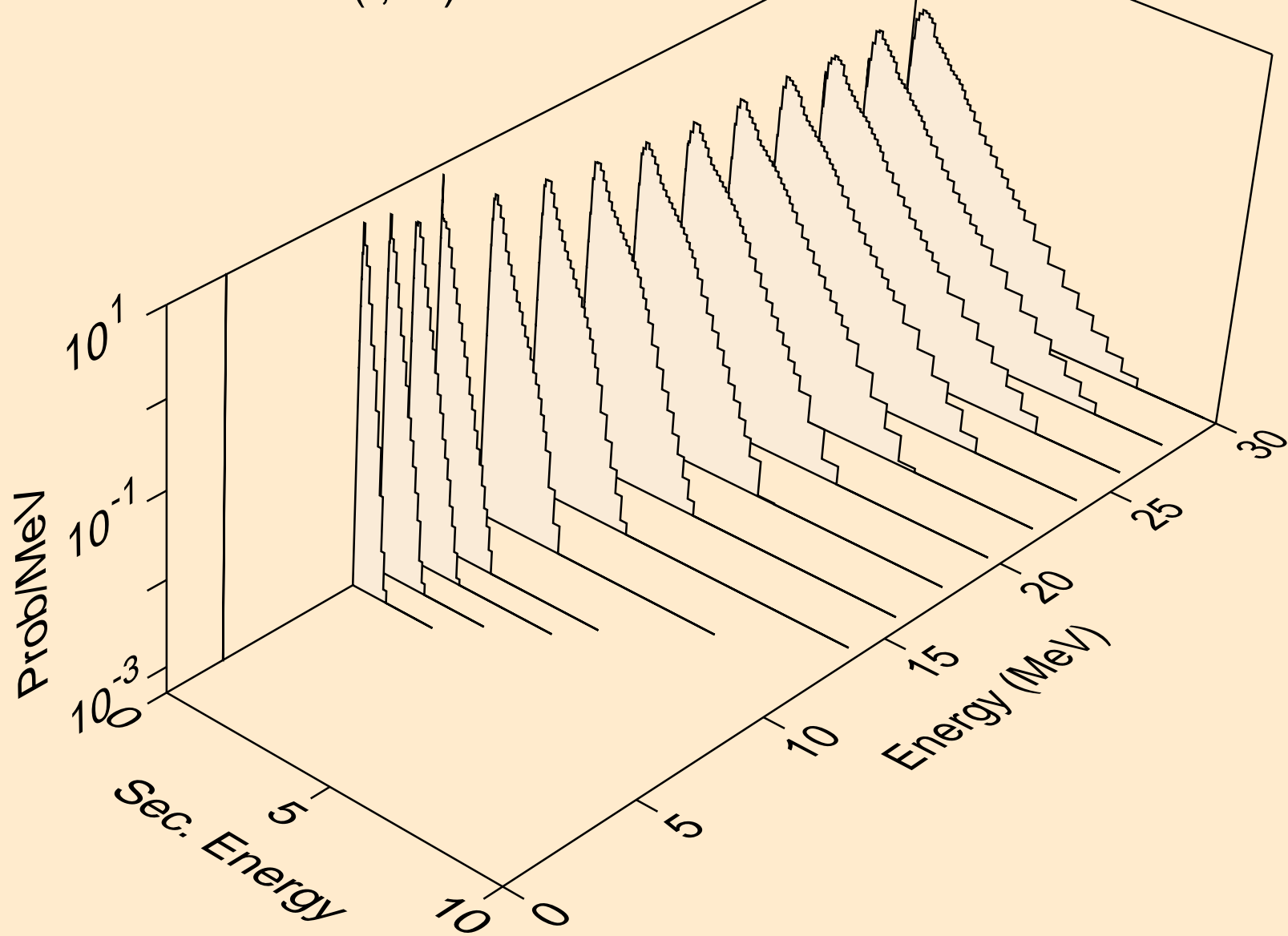

NB106 TRITON ACER TENDL-2021 LIBRARY; T=0.K  
neutrons from (t,3n)a

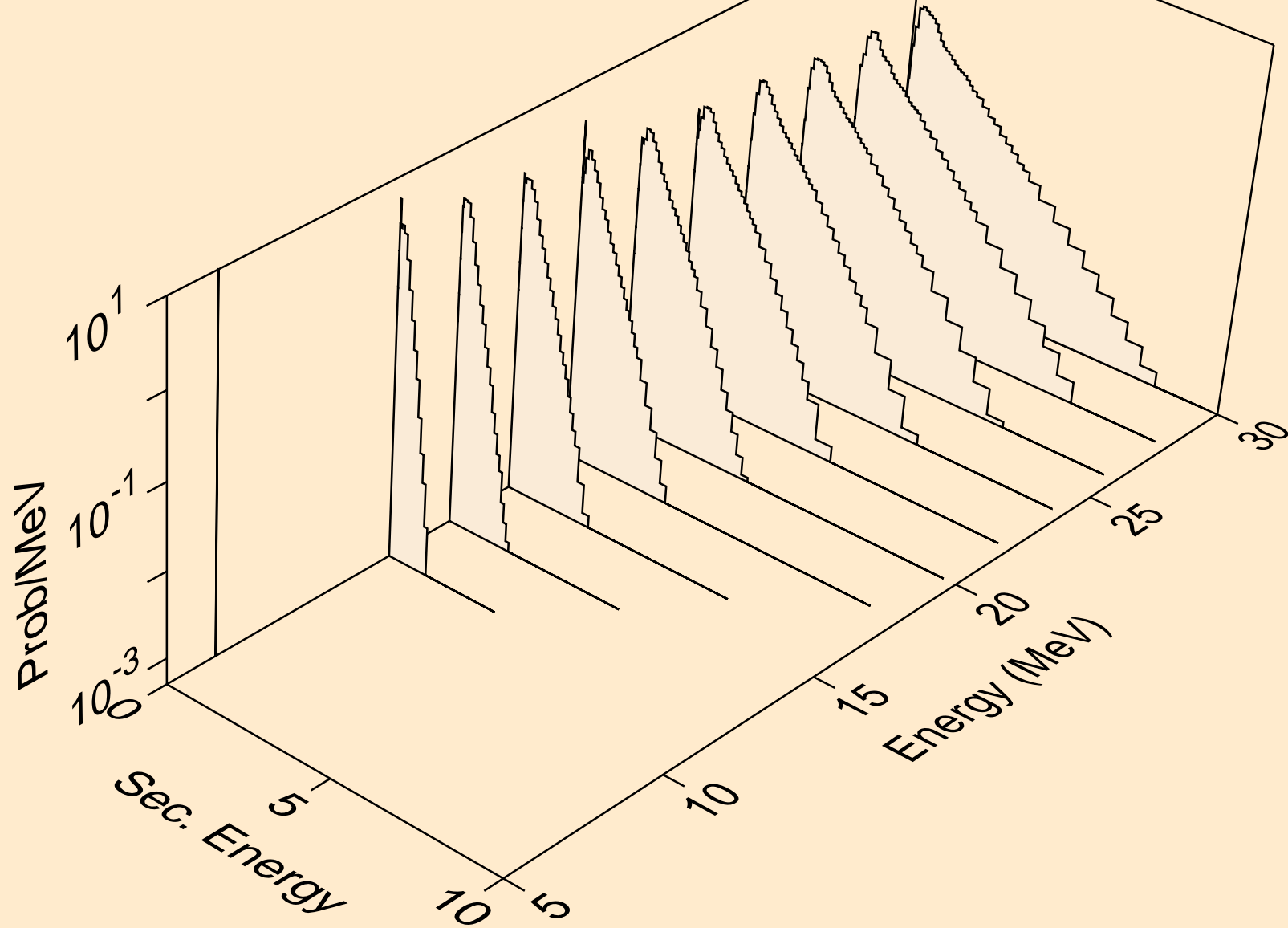

NB106 TRITON ACER TENDL-2021 LIBRARY; T=0.K  
neutrons from (t,n\*)p

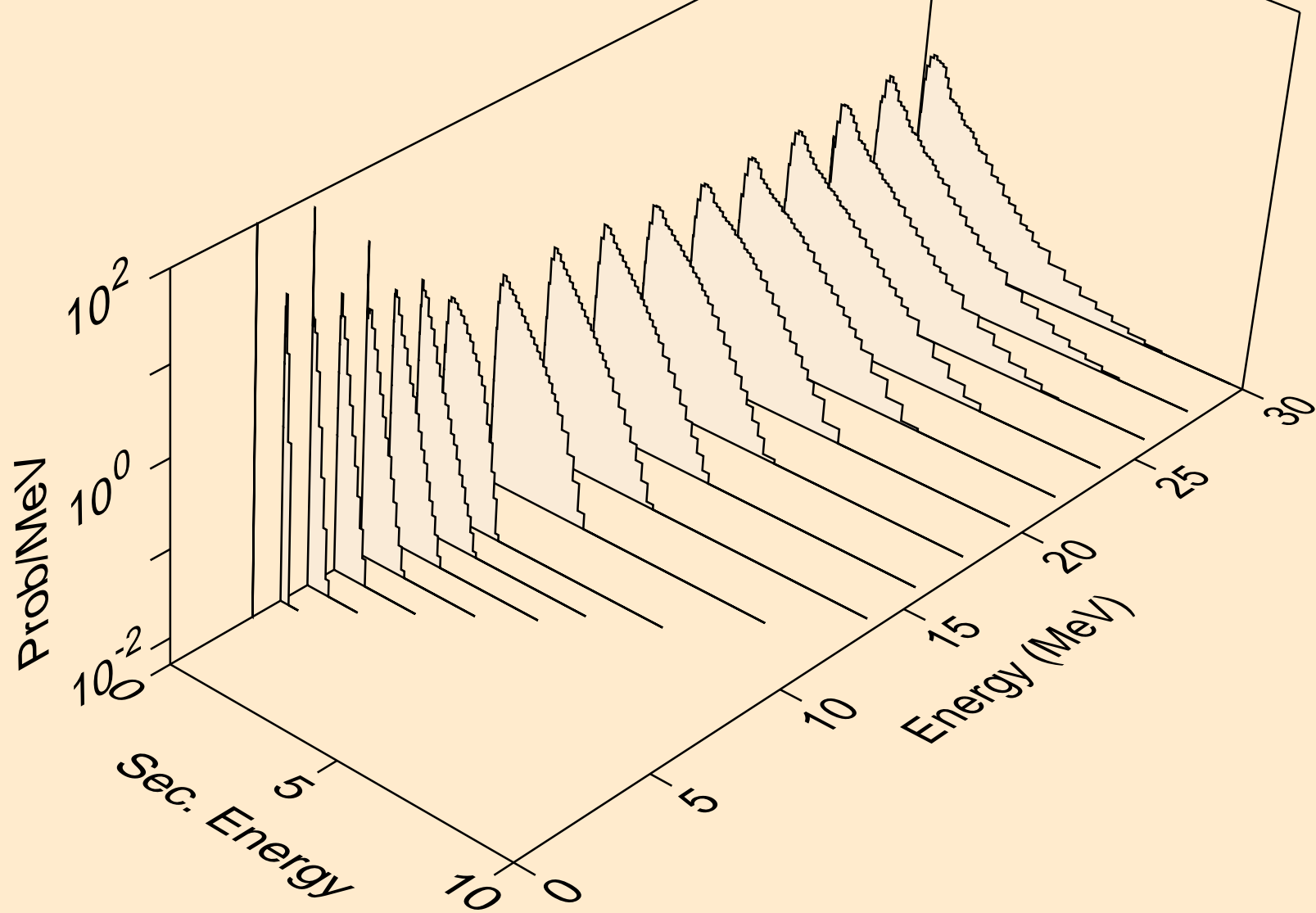

NB106 TRITON ACER TENDL-2021 LIBRARY; T=0.K  
neutrons from (t,n\*)d

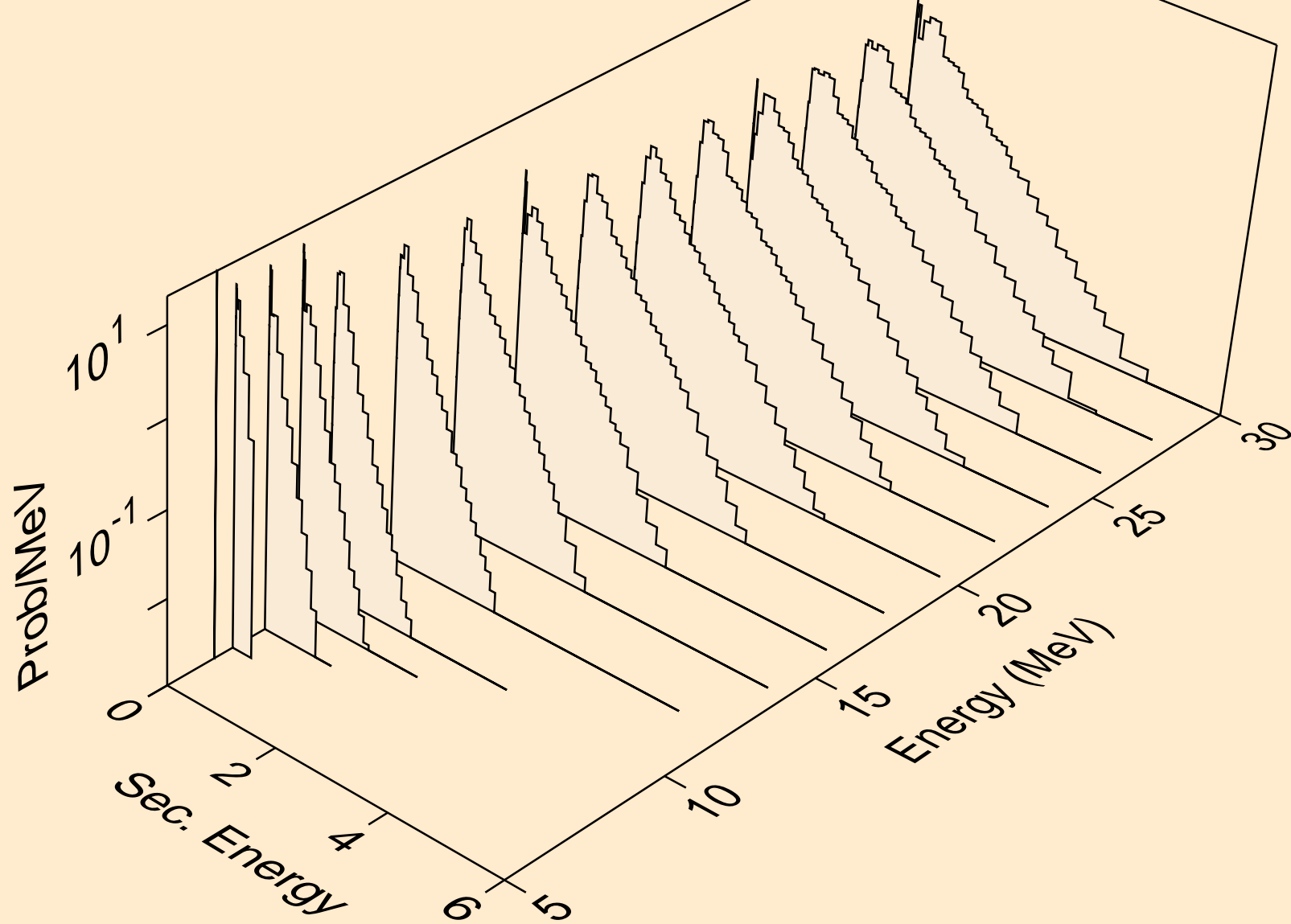

NB106 TRITON ACER TENDL-2021 LIBRARY; T=0.K  
neutrons from (t,n\*)t

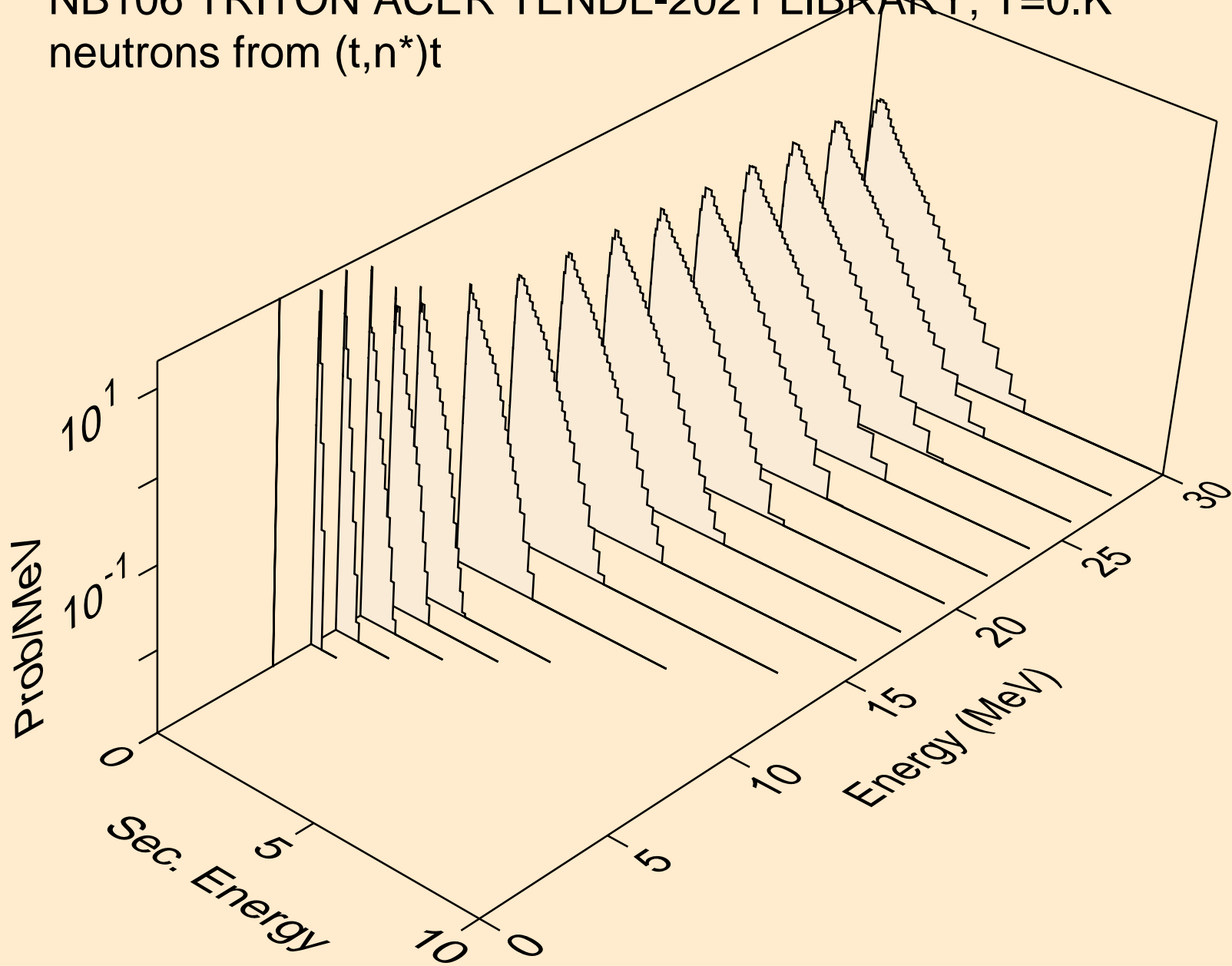

NB106 TRITON ACER TENDL-2021 LIBRARY; T=0.K  
neutrons from (t,n\*)he3

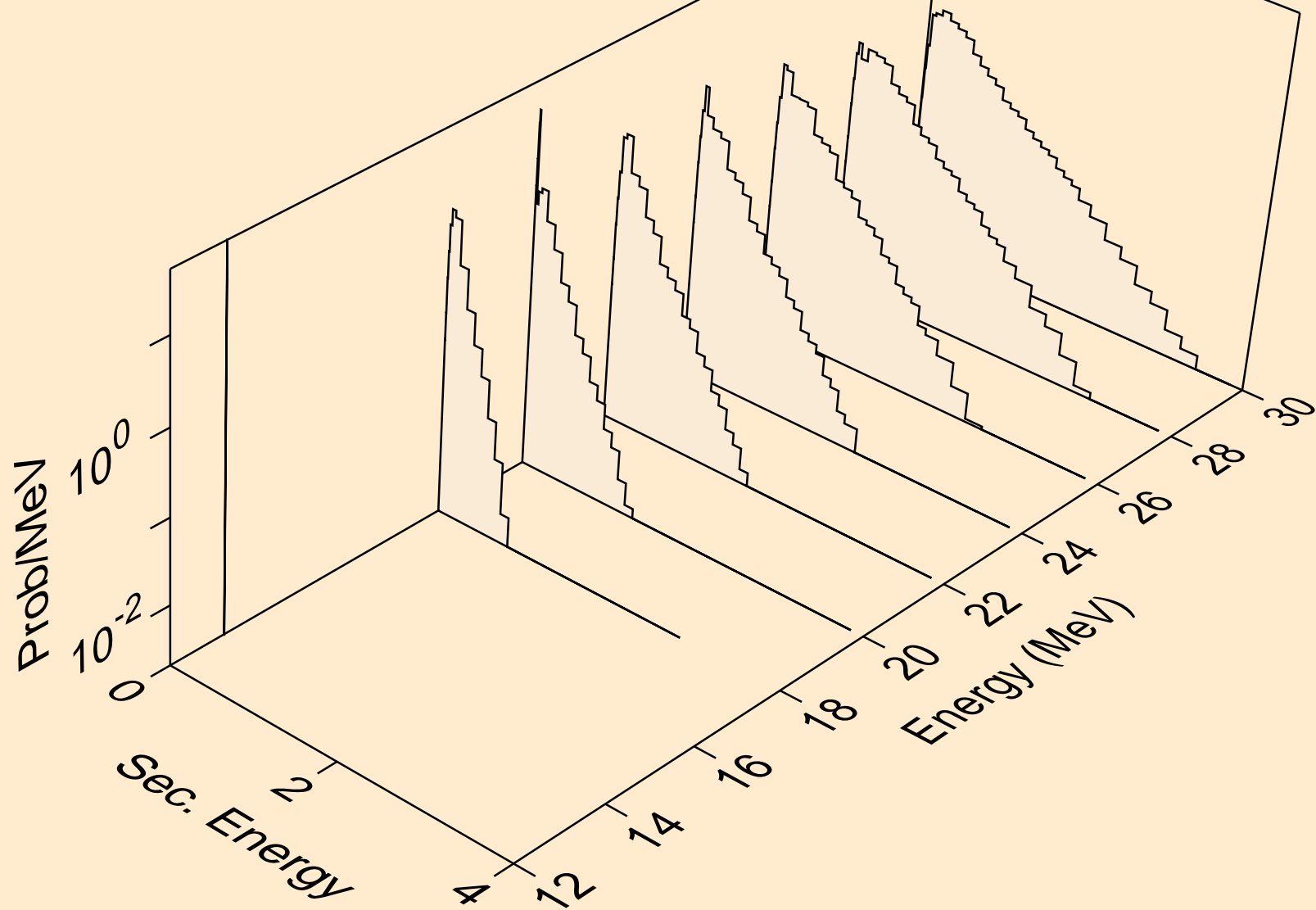

NB106 TRITON ACER TENDL-2021 LIBRARY; T=0.K  
neutrons from (t,4n)

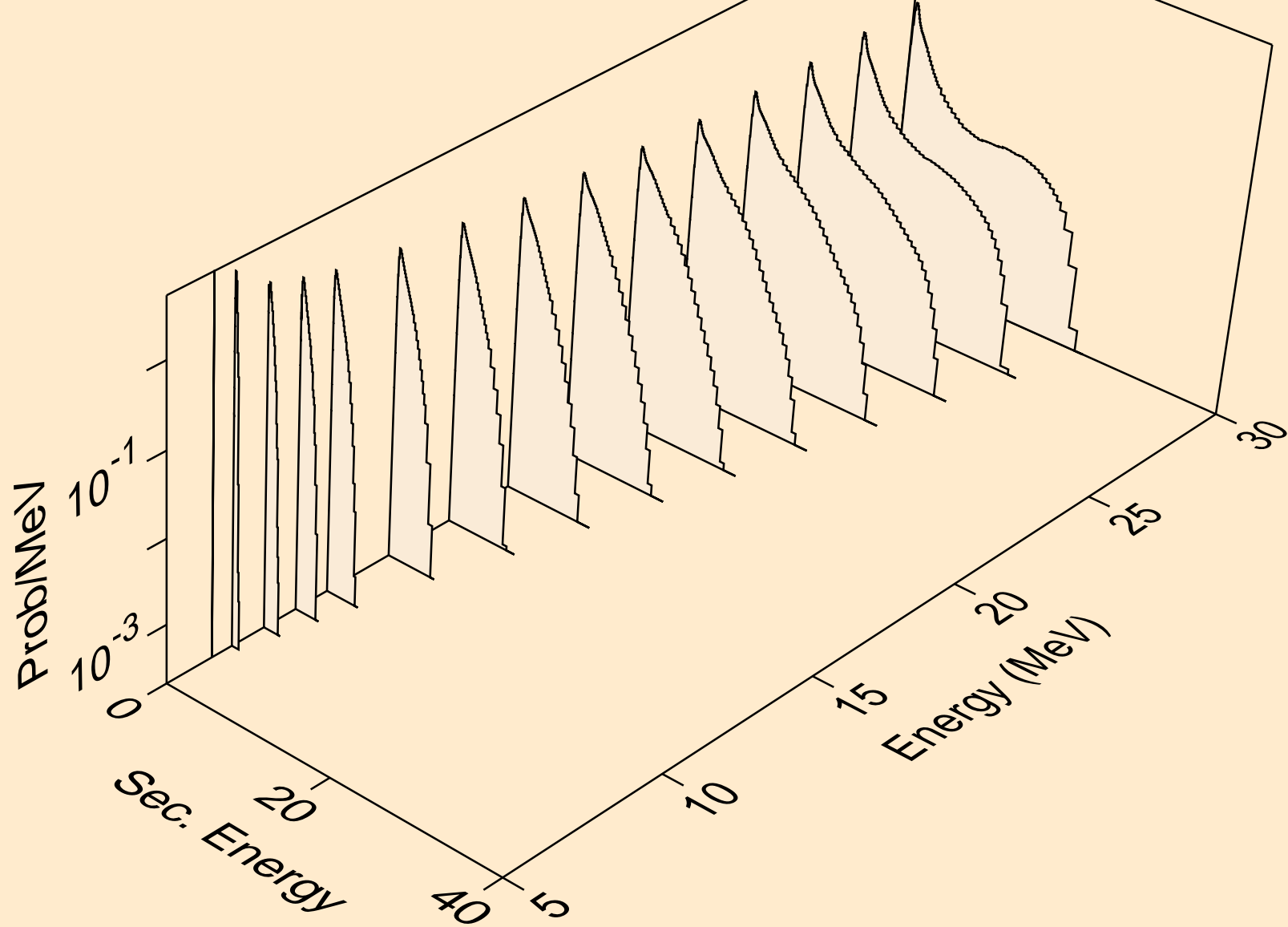



NB106 TRITON ACER TENDL-2021 LIBRARY; T=0.K  
neutrons from (t,2np)

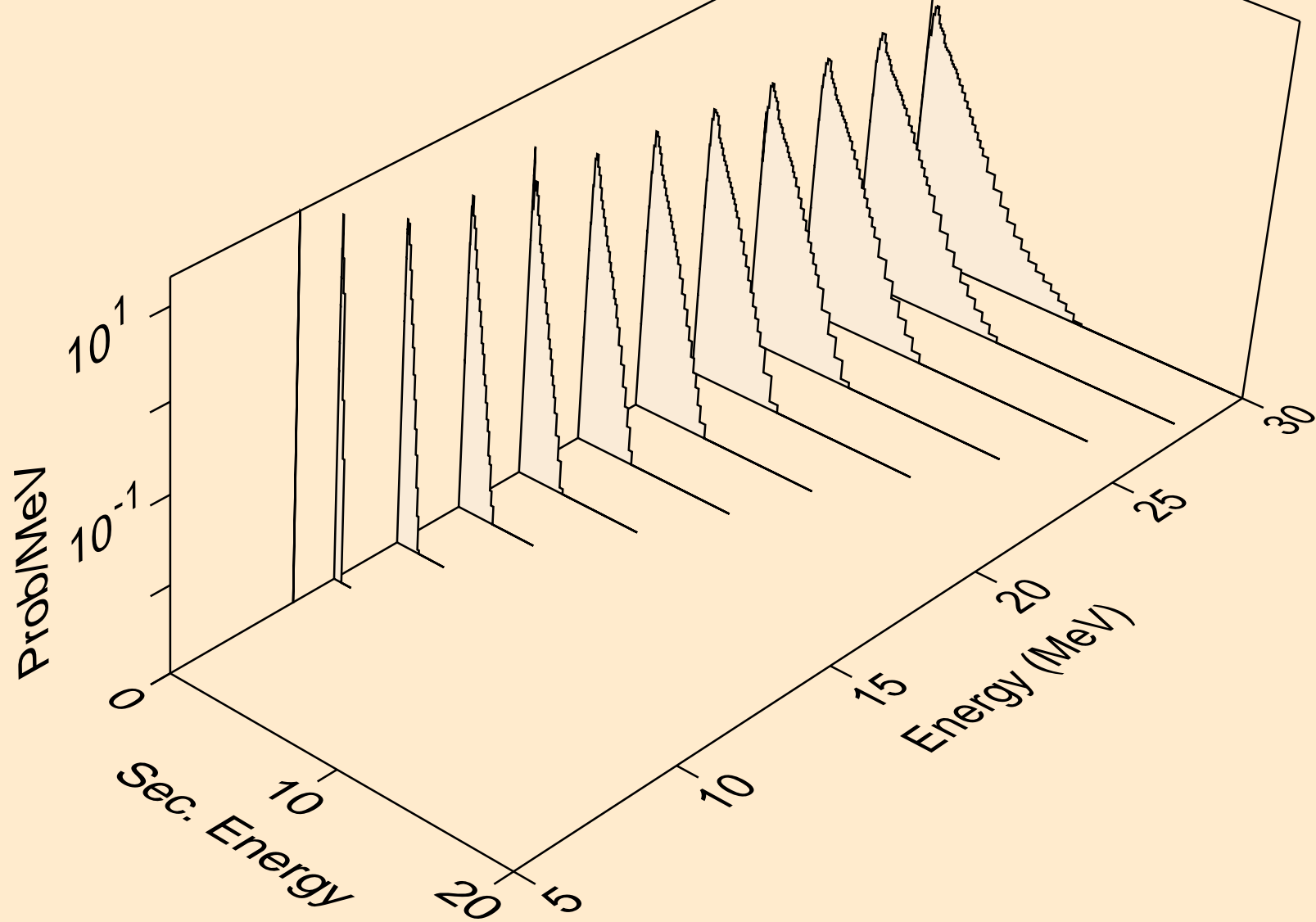

NB106 TRITON ACER TENDL-2021 LIBRARY; T=0.K  
neutrons from (t,3np)

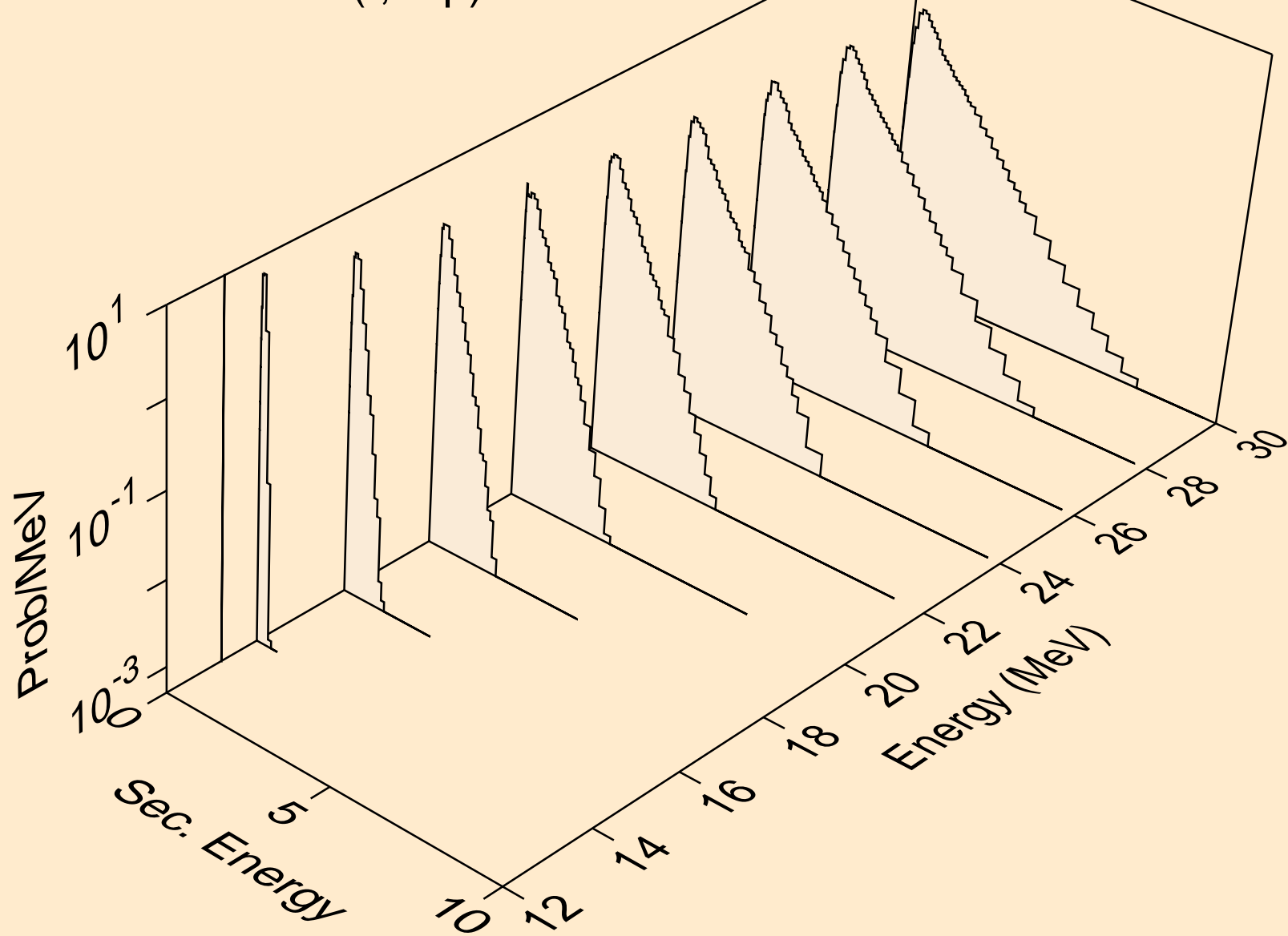

NB106 TRITON ACER TENDL-2021 LIBRARY; T=0.K  
neutrons from (t,2np)

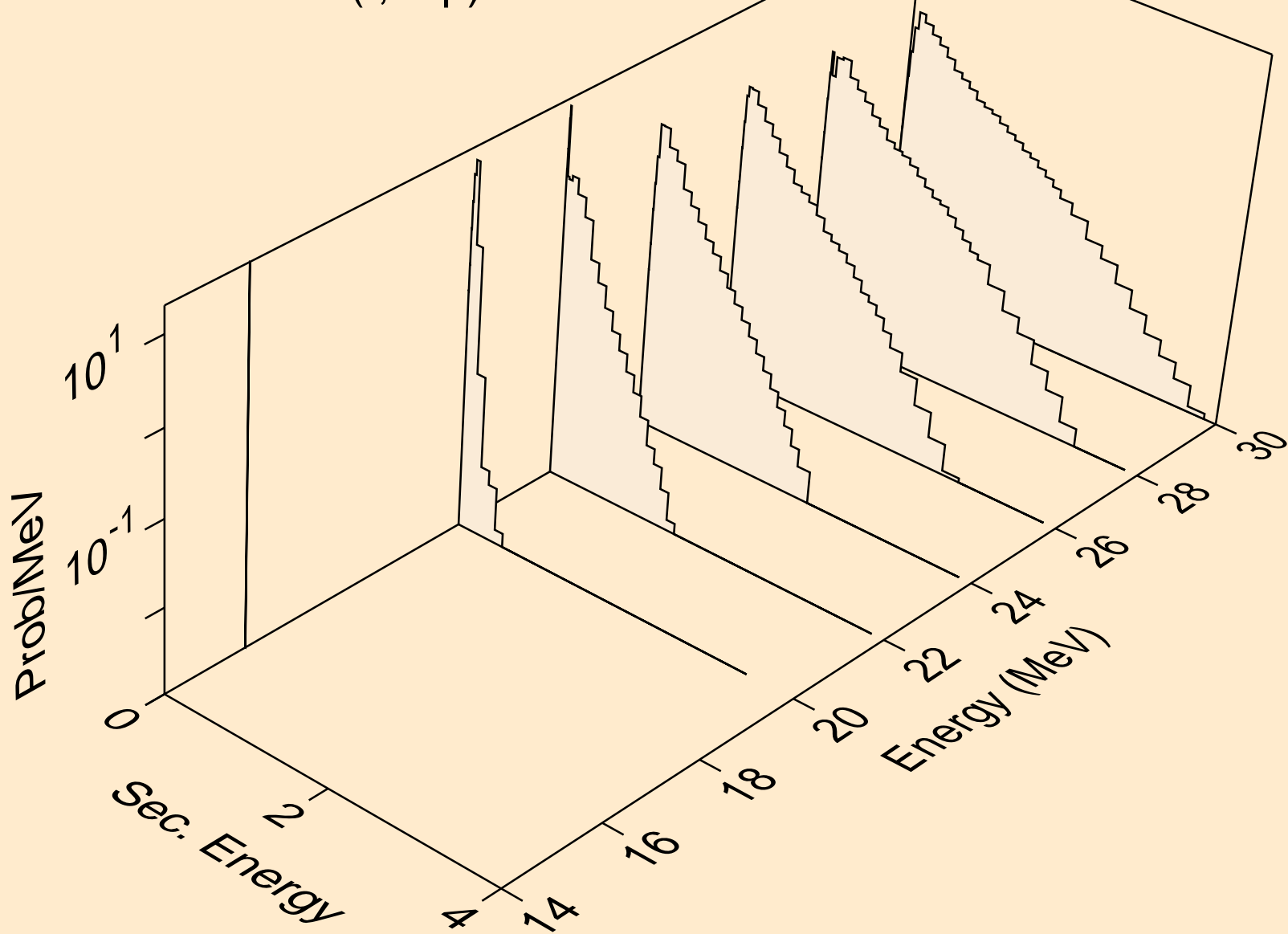

NB106 TRITON ACER TENDL-2021 LIBRARY; T=0.K  
protons from (t,x)

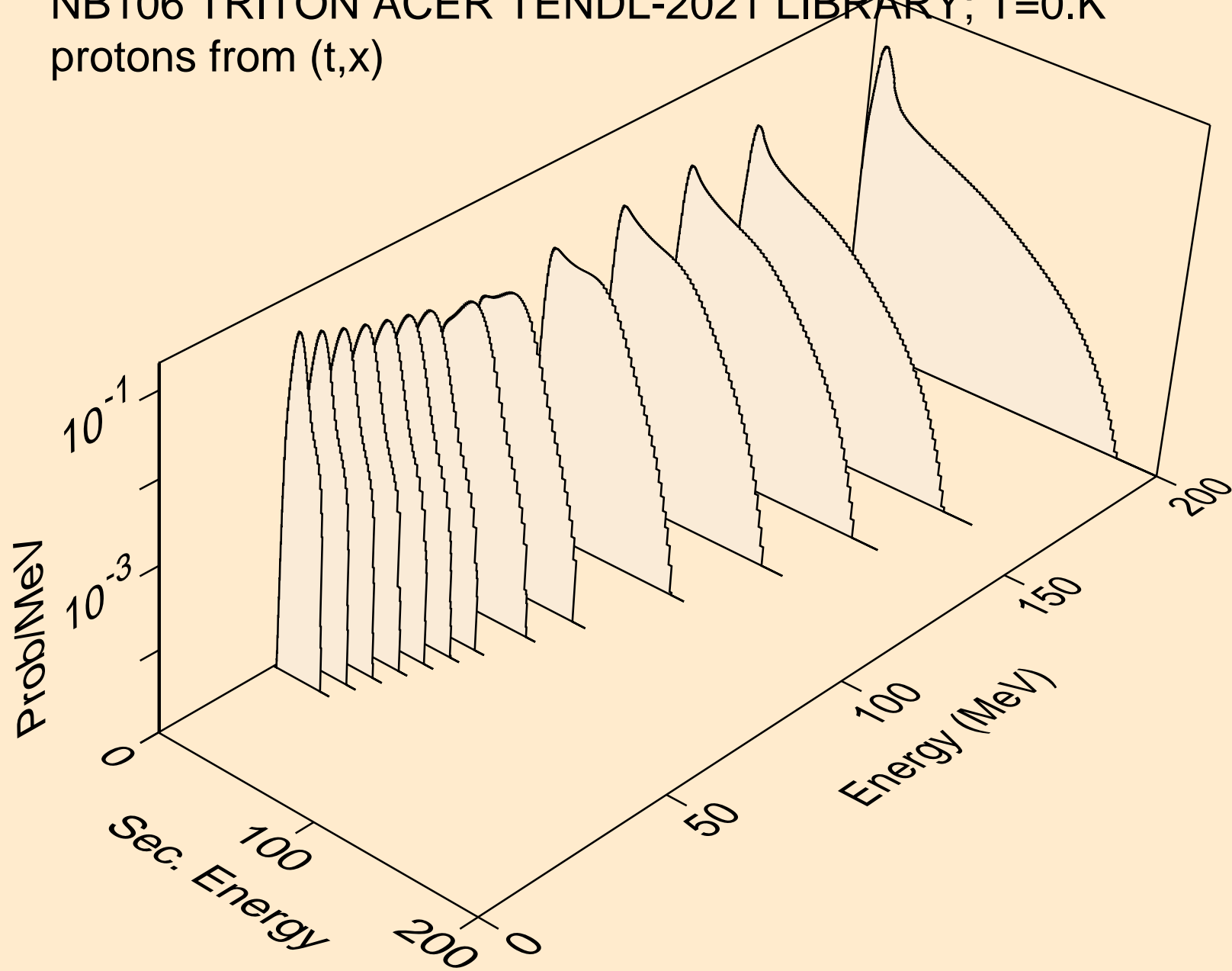

NB106 TRITON ACER TENDL-2021 LIBRARY; T=0.K  
protons from (t,n\*)p

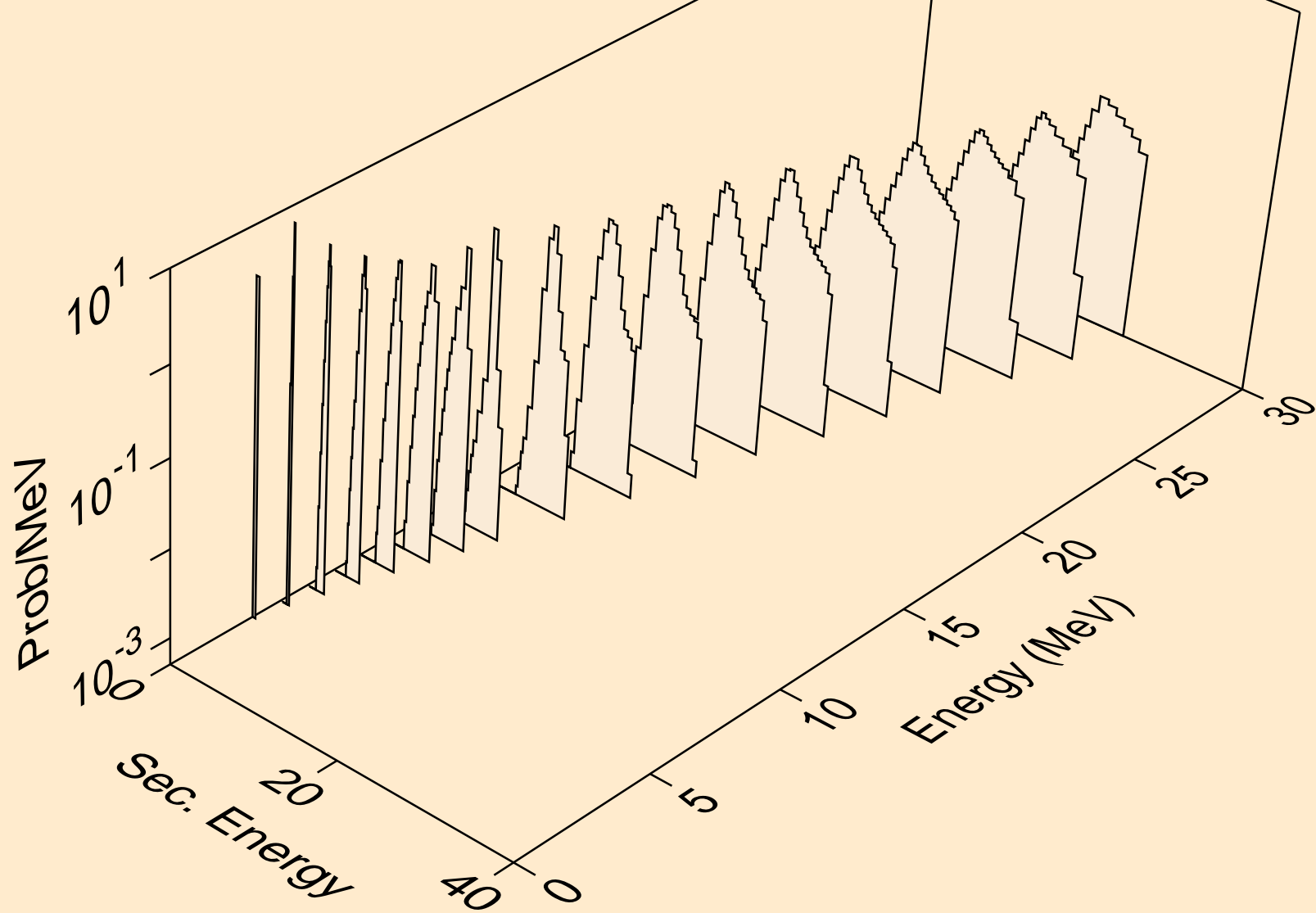

NB106 TRITON ACER TENDL-2021 LIBRARY; T=0.K  
protons from (t,2np)

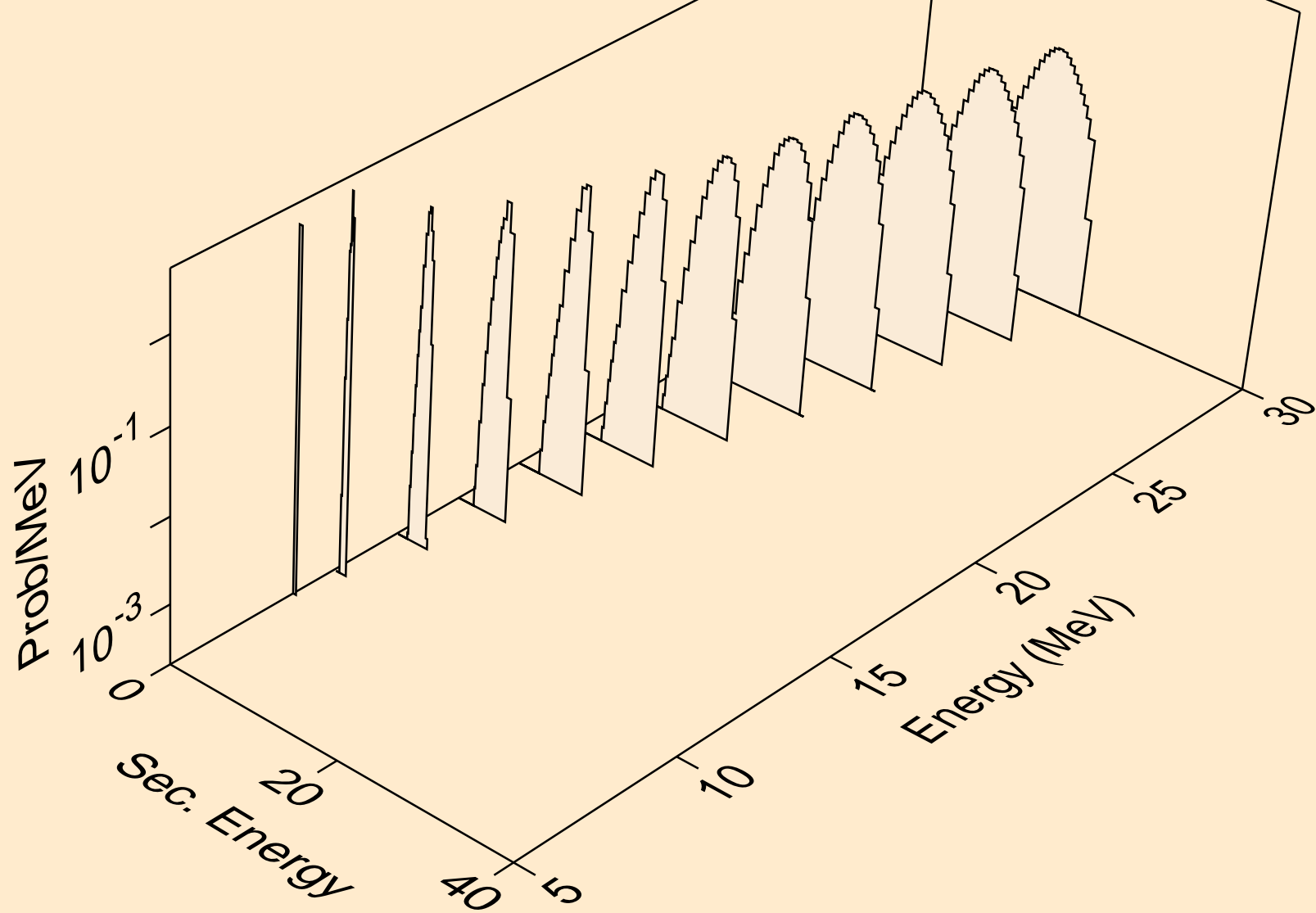

NB106 TRITON ACER TENDL-2021 LIBRARY; T=0.K  
protons from (t,3np)

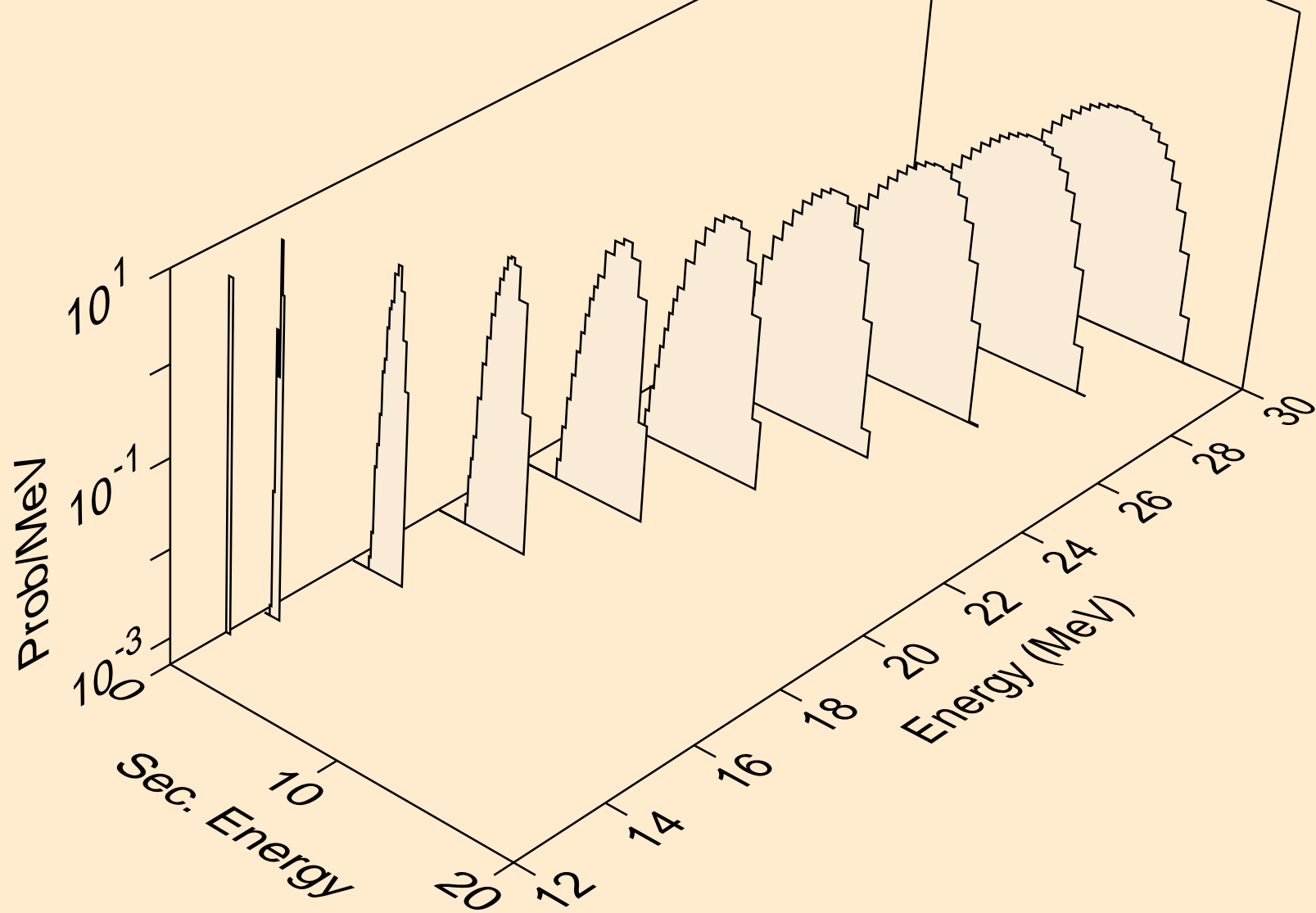

NB106 TRITON ACER TENDL-2021 LIBRARY; T=0.K  
protons from (t,2np)

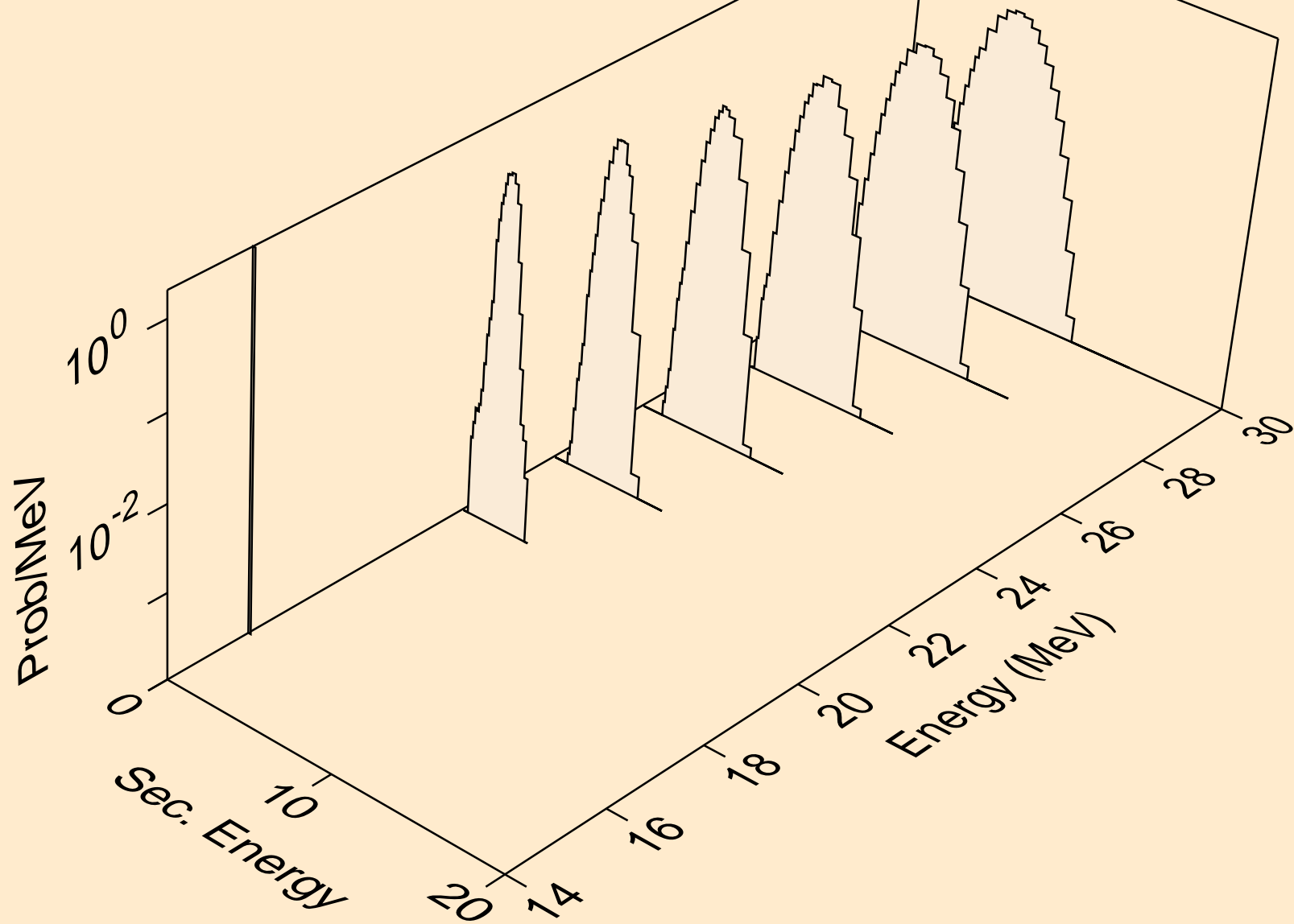



NB106 TRITON ACER TENDL-2021 LIBRARY; T=0.K  
protons from (t,p)

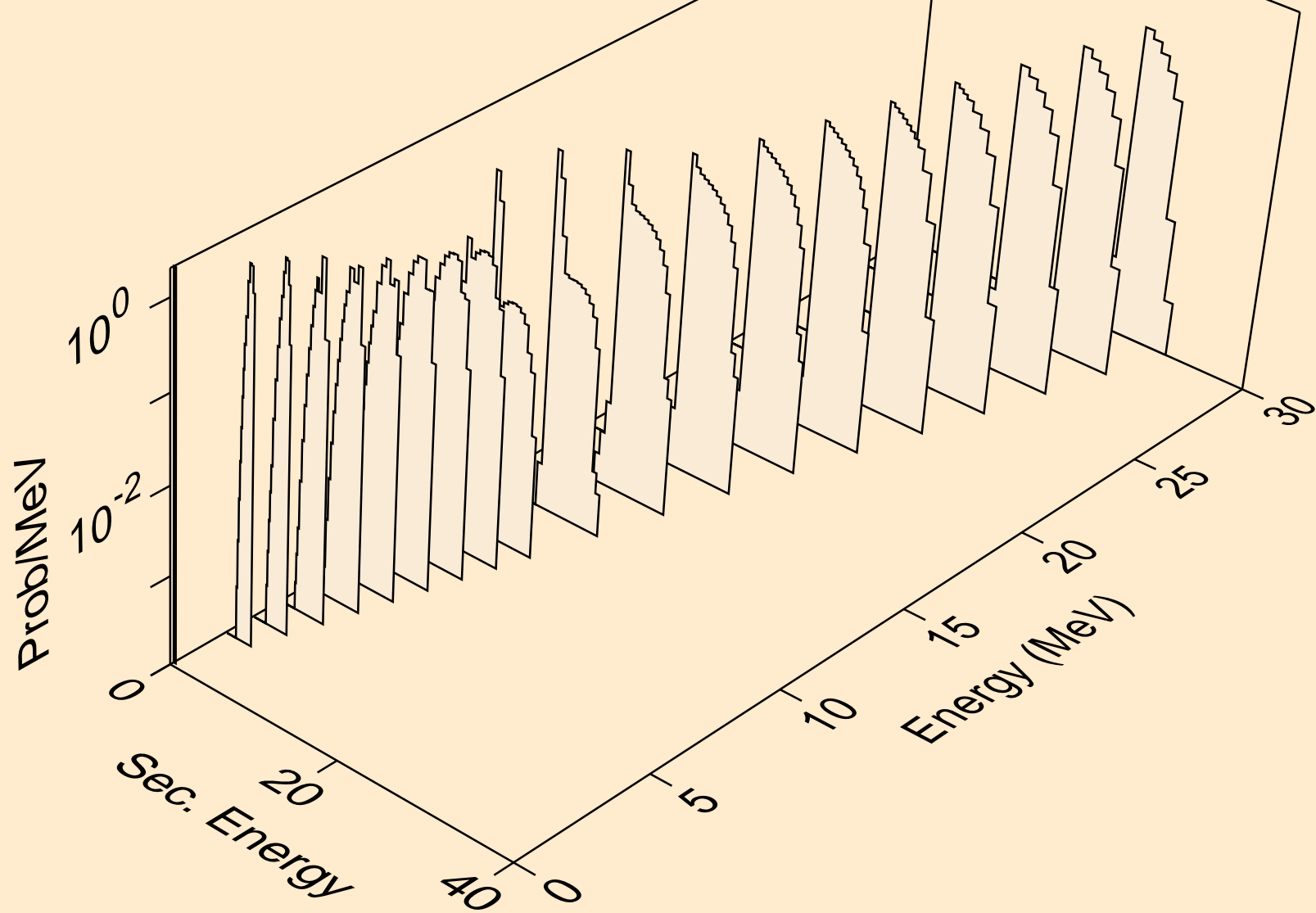

NB106 TRITON ACER TENDL-2021 LIBRARY; T=0.K  
protons from (t,2p)

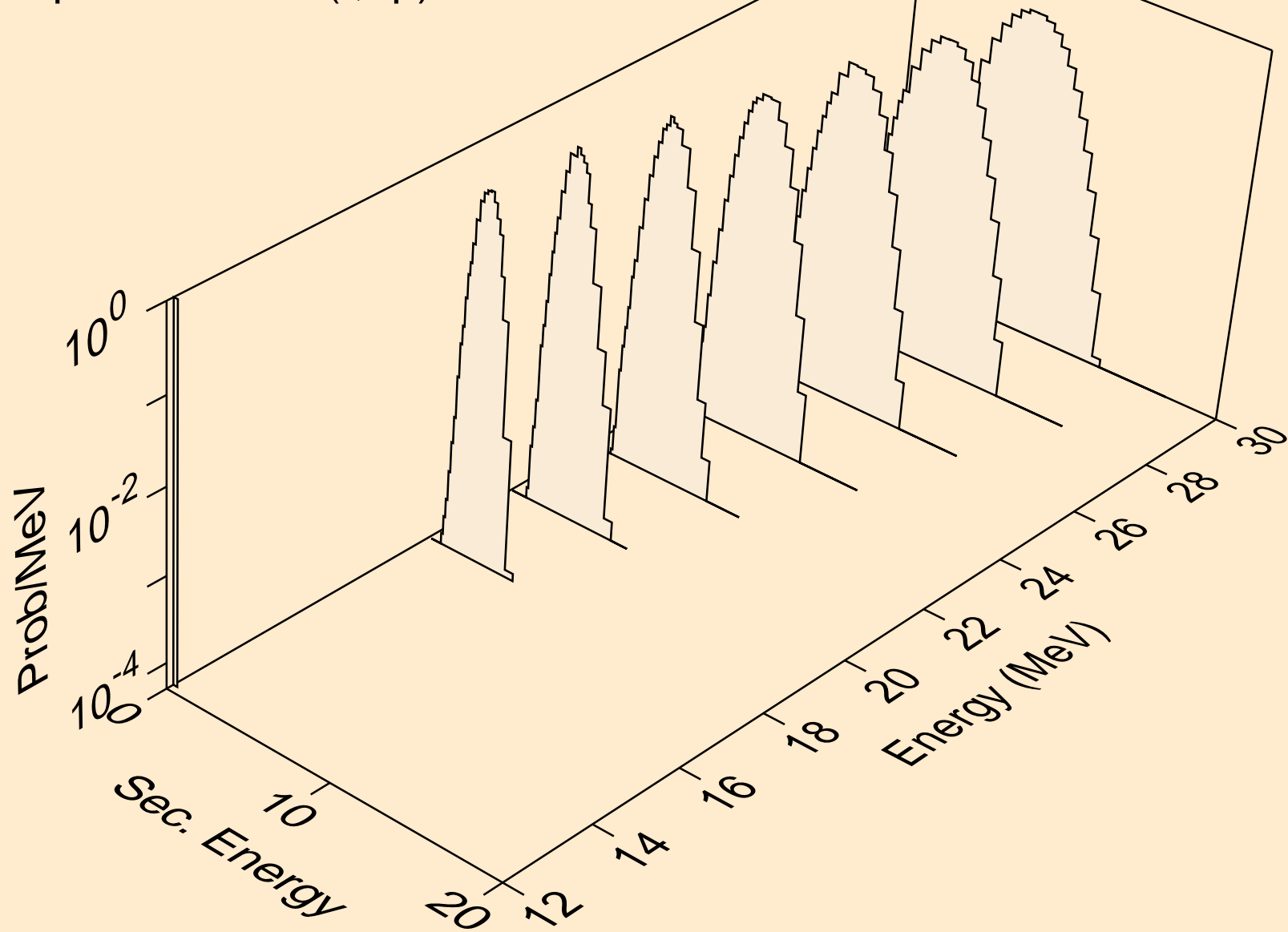

NB106 TRITON ACER TENDL-2021 LIBRARY; T=0.K  
protons from (t,pd)

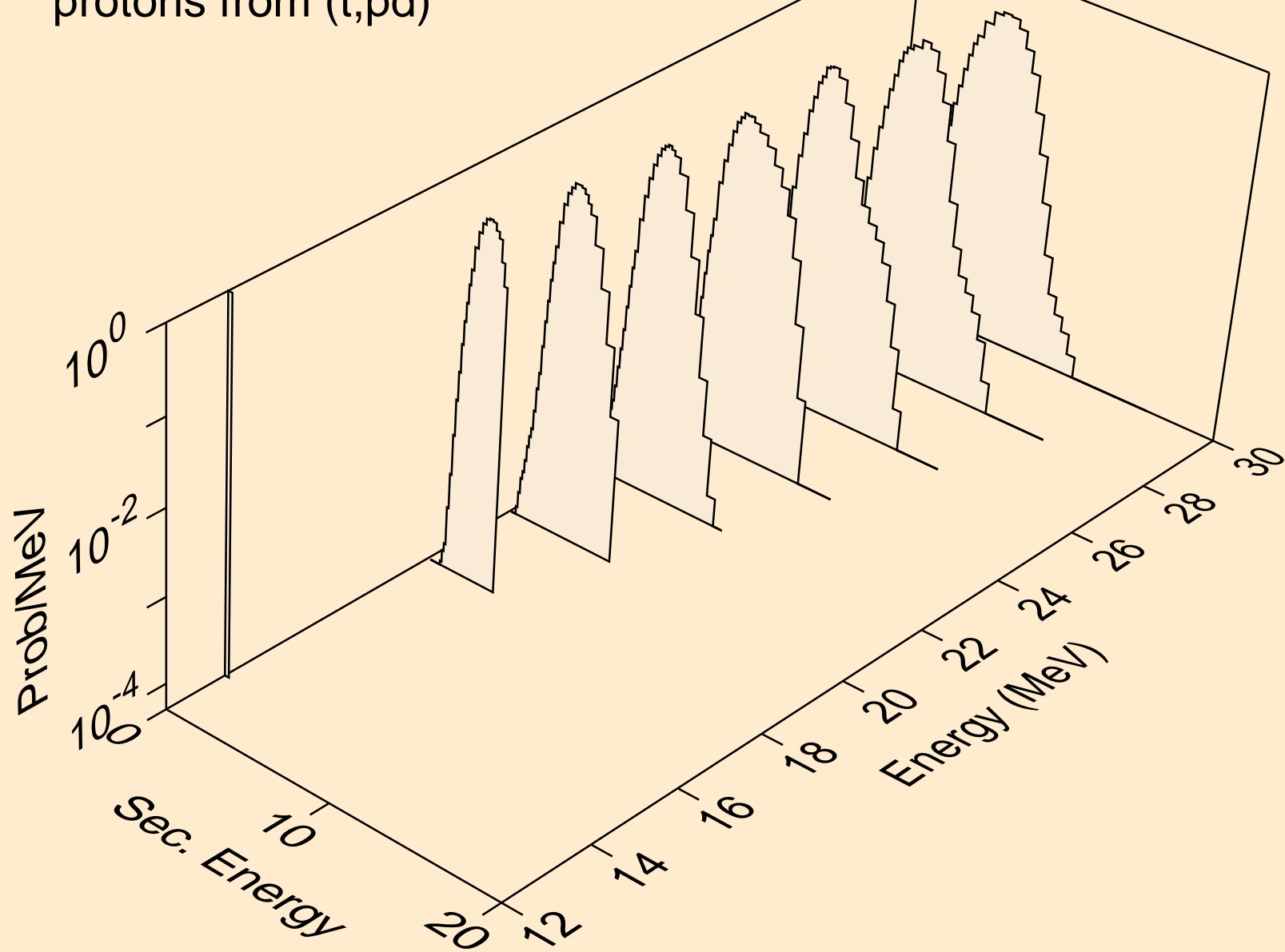

NB106 TRITON ACER TENDL-2021 LIBRARY; T=0.K  
deuterons from (t,x)

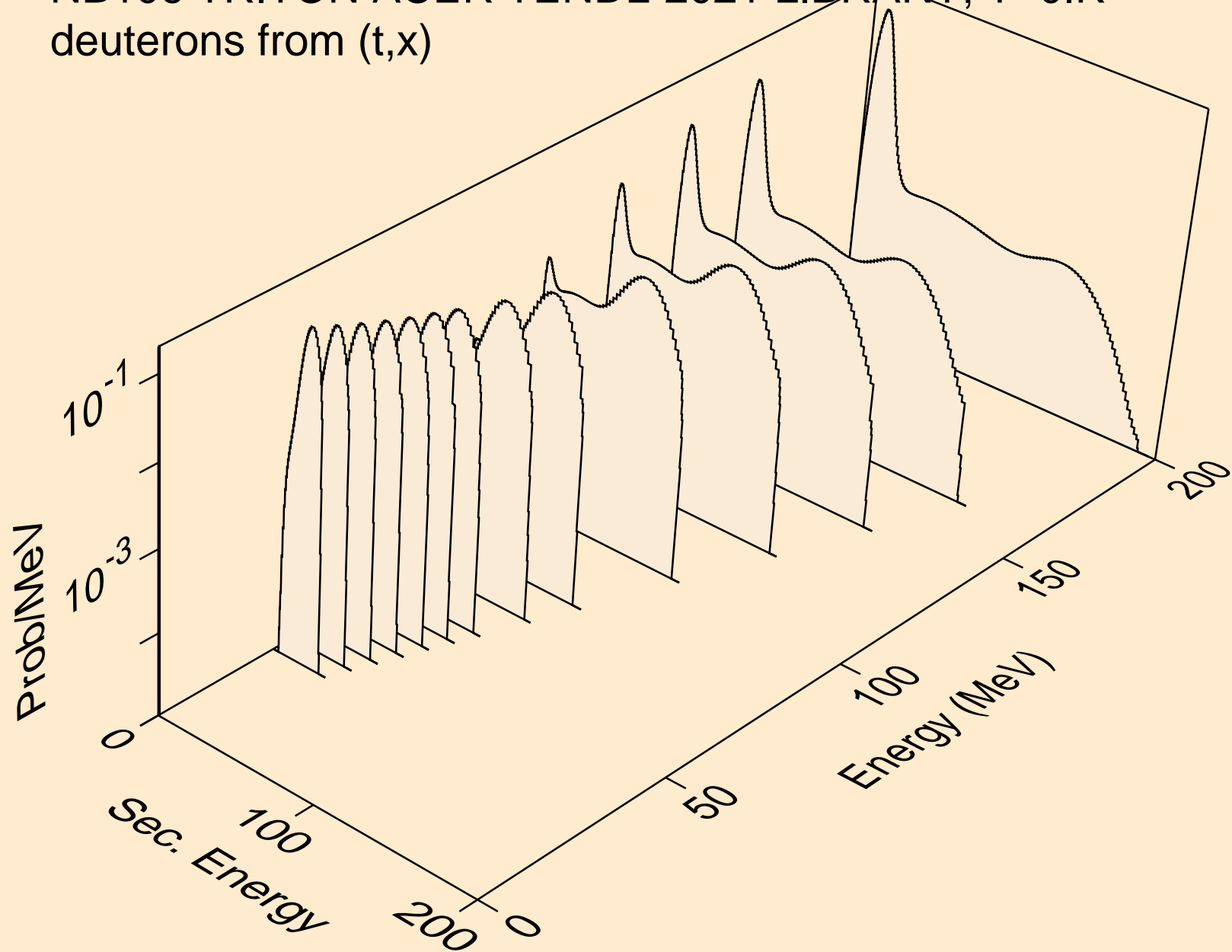

NB106 TRITON ACER TENDL-2021 LIBRARY; T=0.K  
deuterons from (t,2nd)

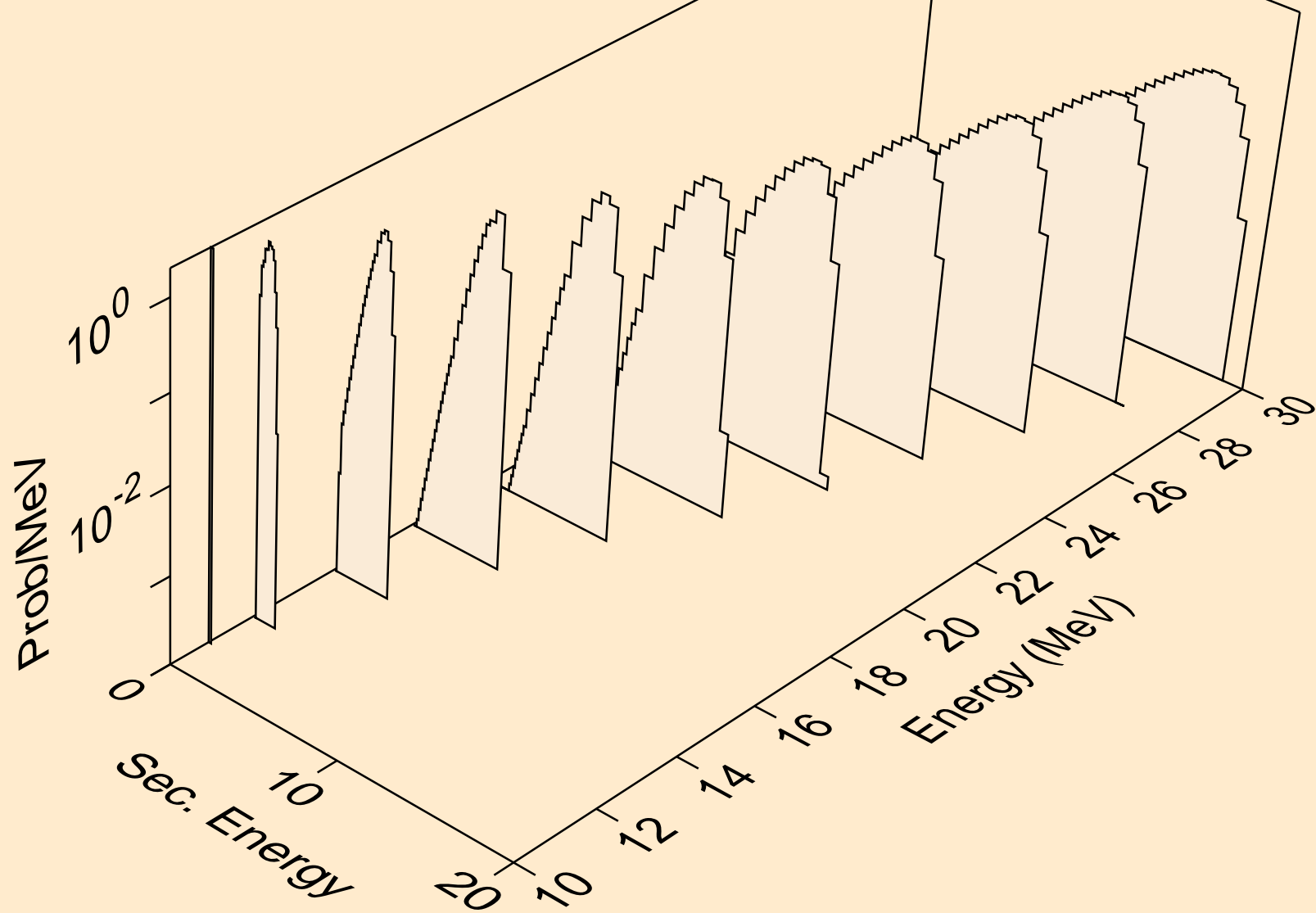

NB106 TRITON ACER TENDL-2021 LIBRARY; T=0.K  
deuterons from (t,n\*)d

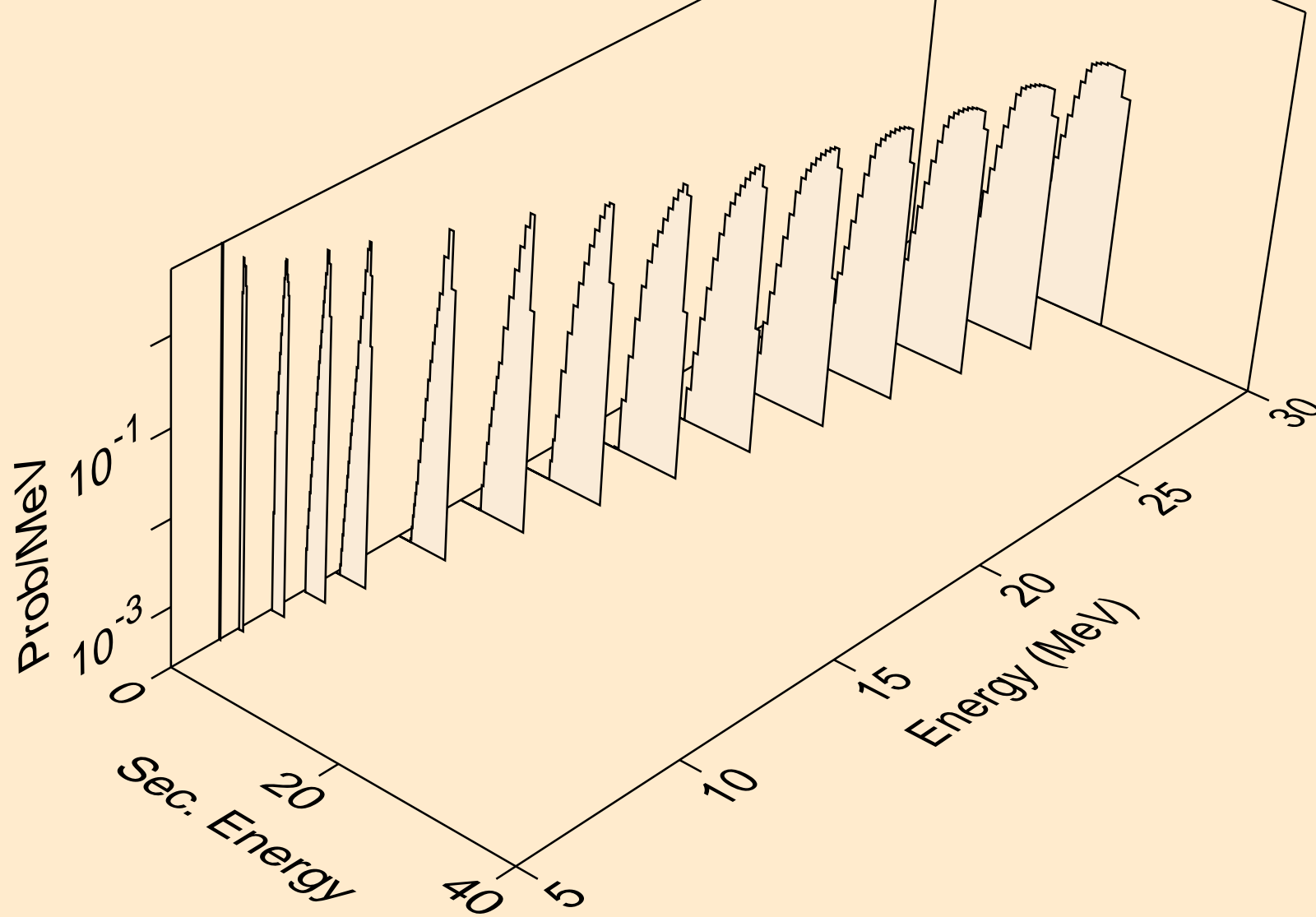

NB106 TRITON ACER TENDL-2021 LIBRARY; T=0.K  
deuterons from (t,d)

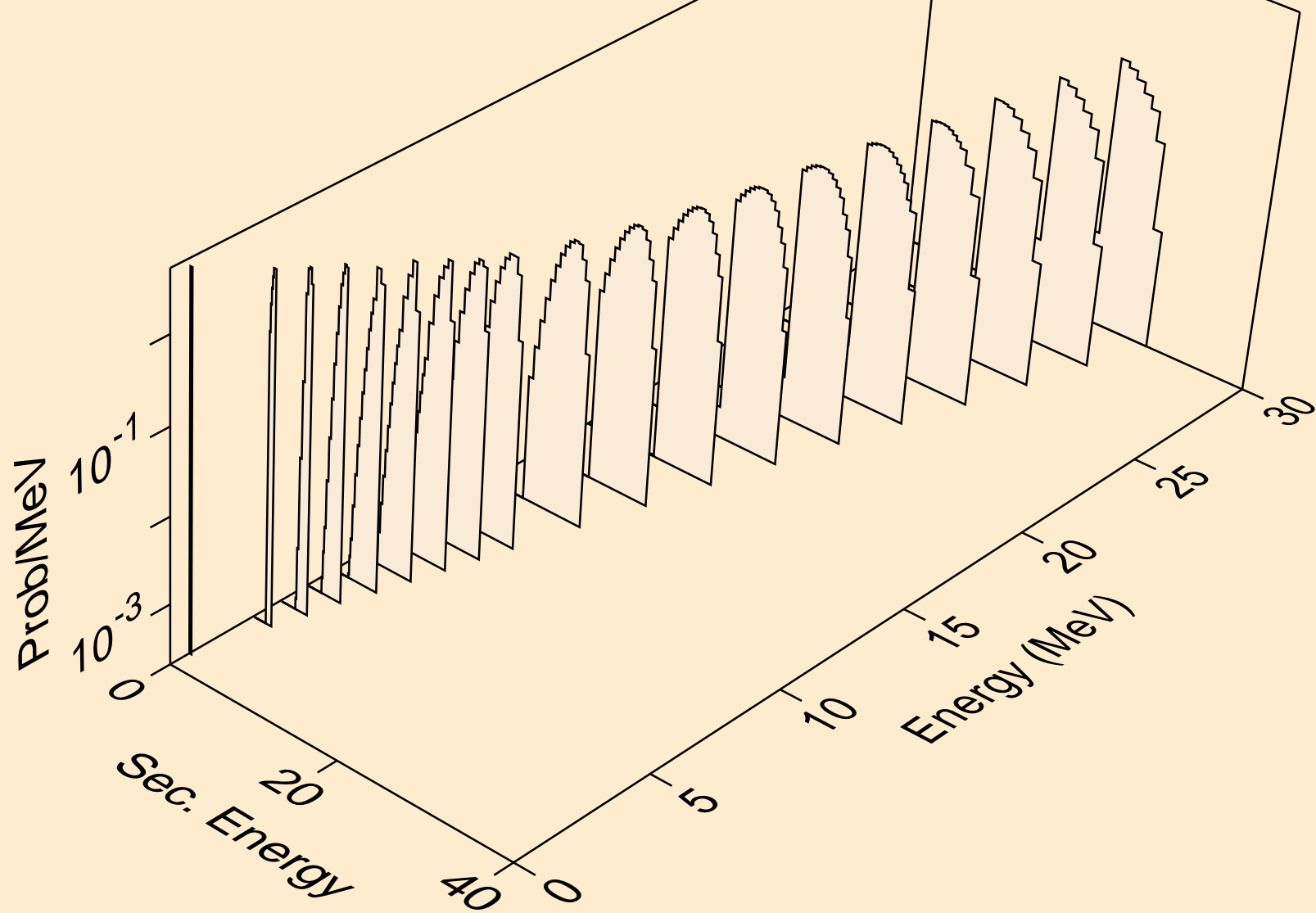

NB106 TRITON ACER TENDL-2021 LIBRARY; T=0.K  
deuterons from (t,pd)

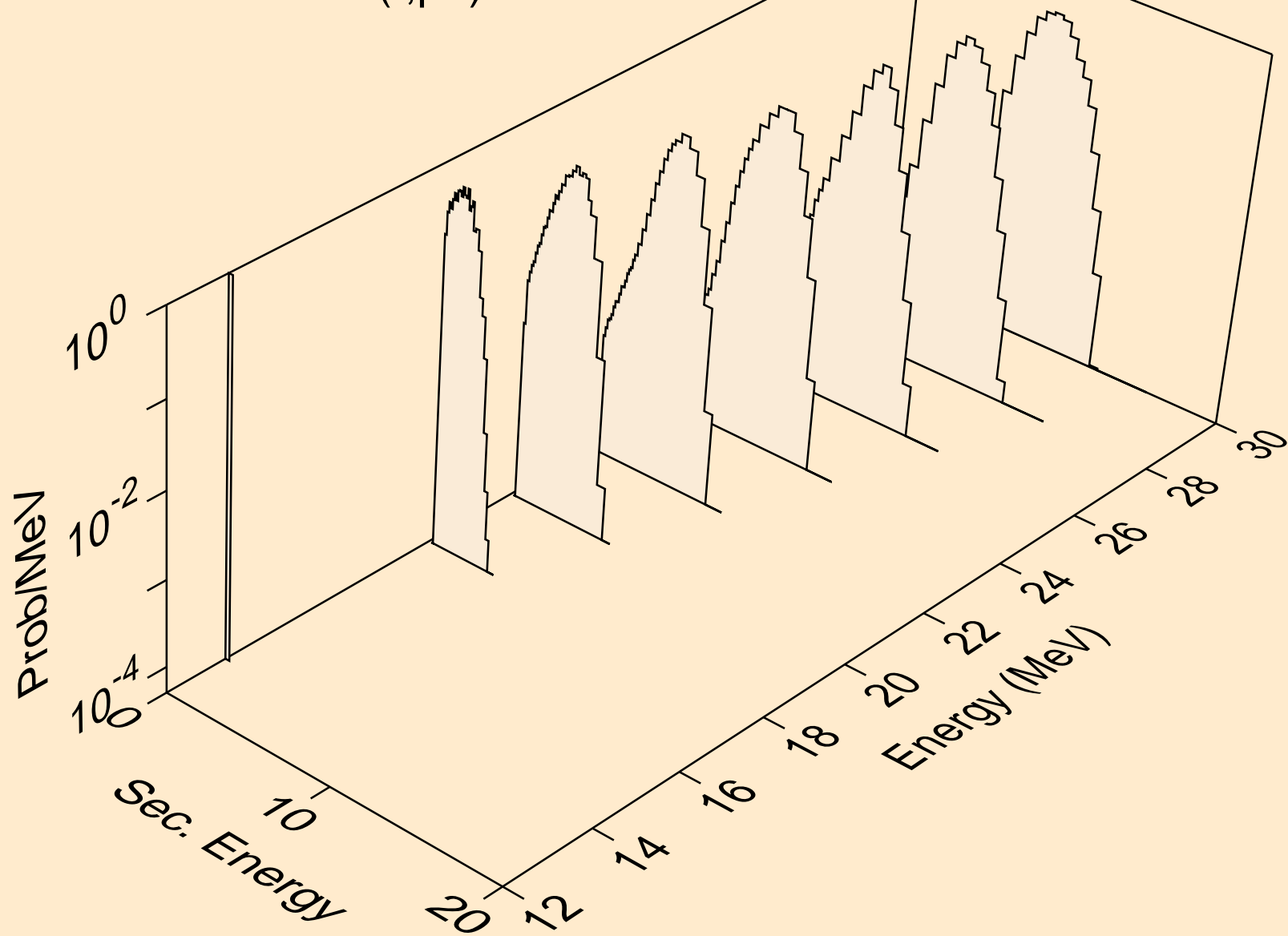



NB106 TRITON ACER TENDL-2021 LIBRARY; T=0.K  
he3s from (t,x)

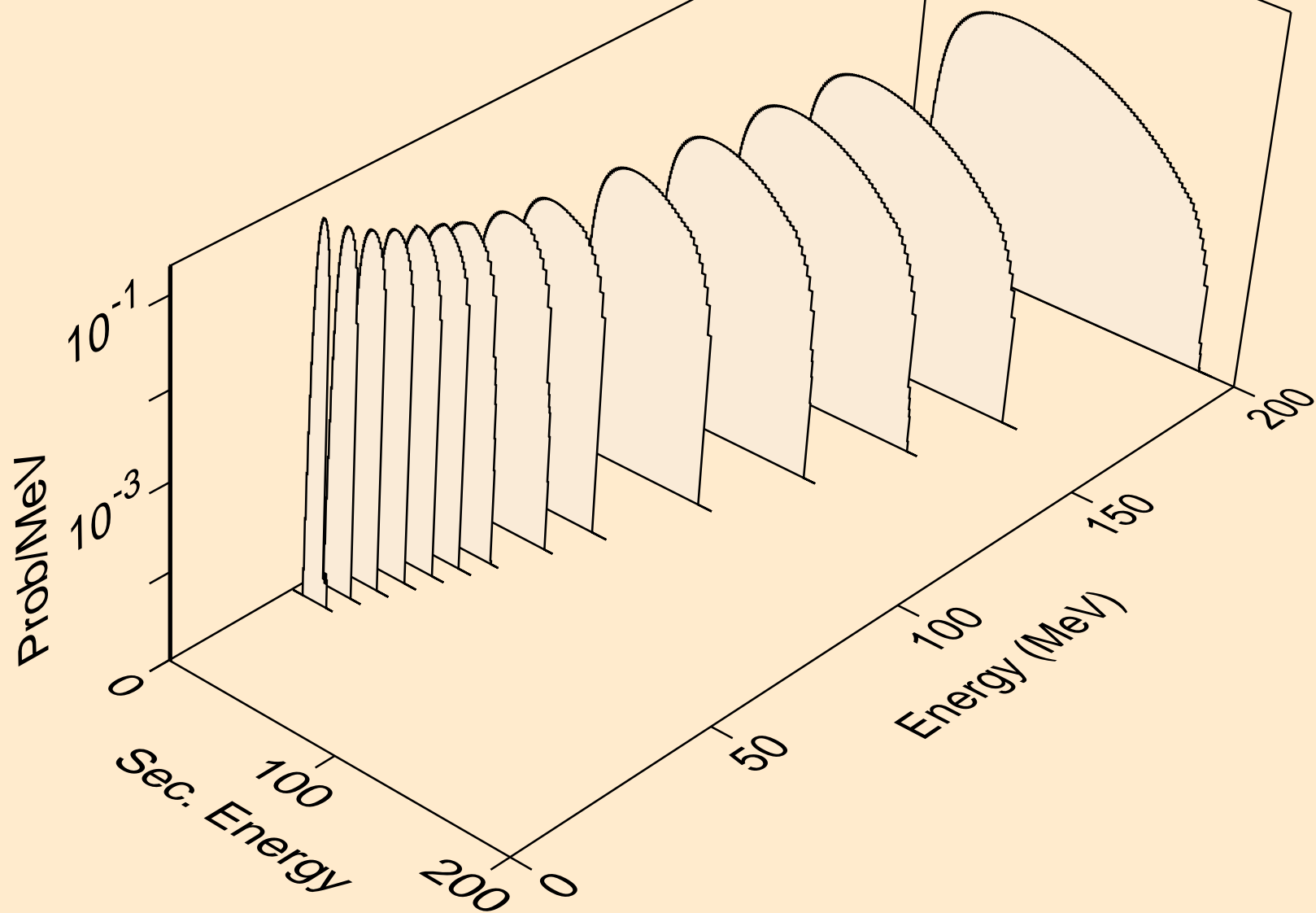

NB106 TRITON ACER TENDL-2021 LIBRARY; T=0.K  
he3s from (t,n\*)he3

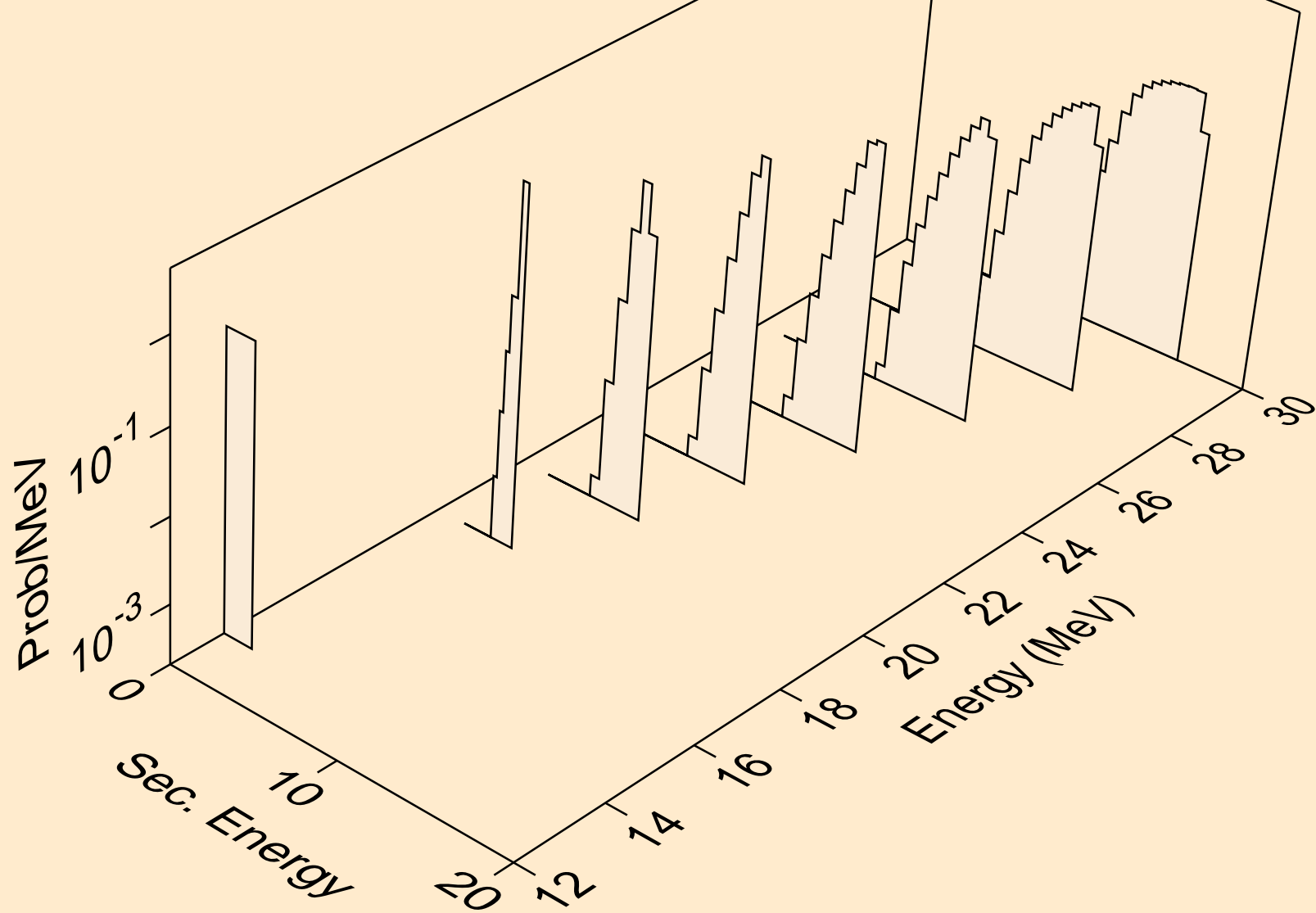

NB106 TRITON ACER TENDL-2021 LIBRARY; T=0.K  
he3s from (t,he3)

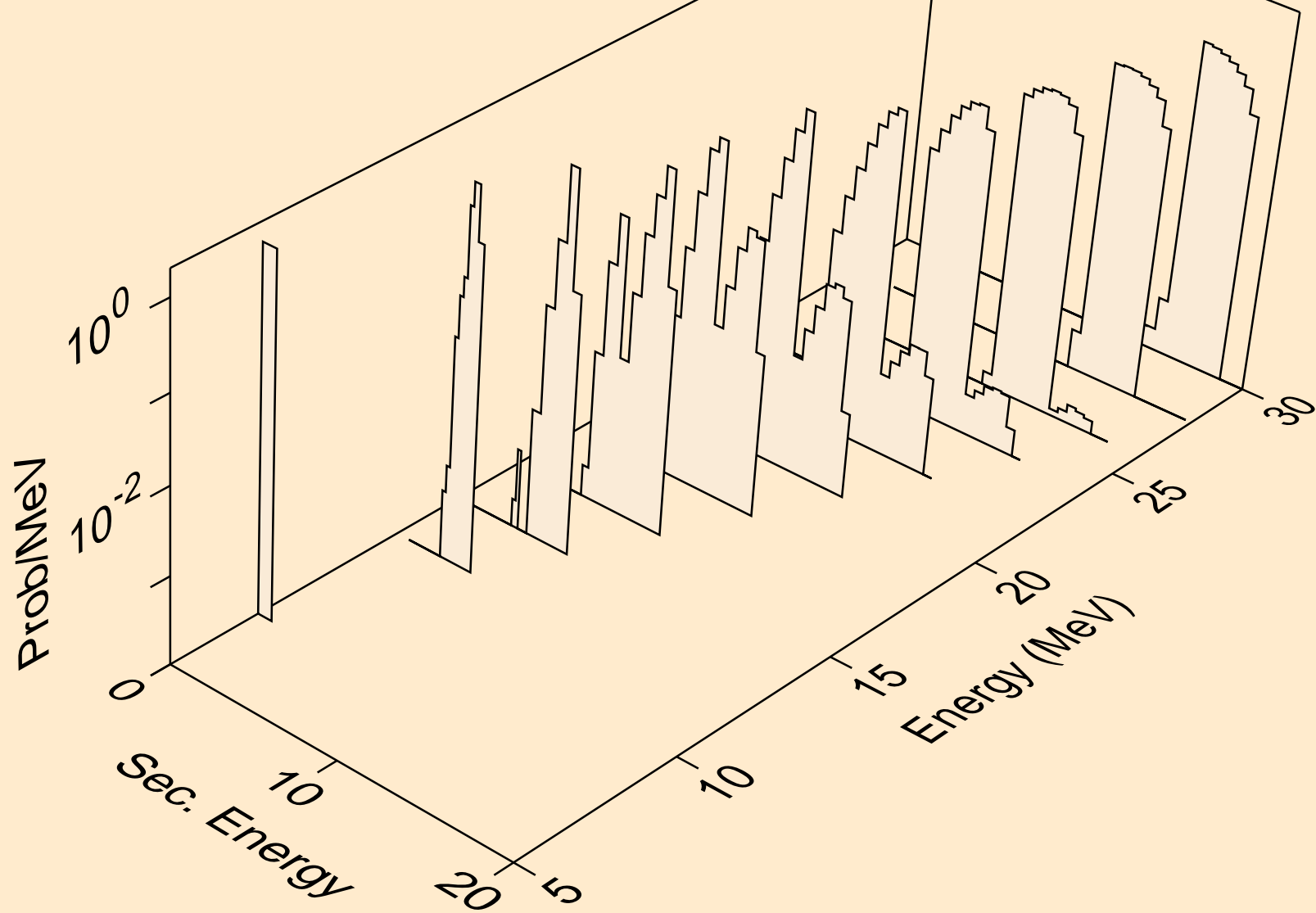

NB106 TRITON ACER TENDL-2021 LIBRARY; T=0.K  
alphas from (t,x)

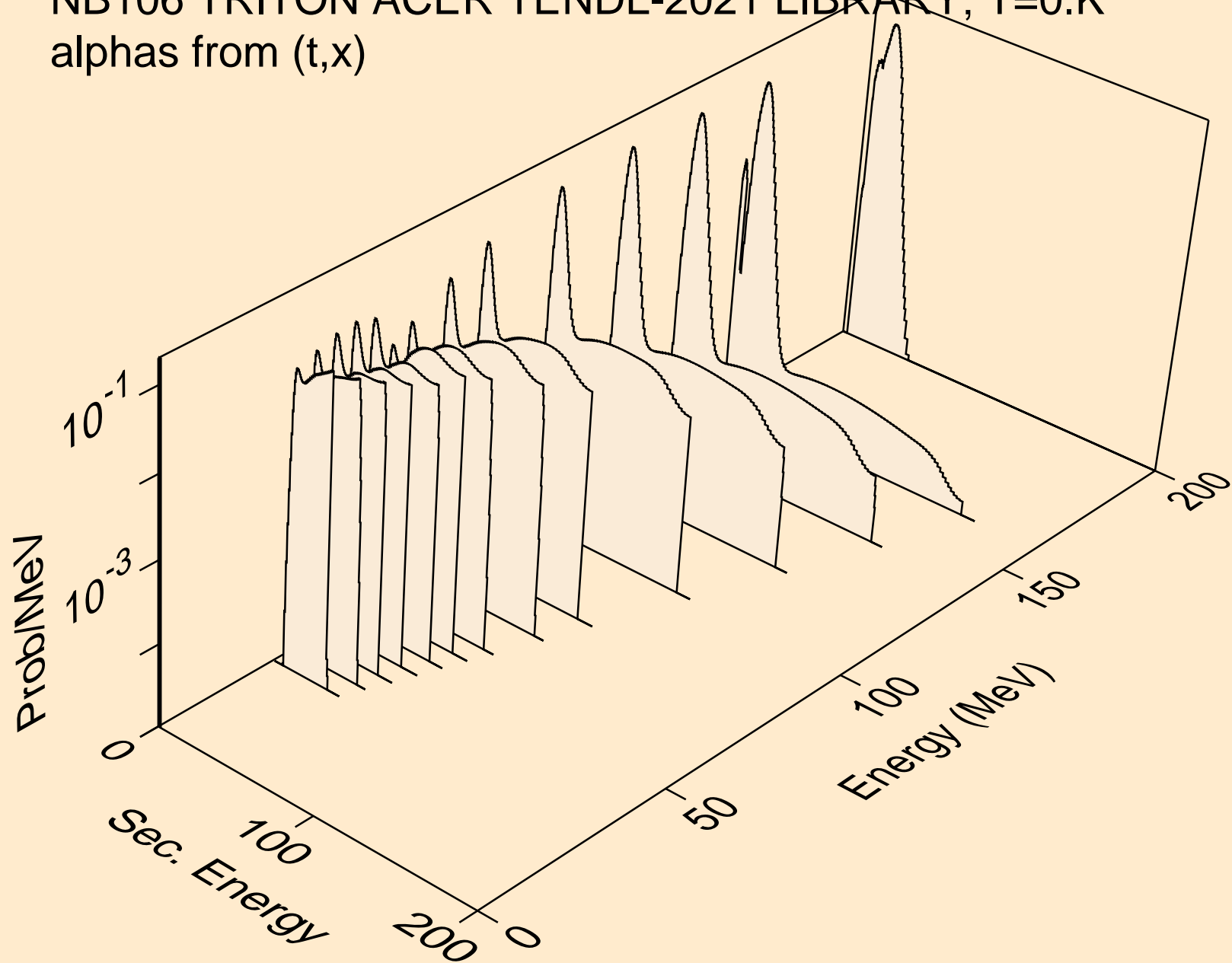

NB106 TRITON ACER TENDL-2021 LIBRARY; T=0.K  
alphas from (t,n\*)a

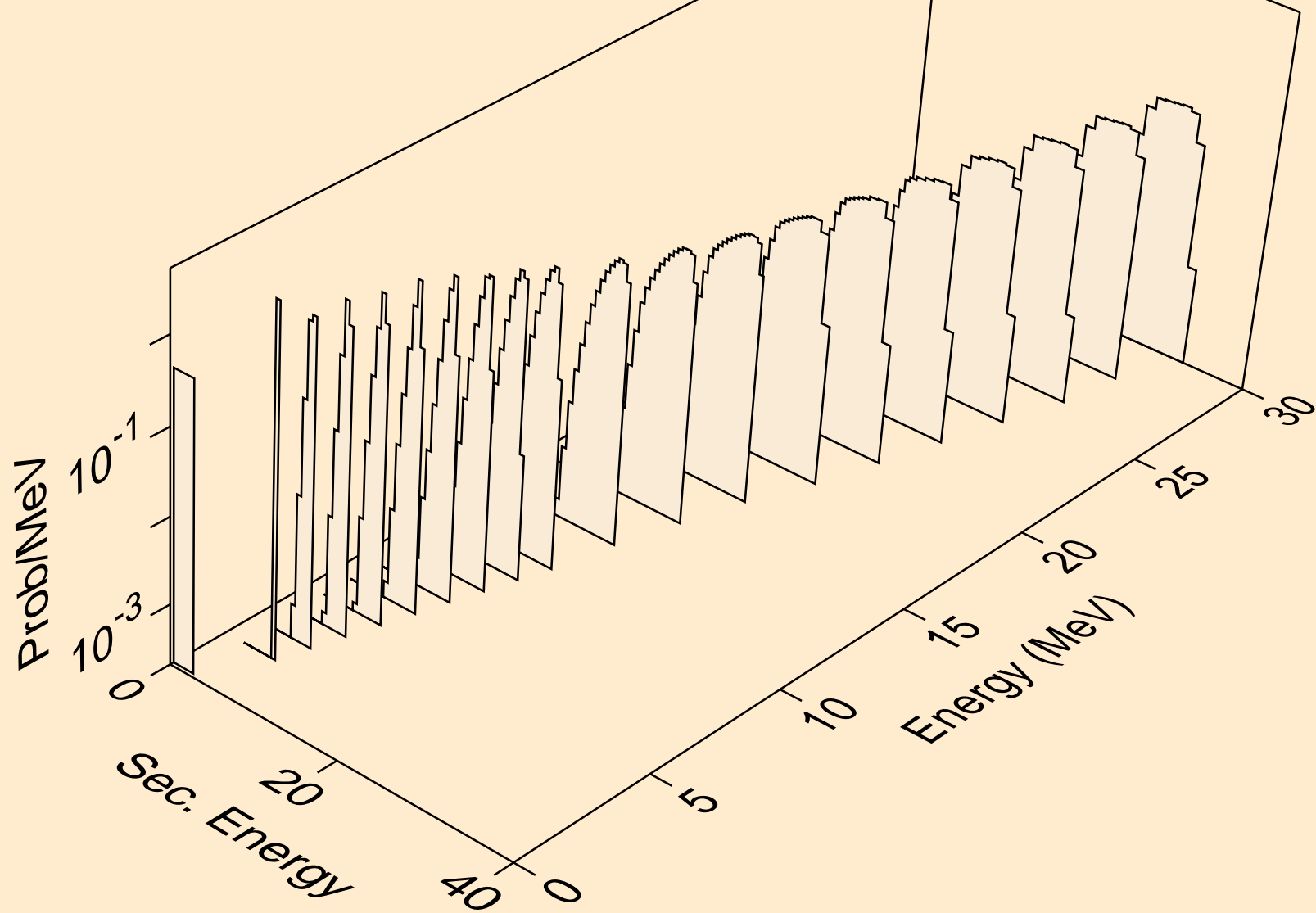

NB106 TRITON ACER TENDL-2021 LIBRARY; T=0.K  
alphas from (t,2n)a

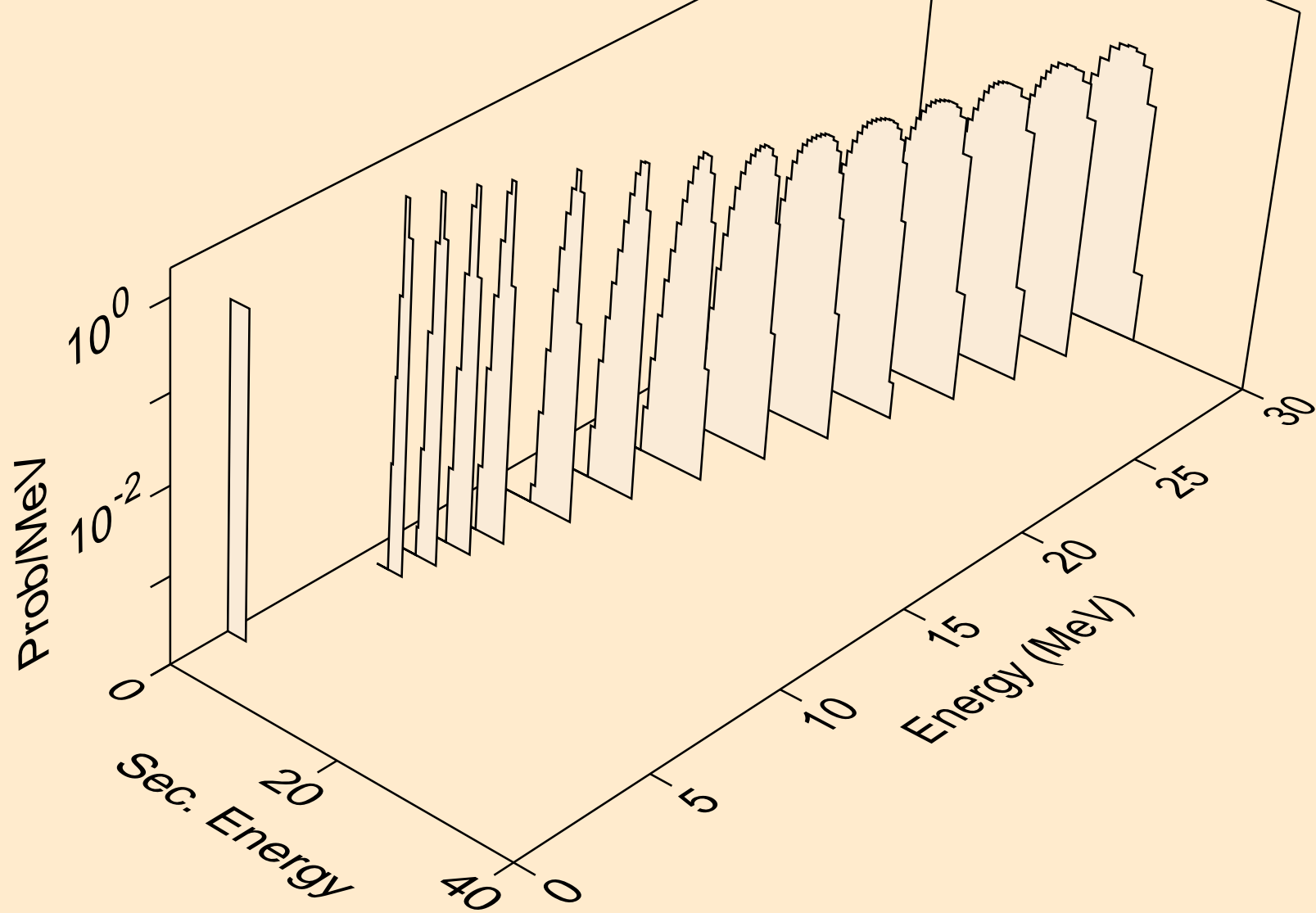

NB106 TRITON ACER TENDL-2021 LIBRARY; T=0.K  
alphas from (t,3n)a

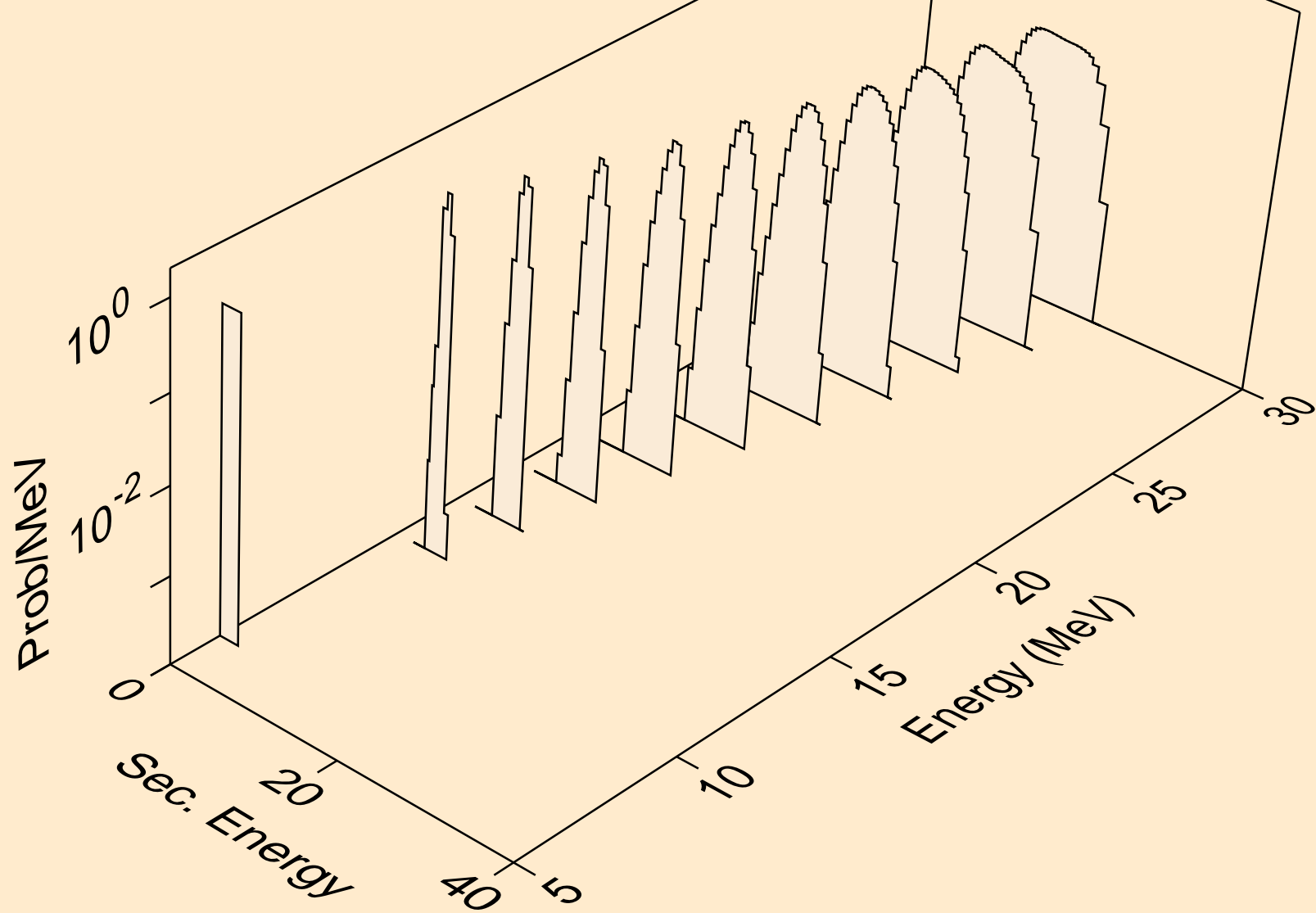

NB106 TRITON ACER TENDL-2021 LIBRARY; T=0.K  
alphas from (t,a)

