

# ND129 TRITON ACER TENDL-2021 LIBRARY; T=0.K

## Principal cross sections

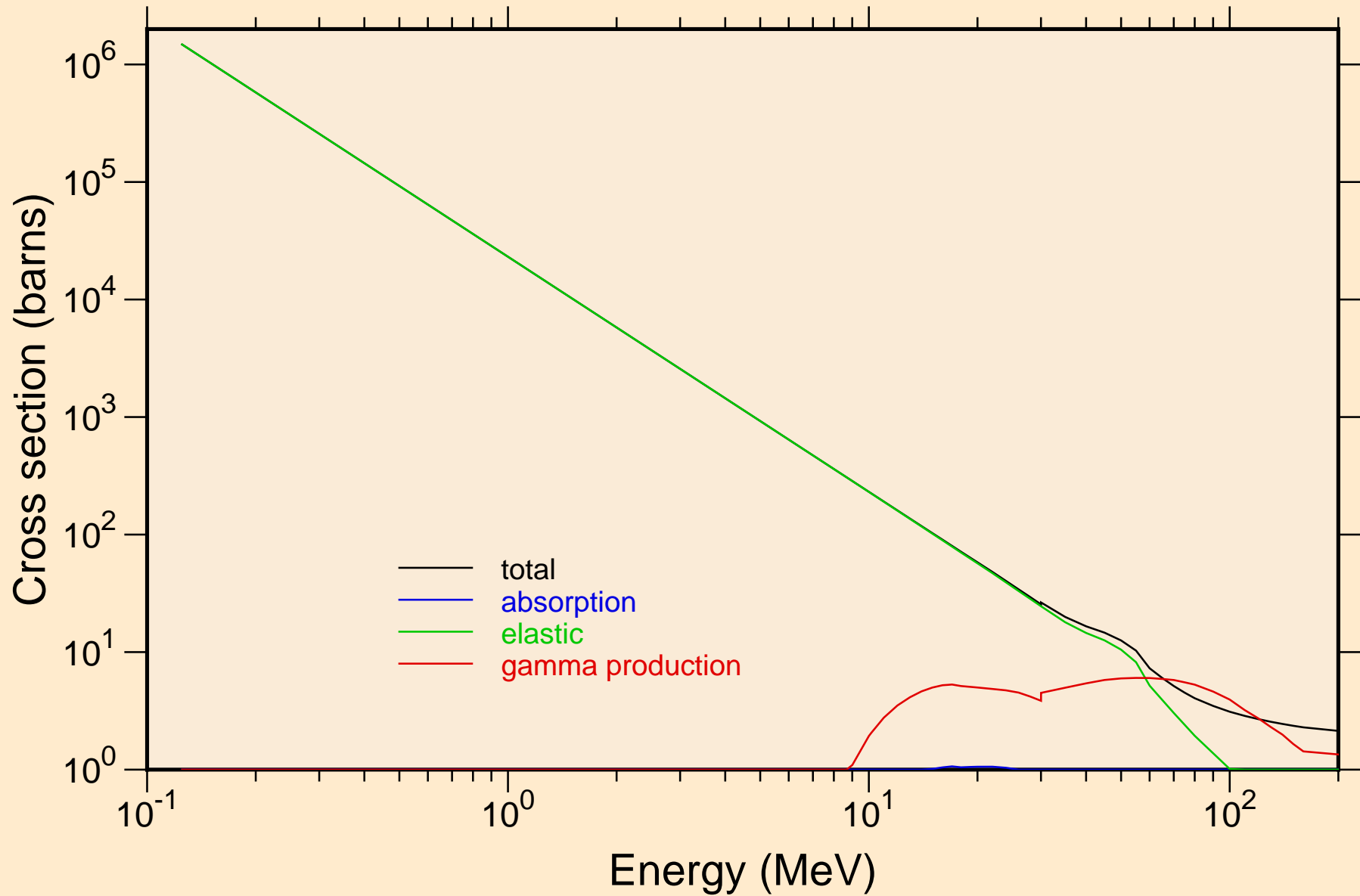

ND129 TRITON ACER TENDL-2021 LIBRARY; T=0.K  
Heating

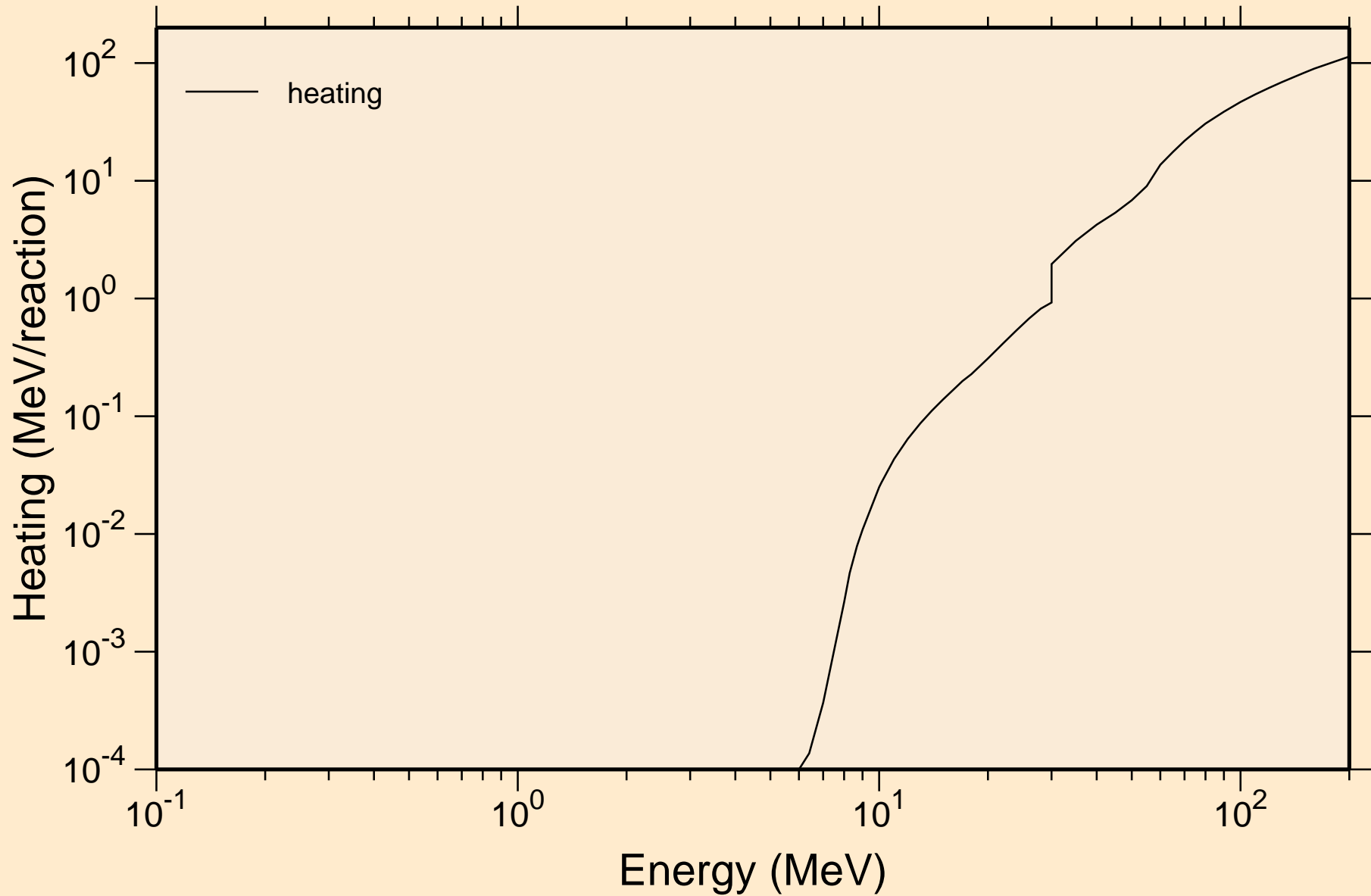

# ND129 TRITON ACER TENDL-2021 LIBRARY; T=0.K

## Principal cross sections

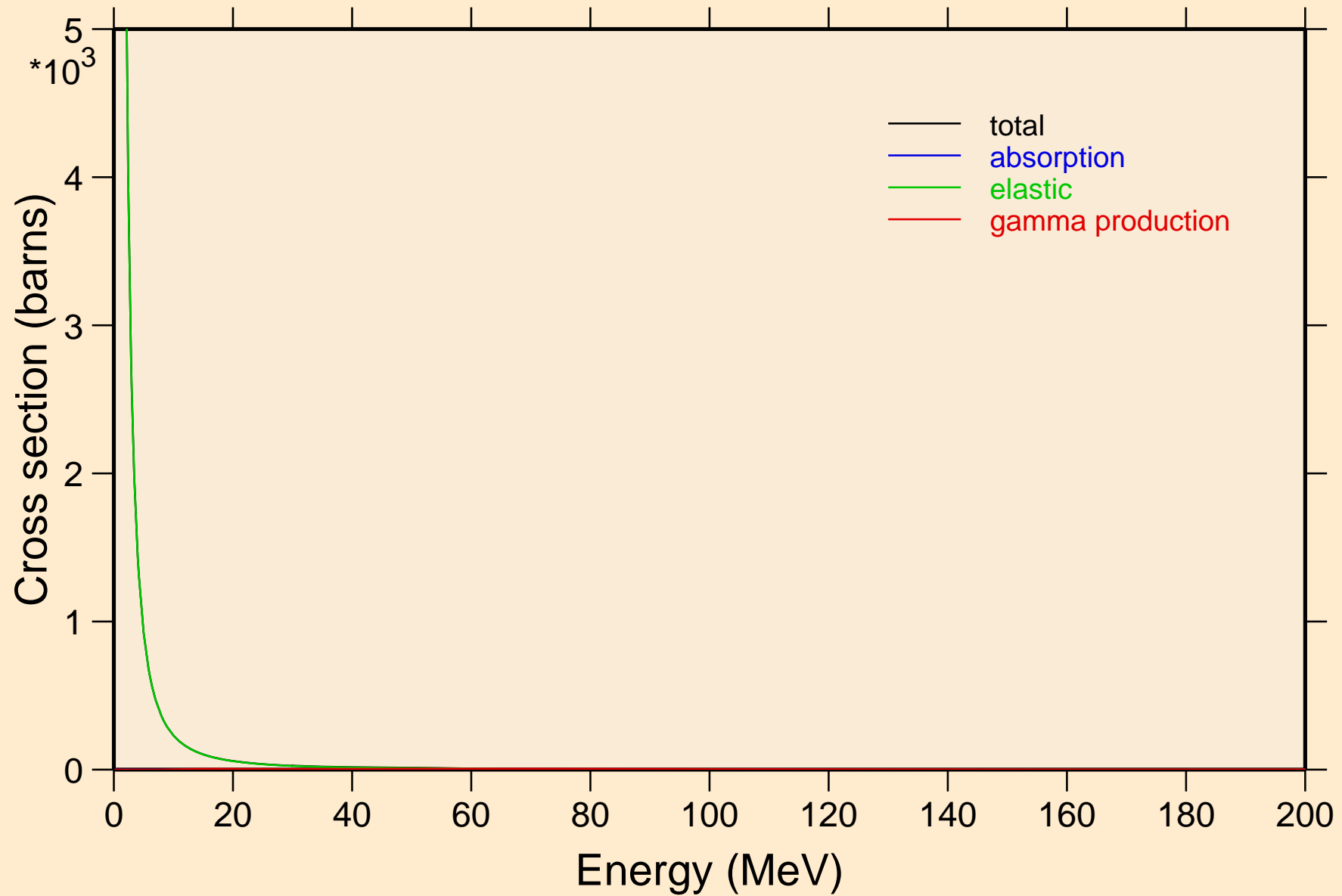

# ND129 TRITON ACER TENDL-2021 LIBRARY; T=0.K

## Heating

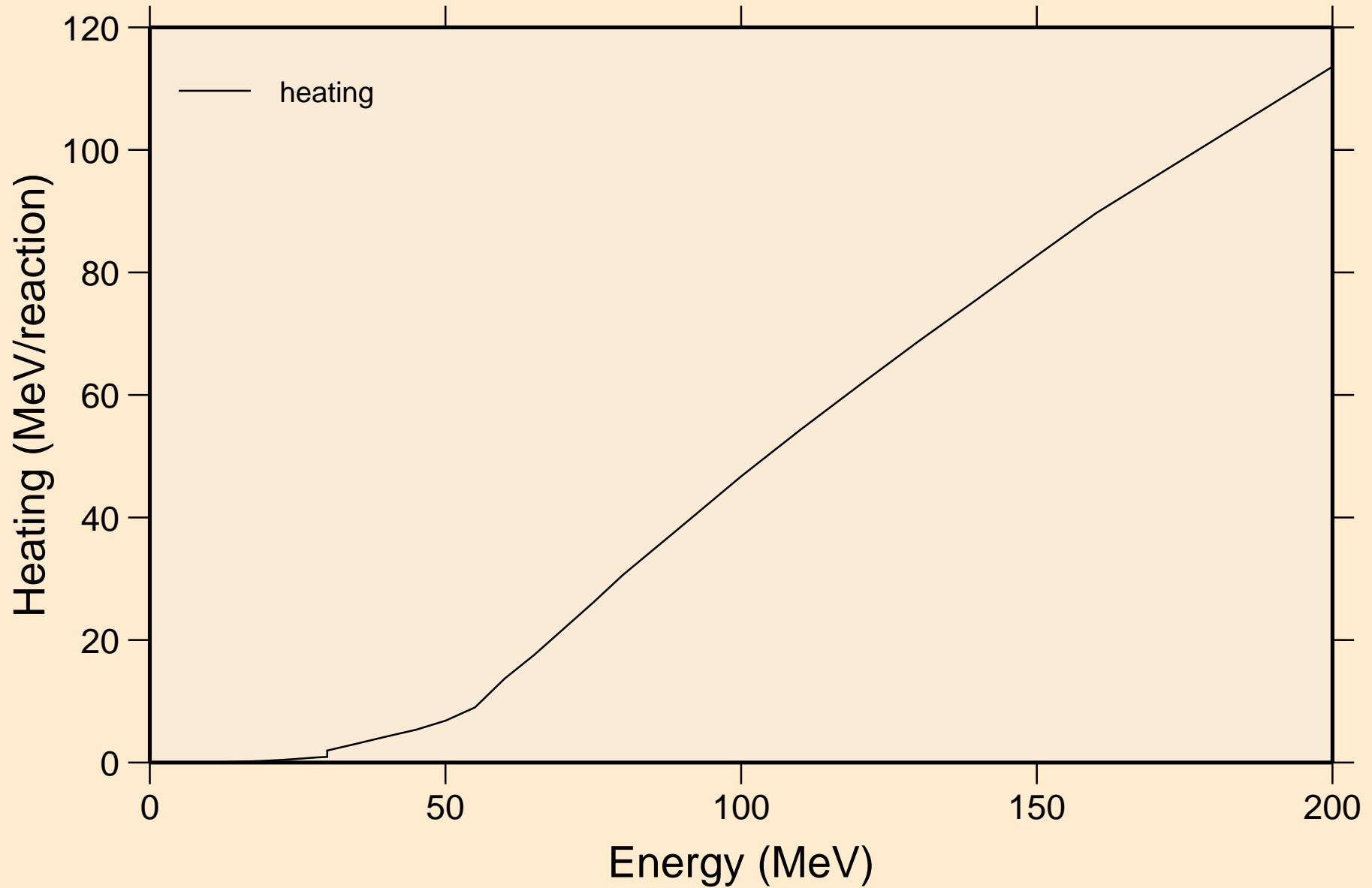

# ND129 TRITON ACER TENDL-2021 LIBRARY; T=0.K

## Threshold reactions

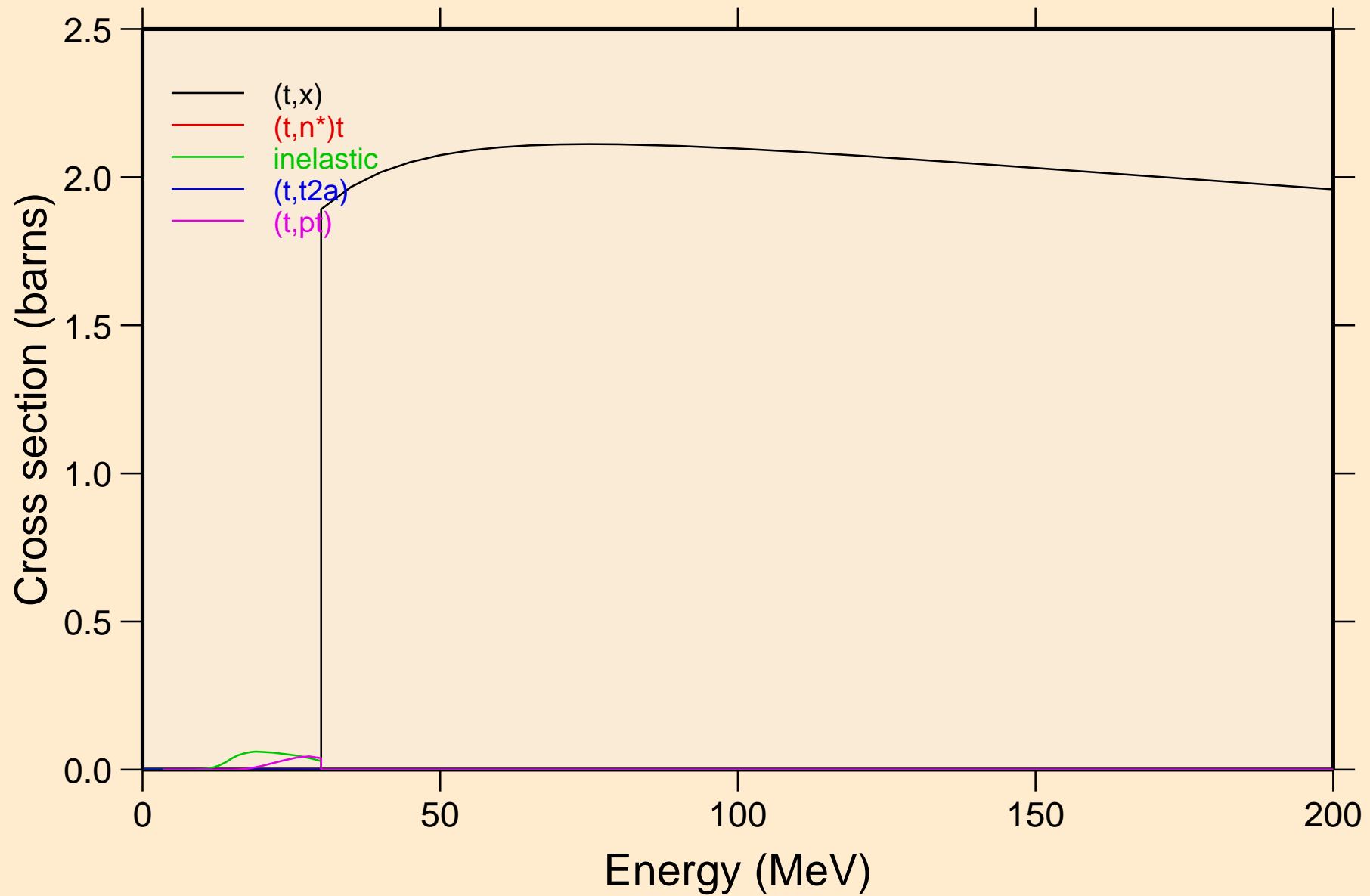

ND129 TRITON ACER TENDL-2021 LIBRARY; T=0.K  
Threshold reactions

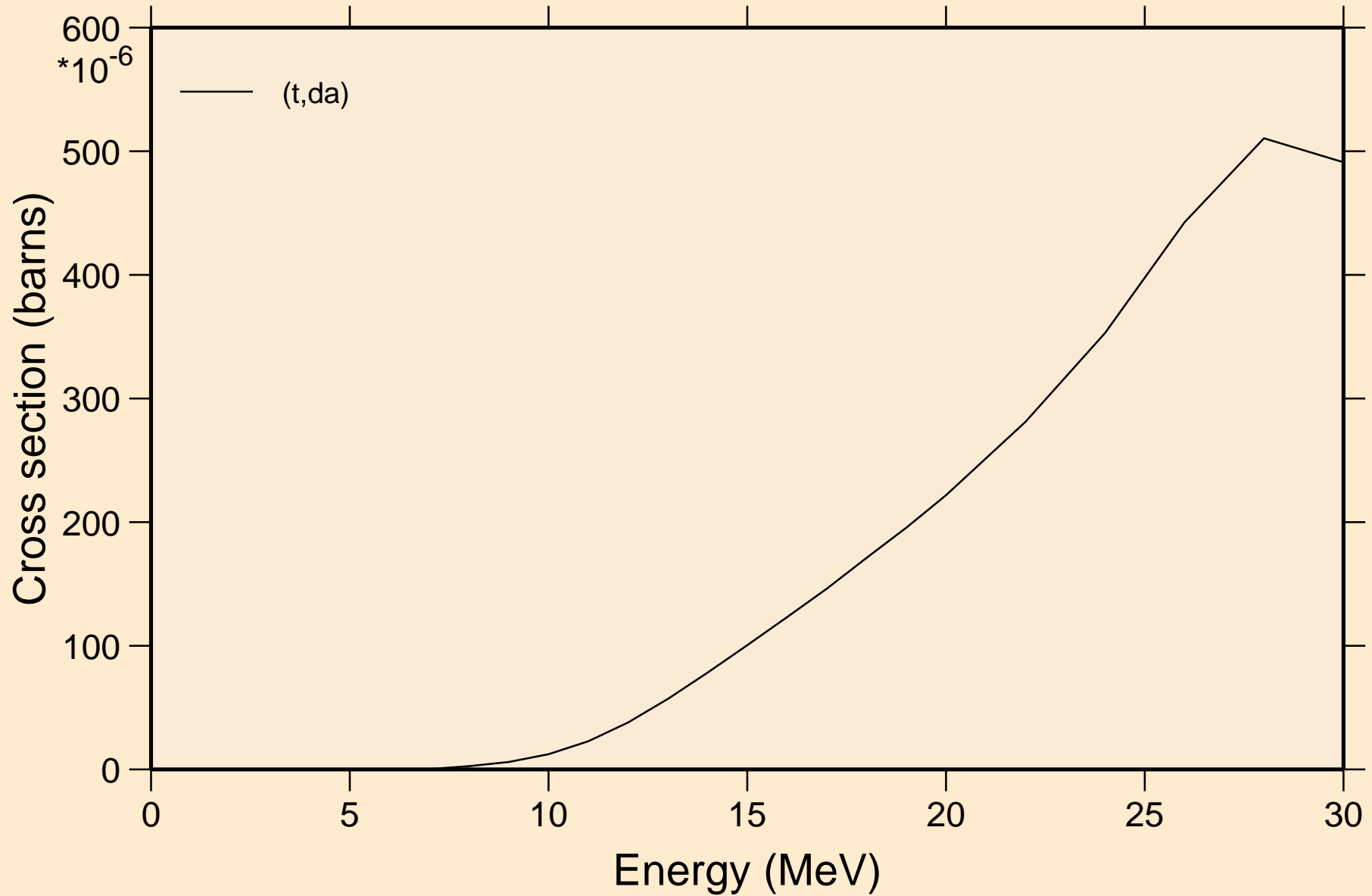

ND129 TRITON ACER TENDL-2021 LIBRARY; T=0.K  
angular distribution for elastic

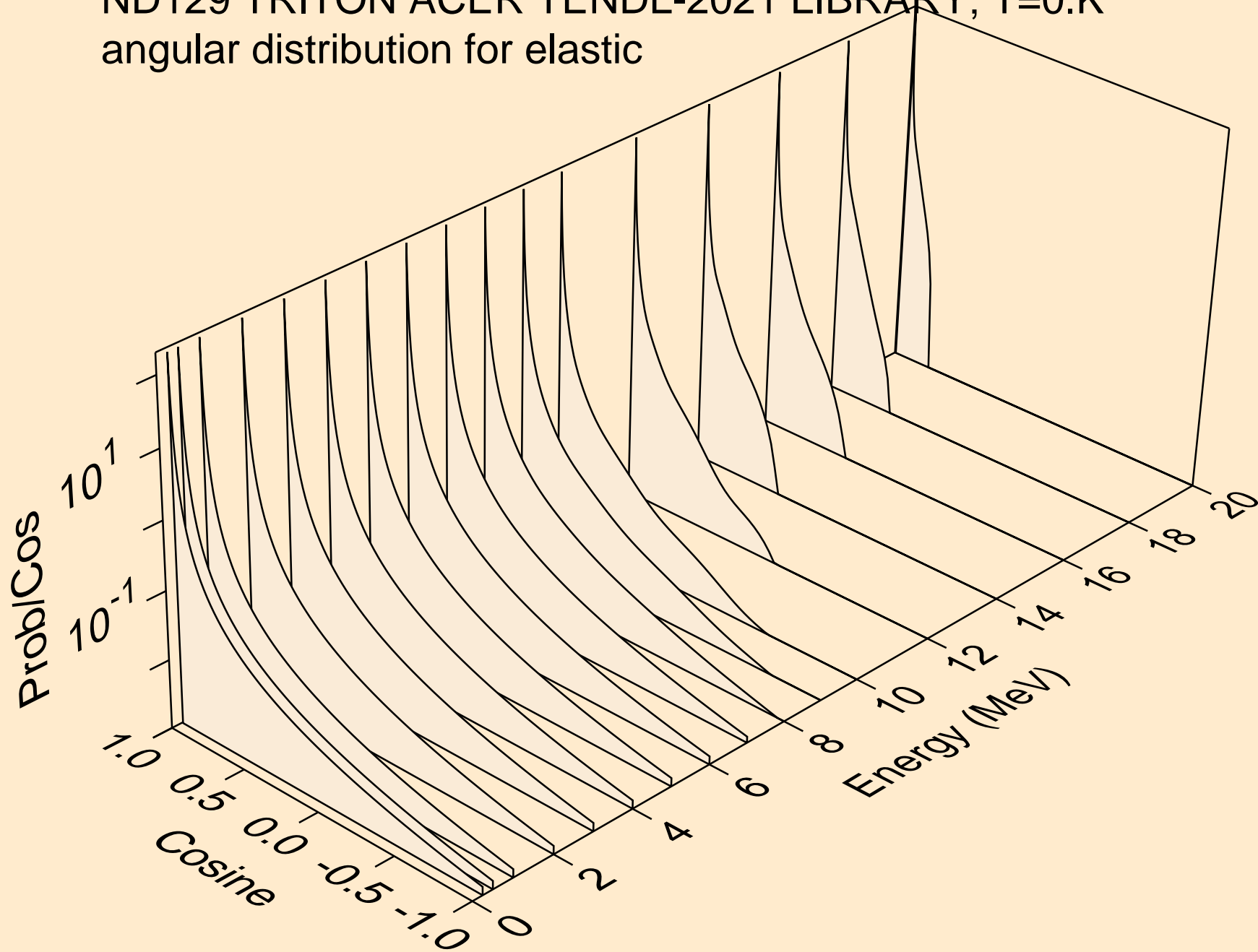

ND129 TRITON ACER TENDL-2021 LIBRARY; T=0.K  
angular distribution for elastic

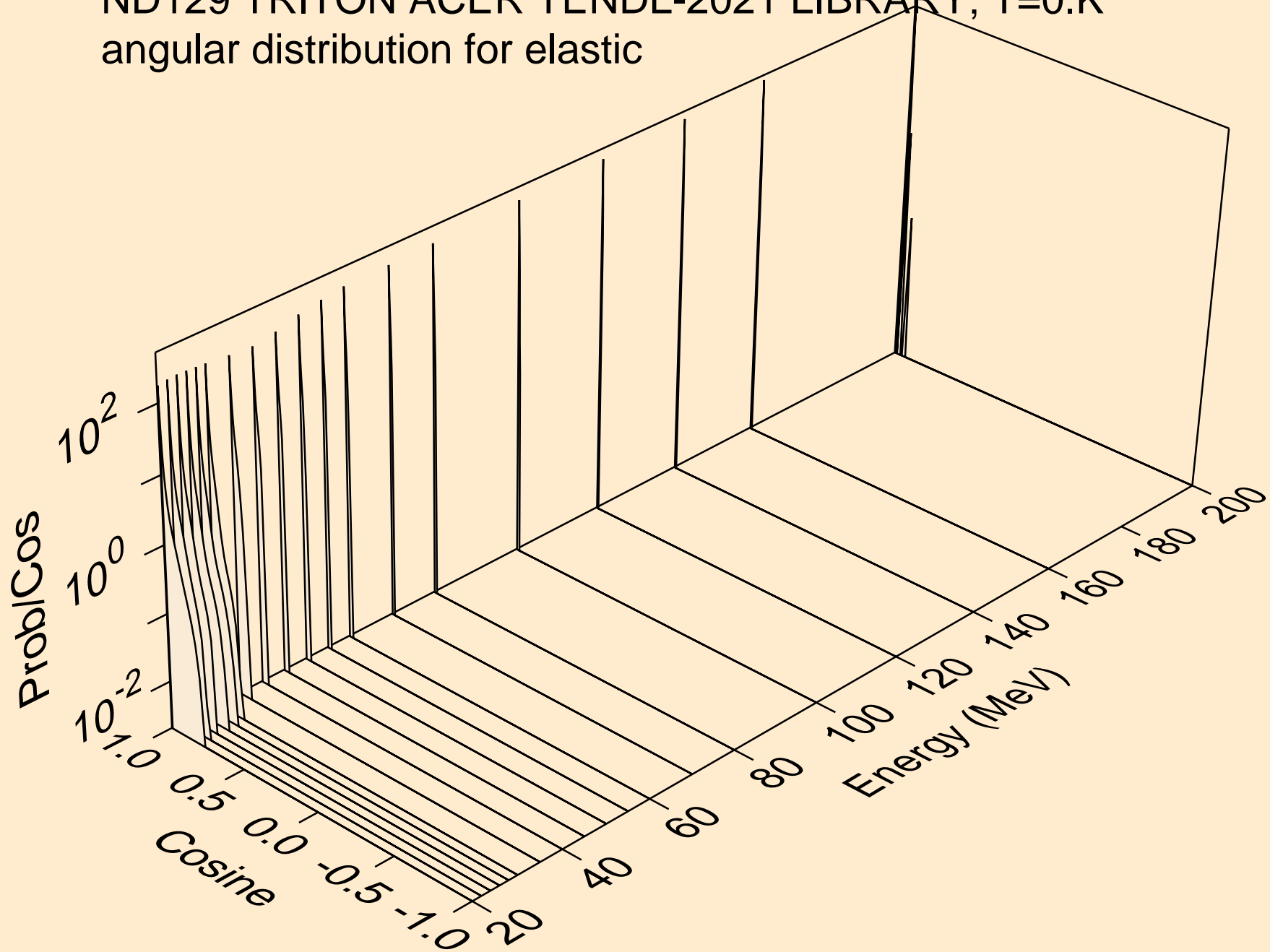



ND129 TRITON ACER TENDL-2021 LIBRARY; T=0.K  
Triton emission for (t,x)

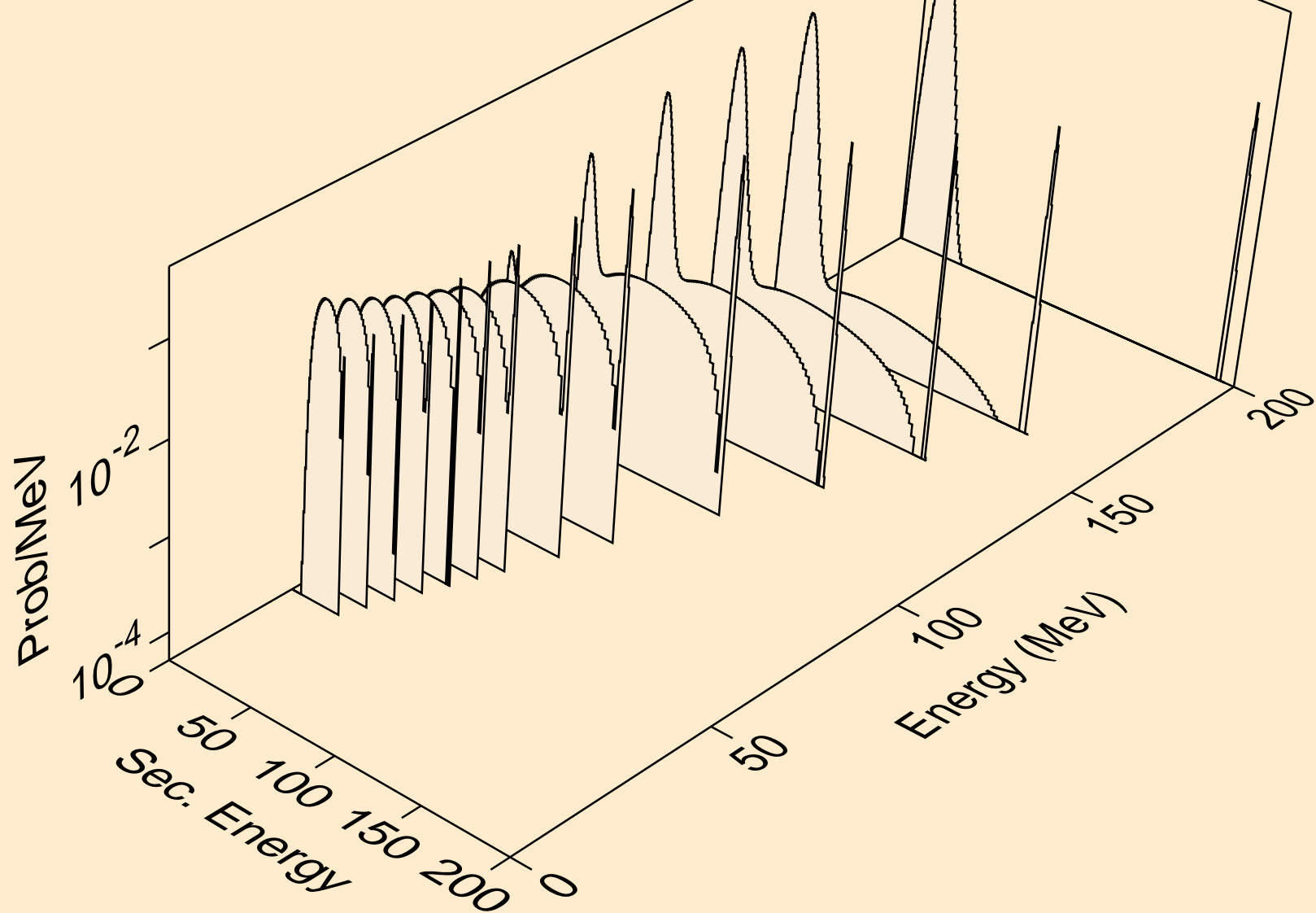

ND129 TRITON ACER TENDL-2021 LIBRARY; T=0.K  
Triton emission for (t,n\*)t

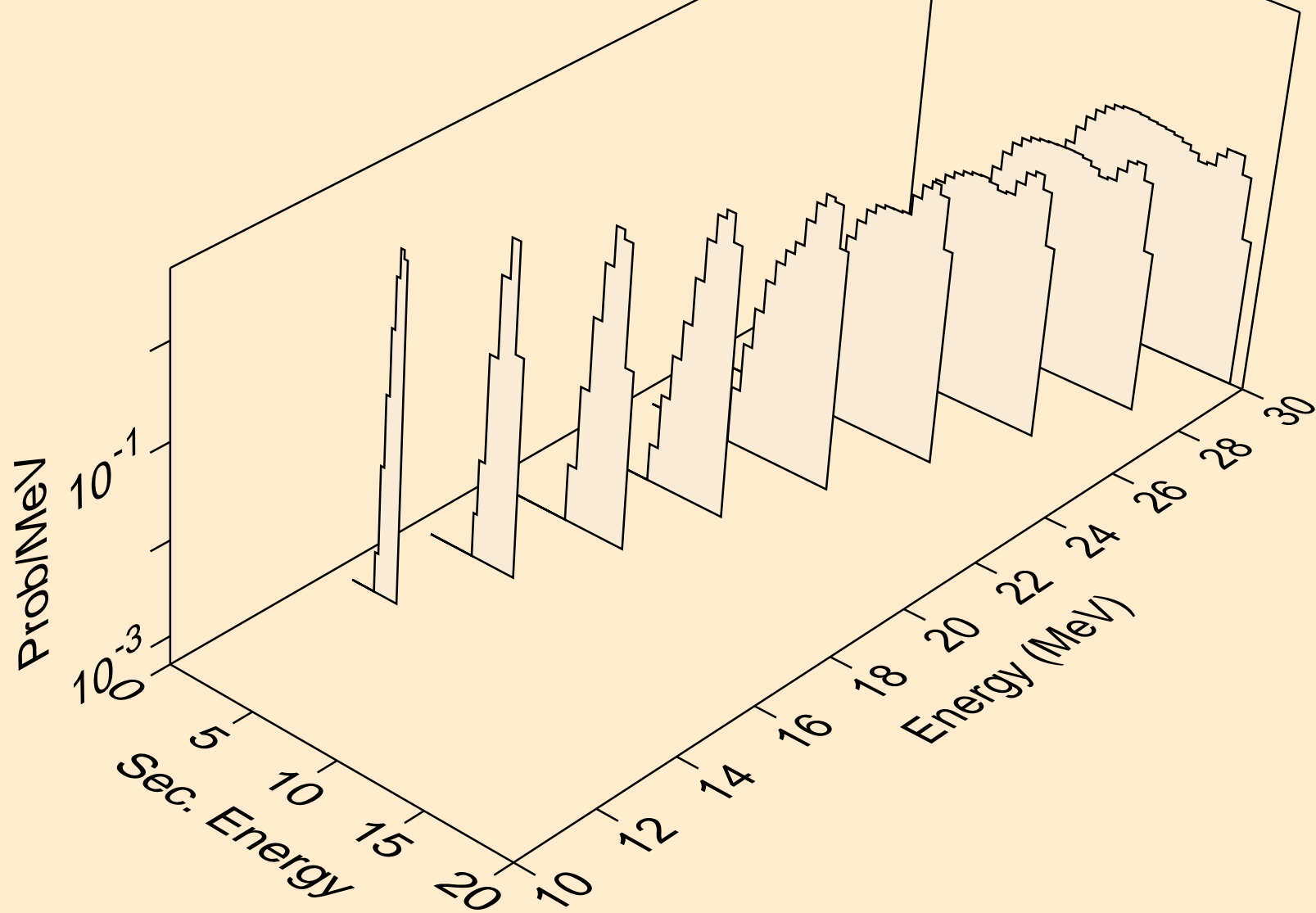

ND129 TRITON ACER TENDL-2021 LIBRARY; T=0.K  
Triton emission for inelastic

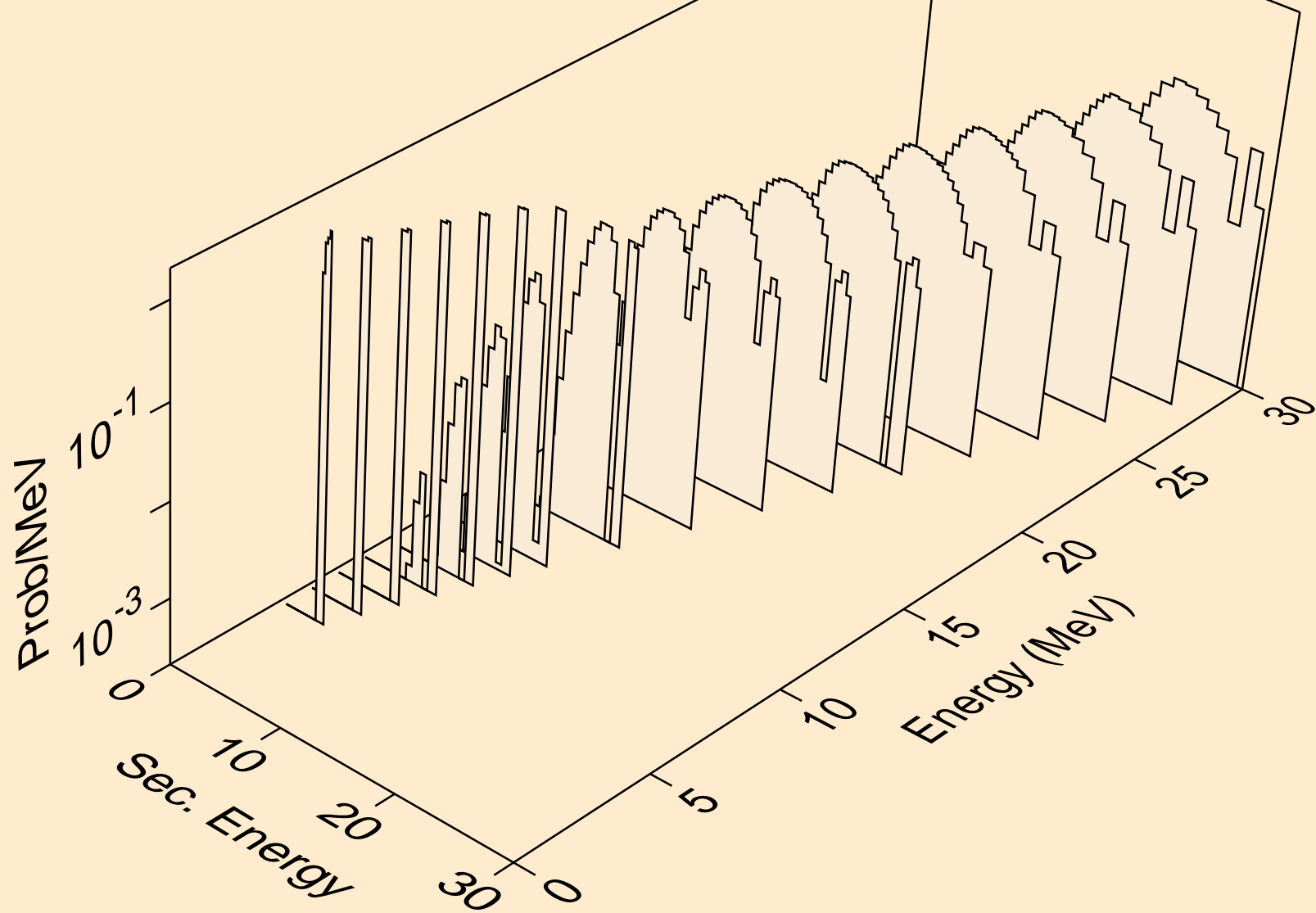

ND129 TRITON ACER TENDL-2021 LIBRARY; T=0.K  
Triton emission for (t,t2a)

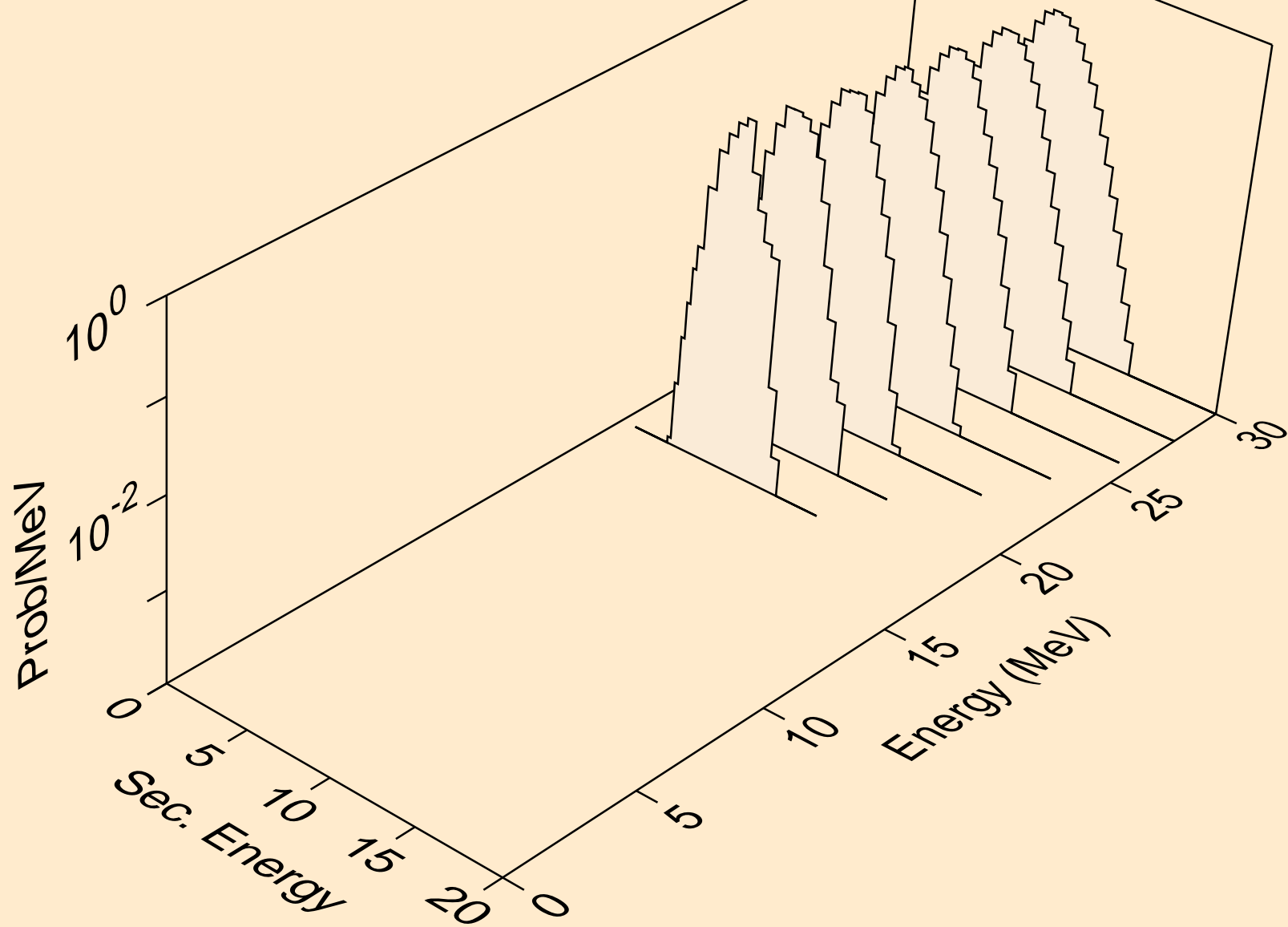

ND129 TRITON ACER TENDL-2021 LIBRARY; T=0.K  
Triton emission for (t,pt)

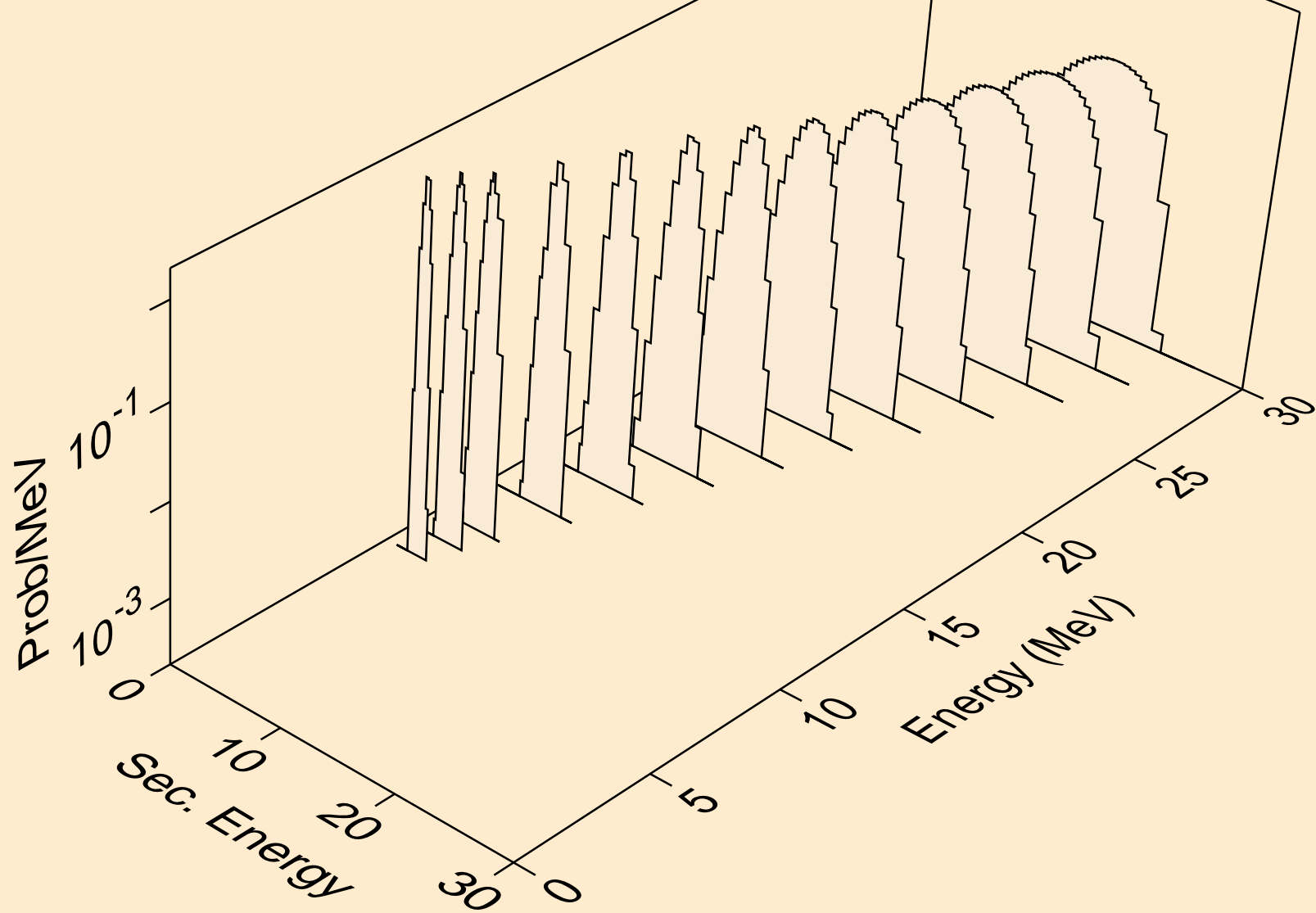

ND129 TRITON ACER TENDL-2021 LIBRARY; T=0.K  
Photon emission for (z,n)

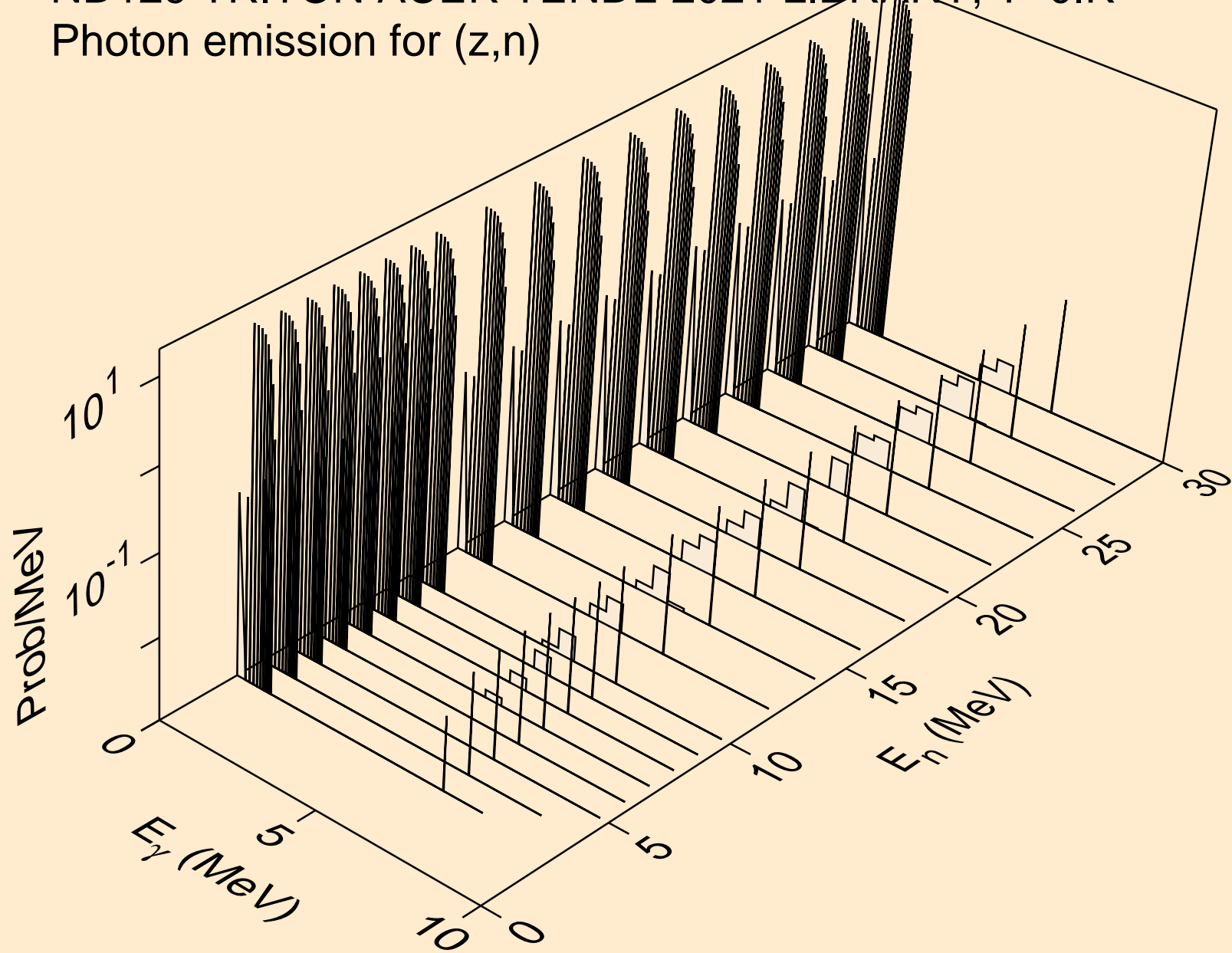

ND129 TRITON ACER TENDL-2021 LIBRARY; T=0.K  
Photon emission for (n,x)

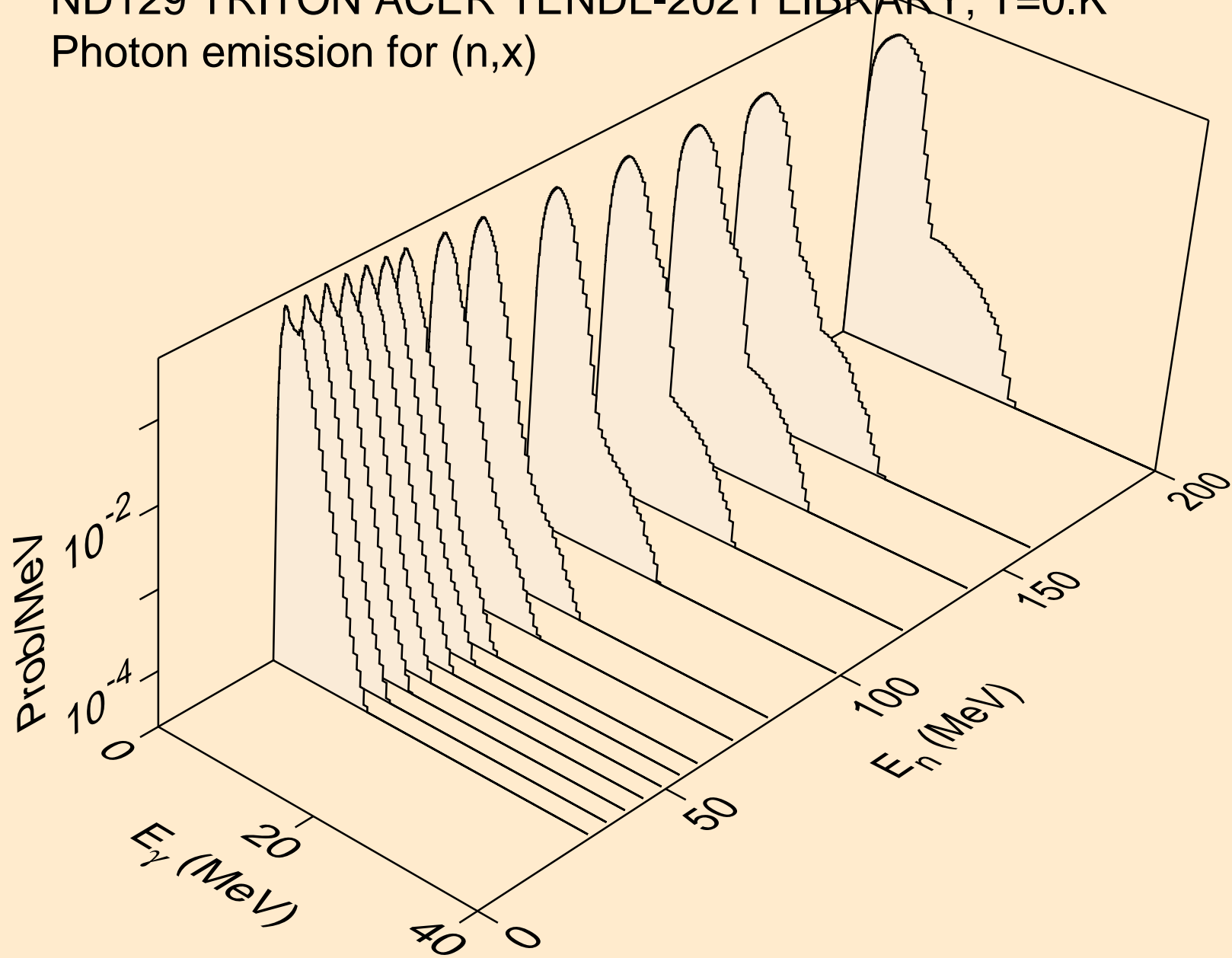

ND129 TRITON ACER TENDL-2021 LIBRARY; T=0.K  
Photon emission for (n,2nd)

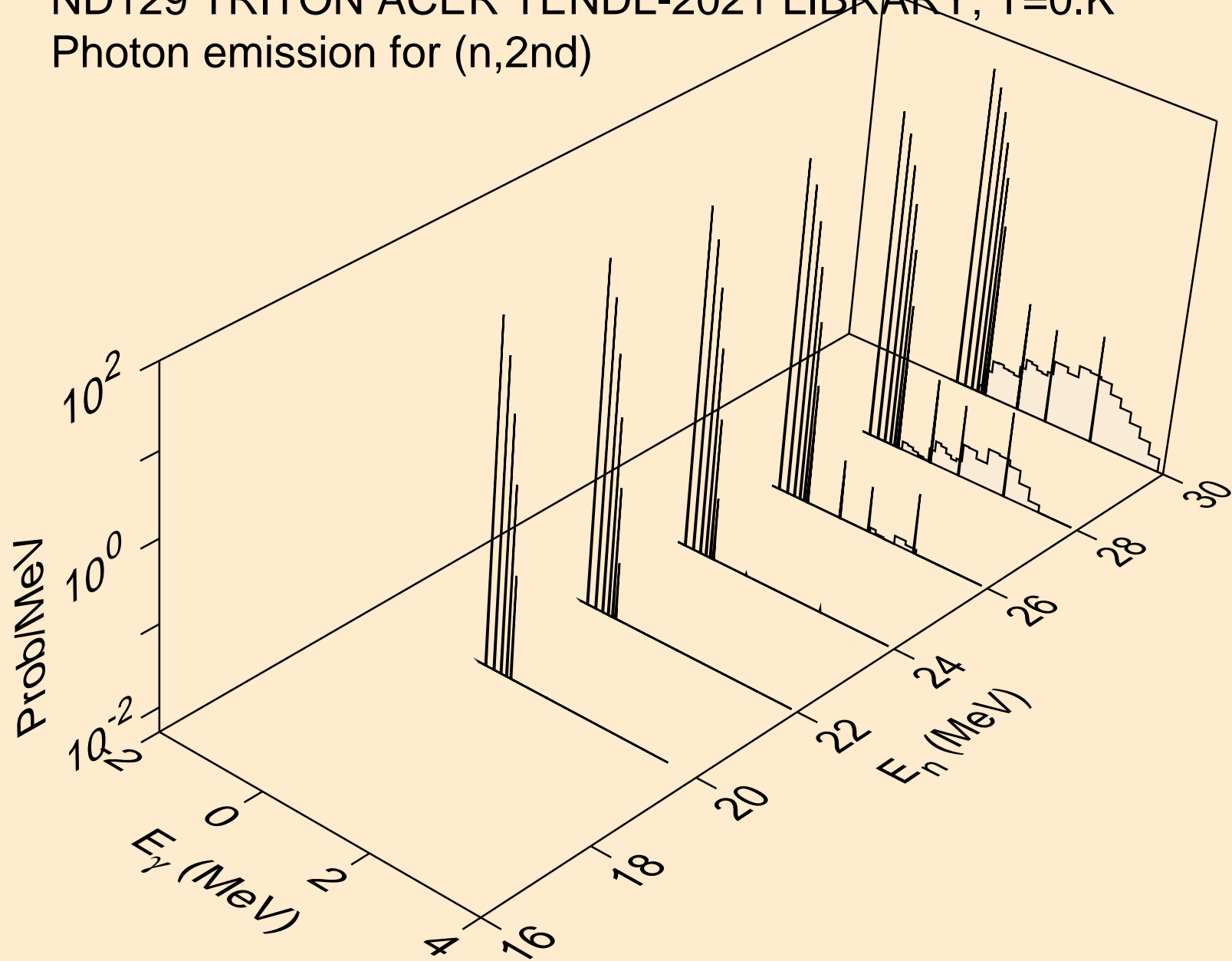



ND129 TRITON ACER TENDL-2021 LIBRARY; T=0.K  
Photon emission for (n,2n)

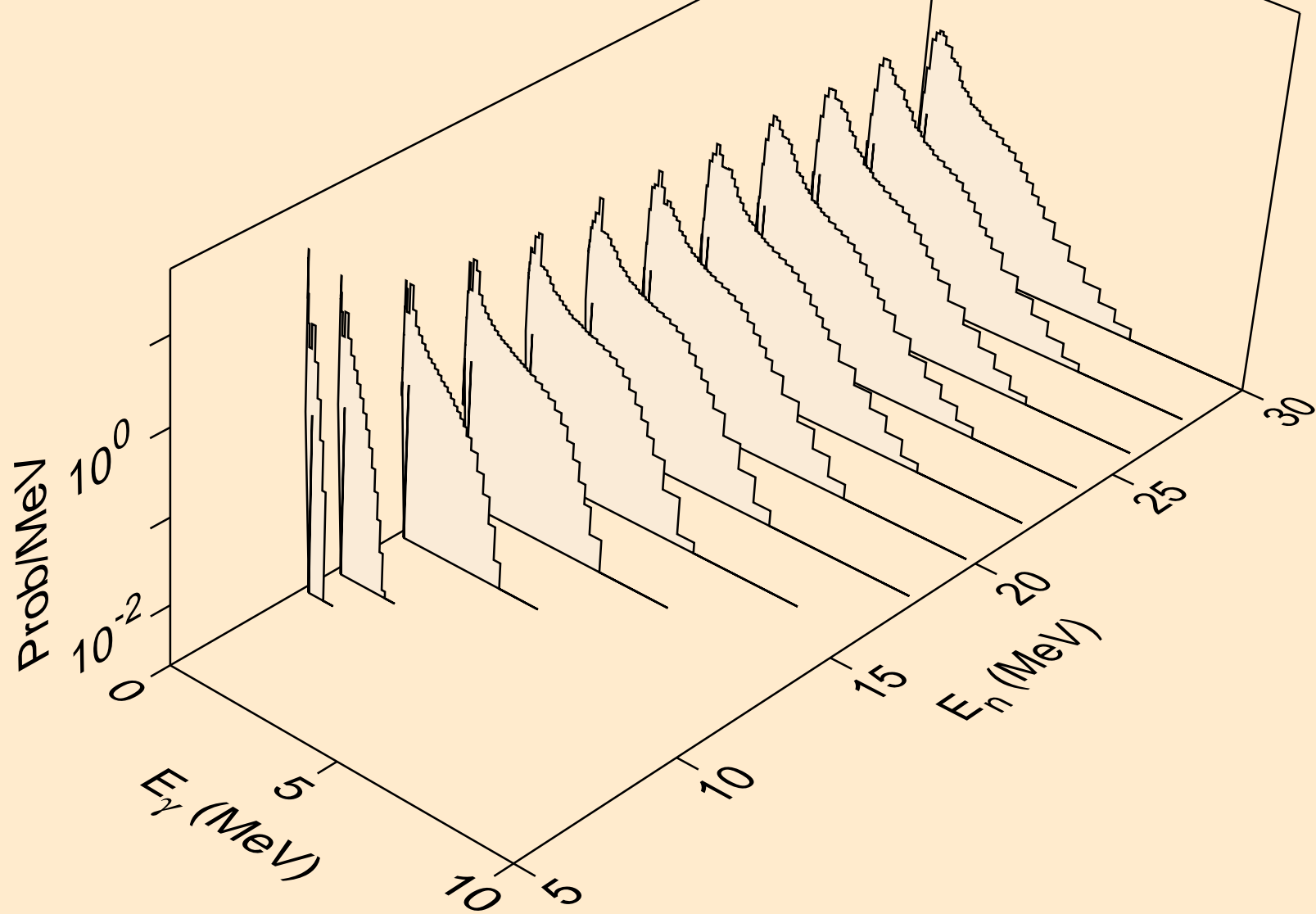

ND129 TRITON ACER TENDL-2021 LIBRARY; T=0.K  
Photon emission for (n,3n)

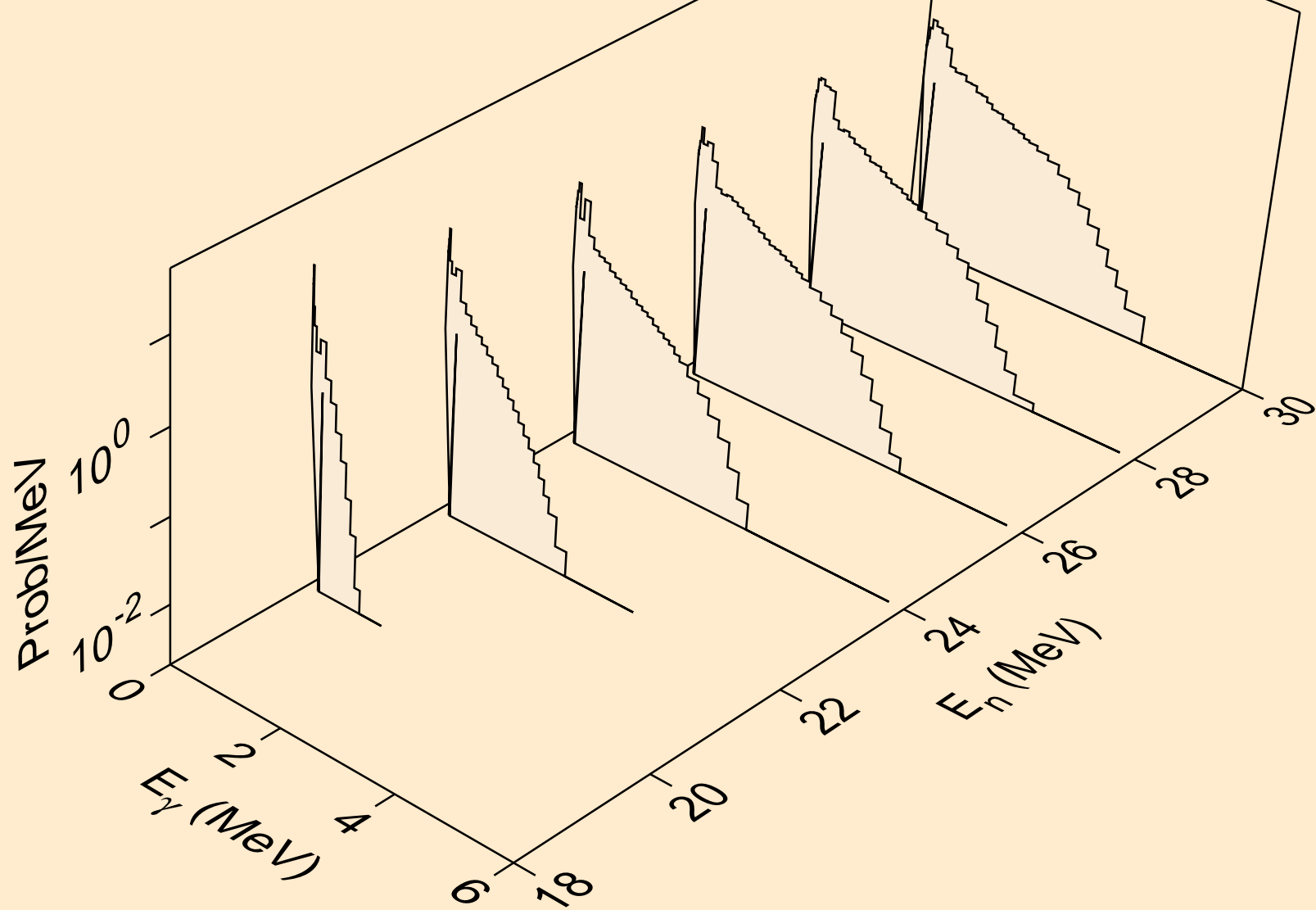

ND129 TRITON ACER TENDL-2021 LIBRARY; T=0.K  
Photon emission for (n,n\*)a

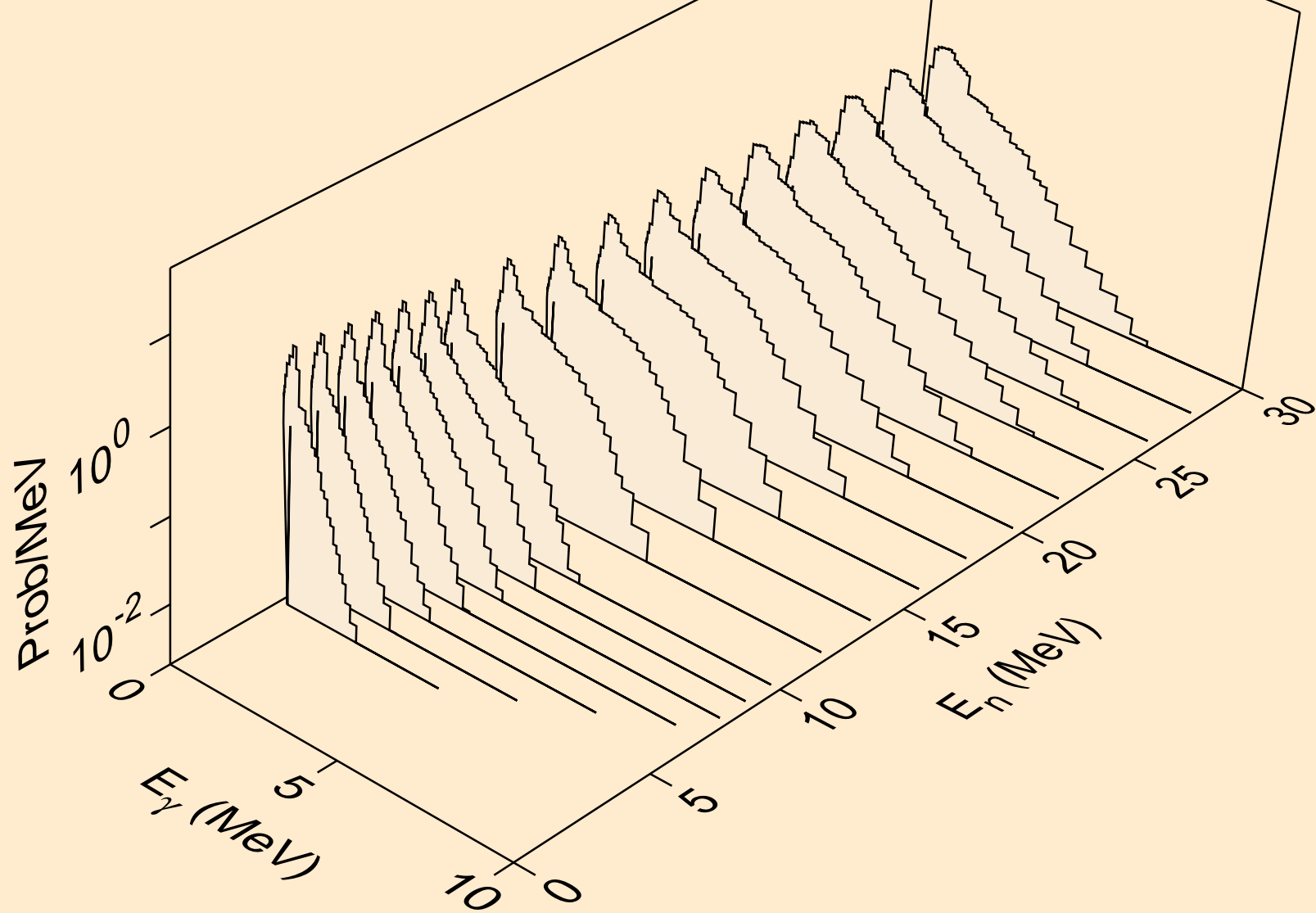

ND129 TRITON ACER TENDL-2021 LIBRARY; T=0.K  
Photon emission for (n,2n)a

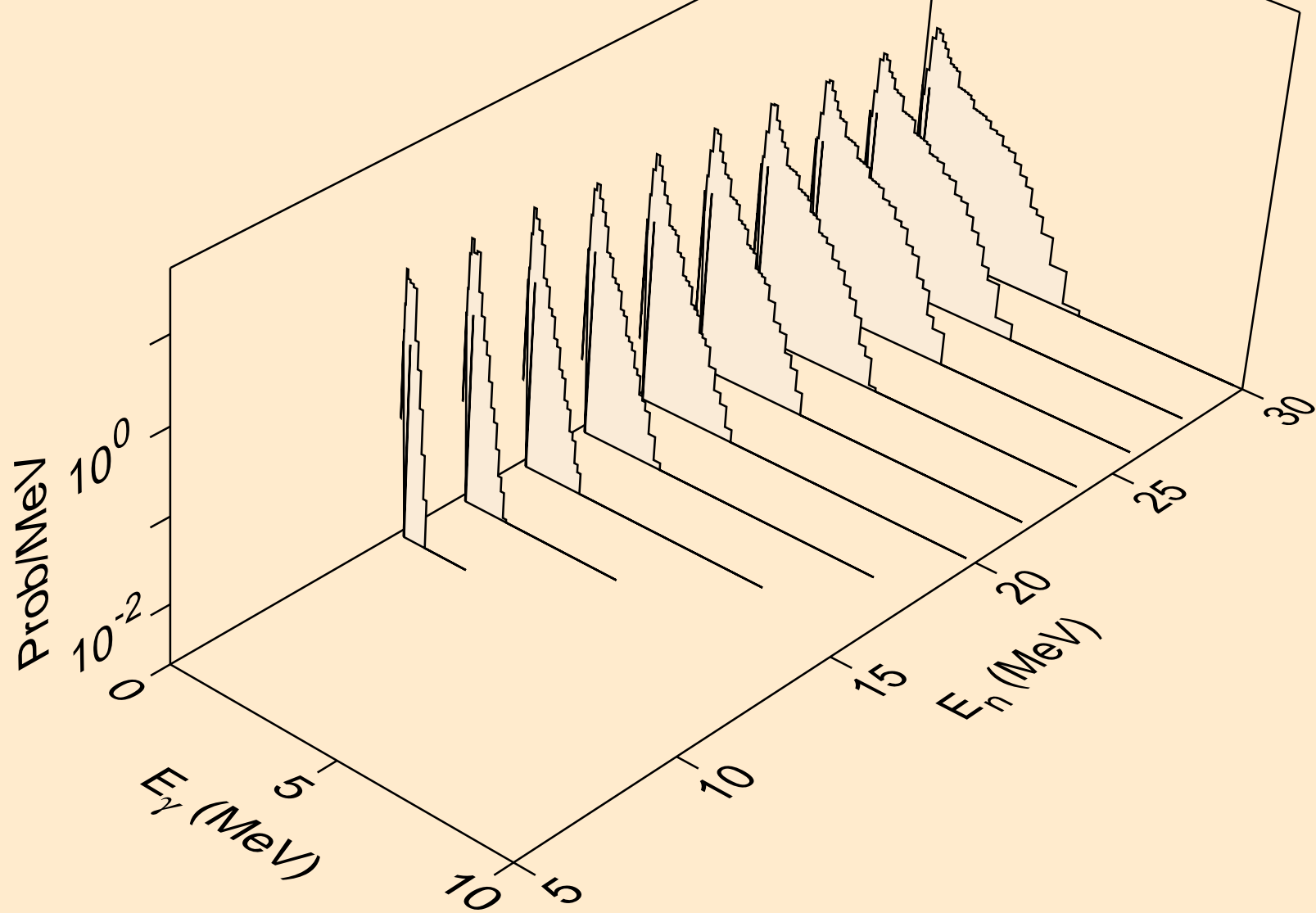

ND129 TRITON ACER TENDL-2021 LIBRARY; T=0.K  
Photon emission for (n,n\*)p

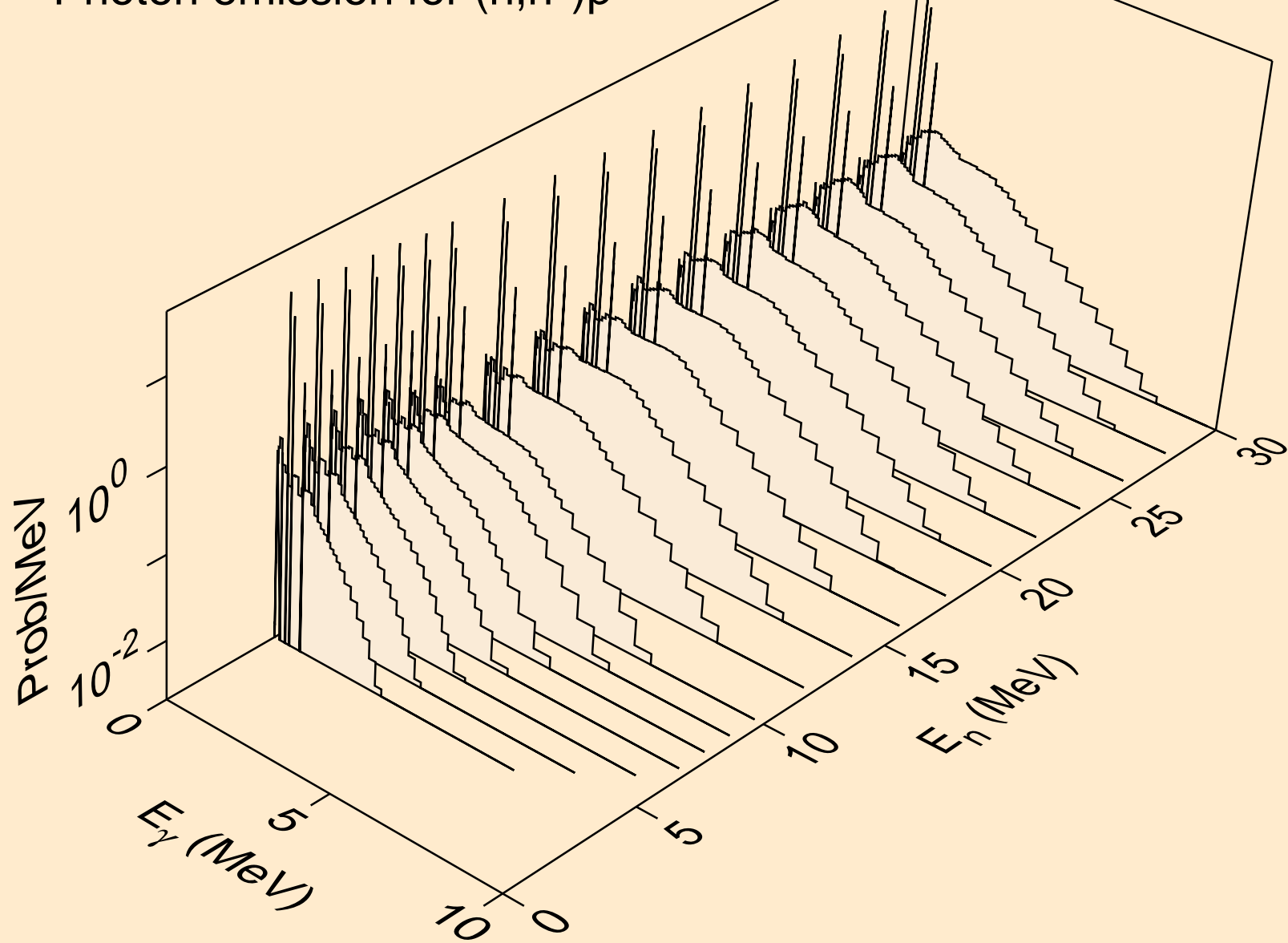

ND129 TRITON ACER TENDL-2021 LIBRARY; T=0.K  
Photon emission for (n,n\*)2a

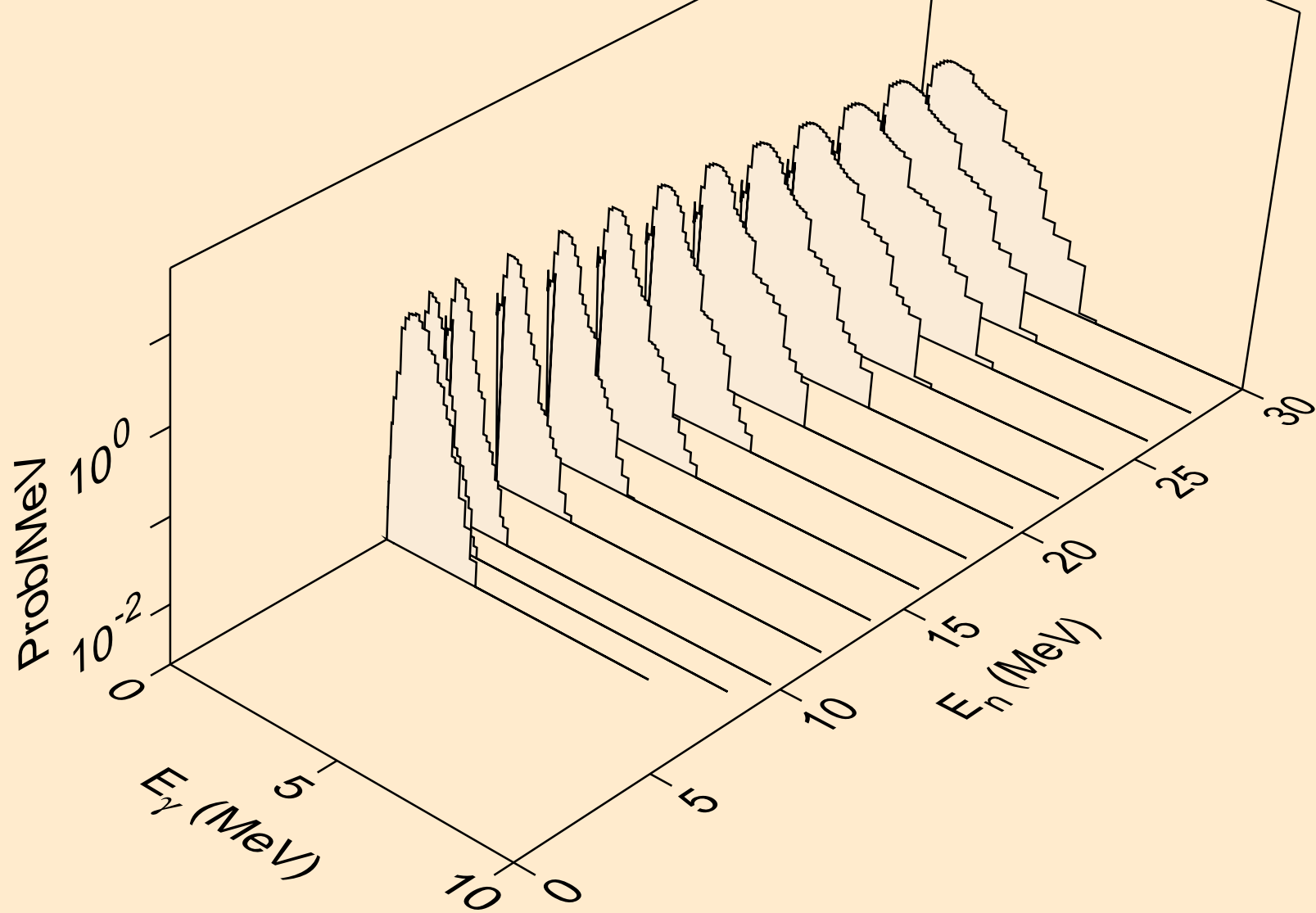

ND129 TRITON ACER TENDL-2021 LIBRARY; T=0.K  
Photon emission for (n,n\*)d

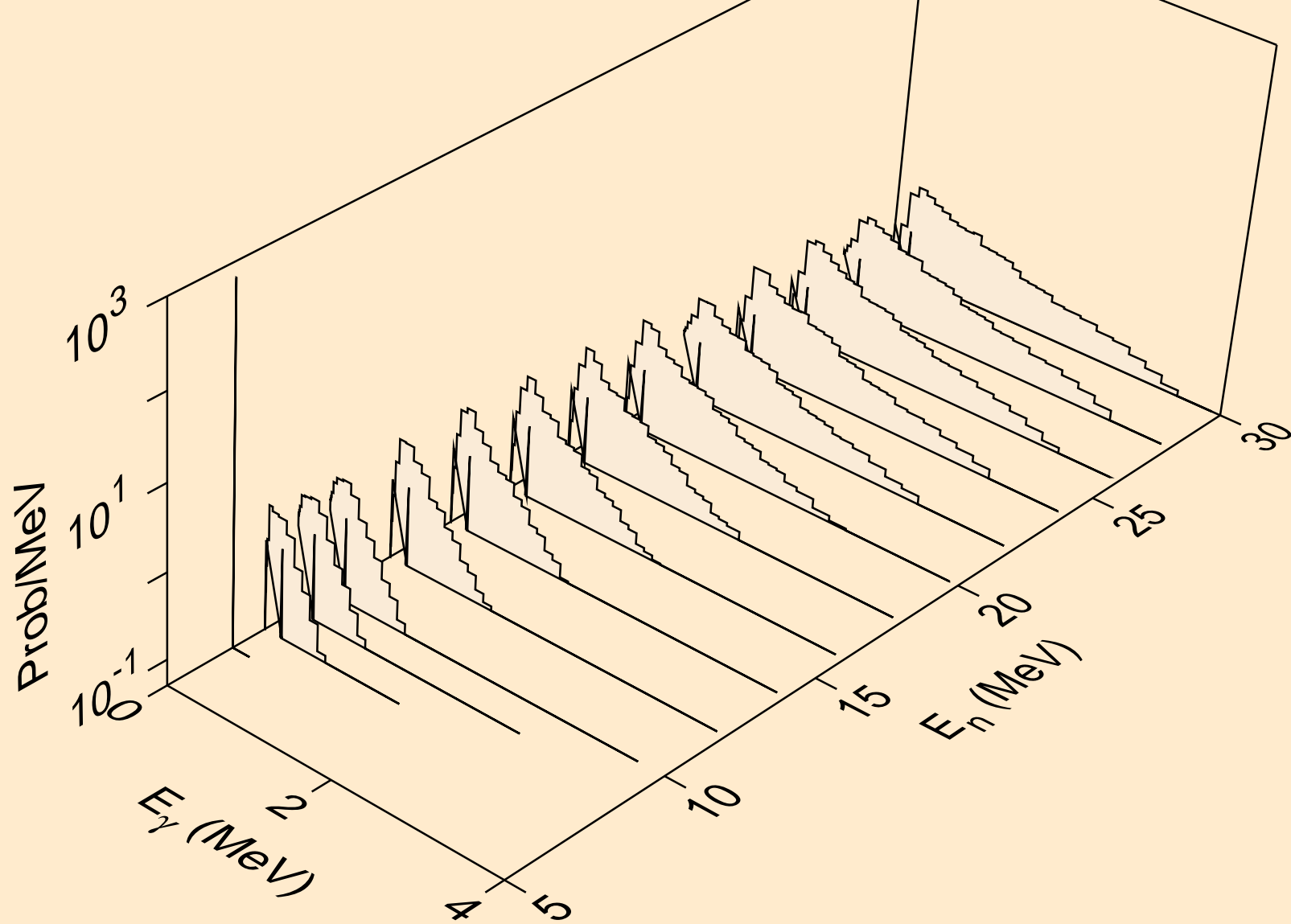

ND129 TRITON ACER TENDL-2021 LIBRARY; T=0.K  
Photon emission for (n,n\*)t

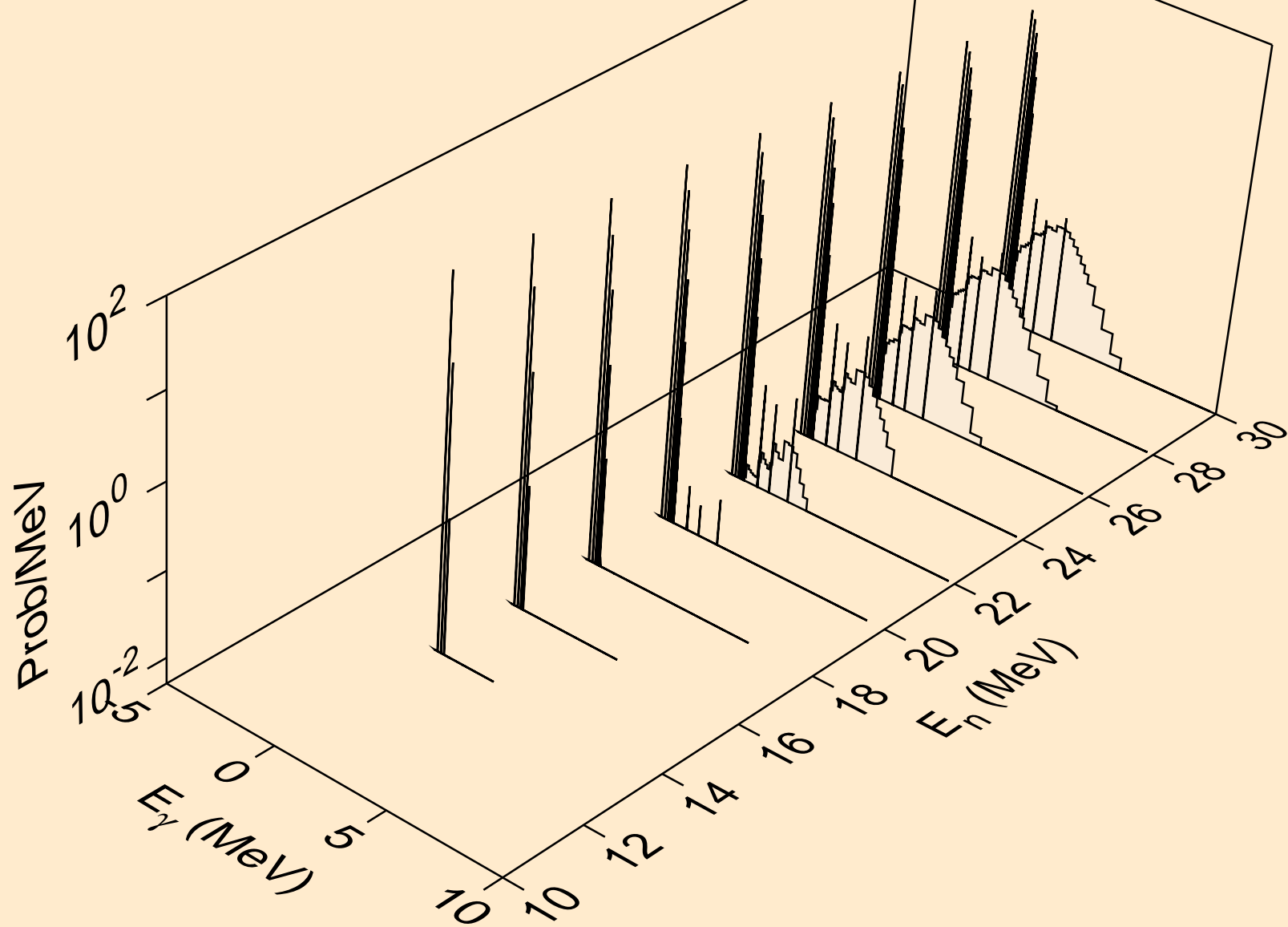



ND129 TRITON ACER TENDL-2021 LIBRARY; T=0.K  
Photon emission for (n,n\*)he3

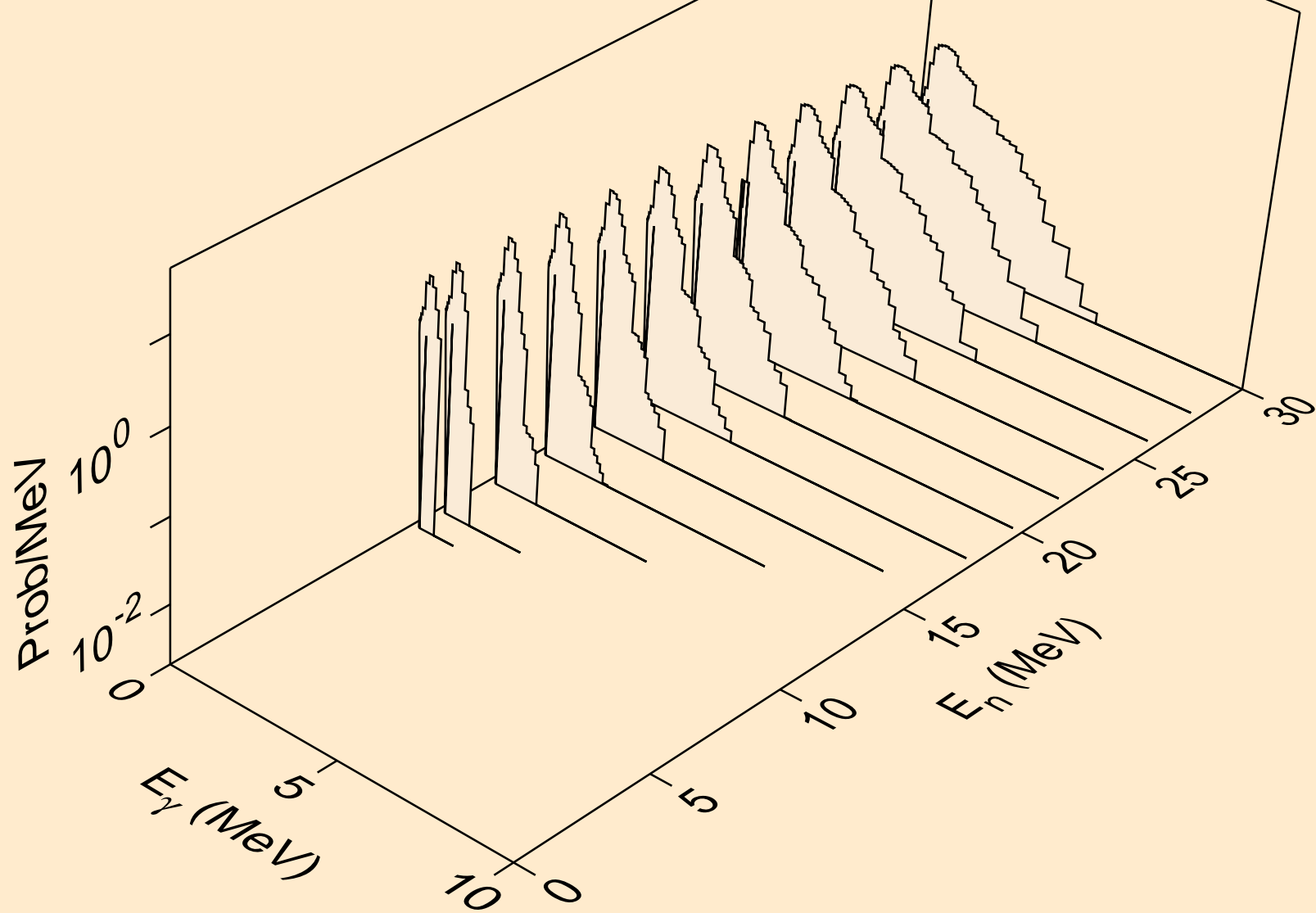

ND129 TRITON ACER TENDL-2021 LIBRARY; T=0.K  
Photon emission for (n,2np)

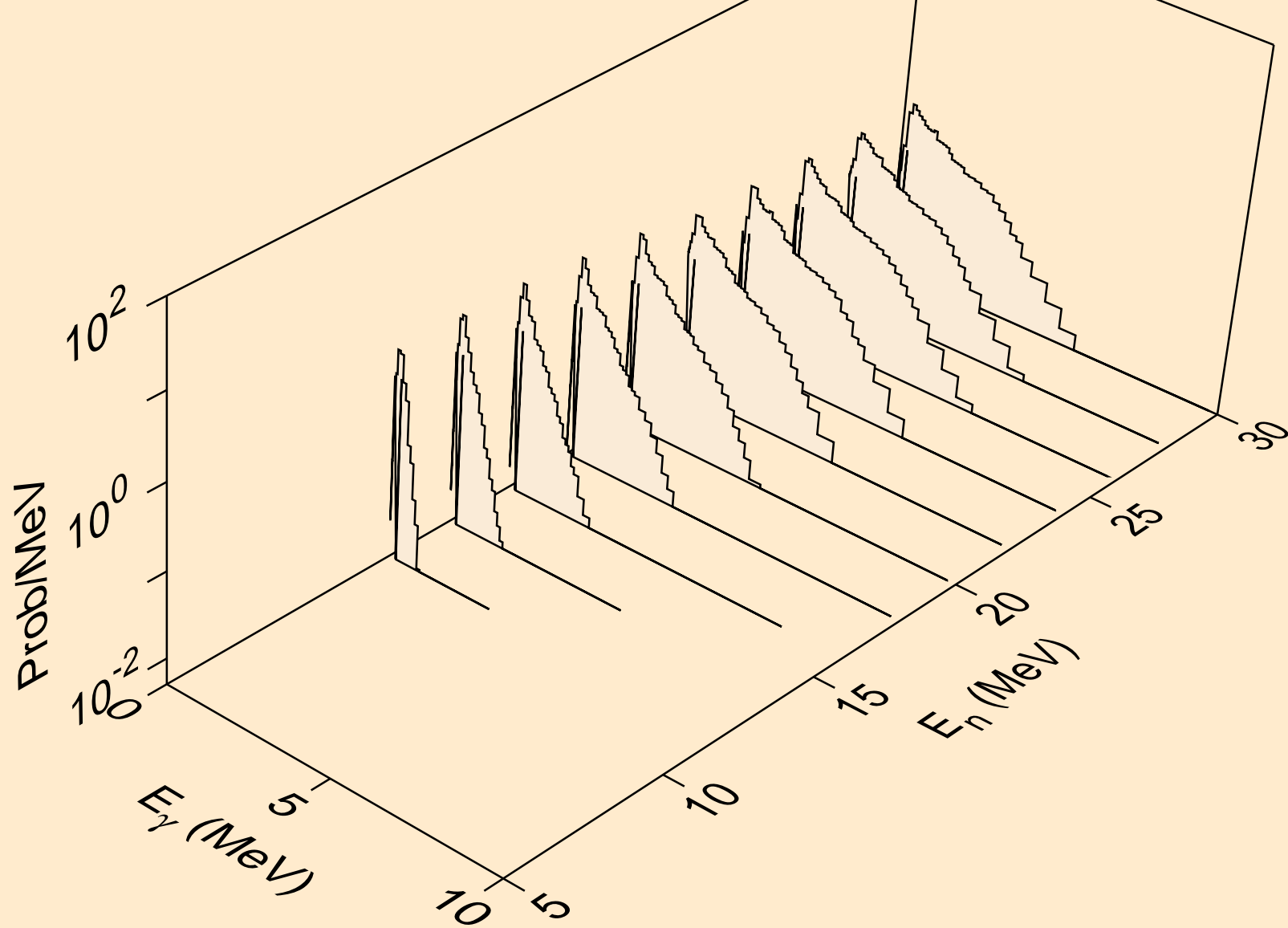

ND129 TRITON ACER TENDL-2021 LIBRARY; T=0.K  
Photon emission for (n,3np)

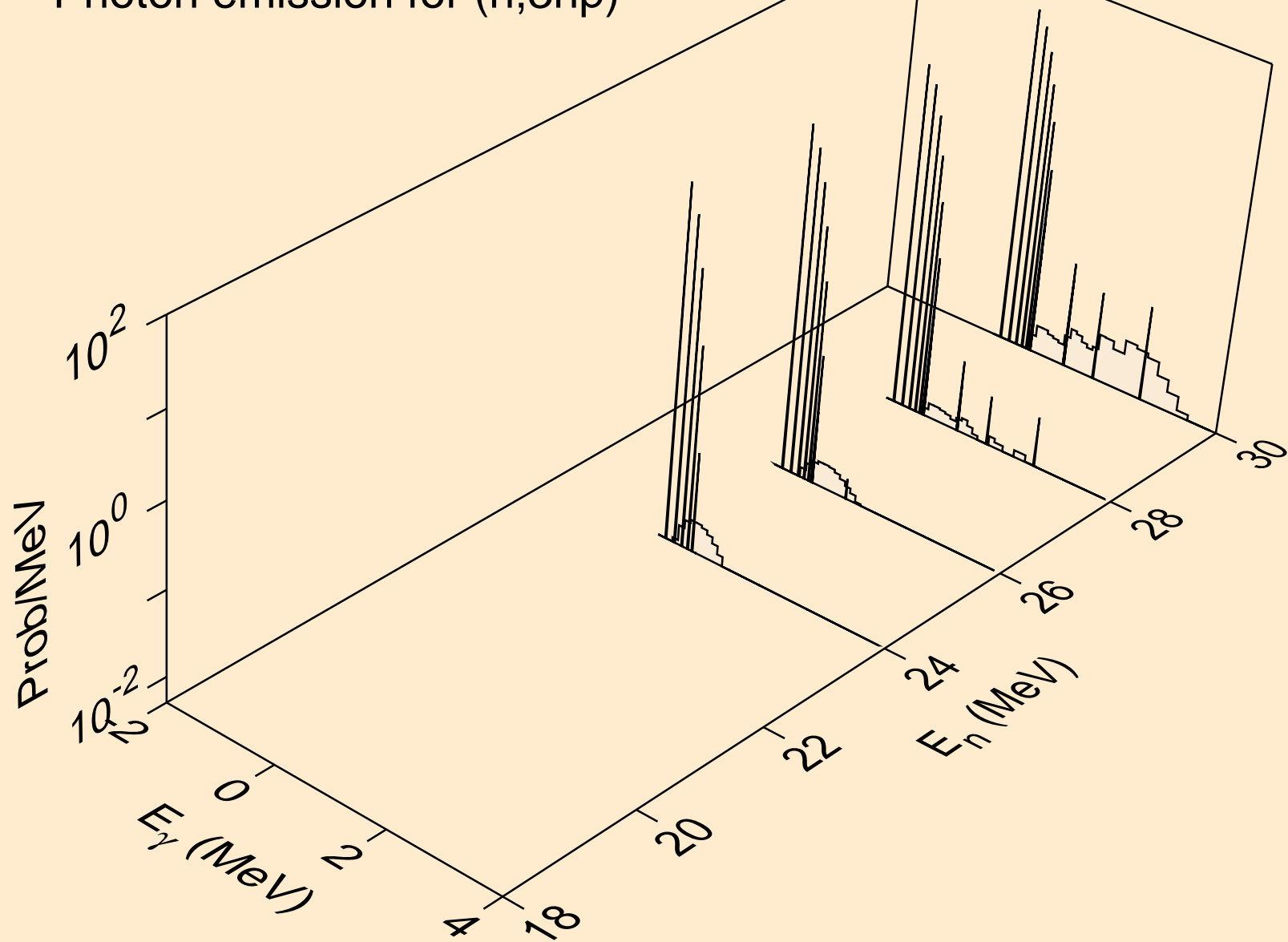

ND129 TRITON ACER TENDL-2021 LIBRARY; T=0.K  
Photon emission for (n,2np)

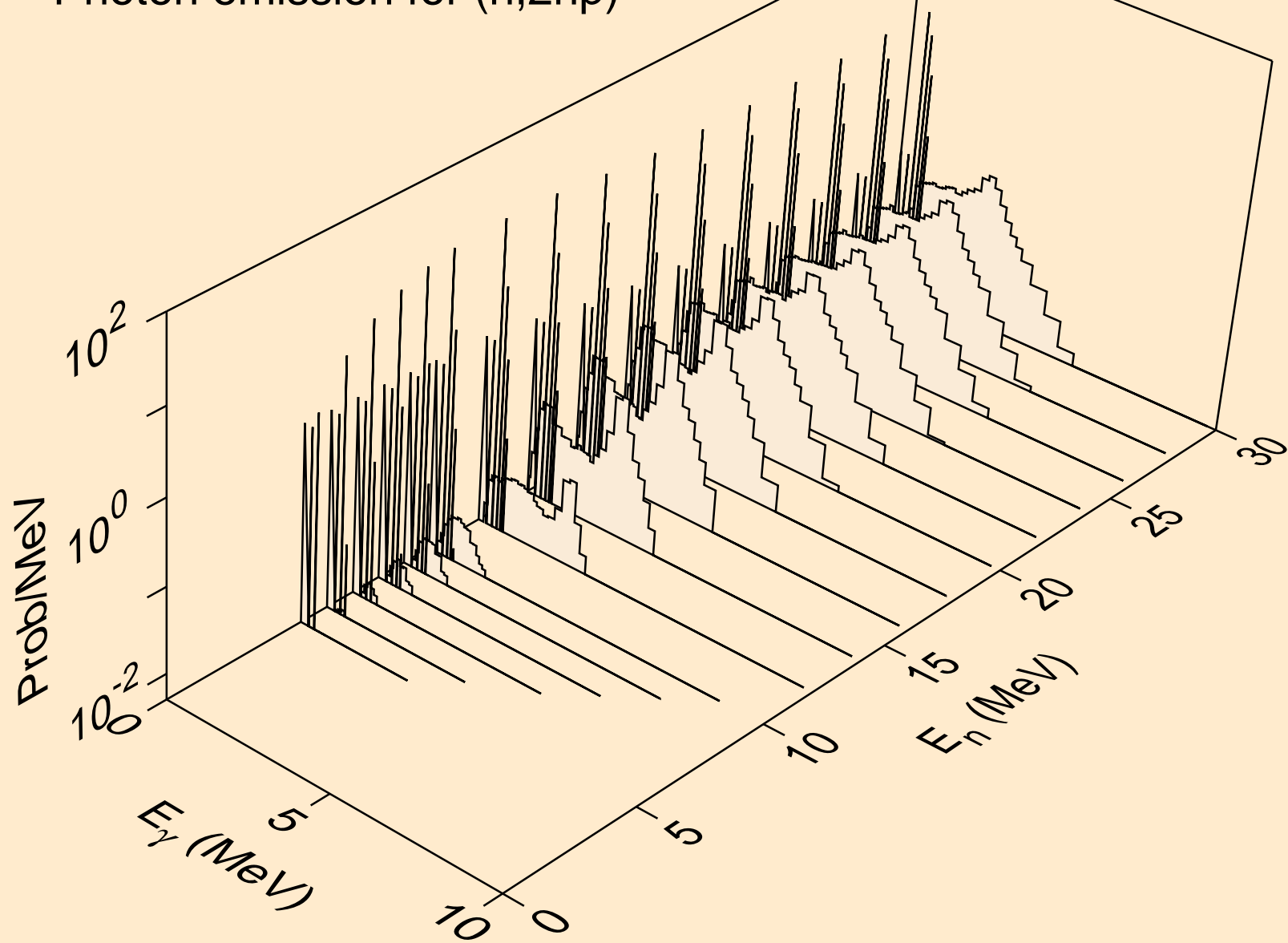

ND129 TRITON ACER TENDL-2021 LIBRARY; T=0.K  
Photon emission for (n,npa)

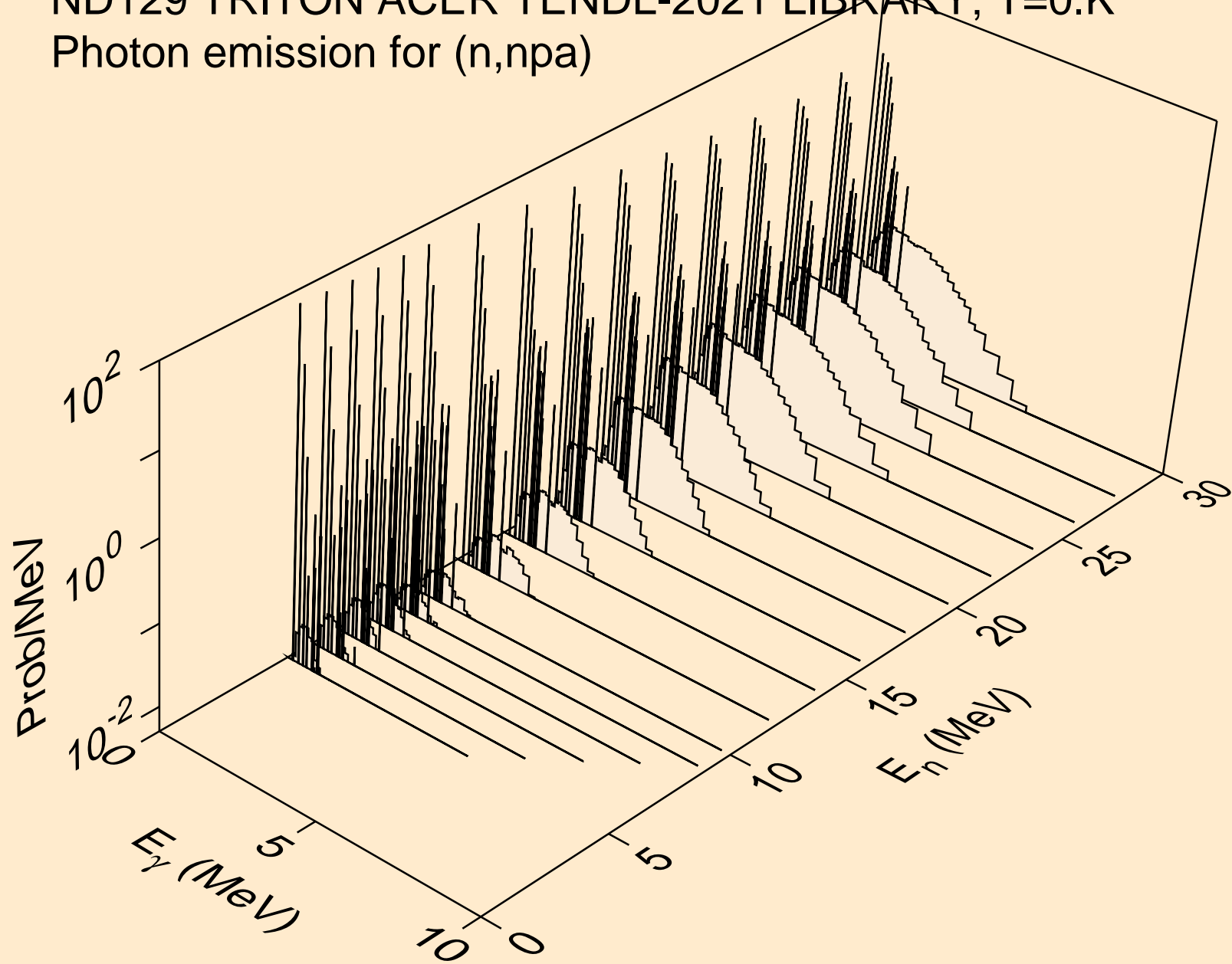

ND129 TRITON ACER TENDL-2021 LIBRARY; T=0.K  
Photon emission for (n,gma)

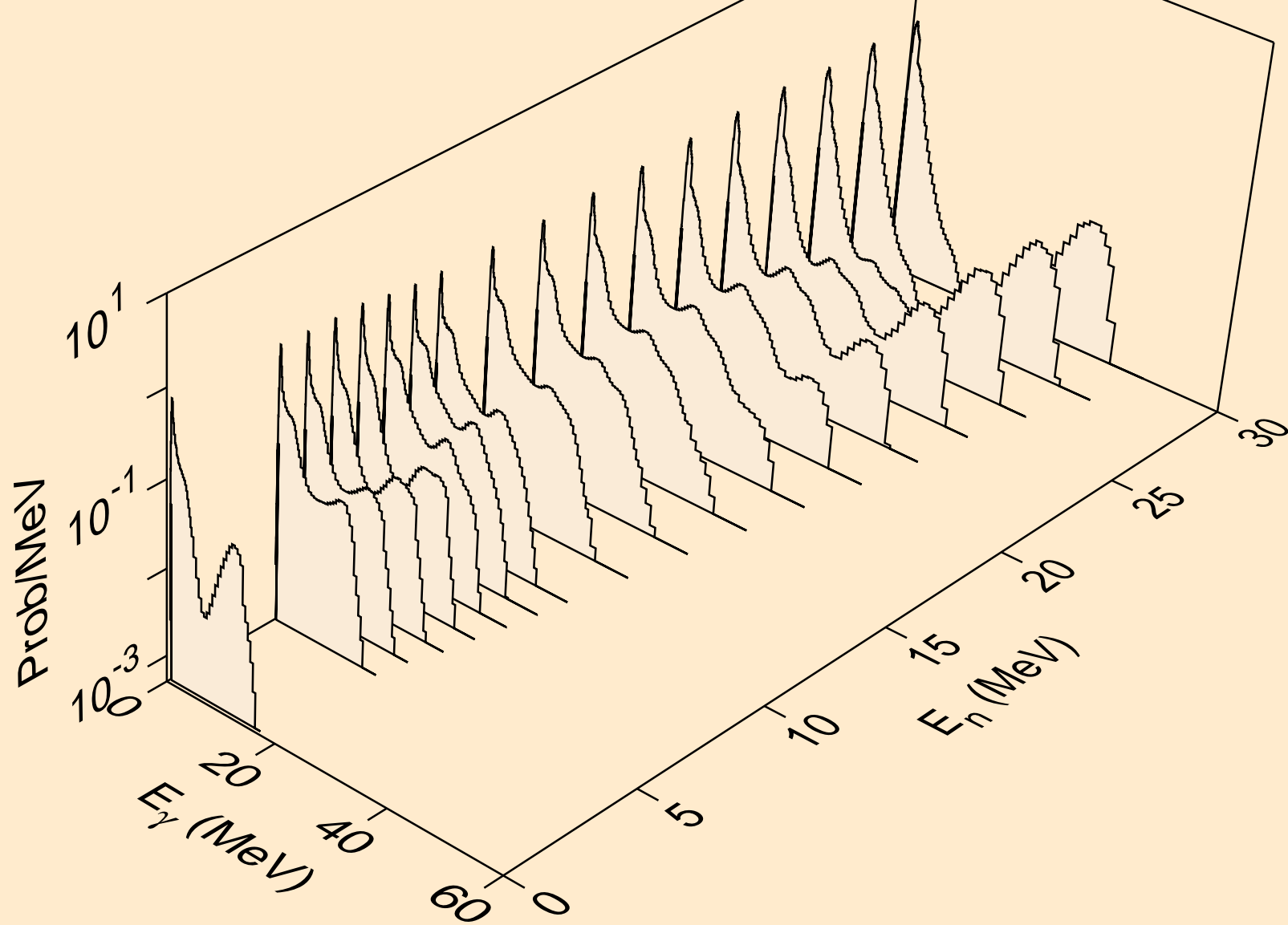

ND129 TRITON ACER TENDL-2021 LIBRARY; T=0.K  
Photon emission for (n,p)

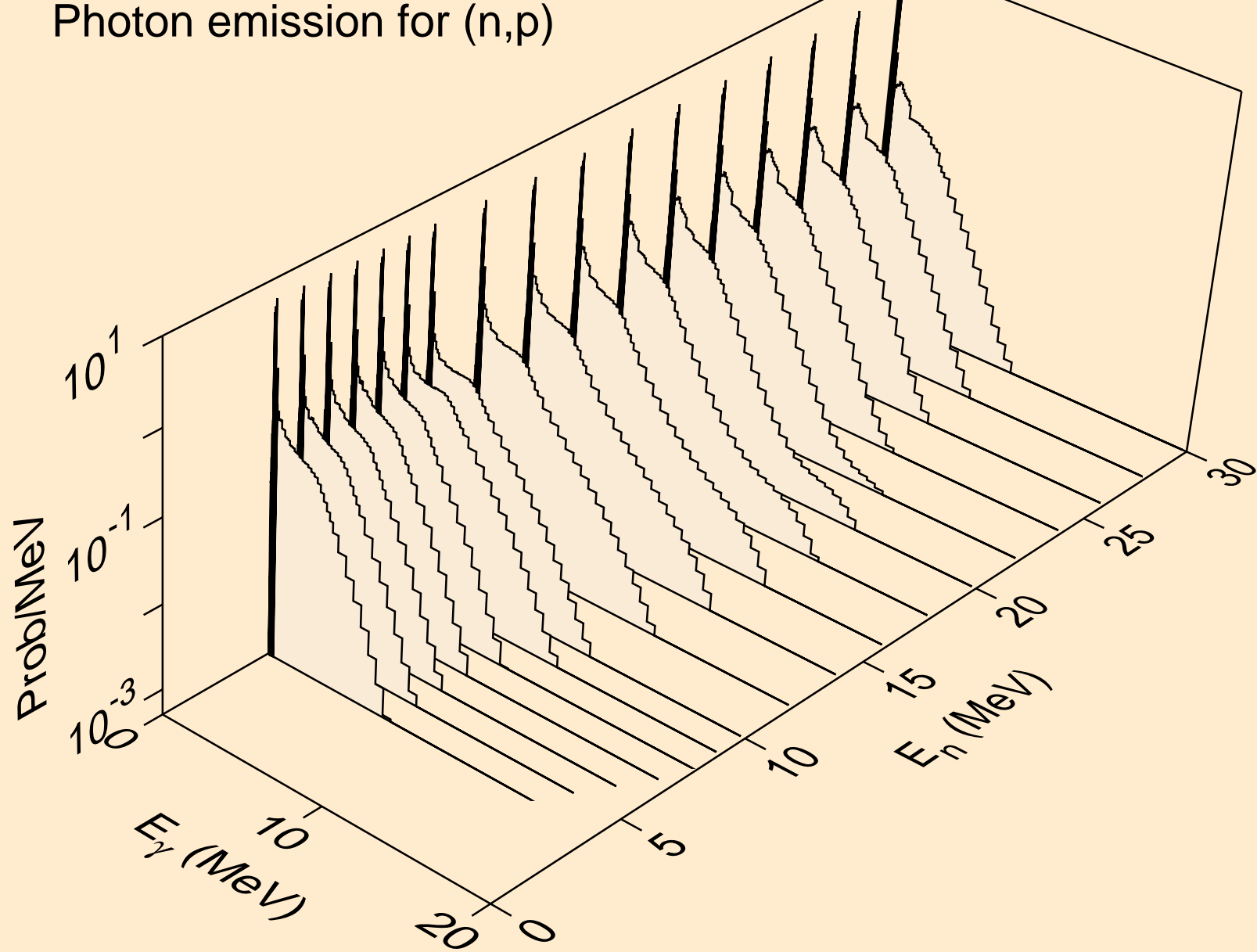

ND129 TRITON ACER TENDL-2021 LIBRARY; T=0.K  
Photon emission for (n,d)

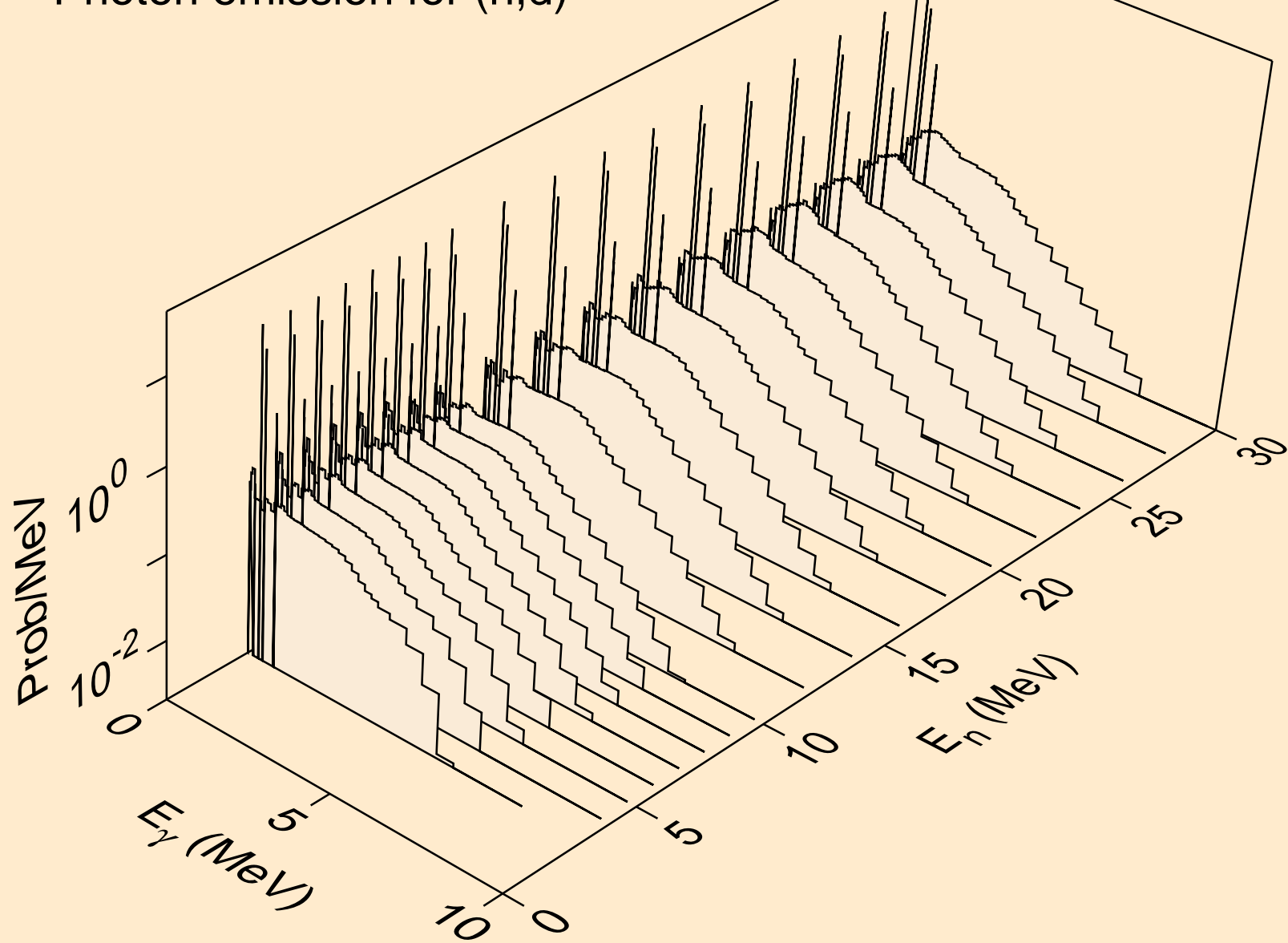



ND129 TRITON ACER TENDL-2021 LIBRARY; T=0.K  
Photon emission for inelastic

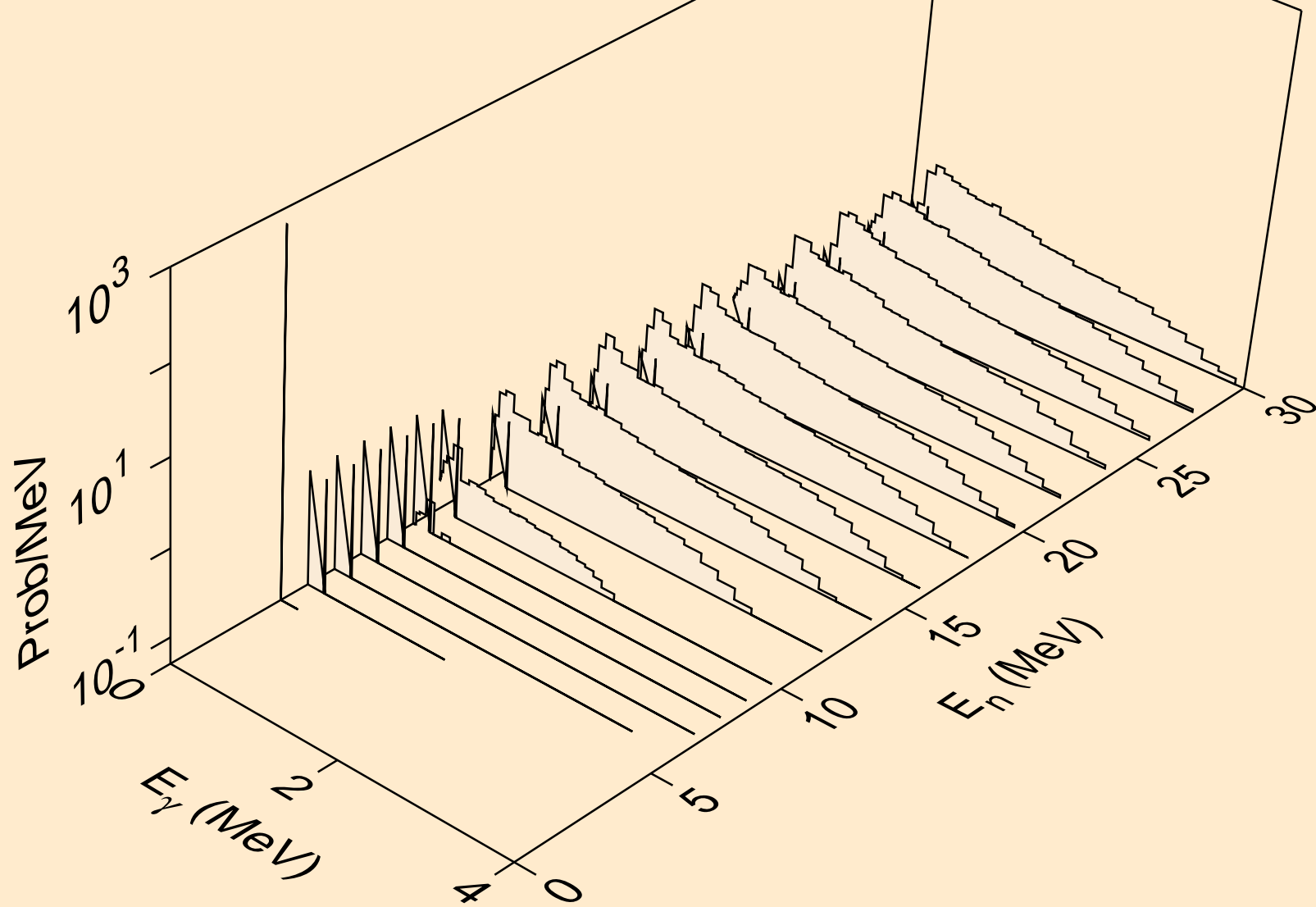

ND129 TRITON ACER TENDL-2021 LIBRARY; T=0.K  
Photon emission for (n,he3)

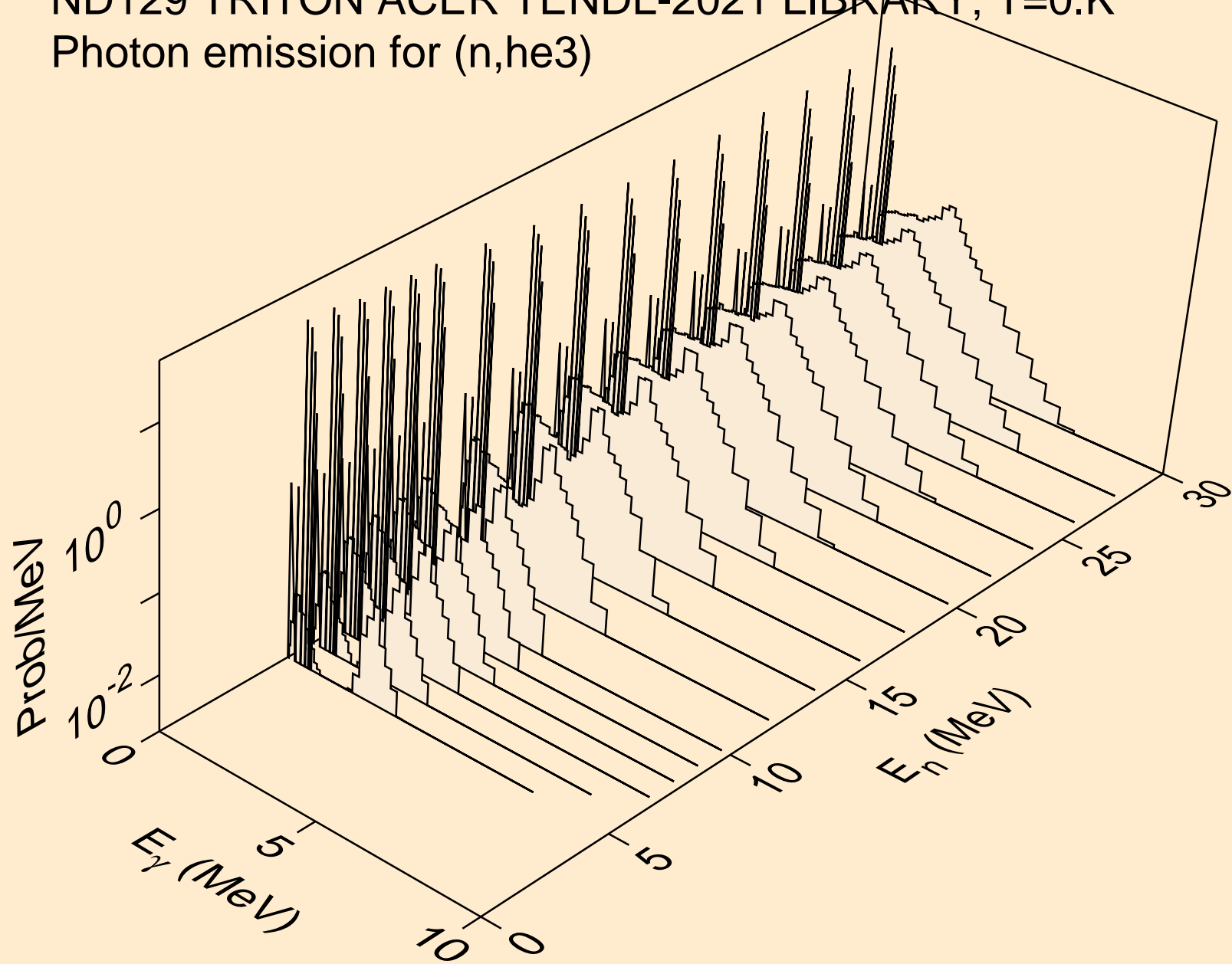

ND129 TRITON ACER TENDL-2021 LIBRARY; T=0.K  
Photon emission for (n,a)

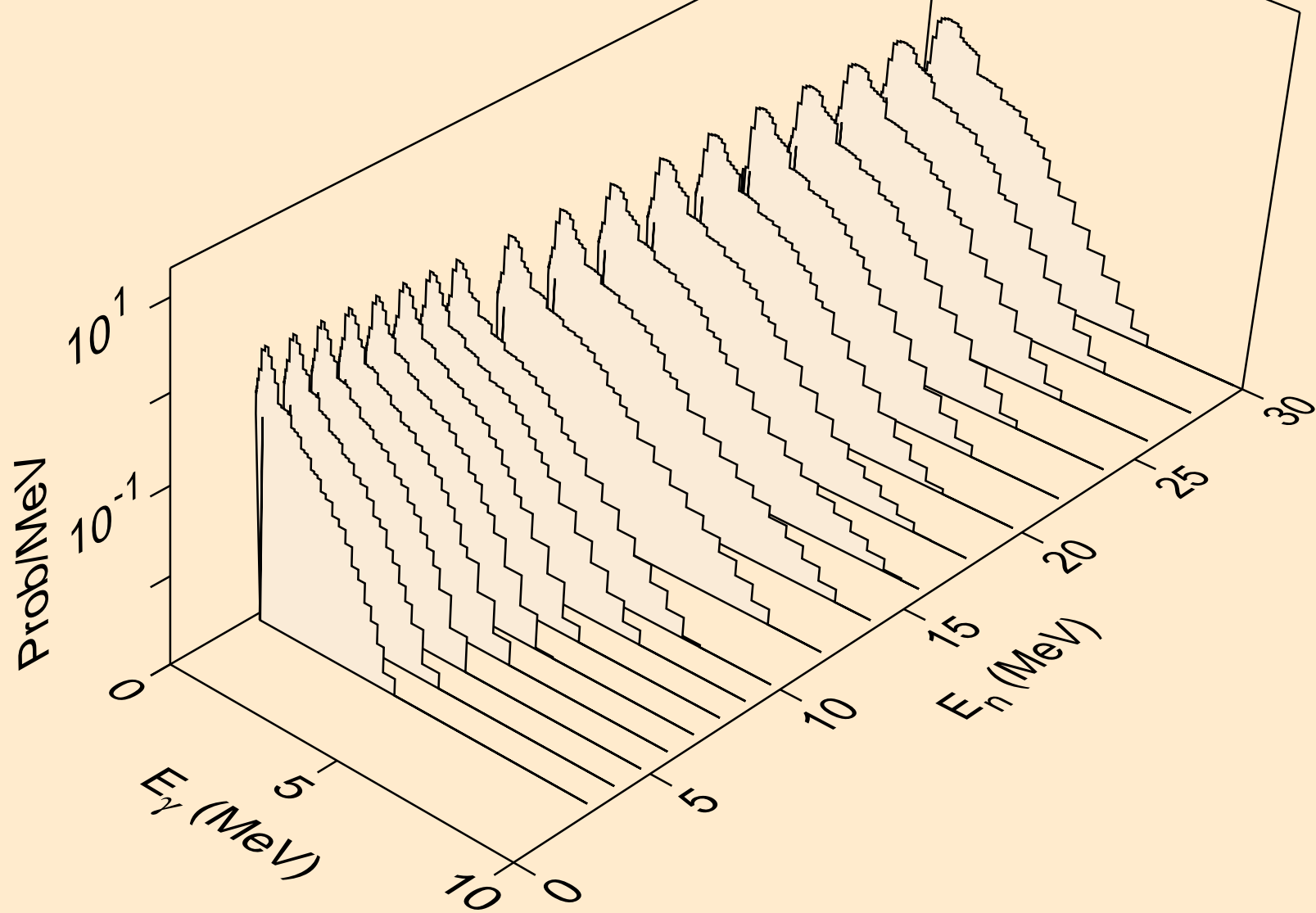

ND129 TRITON ACER TENDL-2021 LIBRARY; T=0.K  
Photon emission for (n,2a)

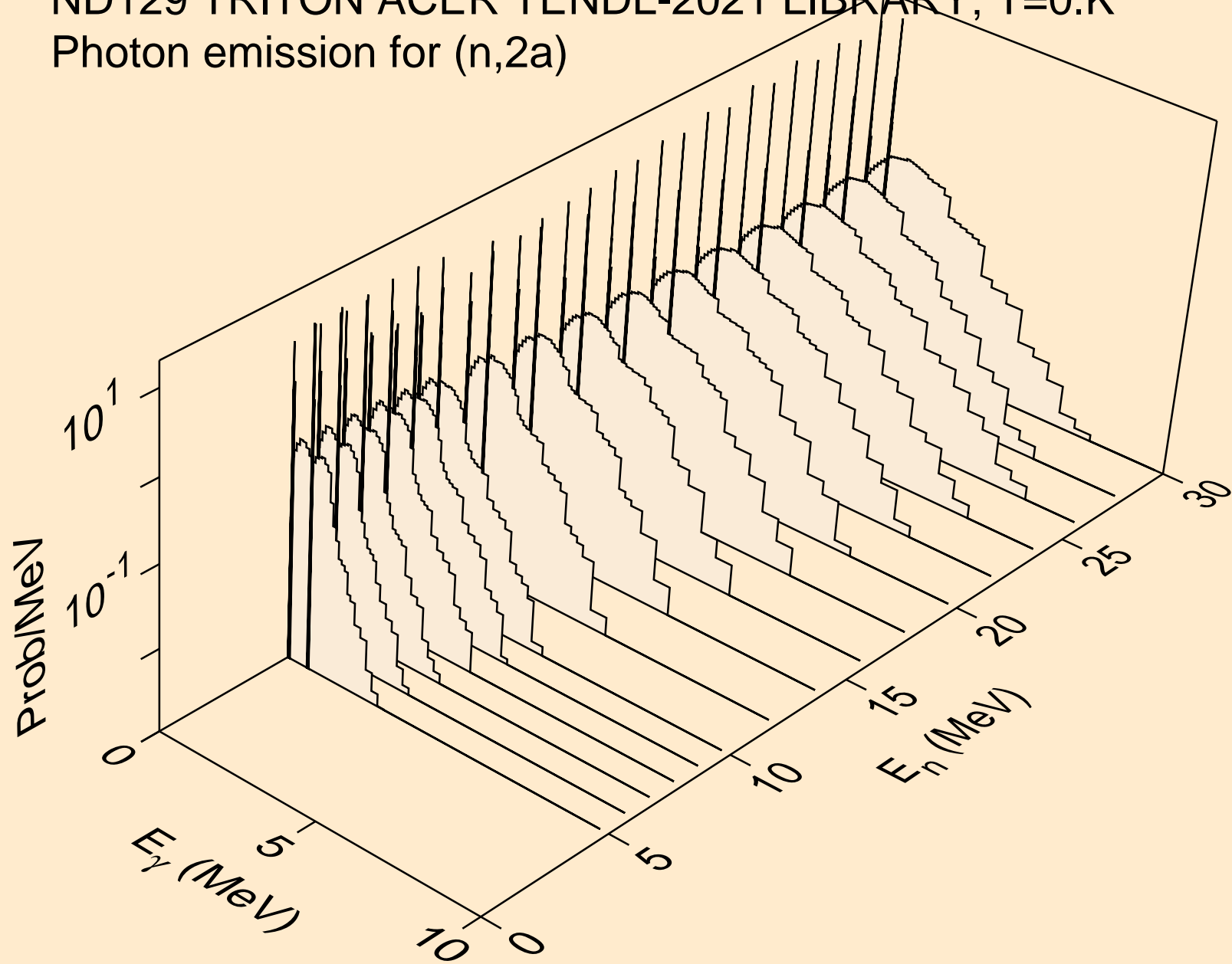

ND129 TRITON ACER TENDL-2021 LIBRARY; T=0.K  
Photon emission for (n,3a)

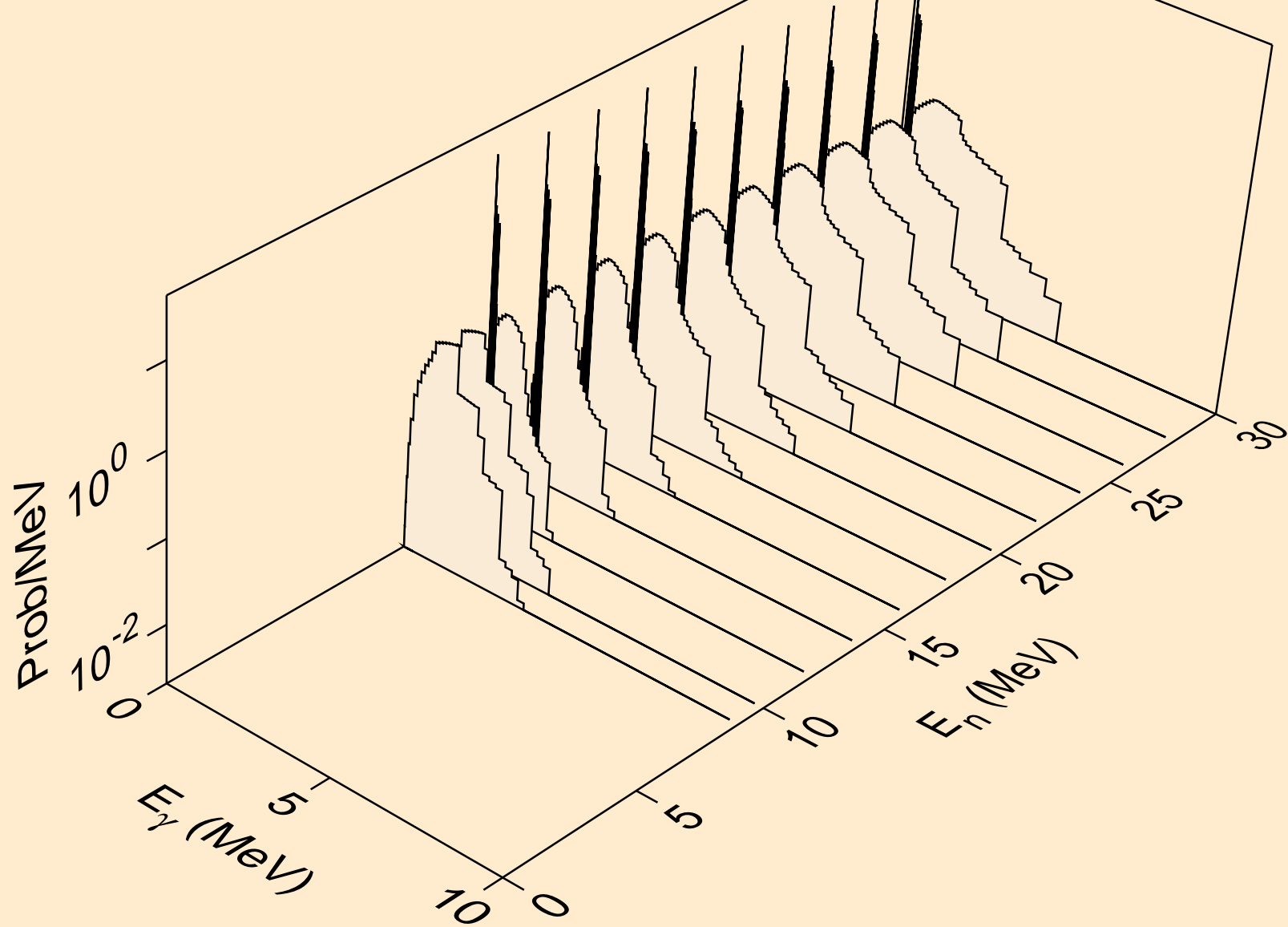

ND129 TRITON ACER TENDL-2021 LIBRARY; T=0.K  
Photon emission for (n,2p)

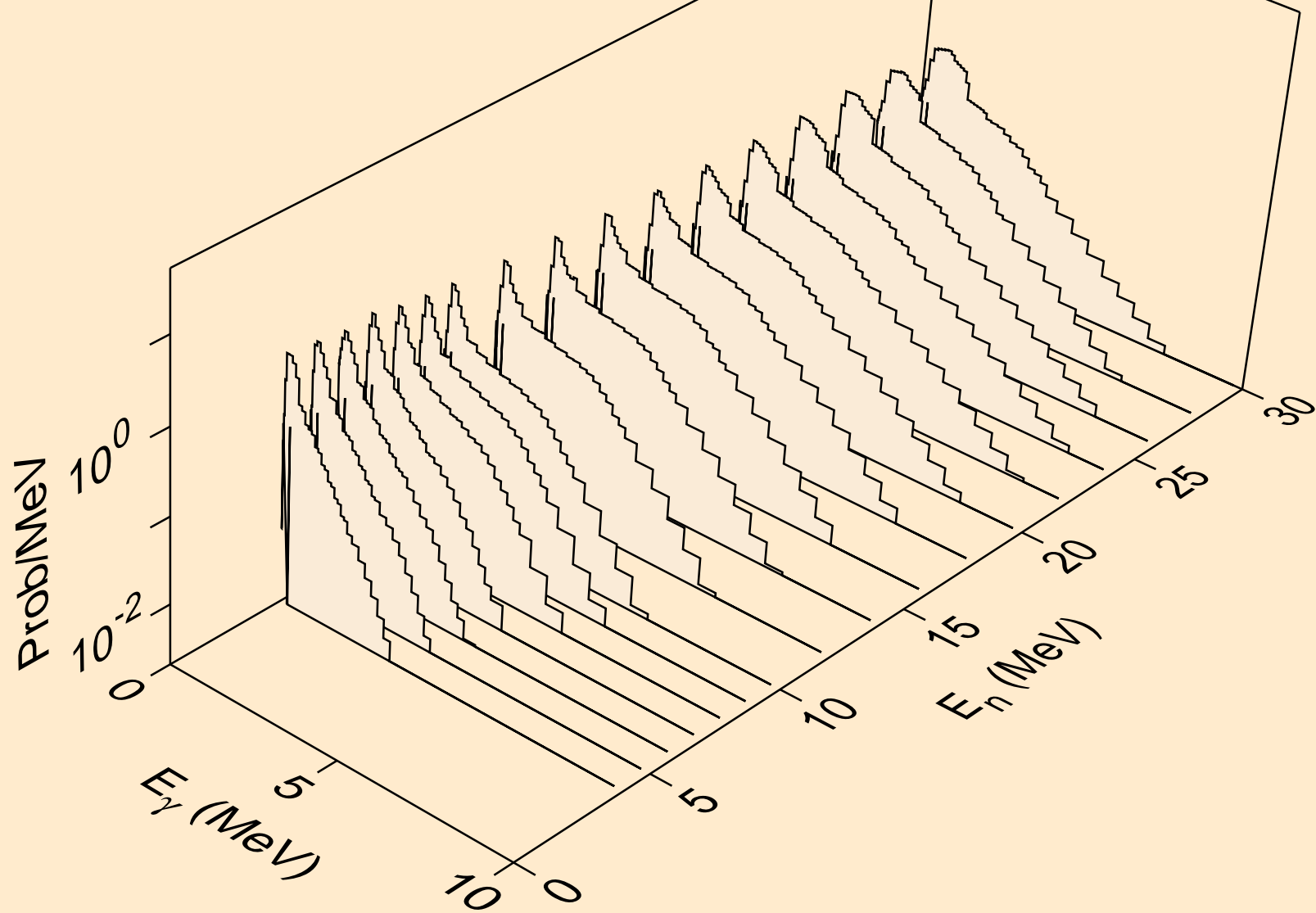

ND129 TRITON ACER TENDL-2021 LIBRARY; T=0.K  
Photon emission for (n,pa)

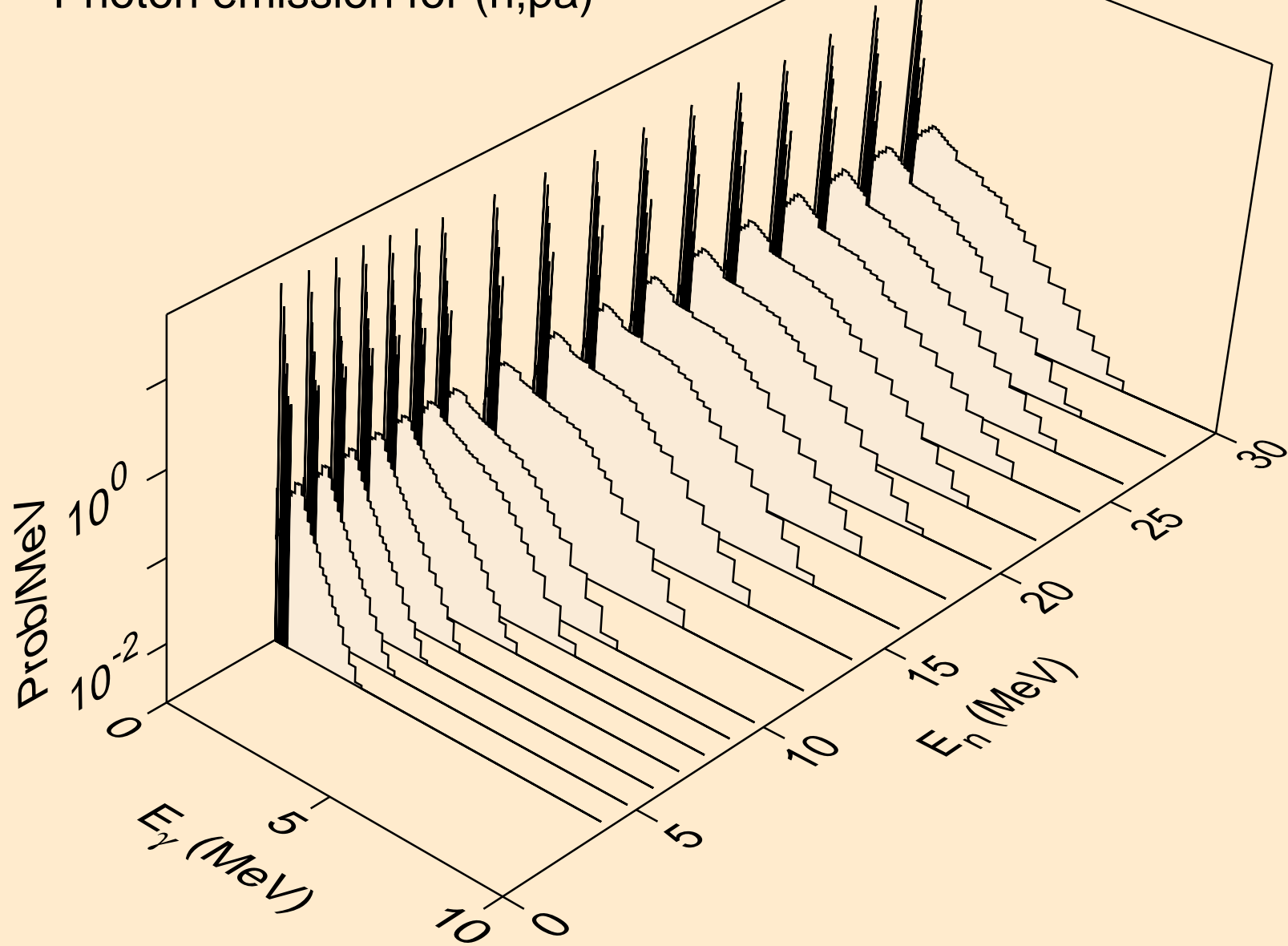

ND129 TRITON ACER TENDL-2021 LIBRARY; T=0.K  
Photon emission for (n,t2a)

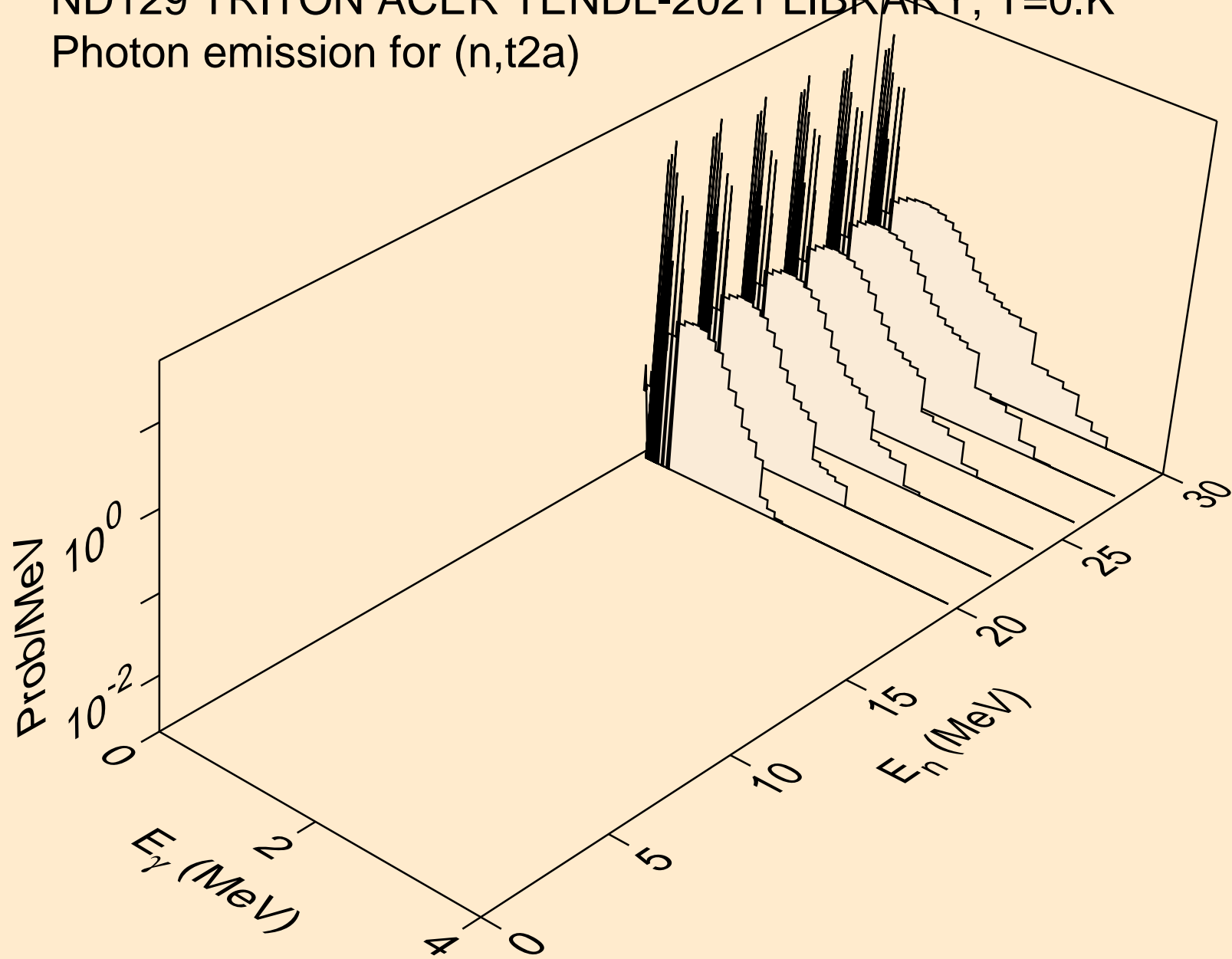



ND129 TRITON ACER TENDL-2021 LIBRARY; T=0.K  
Photon emission for (n,d2a)

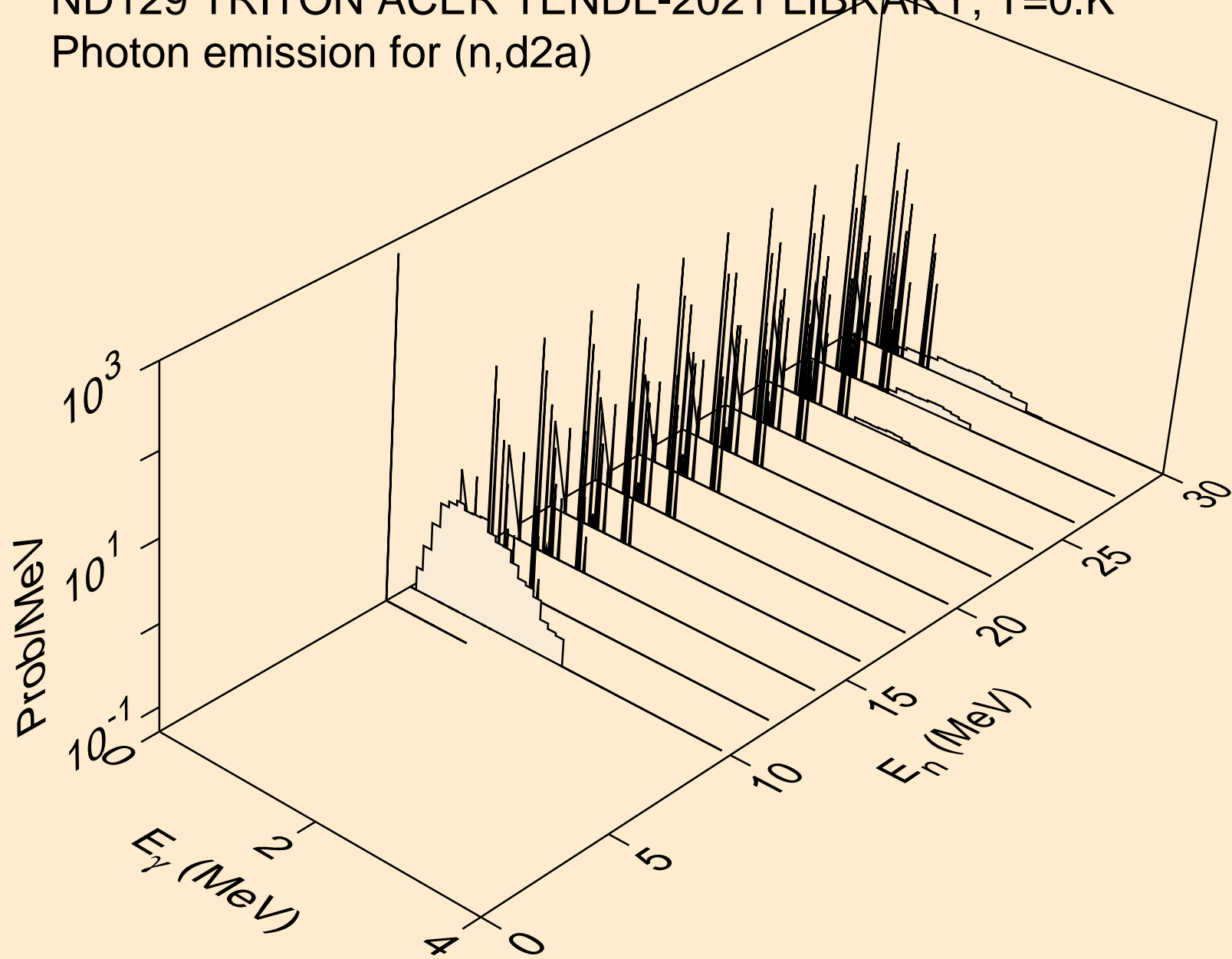

ND129 TRITON ACER TENDL-2021 LIBRARY; T=0.K  
Photon emission for (n,pd)

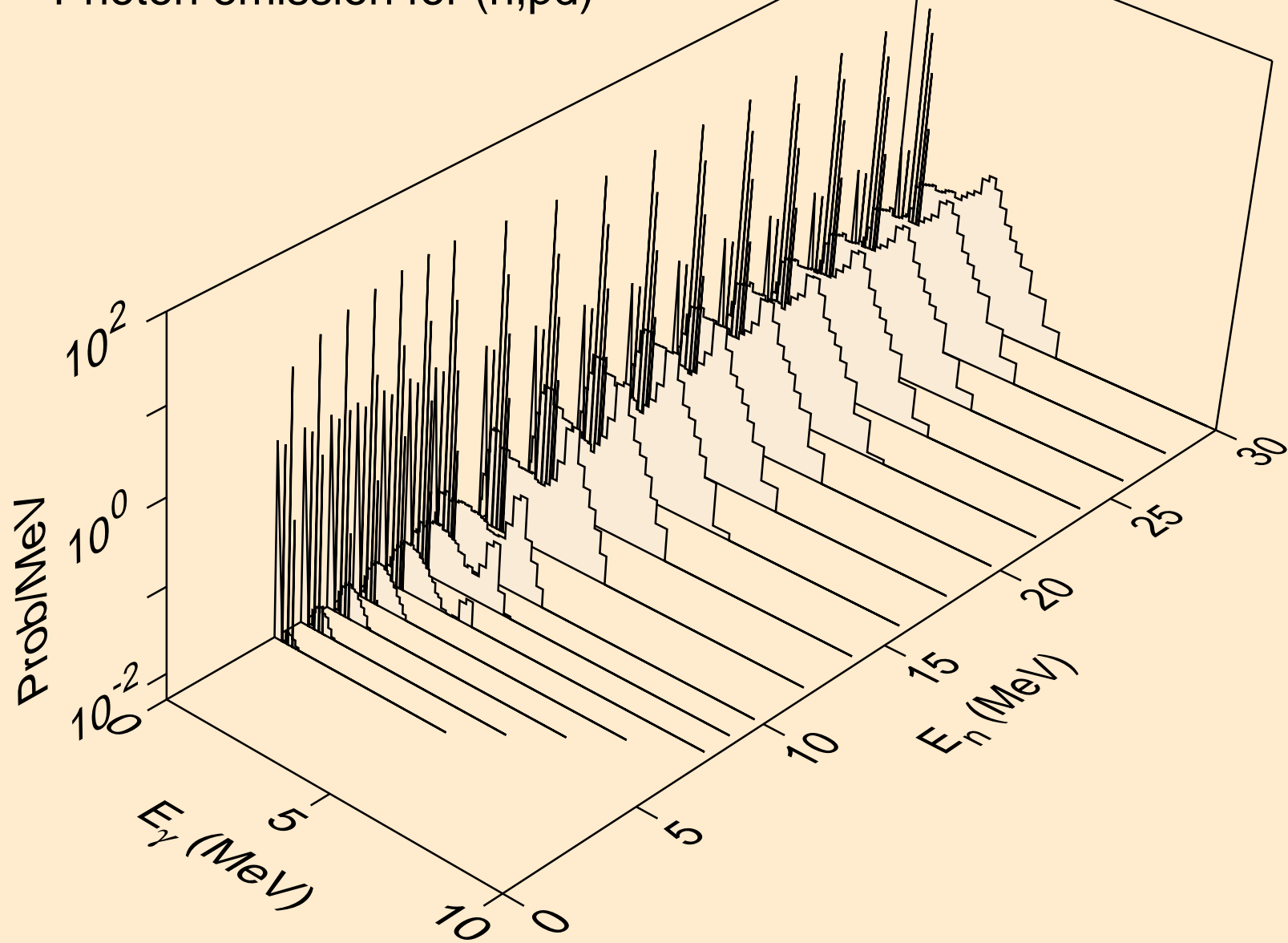

ND129 TRITON ACER TENDL-2021 LIBRARY; T=0.K  
Photon emission for (n,pt)

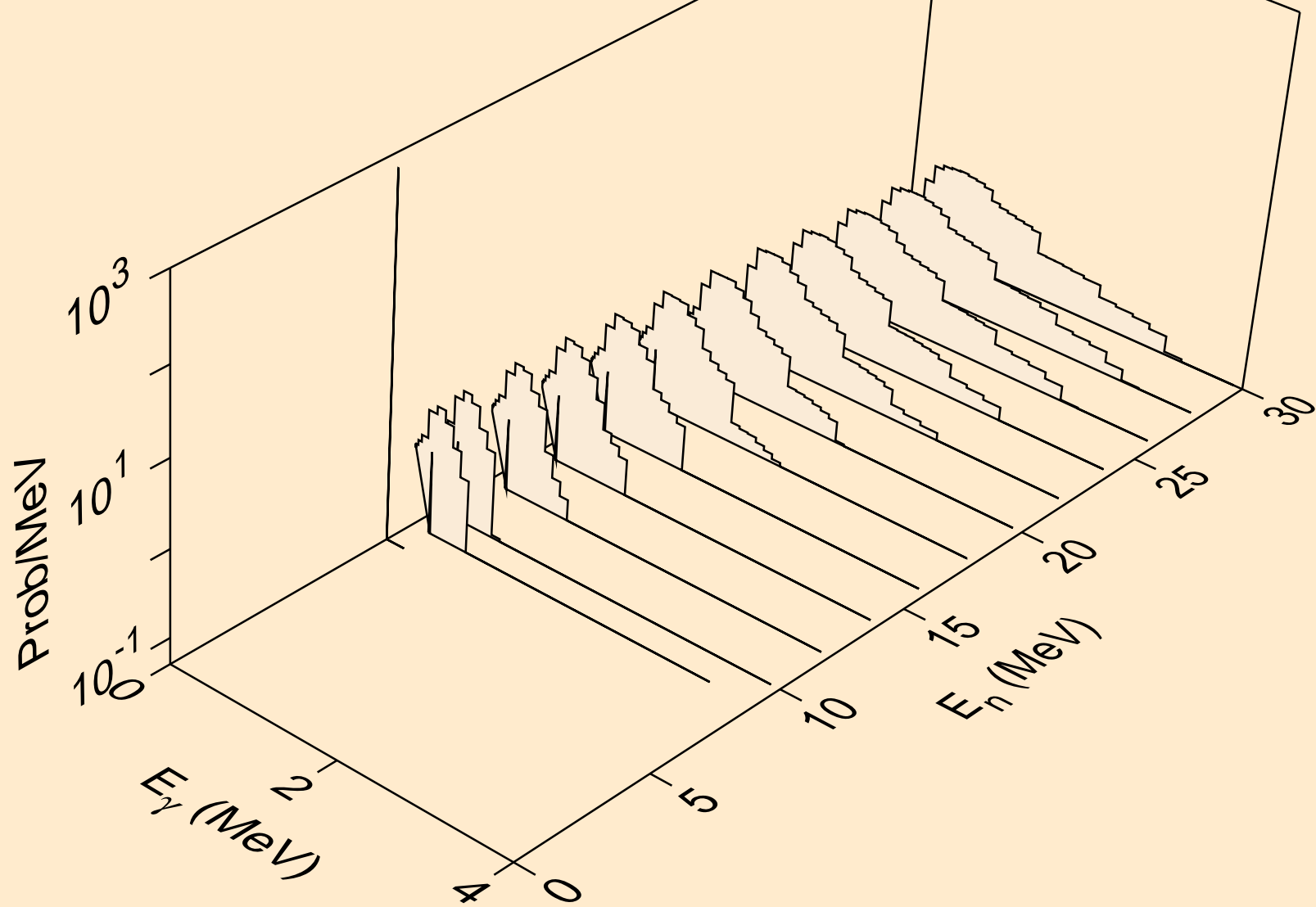

ND129 TRITON ACER TENDL-2021 LIBRARY; T=0.K  
Photon emission for (n,da)

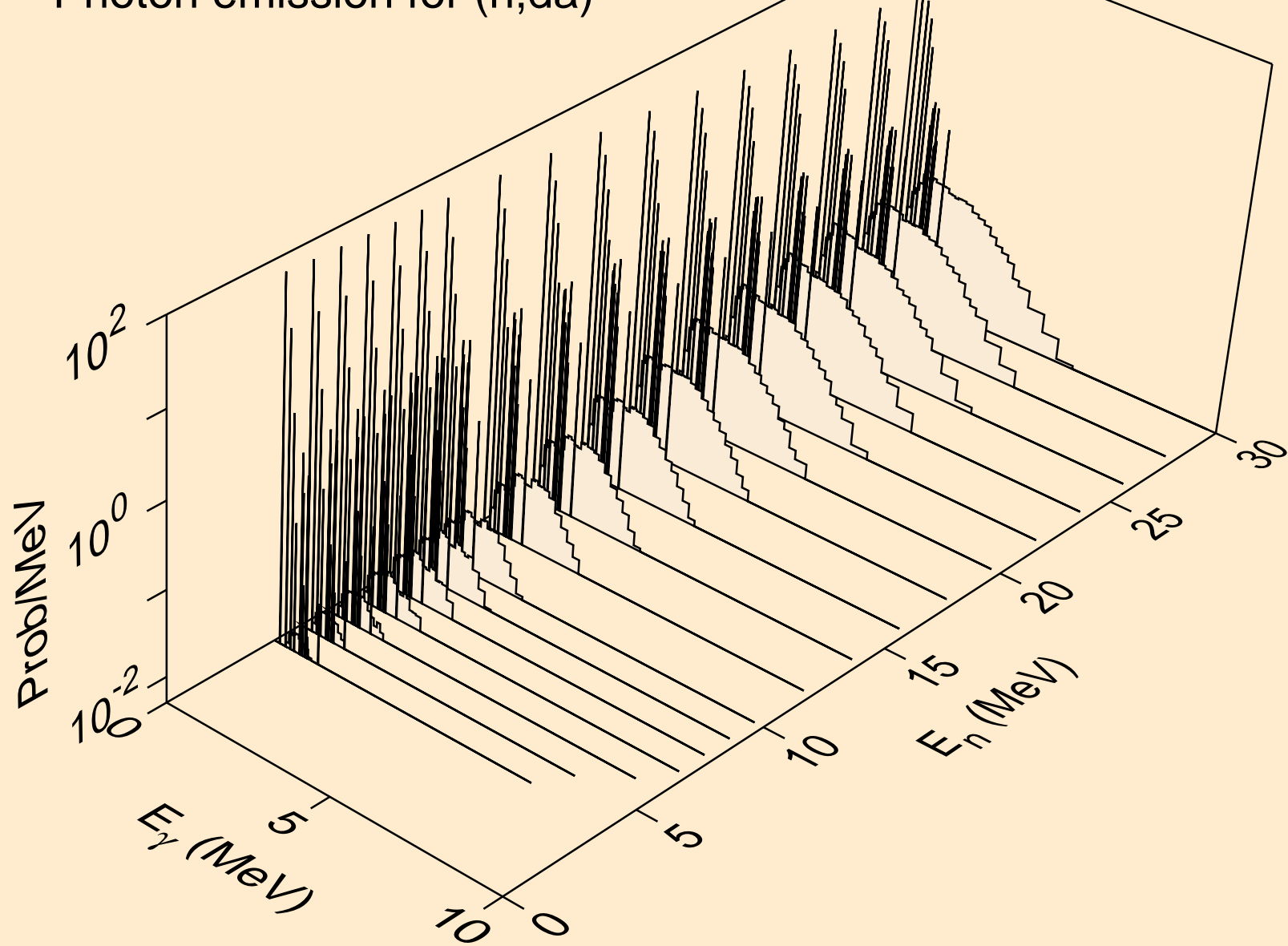

# ND129 TRITON ACER TENDL-2021 LIBRARY; T=0.K

## Particle heating contributions

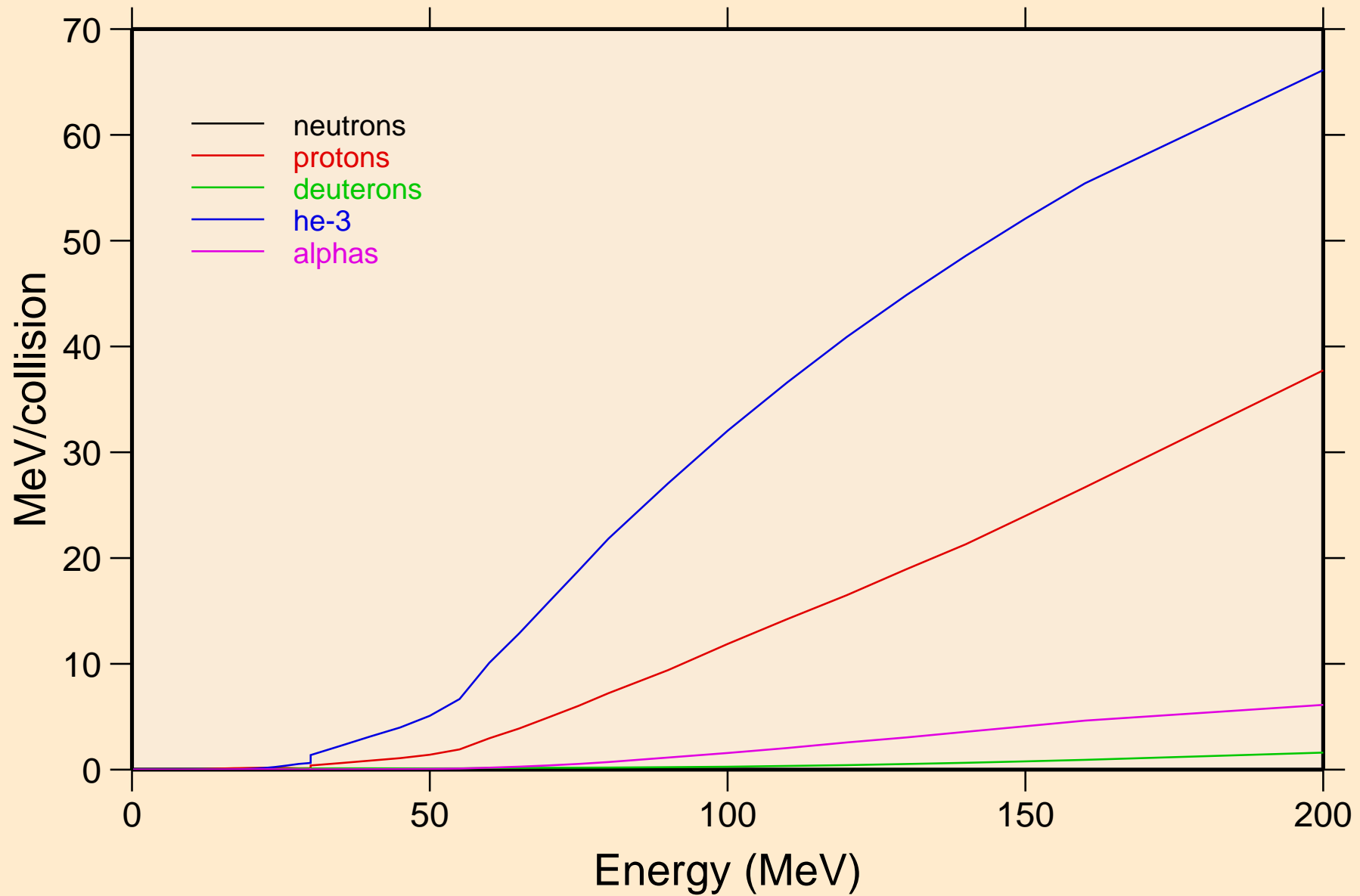

ND129 TRITON ACER TENDL-2021 LIBRARY; T=0.K  
Recoil Heating

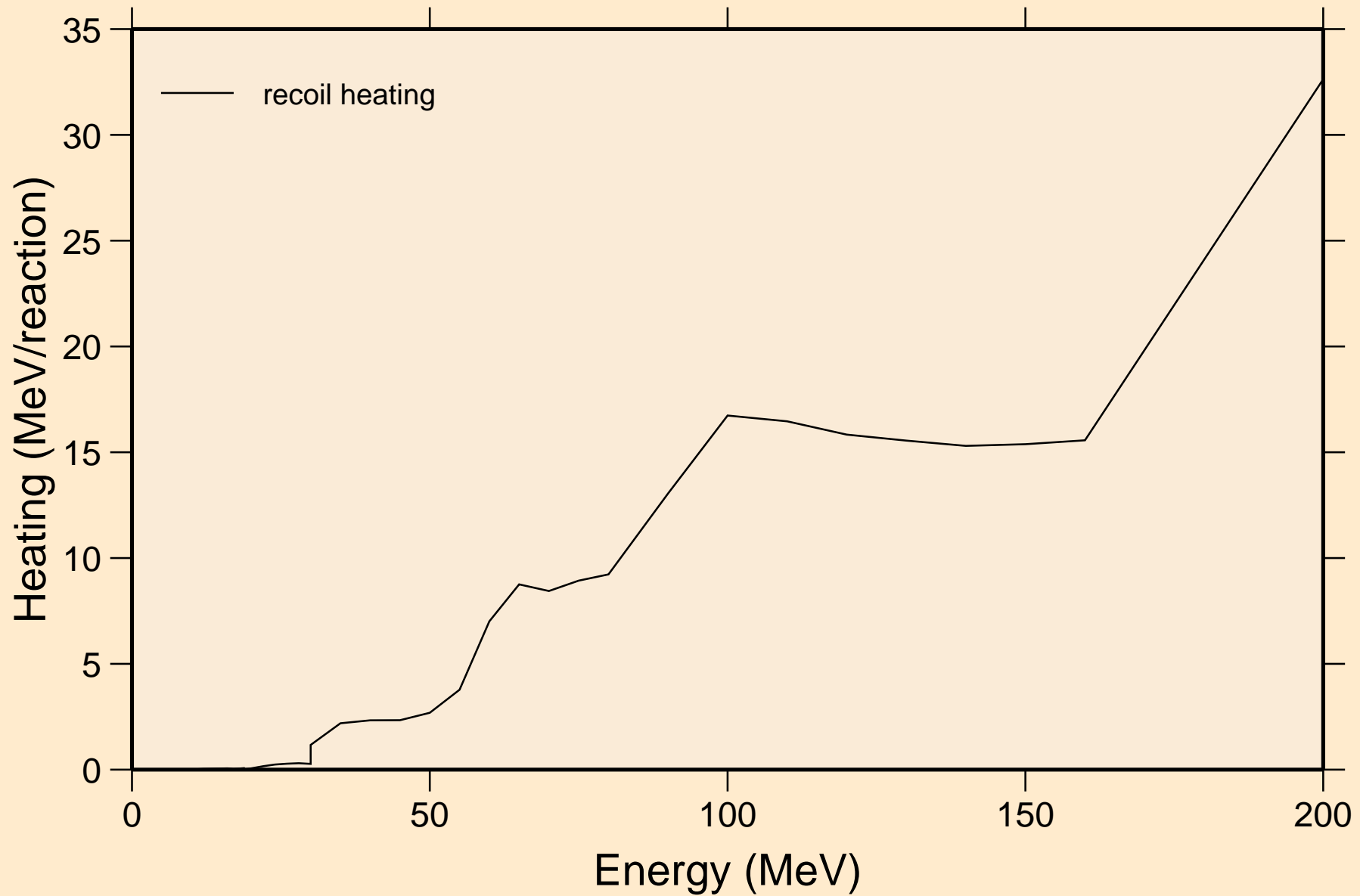

ND129 TRITON ACER TENDL-2021 LIBRARY; T=0.K  
Particle production cross sections

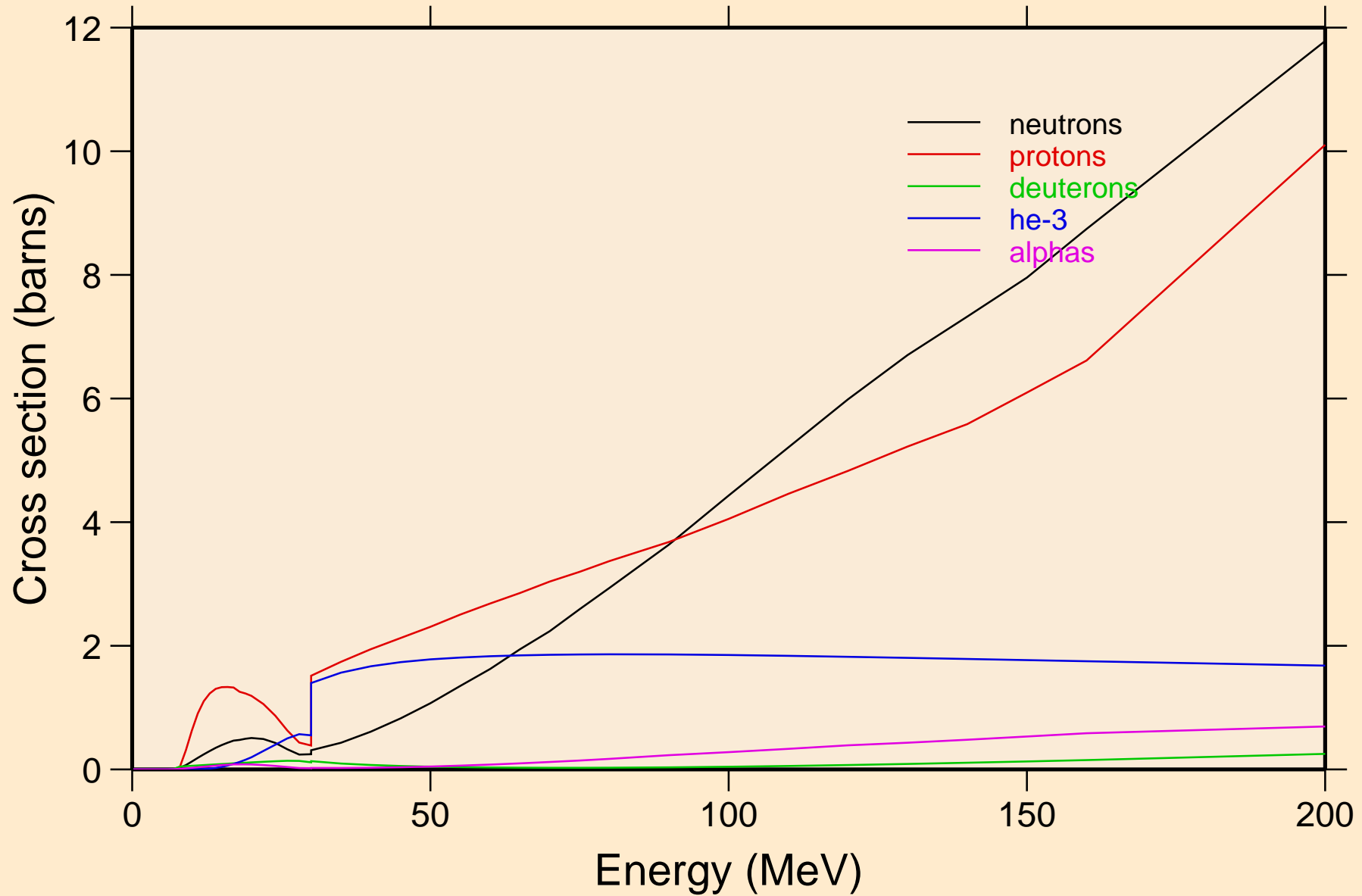

ND129 TRITON ACER TENDL-2021 LIBRARY; T=0.K  
neutrons from (t,n)

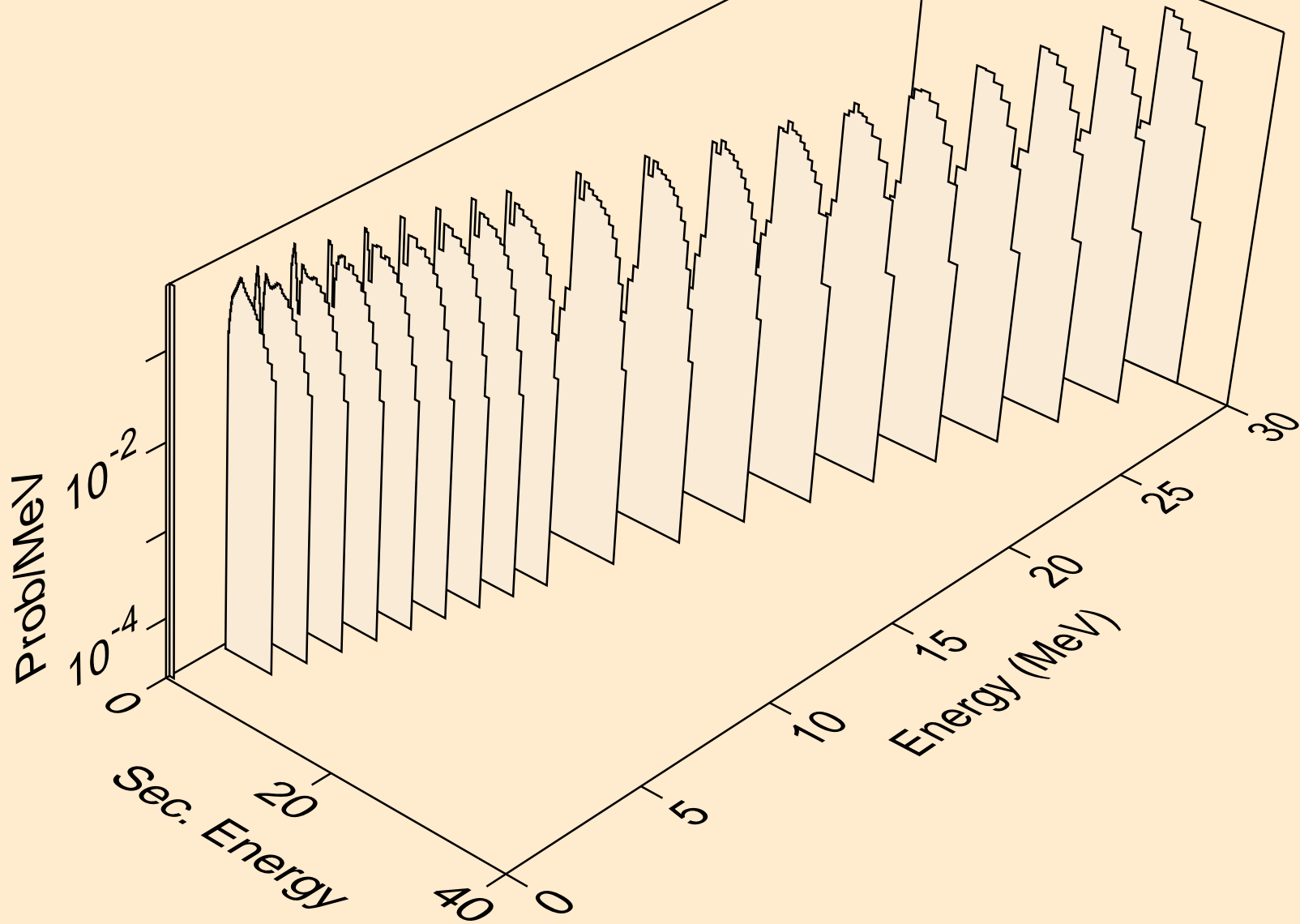



ND129 TRITON ACER TENDL-2021 LIBRARY; T=0.K  
neutrons from (t,x)

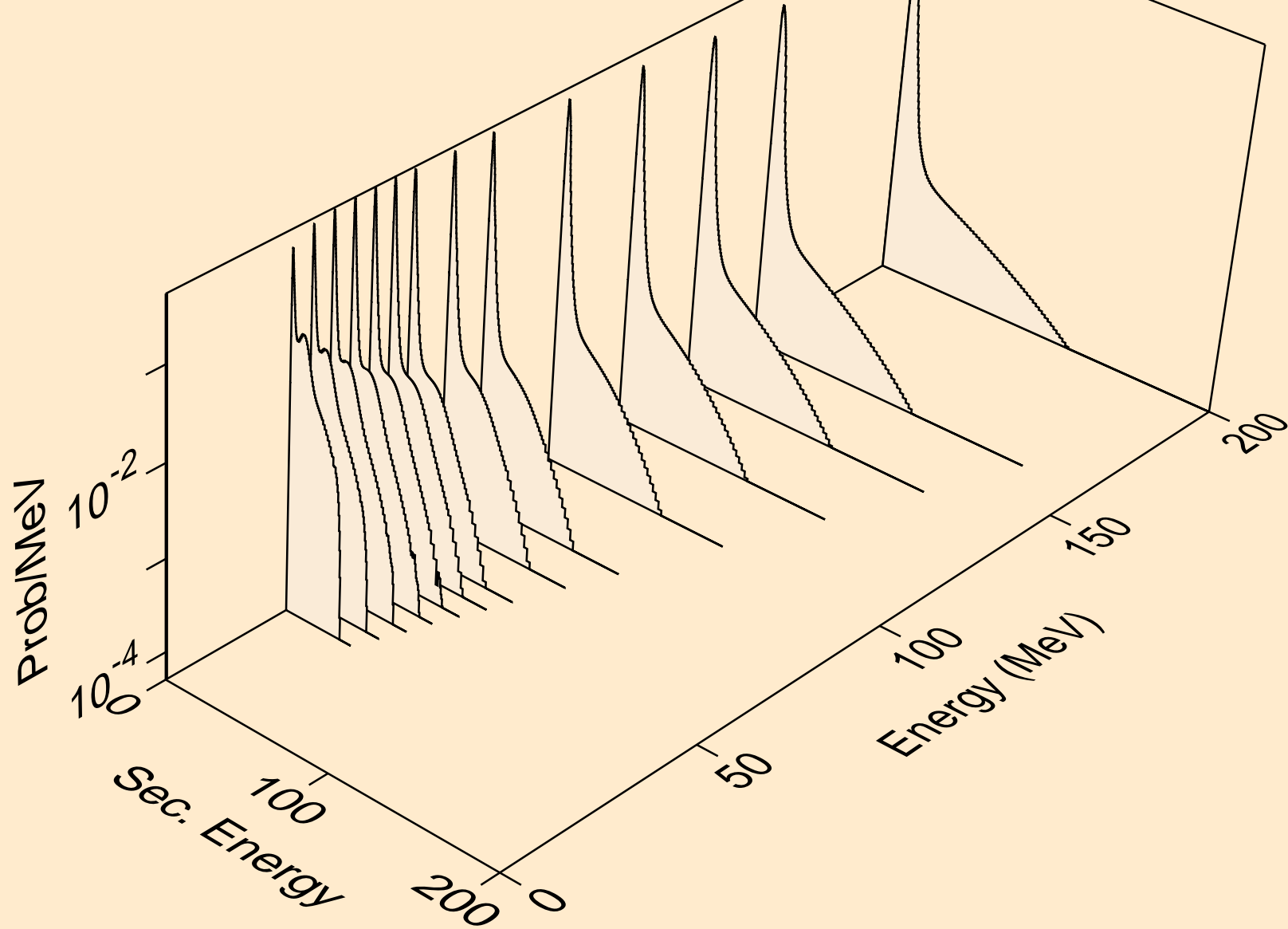

ND129 TRITON ACER TENDL-2021 LIBRARY; T=0.K  
neutrons from (t,2nd)

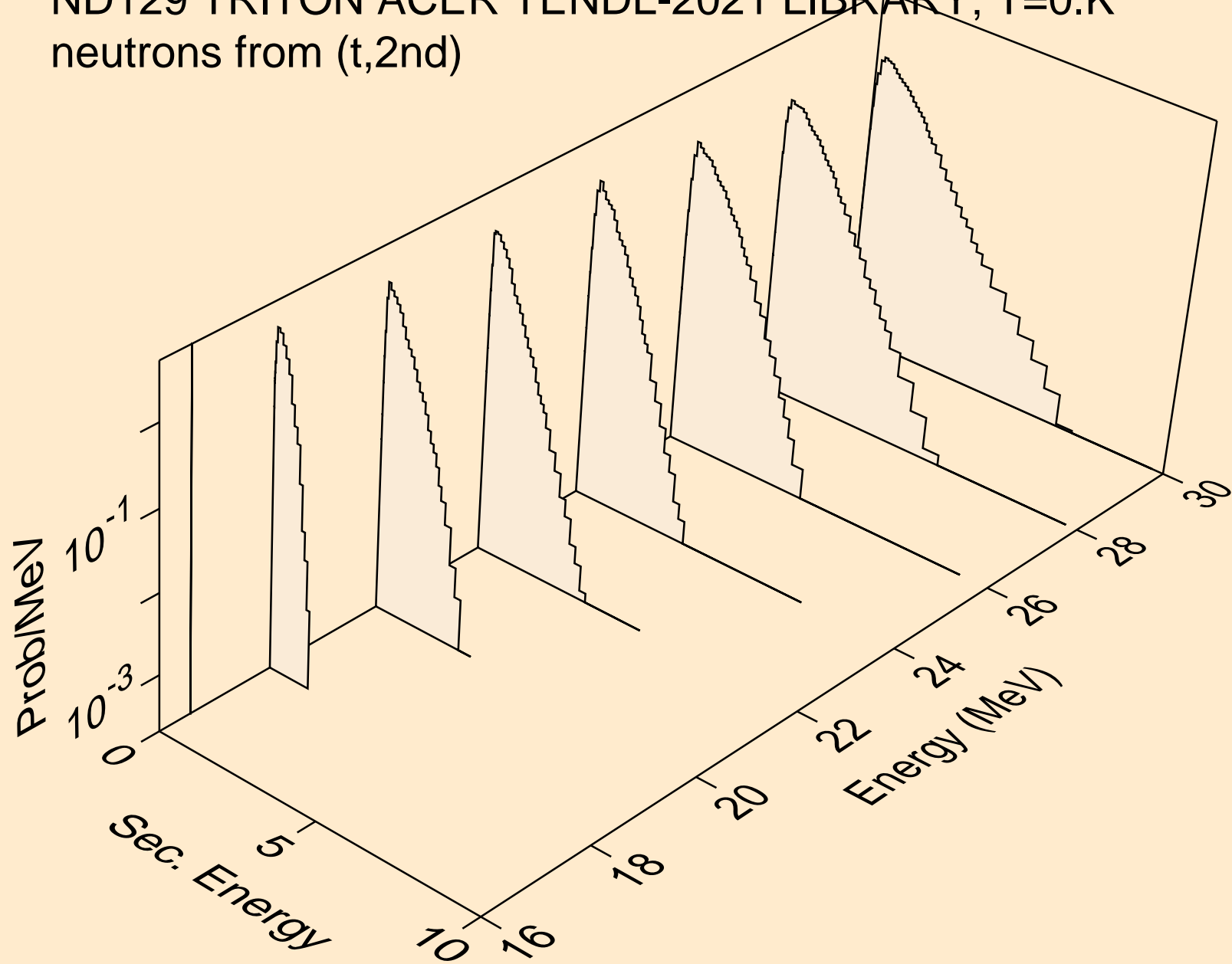

ND129 TRITON ACER TENDL-2021 LIBRARY; T=0.K  
neutrons from (t,2n)

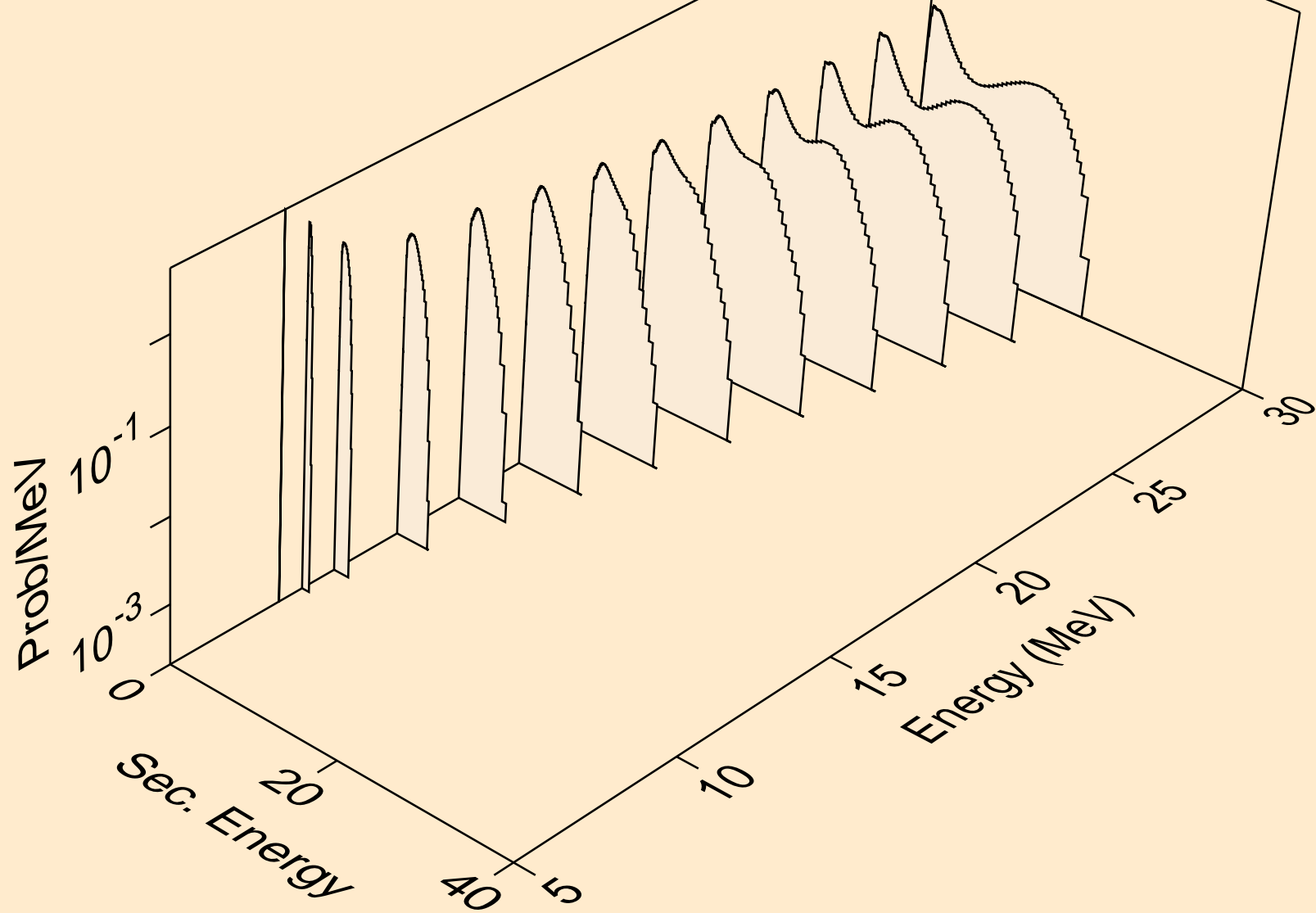

ND129 TRITON ACER TENDL-2021 LIBRARY; T=0.K  
neutrons from (t,3n)

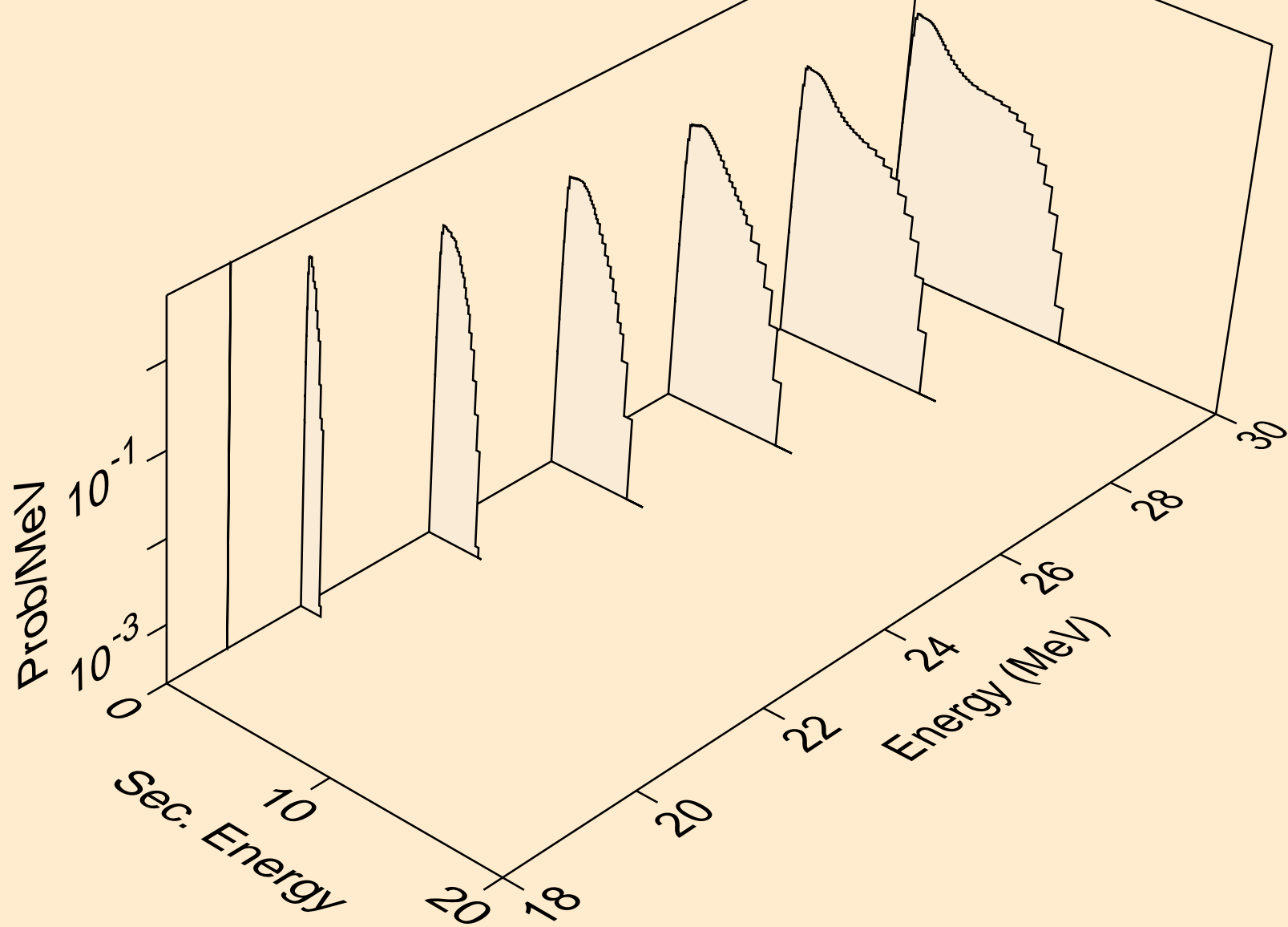

ND129 TRITON ACER TENDL-2021 LIBRARY; T=0.K  
neutrons from (t,n\*)a

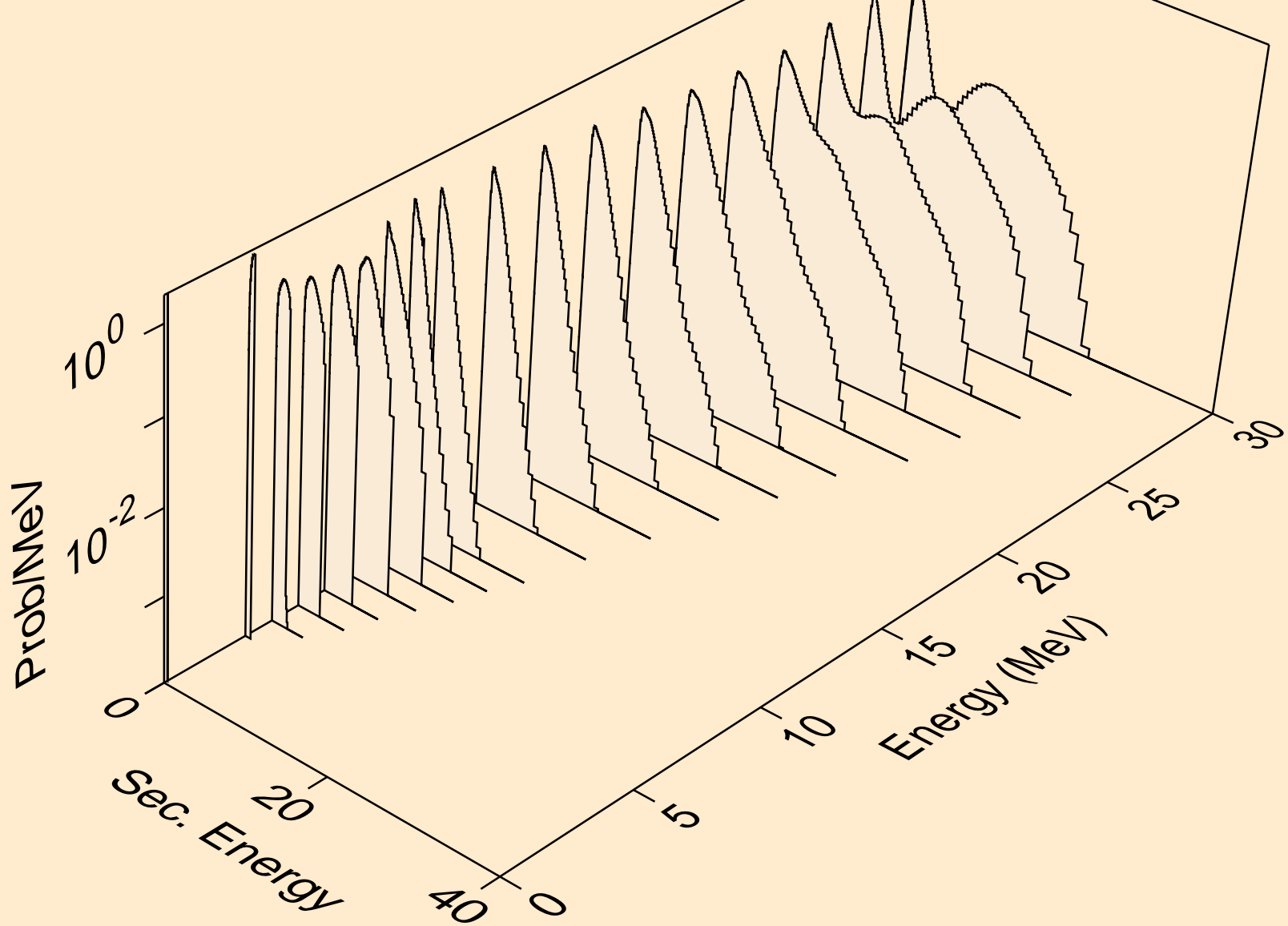

ND129 TRITON ACER TENDL-2021 LIBRARY; T=0.K  
neutrons from (t,2n)a

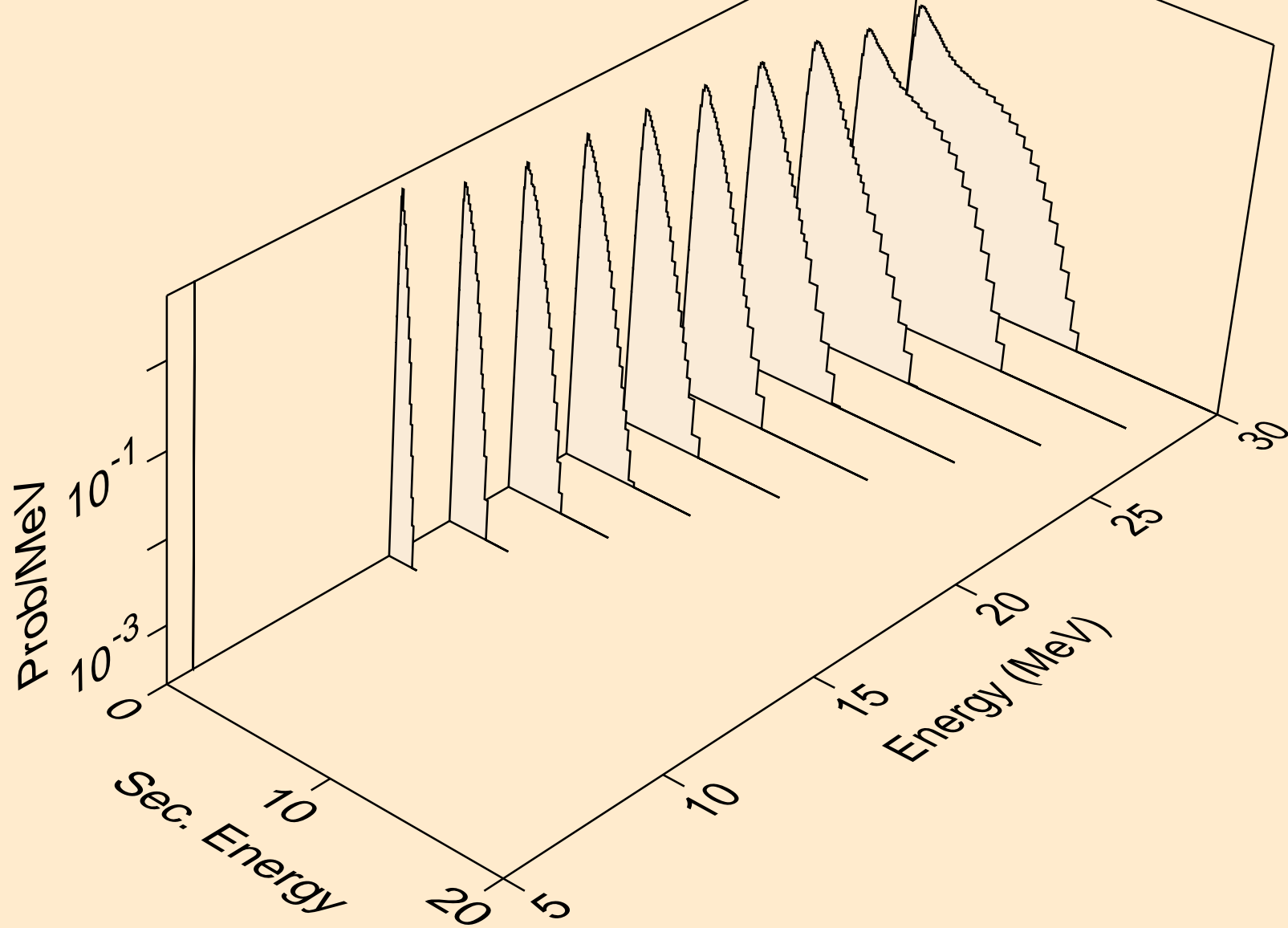

ND129 TRITON ACER TENDL-2021 LIBRARY; T=0.K  
neutrons from (t,n\*)p

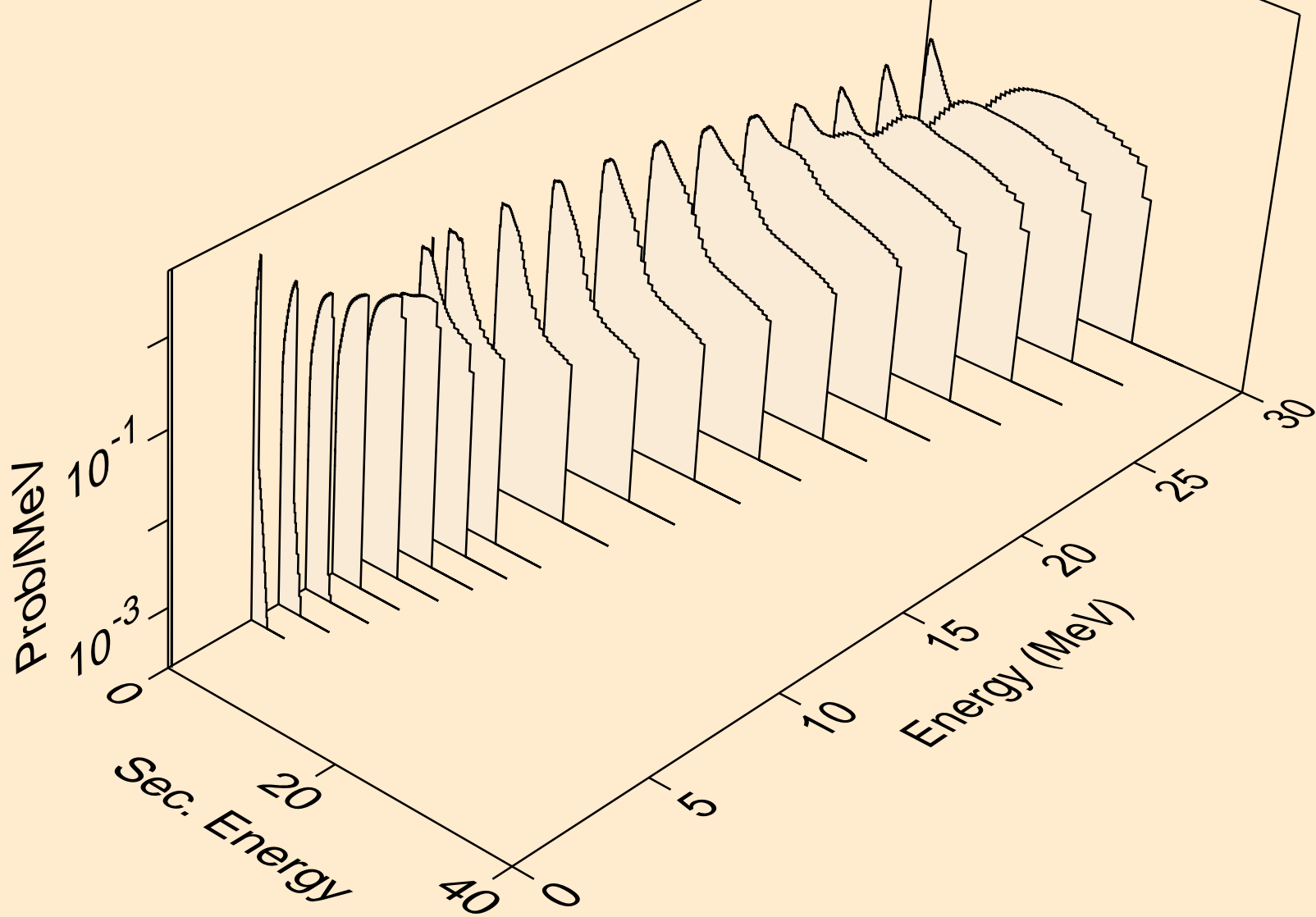

ND129 TRITON ACER TENDL-2021 LIBRARY; T=0.K  
neutrons from (t,n\*)2a

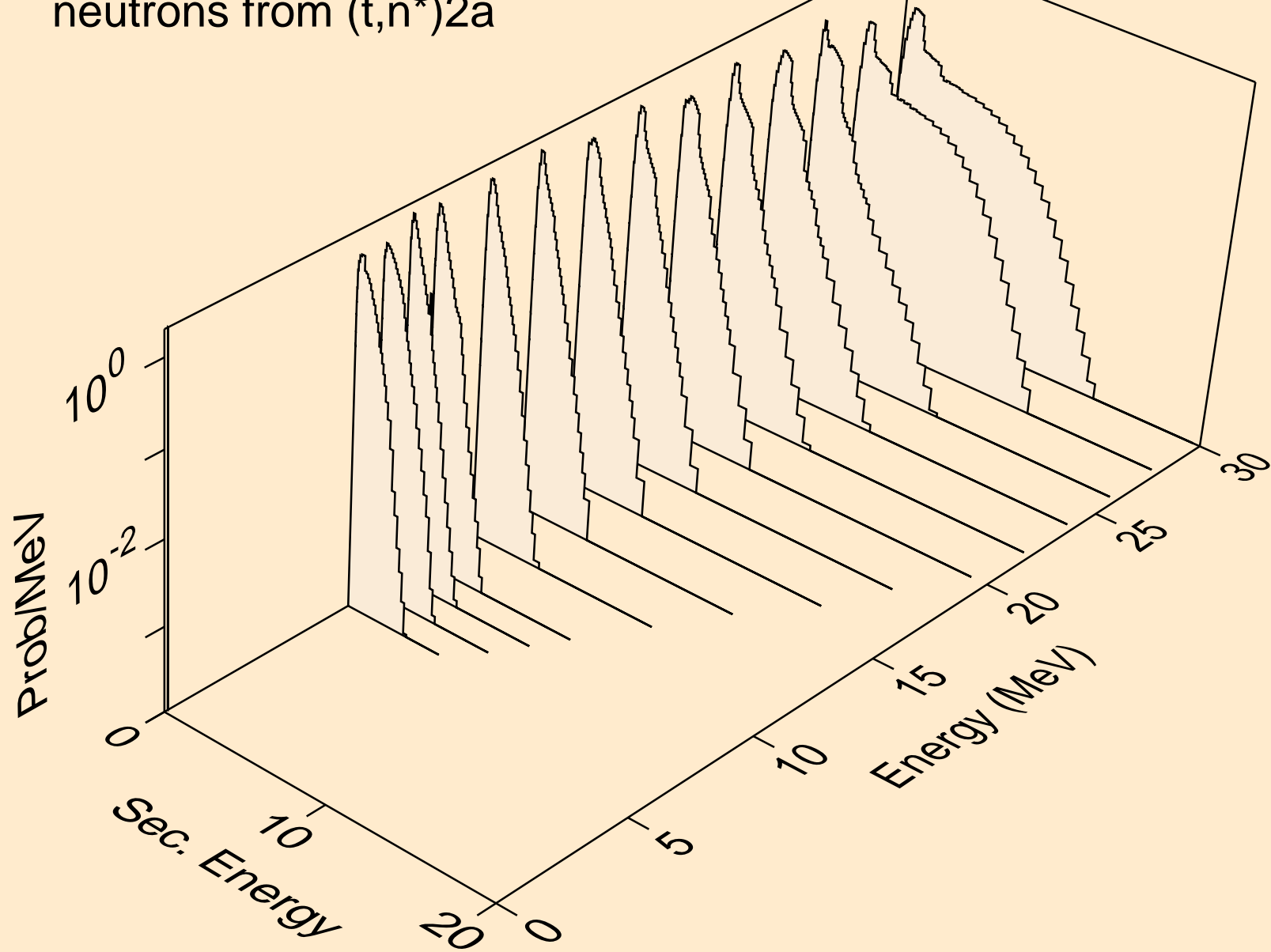



ND129 TRITON ACER TENDL-2021 LIBRARY; T=0.K  
neutrons from (t,n\*)d

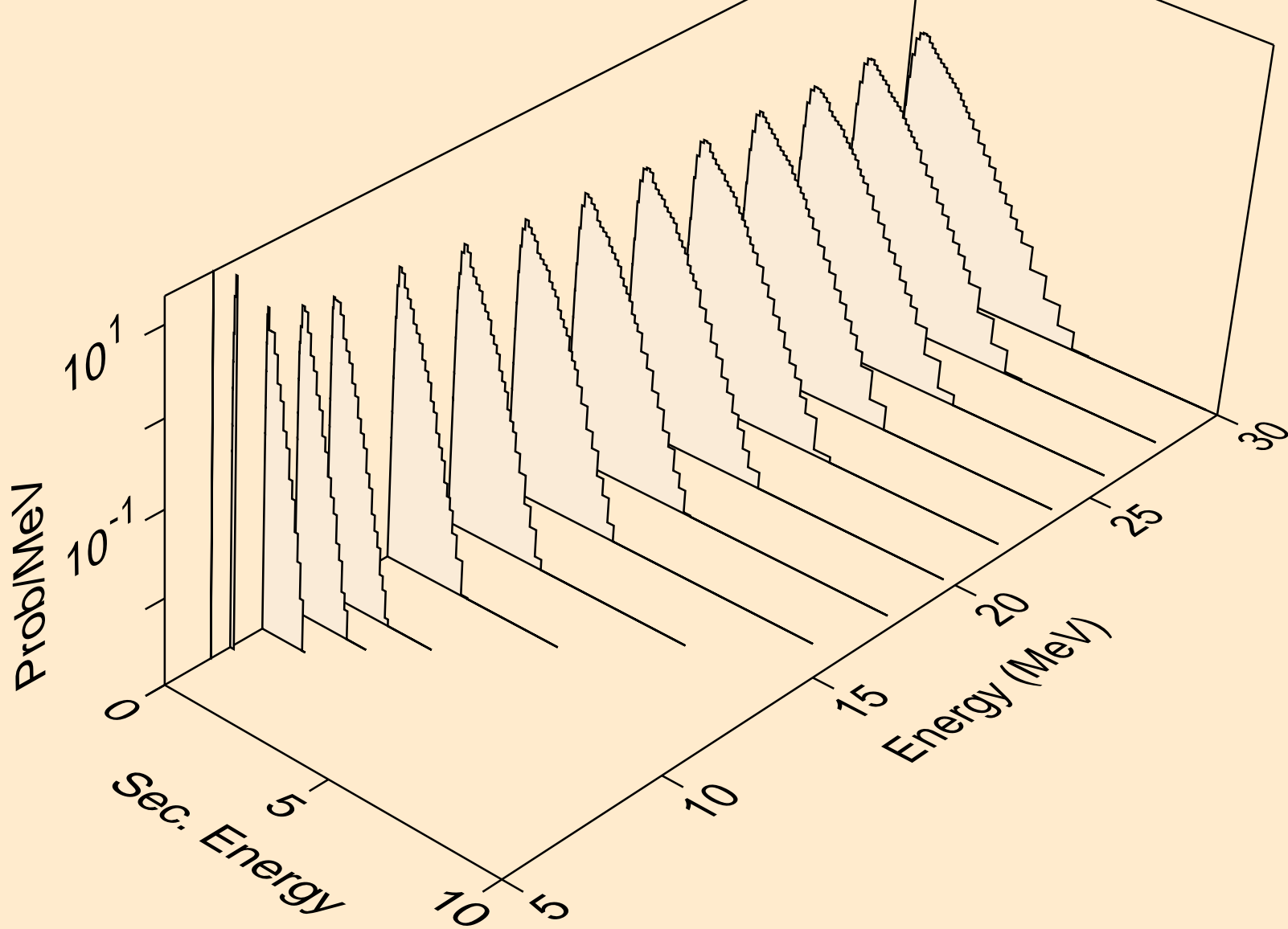

ND129 TRITON ACER TENDL-2021 LIBRARY; T=0.K  
neutrons from (t,n\*)t

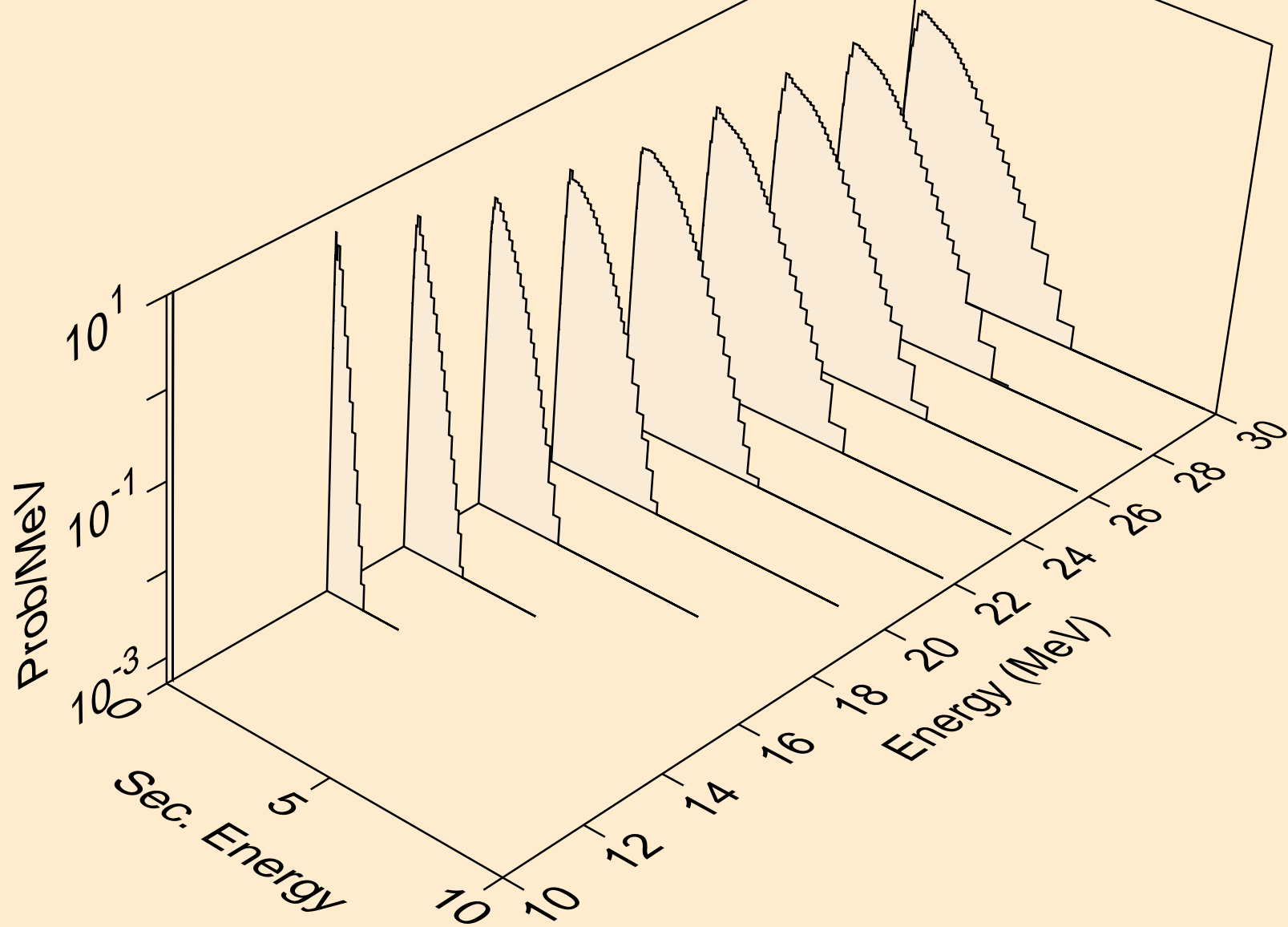

ND129 TRITON ACER TENDL-2021 LIBRARY; T=0.K  
neutrons from (t,n\*)he3

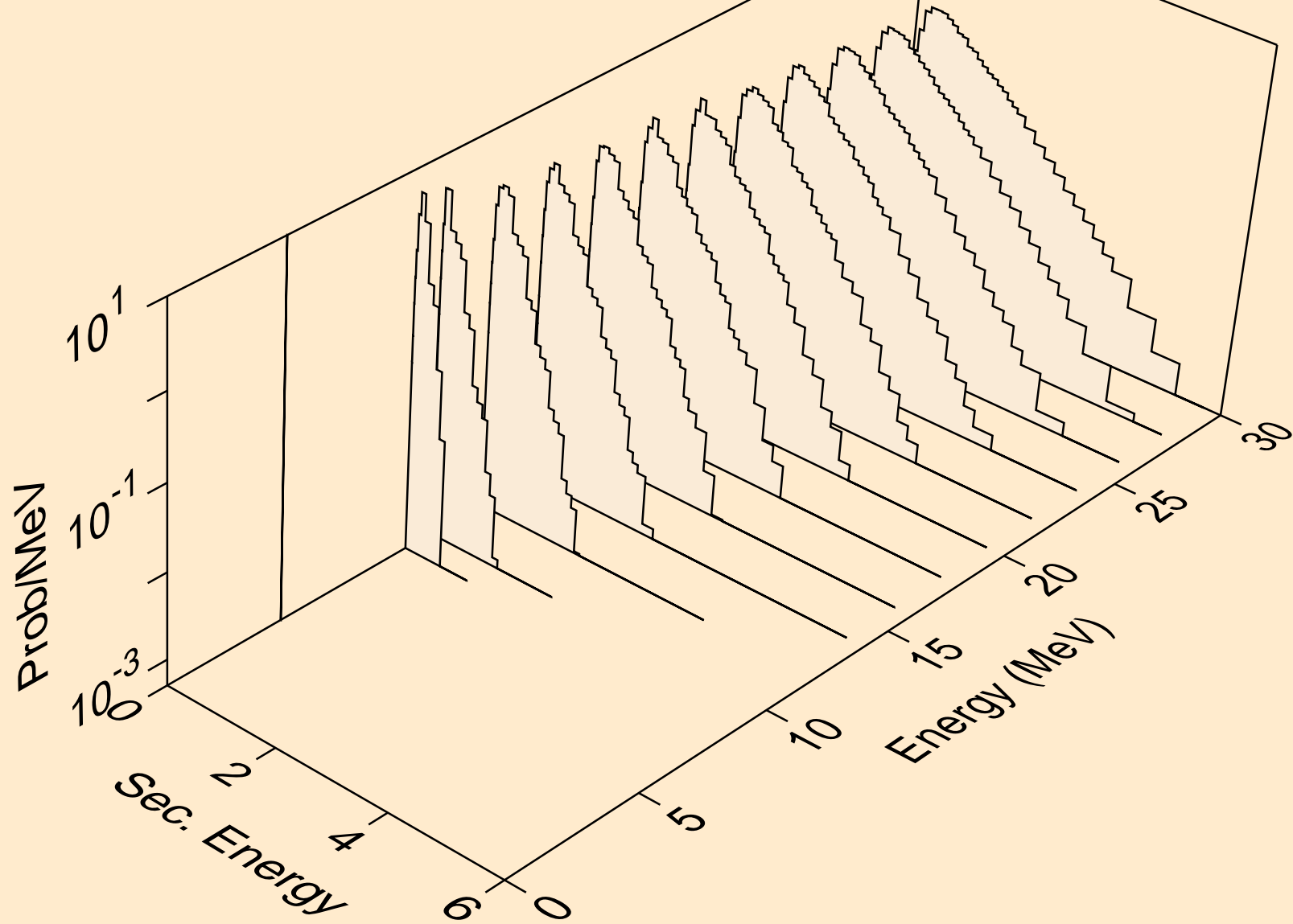

ND129 TRITON ACER TENDL-2021 LIBRARY; T=0.K  
neutrons from (t,2np)

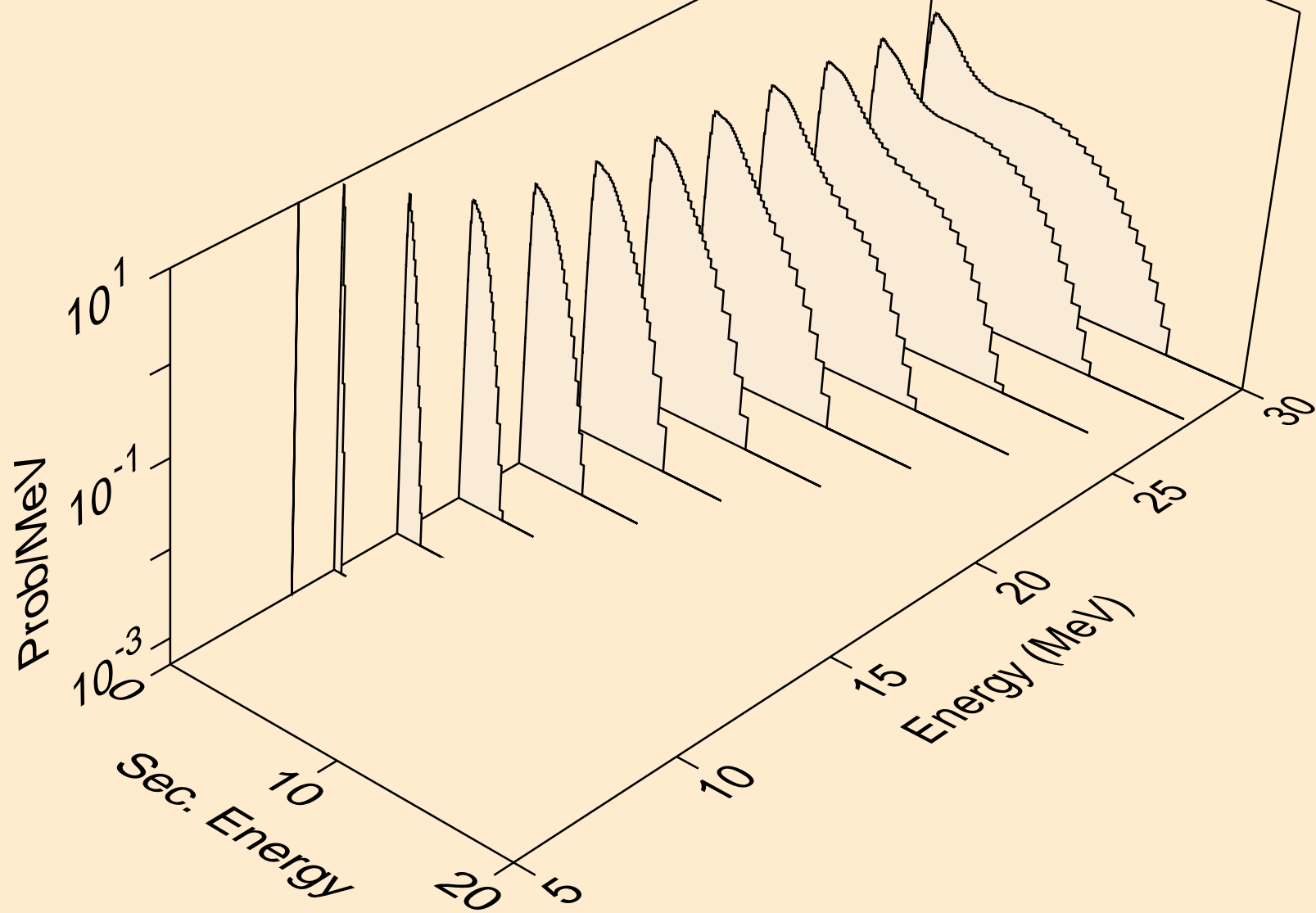

ND129 TRITON ACER TENDL-2021 LIBRARY; T=0.K  
neutrons from (t,3np)

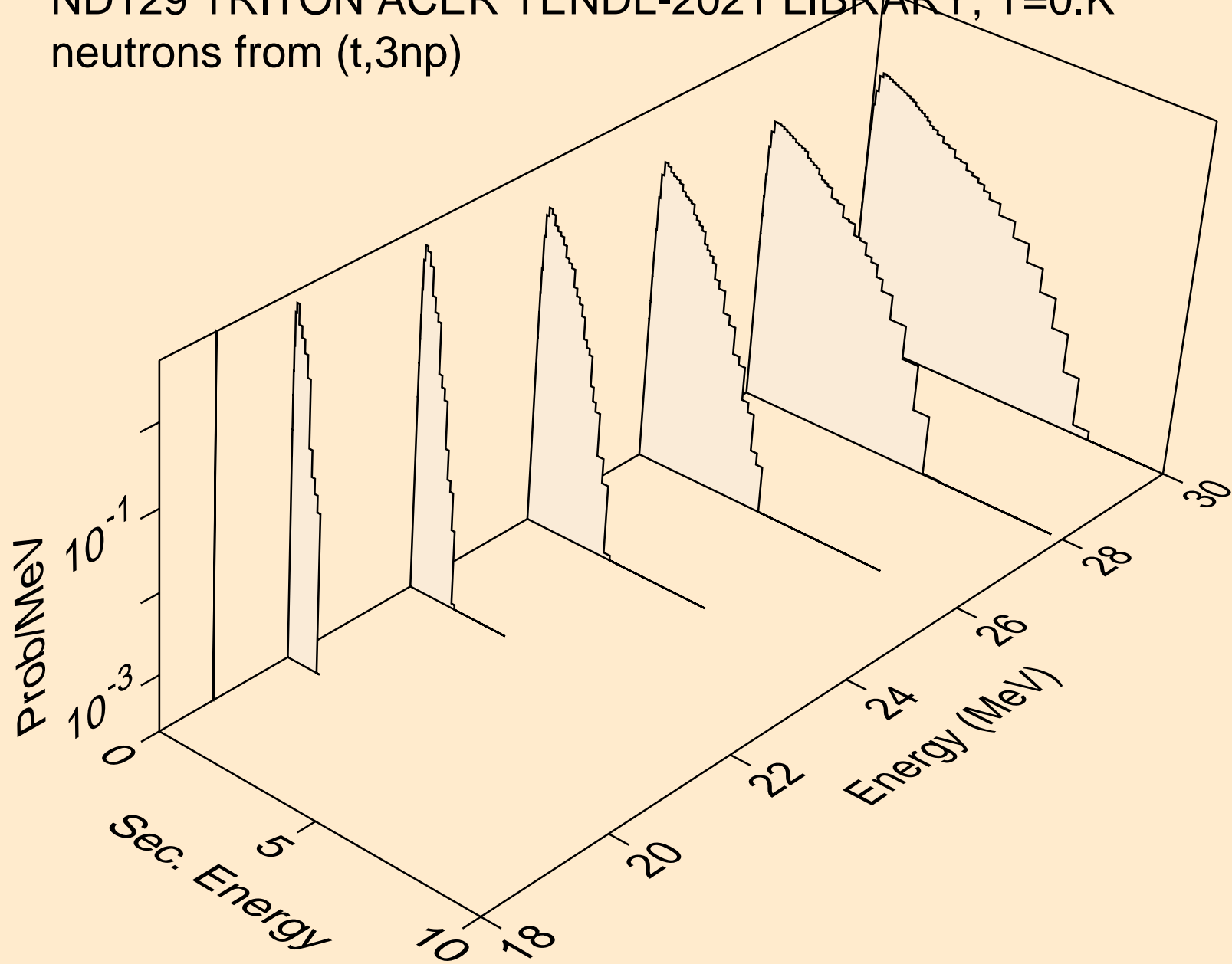

ND129 TRITON ACER TENDL-2021 LIBRARY; T=0.K  
neutrons from (t,2np)

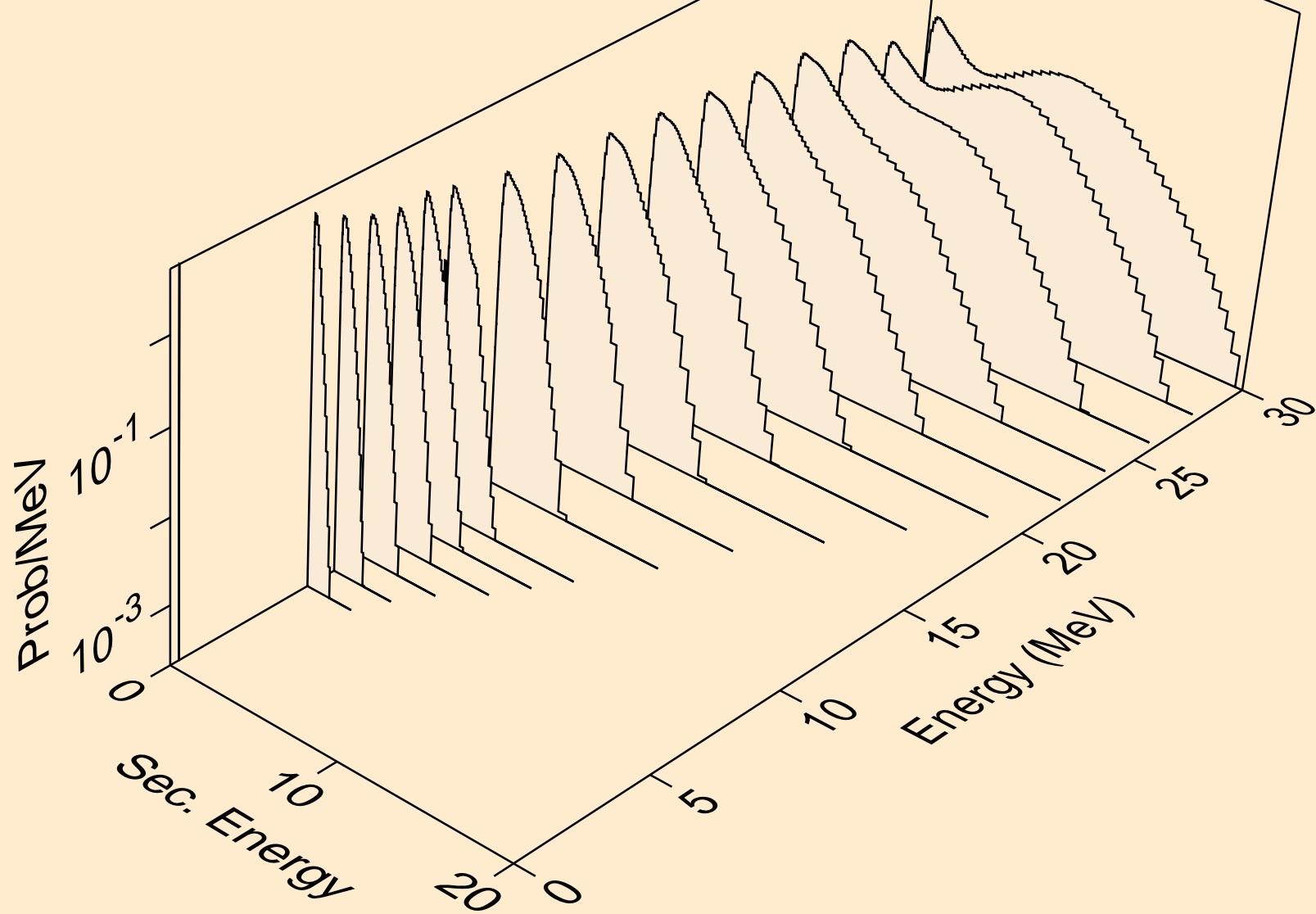

ND129 TRITON ACER TENDL-2021 LIBRARY; T=0.K  
neutrons from (t,npa)

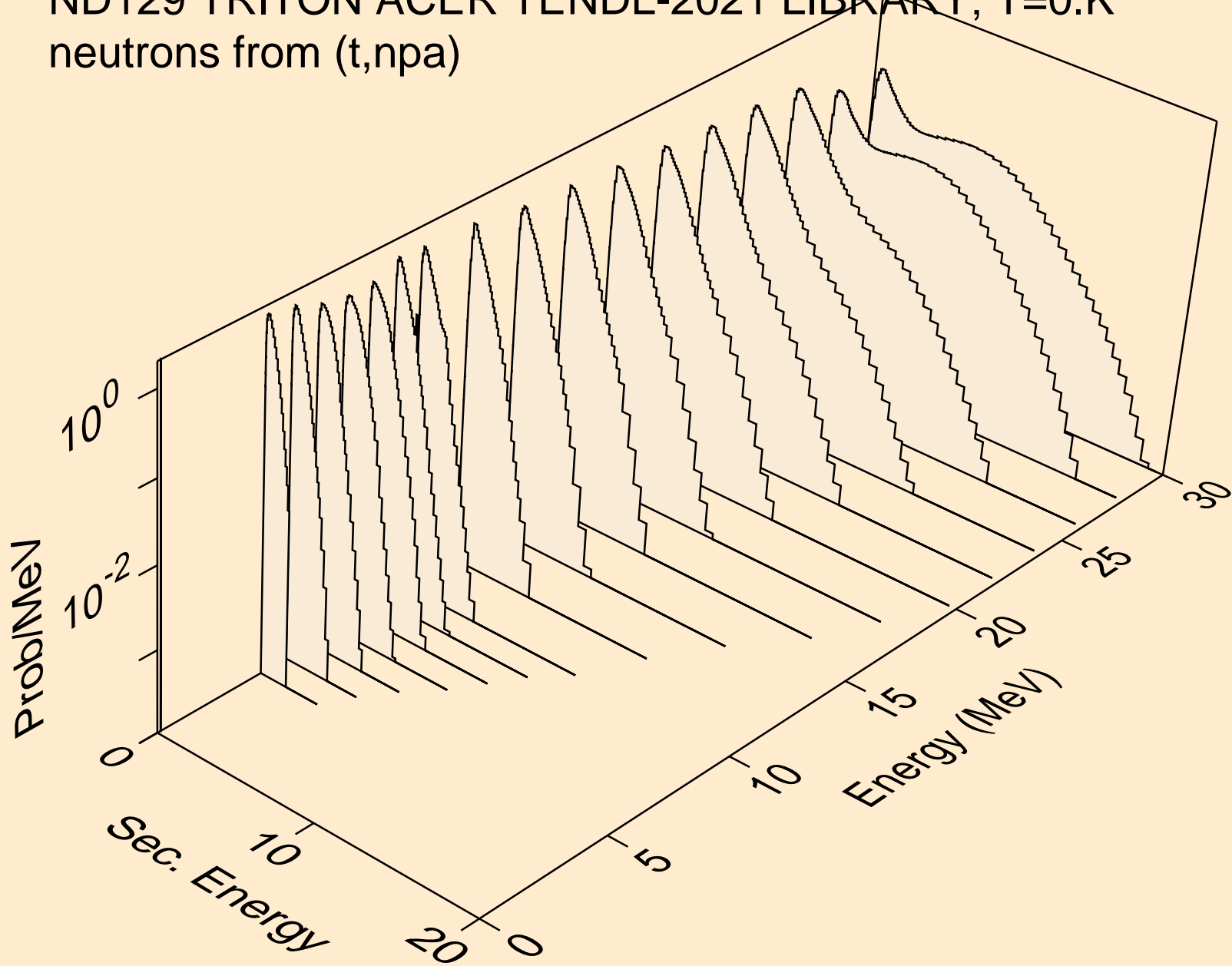

ND129 TRITON ACER TENDL-2021 LIBRARY; T=0.K  
protons from (t,x)

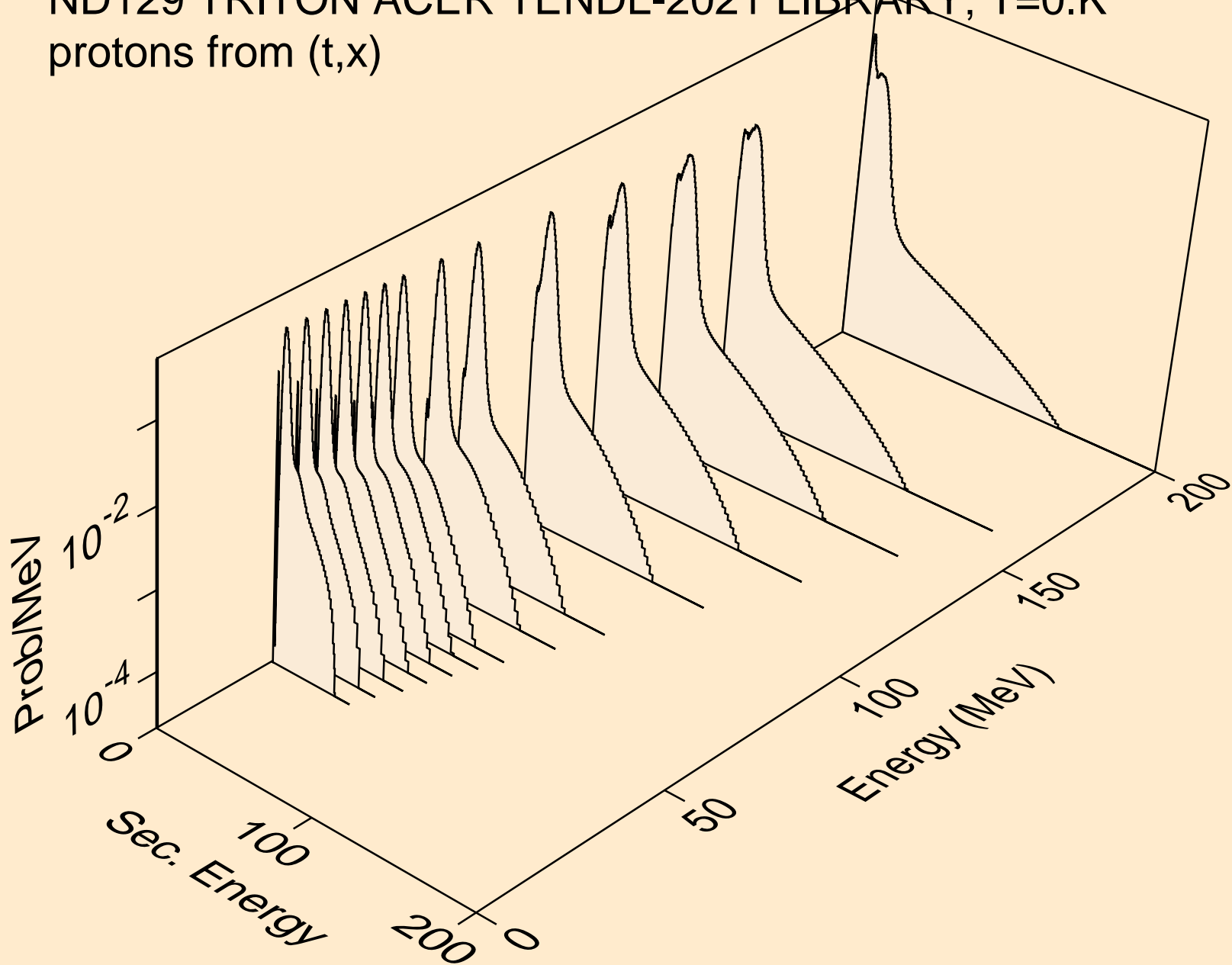



ND129 TRITON ACER TENDL-2021 LIBRARY; T=0.K  
protons from (t,n\*)p

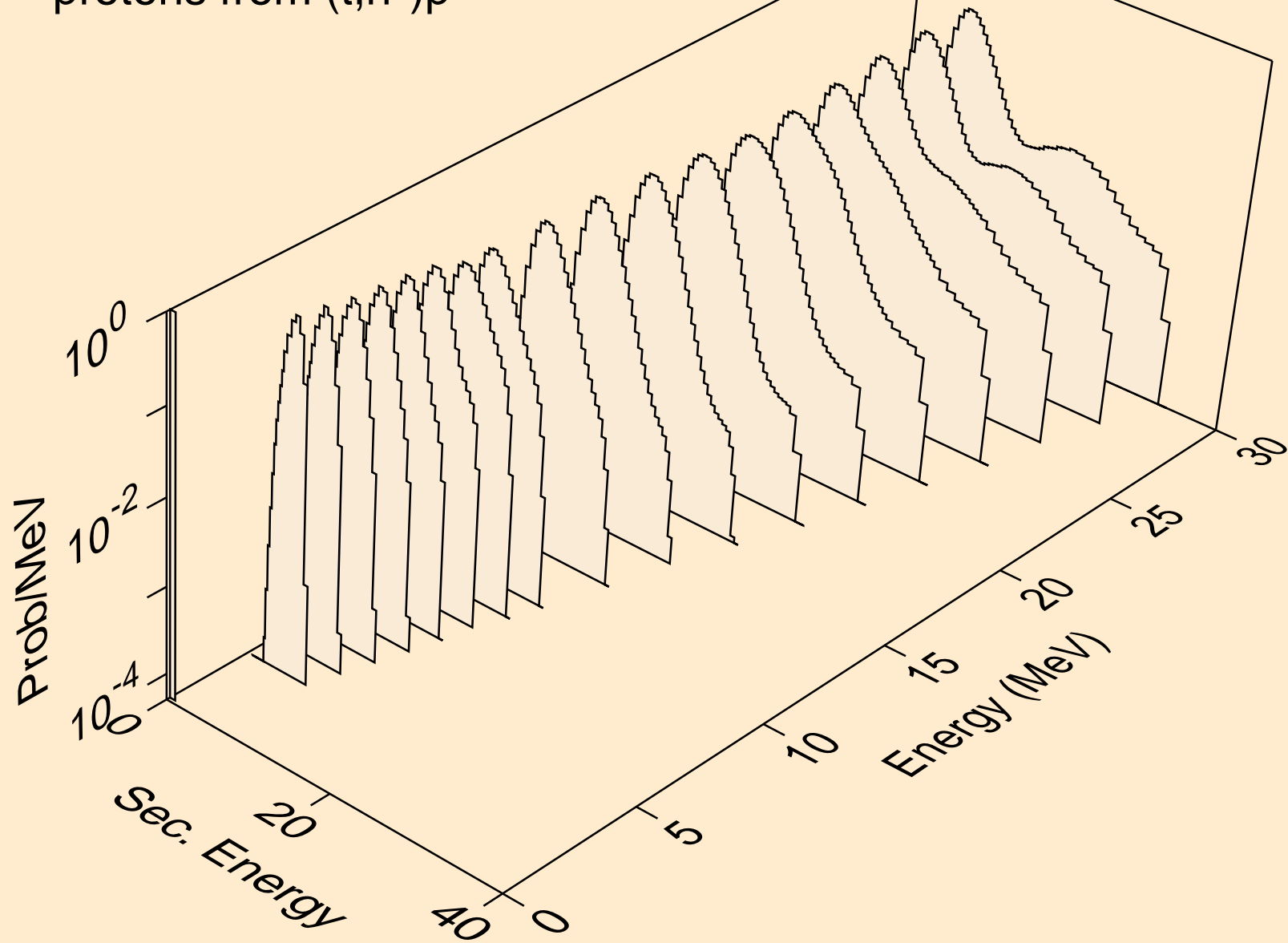

ND129 TRITON ACER TENDL-2021 LIBRARY; T=0.K  
protons from (t,2np)

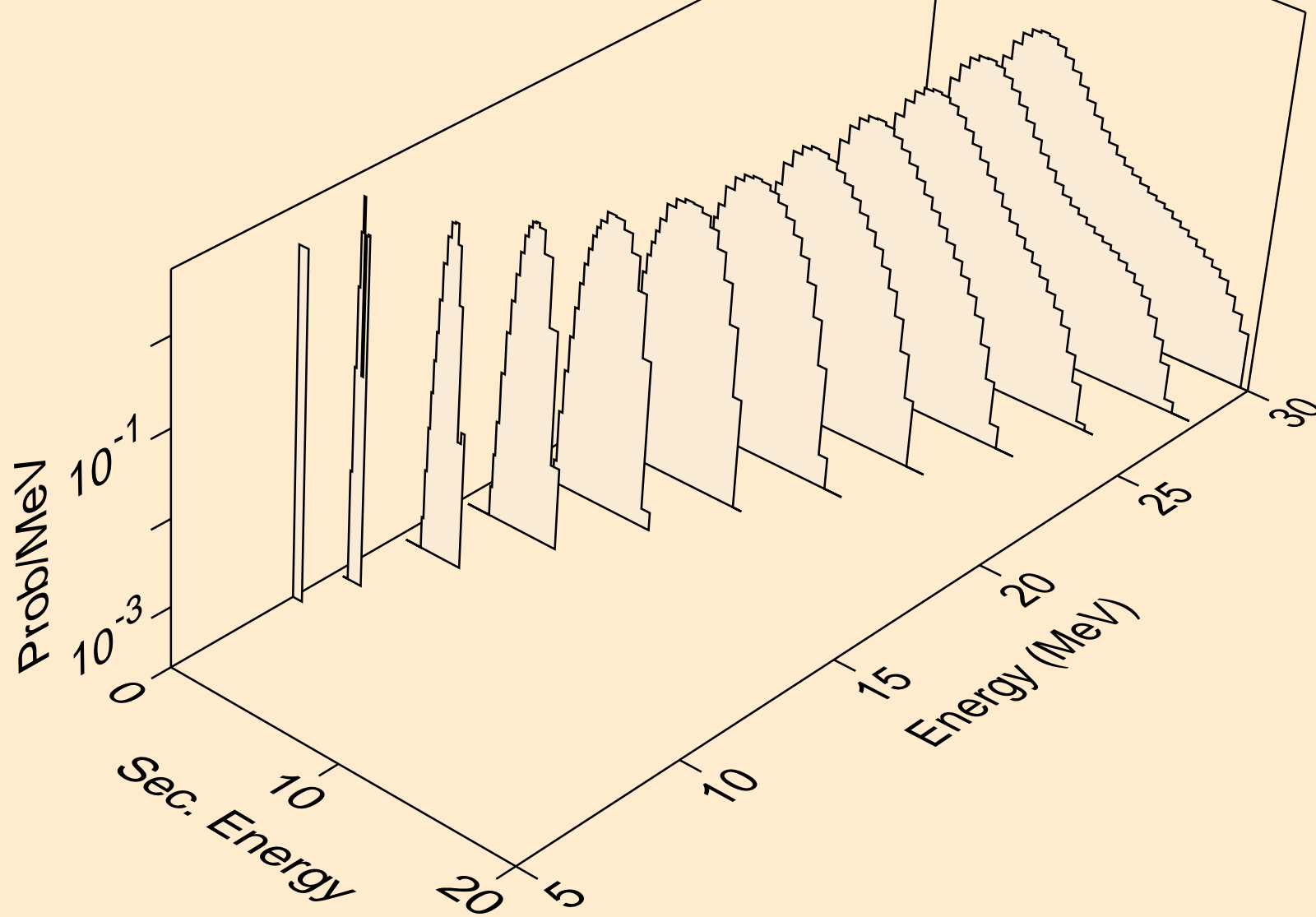

ND129 TRITON ACER TENDL-2021 LIBRARY; T=0.K  
protons from (t,3np)

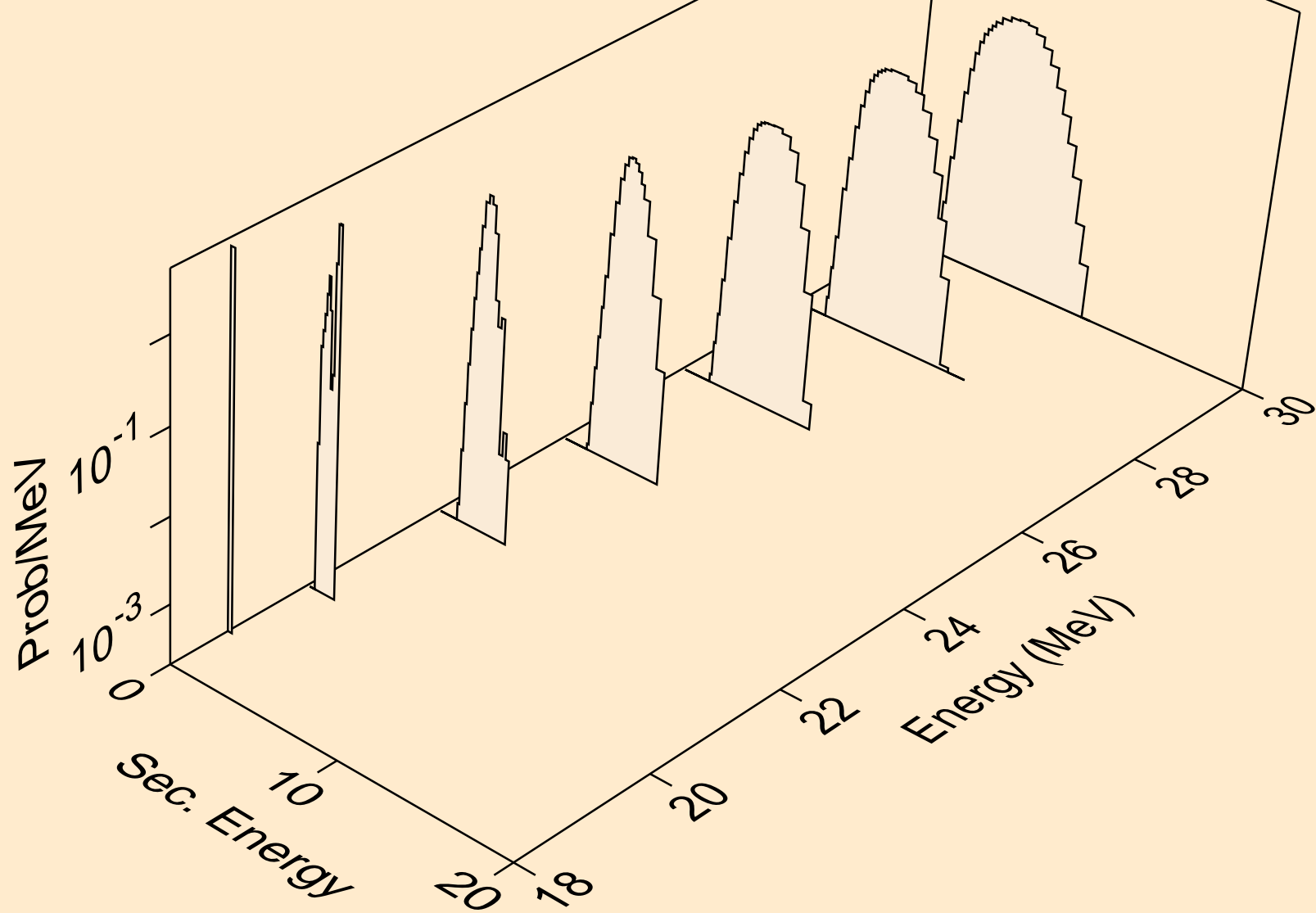

ND129 TRITON ACER TENDL-2021 LIBRARY; T=0.K  
protons from (t,2np)

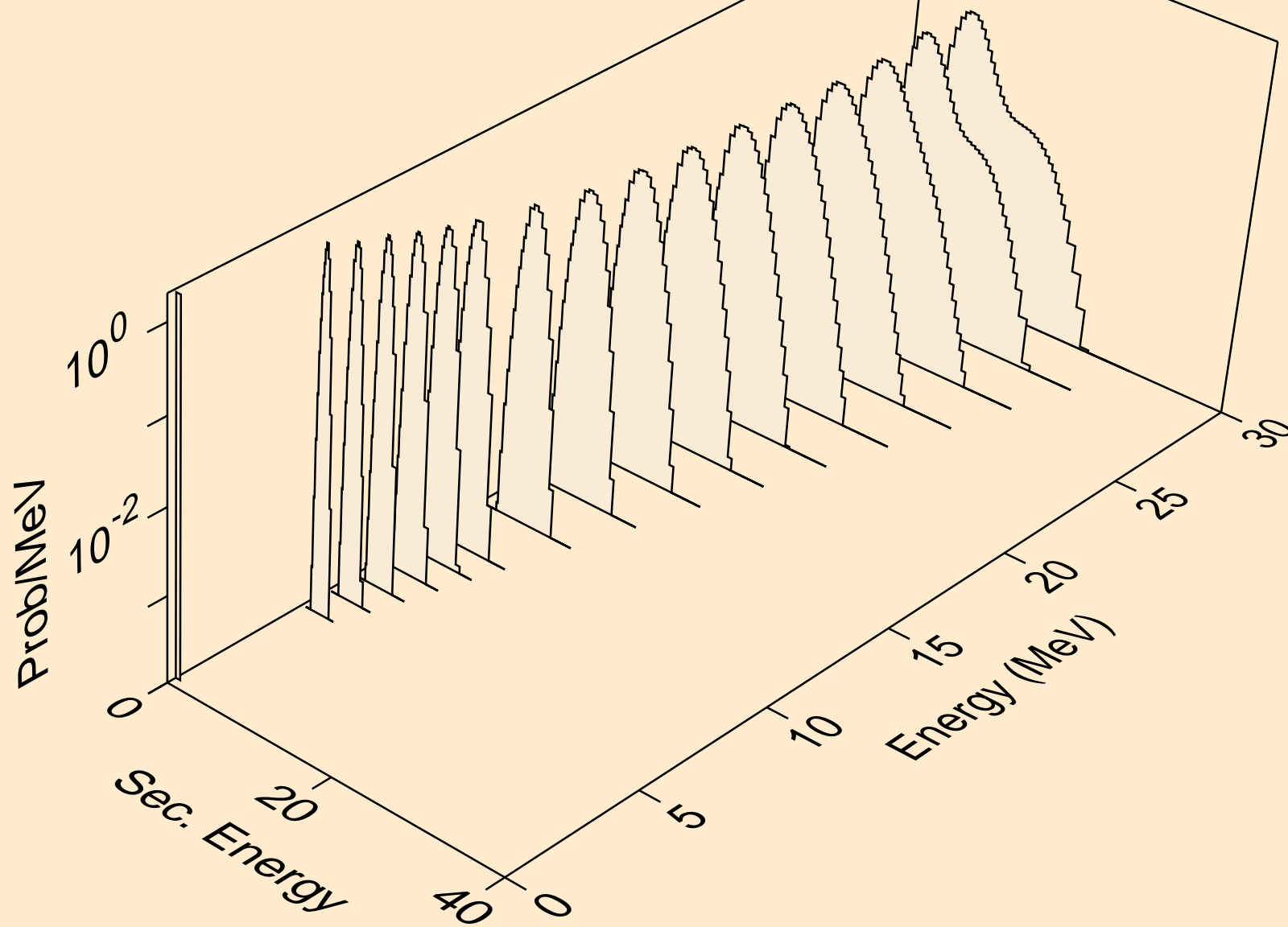

ND129 TRITON ACER TENDL-2021 LIBRARY; T=0.K  
protons from (t,npa)

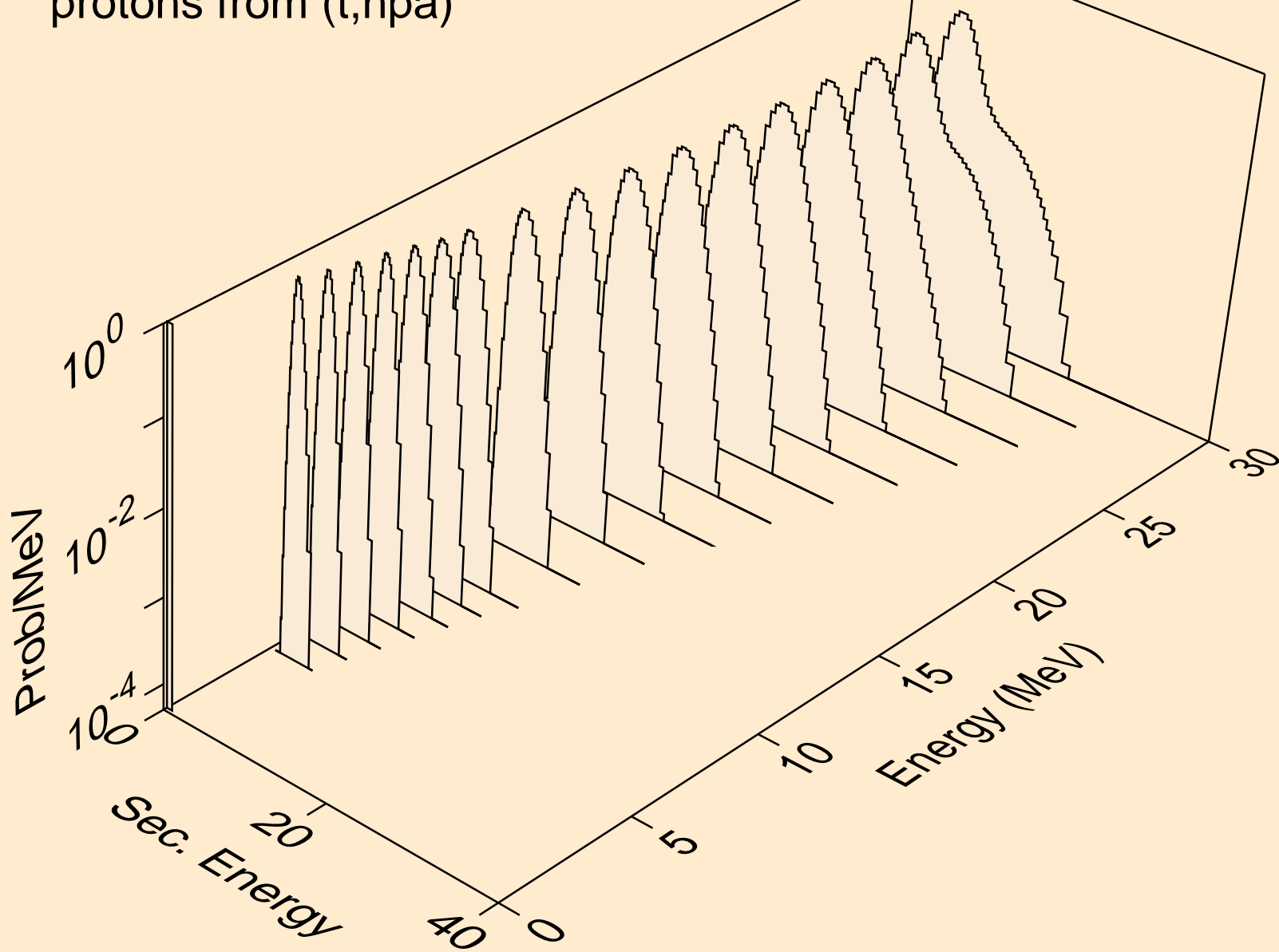

ND129 TRITON ACER TENDL-2021 LIBRARY; T=0.K  
protons from (t,p)

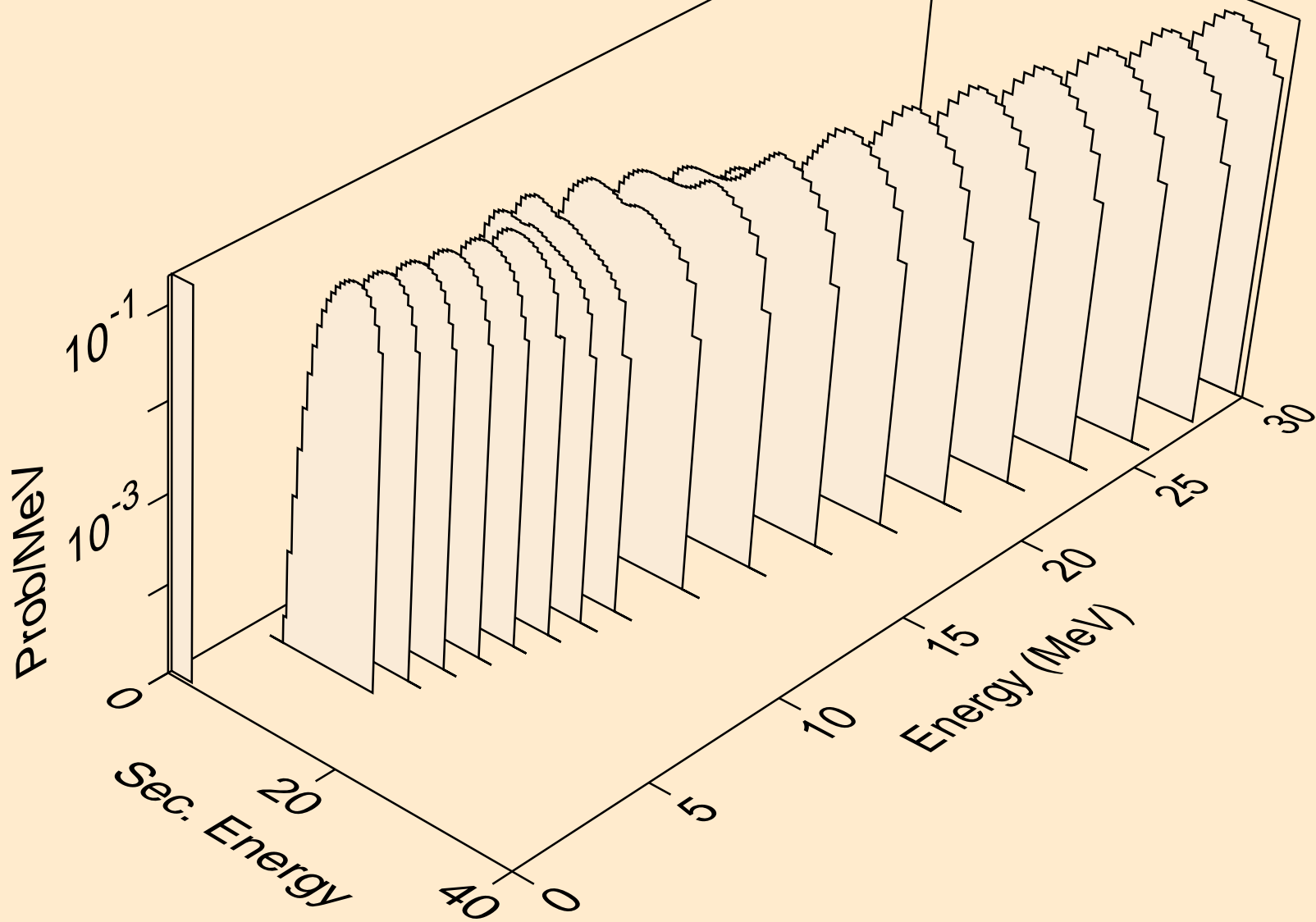

ND129 TRITON ACER TENDL-2021 LIBRARY; T=0.K  
protons from (t,2p)

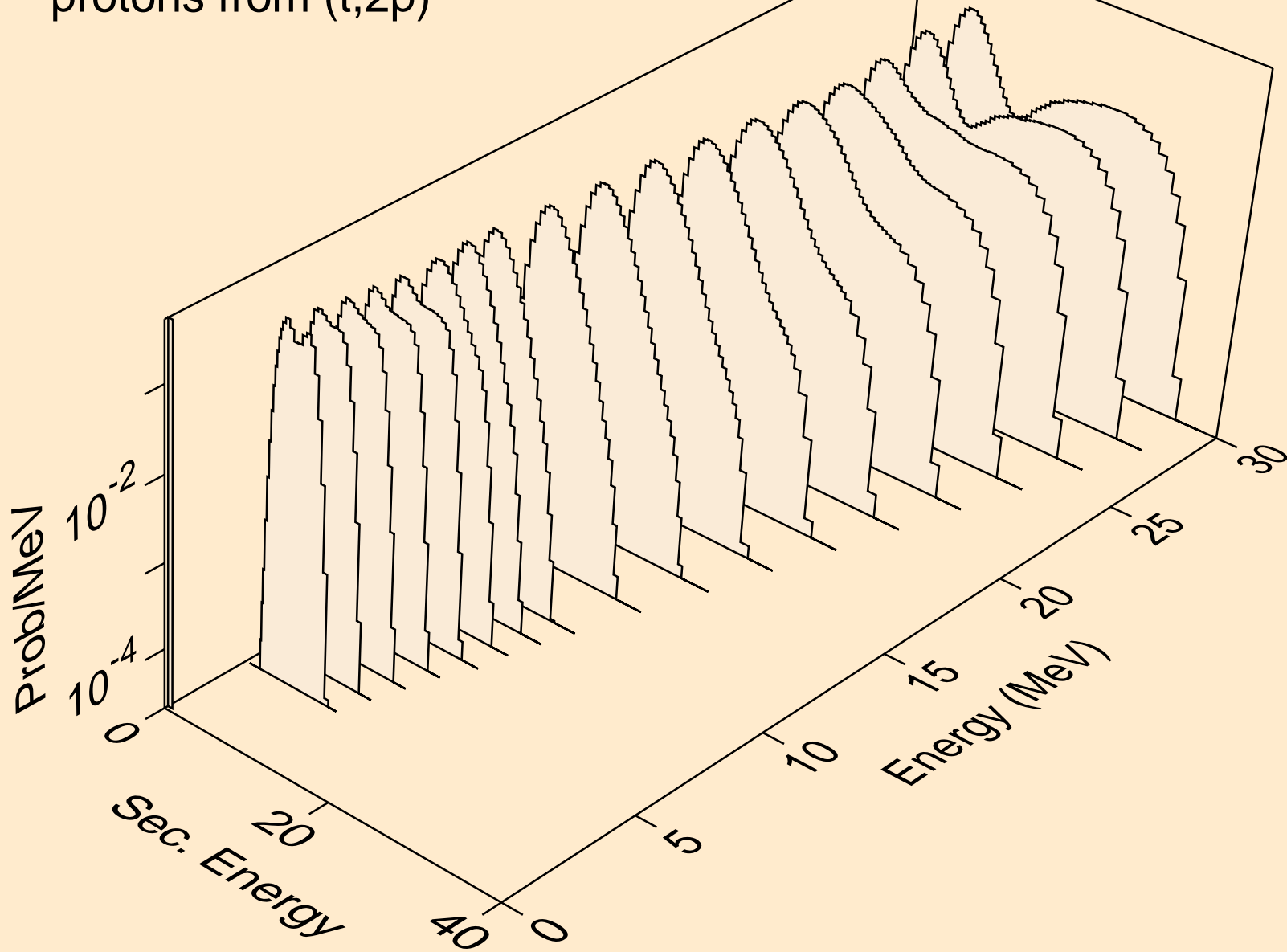

ND129 TRITON ACER TENDL-2021 LIBRARY; T=0.K  
protons from (t,pa)

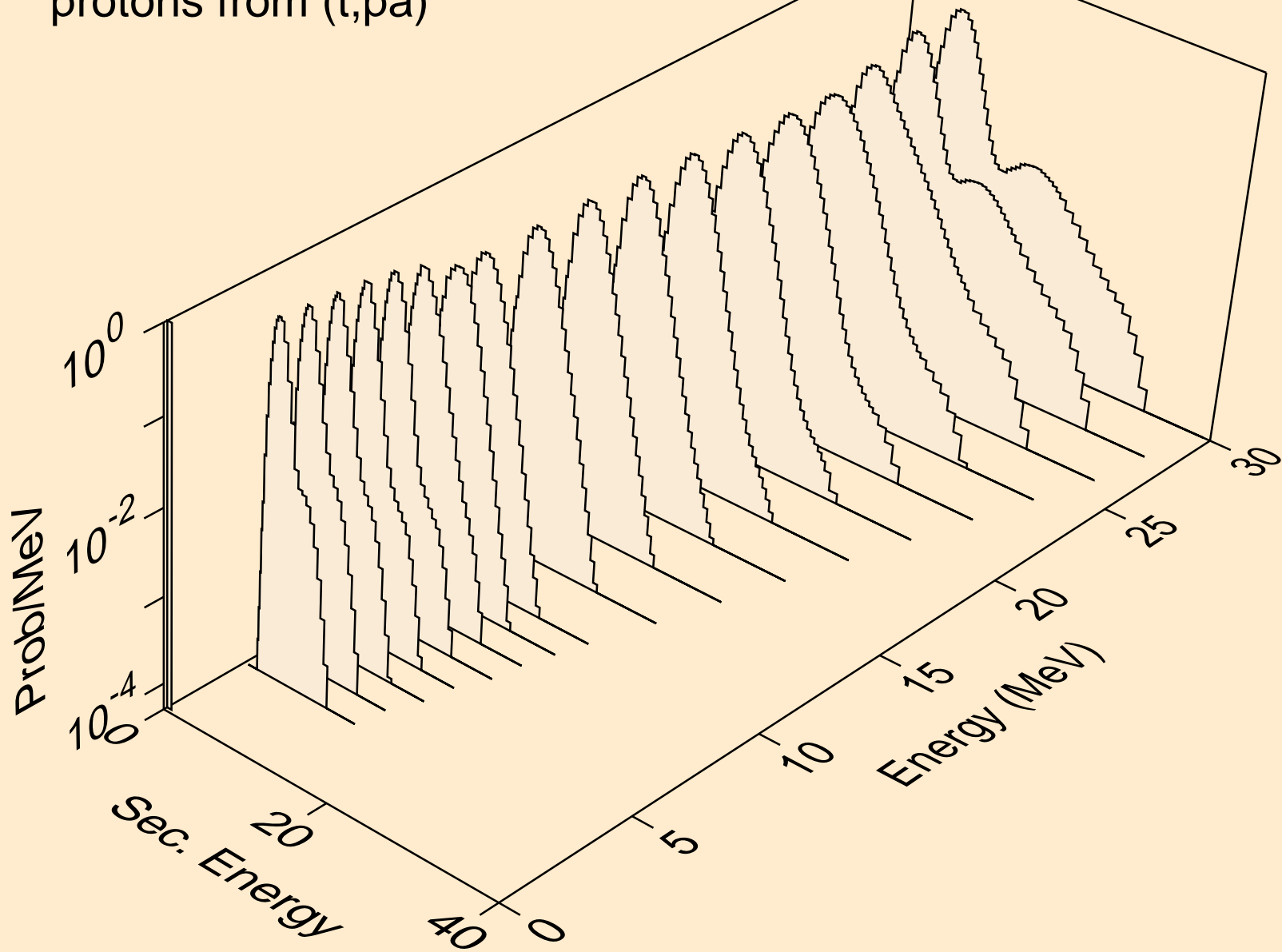



ND129 TRITON ACER TENDL-2021 LIBRARY; T=0.K  
protons from (t,pd)

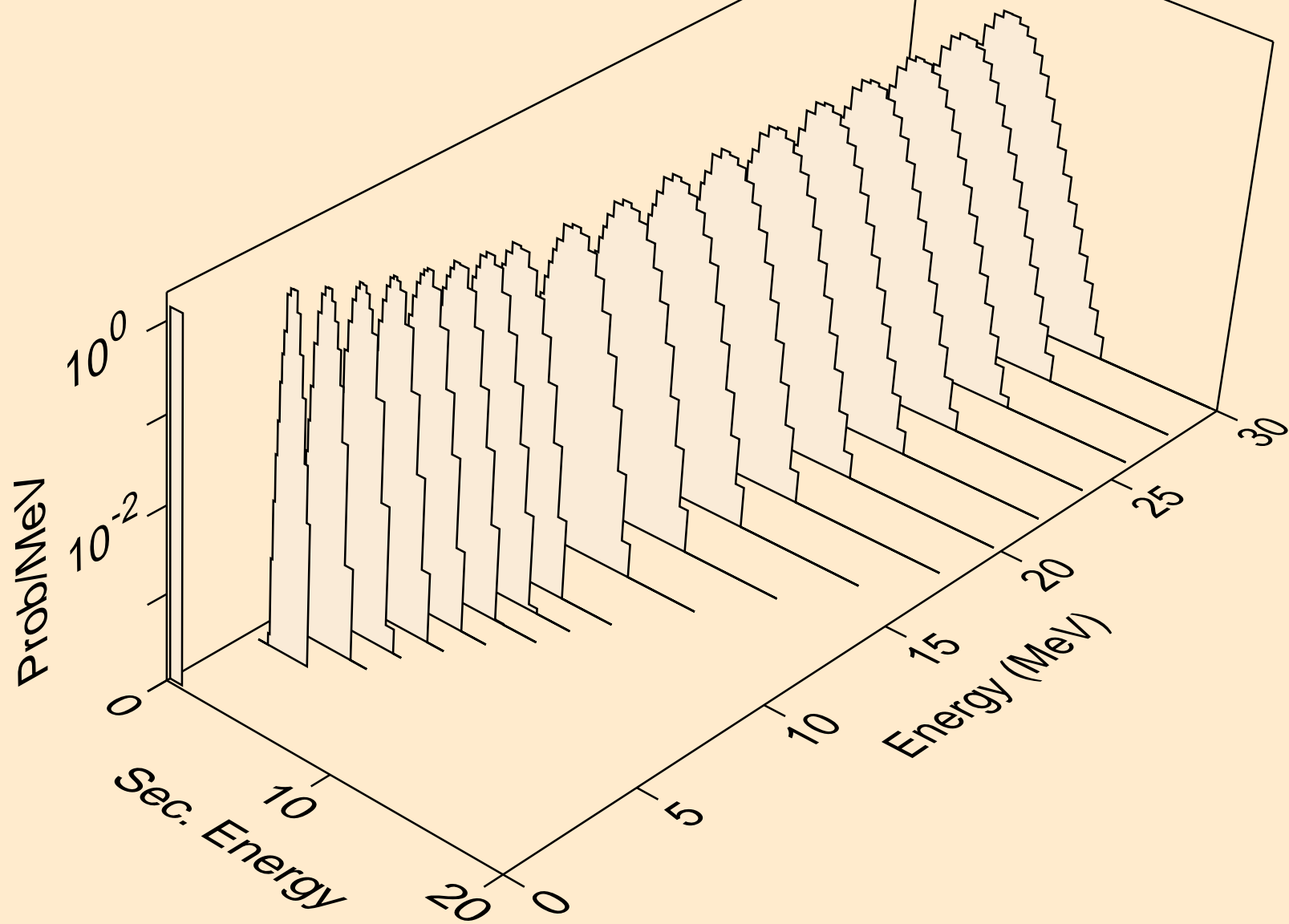

ND129 TRITON ACER TENDL-2021 LIBRARY; T=0.K  
protons from (t,pt)

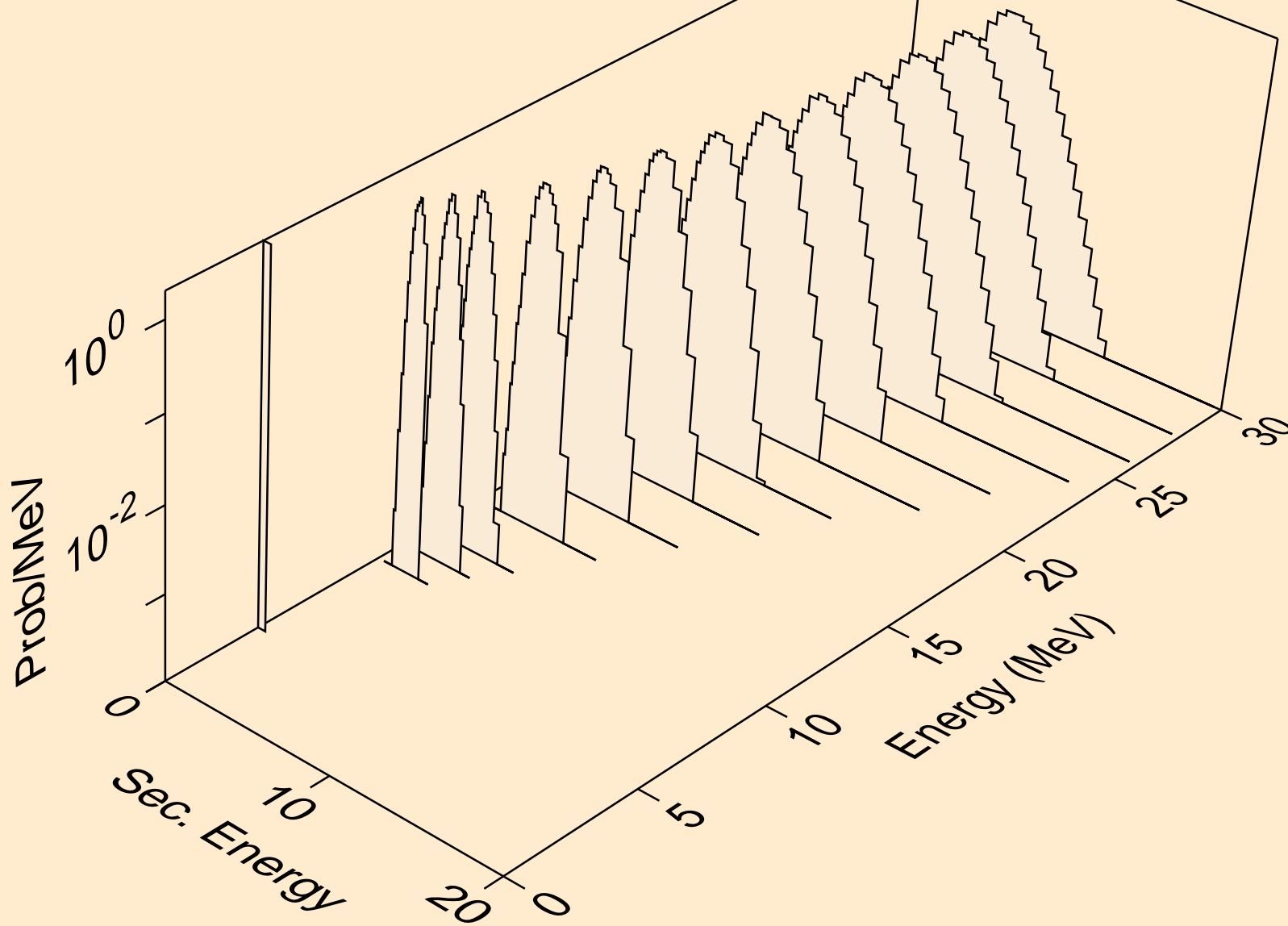

ND129 TRITON ACER TENDL-2021 LIBRARY; T=0.K  
deuterons from (t,x)

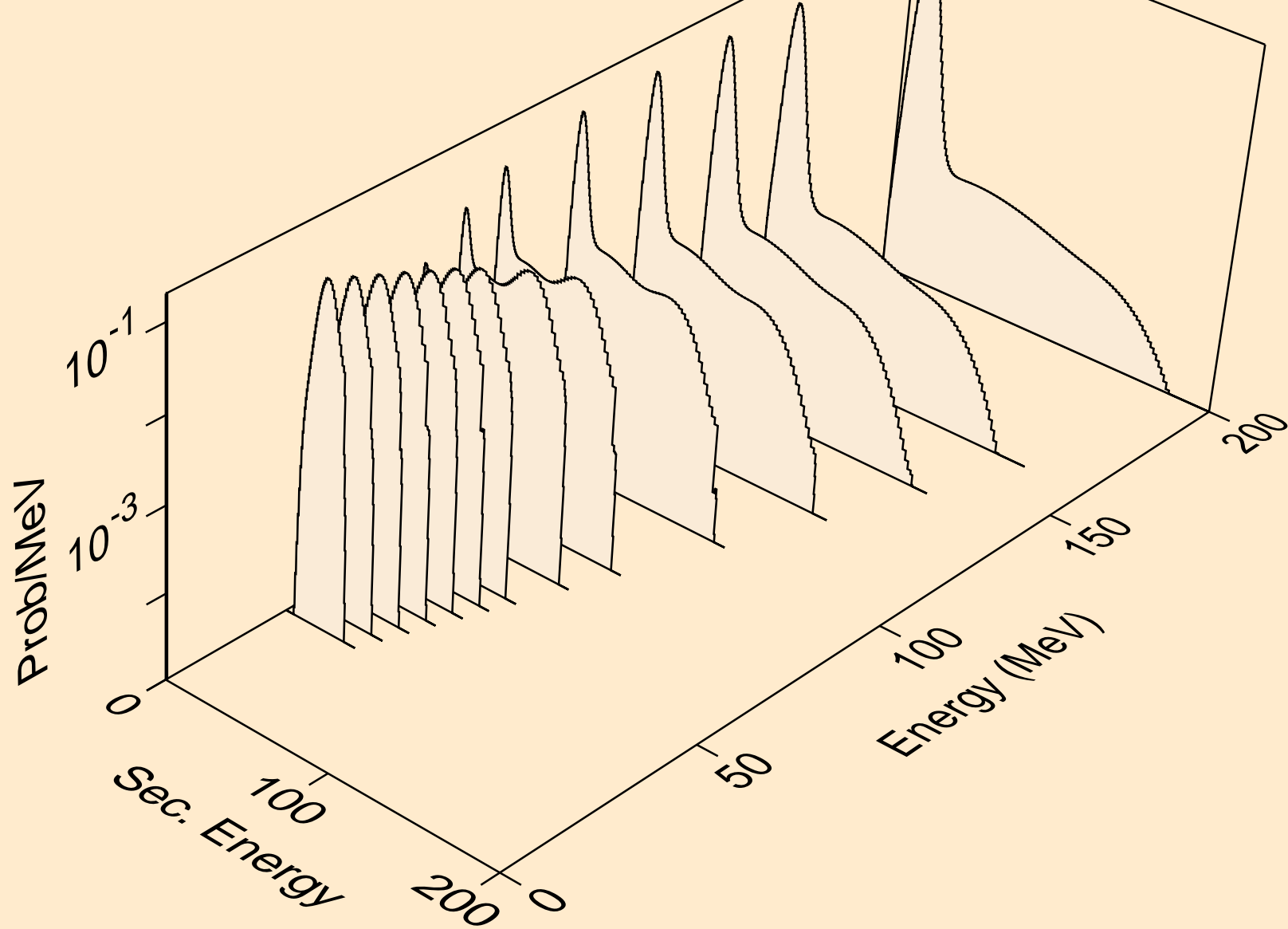

ND129 TRITON ACER TENDL-2021 LIBRARY; T=0.K  
deuterons from (t,2nd)

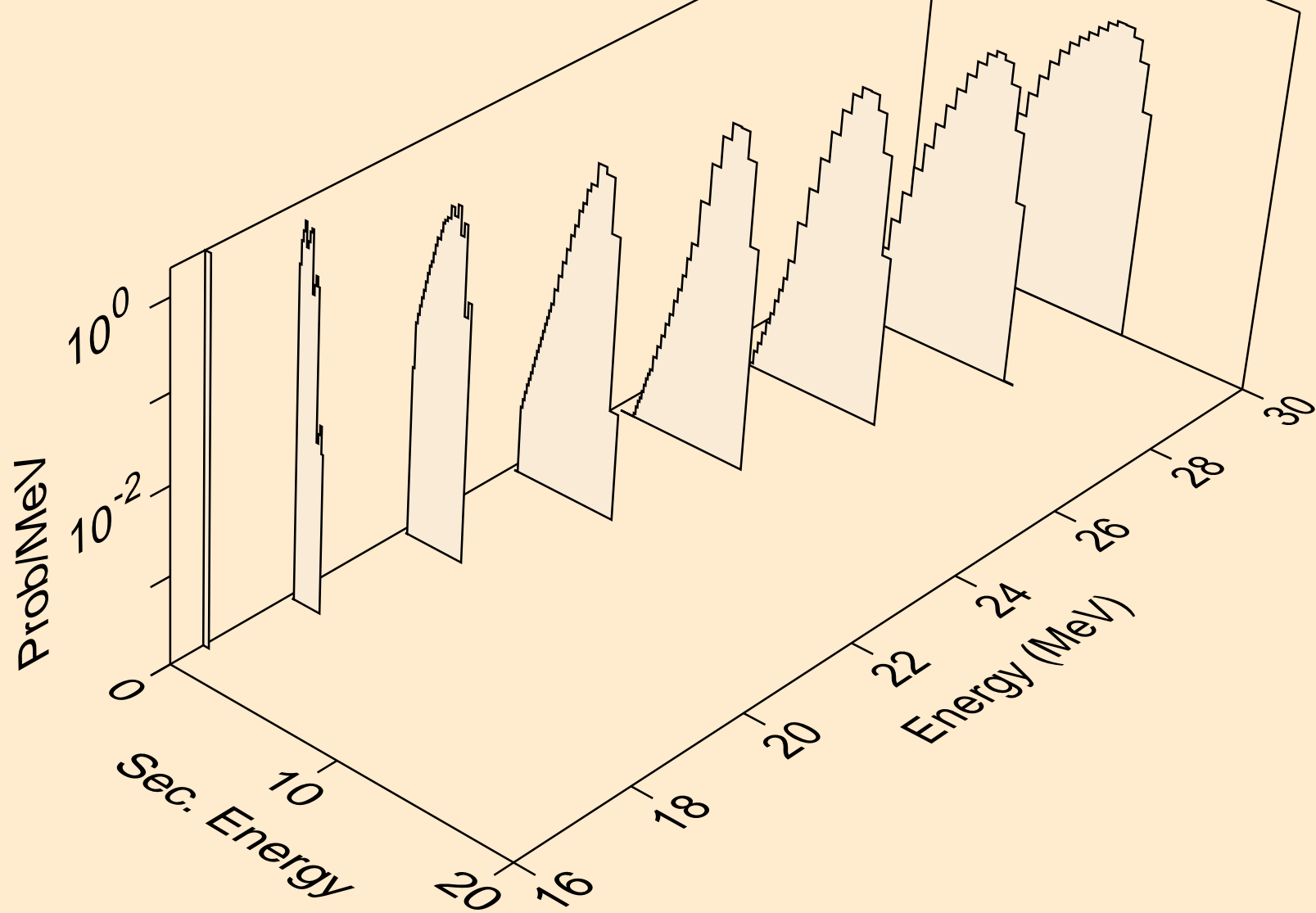

ND129 TRITON ACER TENDL-2021 LIBRARY; T=0.K  
deuterons from (t,n\*)d

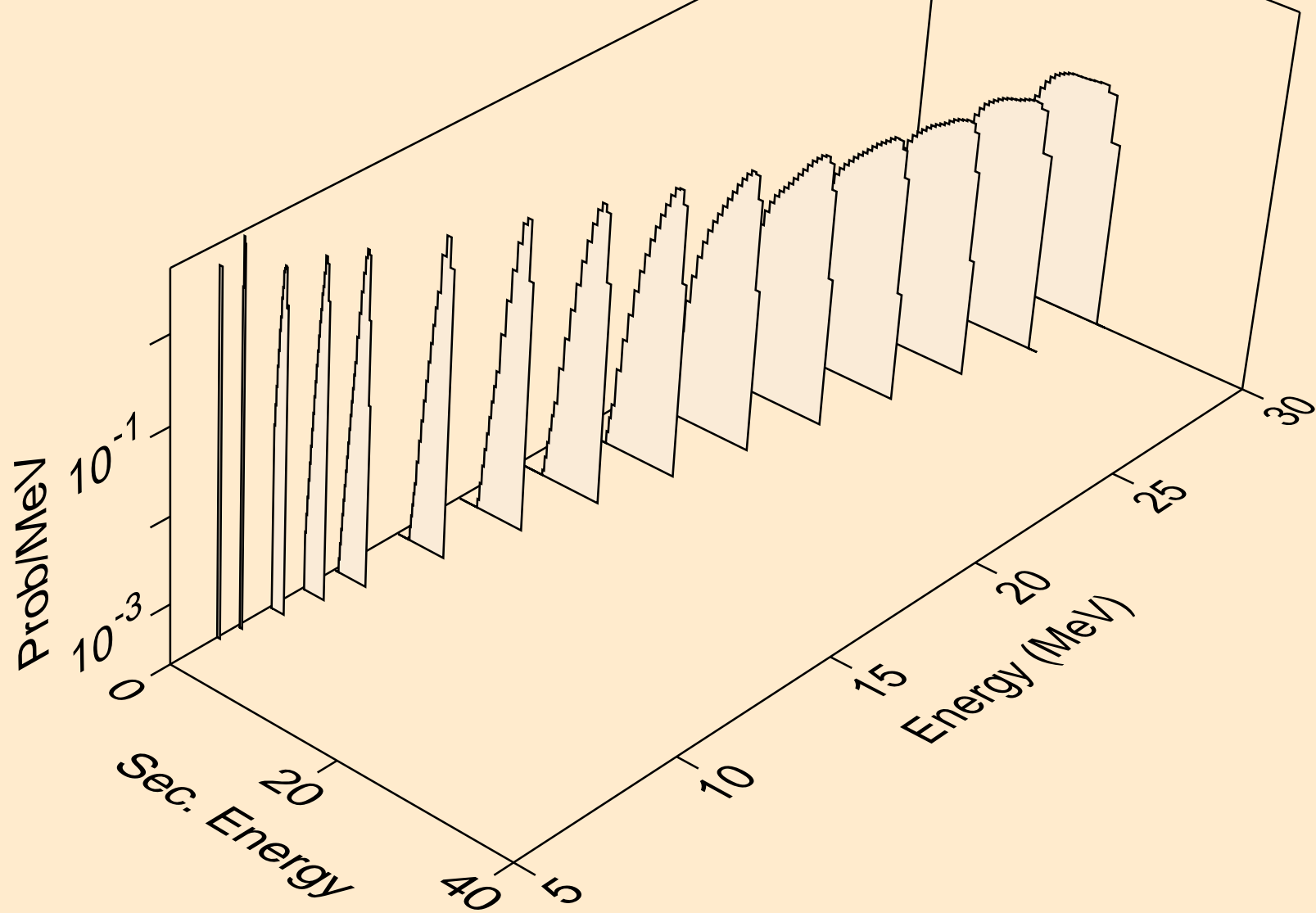

ND129 TRITON ACER TENDL-2021 LIBRARY; T=0.K  
deuterons from (t,d)

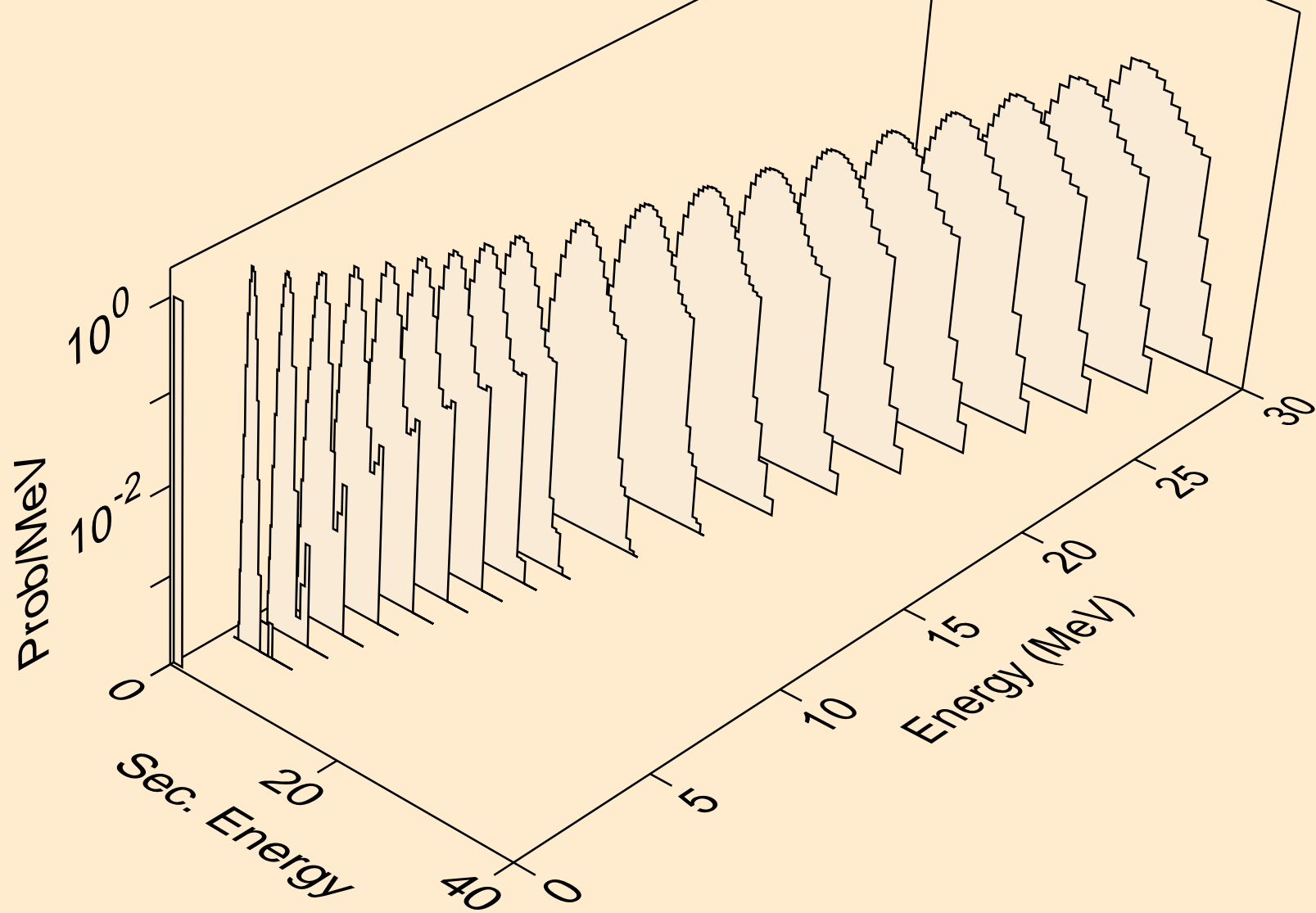

ND129 TRITON ACER TENDL-2021 LIBRARY; T=0.K  
deuterons from (t,d2a)

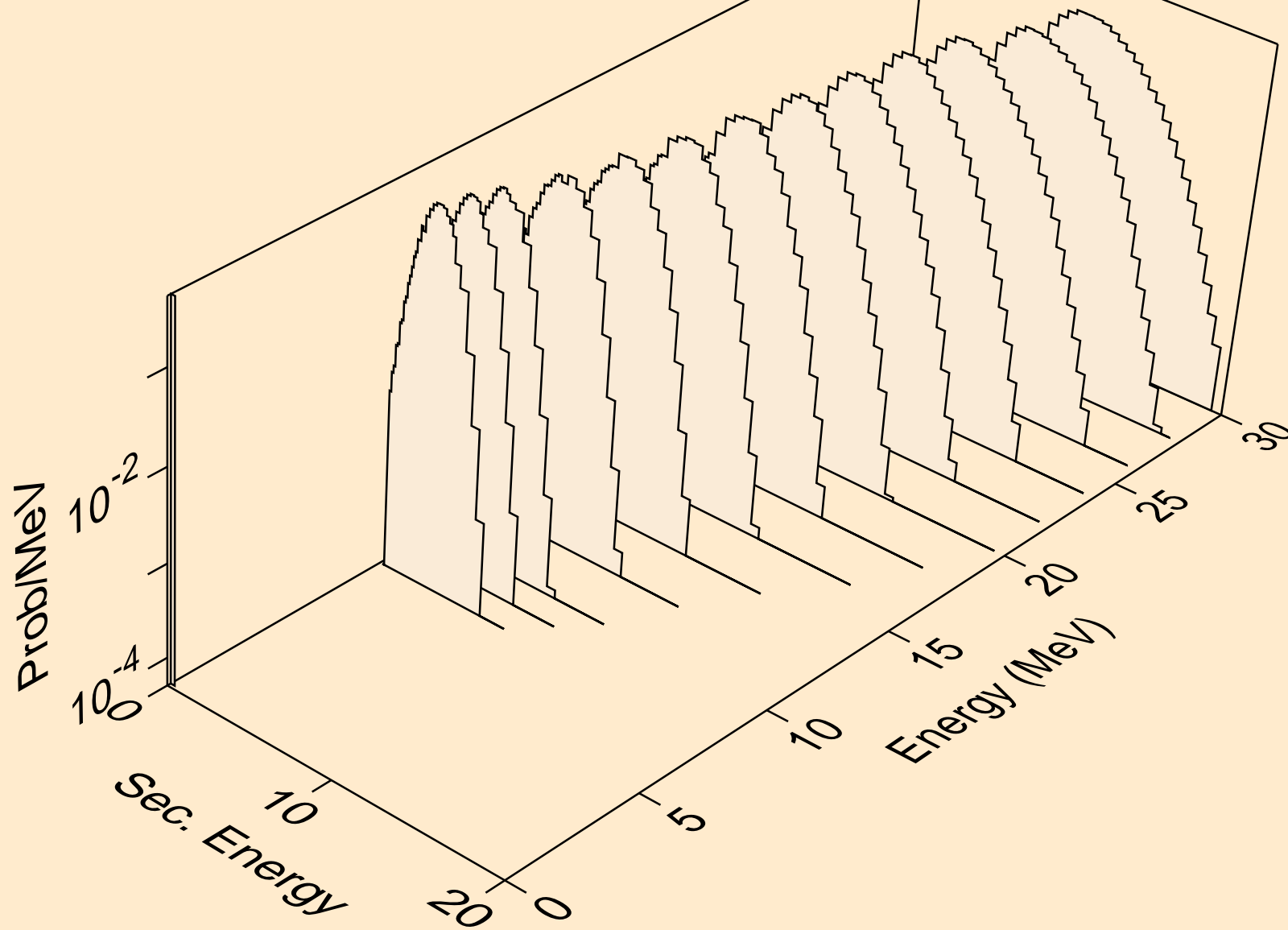

ND129 TRITON ACER TENDL-2021 LIBRARY; T=0.K  
deuterons from (t,pd)

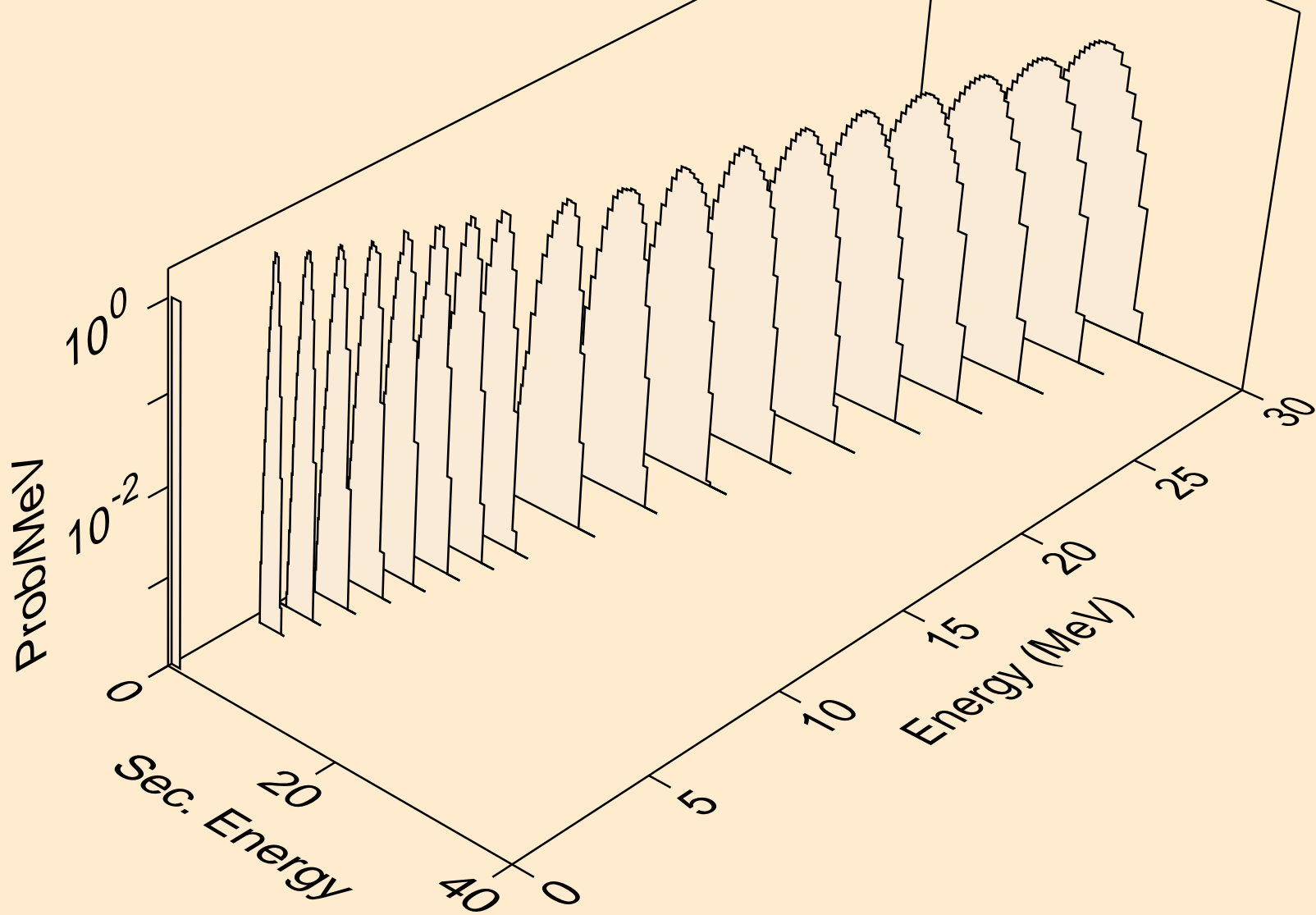



ND129 TRITON ACER TENDL-2021 LIBRARY; T=0.K  
deuterons from (t,da)

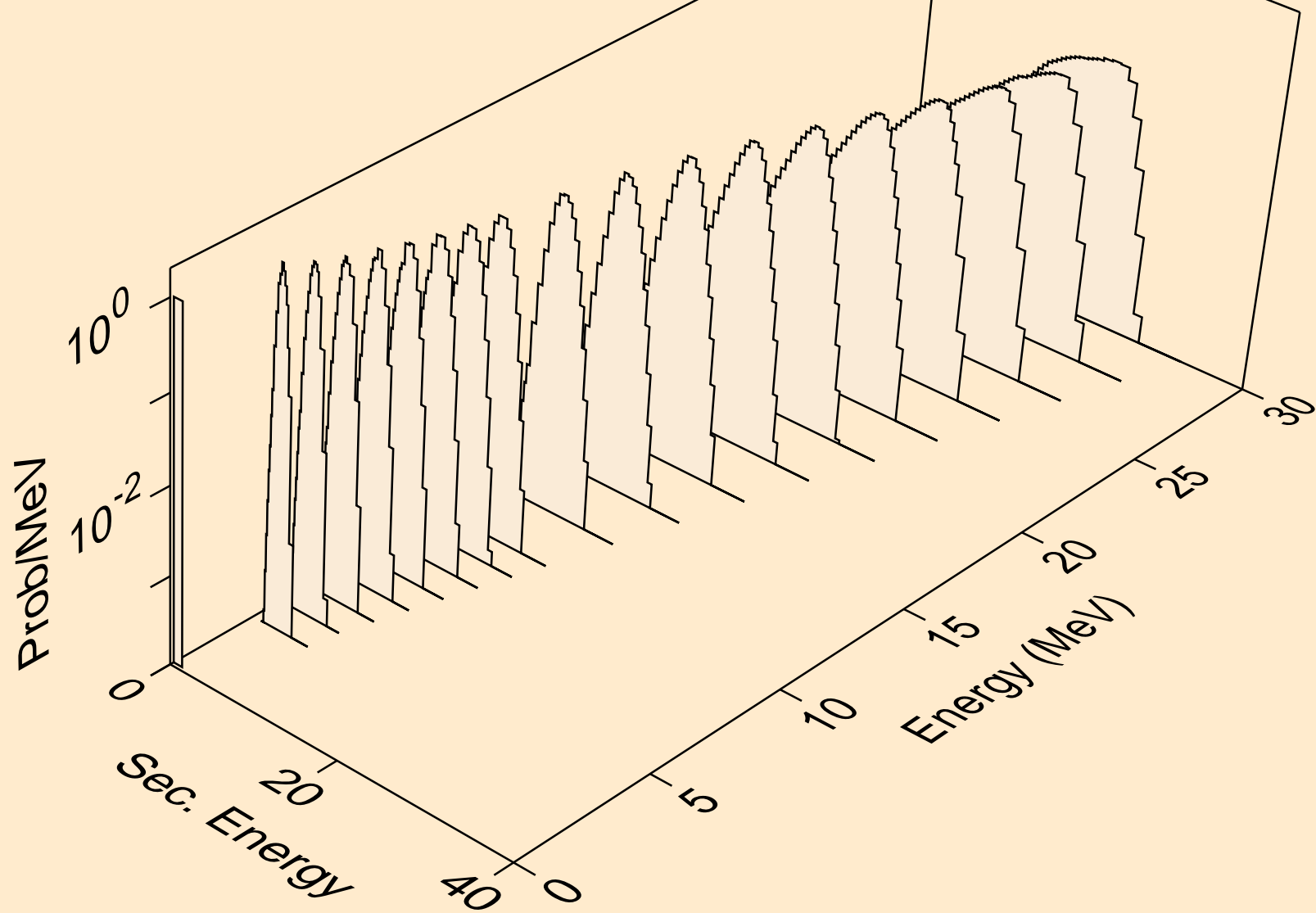

ND129 TRITON ACER TENDL-2021 LIBRARY; T=0.K  
he3s from (t,x)

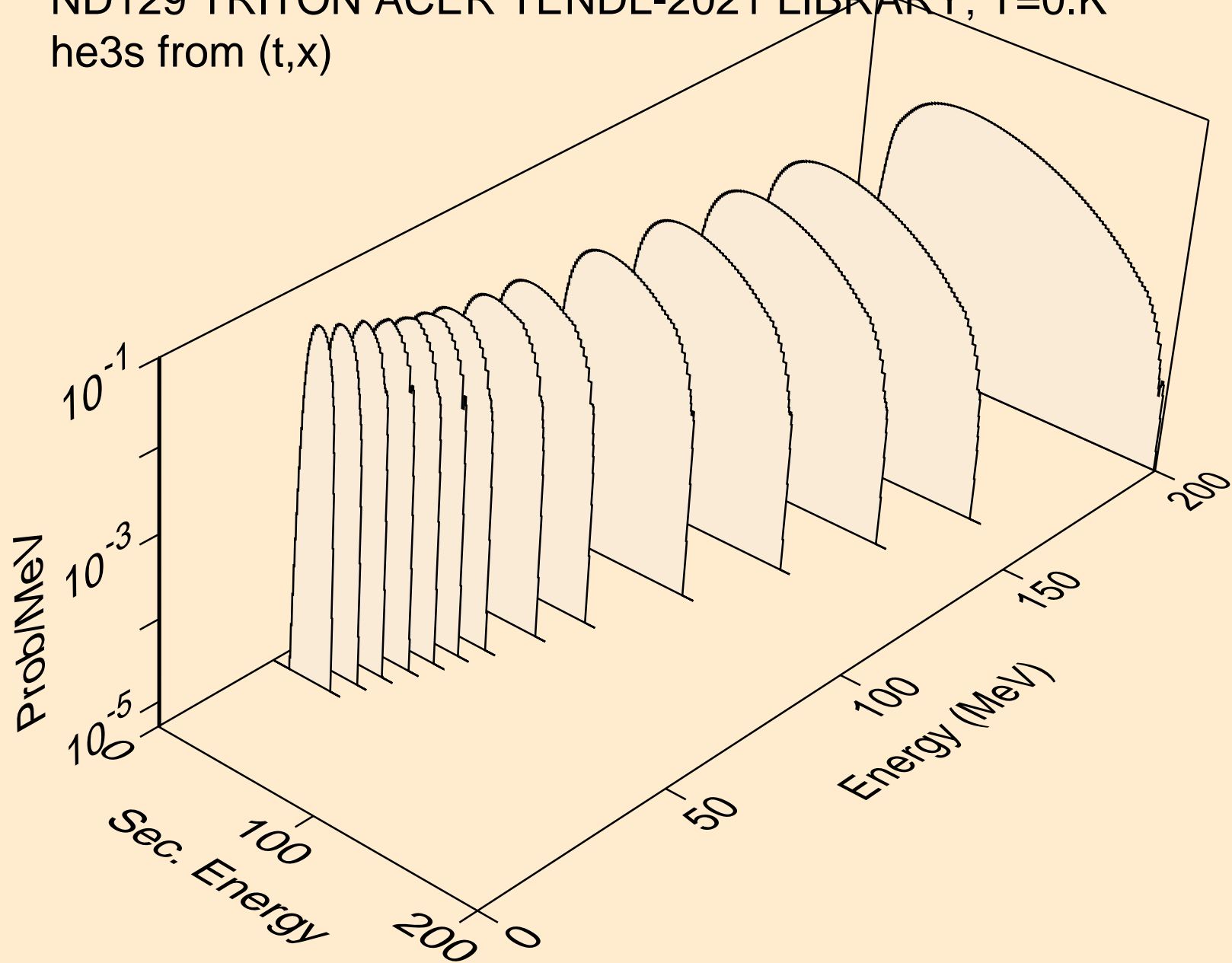

ND129 TRITON ACER TENDL-2021 LIBRARY; T=0.K  
he3s from (t,n\*)he3

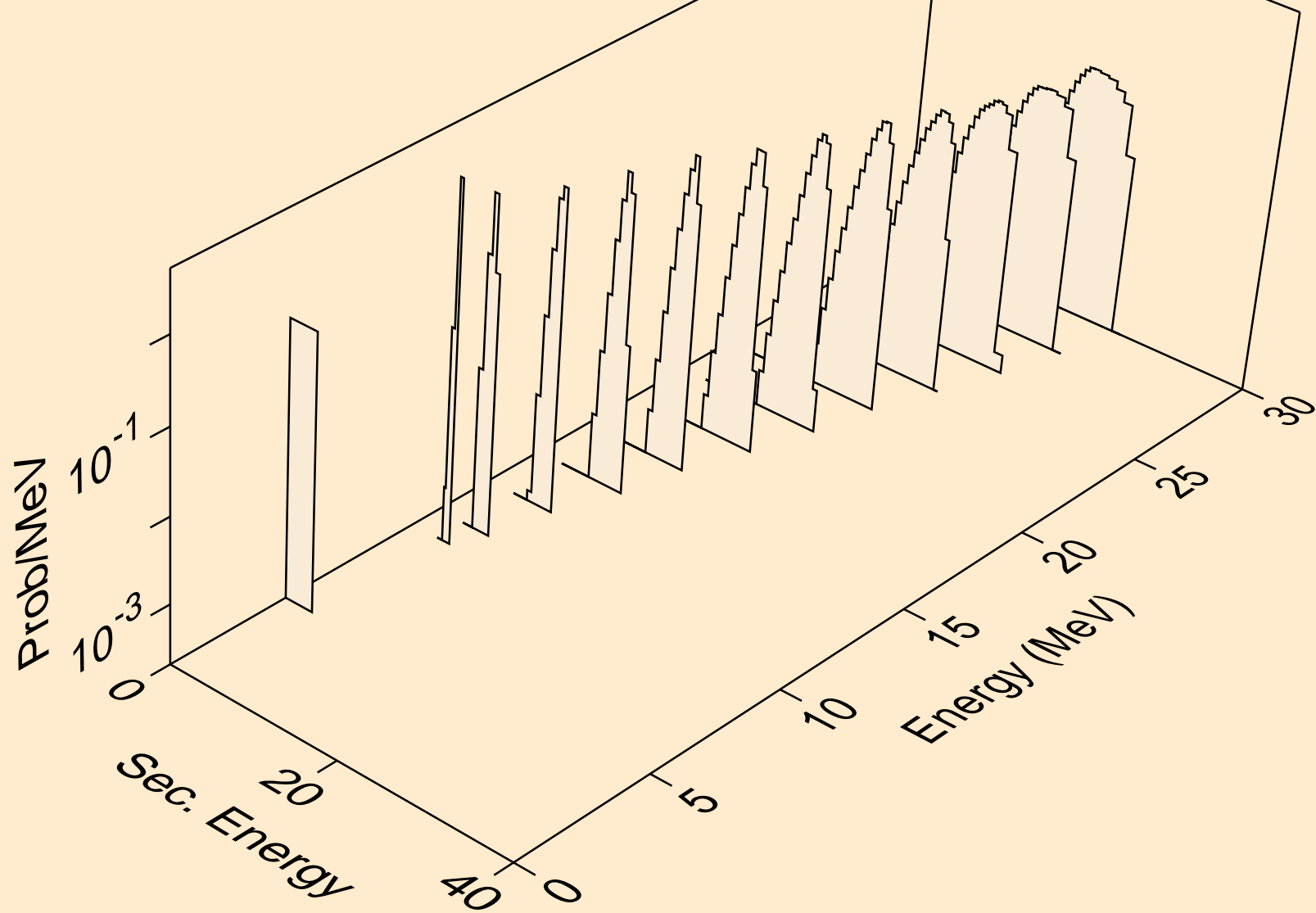

ND129 TRITON ACER TENDL-2021 LIBRARY; T=0.K  
he3s from (t,he3)

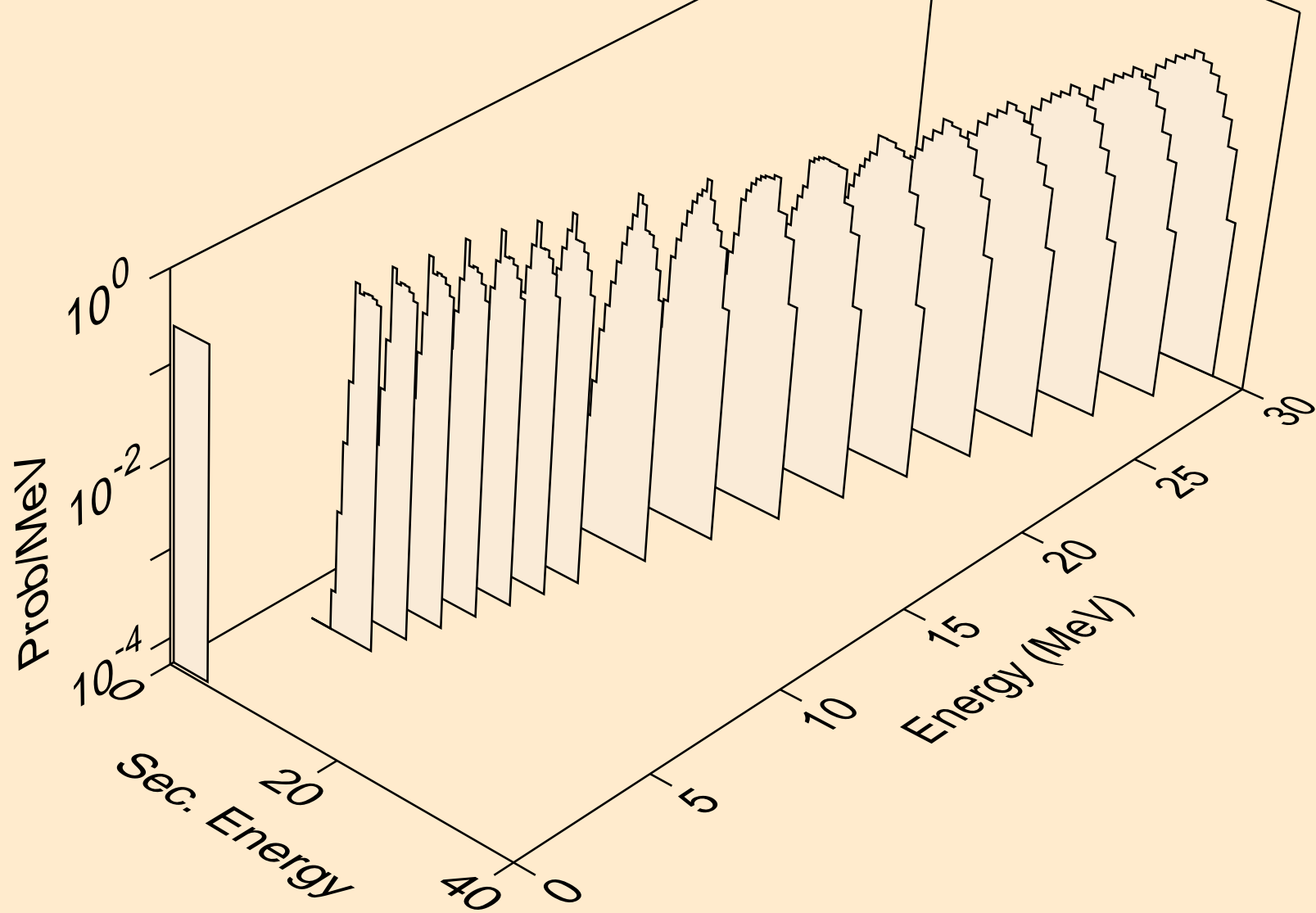

ND129 TRITON ACER TENDL-2021 LIBRARY; T=0.K  
alphas from (t,x)

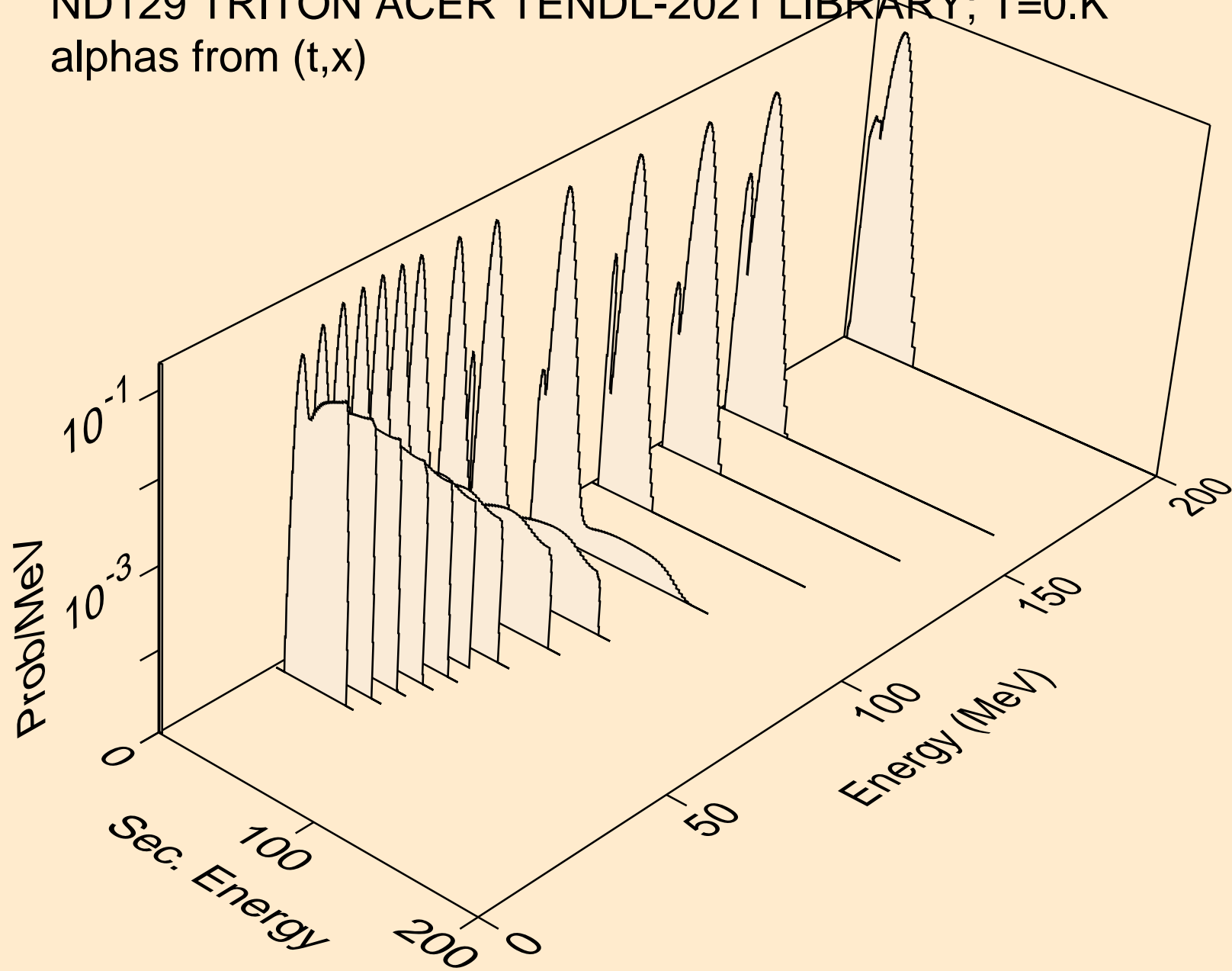

ND129 TRITON ACER TENDL-2021 LIBRARY; T=0.K  
alphas from (t,n\*)a

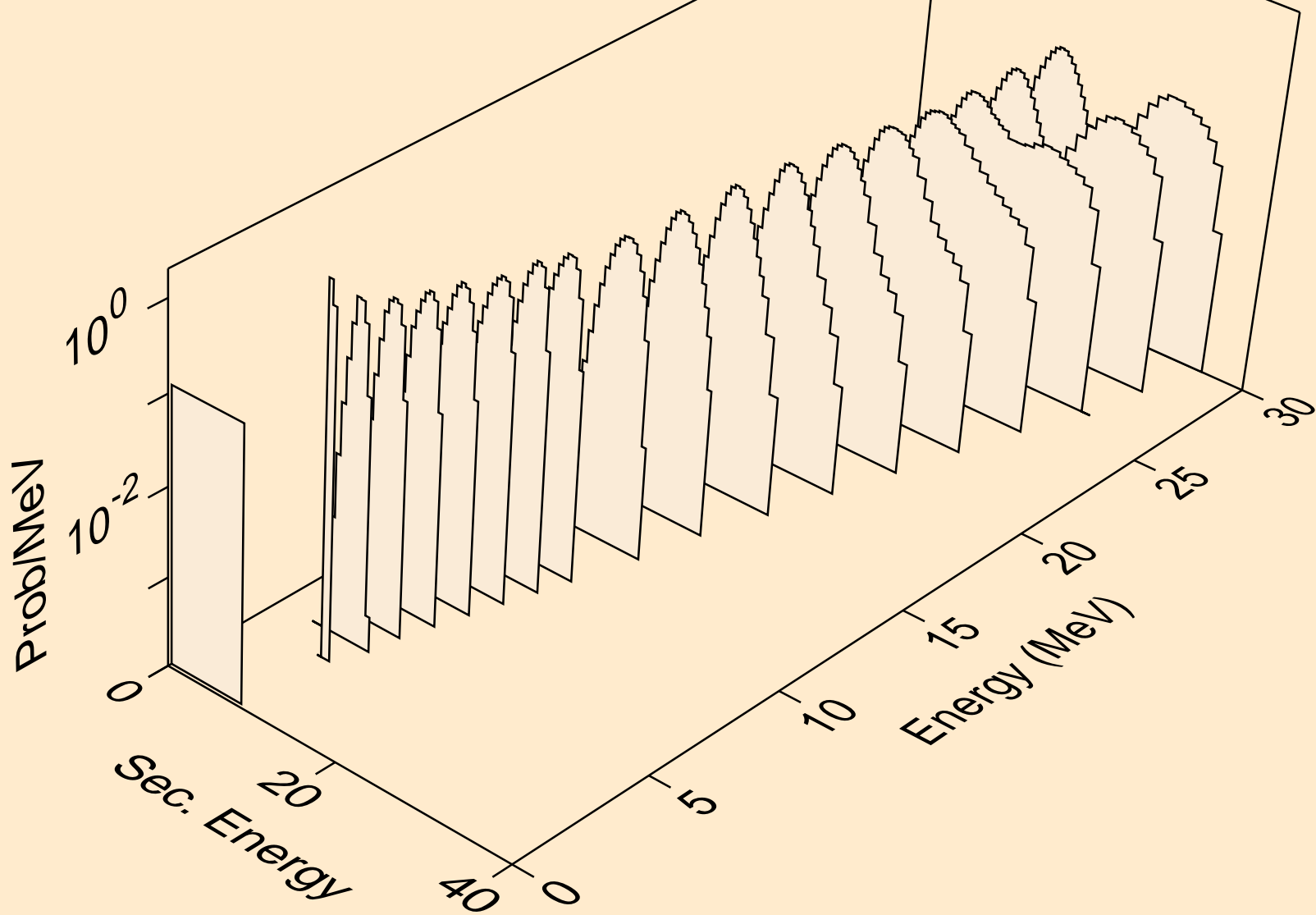

ND129 TRITON ACER TENDL-2021 LIBRARY; T=0.K  
alphas from (t,2n)a

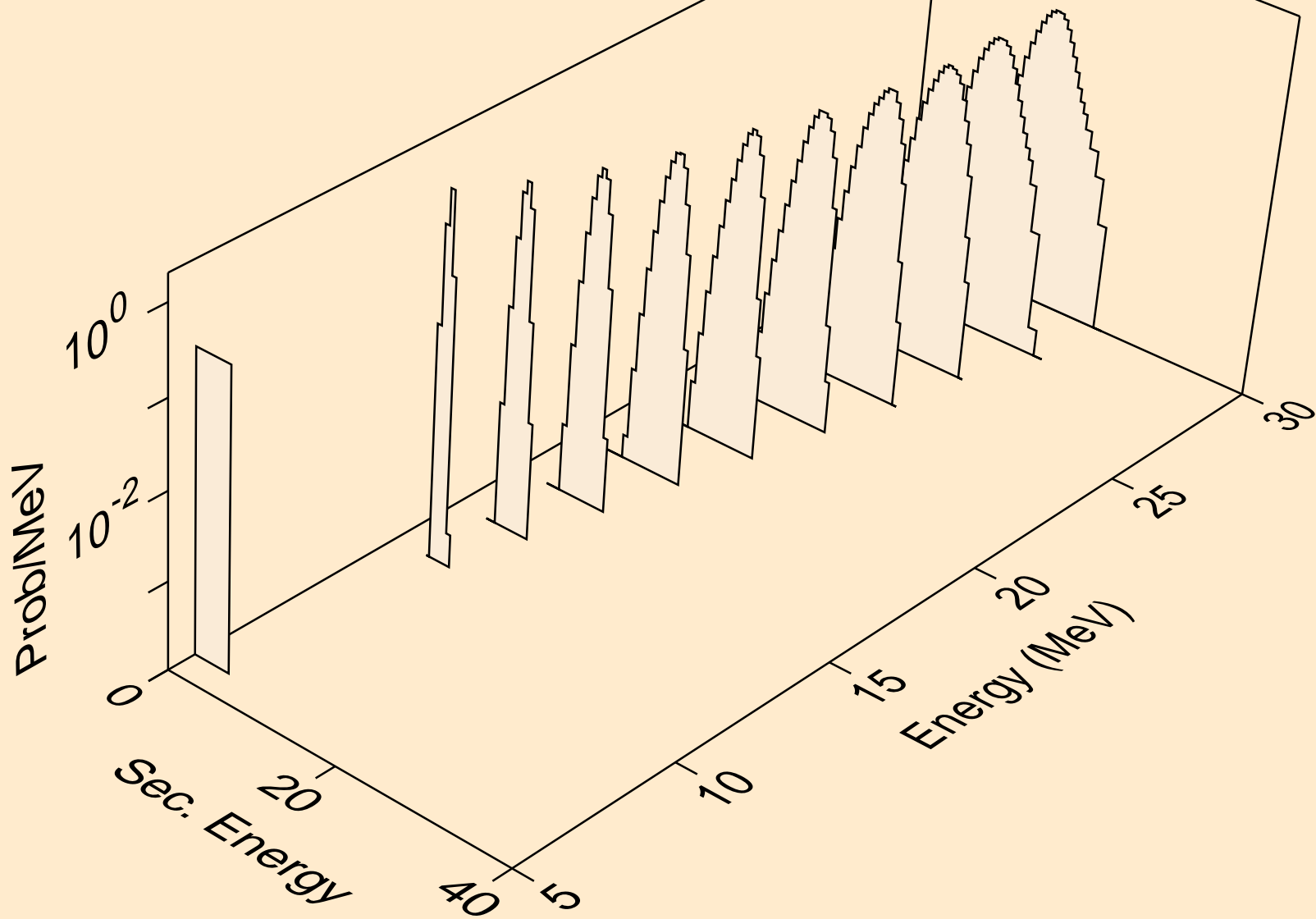

ND129 TRITON ACER TENDL-2021 LIBRARY; T=0.K  
alphas from (t,n\*)2a

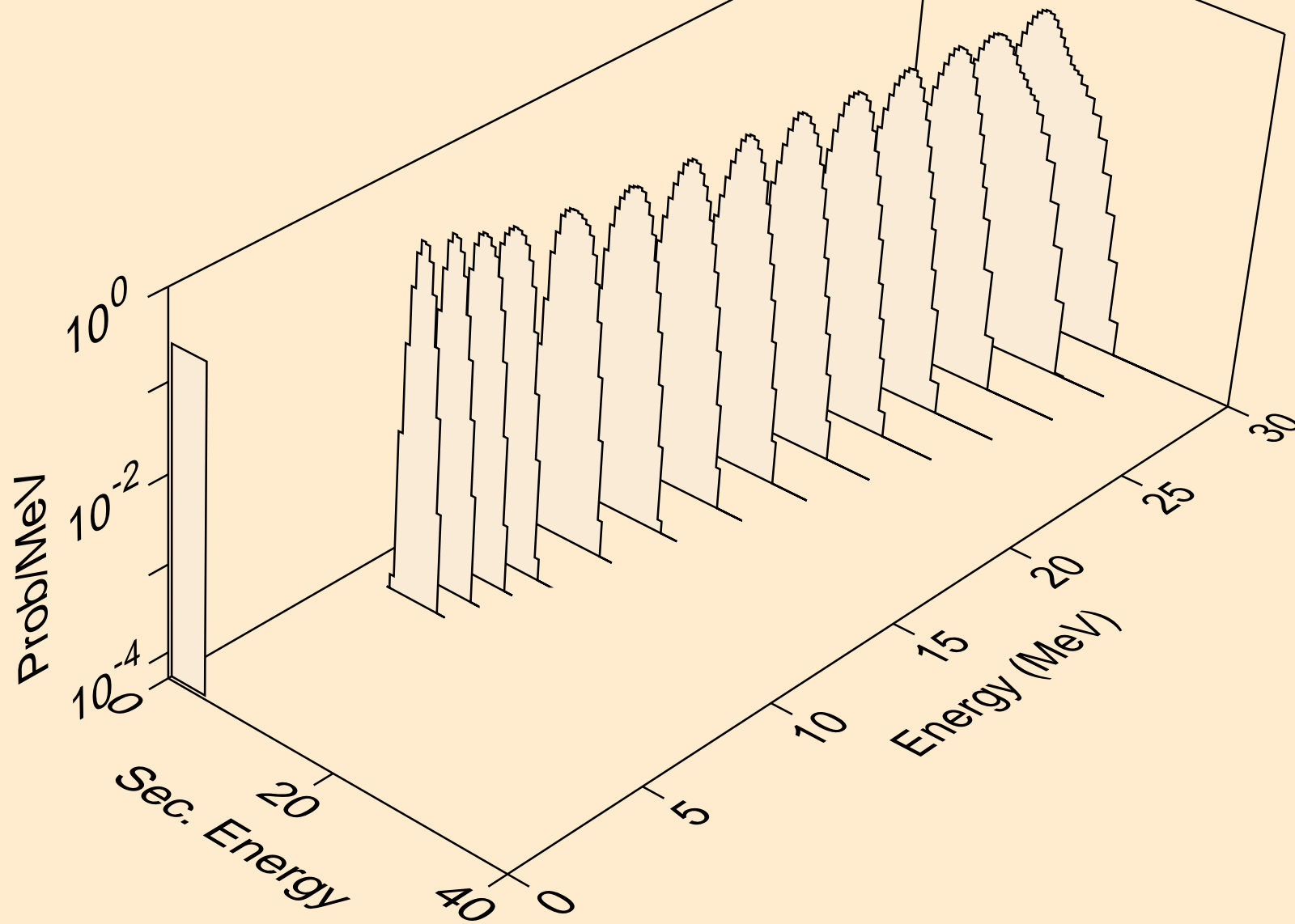



ND129 TRITON ACER TENDL-2021 LIBRARY; T=0.K  
alphas from (t,npa)

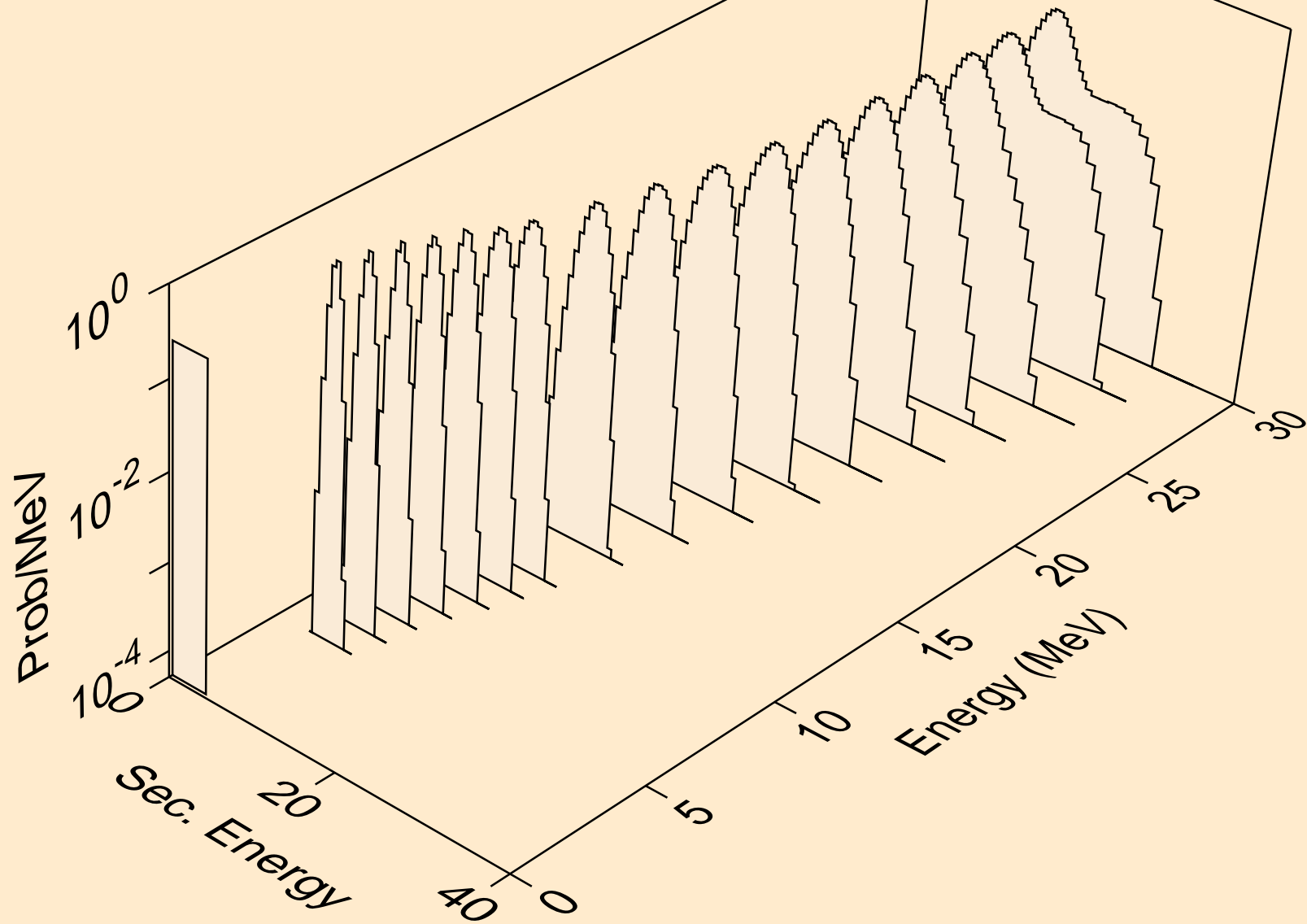

ND129 TRITON ACER TENDL-2021 LIBRARY; T=0.K  
alphas from (t,a)

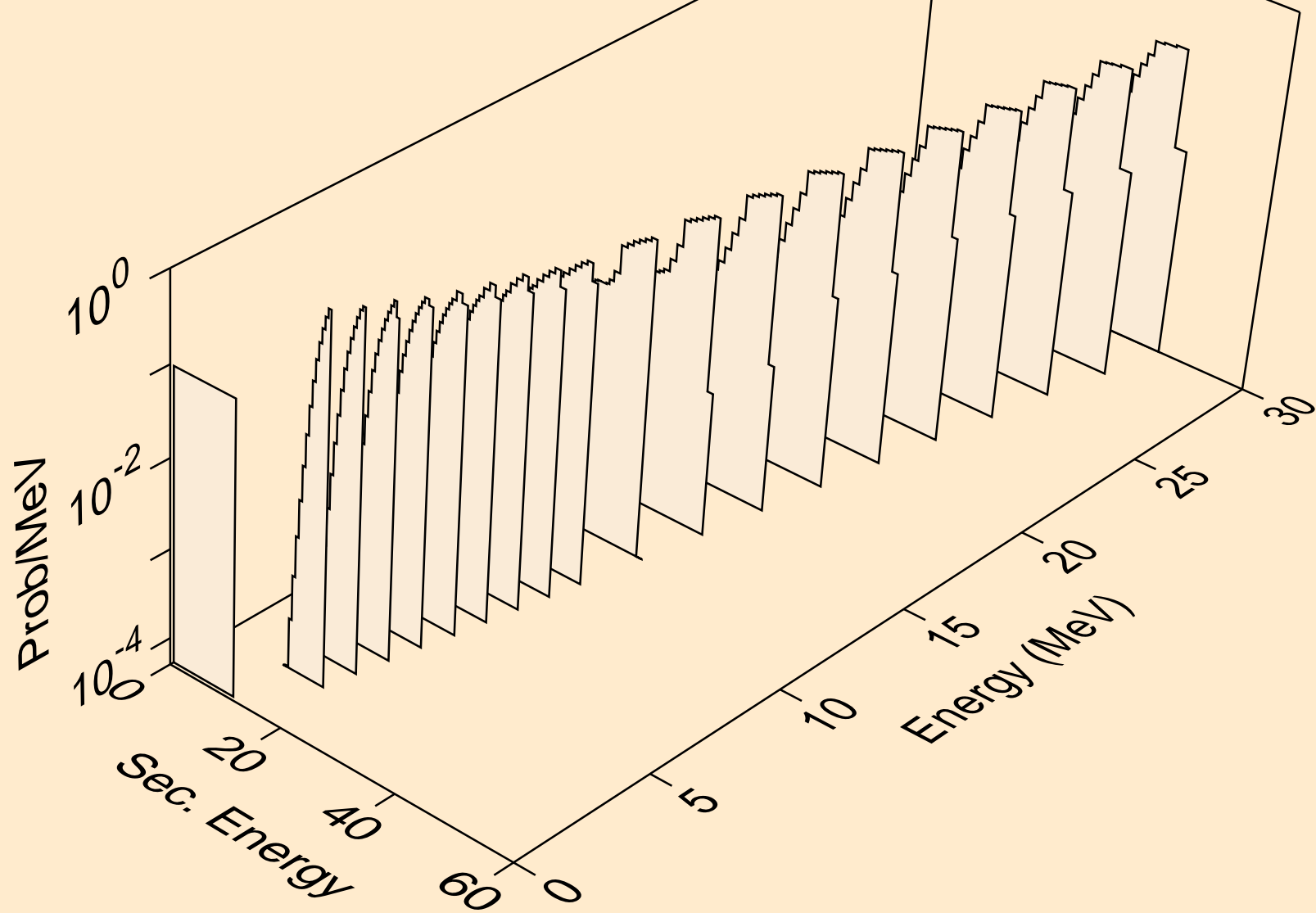

ND129 TRITON ACER TENDL-2021 LIBRARY; T=0.K  
alphas from (t,2a)

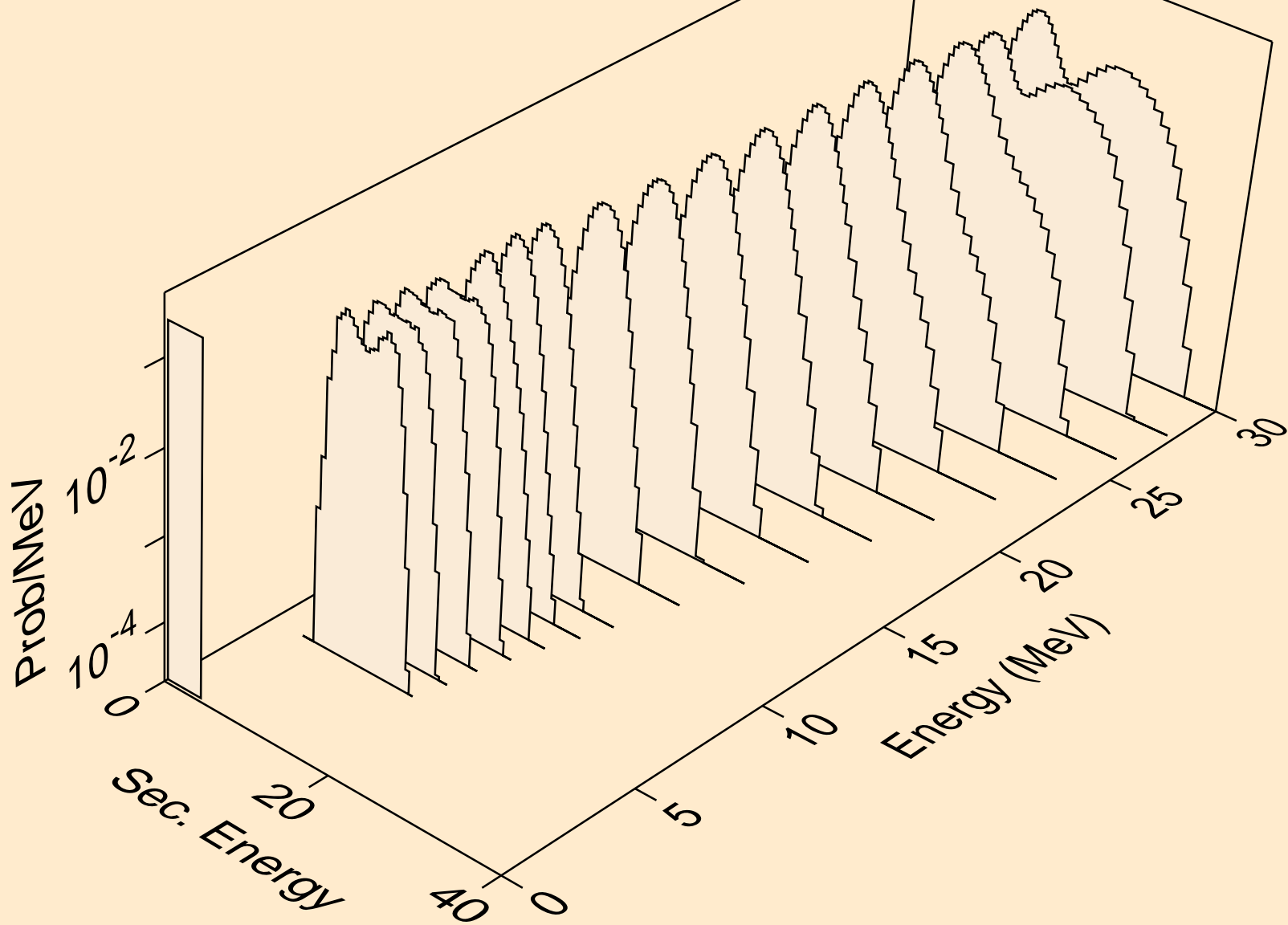

ND129 TRITON ACER TENDL-2021 LIBRARY; T=0.K  
alphas from (t,3a)

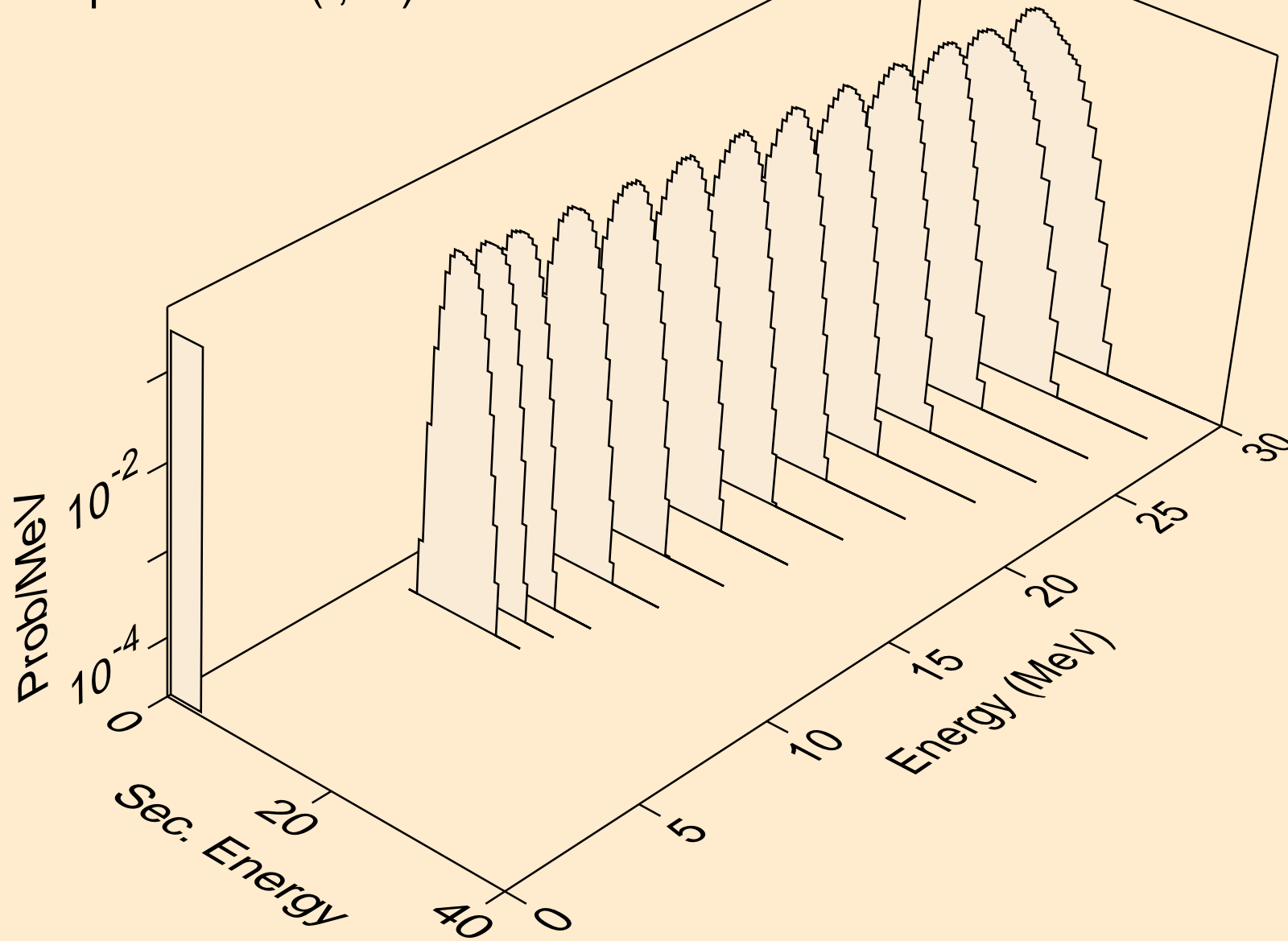

ND129 TRITON ACER TENDL-2021 LIBRARY; T=0.K  
alphas from (t,pa)

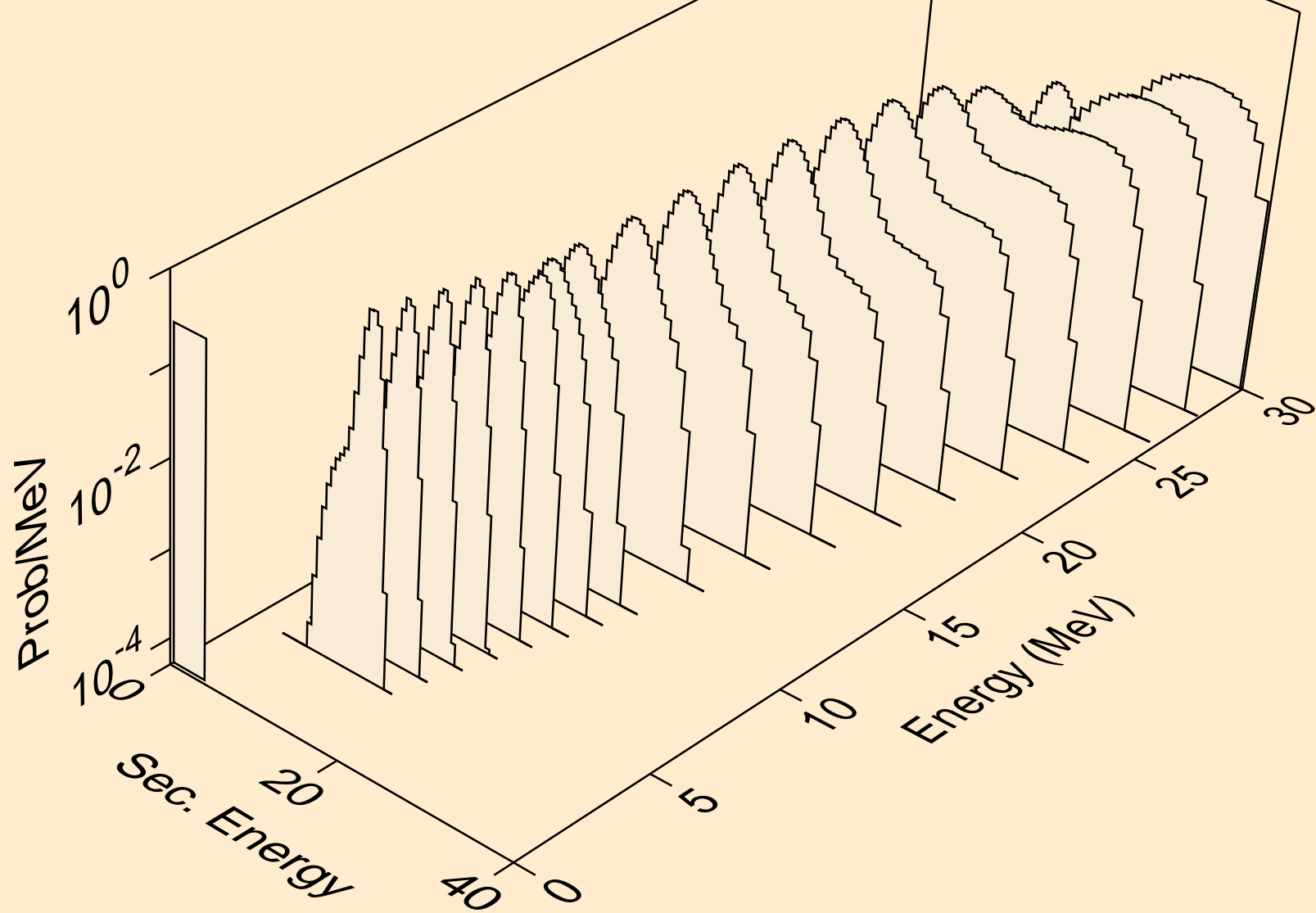

ND129 TRITON ACER TENDL-2021 LIBRARY; T=0.K  
alphas from (t,t2a)

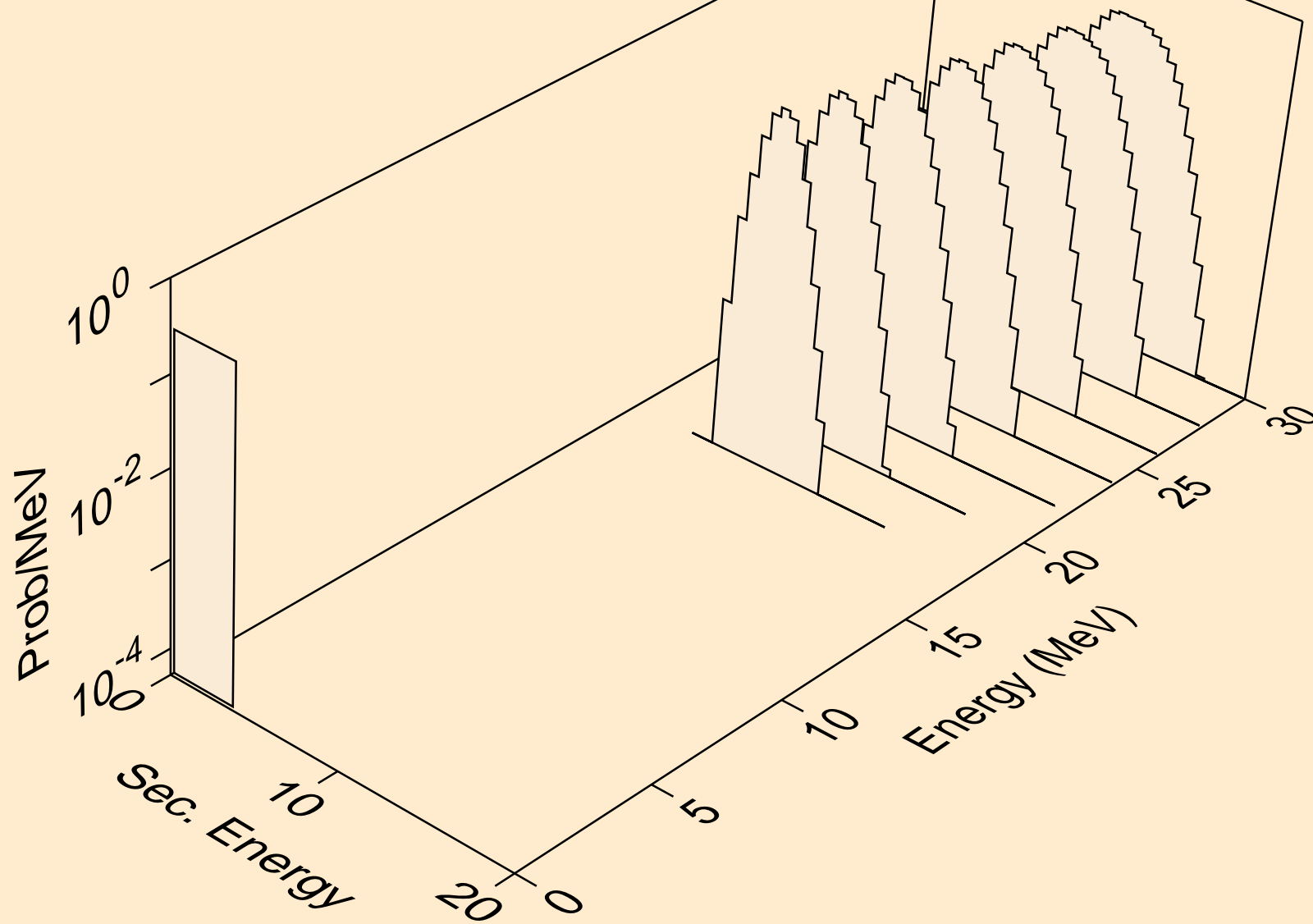

ND129 TRITON ACER TENDL-2021 LIBRARY; T=0.K  
alphas from (t,d2a)

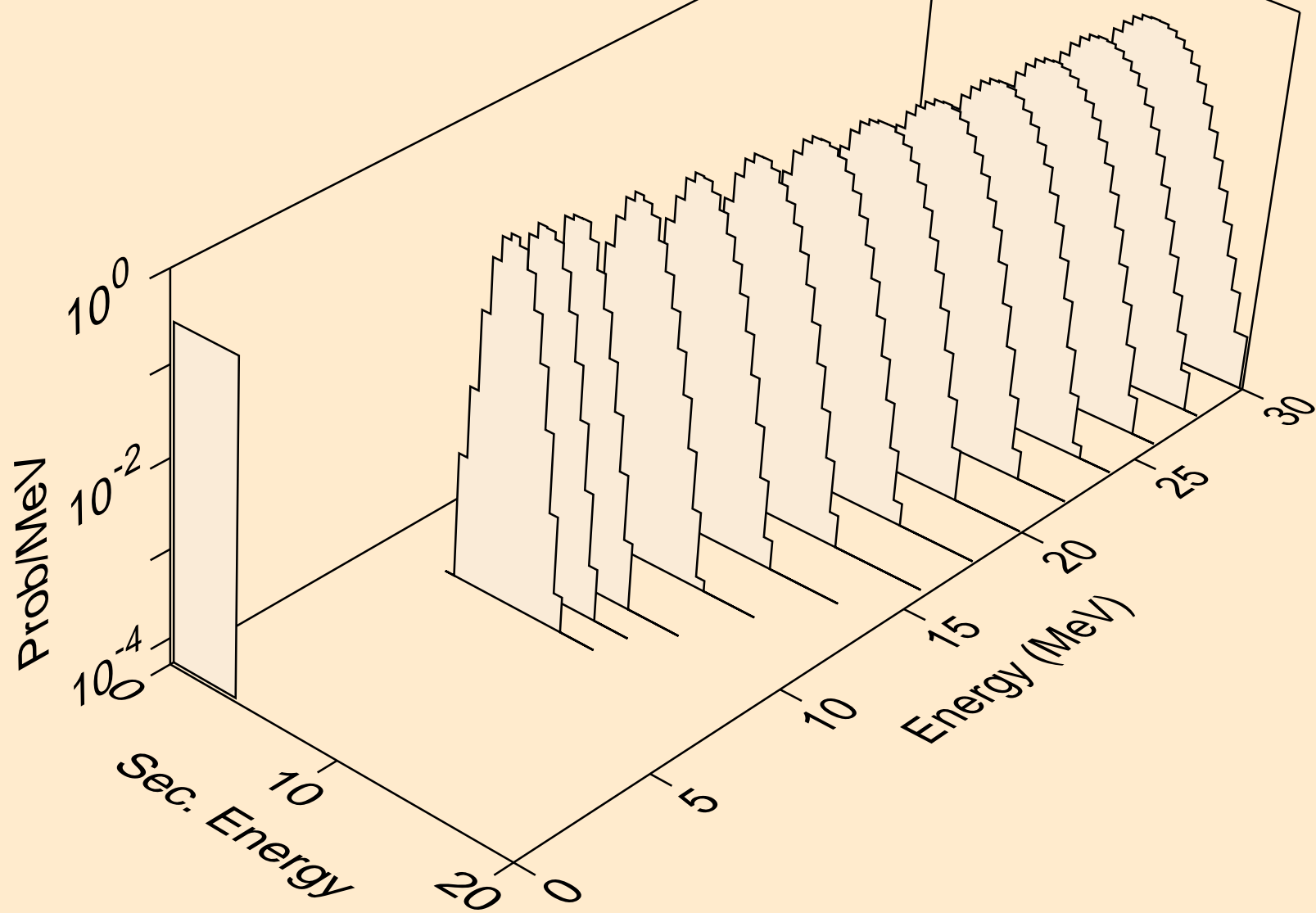

ND129 TRITON ACER TENDL-2021 LIBRARY; T=0.K  
alphas from (t,da)

