

OS183 TRITON ACER TENDL-2021 LIBRARY; T=0.K  
Principal cross sections

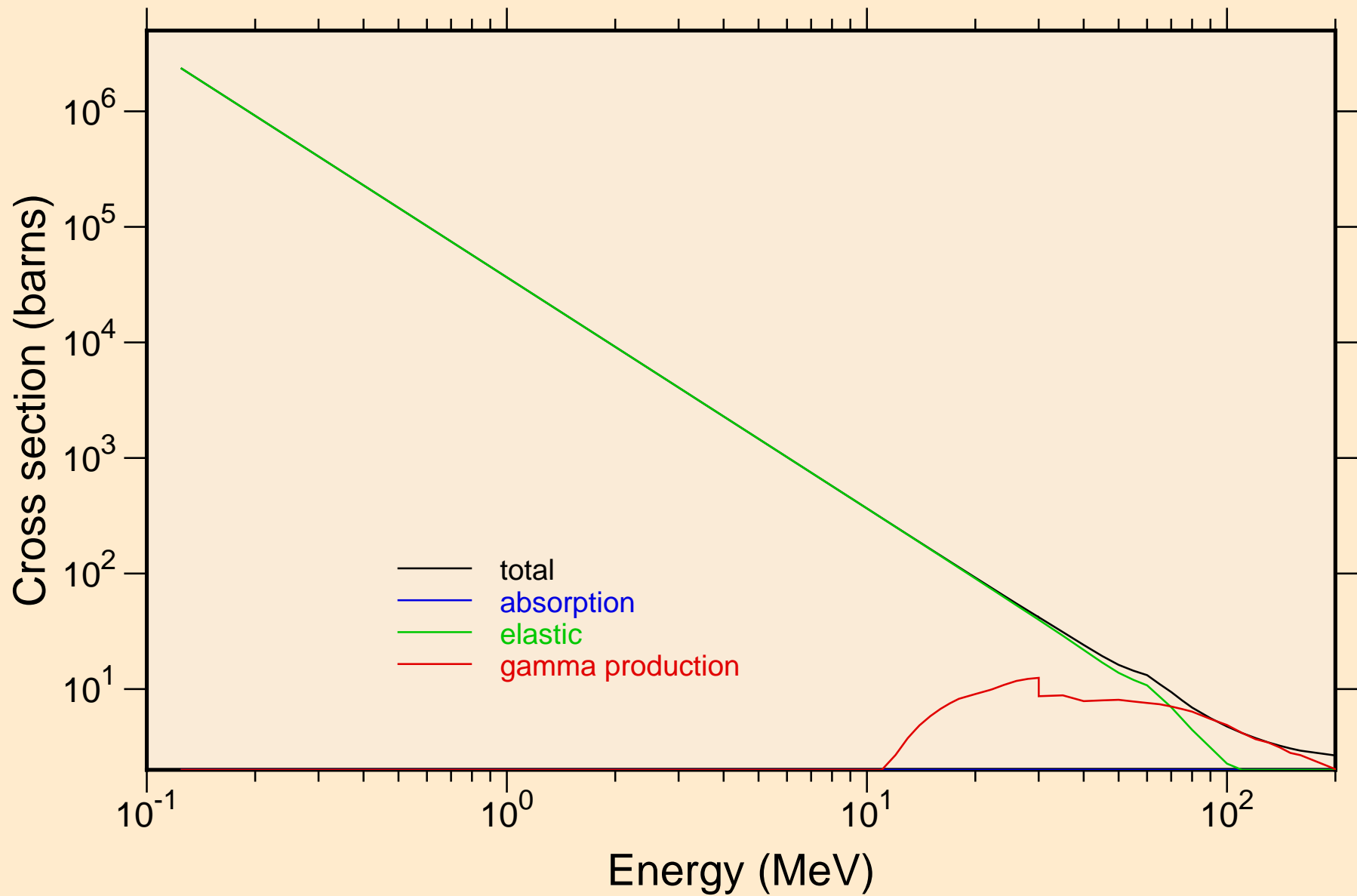

# OS183 TRITON ACER TENDL-2021 LIBRARY; T=0.K

## Heating

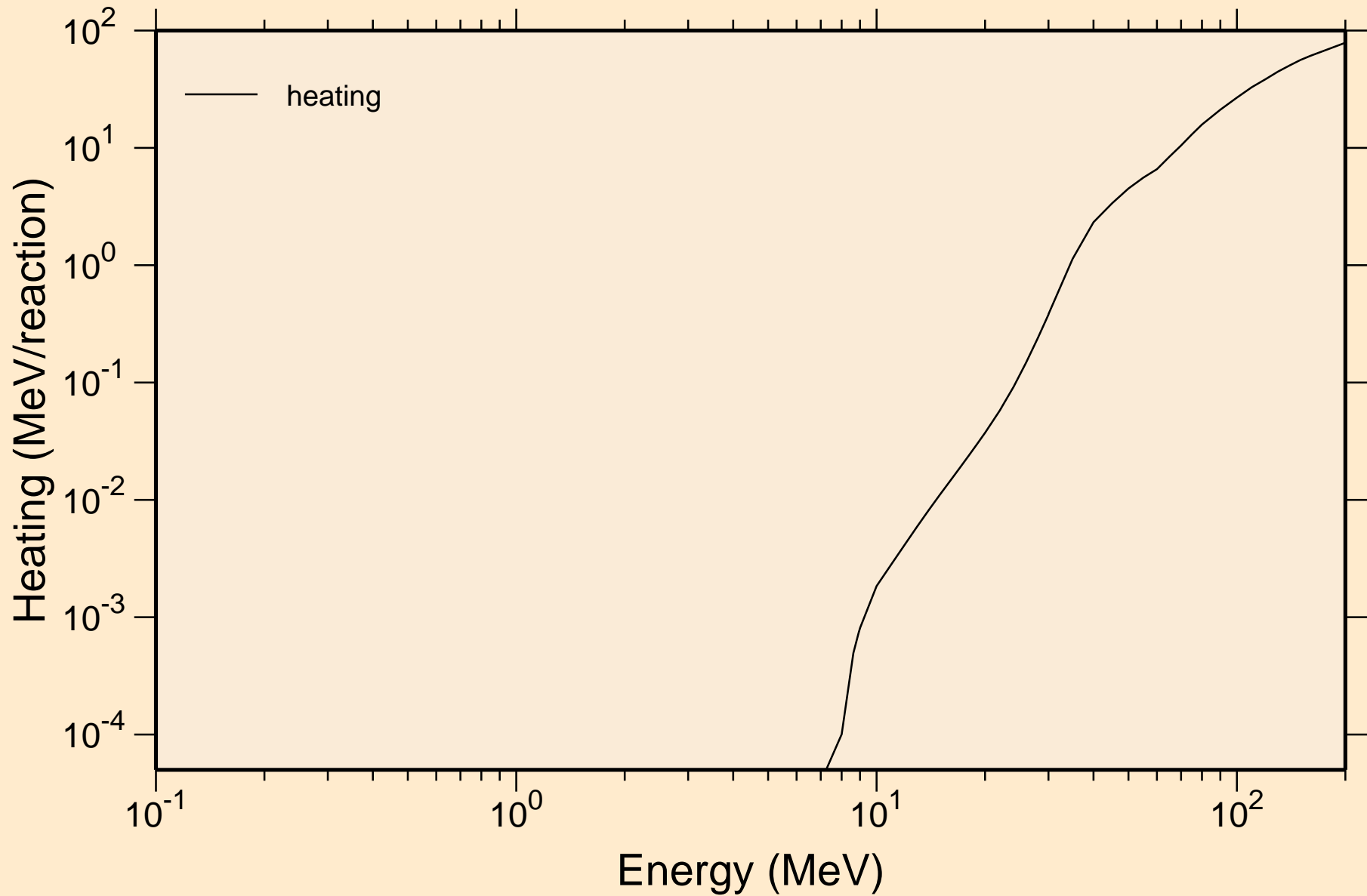

# OS183 TRITON ACER TENDL-2021 LIBRARY; T=0.K

## Principal cross sections

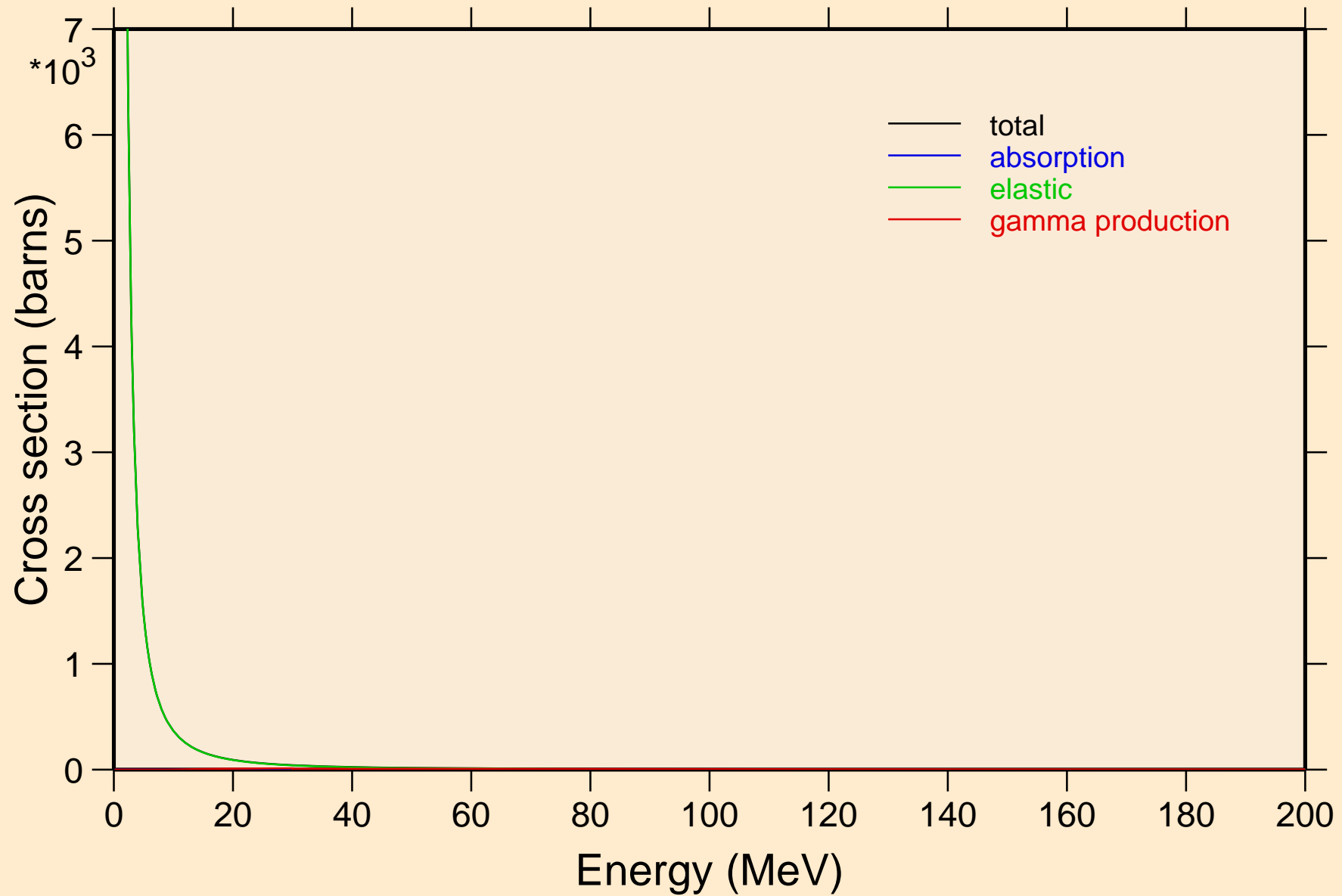

OS183 TRITON ACER TENDL-2021 LIBRARY; T=0.K

Heating

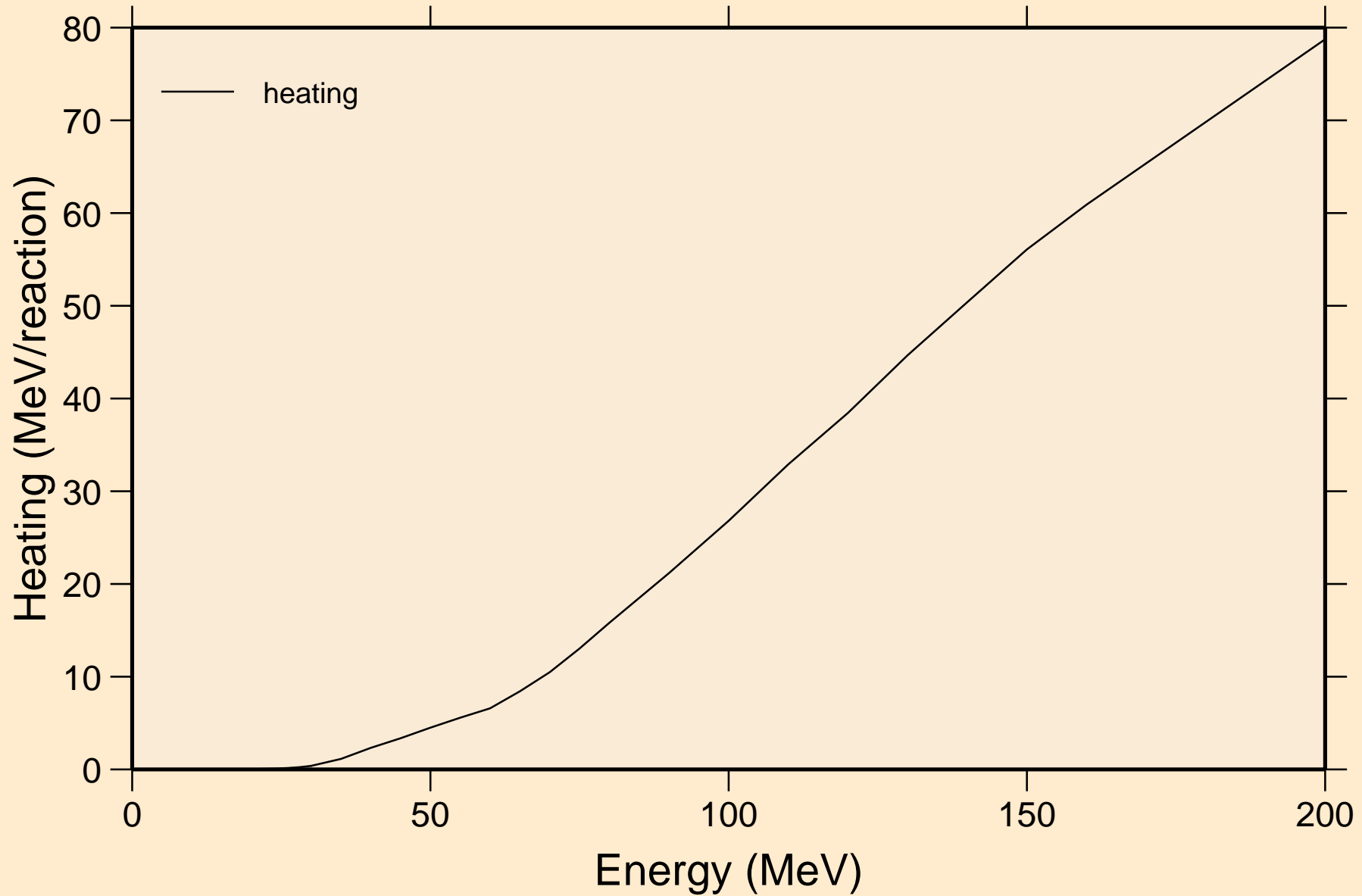

# OS183 TRITON ACER TENDL-2021 LIBRARY; T=0.K

## Threshold reactions

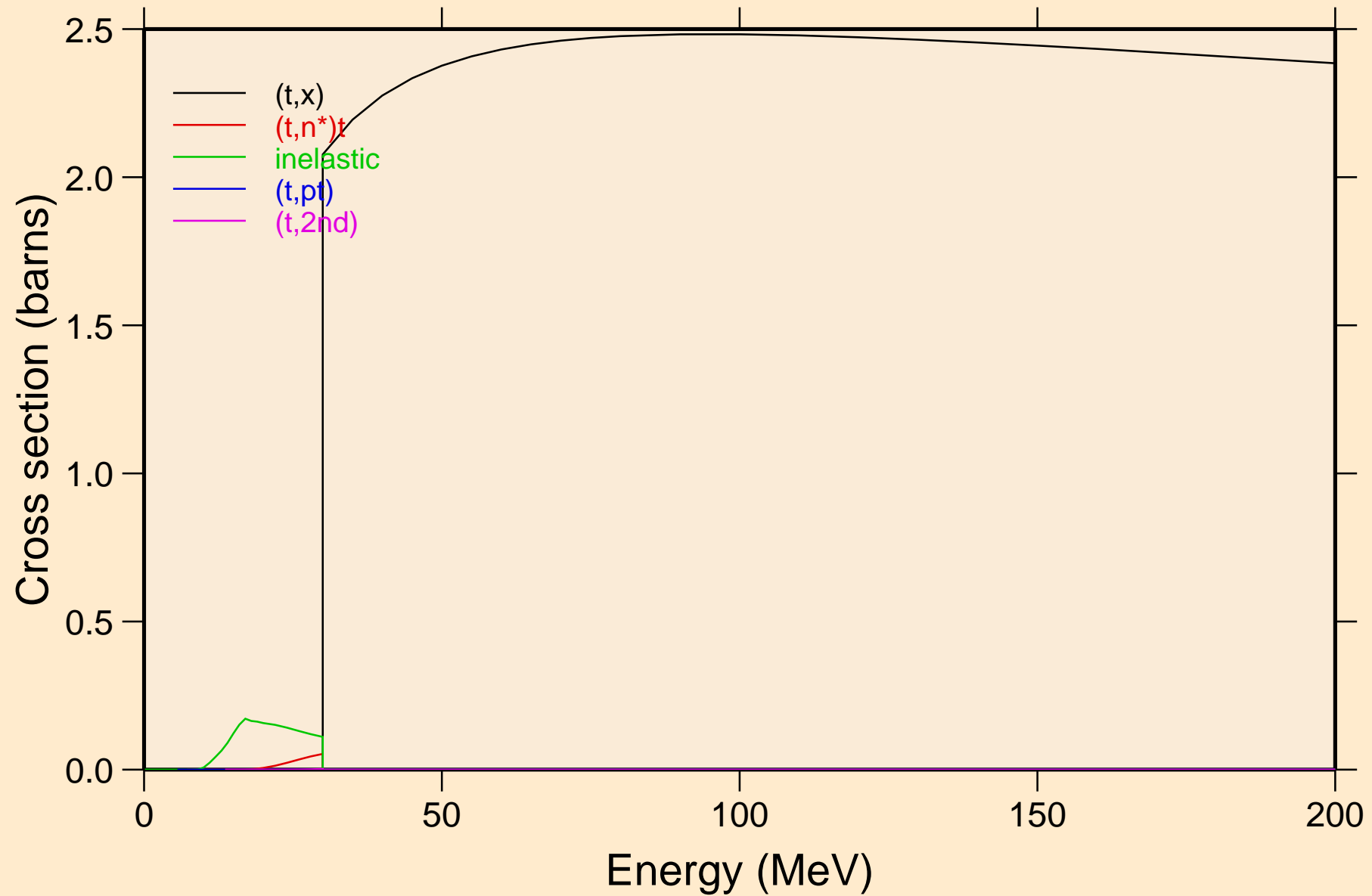

OS183 TRITON ACER TENDL-2021 LIBRARY; T=0.K  
Threshold reactions

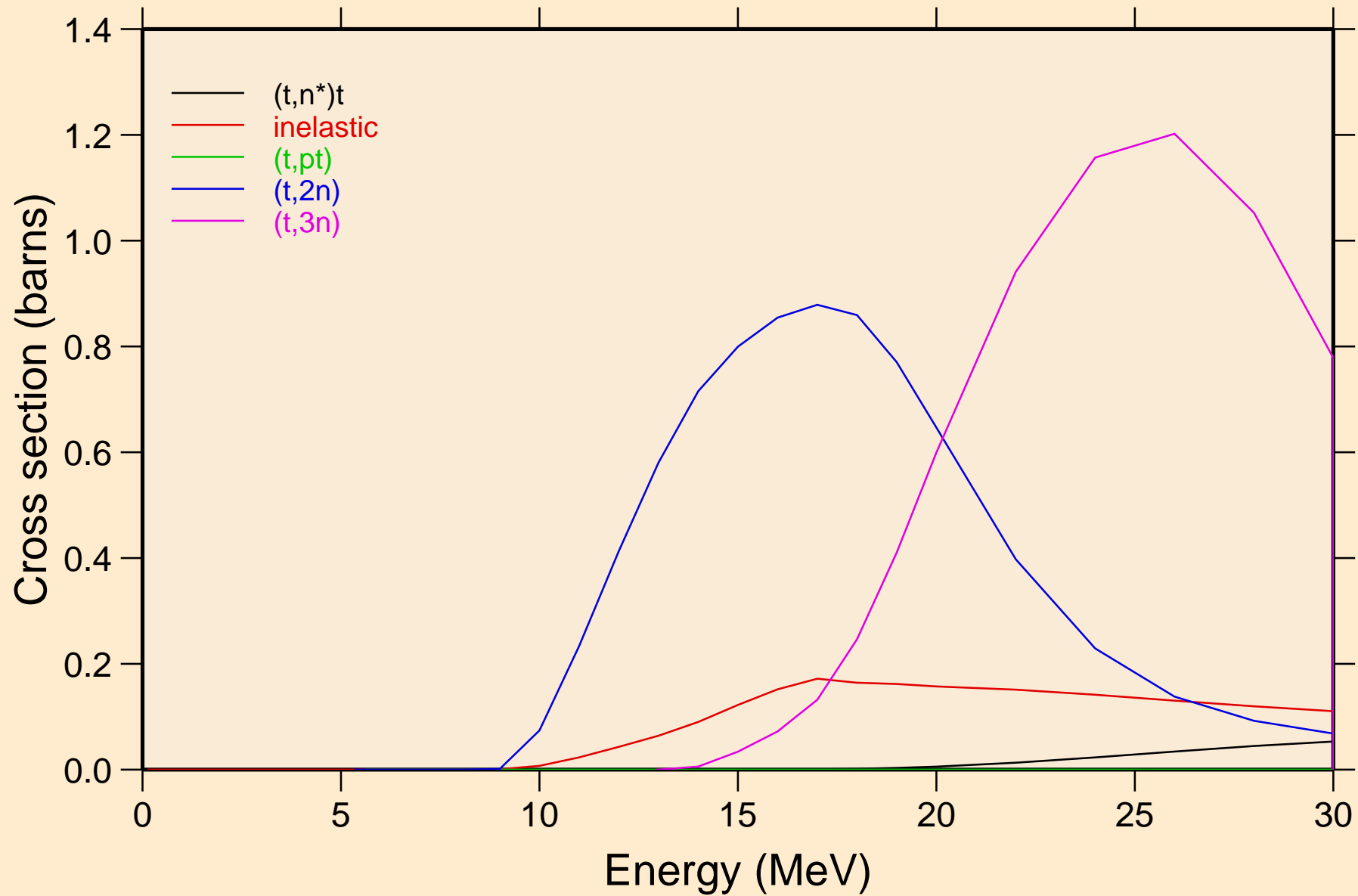

OS183 TRITON ACER TENDL-2021 LIBRARY; T=0.K  
Threshold reactions

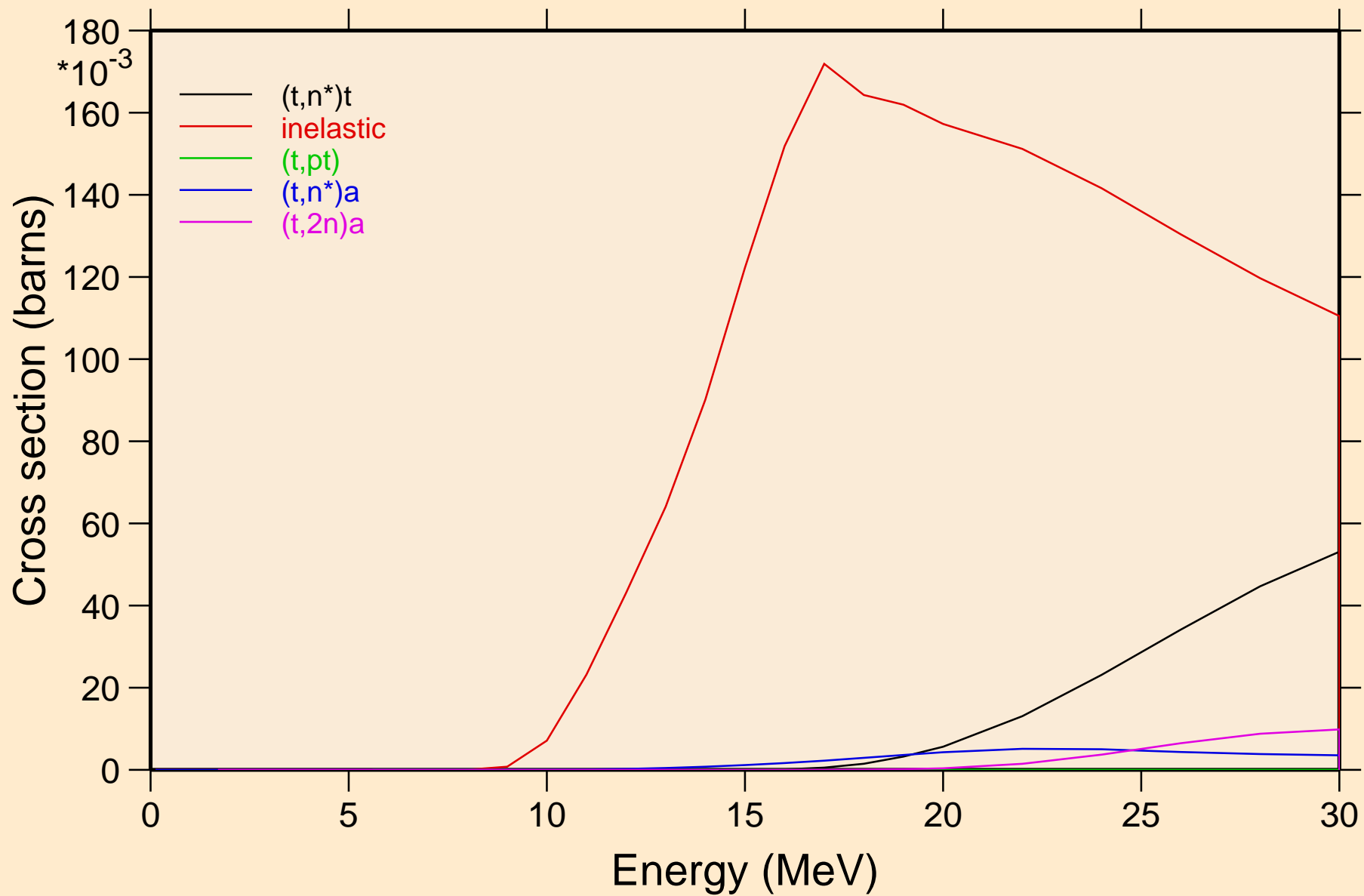

OS183 TRITON ACER TENDL-2021 LIBRARY; T=0.K  
Threshold reactions

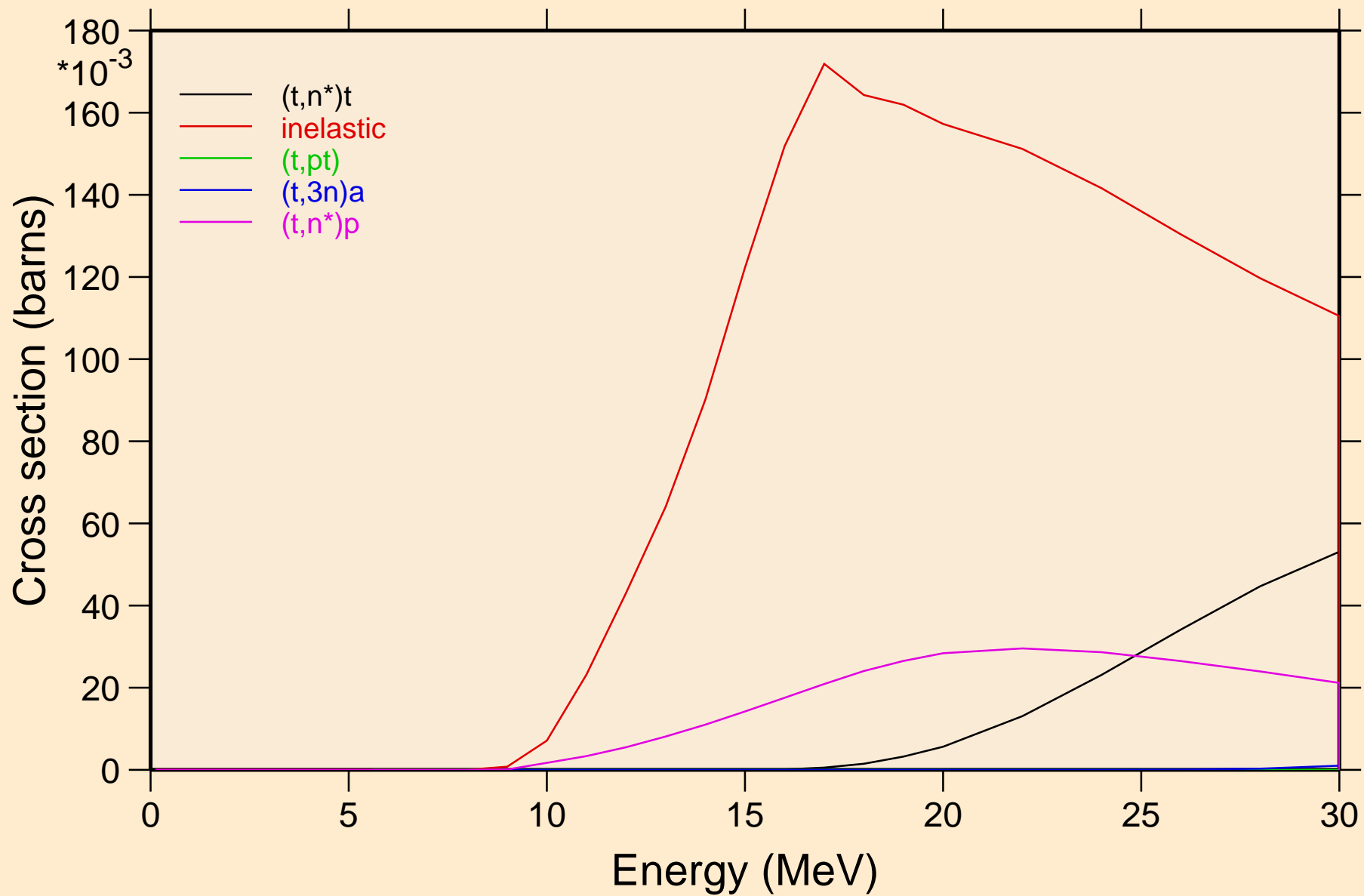



OS183 TRITON ACER TENDL-2021 LIBRARY; T=0.K  
Threshold reactions

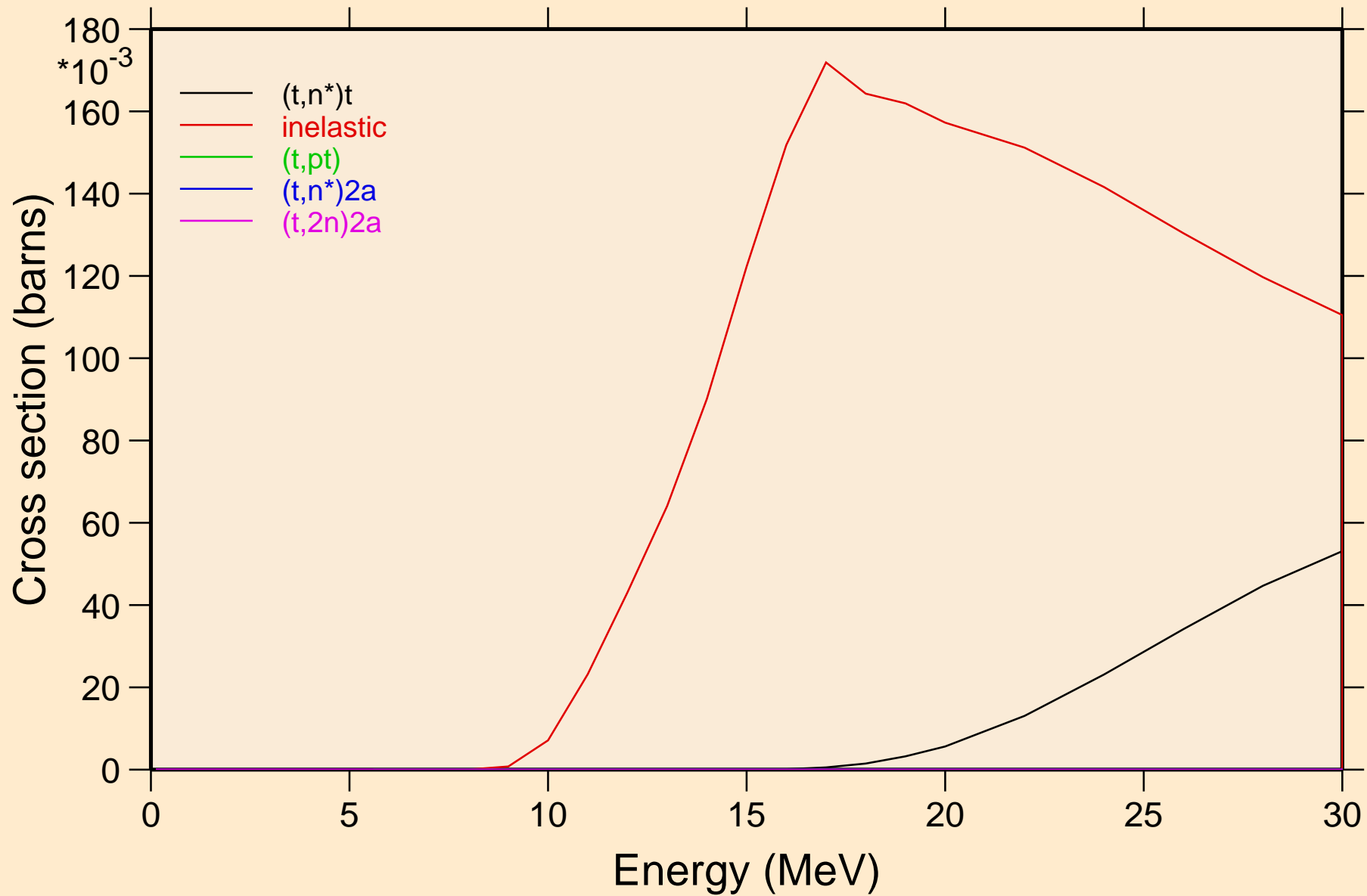

OS183 TRITON ACER TENDL-2021 LIBRARY; T=0.K  
Threshold reactions

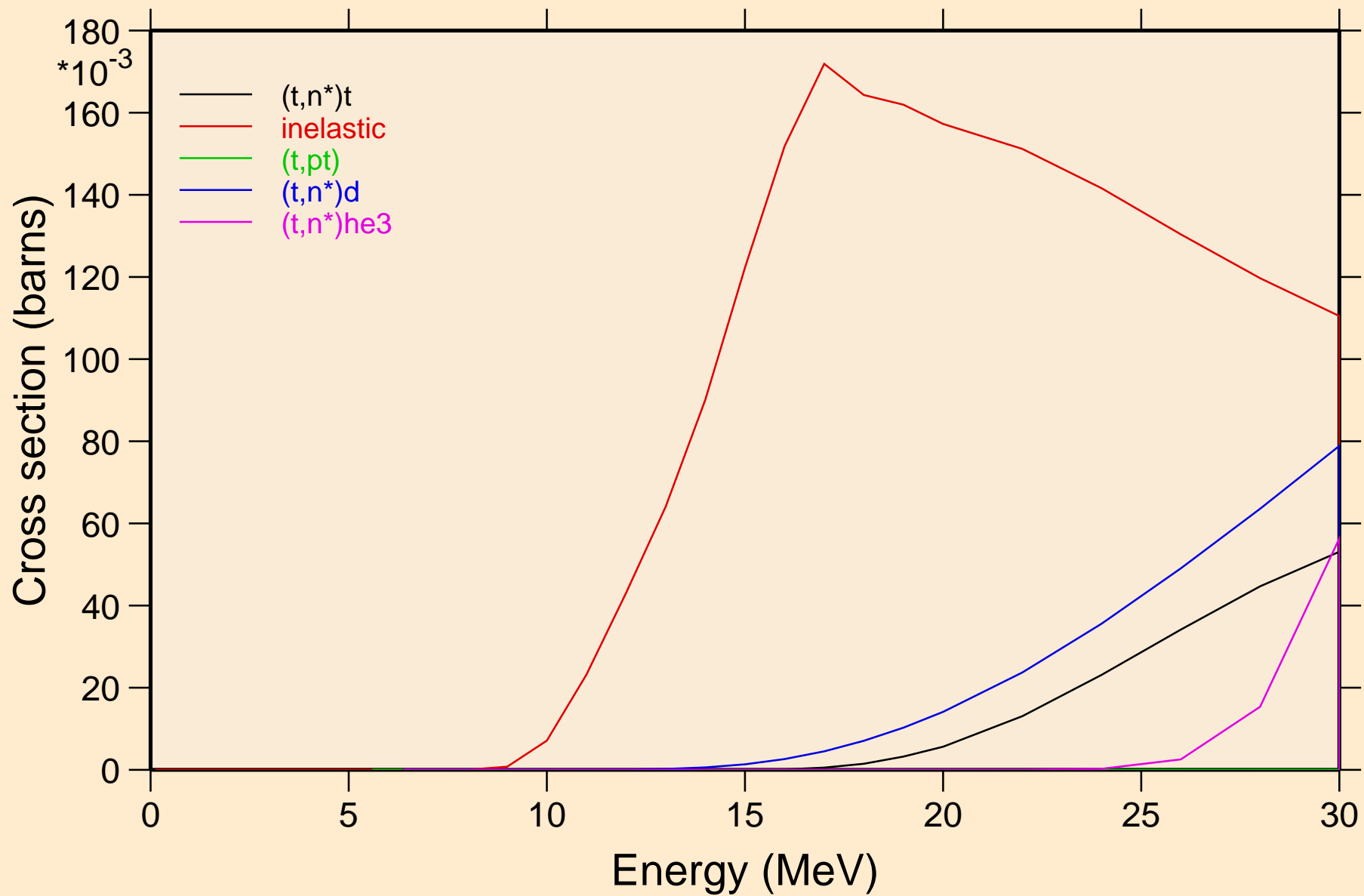

# OS183 TRITON ACER TENDL-2021 LIBRARY; T=0.K

## Threshold reactions

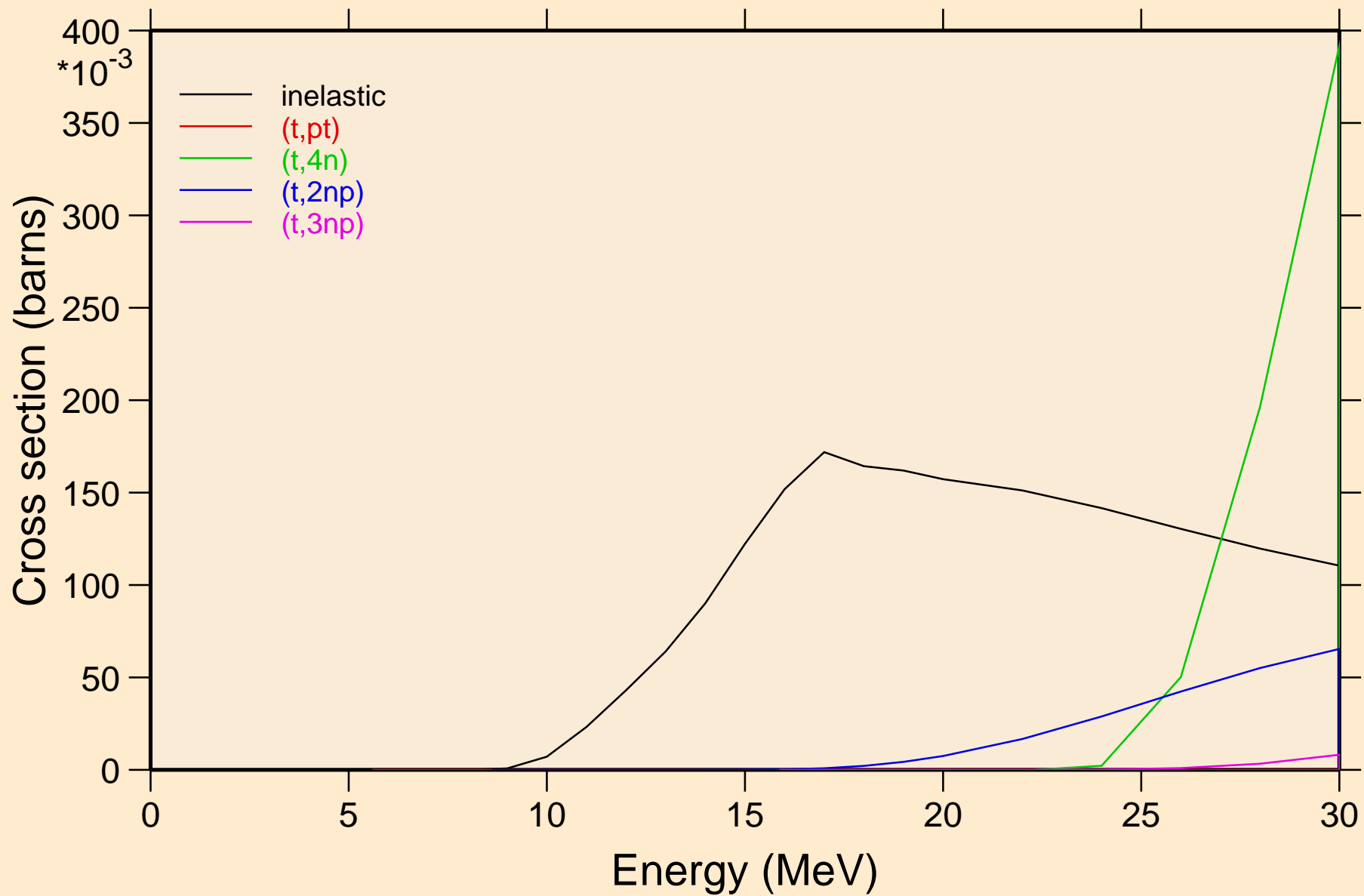

OS183 TRITON ACER TENDL-2021 LIBRARY; T=0.K  
Threshold reactions

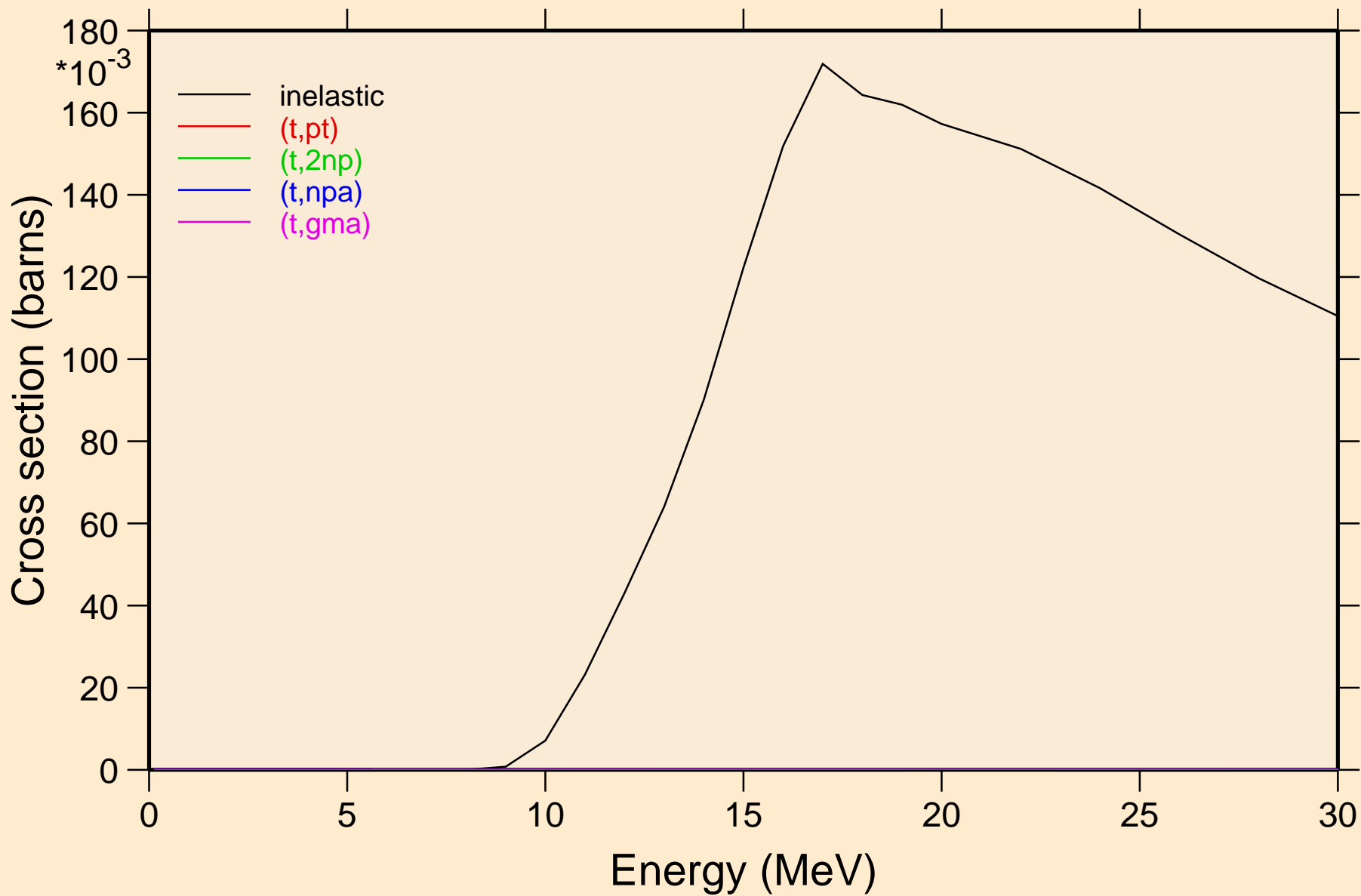

OS183 TRITON ACER TENDL-2021 LIBRARY; T=0.K  
Threshold reactions

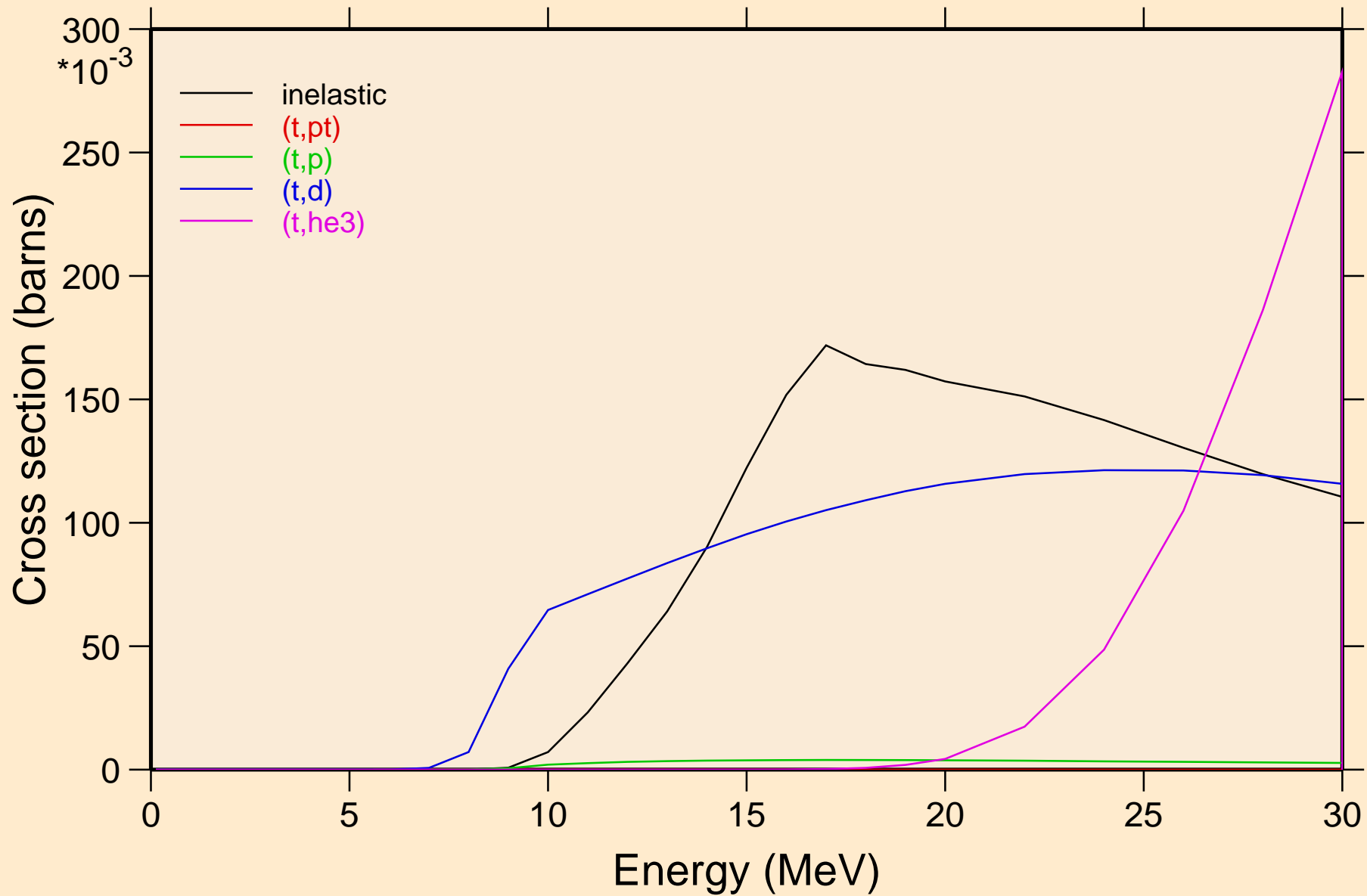

OS183 TRITON ACER TENDL-2021 LIBRARY; T=0.K  
Threshold reactions

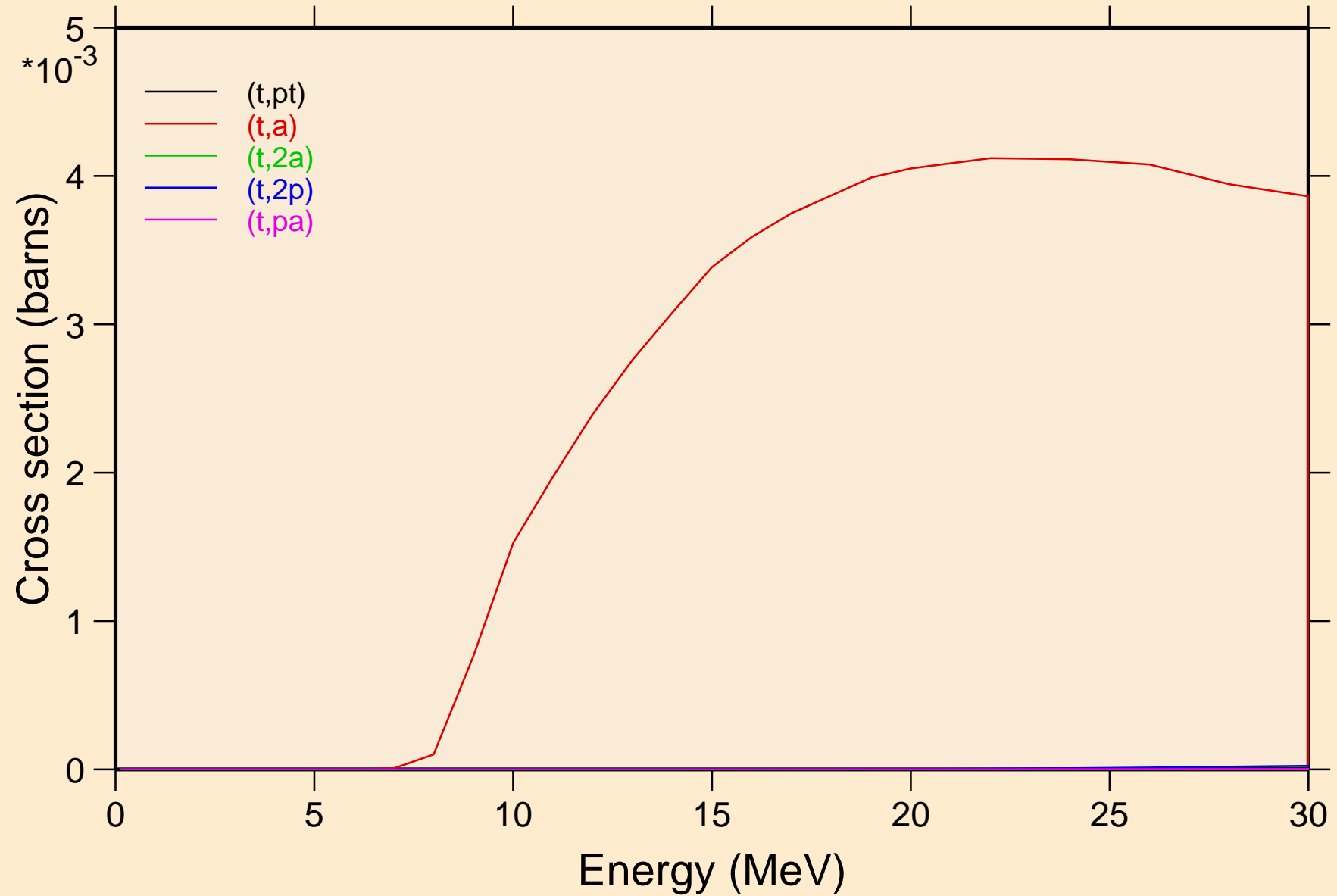

OS183 TRITON ACER TENDL-2021 LIBRARY; T=0.K  
Threshold reactions

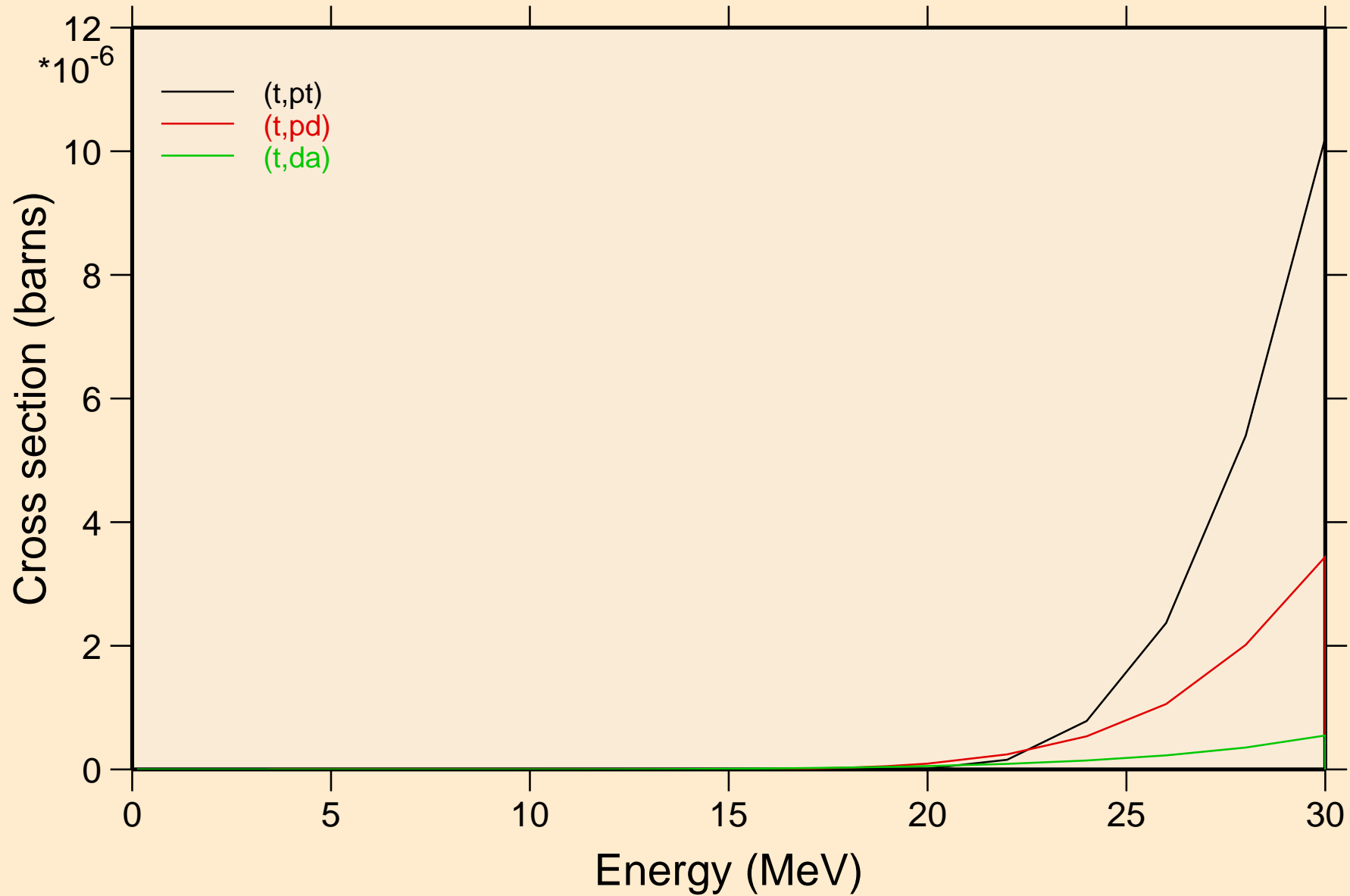

OS183 TRITON ACER TENDL-2021 LIBRARY; T=0.K  
angular distribution for elastic

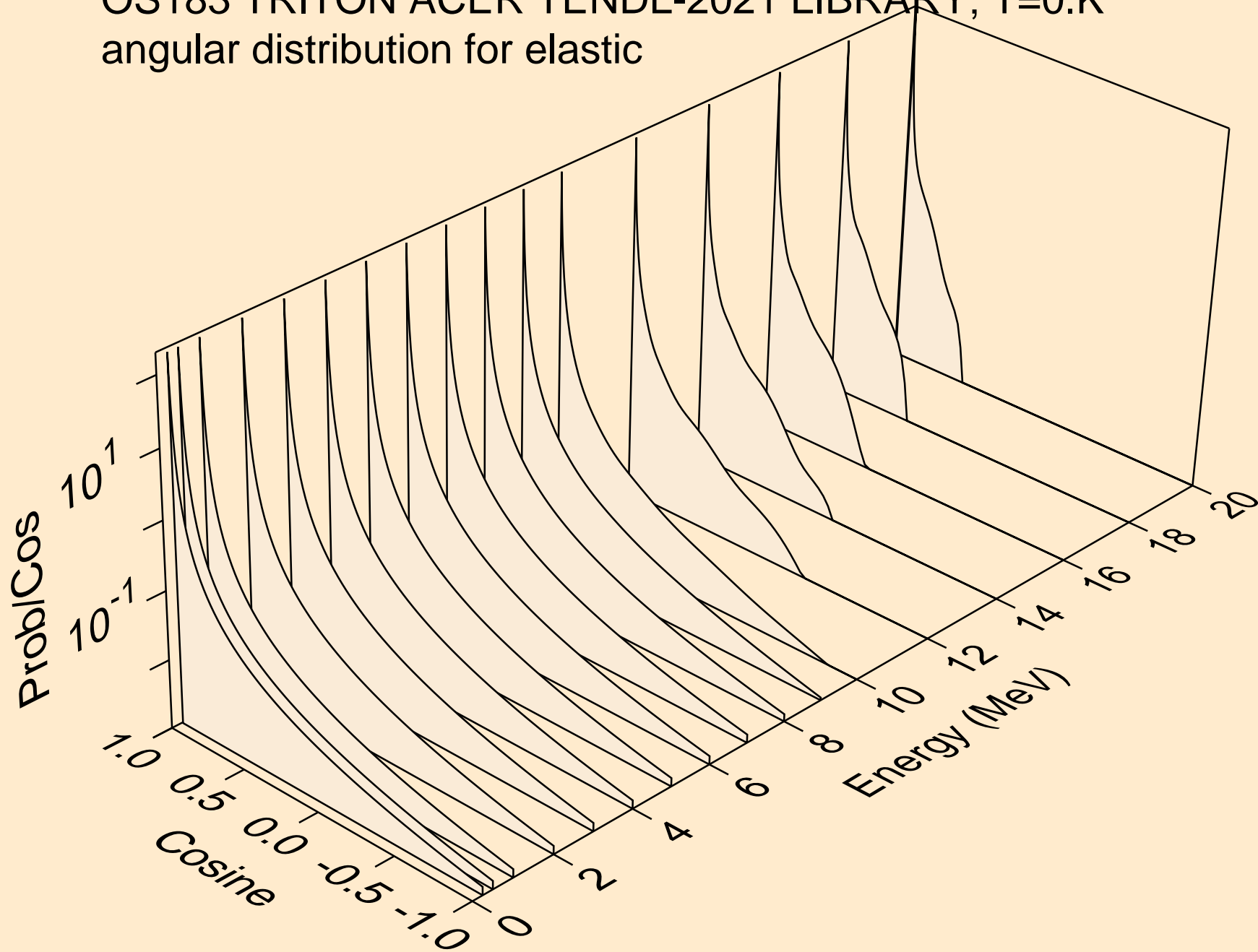



OS183 TRITON ACER TENDL-2021 LIBRARY; T=0.K  
angular distribution for elastic

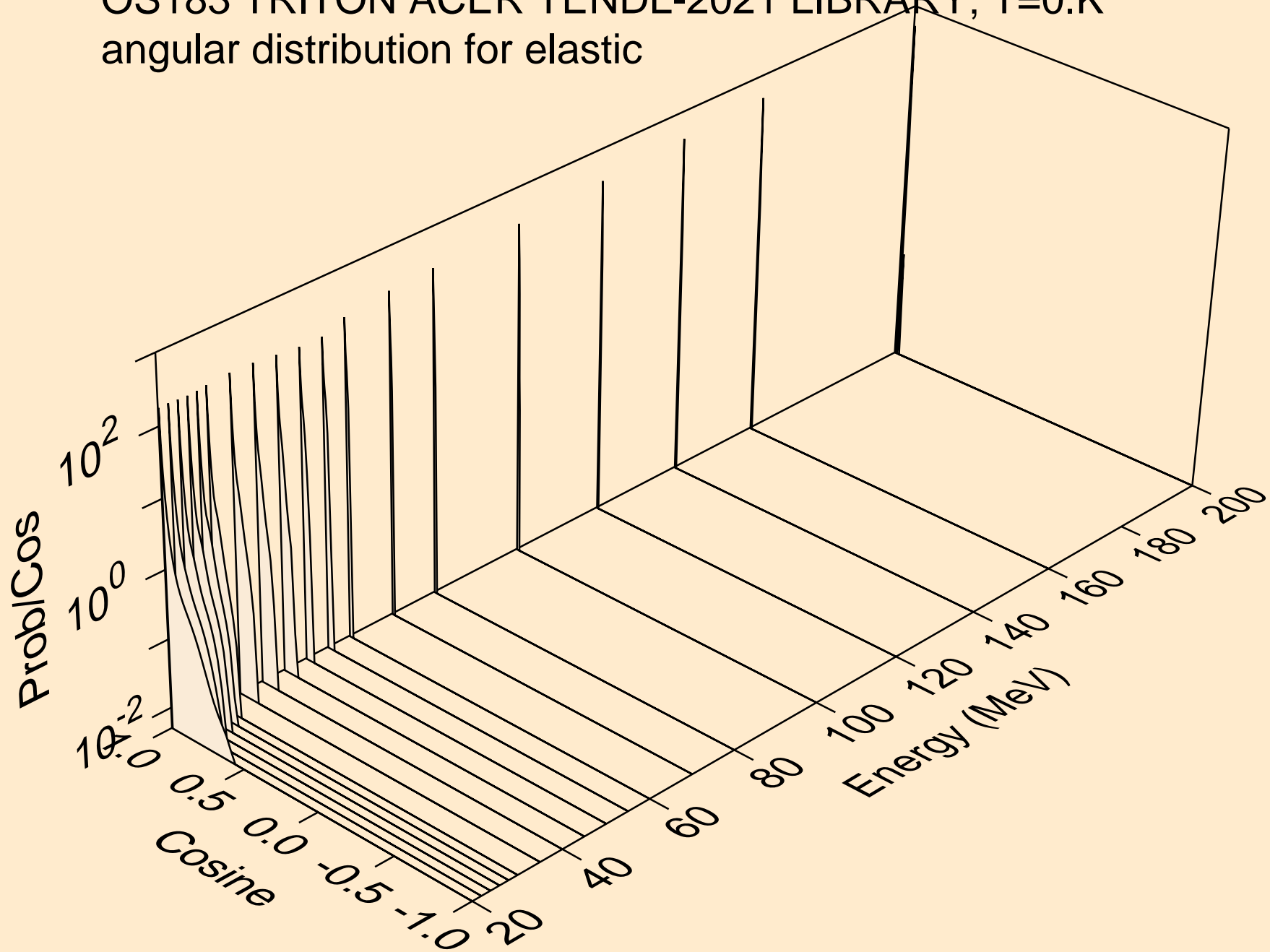

OS183 TRITON ACER TENDL-2021 LIBRARY; T=0.K  
Triton emission for (t,x)

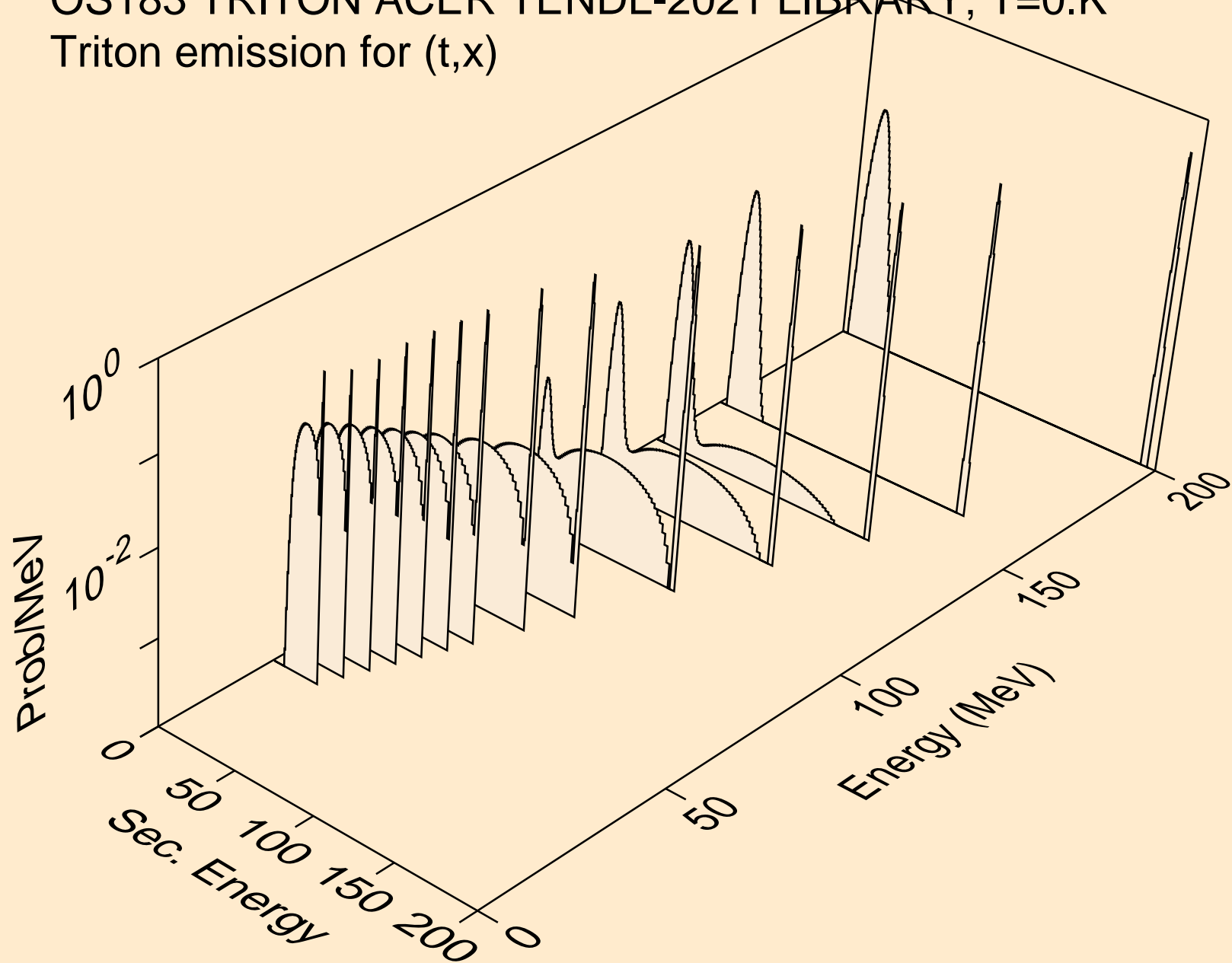

OS183 TRITON ACER TENDL-2021 LIBRARY; T=0.K  
Triton emission for (t,n\*)t

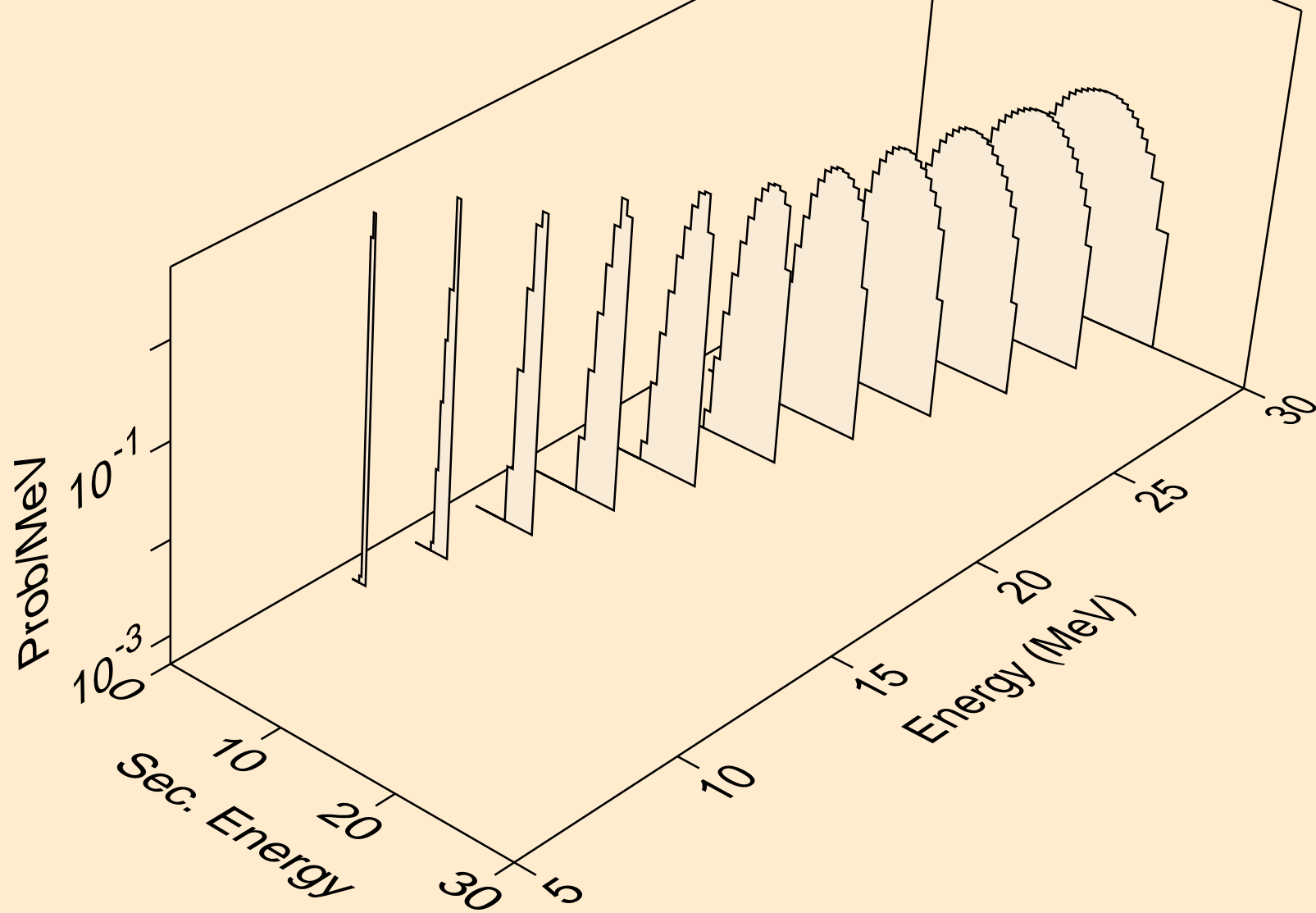

OS183 TRITON ACER TENDL-2021 LIBRARY; T=0.K  
Triton emission for inelastic

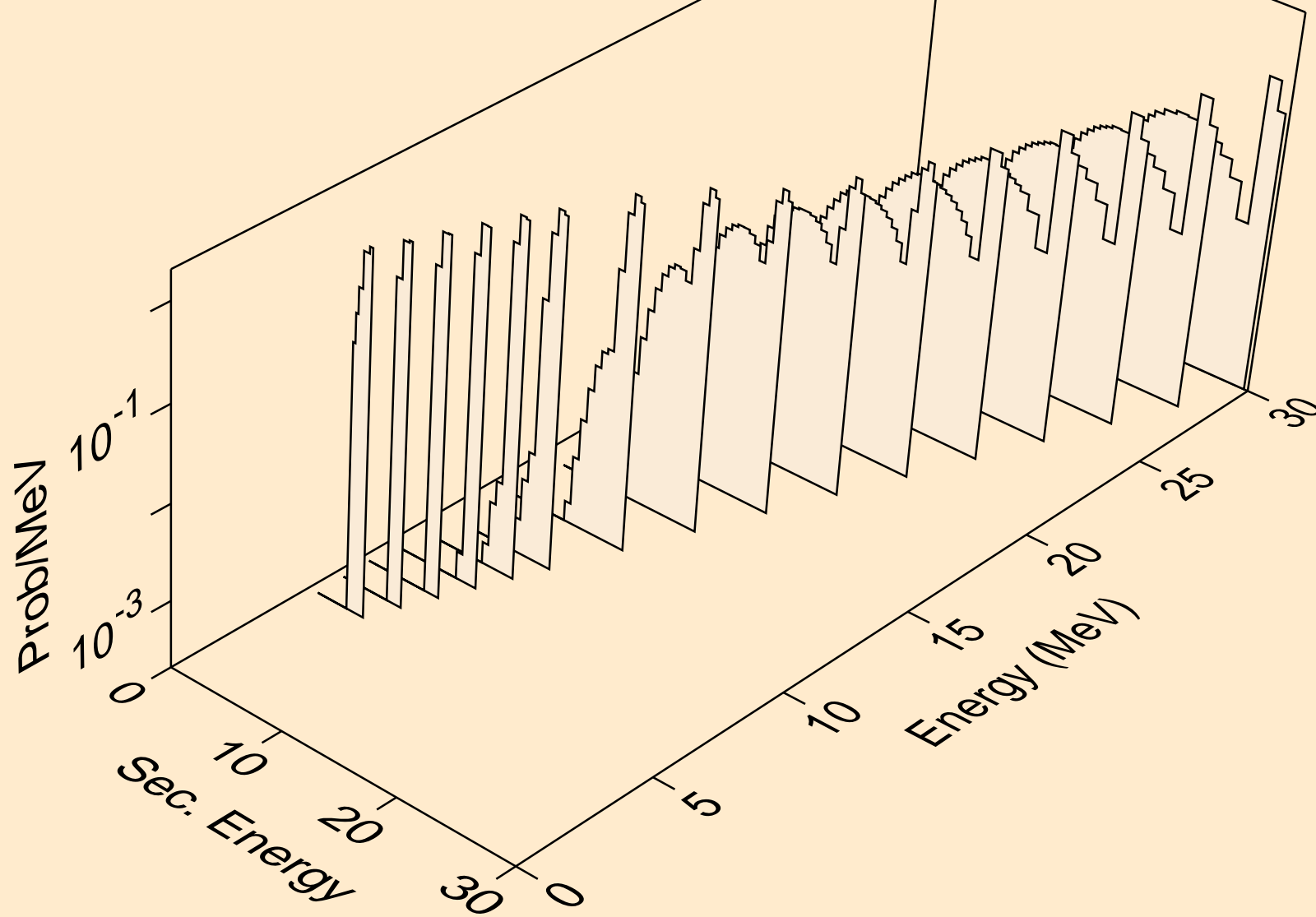

OS183 TRITON ACER TENDL-2021 LIBRARY; T=0.K  
Triton emission for (t,pt)

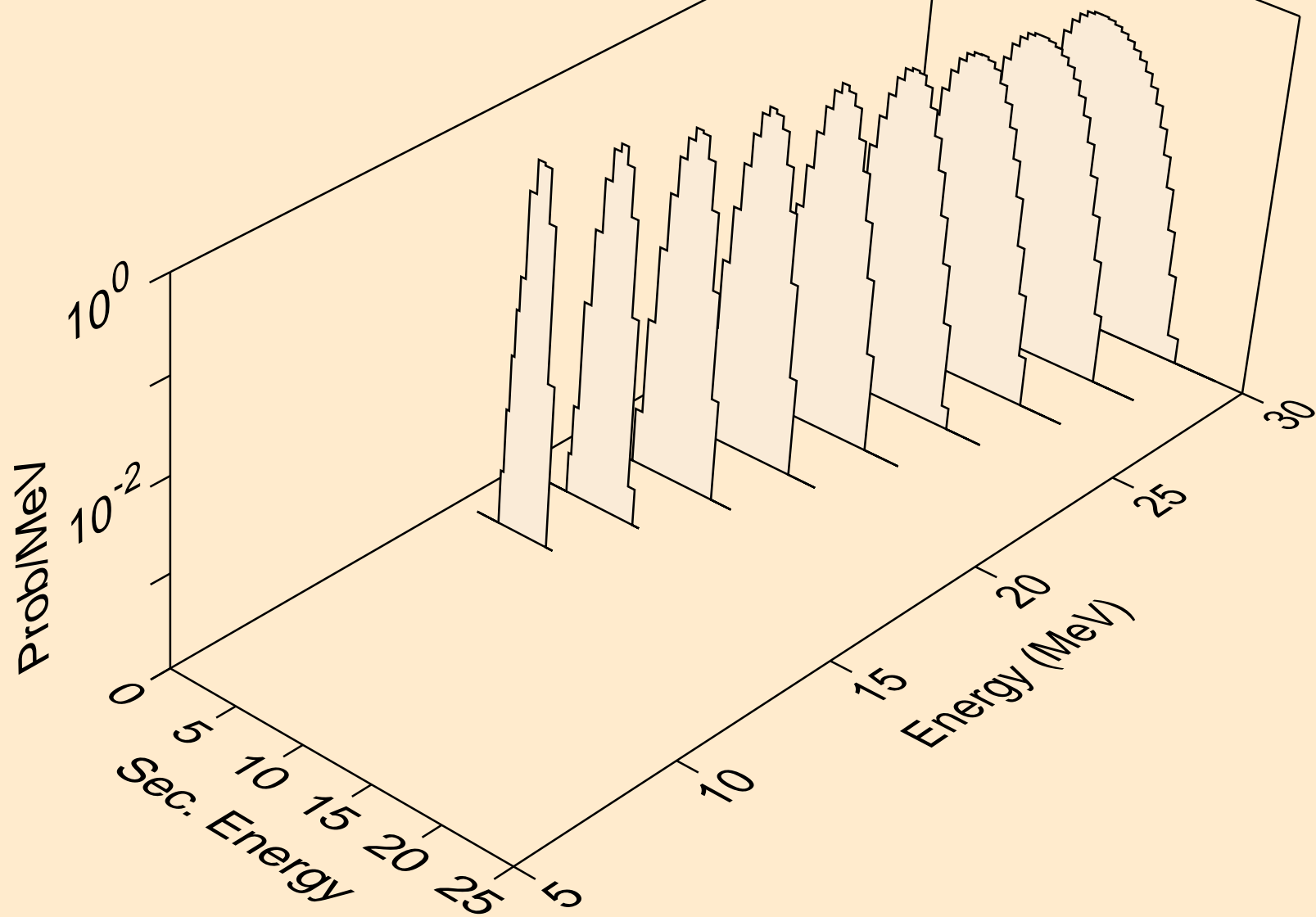

OS183 TRITON ACER TENDL-2021 LIBRARY; T=0.K  
Photon emission for (z,n)

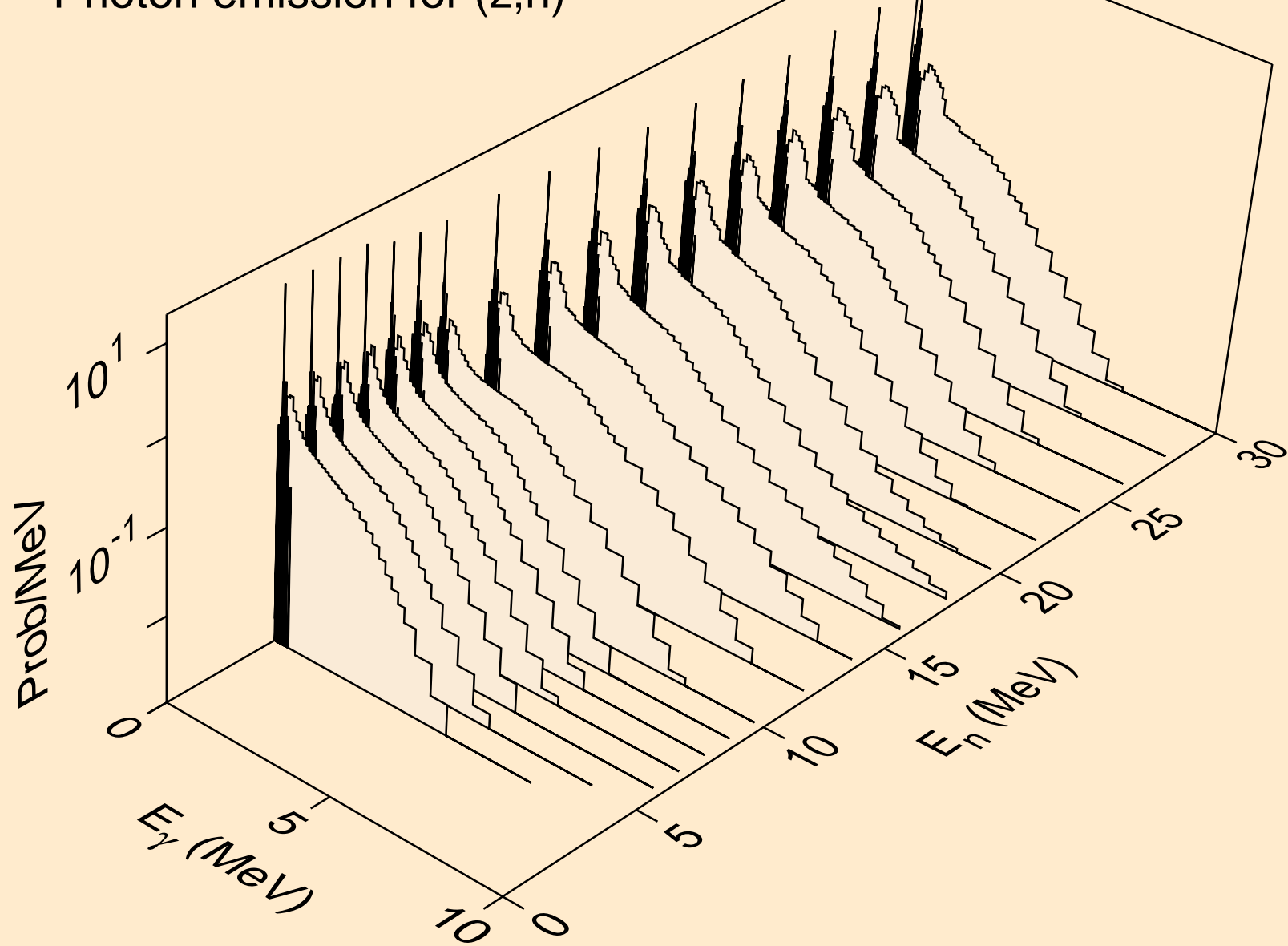

OS183 TRITON ACER TENDL-2021 LIBRARY; T=0.K  
Photon emission for (n,x)

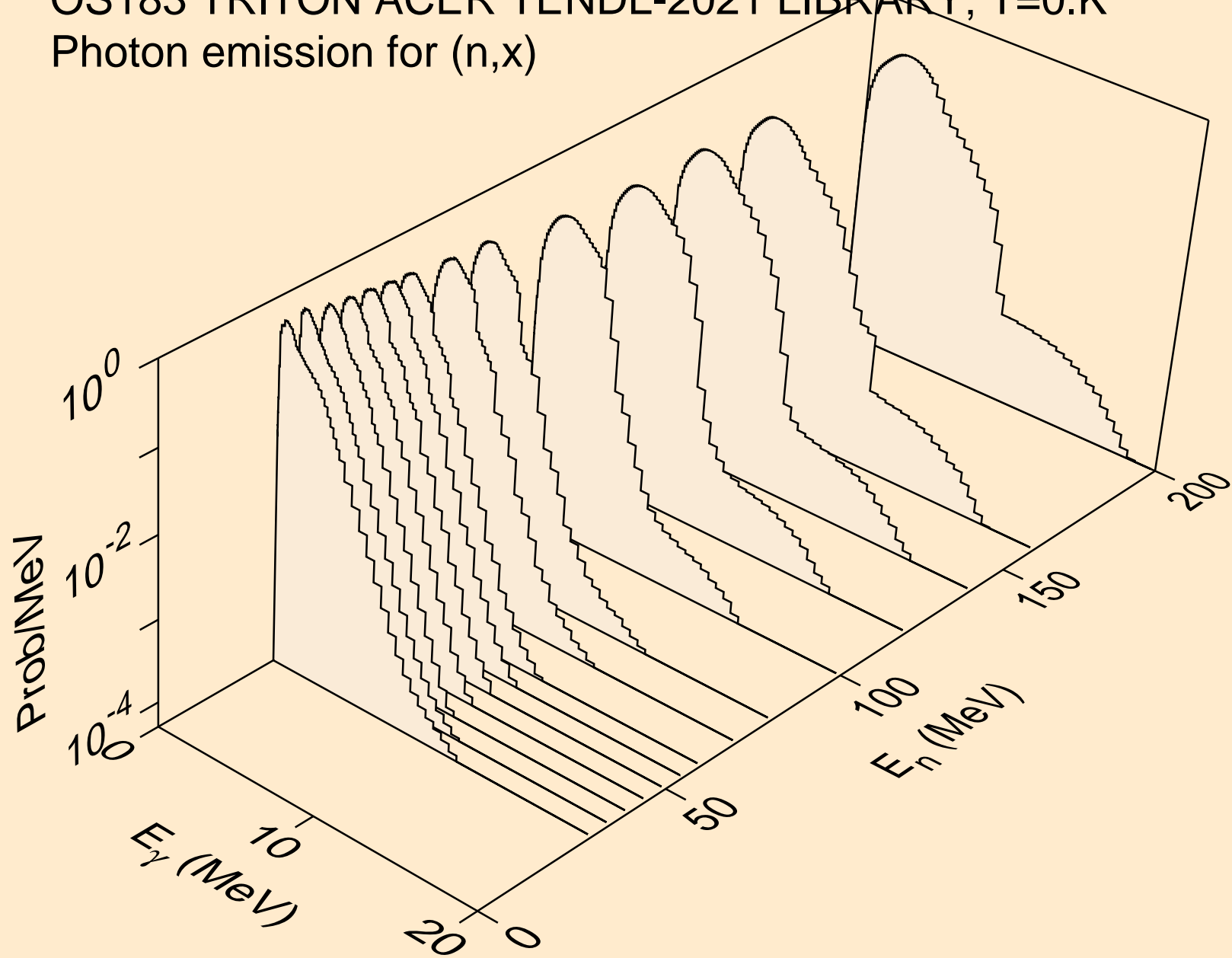

OS183 TRITON ACER TENDL-2021 LIBRARY; T=0.K  
Photon emission for (n,2nd)

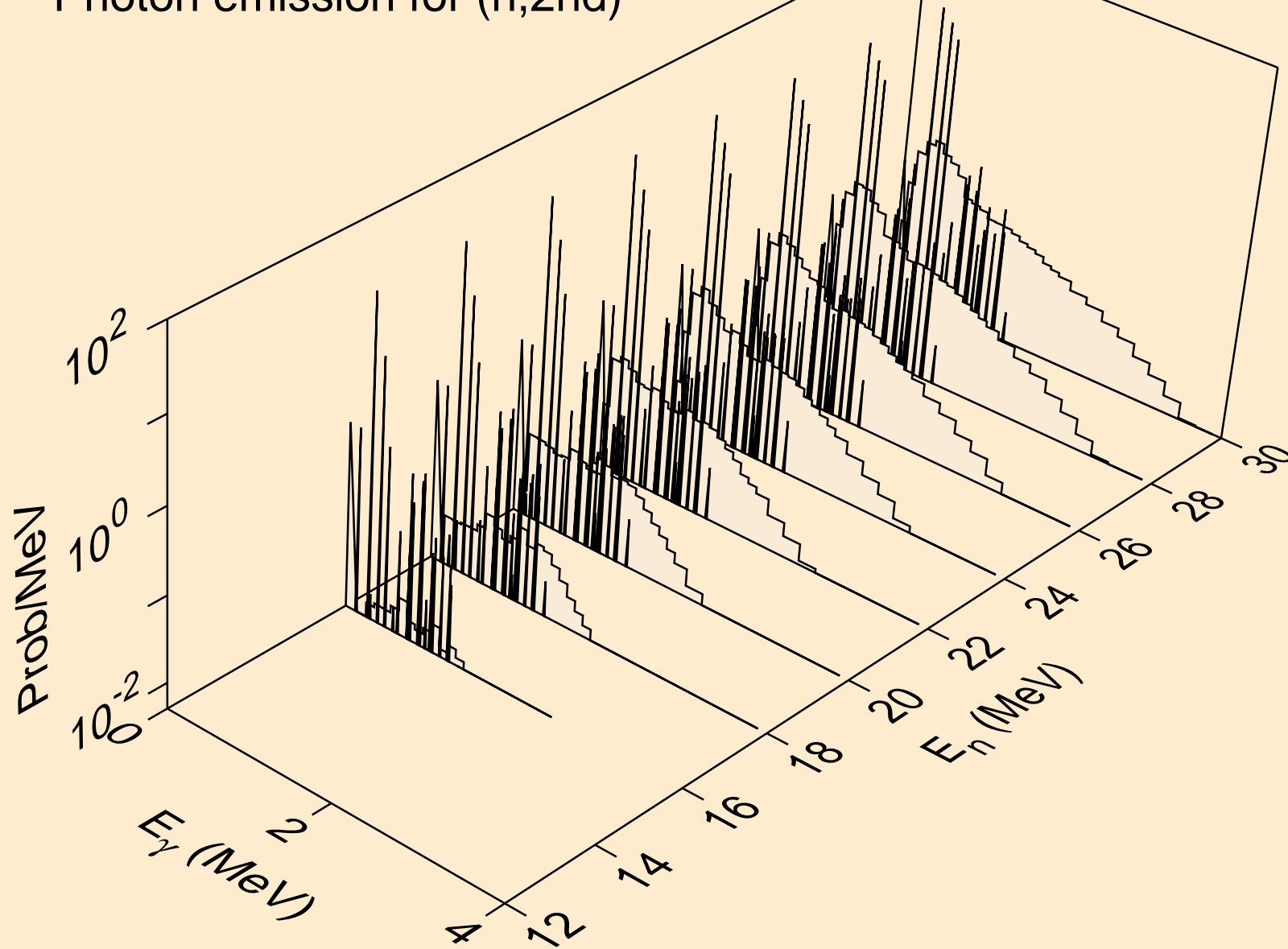



OS183 TRITON ACER TENDL-2021 LIBRARY; T=0.K  
Photon emission for (n,2n)

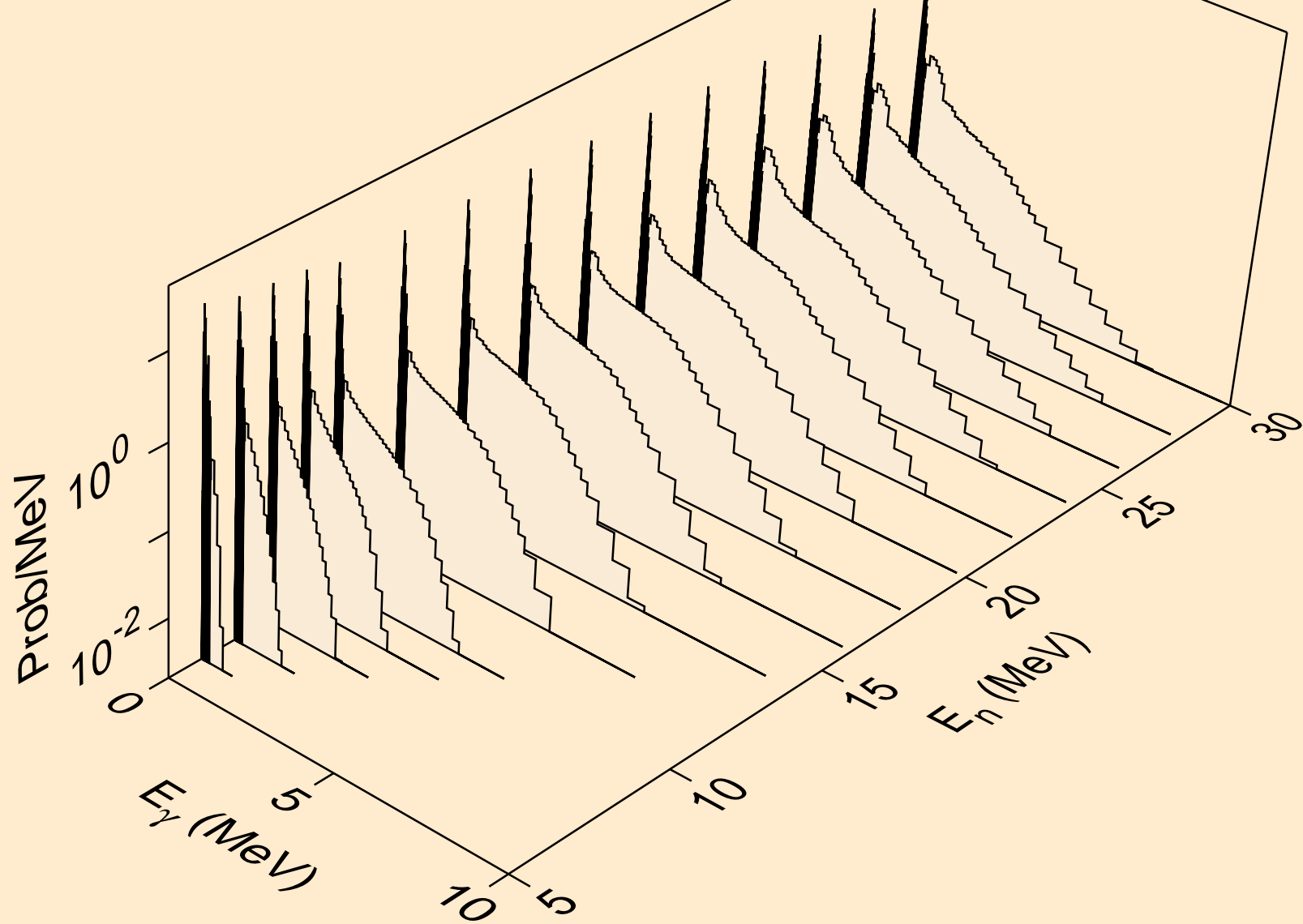

OS183 TRITON ACER TENDL-2021 LIBRARY; T=0.K  
Photon emission for (n,3n)

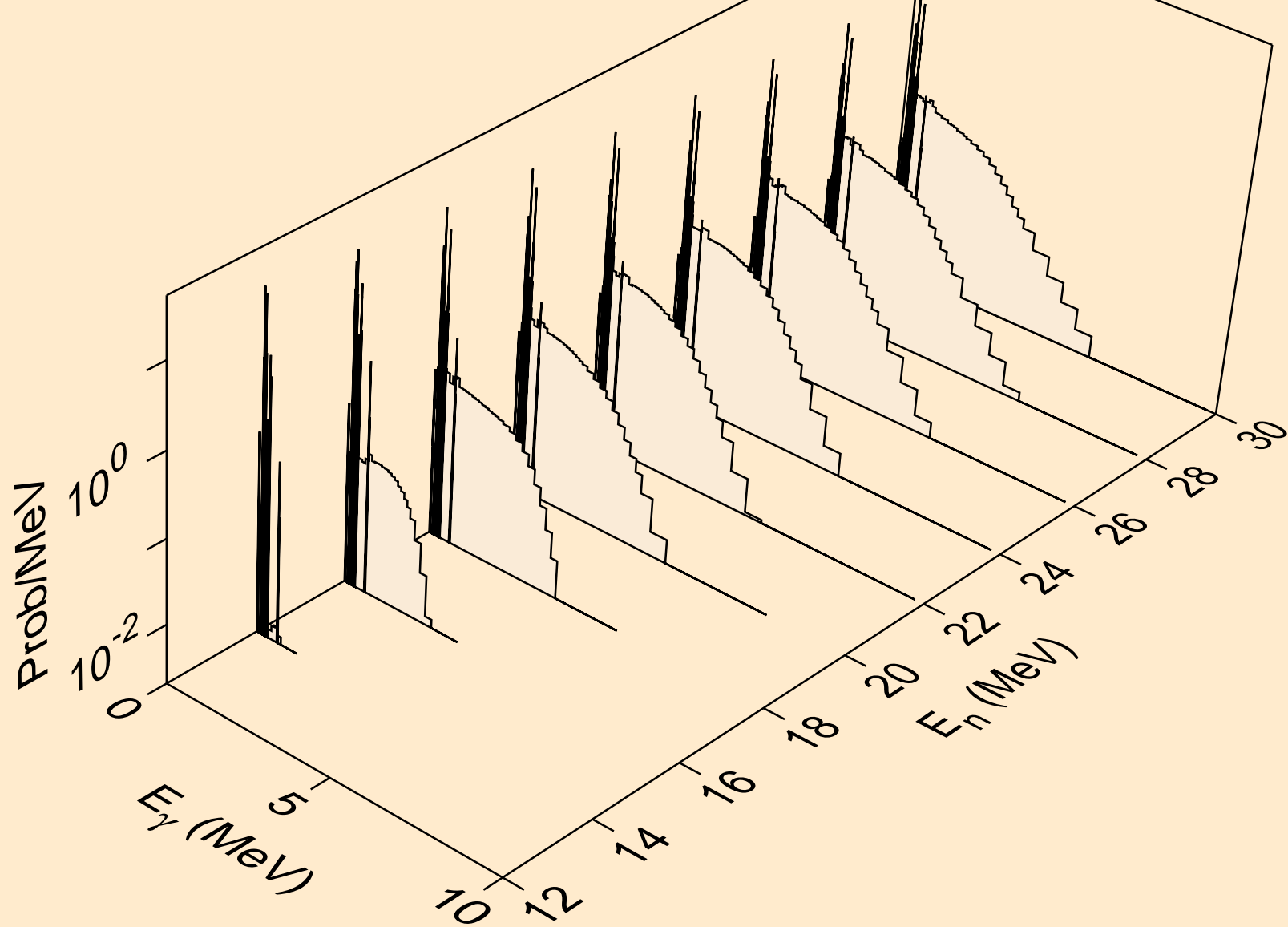

OS183 TRITON ACER TENDL-2021 LIBRARY; T=0.K  
Photon emission for (n,n\*)a

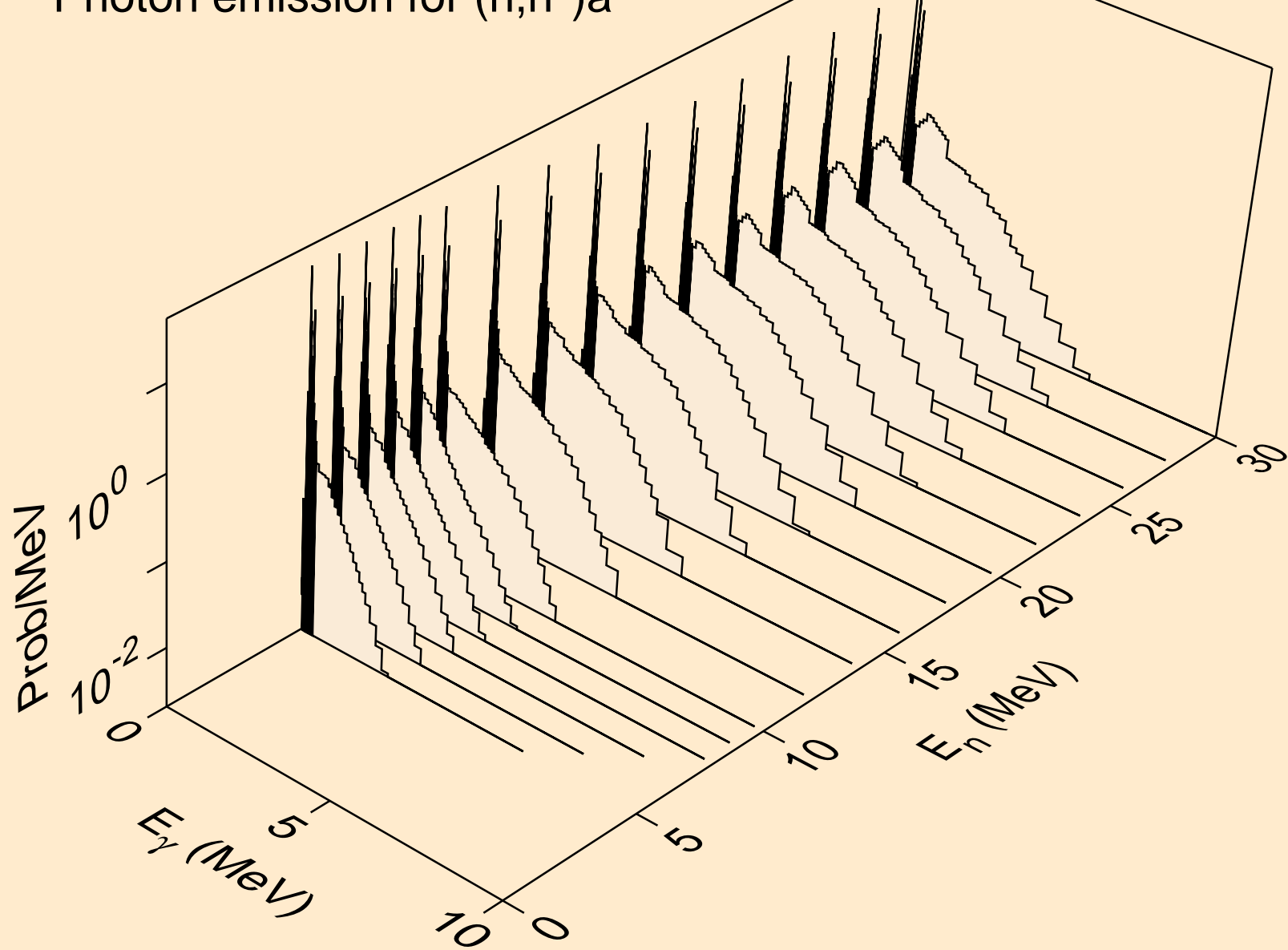

OS183 TRITON ACER TENDL-2021 LIBRARY; T=0.K  
Photon emission for (n,2n)a

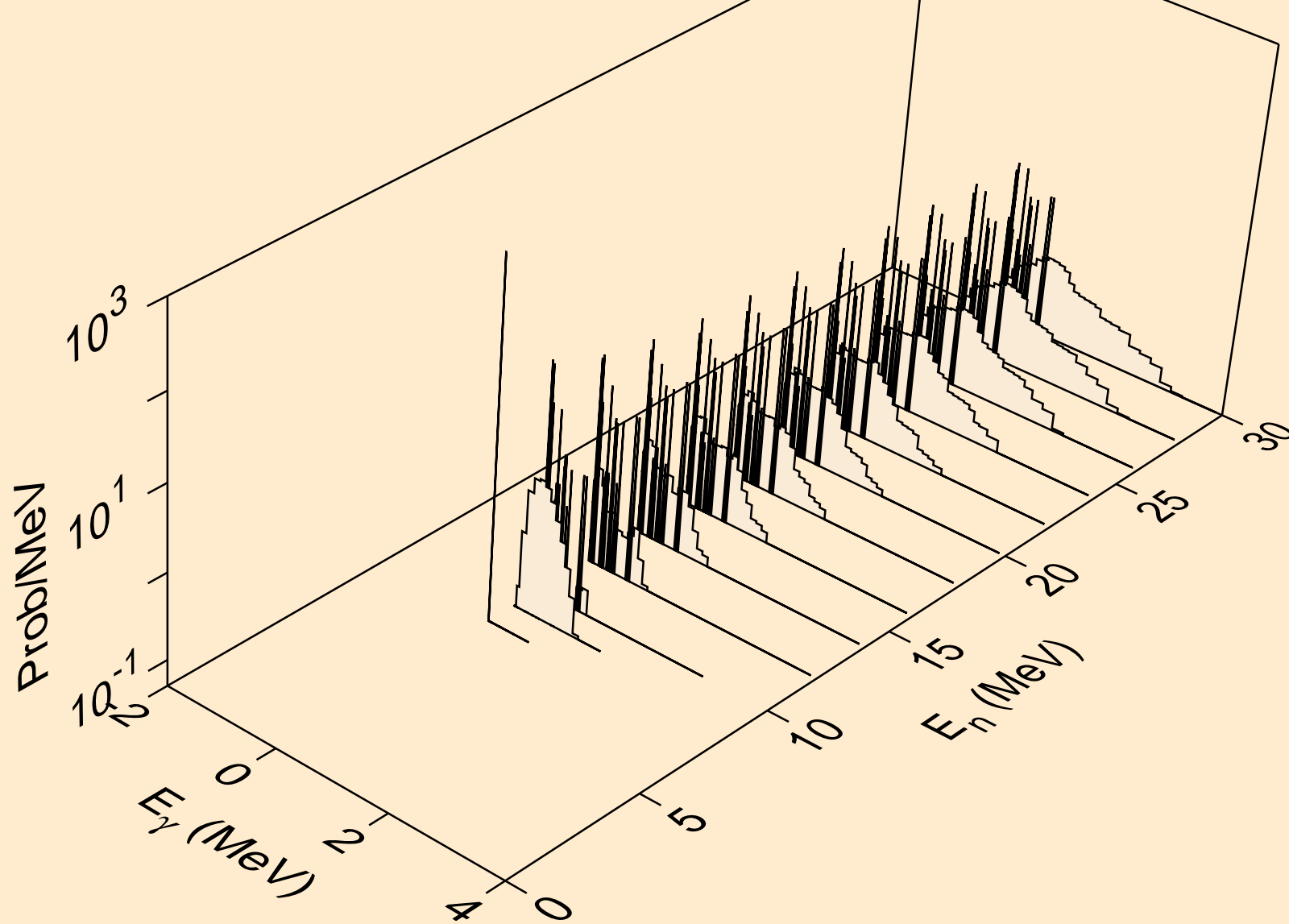

OS183 TRITON ACER TENDL-2021 LIBRARY; T=0.K  
Photon emission for (n,3n)a

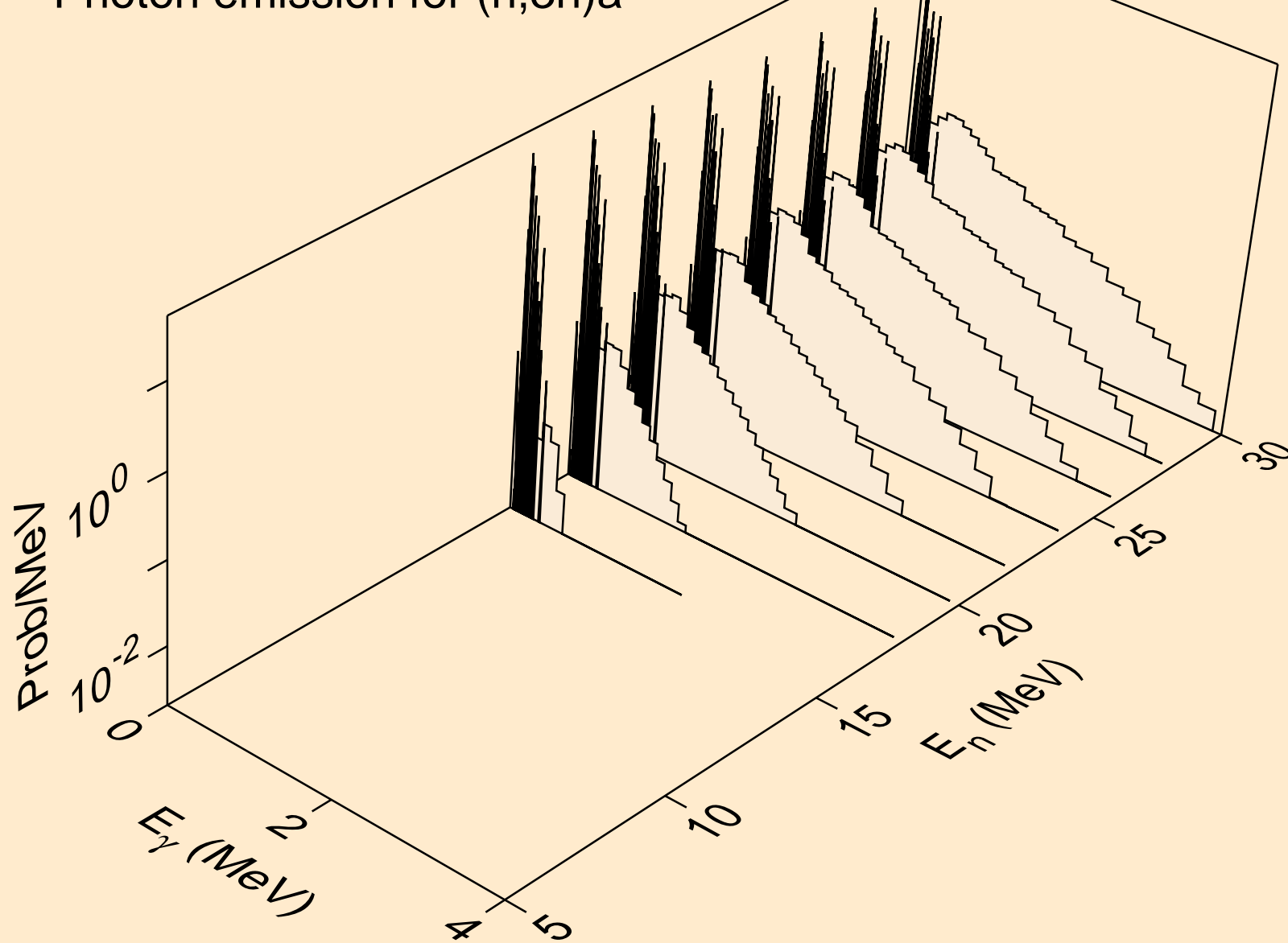

OS183 TRITON ACER TENDL-2021 LIBRARY; T=0.K  
Photon emission for (n,n\*)p

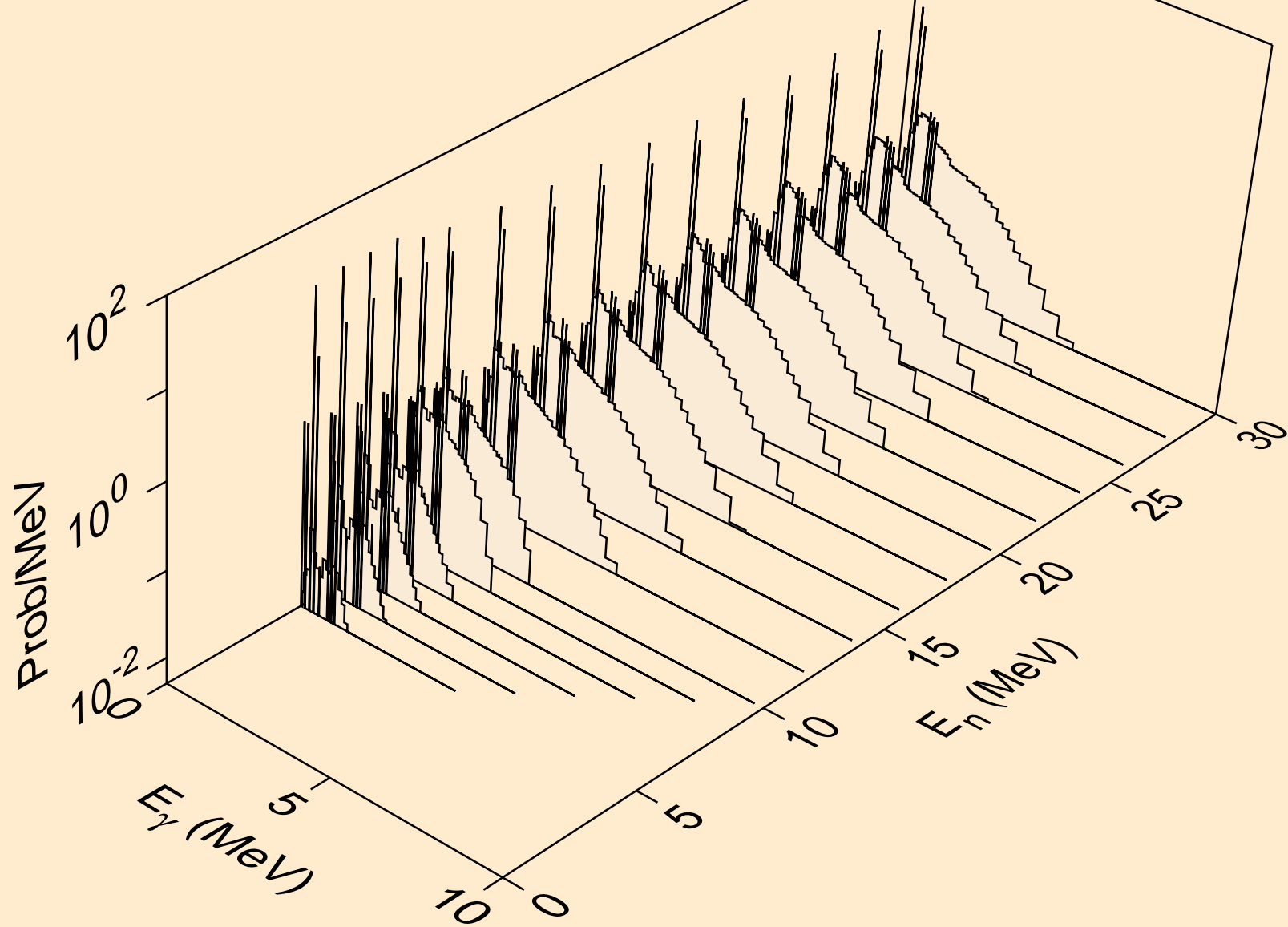

OS183 TRITON ACER TENDL-2021 LIBRARY; T=0.K  
Photon emission for (n,n\*)2a

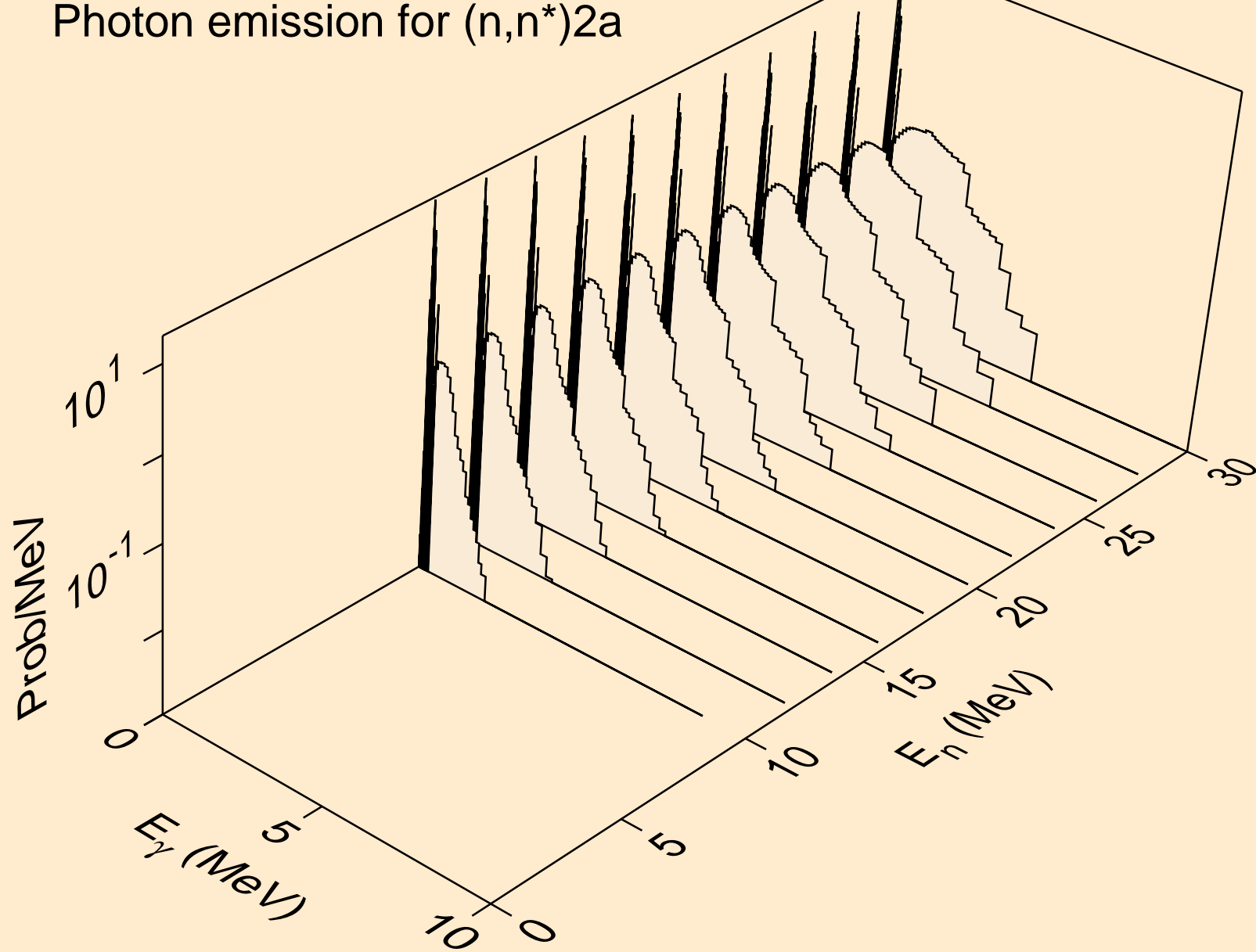

OS183 TRITON ACER TENDL-2021 LIBRARY; T=0.K  
Photon emission for (n,2n)2a

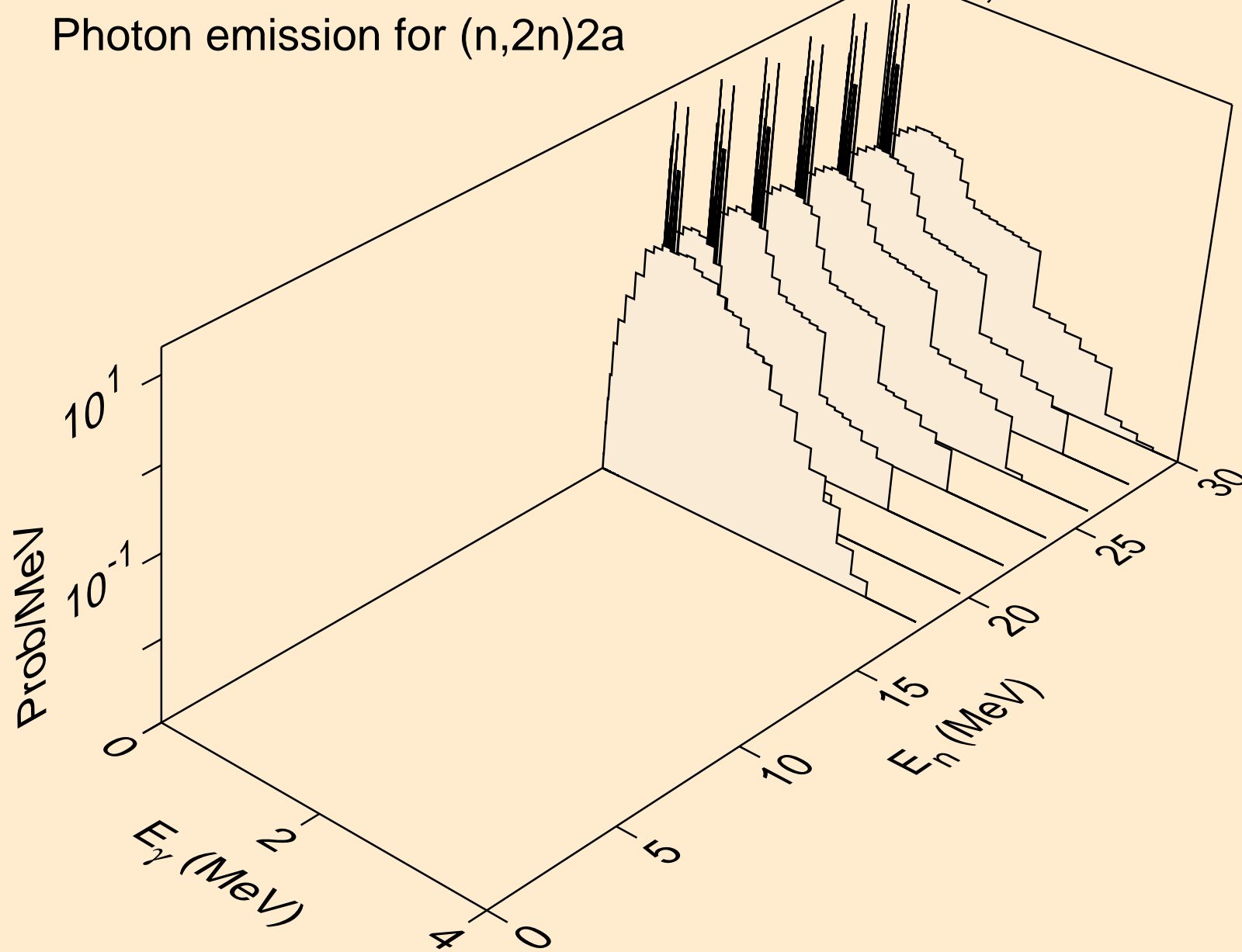



OS183 TRITON ACER TENDL-2021 LIBRARY; T=0.K  
Photon emission for (n,n\*)d

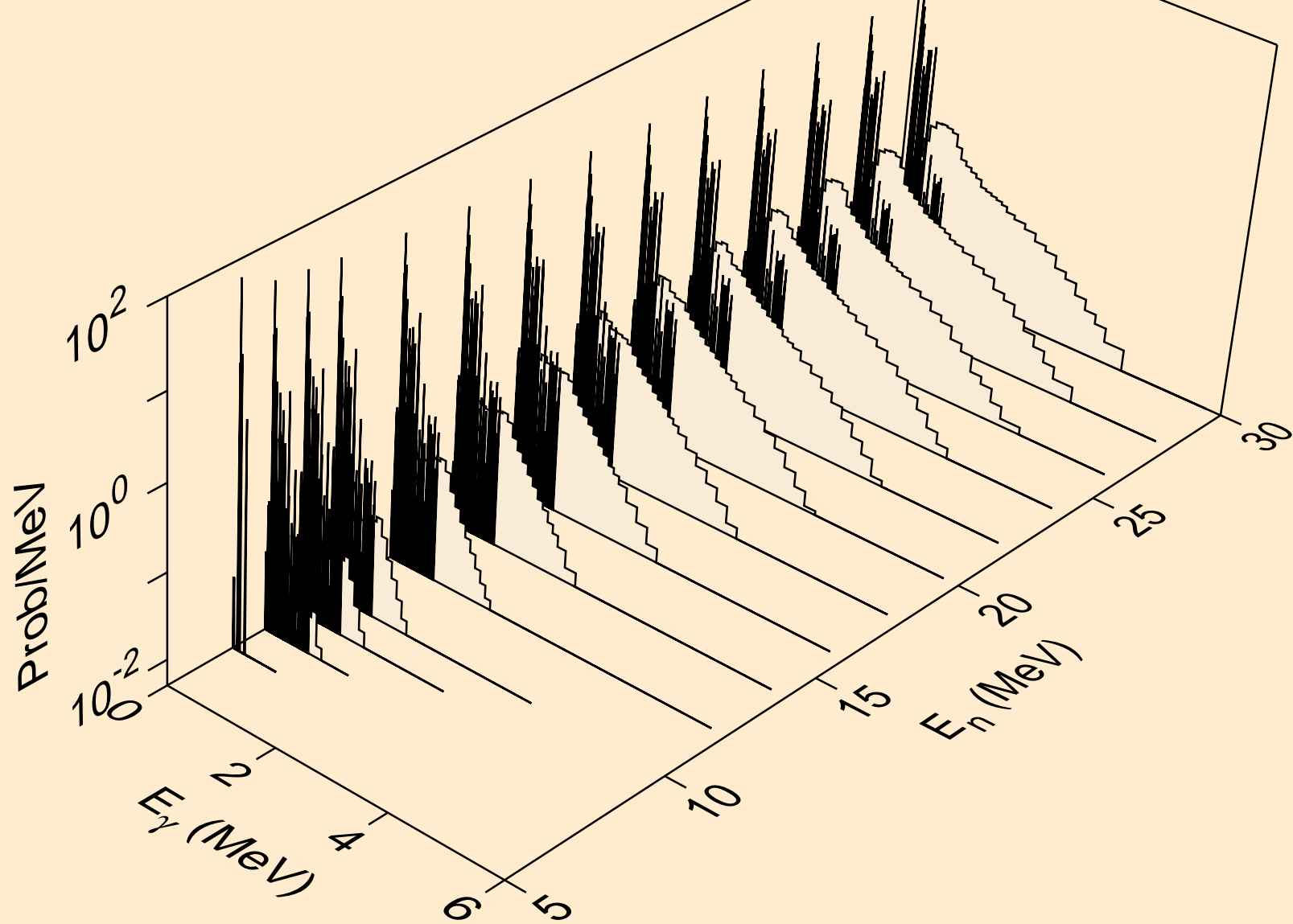

OS183 TRITON ACER TENDL-2021 LIBRARY; T=0.K  
Photon emission for (n,n\*)t

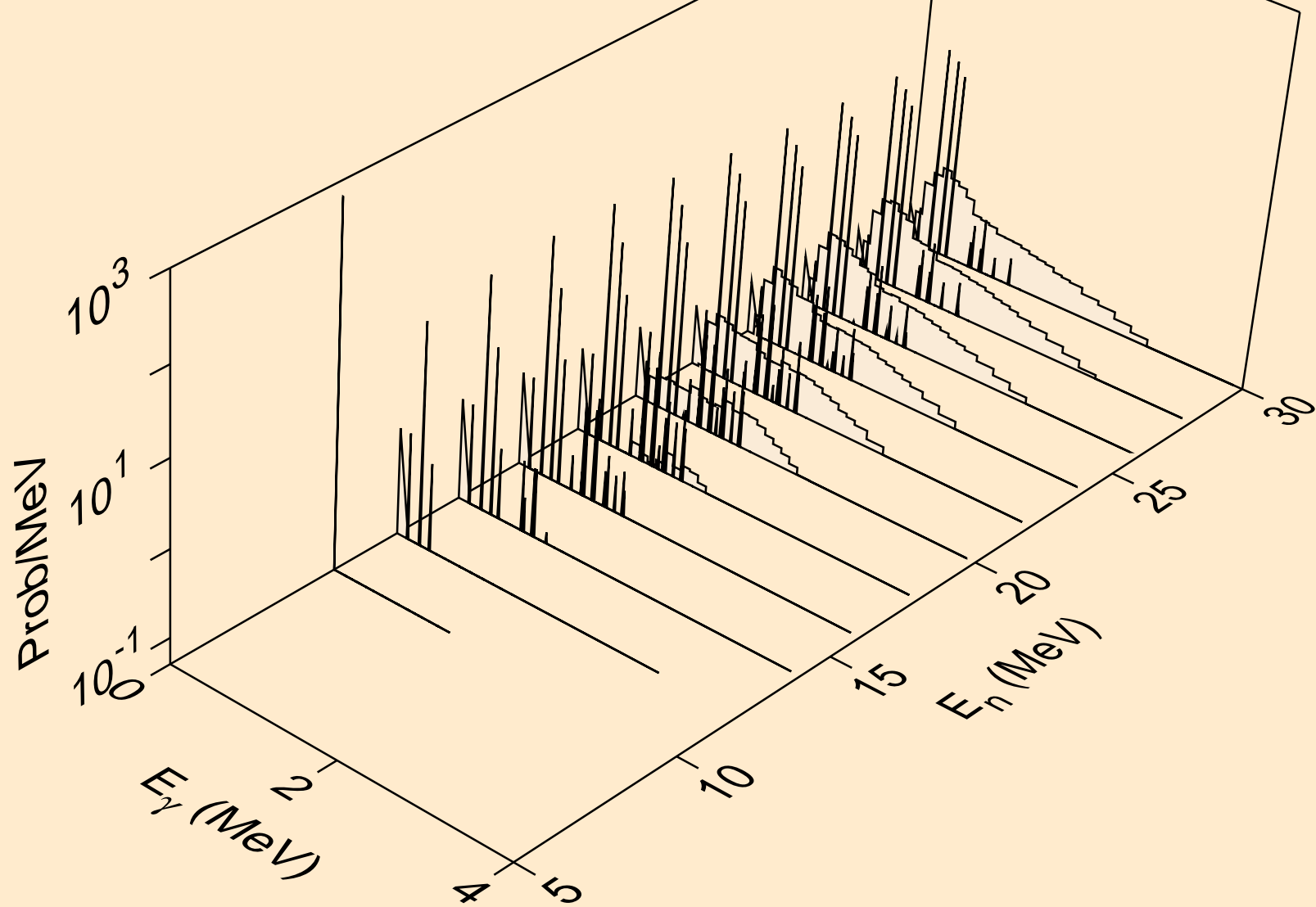

OS183 TRITON ACER TENDL-2021 LIBRARY; T=0.K  
Photon emission for (n,n\*)he3

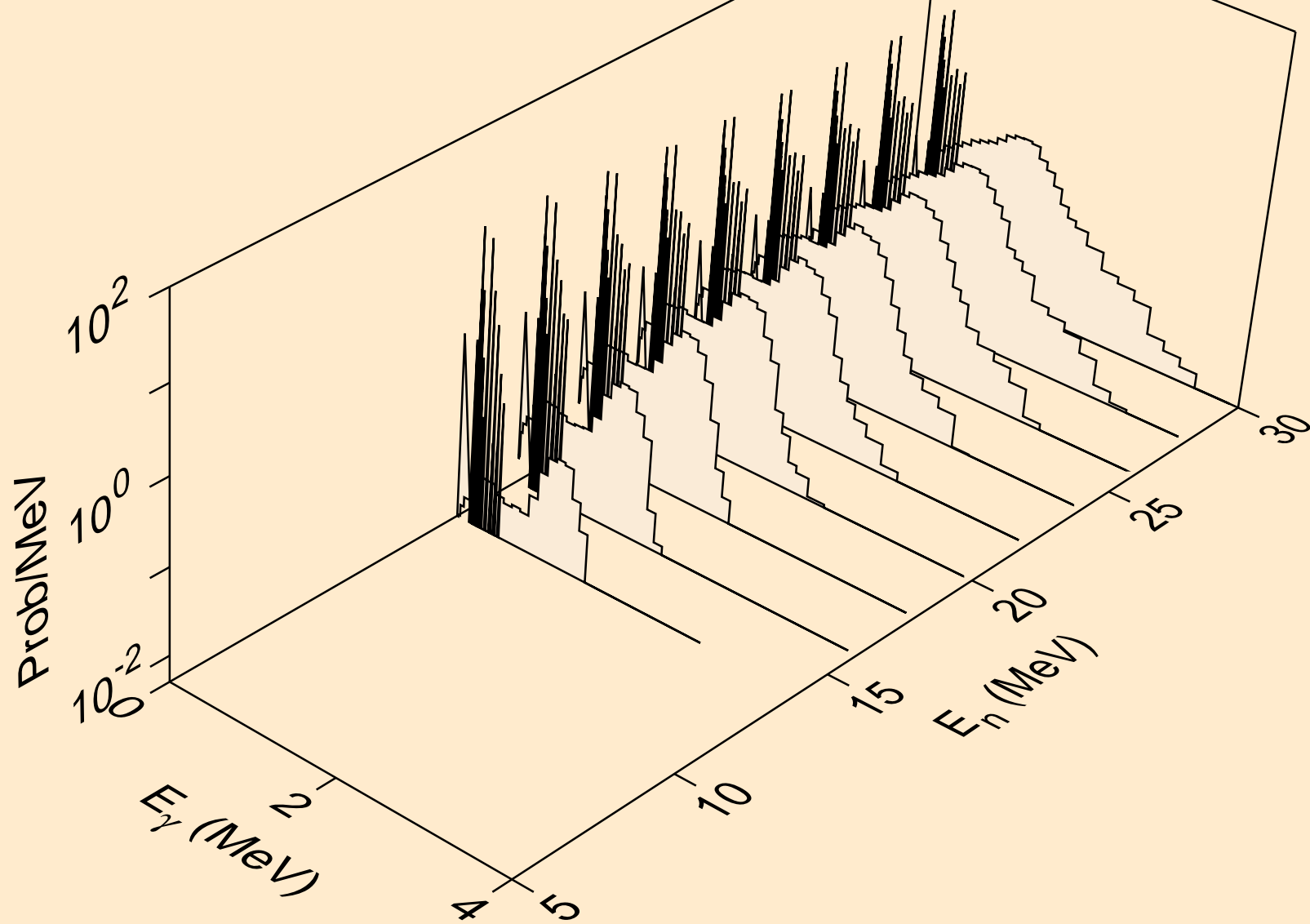

OS183 TRITON ACER TENDL-2021 LIBRARY; T=0.K  
Photon emission for (n,4n)

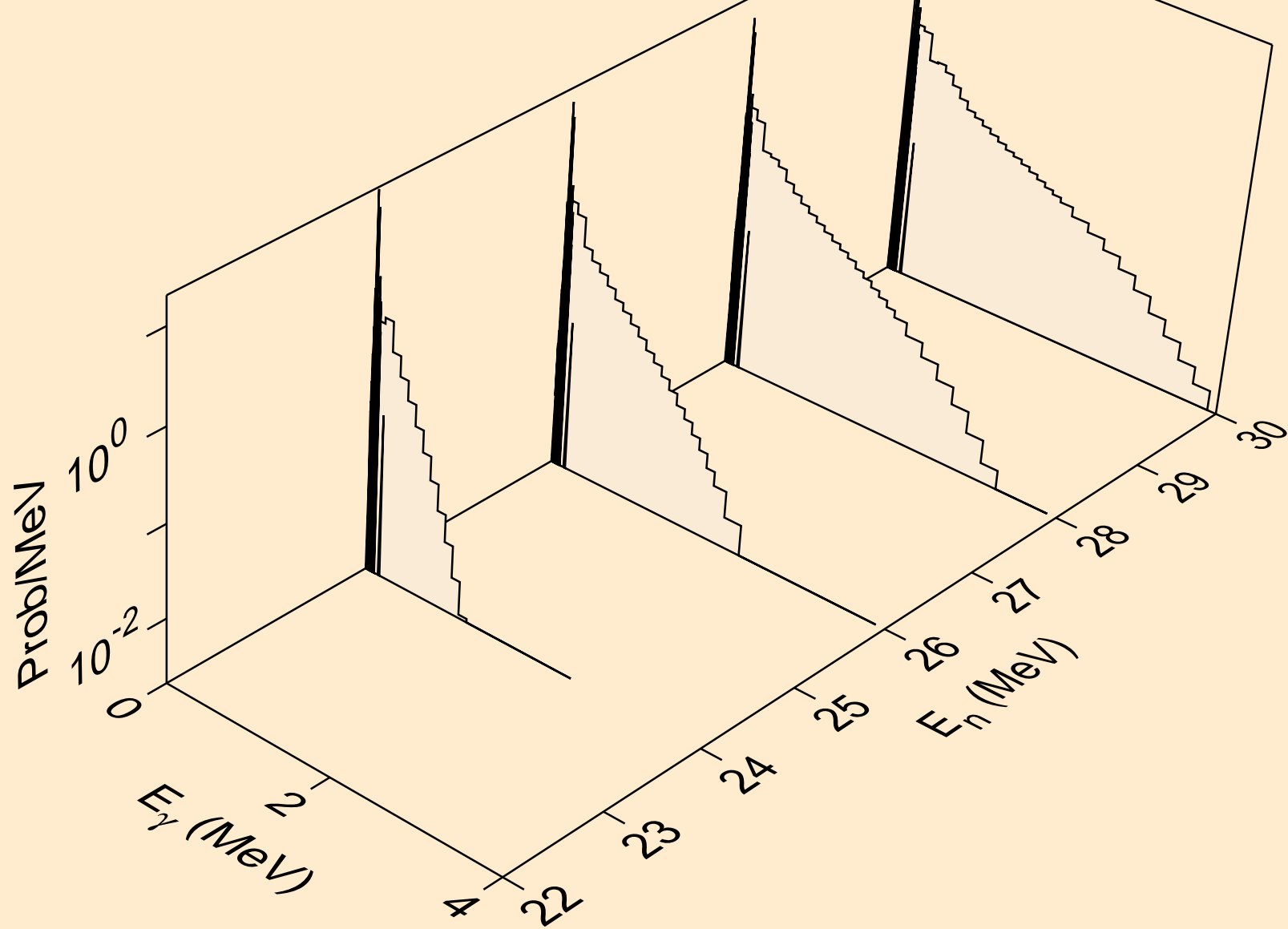

OS183 TRITON ACER TENDL-2021 LIBRARY; T=0.K  
Photon emission for (n,2np)

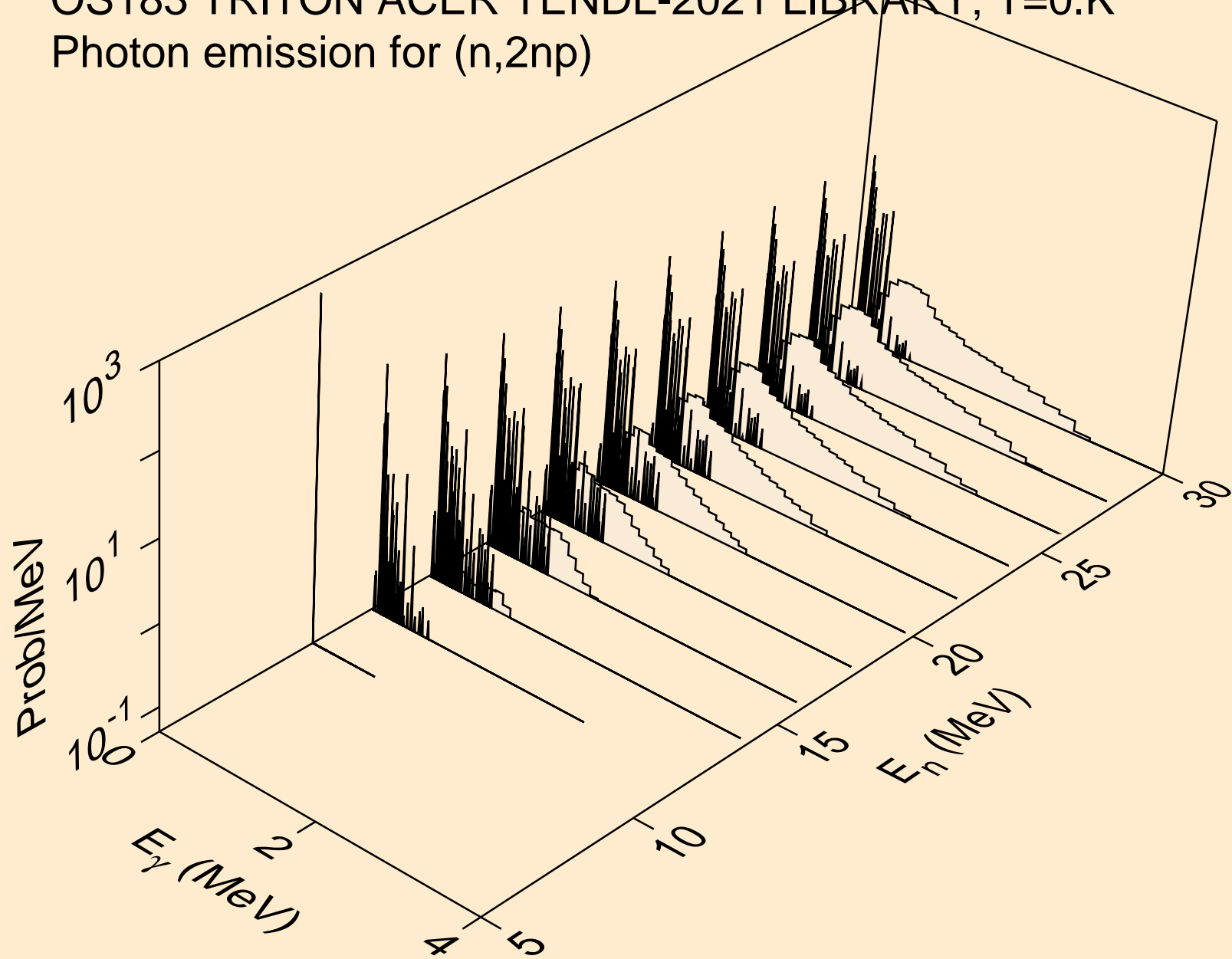

OS183 TRITON ACER TENDL-2021 LIBRARY; T=0.K  
Photon emission for (n,3np)

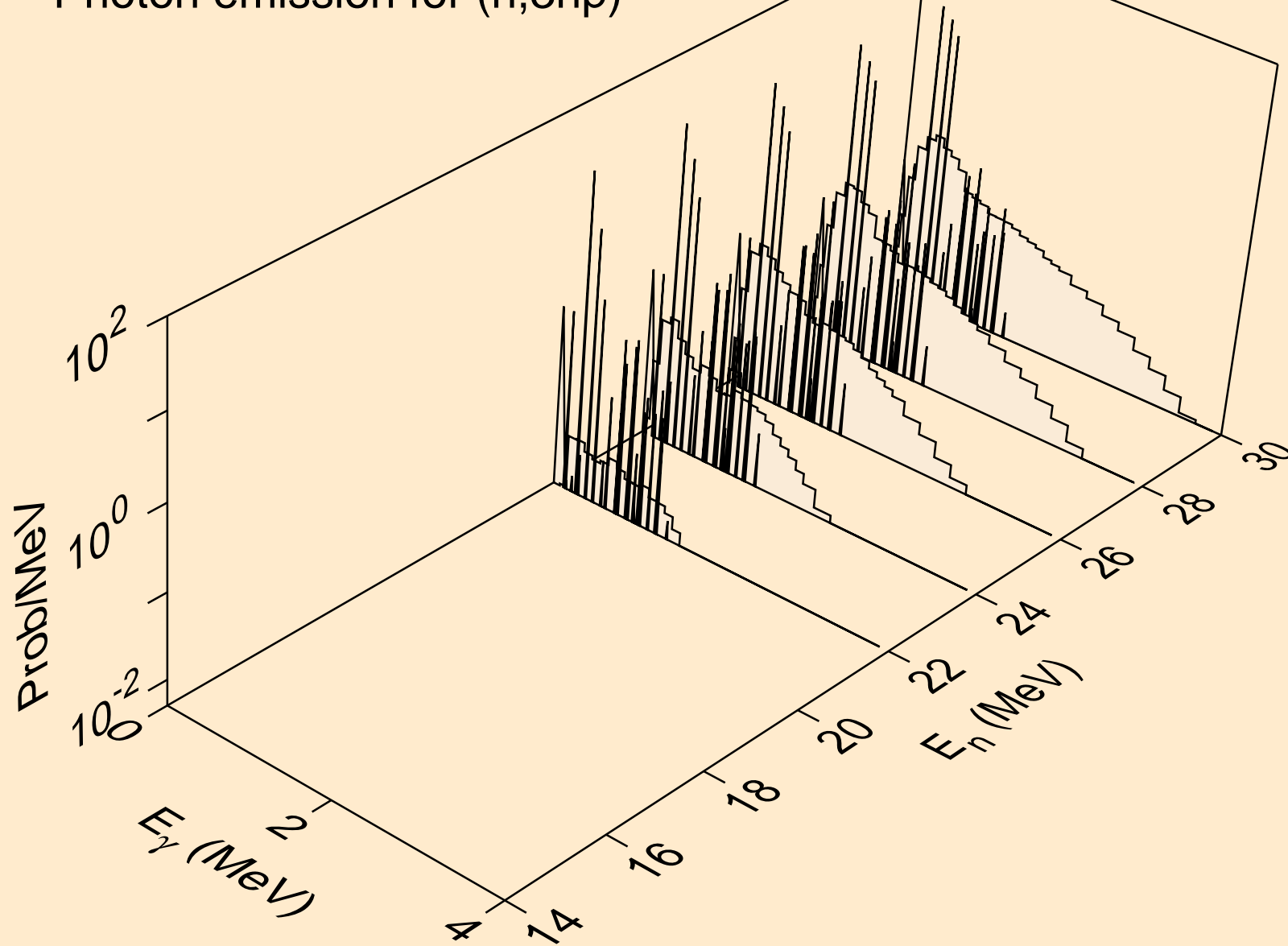

OS183 TRITON ACER TENDL-2021 LIBRARY; T=0.K  
Photon emission for (n,2np)

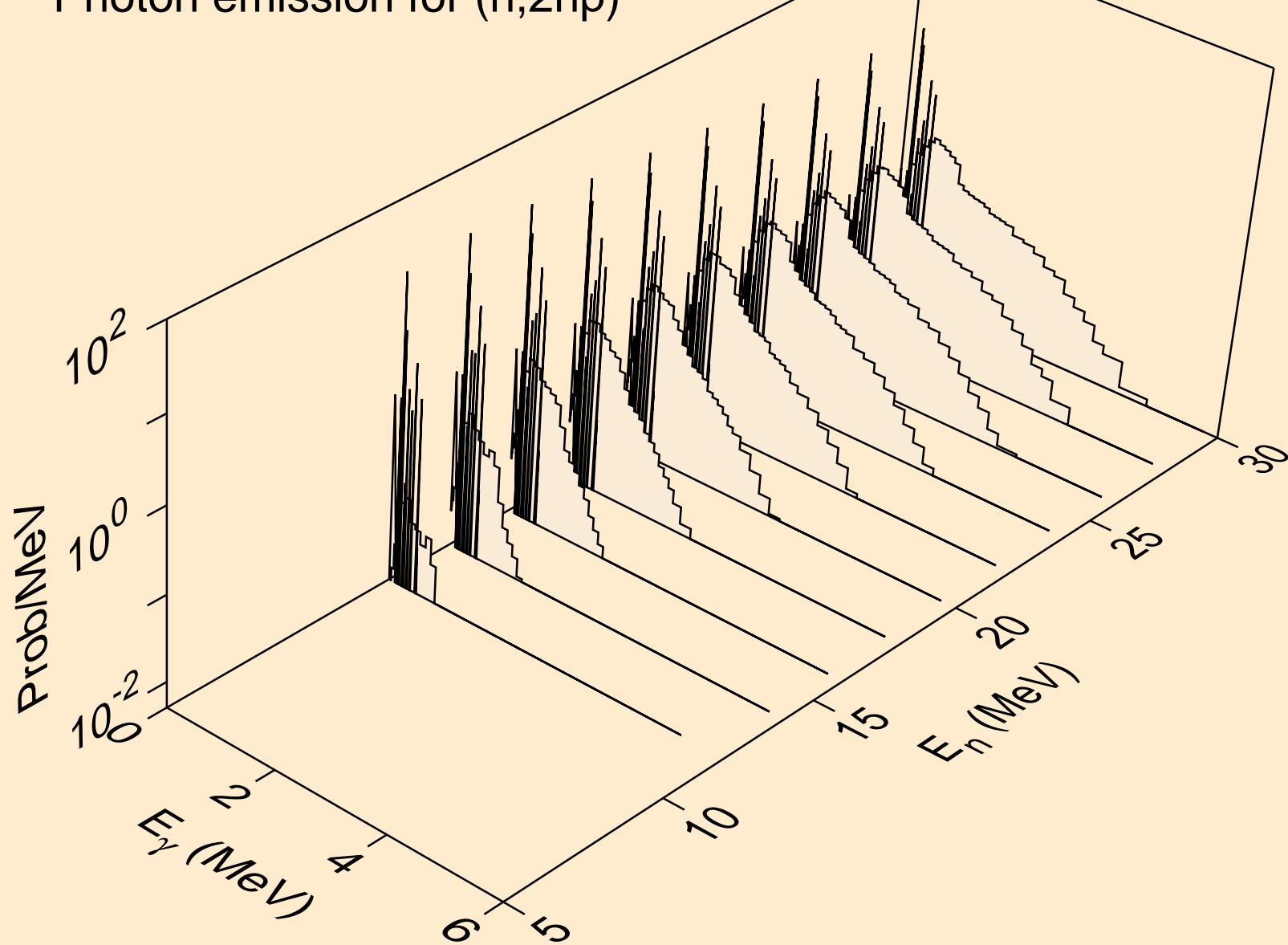

OS183 TRITON ACER TENDL-2021 LIBRARY; T=0.K  
Photon emission for (n,npa)

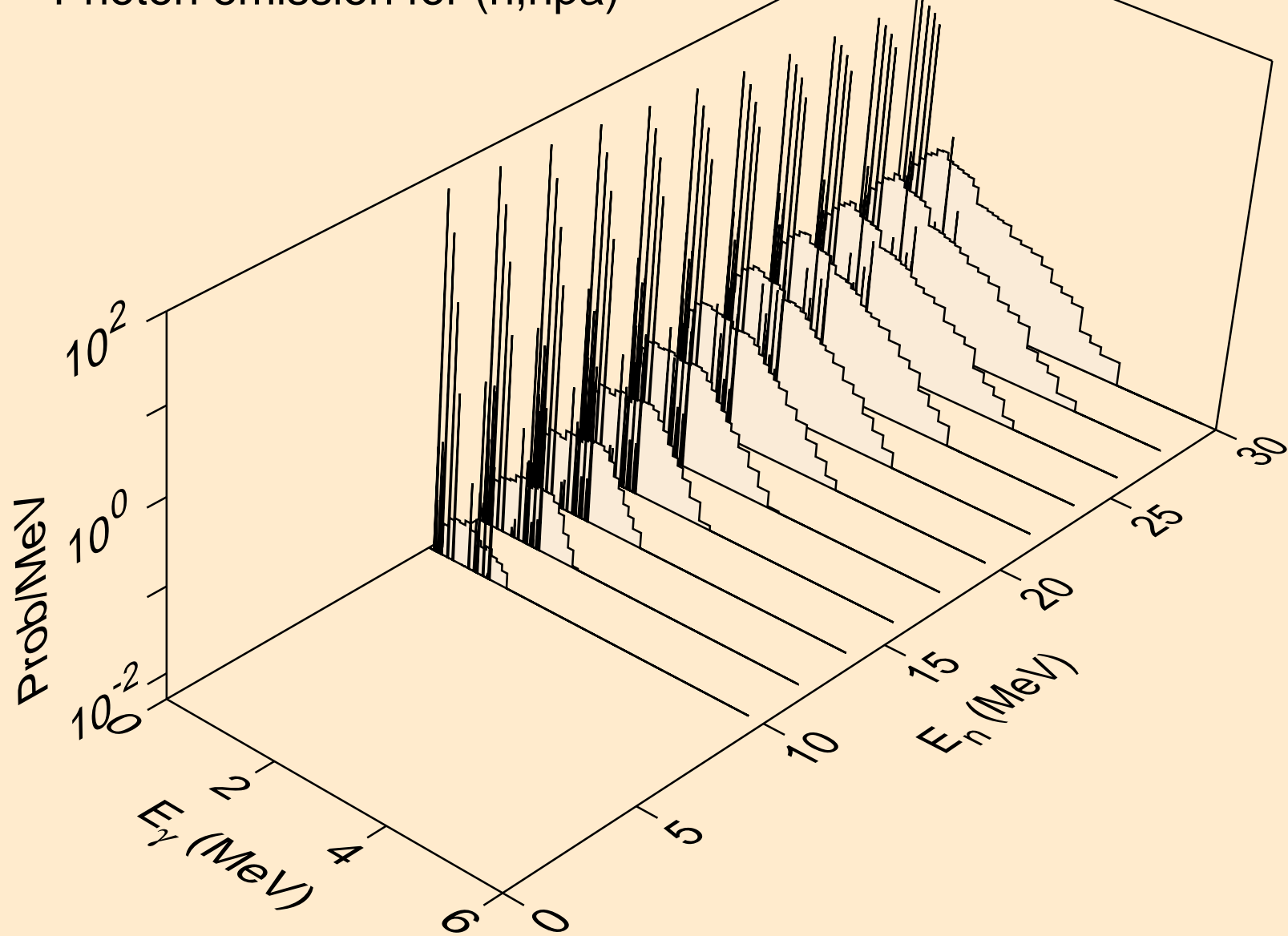



OS183 TRITON ACER TENDL-2021 LIBRARY; T=0.K  
Photon emission for (n,gma)

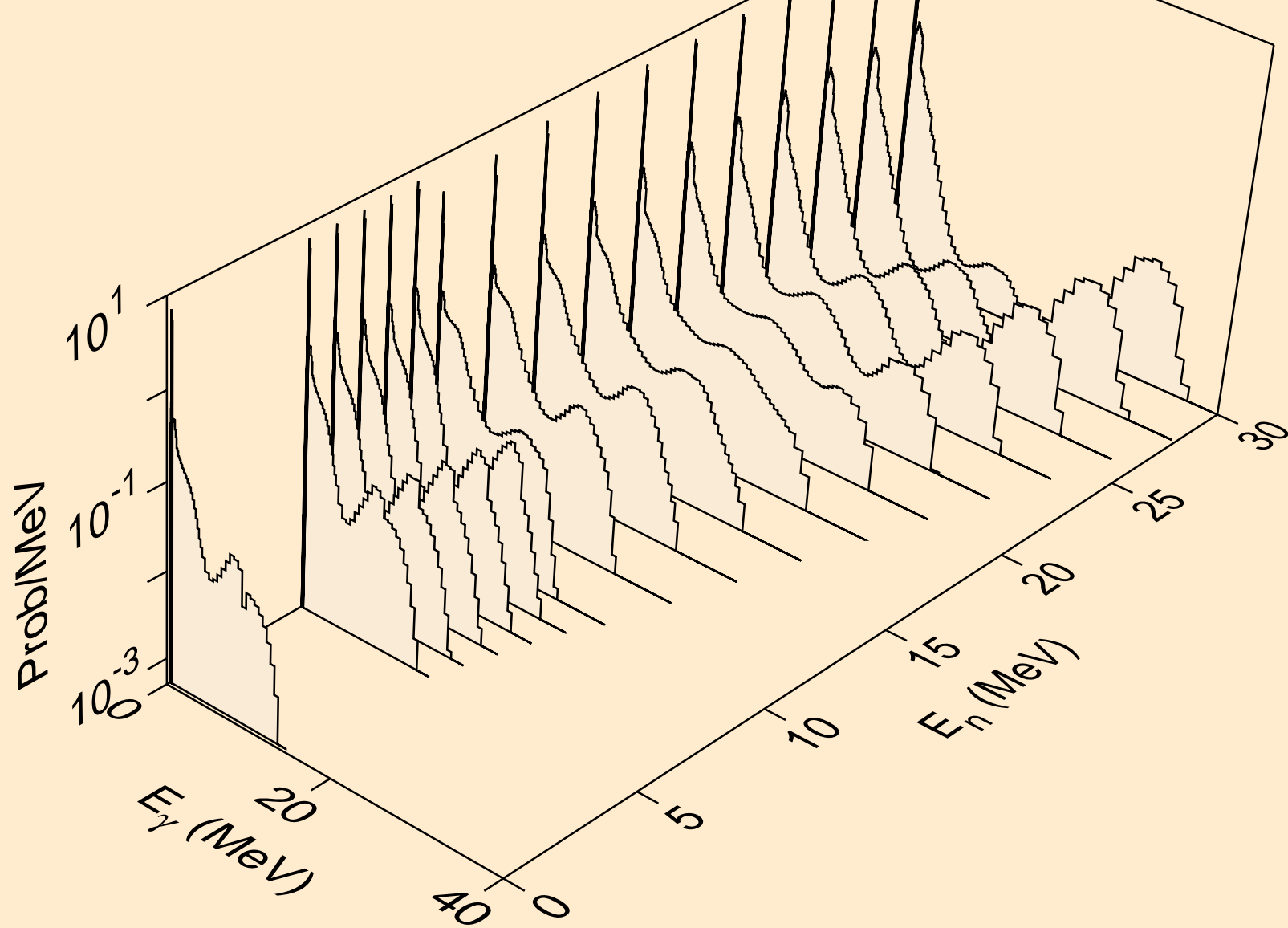

OS183 TRITON ACER TENDL-2021 LIBRARY; T=0.K  
Photon emission for (n,p)

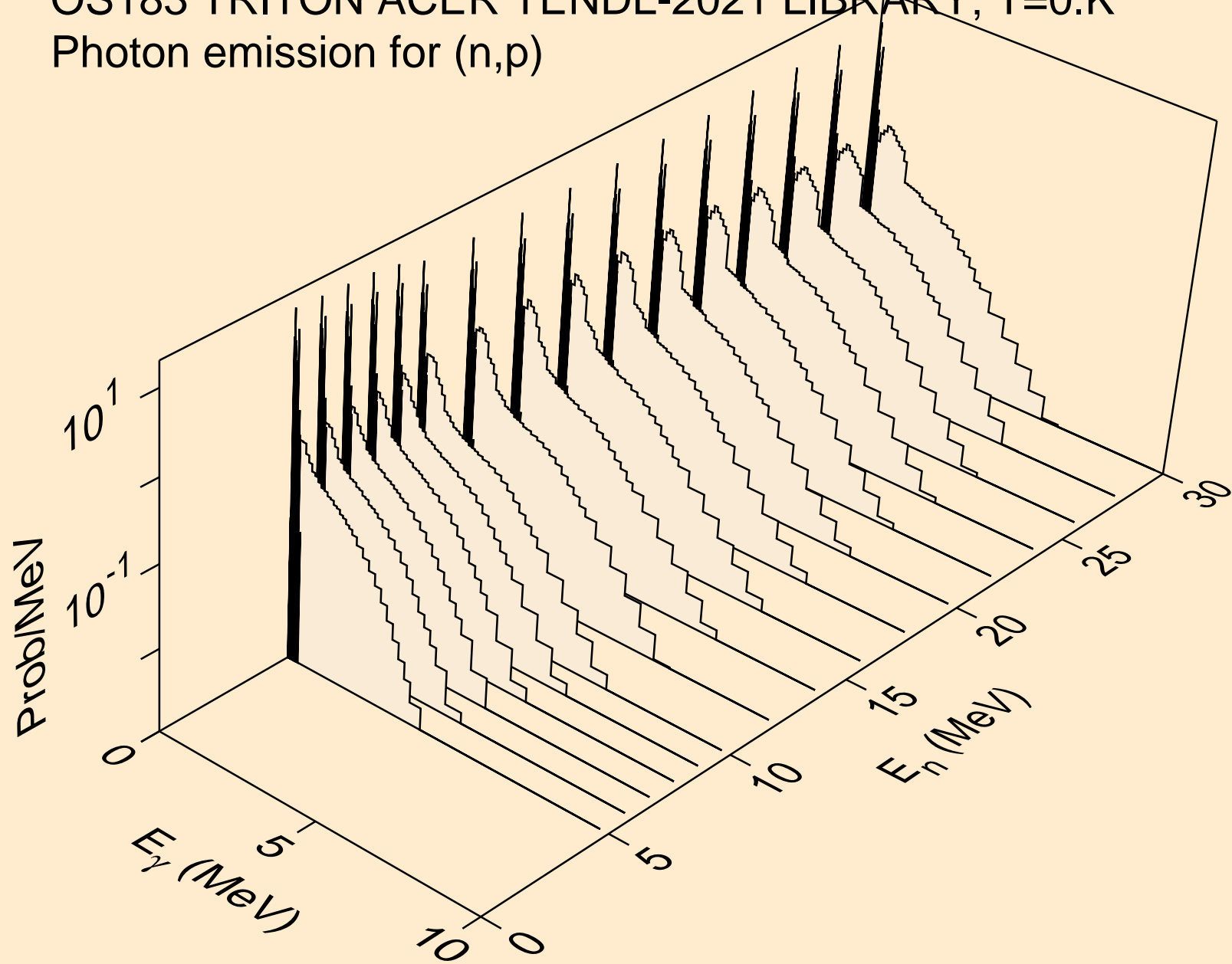

OS183 TRITON ACER TENDL-2021 LIBRARY; T=0.K  
Photon emission for (n,d)

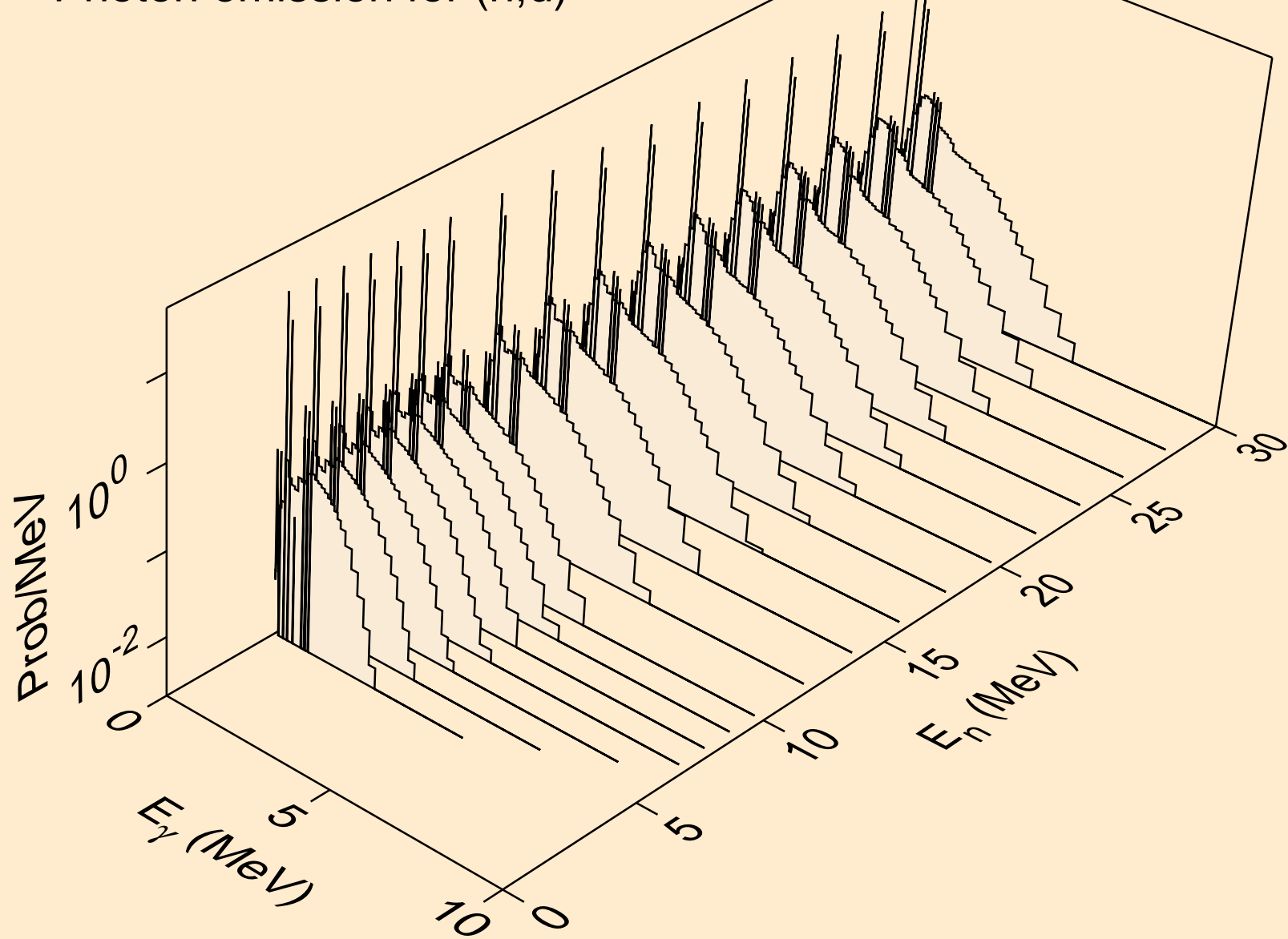

OS183 TRITON ACER TENDL-2021 LIBRARY; T=0.K  
Photon emission for inelastic

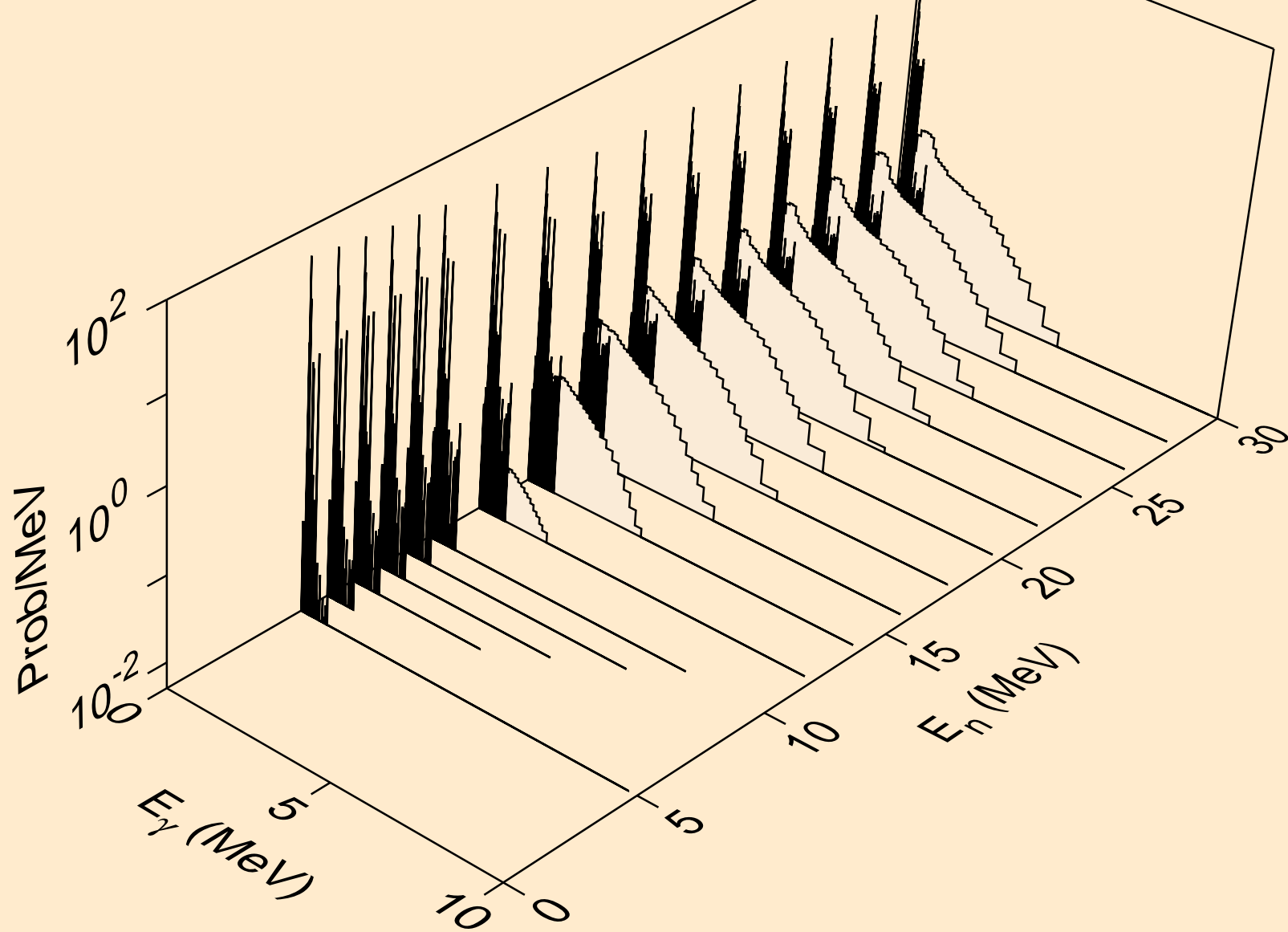

OS183 TRITON ACER TENDL-2021 LIBRARY; T=0.K  
Photon emission for (n,he3)

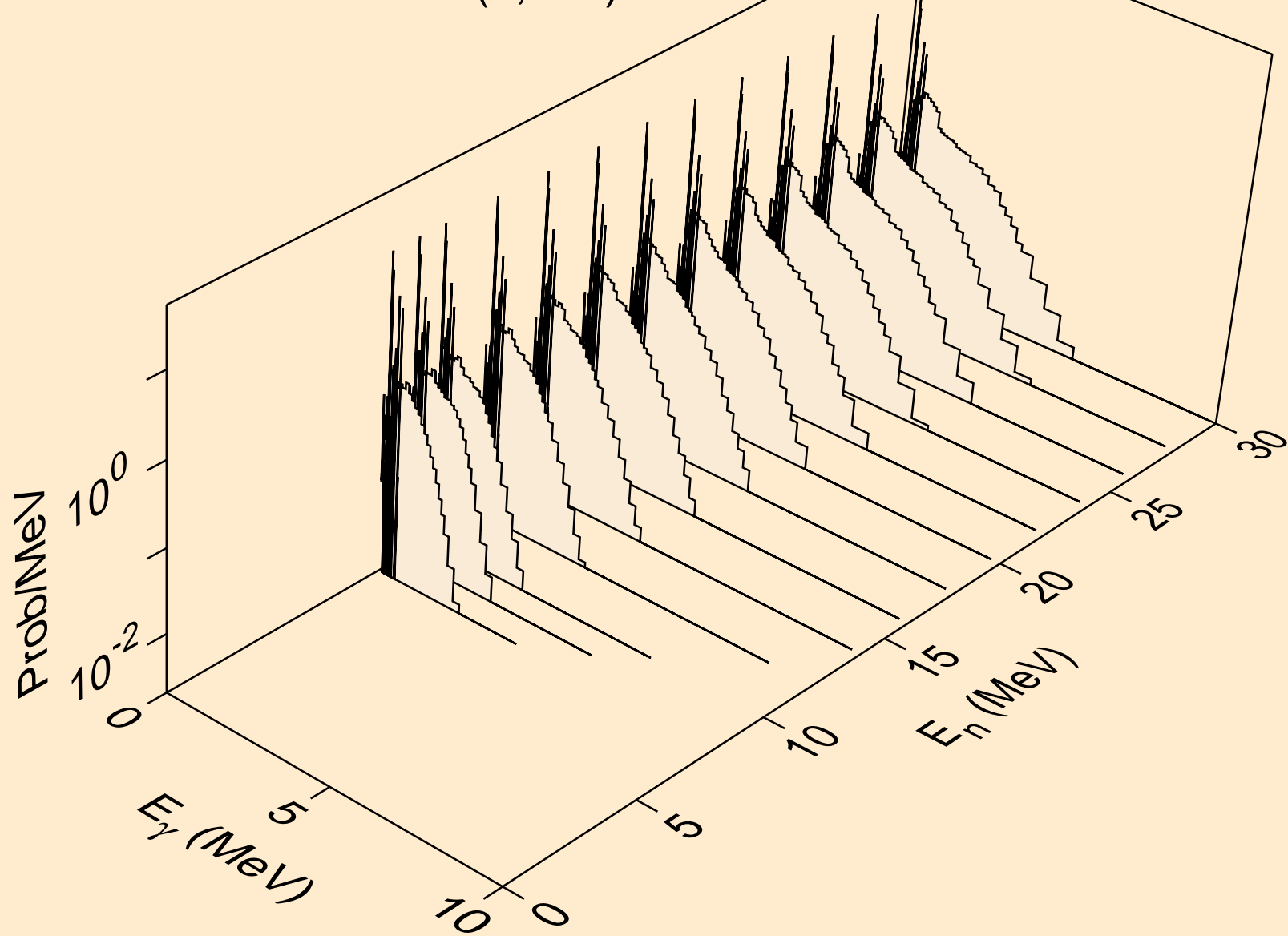

OS183 TRITON ACER TENDL-2021 LIBRARY; T=0.K  
Photon emission for (n,a)

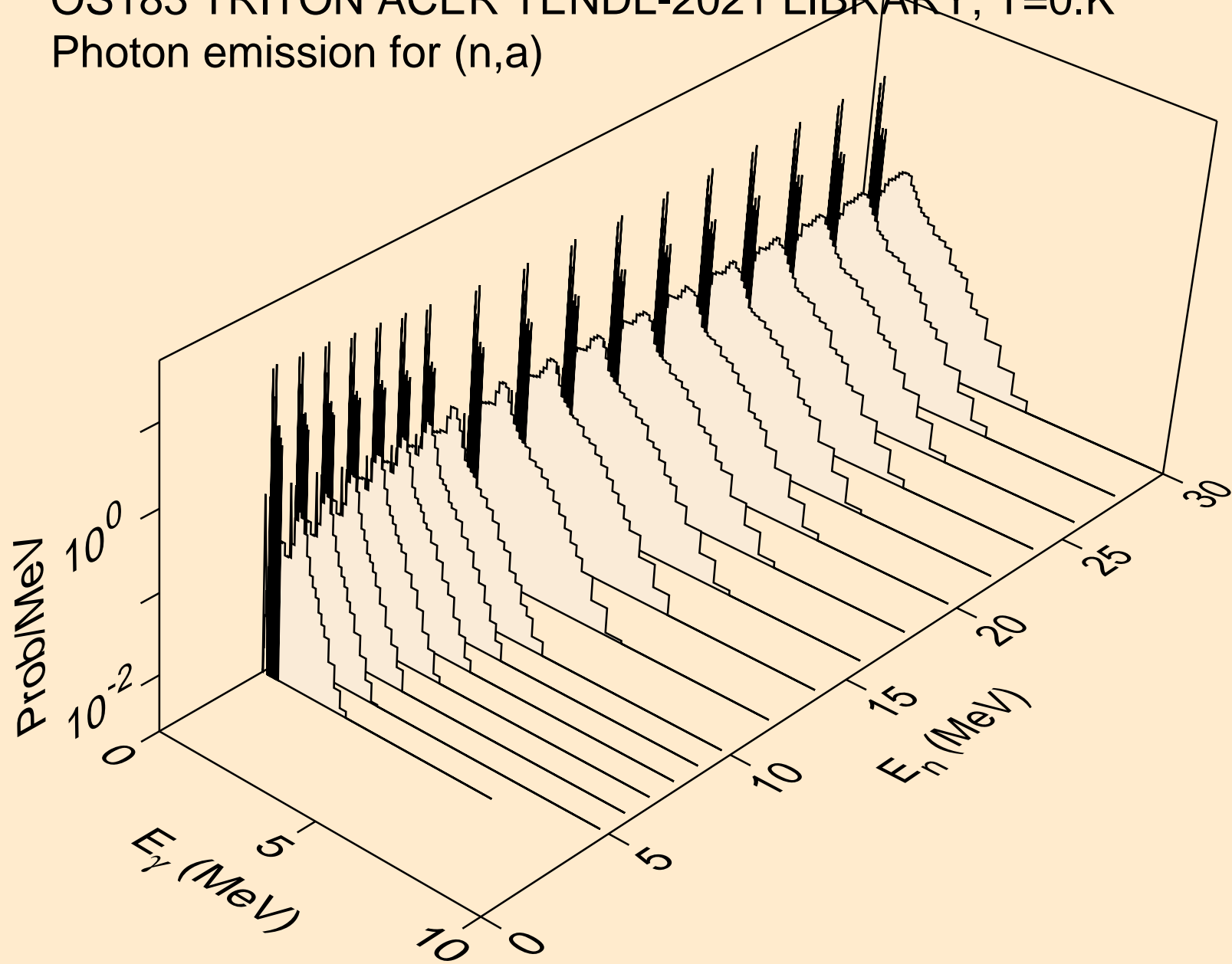

OS183 TRITON ACER TENDL-2021 LIBRARY; T=0.K  
Photon emission for (n,2a)

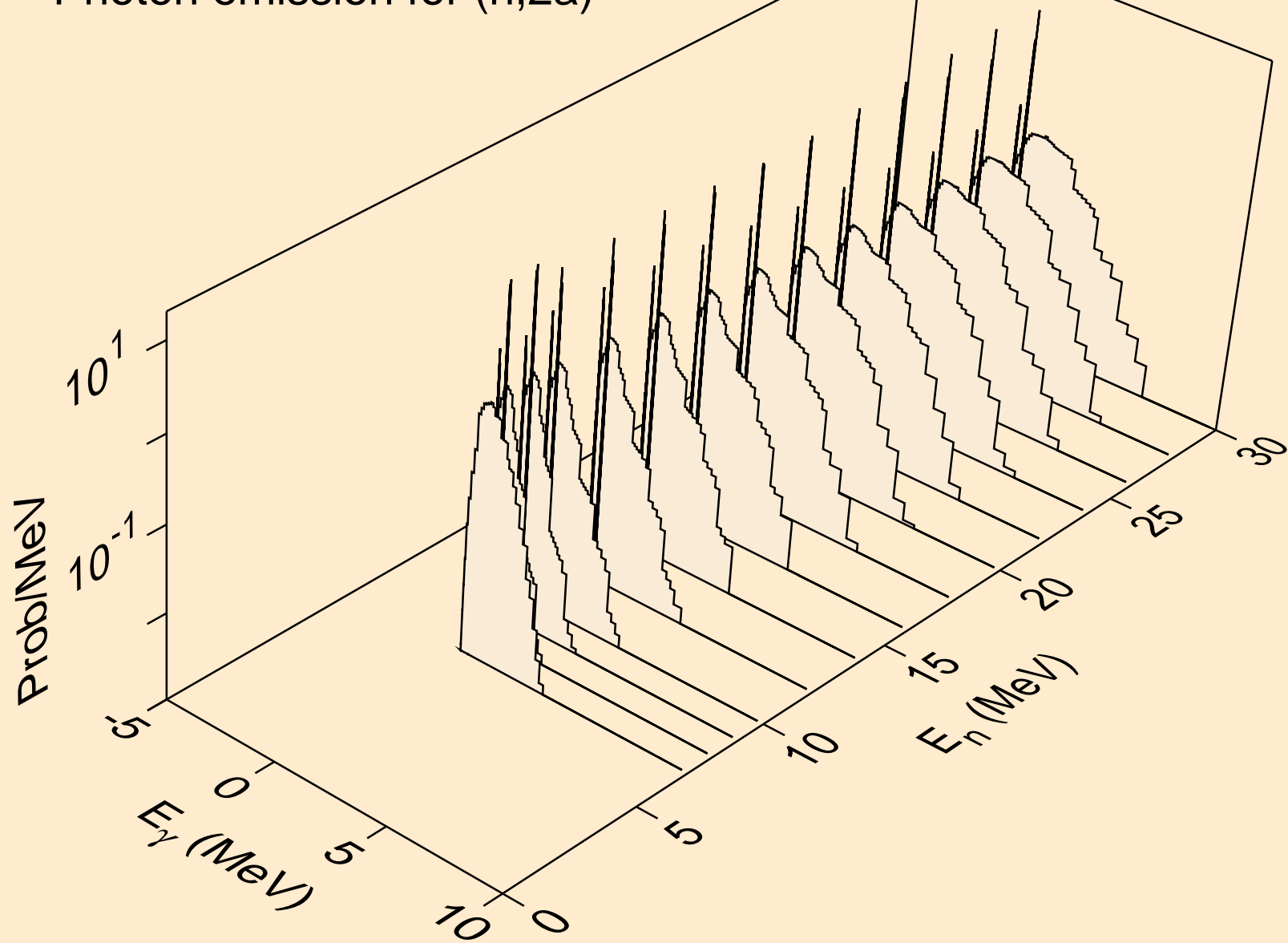

OS183 TRITON ACER TENDL-2021 LIBRARY; T=0.K  
Photon emission for (n,2p)

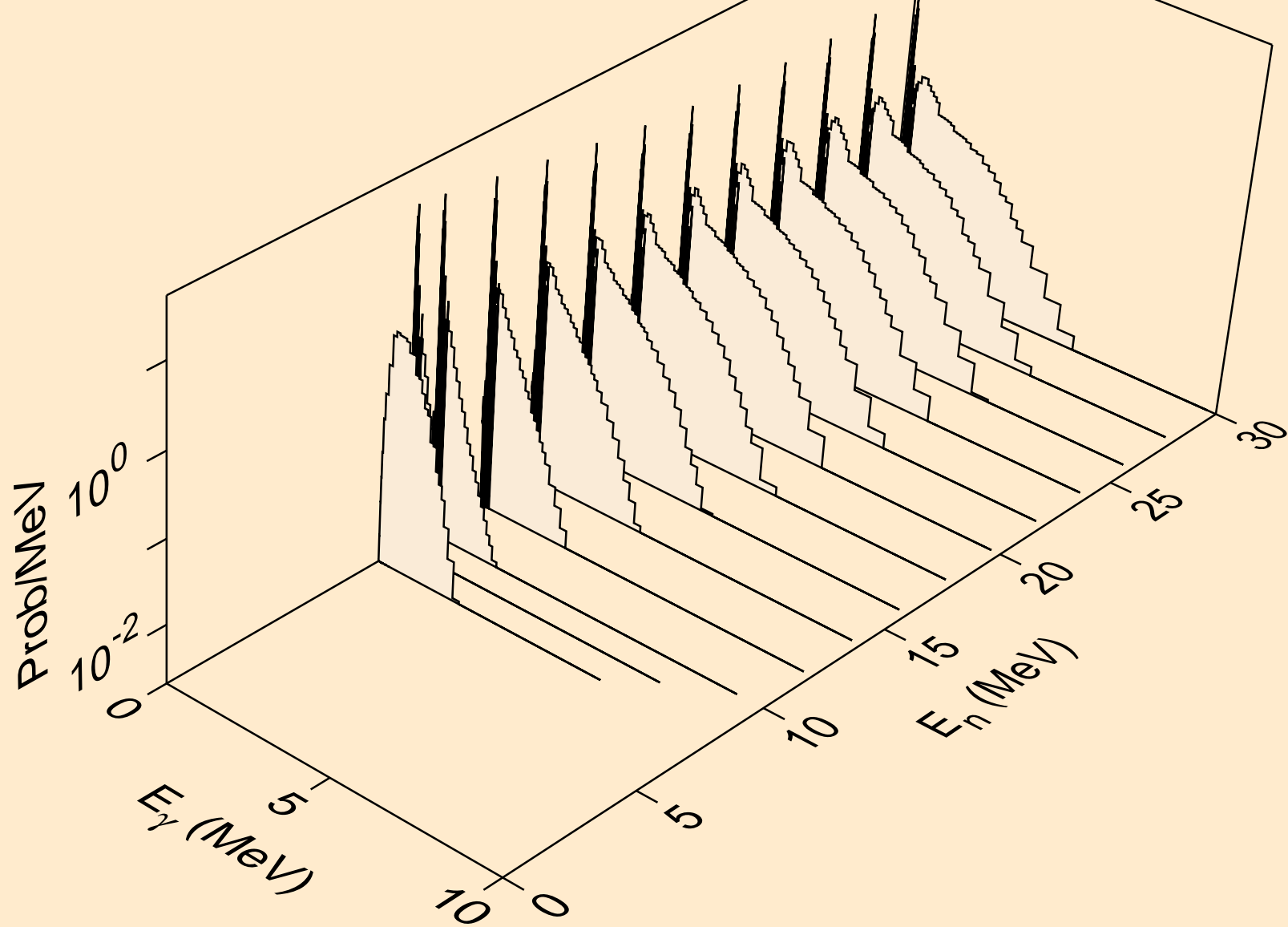



OS183 TRITON ACER TENDL-2021 LIBRARY; T=0.K  
Photon emission for (n,p)

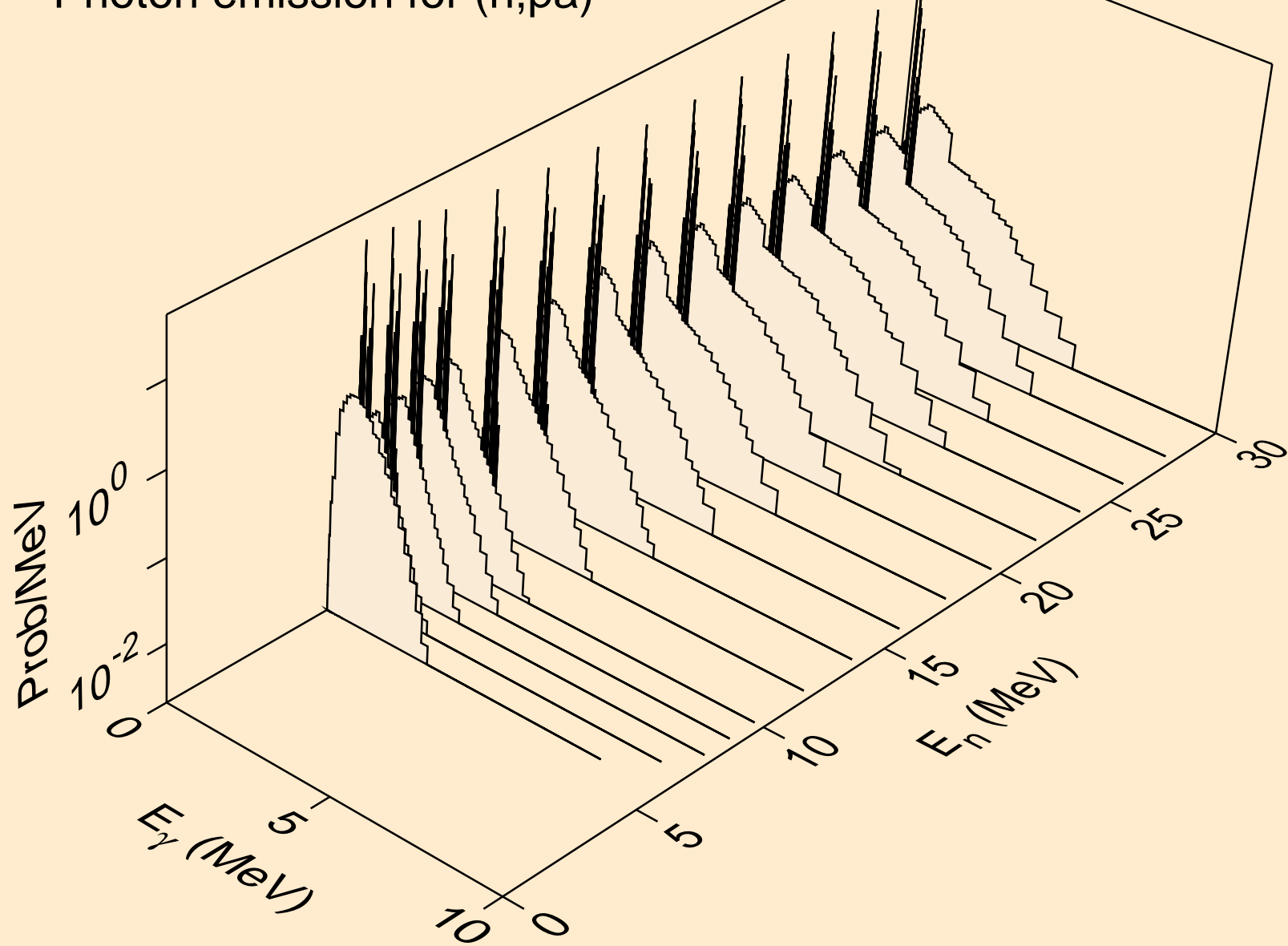

OS183 TRITON ACER TENDL-2021 LIBRARY; T=0.K  
Photon emission for (n,pd)

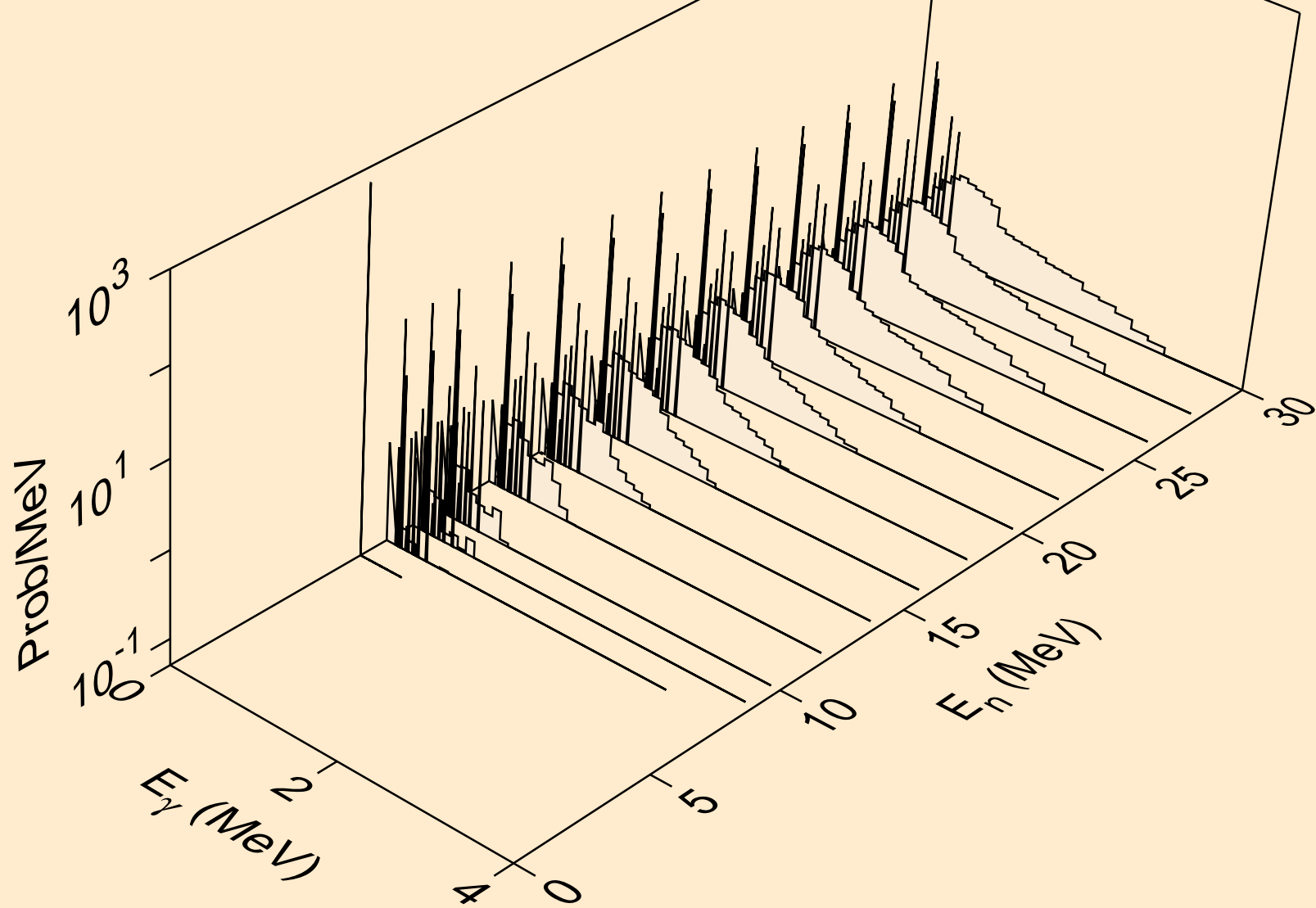

OS183 TRITON ACER TENDL-2021 LIBRARY; T=0.K  
Photon emission for (n,pt)

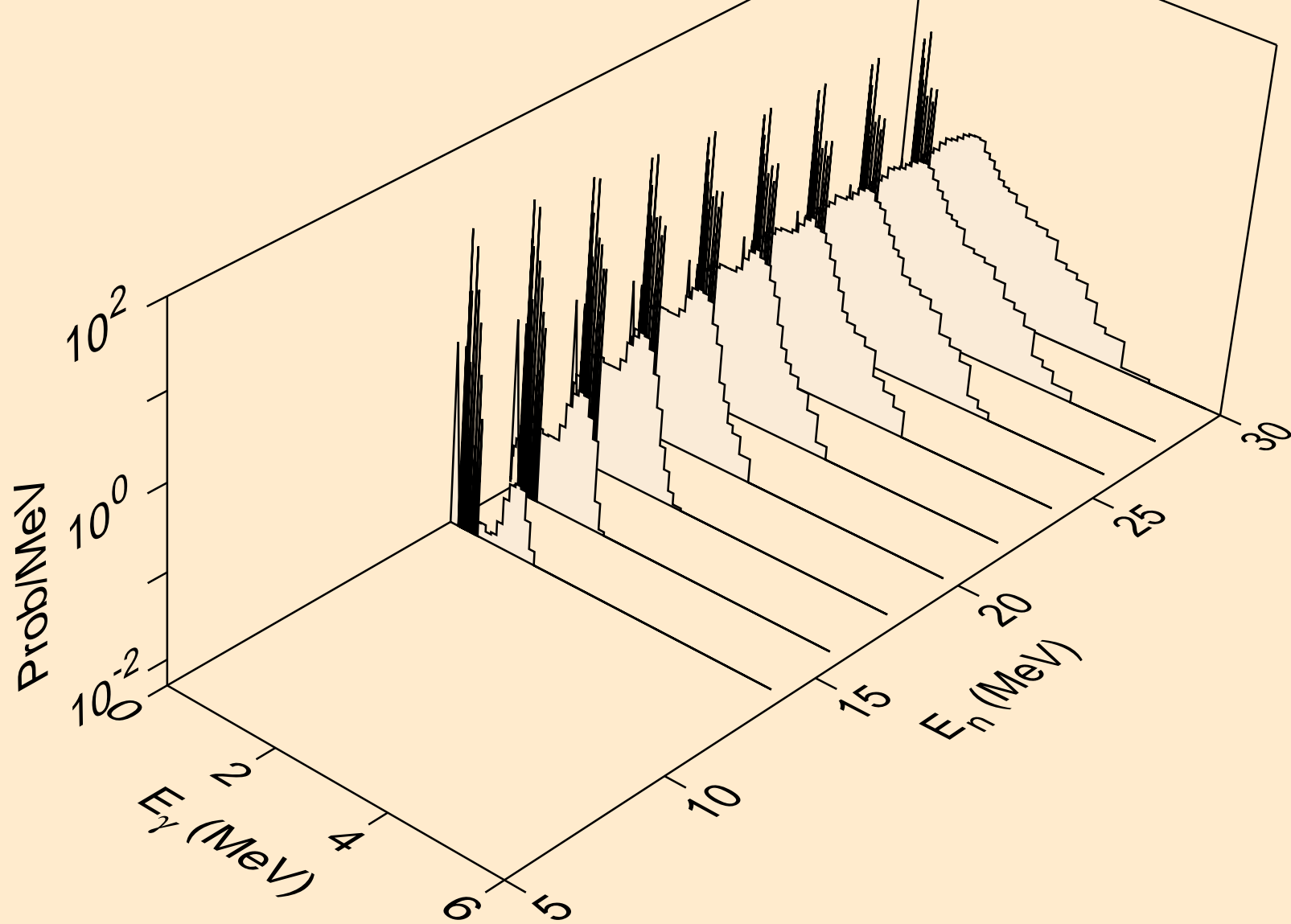

OS183 TRITON ACER TENDL-2021 LIBRARY; T=0.K  
Photon emission for (n,da)

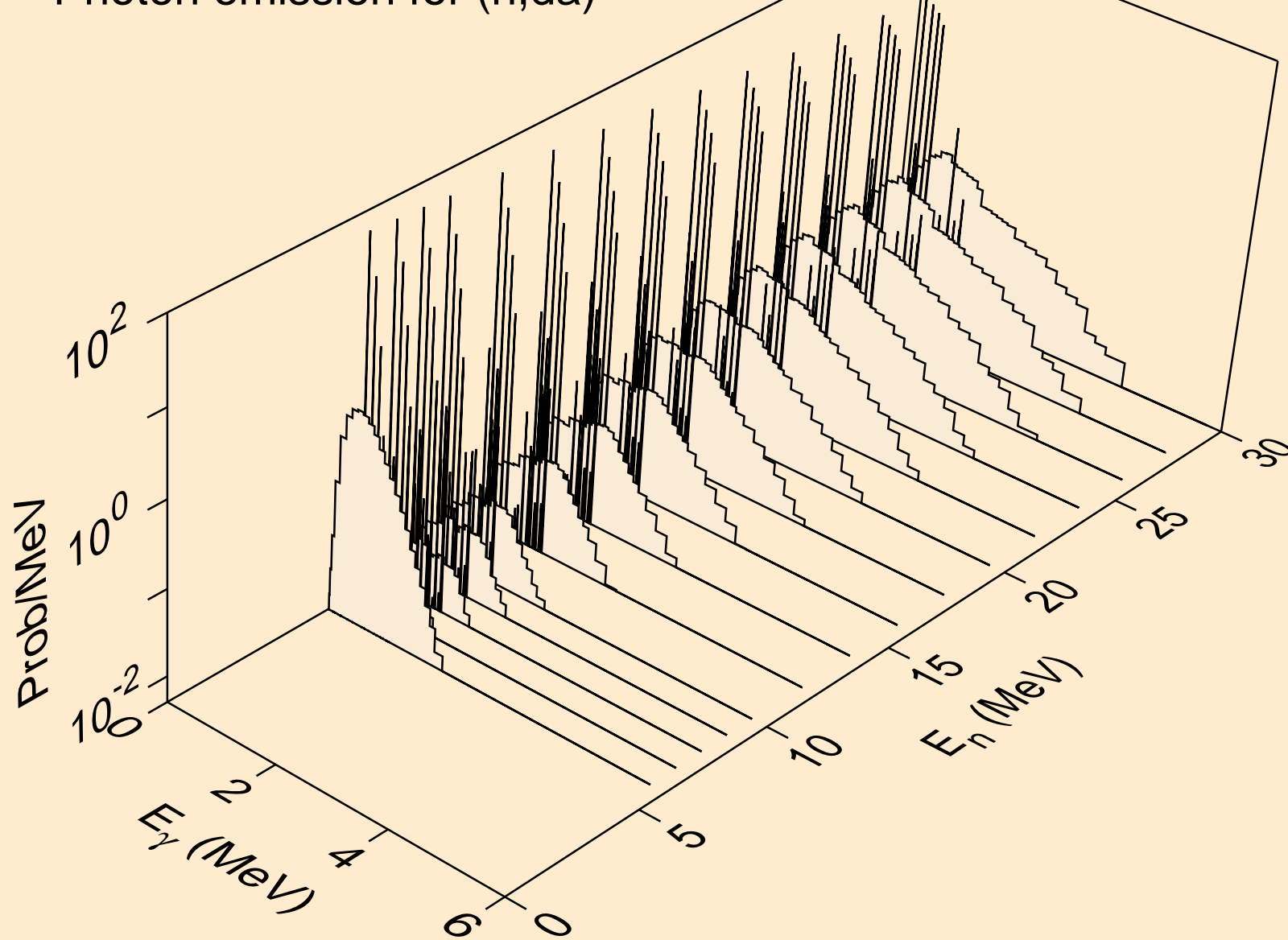

OS183 TRITON ACER TENDL-2021 LIBRARY; T=0.K  
Particle heating contributions

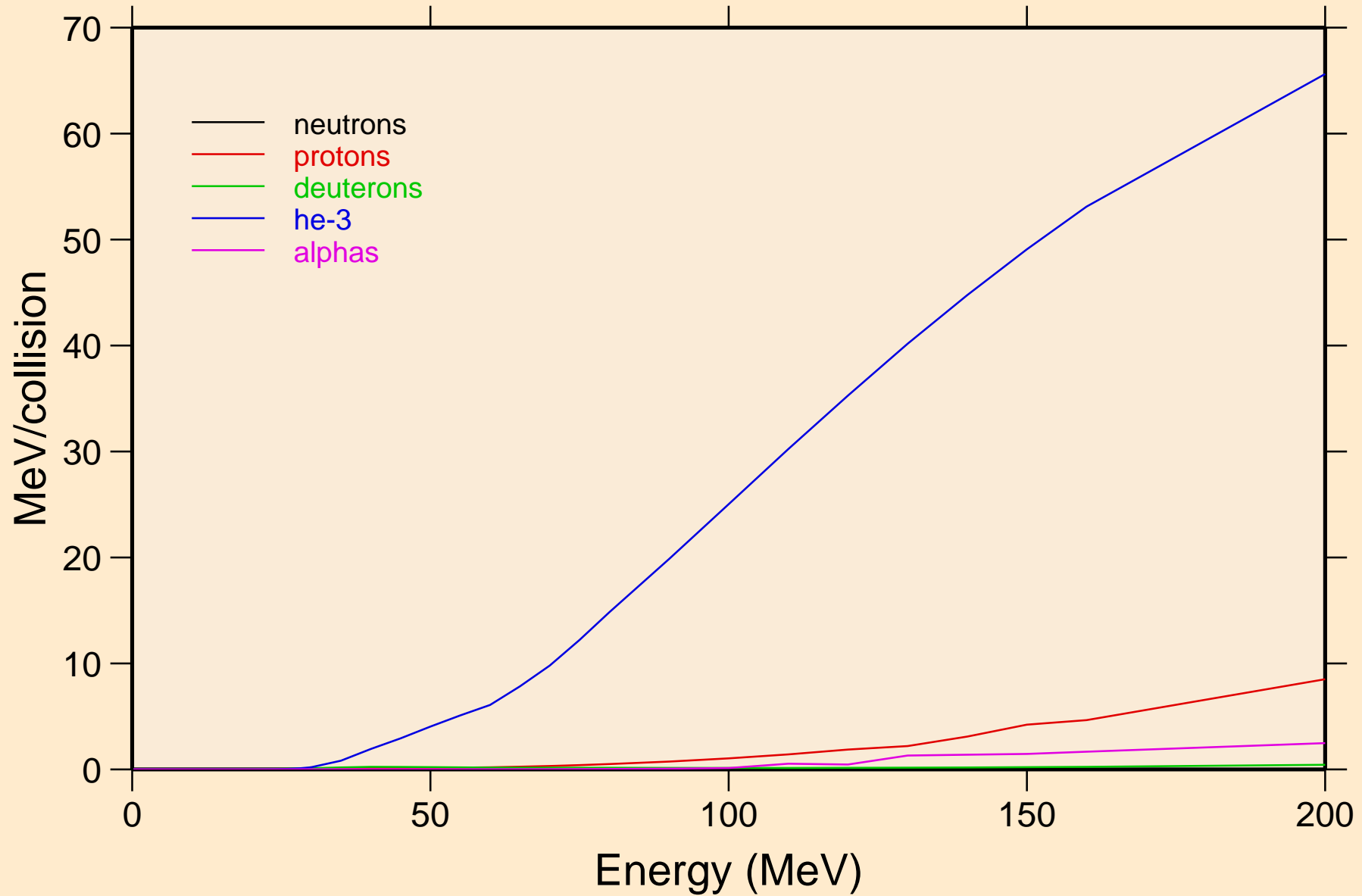

OS183 TRITON ACER TENDL-2021 LIBRARY; T=0.K  
Recoil Heating

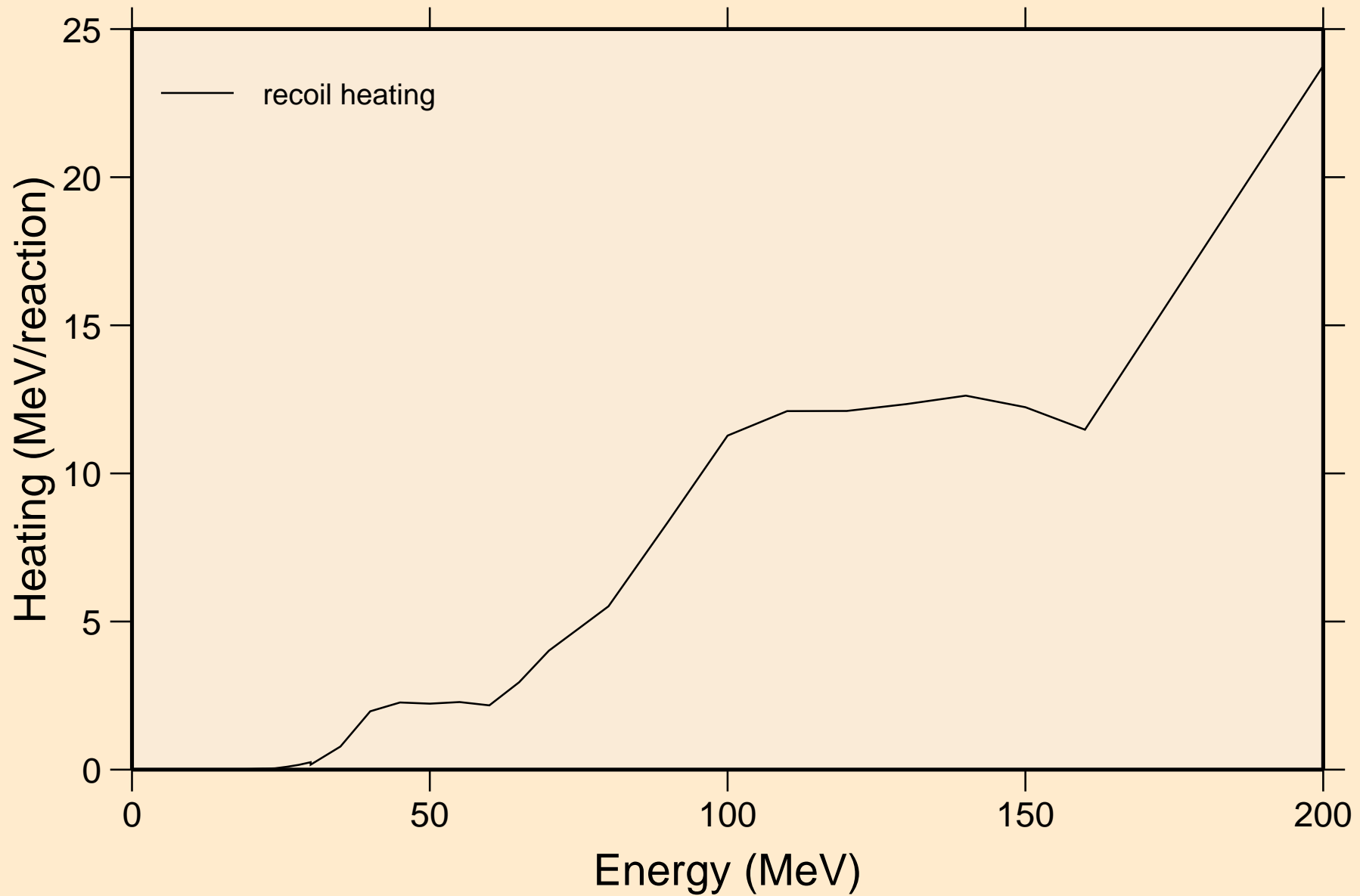

OS183 TRITON ACER TENDL-2021 LIBRARY; T=0.K  
Particle production cross sections

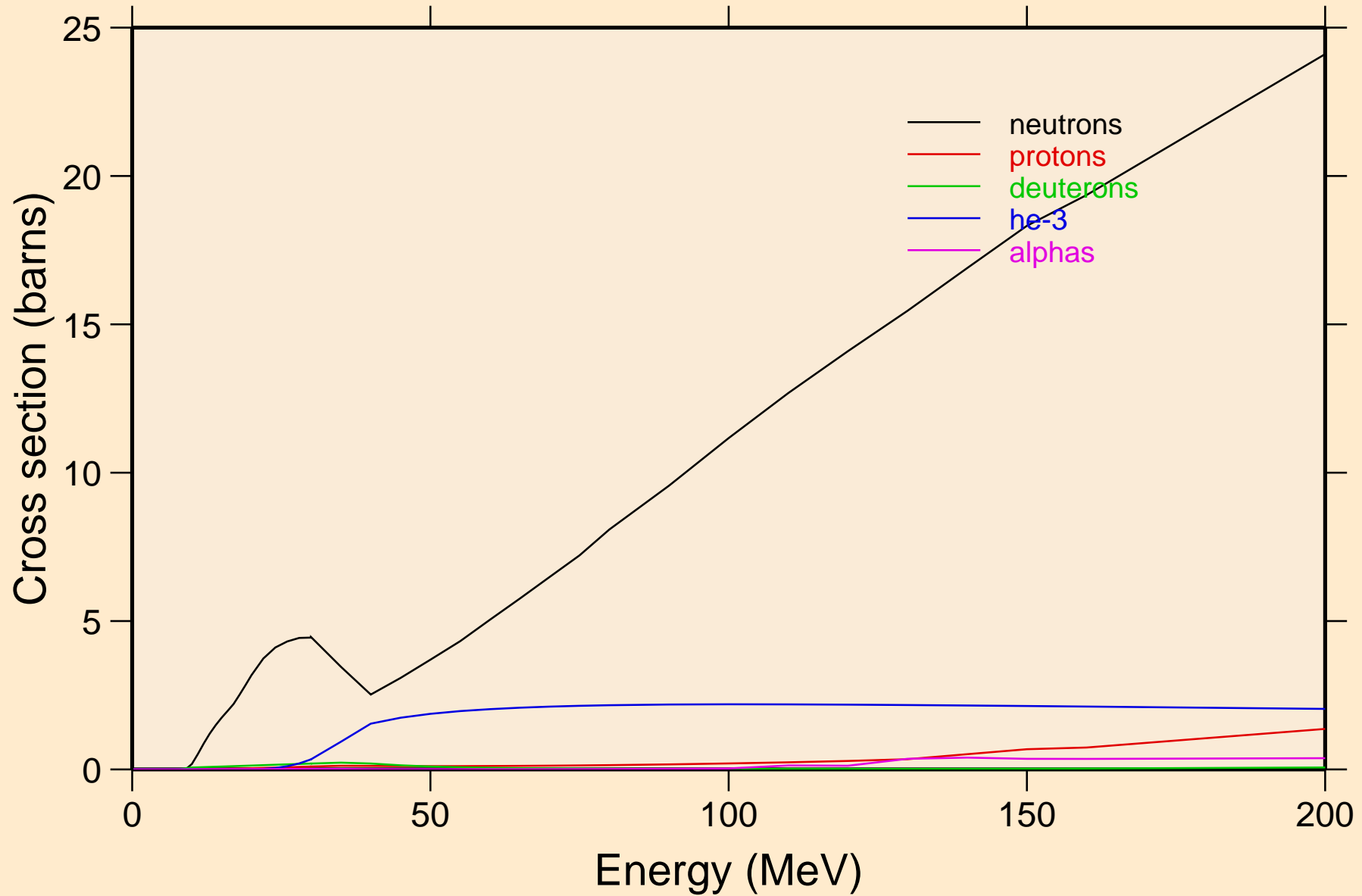

OS183 TRITON ACER TENDL-2021 LIBRARY; T=0.K  
neutrons from (t,n)

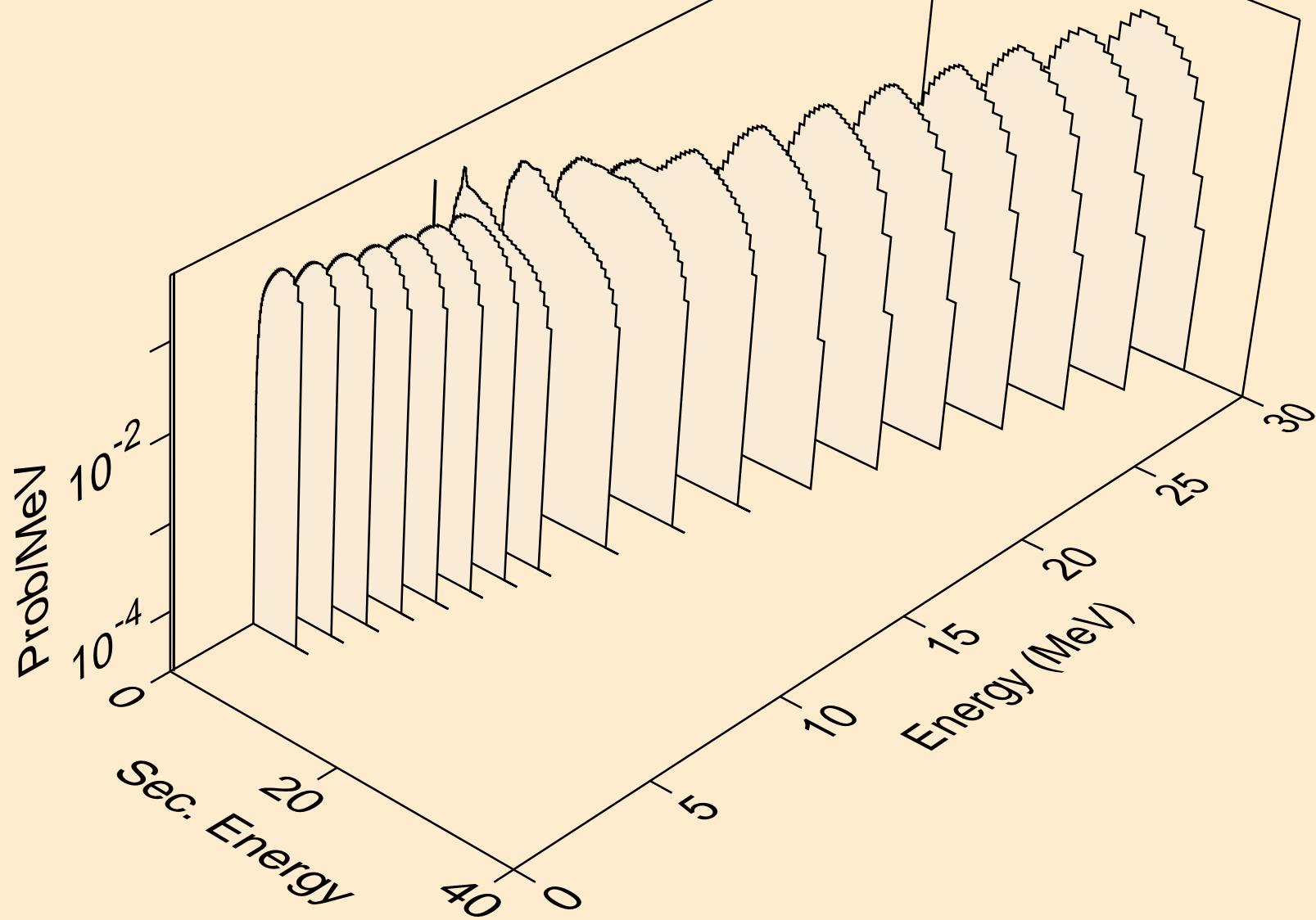



OS183 TRITON ACER TENDL-2021 LIBRARY; T=0.K  
neutrons from (t,x)

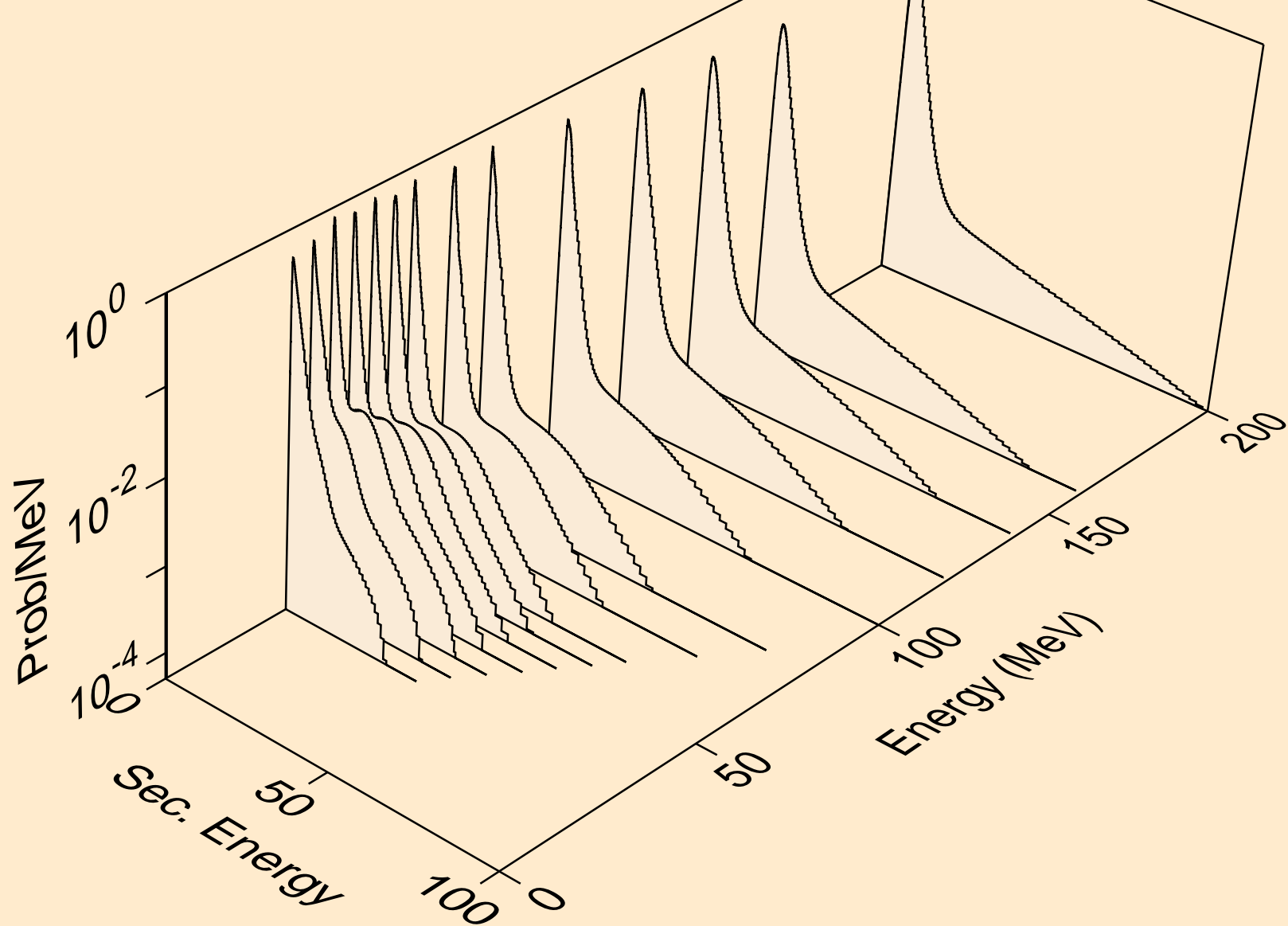

OS183 TRITON ACER TENDL-2021 LIBRARY; T=0.K  
neutrons from (t,2nd)

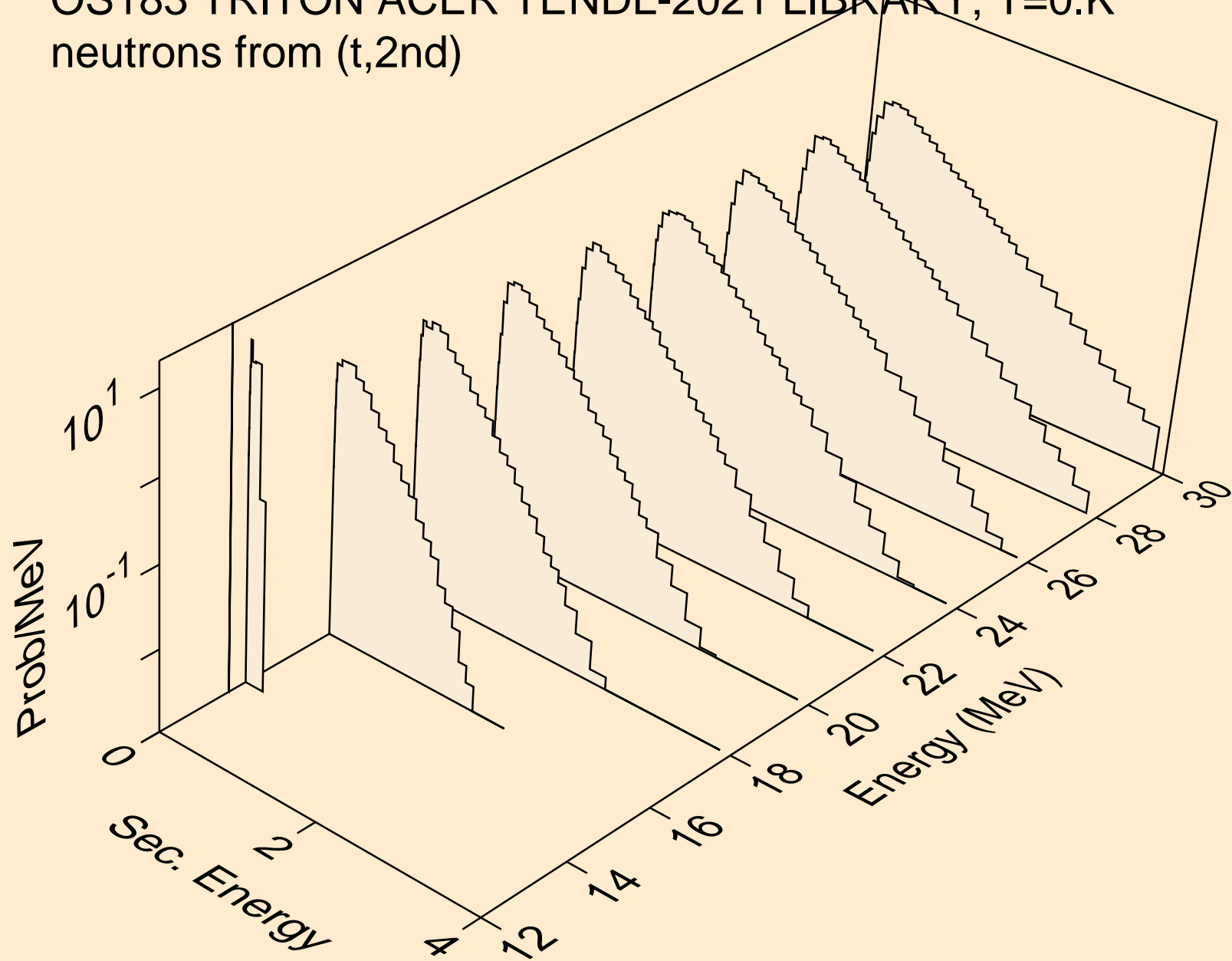

OS183 TRITON ACER TENDL-2021 LIBRARY; T=0.K  
neutrons from (t,2n)

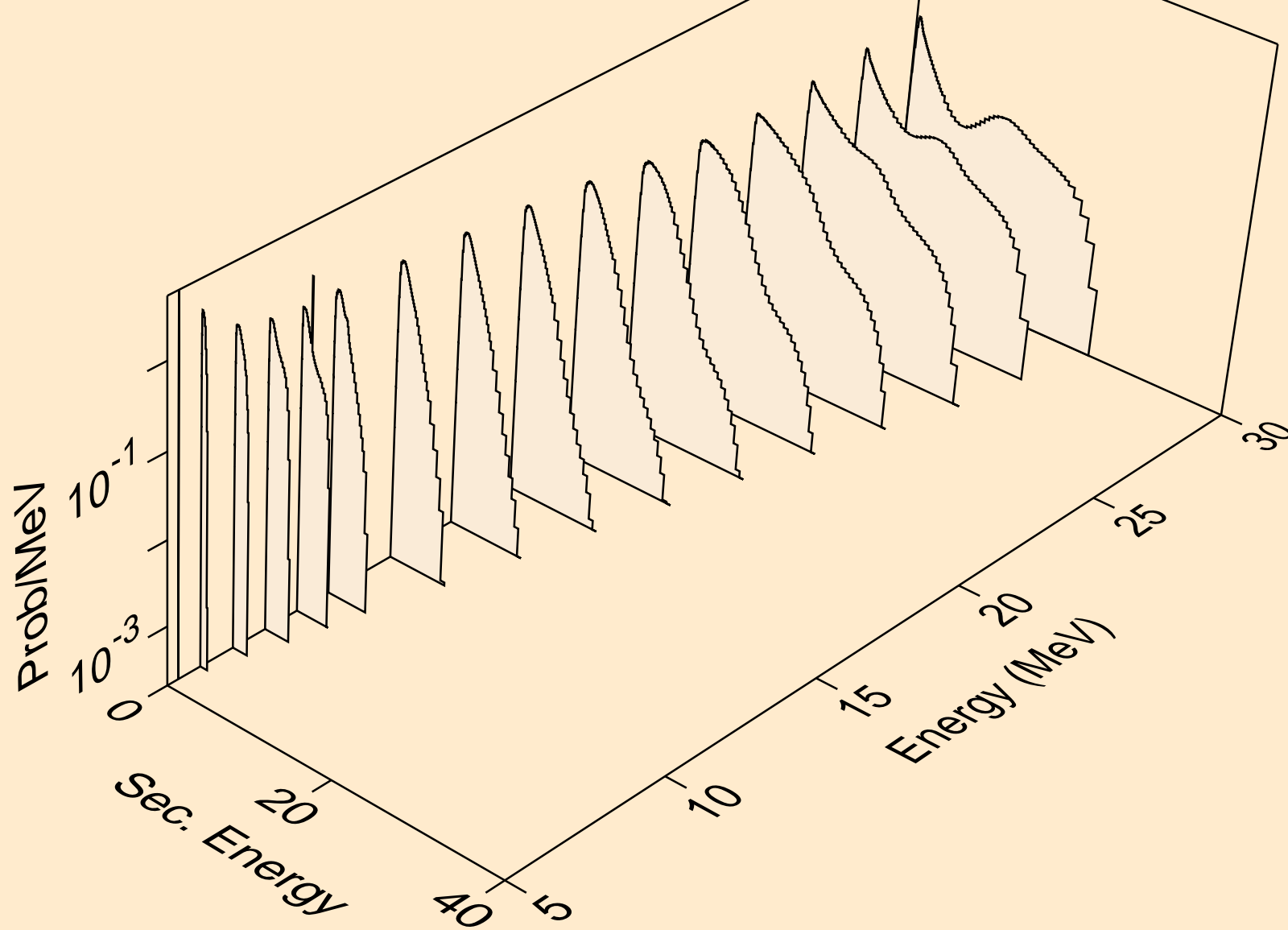

OS183 TRITON ACER TENDL-2021 LIBRARY; T=0.K  
neutrons from (t,3n)

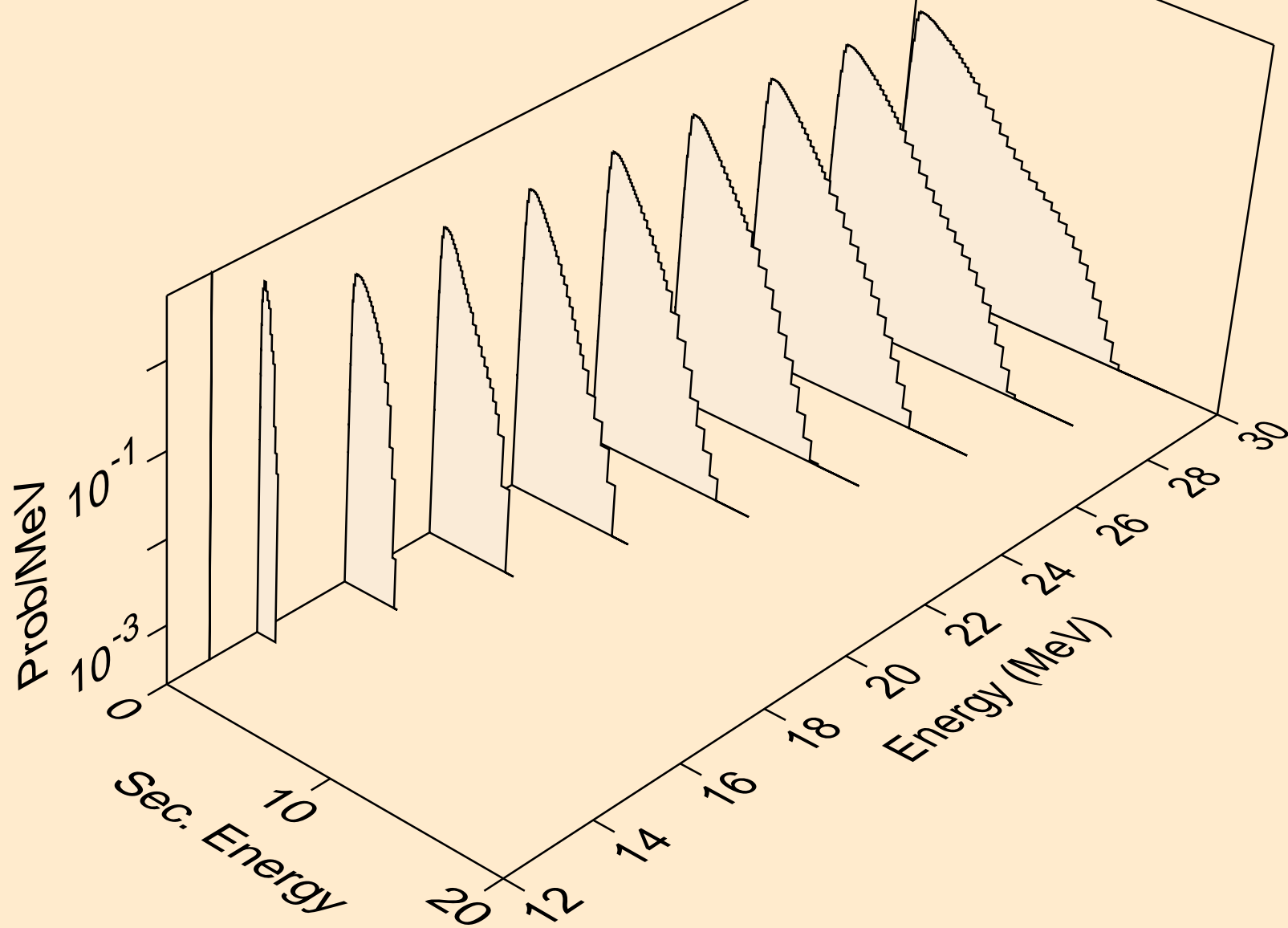

OS183 TRITON ACER TENDL-2021 LIBRARY; T=0.K  
neutrons from (t,n\*)a

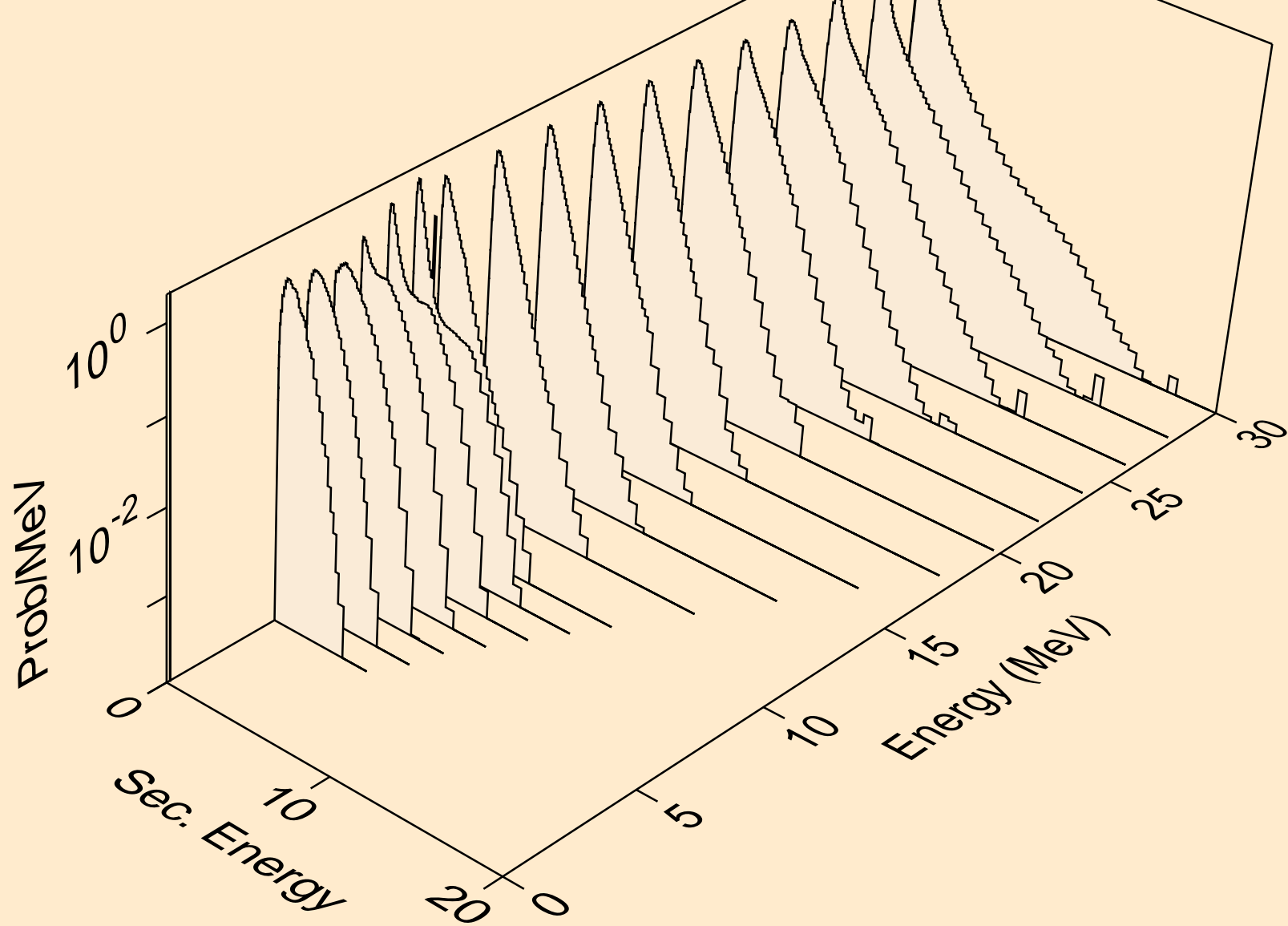

OS183 TRITON ACER TENDL-2021 LIBRARY; T=0.K  
neutrons from (t,2n)a

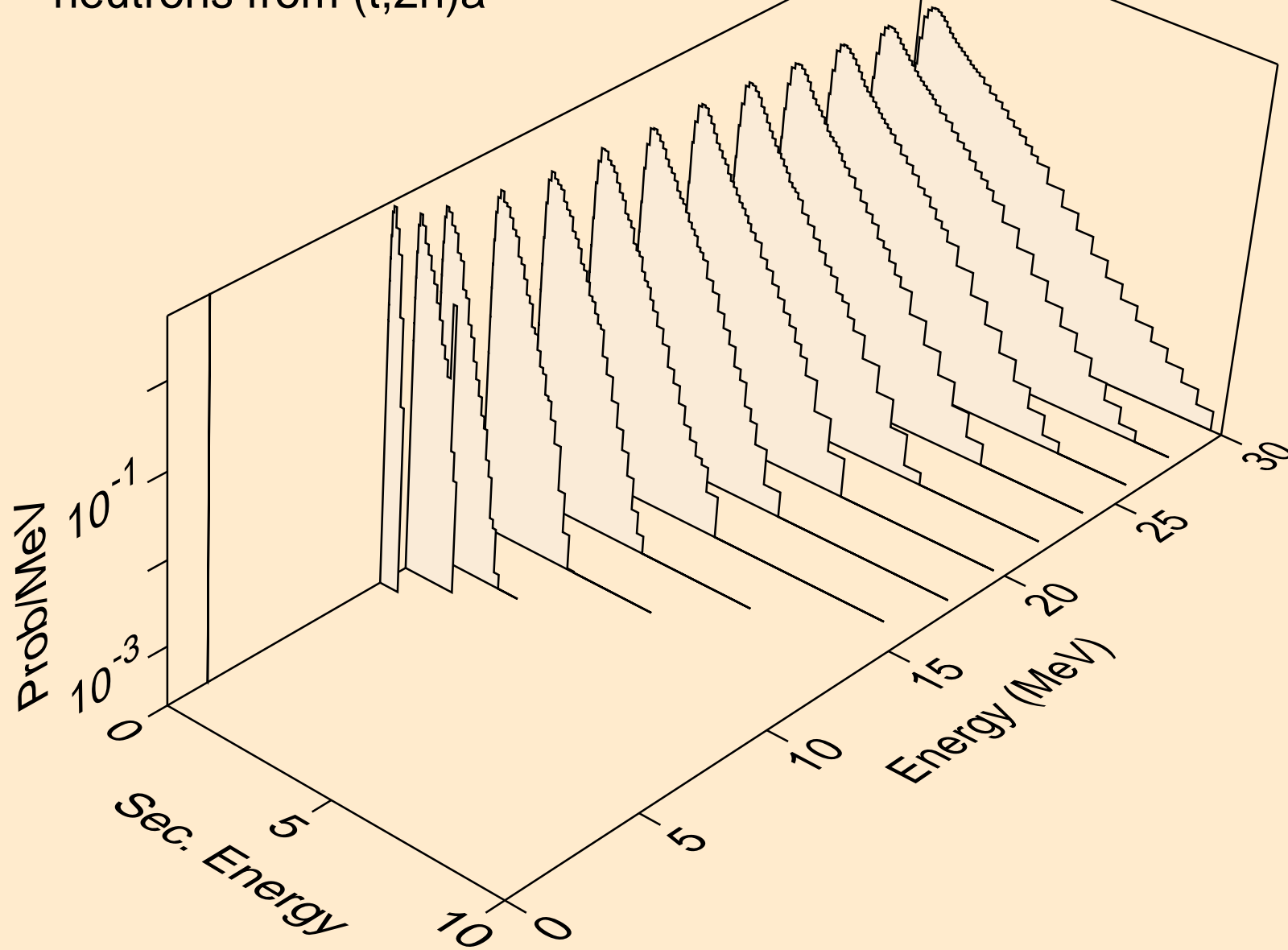

OS183 TRITON ACER TENDL-2021 LIBRARY; T=0.K  
neutrons from (t,3n)a

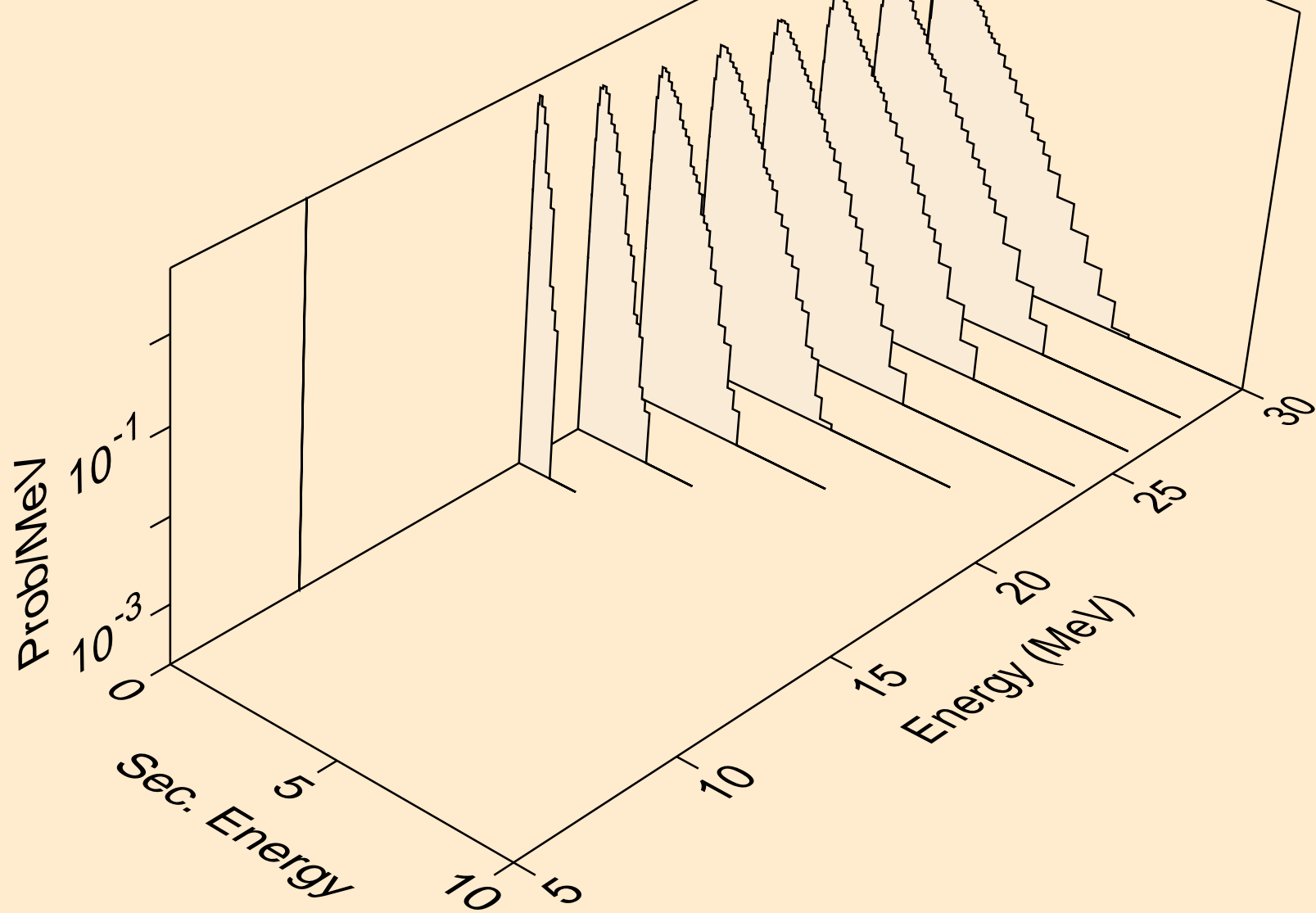

OS183 TRITON ACER TENDL-2021 LIBRARY; T=0.K  
neutrons from (t,n\*)p

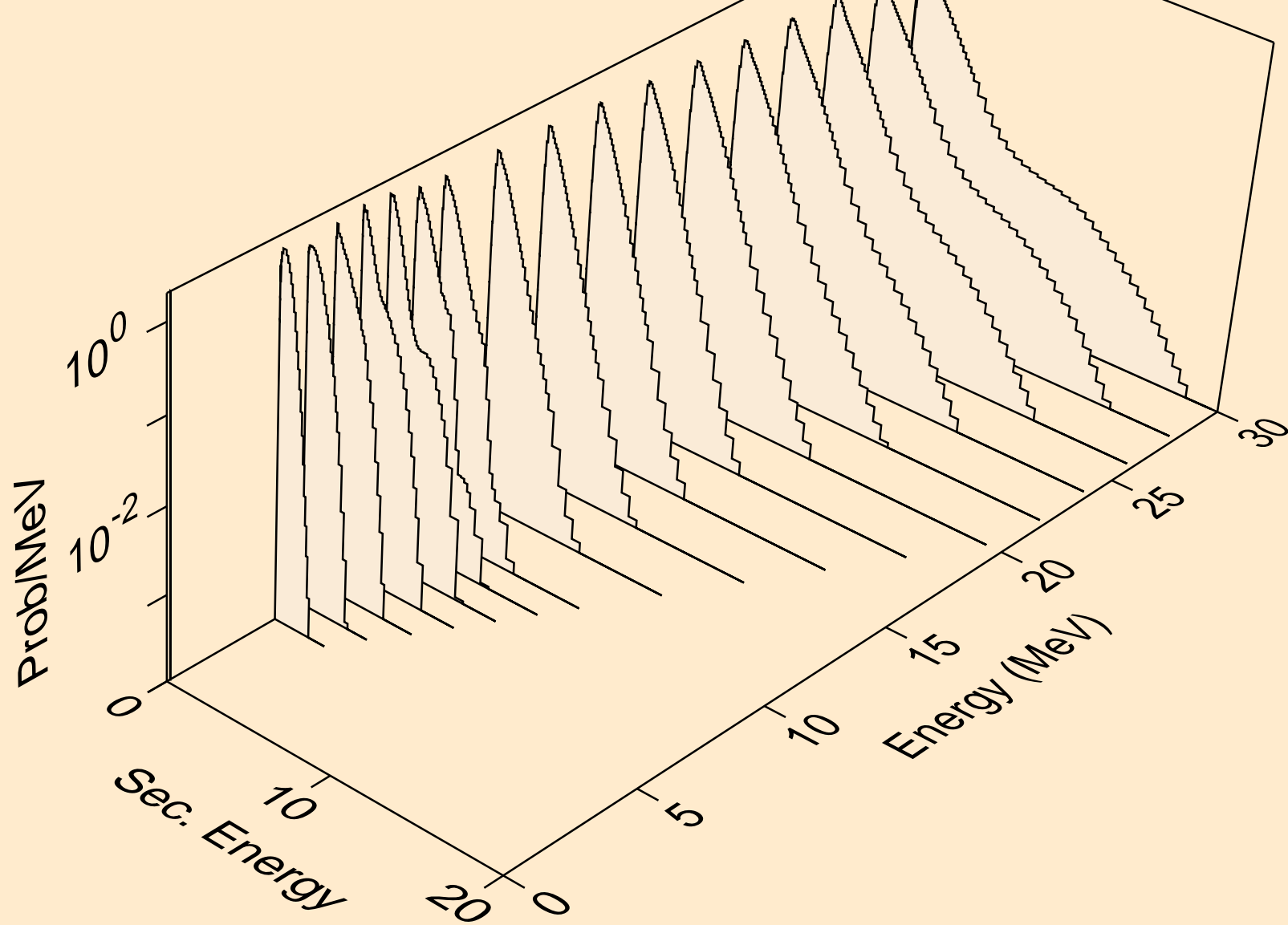



OS183 TRITON ACER TENDL-2021 LIBRARY; T=0.K  
neutrons from (t,n\*)2a

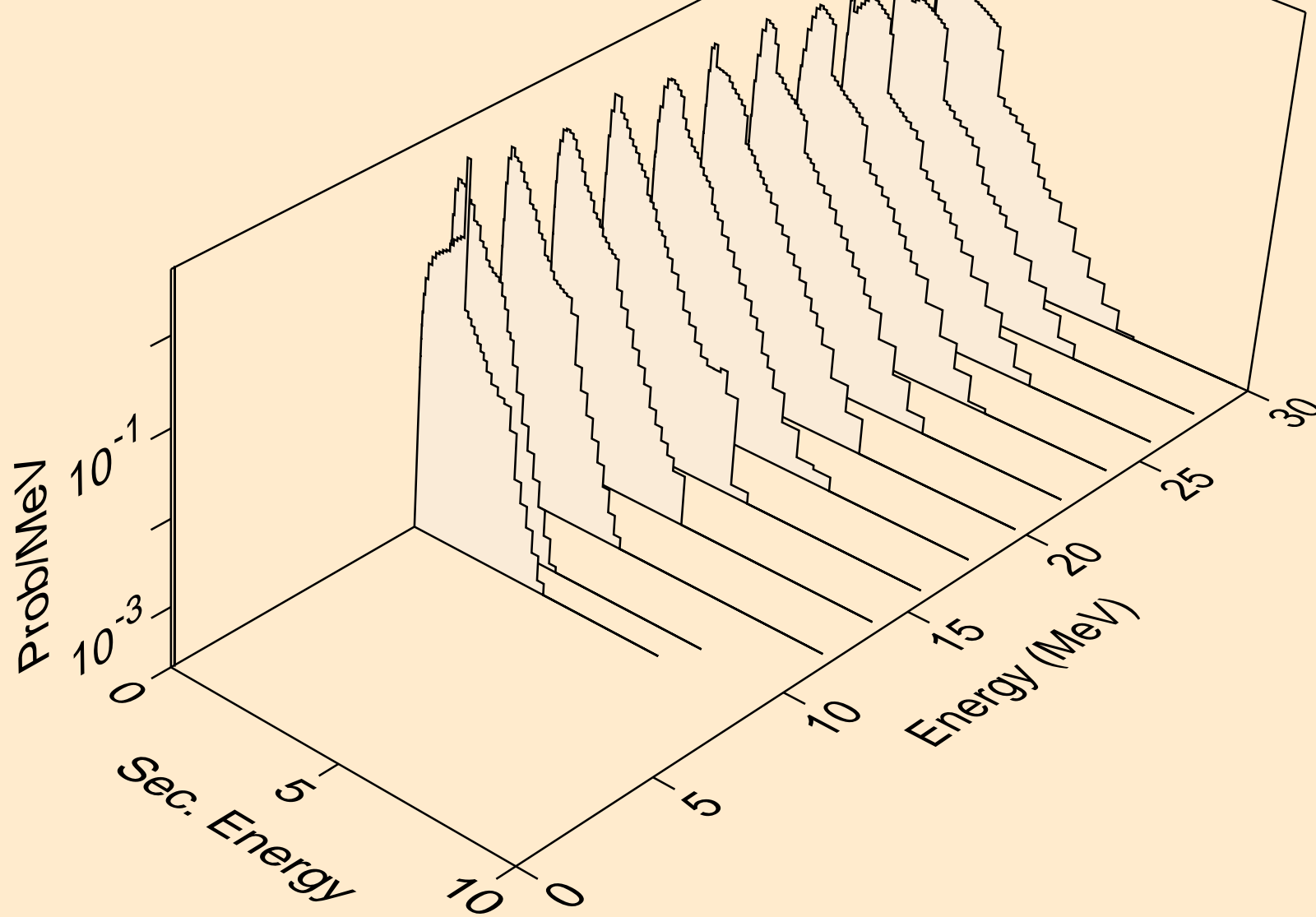

OS183 TRITON ACER TENDL-2021 LIBRARY; T=0.K  
neutrons from (t,2n)2a

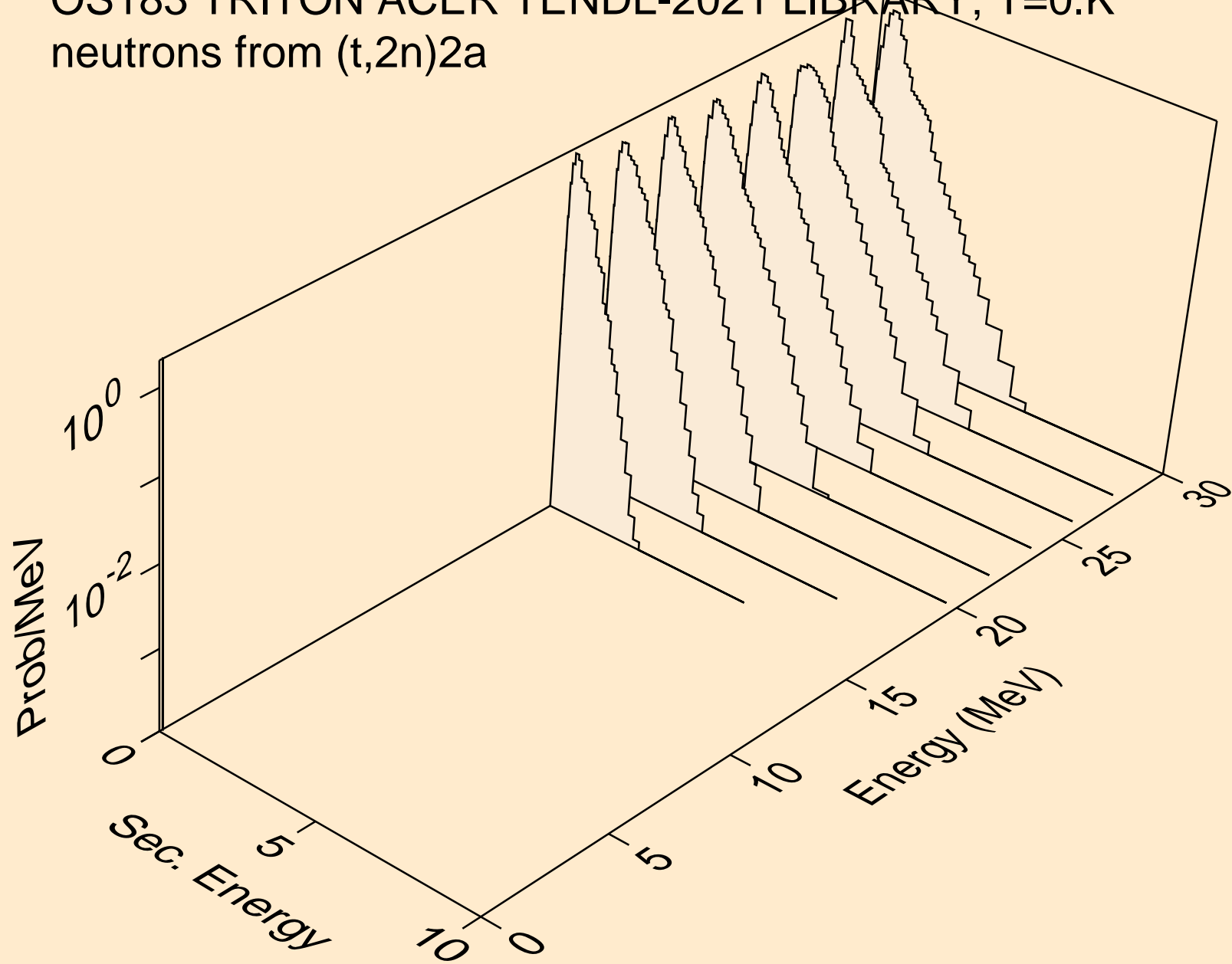

OS183 TRITON ACER TENDL-2021 LIBRARY; T=0.K  
neutrons from (t,n\*)d

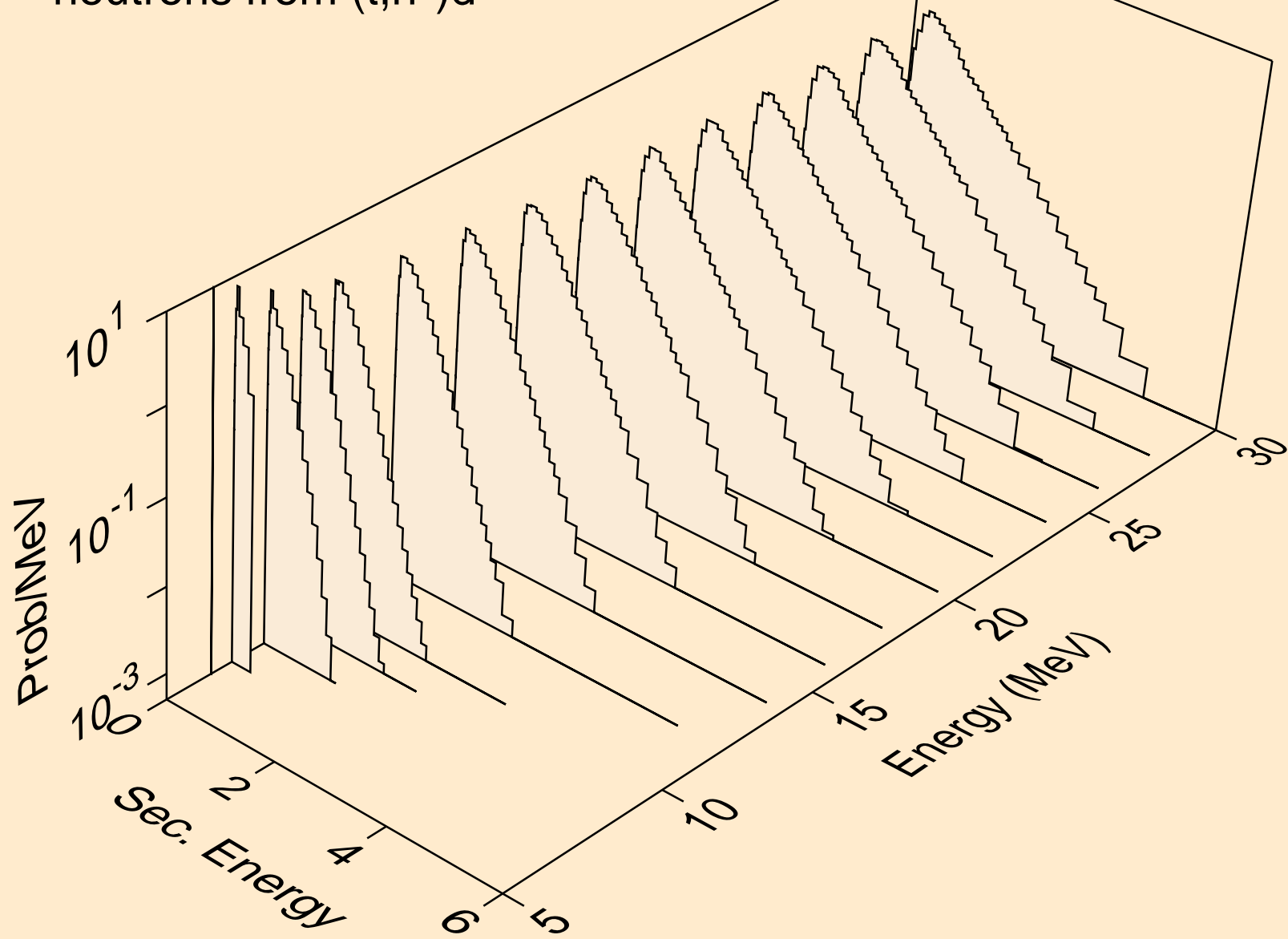

OS183 TRITON ACER TENDL-2021 LIBRARY; T=0.K  
neutrons from (t,n\*)t

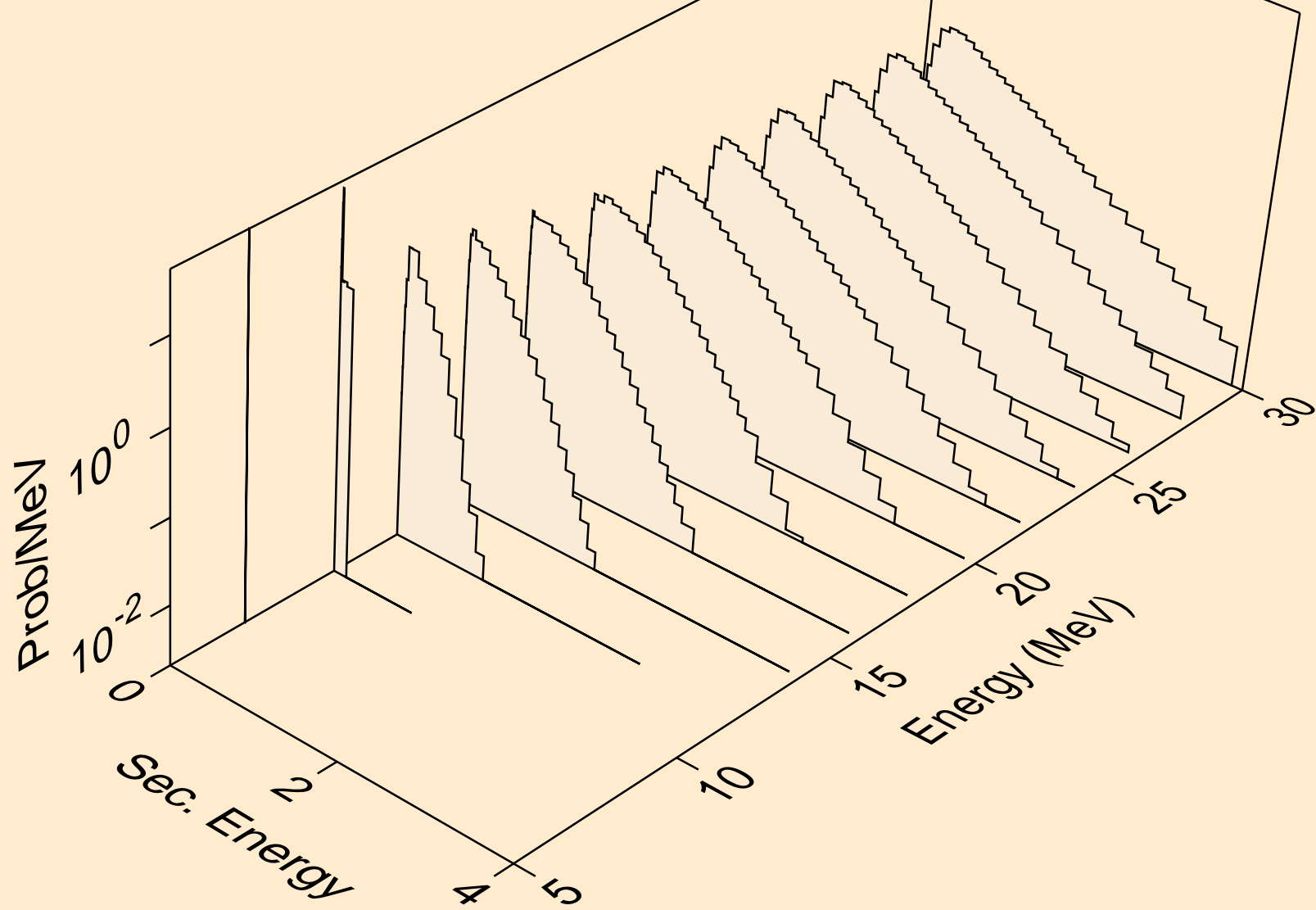

OS183 TRITON ACER TENDL-2021 LIBRARY; T=0.K  
neutrons from (t,n\*)he3

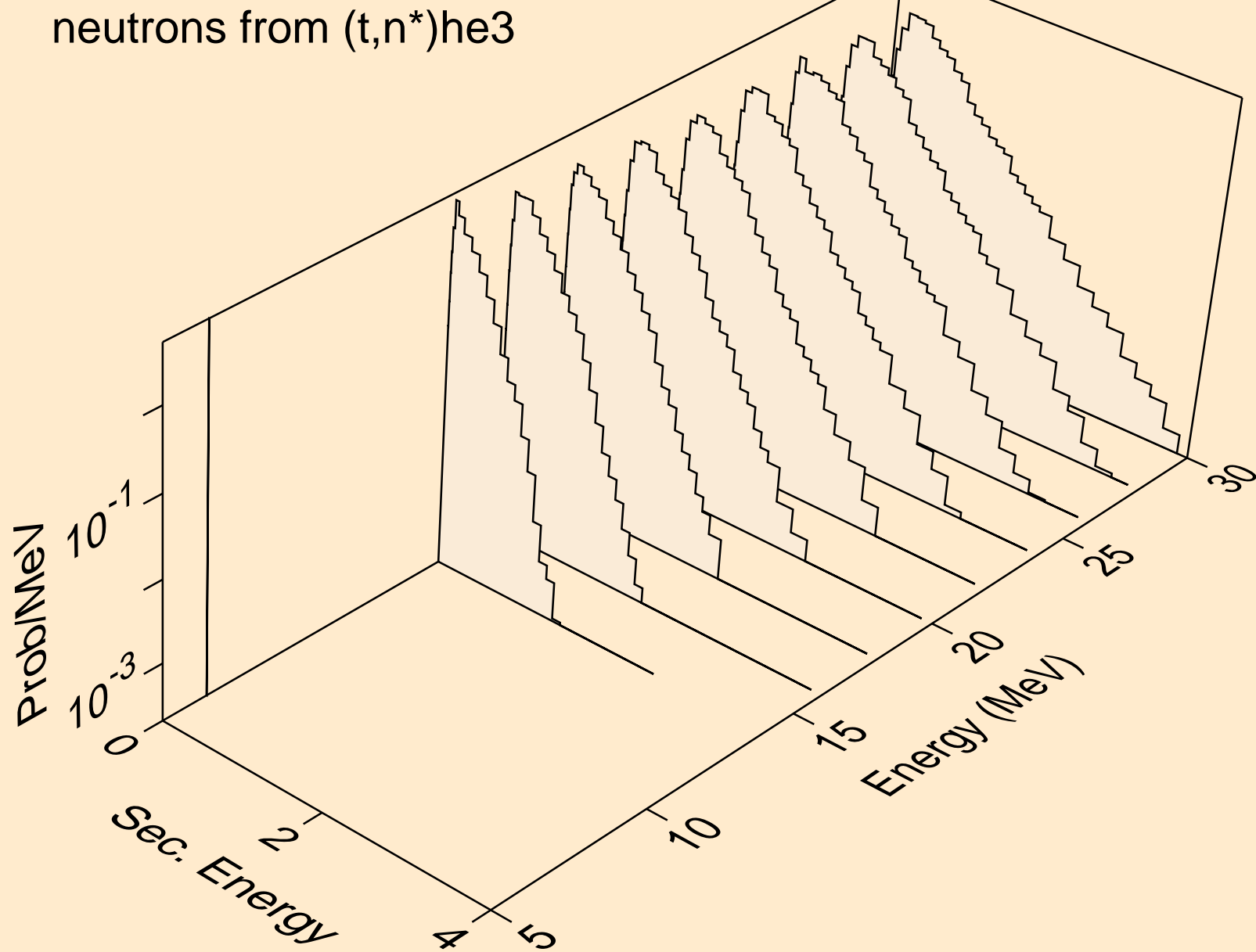

OS183 TRITON ACER TENDL-2021 LIBRARY; T=0.K  
neutrons from (t,4n)

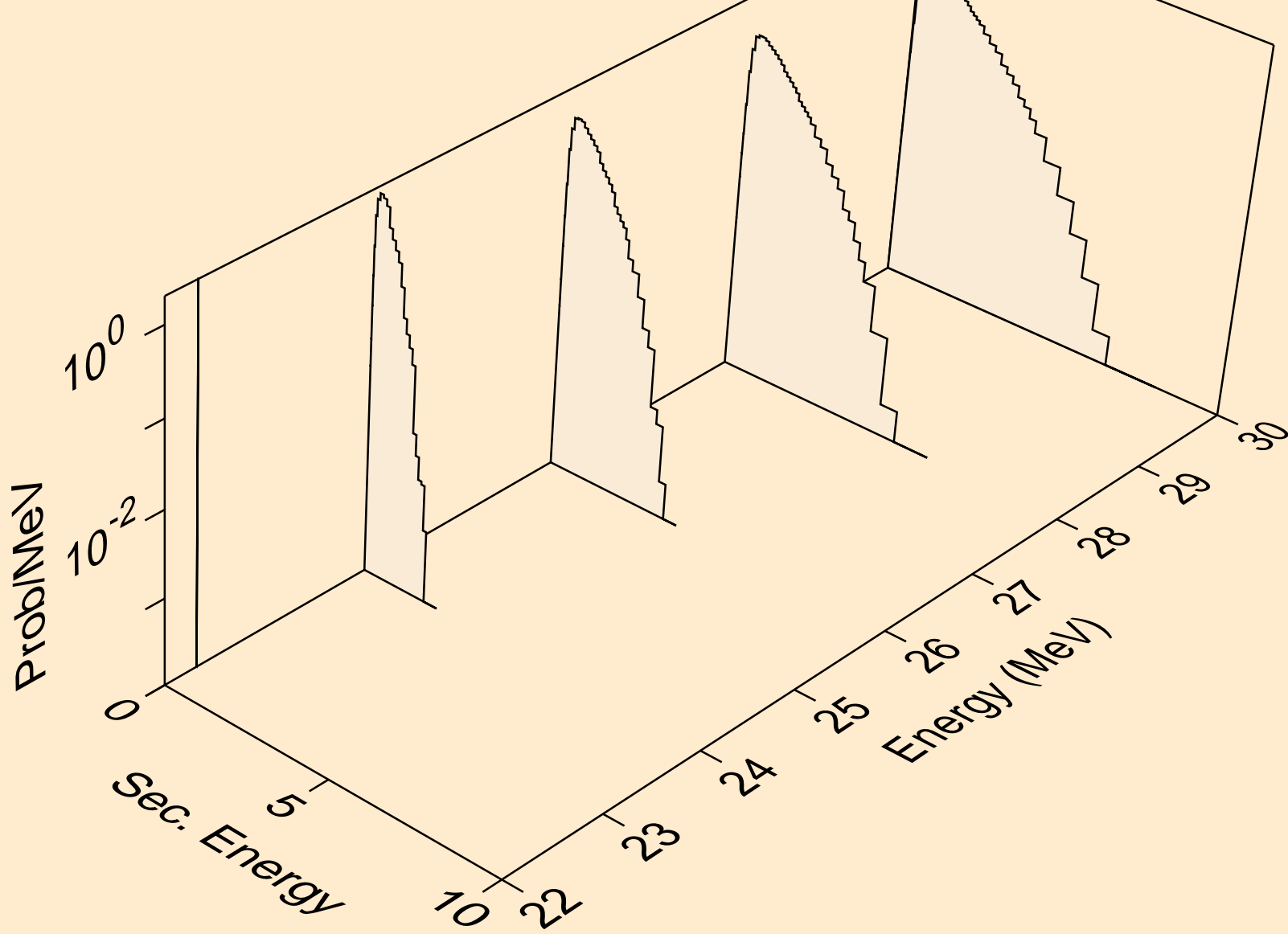

OS183 TRITON ACER TENDL-2021 LIBRARY; T=0.K  
neutrons from (t,2np)

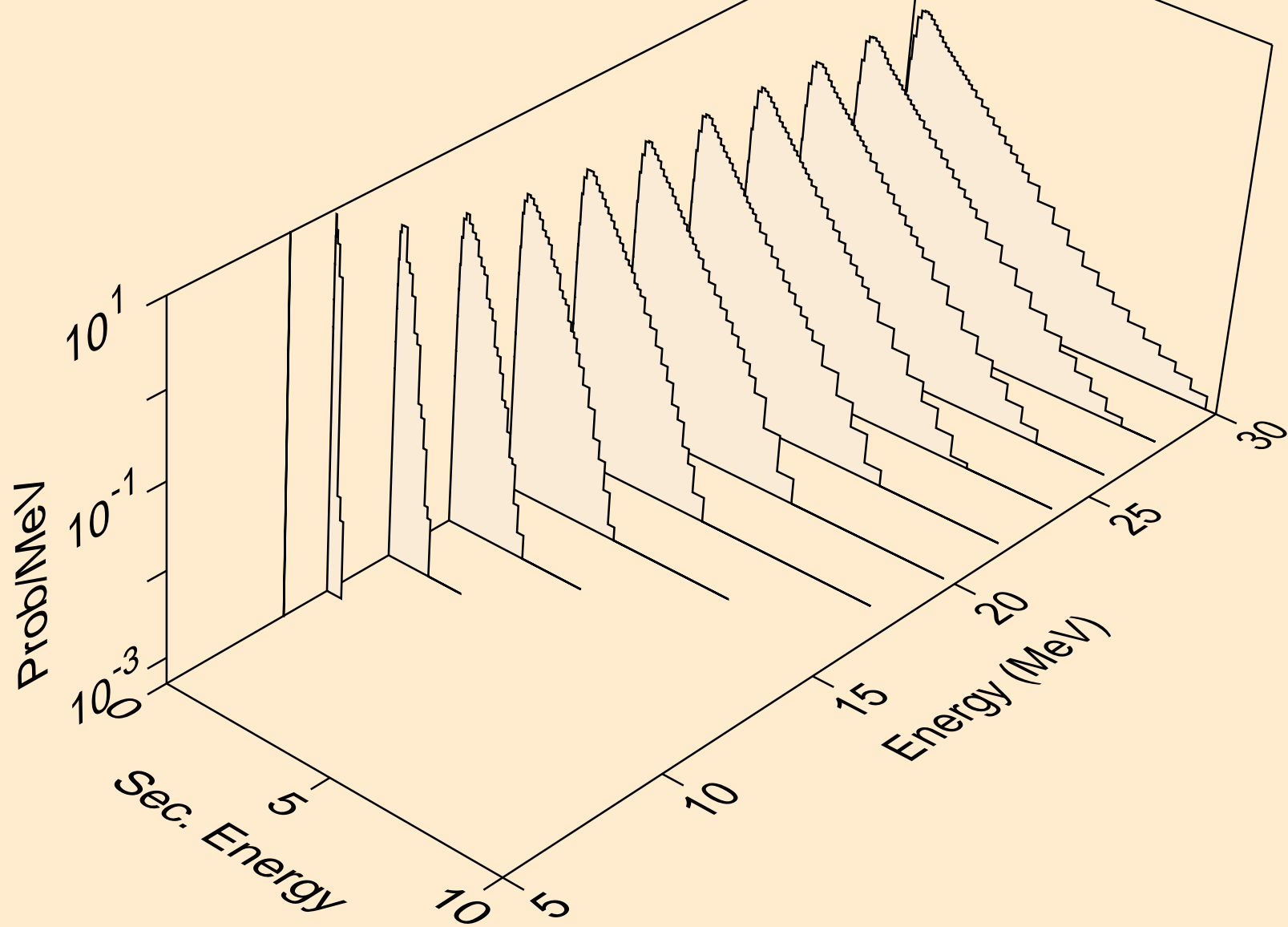

OS183 TRITON ACER TENDL-2021 LIBRARY; T=0.K  
neutrons from (t,3np)

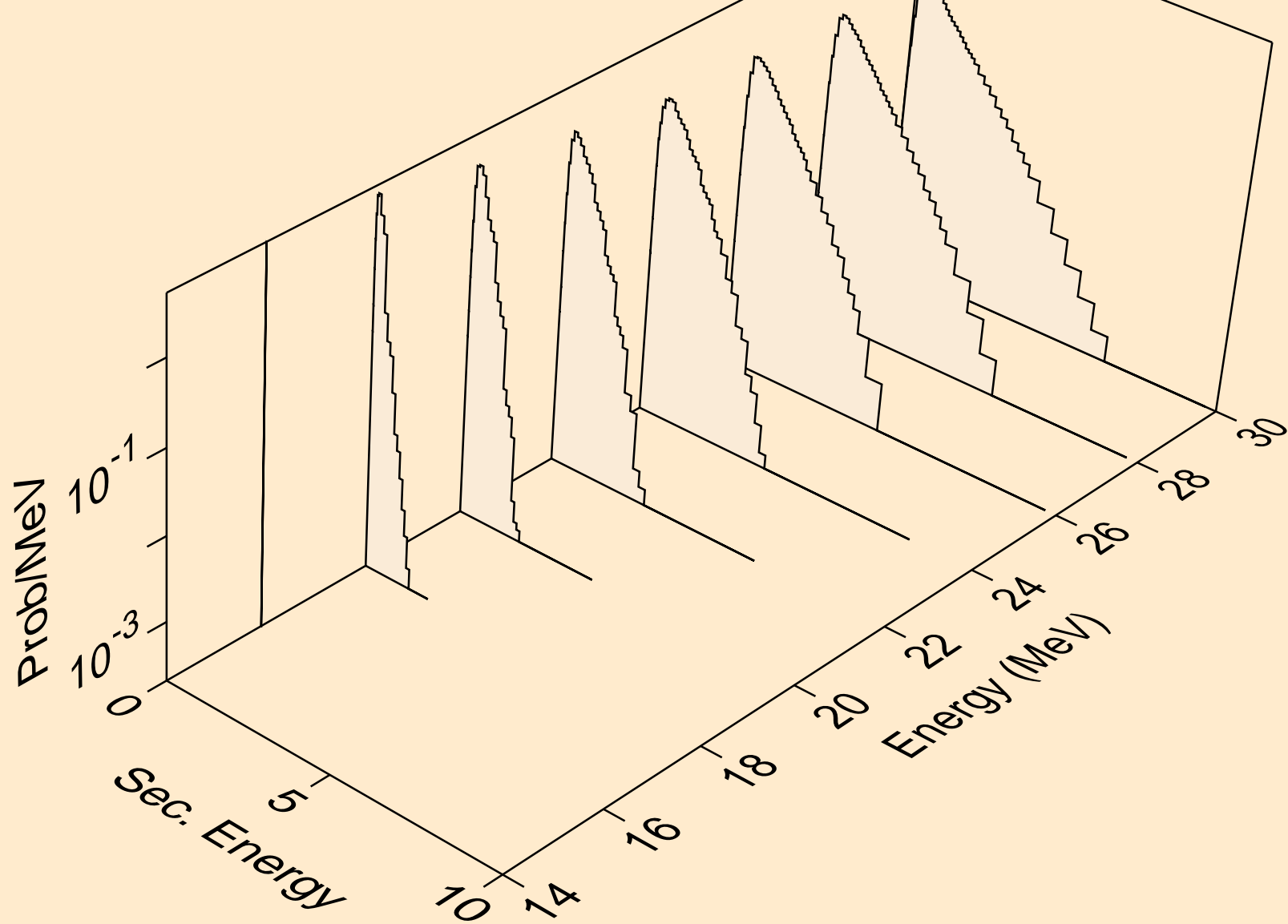



OS183 TRITON ACER TENDL-2021 LIBRARY; T=0.K  
neutrons from (t,2np)

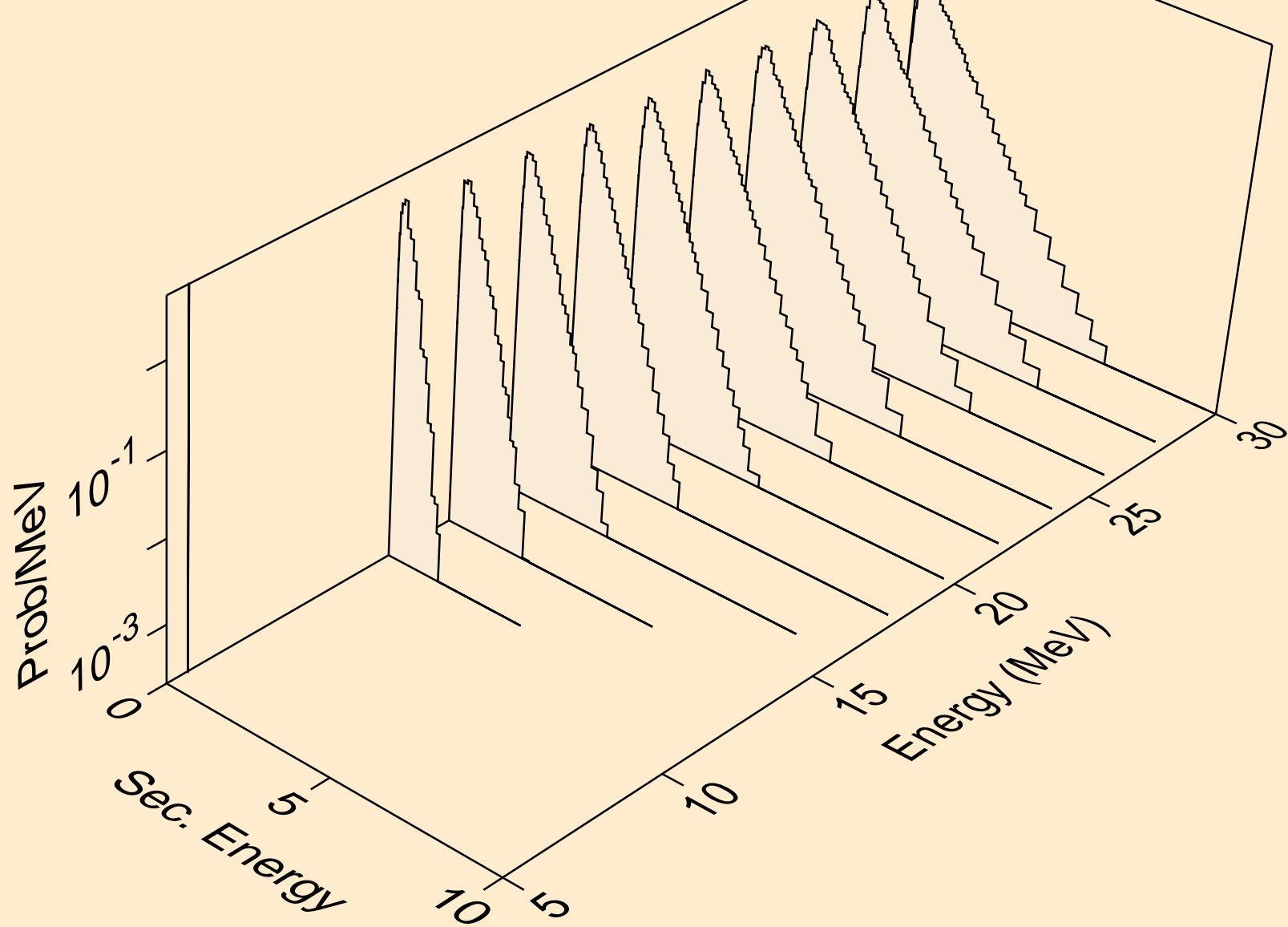

OS183 TRITON ACER TENDL-2021 LIBRARY; T=0.K  
neutrons from (t,npa)

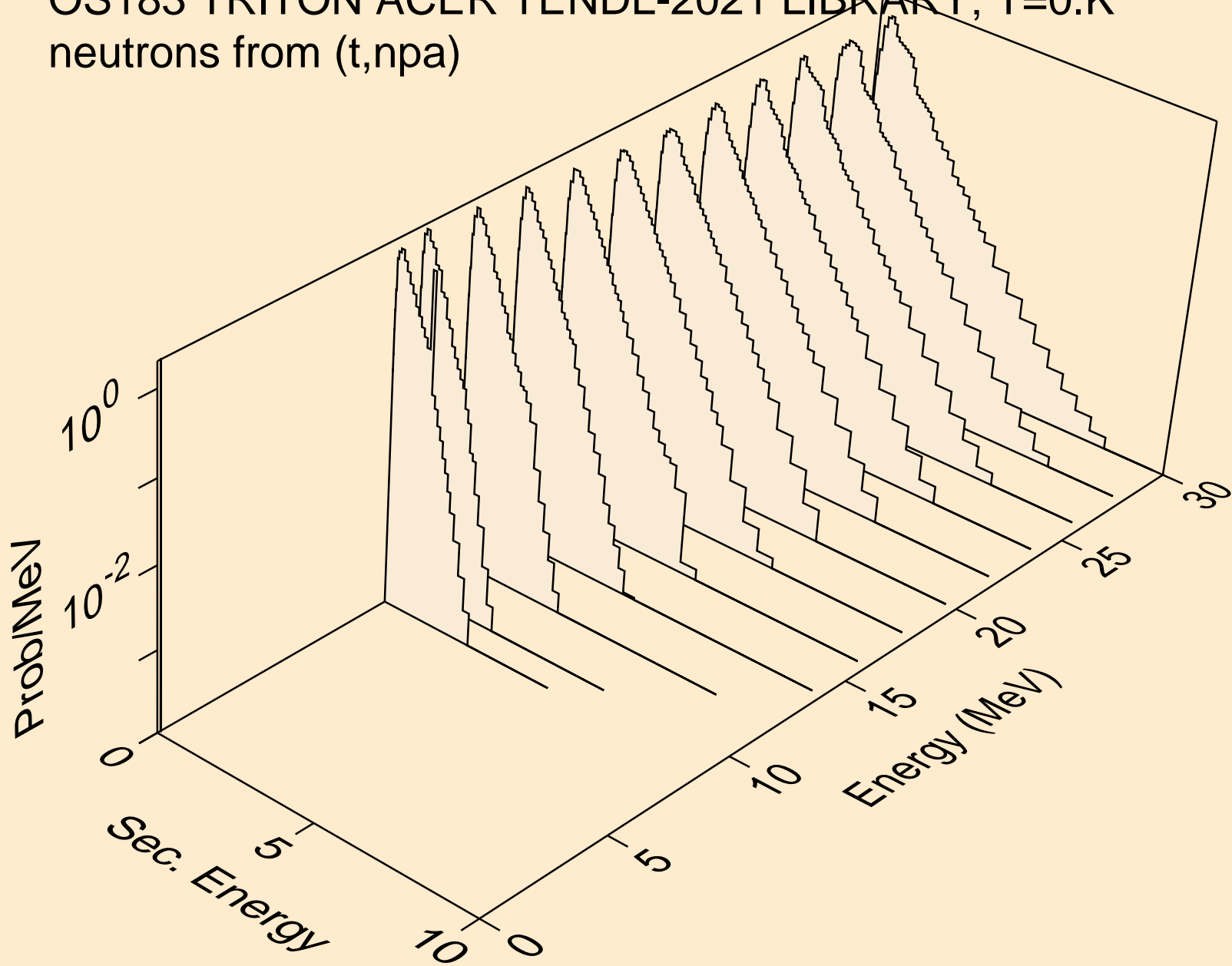

OS183 TRITON ACER TENDL-2021 LIBRARY; T=0.K  
protons from (t,x)

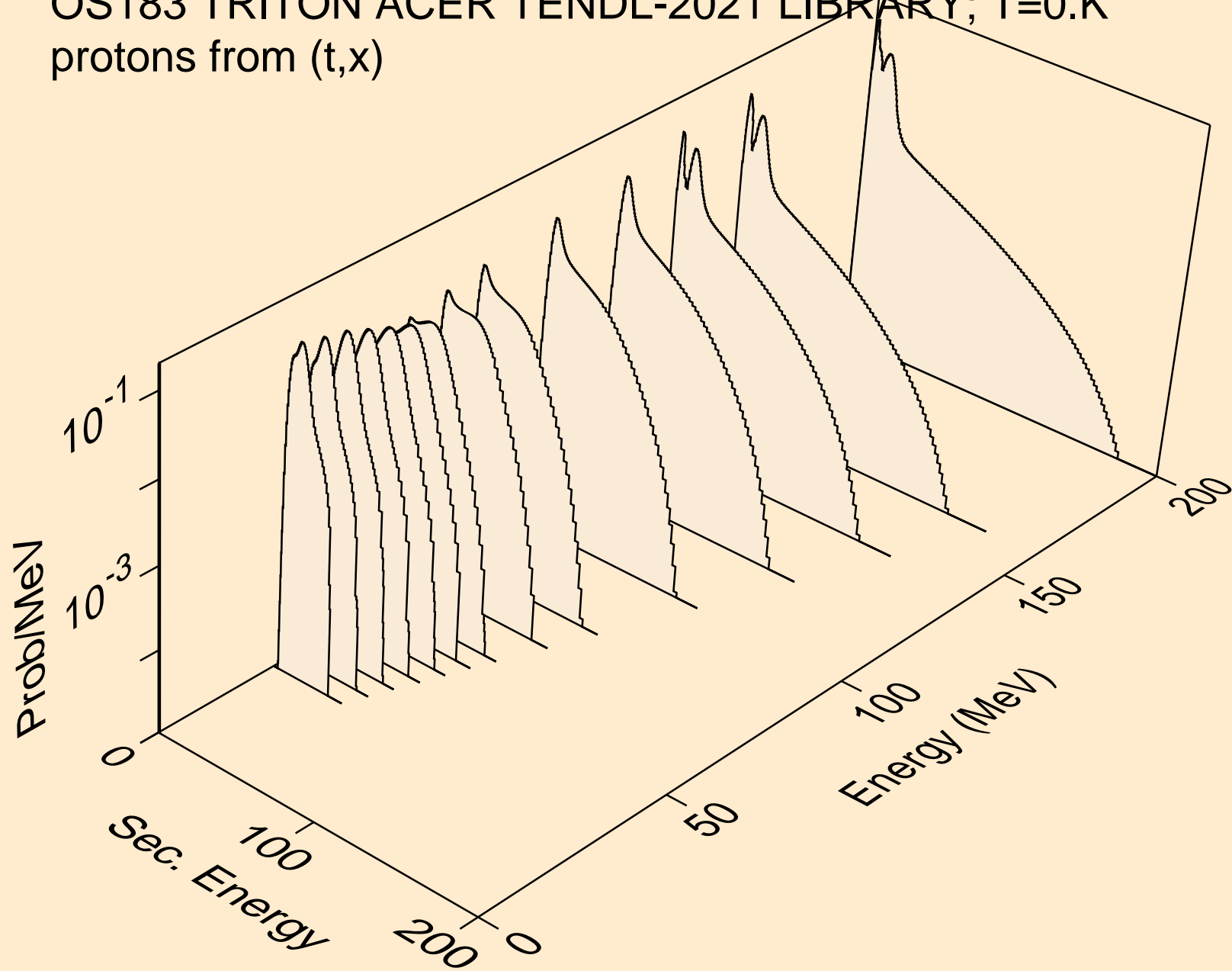

OS183 TRITON ACER TENDL-2021 LIBRARY; T=0.K  
protons from (t,n\*)p

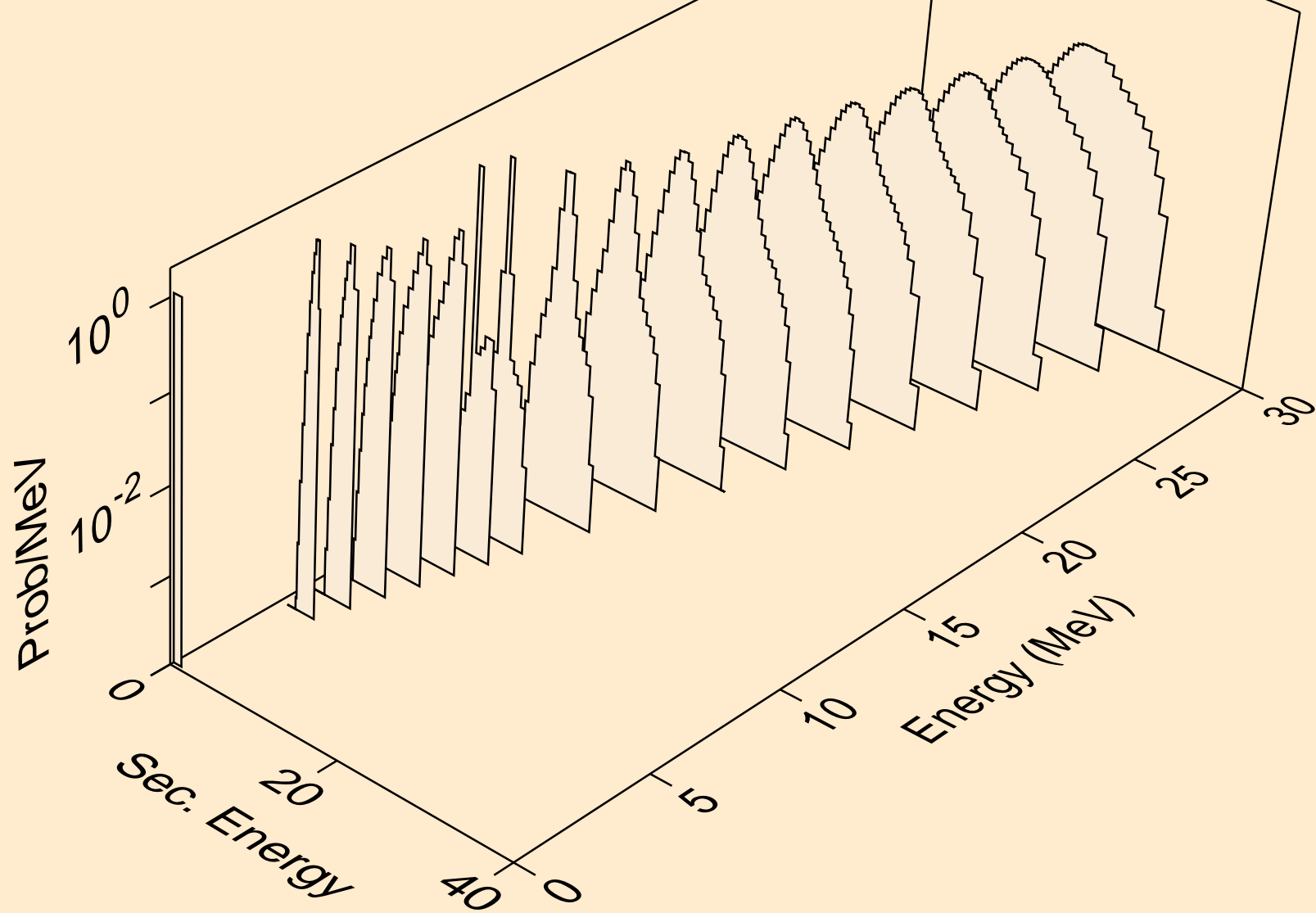

OS183 TRITON ACER TENDL-2021 LIBRARY; T=0.K  
protons from (t,2np)

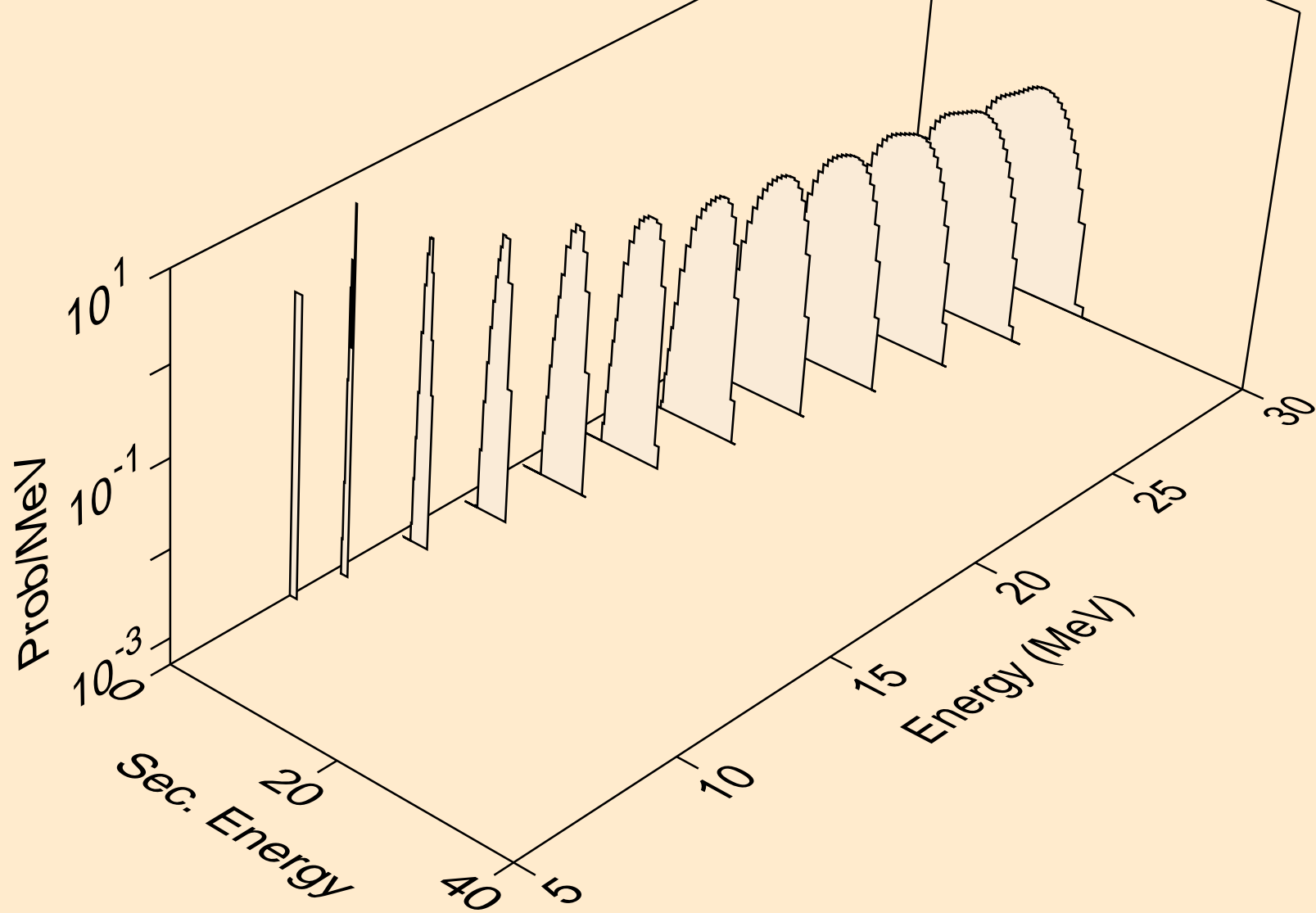

OS183 TRITON ACER TENDL-2021 LIBRARY; T=0.K  
protons from (t,3np)

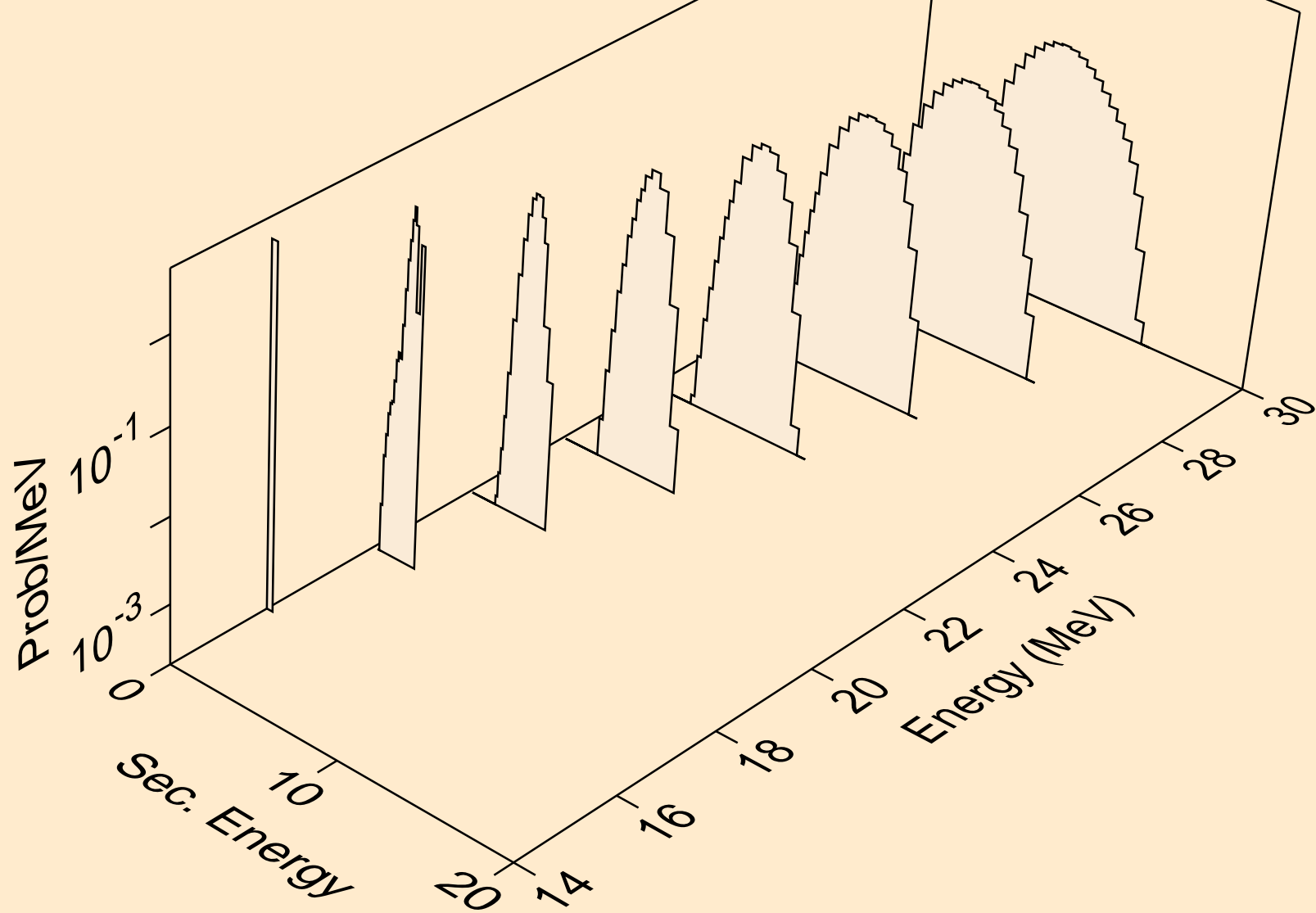

OS183 TRITON ACER TENDL-2021 LIBRARY; T=0.K  
protons from (t,2np)

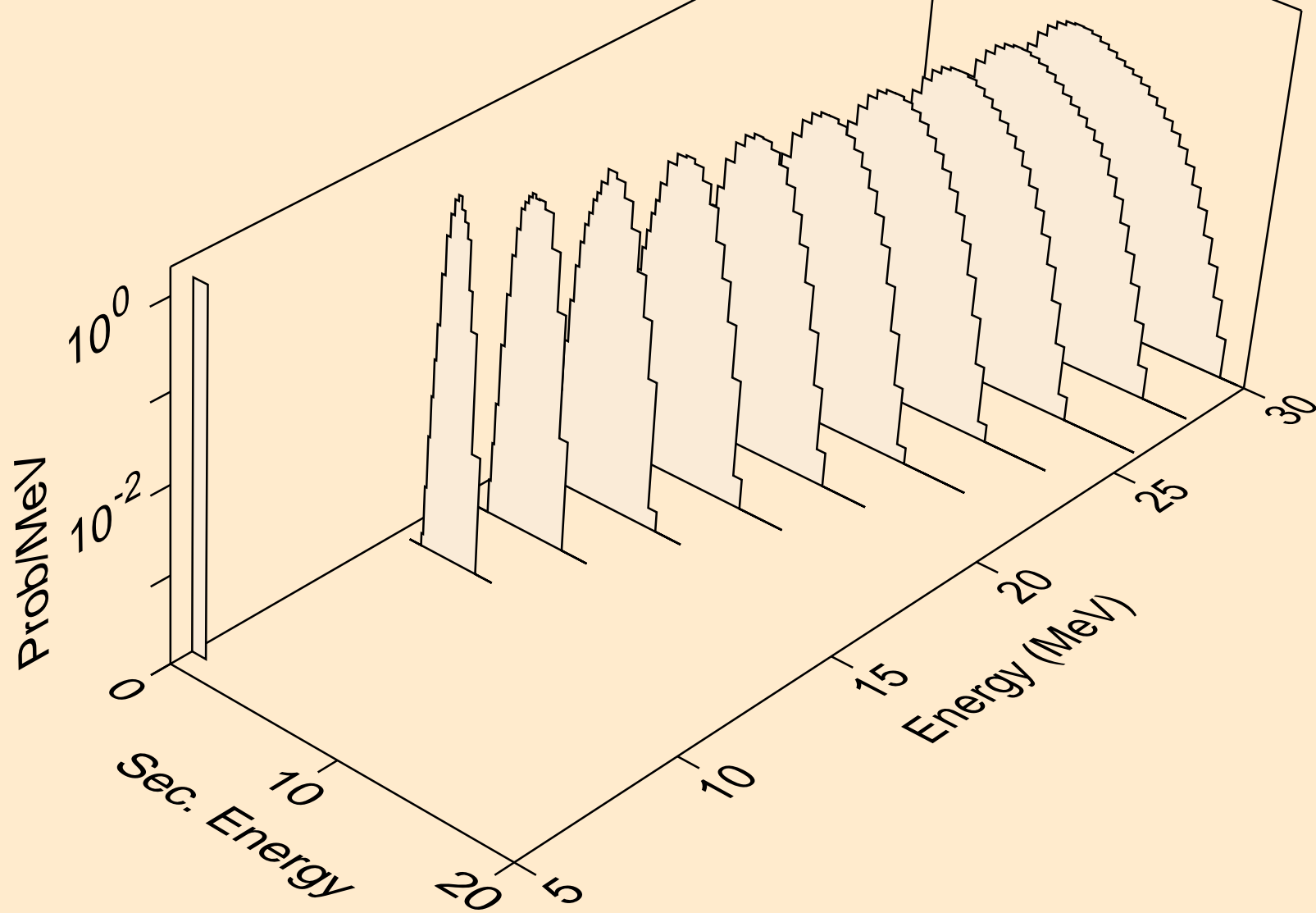

OS183 TRITON ACER TENDL-2021 LIBRARY; T=0.K  
protons from (t,npa)

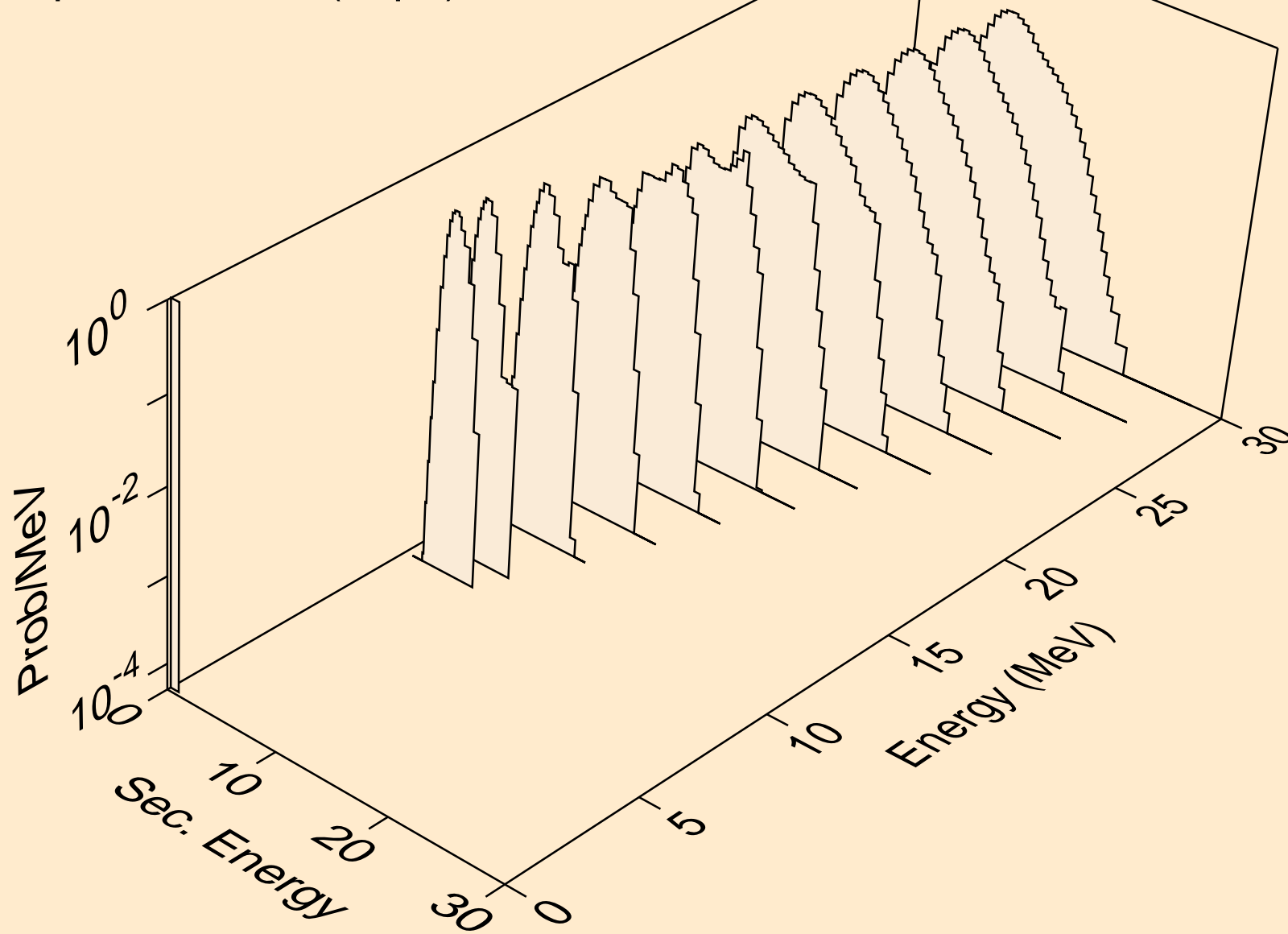



OS183 TRITON ACER TENDL-2021 LIBRARY; T=0.K  
protons from (t,p)

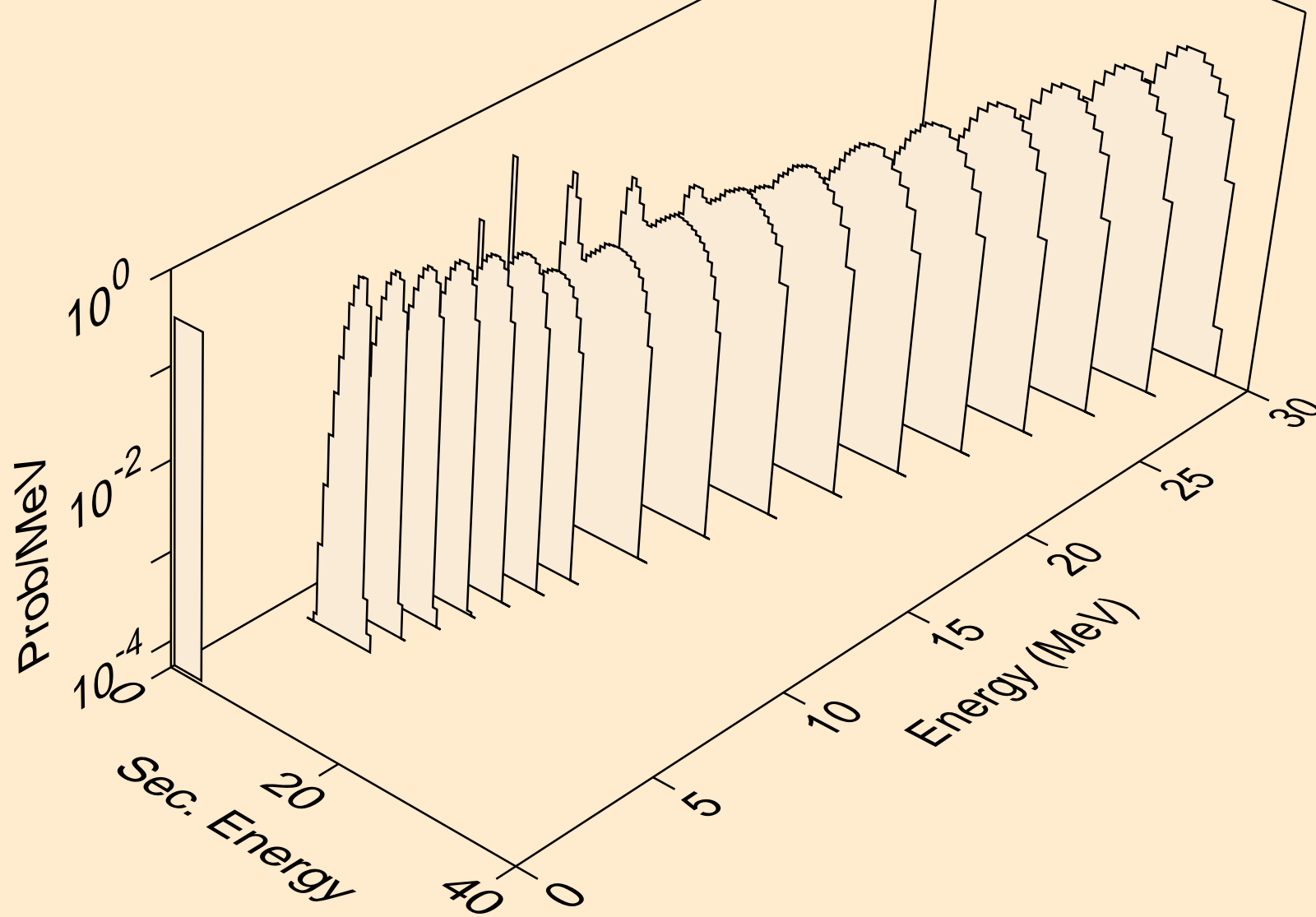

OS183 TRITON ACER TENDL-2021 LIBRARY; T=0.K  
protons from (t,2p)

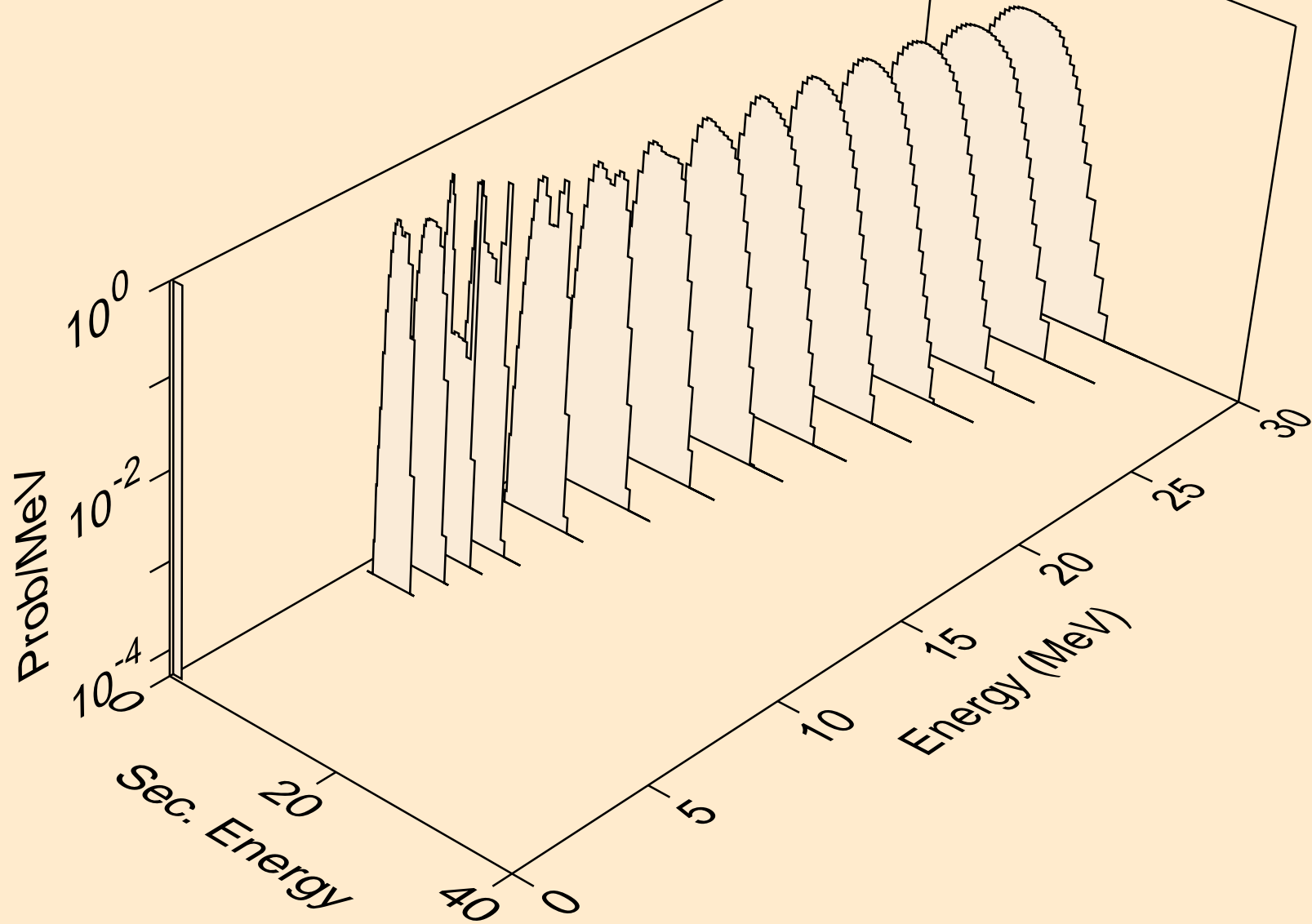

OS183 TRITON ACER TENDL-2021 LIBRARY; T=0.K  
protons from (t,pa)

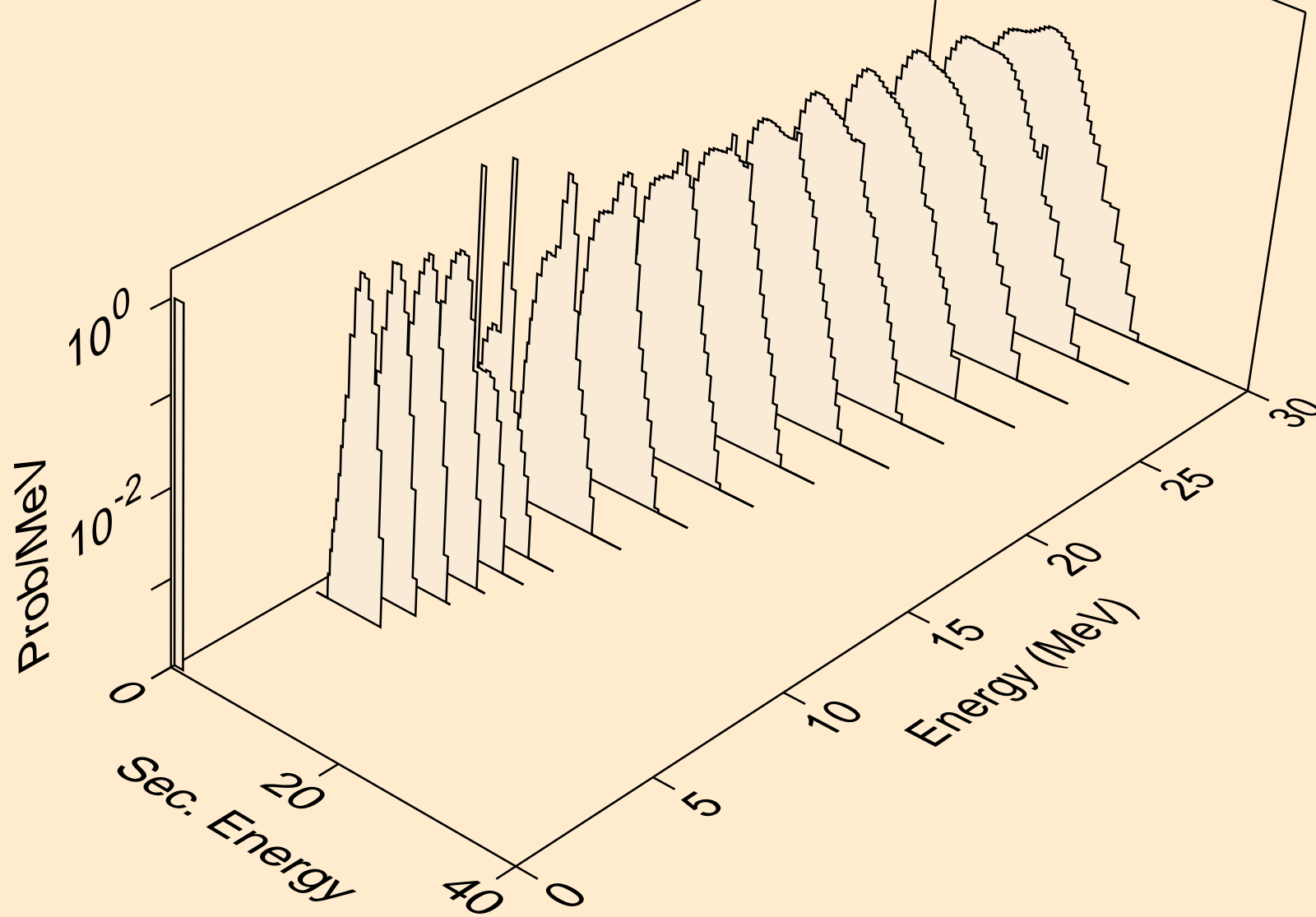

OS183 TRITON ACER TENDL-2021 LIBRARY; T=0.K  
protons from (t,pd)

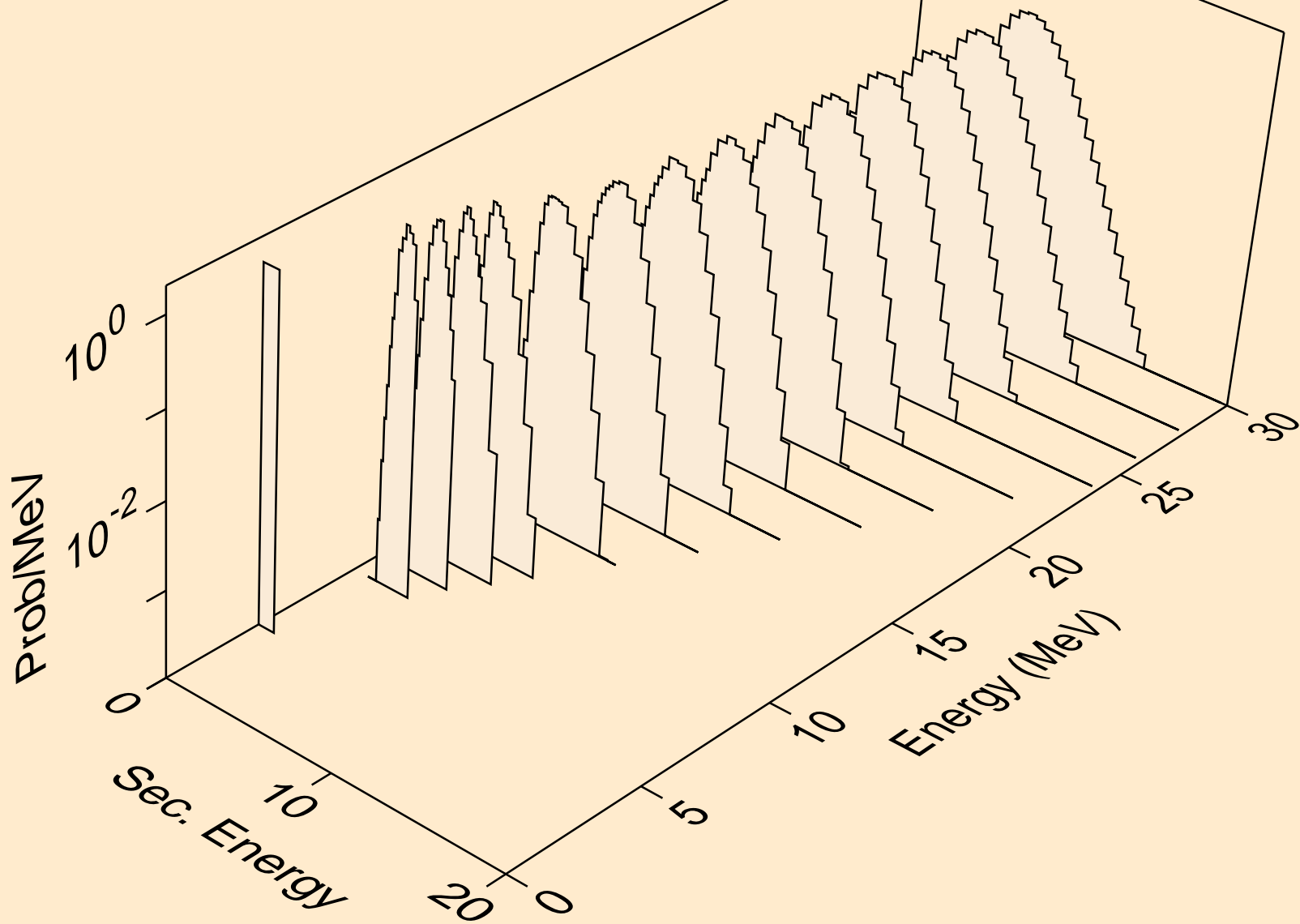

OS183 TRITON ACER TENDL-2021 LIBRARY; T=0.K  
protons from (t,pt)

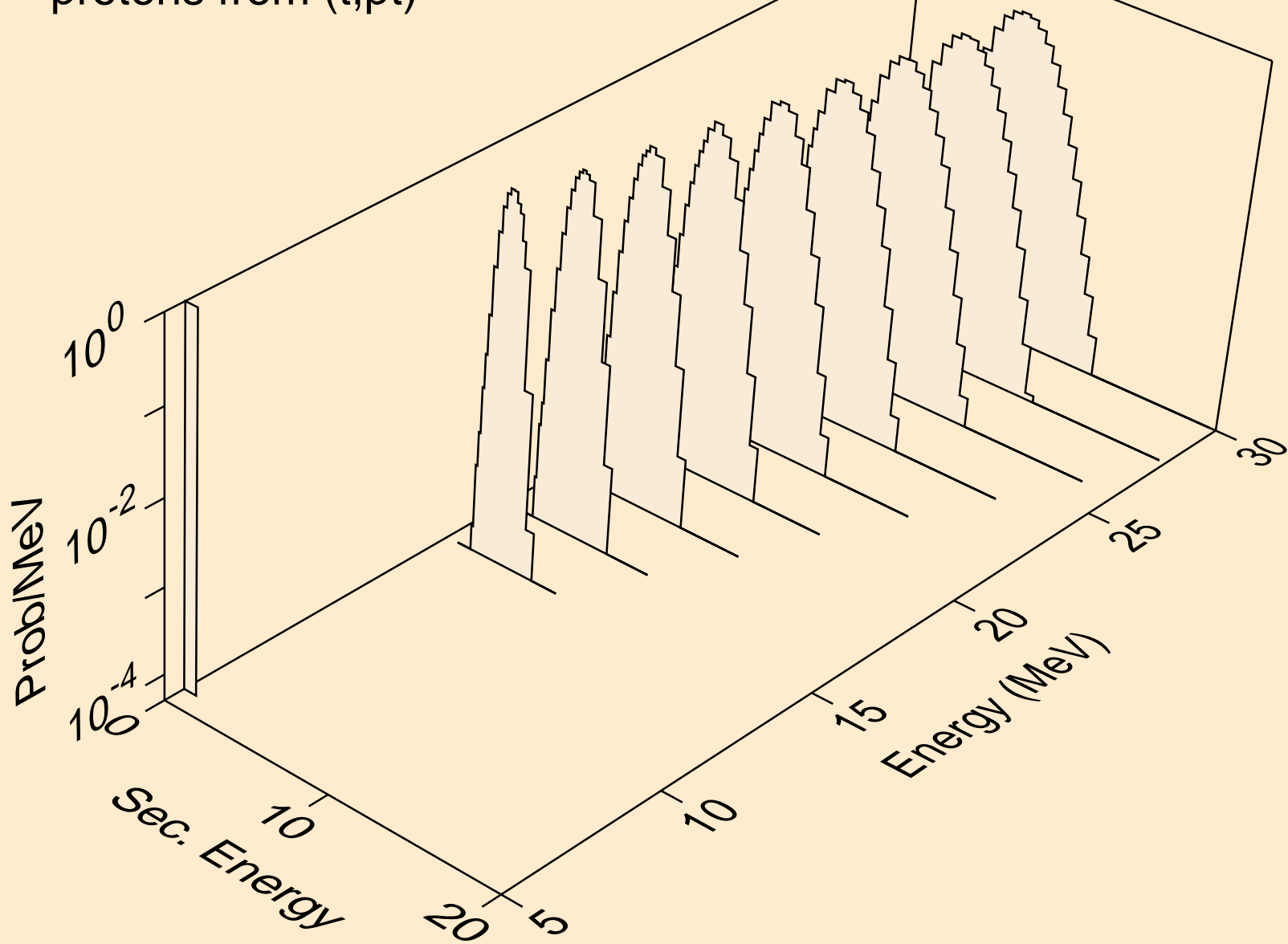

OS183 TRITON ACER TENDL-2021 LIBRARY; T=0.K  
deuterons from (t,x)

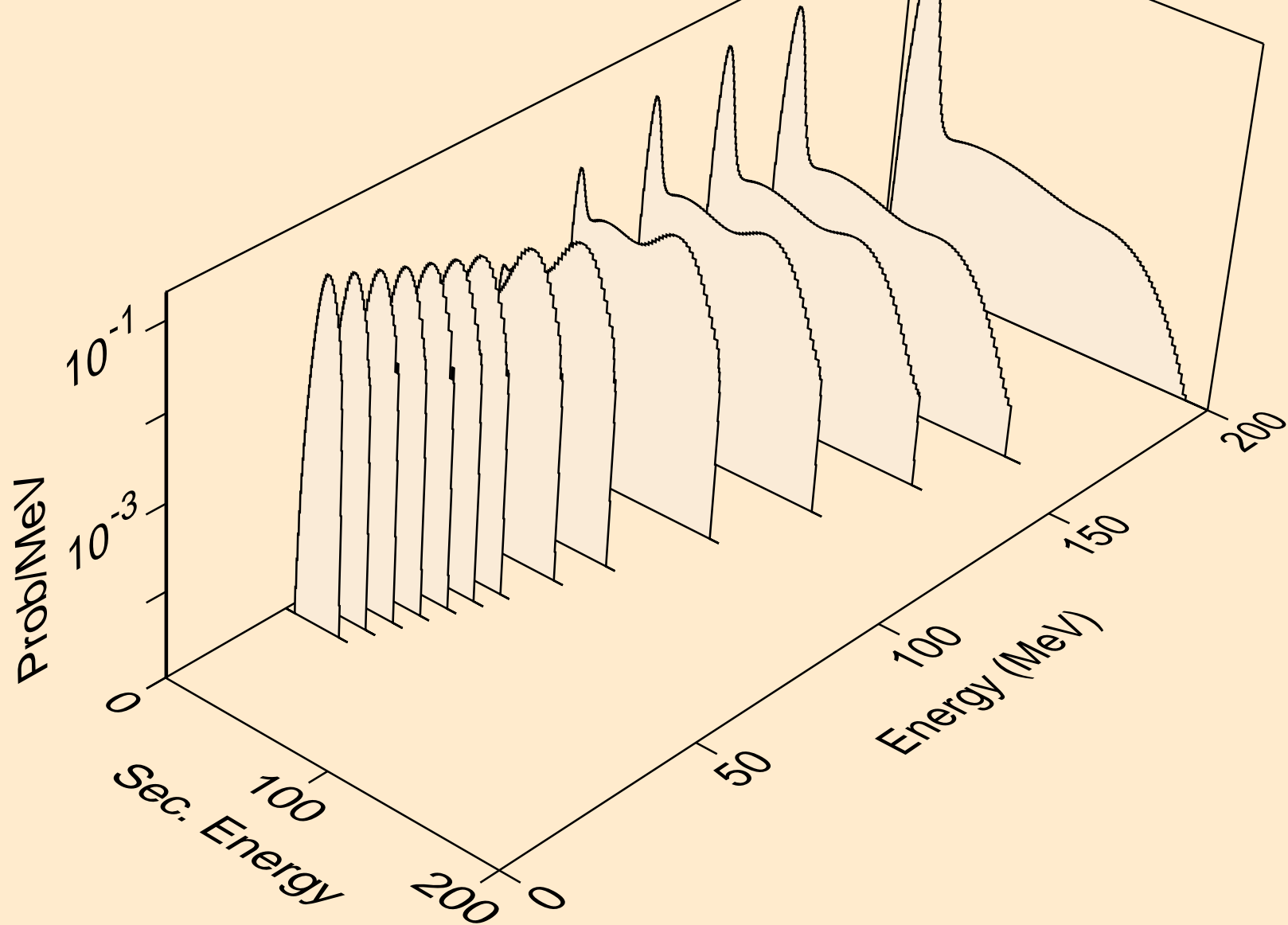

OS183 TRITON ACER TENDL-2021 LIBRARY; T=0.K  
deuterons from (t,2nd)

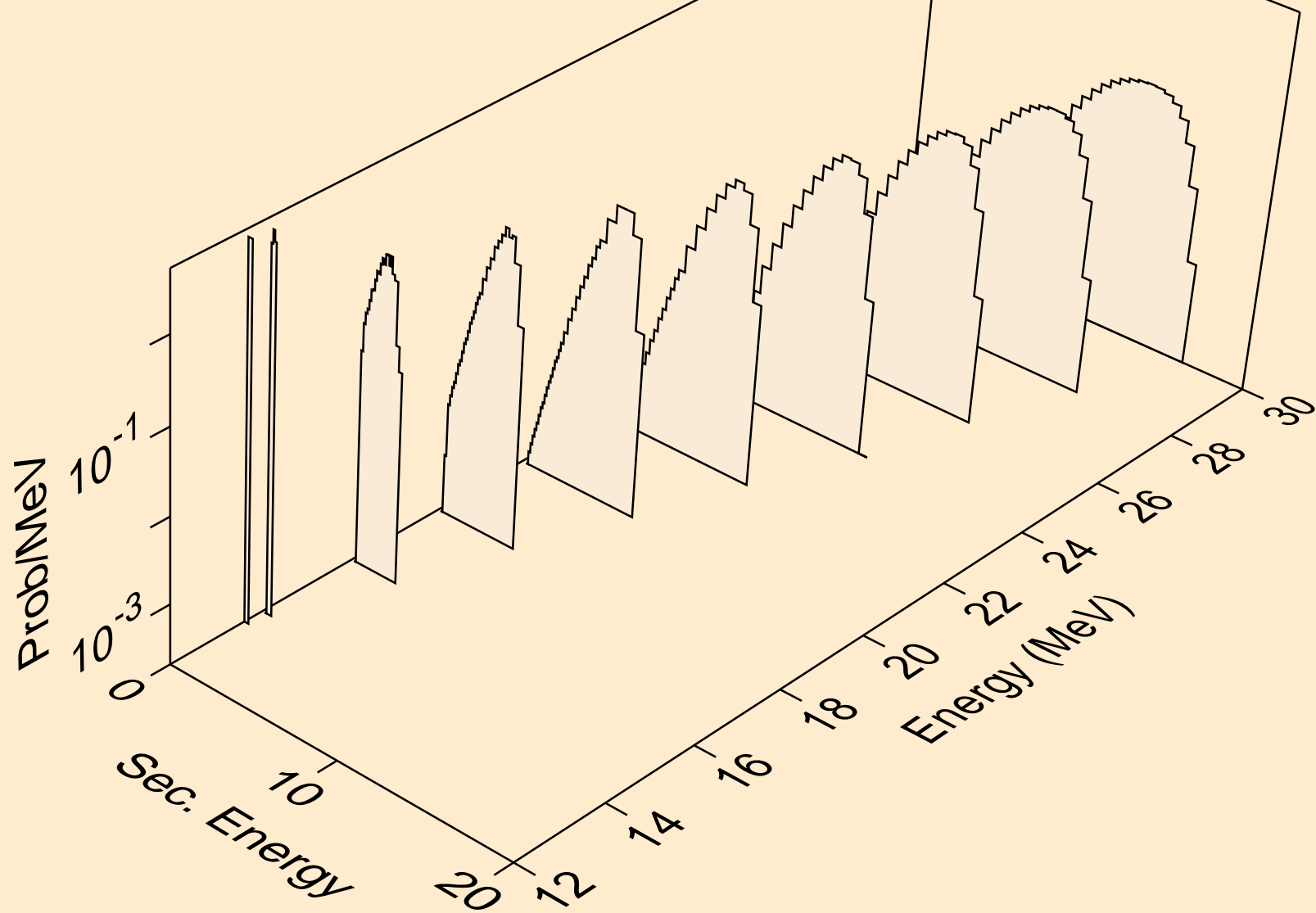

OS183 TRITON ACER TENDL-2021 LIBRARY; T=0.K  
deuterons from (t,n\*)d

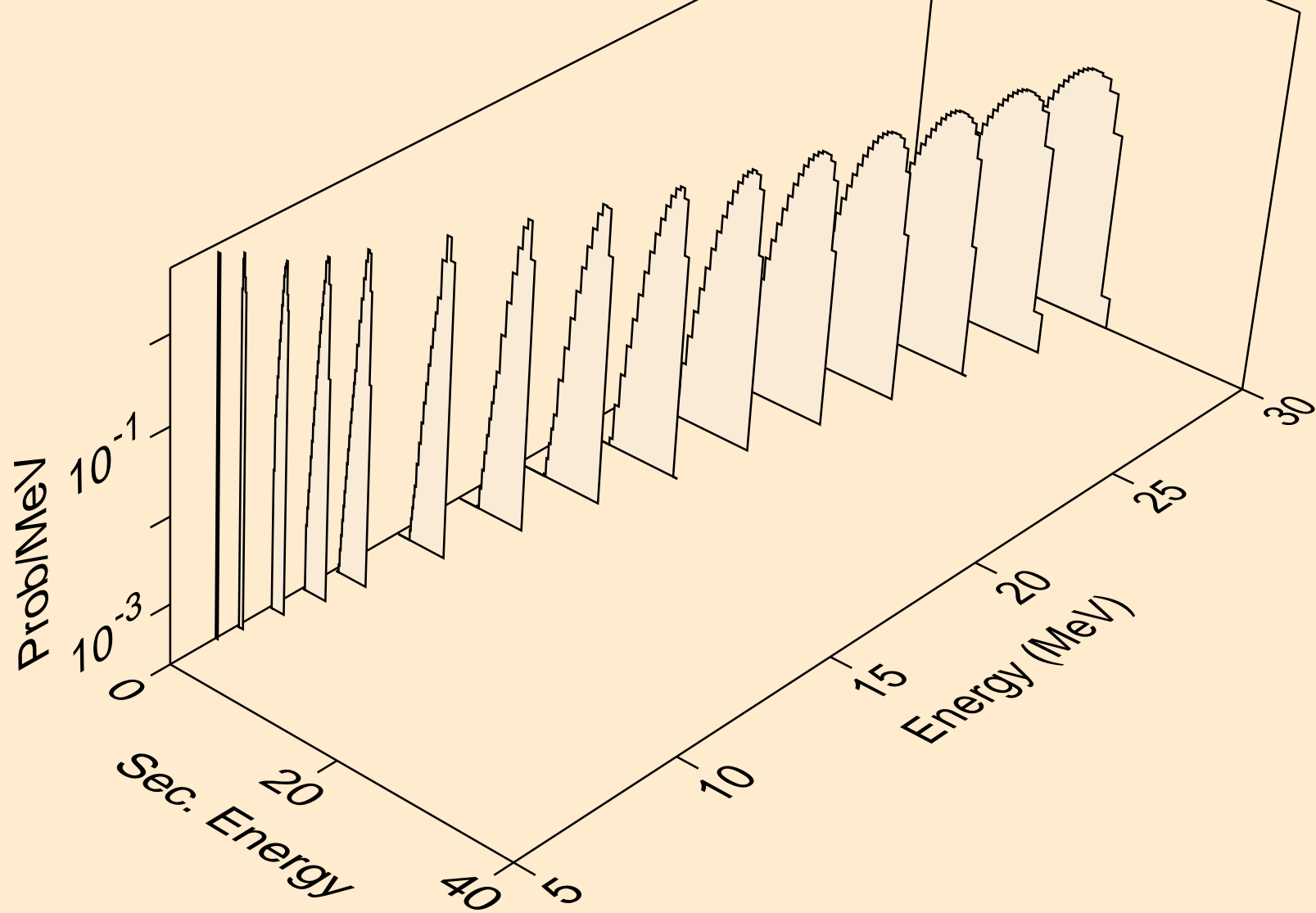



OS183 TRITON ACER TENDL-2021 LIBRARY; T=0.K  
deuterons from (t,d)

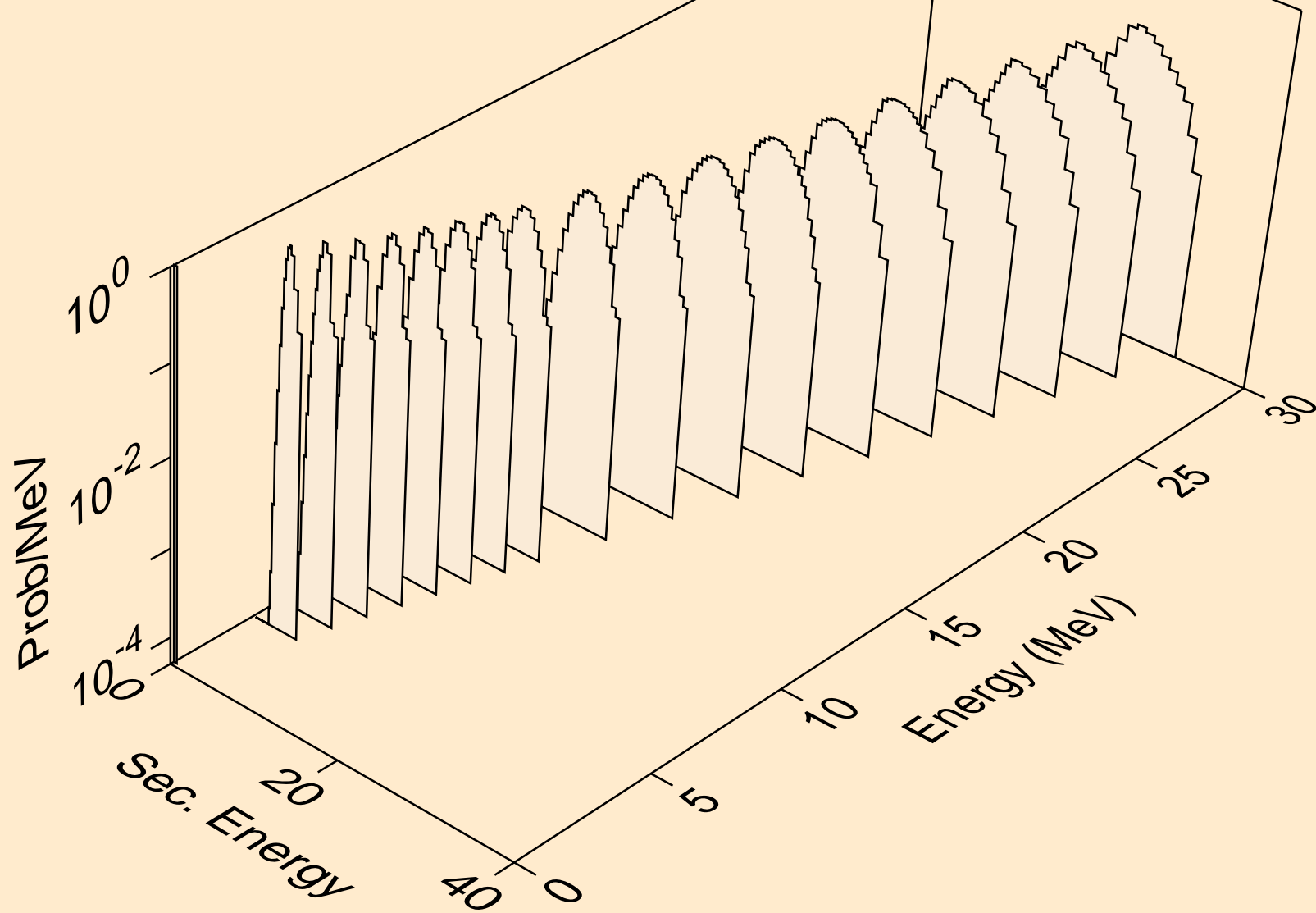

OS183 TRITON ACER TENDL-2021 LIBRARY; T=0.K  
deuterons from (t,pd)

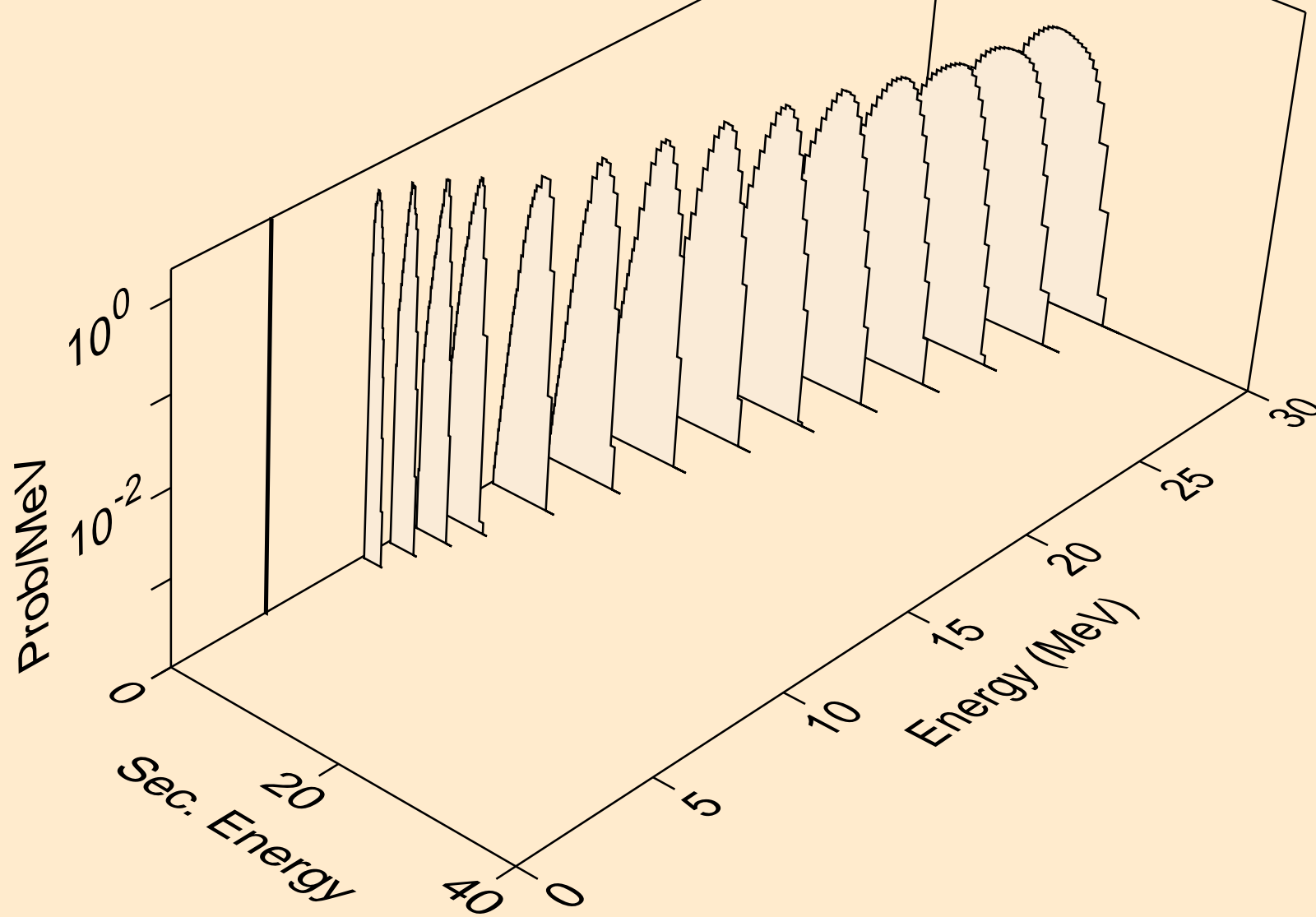

OS183 TRITON ACER TENDL-2021 LIBRARY; T=0.K  
deuterons from (t,da)

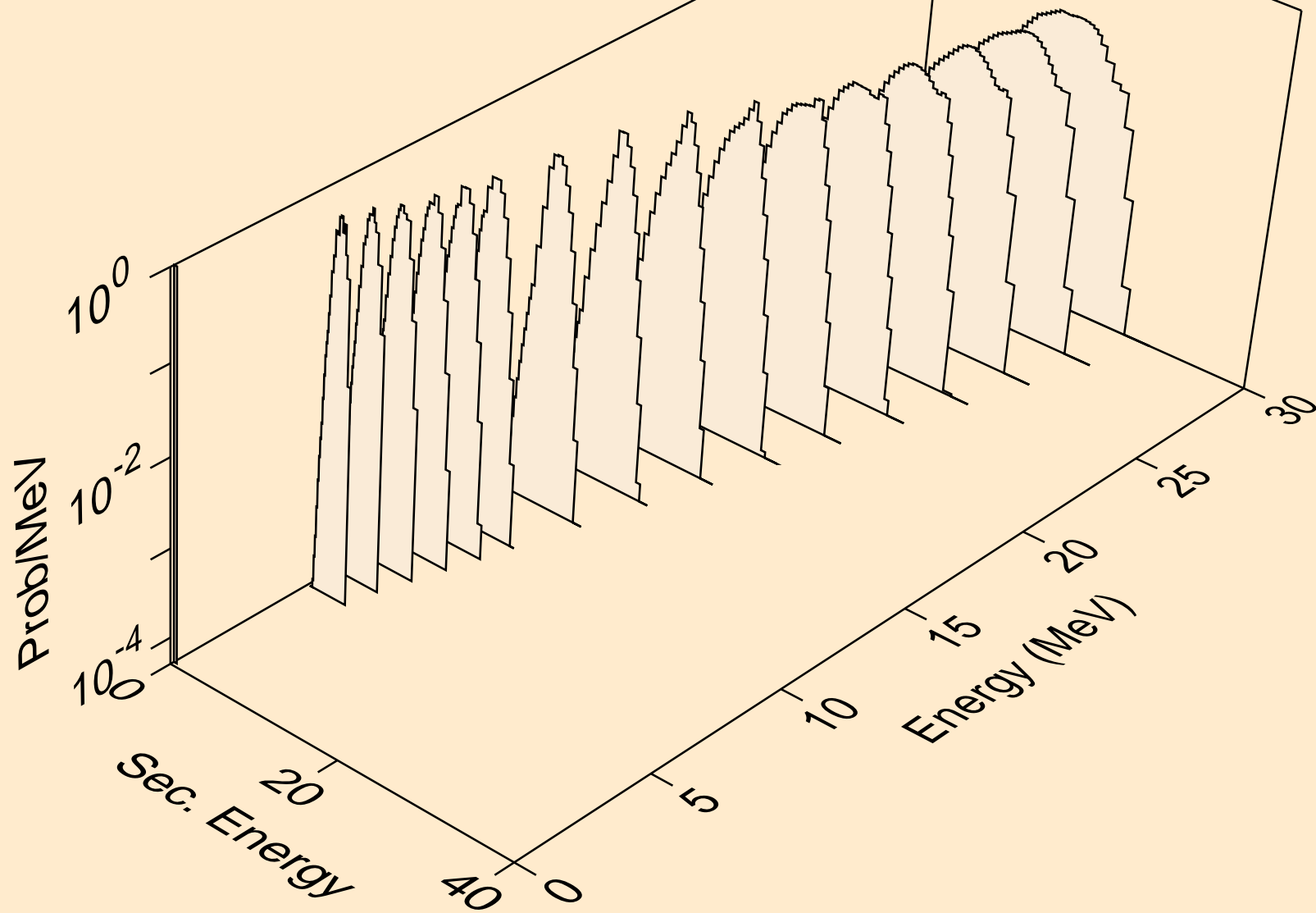

OS183 TRITON ACER TENDL-2021 LIBRARY; T=0.K  
he3s from (t,x)

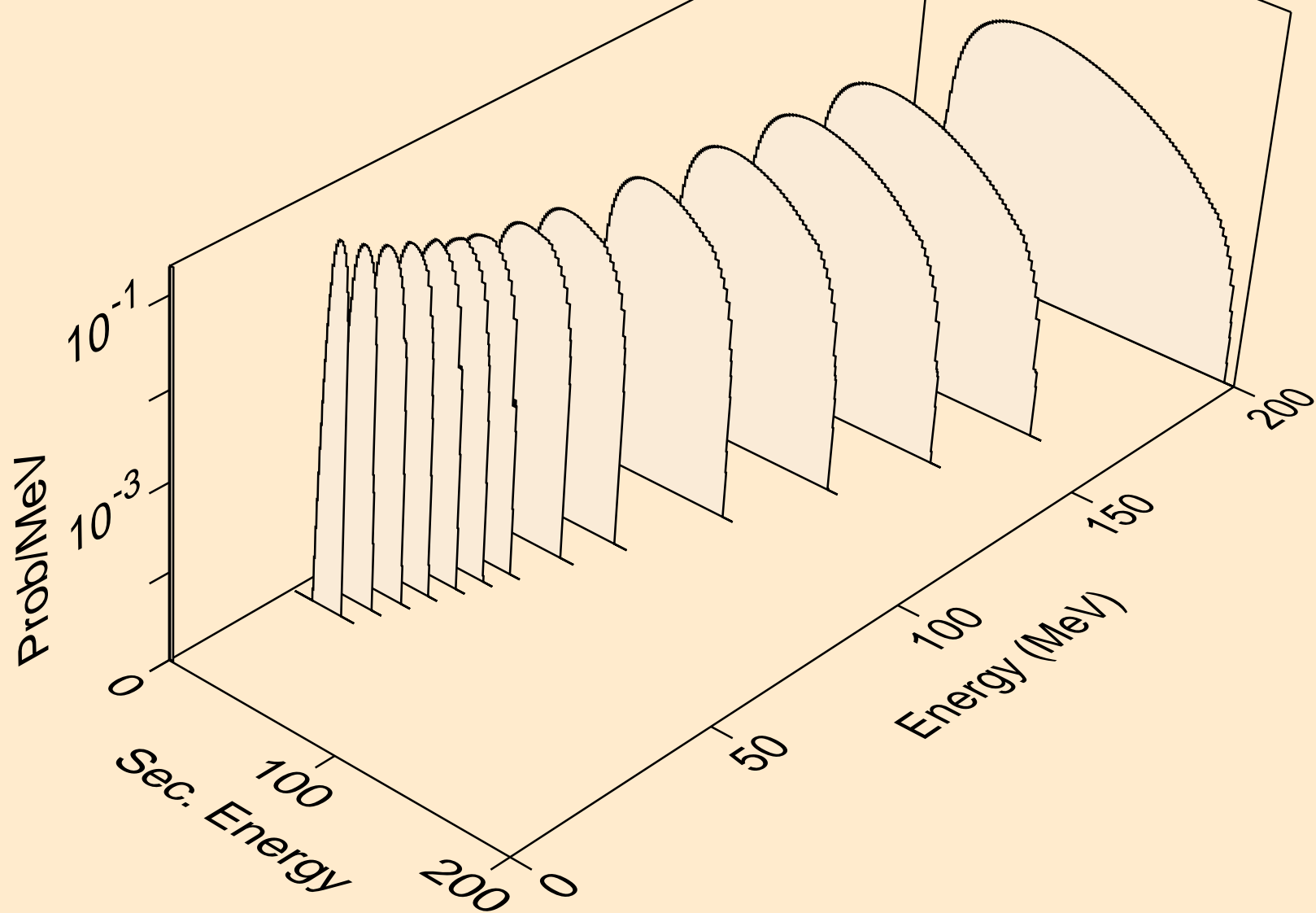

OS183 TRITON ACER TENDL-2021 LIBRARY; T=0.K  
he3s from (t,n\*)he3

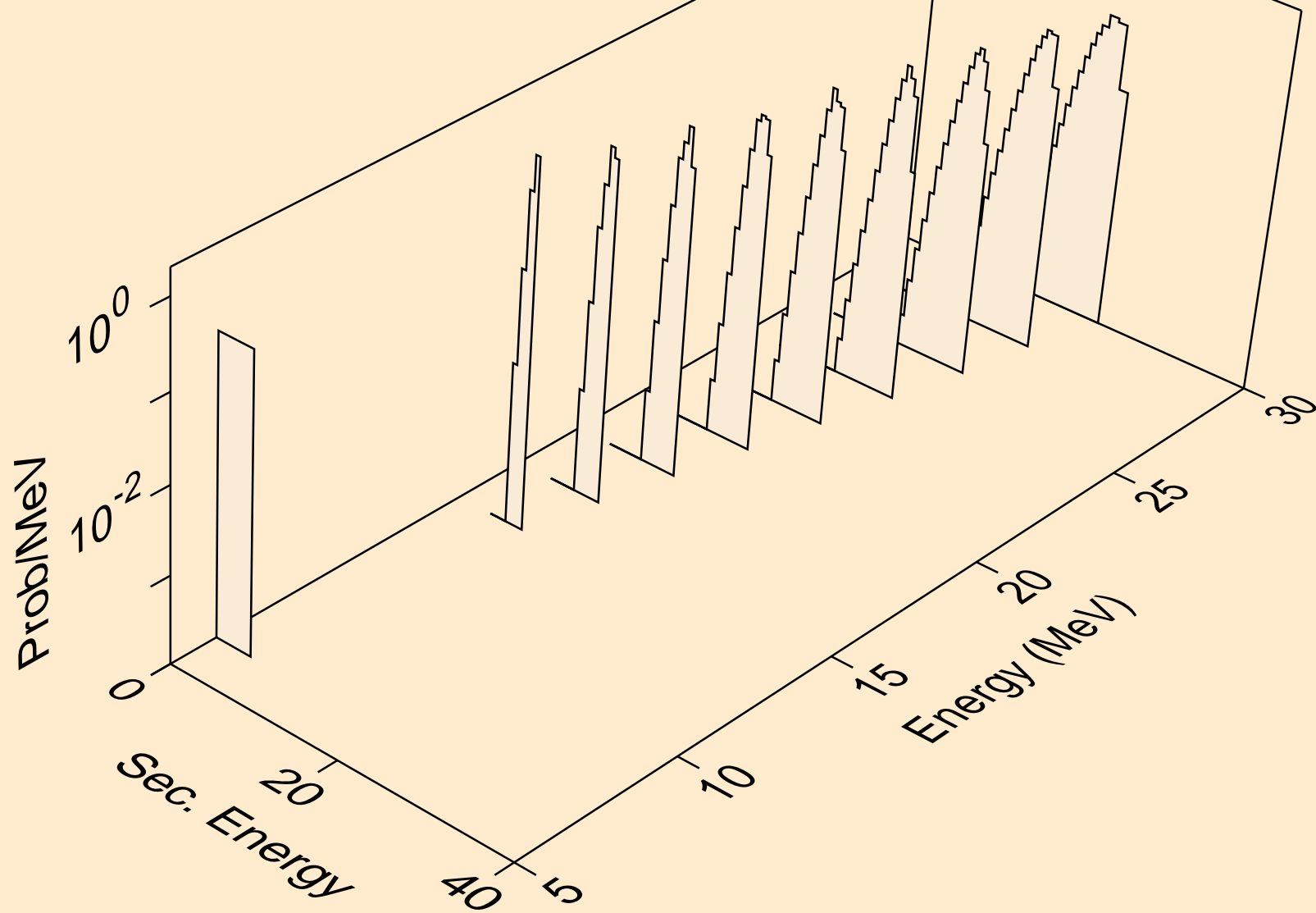

OS183 TRITON ACER TENDL-2021 LIBRARY; T=0.K  
he3s from (t,he3)

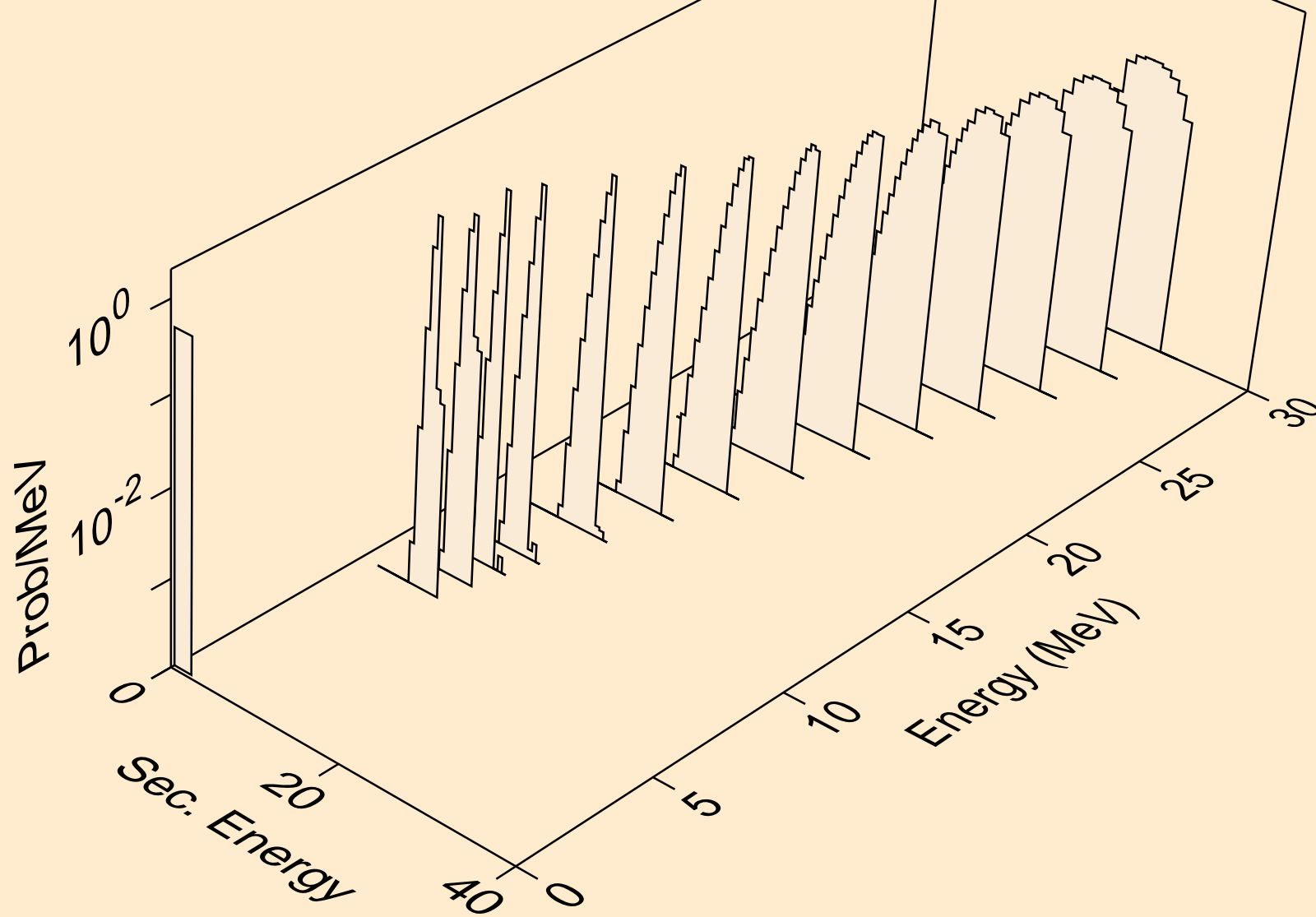

OS183 TRITON ACER TENDL-2021 LIBRARY; T=0.K  
alphas from (t,x)

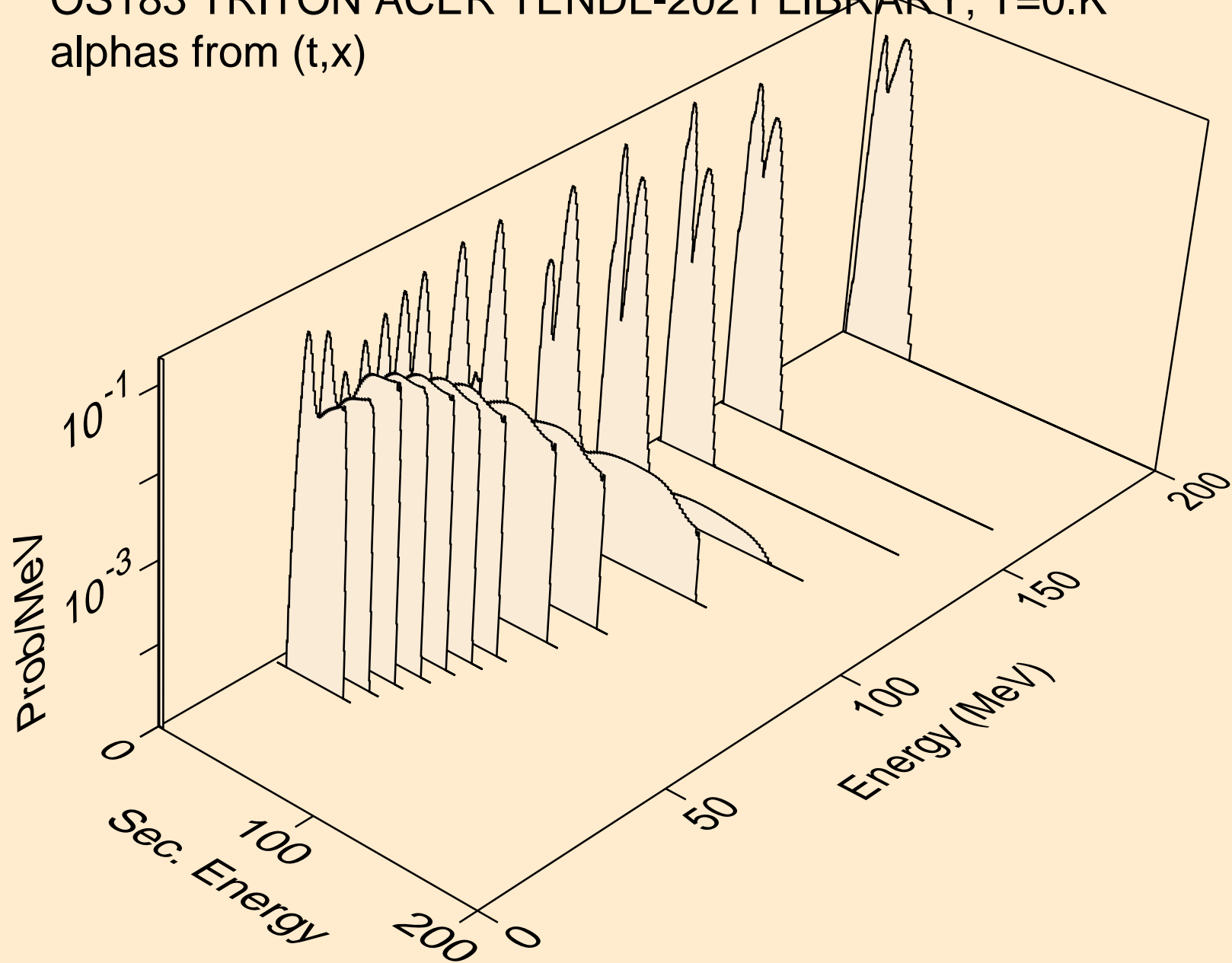

OS183 TRITON ACER TENDL-2021 LIBRARY; T=0.K  
alphas from (t,n\*)a

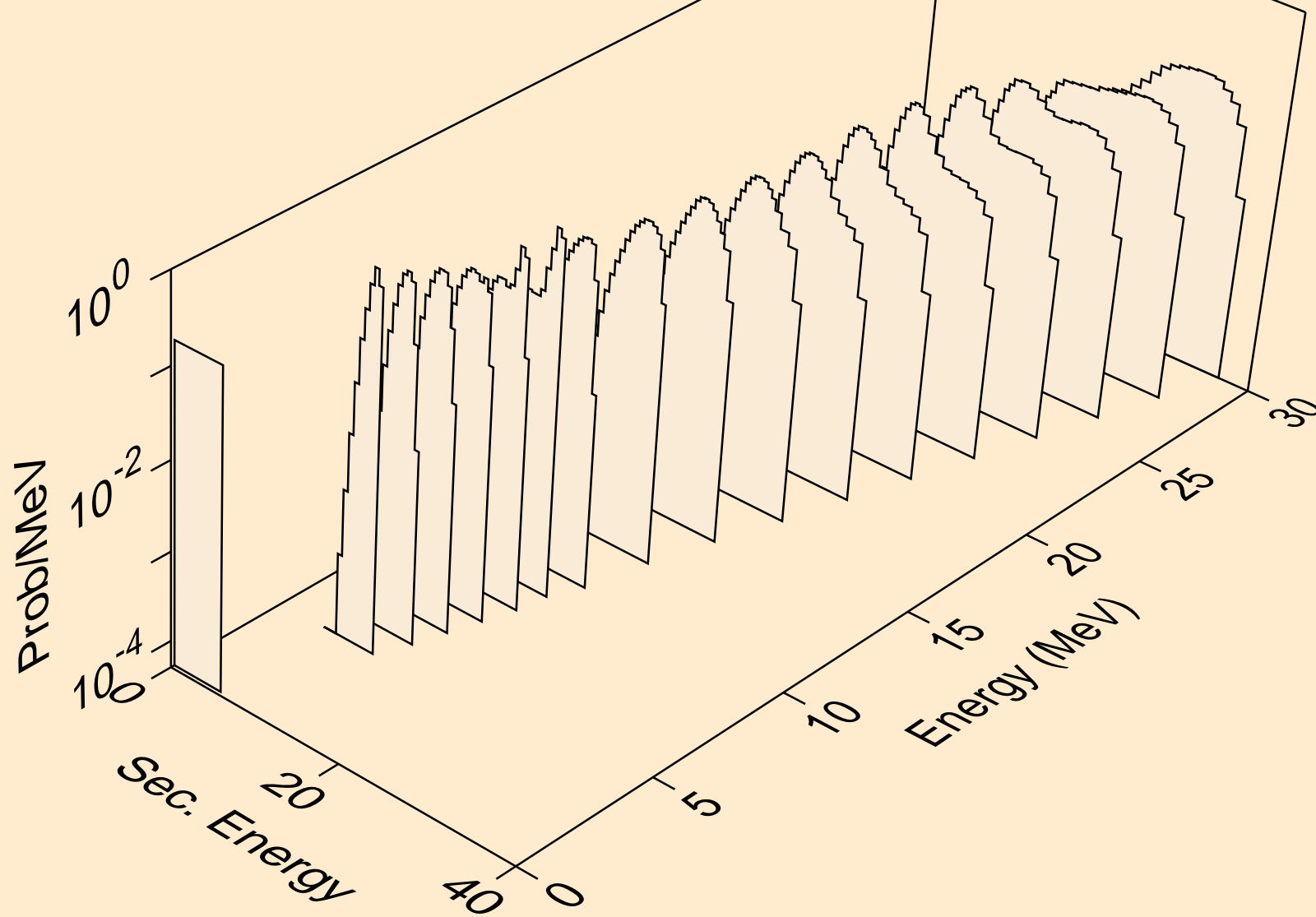



OS183 TRITON ACER TENDL-2021 LIBRARY; T=0.K  
alphas from (t,2n)a

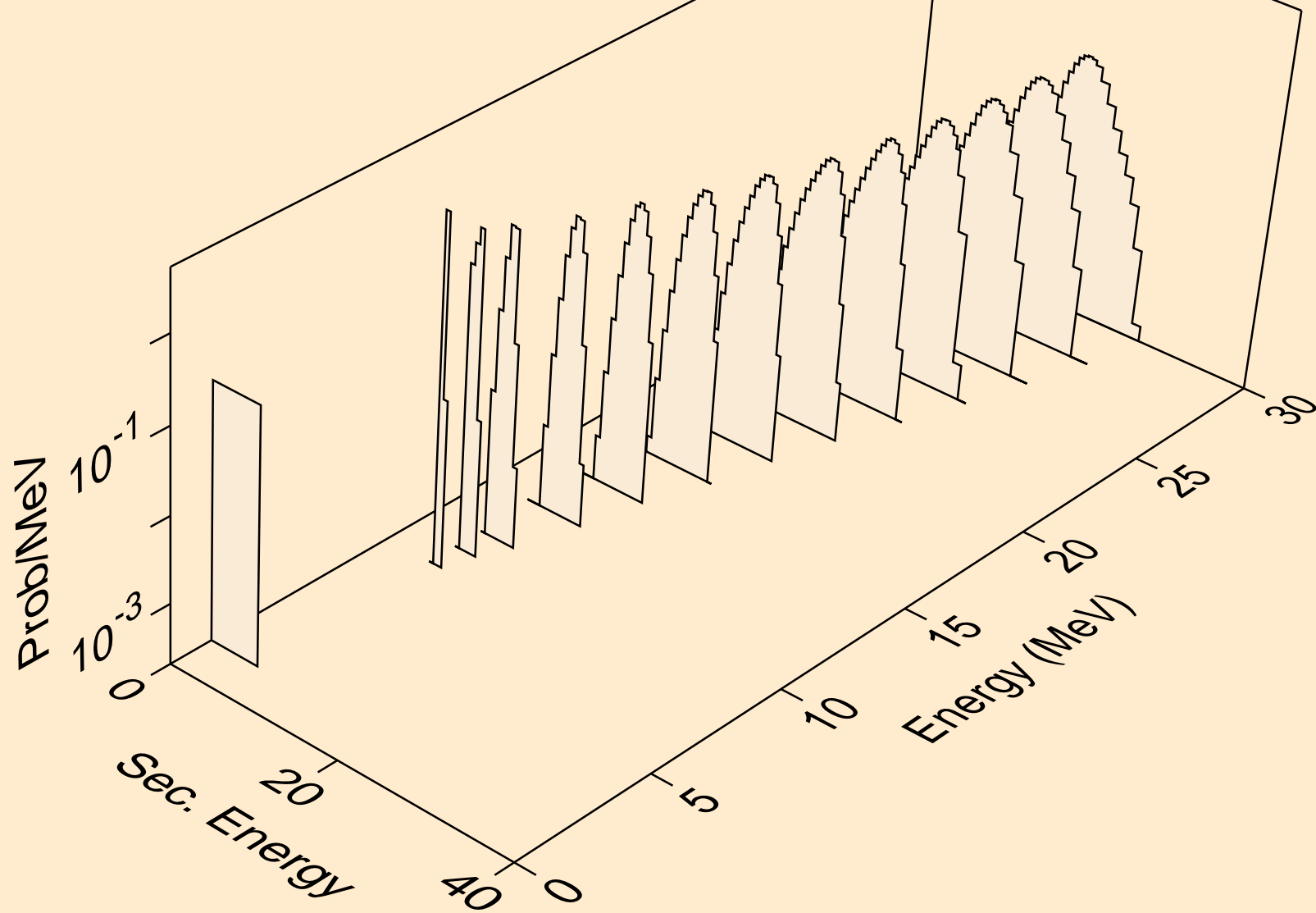

OS183 TRITON ACER TENDL-2021 LIBRARY; T=0.K  
alphas from (t,3n)a

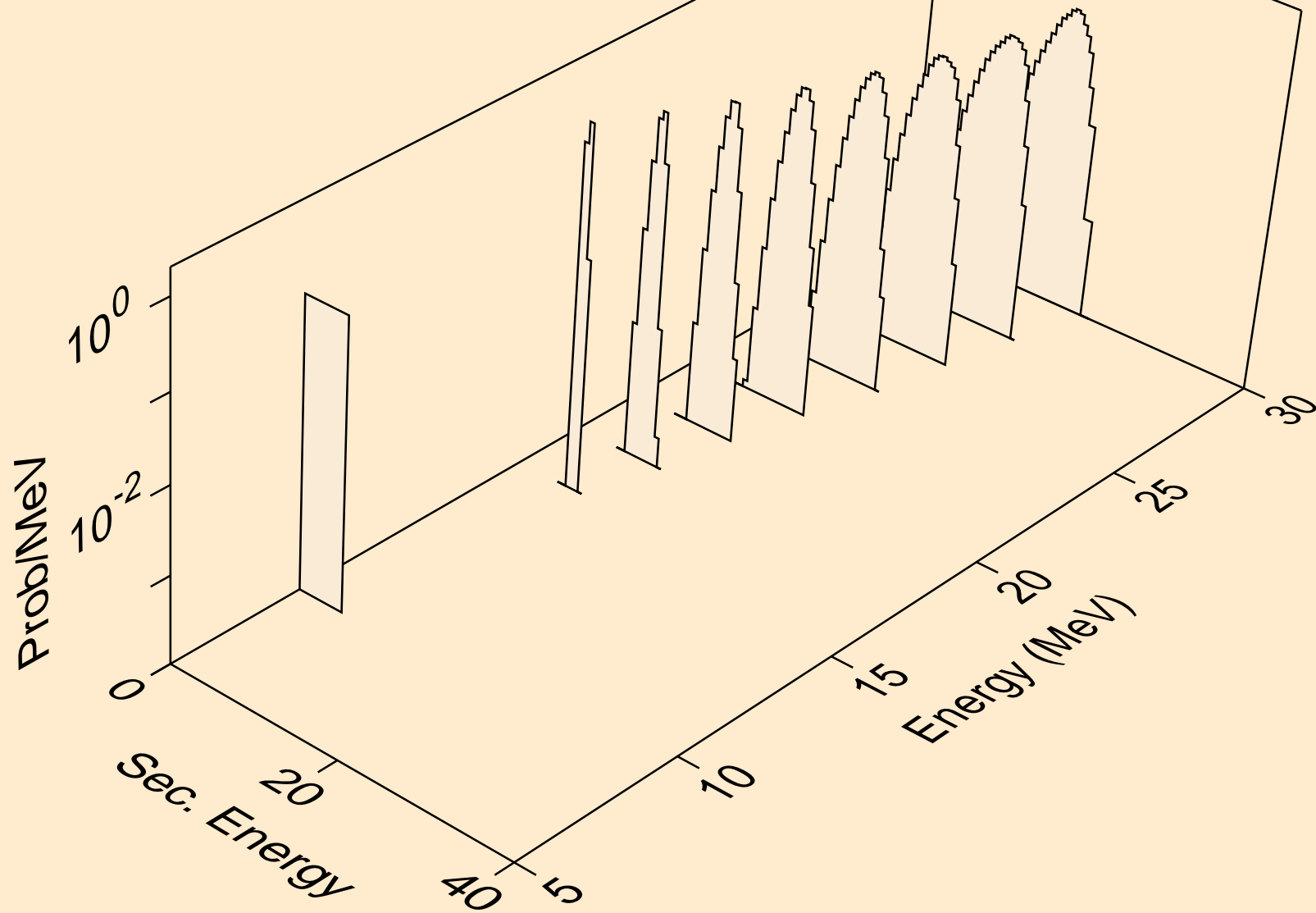

OS183 TRITON ACER TENDL-2021 LIBRARY; T=0.K  
alphas from (t,n\*)2a

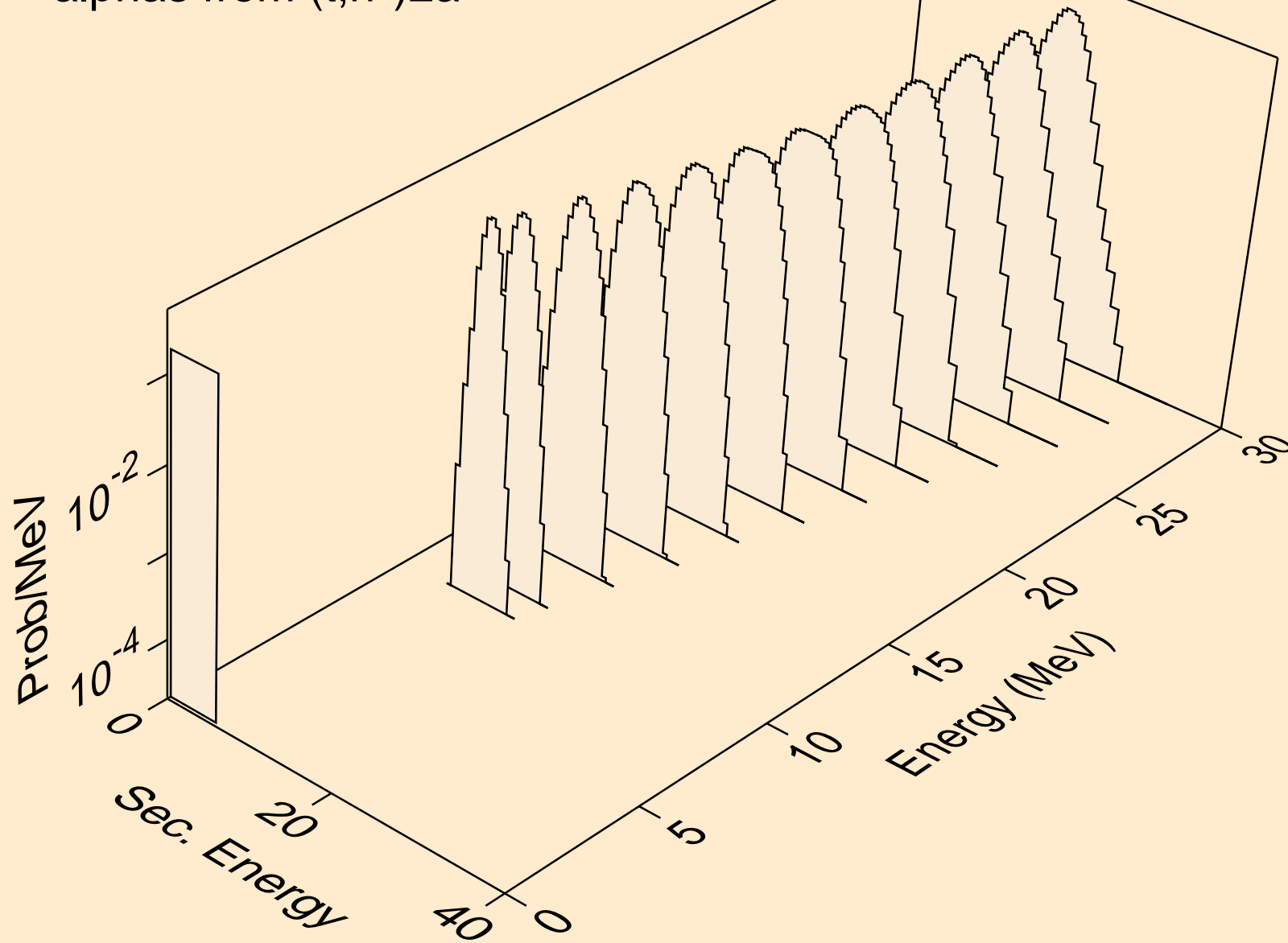

OS183 TRITON ACER TENDL-2021 LIBRARY; T=0.K  
alphas from (t,2n)2a

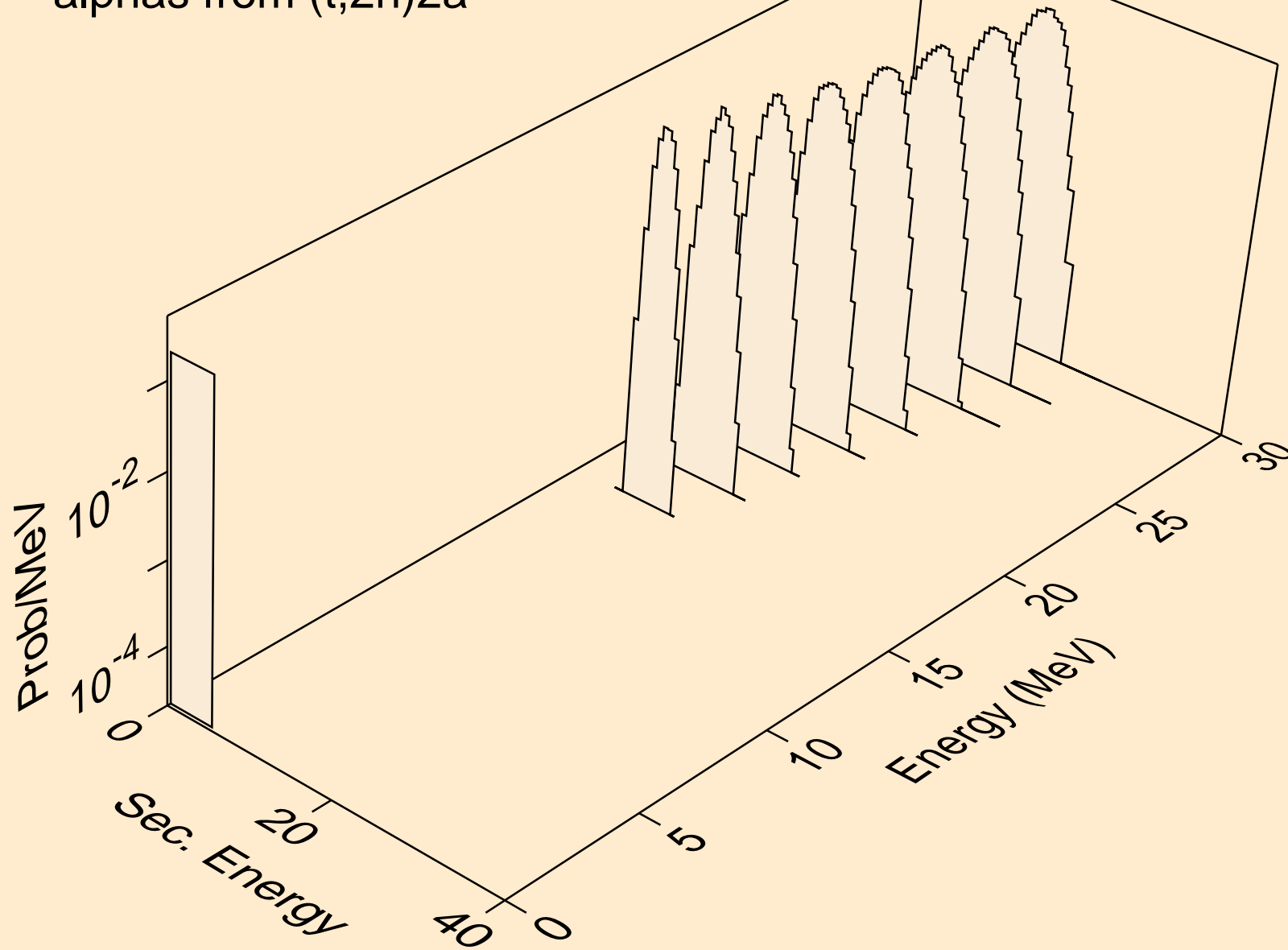

OS183 TRITON ACER TENDL-2021 LIBRARY; T=0.K  
alphas from (t,npa)

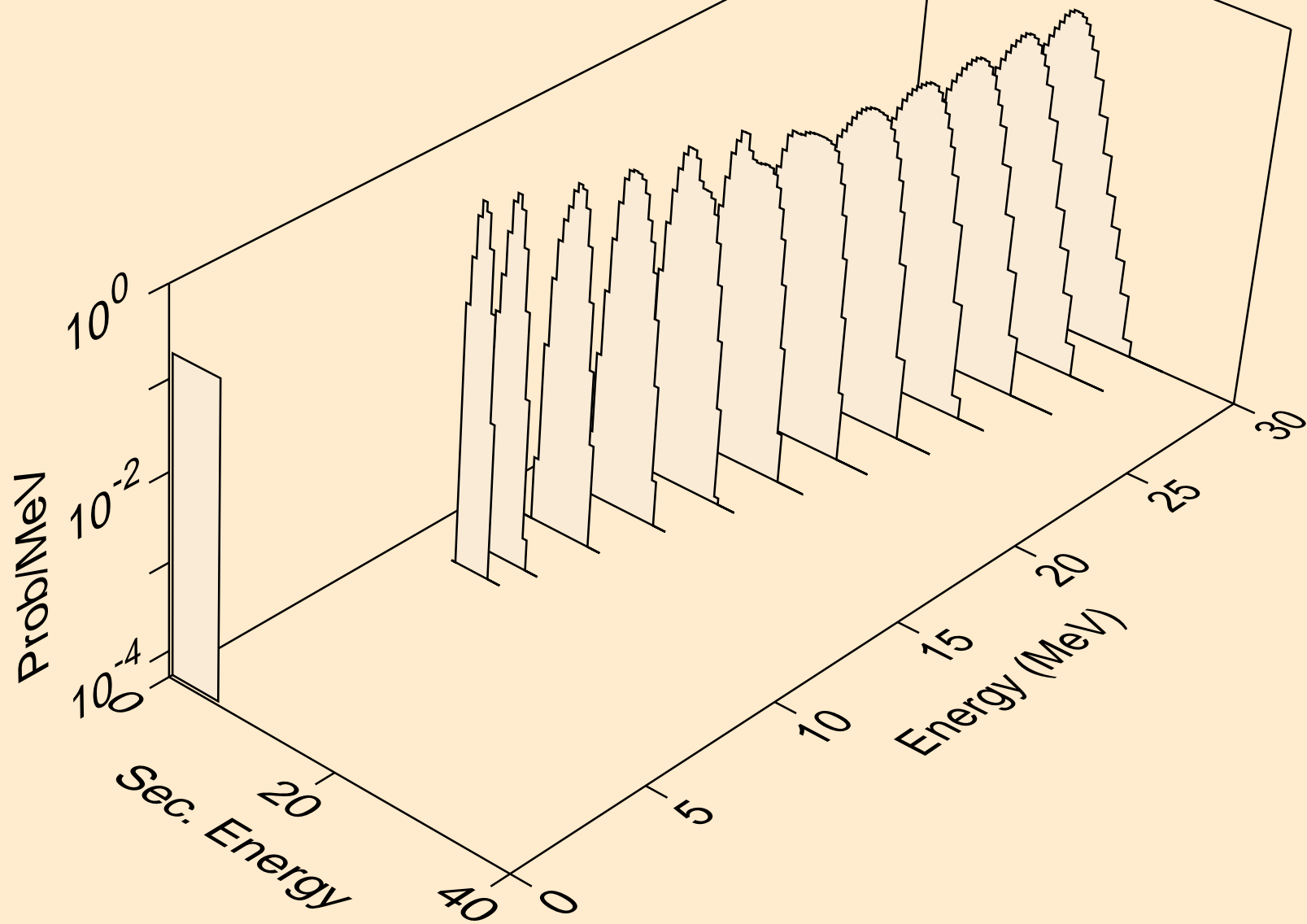

OS183 TRITON ACER TENDL-2021 LIBRARY; T=0.K  
alphas from (t,a)

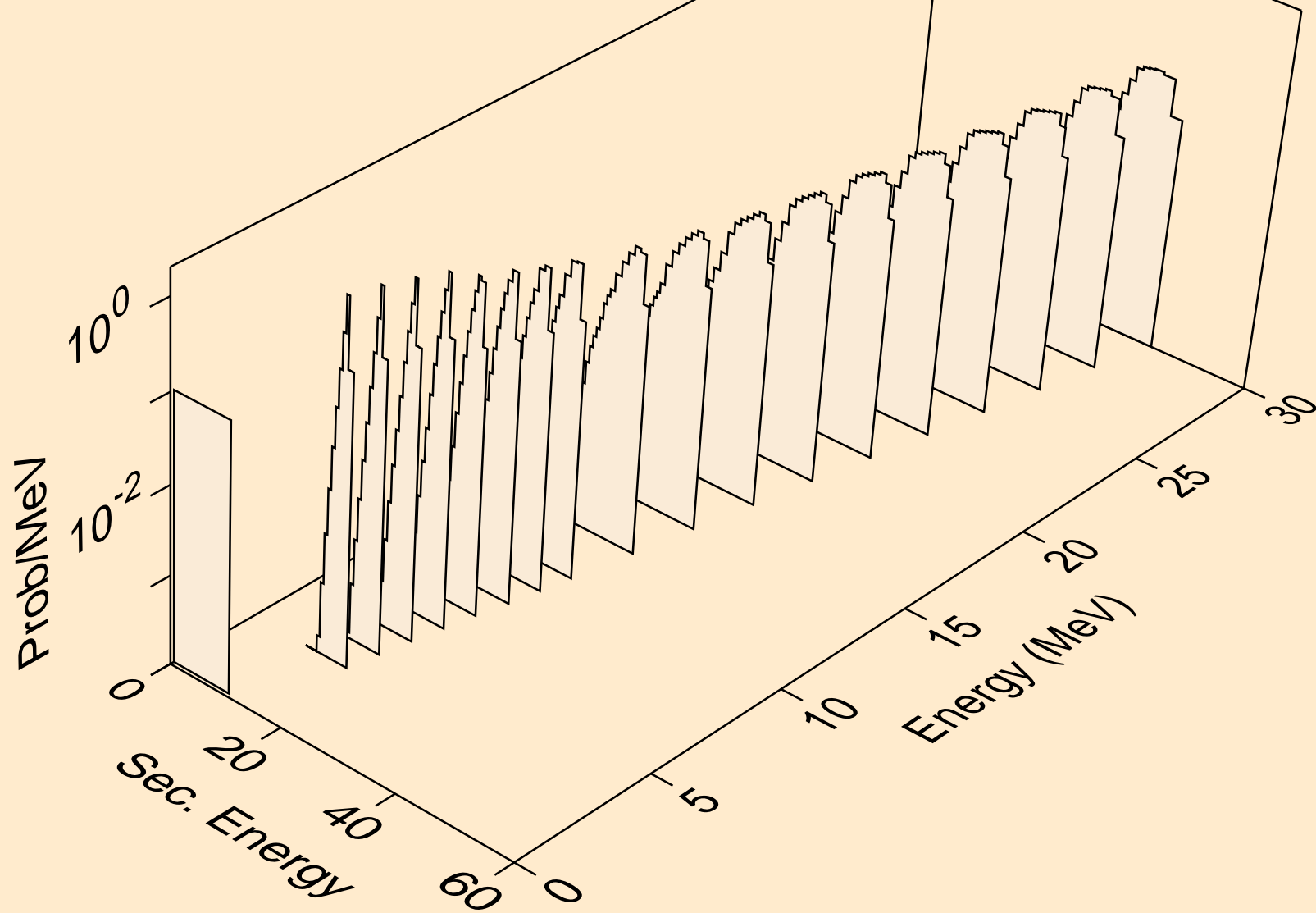

OS183 TRITON ACER TENDL-2021 LIBRARY; T=0.K  
alphas from (t,2a)

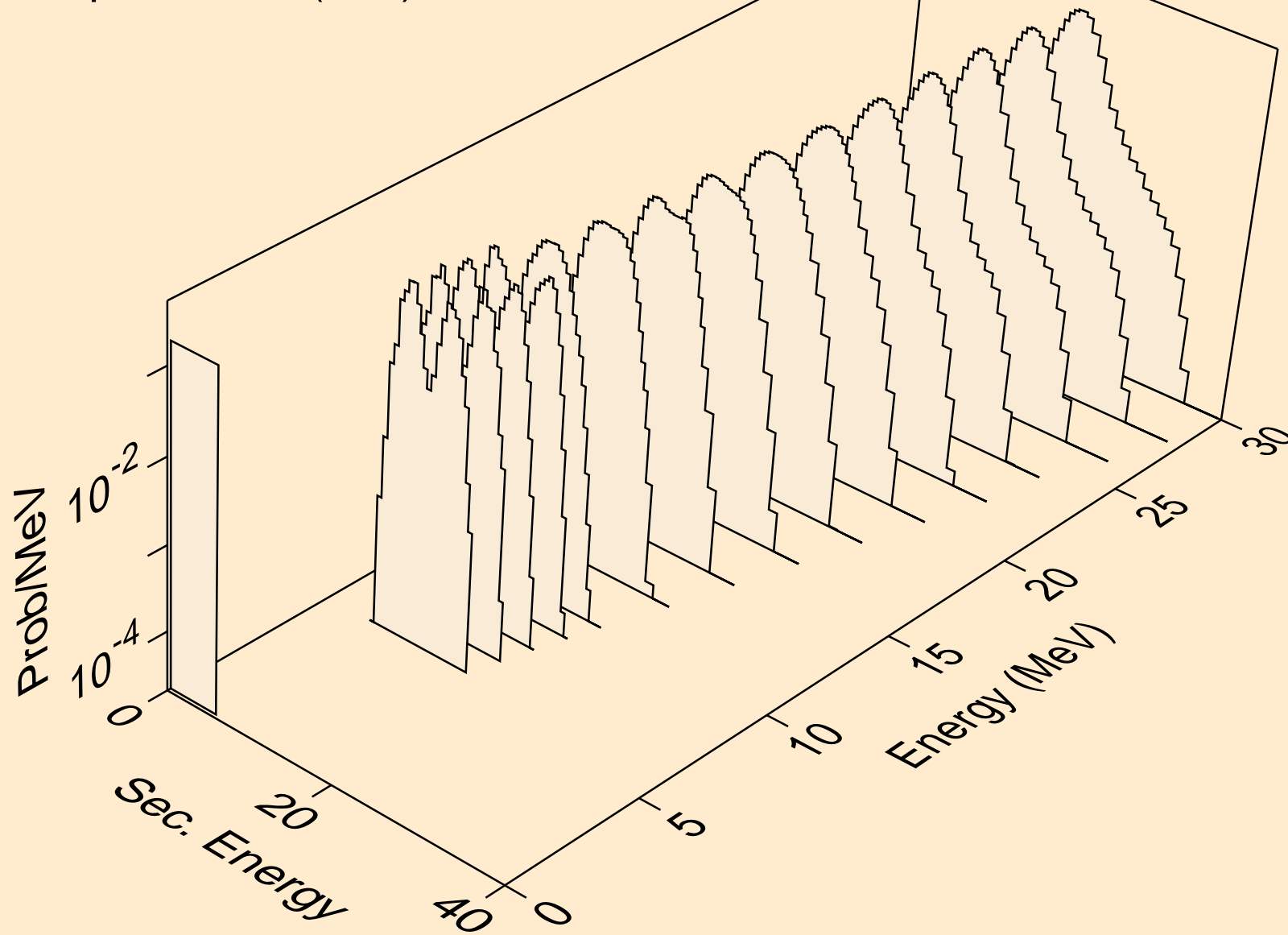

OS183 TRITON ACER TENDL-2021 LIBRARY; T=0.K  
alphas from (t,pa)

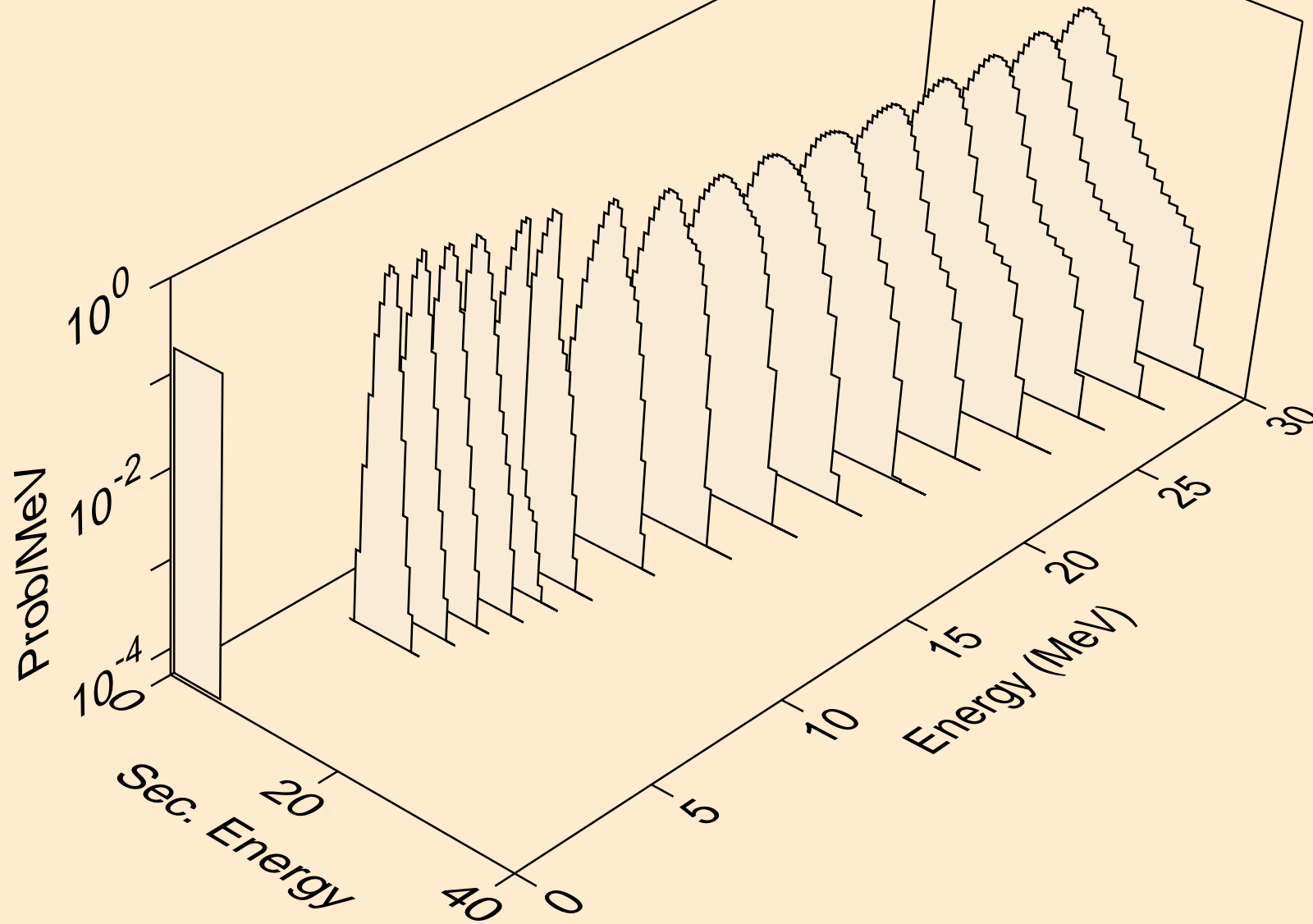



OS183 TRITON ACER TENDL-2021 LIBRARY; T=0.K  
alphas from (t,da)

