

P031 TRITON ACER TENDL-2021 LIBRARY; T=0.K  
Principal cross sections

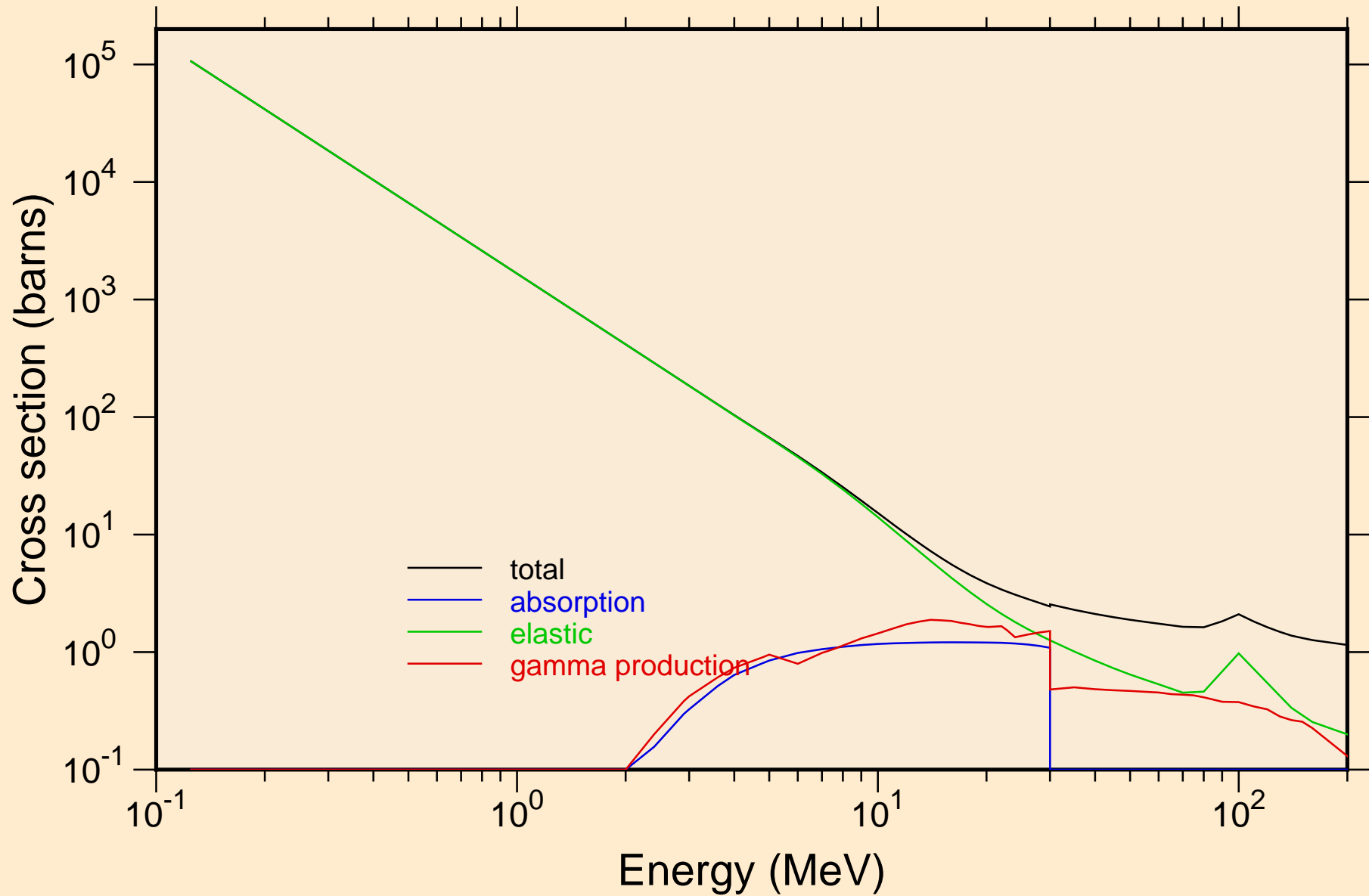

P031 TRITON ACER TENDL-2021 LIBRARY; T=0.K

Heating

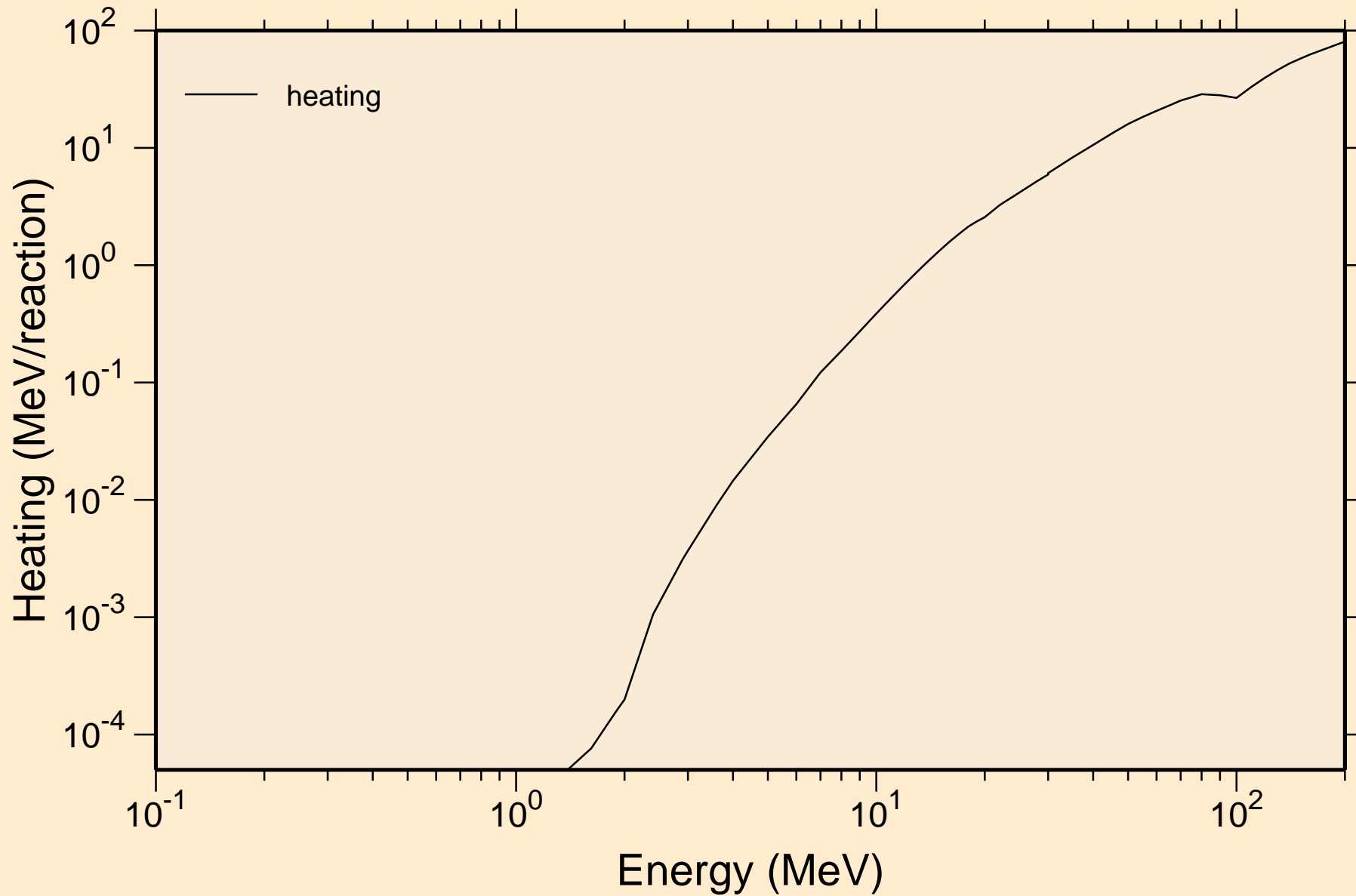

# P031 TRITON ACER TENDL-2021 LIBRARY; T=0.K

## Principal cross sections

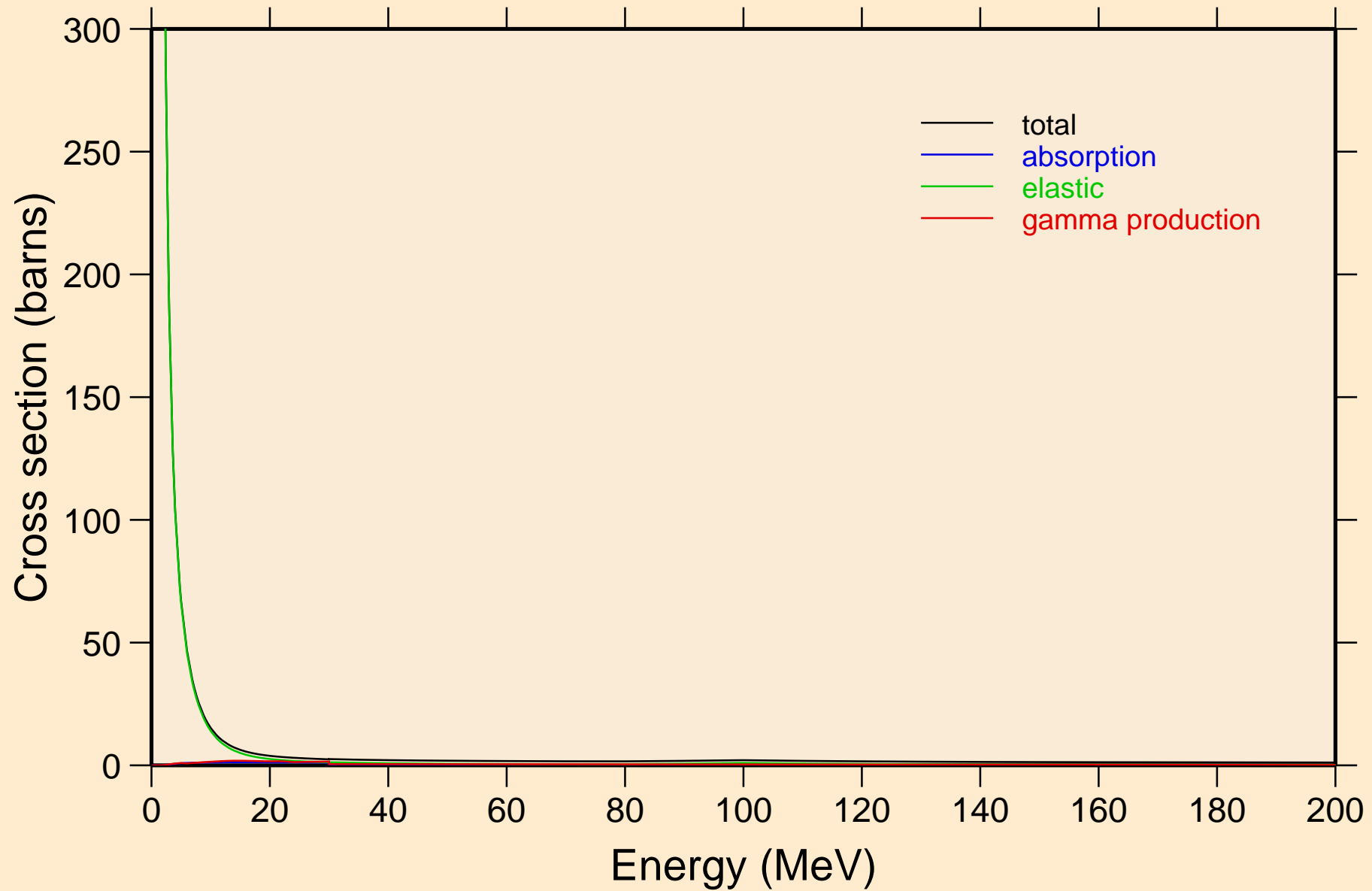

P031 TRITON ACER TENDL-2021 LIBRARY; T=0.K

Heating

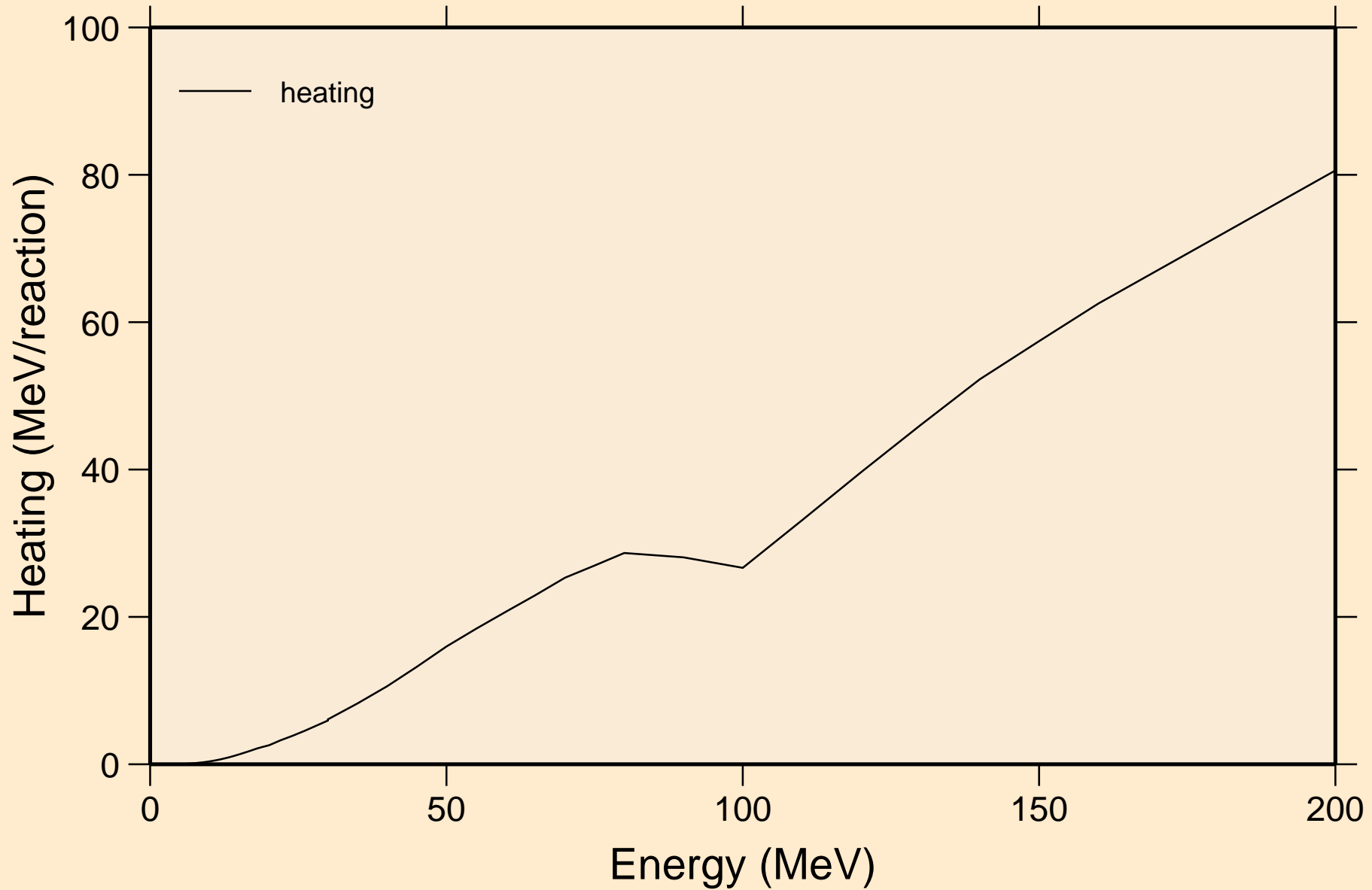

P031 TRITON ACER TENDL-2021 LIBRARY; T=0.K  
Threshold reactions

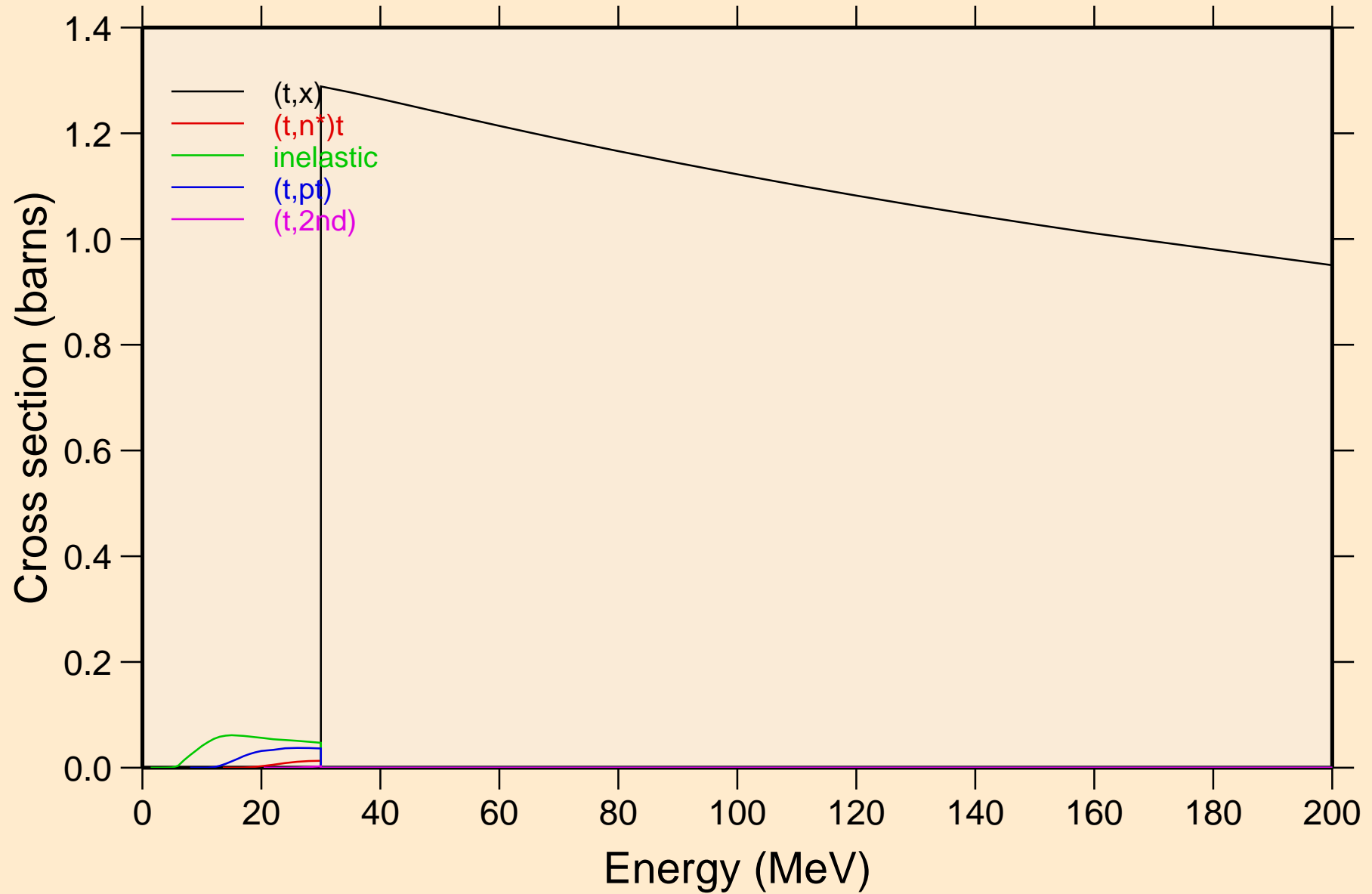

P031 TRITON ACER TENDL-2021 LIBRARY; T=0.K  
Threshold reactions

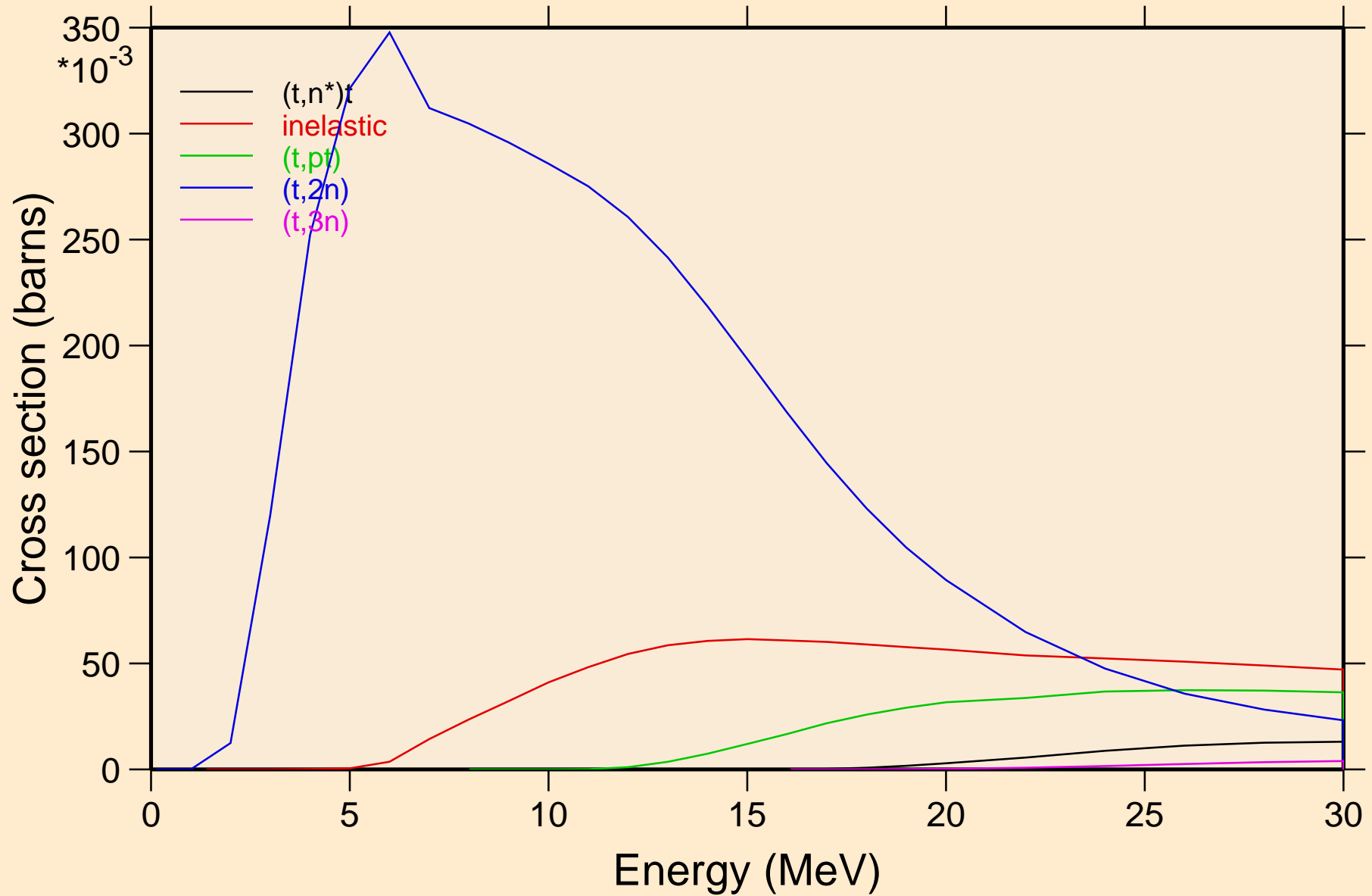

P031 TRITON ACER TENDL-2021 LIBRARY; T=0.K  
Threshold reactions

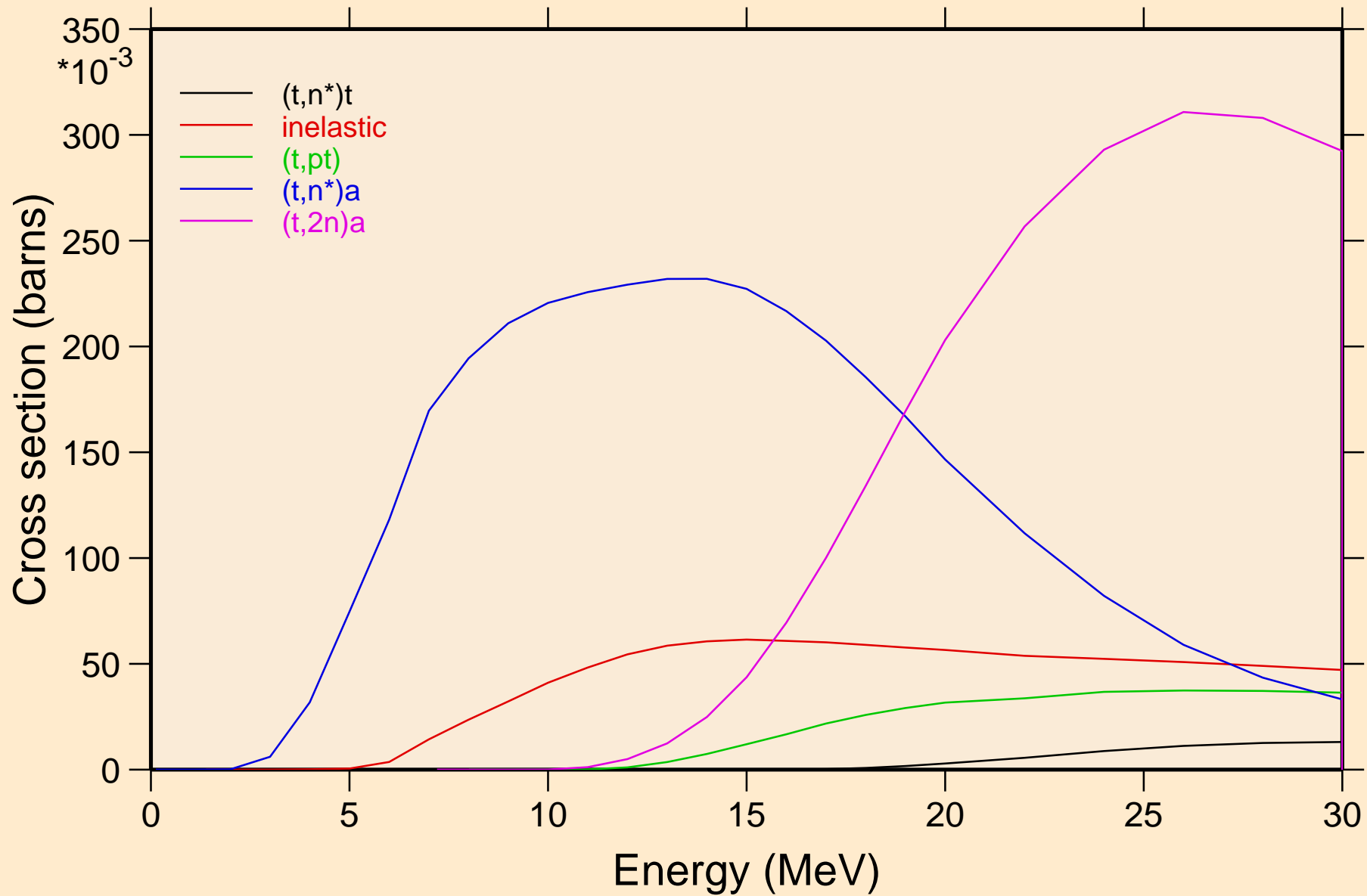

P031 TRITON ACER TENDL-2021 LIBRARY; T=0.K  
Threshold reactions

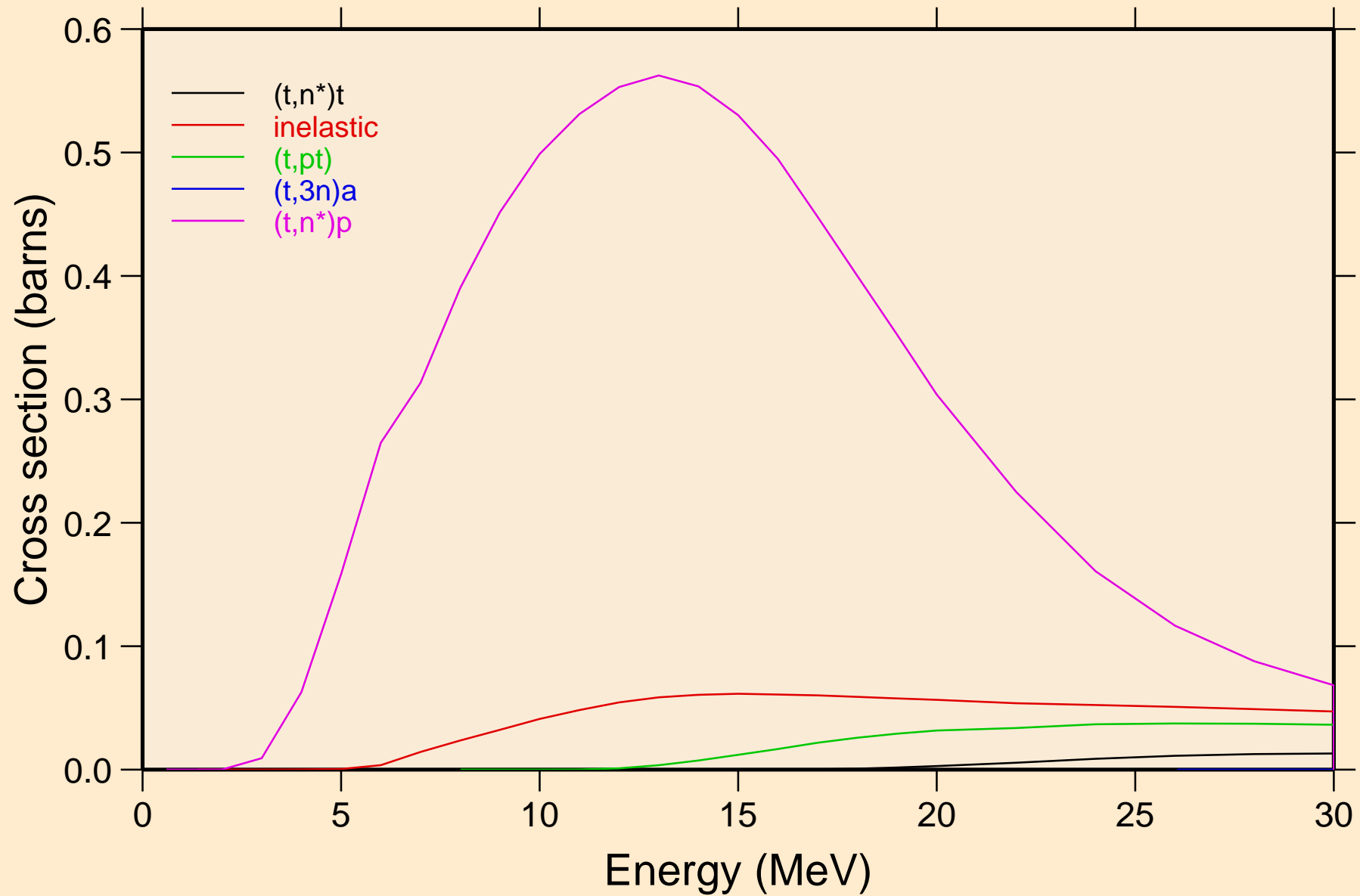



P031 TRITON ACER TENDL-2021 LIBRARY; T=0.K  
Threshold reactions

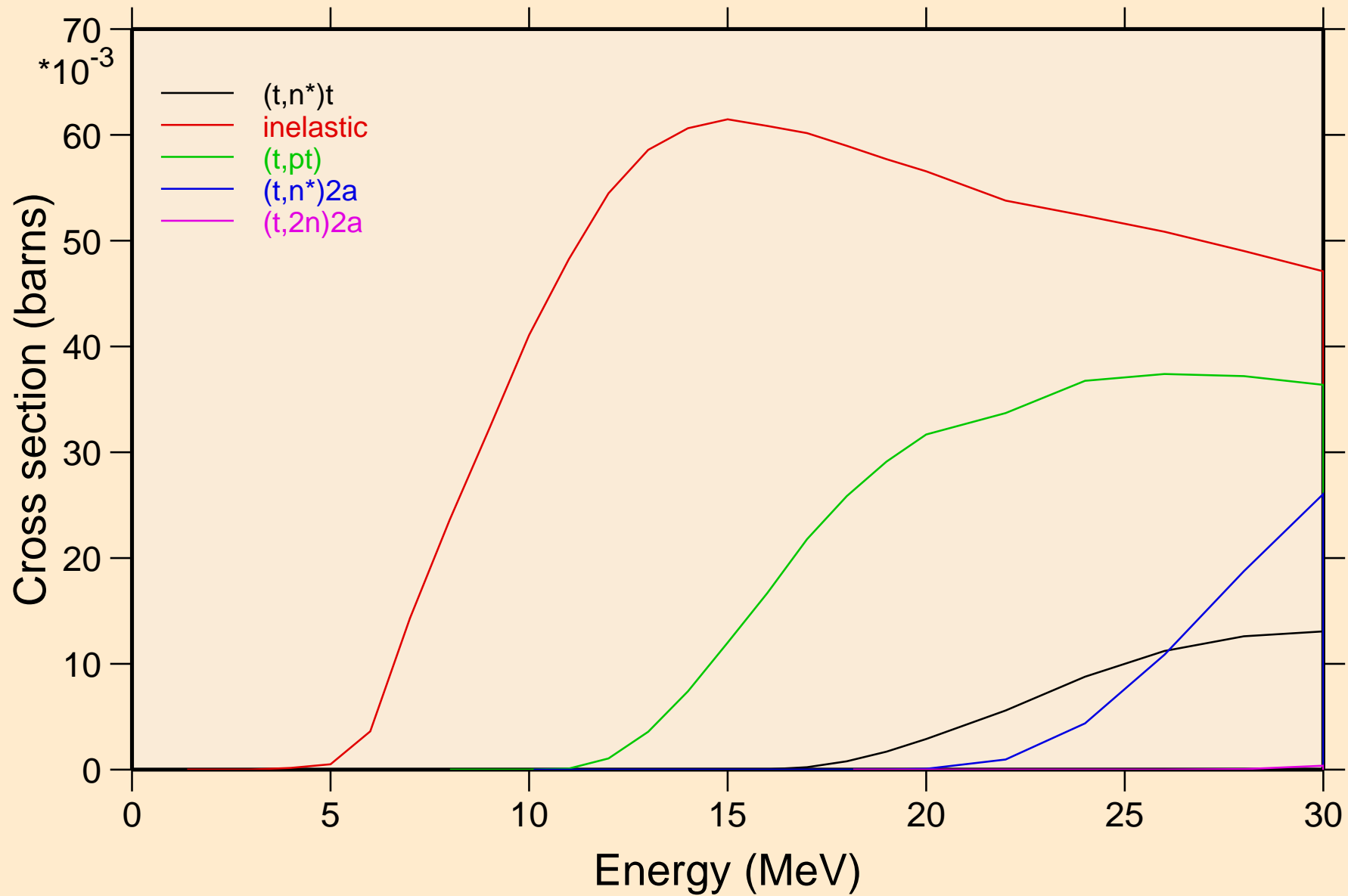

P031 TRITON ACER TENDL-2021 LIBRARY; T=0.K  
Threshold reactions

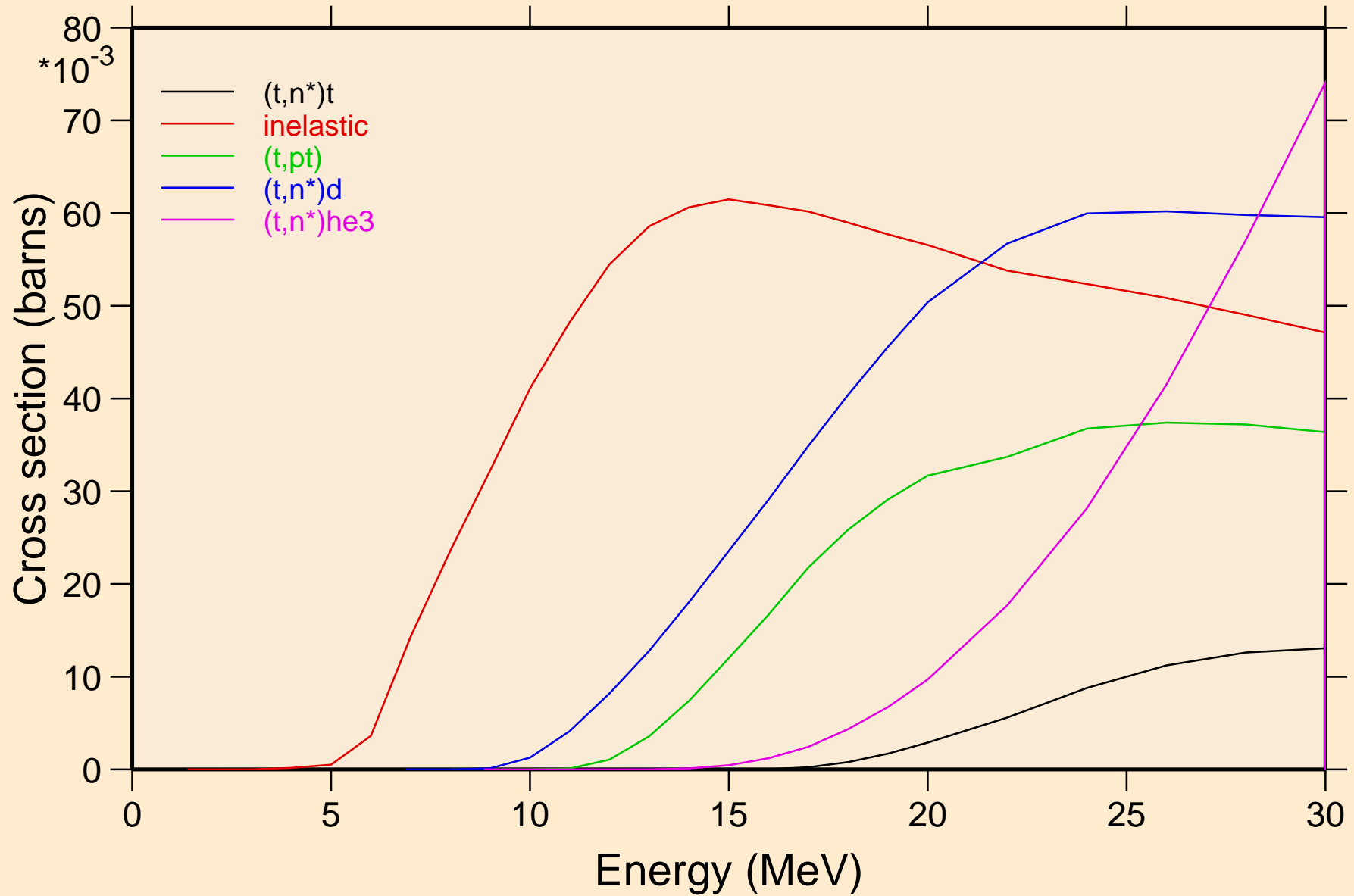

P031 TRITON ACER TENDL-2021 LIBRARY; T=0.K  
Threshold reactions

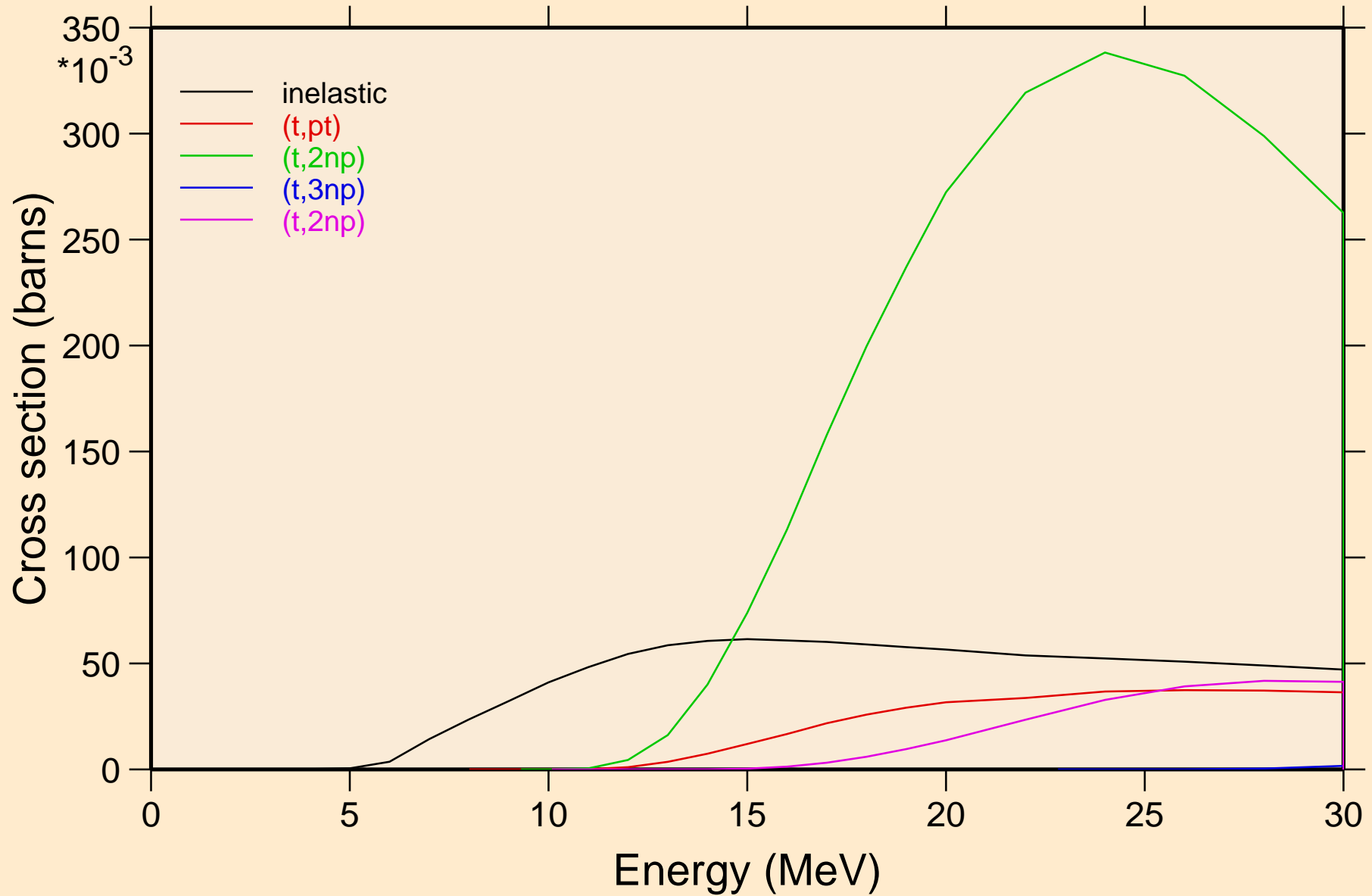

P031 TRITON ACER TENDL-2021 LIBRARY; T=0.K  
Threshold reactions

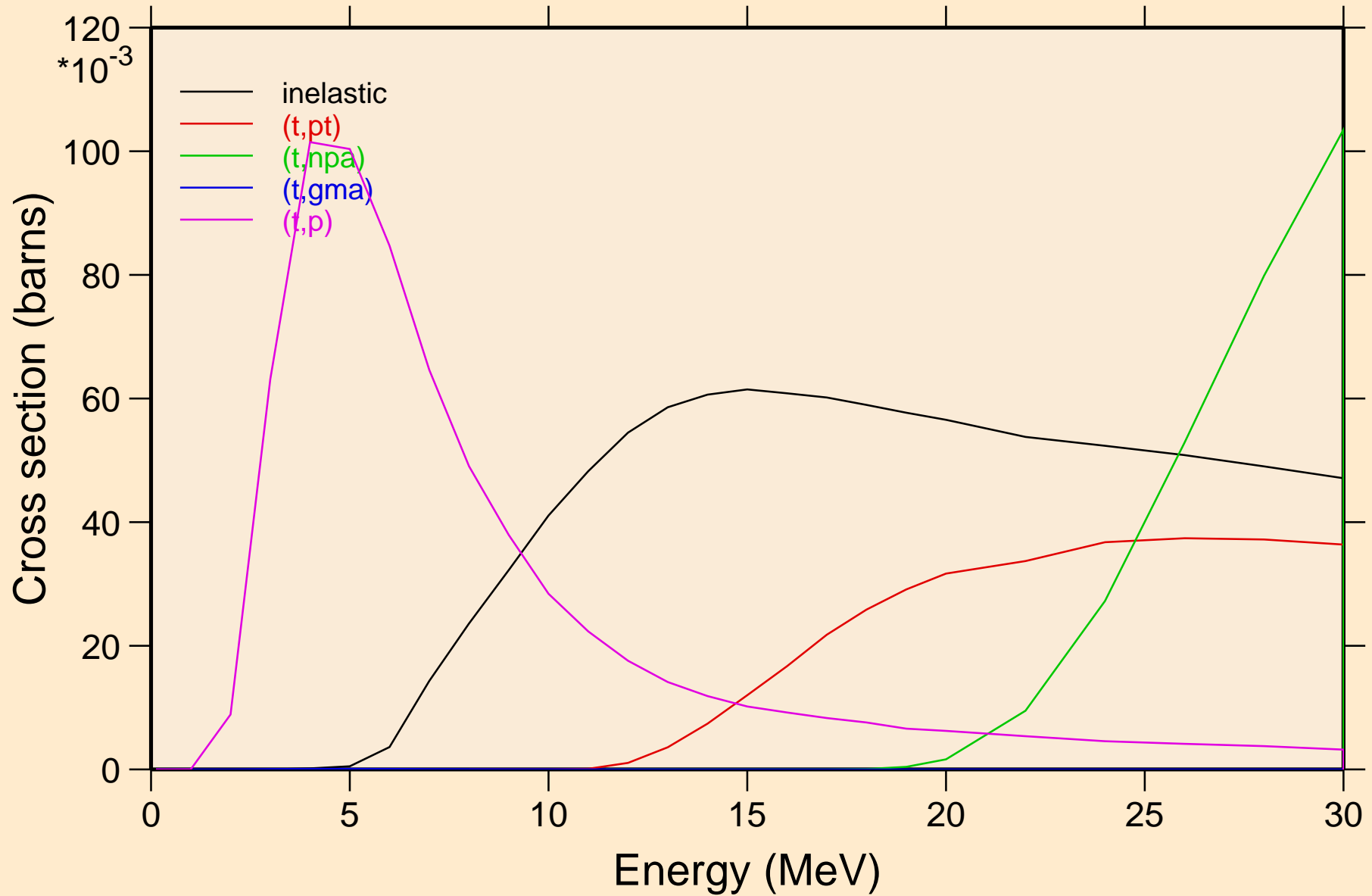

P031 TRITON ACER TENDL-2021 LIBRARY; T=0.K  
Threshold reactions

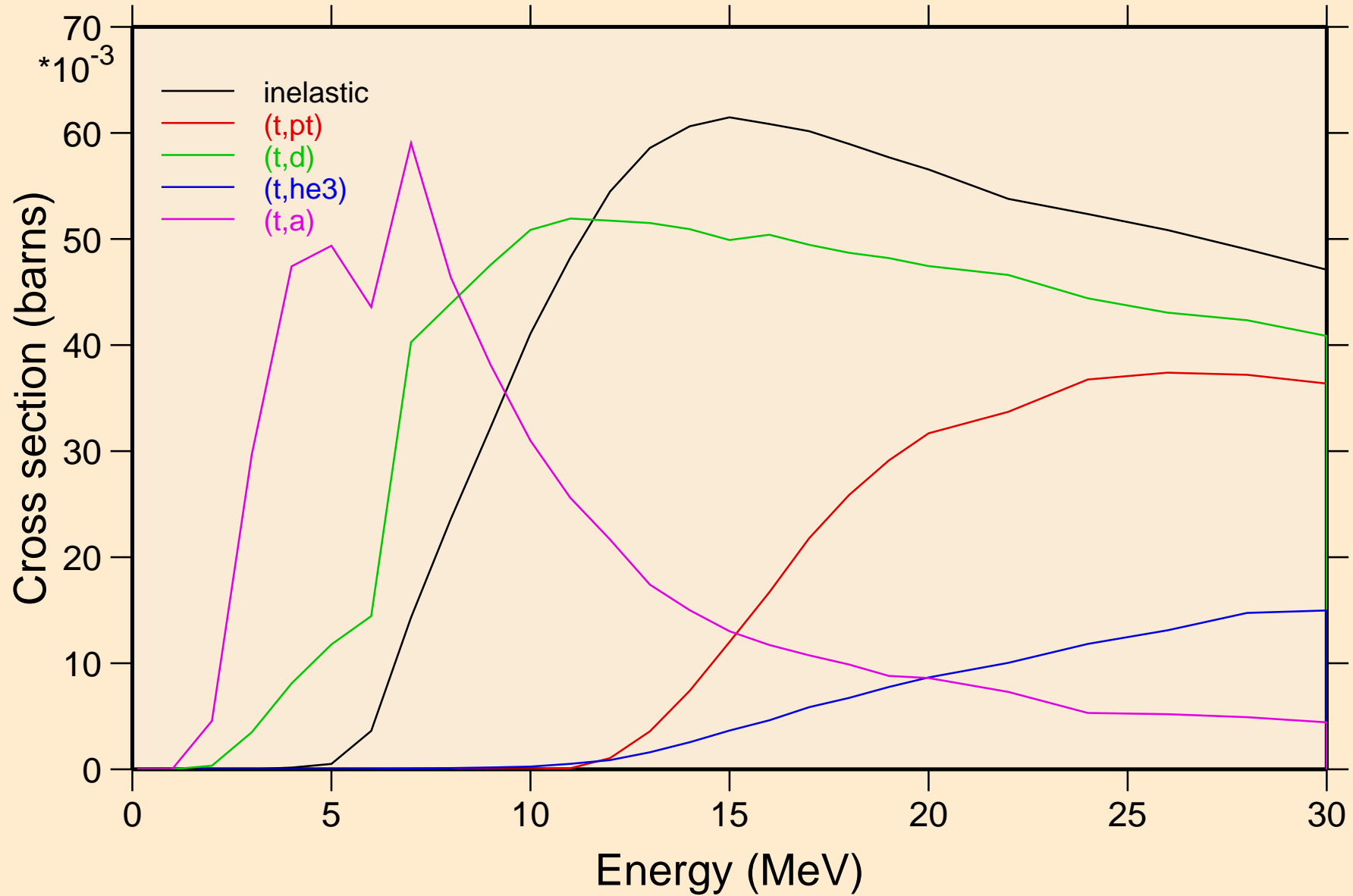

P031 TRITON ACER TENDL-2021 LIBRARY; T=0.K  
Threshold reactions

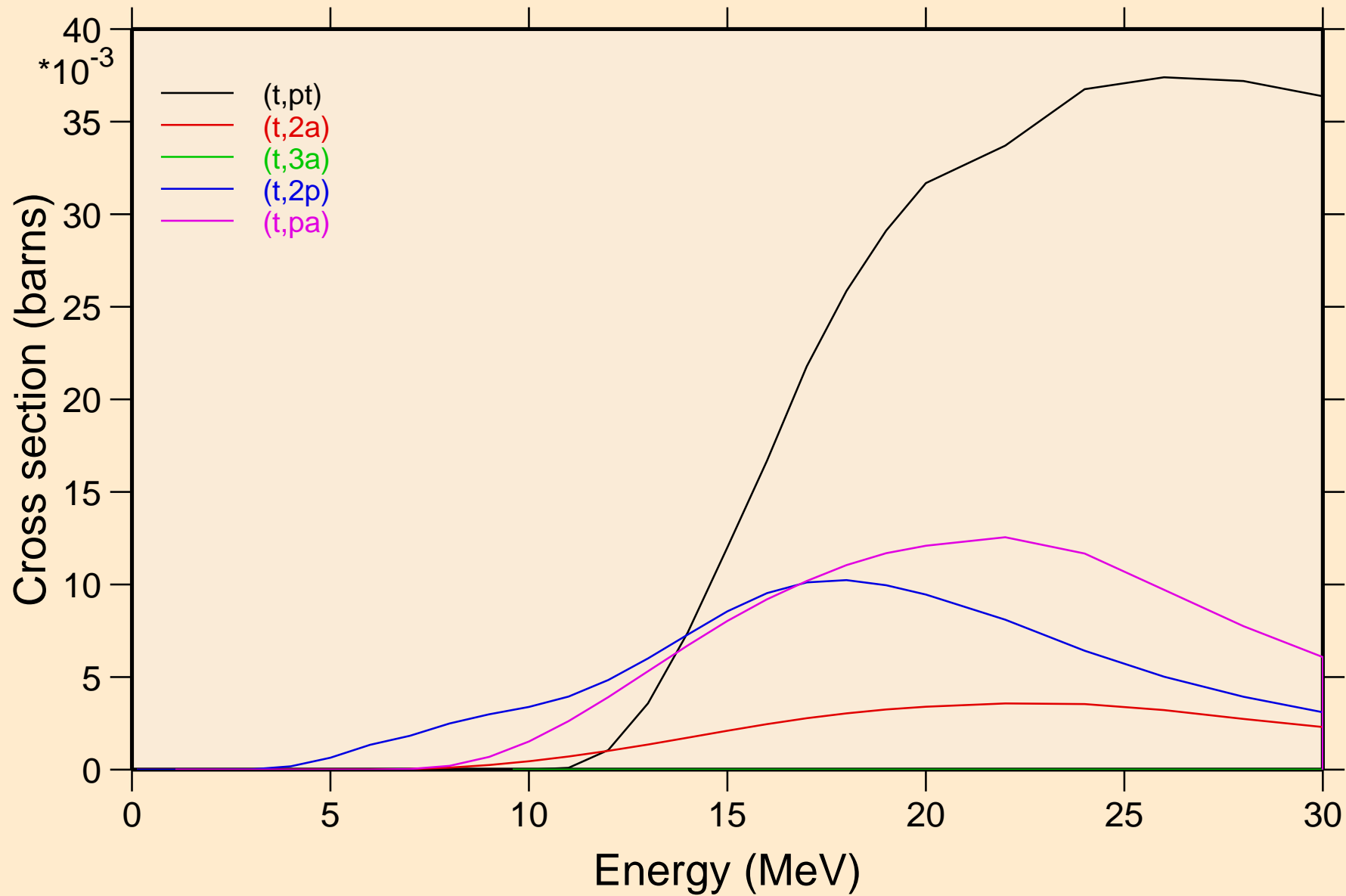

P031 TRITON ACER TENDL-2021 LIBRARY; T=0.K  
Threshold reactions

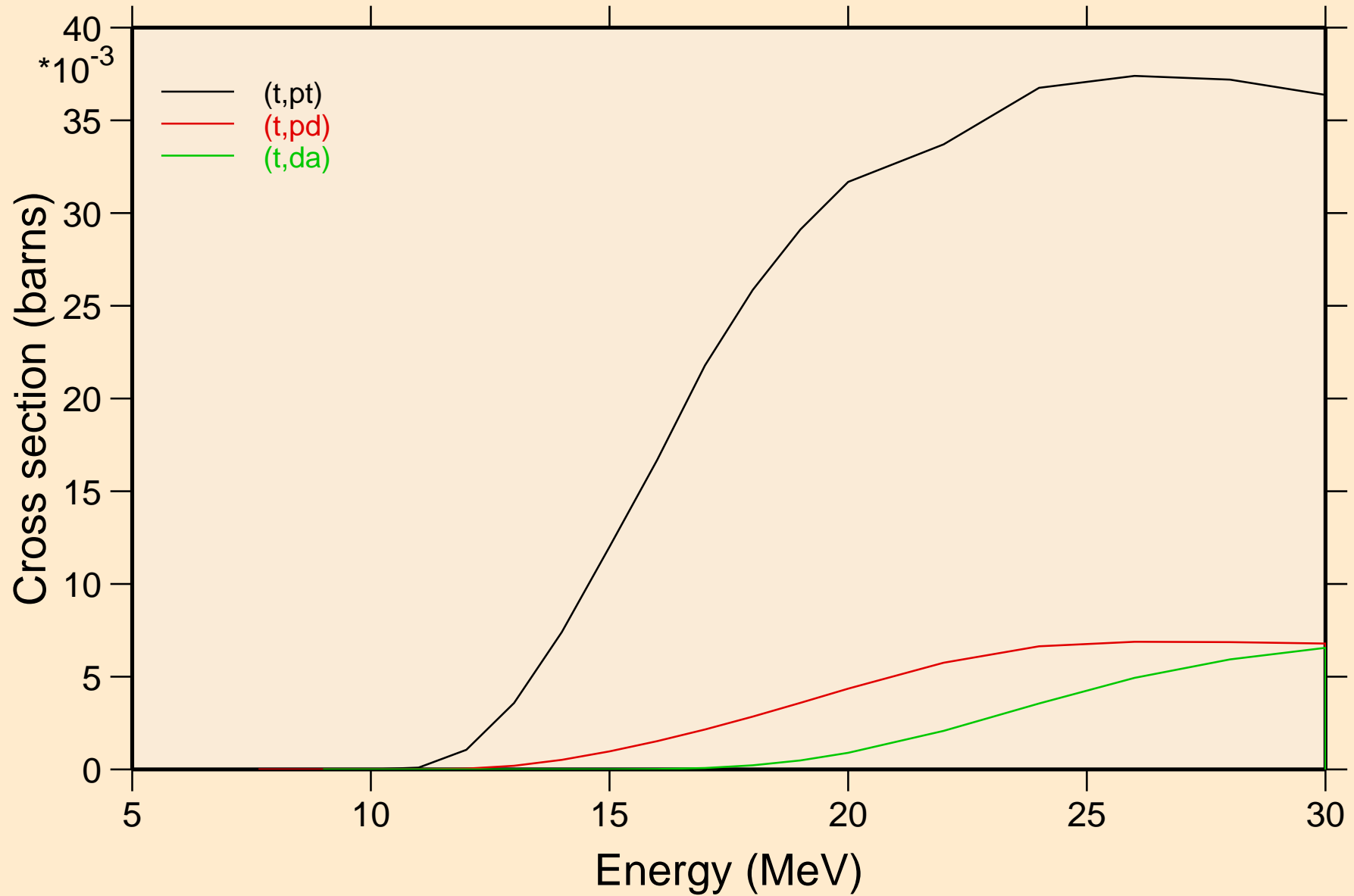

P031 TRITON ACER TENDL-2021 LIBRARY; T=0.K  
angular distribution for elastic

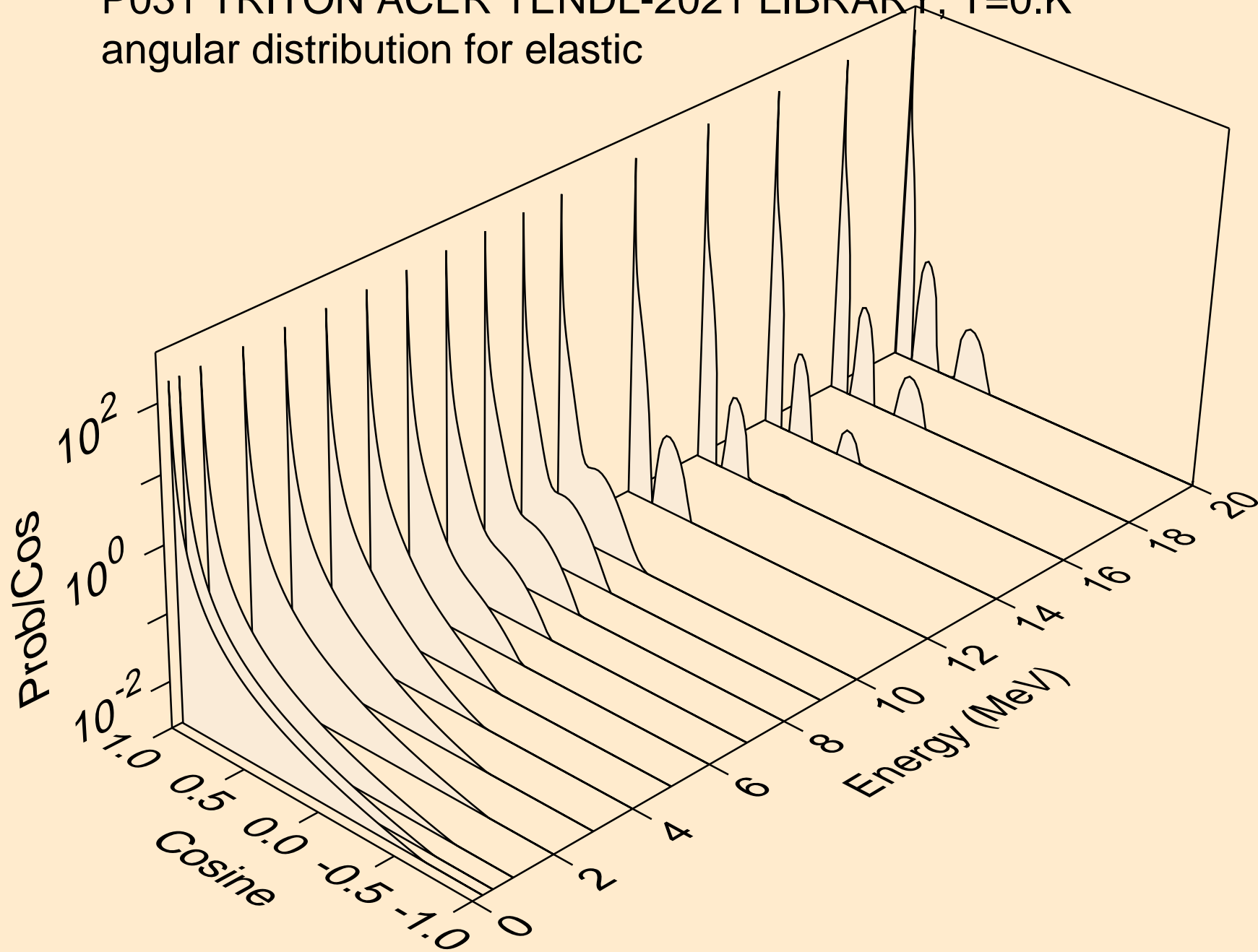



P031 TRITON ACER TENDL-2021 LIBRARY; T=0.K  
angular distribution for elastic

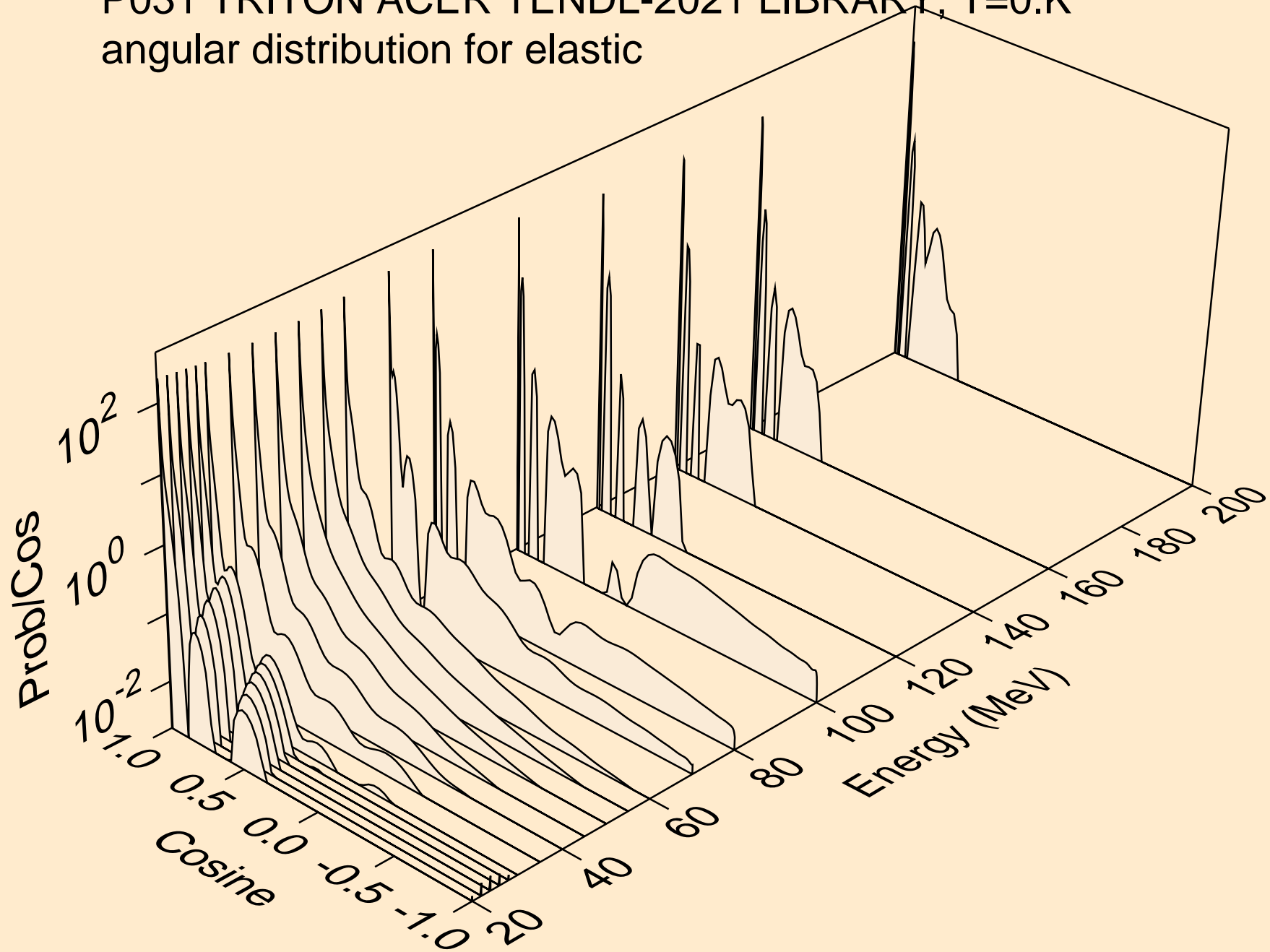

P031 TRITON ACER TENDL-2021 LIBRARY; T=0.K  
Triton emission for (t,x)

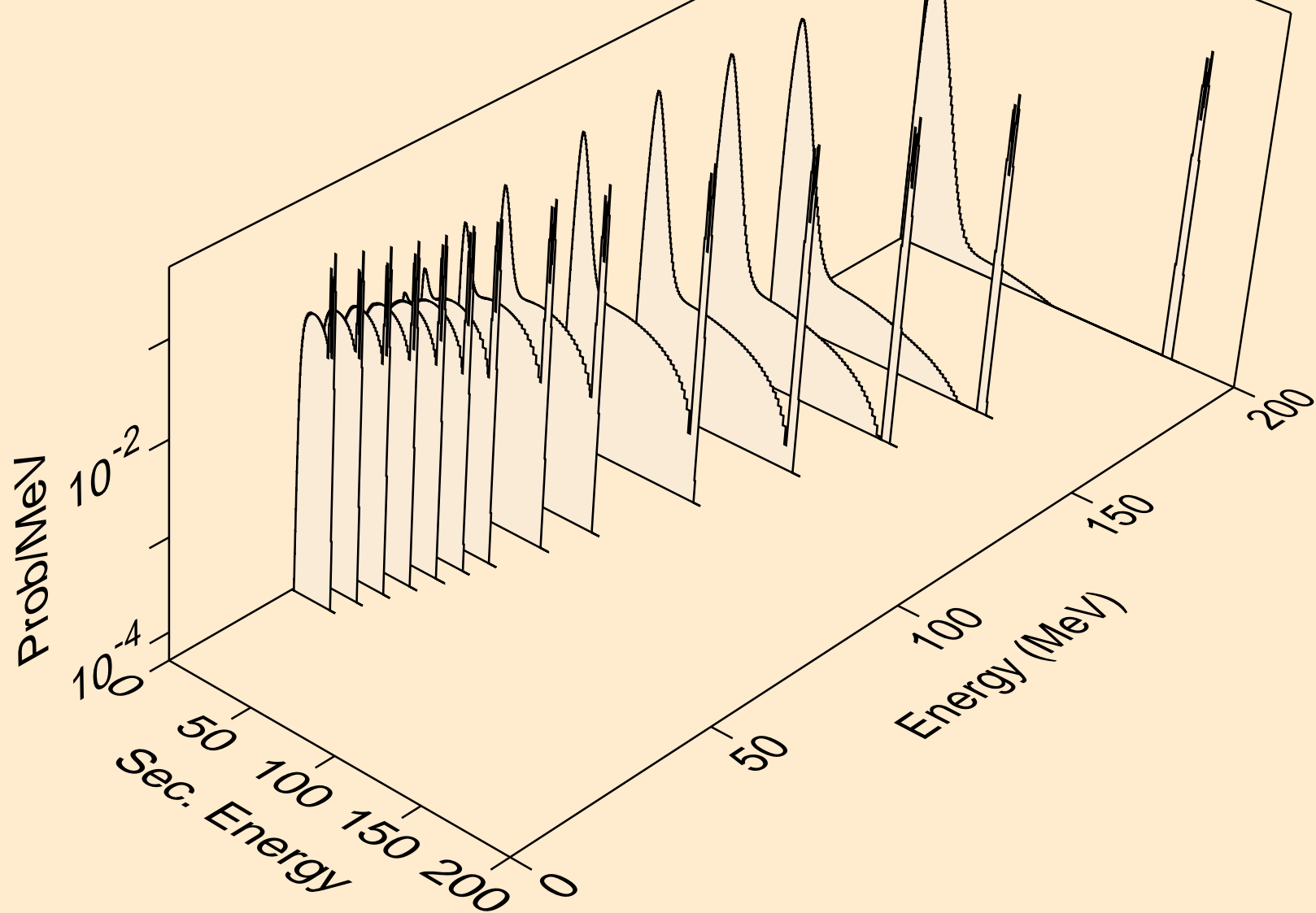

P031 TRITON ACER TENDL-2021 LIBRARY; T=0.K  
Triton emission for (t,n\*)t

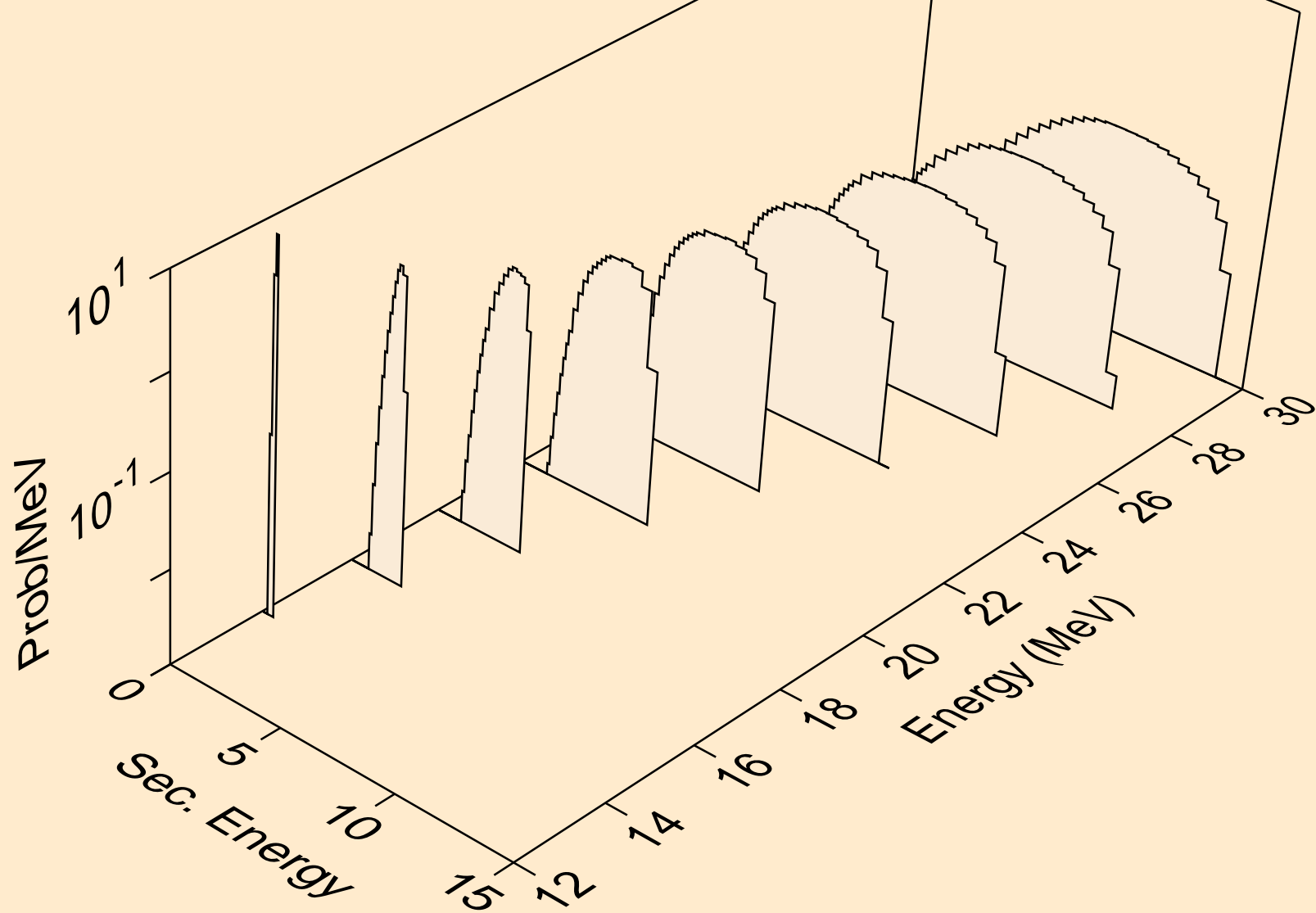

P031 TRITON ACER TENDL-2021 LIBRARY; T=0.K  
Triton emission for inelastic

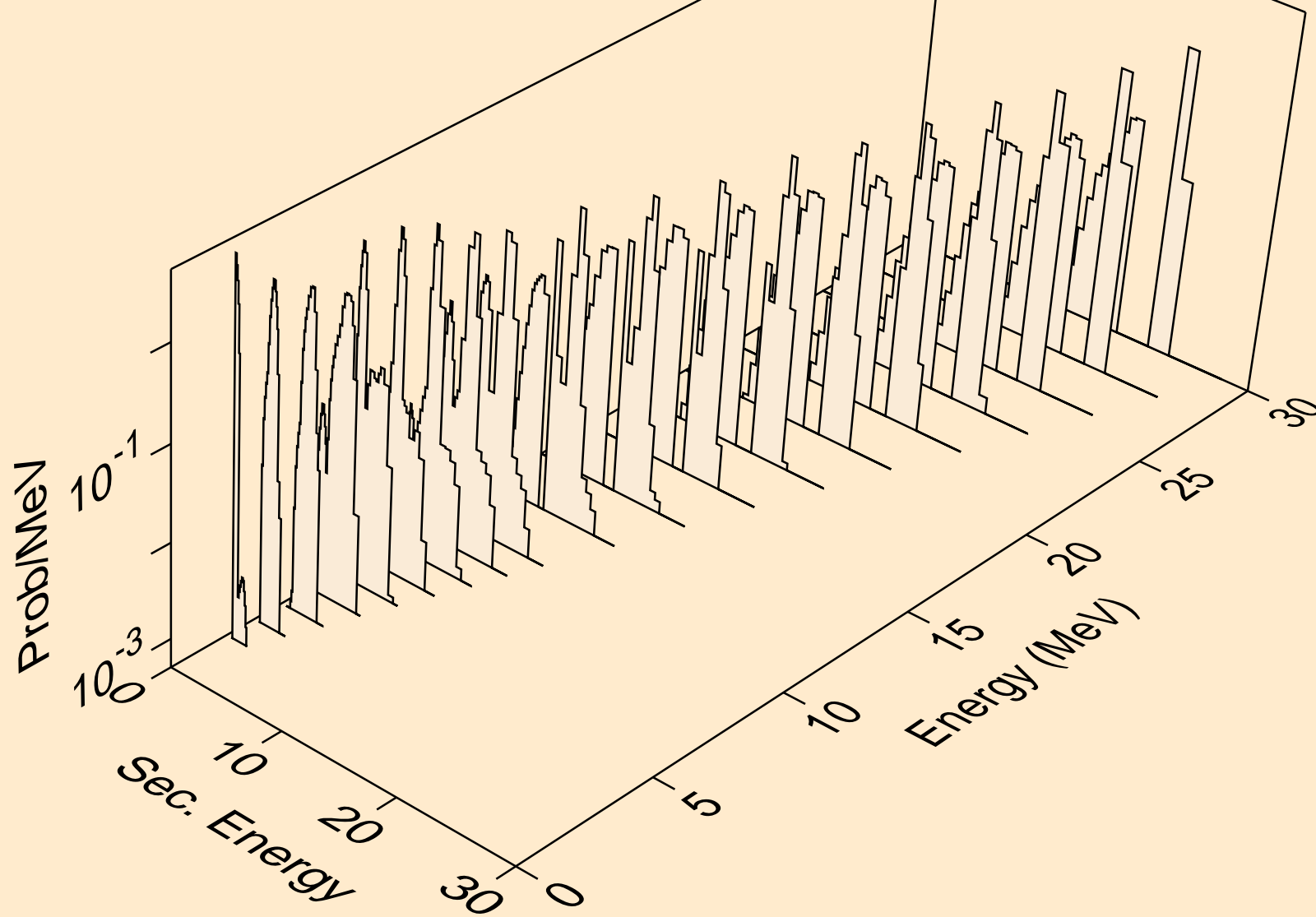

P031 TRITON ACER TENDL-2021 LIBRARY; T=0.K  
Triton emission for (t,pt)

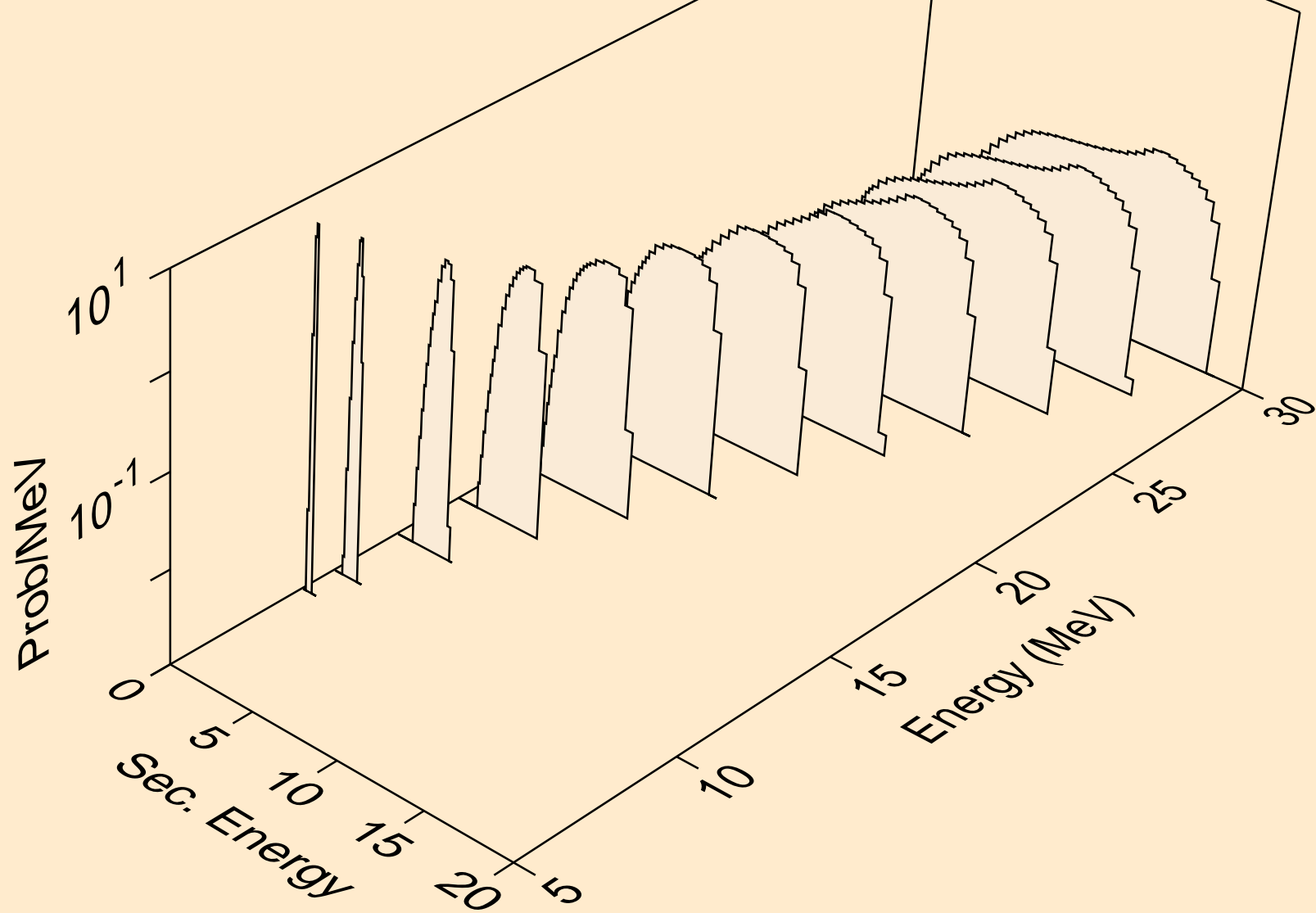

P031 TRITON ACER TENDL-2021 LIBRARY; T=0.K  
Photon emission for (z,n)

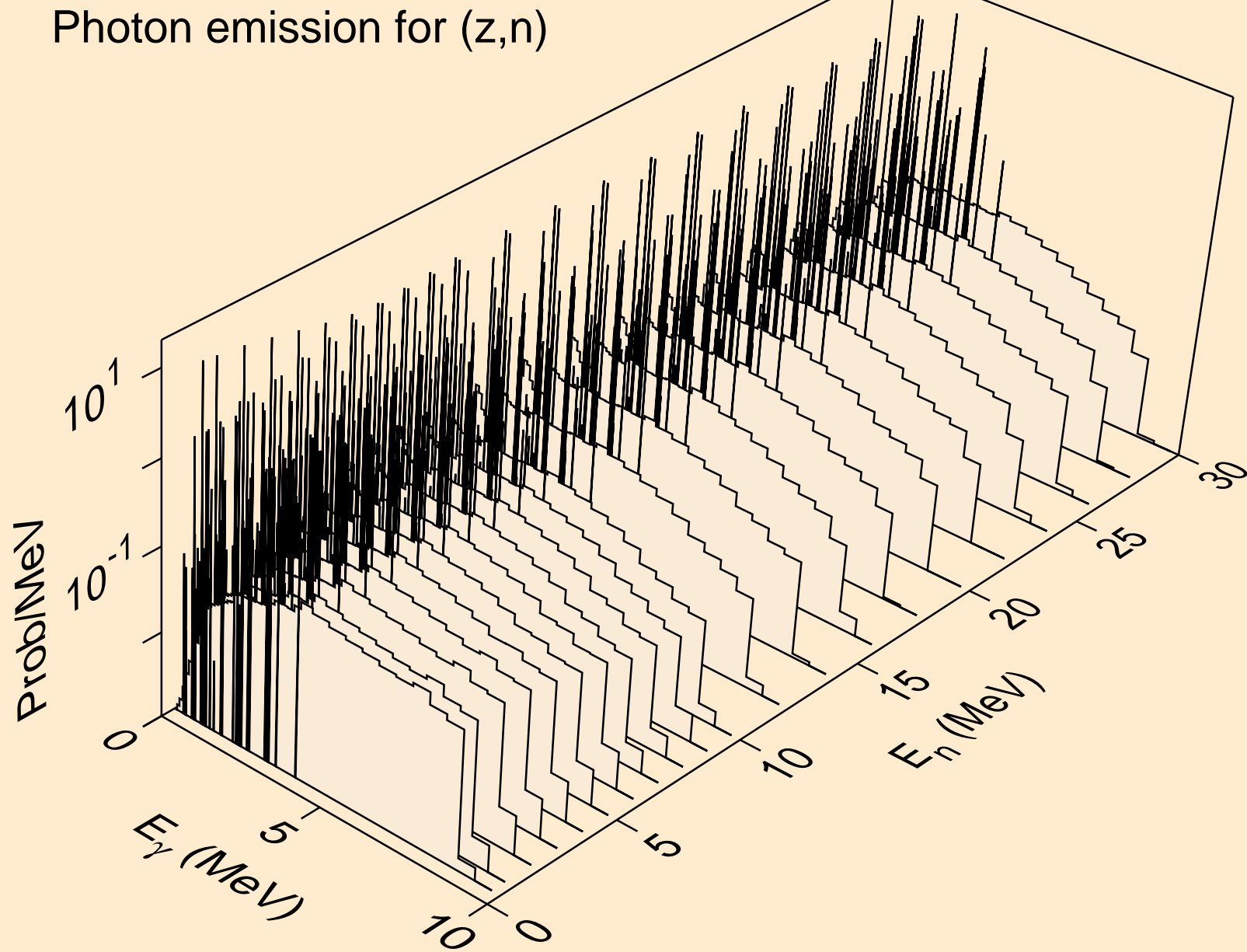

P031 TRITON ACER TENDL-2021 LIBRARY; T=0.K  
Photon emission for (n,x)

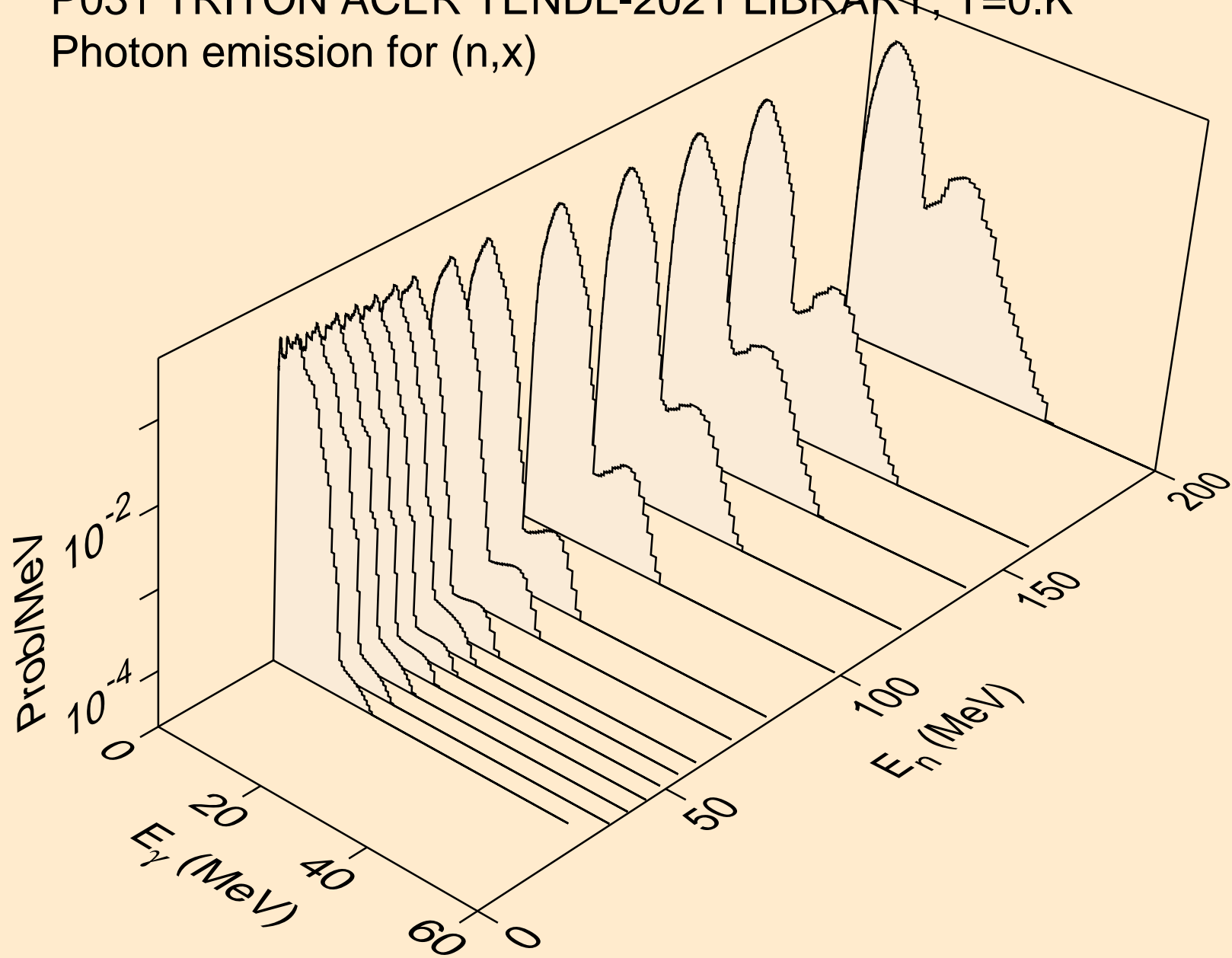

P031 TRITON ACER TENDL-2021 LIBRARY; T=0.K  
Photon emission for (n,2nd)

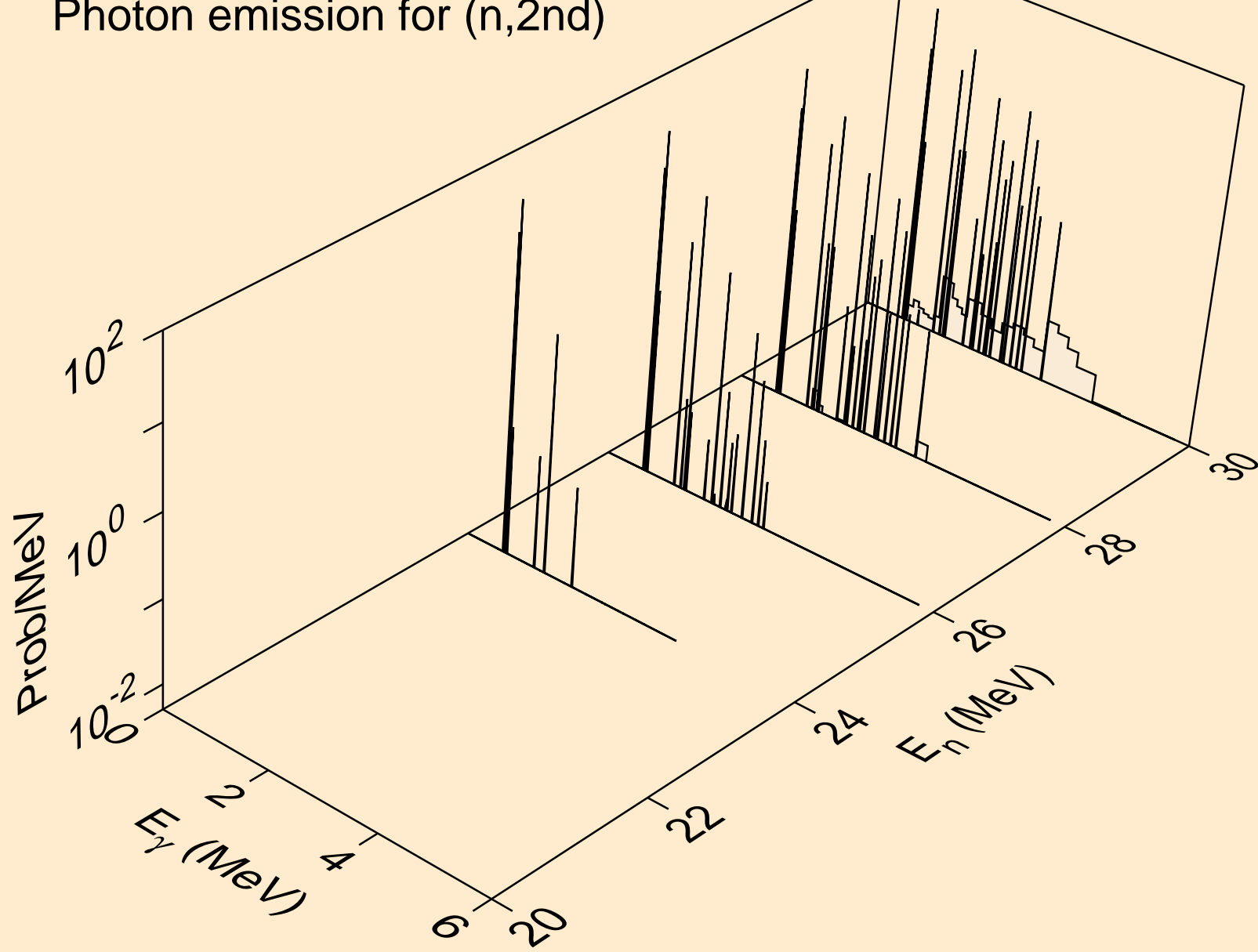



P031 TRITON ACER TENDL-2021 LIBRARY; T=0.K  
Photon emission for (n,2n)

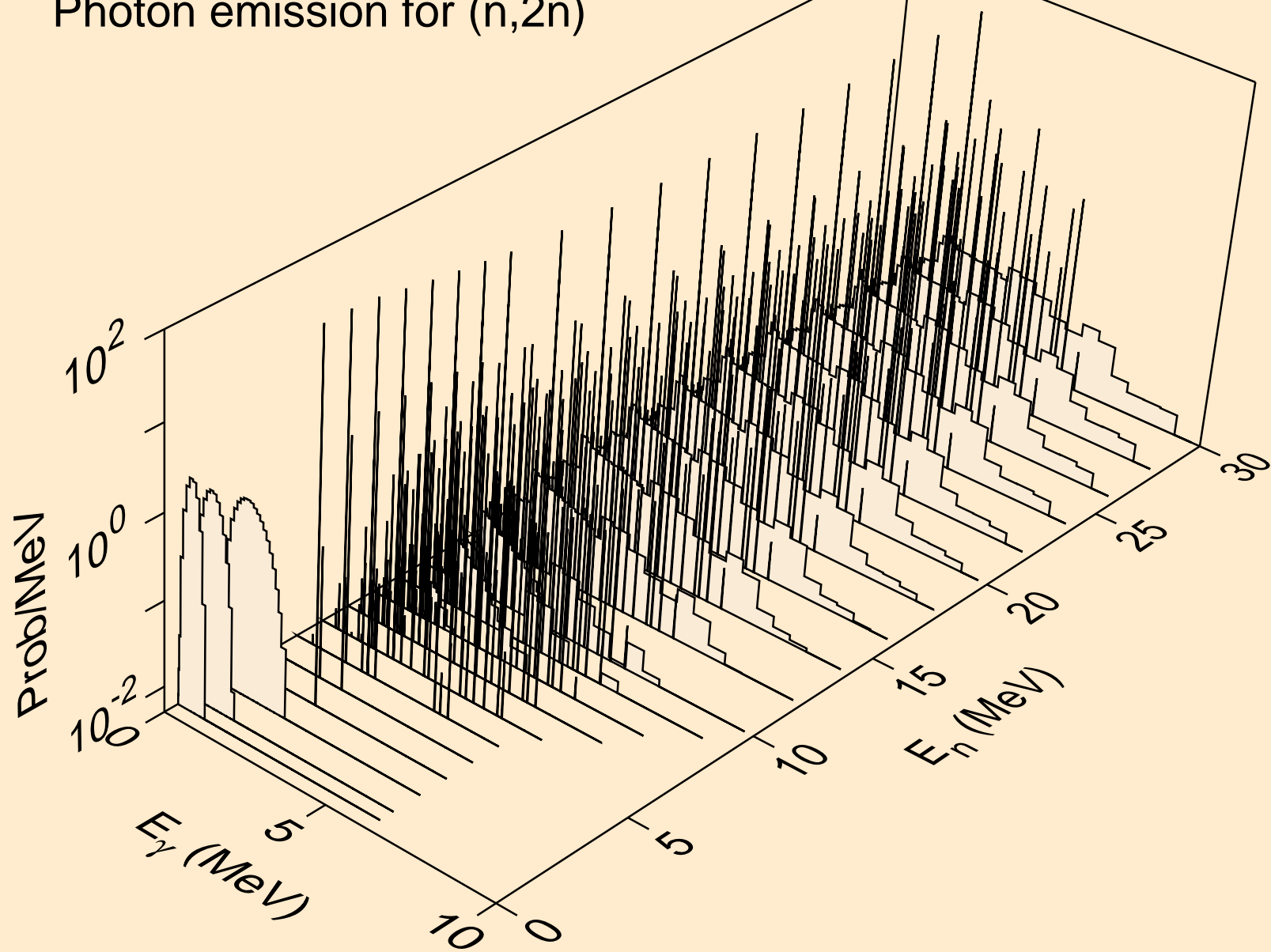

P031 TRITON ACER TENDL-2021 LIBRARY; T=0.K  
Photon emission for (n,3n)

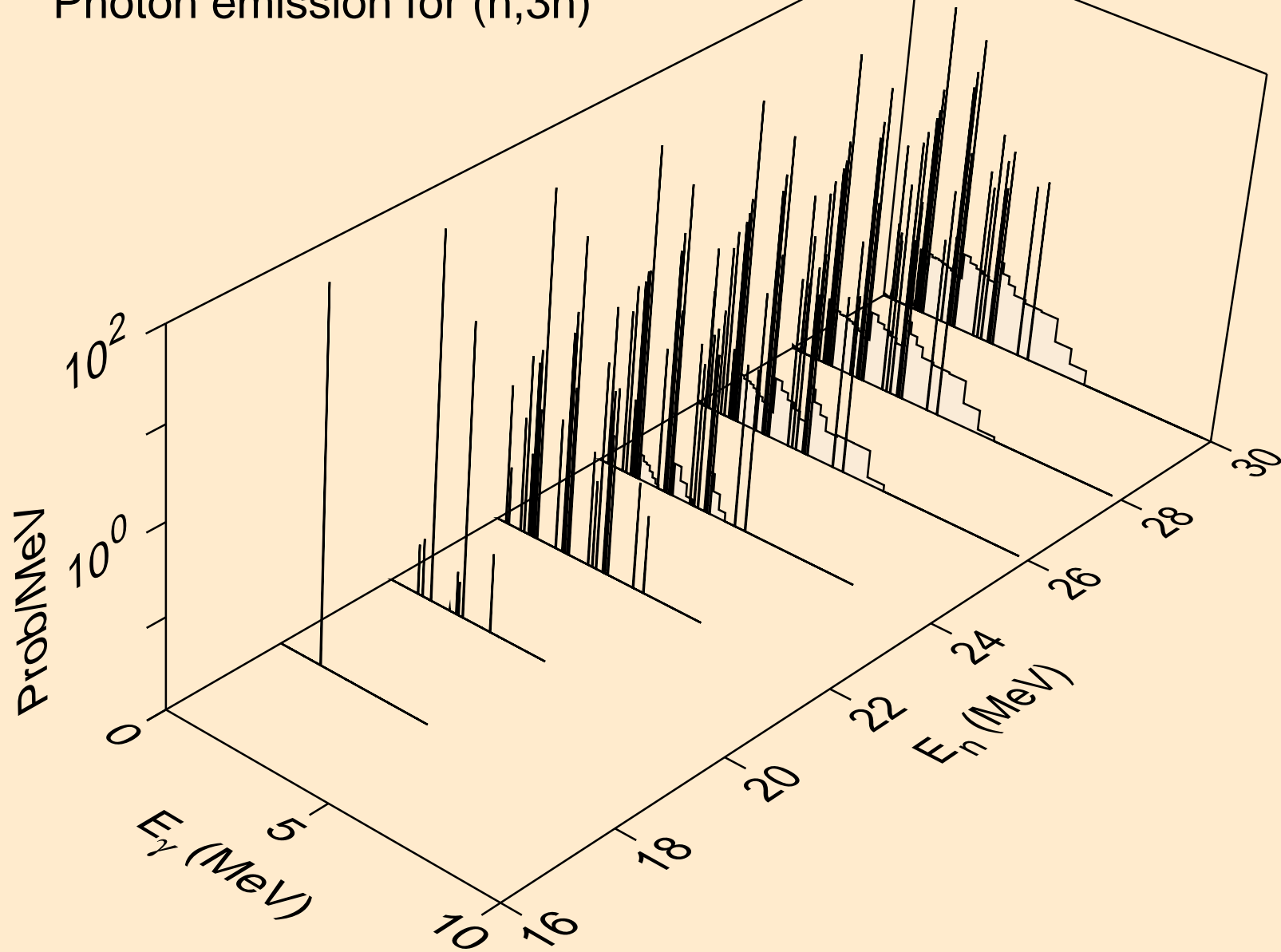

P031 TRITON ACER TENDL-2021 LIBRARY; T=0.K  
Photon emission for (n,n\*)a

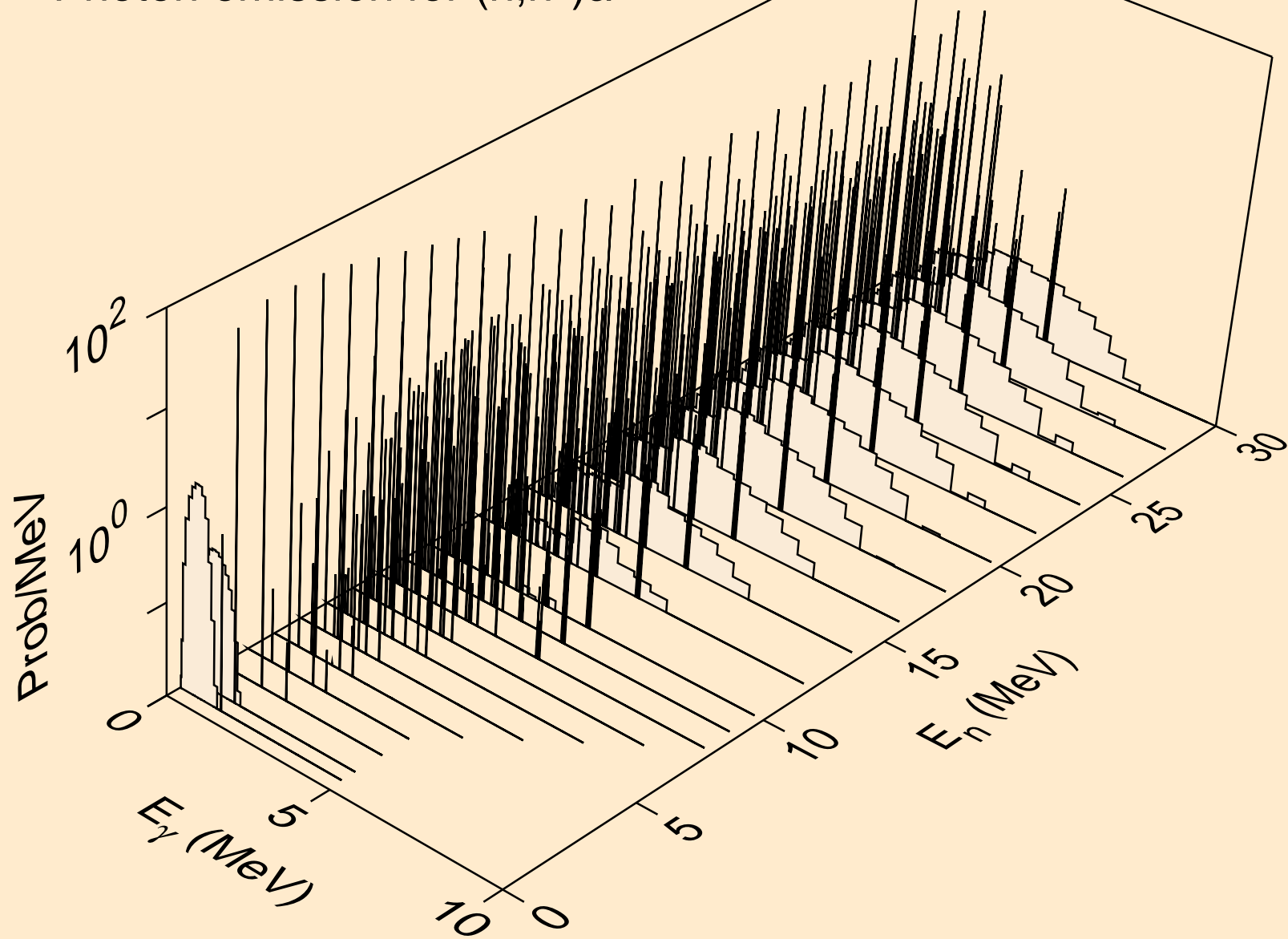

P031 TRITON ACER TENDL-2021 LIBRARY; T=0.K  
Photon emission for (n,2n)a

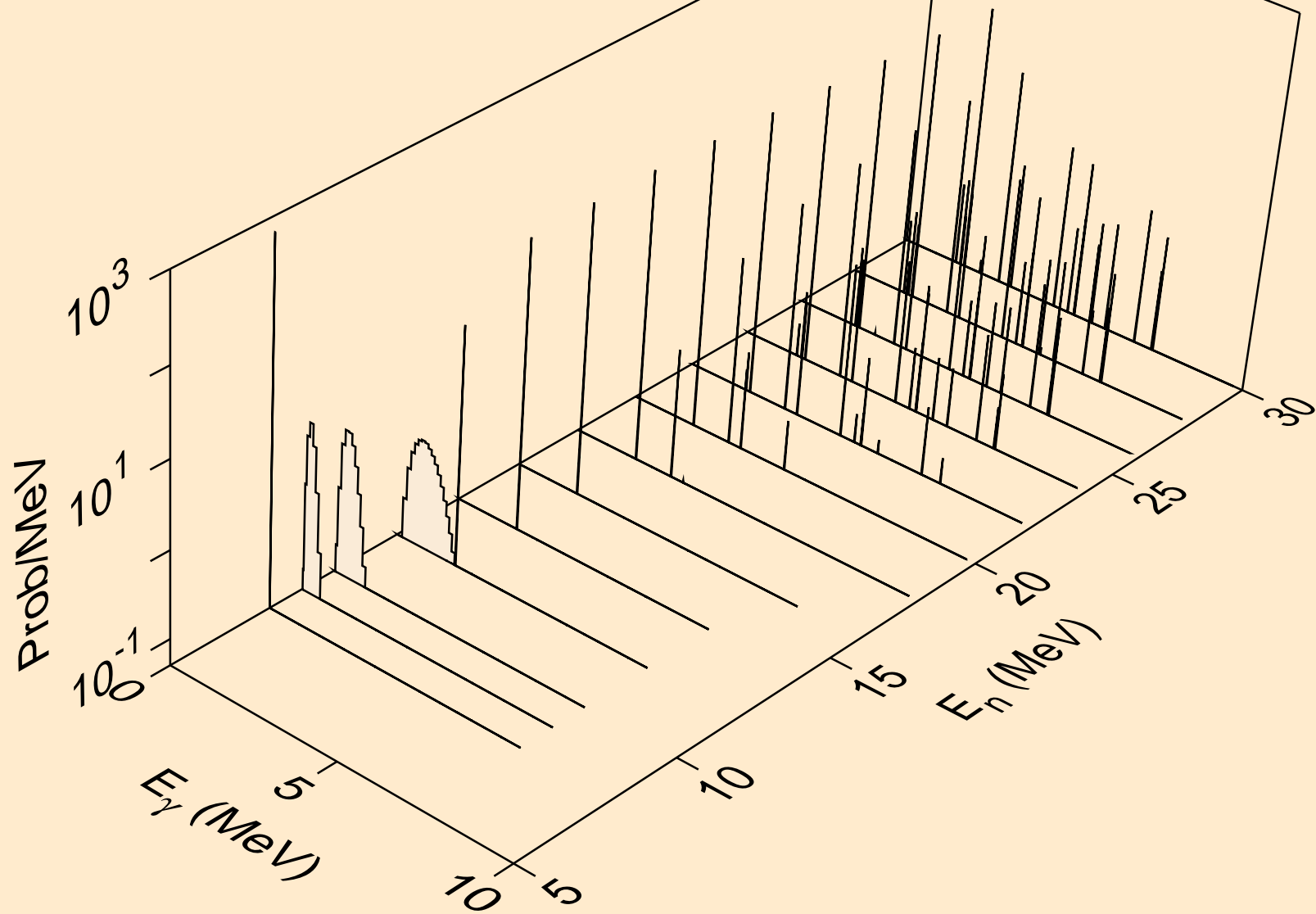

P031 TRITON ACER TENDL-2021 LIBRARY; T=0.K  
Photon emission for (n,3n)a

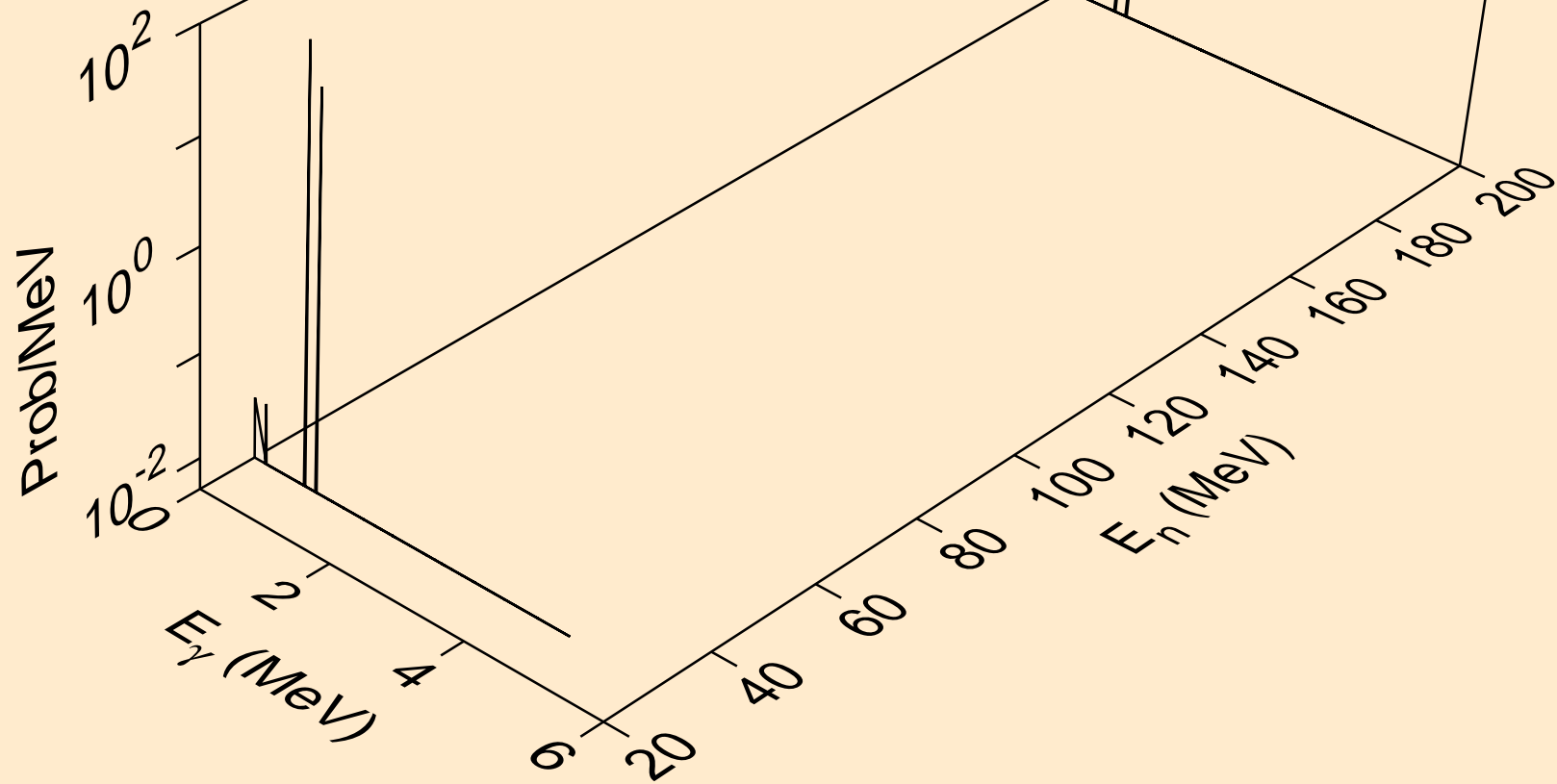

P031 TRITON ACER TENDL-2021 LIBRARY; T=0.K  
Photon emission for (n,n\*)p

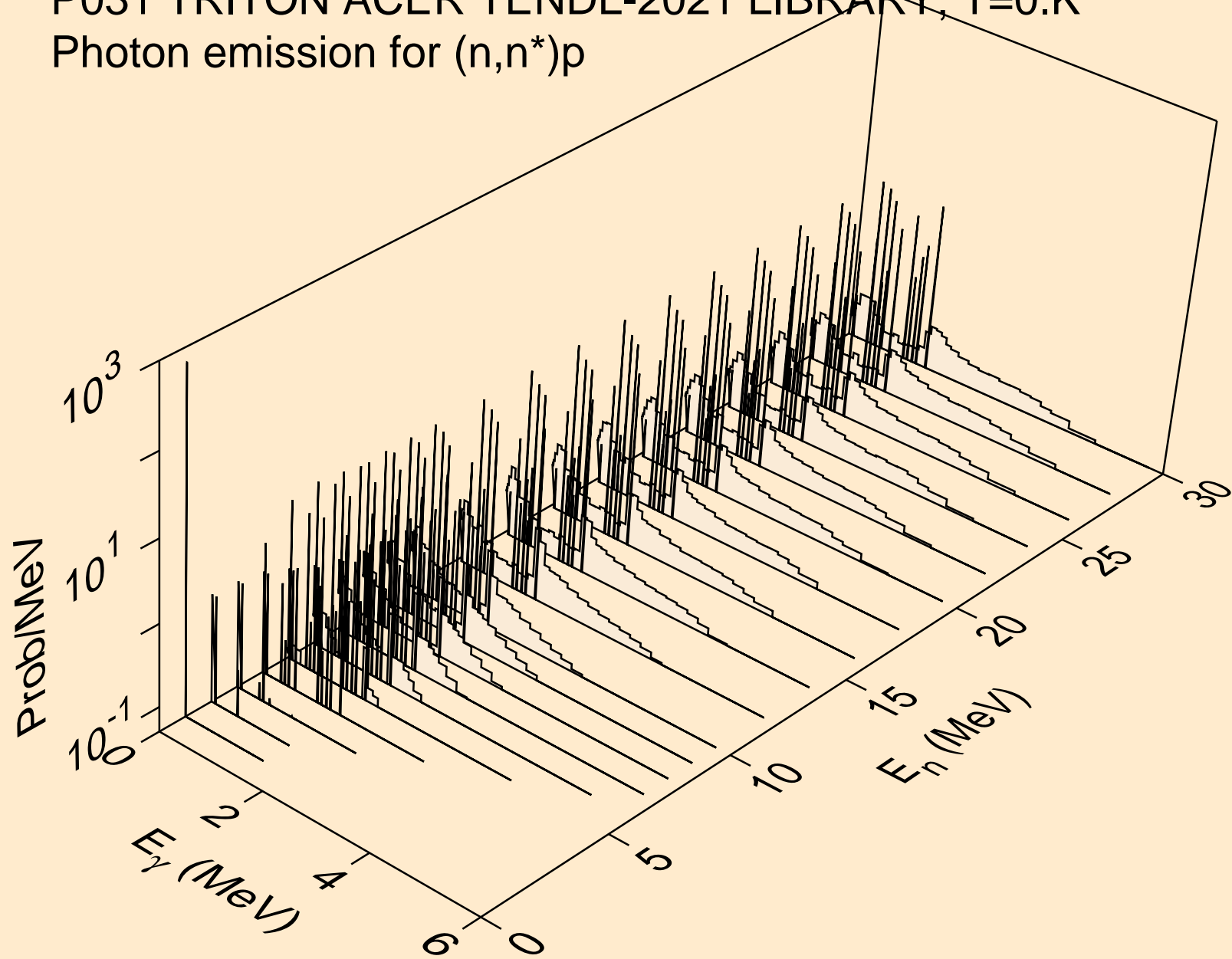

P031 TRITON ACER TENDL-2021 LIBRARY; T=0.K  
Photon emission for (n,n\*)2a

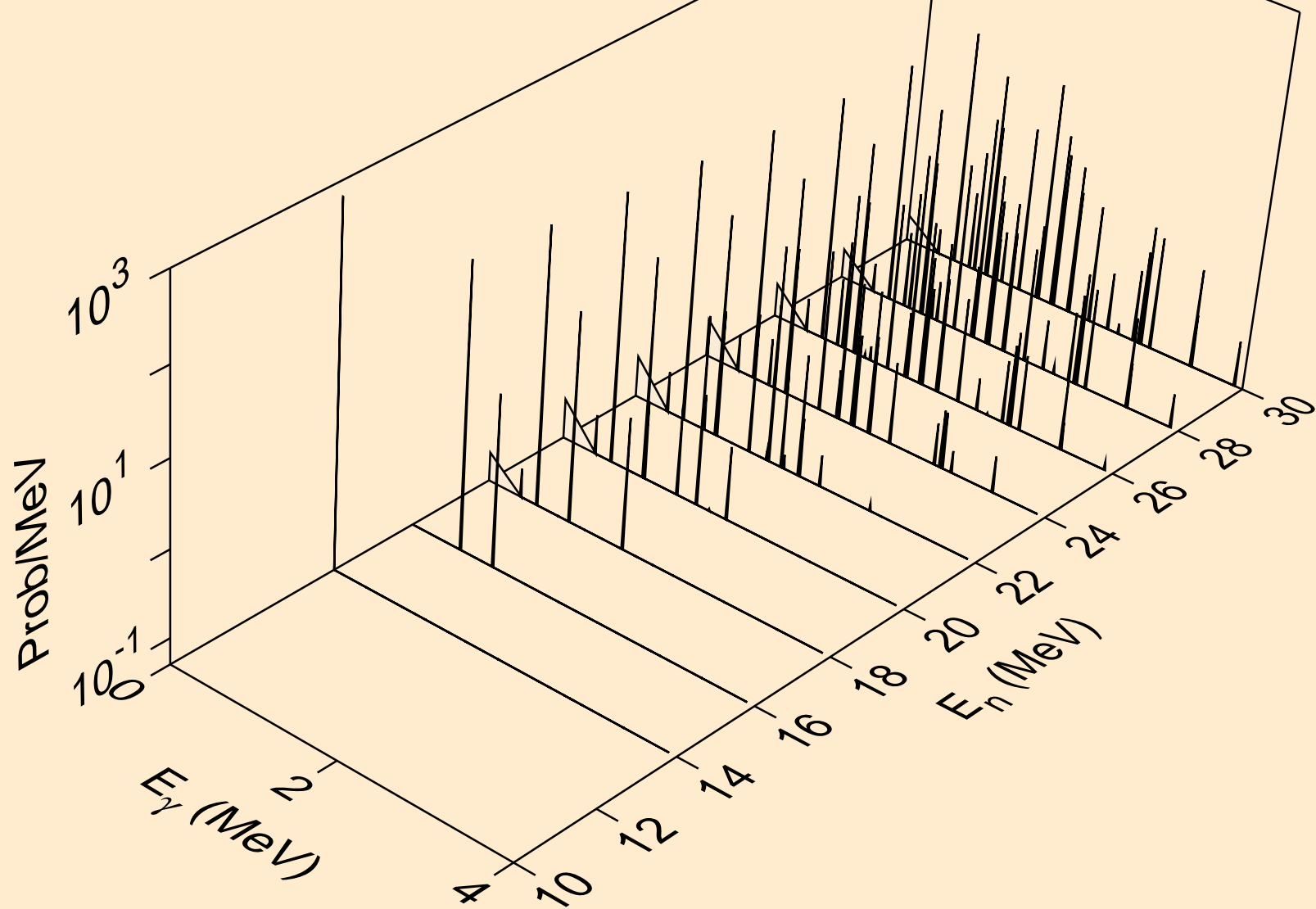

P031 TRITON ACER TENDL-2021 LIBRARY; T=0.K  
Photon emission for (n,2n)2a

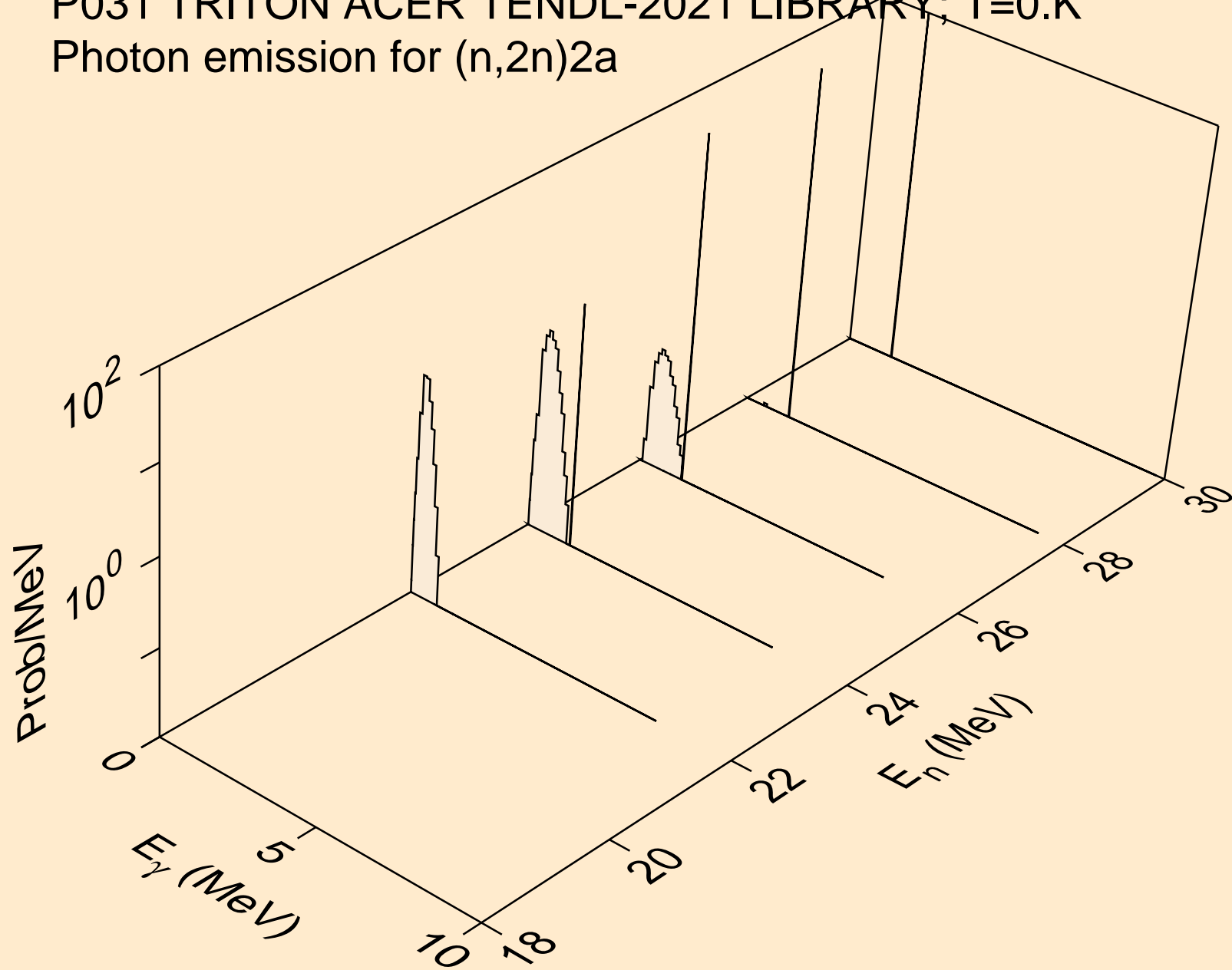



P031 TRITON ACER TENDL-2021 LIBRARY; T=0.K  
Photon emission for (n,n\*)d

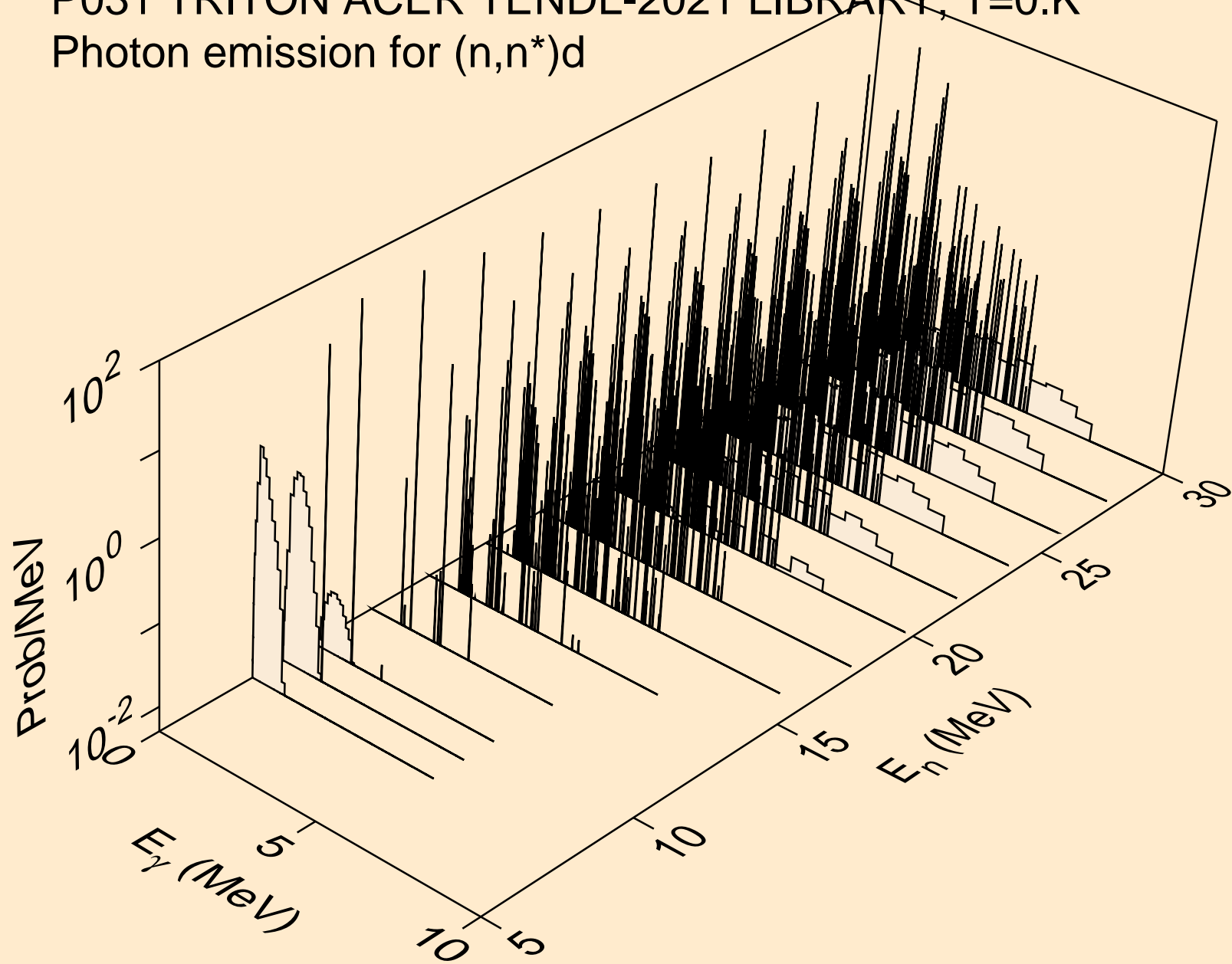

P031 TRITON ACER TENDL-2021 LIBRARY; T=0.K  
Photon emission for (n,n\*)t

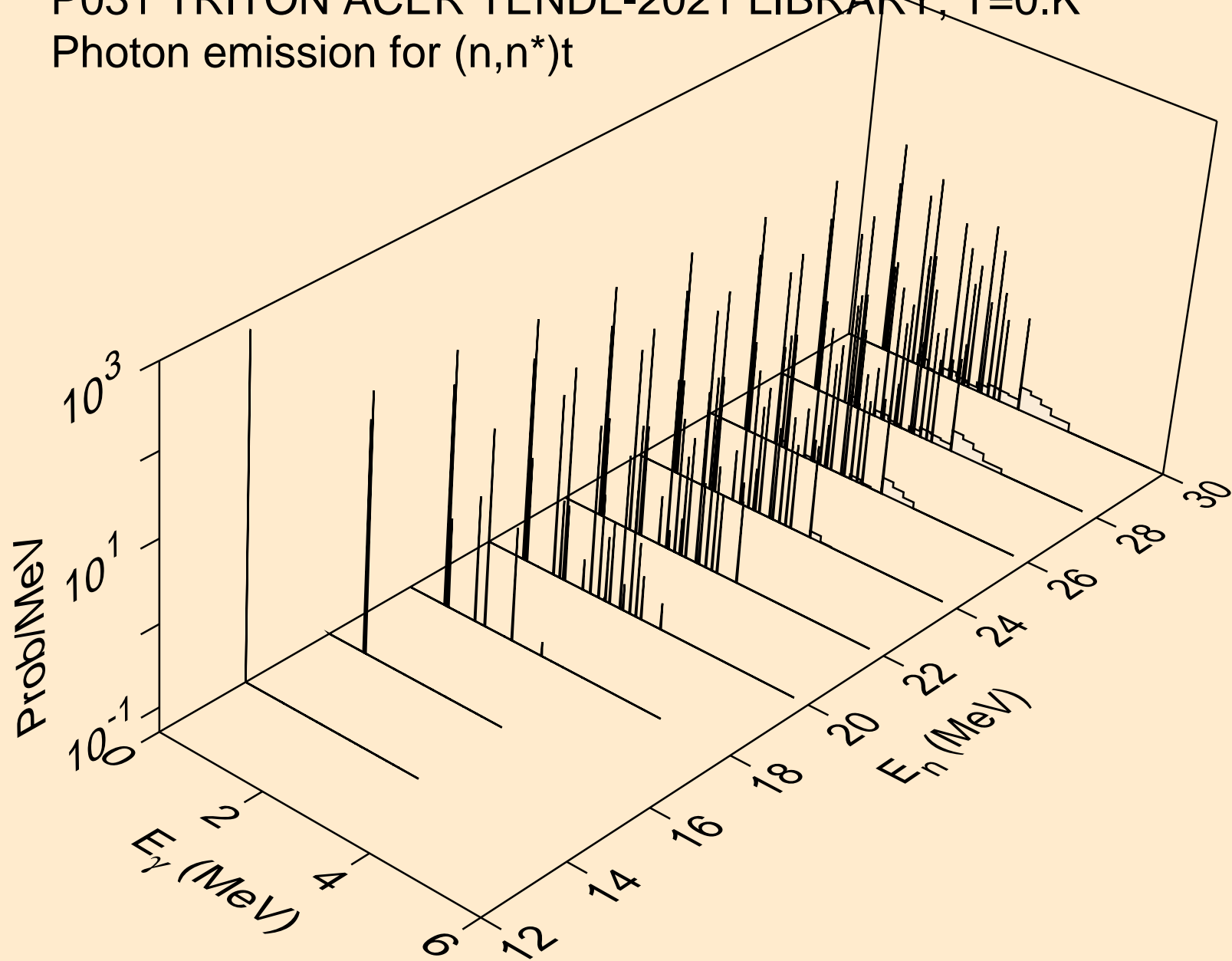

P031 TRITON ACER TENDL-2021 LIBRARY; T=0.K  
Photon emission for (n,n\*)he3

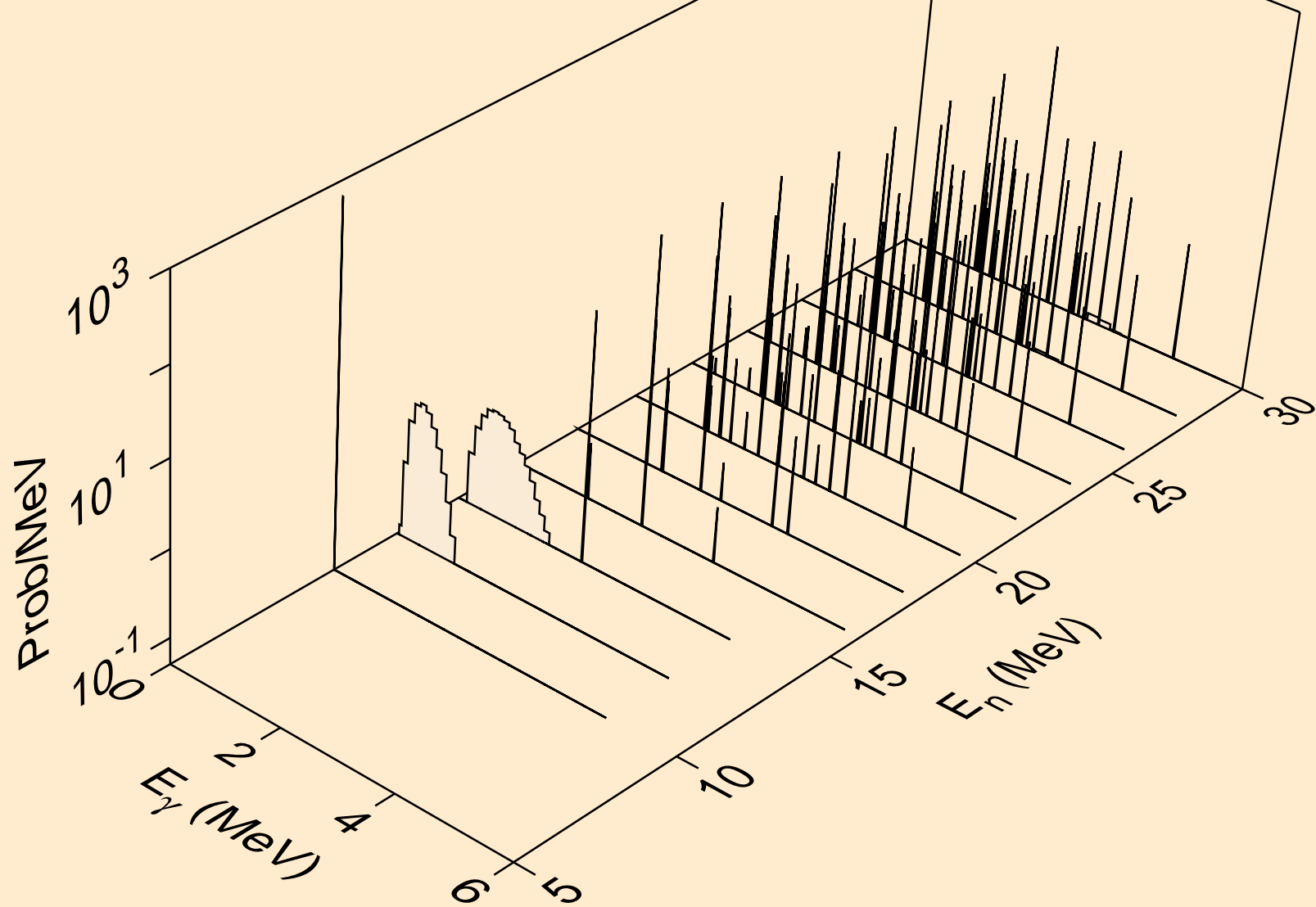

P031 TRITON ACER TENDL-2021 LIBRARY; T=0.K  
Photon emission for (n,2np)

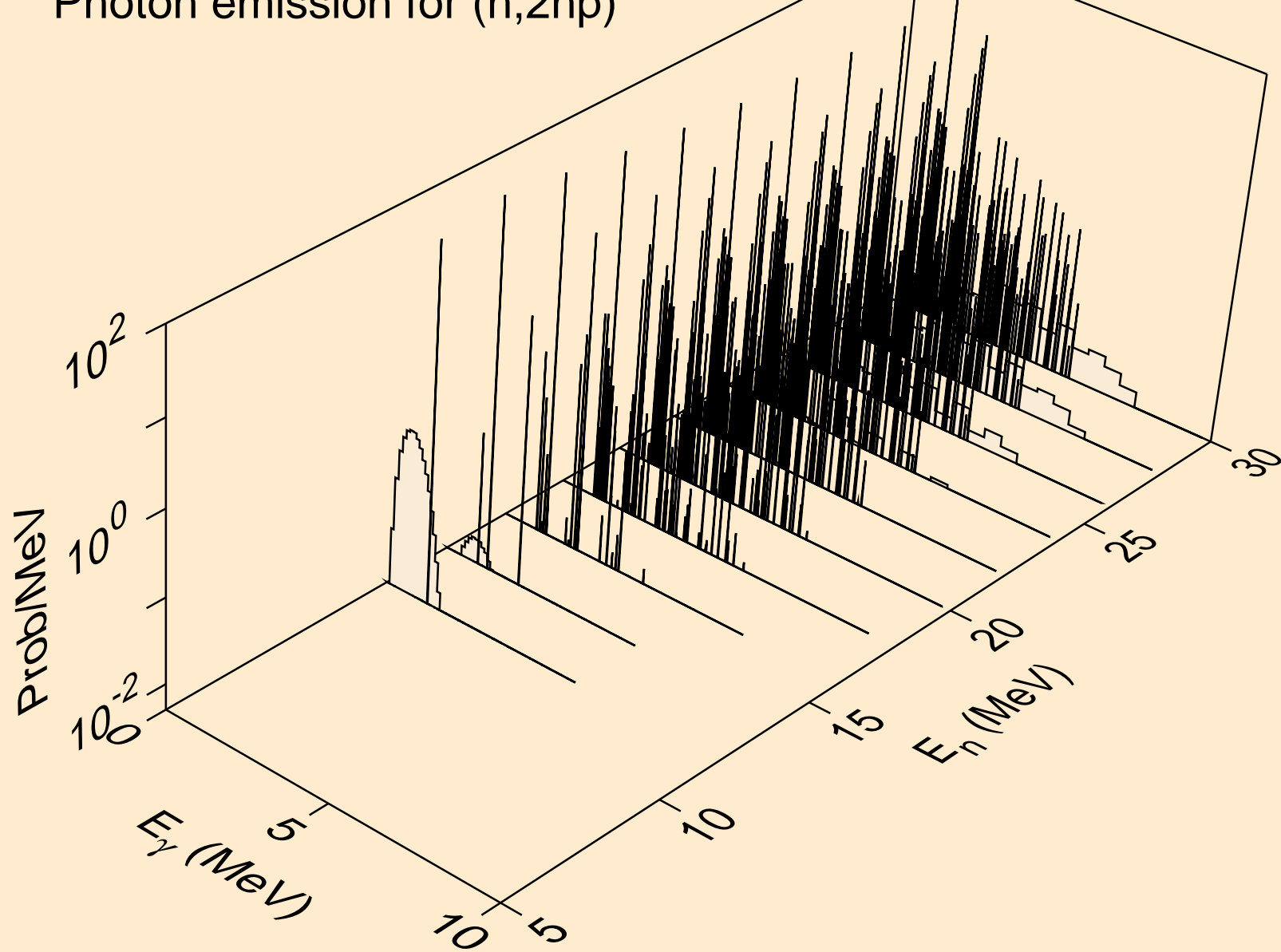

P031 TRITON ACER TENDL-2021 LIBRARY; T=0.K  
Photon emission for (n,3np)

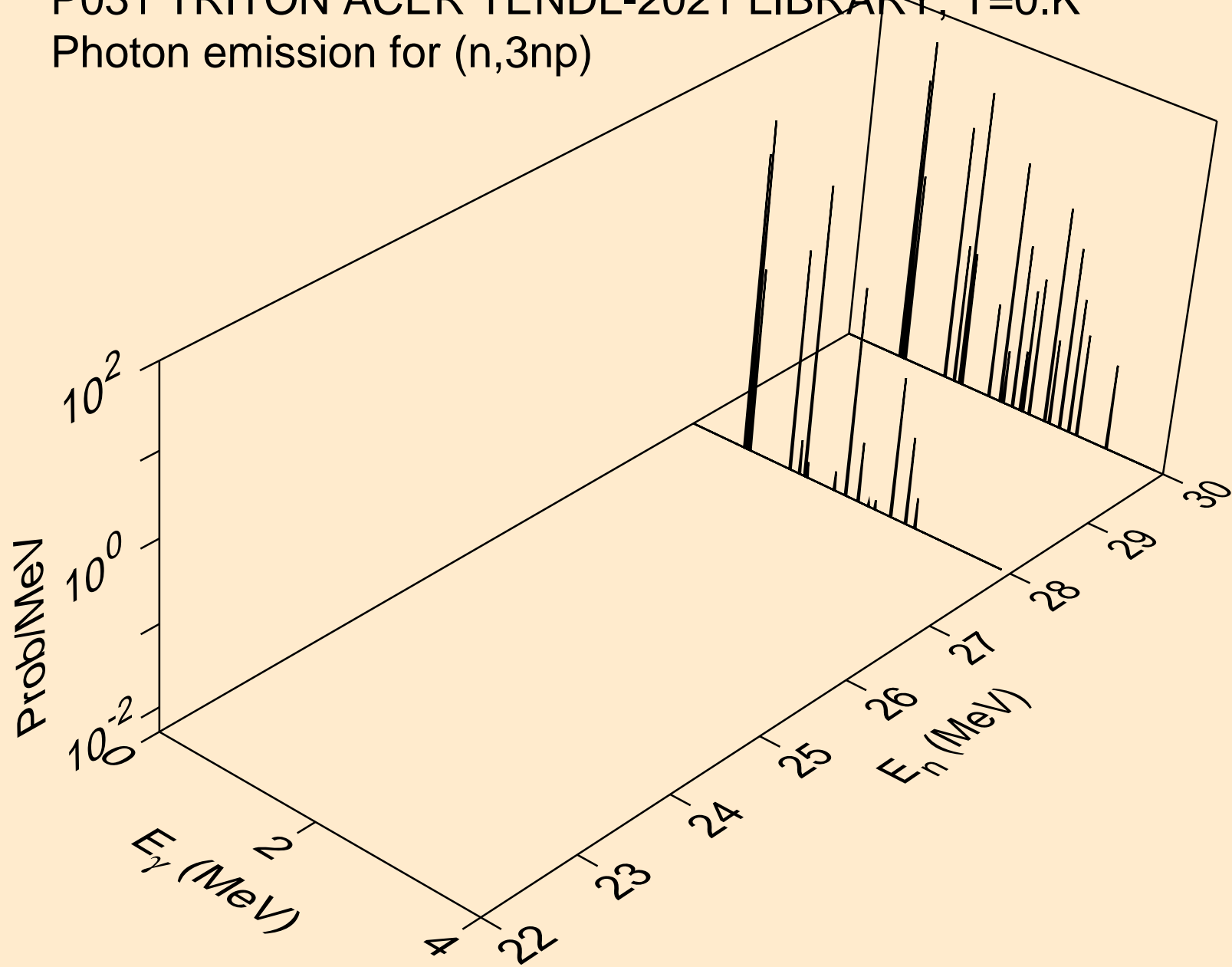

P031 TRITON ACER TENDL-2021 LIBRARY; T=0.K  
Photon emission for (n,2np)

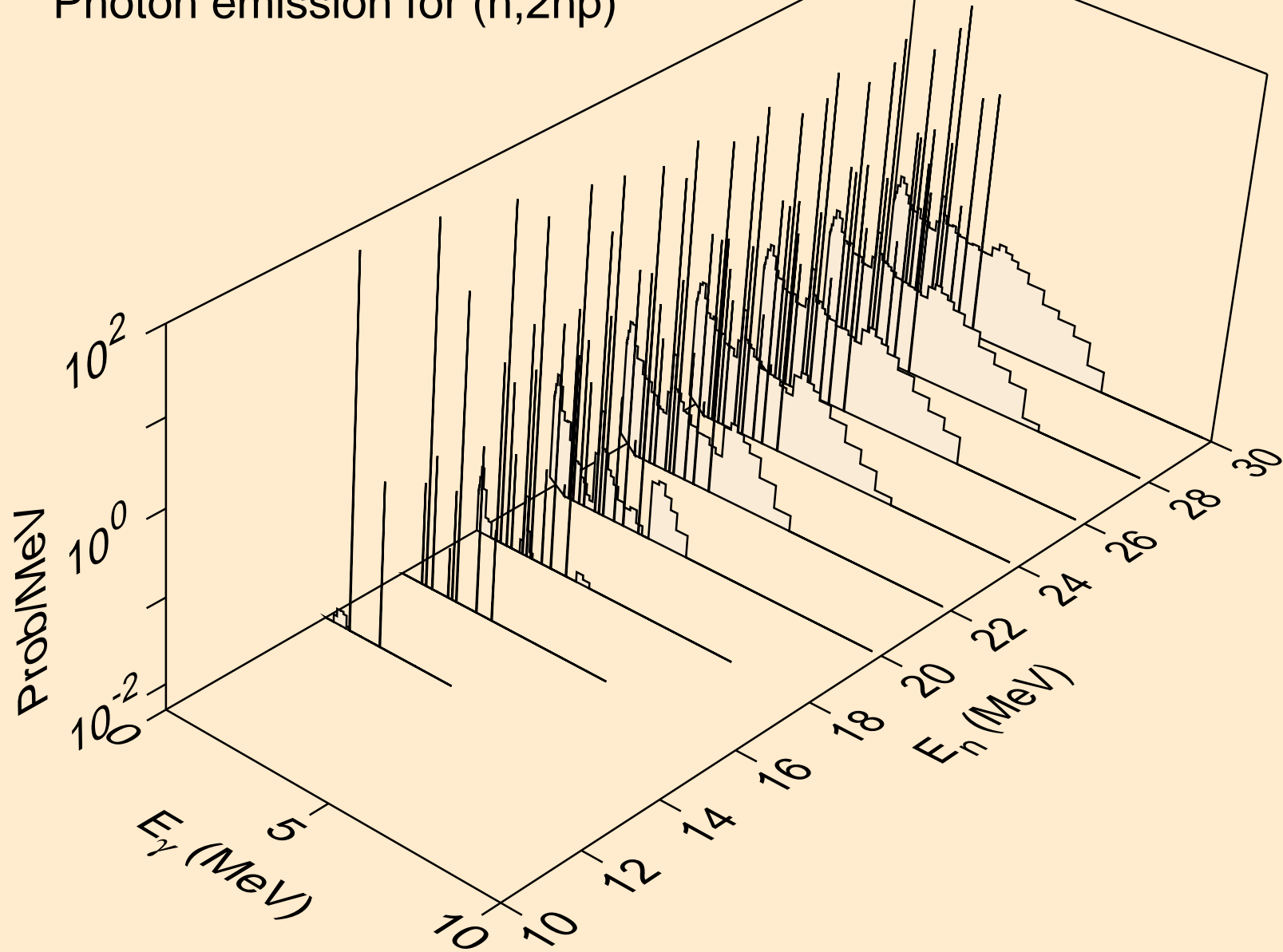

P031 TRITON ACER TENDL-2021 LIBRARY; T=0.K  
Photon emission for (n,npa)

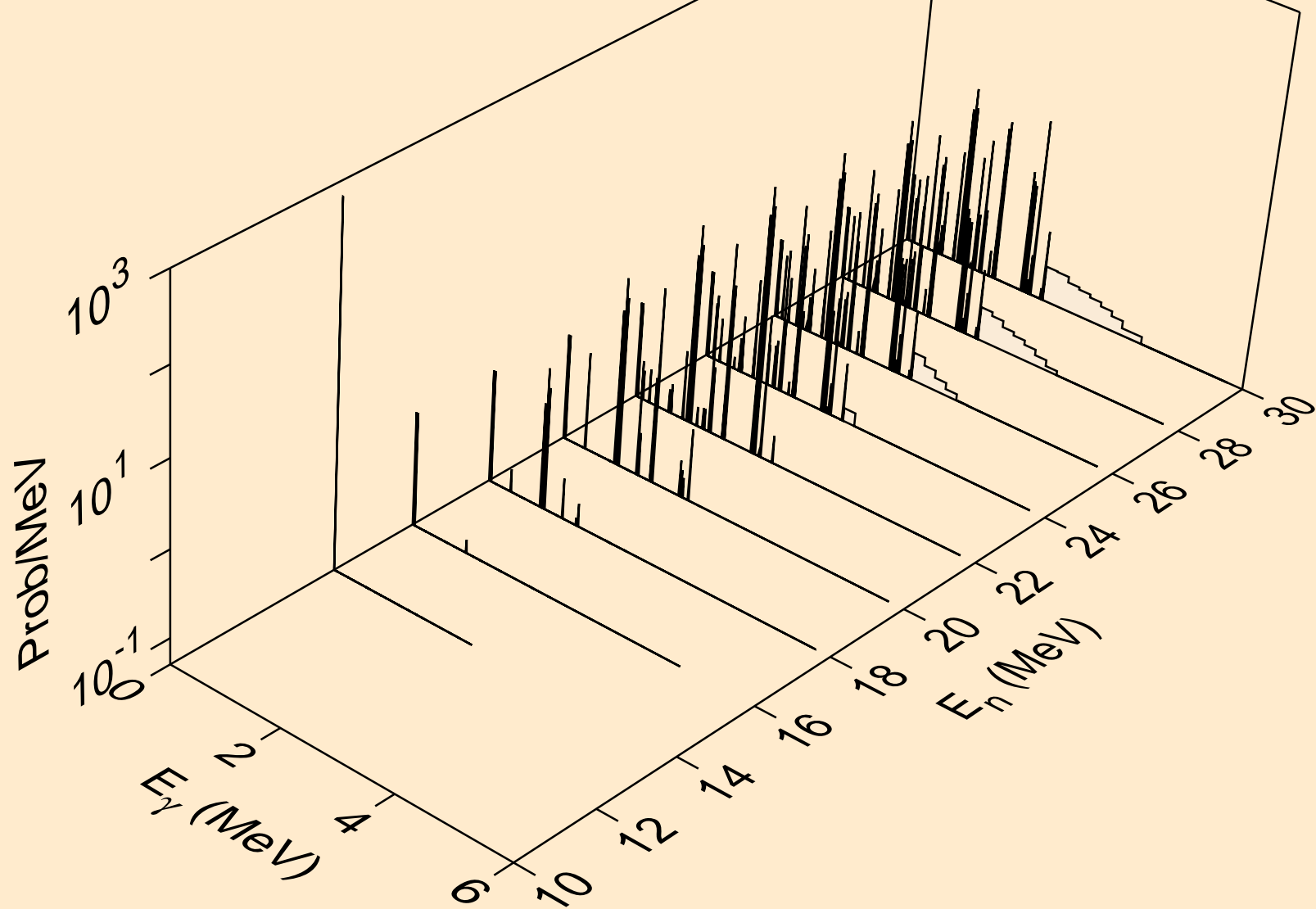

P031 TRITON ACER TENDL-2021 LIBRARY; T=0.K  
Photon emission for (n,gma)

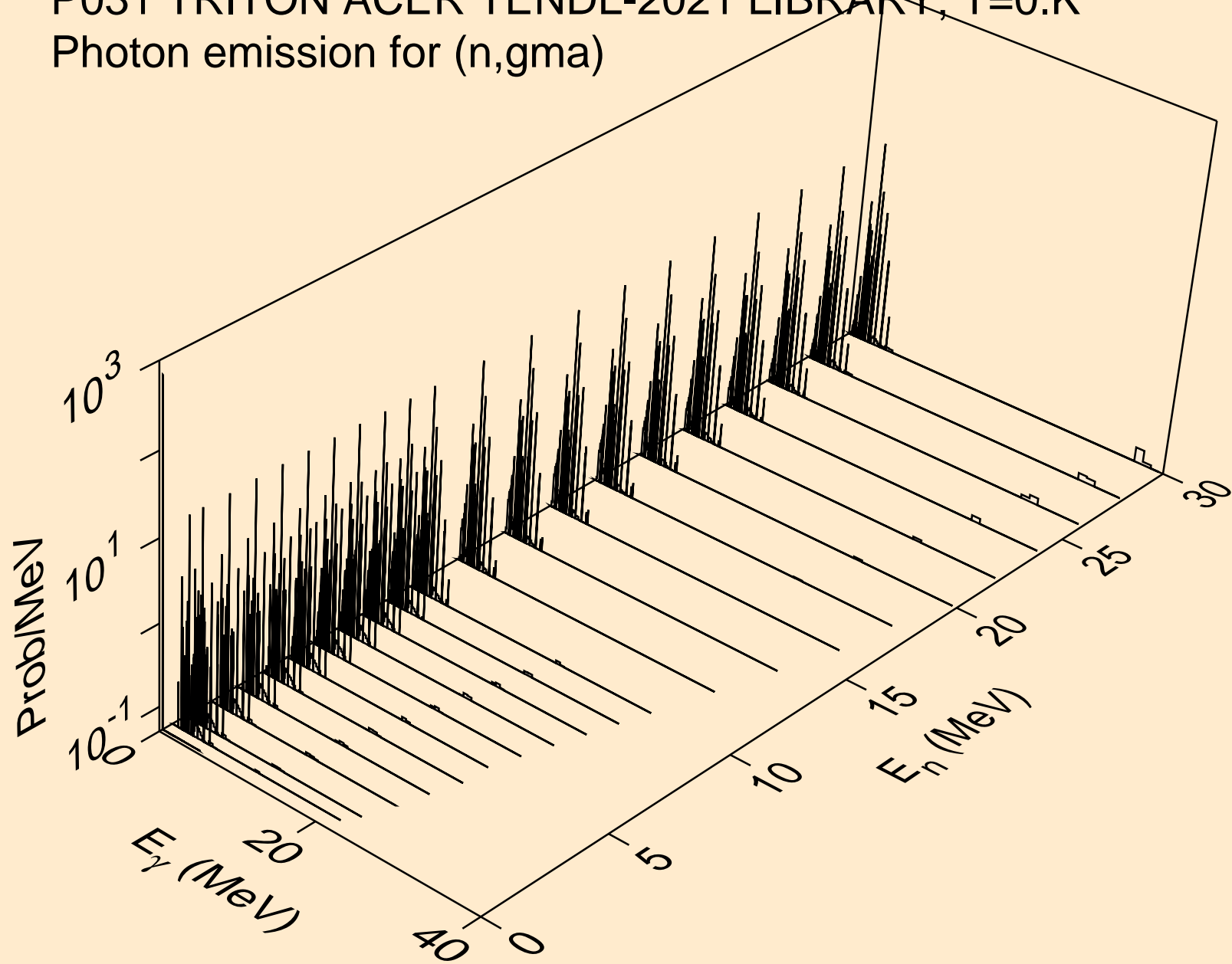



P031 TRITON ACER TENDL-2021 LIBRARY; T=0.K  
Photon emission for (n,p)

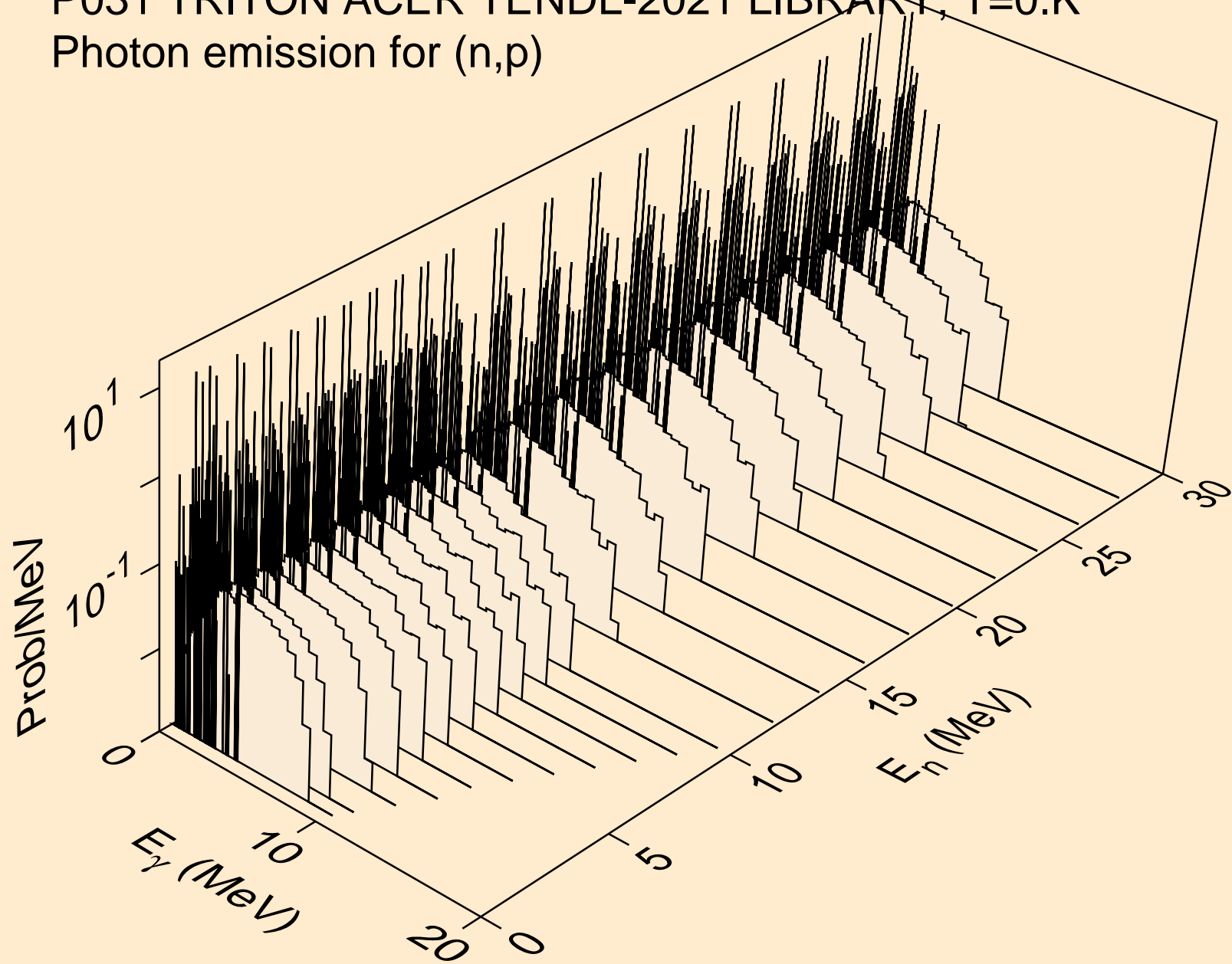

P031 TRITON ACER TENDL-2021 LIBRARY; T=0.K  
Photon emission for (n,d)

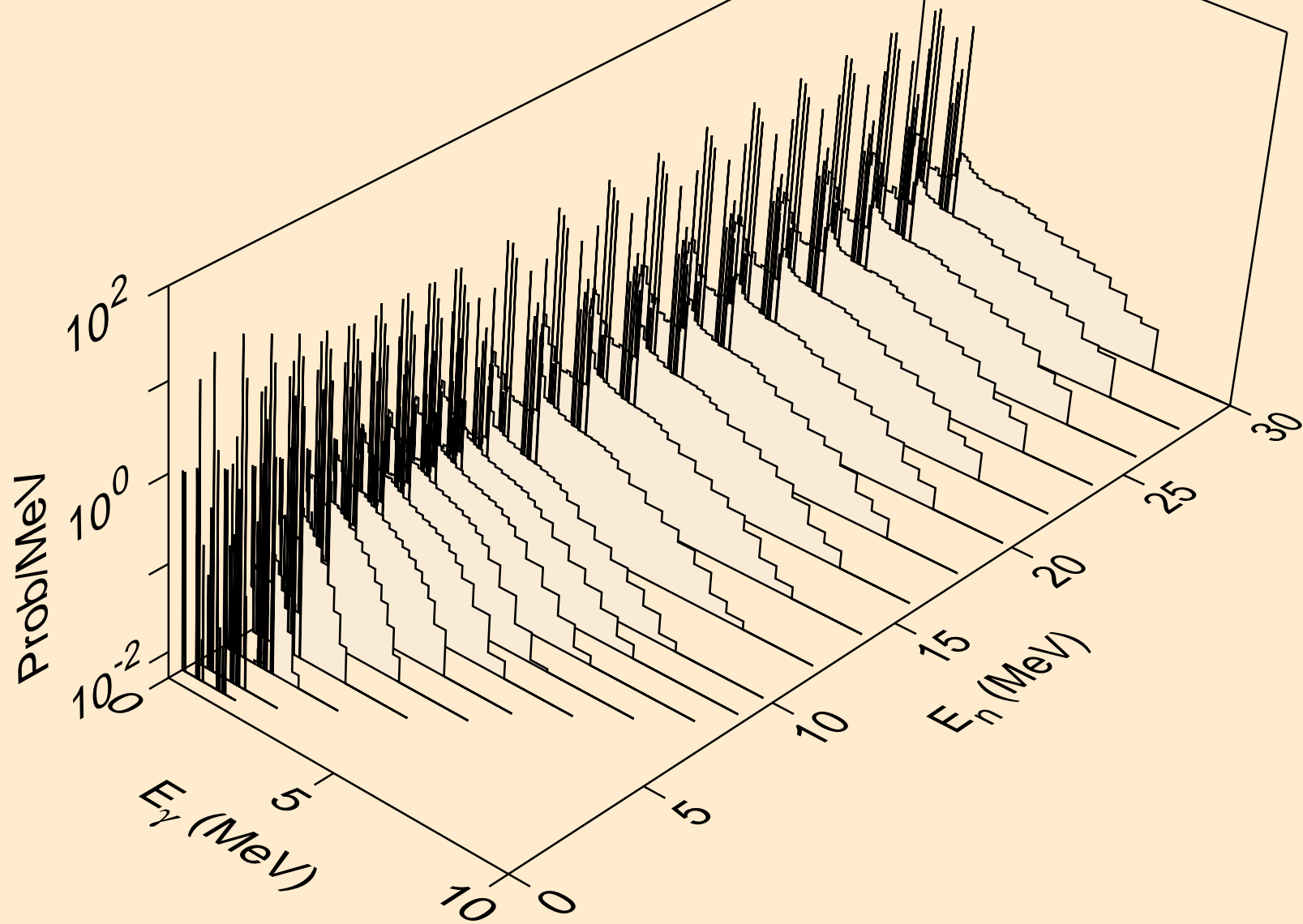

P031 TRITON ACER TENDL-2021 LIBRARY; T=0.K  
Photon emission for inelastic

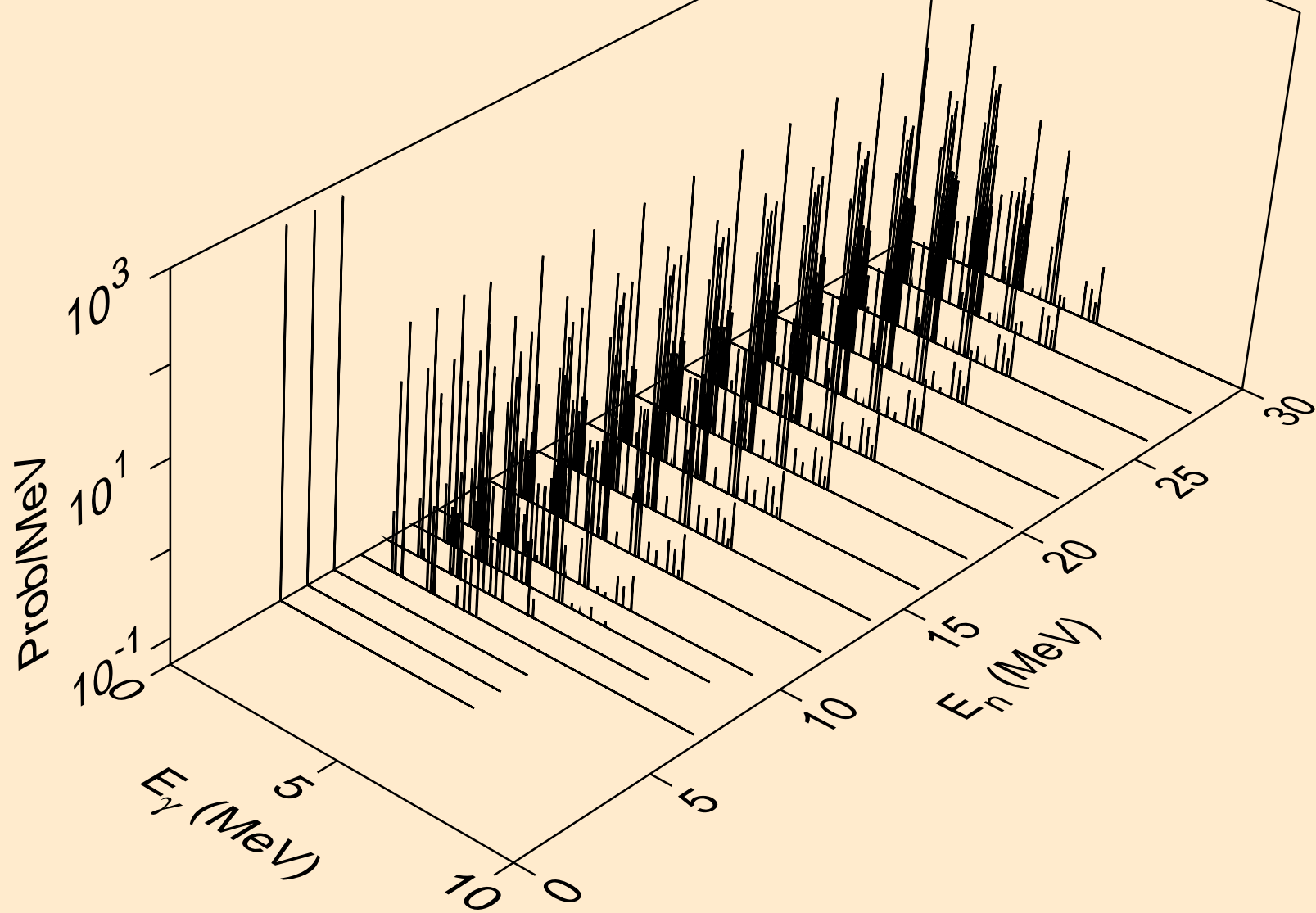

P031 TRITON ACER TENDL-2021 LIBRARY; T=0.K  
Photon emission for (n,he3)

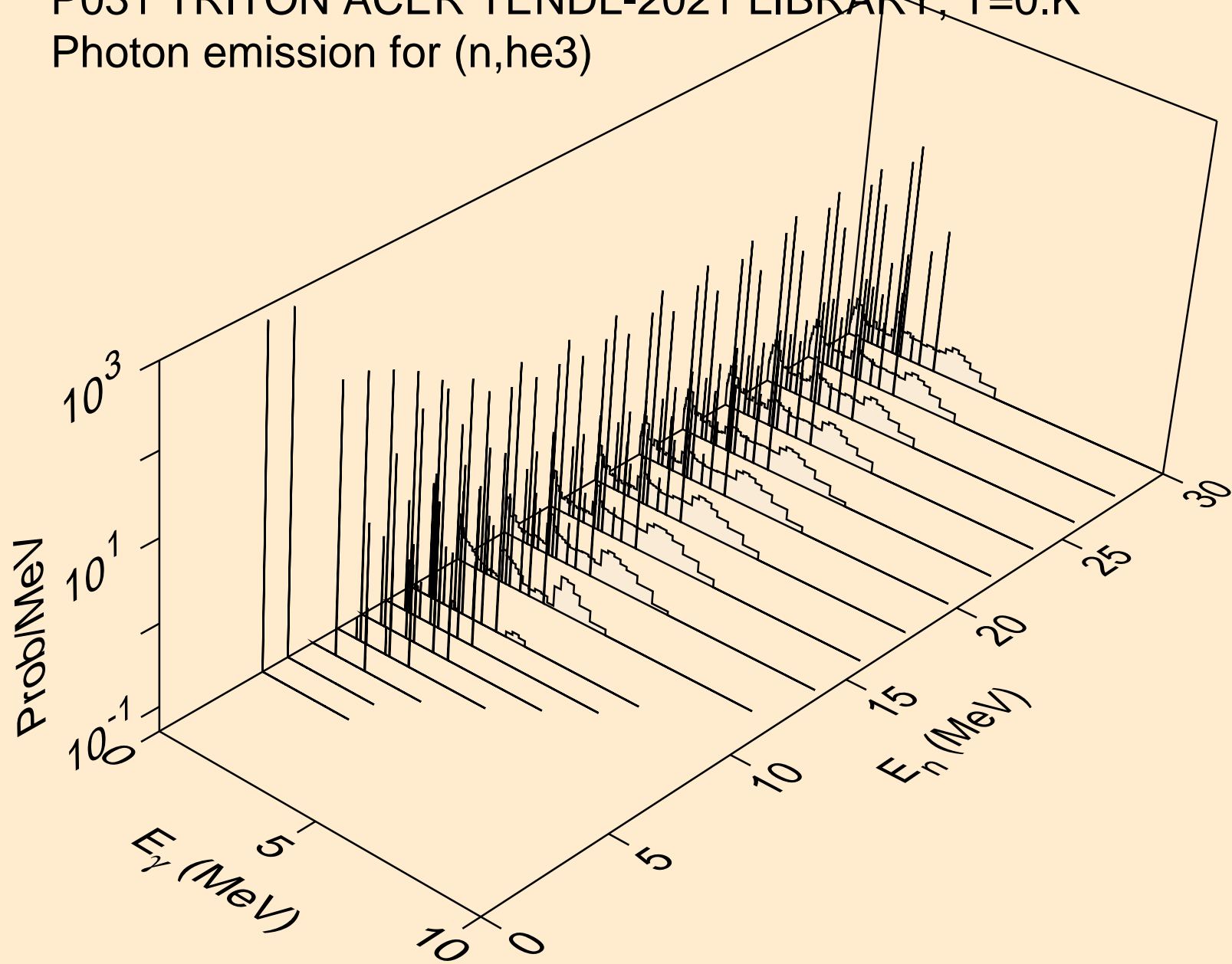

P031 TRITON ACER TENDL-2021 LIBRARY; T=0.K  
Photon emission for (n,a)

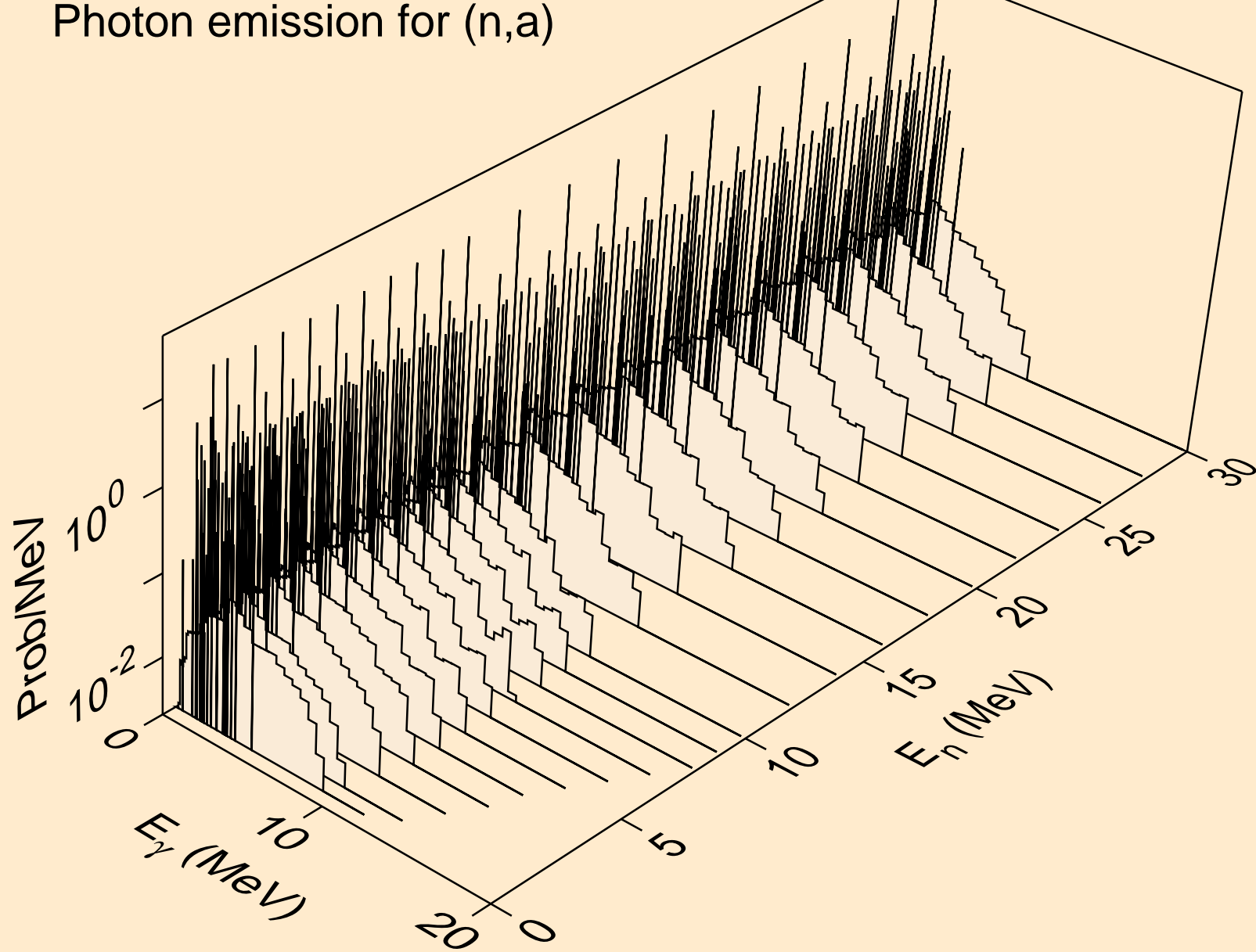

P031 TRITON ACER TENDL-2021 LIBRARY; T=0.K  
Photon emission for (n,2a)

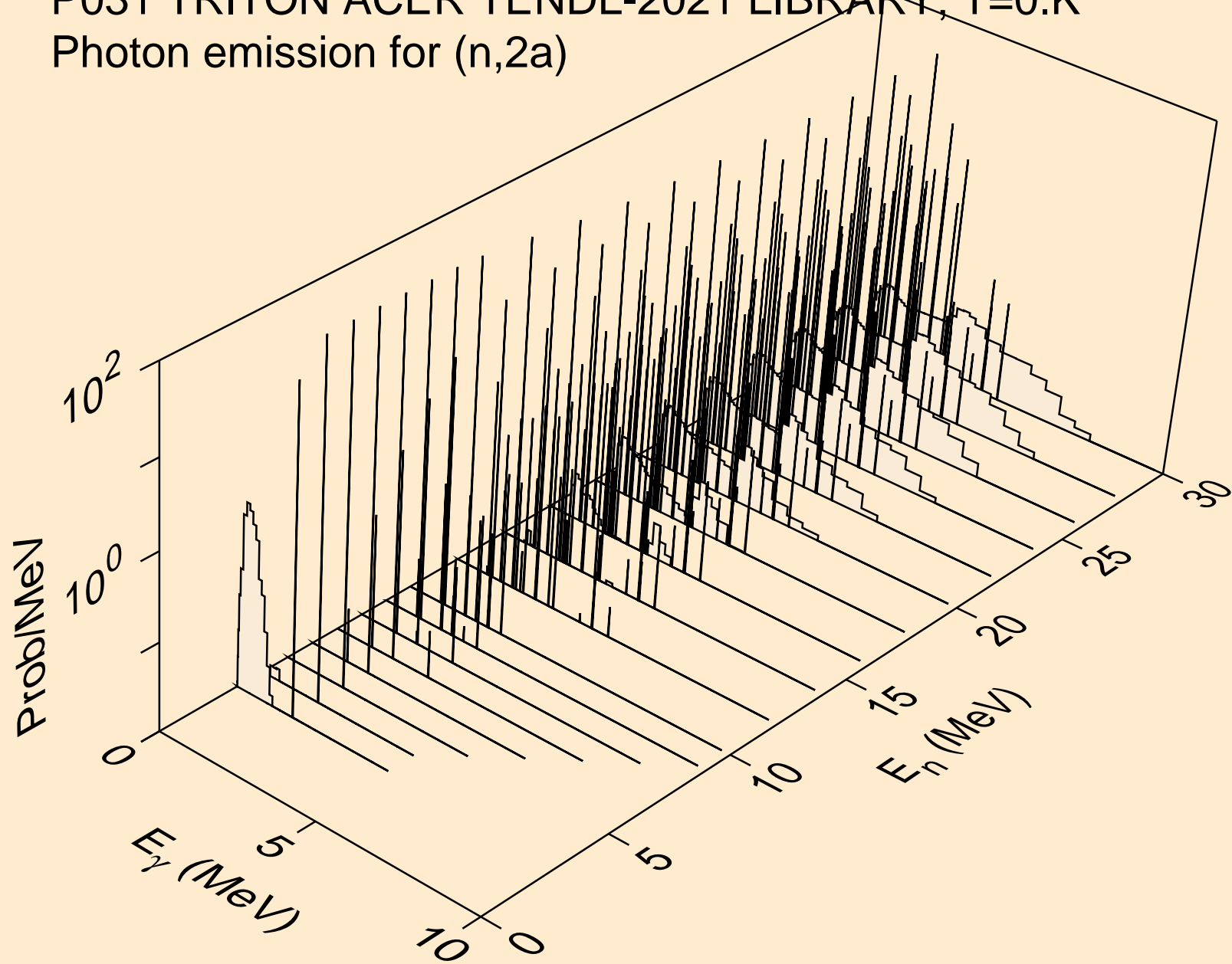

P031 TRITON ACER TENDL-2021 LIBRARY; T=0.K  
Photon emission for (n,3a)

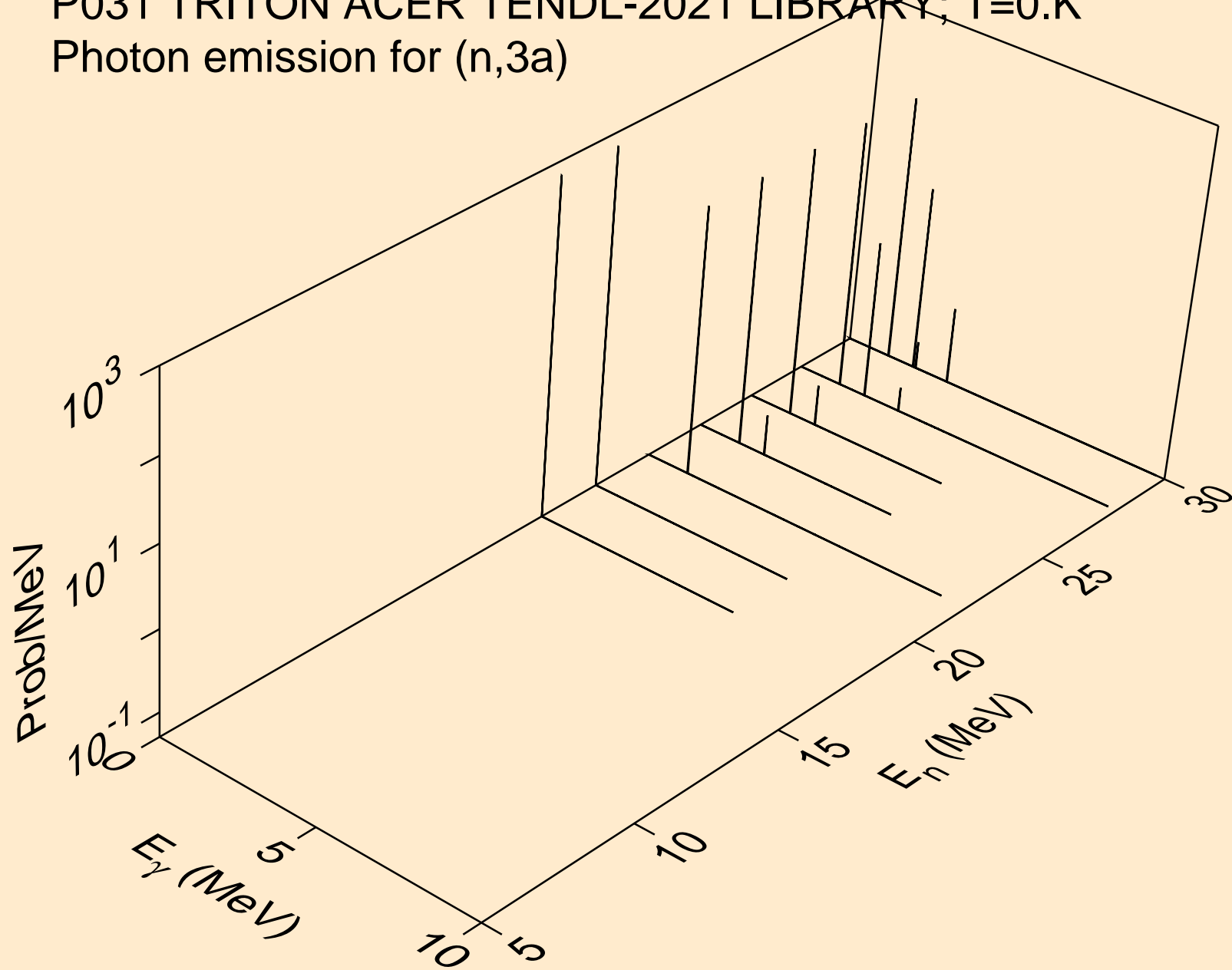

P031 TRITON ACER TENDL-2021 LIBRARY; T=0.K  
Photon emission for (n,2p)

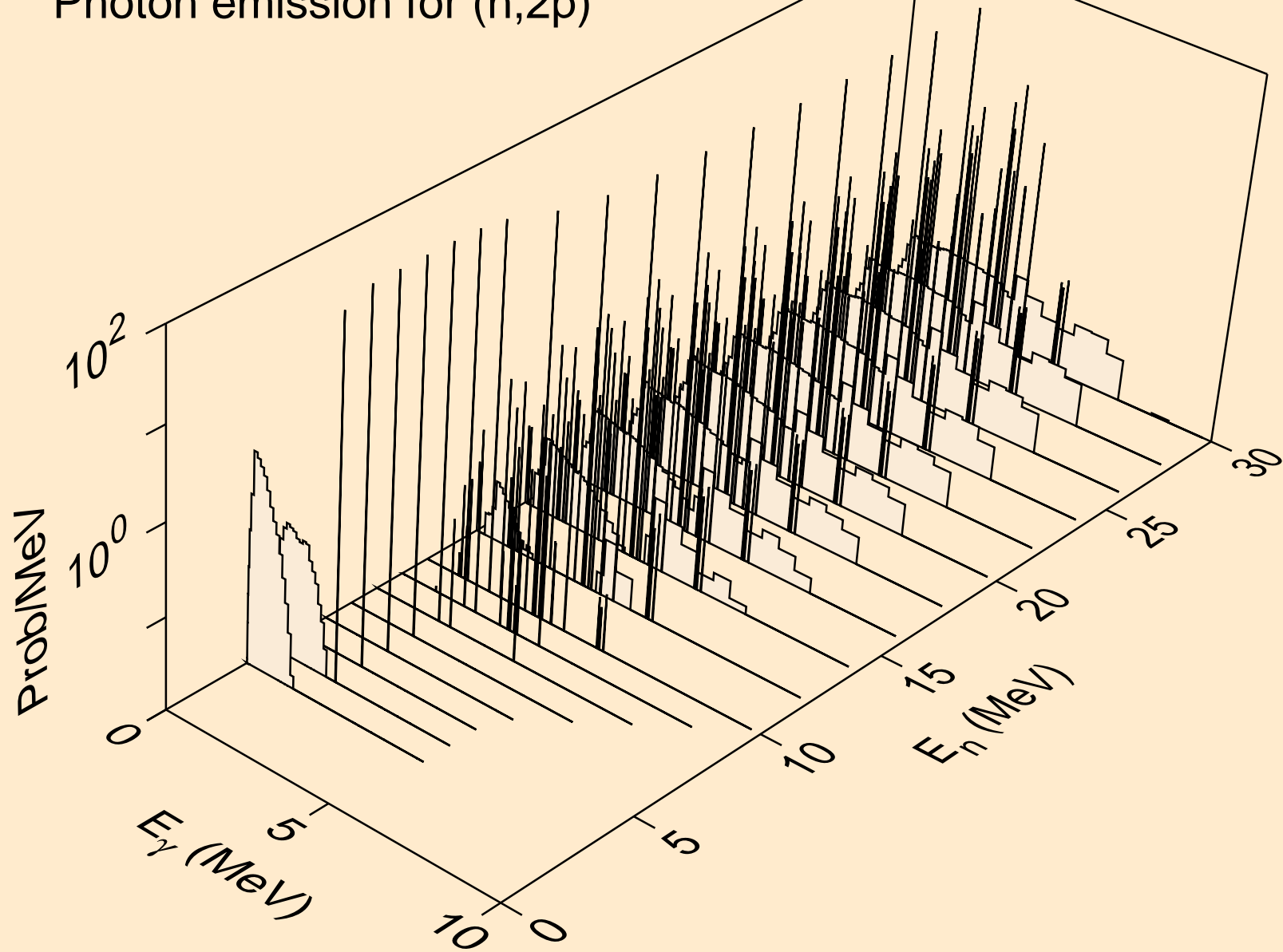



P031 TRITON ACER TENDL-2021 LIBRARY; T=0.K  
Photon emission for (n,pa)

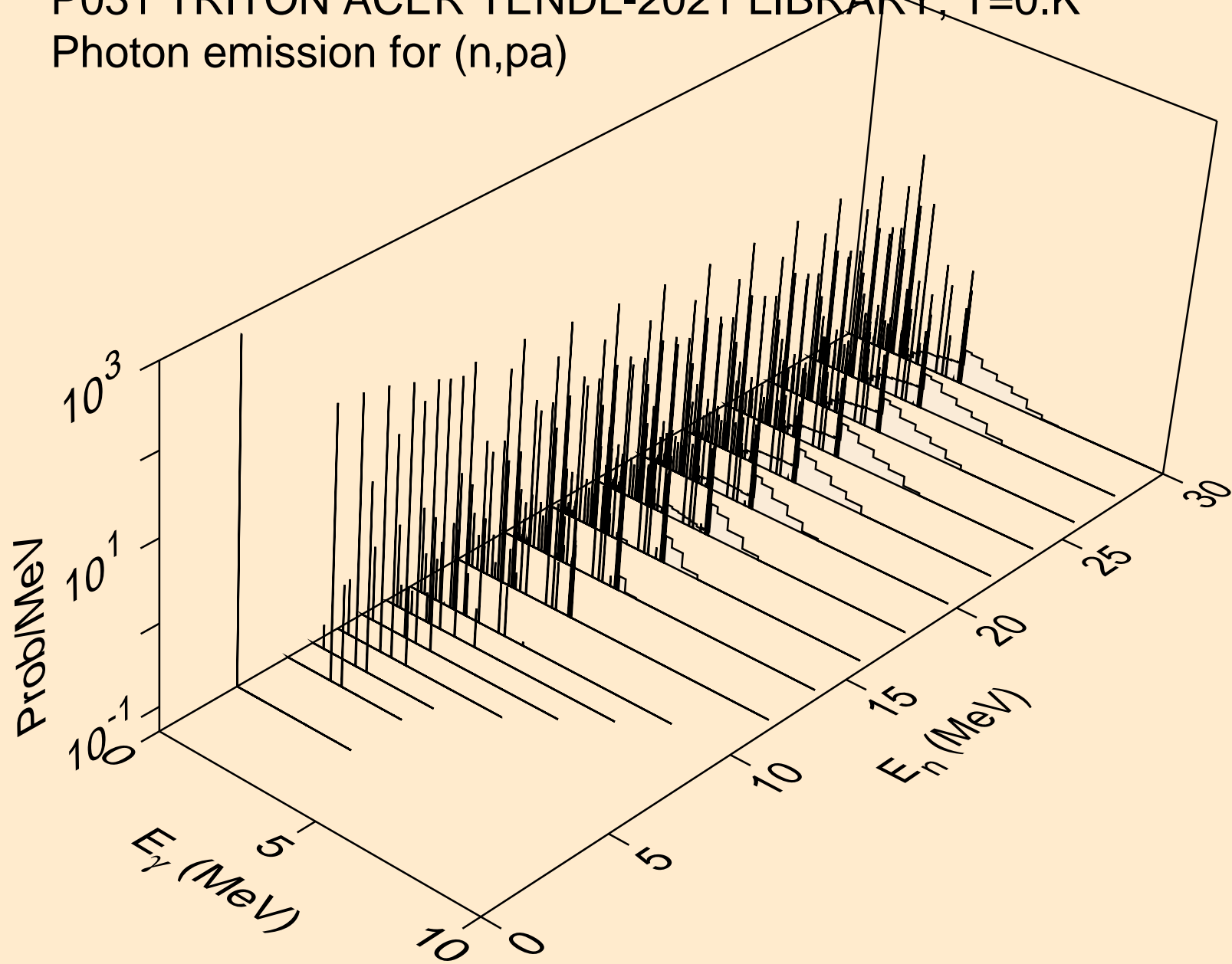

P031 TRITON ACER TENDL-2021 LIBRARY; T=0.K  
Photon emission for (n,pd)

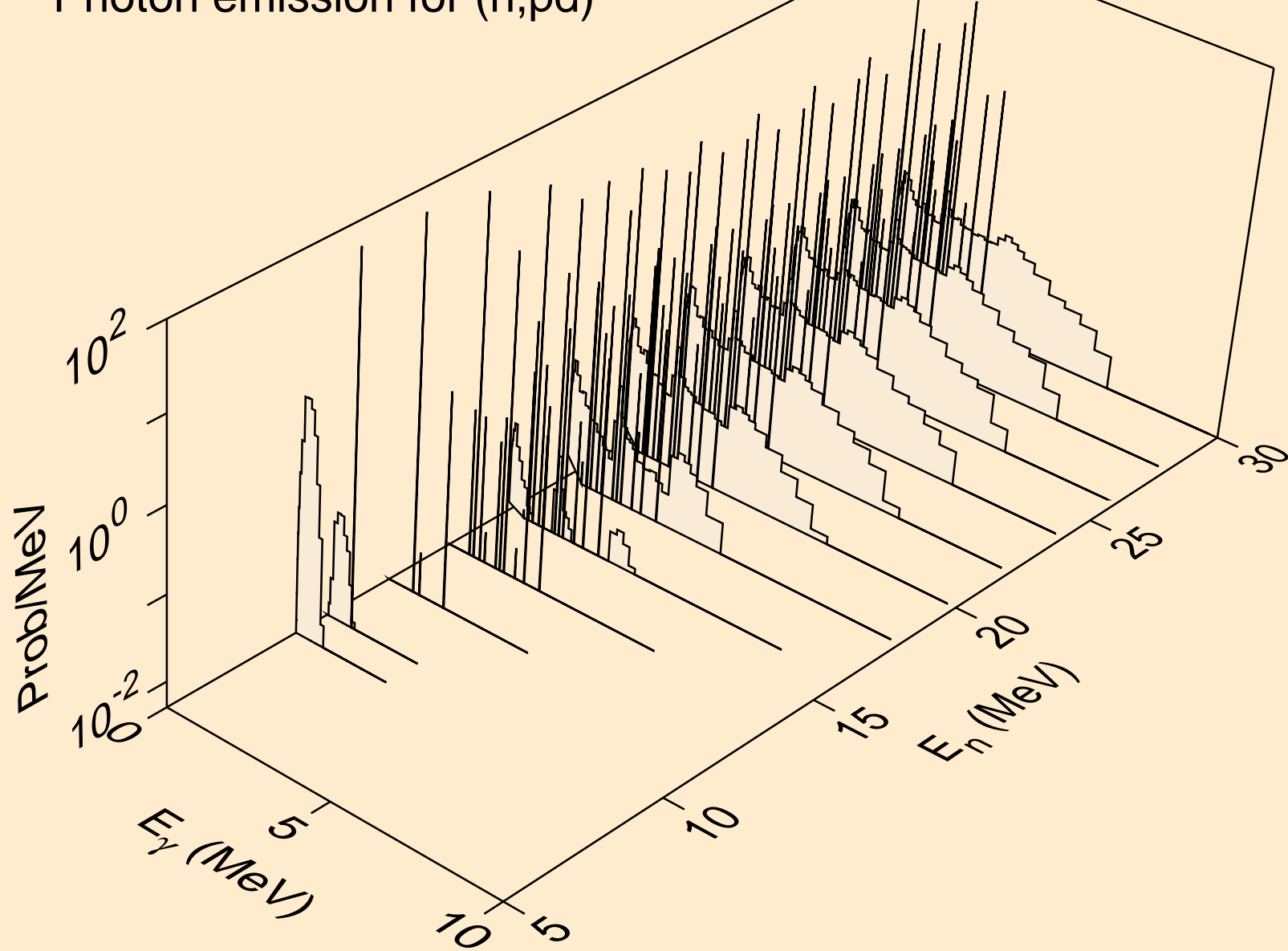

P031 TRITON ACER TENDL-2021 LIBRARY; T=0.K  
Photon emission for (n,pt)

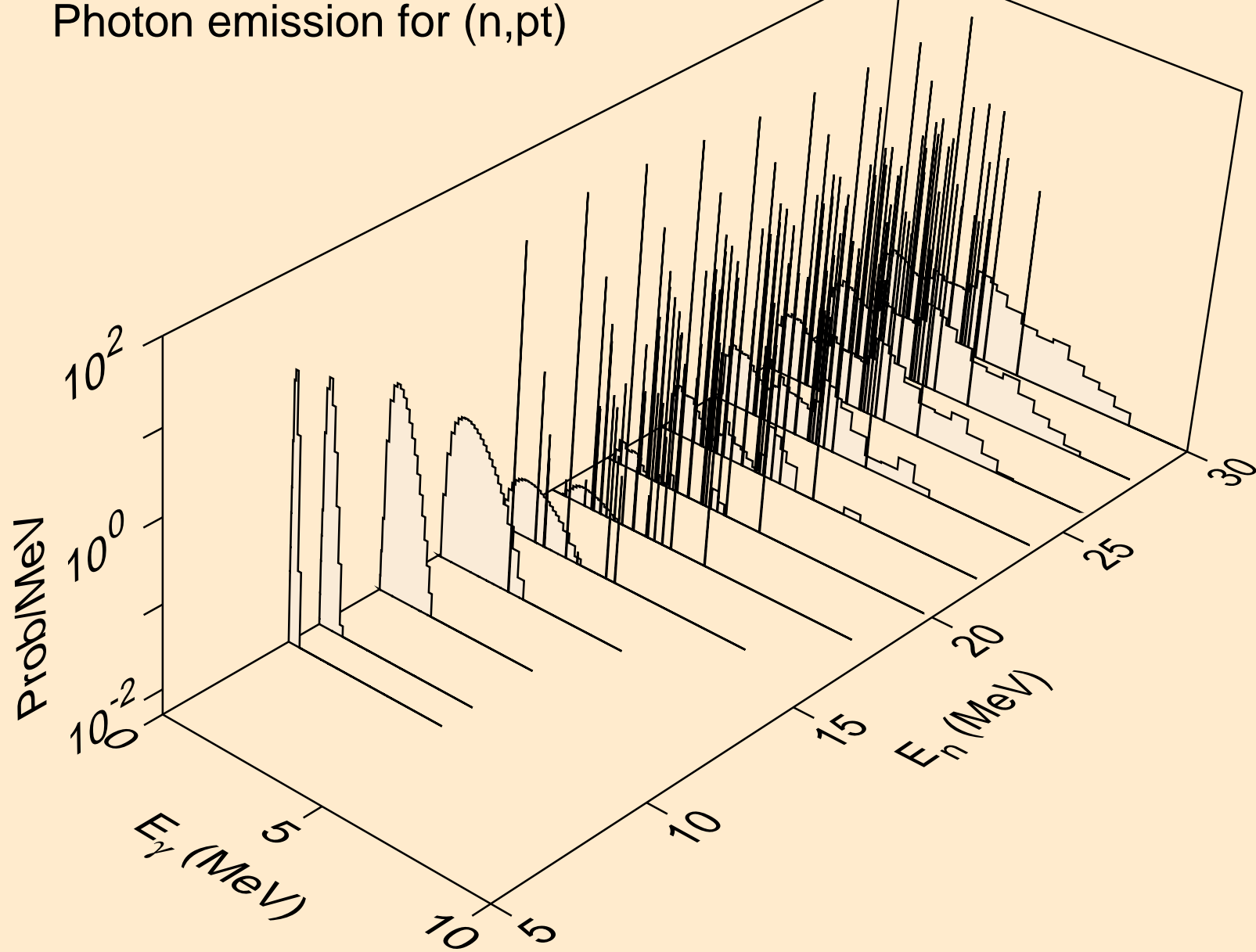

P031 TRITON ACER TENDL-2021 LIBRARY; T=0.K  
Photon emission for (n,da)

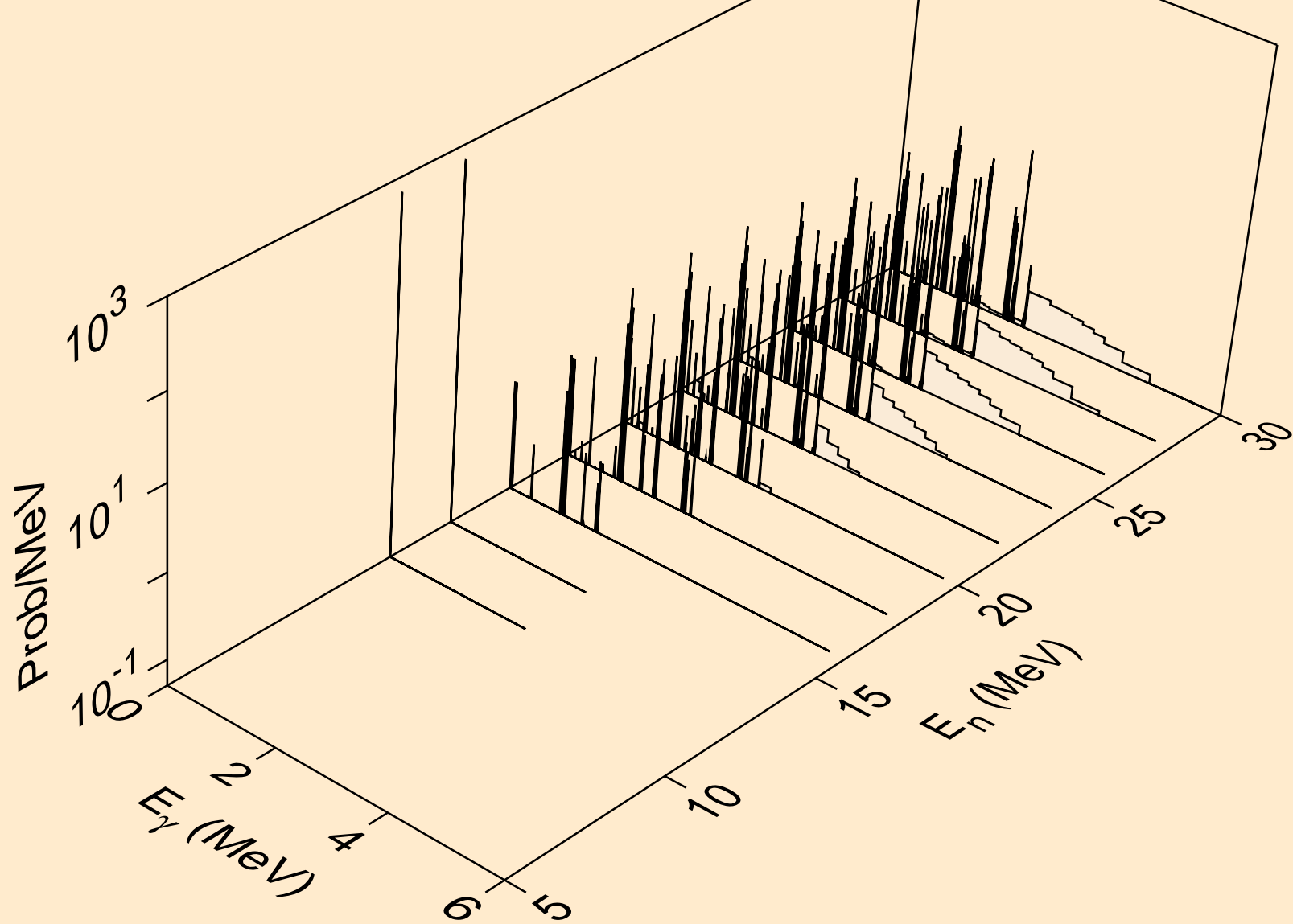

P031 TRITON ACER TENDL-2021 LIBRARY; T=0.K  
Particle heating contributions

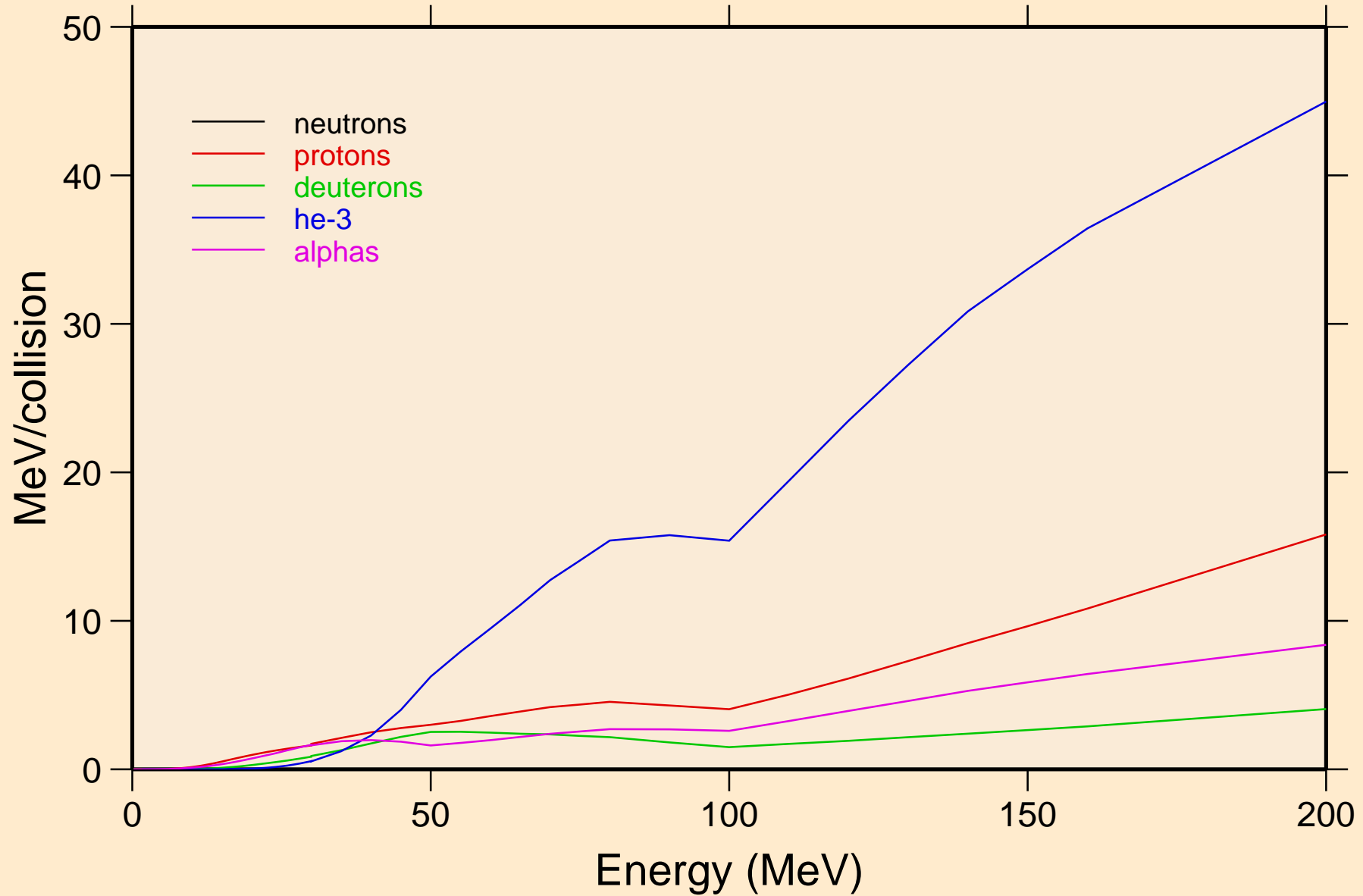

P031 TRITON ACER TENDL-2021 LIBRARY; T=0.K  
Recoil Heating

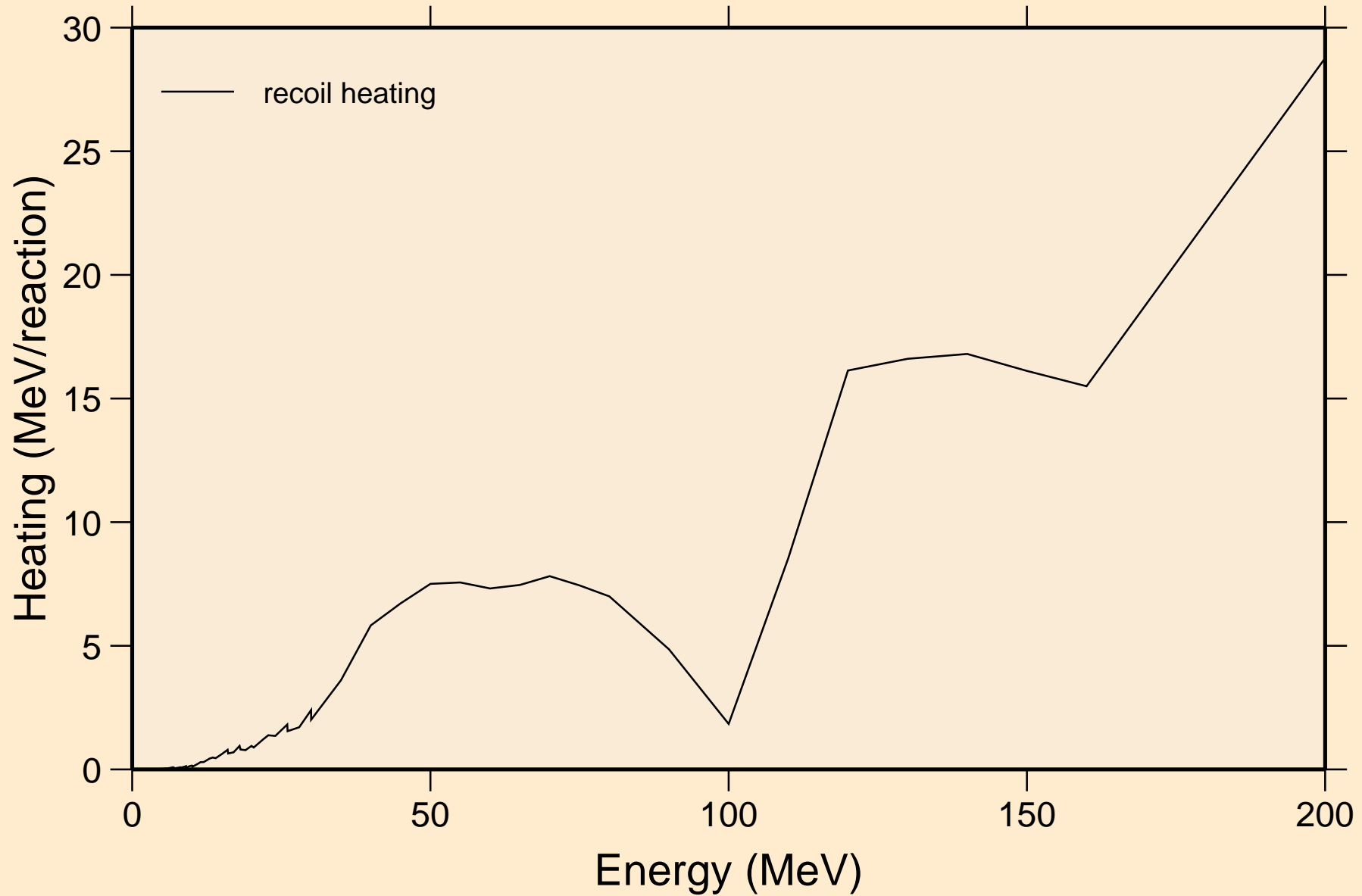

P031 TRITON ACER TENDL-2021 LIBRARY; T=0.K  
Particle production cross sections

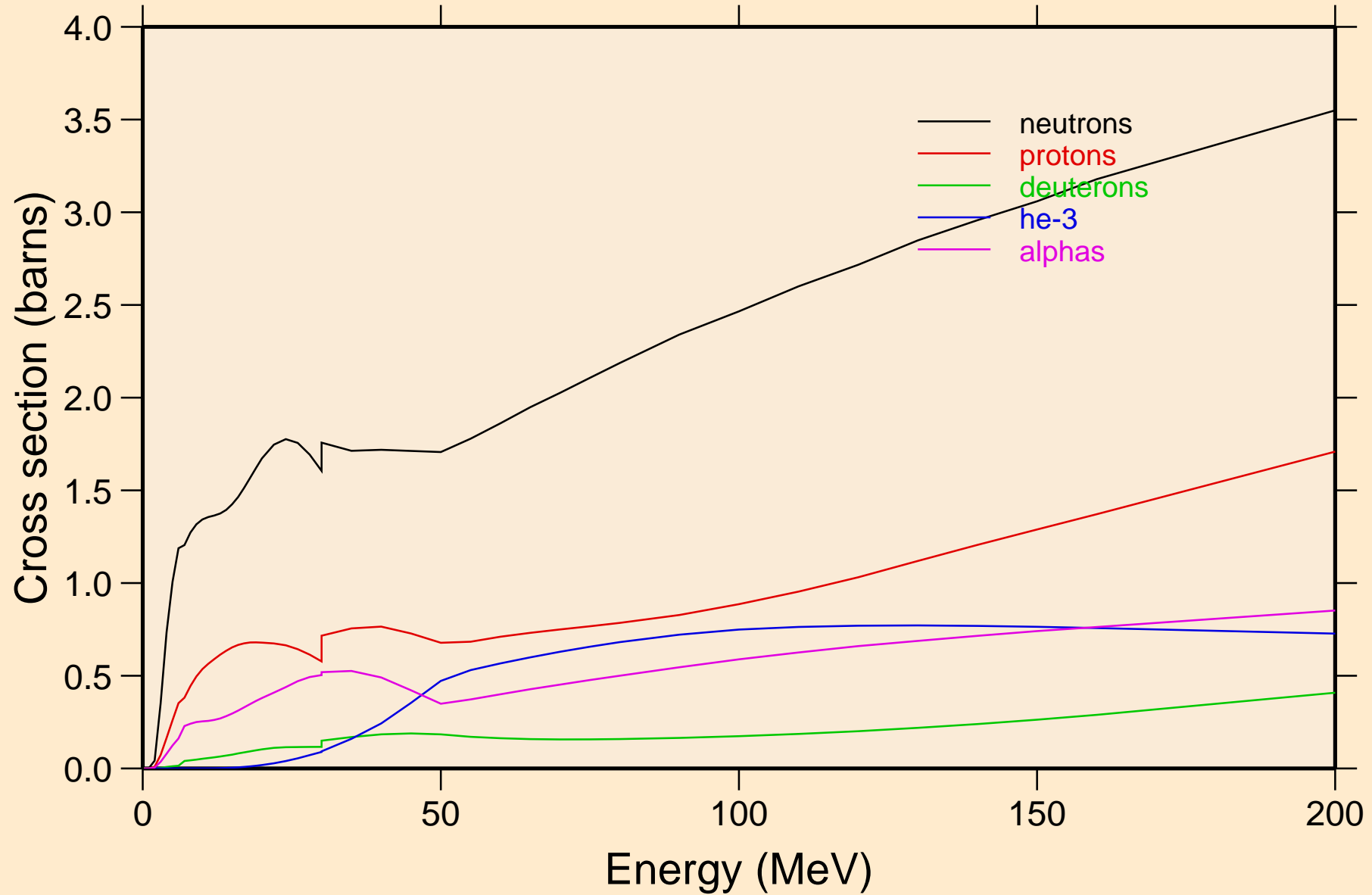

P031 TRITON ACER TENDL-2021 LIBRARY; T=0.K  
neutrons from (t,n)

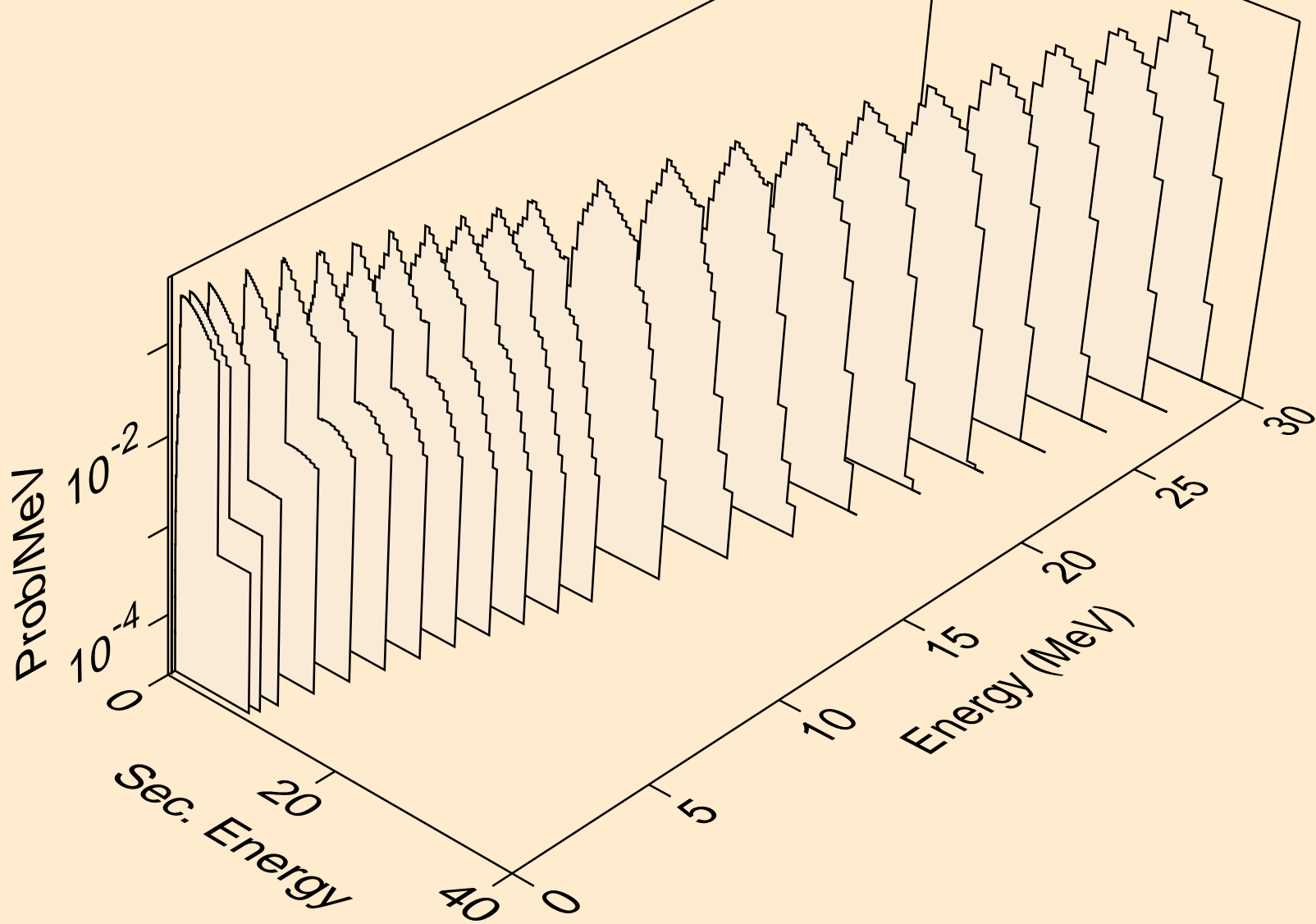



P031 TRITON ACER TENDL-2021 LIBRARY; T=0.K  
neutrons from (t,x)

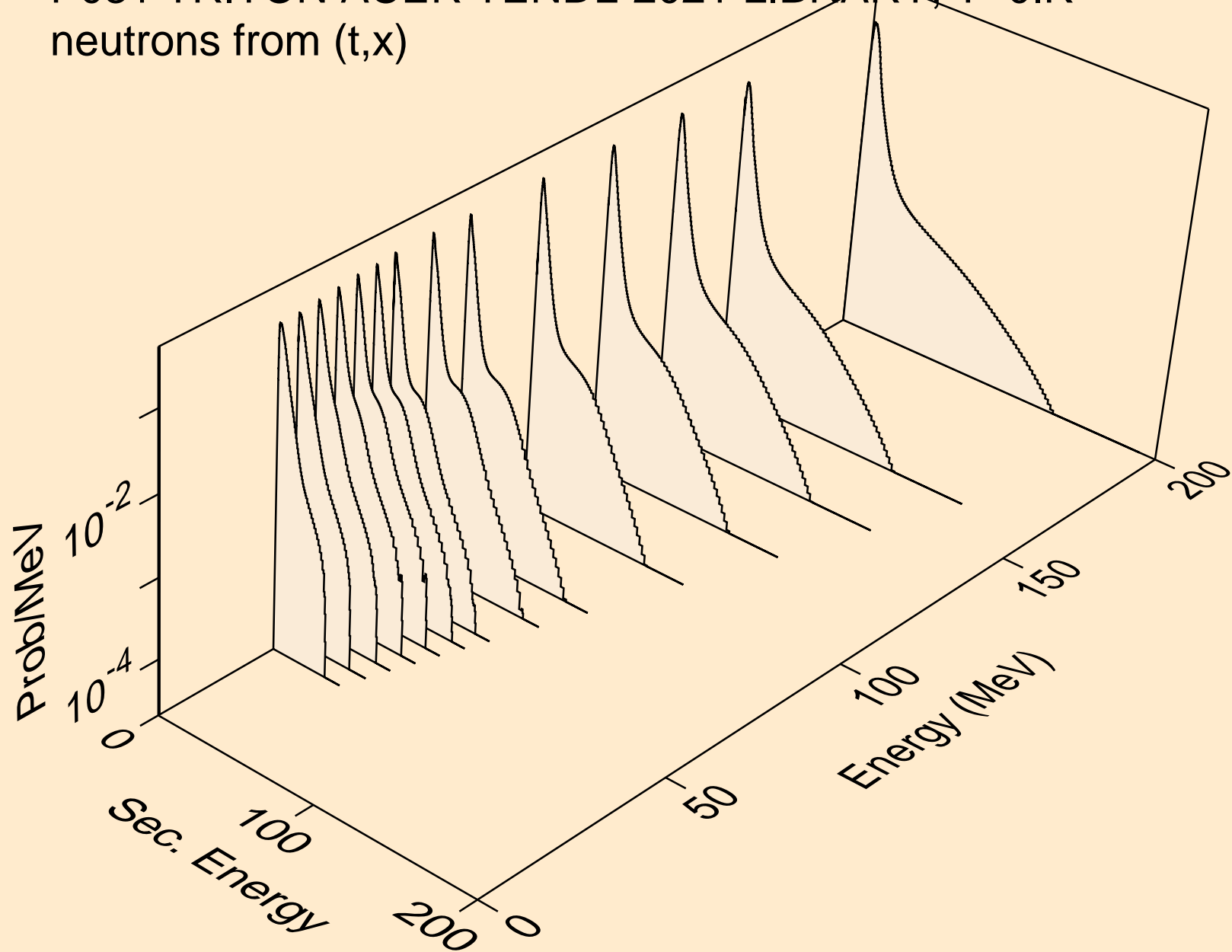

P031 TRITON ACER TENDL-2021 LIBRARY; T=0.K  
neutrons from (t,2nd)

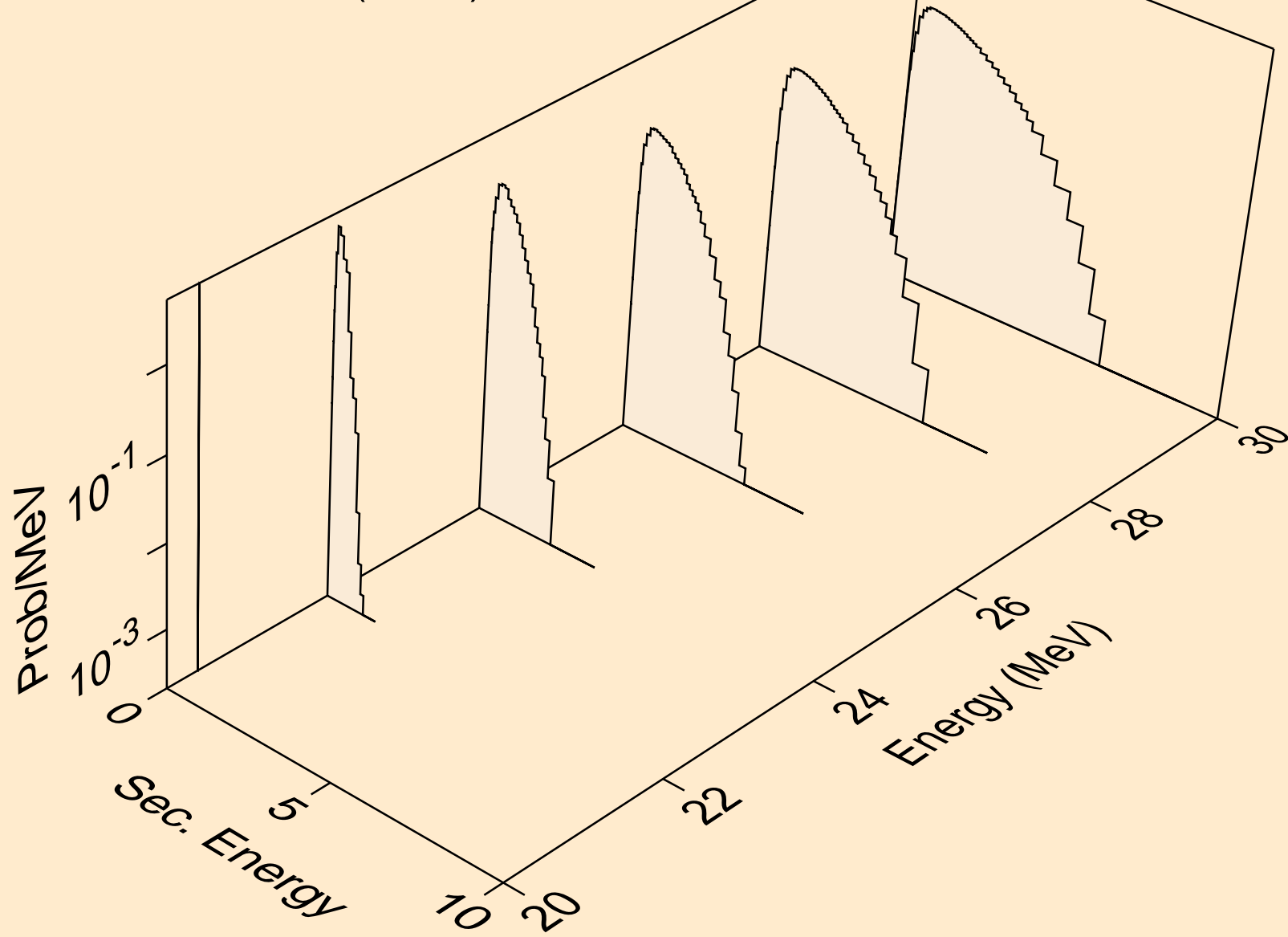

P031 TRITON ACER TENDL-2021 LIBRARY; T=0.K  
neutrons from (t,2n)

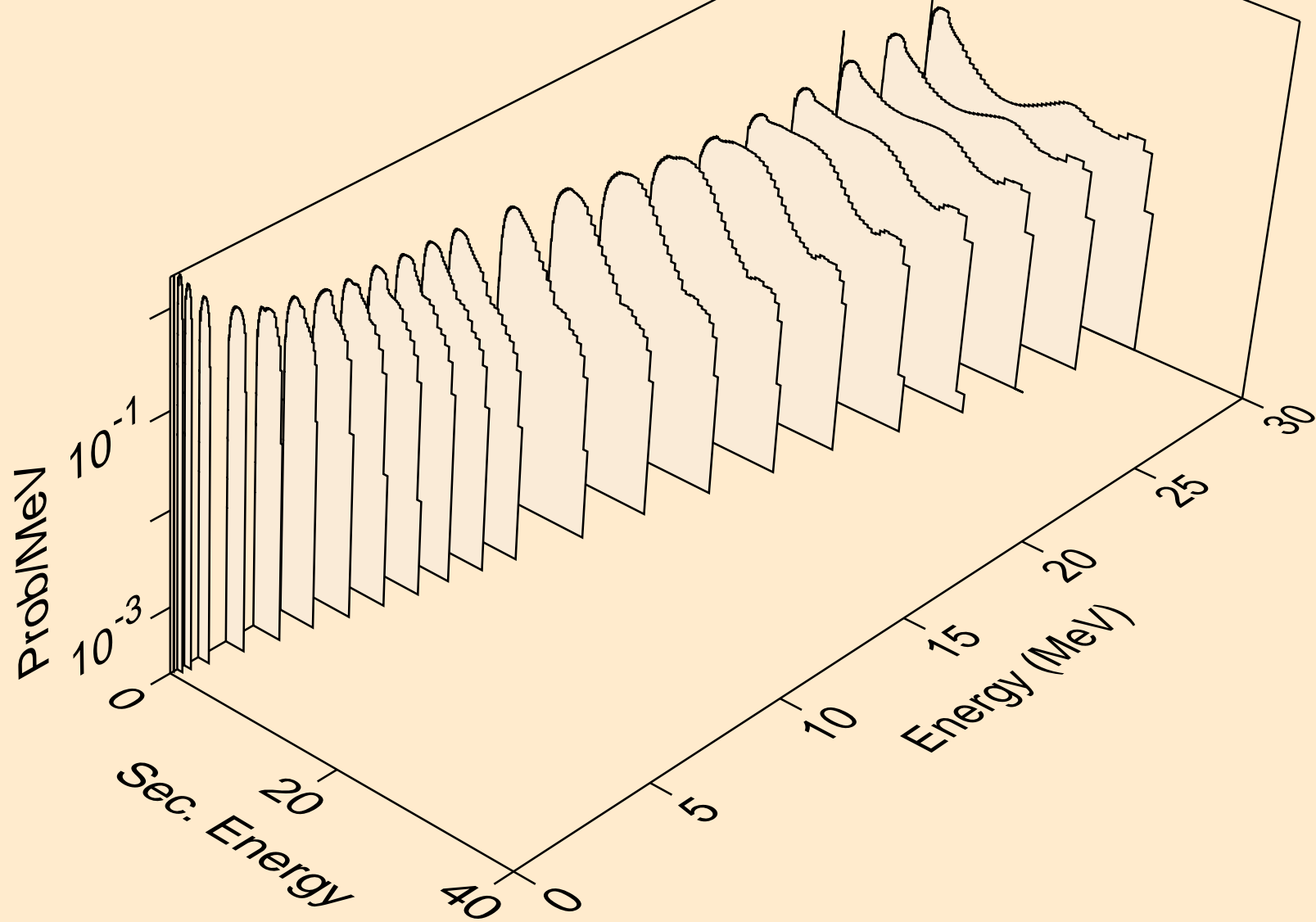

P031 TRITON ACER TENDL-2021 LIBRARY; T=0.K  
neutrons from (t,3n)

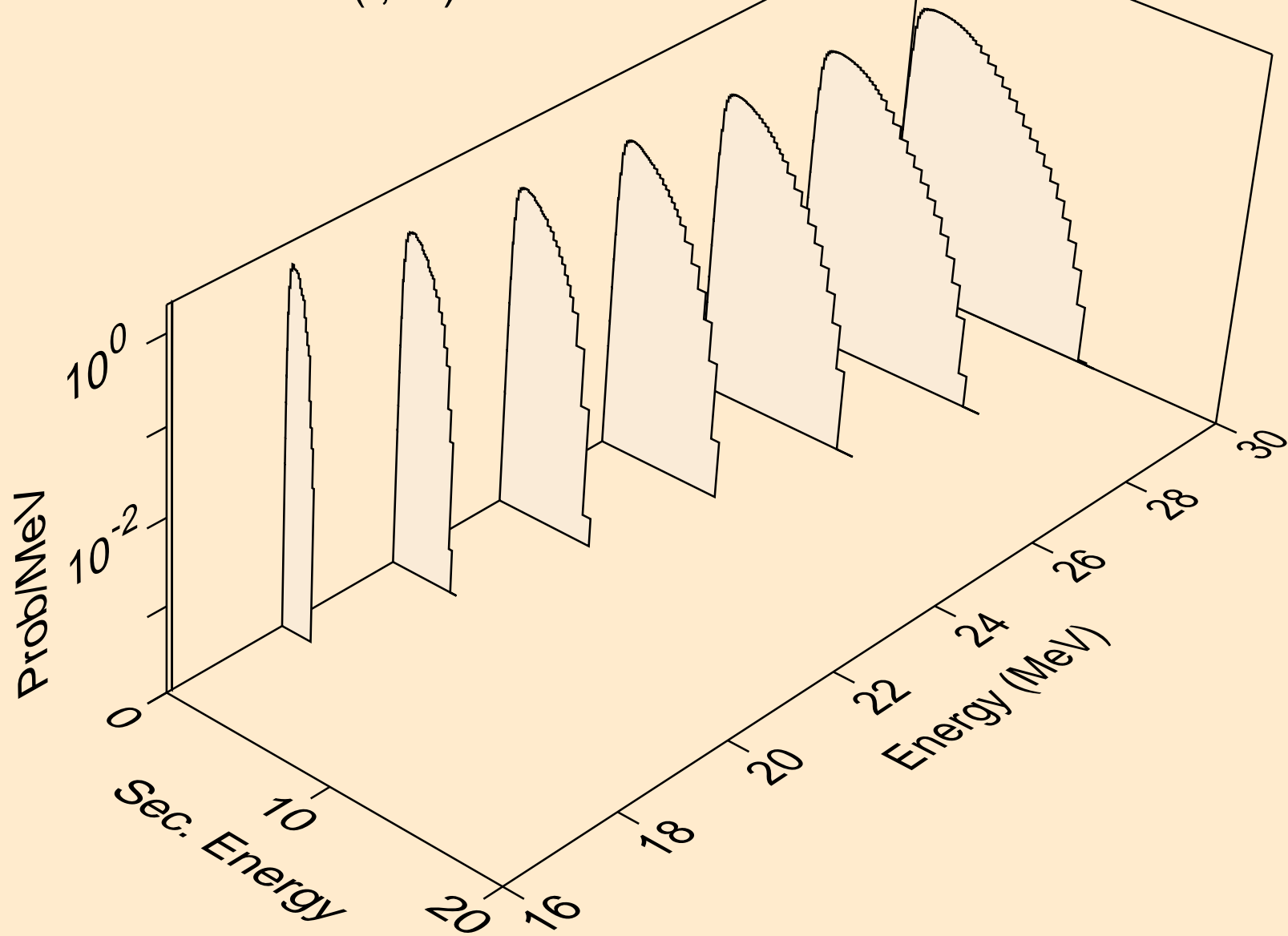

P031 TRITON ACER TENDL-2021 LIBRARY; T=0.K  
neutrons from (t,n\*)a

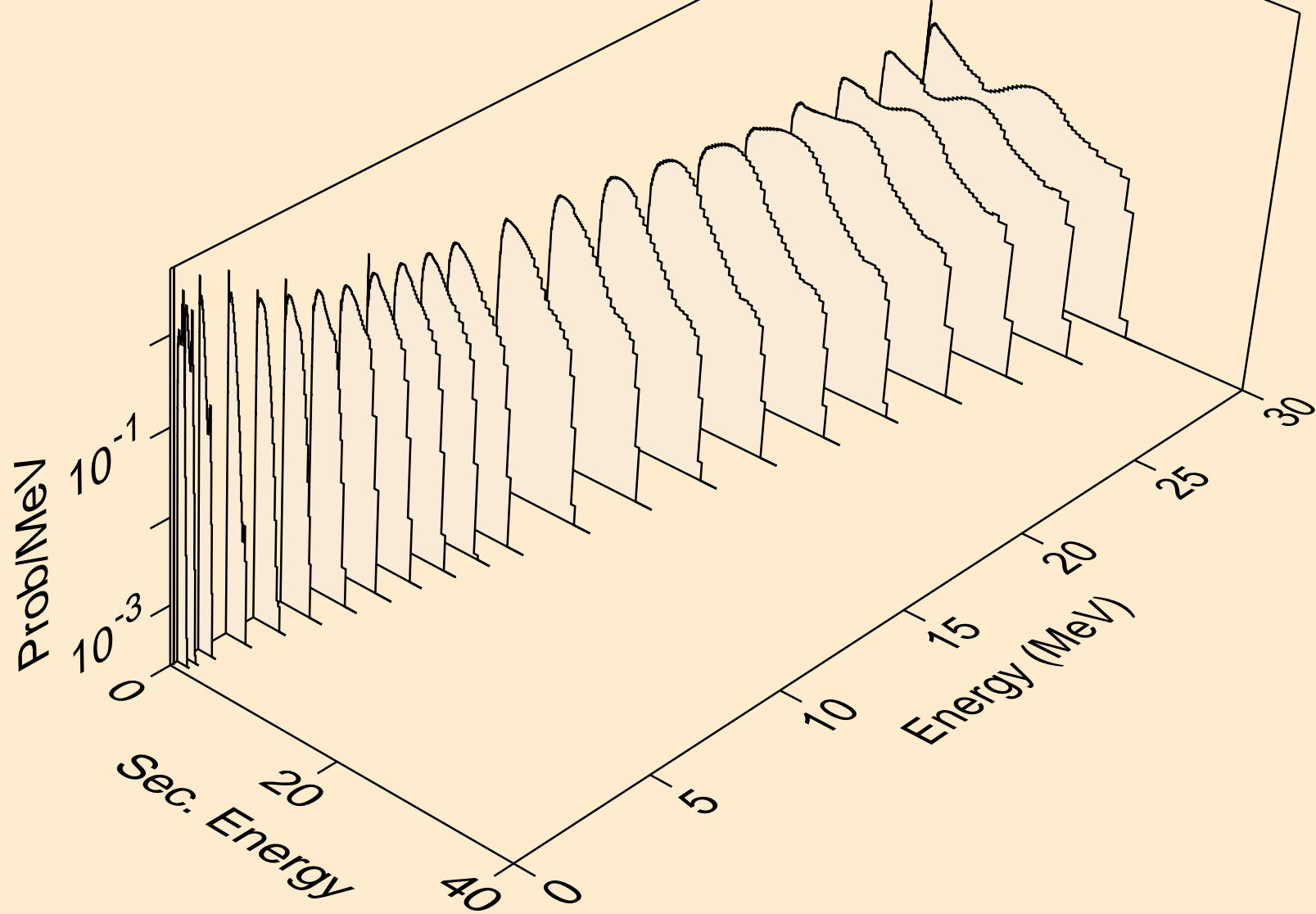

P031 TRITON ACER TENDL-2021 LIBRARY; T=0.K  
neutrons from (t,2n)a

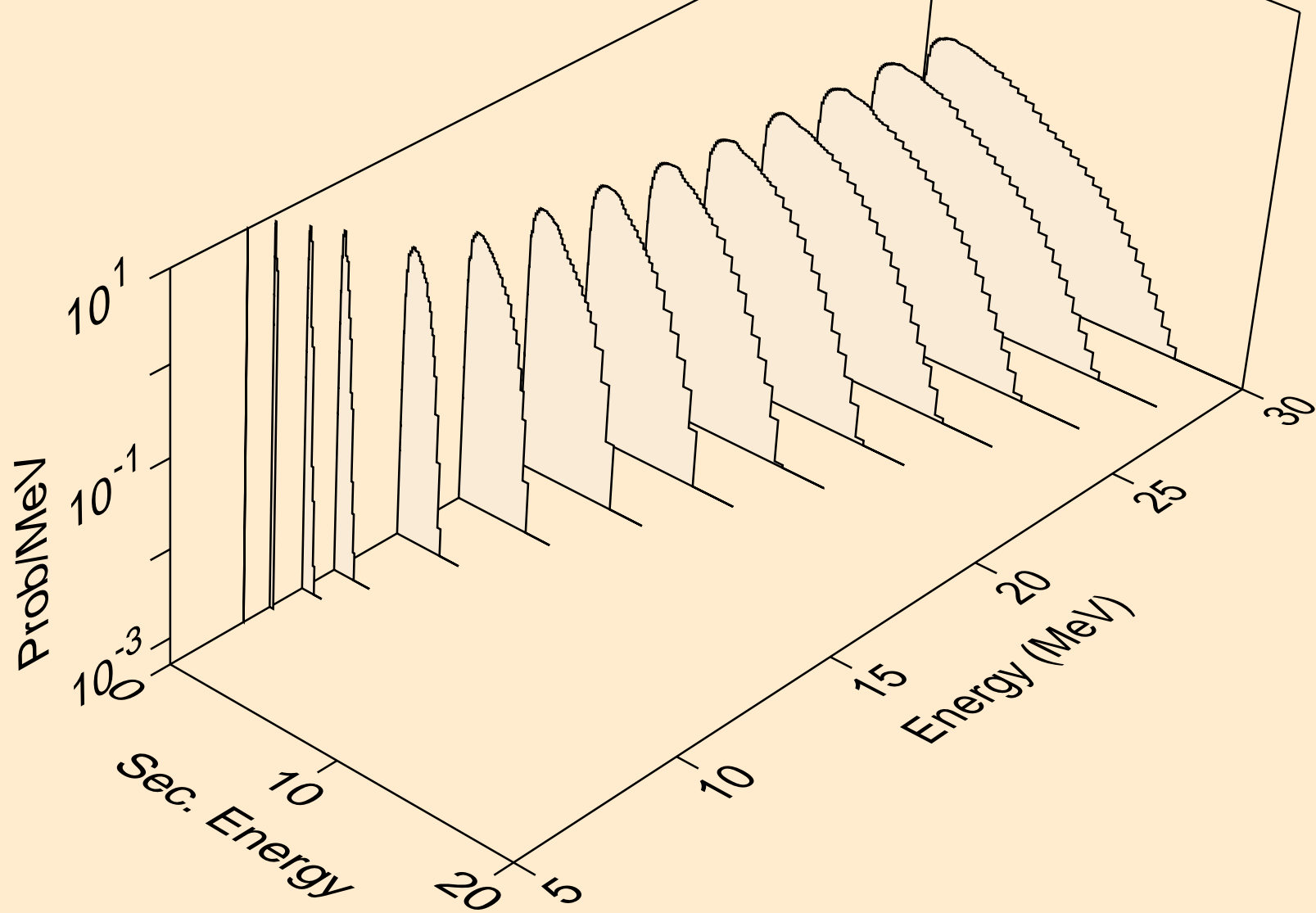

P031 TRITON ACER TENDL-2021 LIBRARY; T=0.K  
neutrons from (t,3n)a

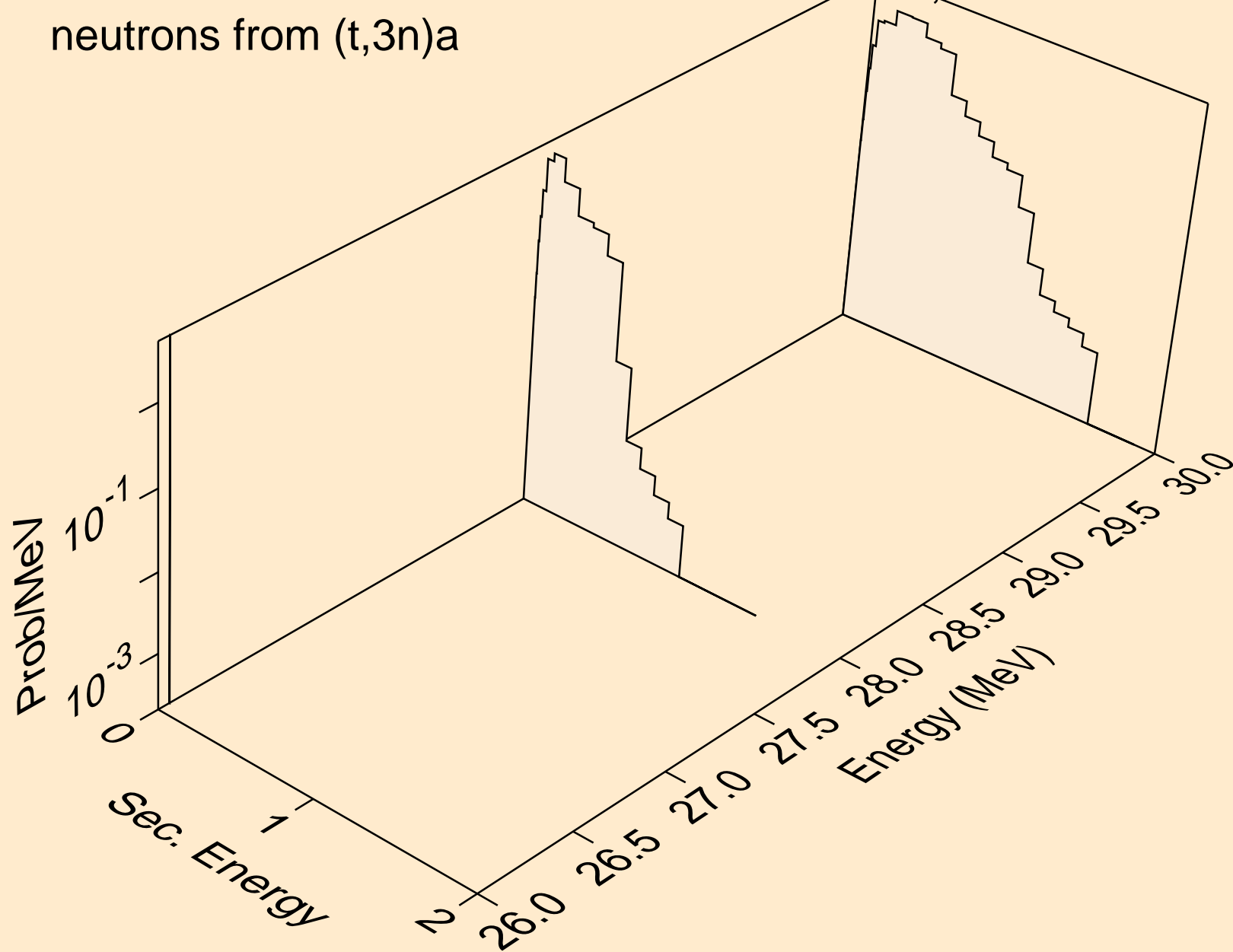

P031 TRITON ACER TENDL-2021 LIBRARY; T=0.K  
neutrons from (t,n\*)p

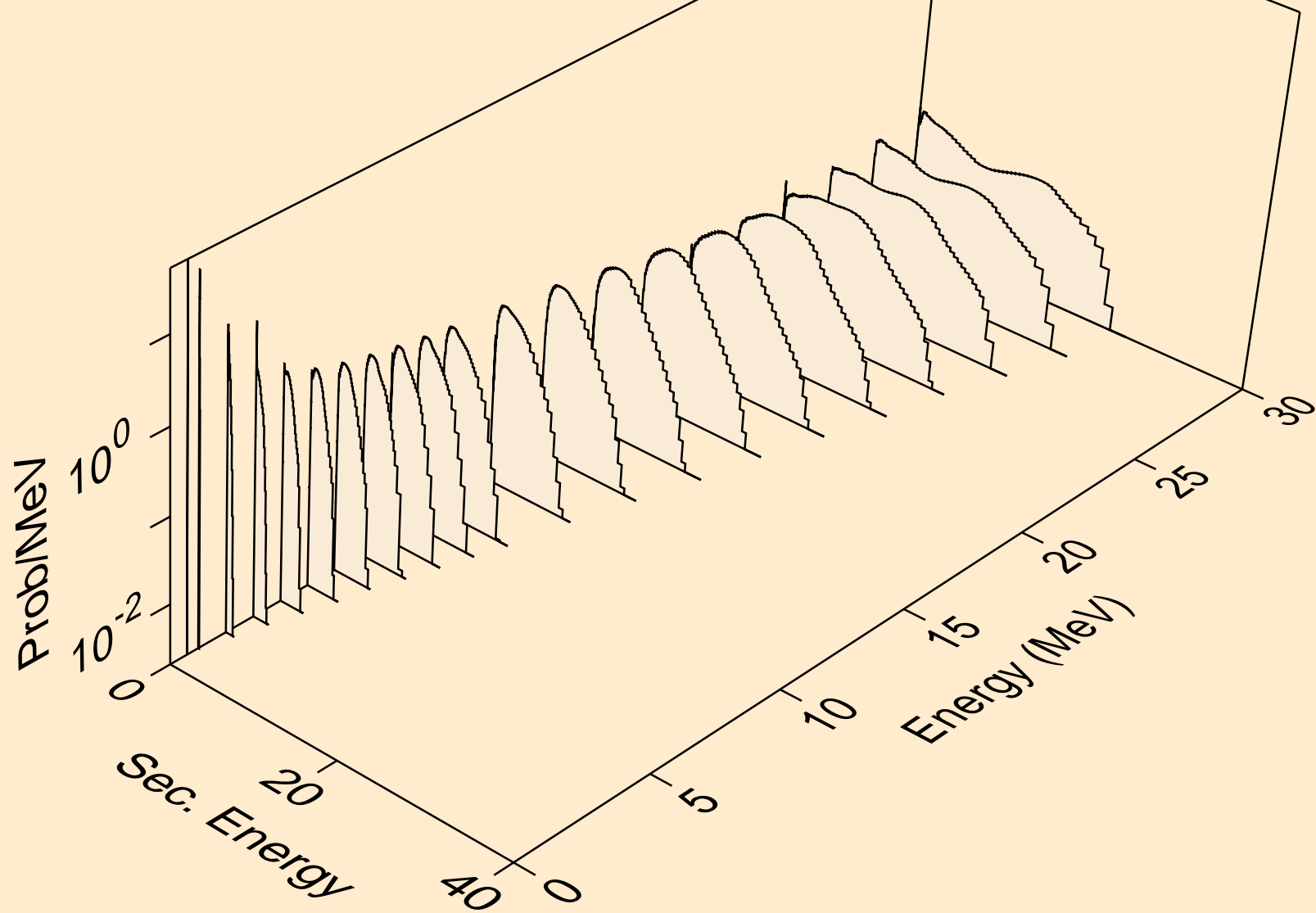



P031 TRITON ACER TENDL-2021 LIBRARY; T=0.K  
neutrons from (t,n\*)2a

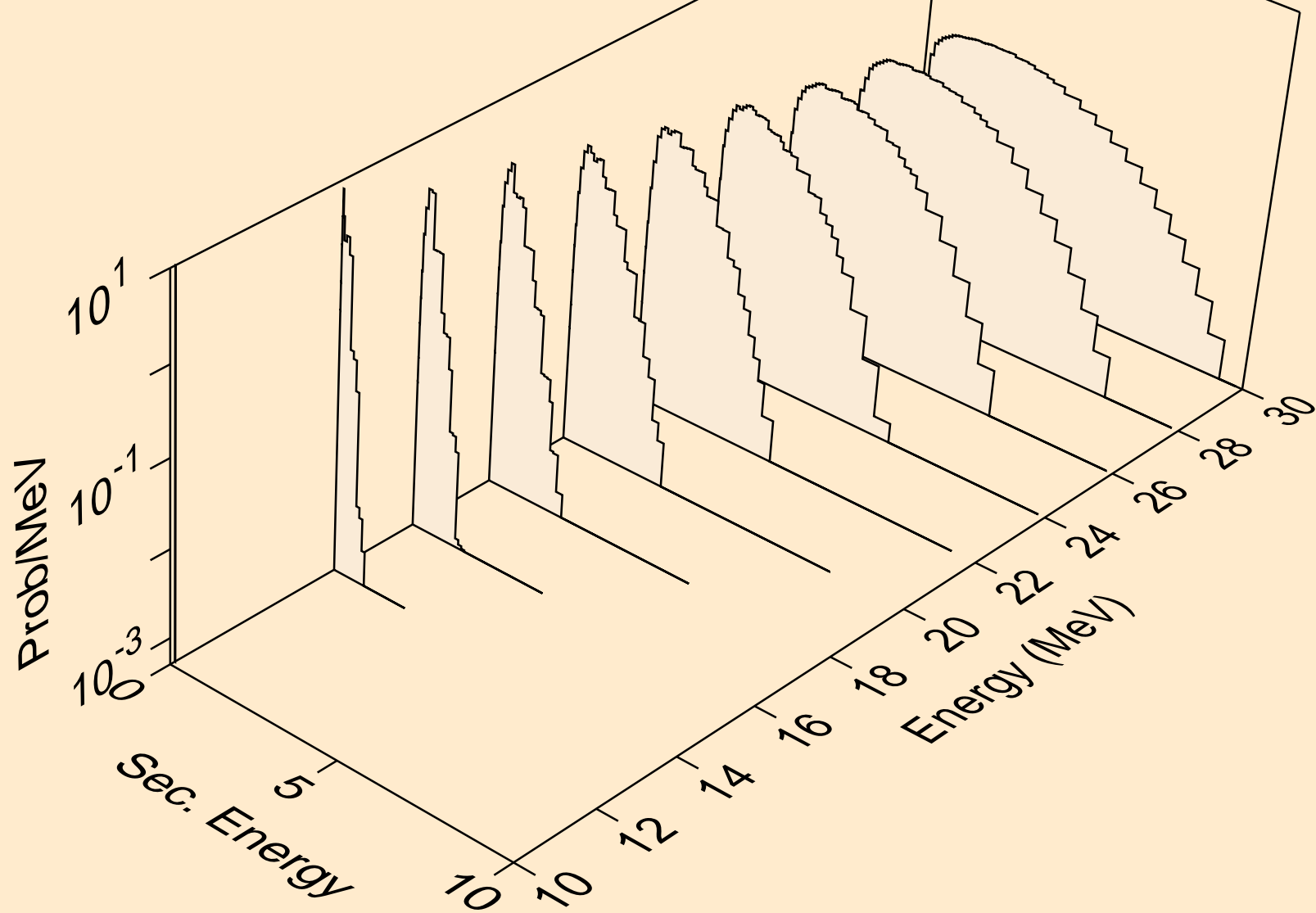

P031 TRITON ACER TENDL-2021 LIBRARY; T=0.K  
neutrons from (t,2n)2a

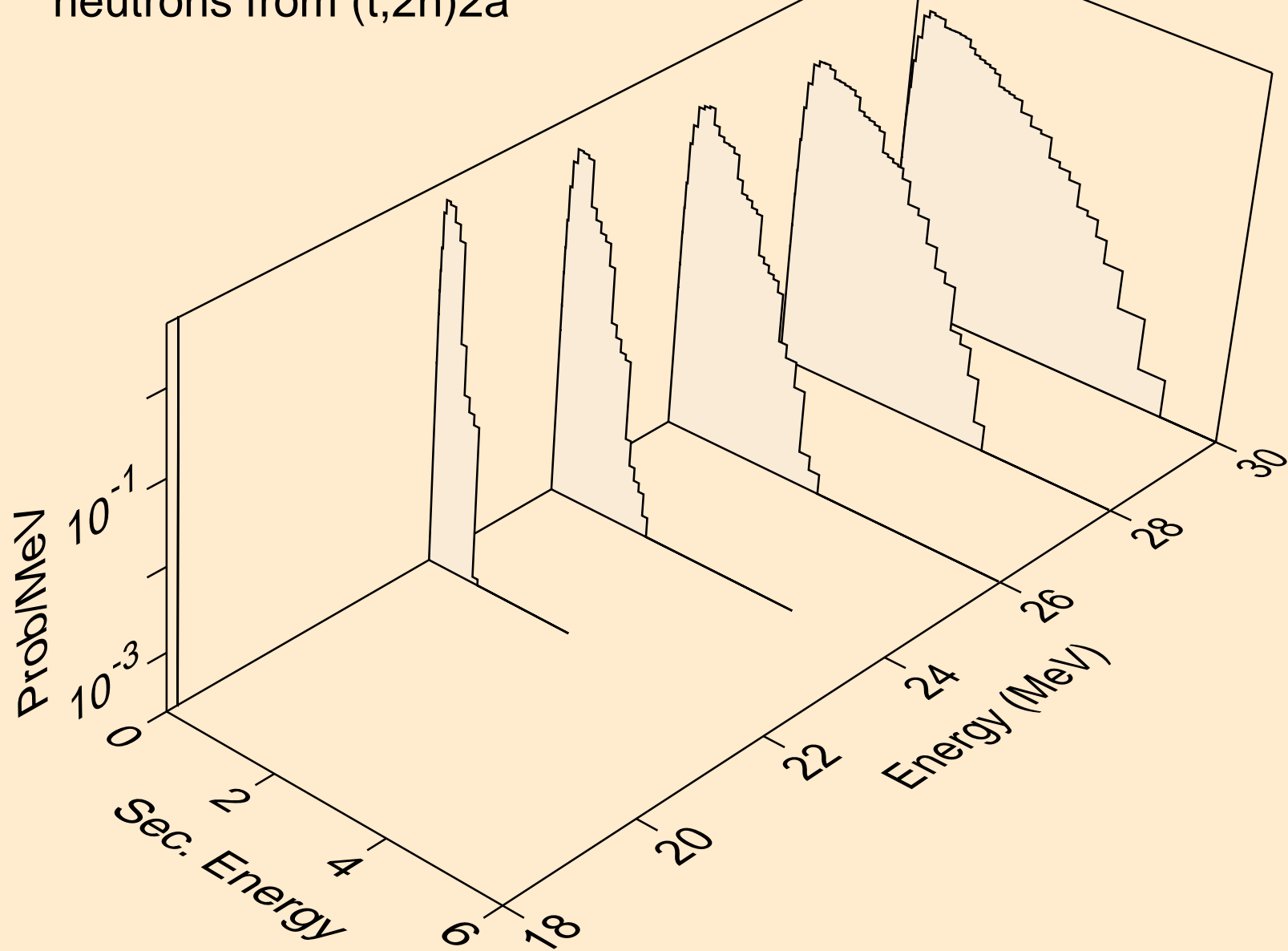

P031 TRITON ACER TENDL-2021 LIBRARY; T=0.K  
neutrons from (t,n\*)d

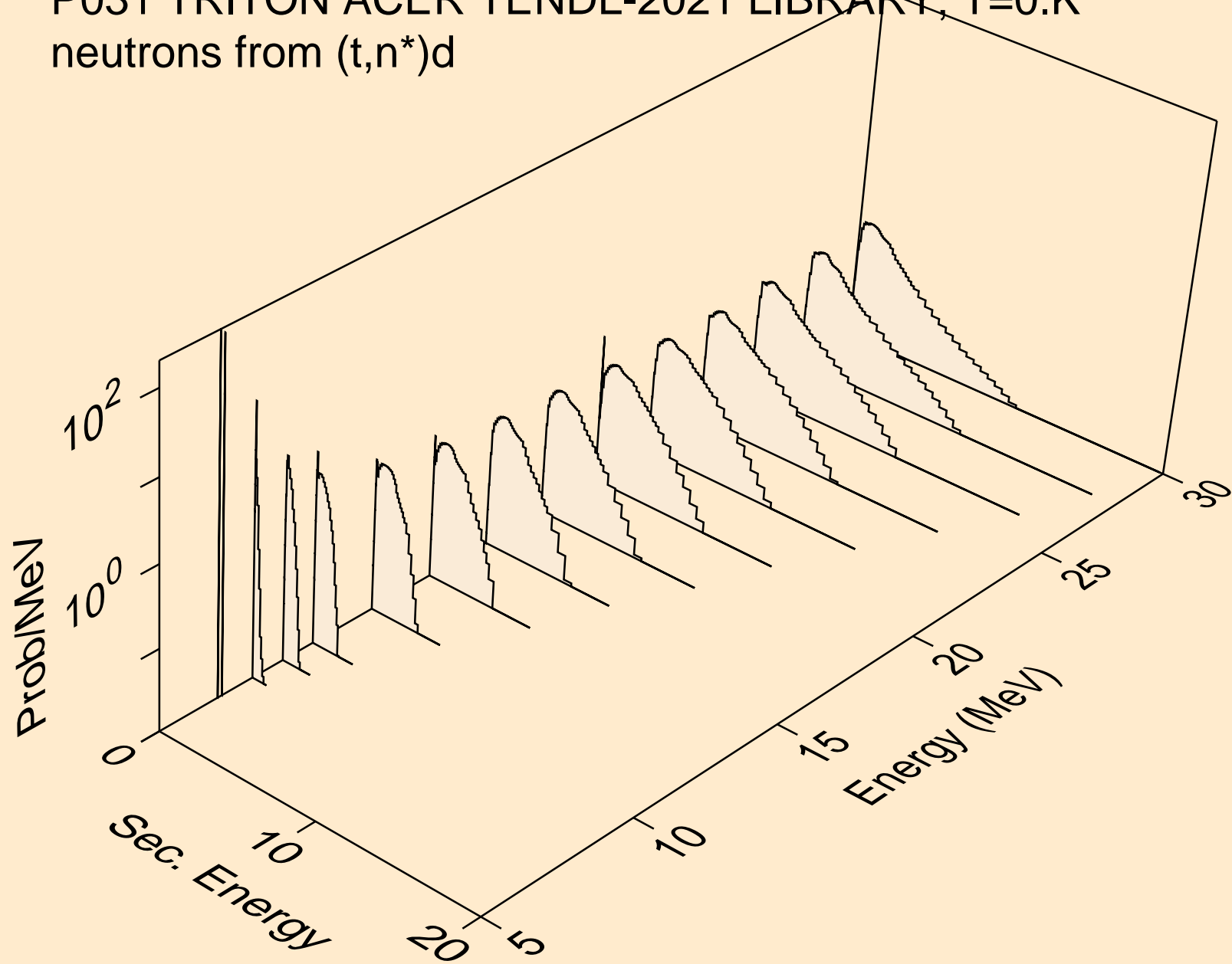

P031 TRITON ACER TENDL-2021 LIBRARY; T=0.K  
neutrons from (t,n\*)t

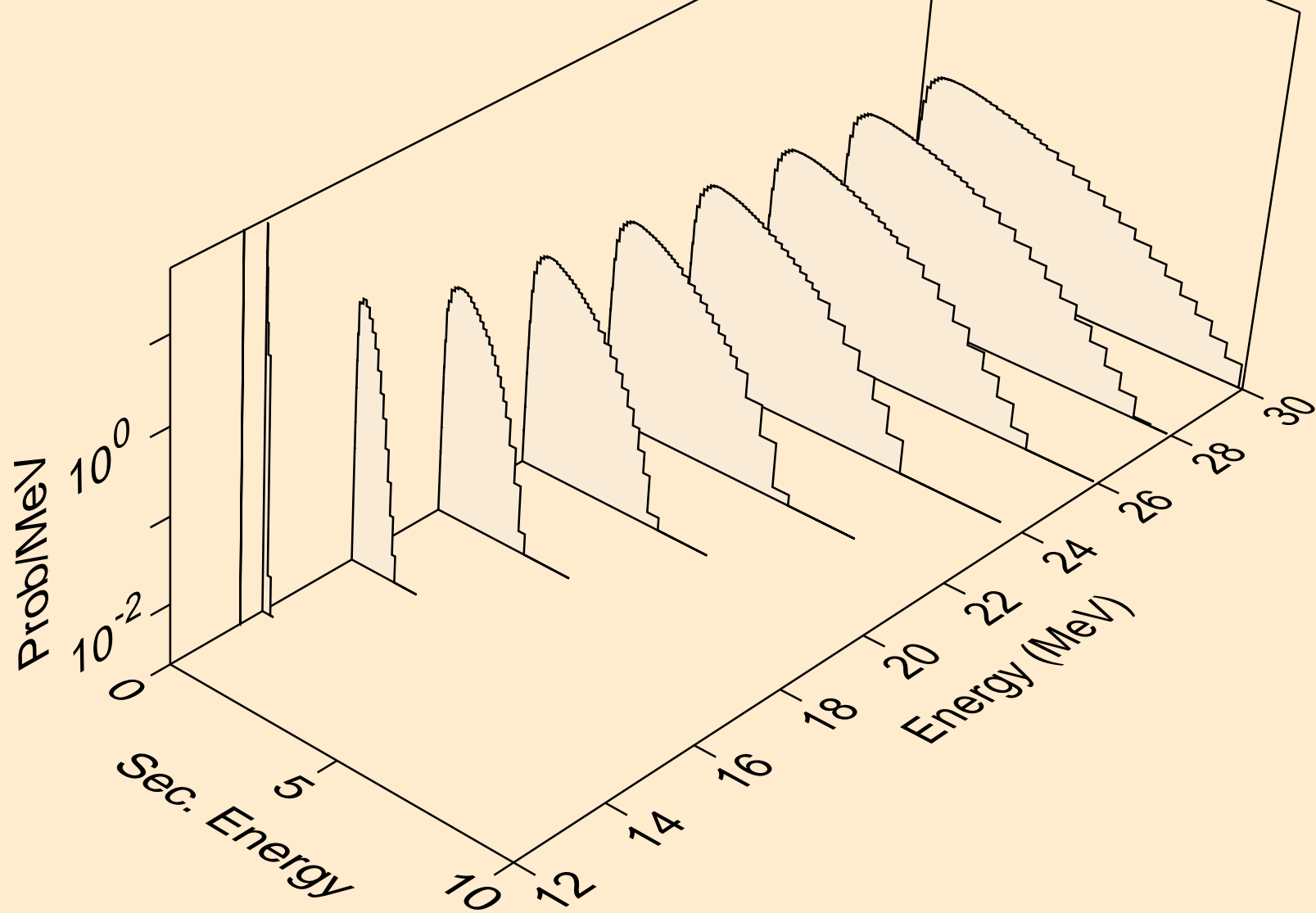

P031 TRITON ACER TENDL-2021 LIBRARY; T=0.K  
neutrons from (t,n\*)he3

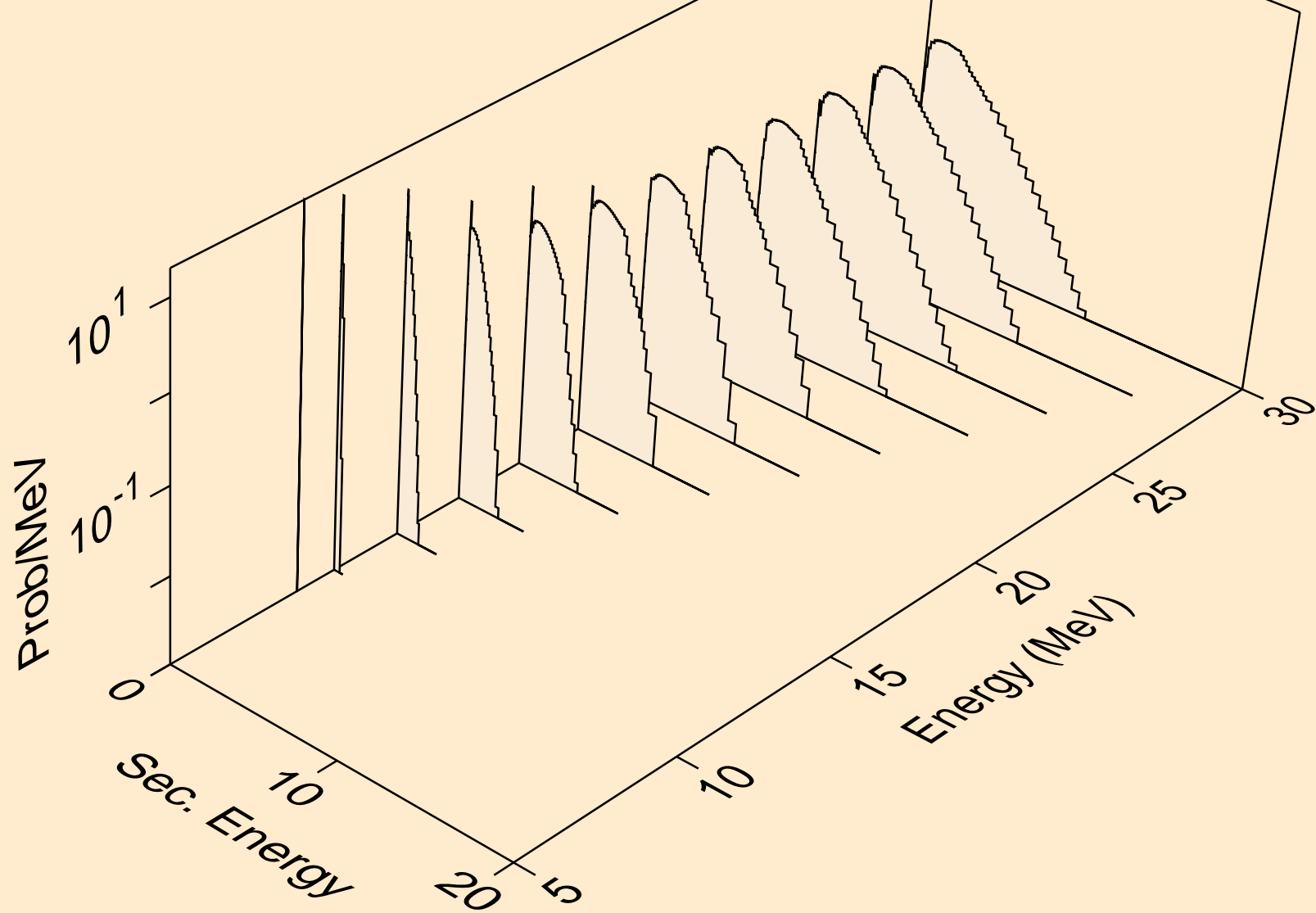

P031 TRITON ACER TENDL-2021 LIBRARY; T=0.K  
neutrons from (t,2np)

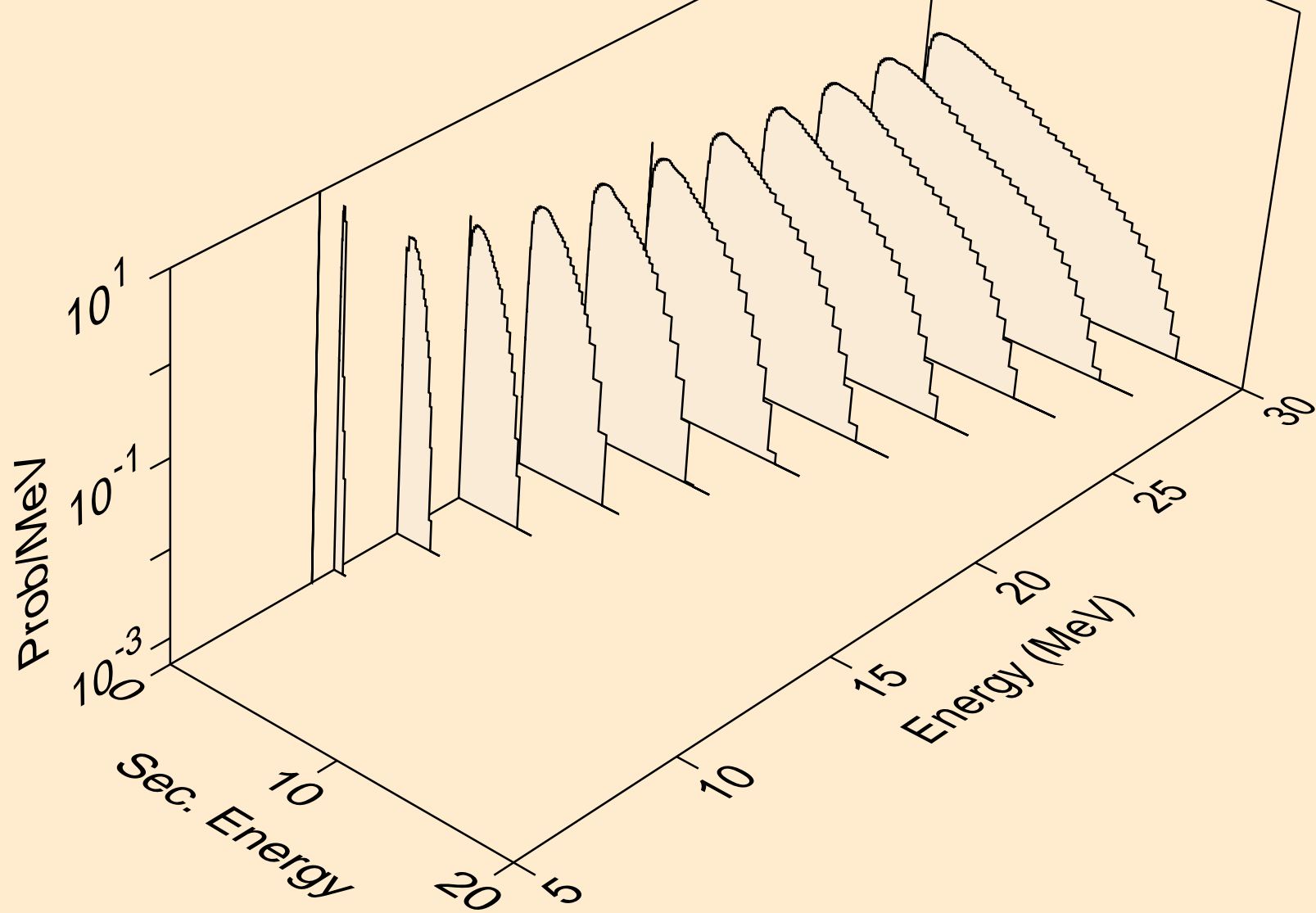

P031 TRITON ACER TENDL-2021 LIBRARY; T=0.K  
neutrons from (t,3np)

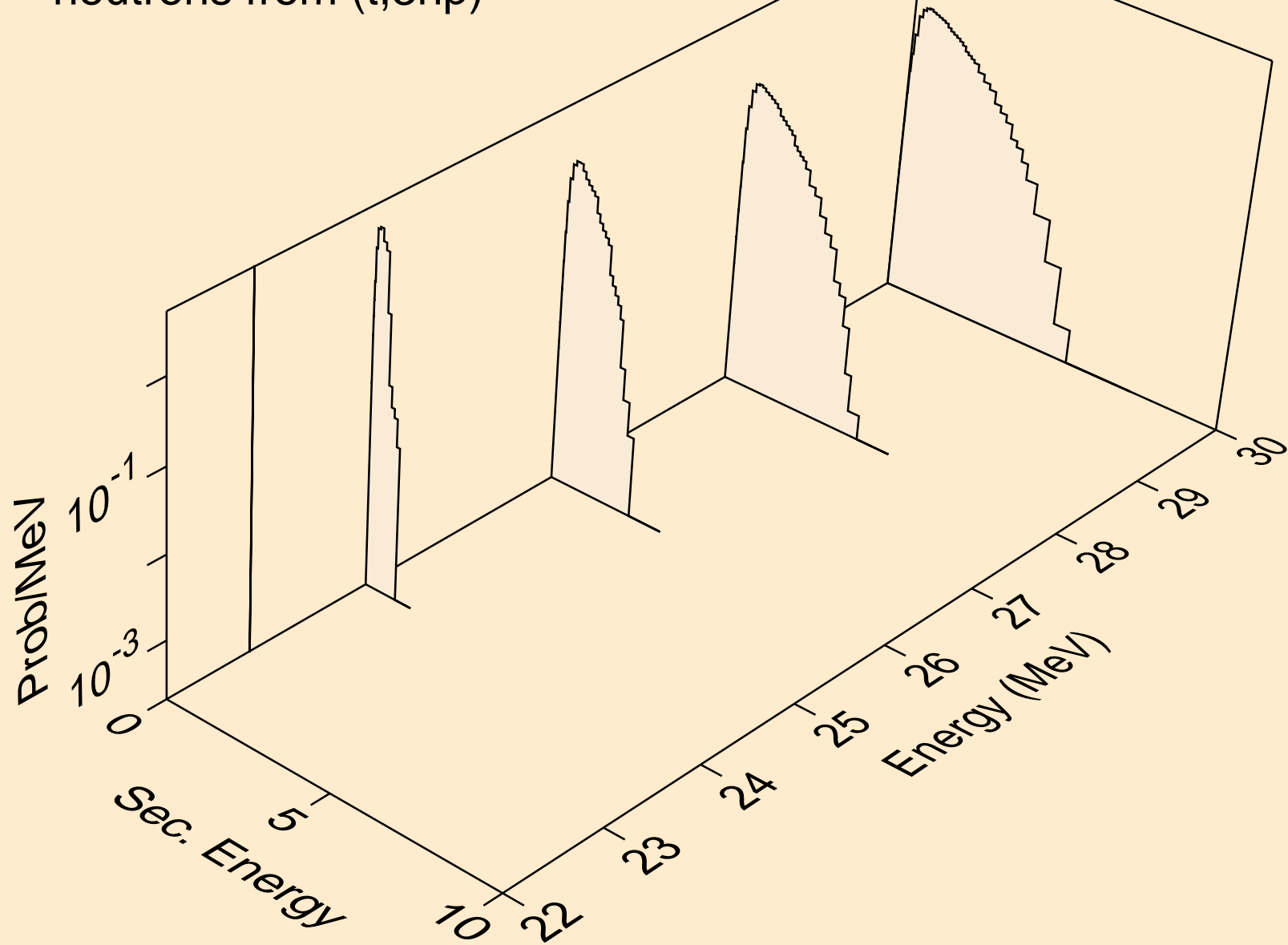

P031 TRITON ACER TENDL-2021 LIBRARY; T=0.K  
neutrons from (t,2np)

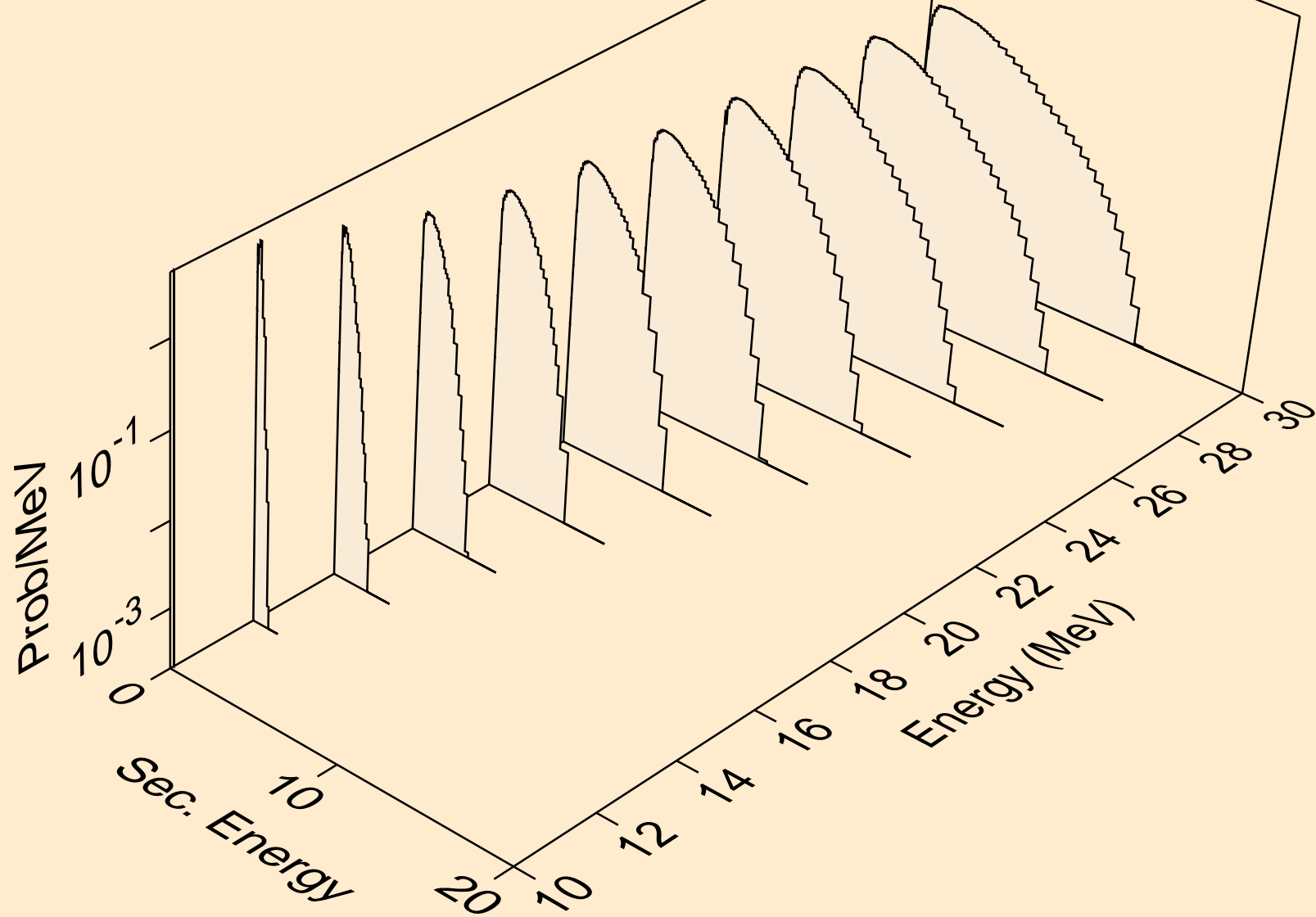



P031 TRITON ACER TENDL-2021 LIBRARY; T=0.K  
neutrons from (t,npa)

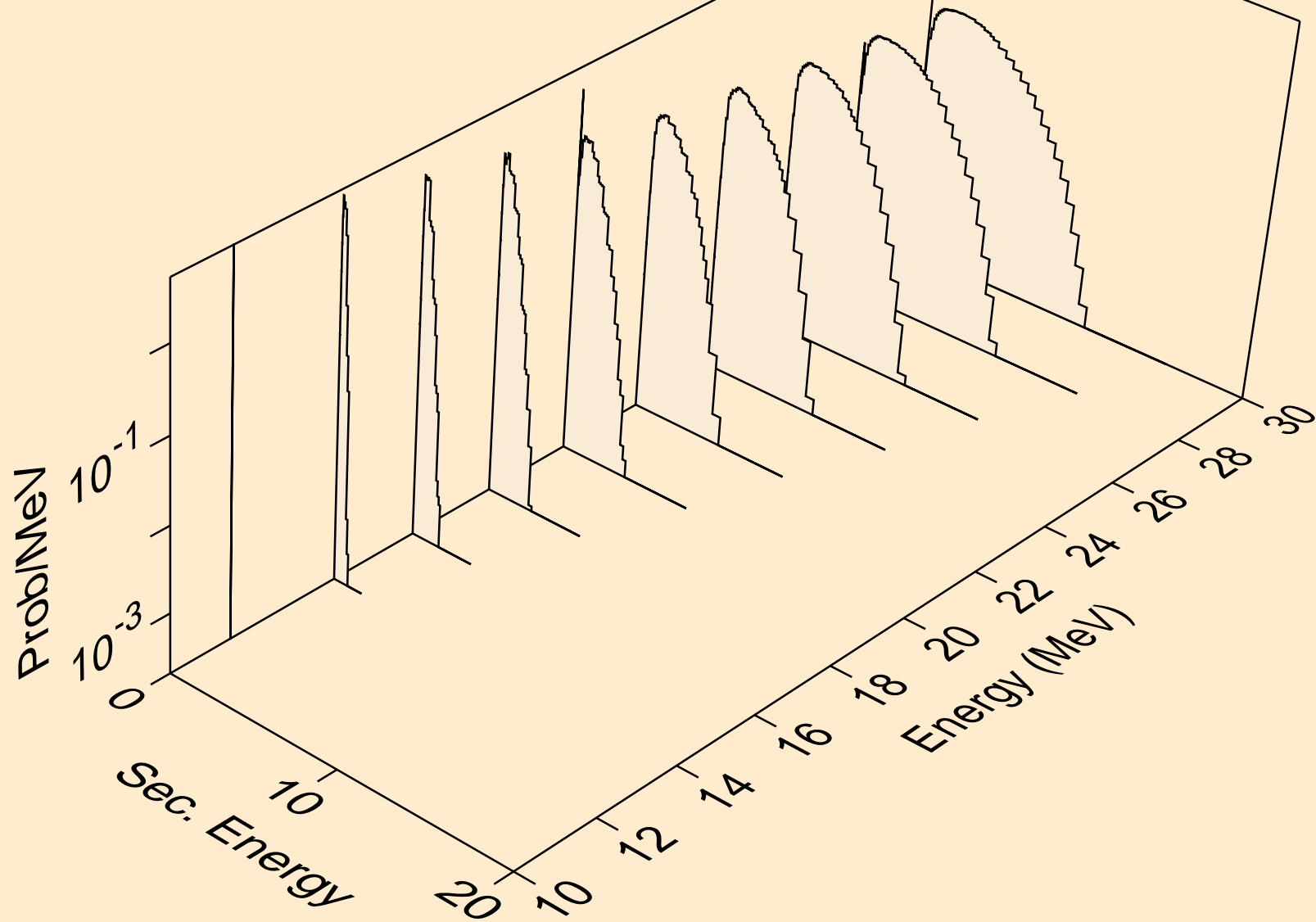

P031 TRITON ACER TENDL-2021 LIBRARY; T=0.K  
protons from (t,x)

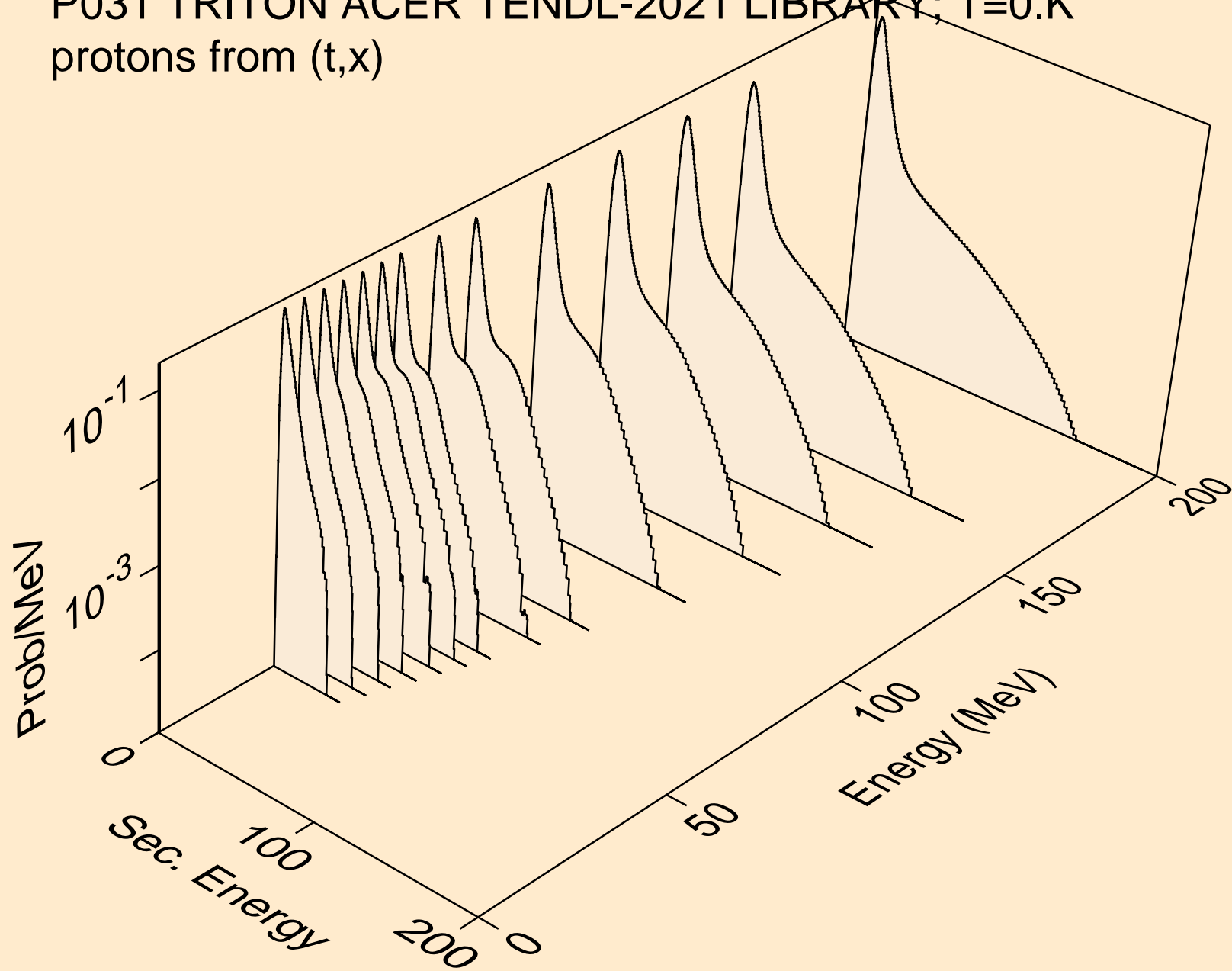

P031 TRITON ACER TENDL-2021 LIBRARY; T=0.K  
protons from (t,n\*)p

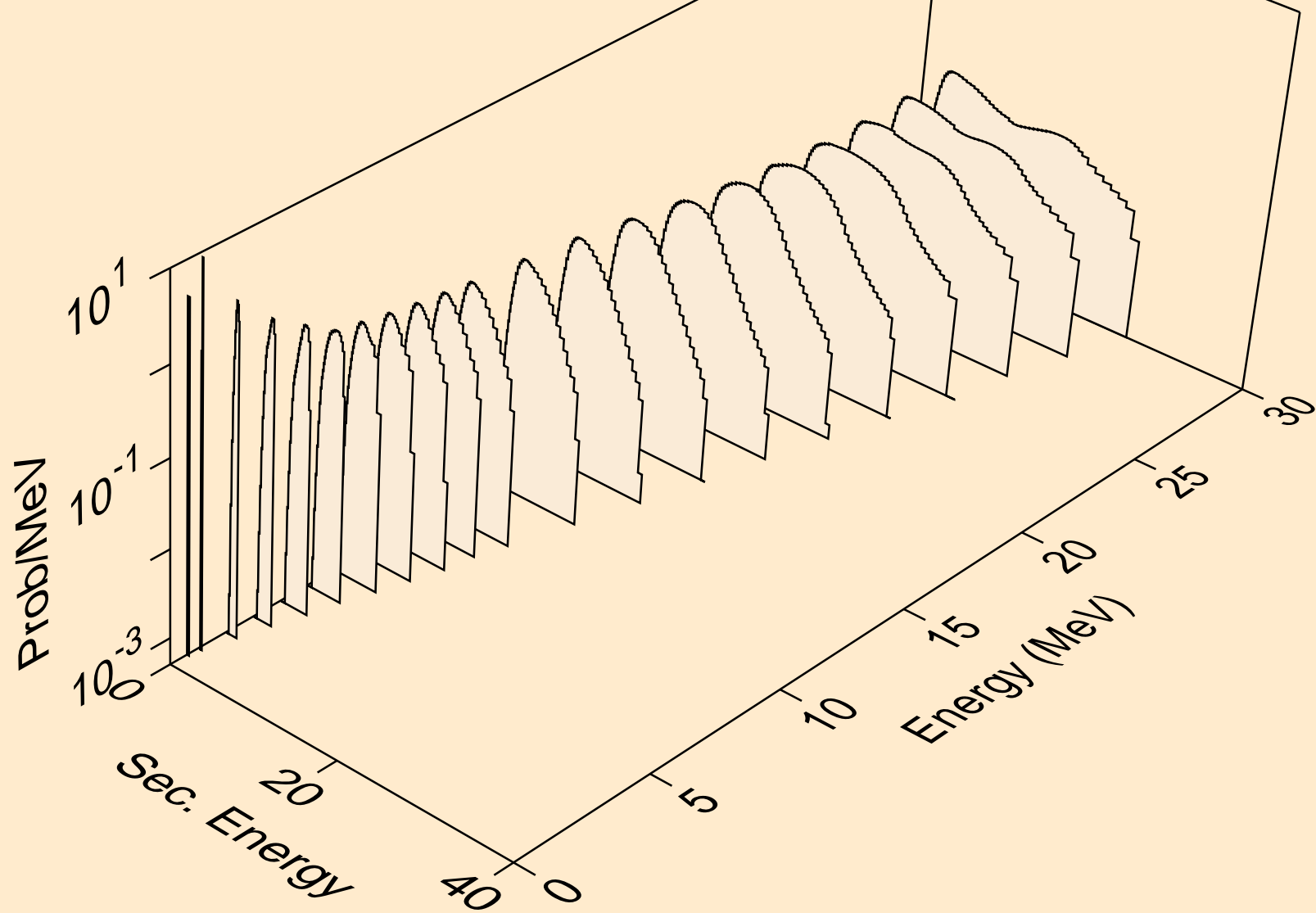

P031 TRITON ACER TENDL-2021 LIBRARY; T=0.K  
protons from (t,2np)

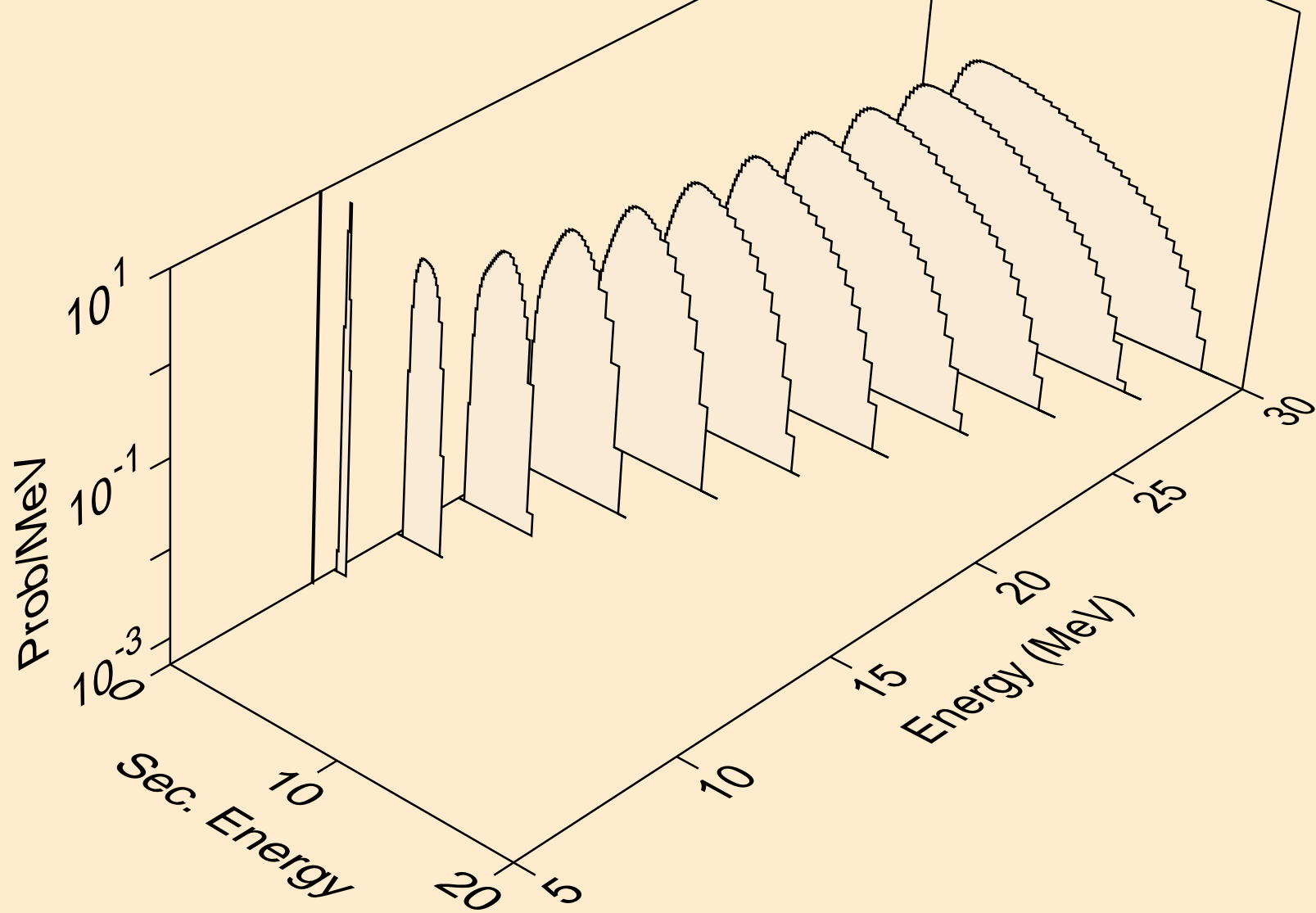

P031 TRITON ACER TENDL-2021 LIBRARY; T=0.K  
protons from (t,3np)

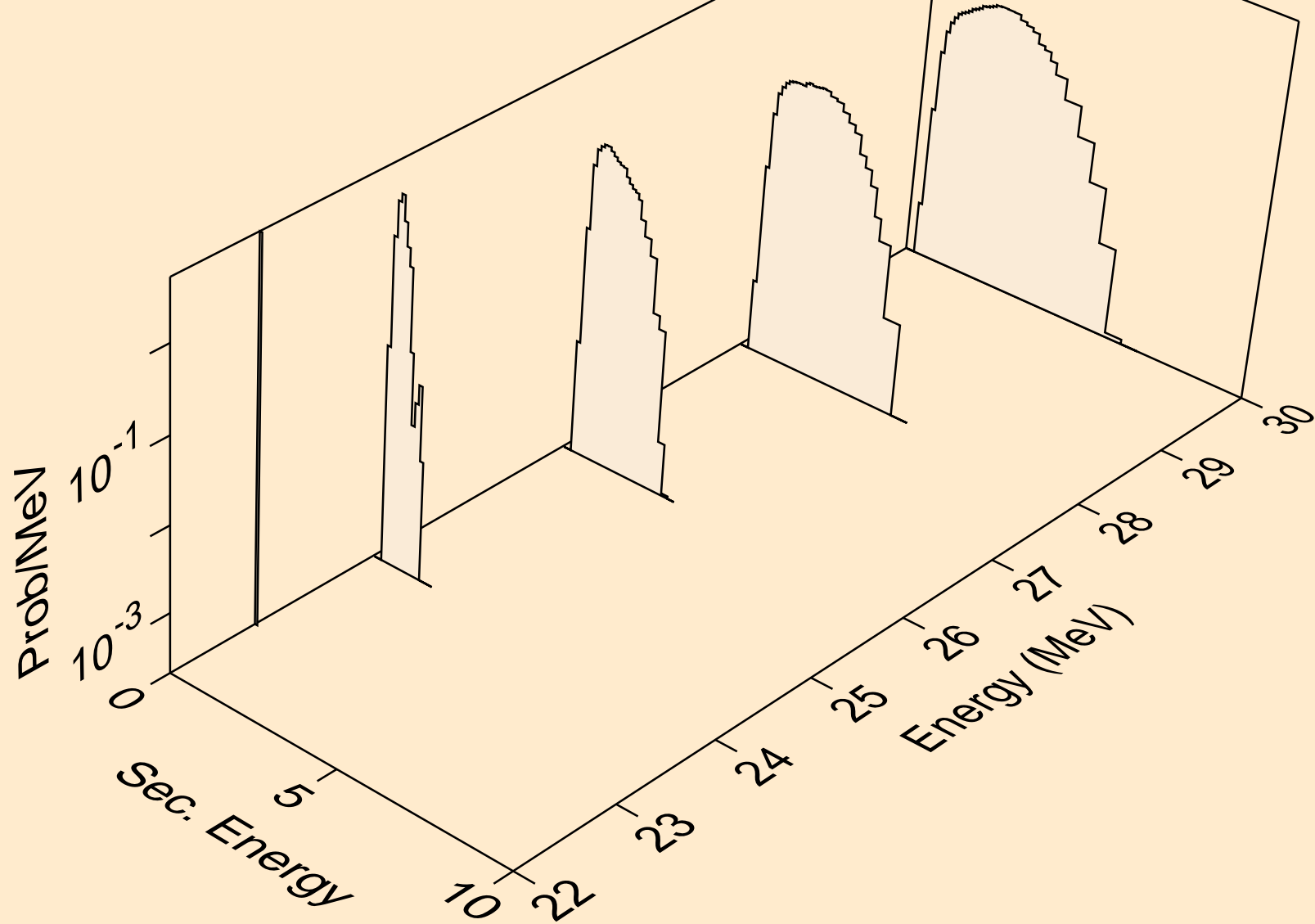

P031 TRITON ACER TENDL-2021 LIBRARY; T=0.K  
protons from (t,2np)

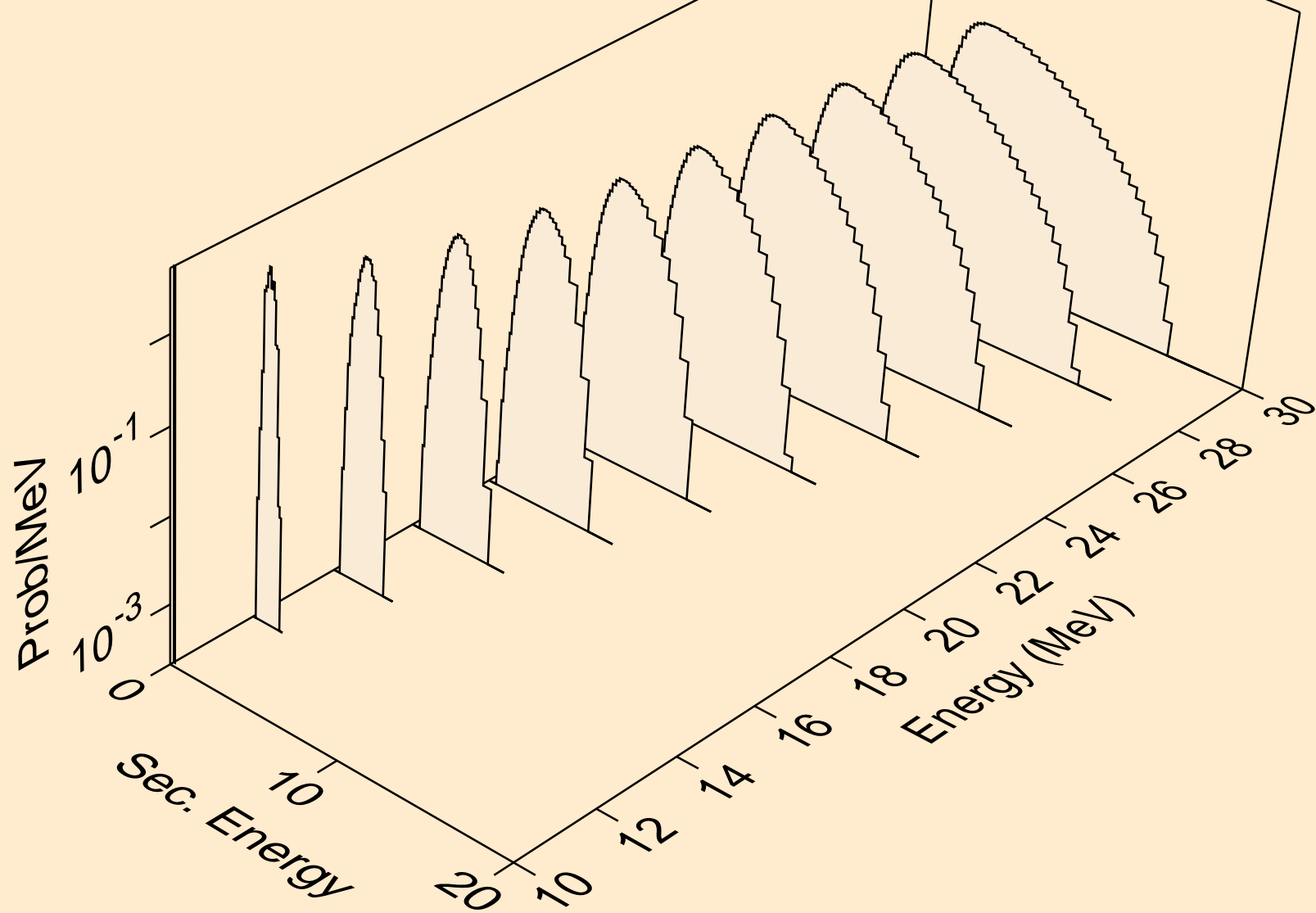

P031 TRITON ACER TENDL-2021 LIBRARY; T=0.K  
protons from (t,npa)

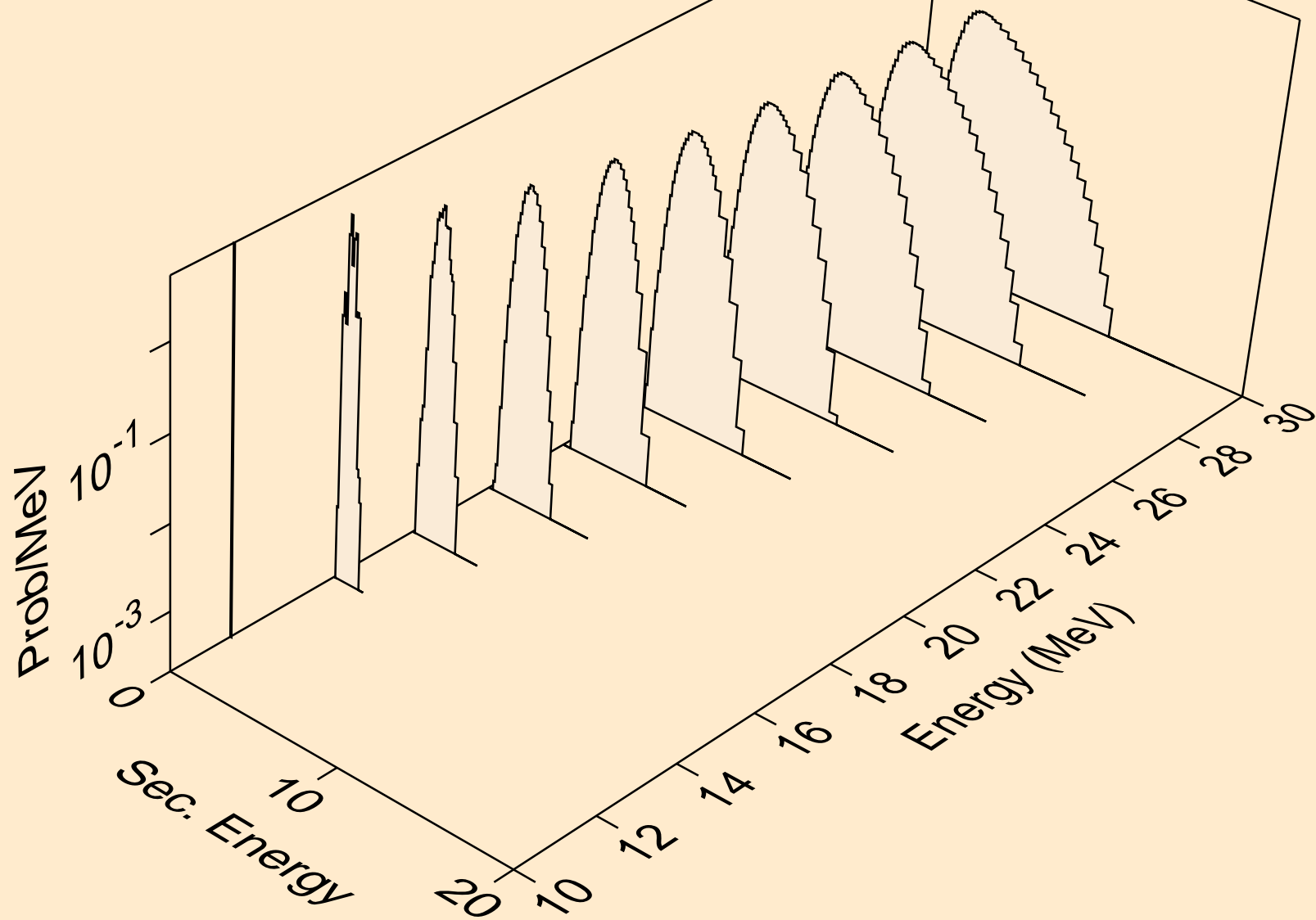

P031 TRITON ACER TENDL-2021 LIBRARY; T=0.K  
protons from (t,p)

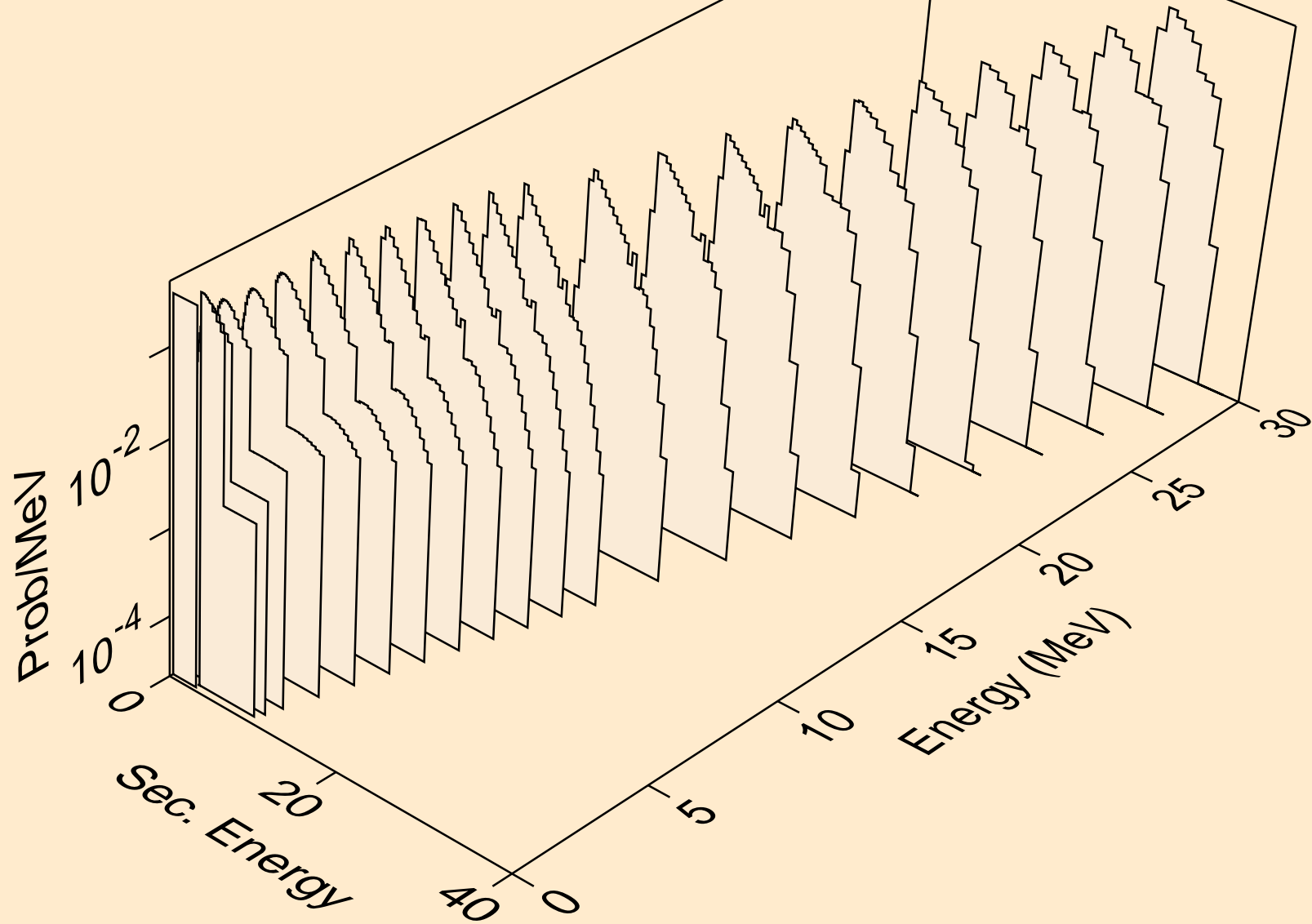



P031 TRITON ACER TENDL-2021 LIBRARY; T=0.K  
protons from (t,2p)

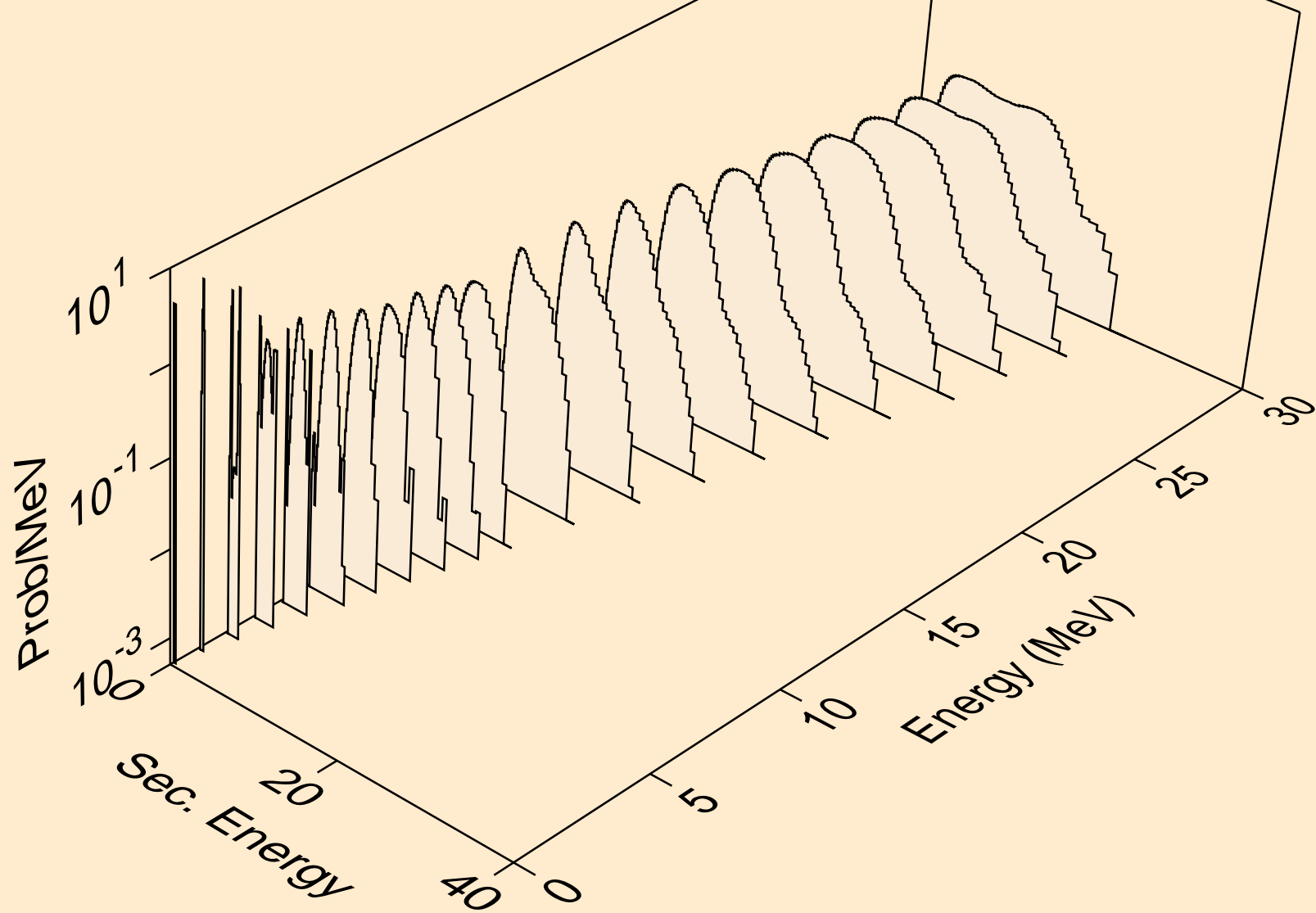

P031 TRITON ACER TENDL-2021 LIBRARY; T=0.K  
protons from (t,pa)

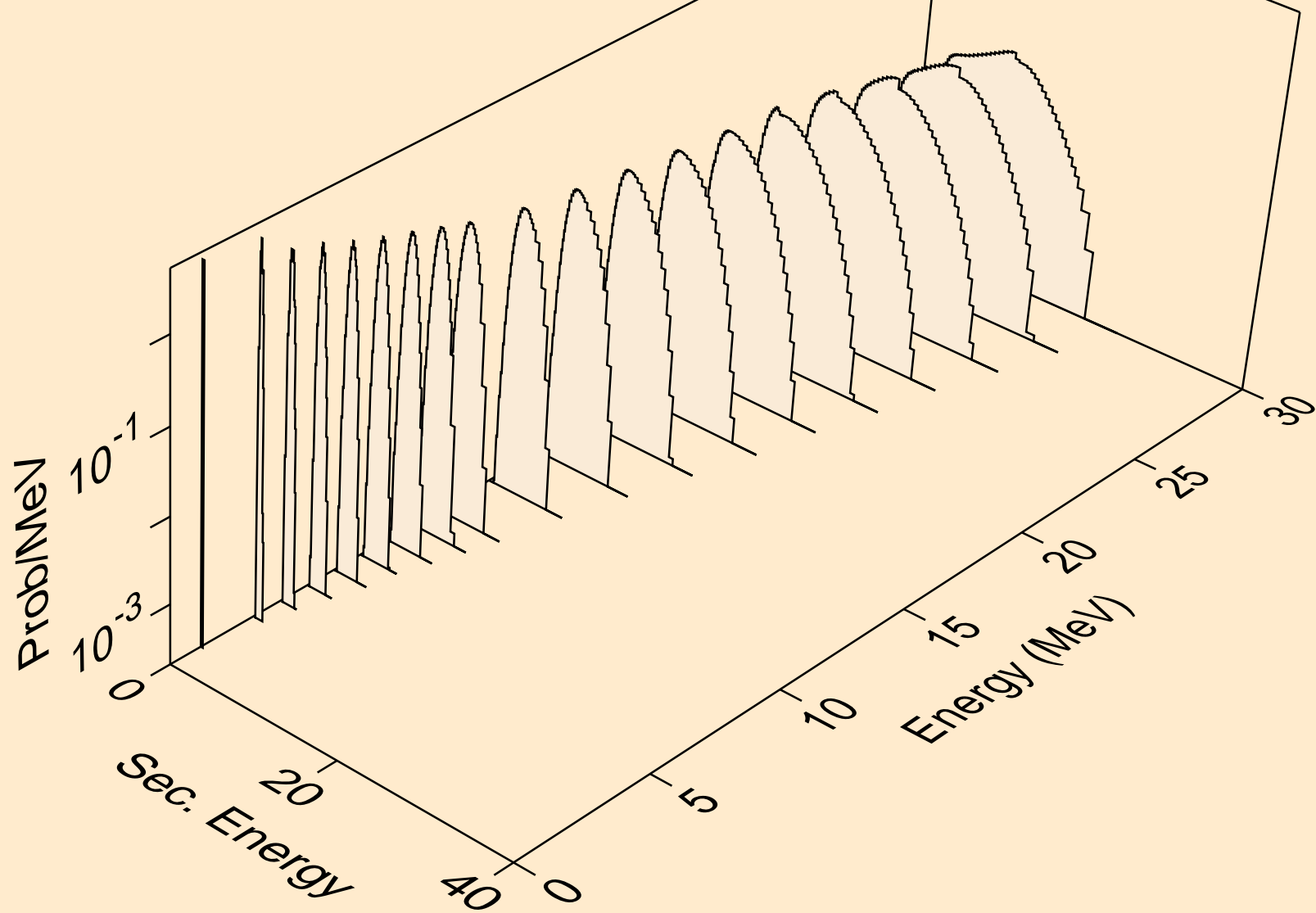

P031 TRITON ACER TENDL-2021 LIBRARY; T=0.K  
protons from (t,pd)

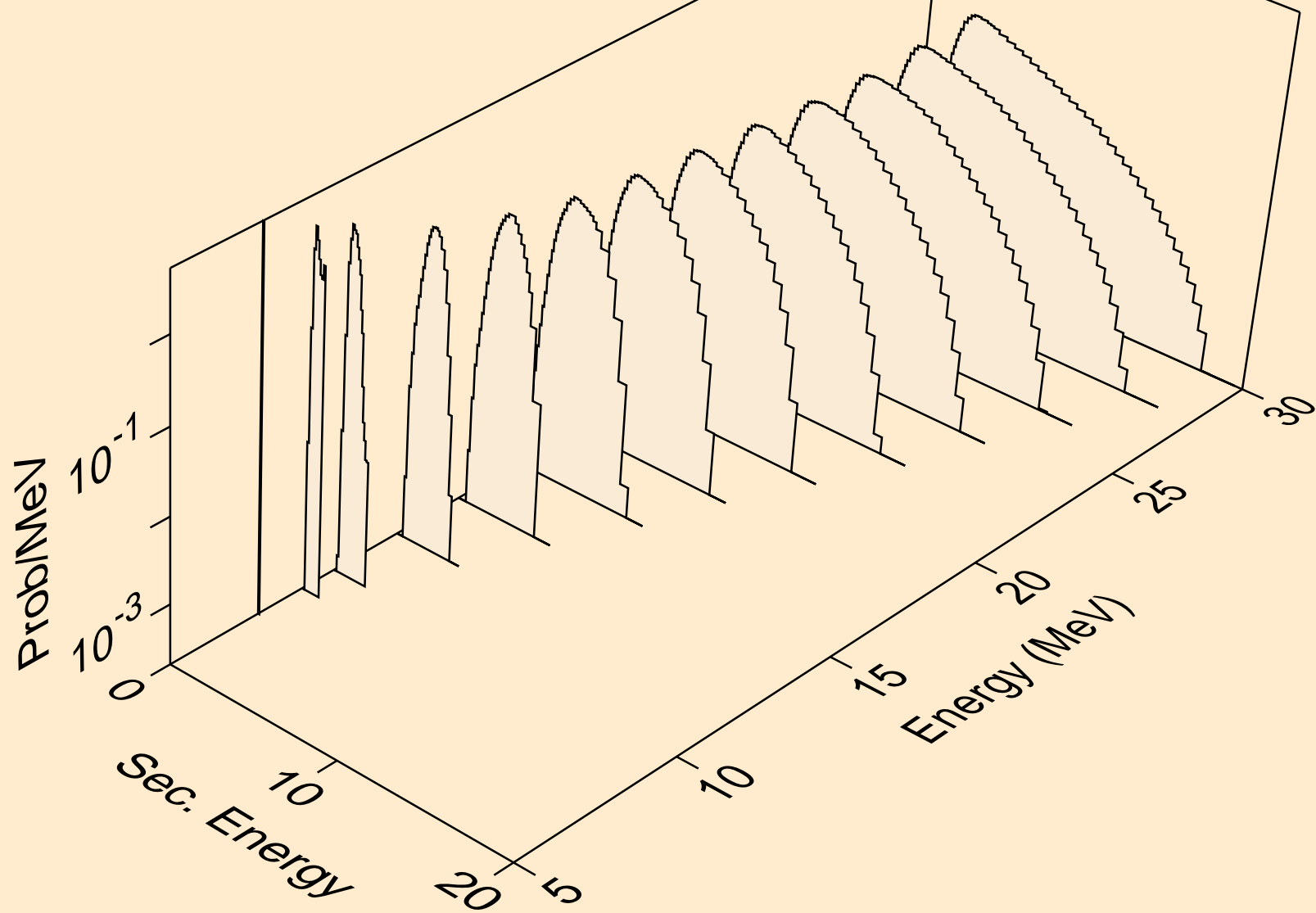

P031 TRITON ACER TENDL-2021 LIBRARY; T=0.K  
protons from (t,pt)

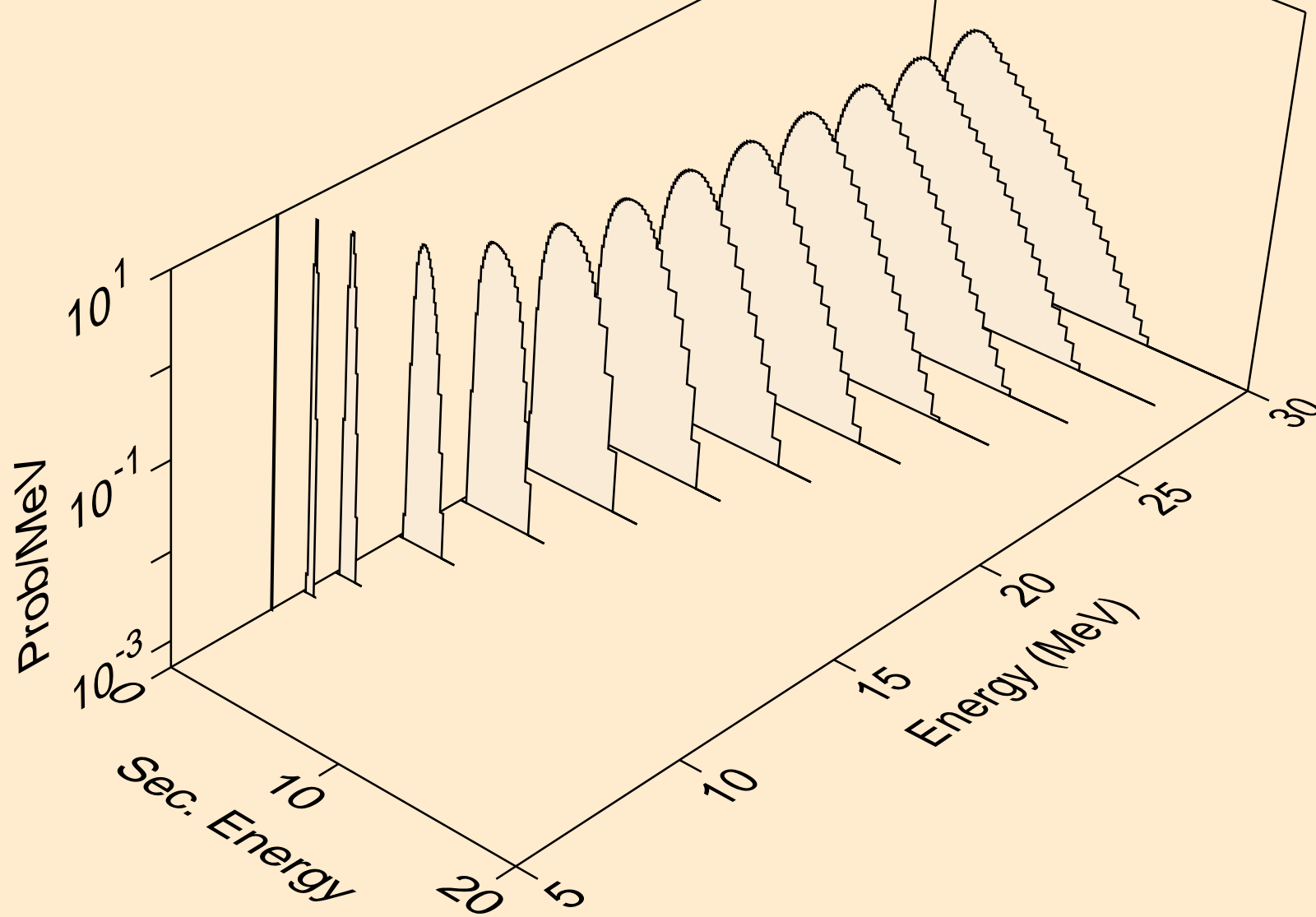

P031 TRITON ACER TENDL-2021 LIBRARY; T=0.K  
deuterons from (t,x)

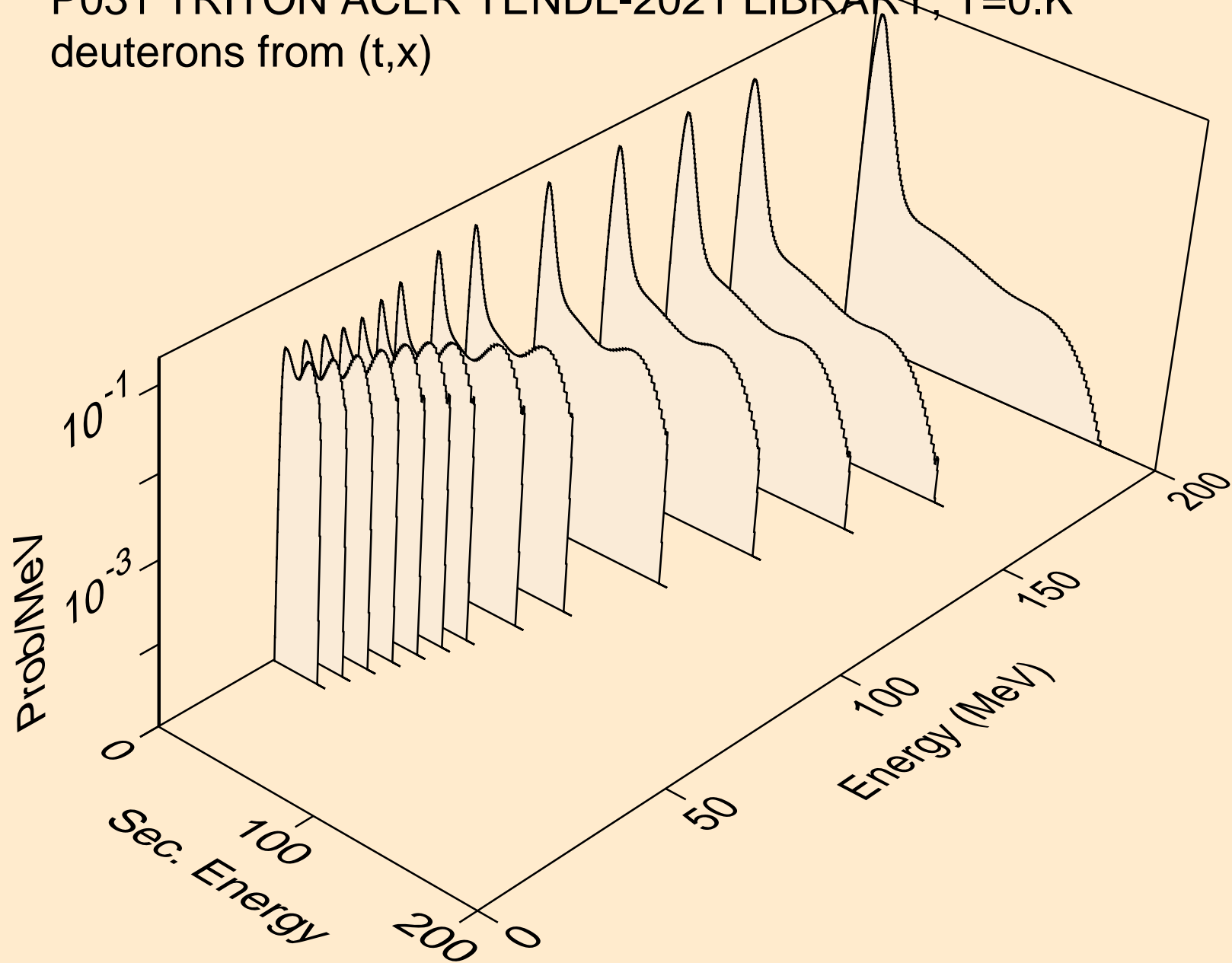

P031 TRITON ACER TENDL-2021 LIBRARY; T=0.K  
deuterons from (t,2nd)

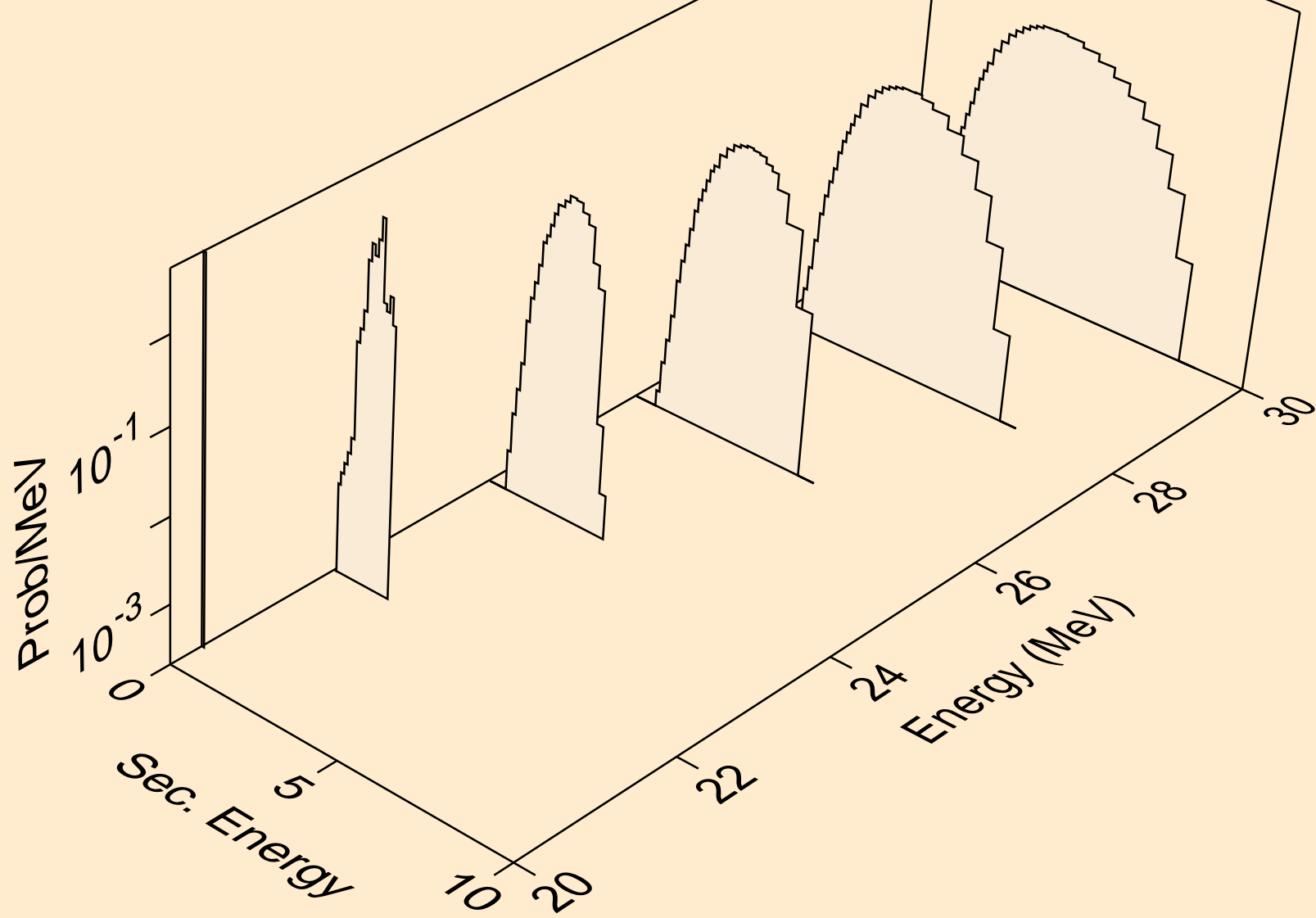

P031 TRITON ACER TENDL-2021 LIBRARY; T=0.K  
deuterons from (t,n\*)d

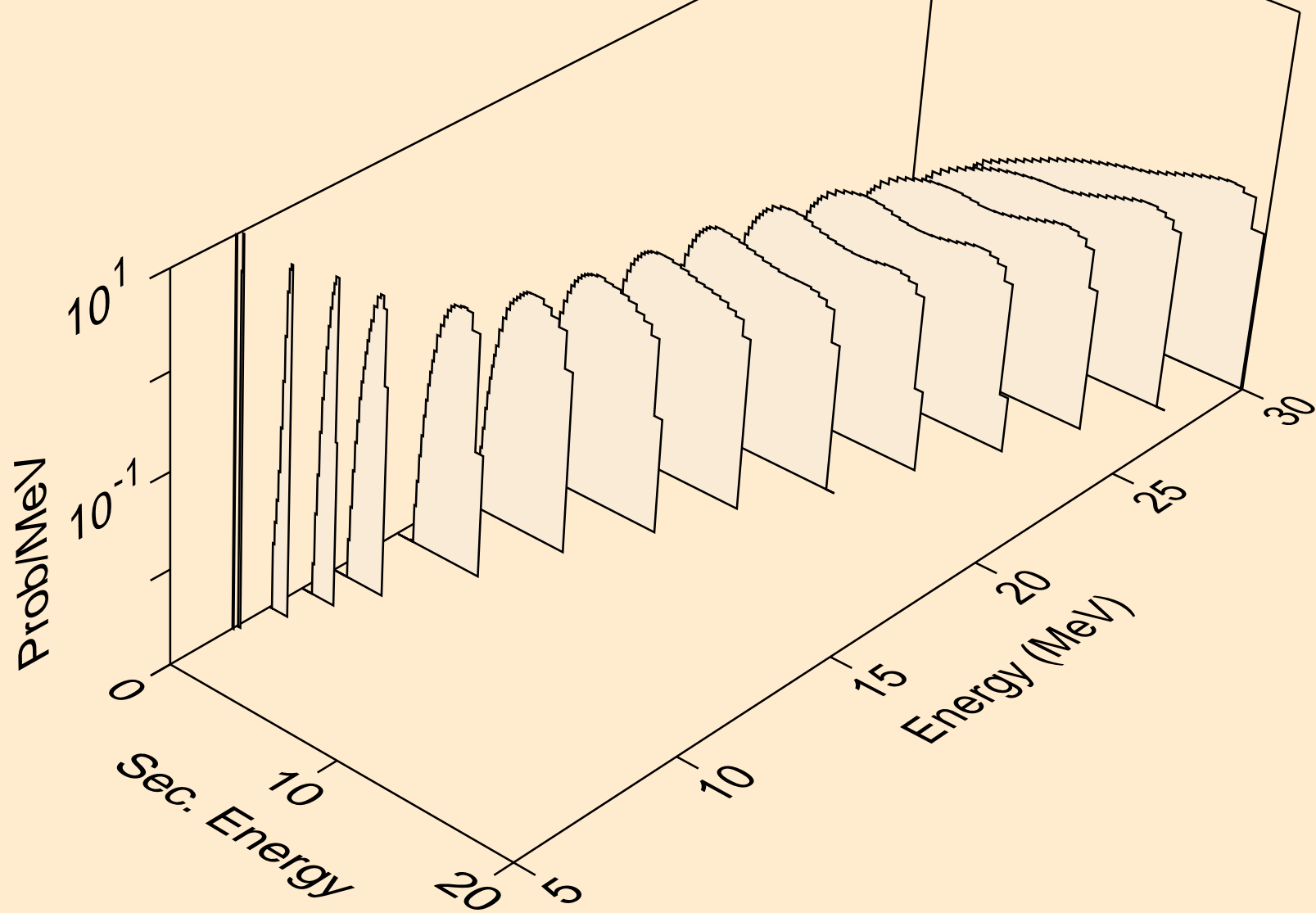

P031 TRITON ACER TENDL-2021 LIBRARY; T=0.K  
deuterons from (t,d)

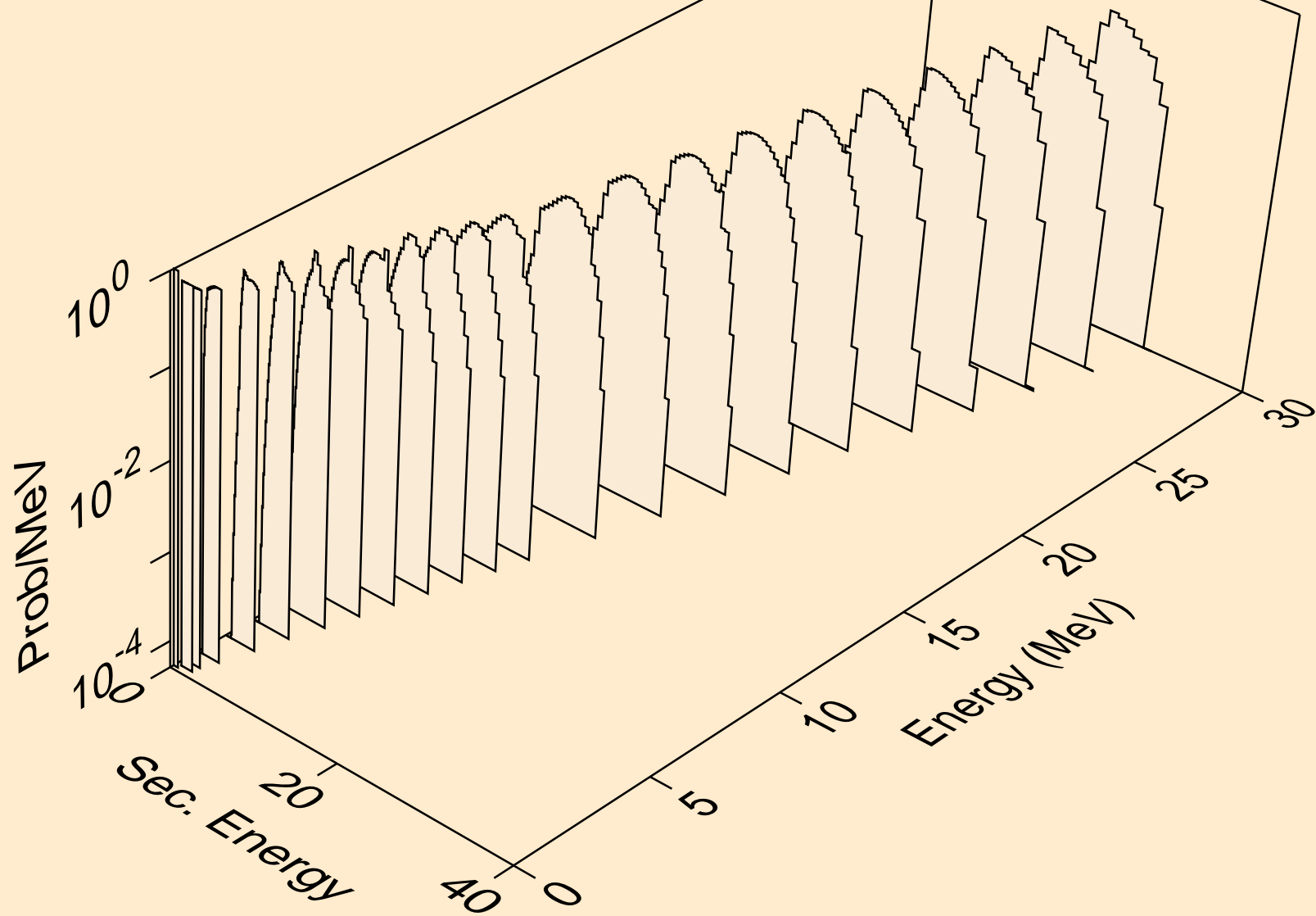



P031 TRITON ACER TENDL-2021 LIBRARY; T=0.K  
deuterons from (t,pd)

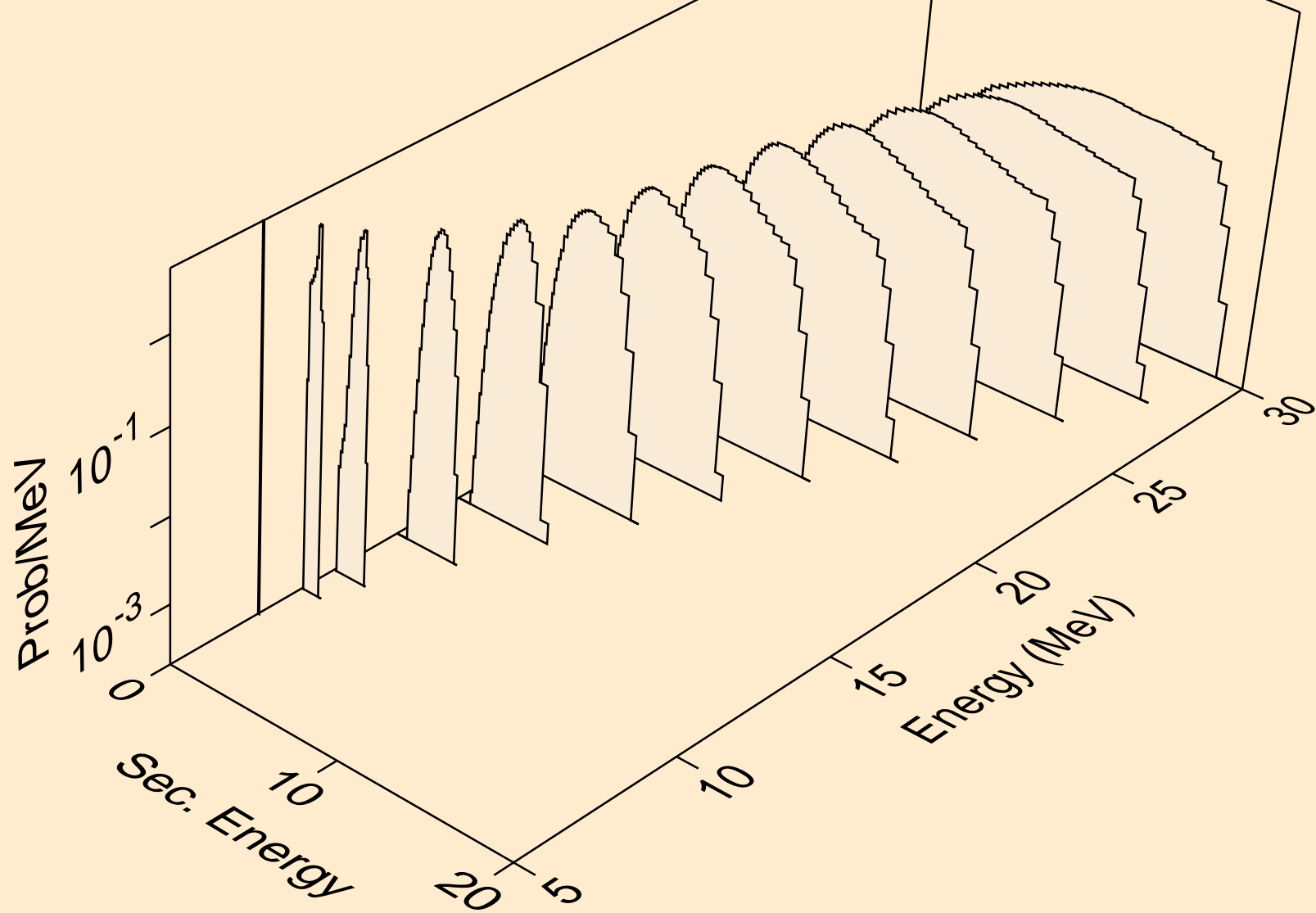

P031 TRITON ACER TENDL-2021 LIBRARY; T=0.K  
deuterons from (t,da)

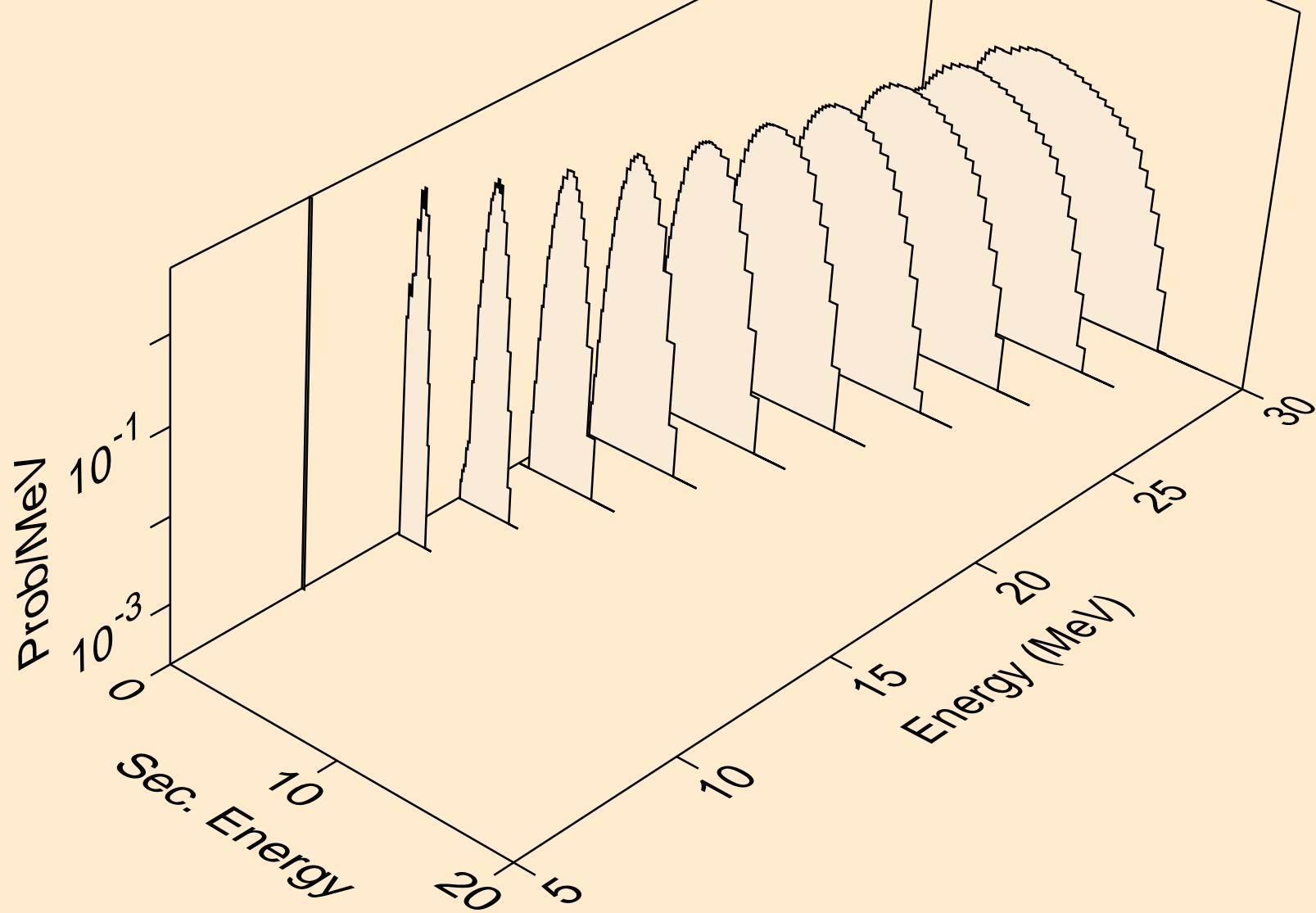

P031 TRITON ACER TENDL-2021 LIBRARY; T=0.K  
he3s from (t,x)

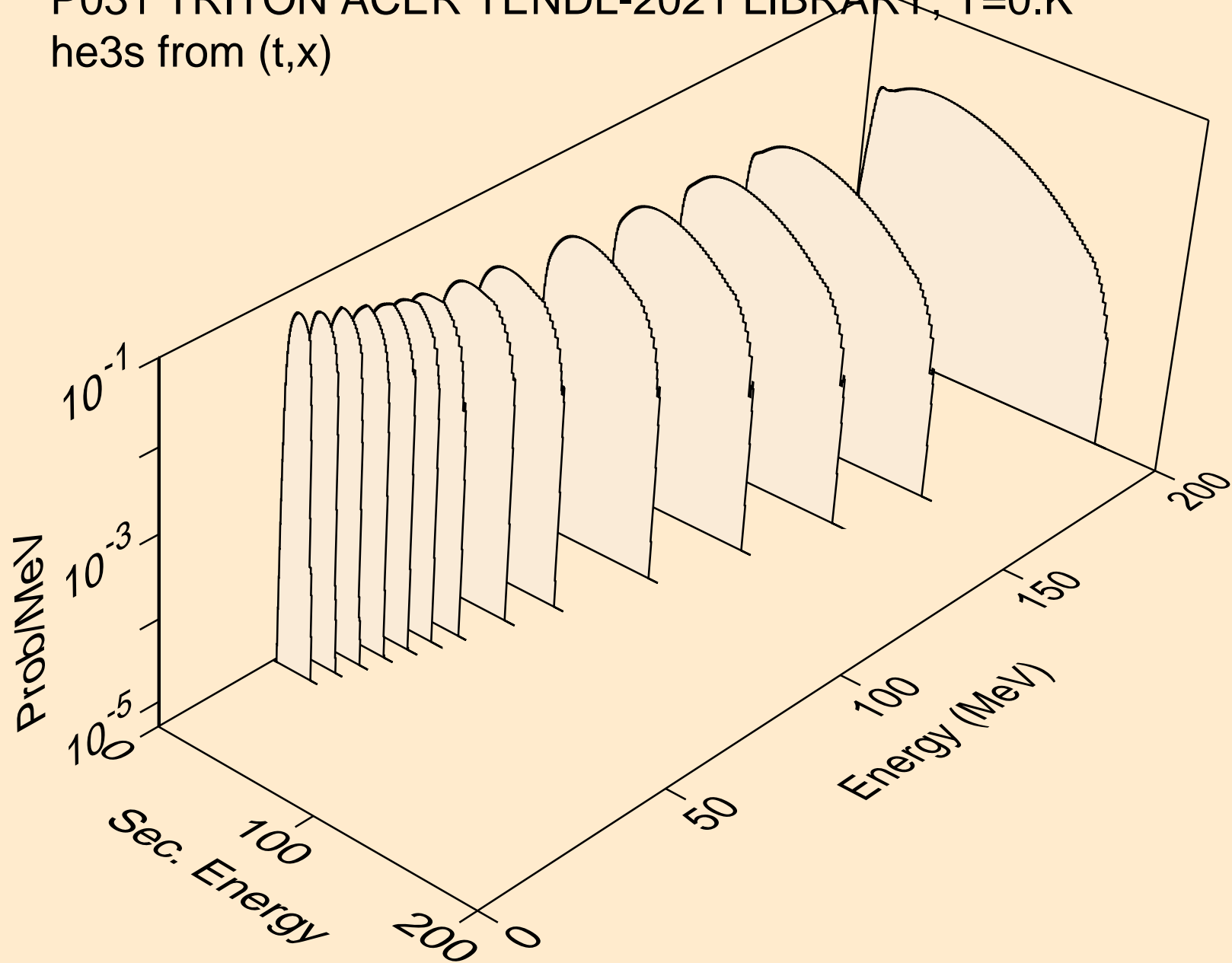

P031 TRITON ACER TENDL-2021 LIBRARY; T=0.K  
he3s from (t,n\*)he3

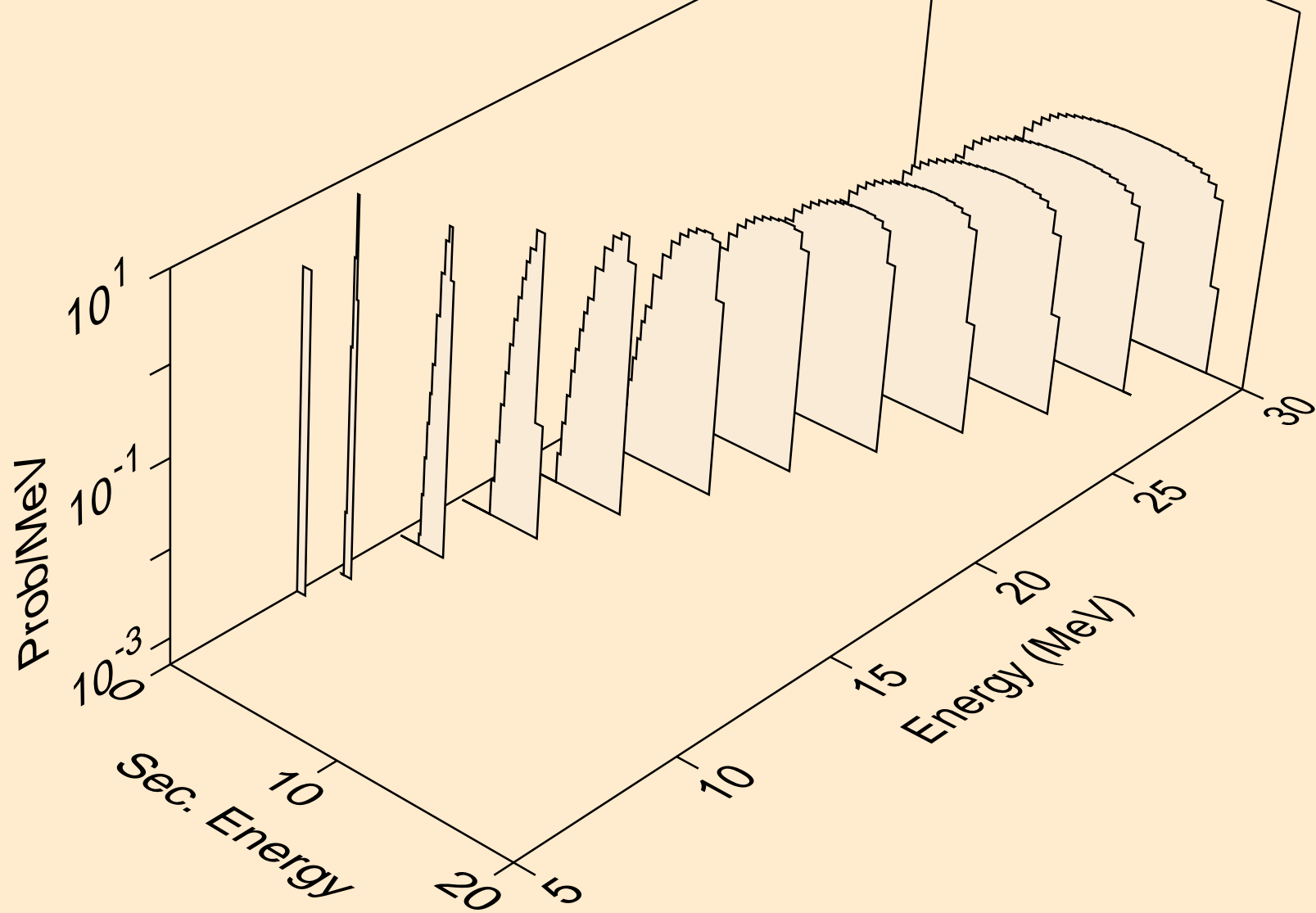

P031 TRITON ACER TENDL-2021 LIBRARY; T=0.K  
he3s from (t,he3)

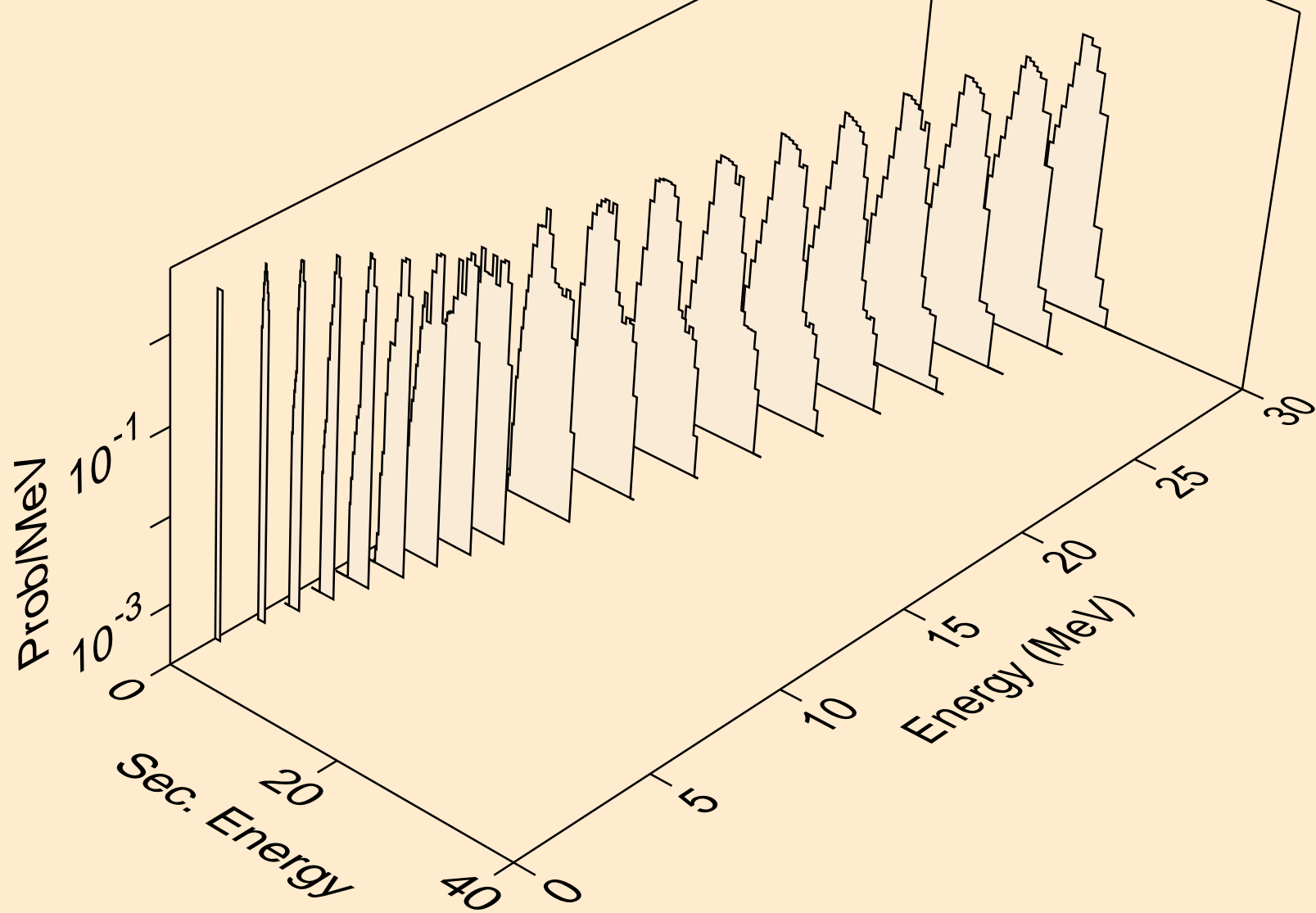

P031 TRITON ACER TENDL-2021 LIBRARY; T=0.K  
alphas from (t,x)

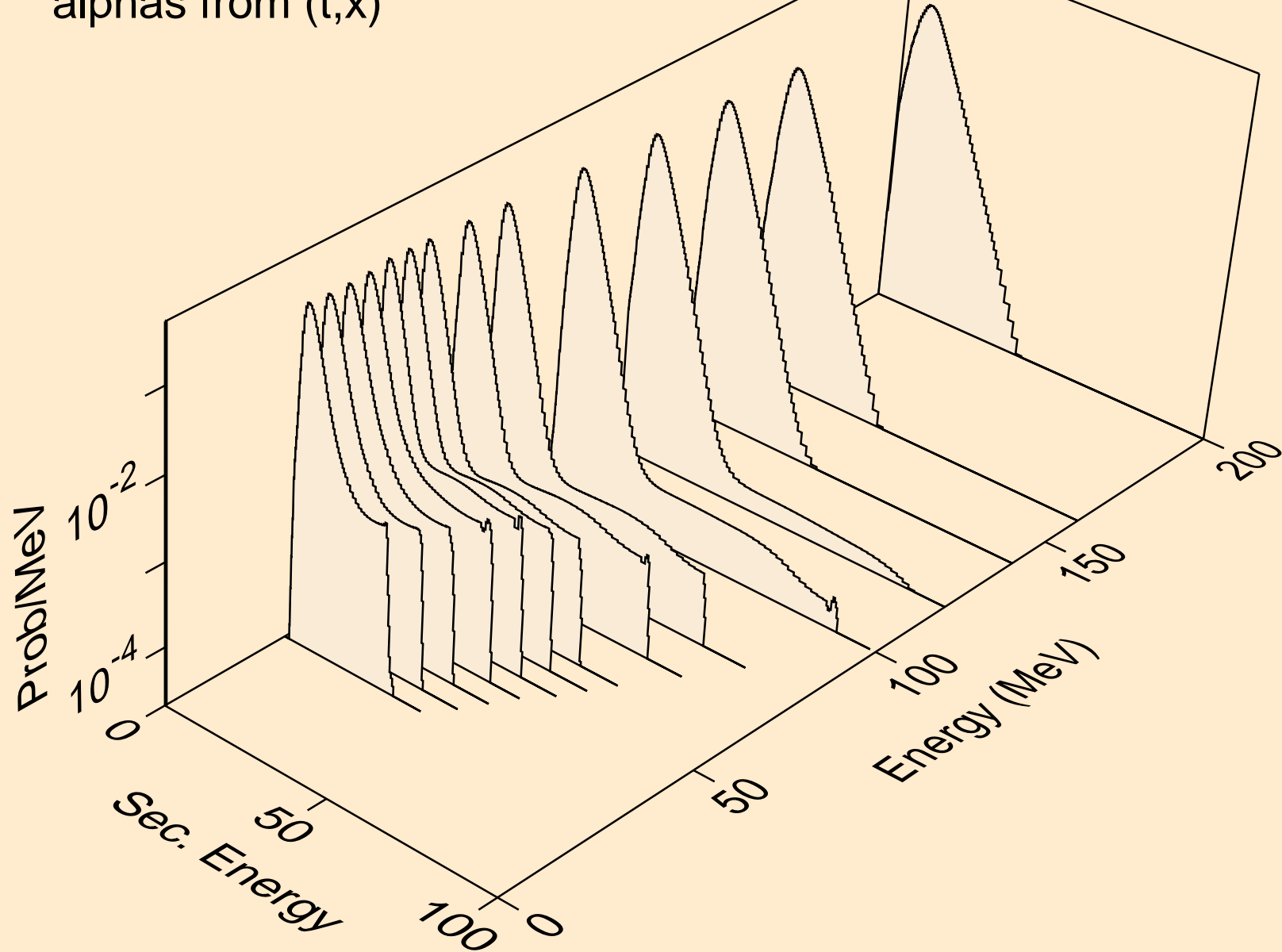

P031 TRITON ACER TENDL-2021 LIBRARY; T=0.K  
alphas from (t,n\*)a

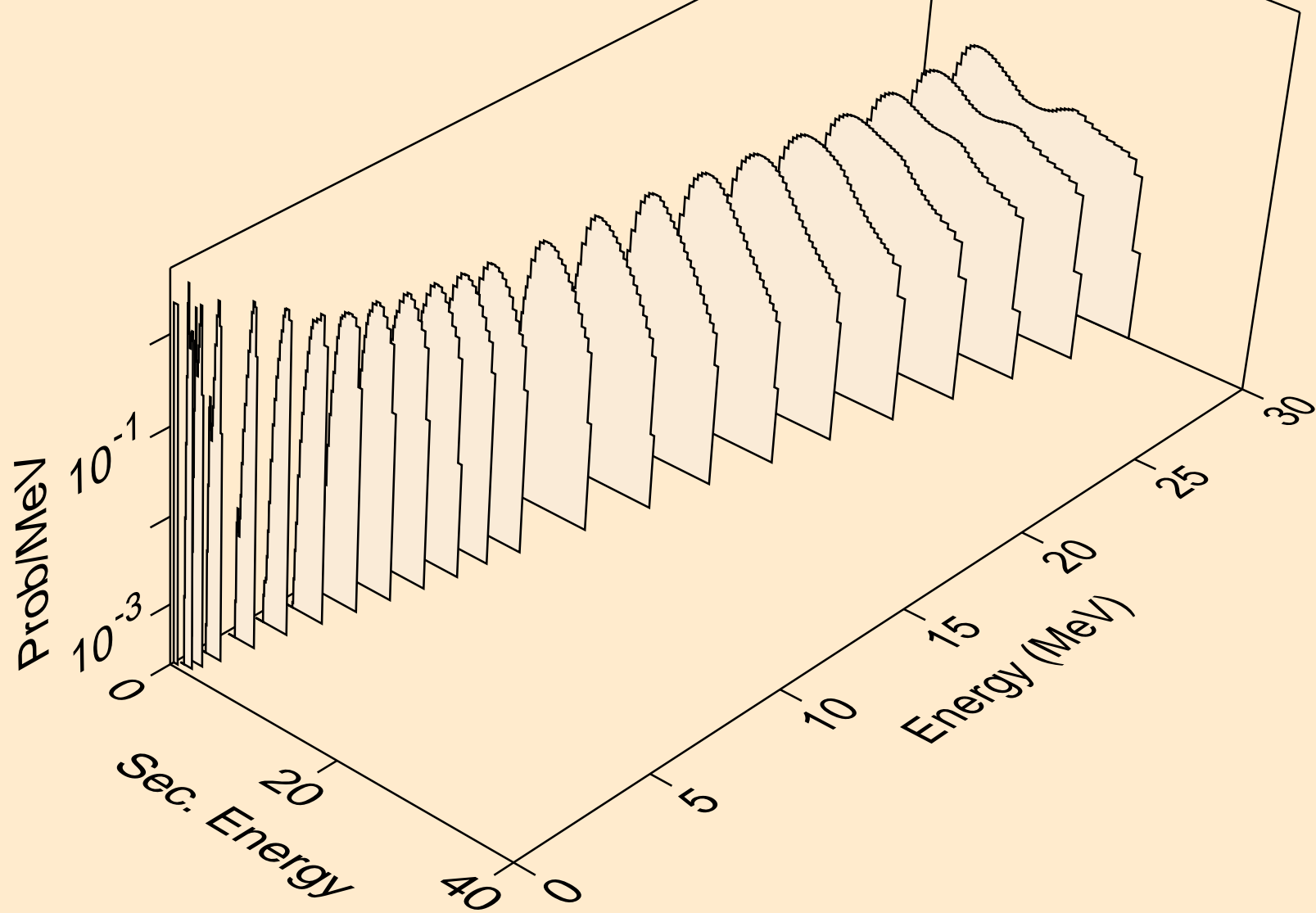

P031 TRITON ACER TENDL-2021 LIBRARY; T=0.K  
alphas from (t,2n)a

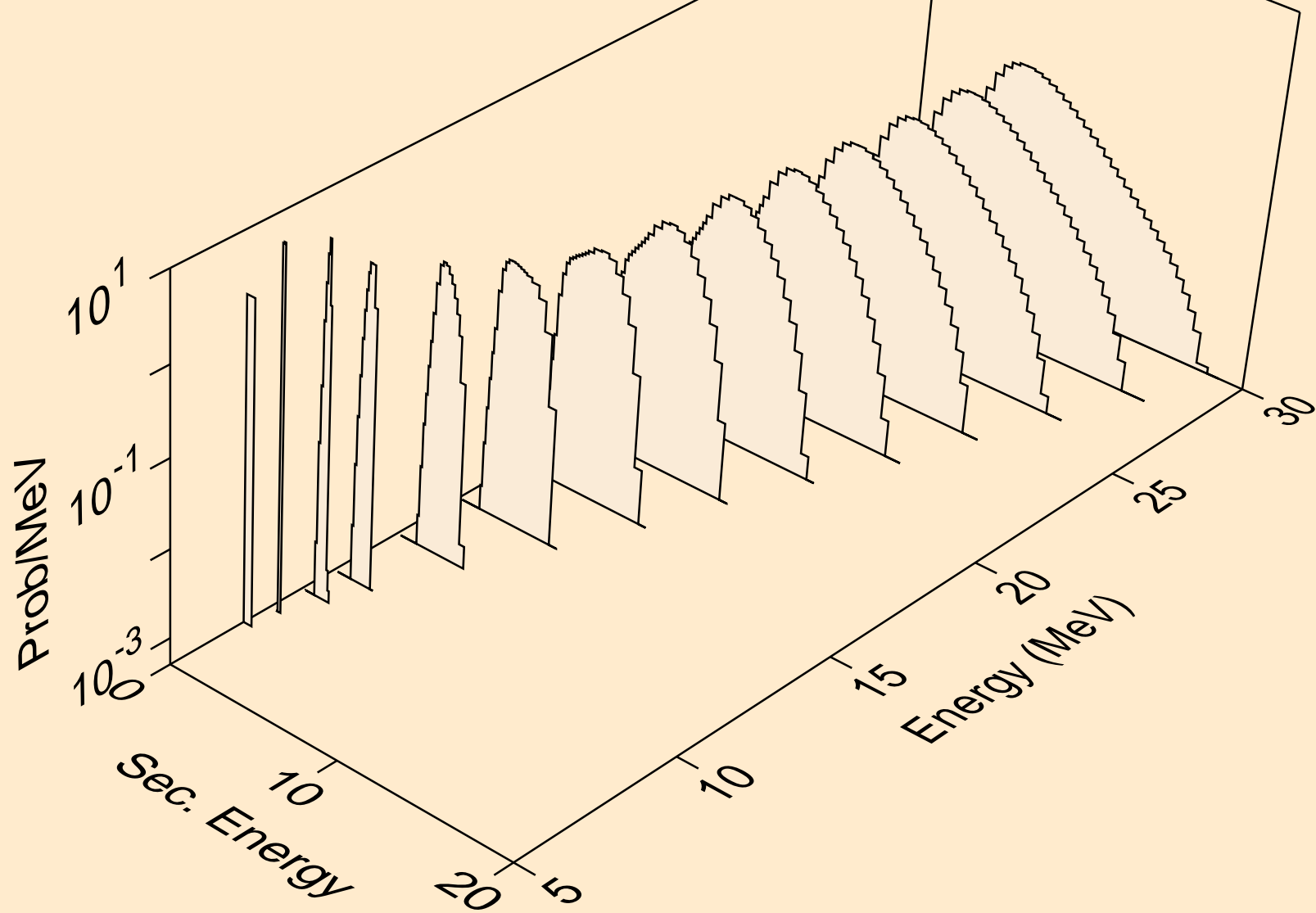



P031 TRITON ACER TENDL-2021 LIBRARY; T=0.K  
alphas from (t,3n)a

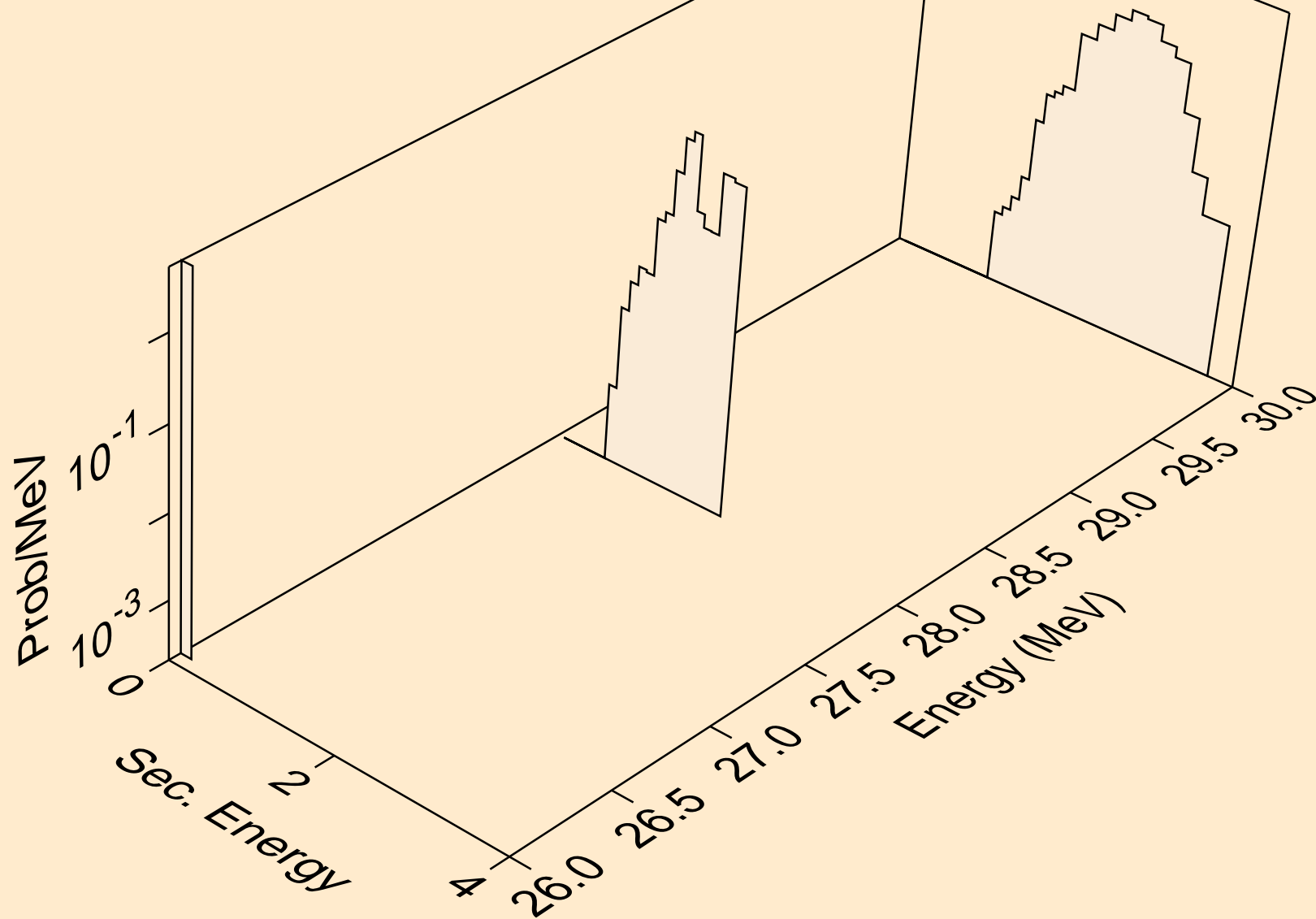

P031 TRITON ACER TENDL-2021 LIBRARY; T=0.K  
alphas from (t,n\*)2a

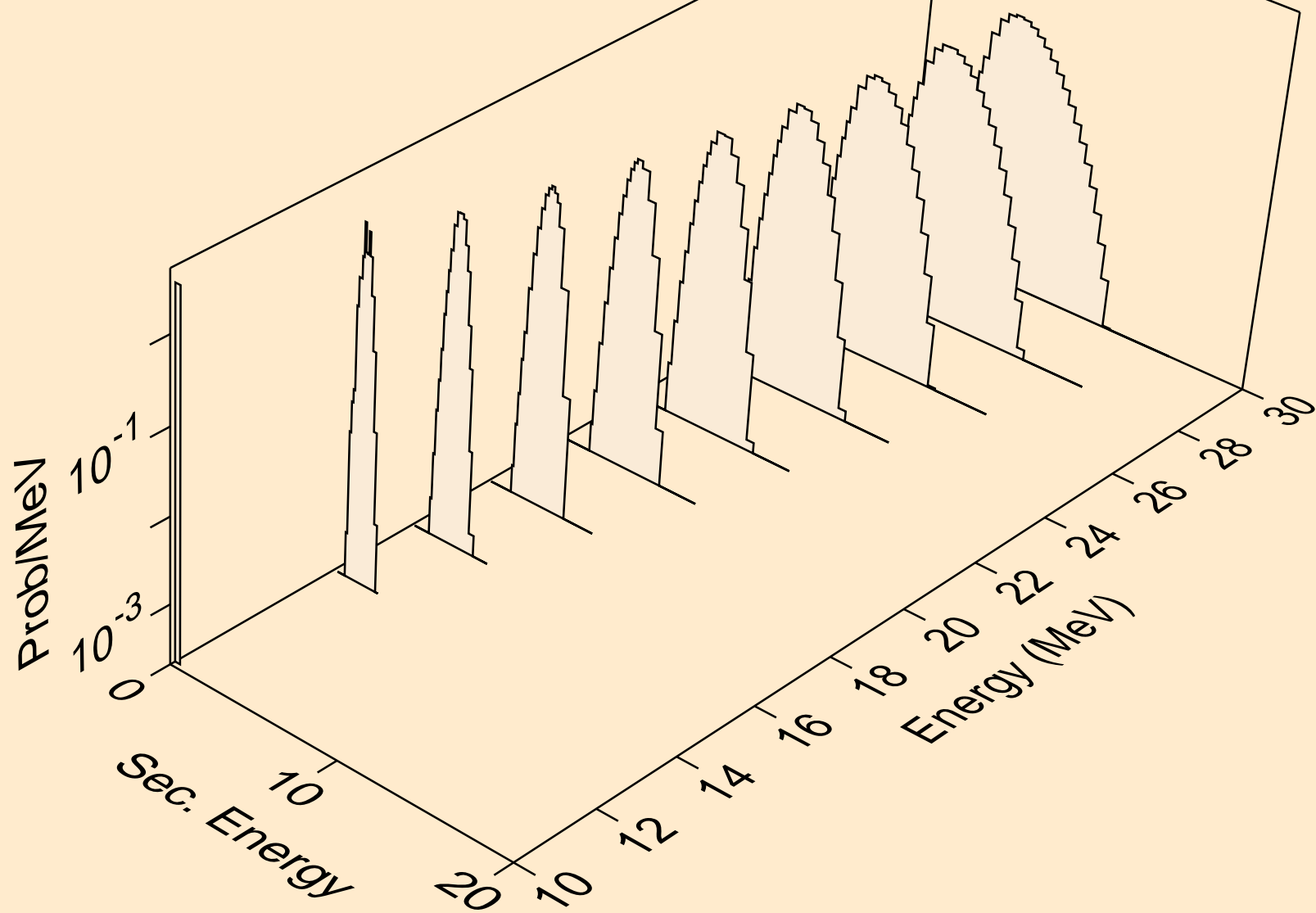

P031 TRITON ACER TENDL-2021 LIBRARY; T=0.K  
alphas from (t,2n)2a

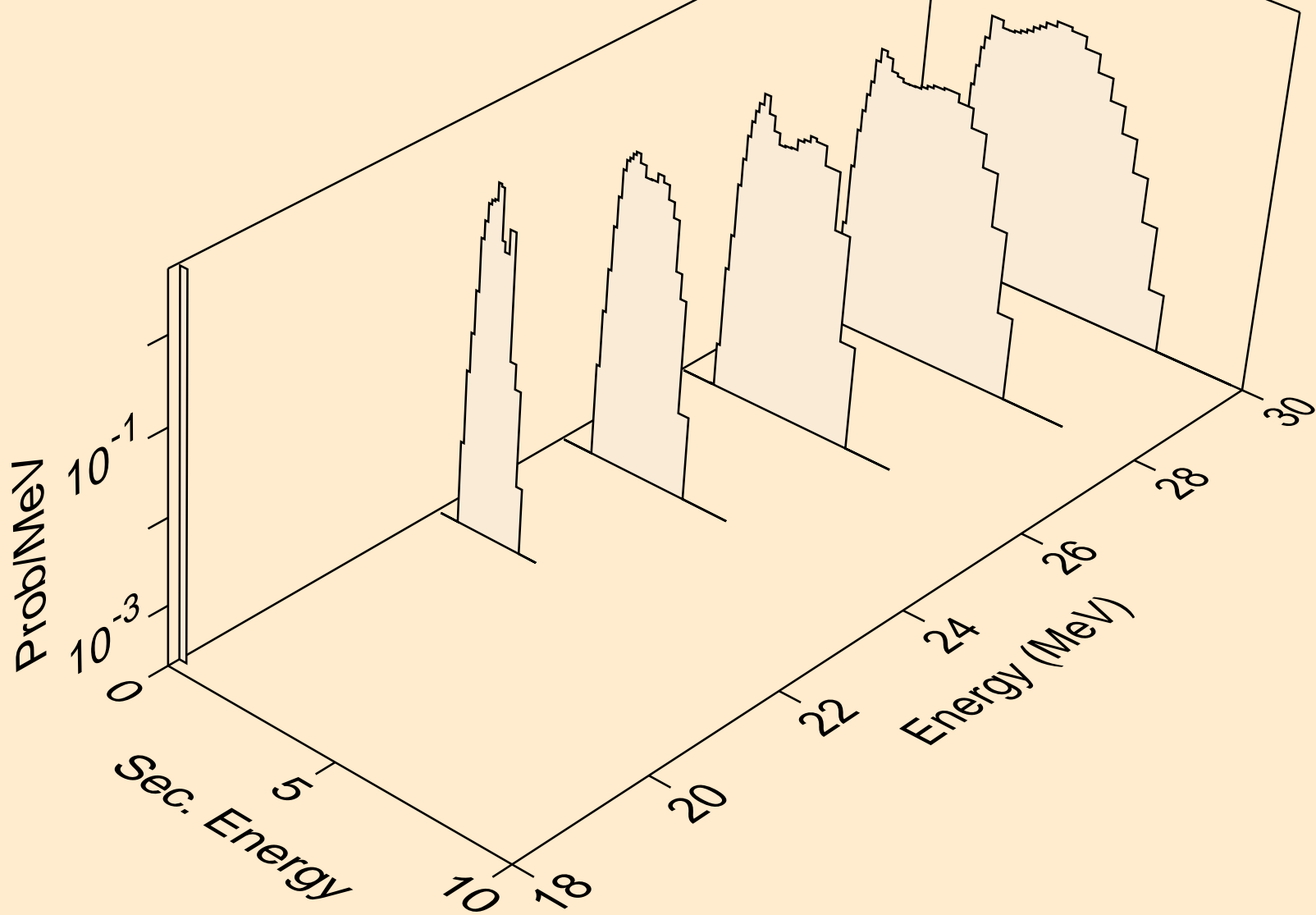

P031 TRITON ACER TENDL-2021 LIBRARY; T=0.K  
alphas from (t,npa)

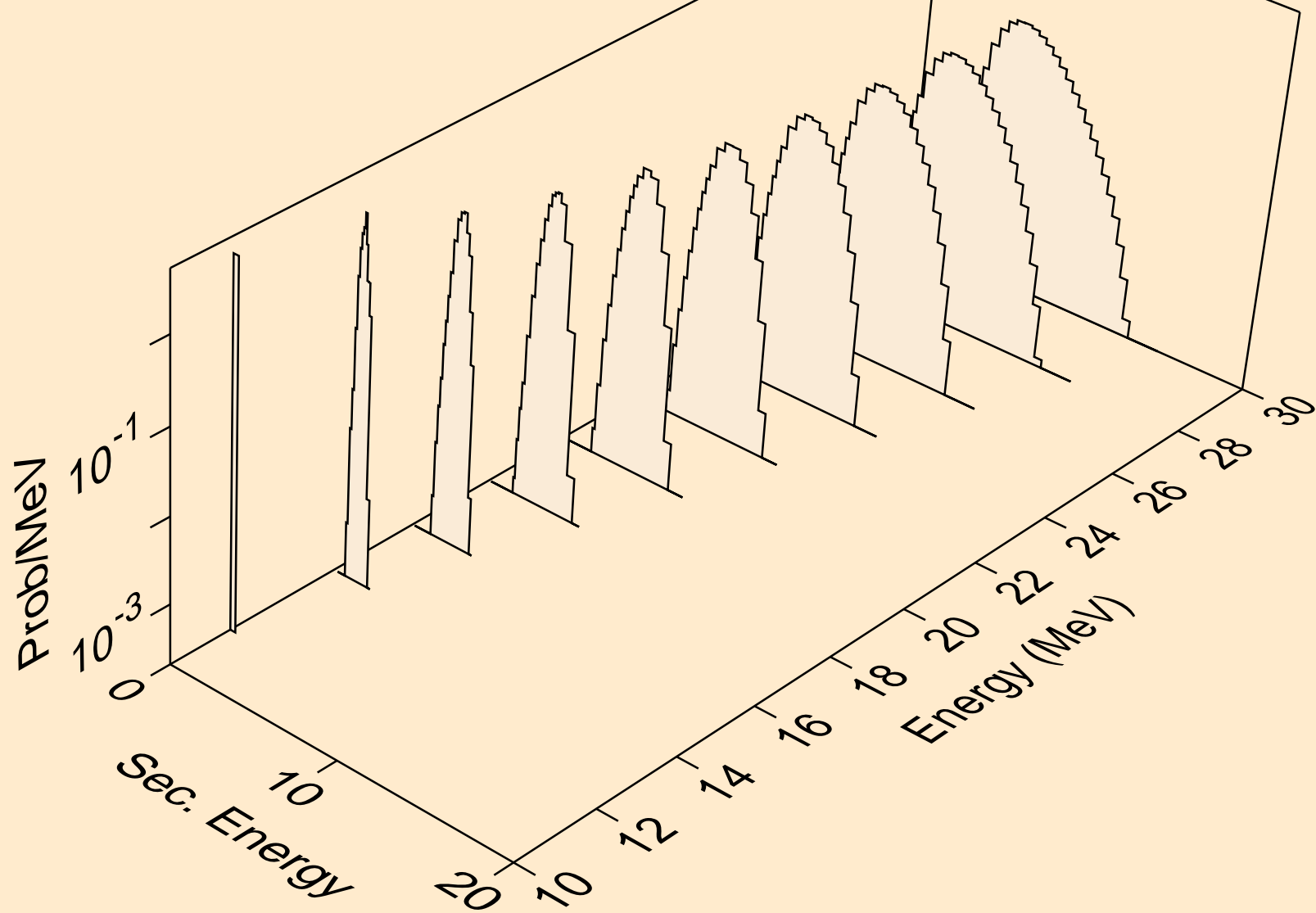

P031 TRITON ACER TENDL-2021 LIBRARY; T=0.K  
alphas from (t,a)

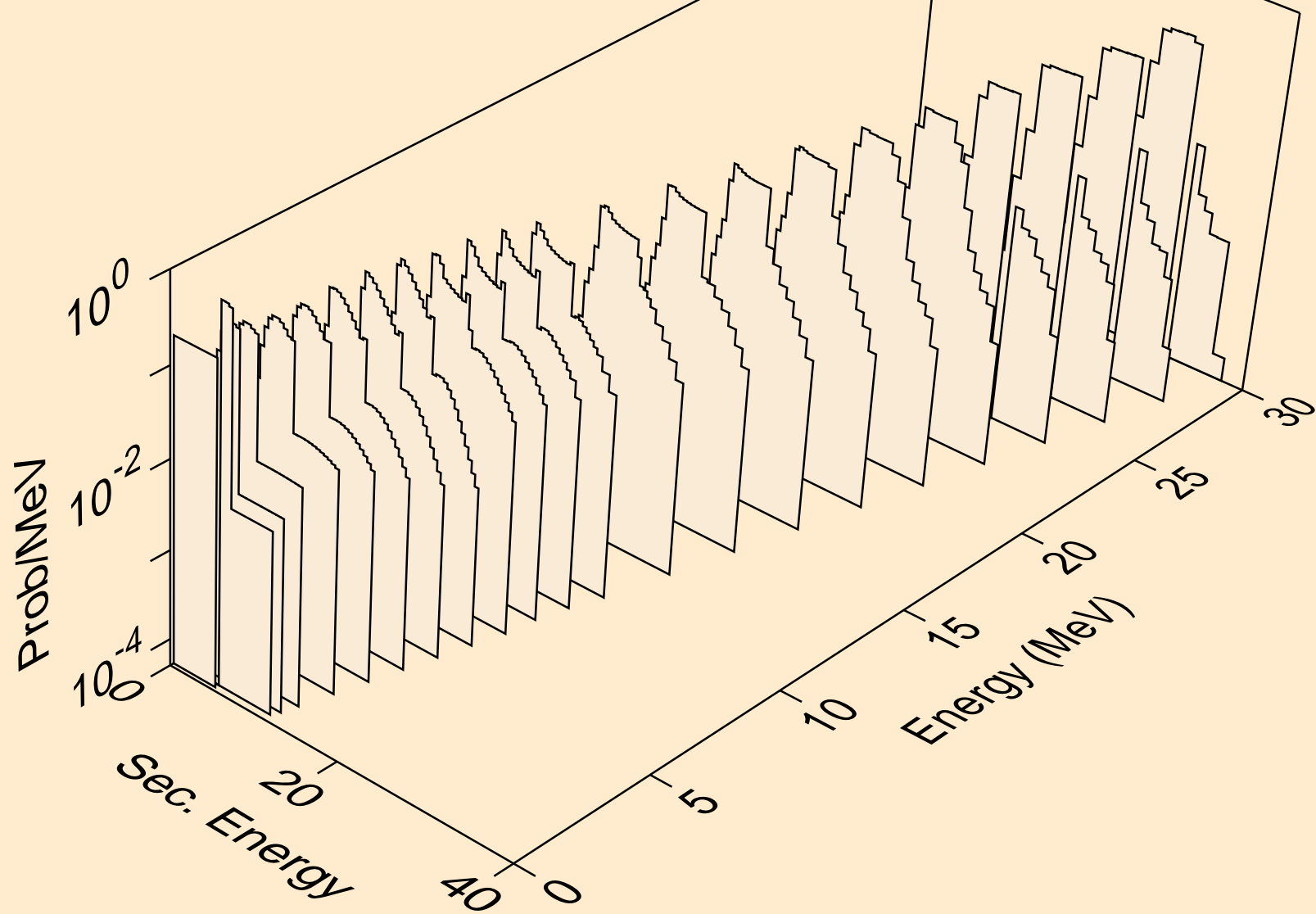

P031 TRITON ACER TENDL-2021 LIBRARY; T=0.K  
alphas from (t,2a)

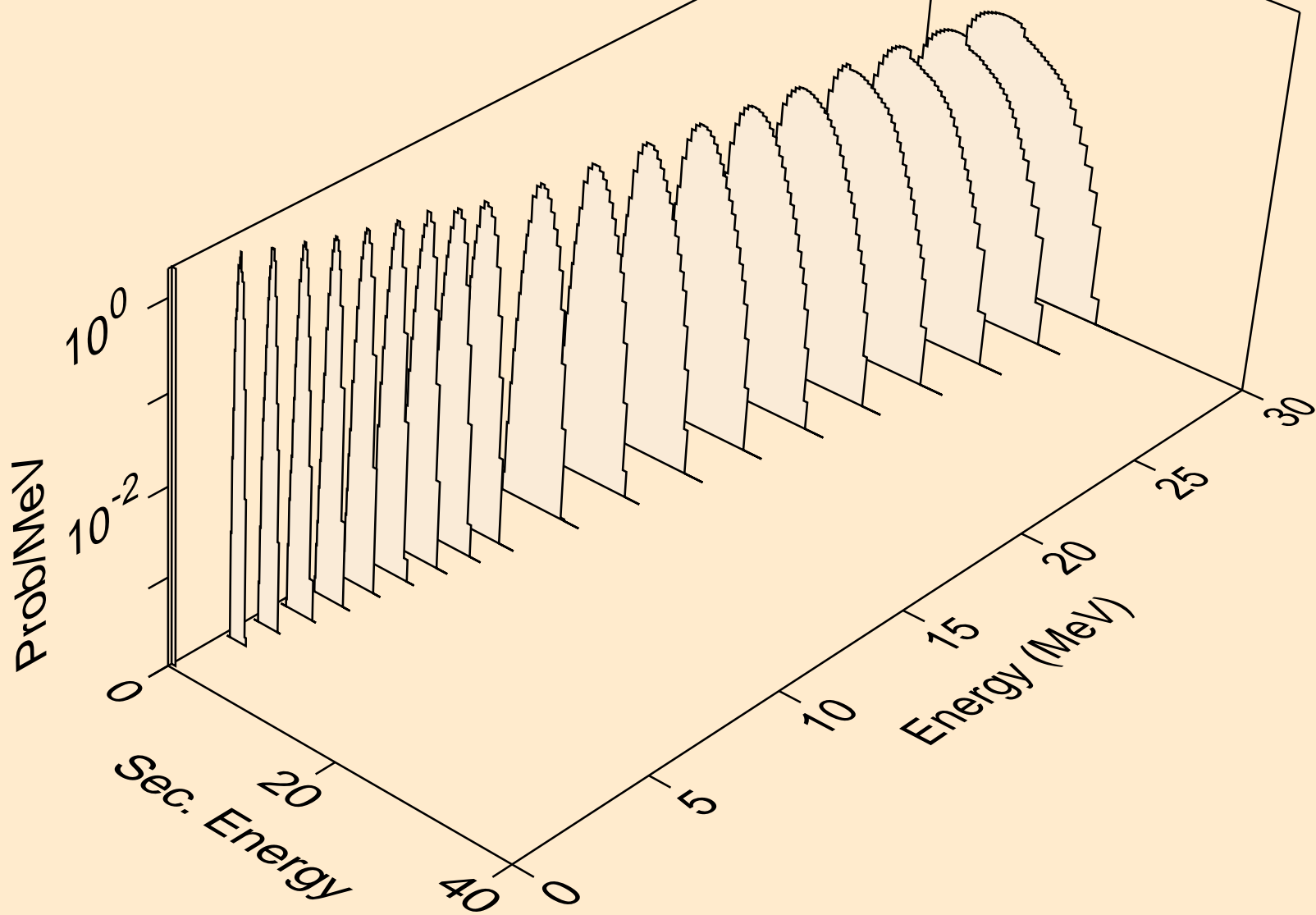

P031 TRITON ACER TENDL-2021 LIBRARY; T=0.K  
alphas from (t,3a)

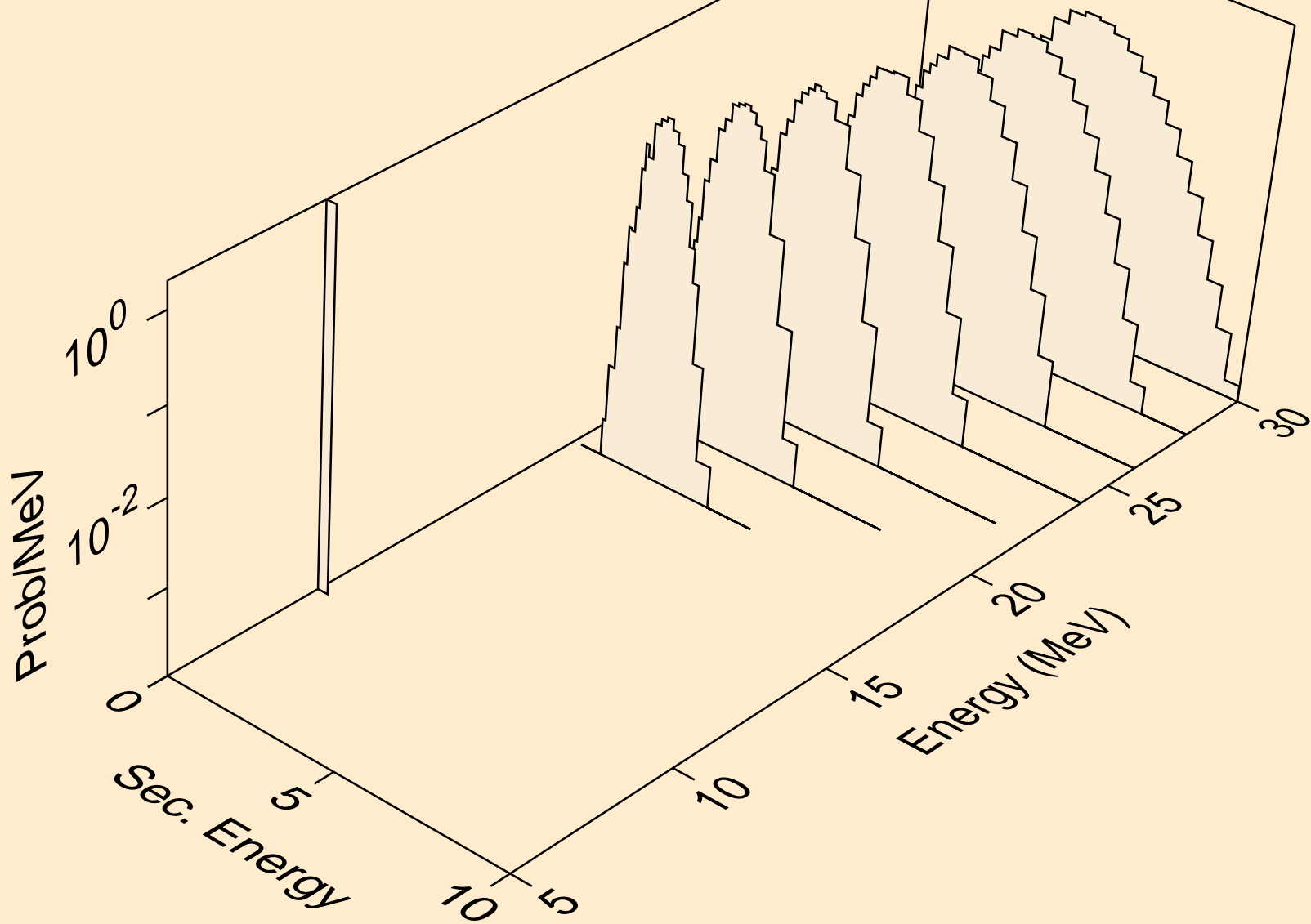

P031 TRITON ACER TENDL-2021 LIBRARY; T=0.K  
alphas from (t,pa)

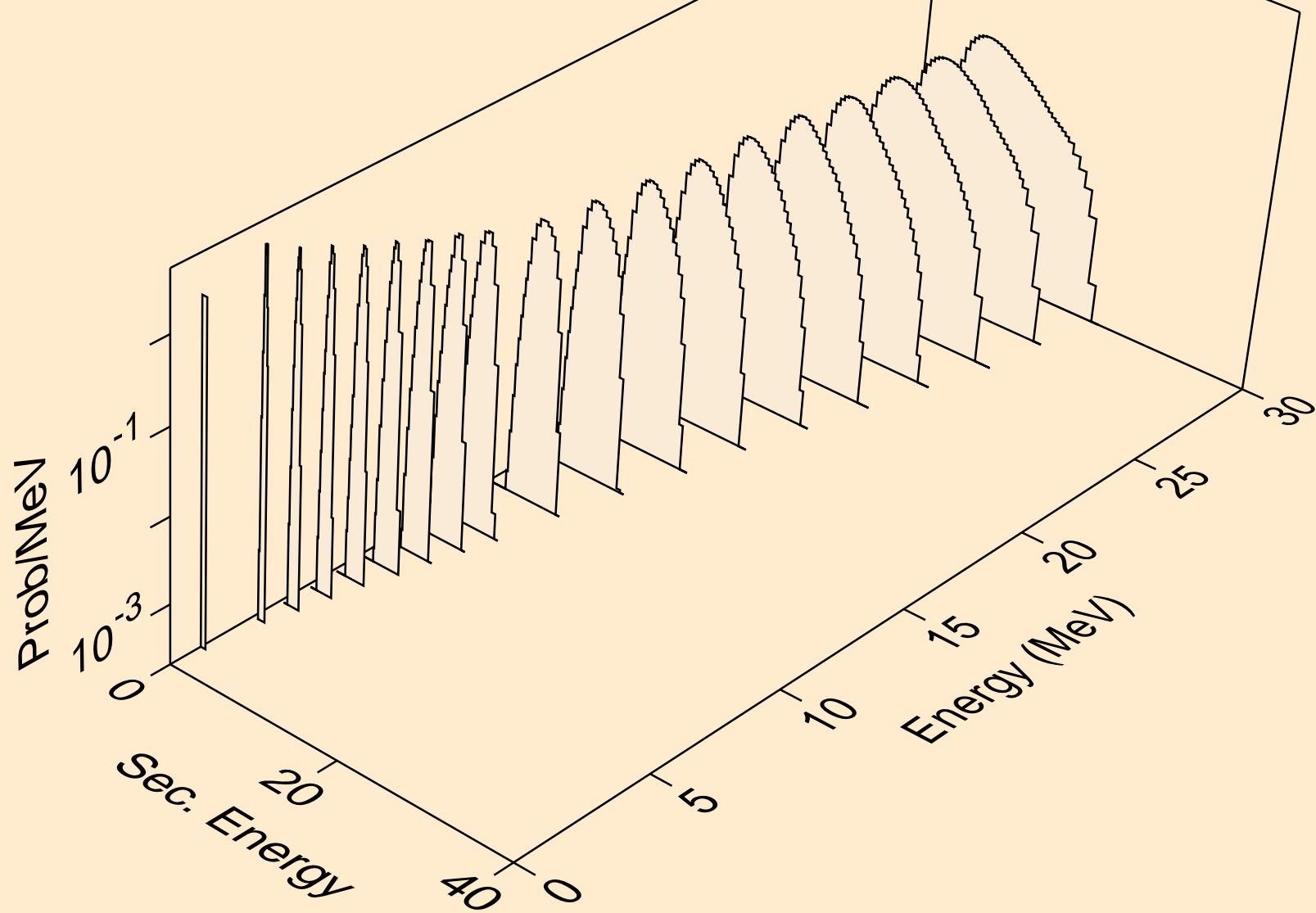



P031 TRITON ACER TENDL-2021 LIBRARY; T=0.K  
alphas from (t,da)

