

PD115M TRITON ACER TENDL-2021 LIBRARY; T=0.K  
Principal cross sections

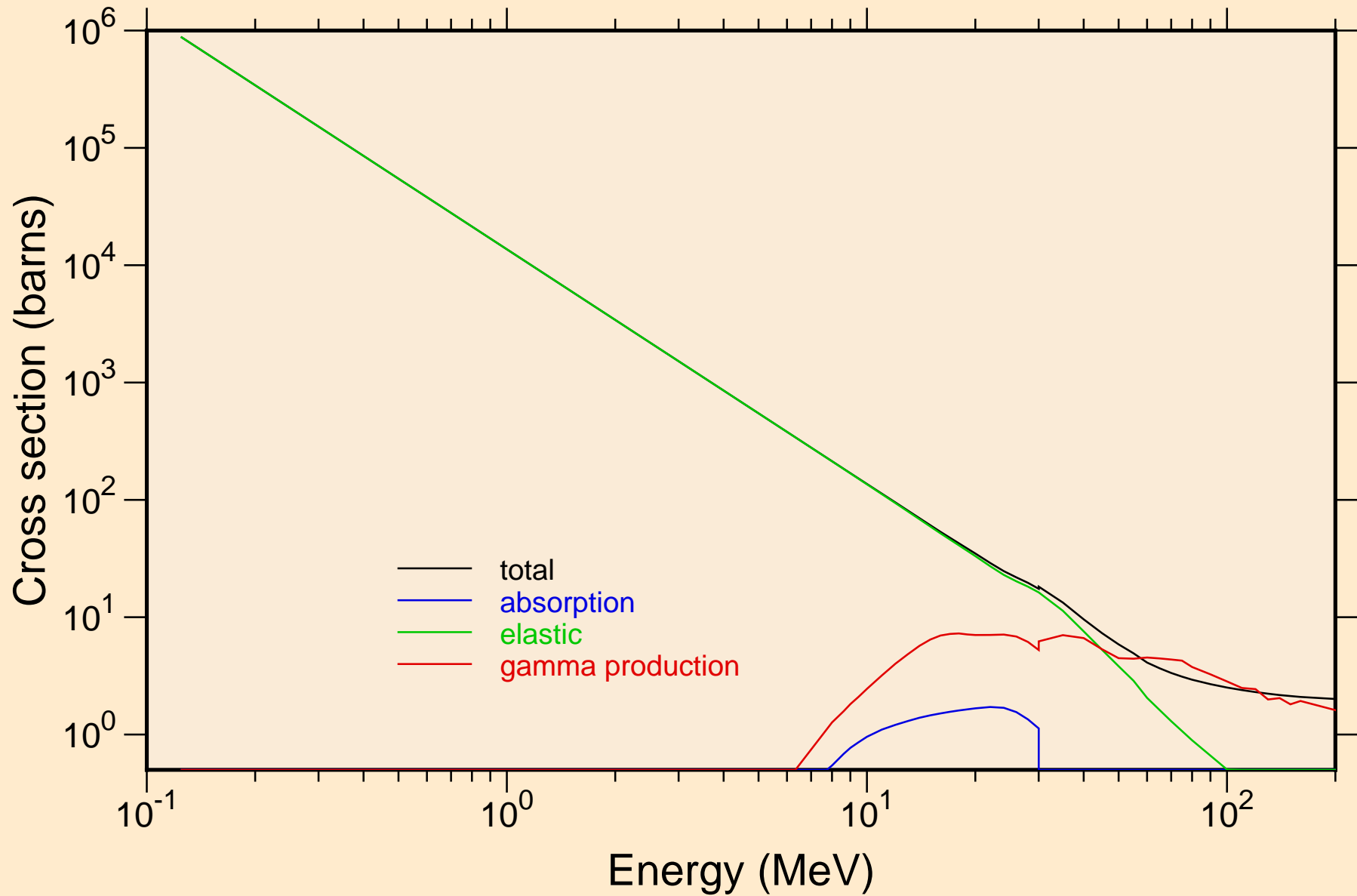

PD115M TRITON ACER TENDL-2021 LIBRARY; T=0.K

Heating

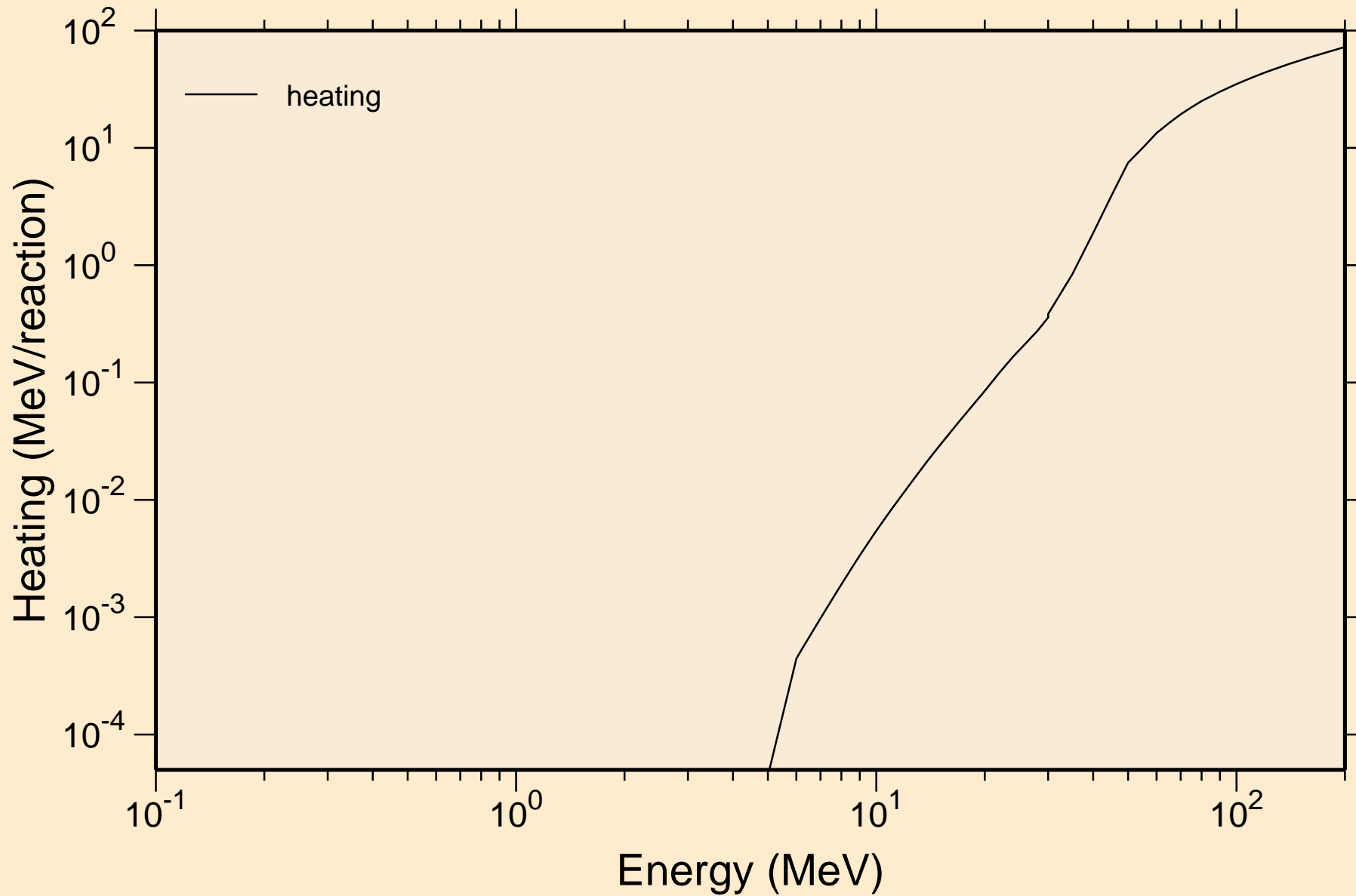

PD115M TRITON ACER TENDL-2021 LIBRARY; T=0.K

Principal cross sections

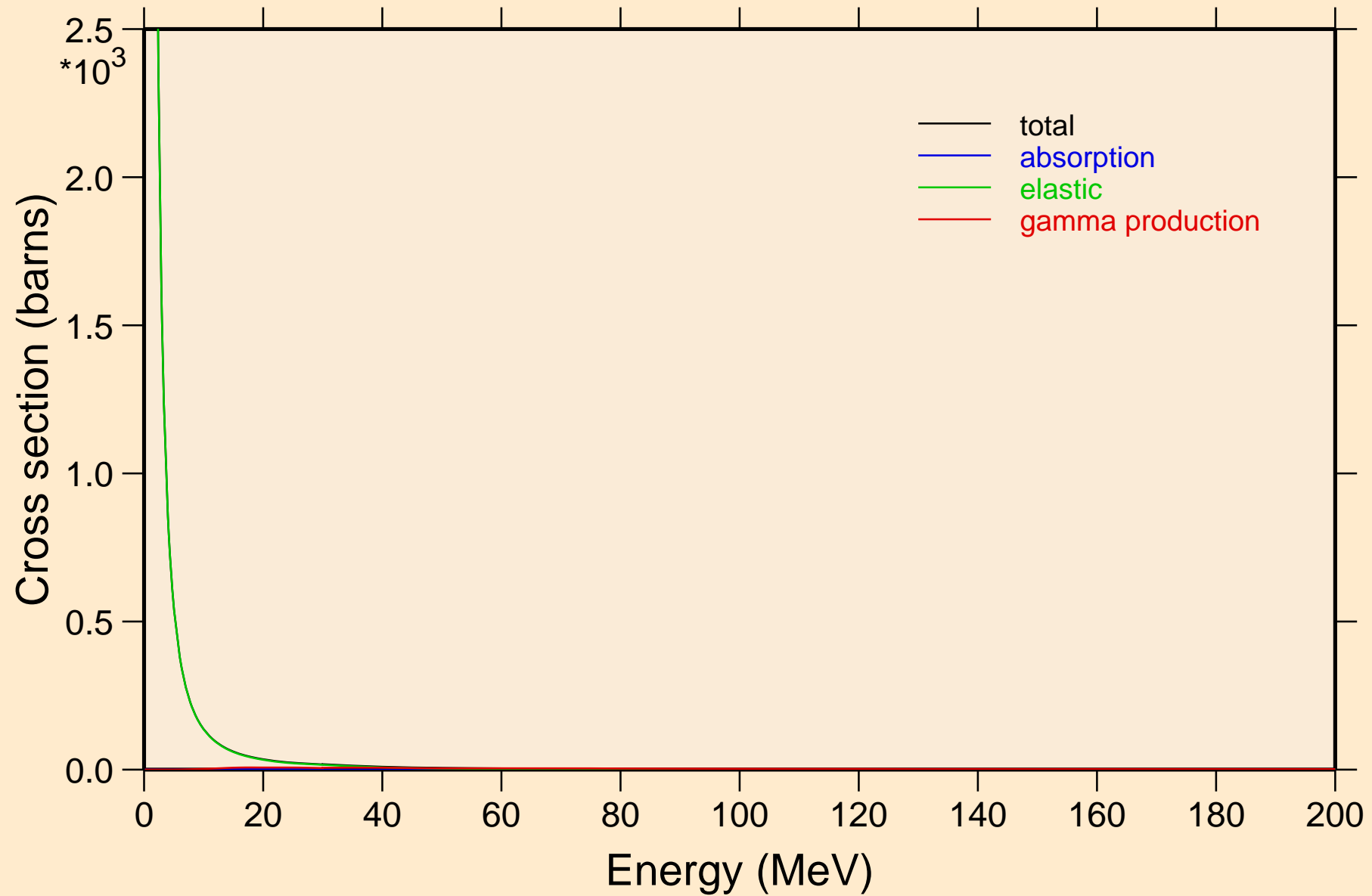

PD115M TRITON ACER TENDL-2021 LIBRARY; T=0.K

Heating

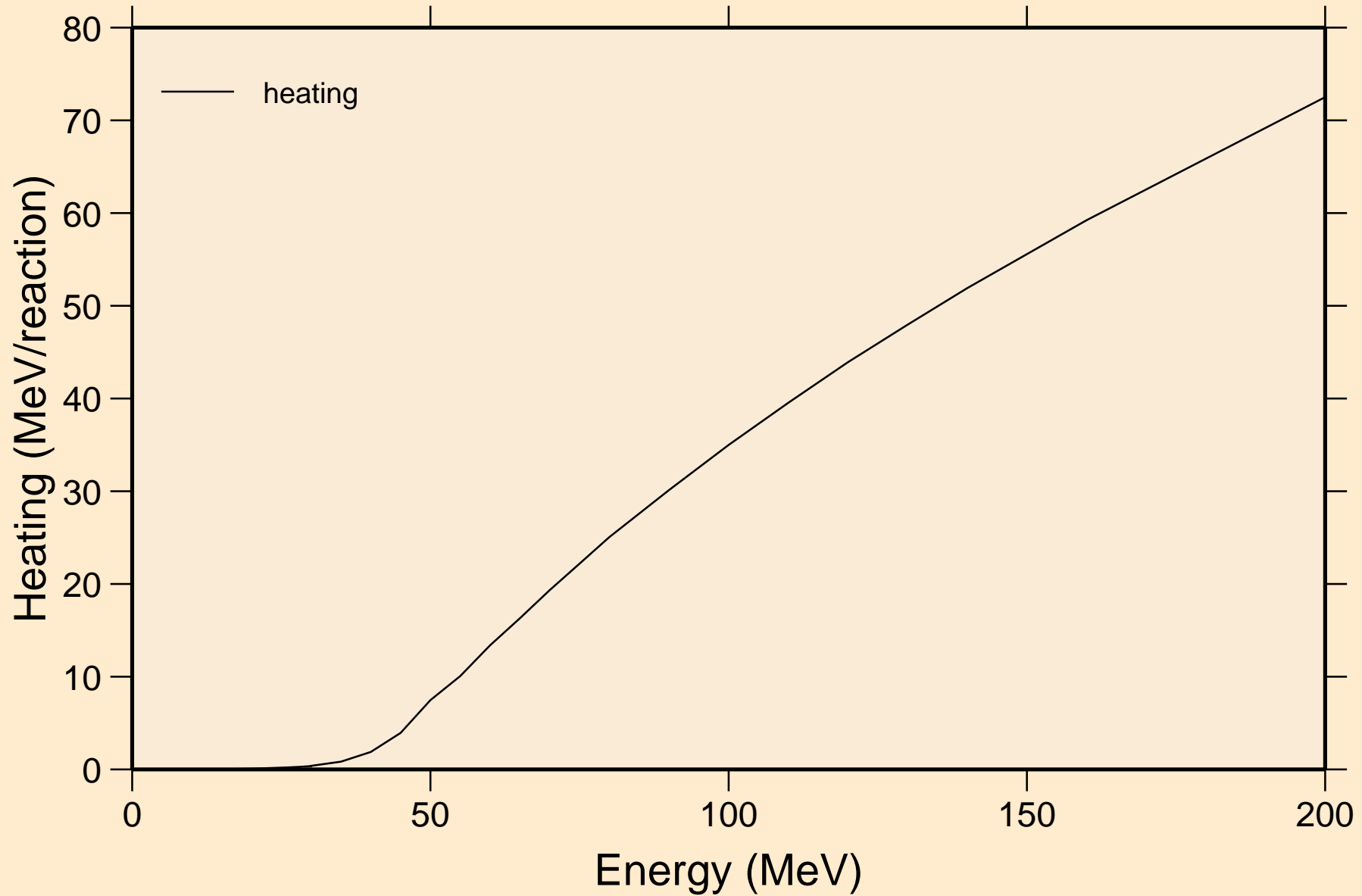

PD115M TRITON ACER TENDL-2021 LIBRARY; T=0.K  
Threshold reactions

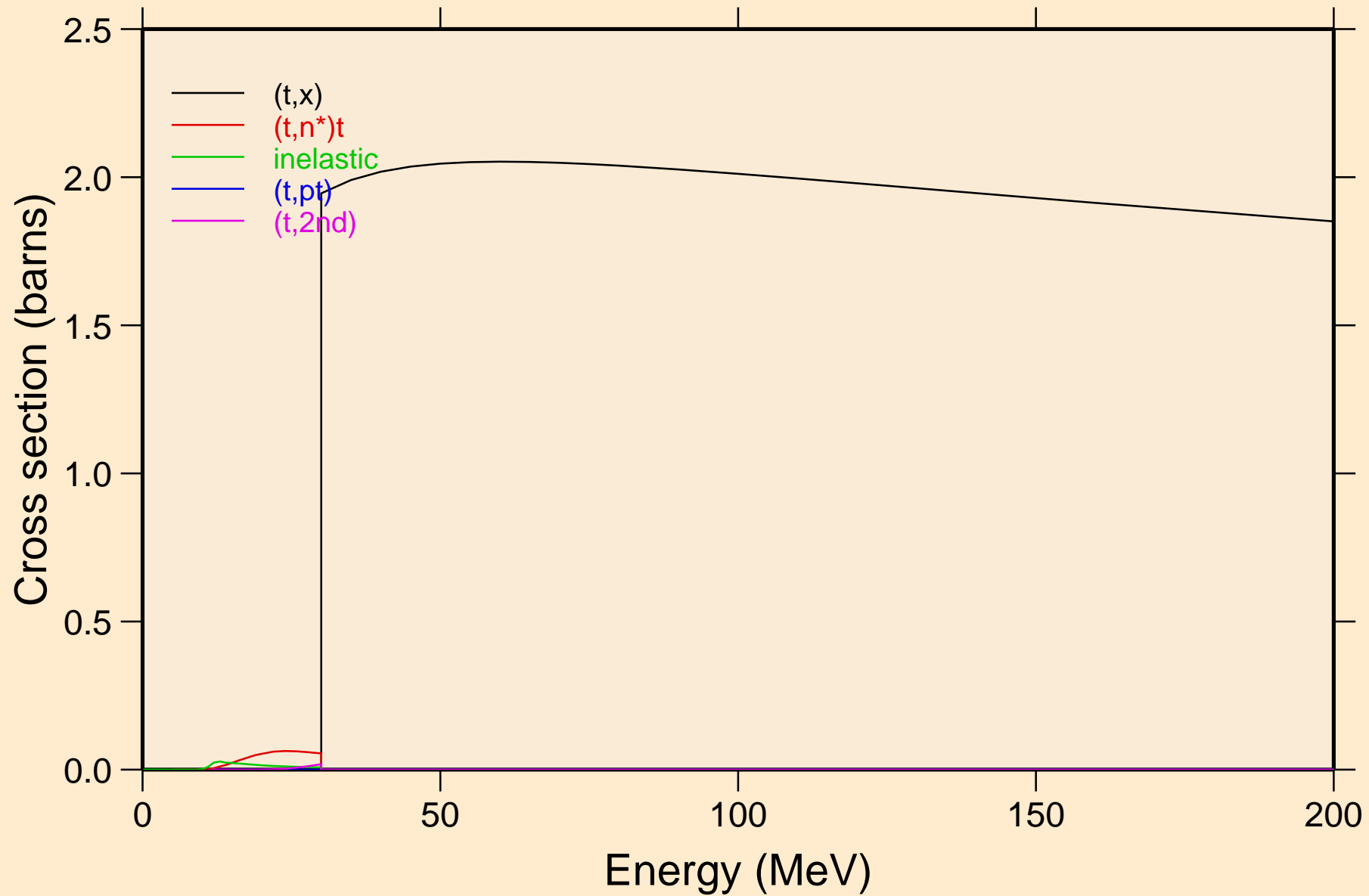

PD115M TRITON ACER TENDL-2021 LIBRARY; T=0.K  
Threshold reactions

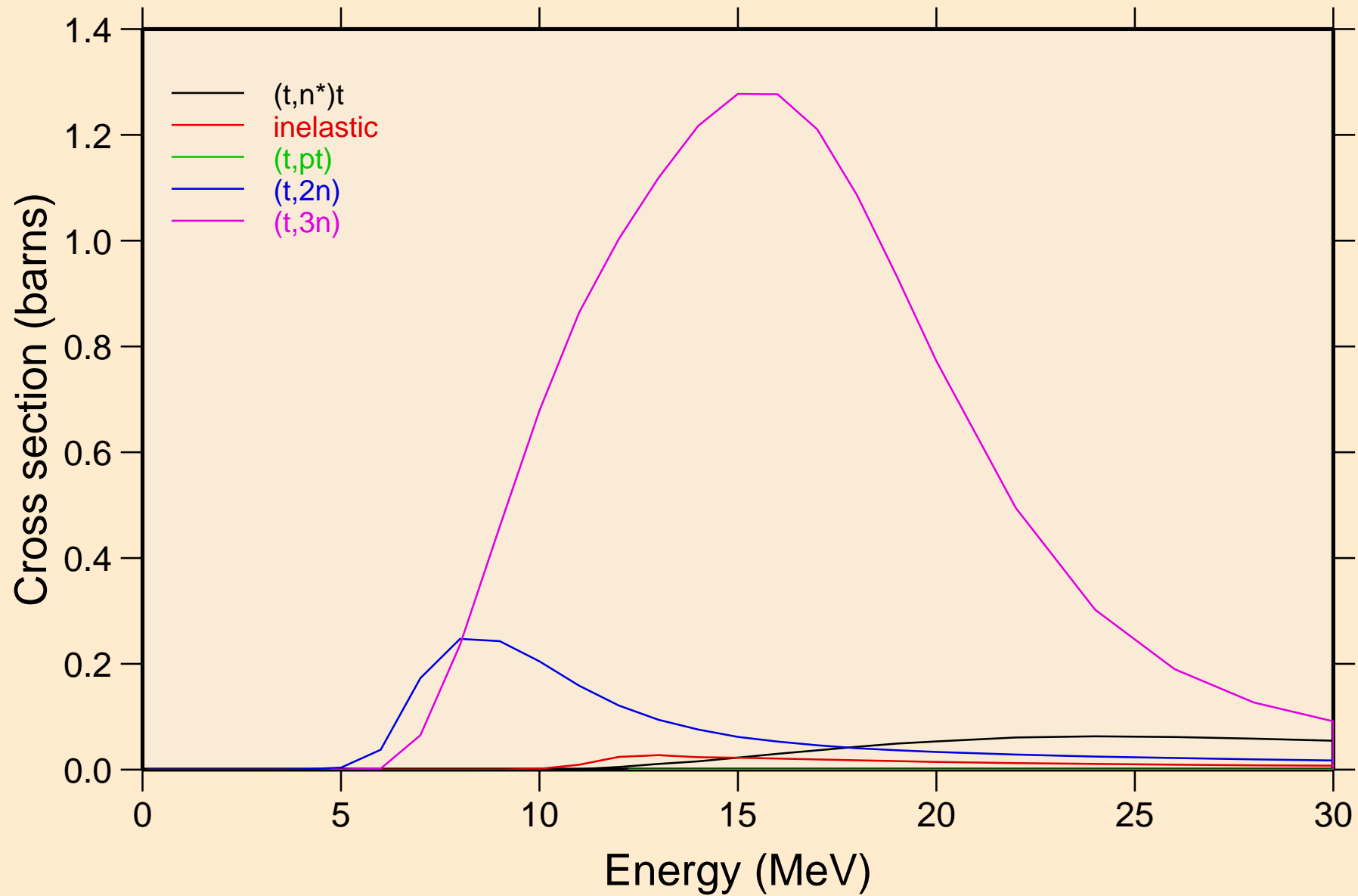

PD115M TRITON ACER TENDL-2021 LIBRARY; T=0.K  
Threshold reactions

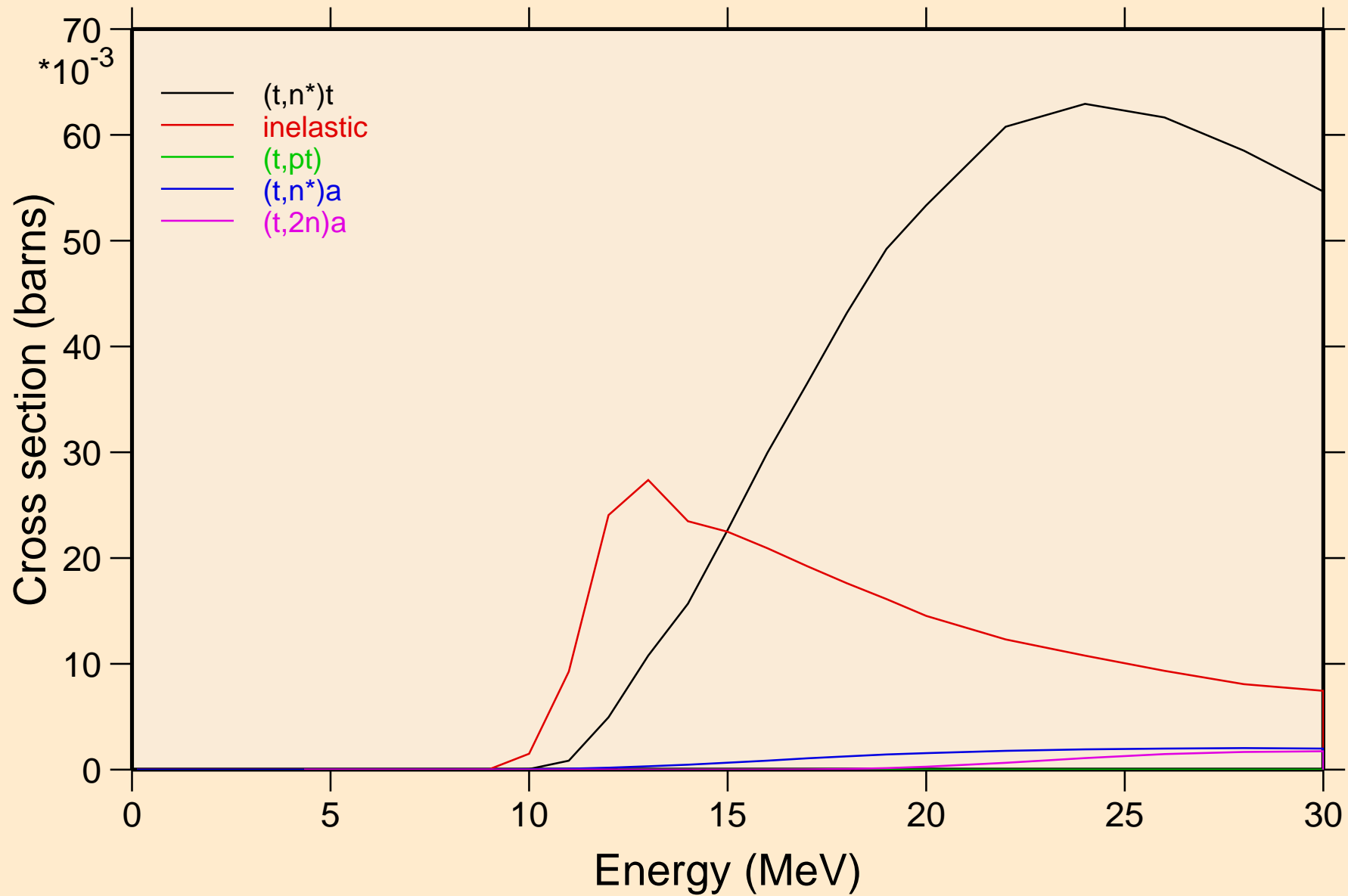

PD115M TRITON ACER TENDL-2021 LIBRARY; T=0.K  
Threshold reactions

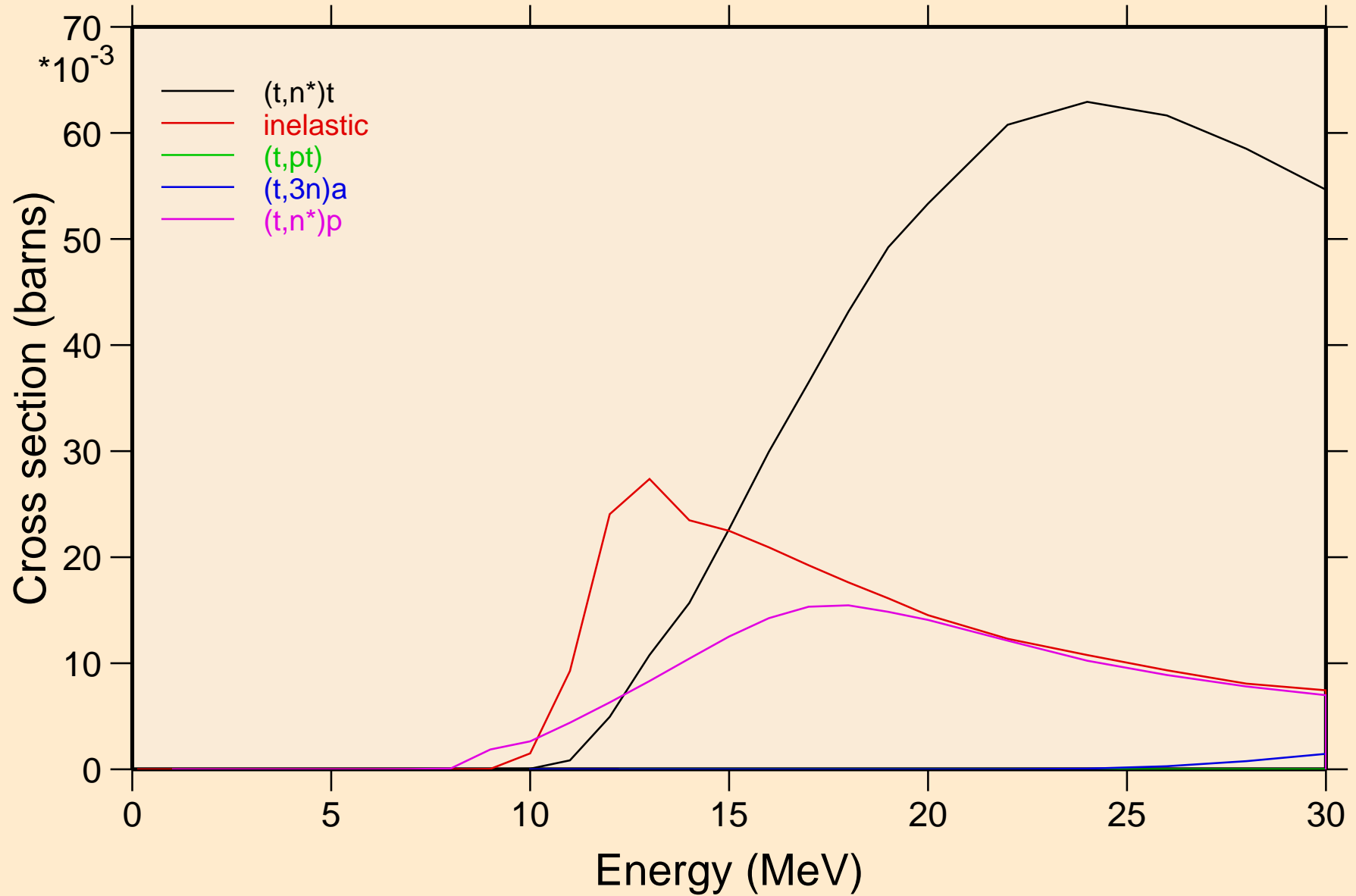



PD115M TRITON ACER TENDL-2021 LIBRARY; T=0.K  
Threshold reactions

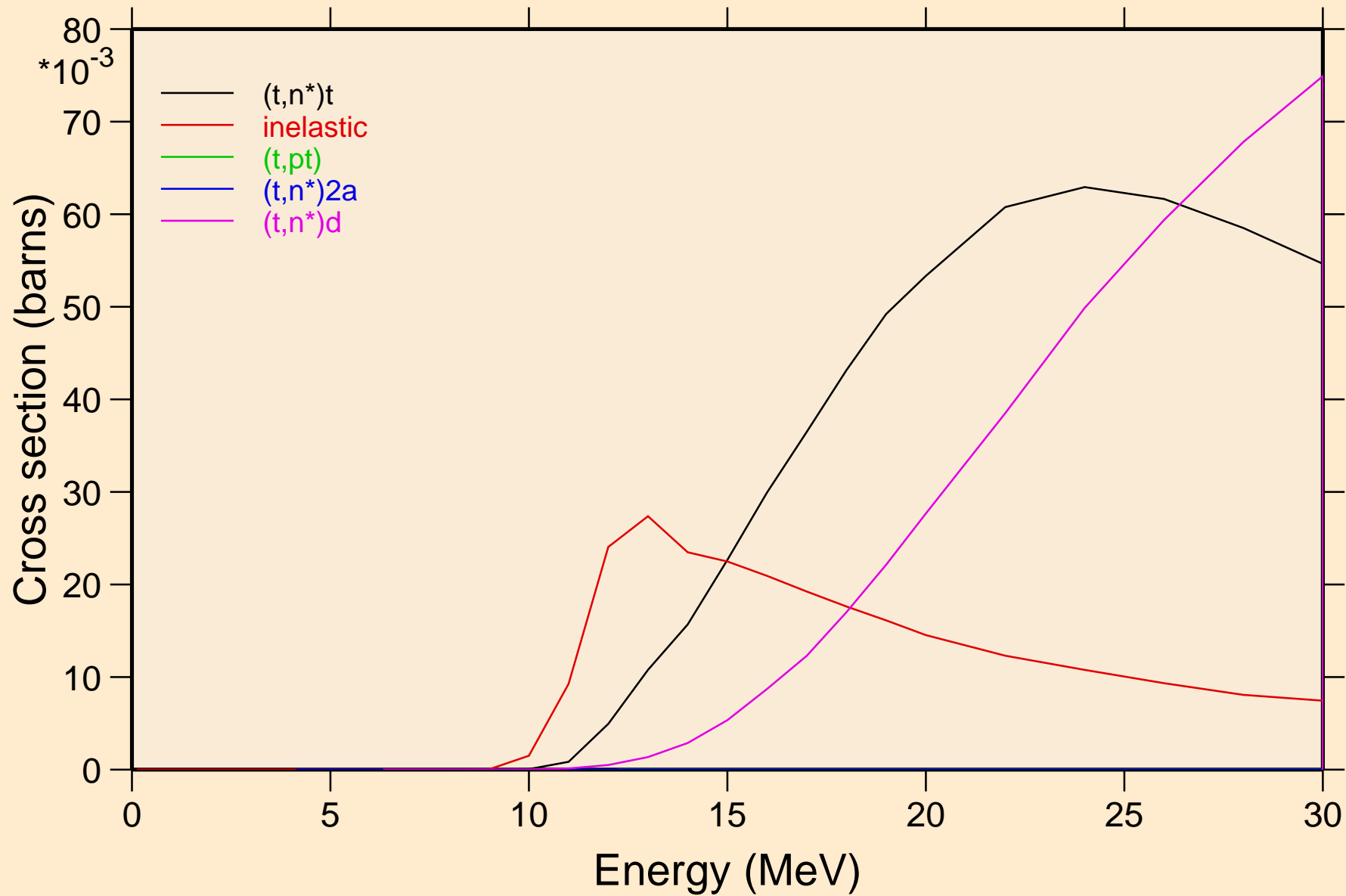

PD115M TRITON ACER TENDL-2021 LIBRARY; T=0.K  
Threshold reactions

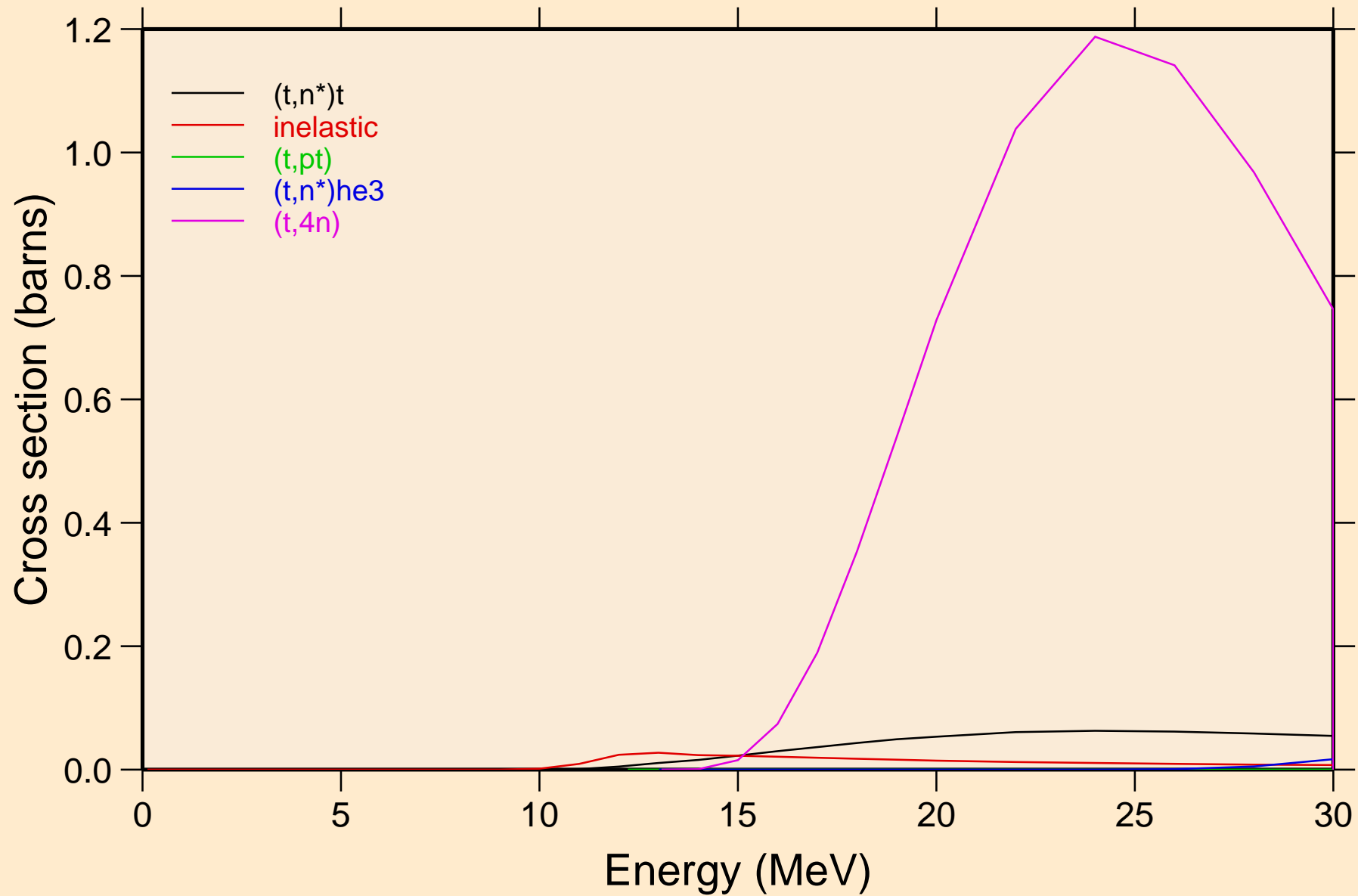

PD115M TRITON ACER TENDL-2021 LIBRARY; T=0.K  
Threshold reactions

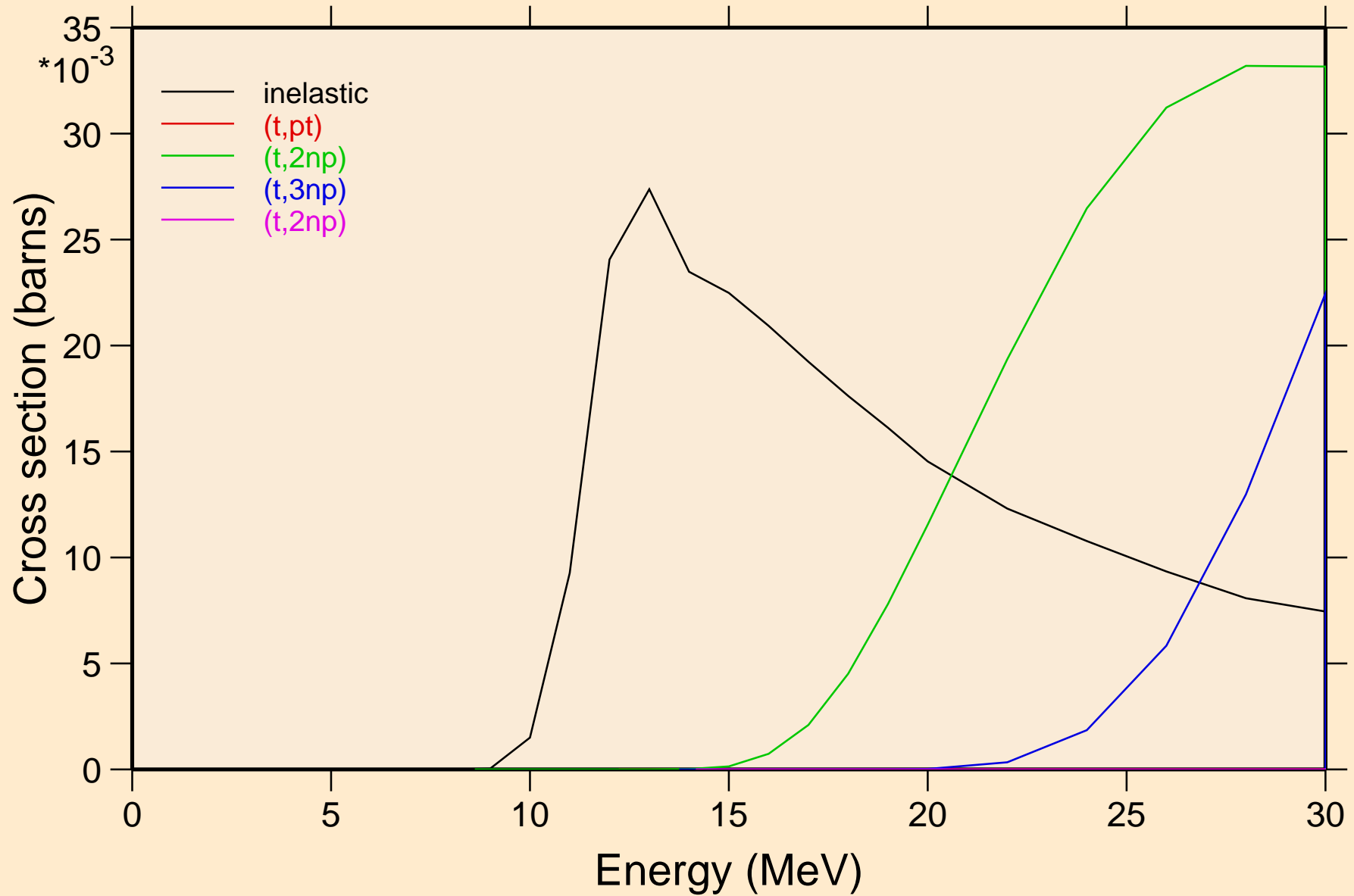

PD115M TRITON ACER TENDL-2021 LIBRARY; T=0.K  
Threshold reactions

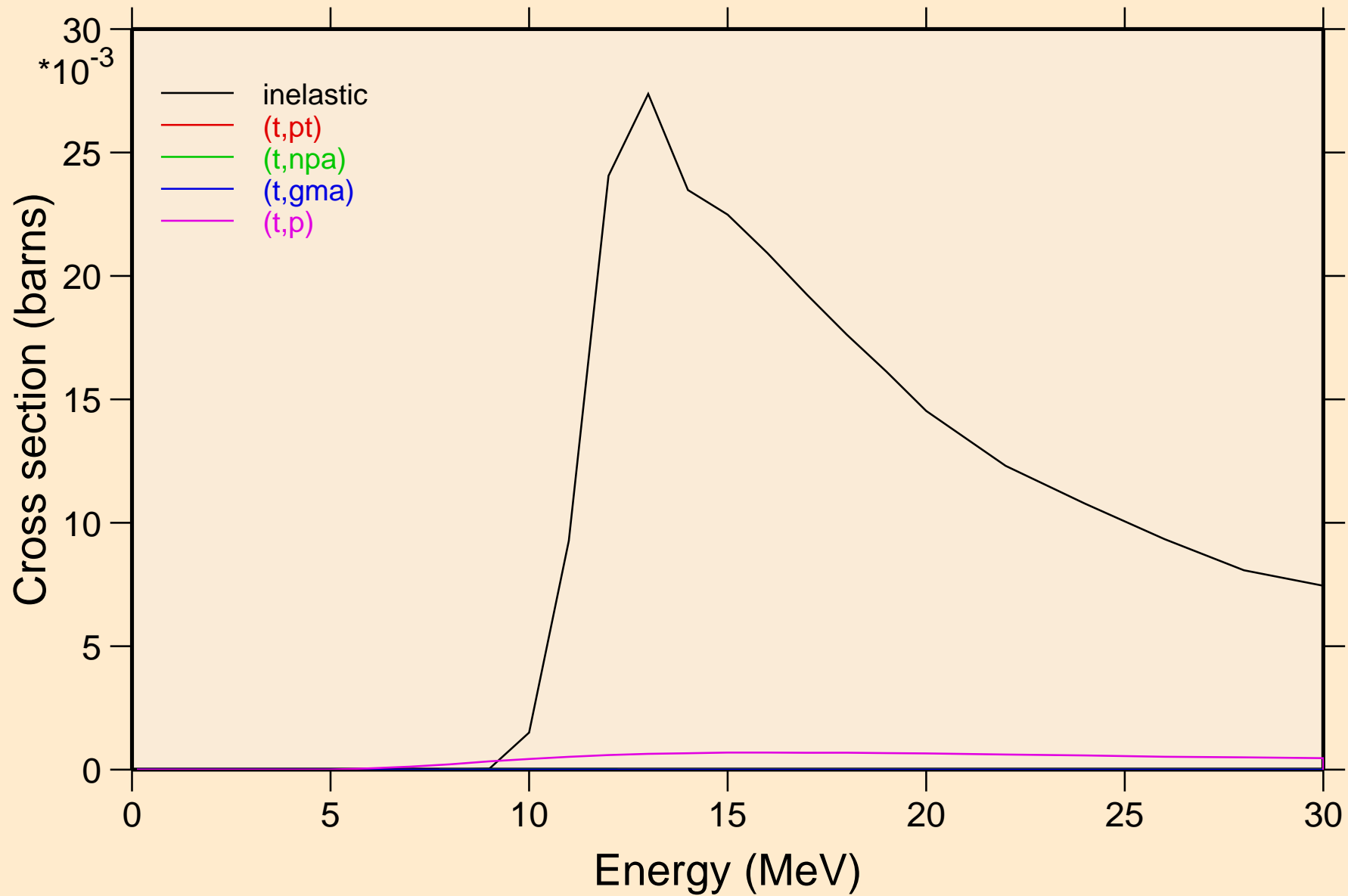

PD115M TRITON ACER TENDL-2021 LIBRARY; T=0.K  
Threshold reactions

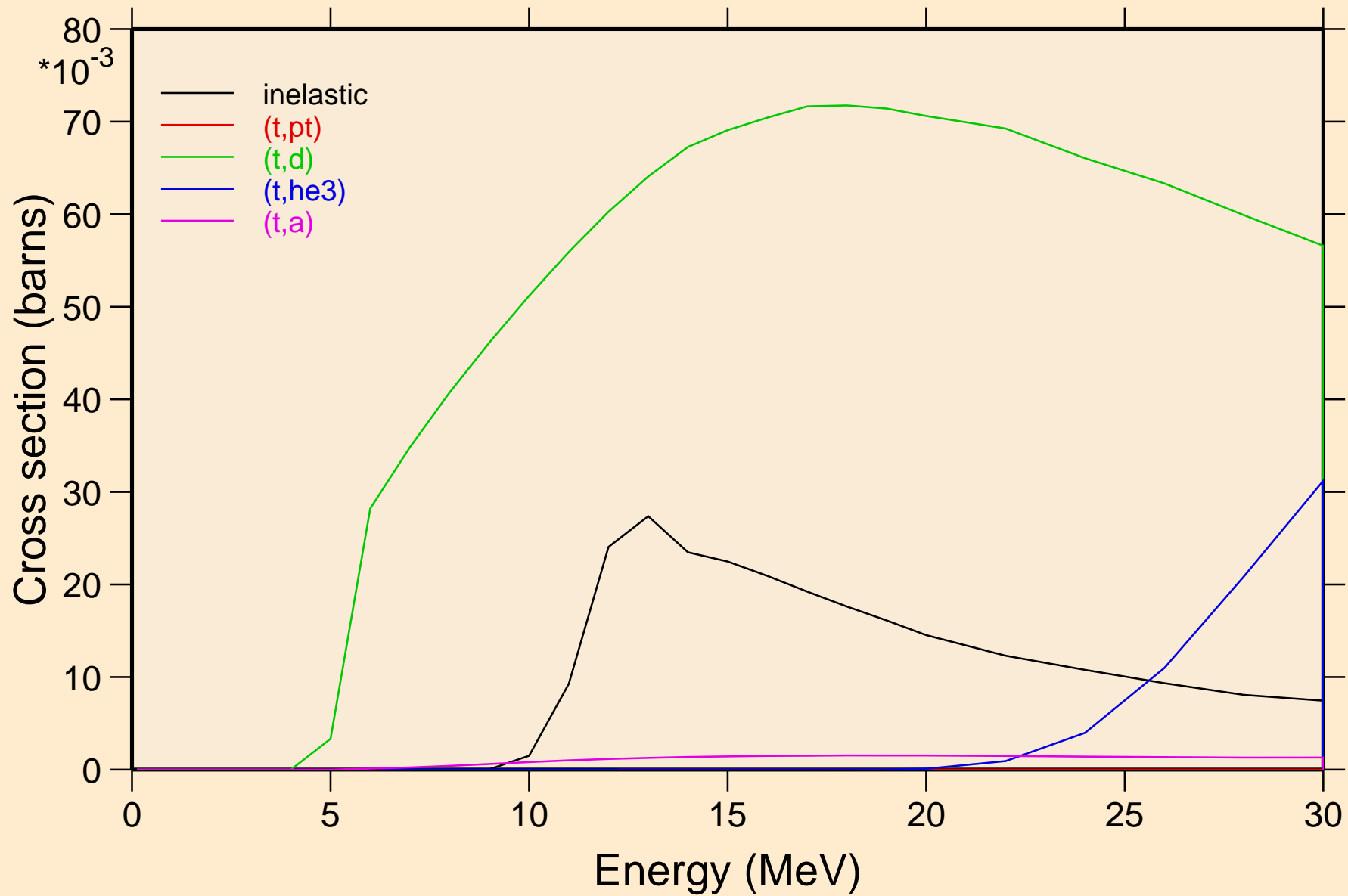

PD115M TRITON ACER TENDL-2021 LIBRARY; T=0.K  
Threshold reactions

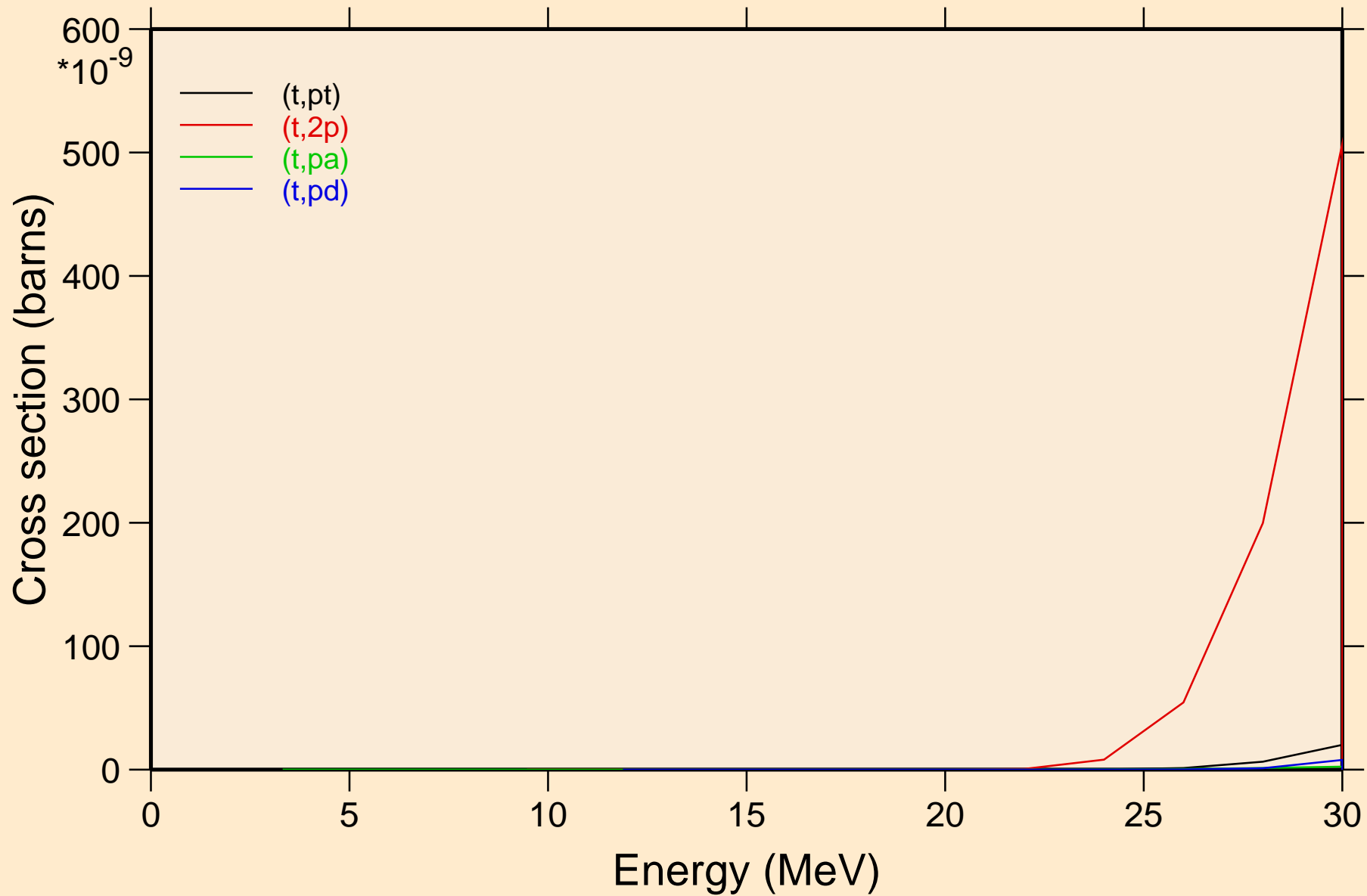

PD115M TRITON ACER TENDL-2021 LIBRARY; T=0.K  
Threshold reactions

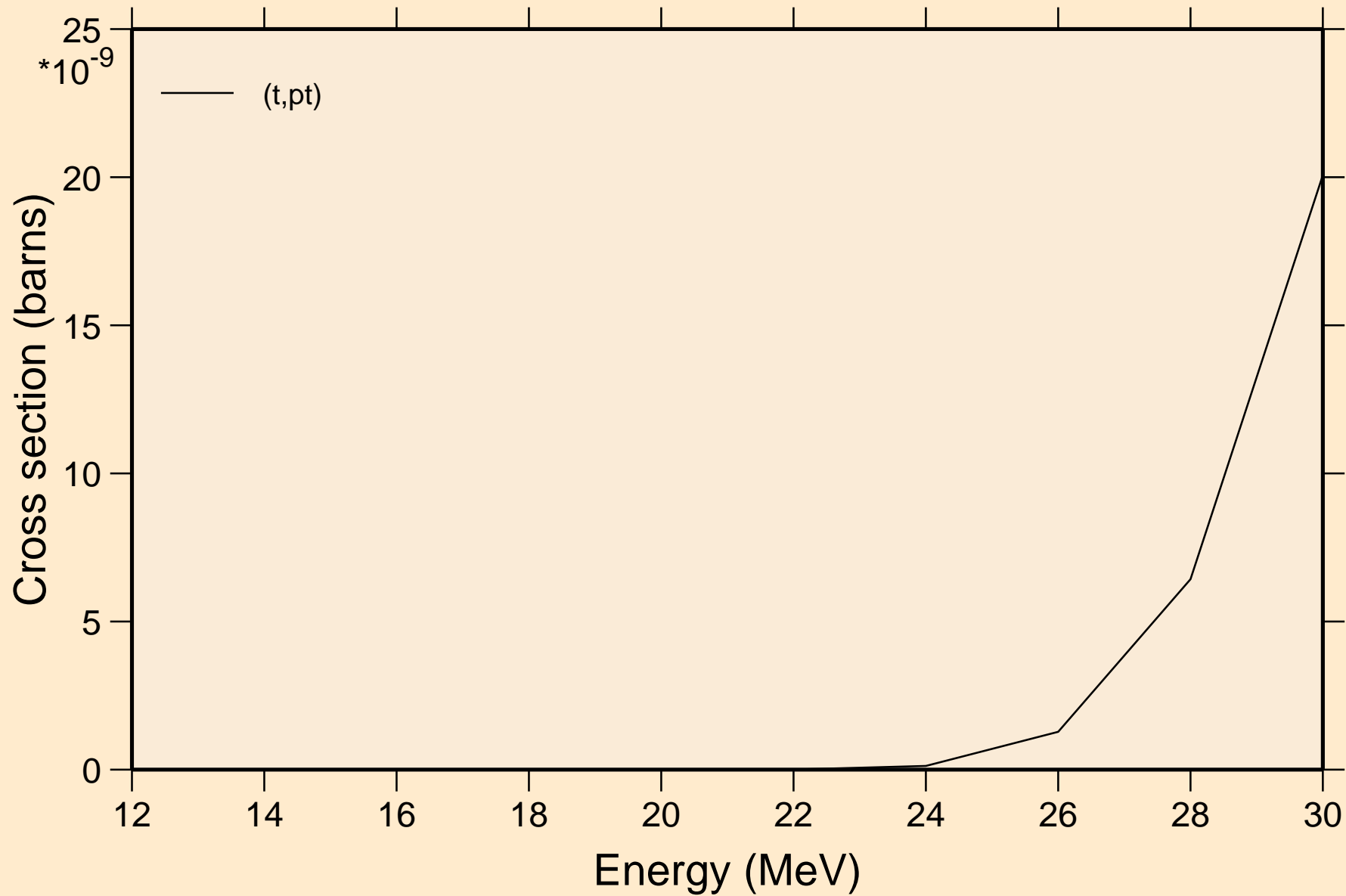

PD115M TRITON ACER TENDL-2021 LIBRARY; T=0.K  
angular distribution for elastic

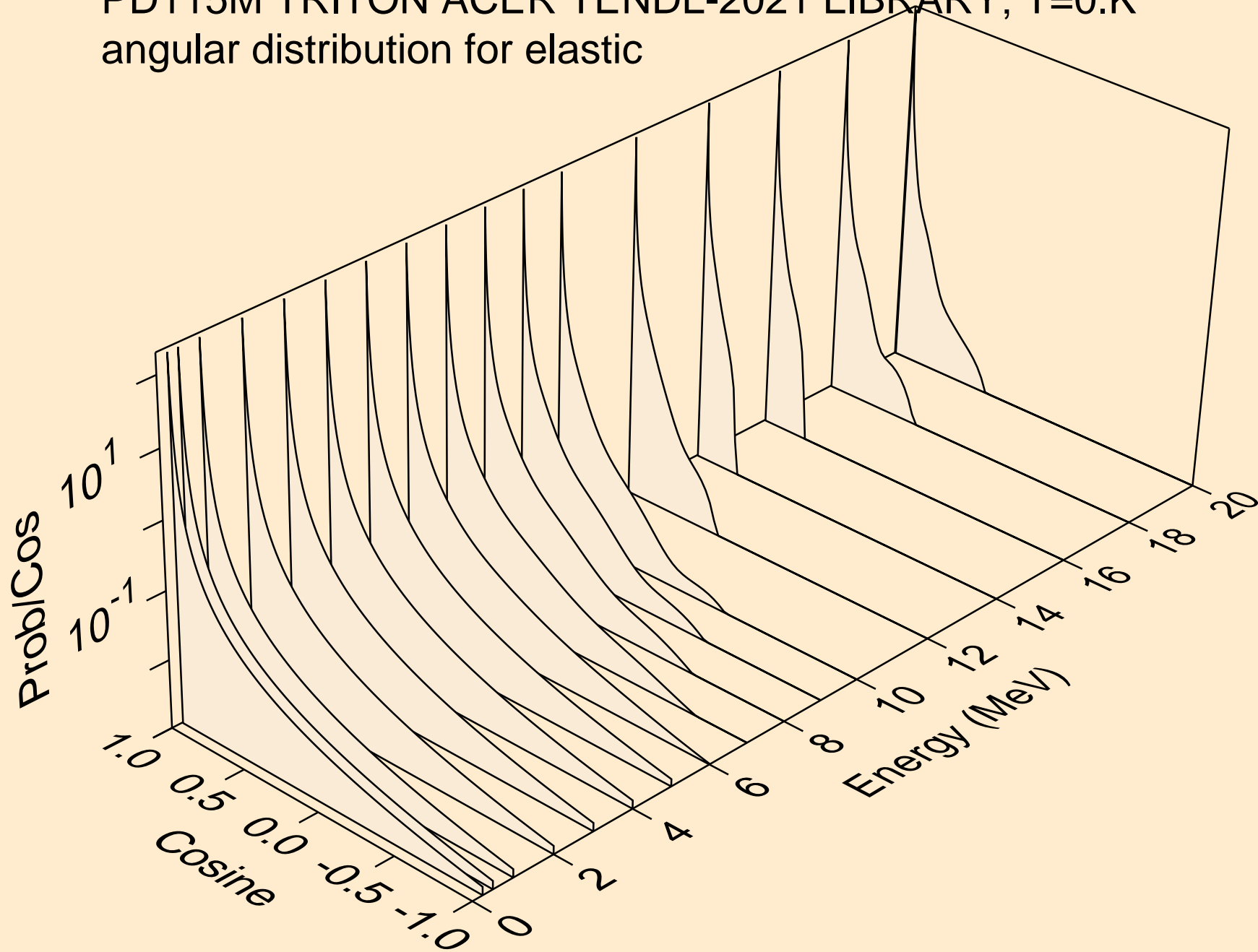



PD115M TRITON ACER TENDL-2021 LIBRARY; T=0.K  
angular distribution for elastic

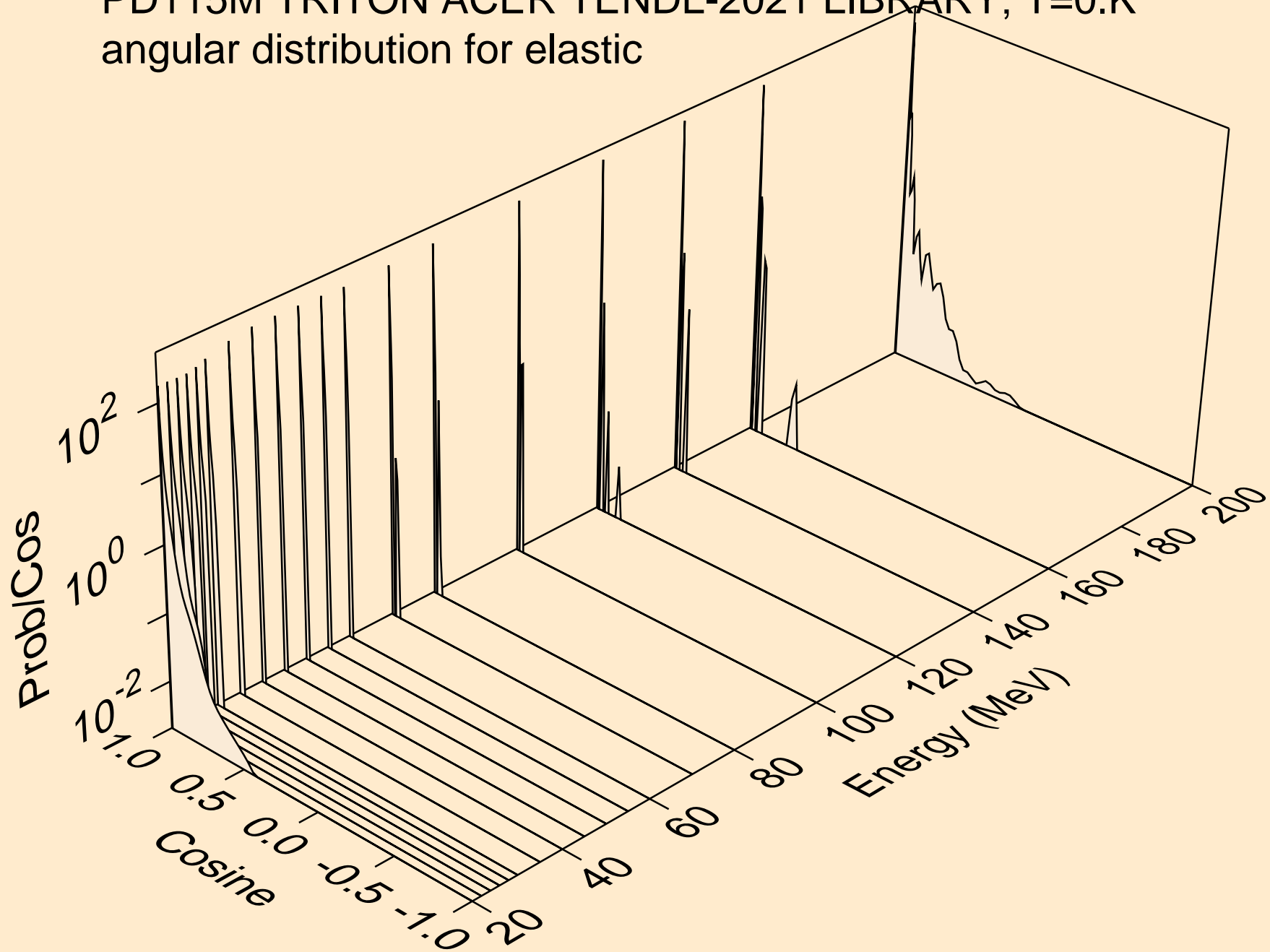

PD115M TRITON ACER TENDL-2021 LIBRARY; T=0.K  
Triton emission for (t,x)

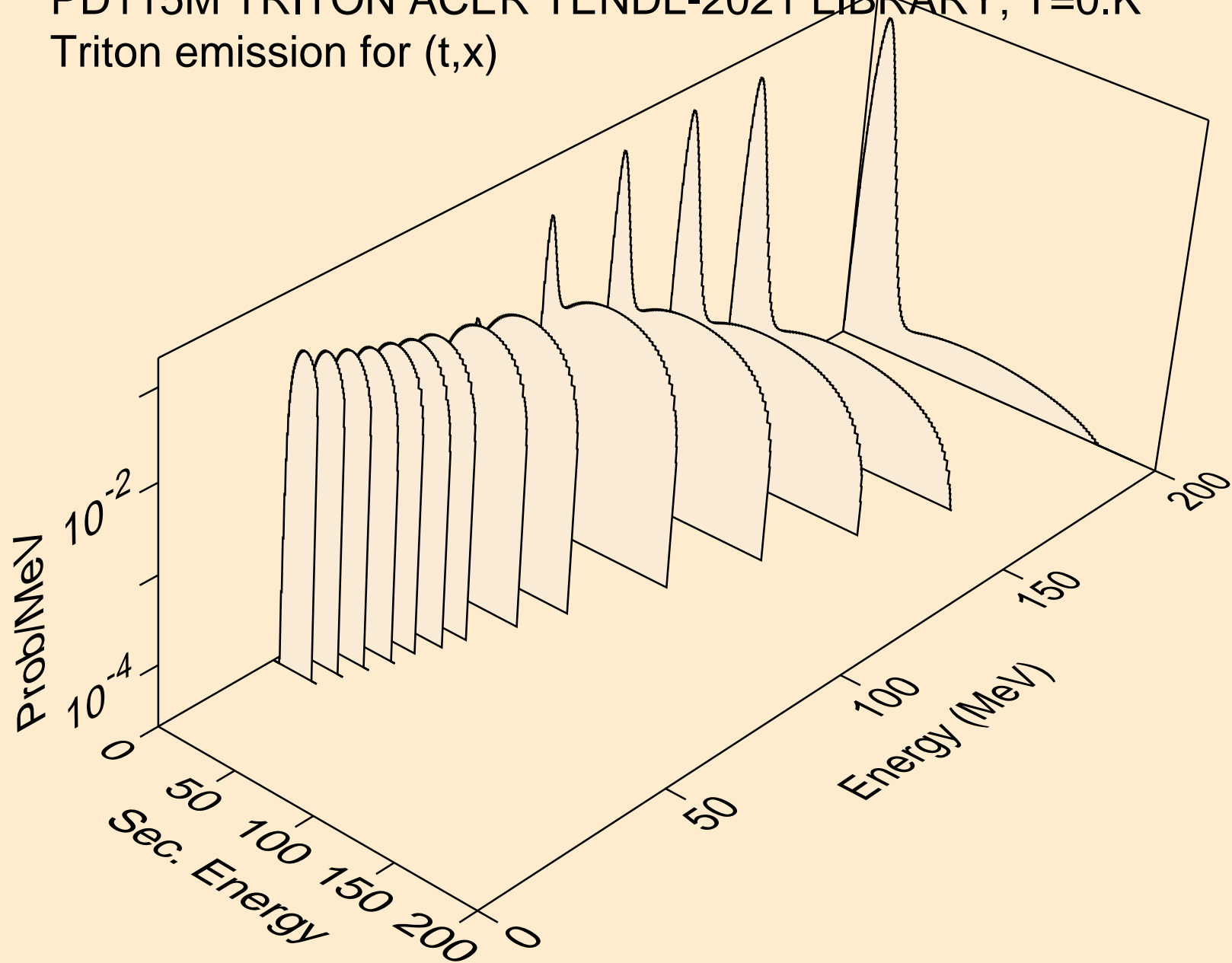

PD115M TRITON ACER TENDL-2021 LIBRARY; T=0.K  
Triton emission for (t,n\*)t

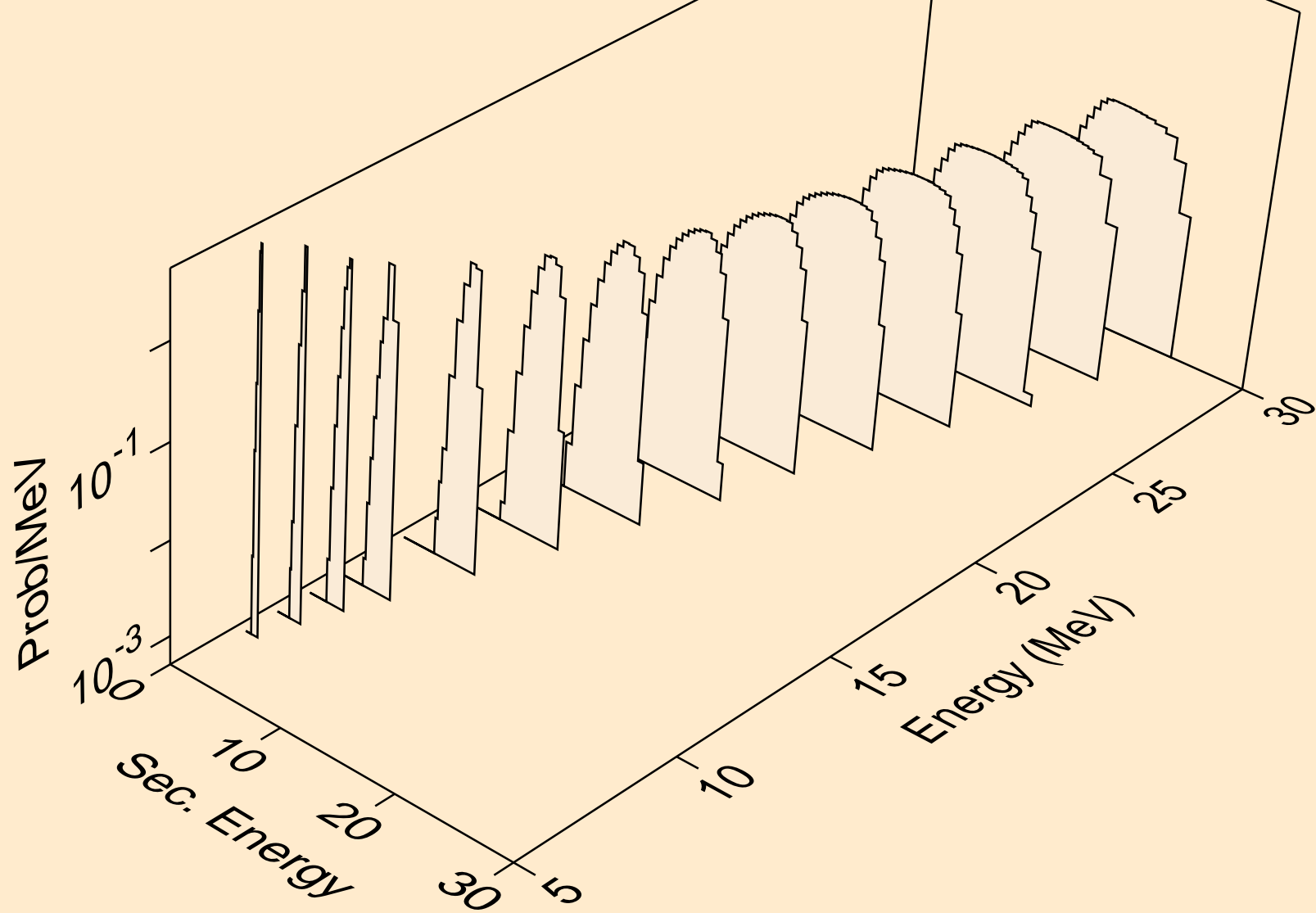

PD115M TRITON ACER TENDL-2021 LIBRARY; T=0.K  
Triton emission for inelastic

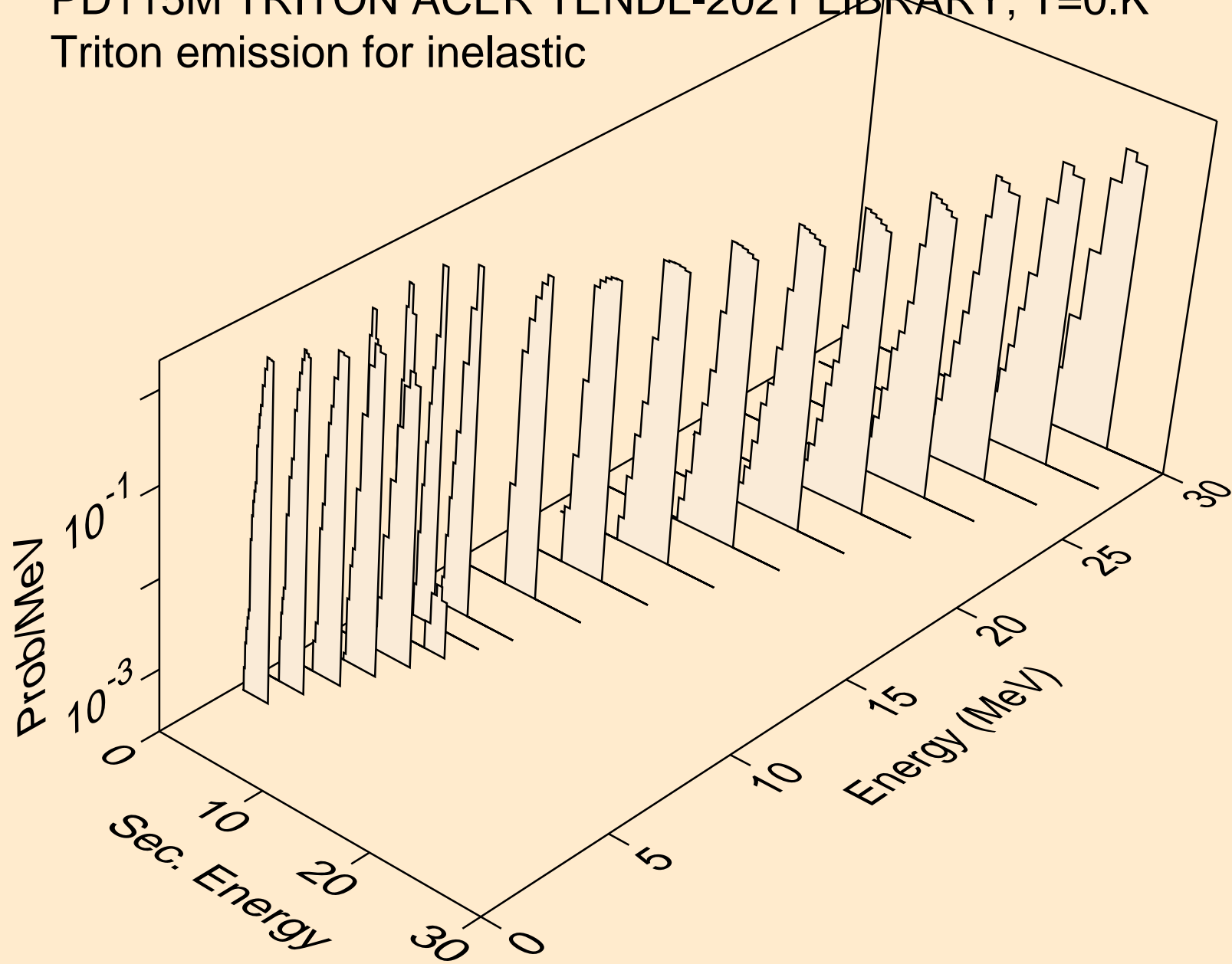

PD115M TRITON ACER TENDL-2021 LIBRARY; T=0.K  
Triton emission for (t,pt)

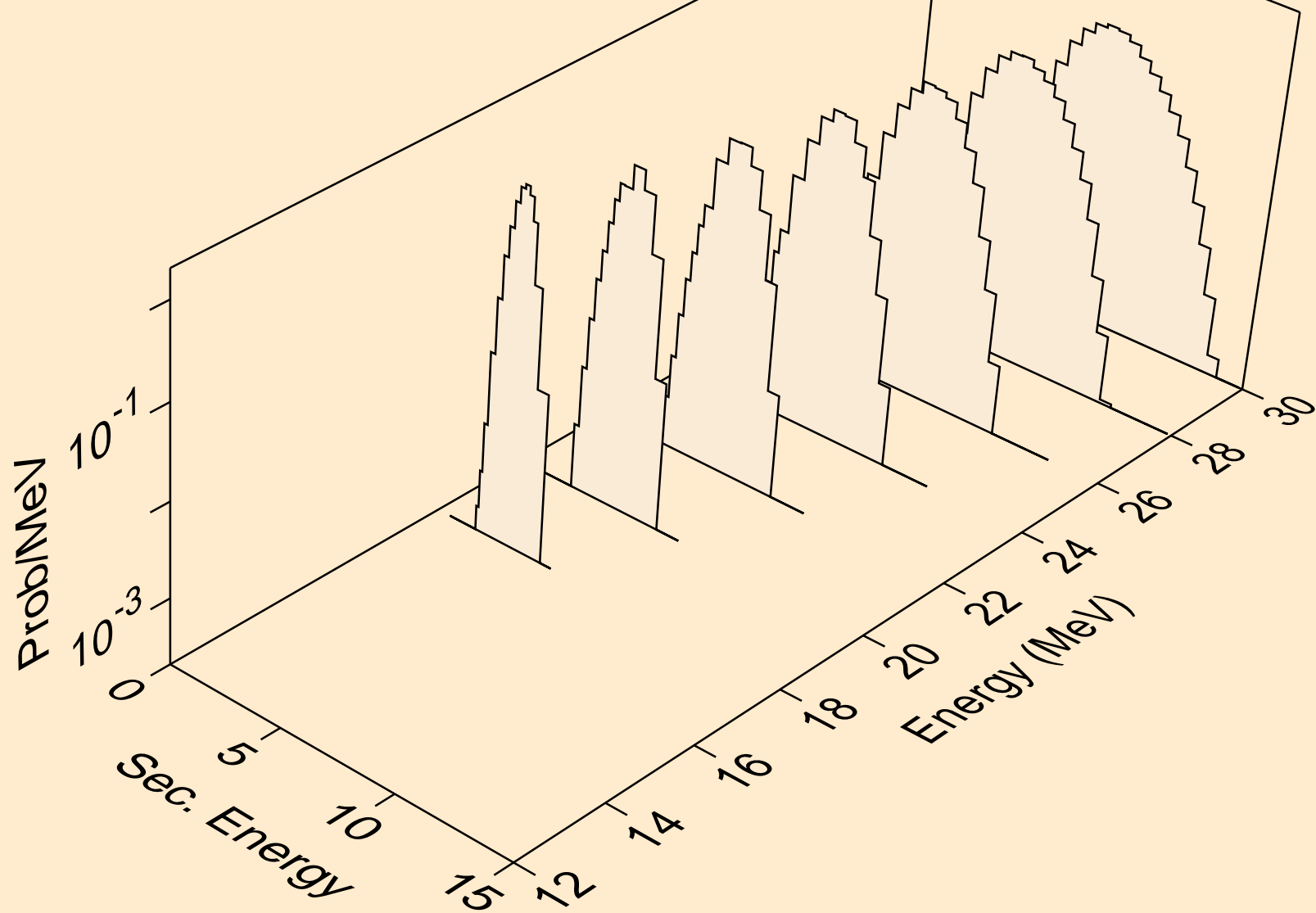

PD115M TRITON ACER TENDL-2021 LIBRARY; T=0.K  
Photon emission for (z,n)

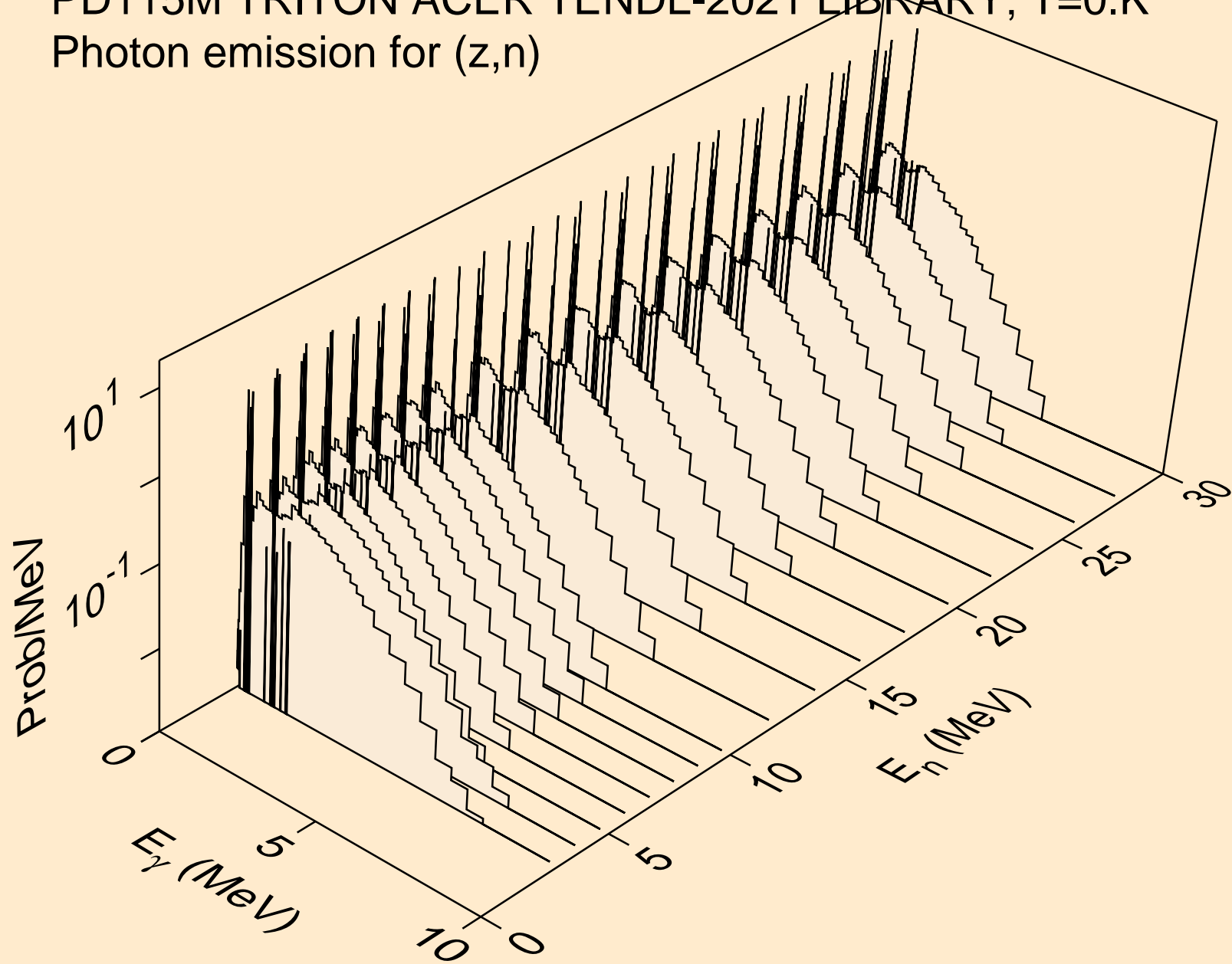

PD115M TRITON ACER TENDL-2021 LIBRARY; T=0.K  
Photon emission for (n,x)

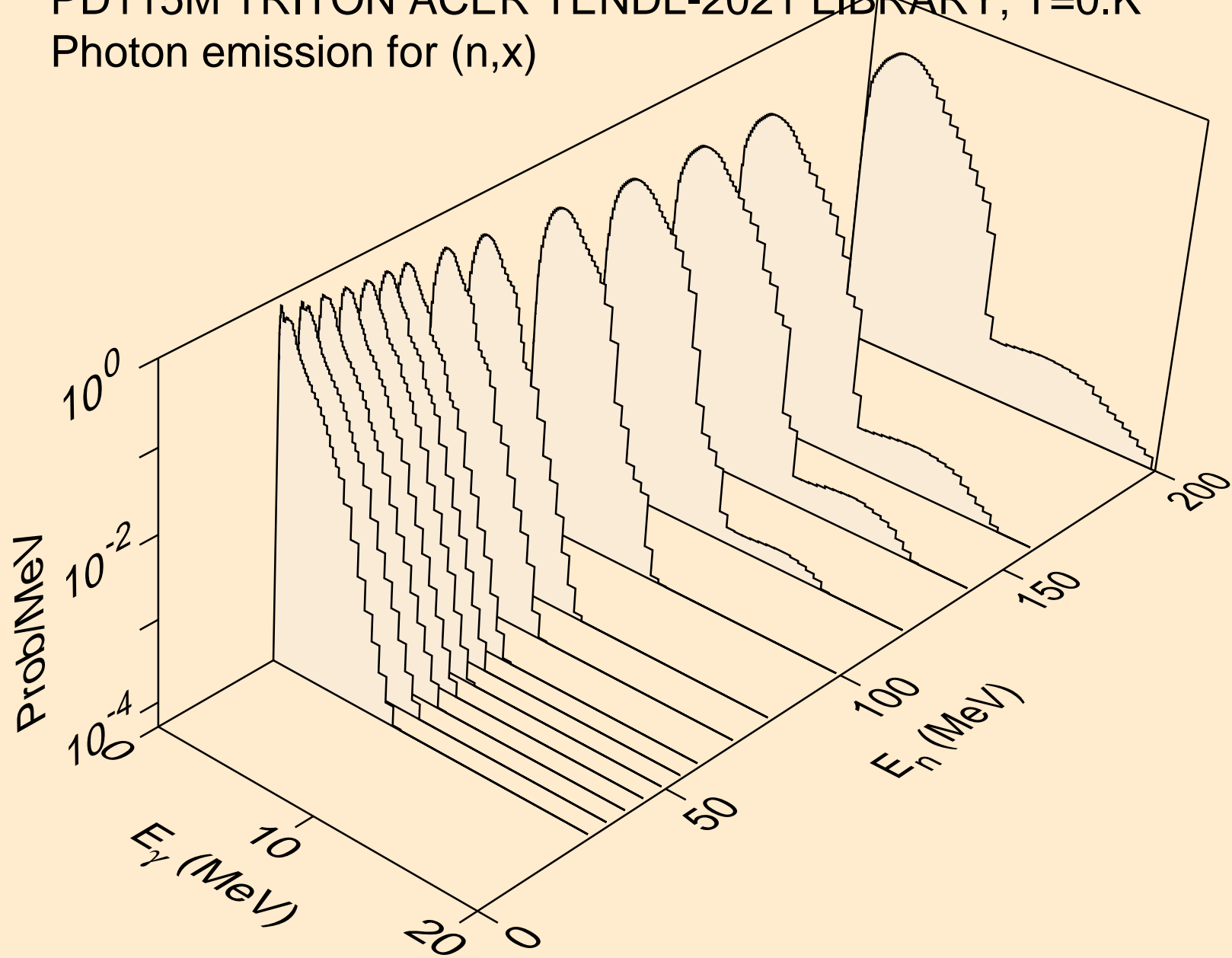

PD115M TRITON ACER TENDL-2021 LIBRARY; T=0.K  
Photon emission for (n,2nd)

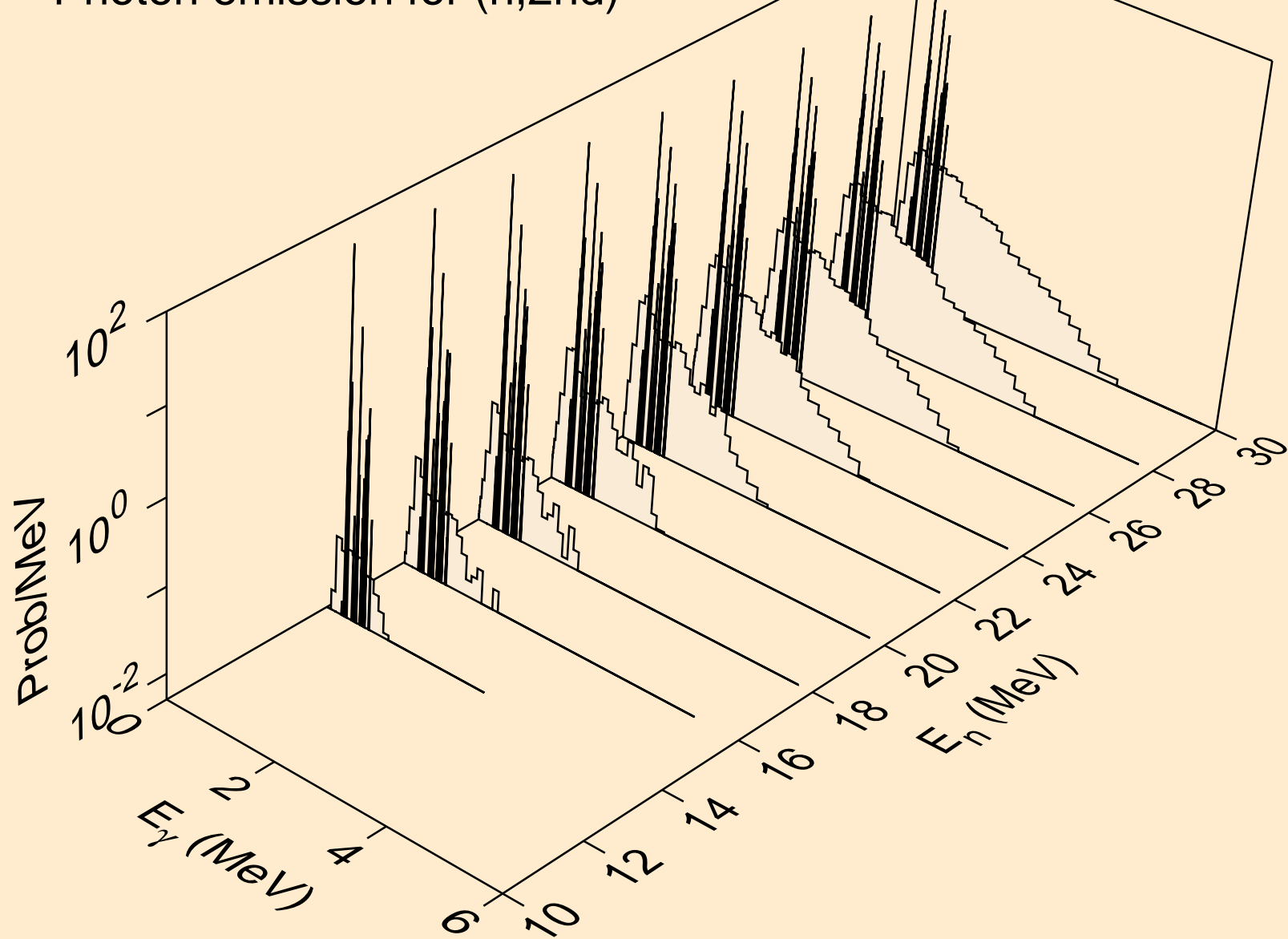



PD115M TRITON ACER TENDL-2021 LIBRARY; T=0.K  
Photon emission for (n,2n)

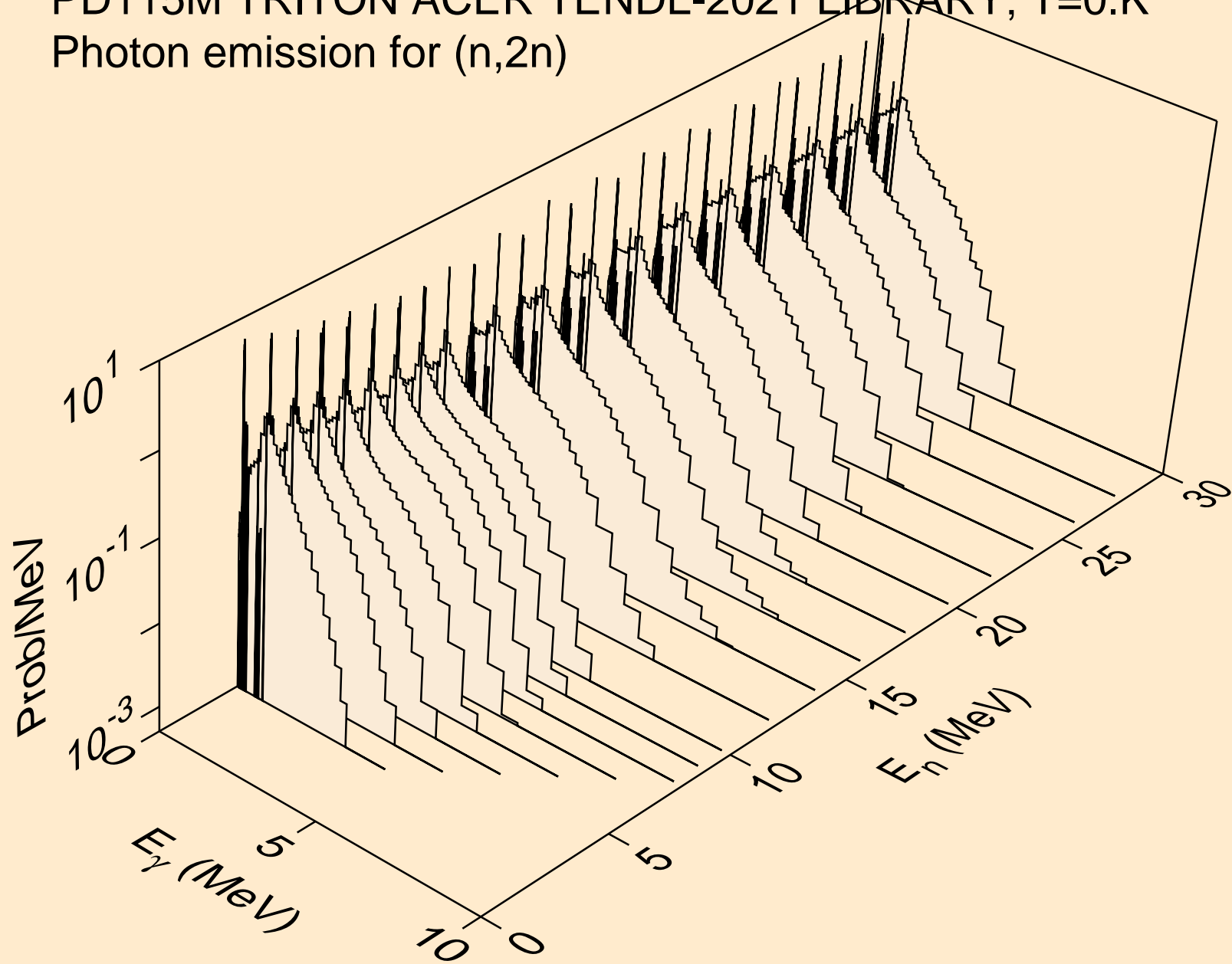

PD115M TRITON ACER TENDL-2021 LIBRARY; T=0.K  
Photon emission for (n,3n)

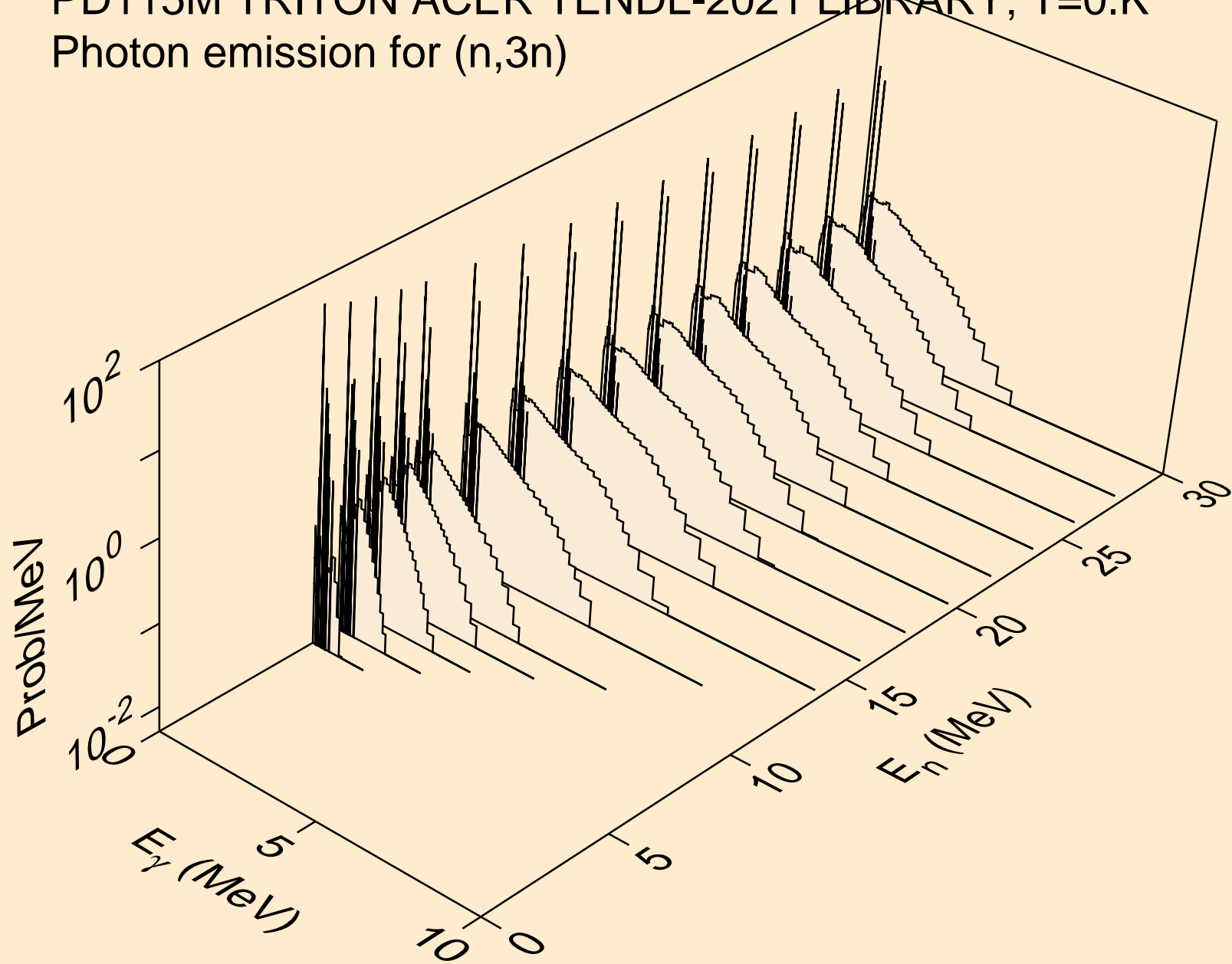

PD115M TRITON ACER TENDL-2021 LIBRARY; T=0.K  
Photon emission for (n,n\*)a

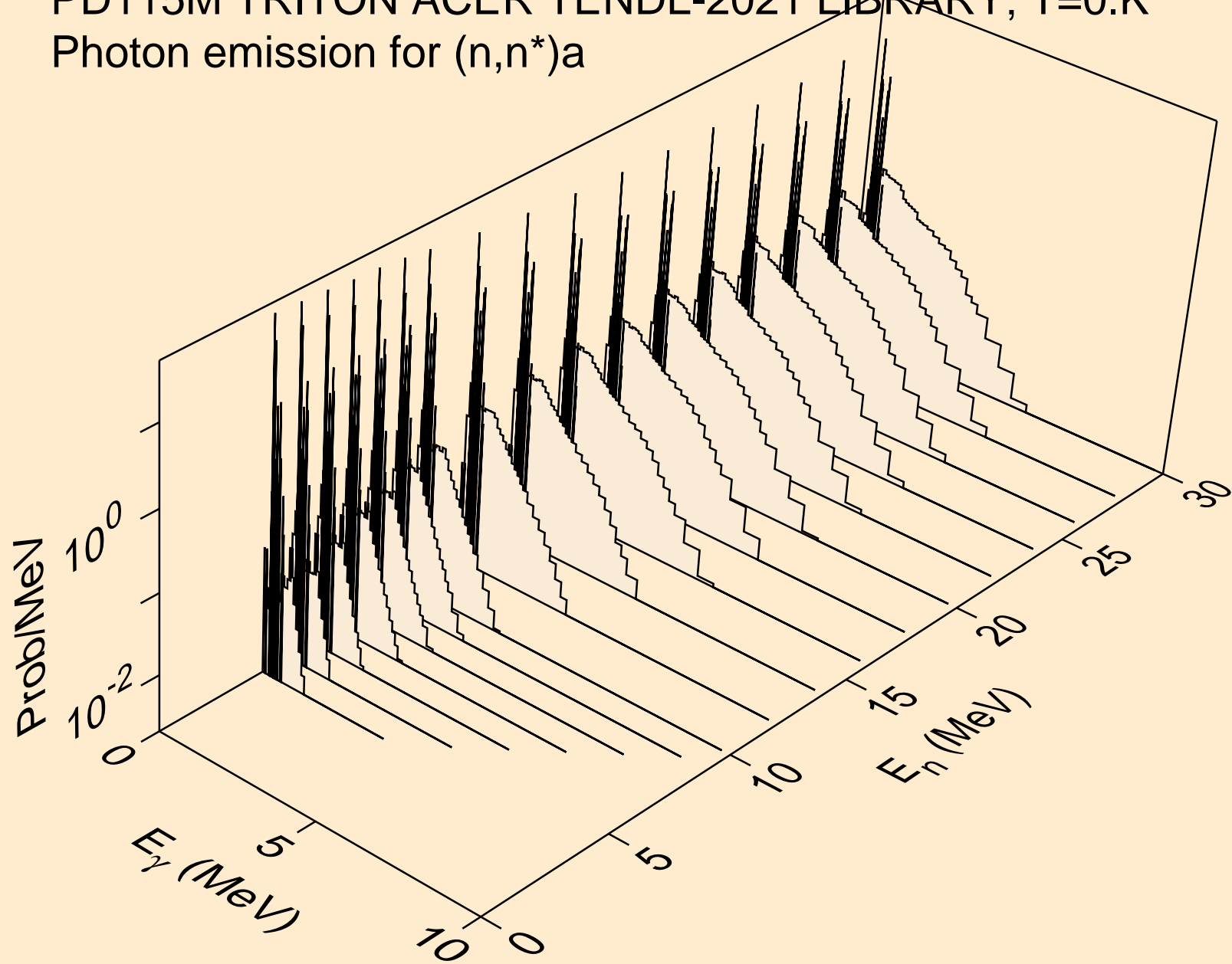

PD115M TRITON ACER TENDL-2021 LIBRARY; T=0.K  
Photon emission for (n,2n) $\alpha$

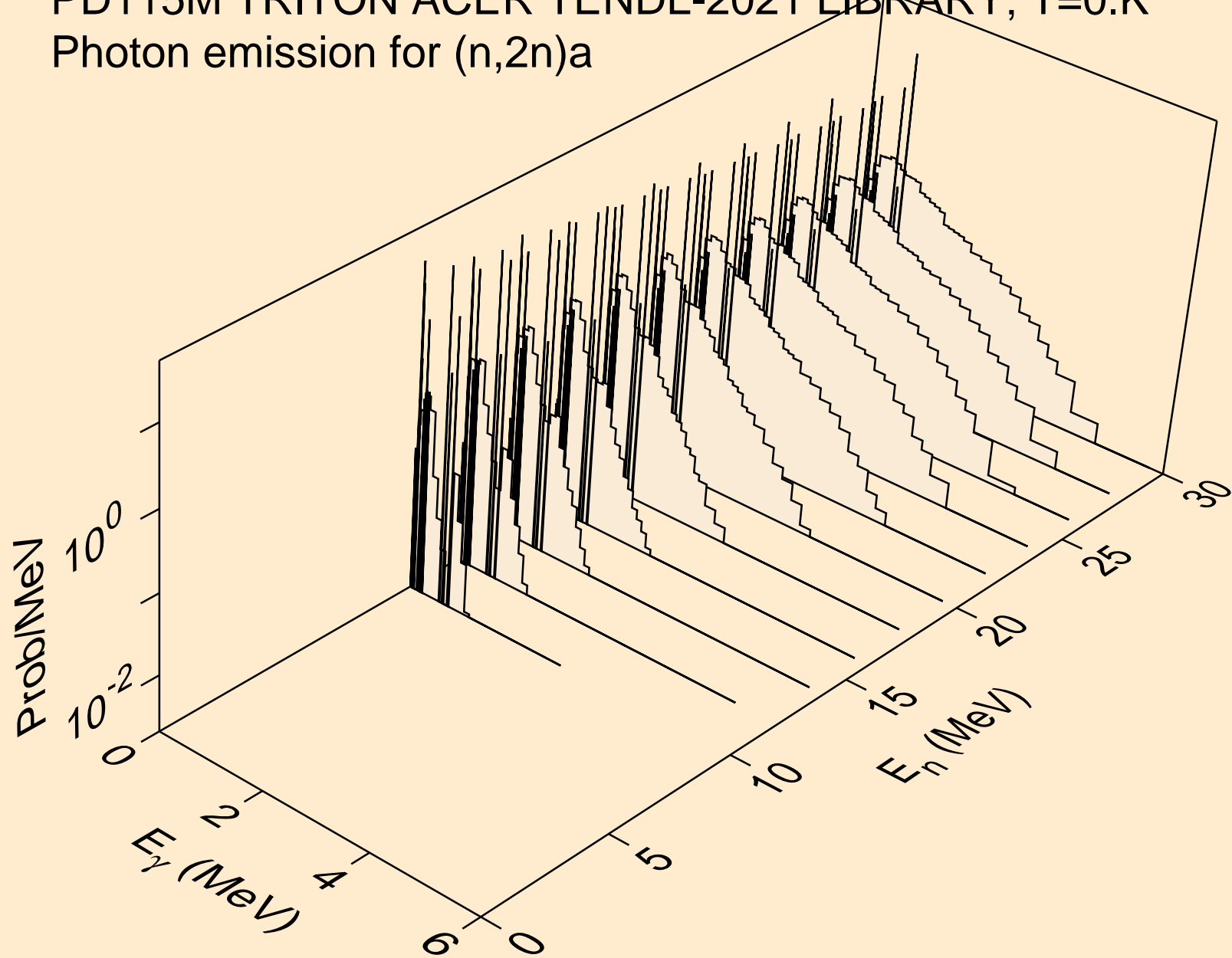

PD115M TRITON ACER TENDL-2021 LIBRARY; T=0.K  
Photon emission for (n,3n)a

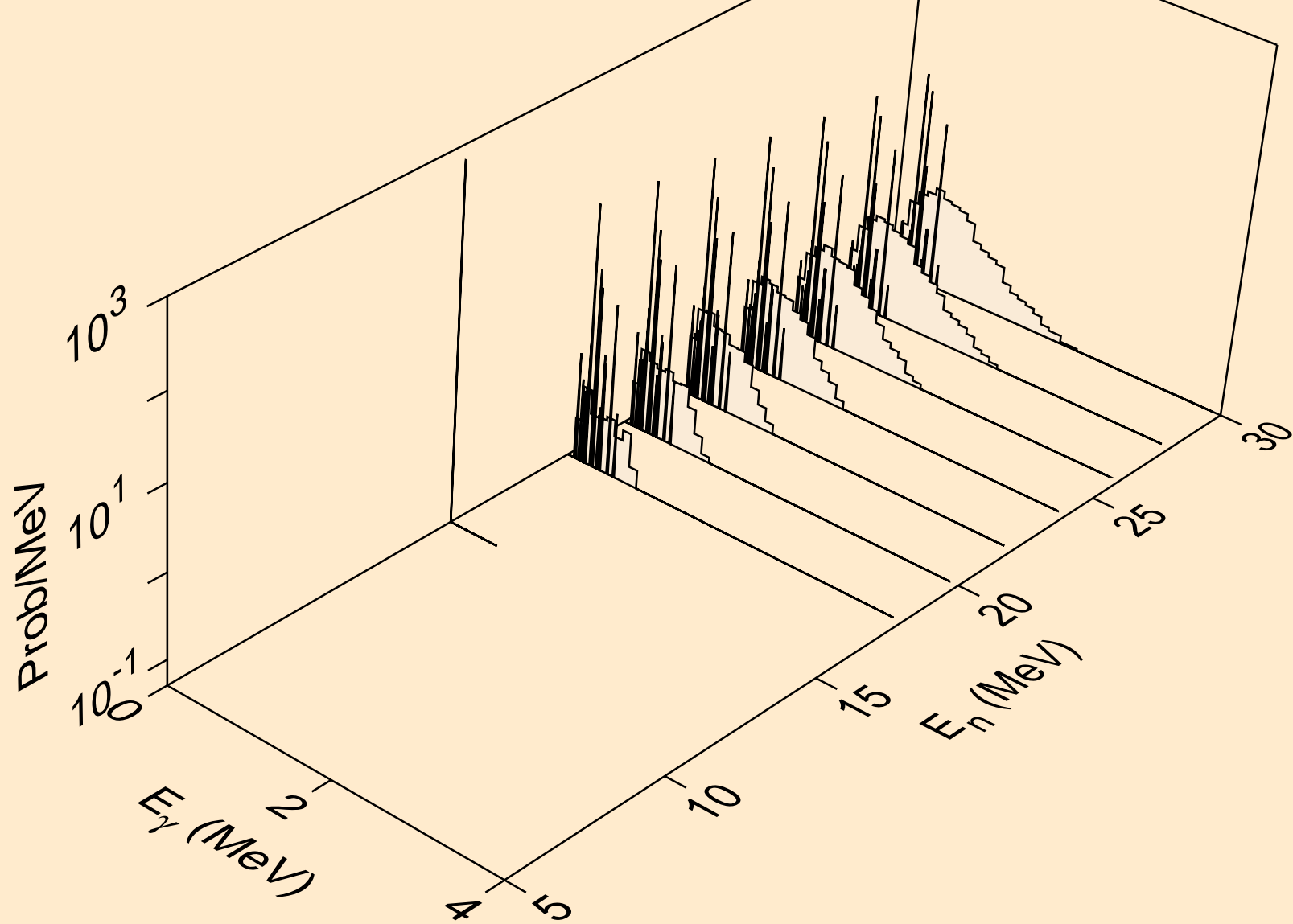

PD115M TRITON ACER TENDL-2021 LIBRARY; T=0.K  
Photon emission for (n,n\*)p

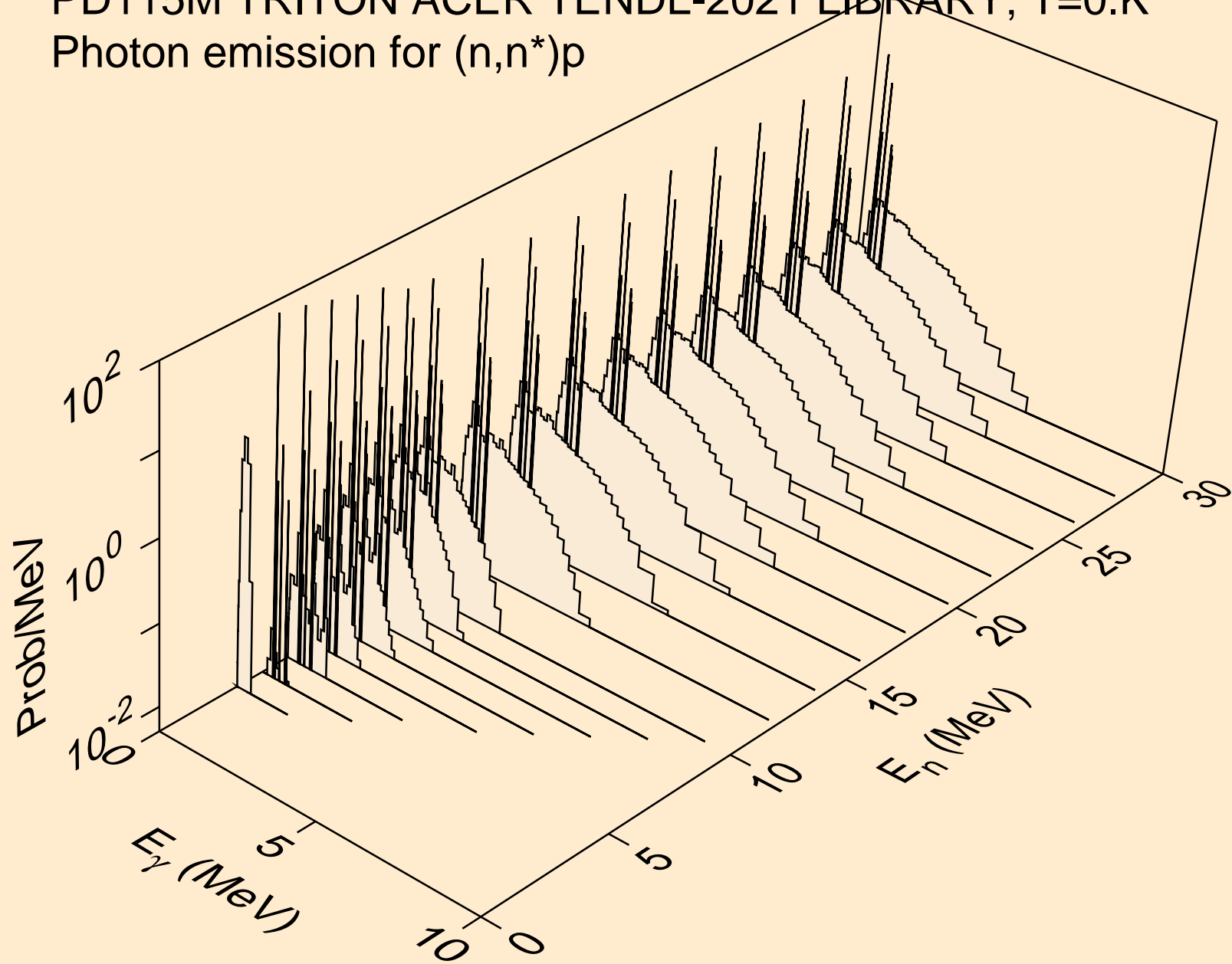

PD115M TRITON ACER TENDL-2021 LIBRARY; T=0.K  
Photon emission for (n,n\*)2a

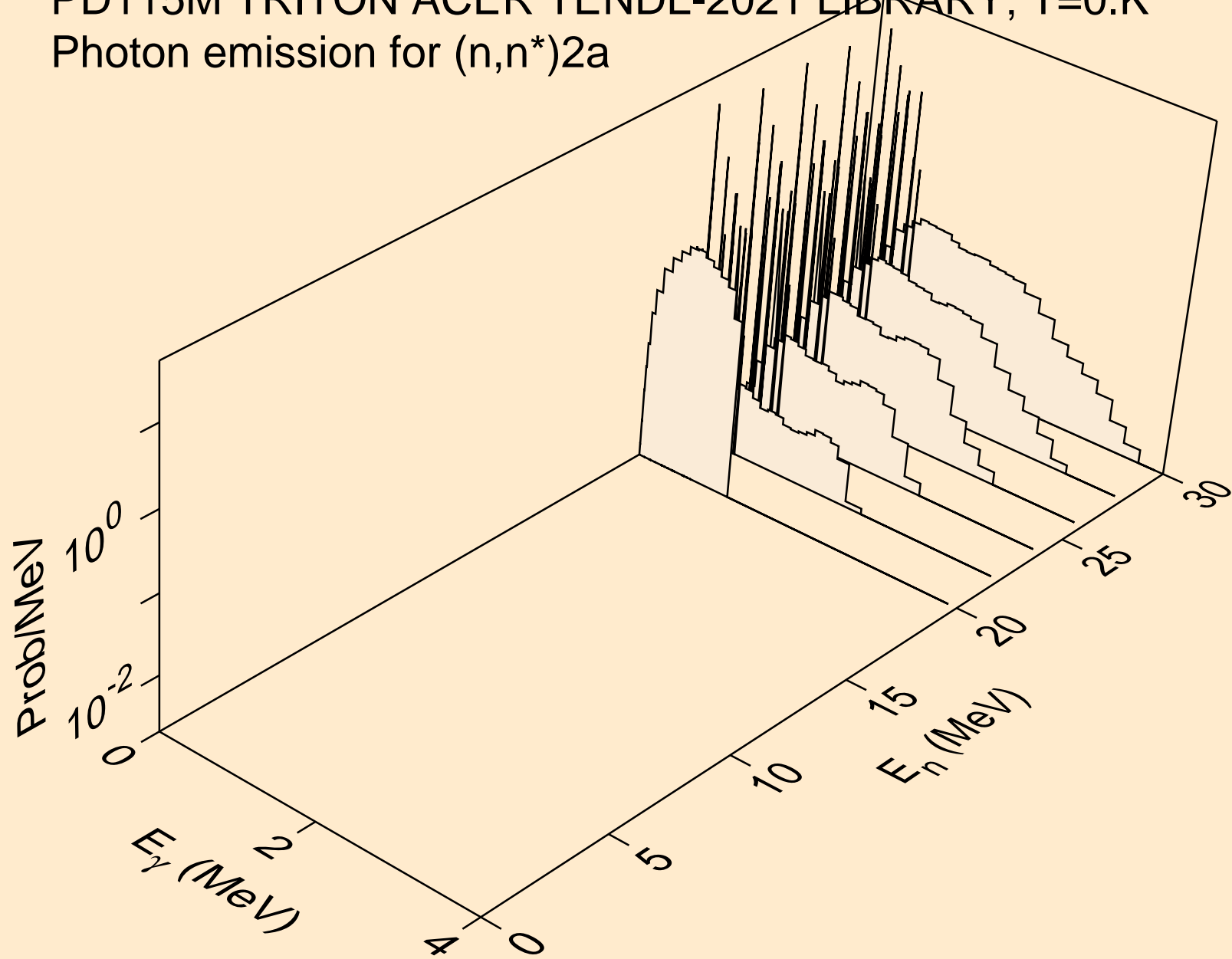

PD115M TRITON ACER TENDL-2021 LIBRARY; T=0.K  
Photon emission for (n,n\*)d

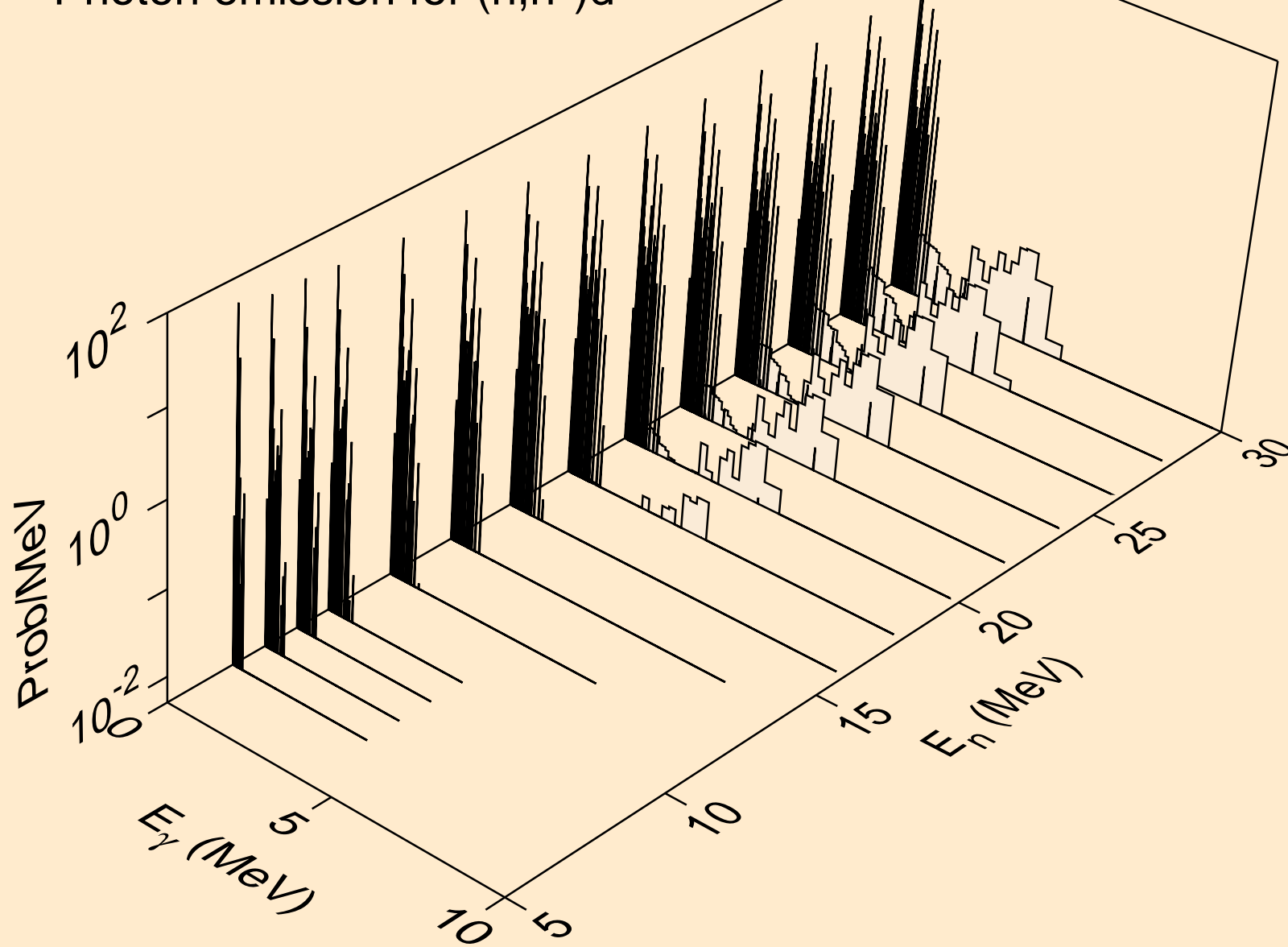



PD115M TRITON ACER TENDL-2021 LIBRARY; T=0.K  
Photon emission for (n,n\*)t

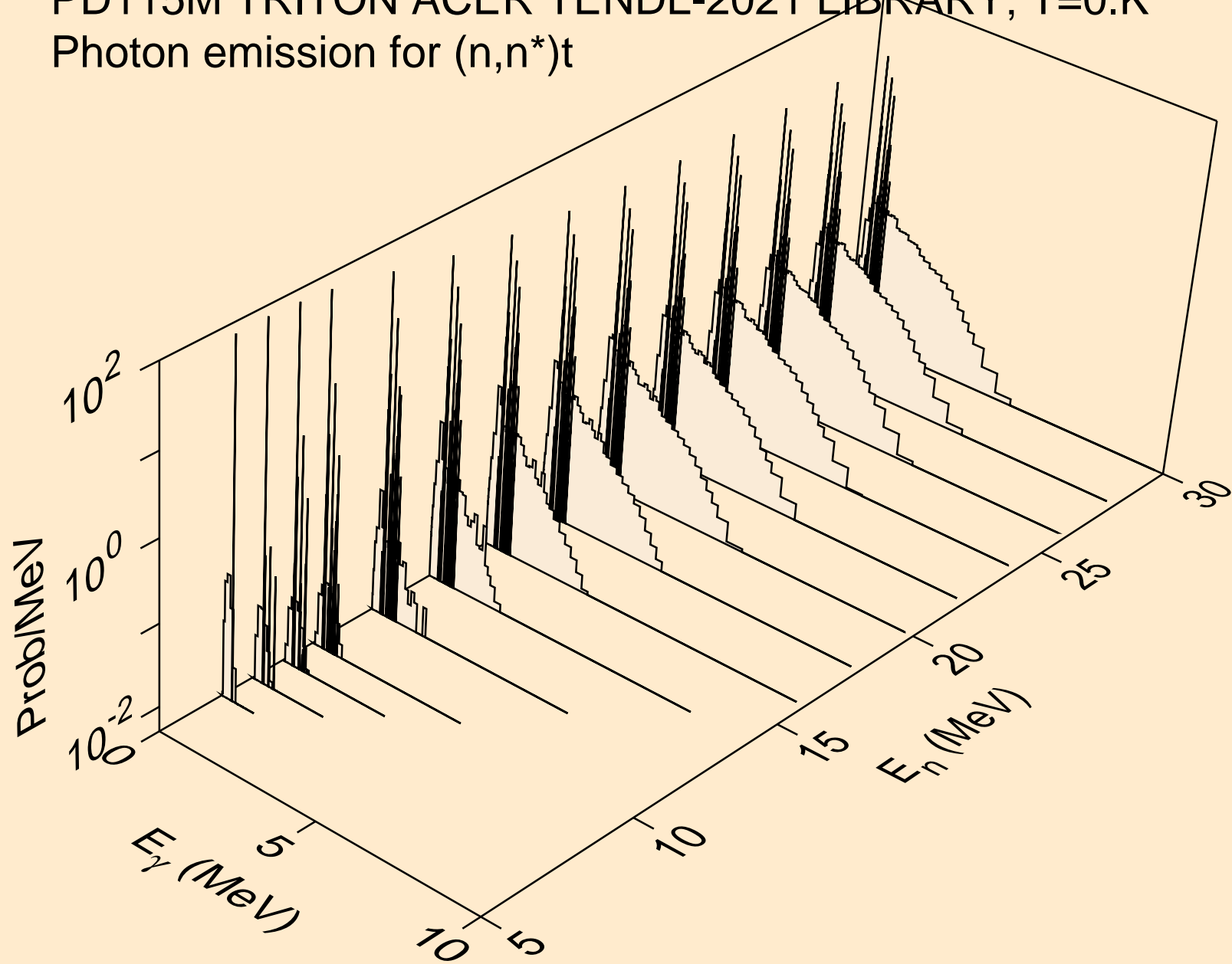

PD115M TRITON ACER TENDL-2021 LIBRARY; T=0.K  
Photon emission for (n,n\*)he3

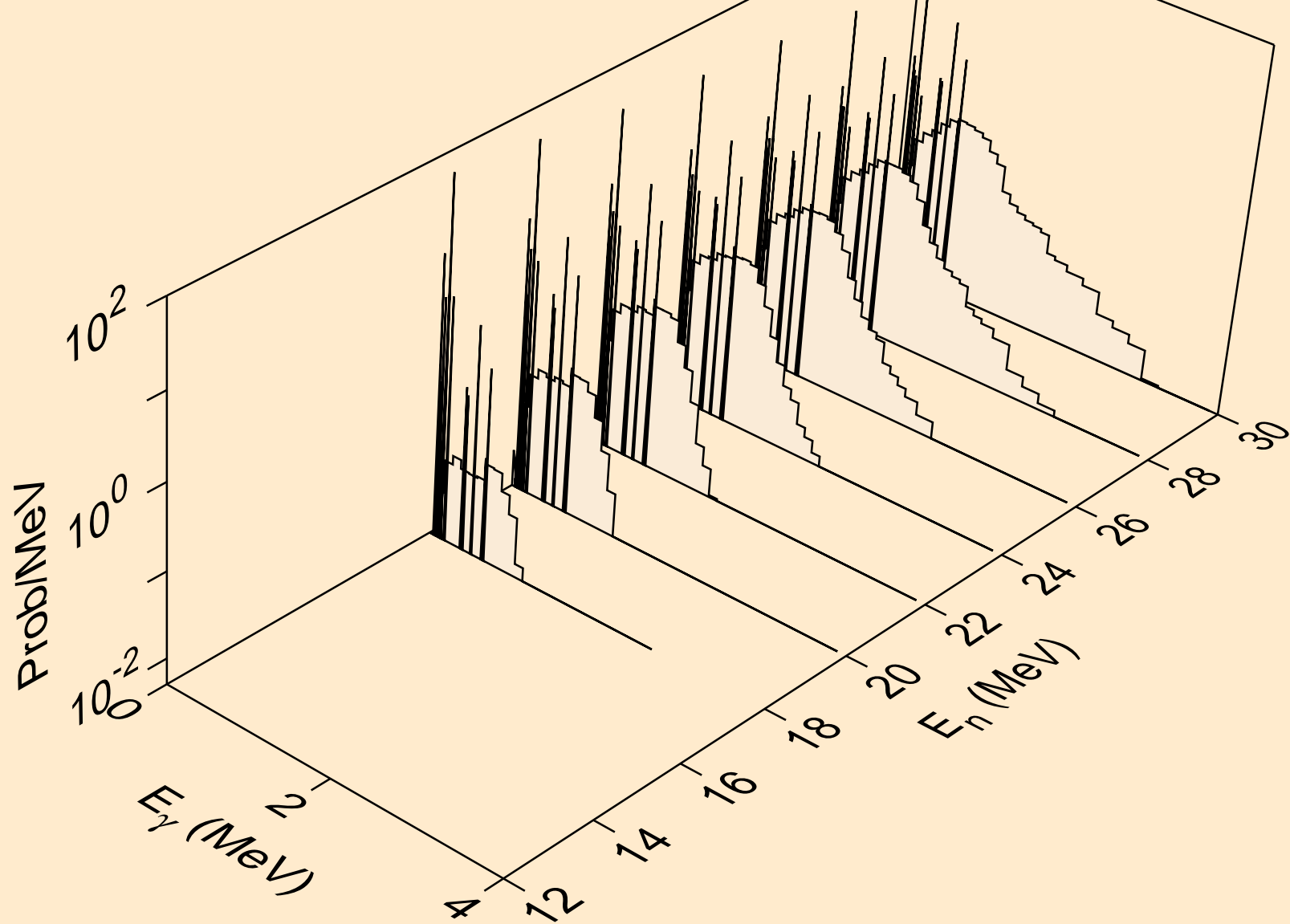

PD115M TRITON ACER TENDL-2021 LIBRARY; T=0.K  
Photon emission for (n,4n)

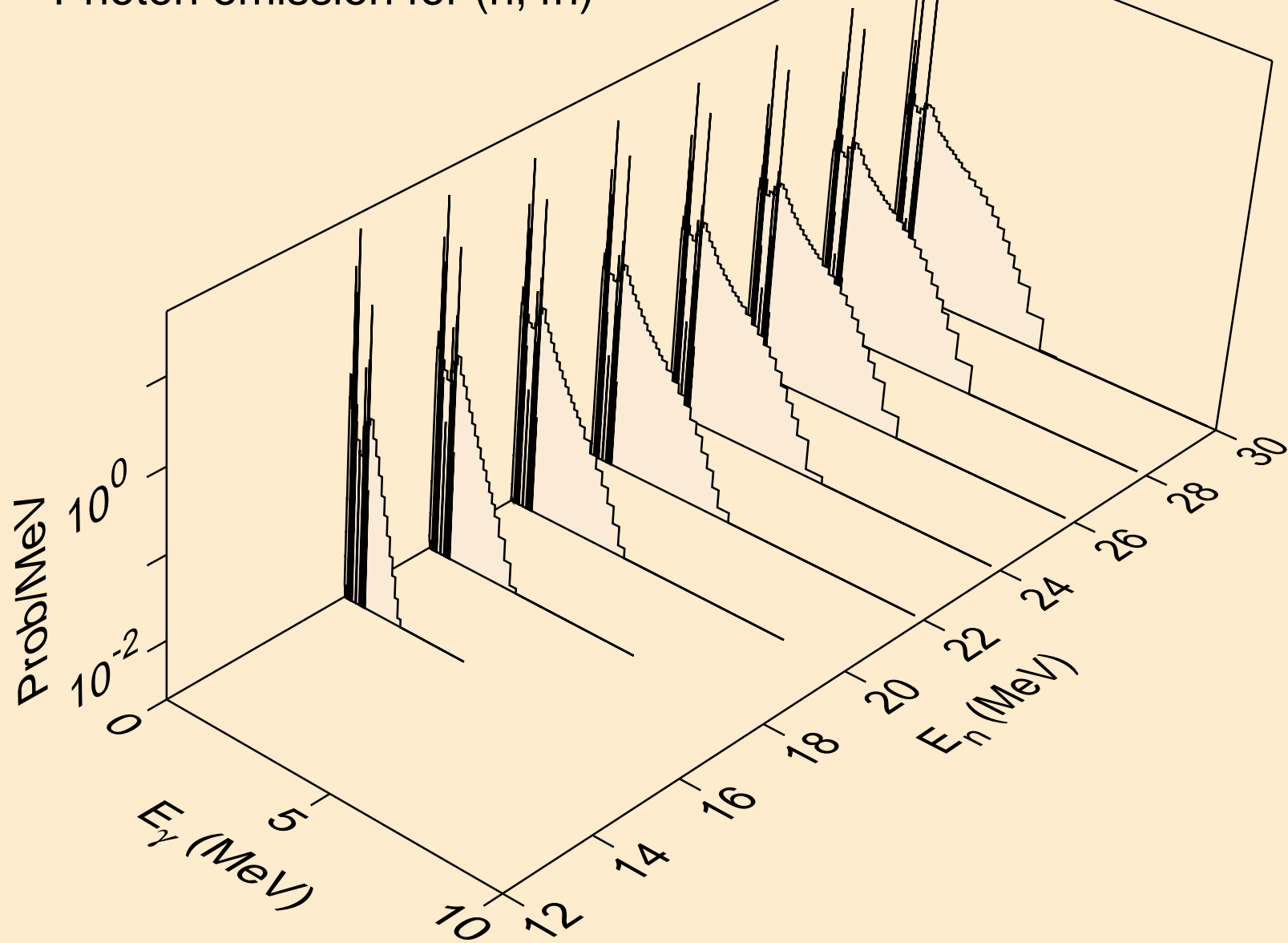

PD115M TRITON ACER TENDL-2021 LIBRARY; T=0.K  
Photon emission for (n,2np)

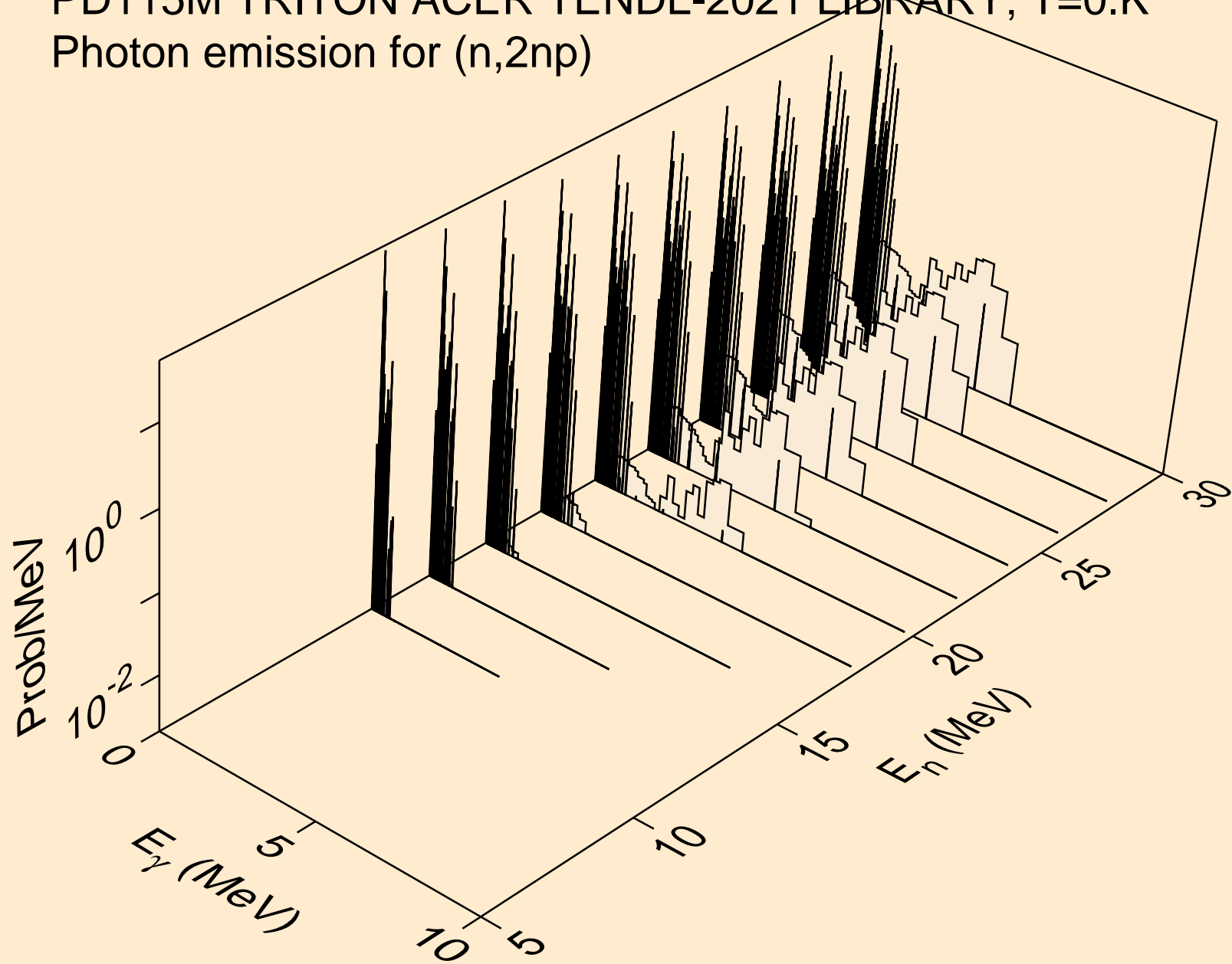

PD115M TRITON ACER TENDL-2021 LIBRARY; T=0.K  
Photon emission for (n,3np)

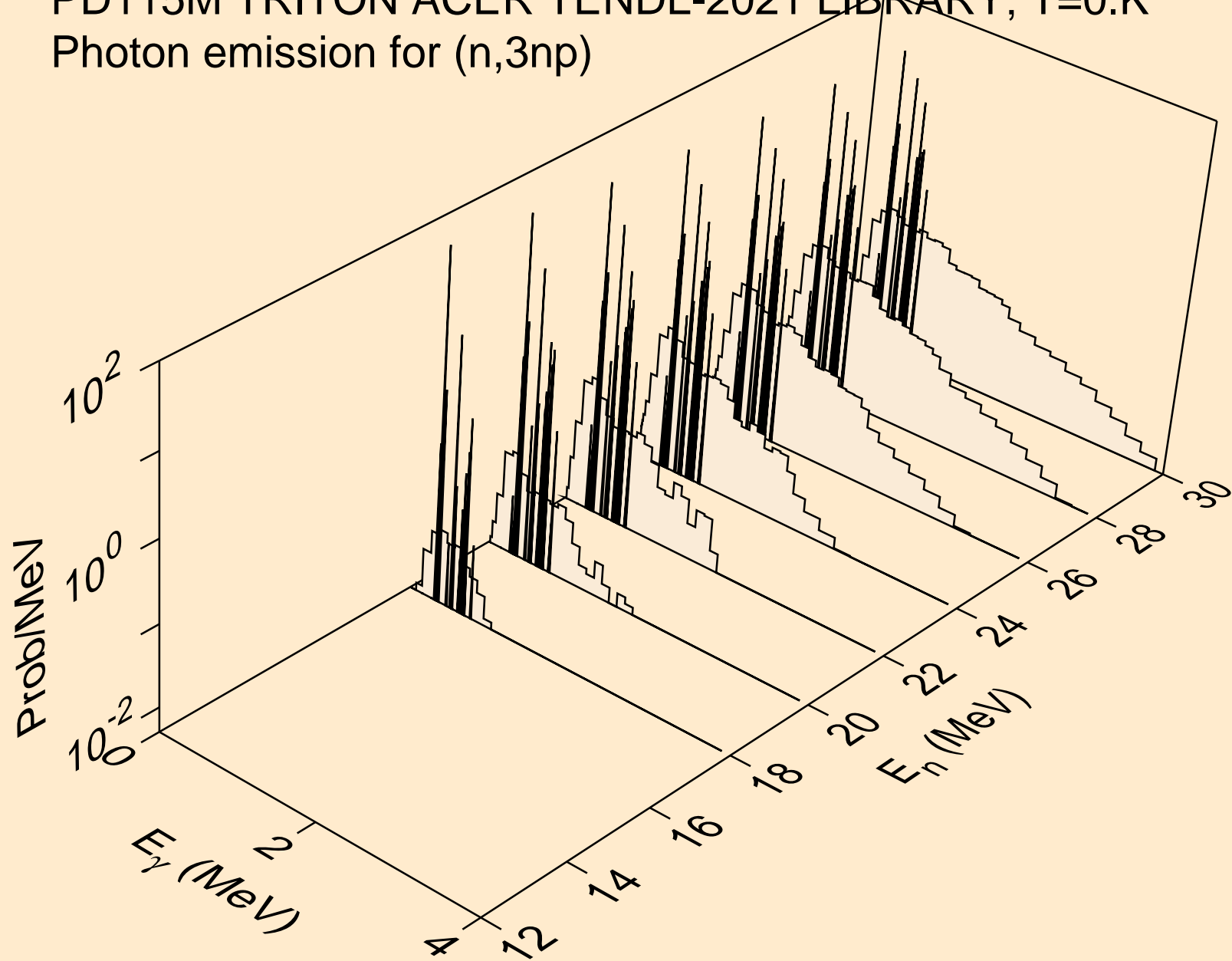

PD115M TRITON ACER TENDL-2021 LIBRARY; T=0.K  
Photon emission for (n,2np)

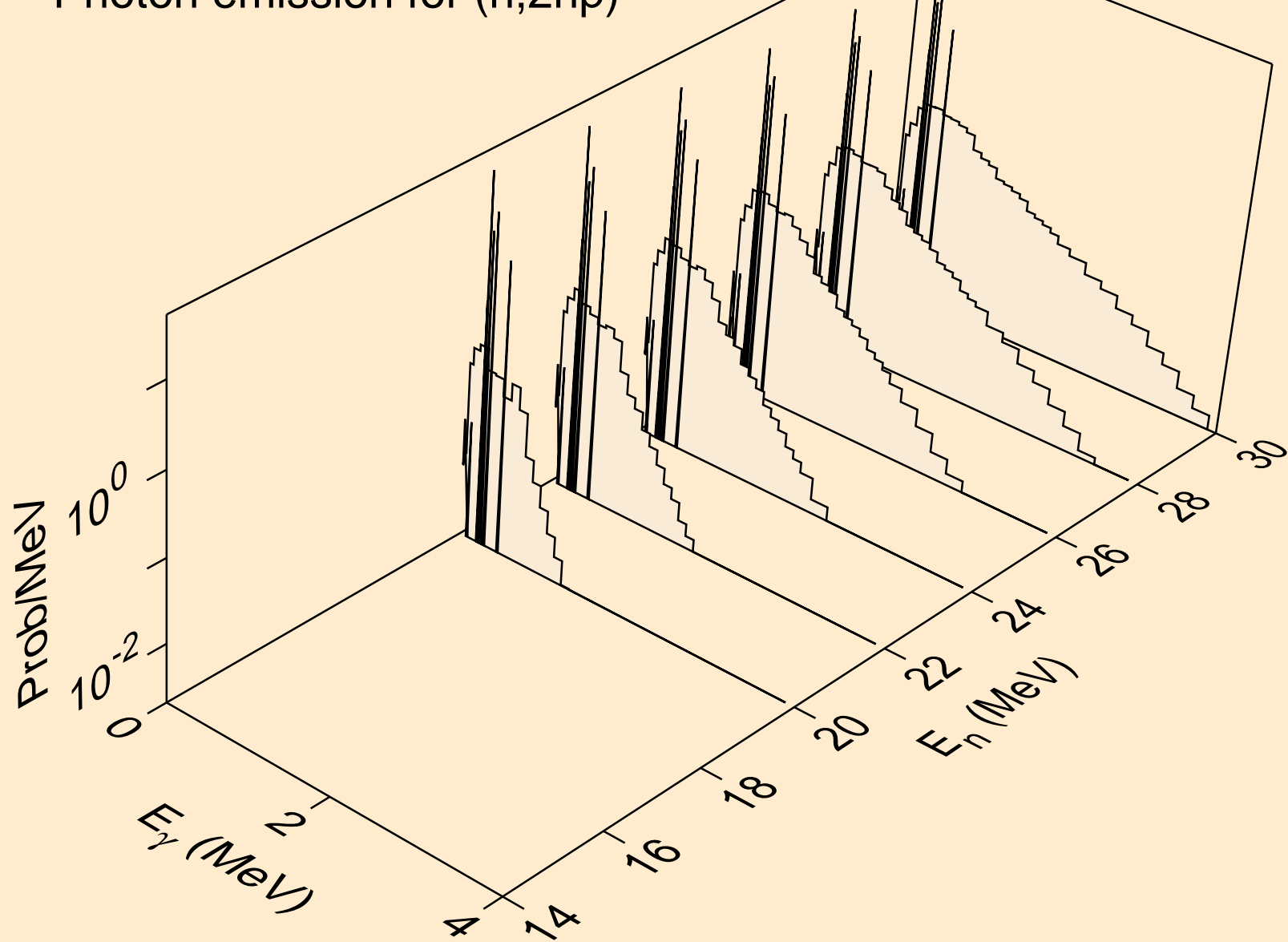

PD115M TRITON ACER TENDL-2021 LIBRARY; T=0.K  
Photon emission for (n,npa)

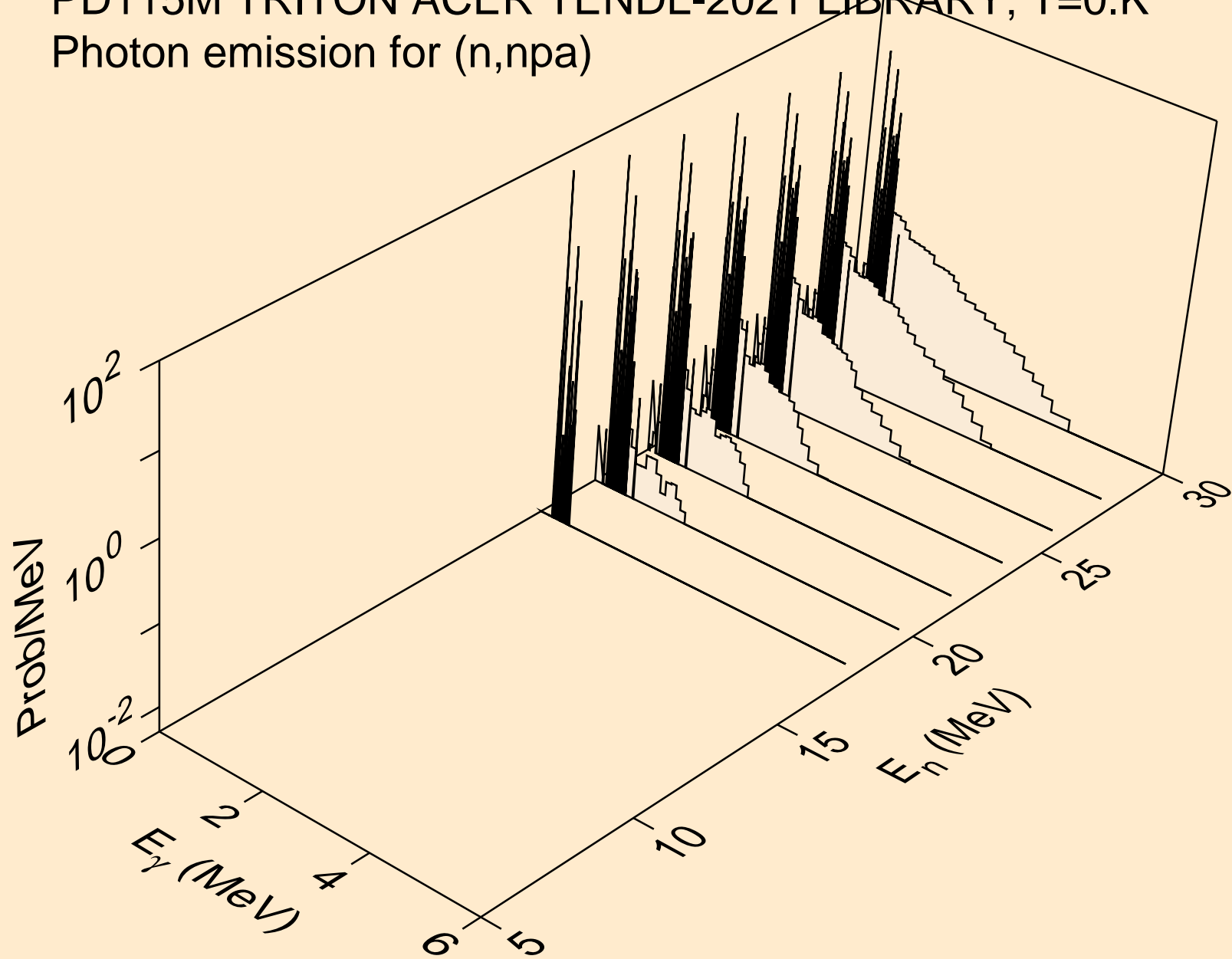

PD115M TRITON ACER TENDL-2021 LIBRARY; T=0.K  
Photon emission for (n,gma)

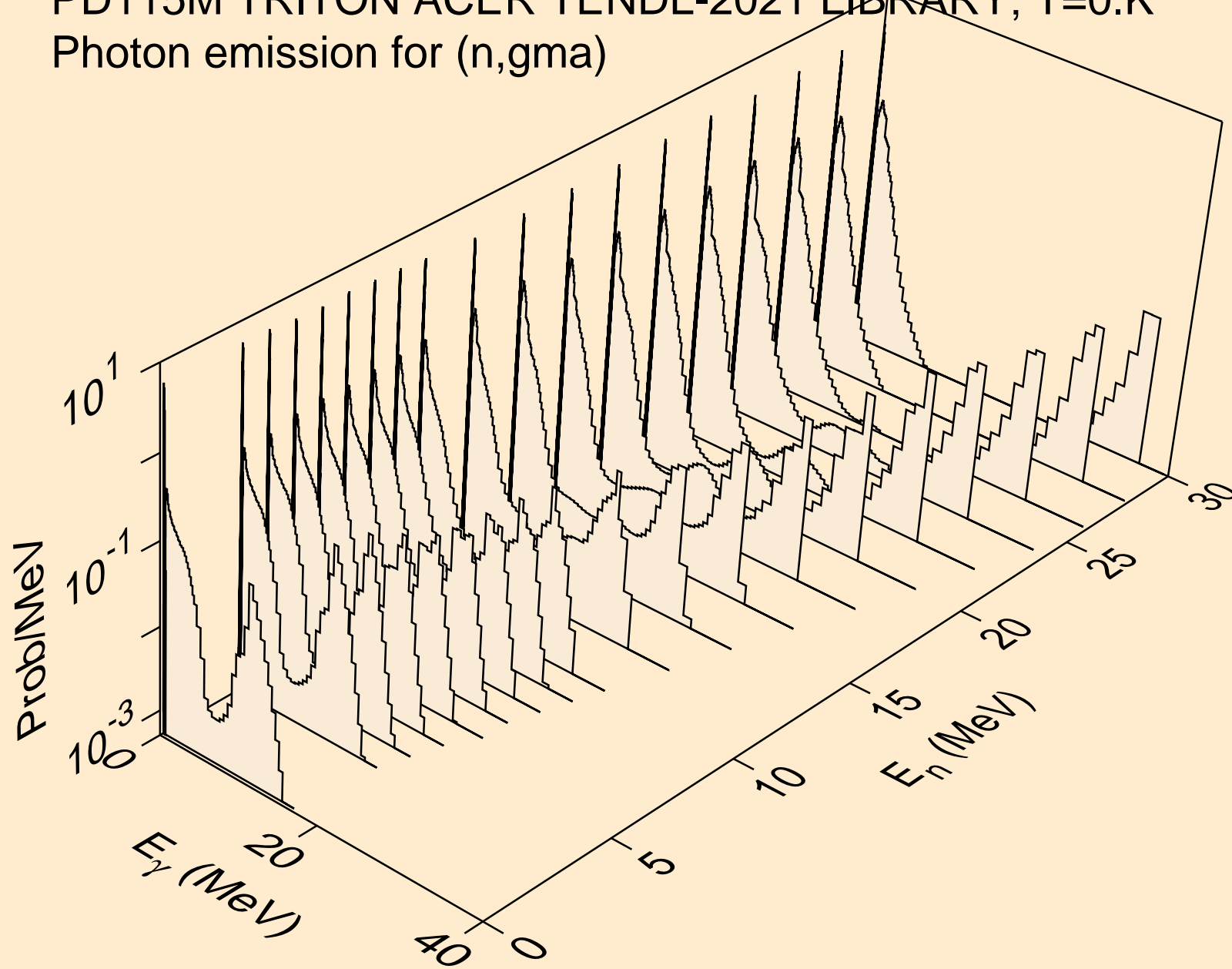



PD115M TRITON ACER TENDL-2021 LIBRARY; T=0.K  
Photon emission for (n,p)

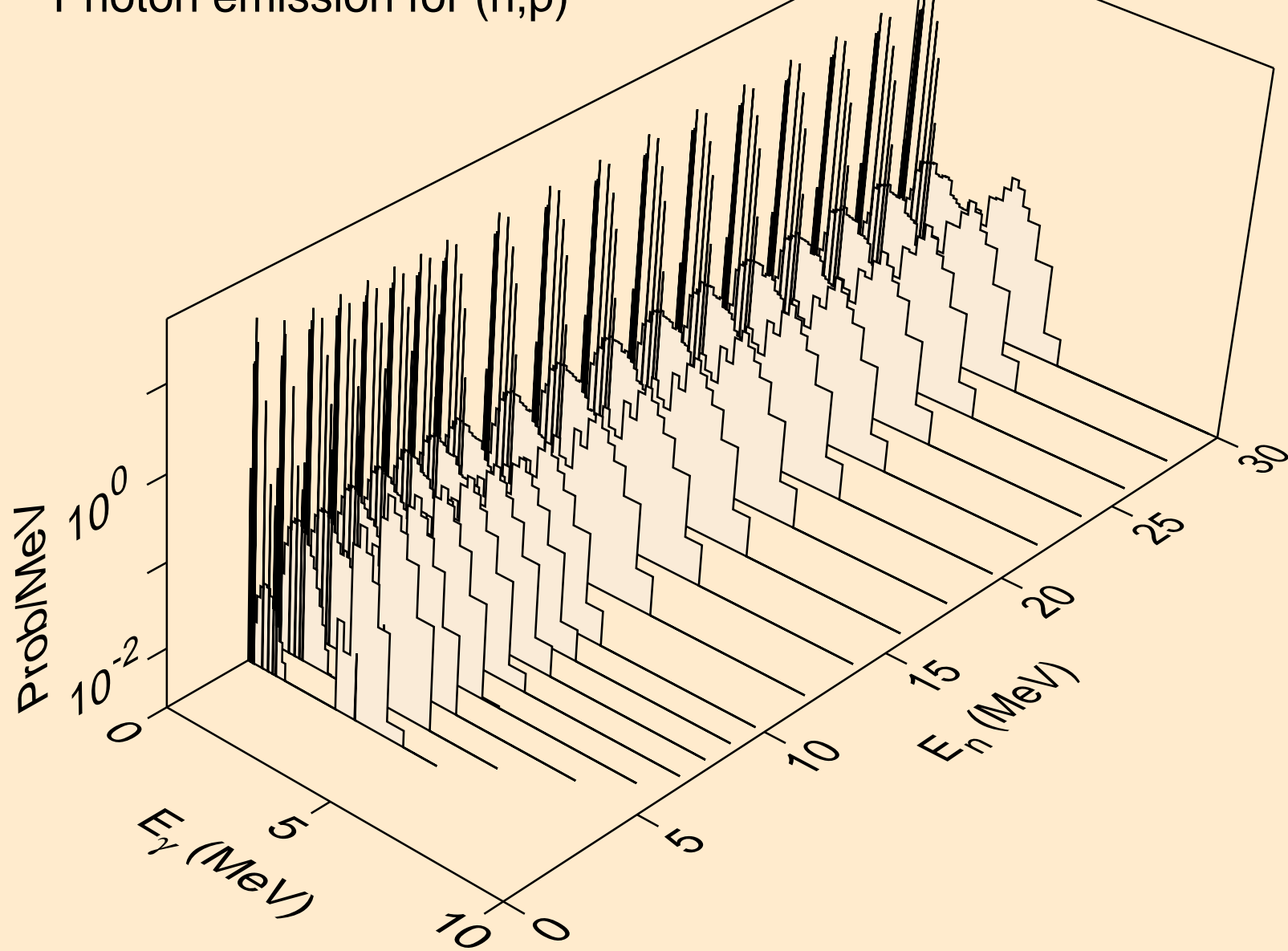

PD115M TRITON ACER TENDL-2021 LIBRARY; T=0.K  
Photon emission for (n,d)

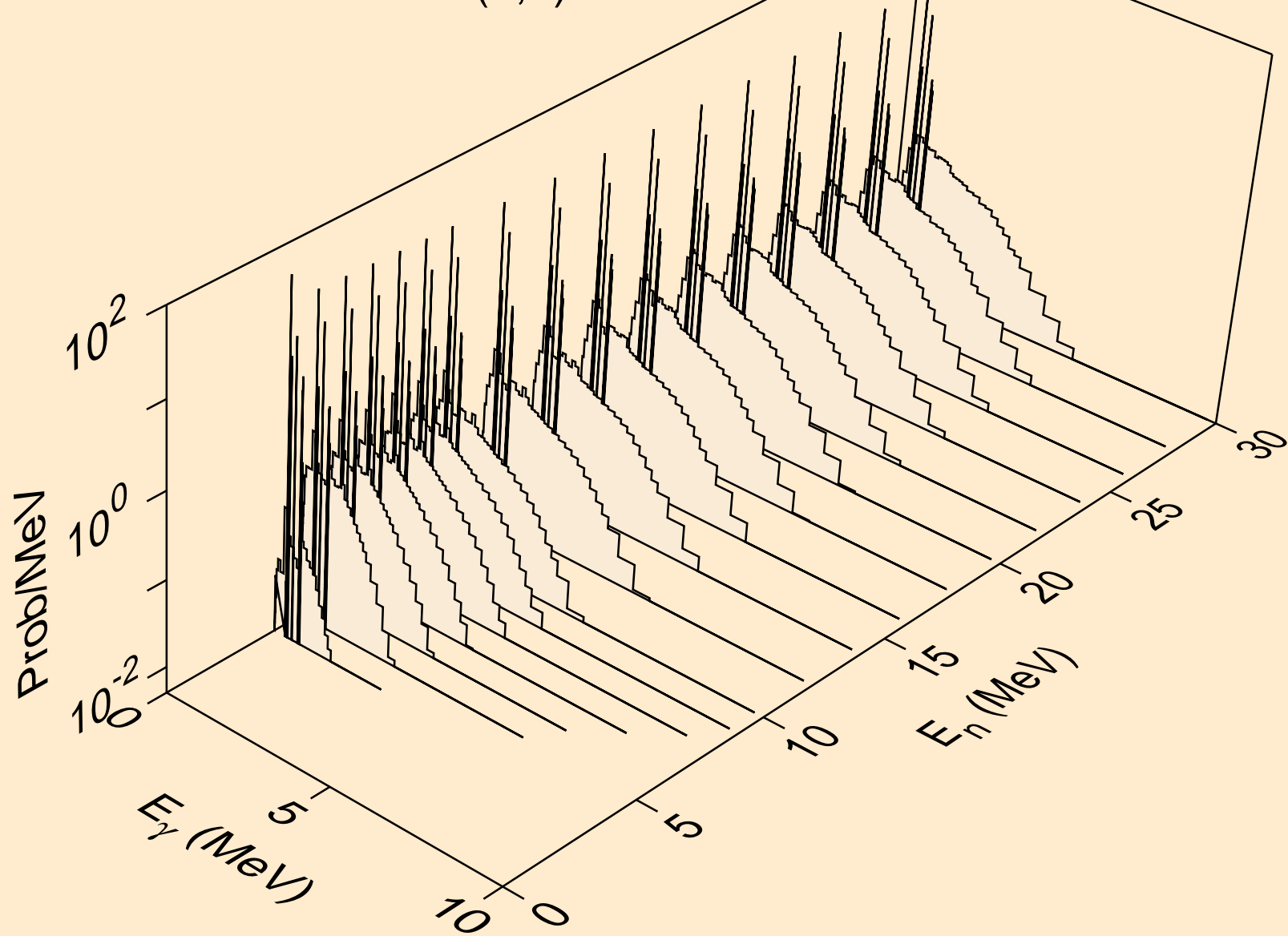

PD115M TRITON ACER TENDL-2021 LIBRARY; T=0.K  
Photon emission for inelastic

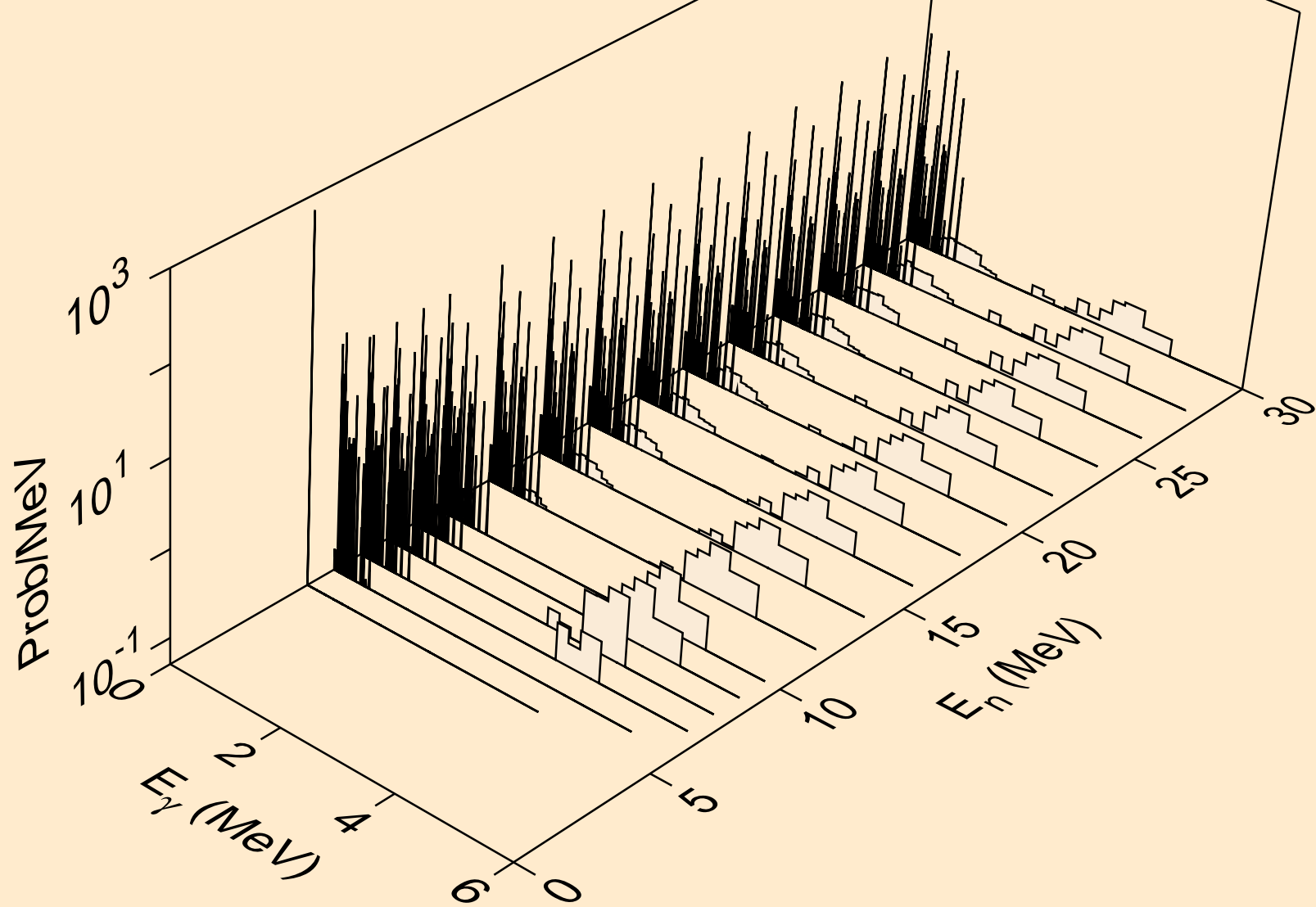

PD115M TRITON ACER TENDL-2021 LIBRARY; T=0.K  
Photon emission for (n,he3)

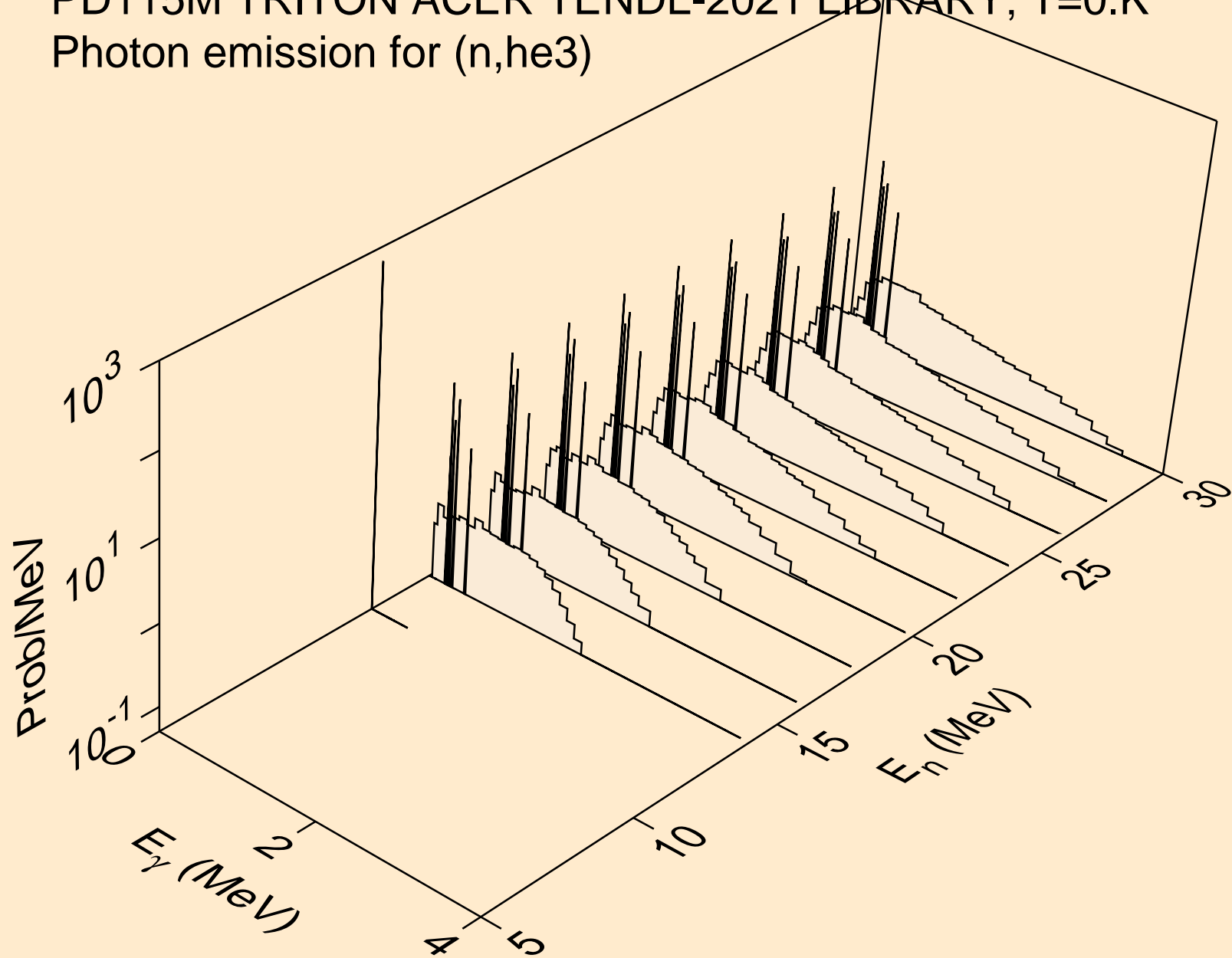

PD115M TRITON ACER TENDL-2021 LIBRARY; T=0.K  
Photon emission for (n,a)

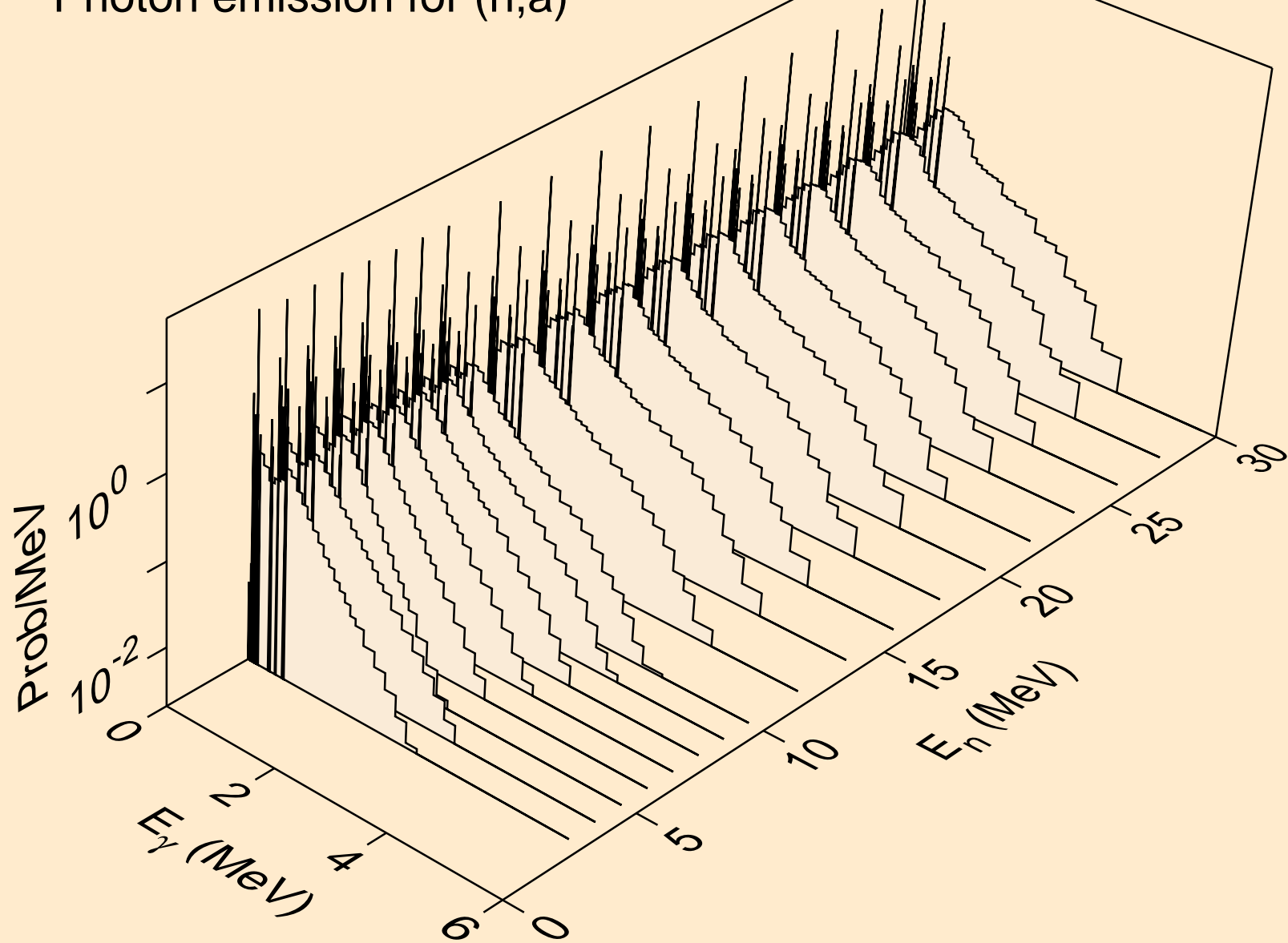

PD115M TRITON ACER TENDL-2021 LIBRARY; T=0.K  
Photon emission for (n,2p)

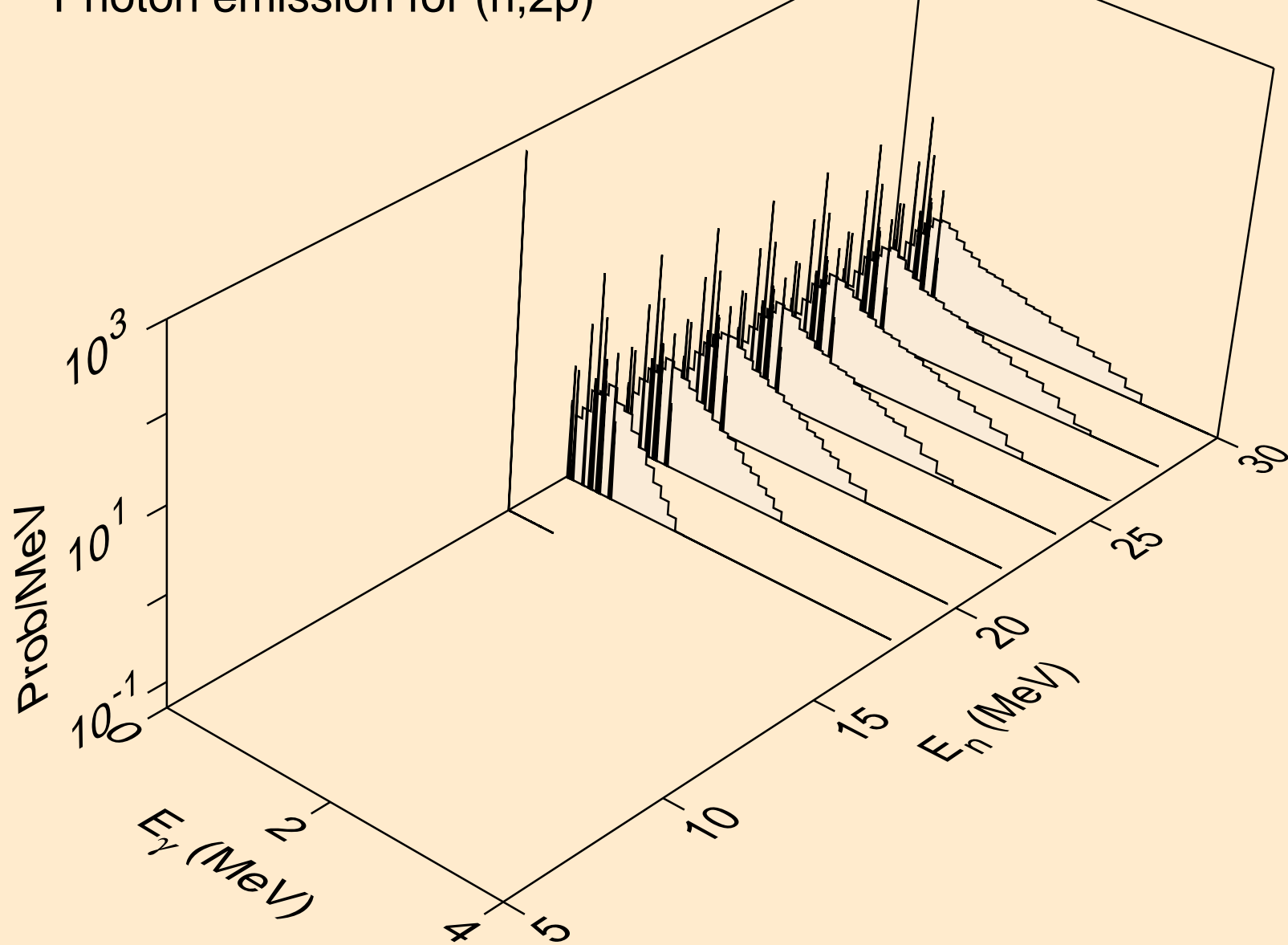

PD115M TRITON ACER TENDL-2021 LIBRARY; T=0.K  
Photon emission for (n,pa)

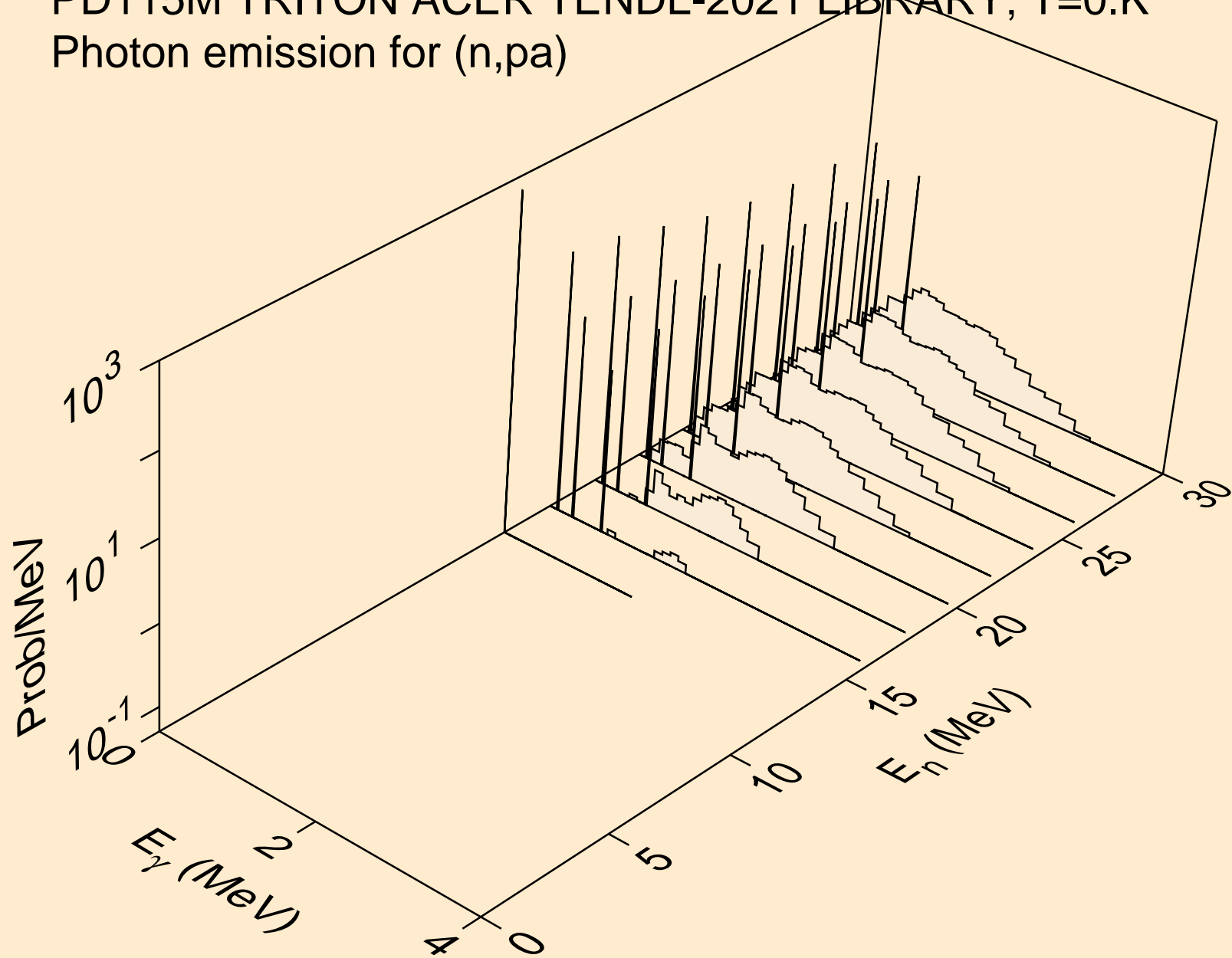

PD115M TRITON ACER TENDL-2021 LIBRARY; T=0.K  
Photon emission for (n,pd)

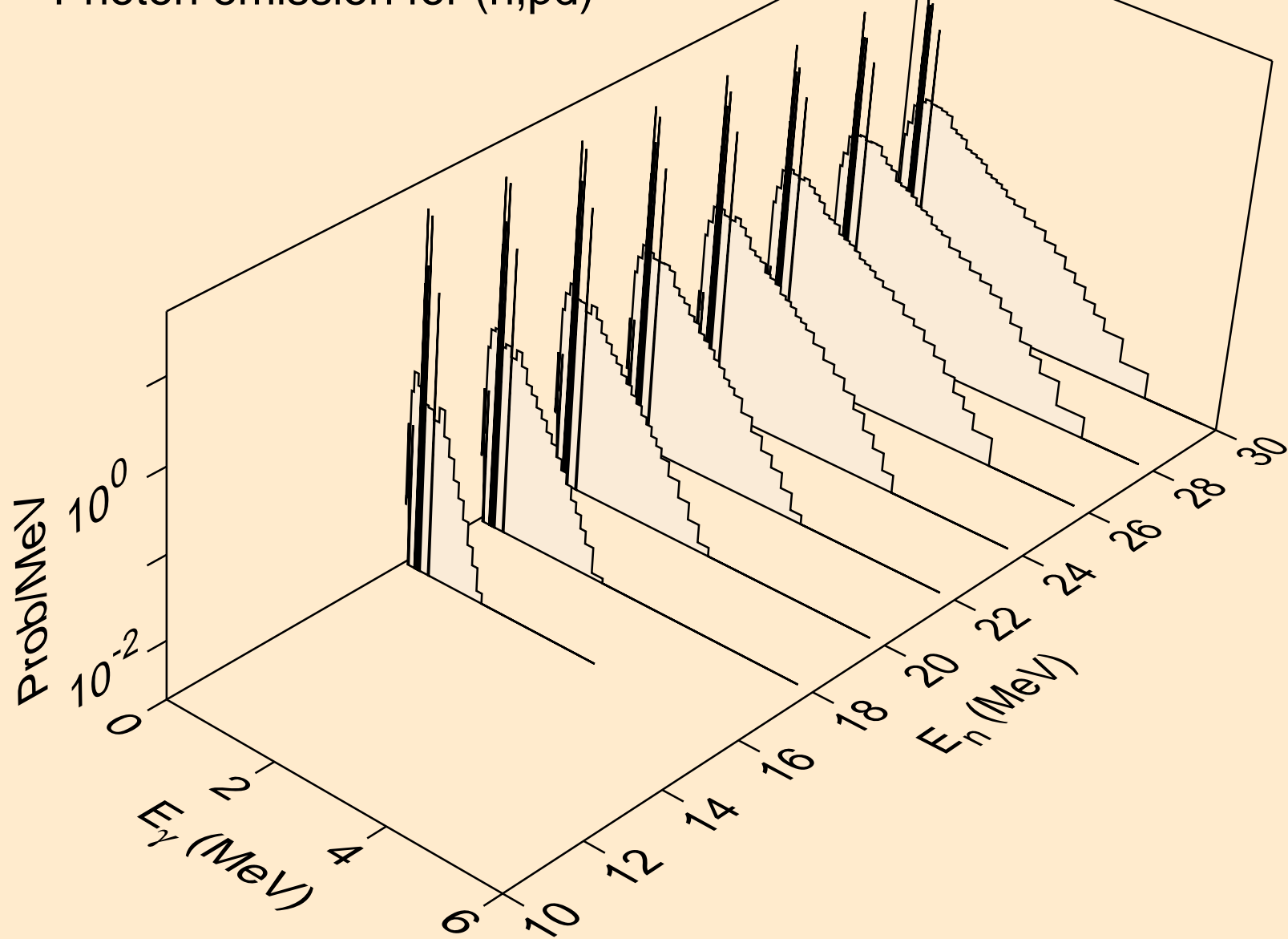



PD115M TRITON ACER TENDL-2021 LIBRARY; T=0.K  
Photon emission for (n,pt)

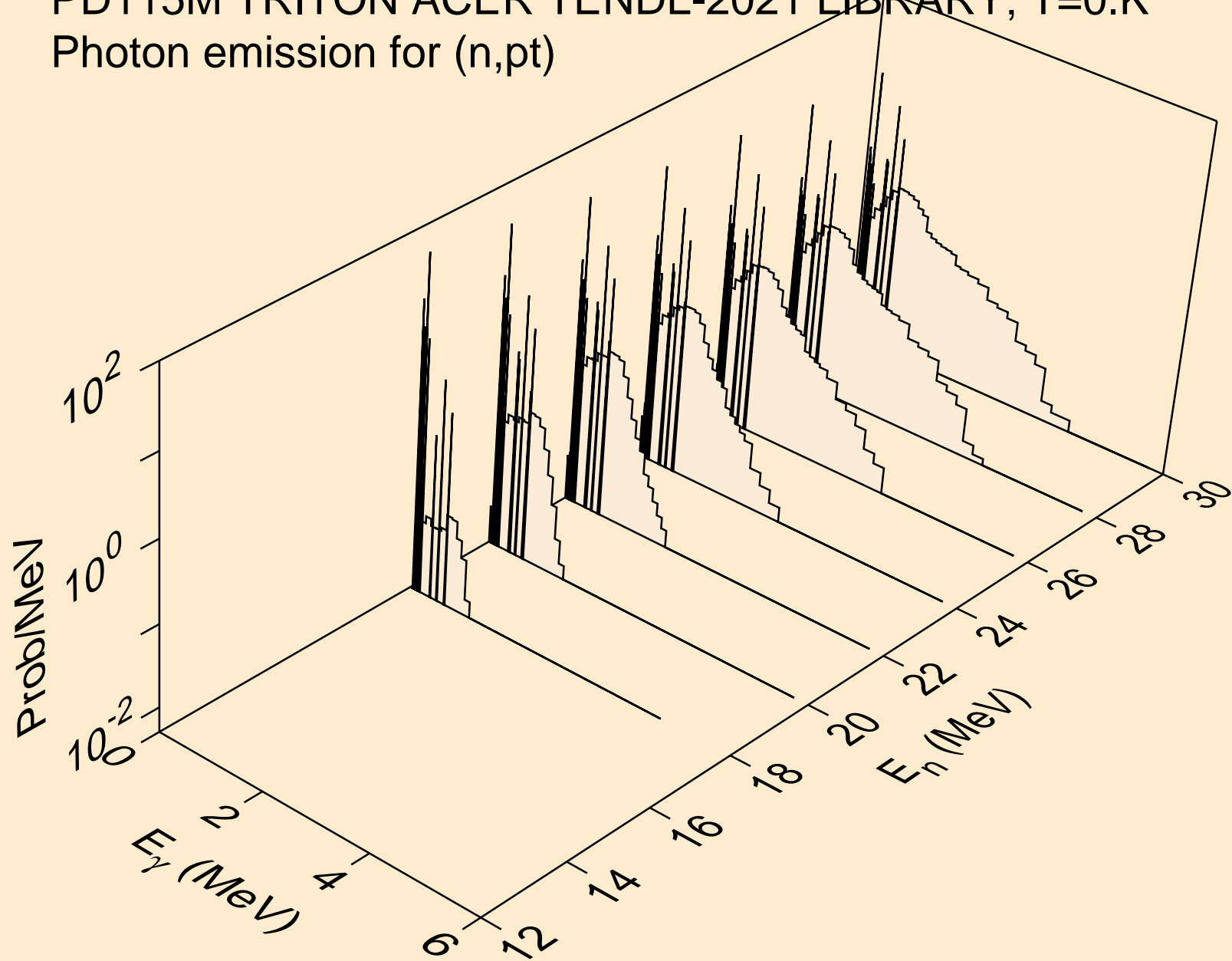

PD115M TRITON ACER TENDL-2021 LIBRARY; T=0.K  
Particle heating contributions

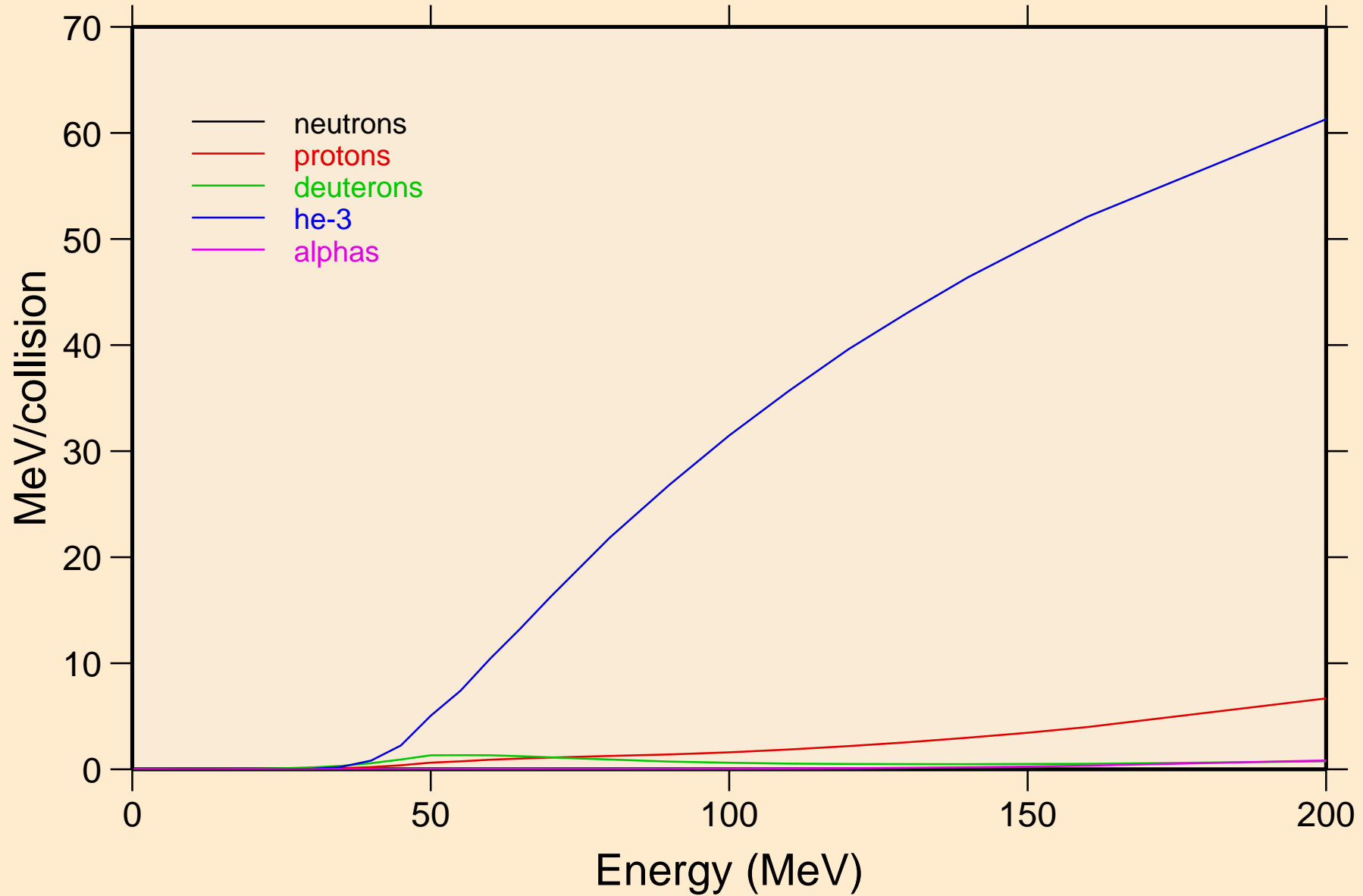

PD115M TRITON ACER TENDL-2021 LIBRARY; T=0.K  
Recoil Heating

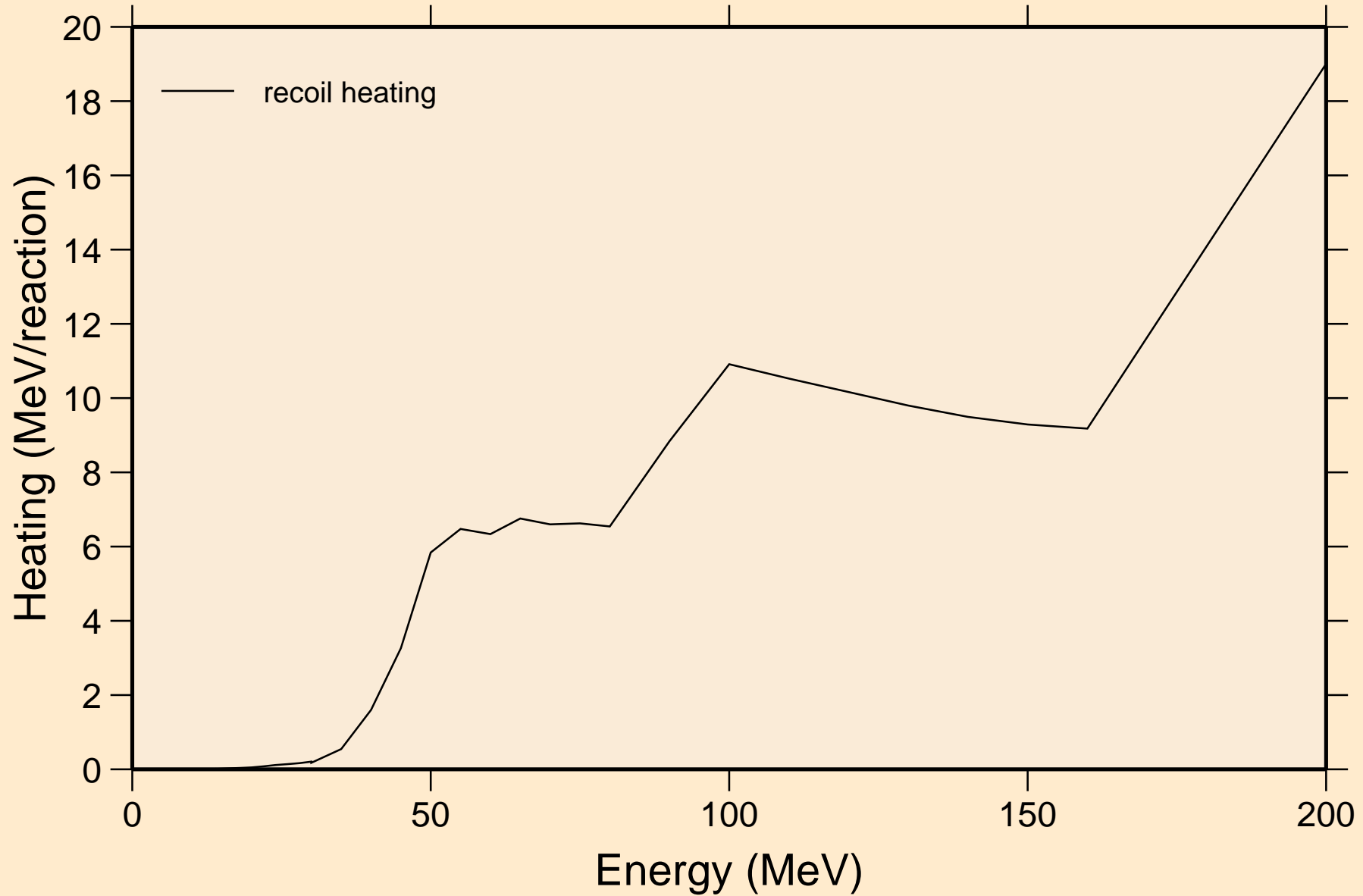

PD115M TRITON ACER TENDL-2021 LIBRARY; T=0.K  
Particle production cross sections

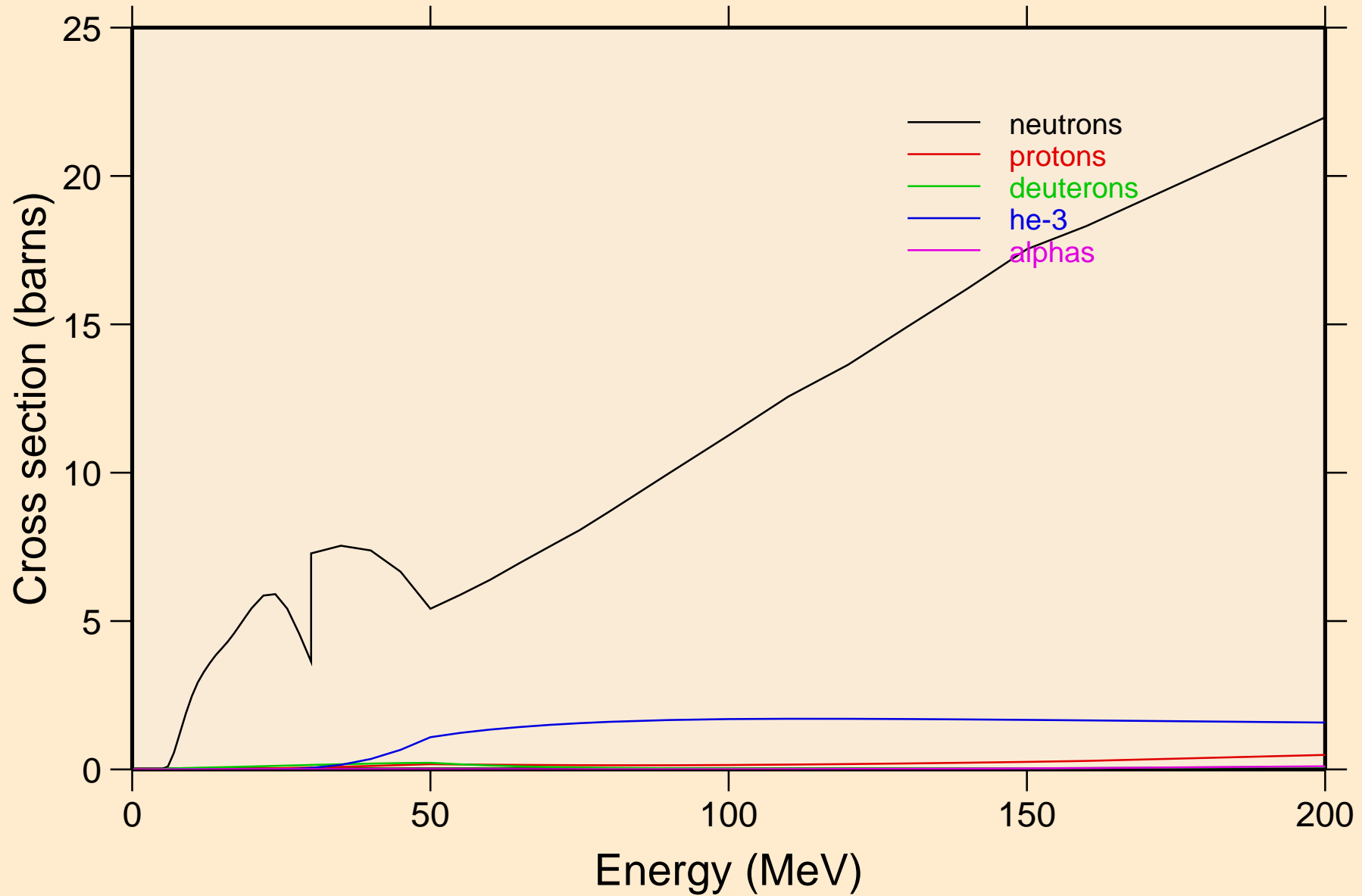

PD115M TRITON ACER TENDL-2021 LIBRARY; T=0.K  
neutrons from (t,n)

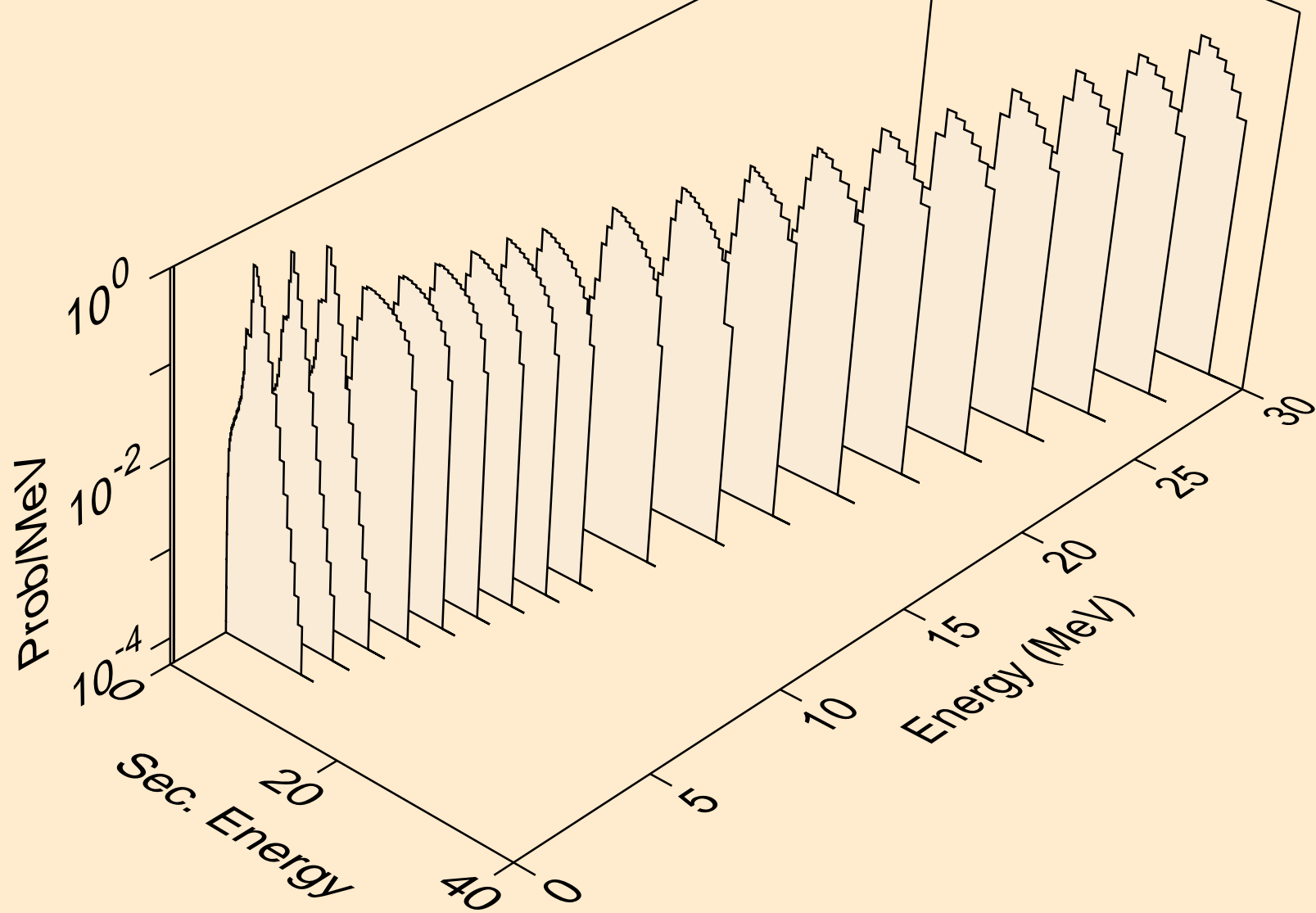

PD115M TRITON ACER TENDL-2021 LIBRARY; T=0.K  
neutrons from (t,x)

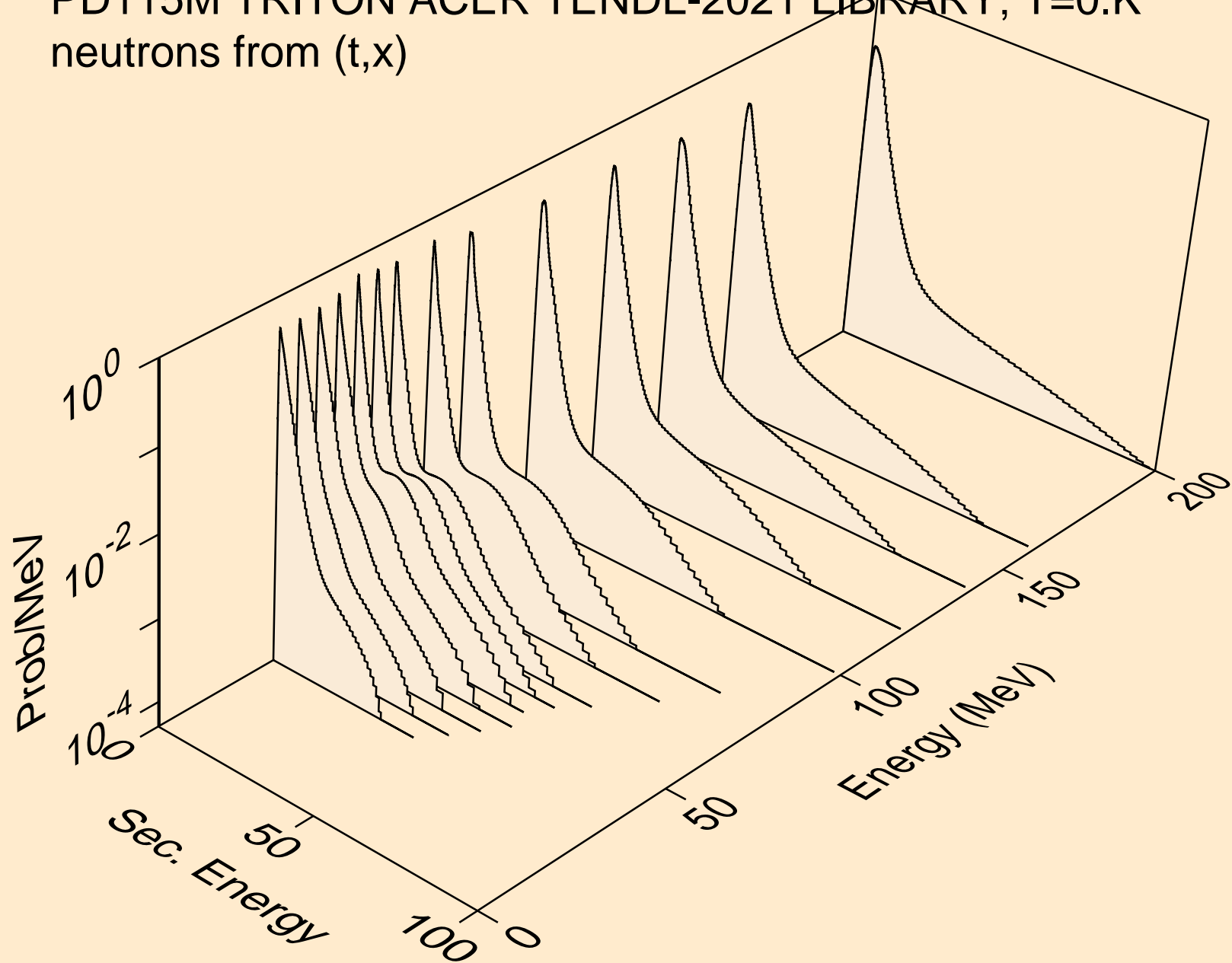

PD115M TRITON ACER TENDL-2021 LIBRARY; T=0.K  
neutrons from (t,2nd)

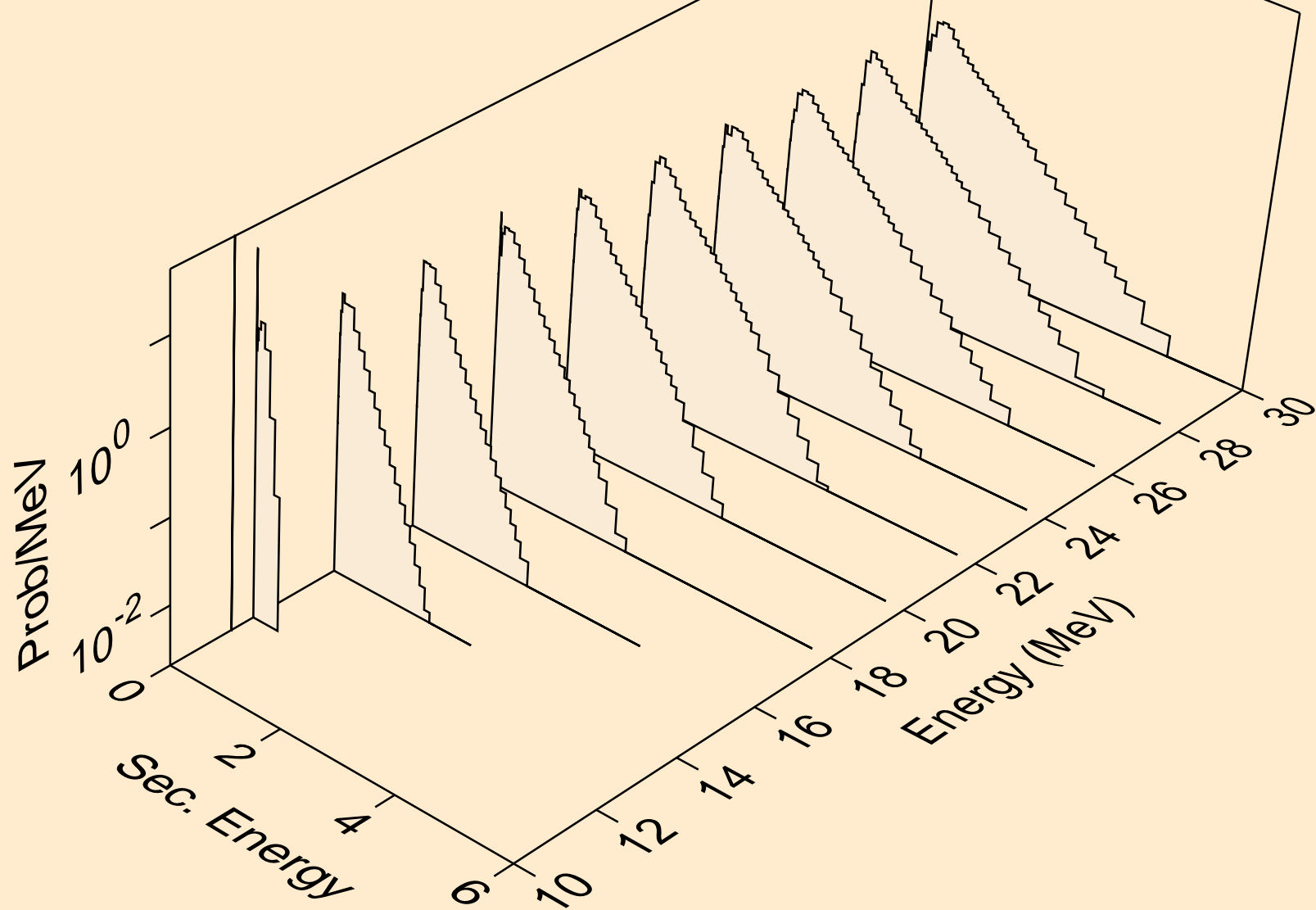

PD115M TRITON ACER TENDL-2021 LIBRARY; T=0.K  
neutrons from (t,2n)

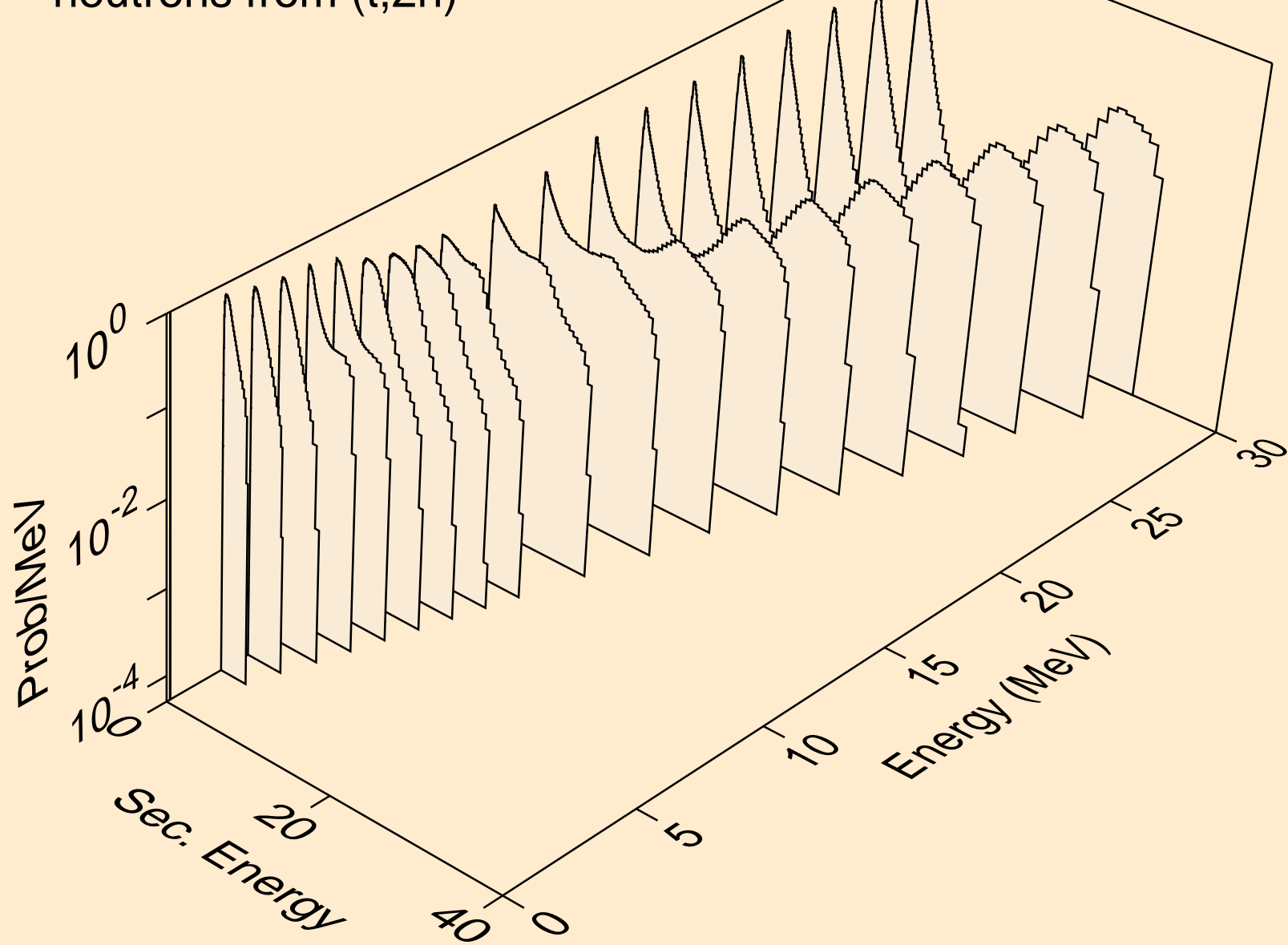



PD115M TRITON ACER TENDL-2021 LIBRARY; T=0.K  
neutrons from (t,3n)

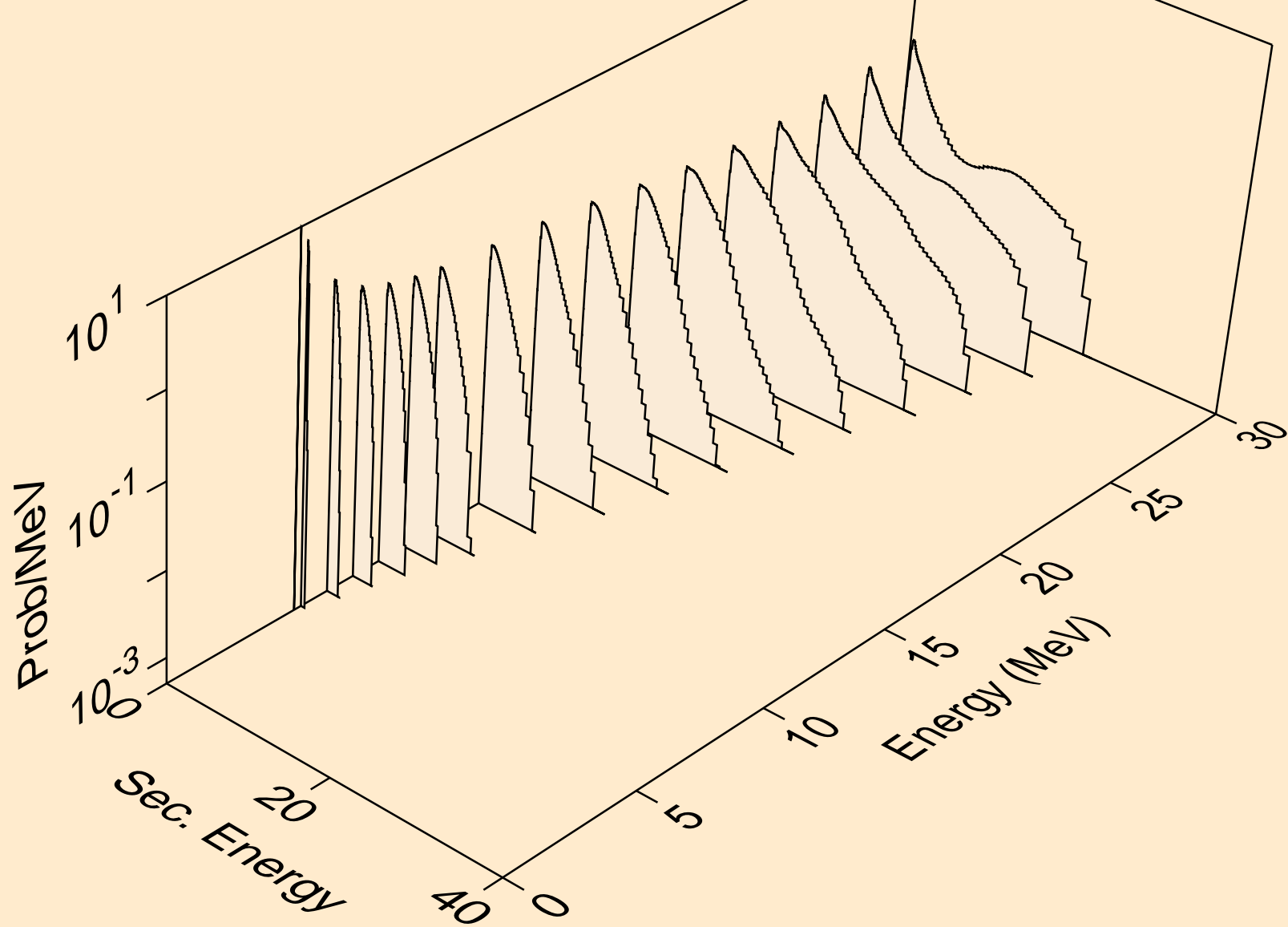

PD115M TRITON ACER TENDL-2021 LIBRARY; T=0.K  
neutrons from (t,n\*)a

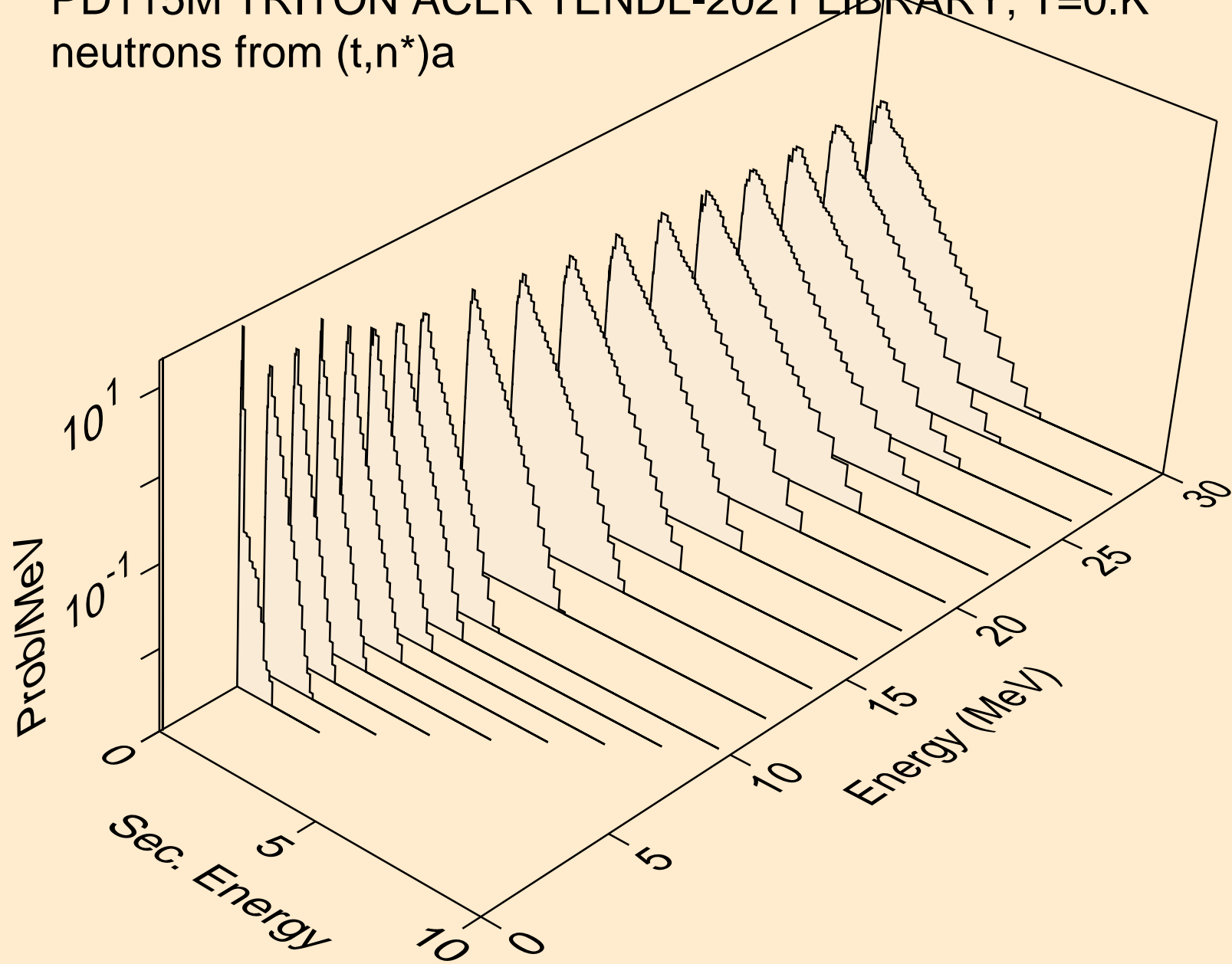

PD115M TRITON ACER TENDL-2021 LIBRARY; T=0.K  
neutrons from (t,2n)a

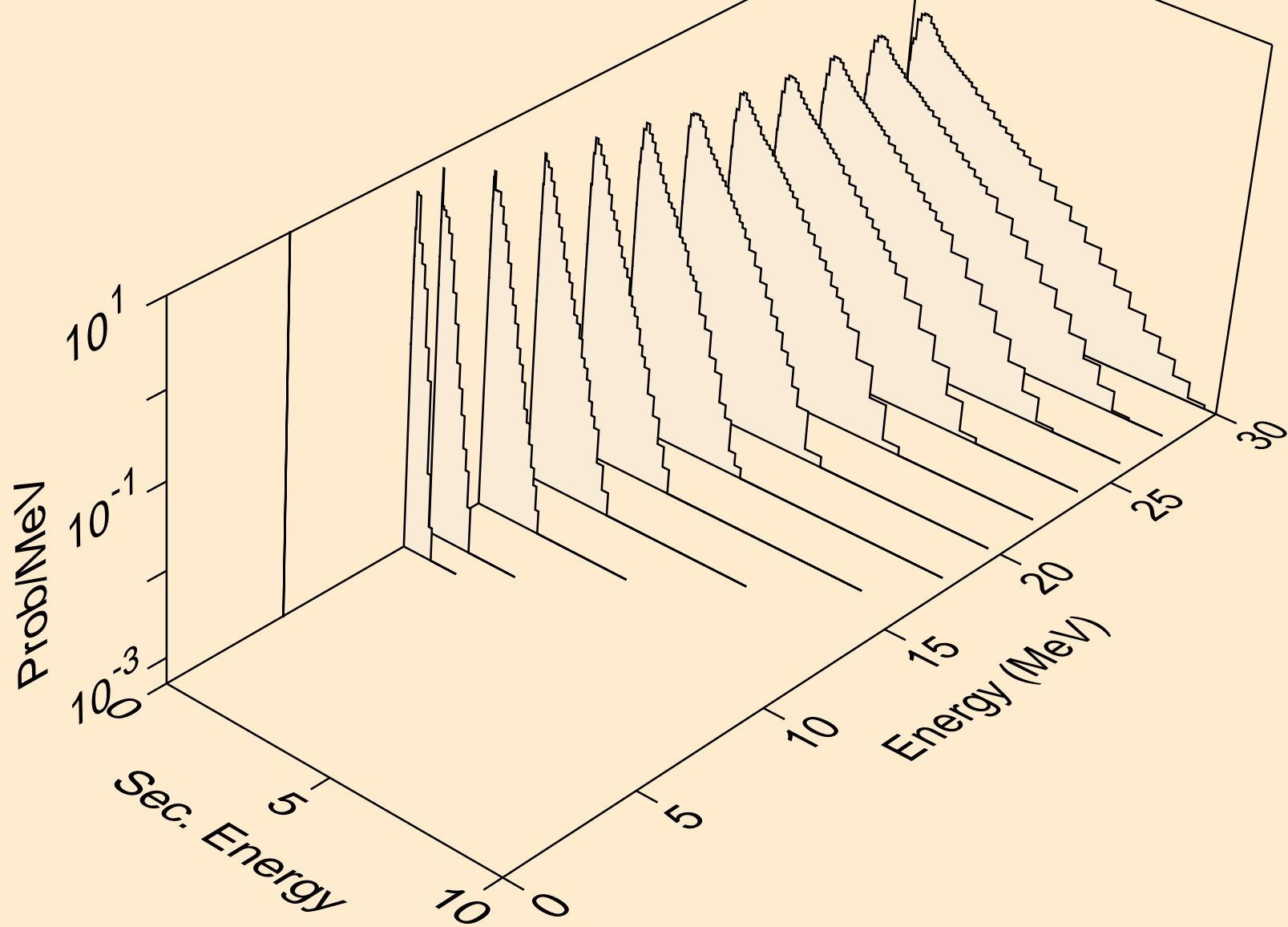

PD115M TRITON ACER TENDL-2021 LIBRARY; T=0.K  
neutrons from (t,3n)a

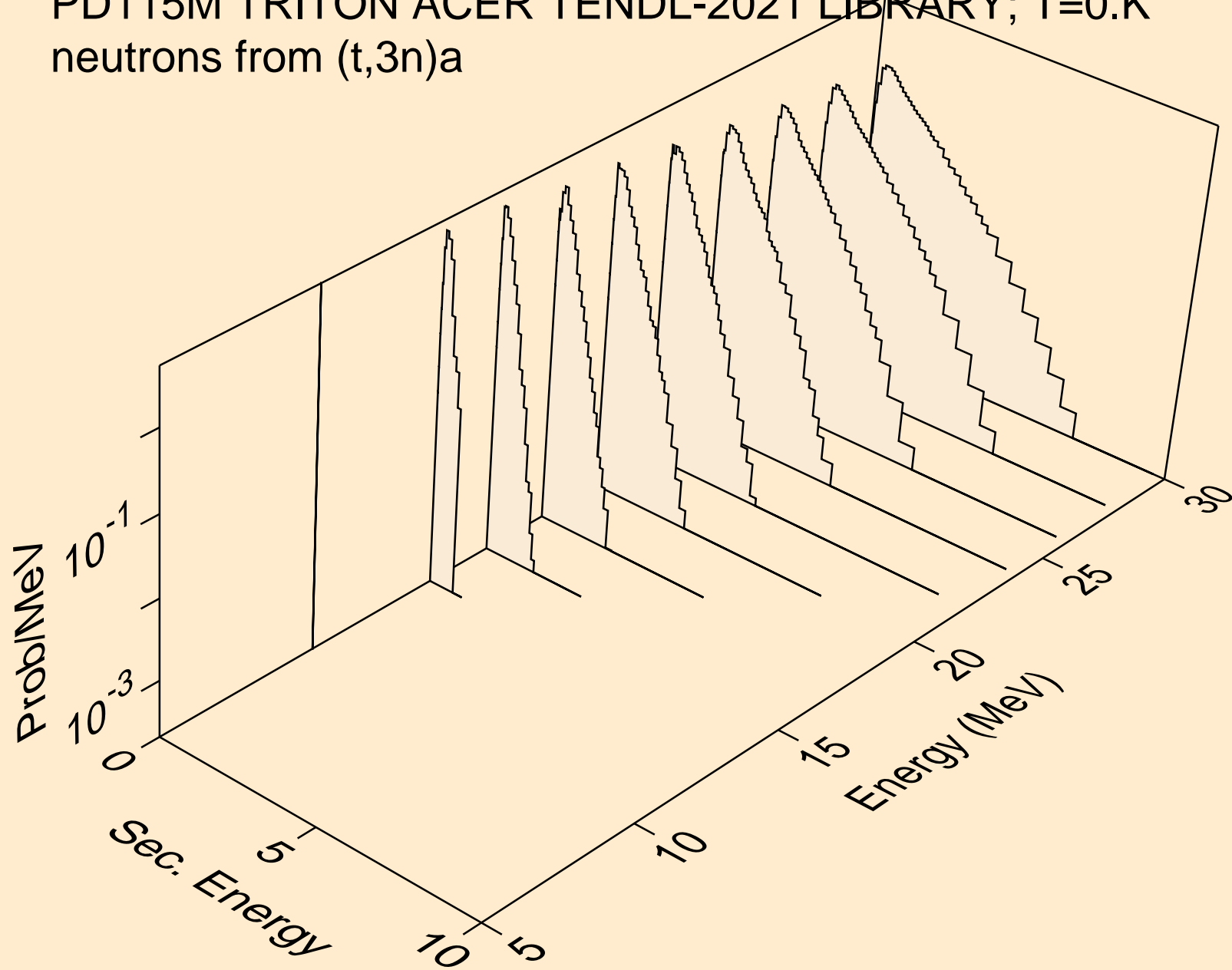

PD115M TRITON ACER TENDL-2021 LIBRARY; T=0.K  
neutrons from (t,n\*)p

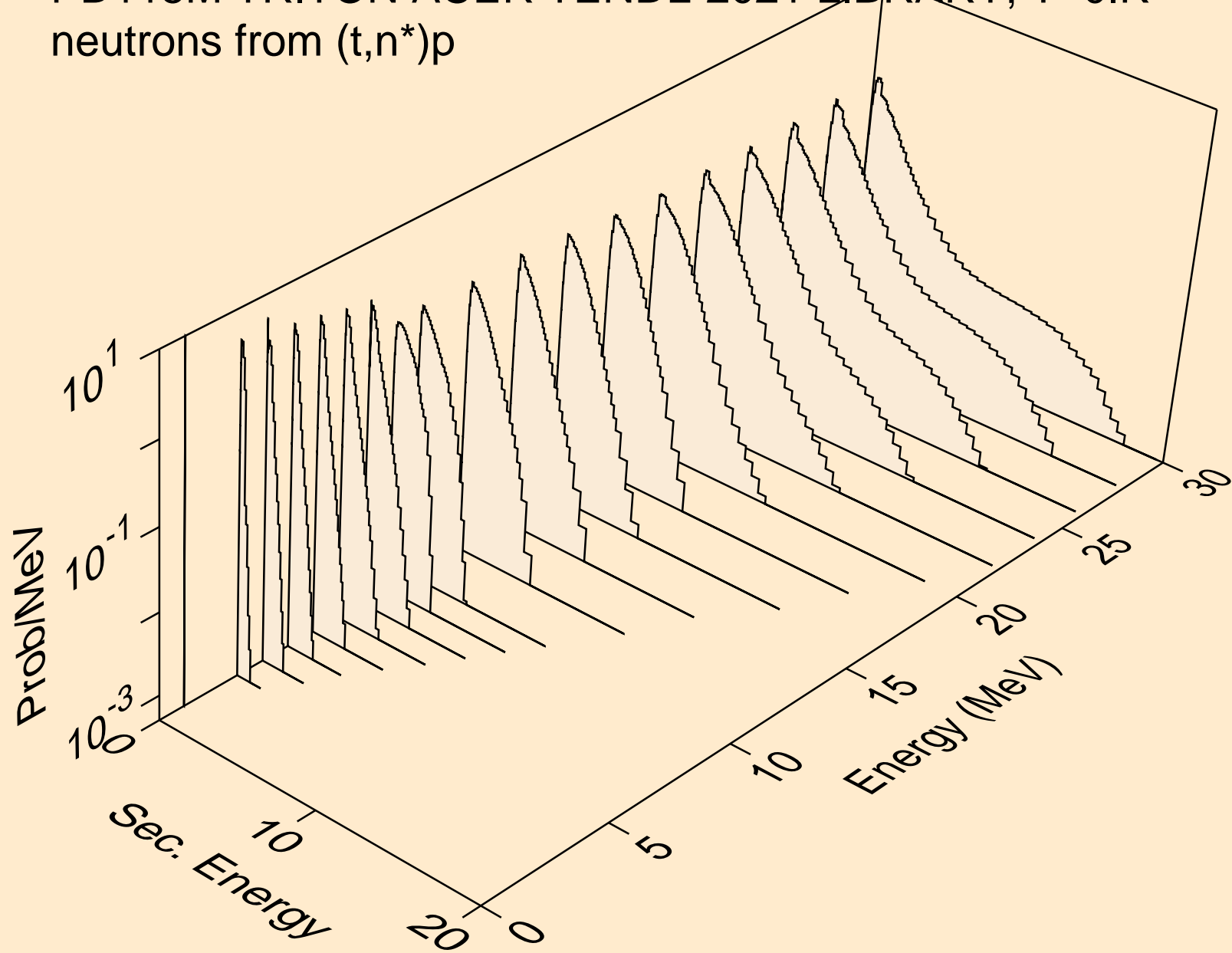

PD115M TRITON ACER TENDL-2021 LIBRARY; T=0.K  
neutrons from (t,n\*)2a

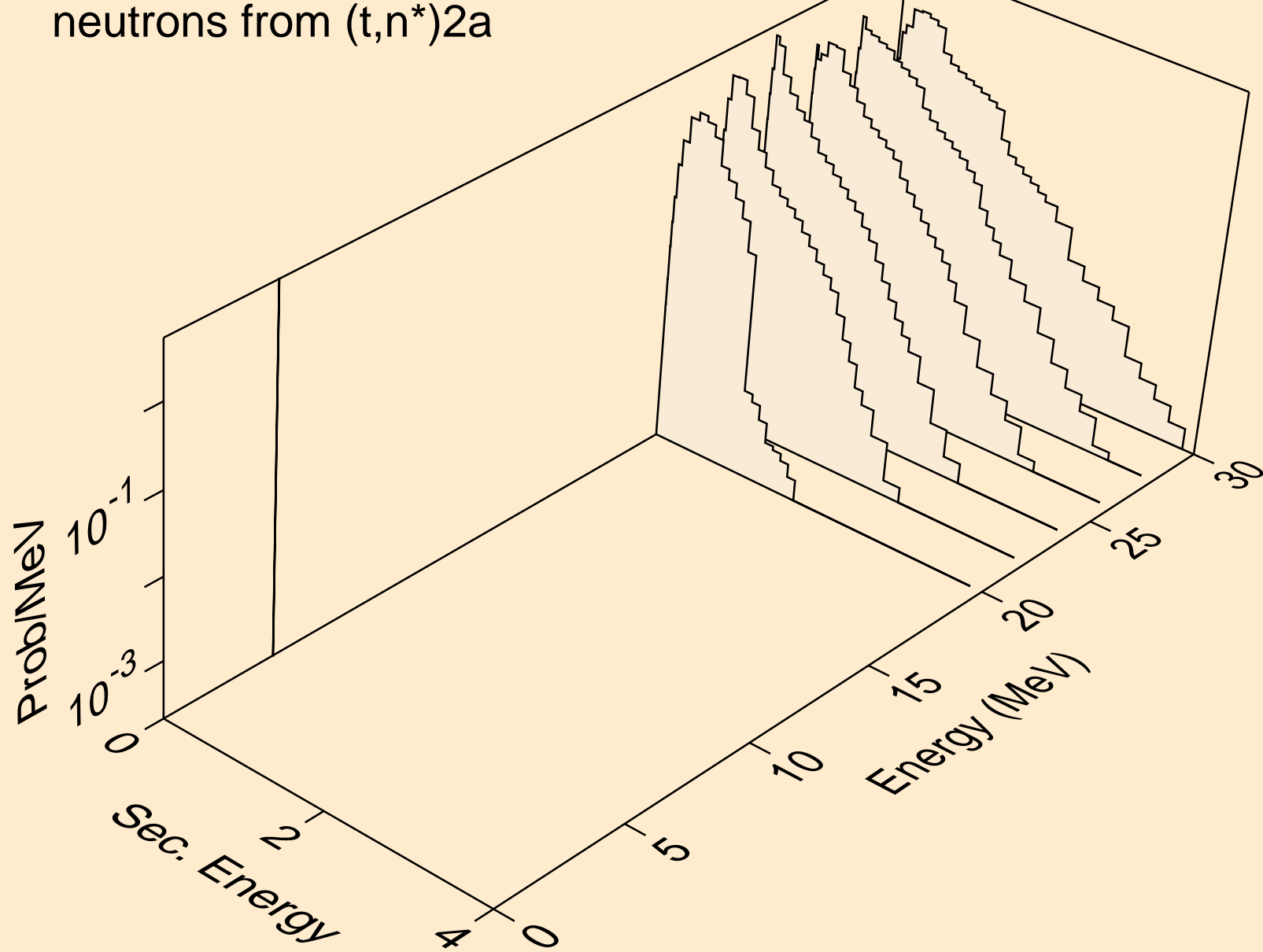

PD115M TRITON ACER TENDL-2021 LIBRARY; T=0.K  
neutrons from (t,n\*)d

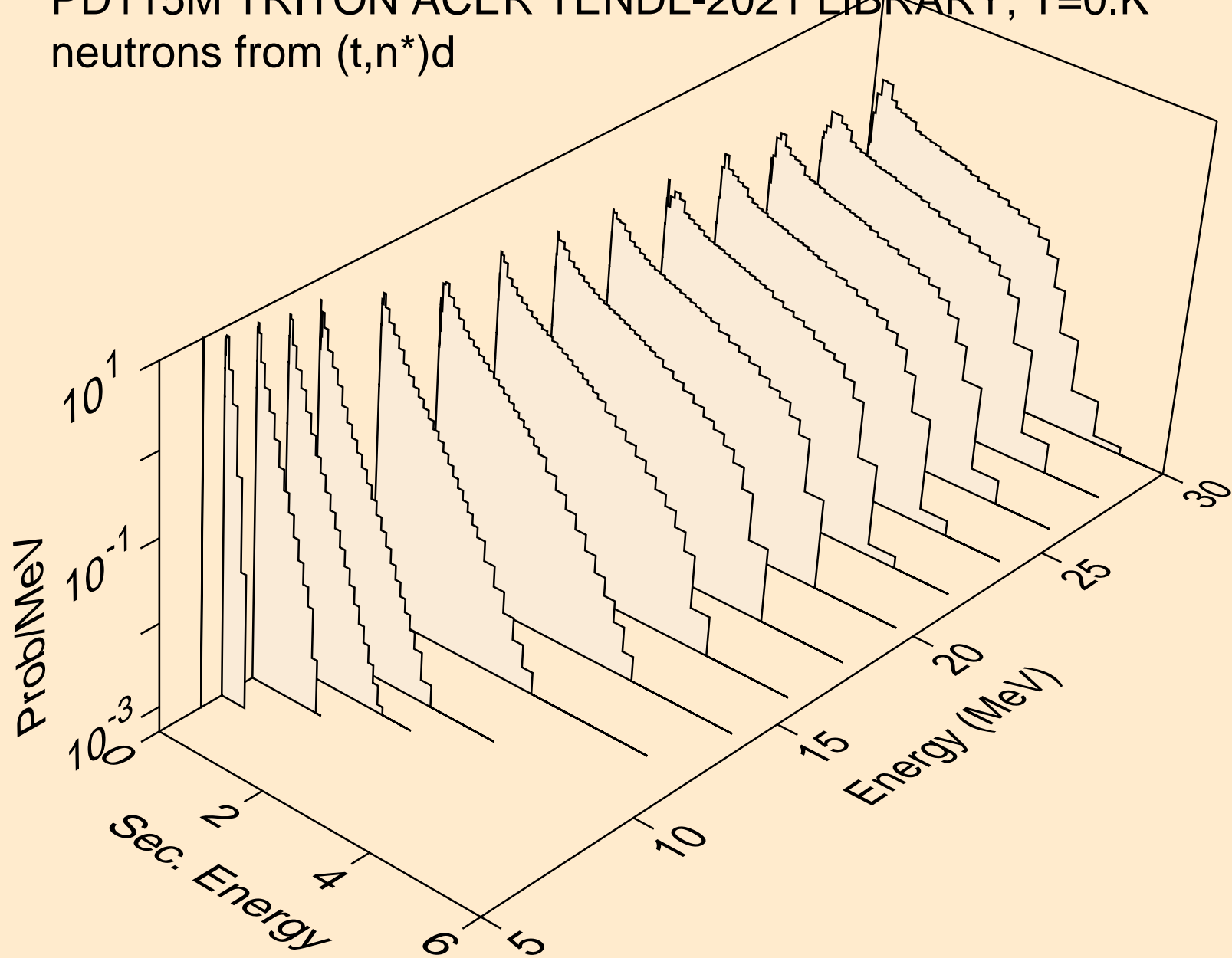

PD115M TRITON ACER TENDL-2021 LIBRARY; T=0.K  
neutrons from (t,n\*)t

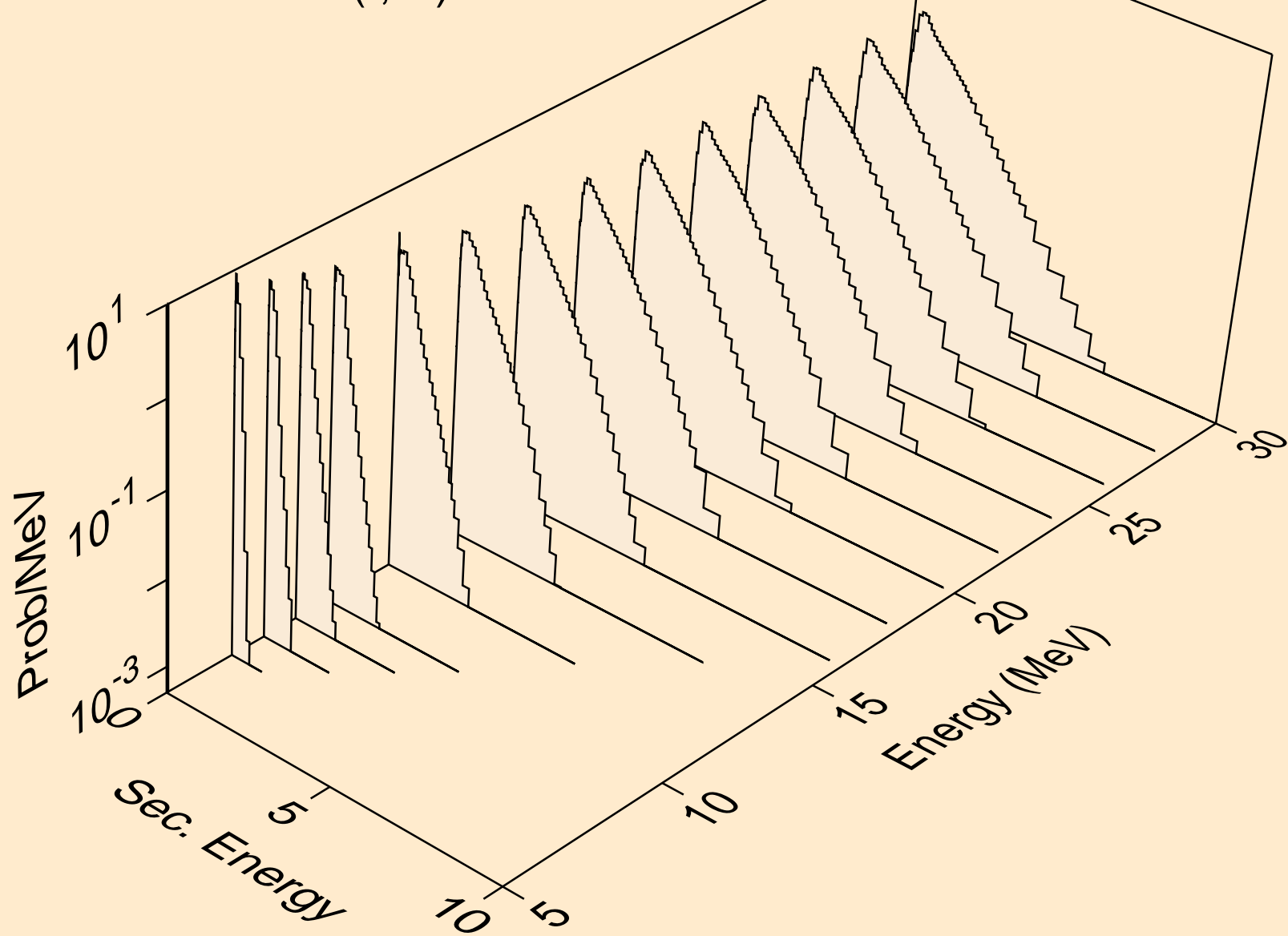



PD115M TRITON ACER TENDL-2021 LIBRARY; T=0.K  
neutrons from (t,n\*)he3

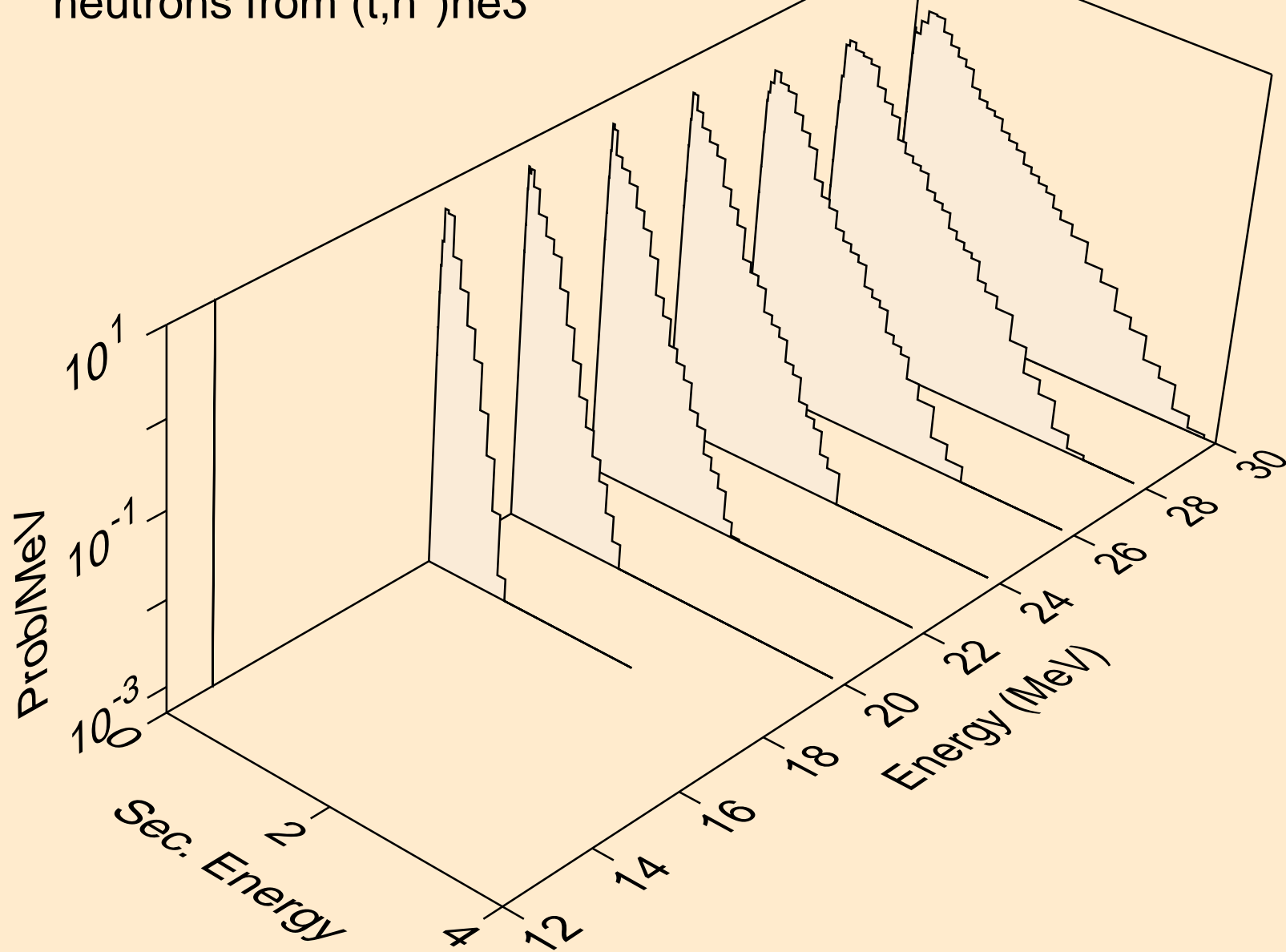

PD115M TRITON ACER TENDL-2021 LIBRARY; T=0.K  
neutrons from (t,4n)

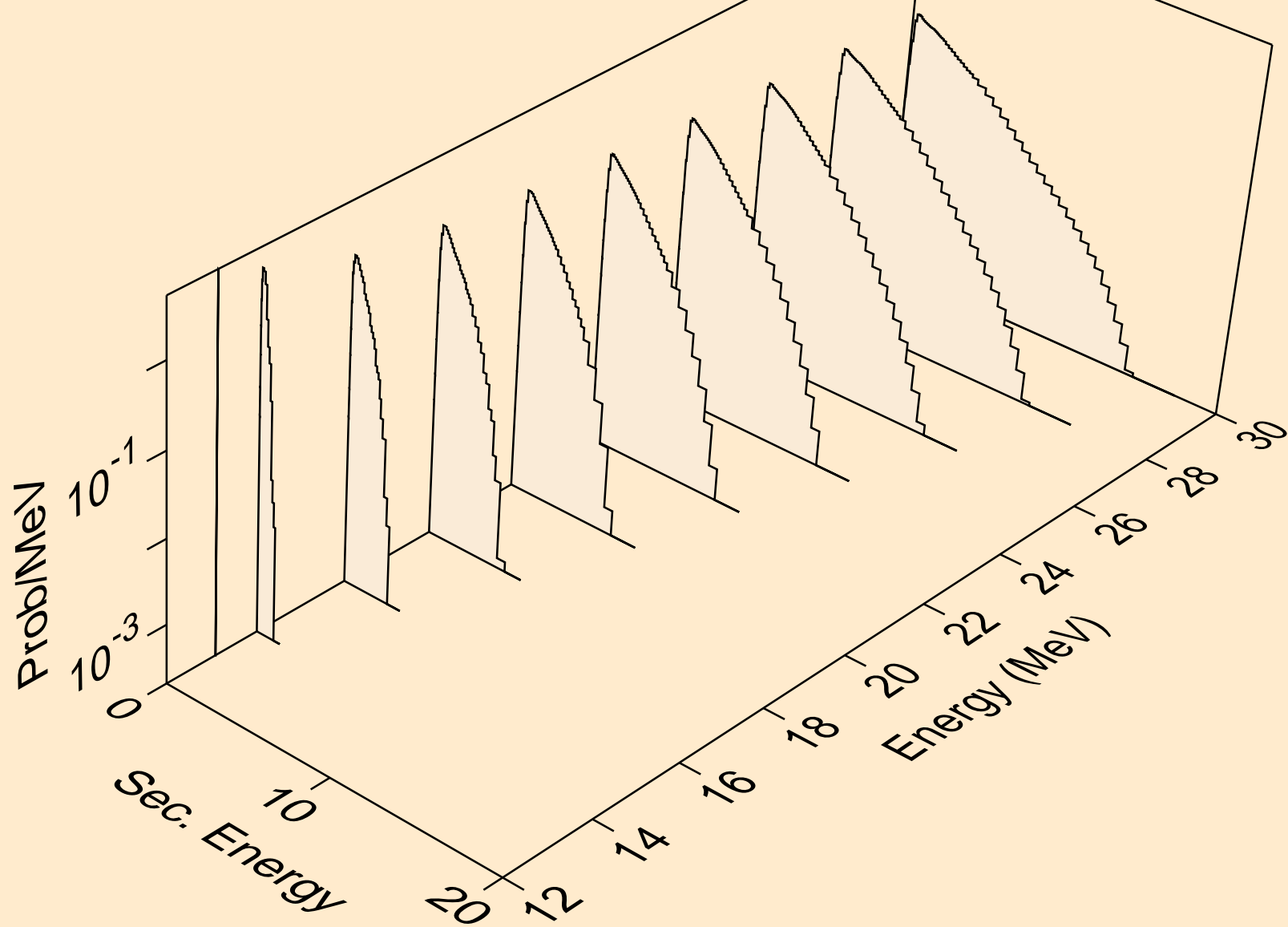

PD115M TRITON ACER TENDL-2021 LIBRARY; T=0.K  
neutrons from (t,2np)

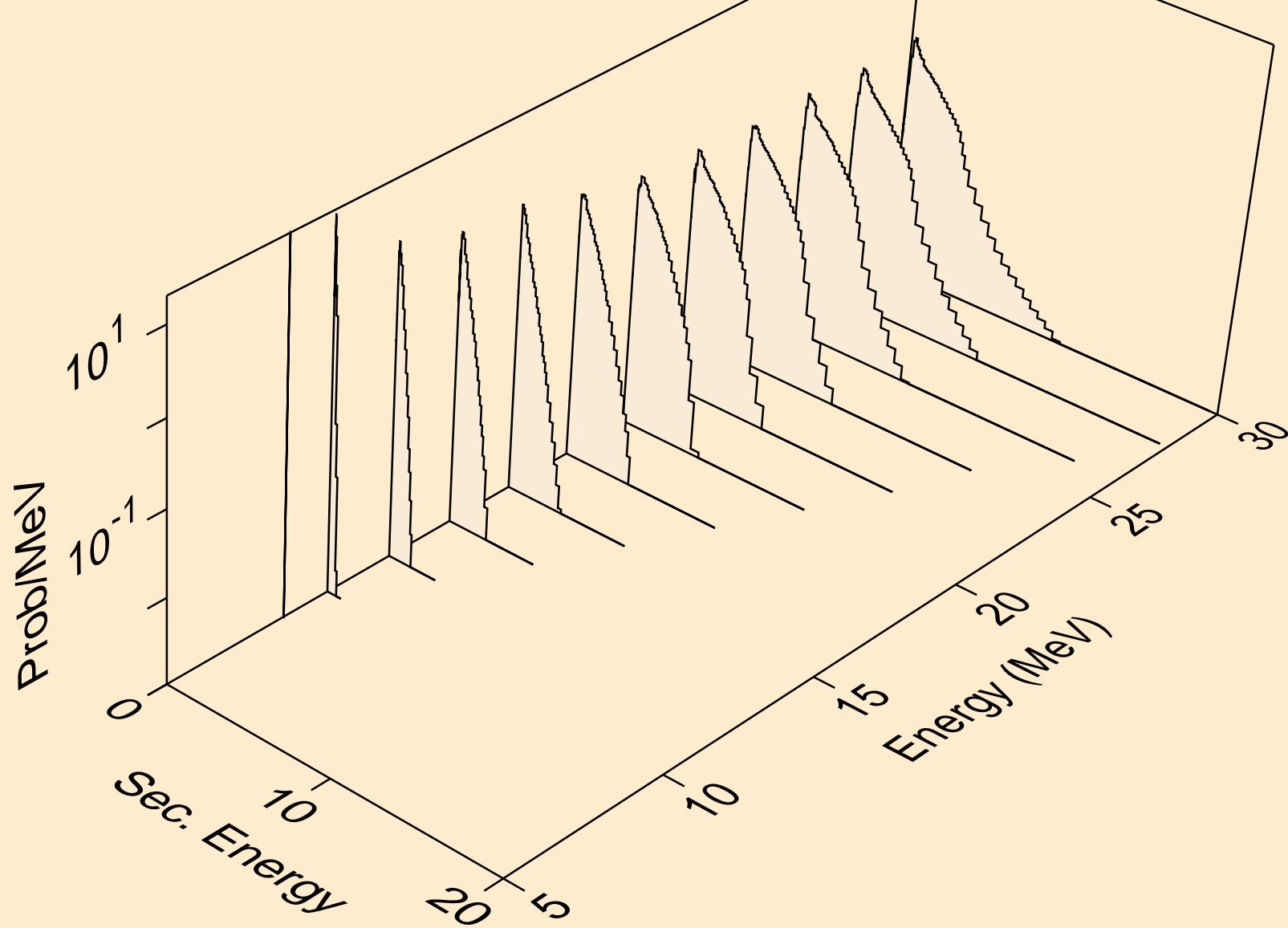

PD115M TRITON ACER TENDL-2021 LIBRARY; T=0.K  
neutrons from (t,3np)

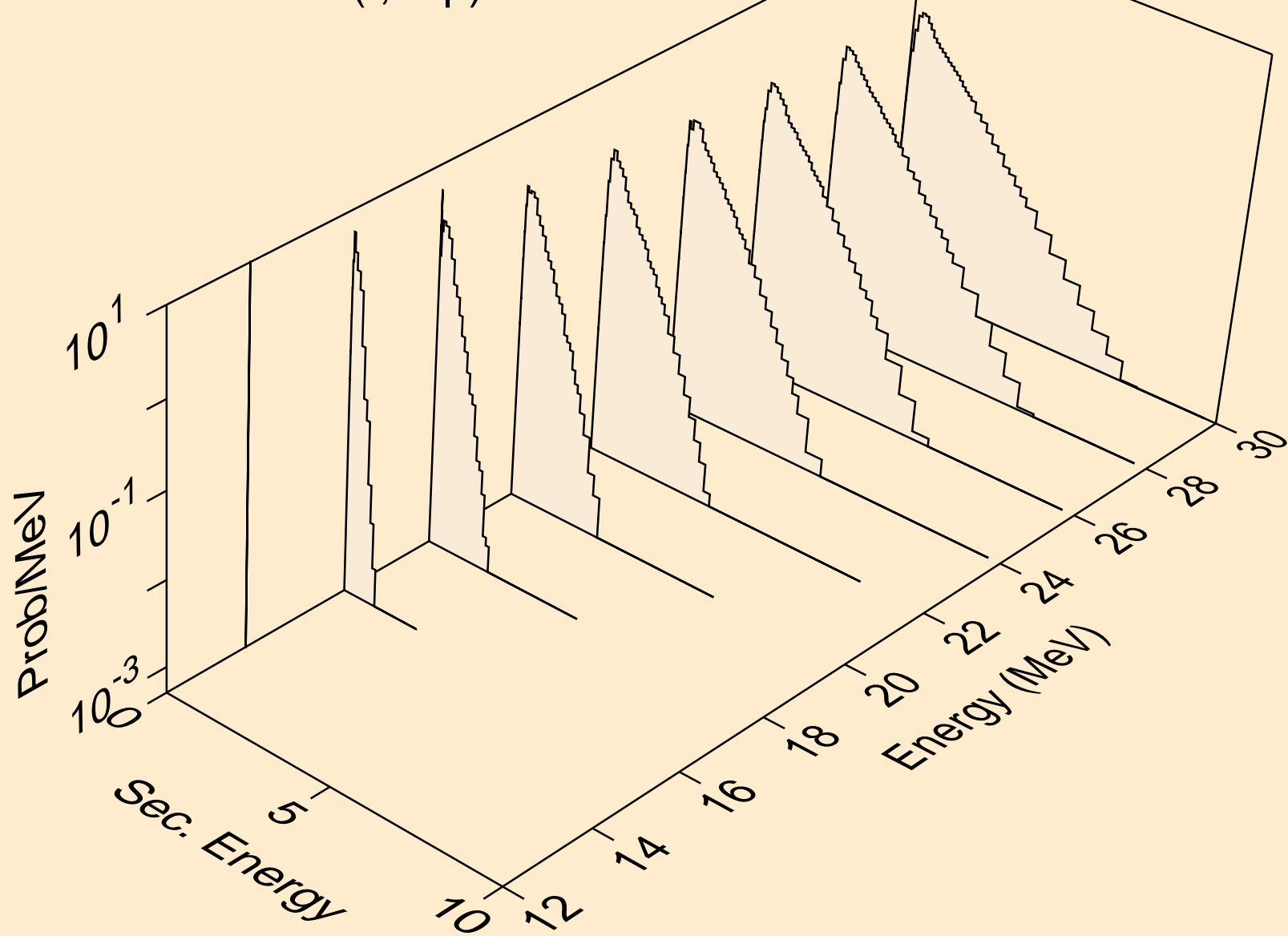

PD115M TRITON ACER TENDL-2021 LIBRARY; T=0.K  
neutrons from (t,2np)

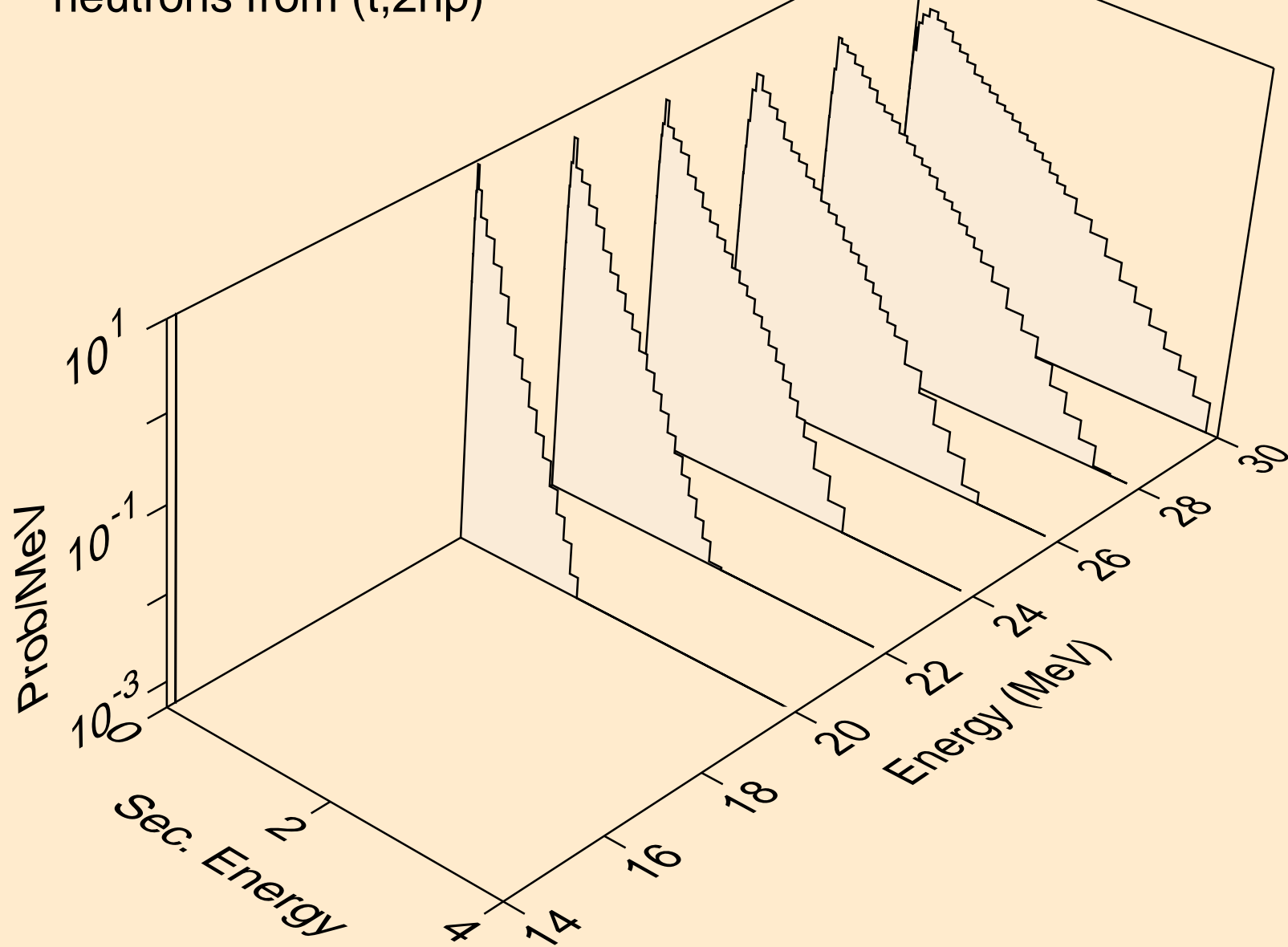

PD115M TRITON ACER TENDL-2021 LIBRARY; T=0.K  
neutrons from (t,npa)

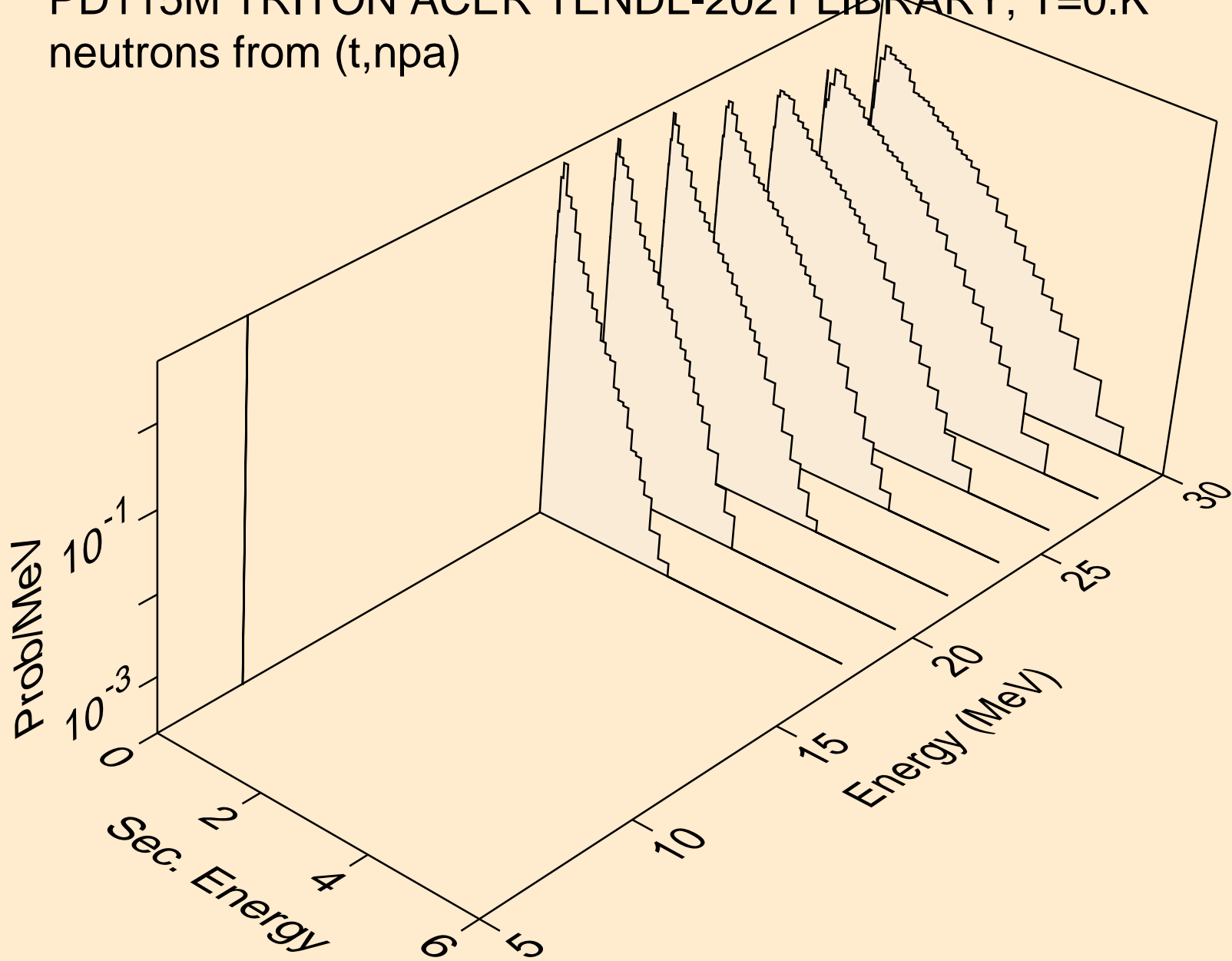

PD115M TRITON ACER TENDL-2021 LIBRARY; T=0.K  
protons from (t,x)

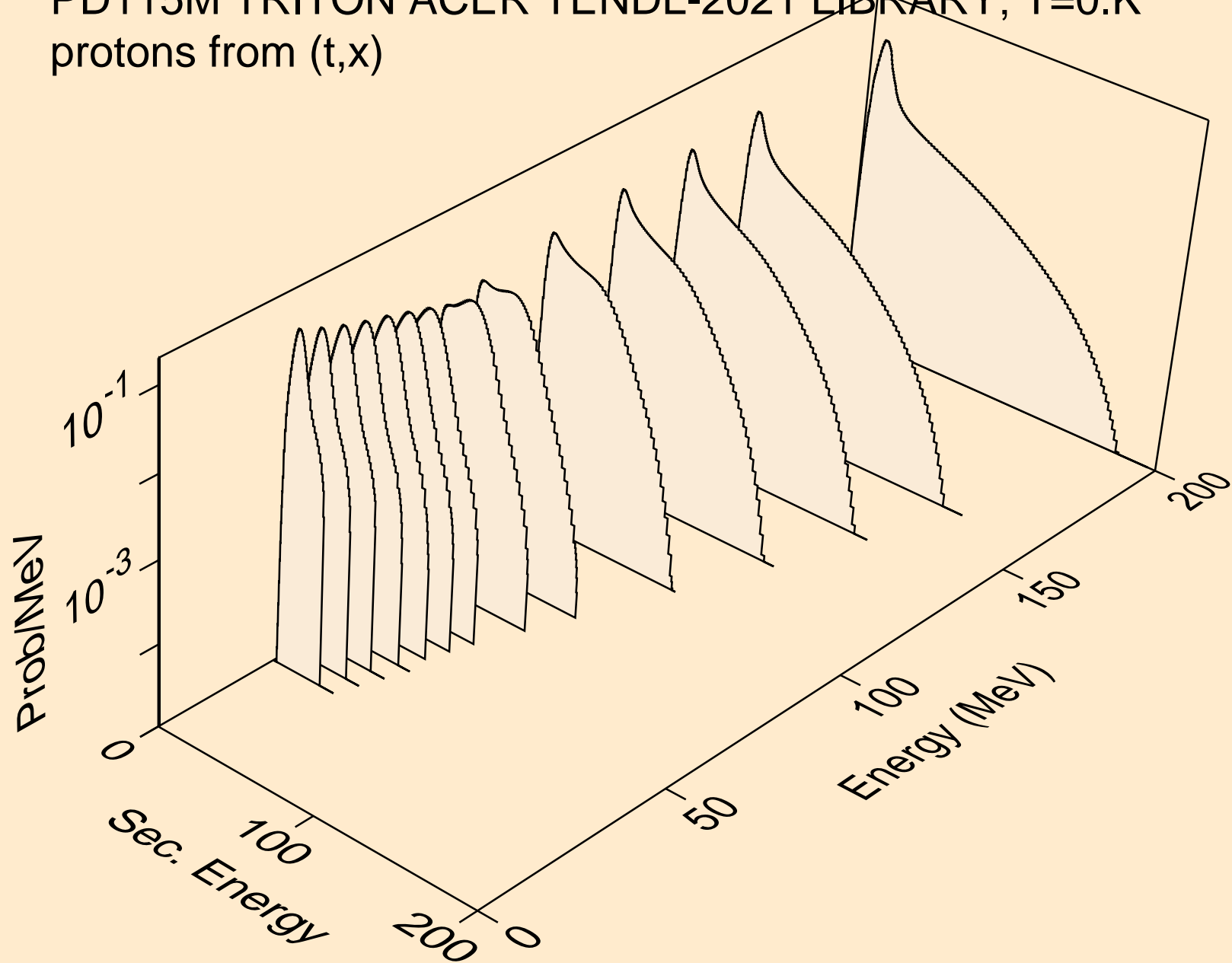

PD115M TRITON ACER TENDL-2021 LIBRARY; T=0.K  
protons from (t,n\*)p

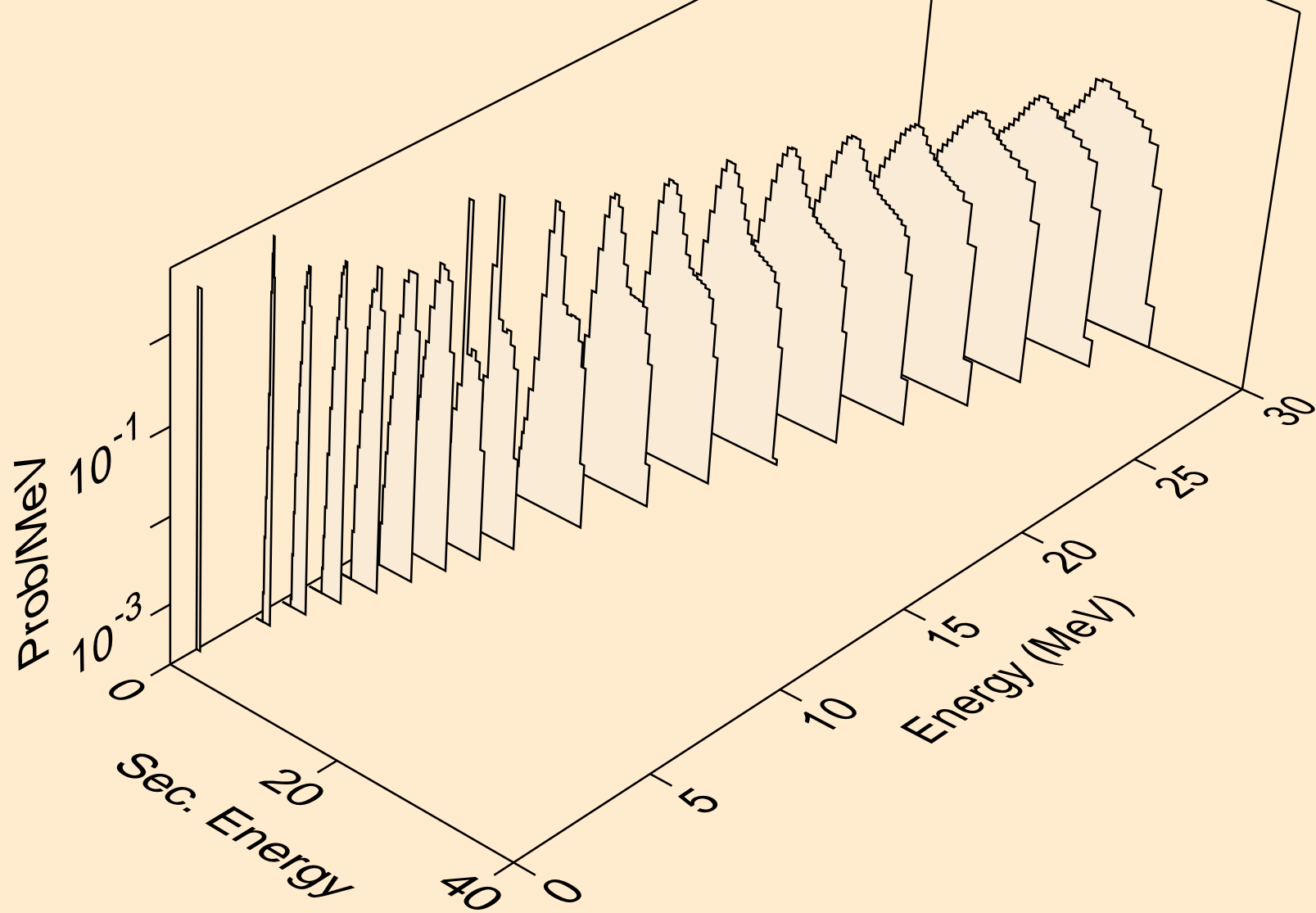



PD115M TRITON ACER TENDL-2021 LIBRARY; T=0.K  
protons from (t,2np)

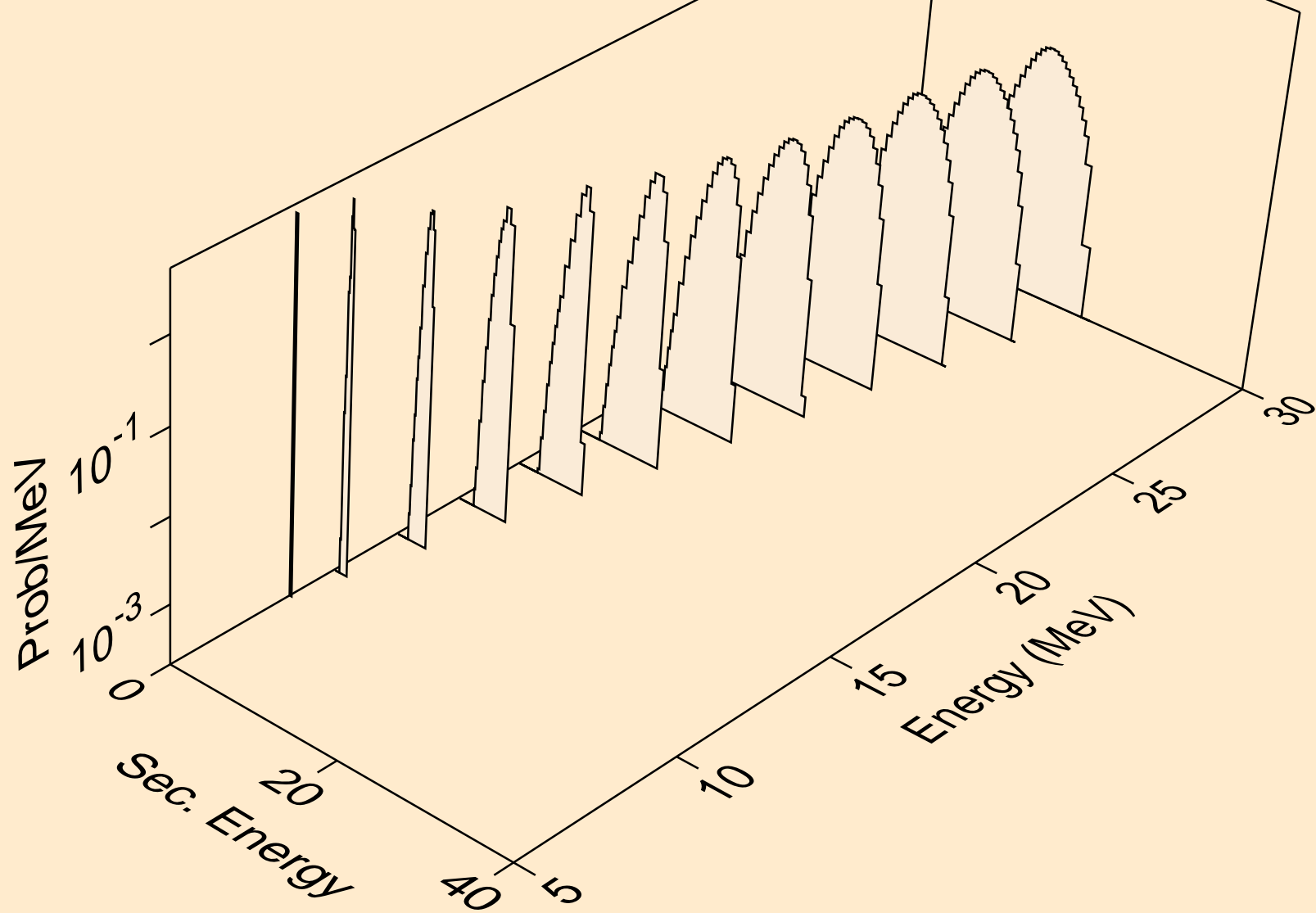

PD115M TRITON ACER TENDL-2021 LIBRARY; T=0.K  
protons from (t,3np)

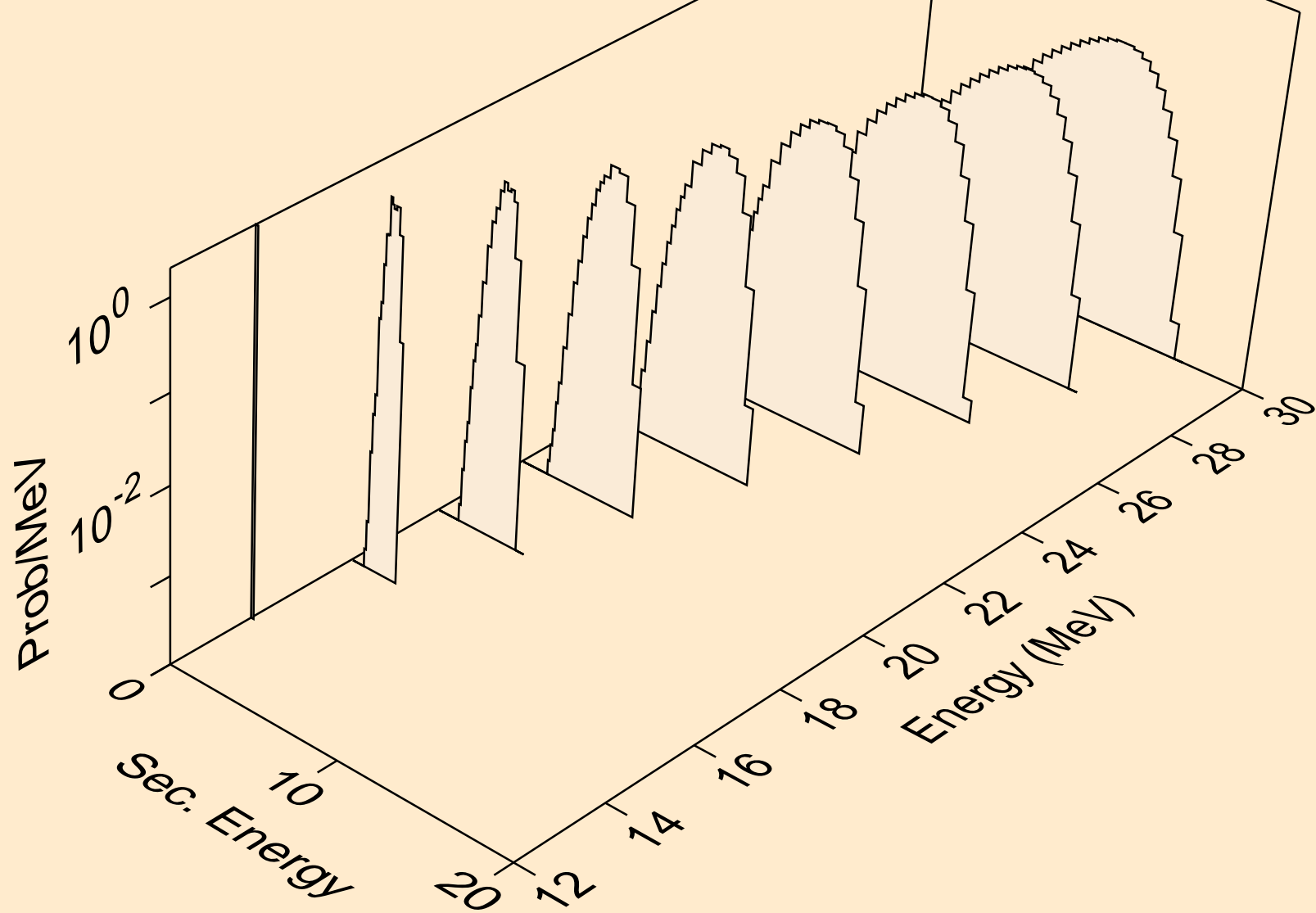

PD115M TRITON ACER TENDL-2021 LIBRARY; T=0.K  
protons from (t,2np)

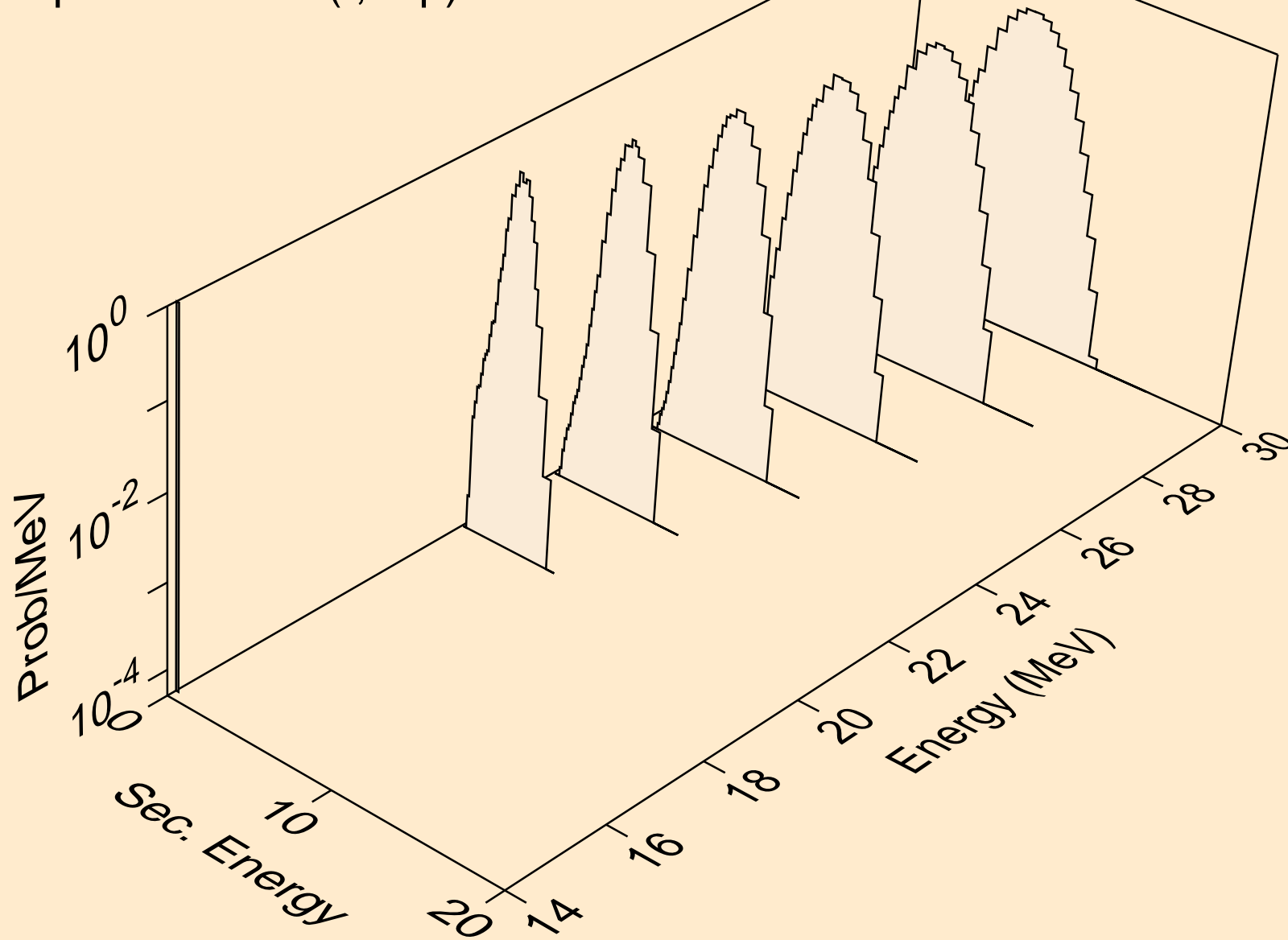

PD115M TRITON ACER TENDL-2021 LIBRARY; T=0.K  
protons from (t,npa)

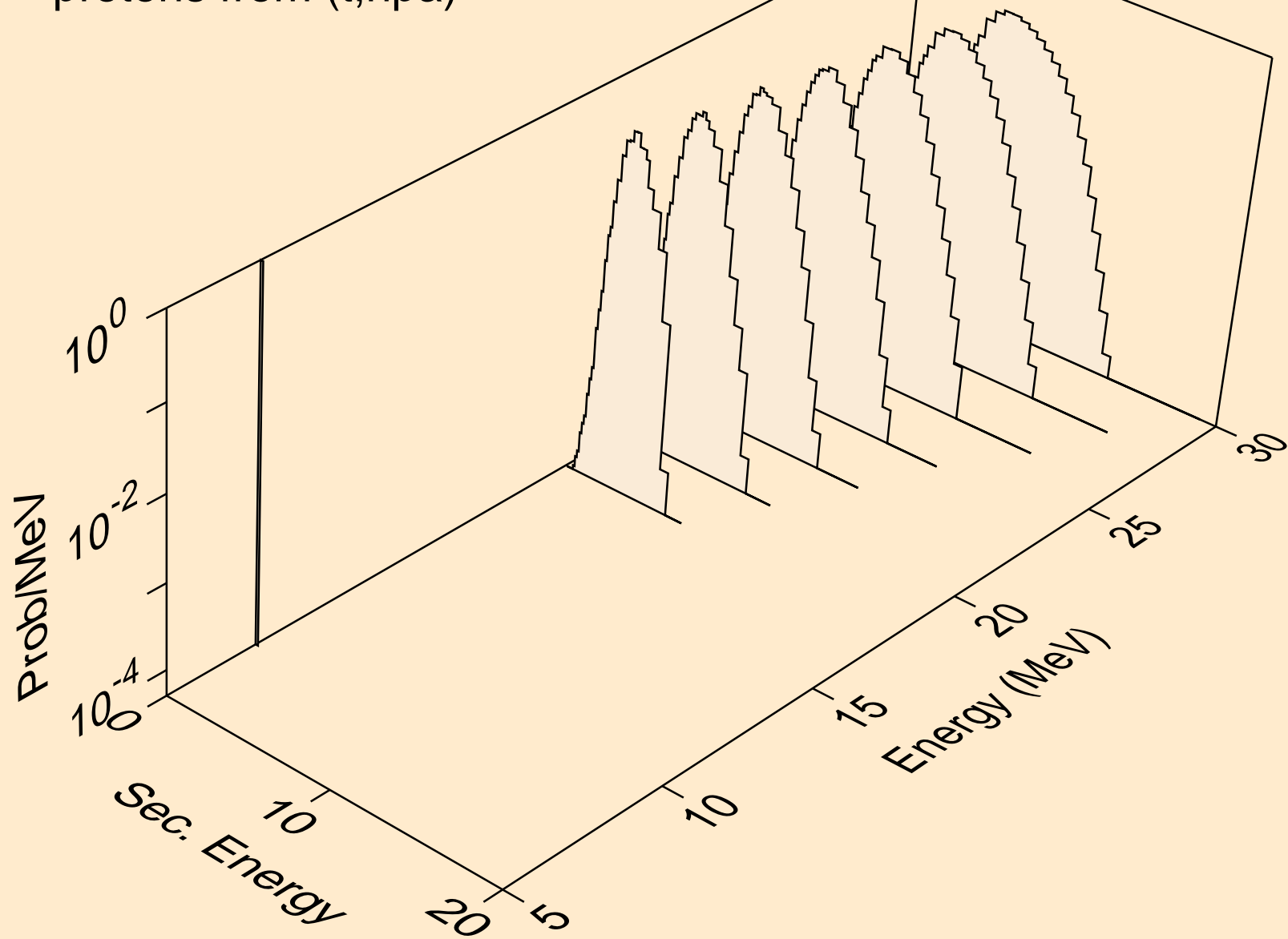

PD115M TRITON ACER TENDL-2021 LIBRARY; T=0.K  
protons from (t,p)

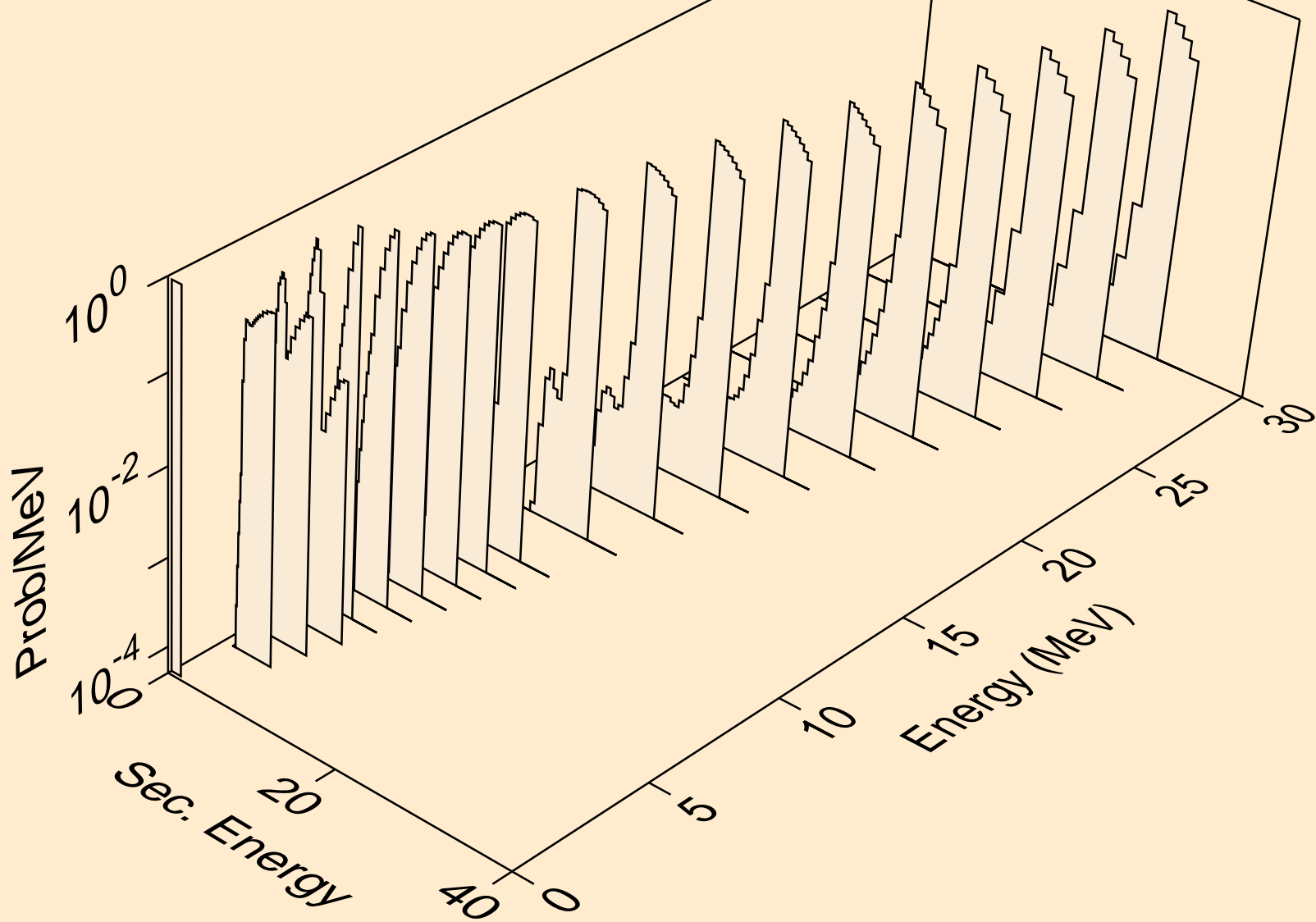

PD115M TRITON ACER TENDL-2021 LIBRARY; T=0.K  
protons from (t,2p)

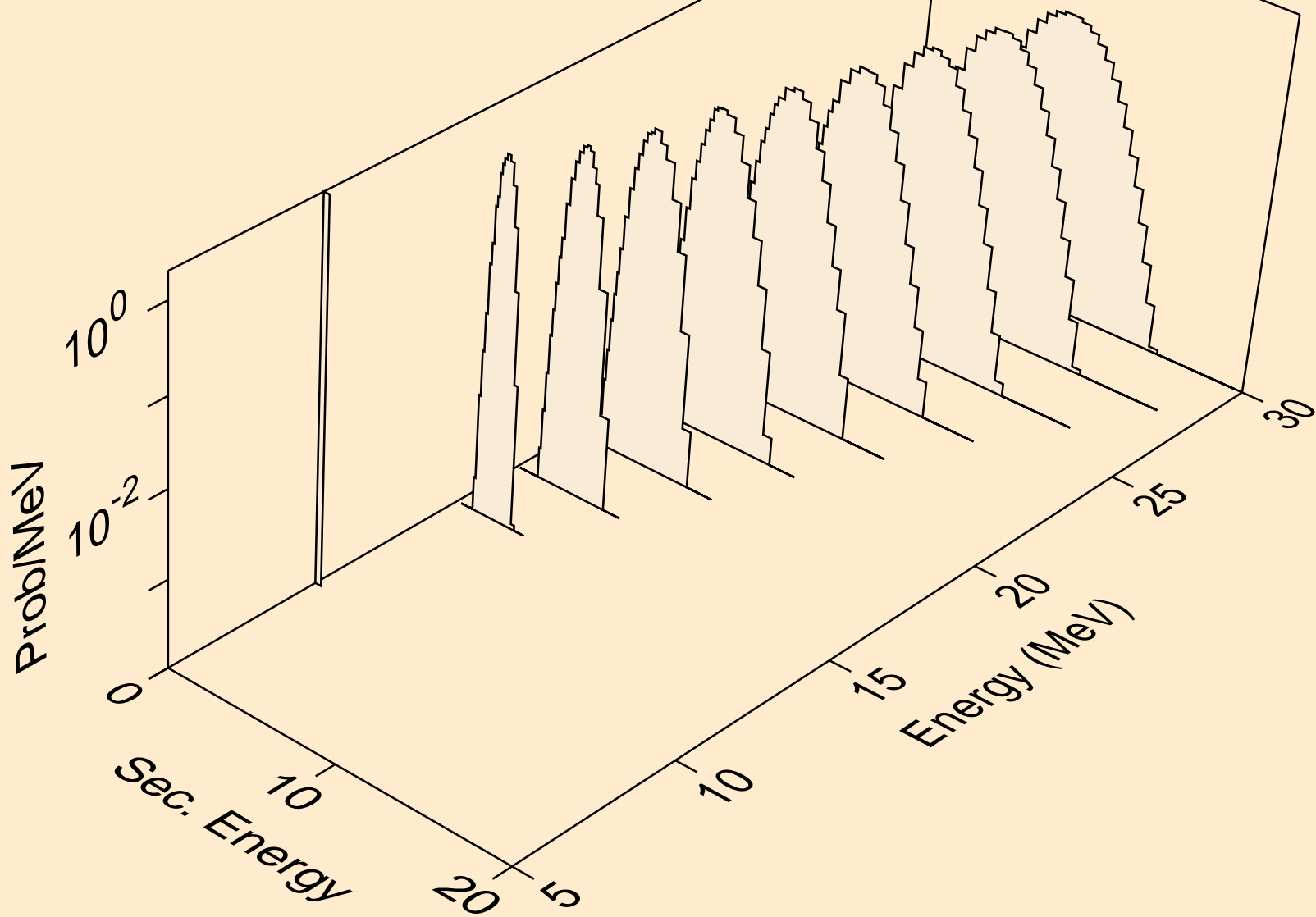

PD115M TRITON ACER TENDL-2021 LIBRARY; T=0.K  
protons from (t,pa)

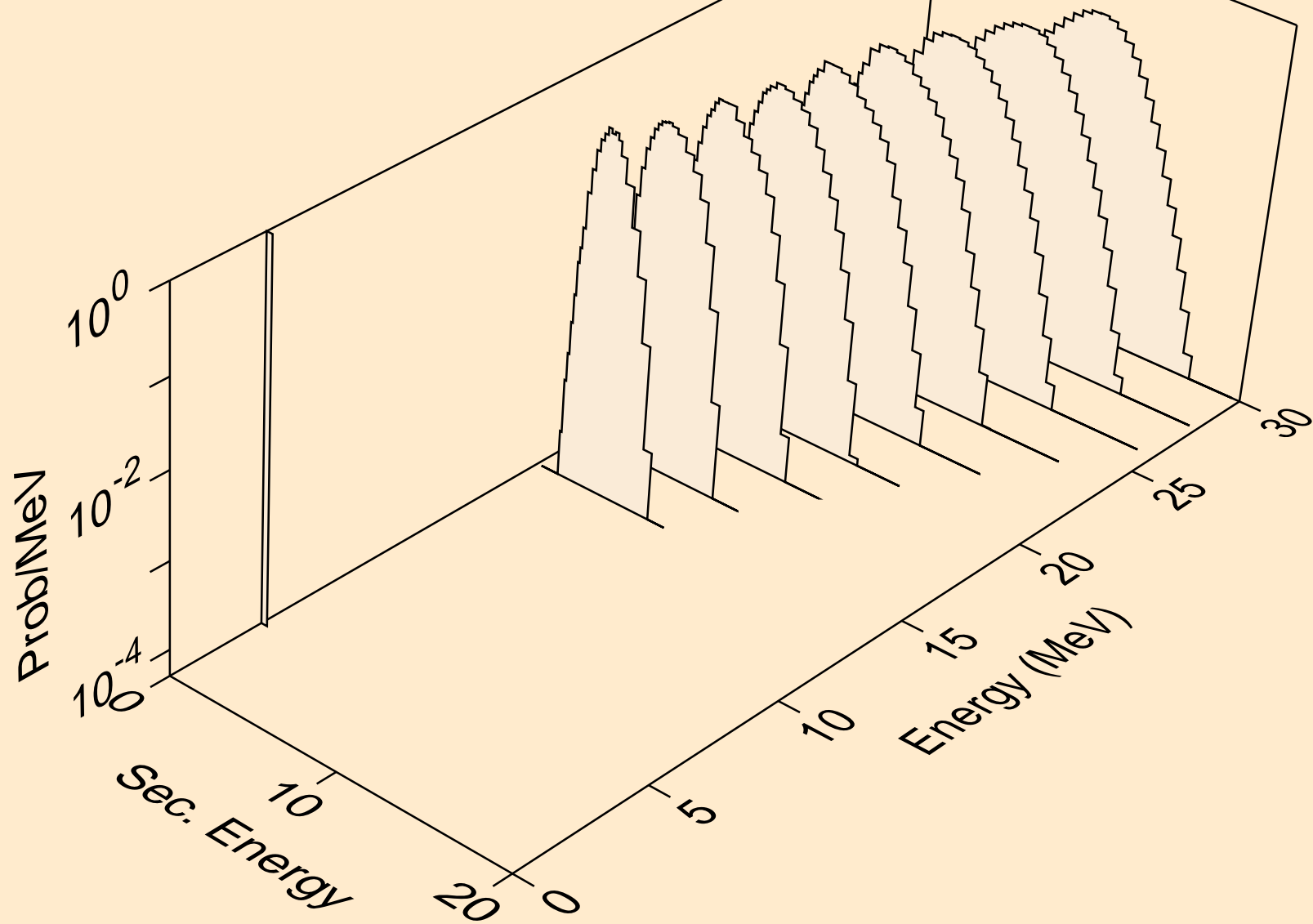

PD115M TRITON ACER TENDL-2021 LIBRARY; T=0.K  
protons from (t,pd)

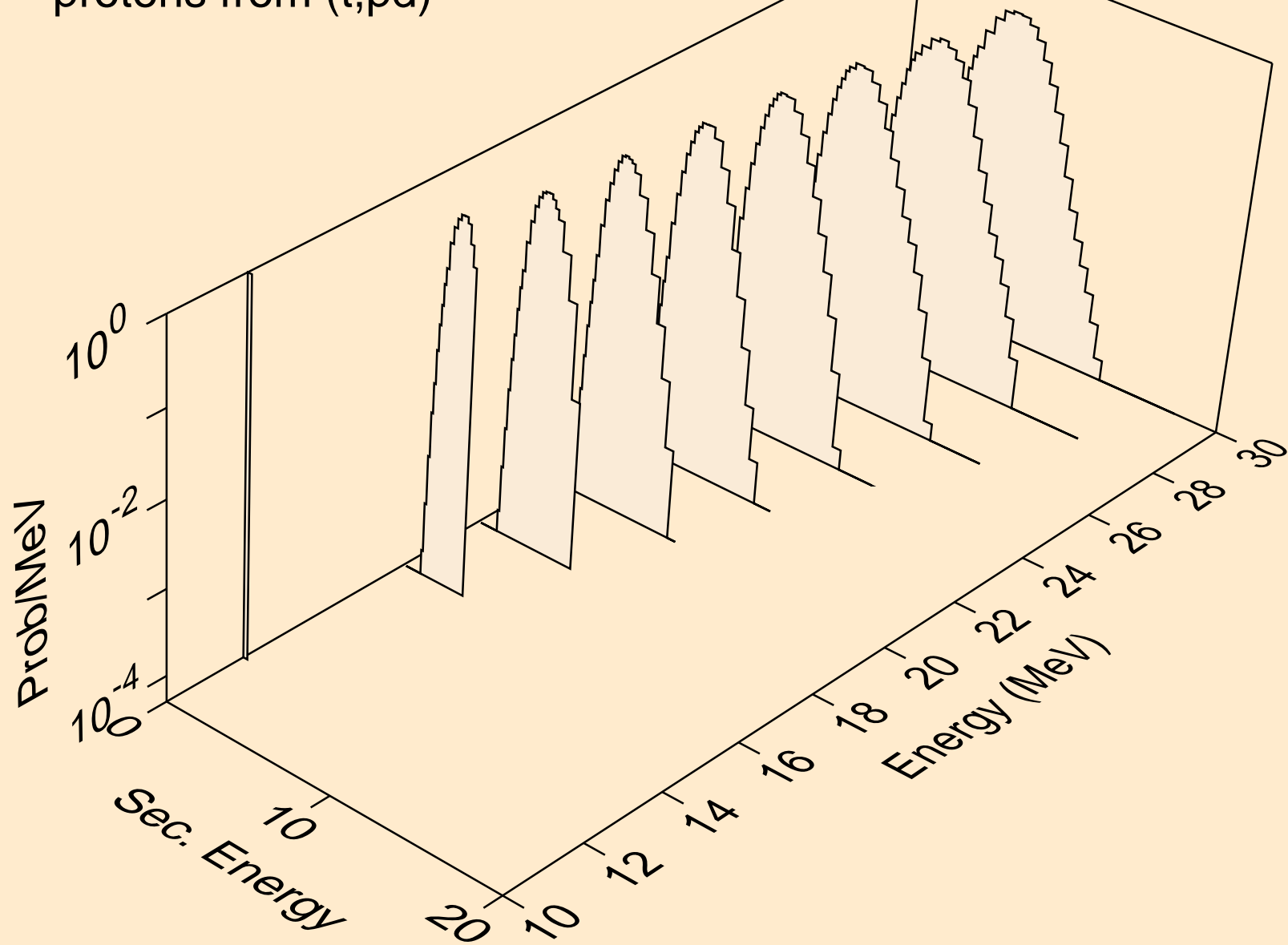



PD115M TRITON ACER TENDL-2021 LIBRARY; T=0.K  
protons from (t,pt)

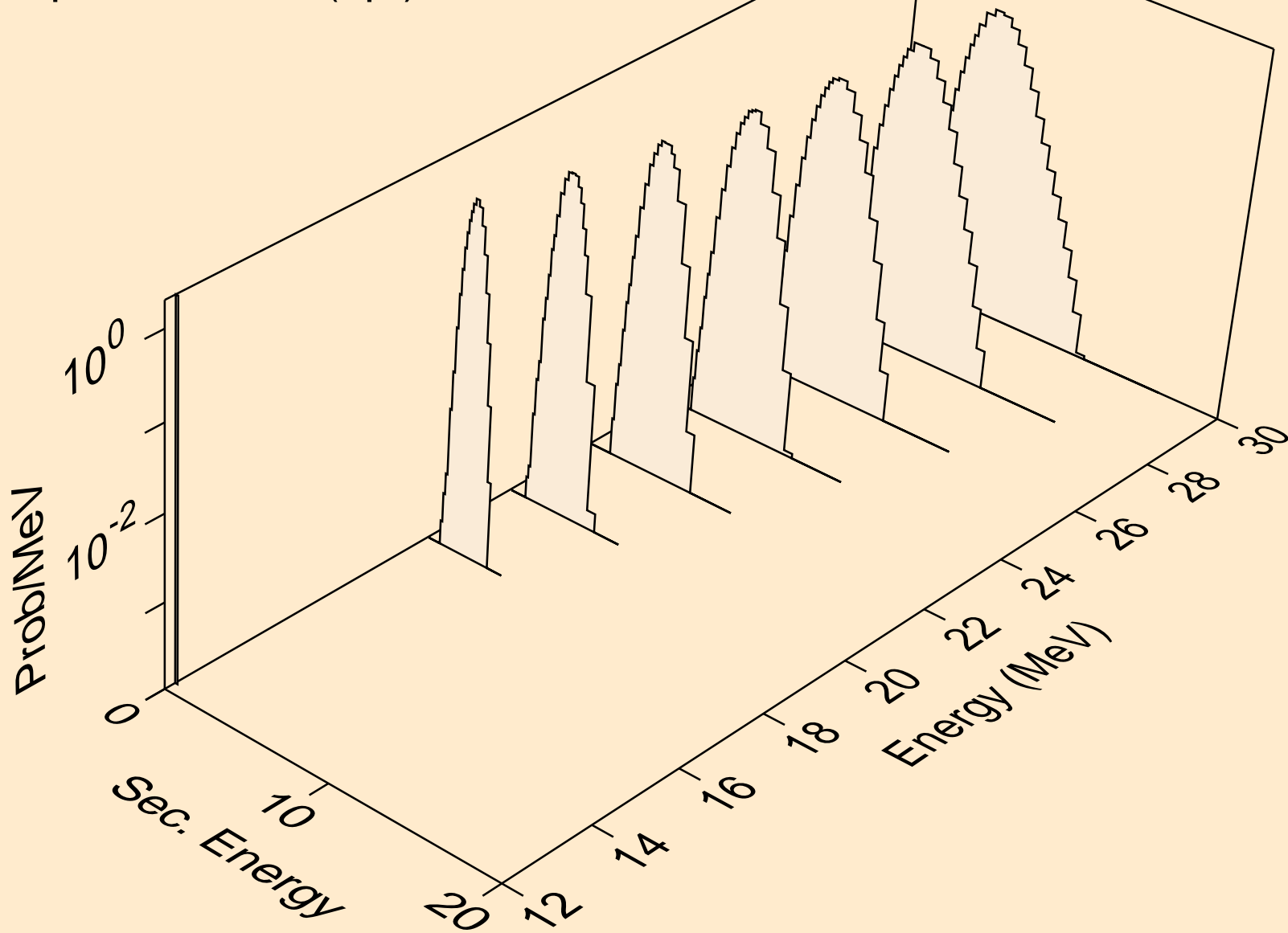

PD115M TRITON ACER TENDL-2021 LIBRARY; T=0.K  
deuterons from (t,x)

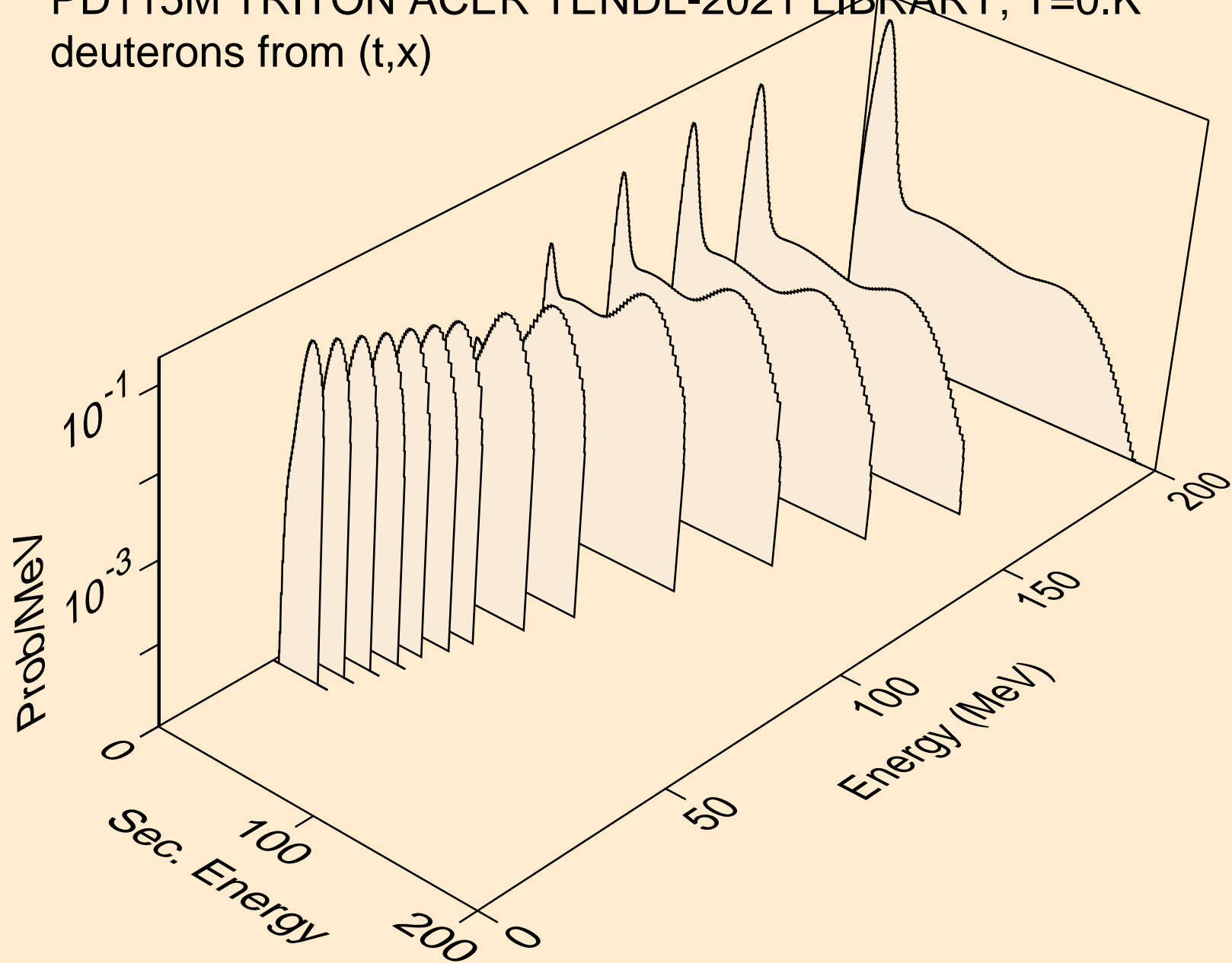

PD115M TRITON ACER TENDL-2021 LIBRARY; T=0.K  
deuterons from (t,2nd)

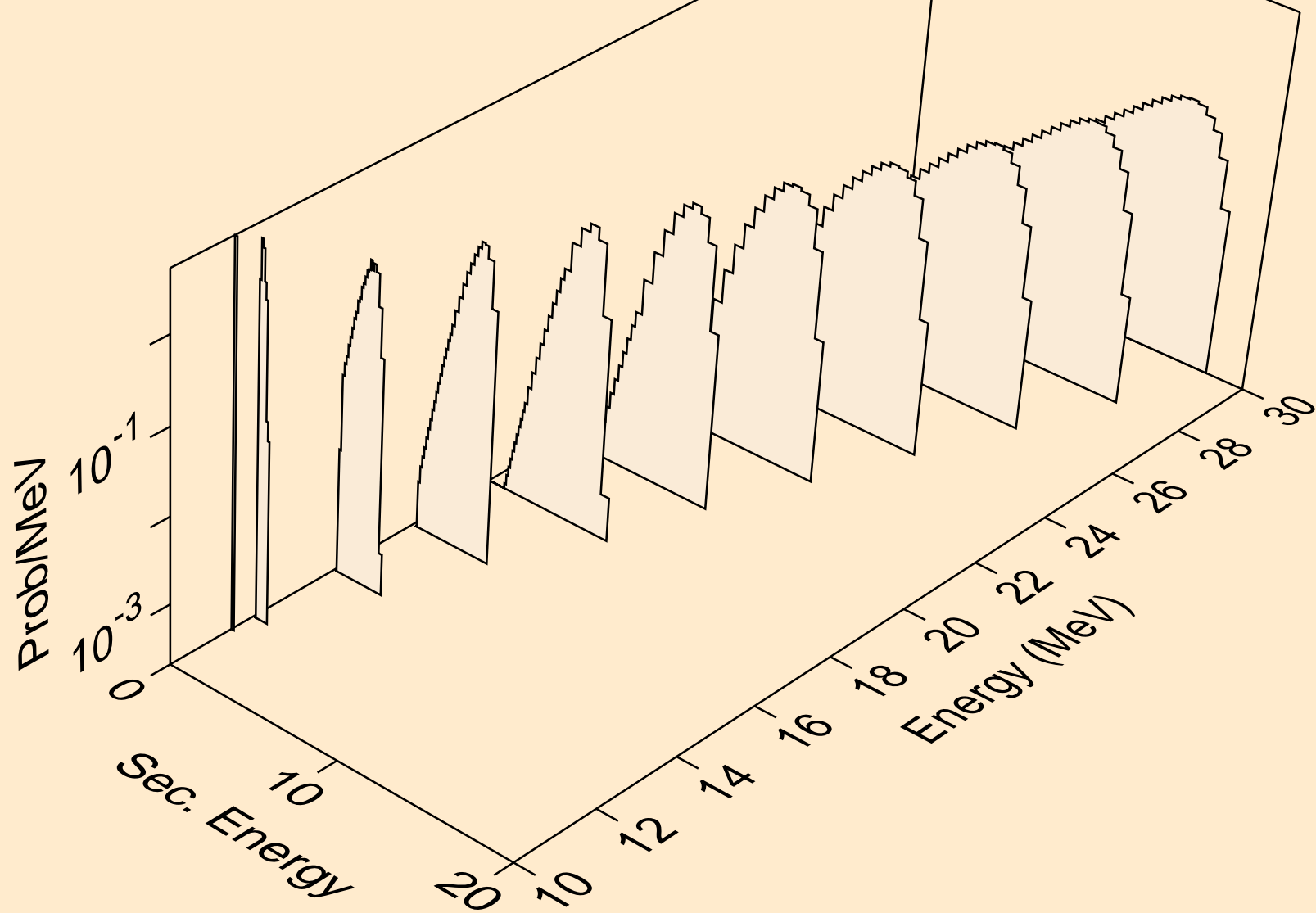

PD115M TRITON ACER TENDL-2021 LIBRARY; T=0.K  
deuterons from (t,n\*)d

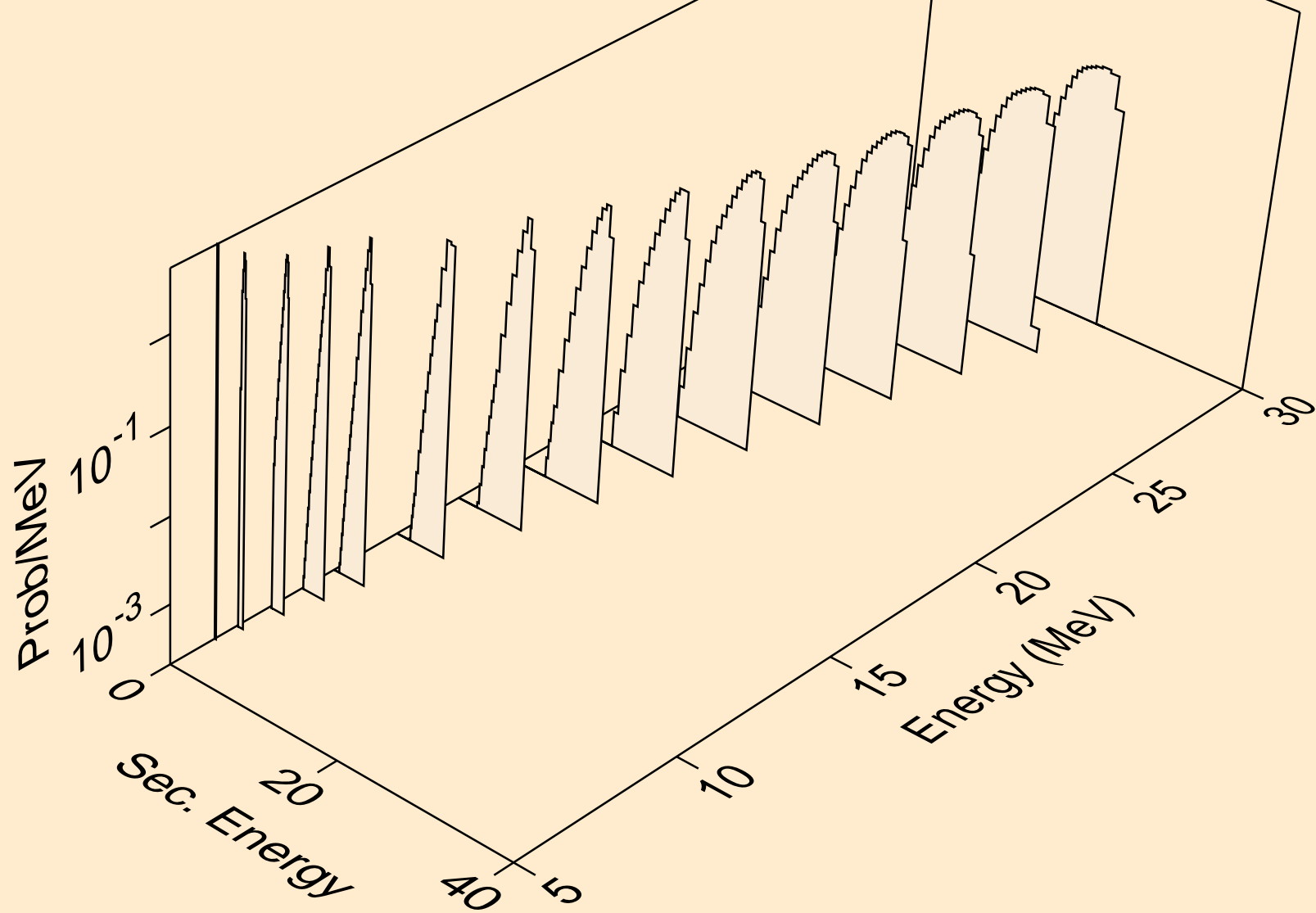

PD115M TRITON ACER TENDL-2021 LIBRARY; T=0.K  
deuterons from (t,d)

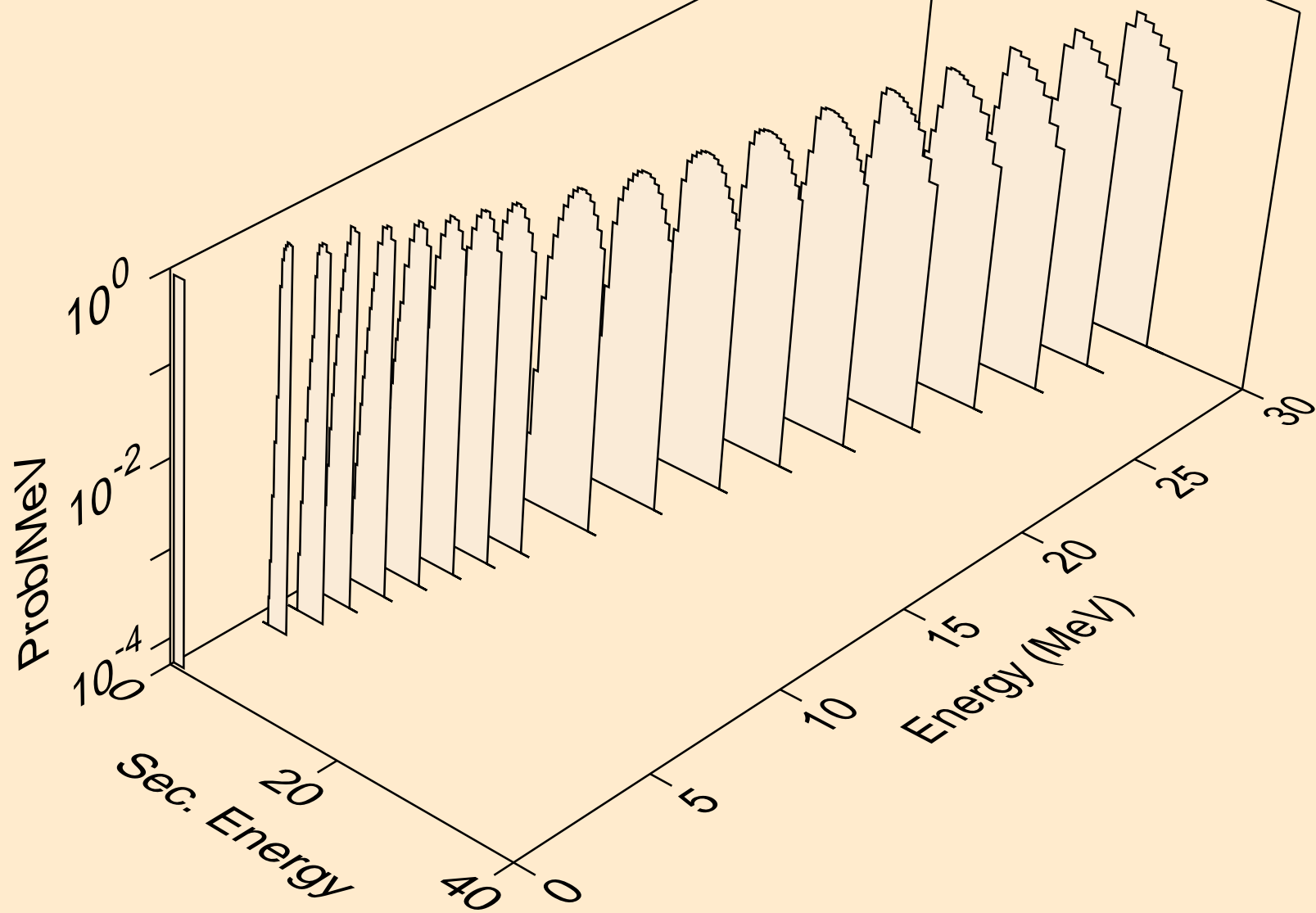

PD115M TRITON ACER TENDL-2021 LIBRARY; T=0.K  
deuterons from (t,pd)

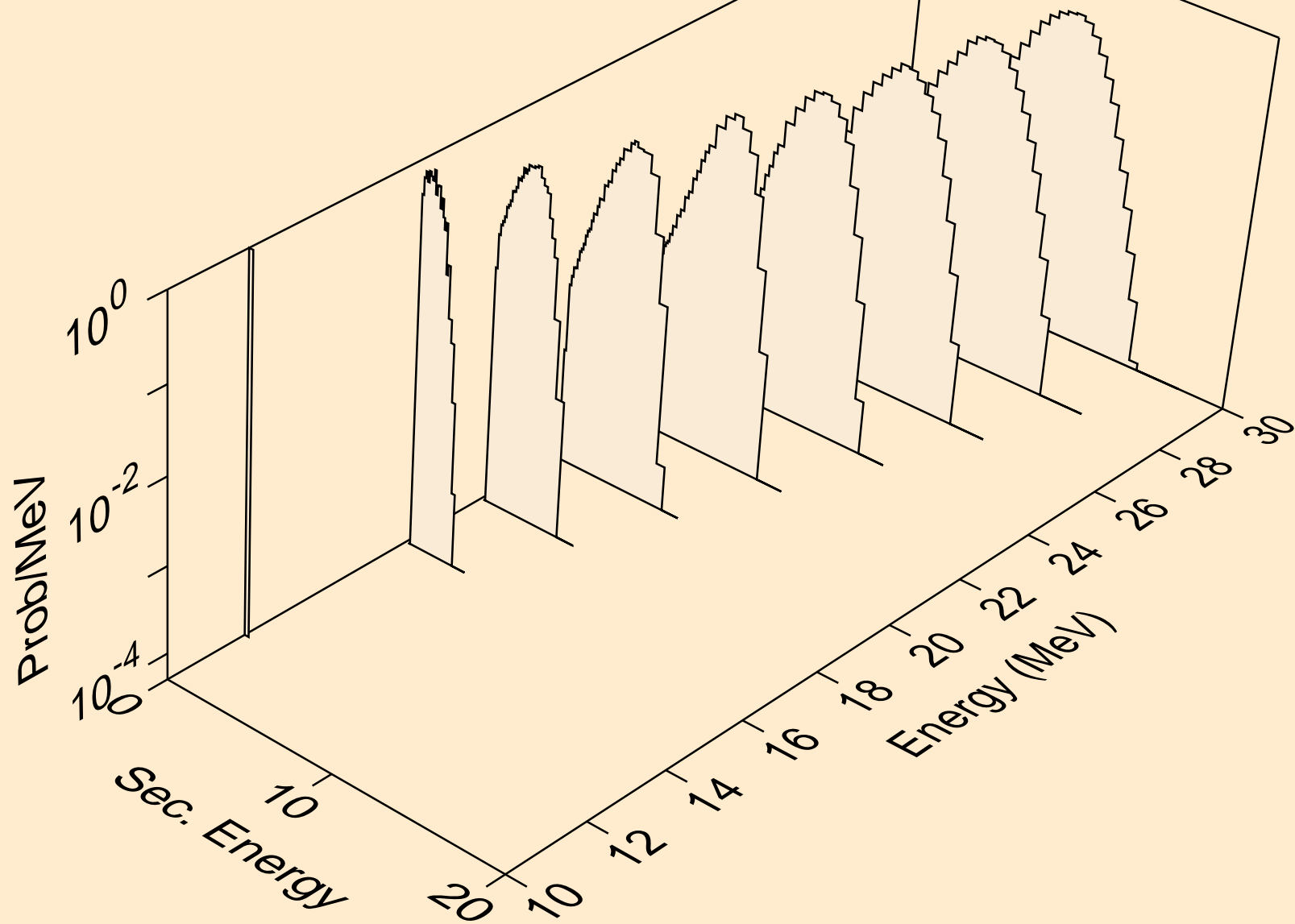

PD115M TRITON ACER TENDL-2021 LIBRARY; T=0.K  
he3s from (t,x)

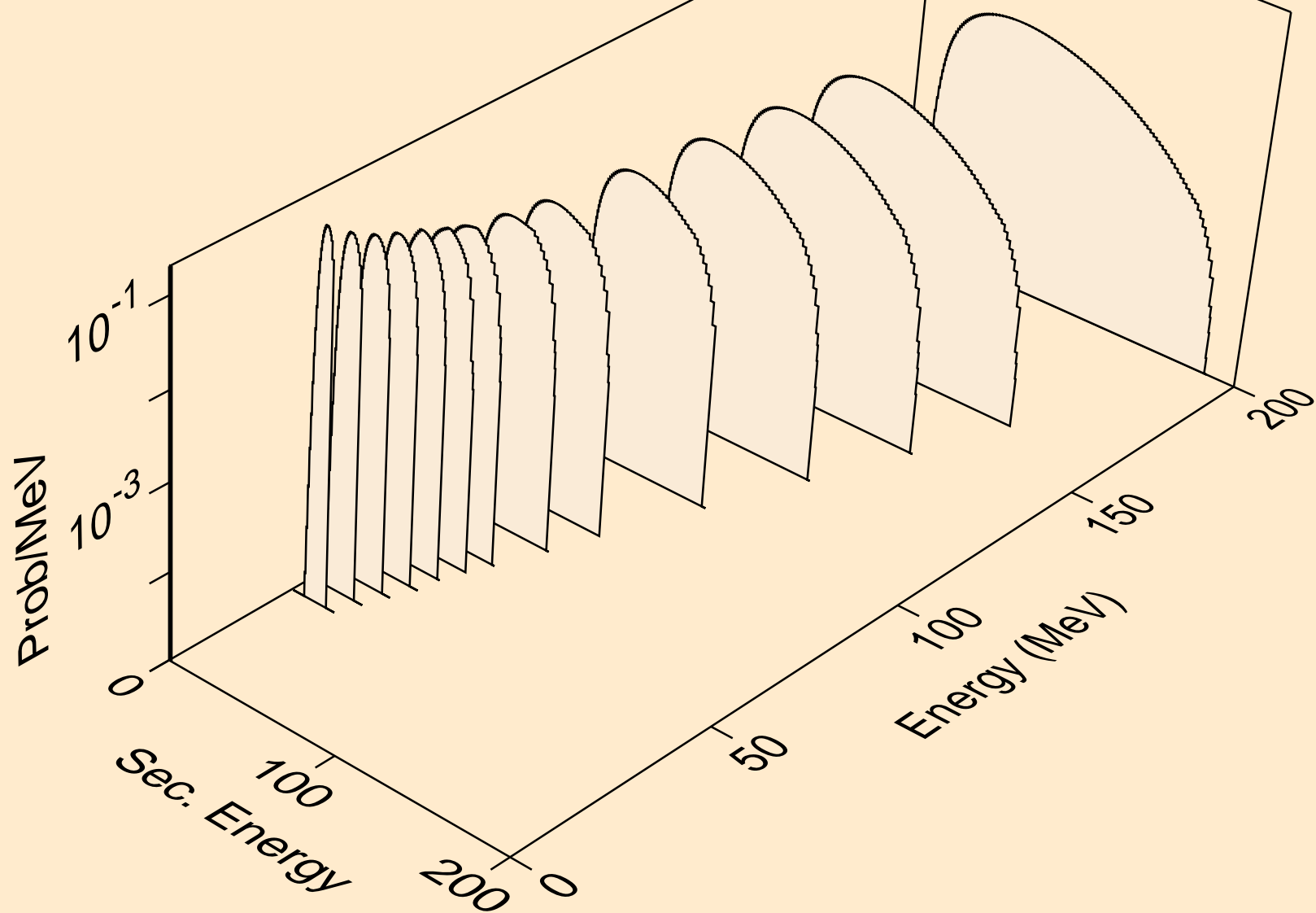

PD115M TRITON ACER TENDL-2021 LIBRARY; T=0.K  
he3s from (t,n\*)he3

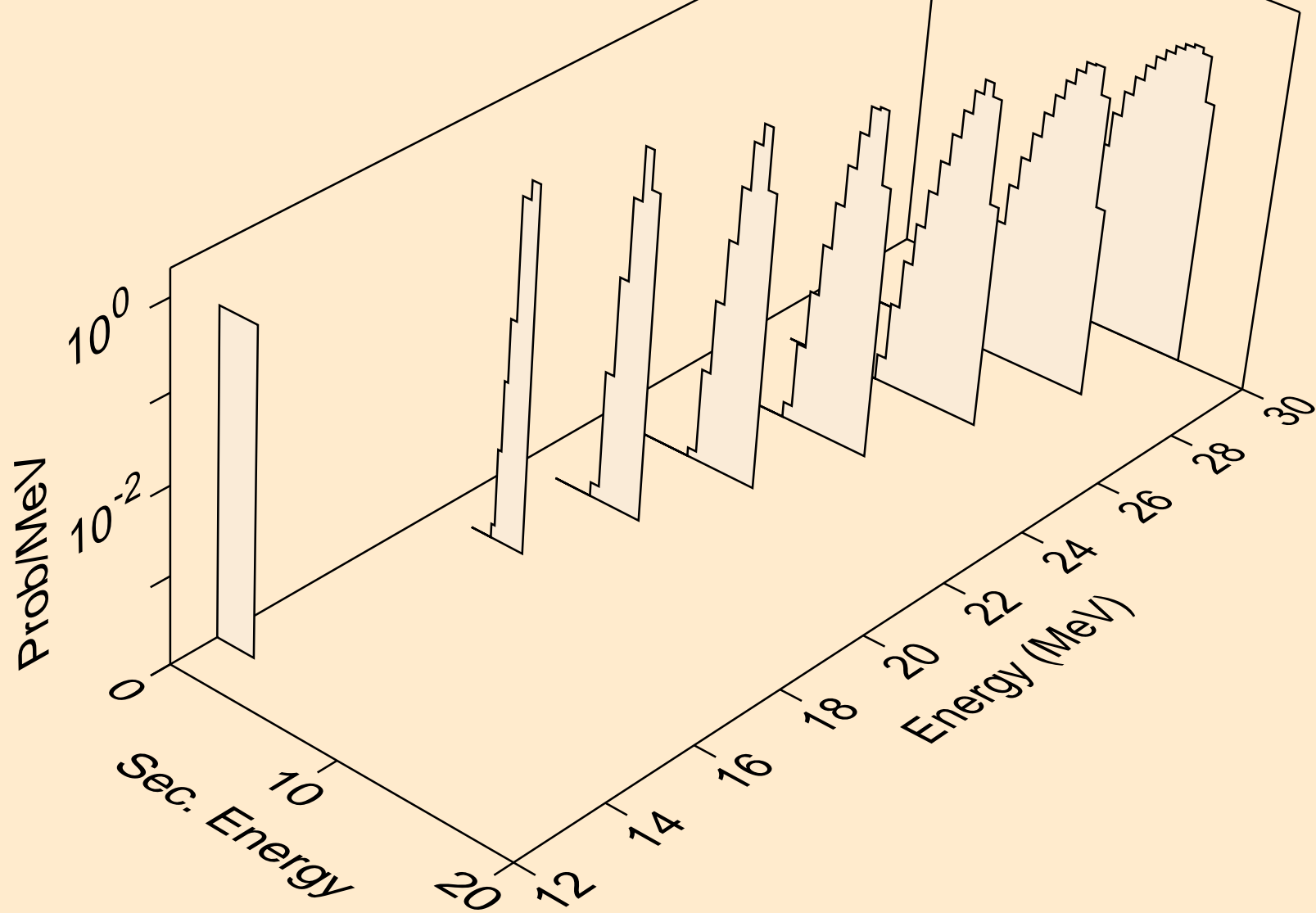



PD115M TRITON ACER TENDL-2021 LIBRARY; T=0.K  
he3s from (t,he3)

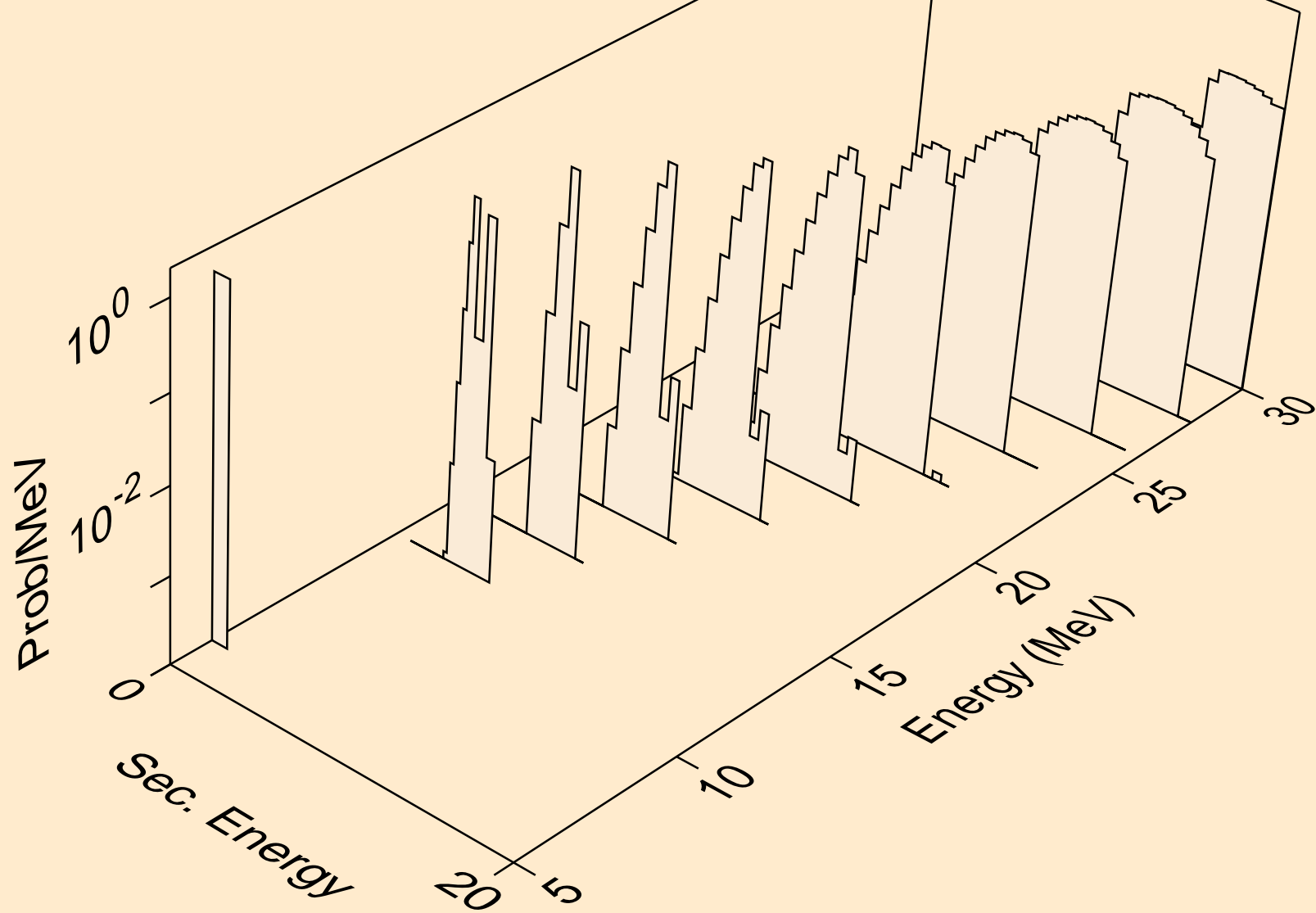

PD115M TRITON ACER TENDL-2021 LIBRARY; T=0.K  
alphas from (t,x)

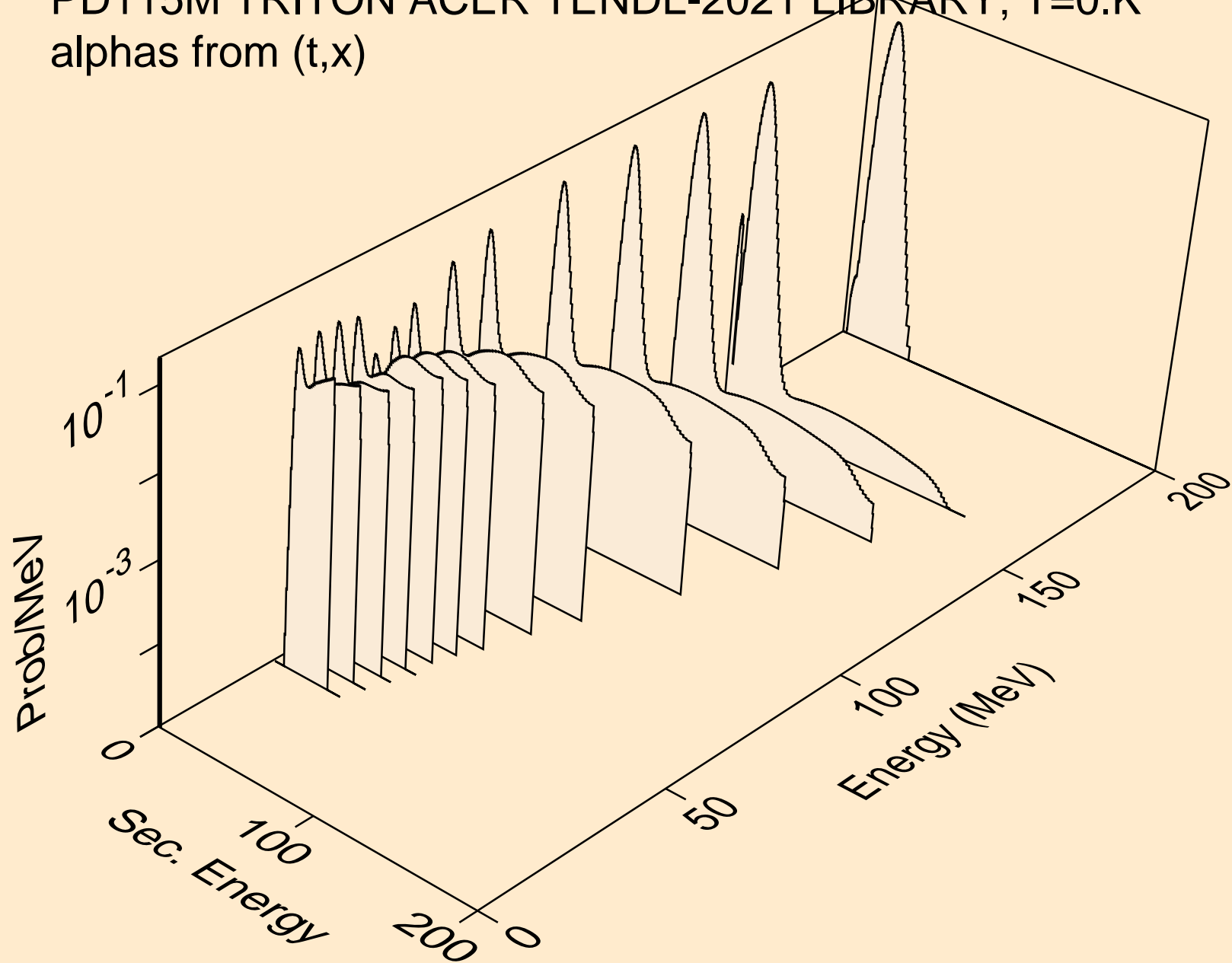

PD115M TRITON ACER TENDL-2021 LIBRARY; T=0.K  
alphas from (t,n\*)a

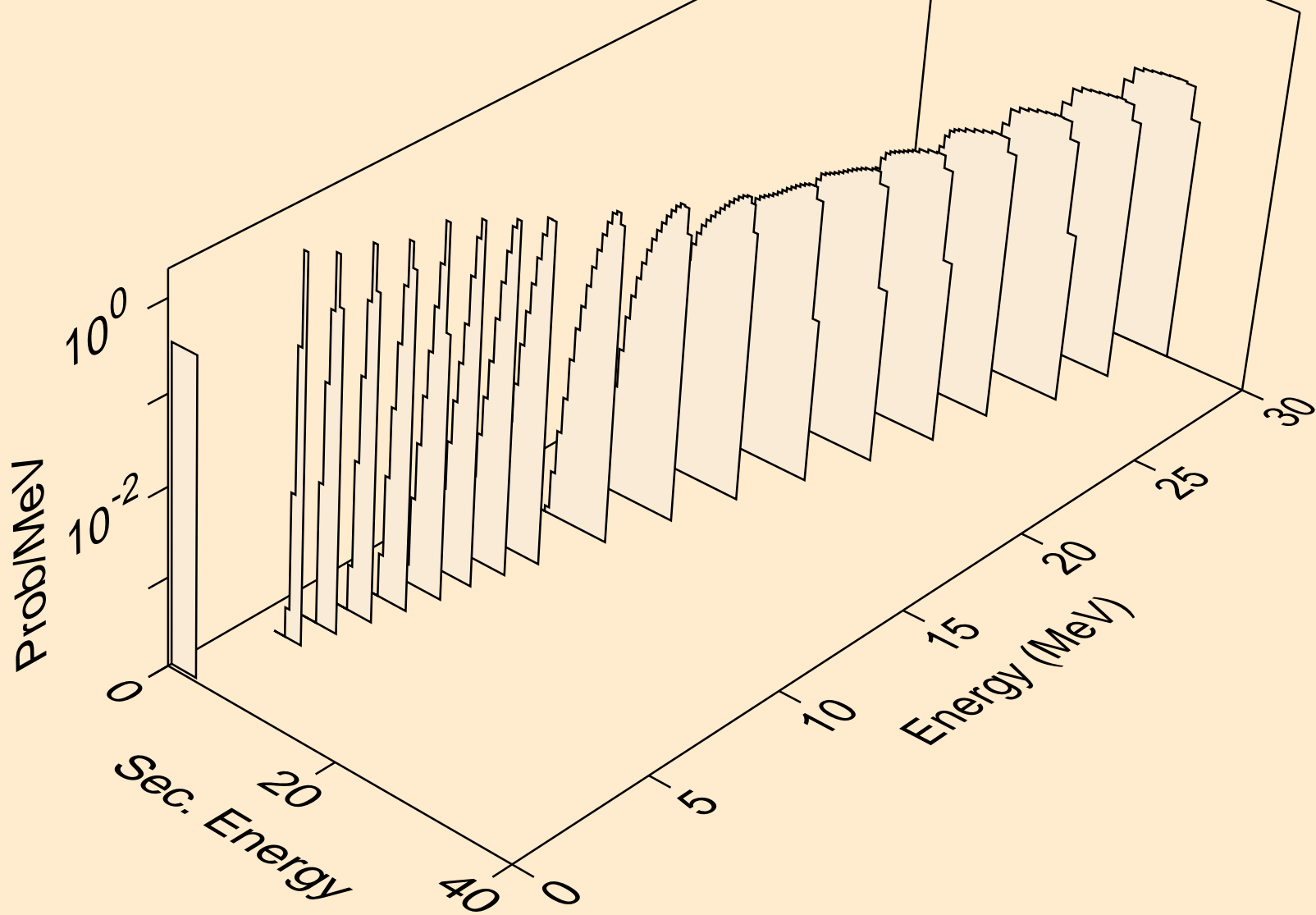

PD115M TRITON ACER TENDL-2021 LIBRARY; T=0.K  
alphas from (t,2n)a

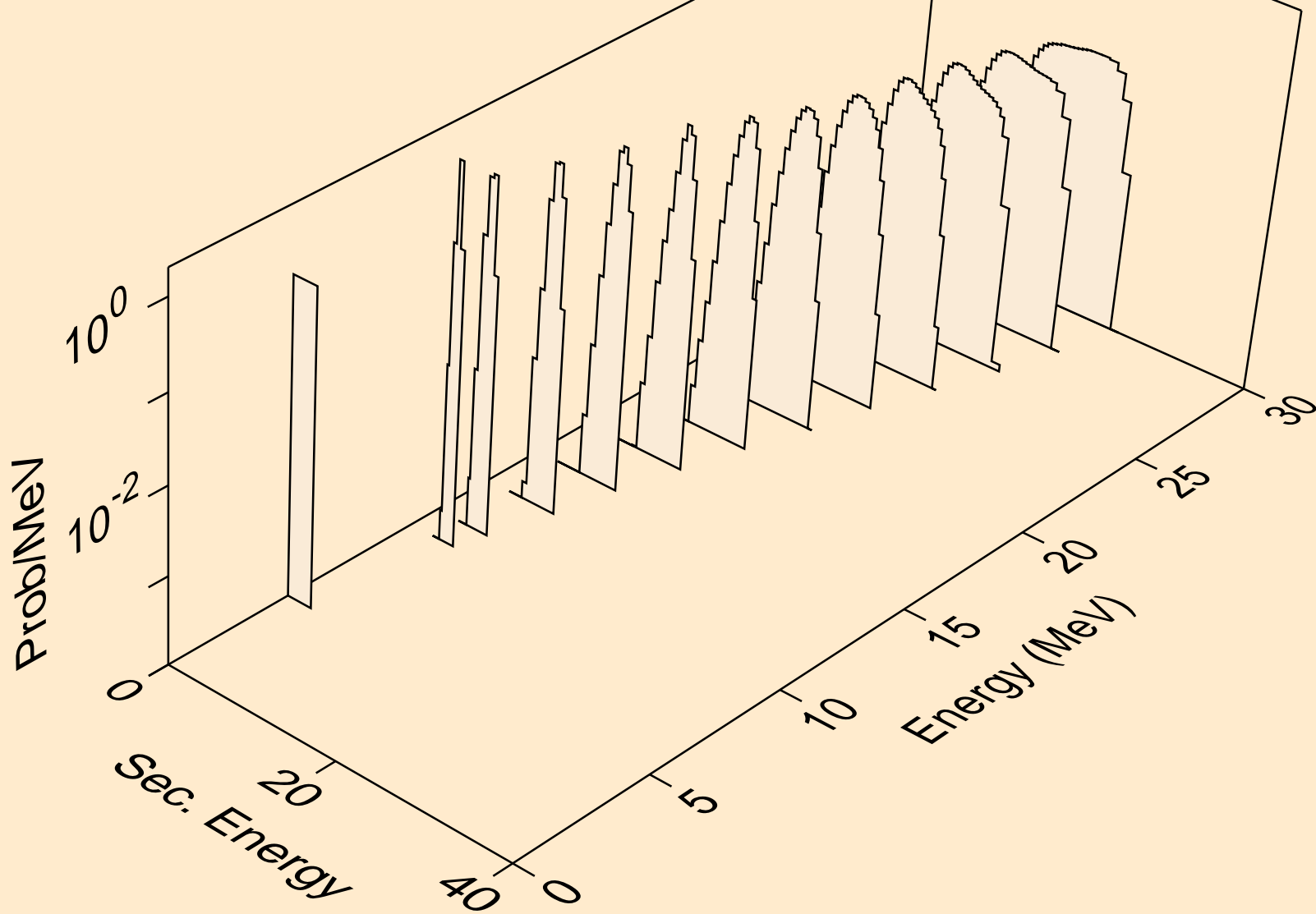

PD115M TRITON ACER TENDL-2021 LIBRARY; T=0.K  
alphas from (t,3n)a

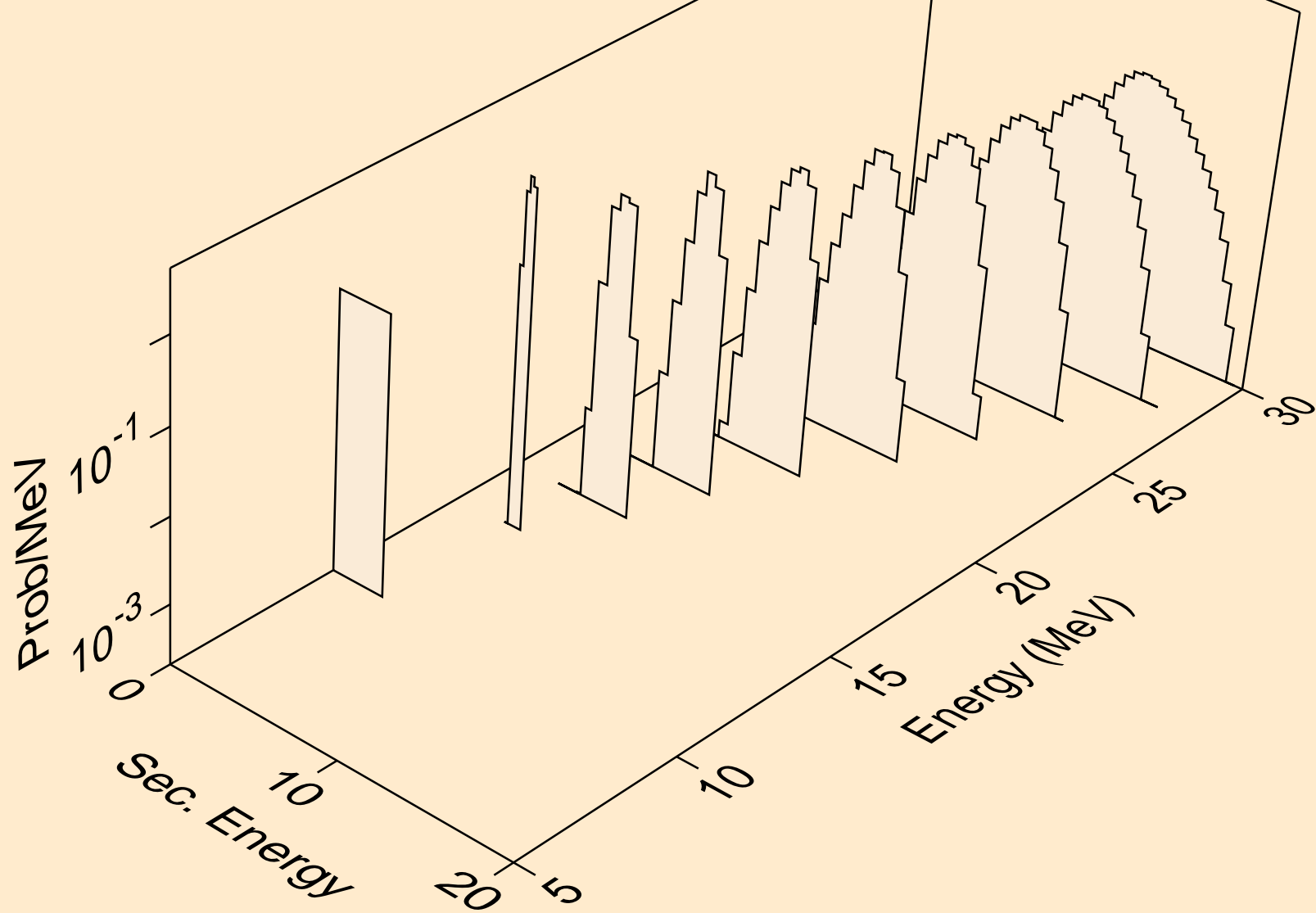

PD115M TRITON ACER TENDL-2021 LIBRARY; T=0.K  
alphas from (t,n\*)2a

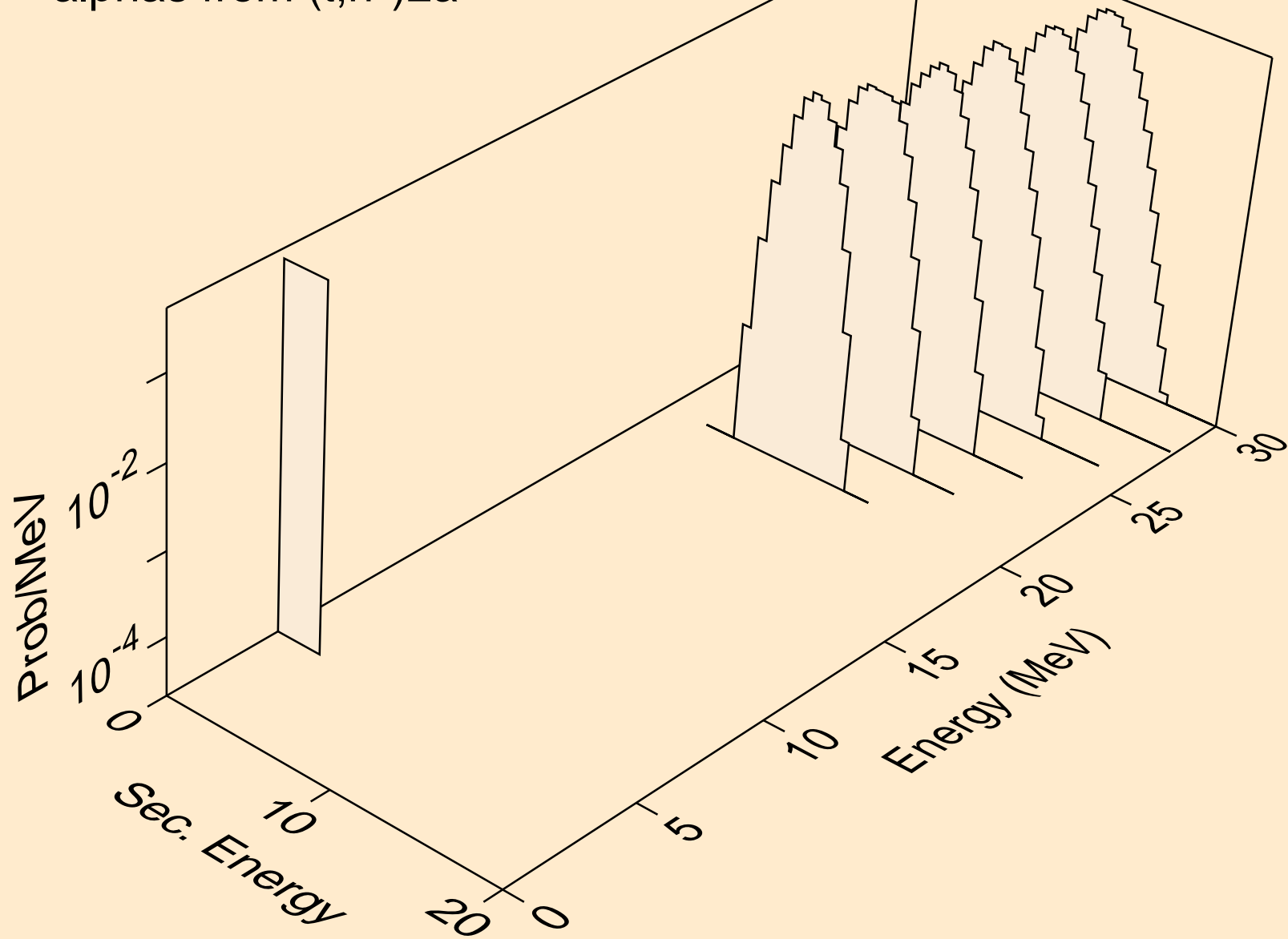

PD115M TRITON ACER TENDL-2021 LIBRARY; T=0.K  
alphas from (t,npa)

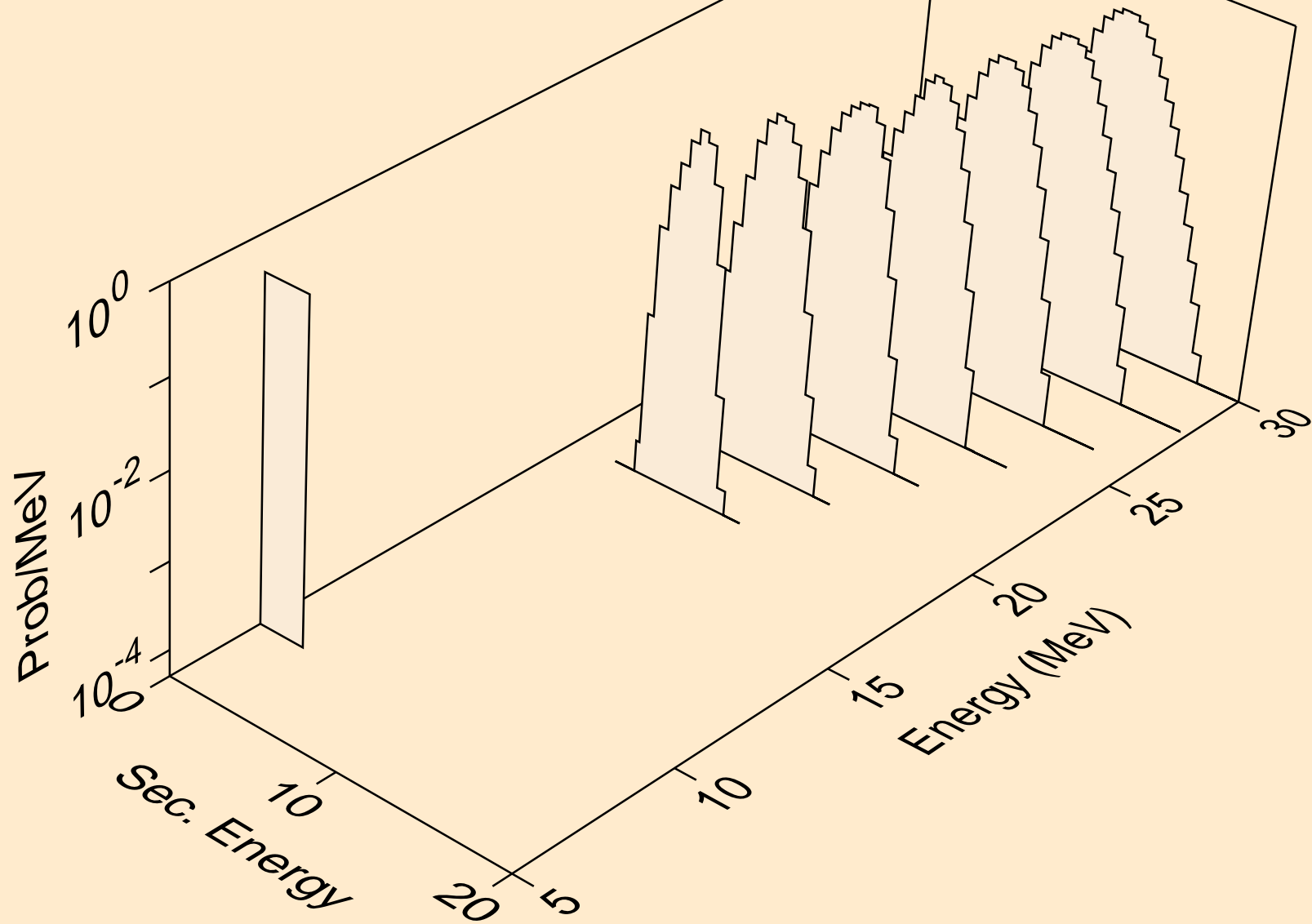

PD115M TRITON ACER TENDL-2021 LIBRARY; T=0.K  
alphas from (t,a)

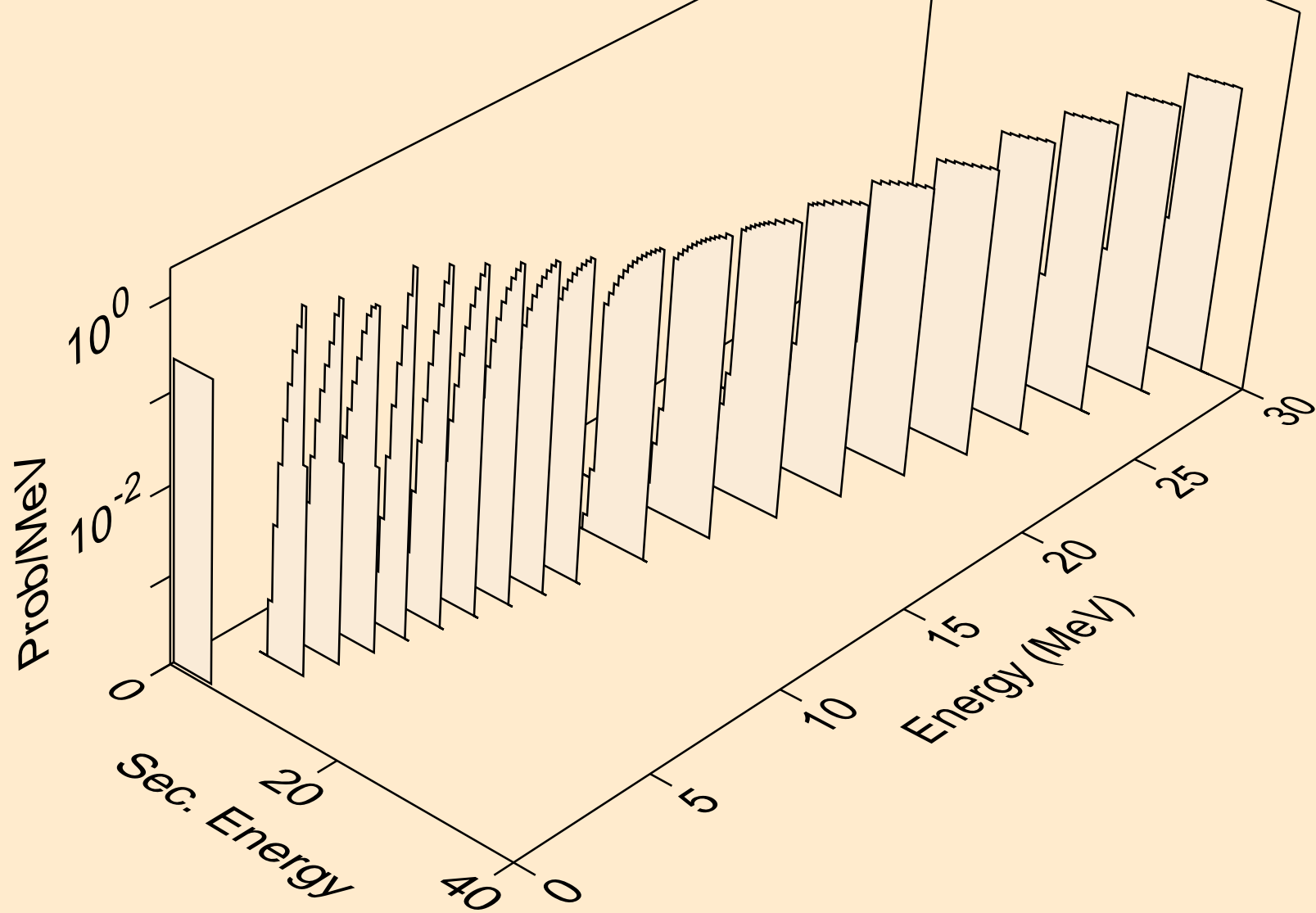



PD115M TRITON ACER TENDL-2021 LIBRARY; T=0.K  
alphas from (t,pa)

