

PO204 TRITON ACER TENDL-2021 LIBRARY; T=0.K  
Principal cross sections

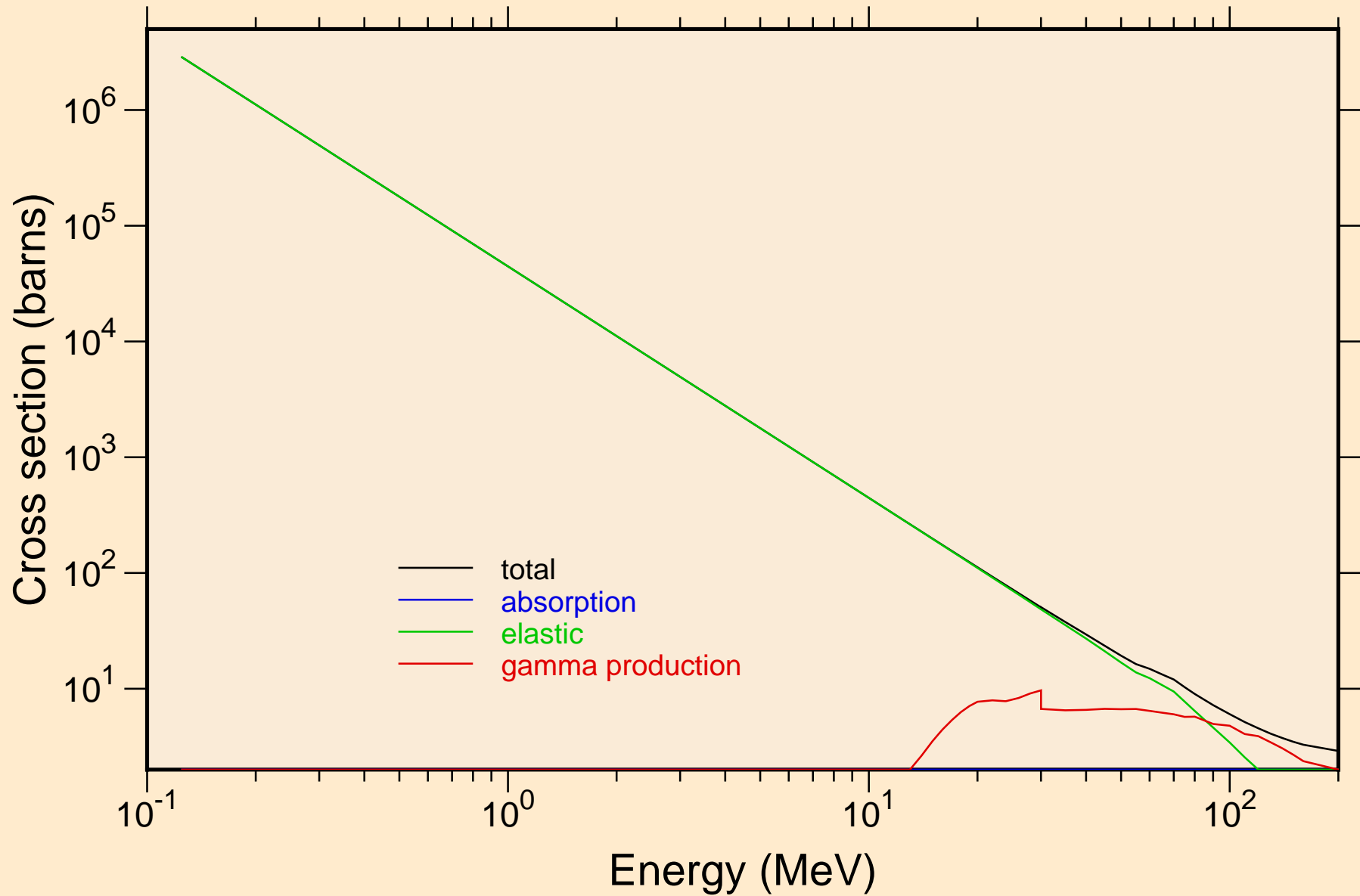

PO204 TRITON ACER TENDL-2021 LIBRARY; T=0.K

Heating

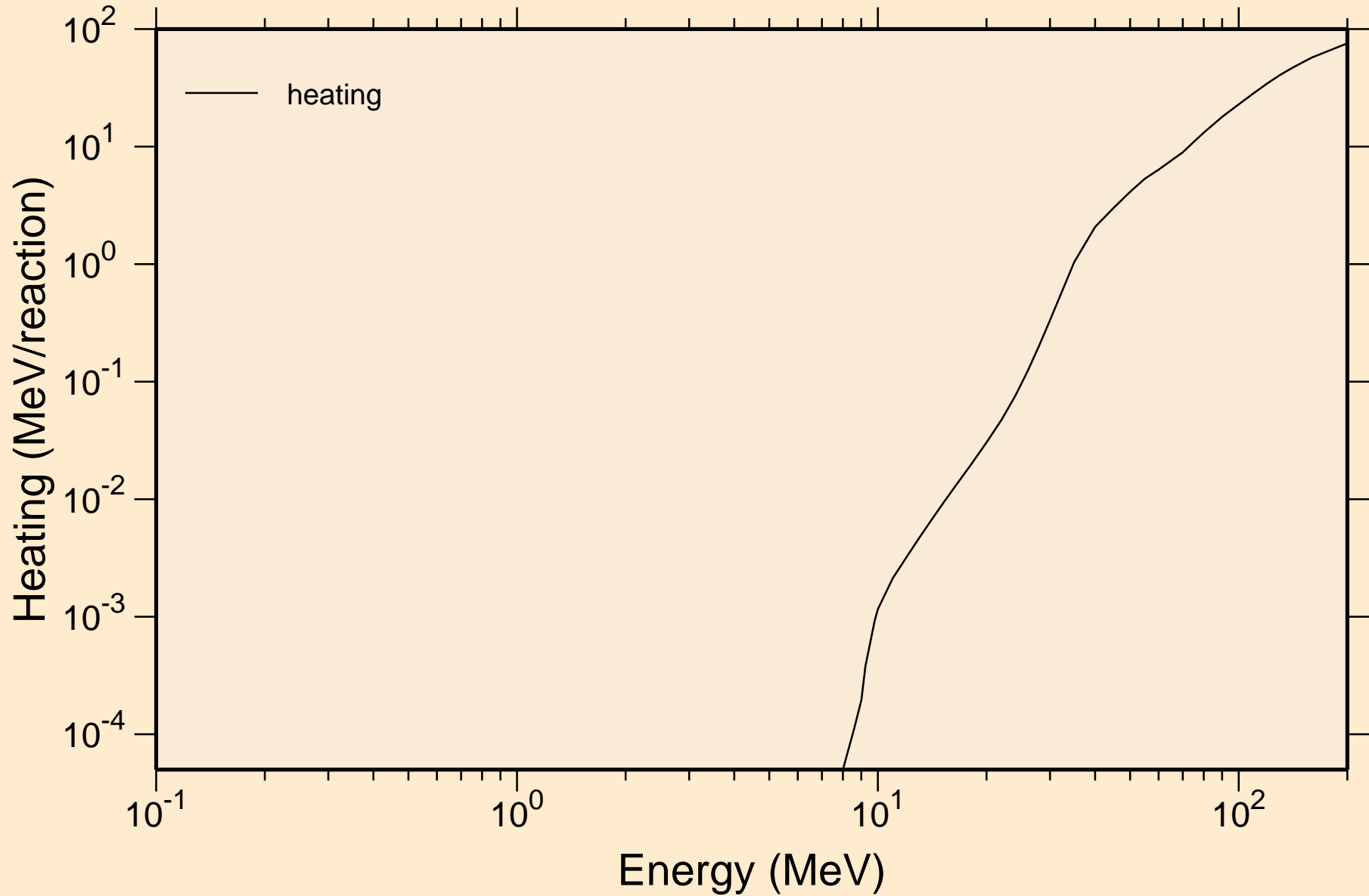

# PO204 TRITON ACER TENDL-2021 LIBRARY; T=0.K

## Principal cross sections

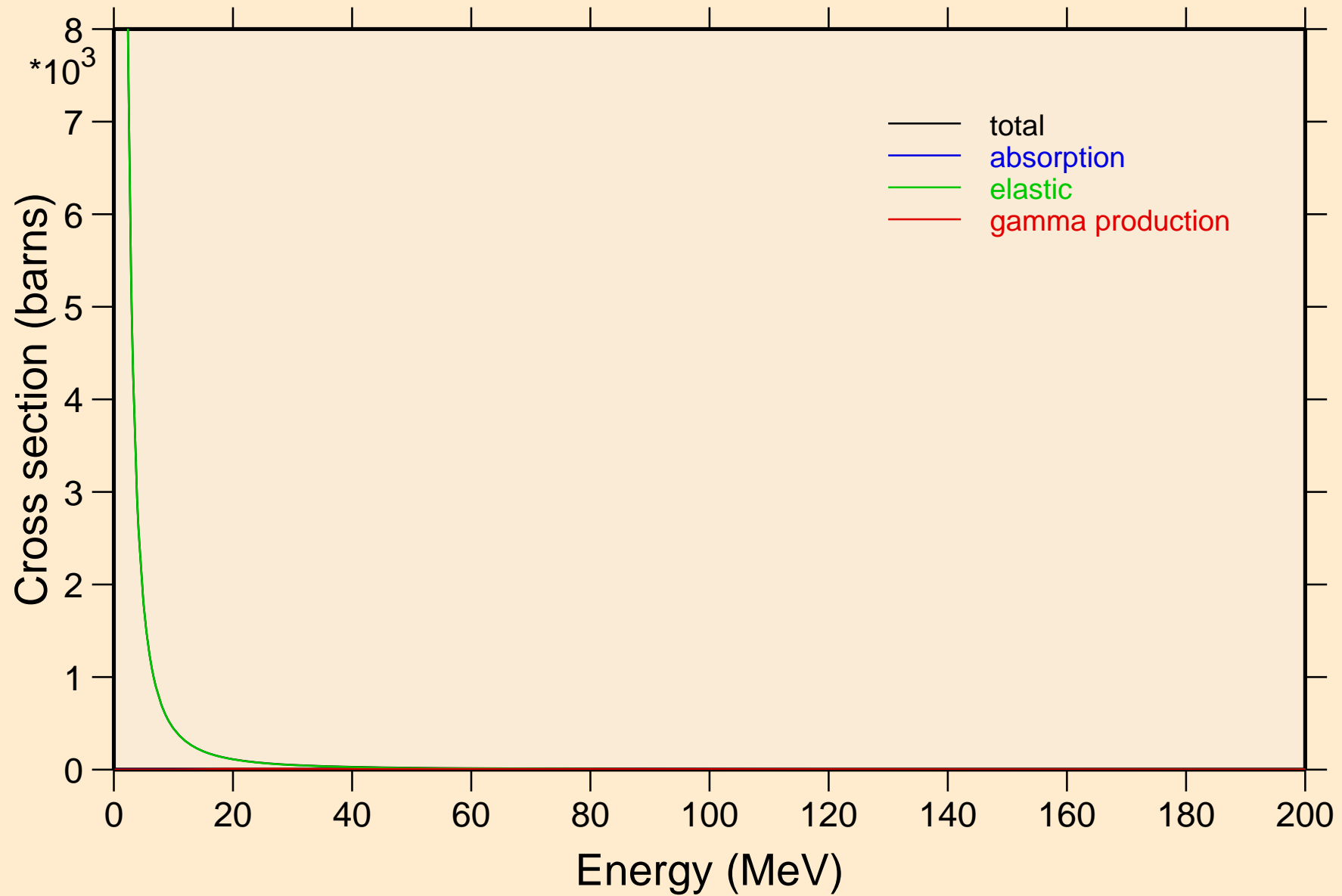

PO204 TRITON ACER TENDL-2021 LIBRARY; T=0.K

Heating

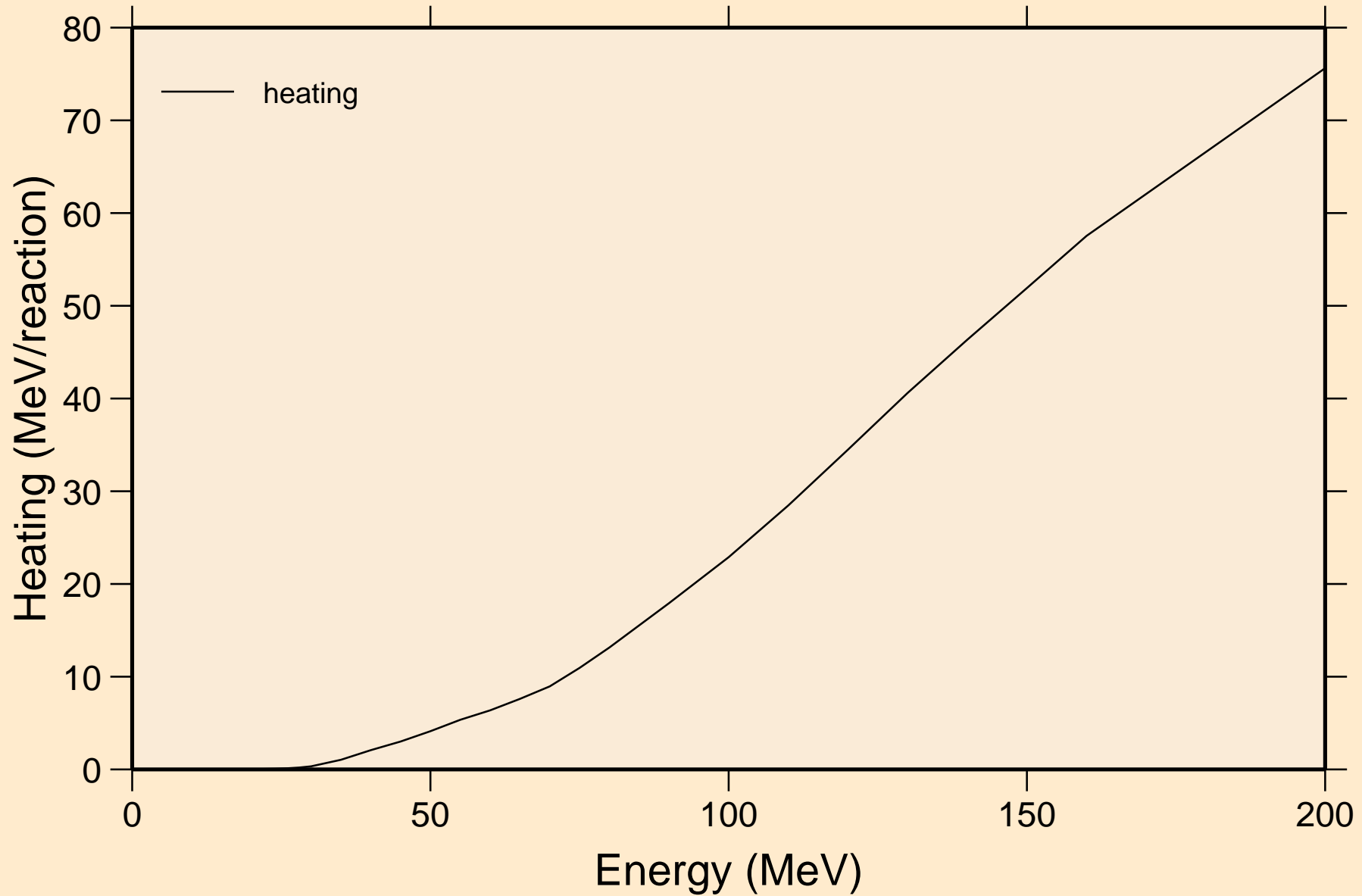

PO204 TRITON ACER TENDL-2021 LIBRARY; T=0.K  
Threshold reactions

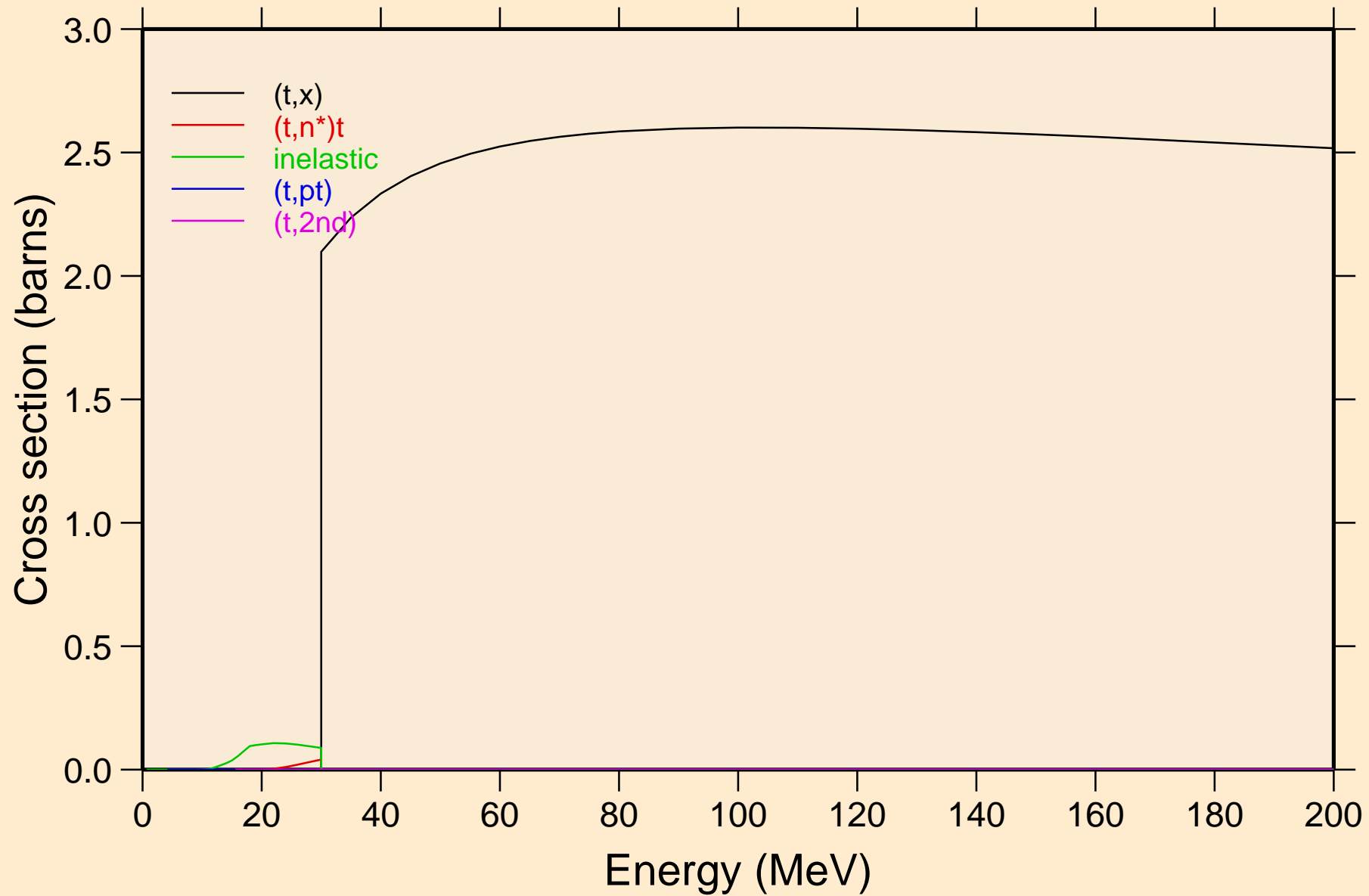

PO204 TRITON ACER TENDL-2021 LIBRARY; T=0.K  
Threshold reactions

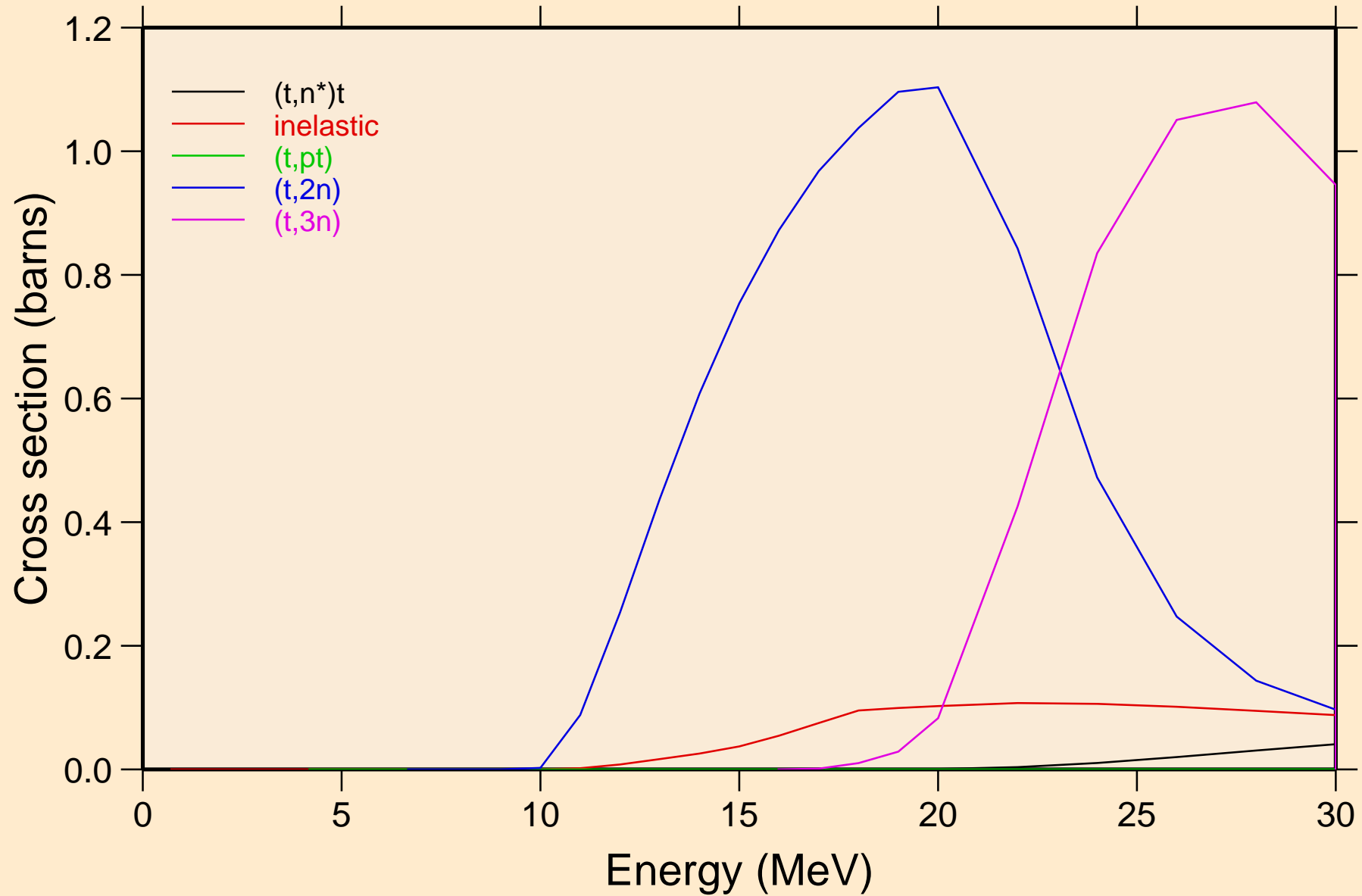

PO204 TRITON ACER TENDL-2021 LIBRARY; T=0.K  
Threshold reactions

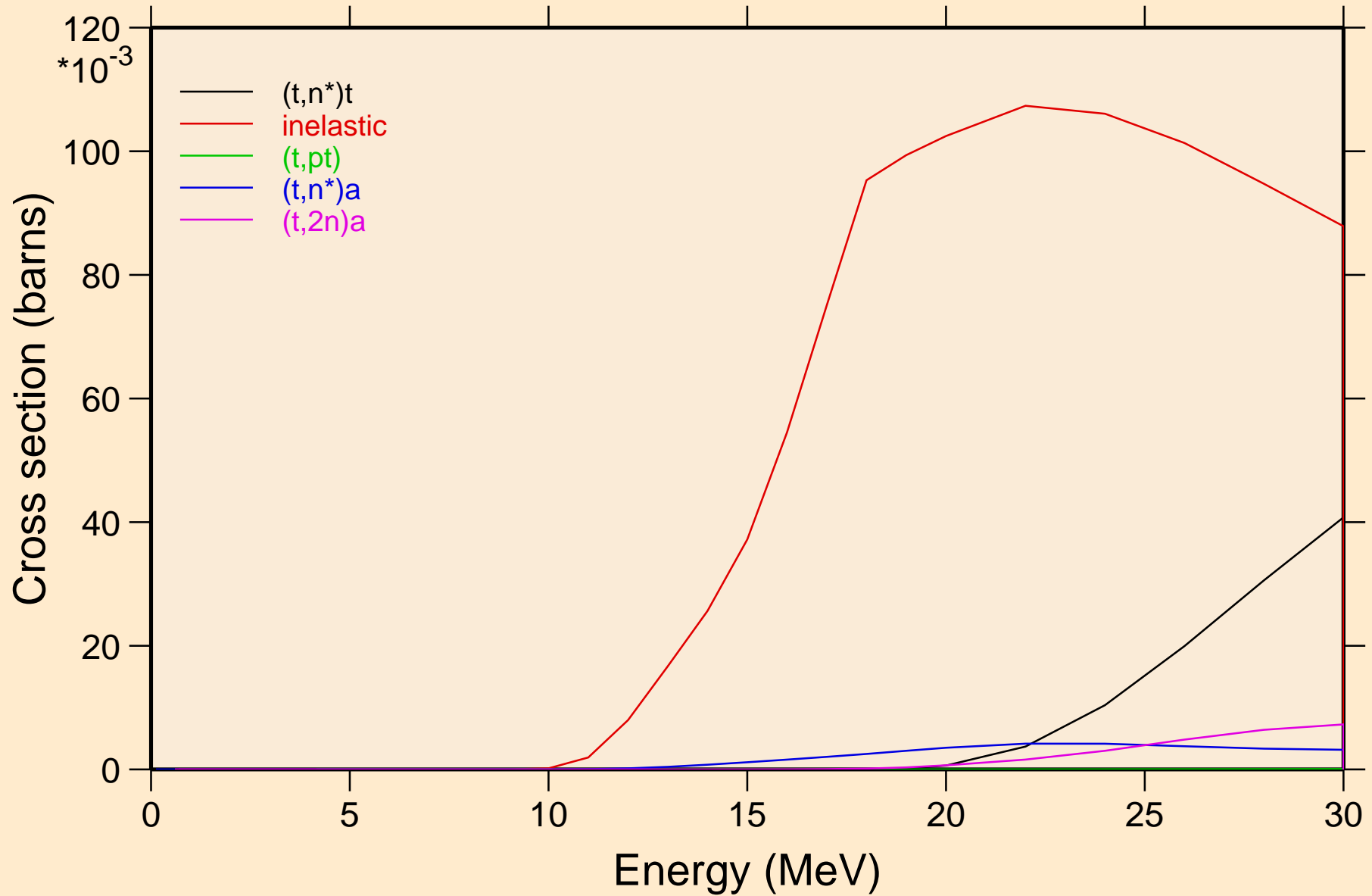

PO204 TRITON ACER TENDL-2021 LIBRARY; T=0.K  
Threshold reactions

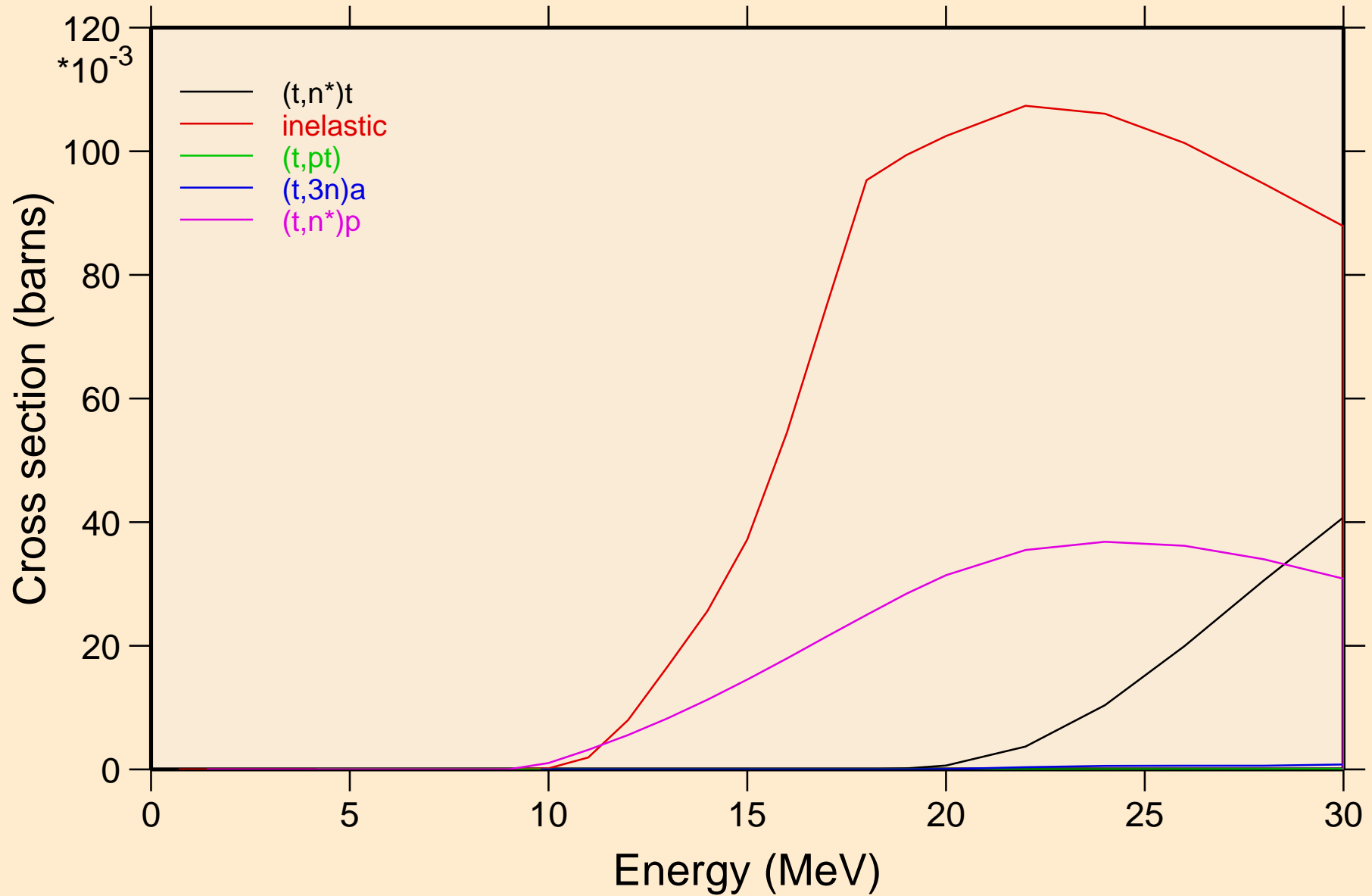



PO204 TRITON ACER TENDL-2021 LIBRARY; T=0.K  
Threshold reactions

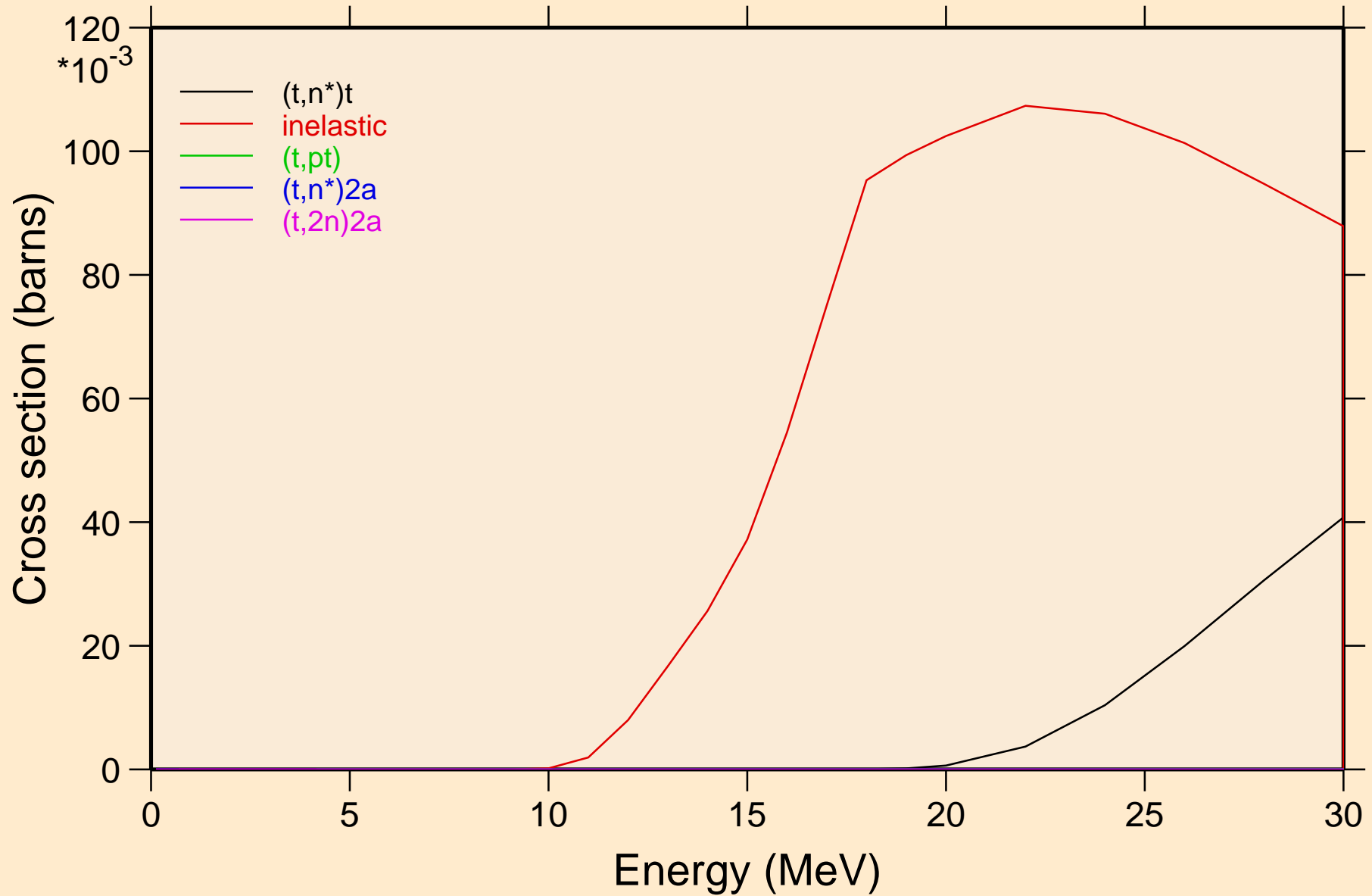

PO204 TRITON ACER TENDL-2021 LIBRARY; T=0.K  
Threshold reactions

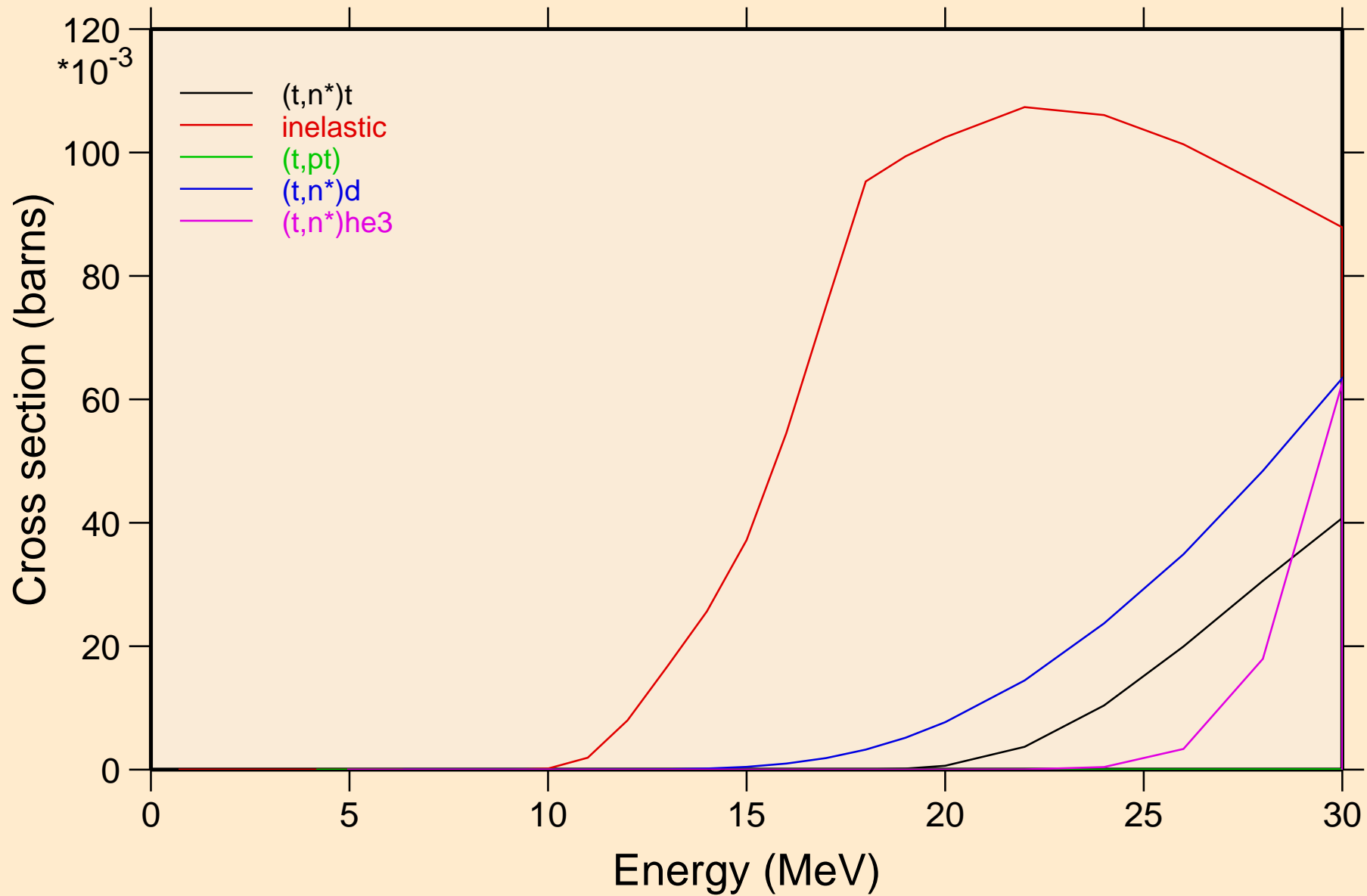

PO204 TRITON ACER TENDL-2021 LIBRARY; T=0.K  
Threshold reactions

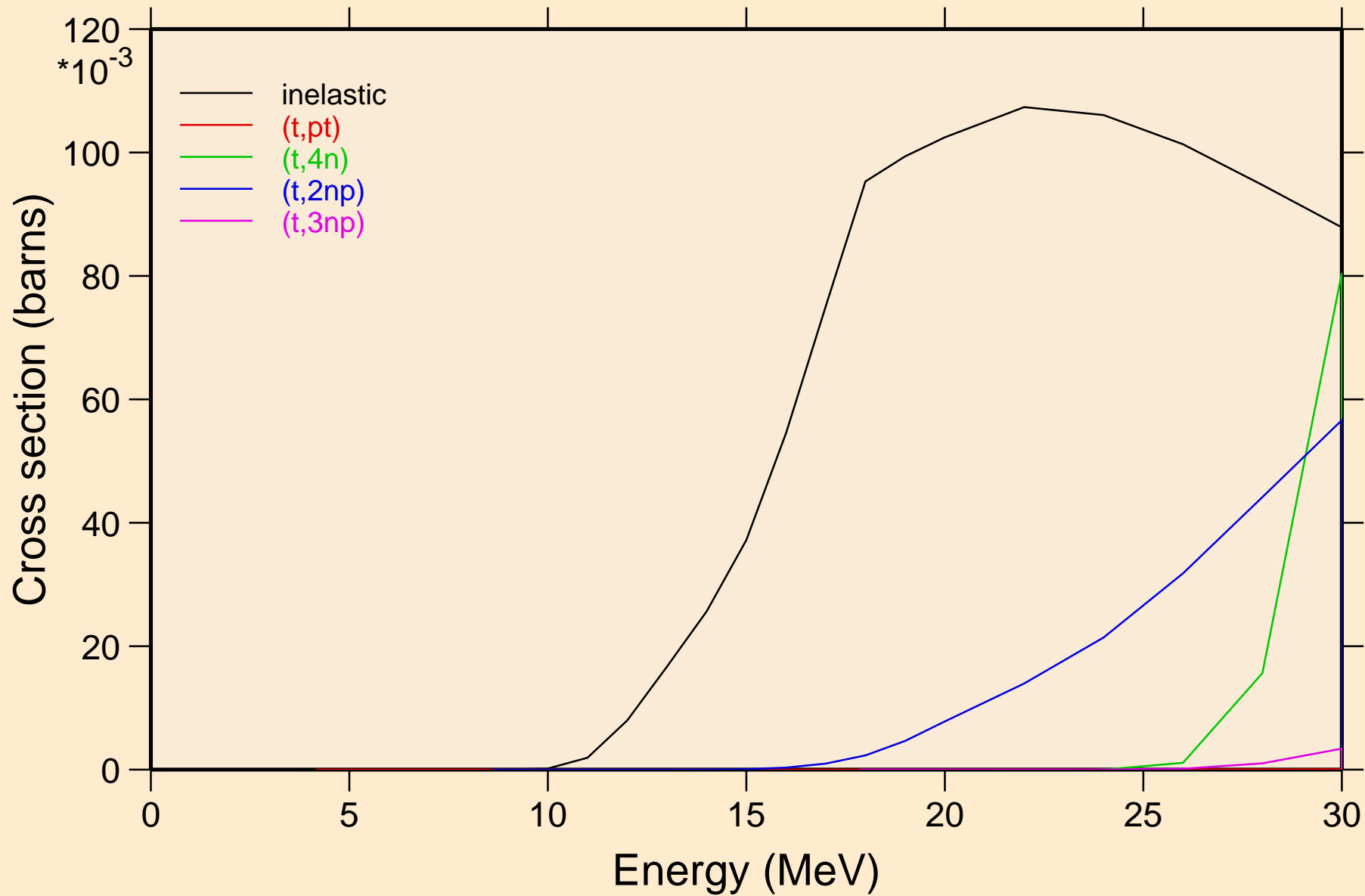

PO204 TRITON ACER TENDL-2021 LIBRARY; T=0.K  
Threshold reactions

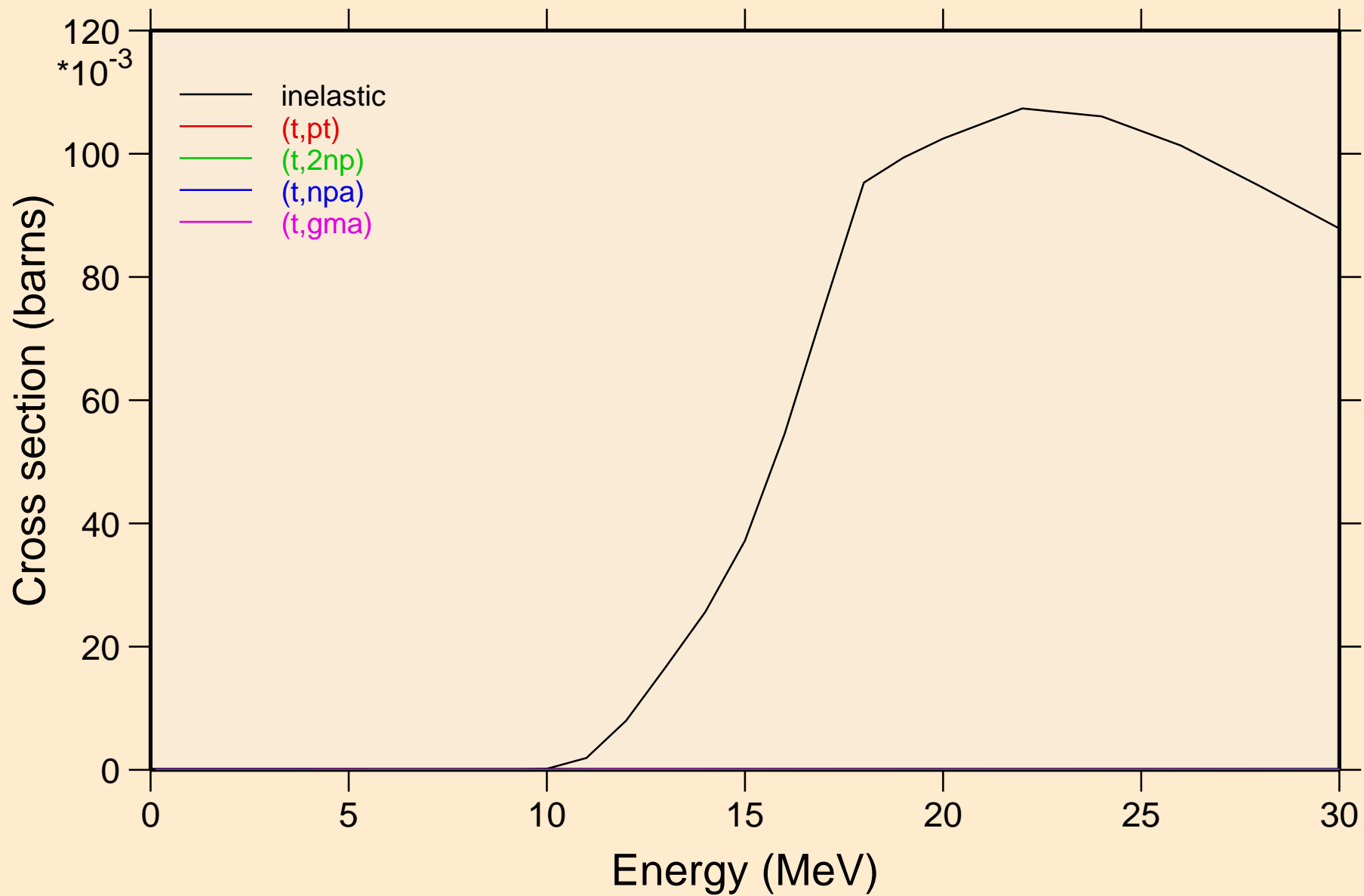

PO204 TRITON ACER TENDL-2021 LIBRARY; T=0.K  
Threshold reactions

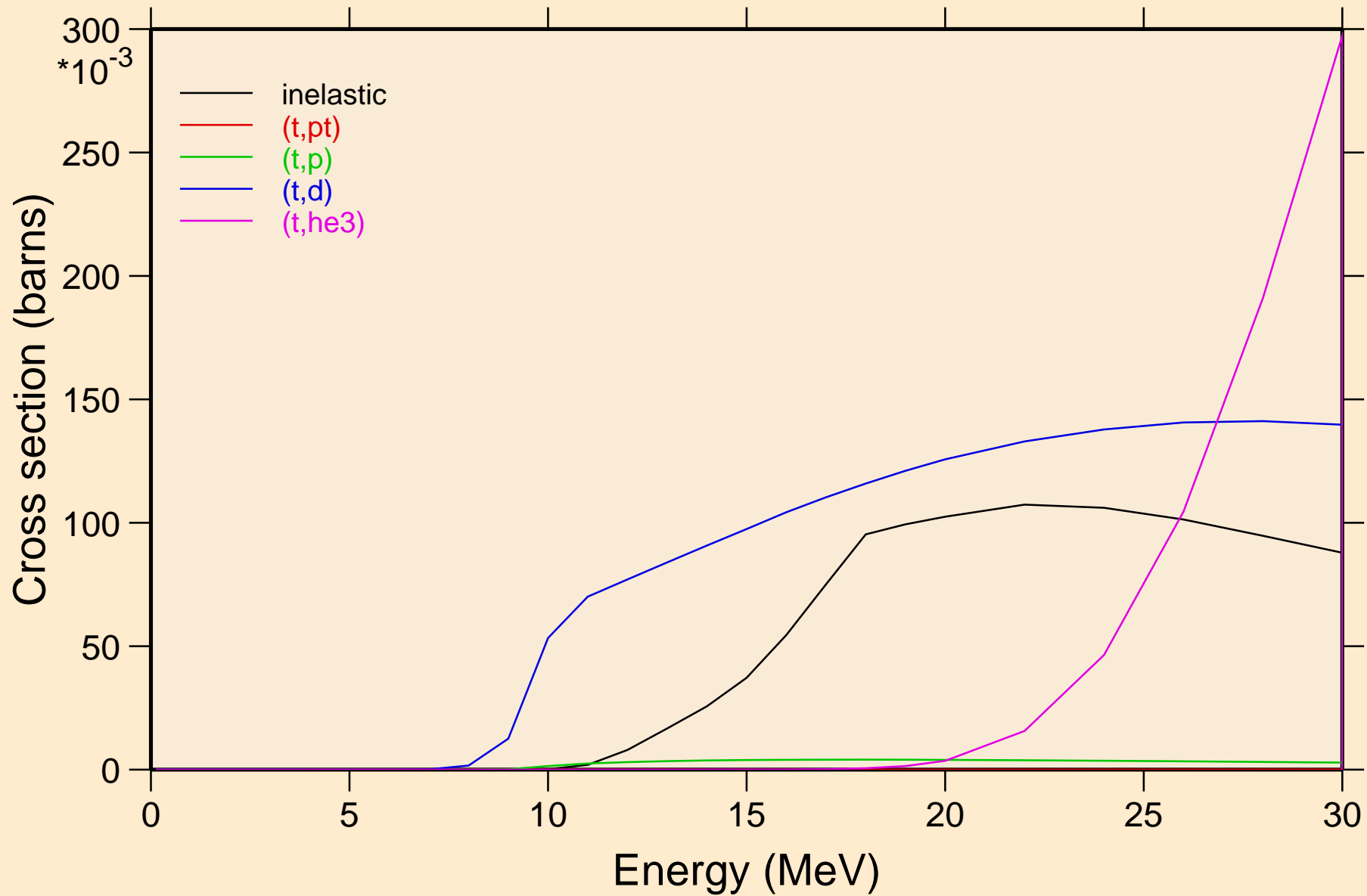

PO204 TRITON ACER TENDL-2021 LIBRARY; T=0.K  
Threshold reactions

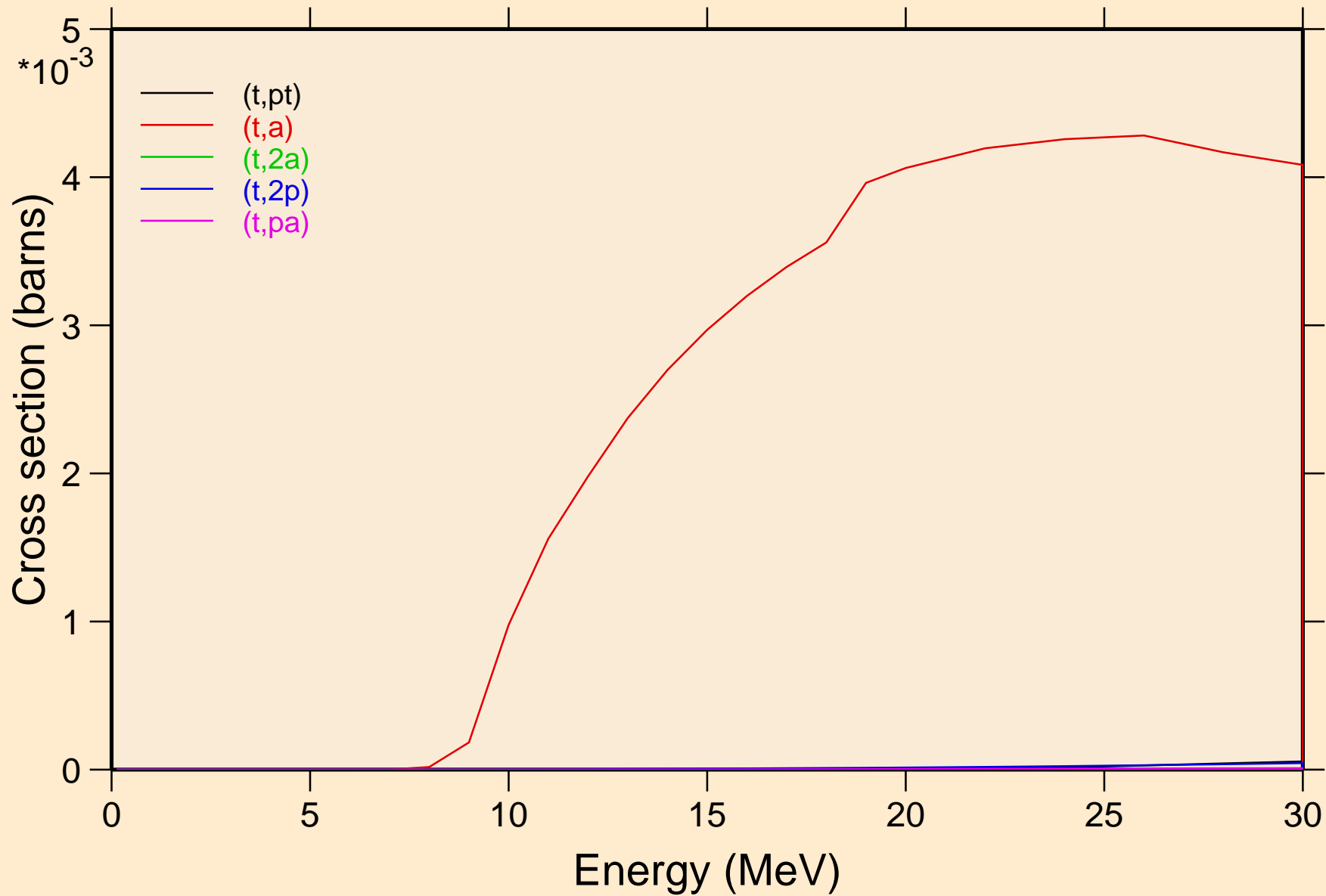

PO204 TRITON ACER TENDL-2021 LIBRARY; T=0.K  
Threshold reactions

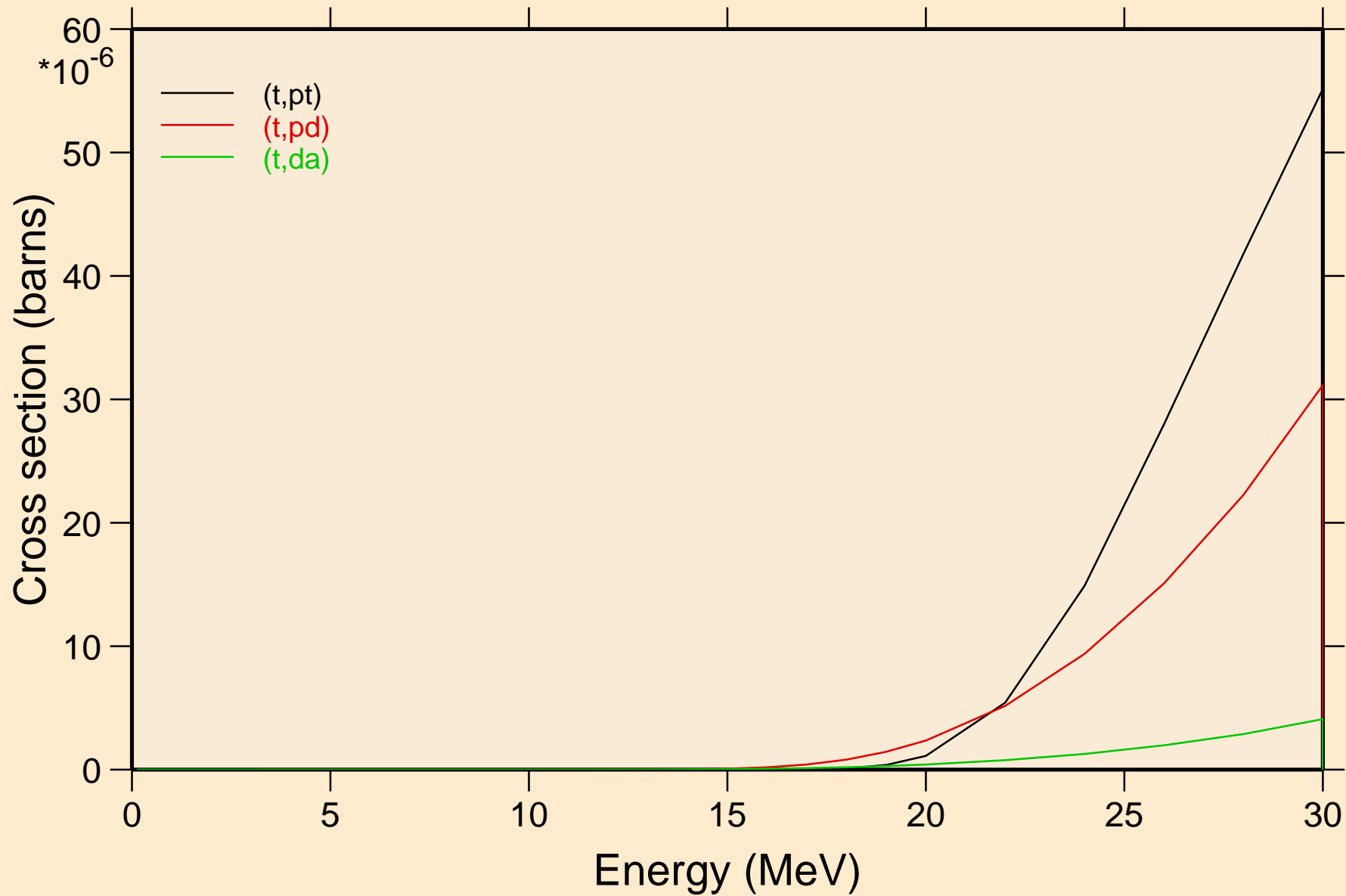

PO204 TRITON ACER TENDL-2021 LIBRARY; T=0.K  
angular distribution for elastic

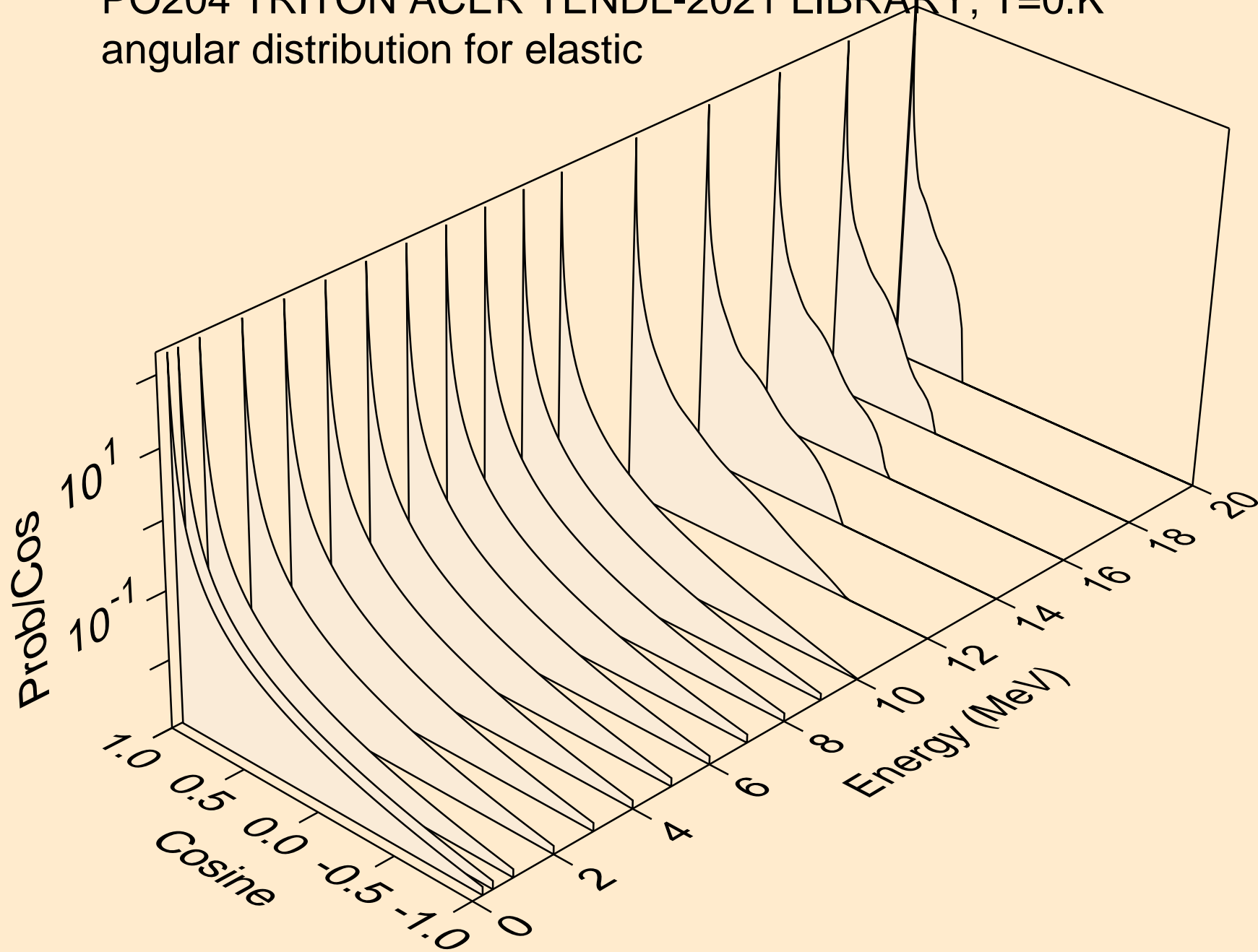



PO204 TRITON ACER TENDL-2021 LIBRARY; T=0.K  
angular distribution for elastic

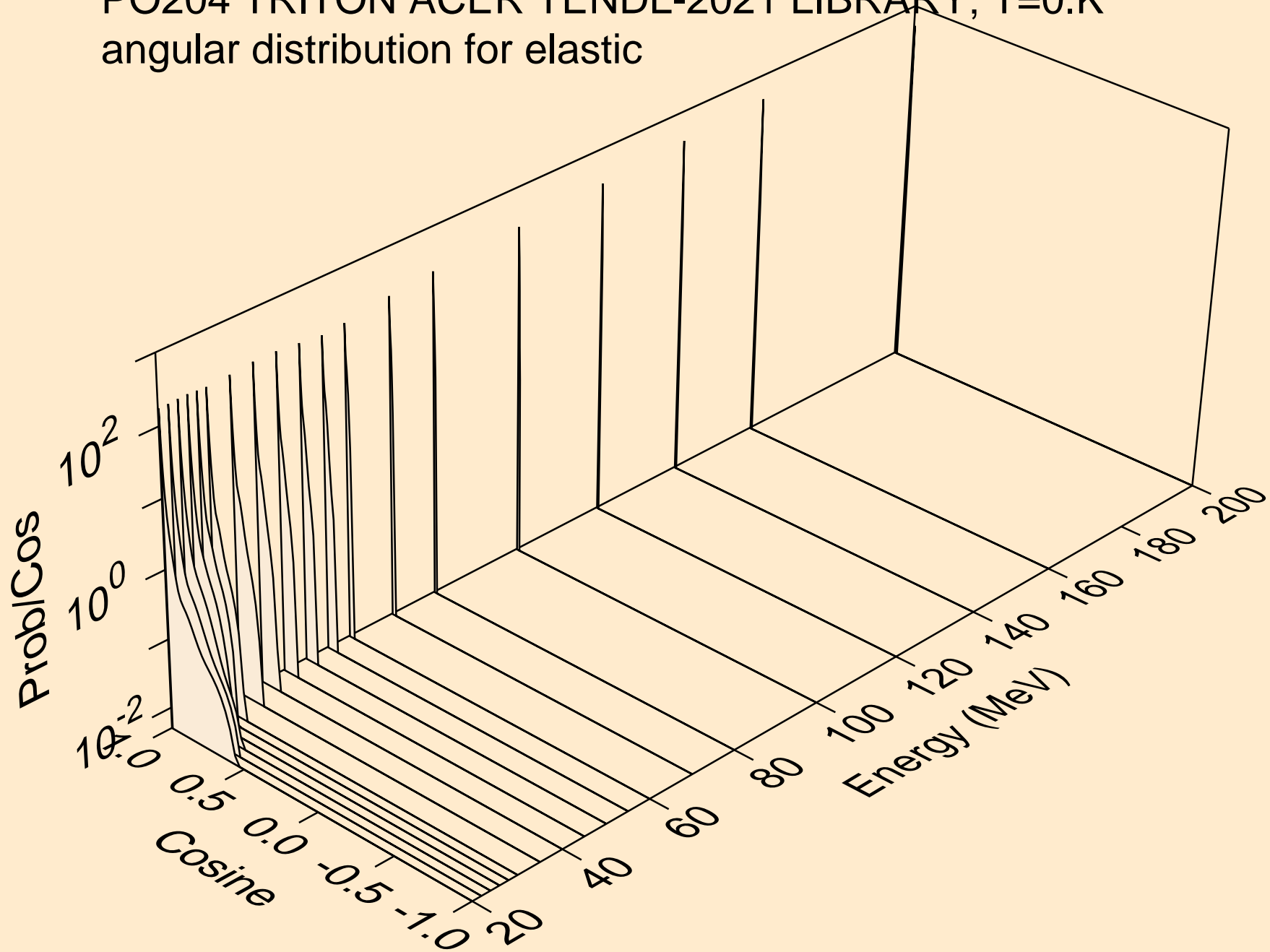

PO204 TRITON ACER TENDL-2021 LIBRARY; T=0.K  
Triton emission for (t,x)

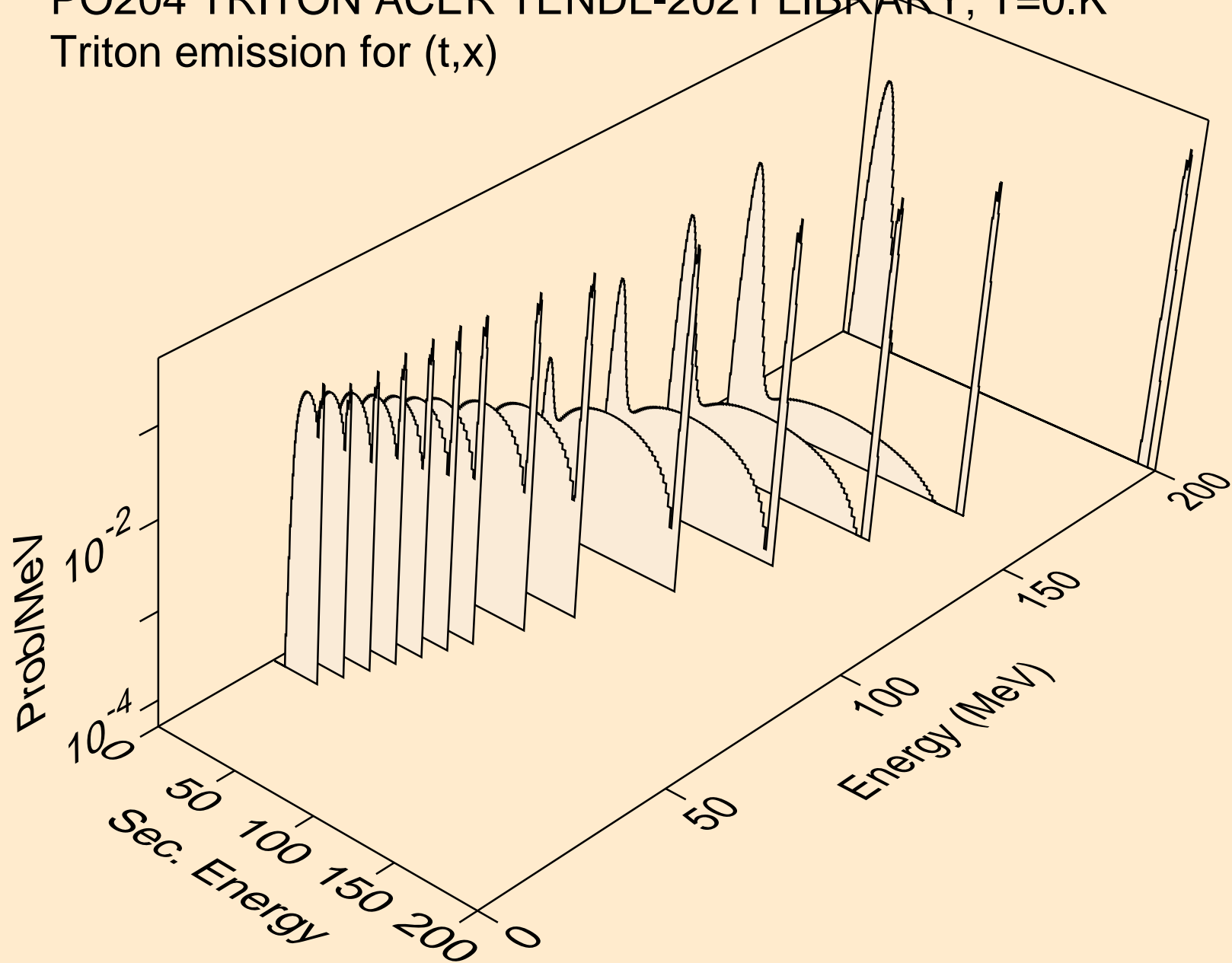

PO204 TRITON ACER TENDL-2021 LIBRARY; T=0.K  
Triton emission for (t,n\*)t

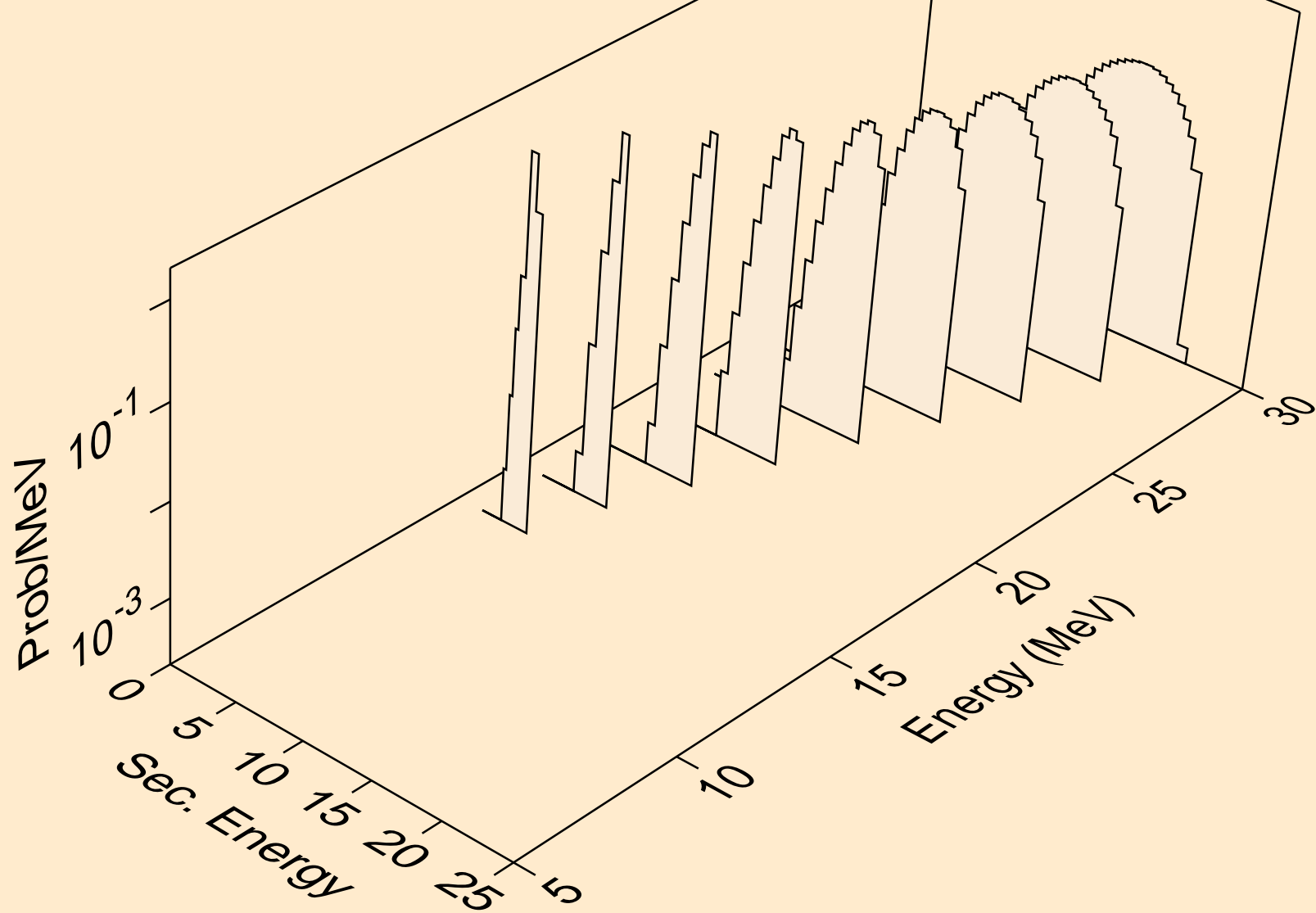

PO204 TRITON ACER TENDL-2021 LIBRARY; T=0.K  
Triton emission for inelastic

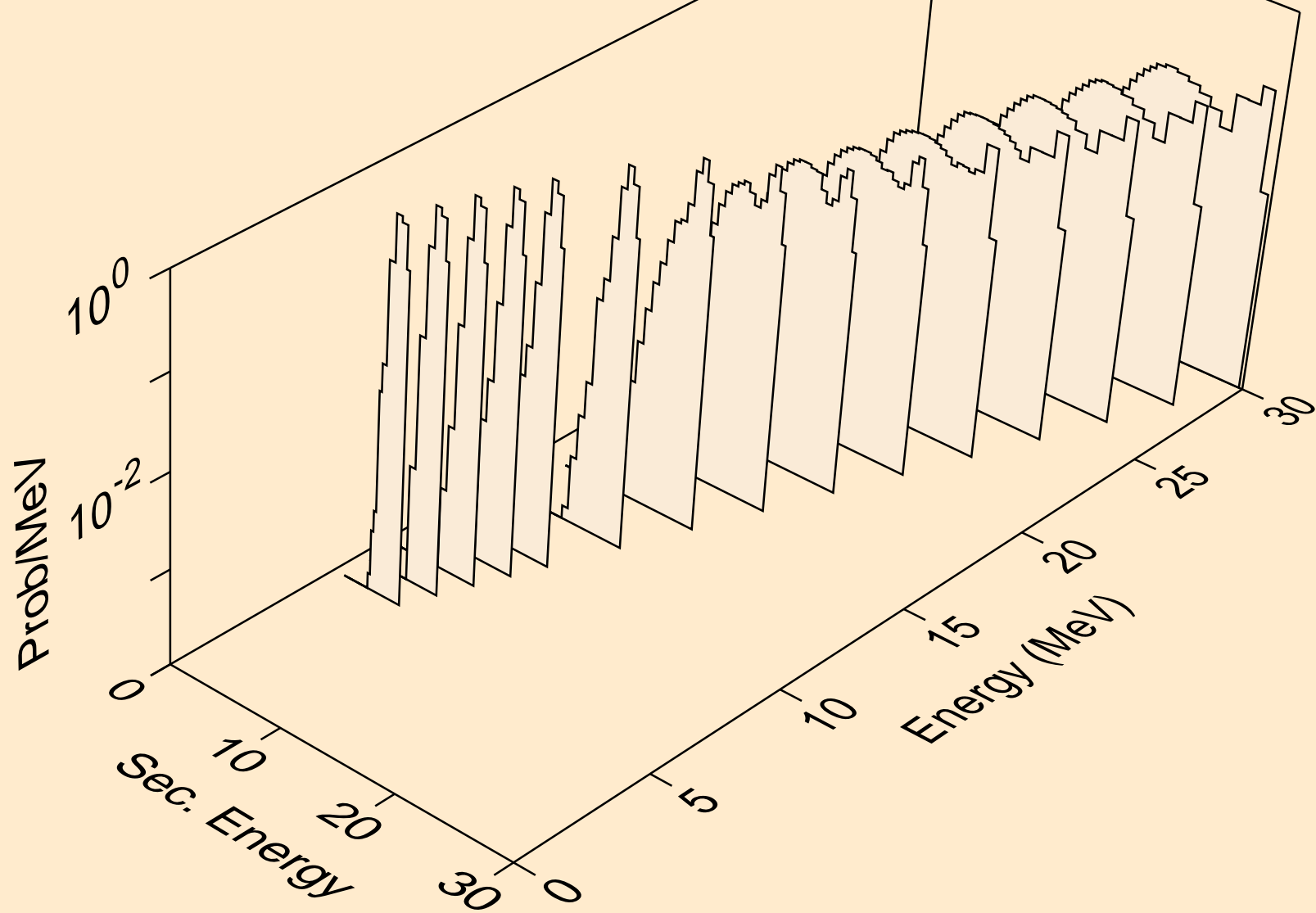

PO204 TRITON ACER TENDL-2021 LIBRARY; T=0.K  
Triton emission for (t,pt)

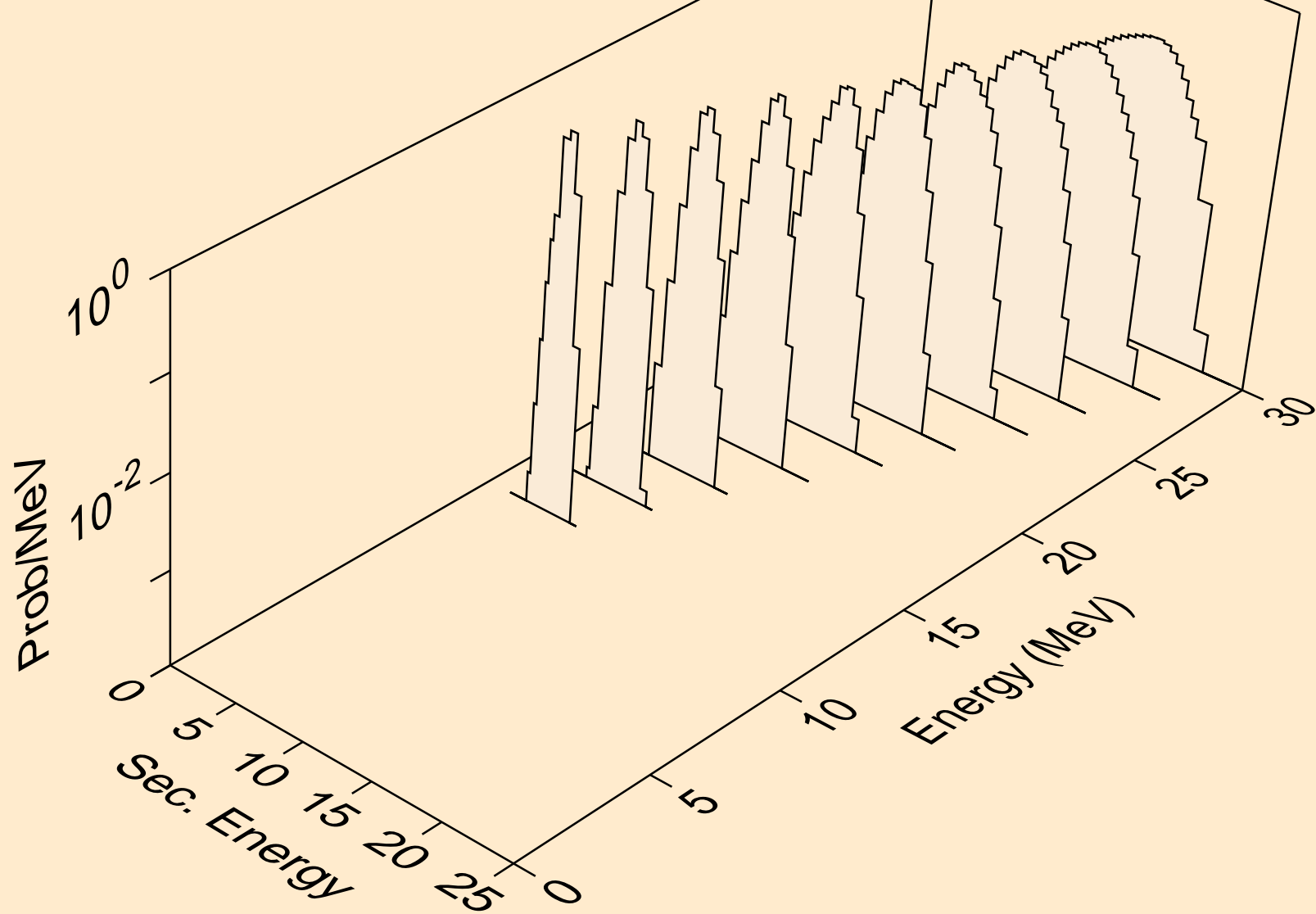

PO204 TRITON ACER TENDL-2021 LIBRARY; T=0.K  
Photon emission for (z,n)

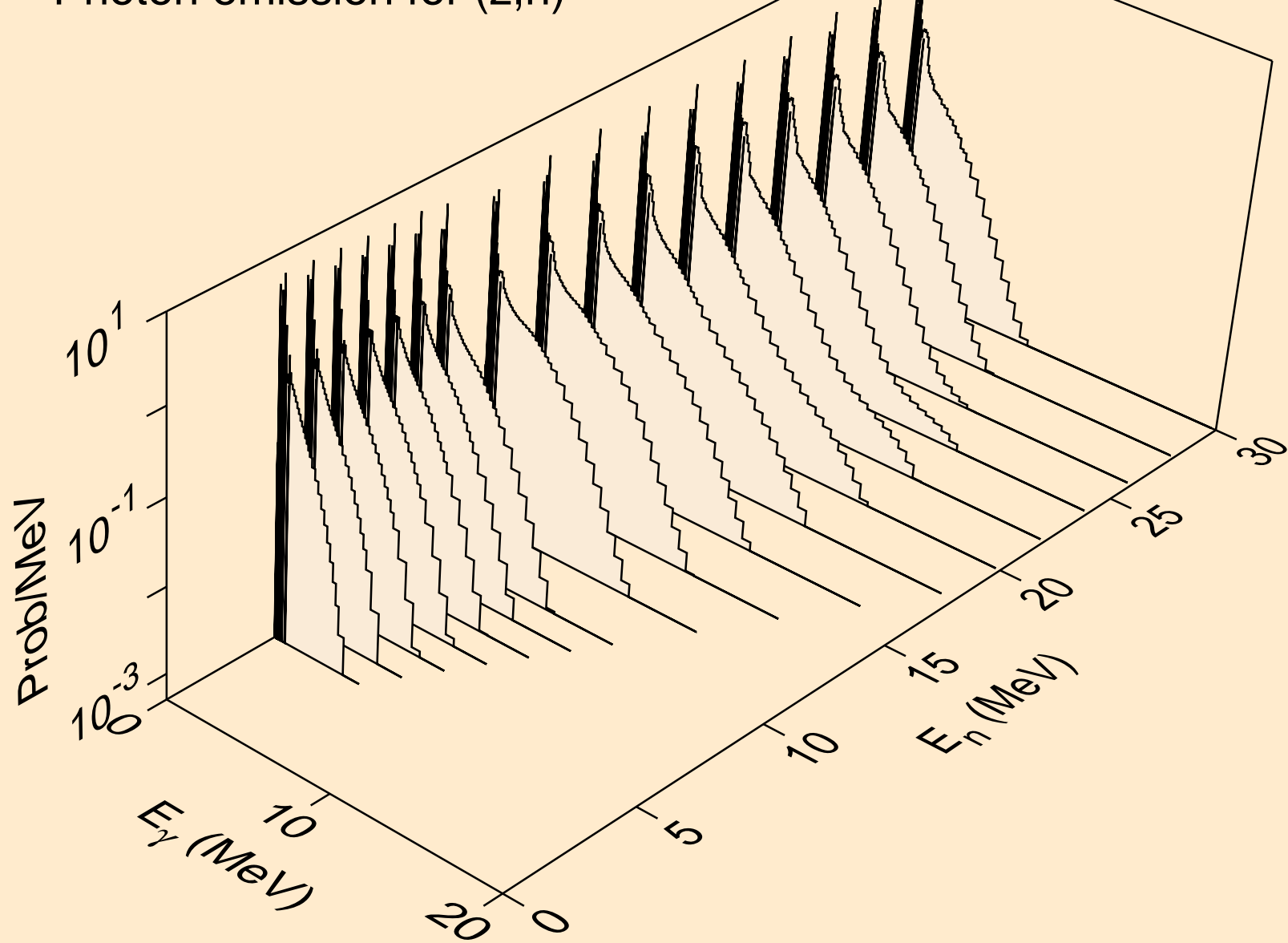

PO204 TRITON ACER TENDL-2021 LIBRARY; T=0.K  
Photon emission for (n,x)

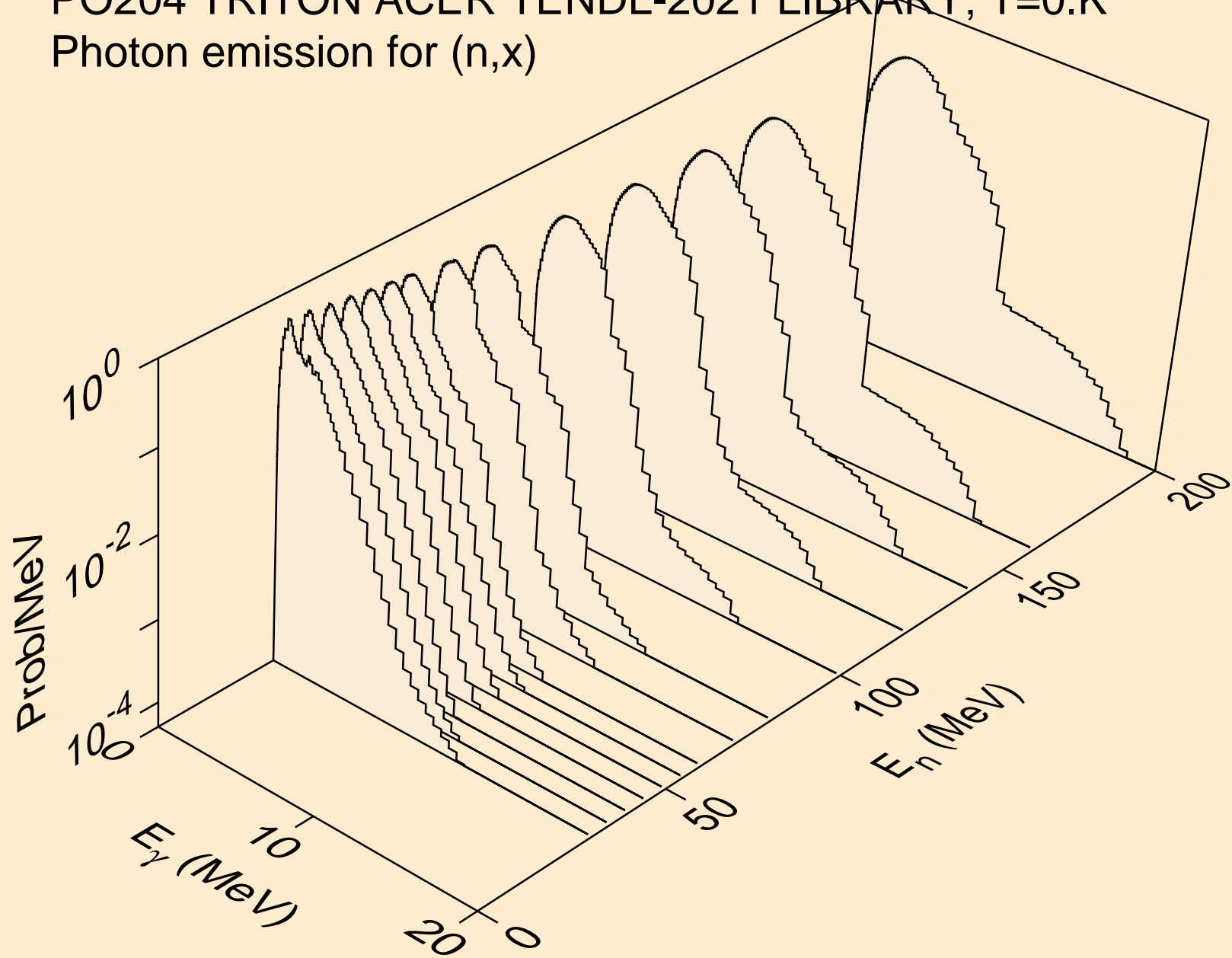

PO204 TRITON ACER TENDL-2021 LIBRARY; T=0.K  
Photon emission for (n,2nd)

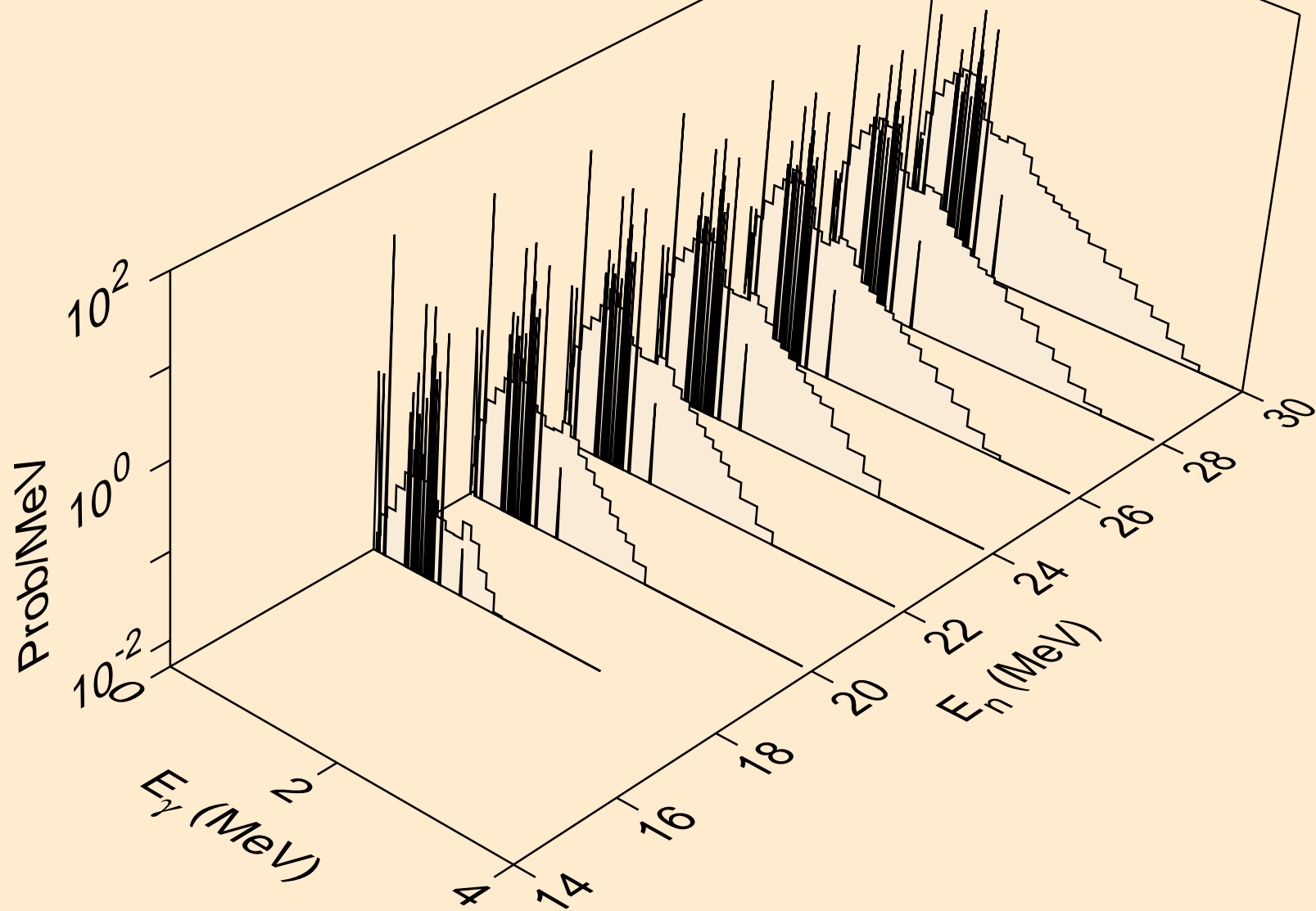



PO204 TRITON ACER TENDL-2021 LIBRARY; T=0.K  
Photon emission for (n,2n)

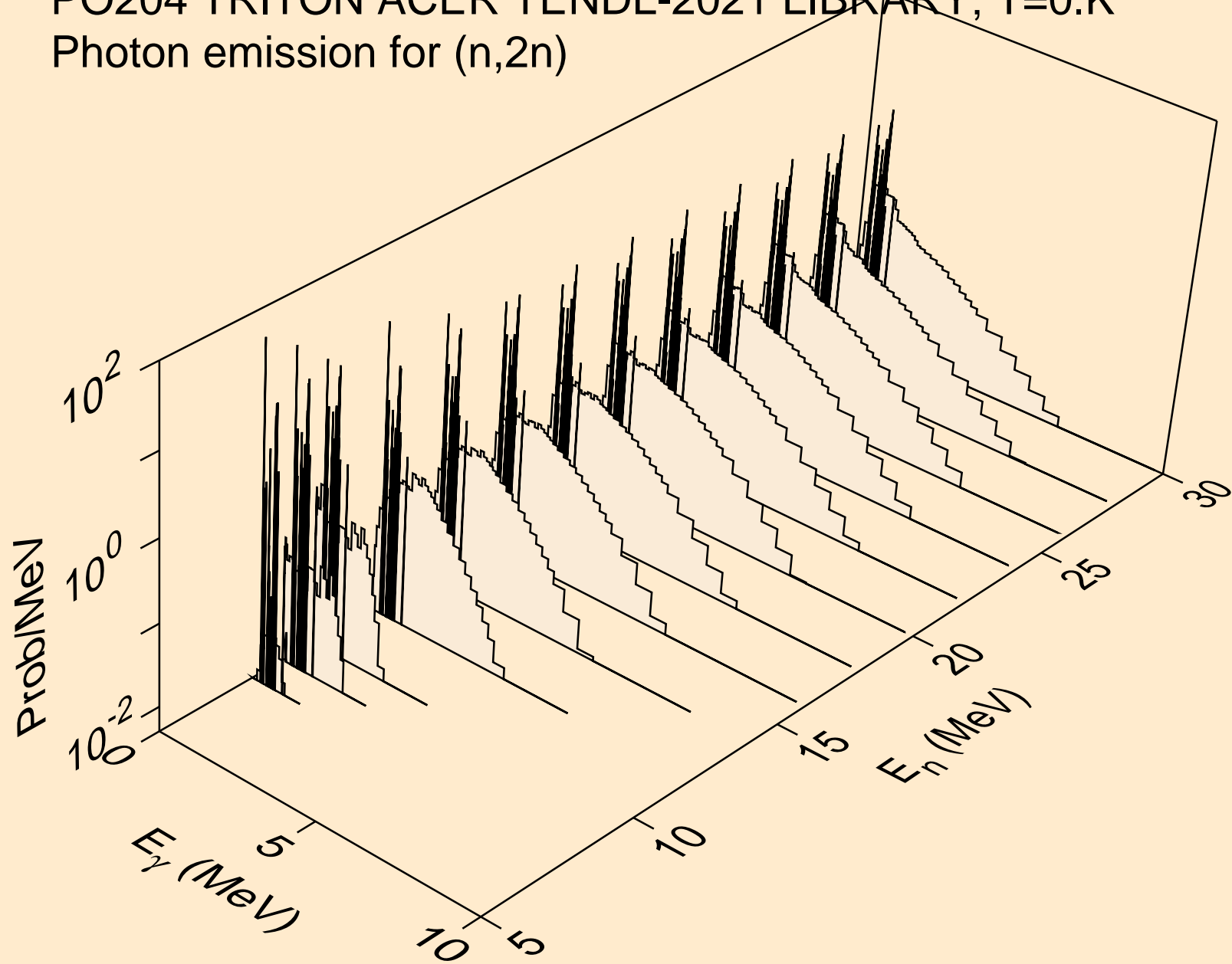

PO204 TRITON ACER TENDL-2021 LIBRARY; T=0.K  
Photon emission for (n,3n)

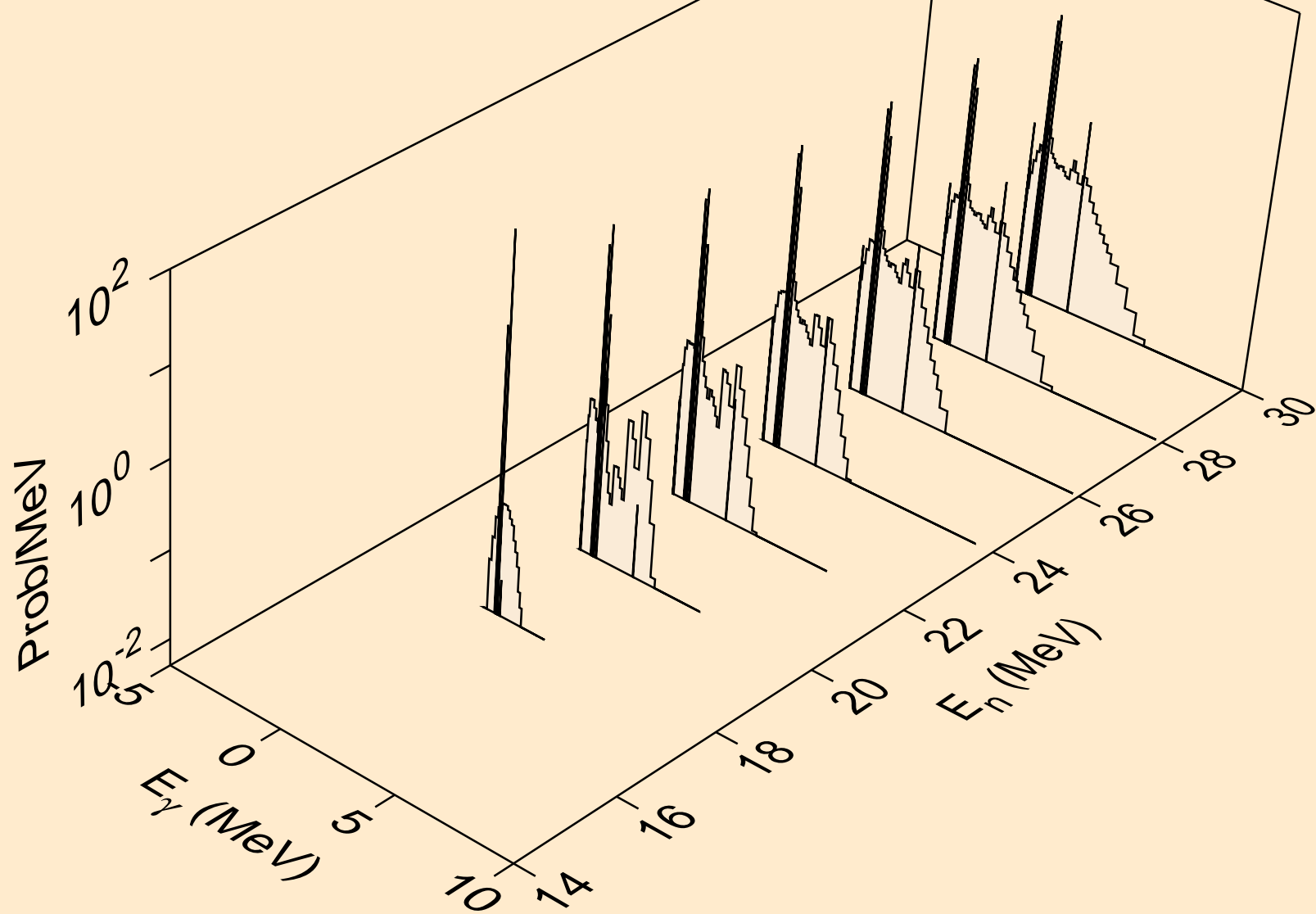

PO204 TRITON ACER TENDL-2021 LIBRARY; T=0.K  
Photon emission for (n,n\*)a

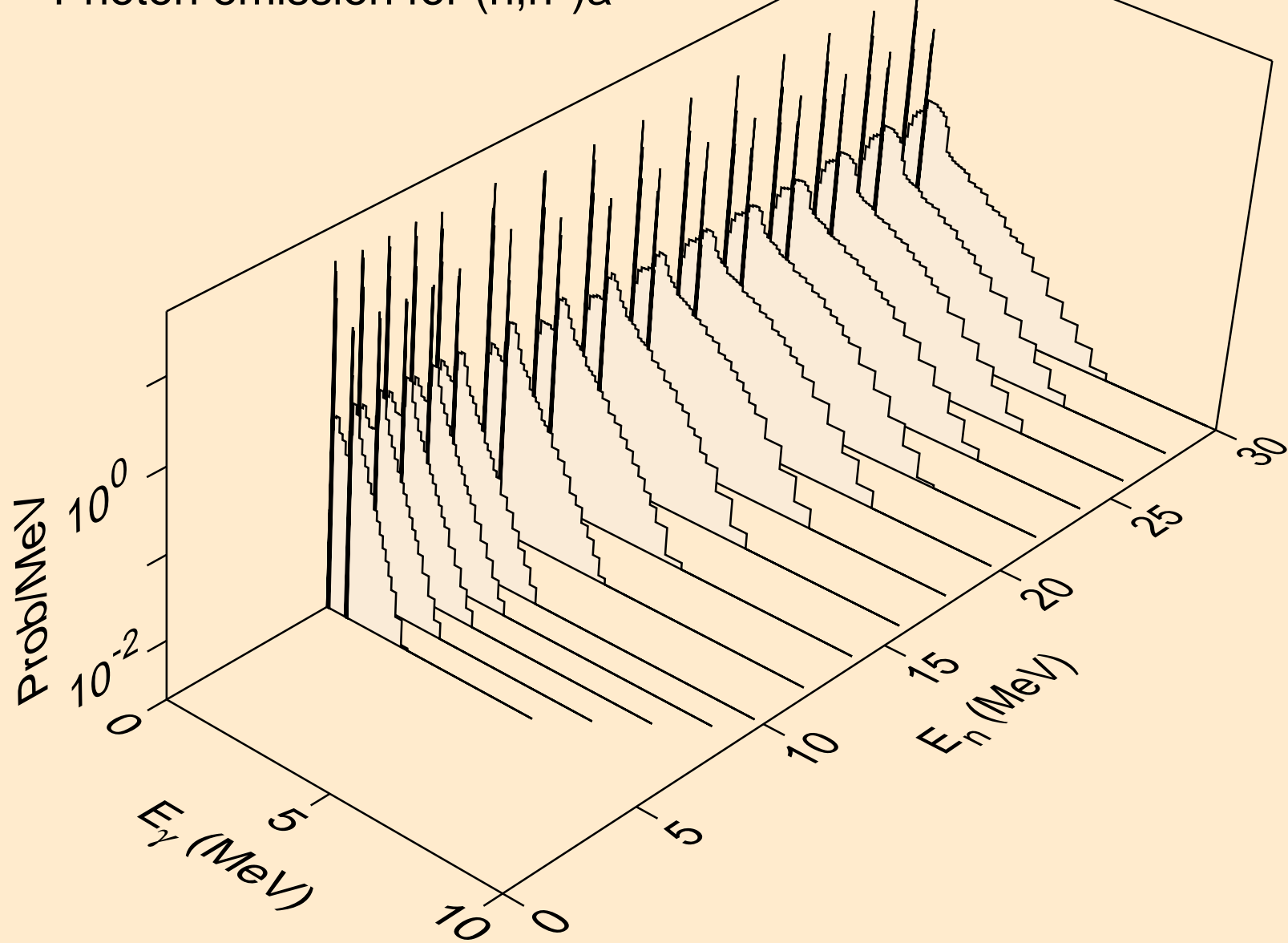

PO204 TRITON ACER TENDL-2021 LIBRARY; T=0.K  
Photon emission for (n,2n)a

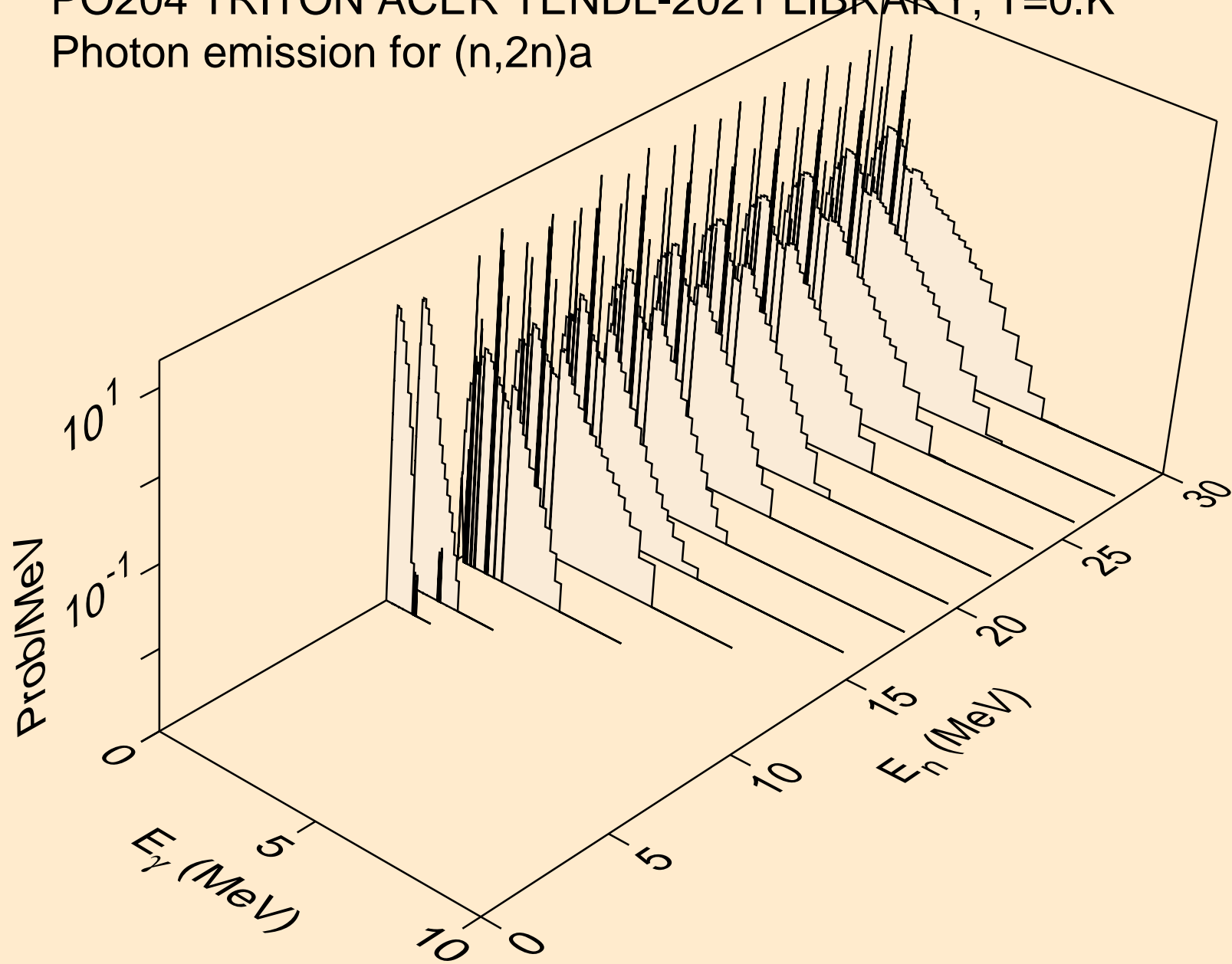

PO204 TRITON ACER TENDL-2021 LIBRARY; T=0.K  
Photon emission for (n,3n)a

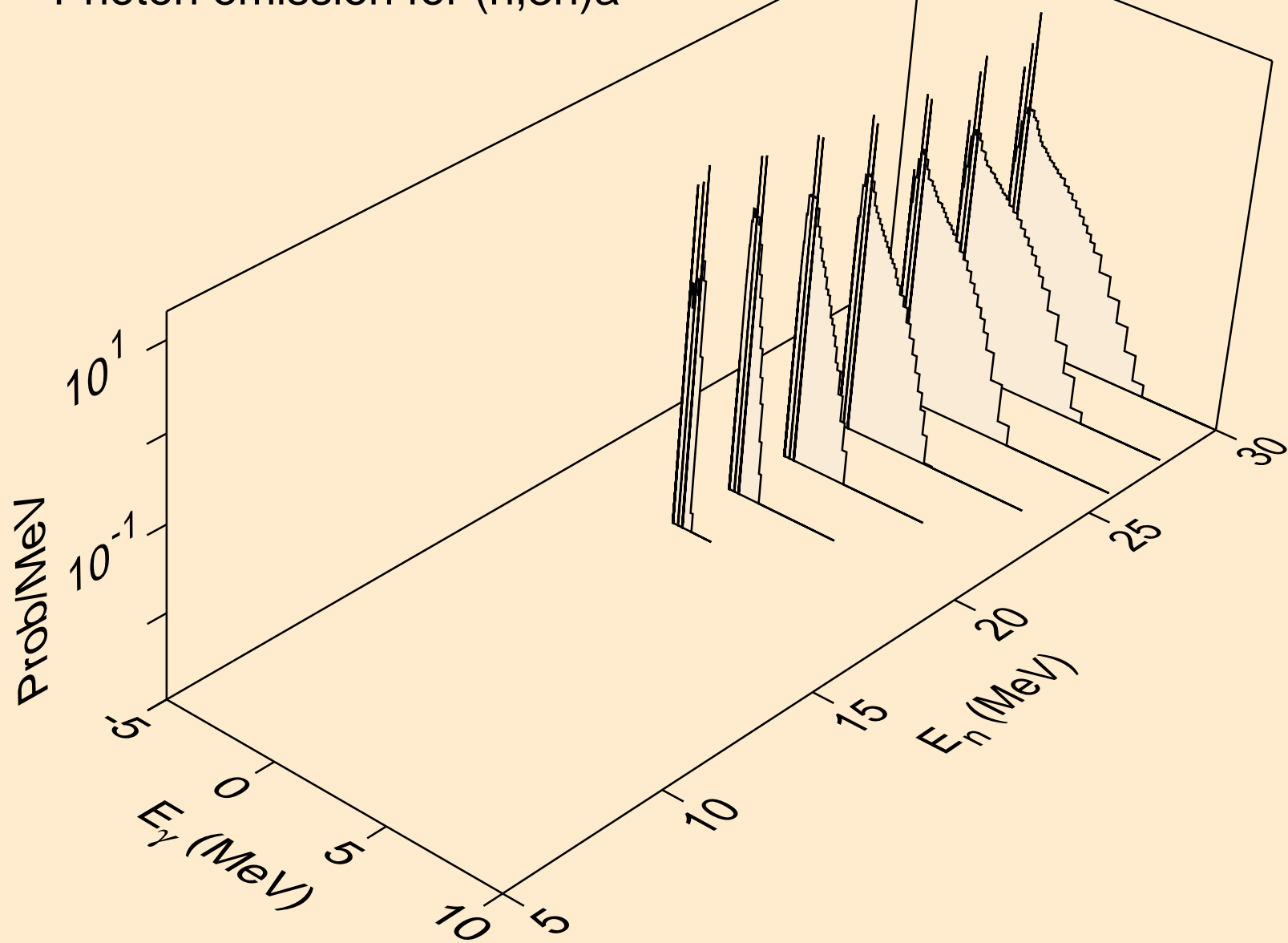

PO204 TRITON ACER TENDL-2021 LIBRARY; T=0.K  
Photon emission for (n,n\*)p

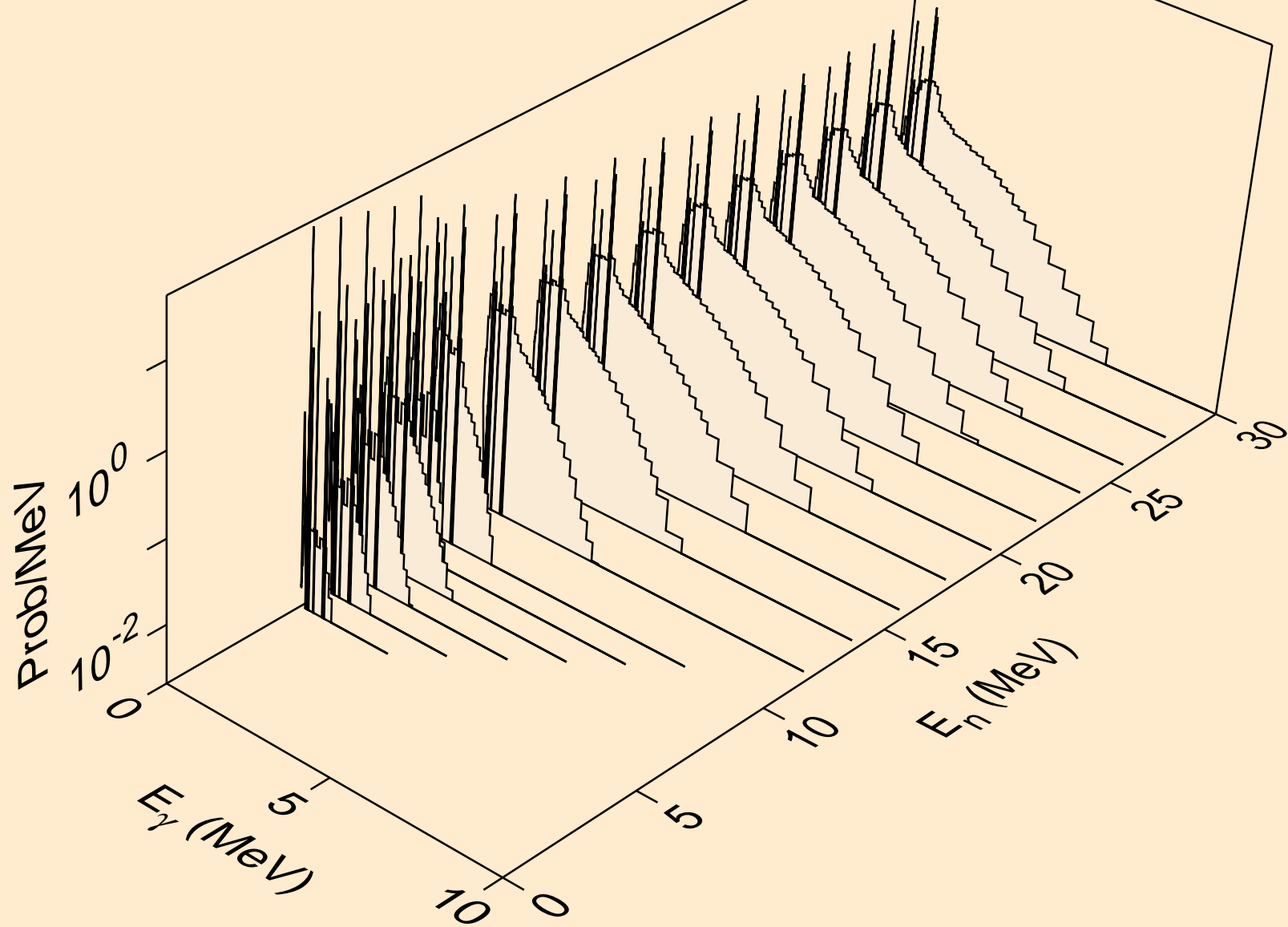

PO204 TRITON ACER TENDL-2021 LIBRARY; T=0.K  
Photon emission for (n,n\*)2a

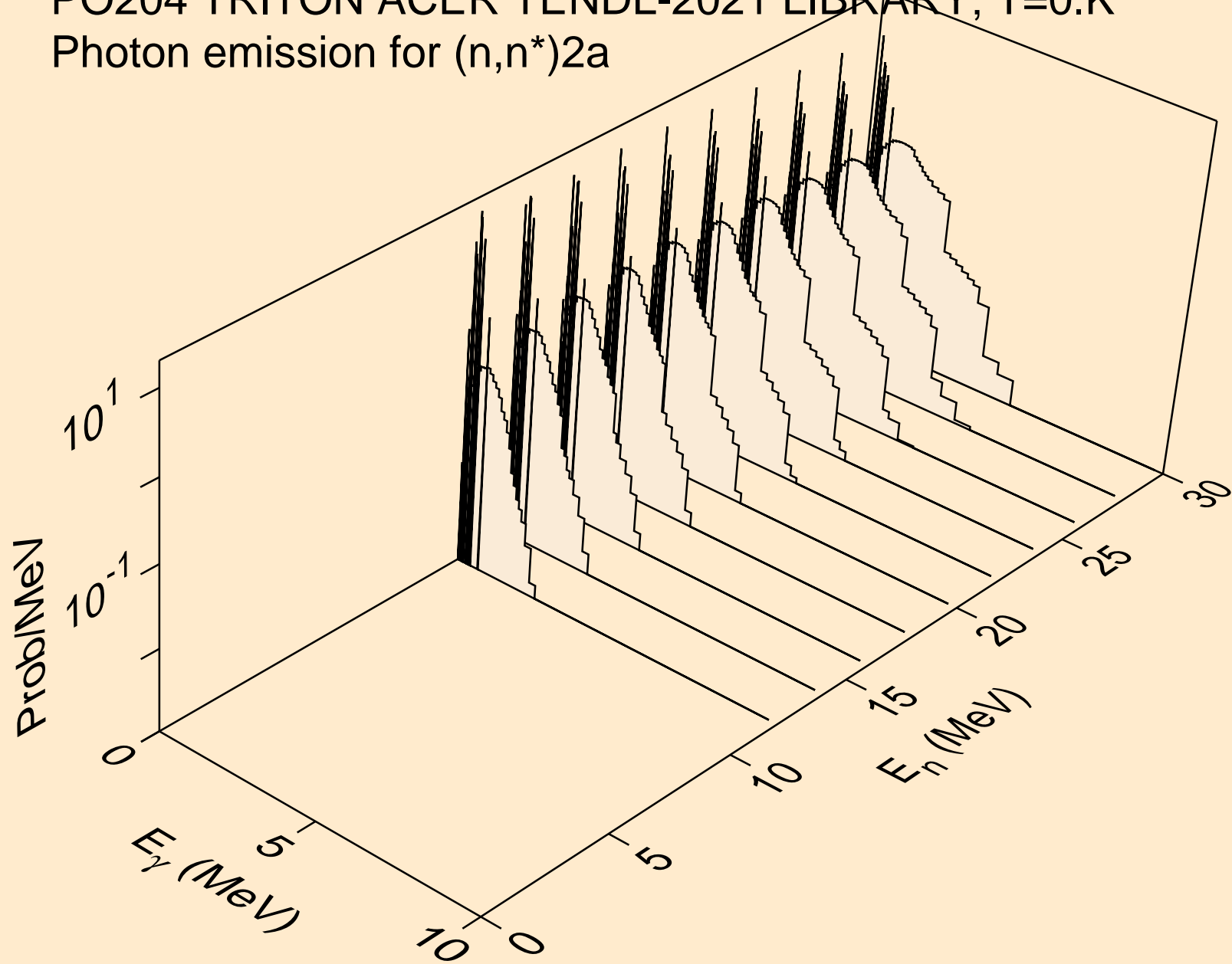

PO204 TRITON ACER TENDL-2021 LIBRARY; T=0.K  
Photon emission for (n,2n)2a

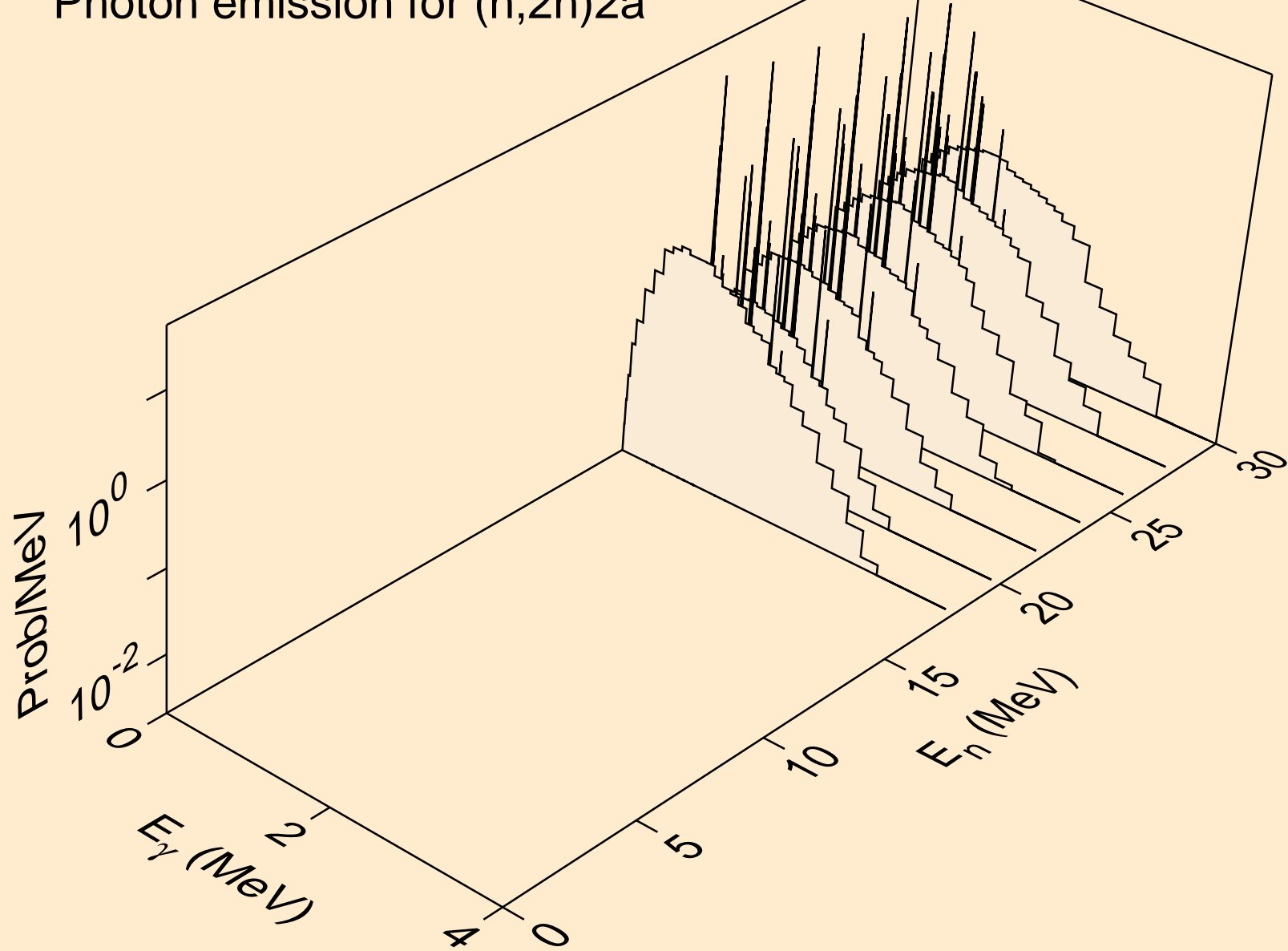



PO204 TRITON ACER TENDL-2021 LIBRARY; T=0.K  
Photon emission for (n,n\*)d

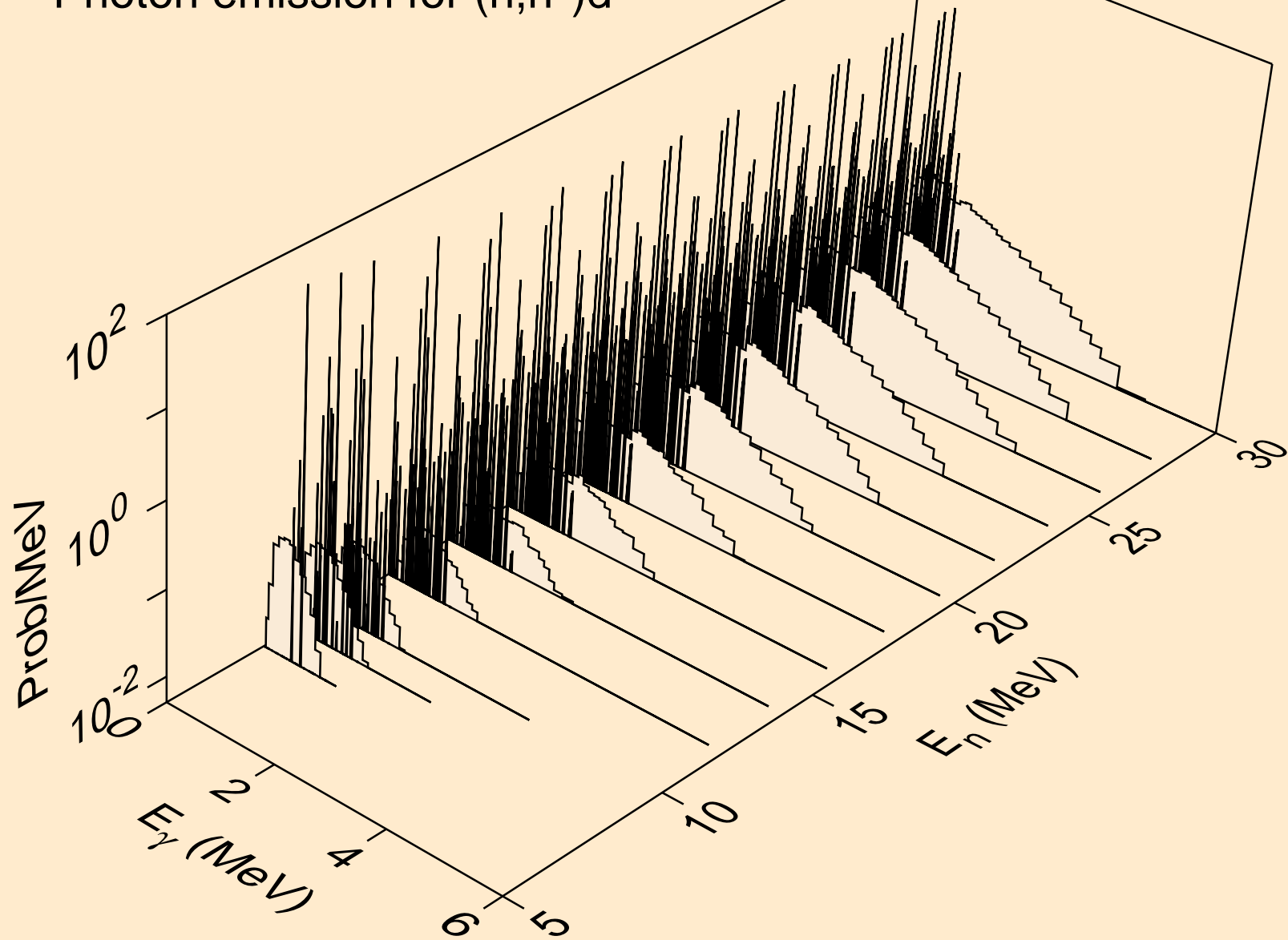

PO204 TRITON ACER TENDL-2021 LIBRARY; T=0.K  
Photon emission for (n,n\*)t

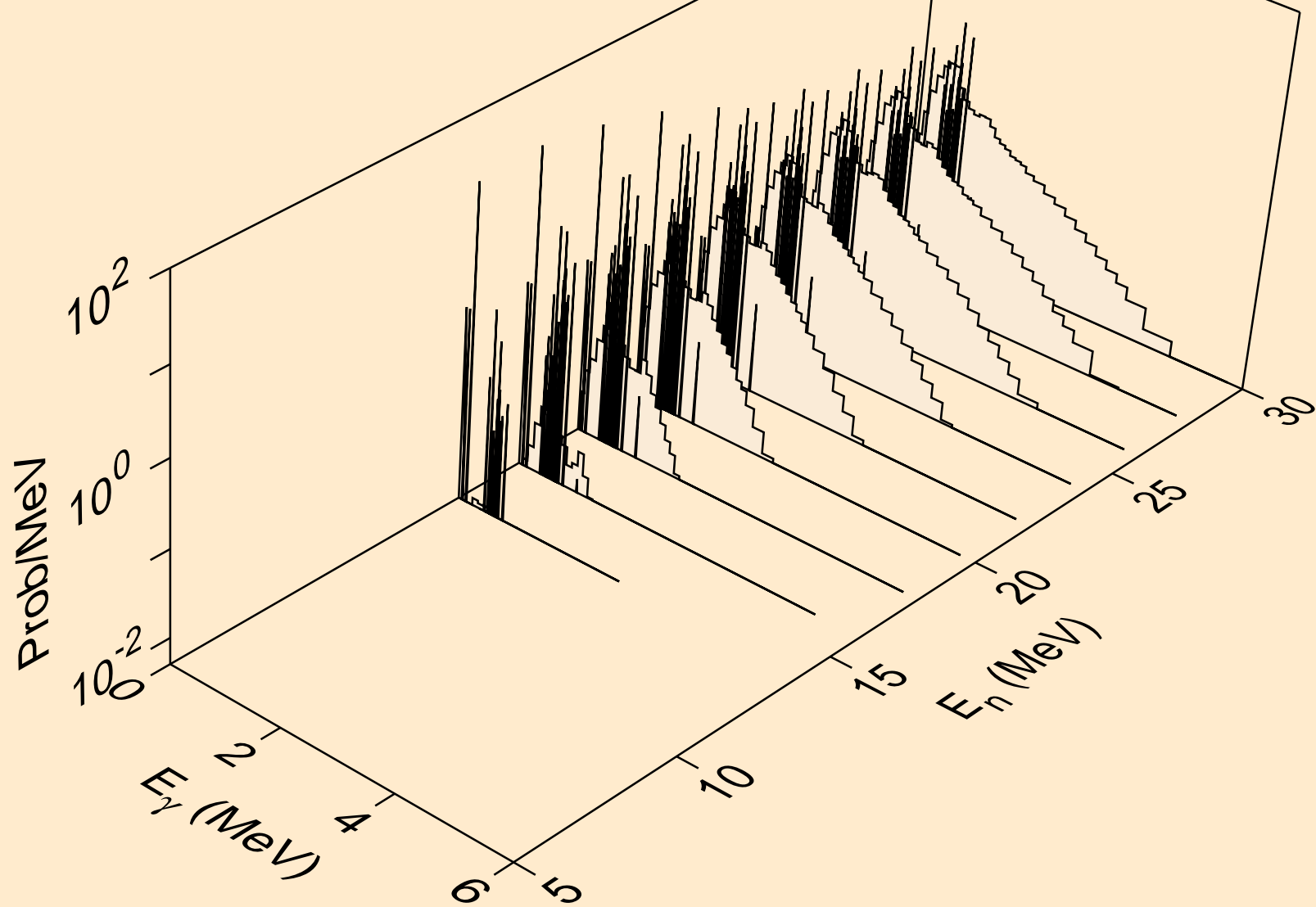

PO204 TRITON ACER TENDL-2021 LIBRARY; T=0.K  
Photon emission for (n,n\*)he3

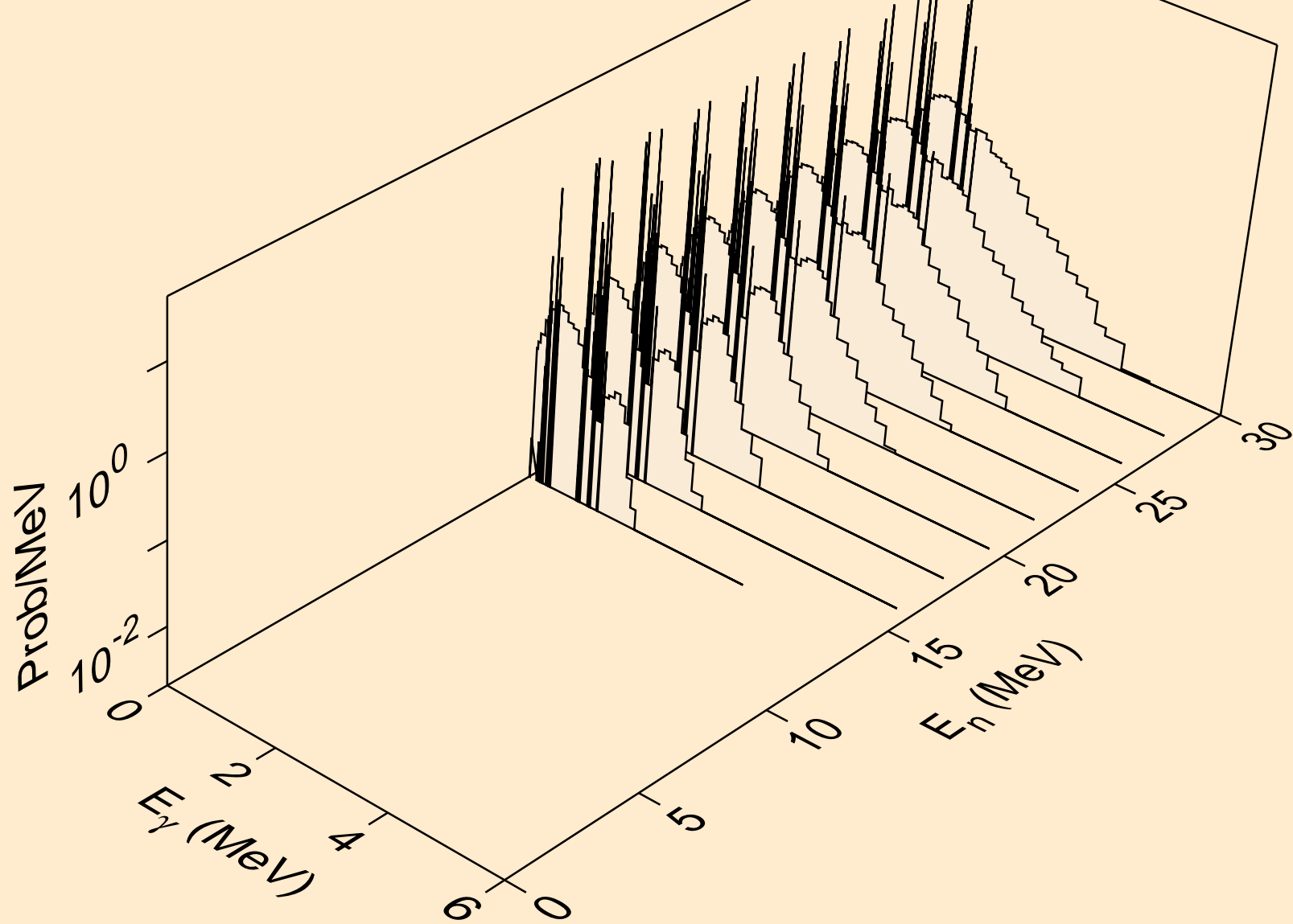

PO204 TRITON ACER TENDL-2021 LIBRARY; T=0.K  
Photon emission for (n,4n)

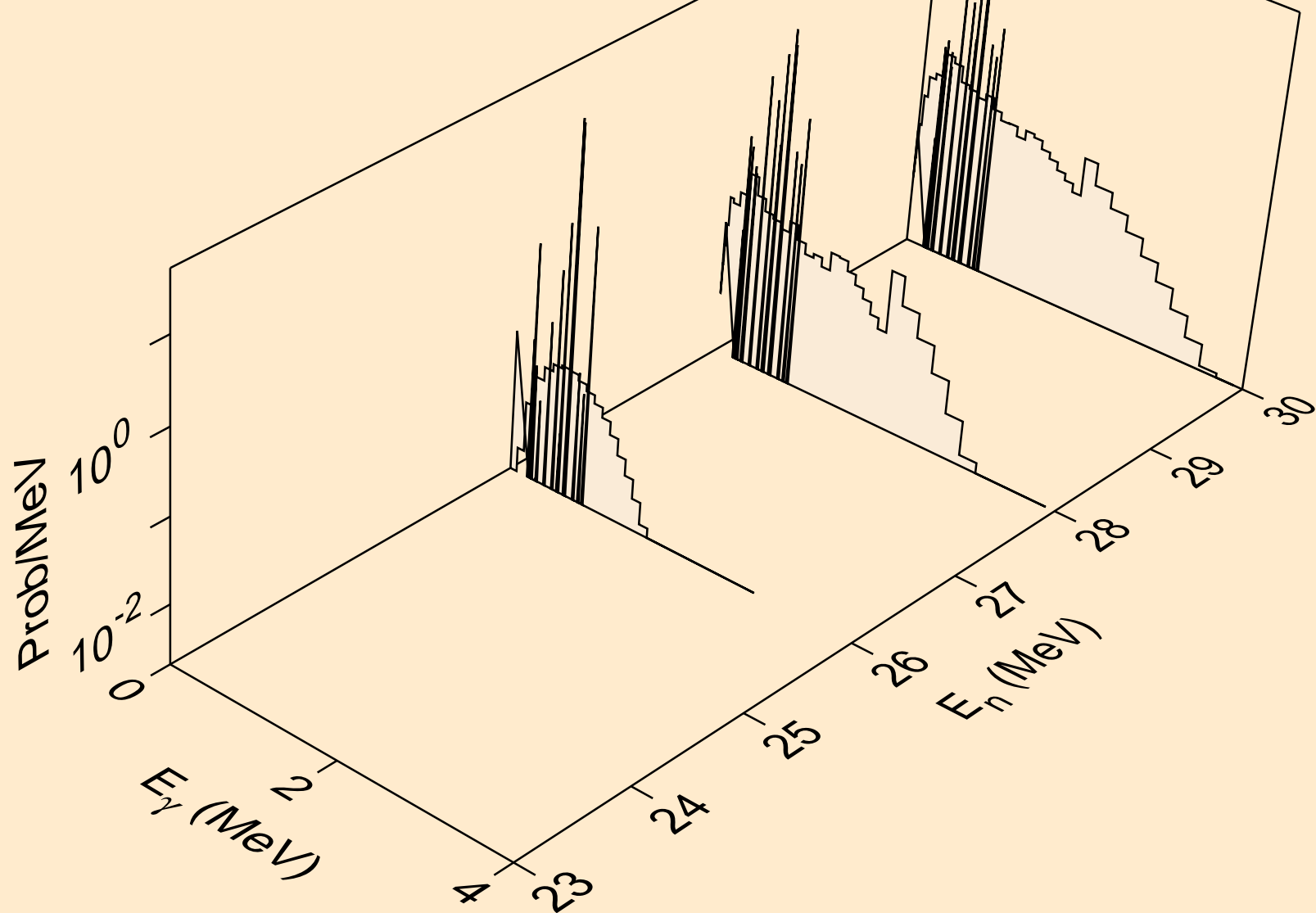

PO204 TRITON ACER TENDL-2021 LIBRARY; T=0.K  
Photon emission for (n,2np)

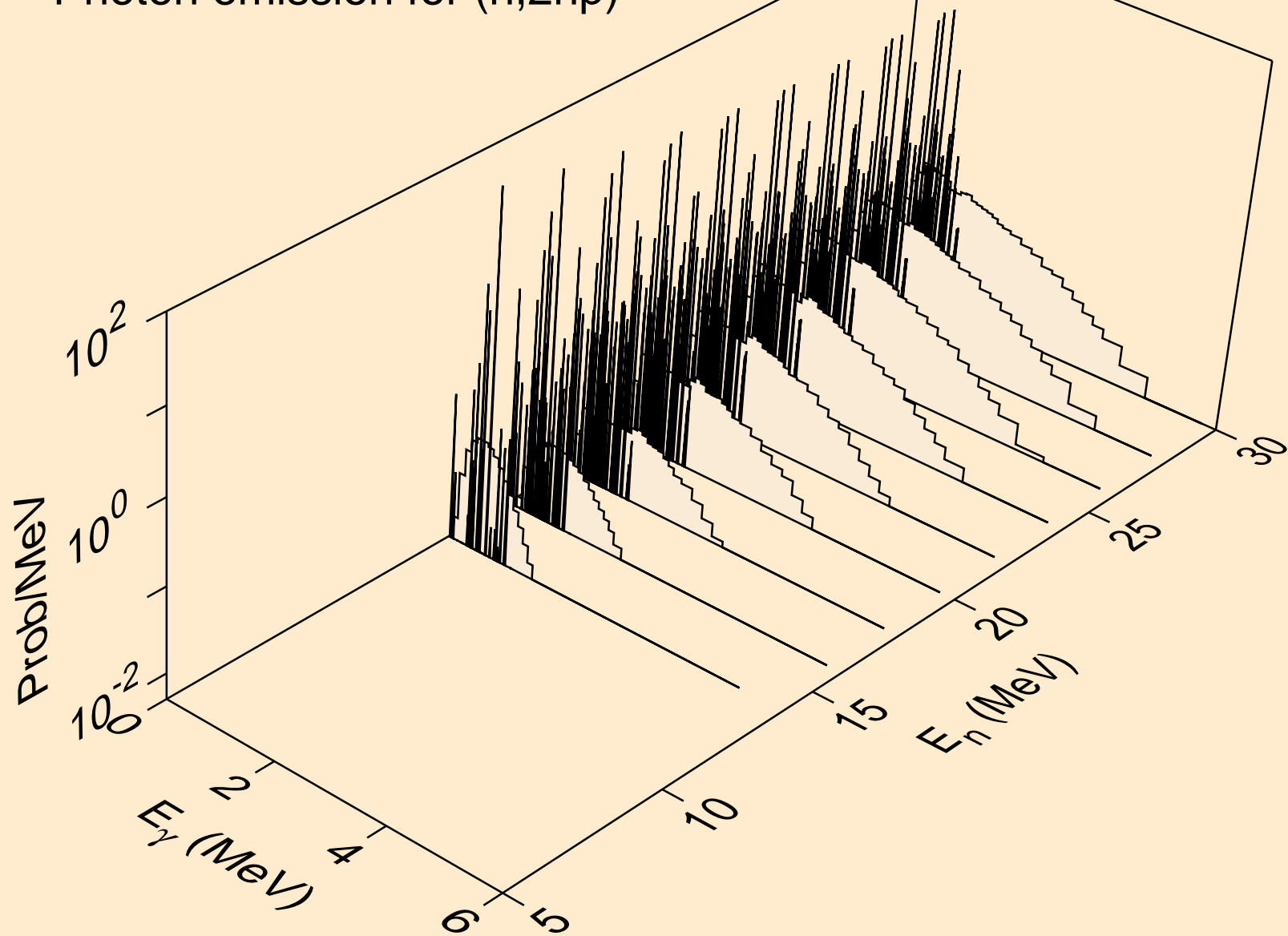

PO204 TRITON ACER TENDL-2021 LIBRARY; T=0.K  
Photon emission for (n,3np)

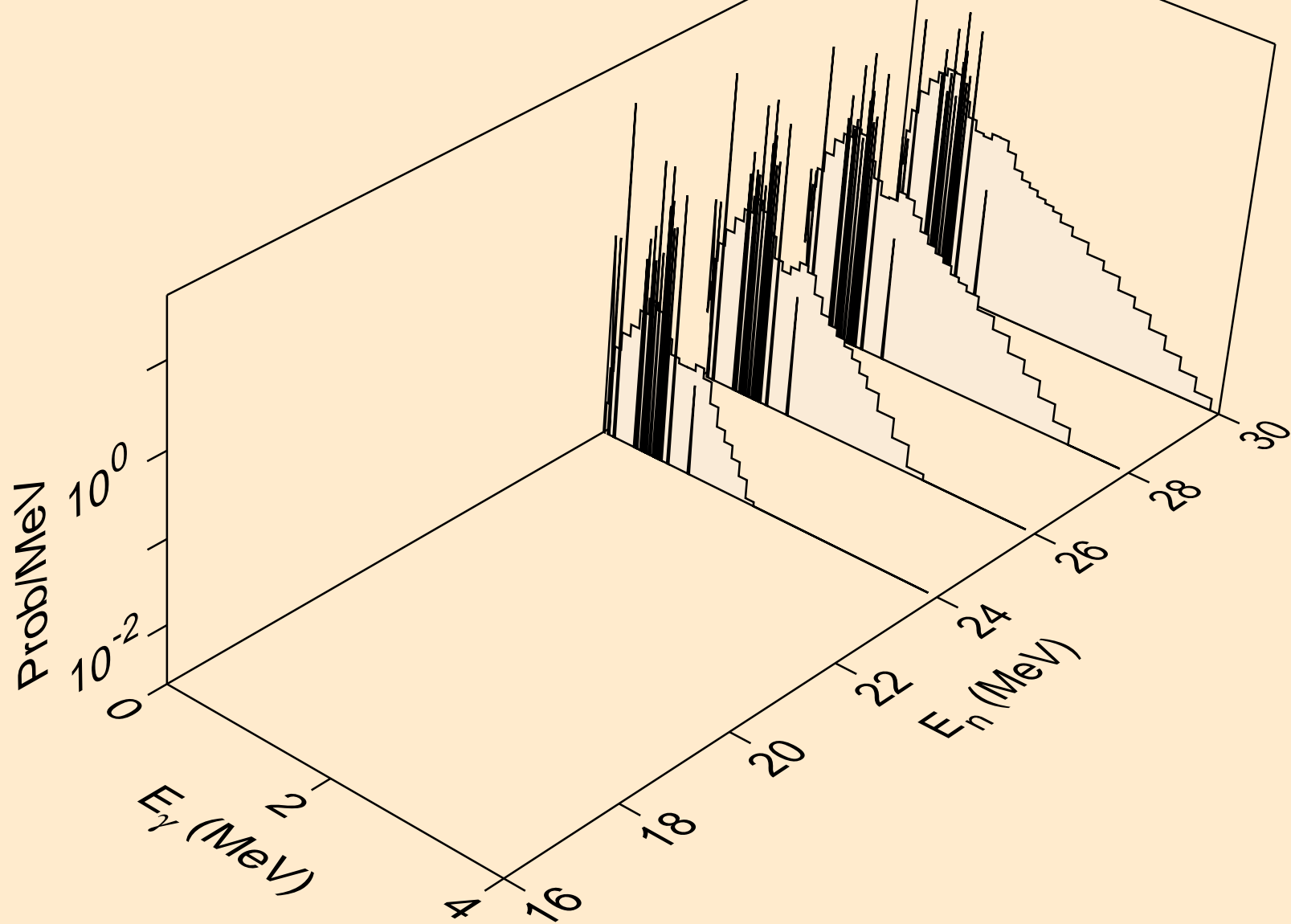

PO204 TRITON ACER TENDL-2021 LIBRARY; T=0.K  
Photon emission for (n,2np)

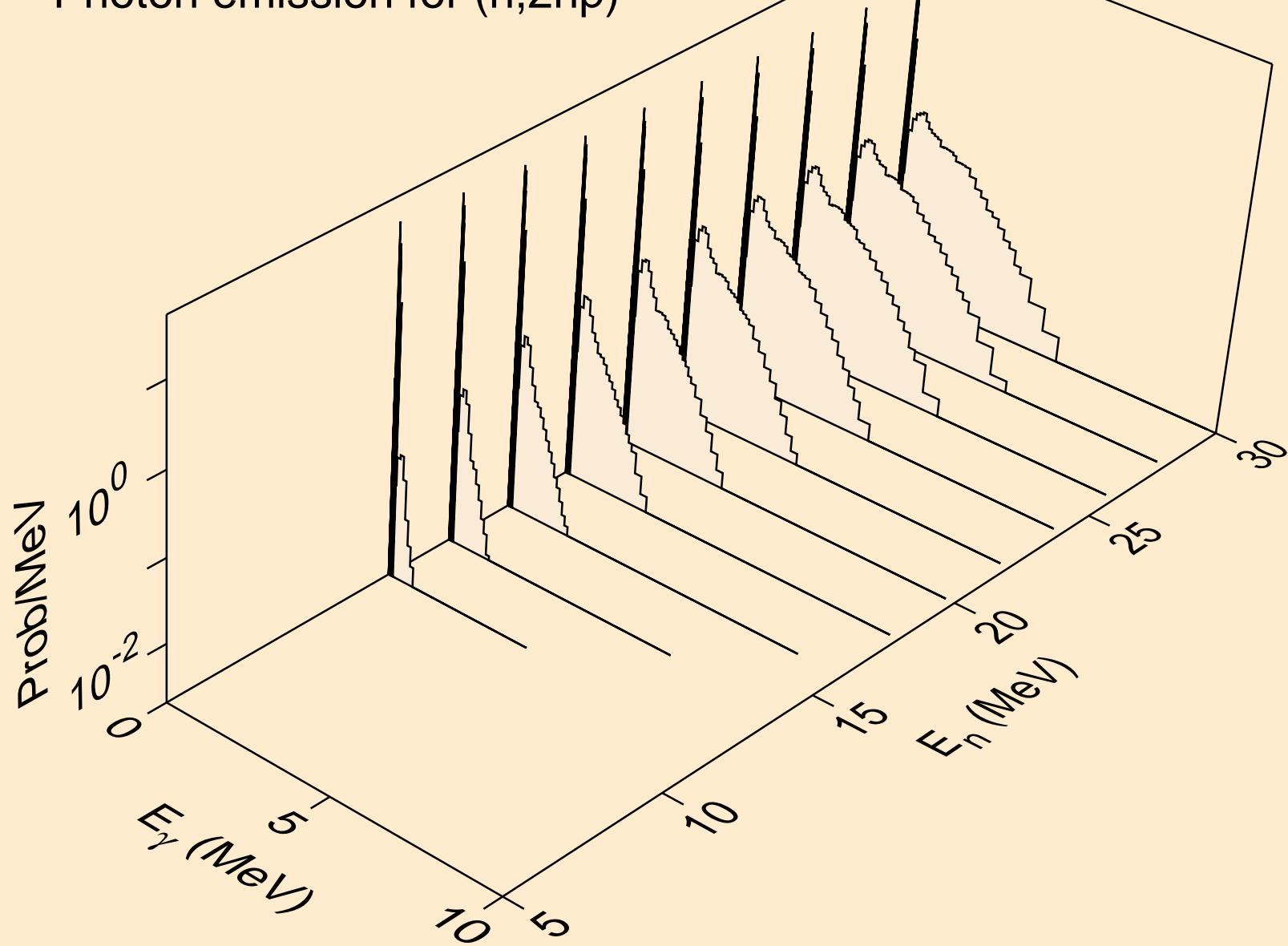

PO204 TRITON ACER TENDL-2021 LIBRARY; T=0.K  
Photon emission for (n,npa)

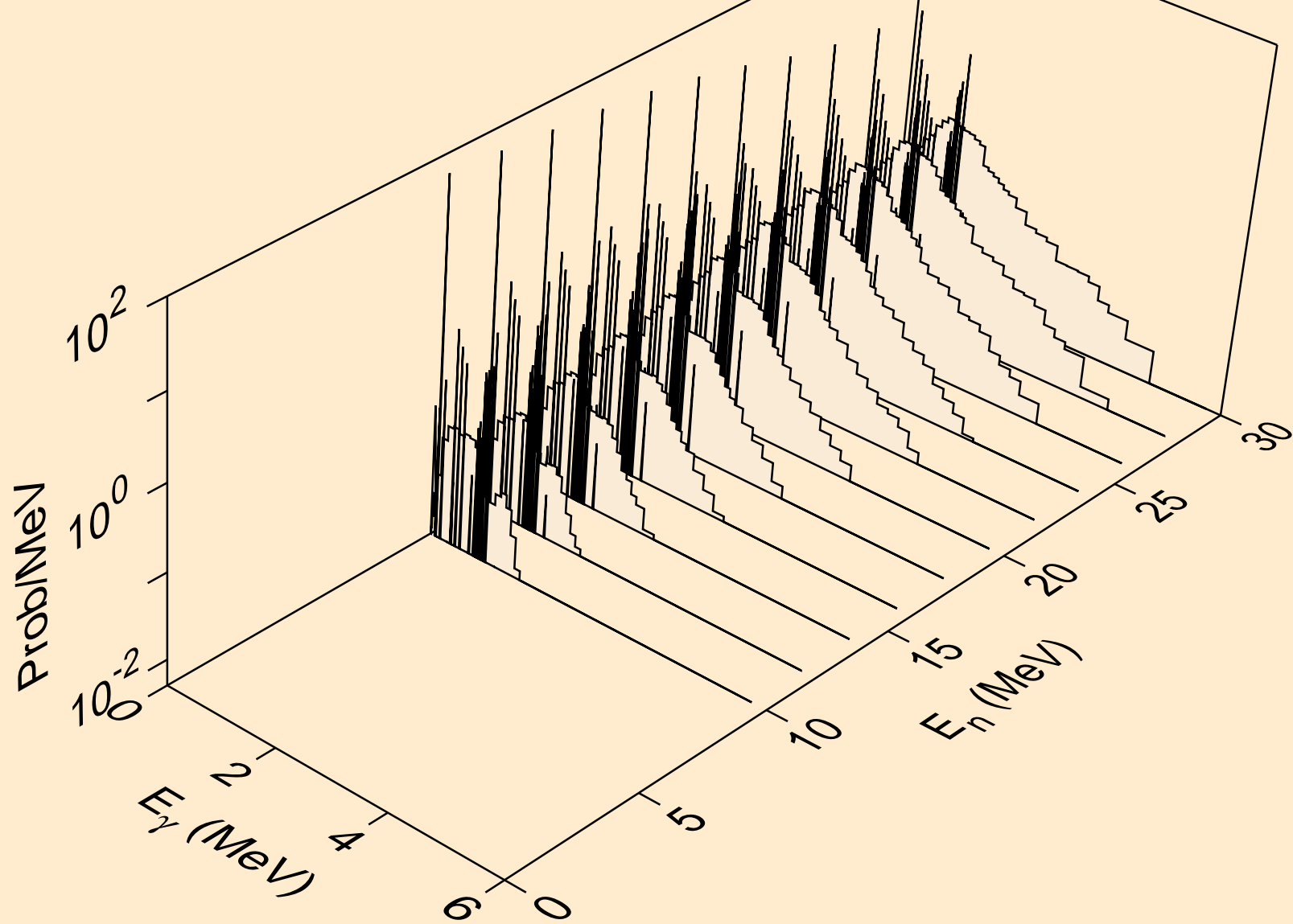



PO204 TRITON ACER TENDL-2021 LIBRARY; T=0.K  
Photon emission for (n,gma)

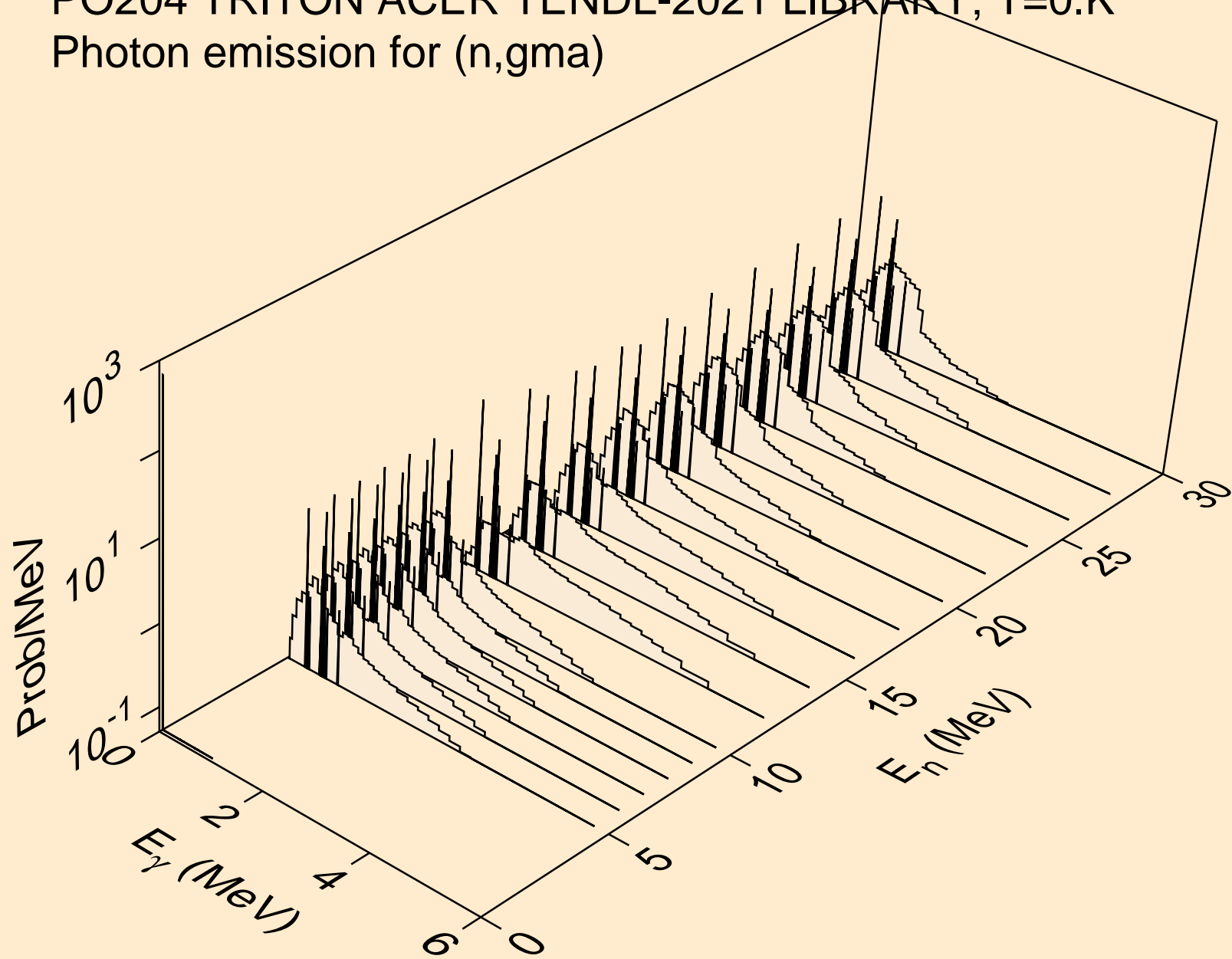

PO204 TRITON ACER TENDL-2021 LIBRARY; T=0.K  
Photon emission for (n,p)

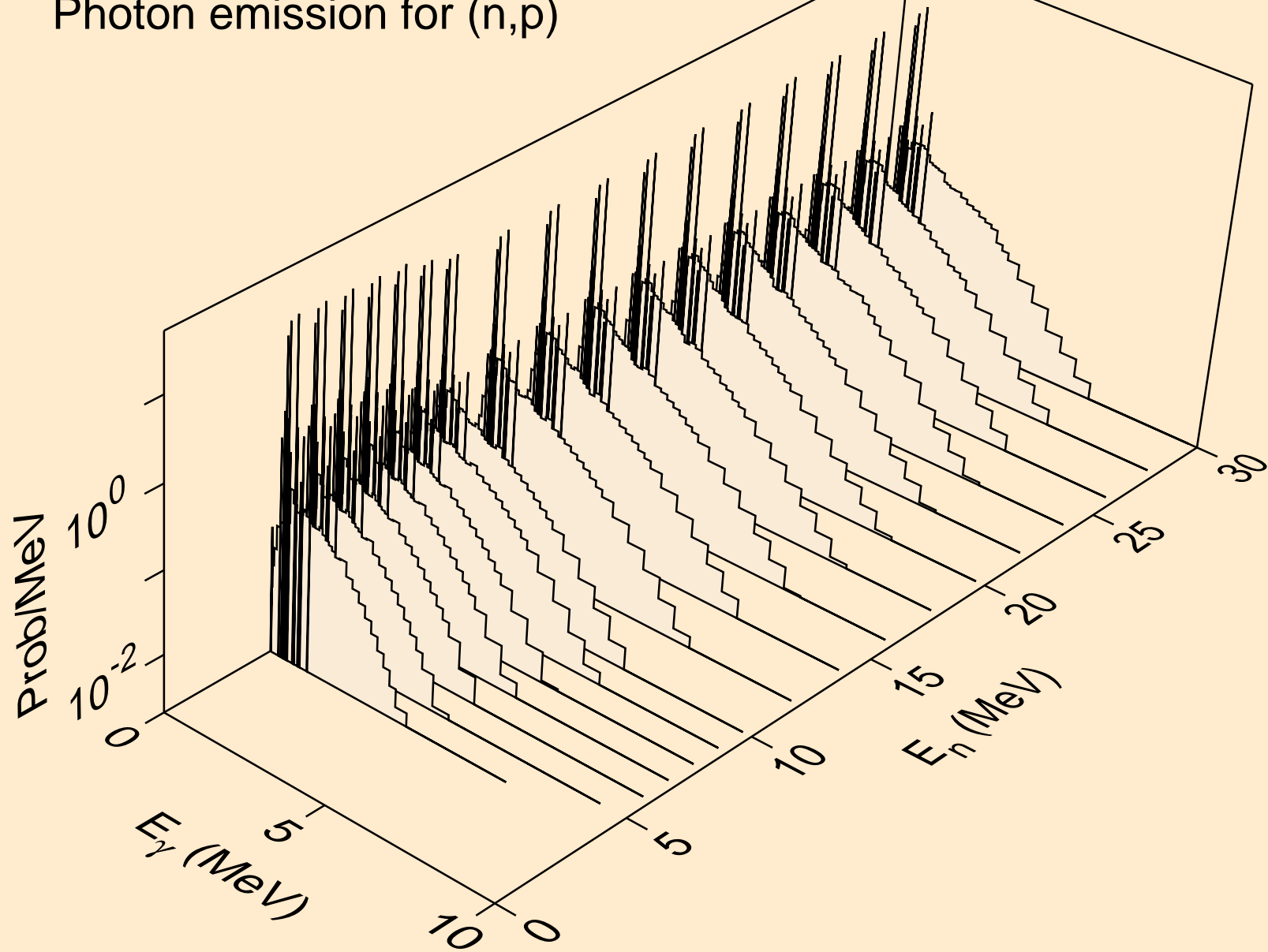

PO204 TRITON ACER TENDL-2021 LIBRARY; T=0.K  
Photon emission for (n,d)

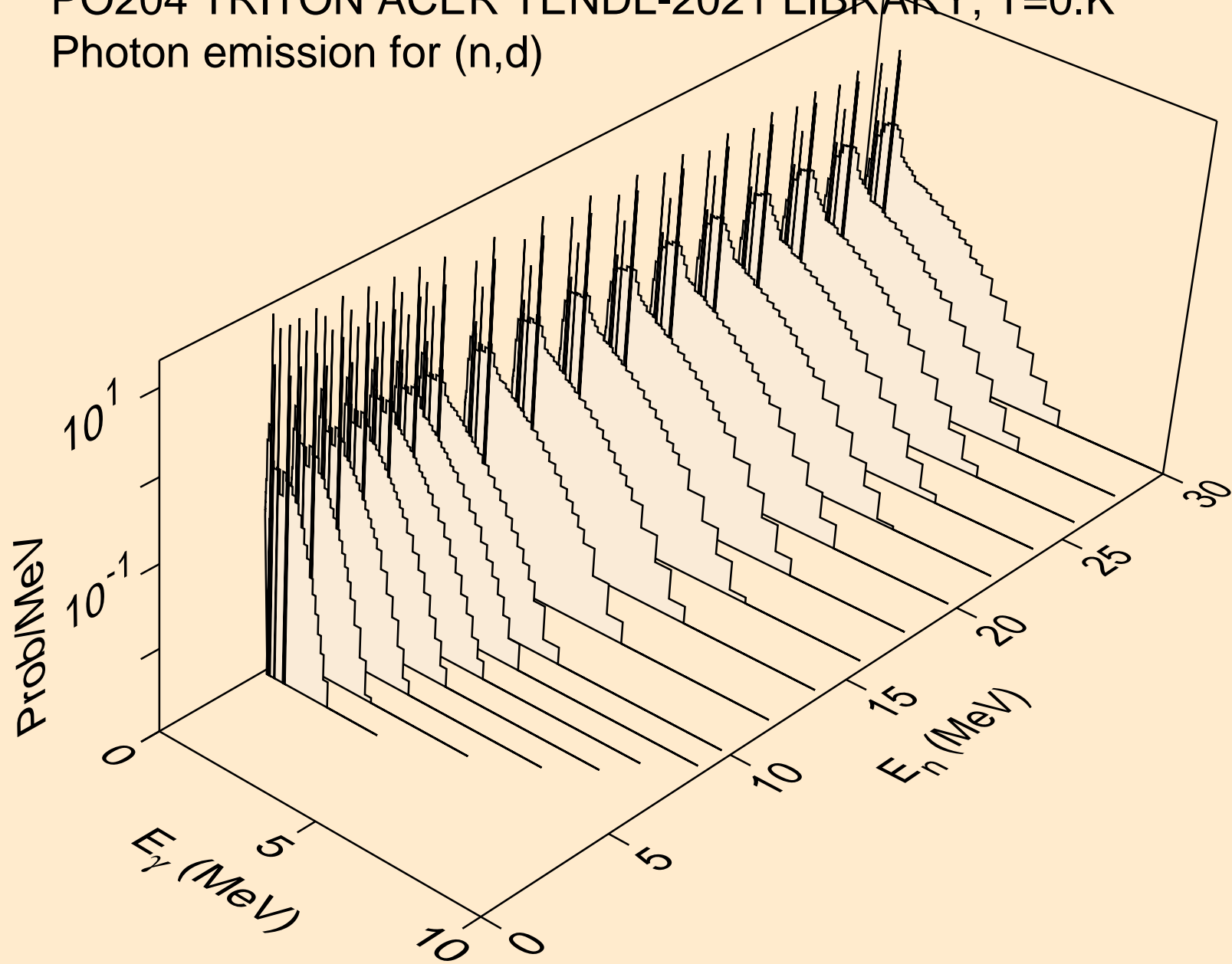

PO204 TRITON ACER TENDL-2021 LIBRARY; T=0.K  
Photon emission for inelastic

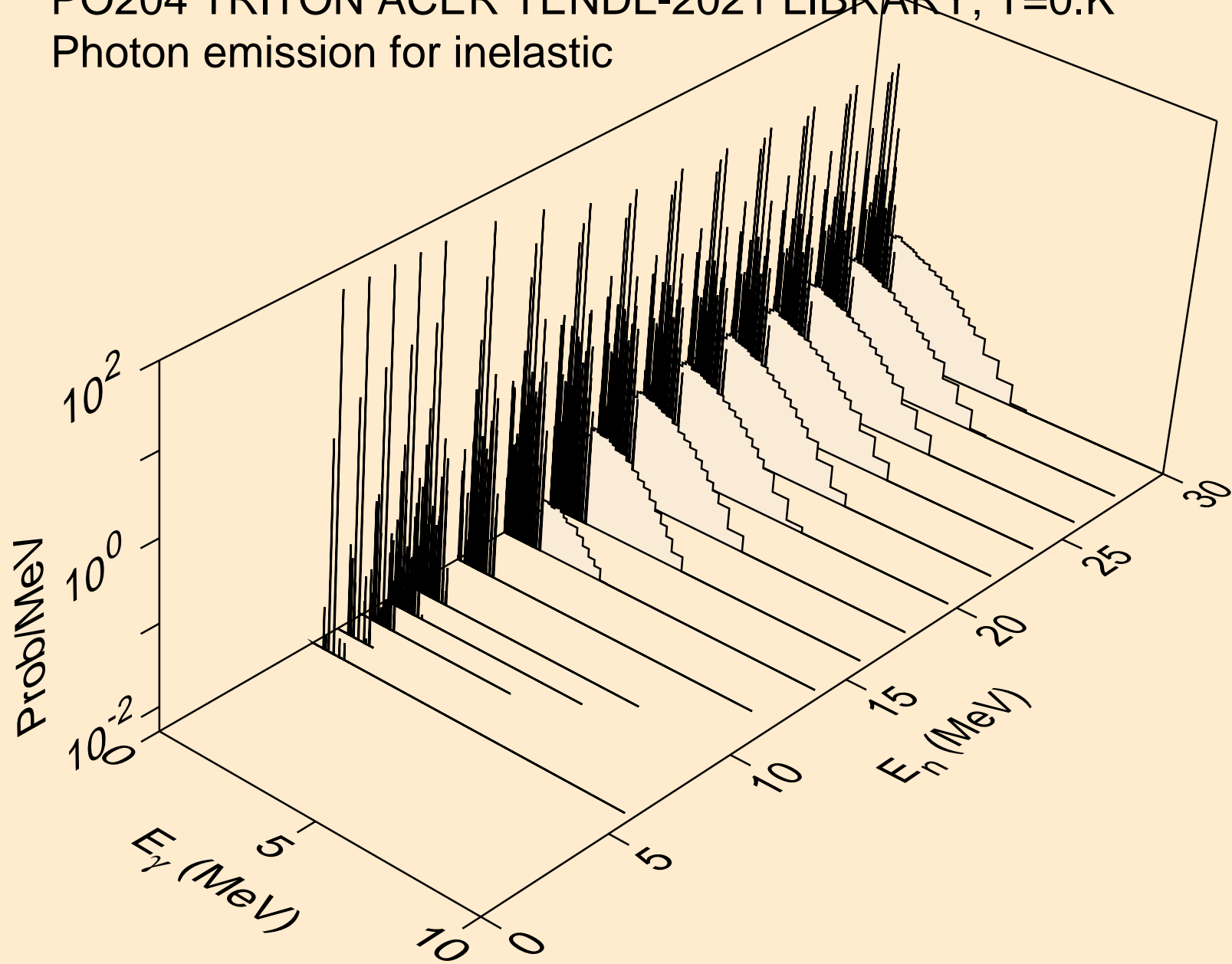

PO204 TRITON ACER TENDL-2021 LIBRARY; T=0.K  
Photon emission for (n,he3)

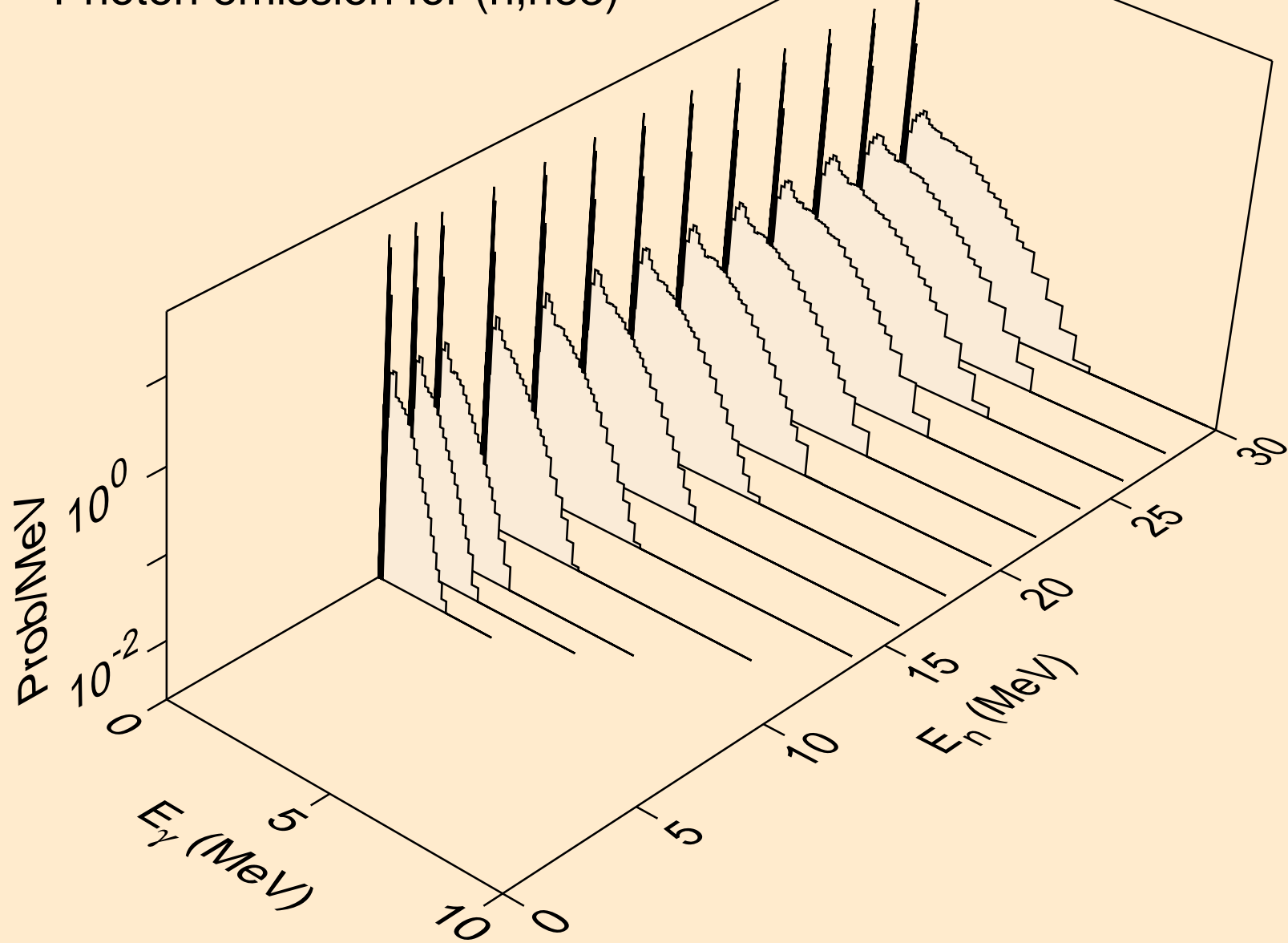

PO204 TRITON ACER TENDL-2021 LIBRARY; T=0.K  
Photon emission for (n,a)

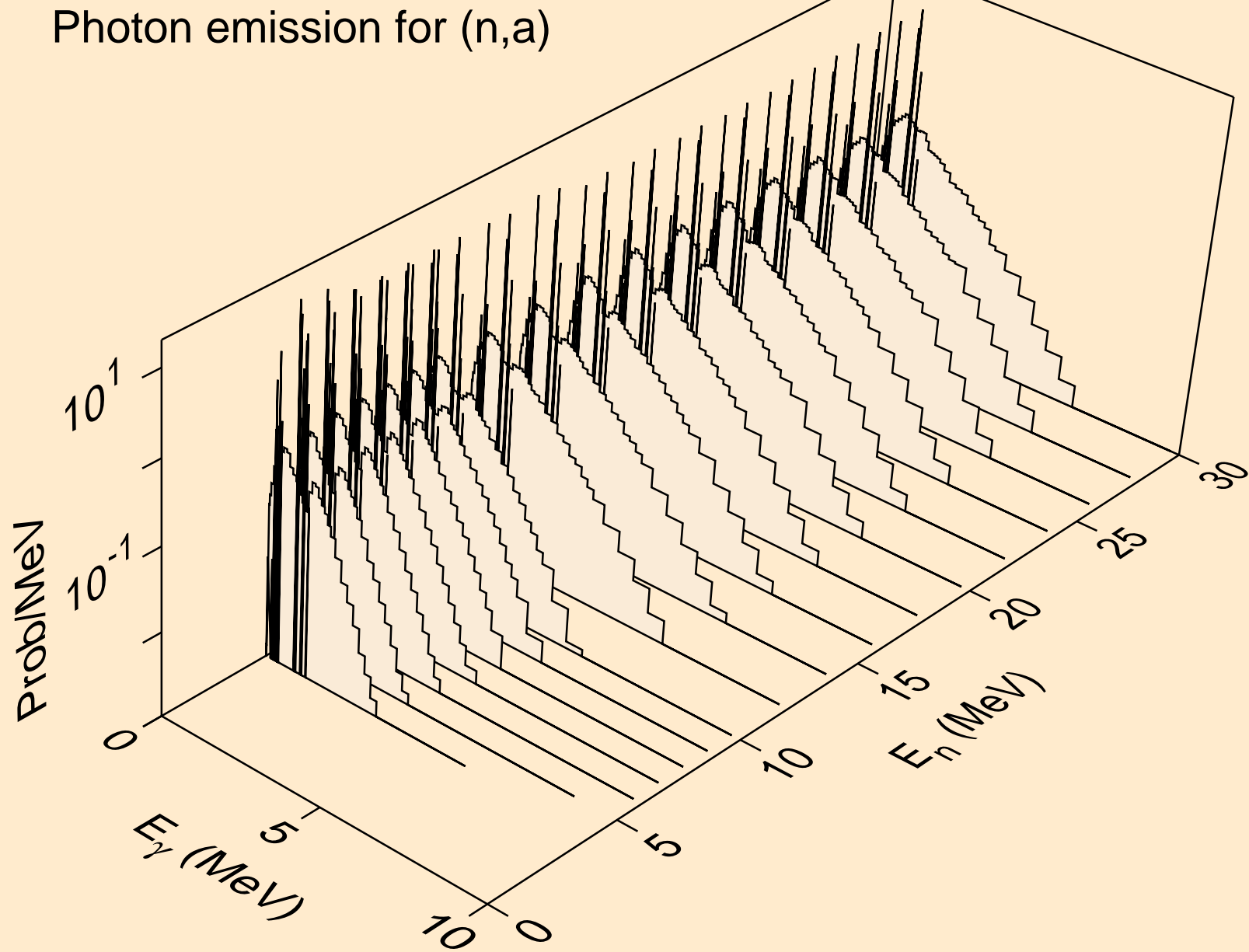

PO204 TRITON ACER TENDL-2021 LIBRARY; T=0.K  
Photon emission for (n,2a)

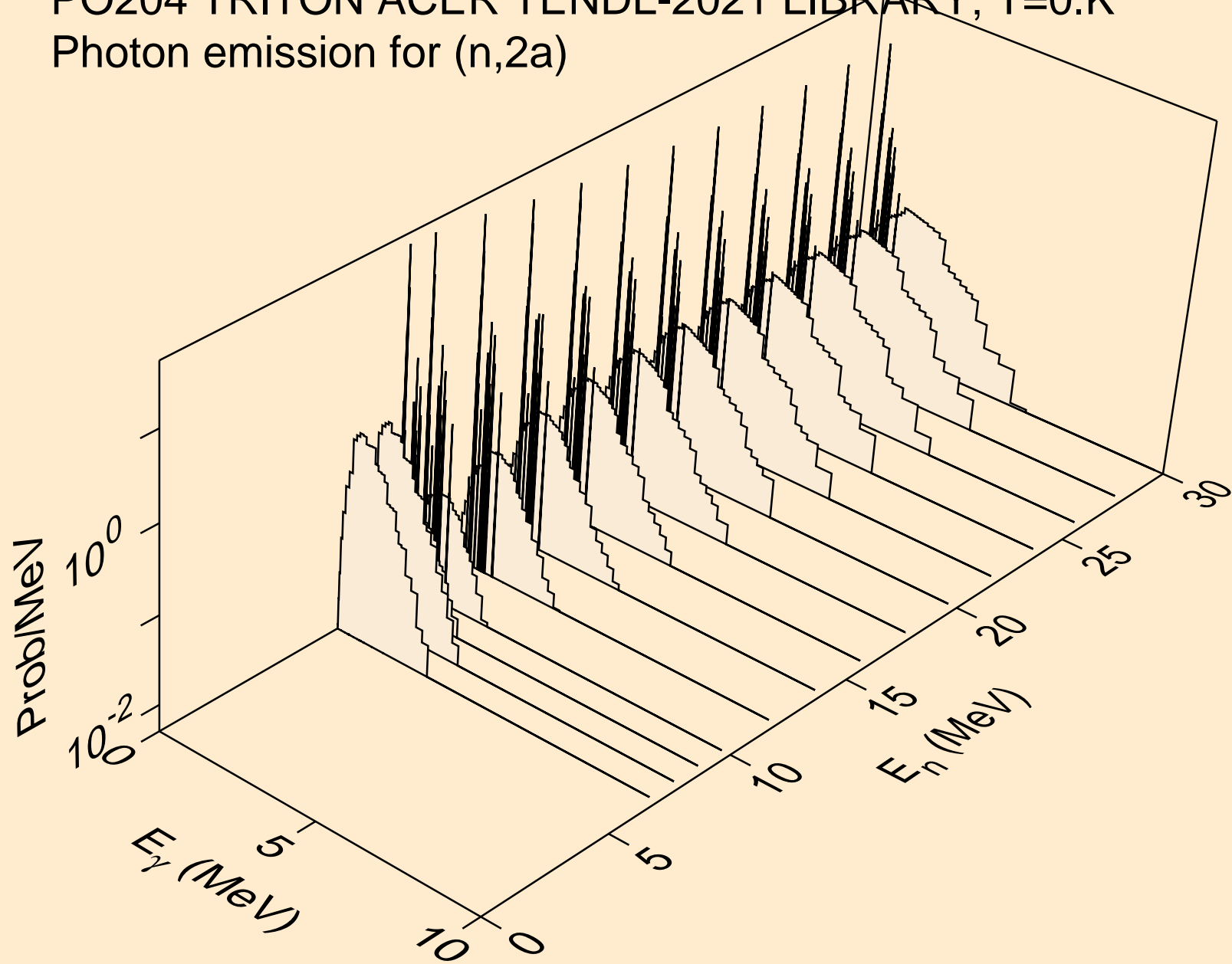

PO204 TRITON ACER TENDL-2021 LIBRARY; T=0.K  
Photon emission for (n,2p)

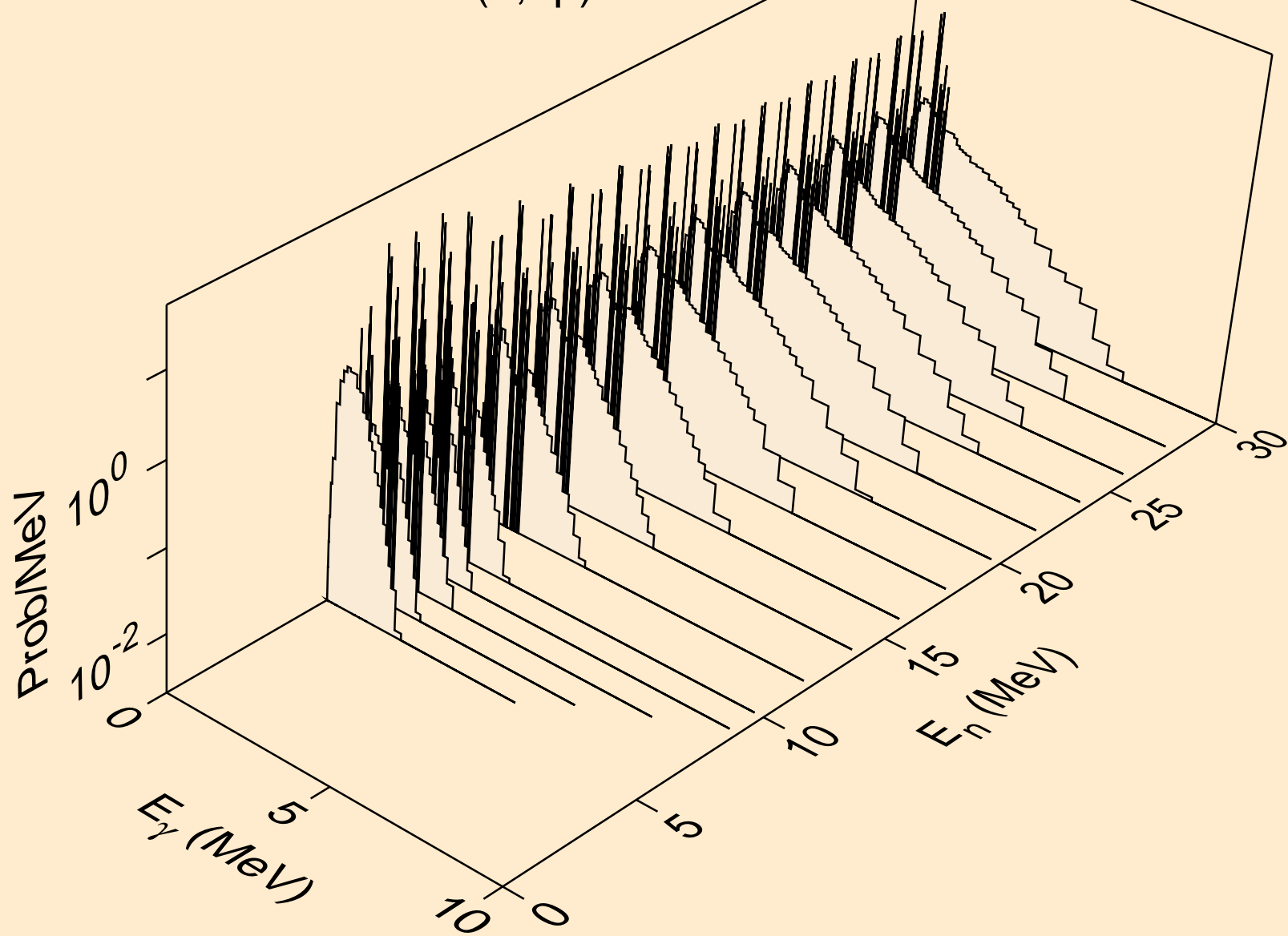



PO204 TRITON ACER TENDL-2021 LIBRARY; T=0.K  
Photon emission for (n,pa)

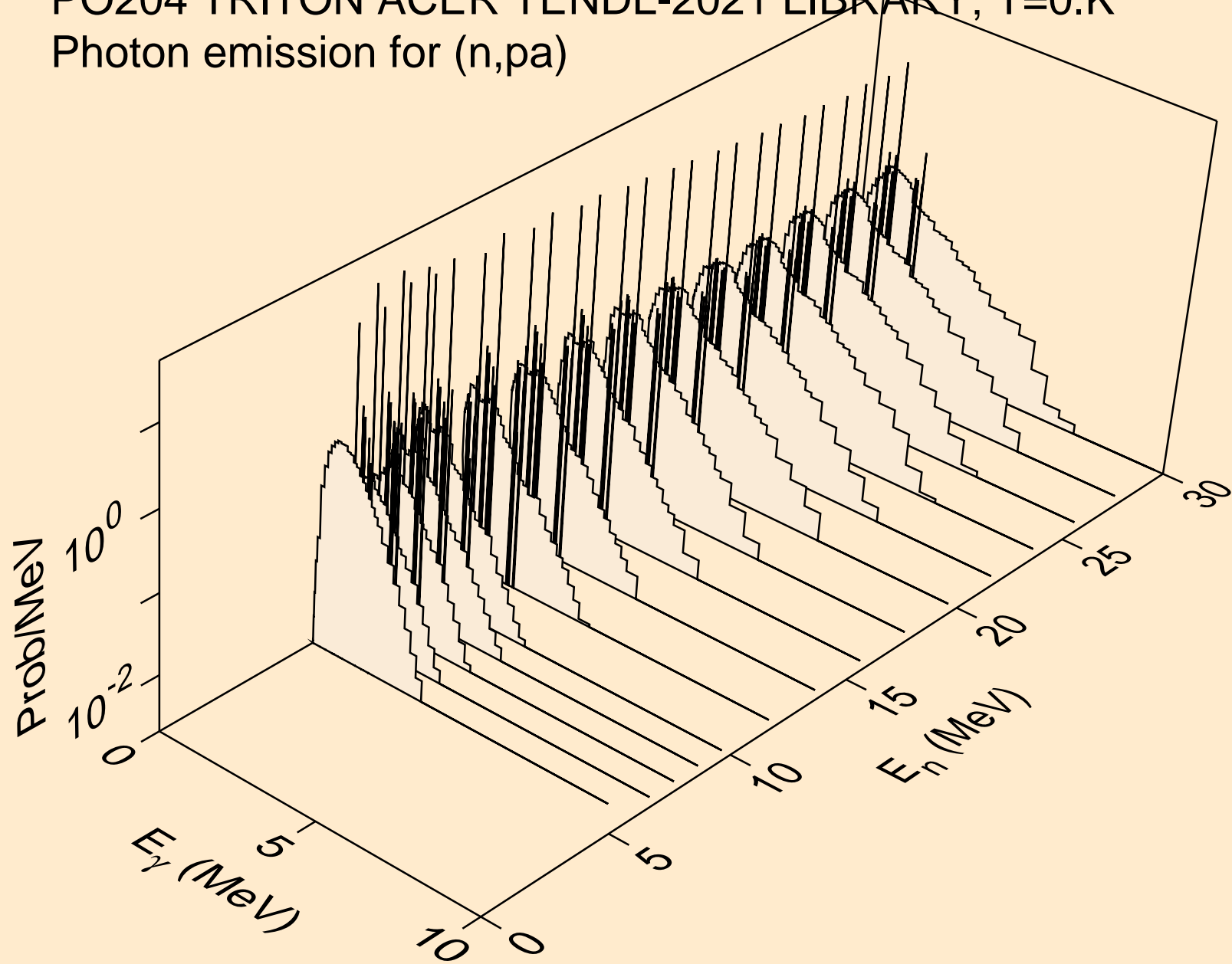

PO204 TRITON ACER TENDL-2021 LIBRARY; T=0.K  
Photon emission for (n,pd)

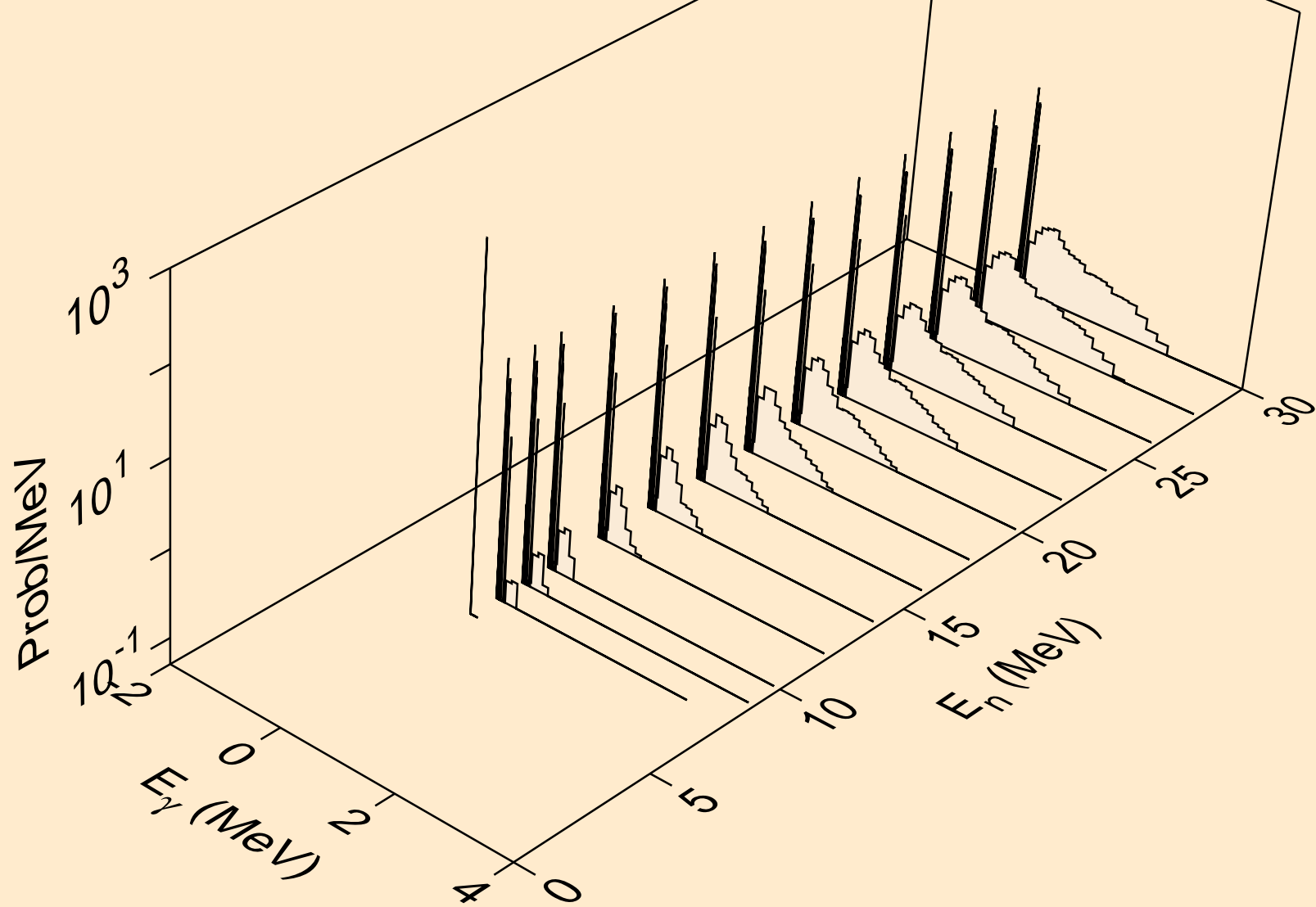

PO204 TRITON ACER TENDL-2021 LIBRARY; T=0.K  
Photon emission for (n,pt)

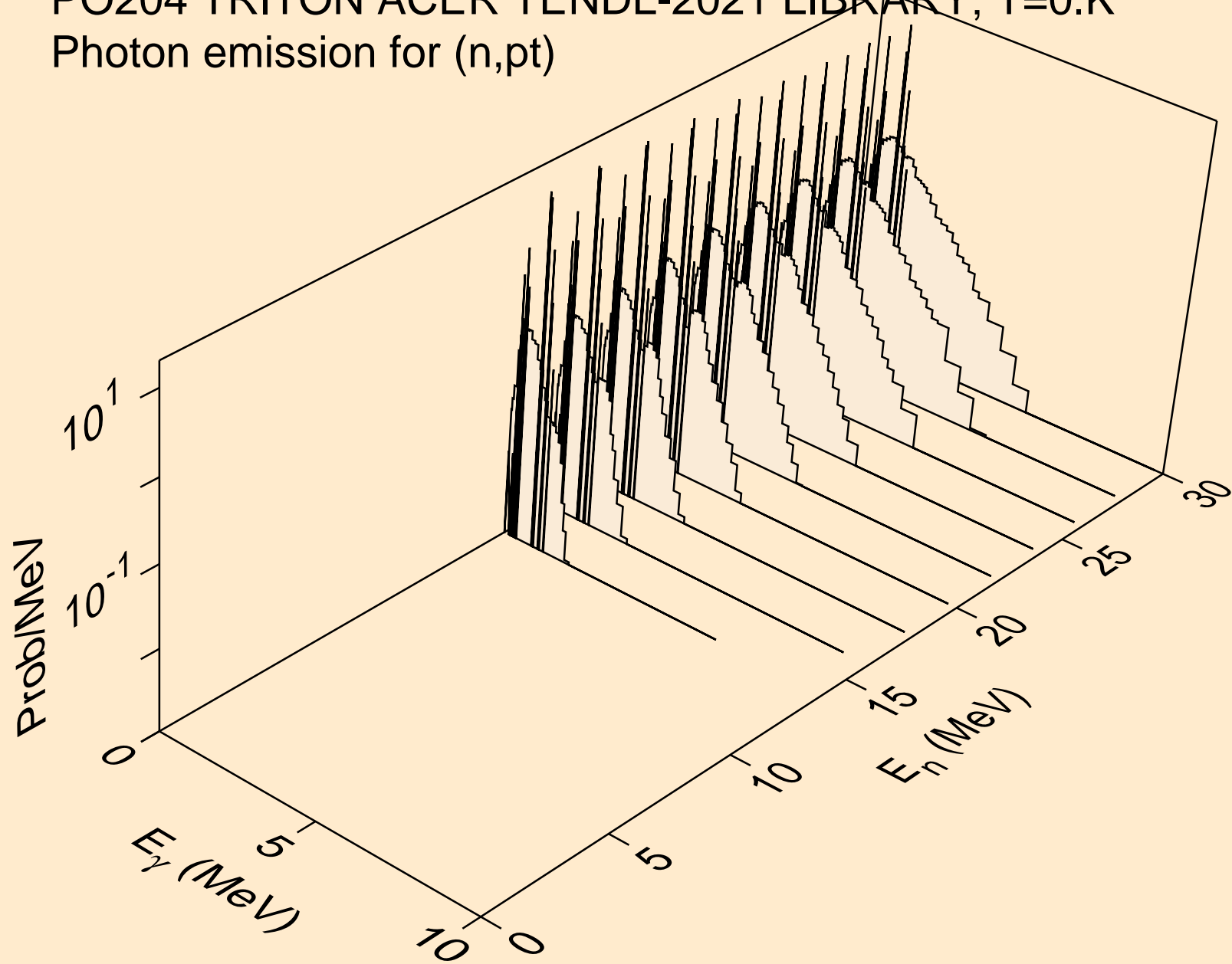

PO204 TRITON ACER TENDL-2021 LIBRARY; T=0.K  
Photon emission for (n,da)

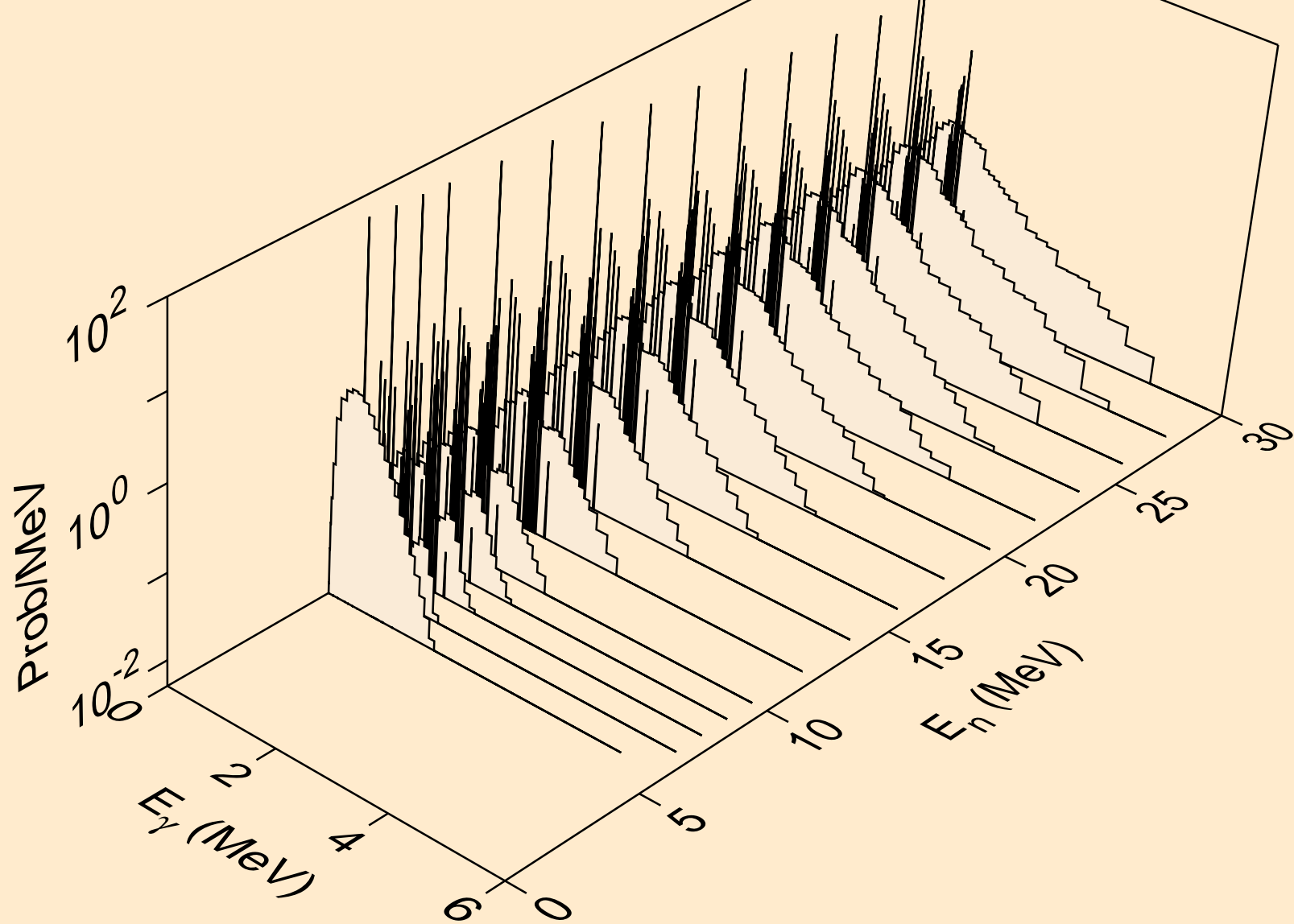

PO204 TRITON ACER TENDL-2021 LIBRARY; T=0.K  
Particle heating contributions

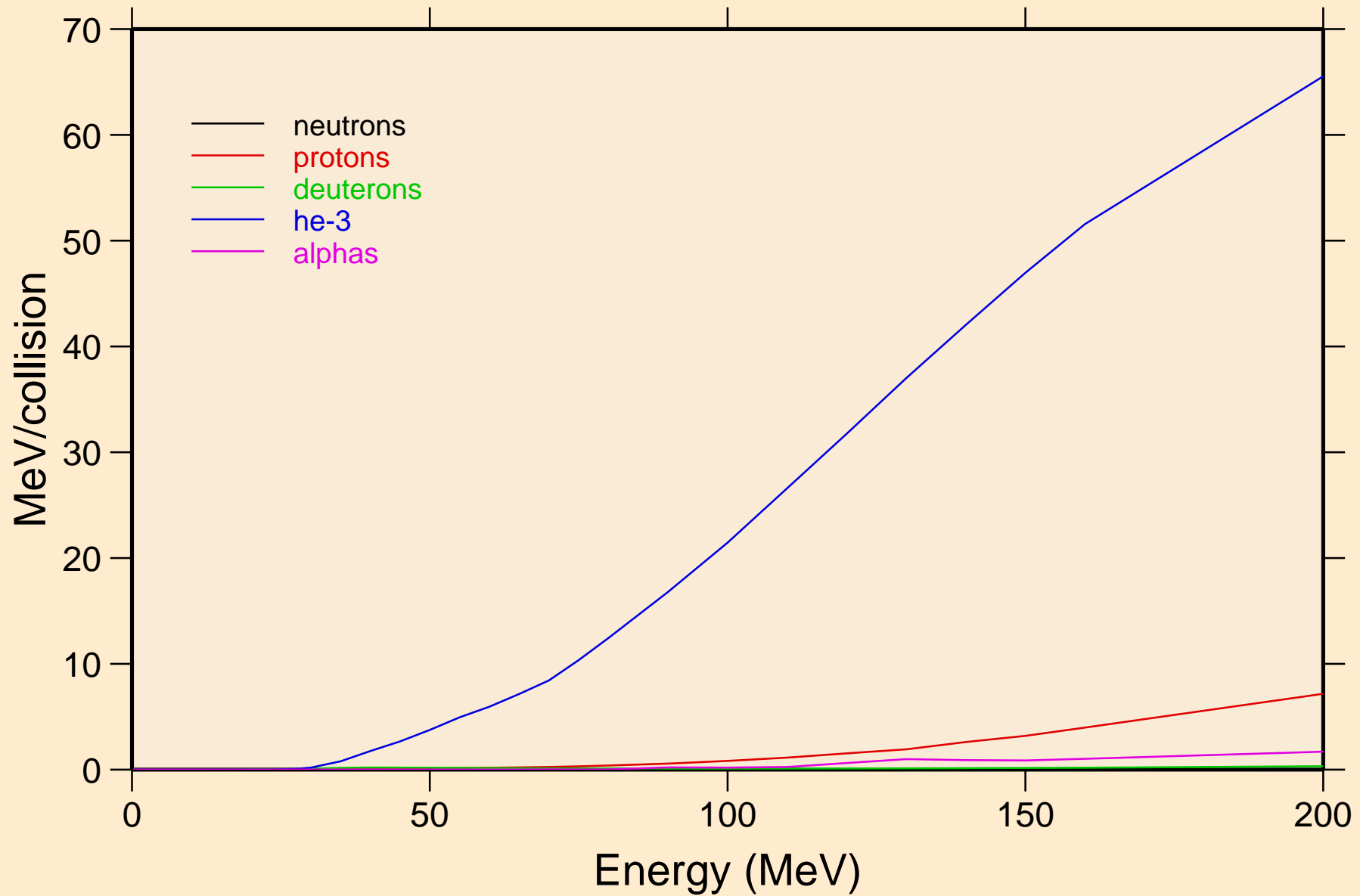

PO204 TRITON ACER TENDL-2021 LIBRARY; T=0.K  
Recoil Heating

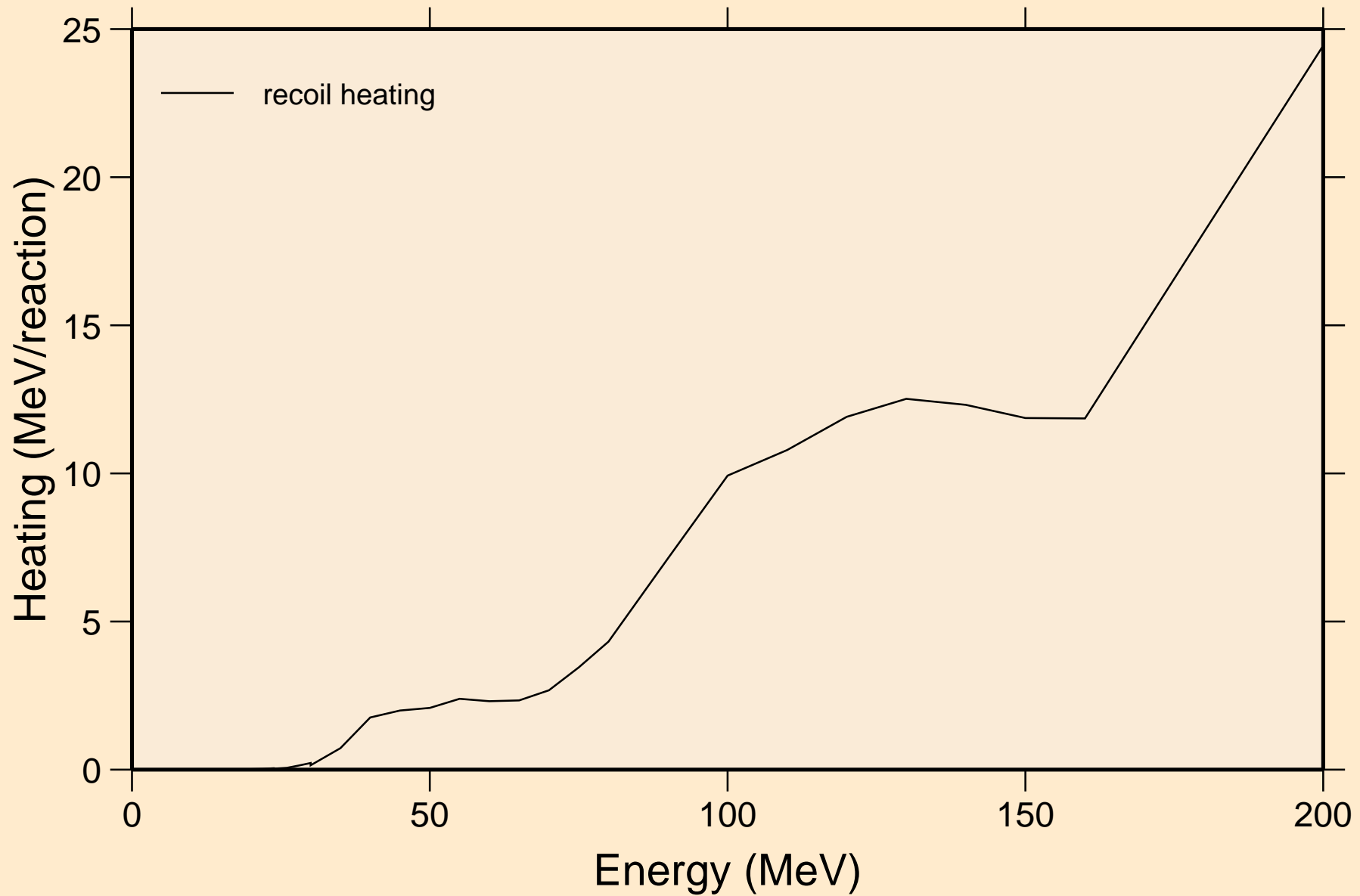

PO204 TRITON ACER TENDL-2021 LIBRARY; T=0.K  
Particle production cross sections

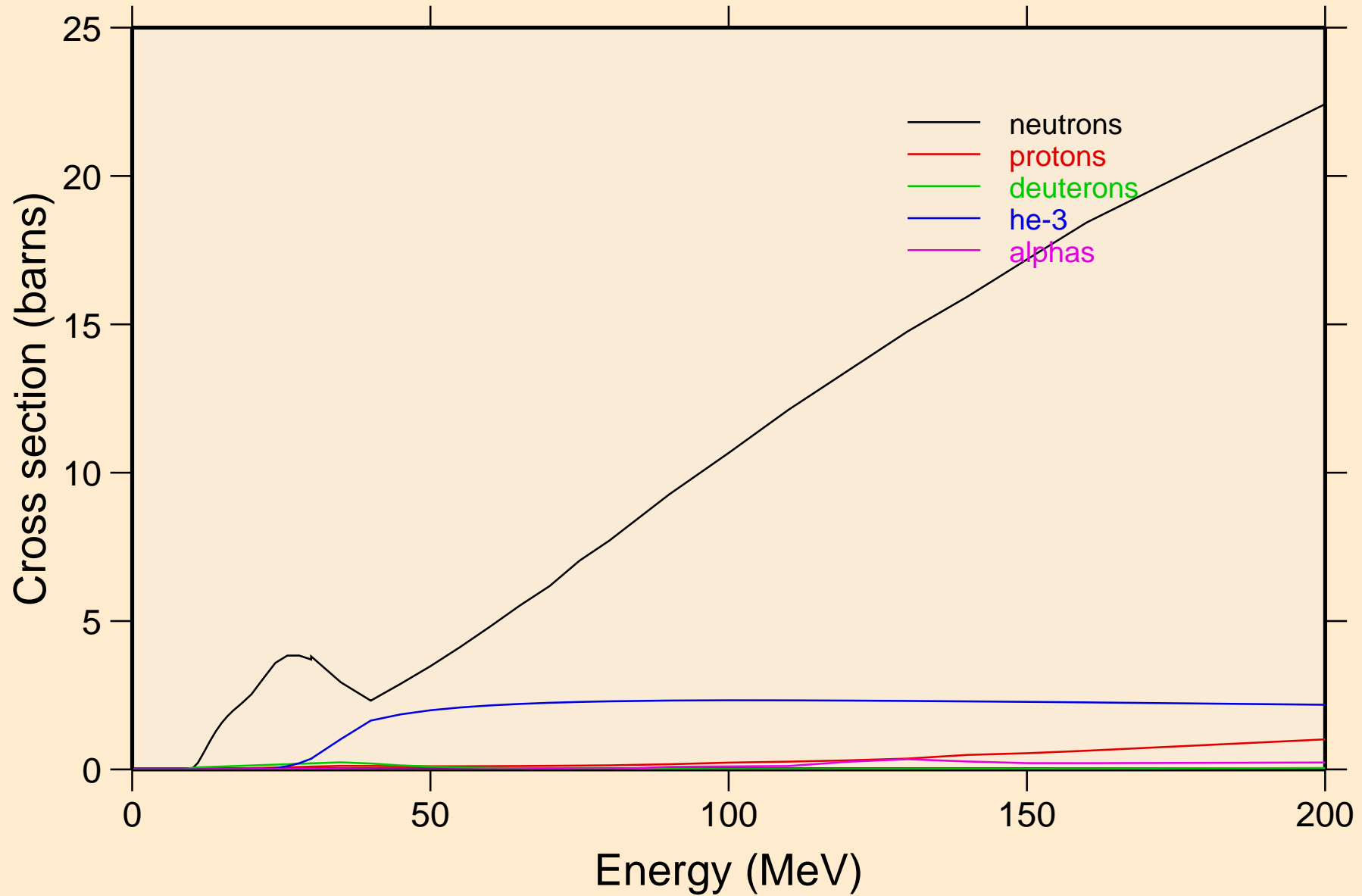

PO204 TRITON ACER TENDL-2021 LIBRARY; T=0.K  
neutrons from (t,n)

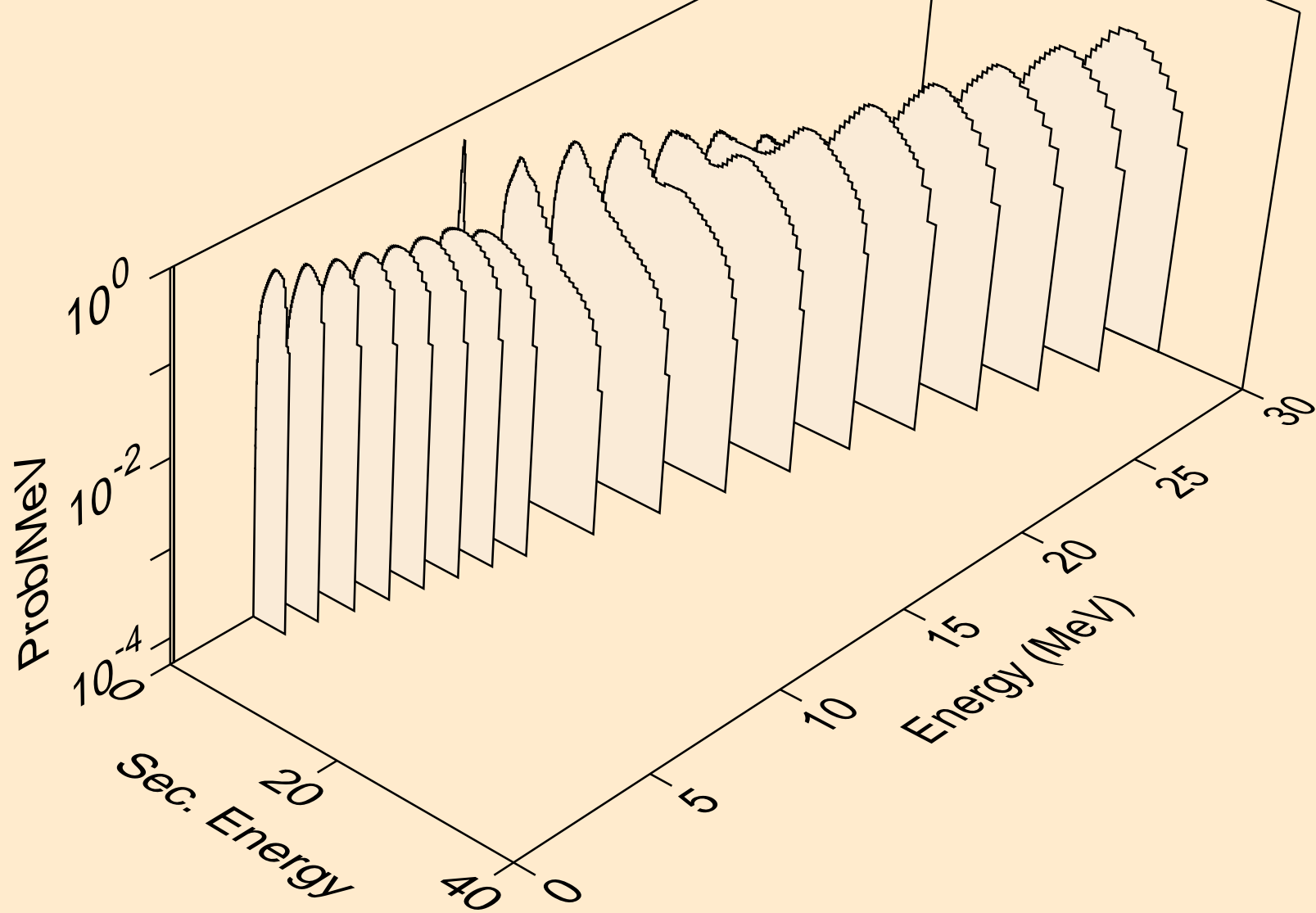



PO204 TRITON ACER TENDL-2021 LIBRARY; T=0.K  
neutrons from (t,x)

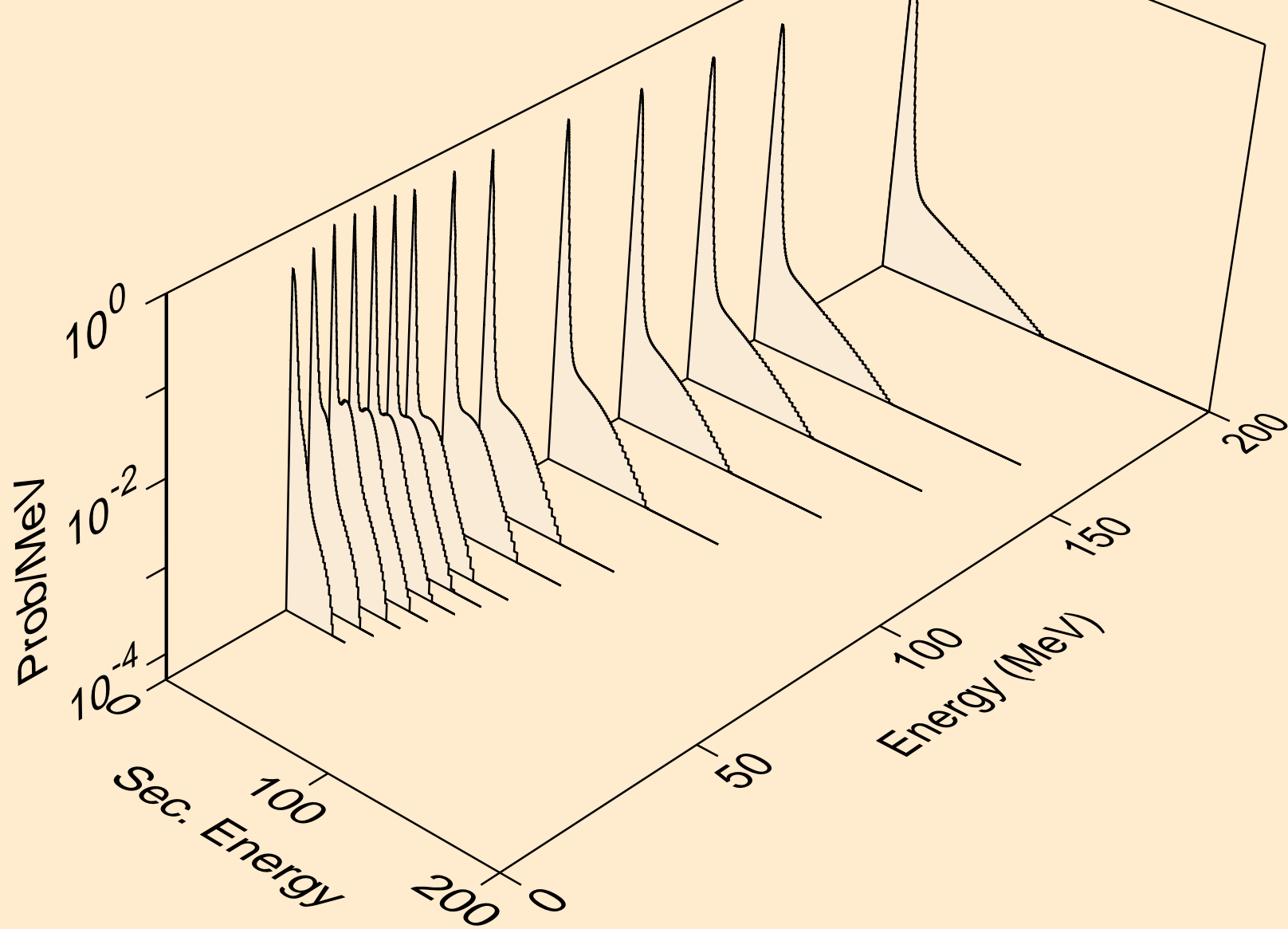

PO204 TRITON ACER TENDL-2021 LIBRARY; T=0.K  
neutrons from (t,2nd)

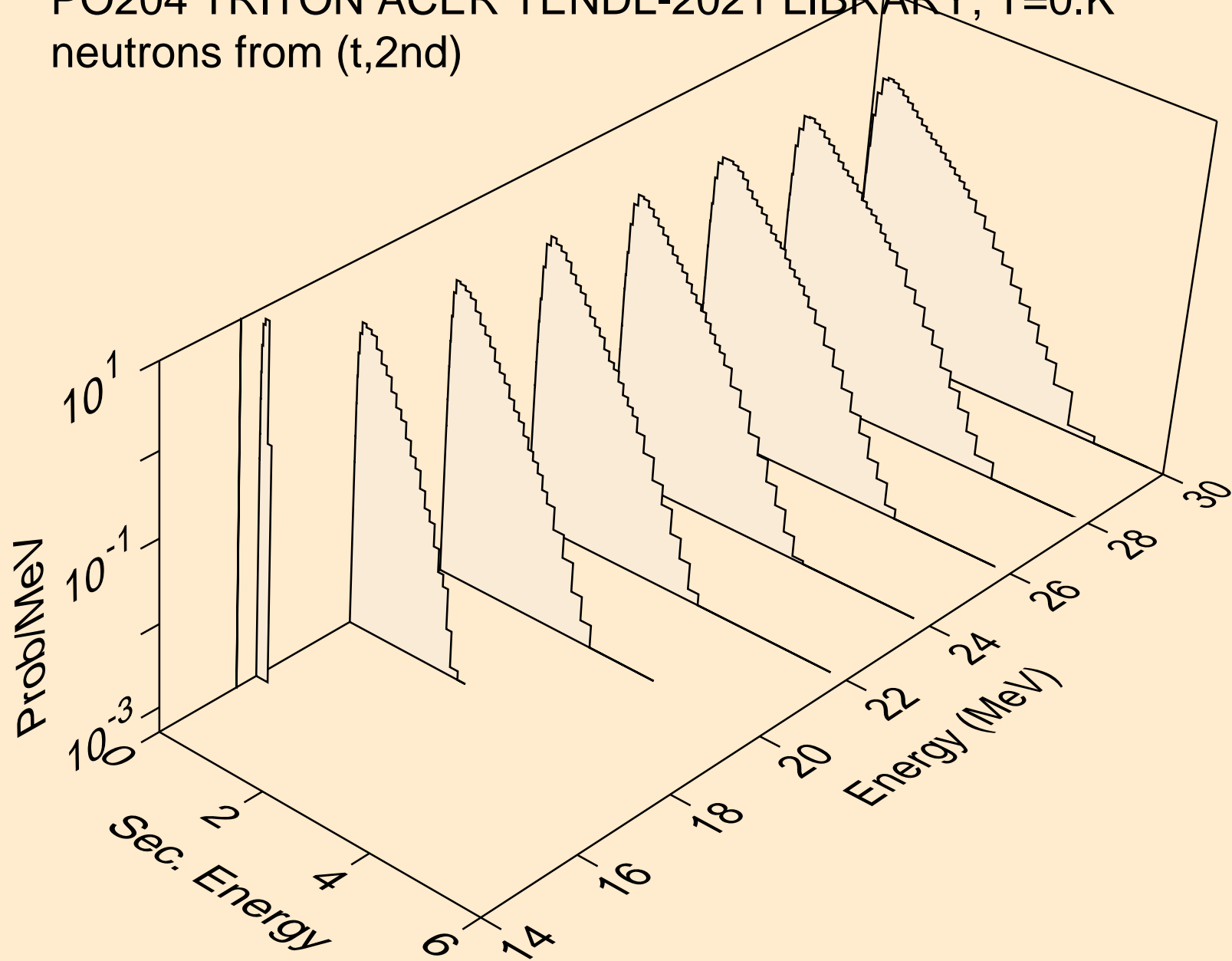

PO204 TRITON ACER TENDL-2021 LIBRARY; T=0.K  
neutrons from (t,2n)

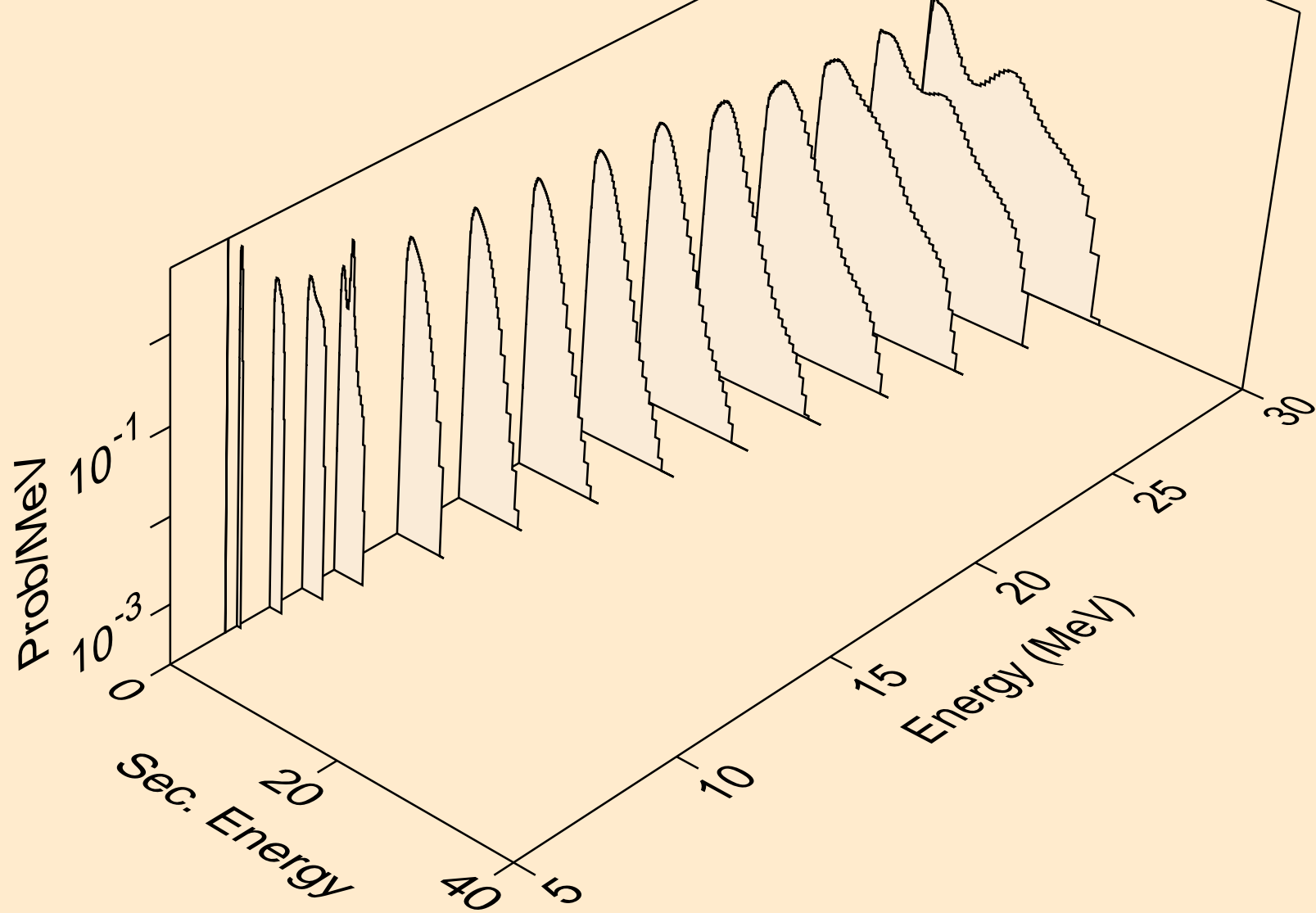

PO204 TRITON ACER TENDL-2021 LIBRARY; T=0.K  
neutrons from (t,3n)

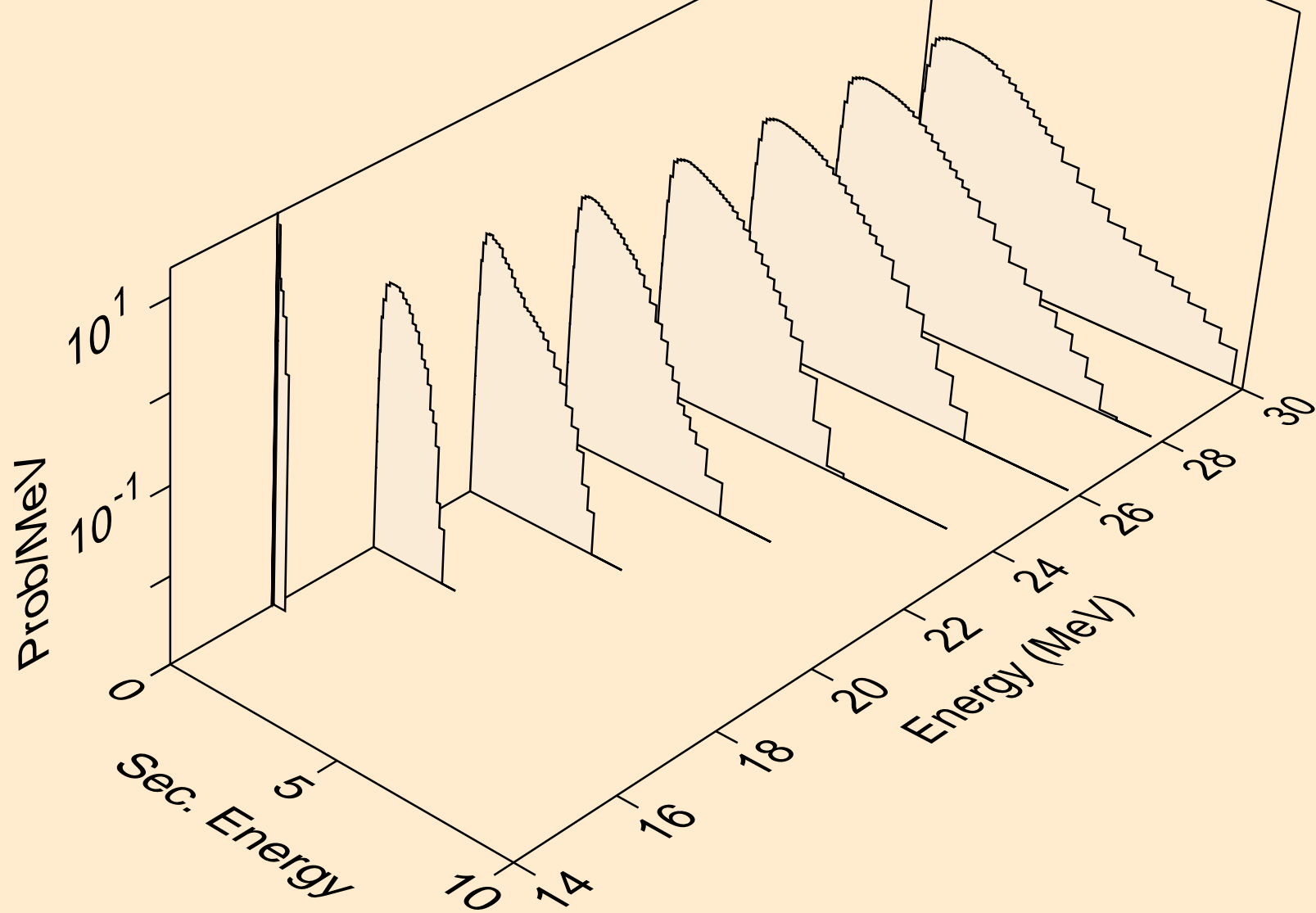

PO204 TRITON ACER TENDL-2021 LIBRARY; T=0.K  
neutrons from (t,n\*)a

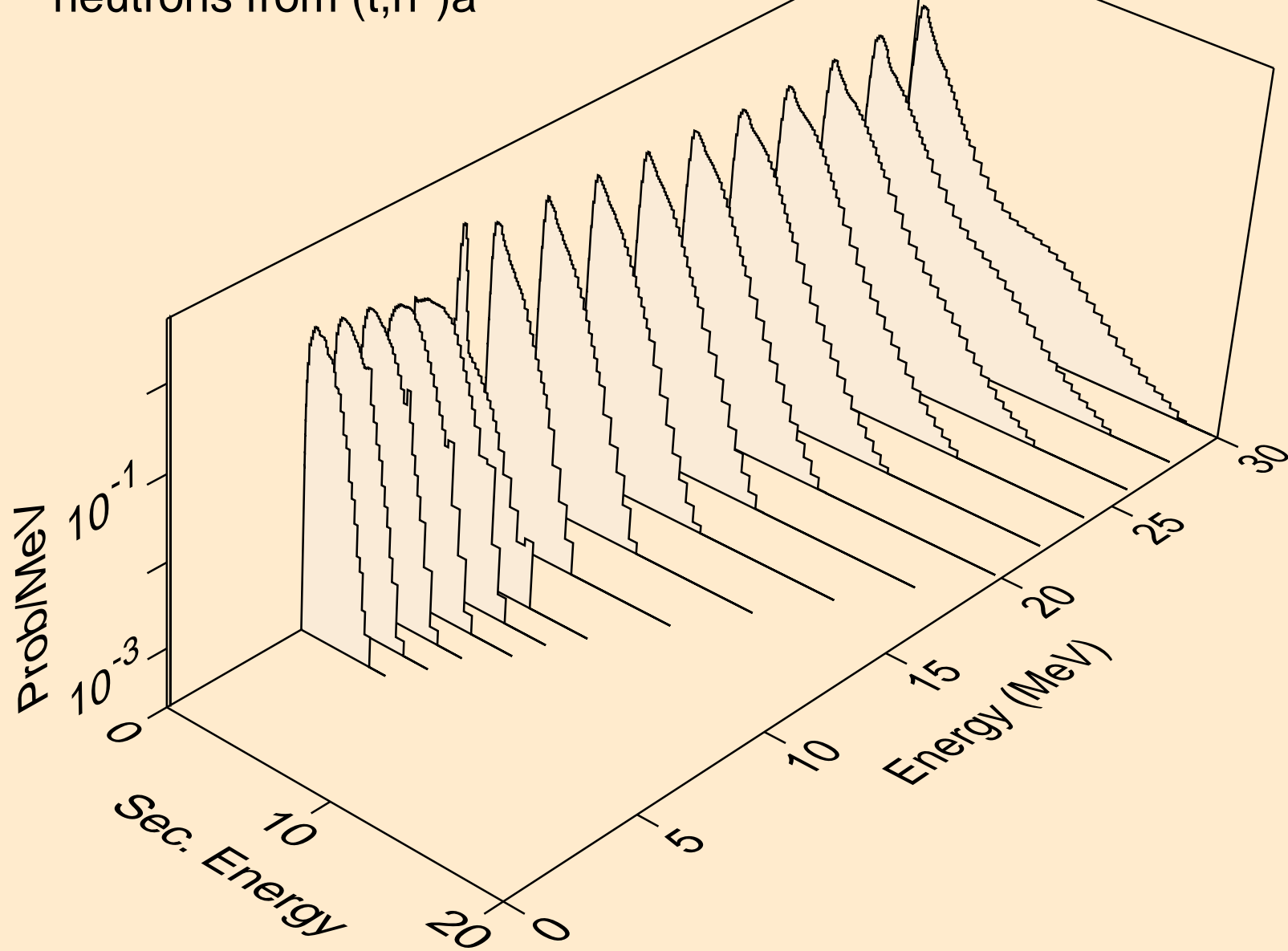

PO204 TRITON ACER TENDL-2021 LIBRARY; T=0.K  
neutrons from (t,2n)a

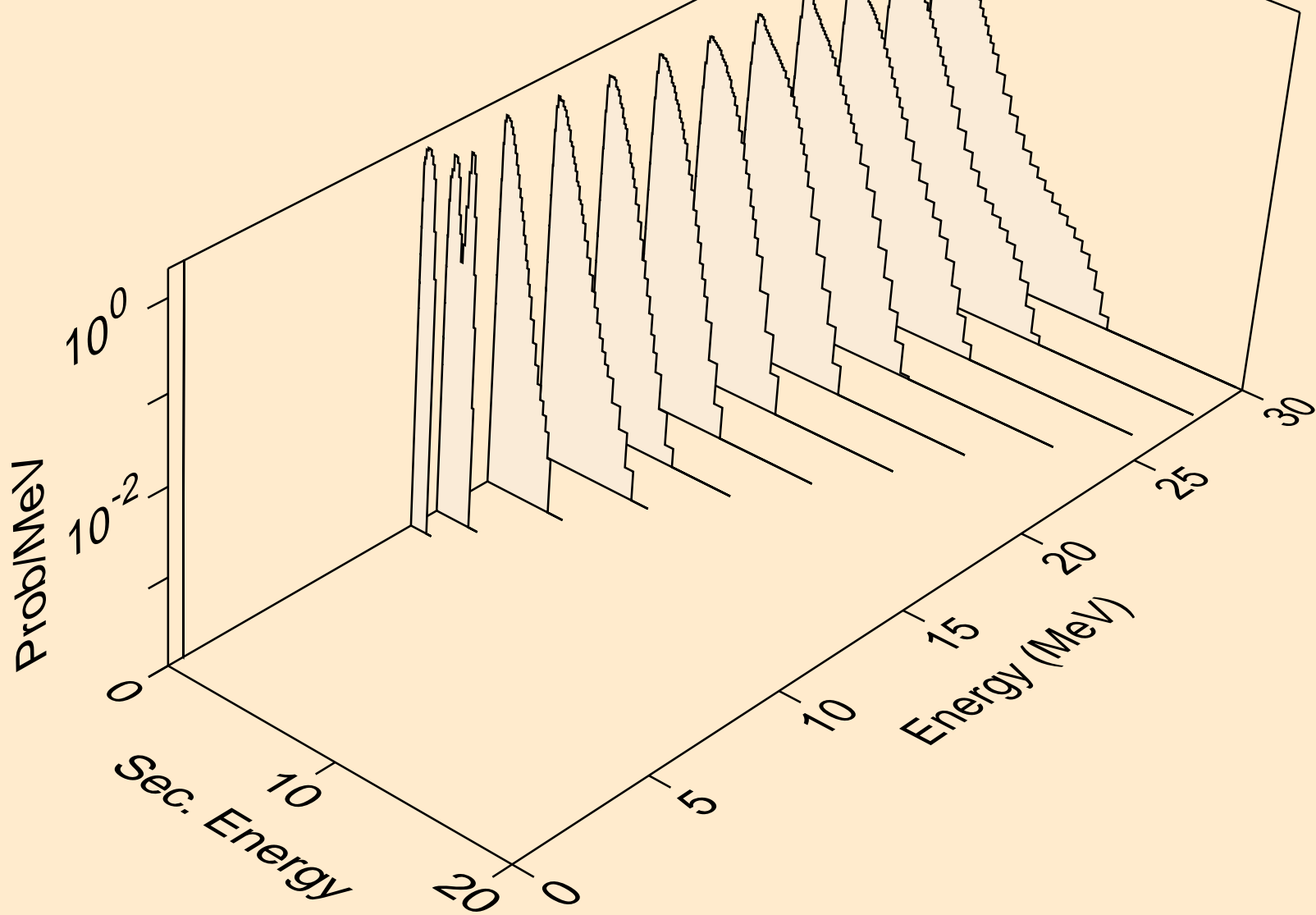

PO204 TRITON ACER TENDL-2021 LIBRARY; T=0.K  
neutrons from (t,3n)a

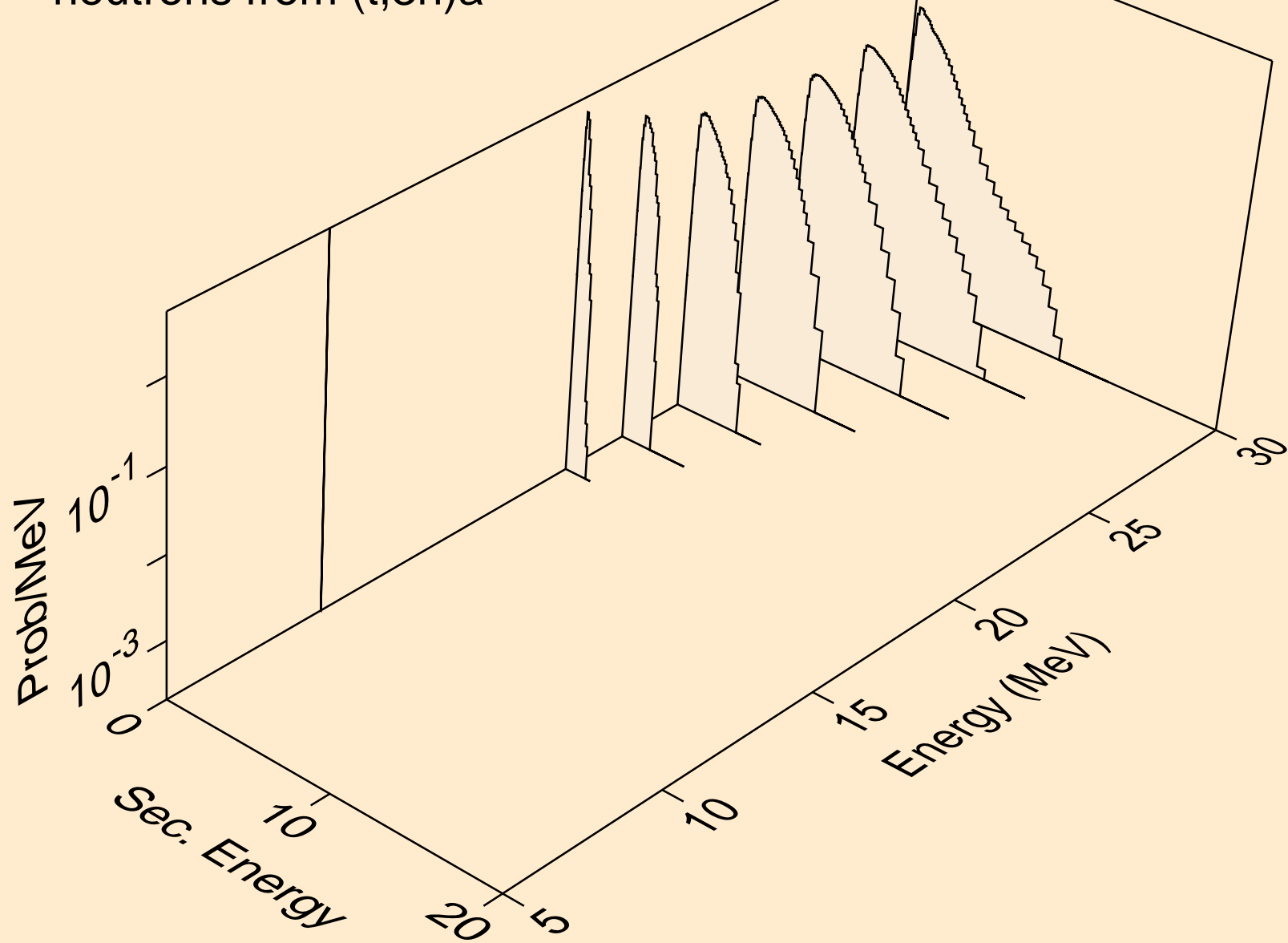

PO204 TRITON ACER TENDL-2021 LIBRARY; T=0.K  
neutrons from (t,n\*)p

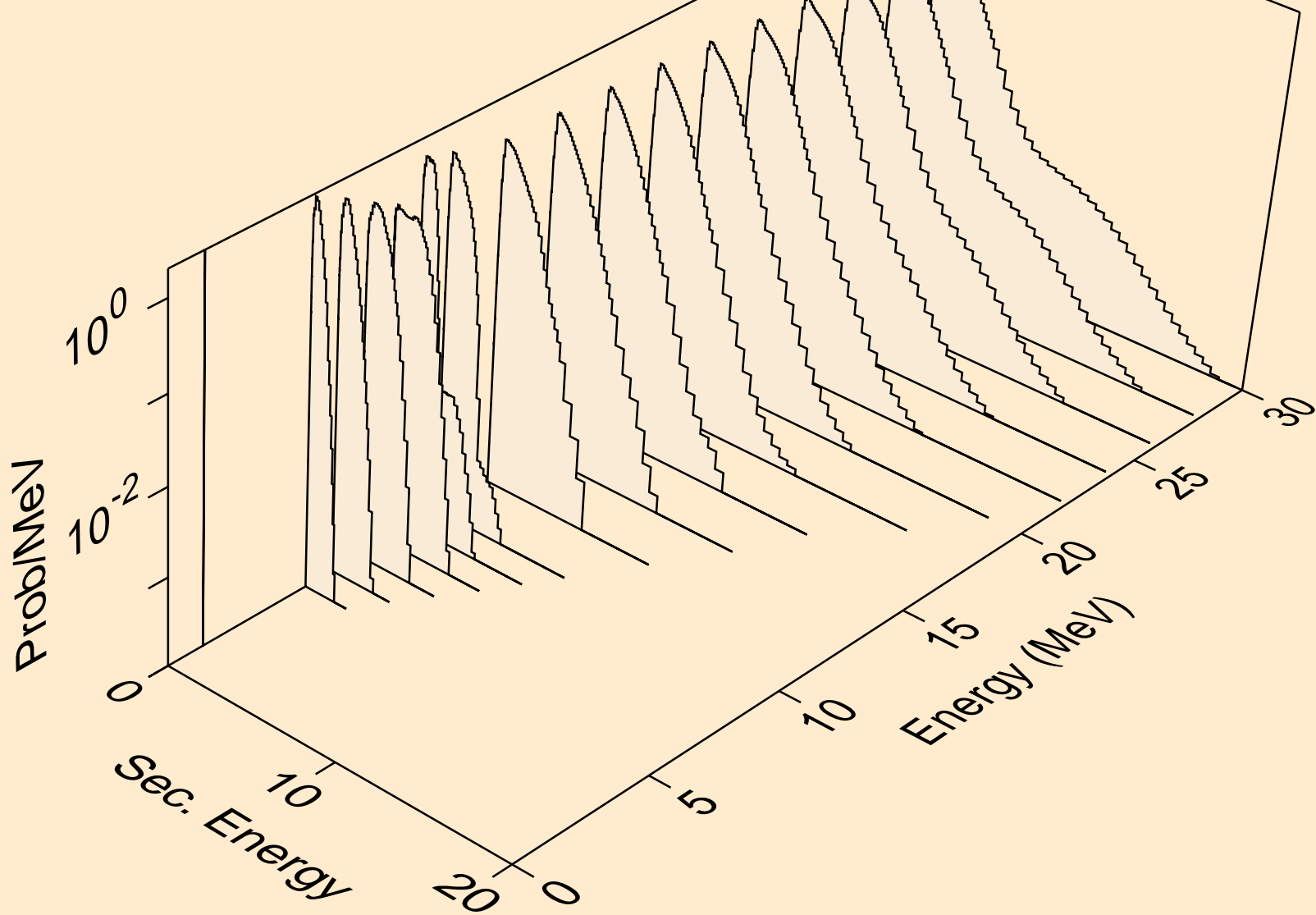



PO204 TRITON ACER TENDL-2021 LIBRARY; T=0.K  
neutrons from (t,n\*)2a

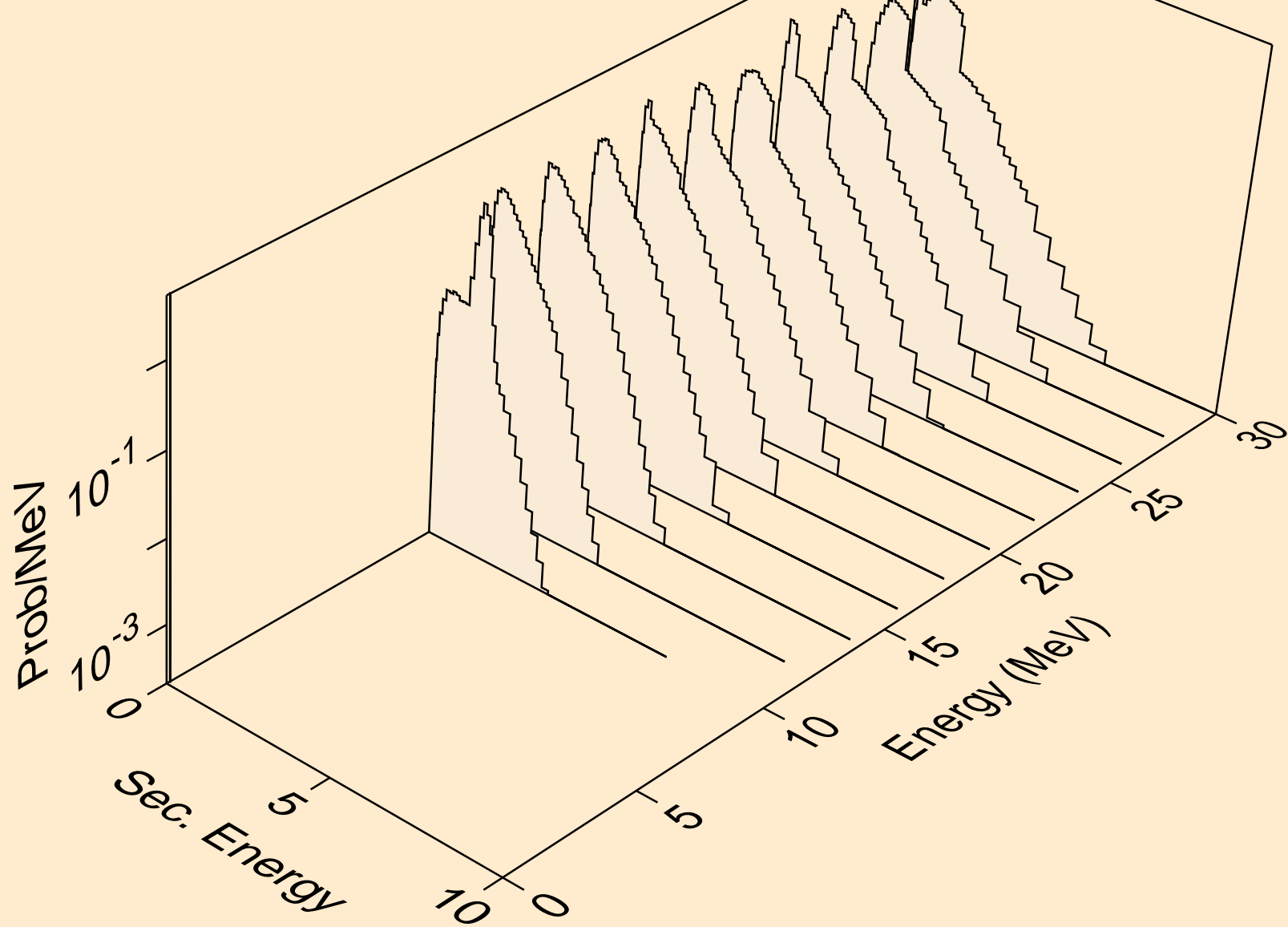

PO204 TRITON ACER TENDL-2021 LIBRARY; T=0.K  
neutrons from (t,2n)2a

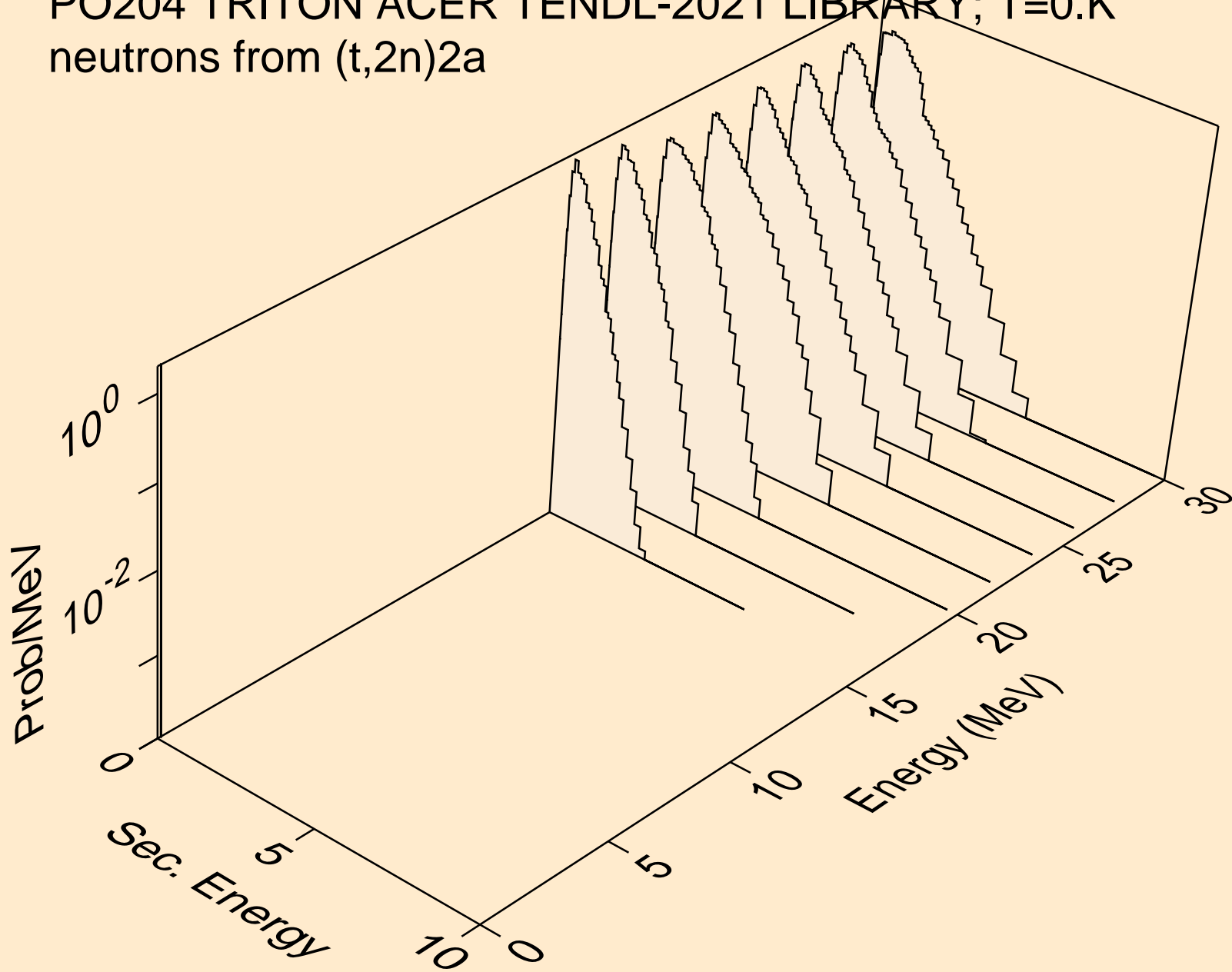

PO204 TRITON ACER TENDL-2021 LIBRARY; T=0.K  
neutrons from (t,n\*)d

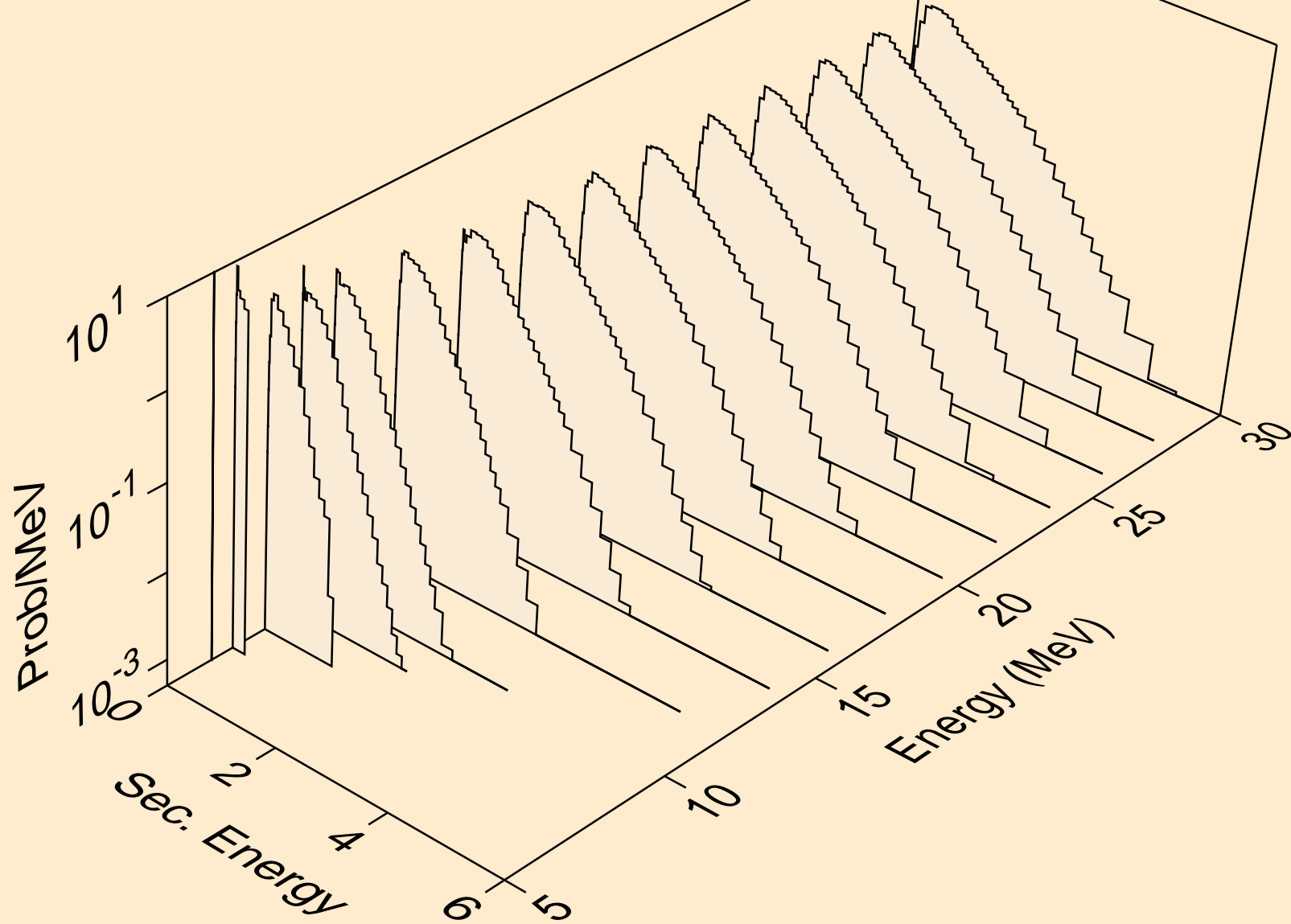

PO204 TRITON ACER TENDL-2021 LIBRARY; T=0.K  
neutrons from (t,n\*)t

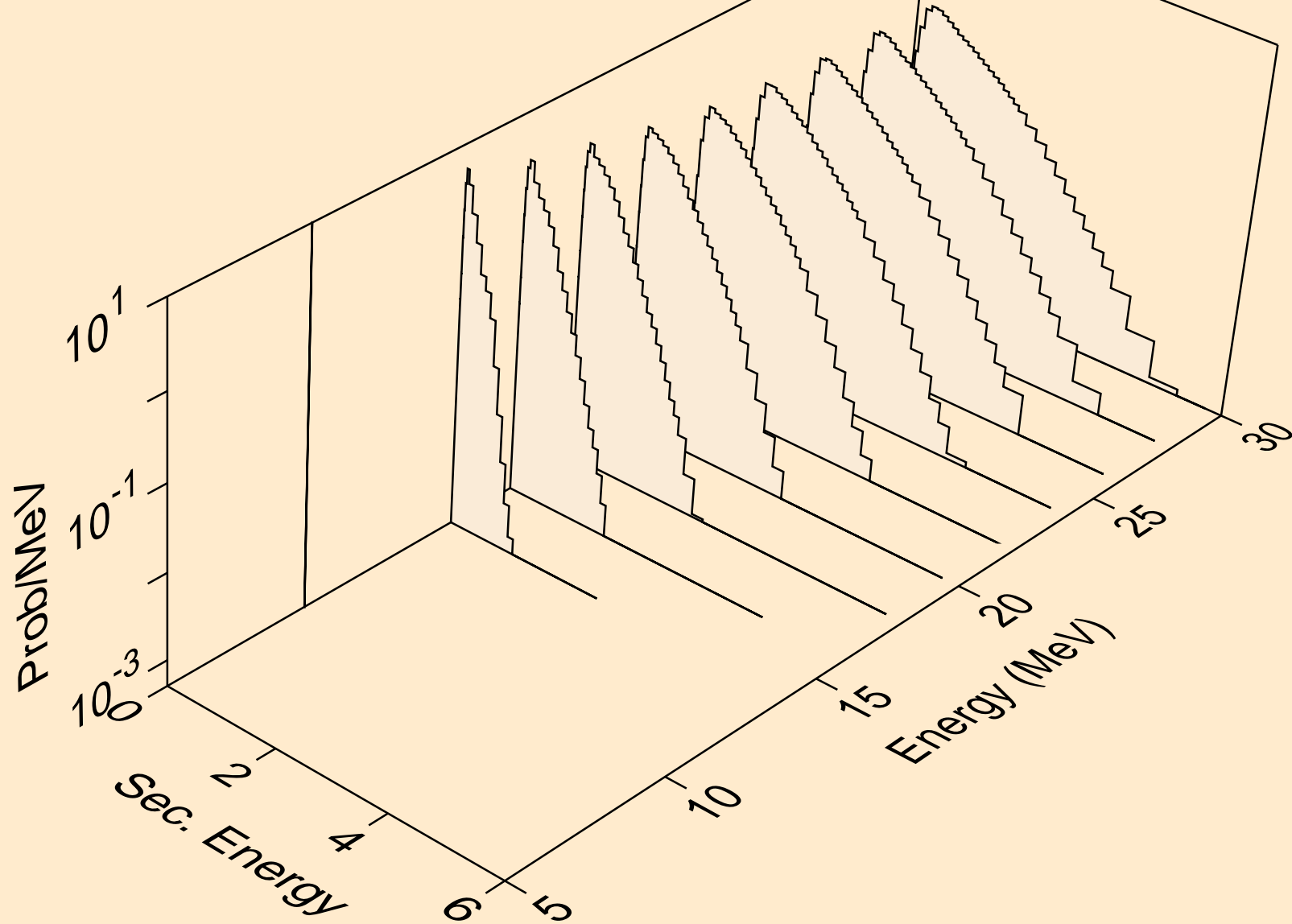

PO204 TRITON ACER TENDL-2021 LIBRARY; T=0.K  
neutrons from (t,n\*)he3

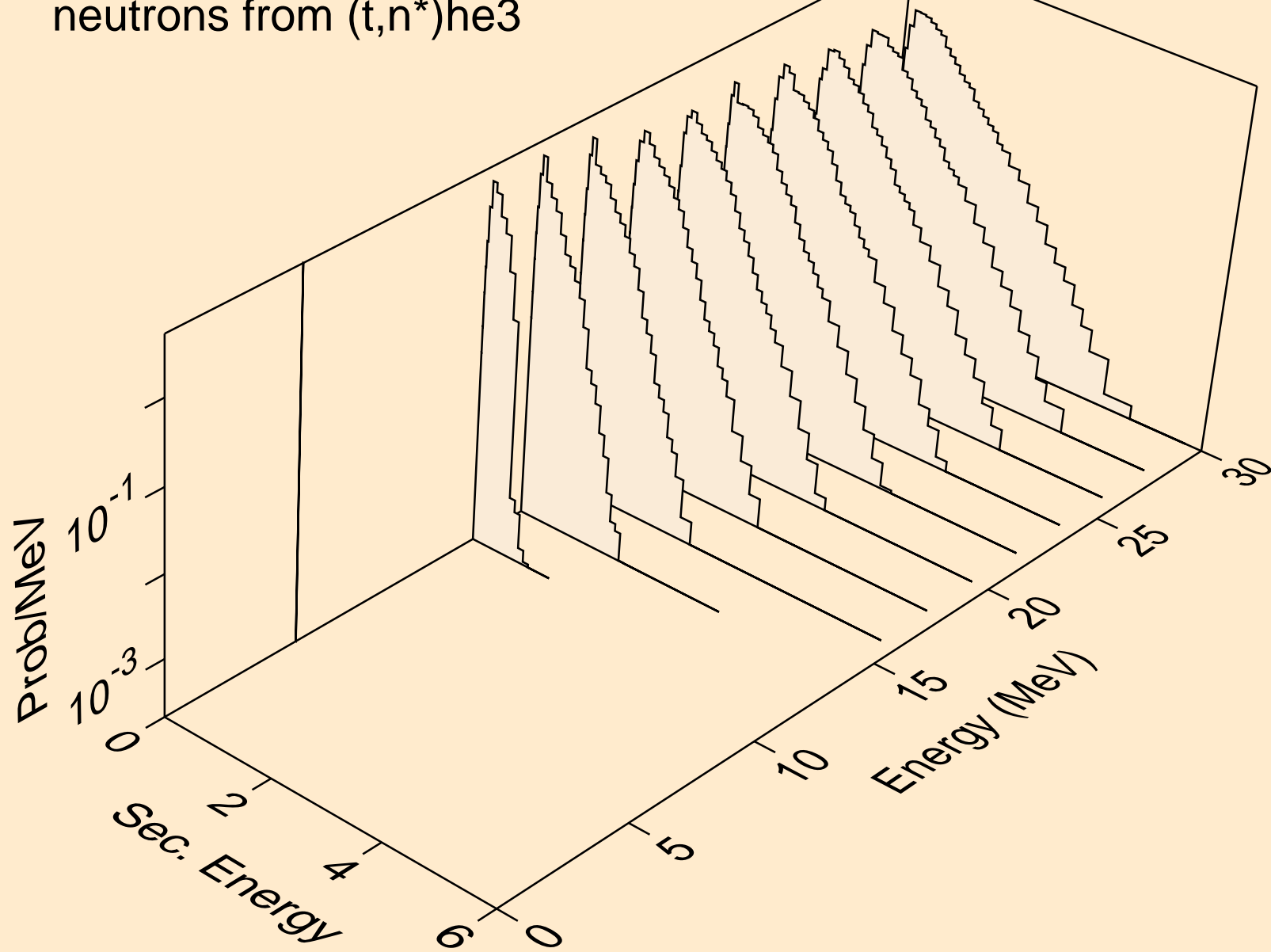

PO204 TRITON ACER TENDL-2021 LIBRARY; T=0.K  
neutrons from (t,4n)

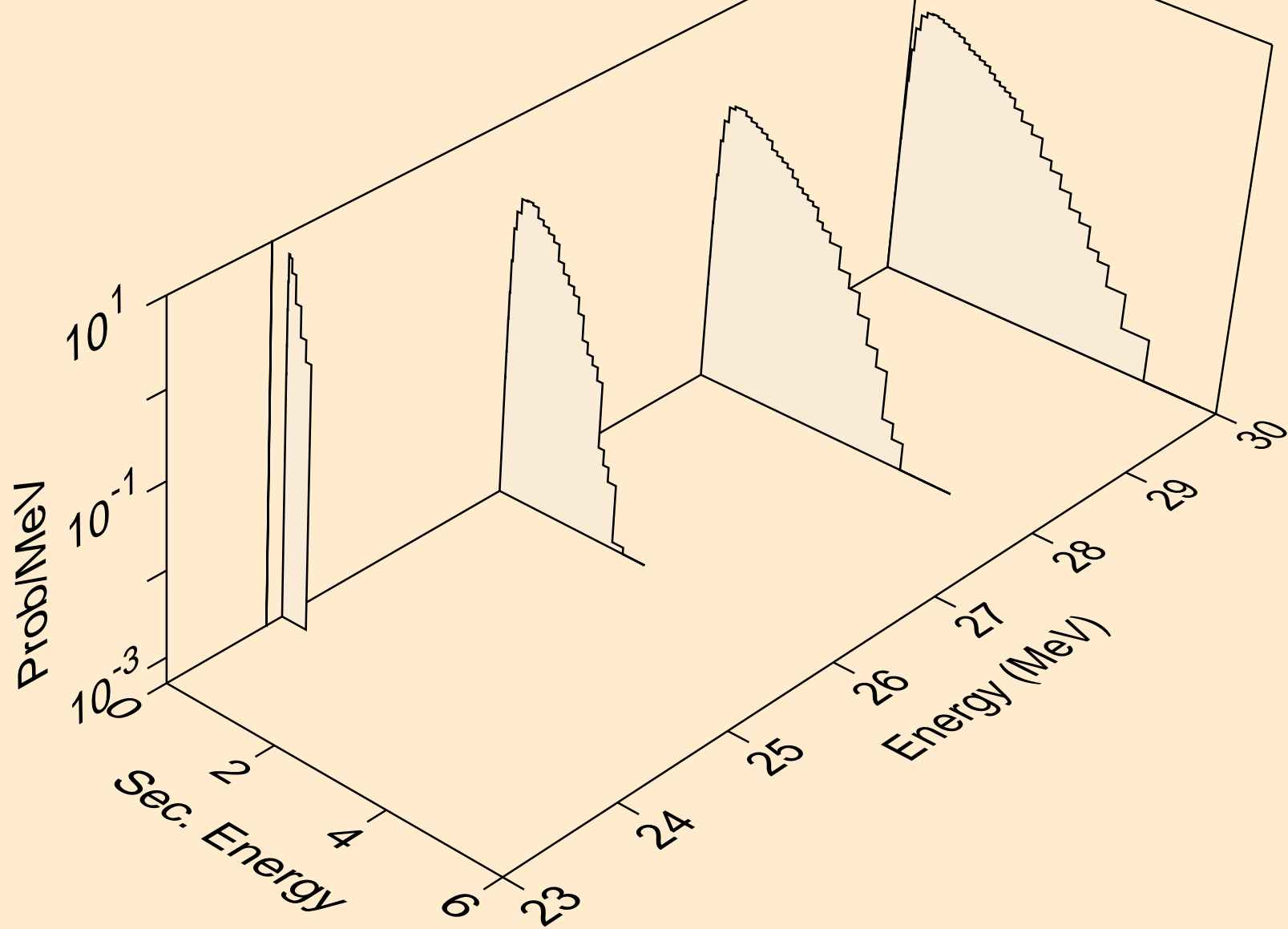

PO204 TRITON ACER TENDL-2021 LIBRARY; T=0.K  
neutrons from (t,2np)

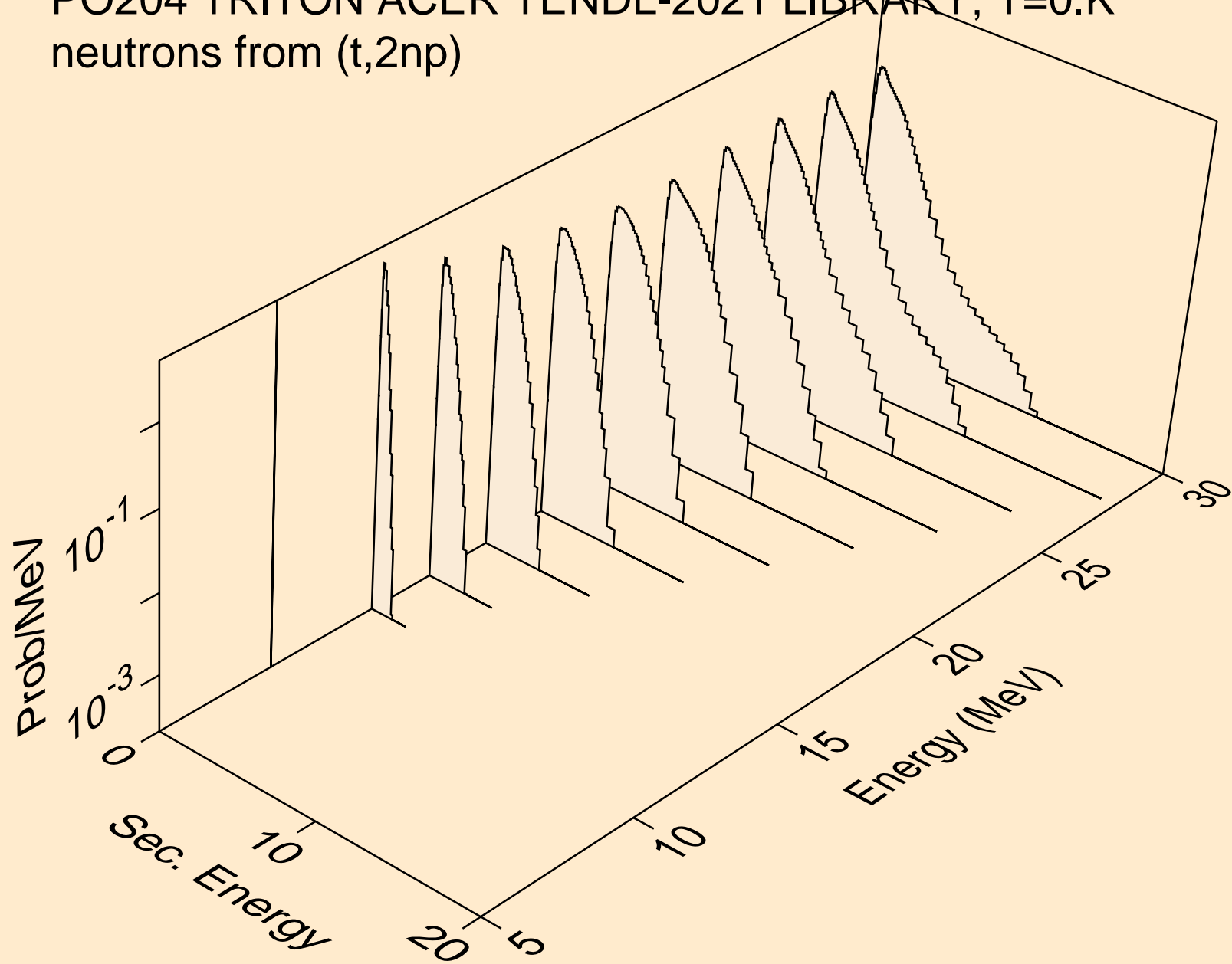

PO204 TRITON ACER TENDL-2021 LIBRARY; T=0.K  
neutrons from (t,3np)

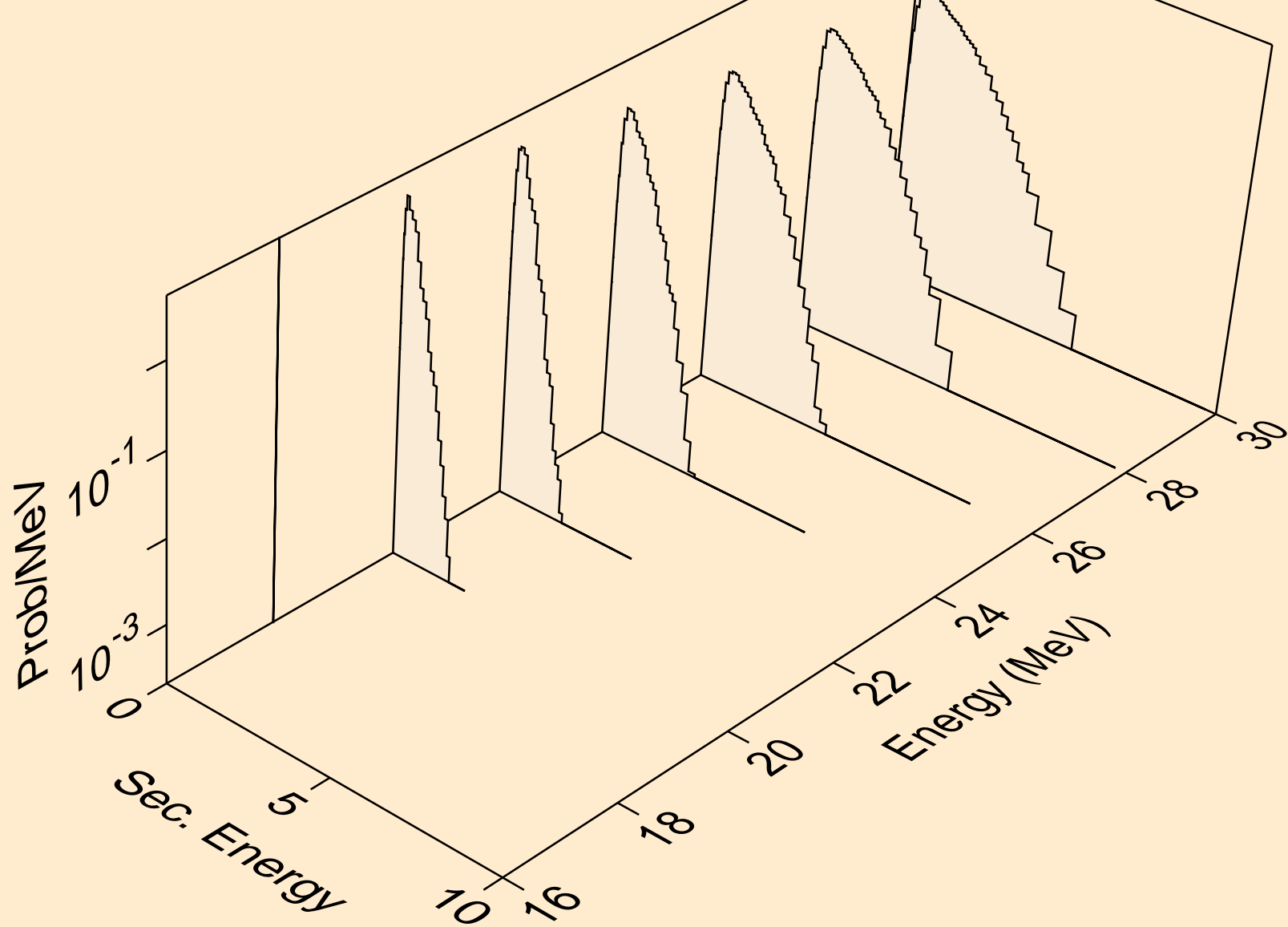



PO204 TRITON ACER TENDL-2021 LIBRARY; T=0.K  
neutrons from (t,2np)

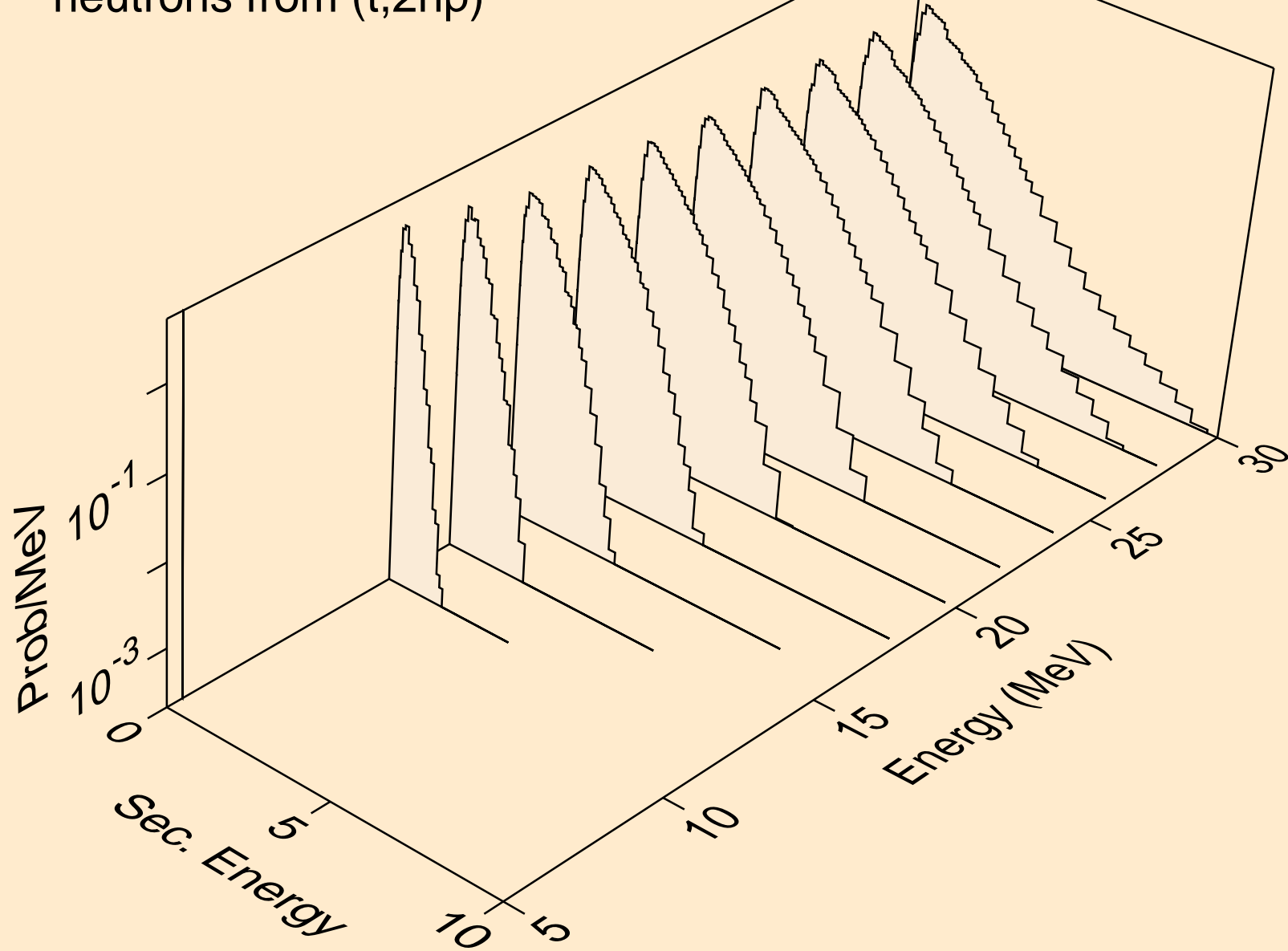

PO204 TRITON ACER TENDL-2021 LIBRARY; T=0.K  
neutrons from (t,npa)

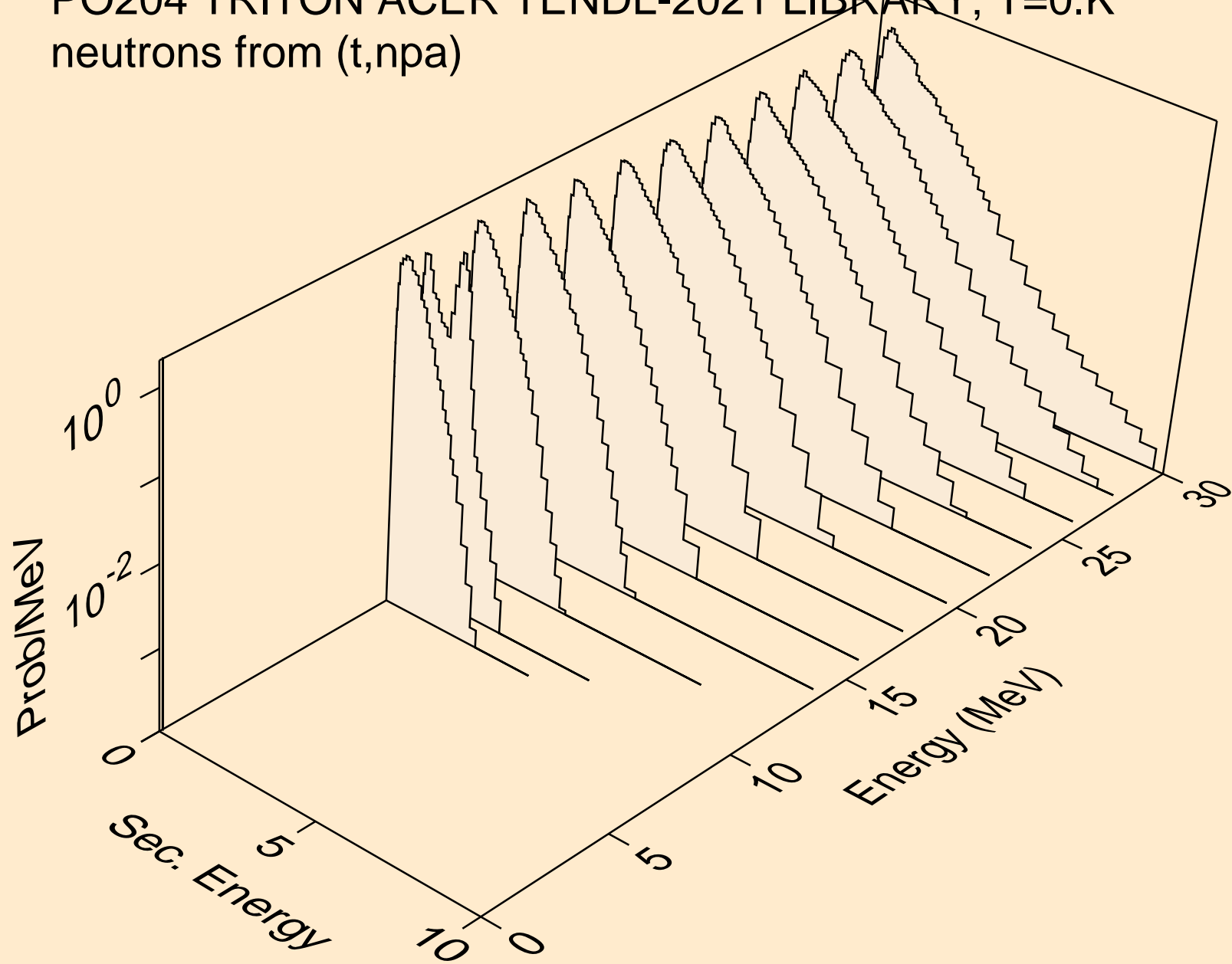

PO204 TRITON ACER TENDL-2021 LIBRARY; T=0.K  
protons from (t,x)

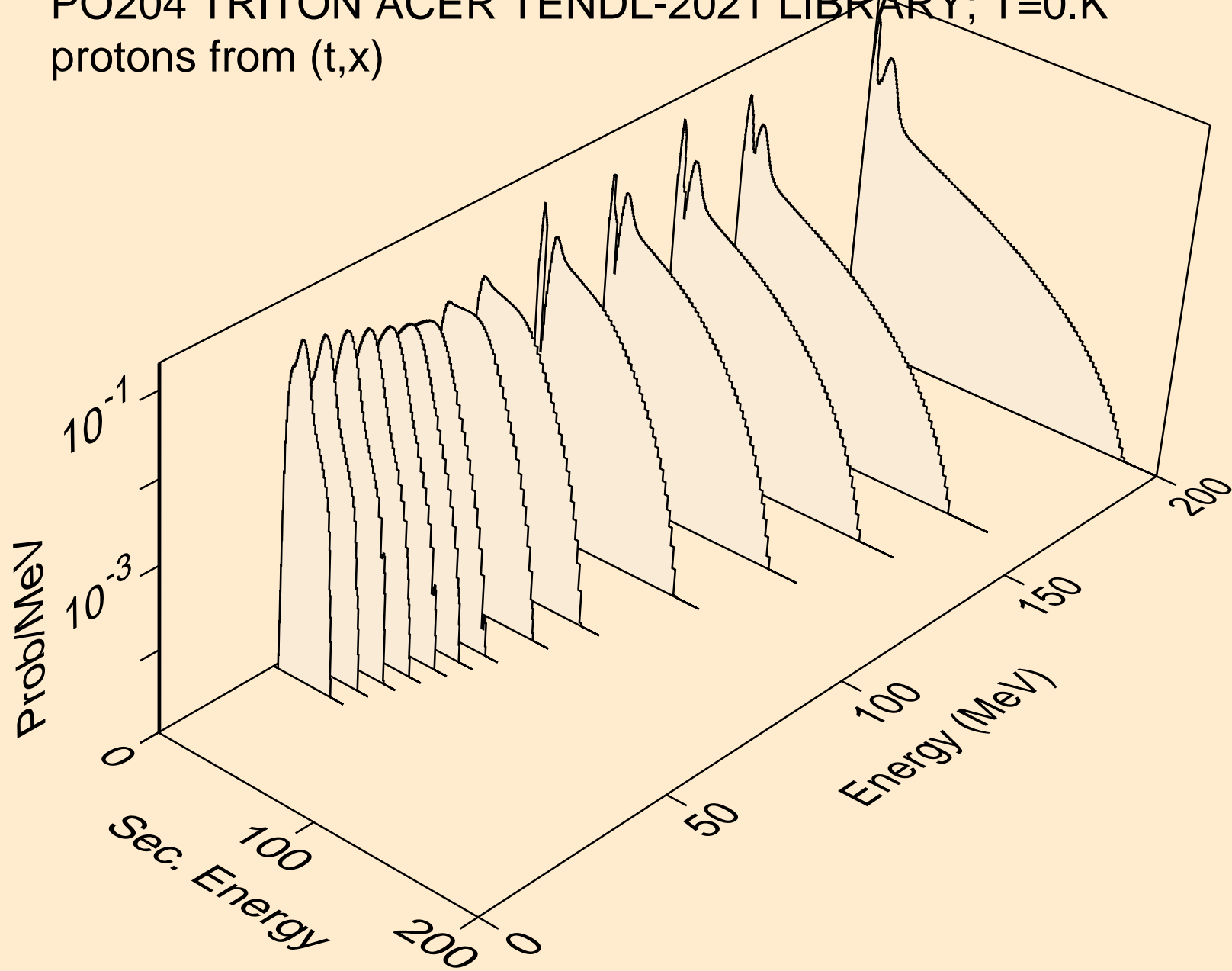

PO204 TRITON ACER TENDL-2021 LIBRARY; T=0.K  
protons from (t,n\*)p

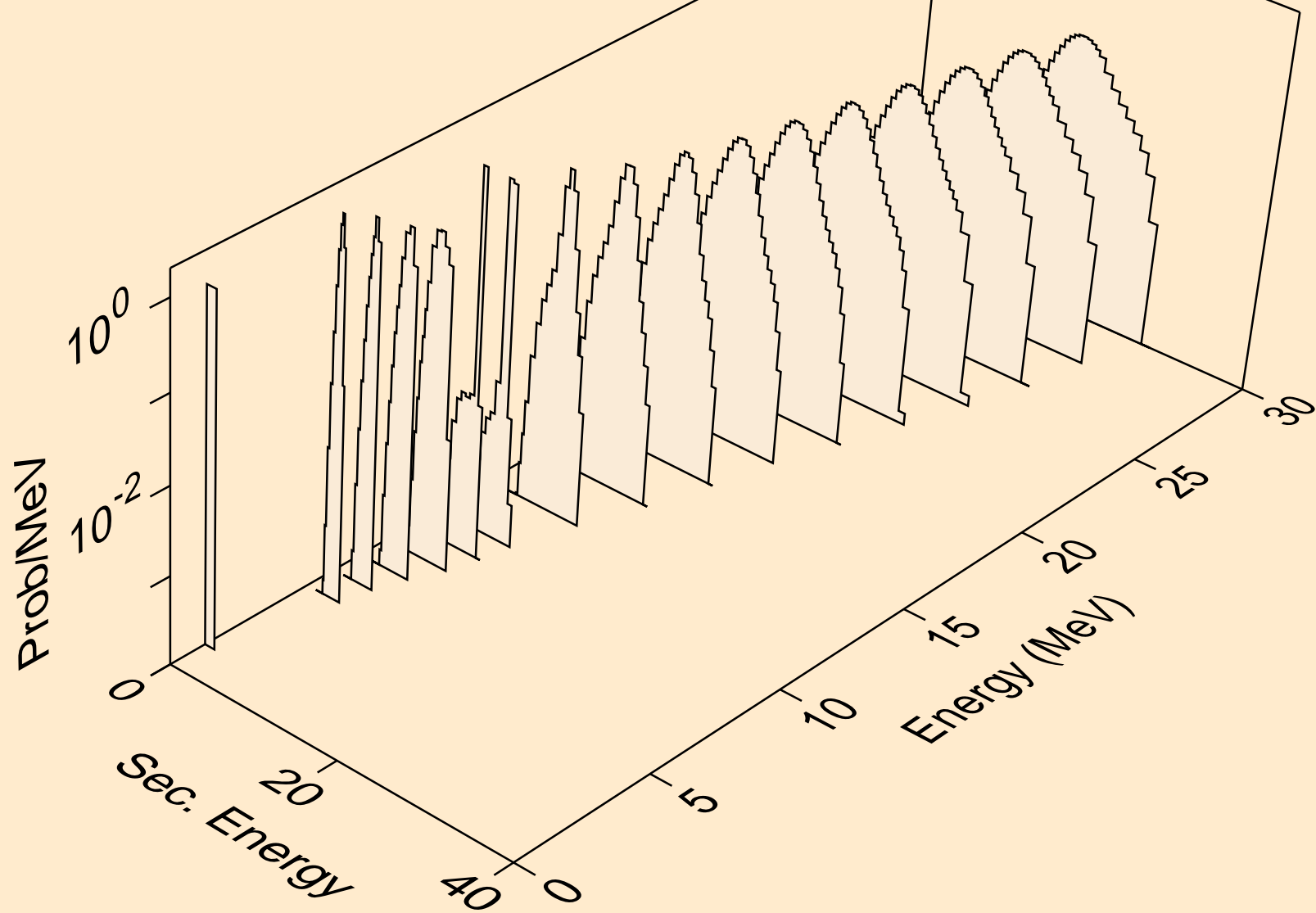

PO204 TRITON ACER TENDL-2021 LIBRARY; T=0.K  
protons from (t,2np)

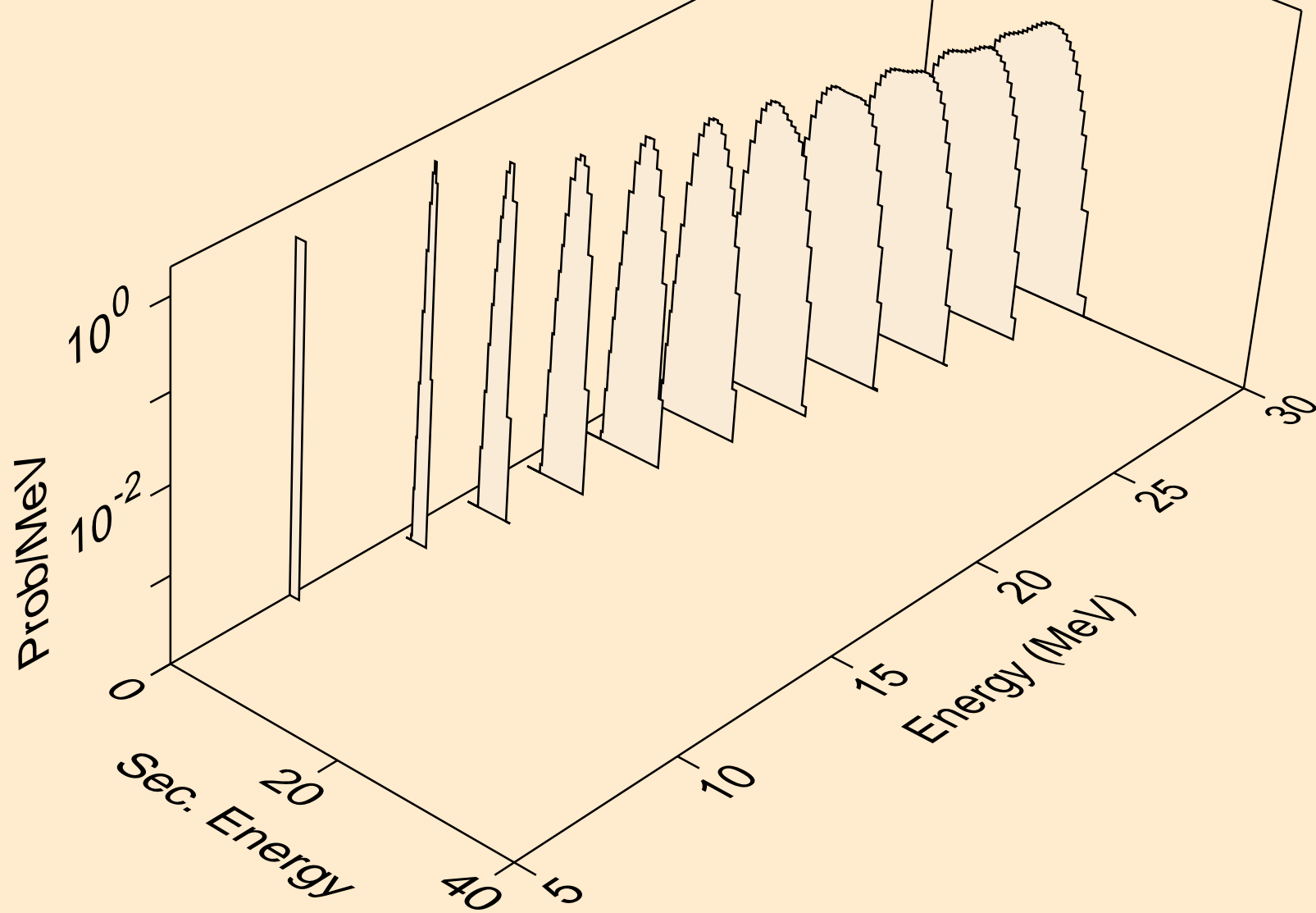

PO204 TRITON ACER TENDL-2021 LIBRARY; T=0.K  
protons from (t,3np)

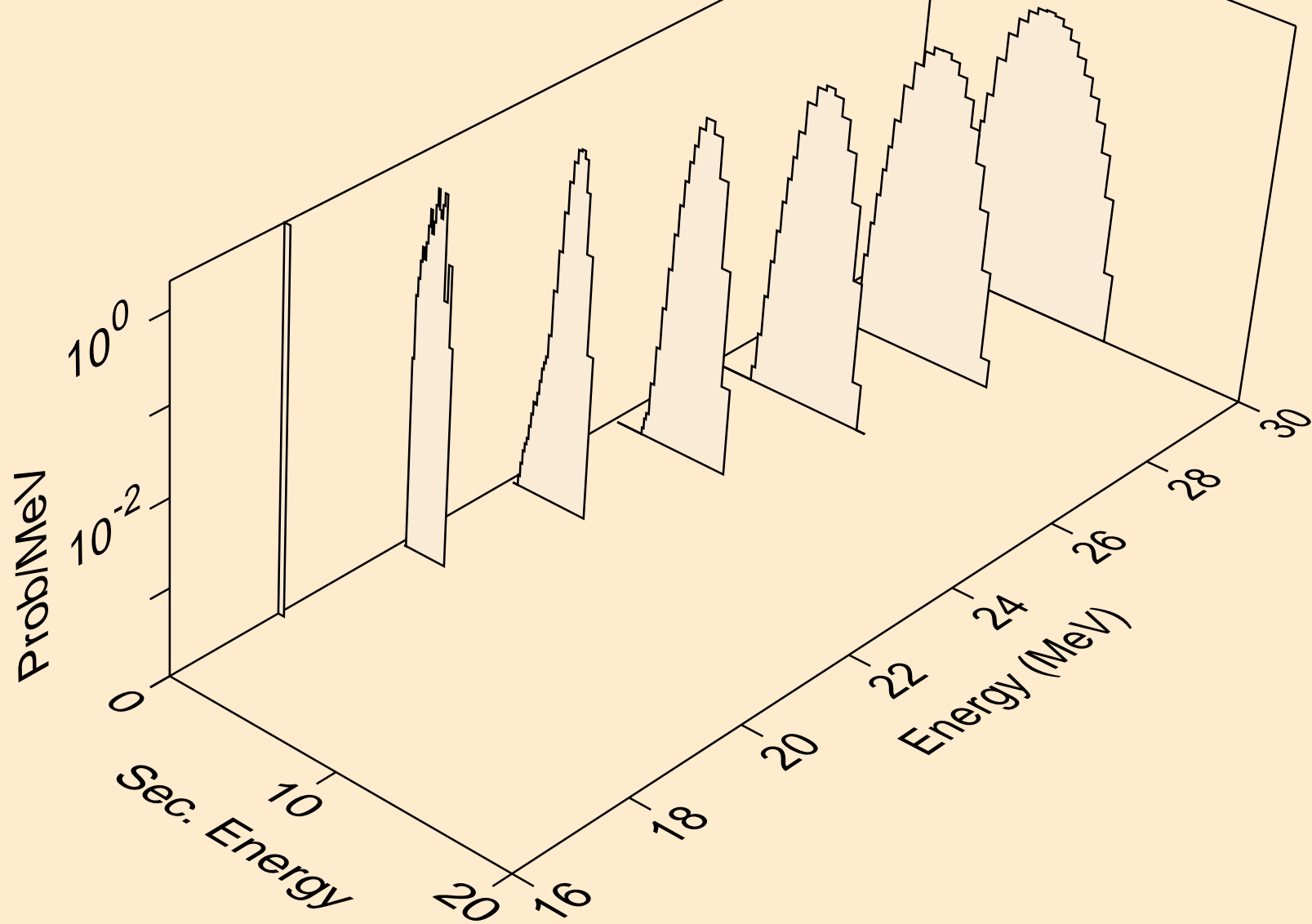

PO204 TRITON ACER TENDL-2021 LIBRARY; T=0.K  
protons from (t,2np)

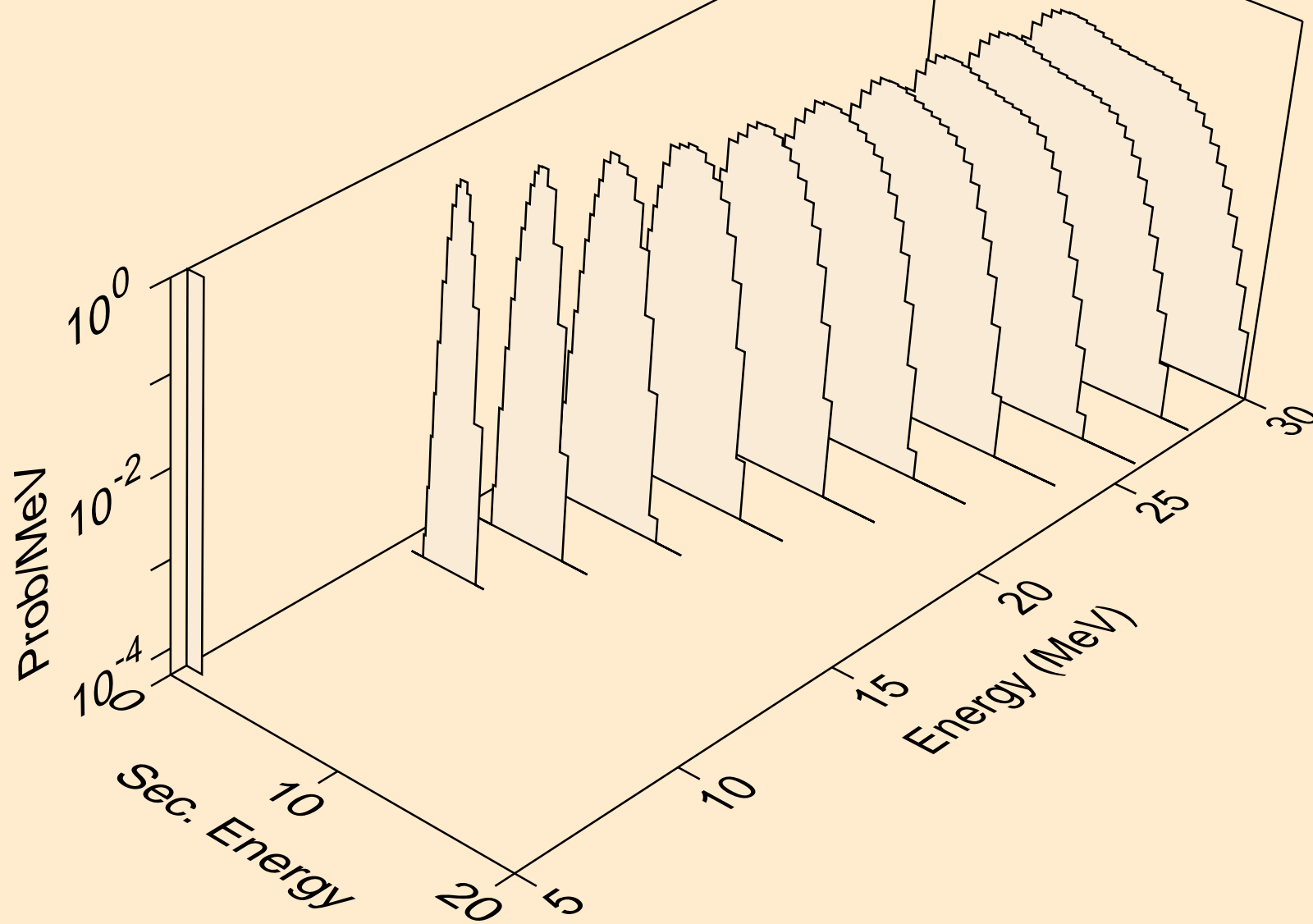

PO204 TRITON ACER TENDL-2021 LIBRARY; T=0.K  
protons from (t,npa)

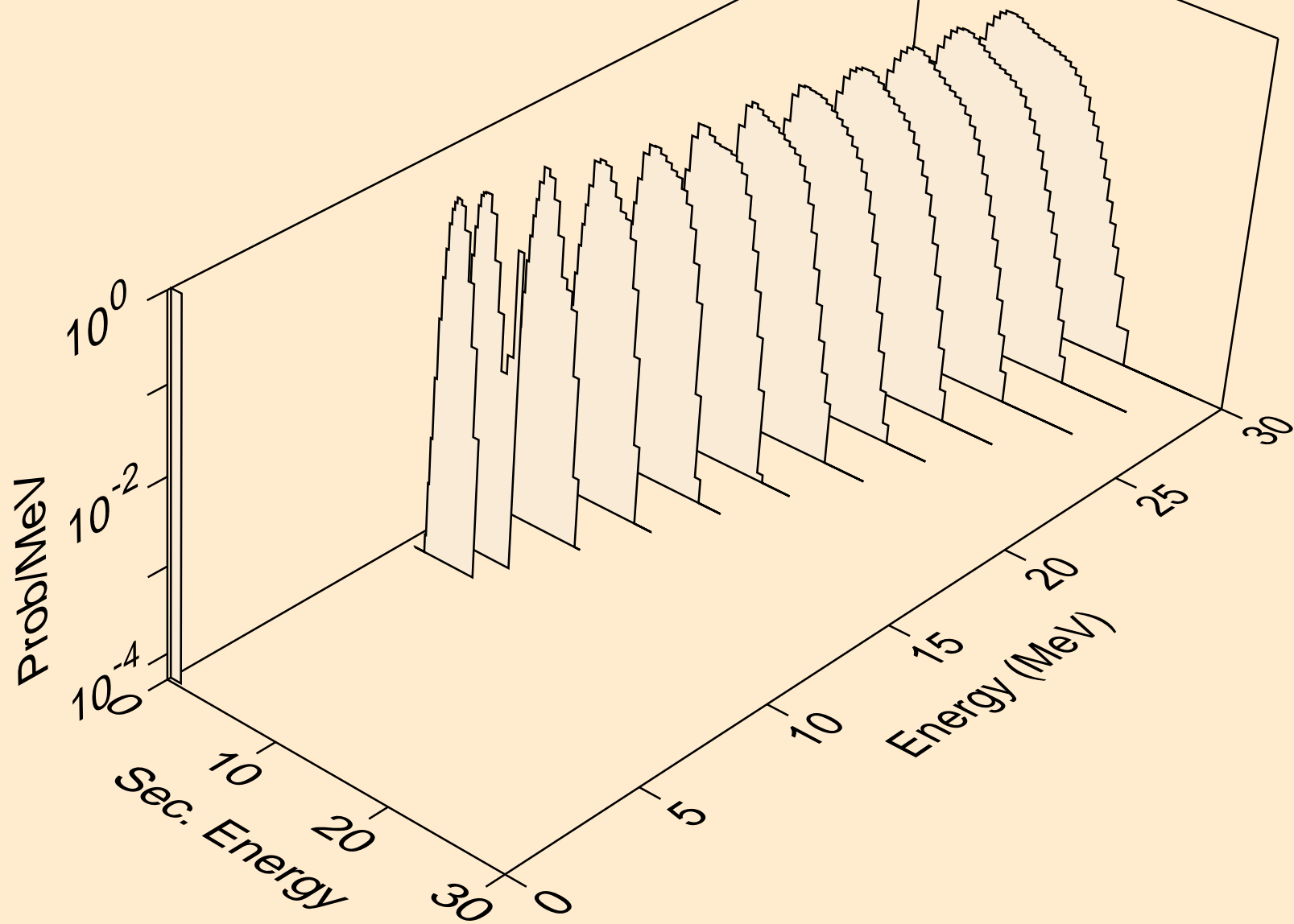



PO204 TRITON ACER TENDL-2021 LIBRARY; T=0.K  
protons from (t,p)

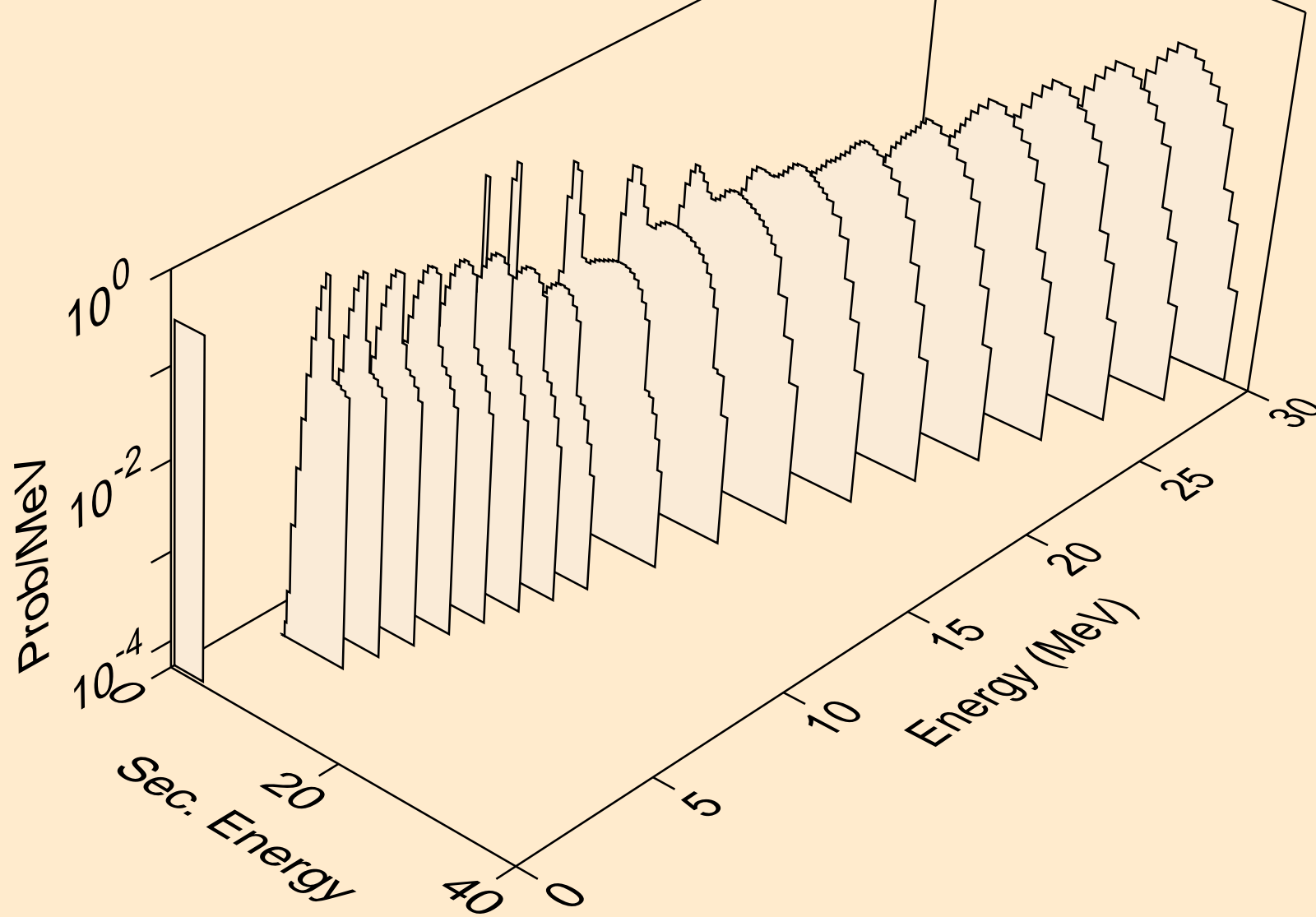

PO204 TRITON ACER TENDL-2021 LIBRARY; T=0.K  
protons from (t,2p)

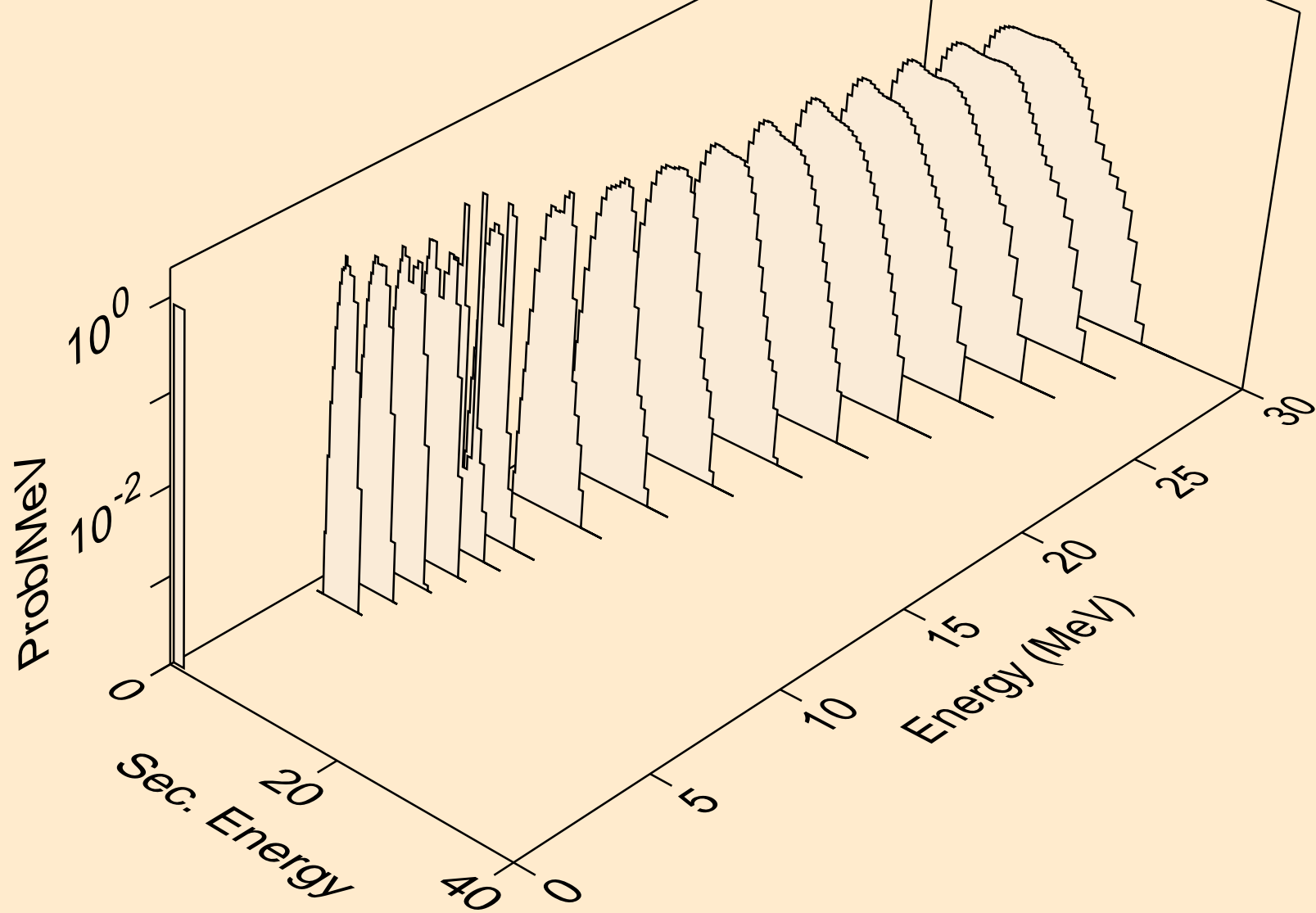

PO204 TRITON ACER TENDL-2021 LIBRARY; T=0.K  
protons from (t,pa)

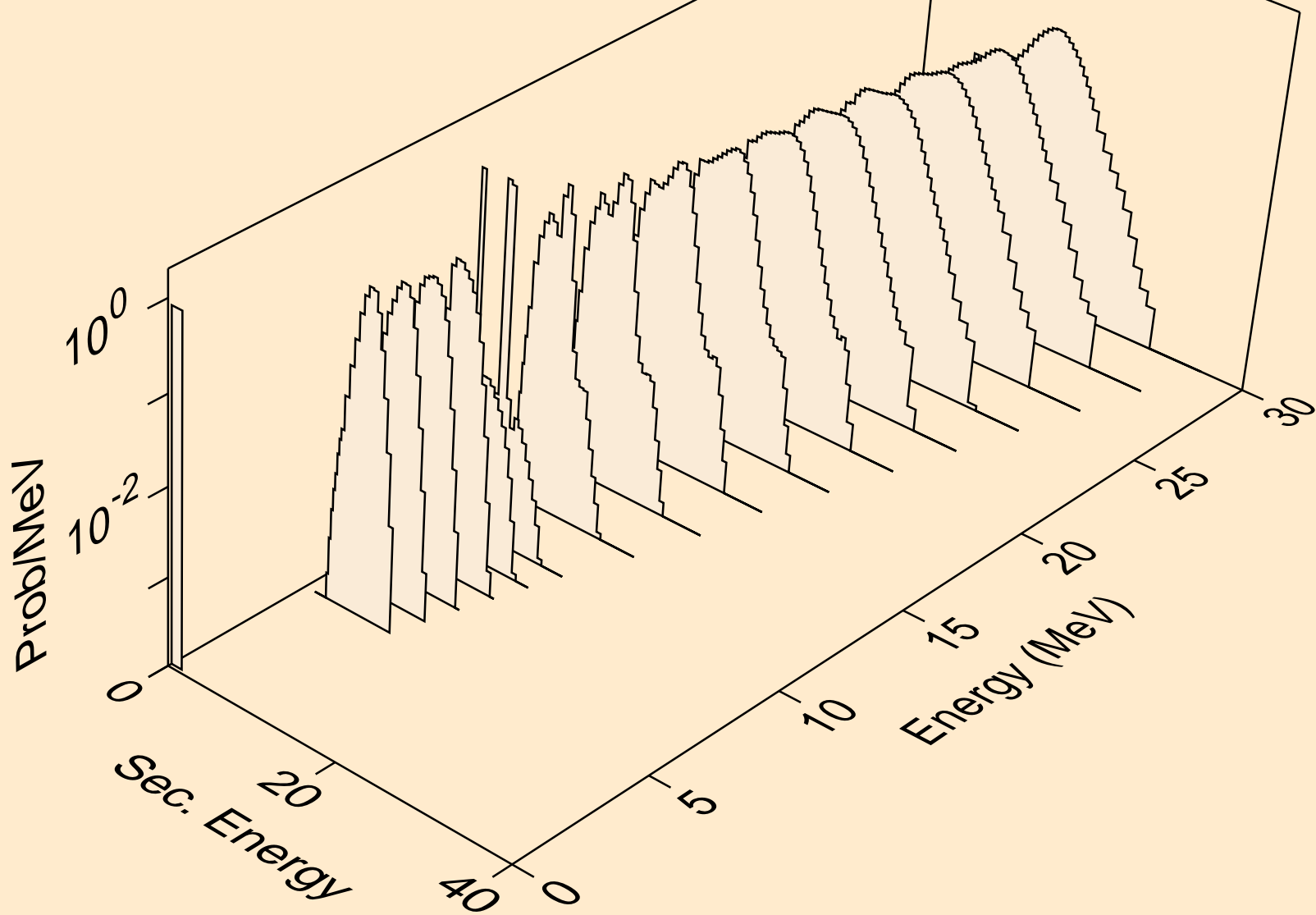

PO204 TRITON ACER TENDL-2021 LIBRARY; T=0.K  
protons from (t,pd)

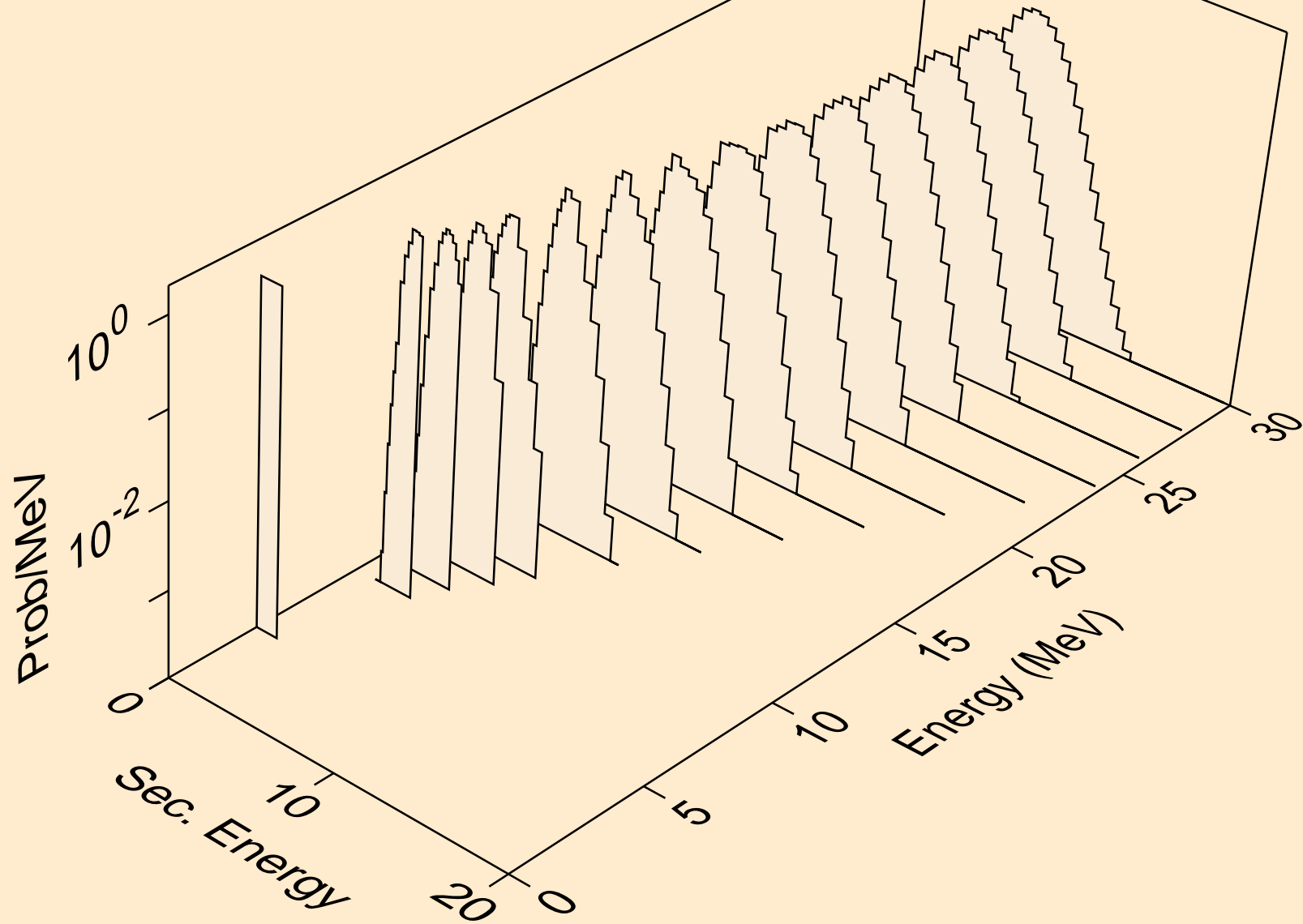

PO204 TRITON ACER TENDL-2021 LIBRARY; T=0.K  
protons from (t,pt)

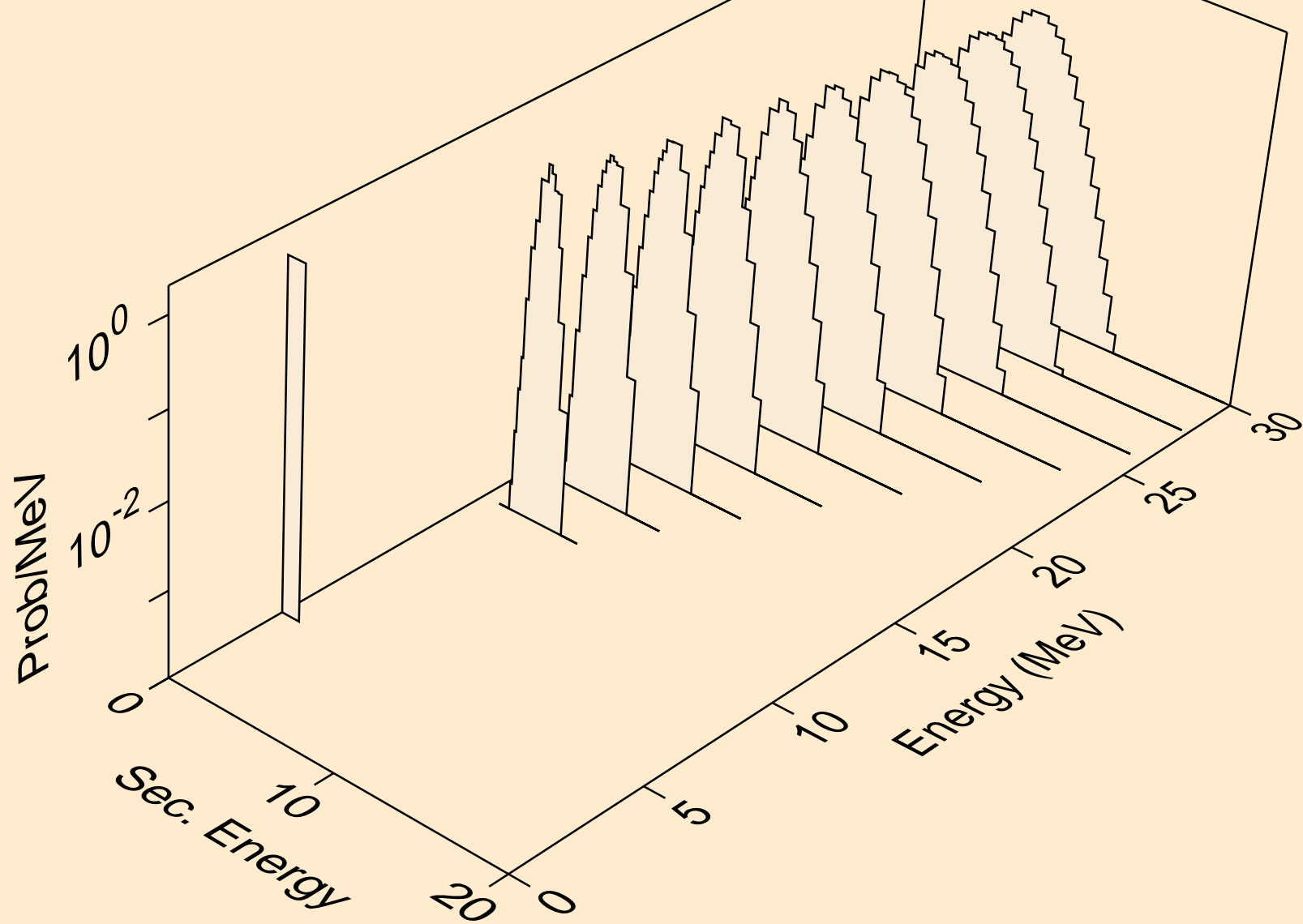

PO204 TRITON ACER TENDL-2021 LIBRARY; T=0.K  
deuterons from (t,x)

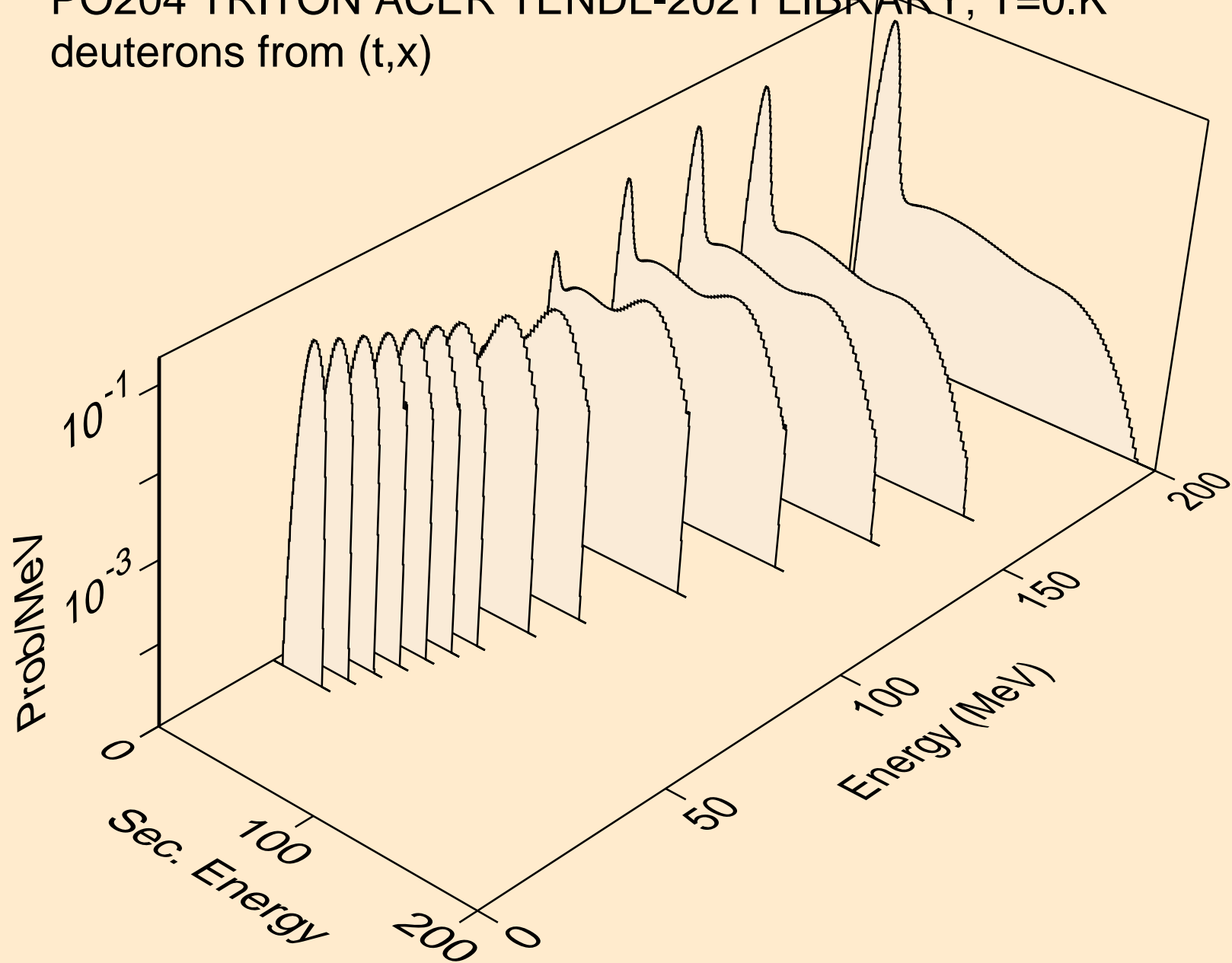

PO204 TRITON ACER TENDL-2021 LIBRARY; T=0.K  
deuterons from (t,2nd)

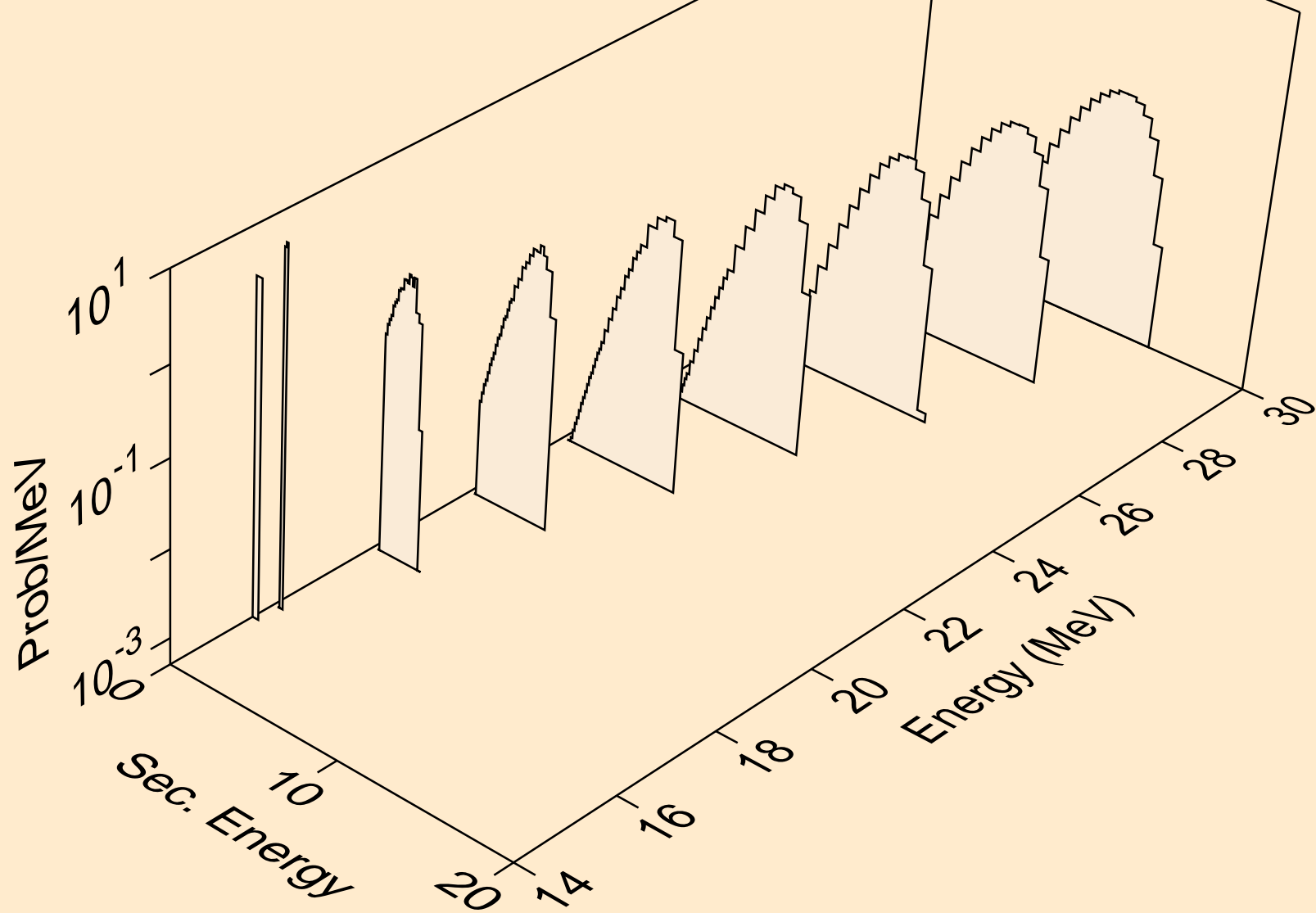

PO204 TRITON ACER TENDL-2021 LIBRARY; T=0.K  
deuterons from (t,n\*)d

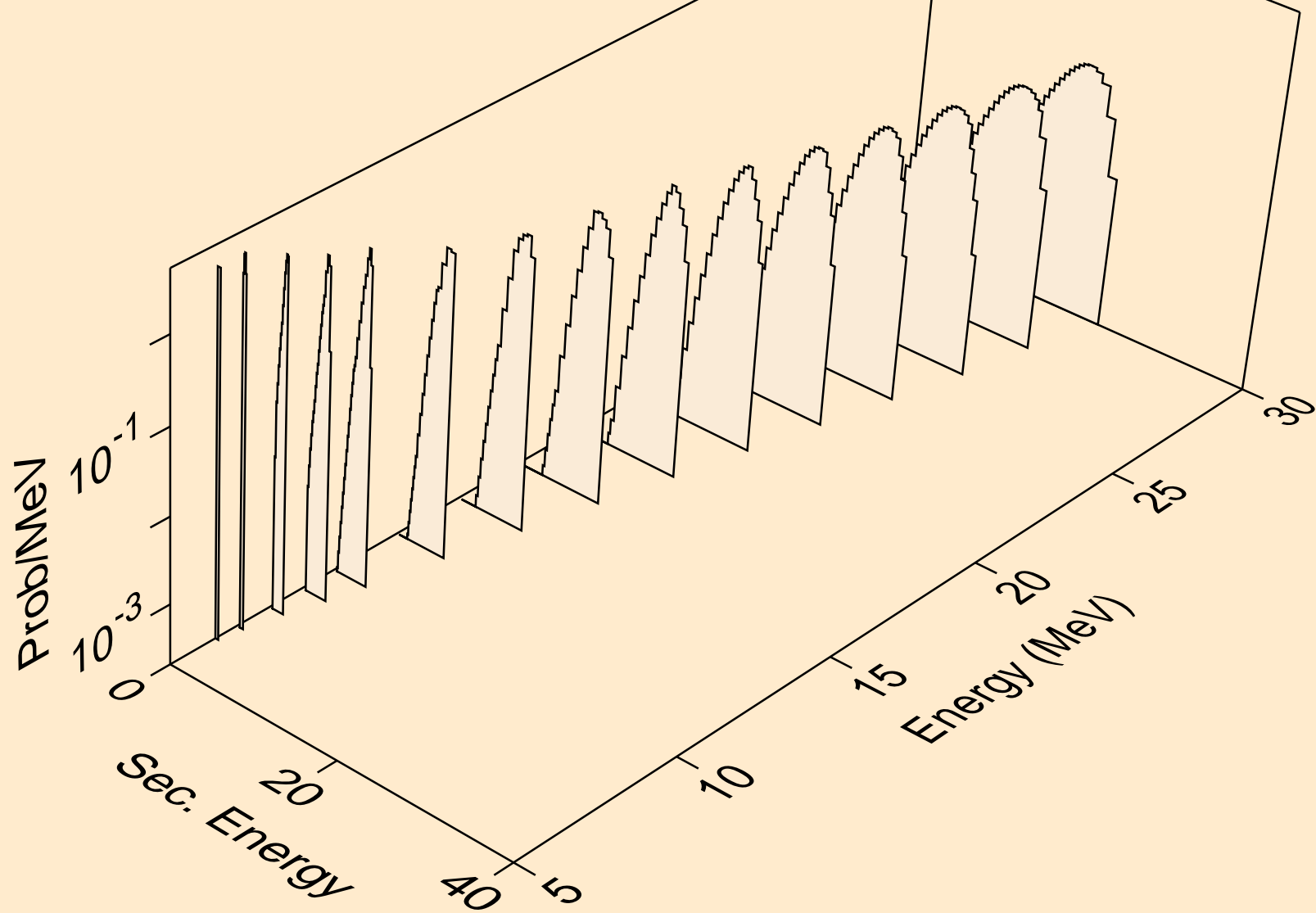



PO204 TRITON ACER TENDL-2021 LIBRARY; T=0.K  
deuterons from (t,d)

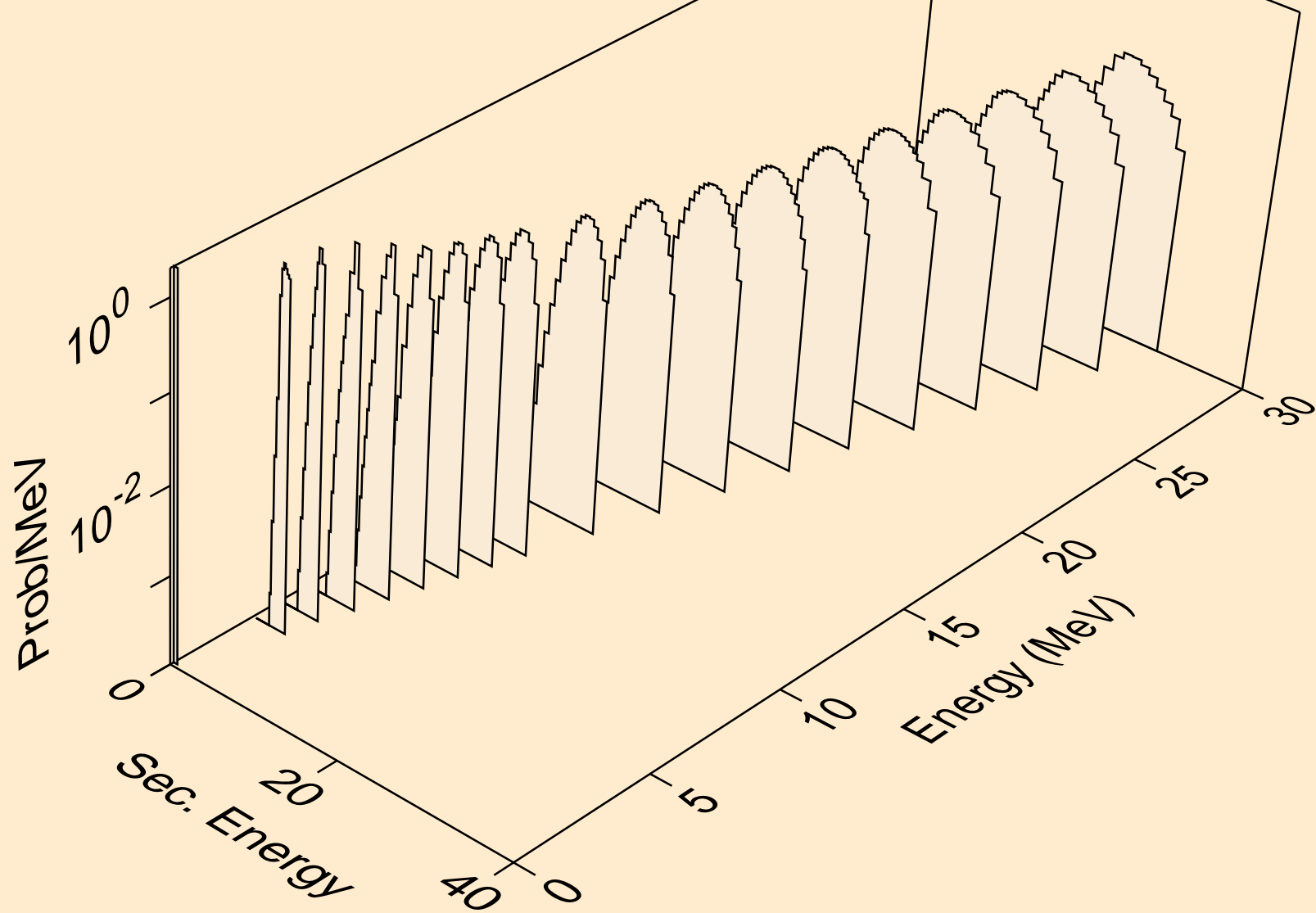

PO204 TRITON ACER TENDL-2021 LIBRARY; T=0.K  
deuterons from (t,pd)

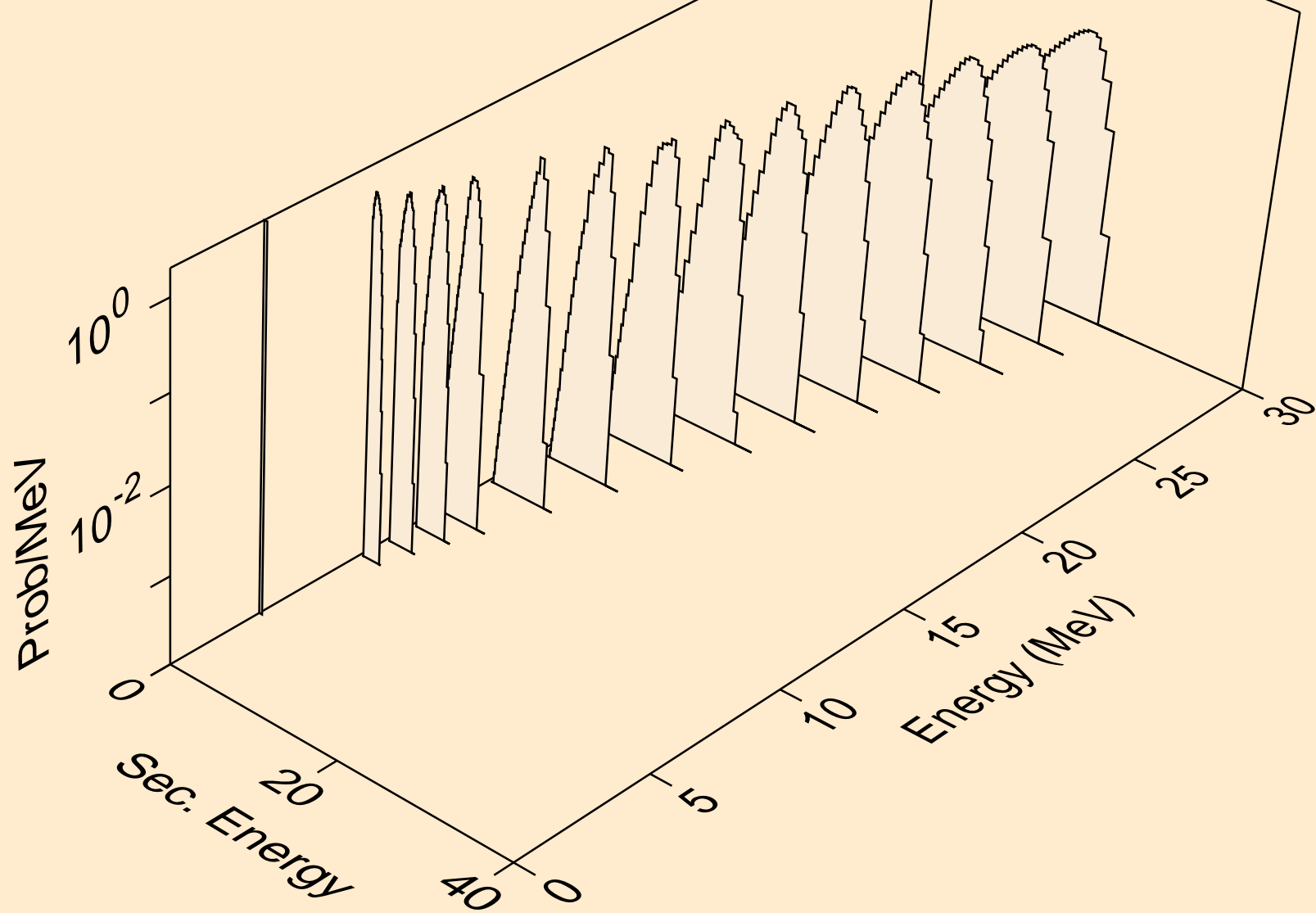

PO204 TRITON ACER TENDL-2021 LIBRARY; T=0.K  
deuterons from (t,da)

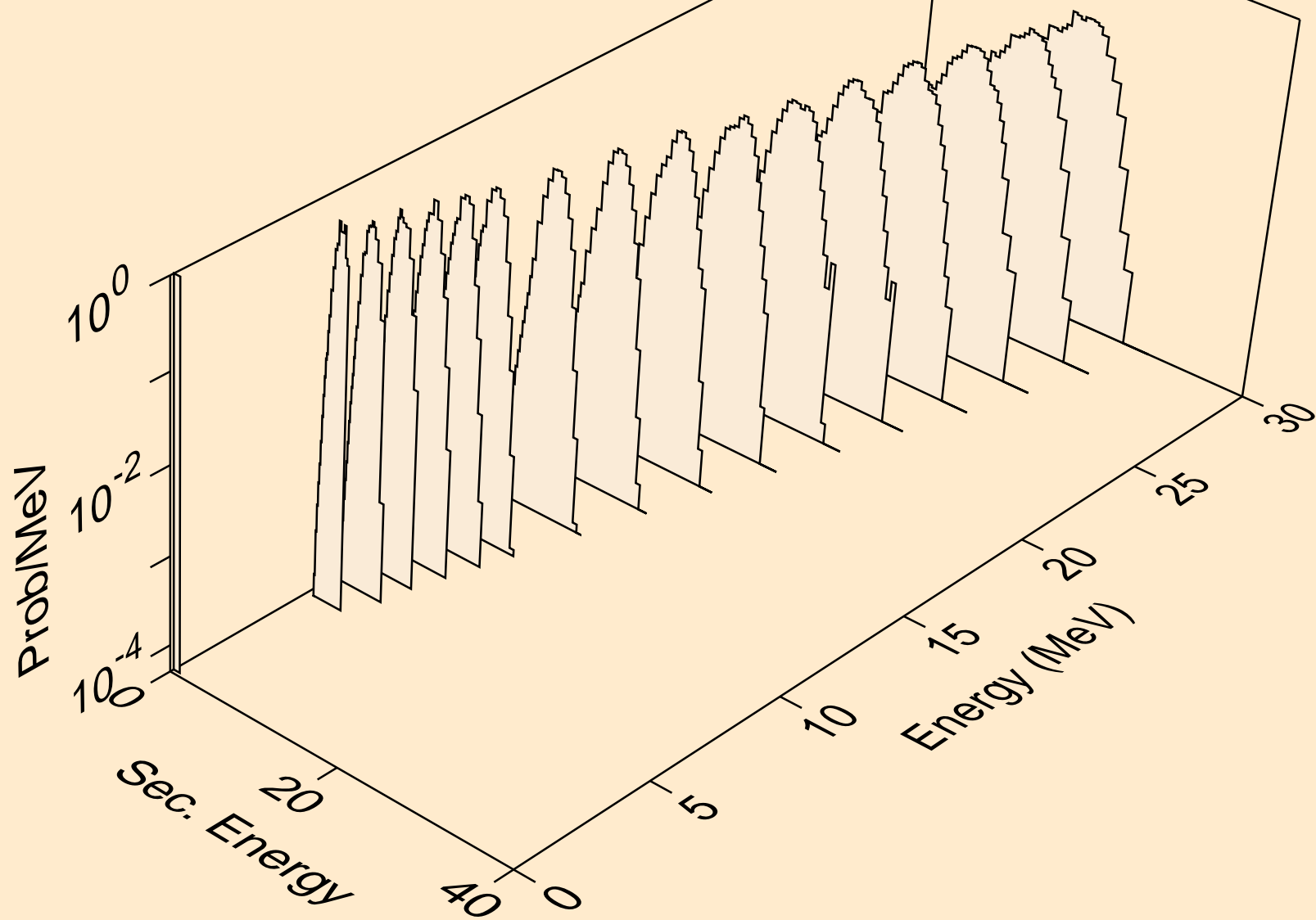

PO204 TRITON ACER TENDL-2021 LIBRARY; T=0.K  
he3s from (t,x)

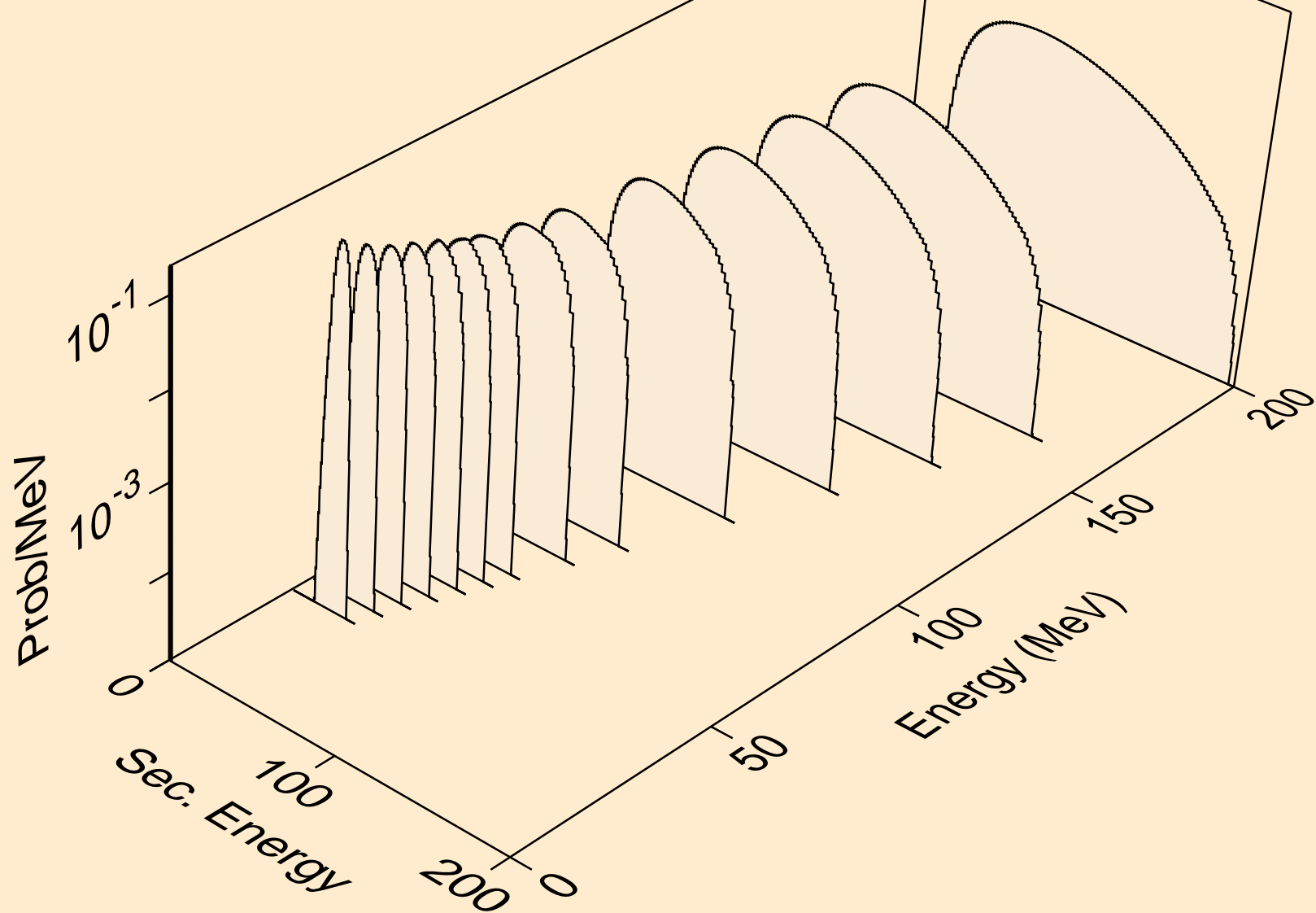

PO204 TRITON ACER TENDL-2021 LIBRARY; T=0.K  
he3s from (t,n\*)he3

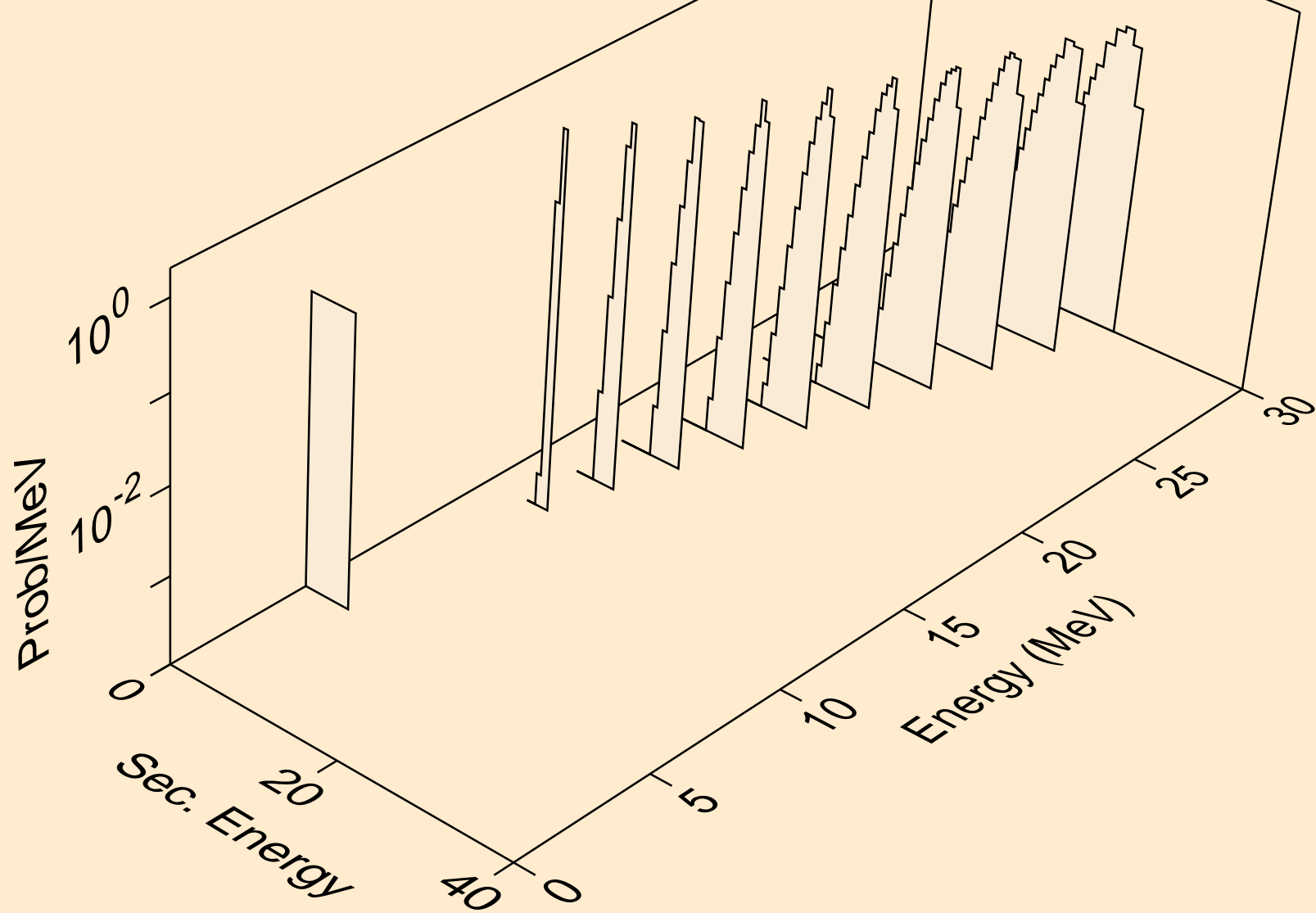

PO204 TRITON ACER TENDL-2021 LIBRARY; T=0.K  
he3s from (t,he3)

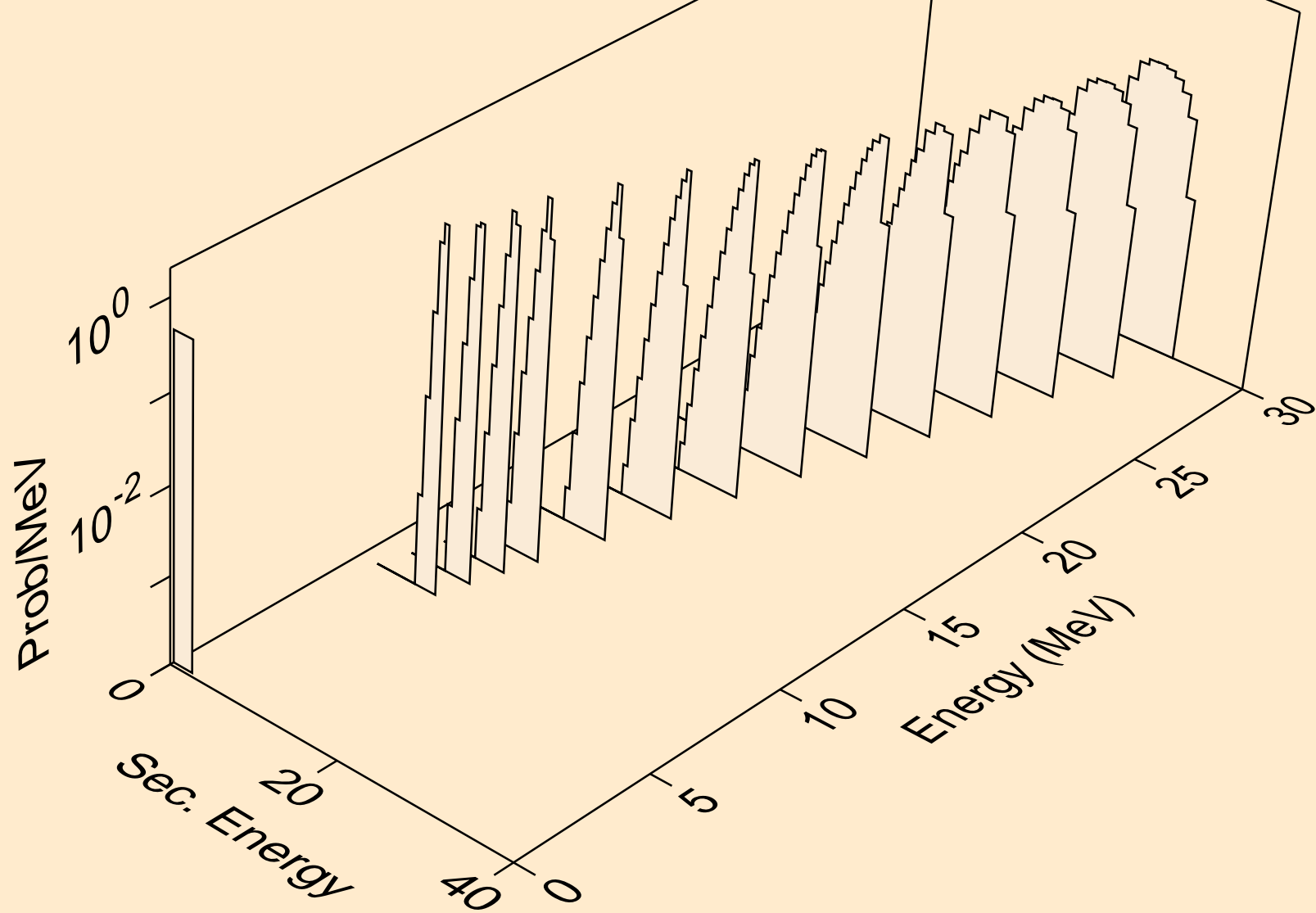

PO204 TRITON ACER TENDL-2021 LIBRARY; T=0.K  
alphas from (t,x)

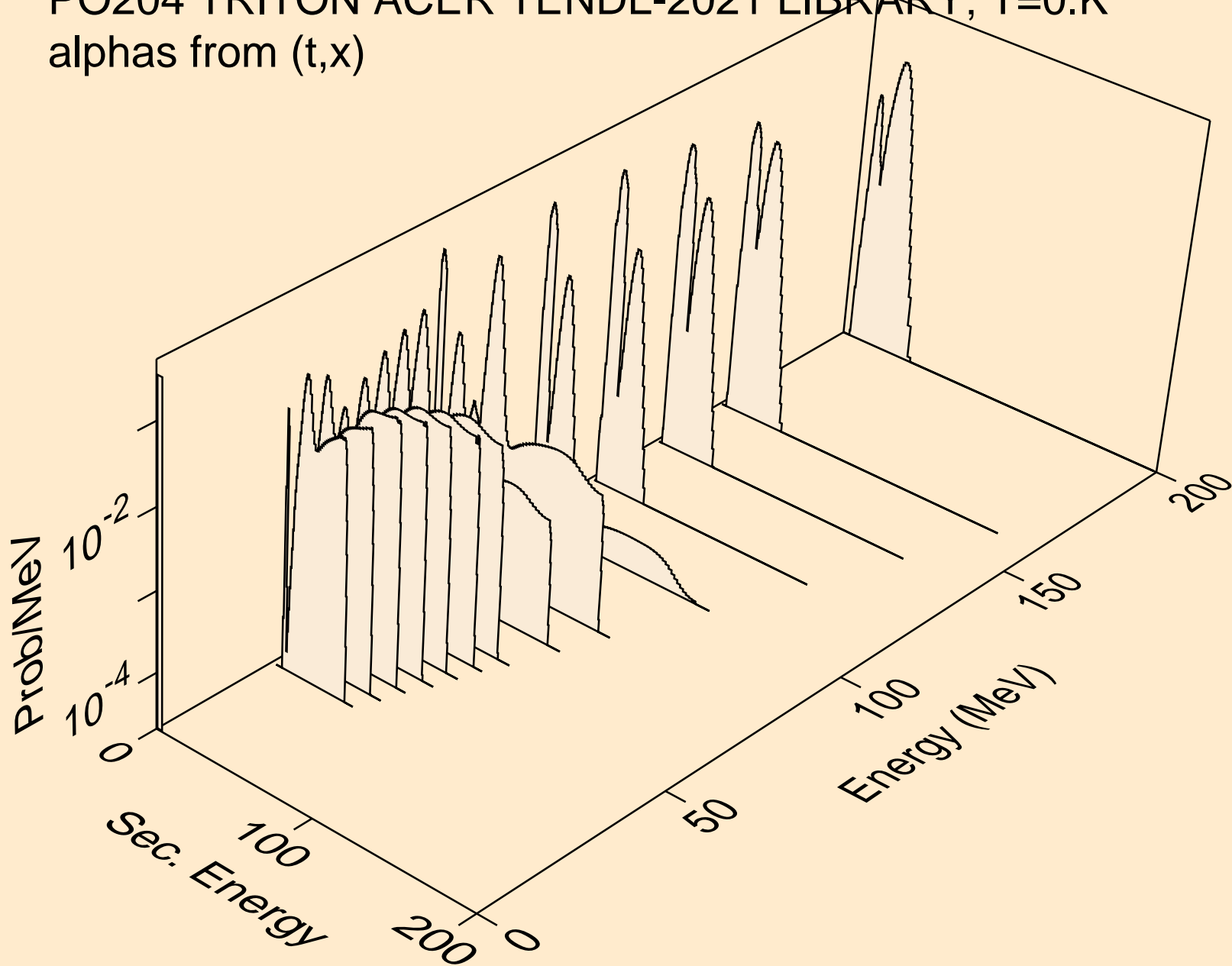

PO204 TRITON ACER TENDL-2021 LIBRARY; T=0.K  
alphas from (t,n\*)a

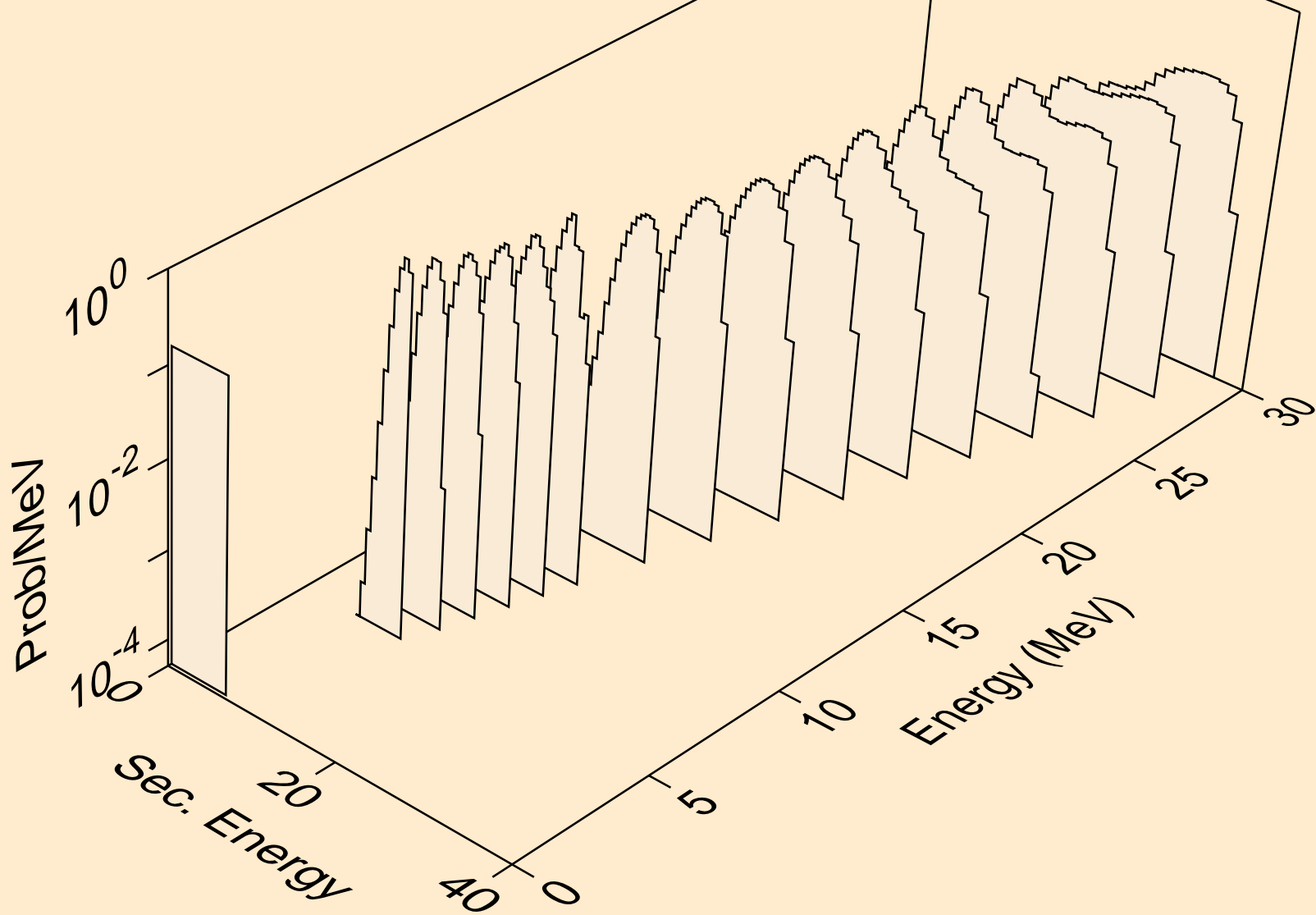



PO204 TRITON ACER TENDL-2021 LIBRARY; T=0.K  
alphas from (t,2n)a

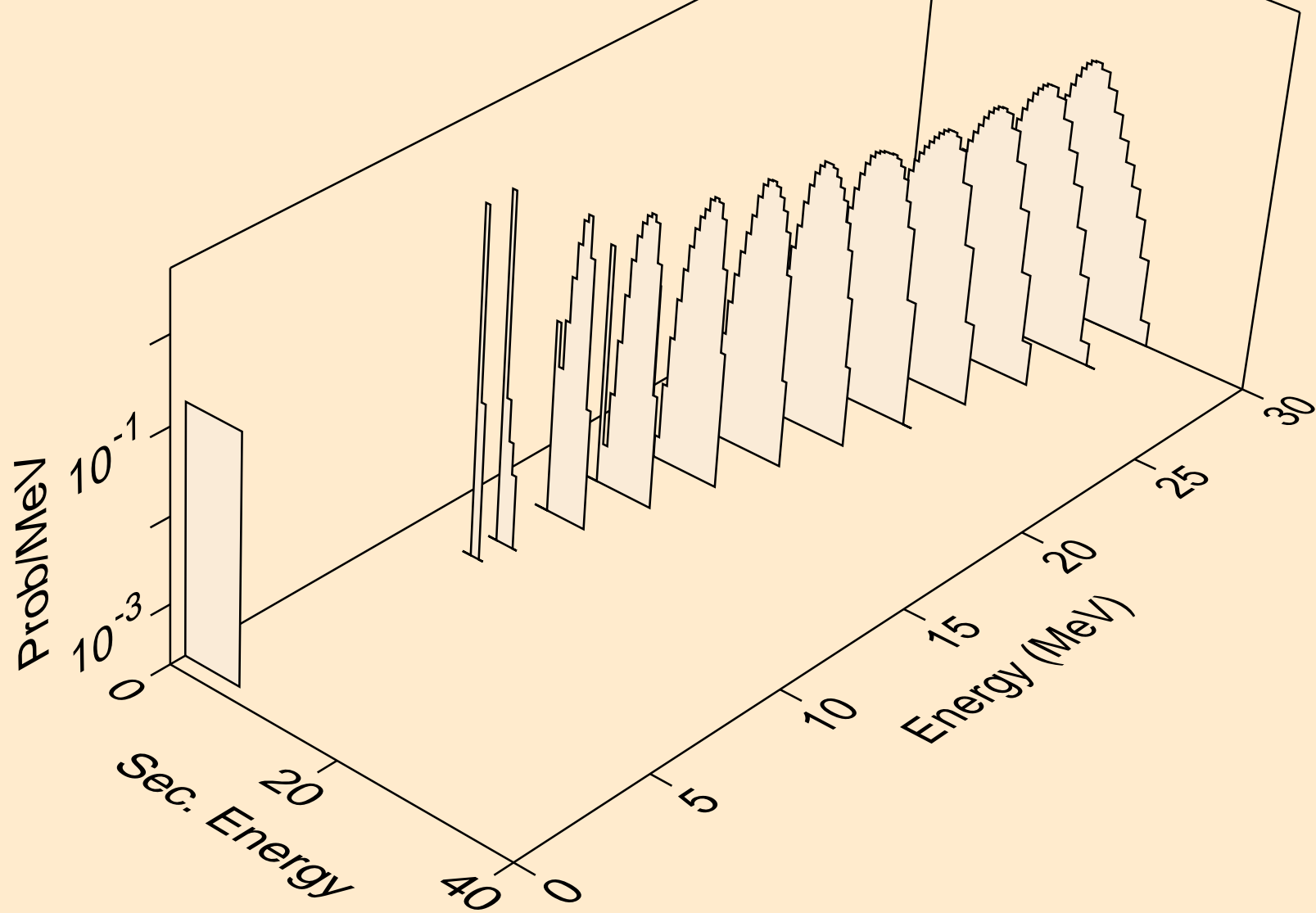

PO204 TRITON ACER TENDL-2021 LIBRARY; T=0.K  
alphas from (t,3n)a

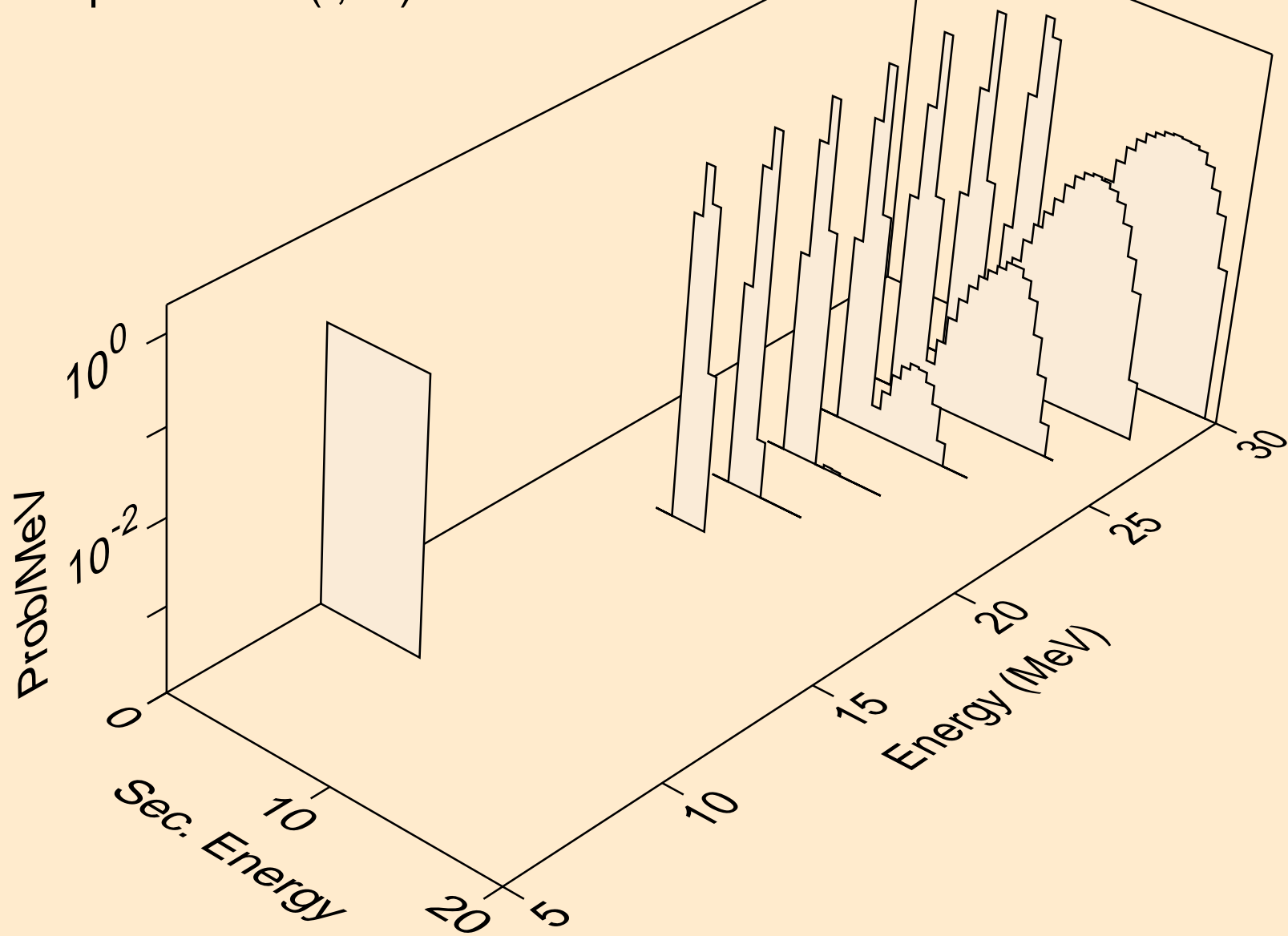

PO204 TRITON ACER TENDL-2021 LIBRARY; T=0.K  
alphas from (t,n\*)2a

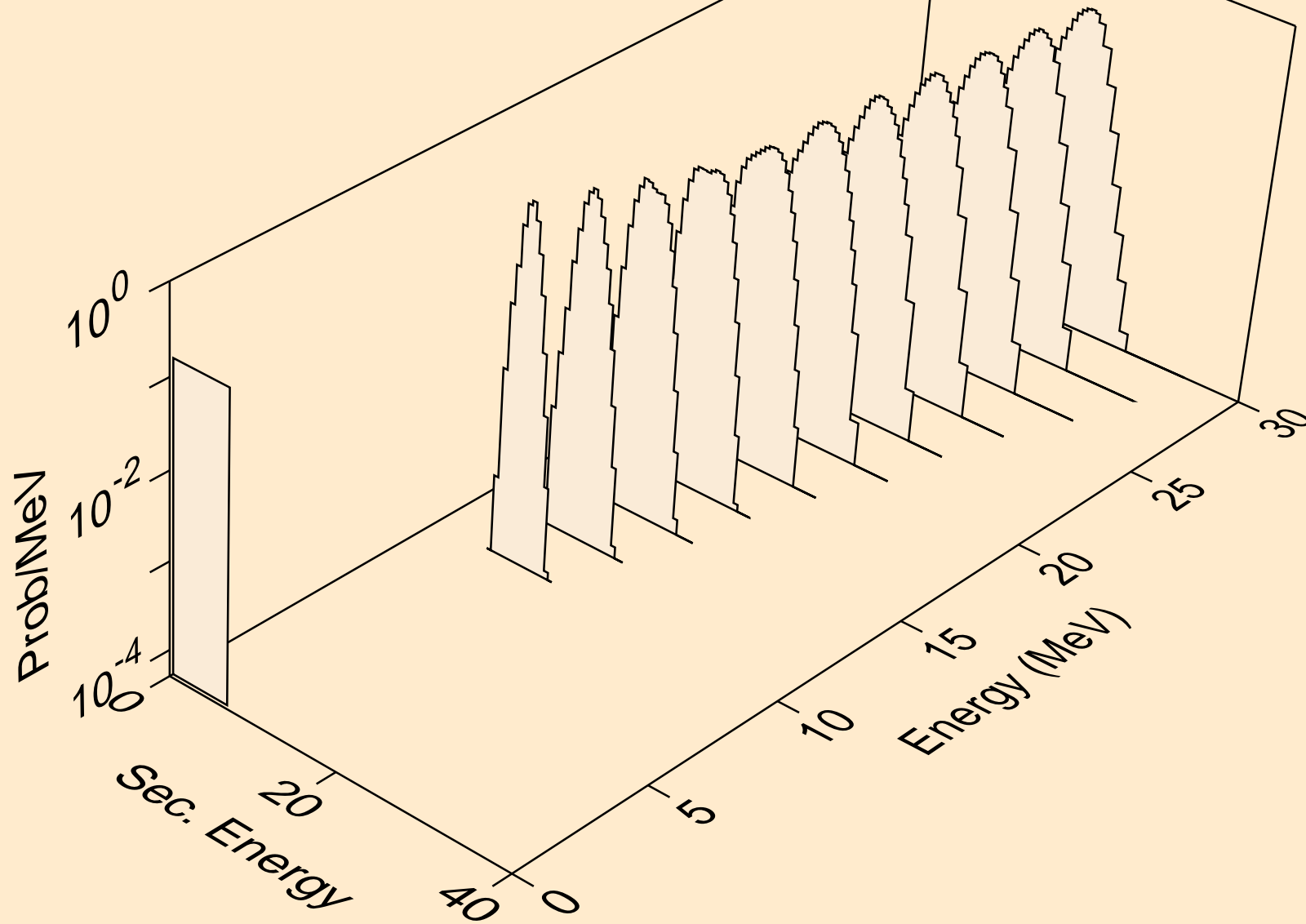

PO204 TRITON ACER TENDL-2021 LIBRARY; T=0.K  
alphas from (t,2n)2a

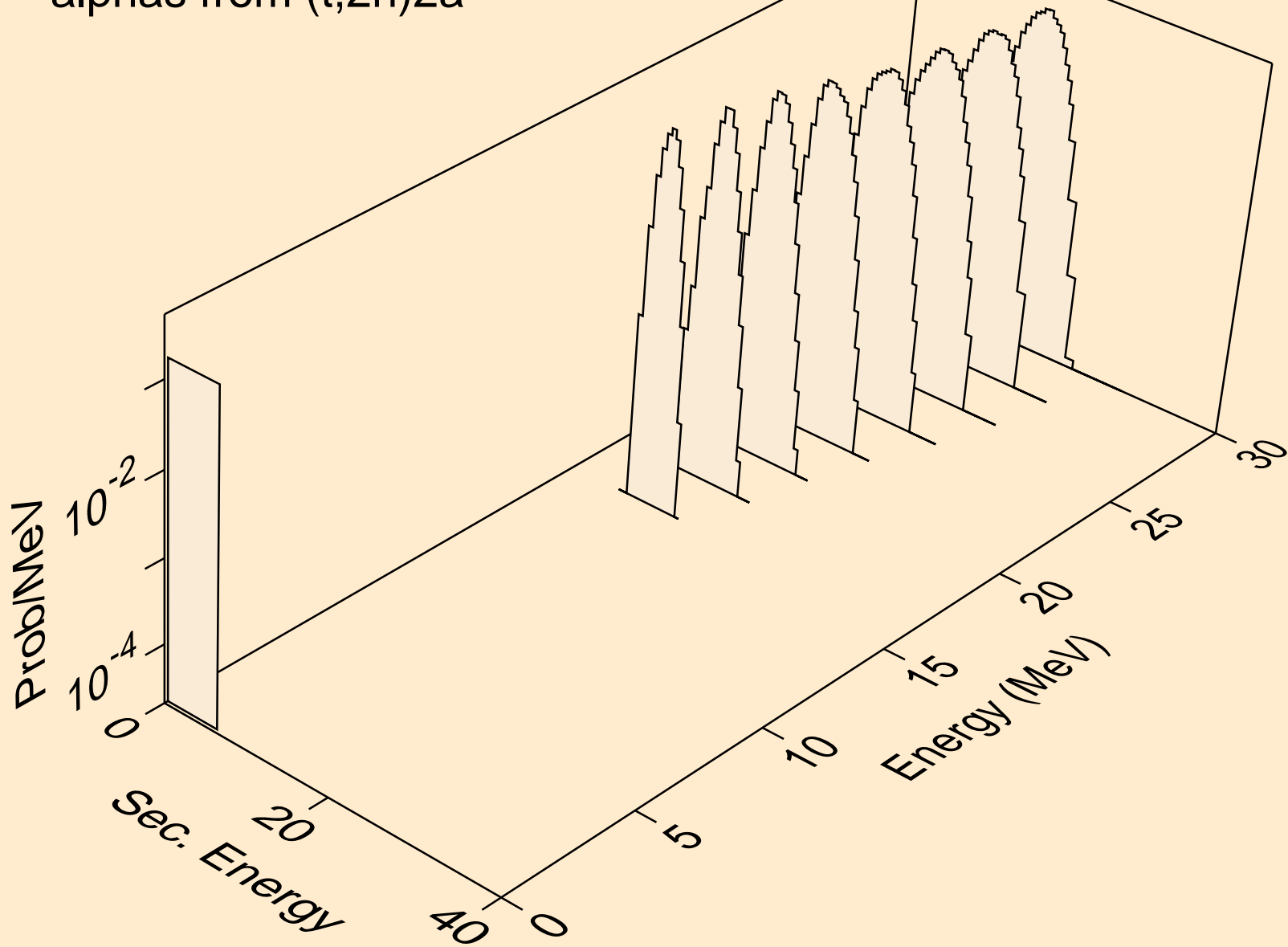

PO204 TRITON ACER TENDL-2021 LIBRARY; T=0.K  
alphas from (t,npa)

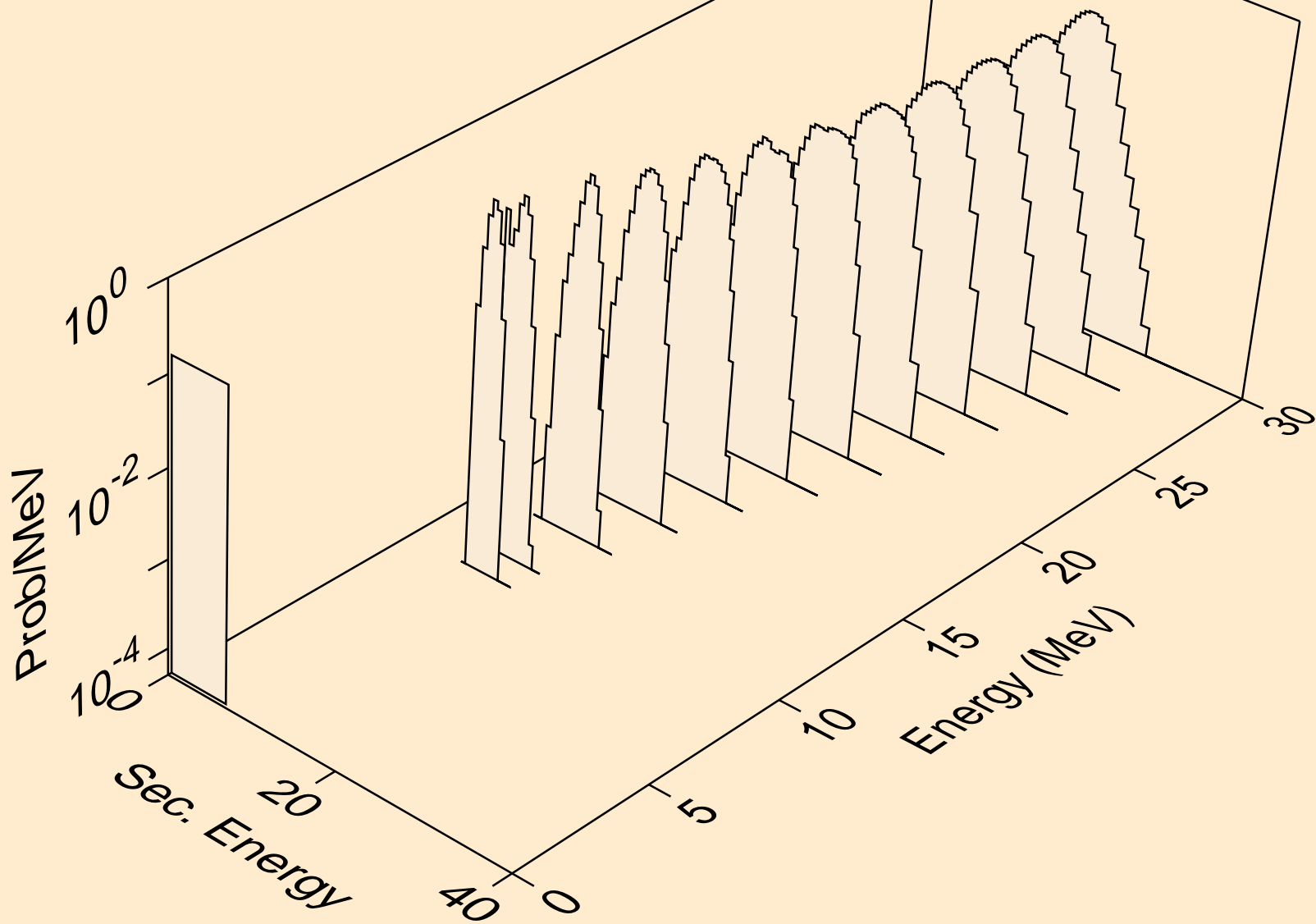

PO204 TRITON ACER TENDL-2021 LIBRARY; T=0.K  
alphas from (t,a)

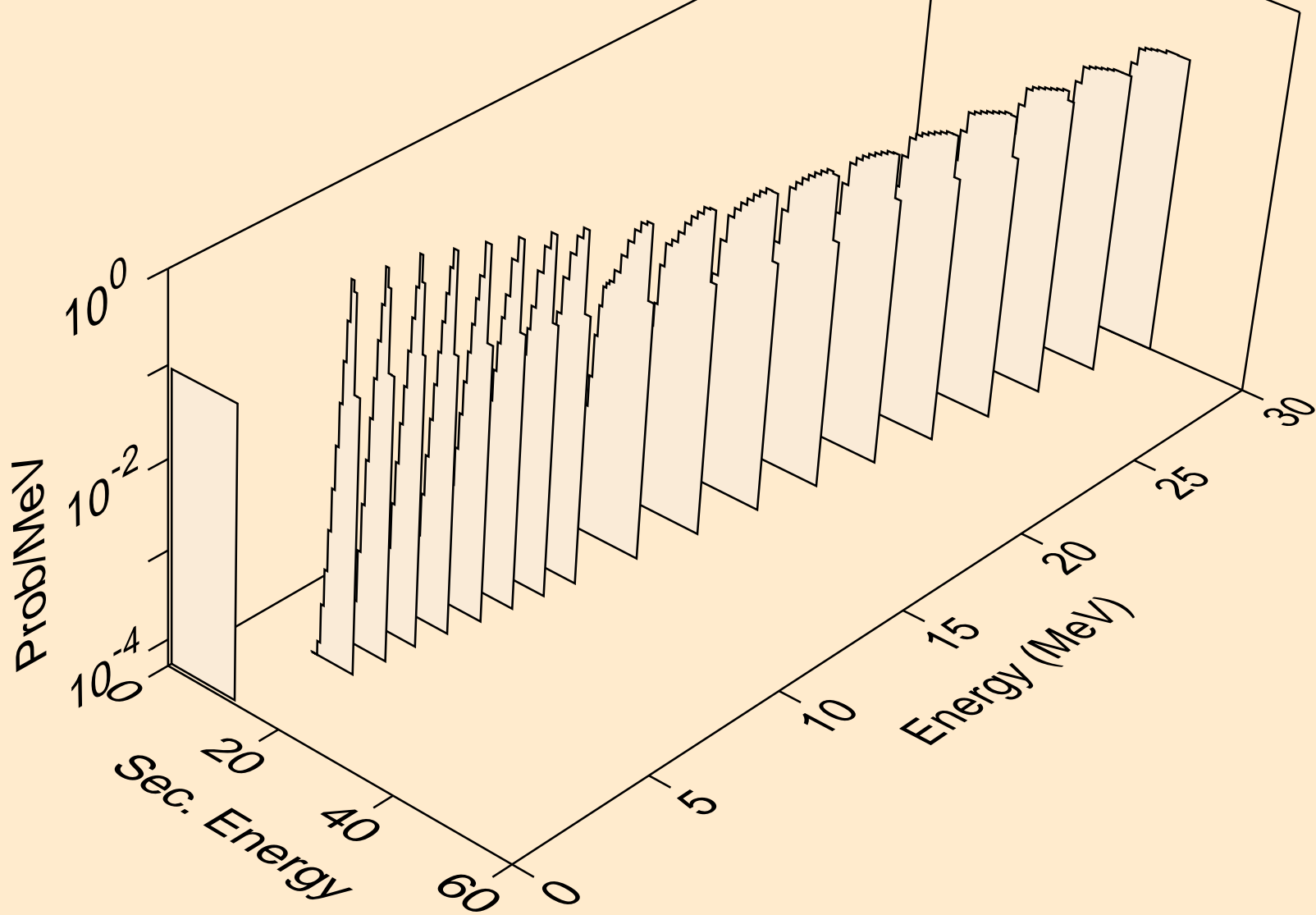

PO204 TRITON ACER TENDL-2021 LIBRARY; T=0.K  
alphas from (t,2a)

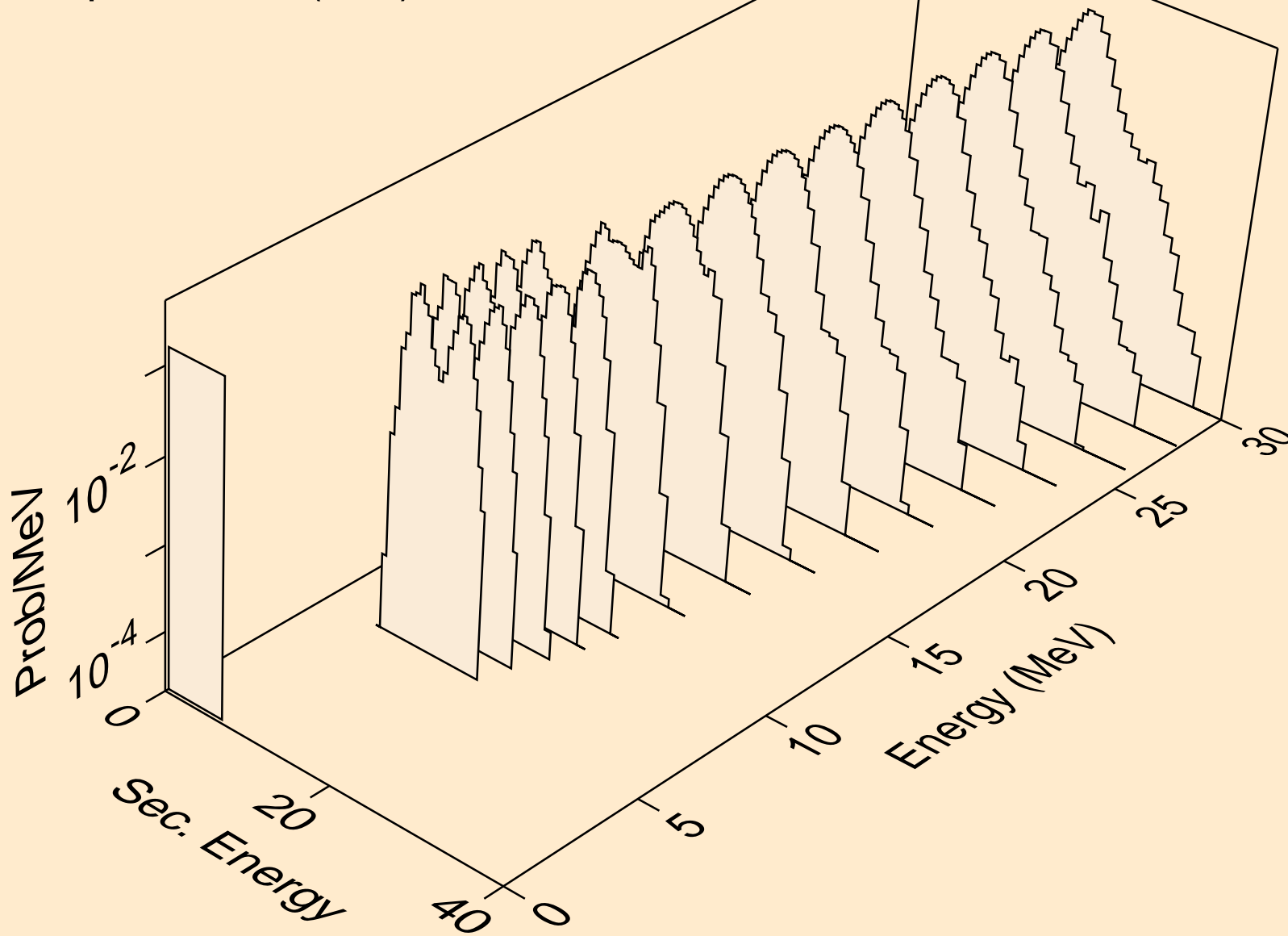

PO204 TRITON ACER TENDL-2021 LIBRARY; T=0.K  
alphas from (t,pa)

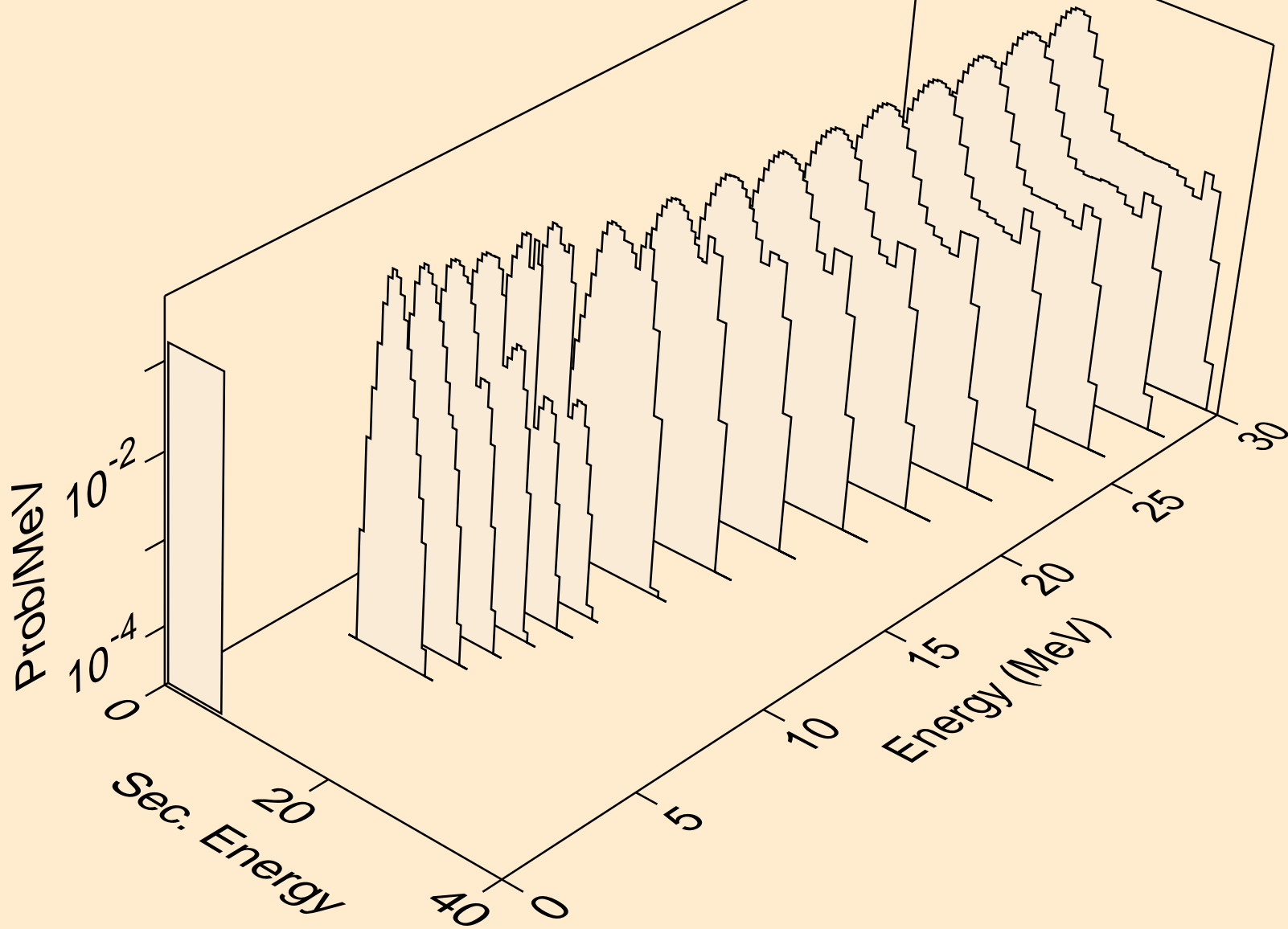



PO204 TRITON ACER TENDL-2021 LIBRARY; T=0.K  
alphas from (t,da)

