

PO226 TRITON ACER TENDL-2021 LIBRARY; T=0.K  
Principal cross sections

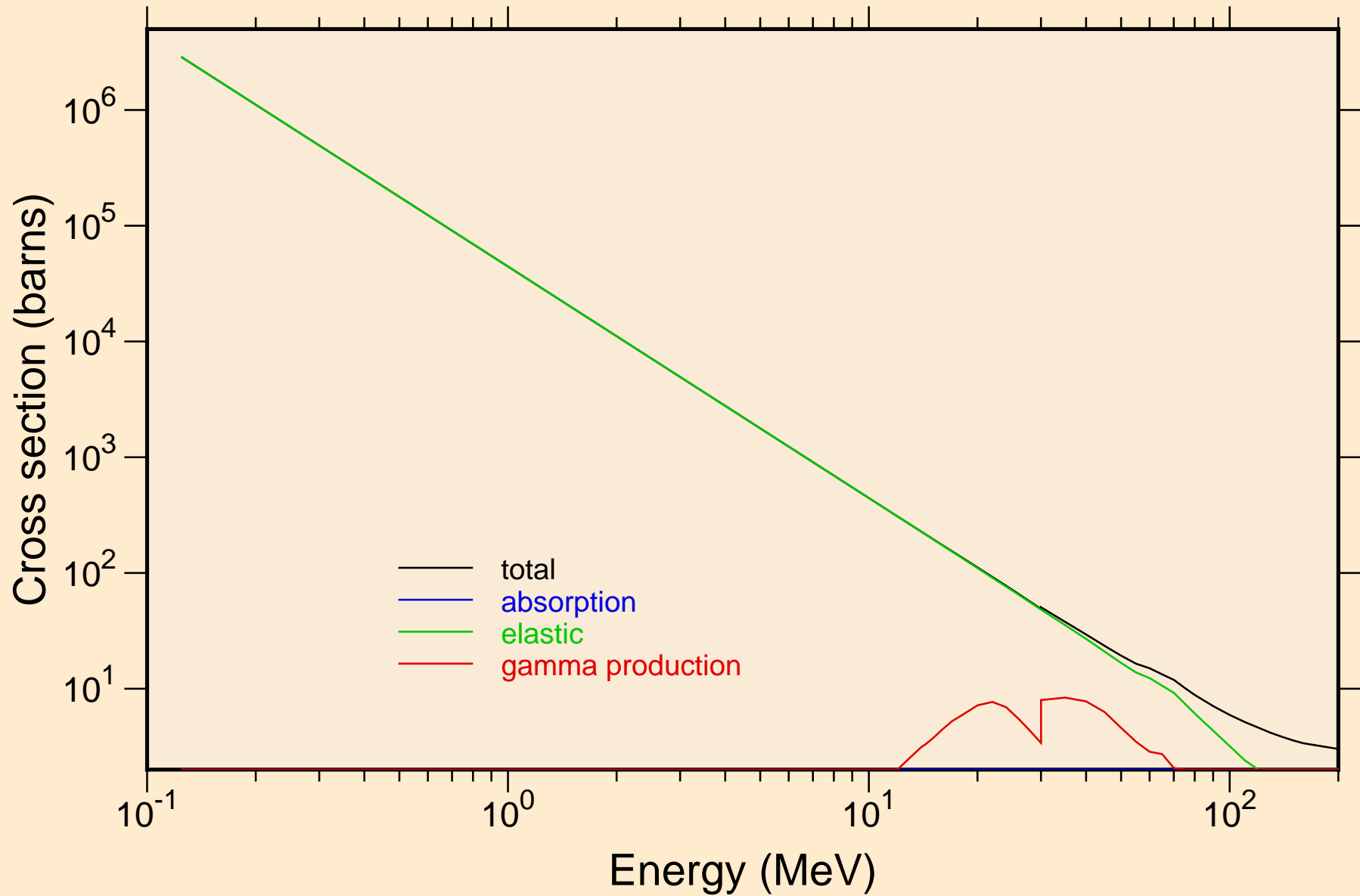

PO226 TRITON ACER TENDL-2021 LIBRARY; T=0.K

Heating

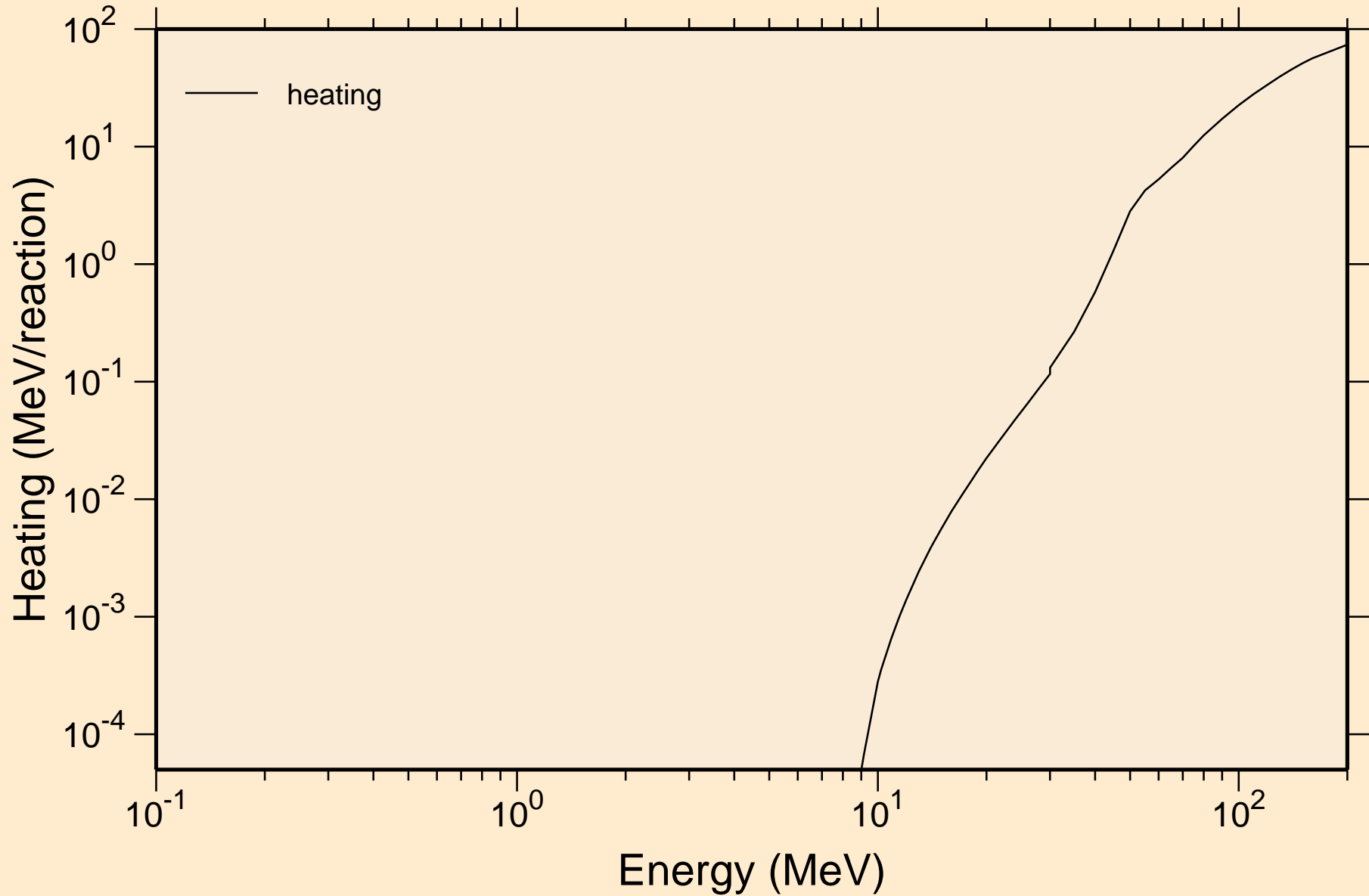

# PO226 TRITON ACER TENDL-2021 LIBRARY; T=0.K

## Principal cross sections

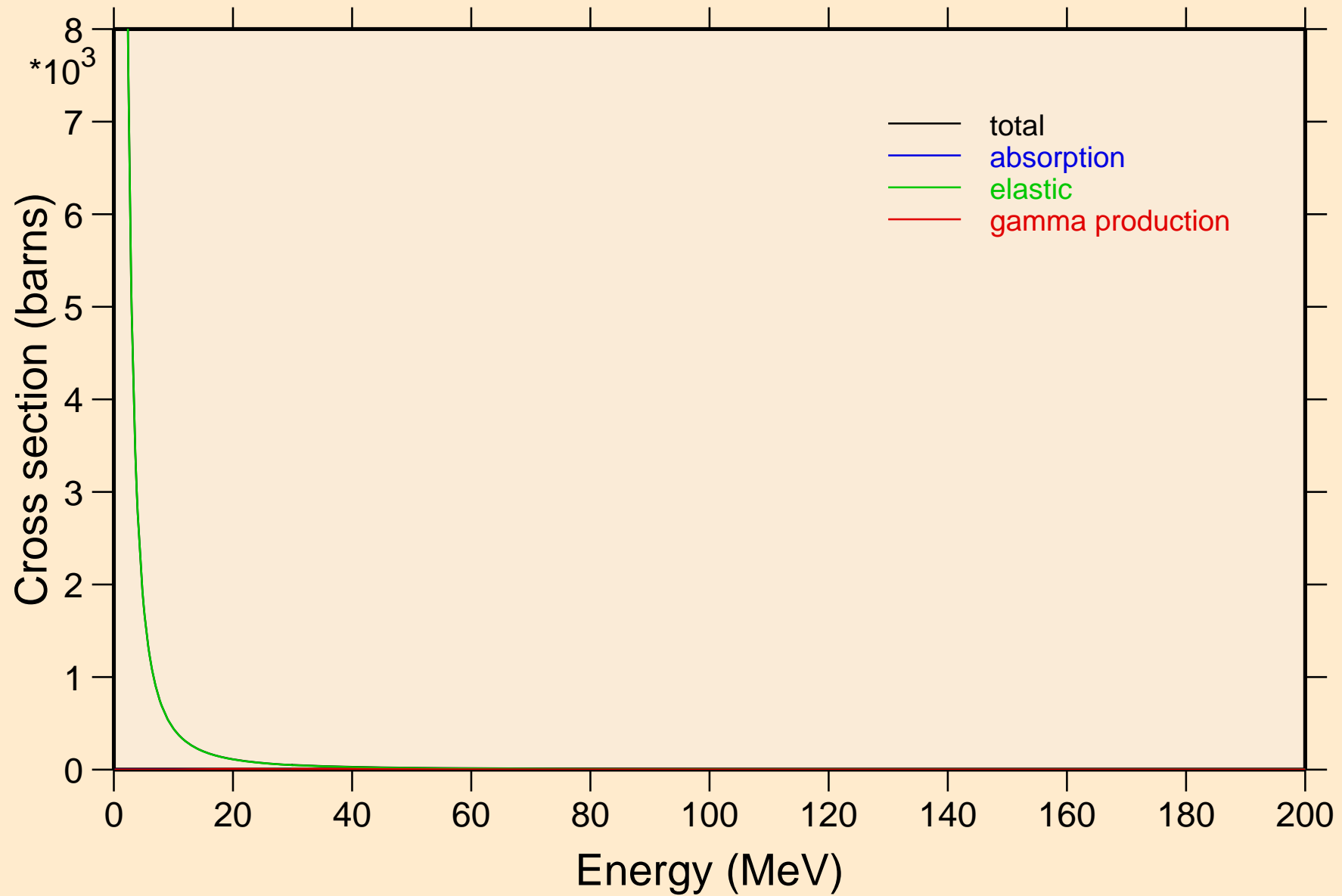

PO226 TRITON ACER TENDL-2021 LIBRARY; T=0.K

Heating

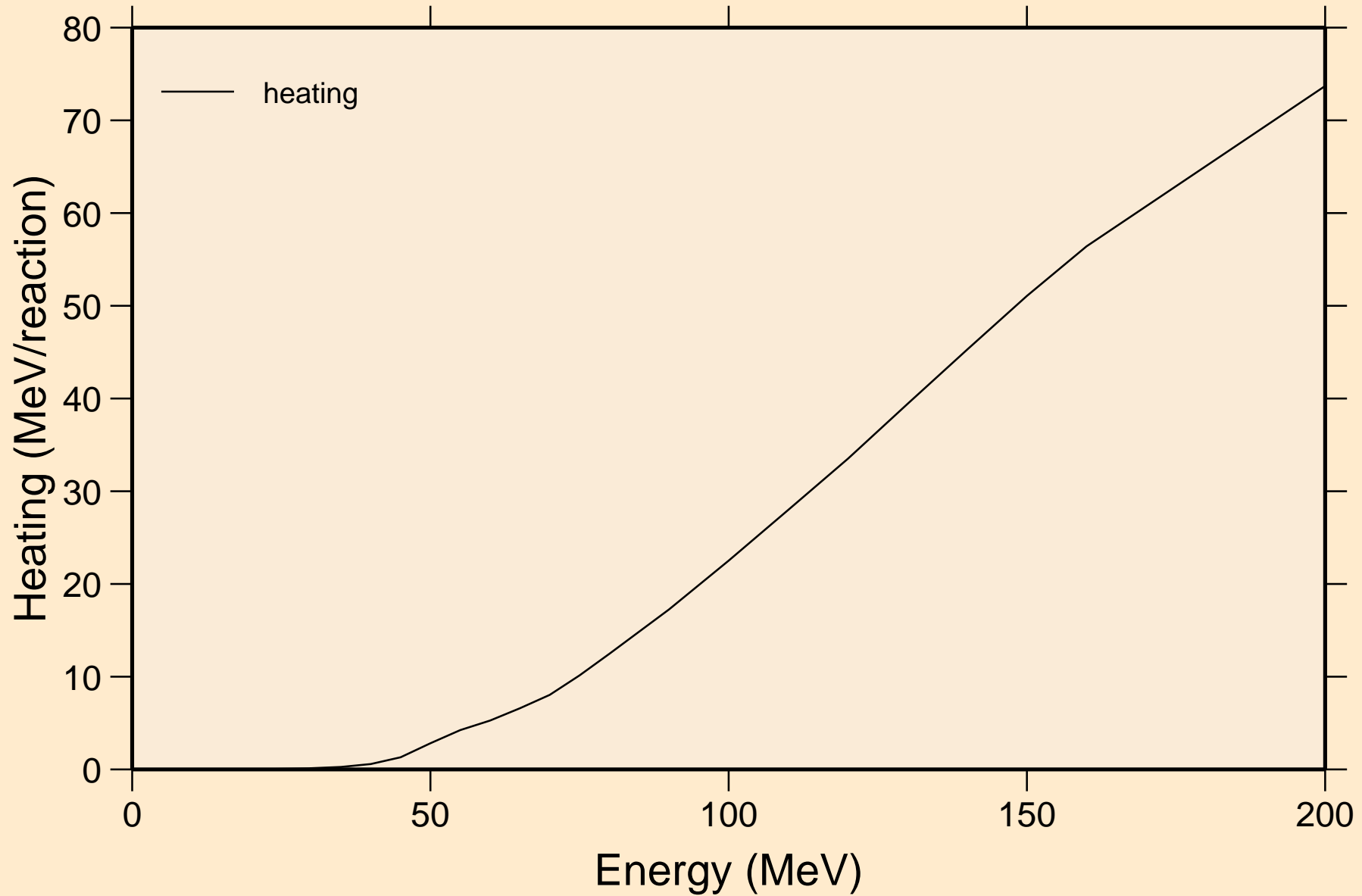

PO226 TRITON ACER TENDL-2021 LIBRARY; T=0.K  
Threshold reactions

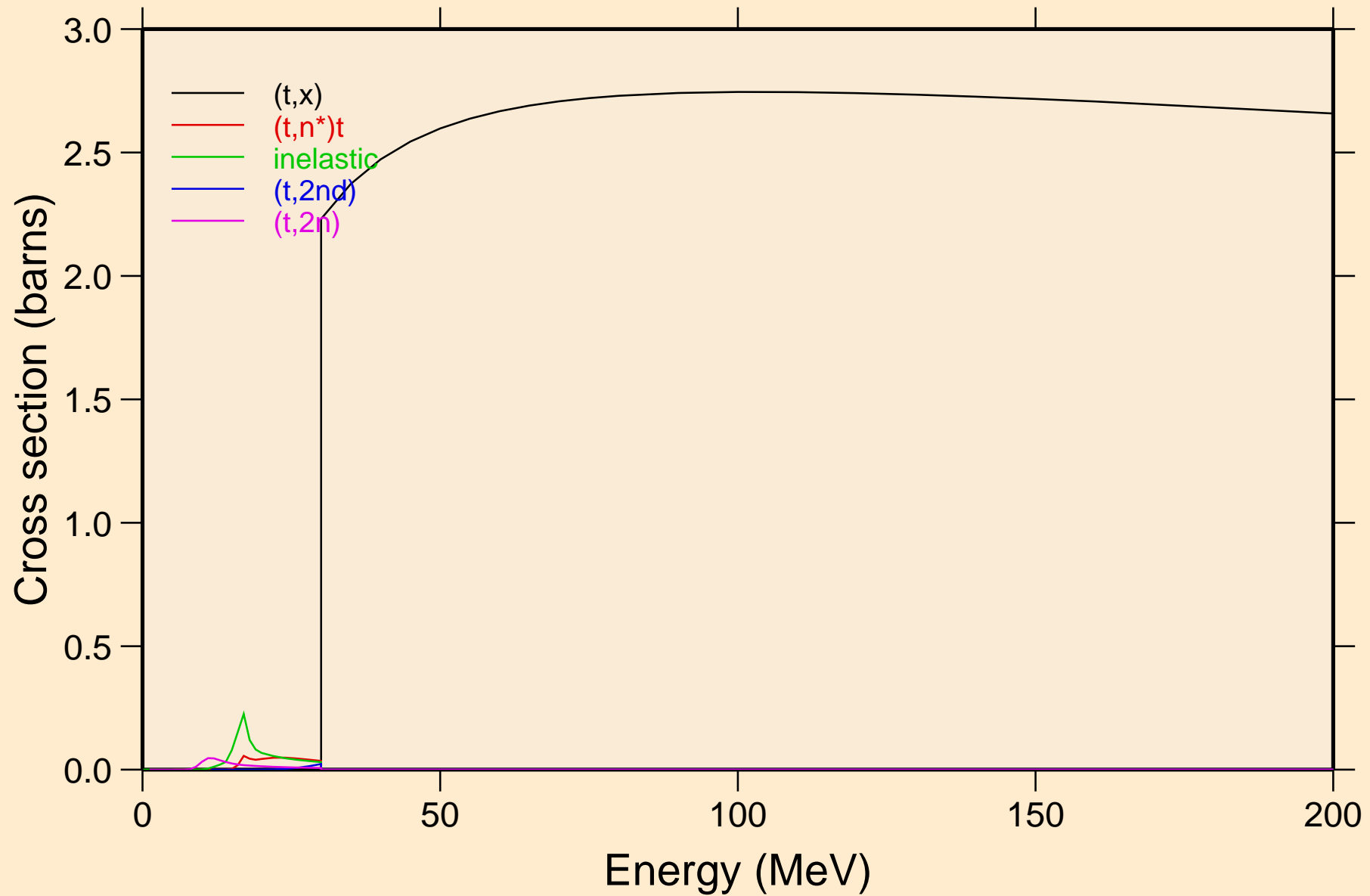

PO226 TRITON ACER TENDL-2021 LIBRARY; T=0.K  
Threshold reactions

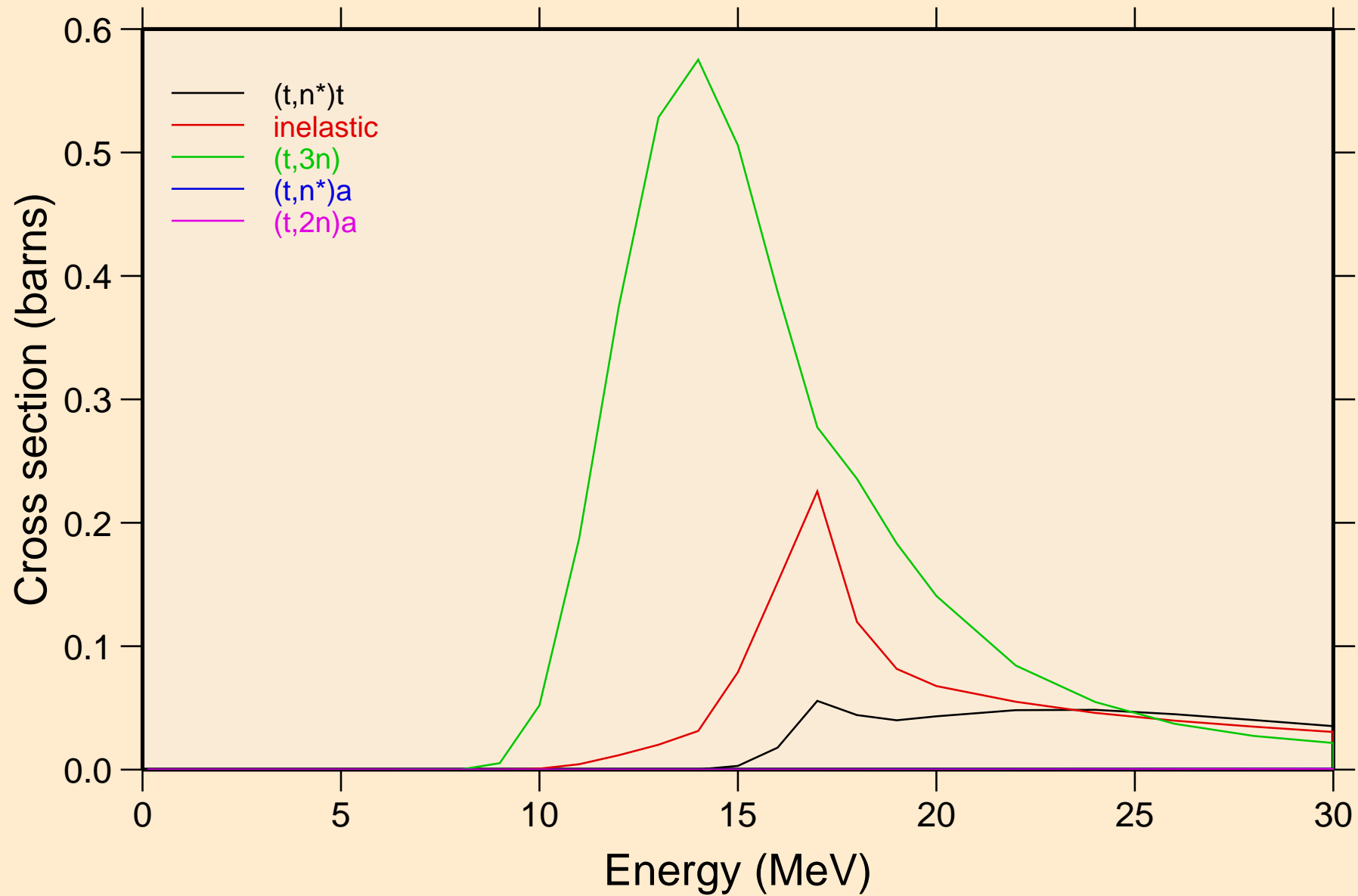

PO226 TRITON ACER TENDL-2021 LIBRARY; T=0.K  
Threshold reactions

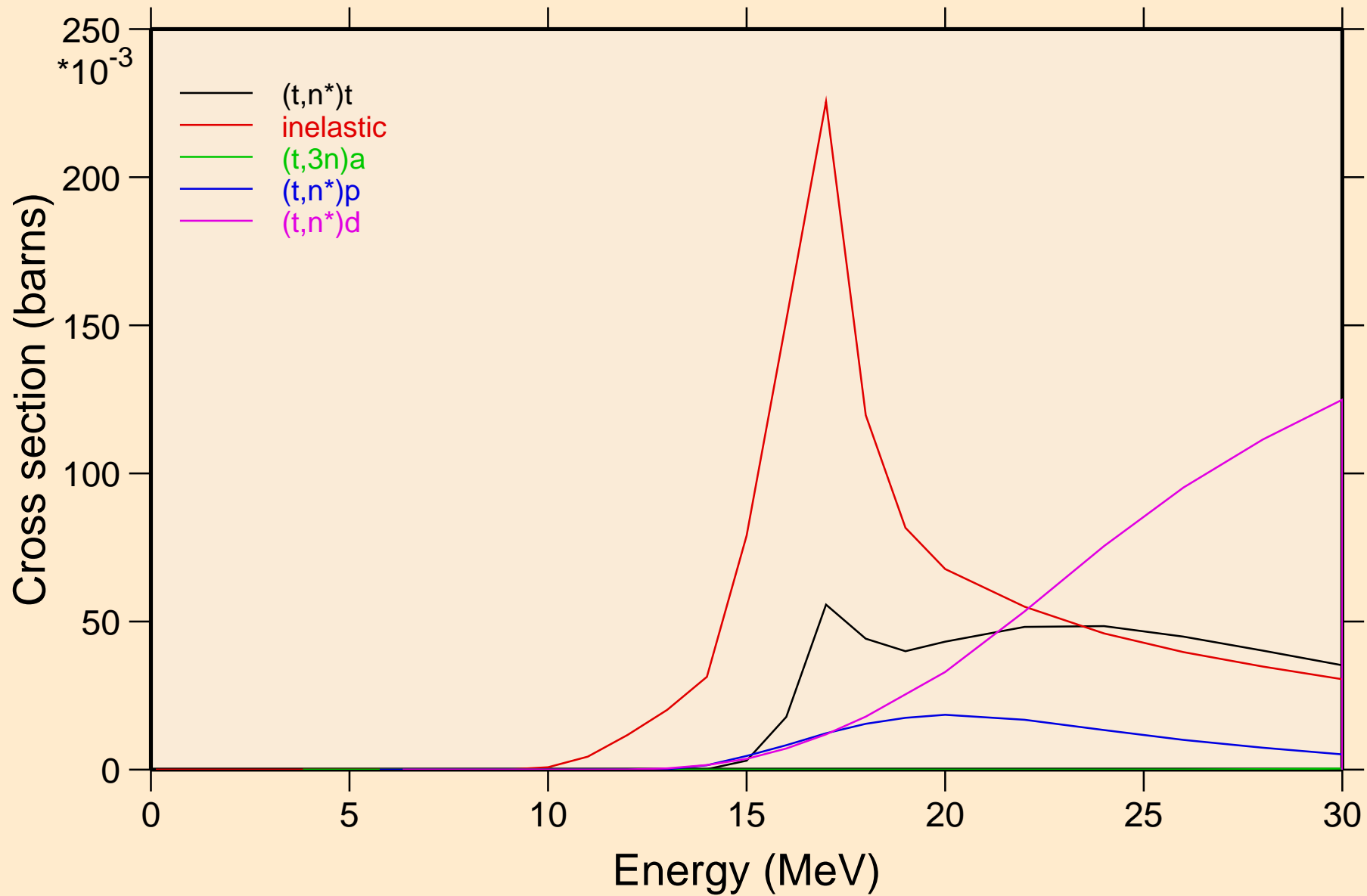

PO226 TRITON ACER TENDL-2021 LIBRARY; T=0.K  
Threshold reactions

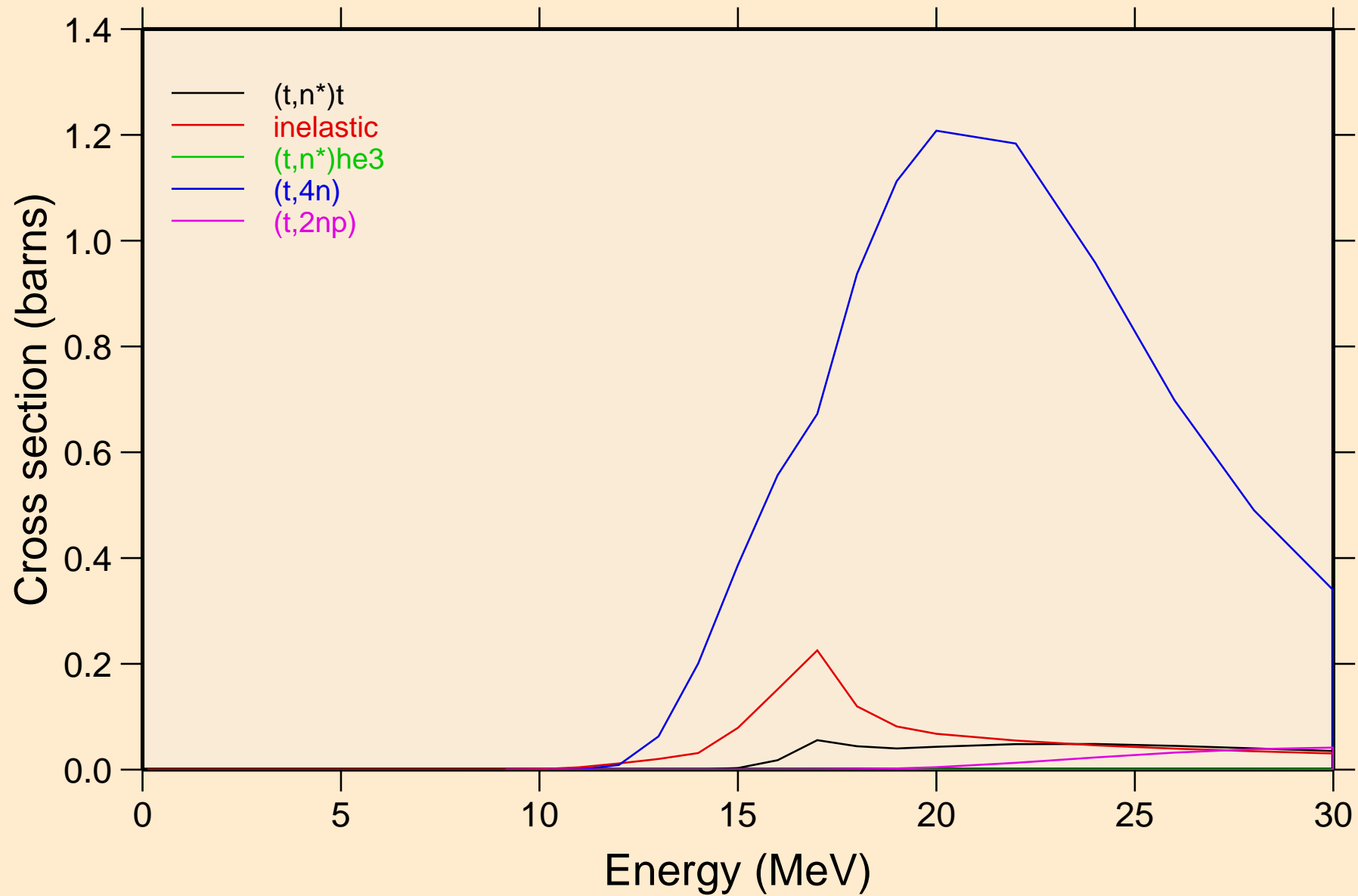



PO226 TRITON ACER TENDL-2021 LIBRARY; T=0.K  
Threshold reactions

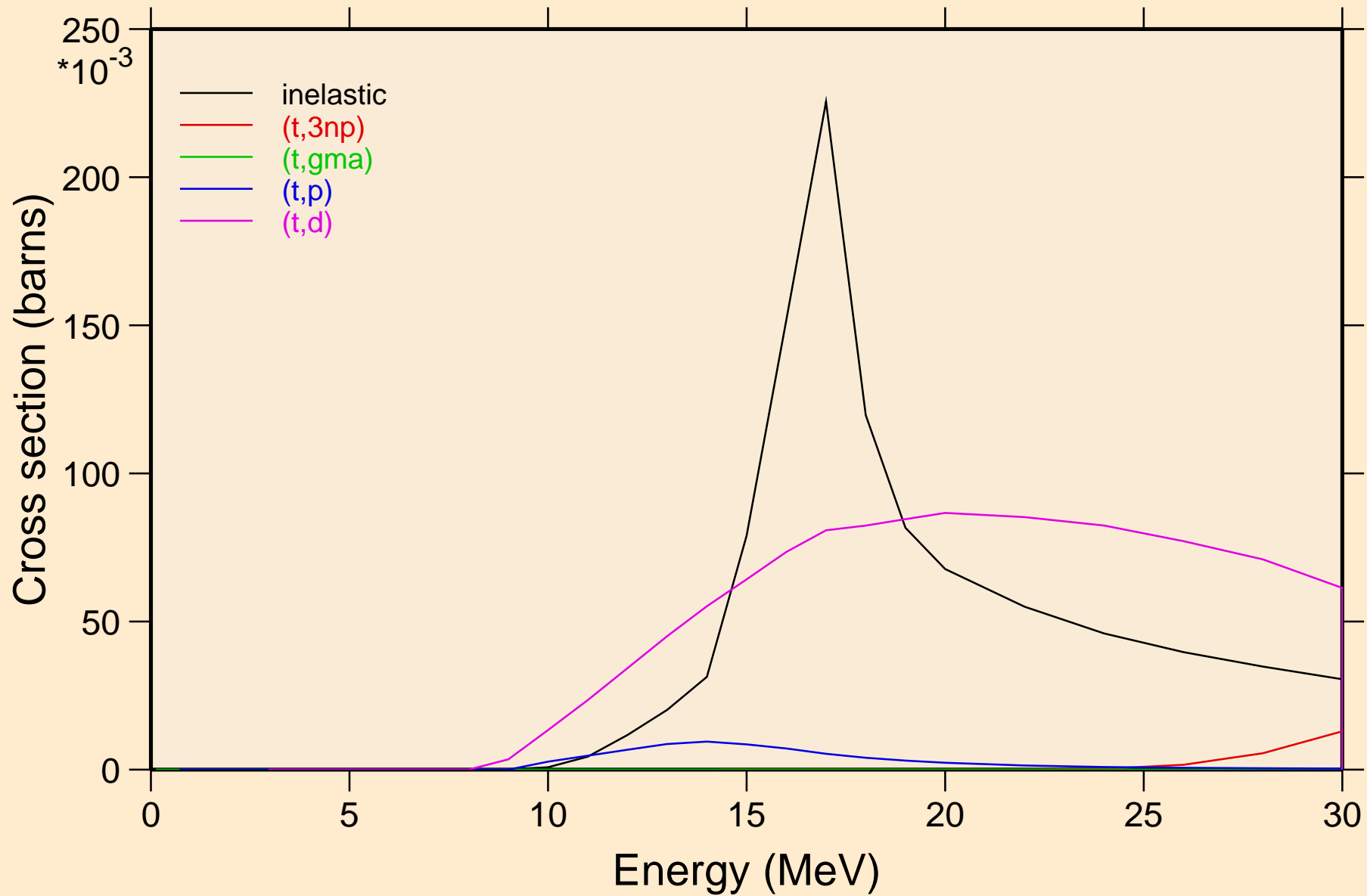

PO226 TRITON ACER TENDL-2021 LIBRARY; T=0.K  
Threshold reactions

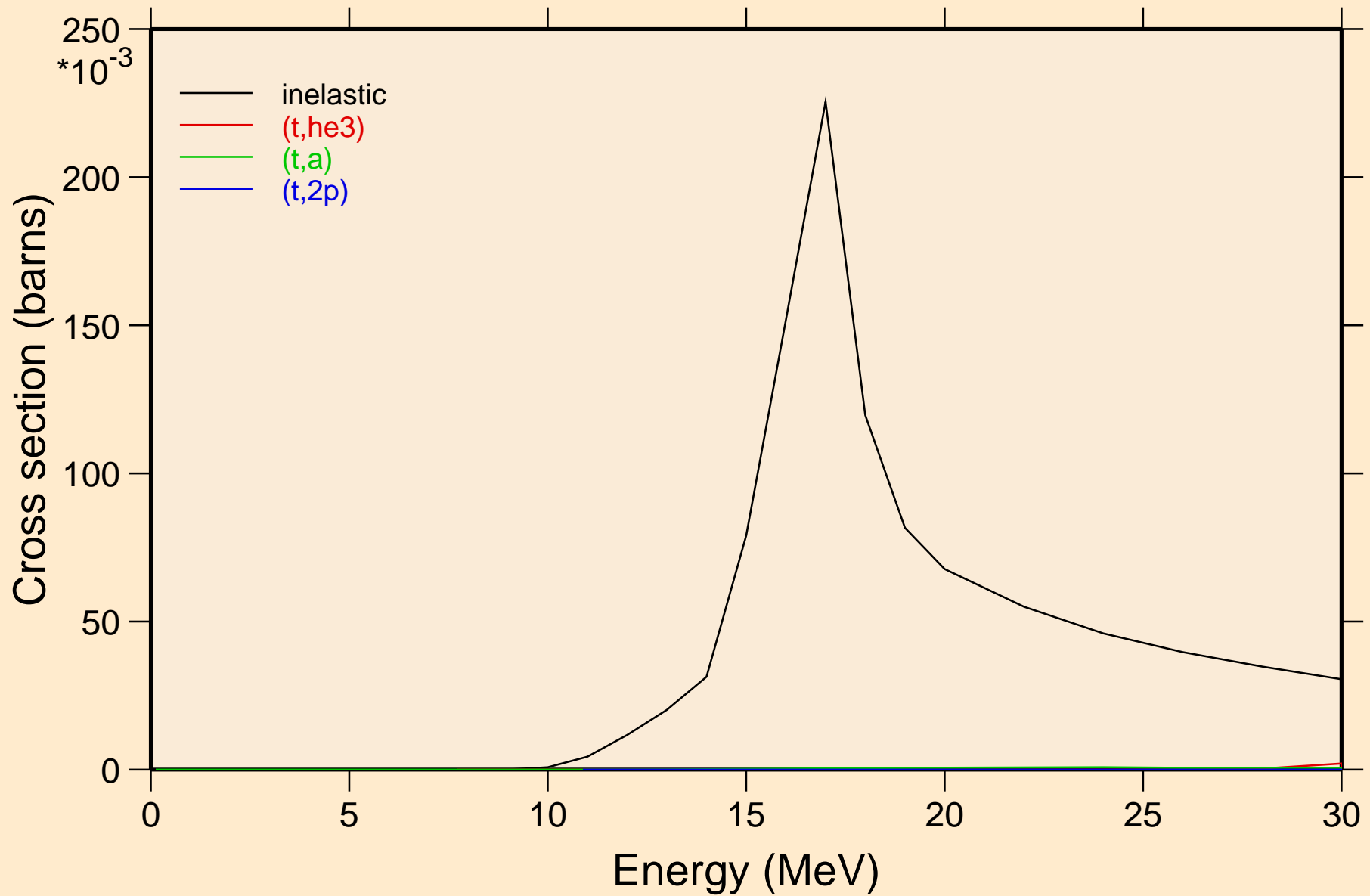

PO226 TRITON ACER TENDL-2021 LIBRARY; T=0.K  
angular distribution for elastic

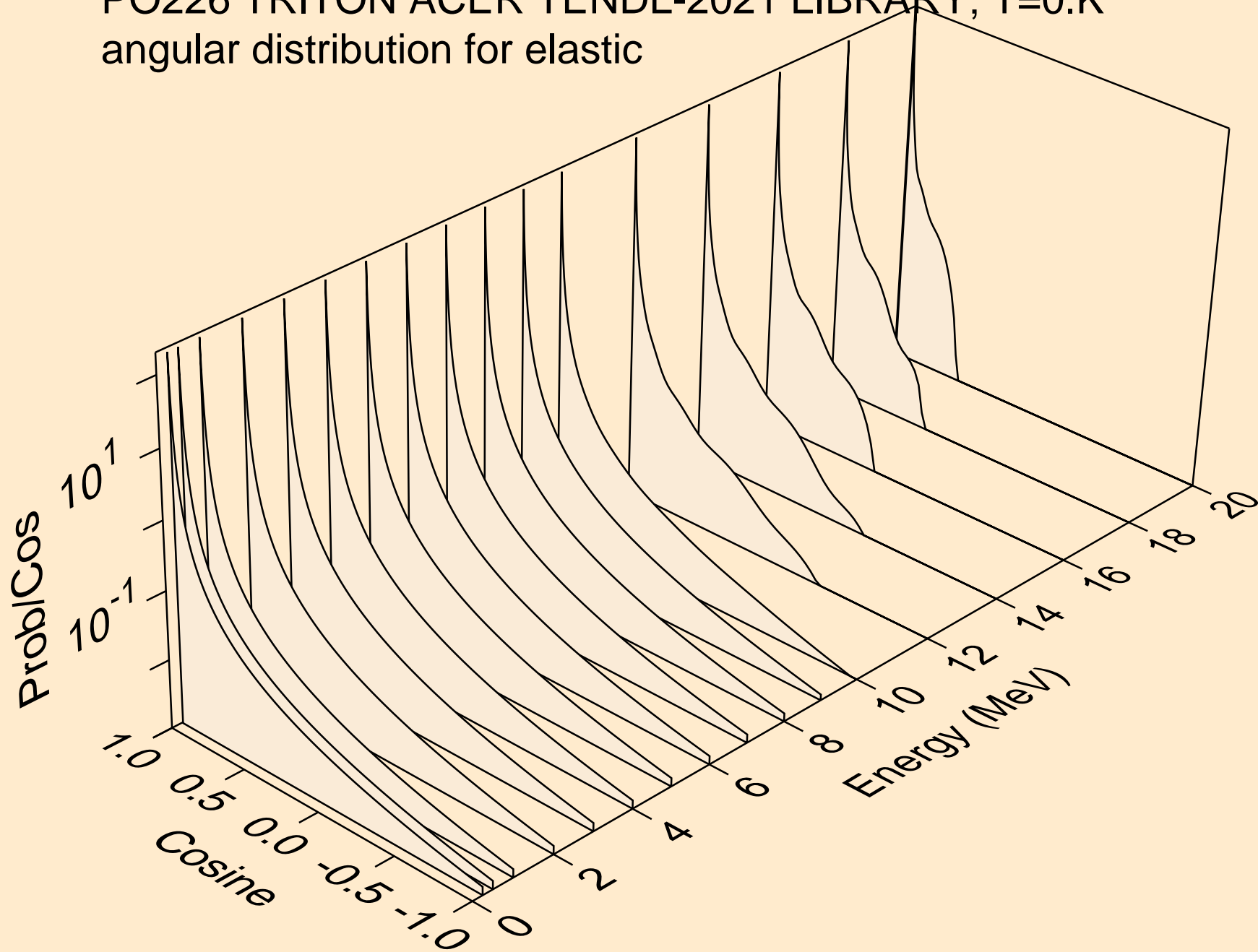

PO226 TRITON ACER TENDL-2021 LIBRARY; T=0.K  
angular distribution for elastic

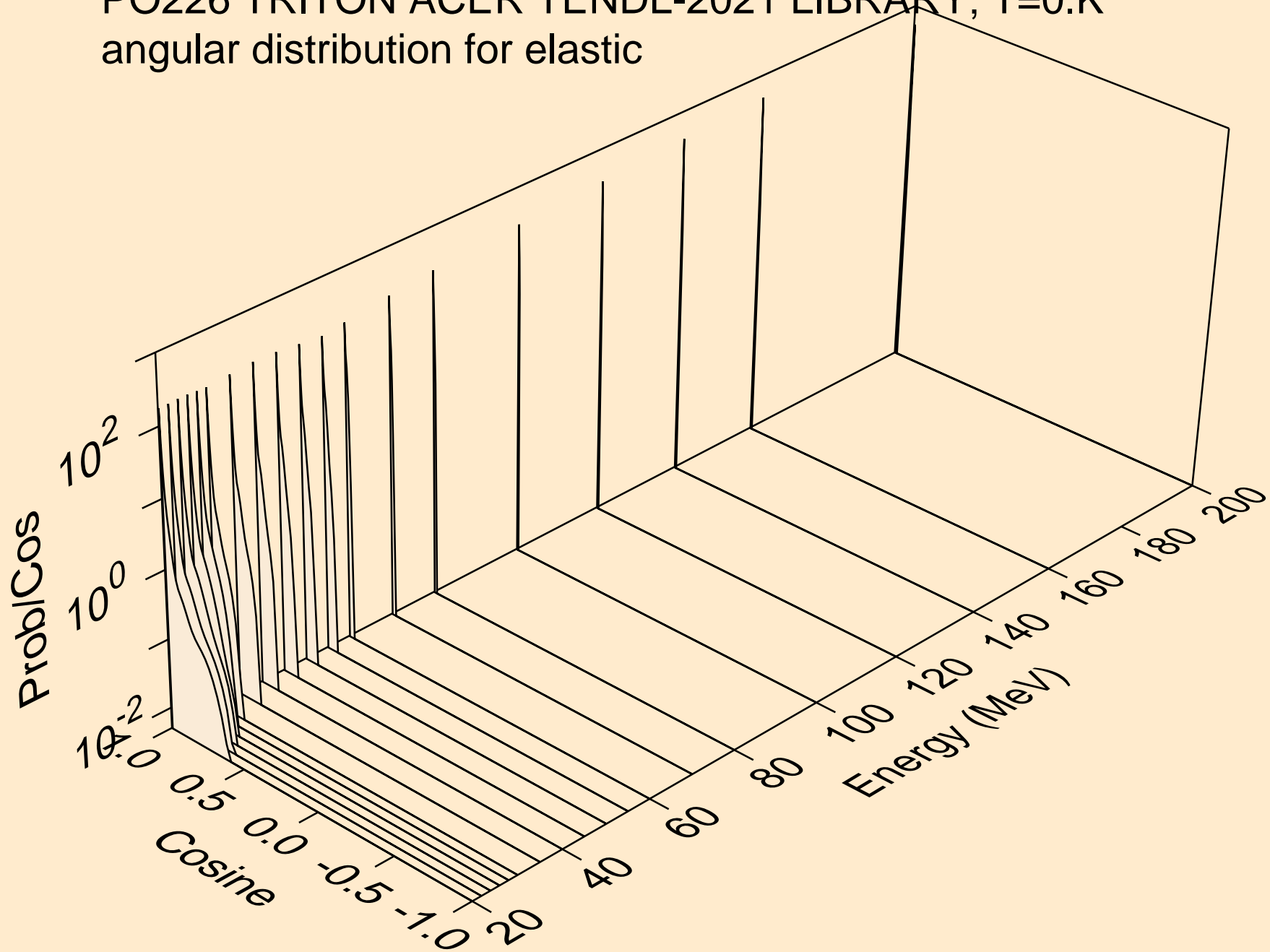

PO226 TRITON ACER TENDL-2021 LIBRARY; T=0.K  
Triton emission for (t,x)

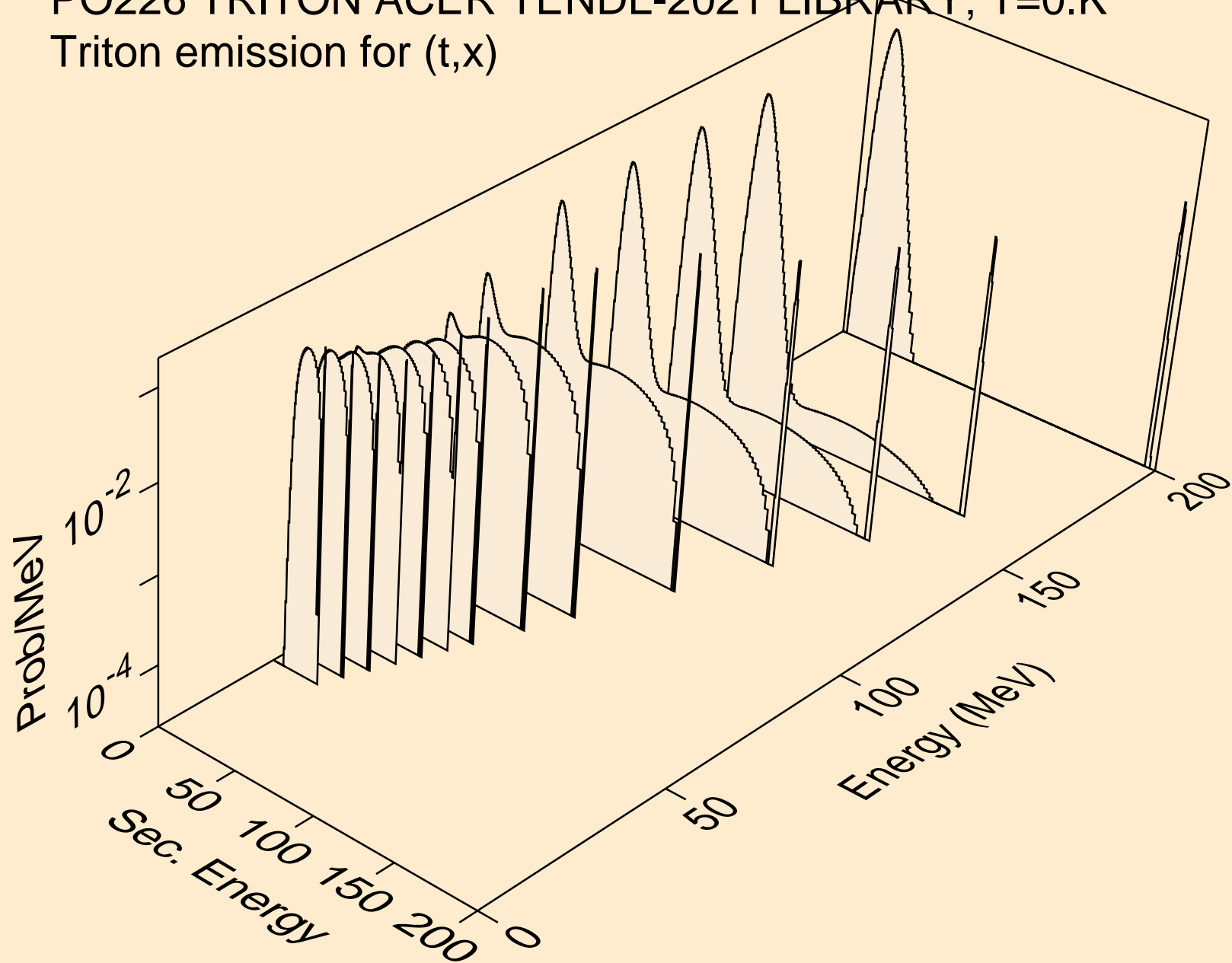

PO226 TRITON ACER TENDL-2021 LIBRARY; T=0.K  
Triton emission for (t,n\*)t

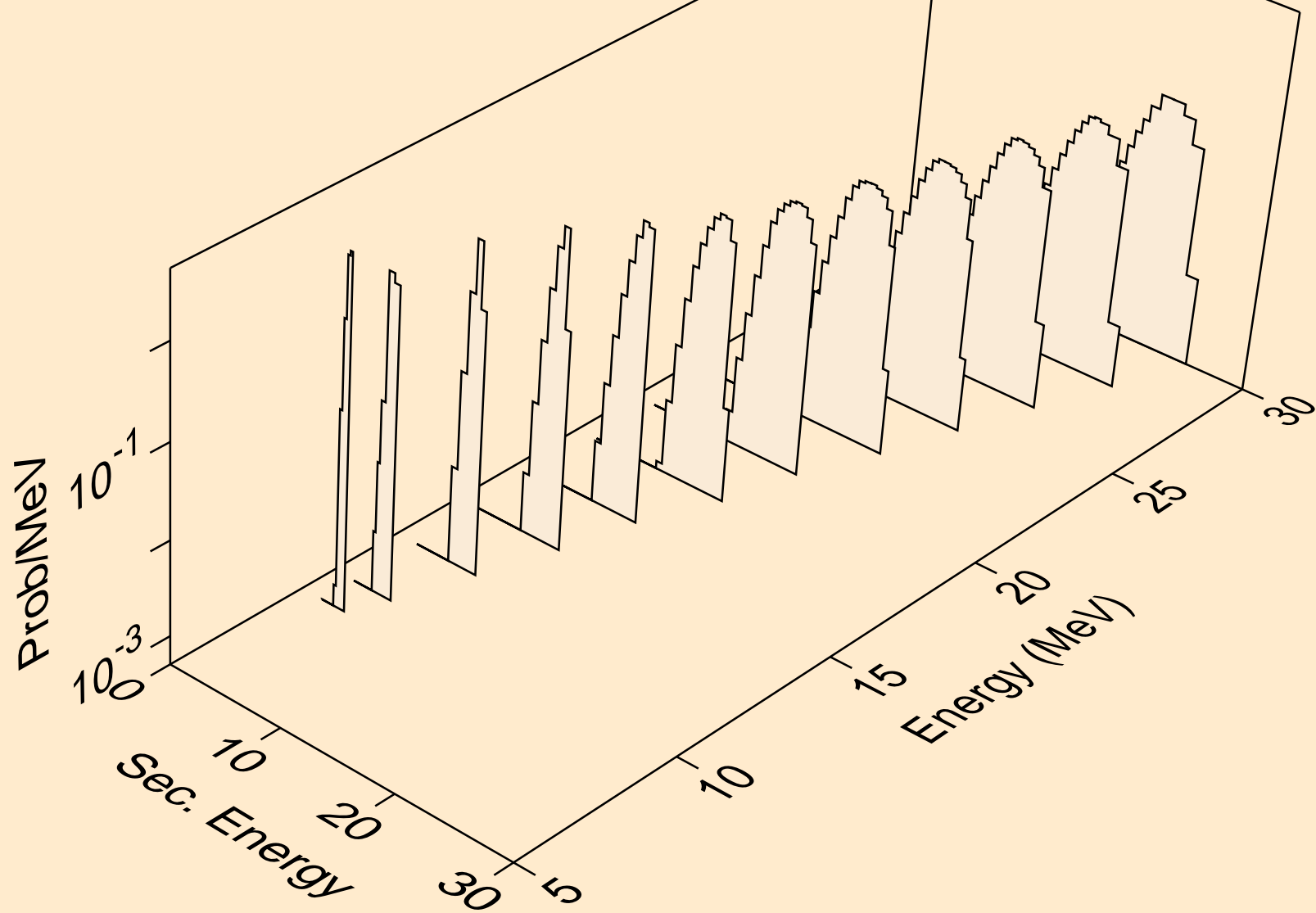

PO226 TRITON ACER TENDL-2021 LIBRARY; T=0.K  
Triton emission for inelastic

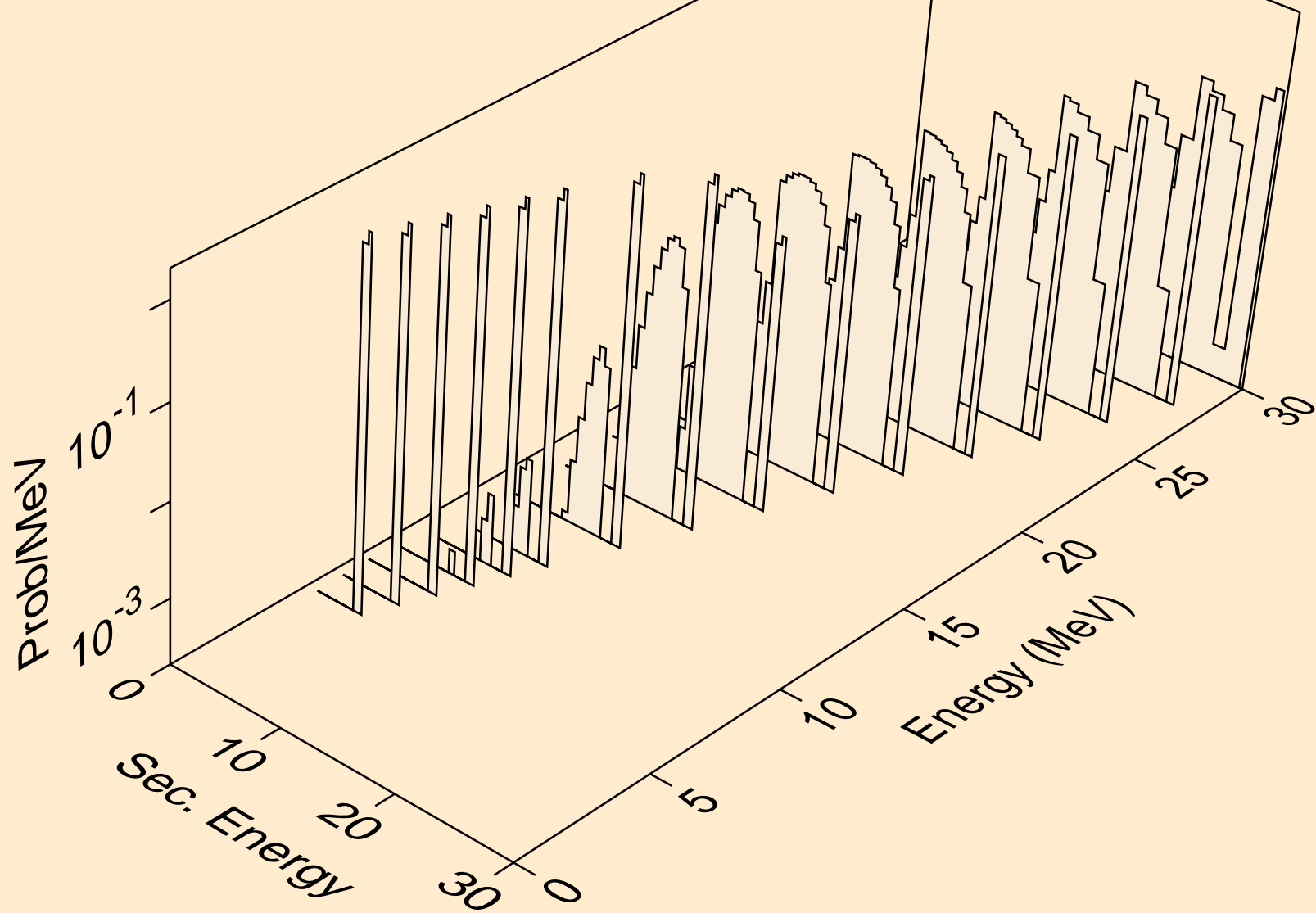

PO226 TRITON ACER TENDL-2021 LIBRARY; T=0.K  
Photon emission for (z,n)

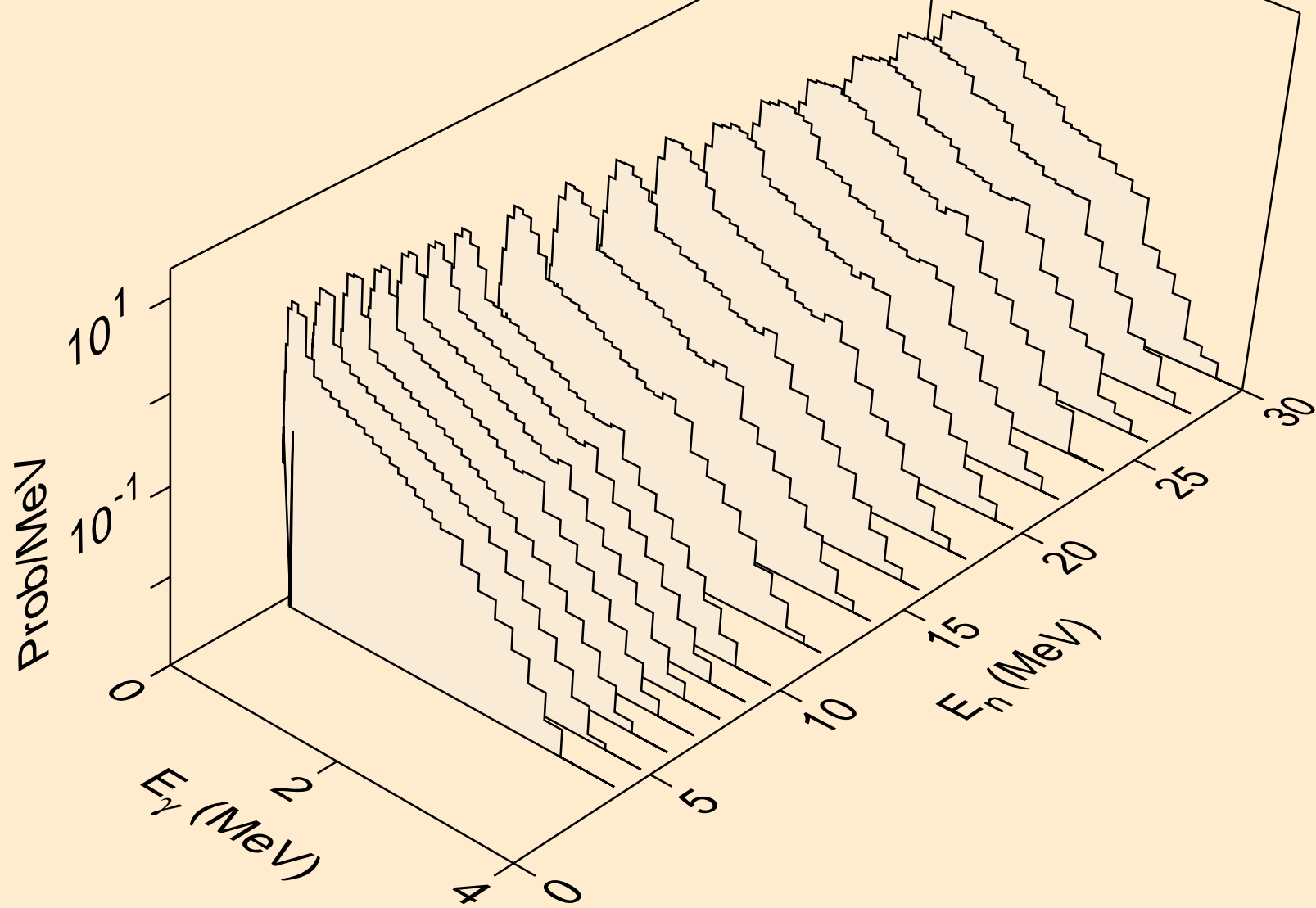



PO226 TRITON ACER TENDL-2021 LIBRARY; T=0.K  
Photon emission for (n,x)

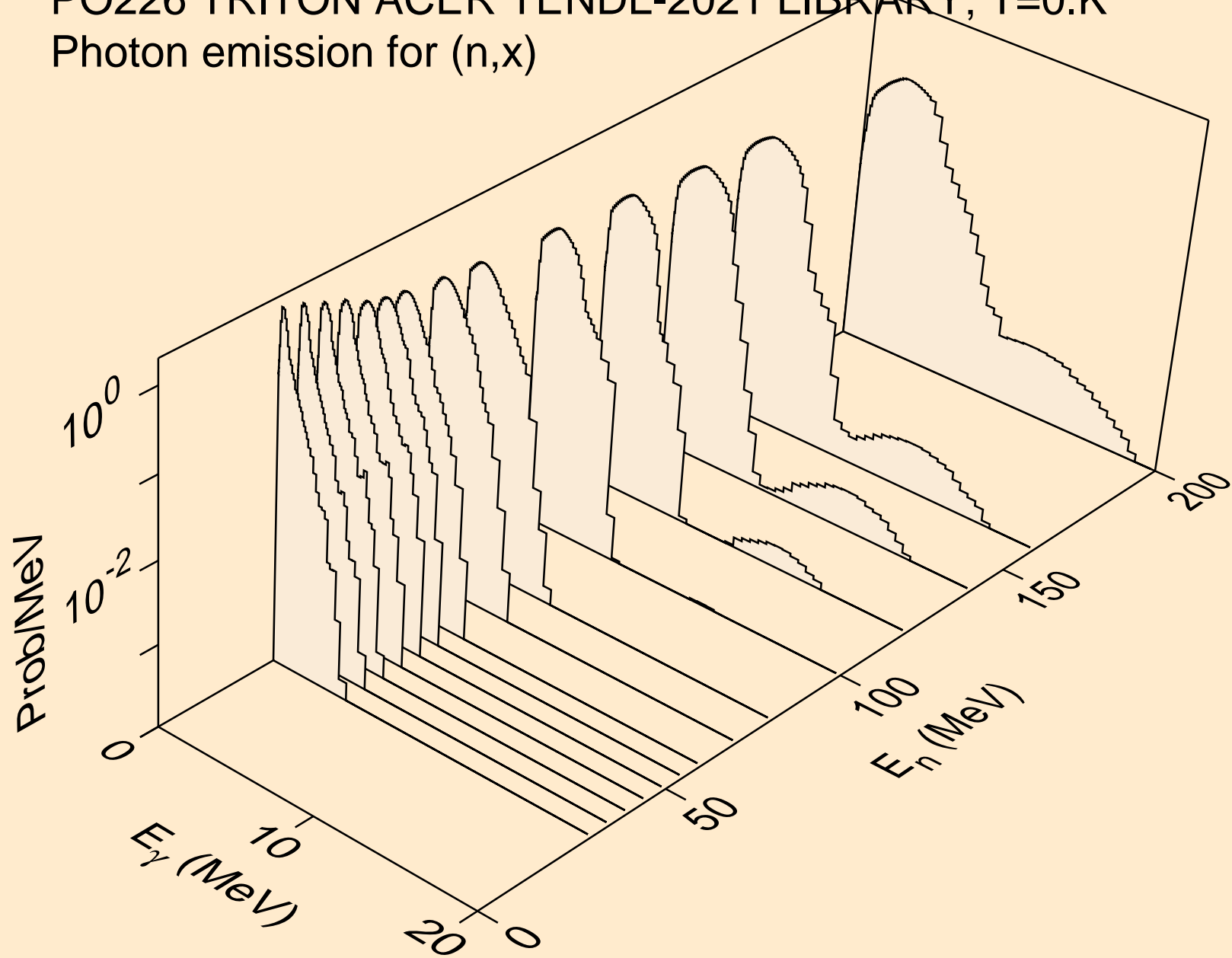

PO226 TRITON ACER TENDL-2021 LIBRARY; T=0.K  
Photon emission for (n,2nd)

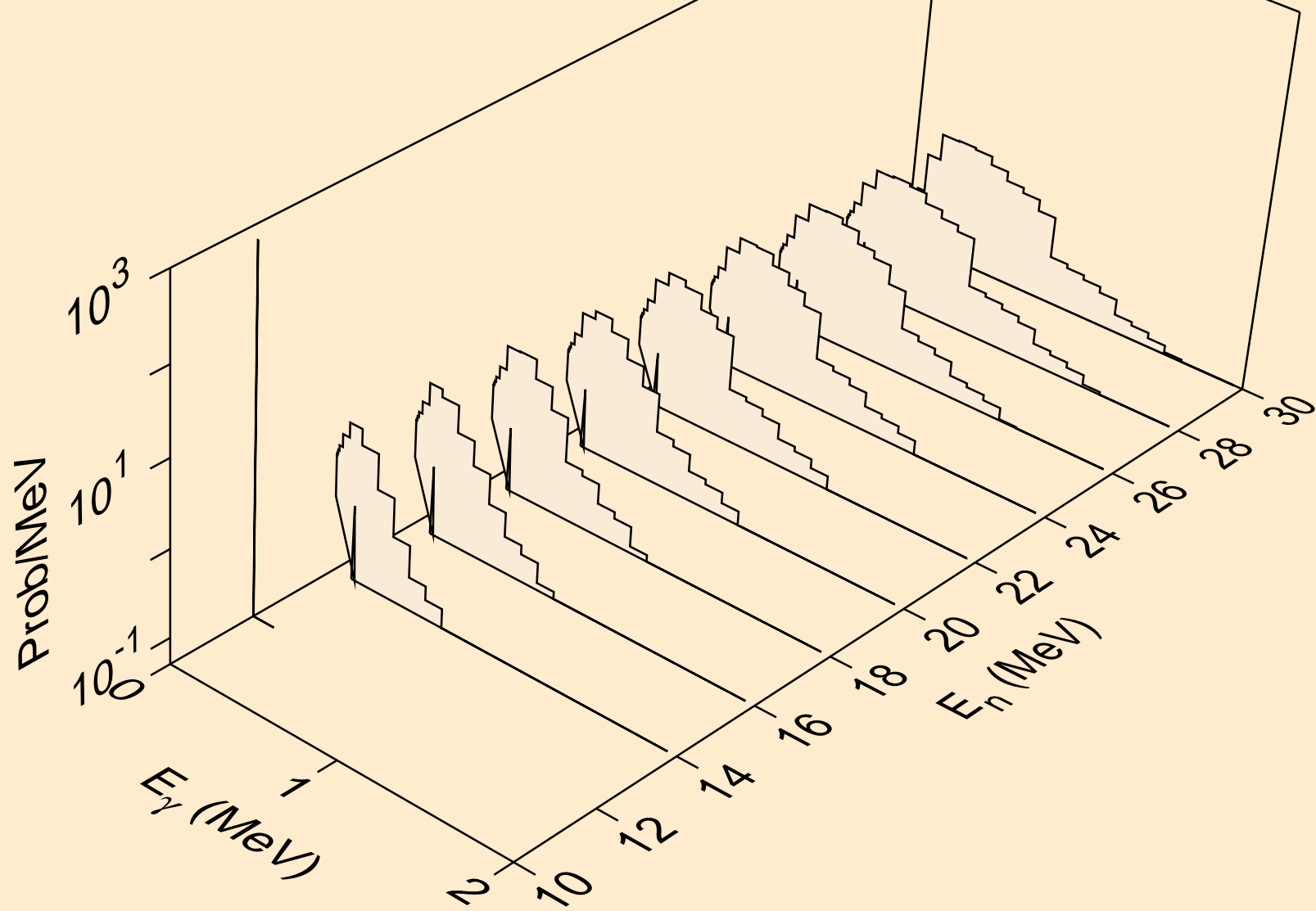

PO226 TRITON ACER TENDL-2021 LIBRARY; T=0.K  
Photon emission for (n,2n)

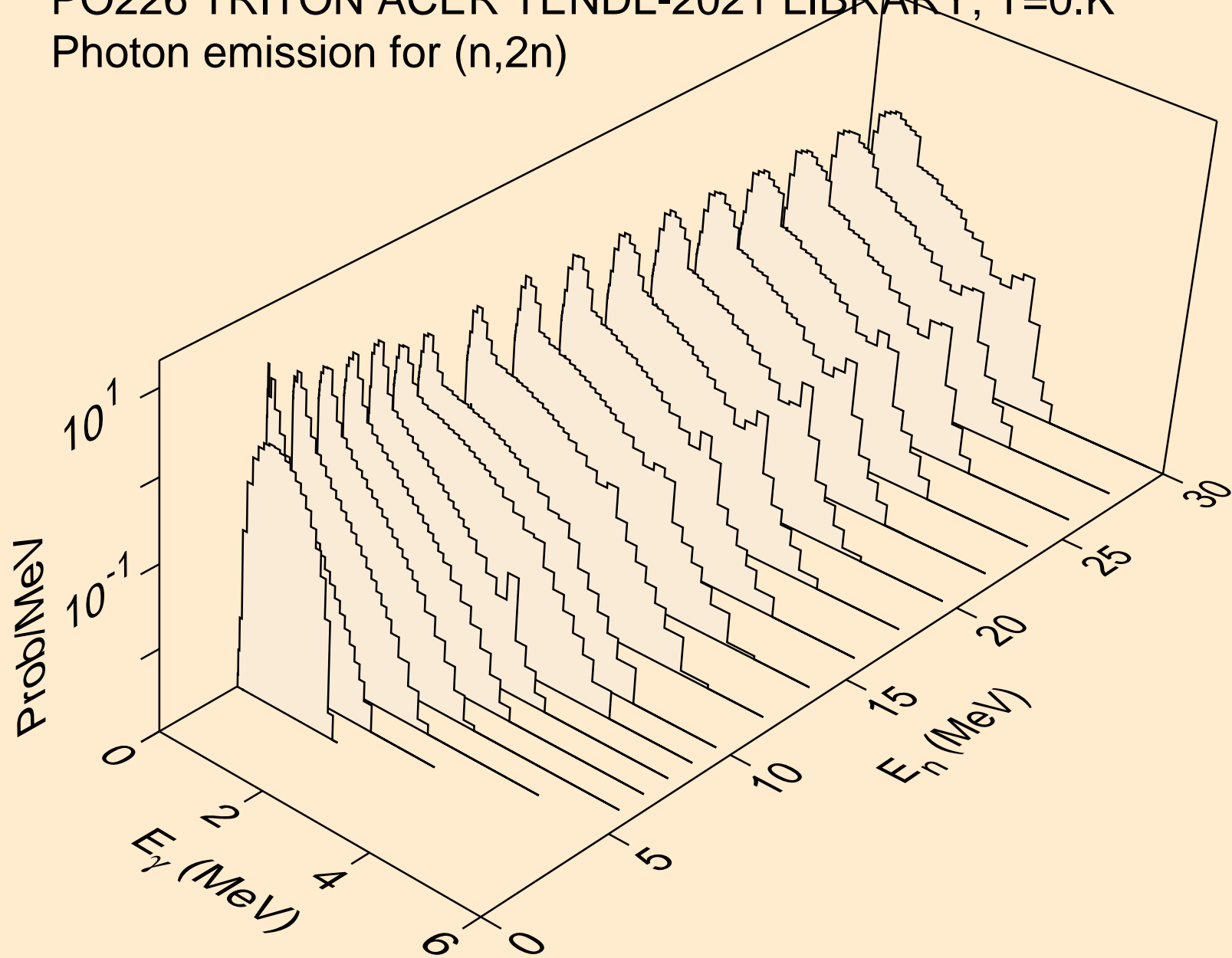

PO226 TRITON ACER TENDL-2021 LIBRARY; T=0.K  
Photon emission for (n,3n)

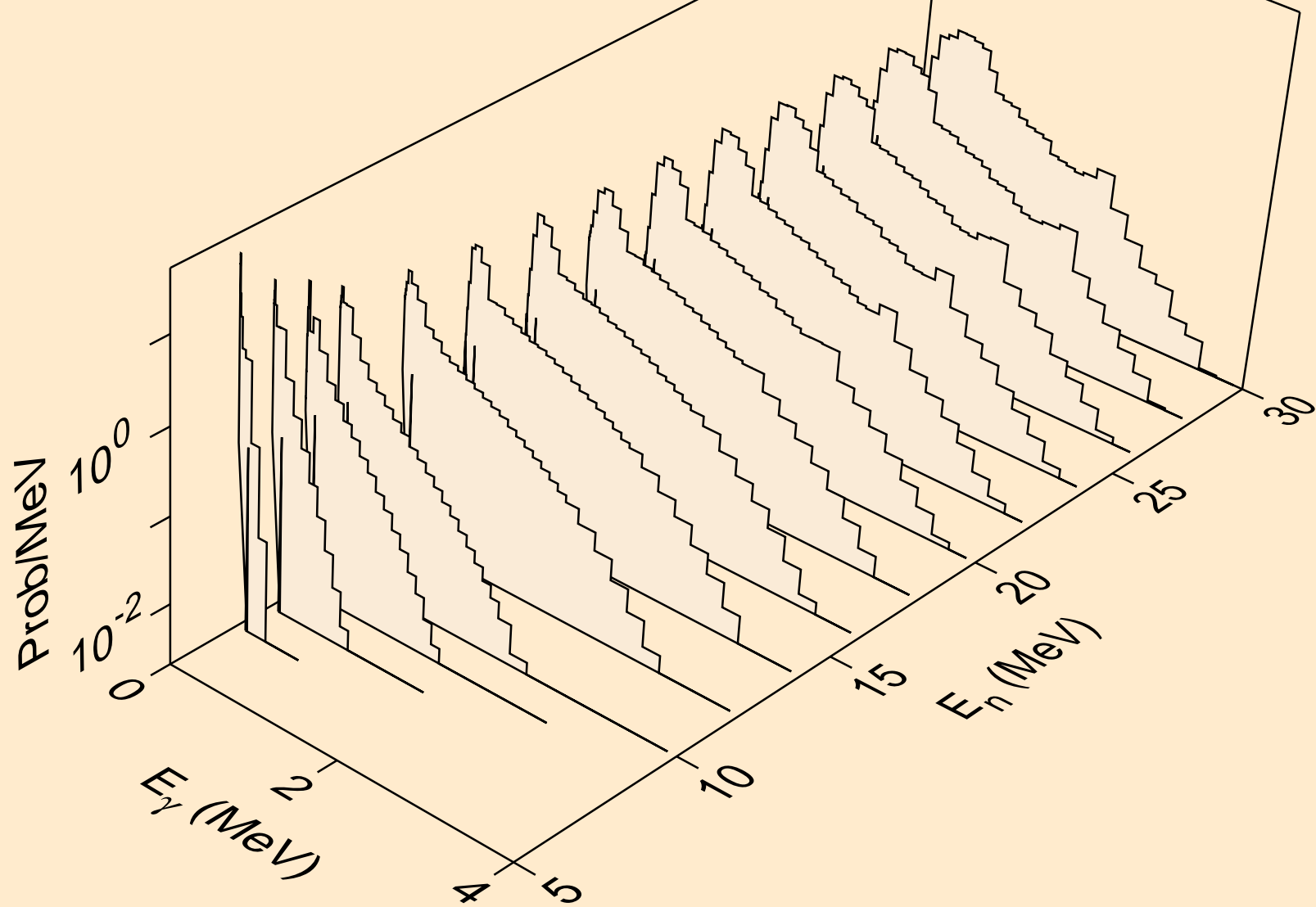

PO226 TRITON ACER TENDL-2021 LIBRARY; T=0.K  
Photon emission for (n,n\*)a

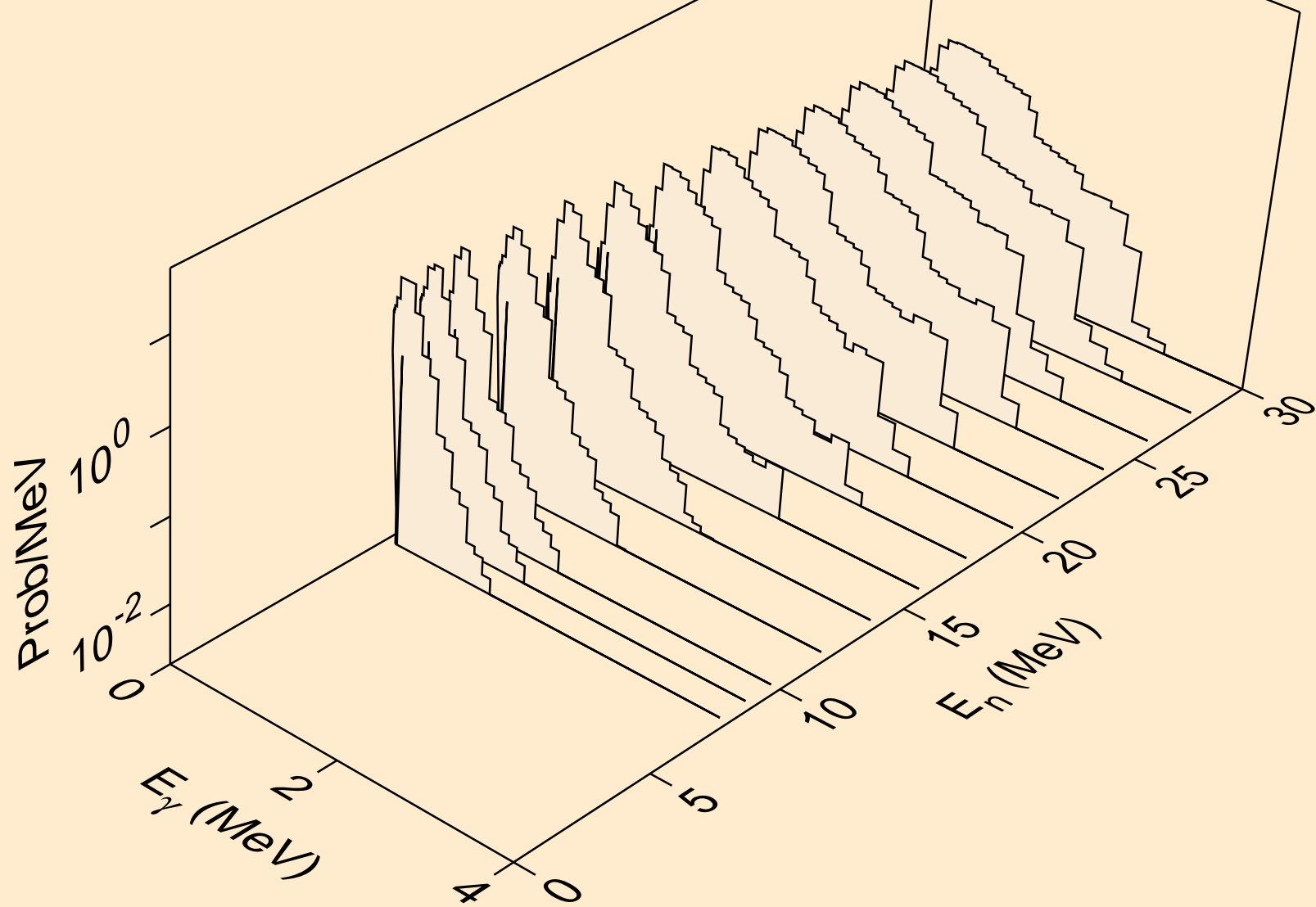

PO226 TRITON ACER TENDL-2021 LIBRARY; T=0.K  
Photon emission for (n,2n)a

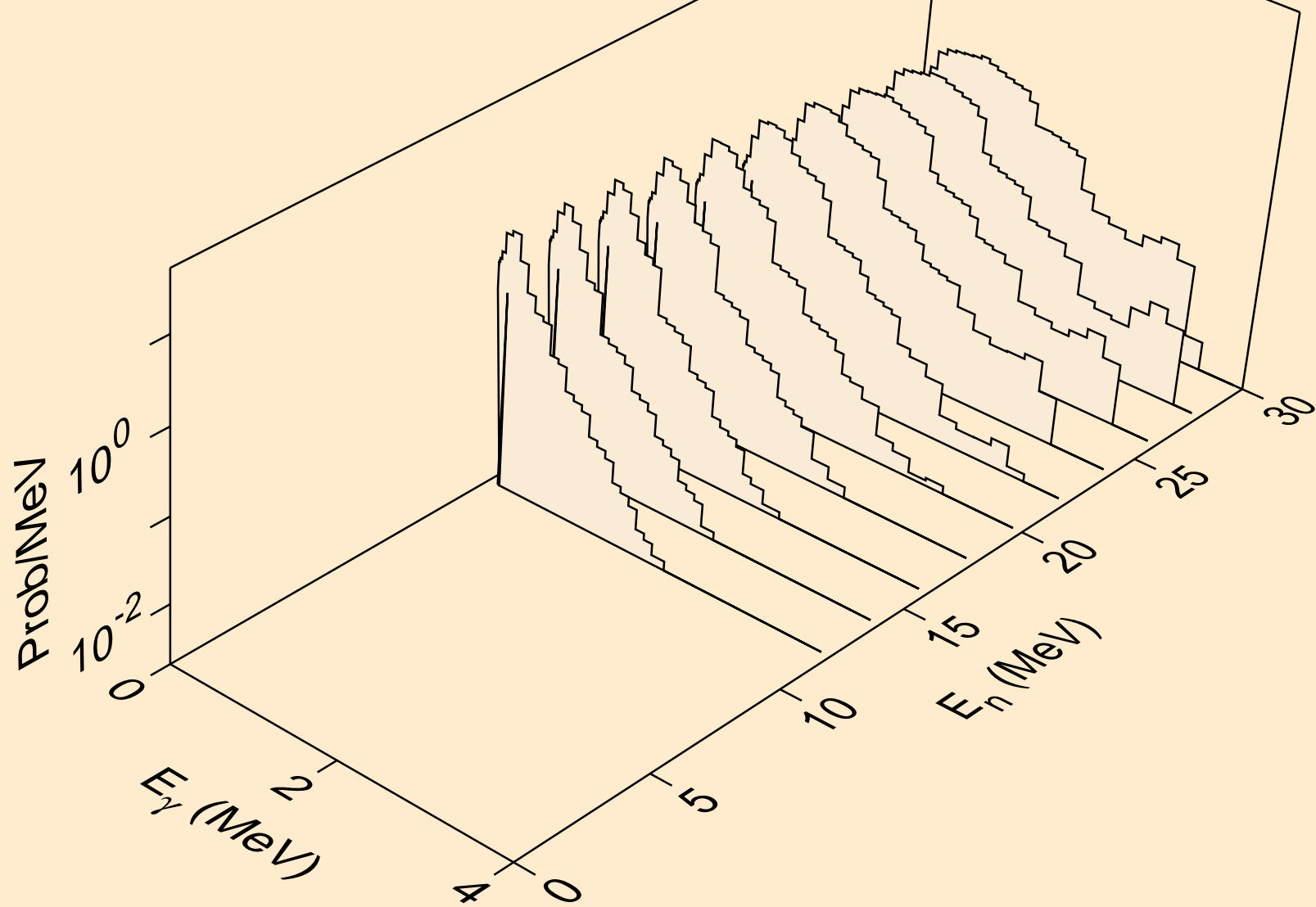

PO226 TRITON ACER TENDL-2021 LIBRARY; T=0.K  
Photon emission for (n,3n)a

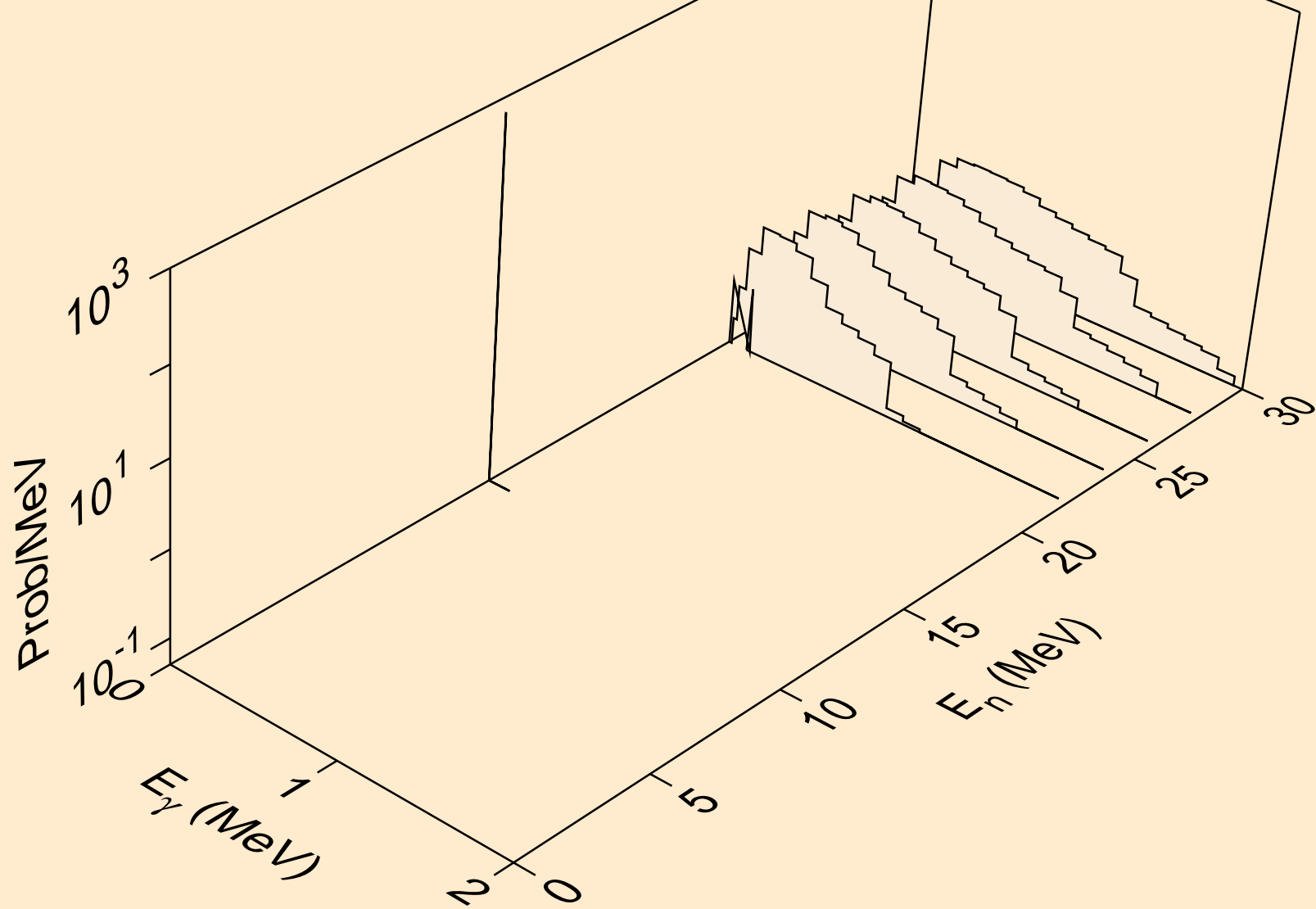

PO226 TRITON ACER TENDL-2021 LIBRARY; T=0.K  
Photon emission for (n,n\*)p

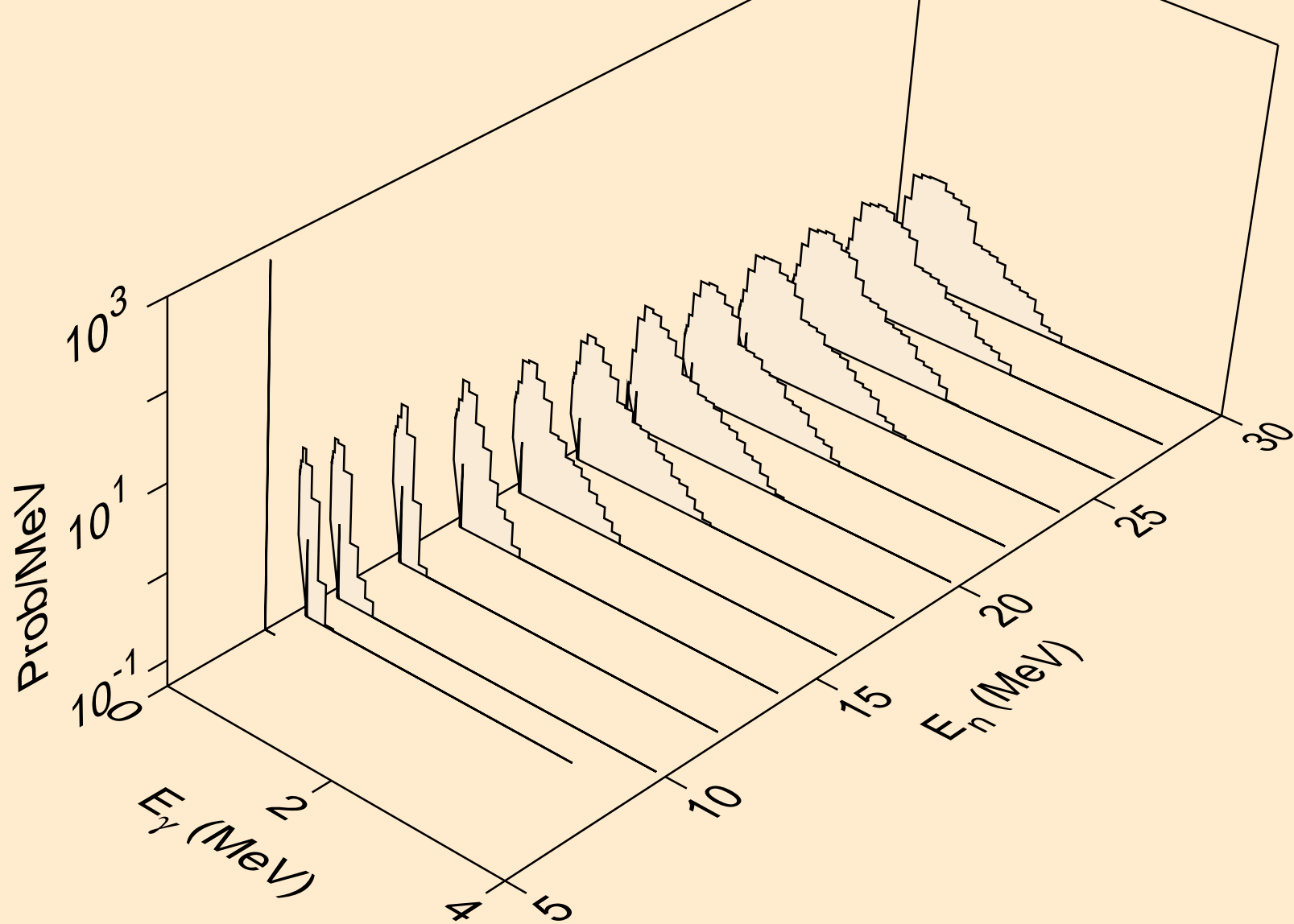



PO226 TRITON ACER TENDL-2021 LIBRARY; T=0.K  
Photon emission for (n,n\*)d

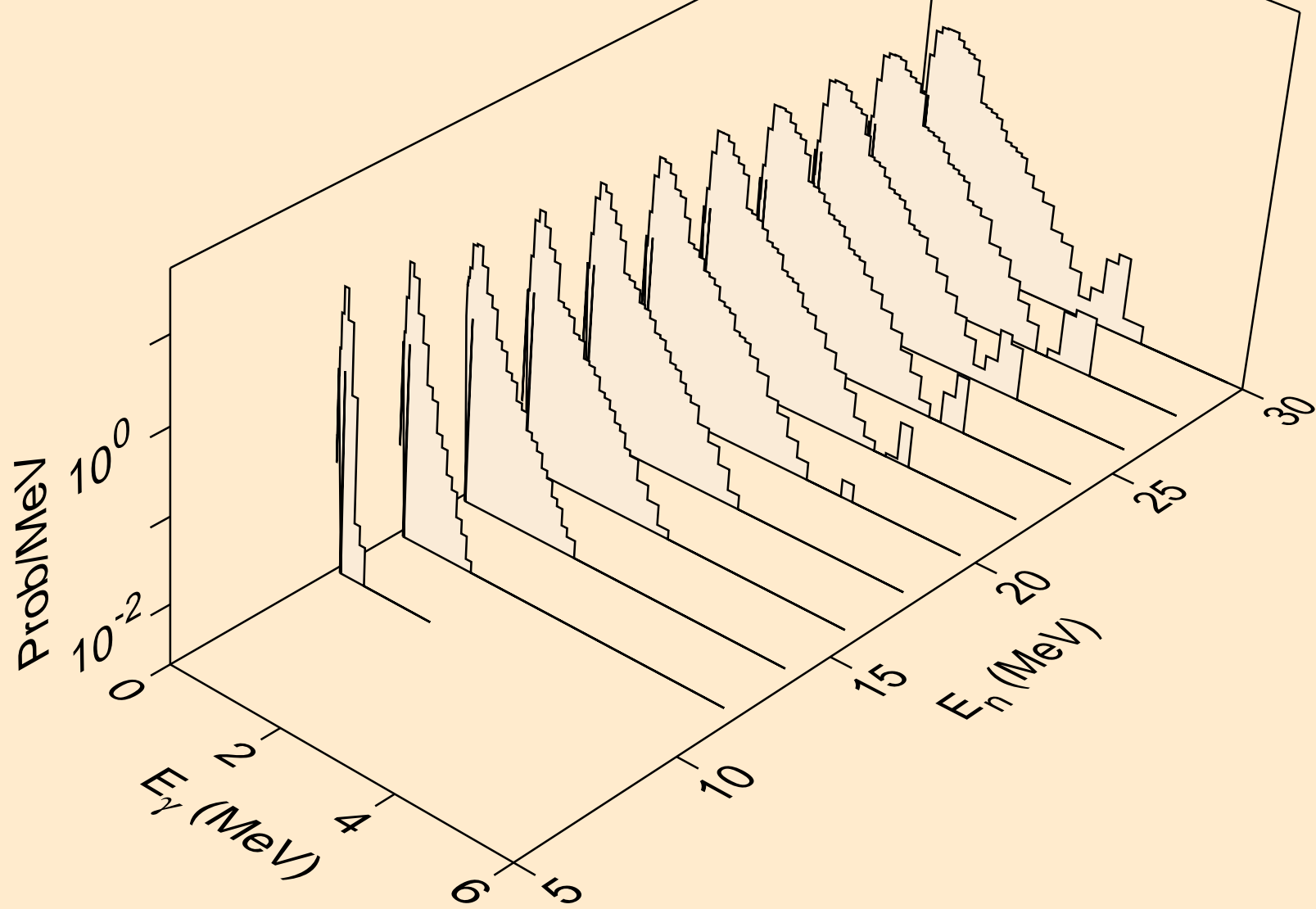

PO226 TRITON ACER TENDL-2021 LIBRARY; T=0.K  
Photon emission for (n,n\*)t

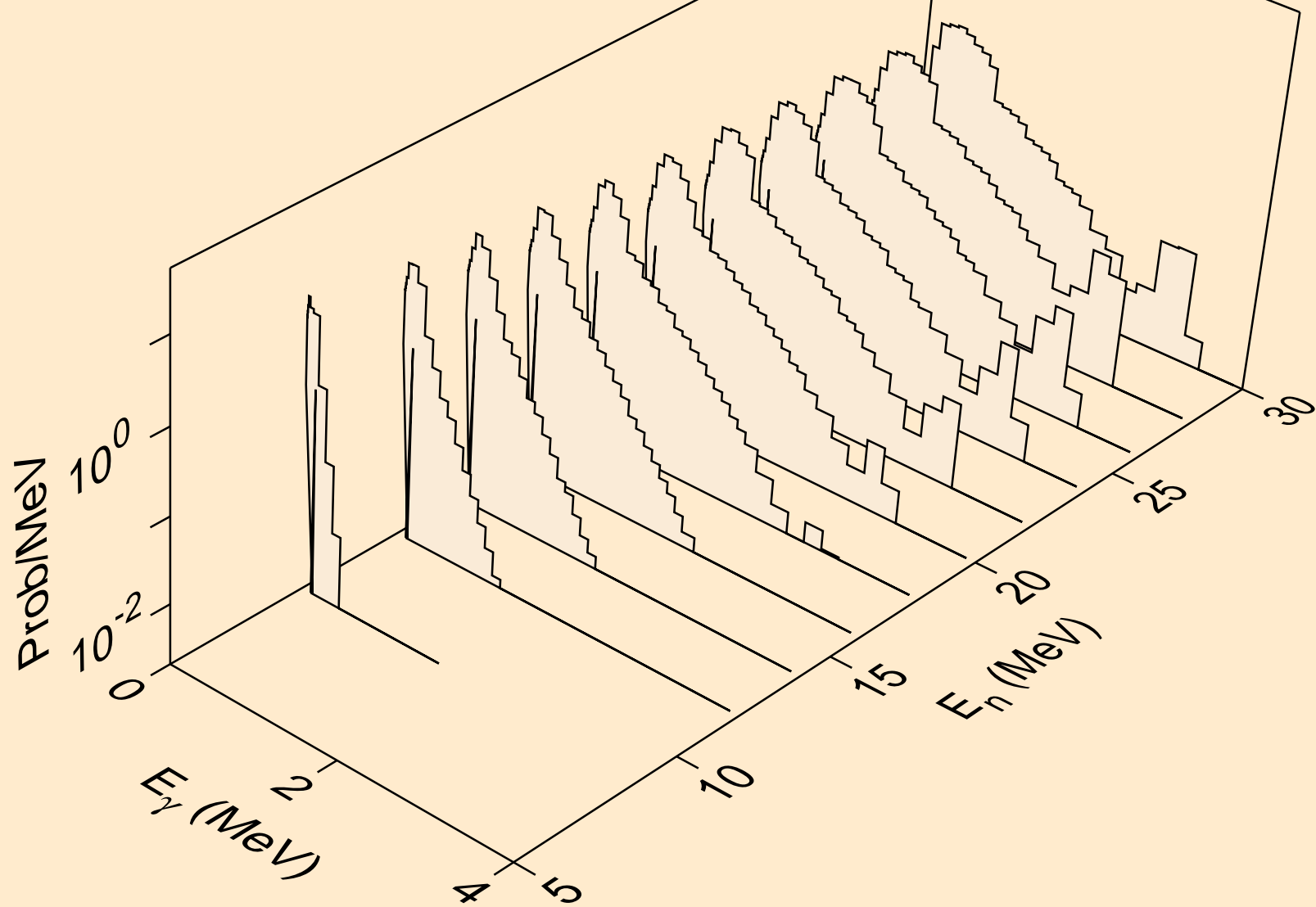

PO226 TRITON ACER TENDL-2021 LIBRARY; T=0.K  
Photon emission for (n,n\*)he3

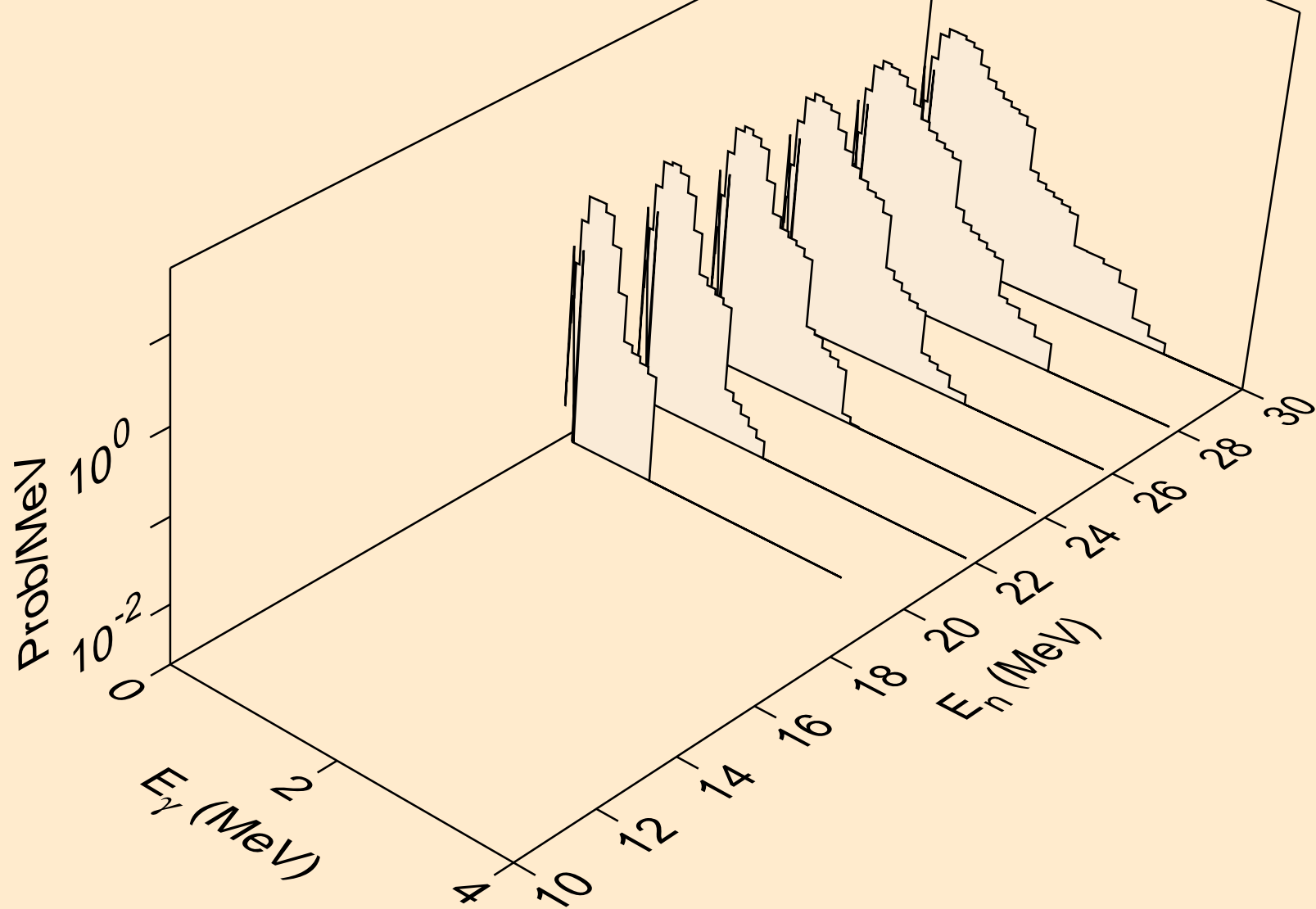

PO226 TRITON ACER TENDL-2021 LIBRARY; T=0.K  
Photon emission for (n,4n)

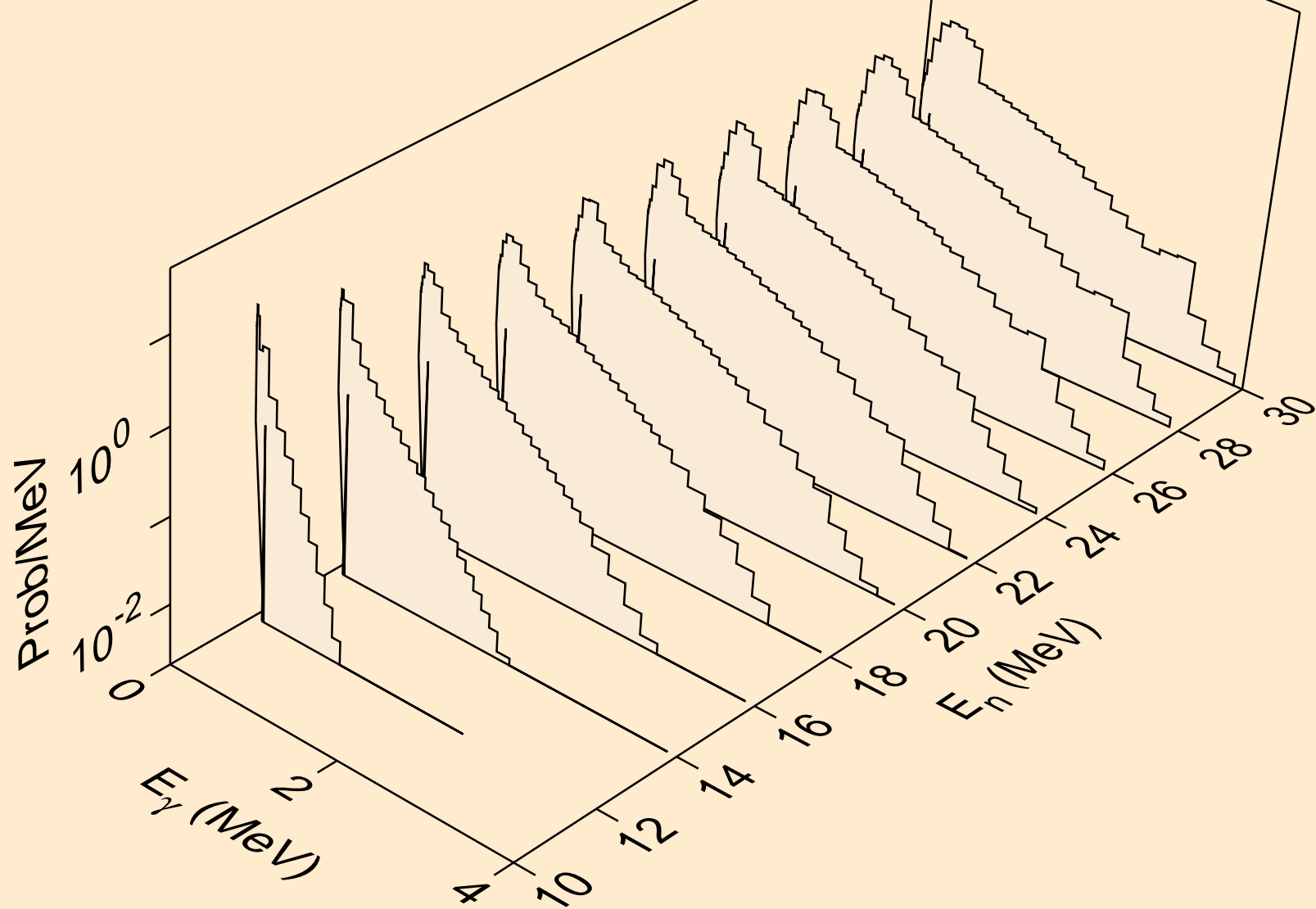

PO226 TRITON ACER TENDL-2021 LIBRARY; T=0.K  
Photon emission for (n,2np)

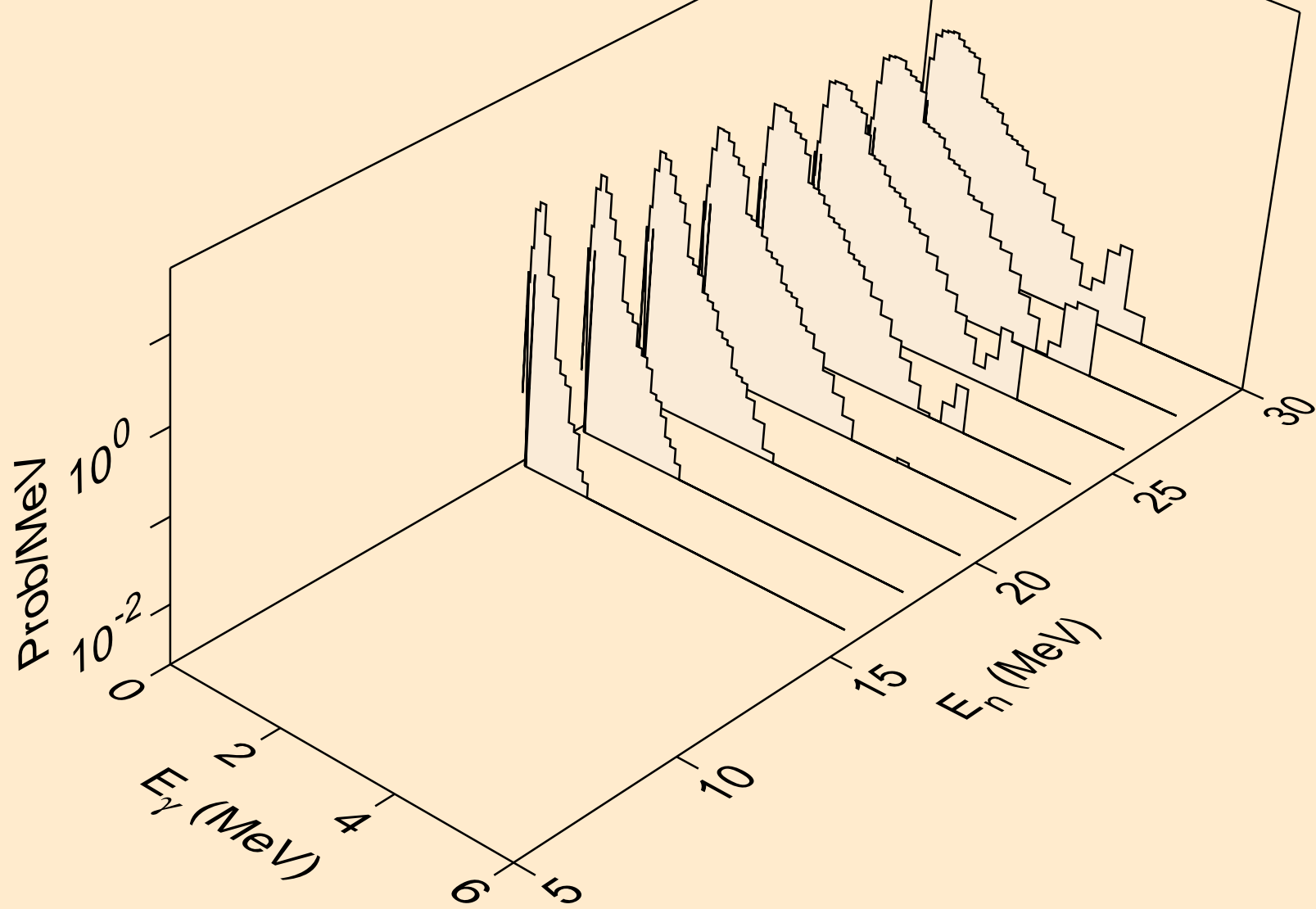

PO226 TRITON ACER TENDL-2021 LIBRARY; T=0.K  
Photon emission for (n,3np)

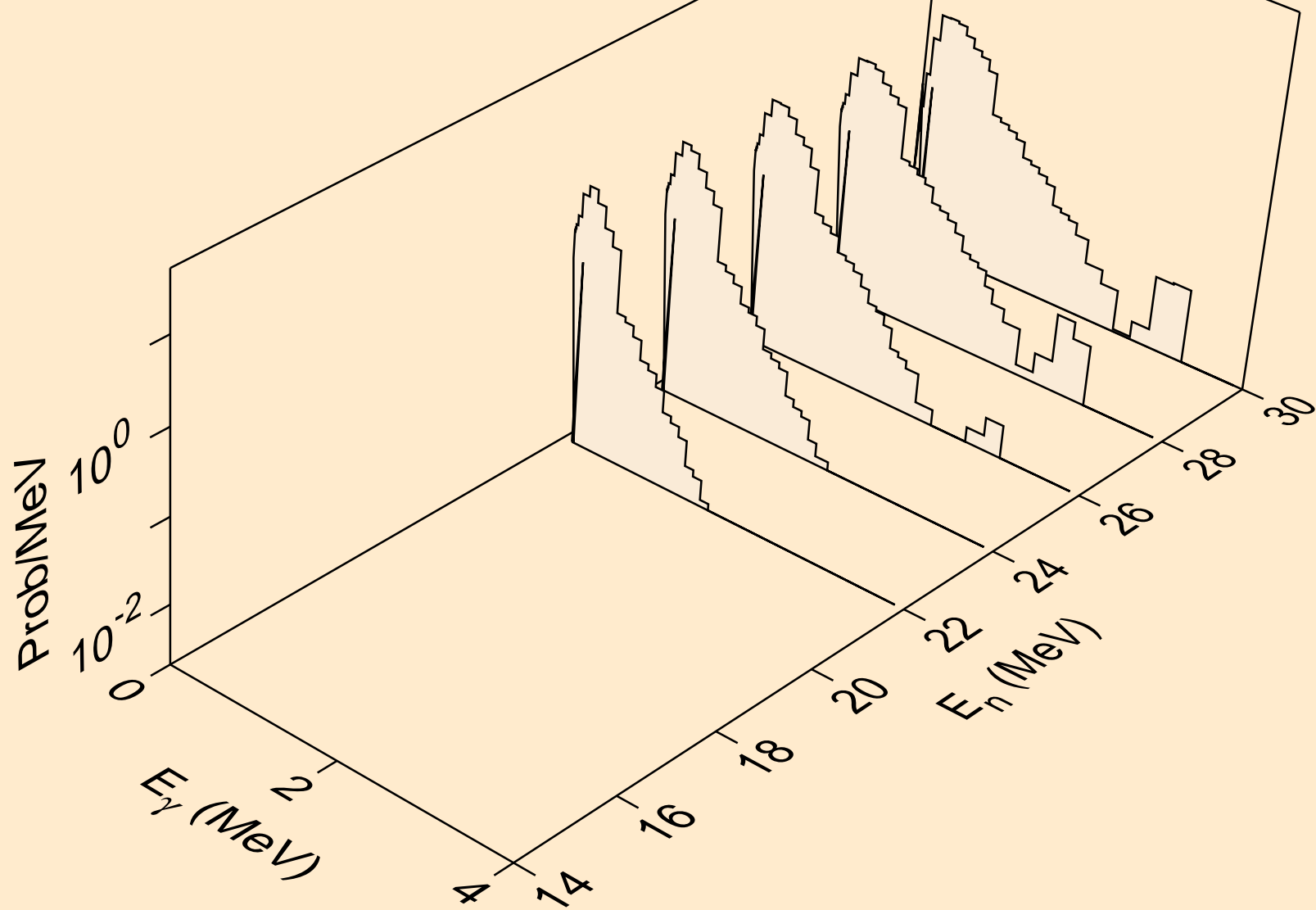

PO226 TRITON ACER TENDL-2021 LIBRARY; T=0.K  
Photon emission for (n,gma)

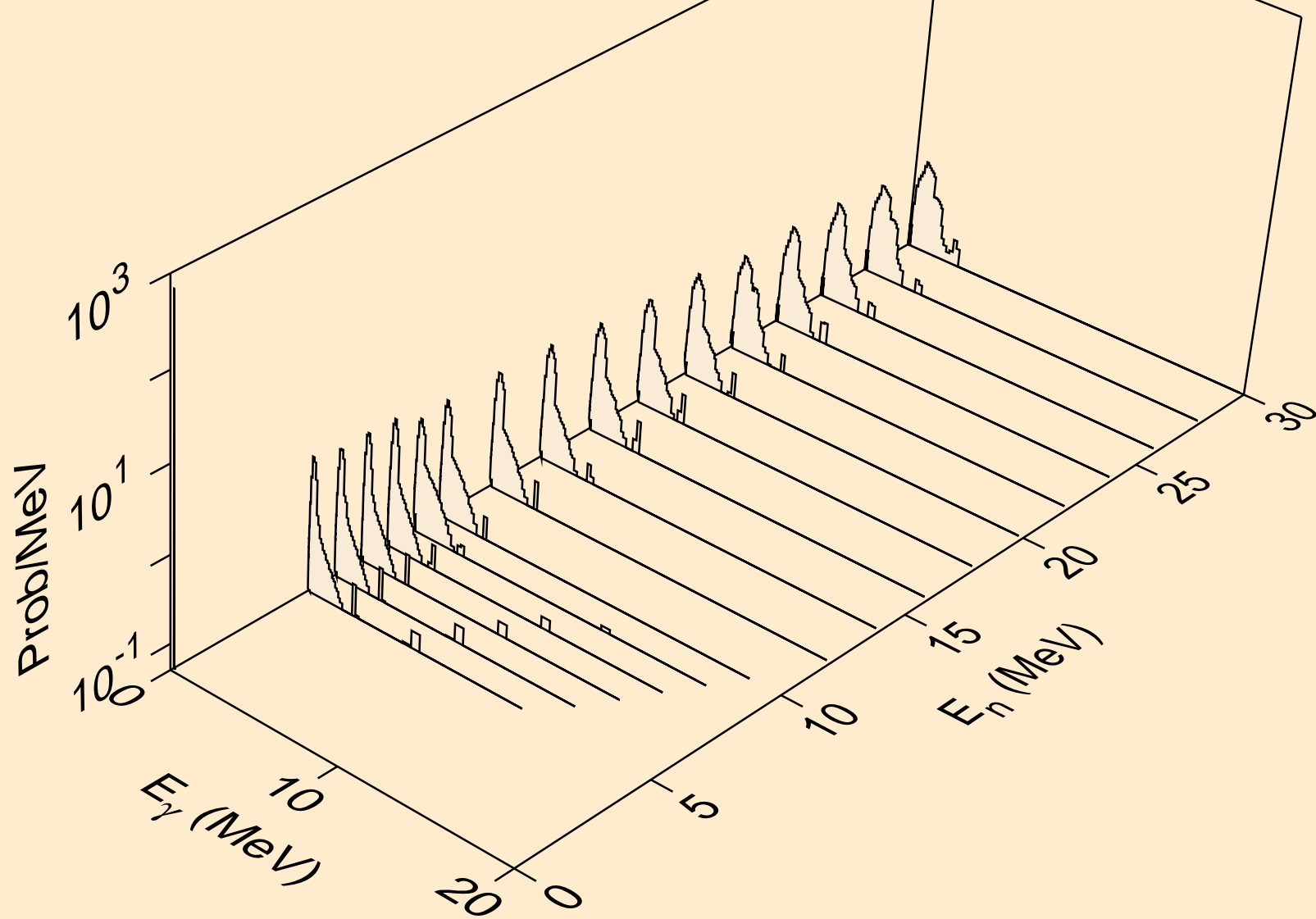

PO226 TRITON ACER TENDL-2021 LIBRARY; T=0.K  
Photon emission for (n,p)

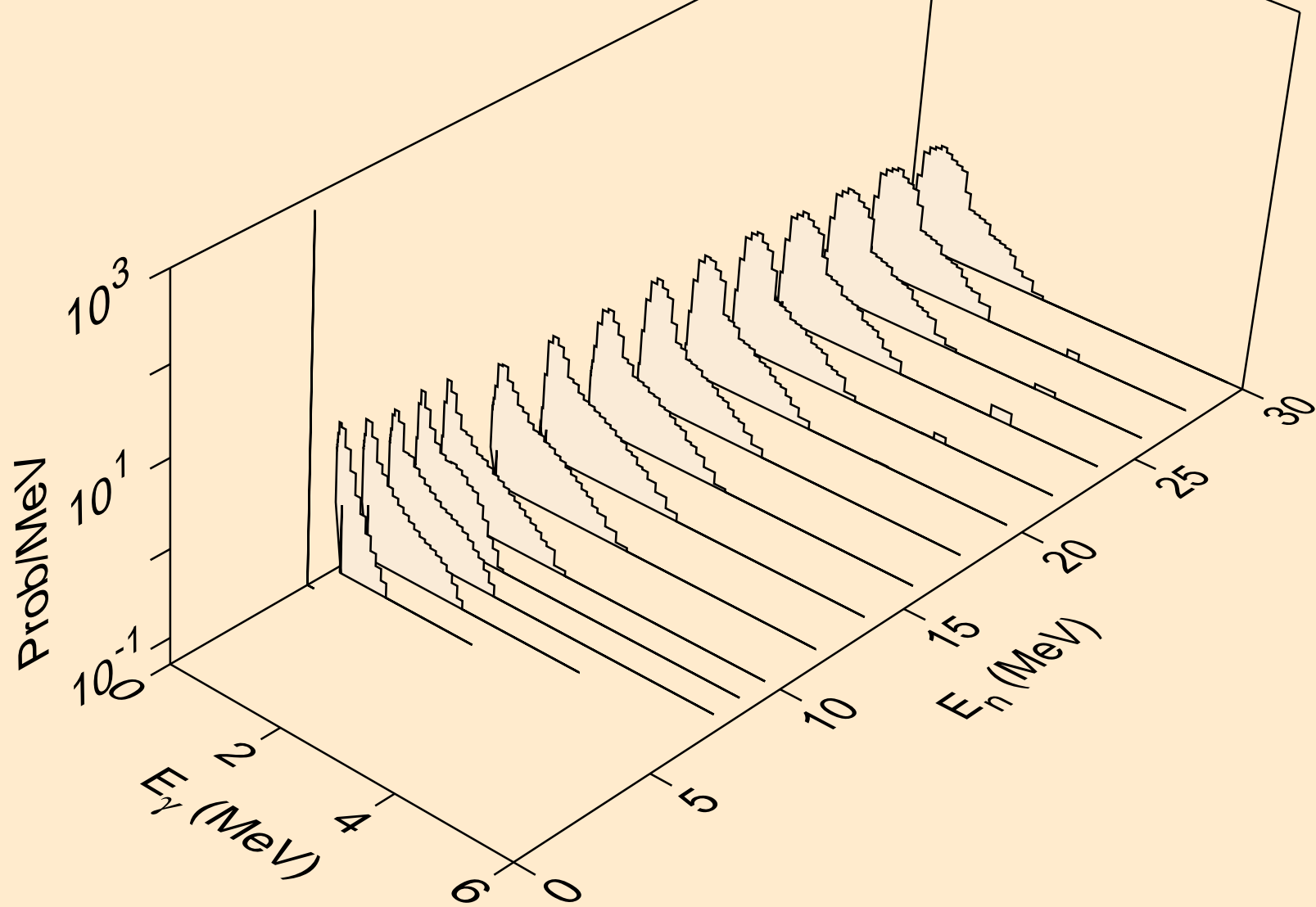



PO226 TRITON ACER TENDL-2021 LIBRARY; T=0.K  
Photon emission for (n,d)

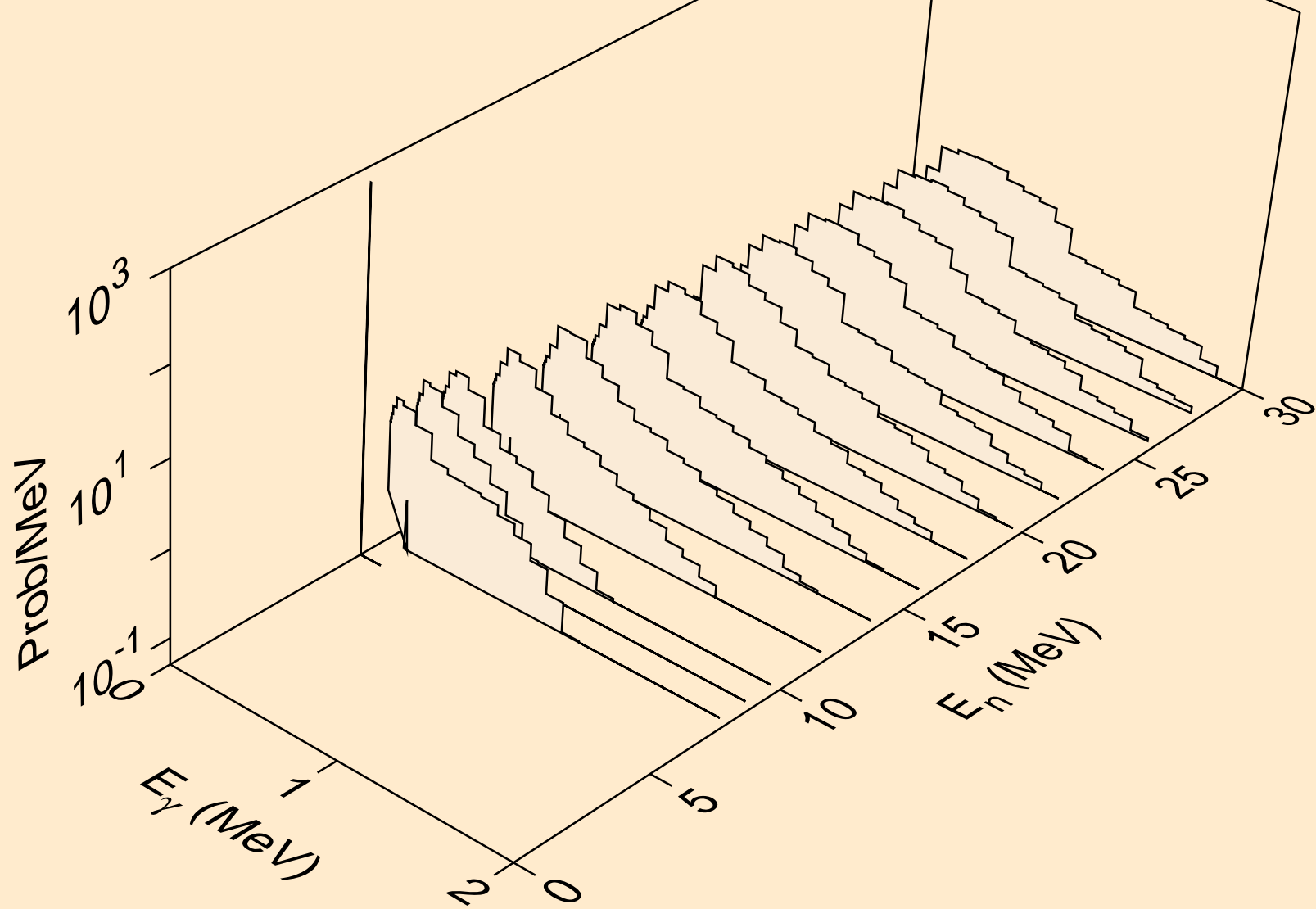

PO226 TRITON ACER TENDL-2021 LIBRARY; T=0.K  
Photon emission for inelastic

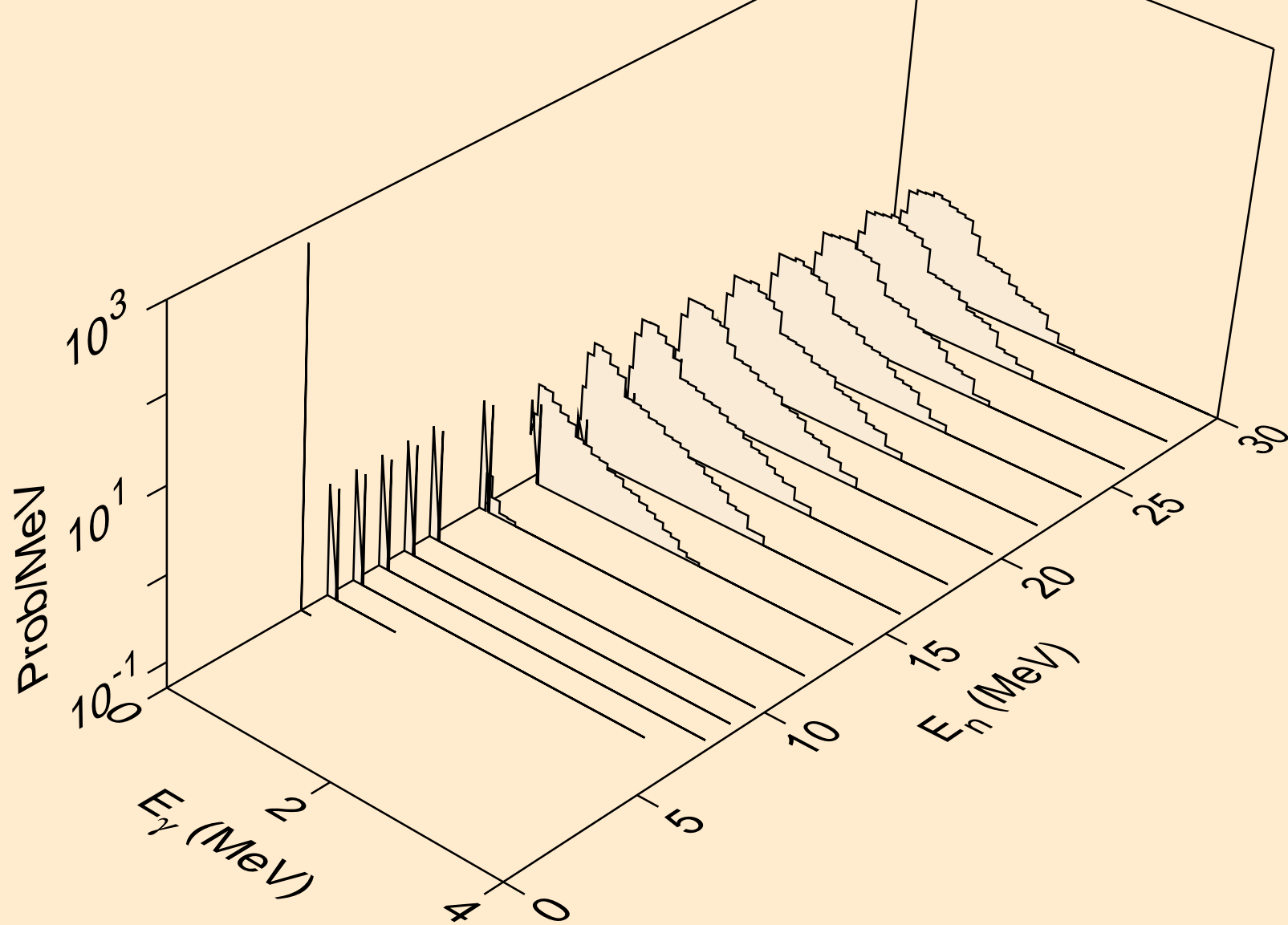

PO226 TRITON ACER TENDL-2021 LIBRARY; T=0.K  
Photon emission for (n,he3)

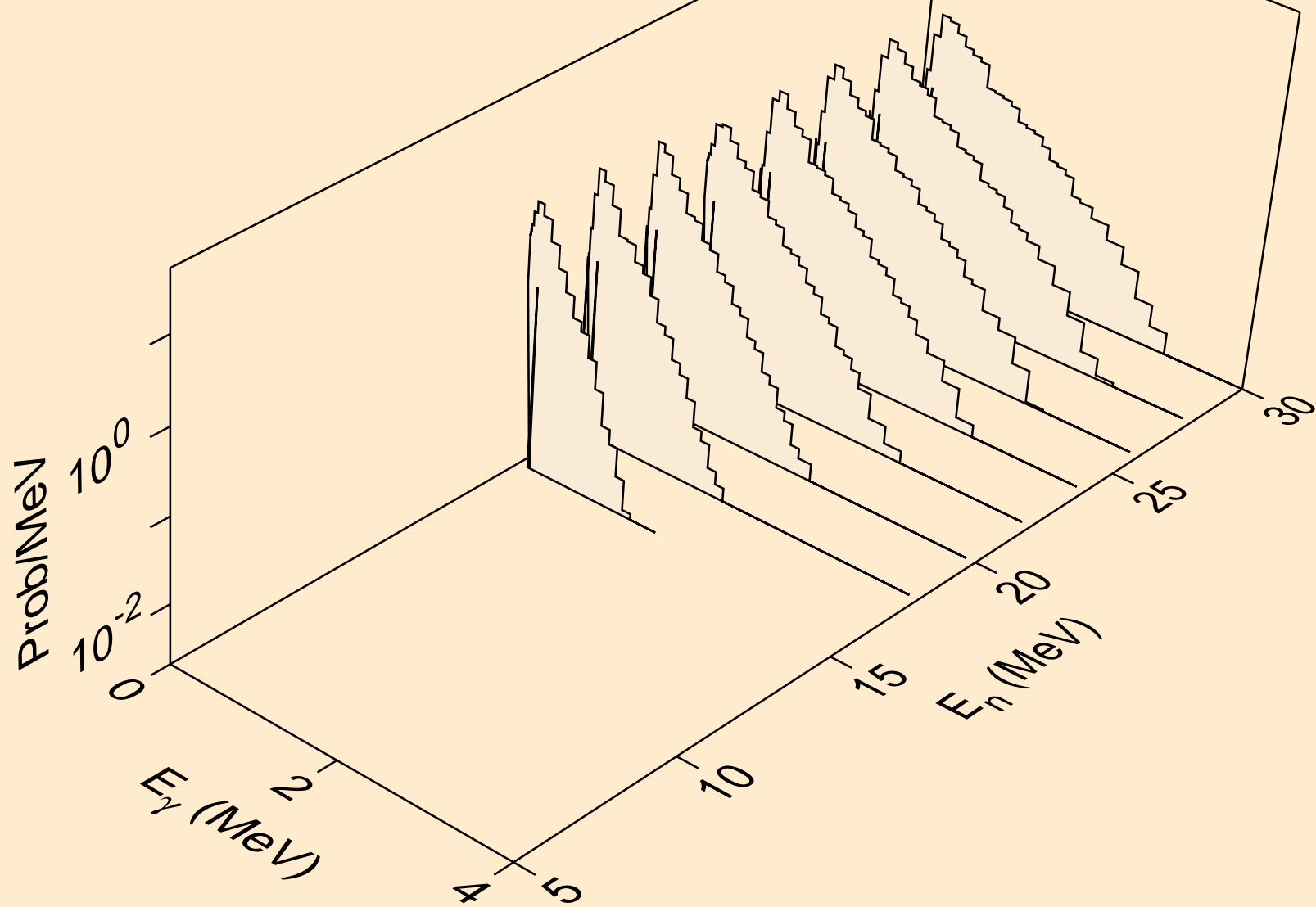

PO226 TRITON ACER TENDL-2021 LIBRARY; T=0.K  
Photon emission for (n,a)

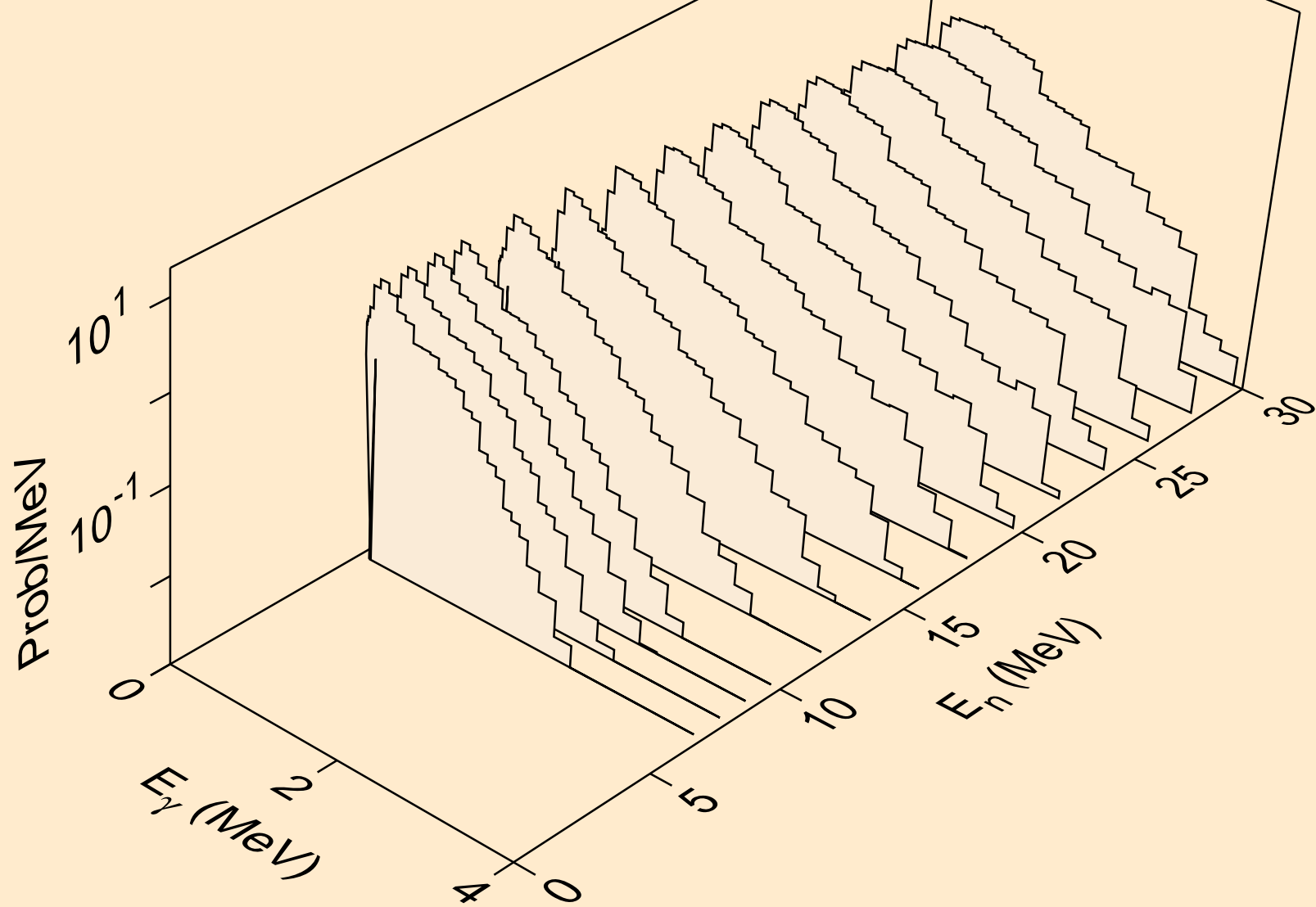

PO226 TRITON ACER TENDL-2021 LIBRARY; T=0.K  
Photon emission for (n,2p)

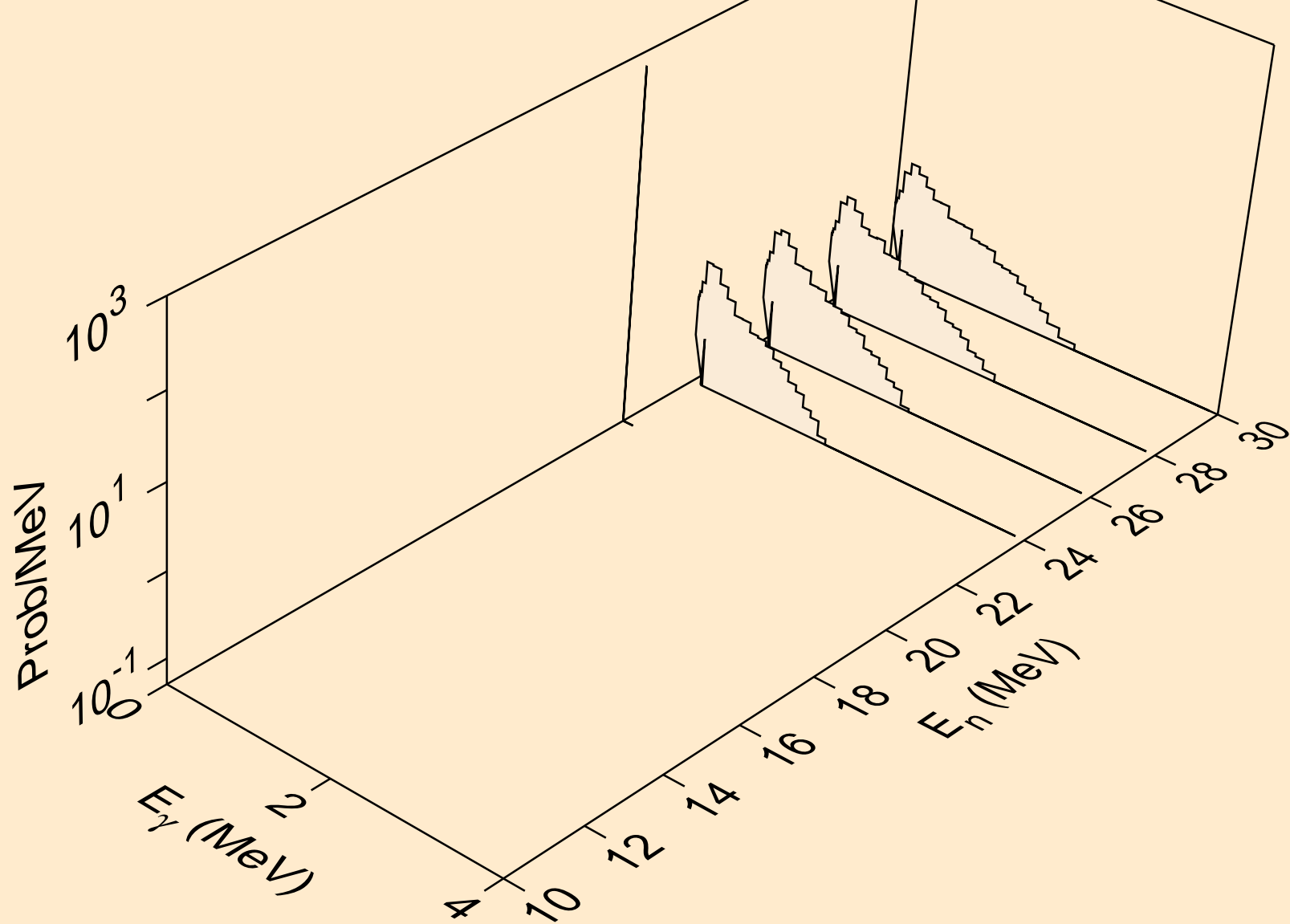

PO226 TRITON ACER TENDL-2021 LIBRARY; T=0.K  
Particle heating contributions

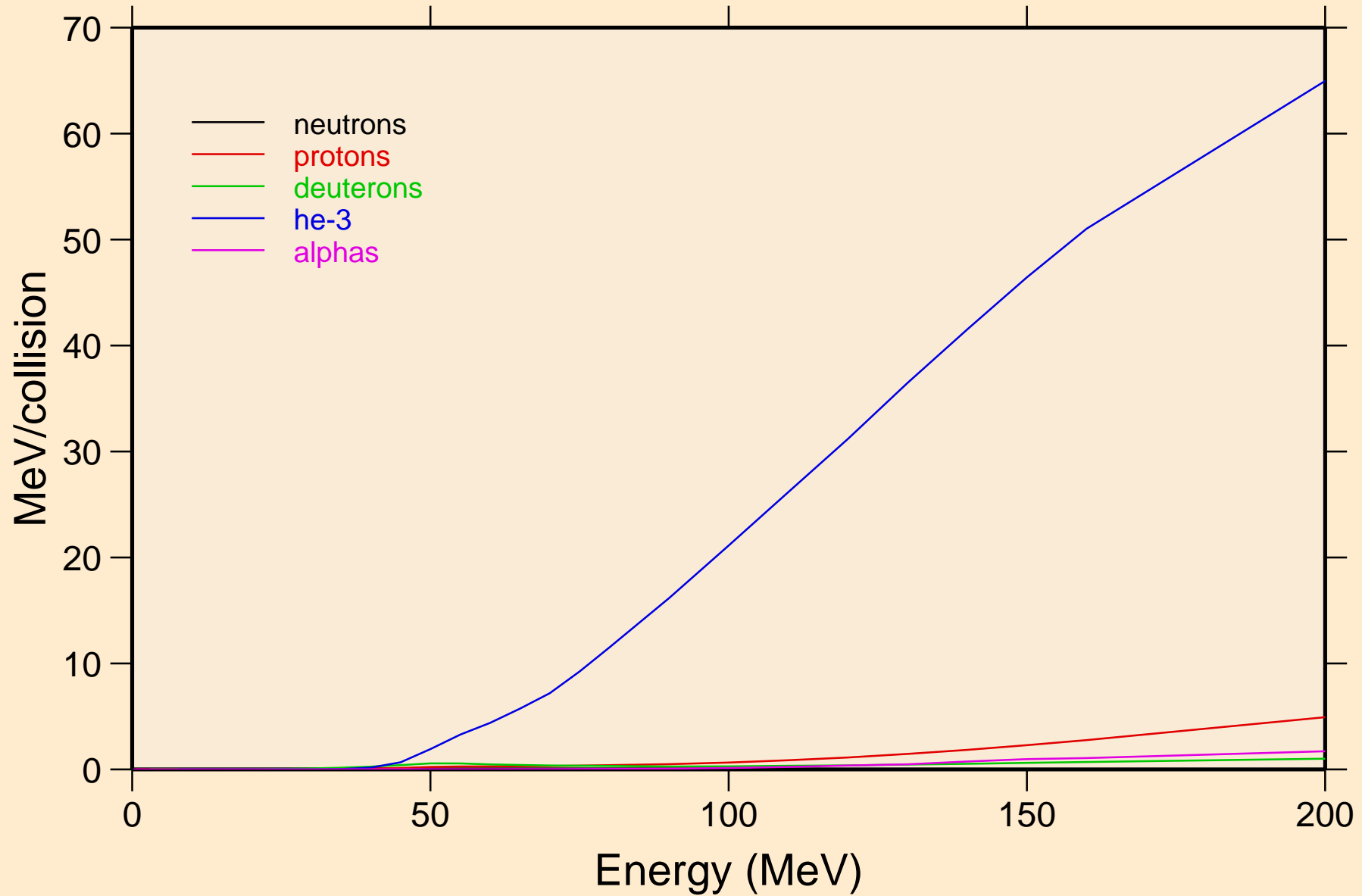

PO226 TRITON ACER TENDL-2021 LIBRARY; T=0.K  
Recoil Heating

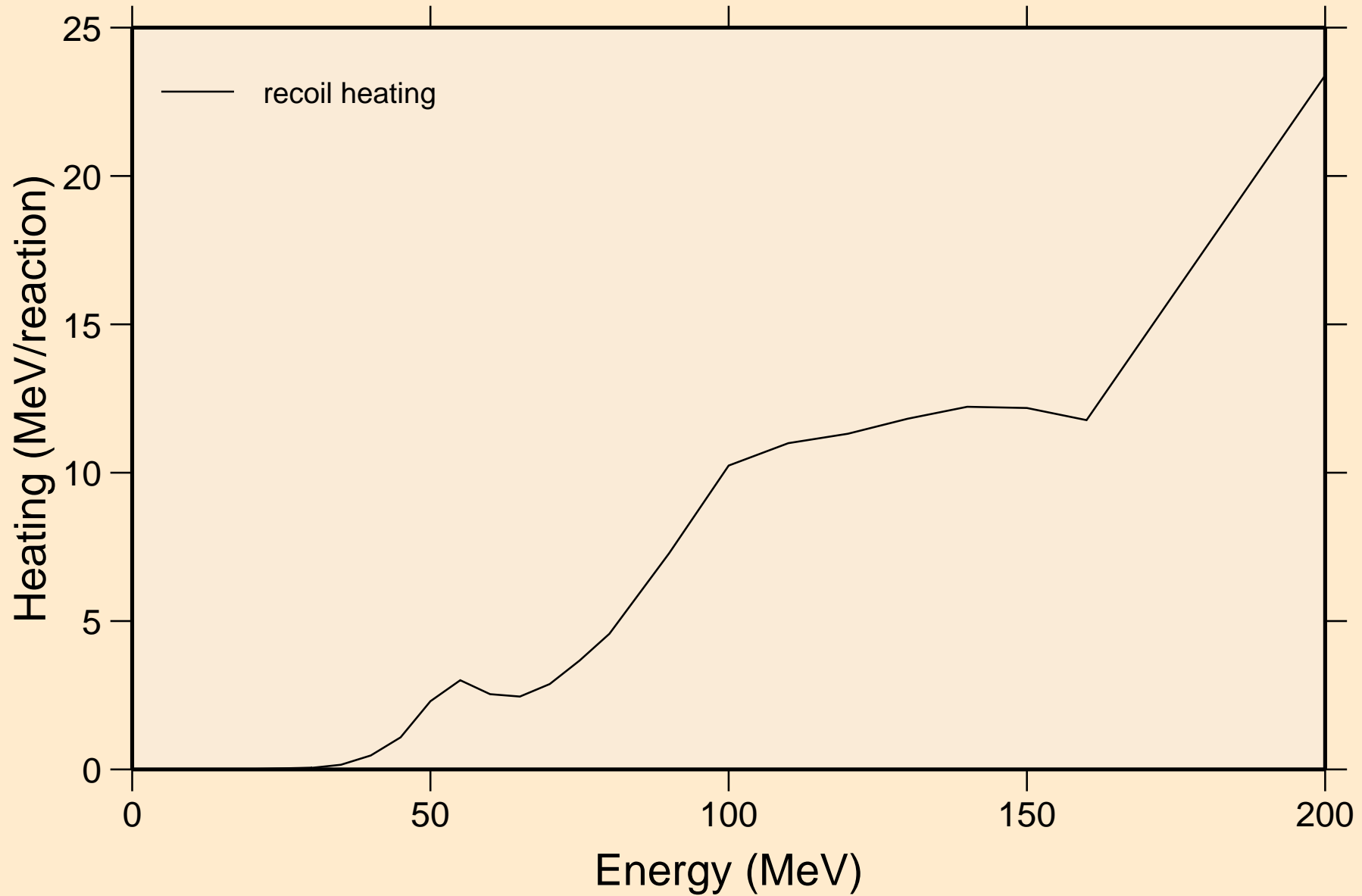

PO226 TRITON ACER TENDL-2021 LIBRARY; T=0.K  
Particle production cross sections

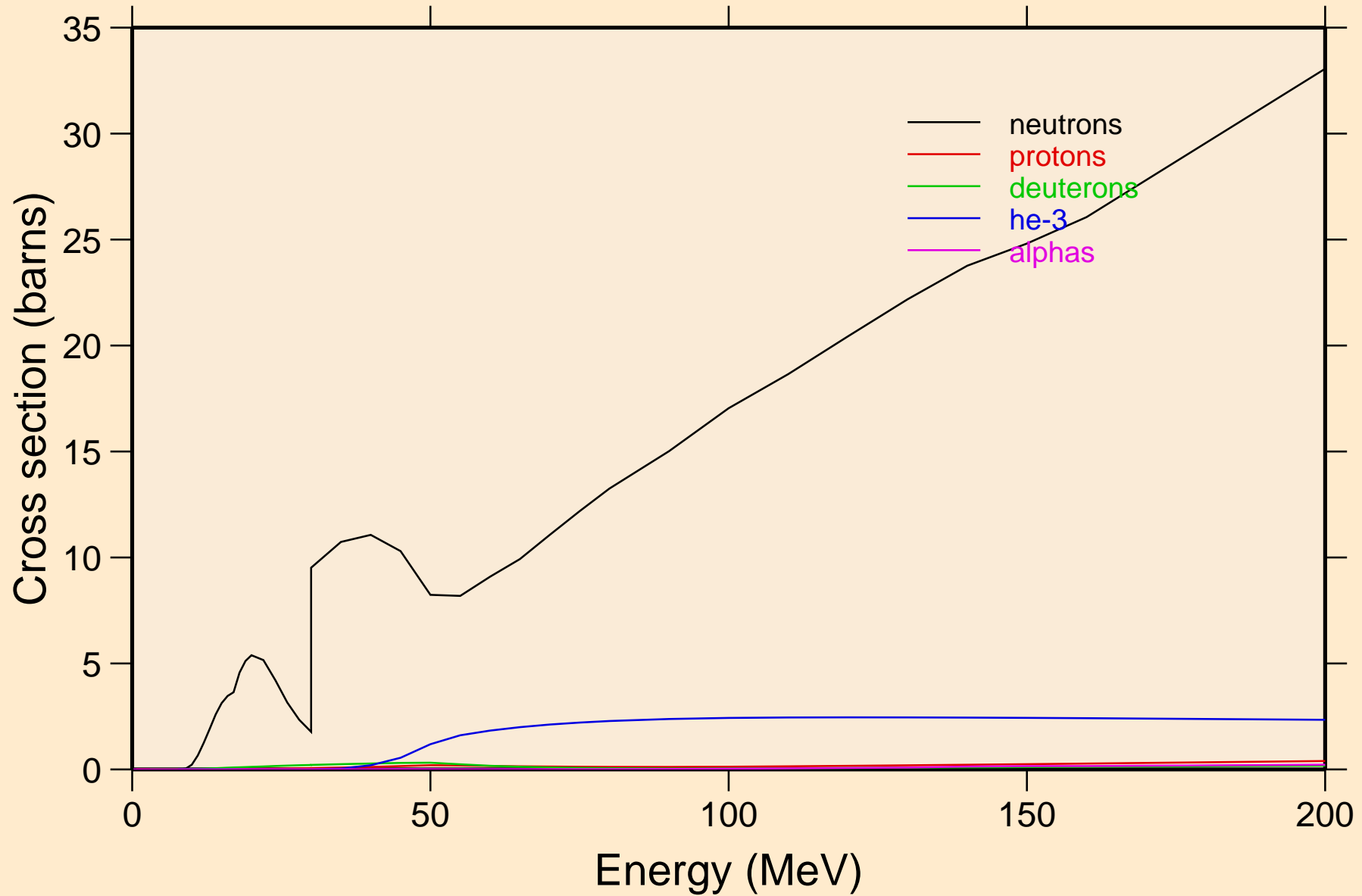



PO226 TRITON ACER TENDL-2021 LIBRARY; T=0.K  
neutrons from (t,n)

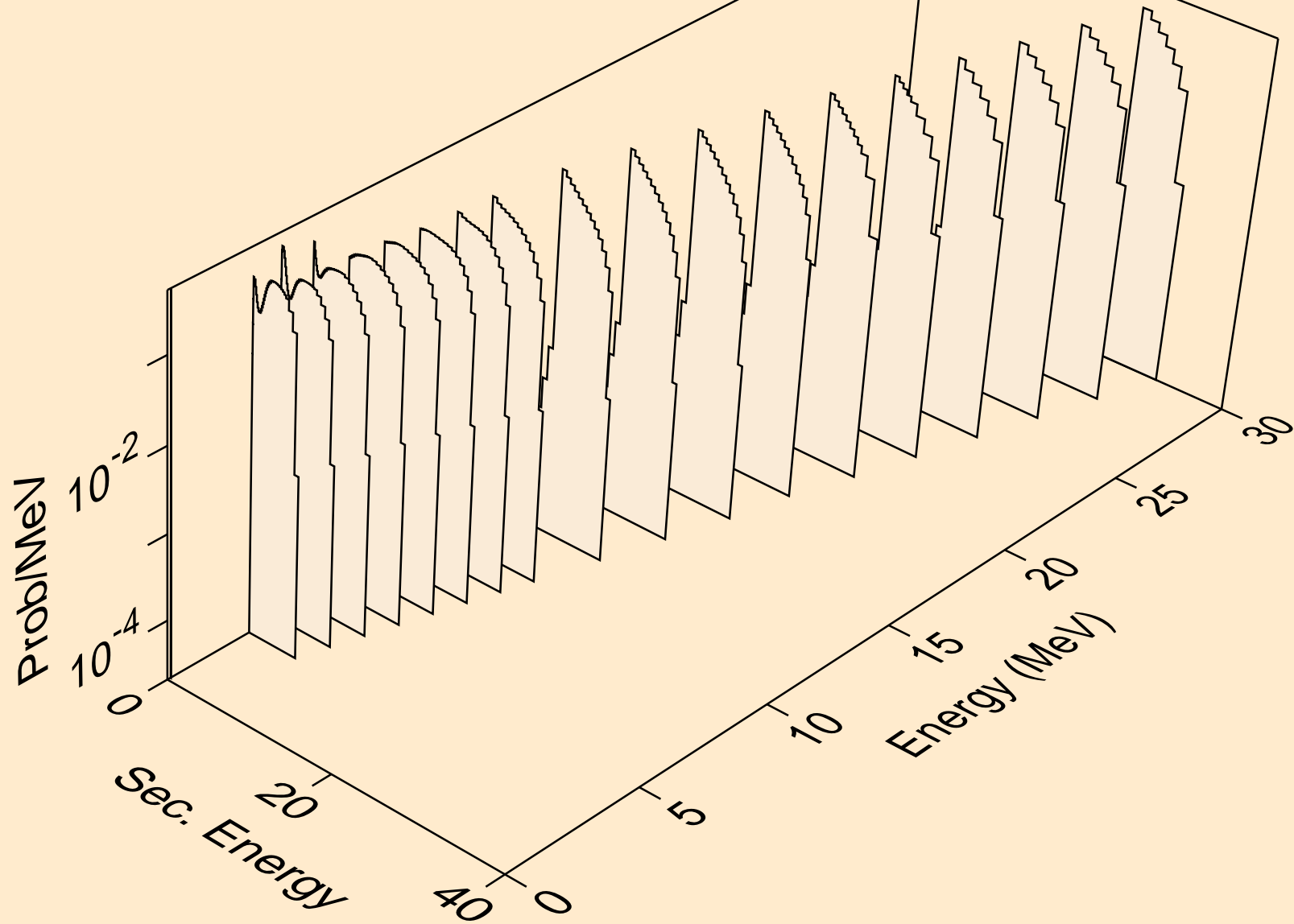

PO226 TRITON ACER TENDL-2021 LIBRARY; T=0.K  
neutrons from (t,x)

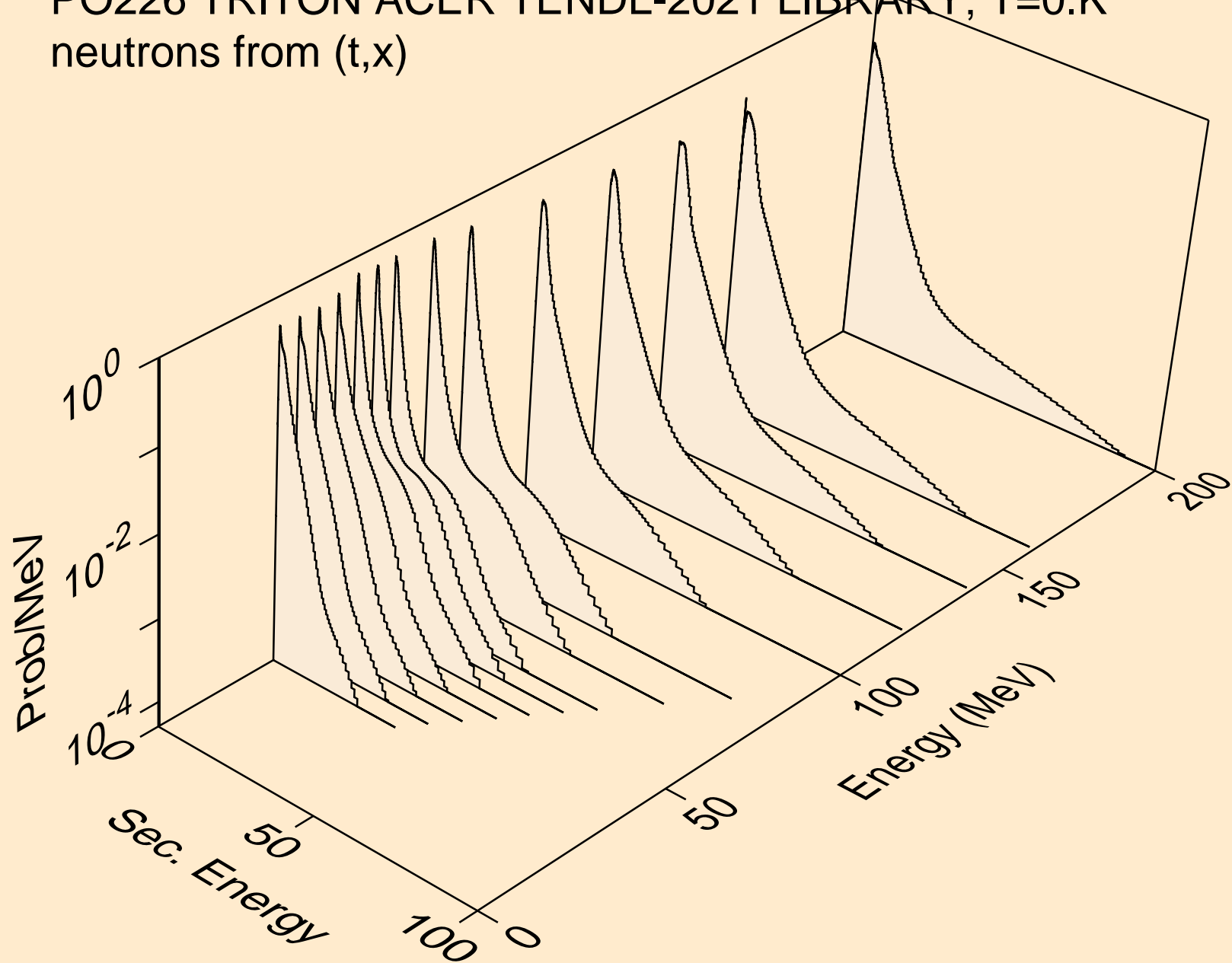

PO226 TRITON ACER TENDL-2021 LIBRARY; T=0.K  
neutrons from (t,2nd)

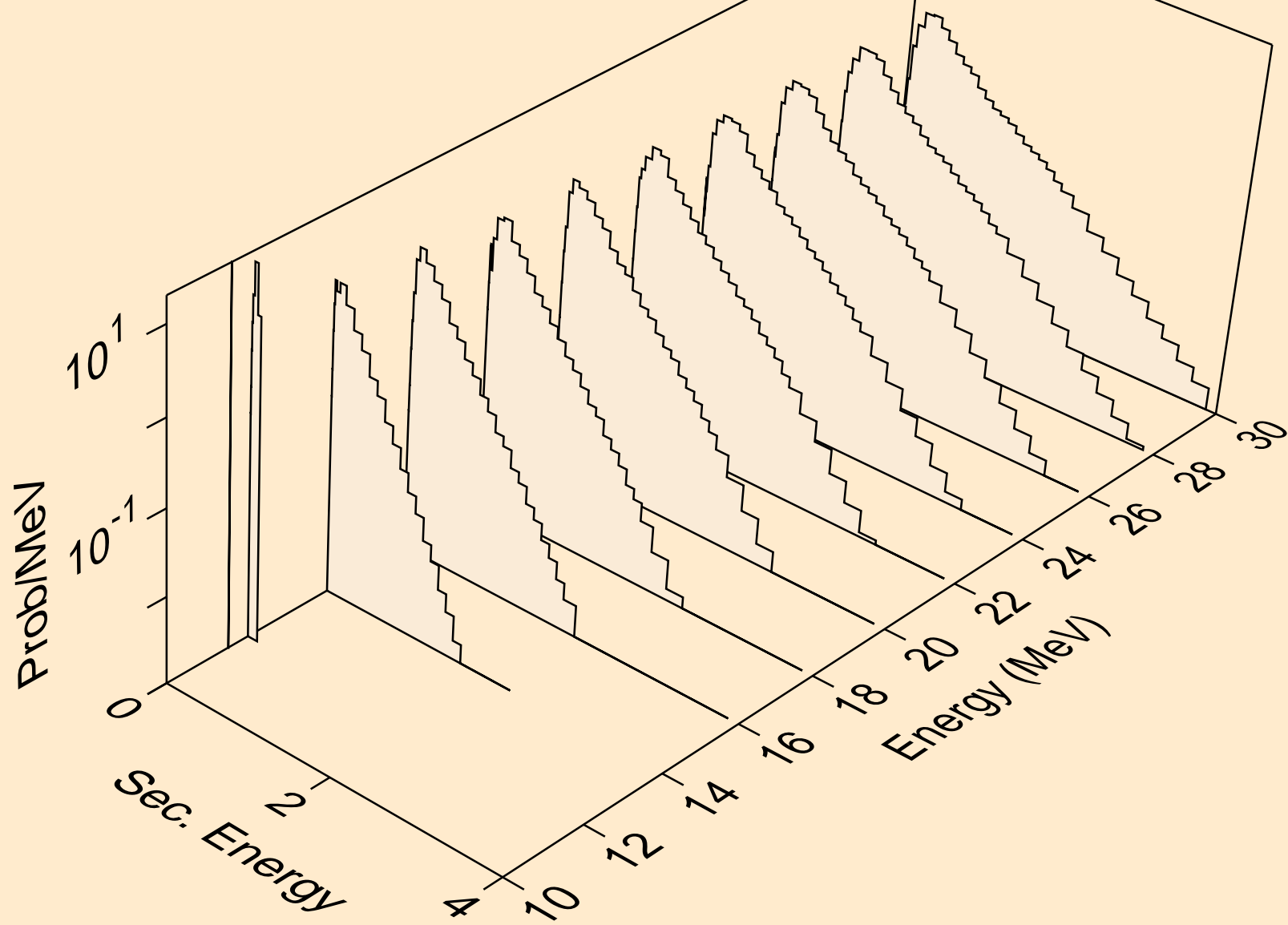

PO226 TRITON ACER TENDL-2021 LIBRARY; T=0.K  
neutrons from (t,2n)

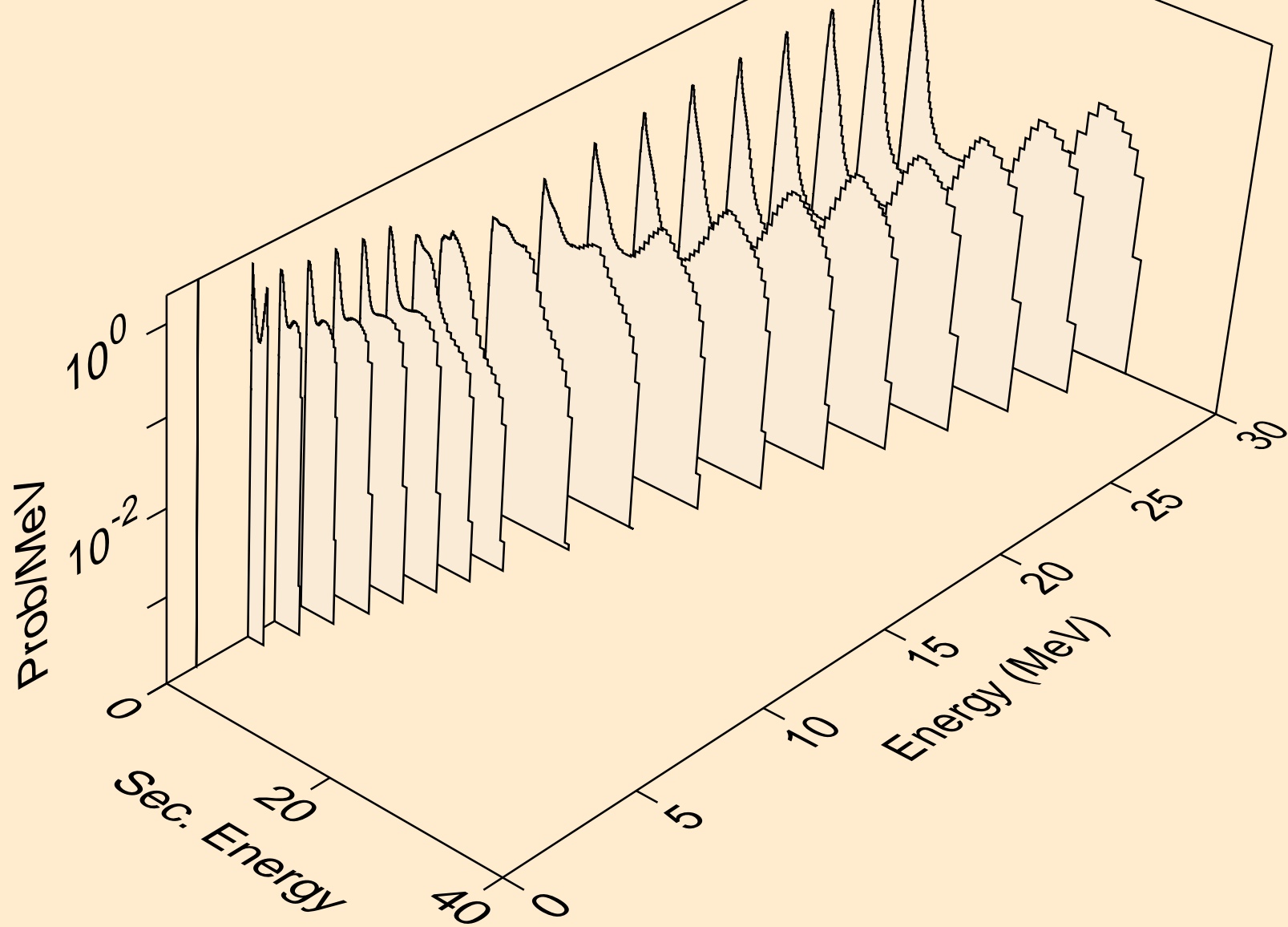

PO226 TRITON ACER TENDL-2021 LIBRARY; T=0.K  
neutrons from (t,3n)

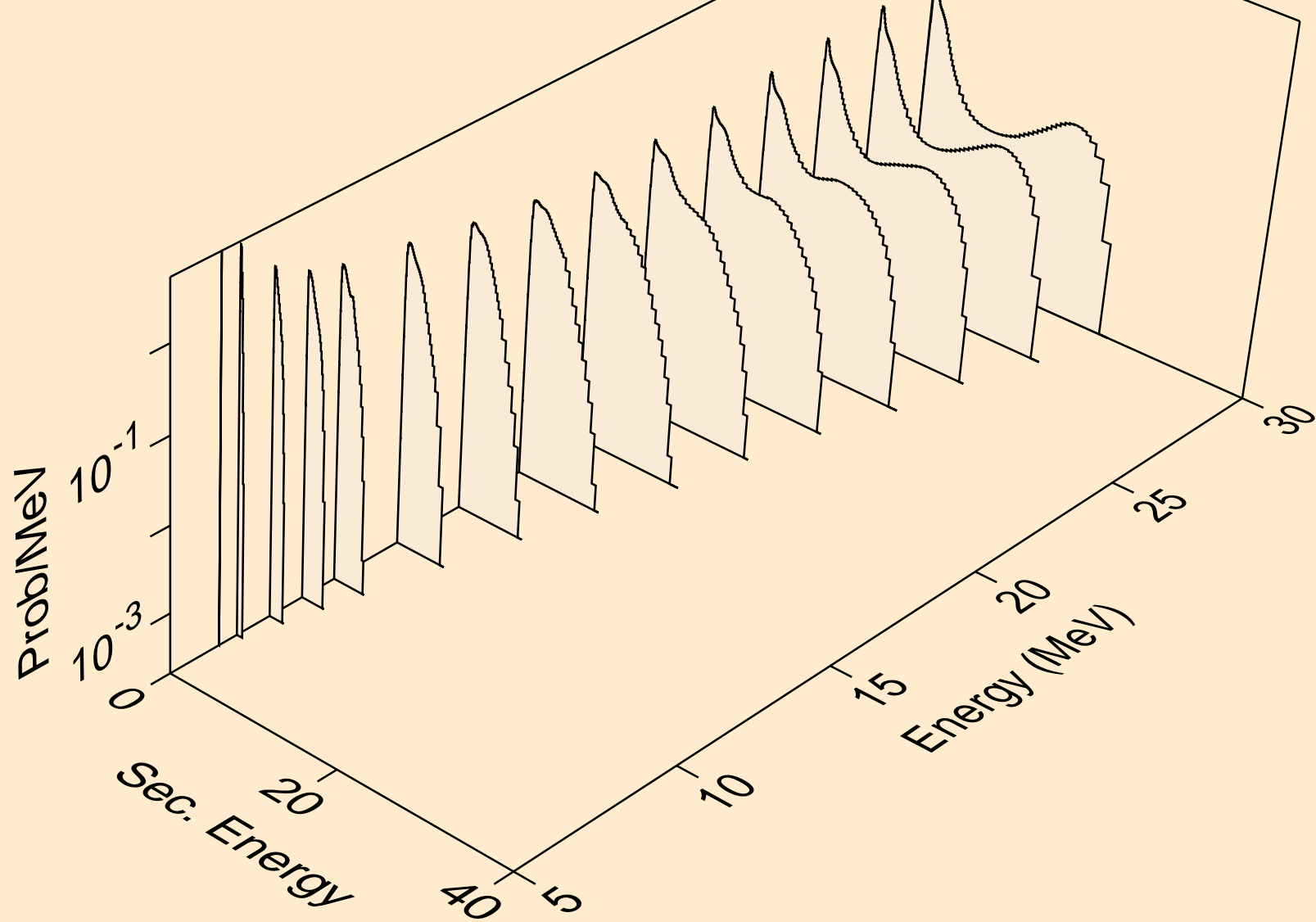

PO226 TRITON ACER TENDL-2021 LIBRARY; T=0.K  
neutrons from (t,n\*)a

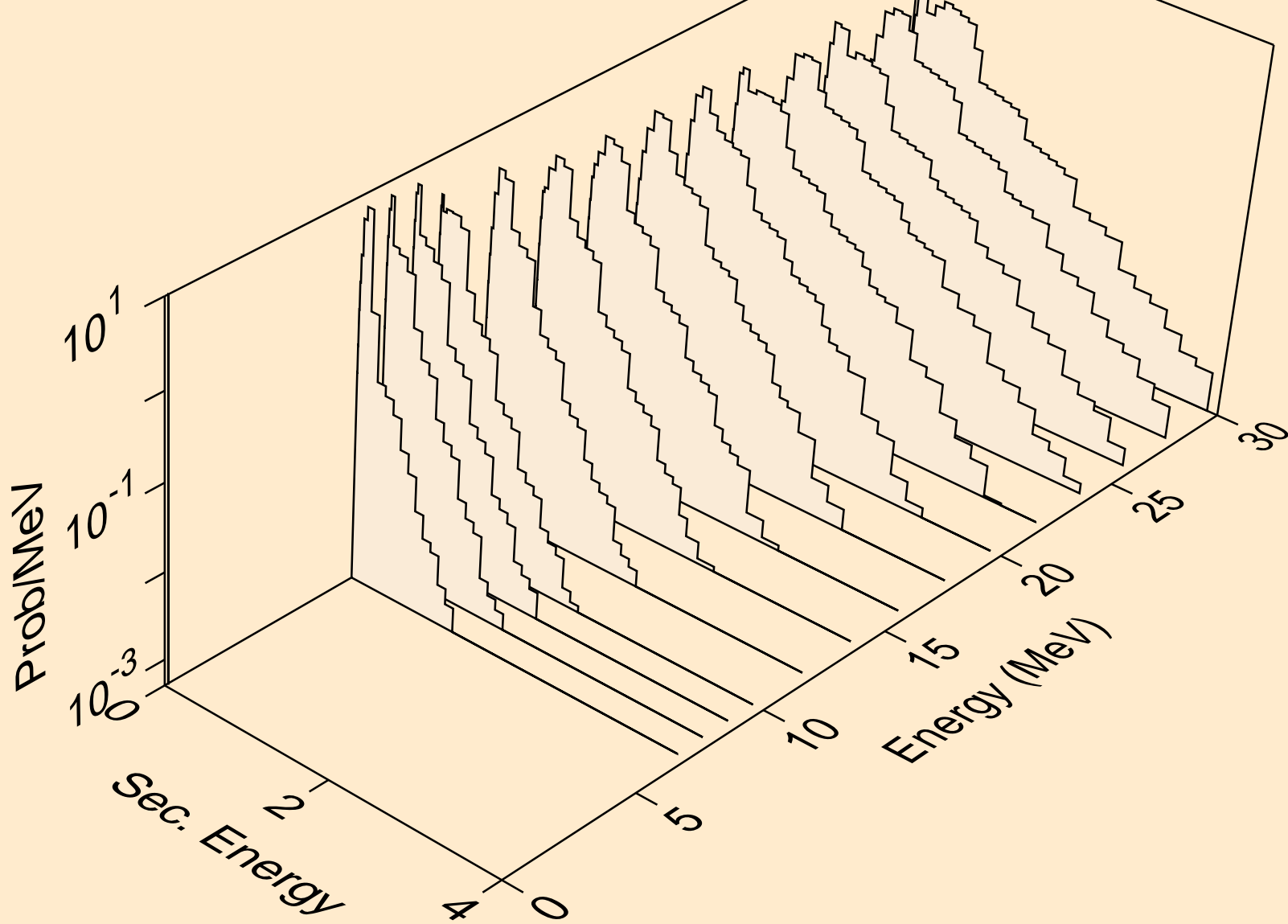

PO226 TRITON ACER TENDL-2021 LIBRARY; T=0.K  
neutrons from (t,2n)a

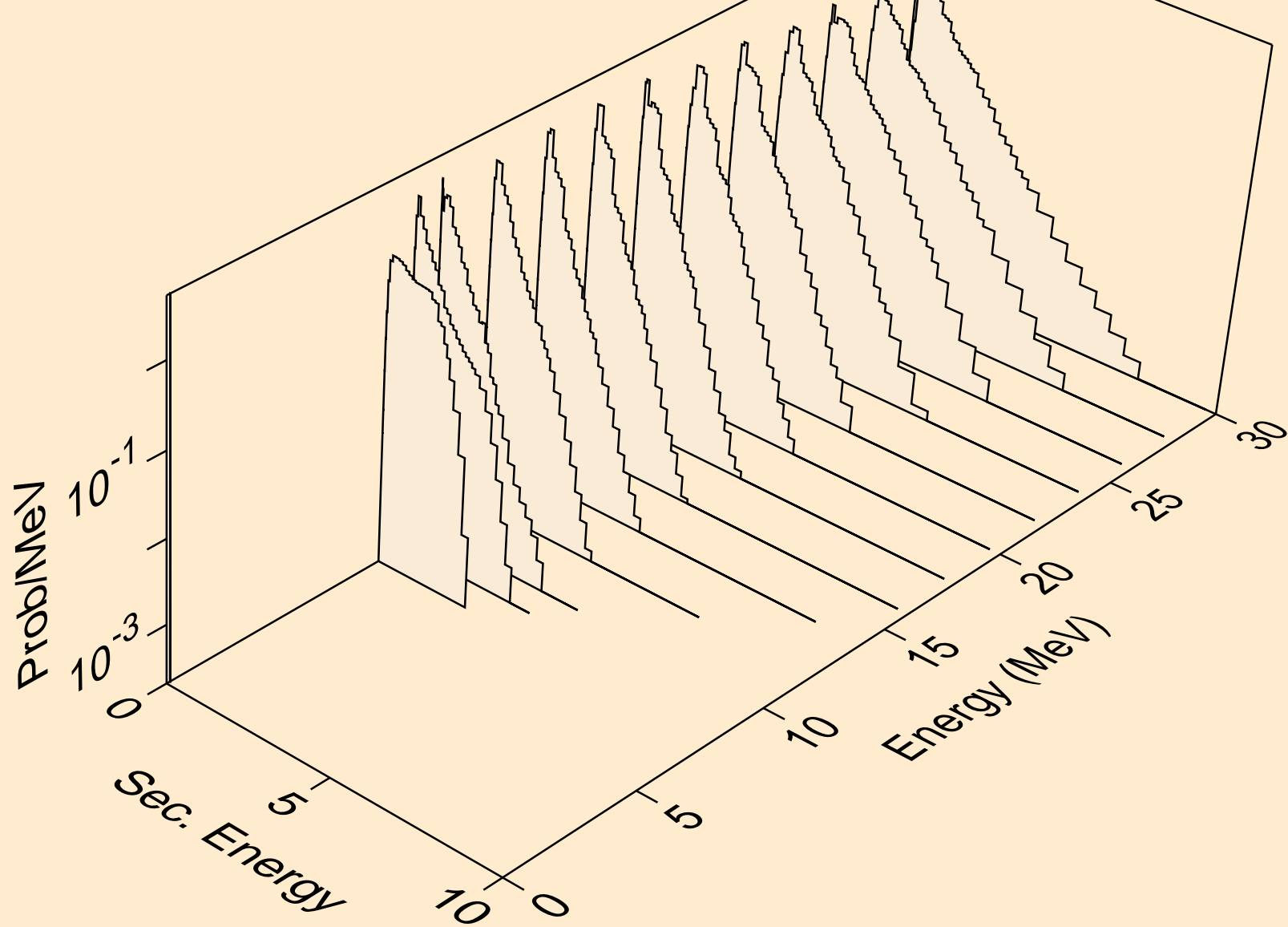

PO226 TRITON ACER TENDL-2021 LIBRARY; T=0.K  
neutrons from (t,3n)a

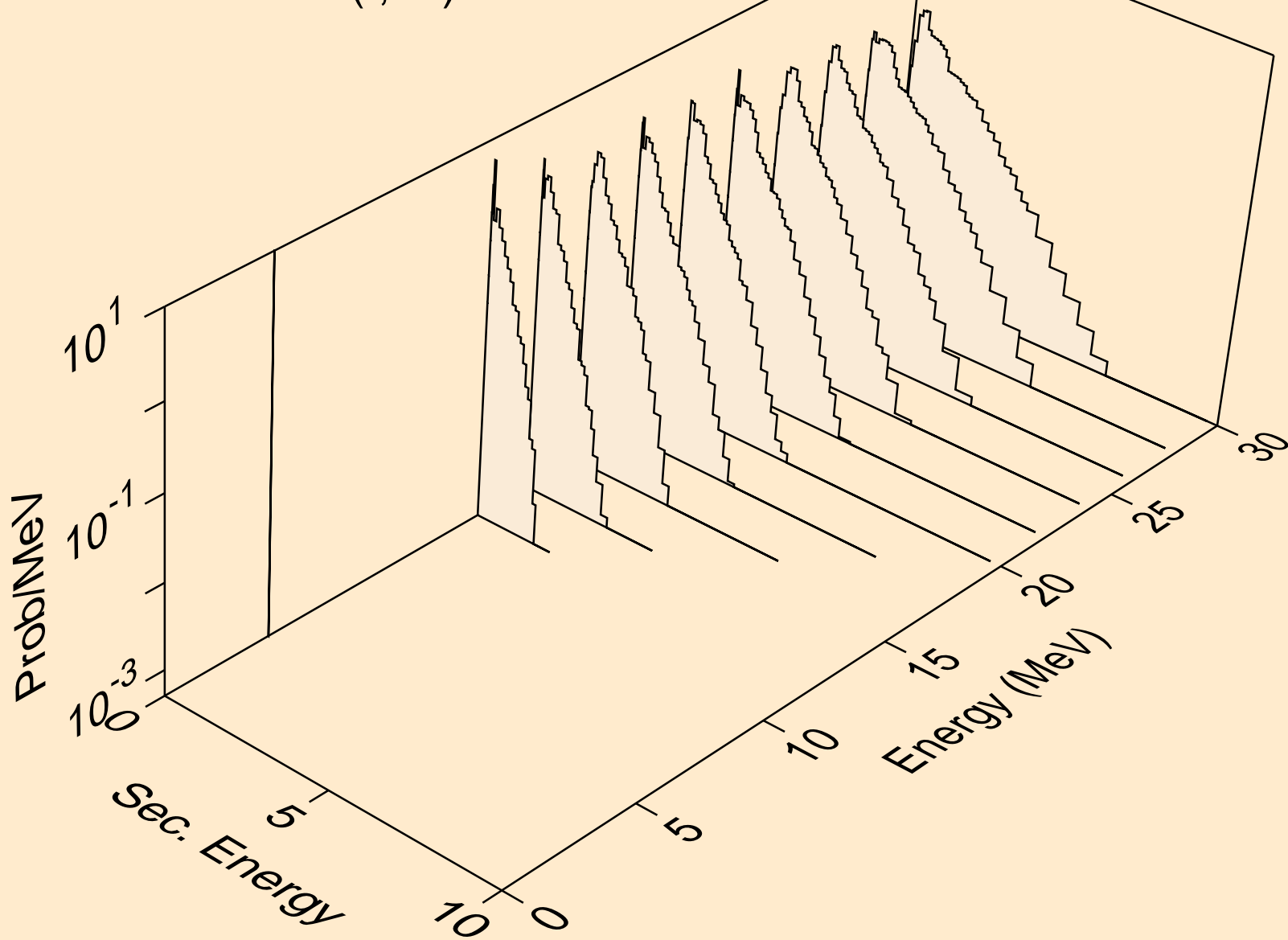



PO226 TRITON ACER TENDL-2021 LIBRARY; T=0.K  
neutrons from (t,n\*)p

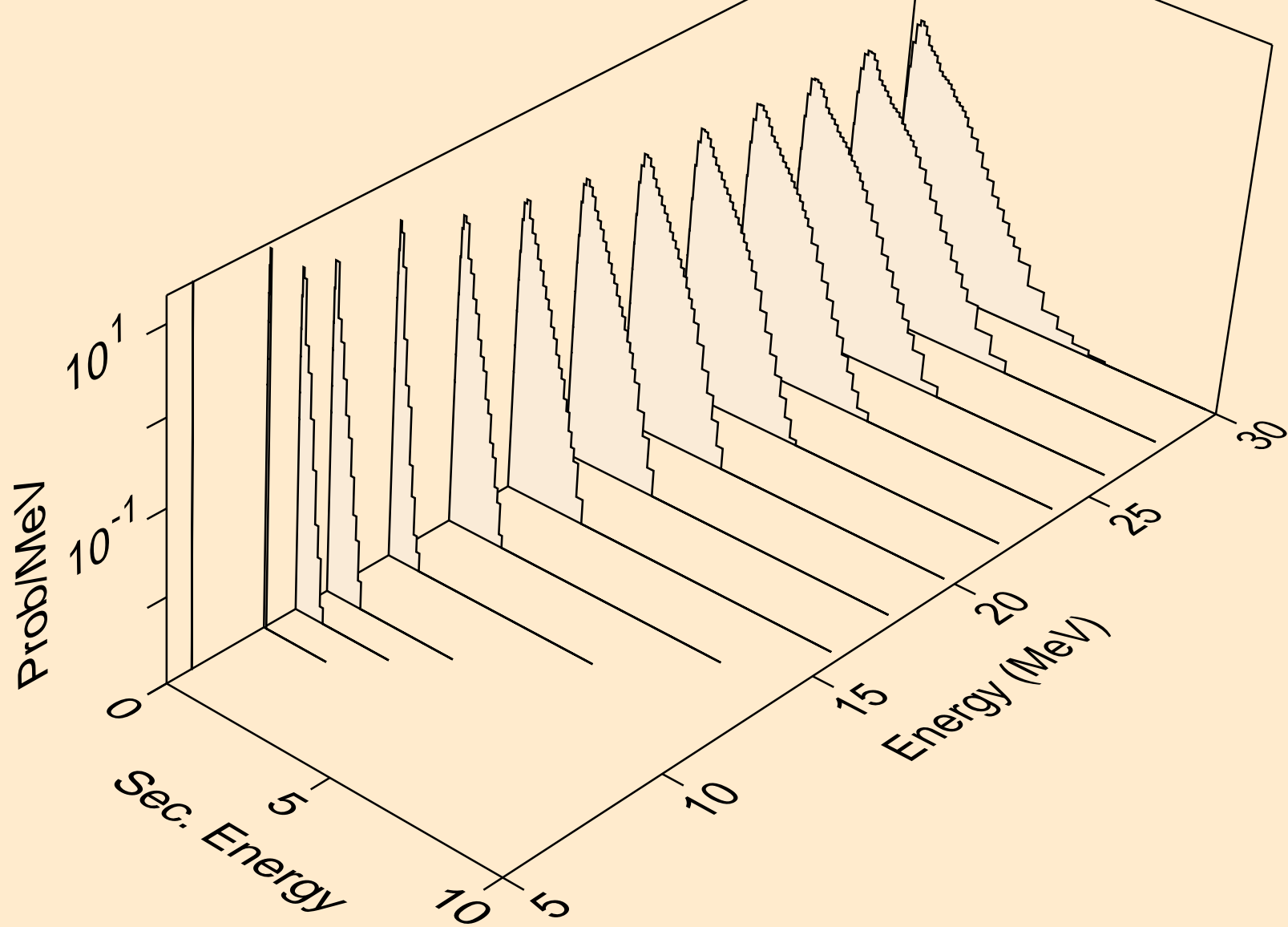

PO226 TRITON ACER TENDL-2021 LIBRARY; T=0.K  
neutrons from (t,n\*)d

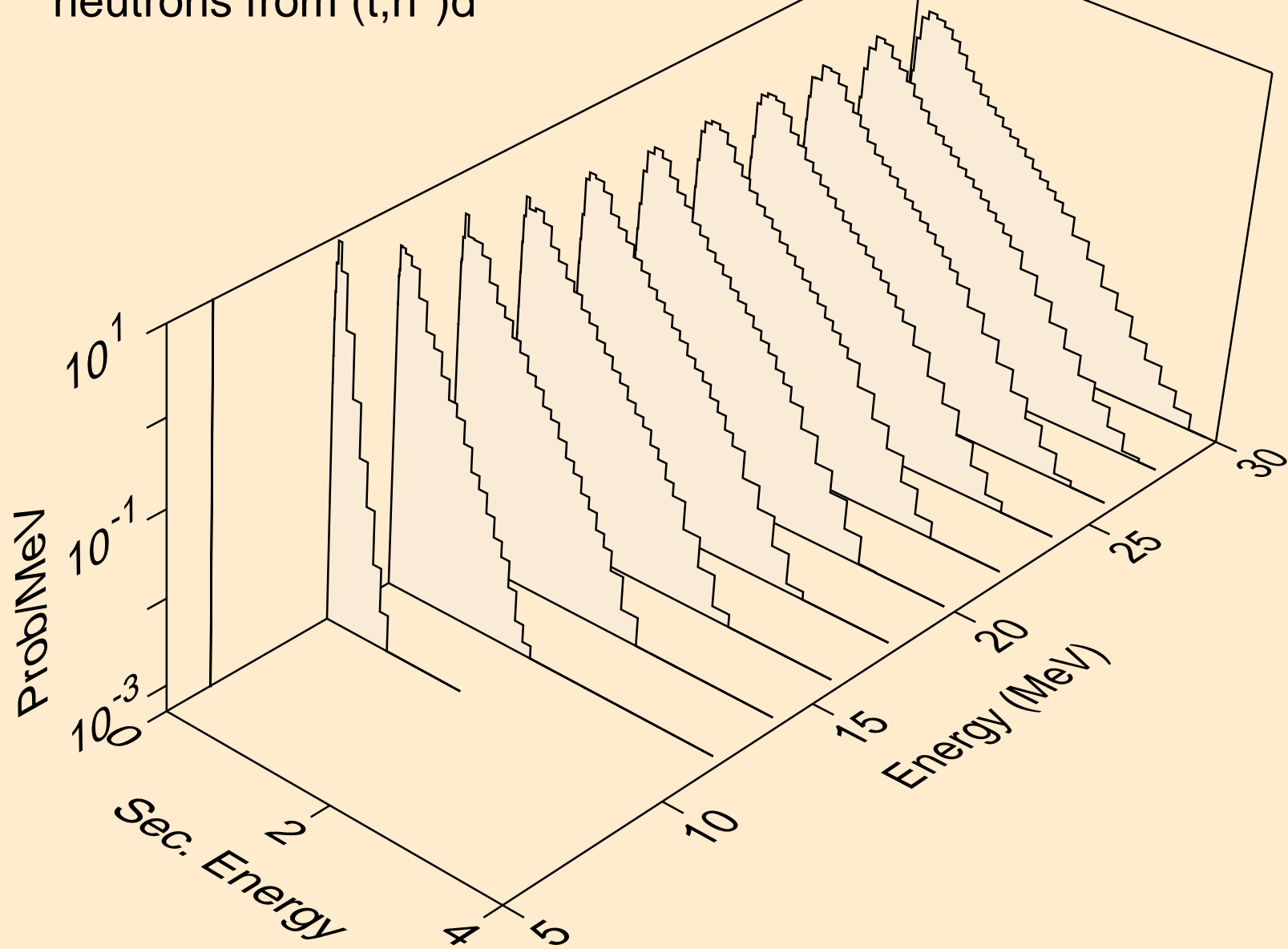

PO226 TRITON ACER TENDL-2021 LIBRARY; T=0.K  
neutrons from (t,n\*)t

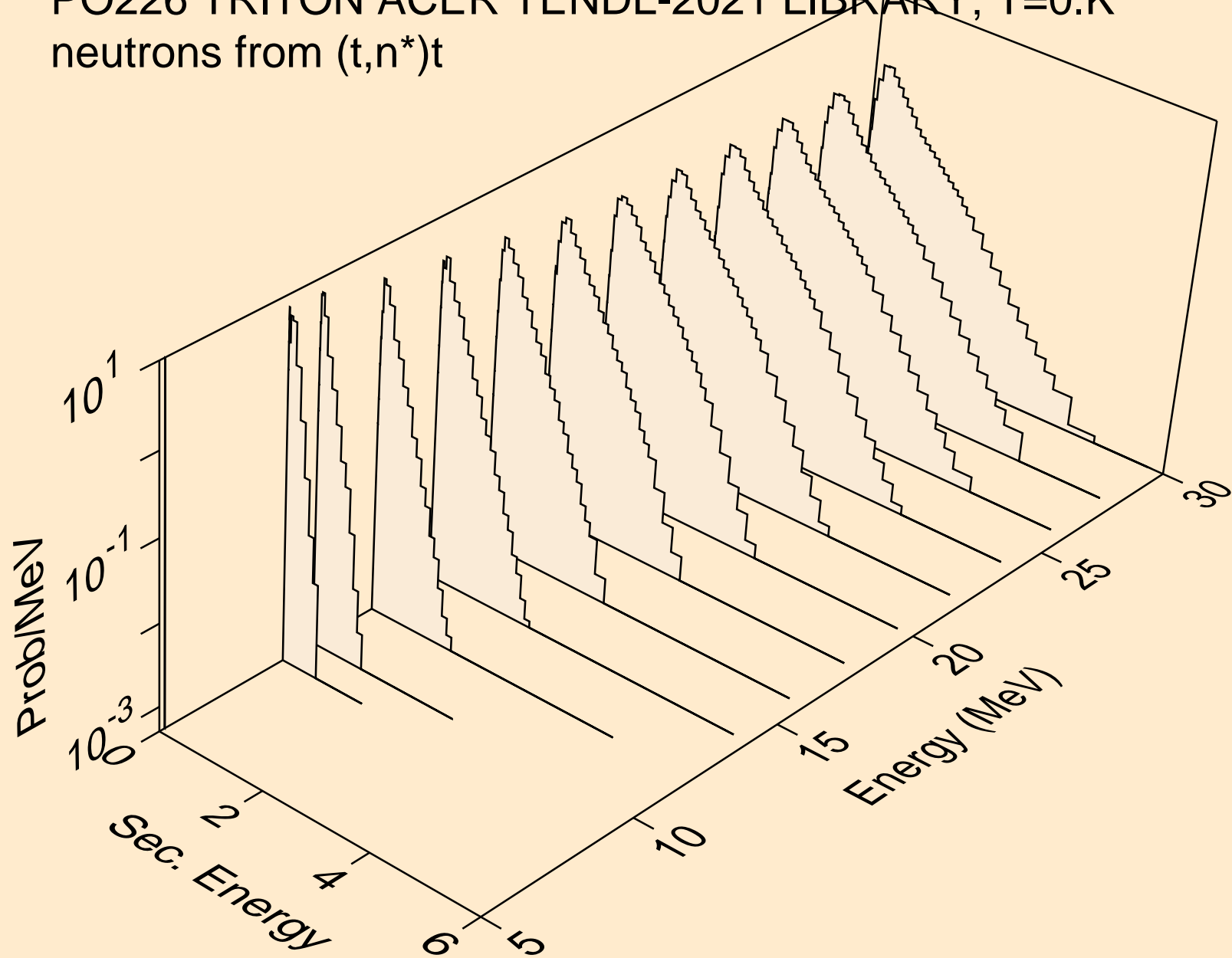

PO226 TRITON ACER TENDL-2021 LIBRARY; T=0.K  
neutrons from (t,n\*)he3

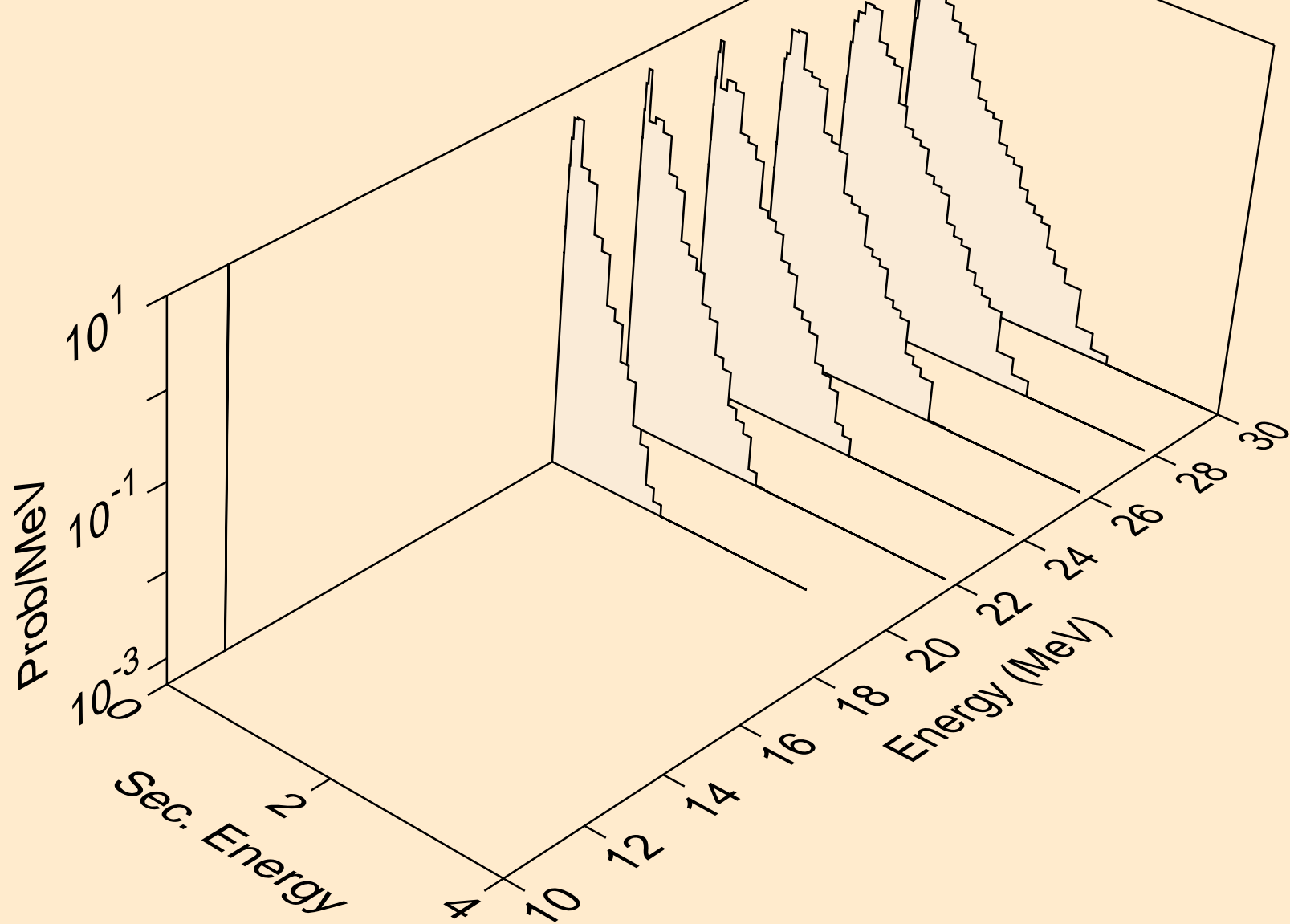

PO226 TRITON ACER TENDL-2021 LIBRARY; T=0.K  
neutrons from (t,4n)

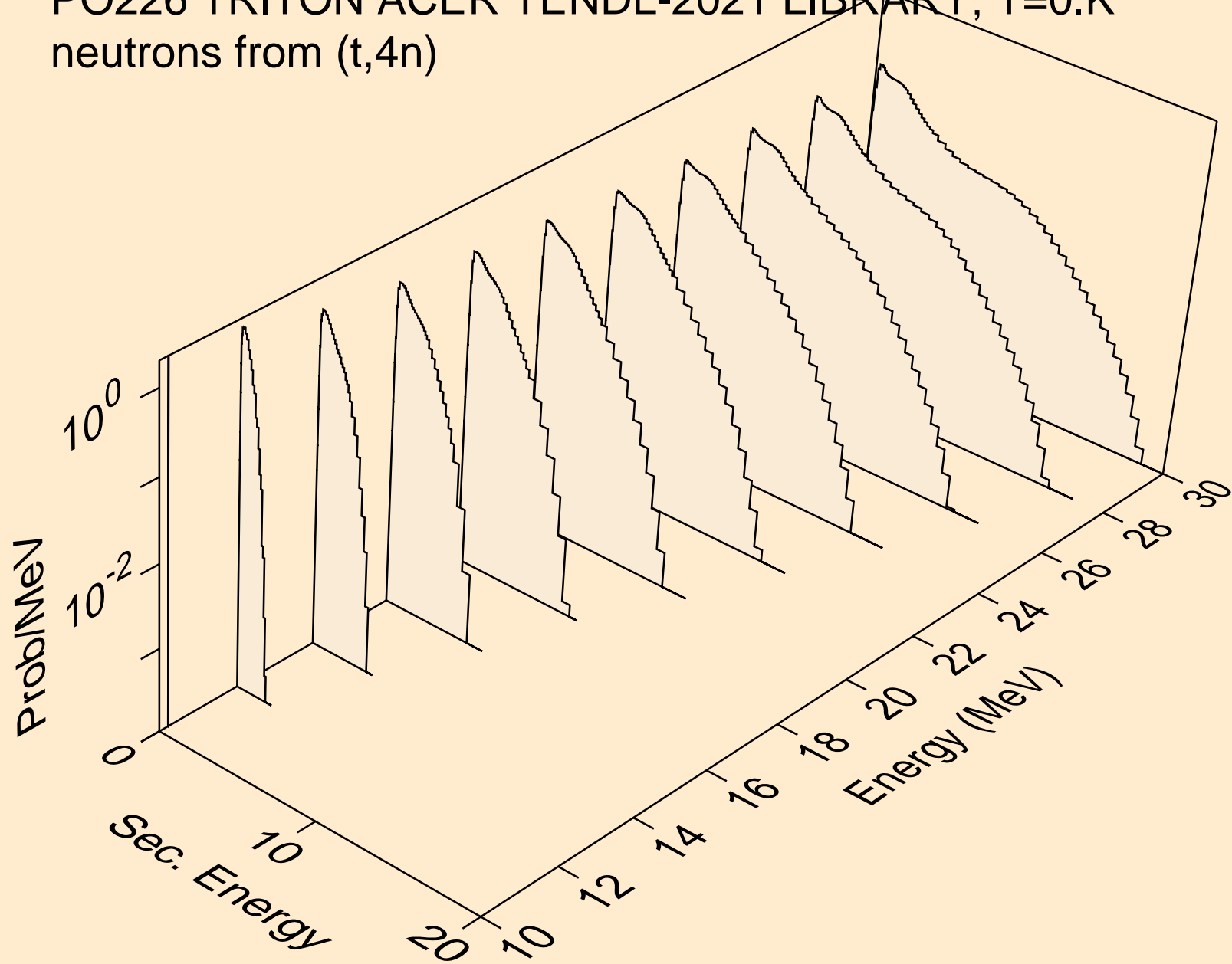

PO226 TRITON ACER TENDL-2021 LIBRARY; T=0.K  
neutrons from (t,2np)

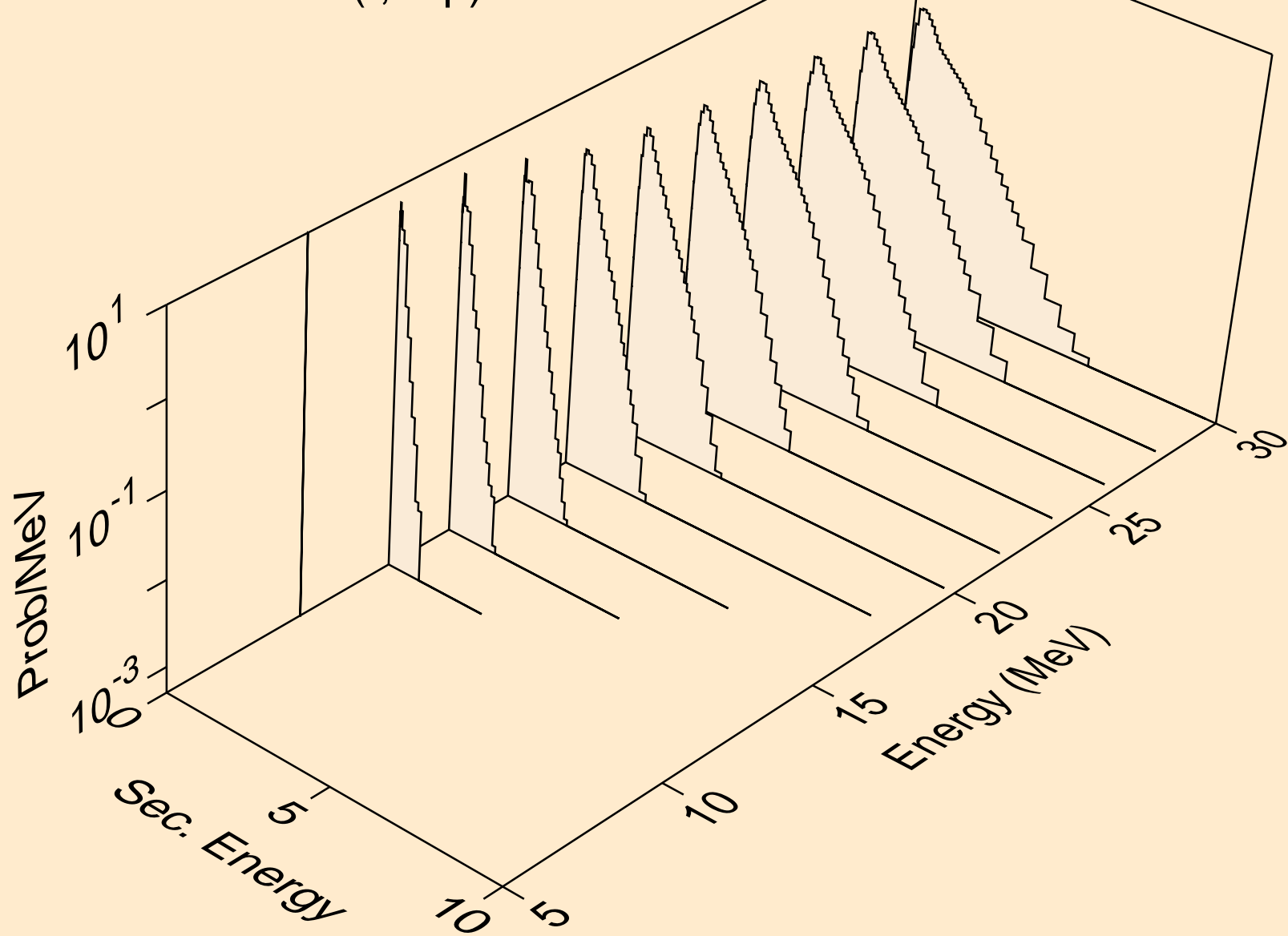

PO226 TRITON ACER TENDL-2021 LIBRARY; T=0.K  
neutrons from (t,3np)

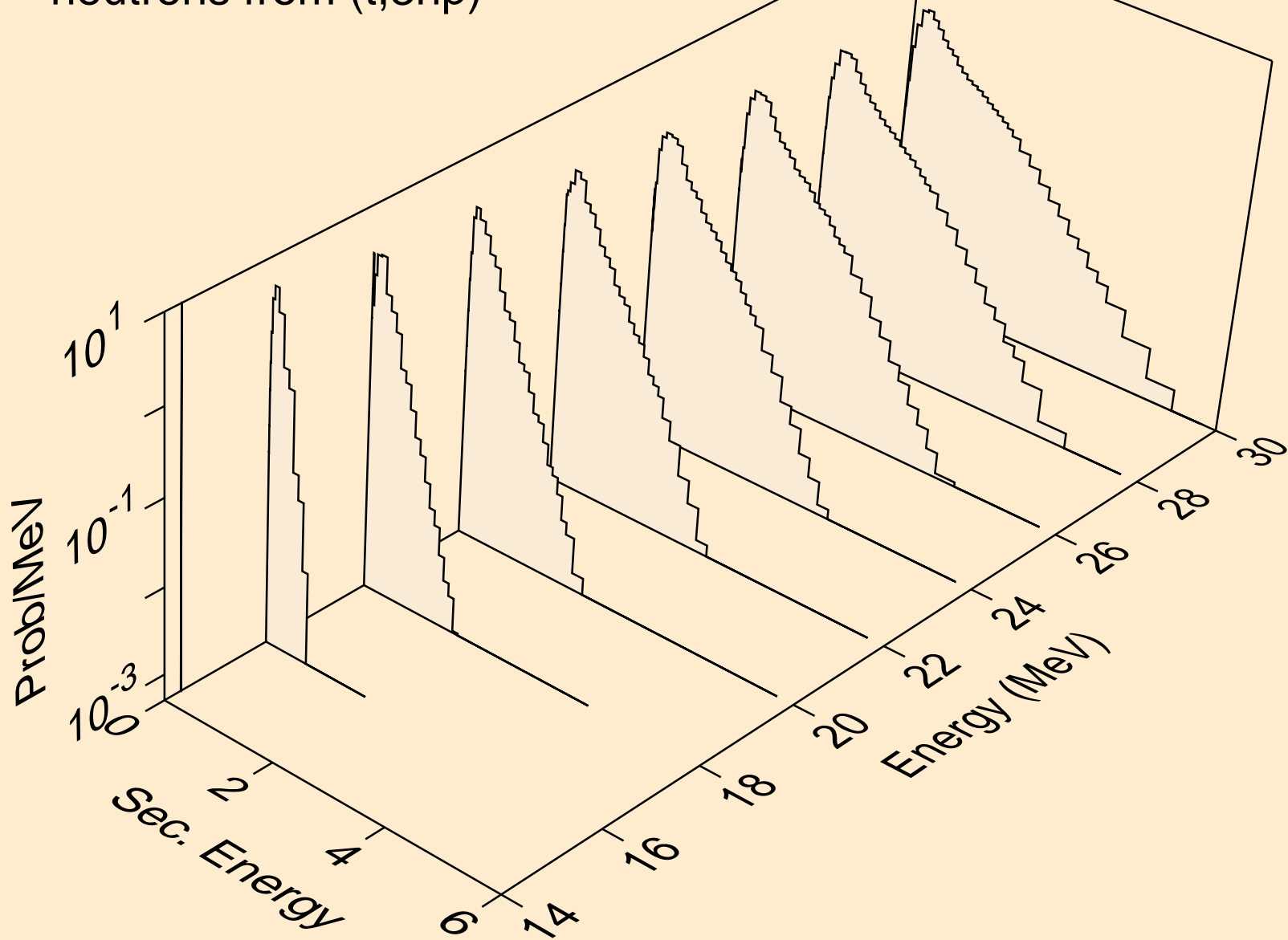

PO226 TRITON ACER TENDL-2021 LIBRARY; T=0.K  
protons from (t,x)

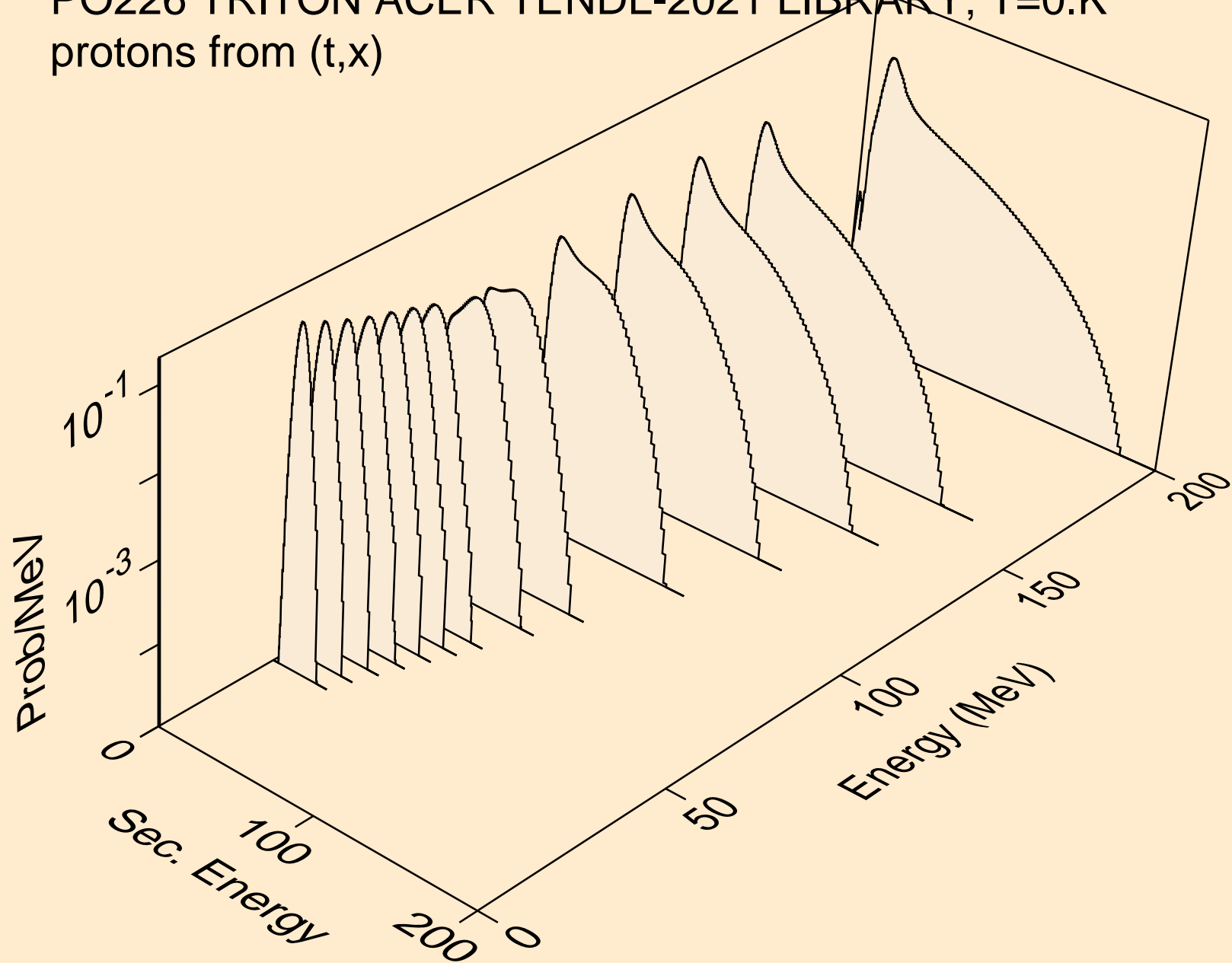



PO226 TRITON ACER TENDL-2021 LIBRARY; T=0.K  
protons from (t,n\*)p

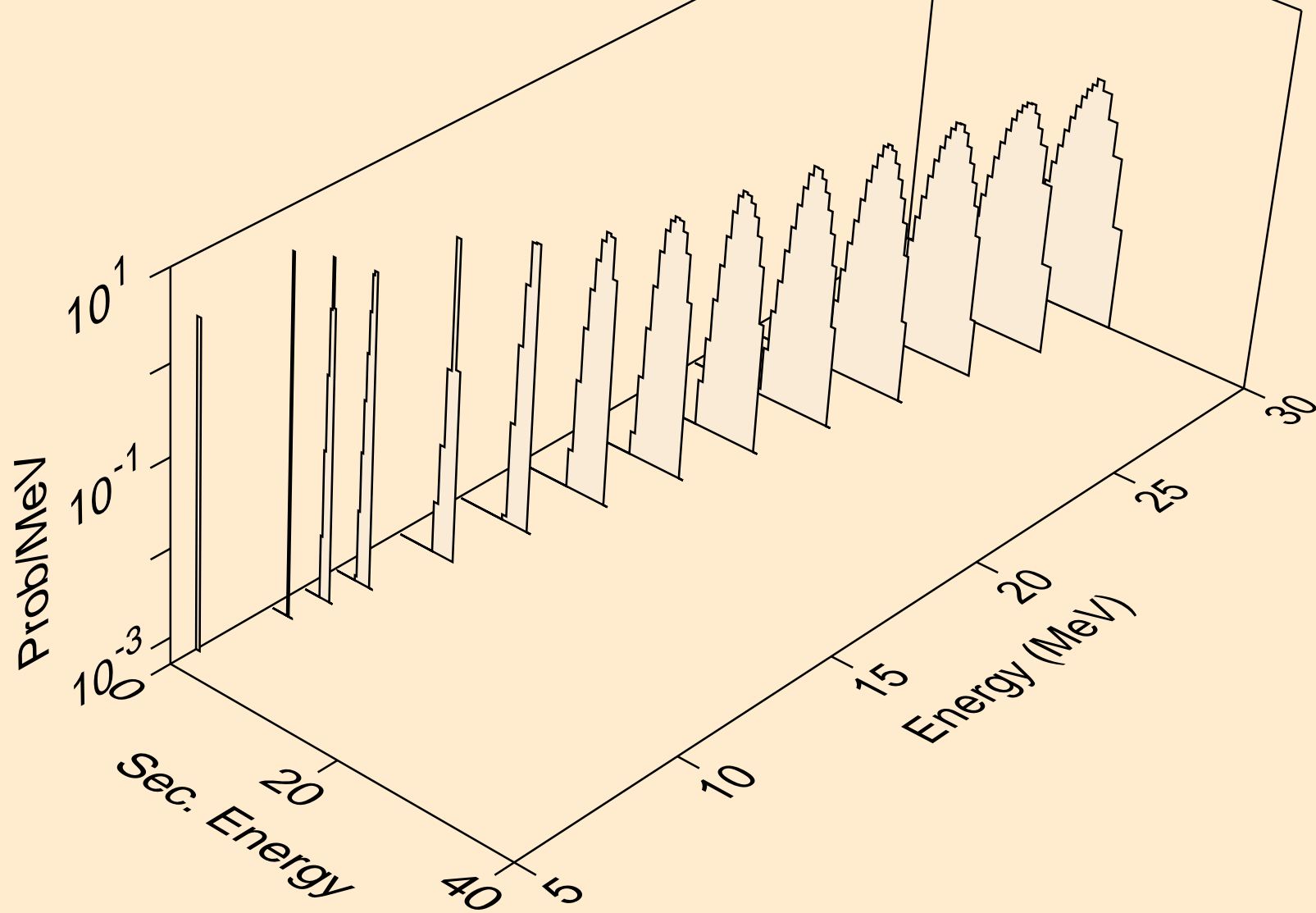

PO226 TRITON ACER TENDL-2021 LIBRARY; T=0.K  
protons from (t,2np)

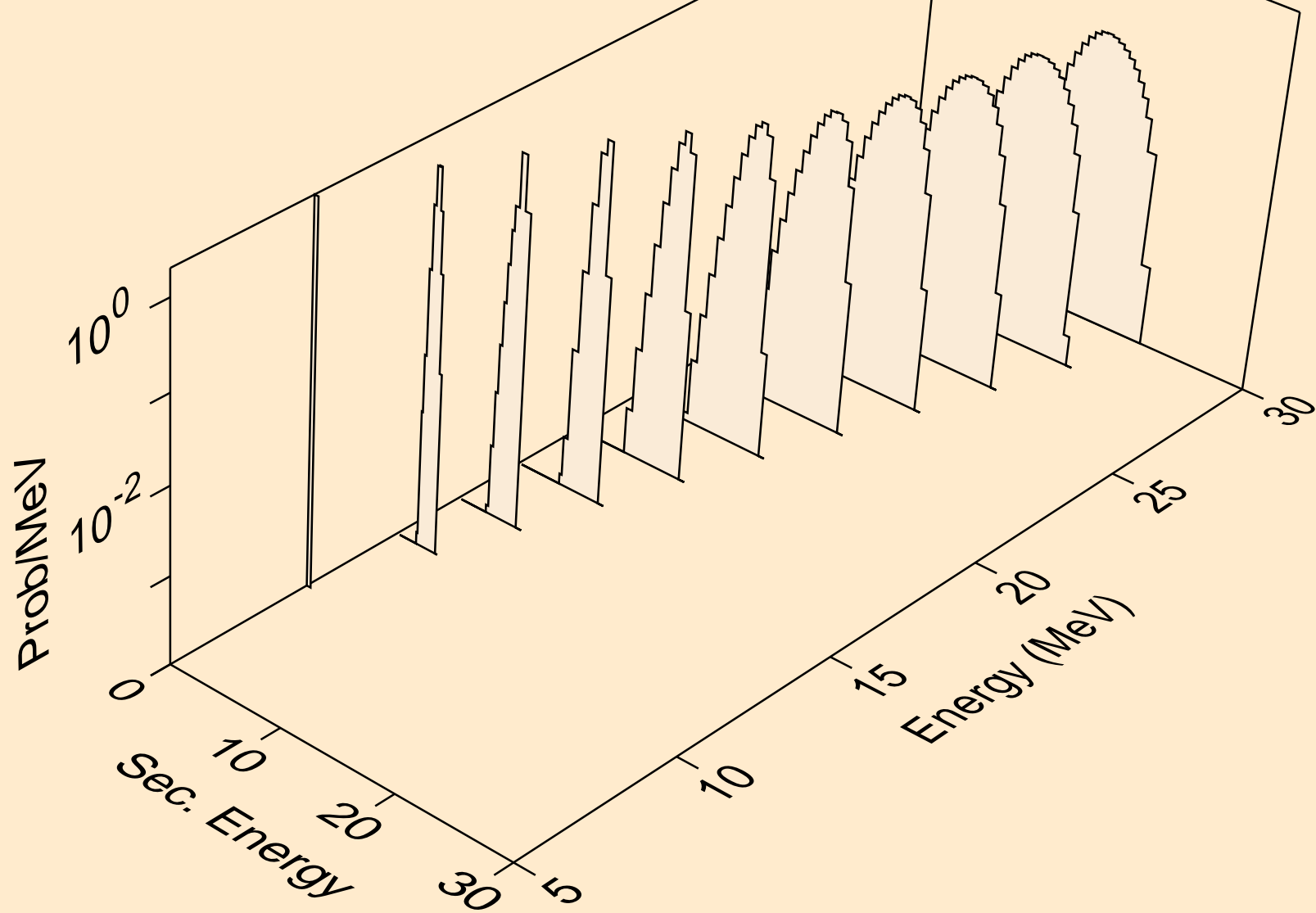

PO226 TRITON ACER TENDL-2021 LIBRARY; T=0.K  
protons from (t,3np)

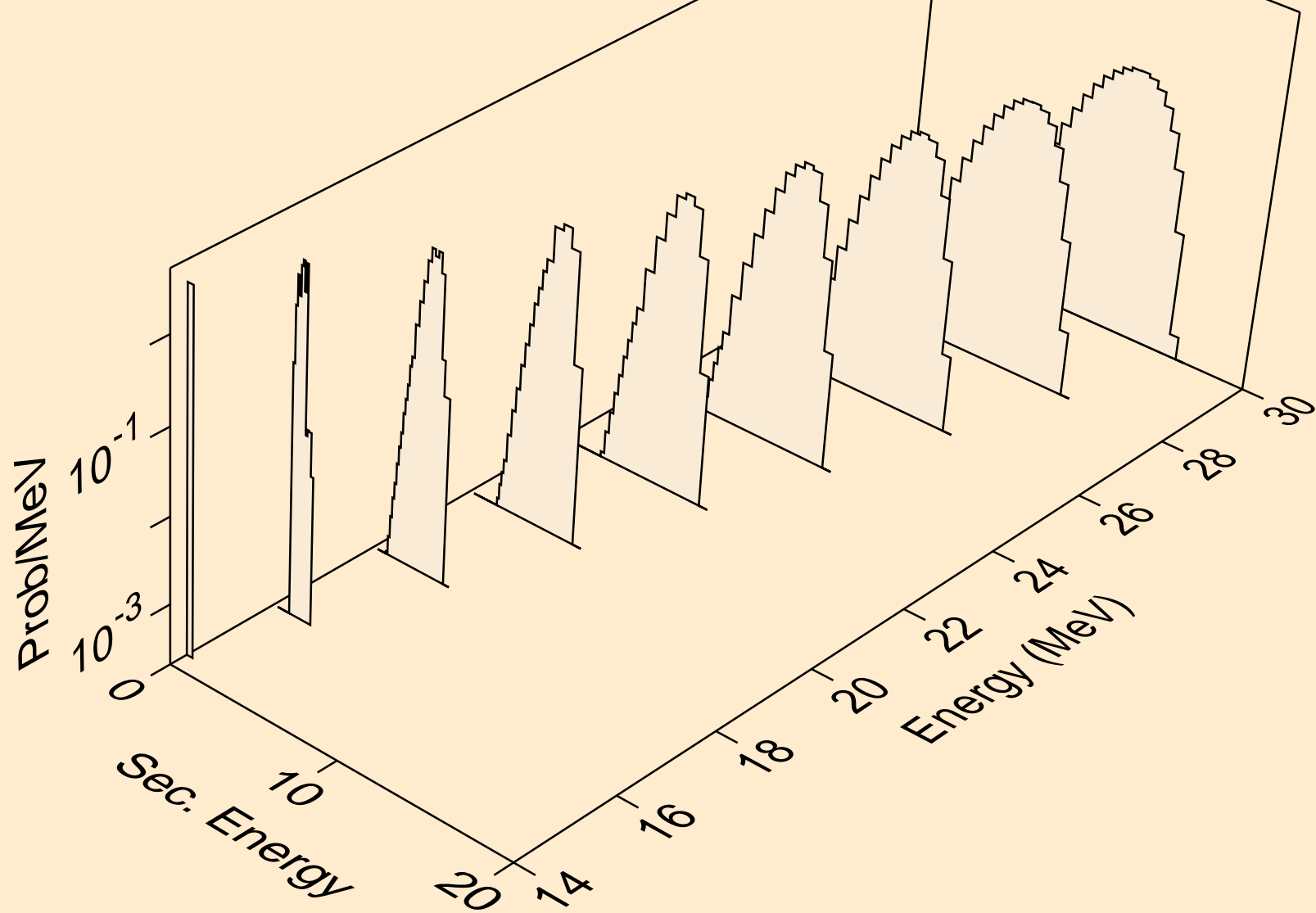

PO226 TRITON ACER TENDL-2021 LIBRARY; T=0.K  
protons from (t,p)

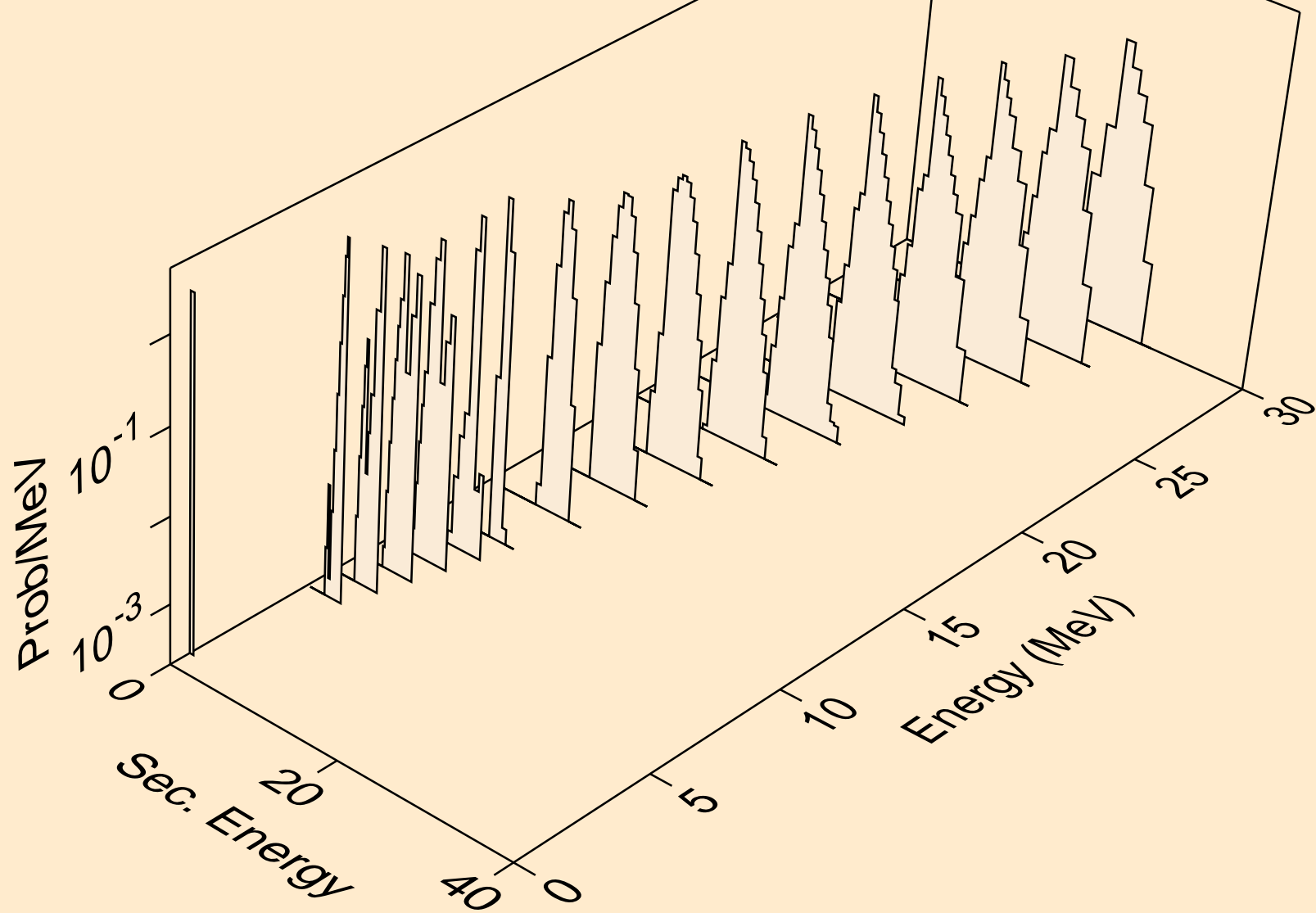

PO226 TRITON ACER TENDL-2021 LIBRARY; T=0.K  
protons from (t,2p)

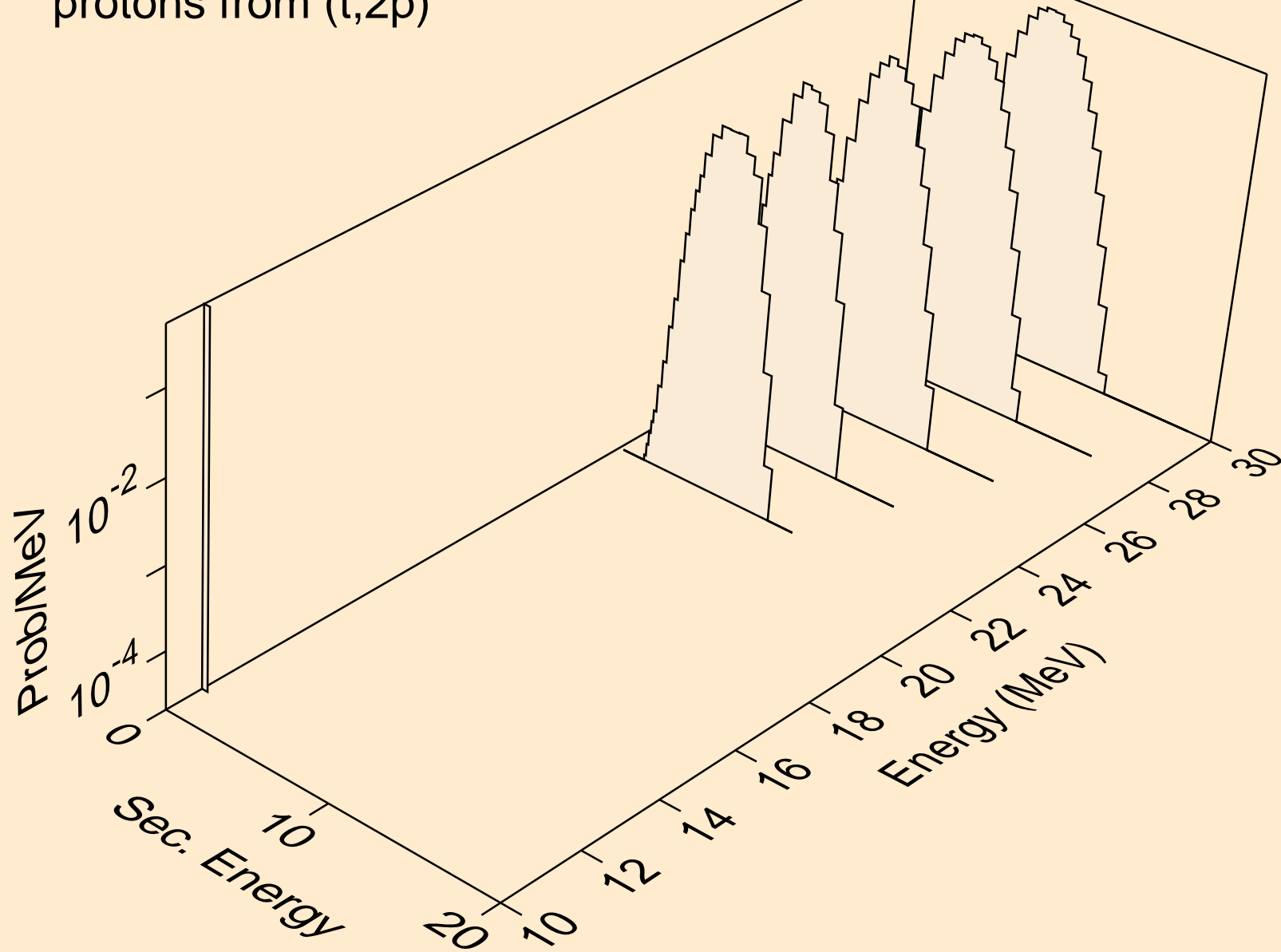

PO226 TRITON ACER TENDL-2021 LIBRARY; T=0.K  
deuterons from (t,x)

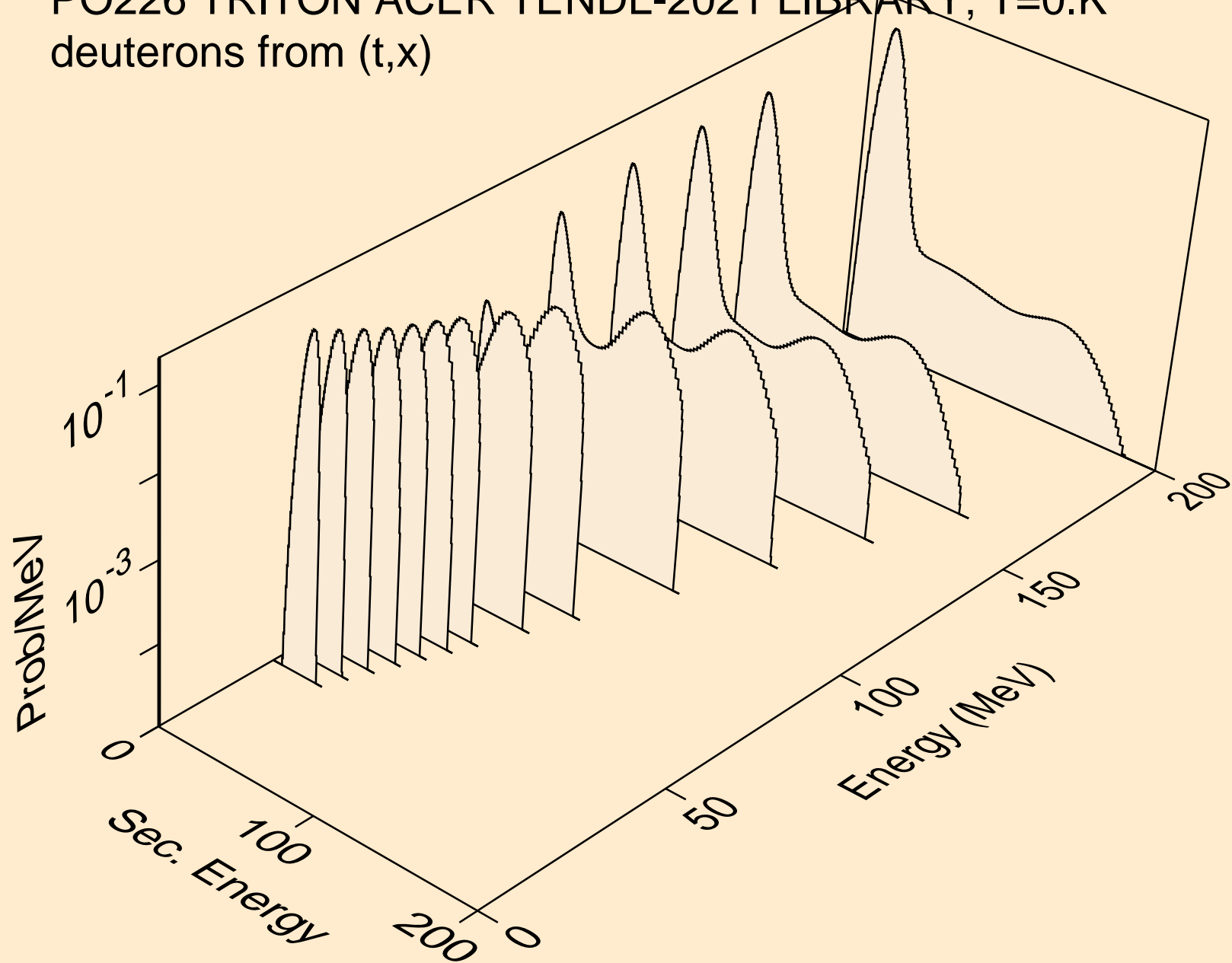

PO226 TRITON ACER TENDL-2021 LIBRARY; T=0.K  
deuterons from (t,2nd)

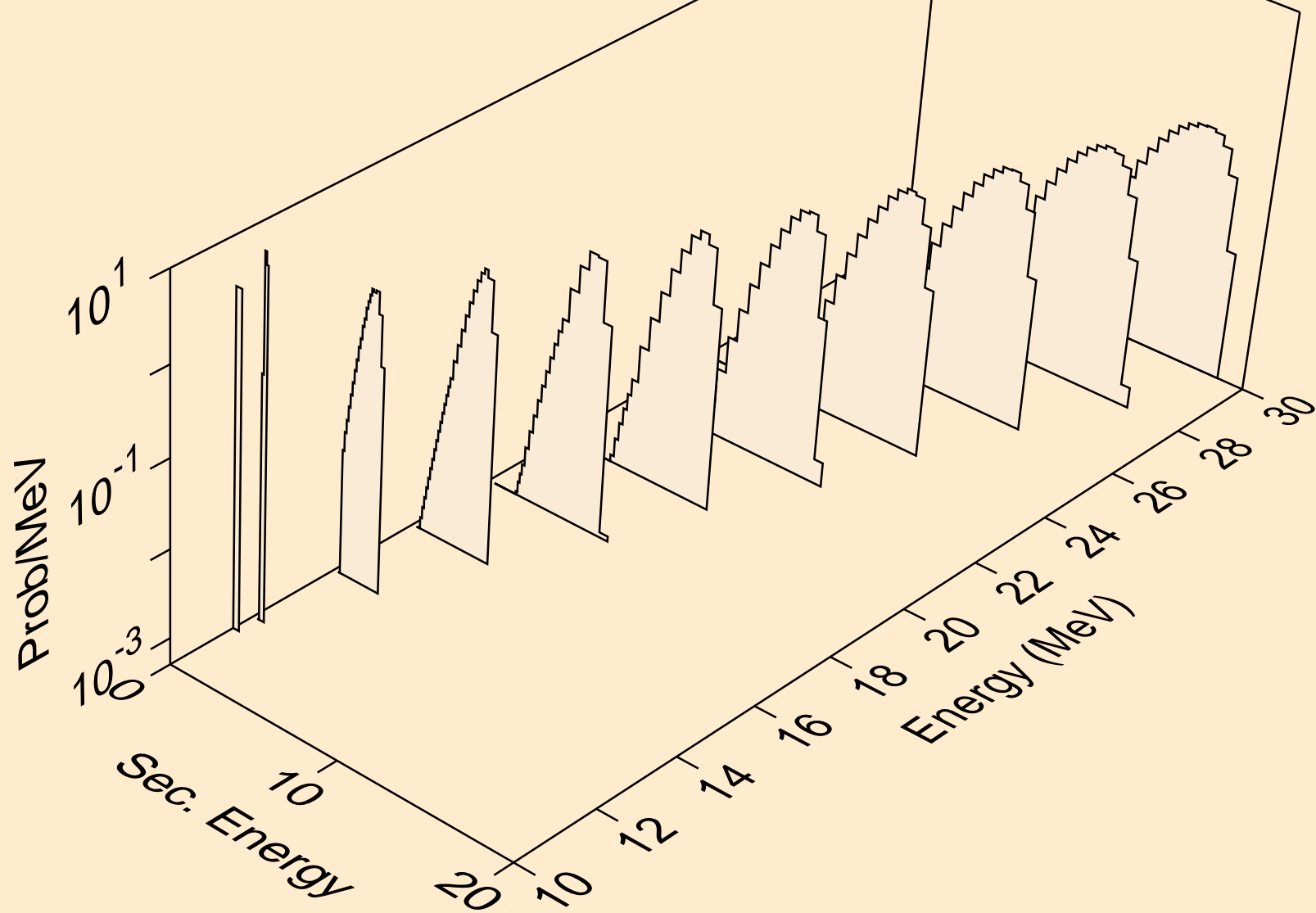

PO226 TRITON ACER TENDL-2021 LIBRARY; T=0.K  
deuterons from (t,n\*)d

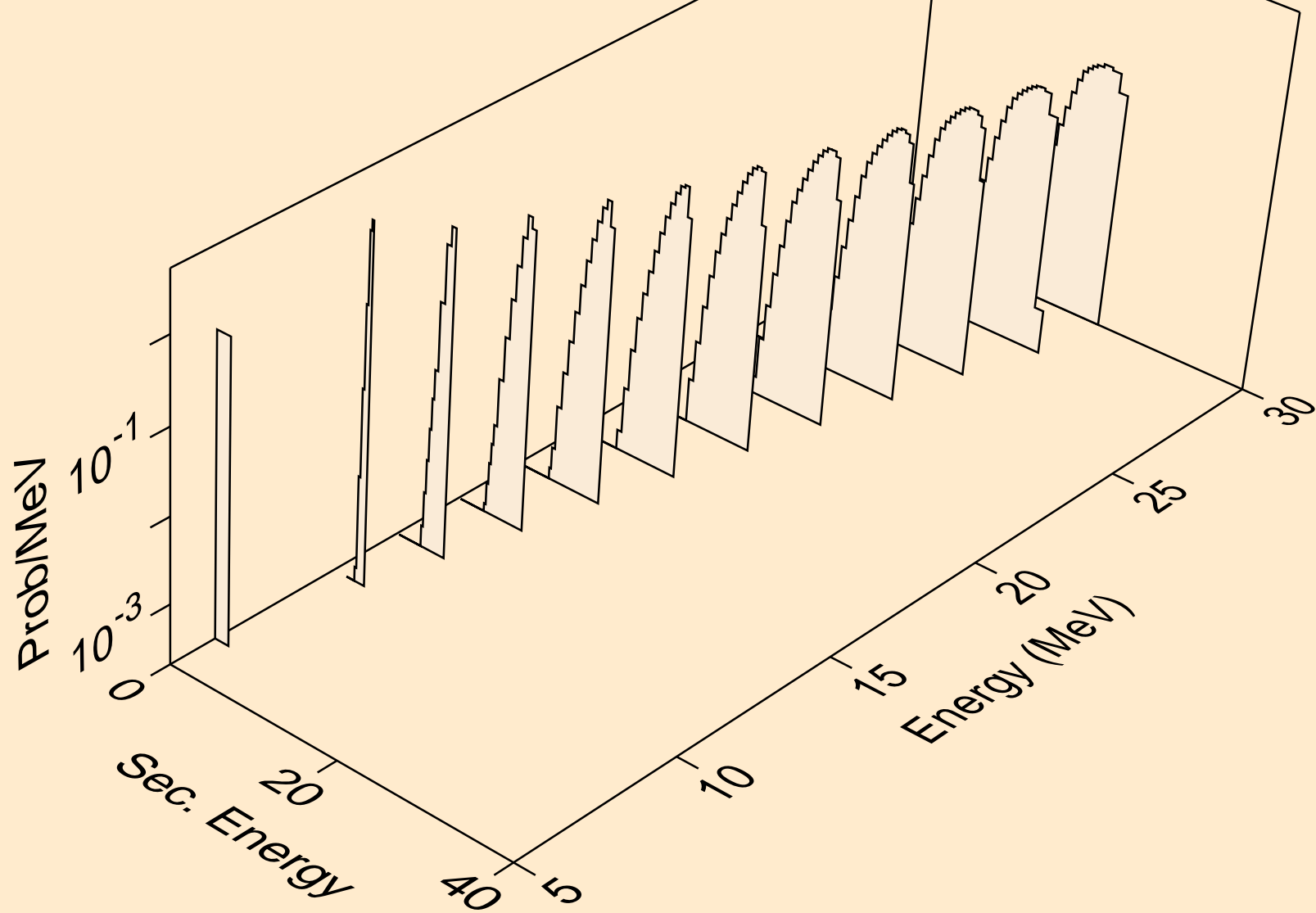



PO226 TRITON ACER TENDL-2021 LIBRARY; T=0.K  
deuterons from (t,d)

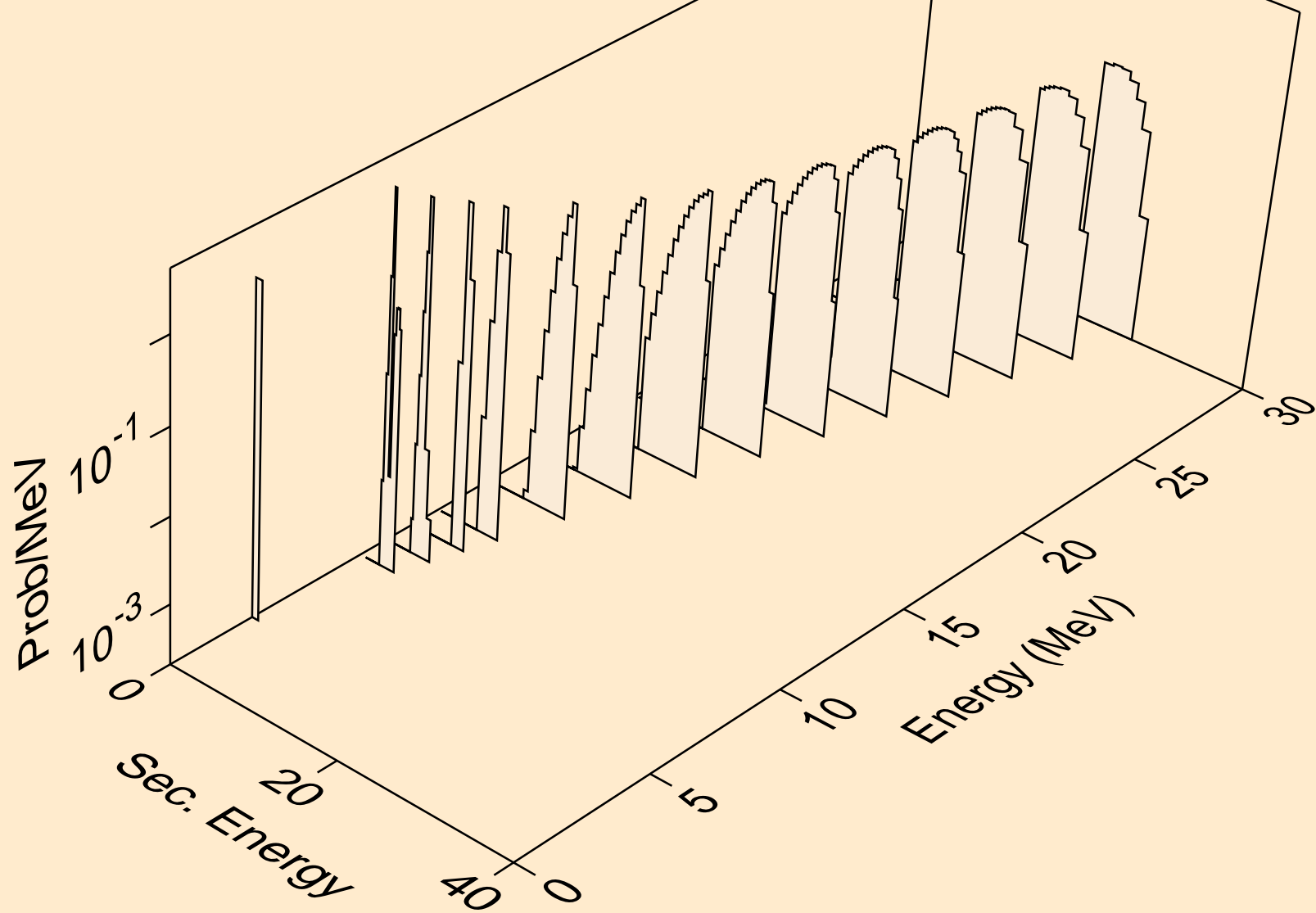

PO226 TRITON ACER TENDL-2021 LIBRARY; T=0.K  
he3s from (t,x)

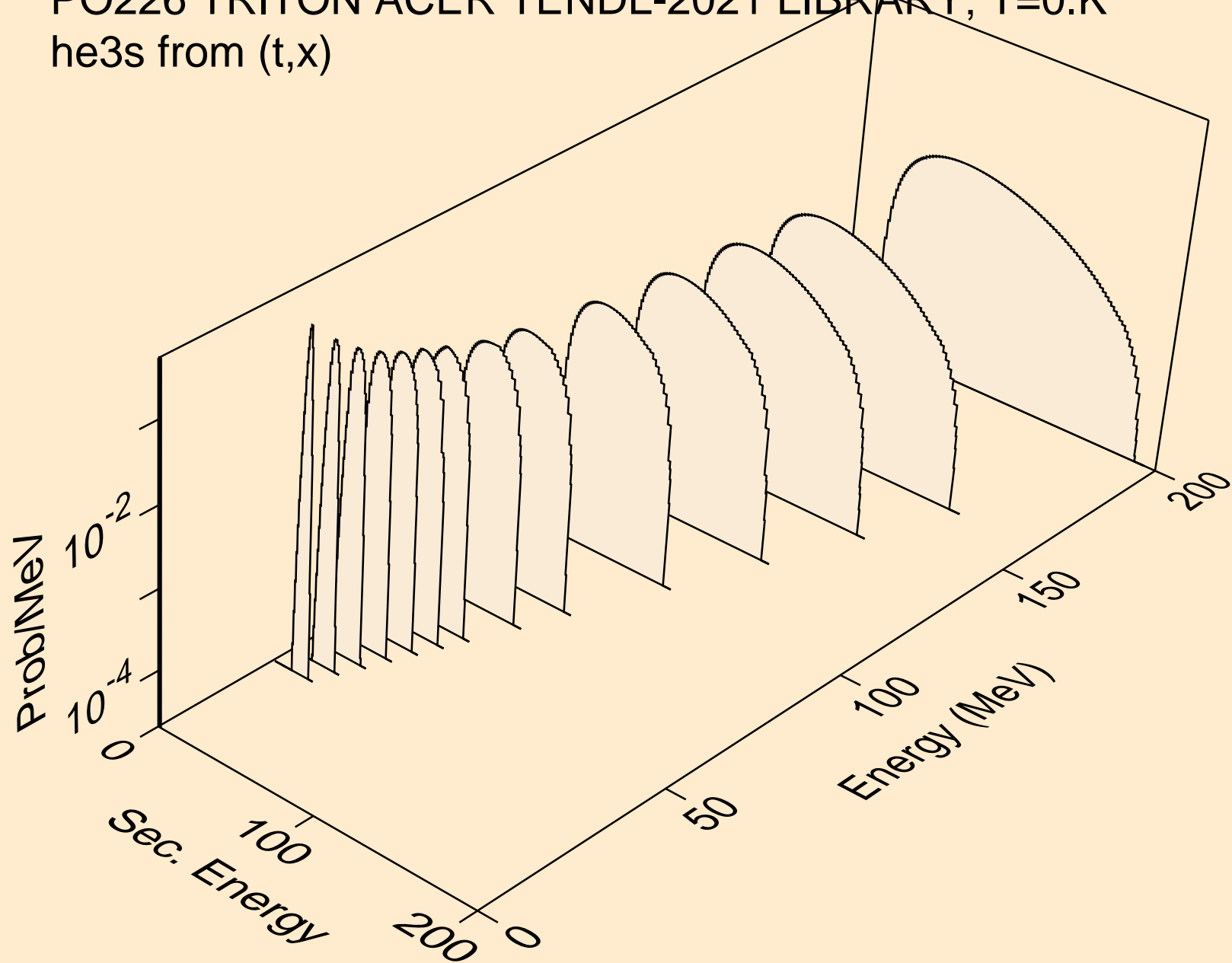

PO226 TRITON ACER TENDL-2021 LIBRARY; T=0.K  
he3s from (t,n\*)he3

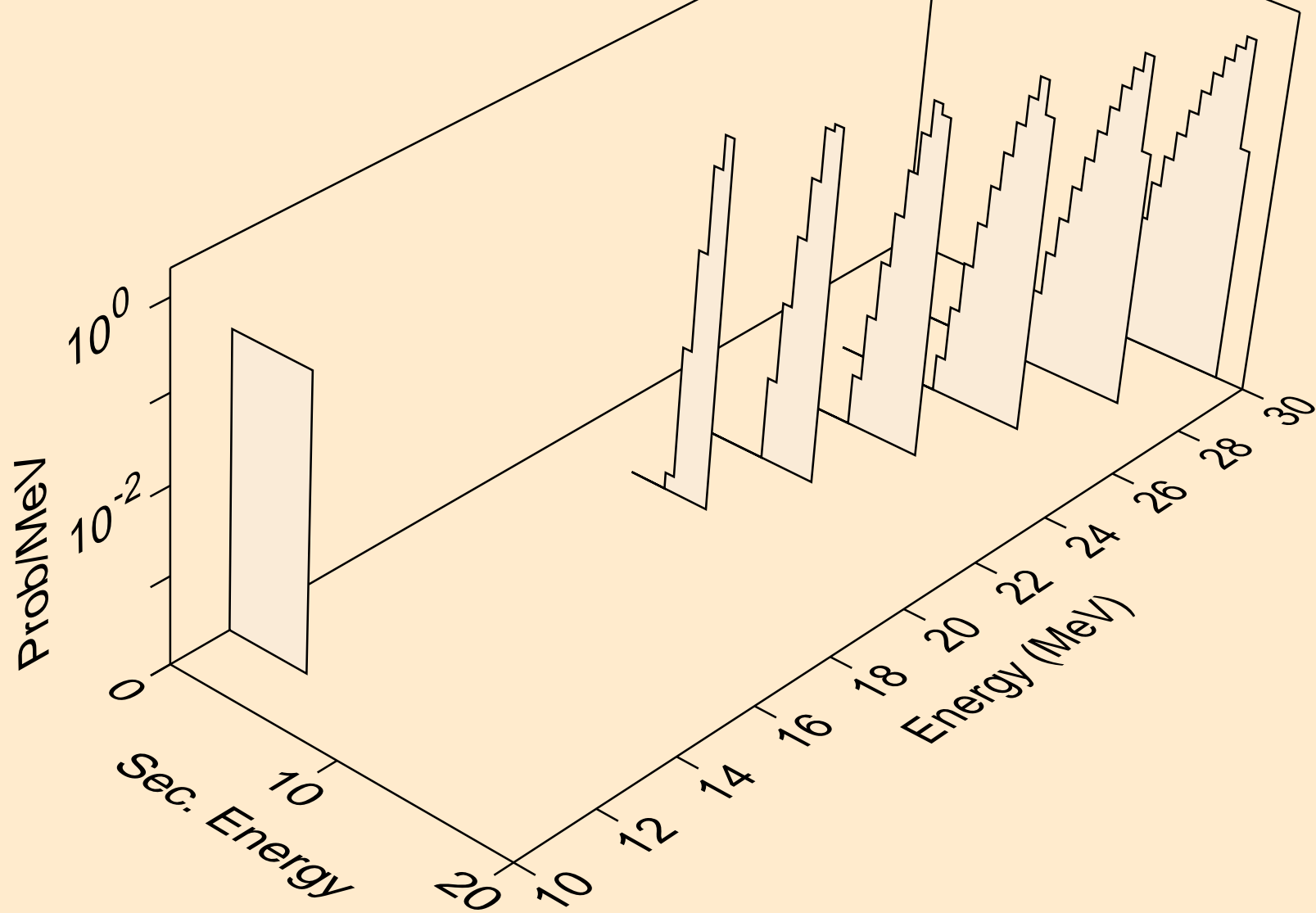

PO226 TRITON ACER TENDL-2021 LIBRARY; T=0.K  
he3s from (t,he3)

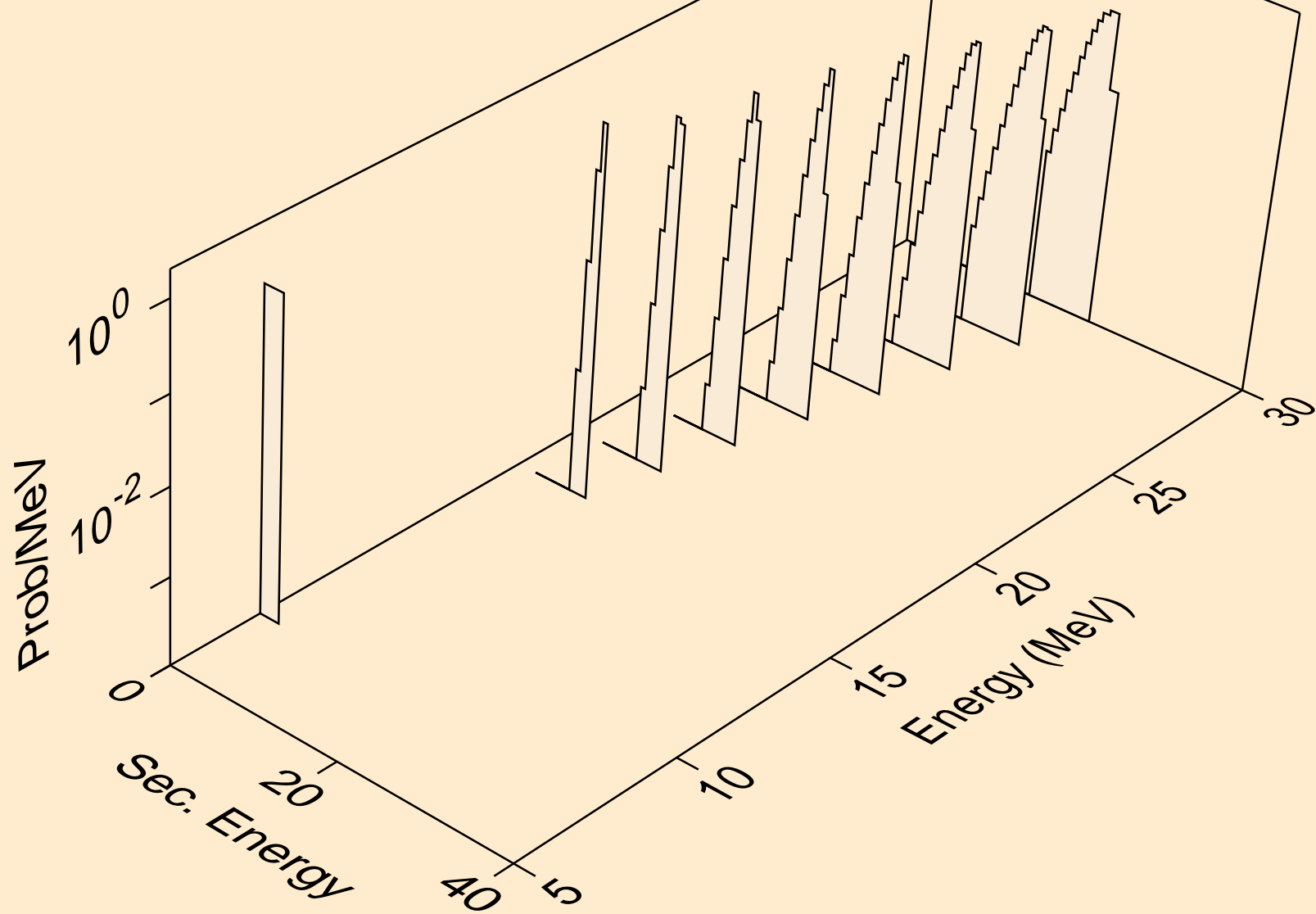

PO226 TRITON ACER TENDL-2021 LIBRARY; T=0.K  
alphas from (t,x)

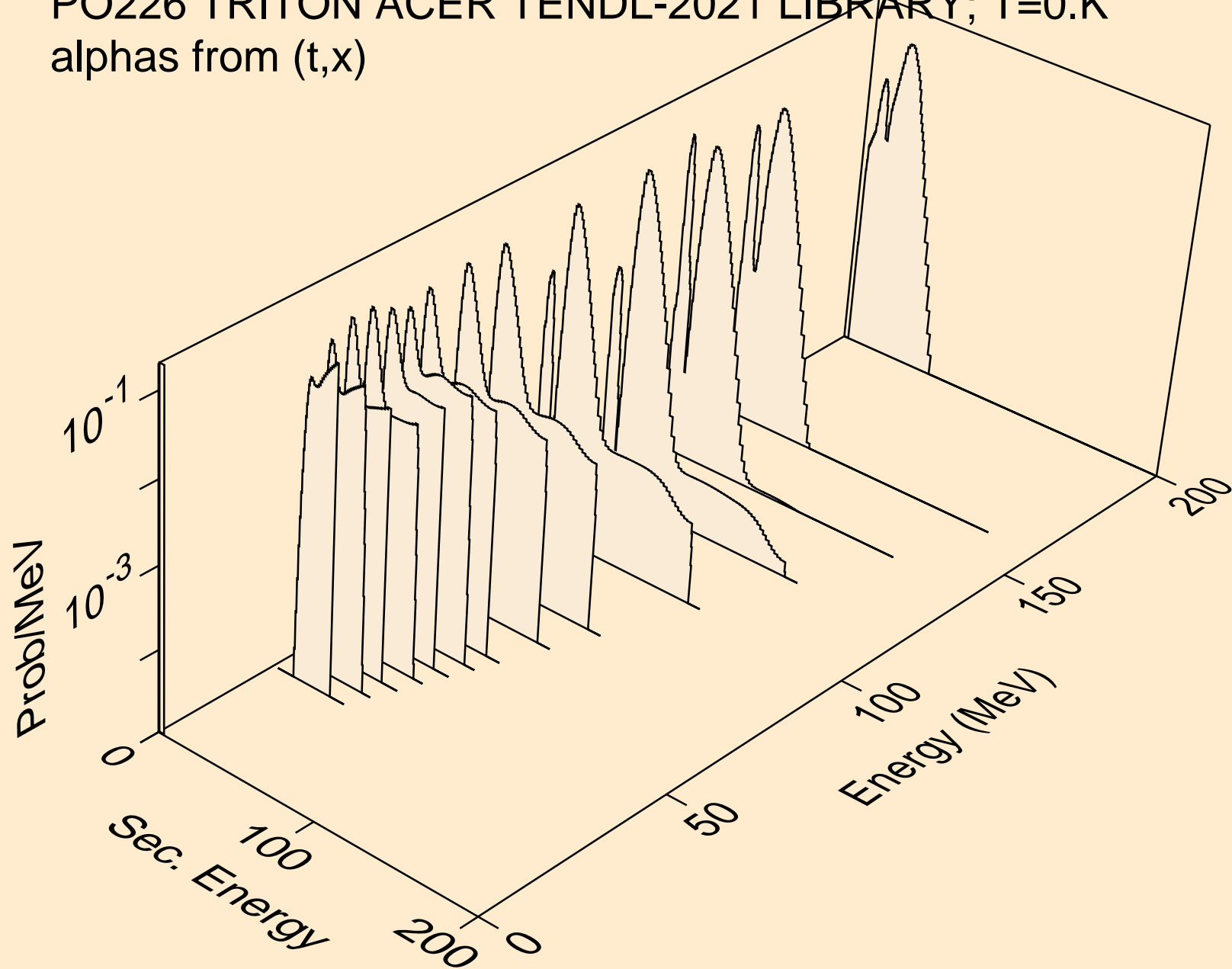

PO226 TRITON ACER TENDL-2021 LIBRARY; T=0.K  
alphas from (t,n\*)a

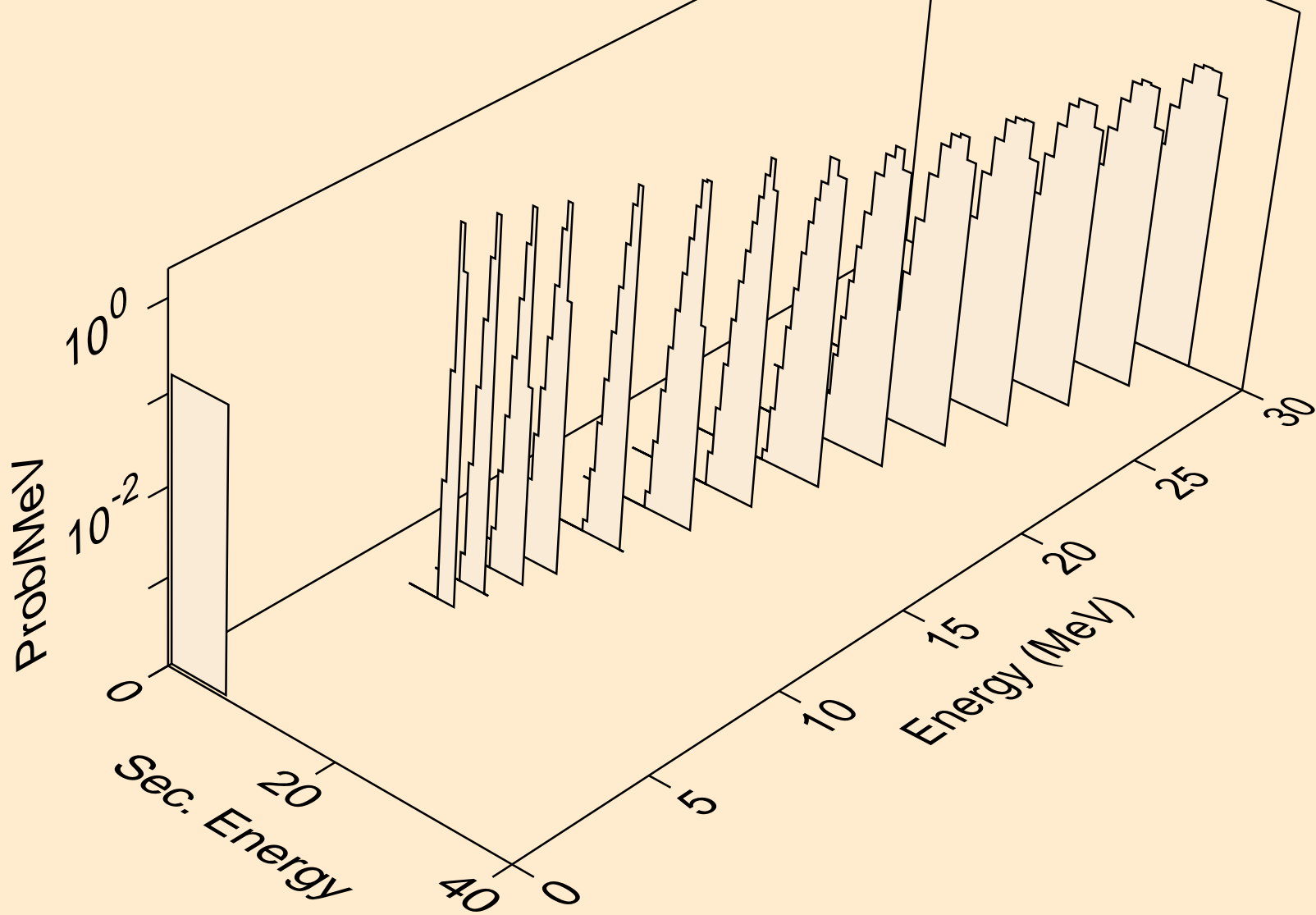

PO226 TRITON ACER TENDL-2021 LIBRARY; T=0.K  
alphas from (t,2n)a

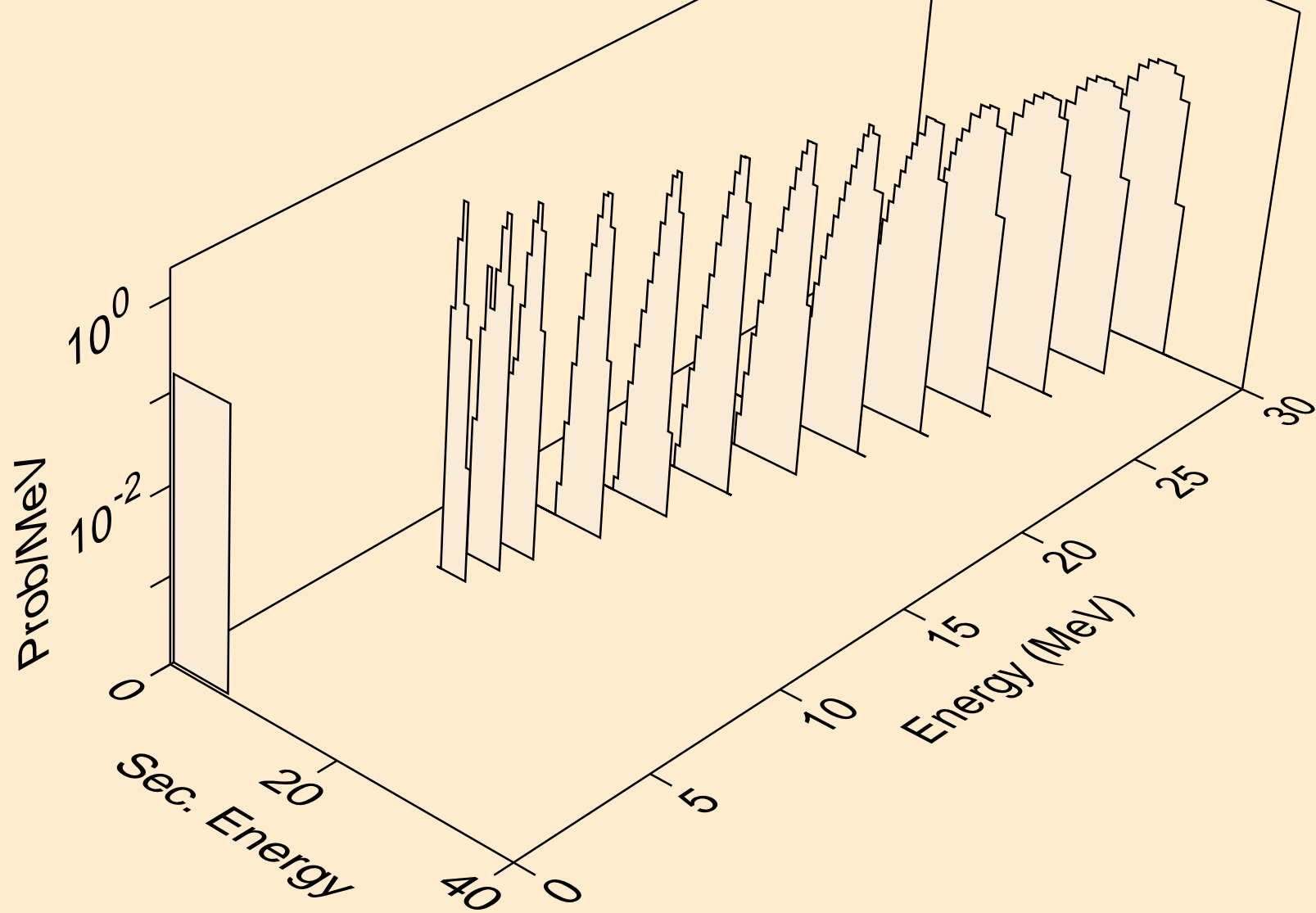

PO226 TRITON ACER TENDL-2021 LIBRARY; T=0.K  
alphas from (t,3n)a

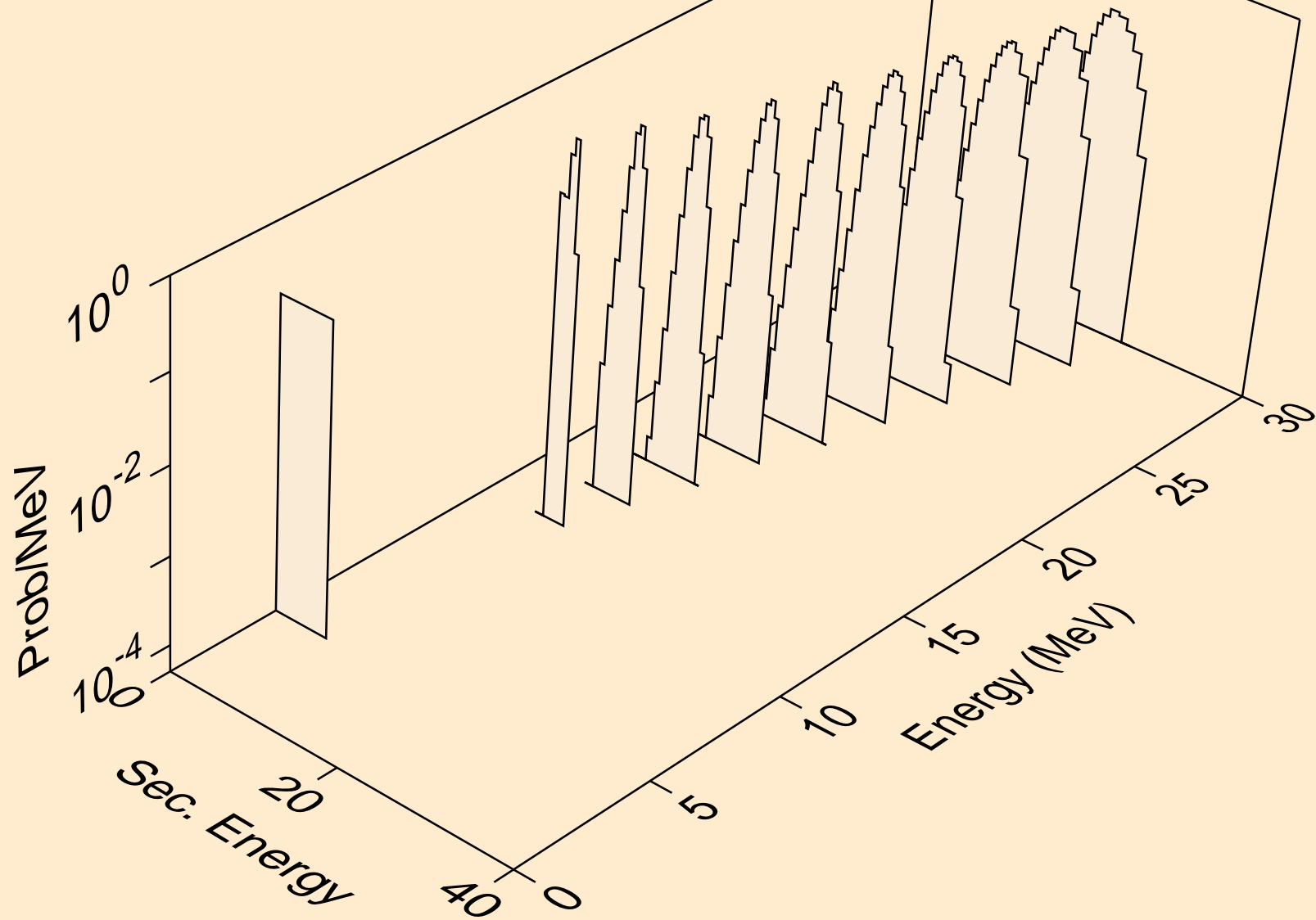



PO226 TRITON ACER TENDL-2021 LIBRARY; T=0.K  
alphas from (t,a)

