

PR124 TRITON ACER TENDL-2021 LIBRARY; T=0.K  
Principal cross sections

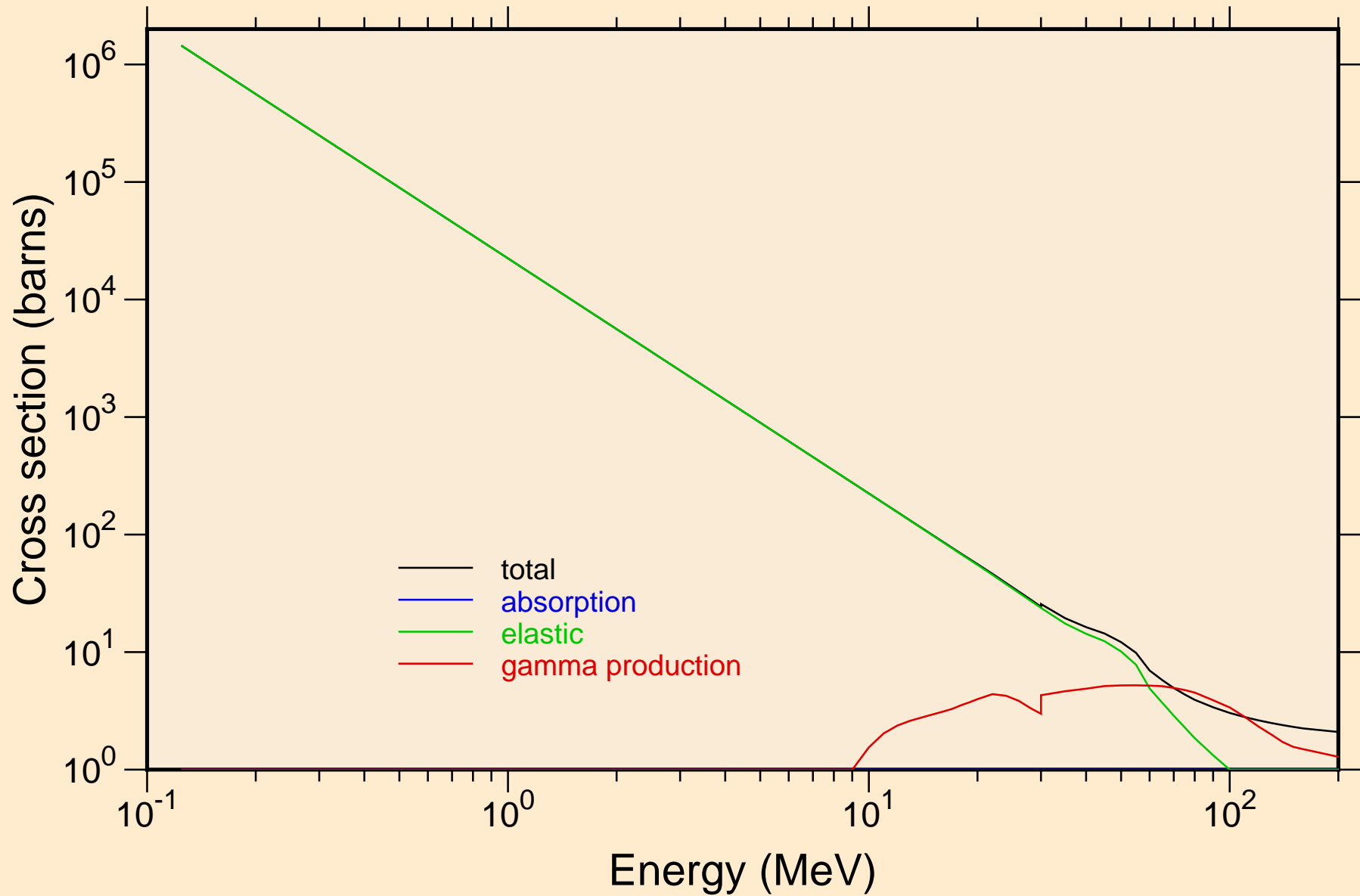

PR124 TRITON ACER TENDL-2021 LIBRARY; T=0.K  
Heating

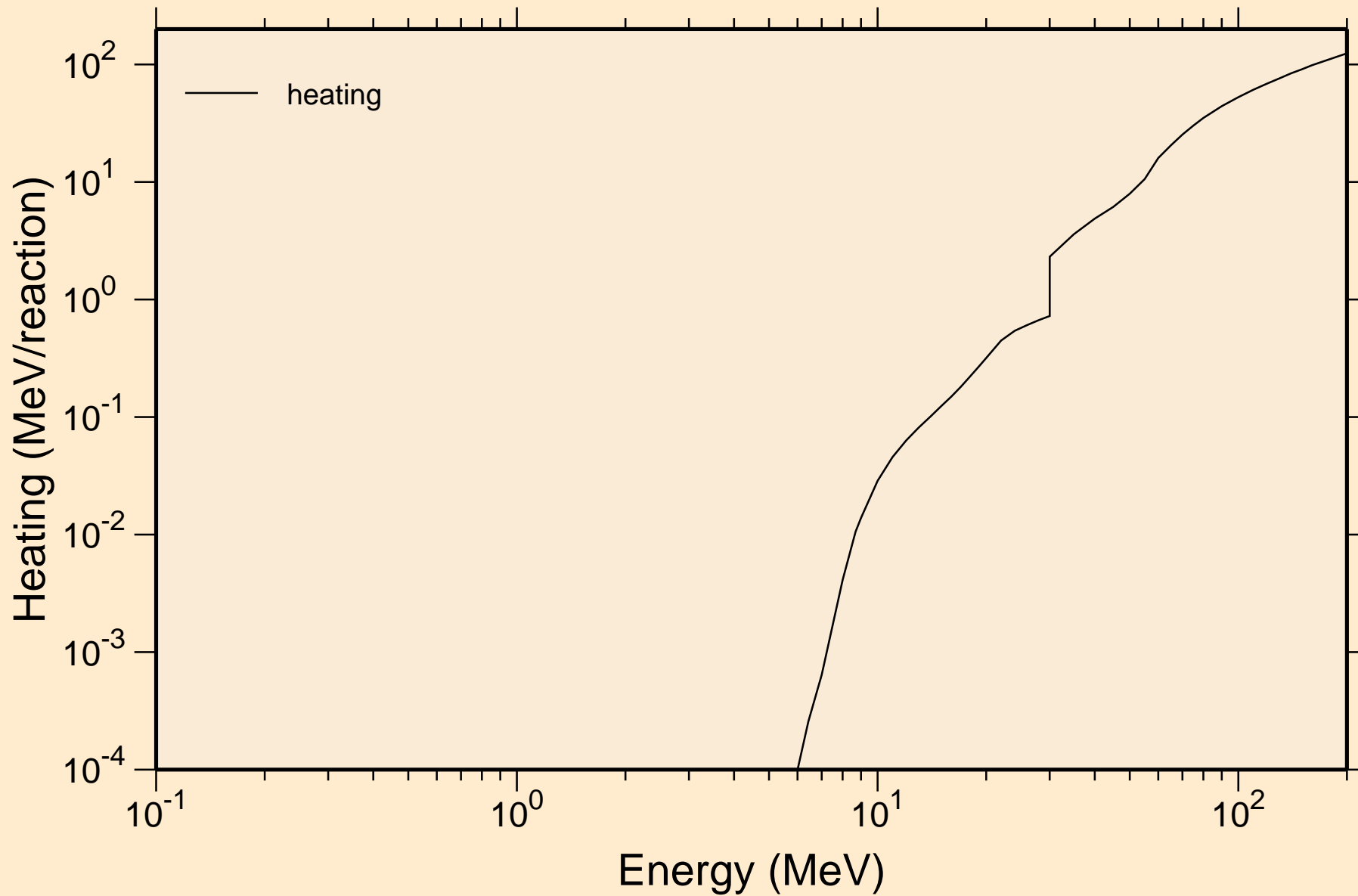

# PR124 TRITON ACER TENDL-2021 LIBRARY; T=0.K

## Principal cross sections

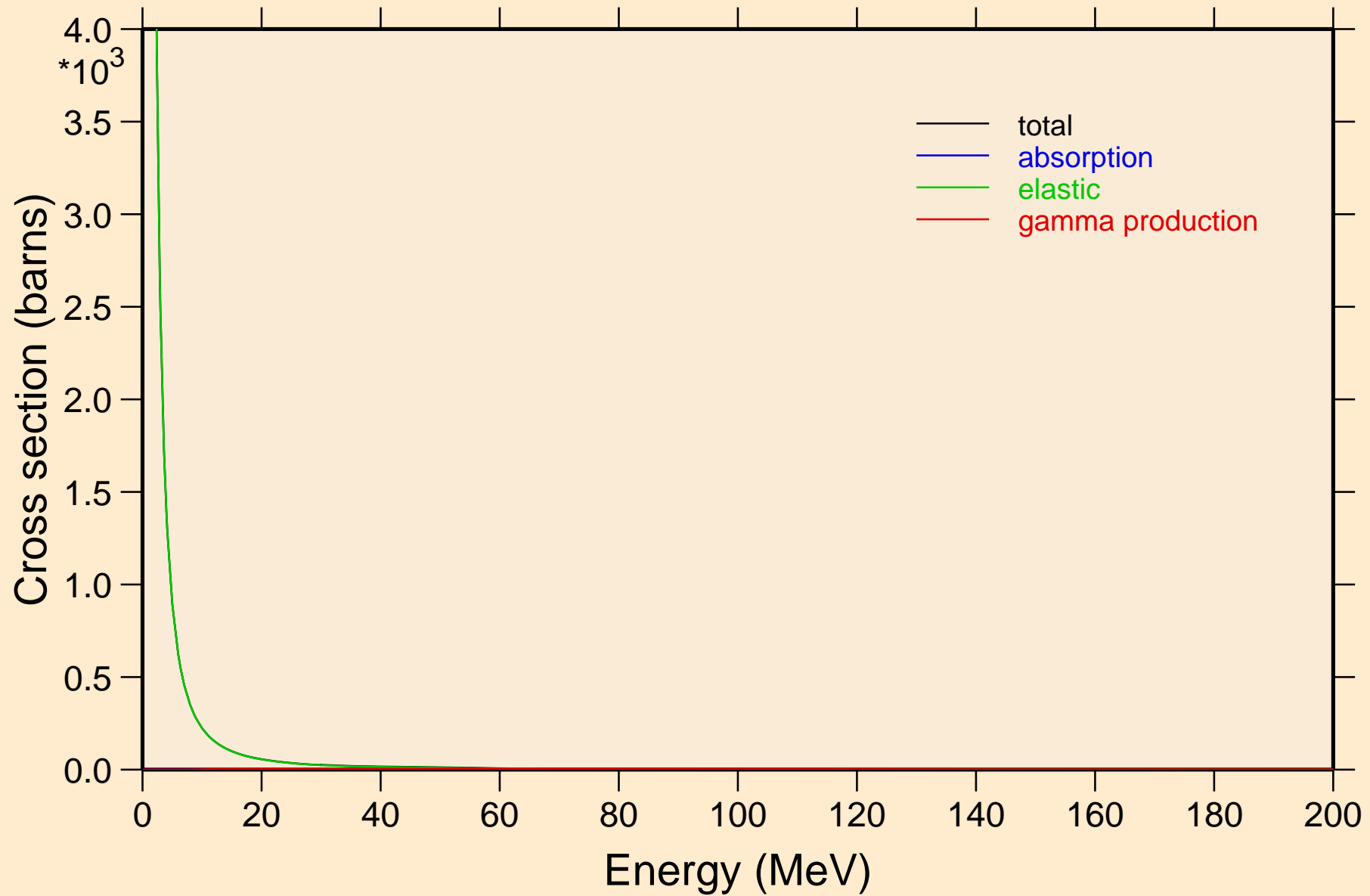

PR124 TRITON ACER TENDL-2021 LIBRARY; T=0.K

Heating

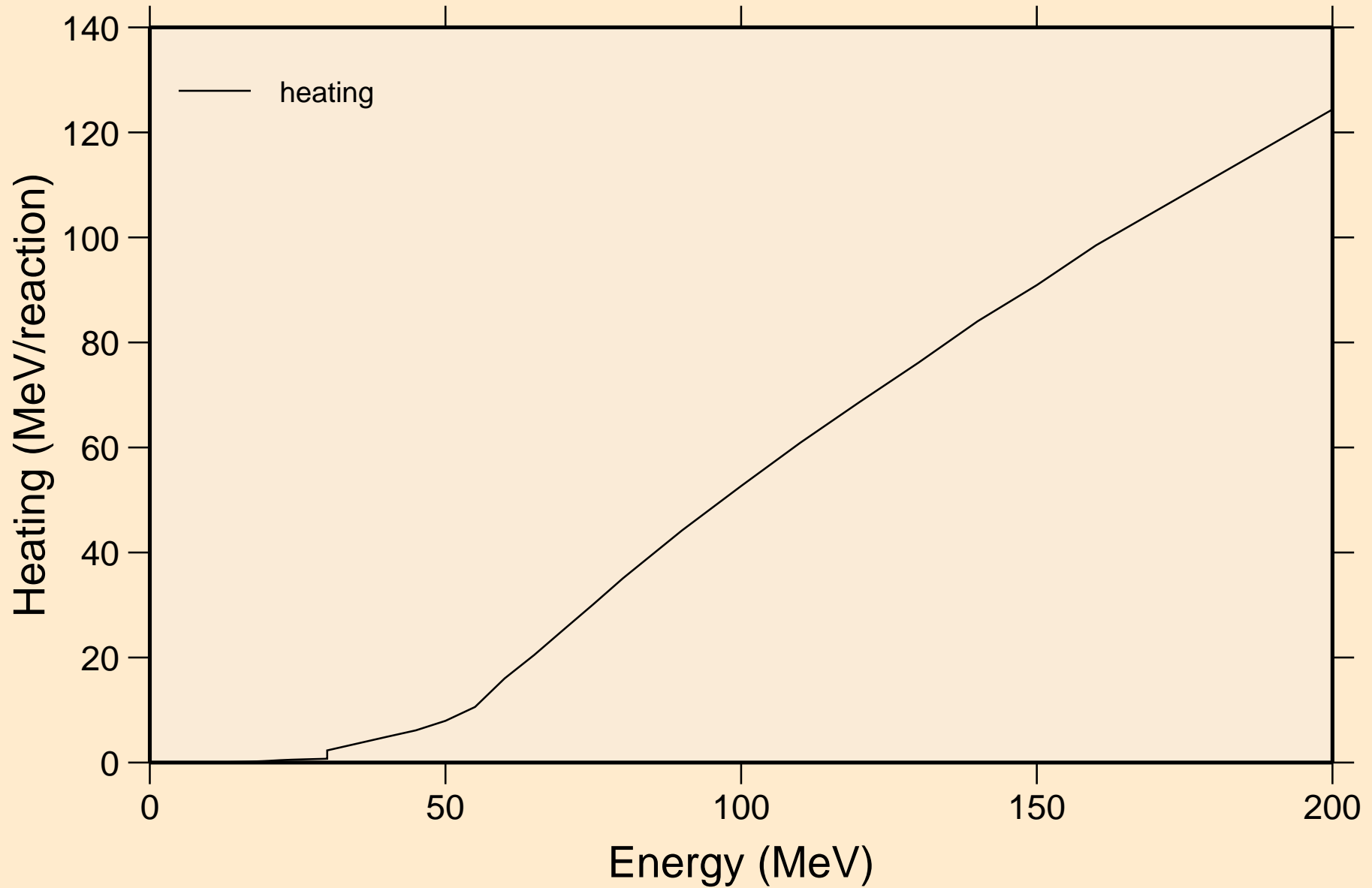

PR124 TRITON ACER TENDL-2021 LIBRARY; T=0.K  
Threshold reactions

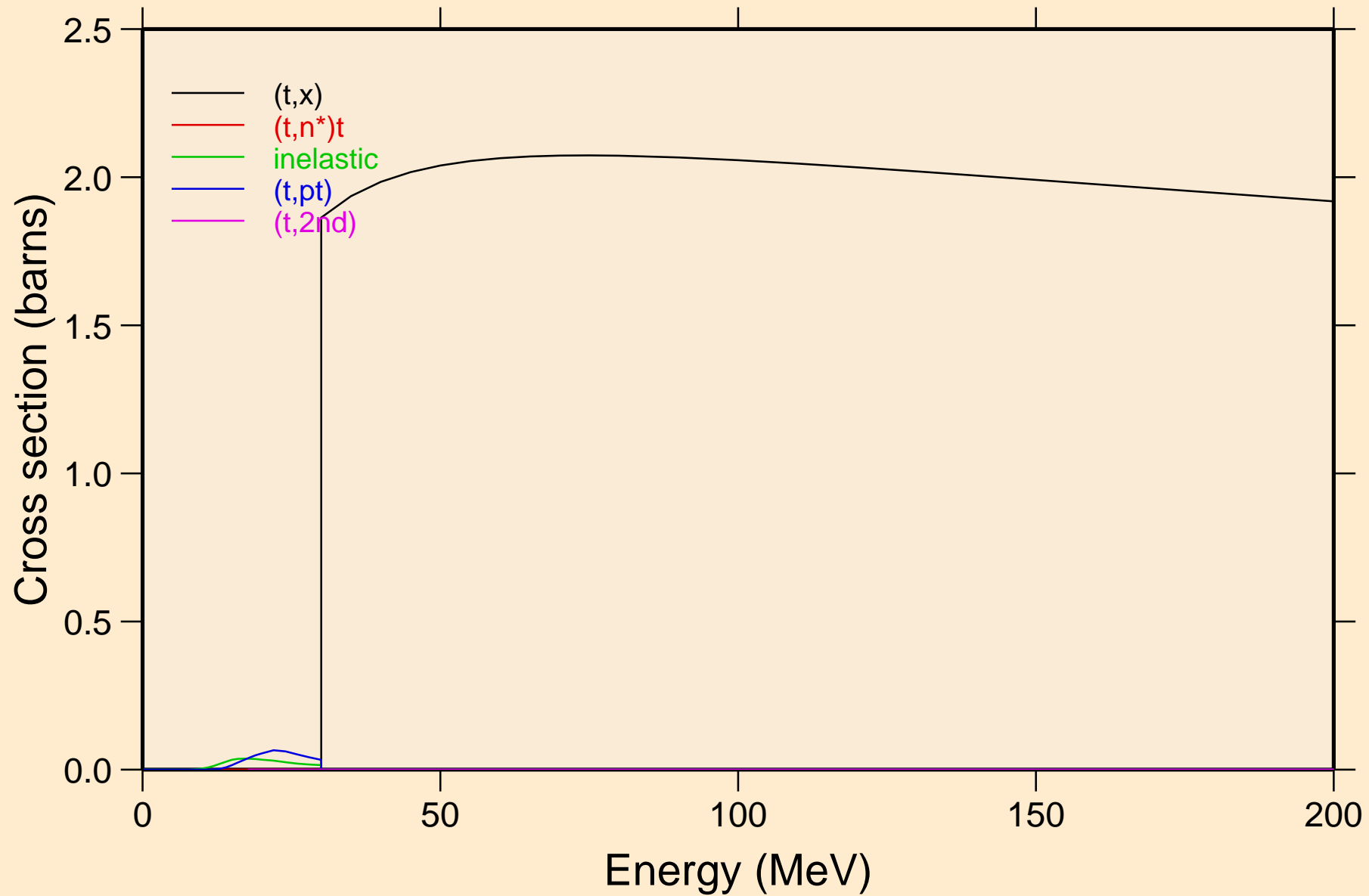

PR124 TRITON ACER TENDL-2021 LIBRARY; T=0.K  
Threshold reactions

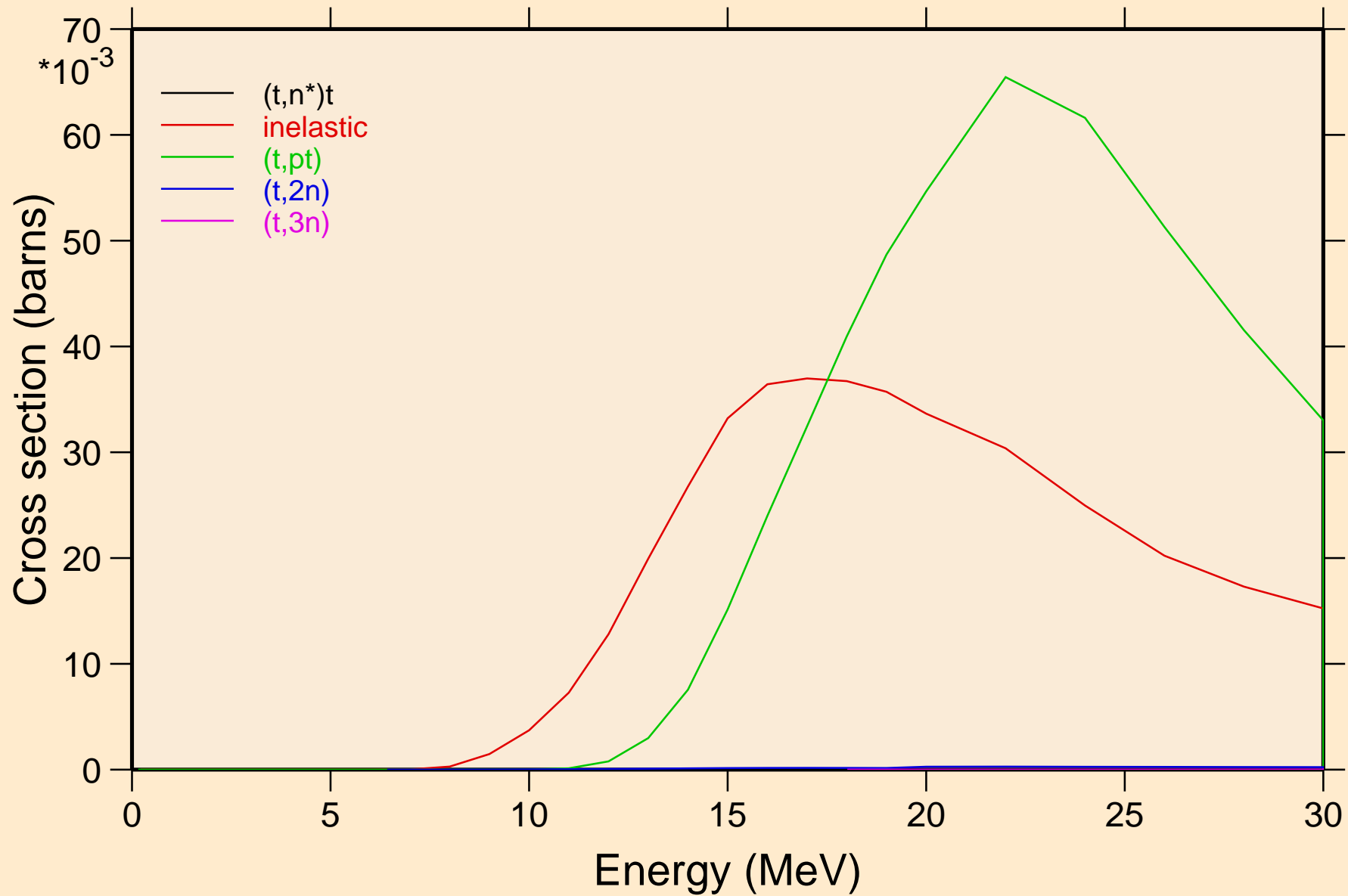

PR124 TRITON ACER TENDL-2021 LIBRARY; T=0.K  
Threshold reactions

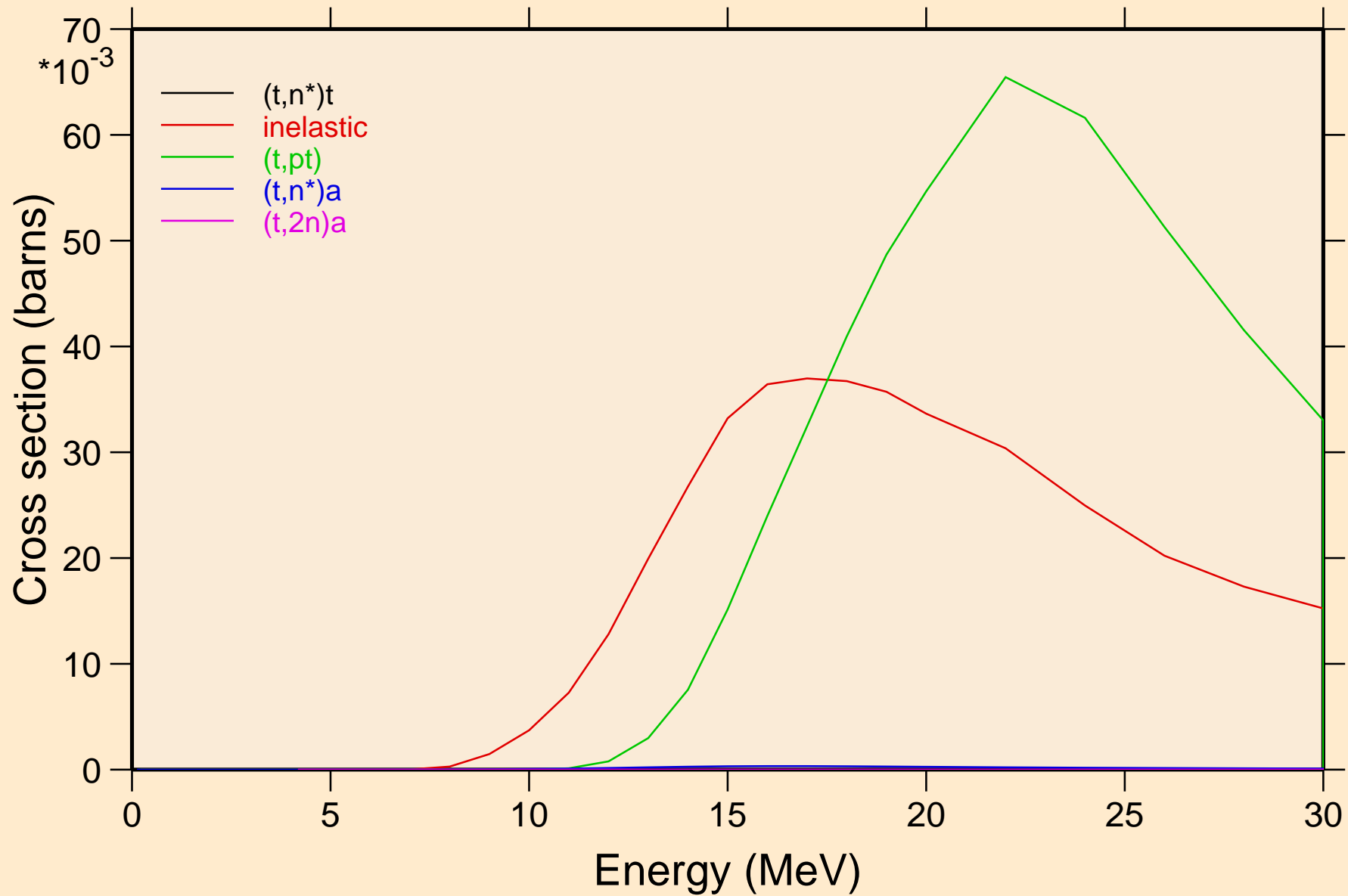

PR124 TRITON ACER TENDL-2021 LIBRARY; T=0.K  
Threshold reactions

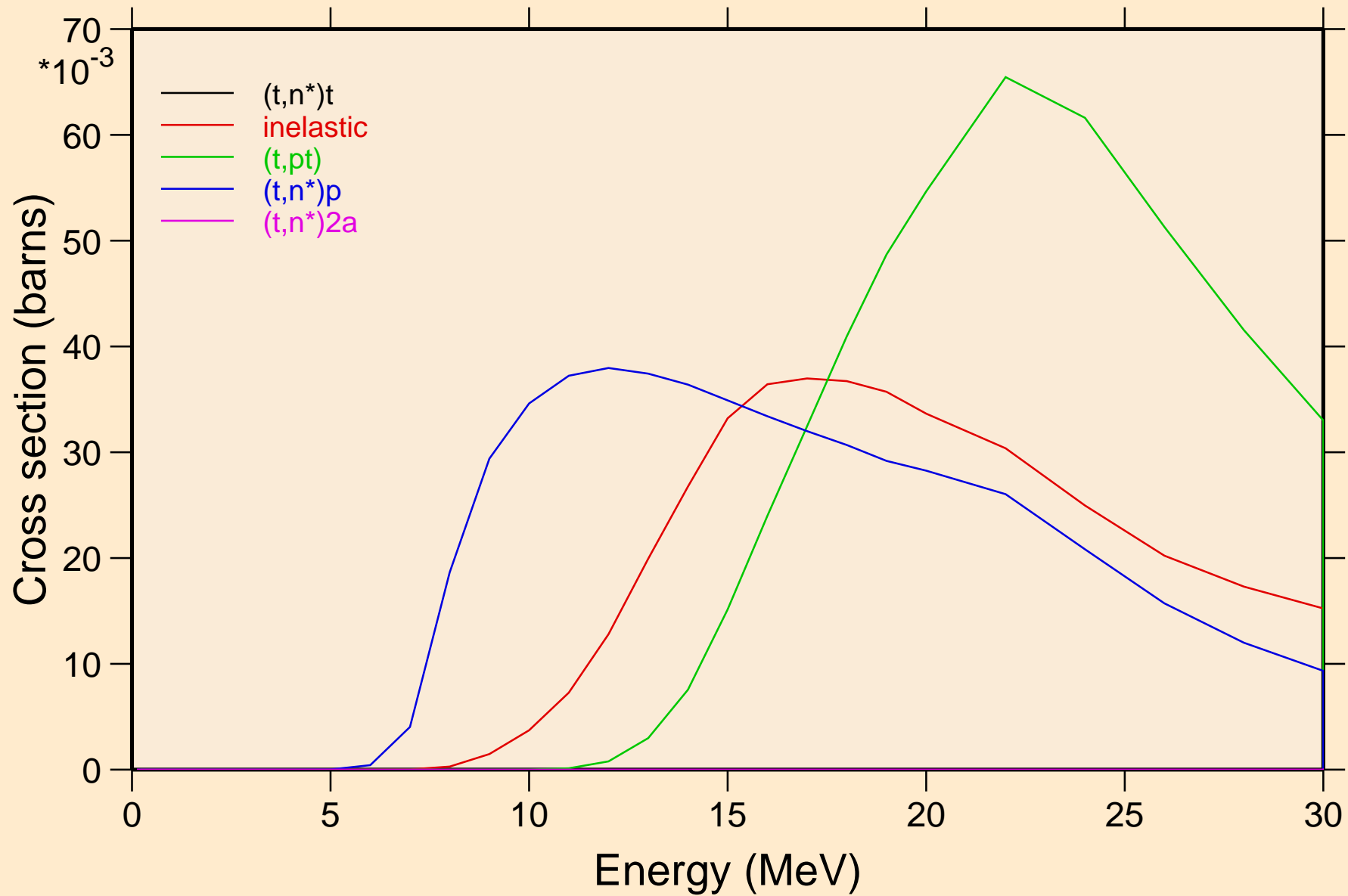



PR124 TRITON ACER TENDL-2021 LIBRARY; T=0.K  
Threshold reactions

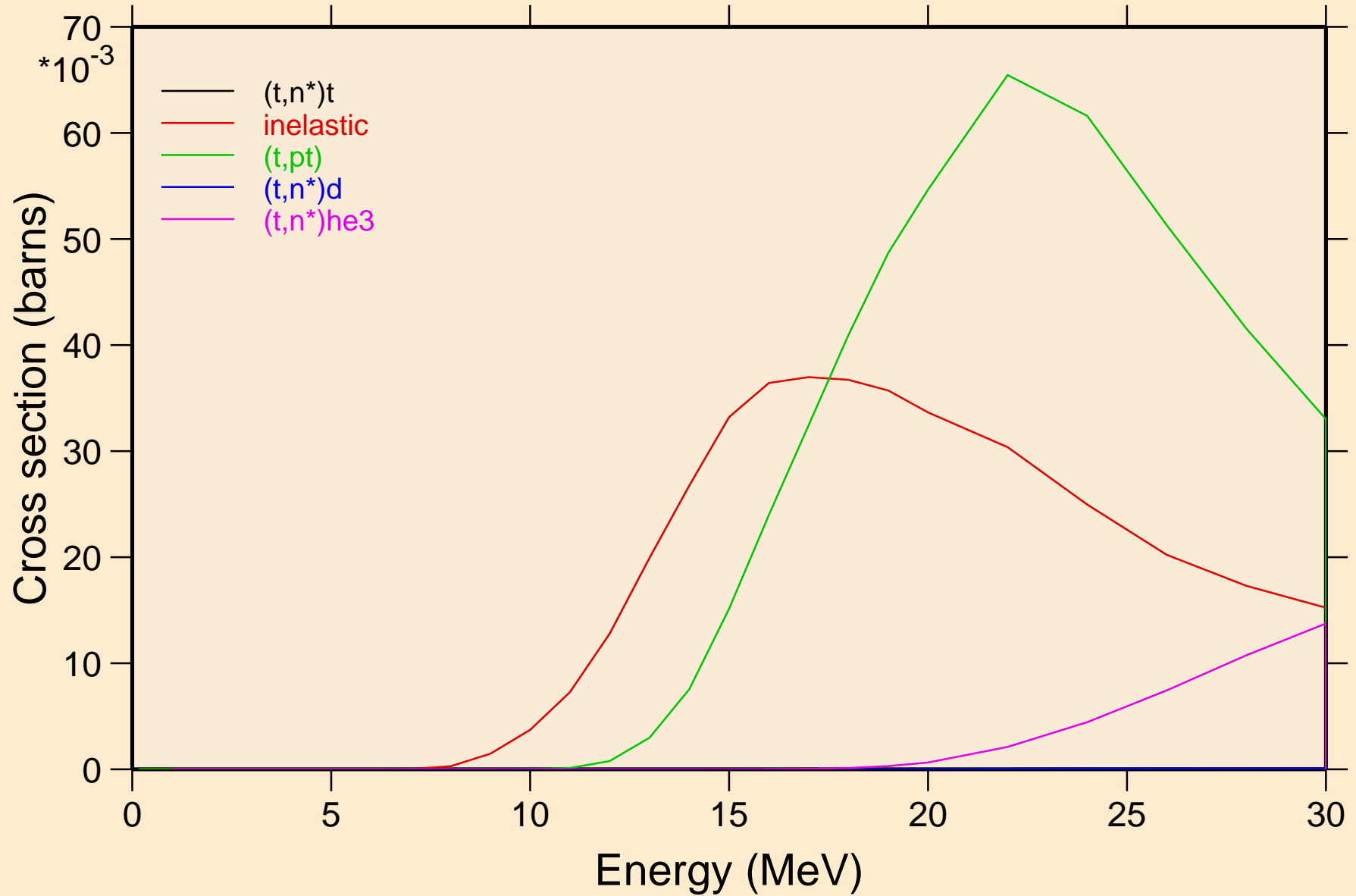

PR124 TRITON ACER TENDL-2021 LIBRARY; T=0.K  
Threshold reactions

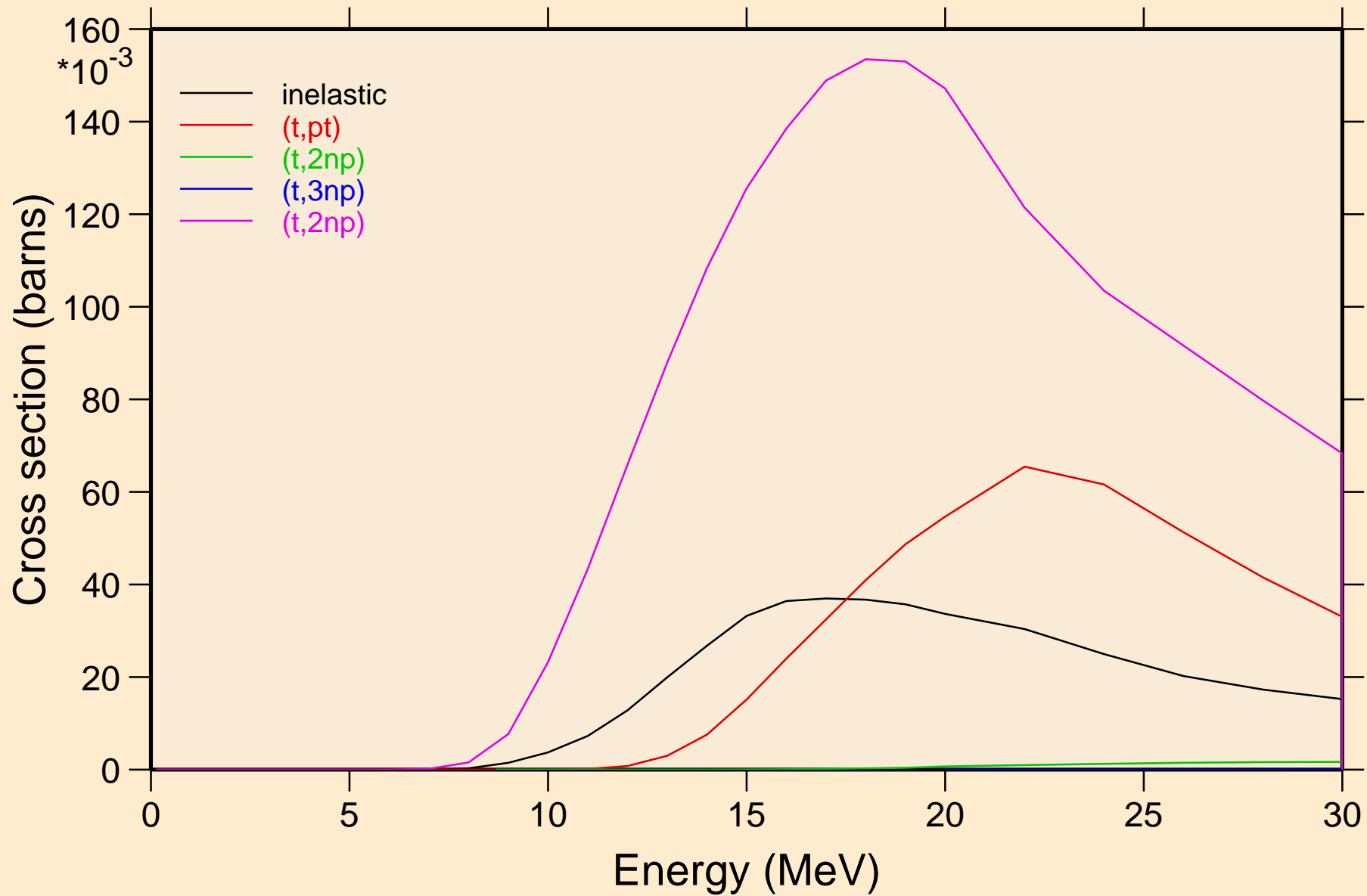

PR124 TRITON ACER TENDL-2021 LIBRARY; T=0.K  
Threshold reactions

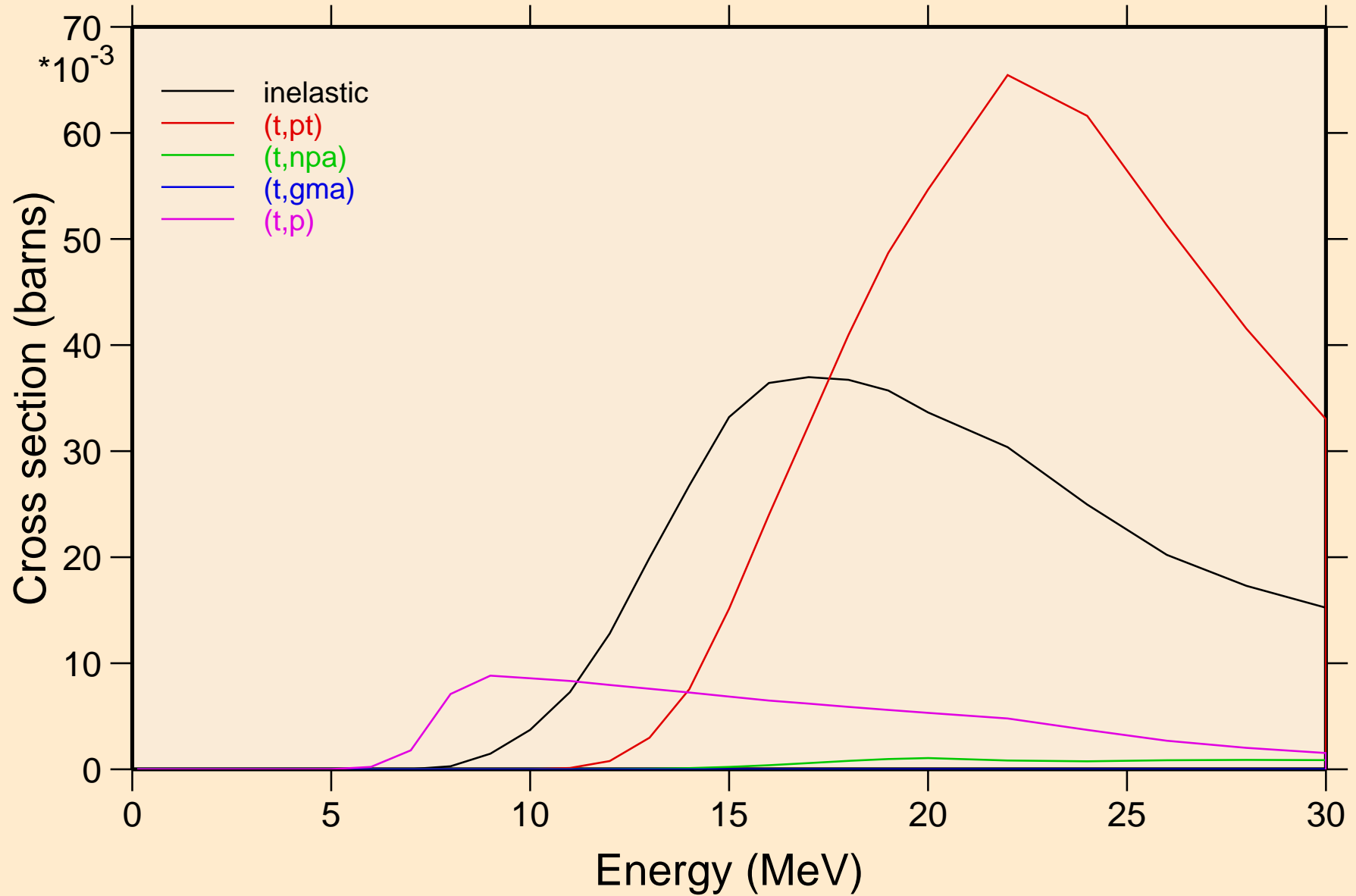

PR124 TRITON ACER TENDL-2021 LIBRARY; T=0.K  
Threshold reactions

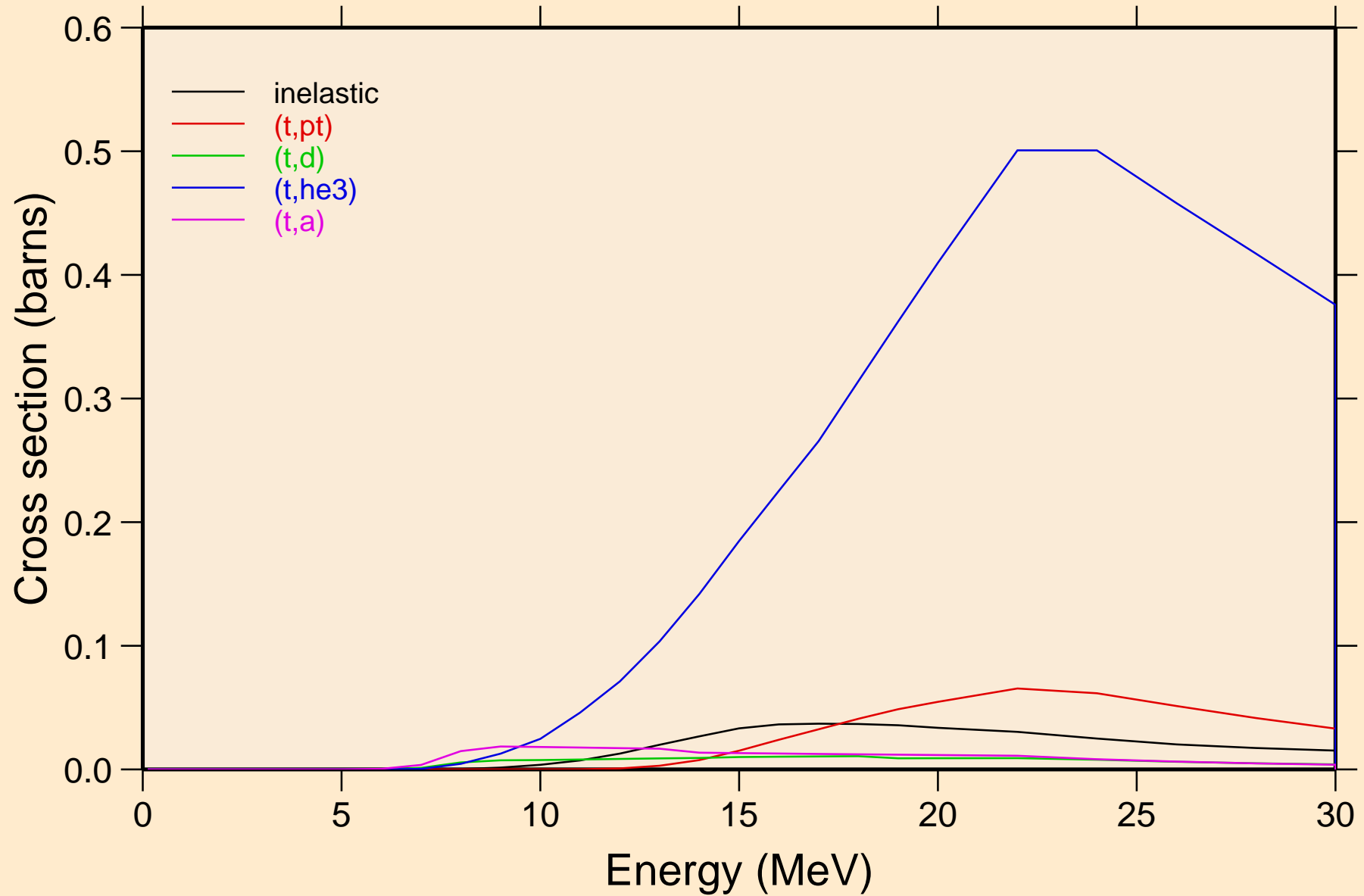

PR124 TRITON ACER TENDL-2021 LIBRARY; T=0.K  
Threshold reactions

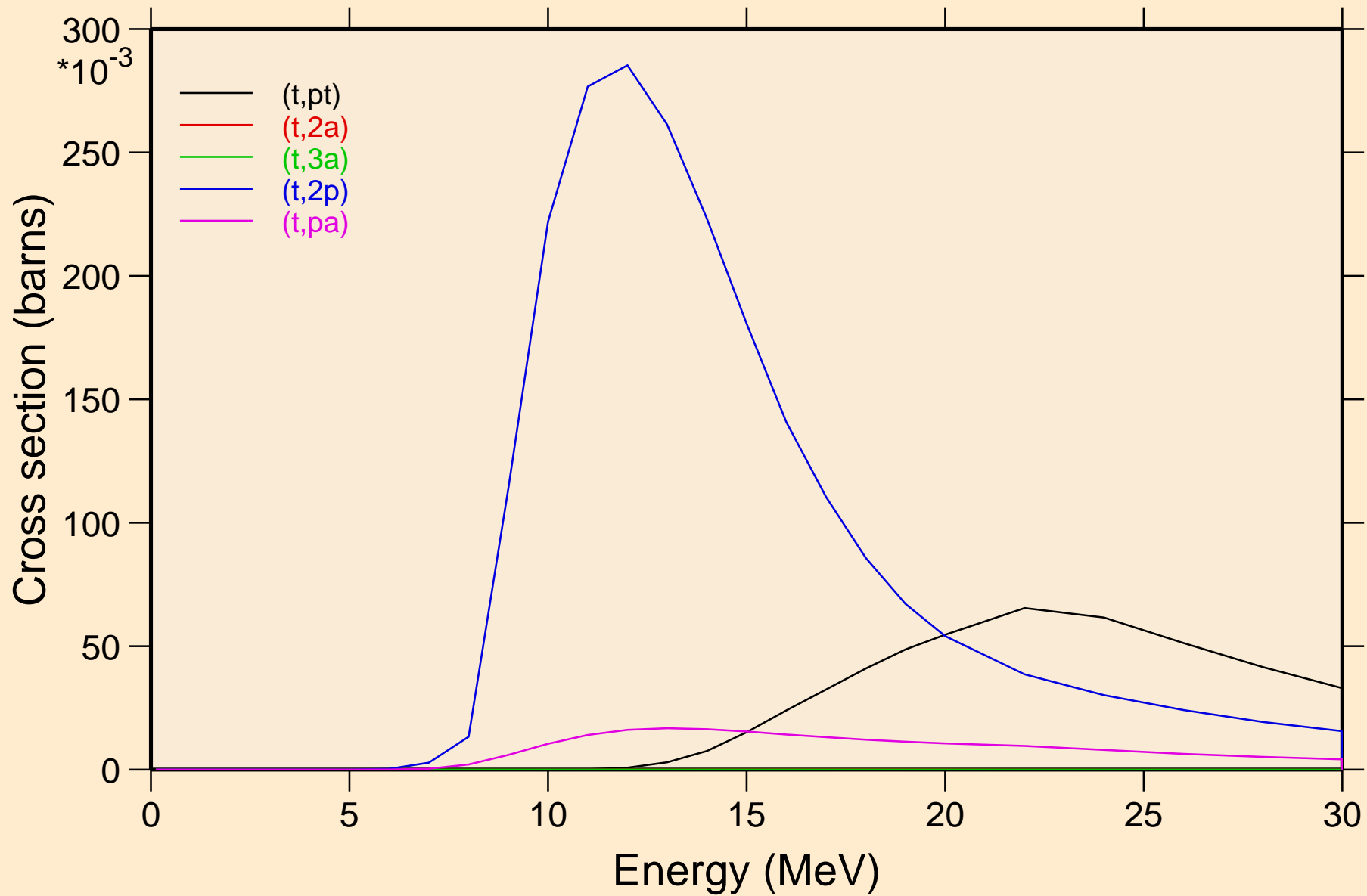

PR124 TRITON ACER TENDL-2021 LIBRARY; T=0.K  
Threshold reactions

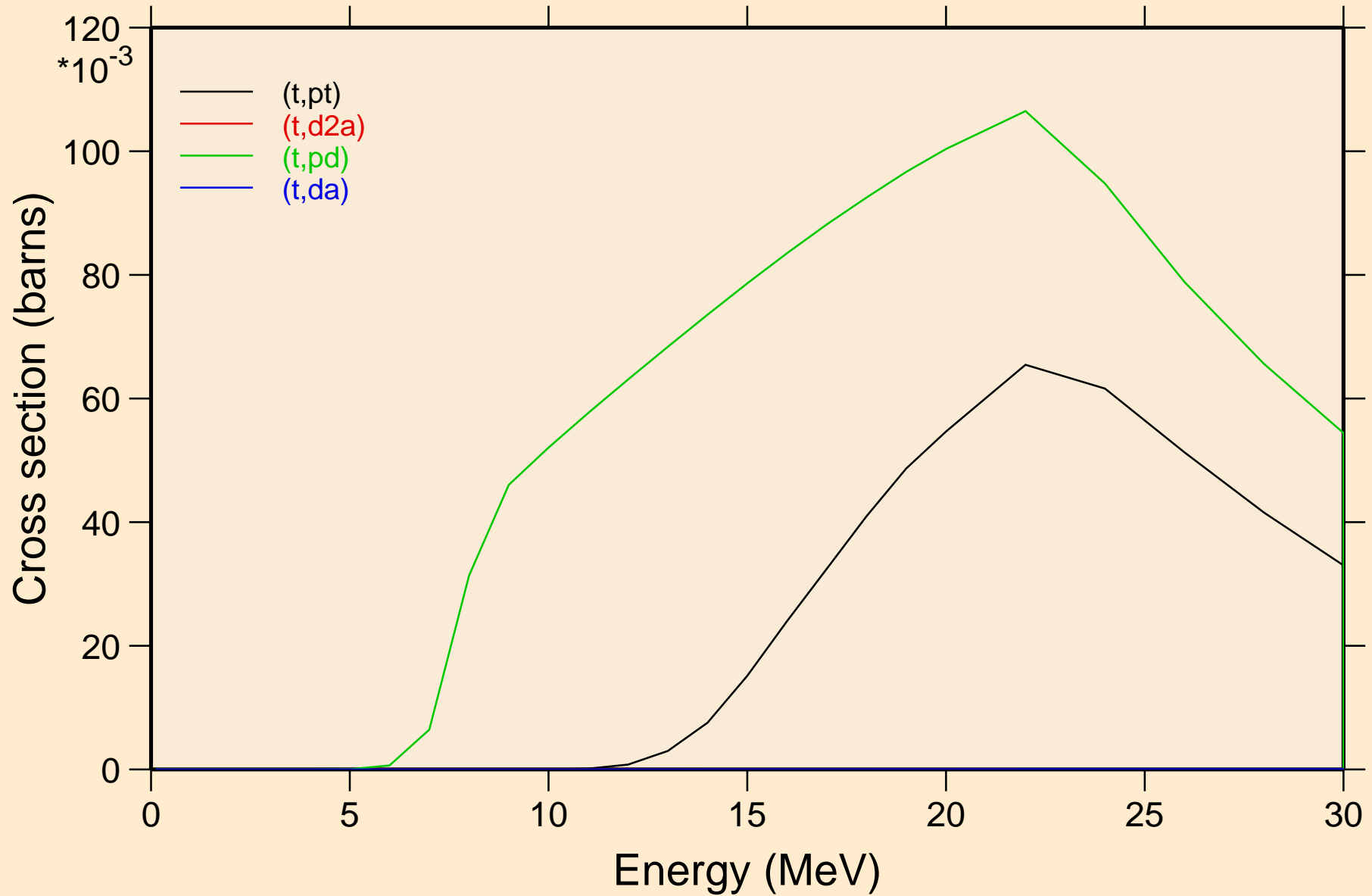

PR124 TRITON ACER TENDL-2021 LIBRARY; T=0.K  
angular distribution for elastic

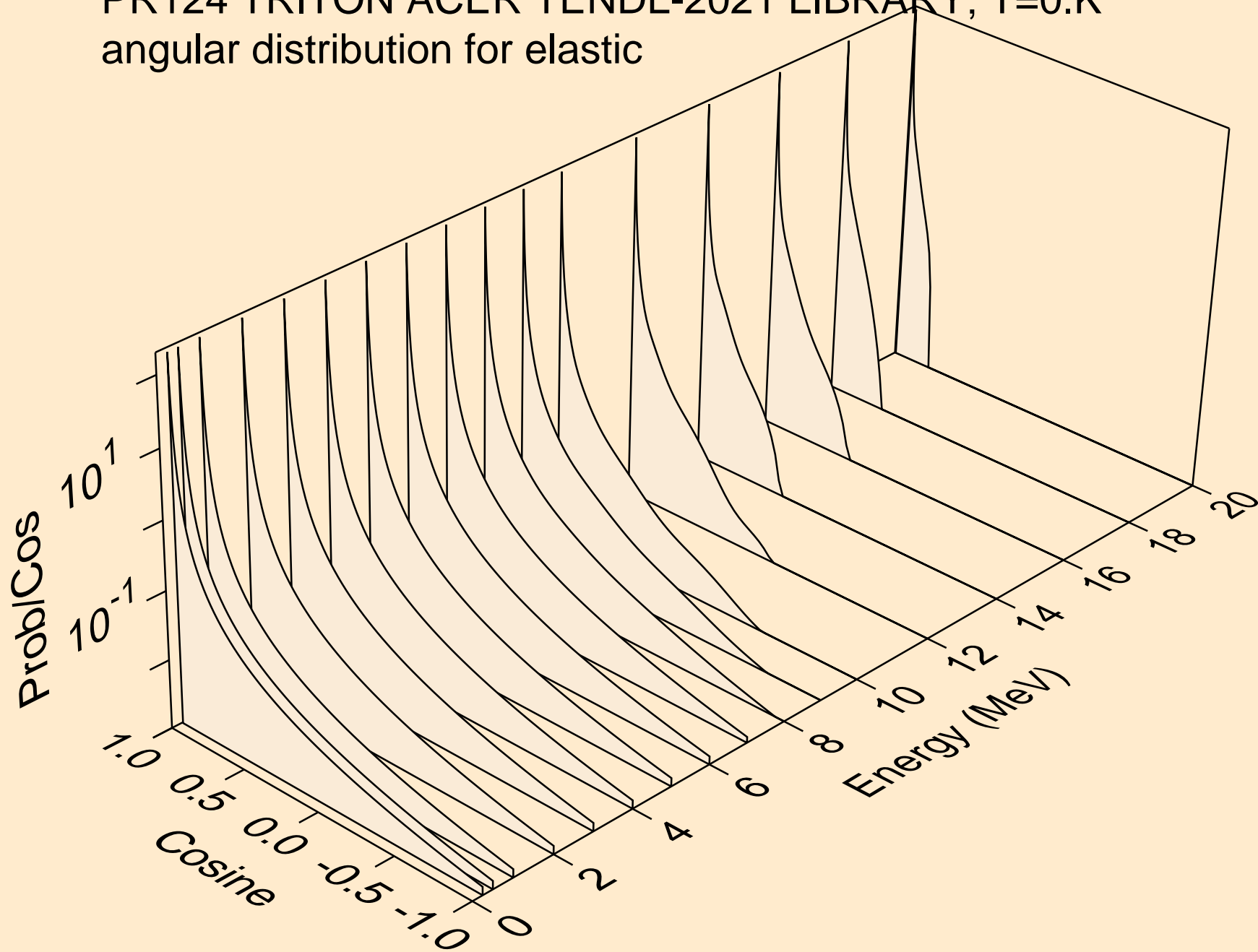

PR124 TRITON ACER TENDL-2021 LIBRARY; T=0.K  
angular distribution for elastic

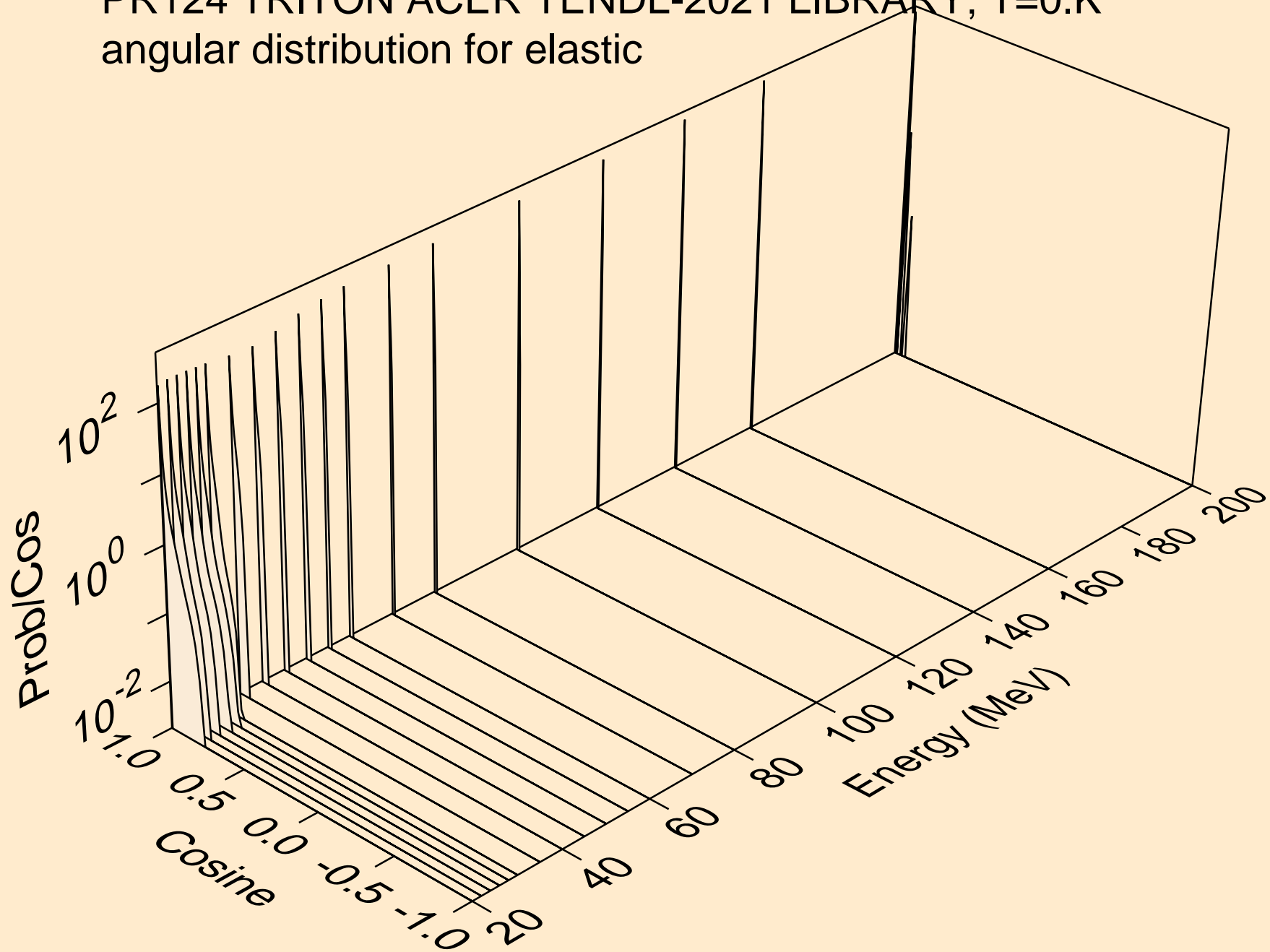



PR124 TRITON ACER TENDL-2021 LIBRARY; T=0.K  
Triton emission for (t,x)

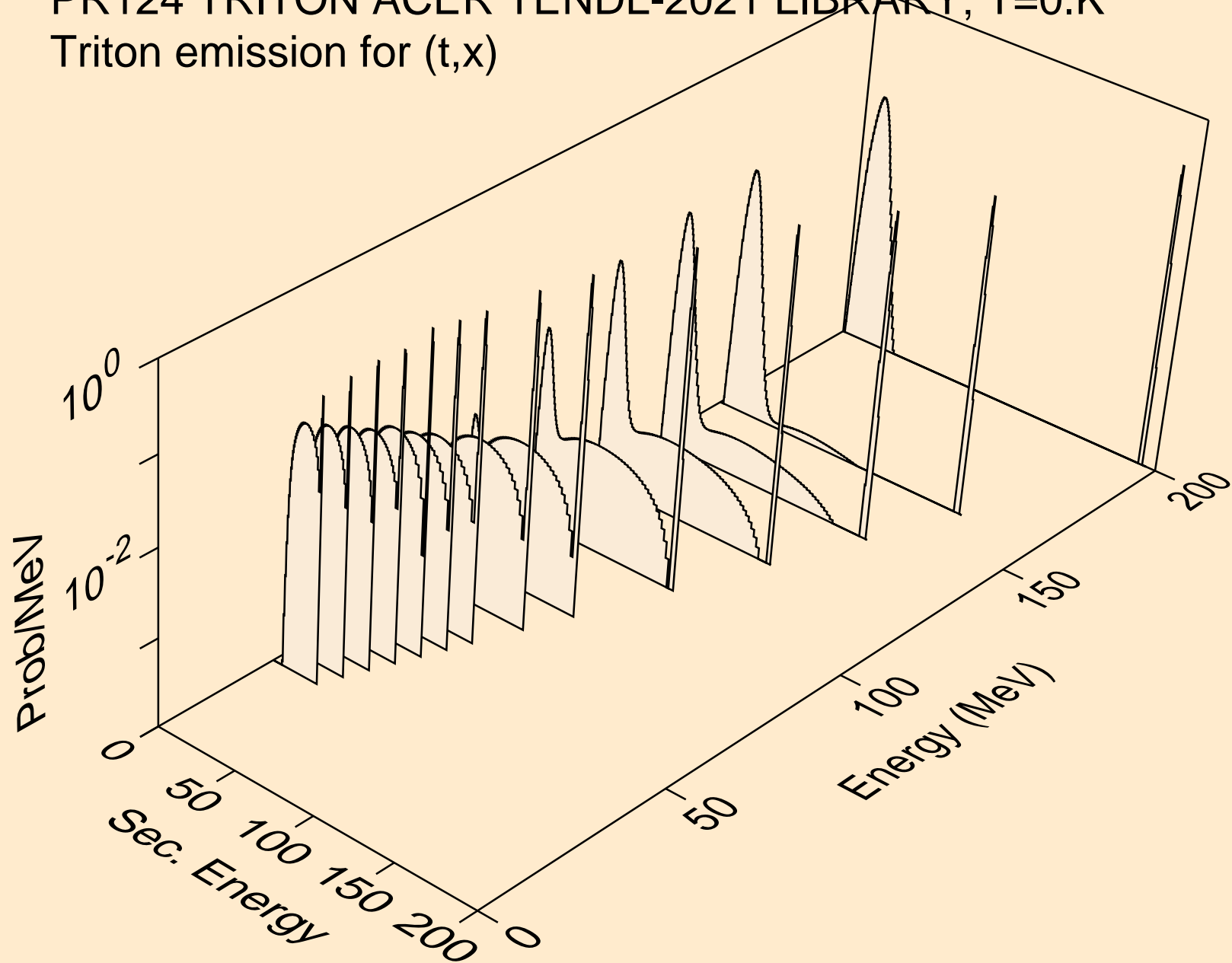

PR124 TRITON ACER TENDL-2021 LIBRARY; T=0.K  
Triton emission for (t,n\*)t

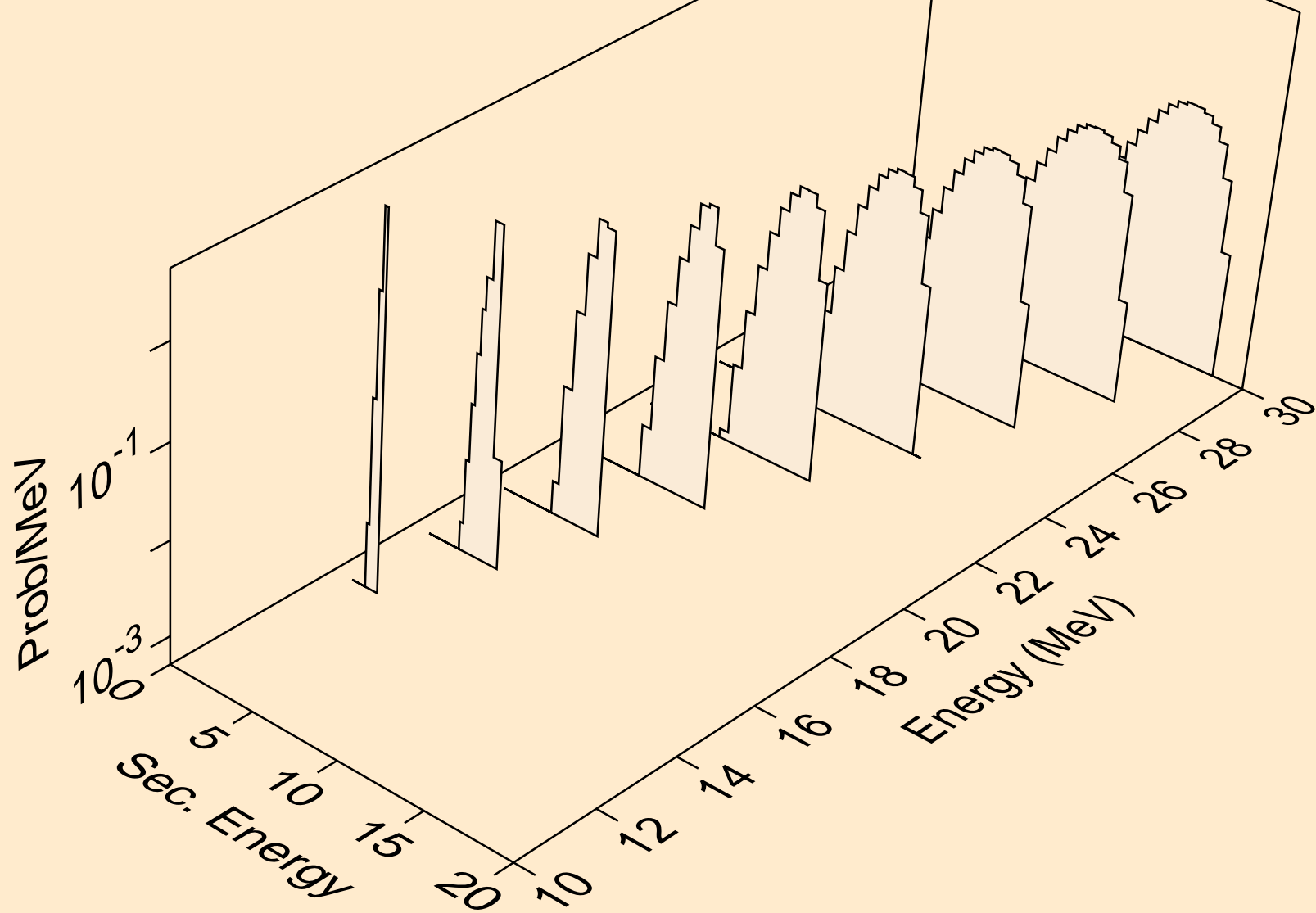

PR124 TRITON ACER TENDL-2021 LIBRARY; T=0.K  
Triton emission for inelastic

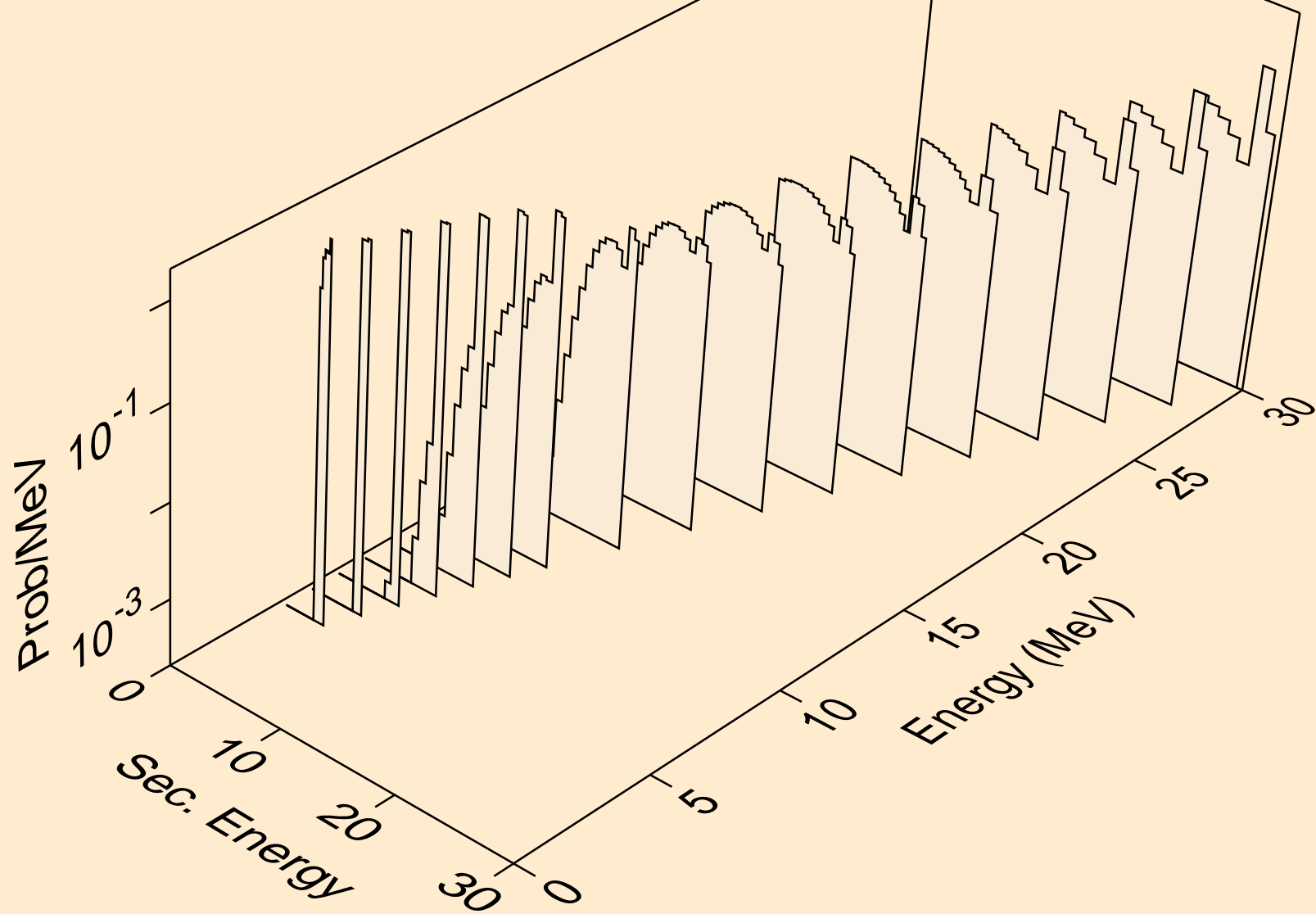

PR124 TRITON ACER TENDL-2021 LIBRARY; T=0.K  
Triton emission for (t,pt)

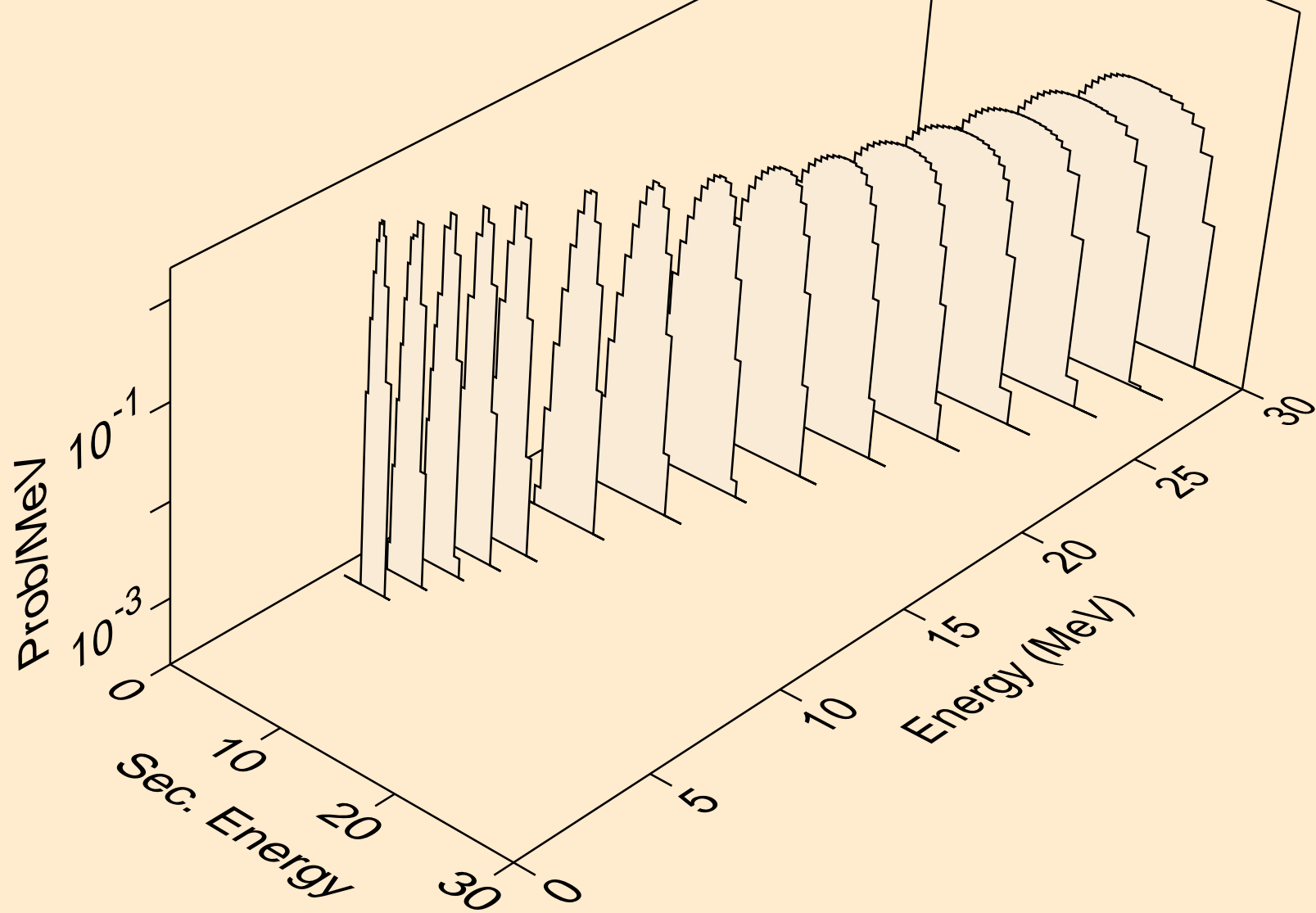

PR124 TRITON ACER TENDL-2021 LIBRARY; T=0.K  
Photon emission for (z,n)

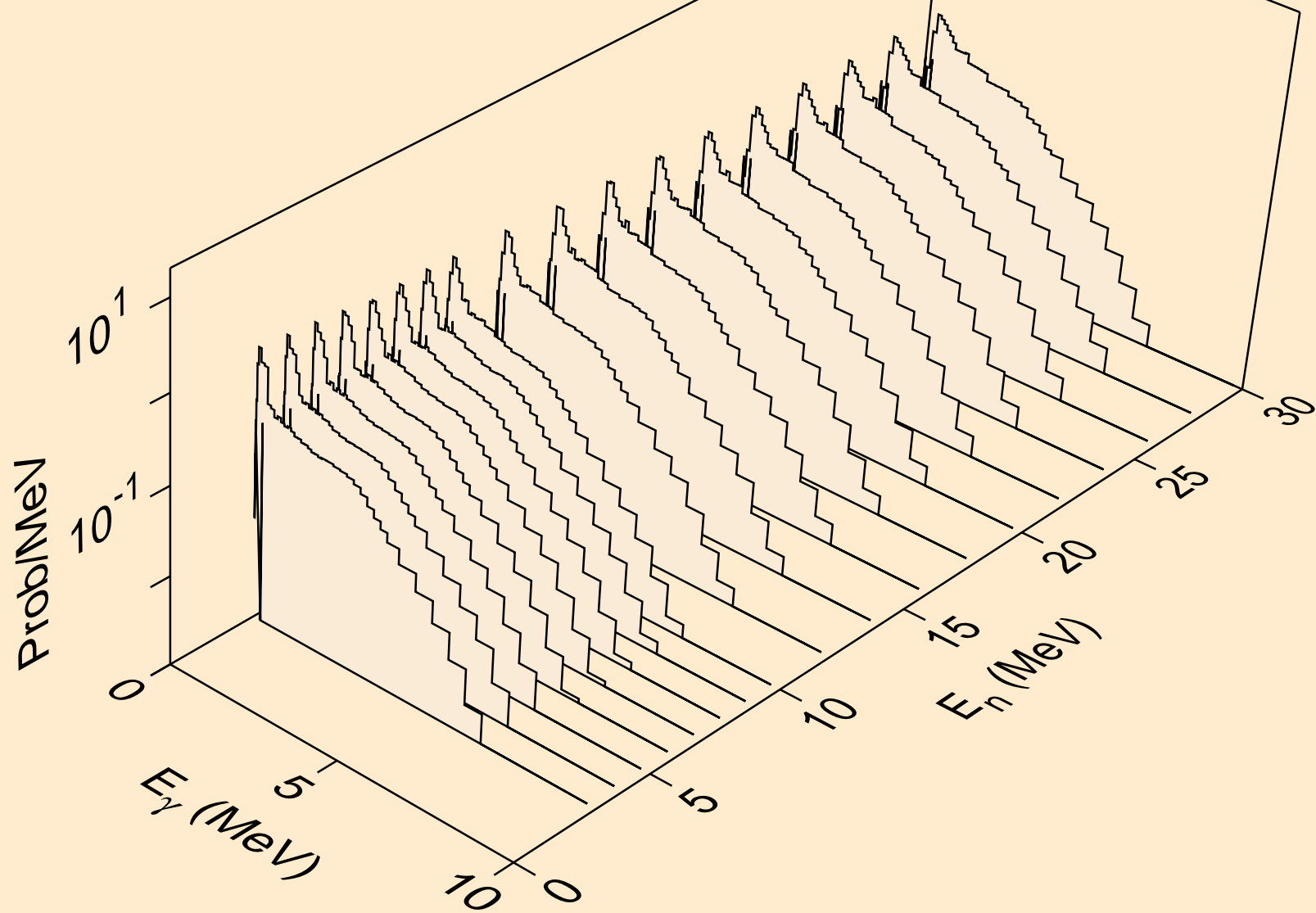

PR124 TRITON ACER TENDL-2021 LIBRARY; T=0.K  
Photon emission for (n,x)

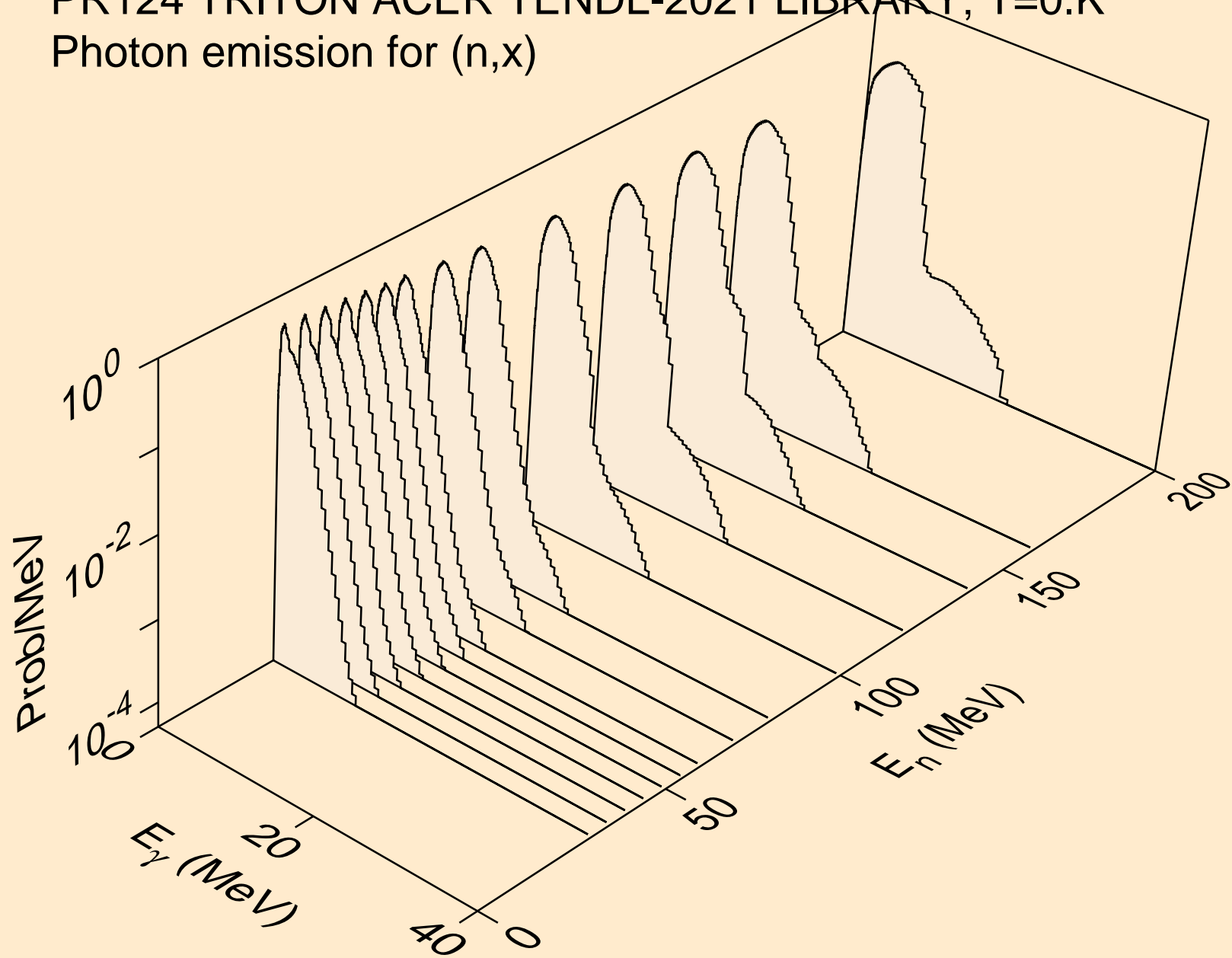

PR124 TRITON ACER TENDL-2021 LIBRARY; T=0.K  
Photon emission for (n,2nd)

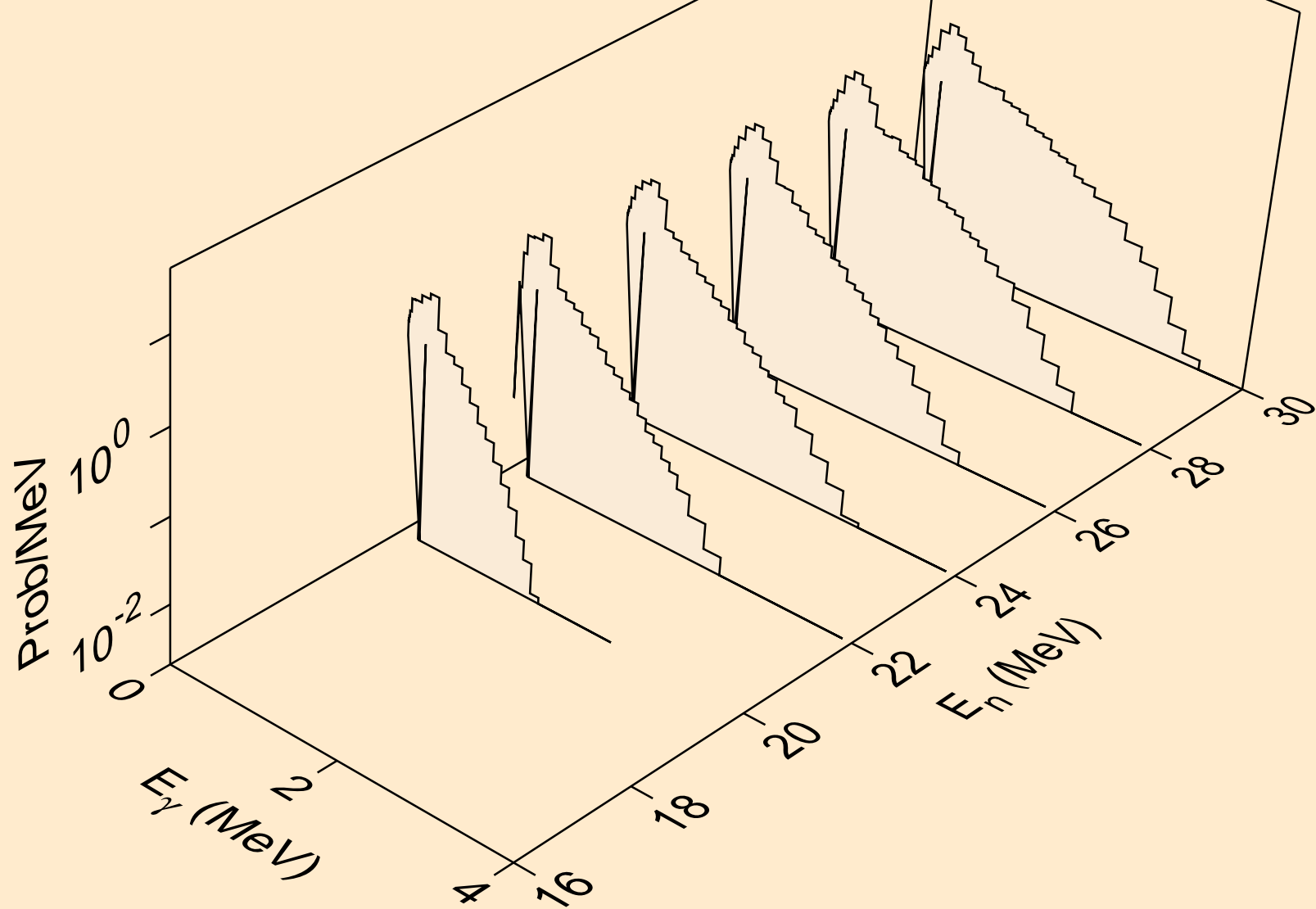

PR124 TRITON ACER TENDL-2021 LIBRARY; T=0.K  
Photon emission for (n,2n)

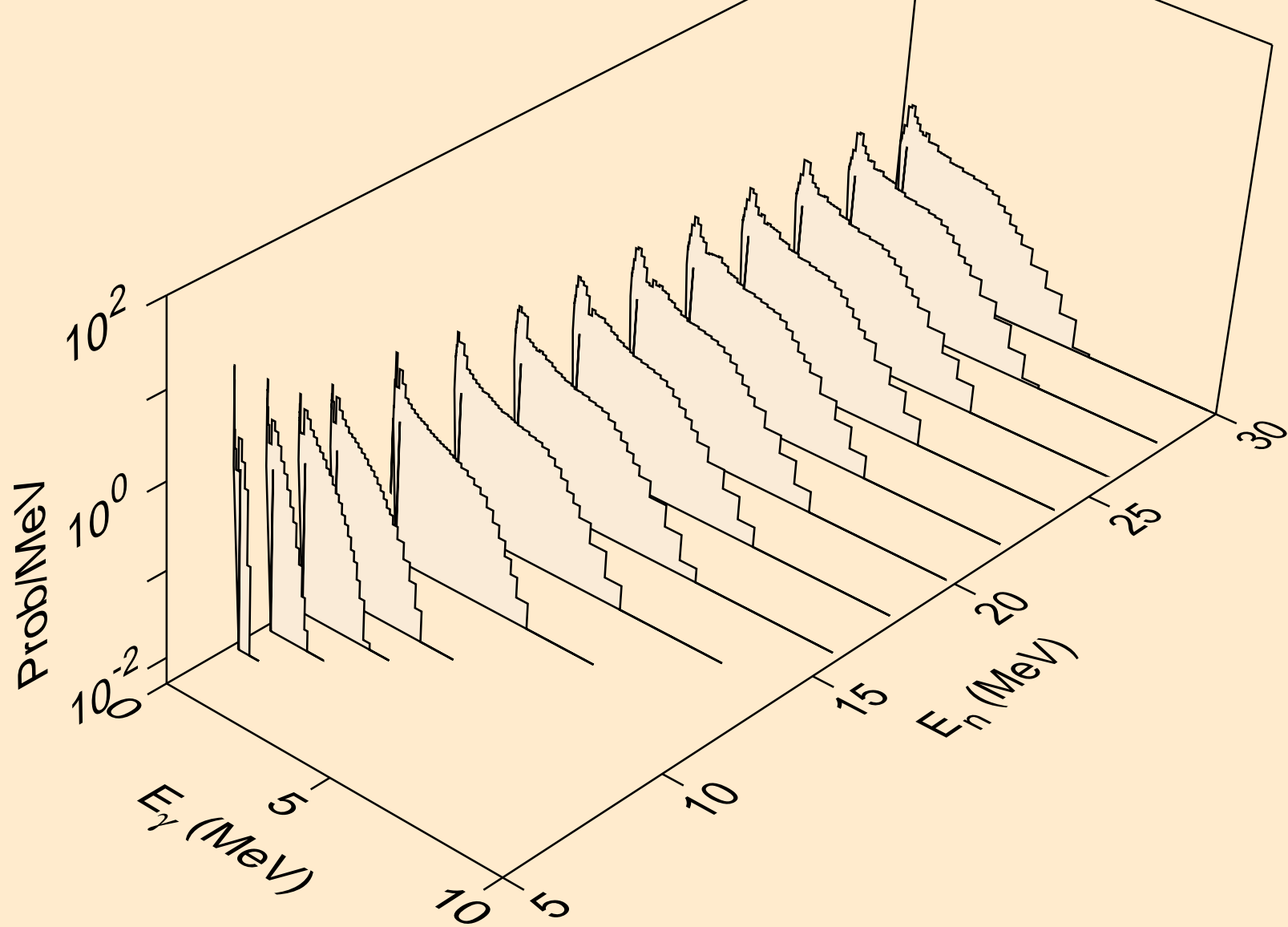



PR124 TRITON ACER TENDL-2021 LIBRARY; T=0.K  
Photon emission for (n,3n)

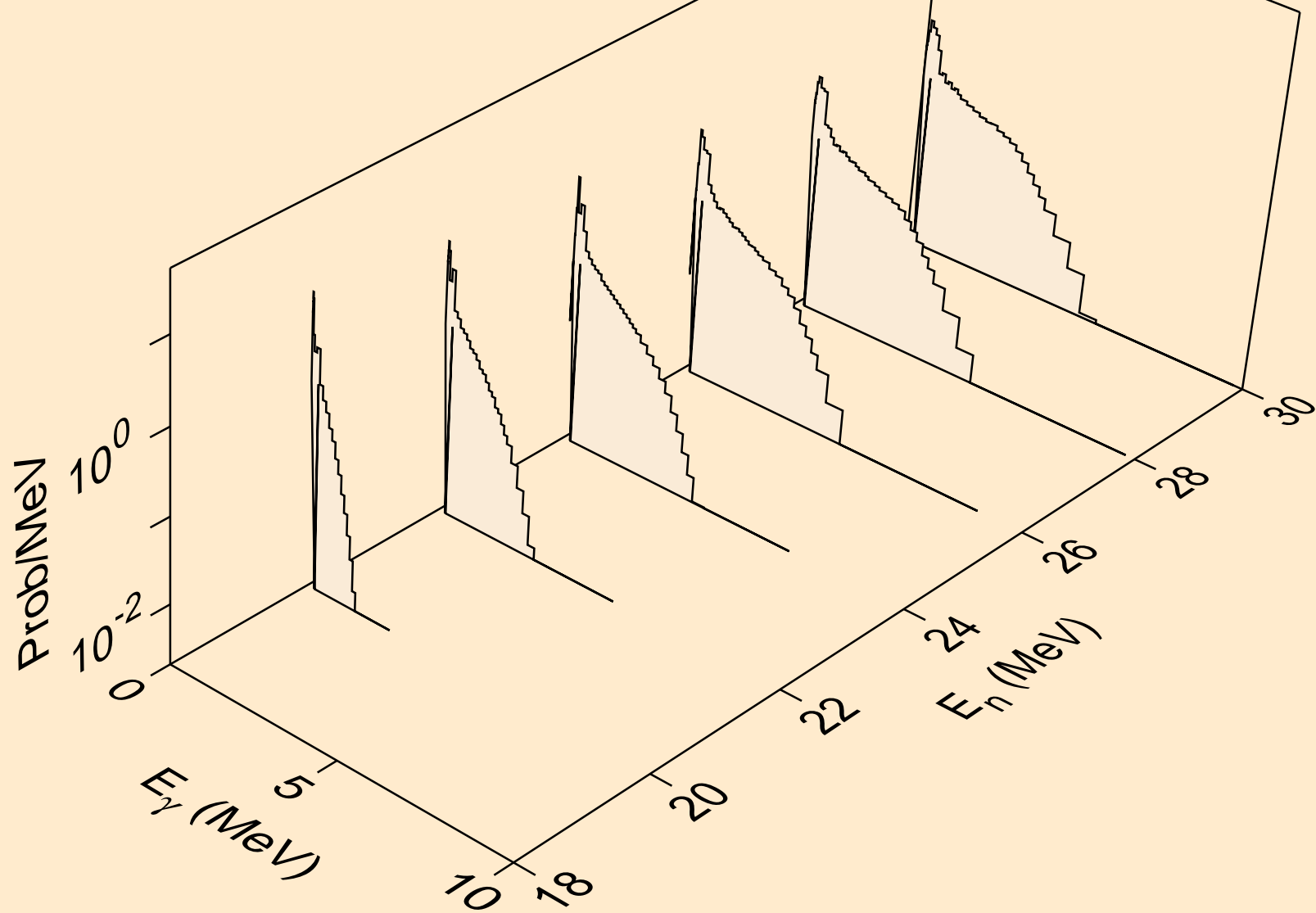

PR124 TRITON ACER TENDL-2021 LIBRARY; T=0.K  
Photon emission for (n,n\*)a

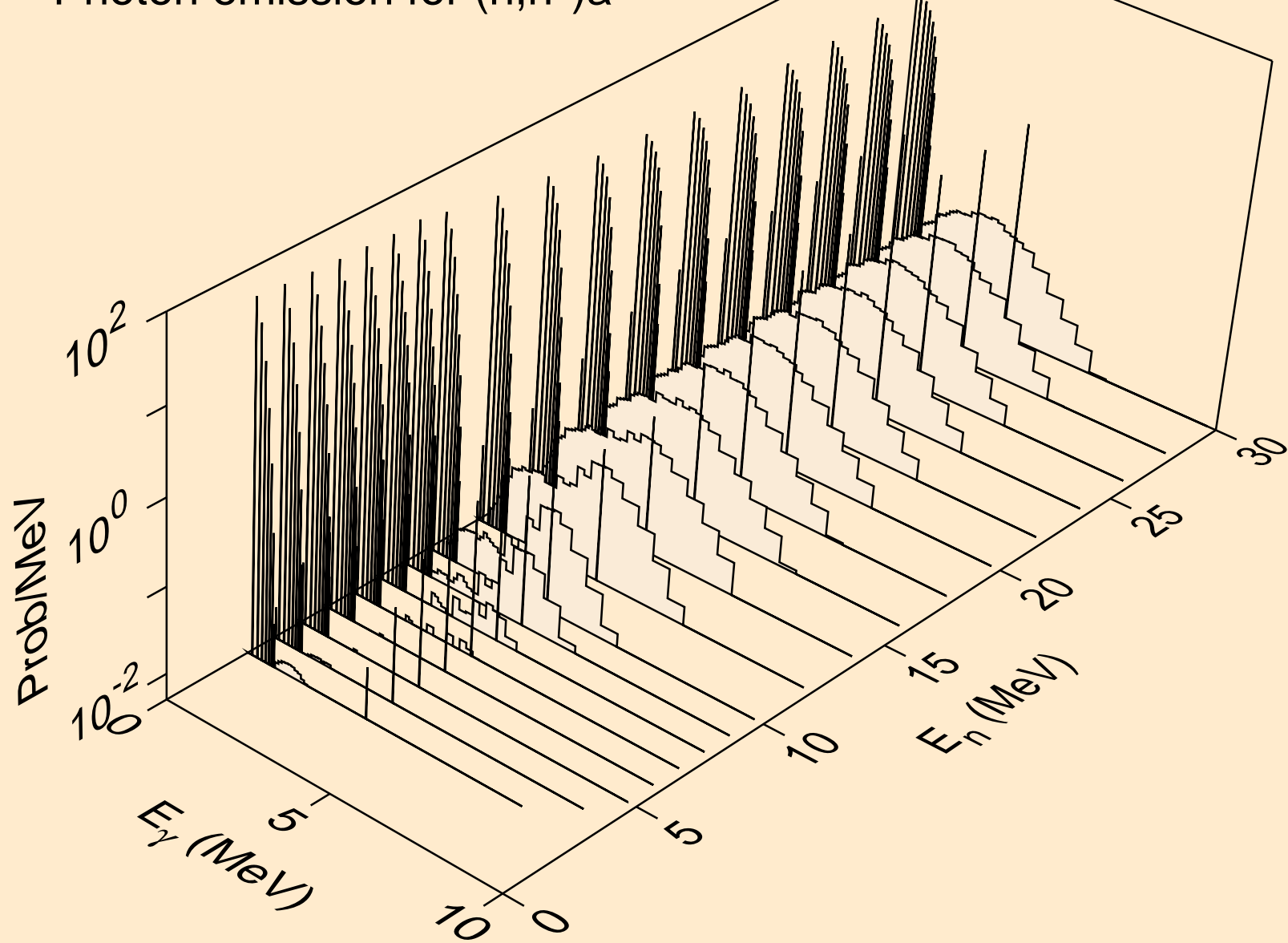

PR124 TRITON ACER TENDL-2021 LIBRARY; T=0.K  
Photon emission for (n,2n)a

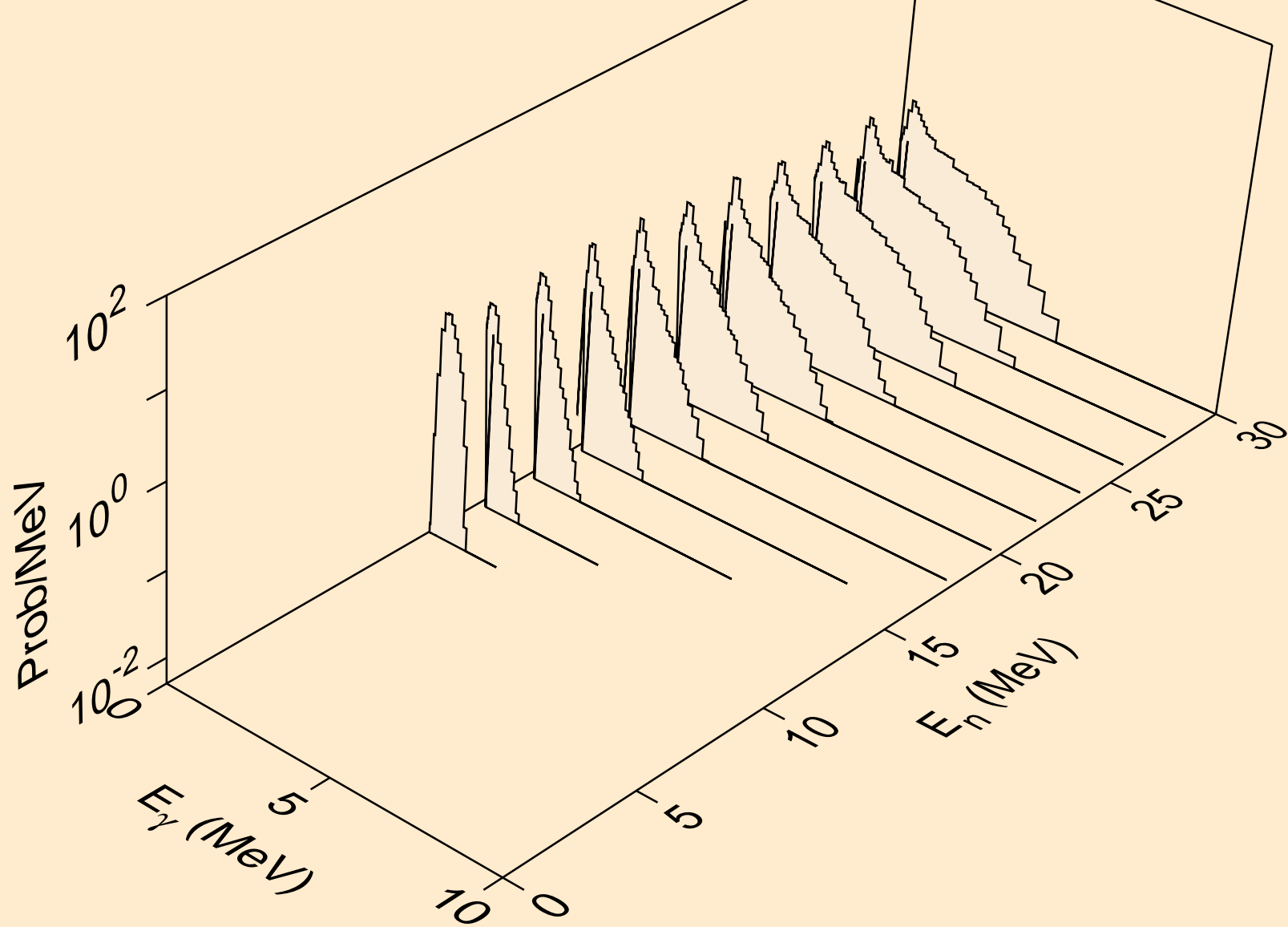

PR124 TRITON ACER TENDL-2021 LIBRARY; T=0.K  
Photon emission for (n,n\*)p

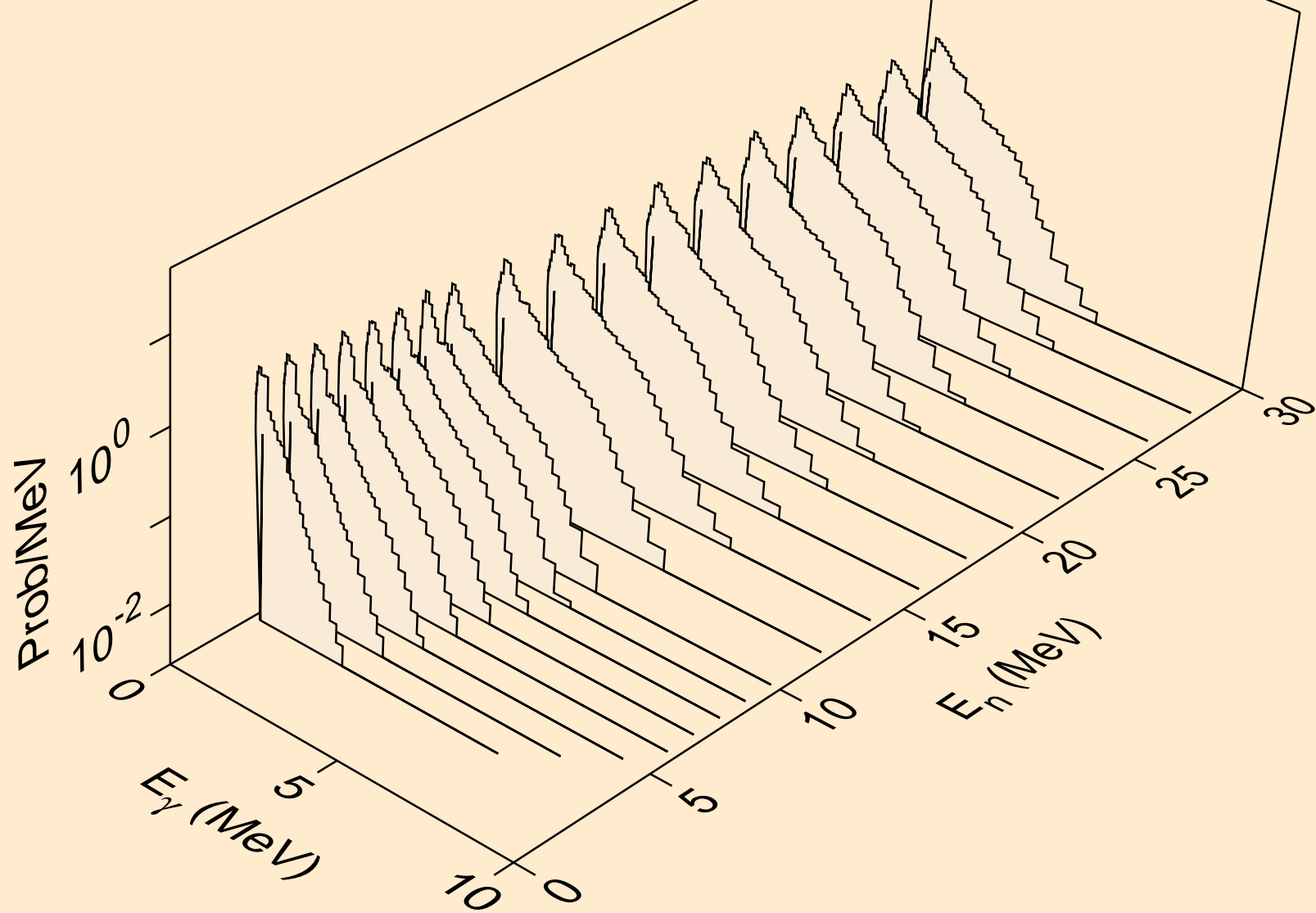

PR124 TRITON ACER TENDL-2021 LIBRARY; T=0.K  
Photon emission for (n,n\*)2a

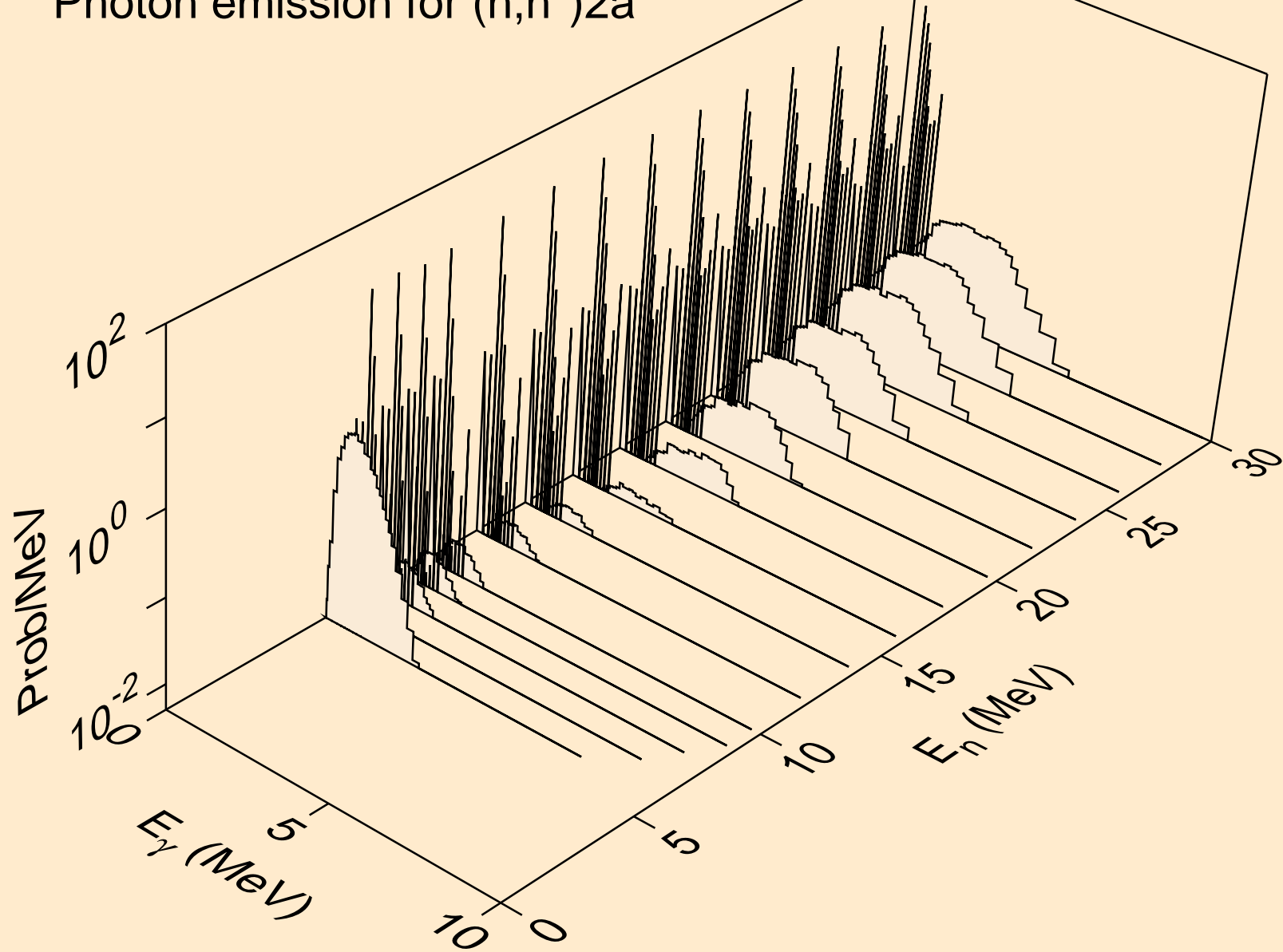

PR124 TRITON ACER TENDL-2021 LIBRARY; T=0.K  
Photon emission for (n,n\*)d

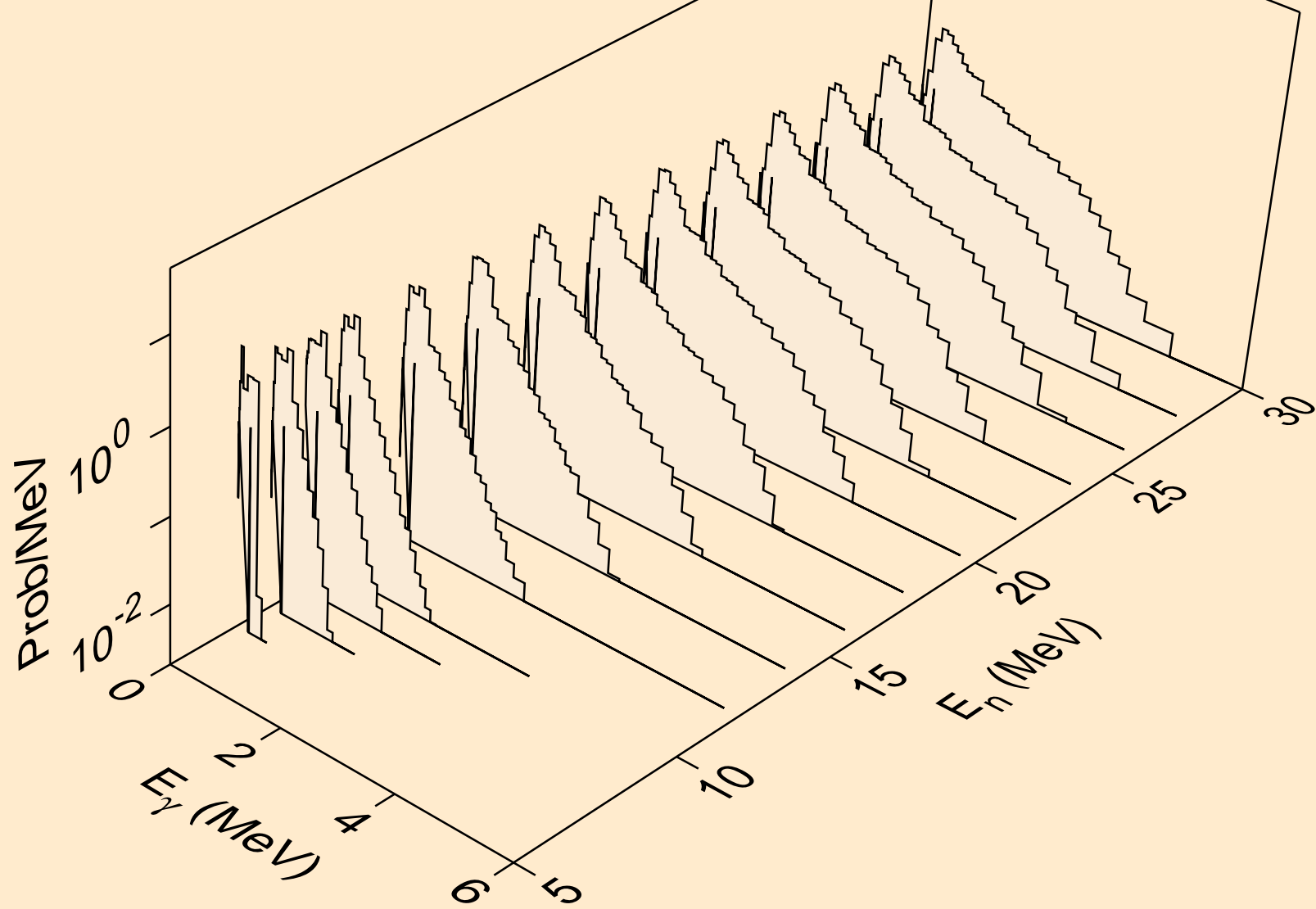

PR124 TRITON ACER TENDL-2021 LIBRARY; T=0.K  
Photon emission for (n,n\*)t

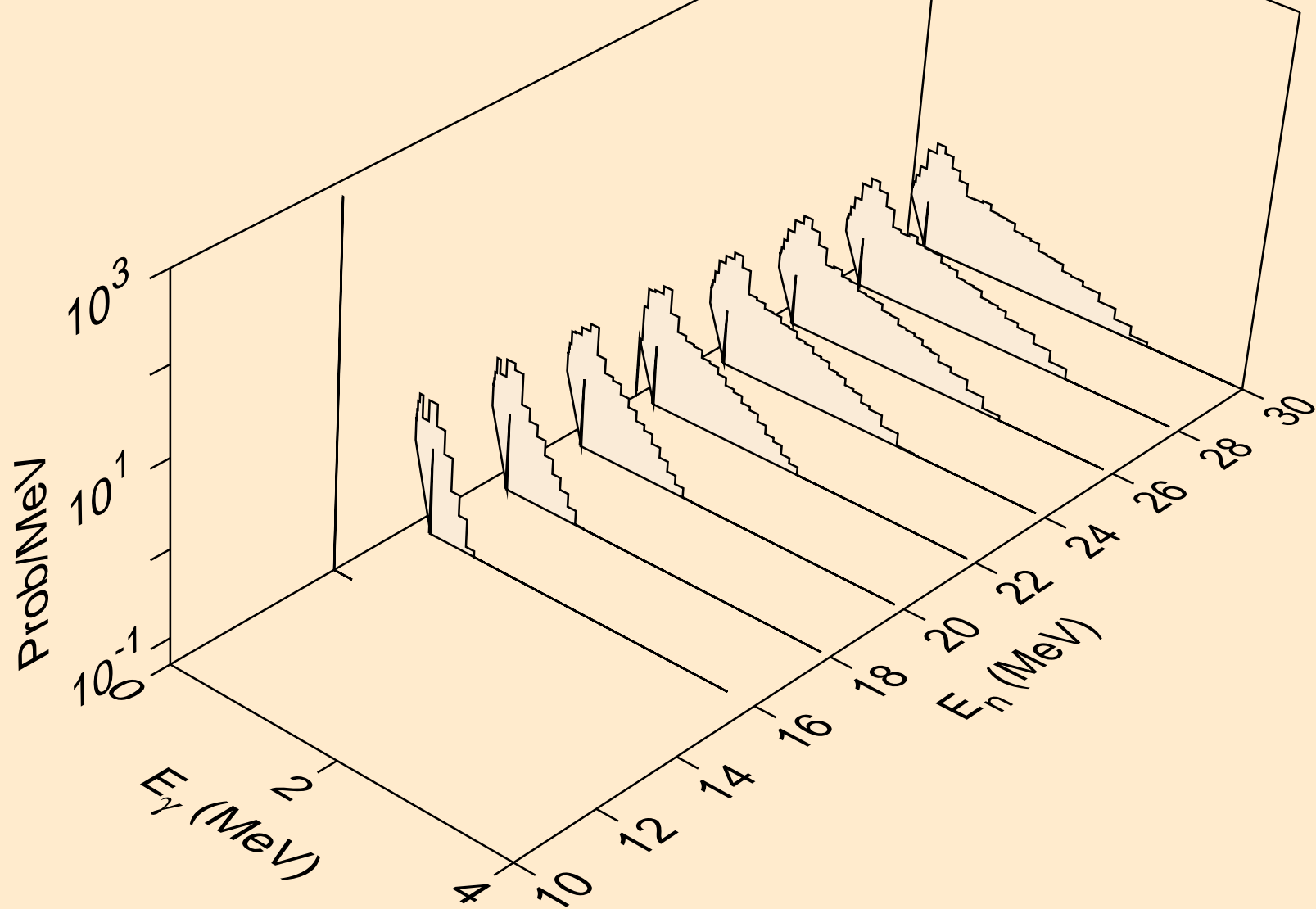

PR124 TRITON ACER TENDL-2021 LIBRARY; T=0.K  
Photon emission for (n,n\*)he3

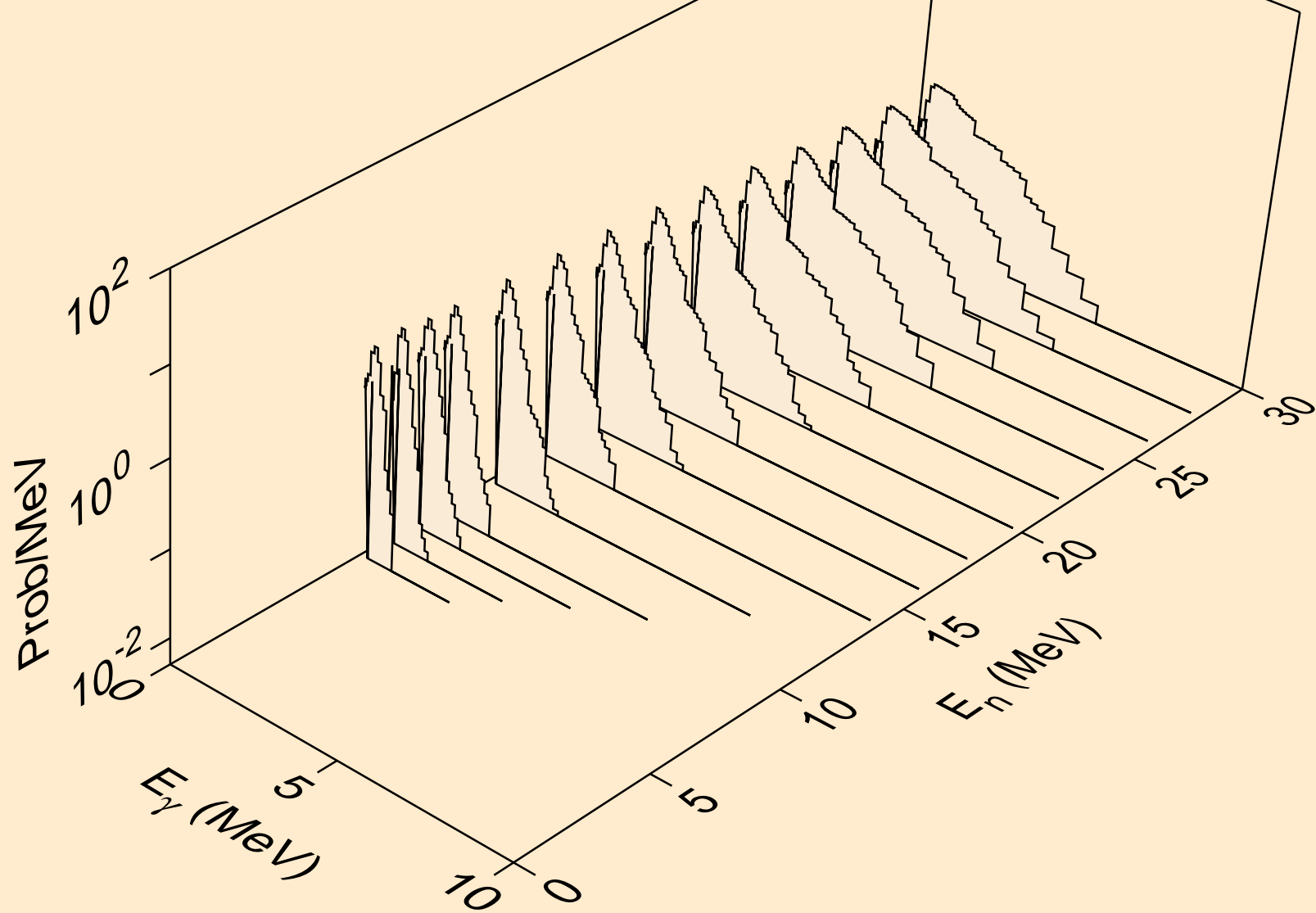



PR124 TRITON ACER TENDL-2021 LIBRARY; T=0.K  
Photon emission for (n,2np)

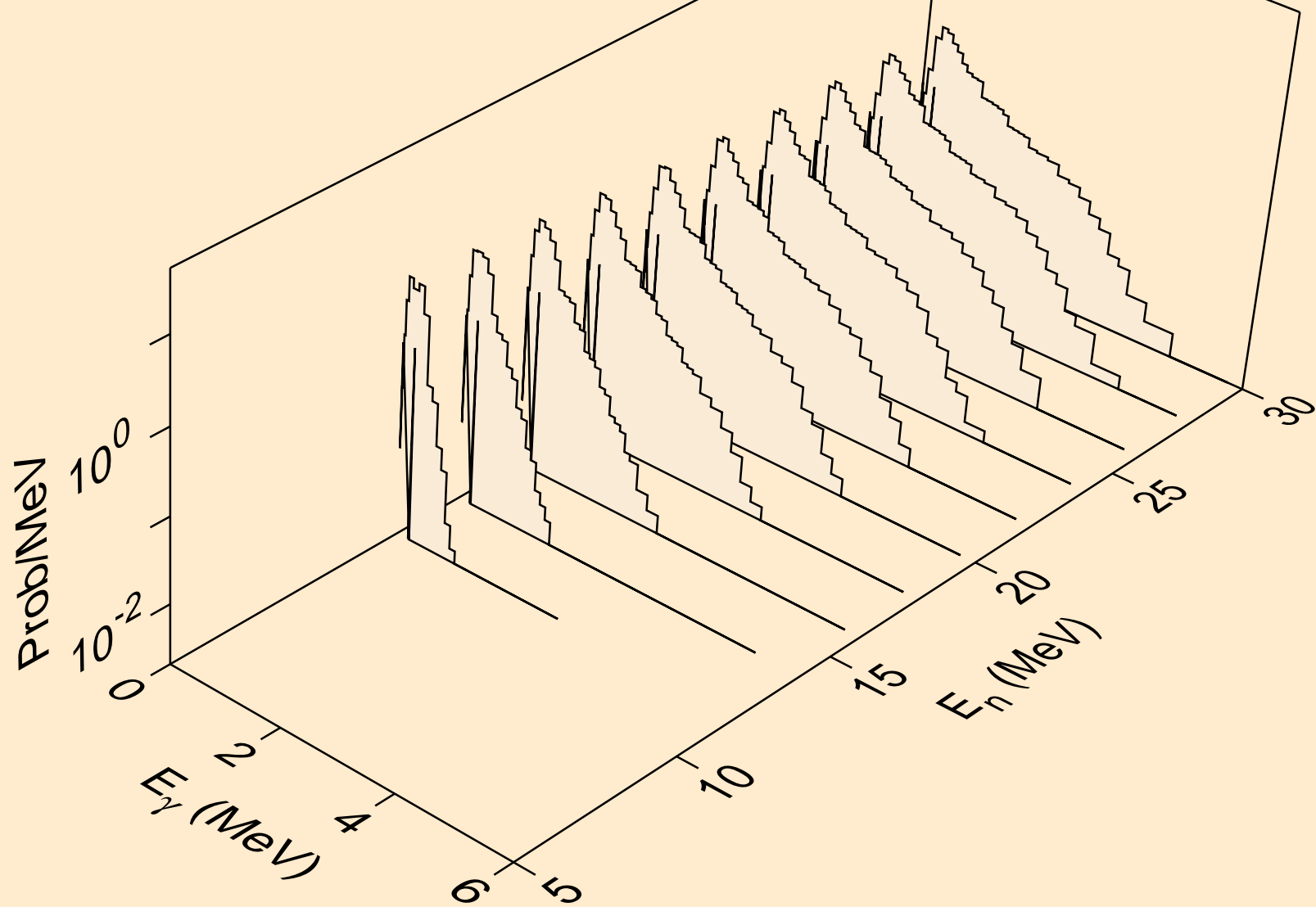

PR124 TRITON ACER TENDL-2021 LIBRARY; T=0.K  
Photon emission for (n,3np)

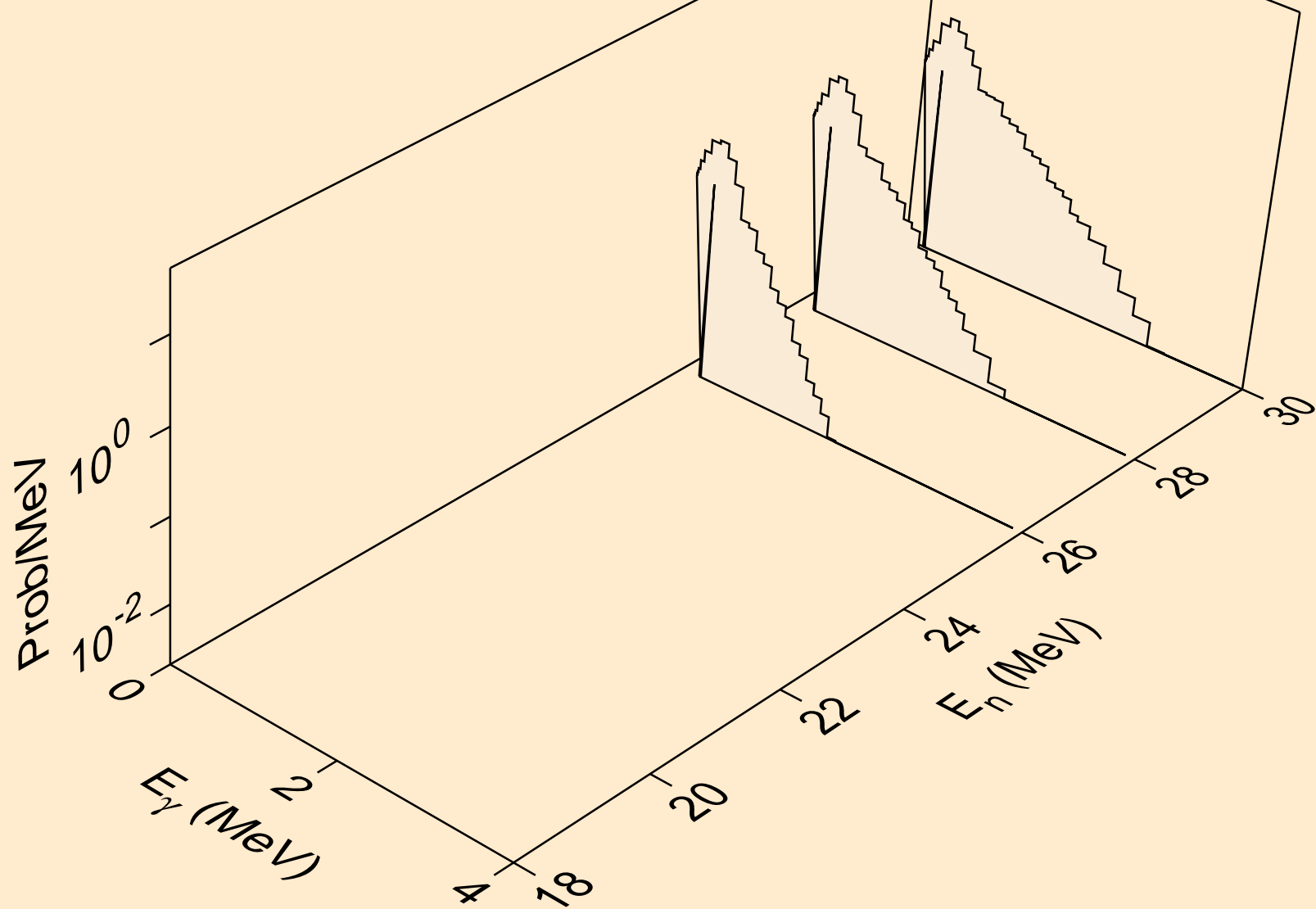

PR124 TRITON ACER TENDL-2021 LIBRARY; T=0.K  
Photon emission for (n,2np)

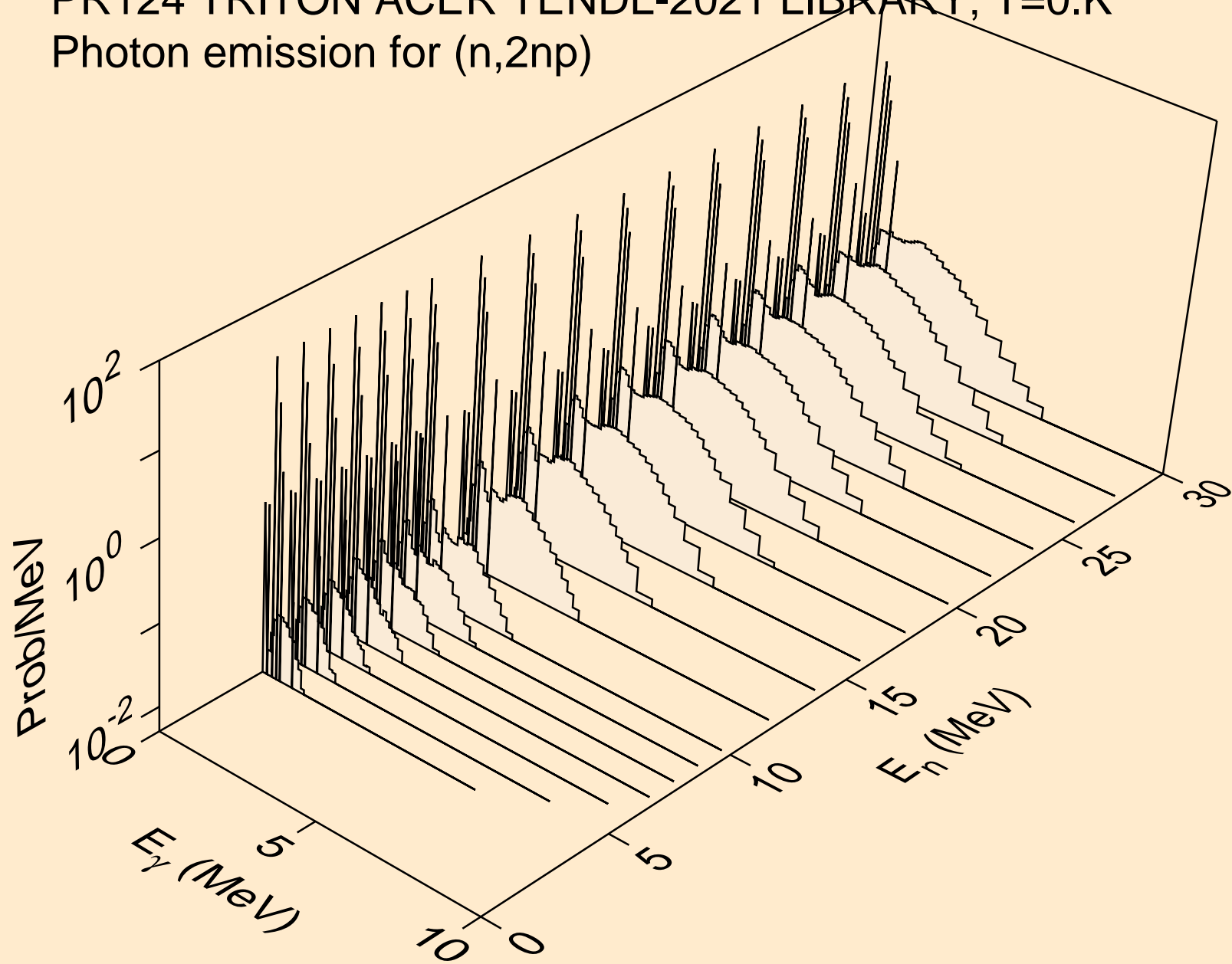

PR124 TRITON ACER TENDL-2021 LIBRARY; T=0.K  
Photon emission for (n,npa)

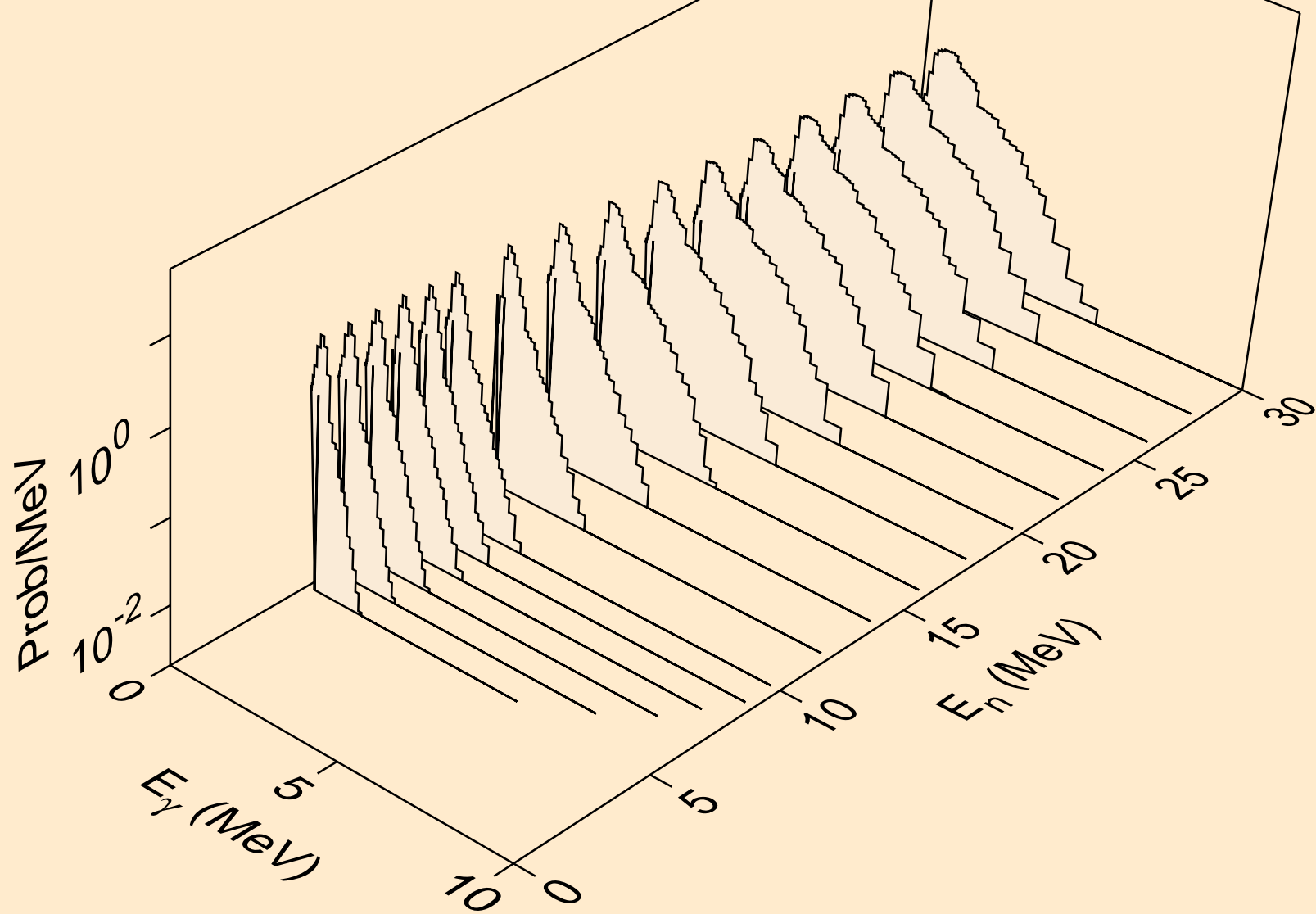

PR124 TRITON ACER TENDL-2021 LIBRARY; T=0.K  
Photon emission for (n,gma)

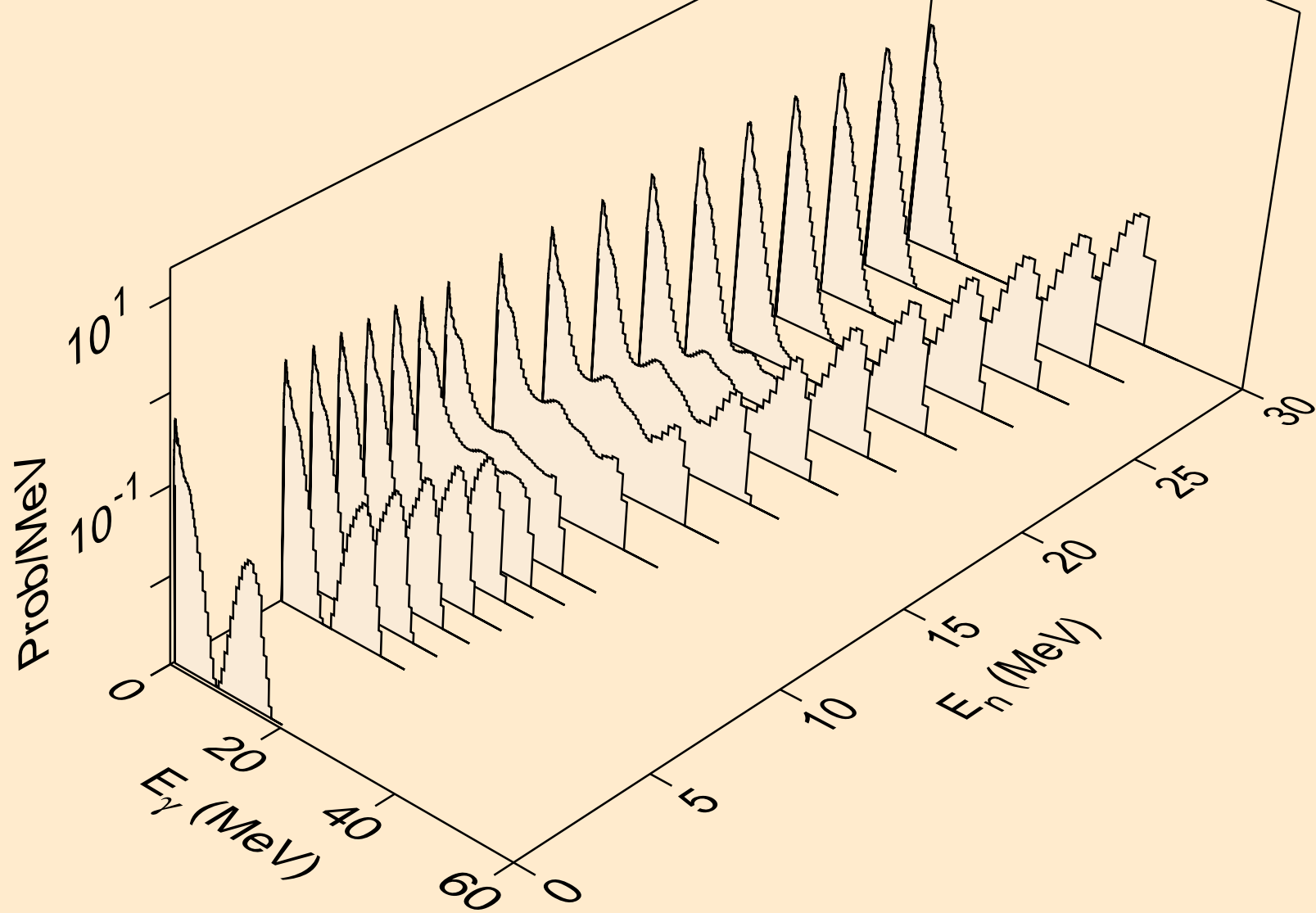

PR124 TRITON ACER TENDL-2021 LIBRARY; T=0.K  
Photon emission for (n,p)

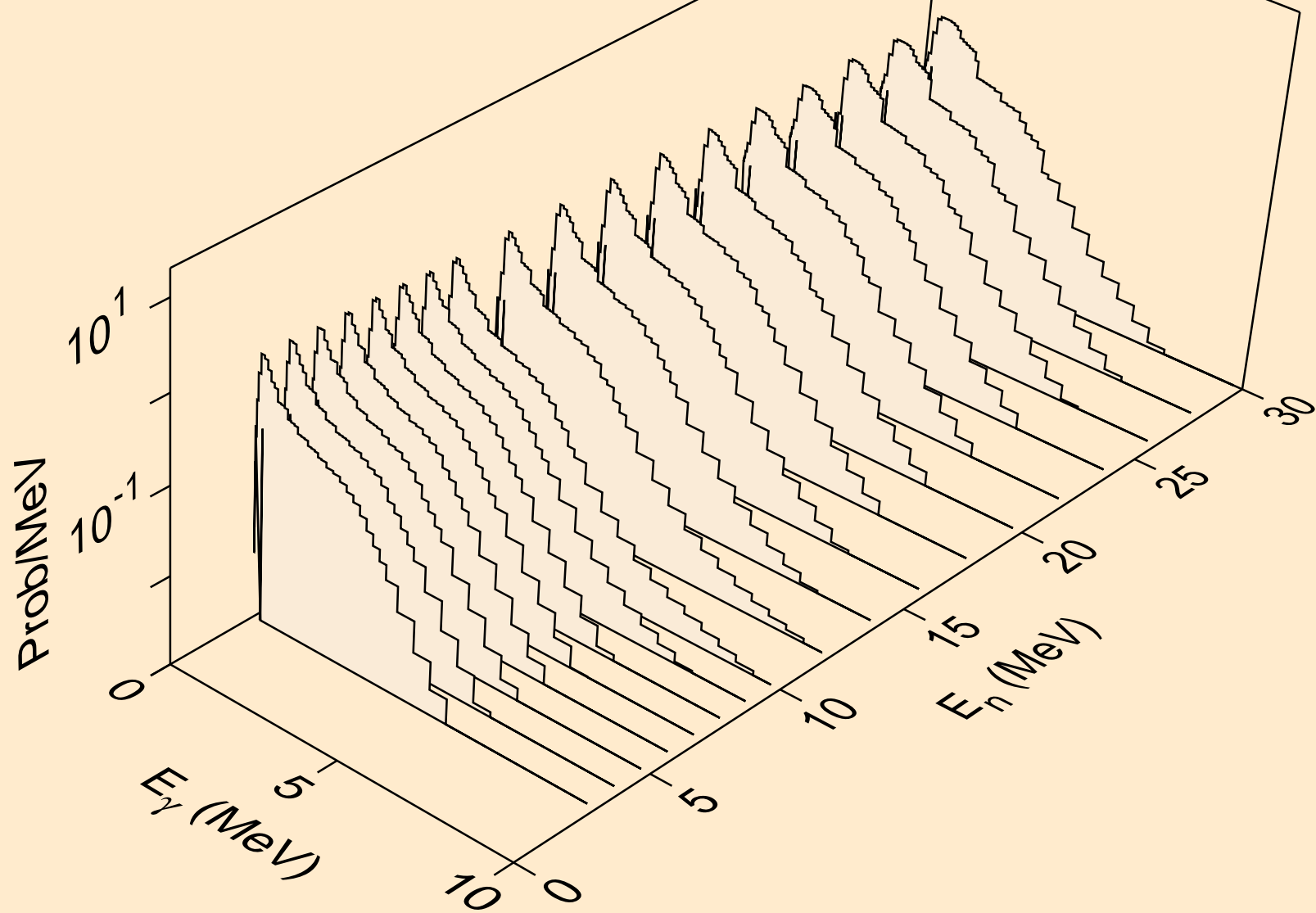

PR124 TRITON ACER TENDL-2021 LIBRARY; T=0.K  
Photon emission for (n,d)

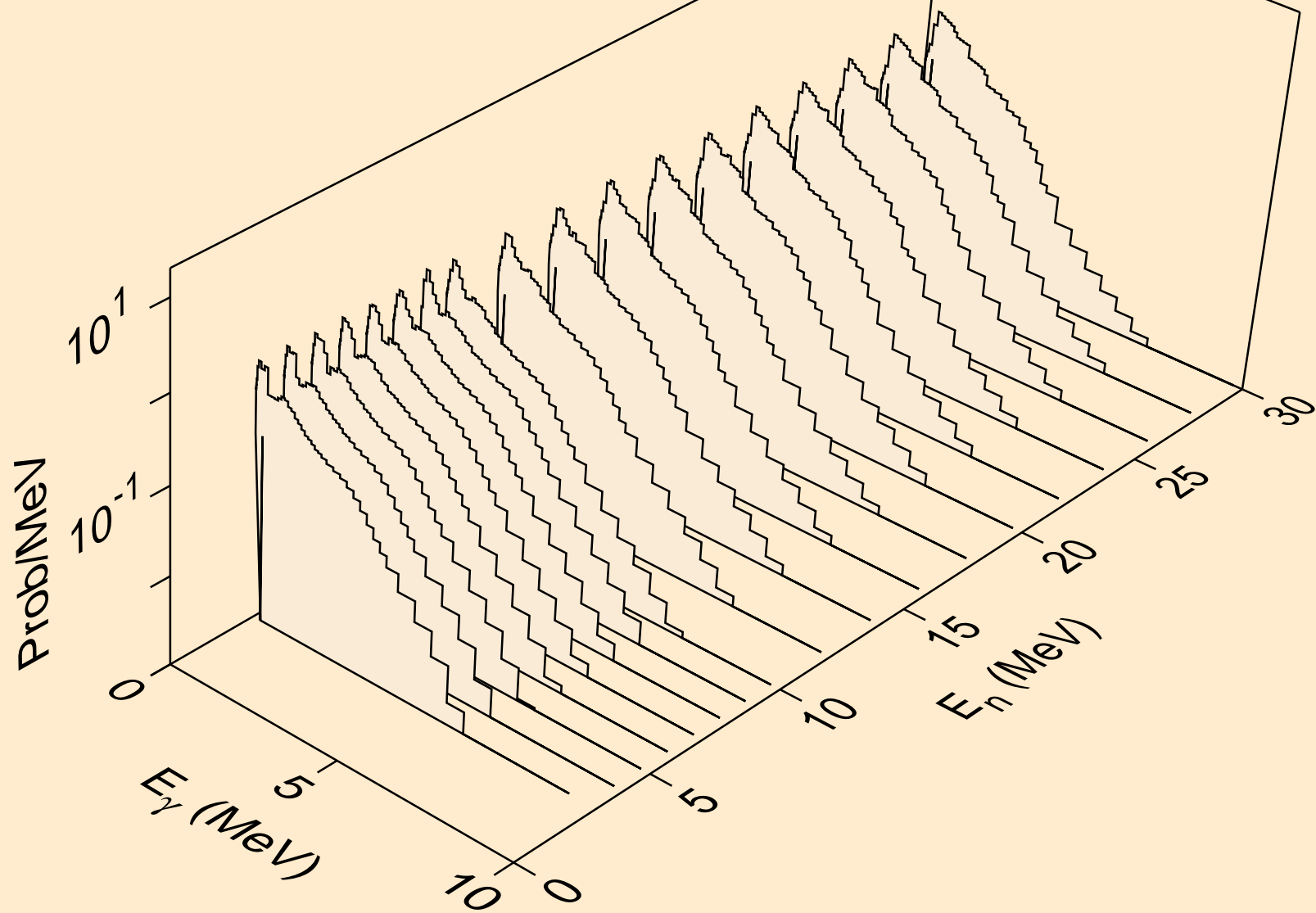

PR124 TRITON ACER TENDL-2021 LIBRARY; T=0.K  
Photon emission for inelastic

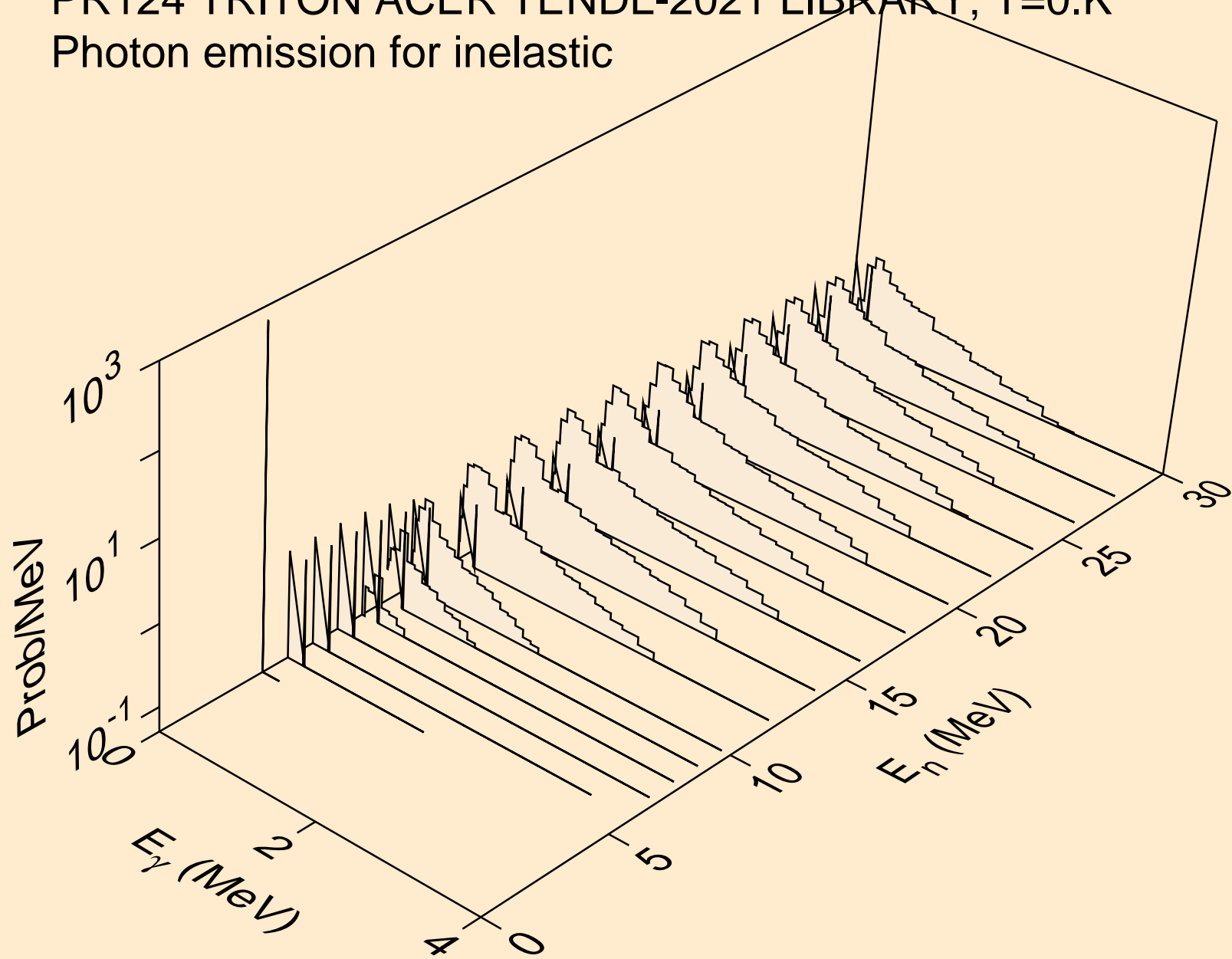



PR124 TRITON ACER TENDL-2021 LIBRARY; T=0.K  
Photon emission for (n,he3)

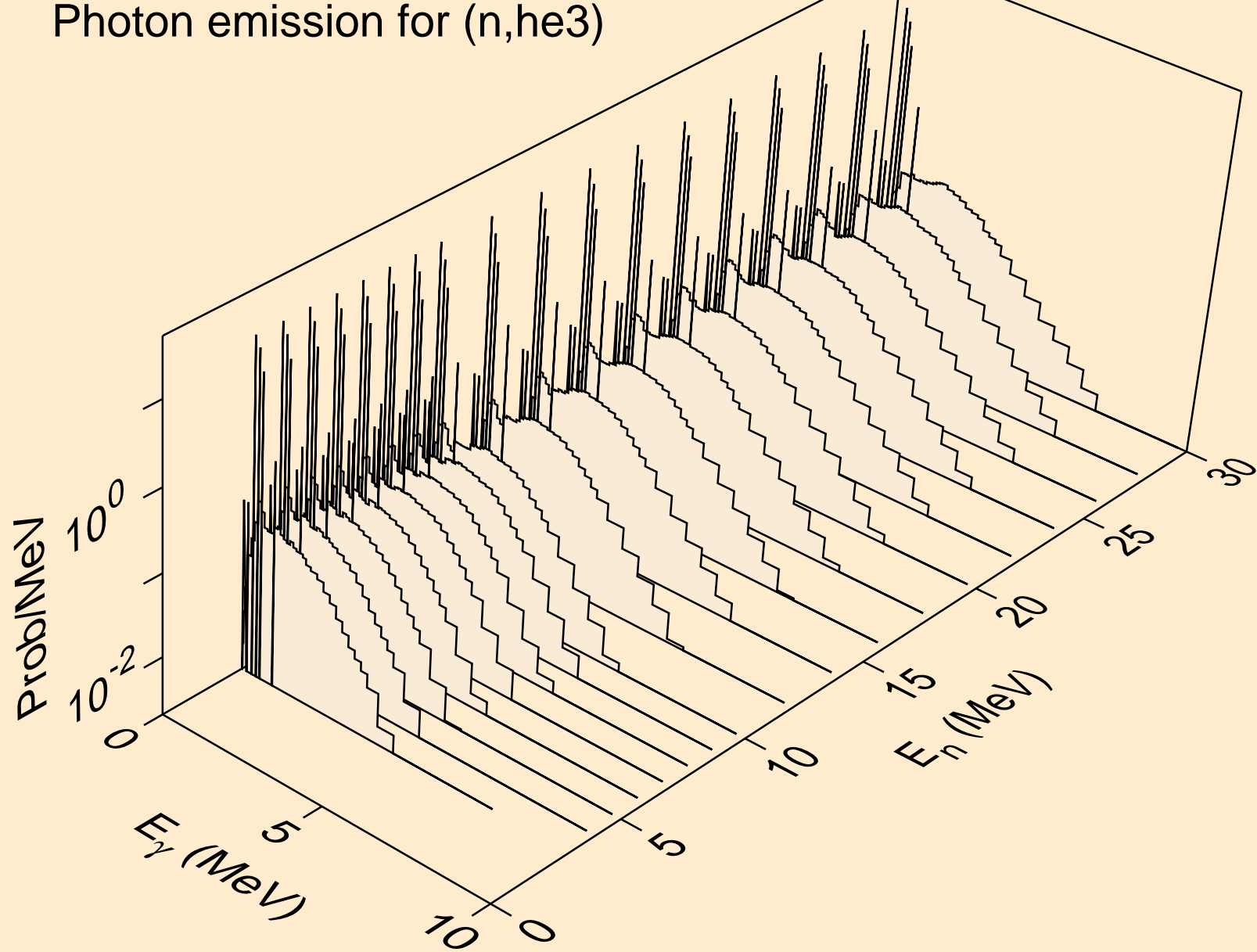

PR124 TRITON ACER TENDL-2021 LIBRARY; T=0.K  
Photon emission for (n,a)

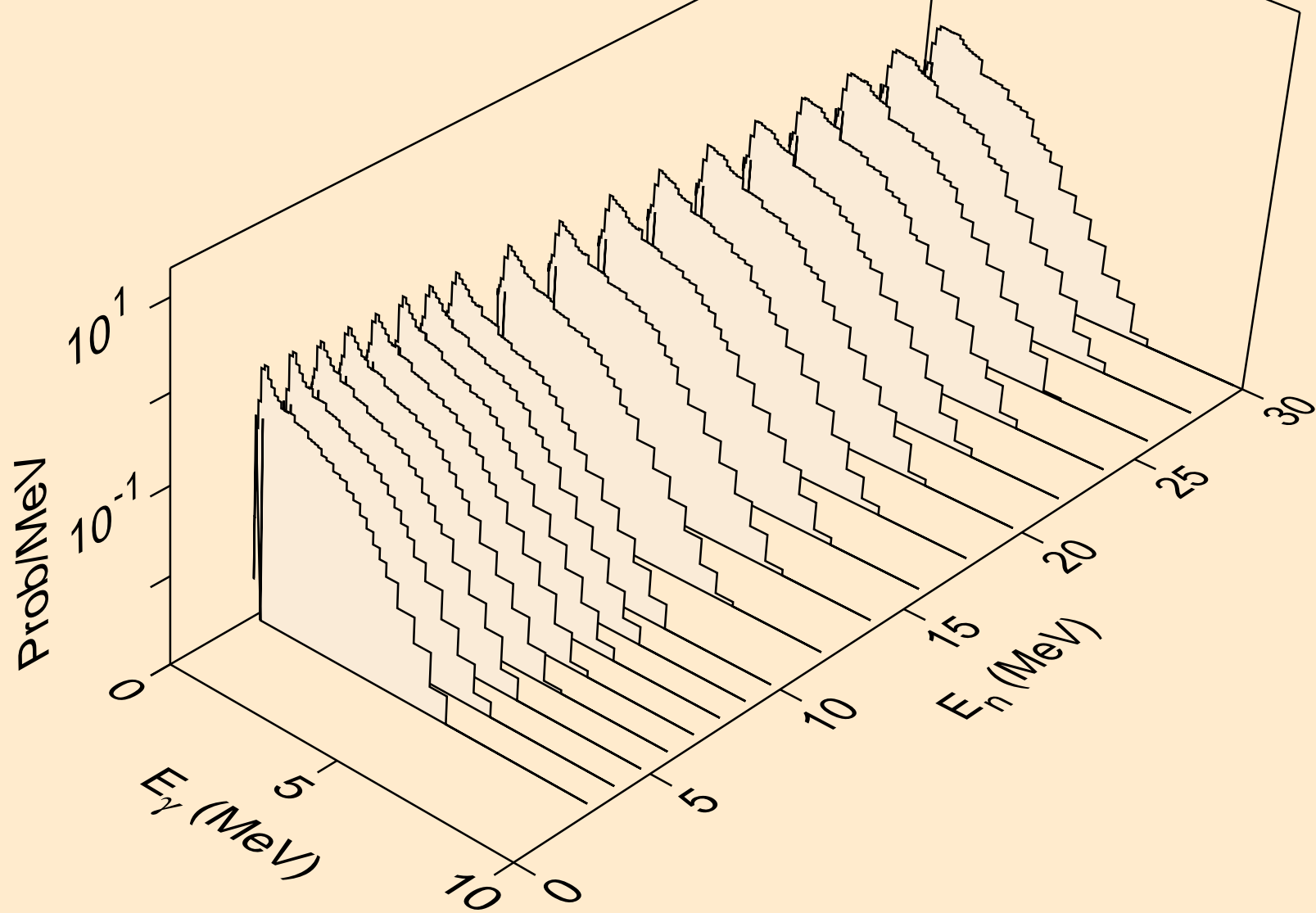

PR124 TRITON ACER TENDL-2021 LIBRARY; T=0.K  
Photon emission for (n,2a)

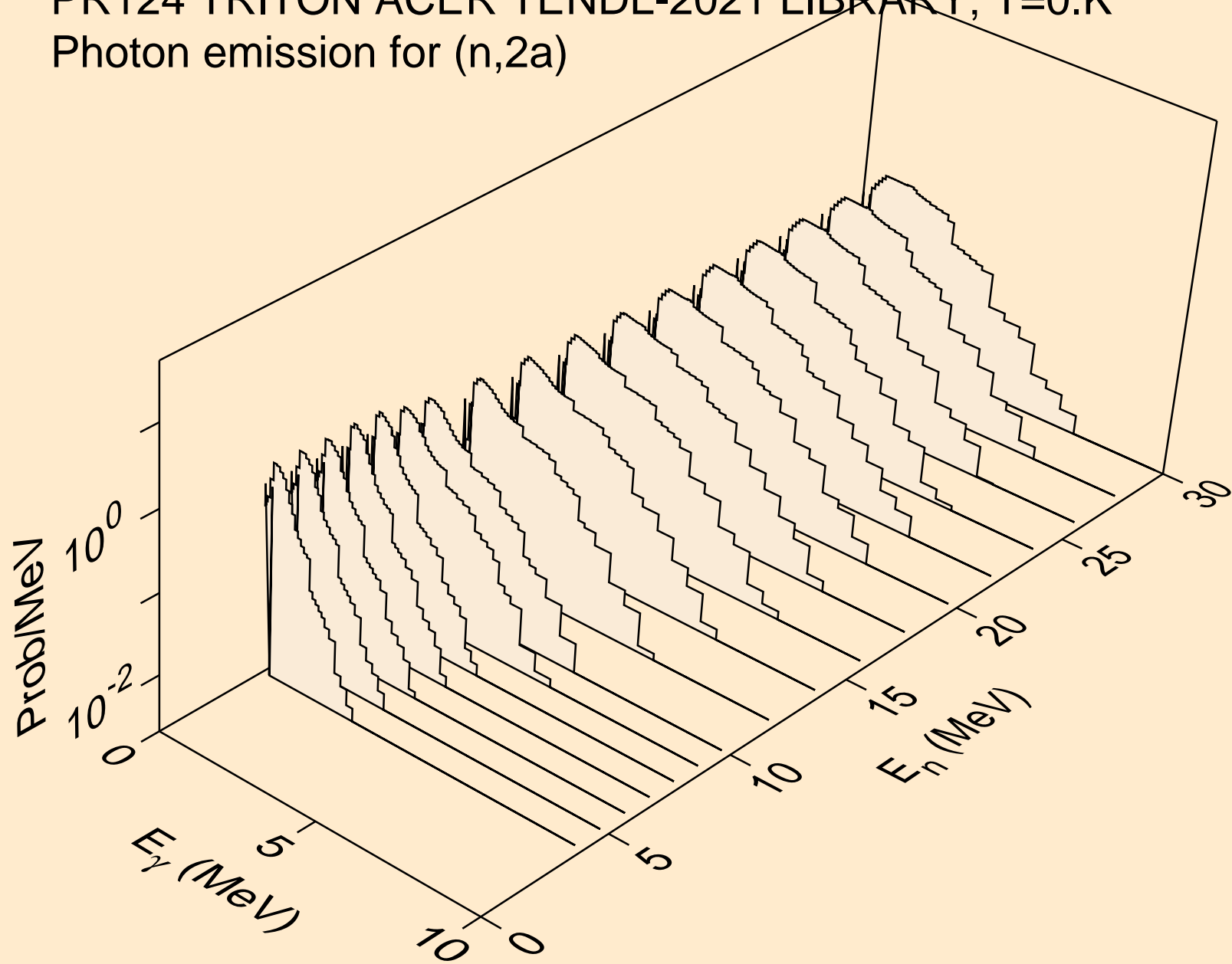

PR124 TRITON ACER TENDL-2021 LIBRARY; T=0.K  
Photon emission for (n,3a)

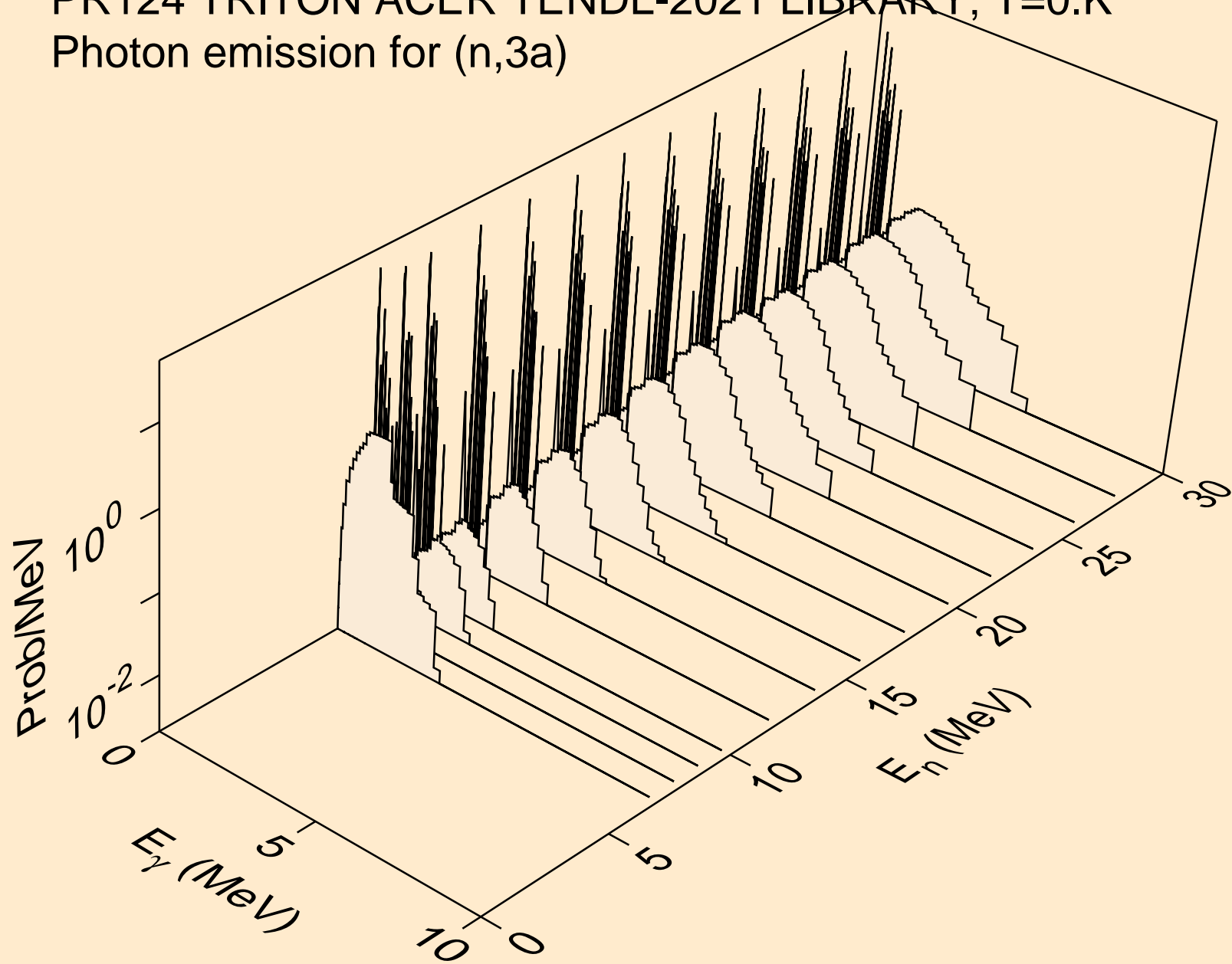

PR124 TRITON ACER TENDL-2021 LIBRARY; T=0.K  
Photon emission for (n,2p)

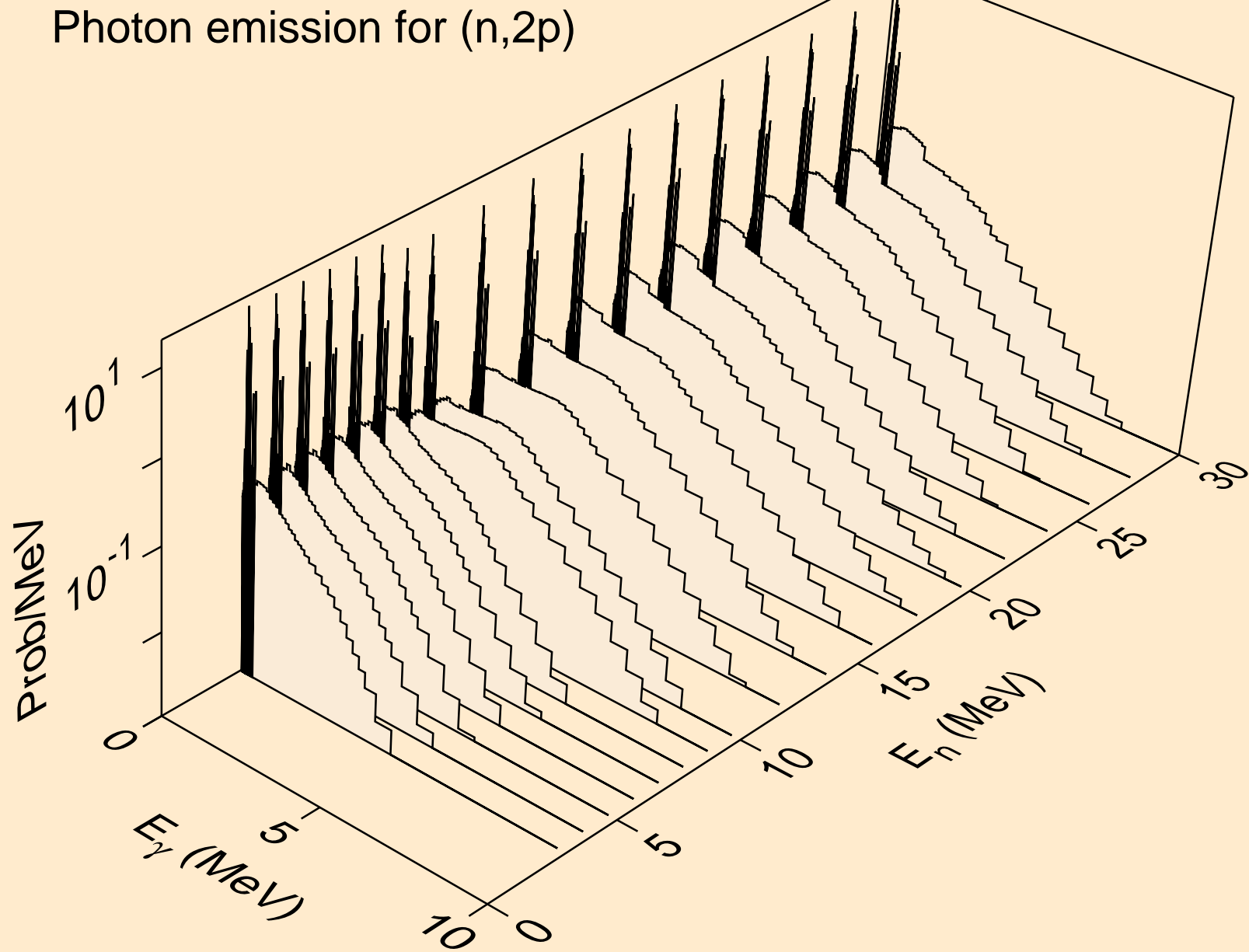

PR124 TRITON ACER TENDL-2021 LIBRARY; T=0.K  
Photon emission for (n,pa)

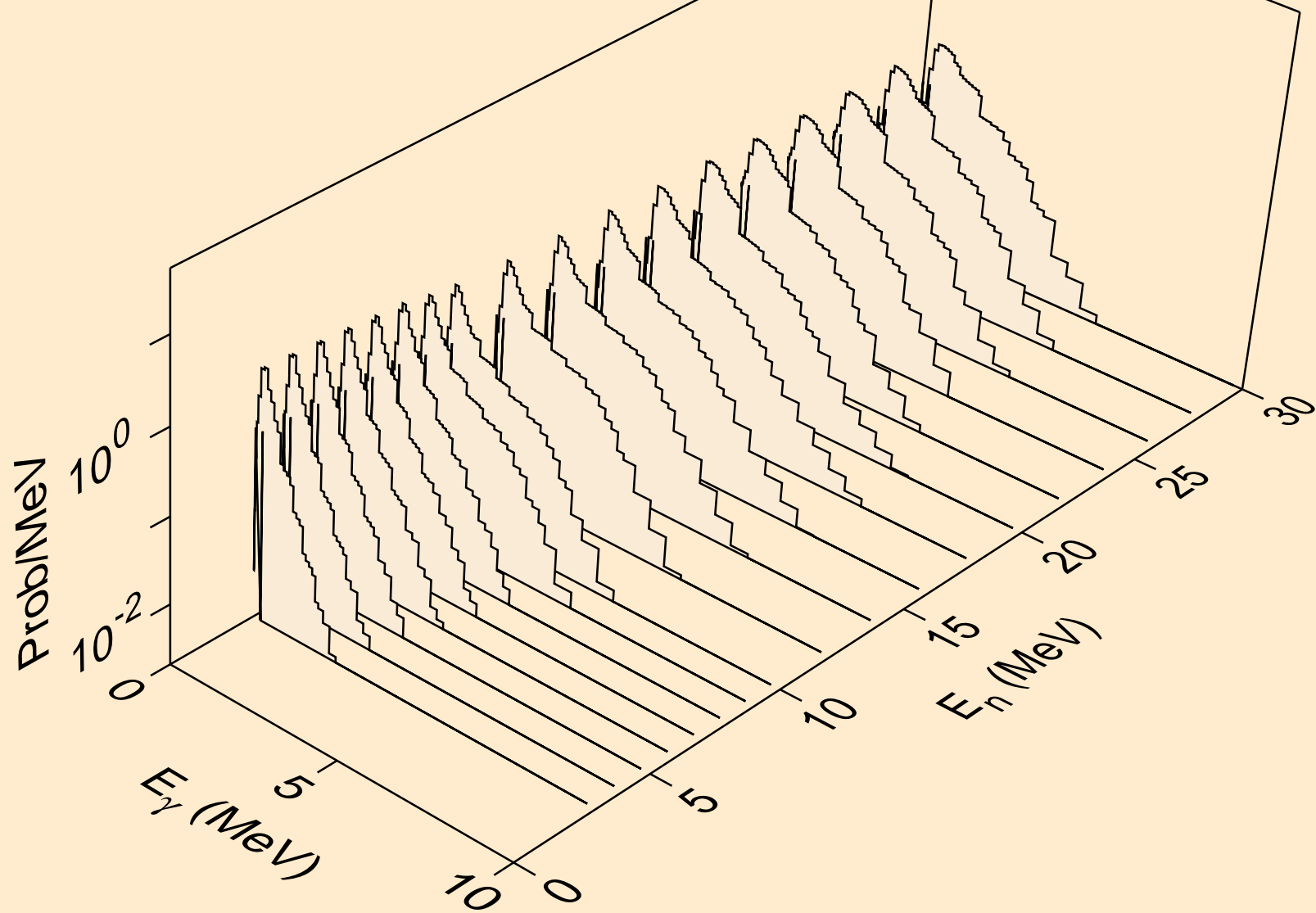

PR124 TRITON ACER TENDL-2021 LIBRARY; T=0.K  
Photon emission for (n,d2a)

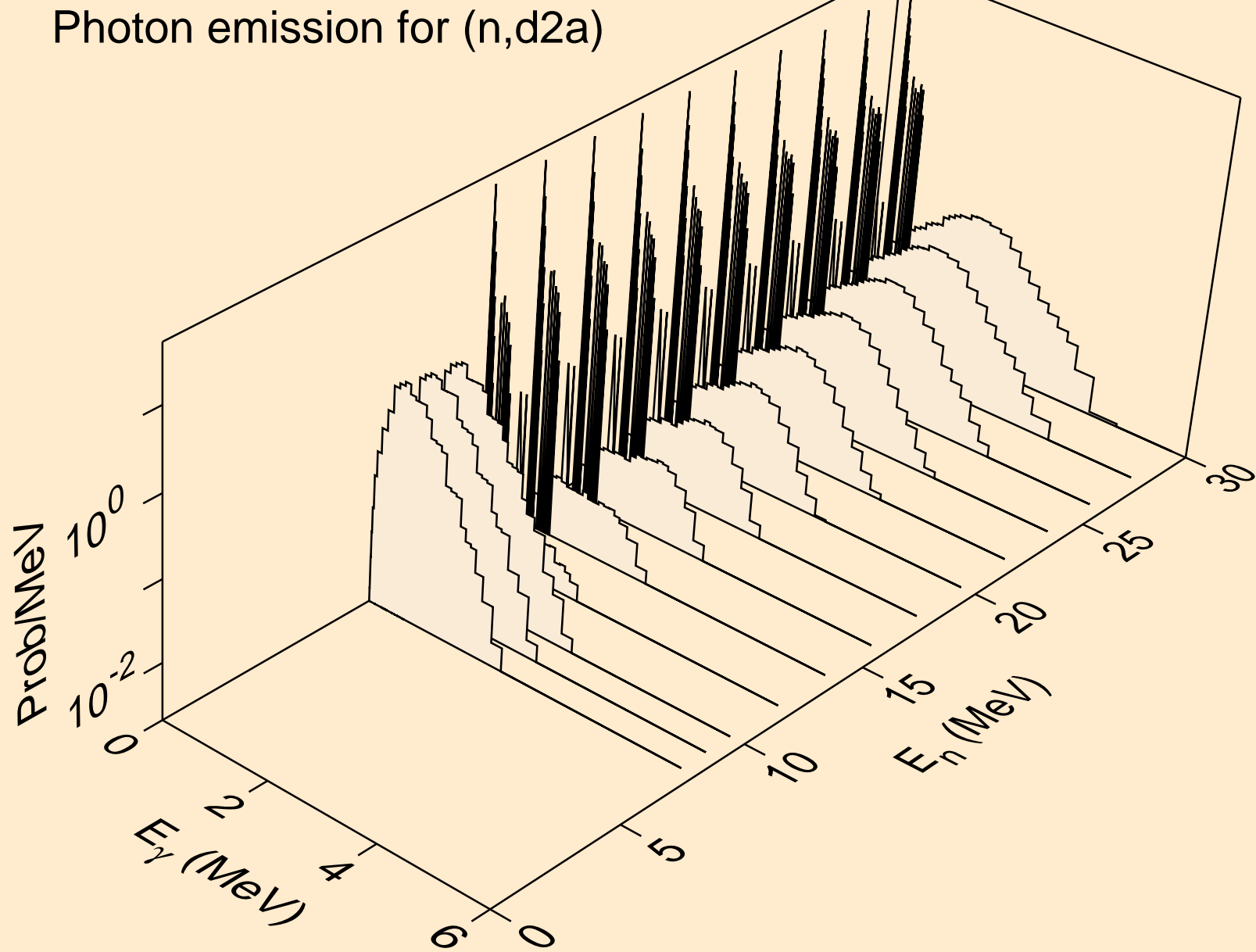

PR124 TRITON ACER TENDL-2021 LIBRARY; T=0.K  
Photon emission for (n,pd)

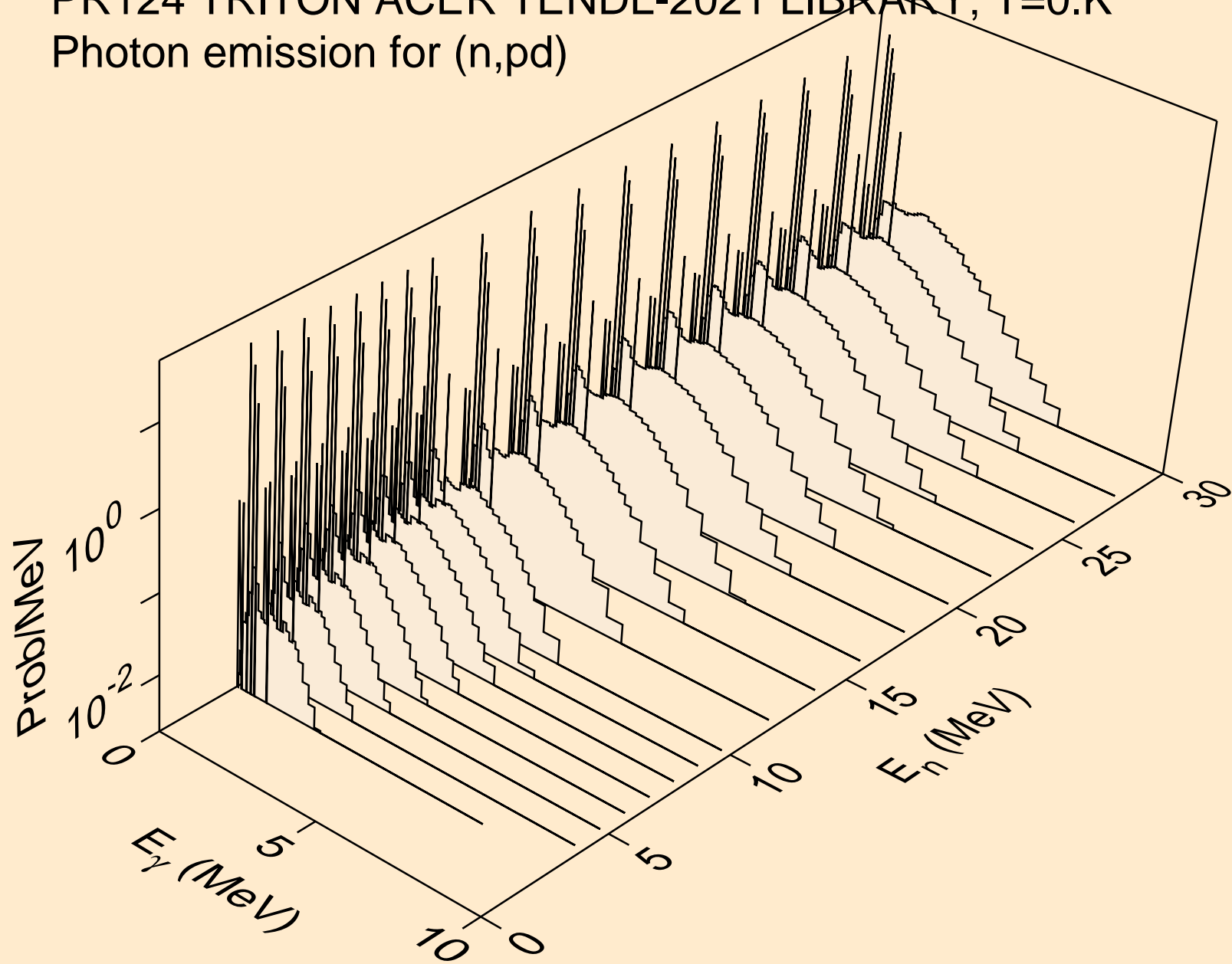



PR124 TRITON ACER TENDL-2021 LIBRARY; T=0.K  
Photon emission for (n,pt)

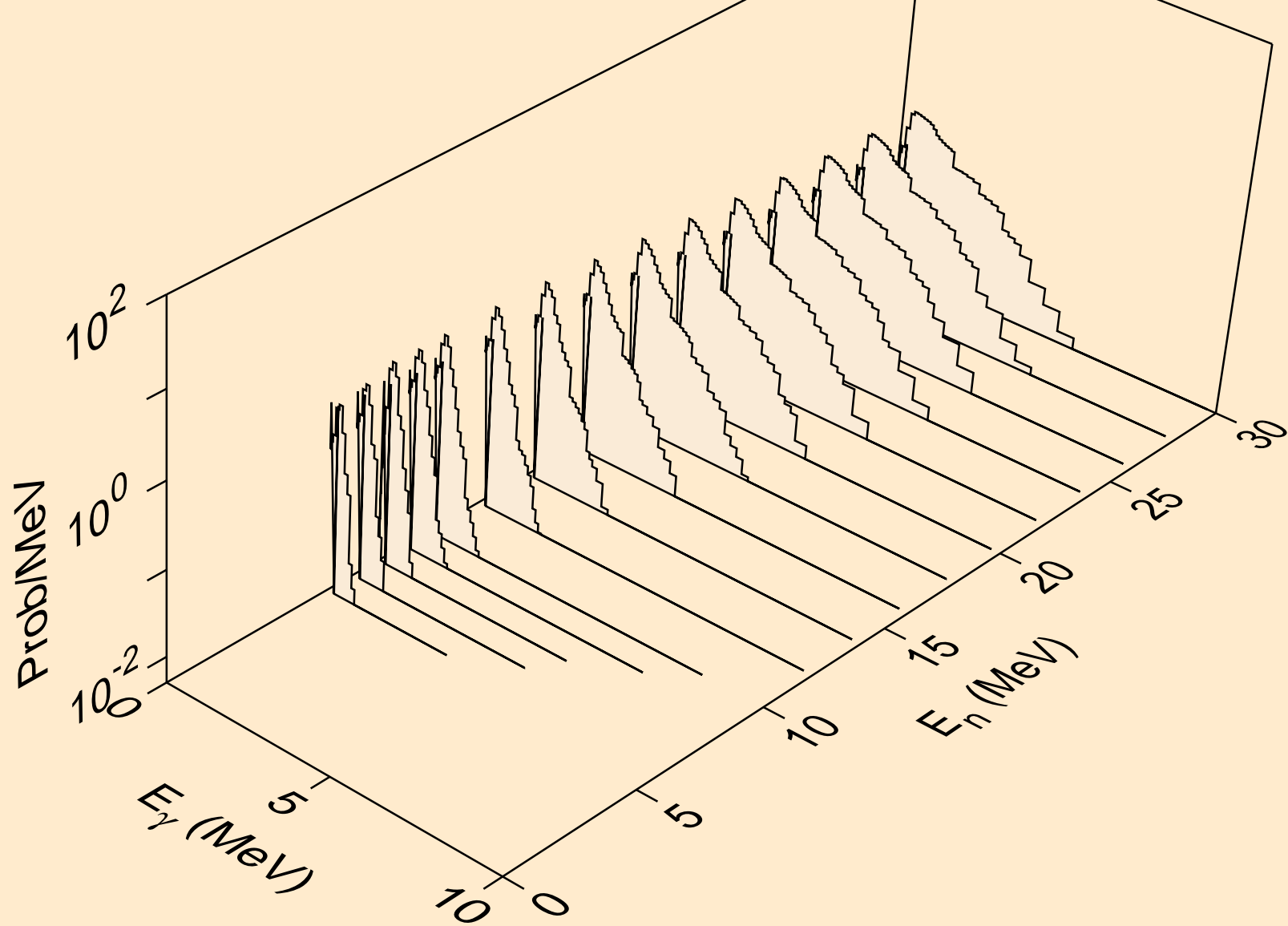

PR124 TRITON ACER TENDL-2021 LIBRARY; T=0.K  
Photon emission for (n,da)

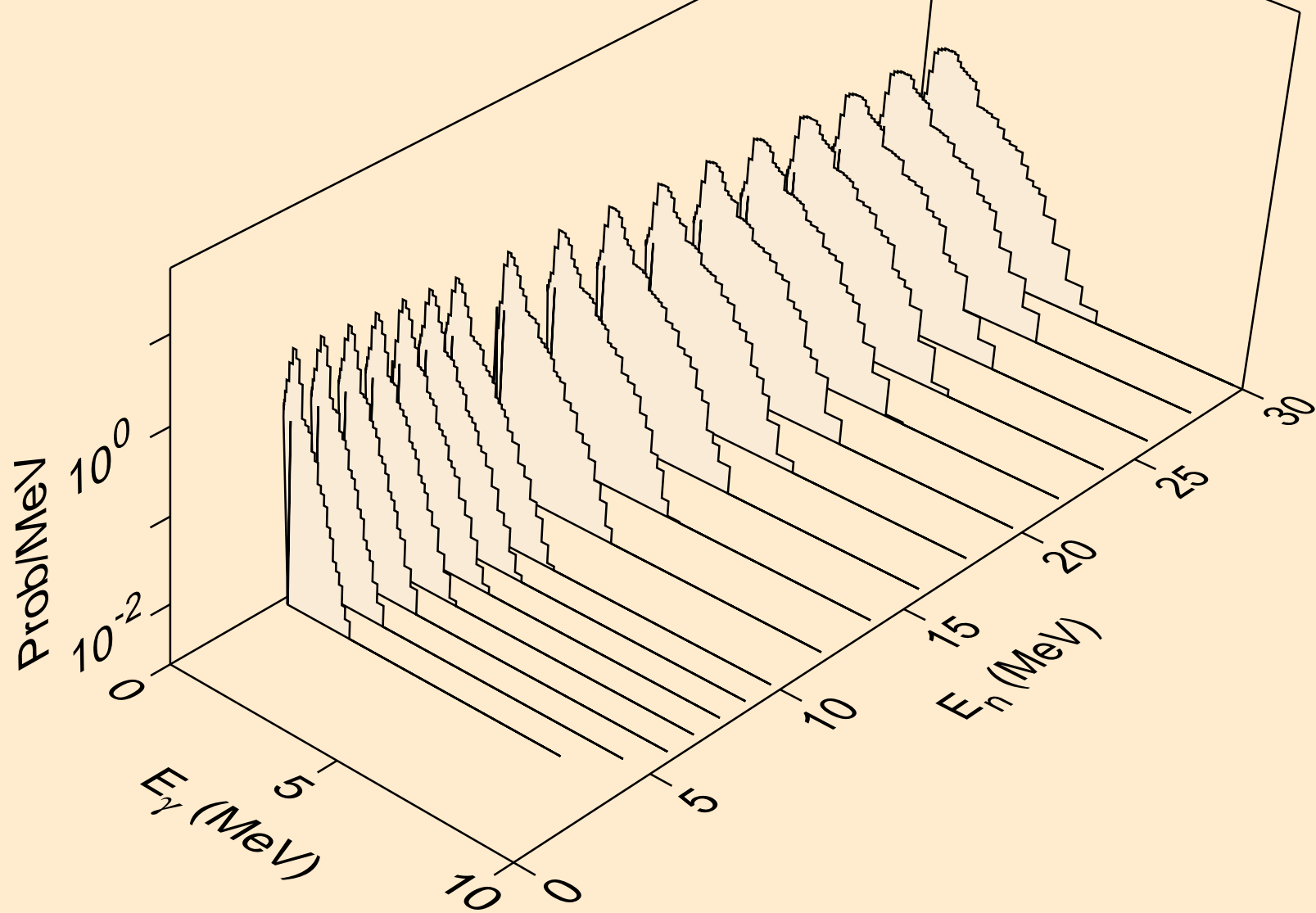

PR124 TRITON ACER TENDL-2021 LIBRARY; T=0.K  
Particle heating contributions

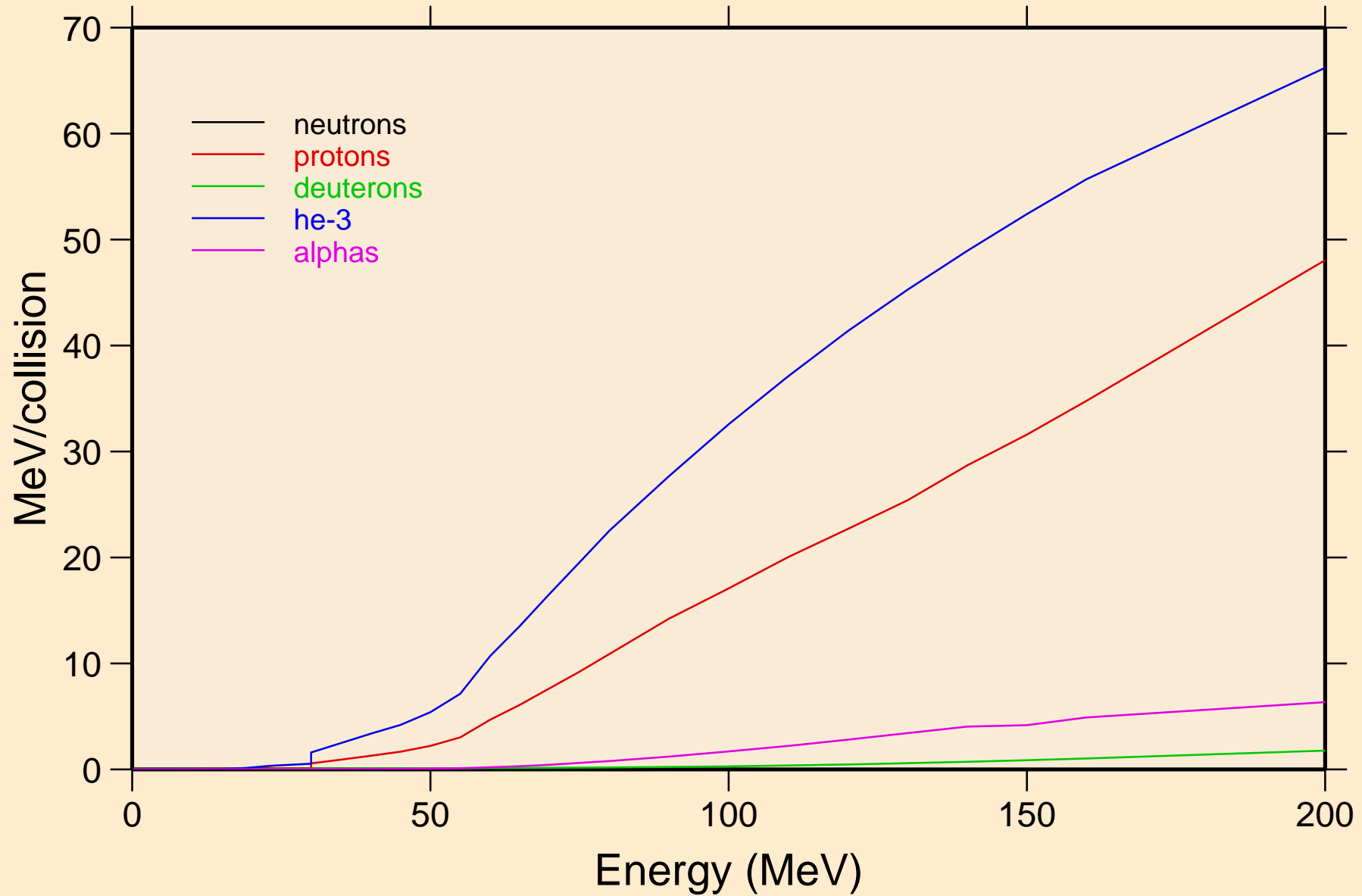

PR124 TRITON ACER TENDL-2021 LIBRARY; T=0.K  
Recoil Heating

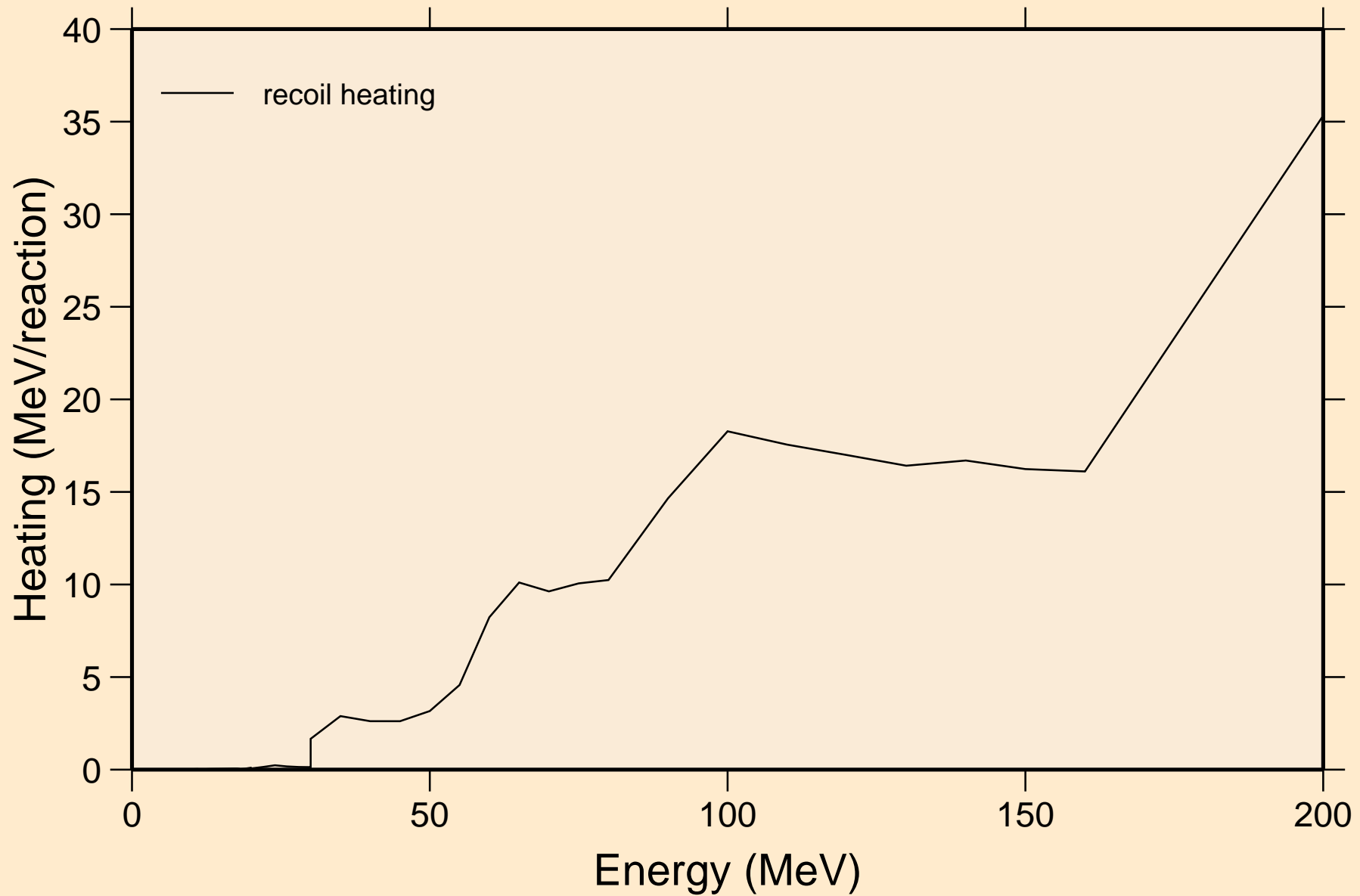

PR124 TRITON ACER TENDL-2021 LIBRARY; T=0.K  
Particle production cross sections

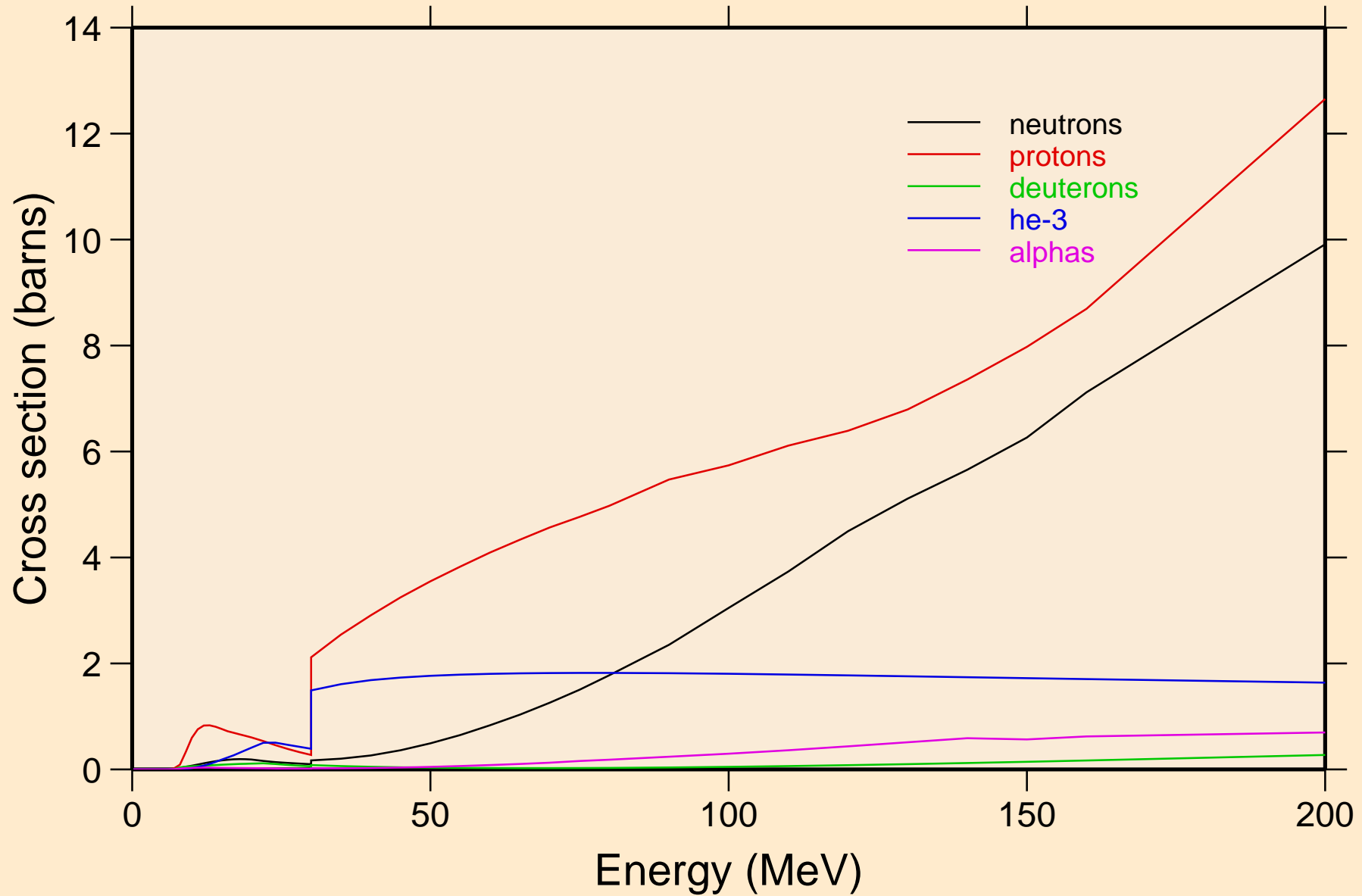

PR124 TRITON ACER TENDL-2021 LIBRARY; T=0.K  
neutrons from (t,n)

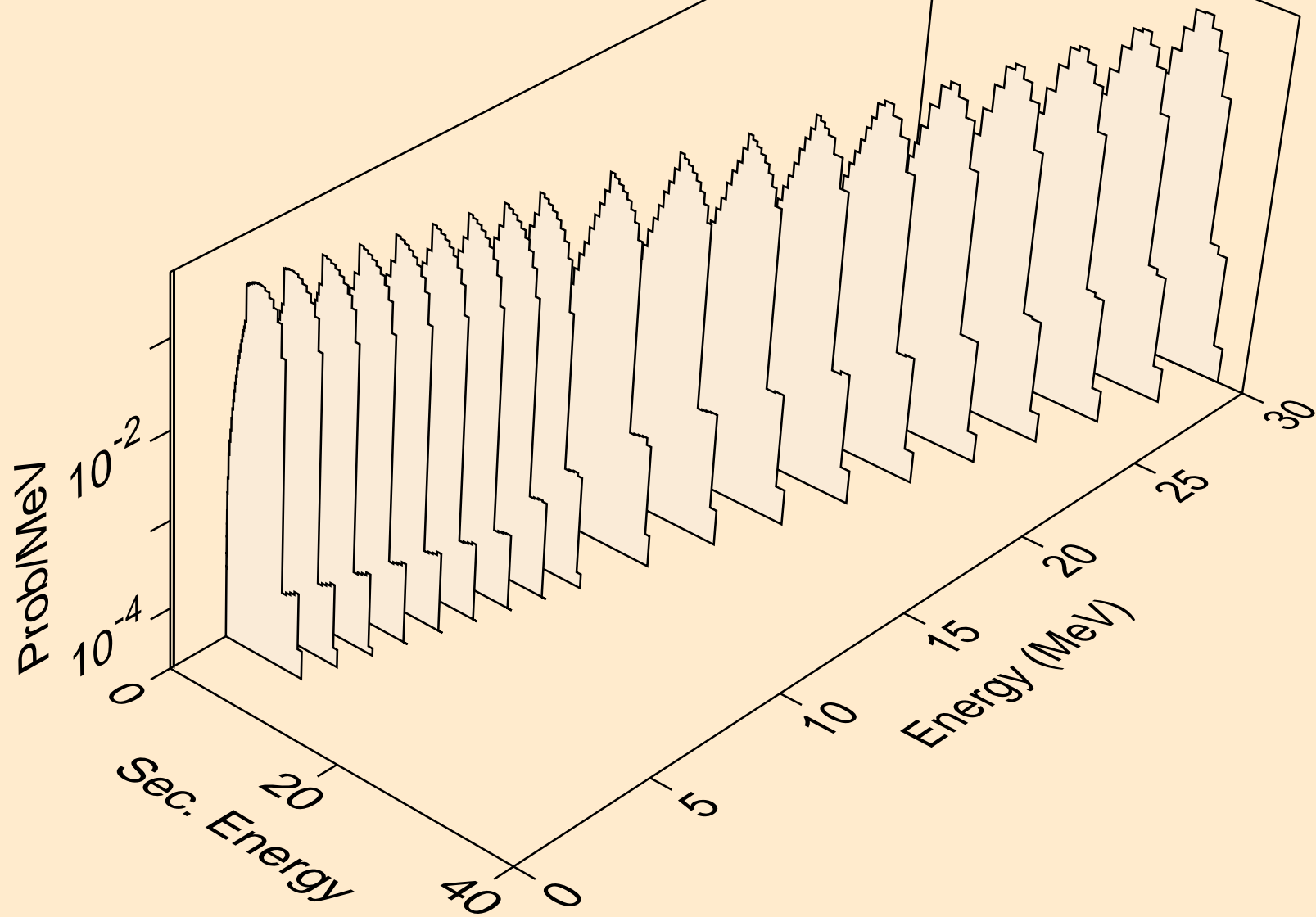

PR124 TRITON ACER TENDL-2021 LIBRARY; T=0.K  
neutrons from (t,x)

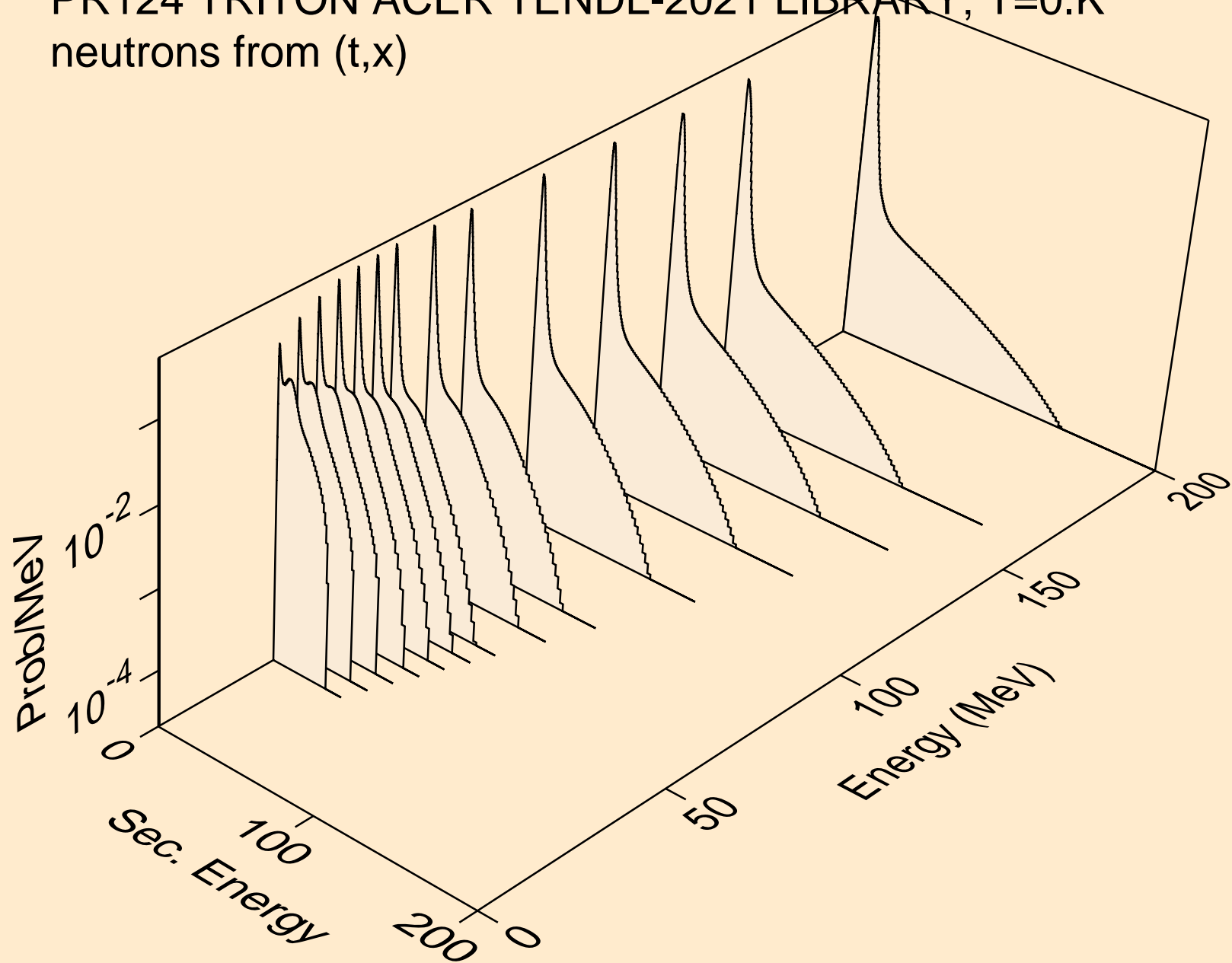

PR124 TRITON ACER TENDL-2021 LIBRARY; T=0.K  
neutrons from (t,2nd)

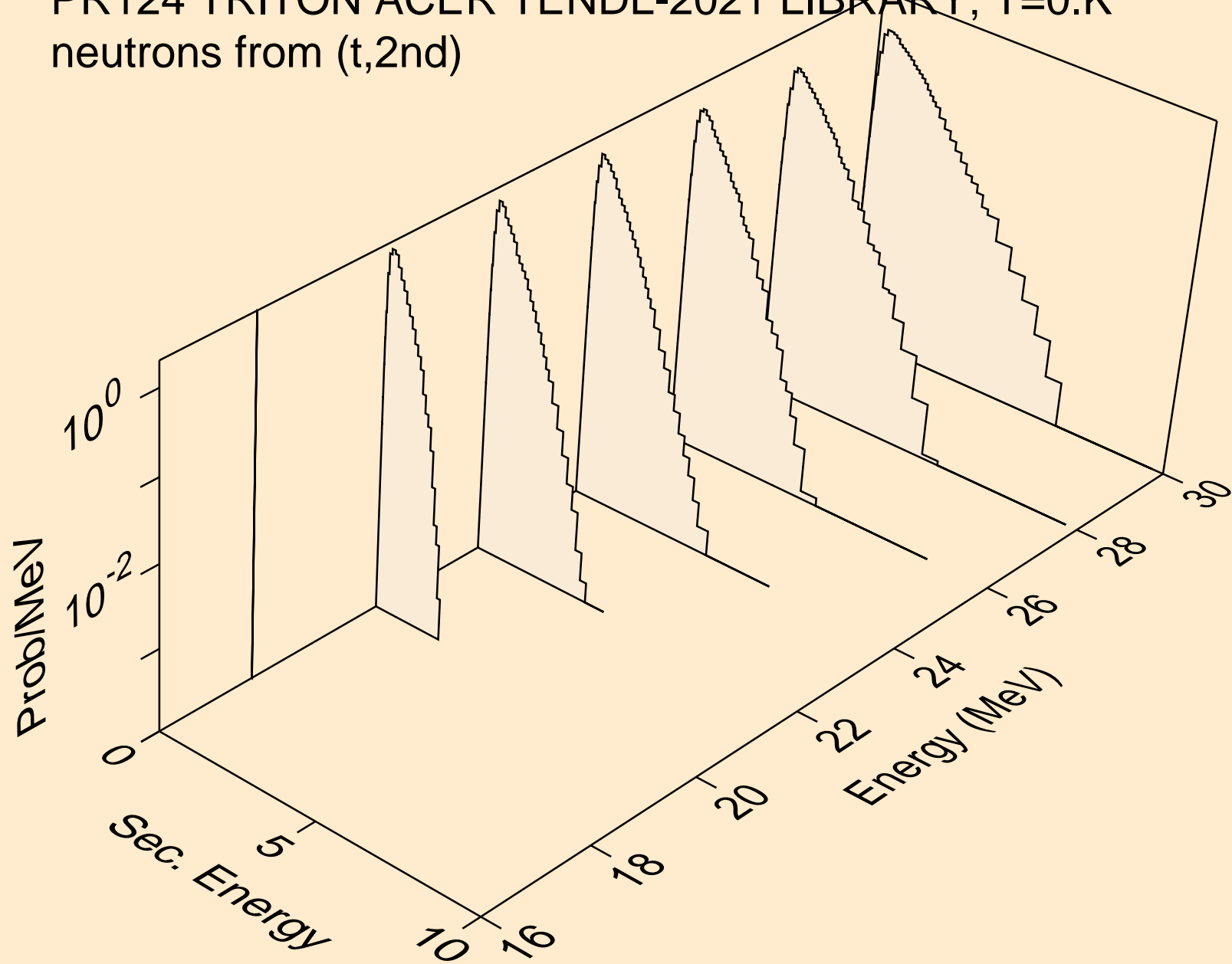



PR124 TRITON ACER TENDL-2021 LIBRARY; T=0.K  
neutrons from (t,2n)

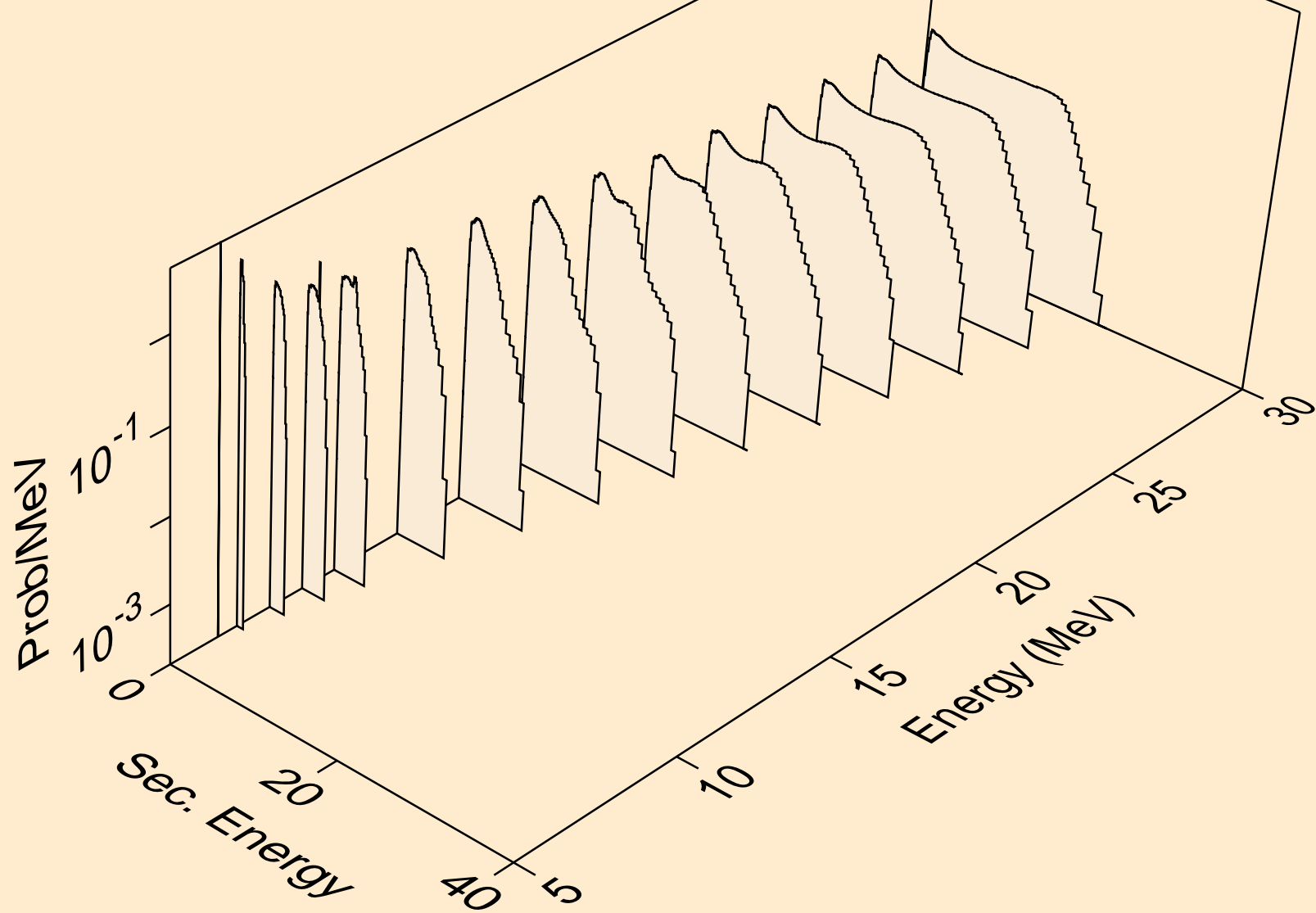

PR124 TRITON ACER TENDL-2021 LIBRARY; T=0.K  
neutrons from (t,3n)

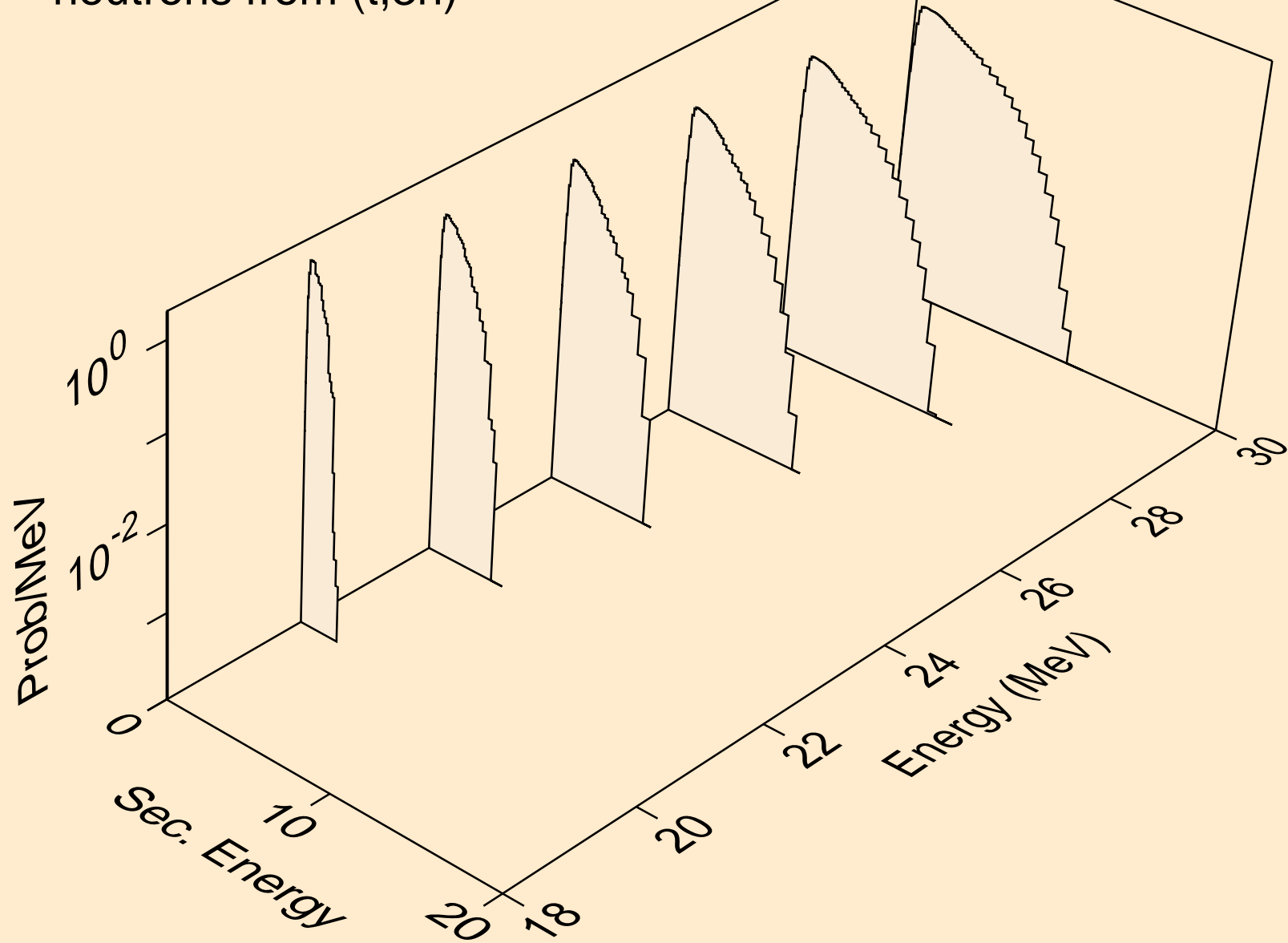

PR124 TRITON ACER TENDL-2021 LIBRARY; T=0.K  
neutrons from (t,n\*)a

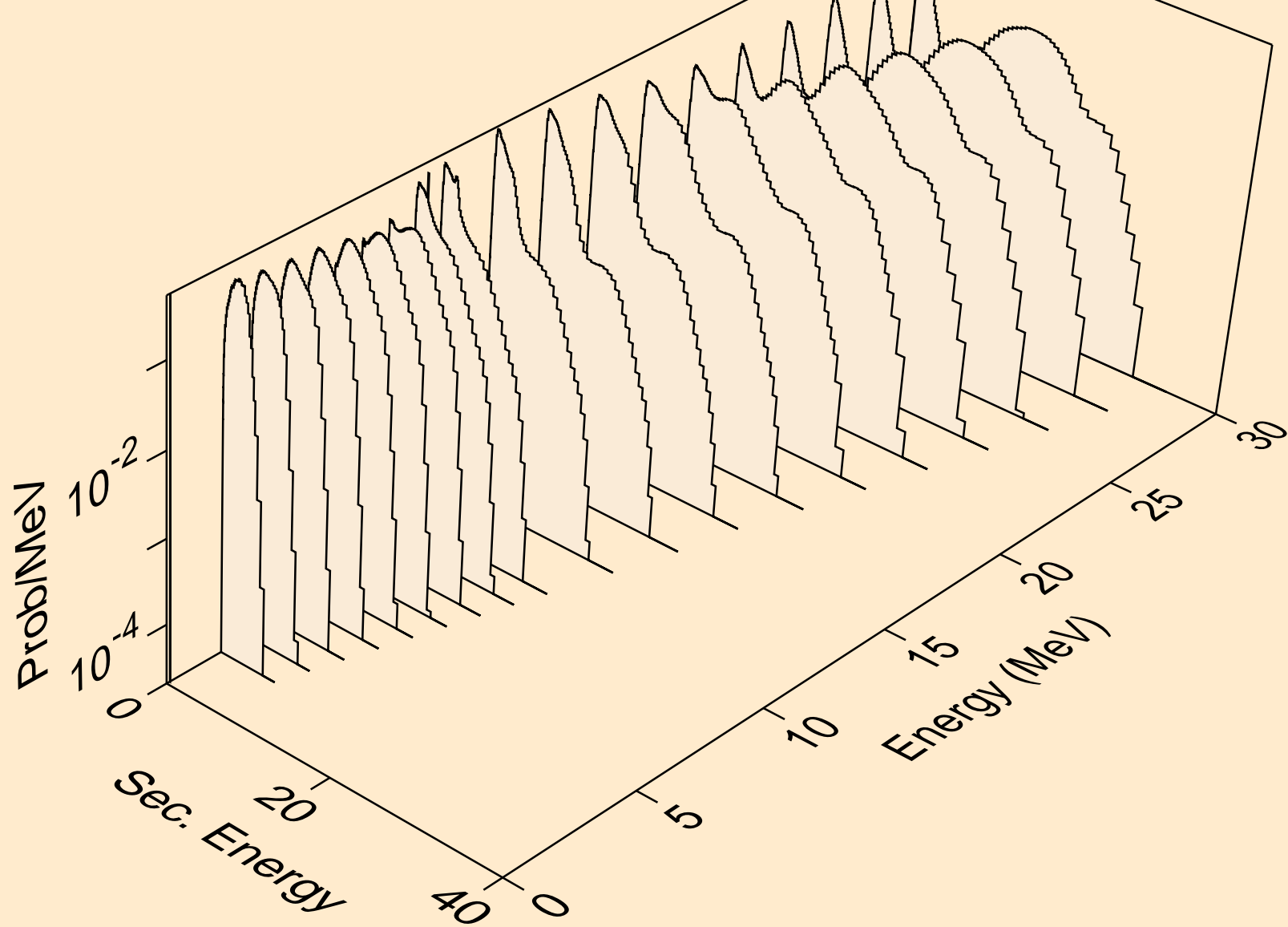

PR124 TRITON ACER TENDL-2021 LIBRARY; T=0.K  
neutrons from (t,2n)a

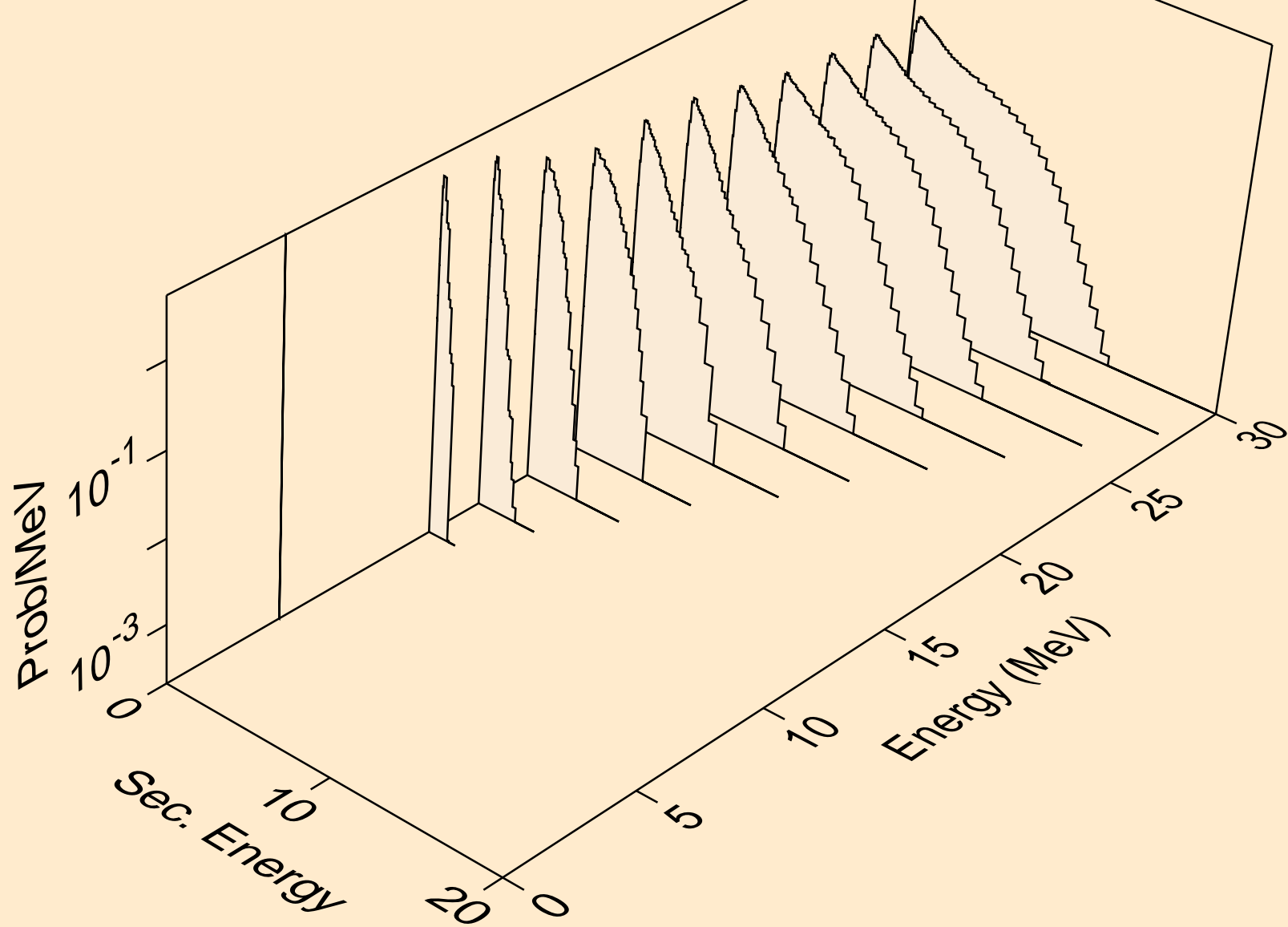

PR124 TRITON ACER TENDL-2021 LIBRARY; T=0.K  
neutrons from (t,n\*)p

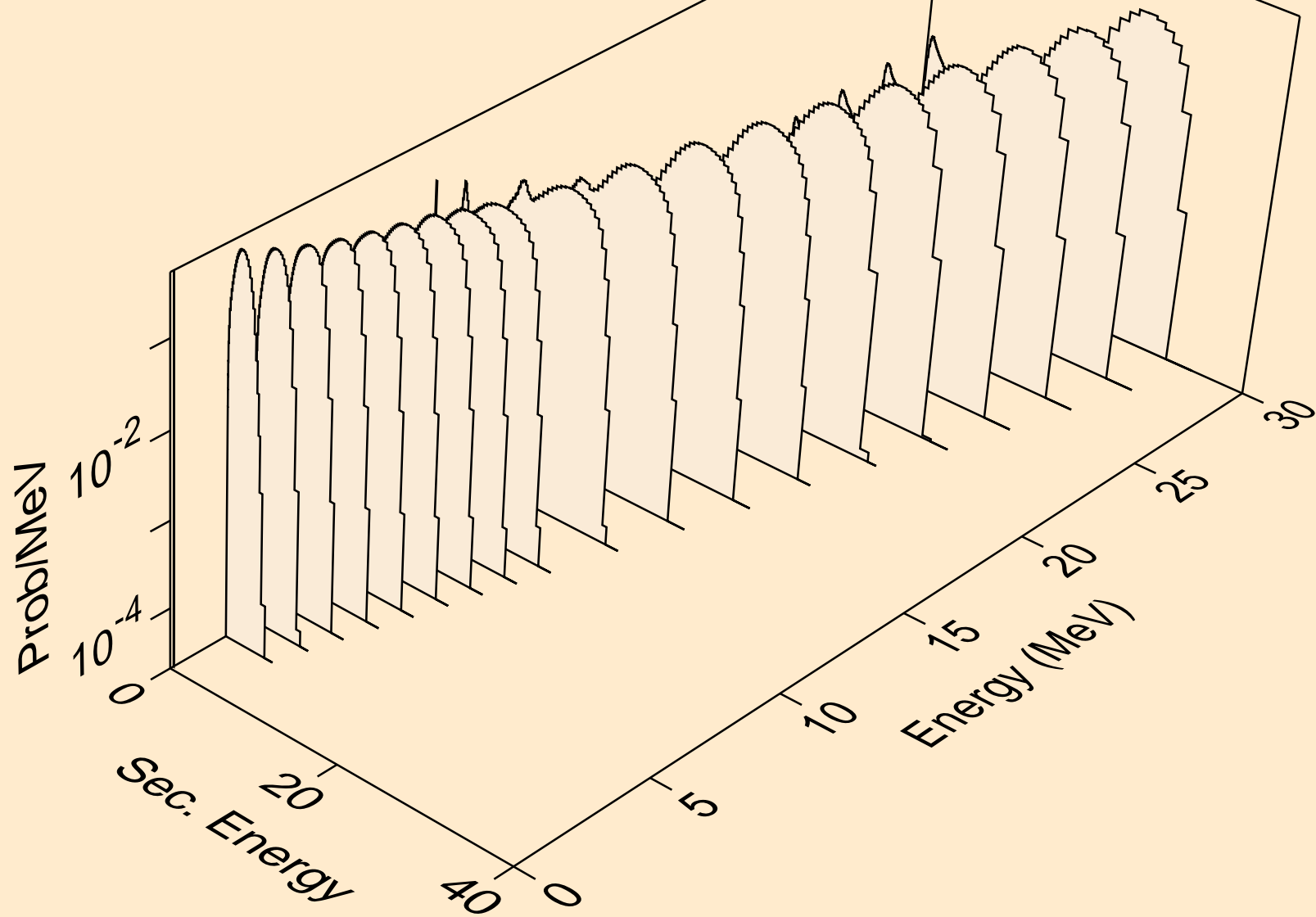

PR124 TRITON ACER TENDL-2021 LIBRARY; T=0.K  
neutrons from (t,n\*)2a

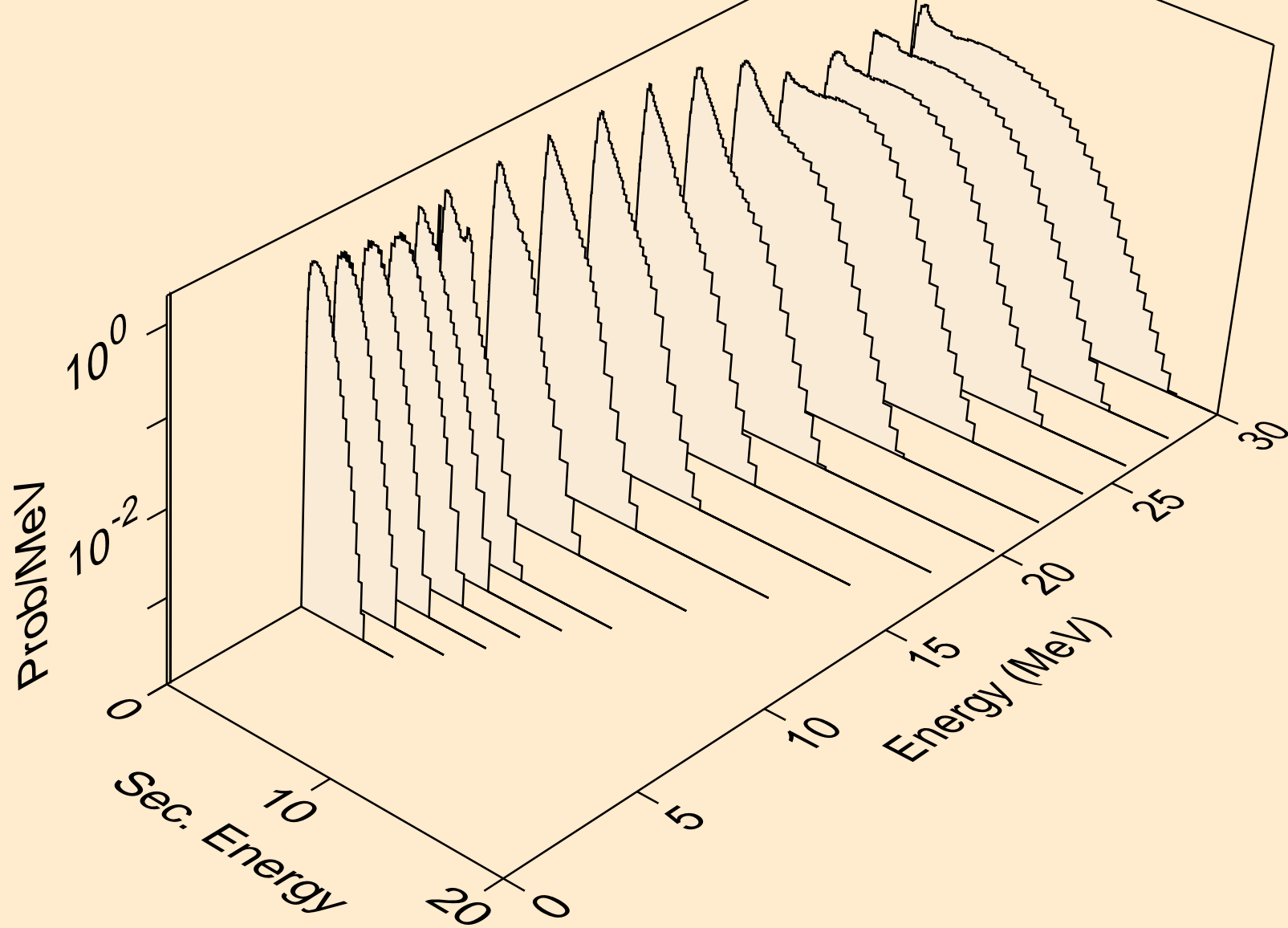

PR124 TRITON ACER TENDL-2021 LIBRARY; T=0.K  
neutrons from (t,n\*)d

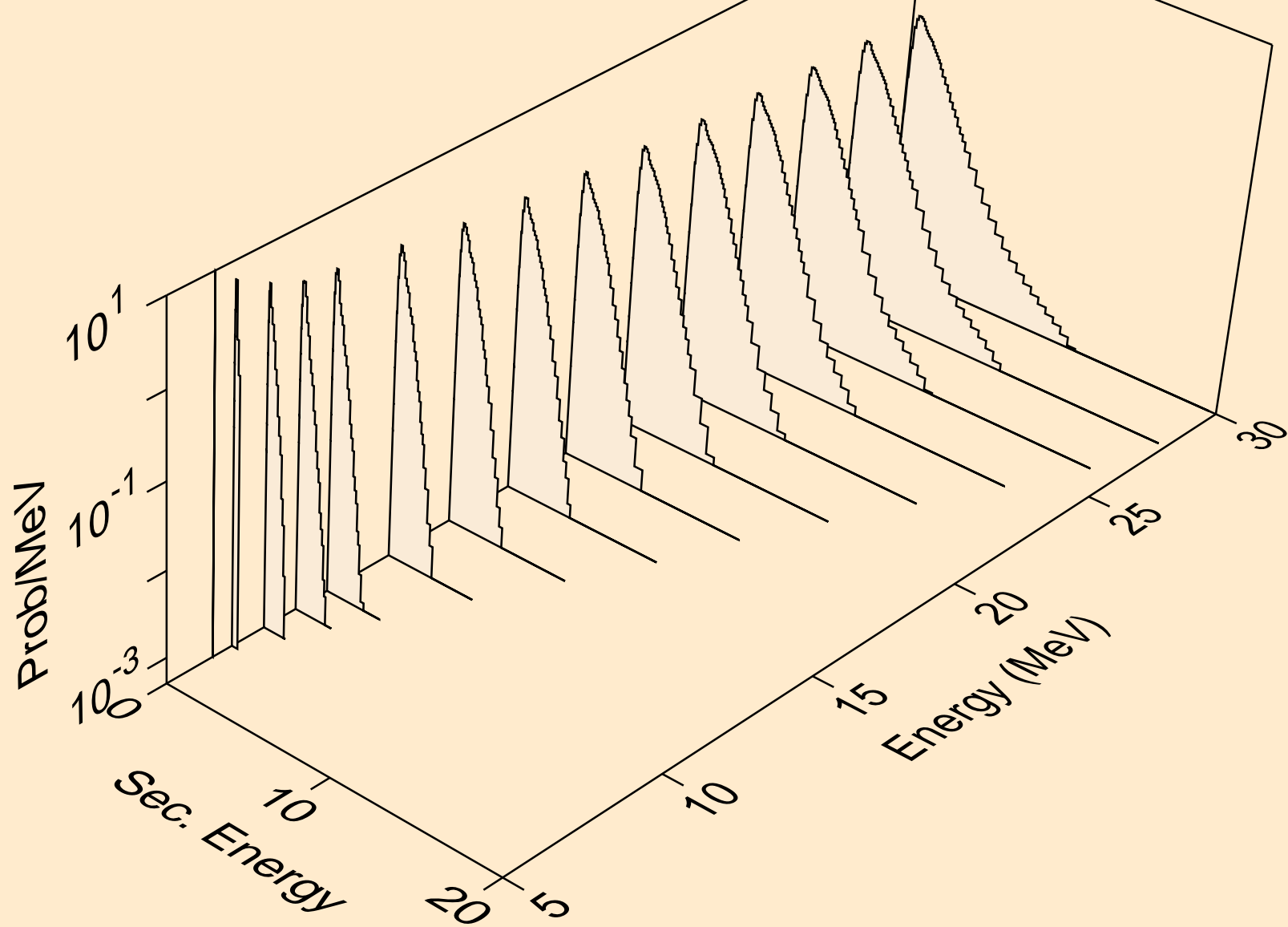

PR124 TRITON ACER TENDL-2021 LIBRARY; T=0.K  
neutrons from (t,n\*)t

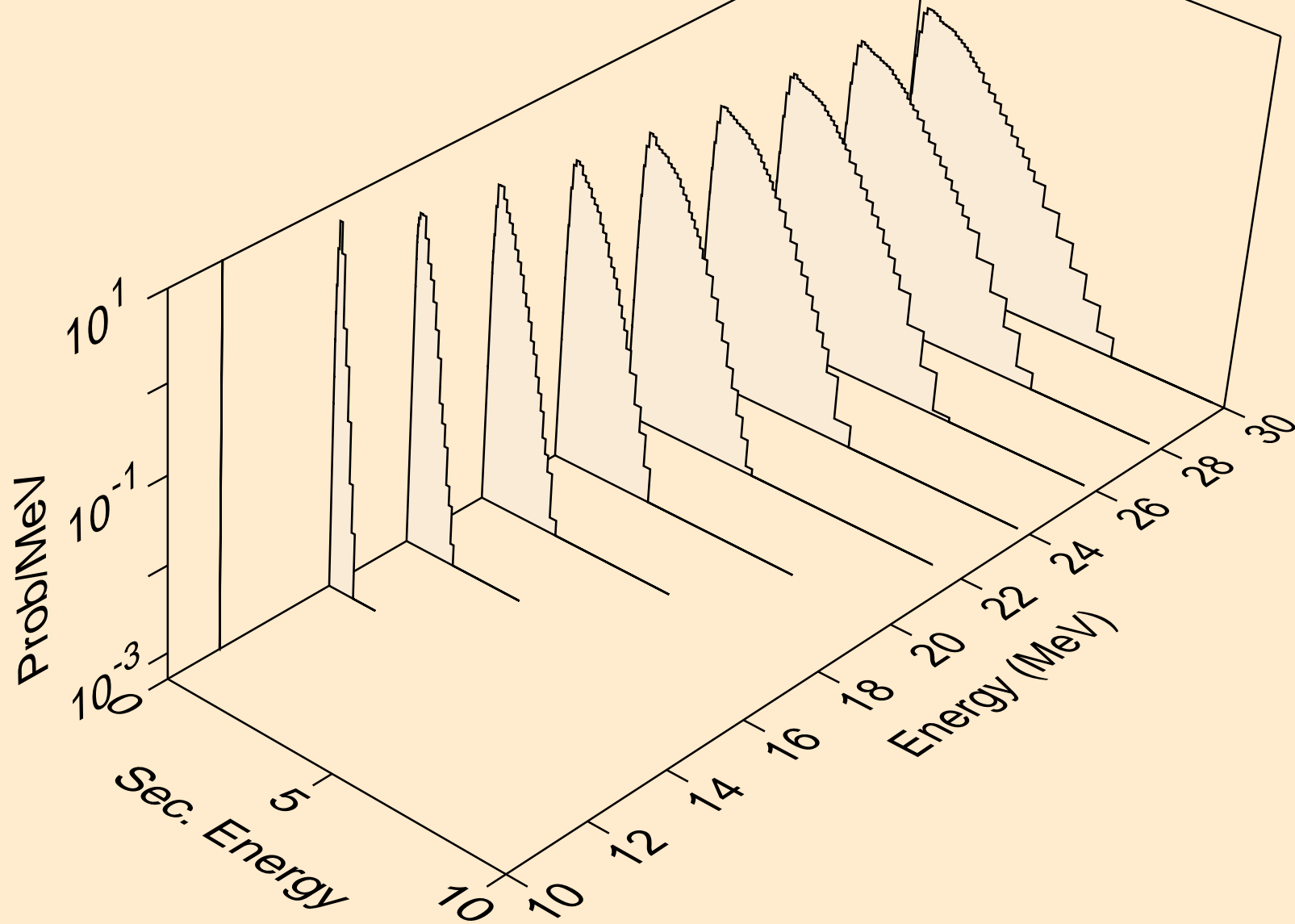



PR124 TRITON ACER TENDL-2021 LIBRARY; T=0.K  
neutrons from (t,n\*)he3

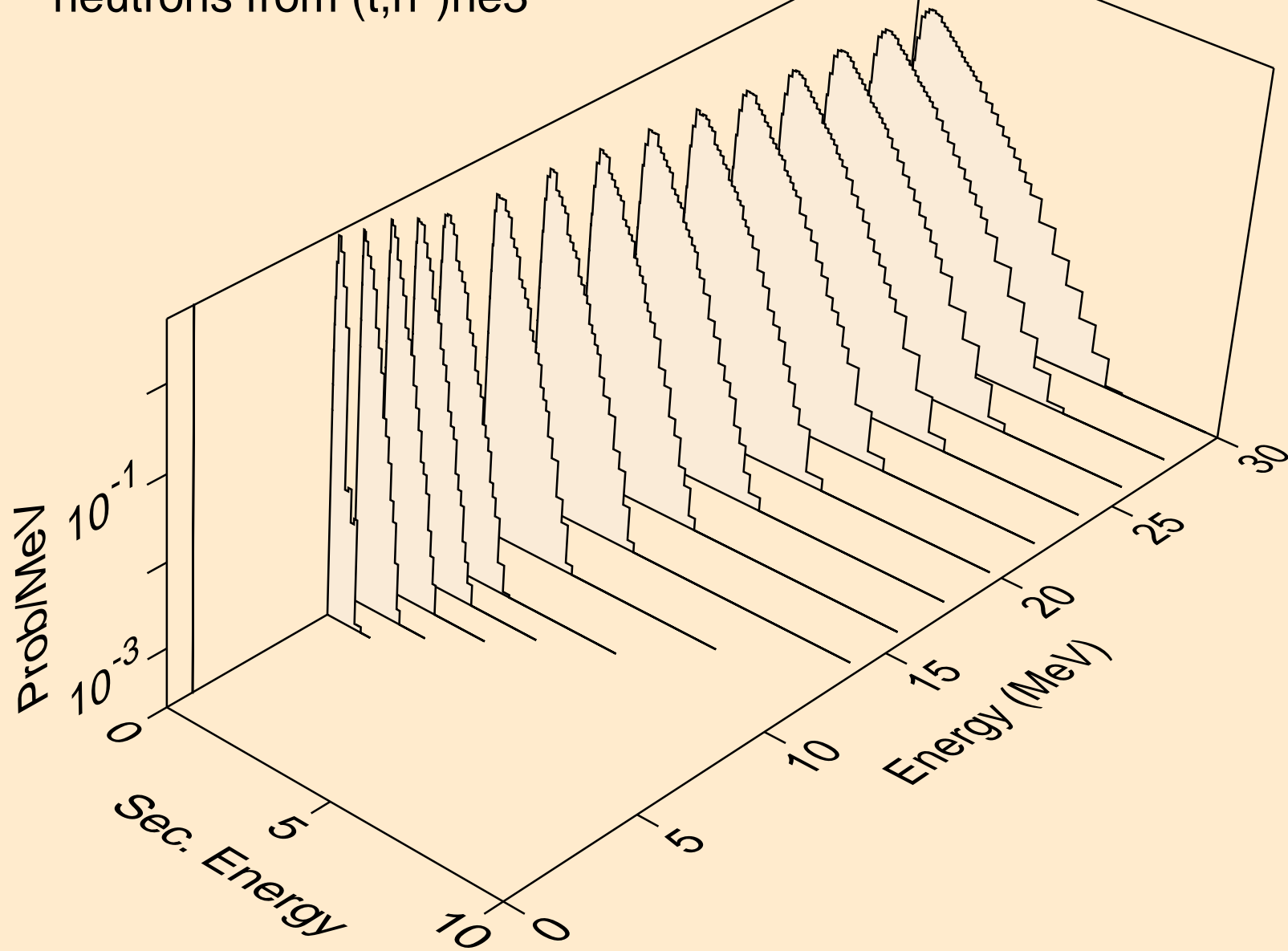

PR124 TRITON ACER TENDL-2021 LIBRARY; T=0.K  
neutrons from (t,2np)

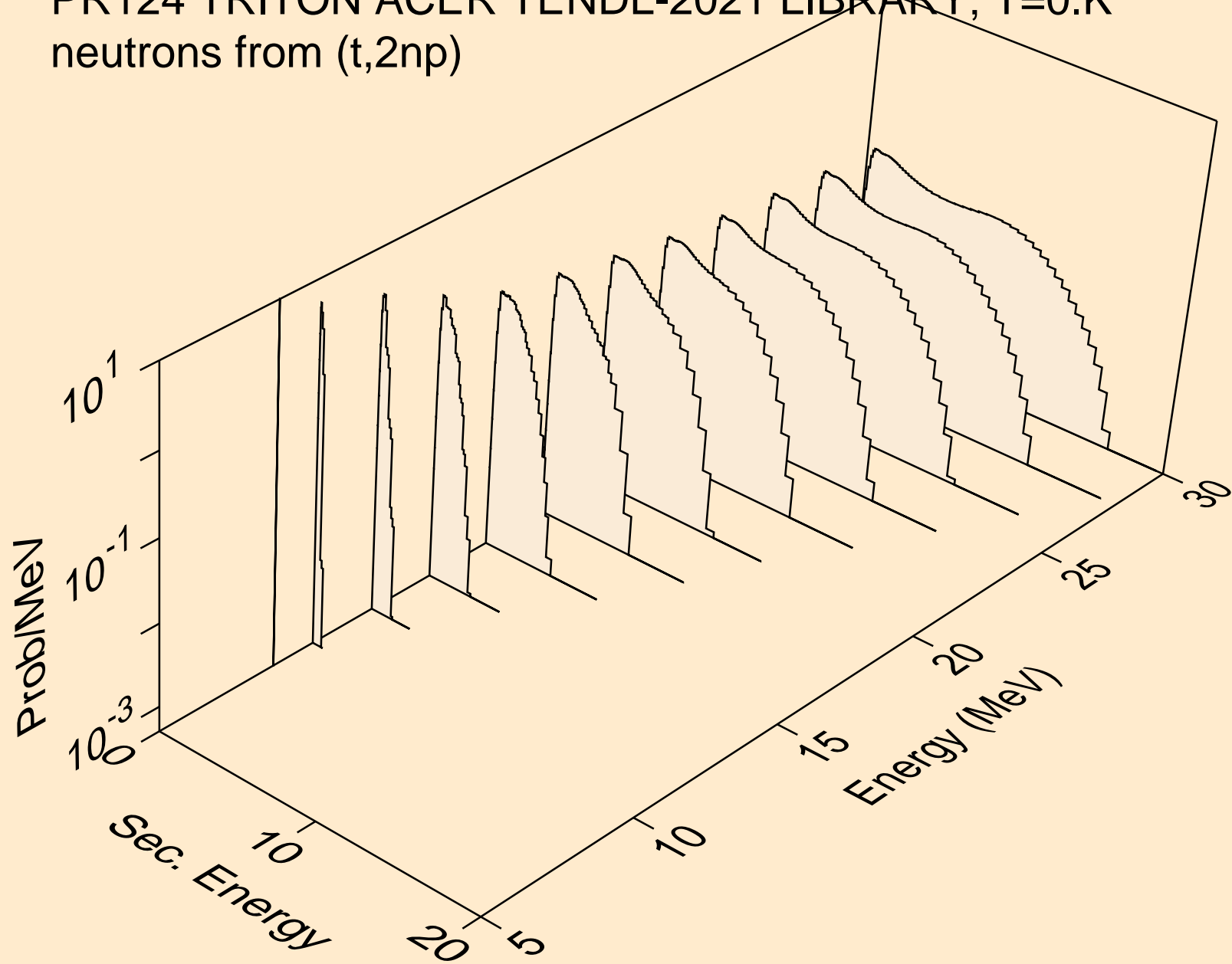

PR124 TRITON ACER TENDL-2021 LIBRARY; T=0.K  
neutrons from (t,3np)

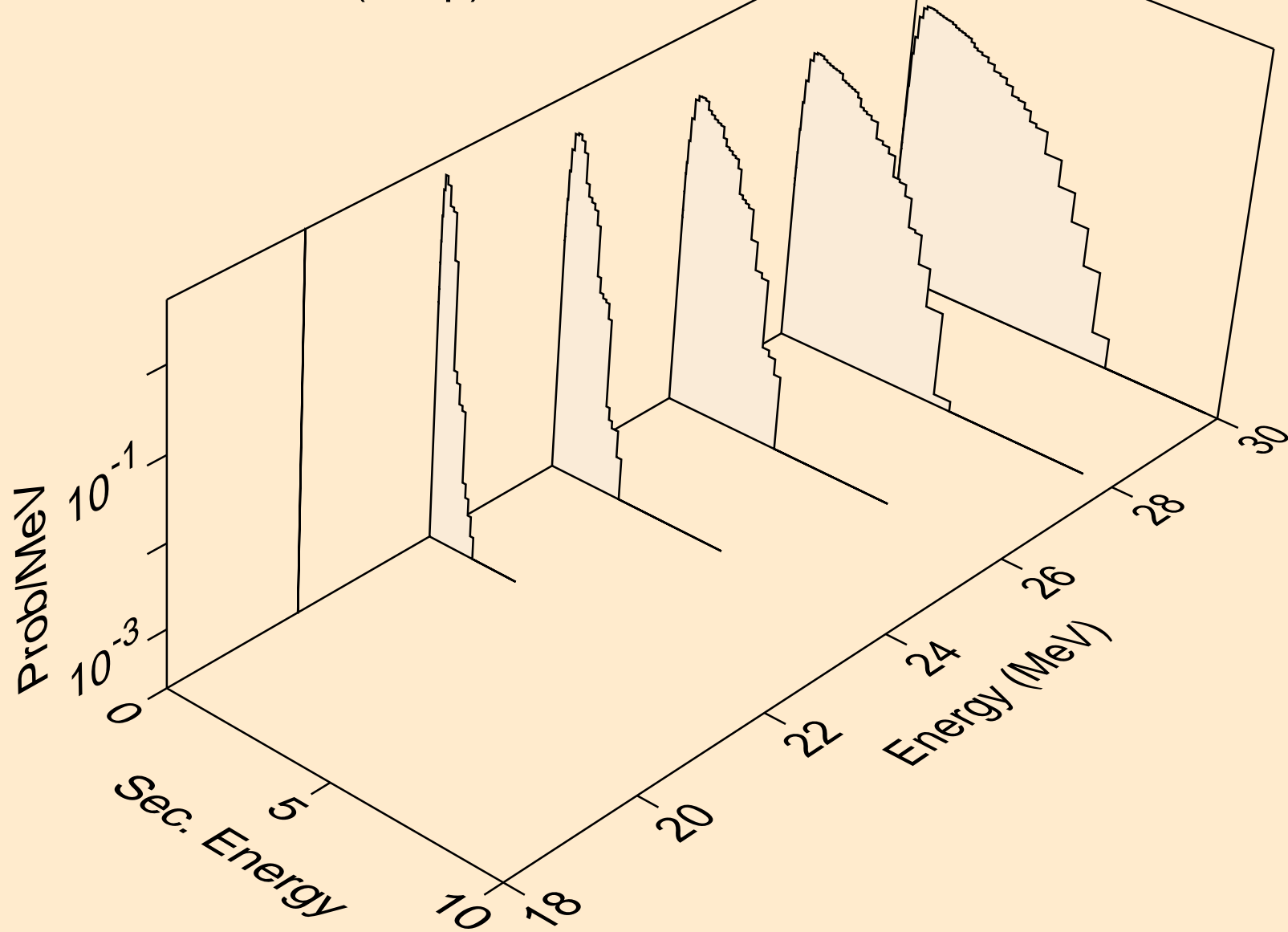

PR124 TRITON ACER TENDL-2021 LIBRARY; T=0.K  
neutrons from (t,2np)

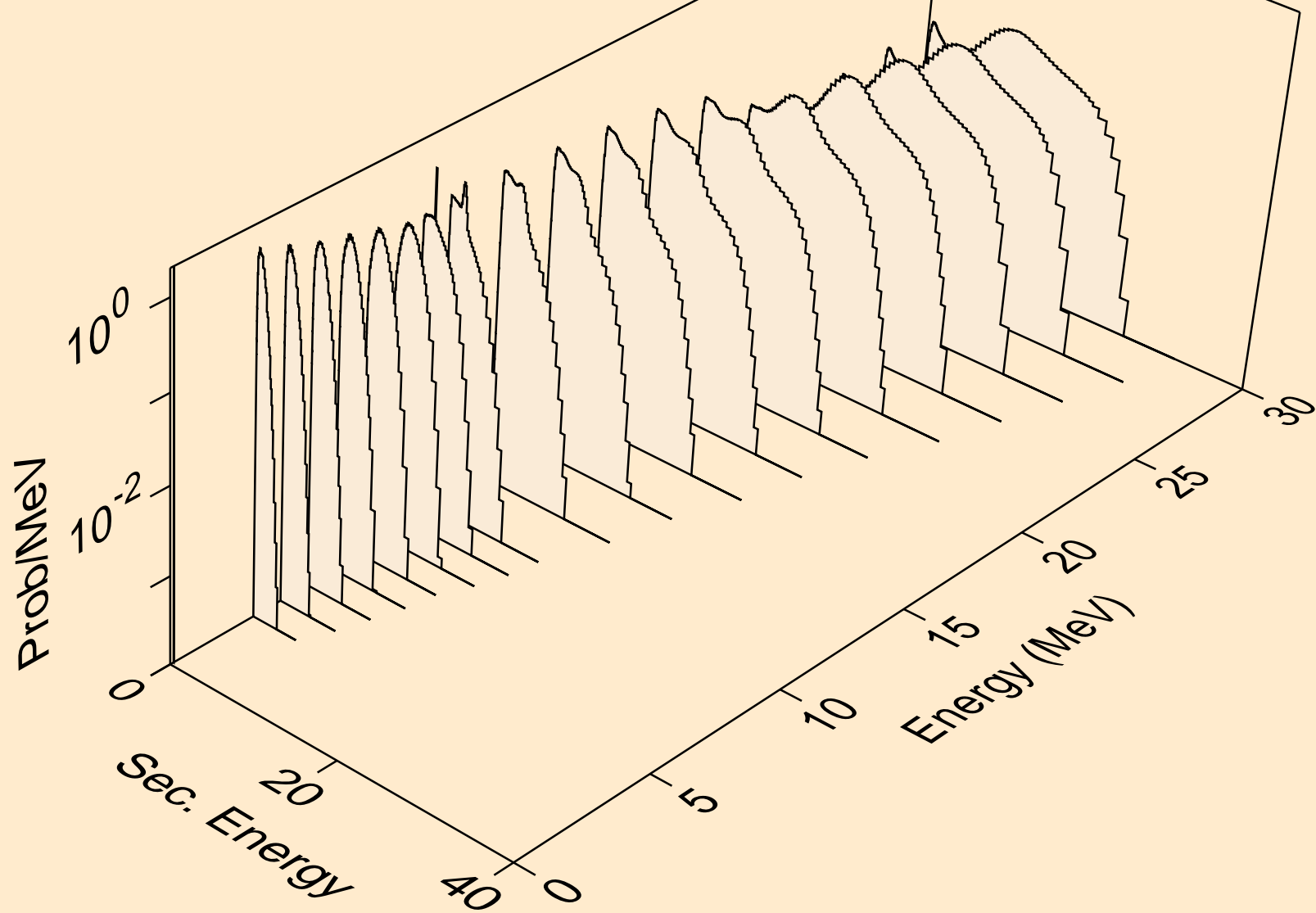

PR124 TRITON ACER TENDL-2021 LIBRARY; T=0.K  
neutrons from (t,npa)

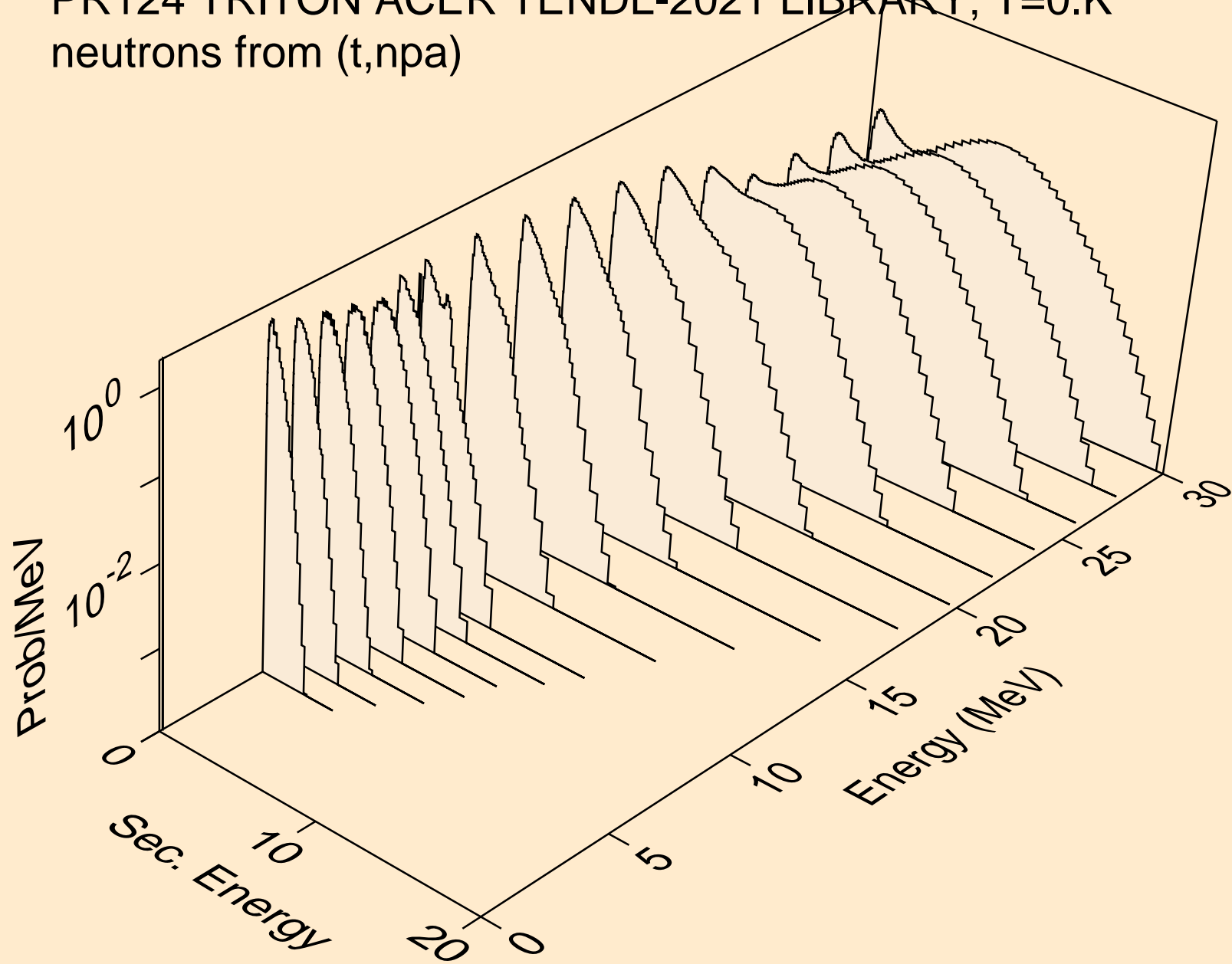

PR124 TRITON ACER TENDL-2021 LIBRARY; T=0.K  
protons from (t,x)

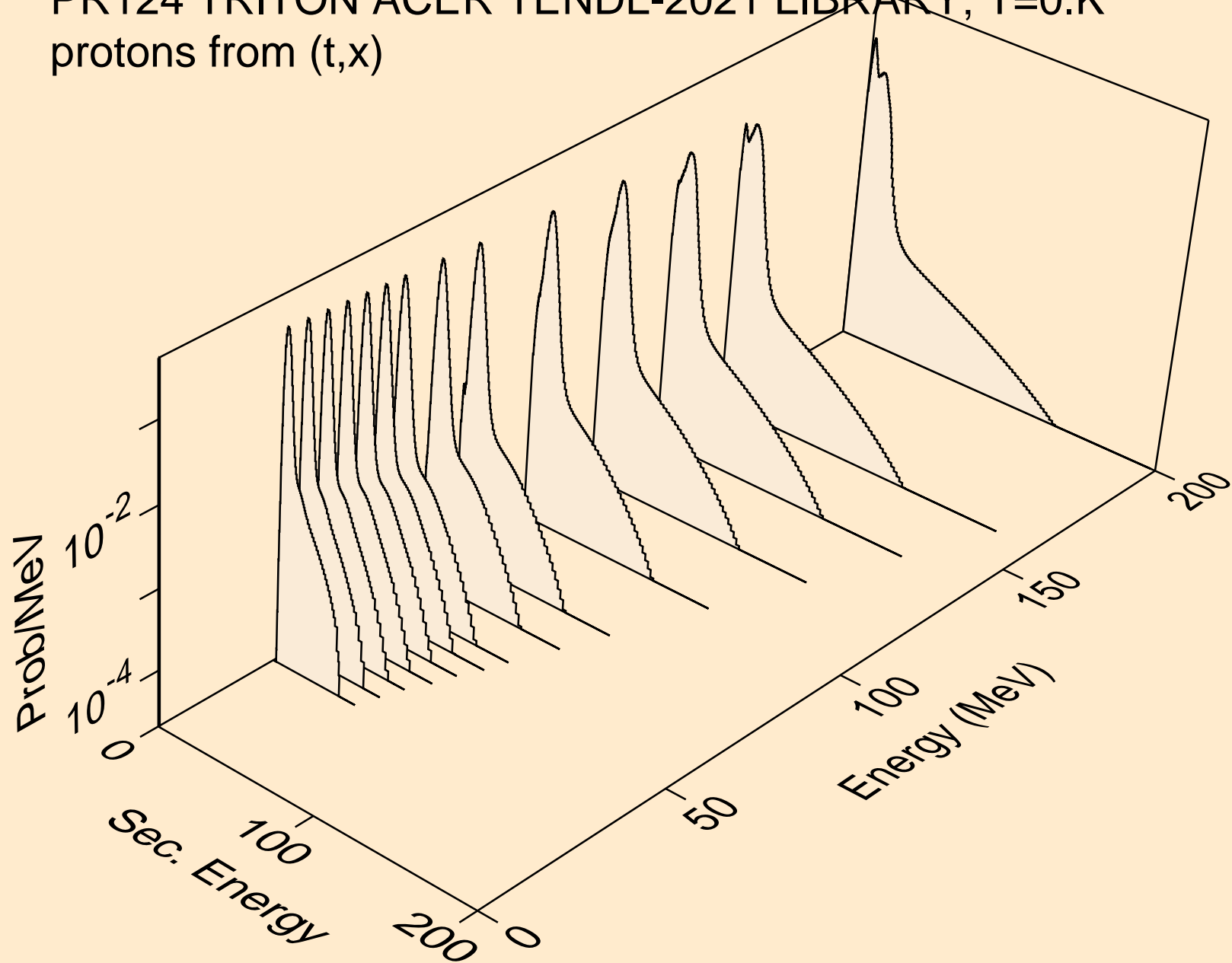

PR124 TRITON ACER TENDL-2021 LIBRARY; T=0.K  
protons from (t,n\*)p

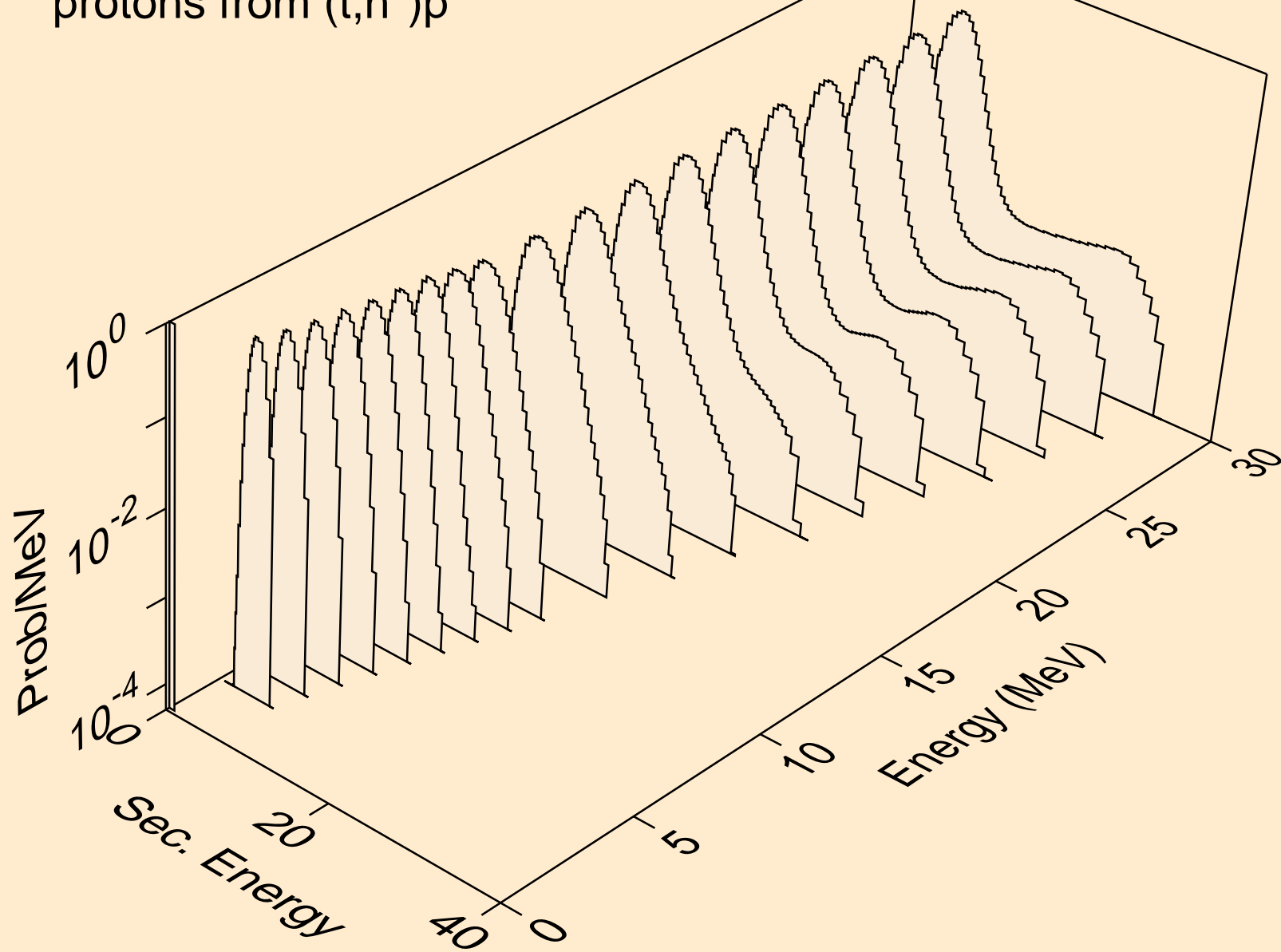

PR124 TRITON ACER TENDL-2021 LIBRARY; T=0.K  
protons from (t,2np)

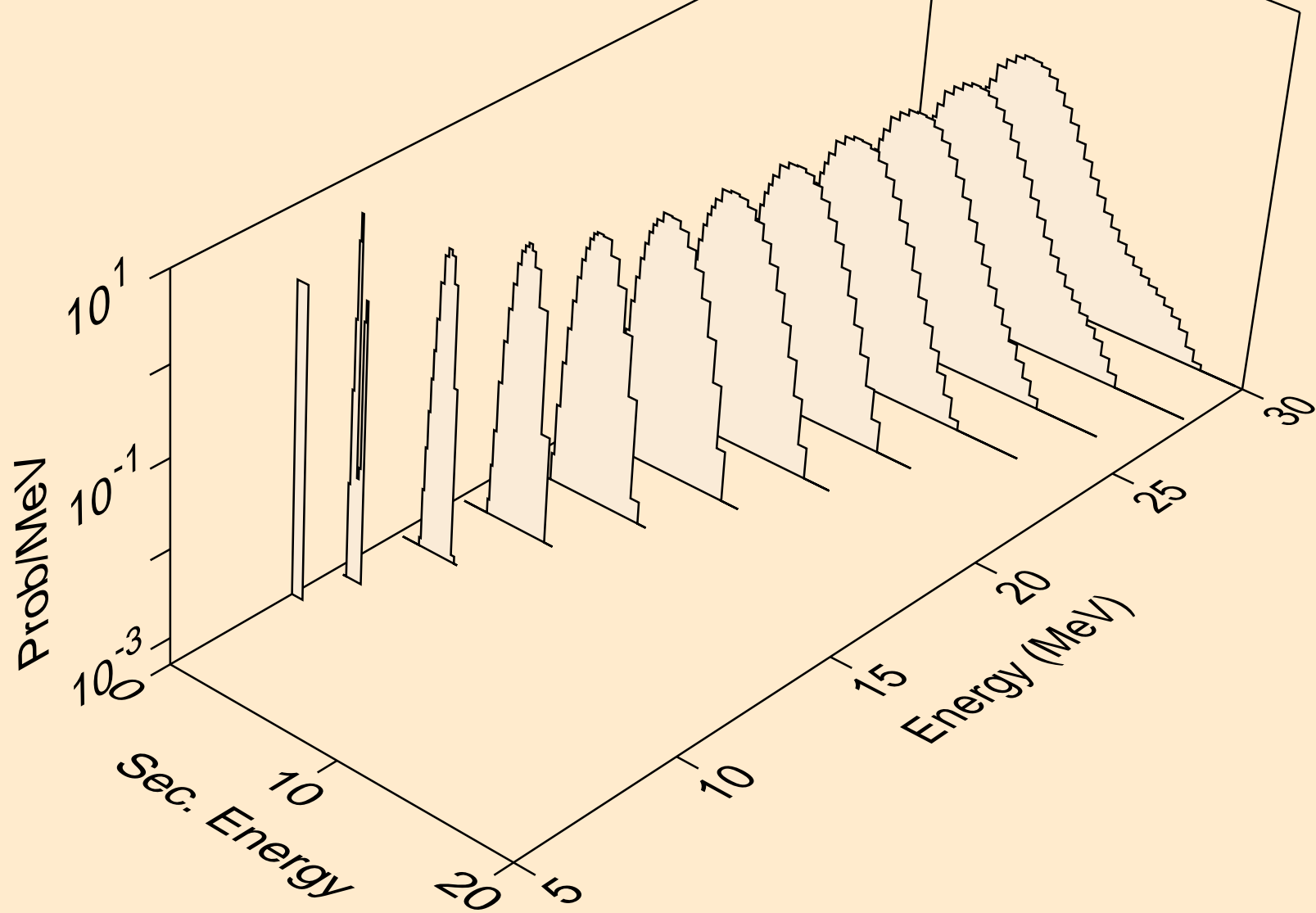



PR124 TRITON ACER TENDL-2021 LIBRARY; T=0.K  
protons from (t,3np)

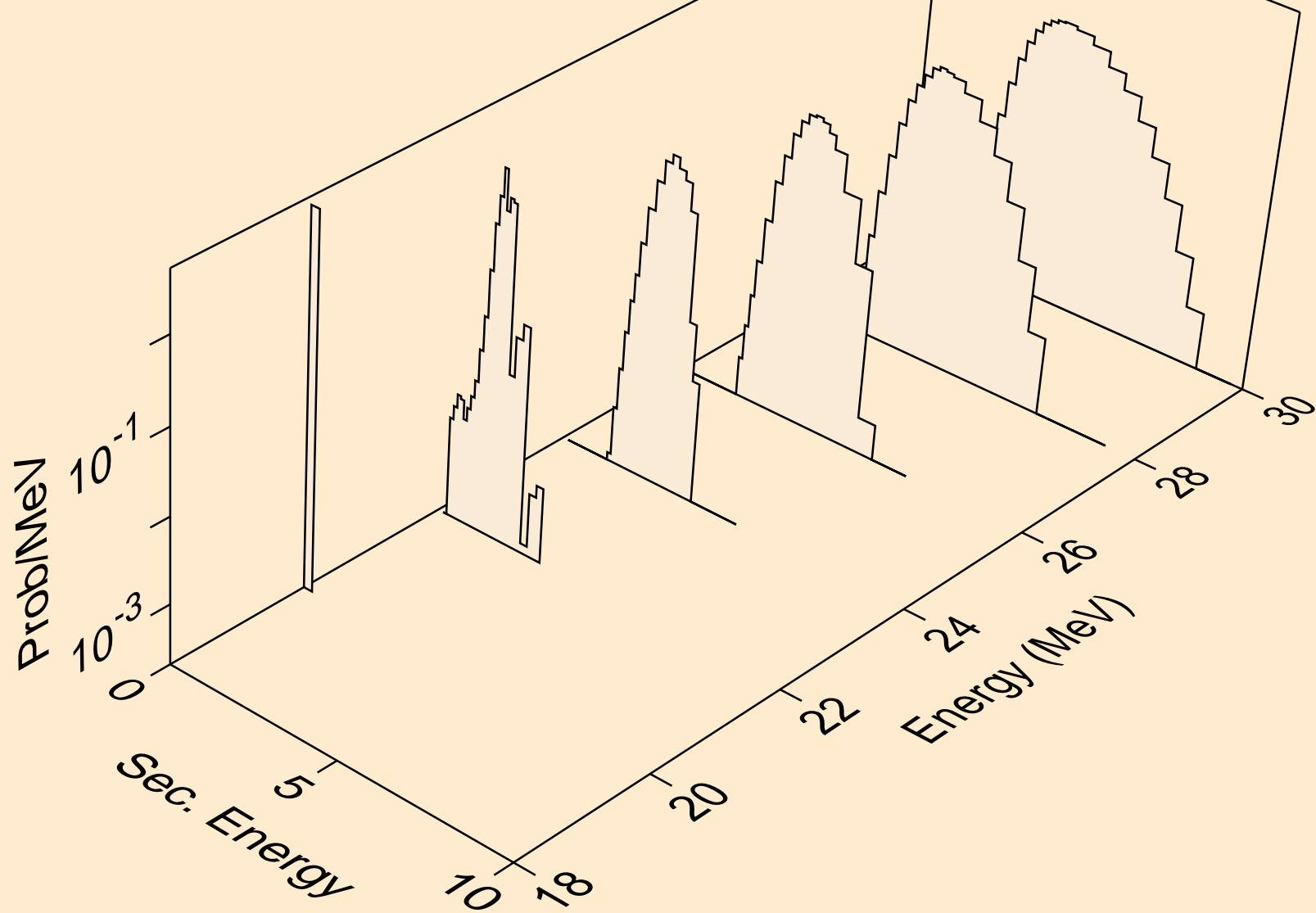

PR124 TRITON ACER TENDL-2021 LIBRARY; T=0.K  
protons from (t,2np)

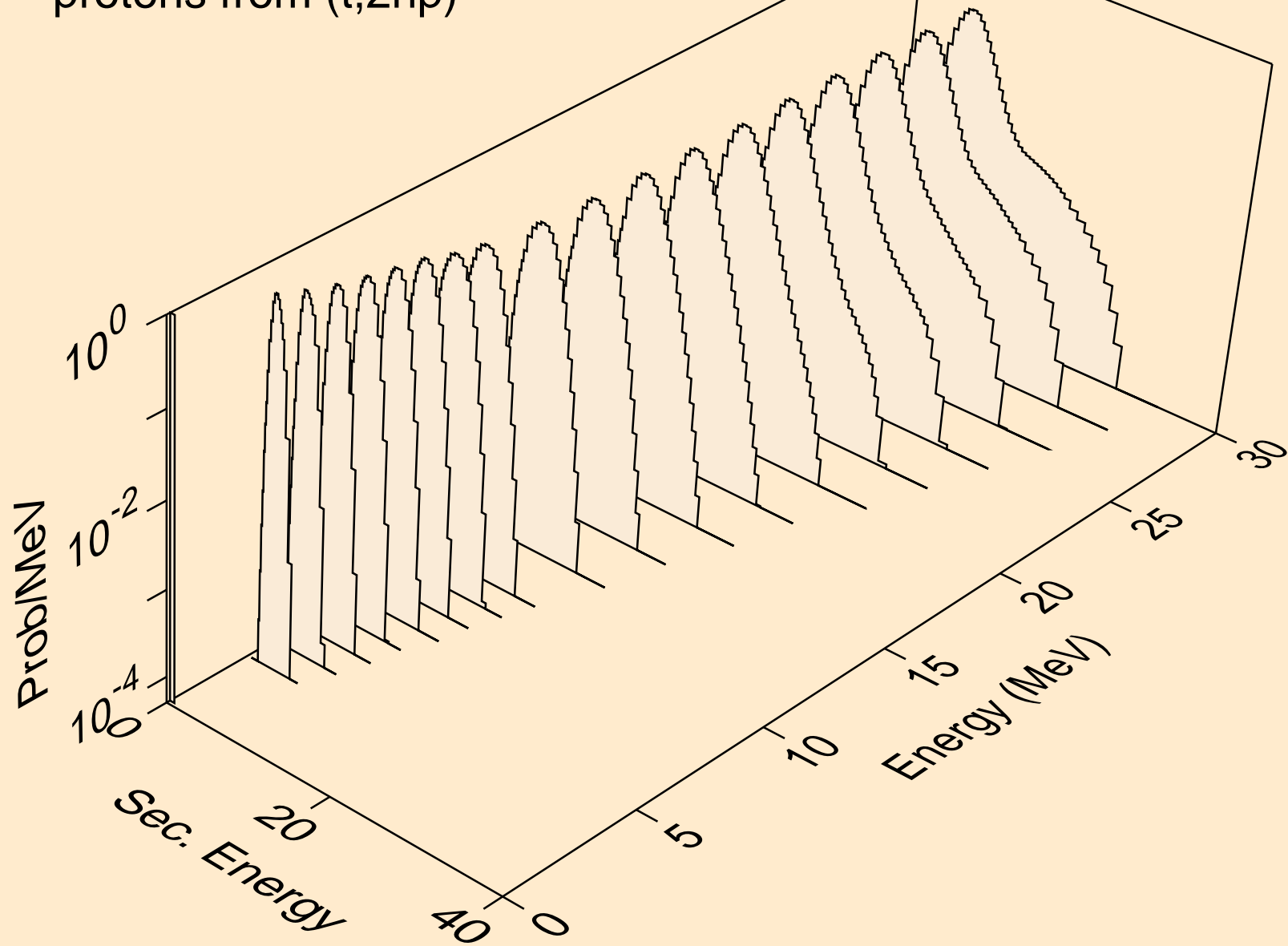

PR124 TRITON ACER TENDL-2021 LIBRARY; T=0.K  
protons from (t,npa)

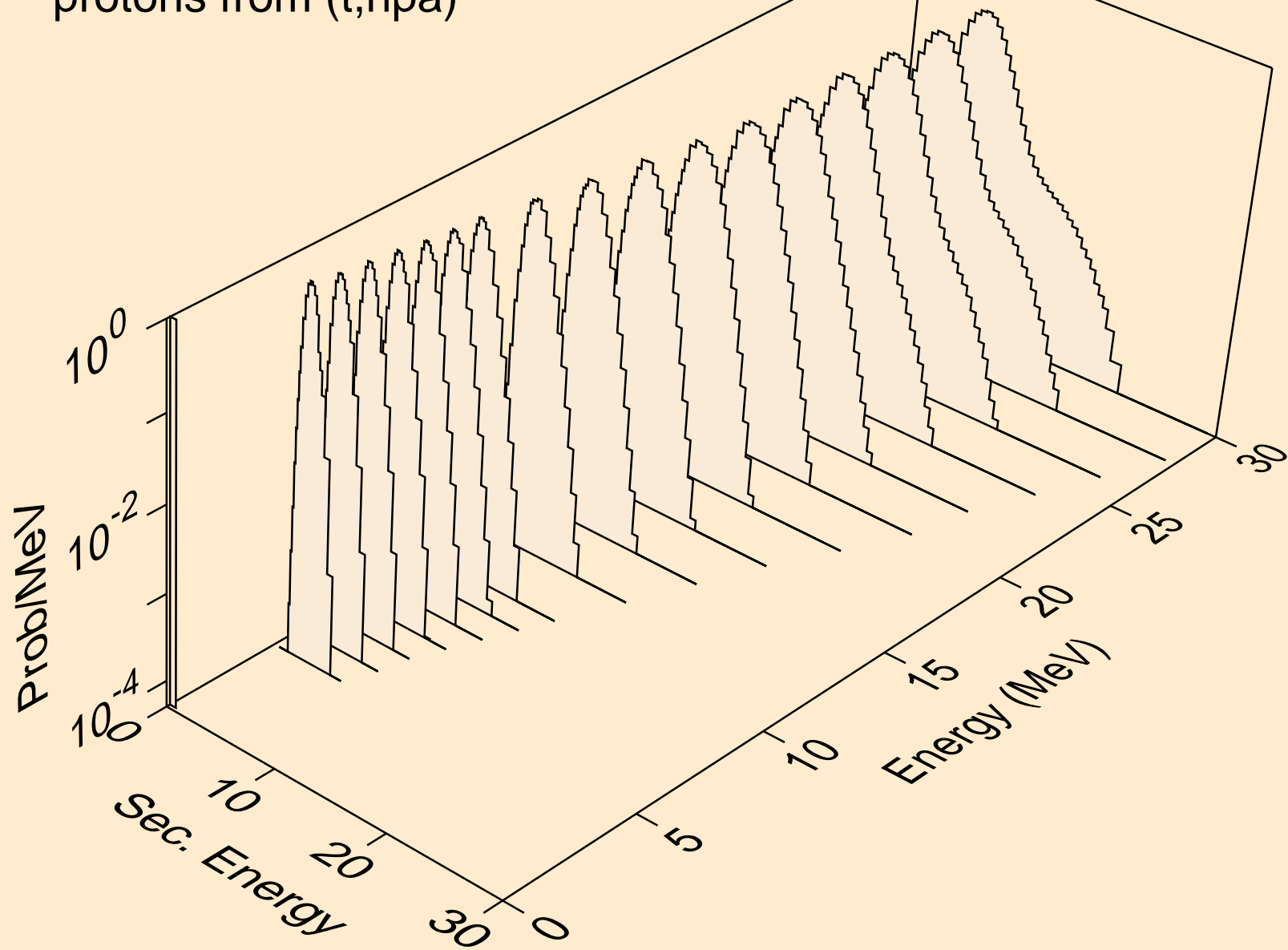

PR124 TRITON ACER TENDL-2021 LIBRARY; T=0.K  
protons from (t,p)

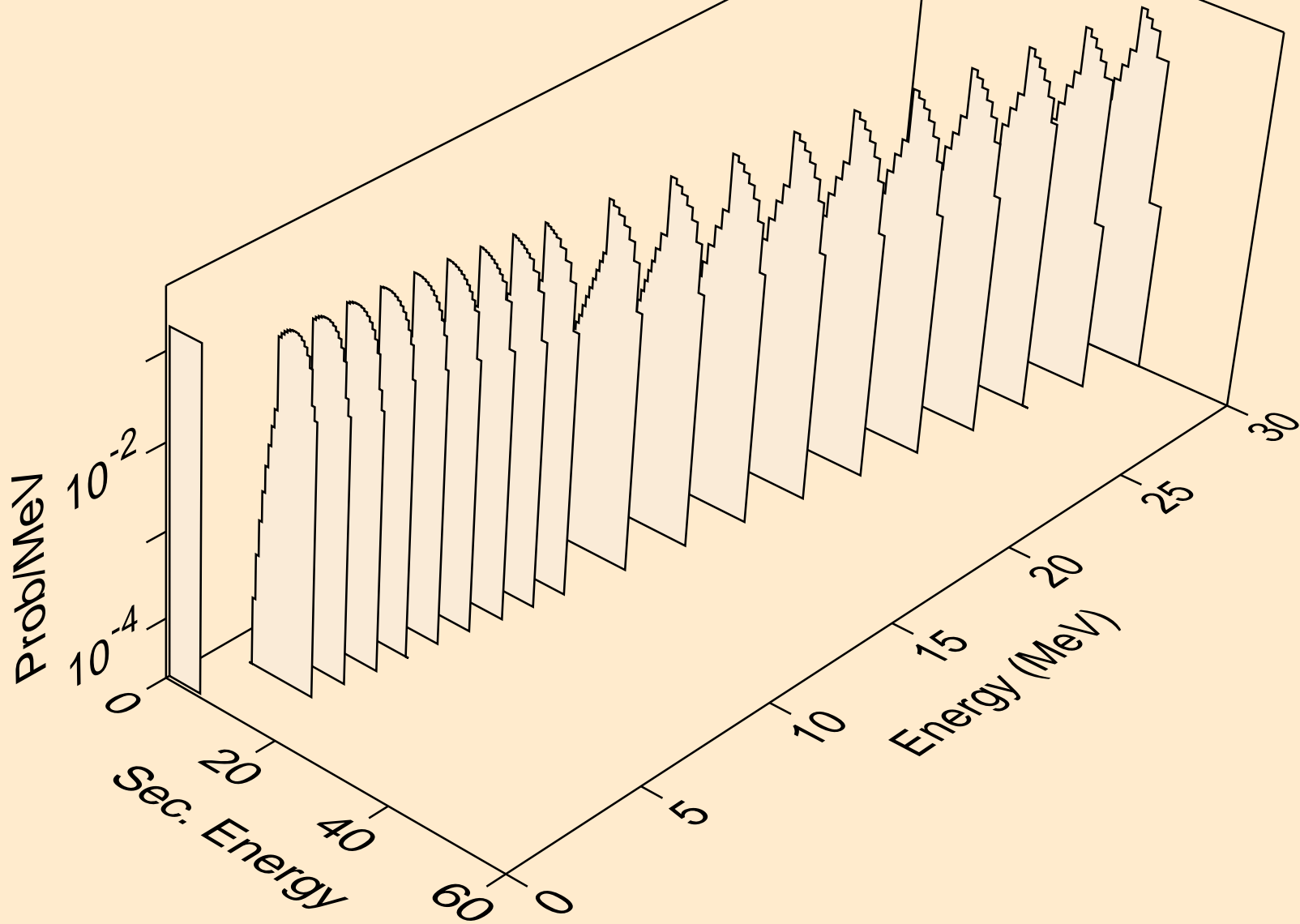

PR124 TRITON ACER TENDL-2021 LIBRARY; T=0.K  
protons from (t,2p)

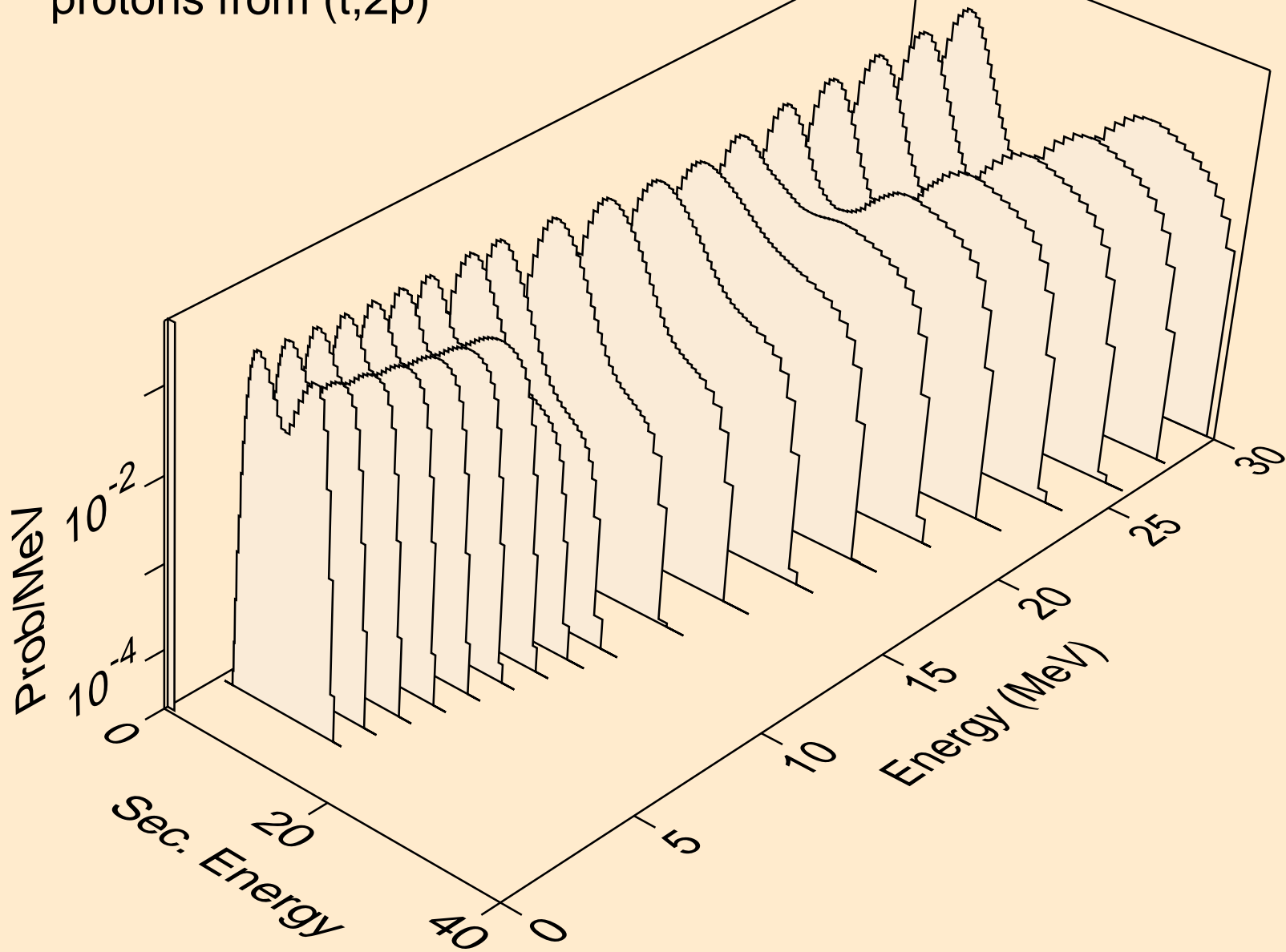

PR124 TRITON ACER TENDL-2021 LIBRARY; T=0.K  
protons from (t,pa)

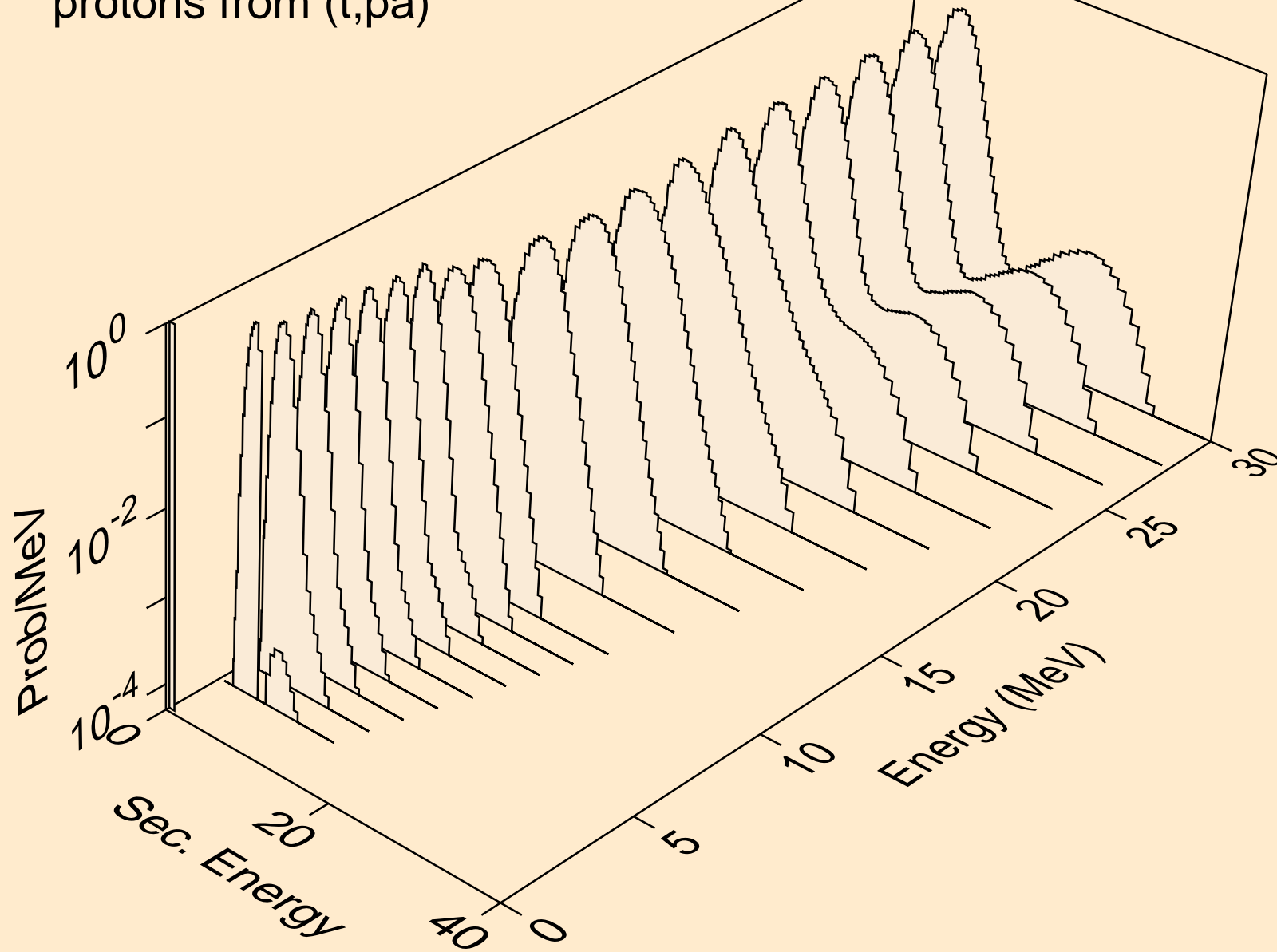

PR124 TRITON ACER TENDL-2021 LIBRARY; T=0.K  
protons from (t,pd)

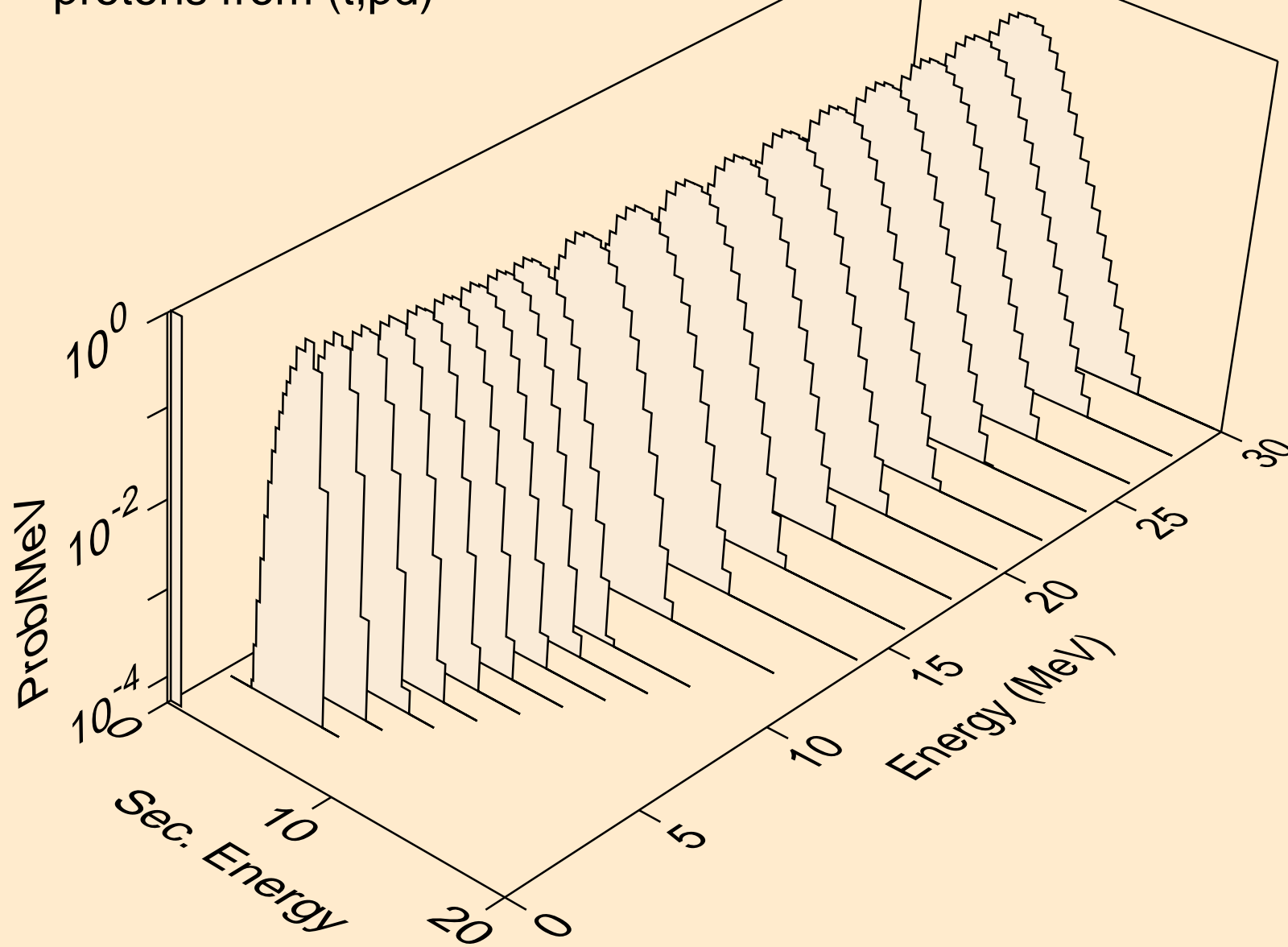

PR124 TRITON ACER TENDL-2021 LIBRARY; T=0.K  
protons from (t,pt)

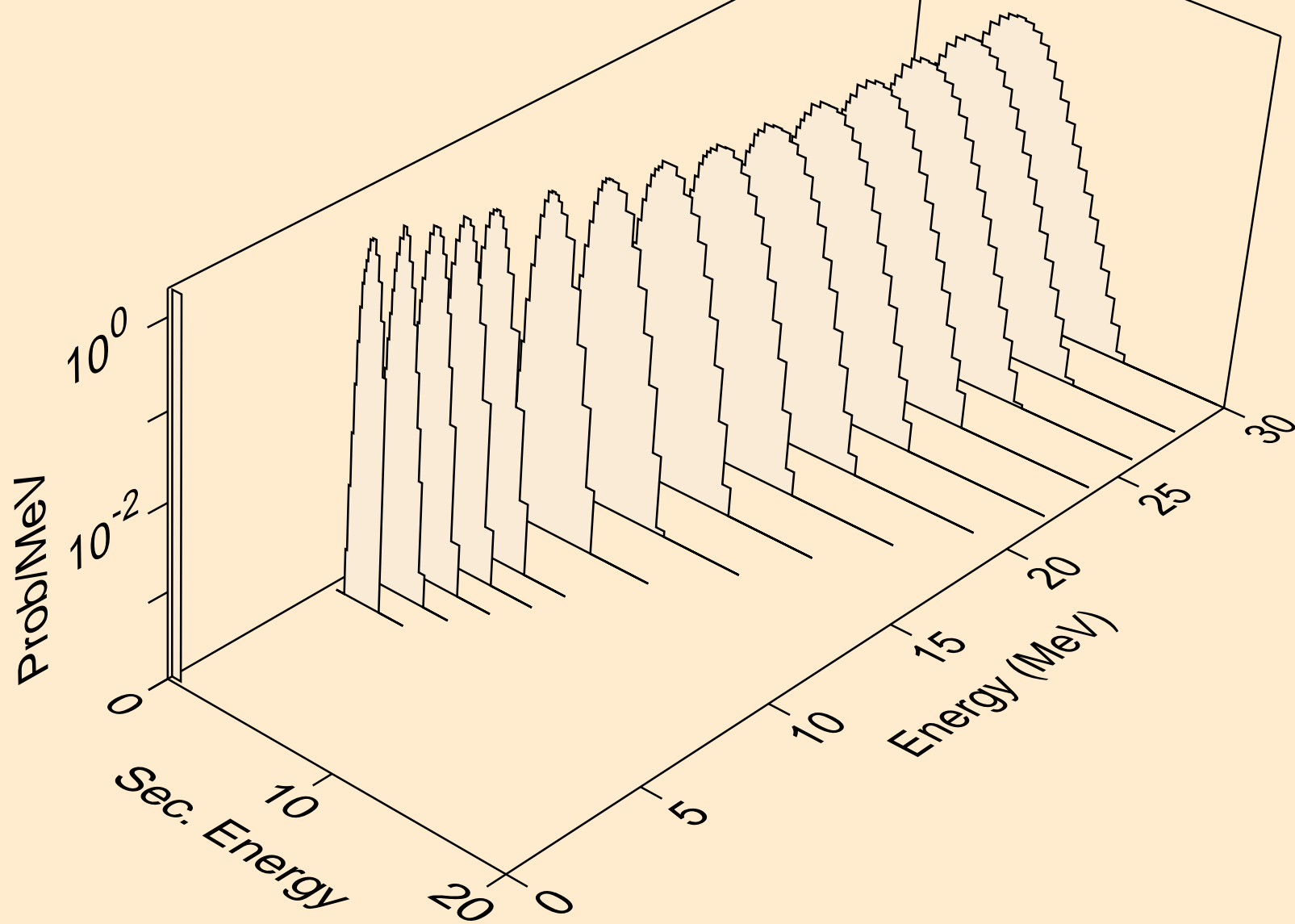



PR124 TRITON ACER TENDL-2021 LIBRARY; T=0.K  
deuterons from (t,x)

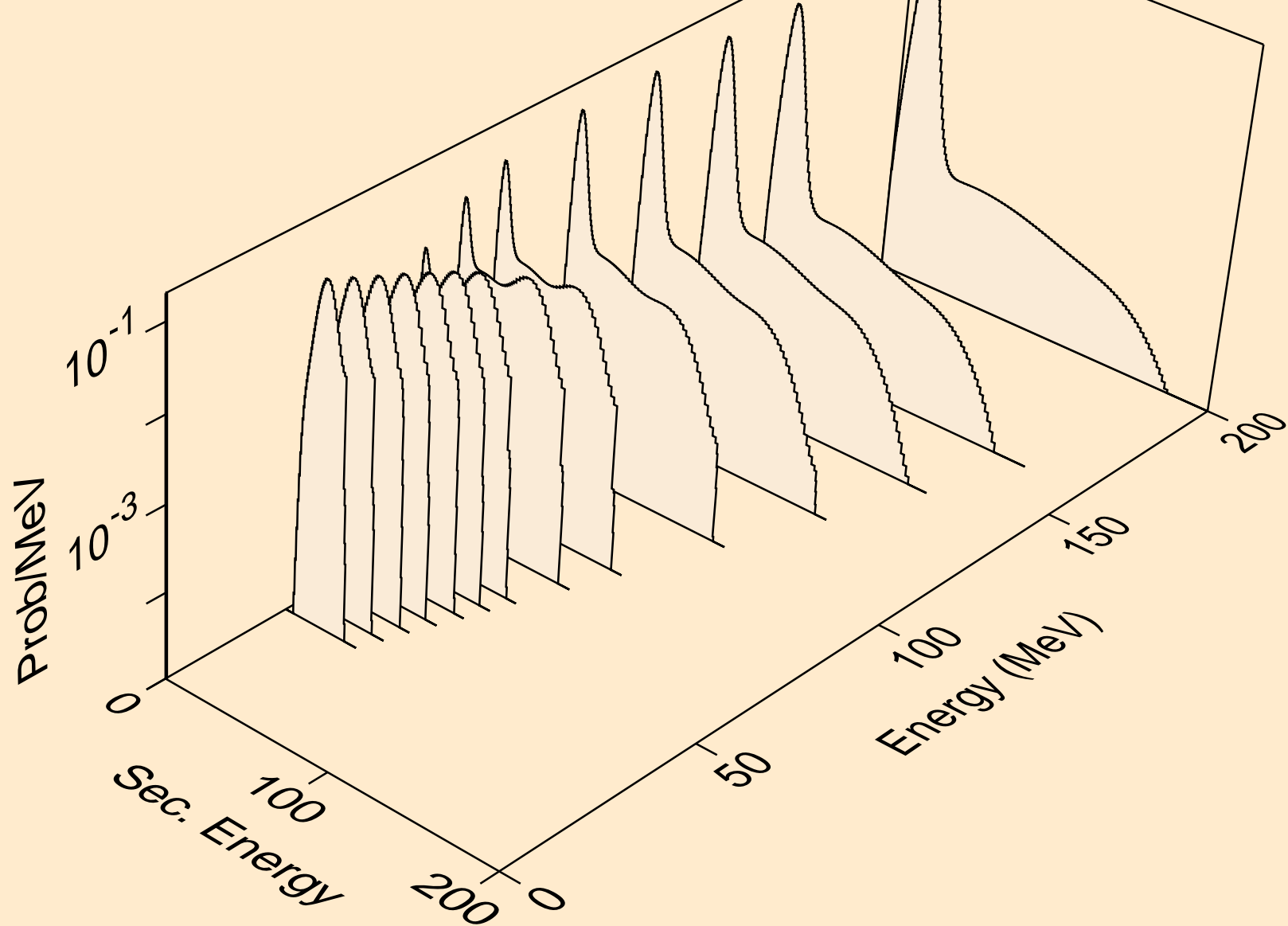

PR124 TRITON ACER TENDL-2021 LIBRARY; T=0.K  
deuterons from (t,2nd)

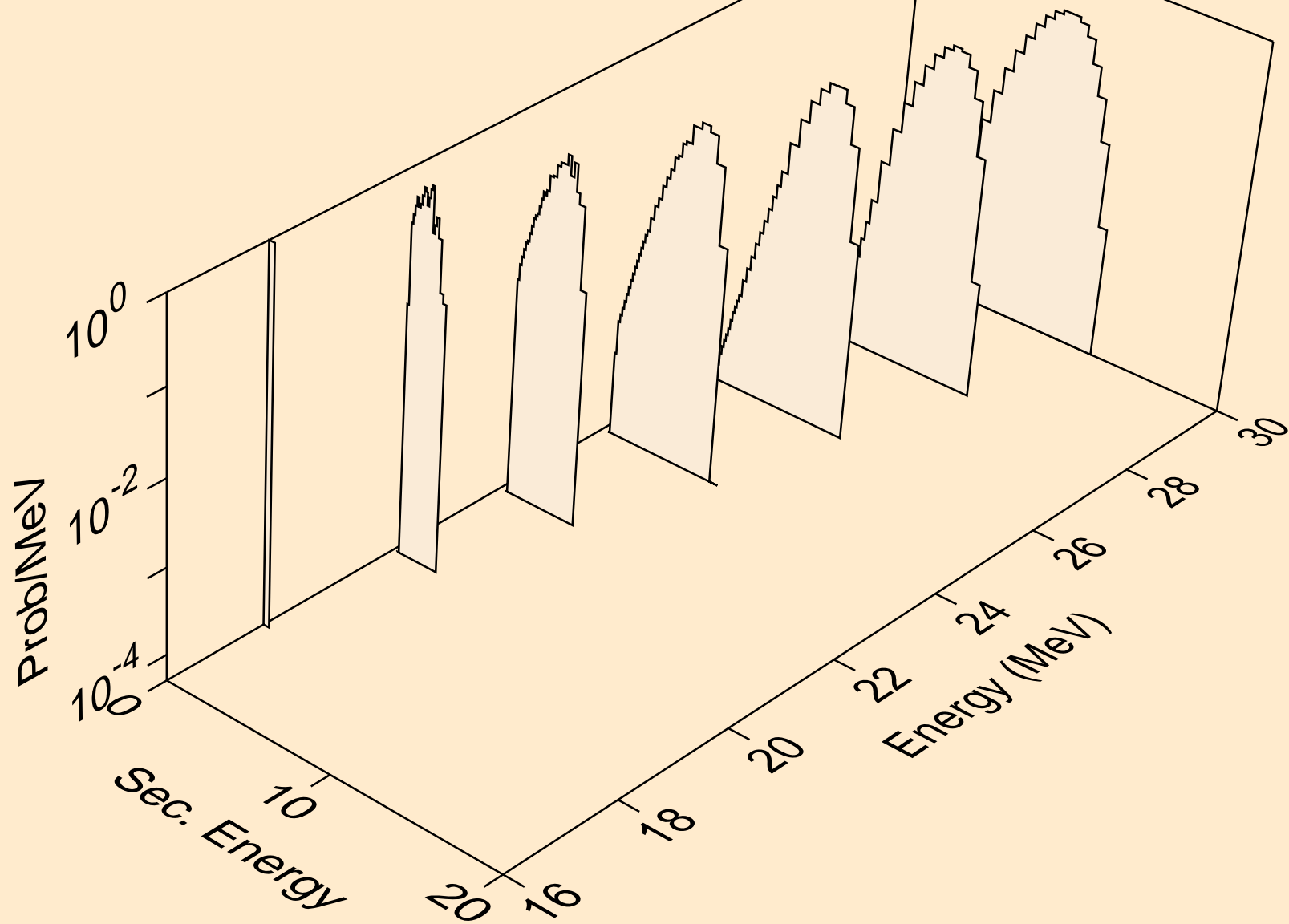

PR124 TRITON ACER TENDL-2021 LIBRARY; T=0.K  
deuterons from (t,n\*)d

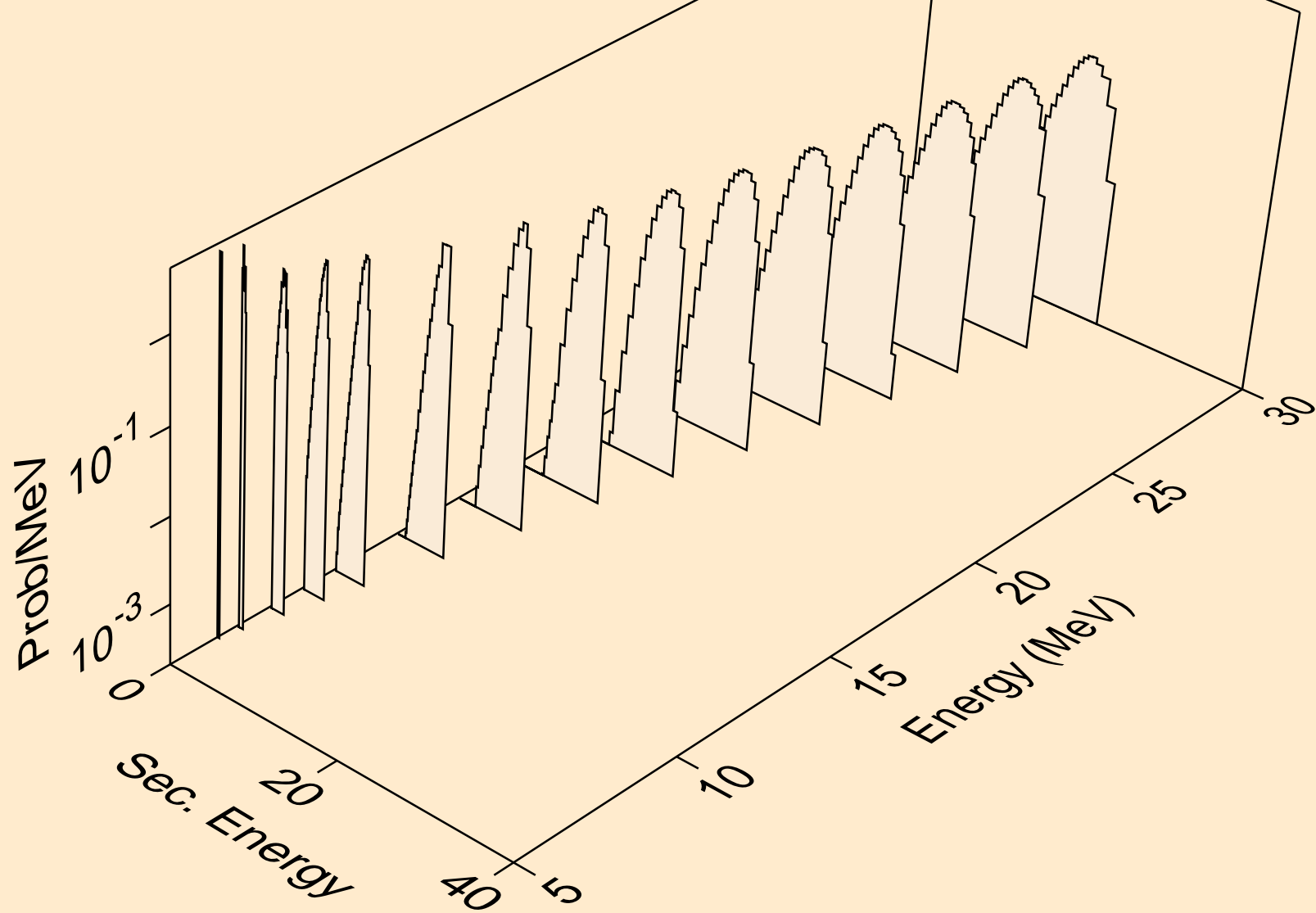

PR124 TRITON ACER TENDL-2021 LIBRARY; T=0.K  
deuterons from (t,d)

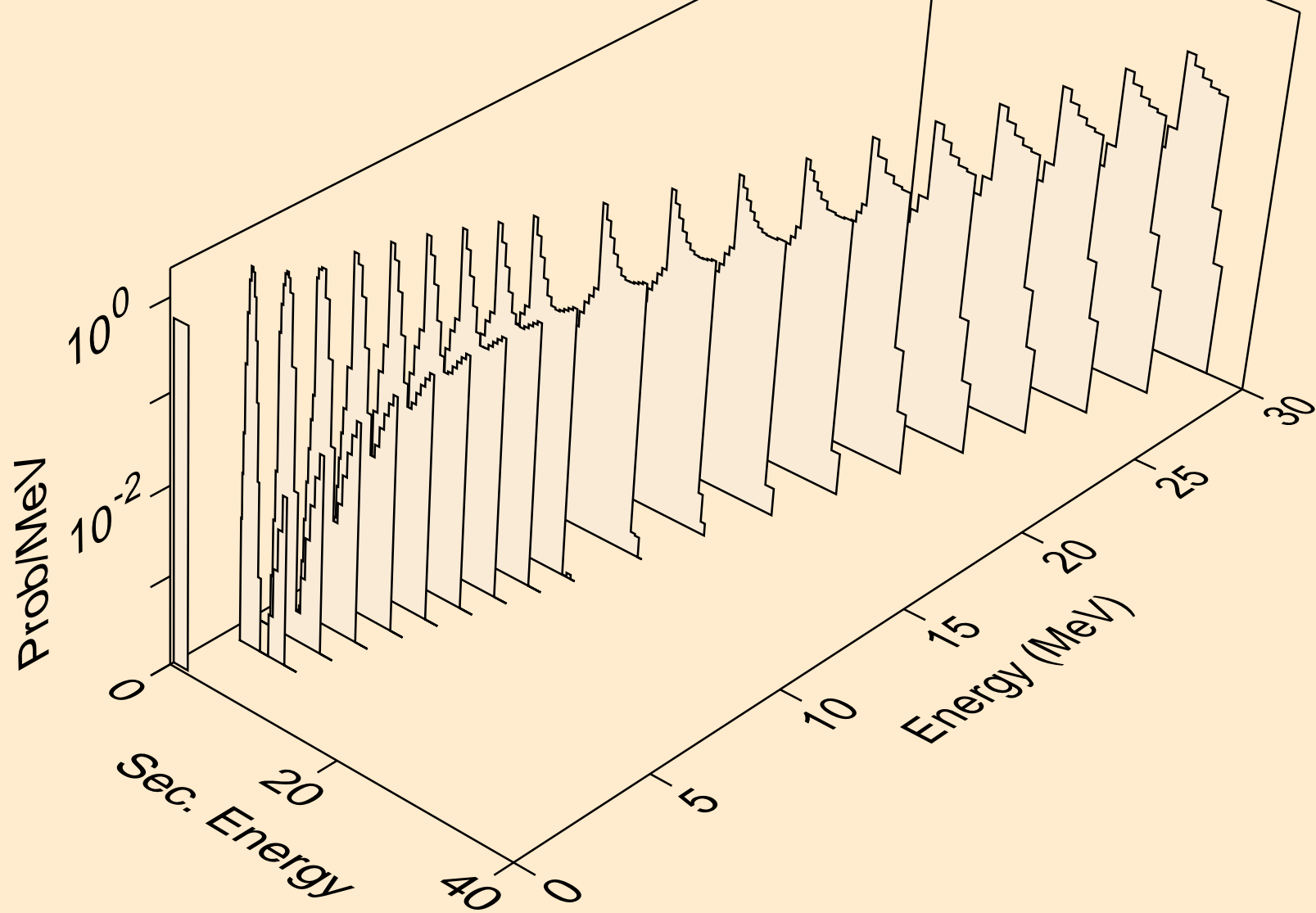

PR124 TRITON ACER TENDL-2021 LIBRARY; T=0.K  
deuterons from (t,d2a)

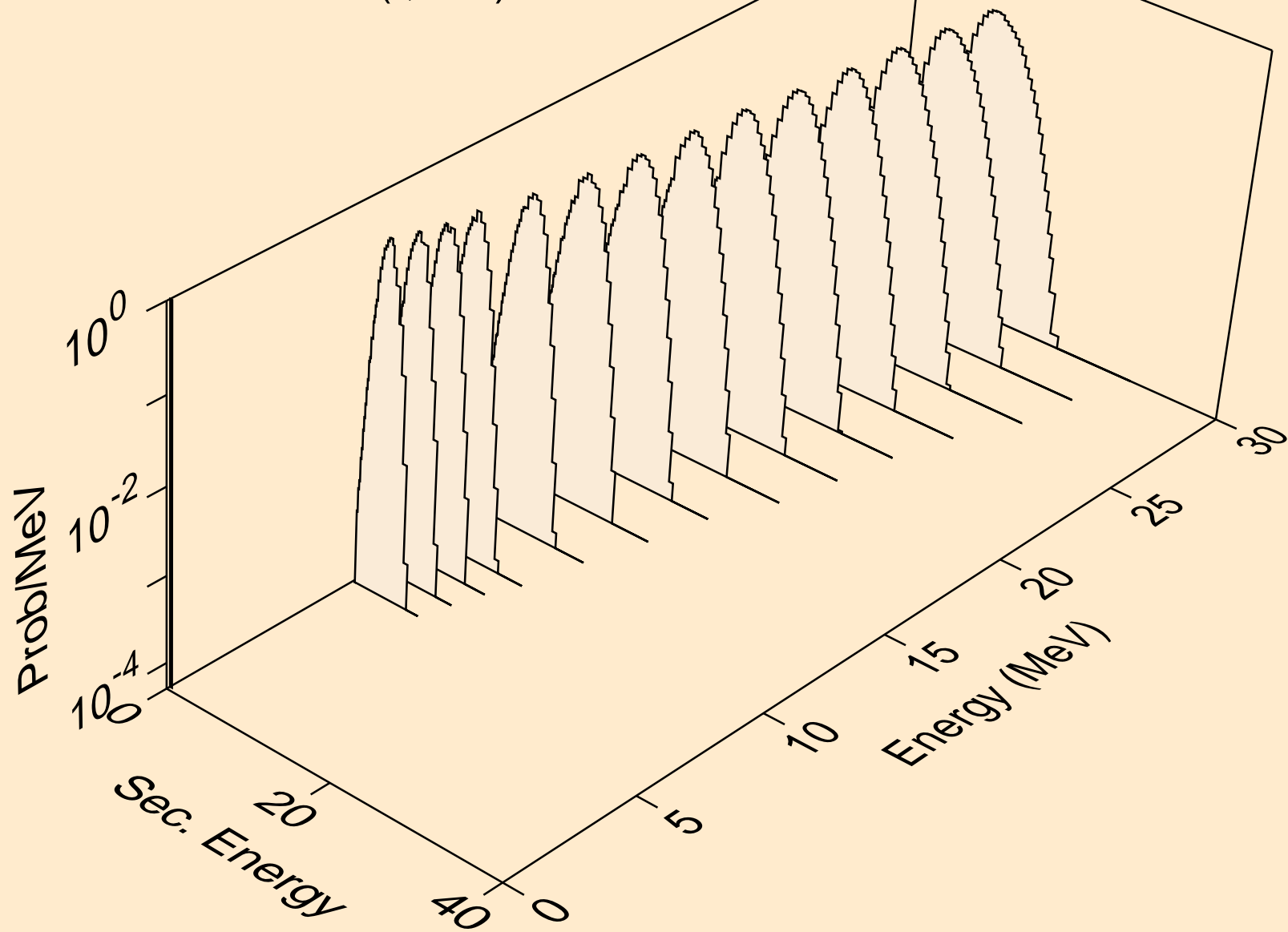

PR124 TRITON ACER TENDL-2021 LIBRARY; T=0.K  
deuterons from (t,pd)

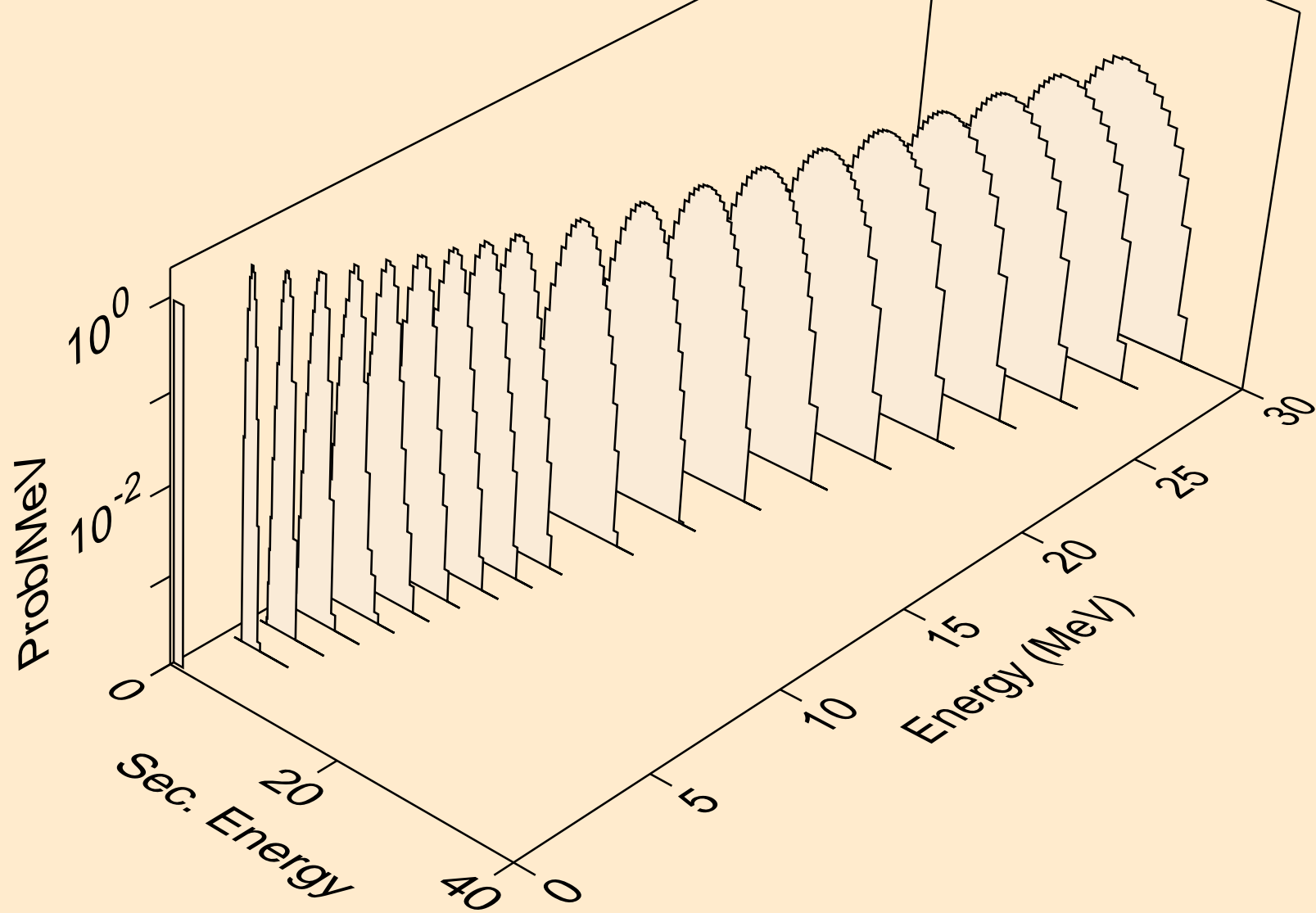

PR124 TRITON ACER TENDL-2021 LIBRARY; T=0.K  
deuterons from (t,da)

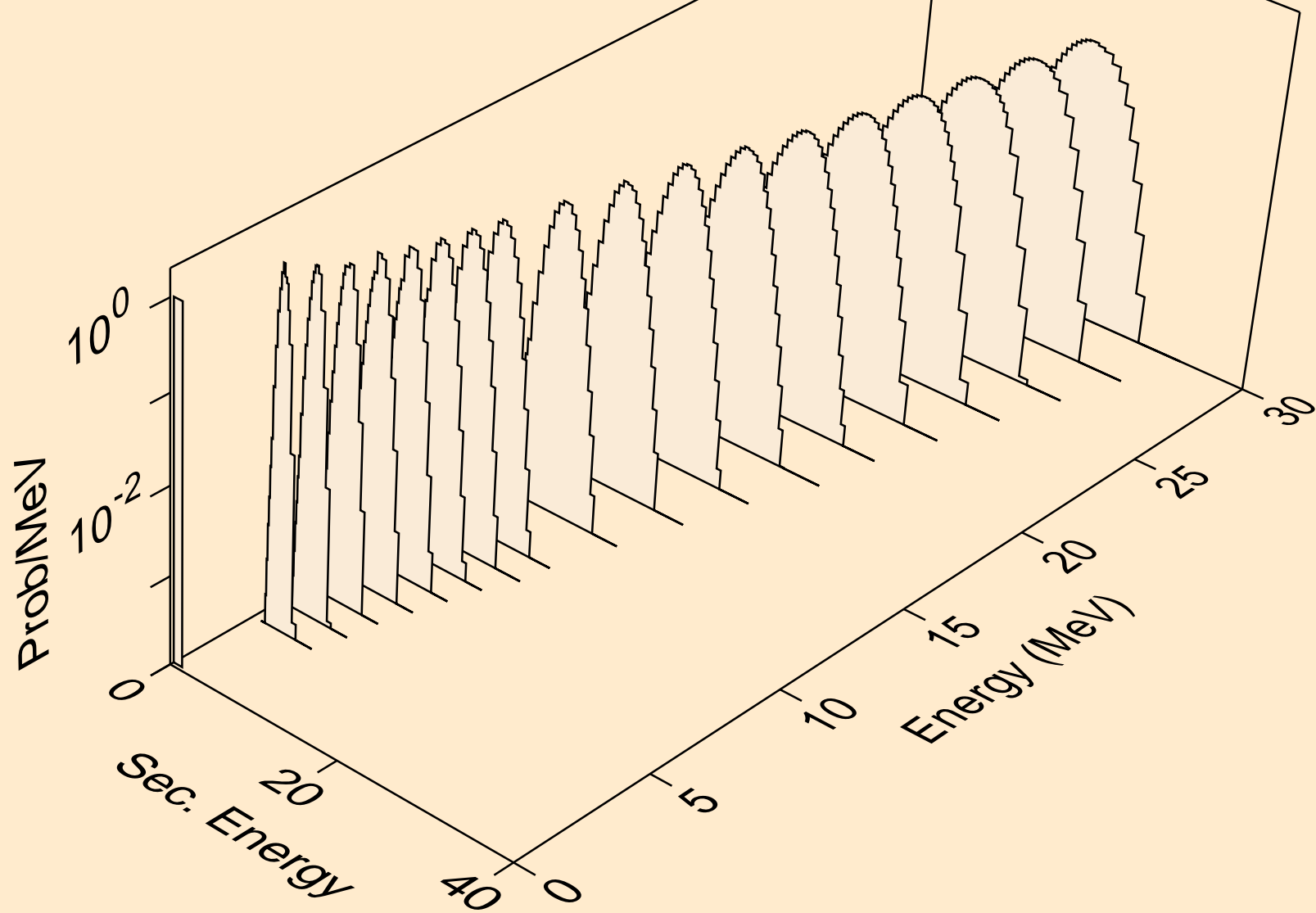

PR124 TRITON ACER TENDL-2021 LIBRARY; T=0.K  
he3s from (t,x)

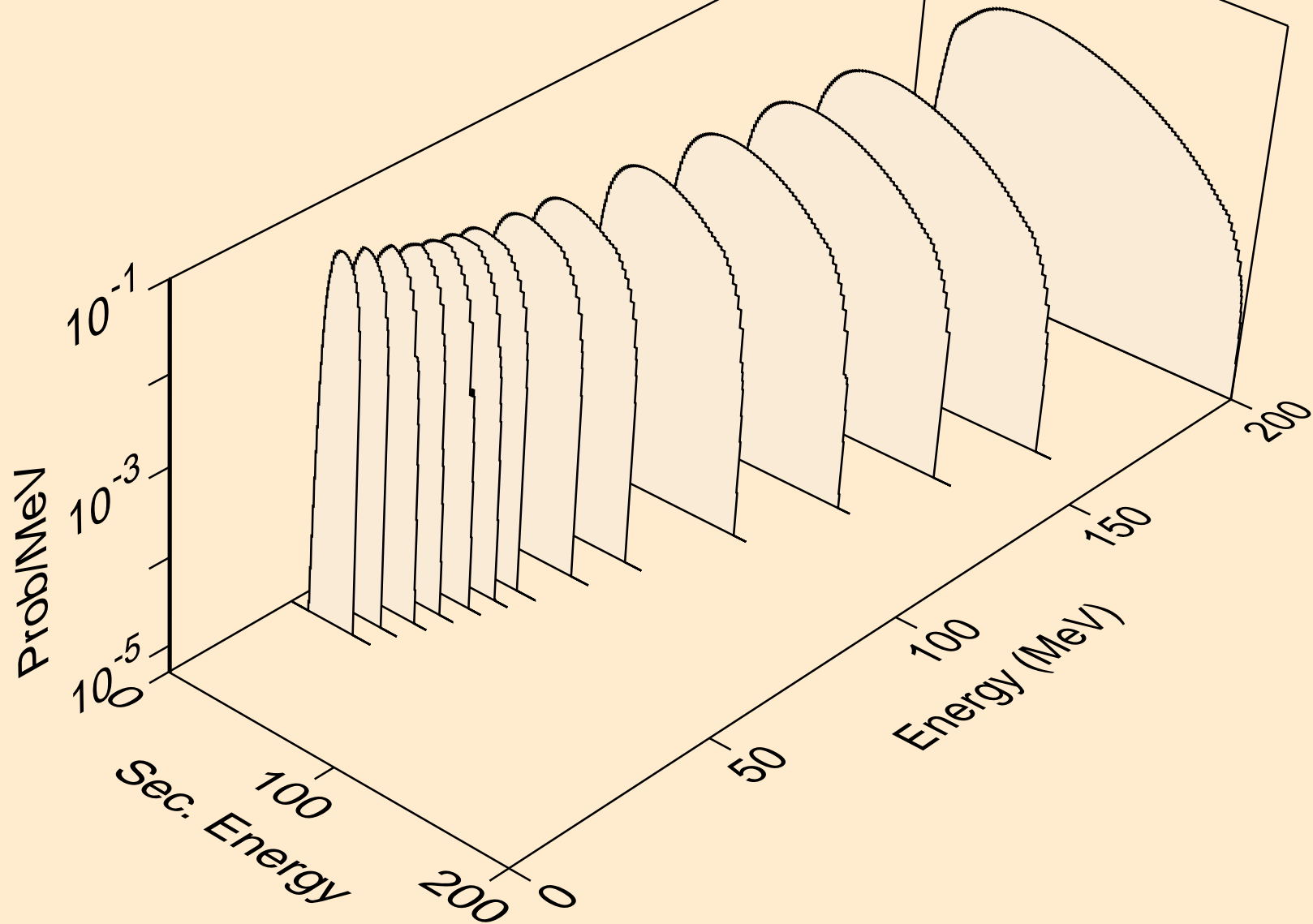



PR124 TRITON ACER TENDL-2021 LIBRARY; T=0.K  
he3s from (t,n\*)he3

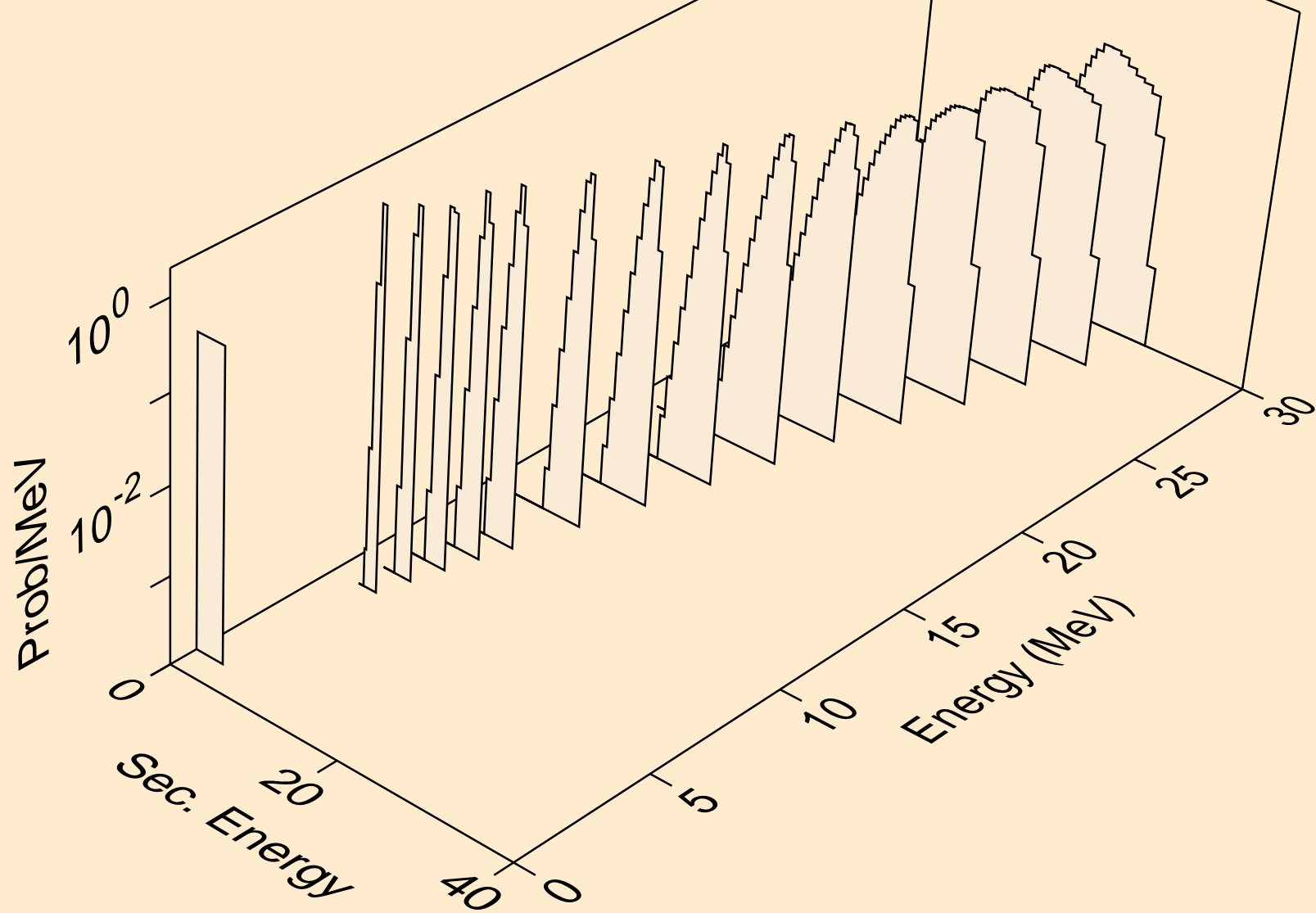

PR124 TRITON ACER TENDL-2021 LIBRARY; T=0.K  
he3s from (t,he3)

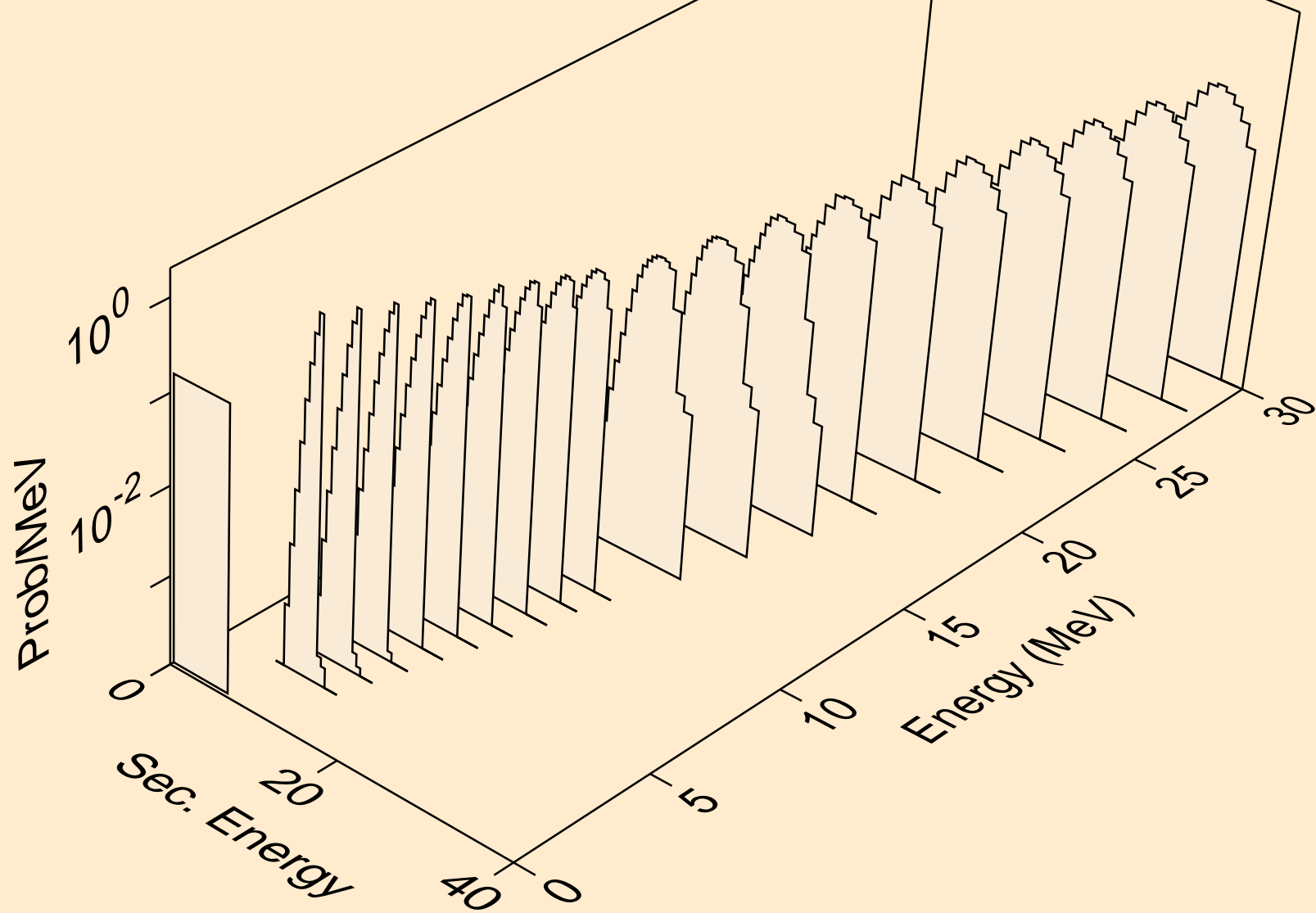

PR124 TRITON ACER TENDL-2021 LIBRARY; T=0.K  
alphas from (t,x)

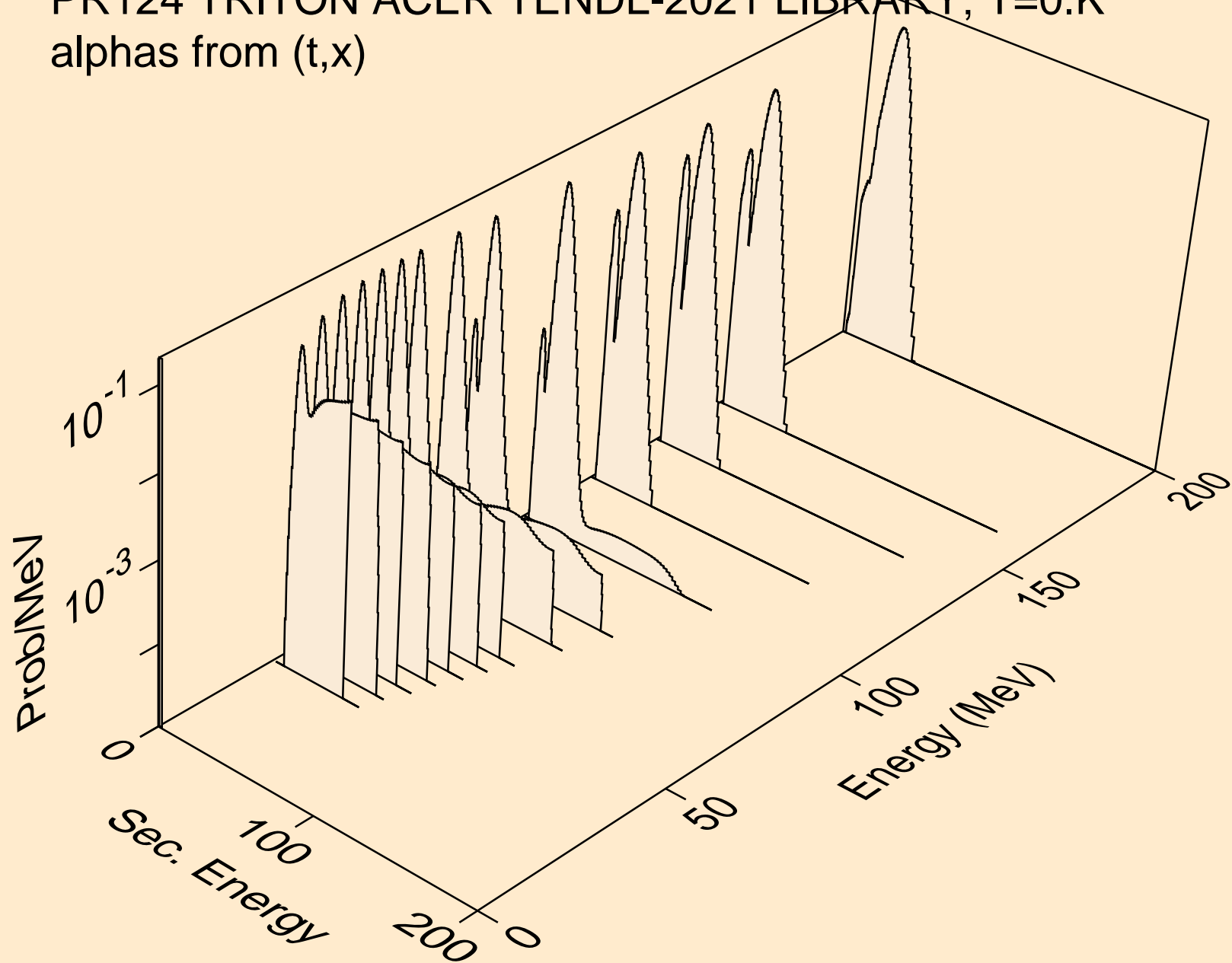

PR124 TRITON ACER TENDL-2021 LIBRARY; T=0.K  
alphas from (t,n\*)a

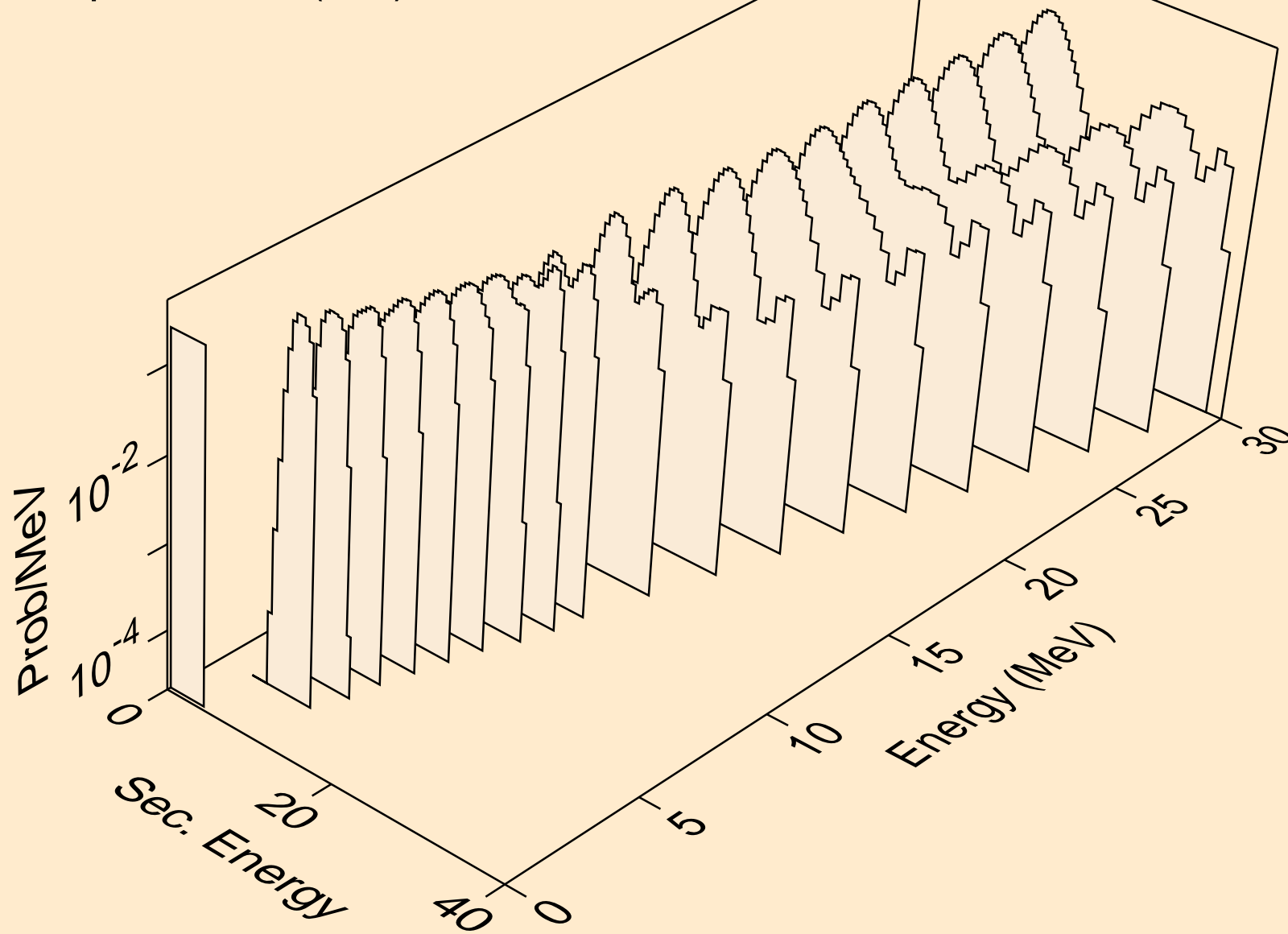

PR124 TRITON ACER TENDL-2021 LIBRARY; T=0.K  
alphas from (t,2n)a

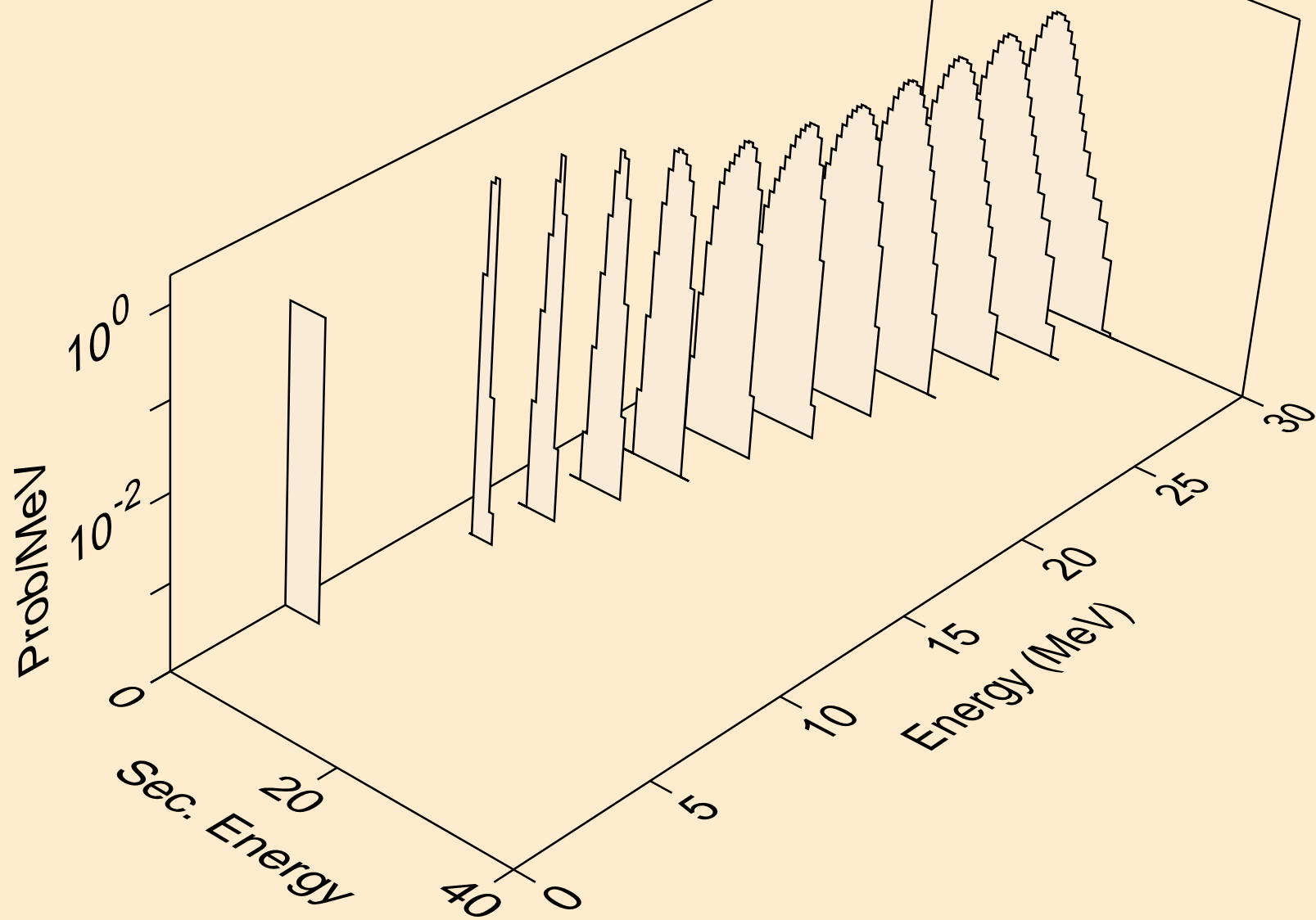

PR124 TRITON ACER TENDL-2021 LIBRARY; T=0.K  
alphas from (t,n\*)2a

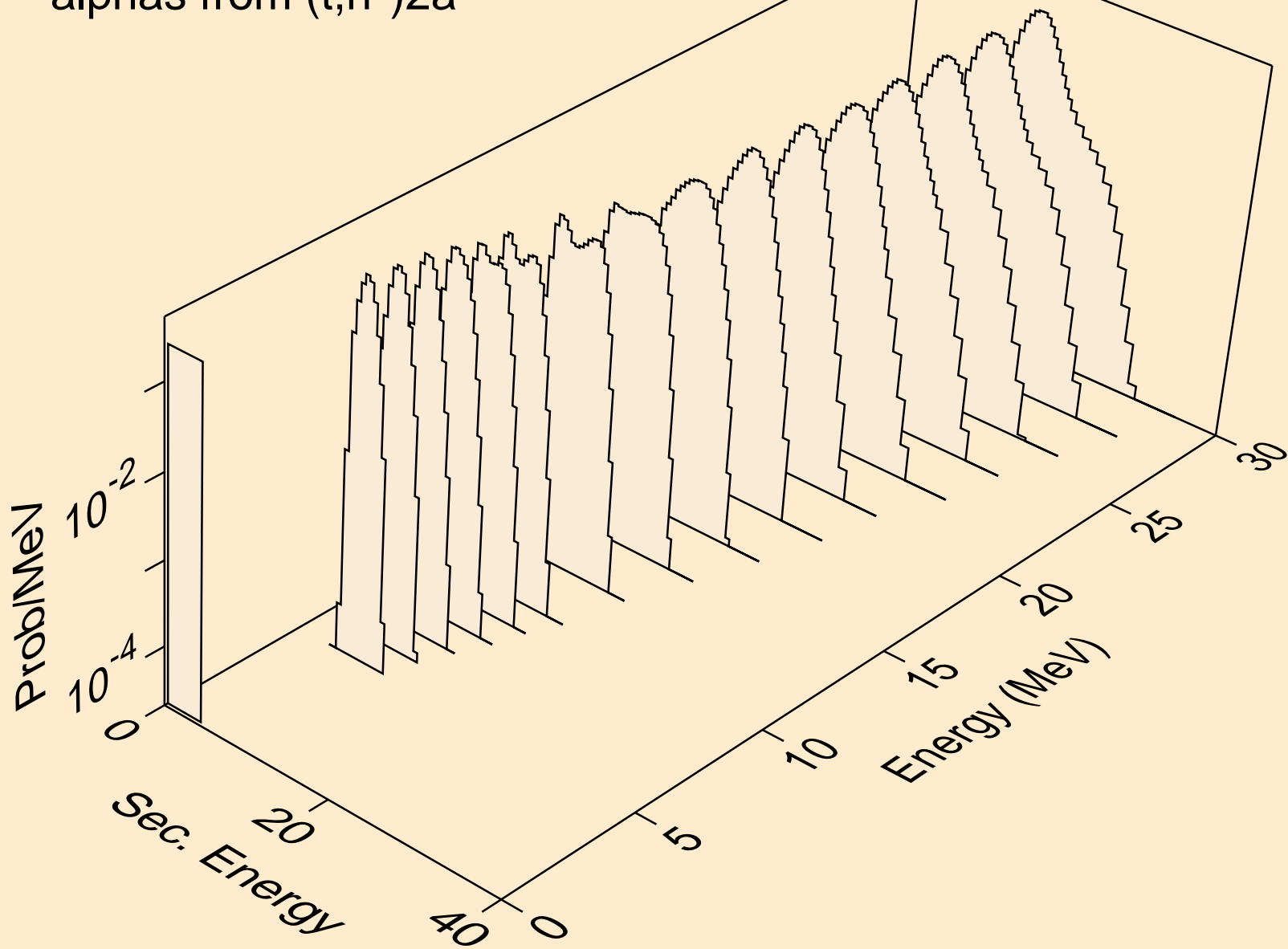

PR124 TRITON ACER TENDL-2021 LIBRARY; T=0.K  
alphas from (t,npa)

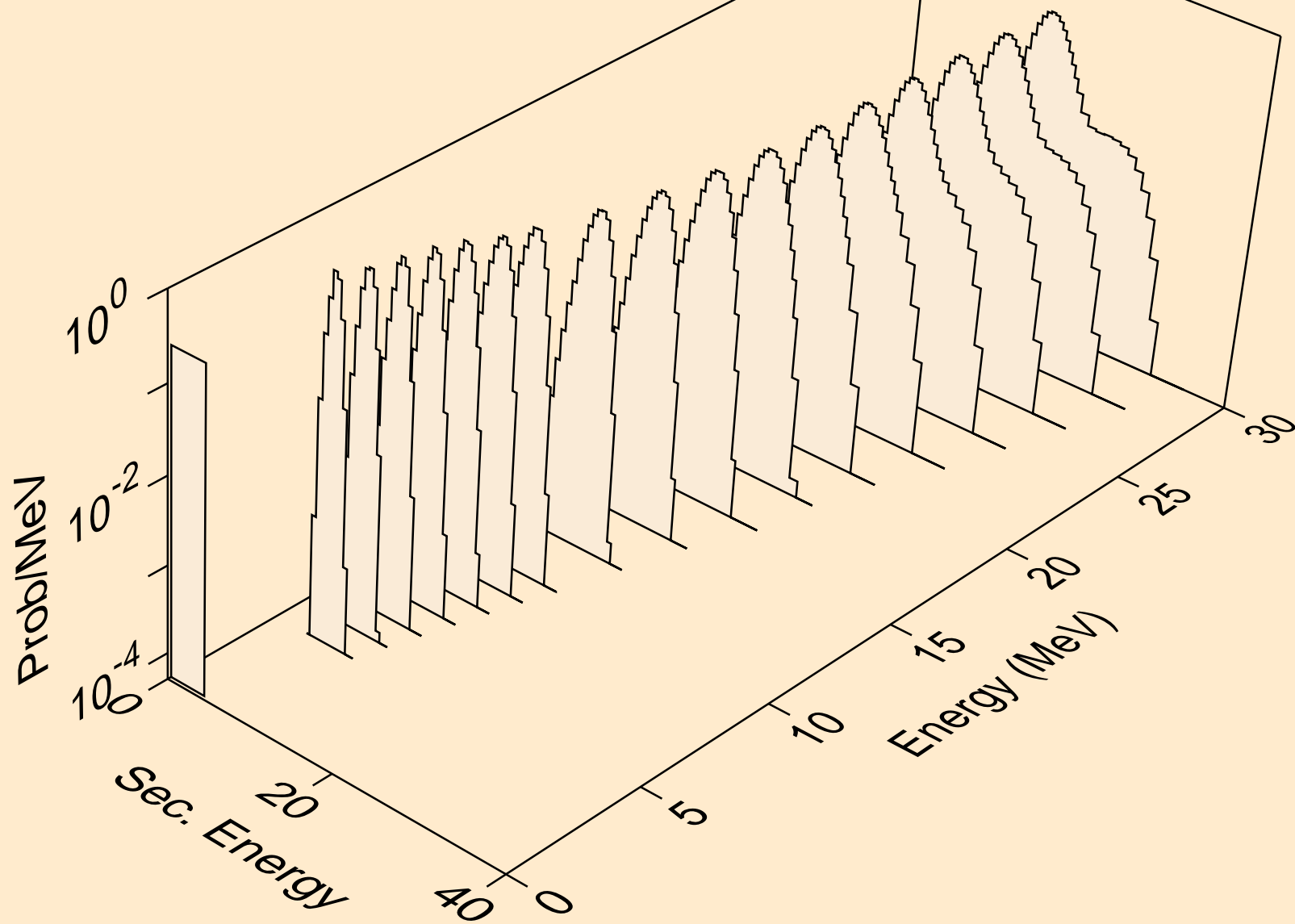

PR124 TRITON ACER TENDL-2021 LIBRARY; T=0.K  
alphas from (t,a)

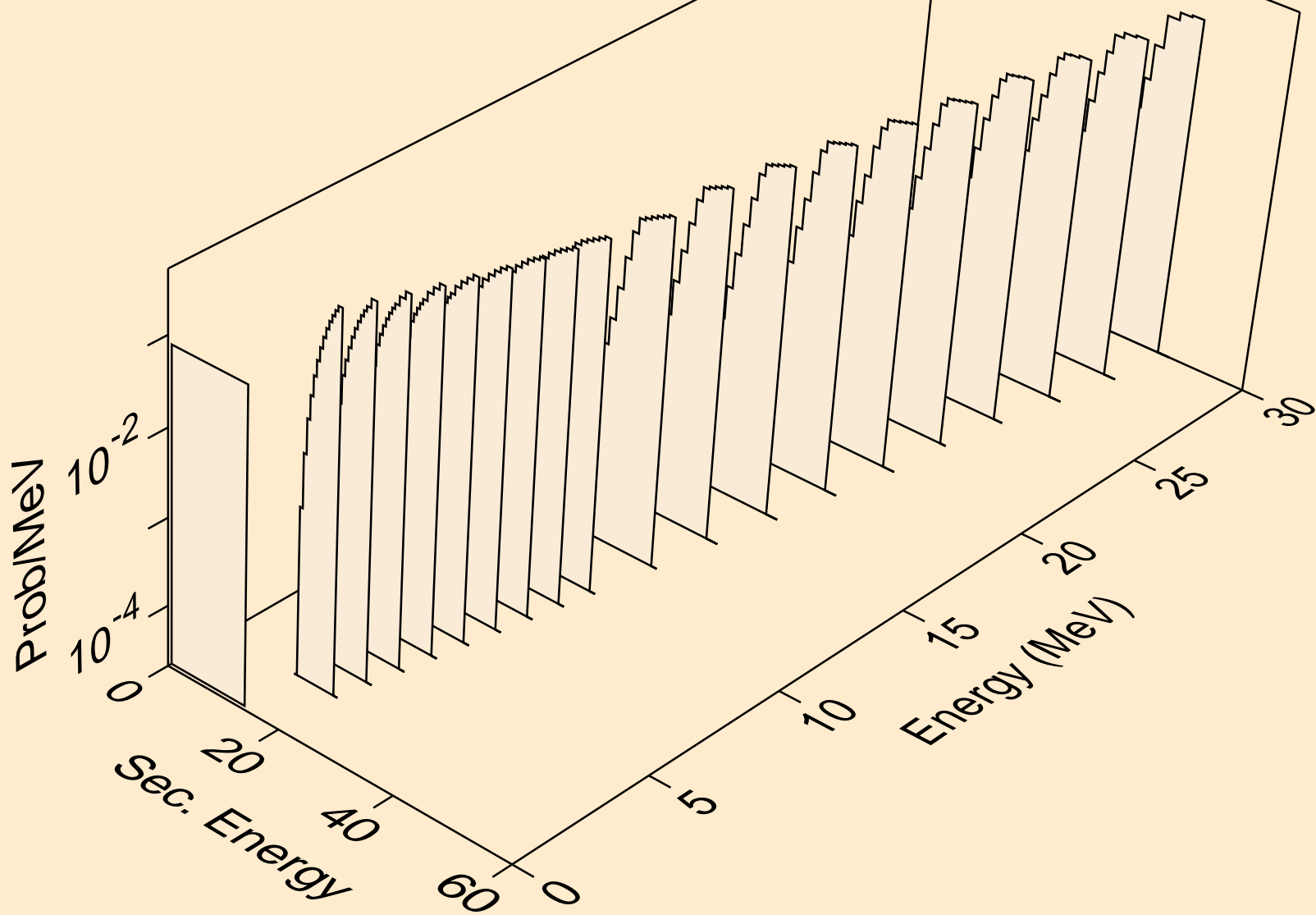



PR124 TRITON ACER TENDL-2021 LIBRARY; T=0.K  
alphas from (t,2a)

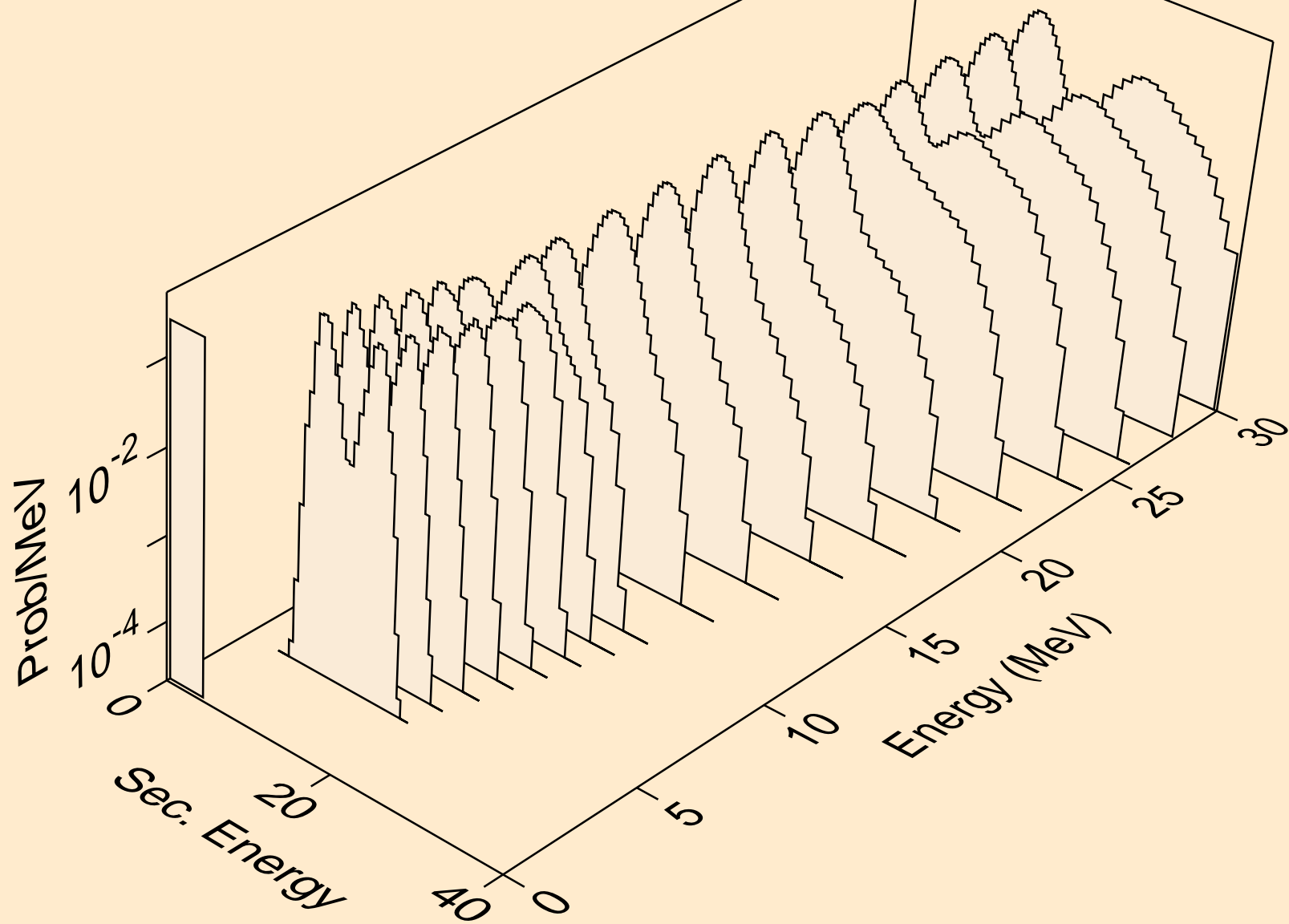

PR124 TRITON ACER TENDL-2021 LIBRARY; T=0.K  
alphas from (t,3a)

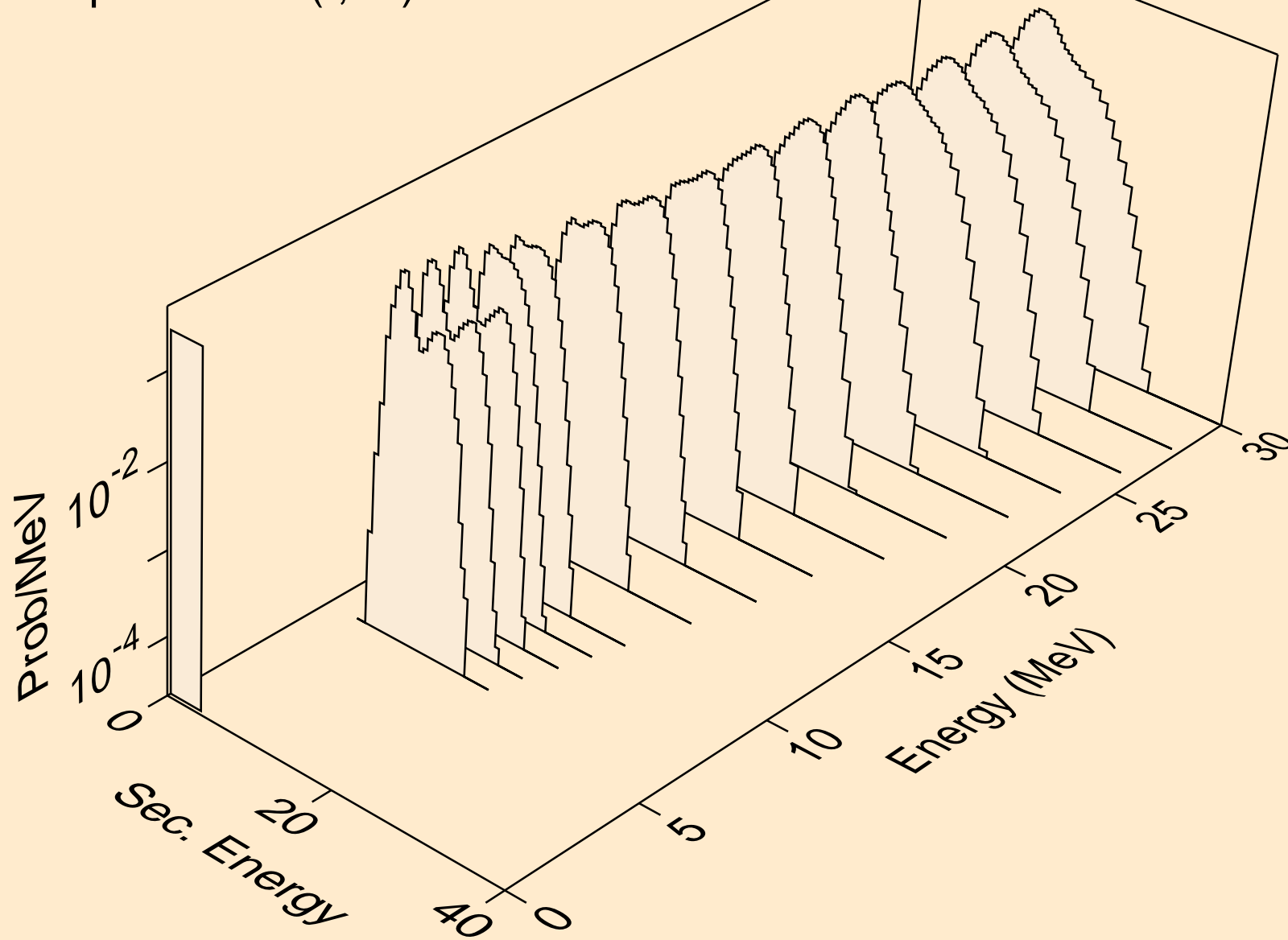

PR124 TRITON ACER TENDL-2021 LIBRARY; T=0.K  
alphas from (t,pa)

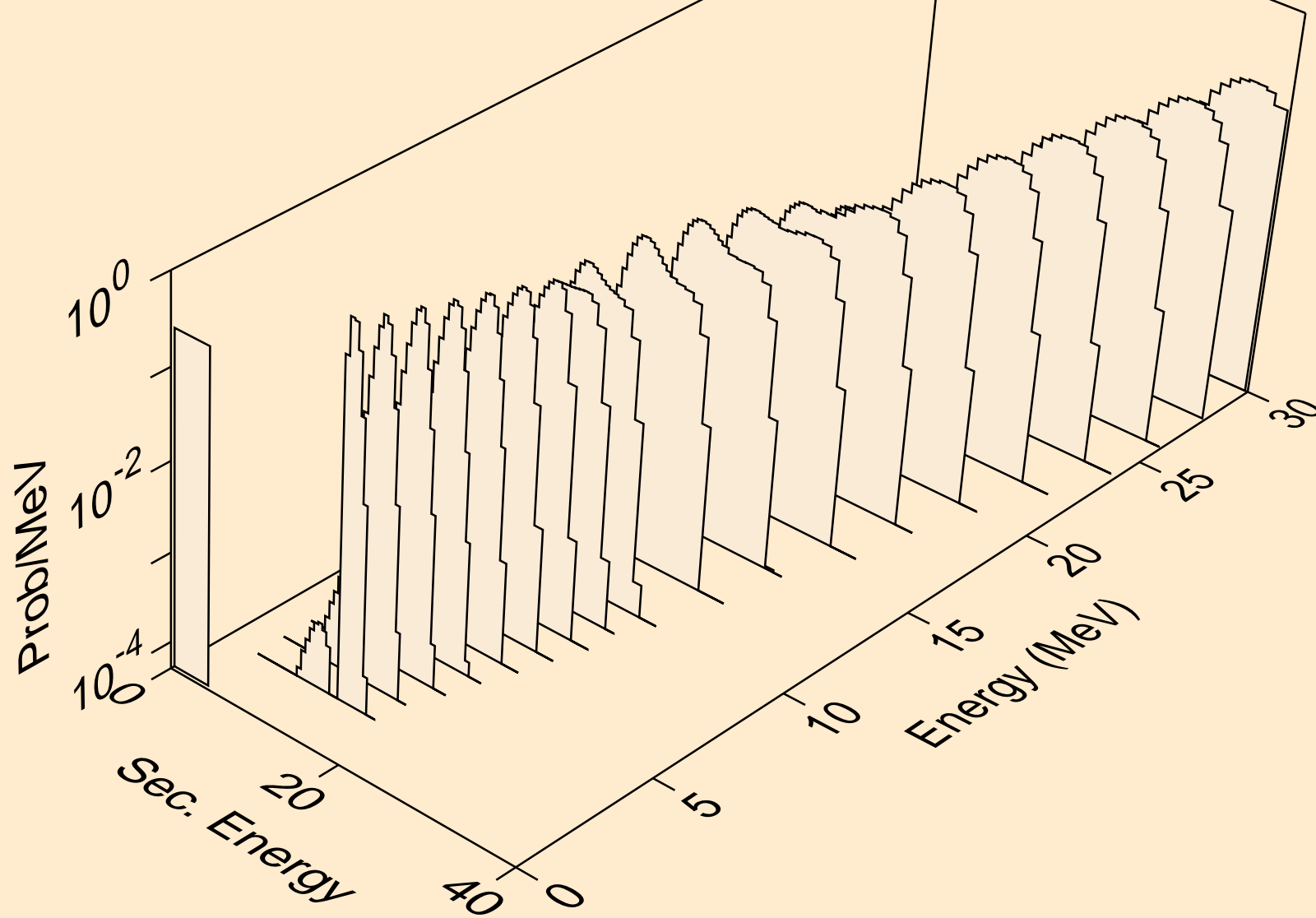

PR124 TRITON ACER TENDL-2021 LIBRARY; T=0.K  
alphas from (t,d2a)

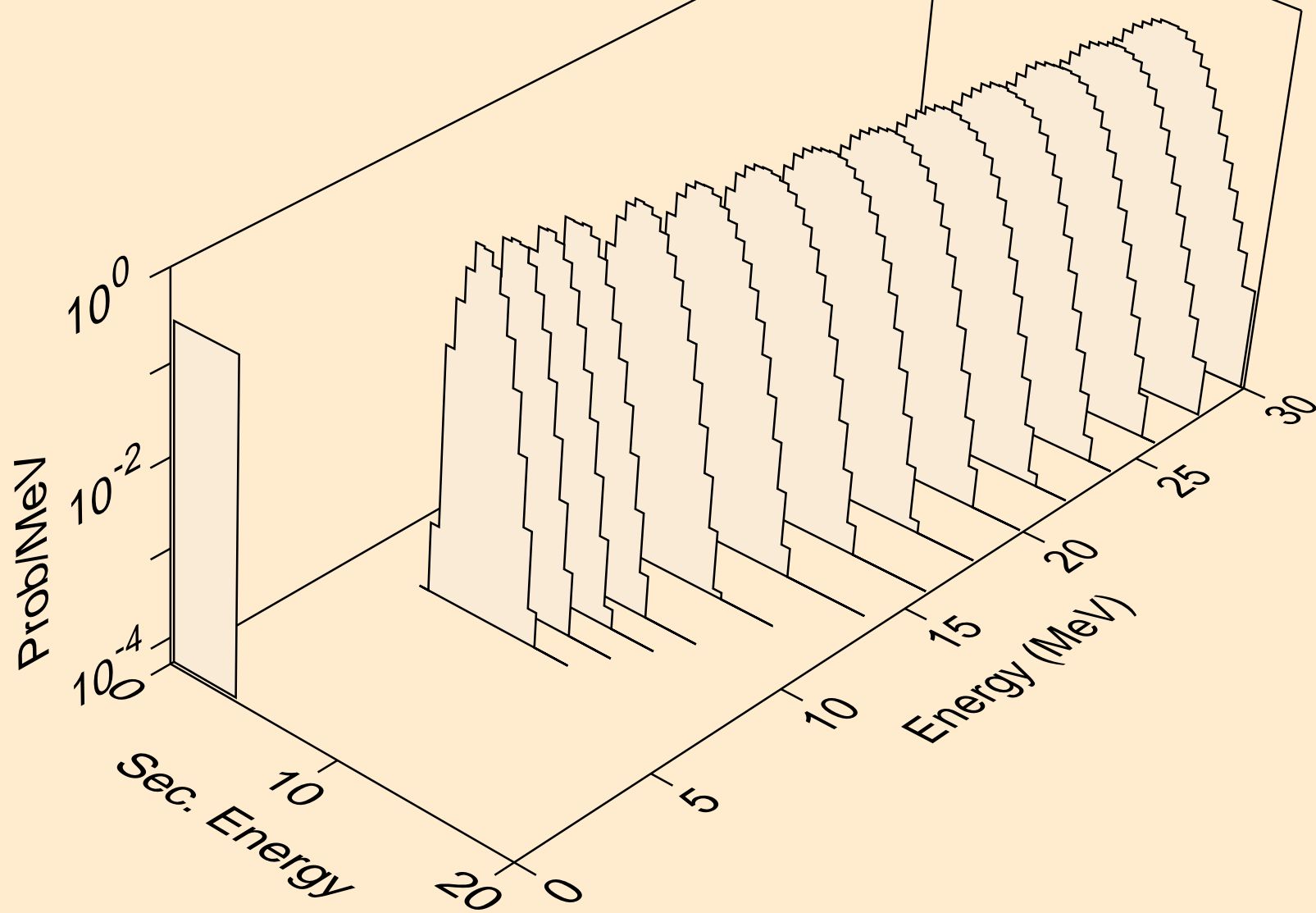

PR124 TRITON ACER TENDL-2021 LIBRARY; T=0.K  
alphas from (t,da)

