

PT193M TRITON ACER TENDL-2021 LIBRARY; T=0.K  
Principal cross sections

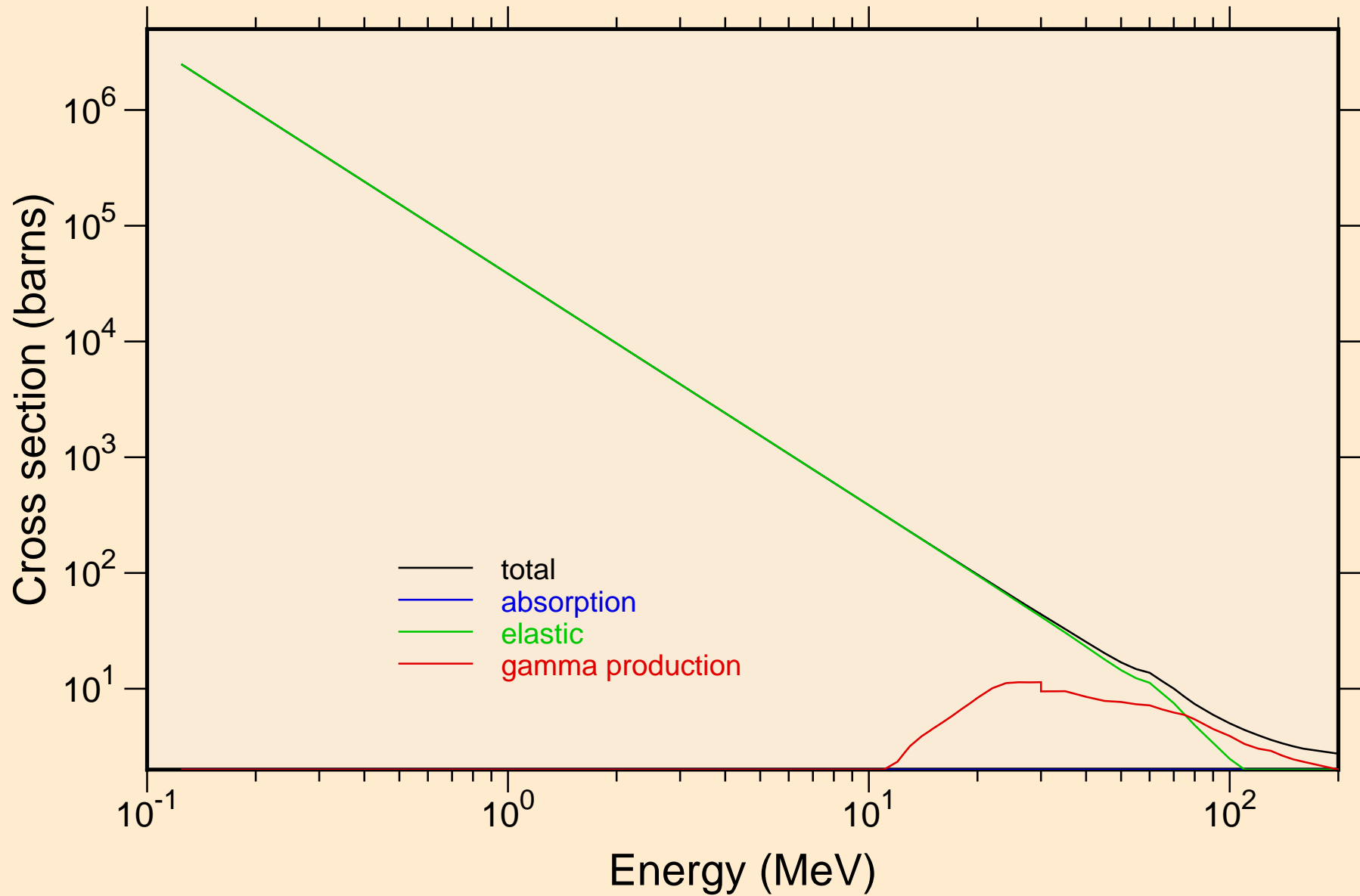

PT193M TRITON ACER TENDL-2021 LIBRARY; T=0.K

Heating

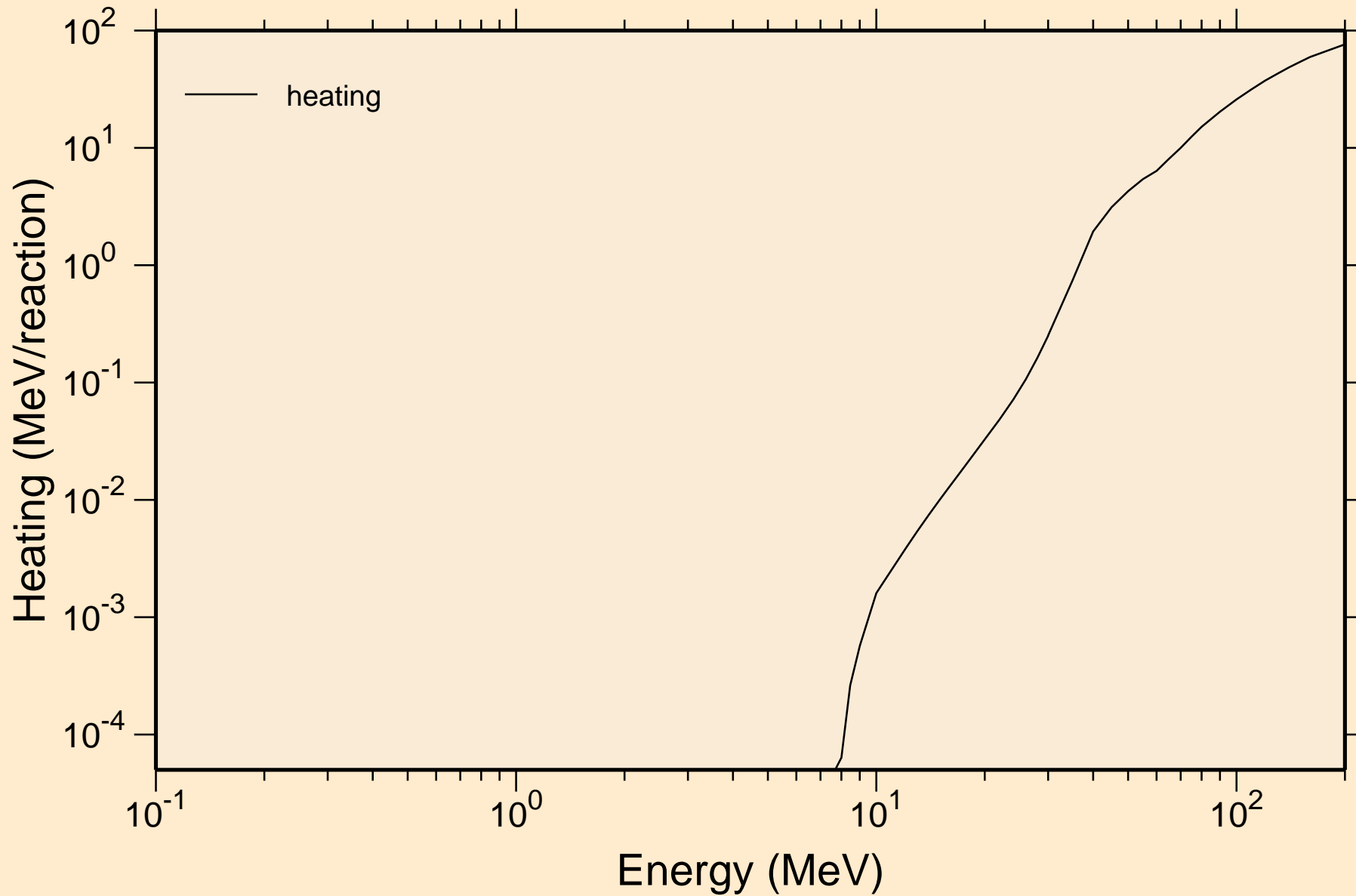

PT193M TRITON ACER TENDL-2021 LIBRARY; T=0.K

Principal cross sections

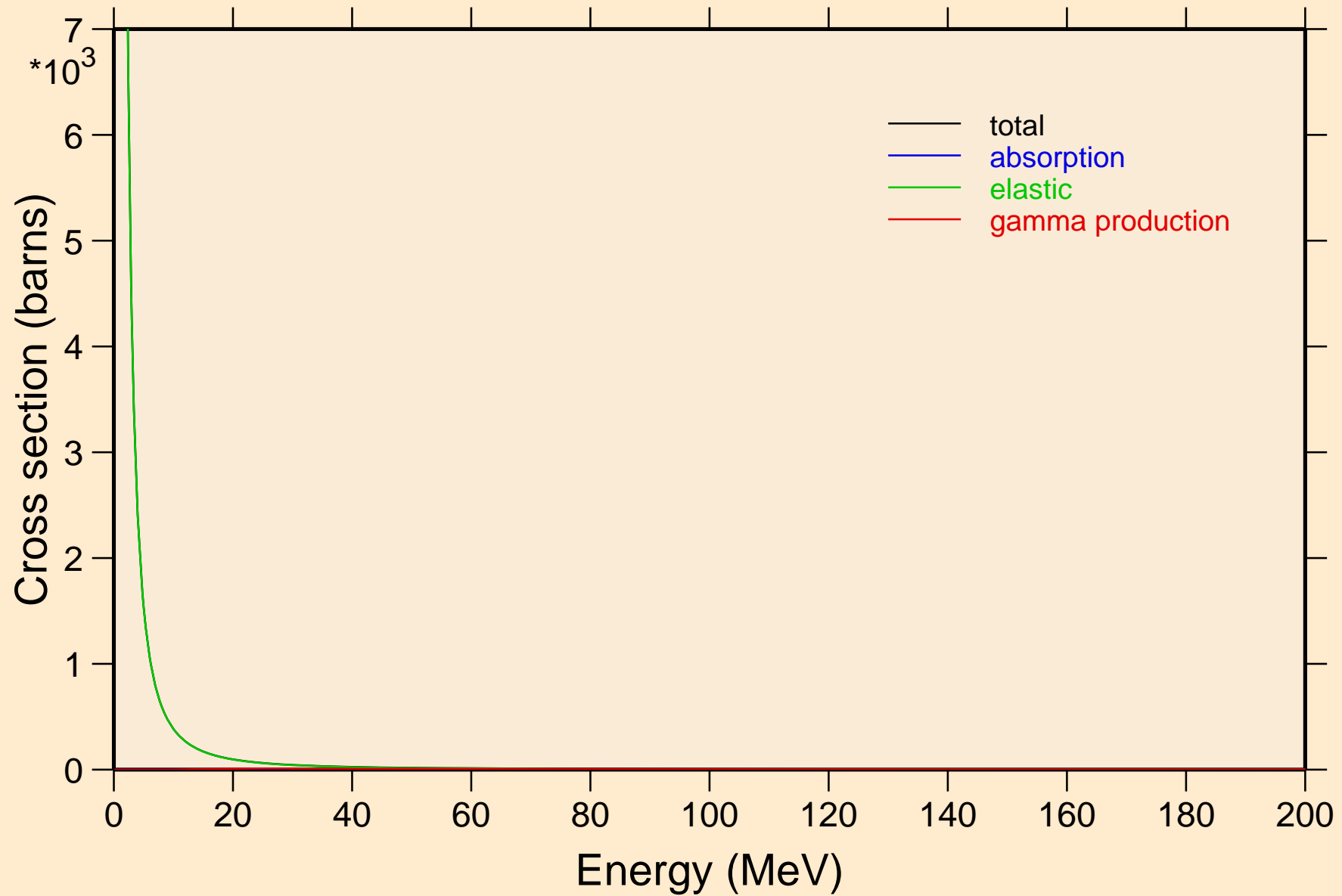

PT193M TRITON ACER TENDL-2021 LIBRARY; T=0.K

Heating

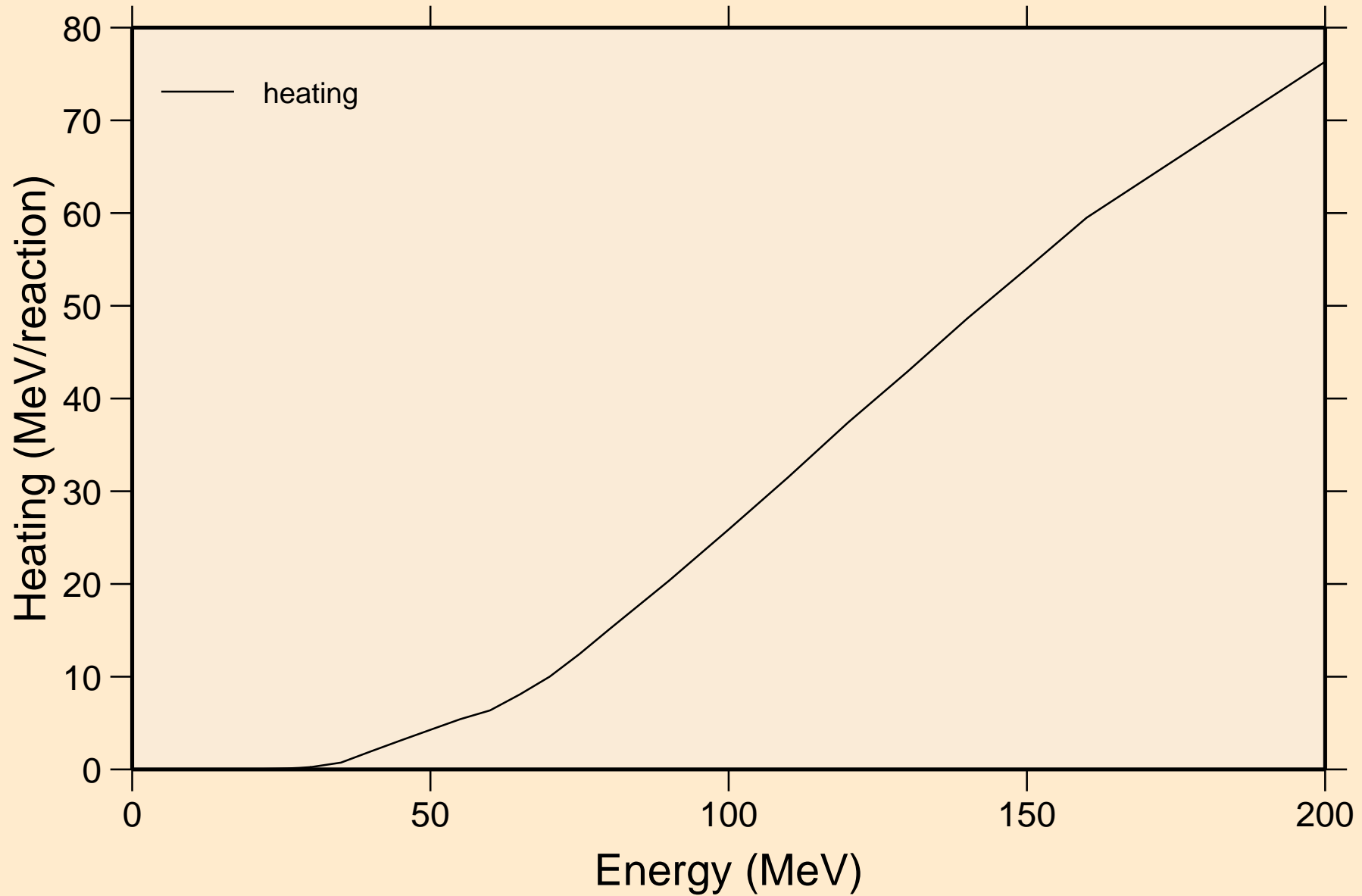

PT193M TRITON ACER TENDL-2021 LIBRARY; T=0.K  
Threshold reactions

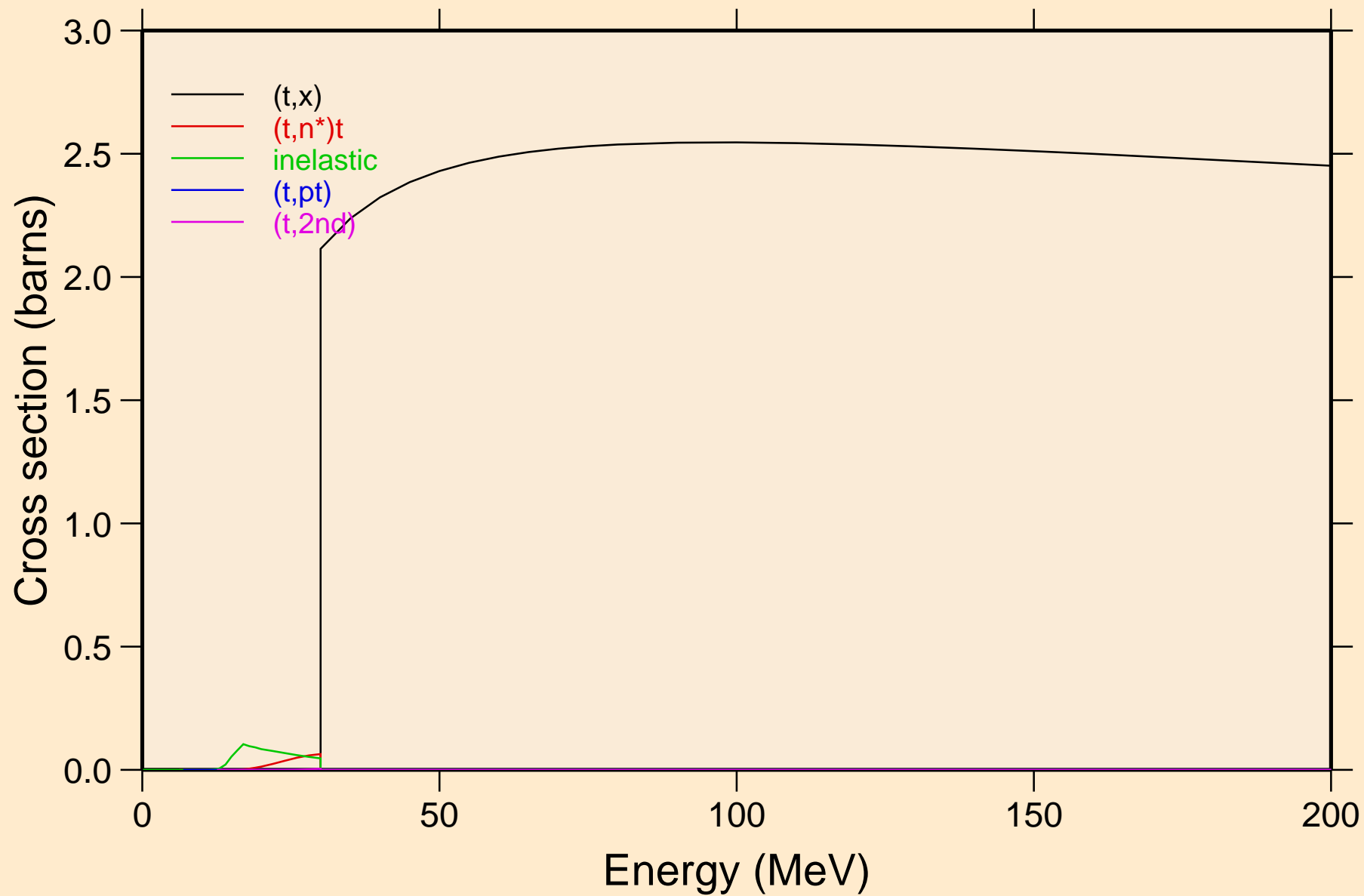

PT193M TRITON ACER TENDL-2021 LIBRARY; T=0.K  
Threshold reactions

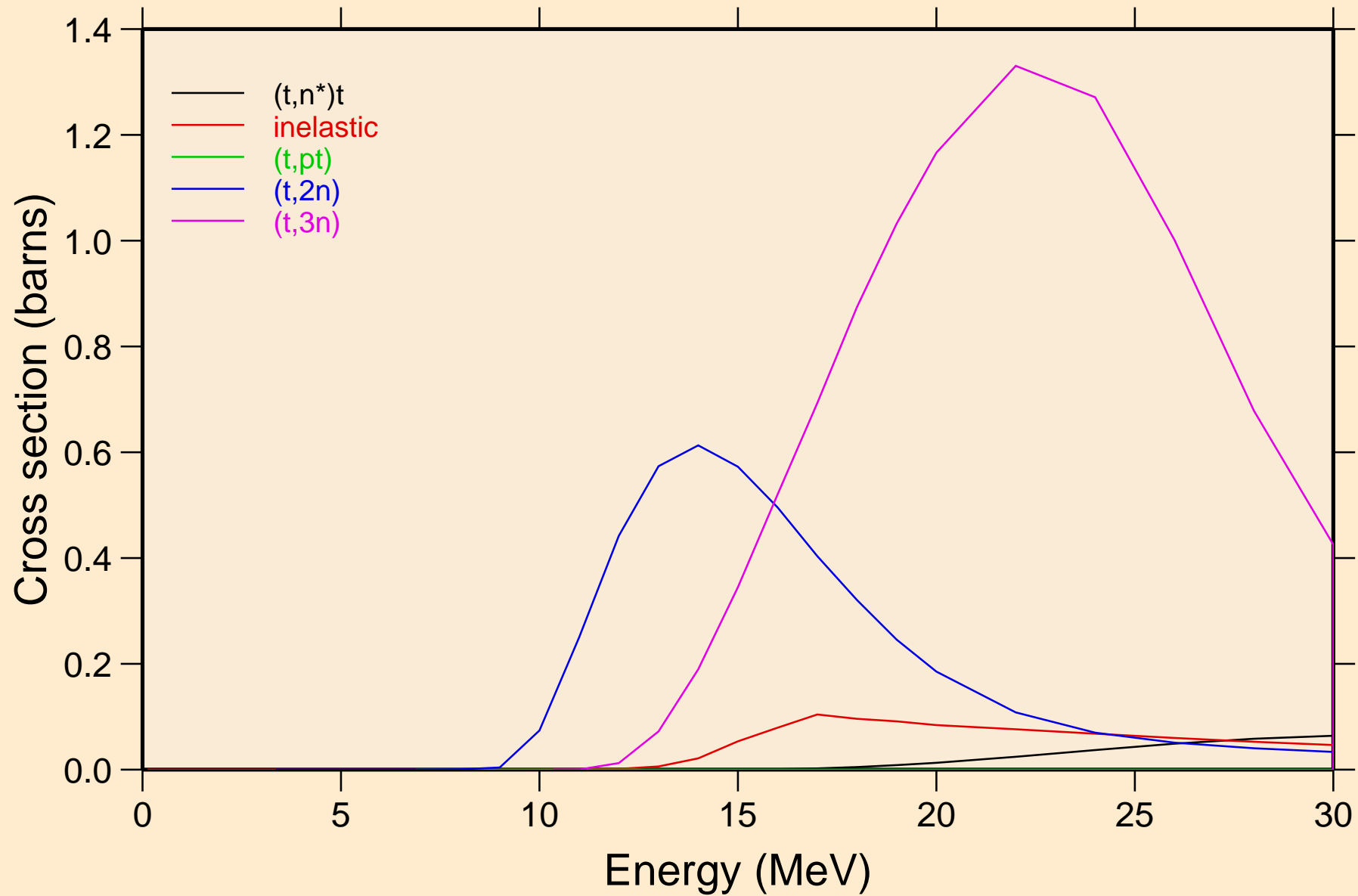

PT193M TRITON ACER TENDL-2021 LIBRARY; T=0.K  
Threshold reactions

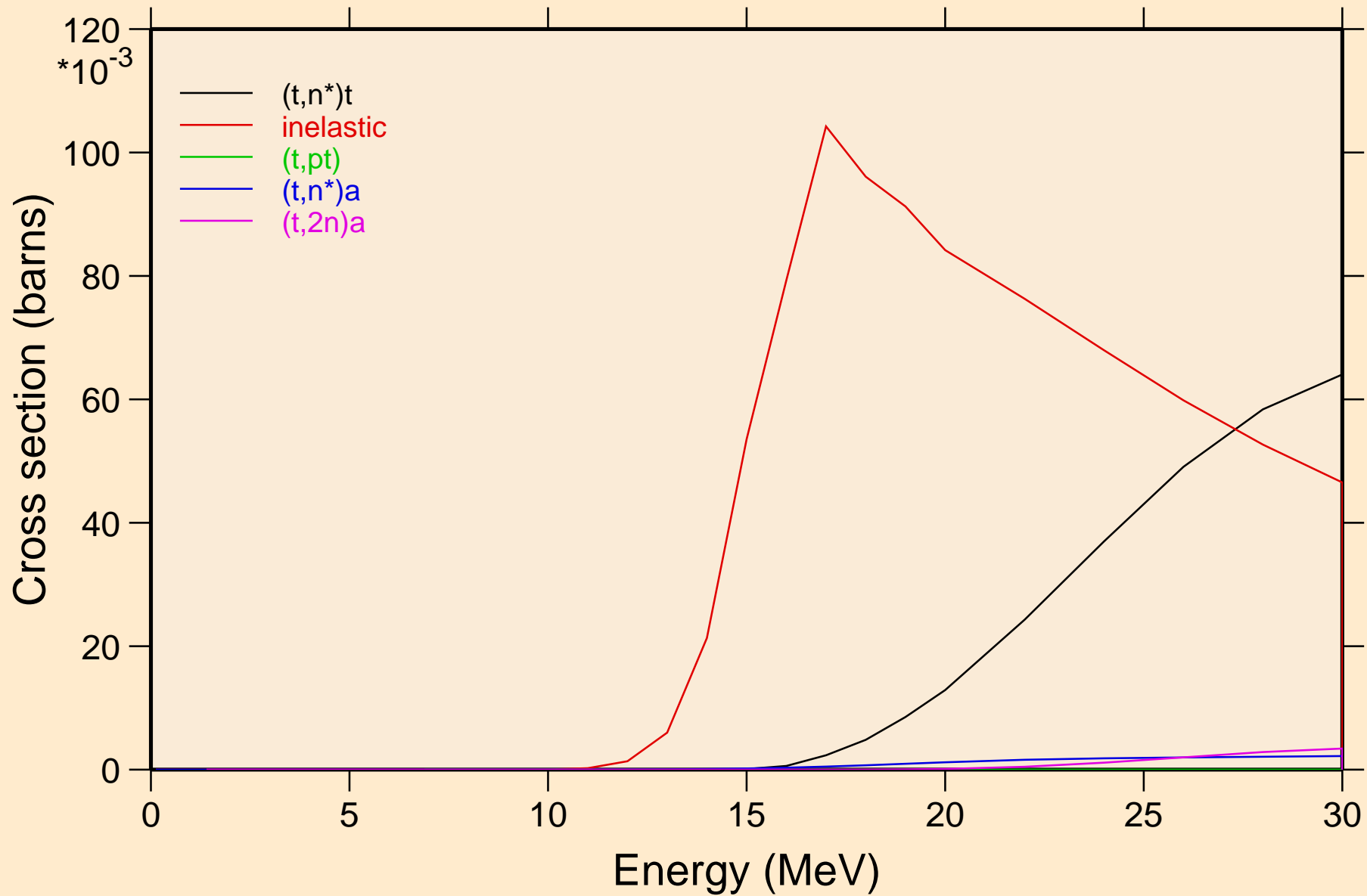

PT193M TRITON ACER TENDL-2021 LIBRARY; T=0.K  
Threshold reactions

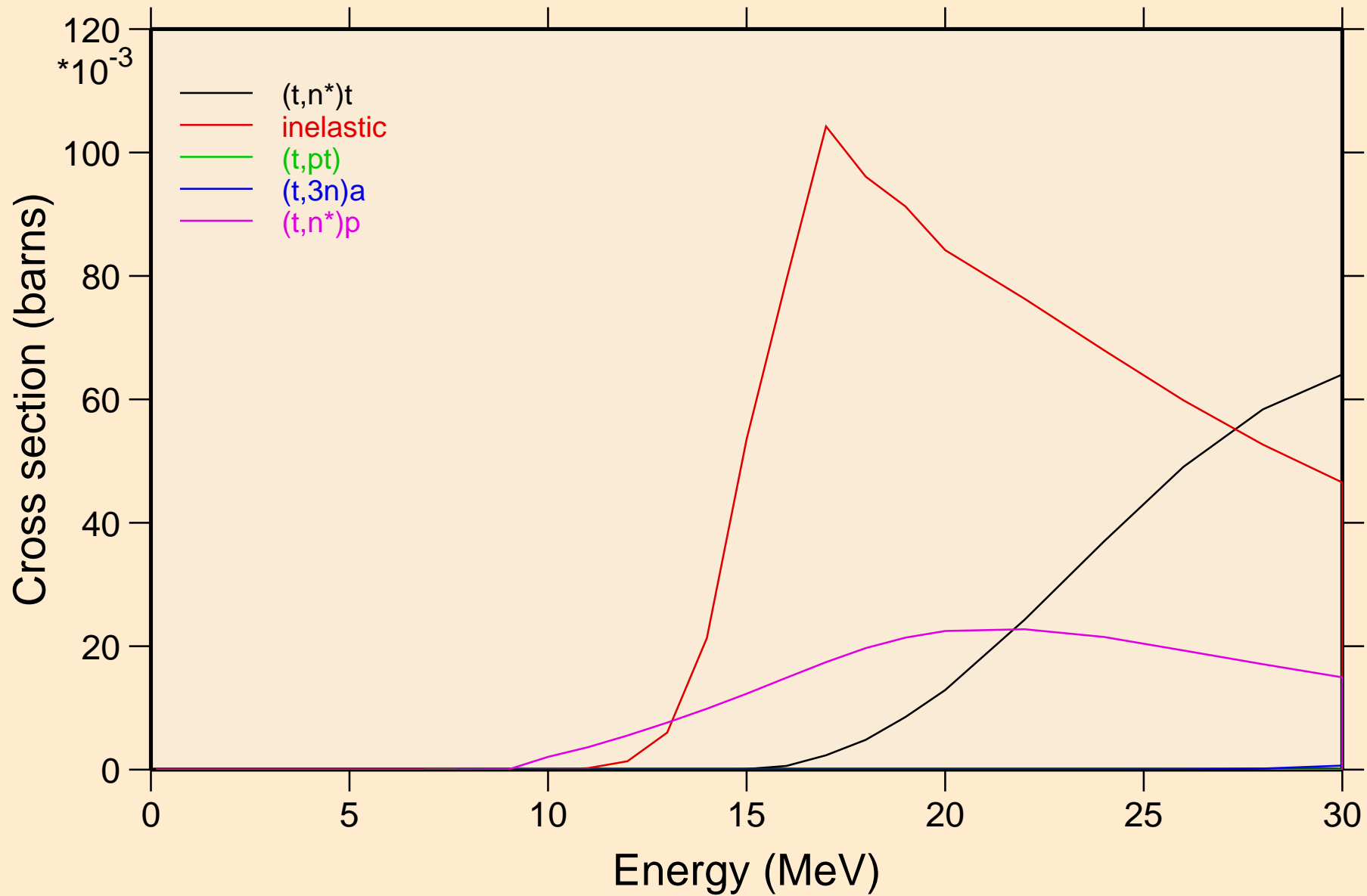



PT193M TRITON ACER TENDL-2021 LIBRARY; T=0.K  
Threshold reactions

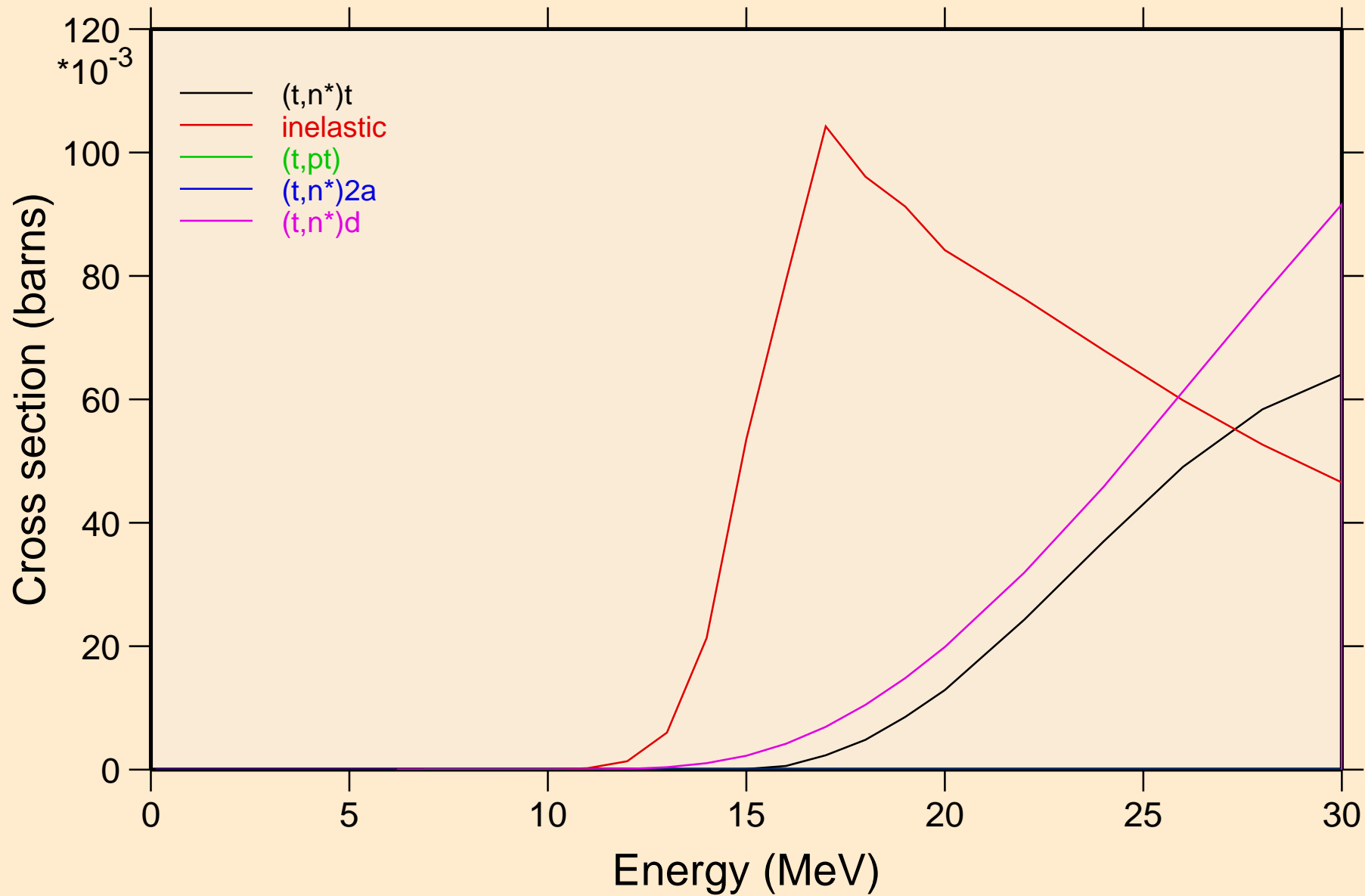

PT193M TRITON ACER TENDL-2021 LIBRARY; T=0.K  
Threshold reactions

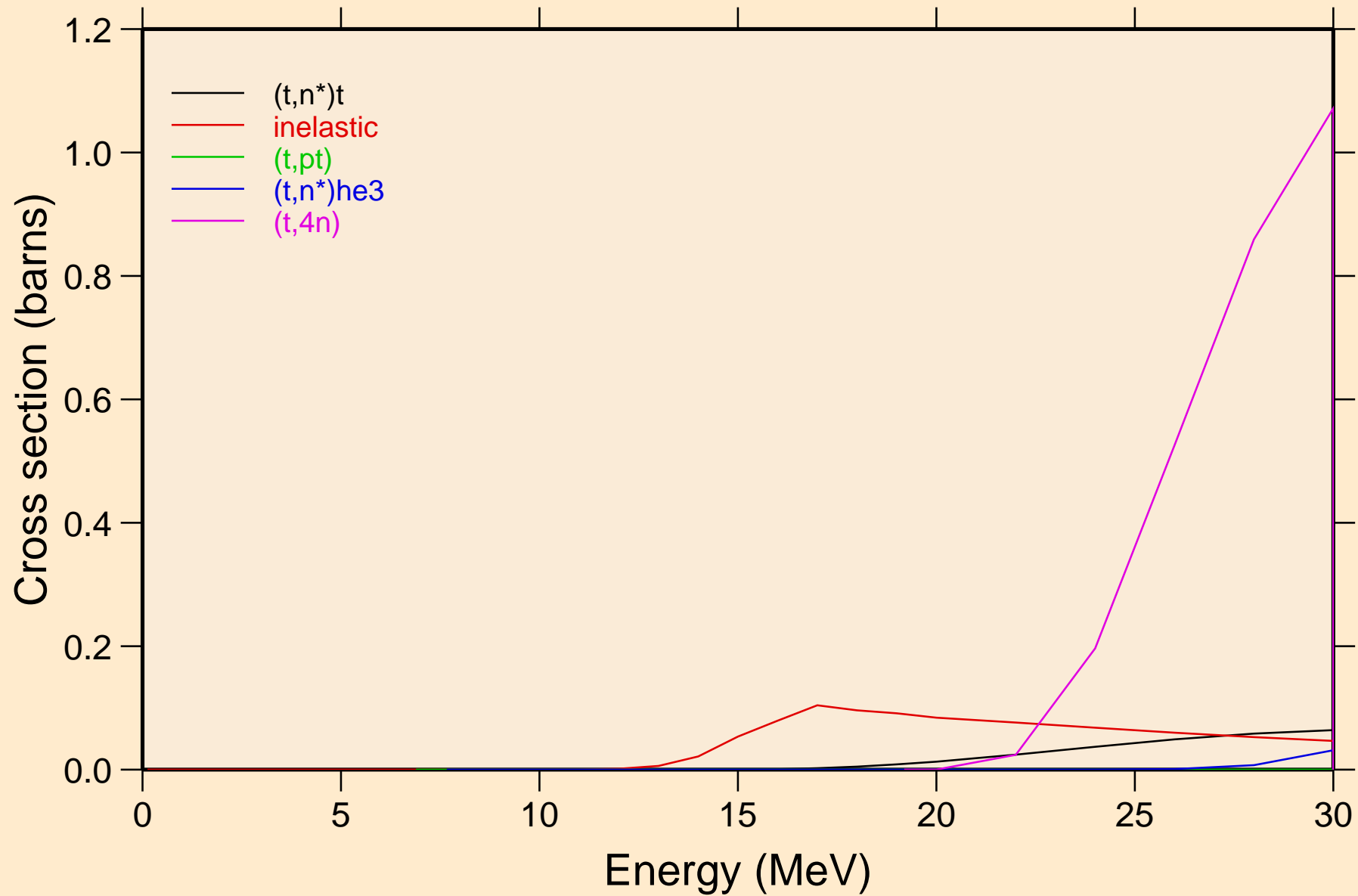

PT193M TRITON ACER TENDL-2021 LIBRARY; T=0.K  
Threshold reactions

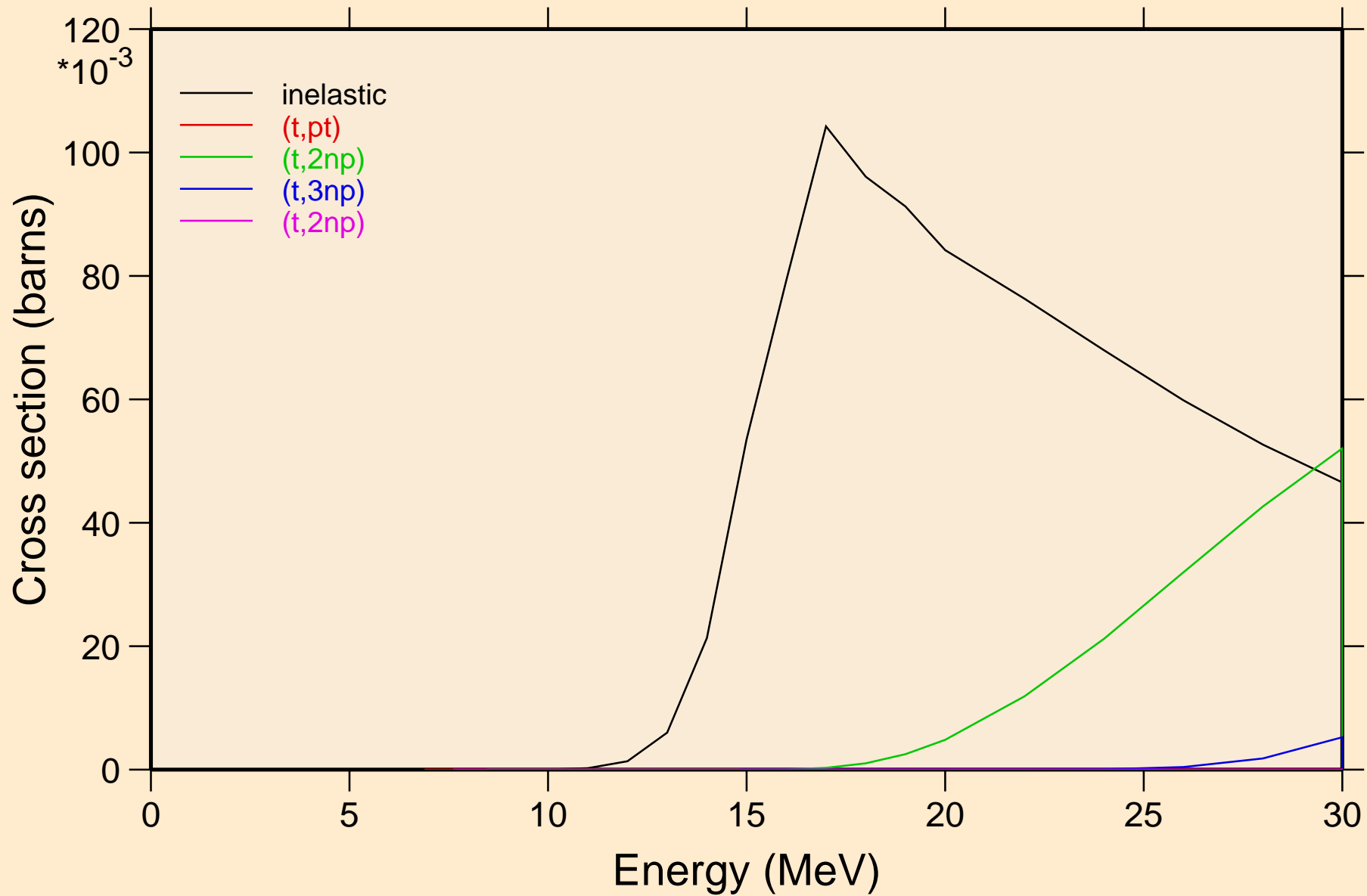

PT193M TRITON ACER TENDL-2021 LIBRARY; T=0.K  
Threshold reactions

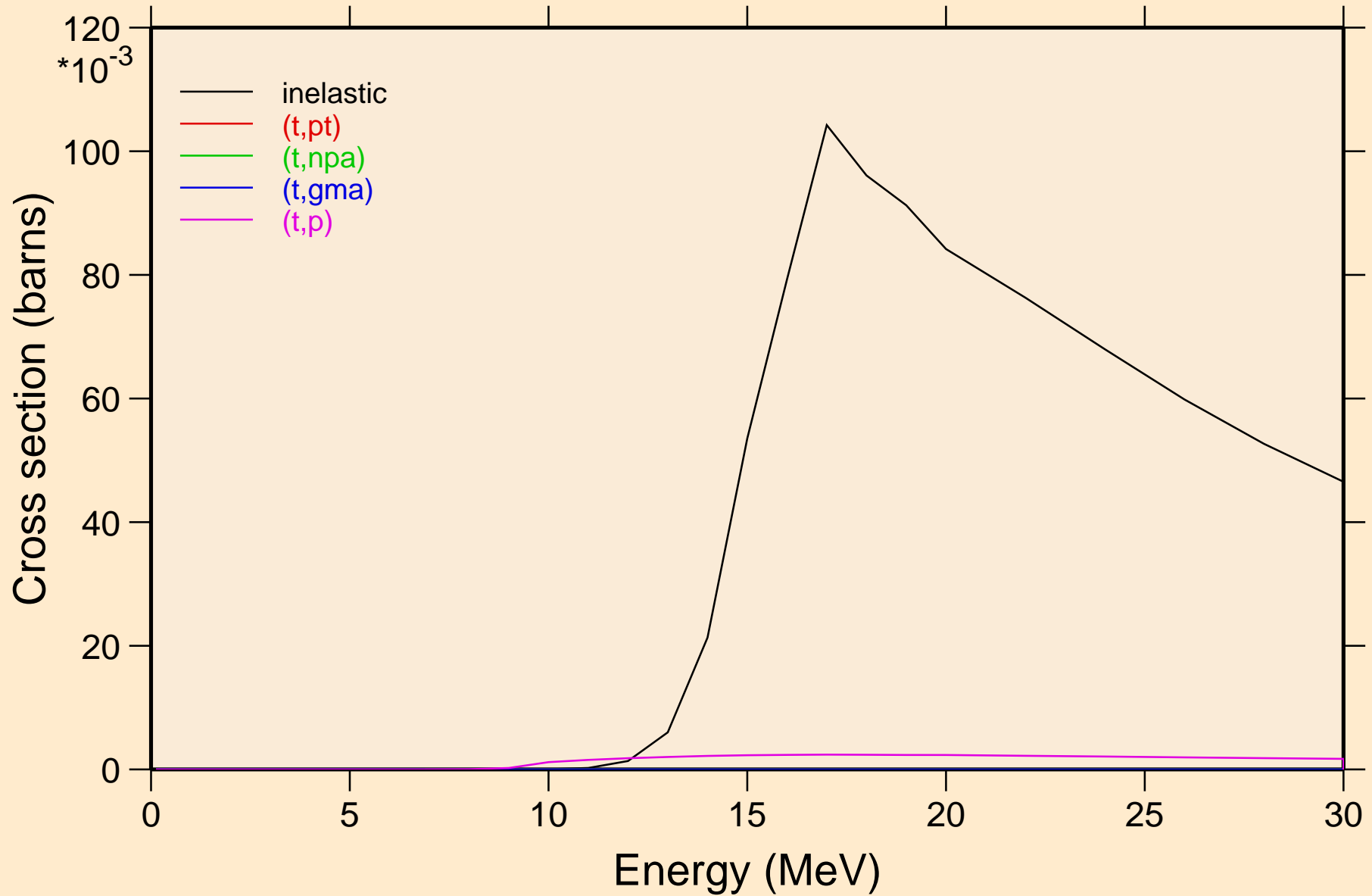

PT193M TRITON ACER TENDL-2021 LIBRARY; T=0.K  
Threshold reactions

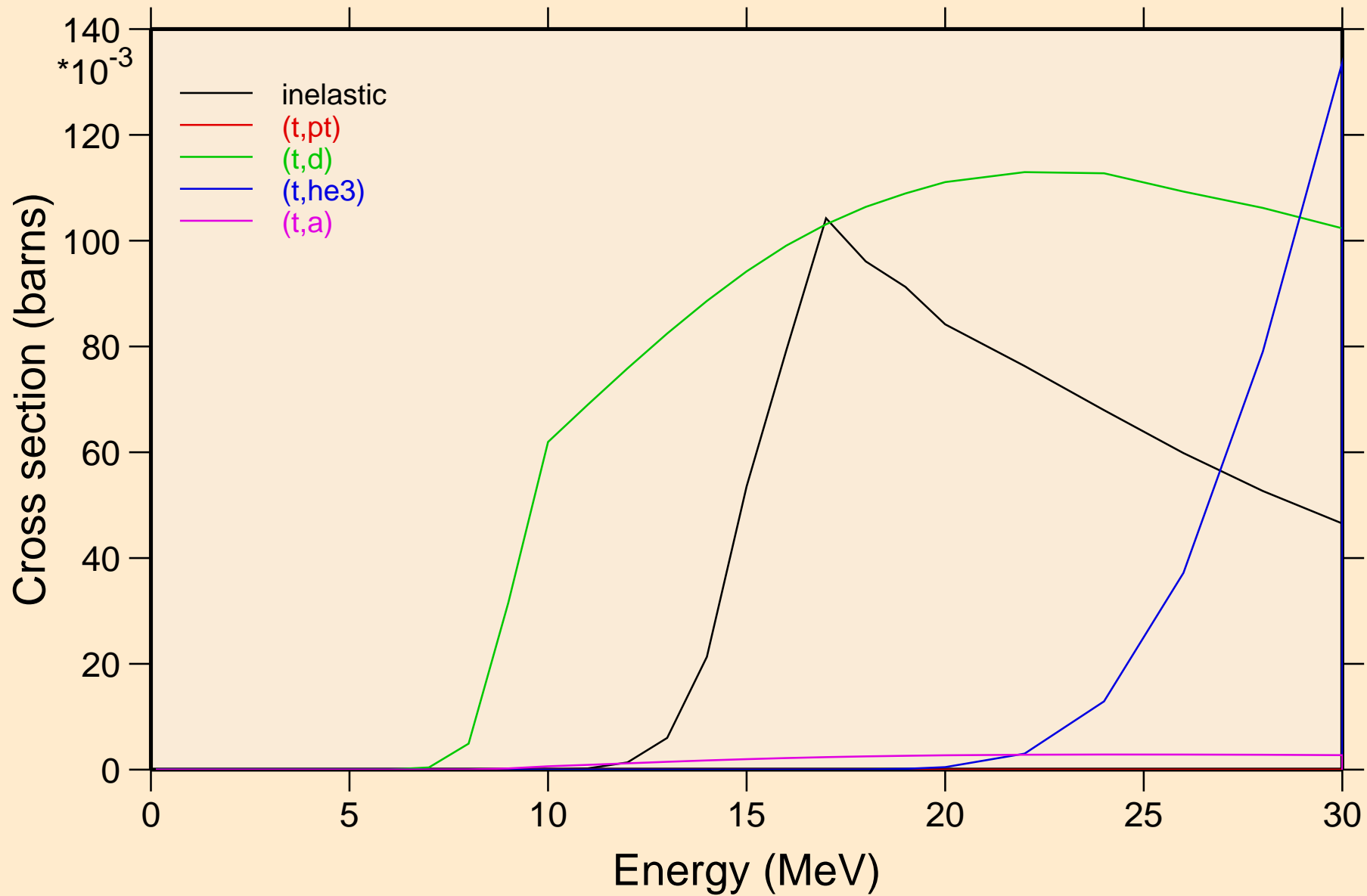

PT193M TRITON ACER TENDL-2021 LIBRARY; T=0.K  
Threshold reactions

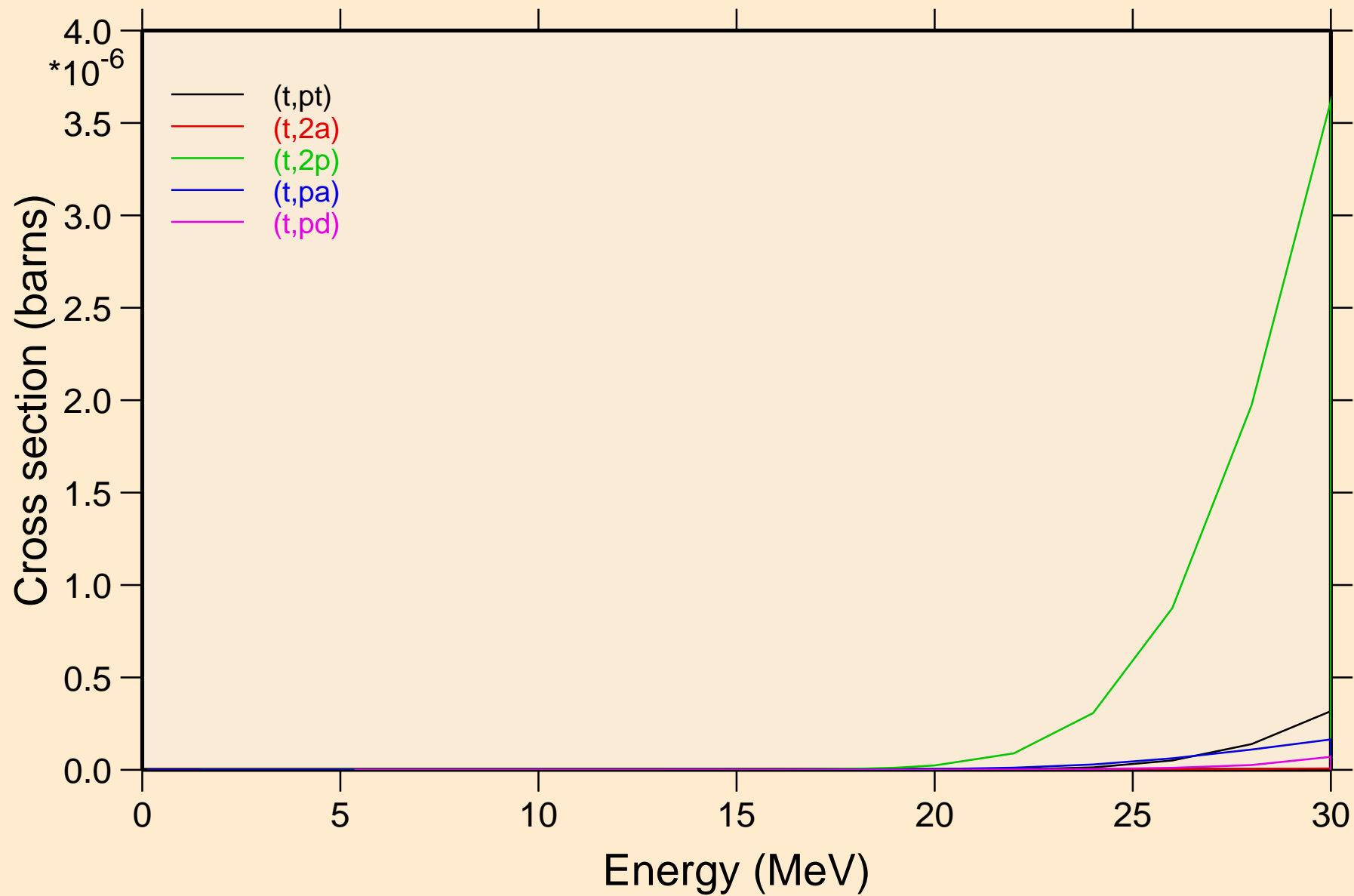

PT193M TRITON ACER TENDL-2021 LIBRARY; T=0.K  
Threshold reactions

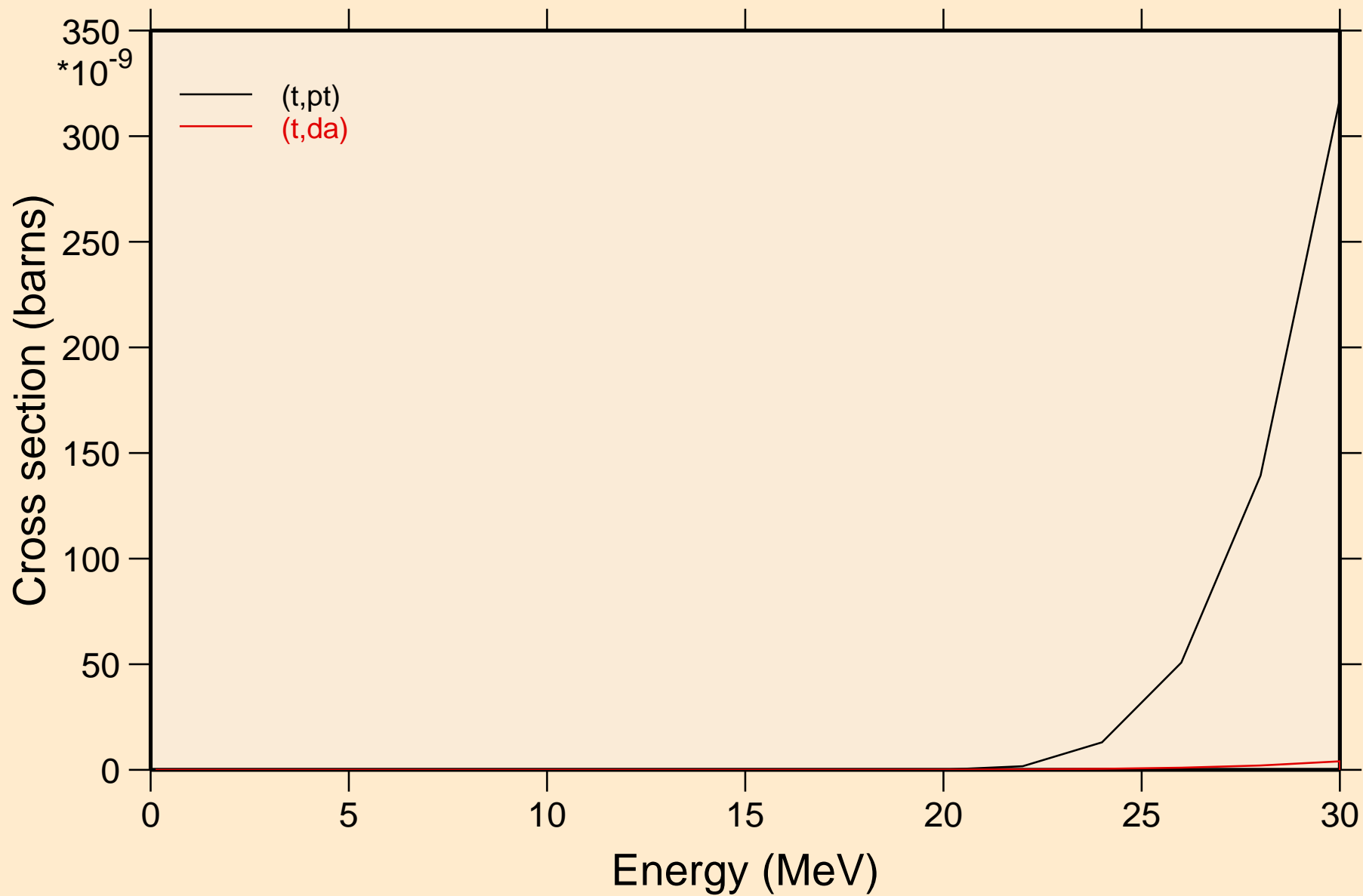

PT193M TRITON ACER TENDL-2021 LIBRARY; T=0.K  
angular distribution for elastic

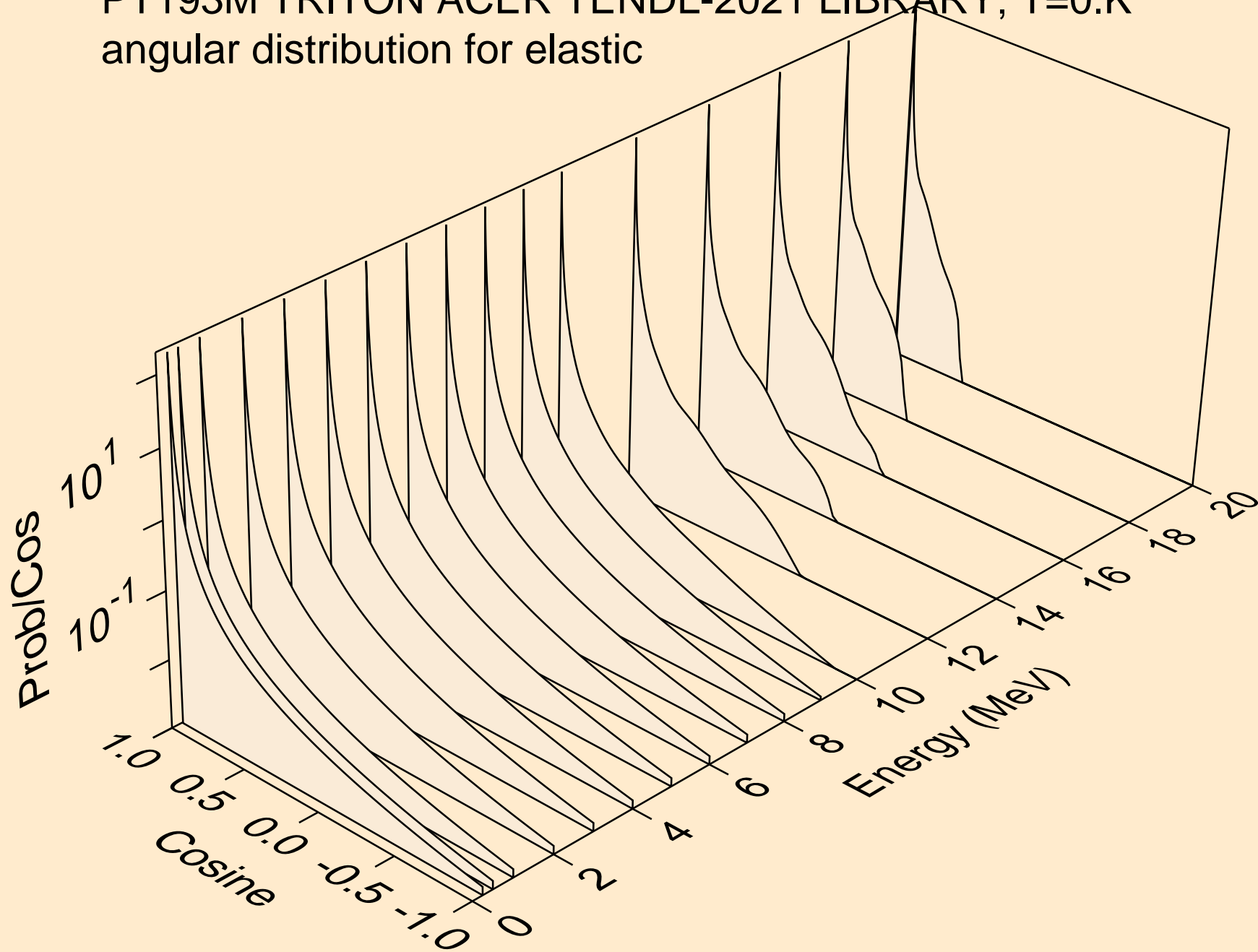



PT193M TRITON ACER TENDL-2021 LIBRARY; T=0.K  
angular distribution for elastic

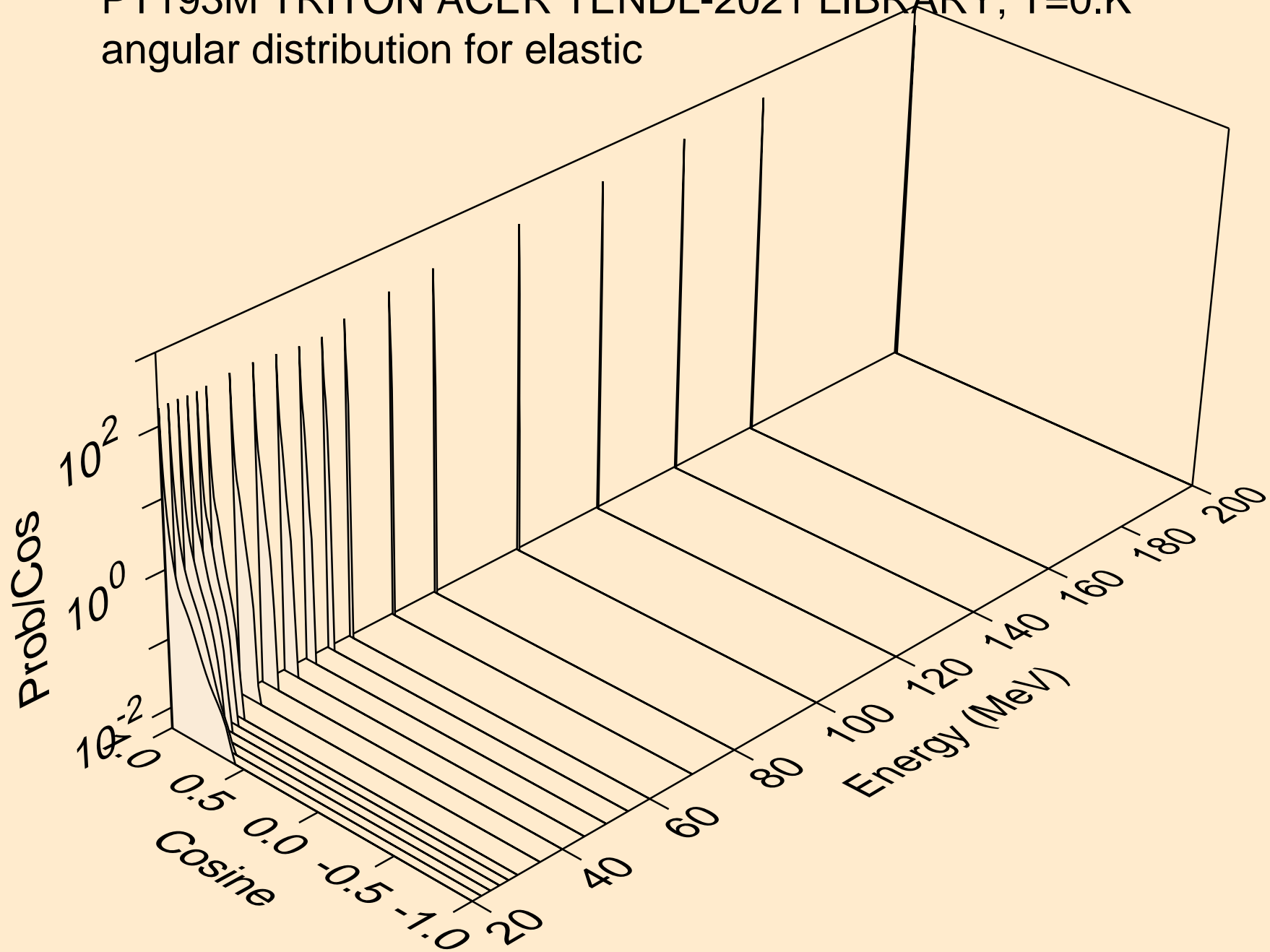

PT193M TRITON ACER TENDL-2021 LIBRARY; T=0.K  
Triton emission for (t,x)

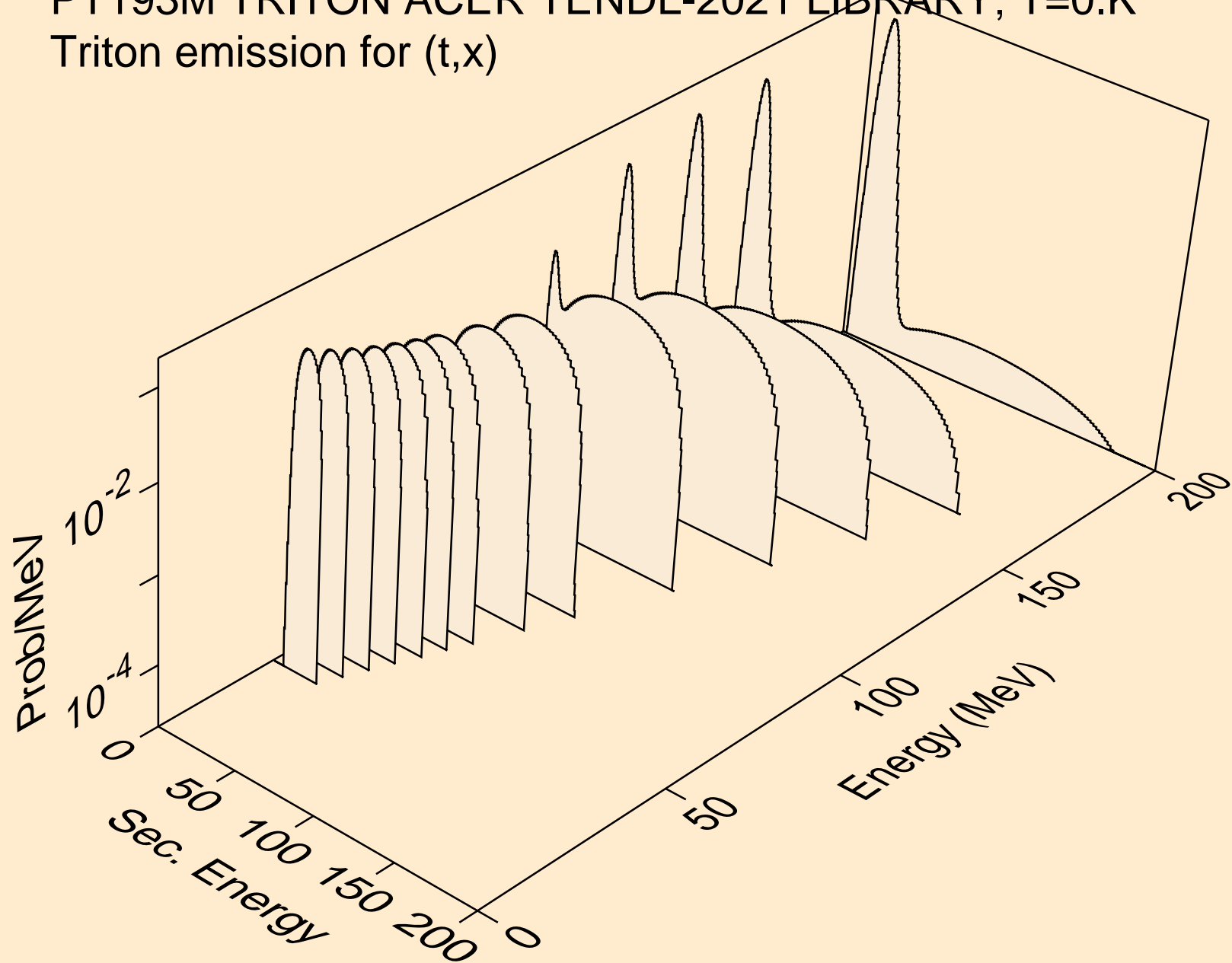

PT193M TRITON ACER TENDL-2021 LIBRARY; T=0.K  
Triton emission for (t,n\*)t

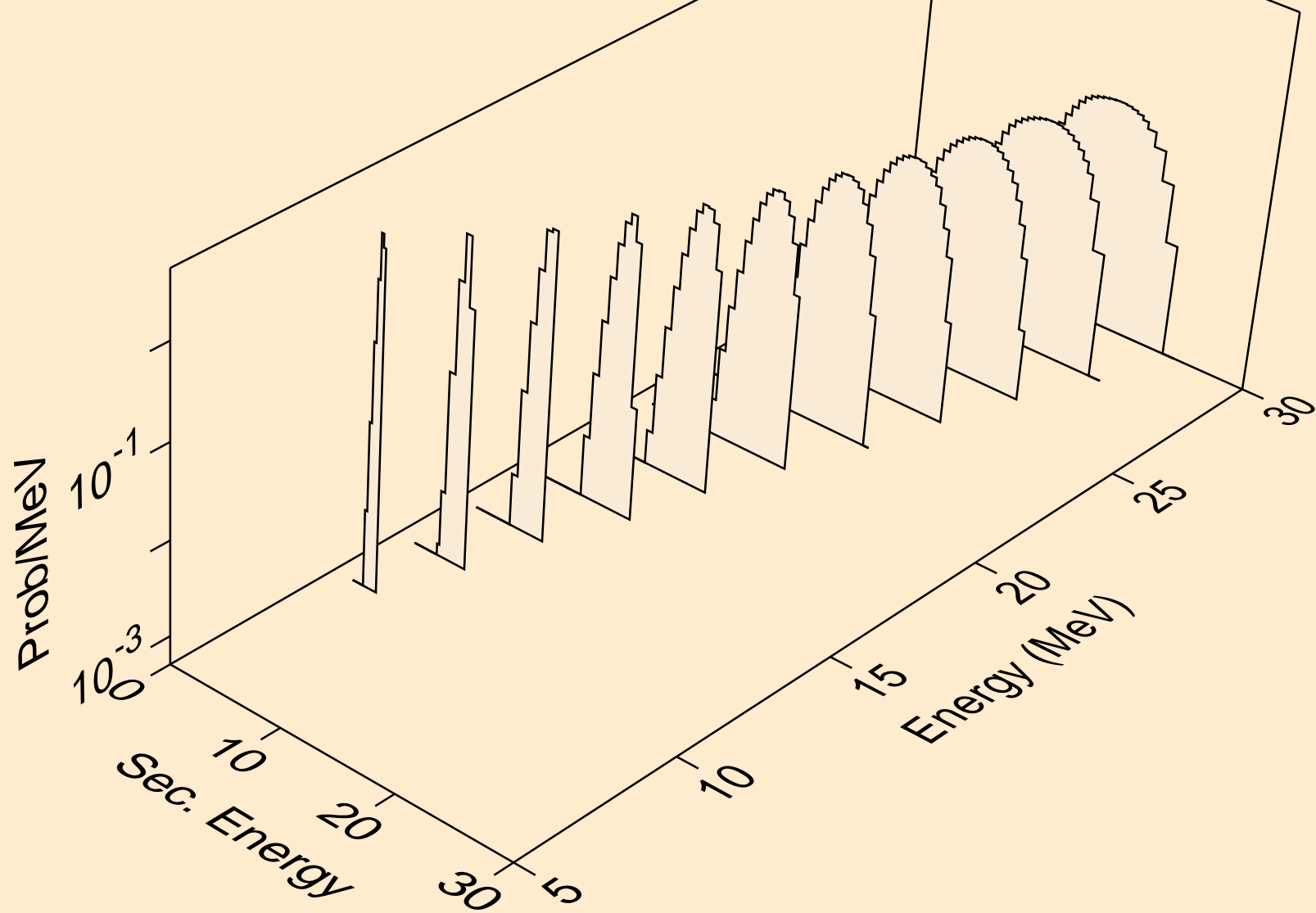

PT193M TRITON ACER TENDL-2021 LIBRARY; T=0.K  
Triton emission for inelastic

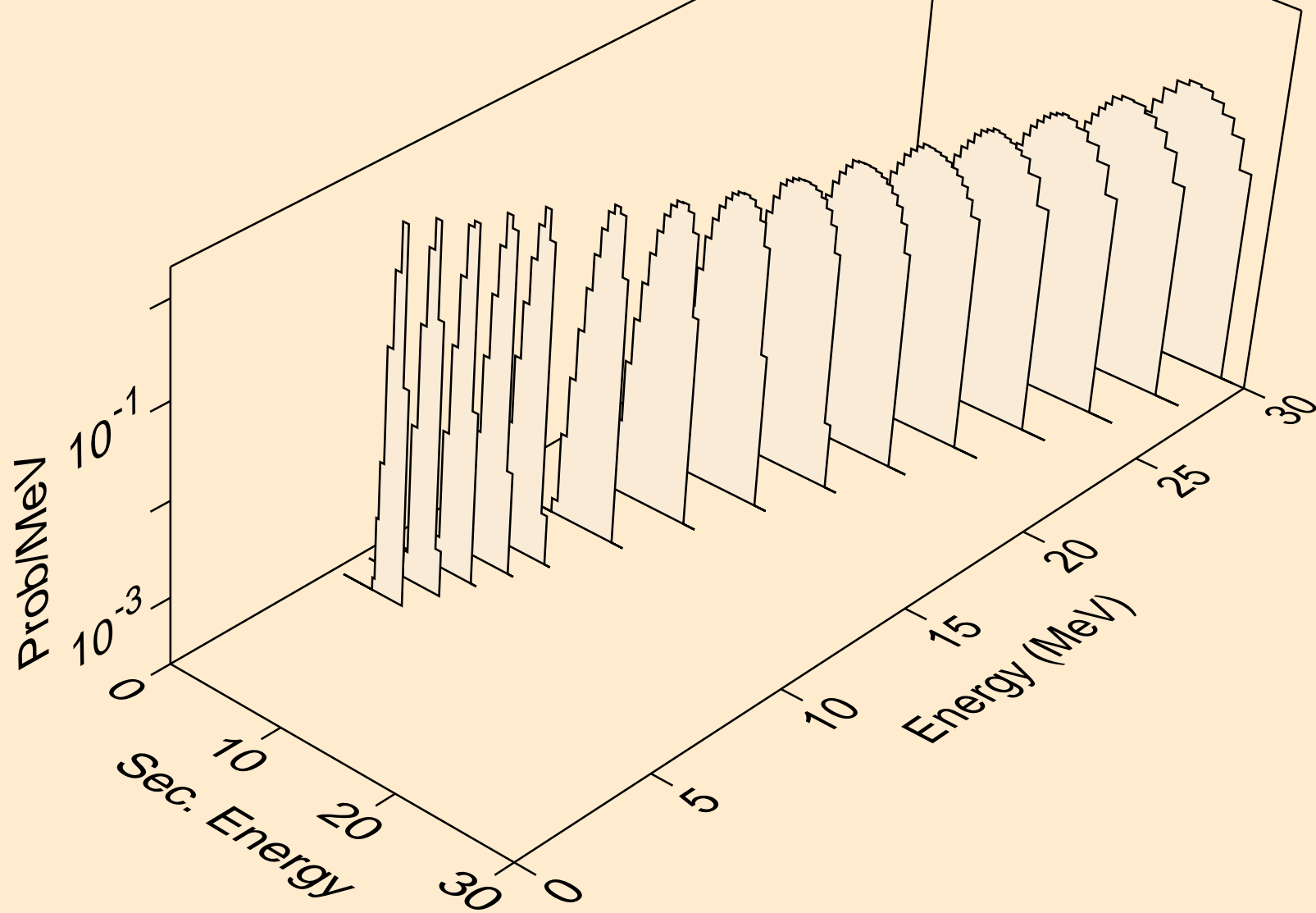

PT193M TRITON ACER TENDL-2021 LIBRARY; T=0.K  
Triton emission for (t,pt)

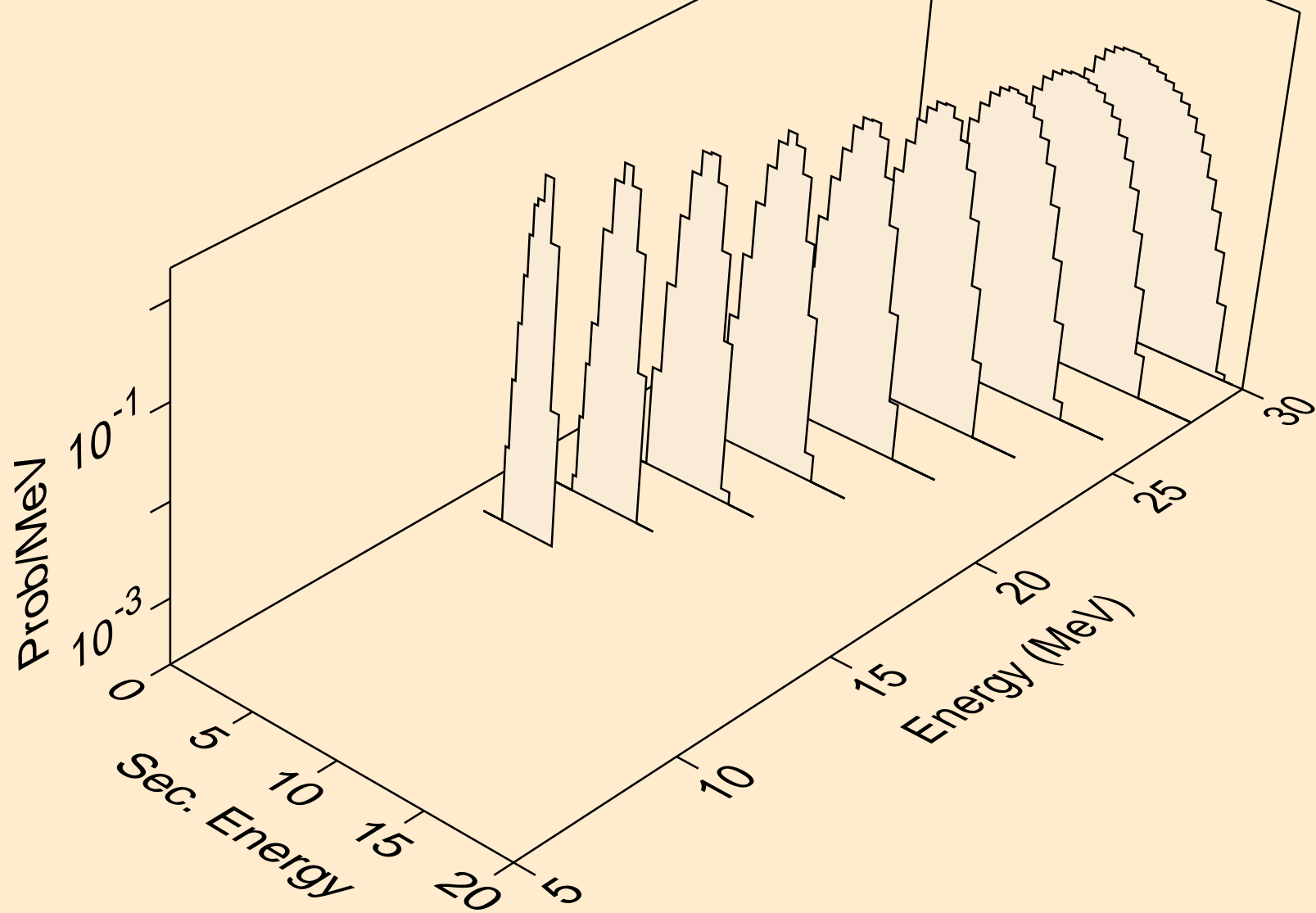

PT193M TRITON ACER TENDL-2021 LIBRARY; T=0.K  
Photon emission for (z,n)

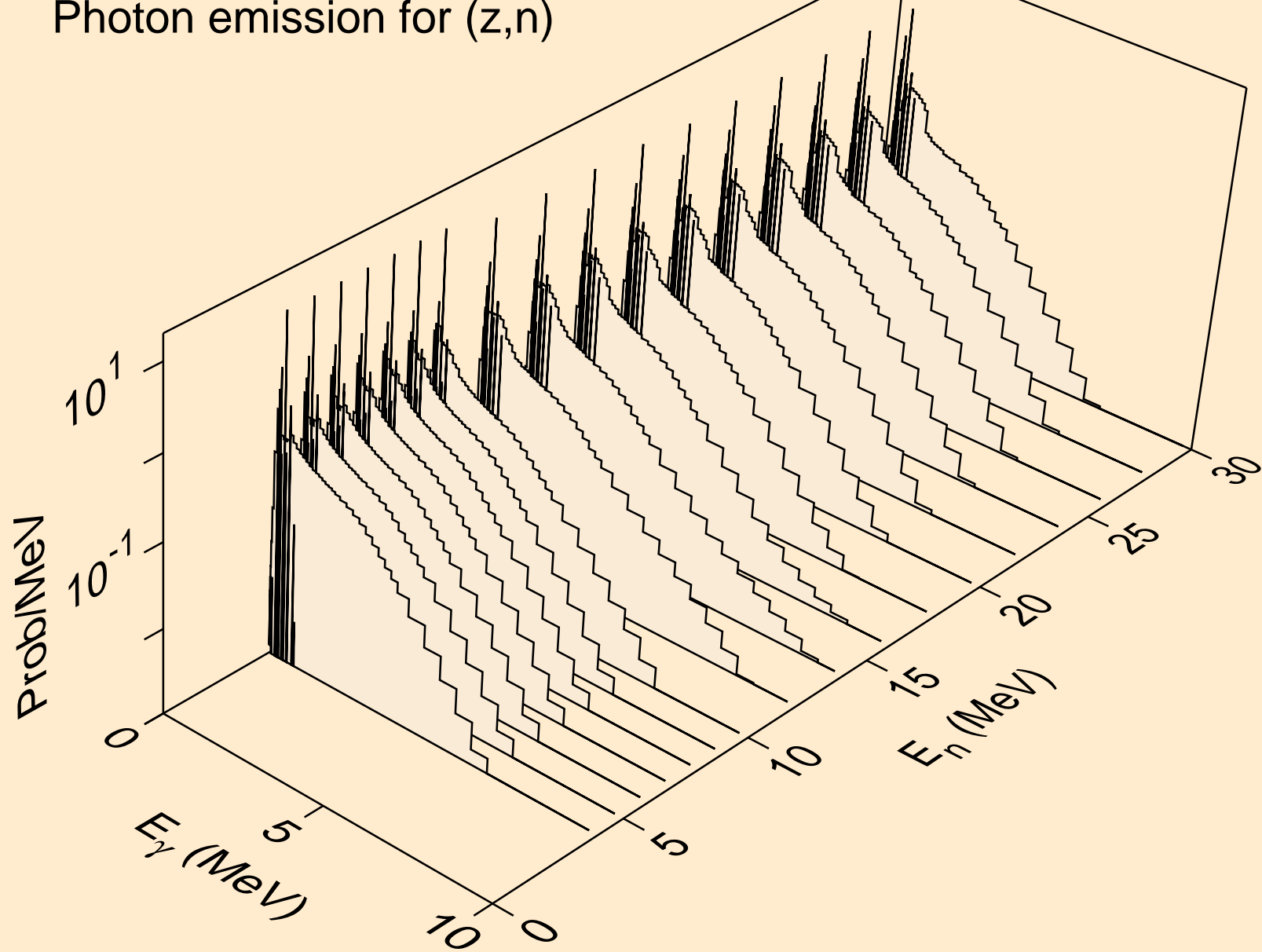

PT193M TRITON ACER TENDL-2021 LIBRARY; T=0.K  
Photon emission for (n,x)

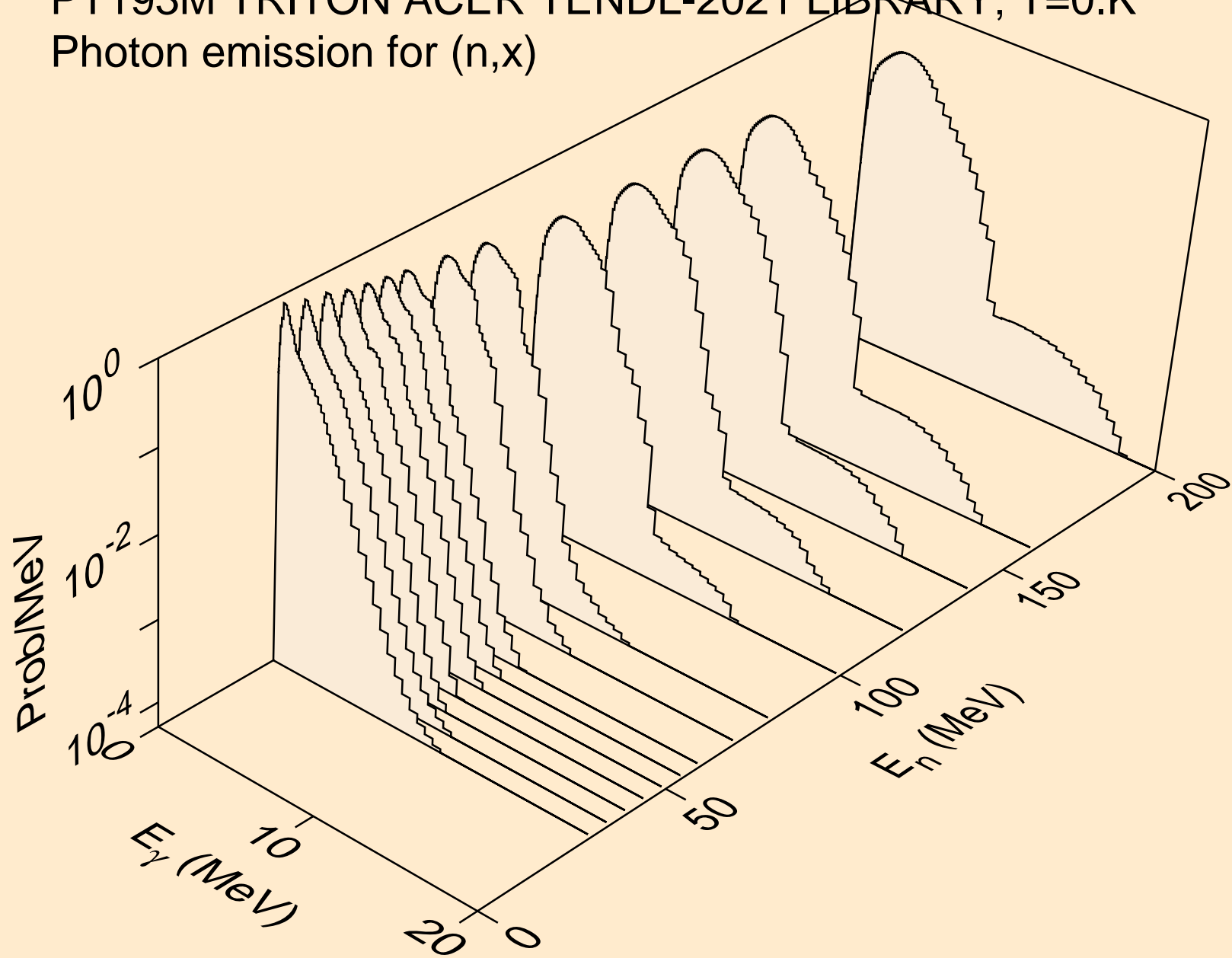

PT193M TRITON ACER TENDL-2021 LIBRARY; T=0.K  
Photon emission for (n,2nd)

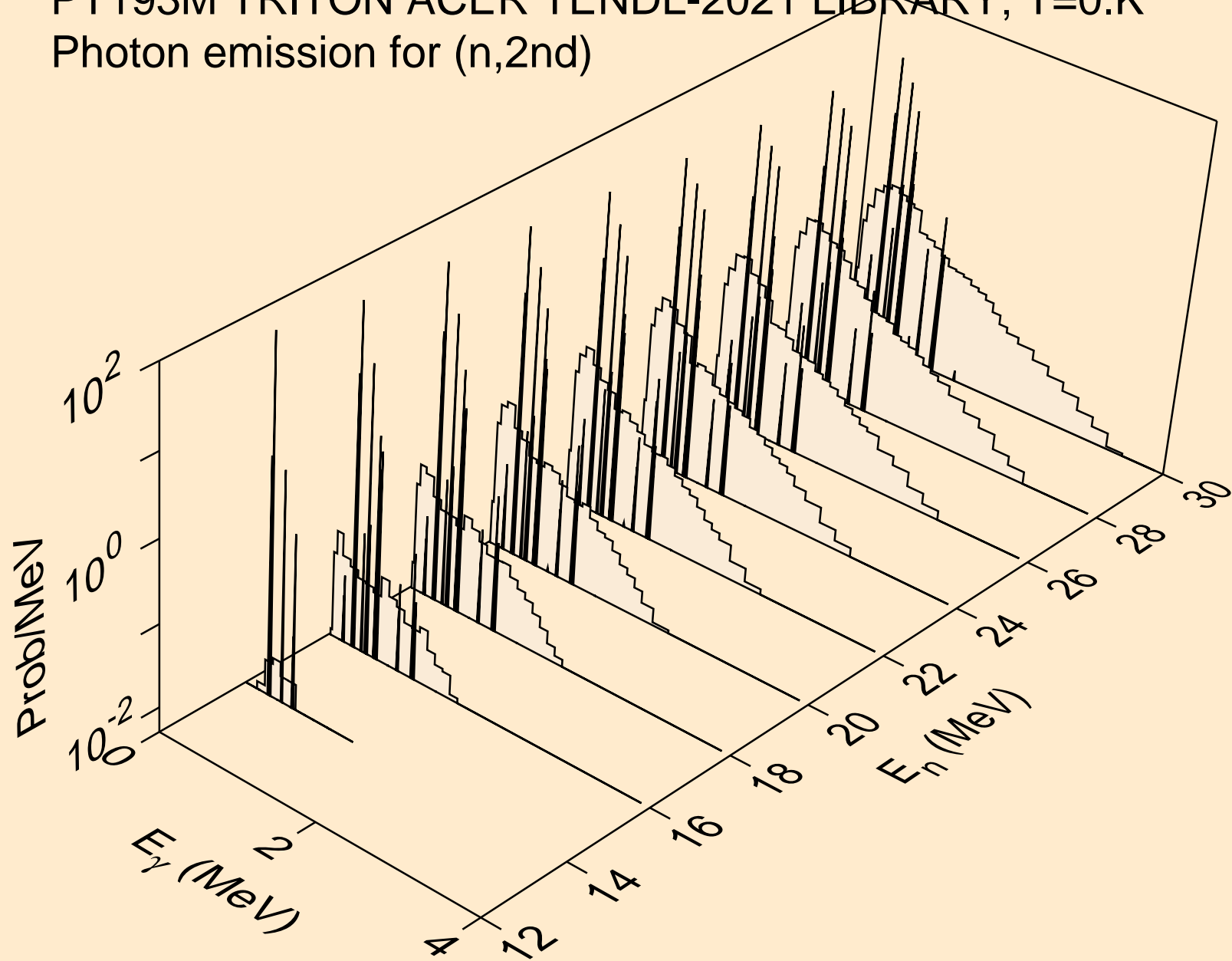



PT193M TRITON ACER TENDL-2021 LIBRARY; T=0.K  
Photon emission for (n,2n)

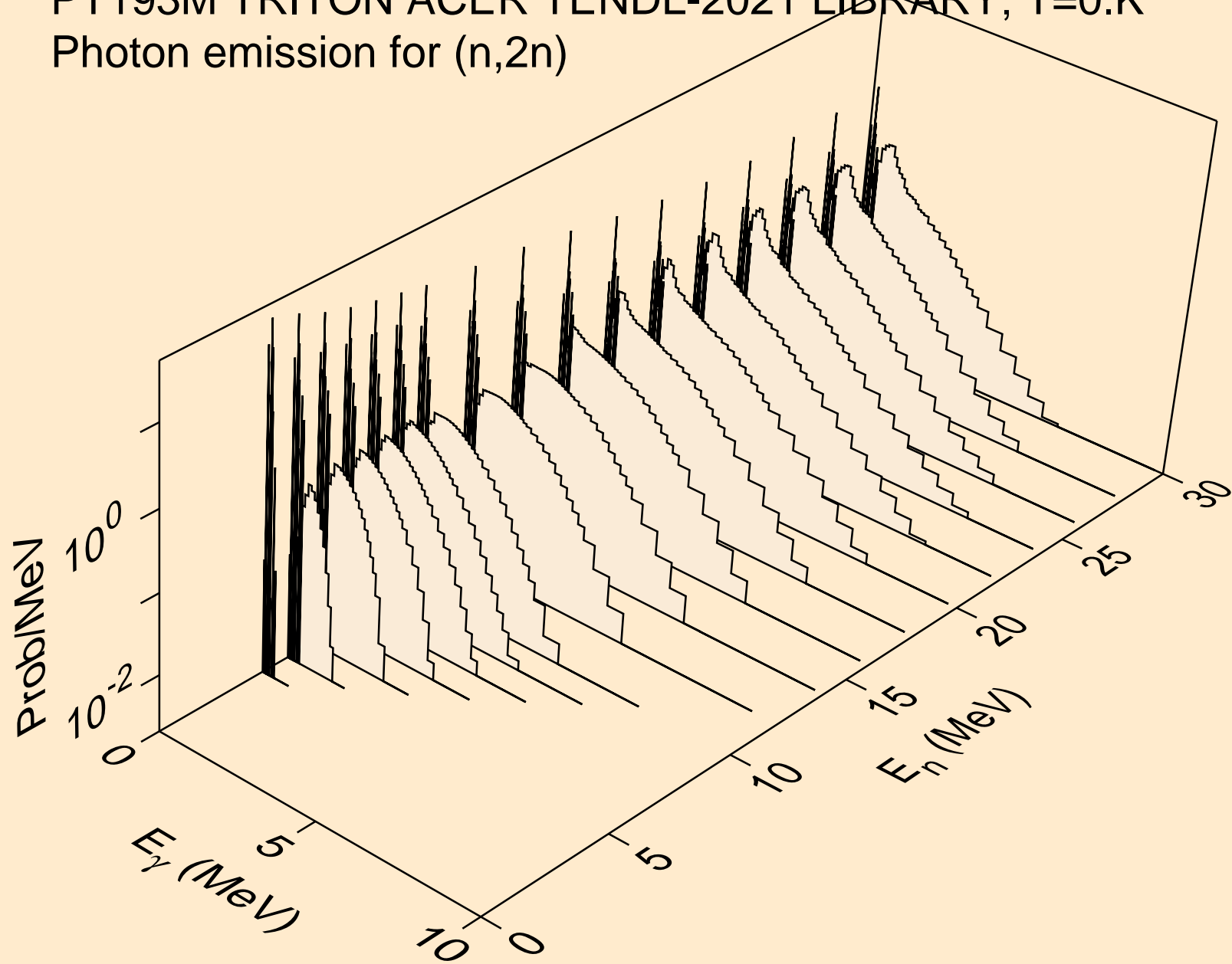

PT193M TRITON ACER TENDL-2021 LIBRARY; T=0.K  
Photon emission for (n,3n)

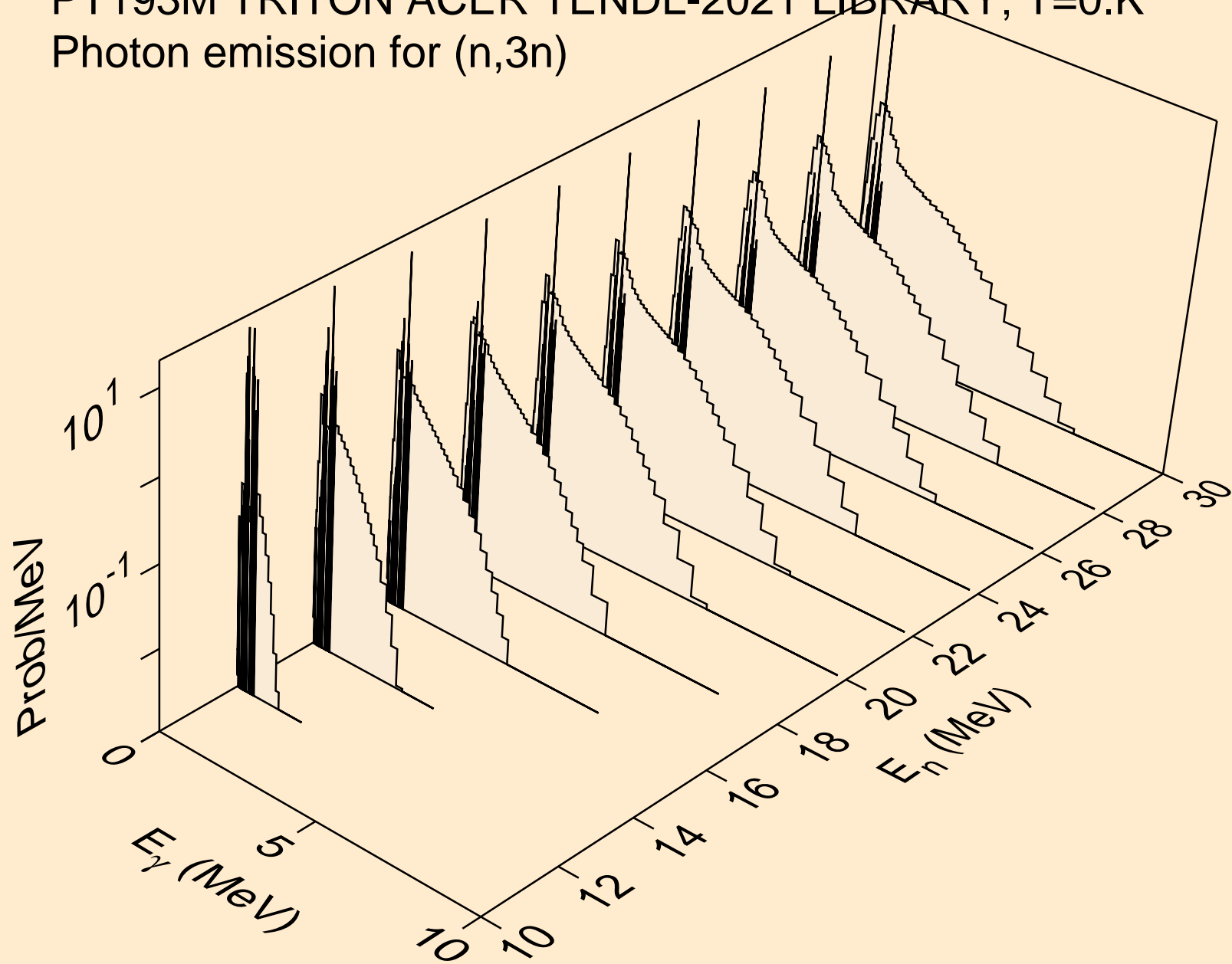

PT193M TRITON ACER TENDL-2021 LIBRARY; T=0.K  
Photon emission for (n,n\*)a

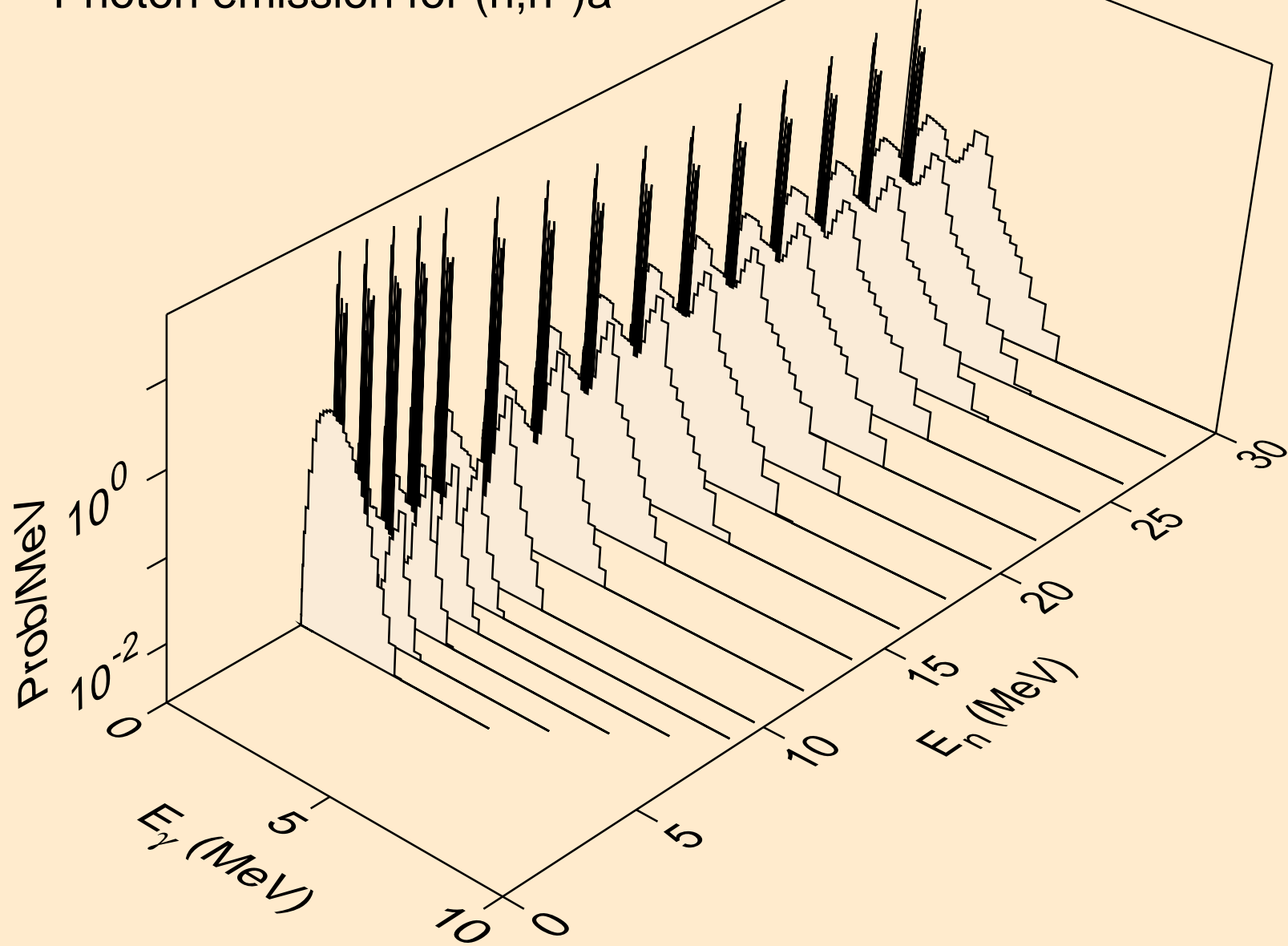

PT193M TRITON ACER TENDL-2021 LIBRARY; T=0.K  
Photon emission for (n,2n)a

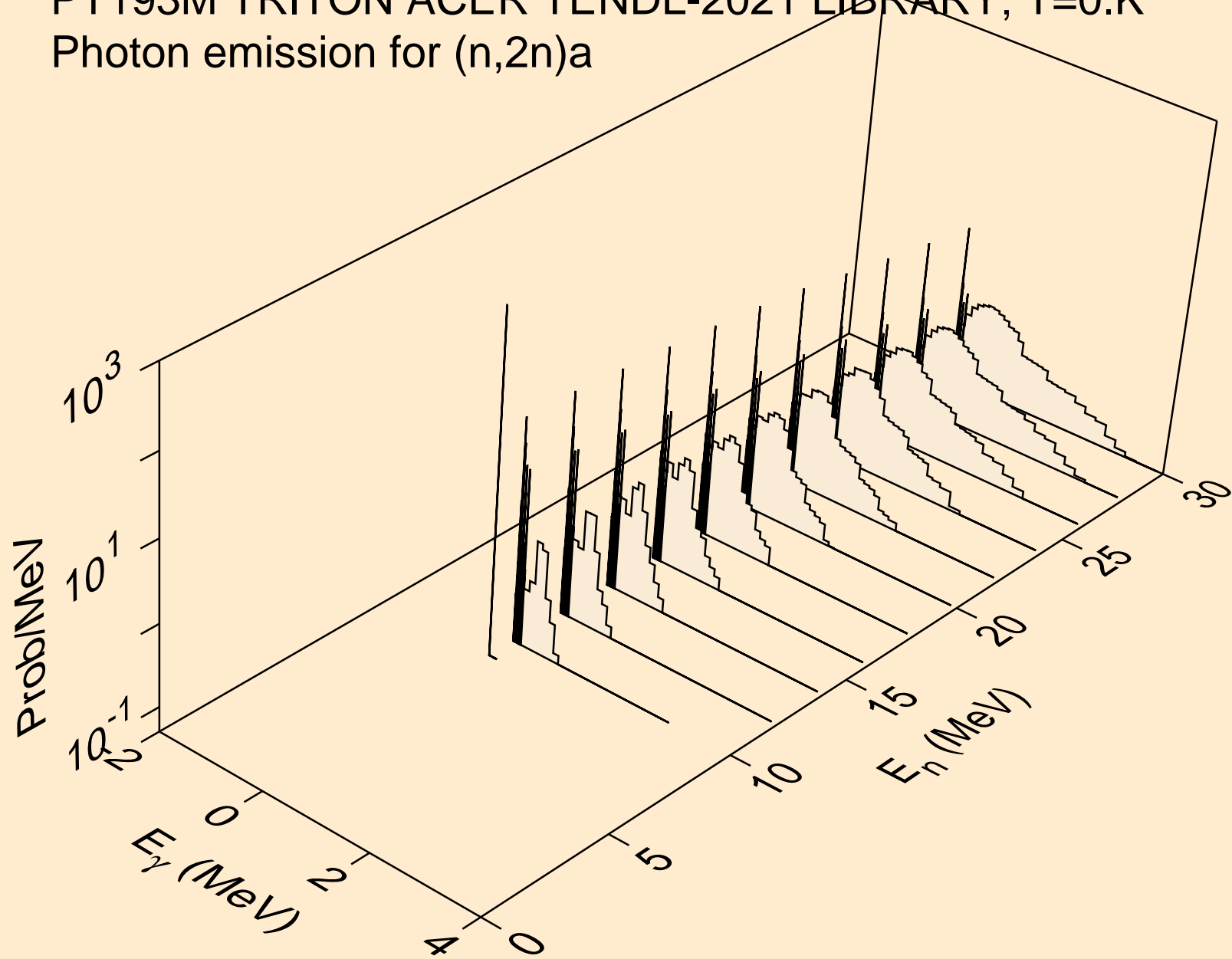

PT193M TRITON ACER TENDL-2021 LIBRARY; T=0.K  
Photon emission for (n,3n)a

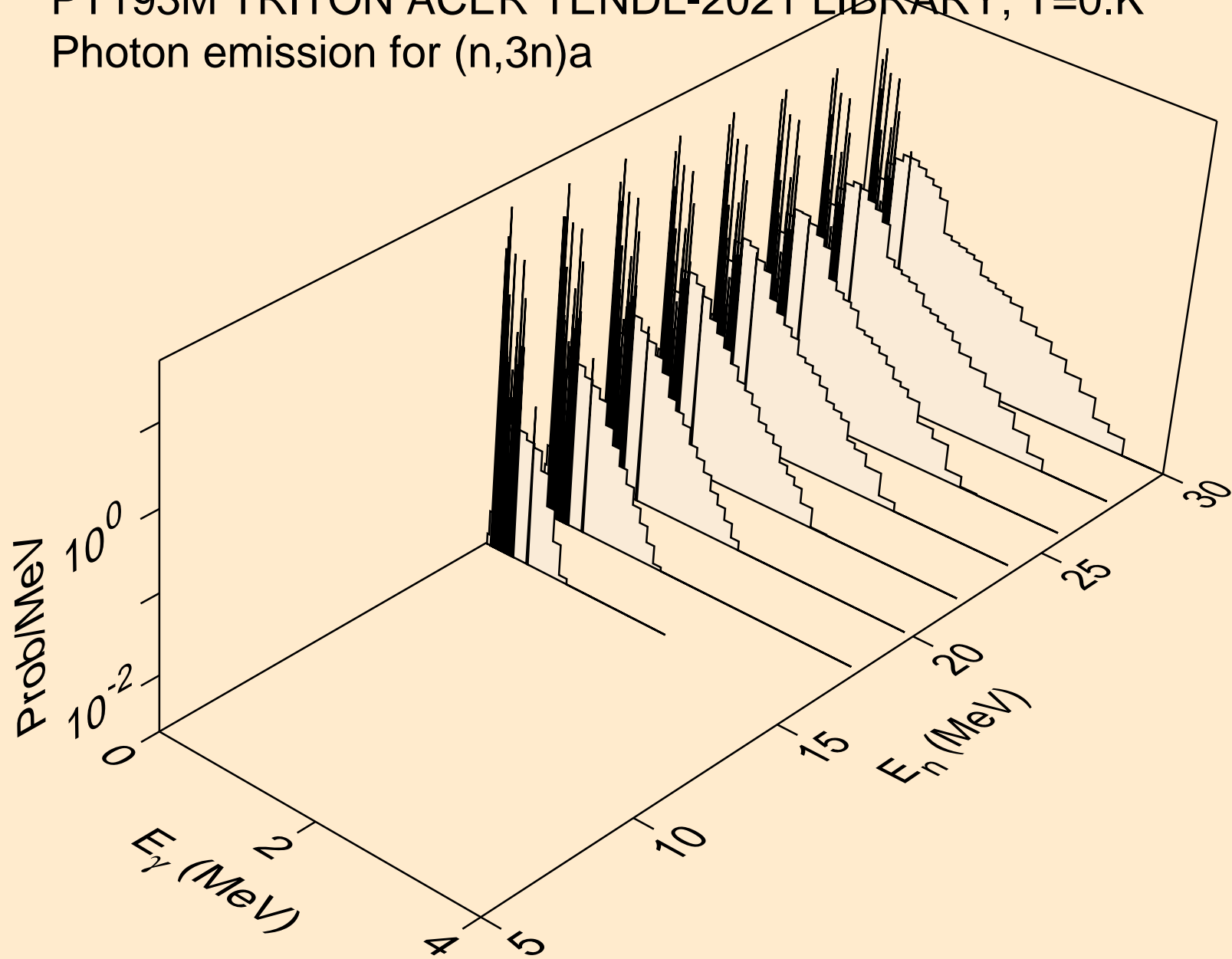

PT193M TRITON ACER TENDL-2021 LIBRARY; T=0.K  
Photon emission for (n,n\*)p

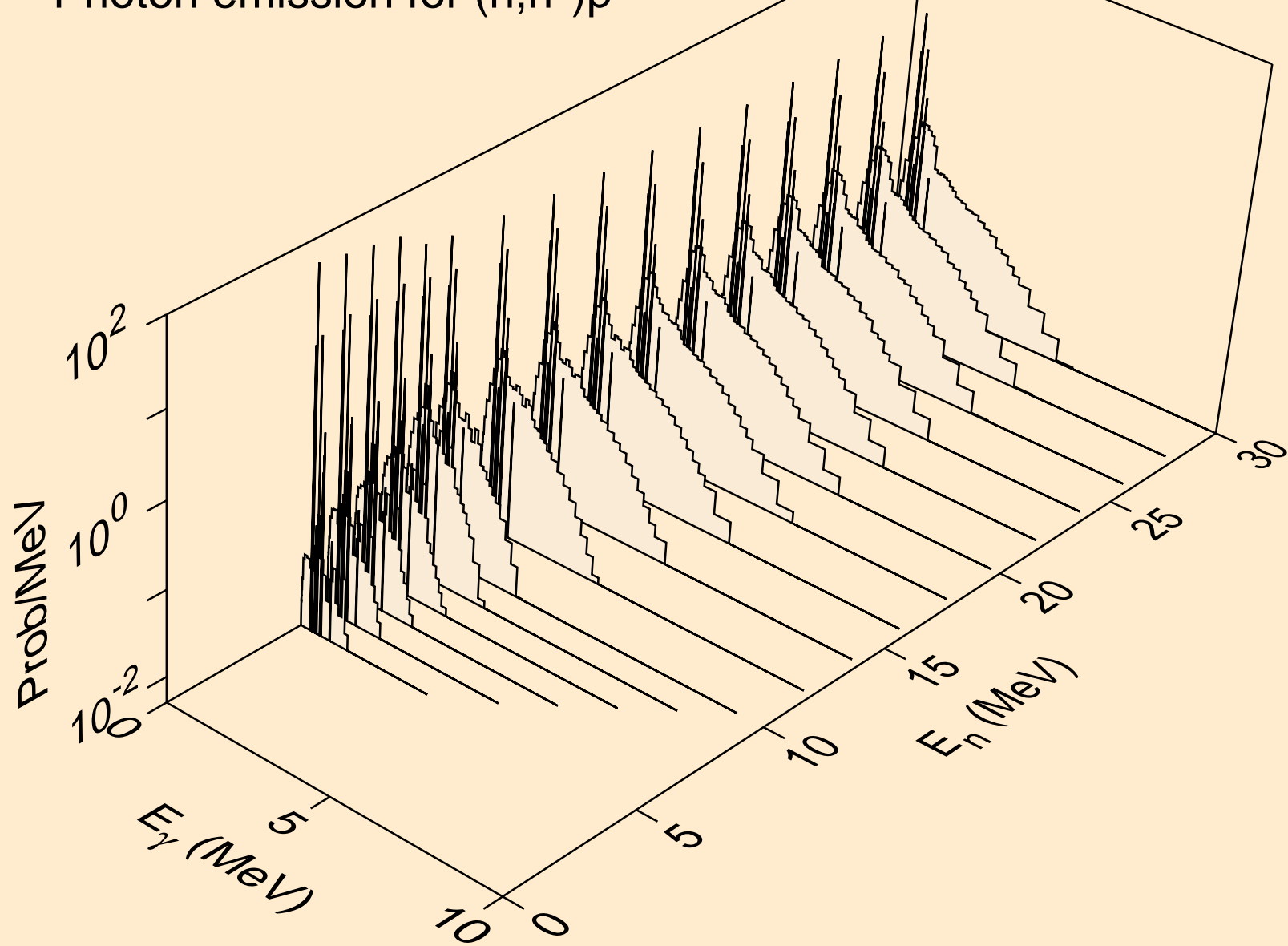

PT193M TRITON ACER TENDL-2021 LIBRARY; T=0.K  
Photon emission for (n,n\*)2a

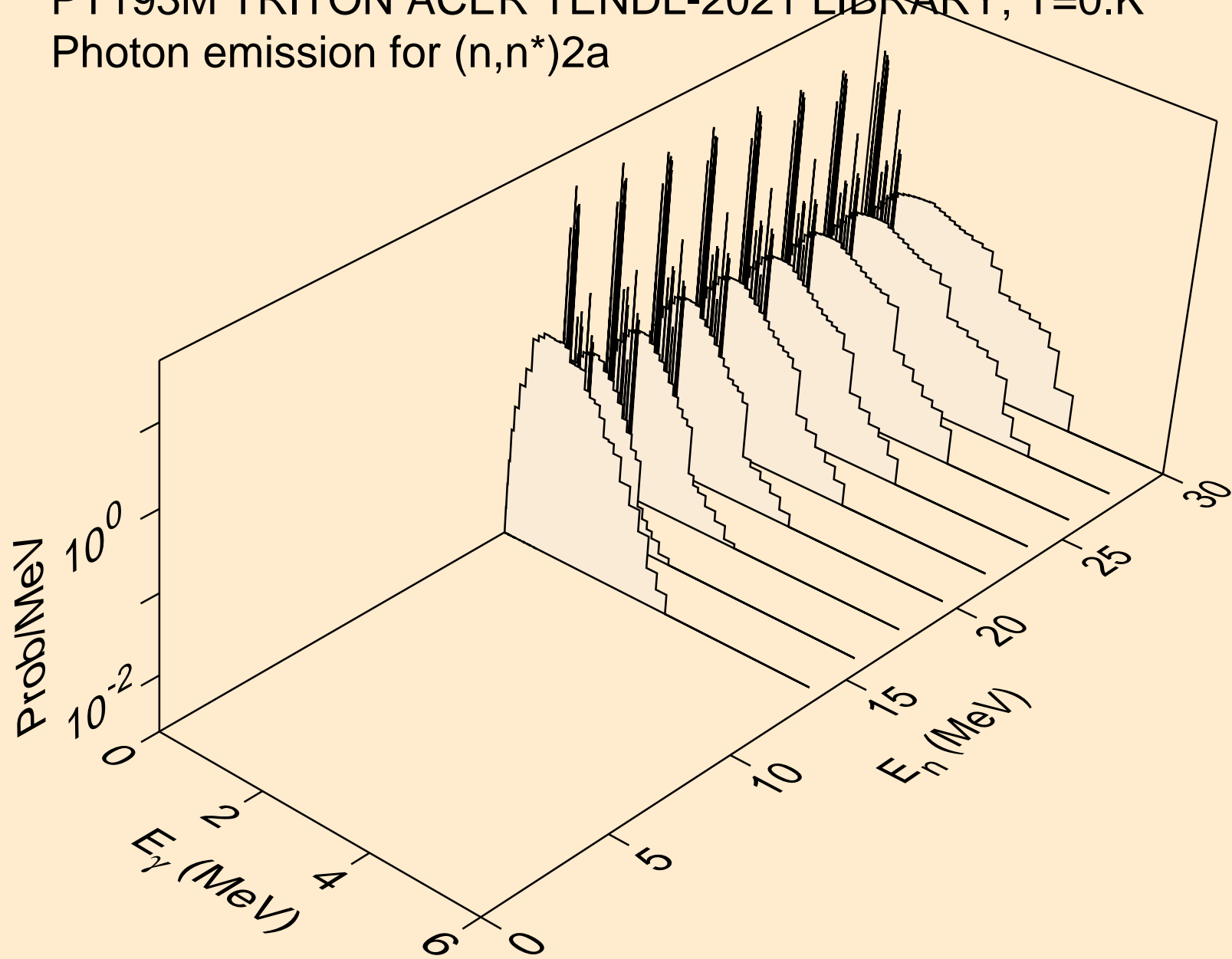

PT193M TRITON ACER TENDL-2021 LIBRARY; T=0.K  
Photon emission for (n,n\*)d

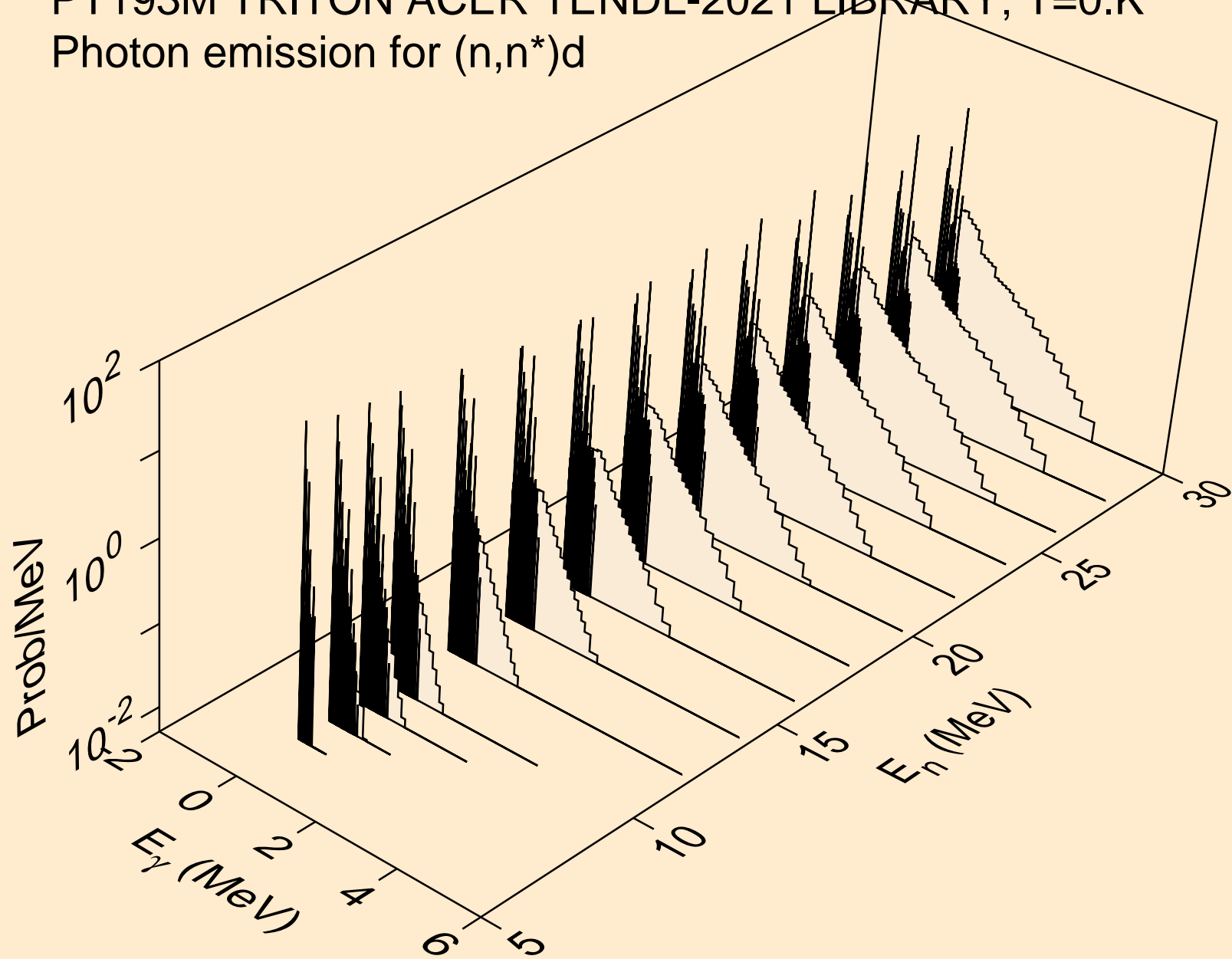



PT193M TRITON ACER TENDL-2021 LIBRARY; T=0.K  
Photon emission for (n,n\*)t

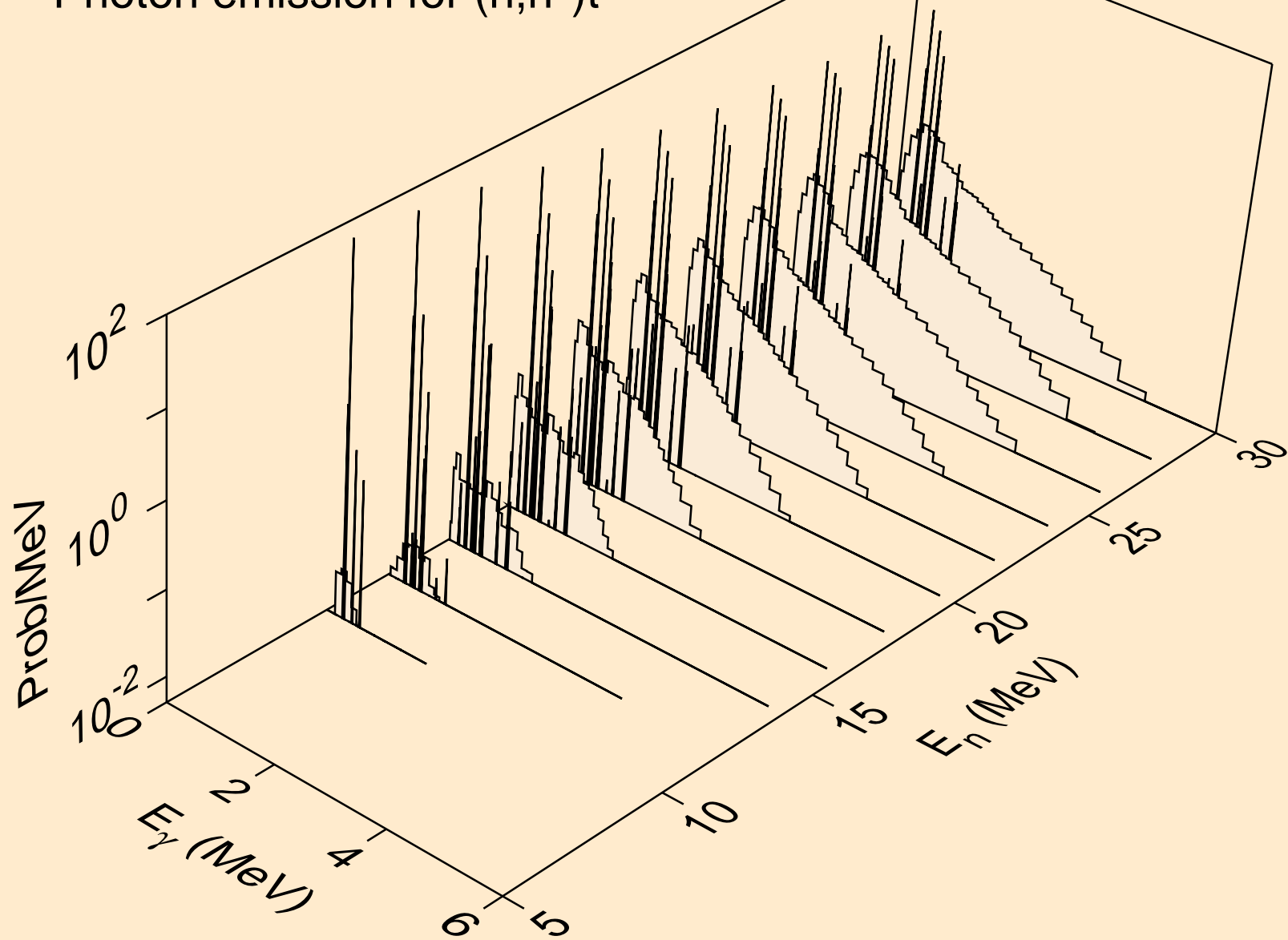

PT193M TRITON ACER TENDL-2021 LIBRARY; T=0.K  
Photon emission for (n,n\*)he3

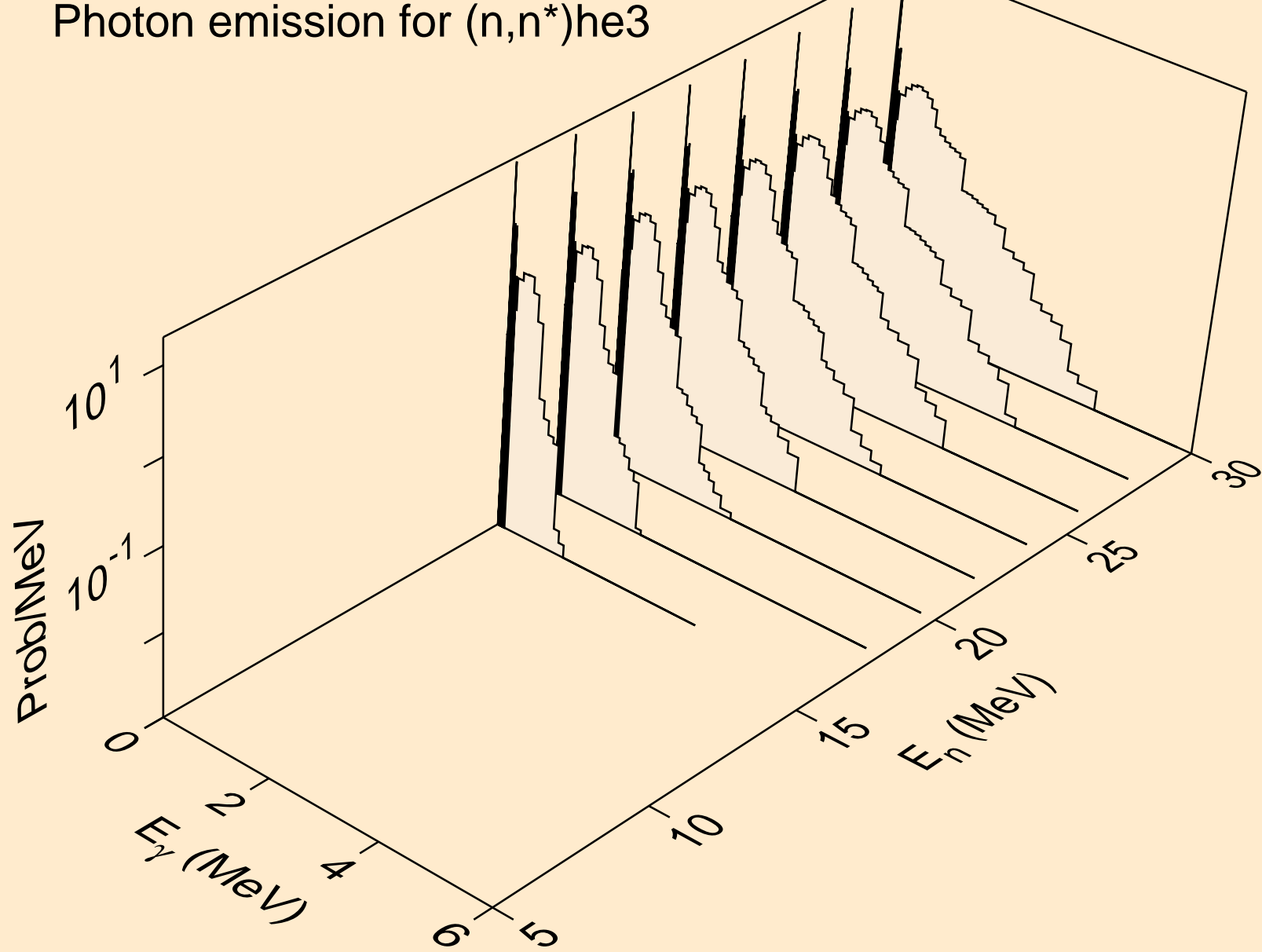

PT193M TRITON ACER TENDL-2021 LIBRARY; T=0.K  
Photon emission for (n,4n)

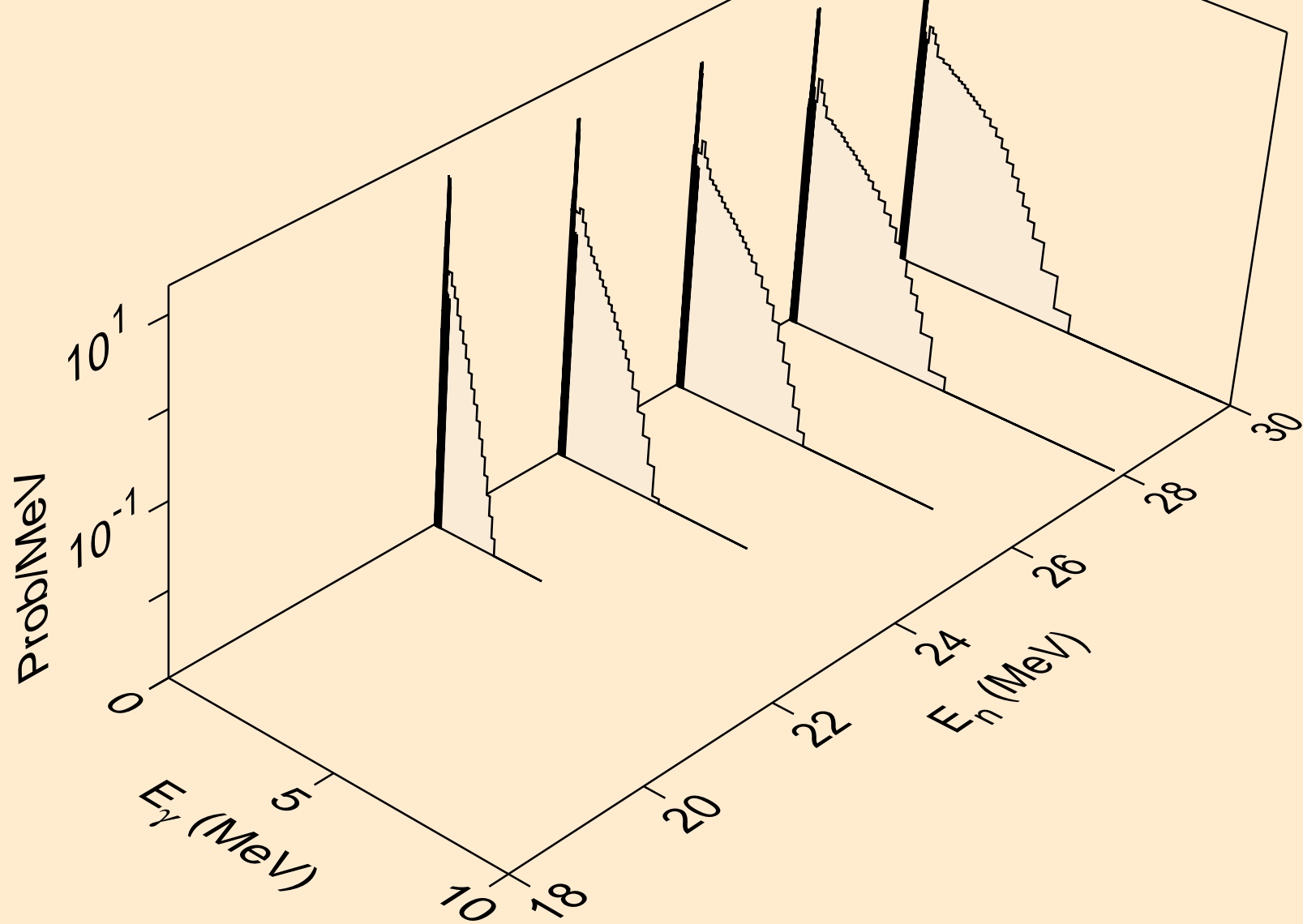

PT193M TRITON ACER TENDL-2021 LIBRARY; T=0.K  
Photon emission for (n,2np)

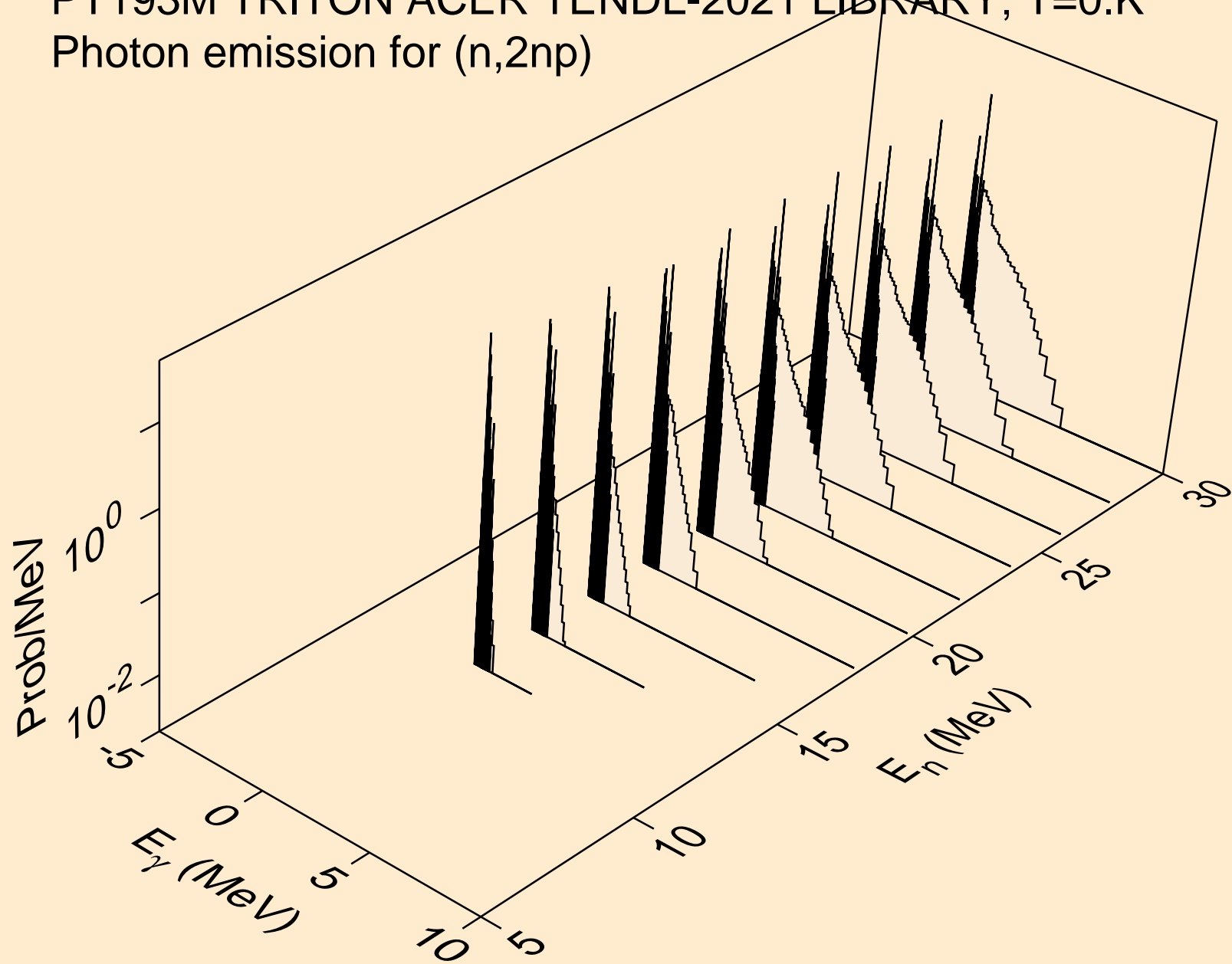

PT193M TRITON ACER TENDL-2021 LIBRARY; T=0.K  
Photon emission for (n,3np)

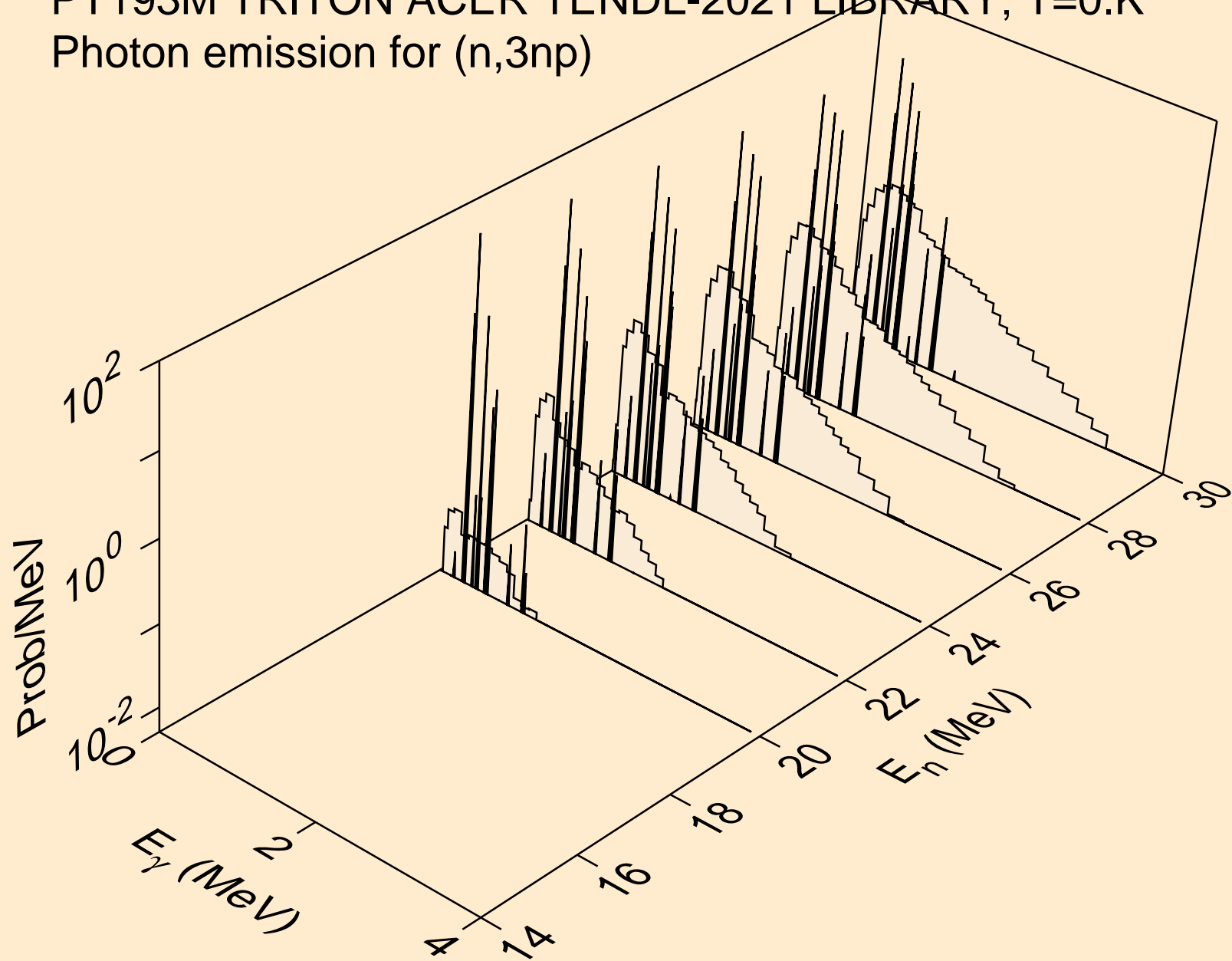

PT193M TRITON ACER TENDL-2021 LIBRARY; T=0.K  
Photon emission for (n,2np)

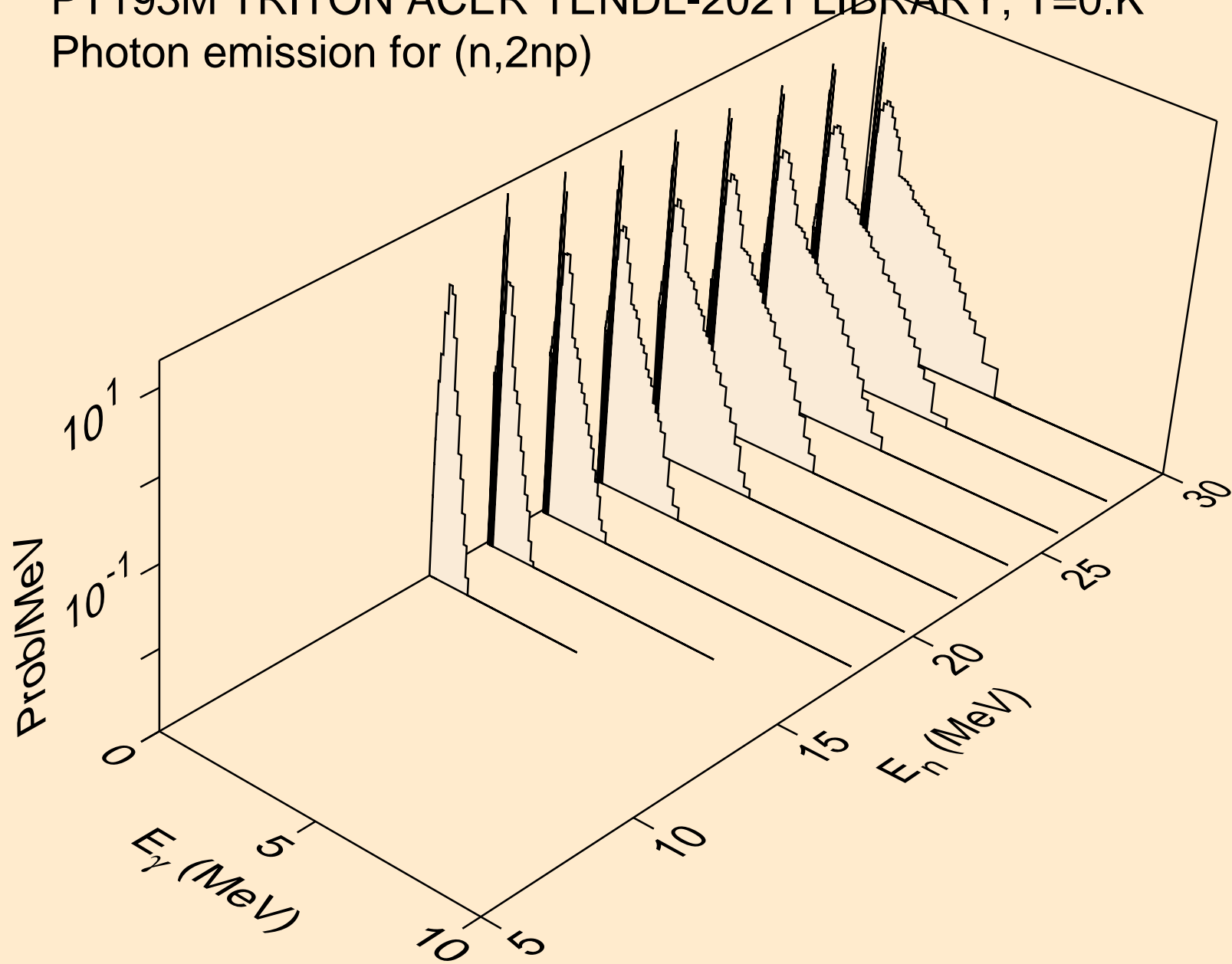

PT193M TRITON ACER TENDL-2021 LIBRARY; T=0.K  
Photon emission for (n,npa)

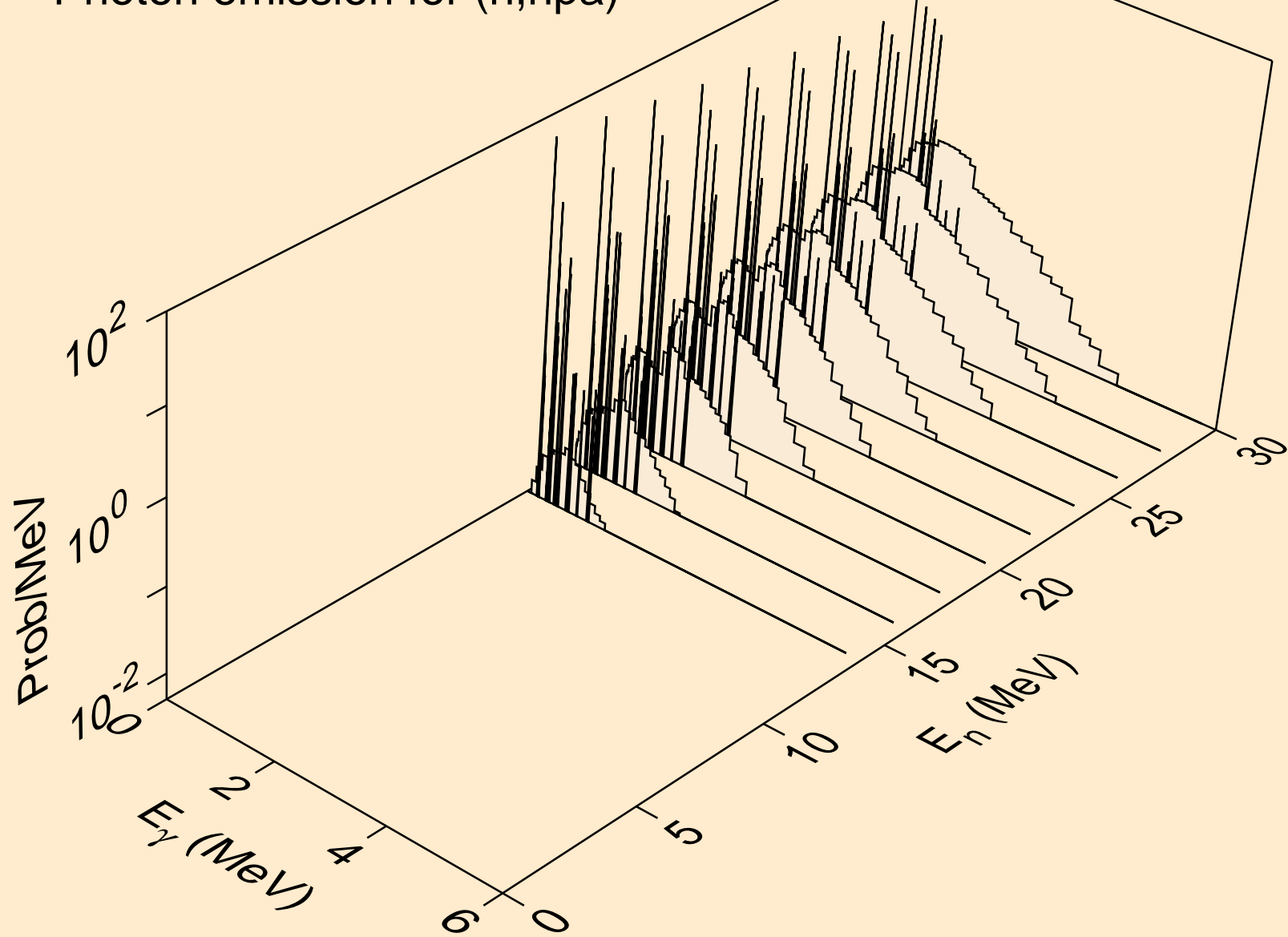

PT193M TRITON ACER TENDL-2021 LIBRARY; T=0.K  
Photon emission for (n,gma)

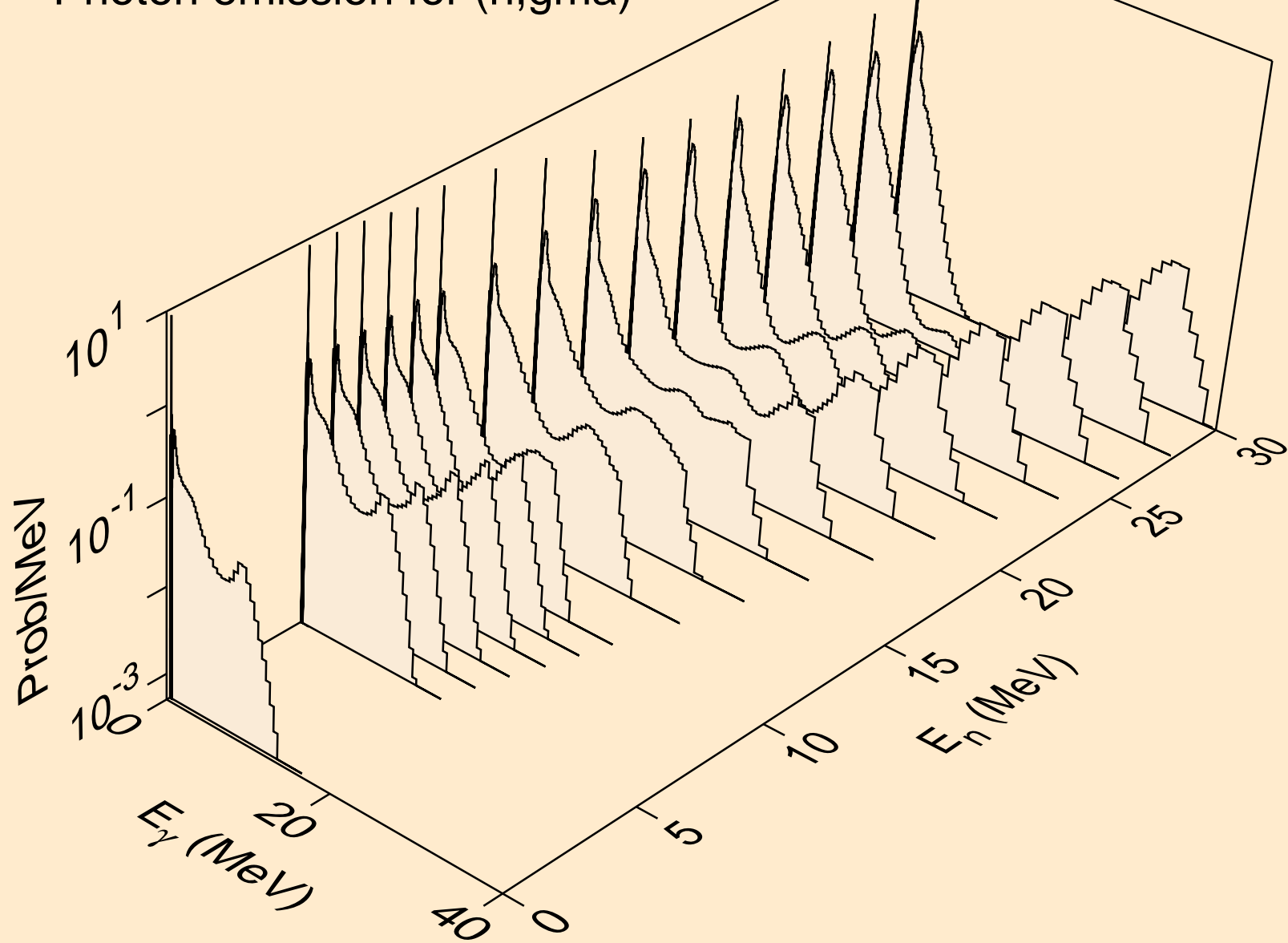



PT193M TRITON ACER TENDL-2021 LIBRARY; T=0.K  
Photon emission for (n,p)

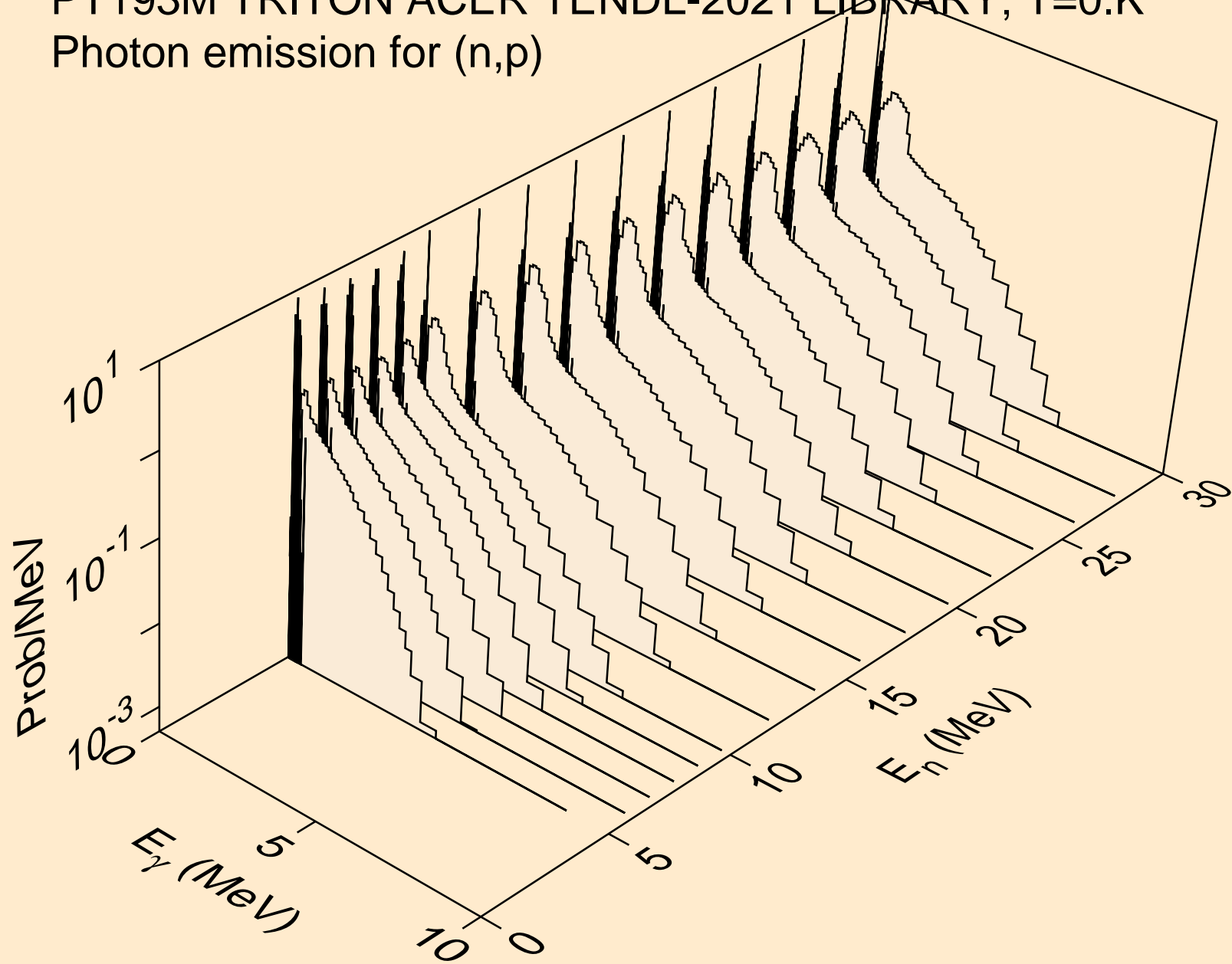

PT193M TRITON ACER TENDL-2021 LIBRARY; T=0.K  
Photon emission for (n,d)

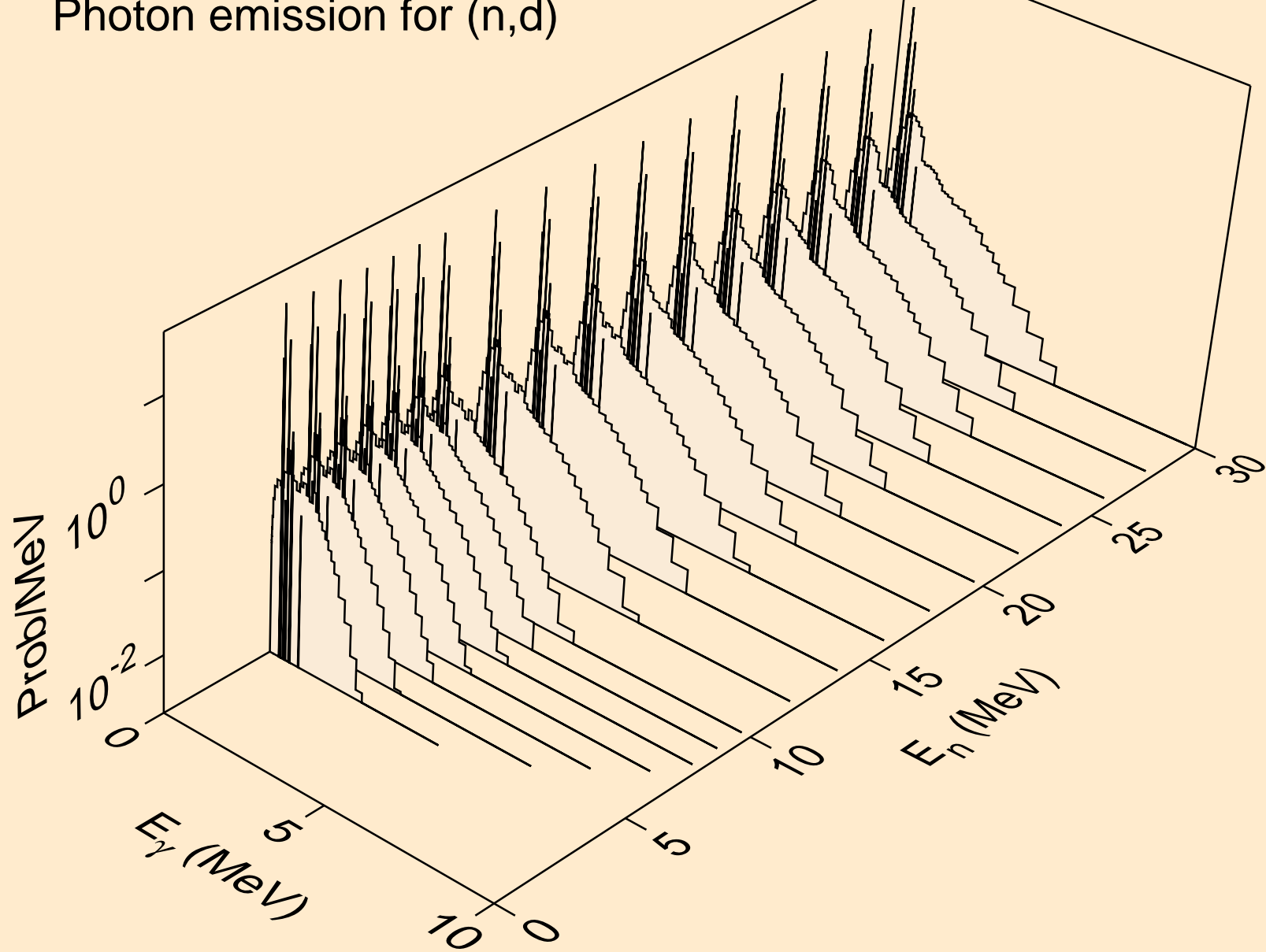

PT193M TRITON ACER TENDL-2021 LIBRARY; T=0.K  
Photon emission for inelastic

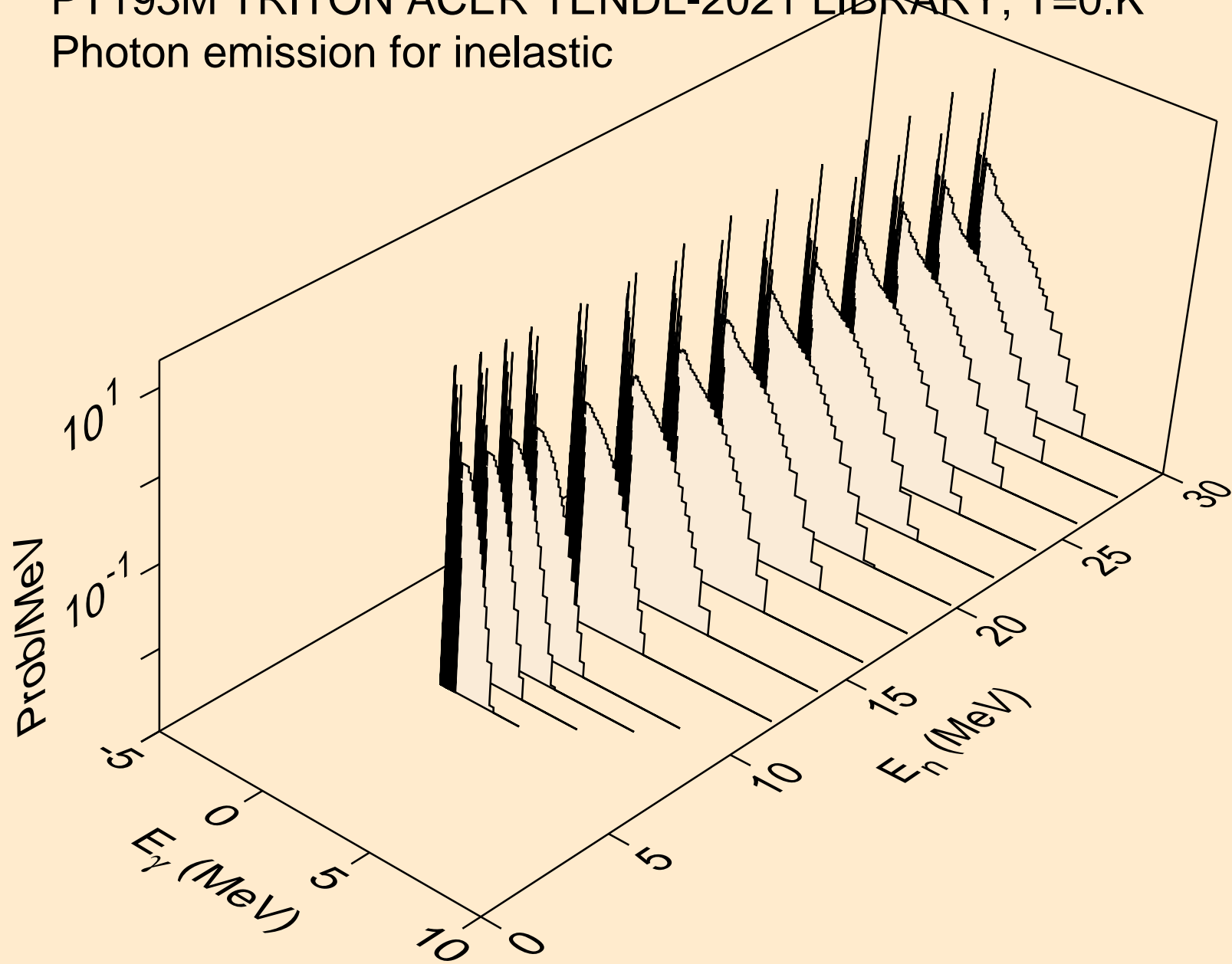

PT193M TRITON ACER TENDL-2021 LIBRARY; T=0.K  
Photon emission for (n,he3)

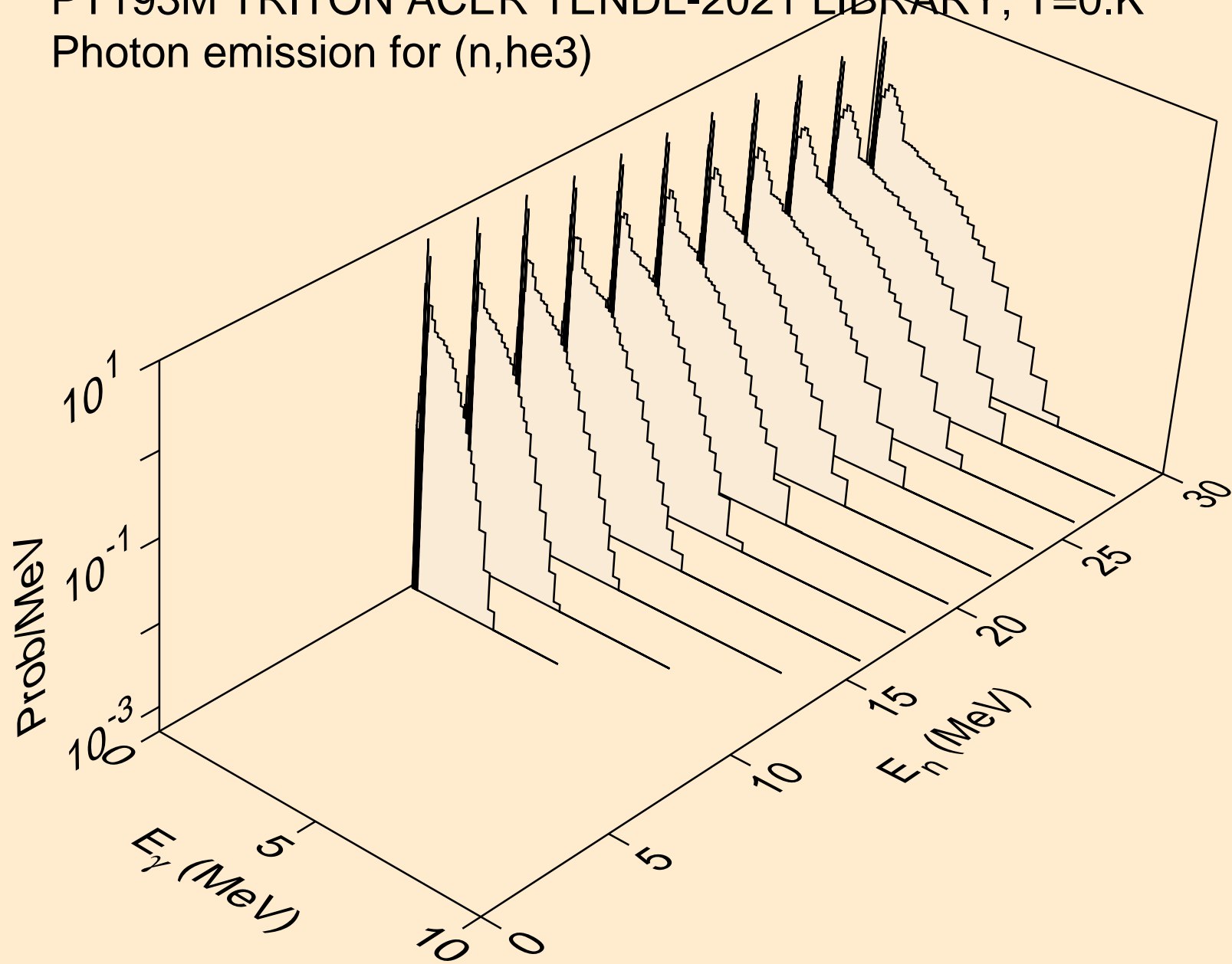

PT193M TRITON ACER TENDL-2021 LIBRARY; T=0.K  
Photon emission for (n,a)

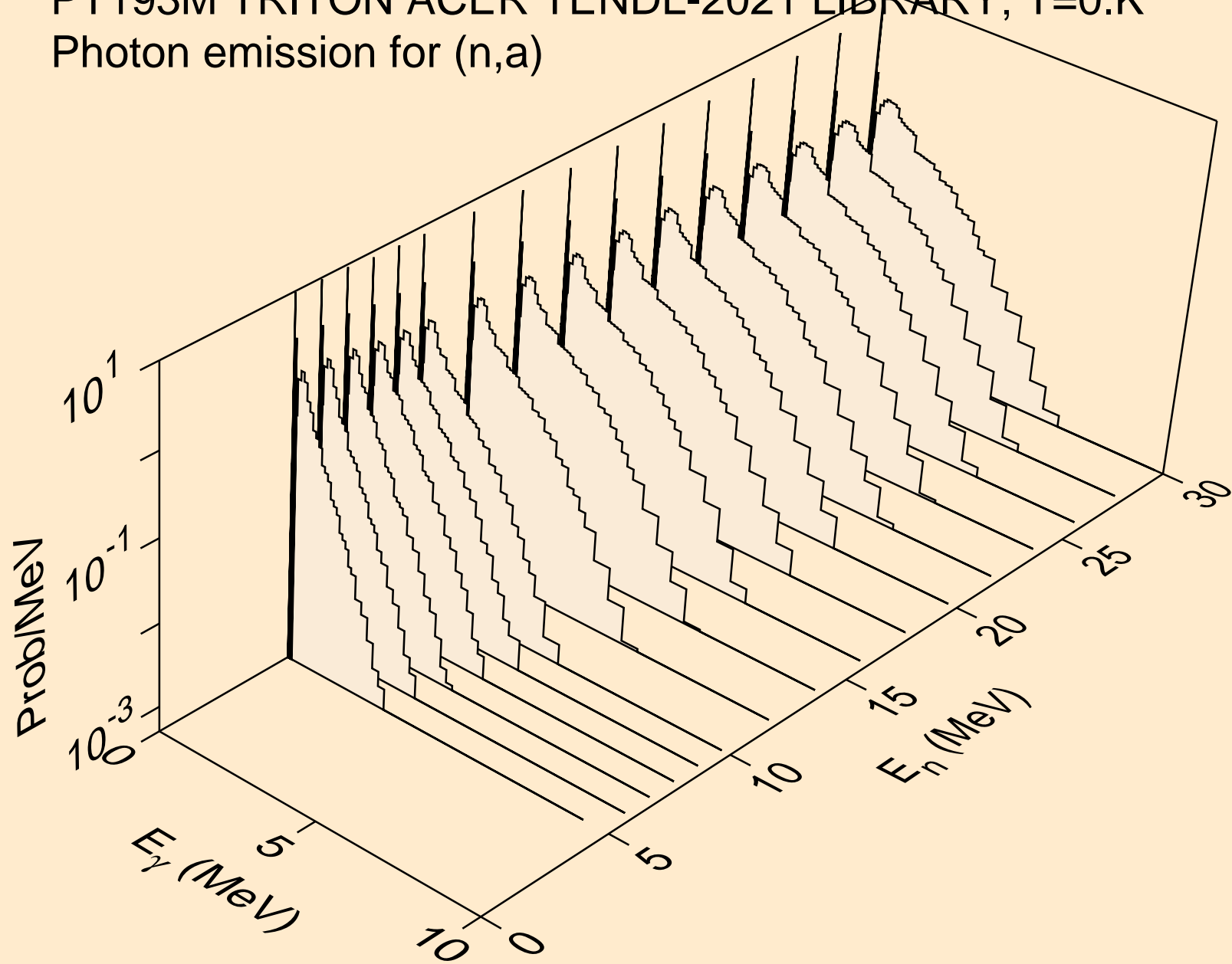

PT193M TRITON ACER TENDL-2021 LIBRARY; T=0.K  
Photon emission for (n,2a)

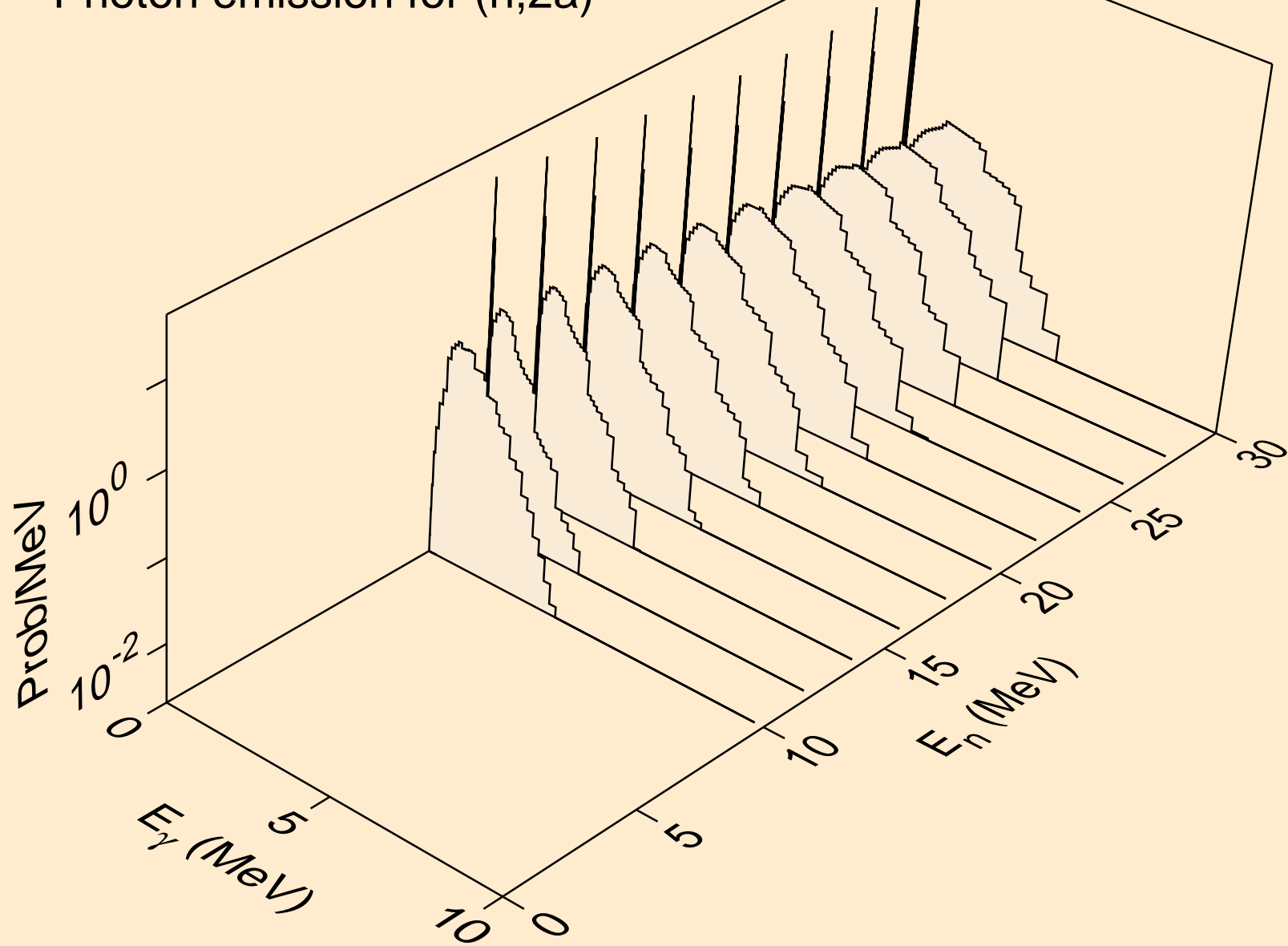

PT193M TRITON ACER TENDL-2021 LIBRARY; T=0.K  
Photon emission for (n,2p)

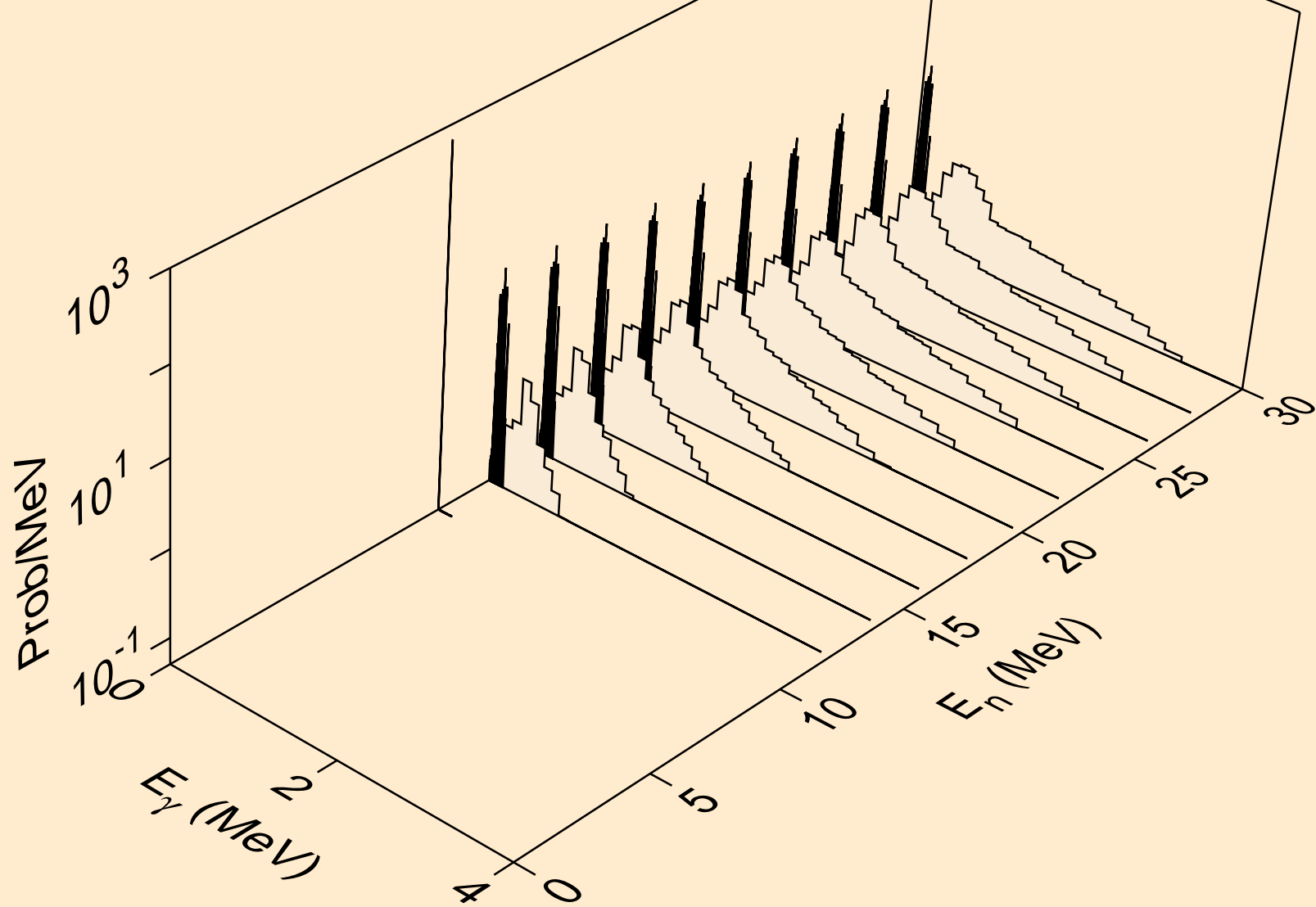

PT193M TRITON ACER TENDL-2021 LIBRARY; T=0.K  
Photon emission for (n,pa)

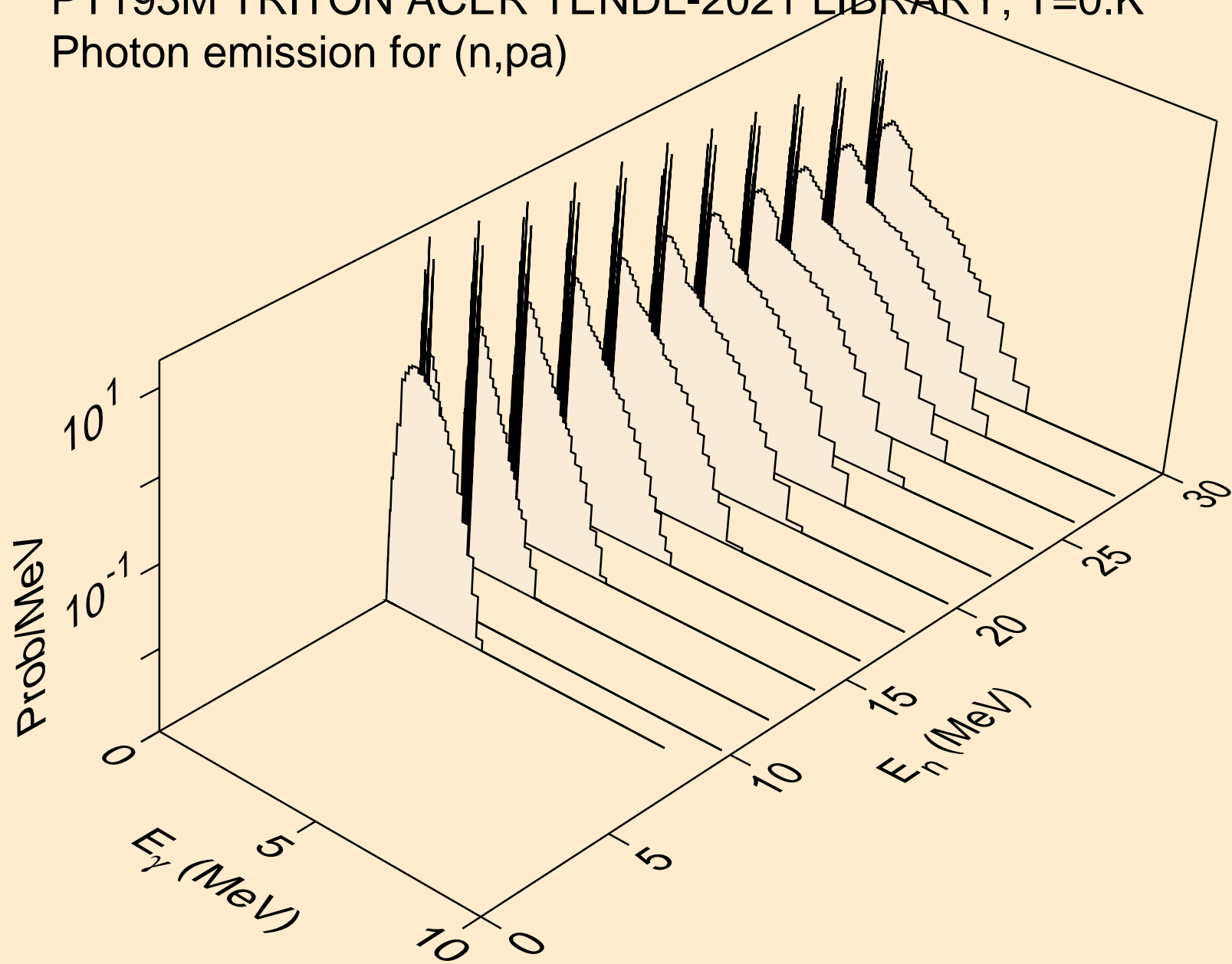



PT193M TRITON ACER TENDL-2021 LIBRARY; T=0.K  
Photon emission for (n,pd)

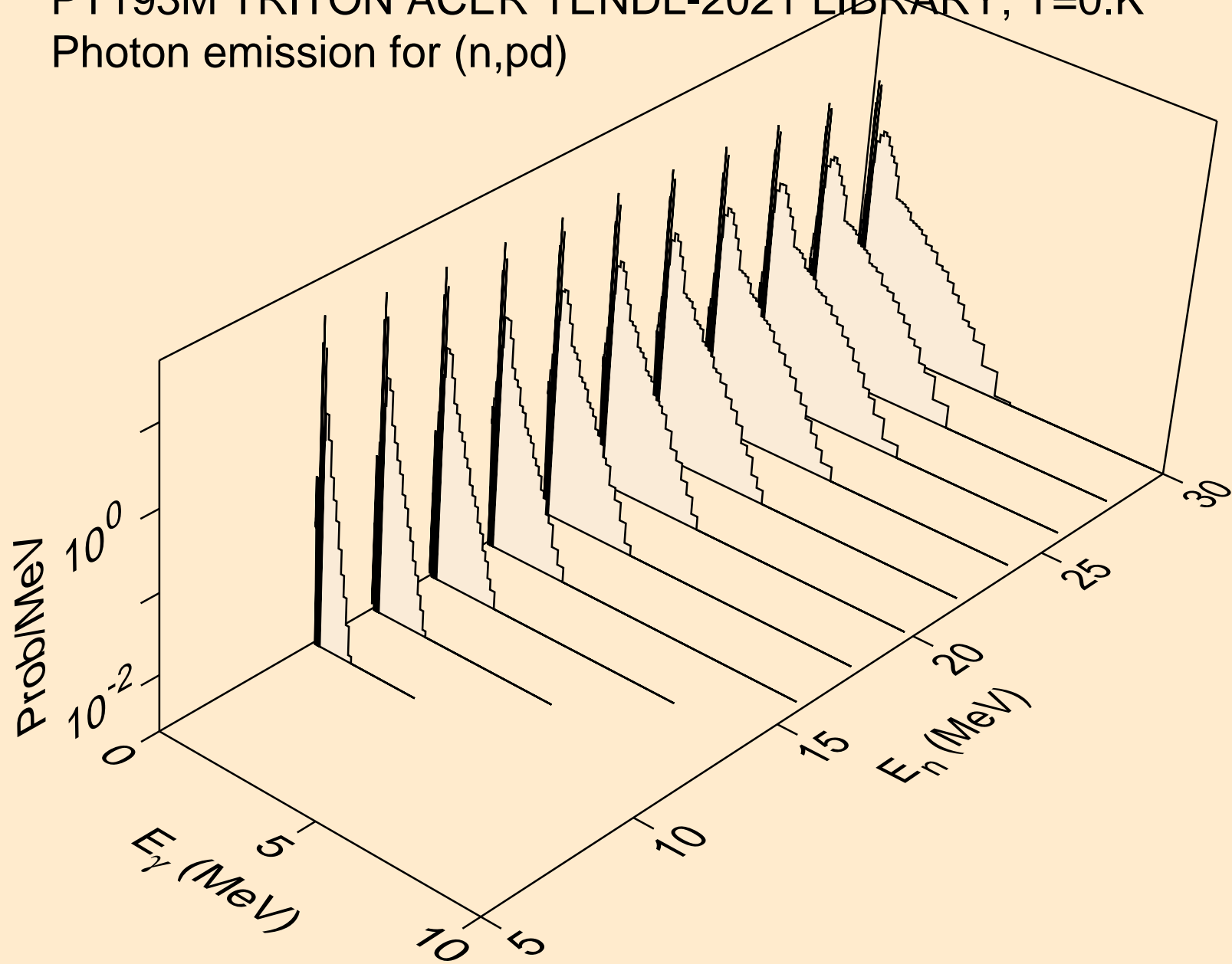

PT193M TRITON ACER TENDL-2021 LIBRARY; T=0.K  
Photon emission for (n,pt)

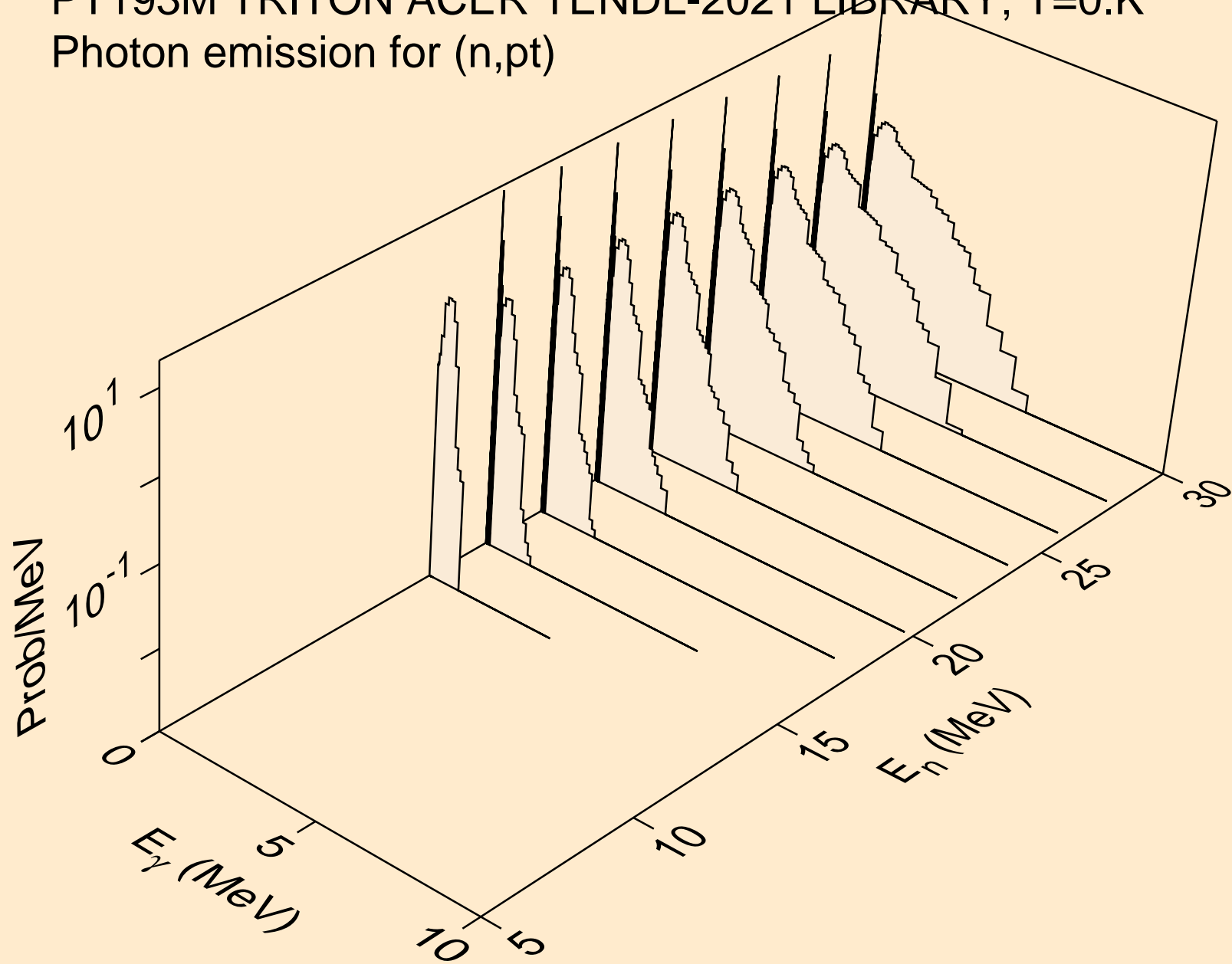

PT193M TRITON ACER TENDL-2021 LIBRARY; T=0.K  
Photon emission for (n,da)

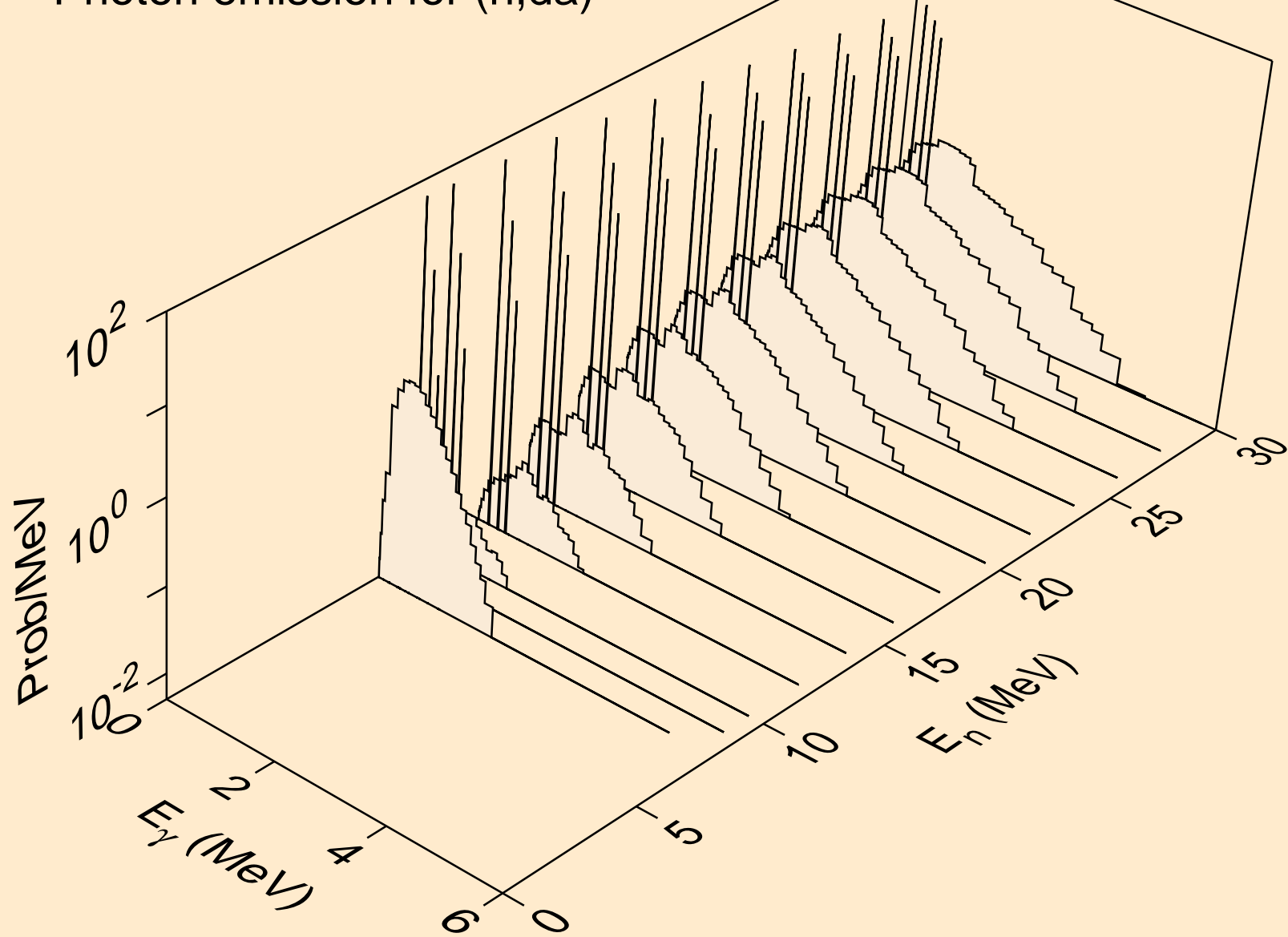

PT193M TRITON ACER TENDL-2021 LIBRARY; T=0.K  
Particle heating contributions

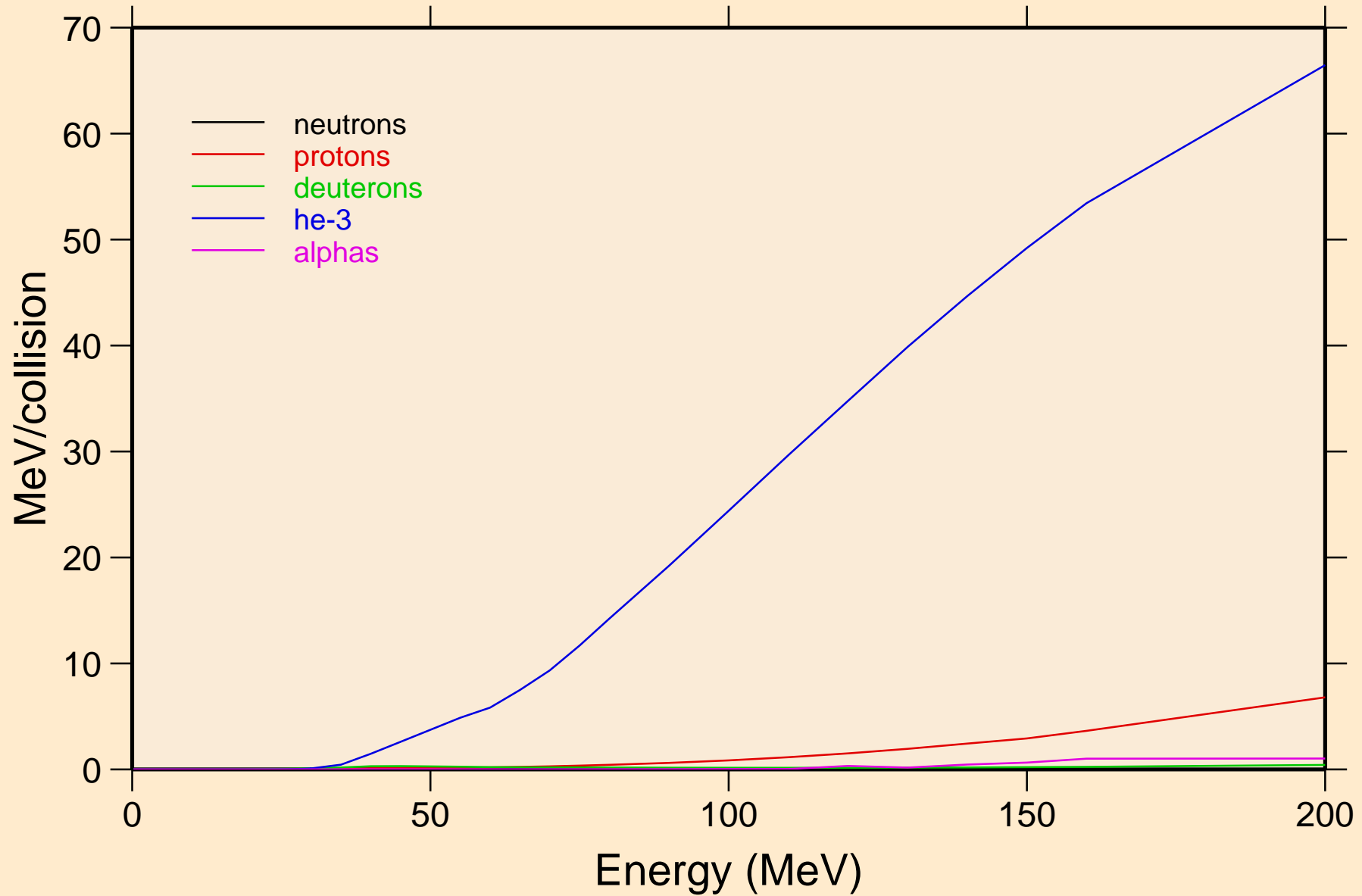

PT193M TRITON ACER TENDL-2021 LIBRARY; T=0.K  
Recoil Heating

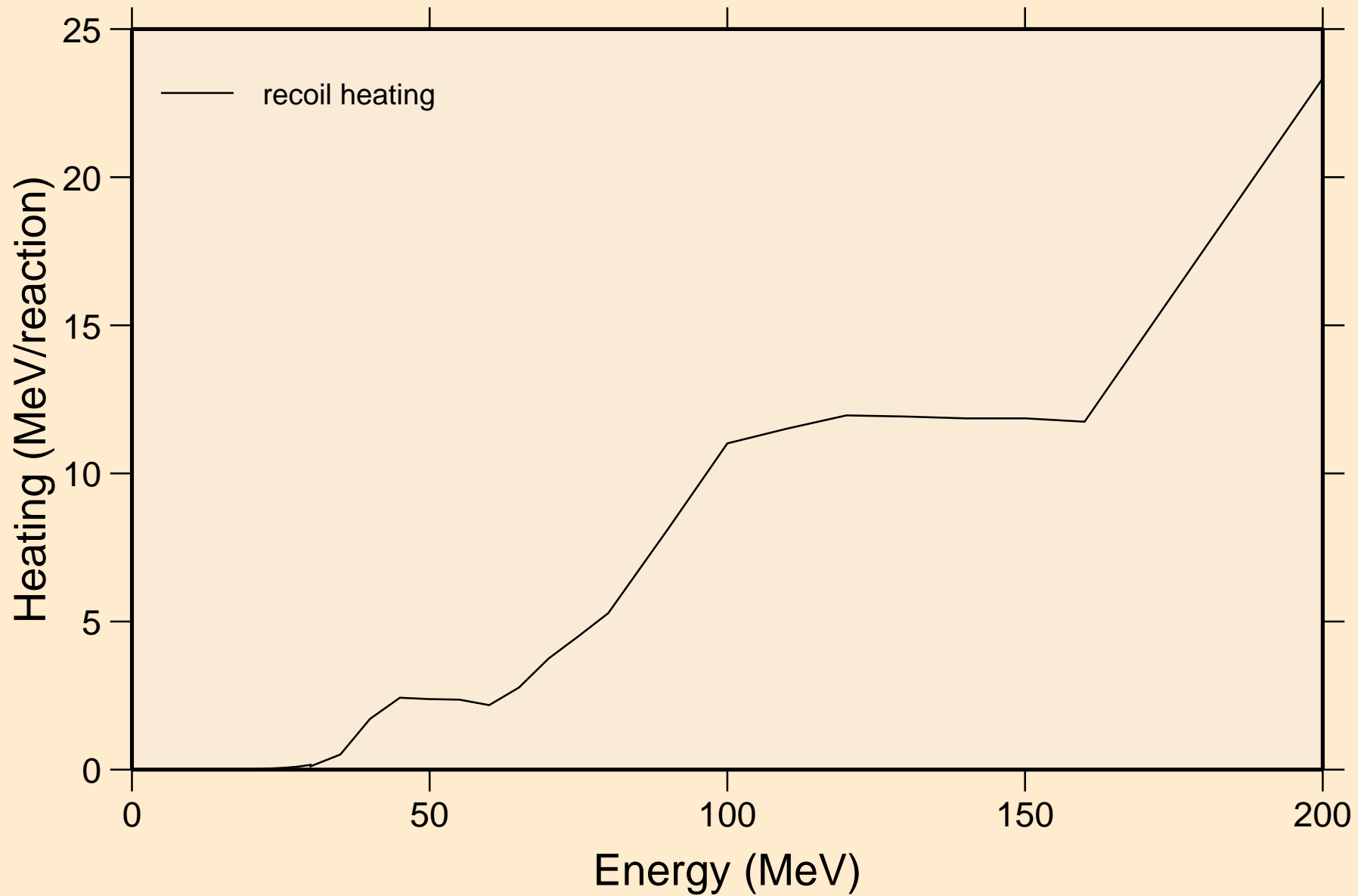

PT193M TRITON ACER TENDL-2021 LIBRARY; T=0.K  
Particle production cross sections

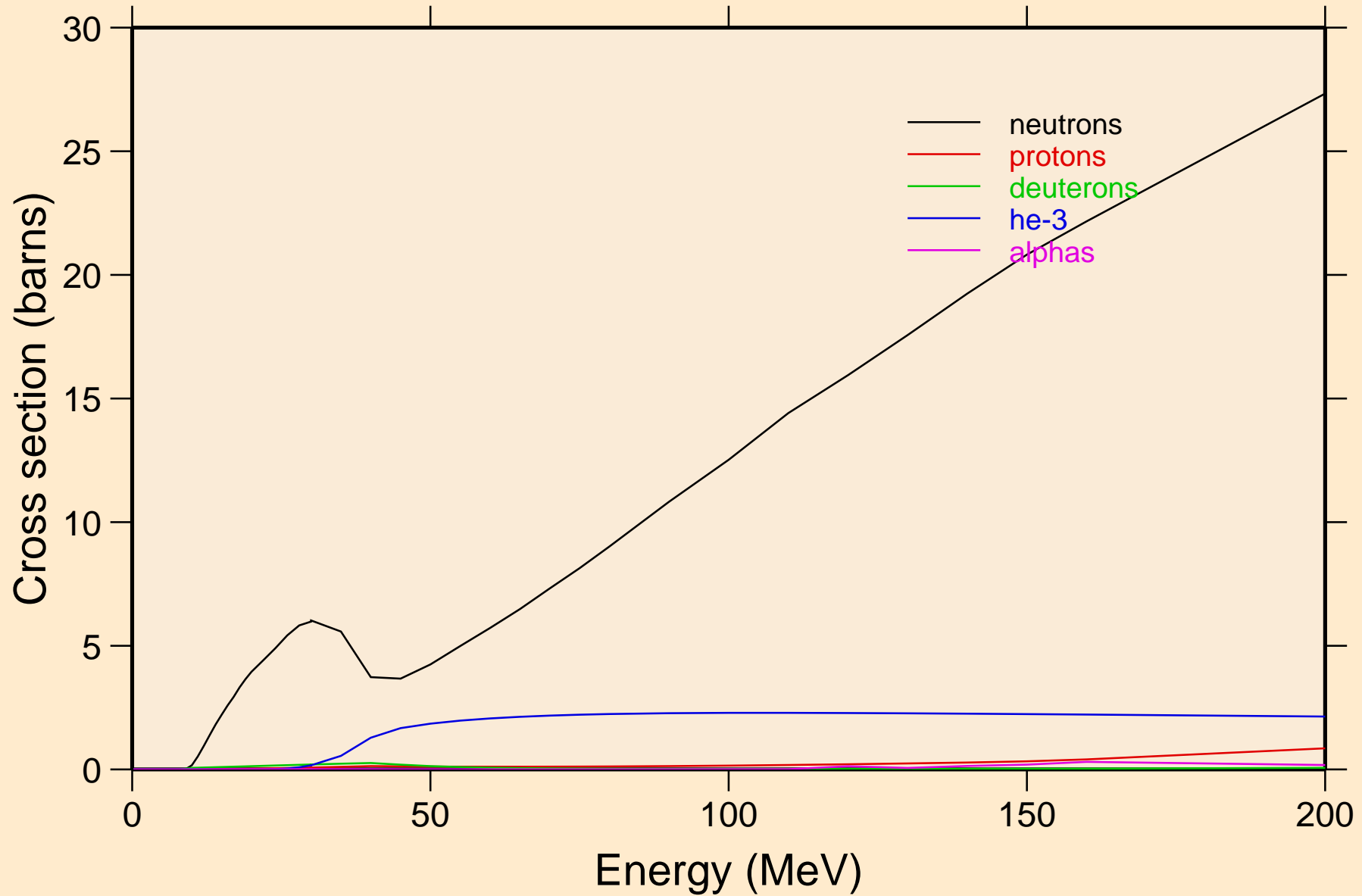

PT193M TRITON ACER TENDL-2021 LIBRARY; T=0.K  
neutrons from (t,n)

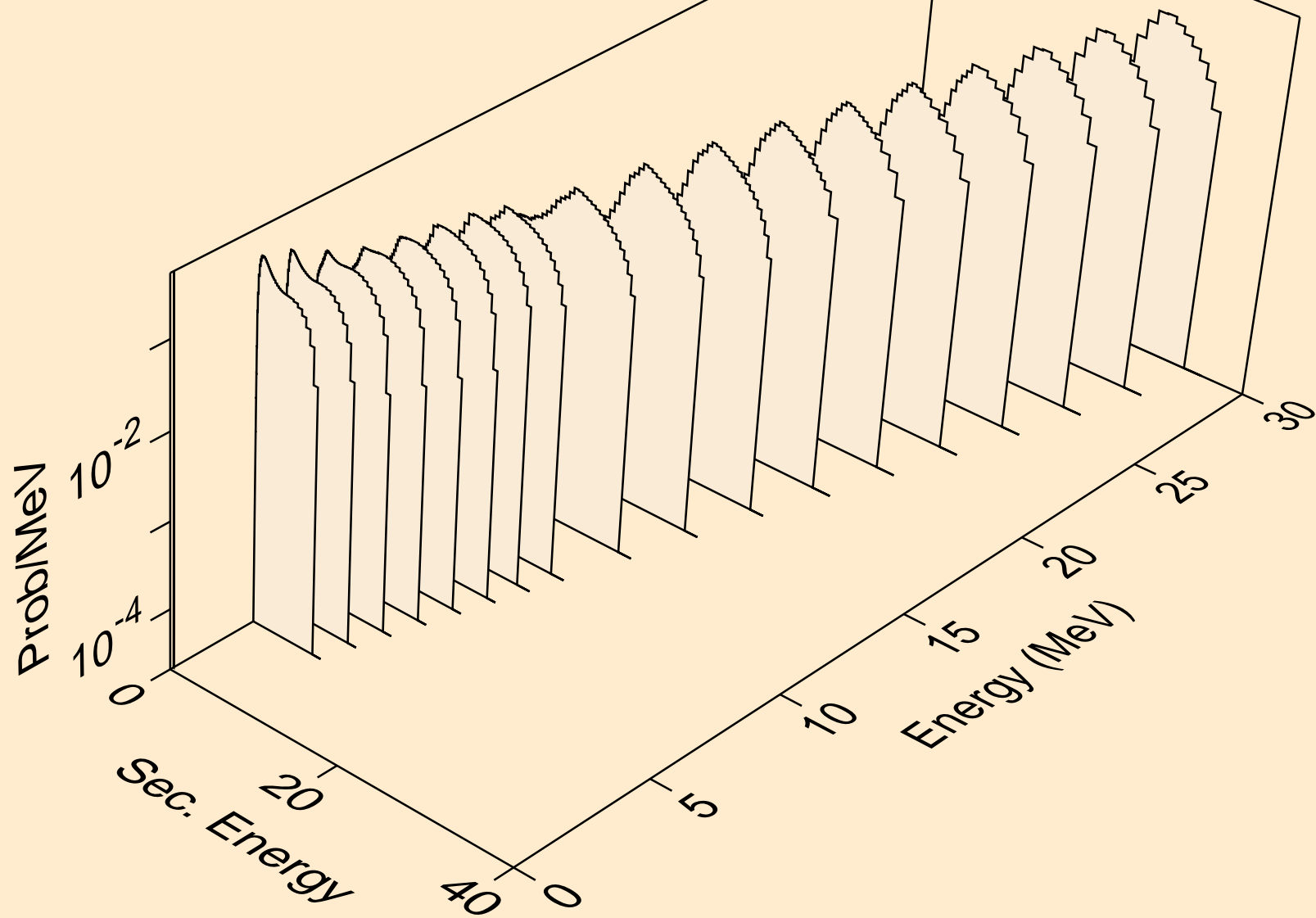

PT193M TRITON ACER TENDL-2021 LIBRARY; T=0.K  
neutrons from (t,x)

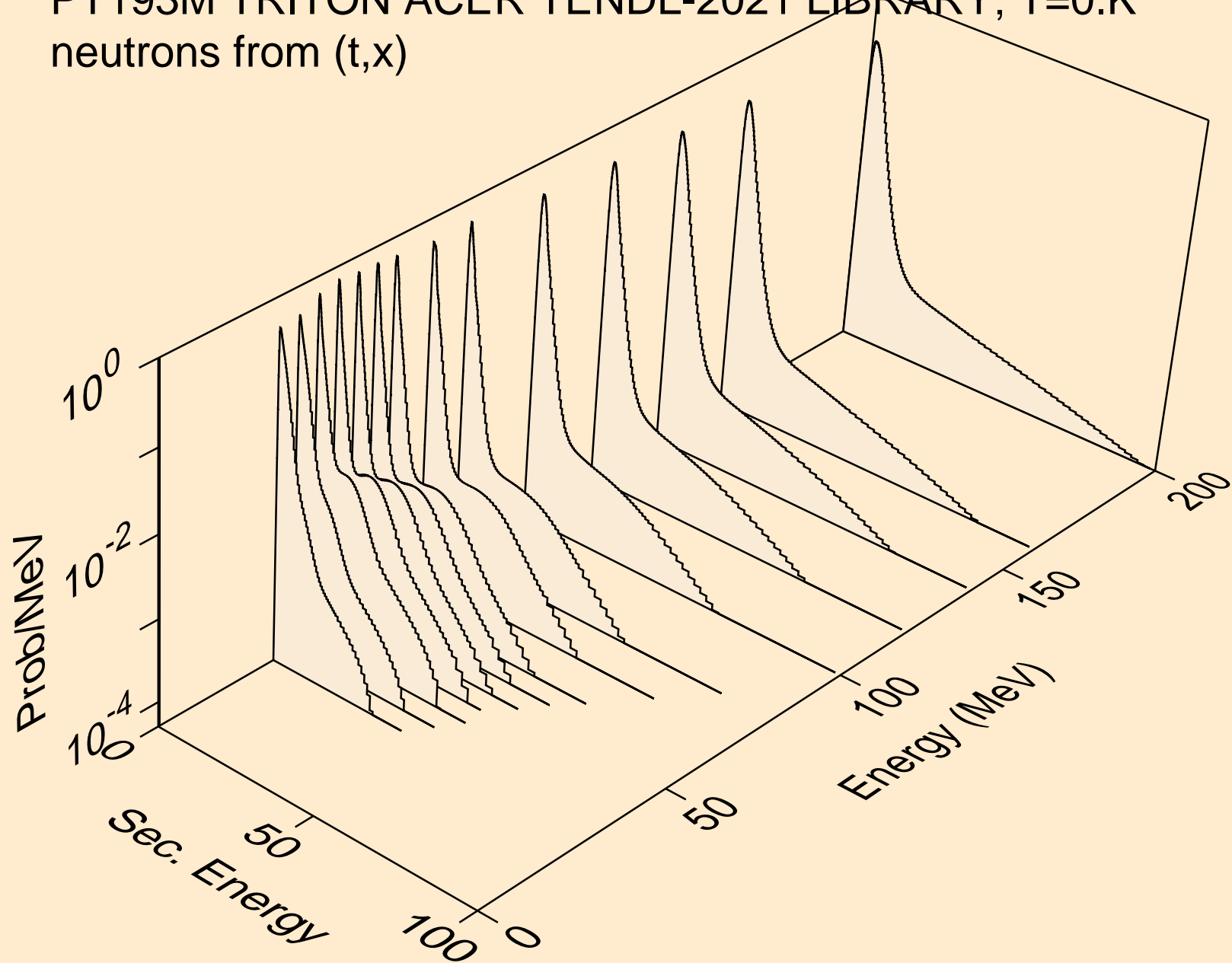



PT193M TRITON ACER TENDL-2021 LIBRARY; T=0.K  
neutrons from (t,2nd)

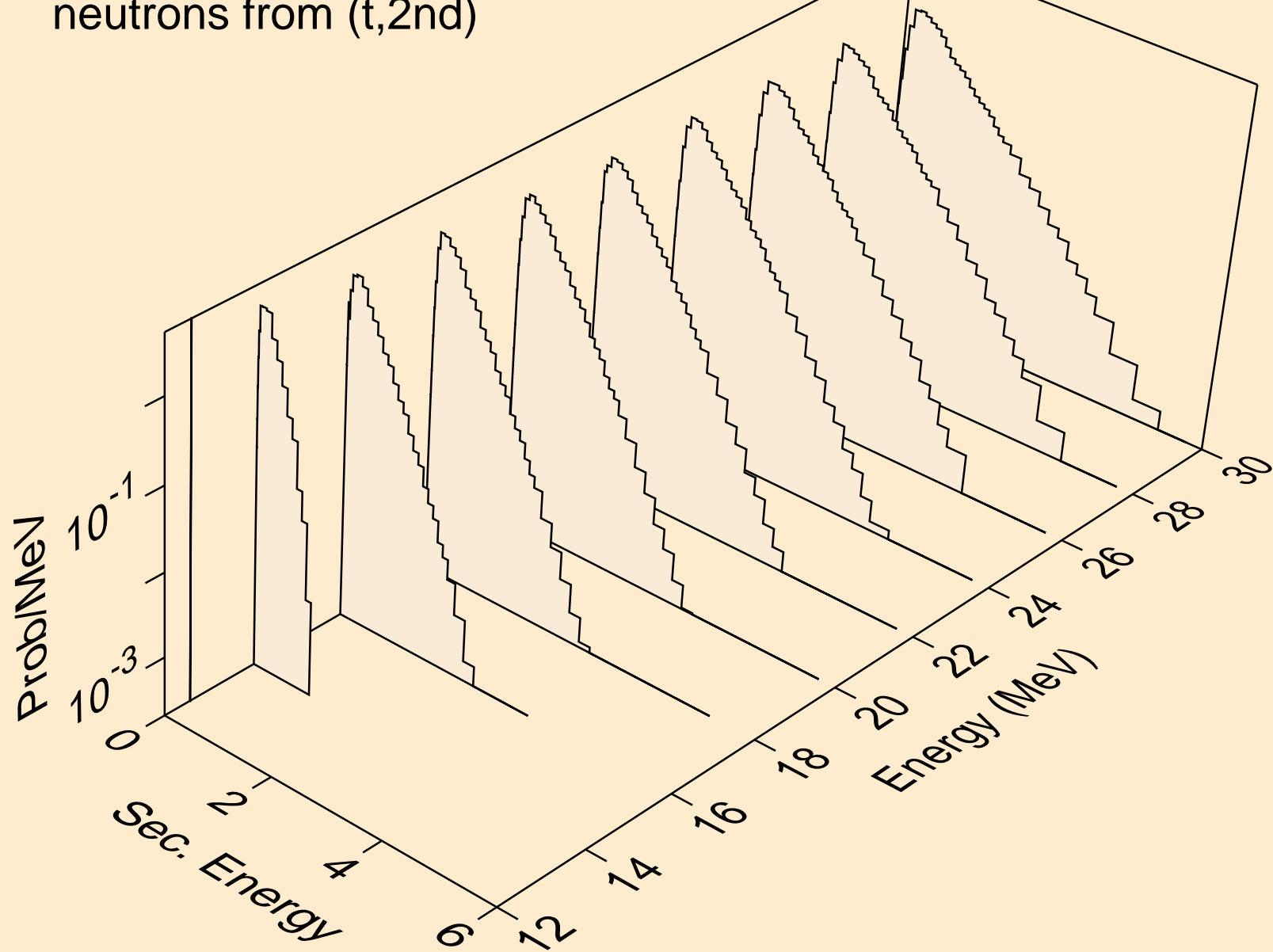

PT193M TRITON ACER TENDL-2021 LIBRARY; T=0.K  
neutrons from (t,2n)

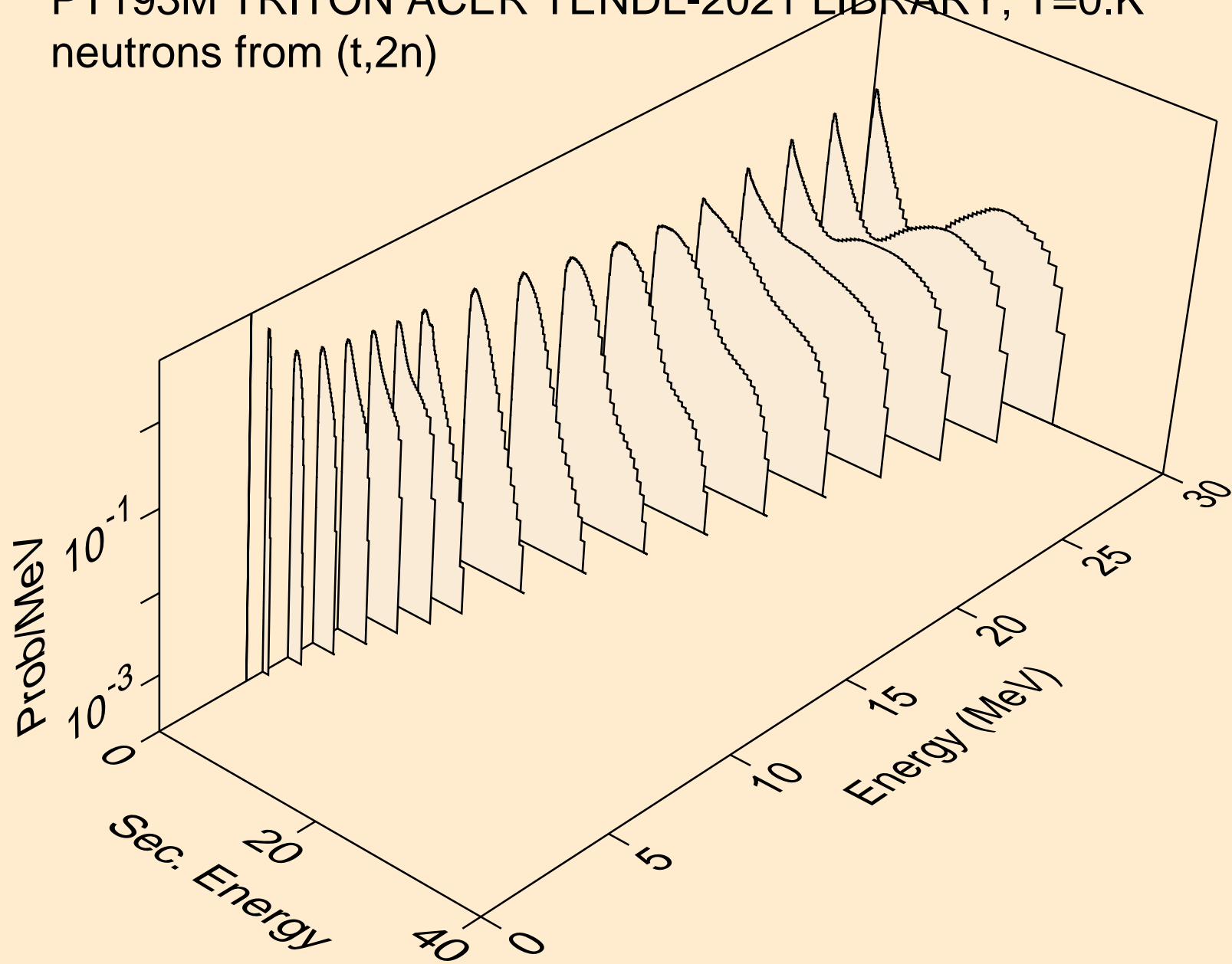

PT193M TRITON ACER TENDL-2021 LIBRARY; T=0.K  
neutrons from (t,3n)

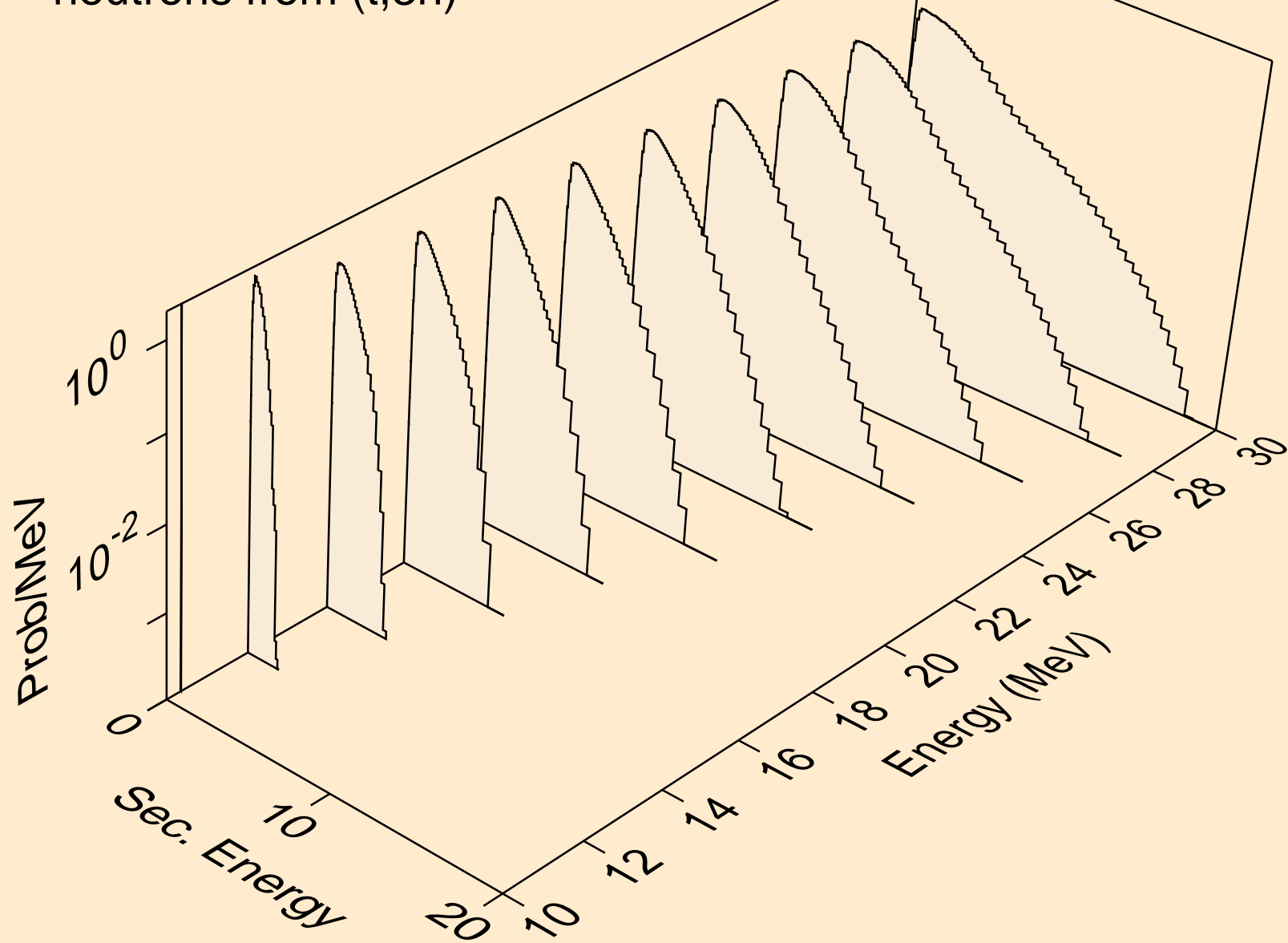

PT193M TRITON ACER TENDL-2021 LIBRARY; T=0.K  
neutrons from (t,n\*)a

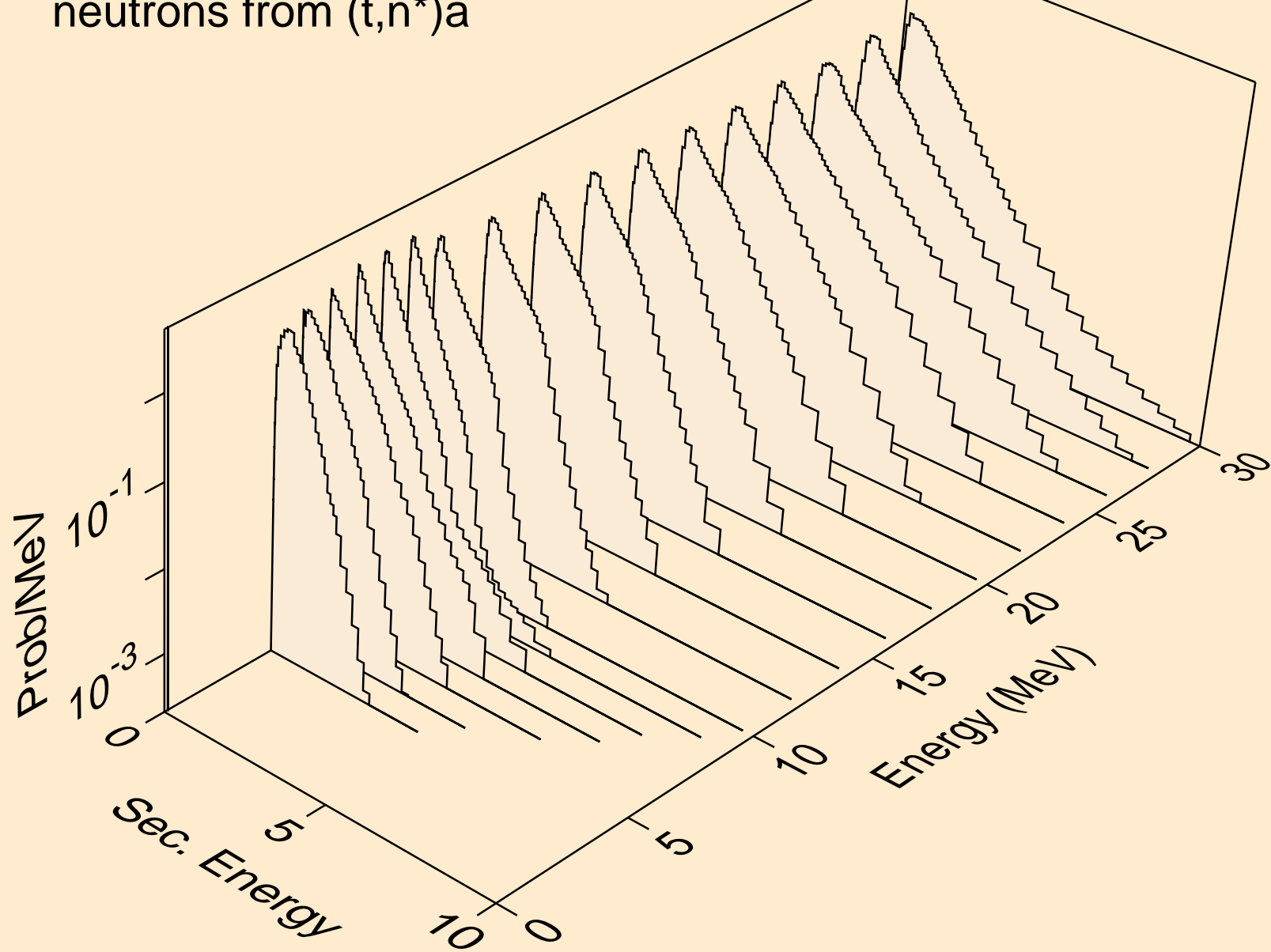

PT193M TRITON ACER TENDL-2021 LIBRARY; T=0.K  
neutrons from (t,2n)a

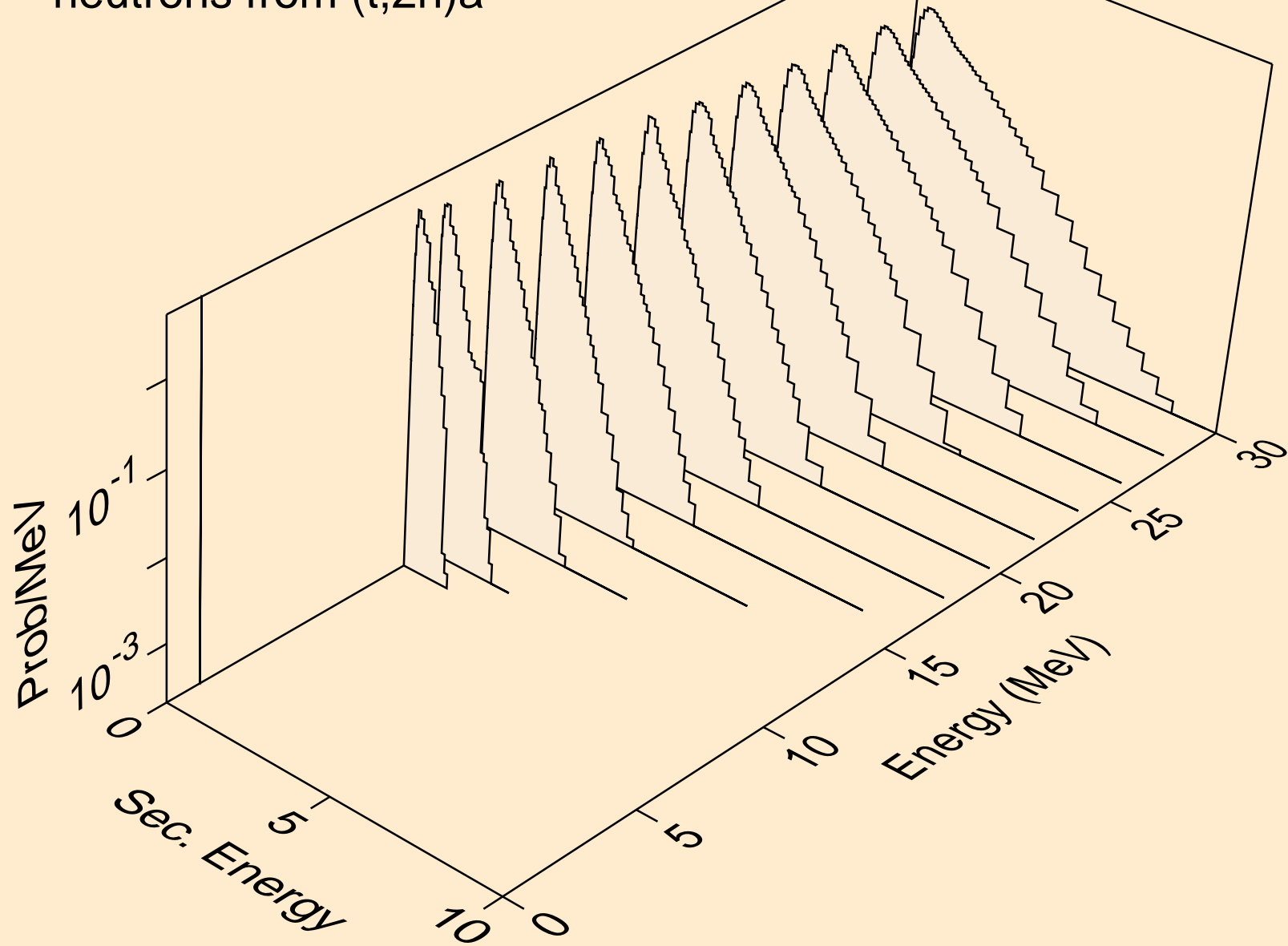

PT193M TRITON ACER TENDL-2021 LIBRARY; T=0.K  
neutrons from (t,3n)a

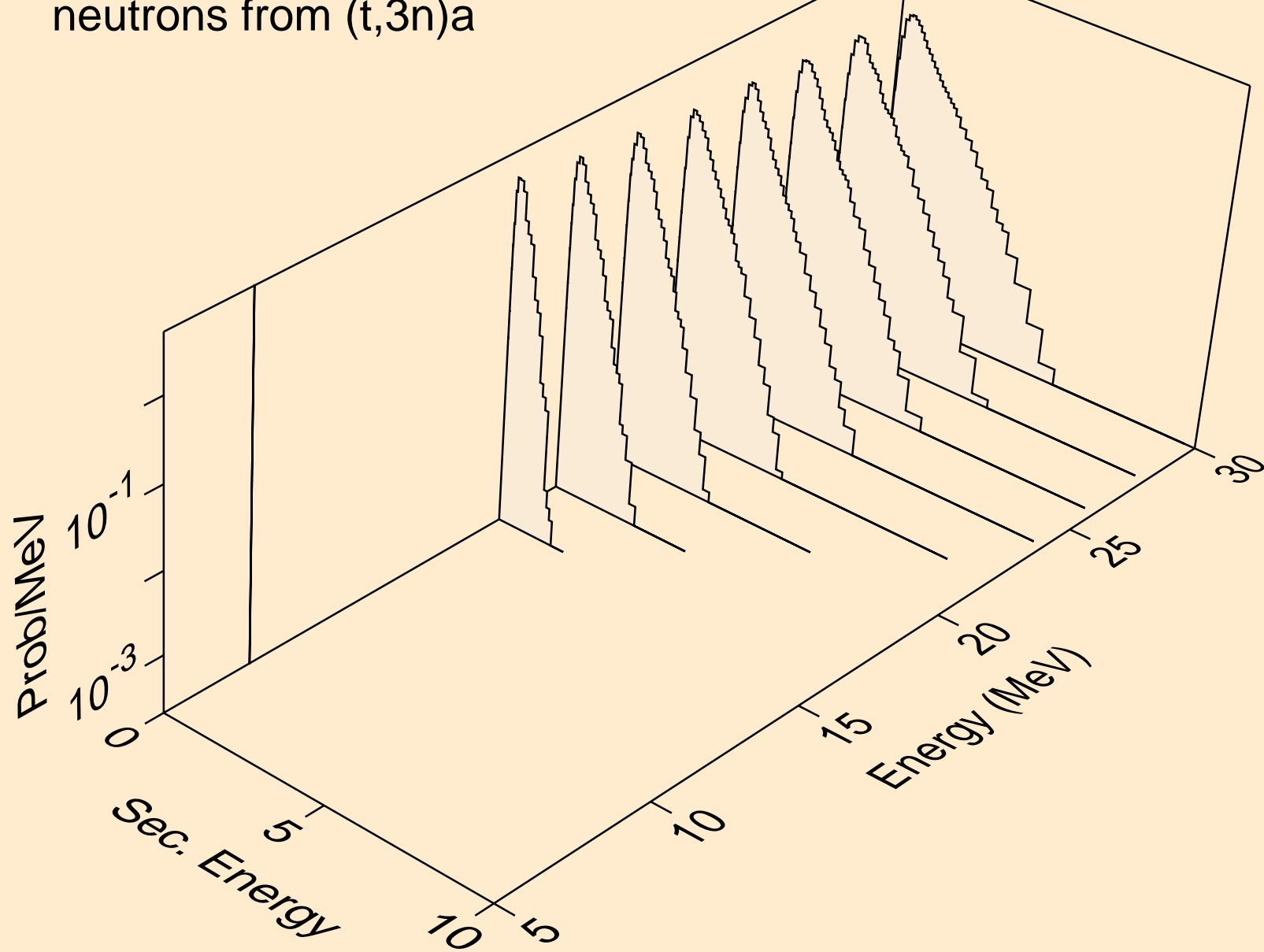

PT193M TRITON ACER TENDL-2021 LIBRARY; T=0.K  
neutrons from (t,n\*)p

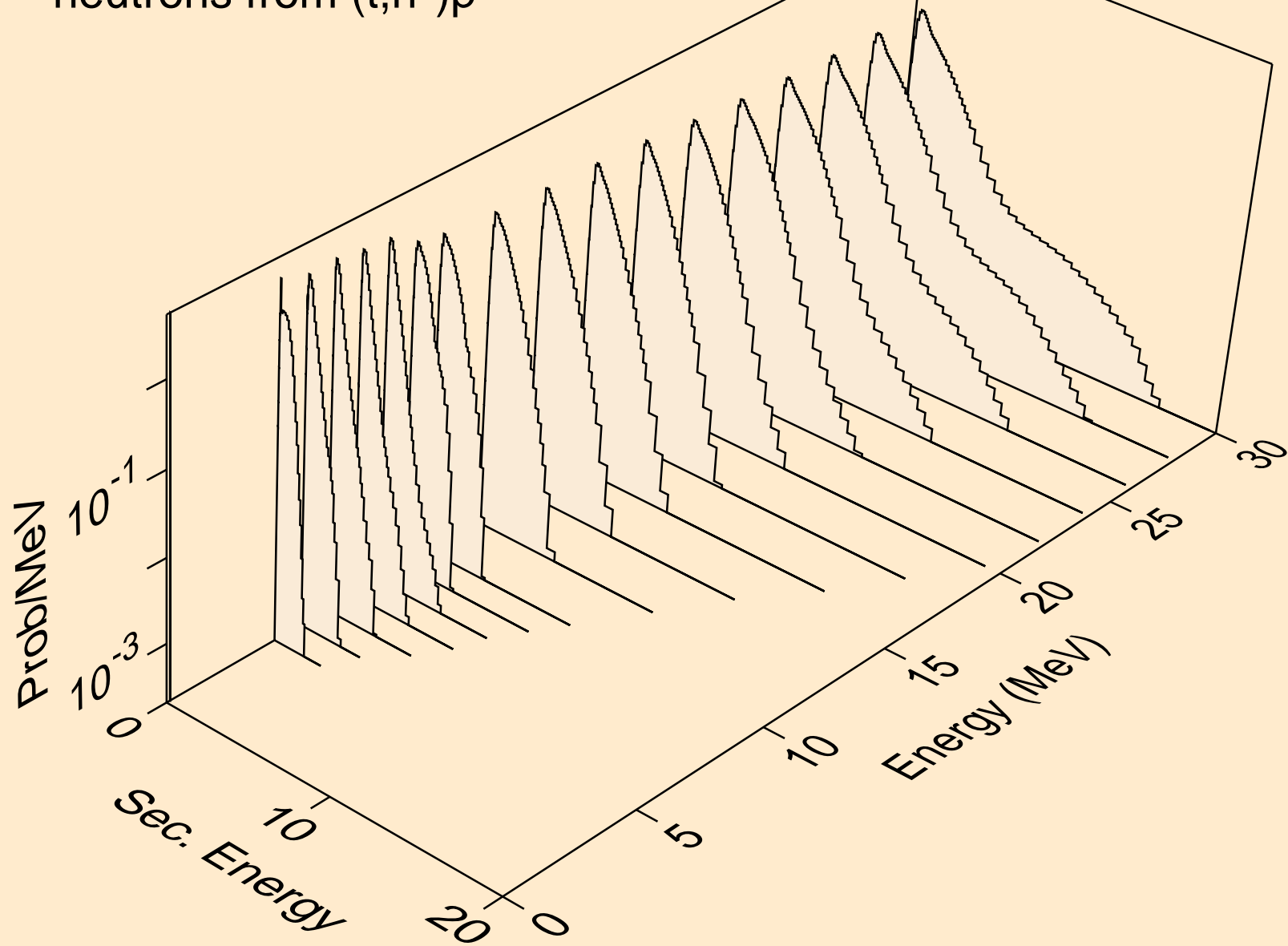

PT193M TRITON ACER TENDL-2021 LIBRARY; T=0.K  
neutrons from (t,n\*)2a

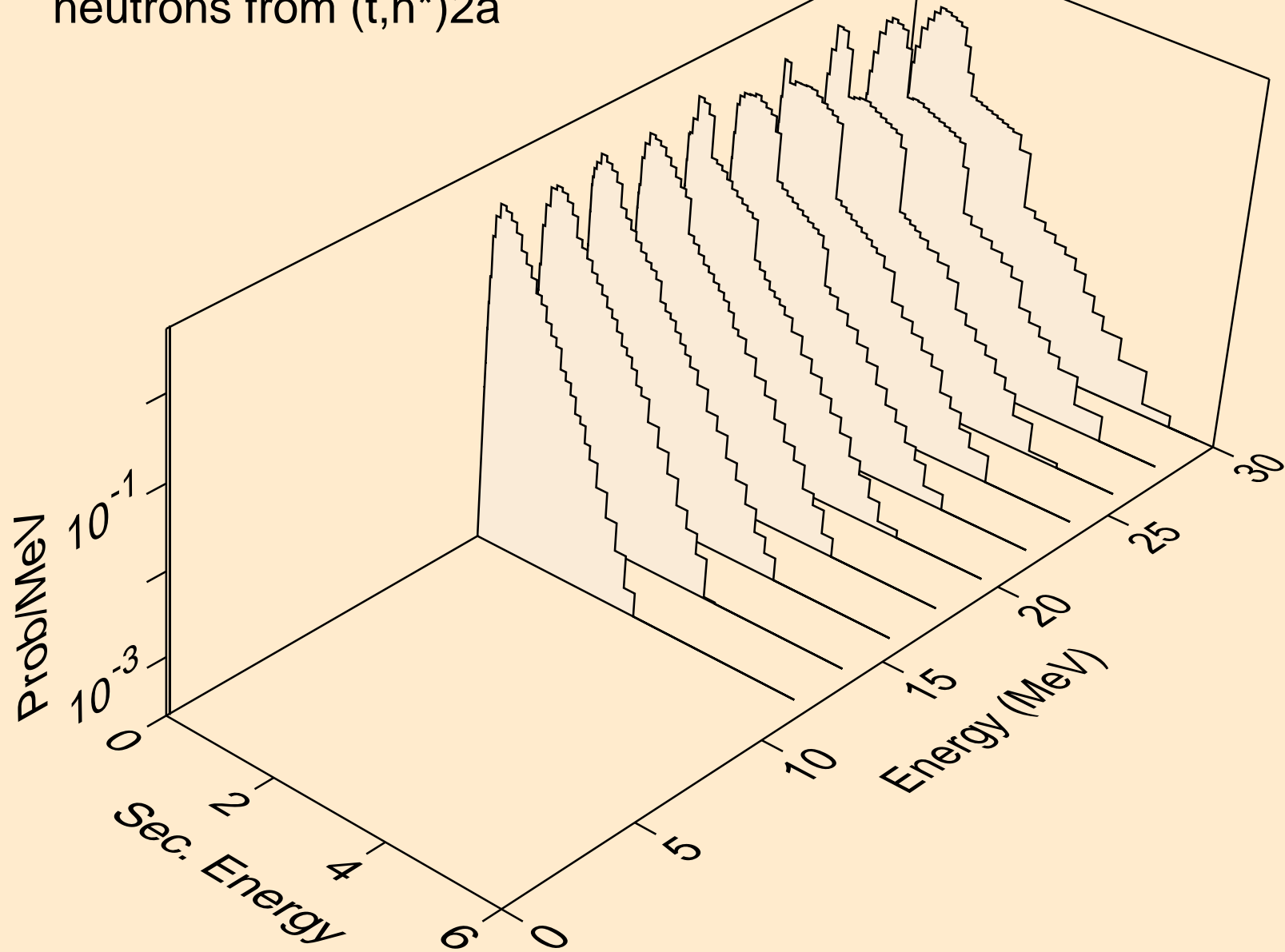



PT193M TRITON ACER TENDL-2021 LIBRARY; T=0.K  
neutrons from (t,n\*)d

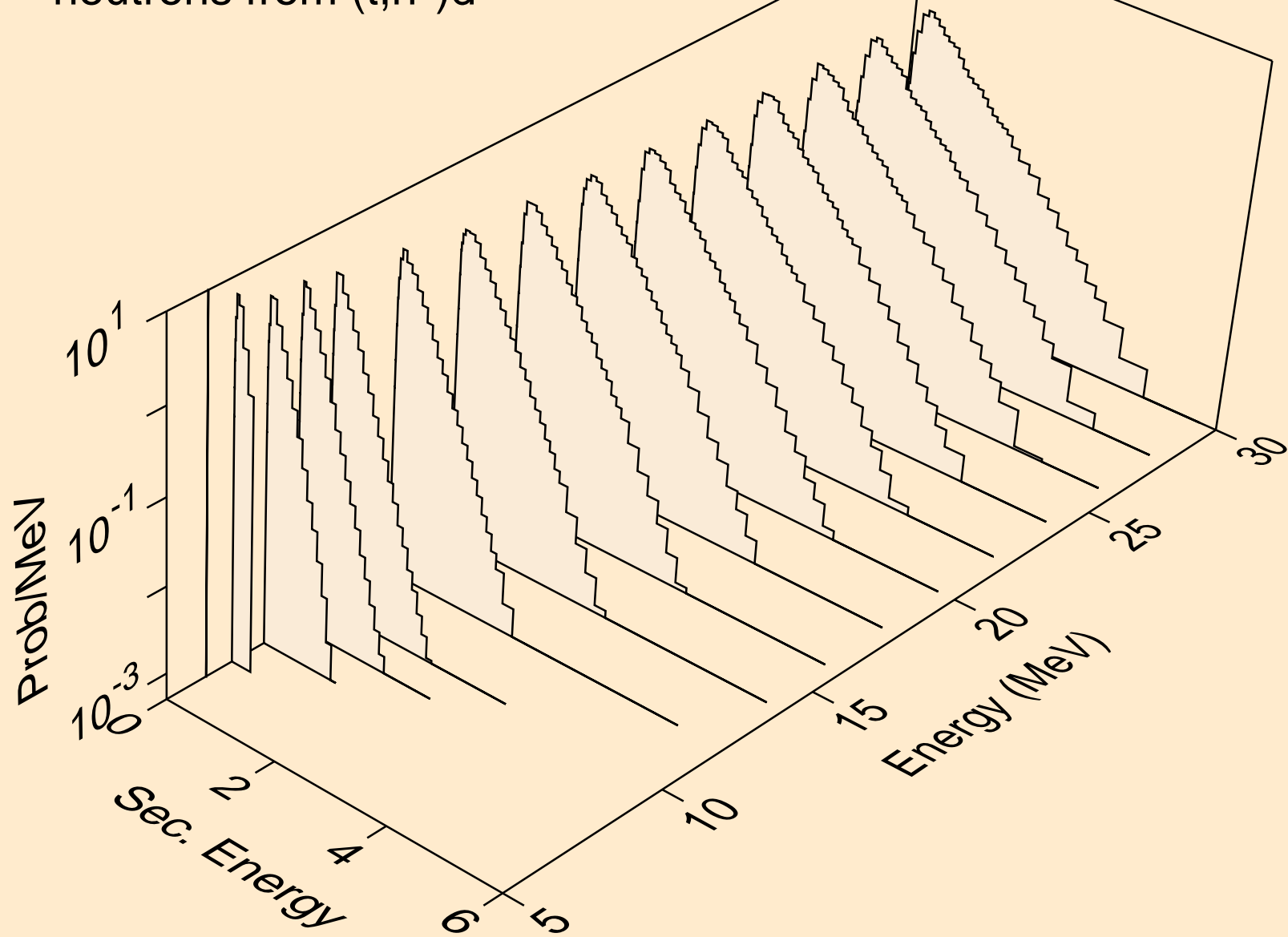

PT193M TRITON ACER TENDL-2021 LIBRARY; T=0.K  
neutrons from (t,n\*)t

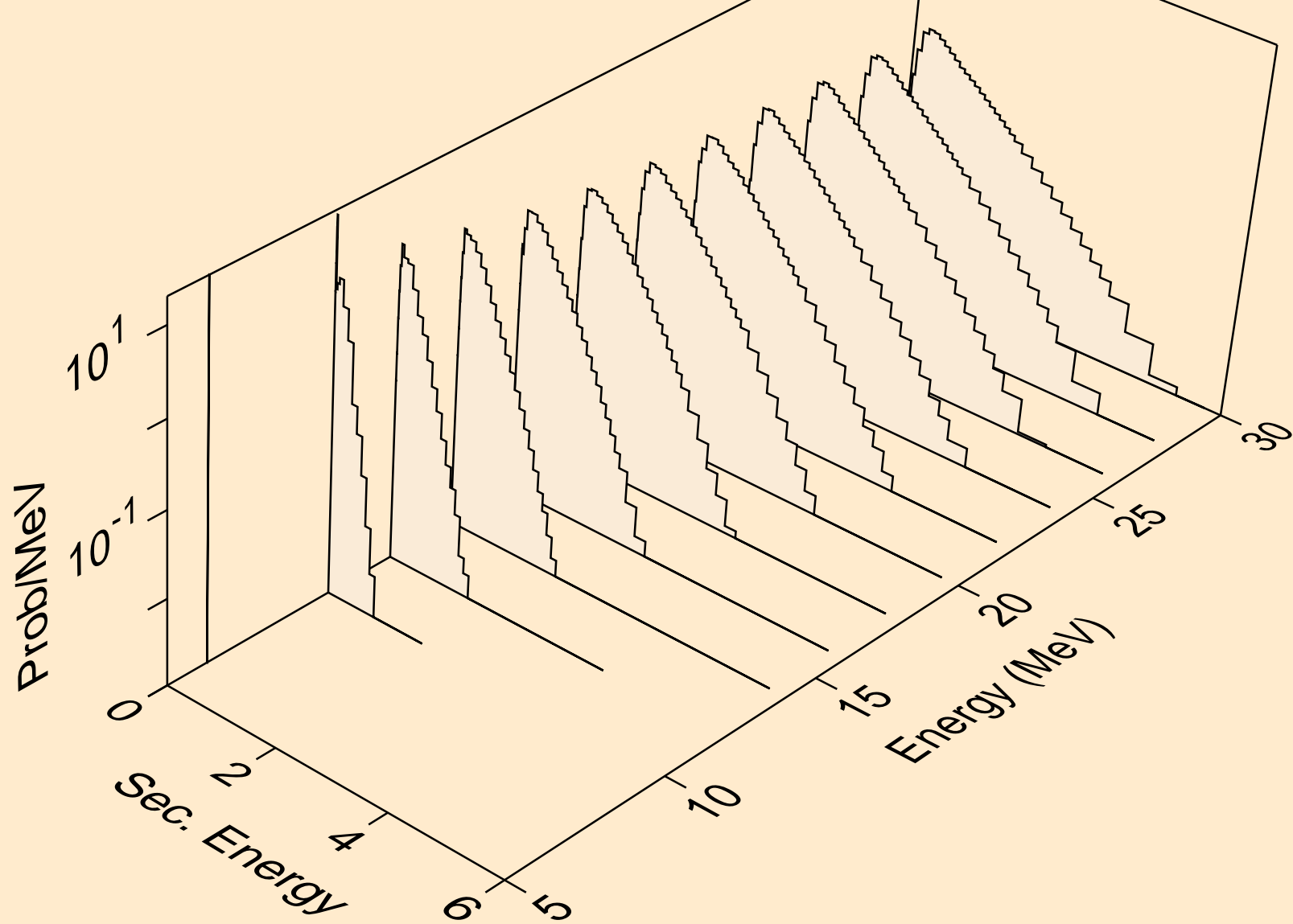

PT193M TRITON ACER TENDL-2021 LIBRARY; T=0.K  
neutrons from (t,n\*)he3

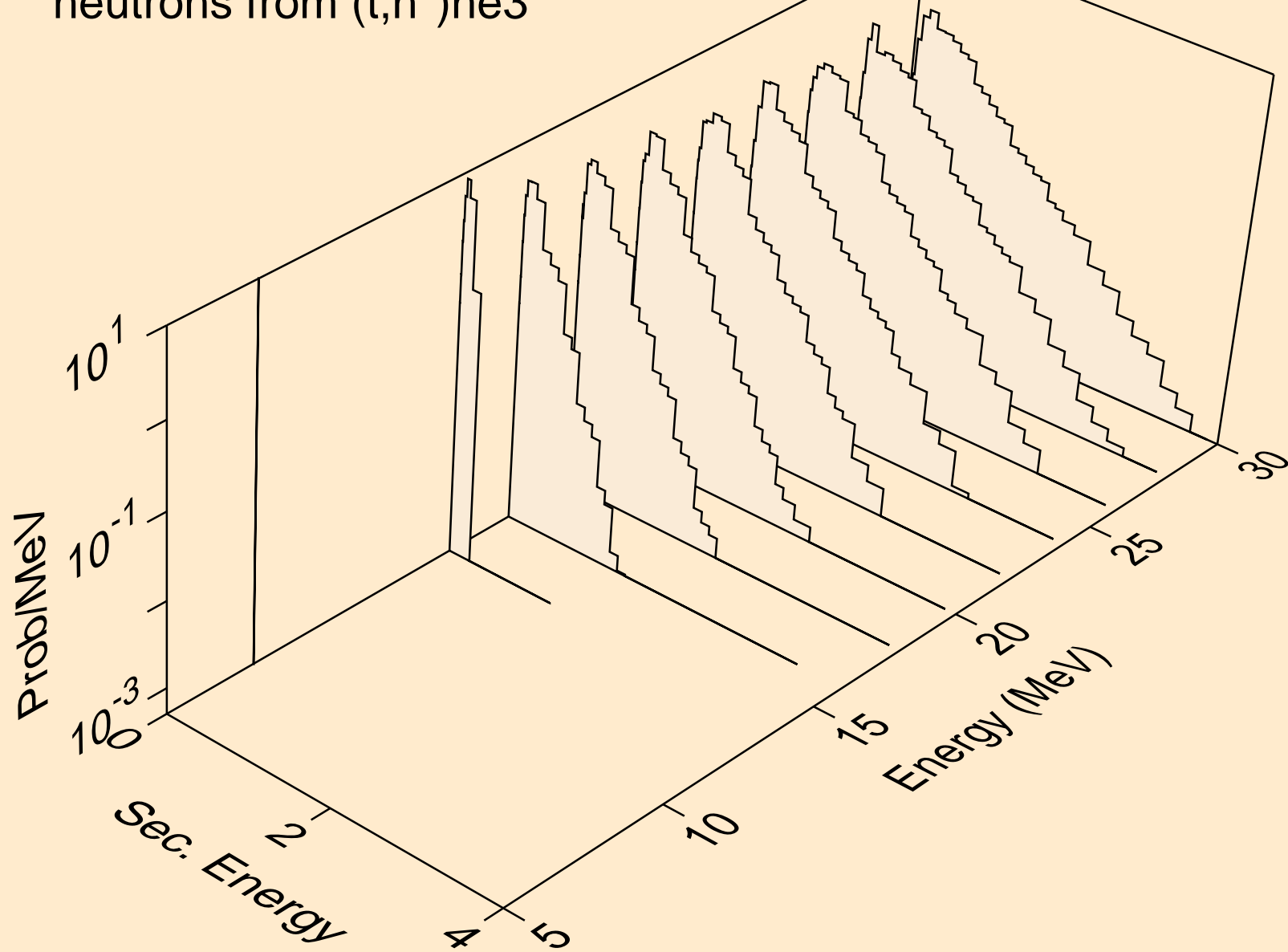

PT193M TRITON ACER TENDL-2021 LIBRARY; T=0.K  
neutrons from (t,4n)

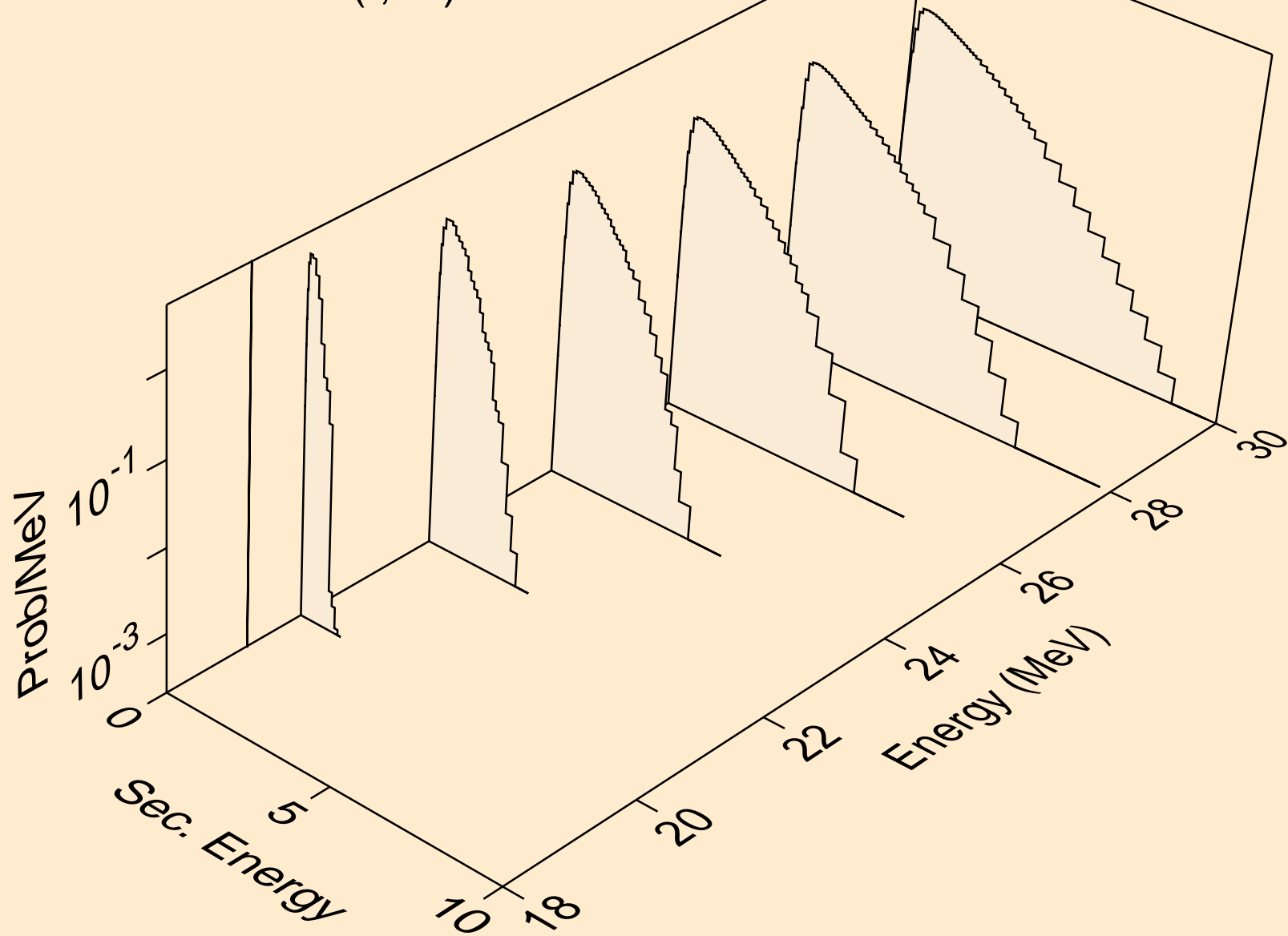

PT193M TRITON ACER TENDL-2021 LIBRARY; T=0.K  
neutrons from (t,2np)

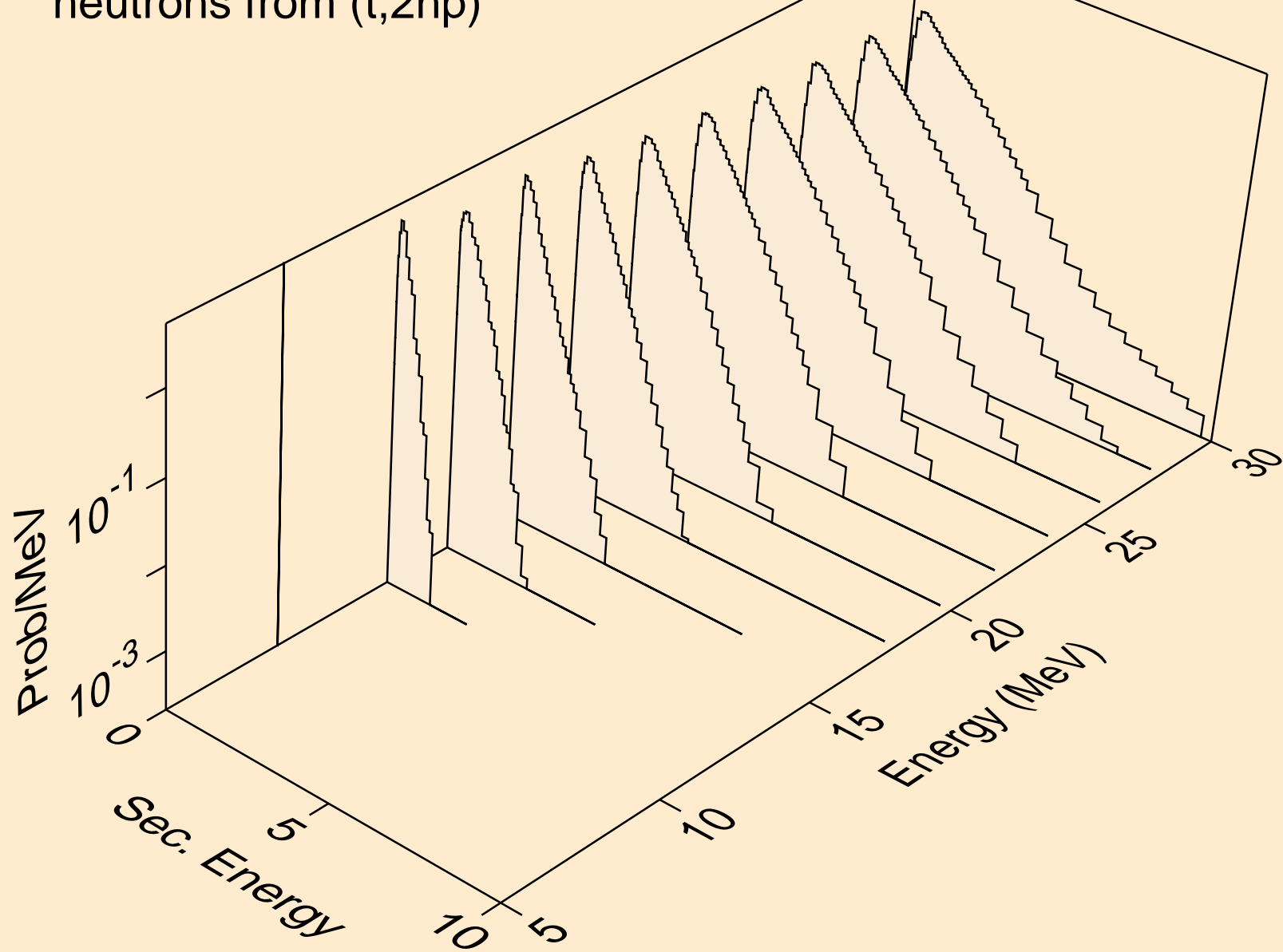

PT193M TRITON ACER TENDL-2021 LIBRARY; T=0.K  
neutrons from (t,3np)

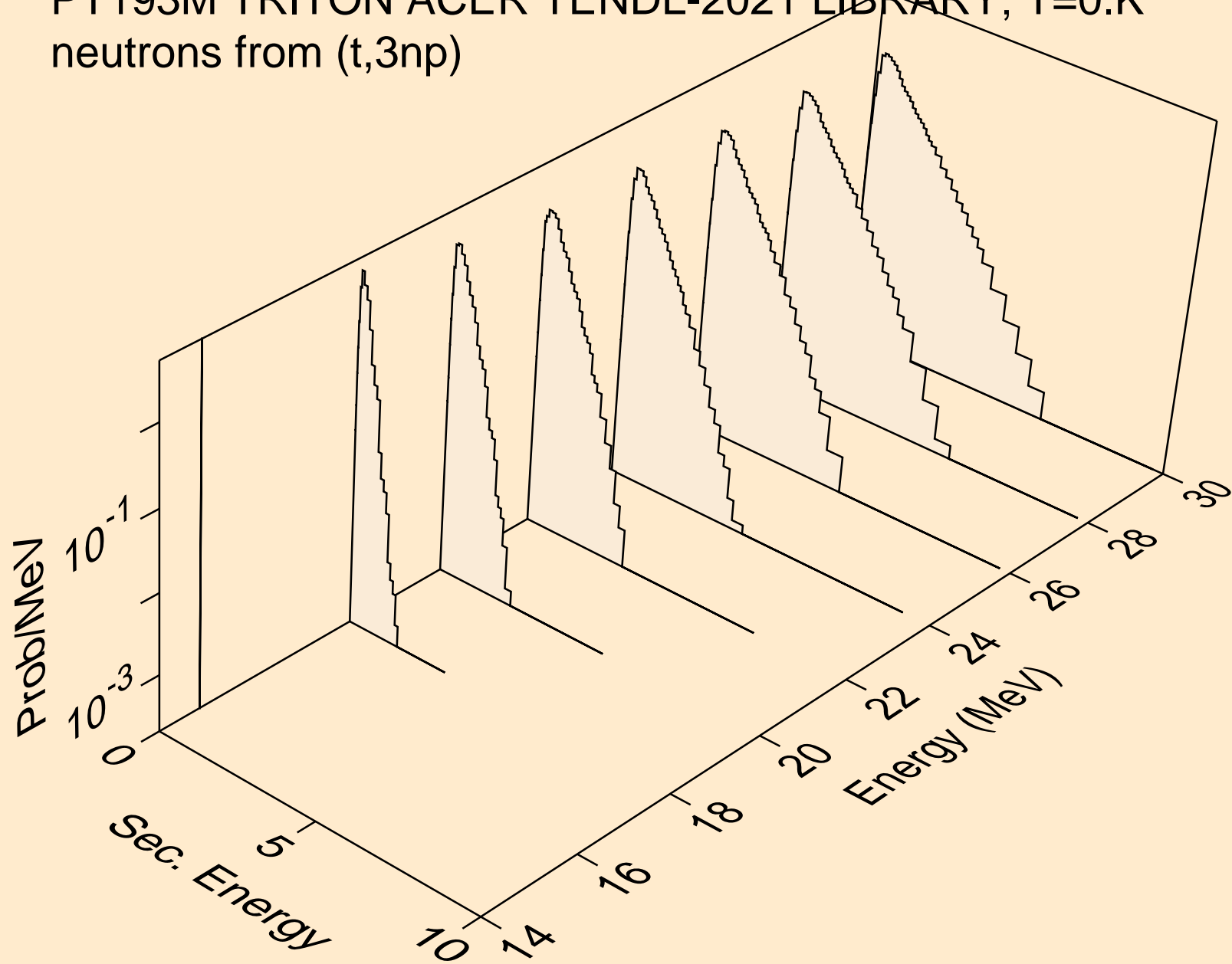

PT193M TRITON ACER TENDL-2021 LIBRARY; T=0.K  
neutrons from (t,2np)

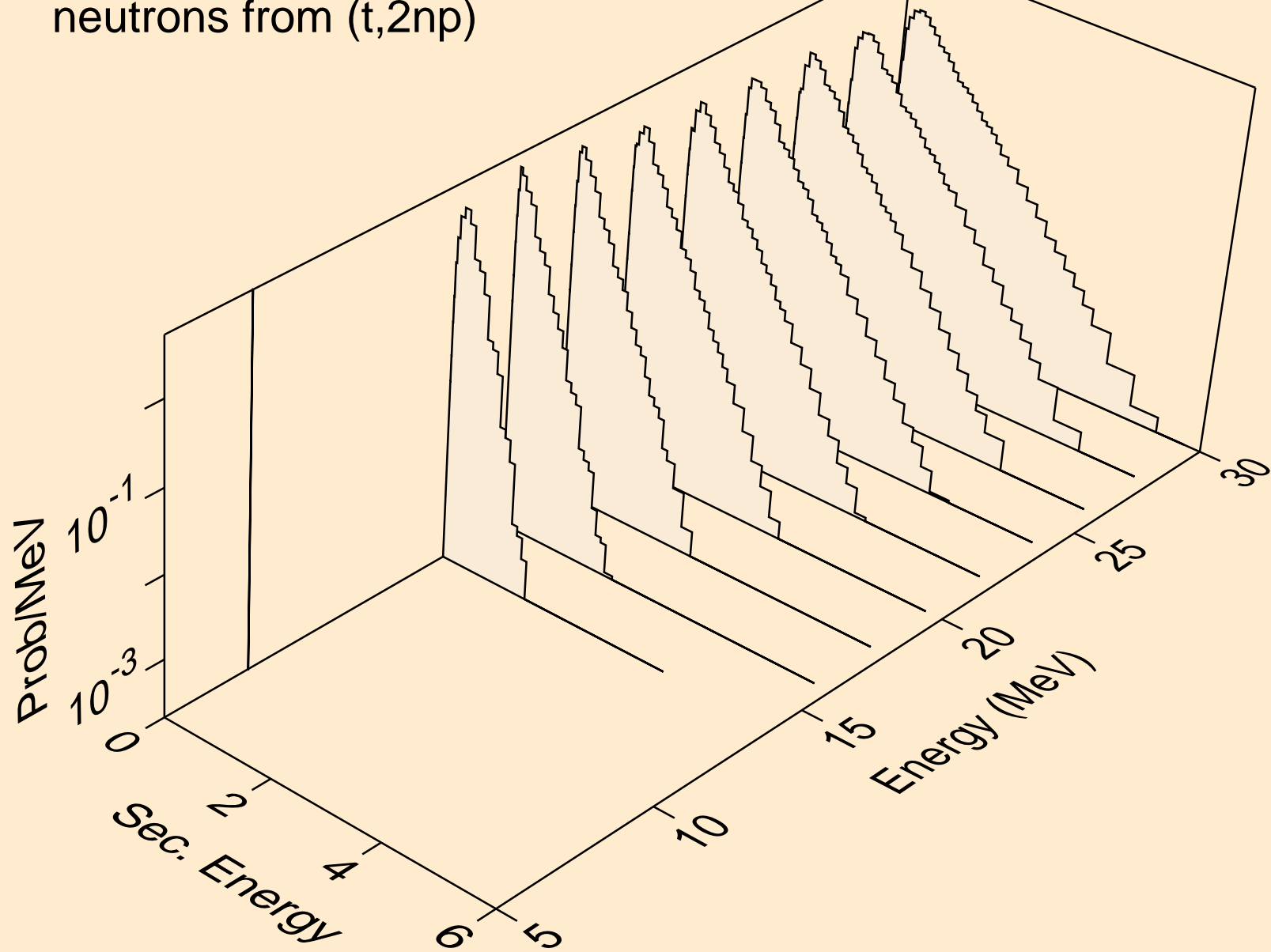

PT193M TRITON ACER TENDL-2021 LIBRARY; T=0.K  
neutrons from (t,npa)

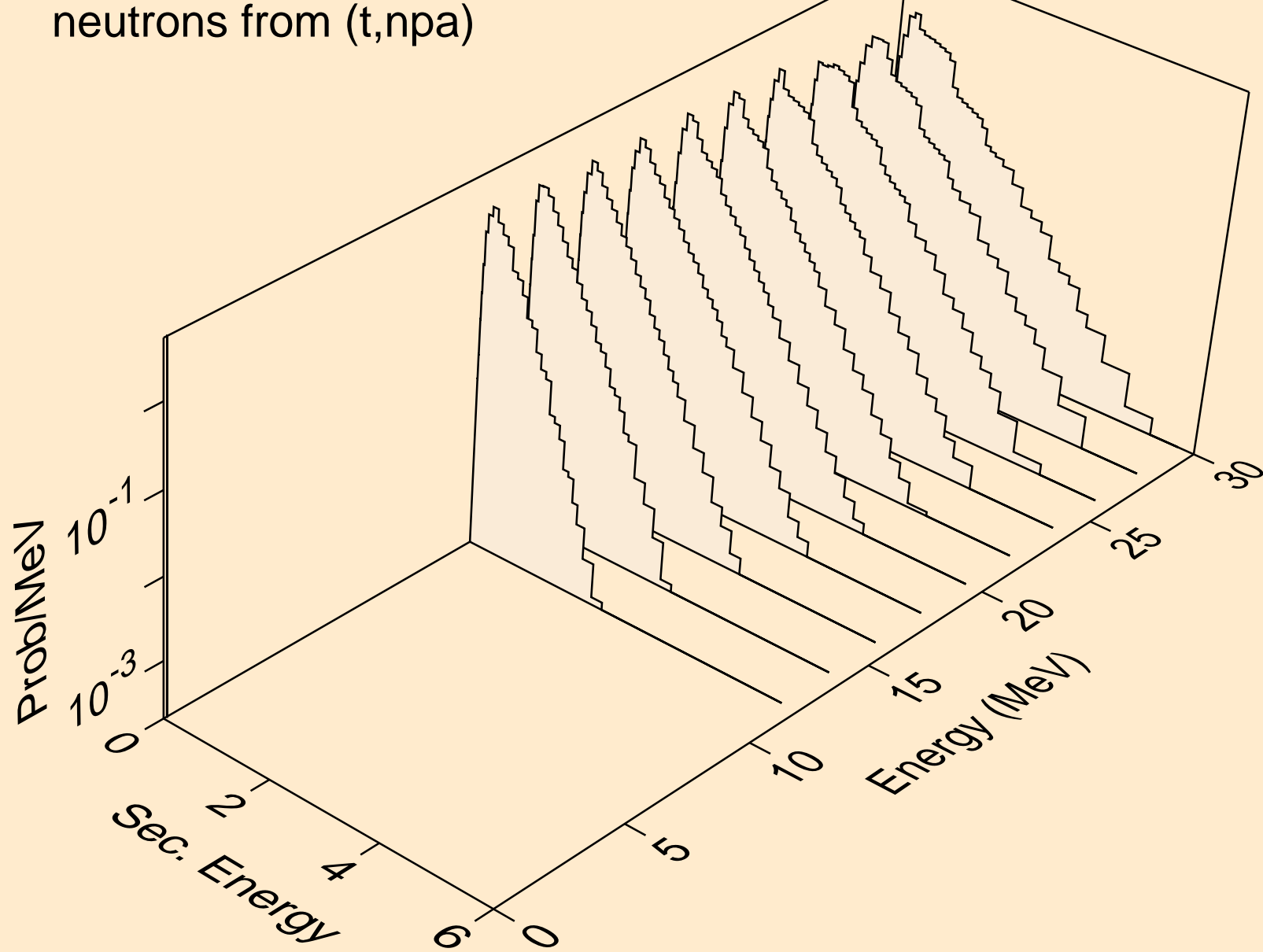



PT193M TRITON ACER TENDL-2021 LIBRARY; T=0.K  
protons from (t,x)

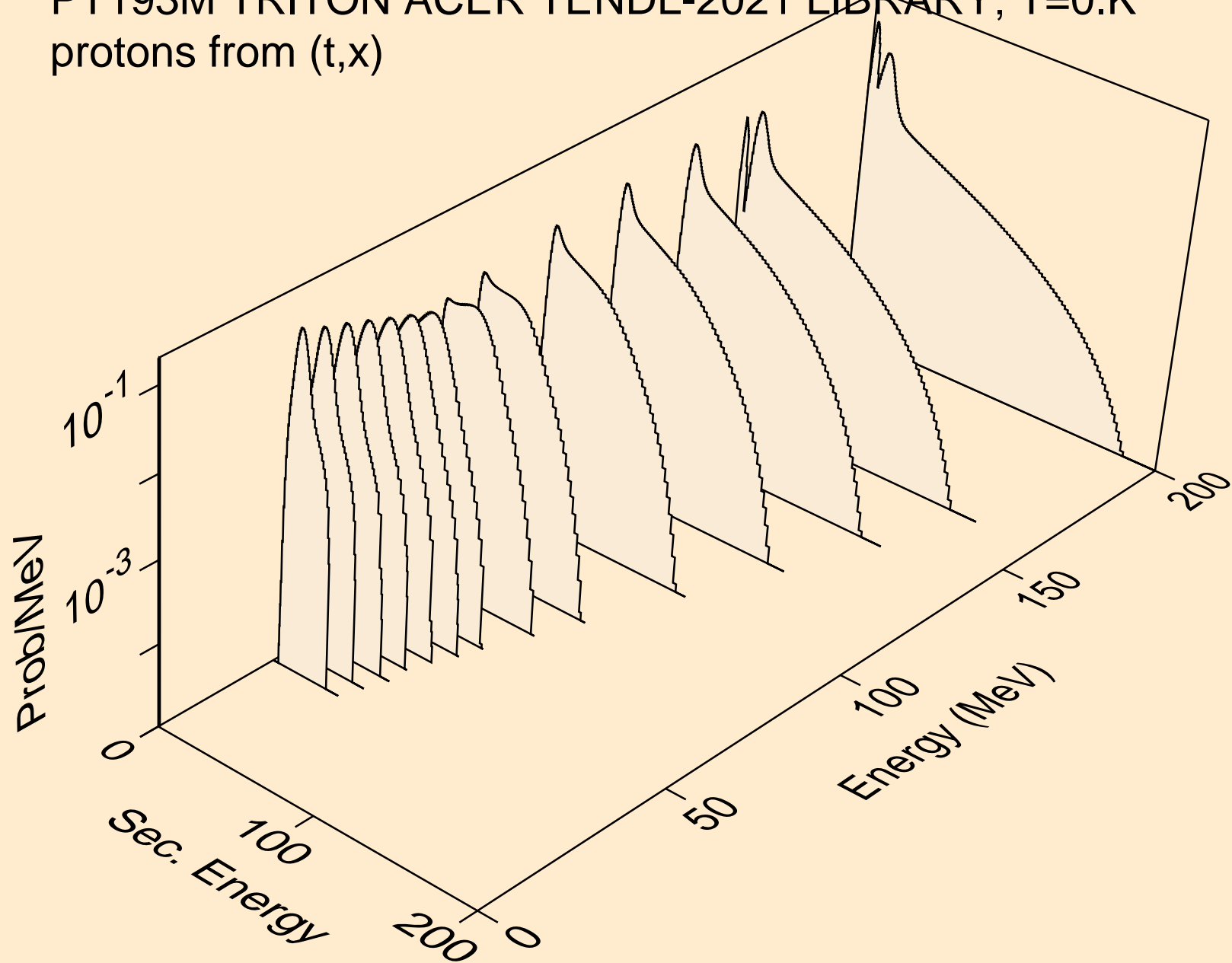

PT193M TRITON ACER TENDL-2021 LIBRARY; T=0.K  
protons from (t,n\*)p

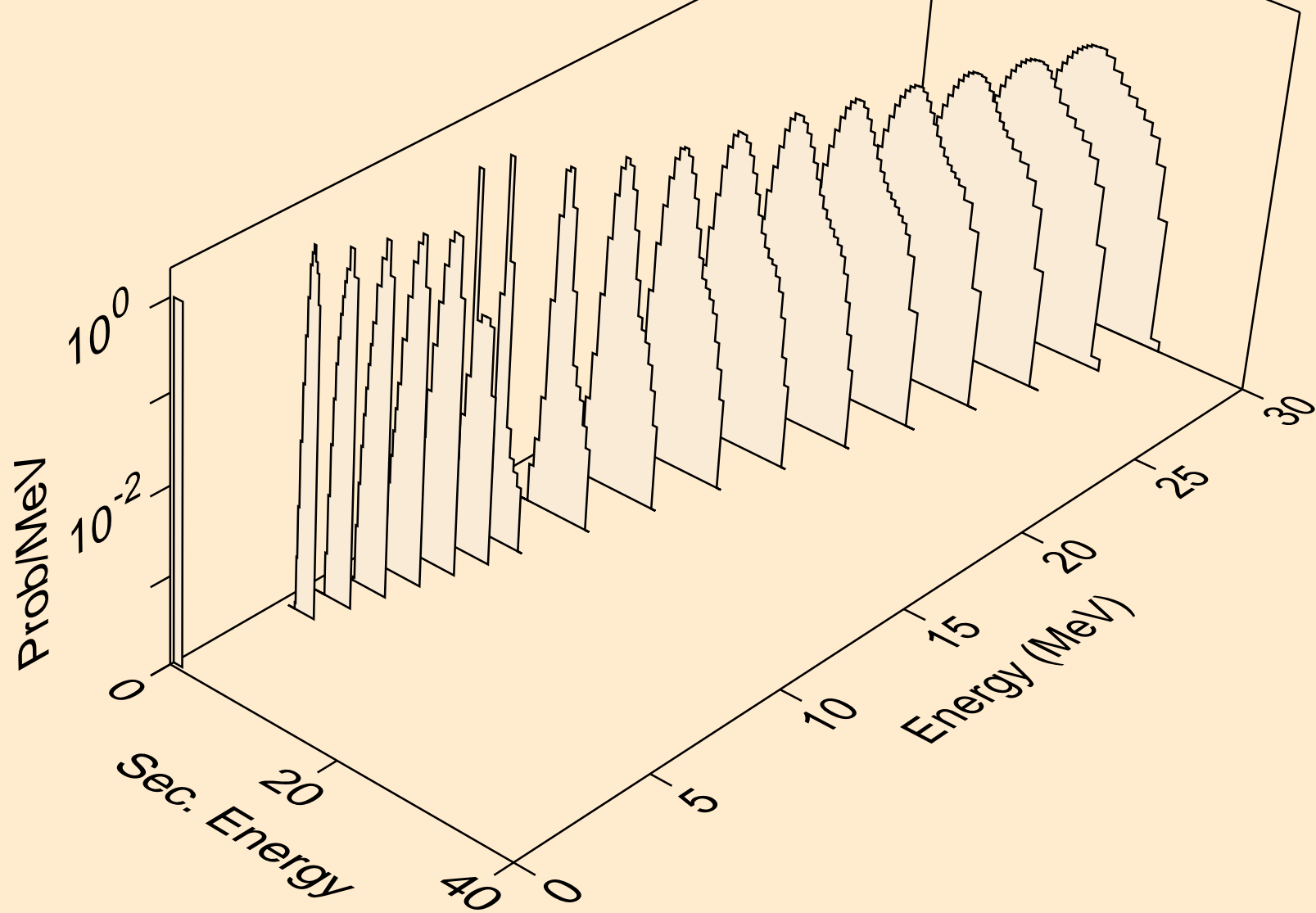

PT193M TRITON ACER TENDL-2021 LIBRARY; T=0.K  
protons from (t,2np)

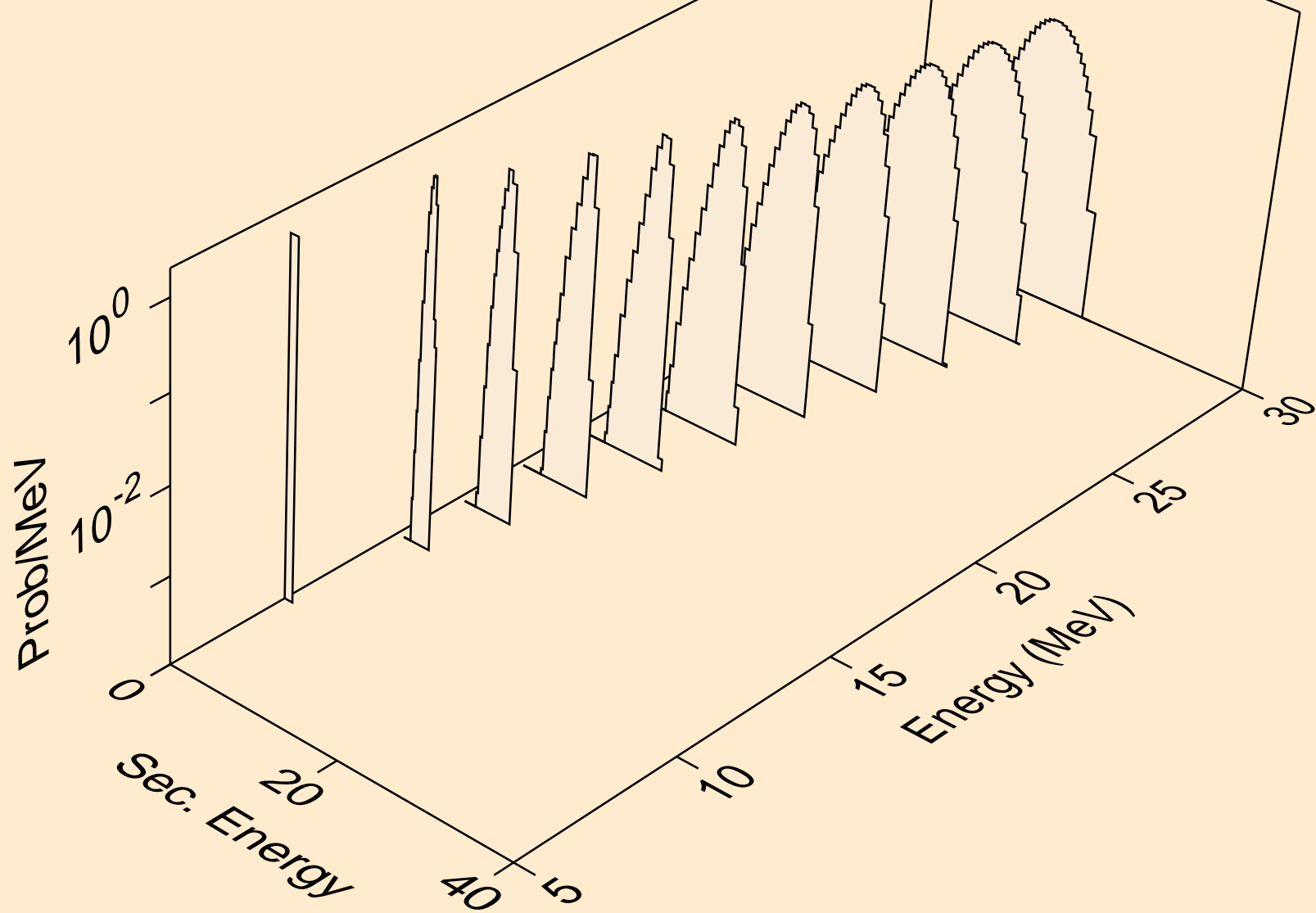

PT193M TRITON ACER TENDL-2021 LIBRARY; T=0.K  
protons from (t,3np)

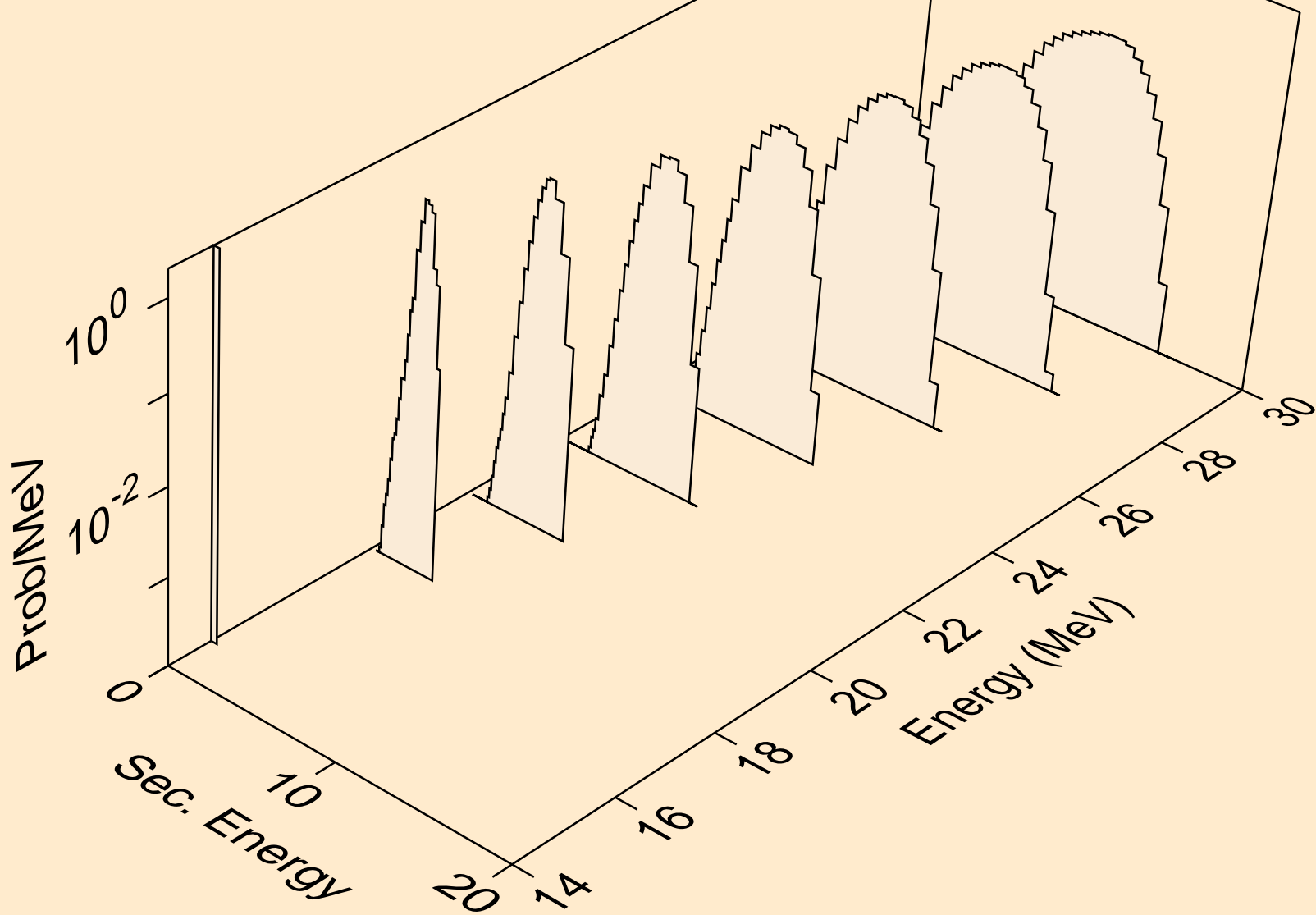

PT193M TRITON ACER TENDL-2021 LIBRARY; T=0.K  
protons from (t,2np)

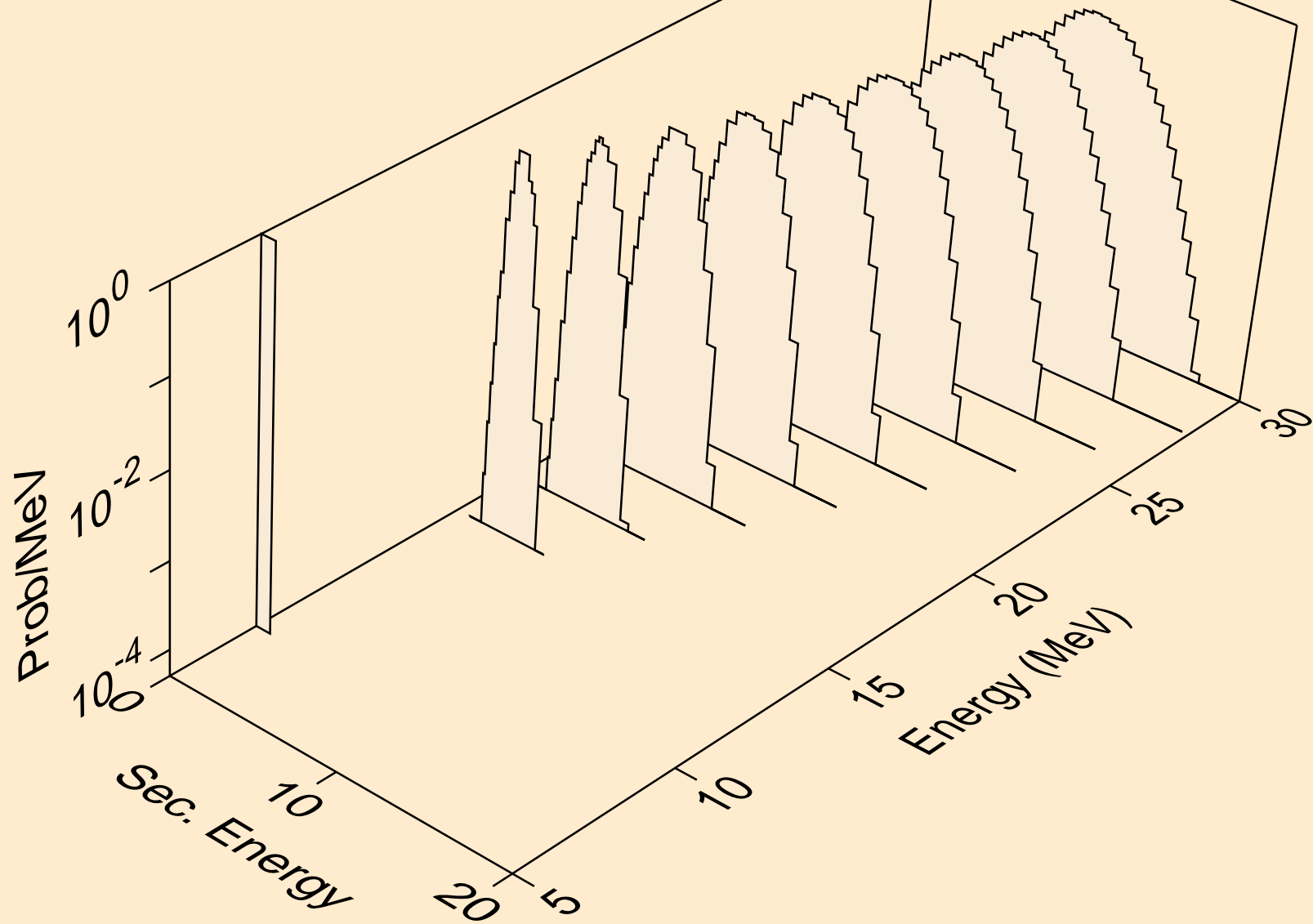

PT193M TRITON ACER TENDL-2021 LIBRARY; T=0.K  
protons from (t,npa)

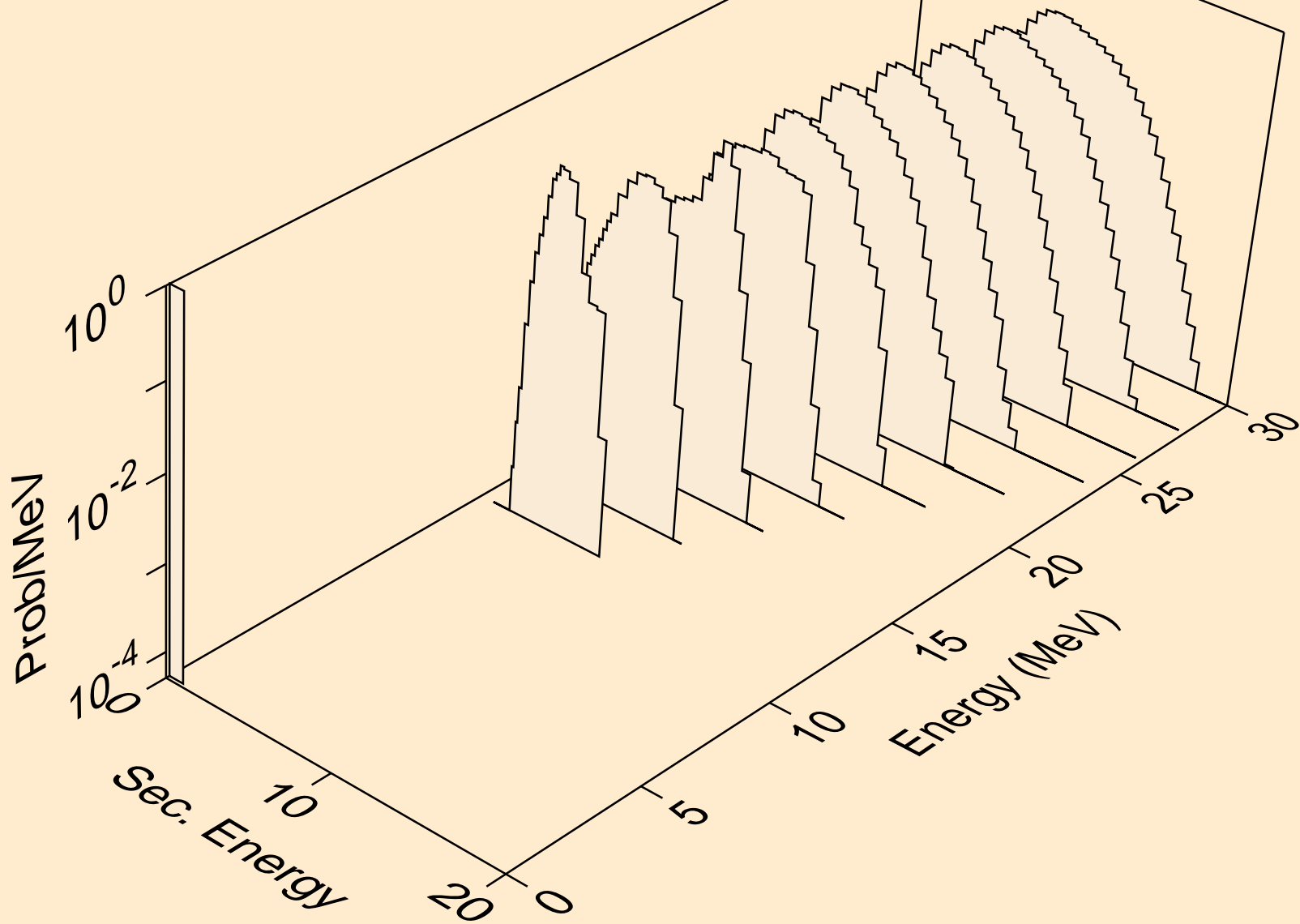

PT193M TRITON ACER TENDL-2021 LIBRARY; T=0.K  
protons from (t,p)

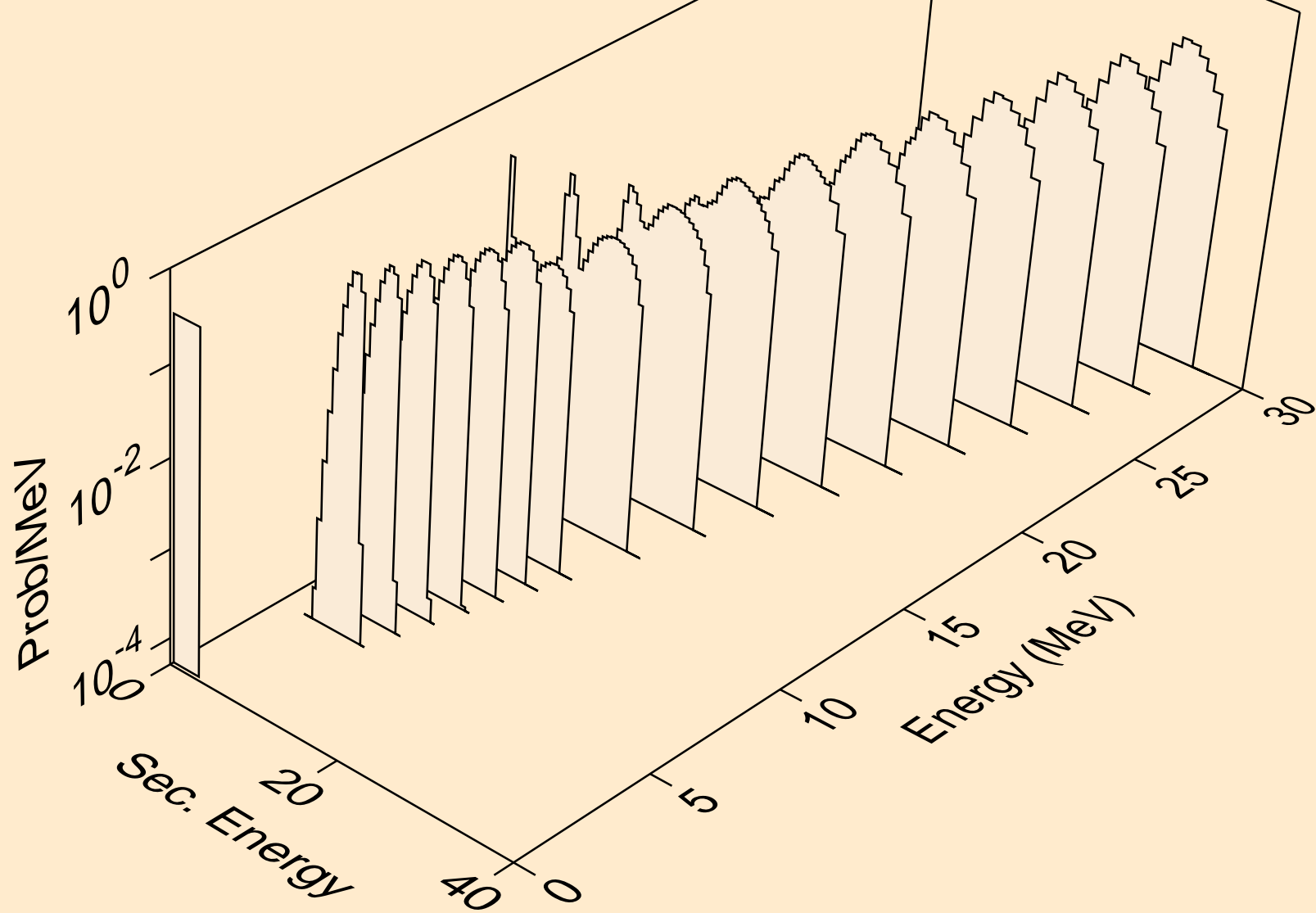

PT193M TRITON ACER TENDL-2021 LIBRARY; T=0.K  
protons from (t,2p)

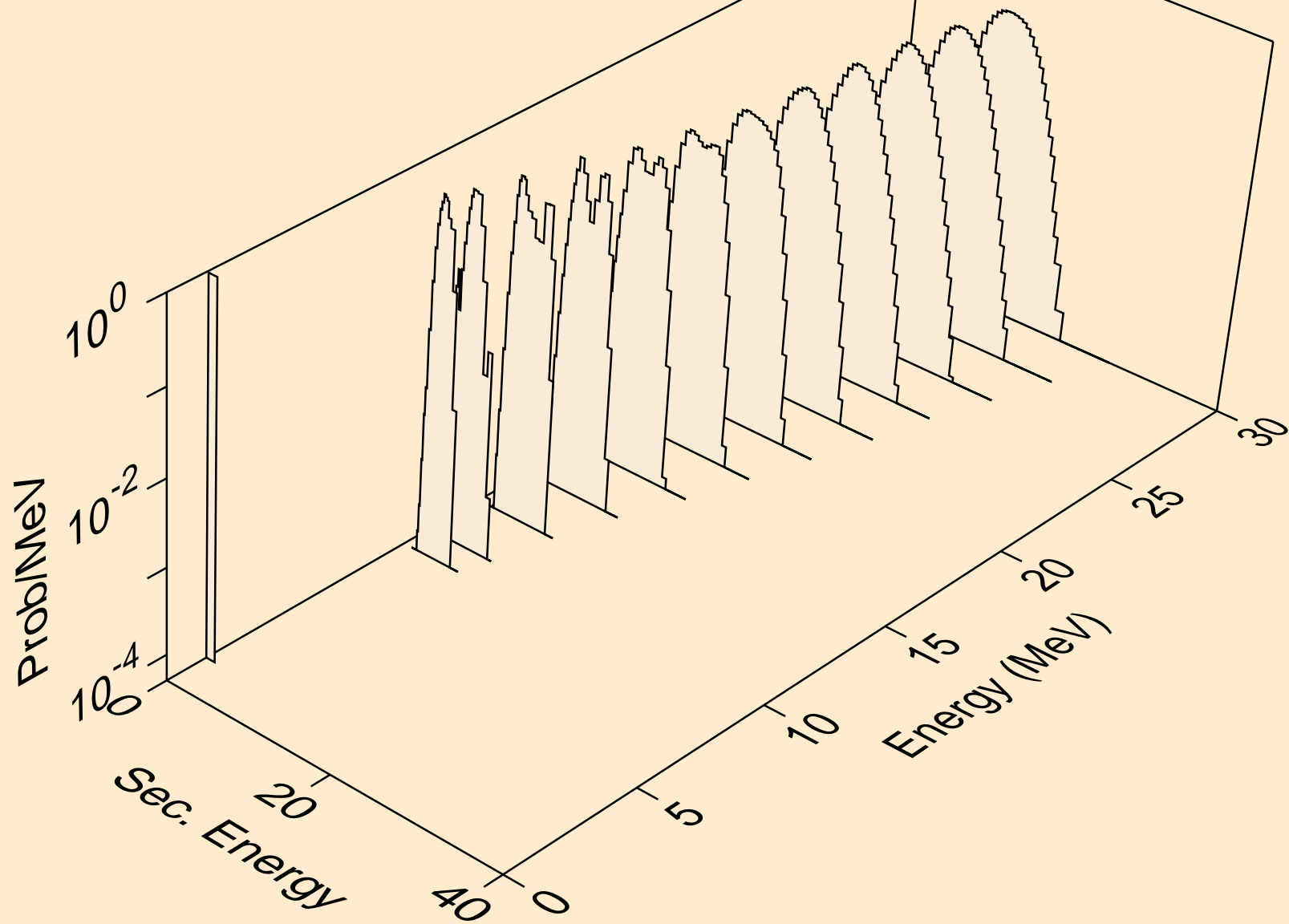



PT193M TRITON ACER TENDL-2021 LIBRARY; T=0.K  
protons from (t,pa)

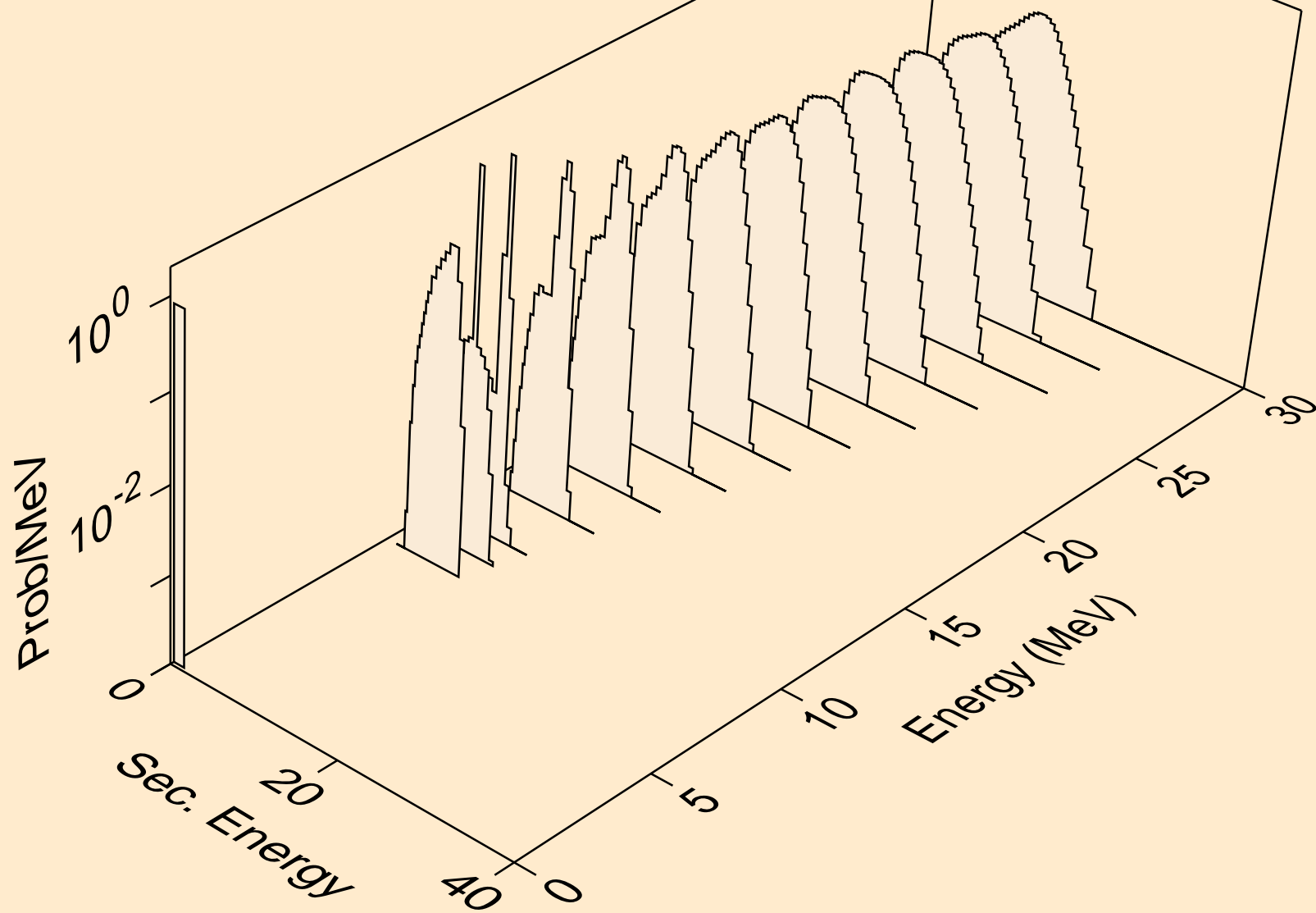

PT193M TRITON ACER TENDL-2021 LIBRARY; T=0.K  
protons from (t,pd)

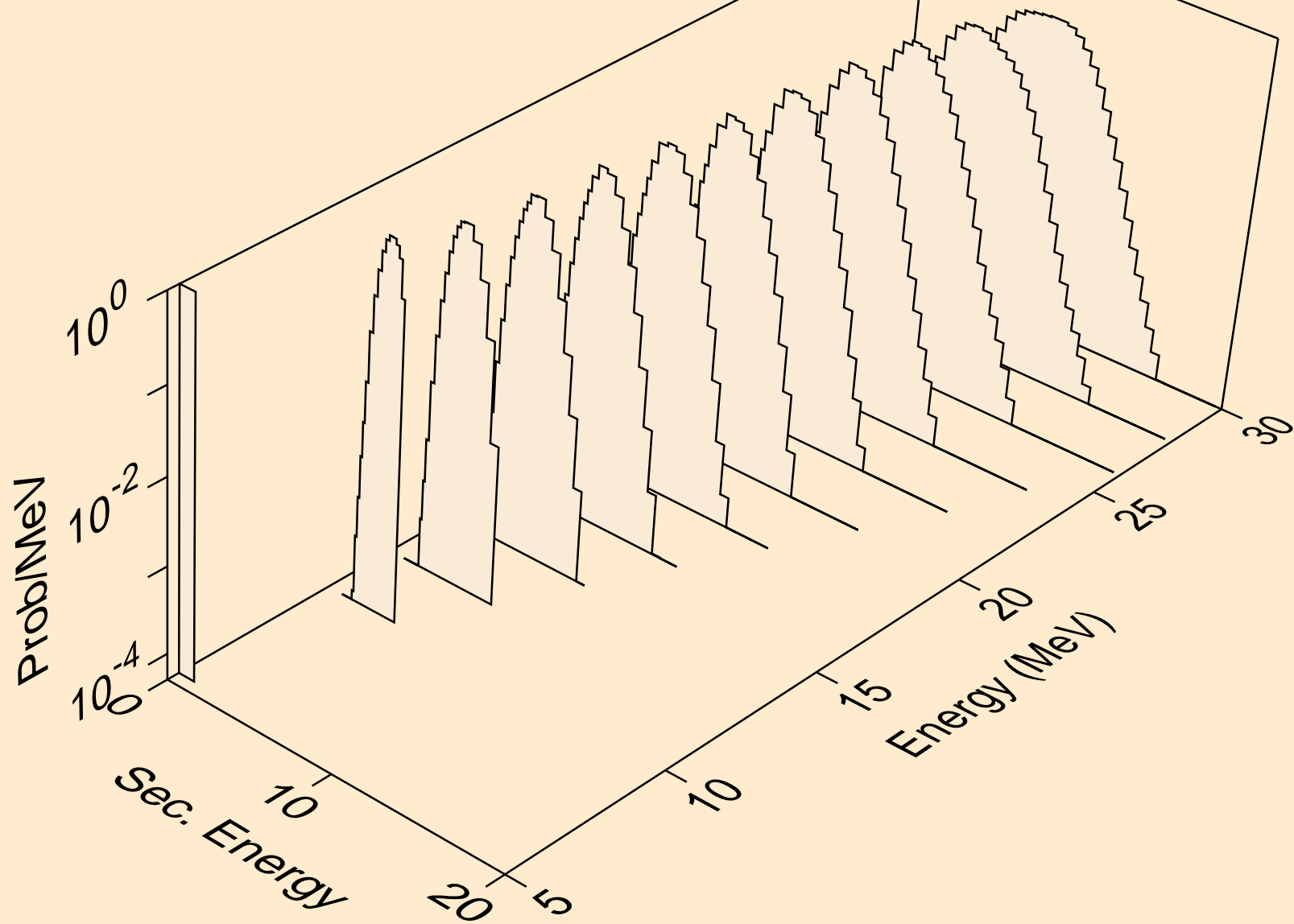

PT193M TRITON ACER TENDL-2021 LIBRARY; T=0.K  
protons from (t,pt)

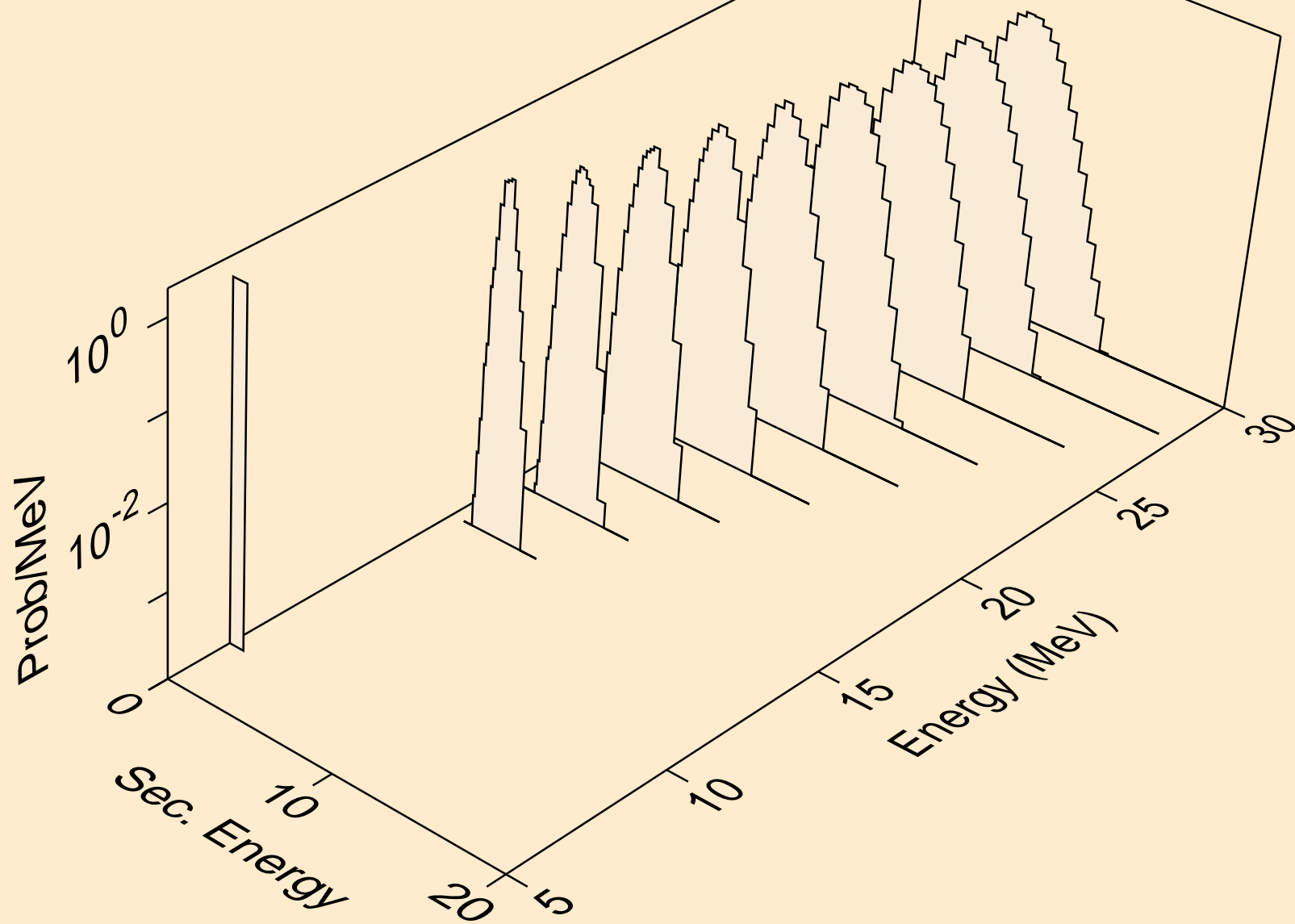

PT193M TRITON ACER TENDL-2021 LIBRARY; T=0.K  
deuterons from (t,x)

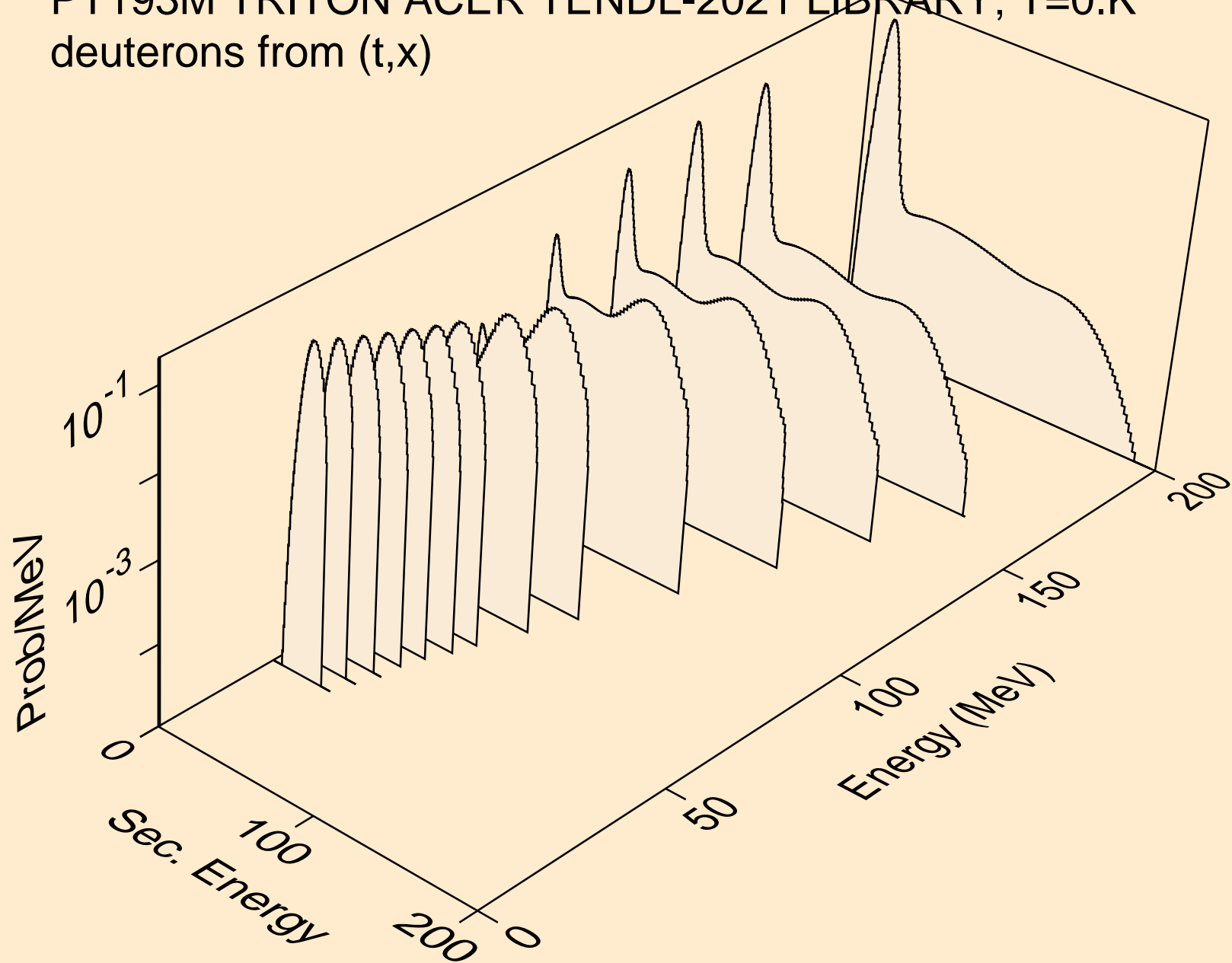

PT193M TRITON ACER TENDL-2021 LIBRARY; T=0.K  
deuterons from (t,2nd)

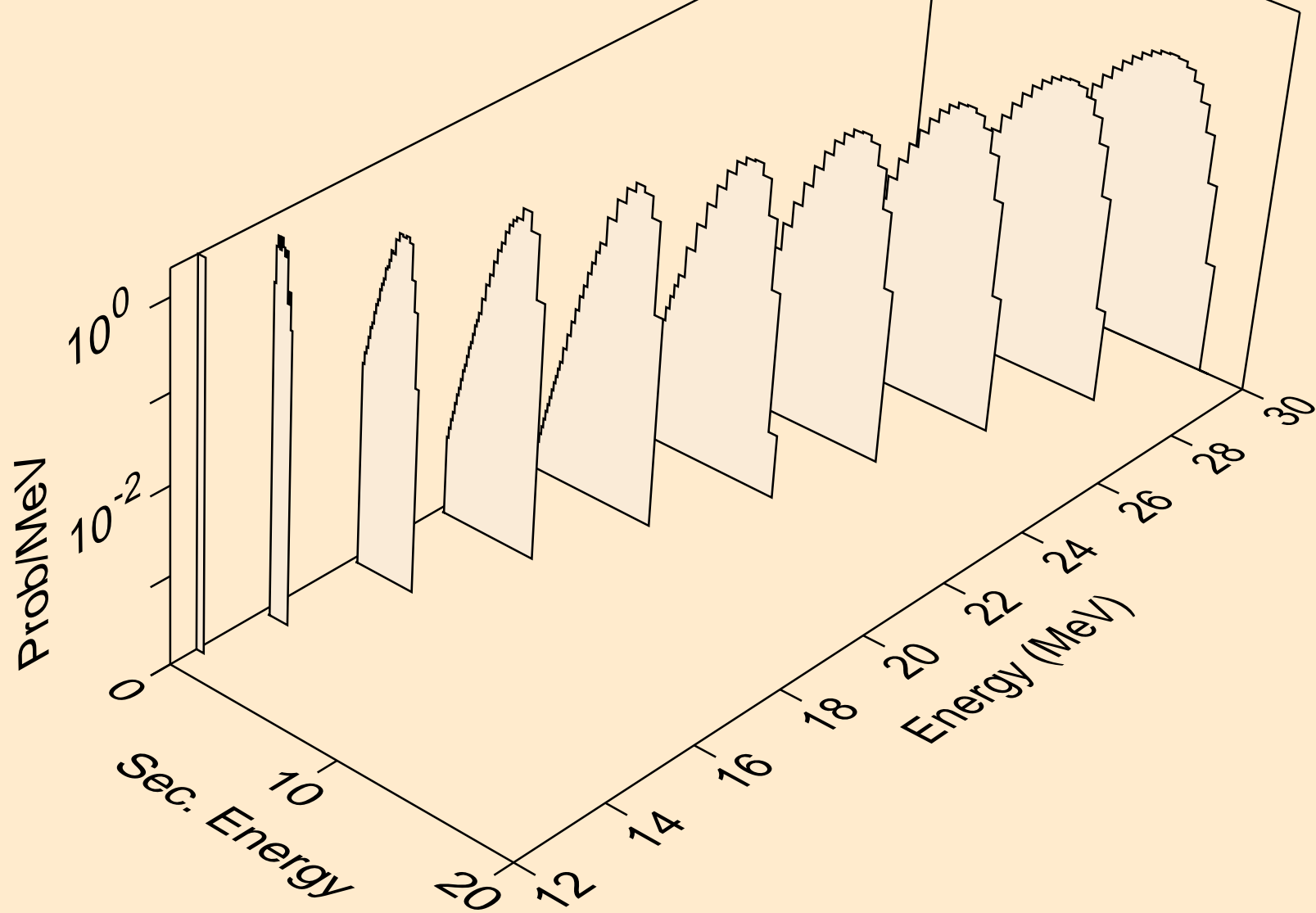

PT193M TRITON ACER TENDL-2021 LIBRARY; T=0.K  
deuterons from (t,n\*)d

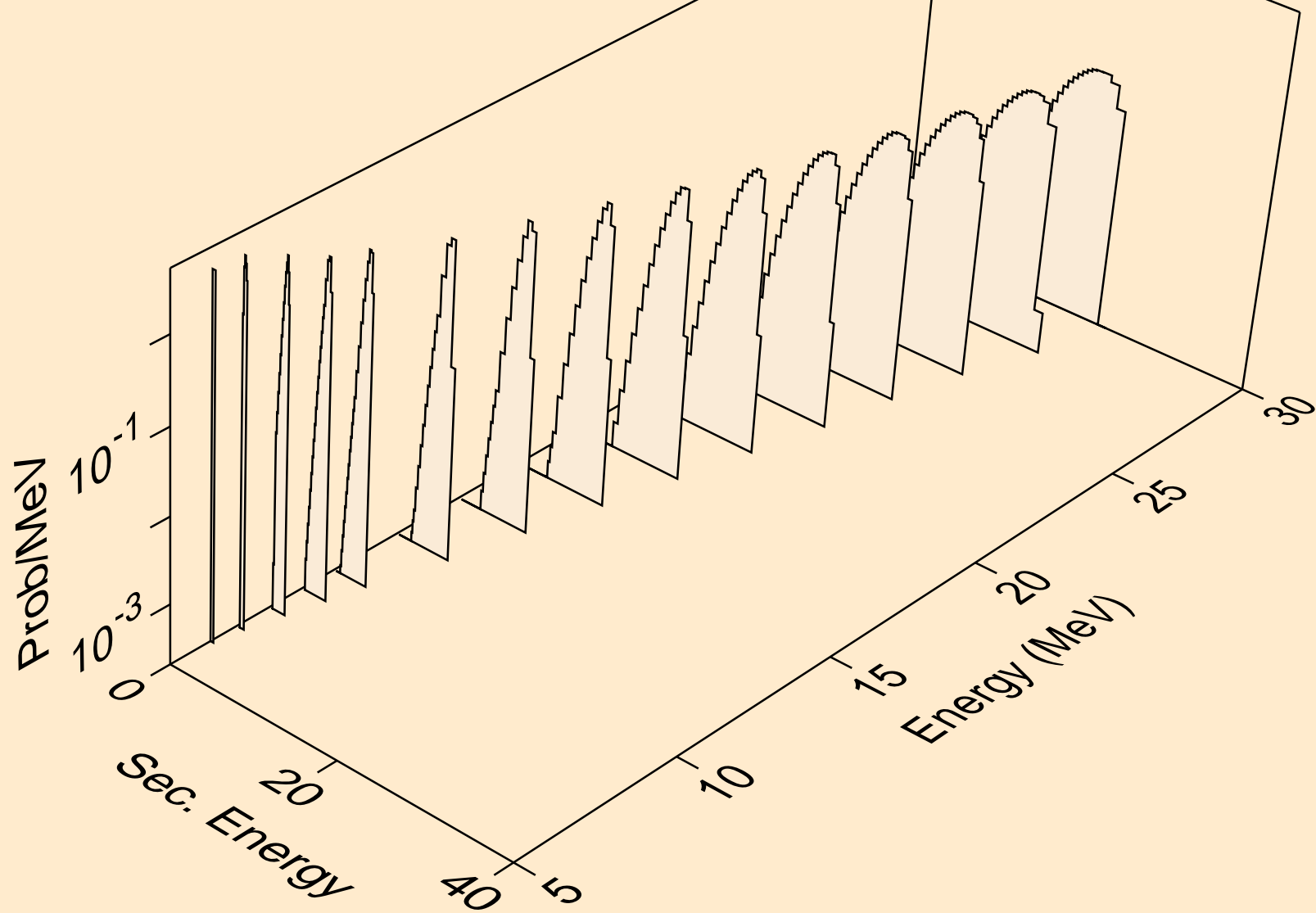

PT193M TRITON ACER TENDL-2021 LIBRARY; T=0.K  
deuterons from (t,d)

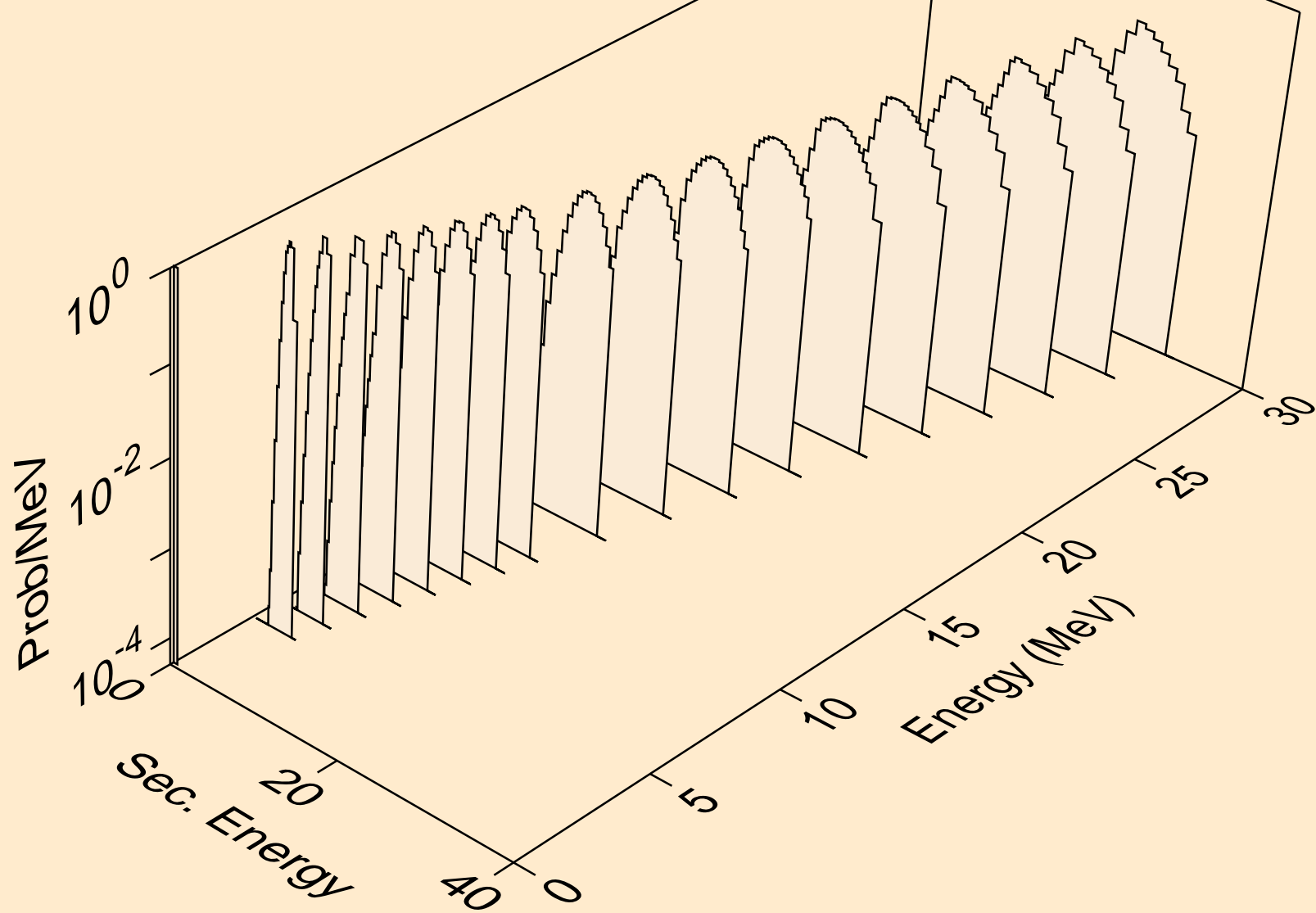

PT193M TRITON ACER TENDL-2021 LIBRARY; T=0.K  
deuterons from (t,pd)

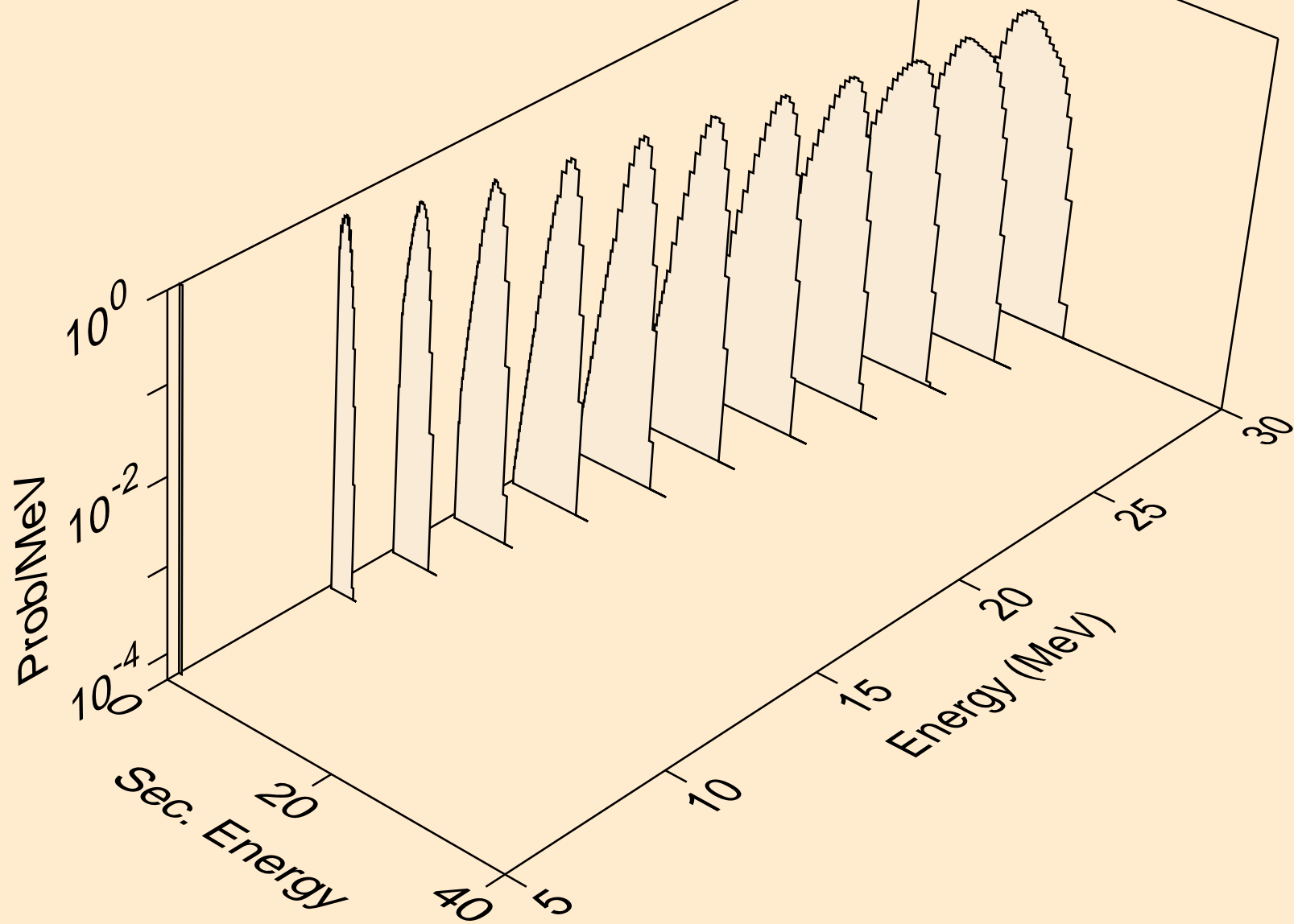



PT193M TRITON ACER TENDL-2021 LIBRARY; T=0.K  
deuterons from (t,da)

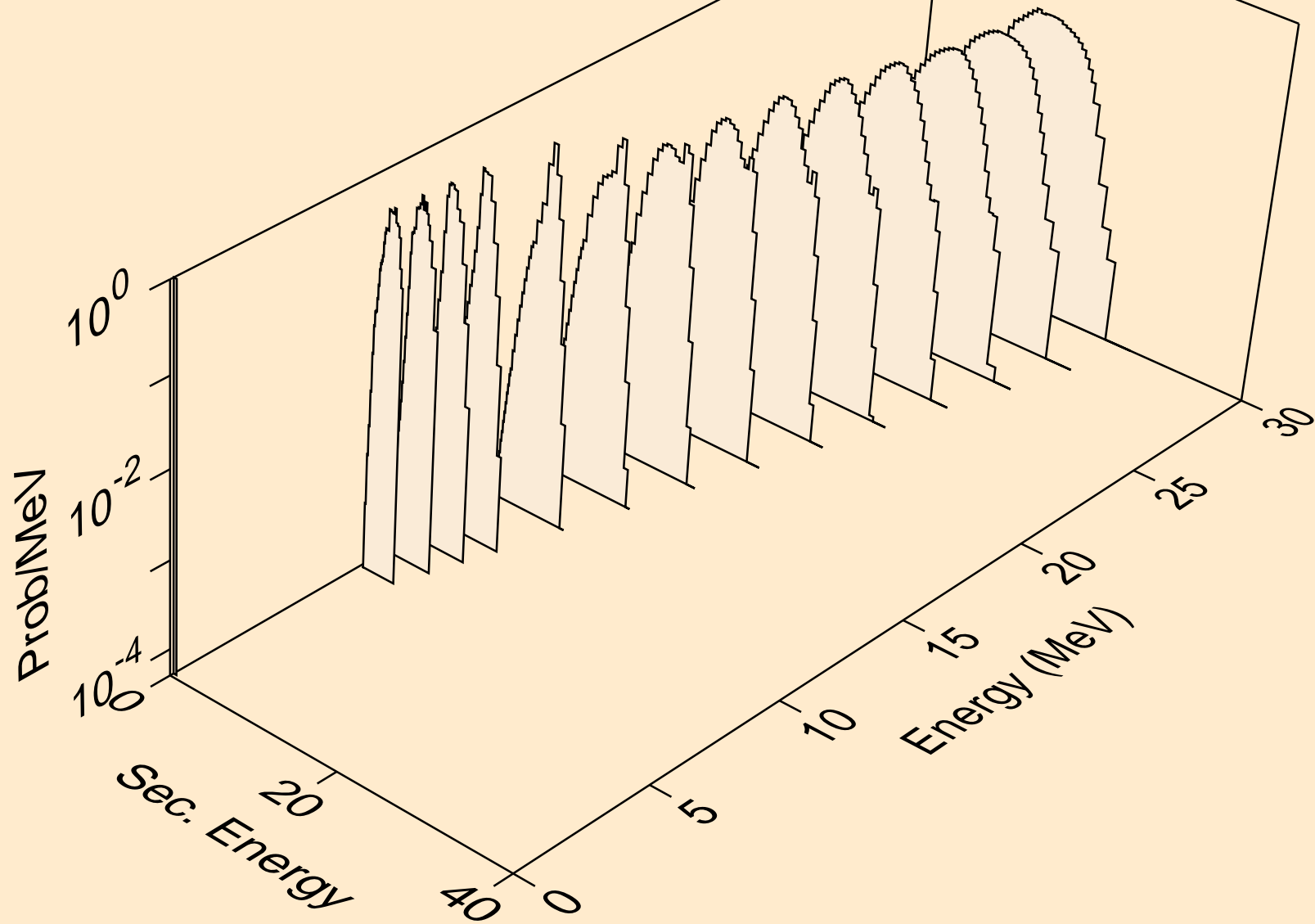

PT193M TRITON ACER TENDL-2021 LIBRARY; T=0.K  
he3s from (t,x)

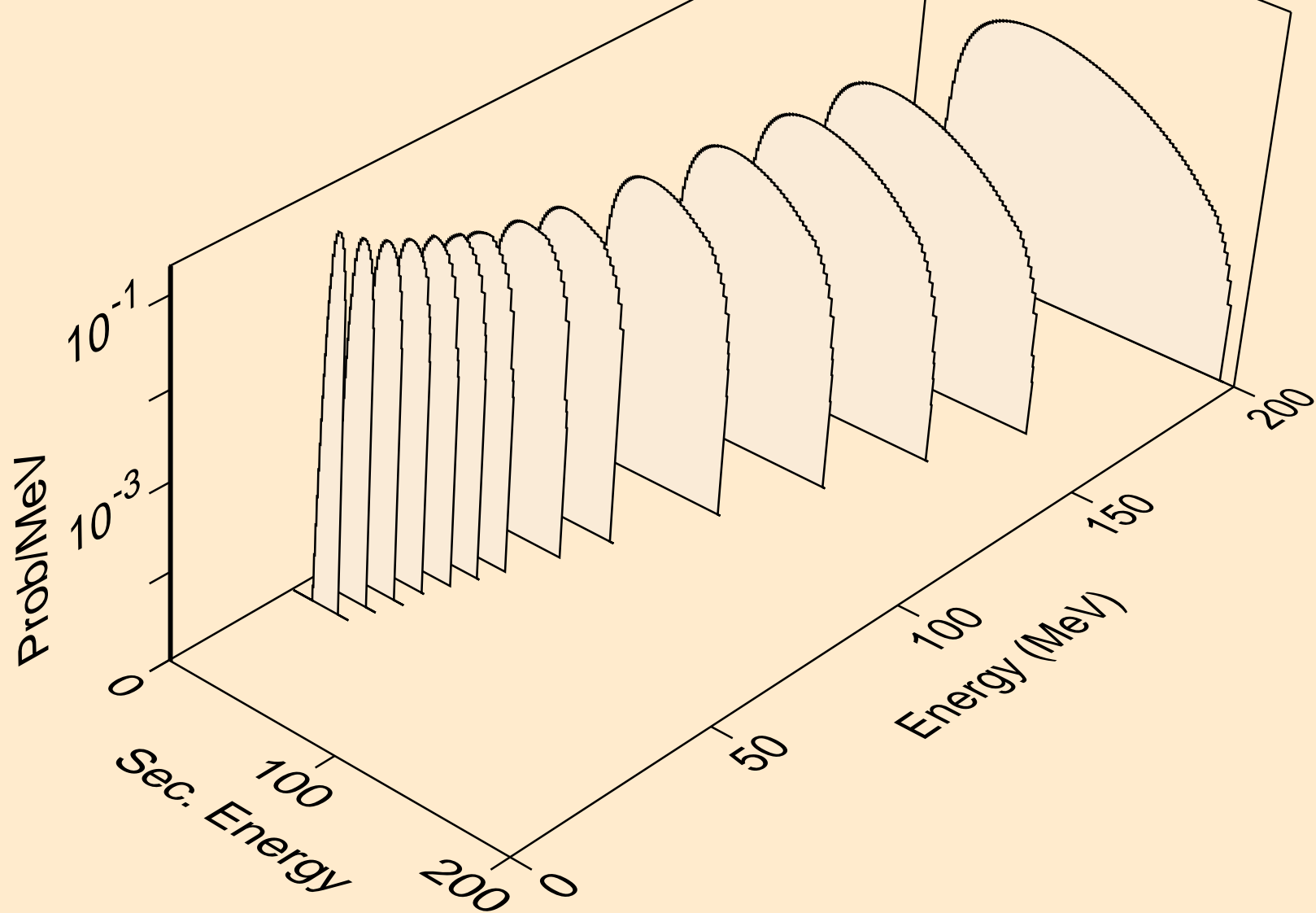

PT193M TRITON ACER TENDL-2021 LIBRARY; T=0.K  
he3s from (t,n\*)he3

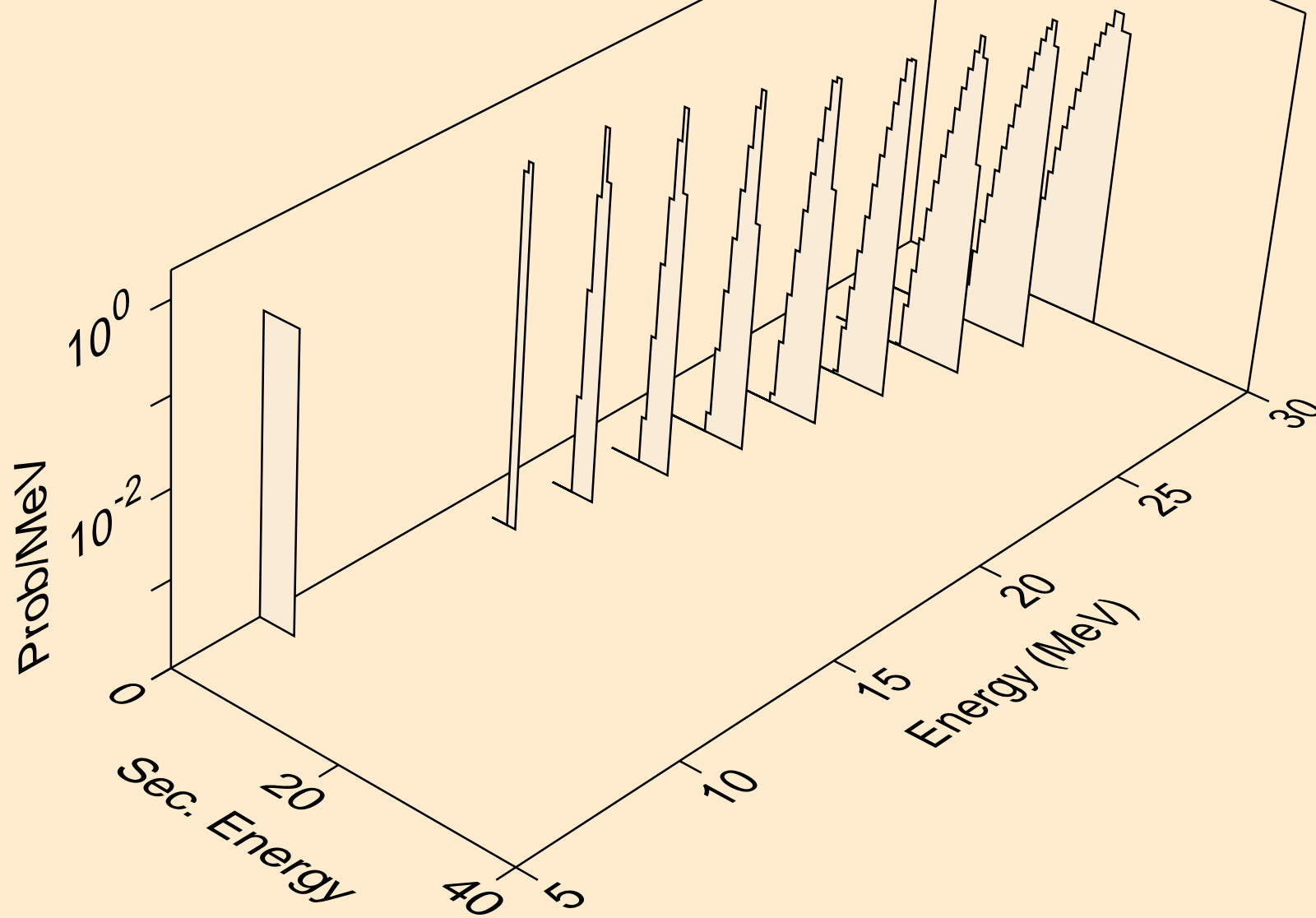

PT193M TRITON ACER TENDL-2021 LIBRARY; T=0.K  
he3s from (t,he3)

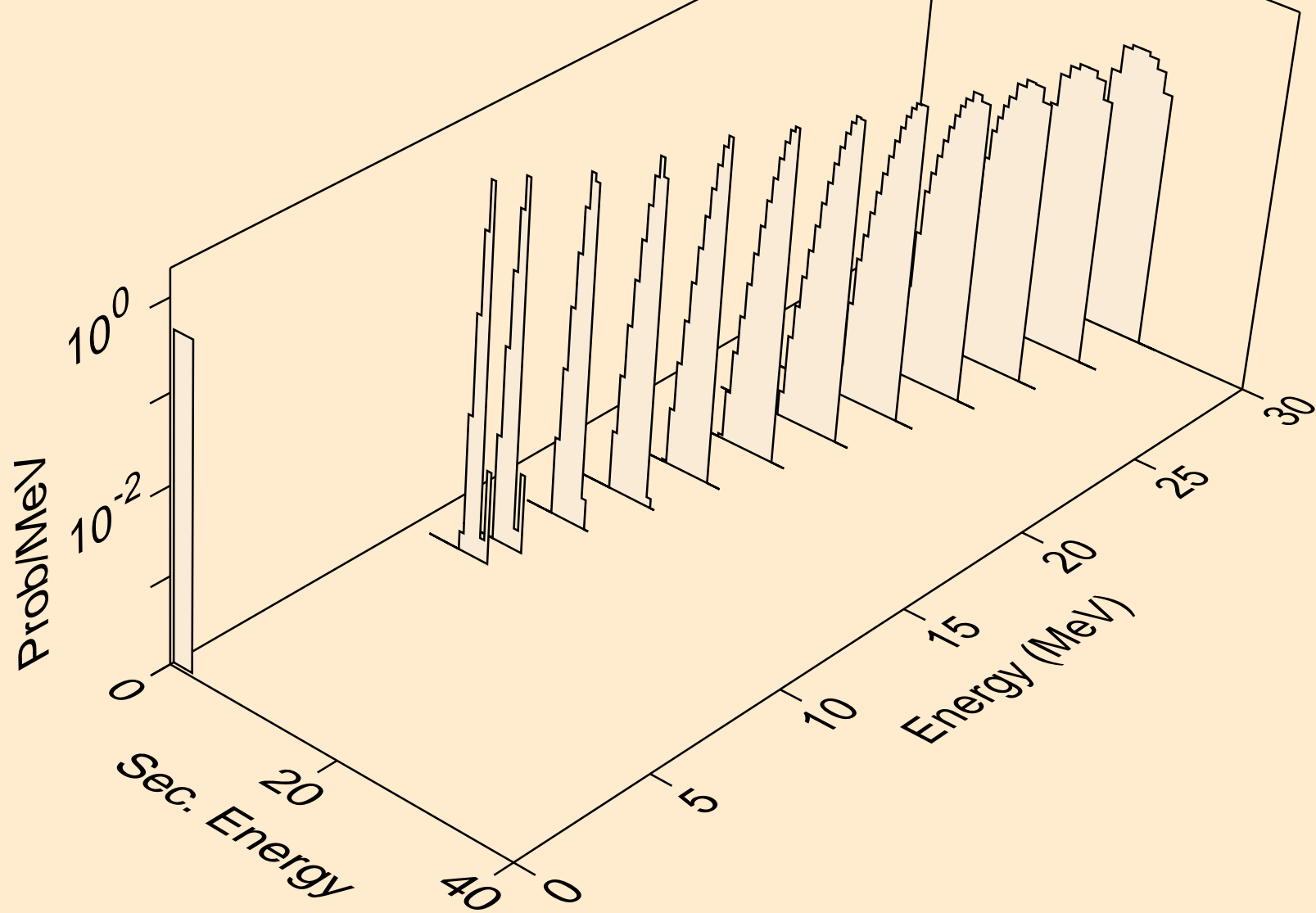

PT193M TRITON ACER TENDL-2021 LIBRARY; T=0.K  
alphas from (t,x)

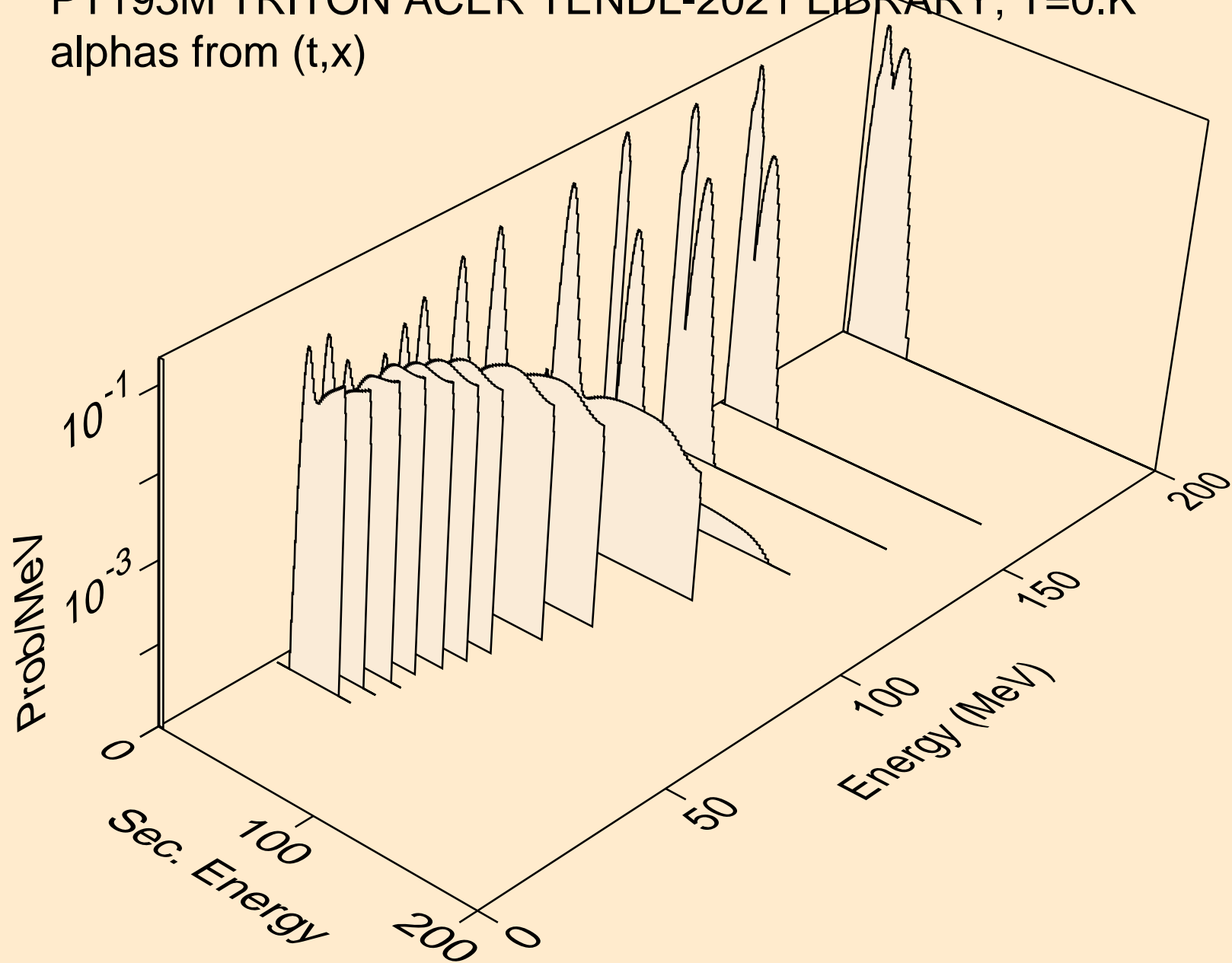

PT193M TRITON ACER TENDL-2021 LIBRARY; T=0.K  
alphas from (t,n\*)a

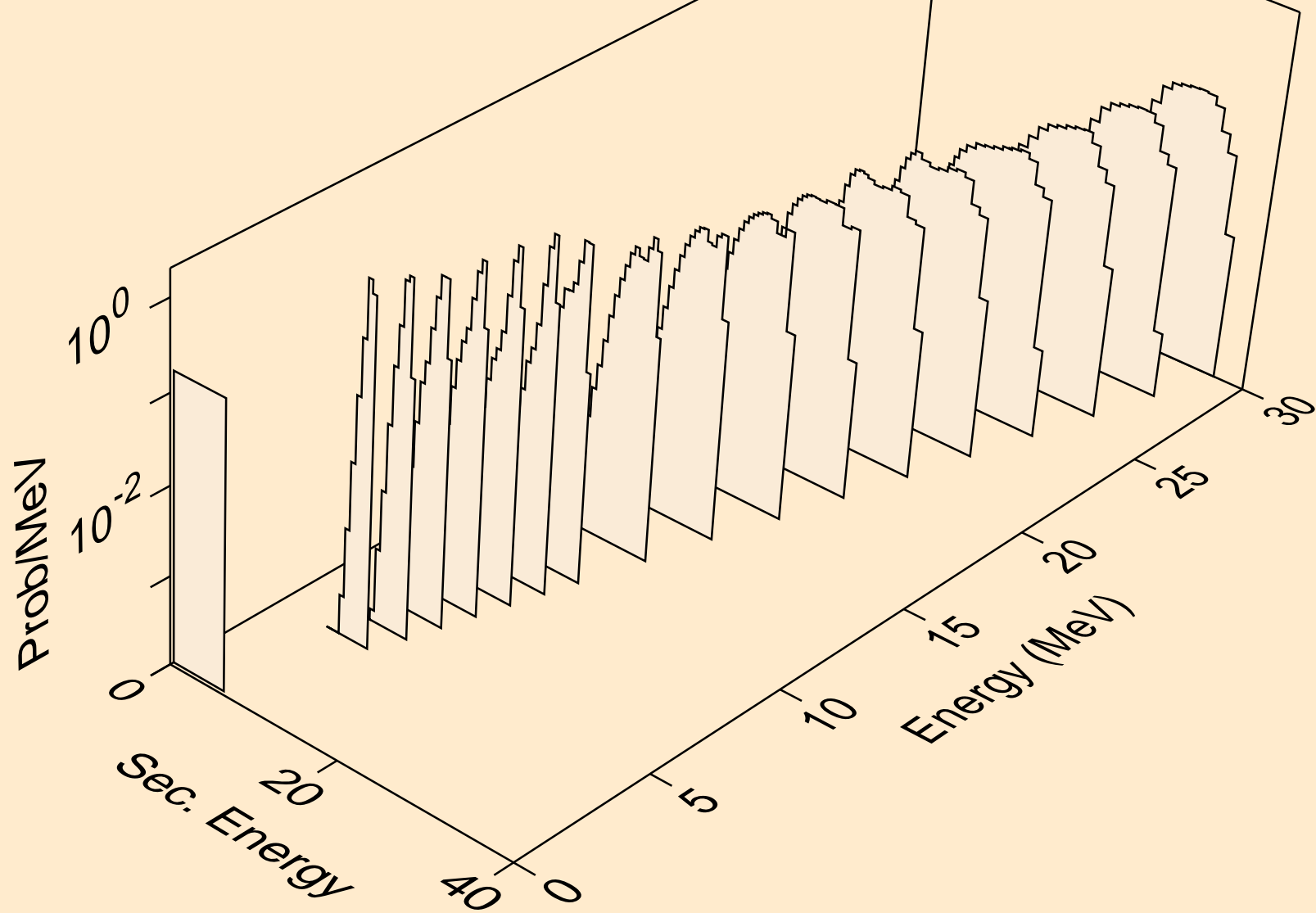

PT193M TRITON ACER TENDL-2021 LIBRARY; T=0.K  
alphas from (t,2n)a

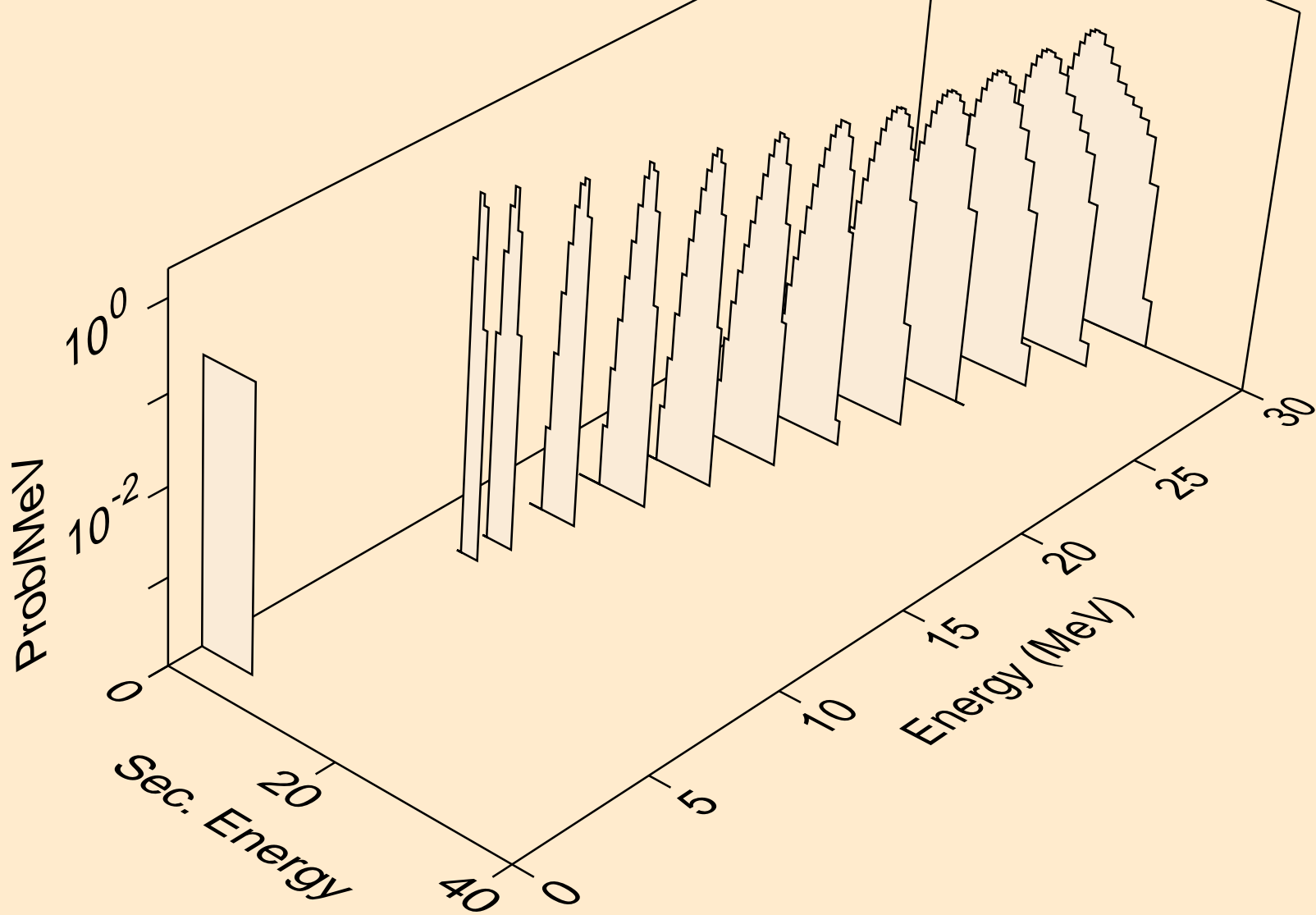

PT193M TRITON ACER TENDL-2021 LIBRARY; T=0.K  
alphas from (t,3n)a

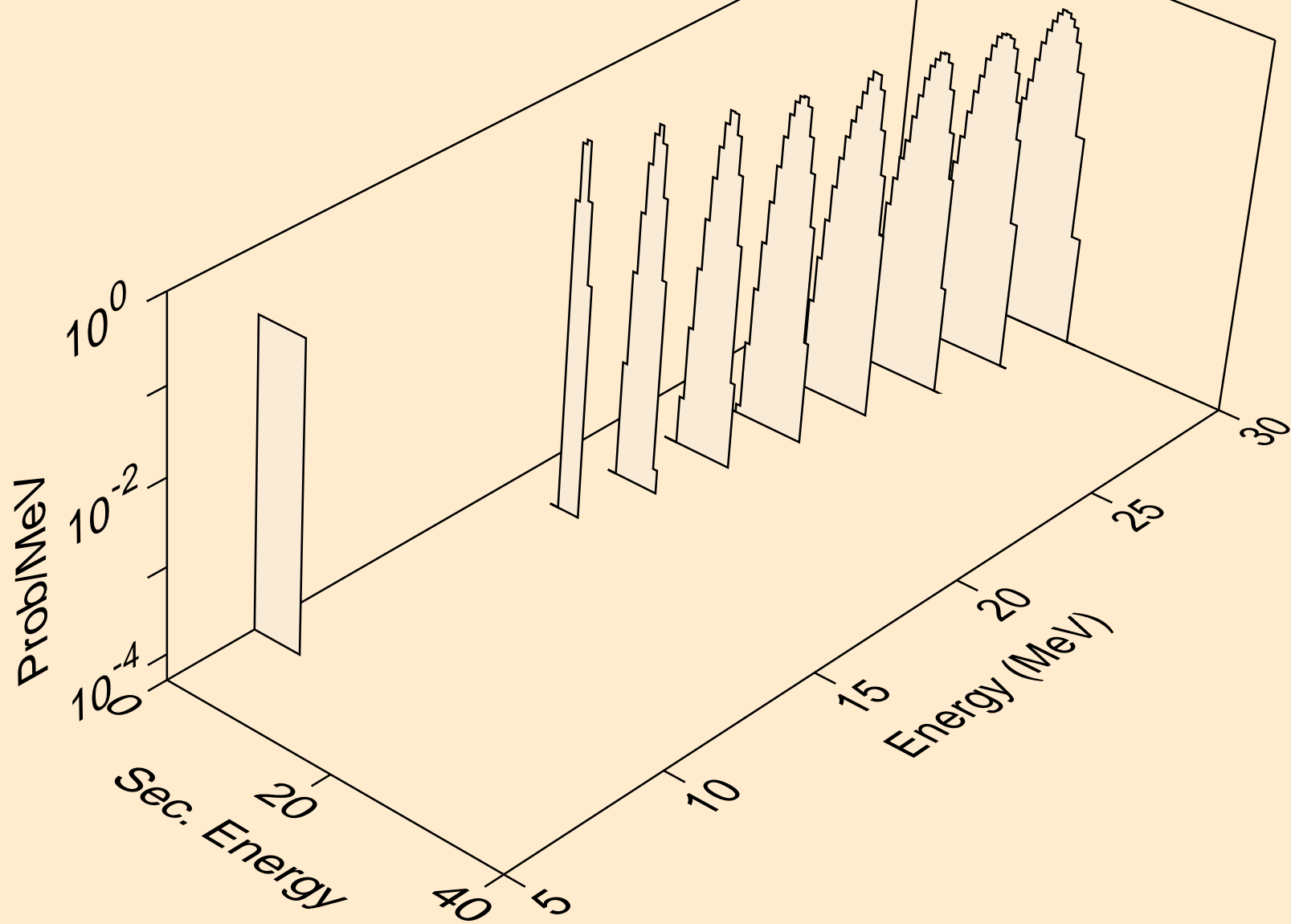



PT193M TRITON ACER TENDL-2021 LIBRARY; T=0.K  
alphas from (t,n\*)2a

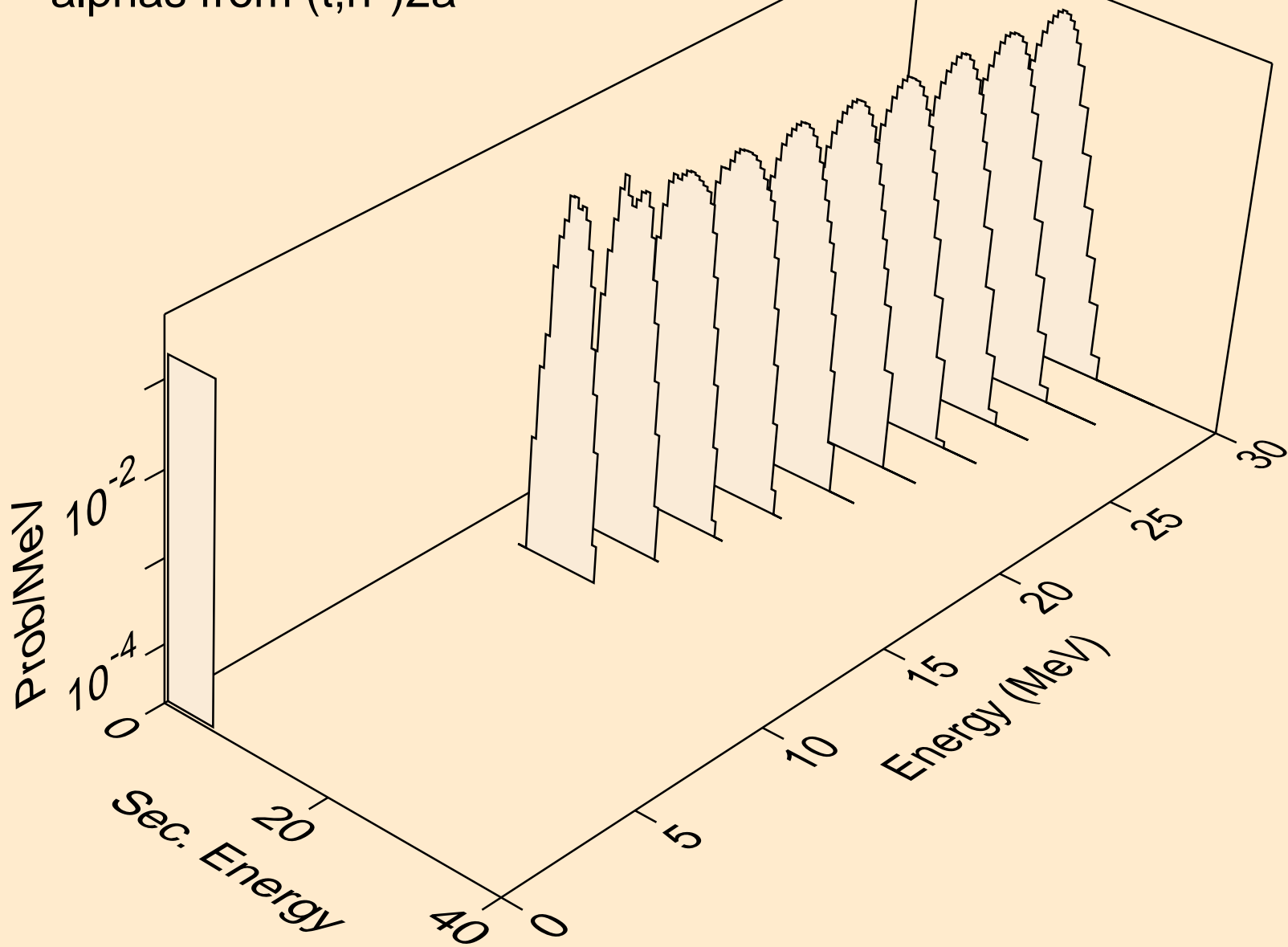

PT193M TRITON ACER TENDL-2021 LIBRARY; T=0.K  
alphas from (t,npa)

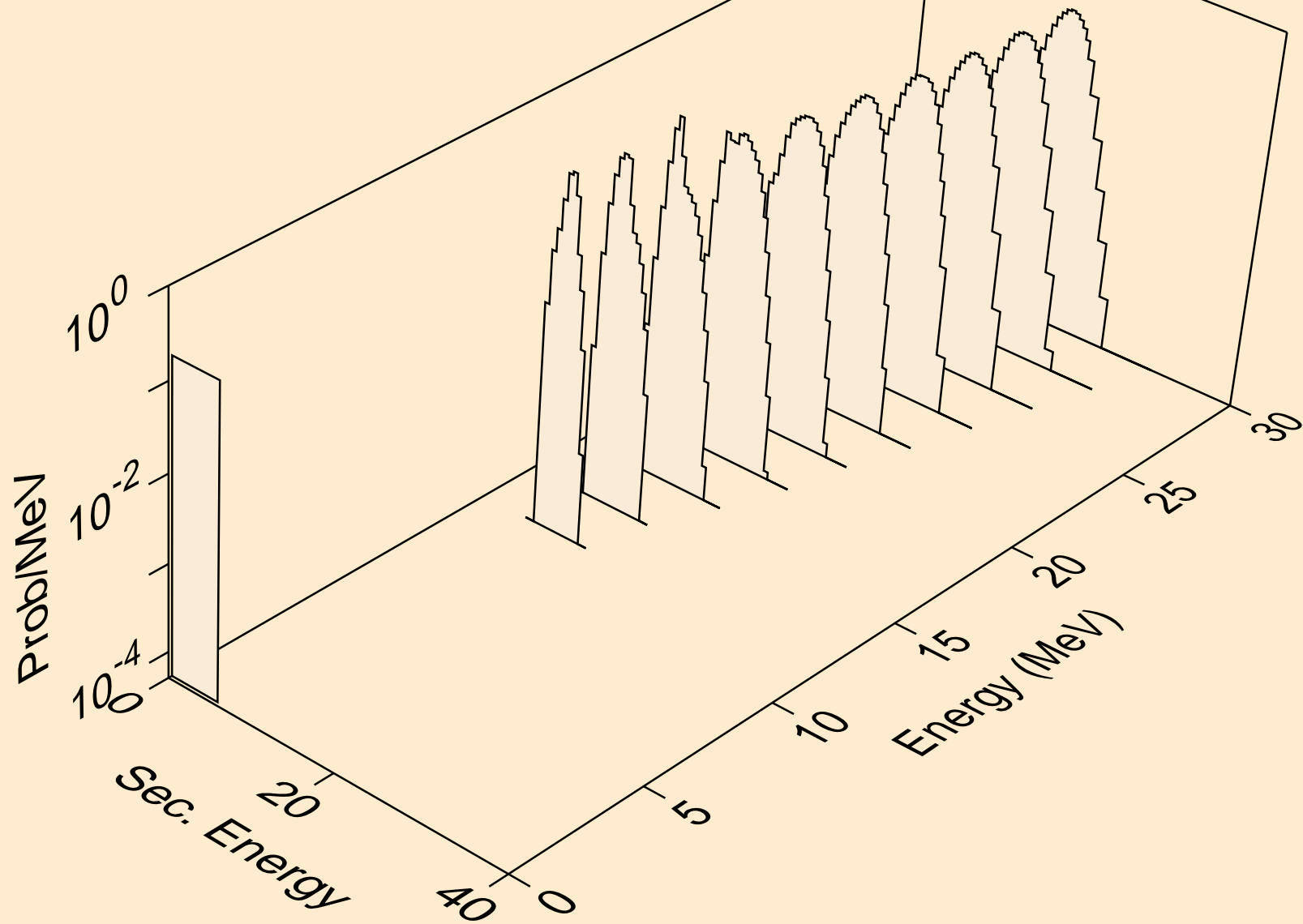

PT193M TRITON ACER TENDL-2021 LIBRARY; T=0.K  
alphas from (t,a)

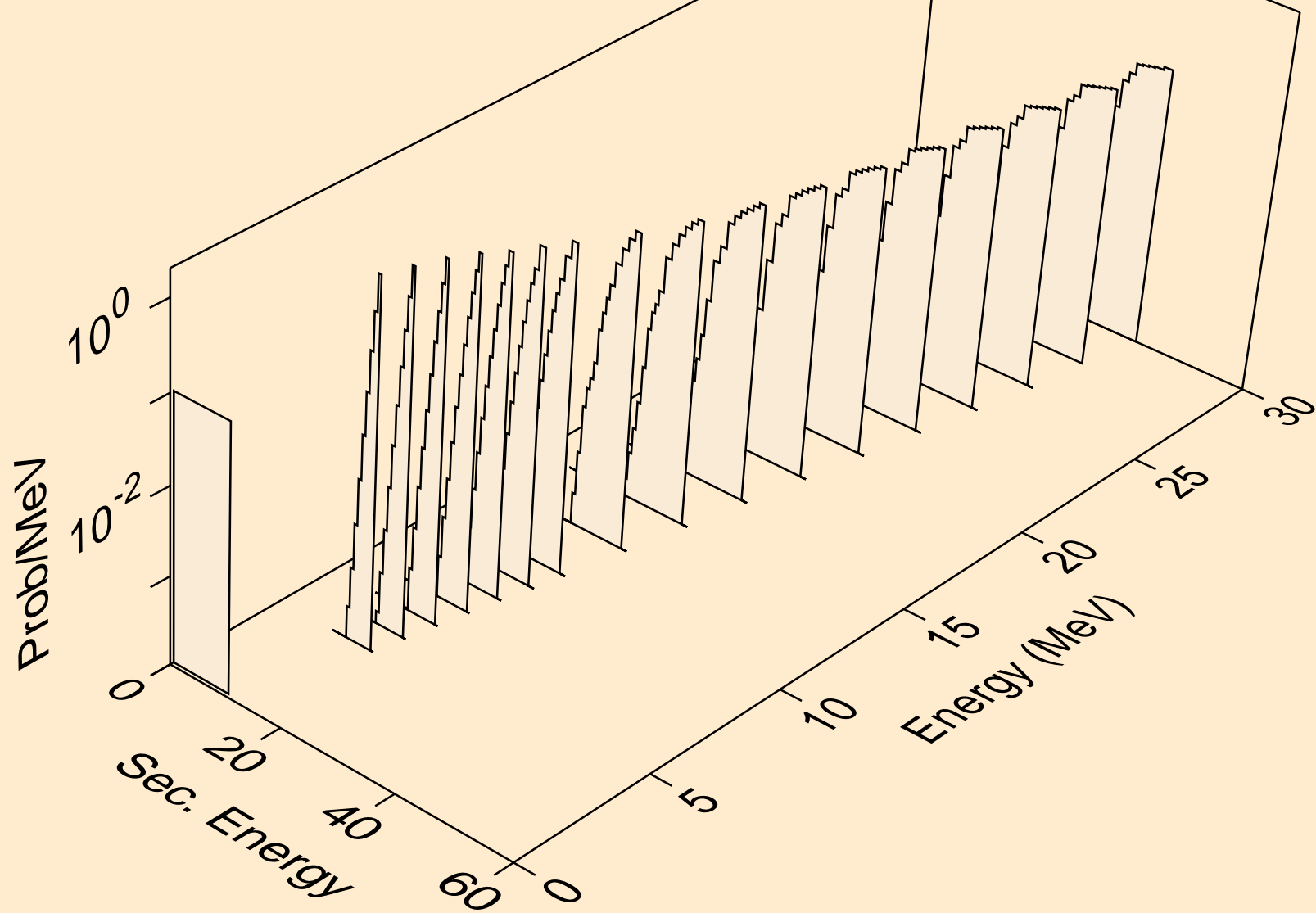

PT193M TRITON ACER TENDL-2021 LIBRARY; T=0.K  
alphas from (t,2a)

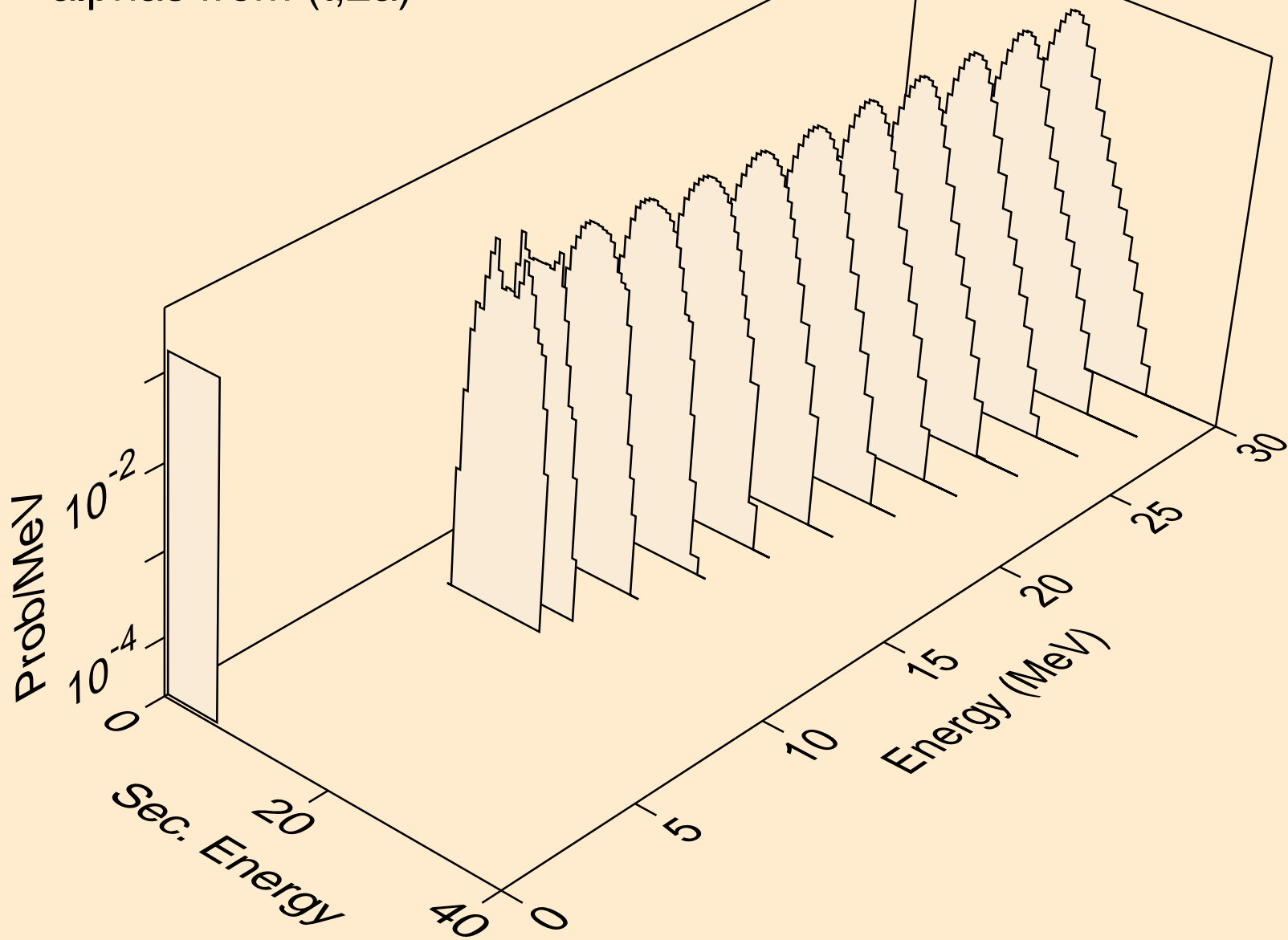

PT193M TRITON ACER TENDL-2021 LIBRARY; T=0.K  
alphas from (t,pa)

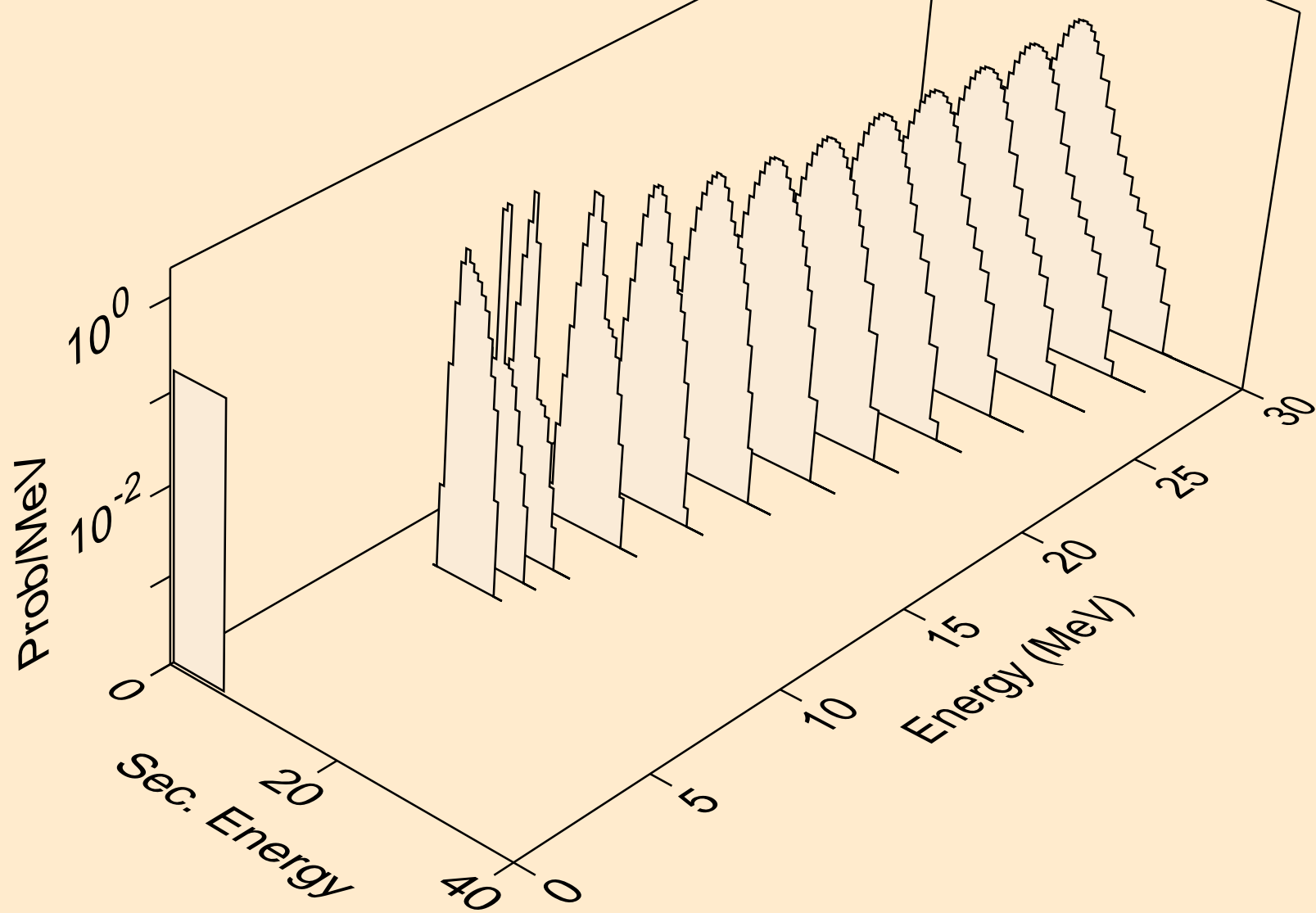

PT193M TRITON ACER TENDL-2021 LIBRARY; T=0.K  
alphas from (t,da)

