

RB093 TRITON ACER TENDL-2021 LIBRARY; T=0.K  
Principal cross sections

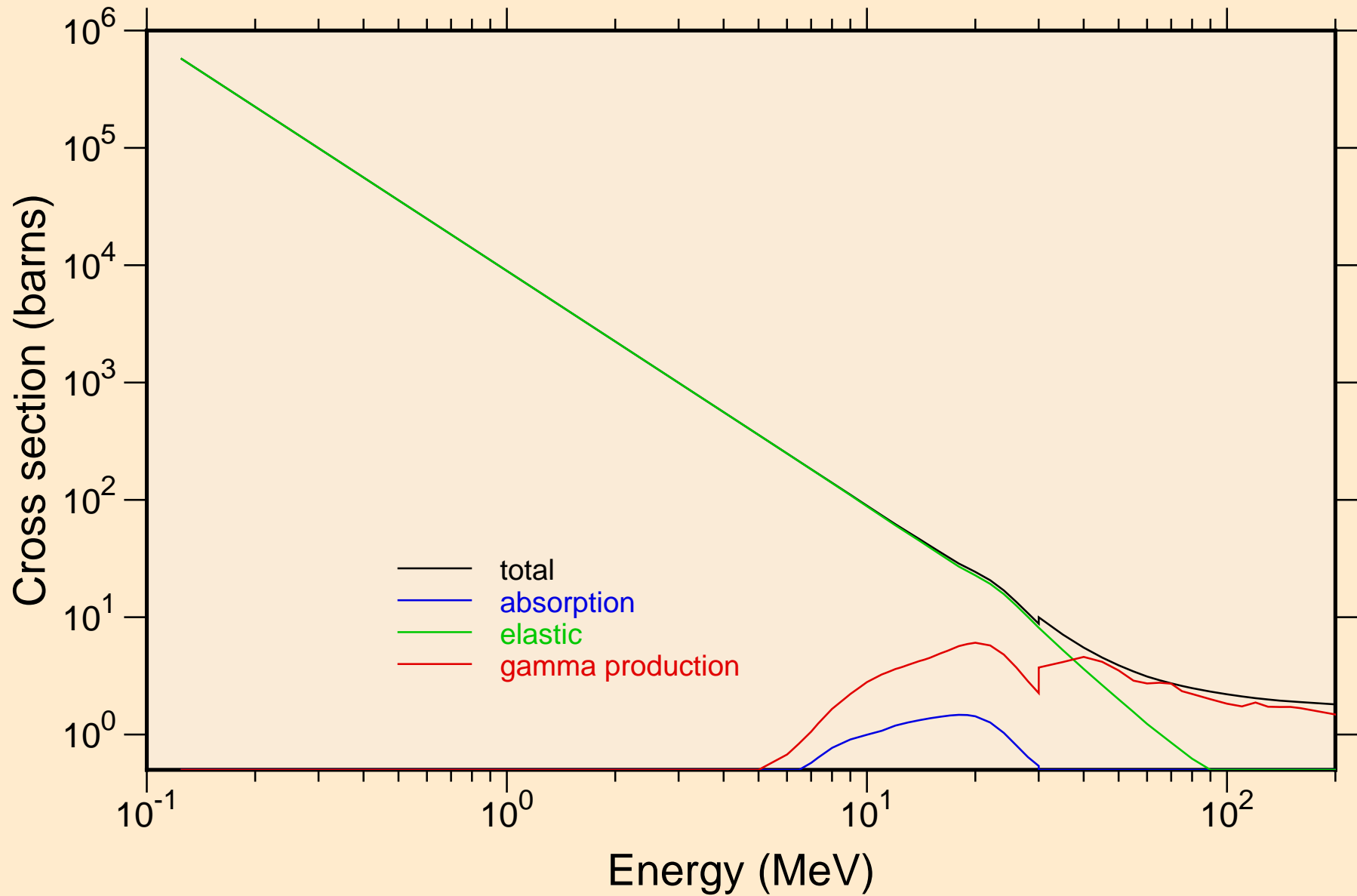

RB093 TRITON ACER TENDL-2021 LIBRARY; T=0.K

Heating

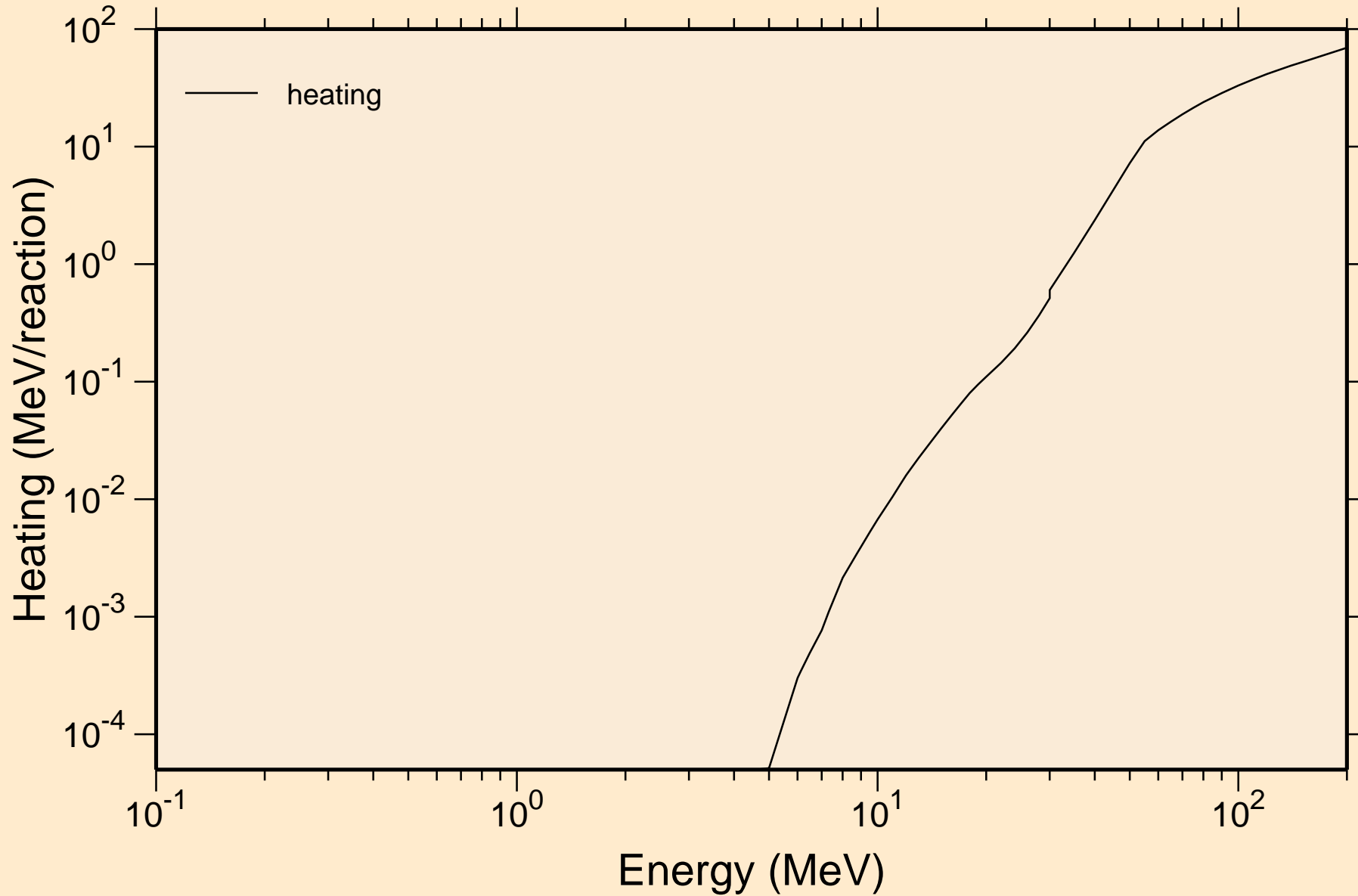

RB093 TRITON ACER TENDL-2021 LIBRARY; T=0.K  
Principal cross sections

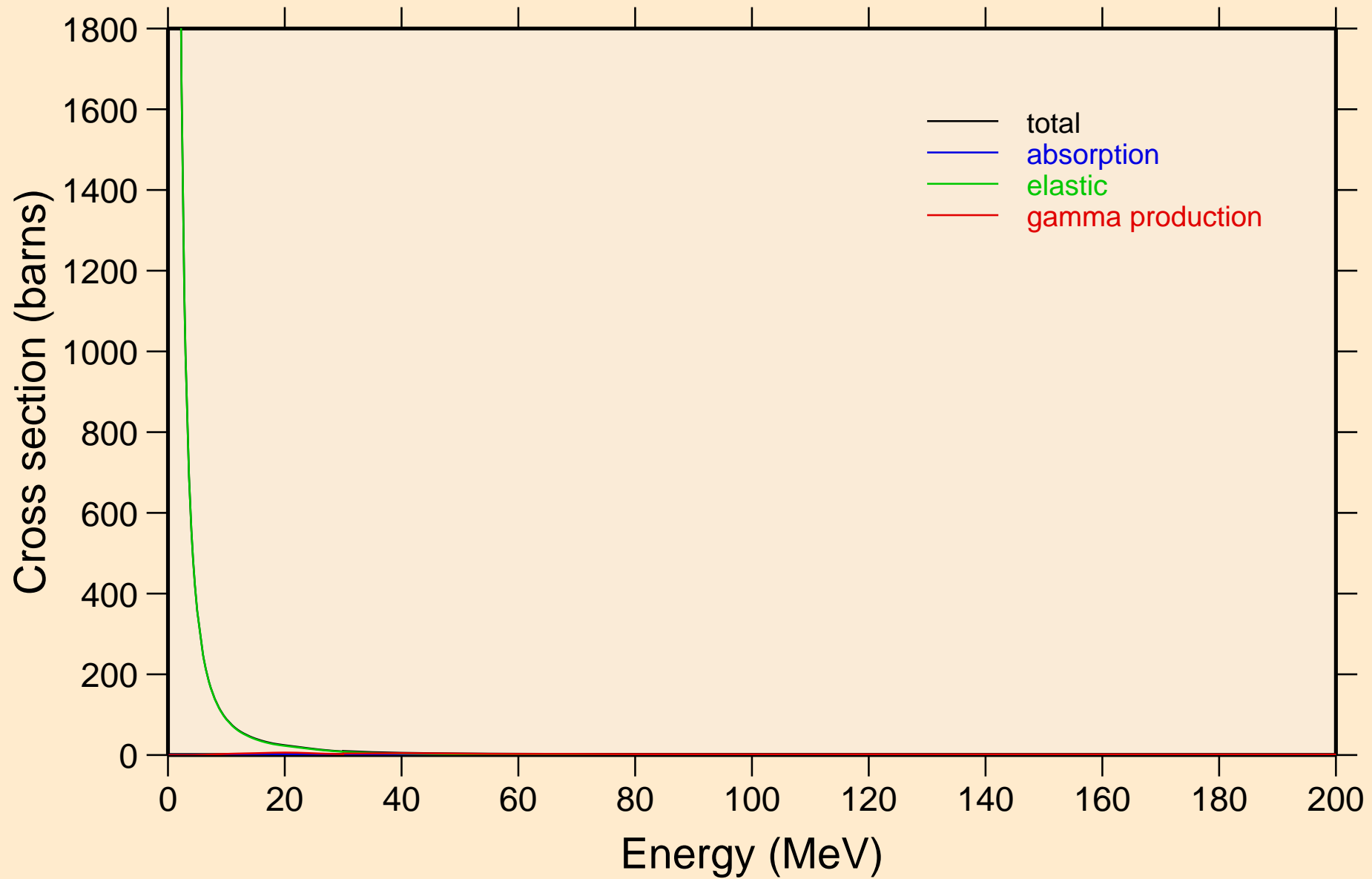

RB093 TRITON ACER TENDL-2021 LIBRARY; T=0.K

Heating

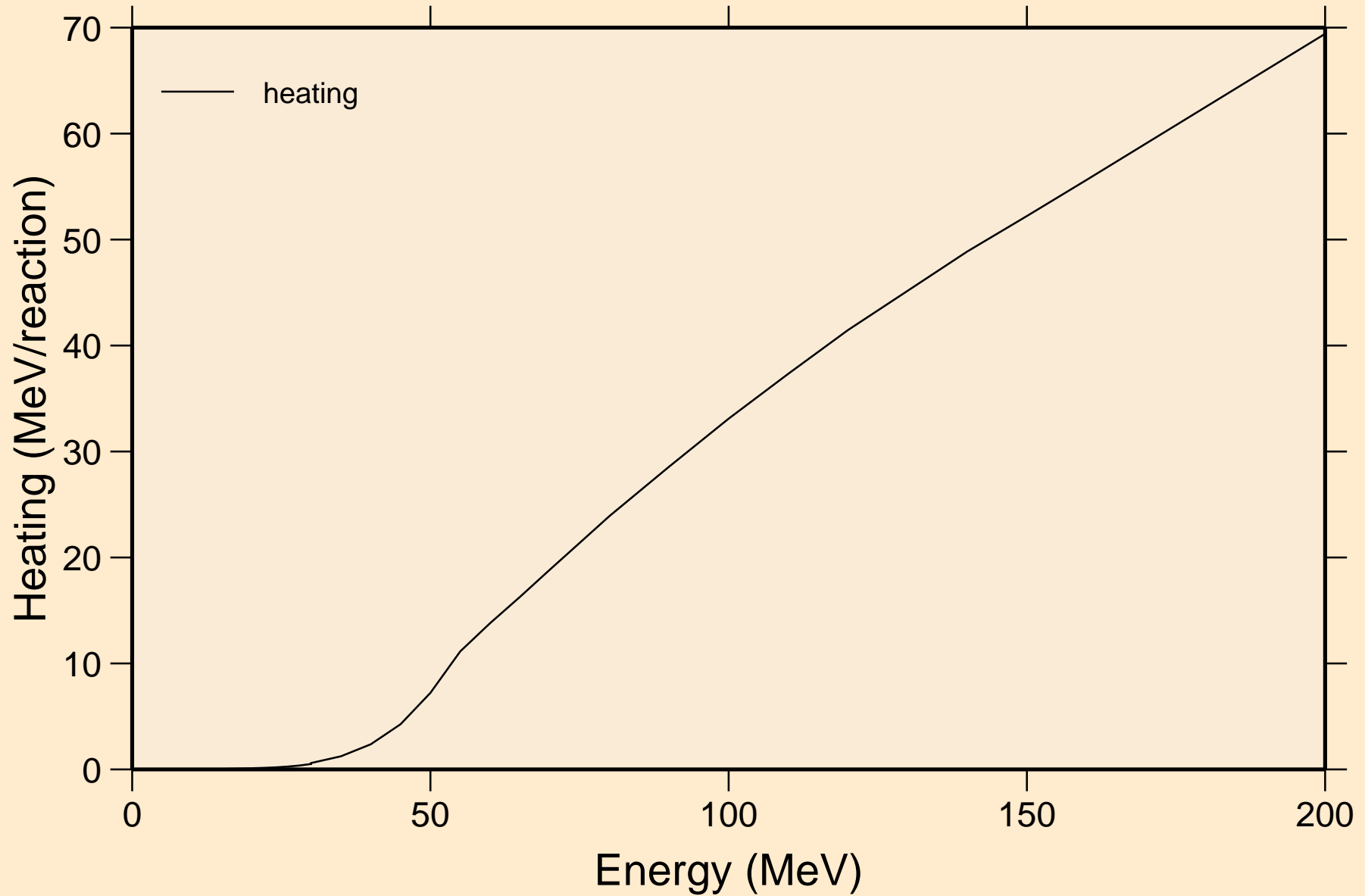

RB093 TRITON ACER TENDL-2021 LIBRARY; T=0.K  
Threshold reactions

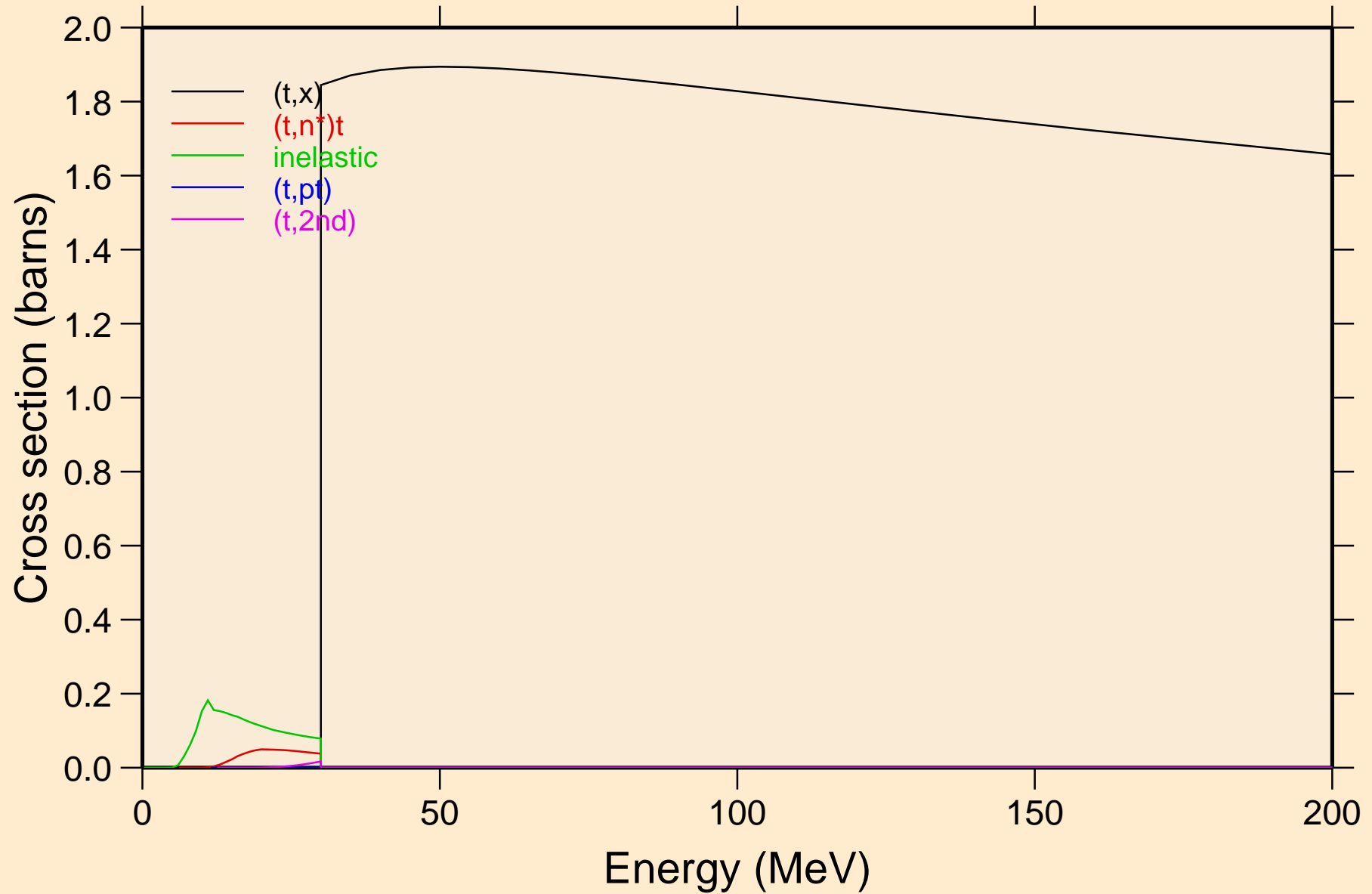

RB093 TRITON ACER TENDL-2021 LIBRARY; T=0.K  
Threshold reactions

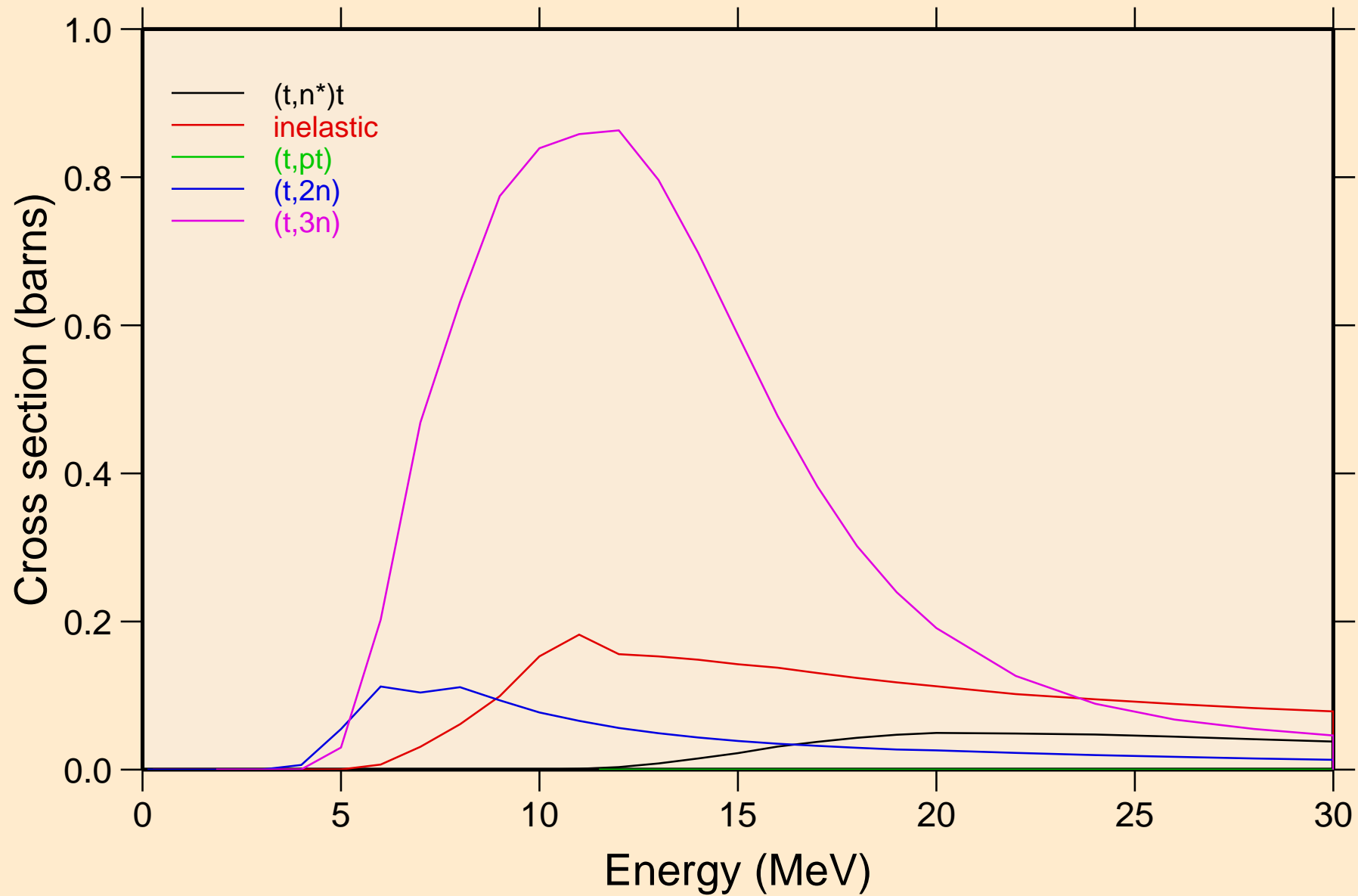

RB093 TRITON ACER TENDL-2021 LIBRARY; T=0.K  
Threshold reactions

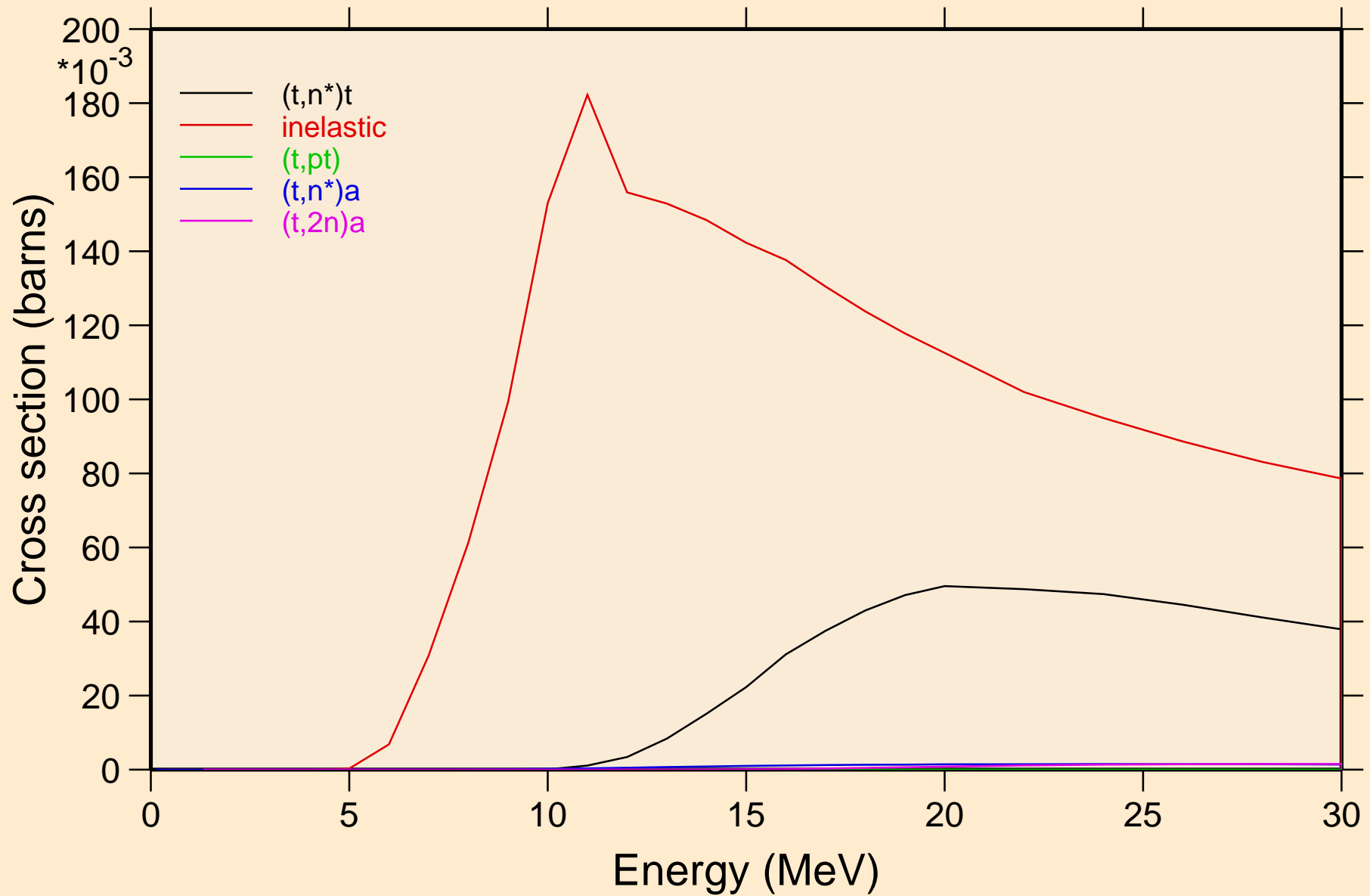

RB093 TRITON ACER TENDL-2021 LIBRARY; T=0.K  
Threshold reactions

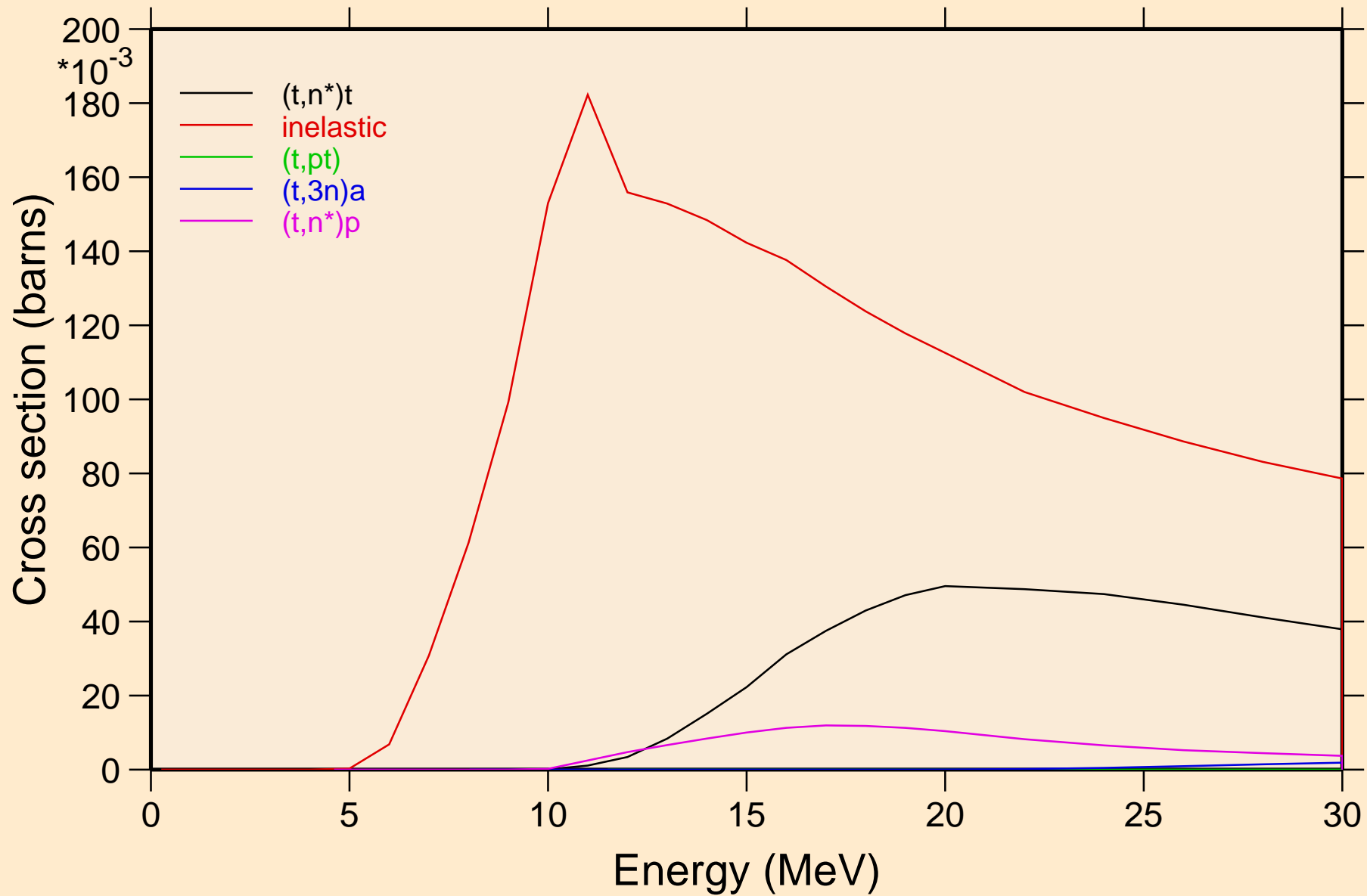



RB093 TRITON ACER TENDL-2021 LIBRARY; T=0.K  
Threshold reactions

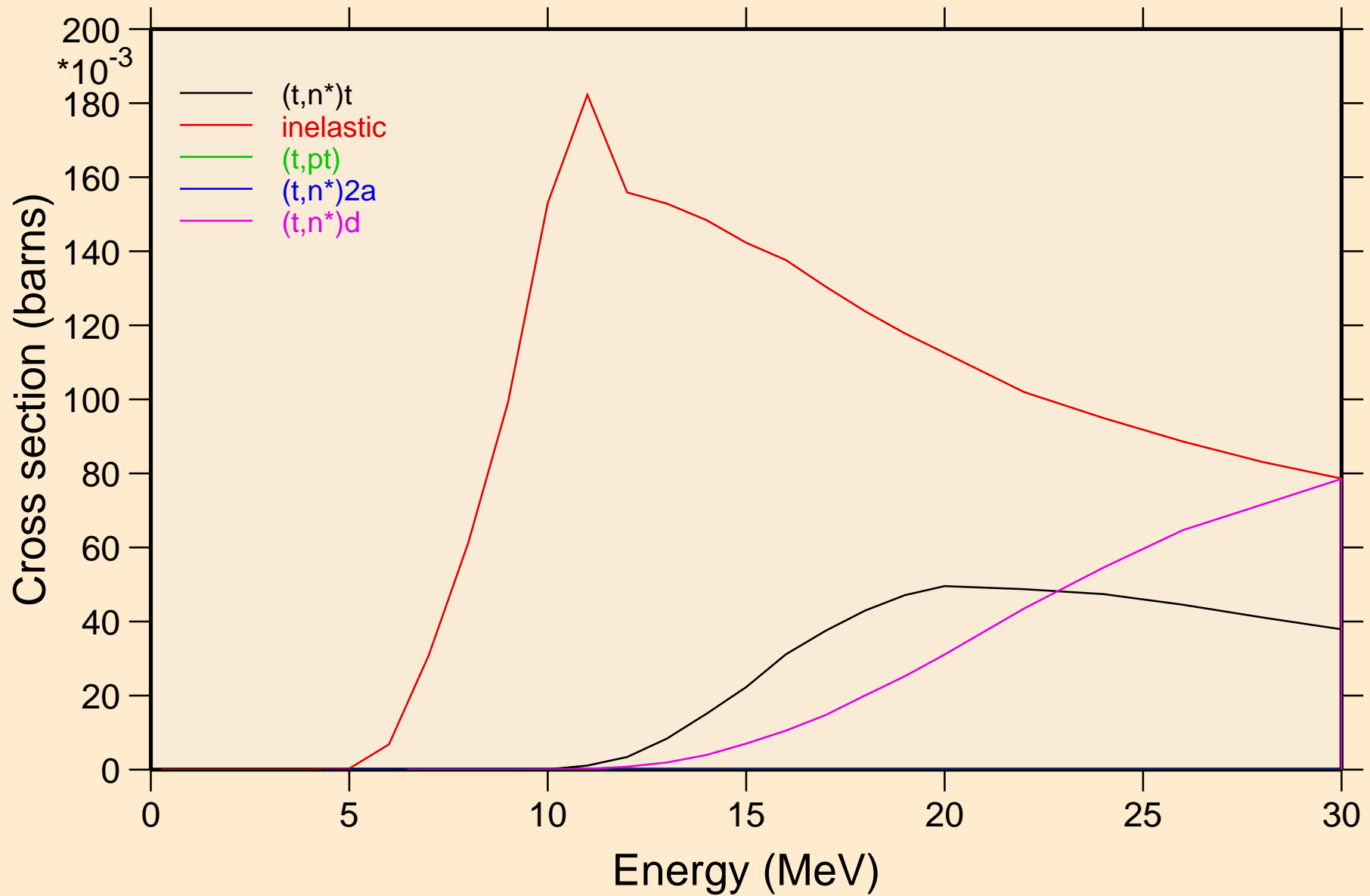

RB093 TRITON ACER TENDL-2021 LIBRARY; T=0.K  
Threshold reactions

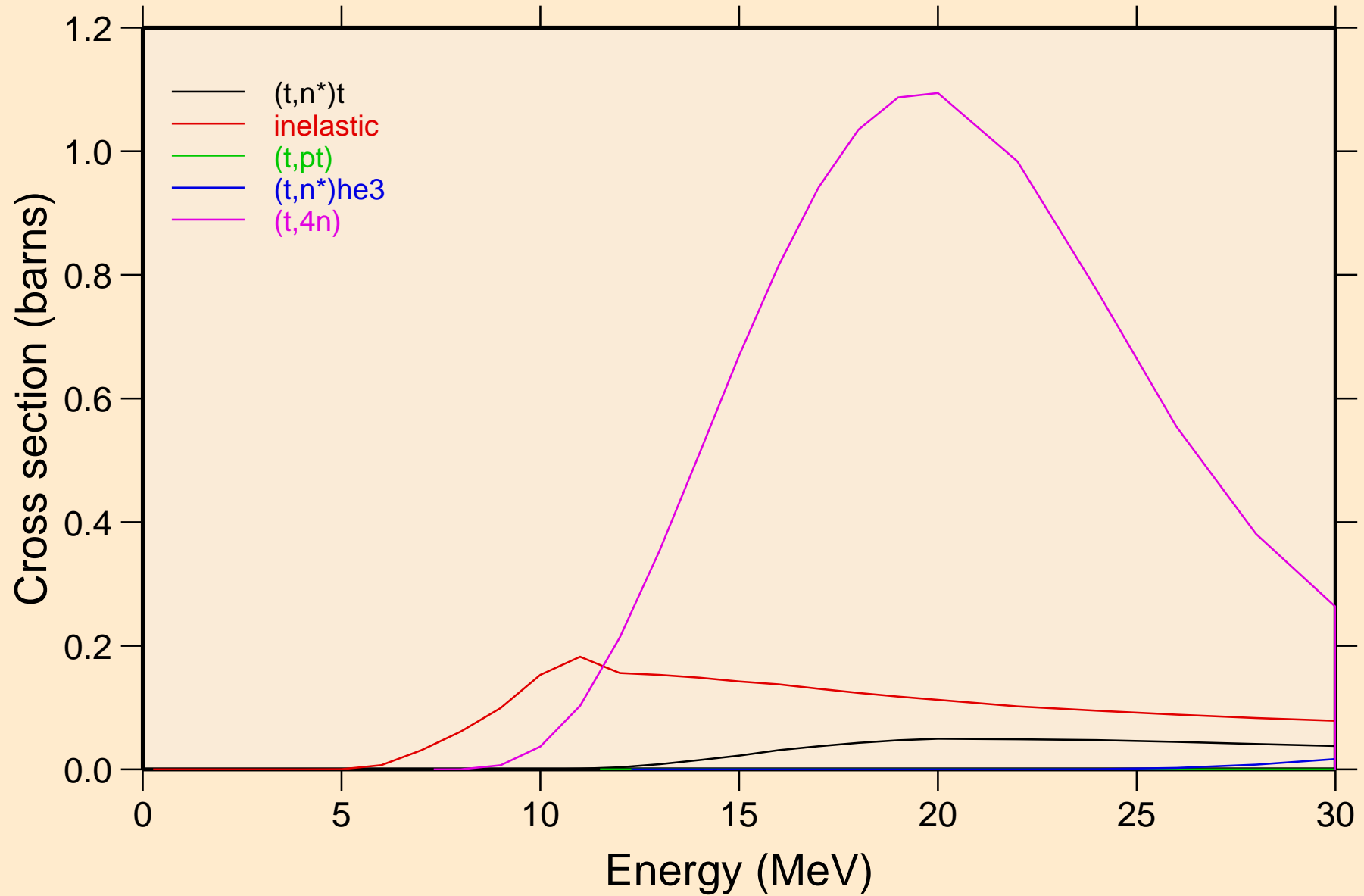

RB093 TRITON ACER TENDL-2021 LIBRARY; T=0.K  
Threshold reactions

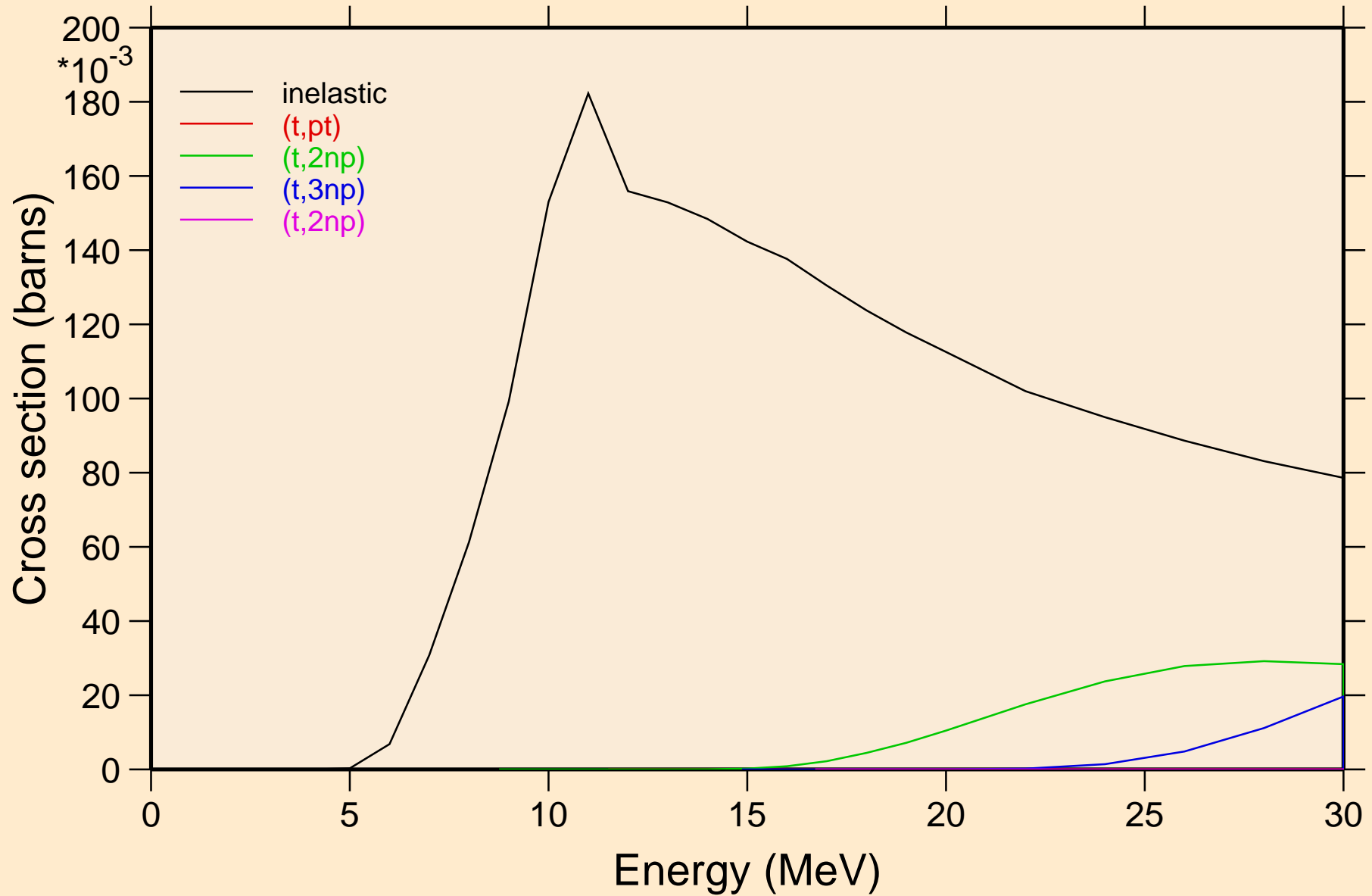

RB093 TRITON ACER TENDL-2021 LIBRARY; T=0.K  
Threshold reactions

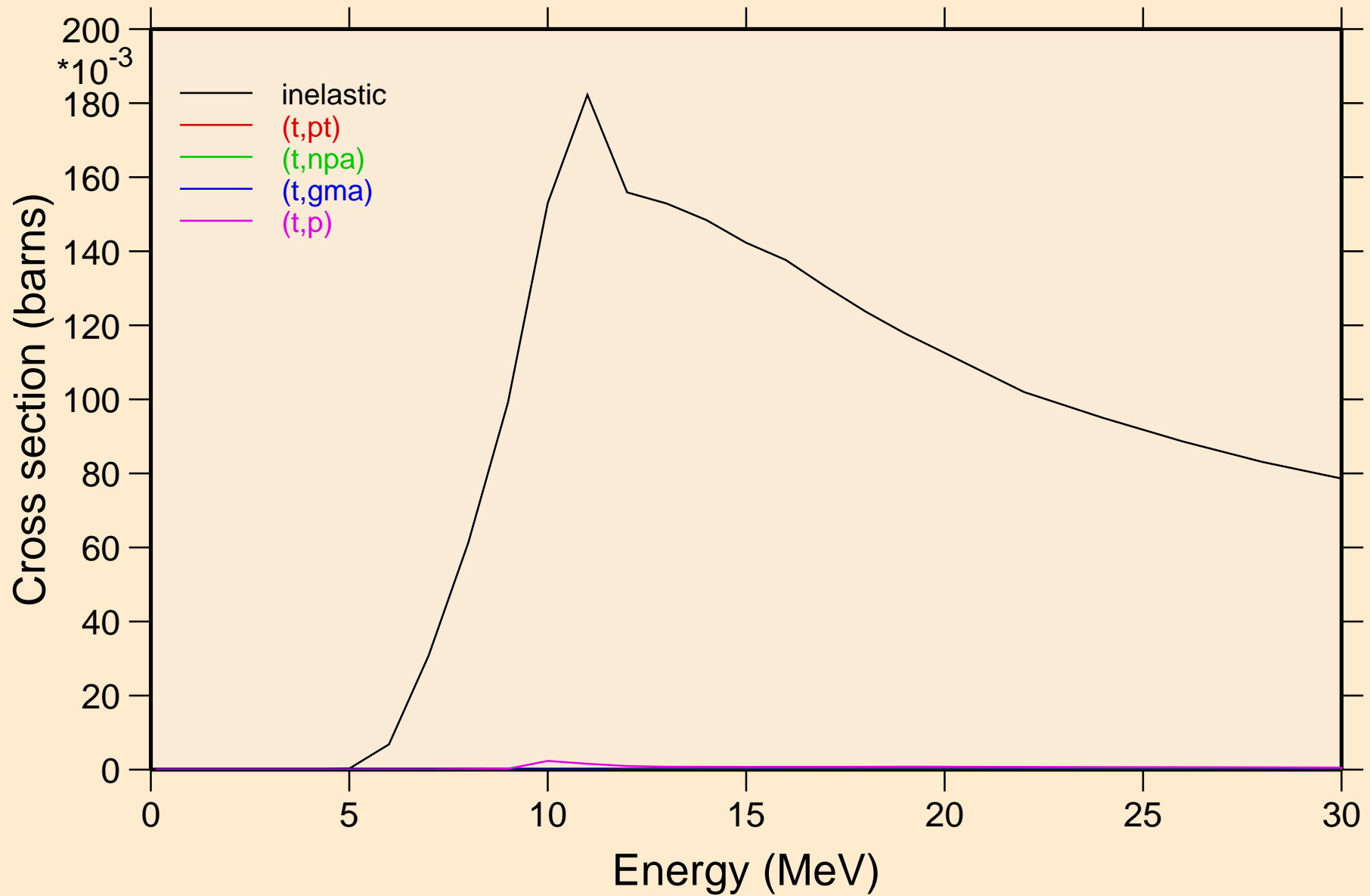

RB093 TRITON ACER TENDL-2021 LIBRARY; T=0.K  
Threshold reactions

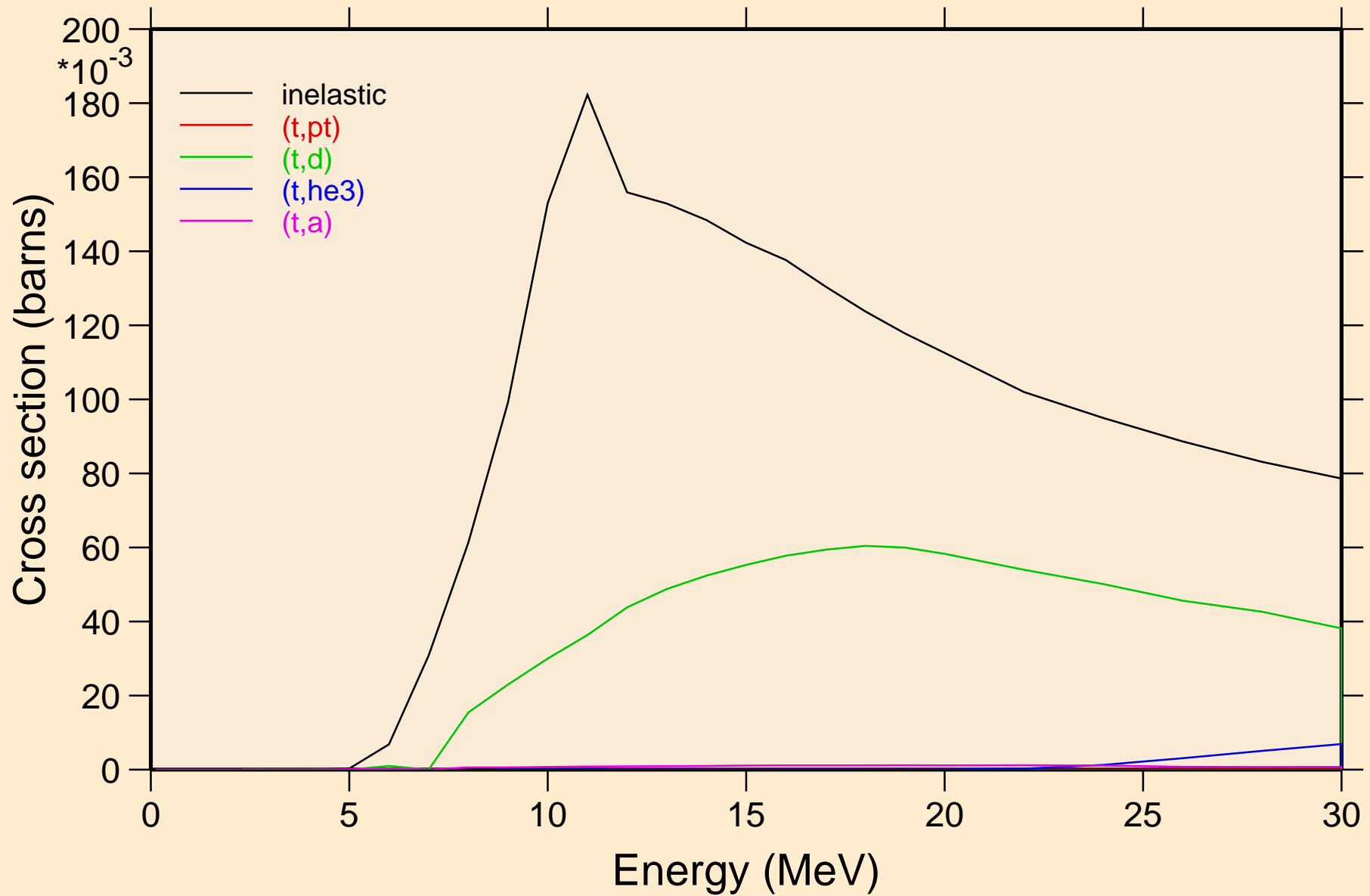

RB093 TRITON ACER TENDL-2021 LIBRARY; T=0.K  
Threshold reactions

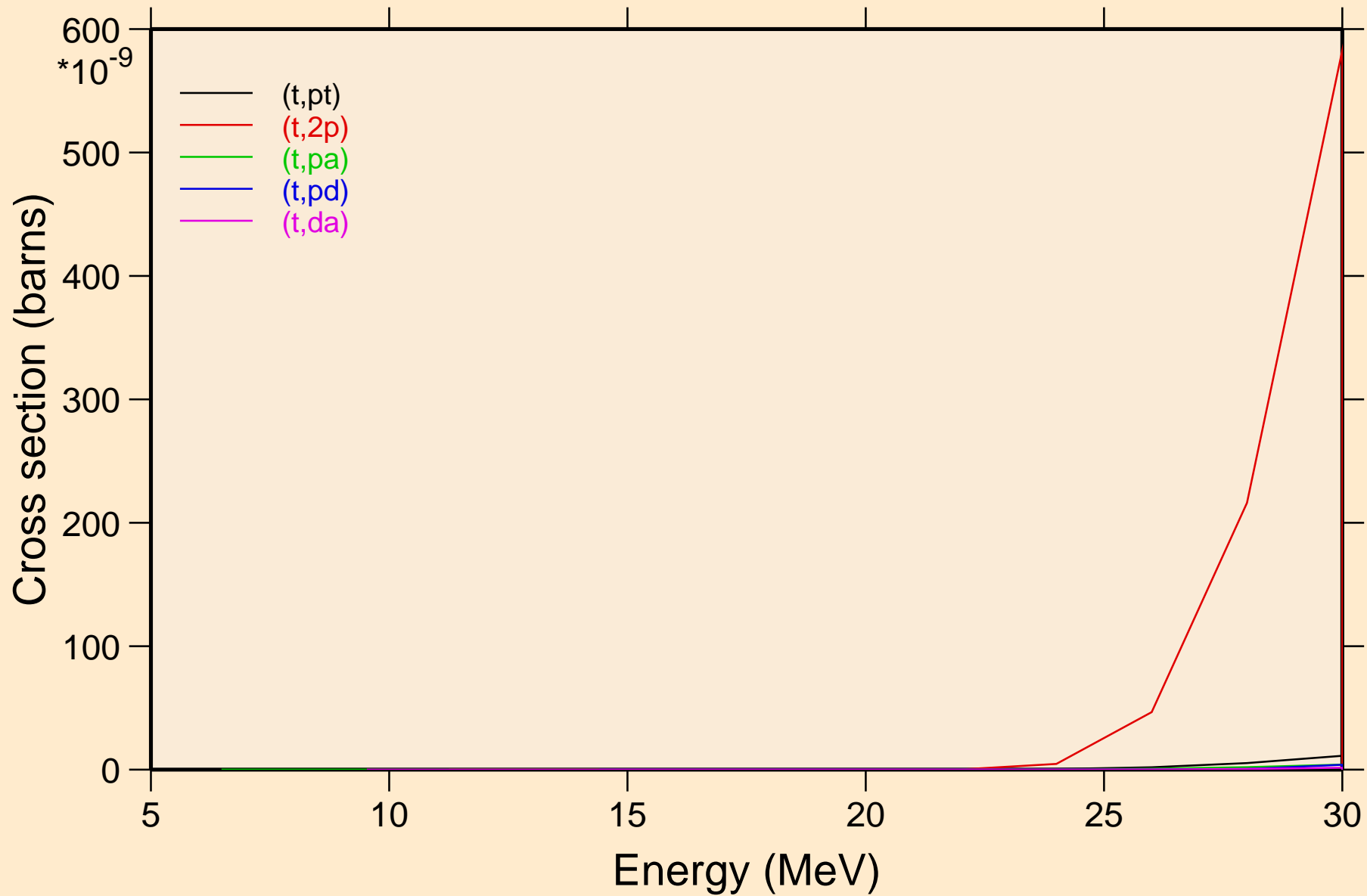

RB093 TRITON ACER TENDL-2021 LIBRARY; T=0.K  
angular distribution for elastic

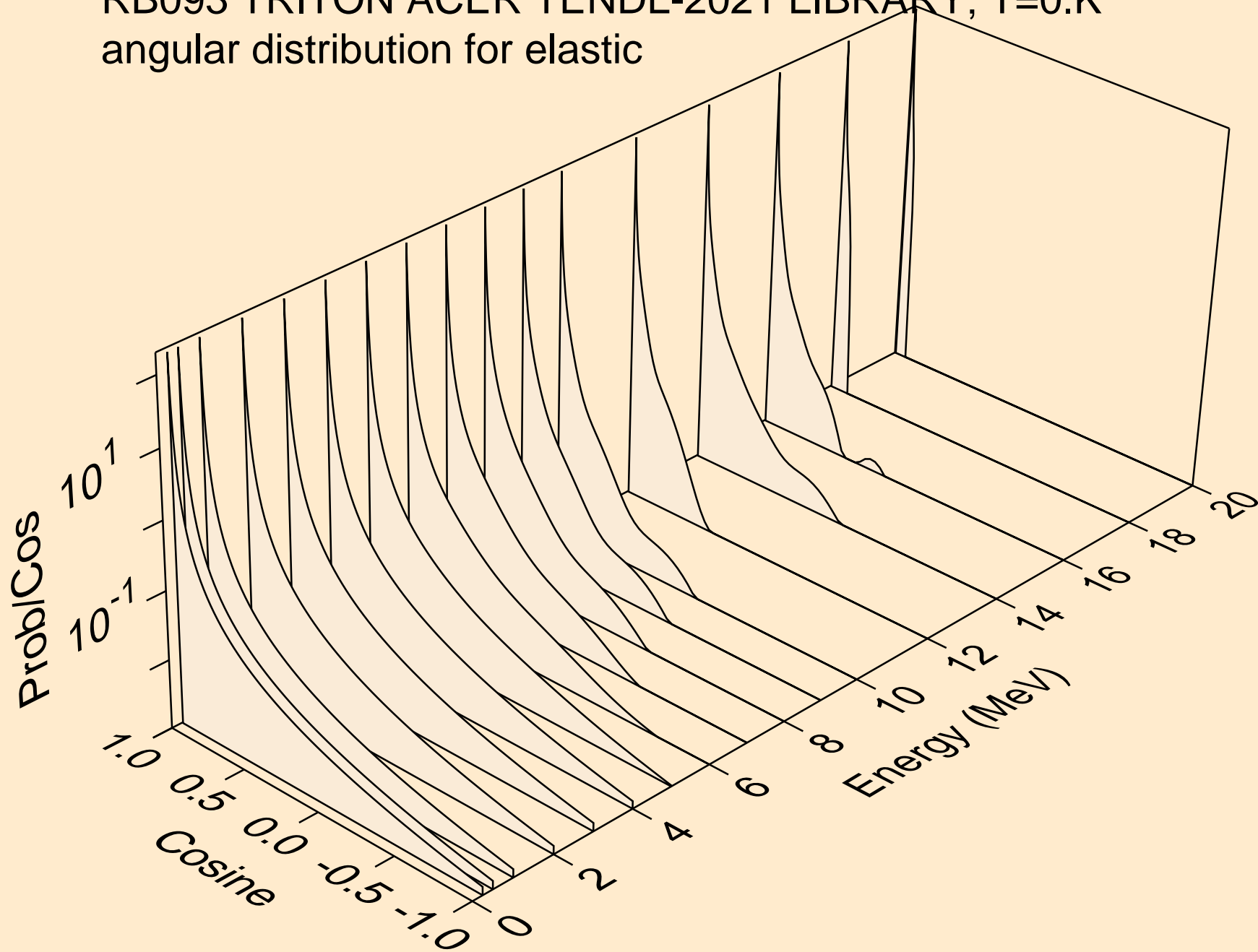

RB093 TRITON ACER TENDL-2021 LIBRARY; T=0.K  
angular distribution for elastic

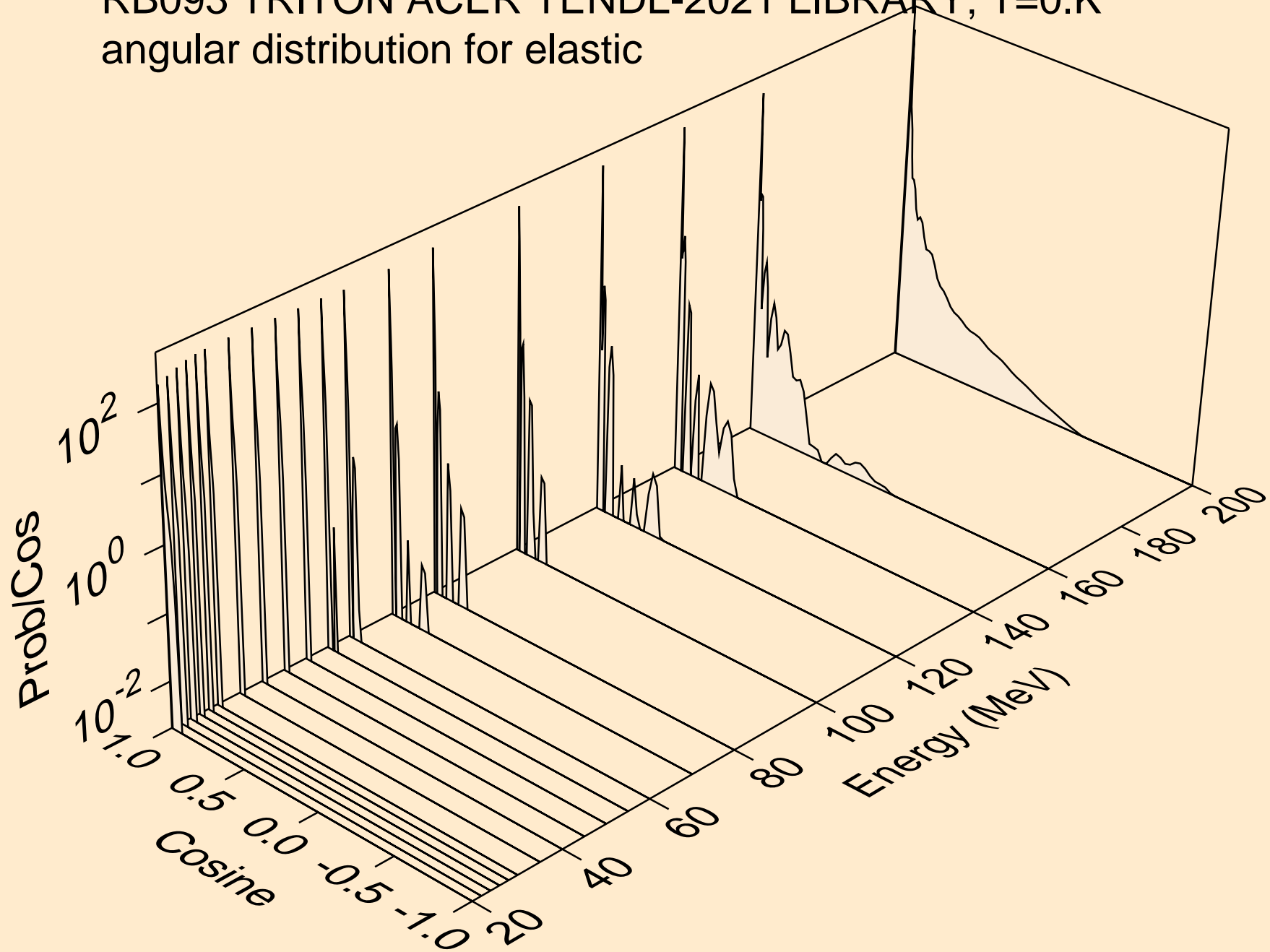



RB093 TRITON ACER TENDL-2021 LIBRARY; T=0.K  
Triton emission for (t,x)

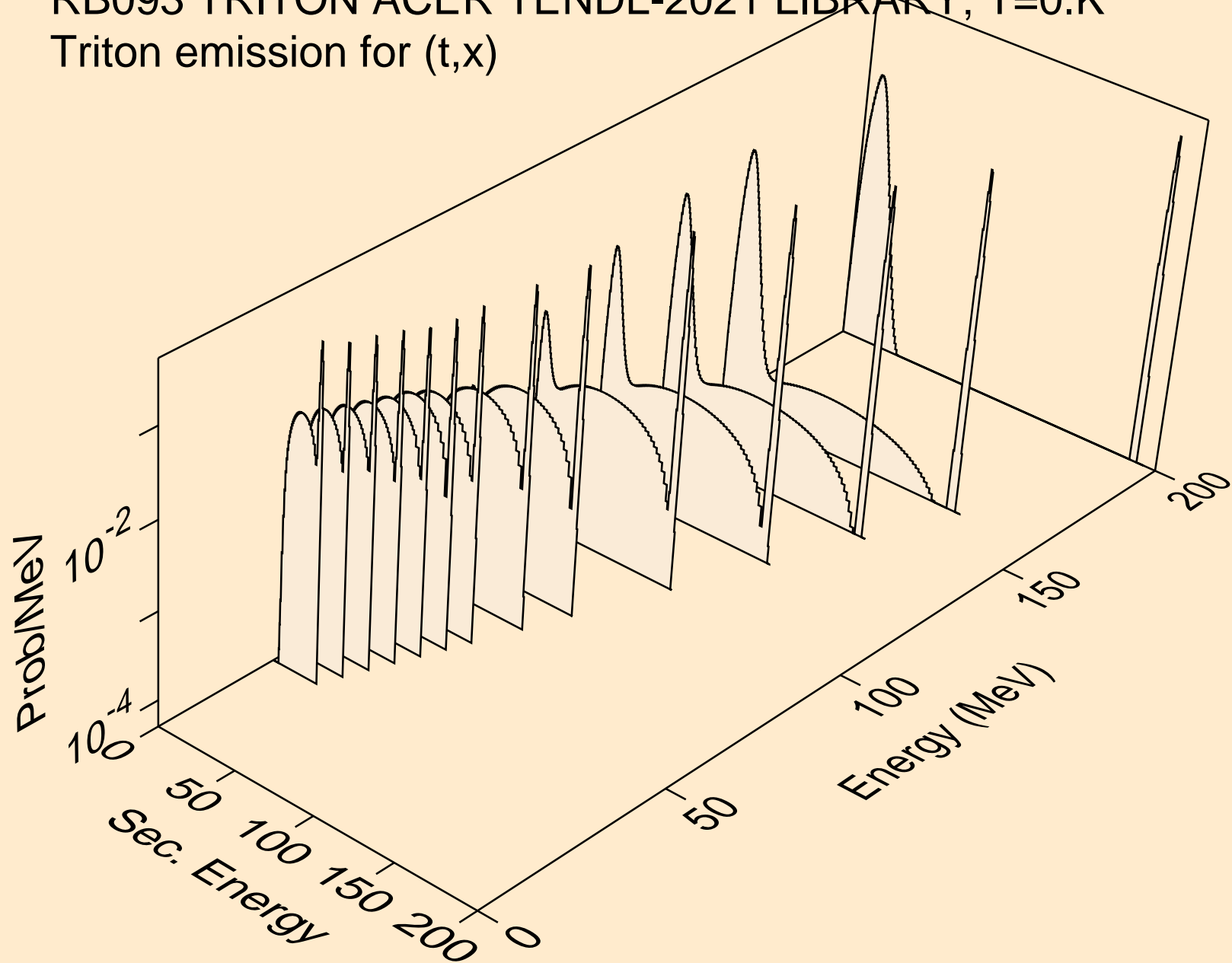

RB093 TRITON ACER TENDL-2021 LIBRARY; T=0.K  
Triton emission for (t,n\*)t

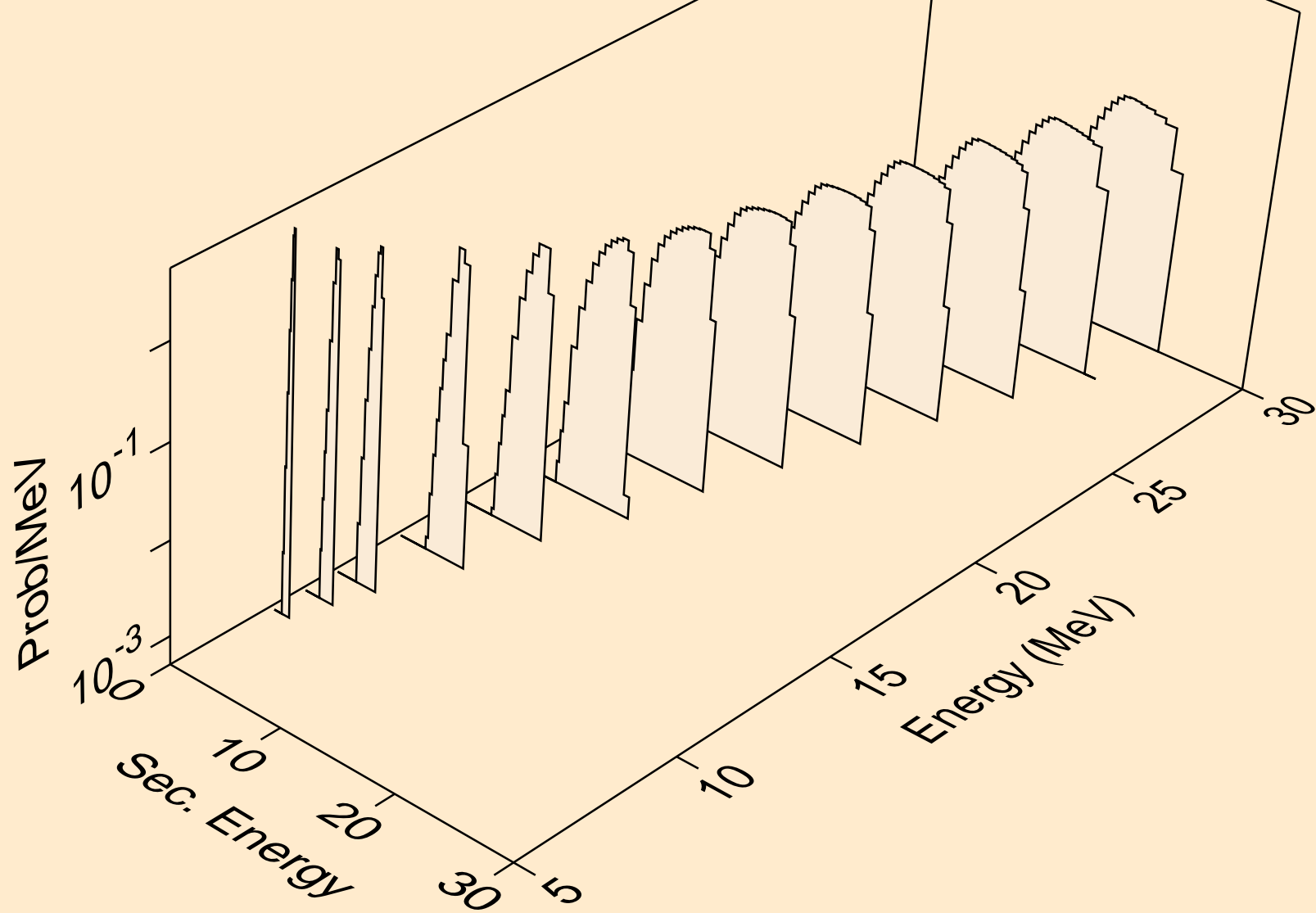

RB093 TRITON ACER TENDL-2021 LIBRARY; T=0.K  
Triton emission for inelastic

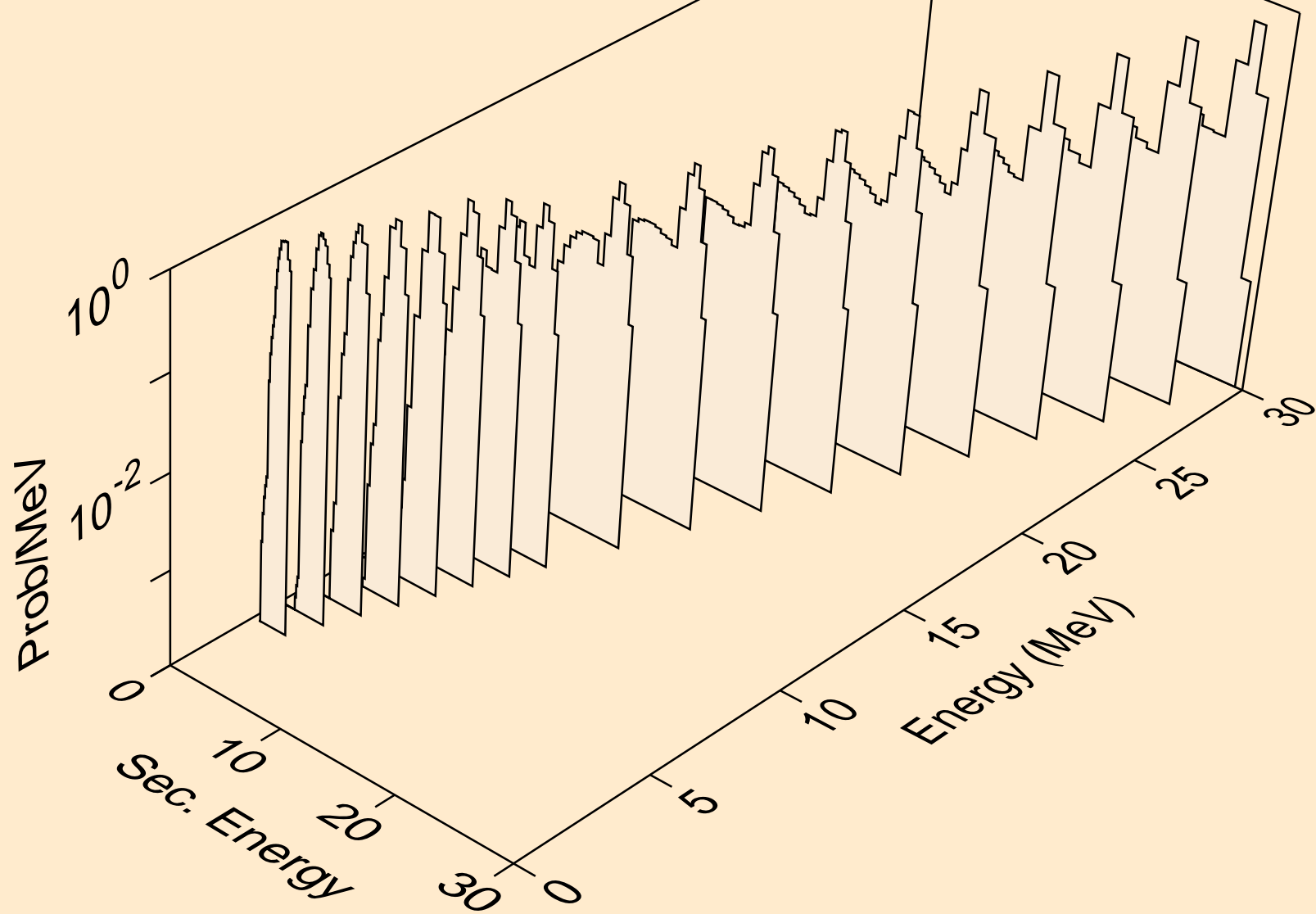

RB093 TRITON ACER TENDL-2021 LIBRARY; T=0.K  
Triton emission for (t,pt)

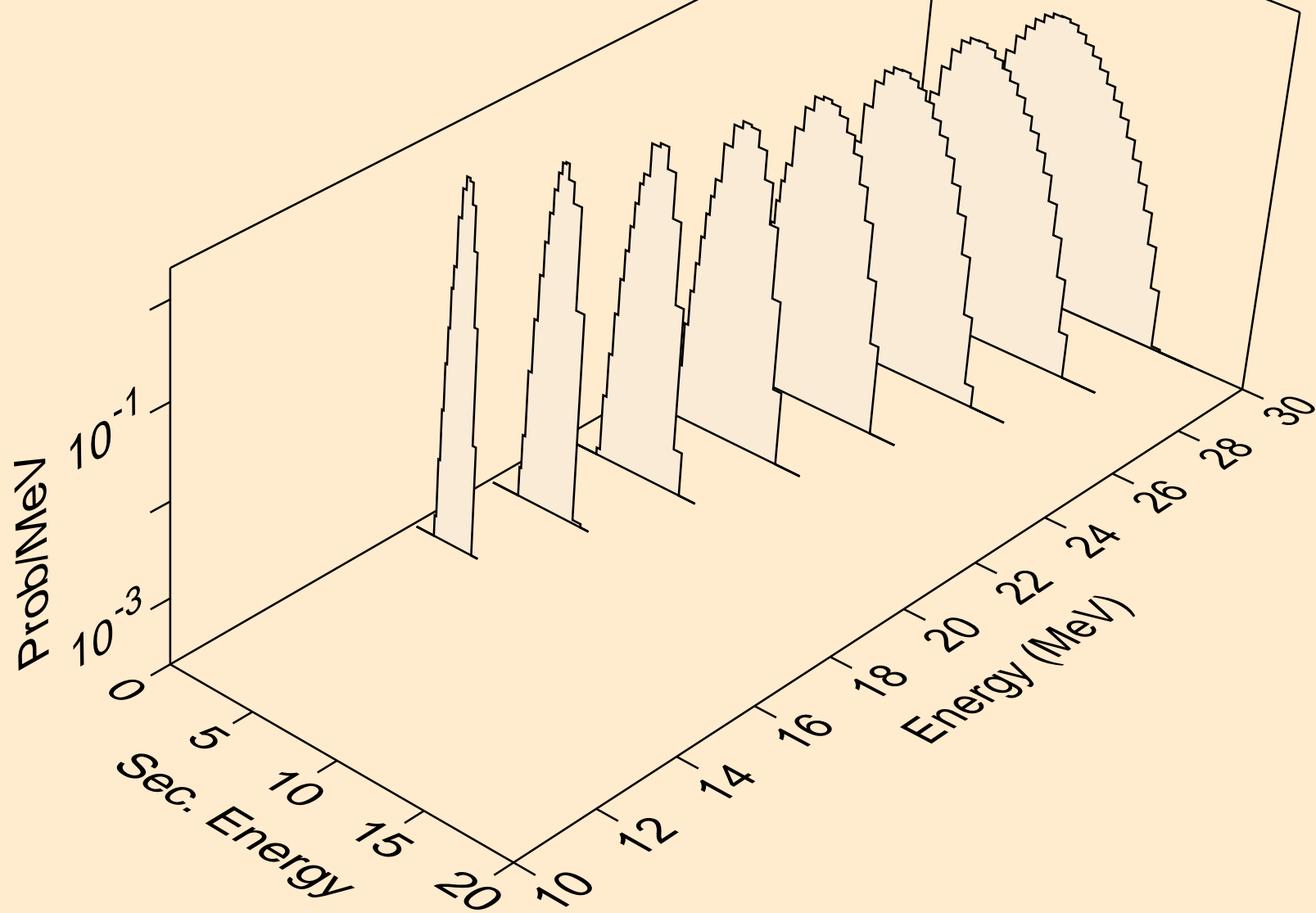

RB093 TRITON ACER TENDL-2021 LIBRARY; T=0.K  
Photon emission for (z,n)

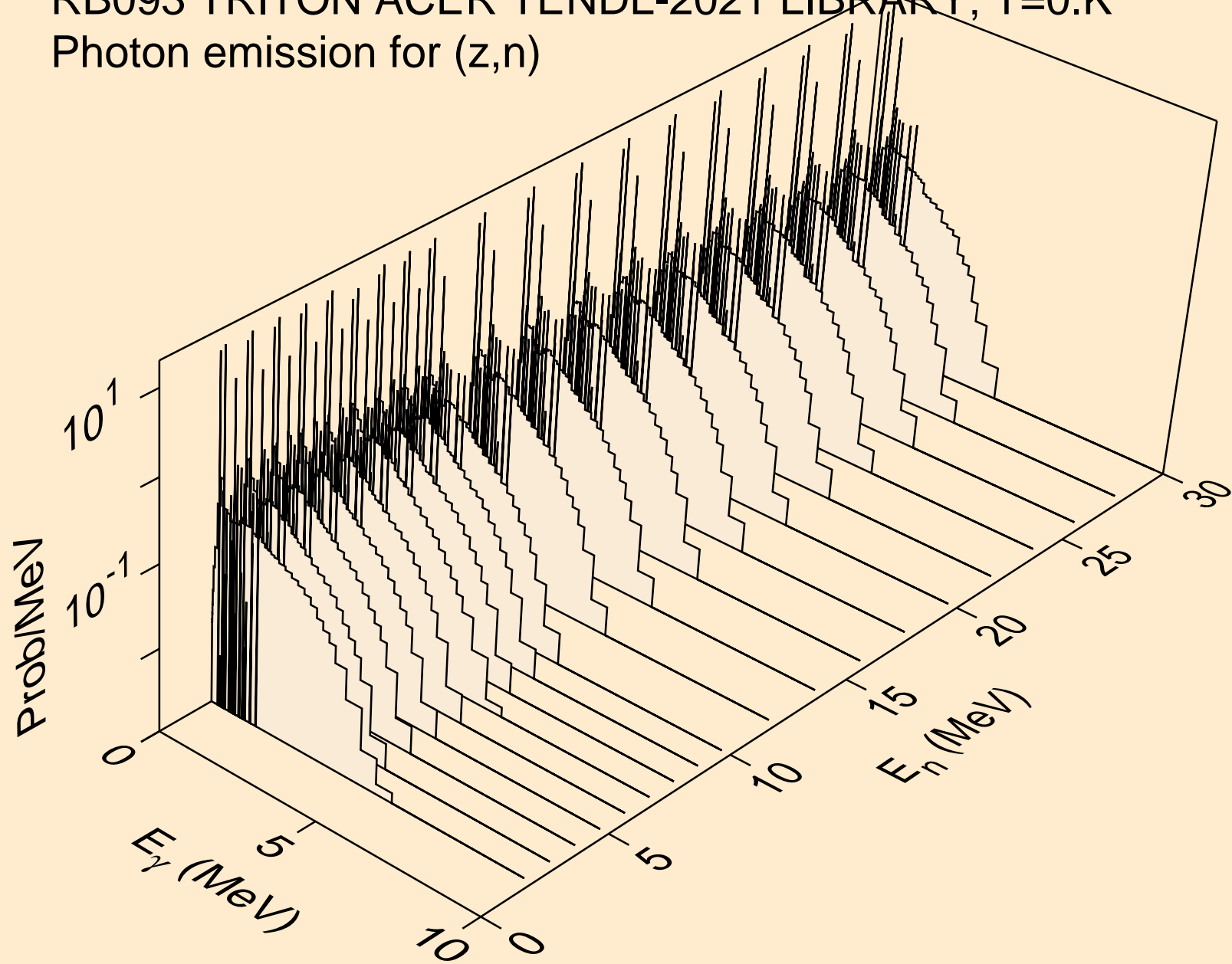

RB093 TRITON ACER TENDL-2021 LIBRARY; T=0.K  
Photon emission for (n,x)

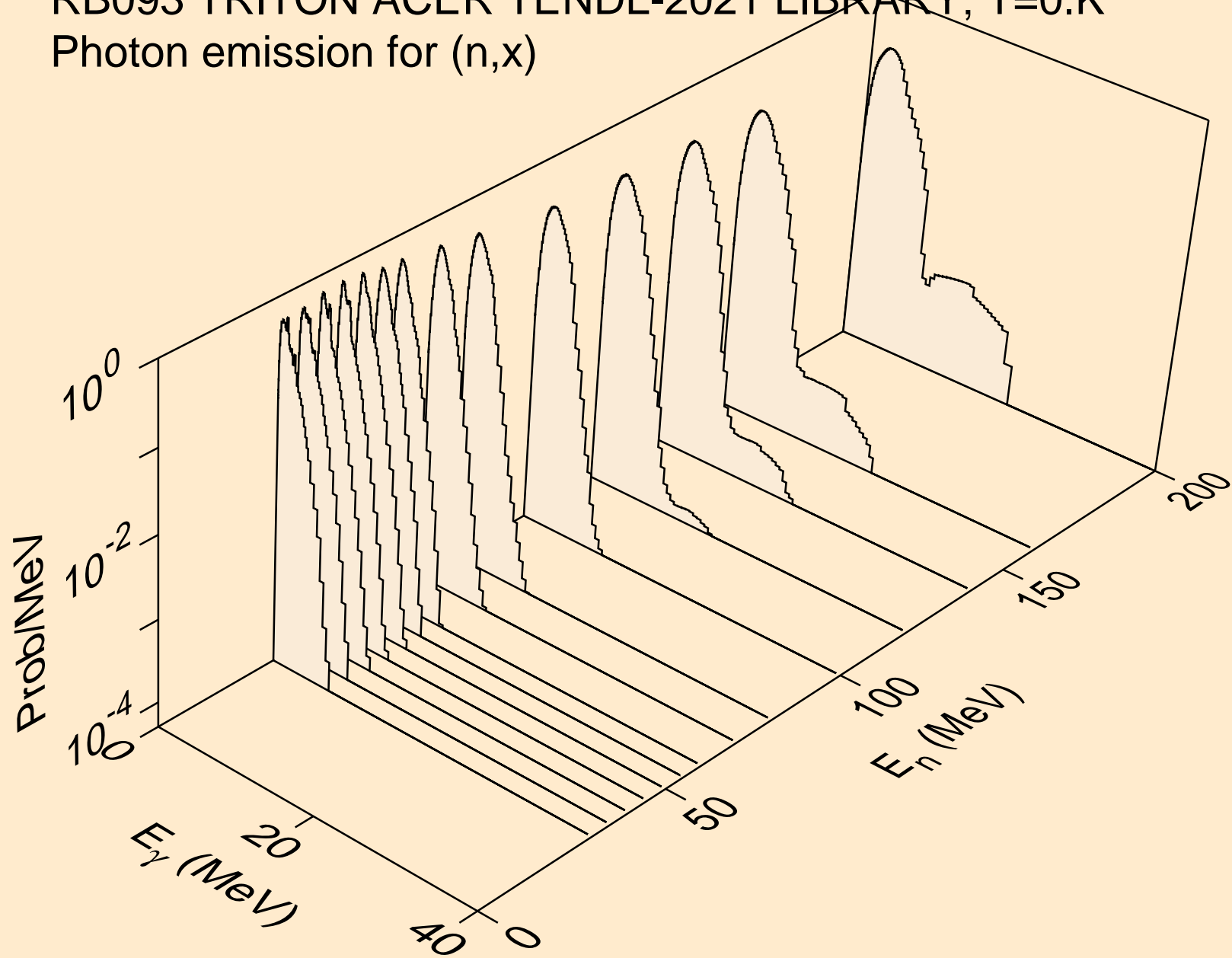

RB093 TRITON ACER TENDL-2021 LIBRARY; T=0.K  
Photon emission for (n,2nd)

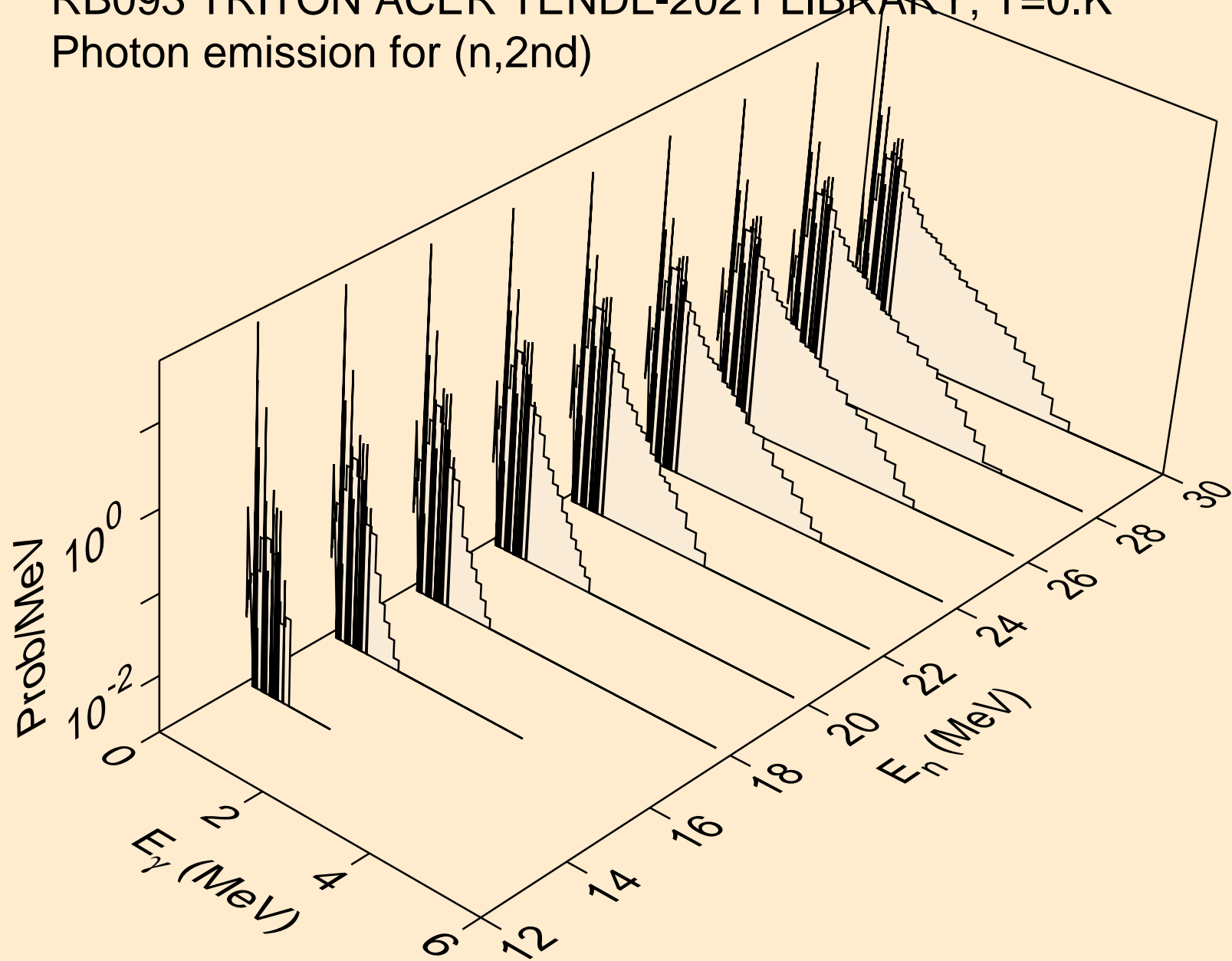

RB093 TRITON ACER TENDL-2021 LIBRARY; T=0.K  
Photon emission for (n,2n)

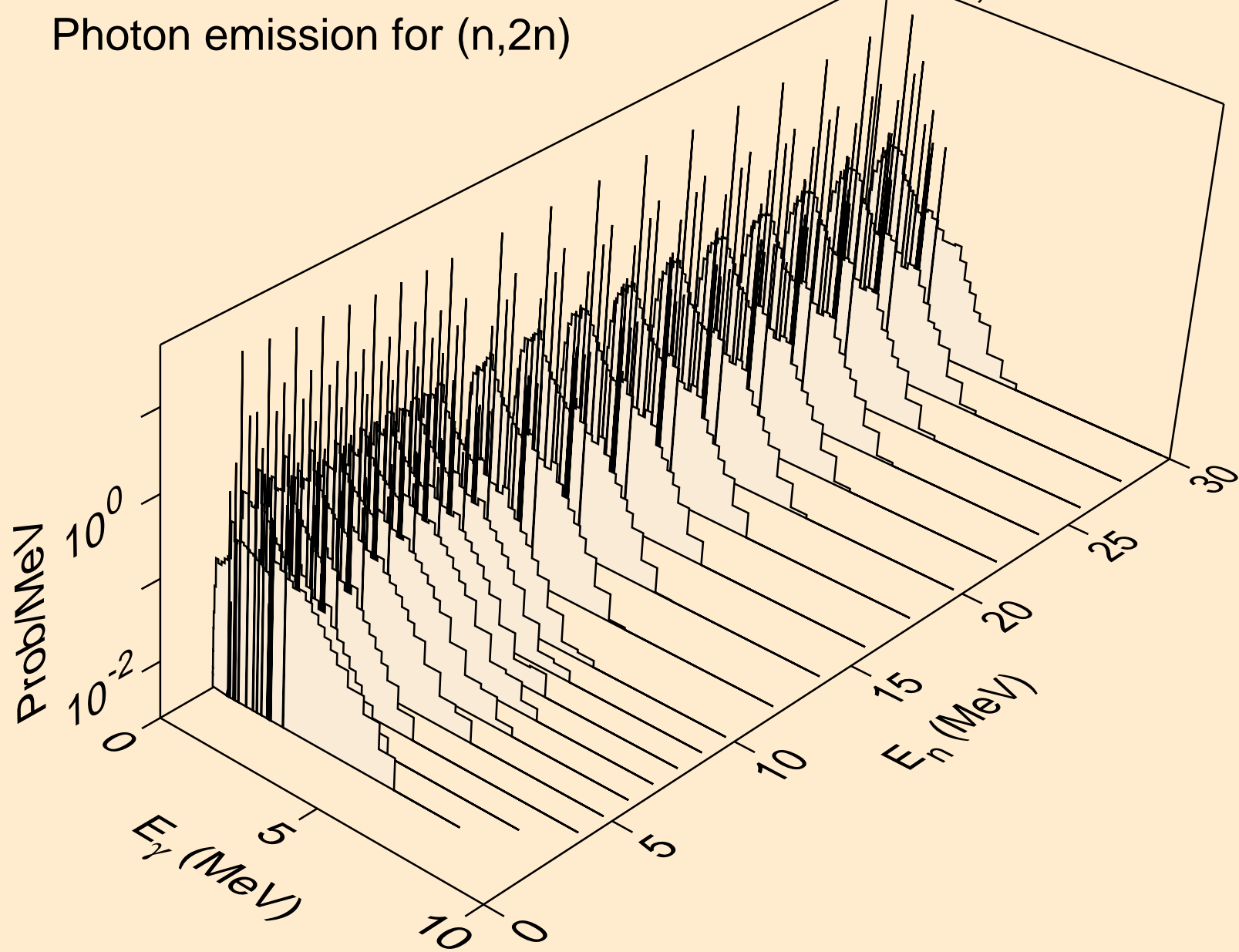



RB093 TRITON ACER TENDL-2021 LIBRARY; T=0.K  
Photon emission for (n,3n)

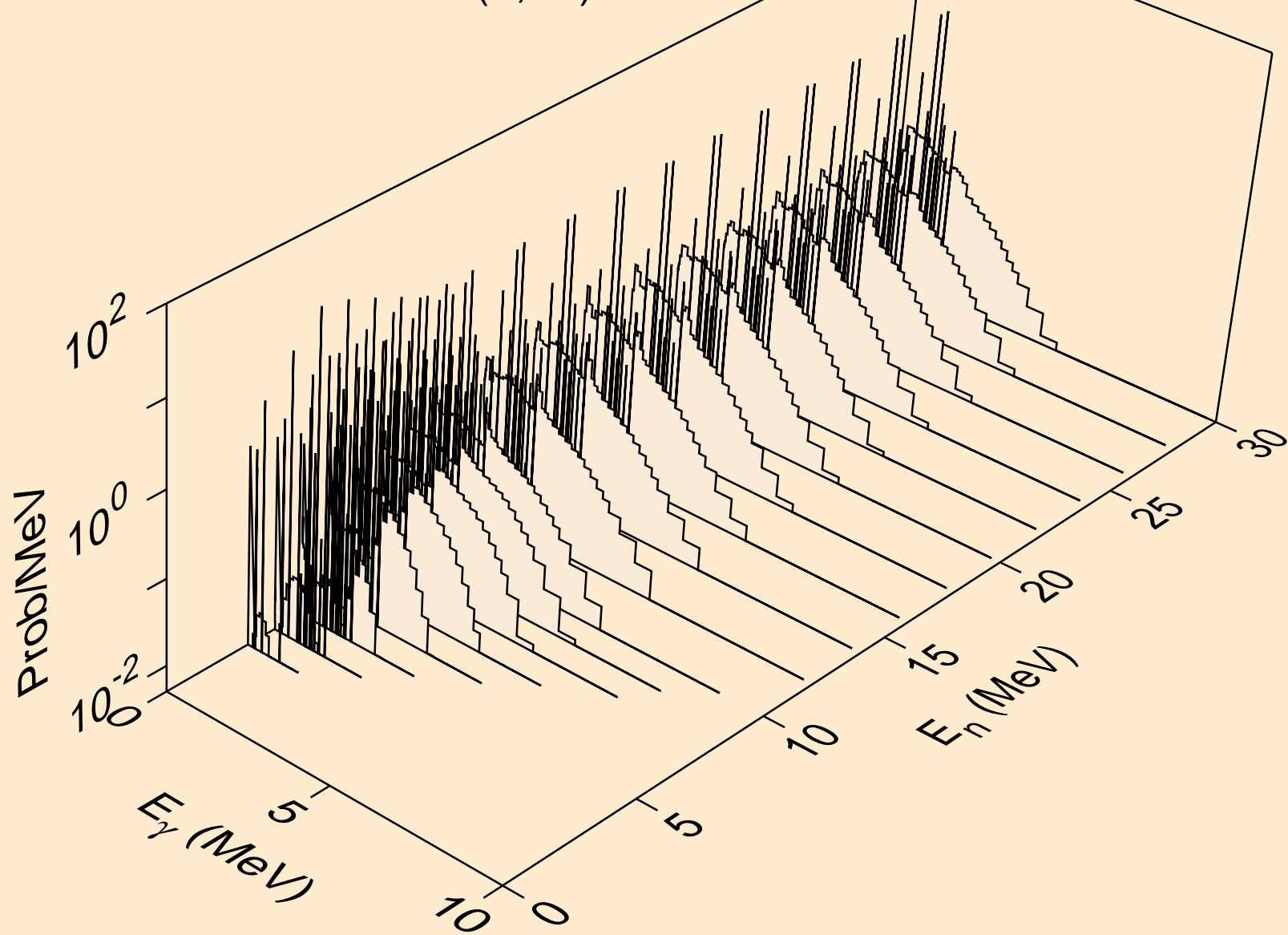

RB093 TRITON ACER TENDL-2021 LIBRARY; T=0.K  
Photon emission for (n,n\*)a

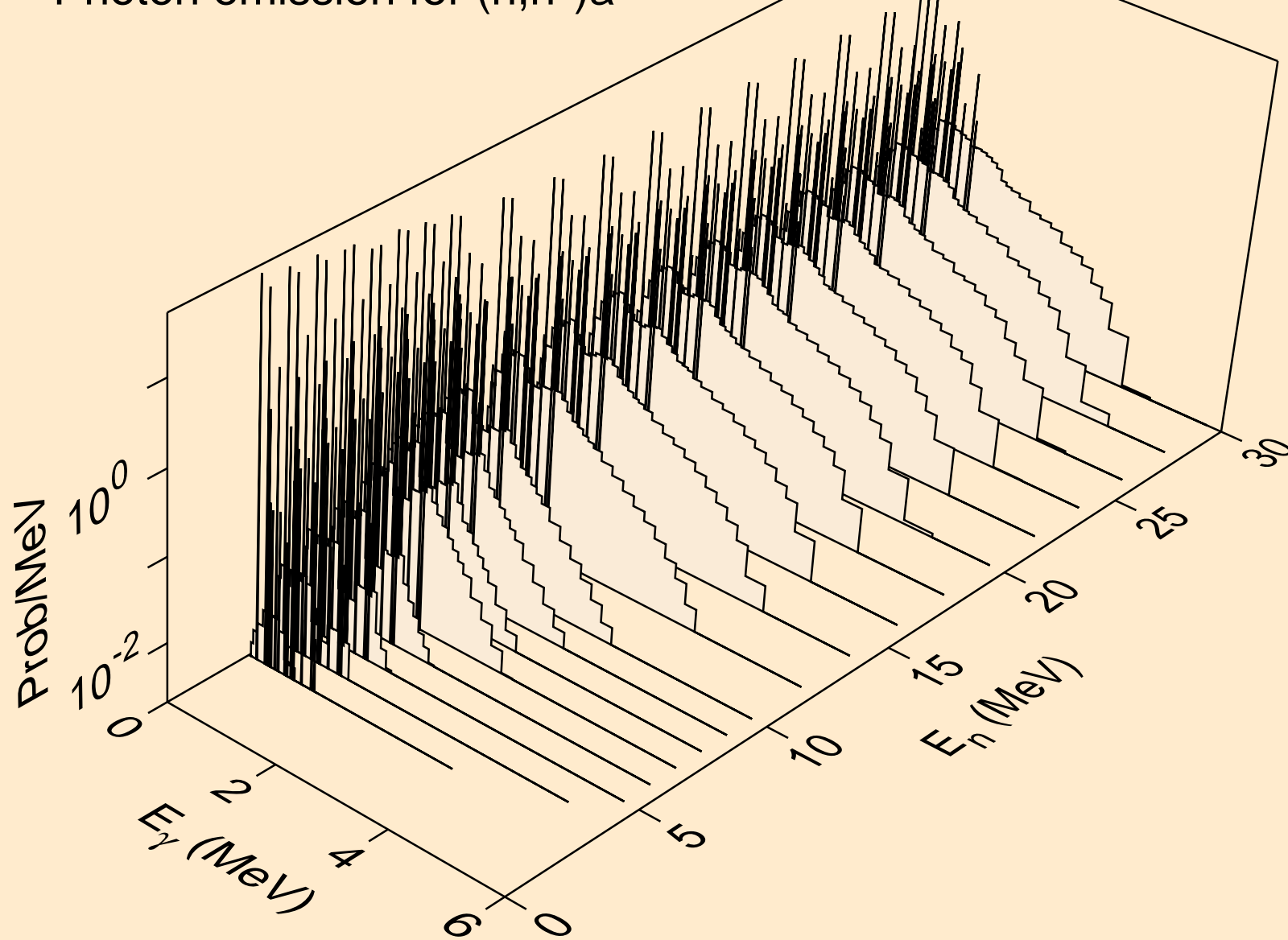

RB093 TRITON ACER TENDL-2021 LIBRARY; T=0.K  
Photon emission for (n,2n)a

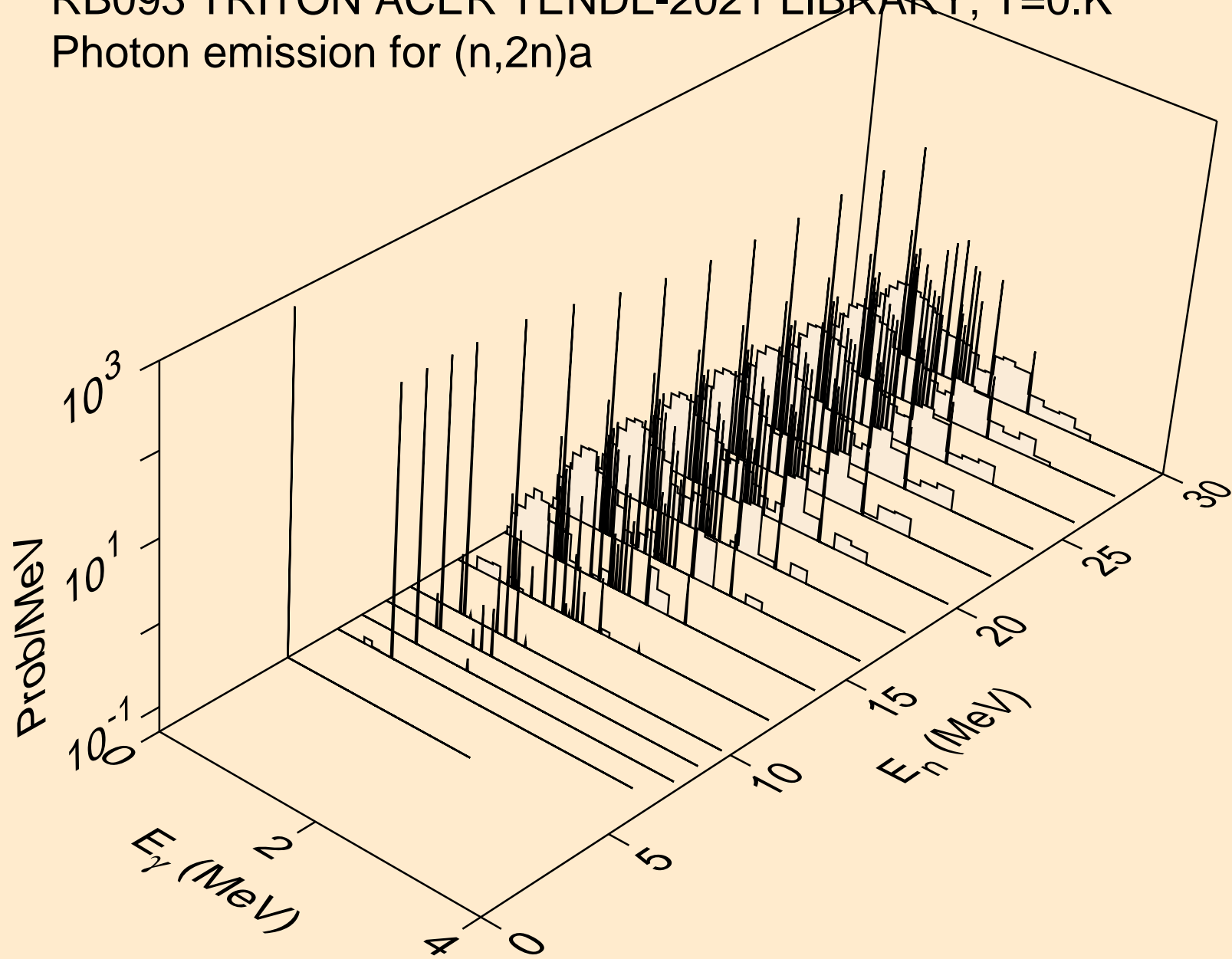

RB093 TRITON ACER TENDL-2021 LIBRARY; T=0.K  
Photon emission for (n,3n)a

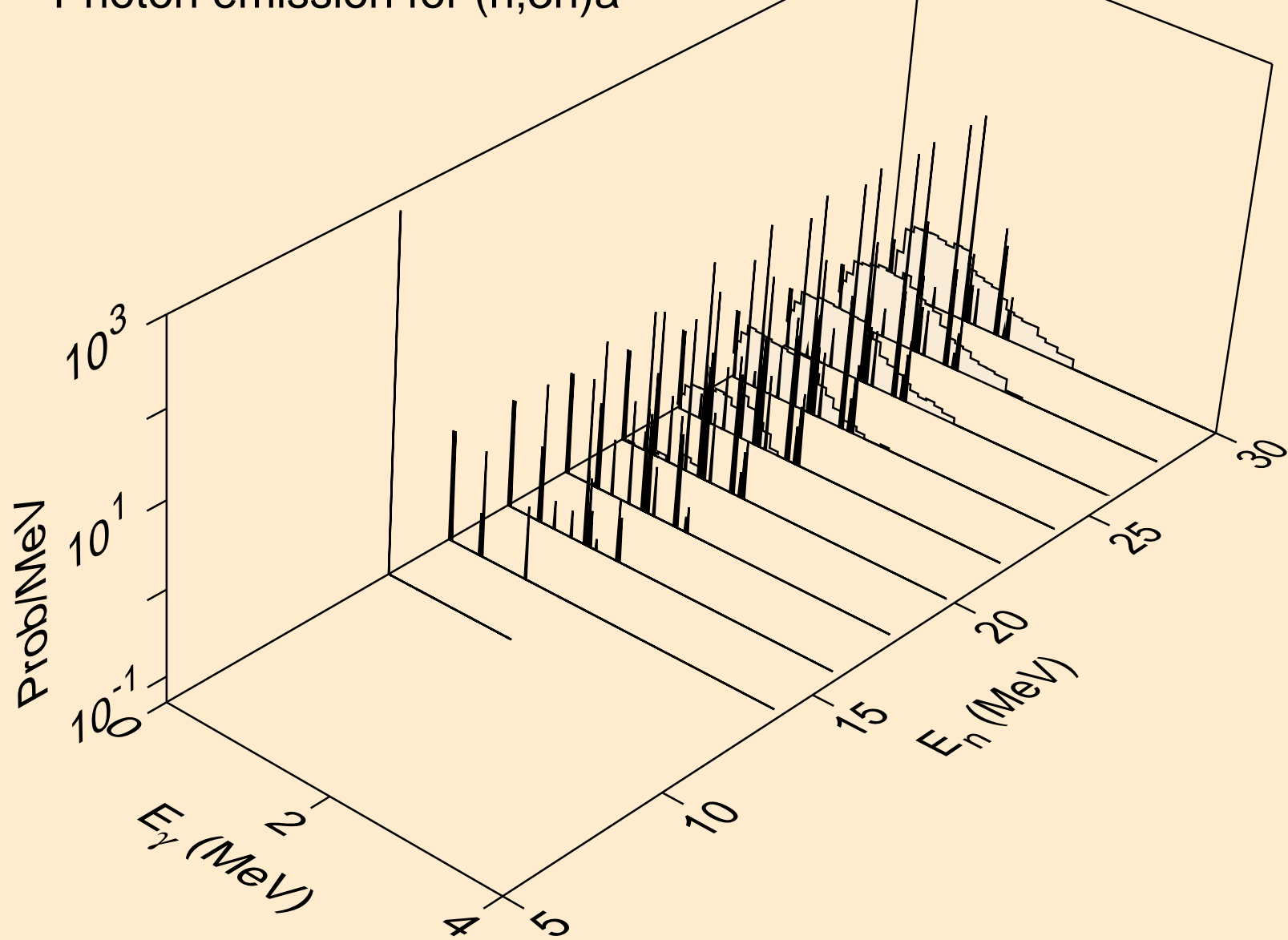

RB093 TRITON ACER TENDL-2021 LIBRARY; T=0.K  
Photon emission for (n,n\*)p

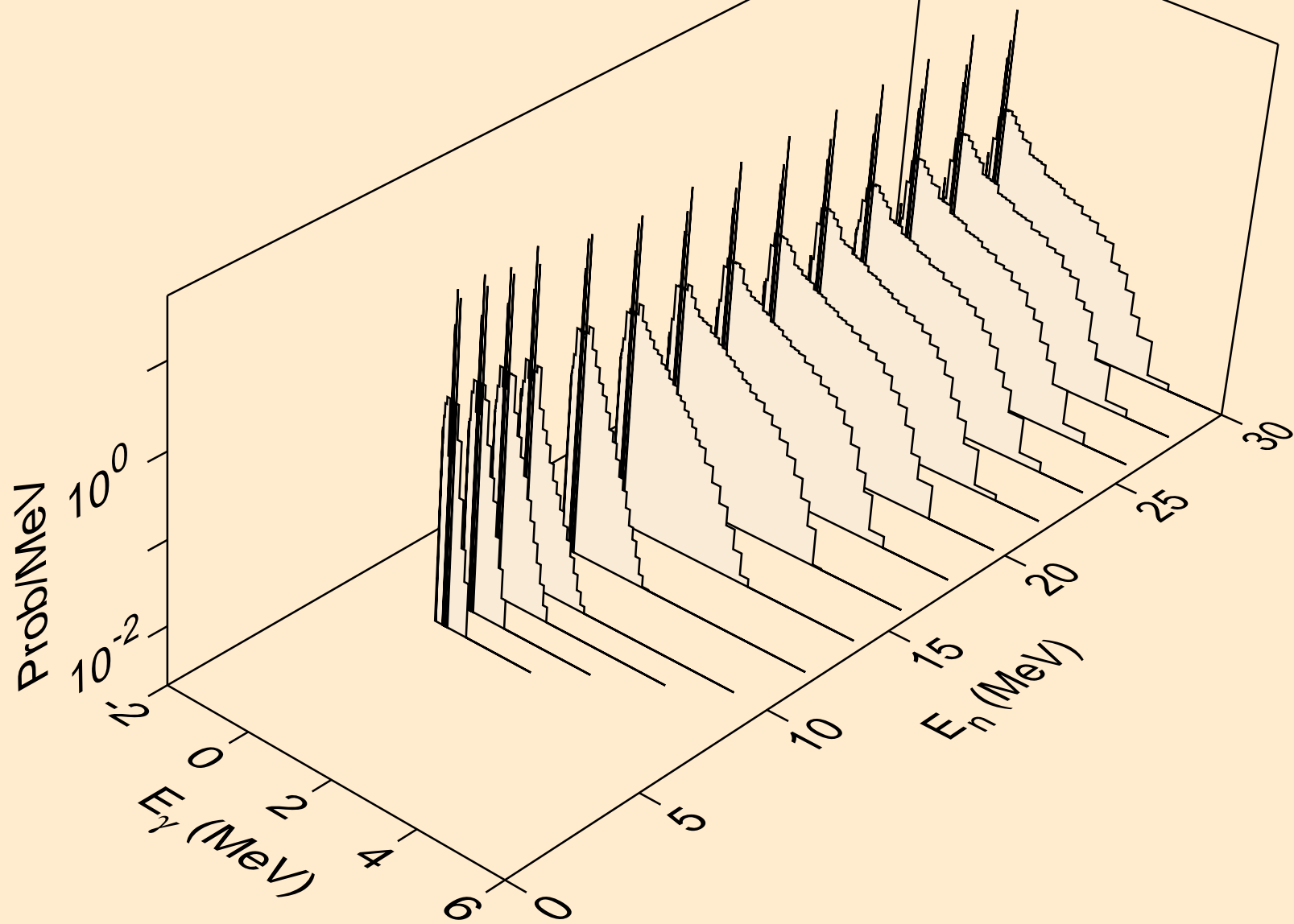

RB093 TRITON ACER TENDL-2021 LIBRARY; T=0.K  
Photon emission for (n,n\*)2a

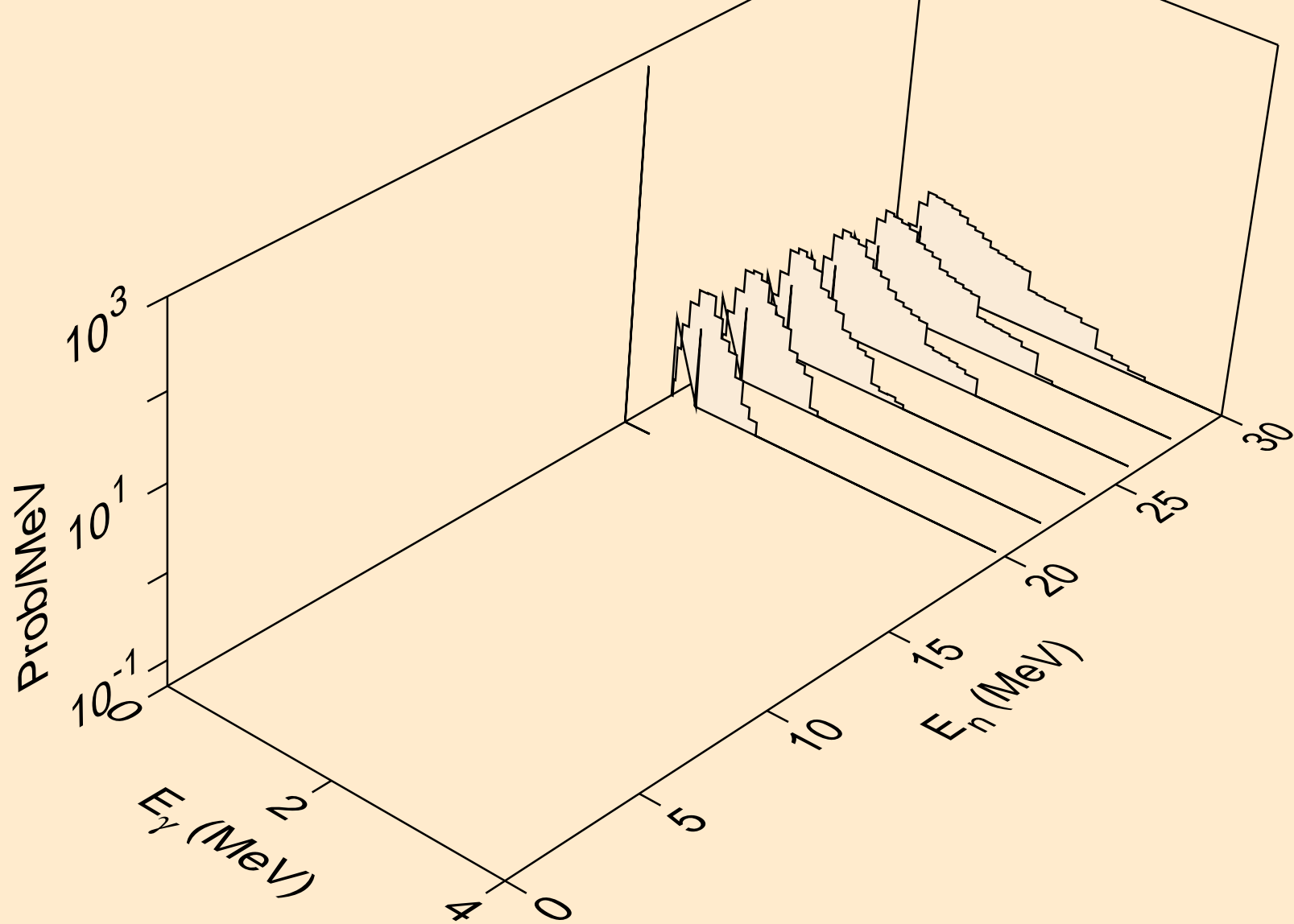

RB093 TRITON ACER TENDL-2021 LIBRARY; T=0.K  
Photon emission for (n,n\*)d

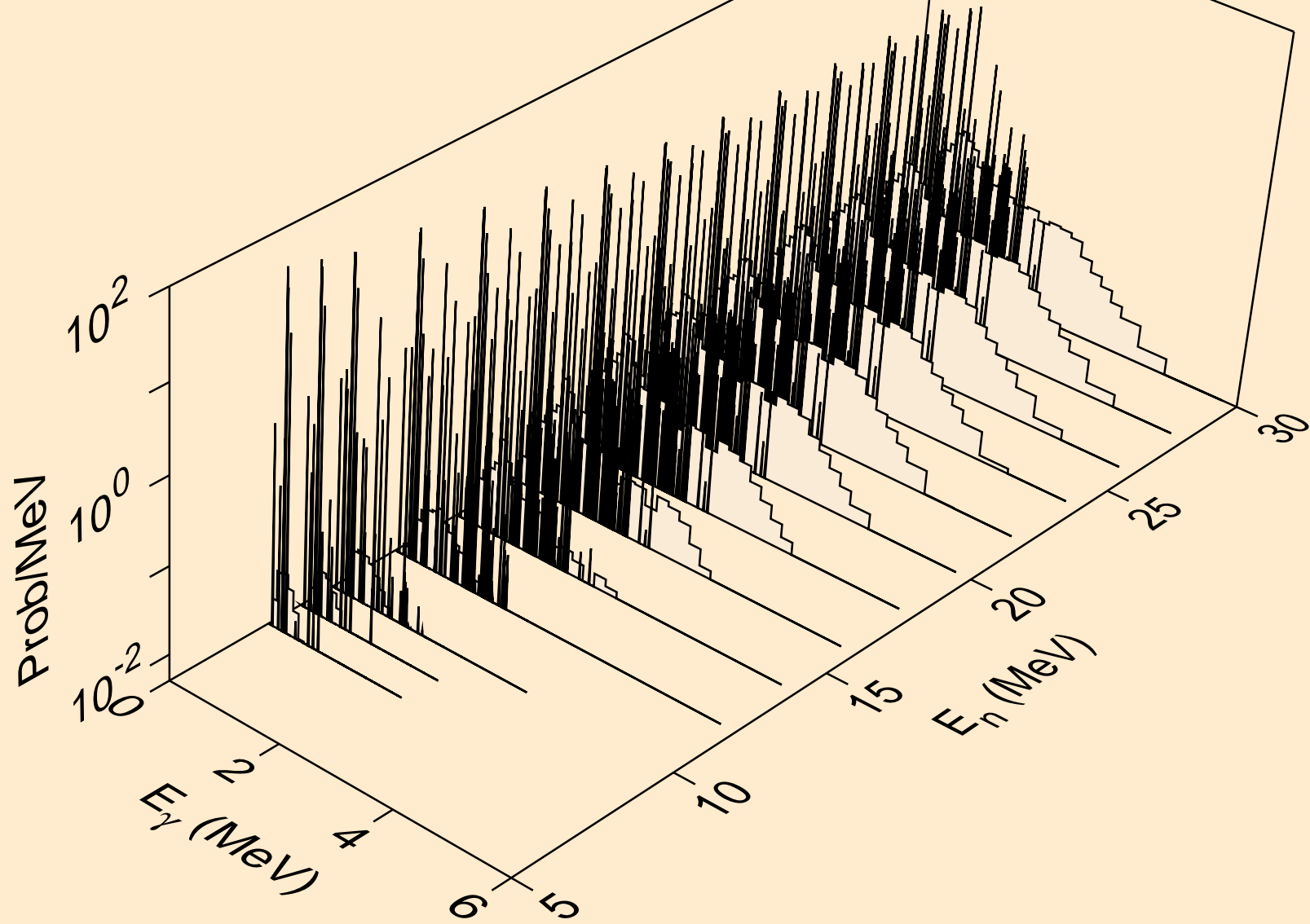

RB093 TRITON ACER TENDL-2021 LIBRARY; T=0.K  
Photon emission for (n,n\*)t

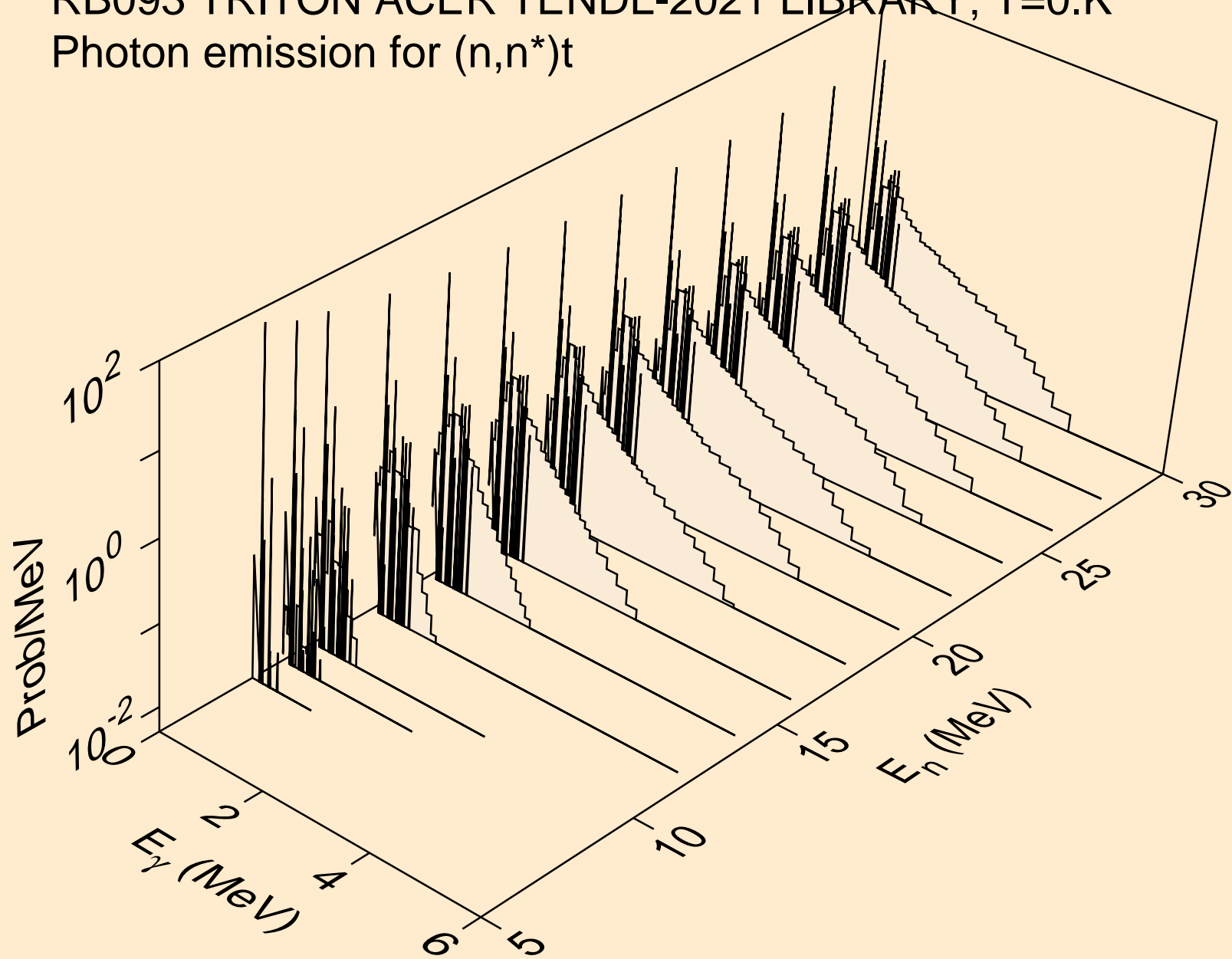



RB093 TRITON ACER TENDL-2021 LIBRARY; T=0.K  
Photon emission for (n,n\*)he3

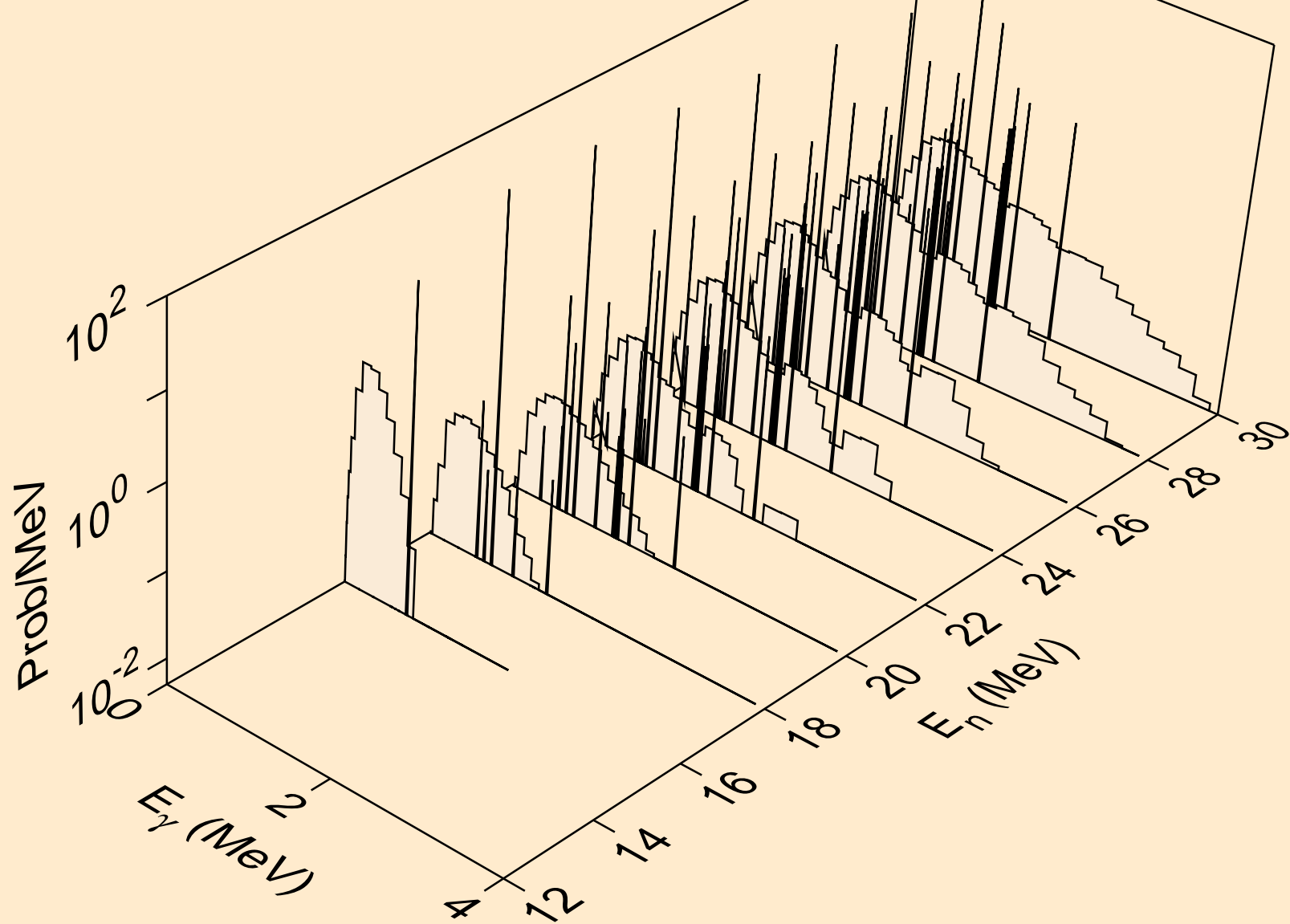

RB093 TRITON ACER TENDL-2021 LIBRARY; T=0.K  
Photon emission for (n,4n)

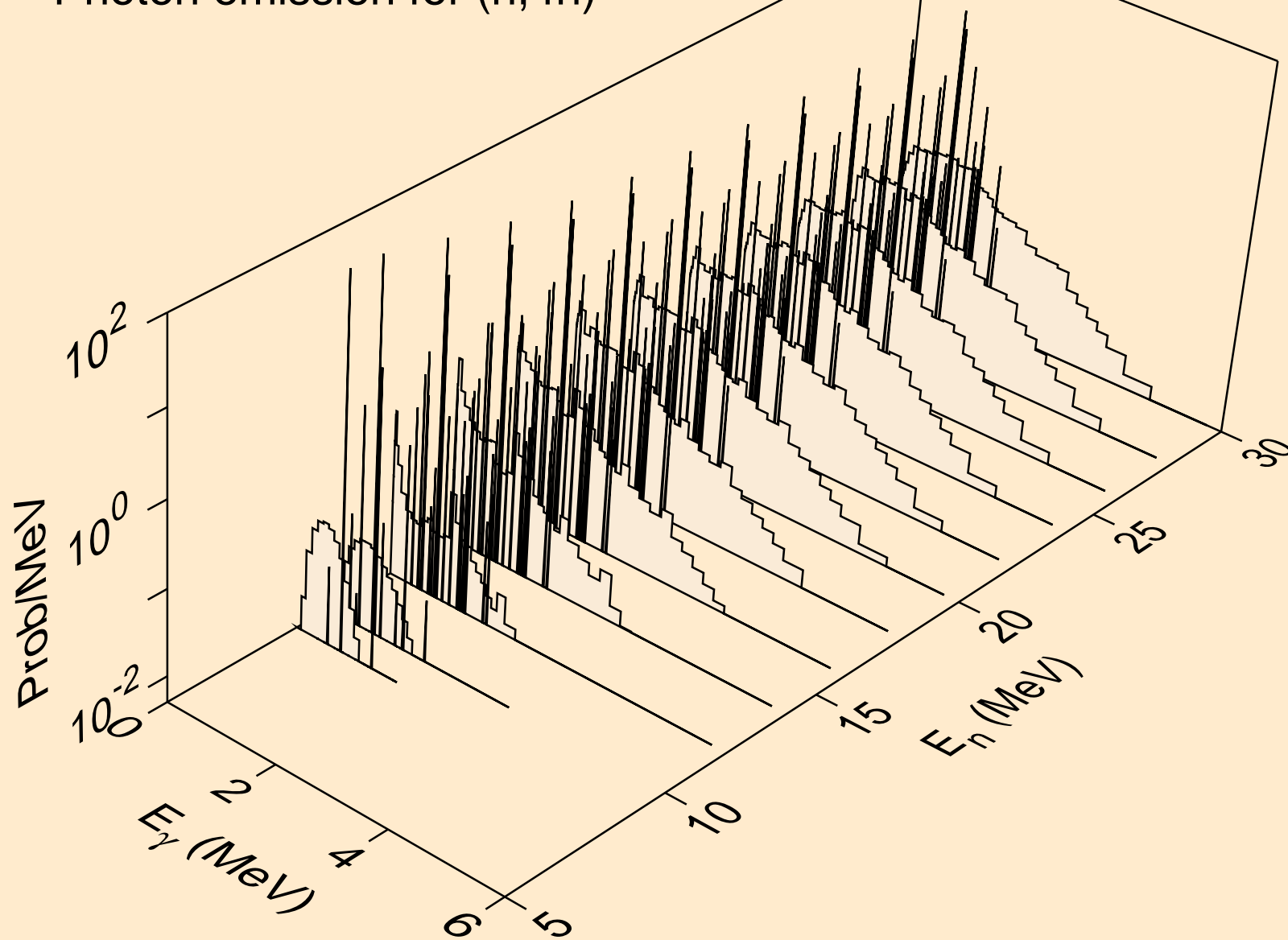

RB093 TRITON ACER TENDL-2021 LIBRARY; T=0.K  
Photon emission for (n,2np)

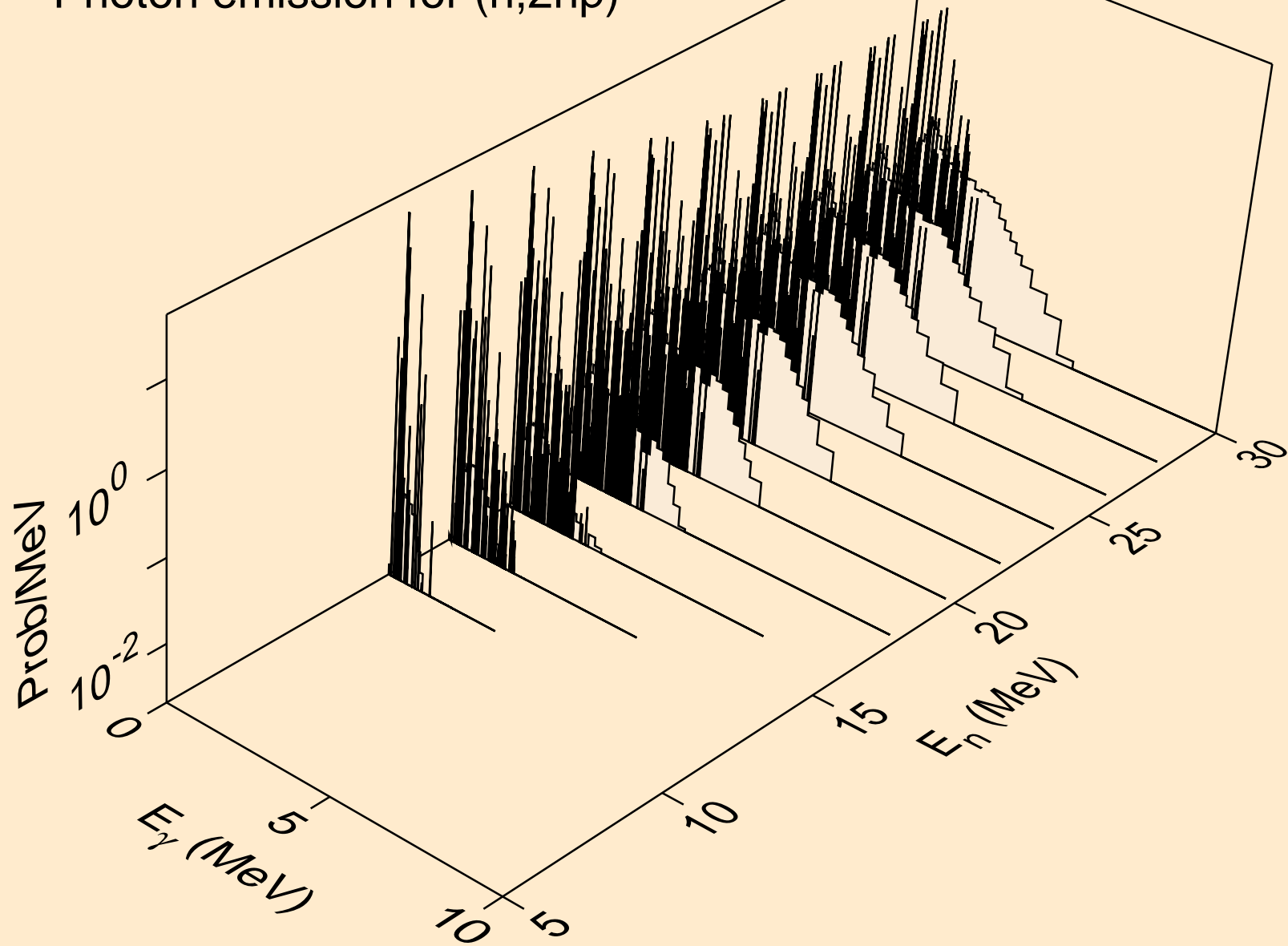

RB093 TRITON ACER TENDL-2021 LIBRARY; T=0.K  
Photon emission for (n,3np)

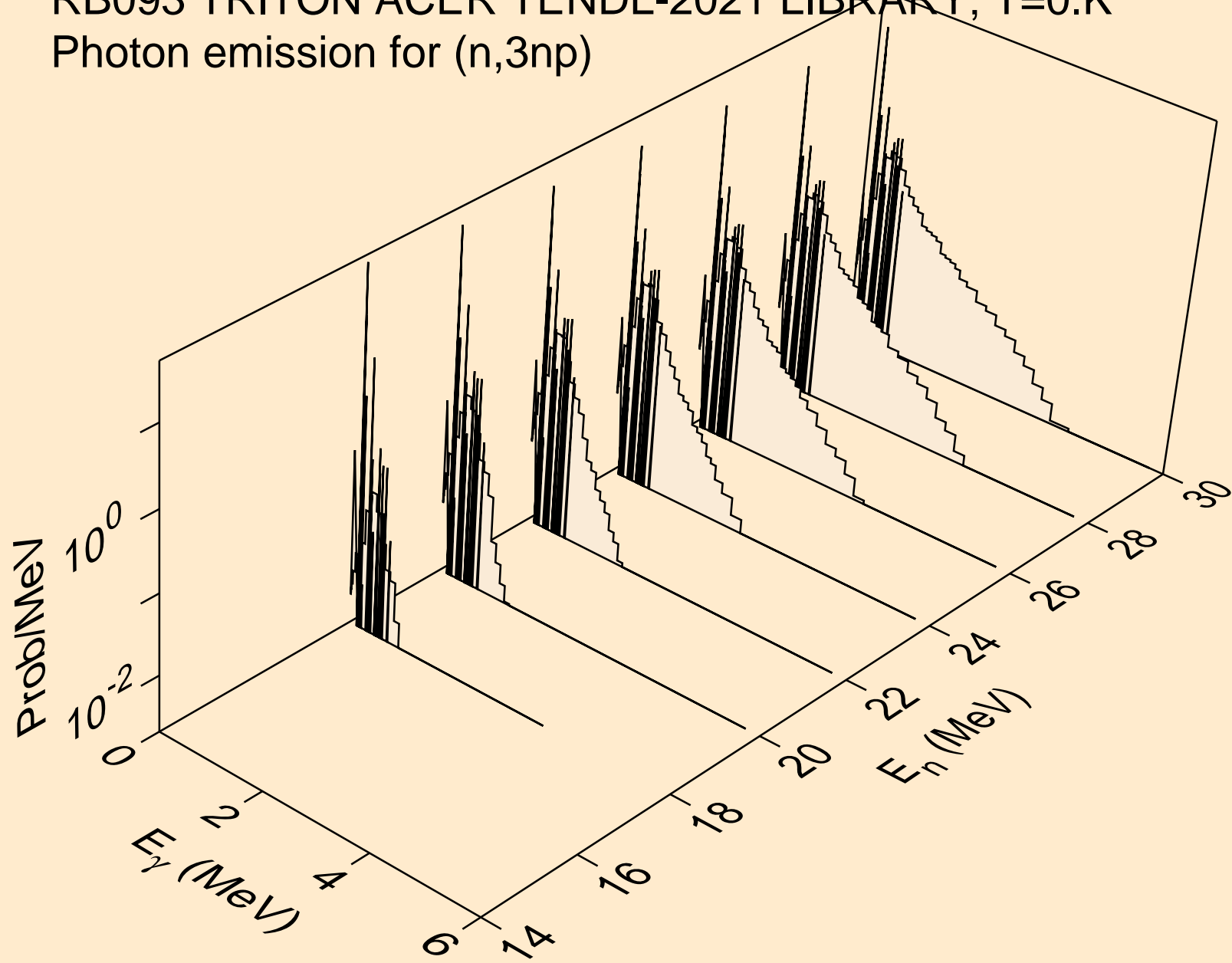

RB093 TRITON ACER TENDL-2021 LIBRARY; T=0.K  
Photon emission for (n,2np)

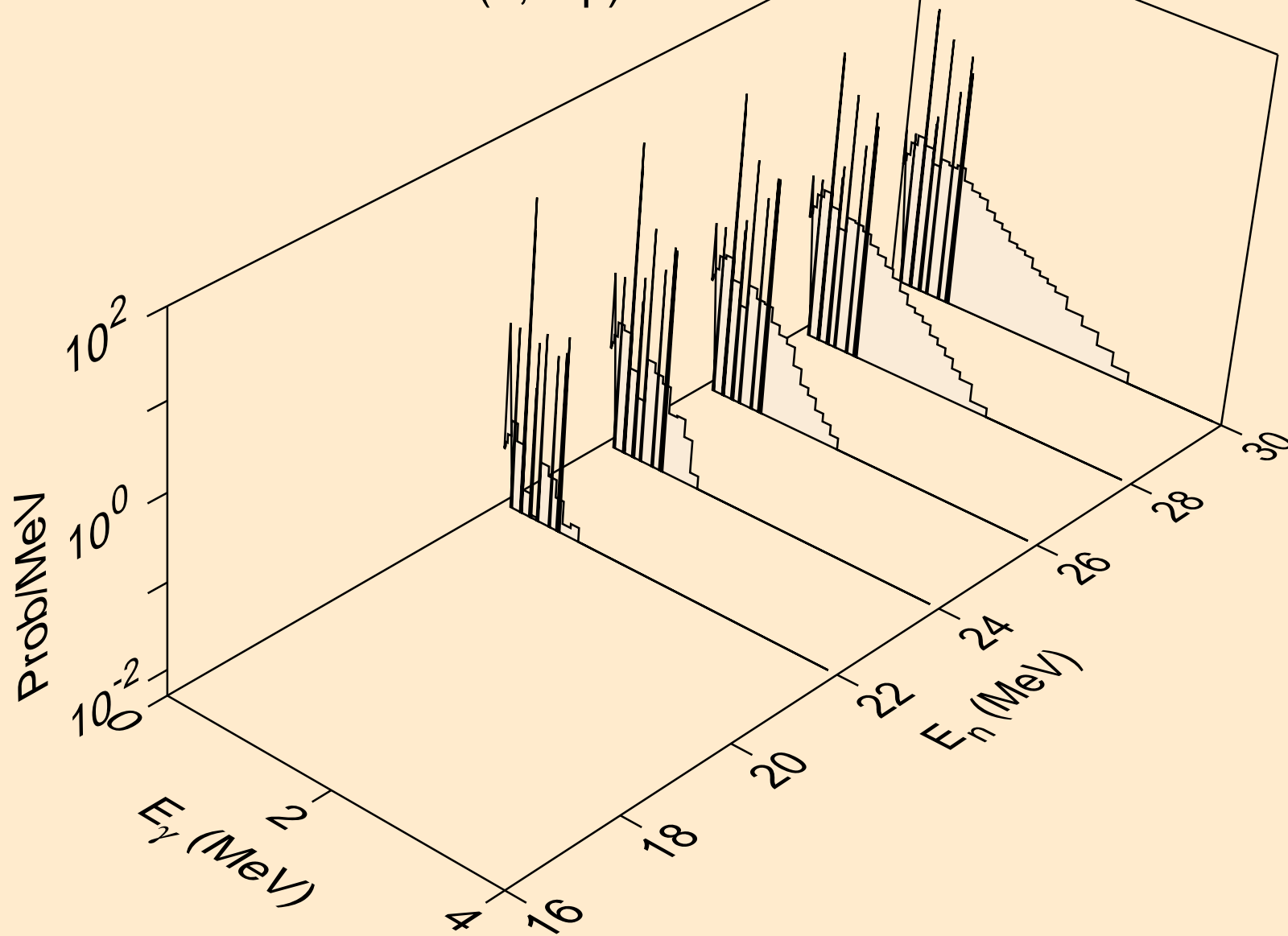

RB093 TRITON ACER TENDL-2021 LIBRARY; T=0.K  
Photon emission for (n,npa)

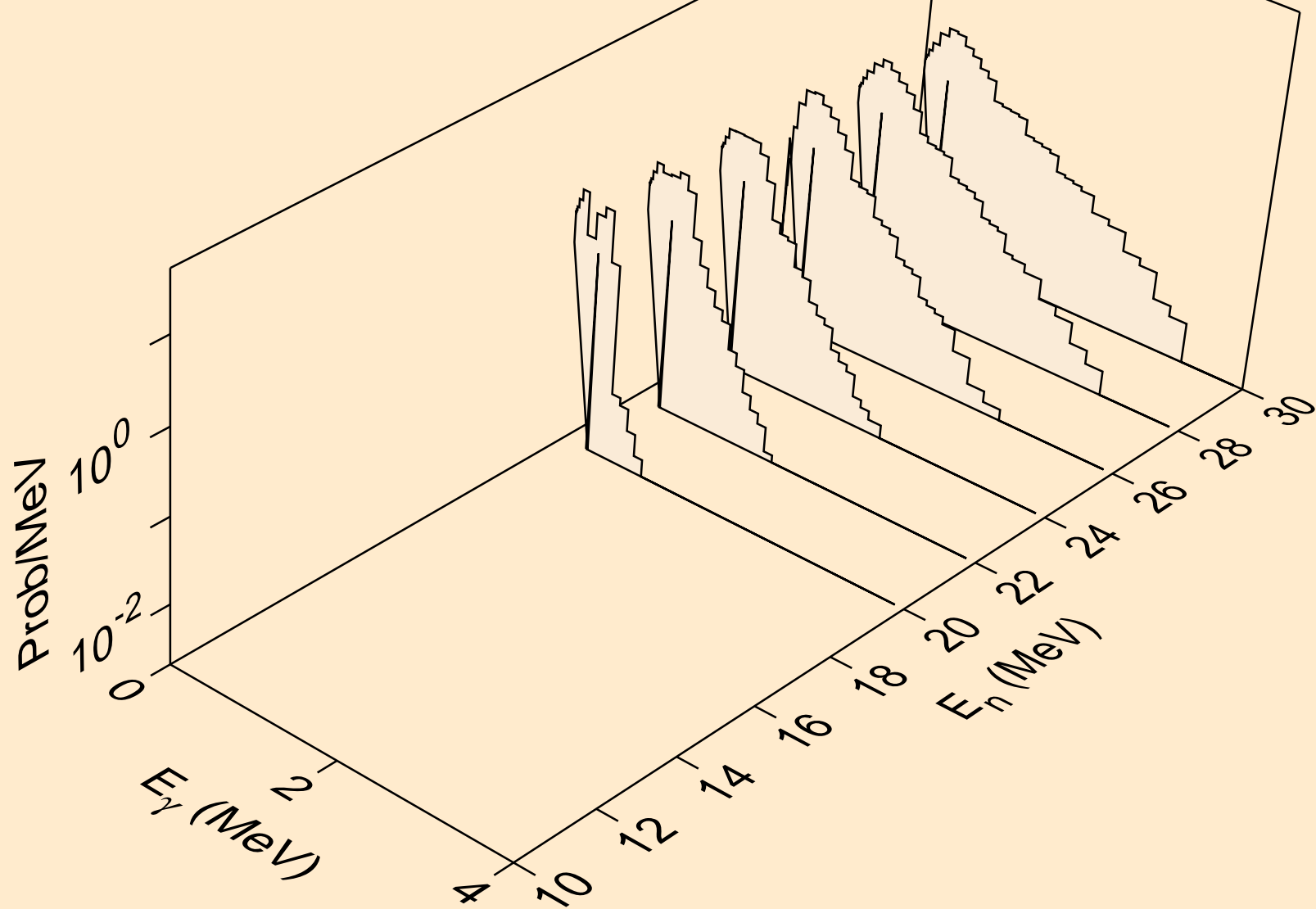

RB093 TRITON ACER TENDL-2021 LIBRARY; T=0.K  
Photon emission for (n,gma)

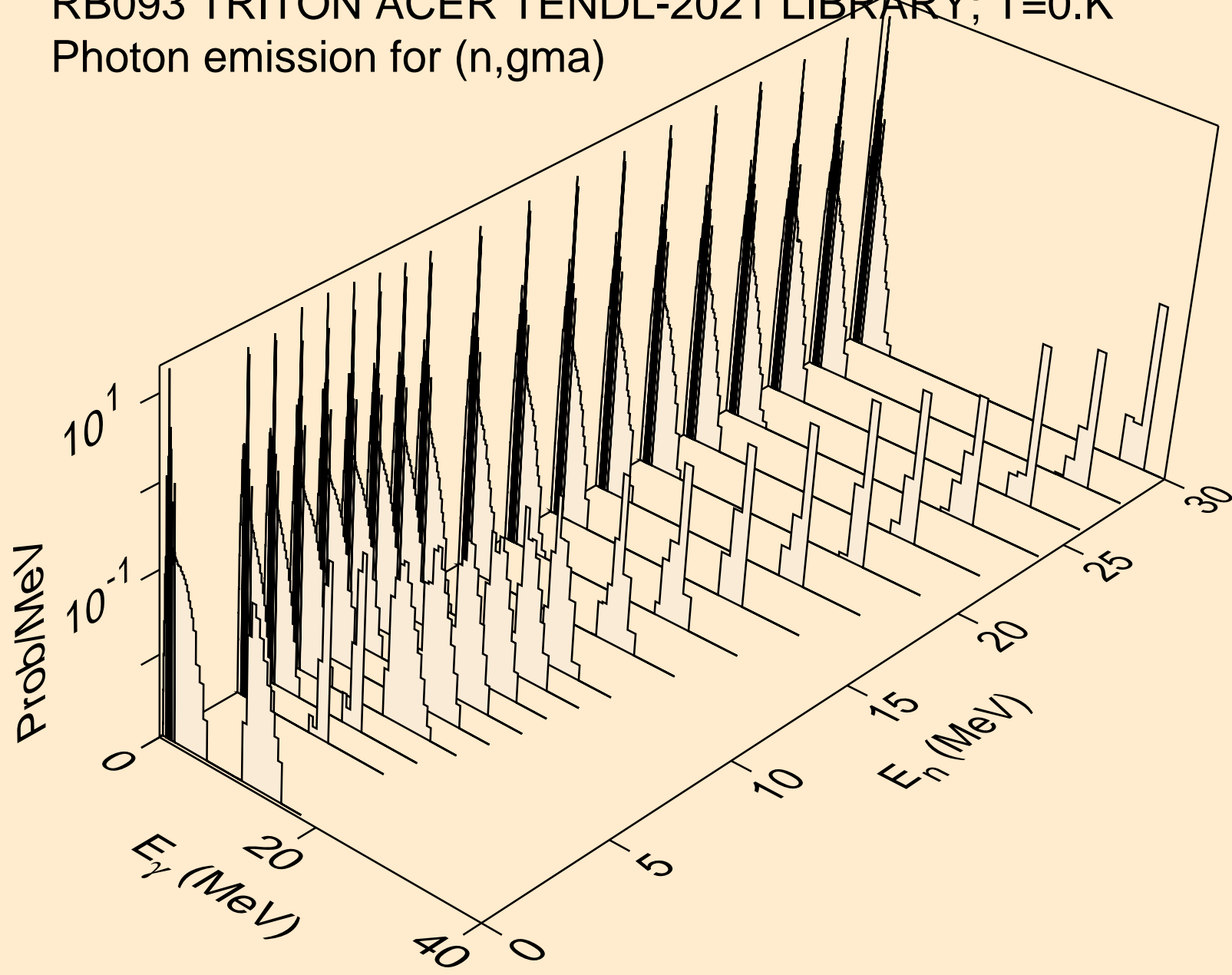

RB093 TRITON ACER TENDL-2021 LIBRARY; T=0.K  
Photon emission for (n,p)

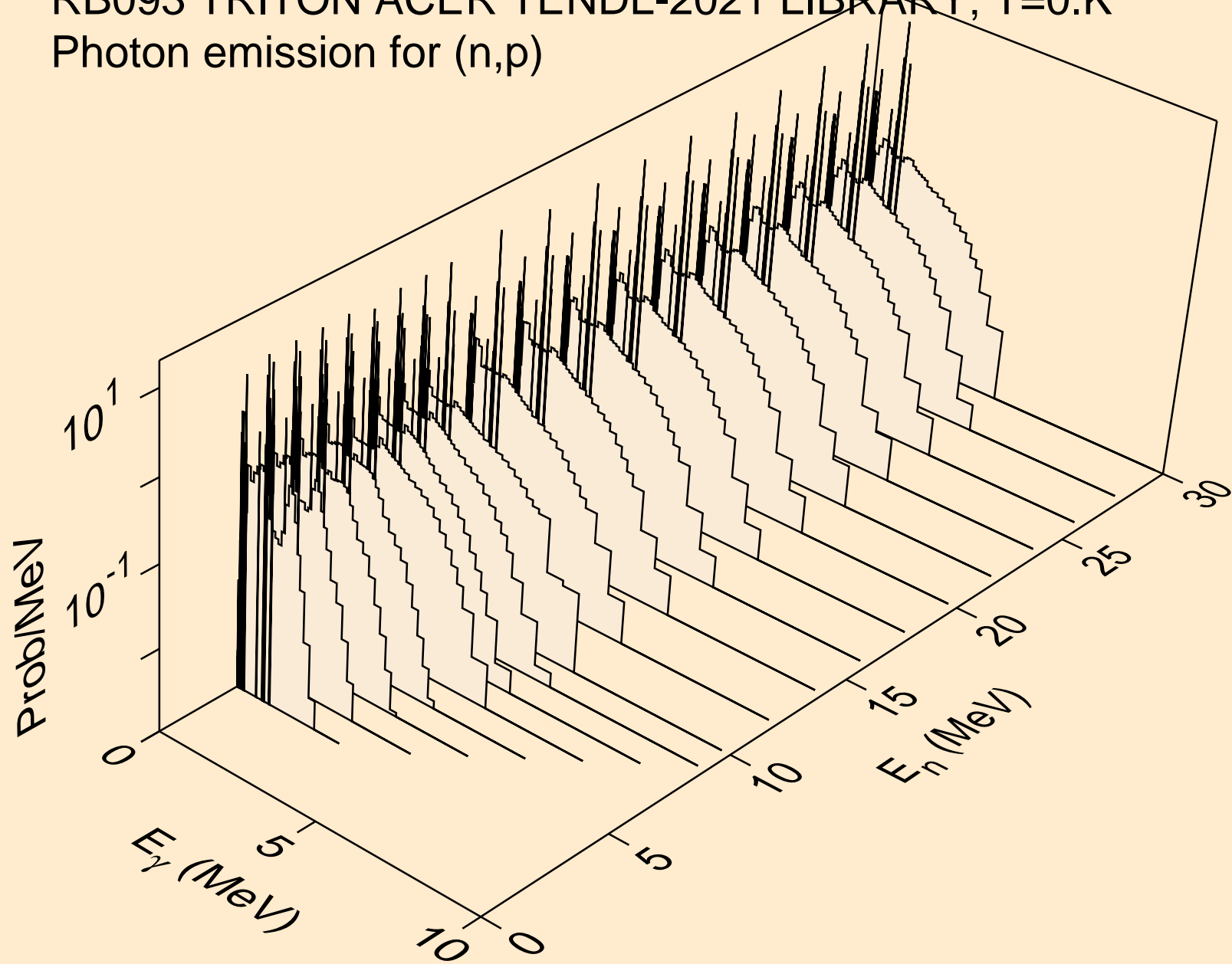



RB093 TRITON ACER TENDL-2021 LIBRARY; T=0.K  
Photon emission for (n,d)

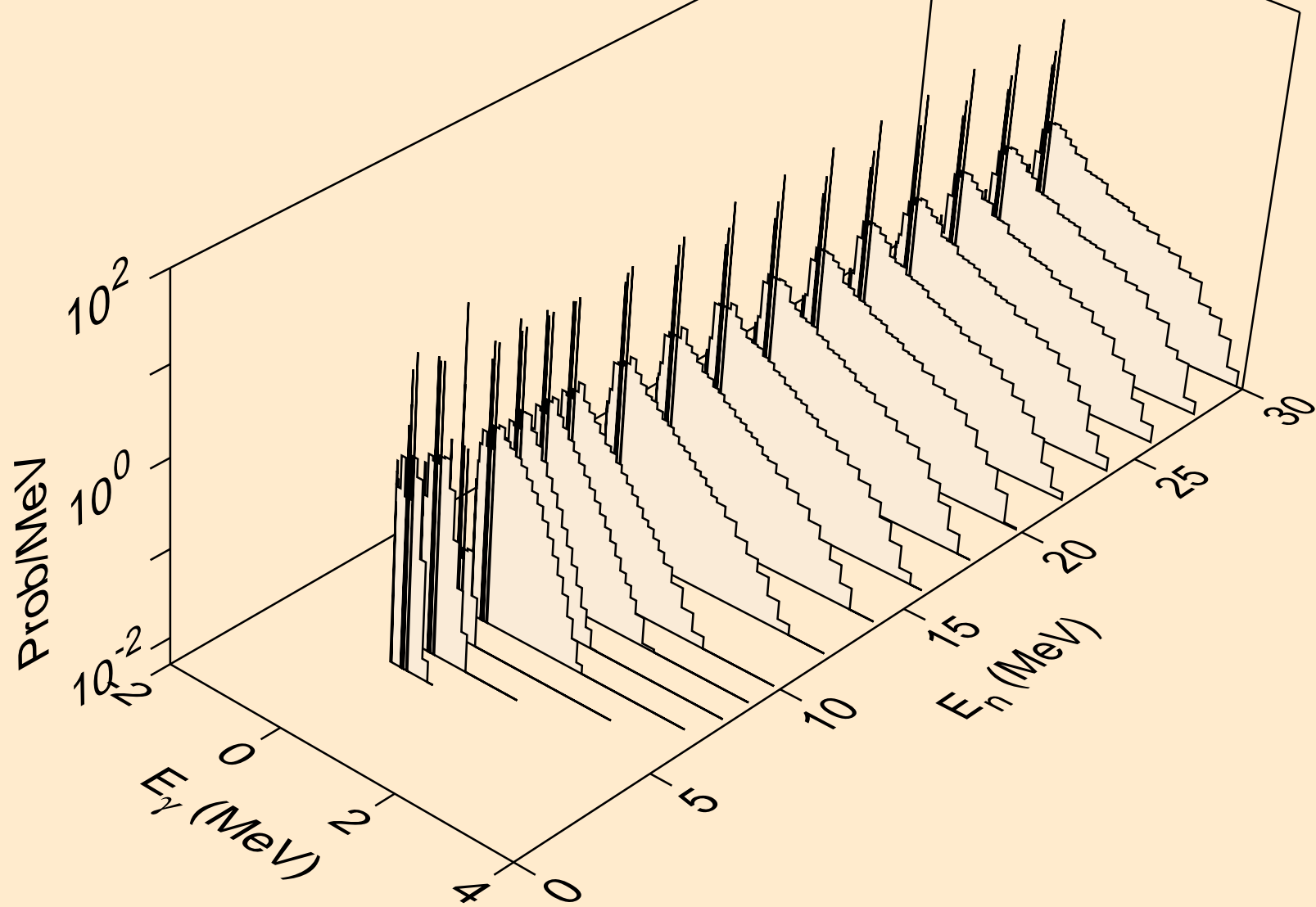

RB093 TRITON ACER TENDL-2021 LIBRARY; T=0.K  
Photon emission for inelastic

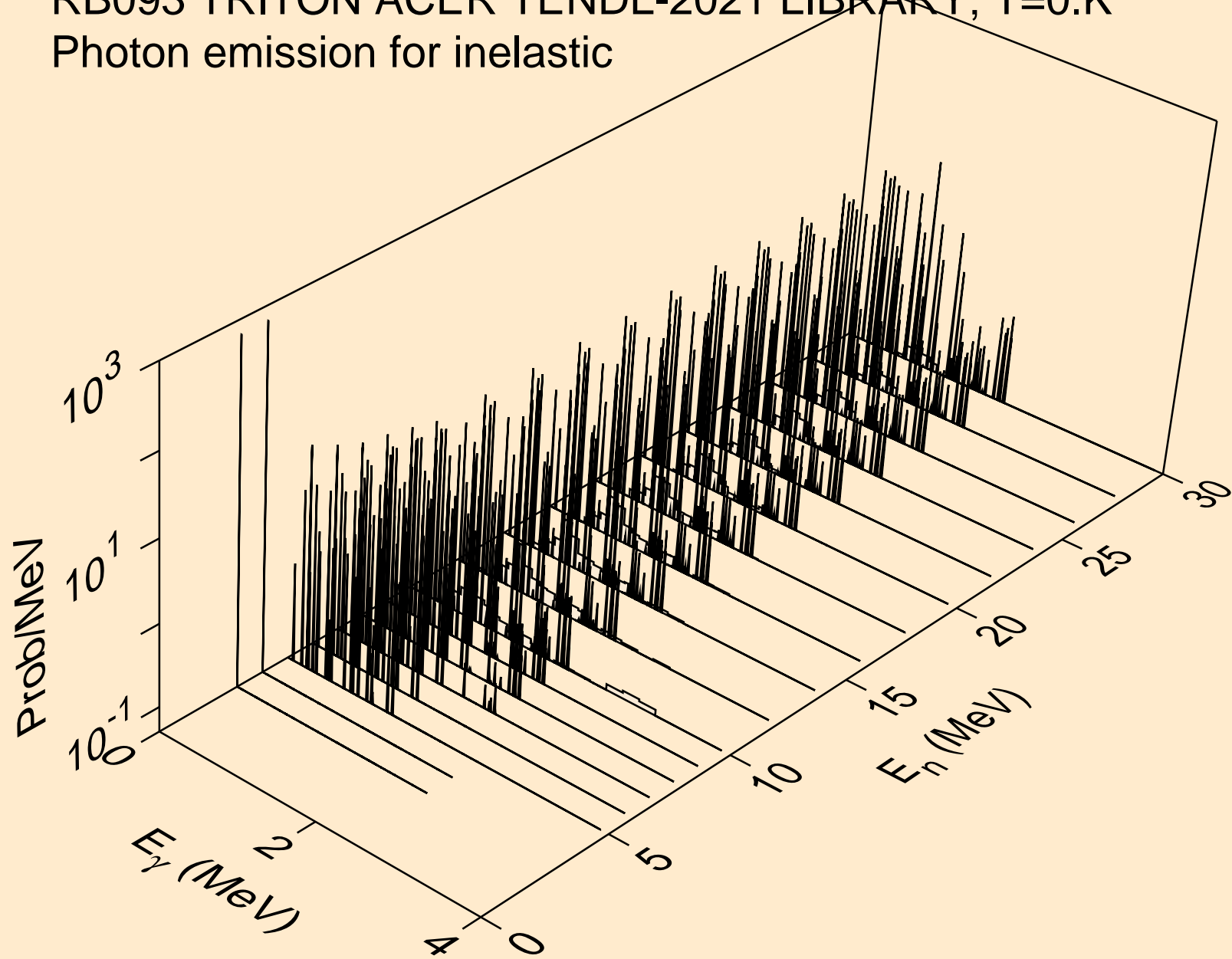

RB093 TRITON ACER TENDL-2021 LIBRARY; T=0.K  
Photon emission for (n,he3)

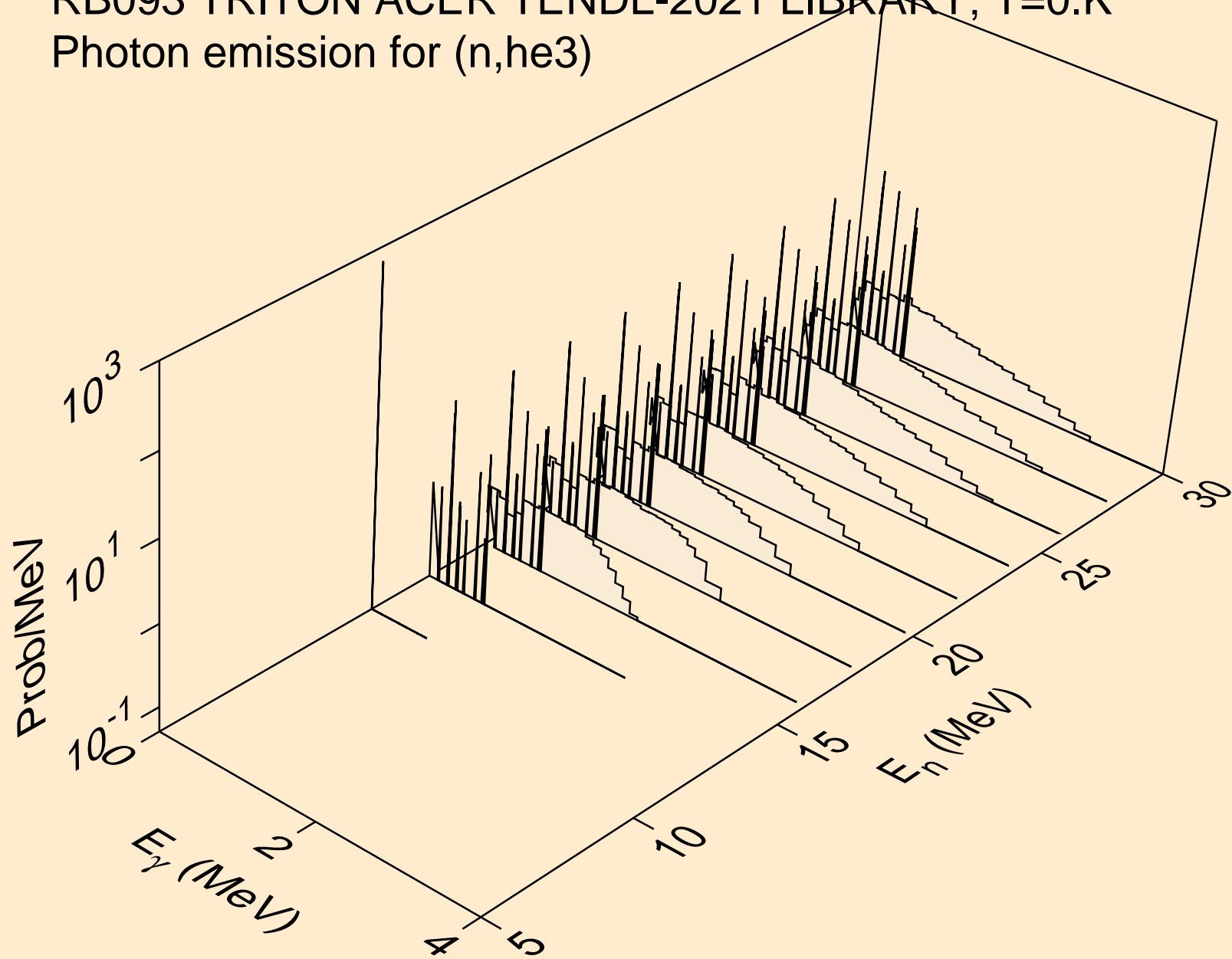

RB093 TRITON ACER TENDL-2021 LIBRARY; T=0.K  
Photon emission for (n,a)

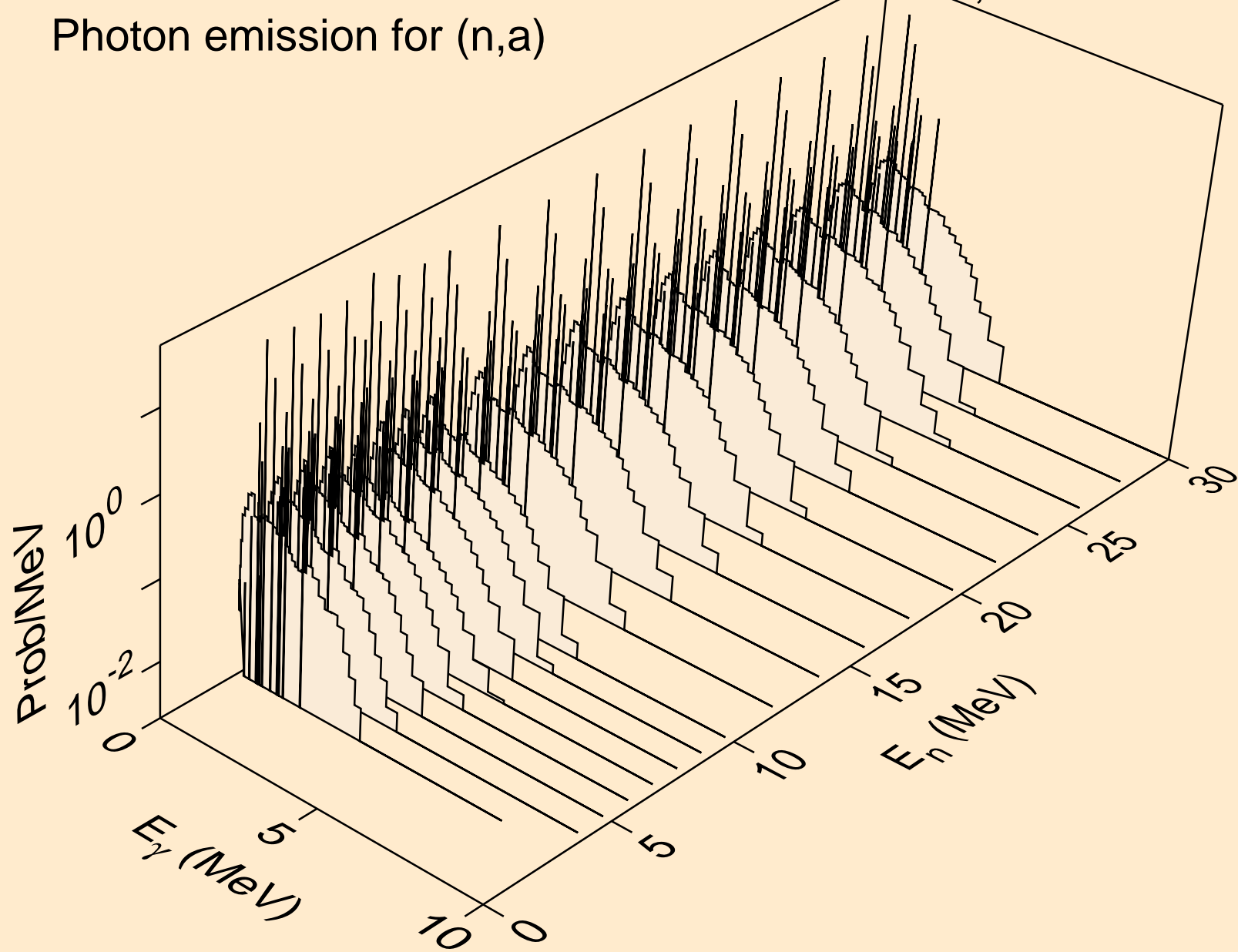

RB093 TRITON ACER TENDL-2021 LIBRARY; T=0.K  
Photon emission for (n,2p)

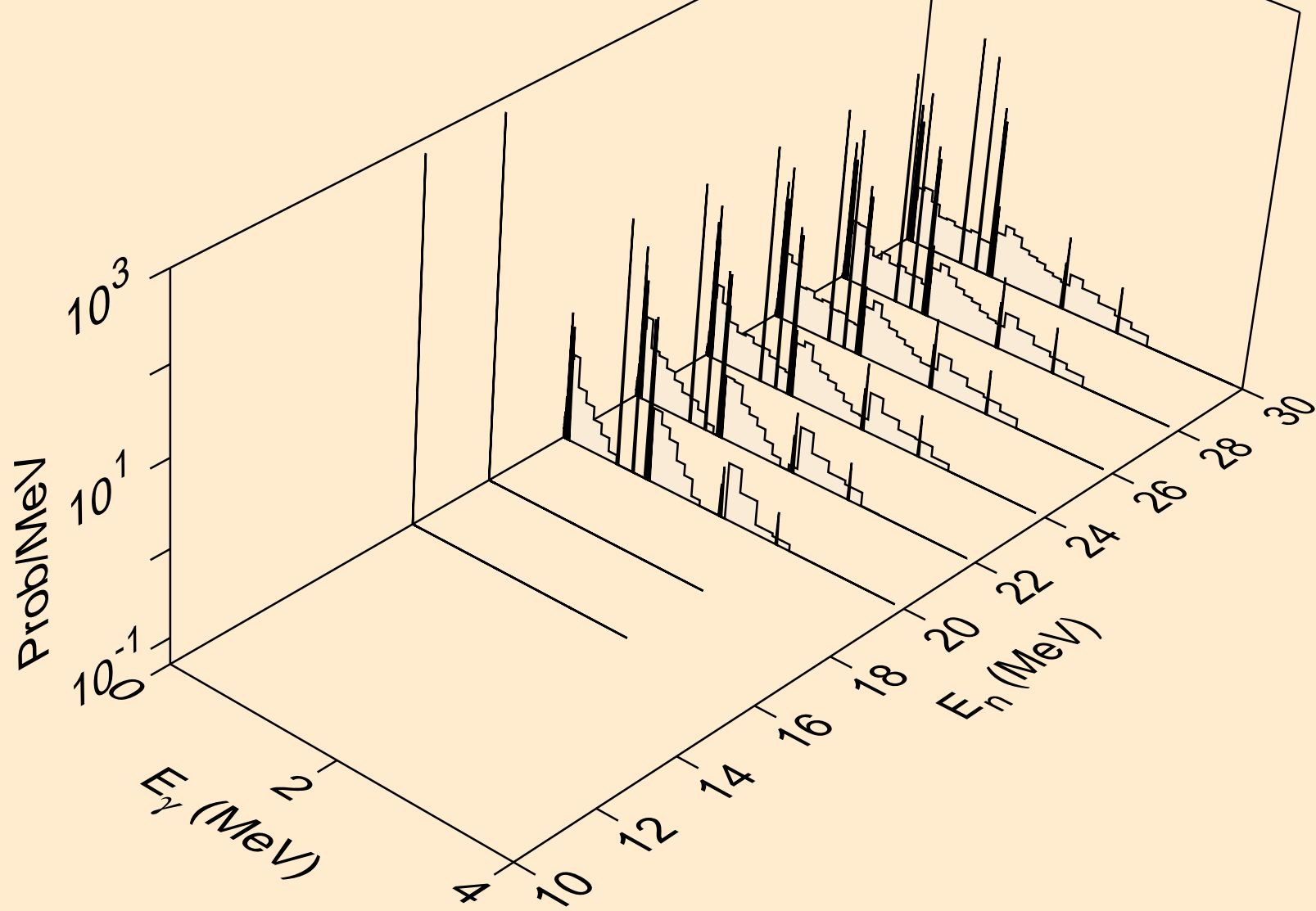

RB093 TRITON ACER TENDL-2021 LIBRARY; T=0.K  
Photon emission for (n,pa)

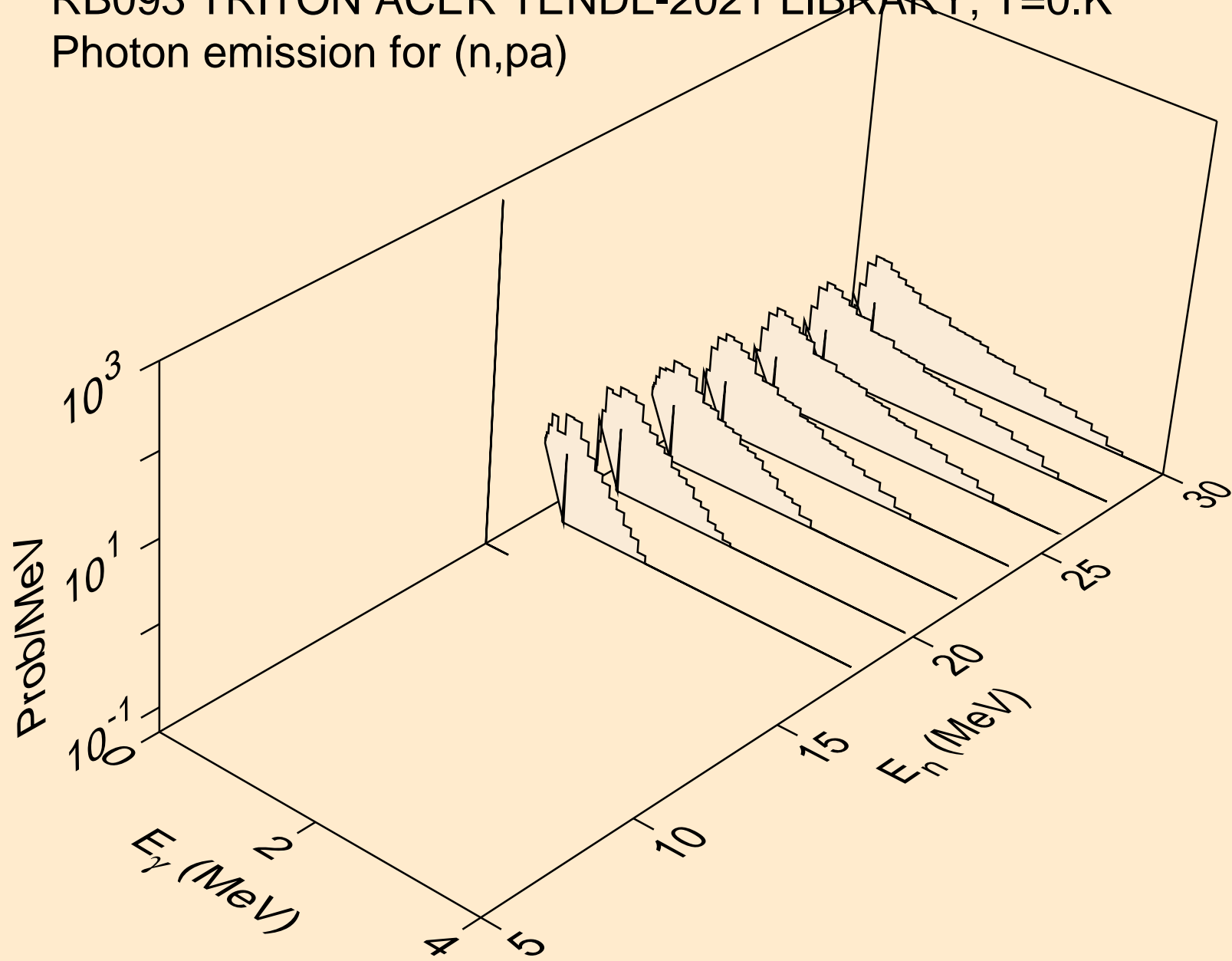

RB093 TRITON ACER TENDL-2021 LIBRARY; T=0.K  
Photon emission for (n,pd)

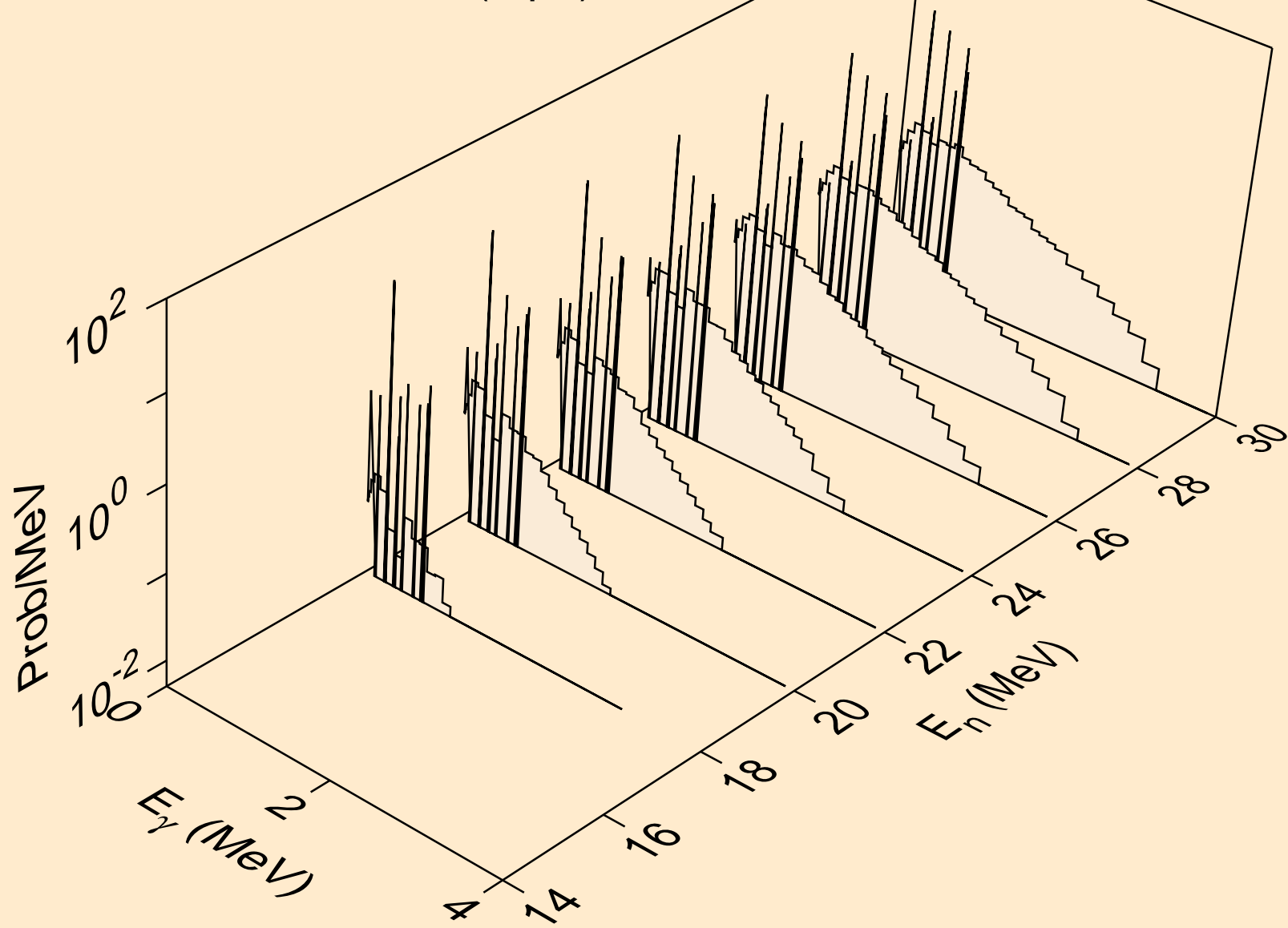

RB093 TRITON ACER TENDL-2021 LIBRARY; T=0.K  
Photon emission for (n,pt)

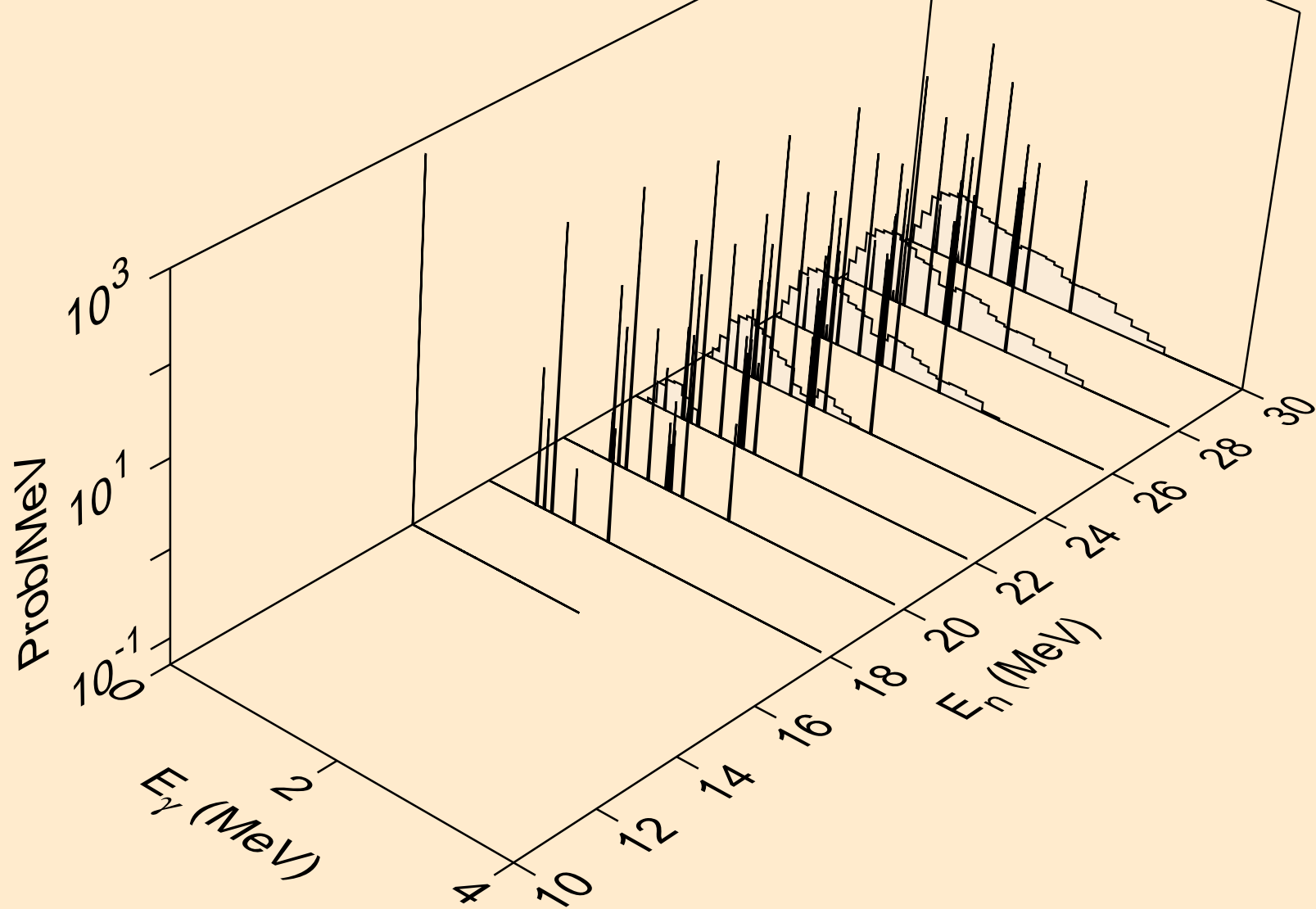



RB093 TRITON ACER TENDL-2021 LIBRARY; T=0.K  
Photon emission for (n,da)

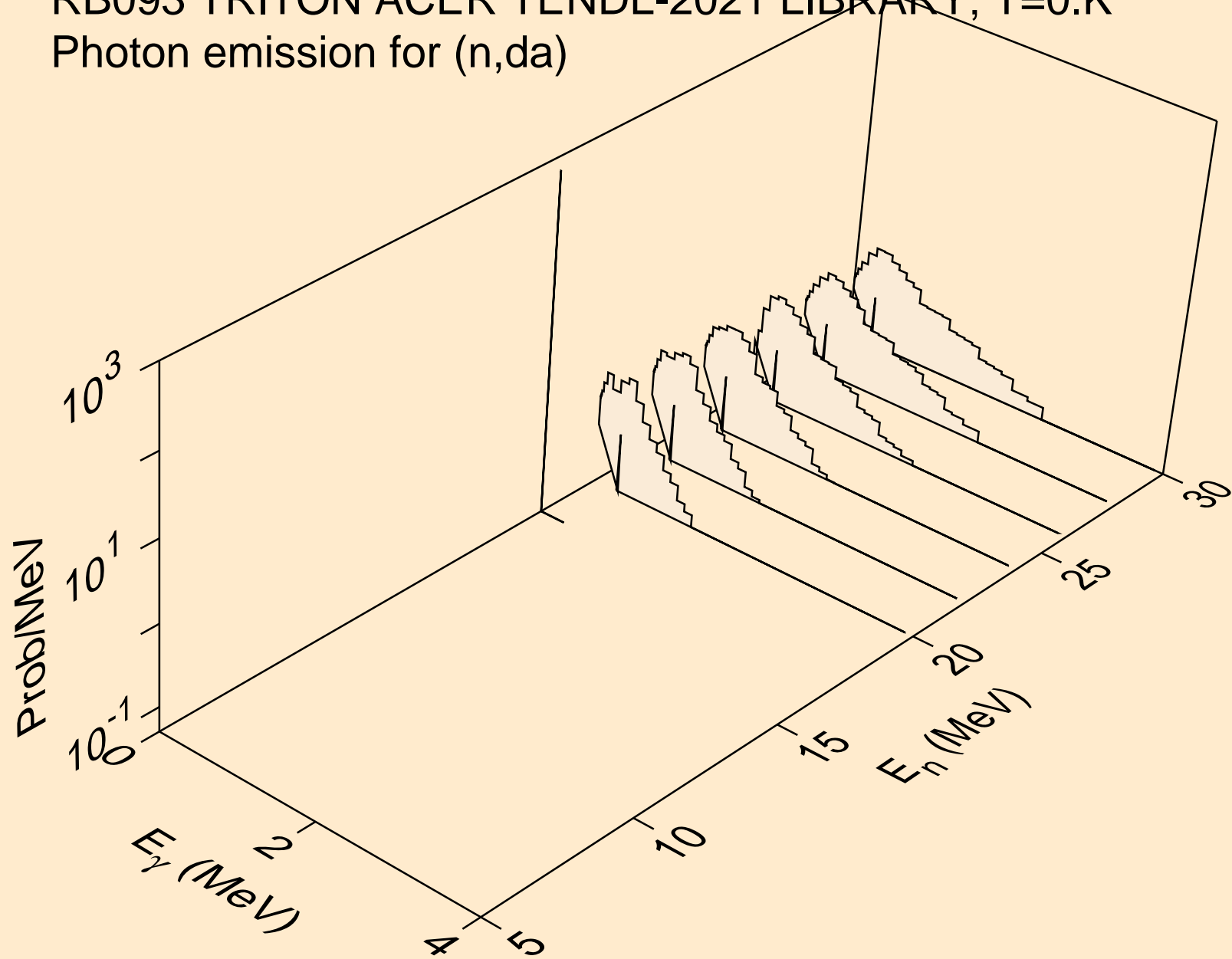

RB093 TRITON ACER TENDL-2021 LIBRARY; T=0.K  
Particle heating contributions

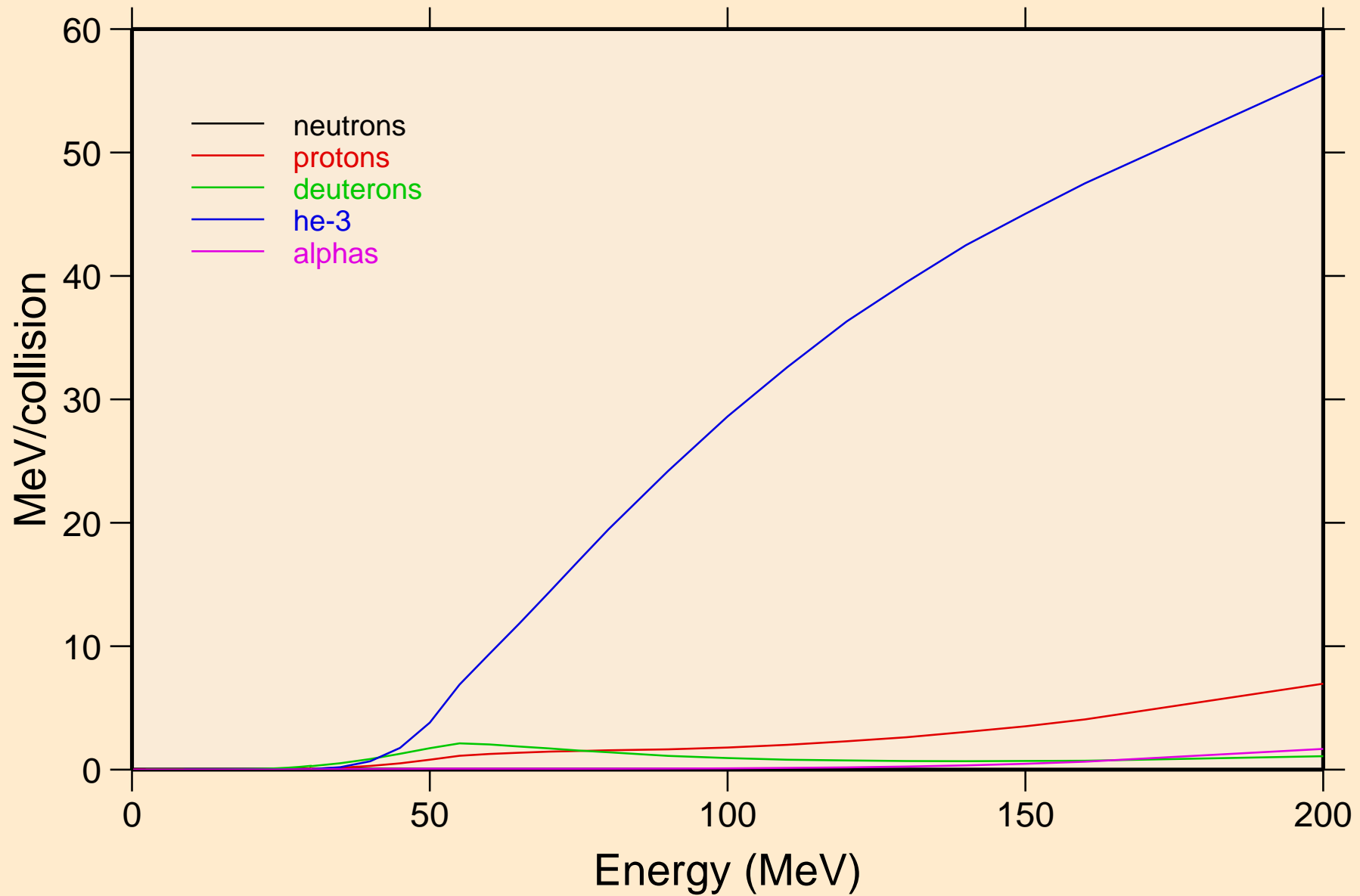

RB093 TRITON ACER TENDL-2021 LIBRARY; T=0.K  
Recoil Heating

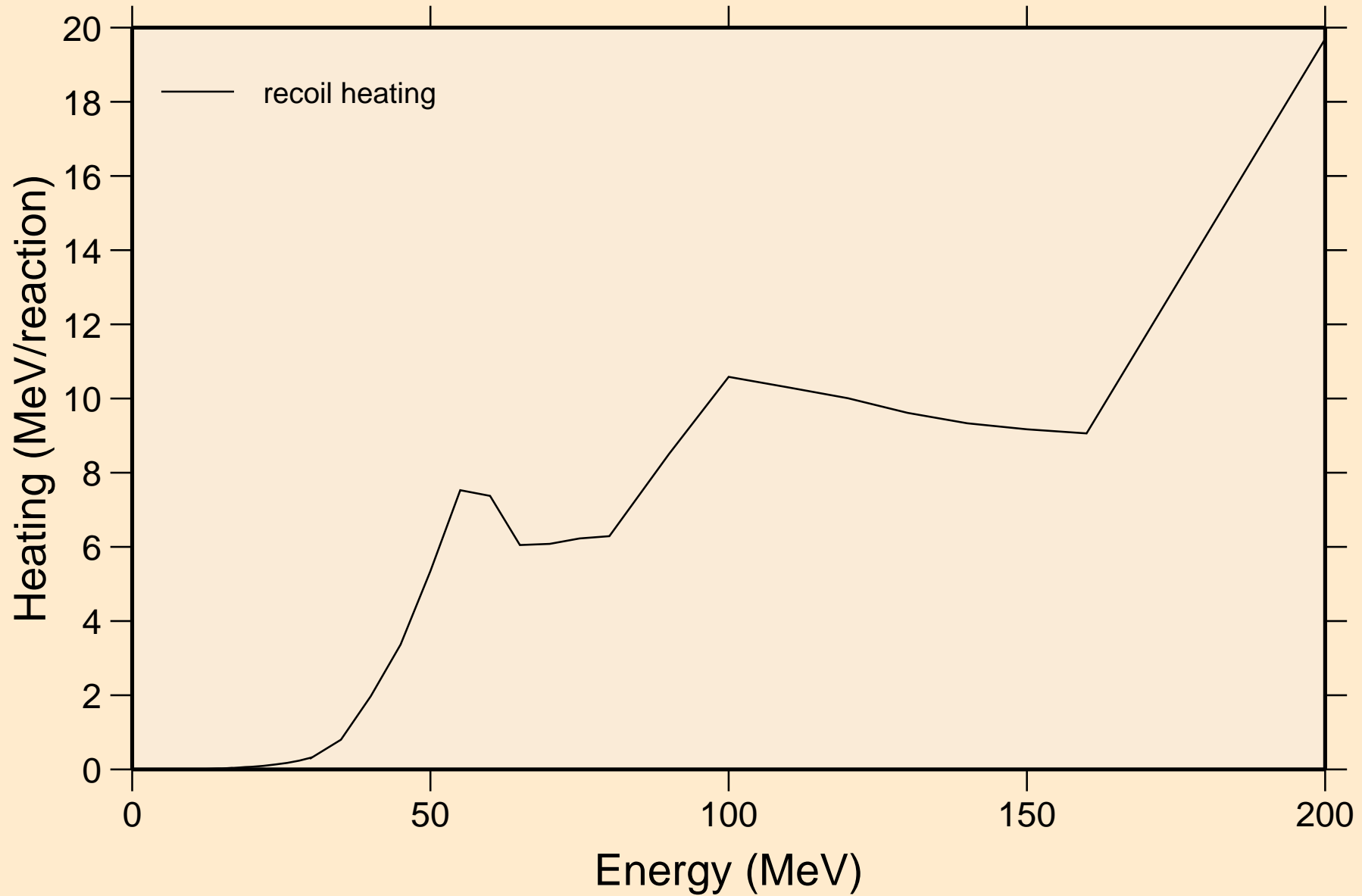

RB093 TRITON ACER TENDL-2021 LIBRARY; T=0.K  
Particle production cross sections

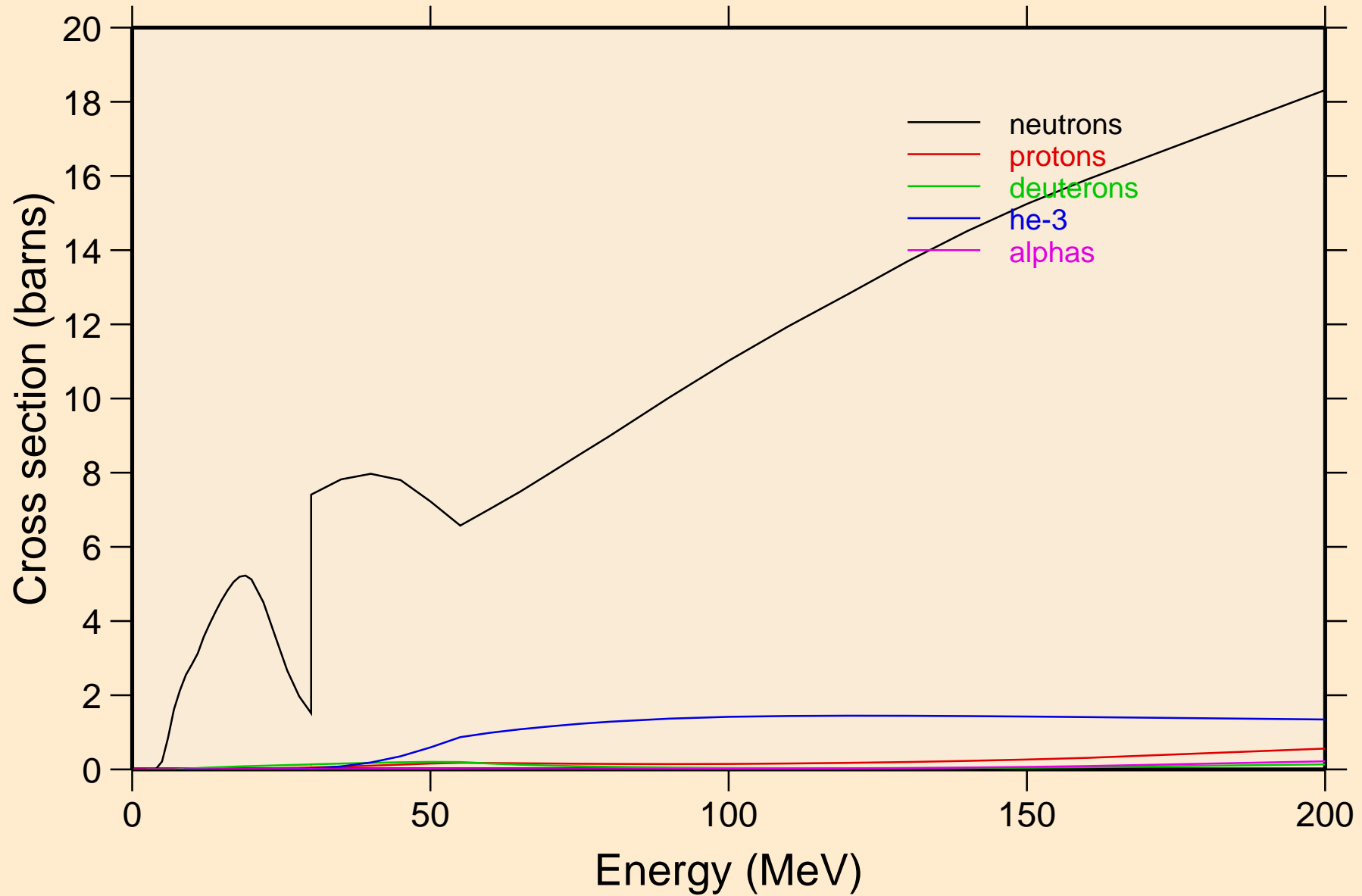

RB093 TRITON ACER TENDL-2021 LIBRARY; T=0.K  
neutrons from (t,n)

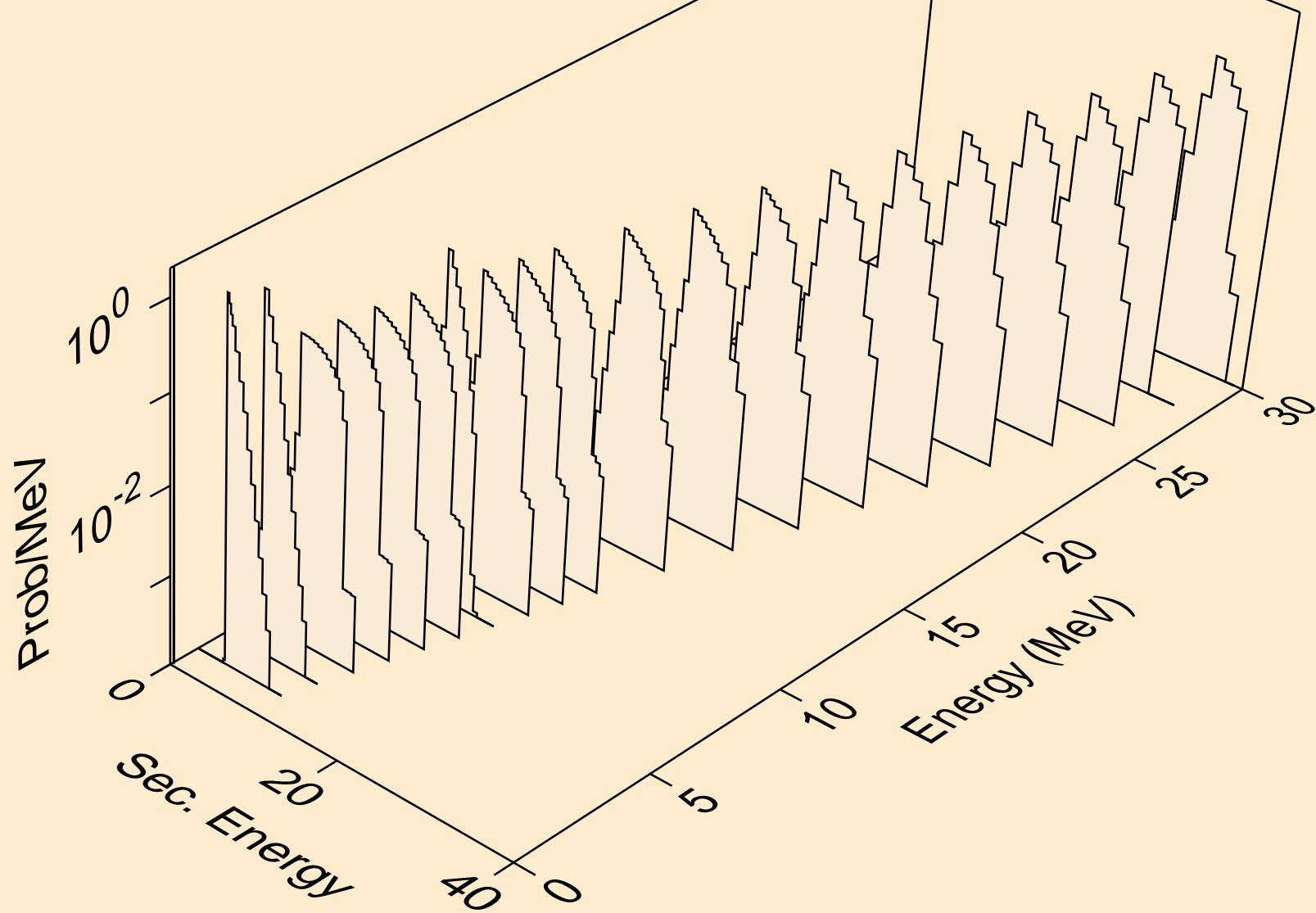

RB093 TRITON ACER TENDL-2021 LIBRARY; T=0.K  
neutrons from (t,x)

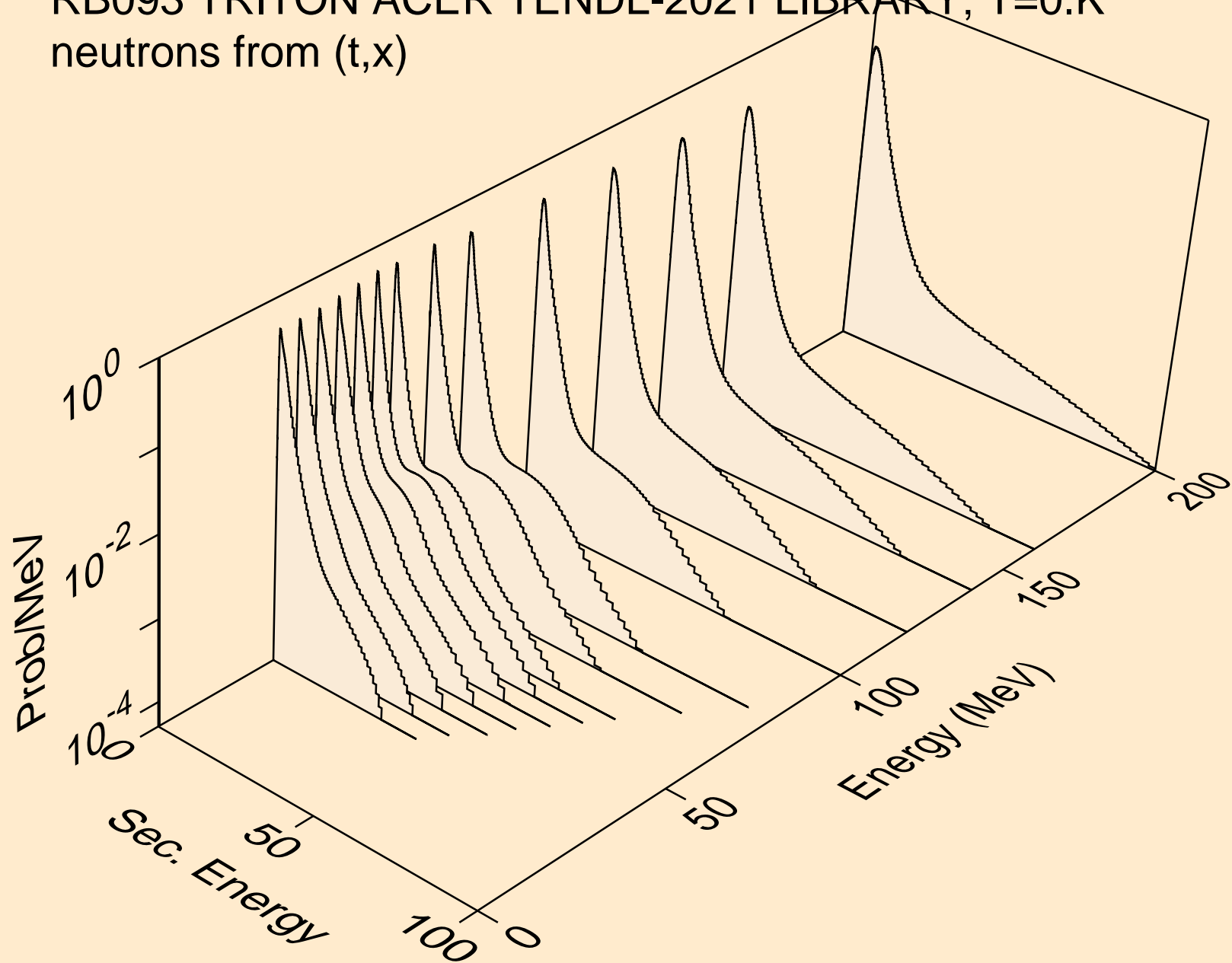

RB093 TRITON ACER TENDL-2021 LIBRARY; T=0.K  
neutrons from (t,2nd)

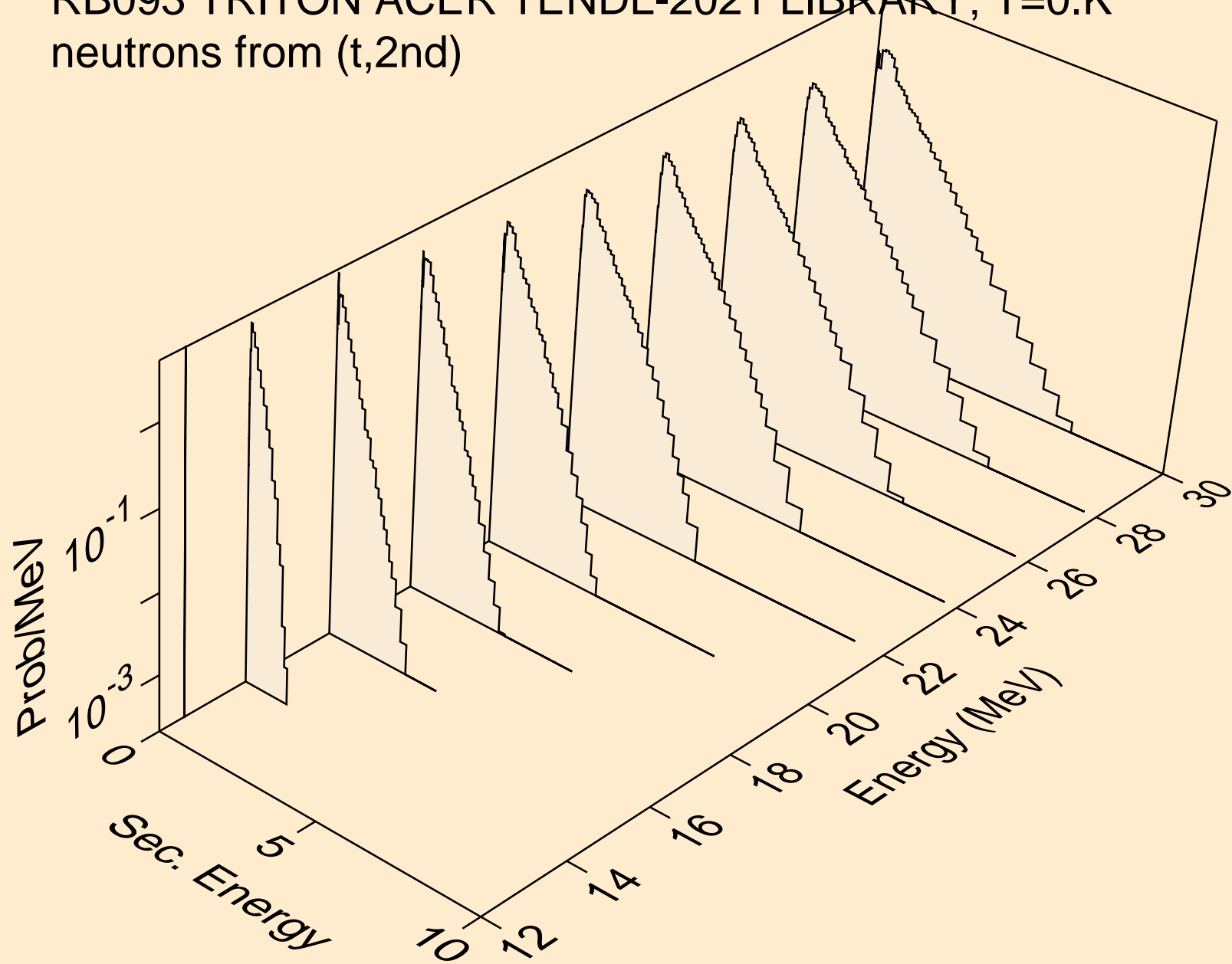

RB093 TRITON ACER TENDL-2021 LIBRARY; T=0.K  
neutrons from (t,2n)

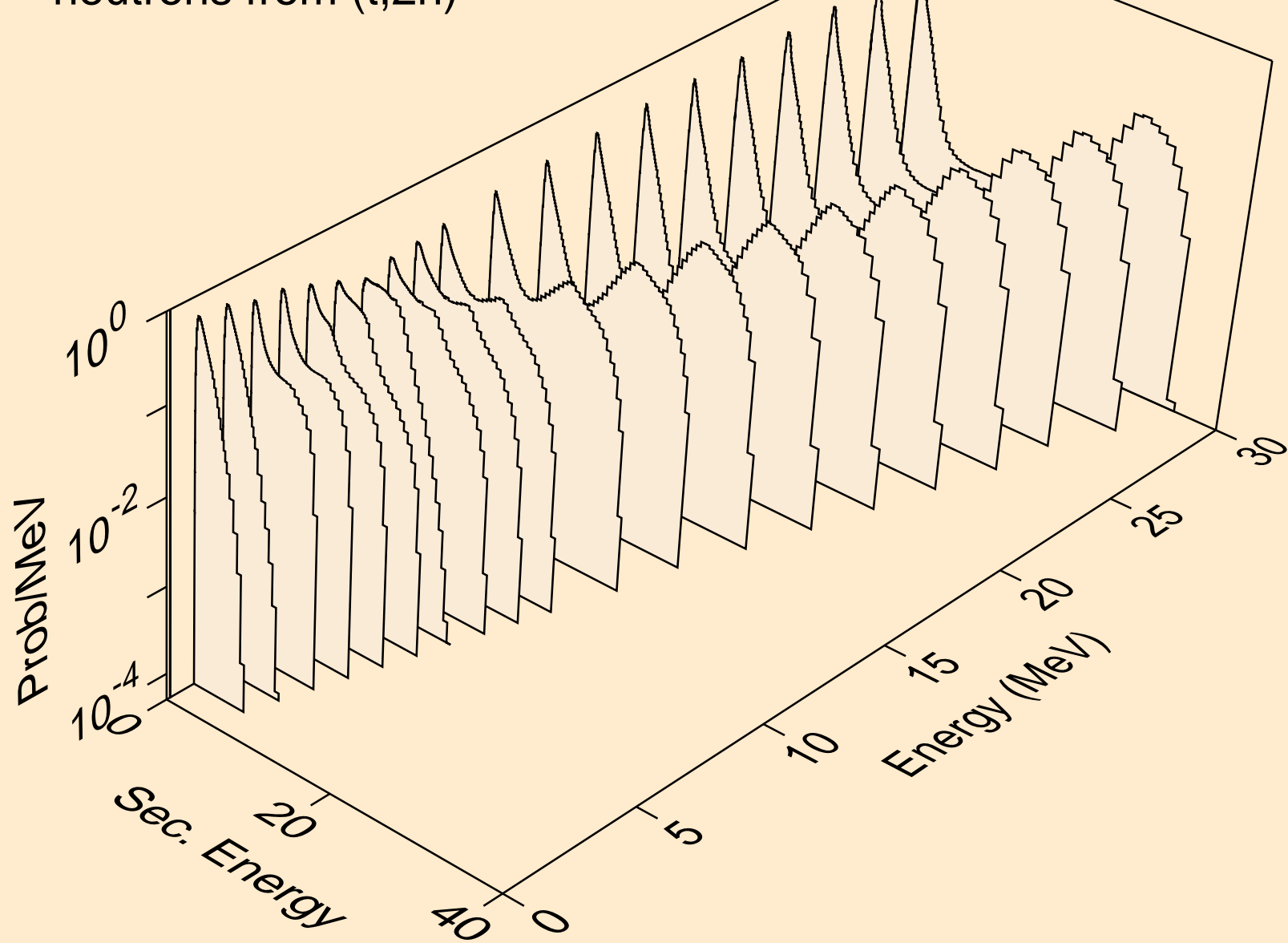



RB093 TRITON ACER TENDL-2021 LIBRARY; T=0.K  
neutrons from (t,3n)

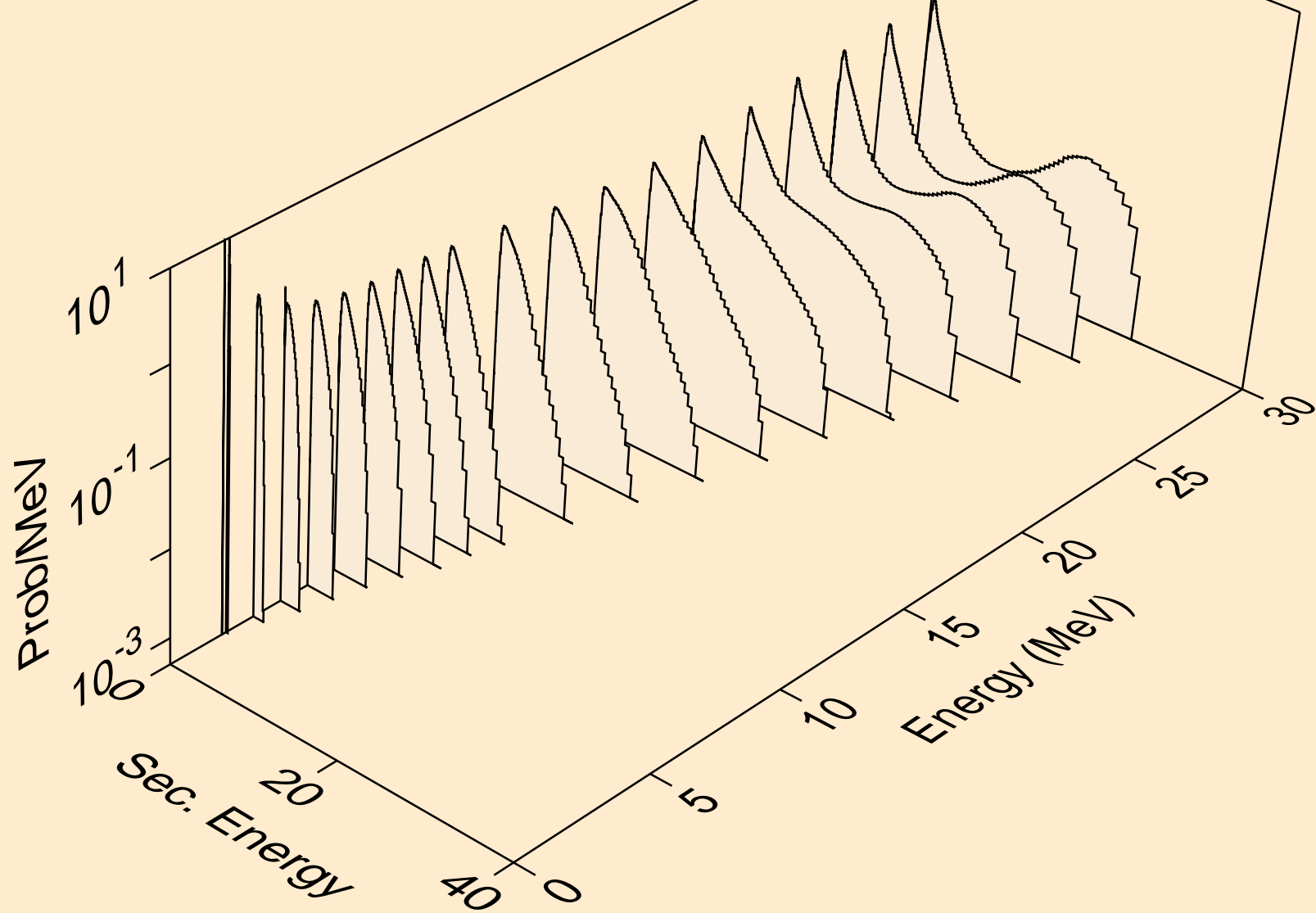

RB093 TRITON ACER TENDL-2021 LIBRARY; T=0.K  
neutrons from (t,n\*)a

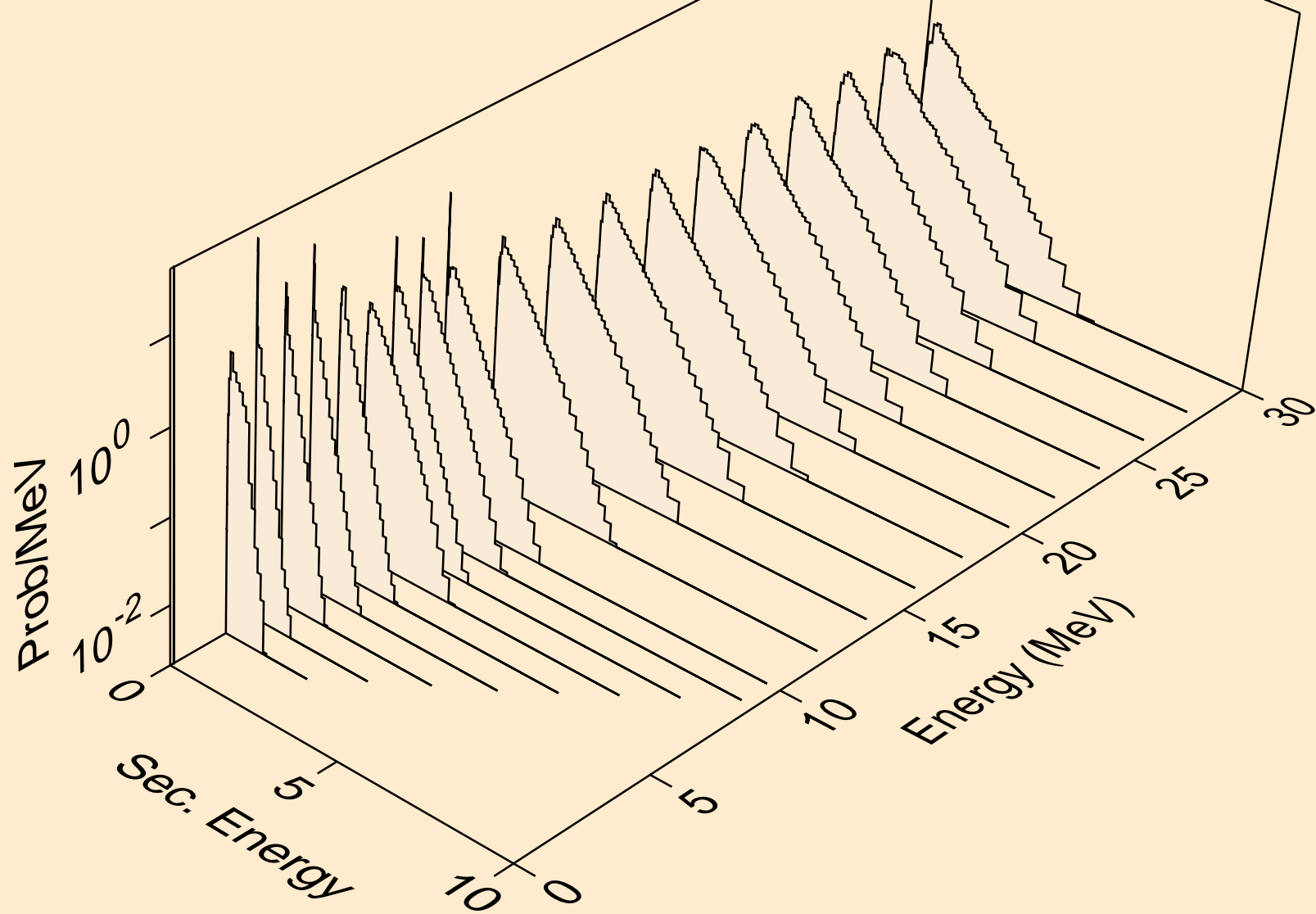

RB093 TRITON ACER TENDL-2021 LIBRARY; T=0.K  
neutrons from (t,2n)a

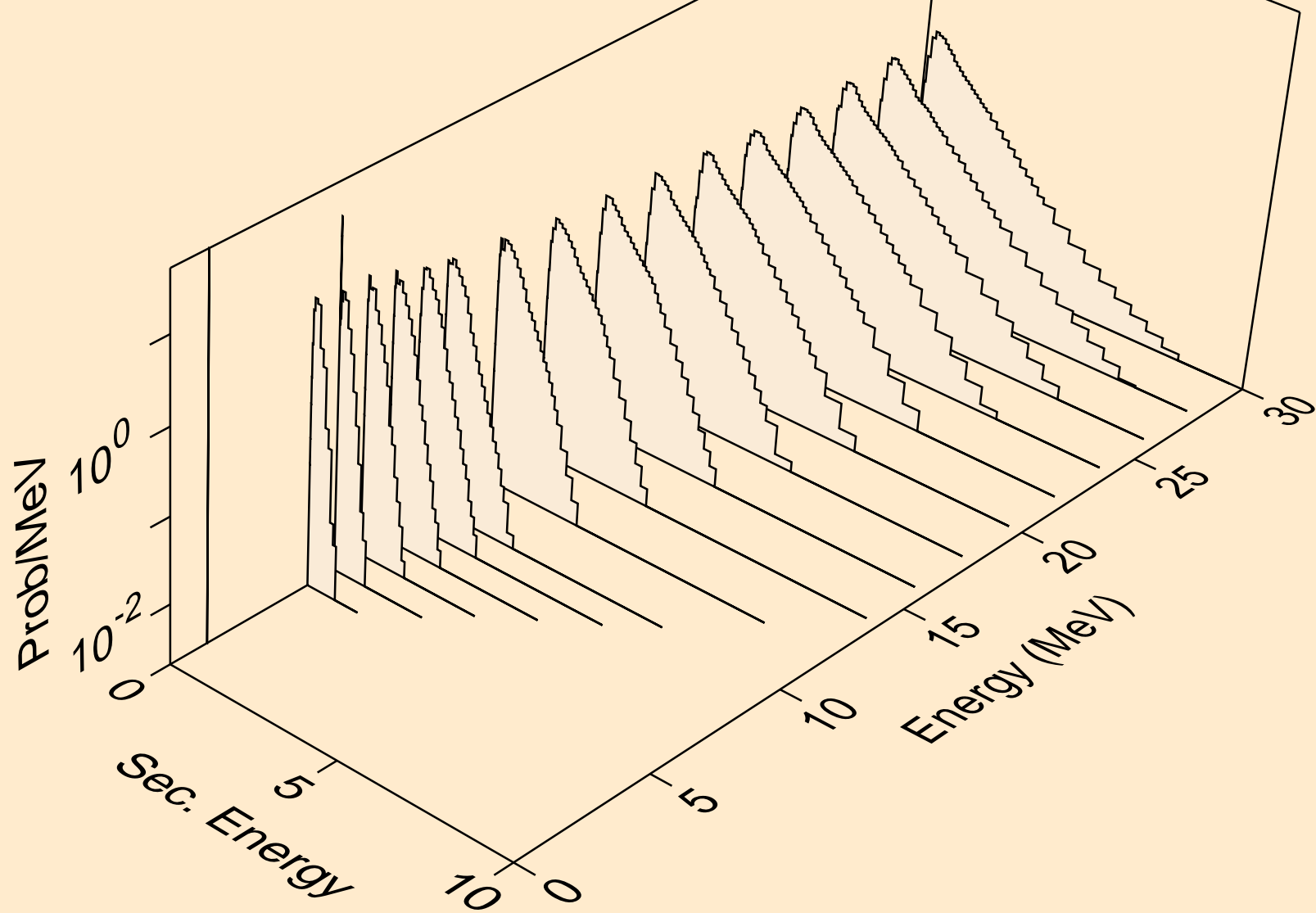

RB093 TRITON ACER TENDL-2021 LIBRARY; T=0.K  
neutrons from (t,3n)a

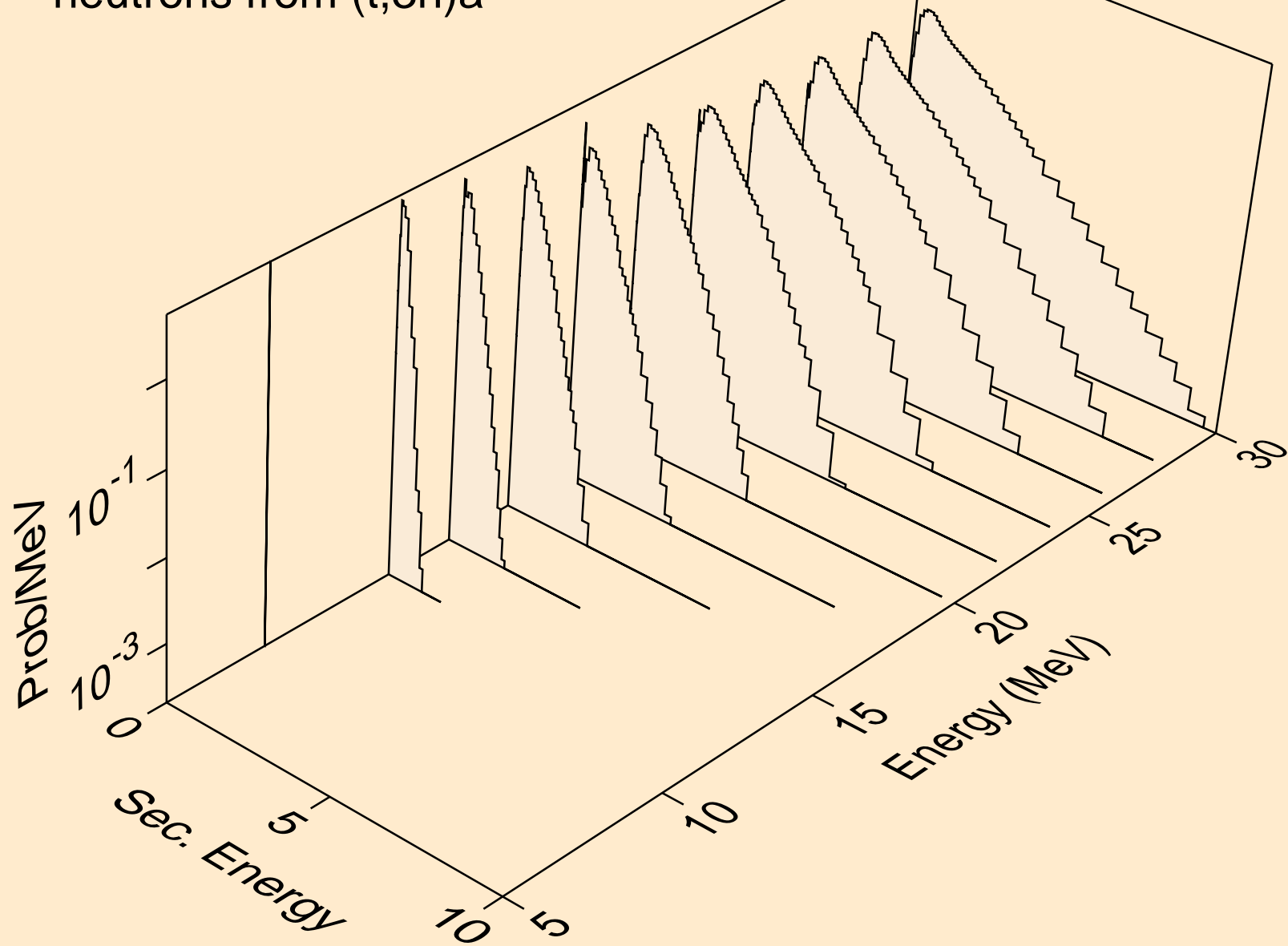

RB093 TRITON ACER TENDL-2021 LIBRARY; T=0.K  
neutrons from (t,n\*)p

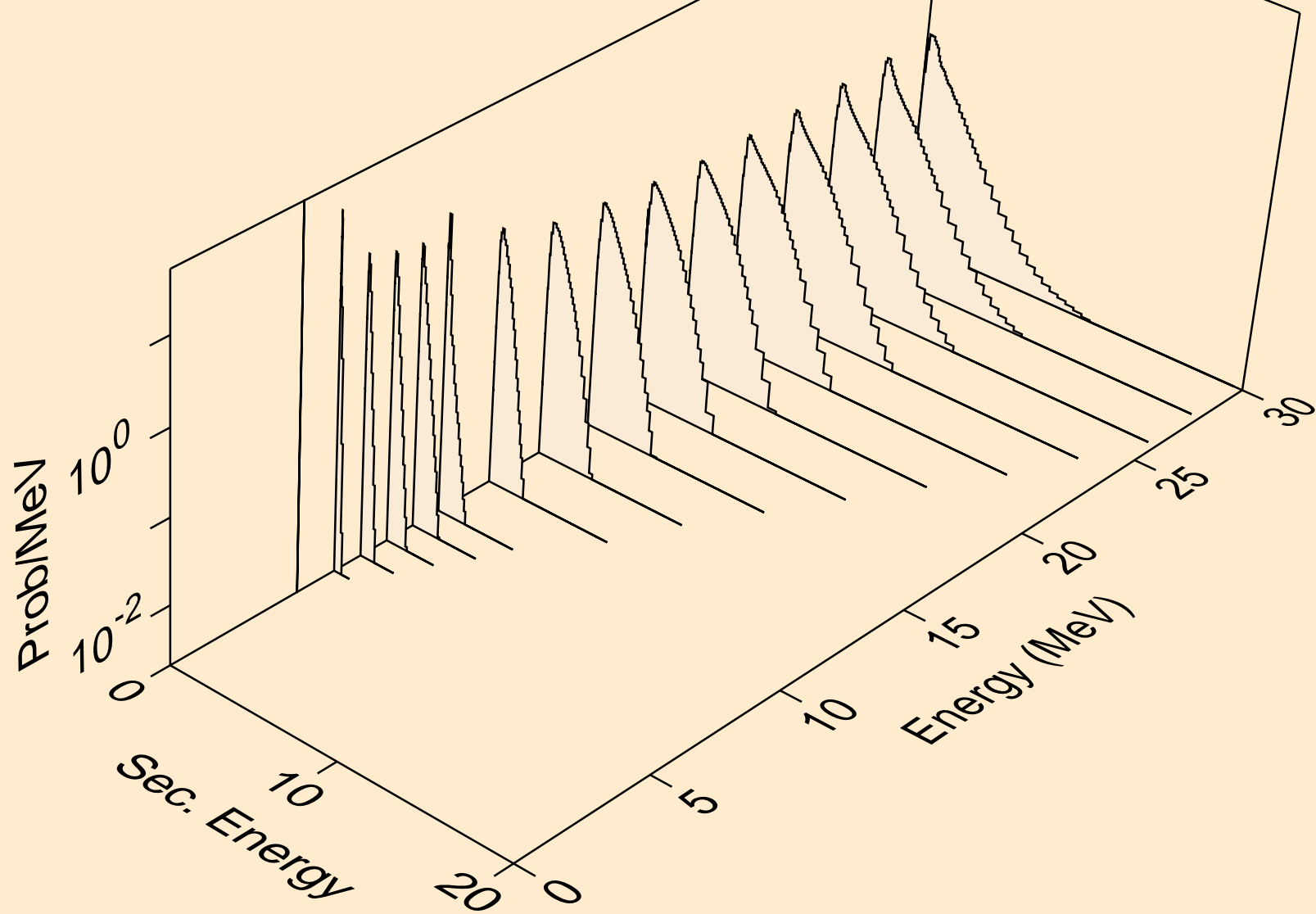

RB093 TRITON ACER TENDL-2021 LIBRARY; T=0.K  
neutrons from (t,n\*)2a

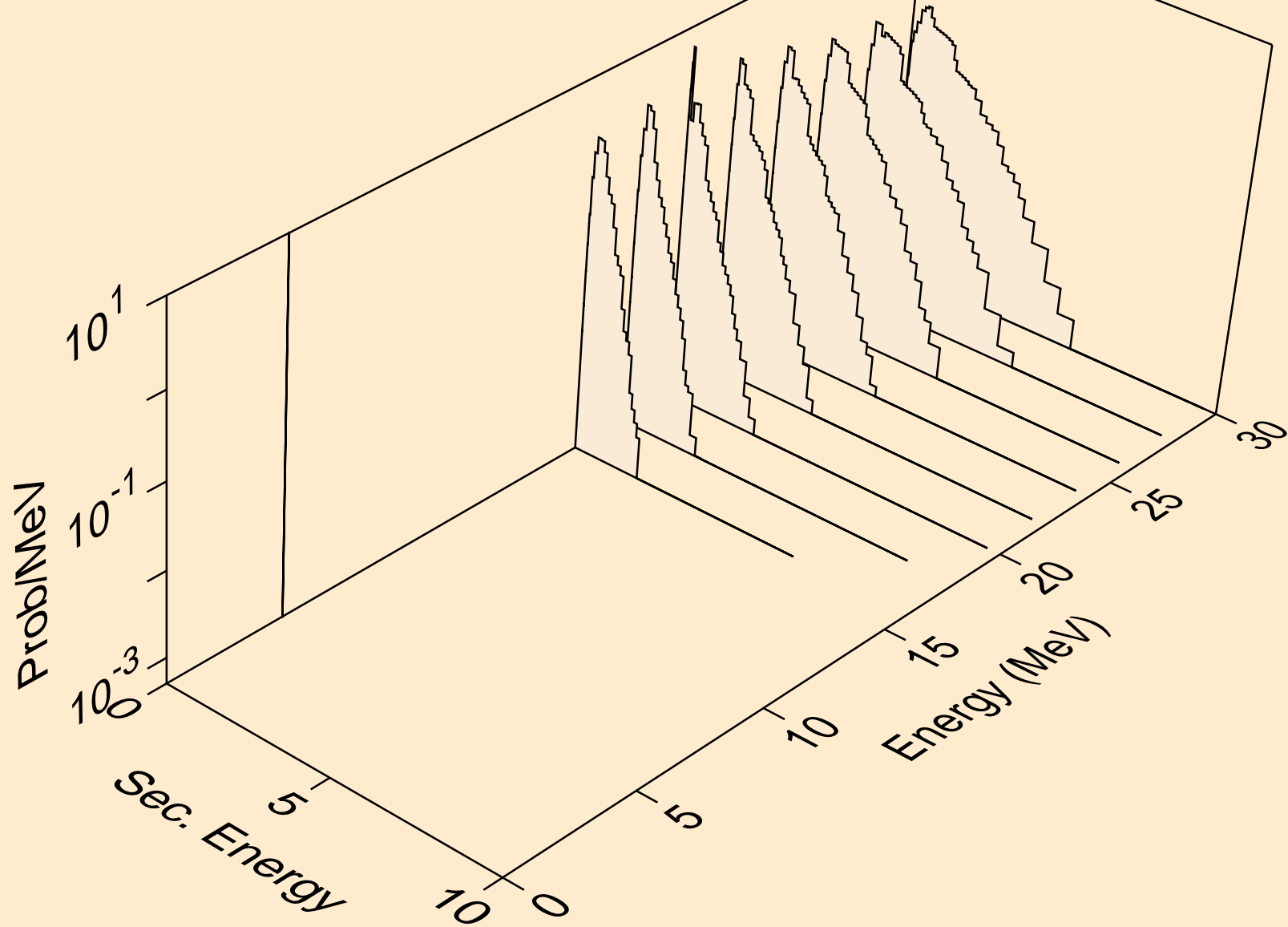

RB093 TRITON ACER TENDL-2021 LIBRARY; T=0.K  
neutrons from (t,n\*)d

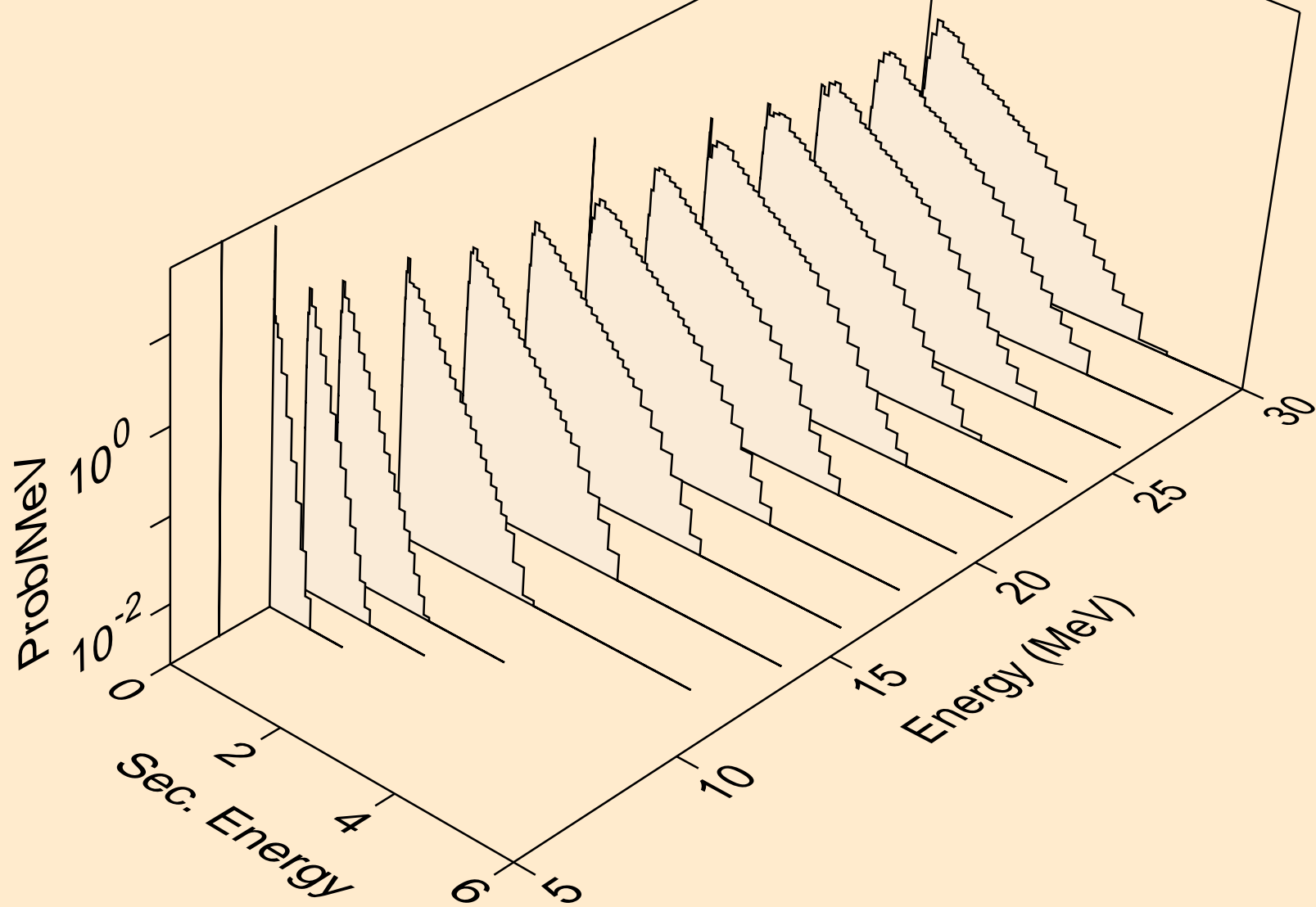

RB093 TRITON ACER TENDL-2021 LIBRARY; T=0.K  
neutrons from (t,n\*)t

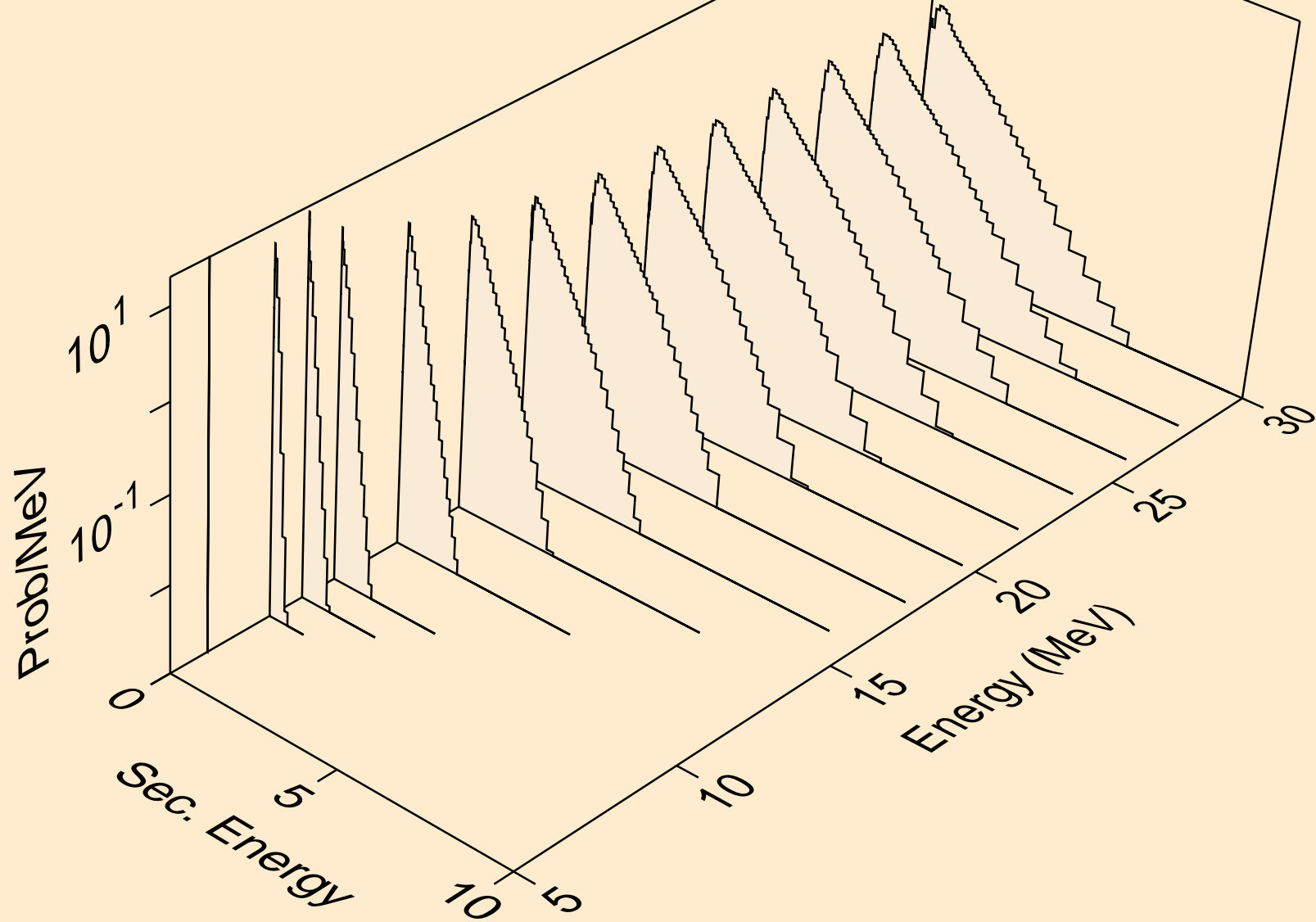



RB093 TRITON ACER TENDL-2021 LIBRARY; T=0.K  
neutrons from (t,n\*)he3

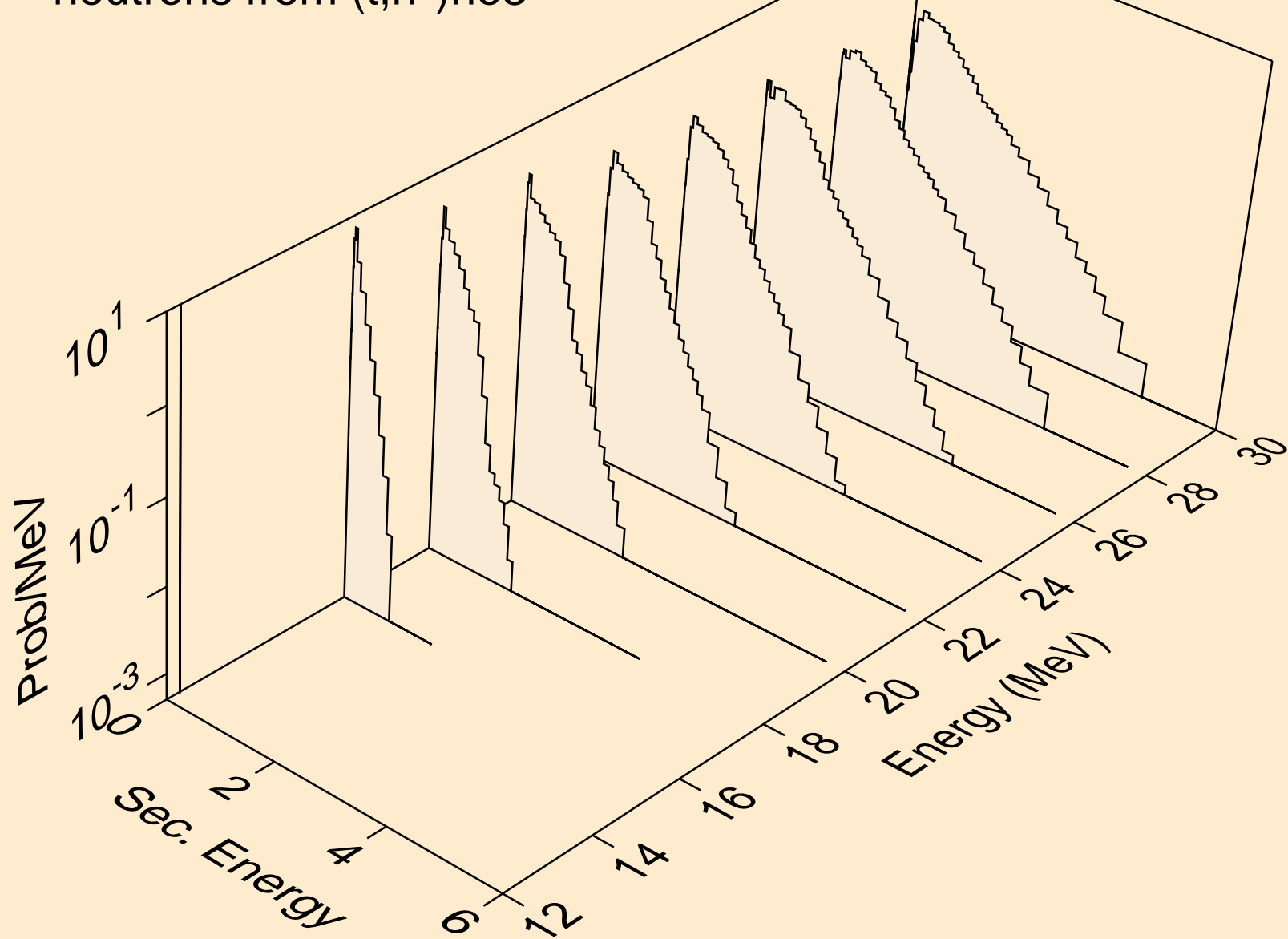

RB093 TRITON ACER TENDL-2021 LIBRARY; T=0.K  
neutrons from (t,4n)

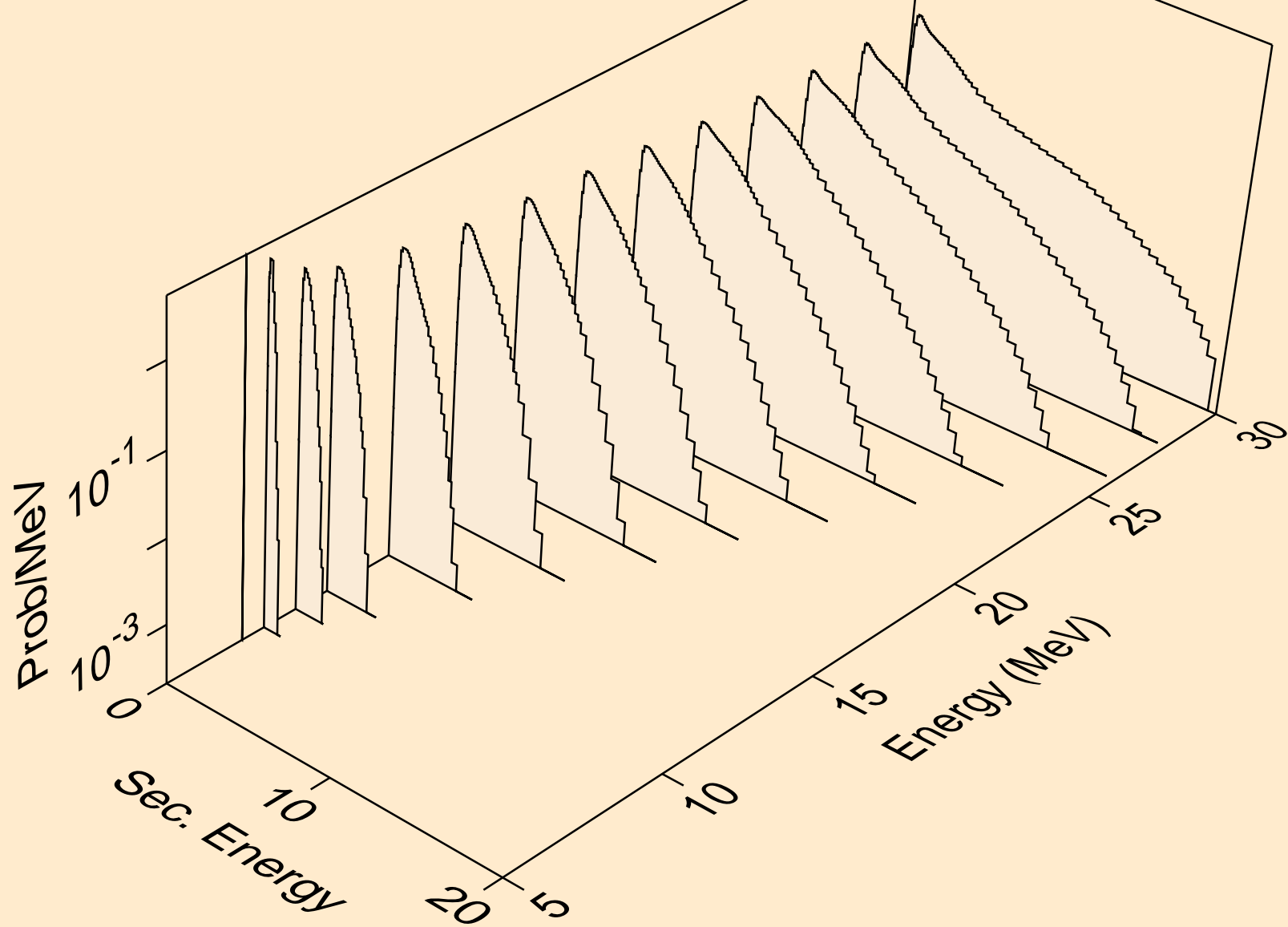

RB093 TRITON ACER TENDL-2021 LIBRARY; T=0.K  
neutrons from (t,2np)

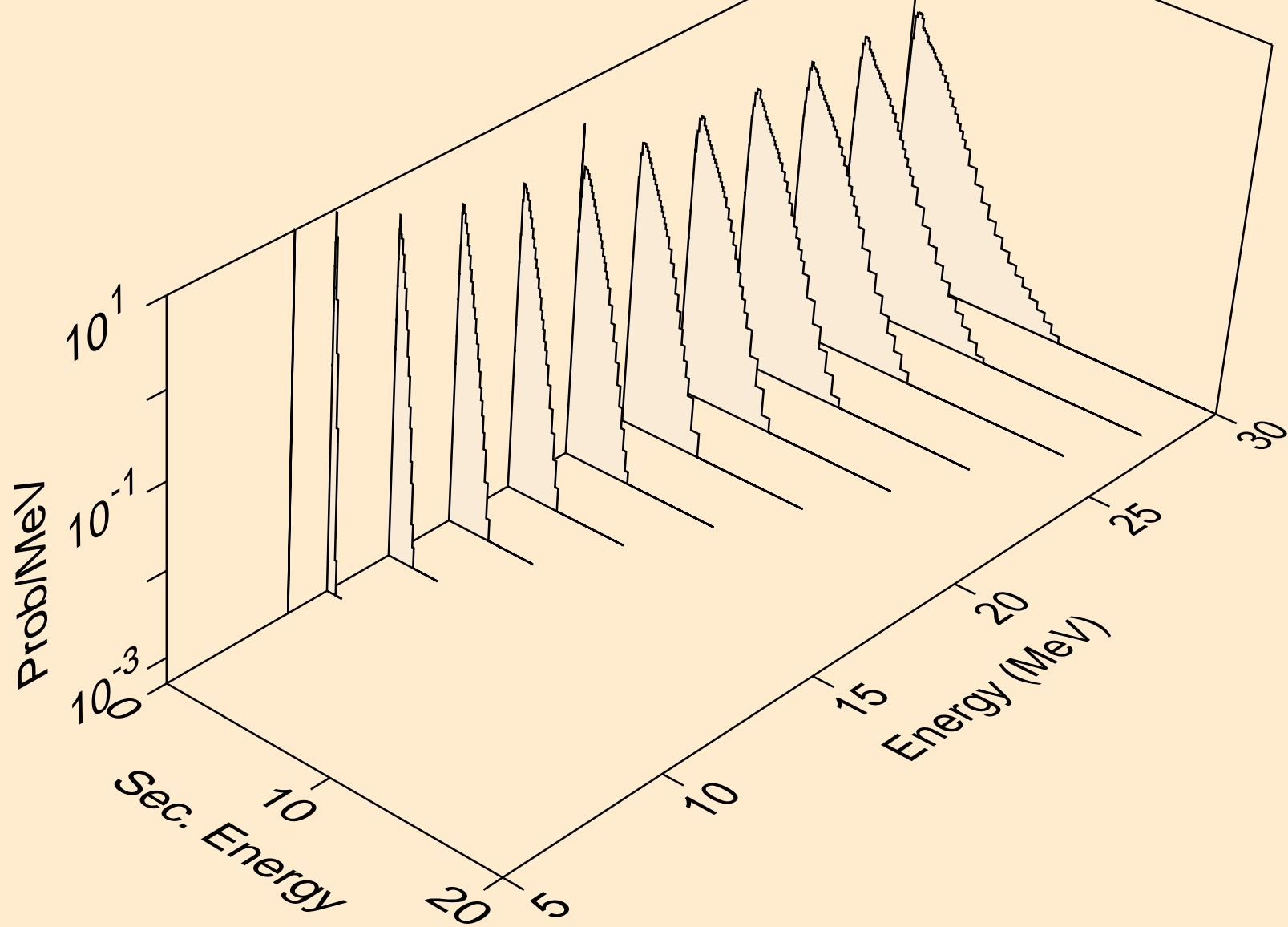

RB093 TRITON ACER TENDL-2021 LIBRARY; T=0.K  
neutrons from (t,3np)

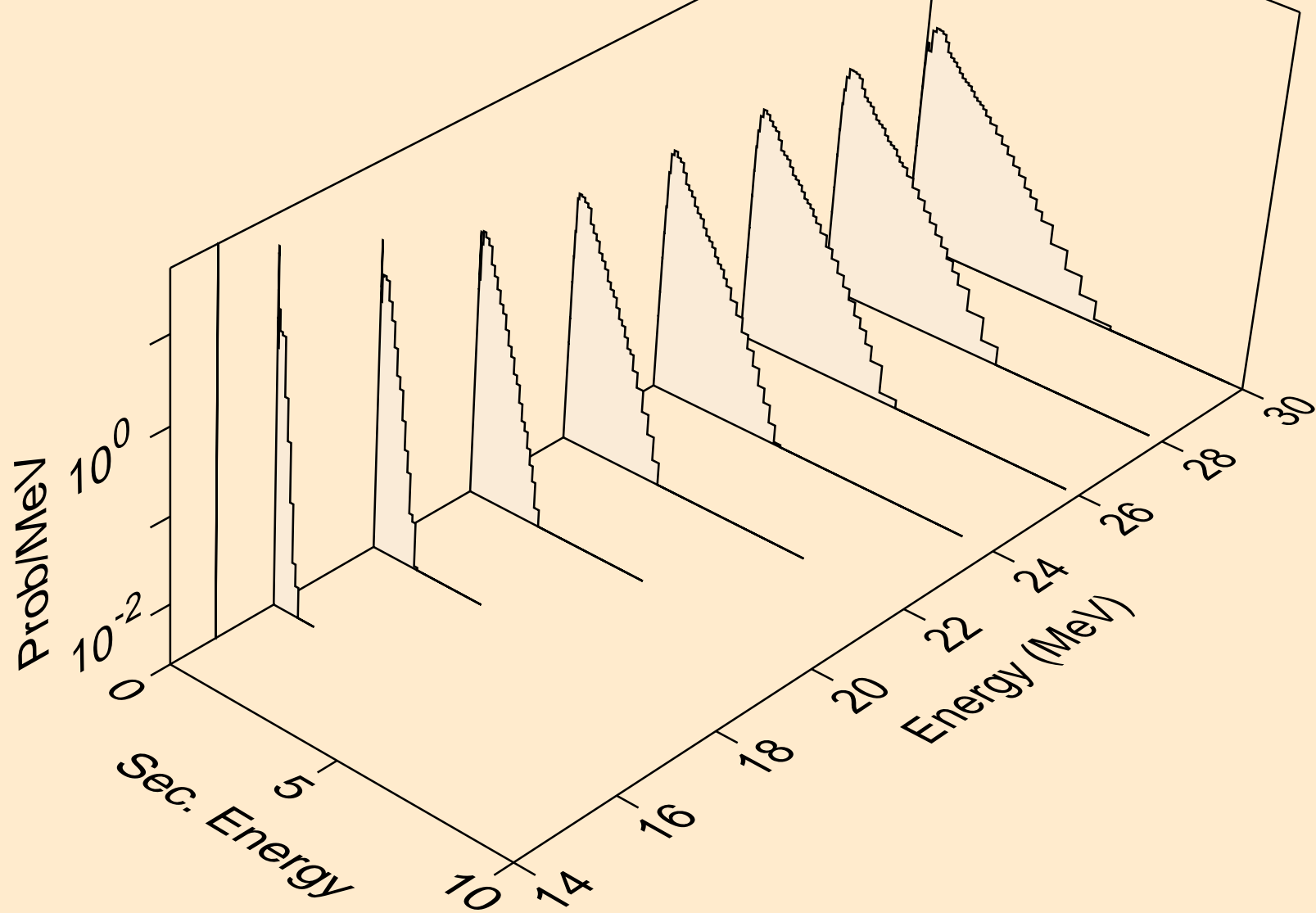

RB093 TRITON ACER TENDL-2021 LIBRARY; T=0.K  
neutrons from (t,2np)

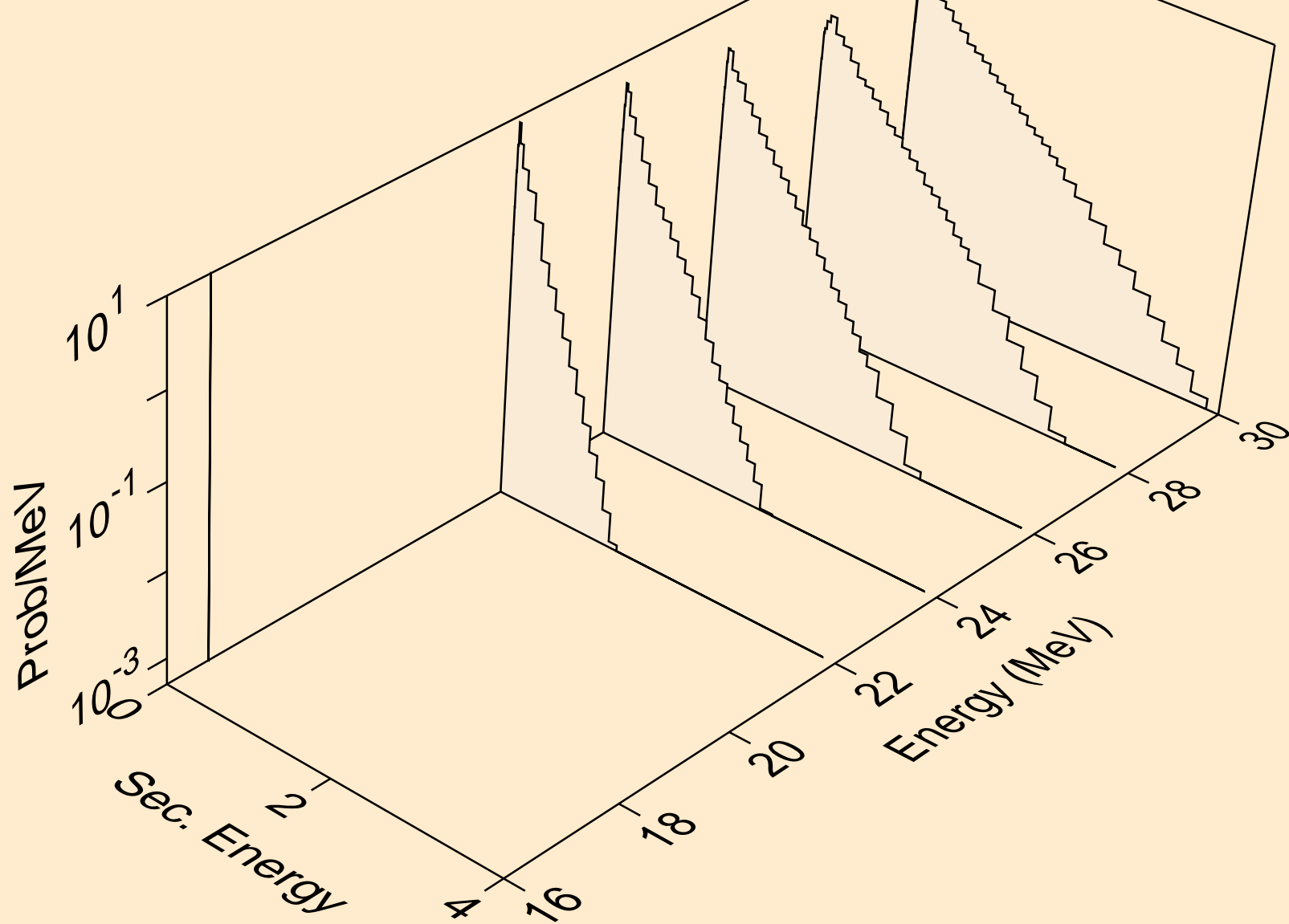

RB093 TRITON ACER TENDL-2021 LIBRARY; T=0.K  
neutrons from (t,npa)

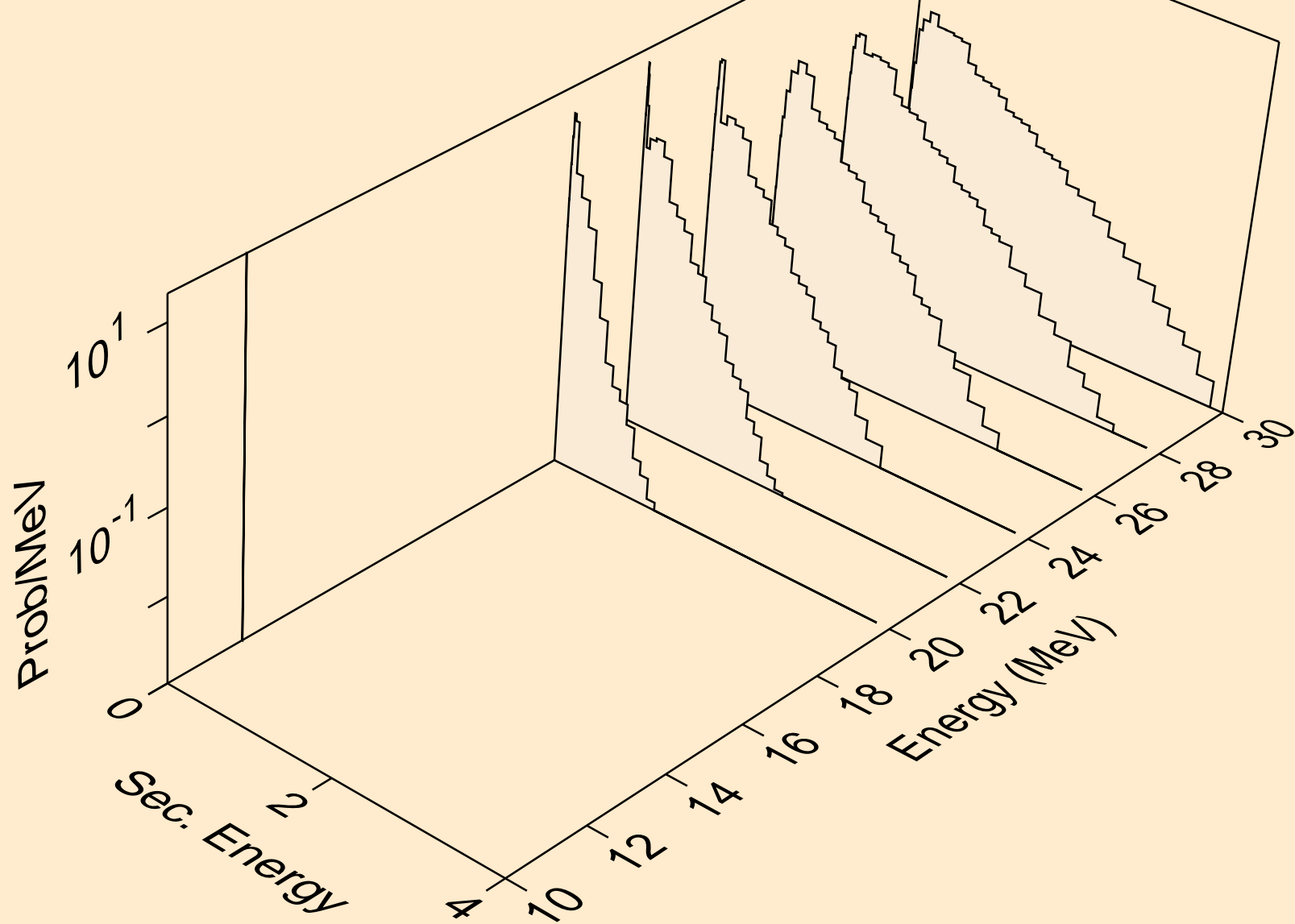

RB093 TRITON ACER TENDL-2021 LIBRARY; T=0.K  
protons from (t,x)

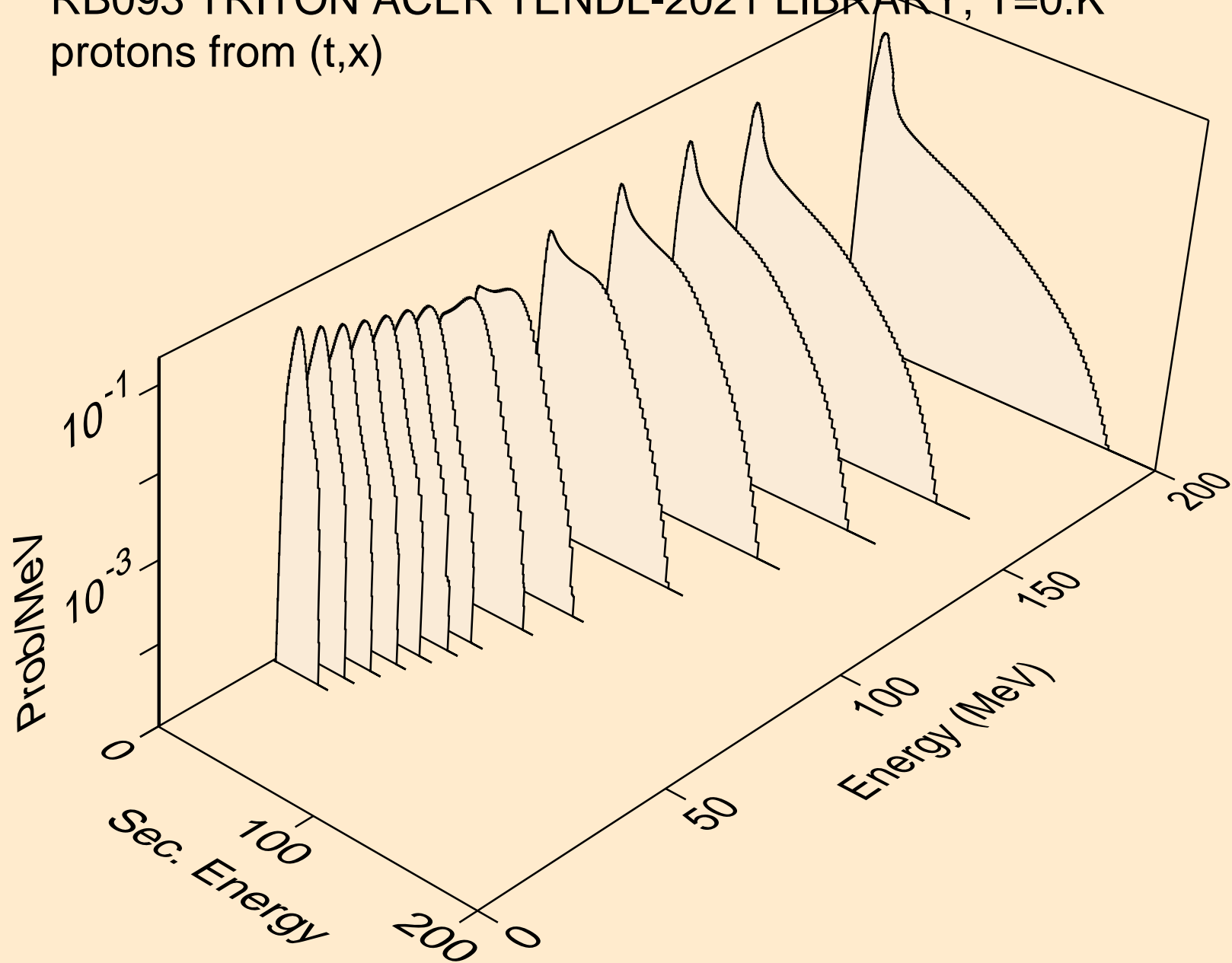

RB093 TRITON ACER TENDL-2021 LIBRARY; T=0.K  
protons from (t,n\*)p

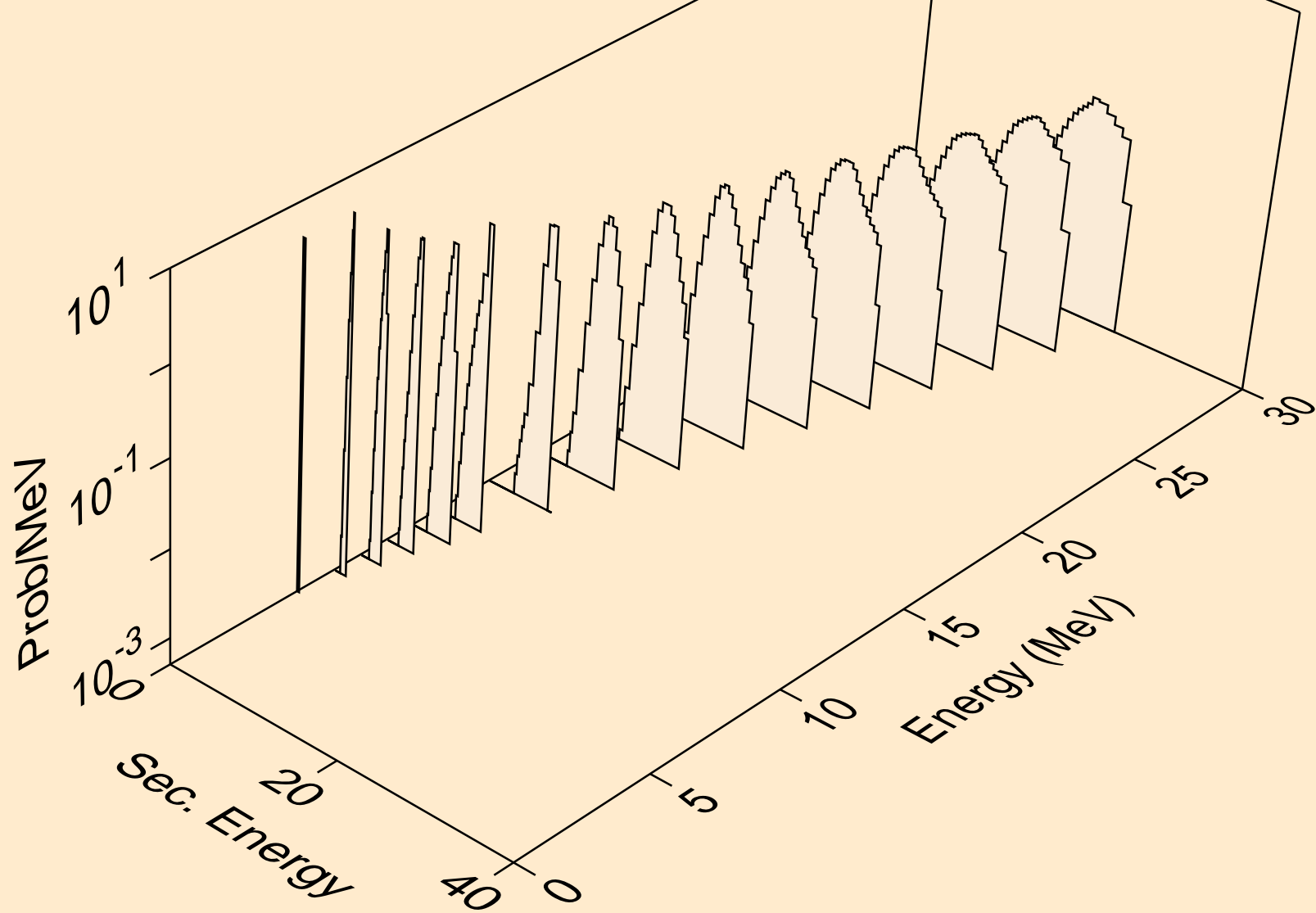



RB093 TRITON ACER TENDL-2021 LIBRARY; T=0.K  
protons from (t,2np)

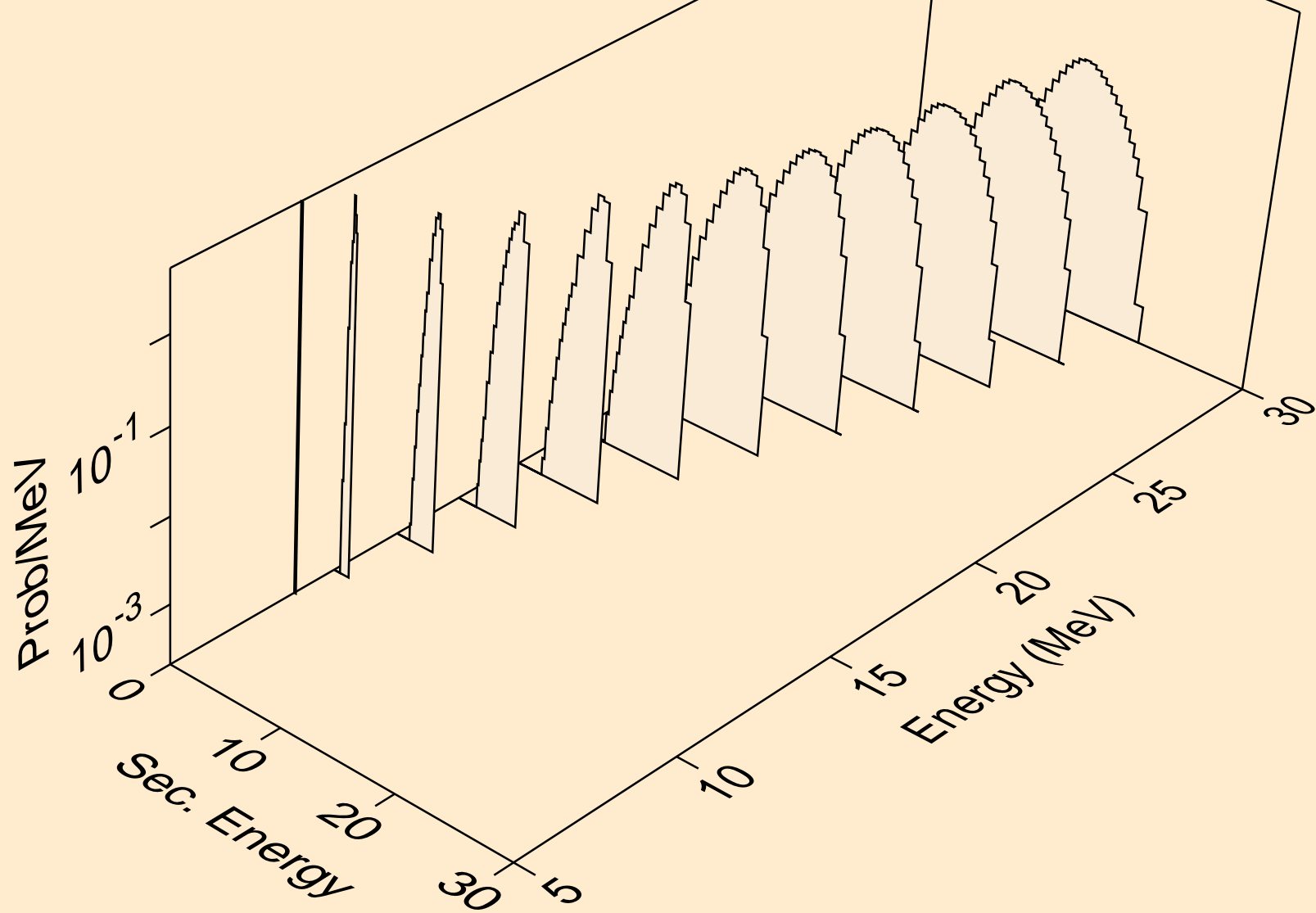

RB093 TRITON ACER TENDL-2021 LIBRARY; T=0.K  
protons from (t,3np)

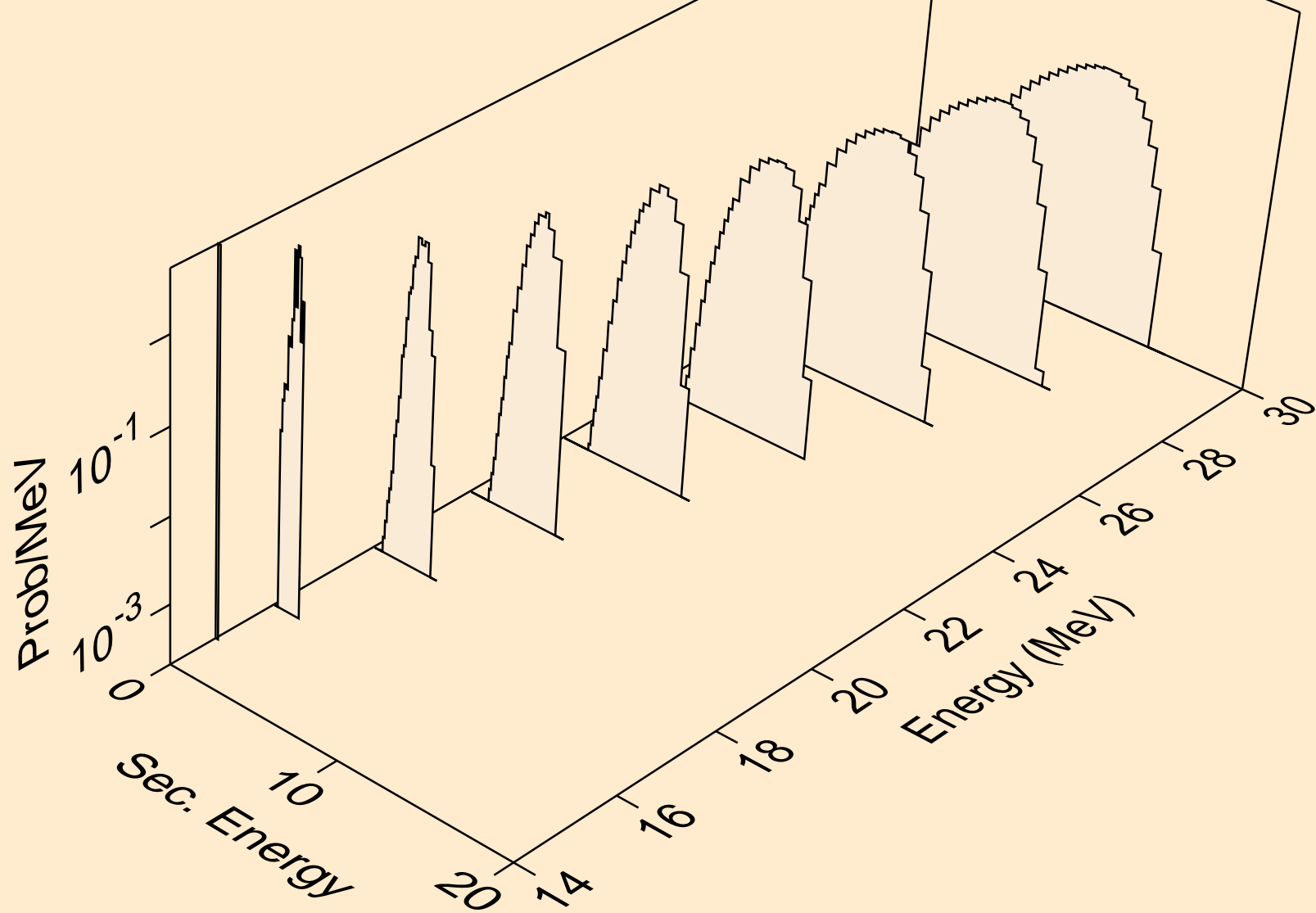

RB093 TRITON ACER TENDL-2021 LIBRARY; T=0.K  
protons from (t,2np)

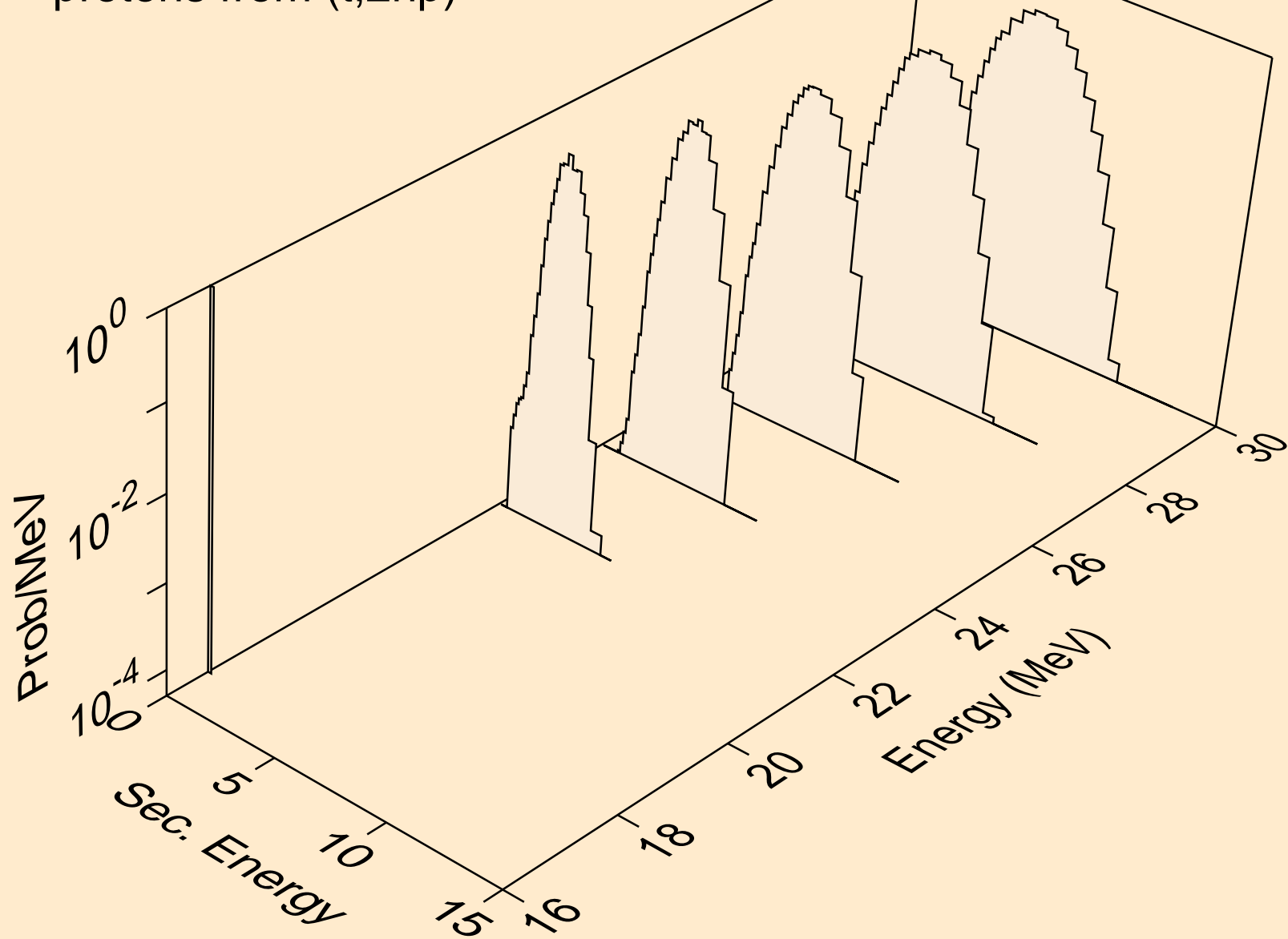

RB093 TRITON ACER TENDL-2021 LIBRARY; T=0.K  
protons from (t,npa)

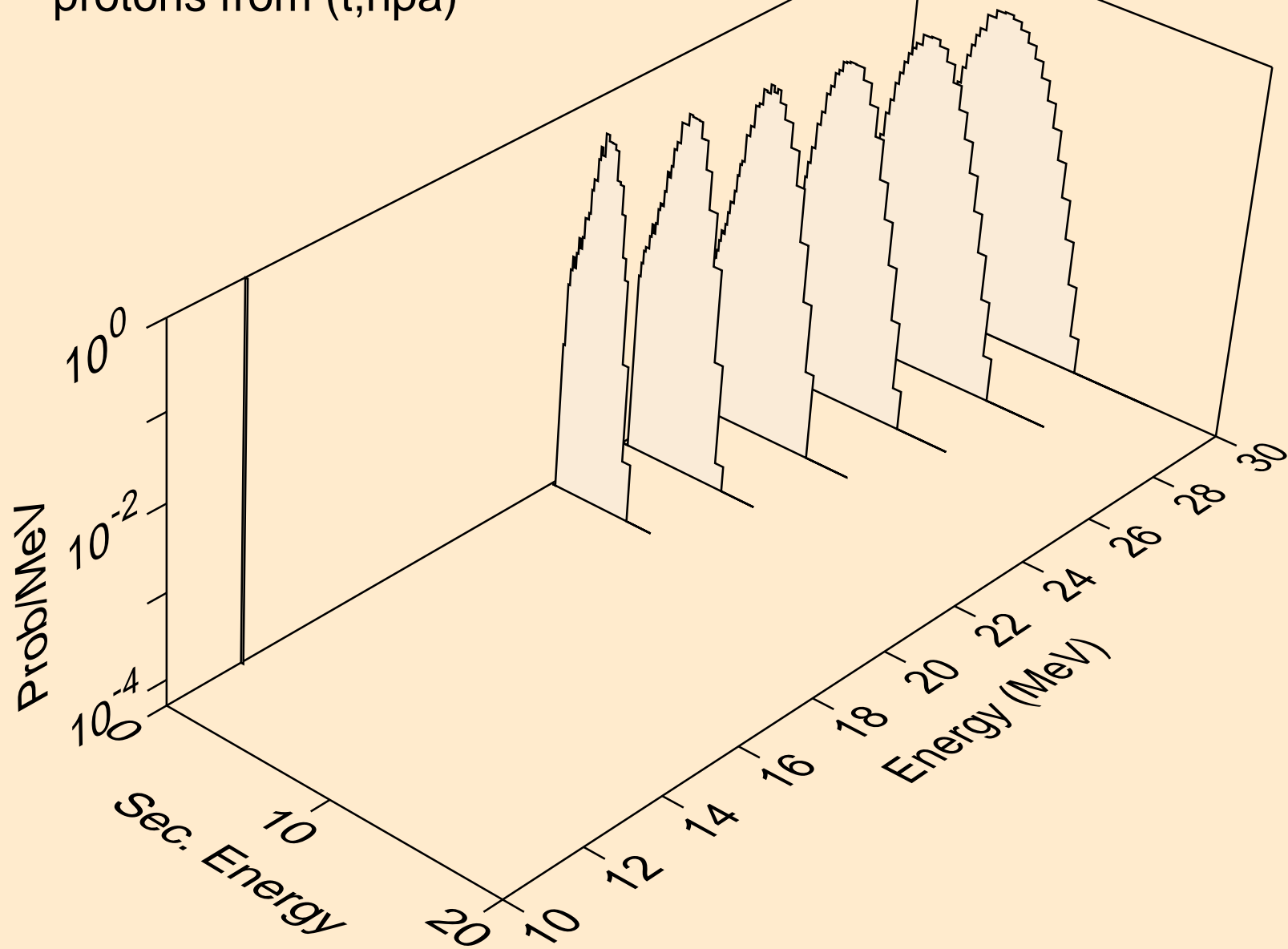

RB093 TRITON ACER TENDL-2021 LIBRARY; T=0.K  
protons from (t,p)

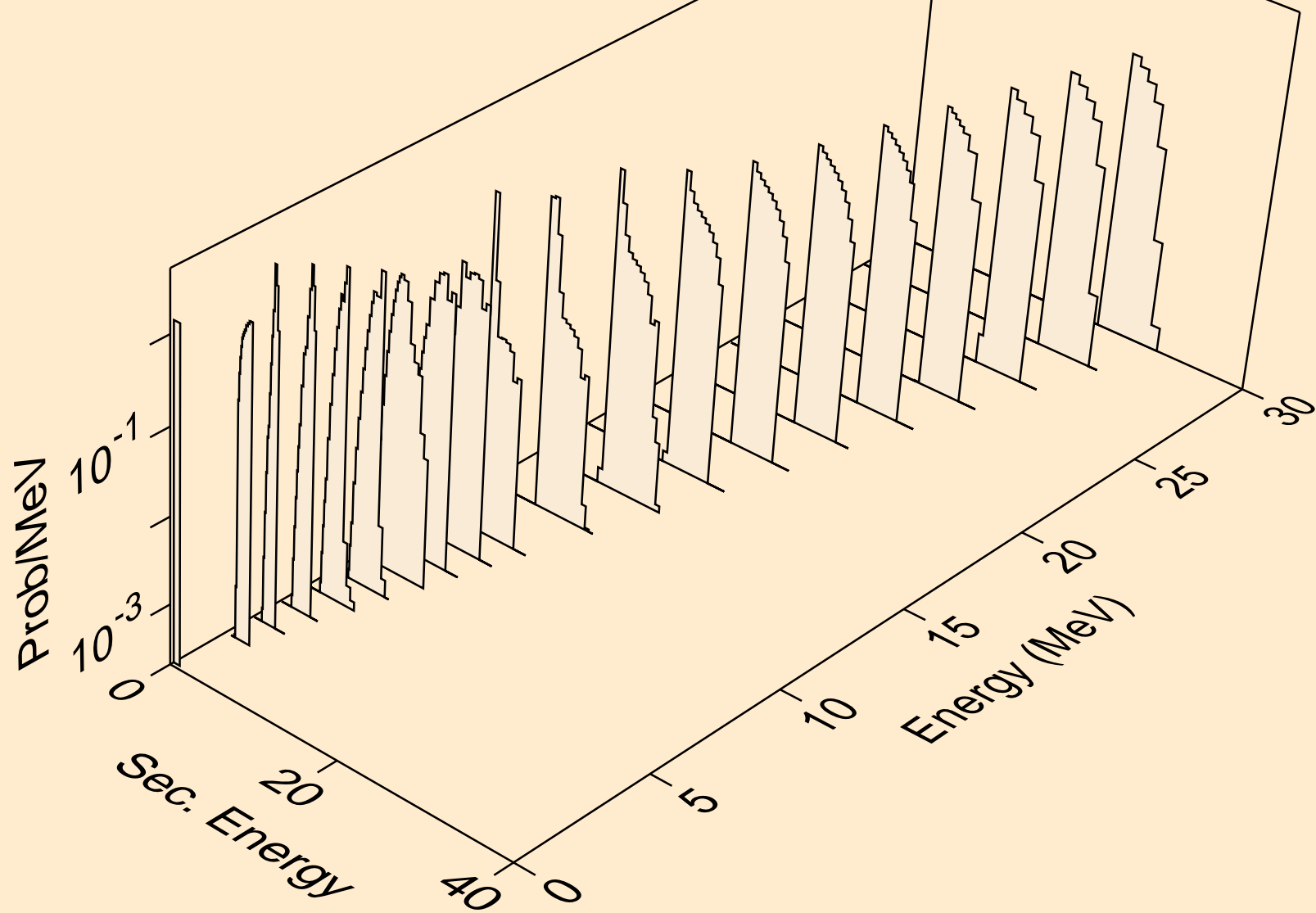

RB093 TRITON ACER TENDL-2021 LIBRARY; T=0.K  
protons from (t,2p)

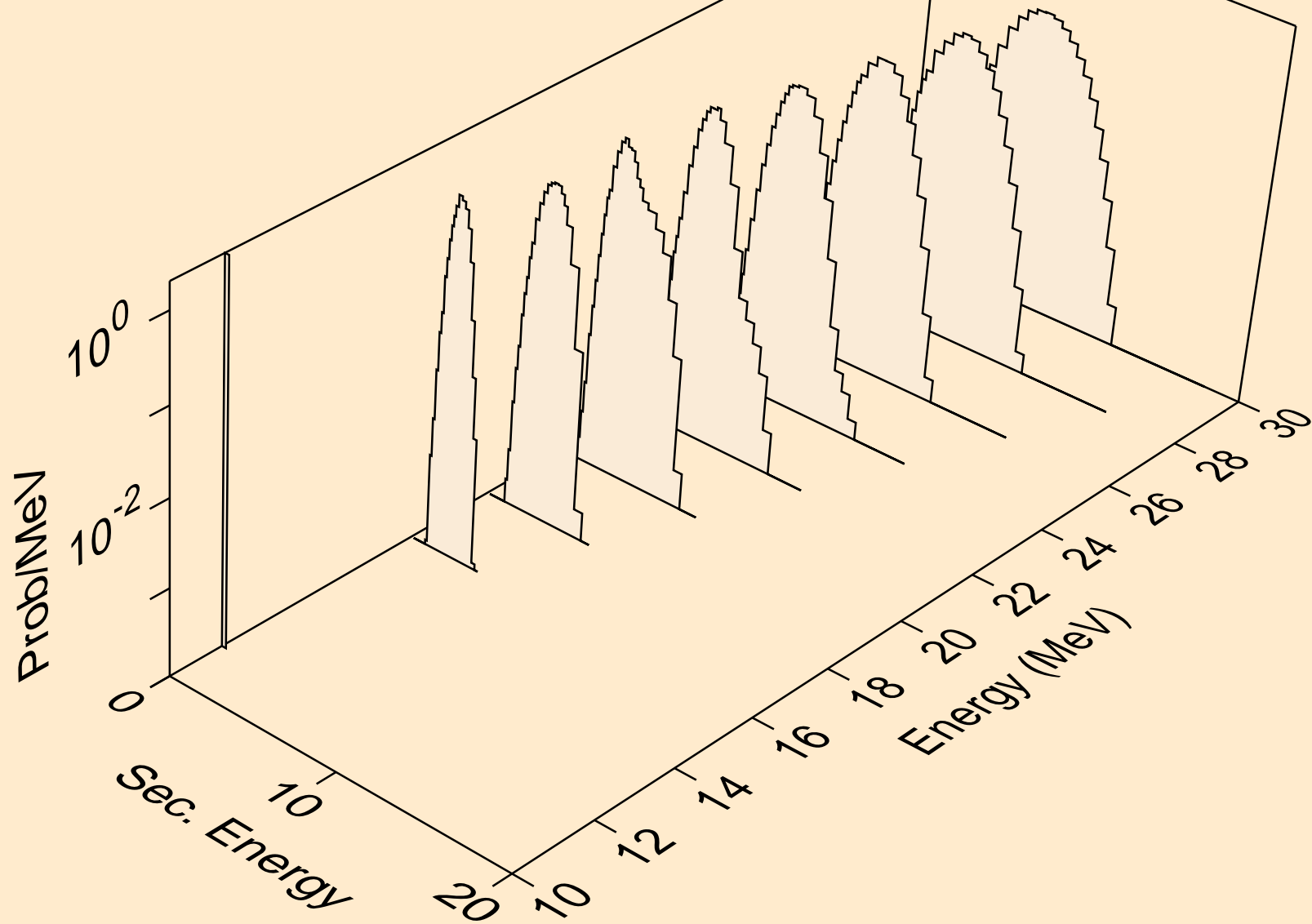

RB093 TRITON ACER TENDL-2021 LIBRARY; T=0.K  
protons from (t,pa)

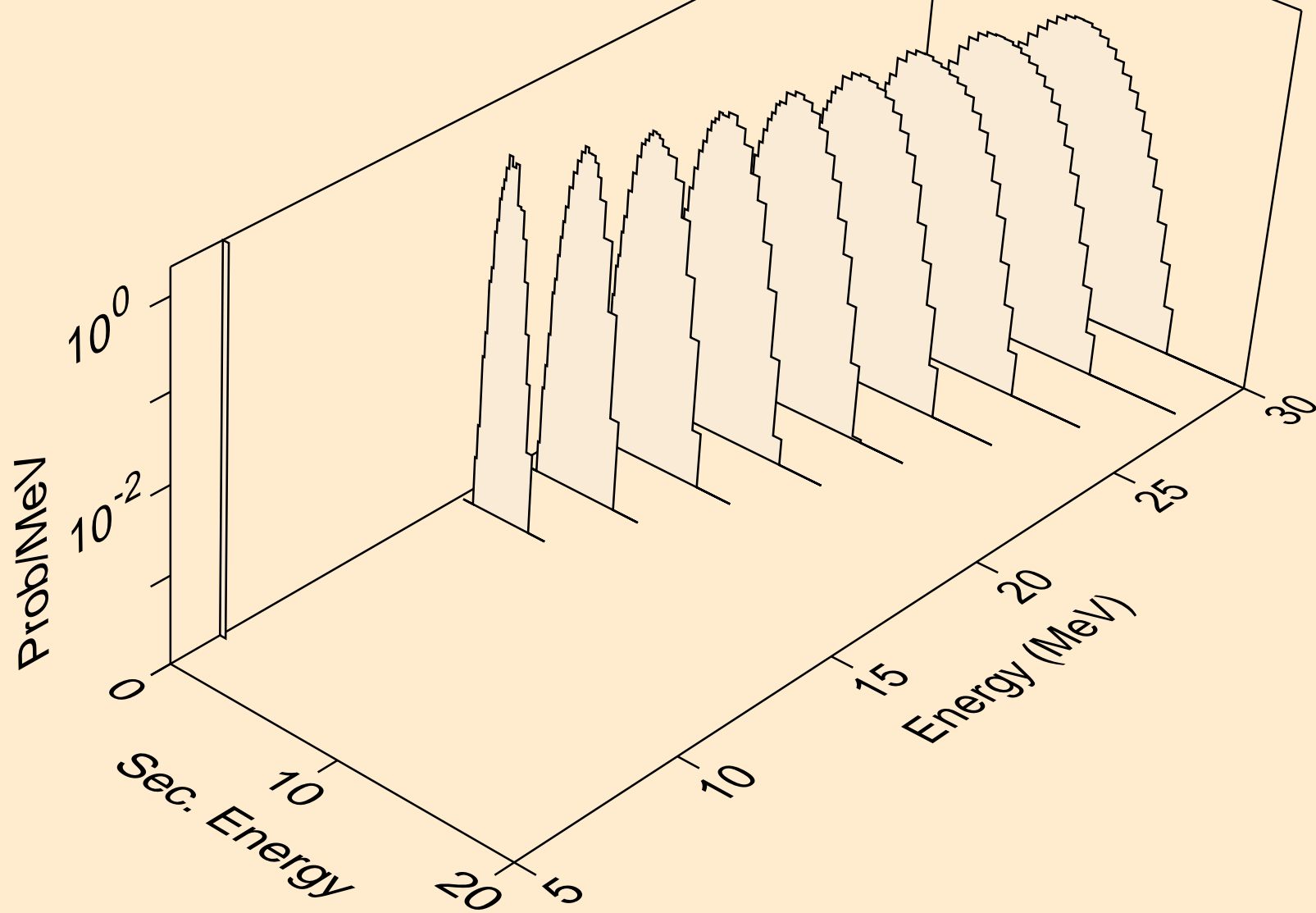

RB093 TRITON ACER TENDL-2021 LIBRARY; T=0.K  
protons from (t,pd)

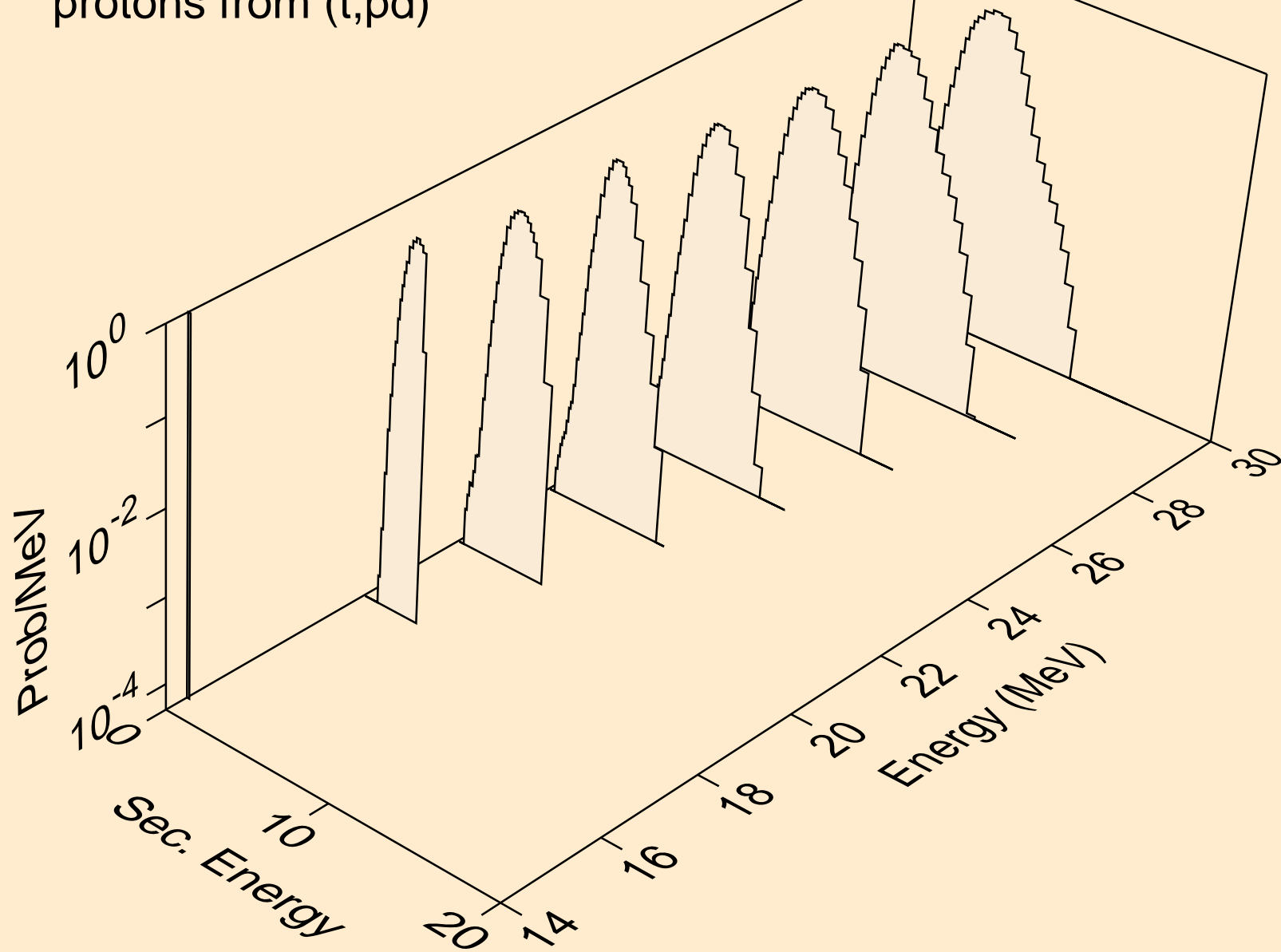



RB093 TRITON ACER TENDL-2021 LIBRARY; T=0.K  
protons from (t,pt)

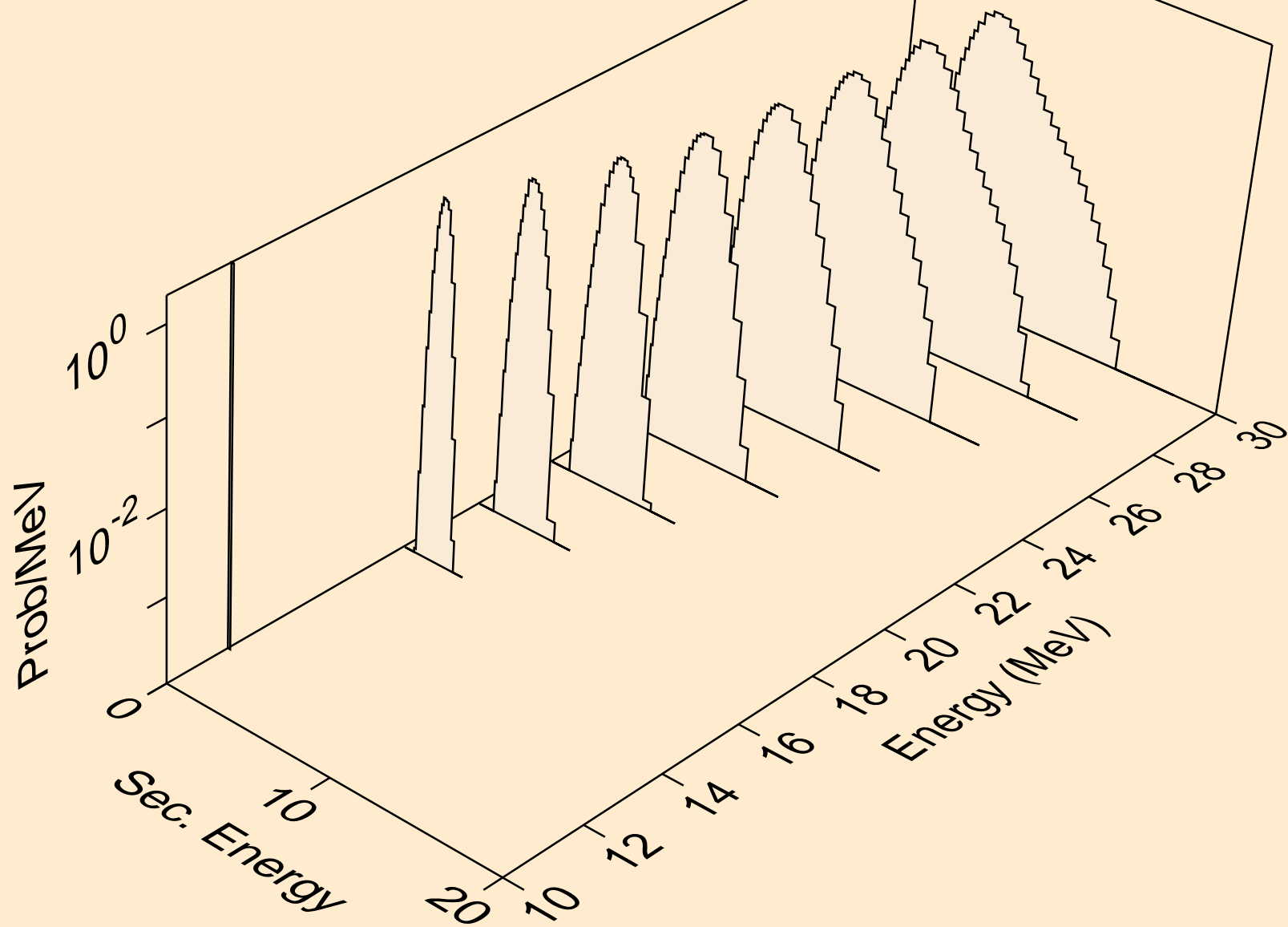

RB093 TRITON ACER TENDL-2021 LIBRARY; T=0.K  
deuterons from (t,x)

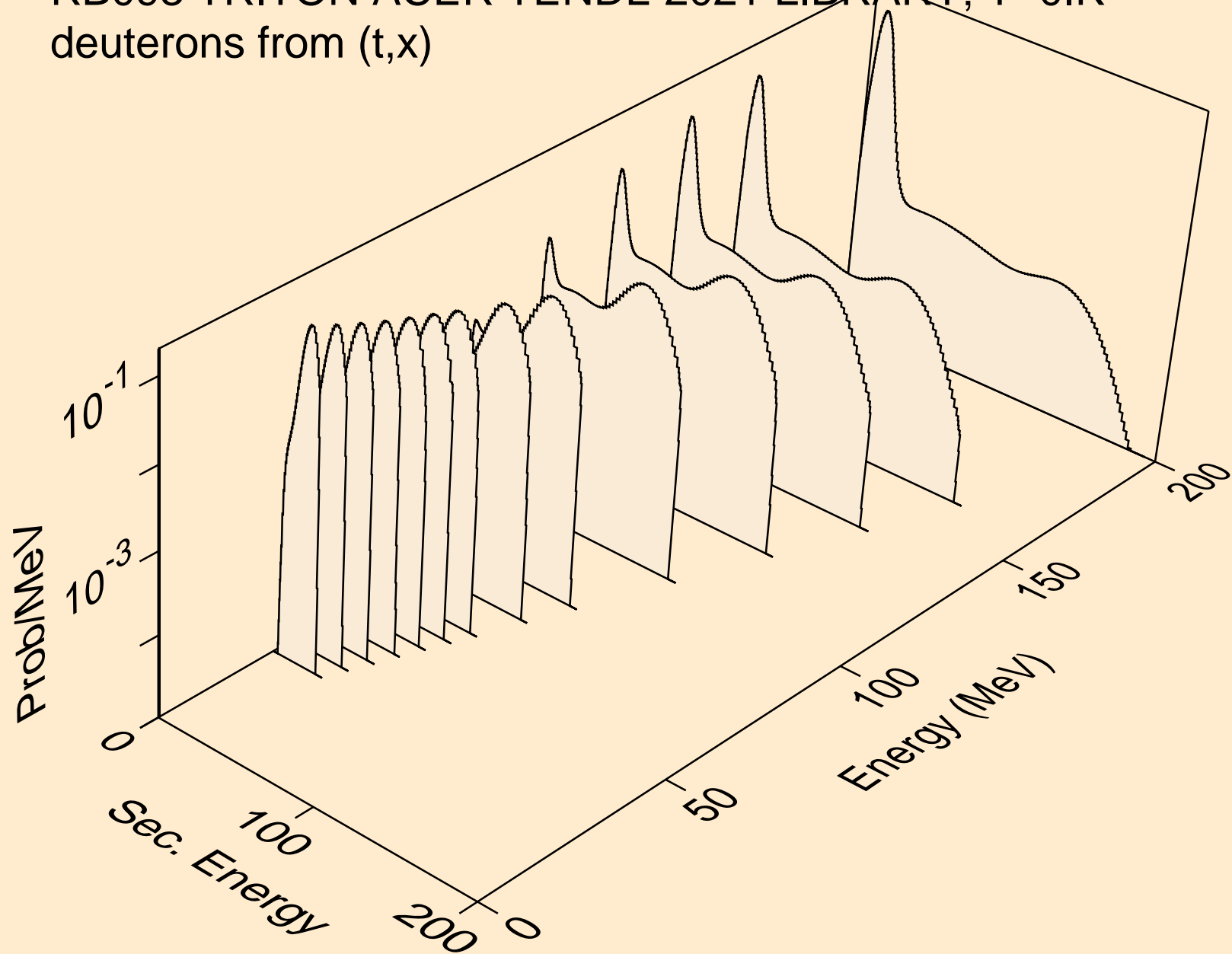

RB093 TRITON ACER TENDL-2021 LIBRARY; T=0.K  
deuterons from (t,2nd)

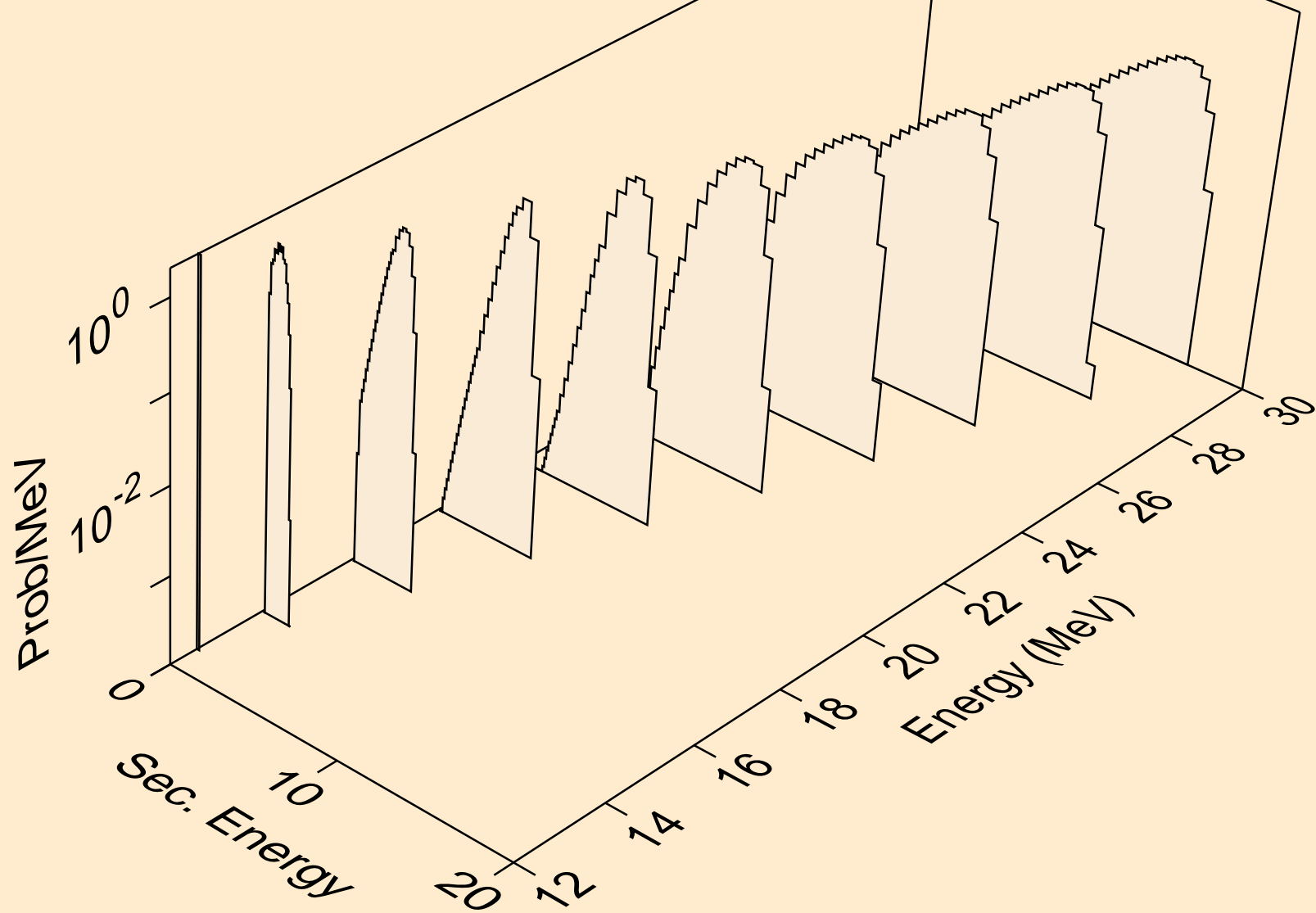

RB093 TRITON ACER TENDL-2021 LIBRARY; T=0.K  
deuterons from (t,n\*)d

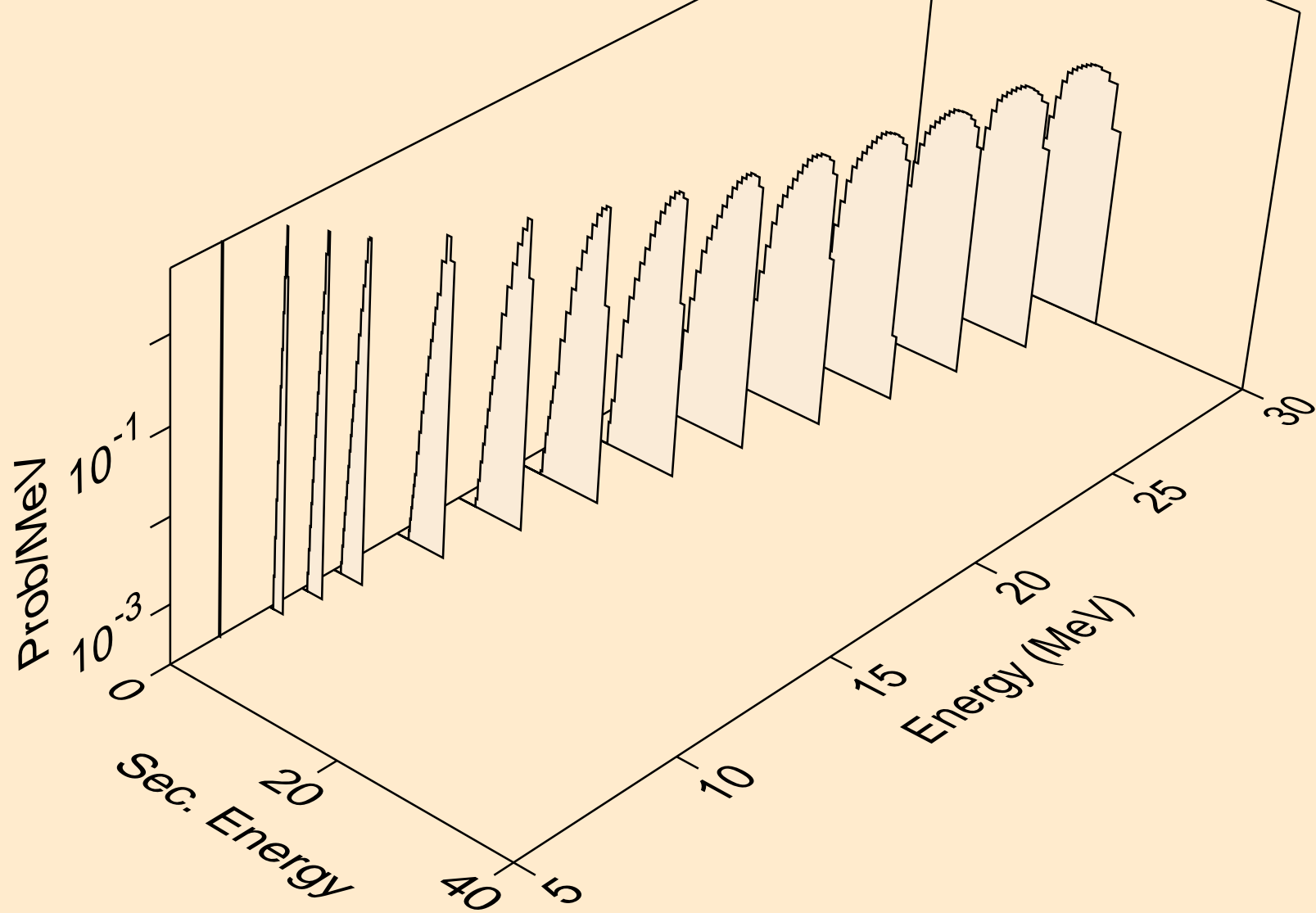

RB093 TRITON ACER TENDL-2021 LIBRARY; T=0.K  
deuterons from (t,d)

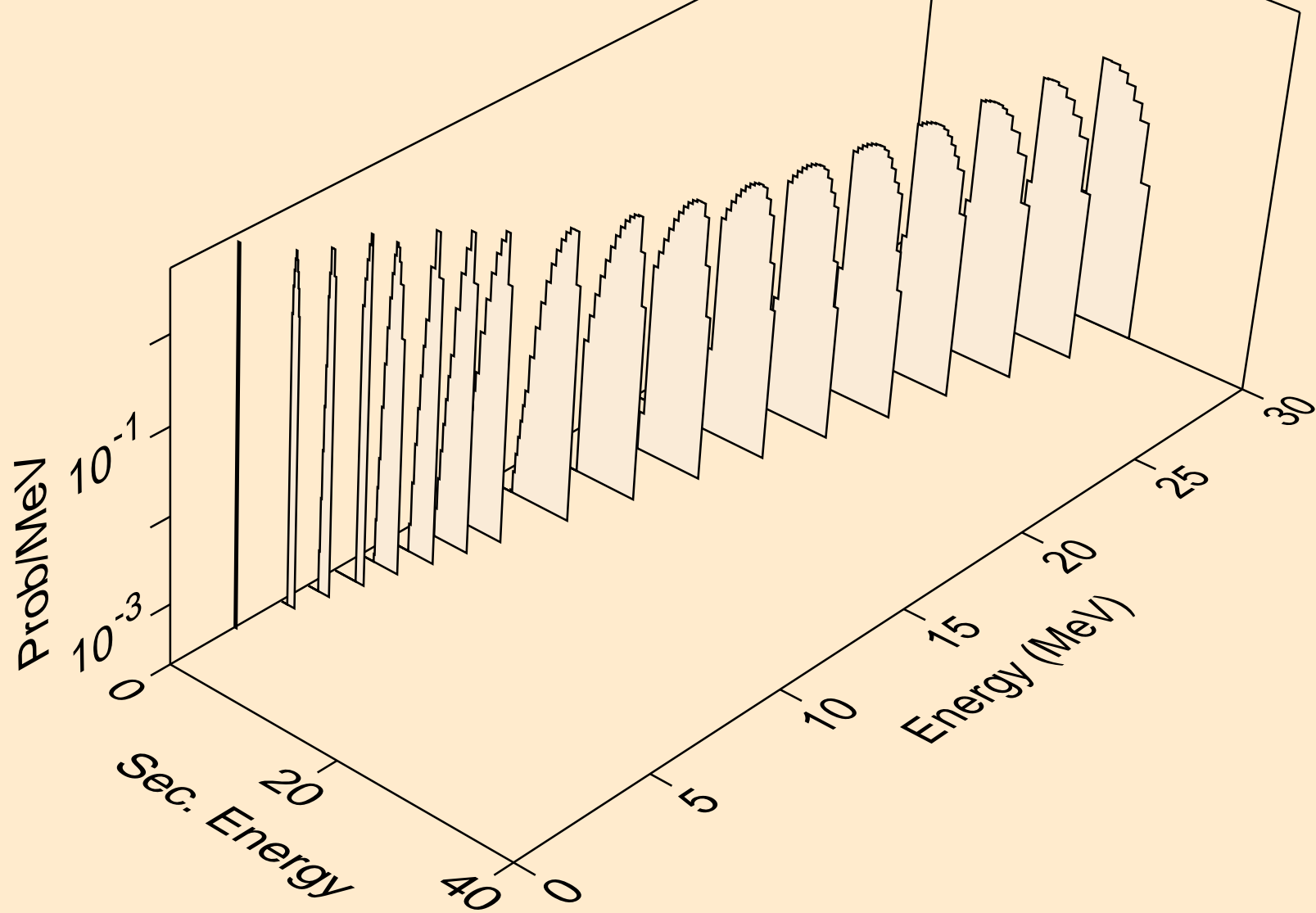

RB093 TRITON ACER TENDL-2021 LIBRARY; T=0.K  
deuterons from (t,pd)

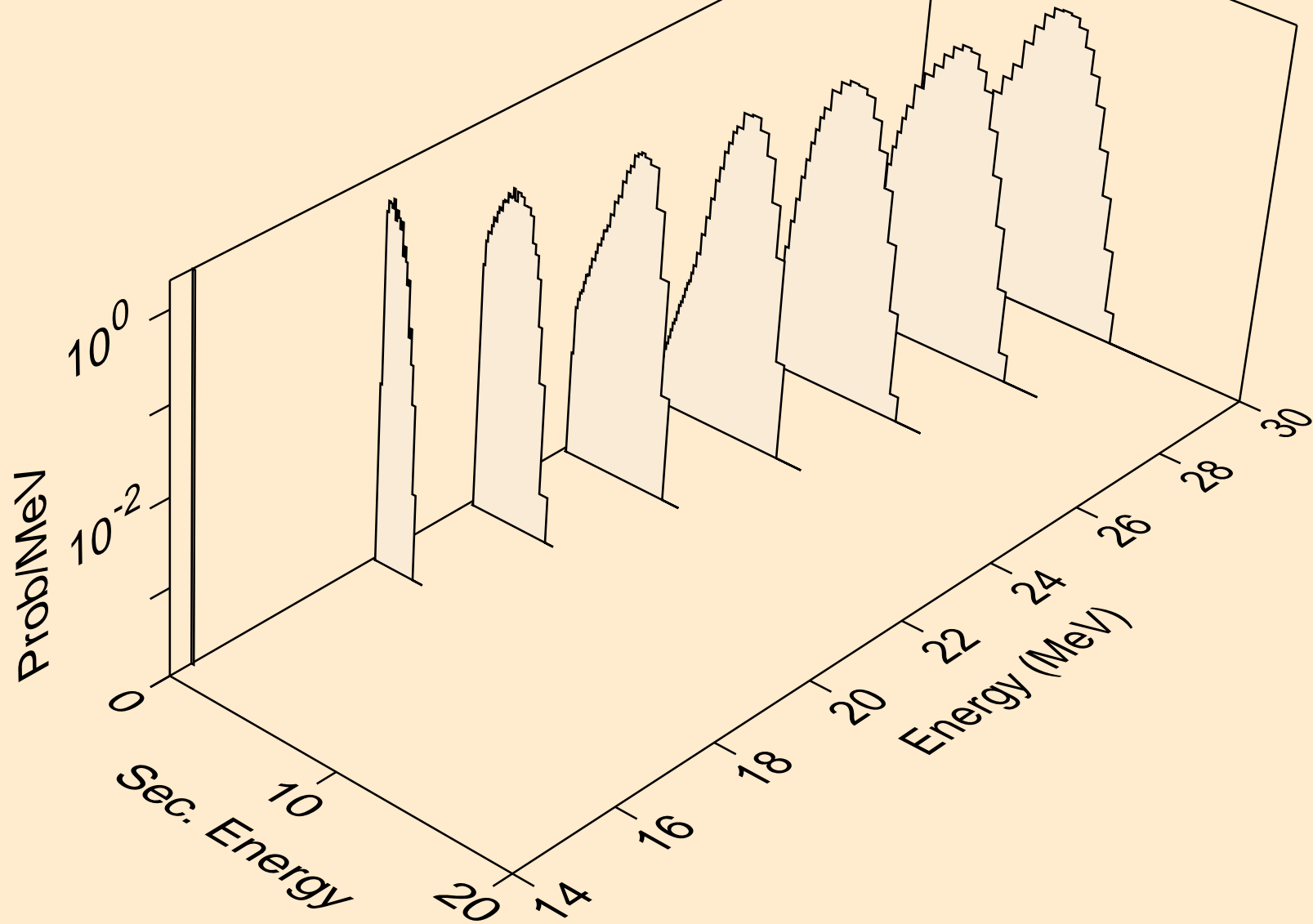

RB093 TRITON ACER TENDL-2021 LIBRARY; T=0.K  
deuterons from (t,da)

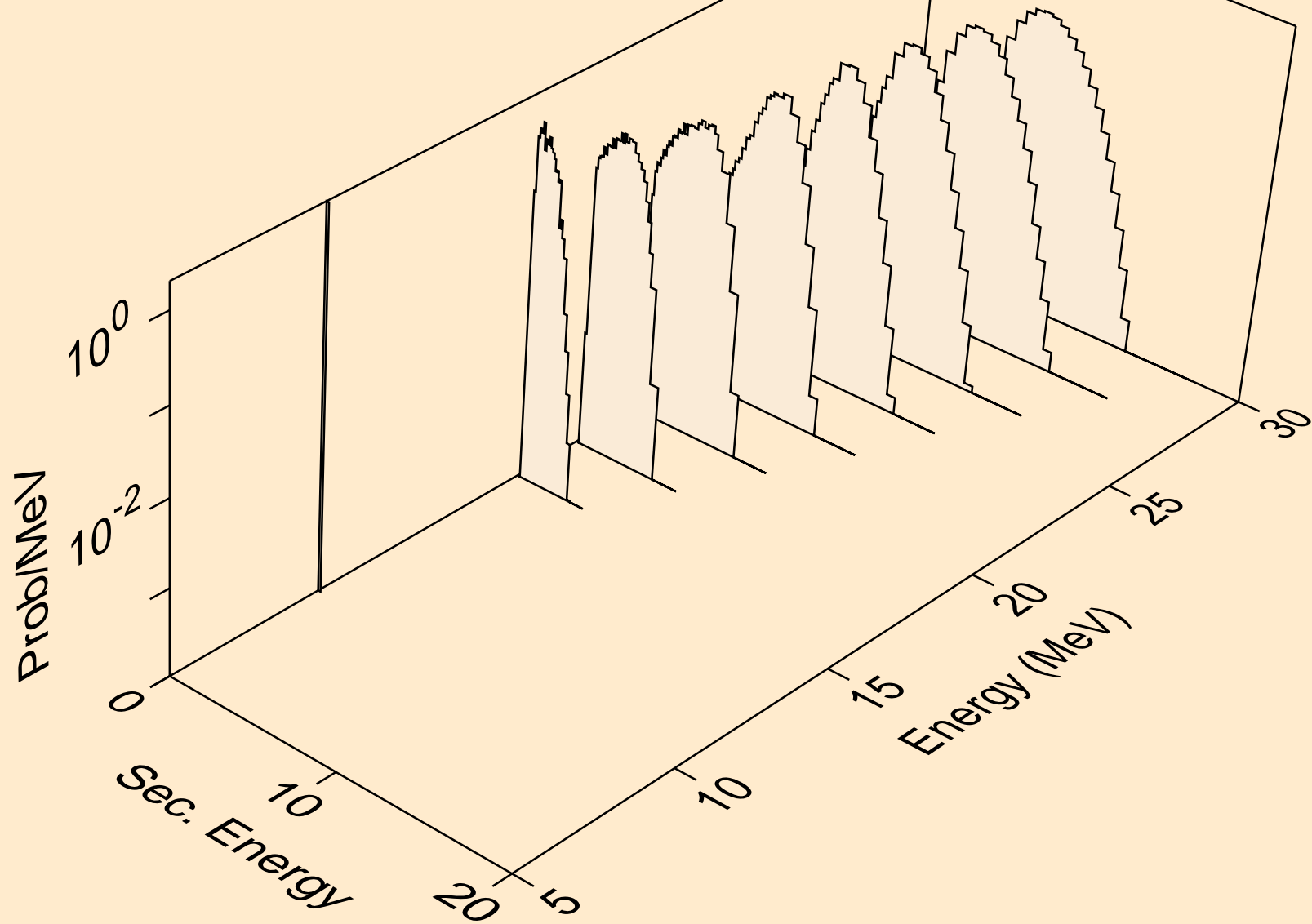

RB093 TRITON ACER TENDL-2021 LIBRARY; T=0.K  
he3s from (t,x)

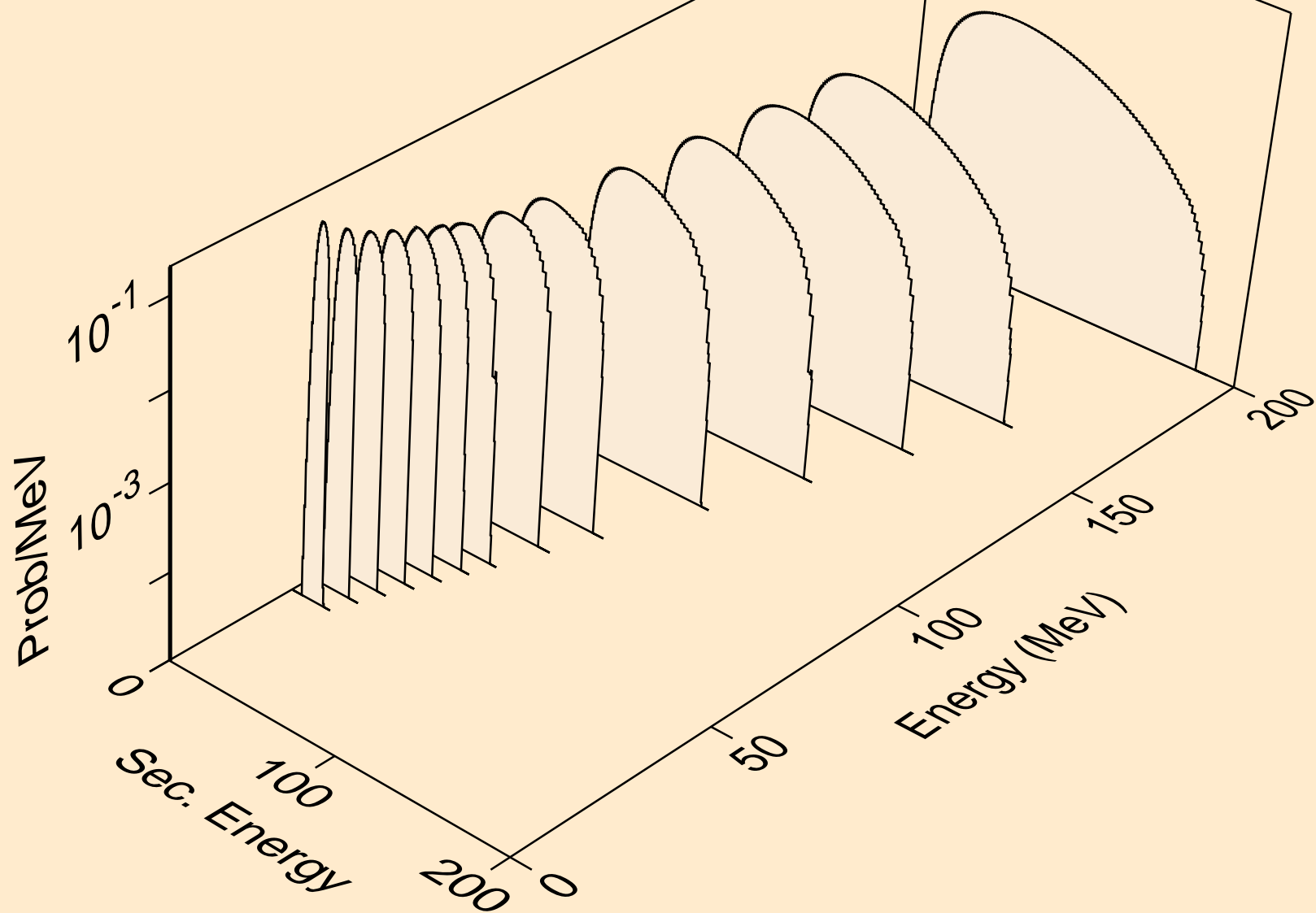



RB093 TRITON ACER TENDL-2021 LIBRARY; T=0.K  
he3s from (t,n\*)he3

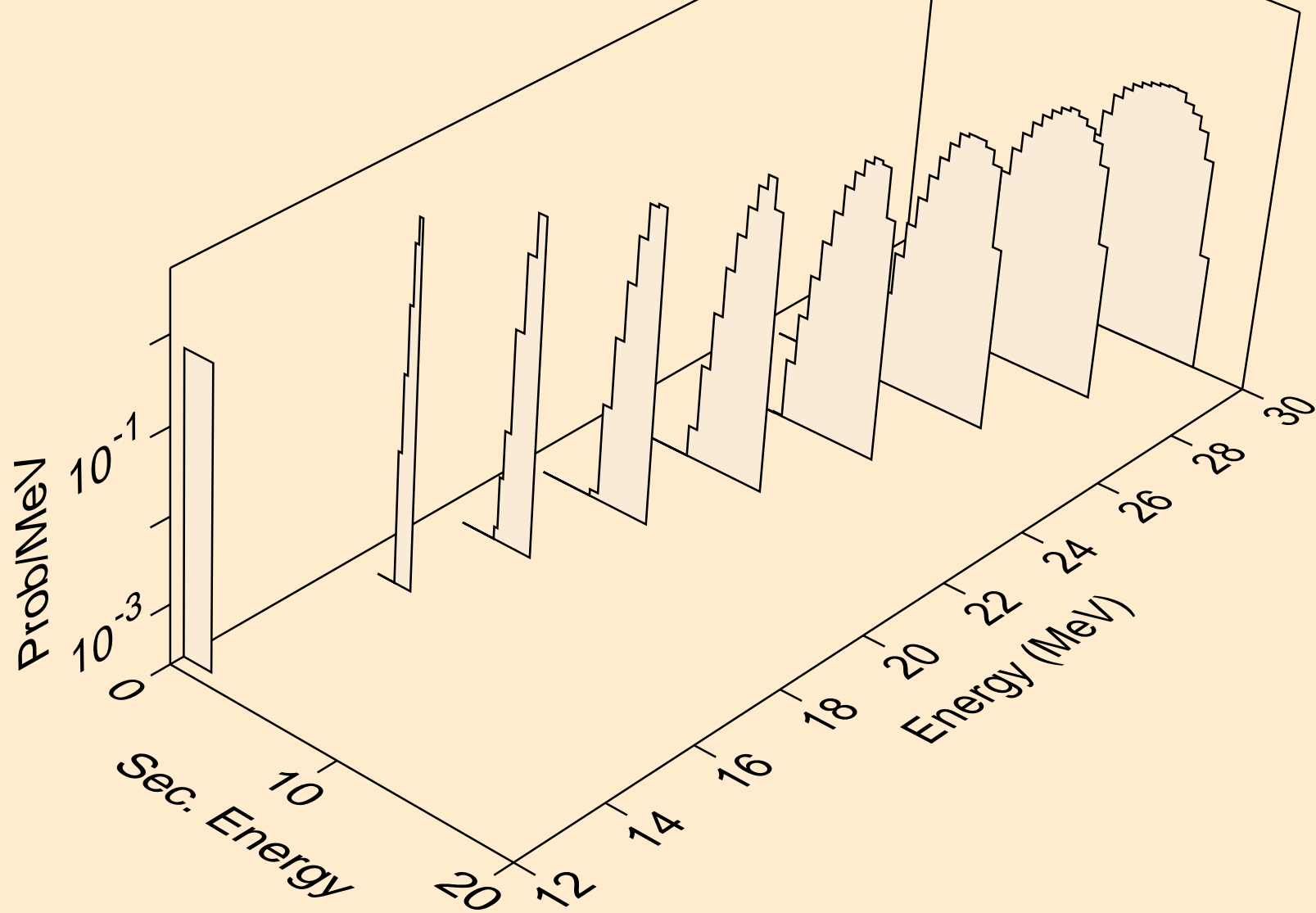

RB093 TRITON ACER TENDL-2021 LIBRARY; T=0.K  
he3s from (t,he3)

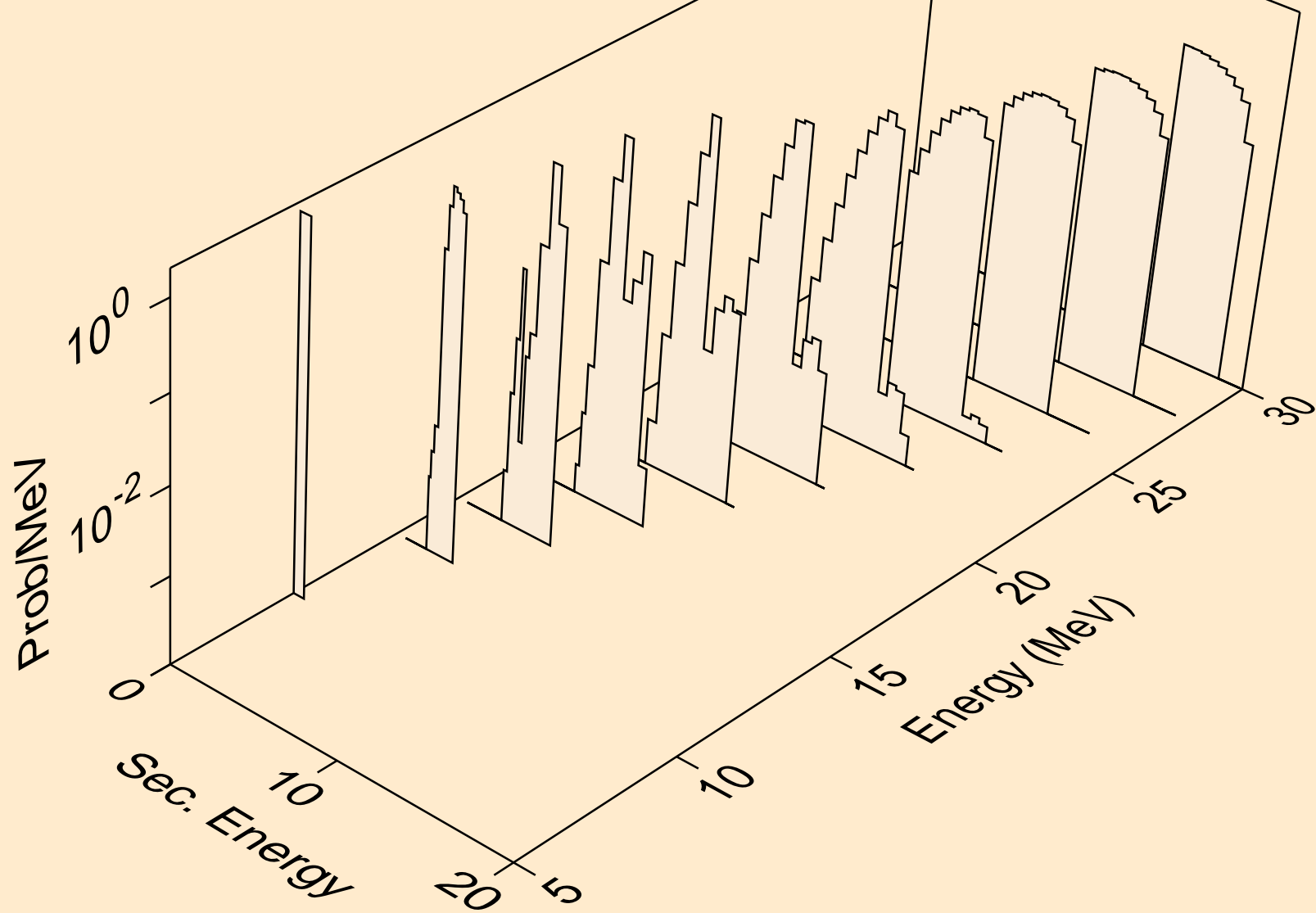

RB093 TRITON ACER TENDL-2021 LIBRARY; T=0.K  
alphas from (t,x)

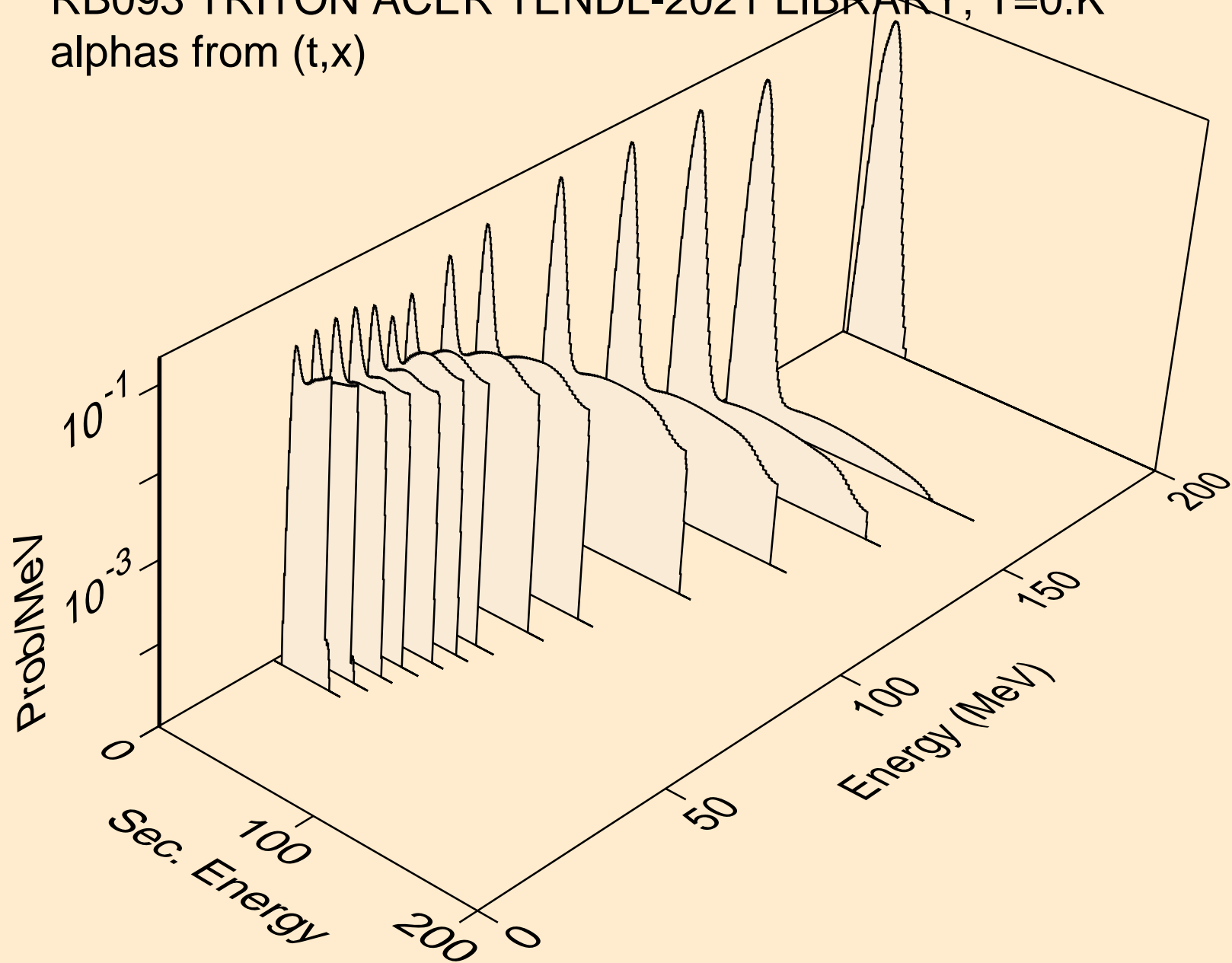

RB093 TRITON ACER TENDL-2021 LIBRARY; T=0.K  
alphas from (t,n\*)a

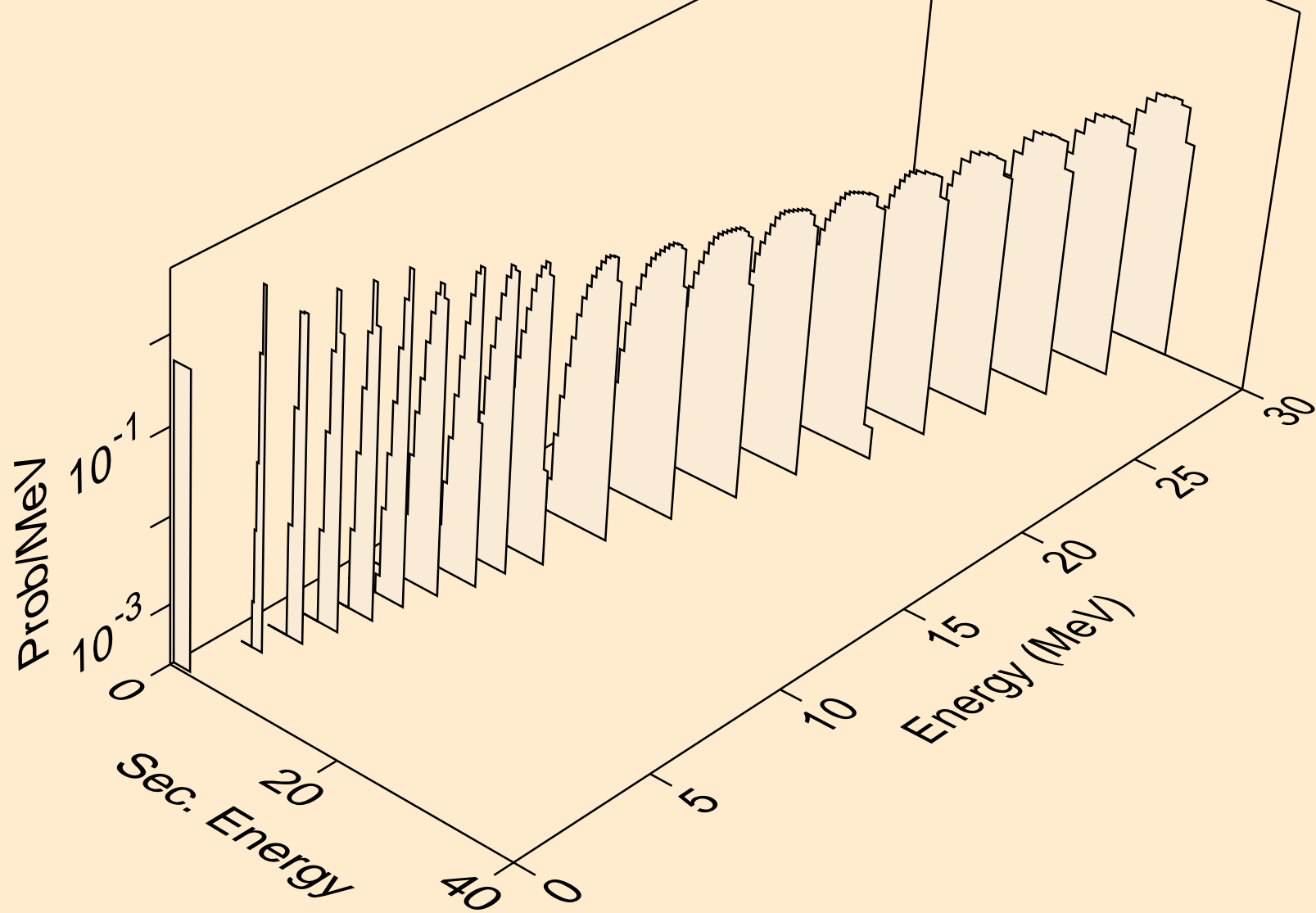

RB093 TRITON ACER TENDL-2021 LIBRARY; T=0.K  
alphas from (t,2n)a

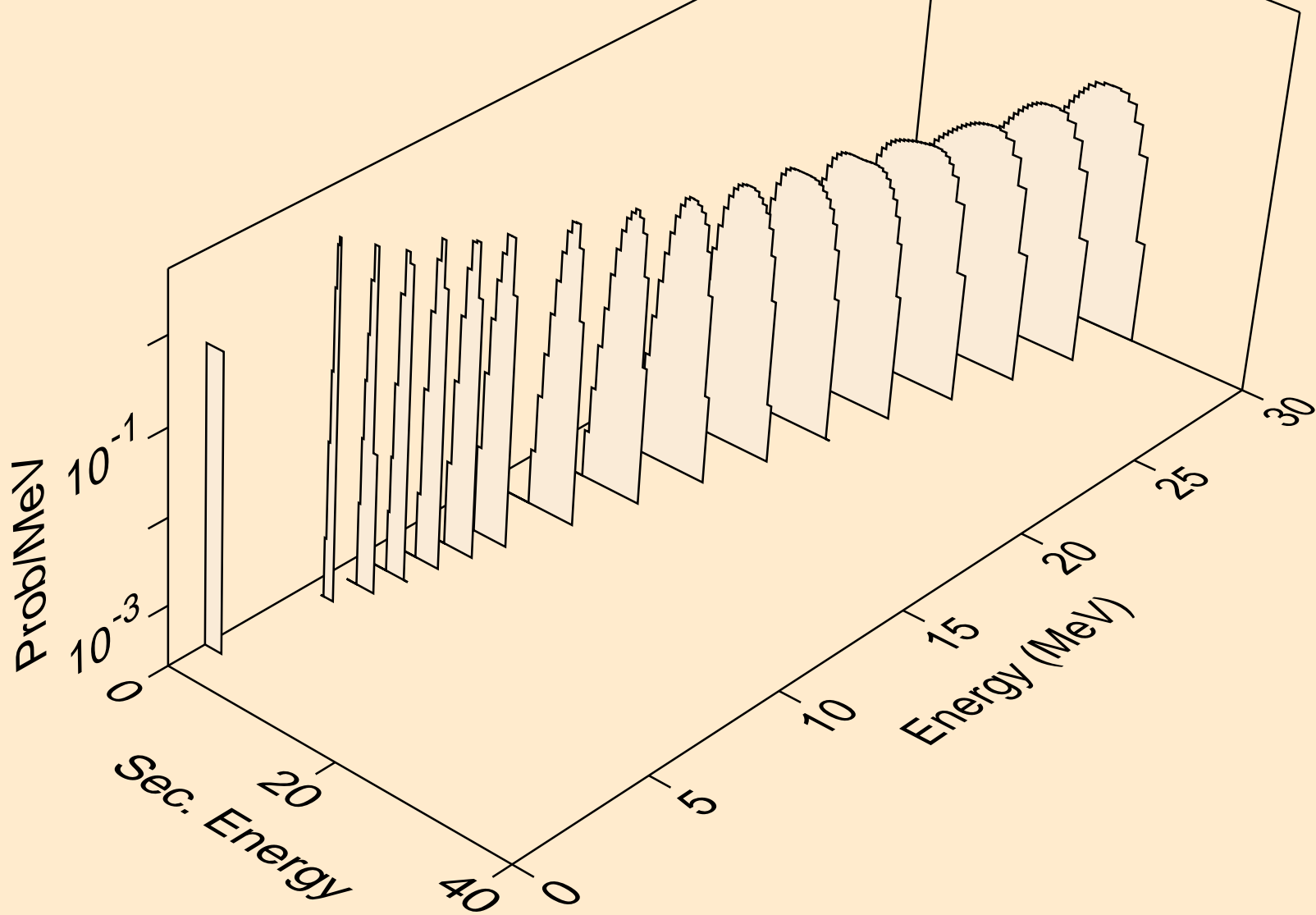

RB093 TRITON ACER TENDL-2021 LIBRARY; T=0.K  
alphas from (t,3n)a

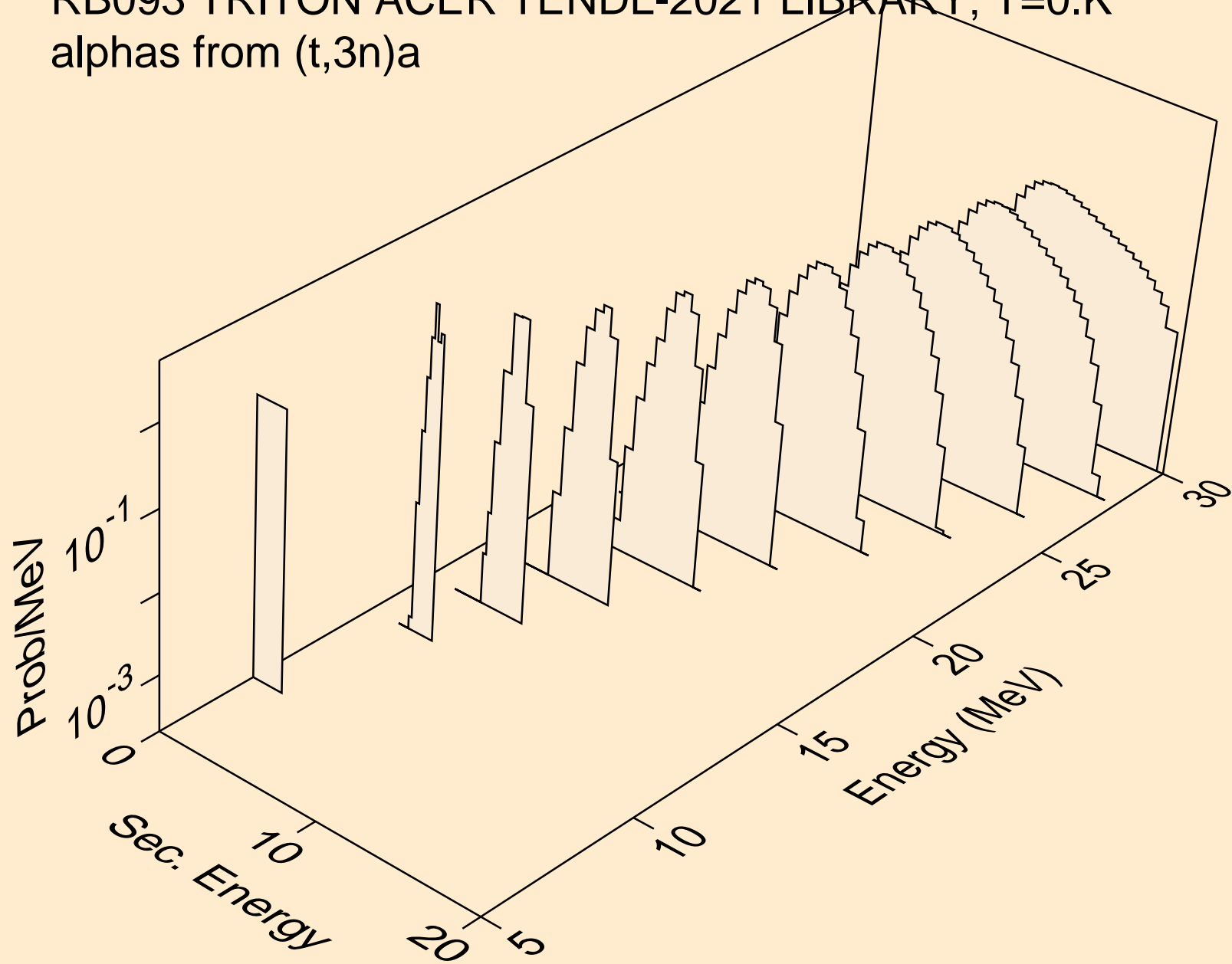

RB093 TRITON ACER TENDL-2021 LIBRARY; T=0.K  
alphas from (t,n\*)2a

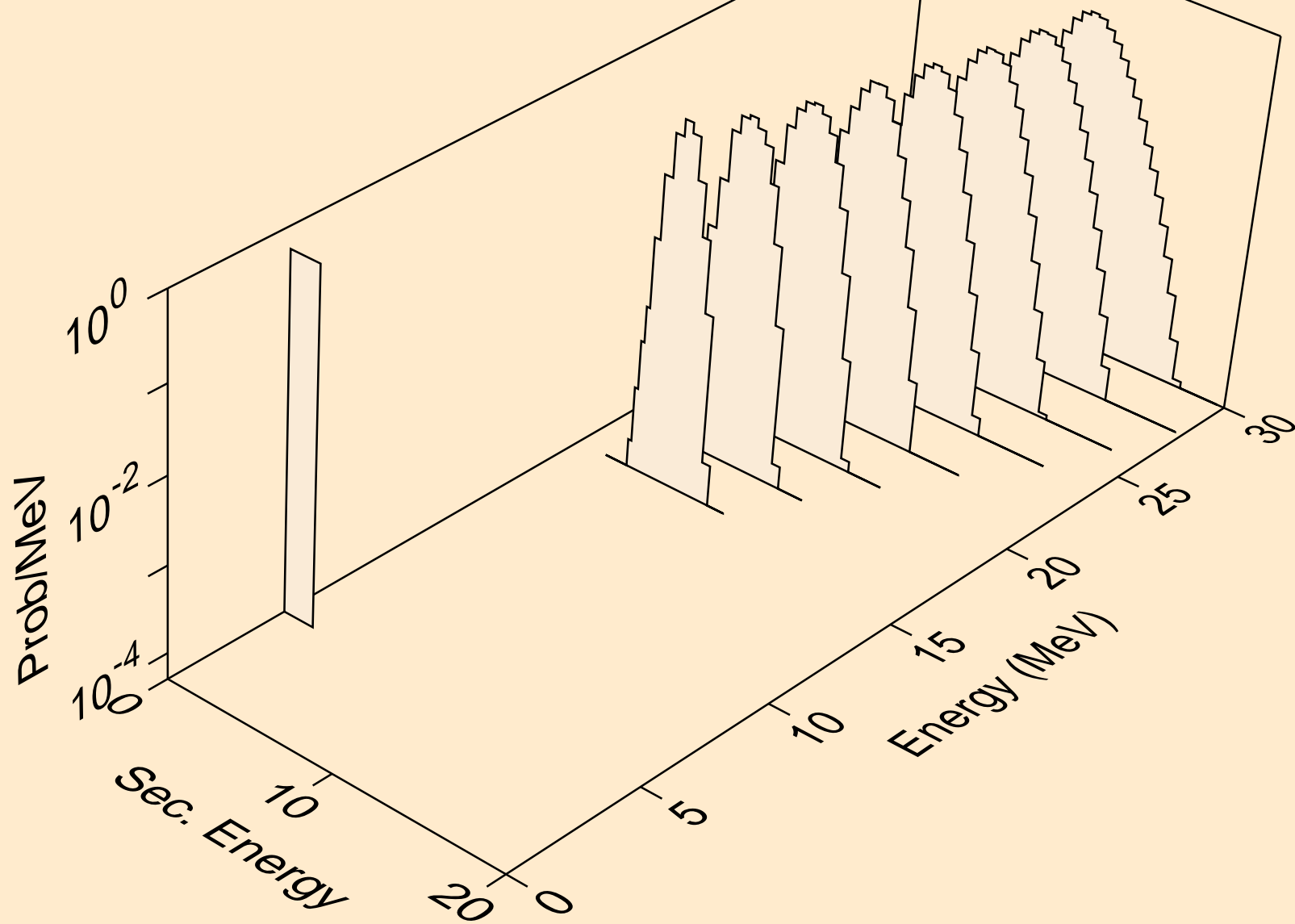

RB093 TRITON ACER TENDL-2021 LIBRARY; T=0.K  
alphas from (t,npa)

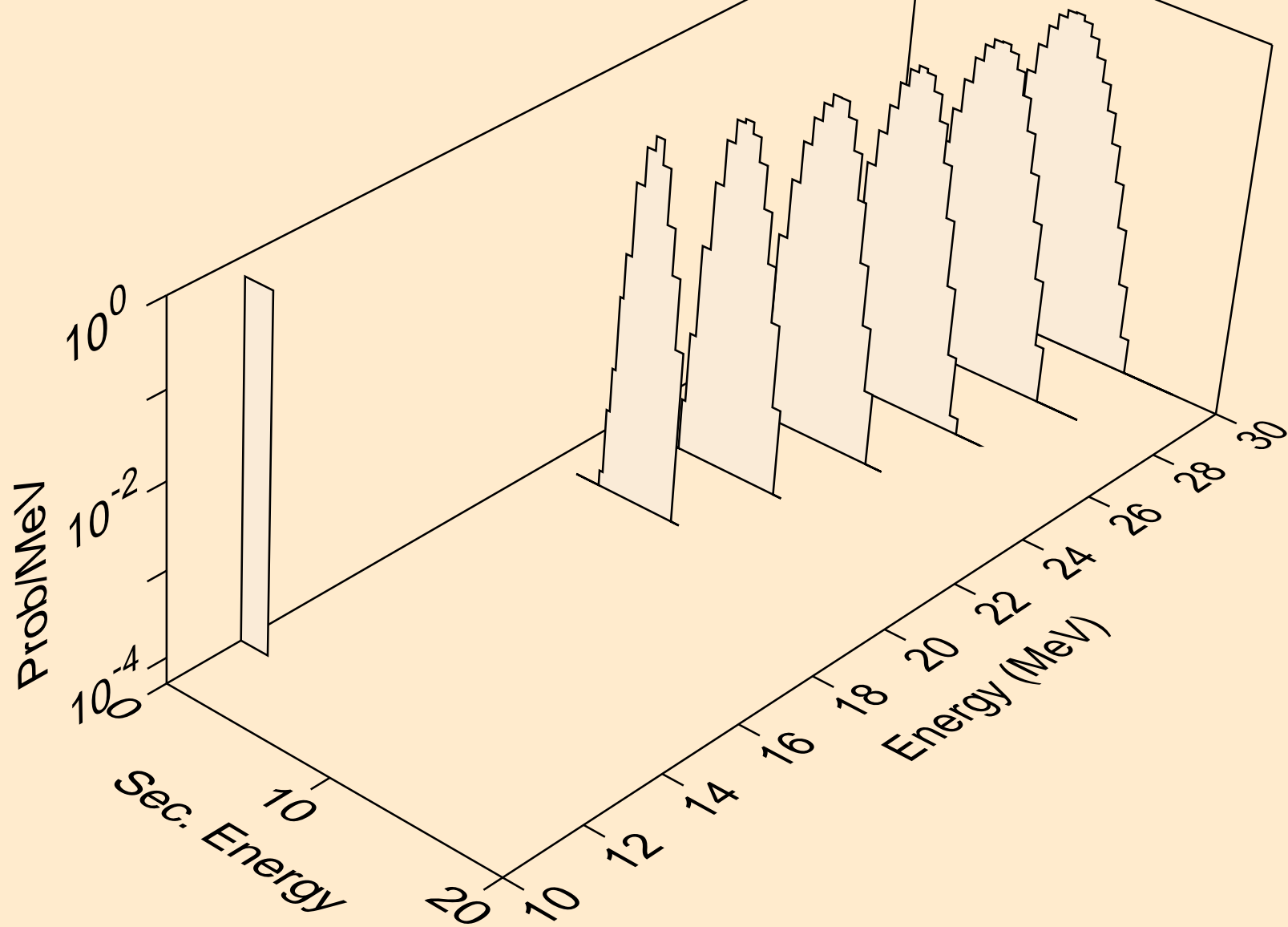



RB093 TRITON ACER TENDL-2021 LIBRARY; T=0.K  
alphas from (t,a)

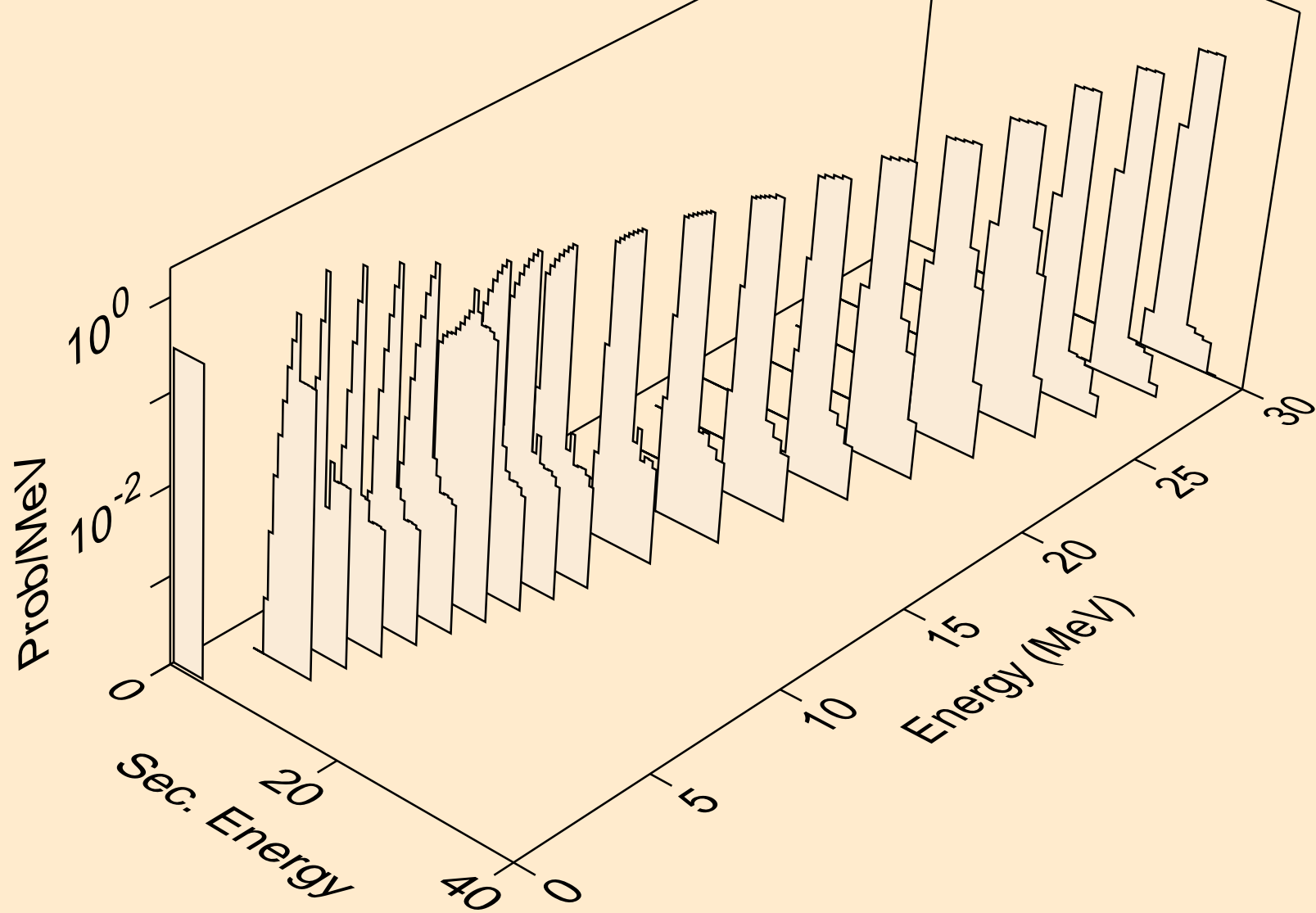

RB093 TRITON ACER TENDL-2021 LIBRARY; T=0.K  
alphas from (t,pa)

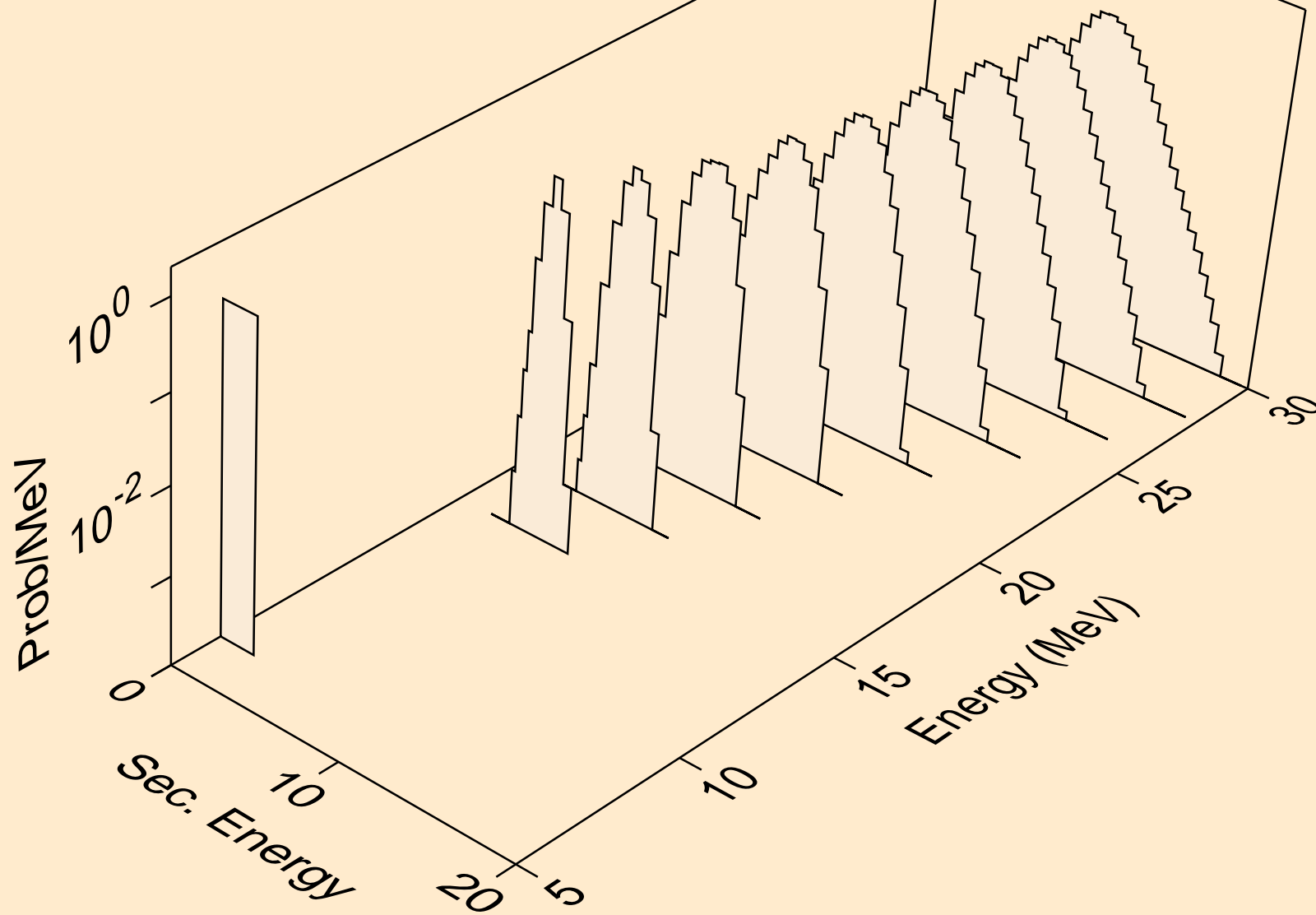

RB093 TRITON ACER TENDL-2021 LIBRARY; T=0.K  
alphas from (t,da)

