

RE178 TRITON ACER TENDL-2021 LIBRARY; T=0.K  
Principal cross sections

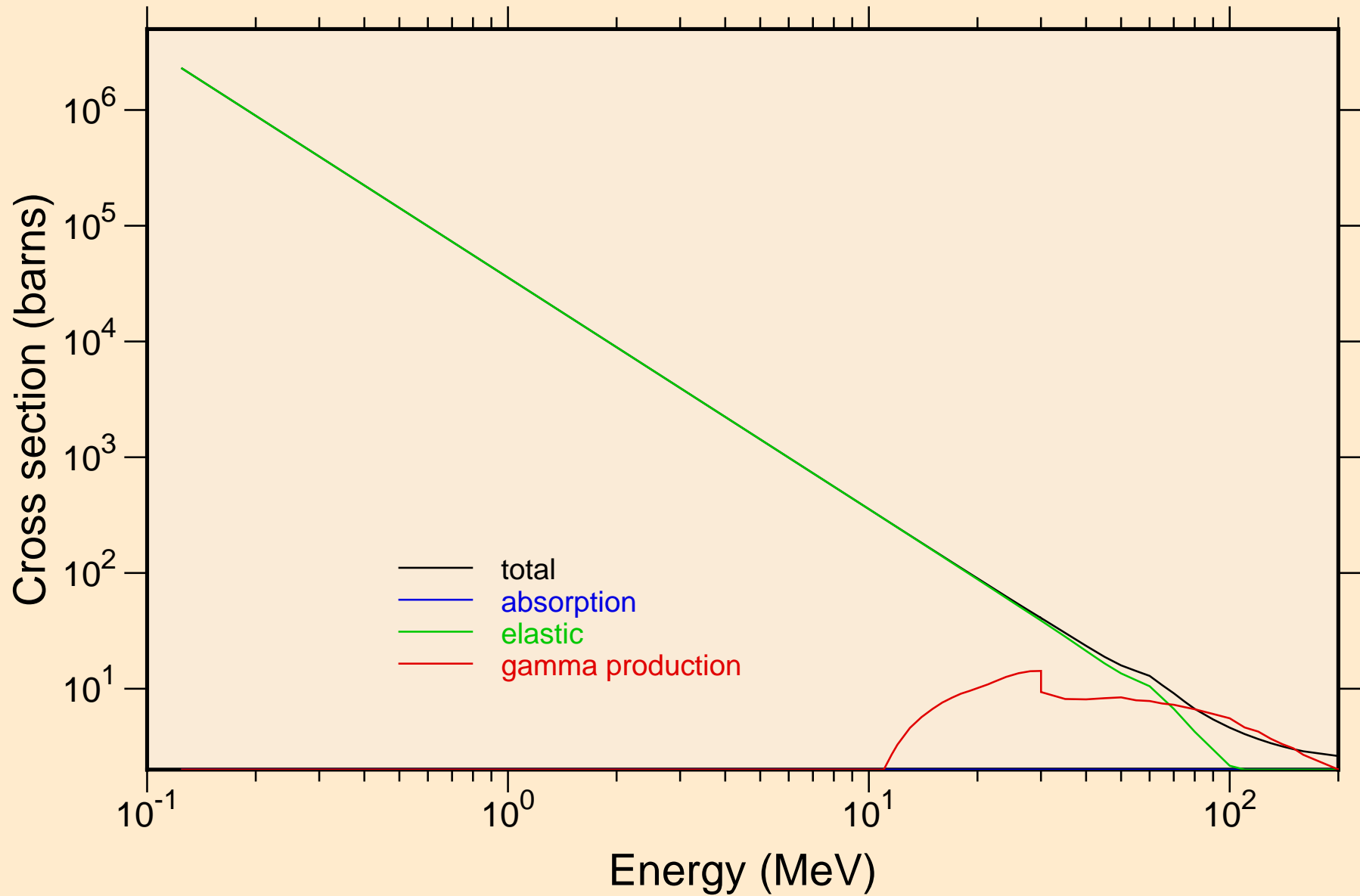

RE178 TRITON ACER TENDL-2021 LIBRARY; T=0.K

Heating

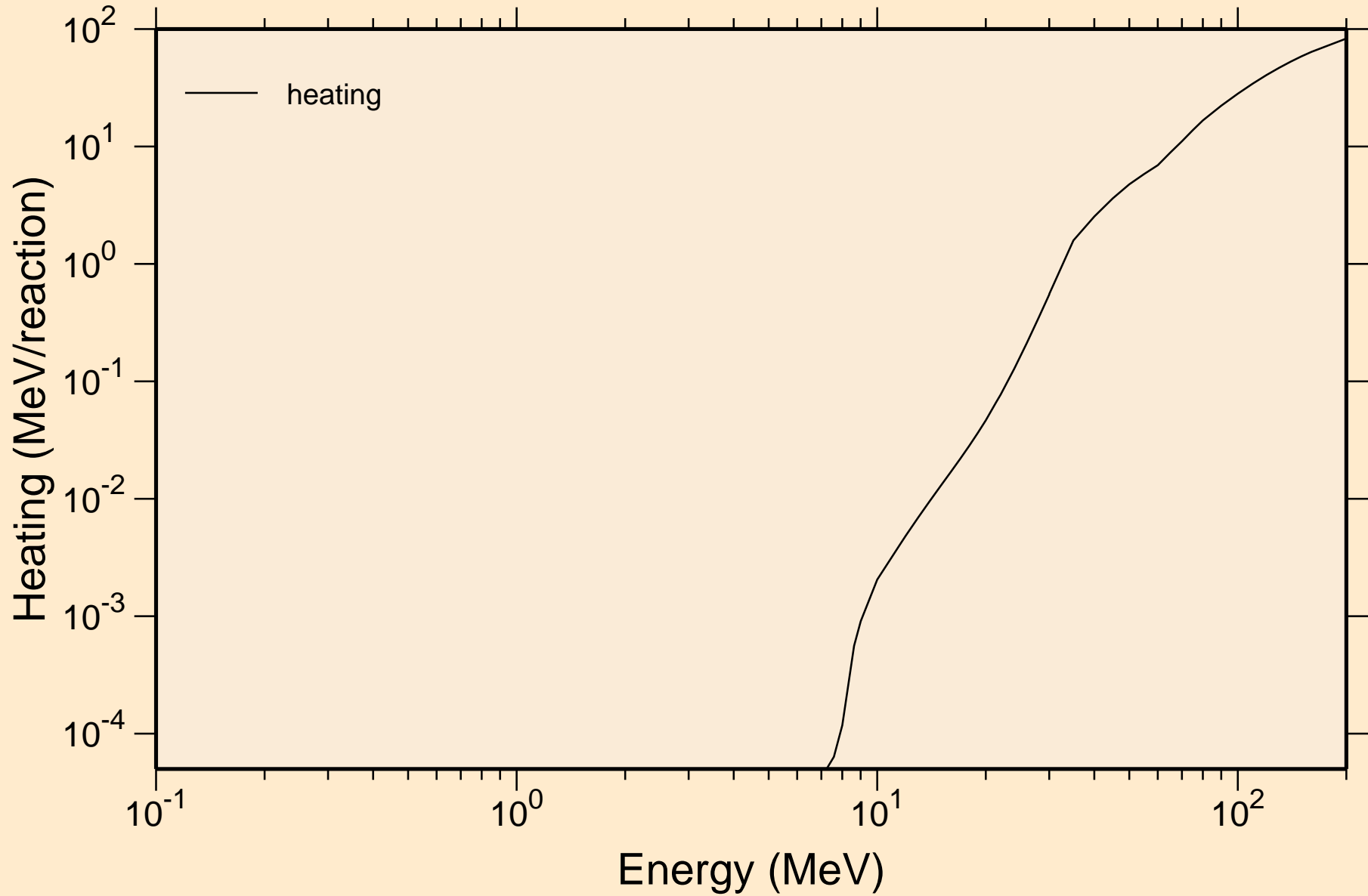

# RE178 TRITON ACER TENDL-2021 LIBRARY; T=0.K

## Principal cross sections

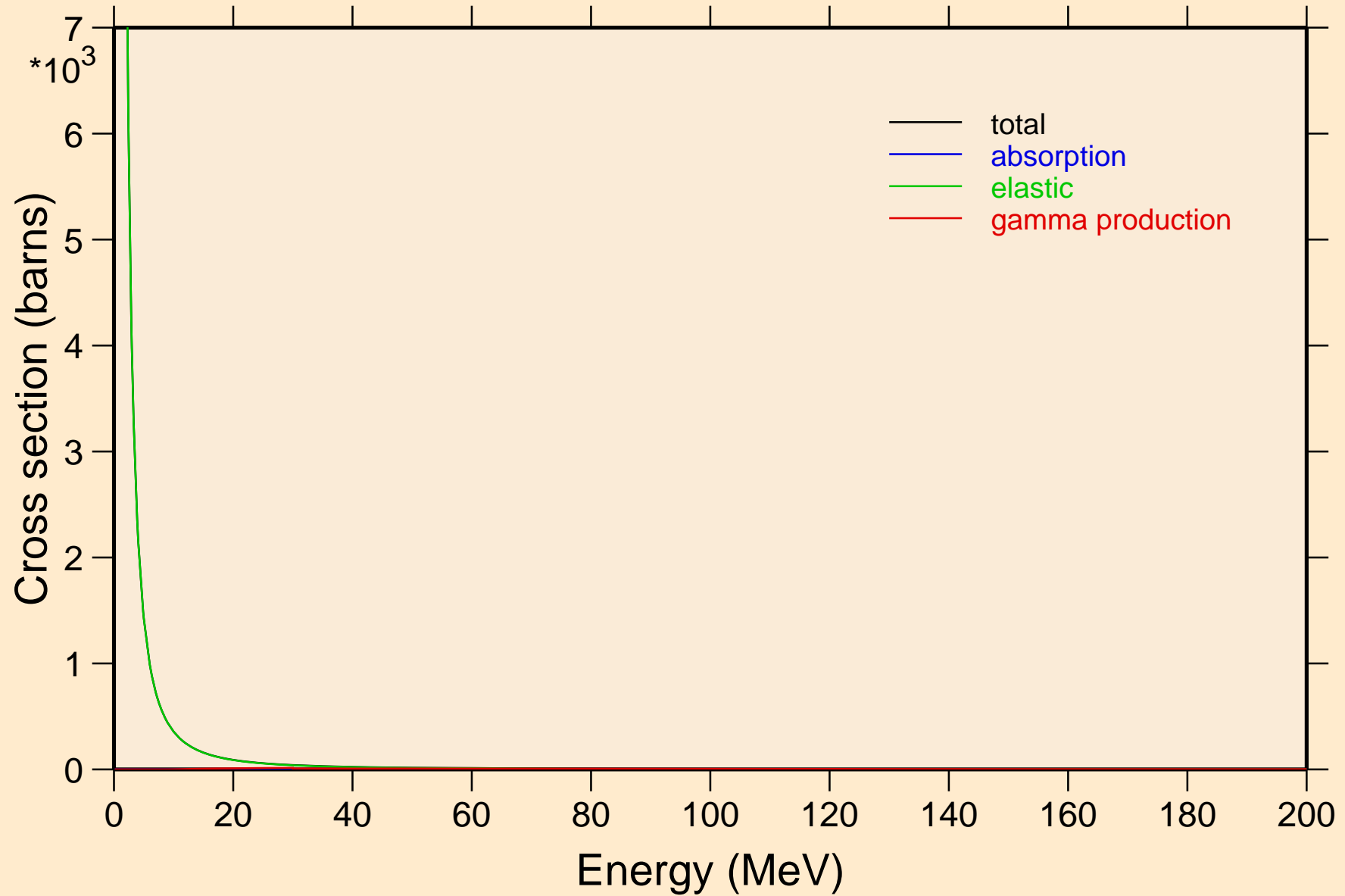

RE178 TRITON ACER TENDL-2021 LIBRARY; T=0.K

Heating

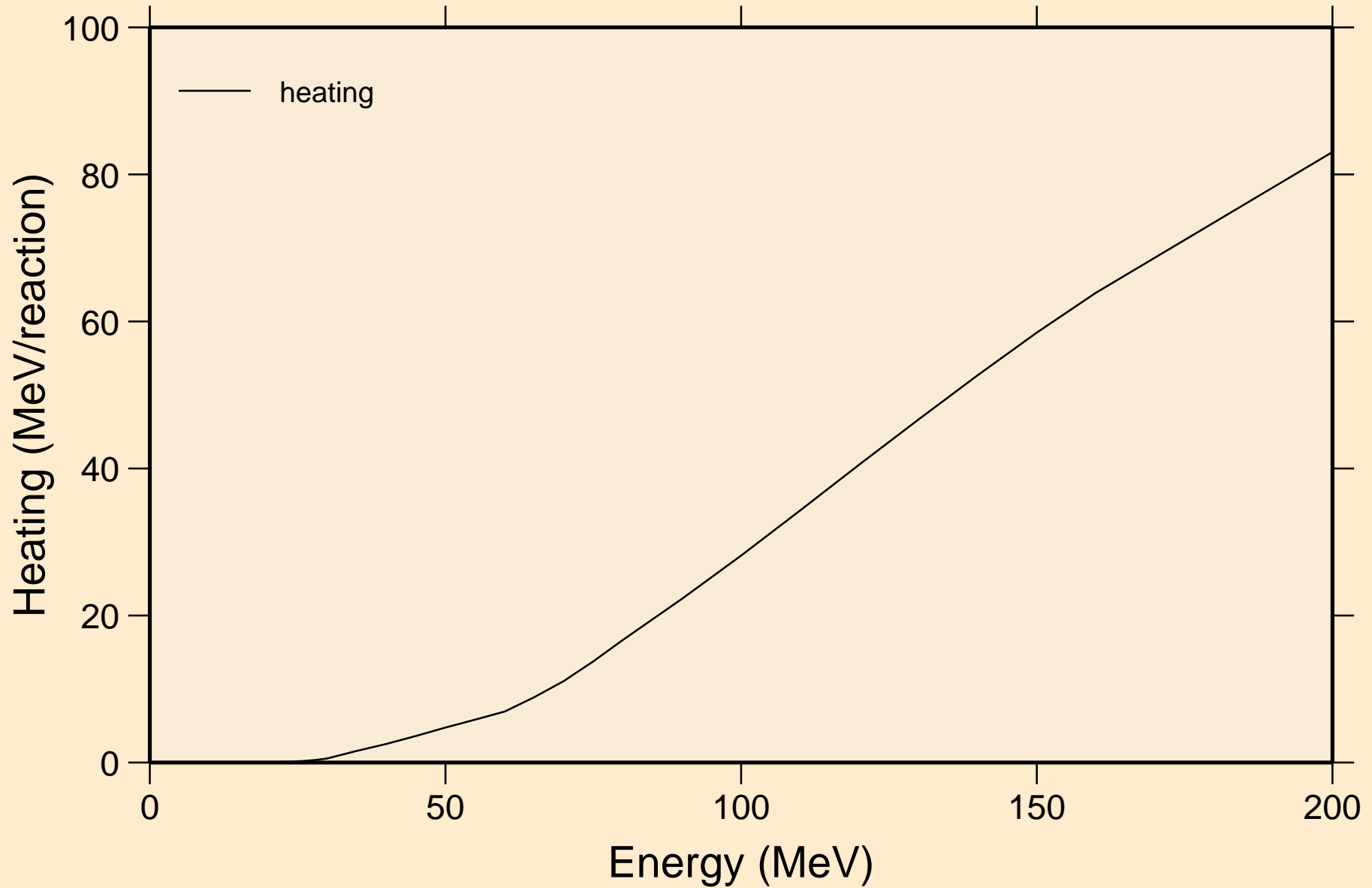

RE178 TRITON ACER TENDL-2021 LIBRARY; T=0.K  
Threshold reactions

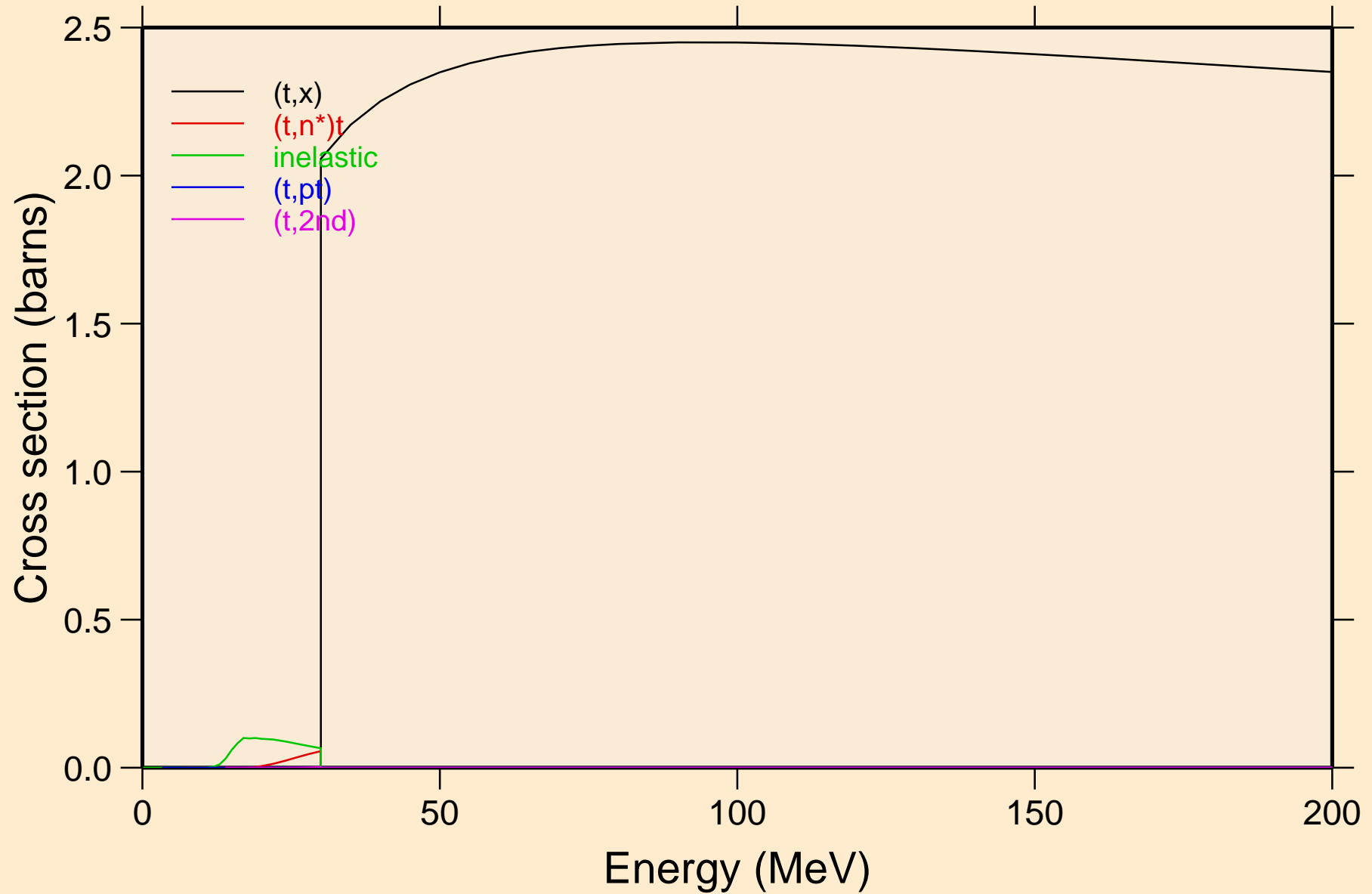

RE178 TRITON ACER TENDL-2021 LIBRARY; T=0.K  
Threshold reactions

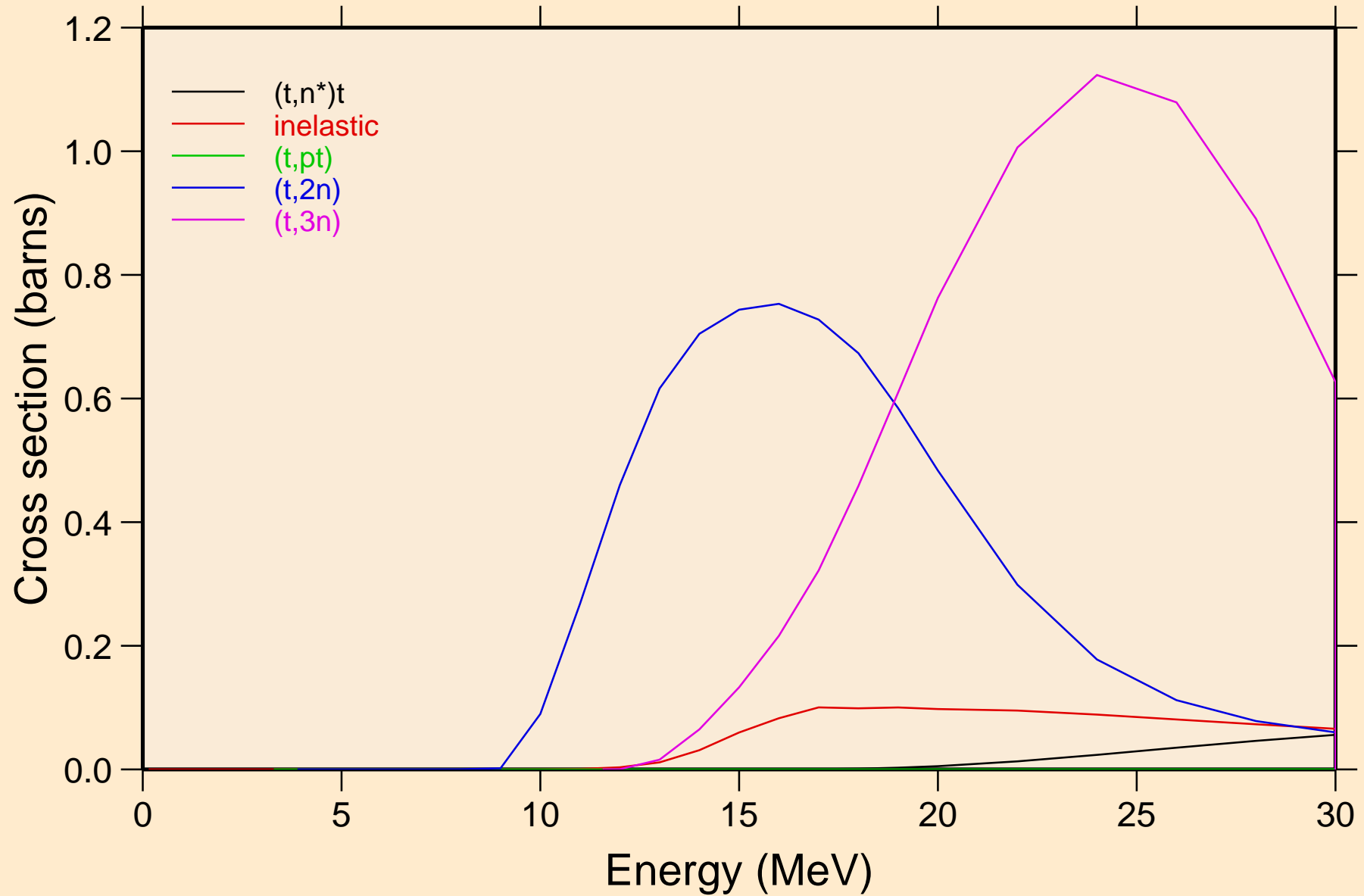

RE178 TRITON ACER TENDL-2021 LIBRARY; T=0.K  
Threshold reactions

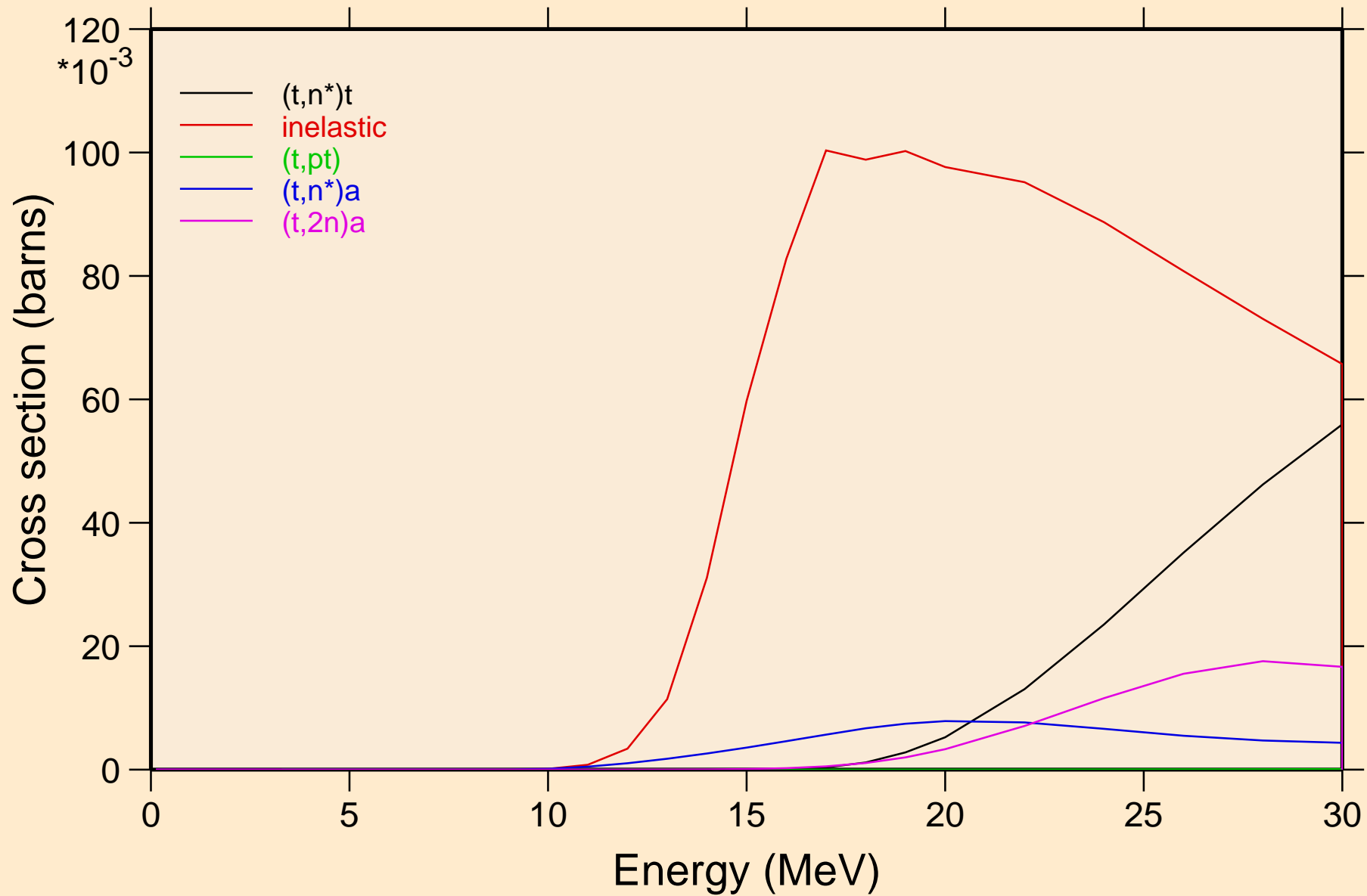

RE178 TRITON ACER TENDL-2021 LIBRARY; T=0.K  
Threshold reactions

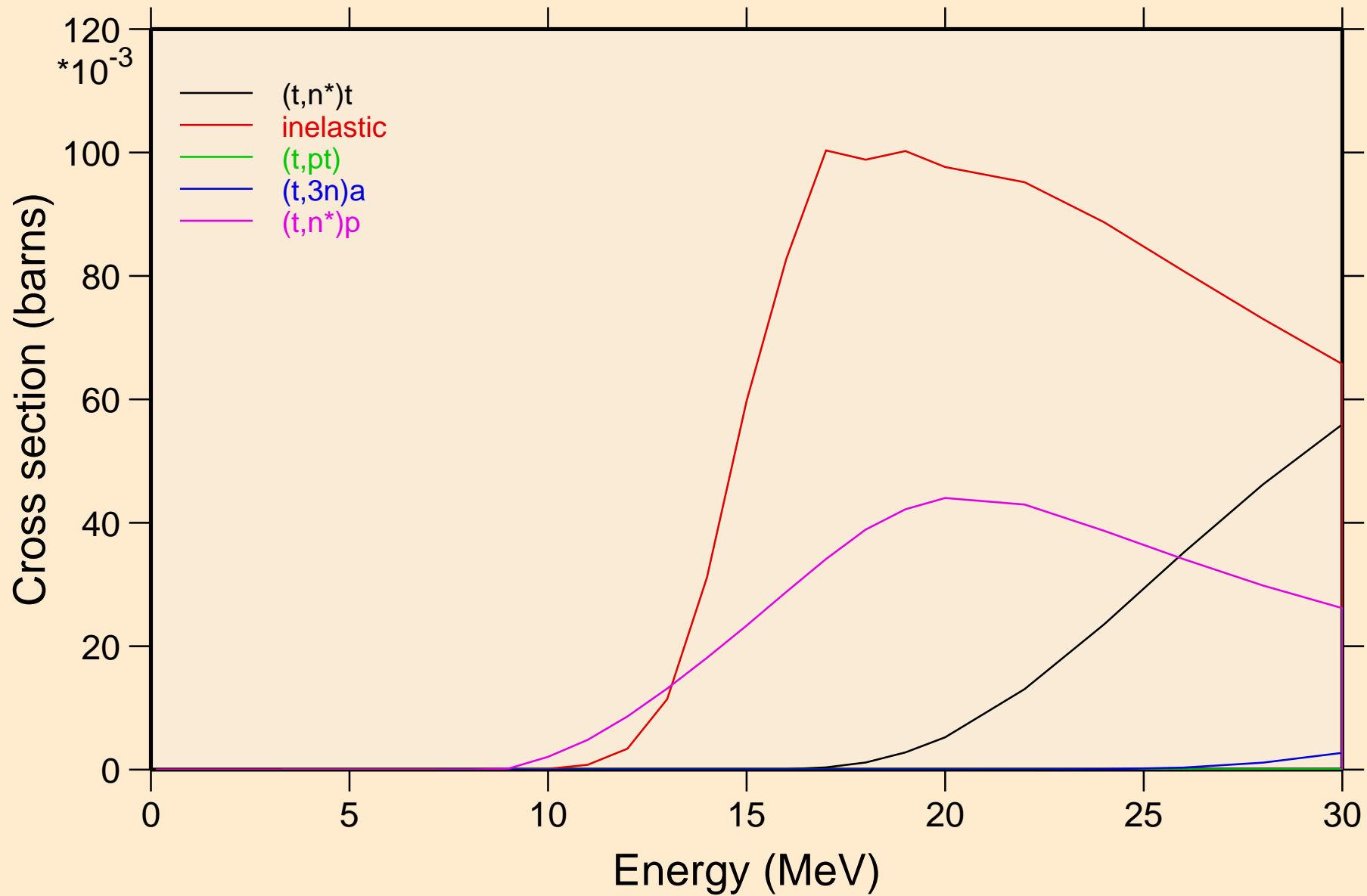



RE178 TRITON ACER TENDL-2021 LIBRARY; T=0.K  
Threshold reactions

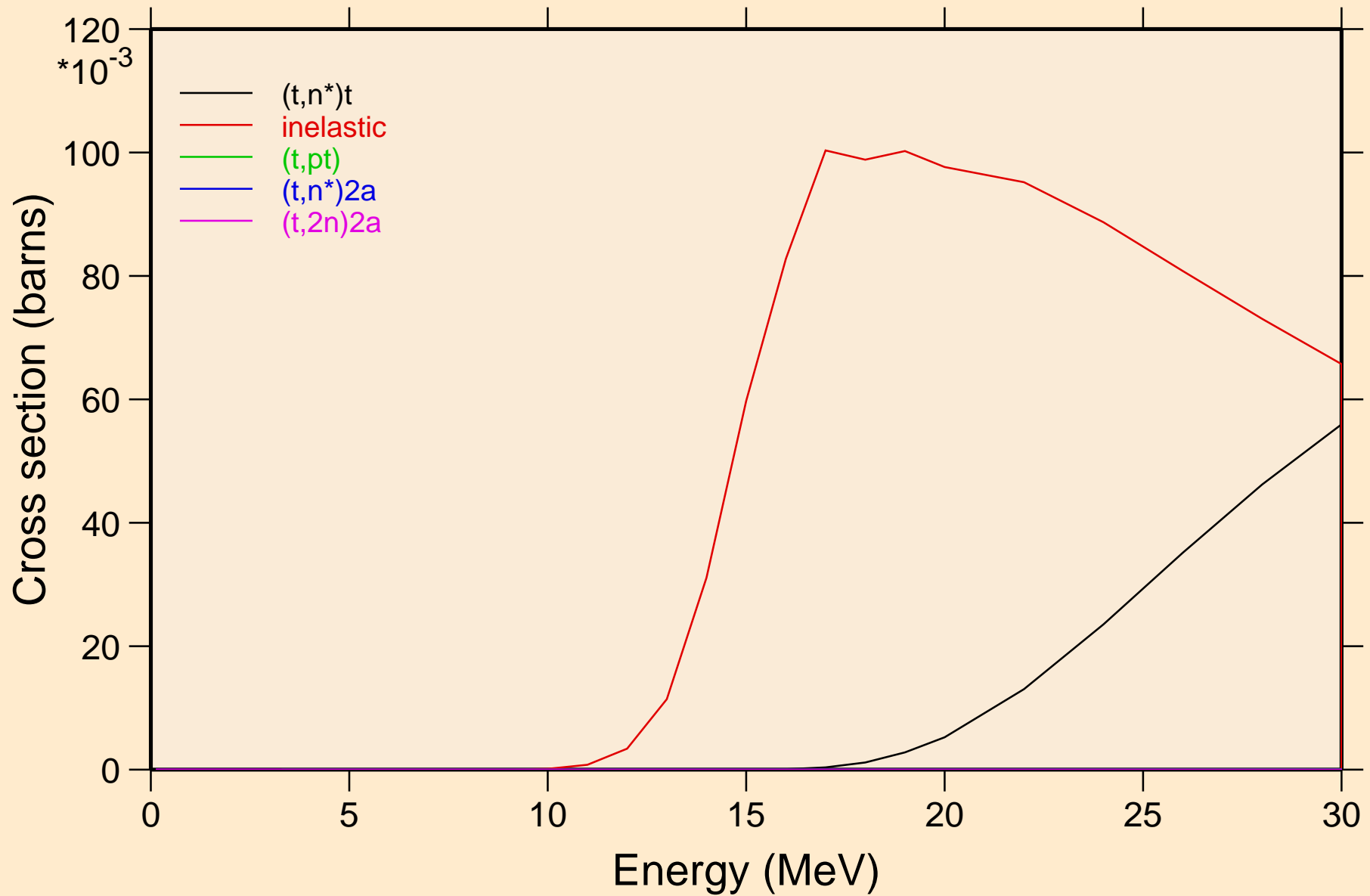

RE178 TRITON ACER TENDL-2021 LIBRARY; T=0.K  
Threshold reactions

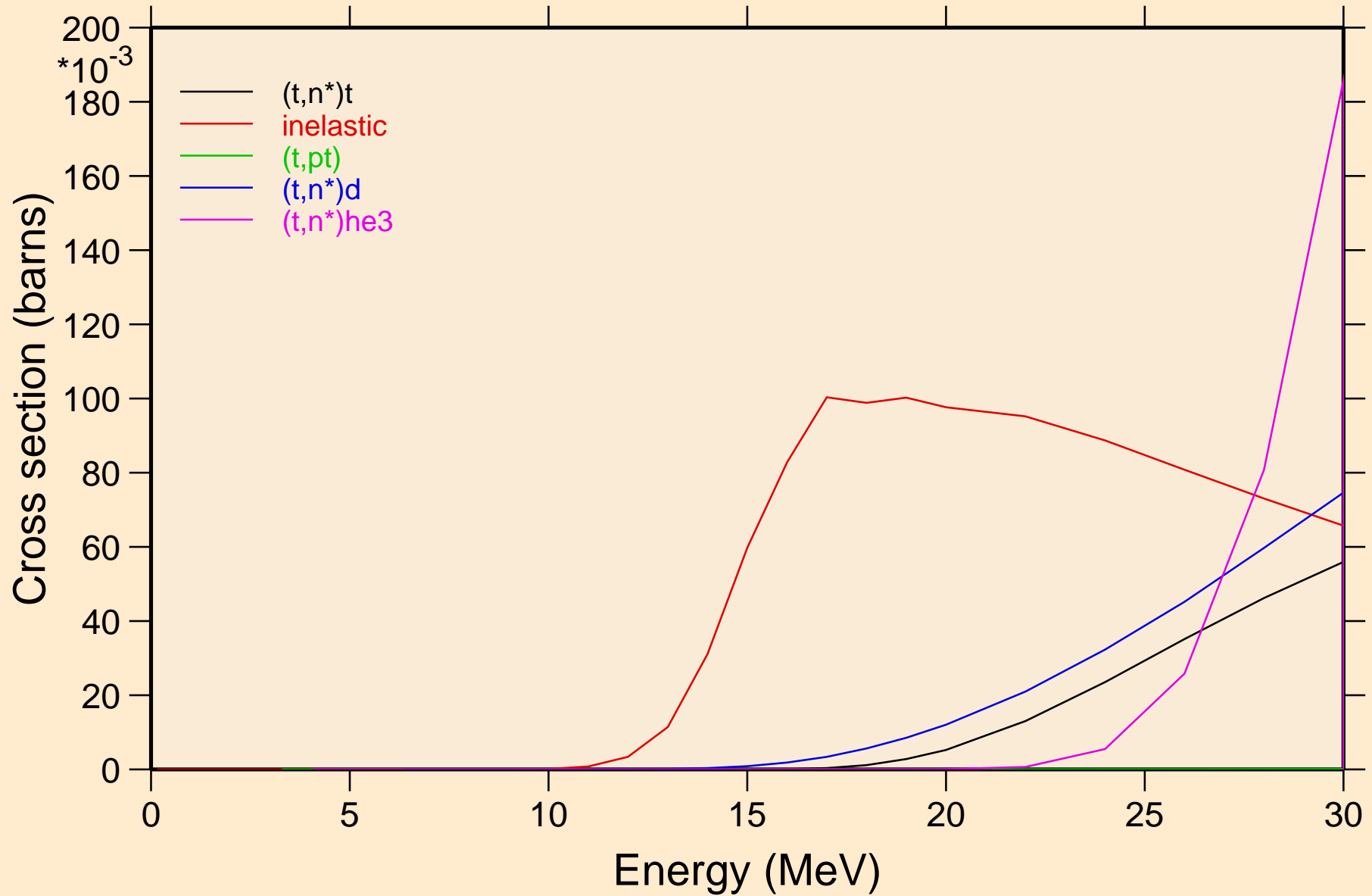

RE178 TRITON ACER TENDL-2021 LIBRARY; T=0.K  
Threshold reactions

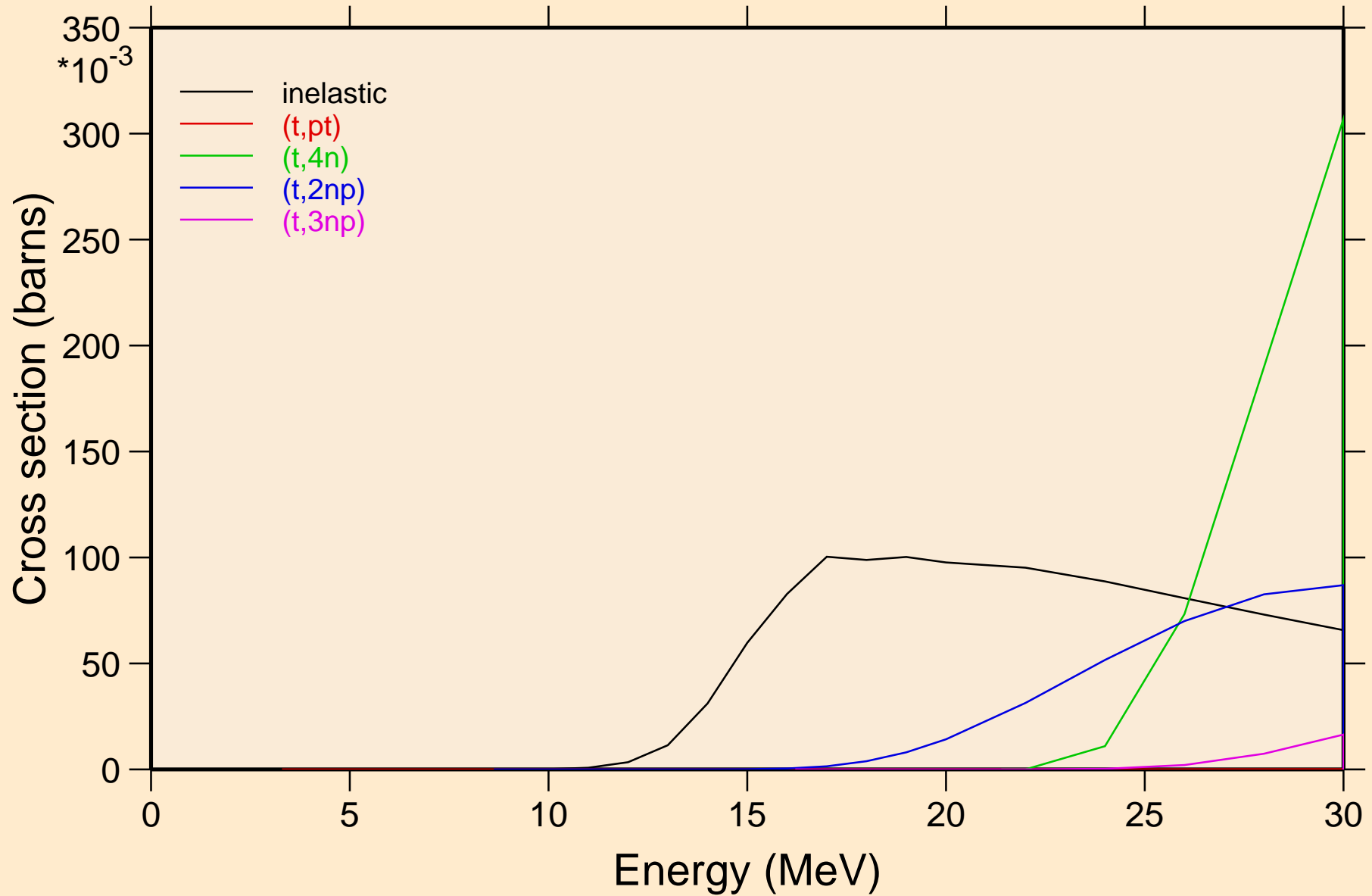

RE178 TRITON ACER TENDL-2021 LIBRARY; T=0.K  
Threshold reactions

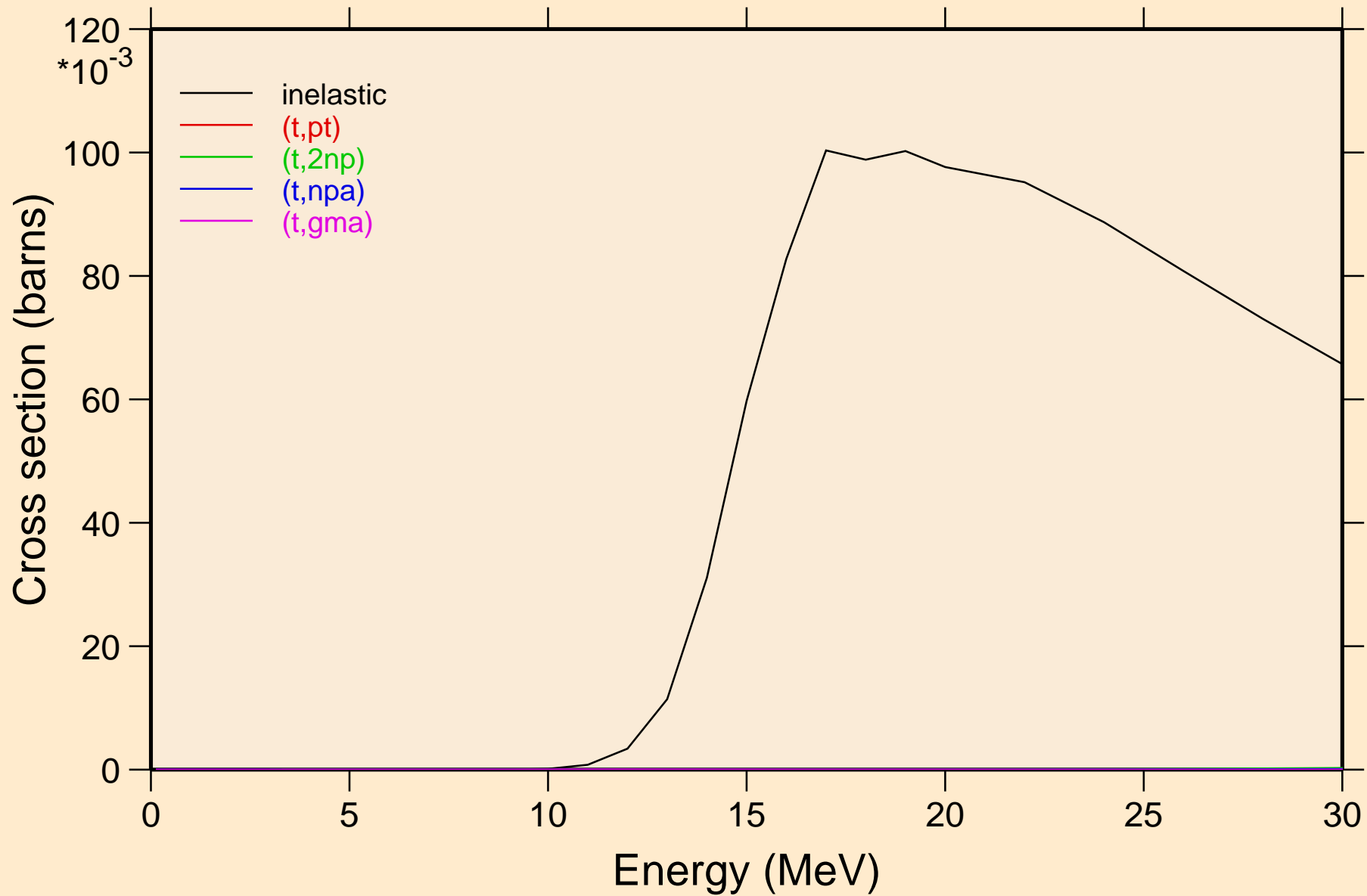

RE178 TRITON ACER TENDL-2021 LIBRARY; T=0.K  
Threshold reactions

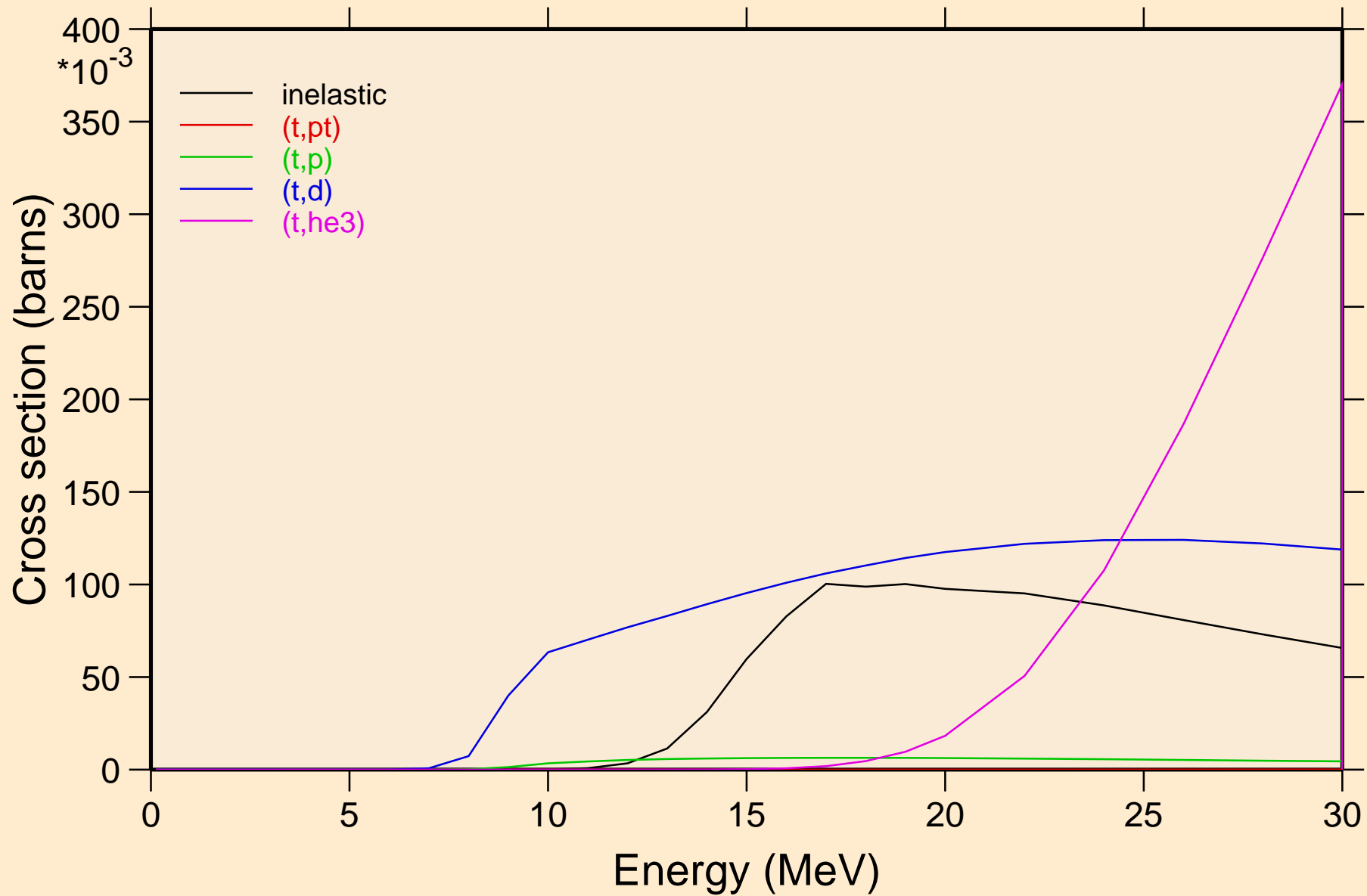

RE178 TRITON ACER TENDL-2021 LIBRARY; T=0.K  
Threshold reactions

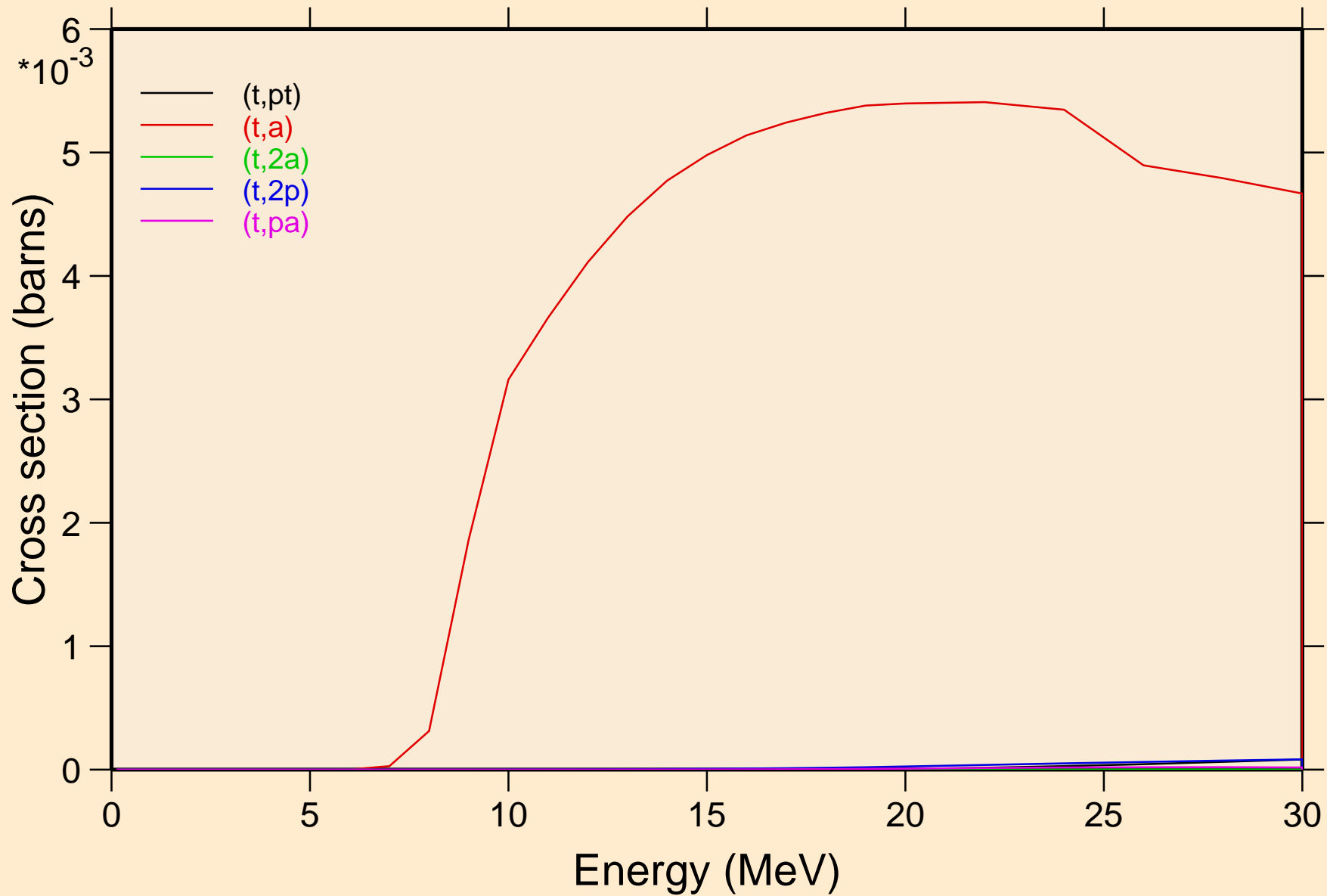

RE178 TRITON ACER TENDL-2021 LIBRARY; T=0.K  
Threshold reactions

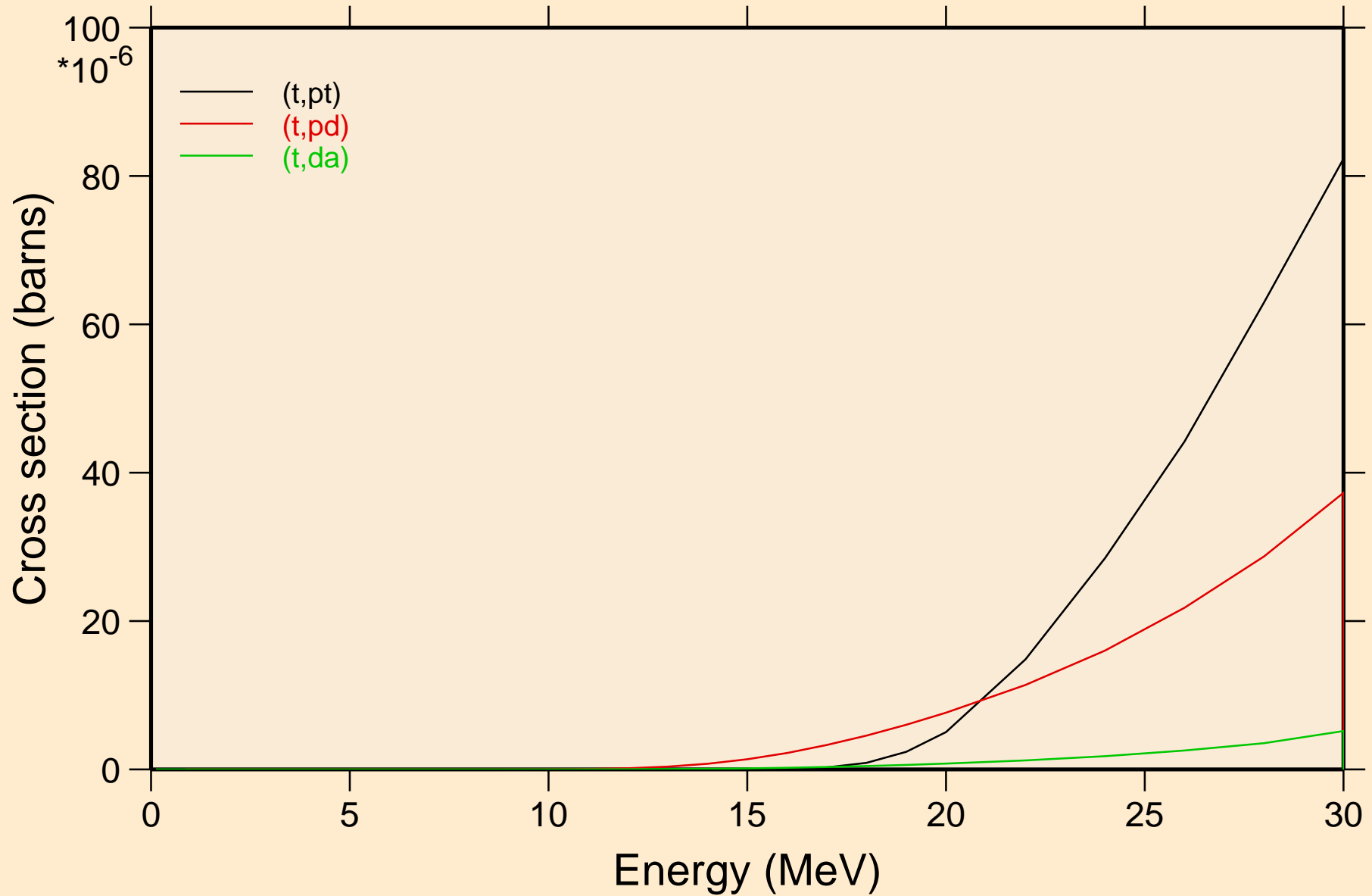

RE178 TRITON ACER TENDL-2021 LIBRARY; T=0.K  
angular distribution for elastic

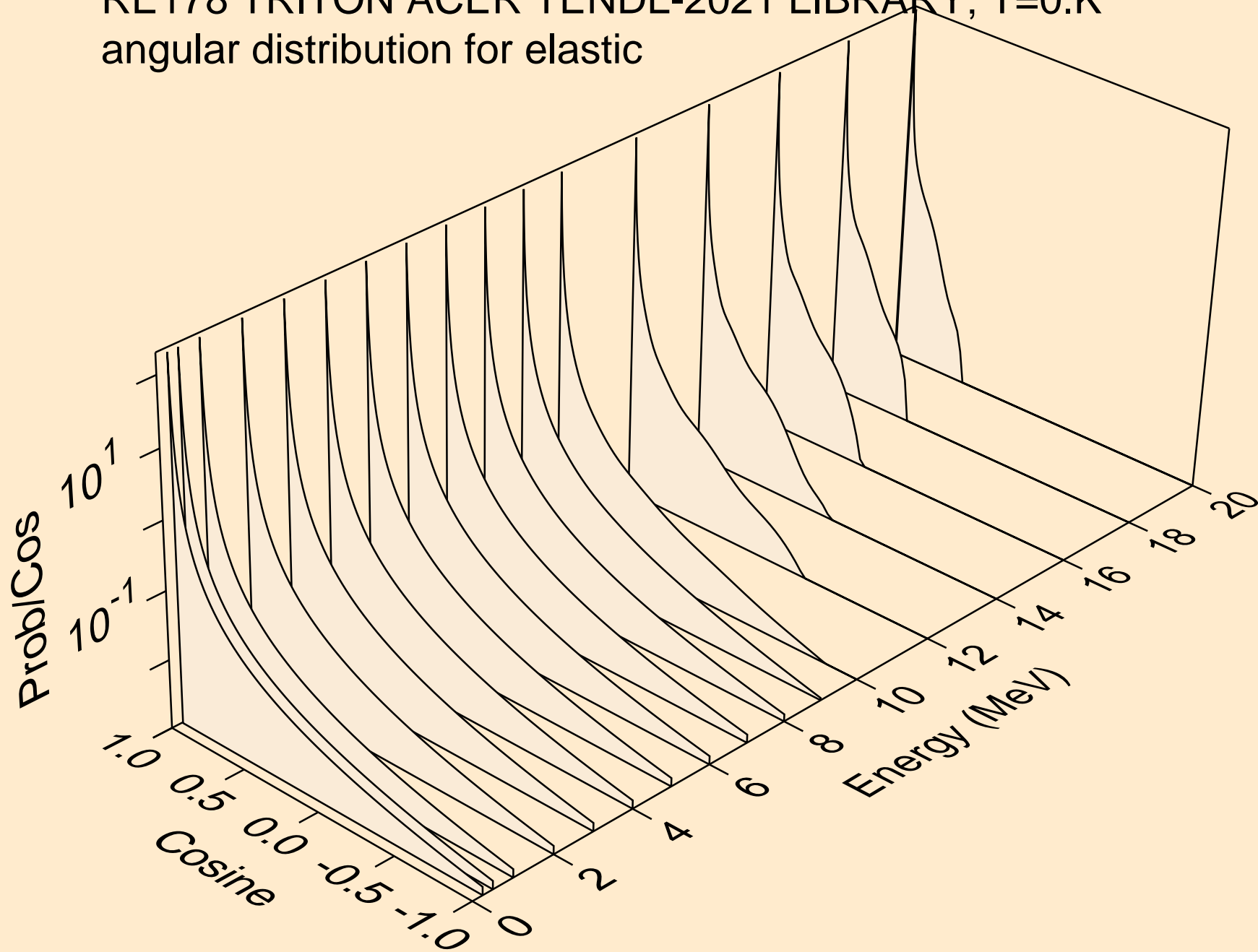



RE178 TRITON ACER TENDL-2021 LIBRARY; T=0.K  
angular distribution for elastic

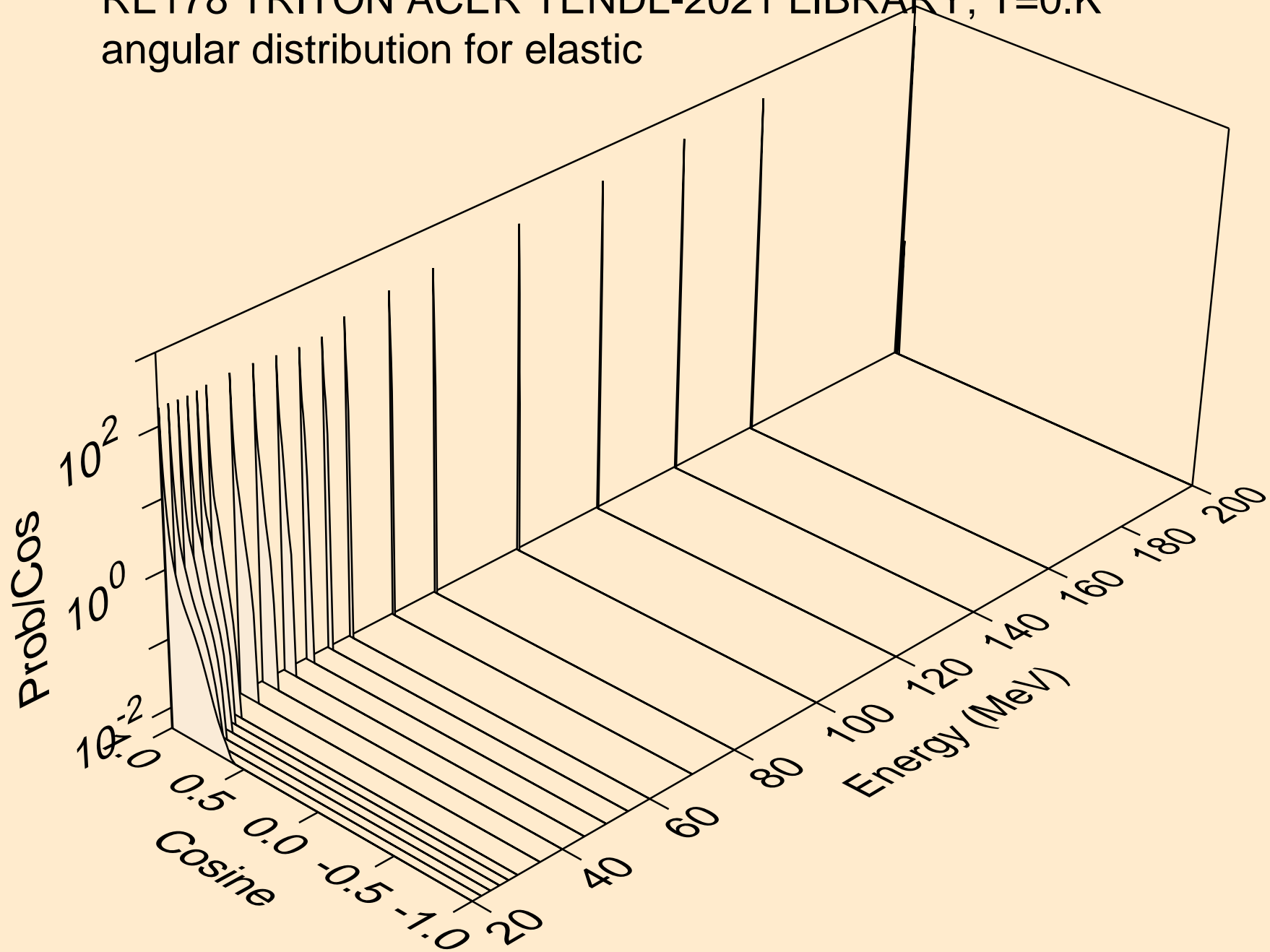

RE178 TRITON ACER TENDL-2021 LIBRARY; T=0.K  
Triton emission for (t,x)

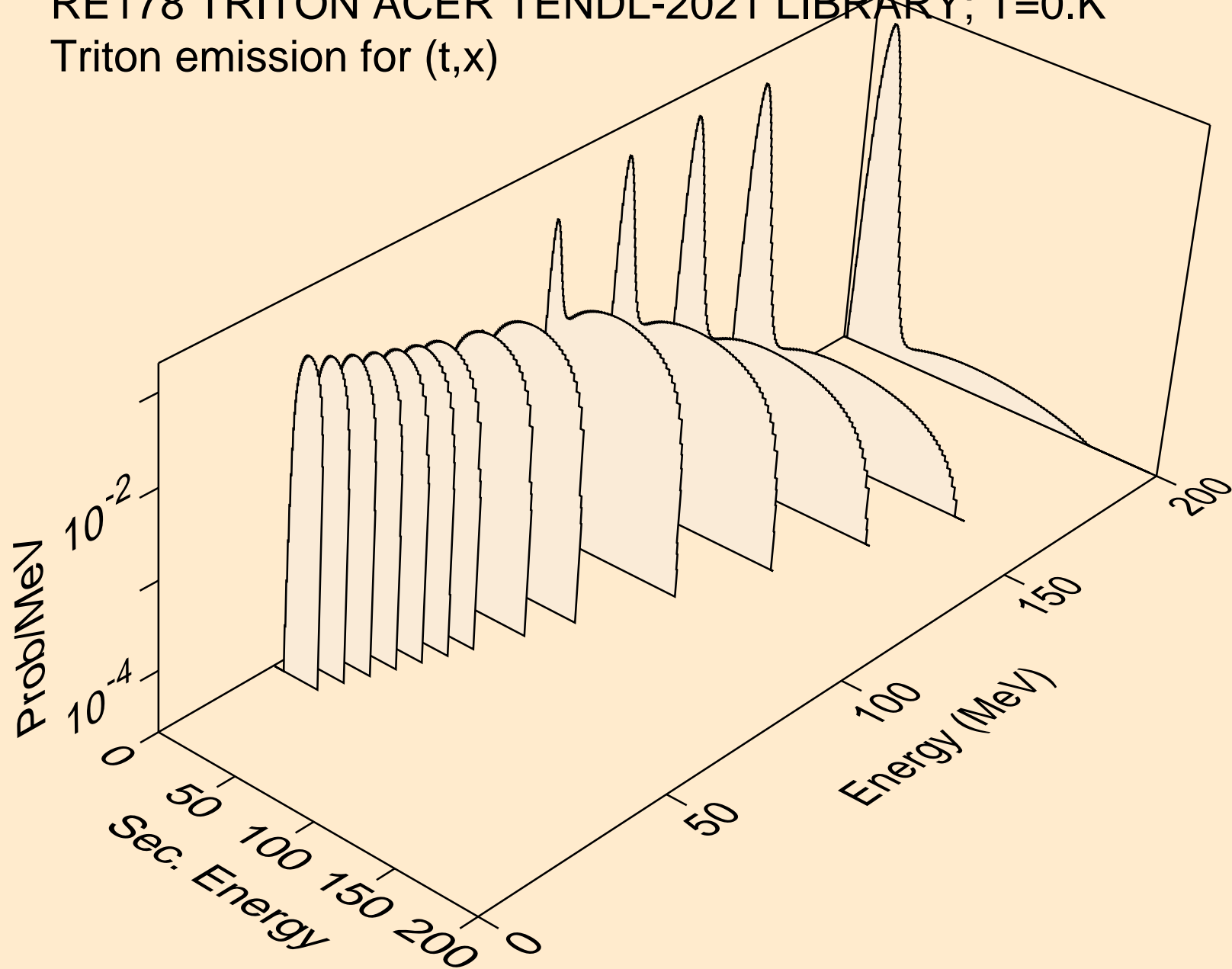

RE178 TRITON ACER TENDL-2021 LIBRARY; T=0.K  
Triton emission for (t,n\*)t

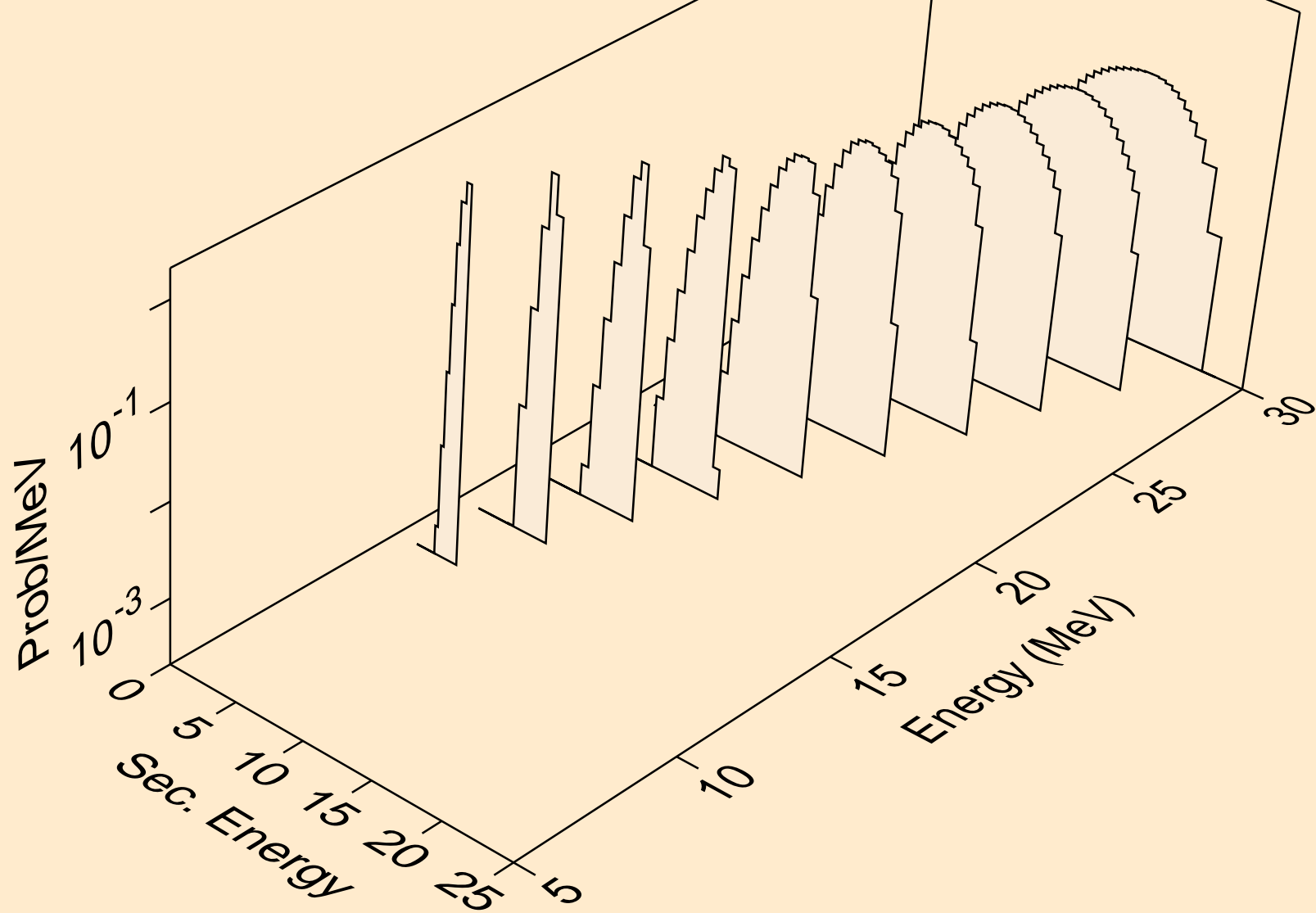

RE178 TRITON ACER TENDL-2021 LIBRARY; T=0.K  
Triton emission for inelastic

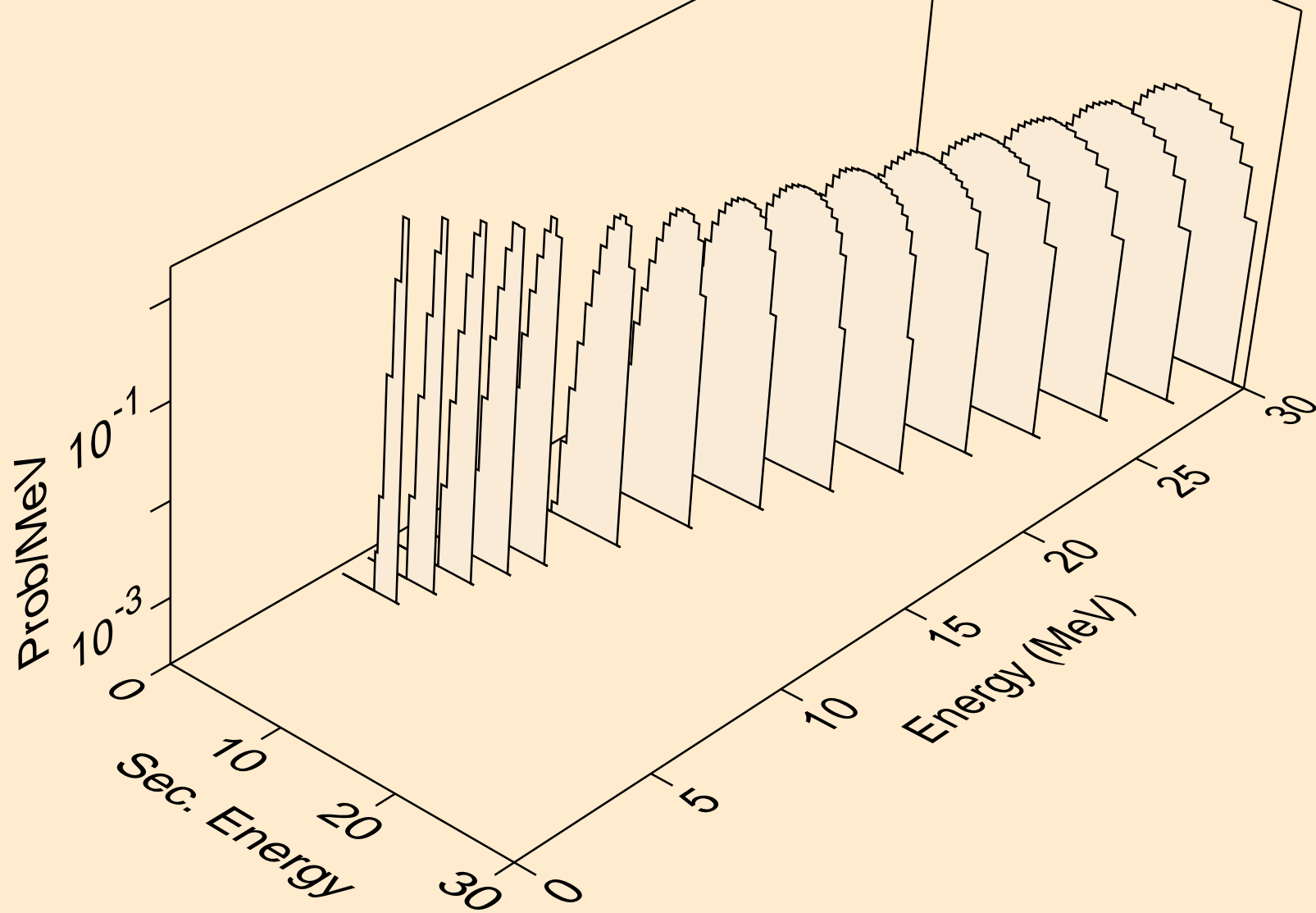

RE178 TRITON ACER TENDL-2021 LIBRARY; T=0.K  
Triton emission for (t,pt)

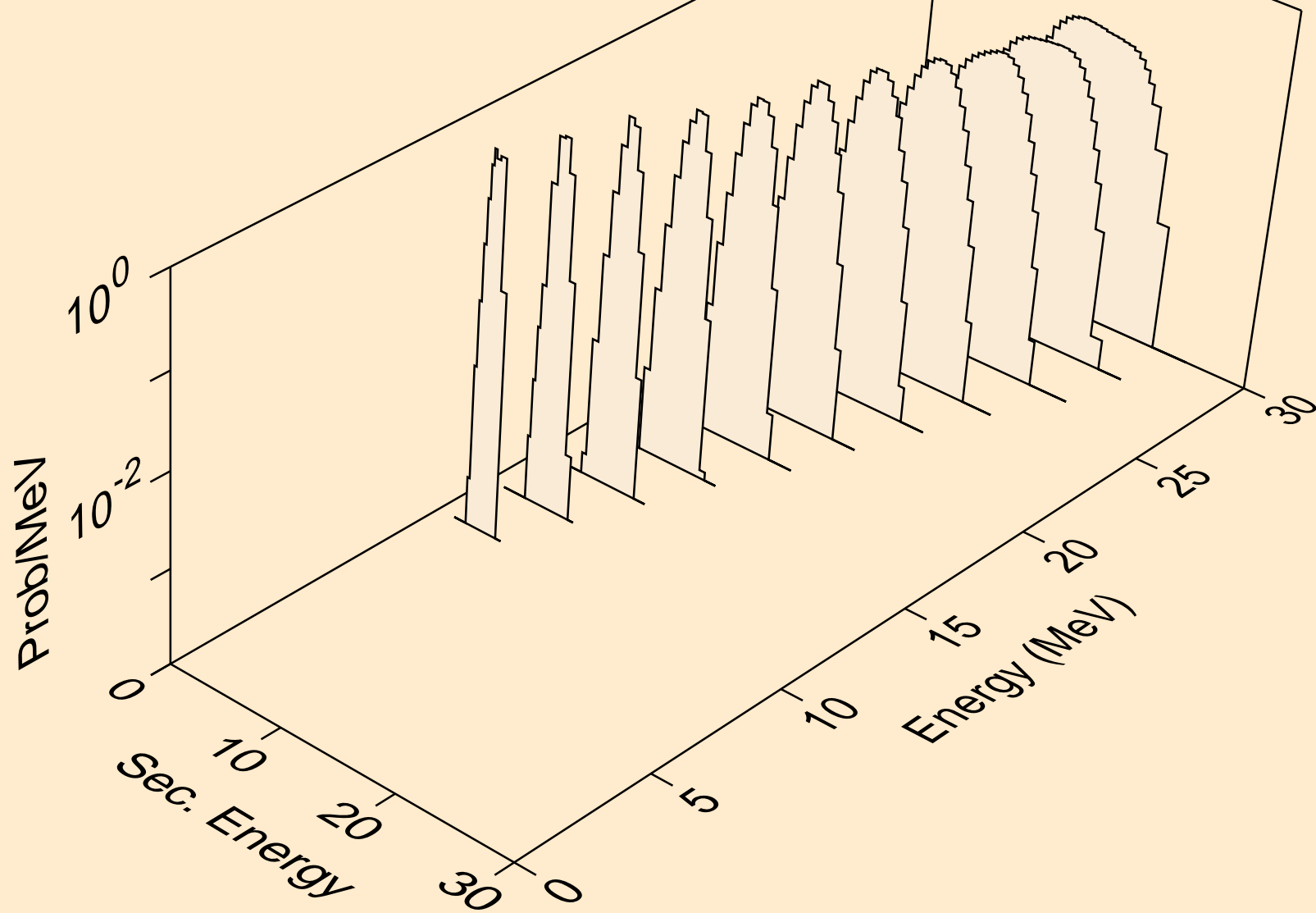

RE178 TRITON ACER TENDL-2021 LIBRARY; T=0.K  
Photon emission for (z,n)

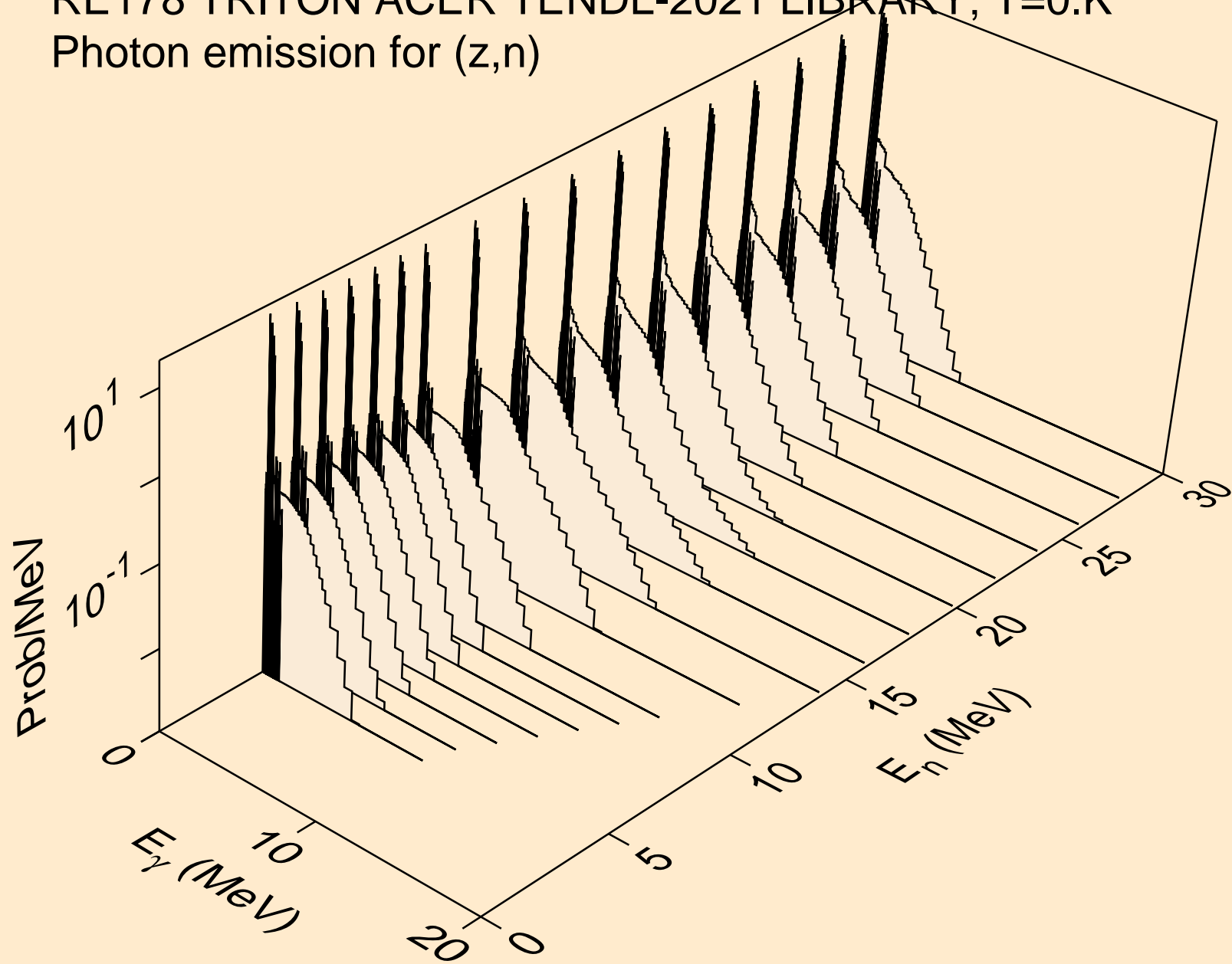

RE178 TRITON ACER TENDL-2021 LIBRARY; T=0.K  
Photon emission for (n,x)

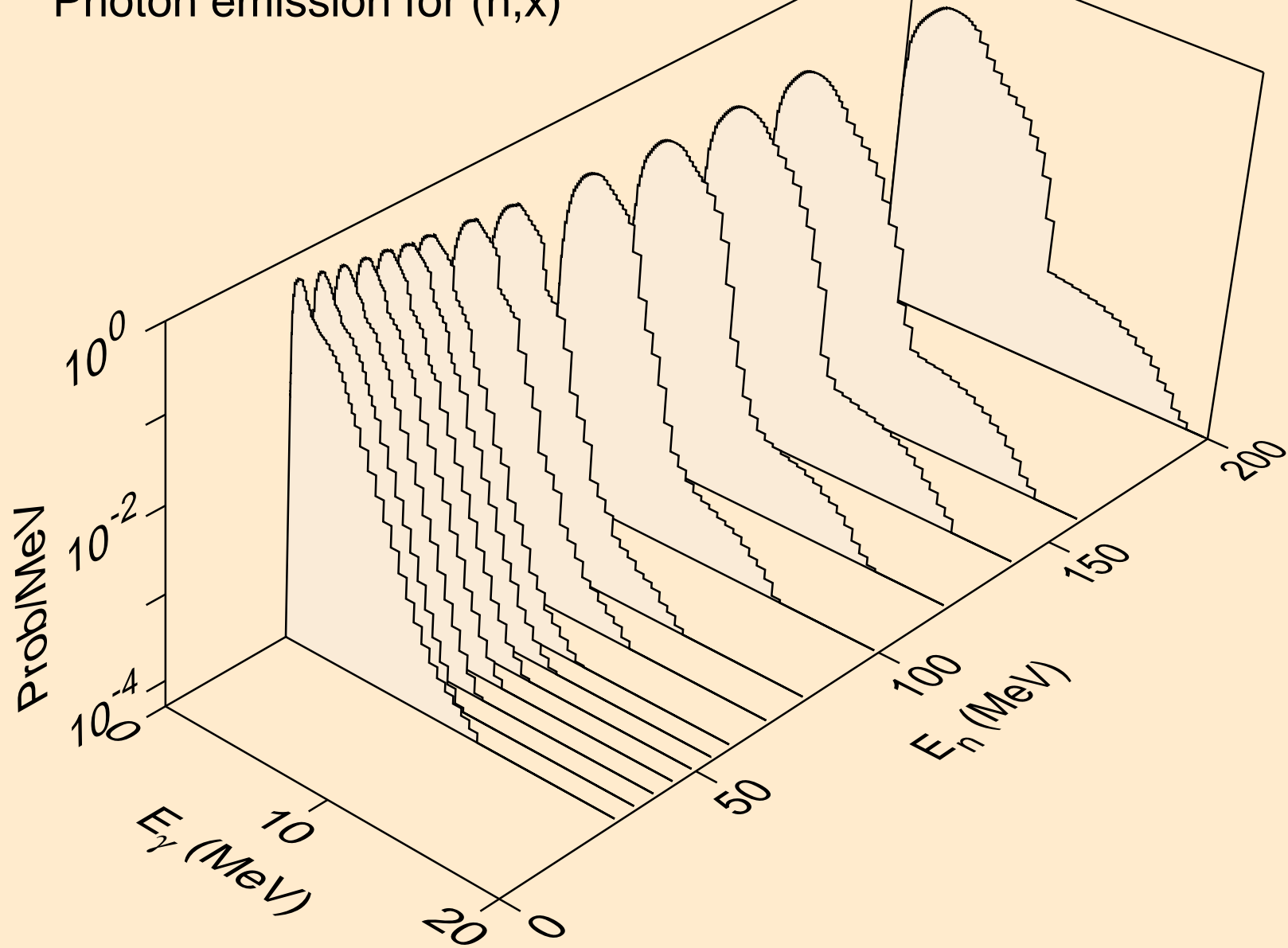

RE178 TRITON ACER TENDL-2021 LIBRARY; T=0.K  
Photon emission for (n,2nd)

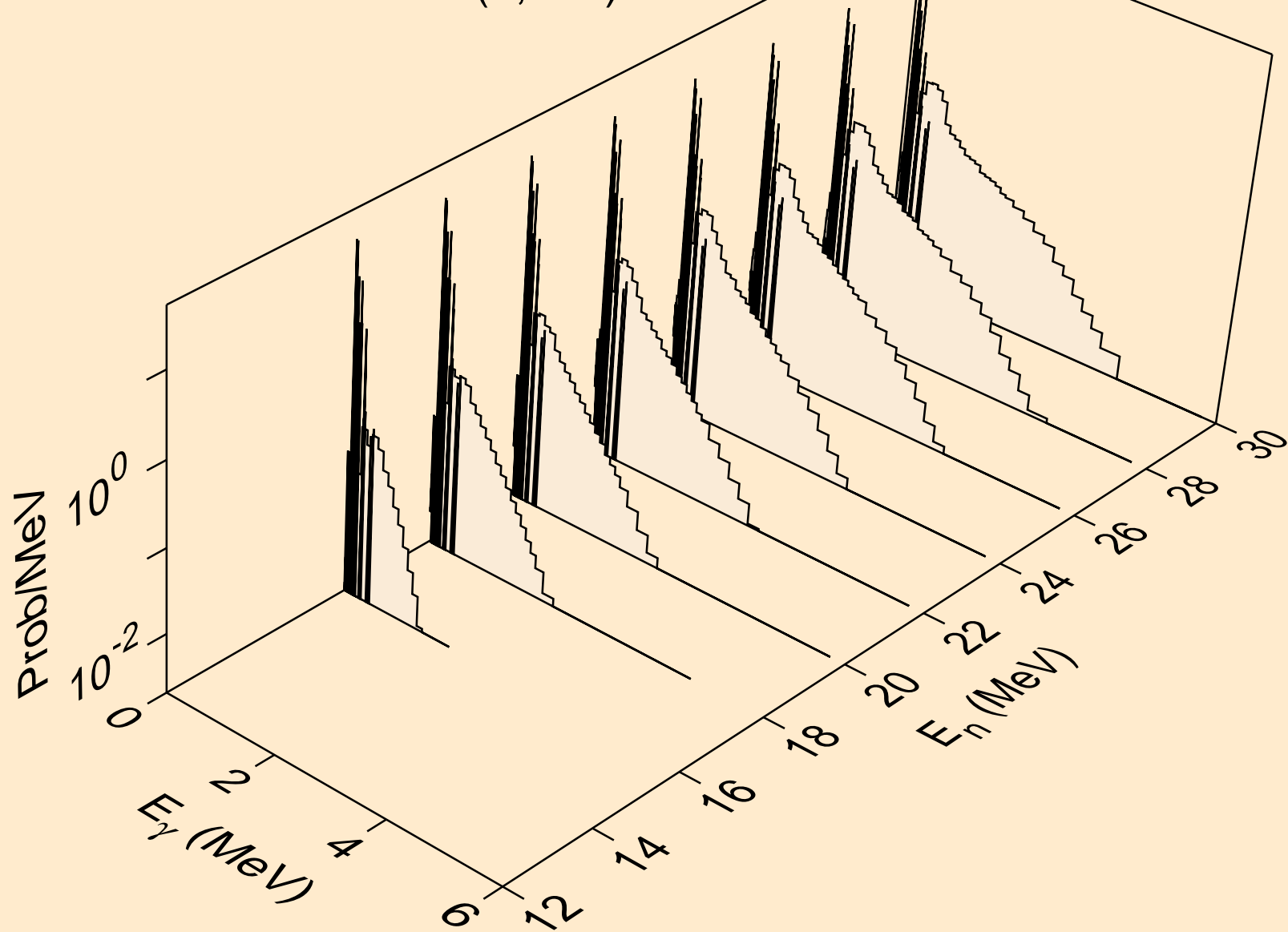



RE178 TRITON ACER TENDL-2021 LIBRARY; T=0.K  
Photon emission for (n,2n)

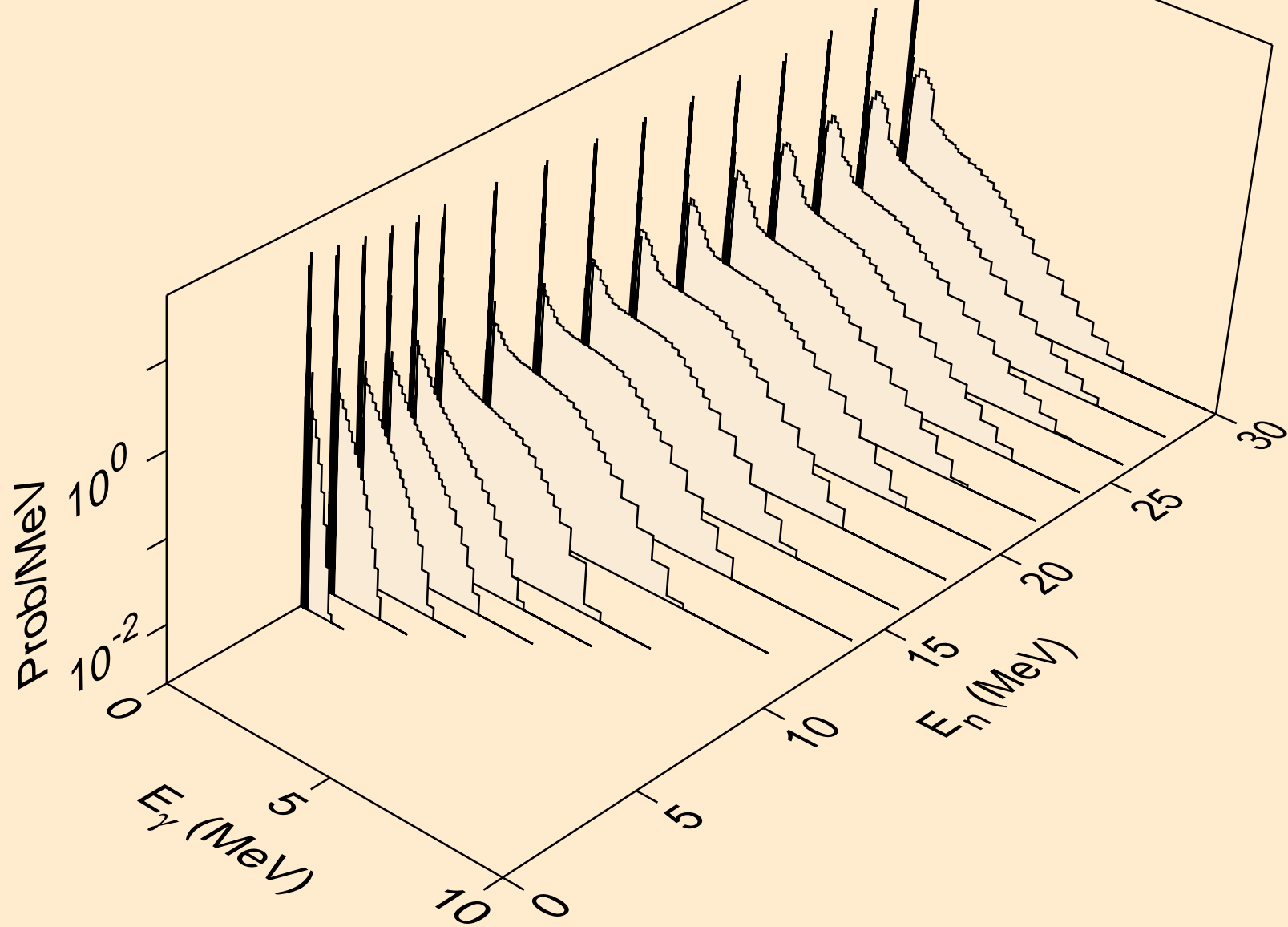

RE178 TRITON ACER TENDL-2021 LIBRARY; T=0.K  
Photon emission for (n,3n)

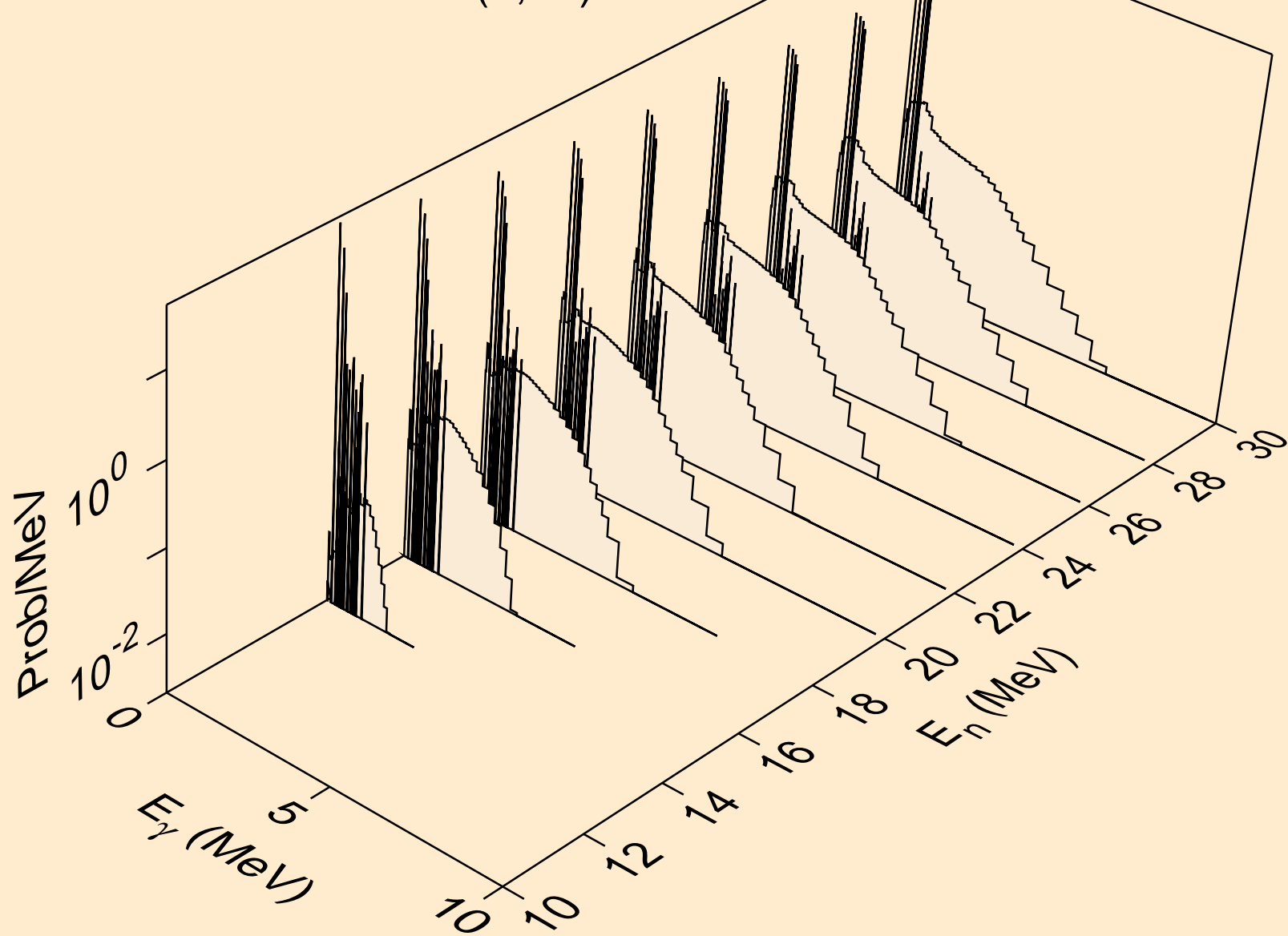

RE178 TRITON ACER TENDL-2021 LIBRARY; T=0.K  
Photon emission for (n,n\*)a

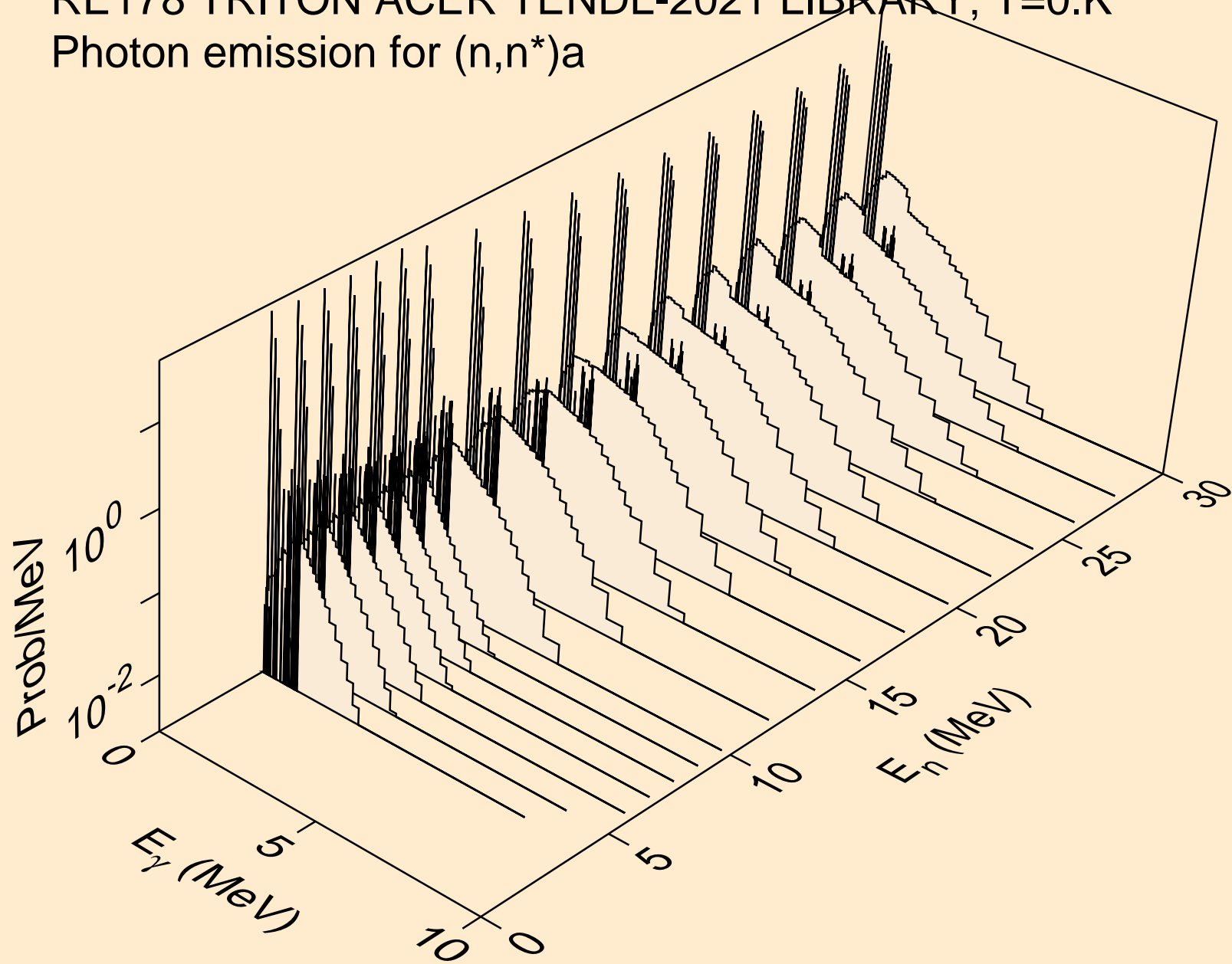

RE178 TRITON ACER TENDL-2021 LIBRARY; T=0.K  
Photon emission for (n,2n)a

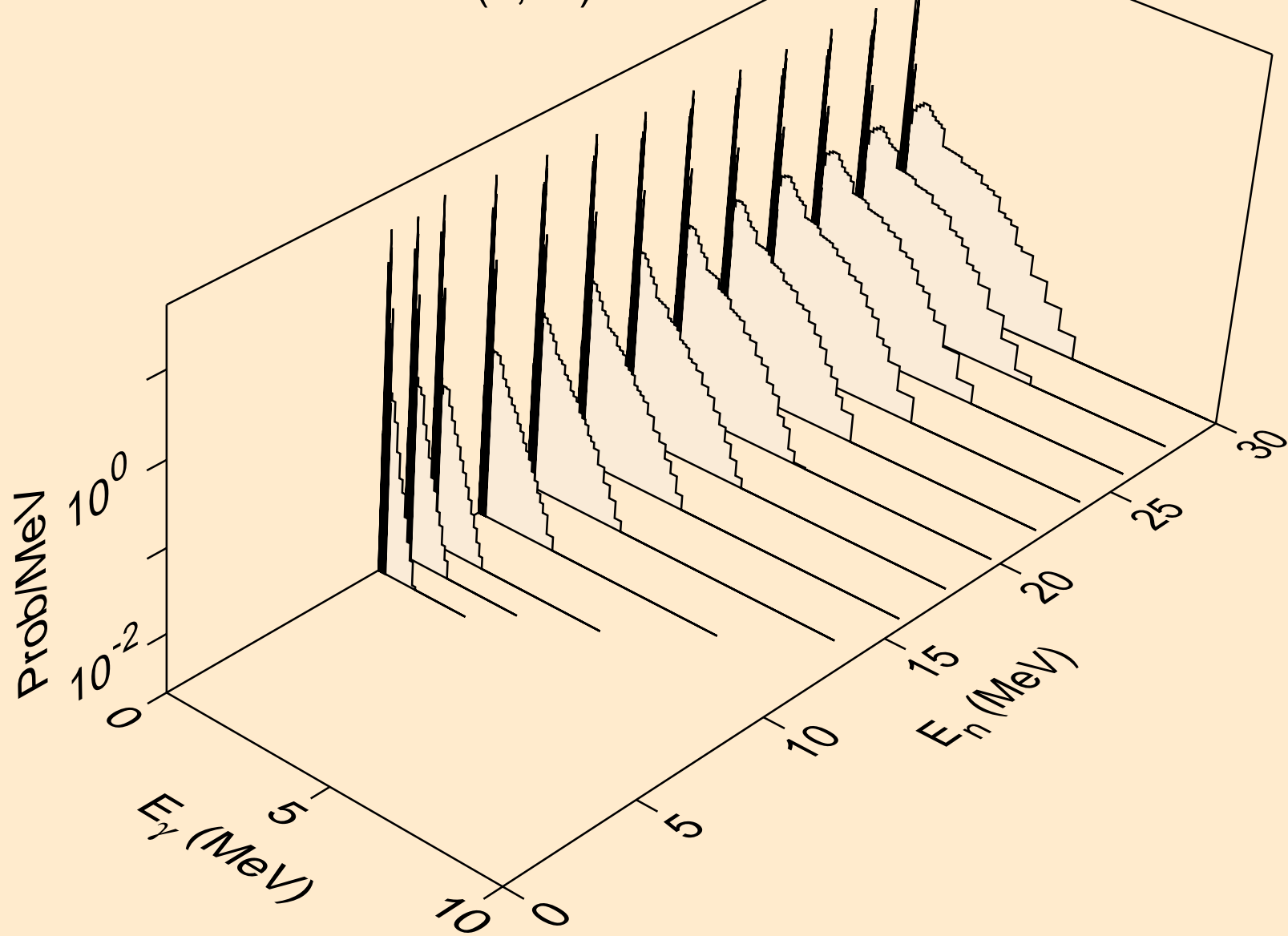

RE178 TRITON ACER TENDL-2021 LIBRARY; T=0.K  
Photon emission for (n,3n)a

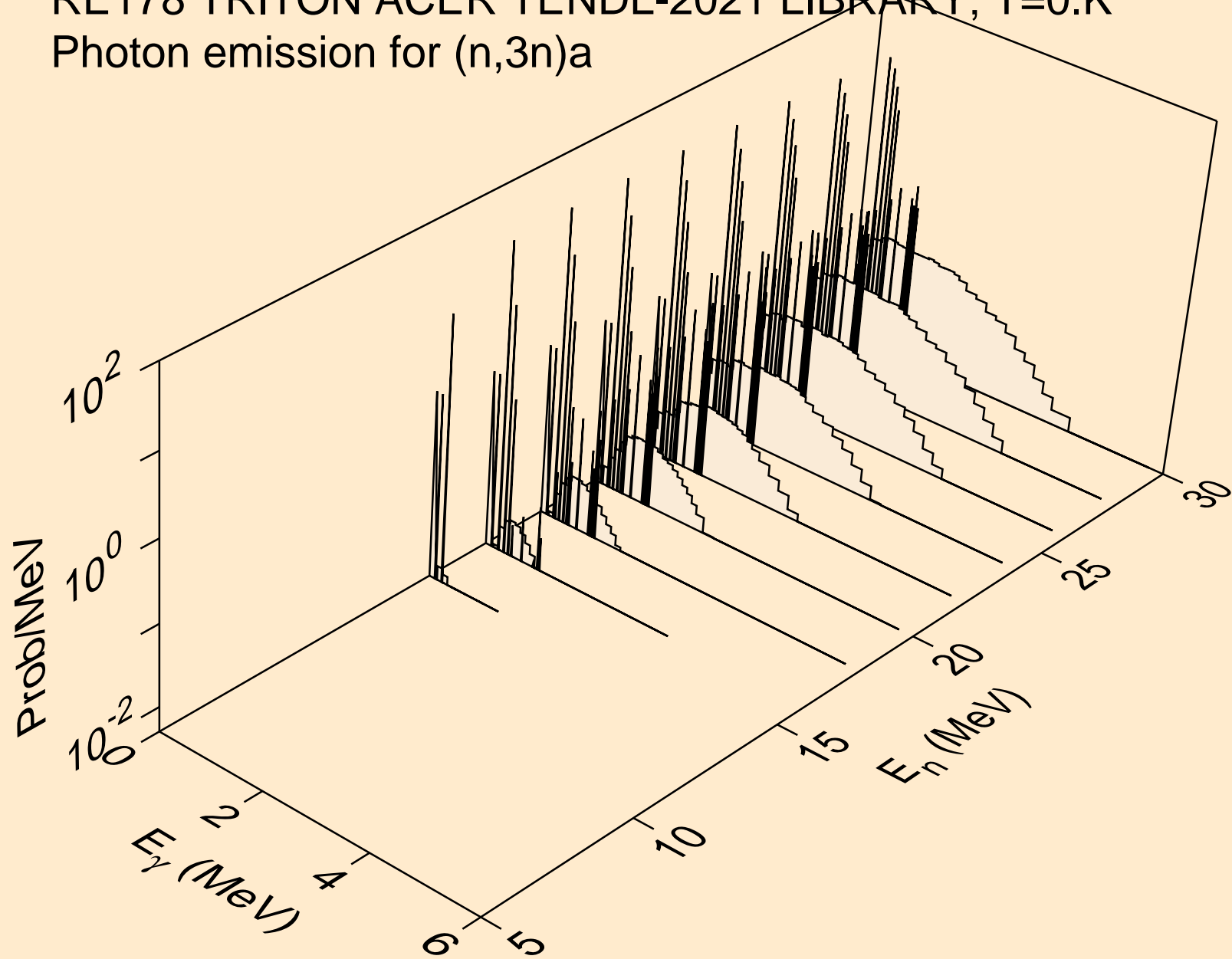

RE178 TRITON ACER TENDL-2021 LIBRARY; T=0.K  
Photon emission for (n,n\*)p

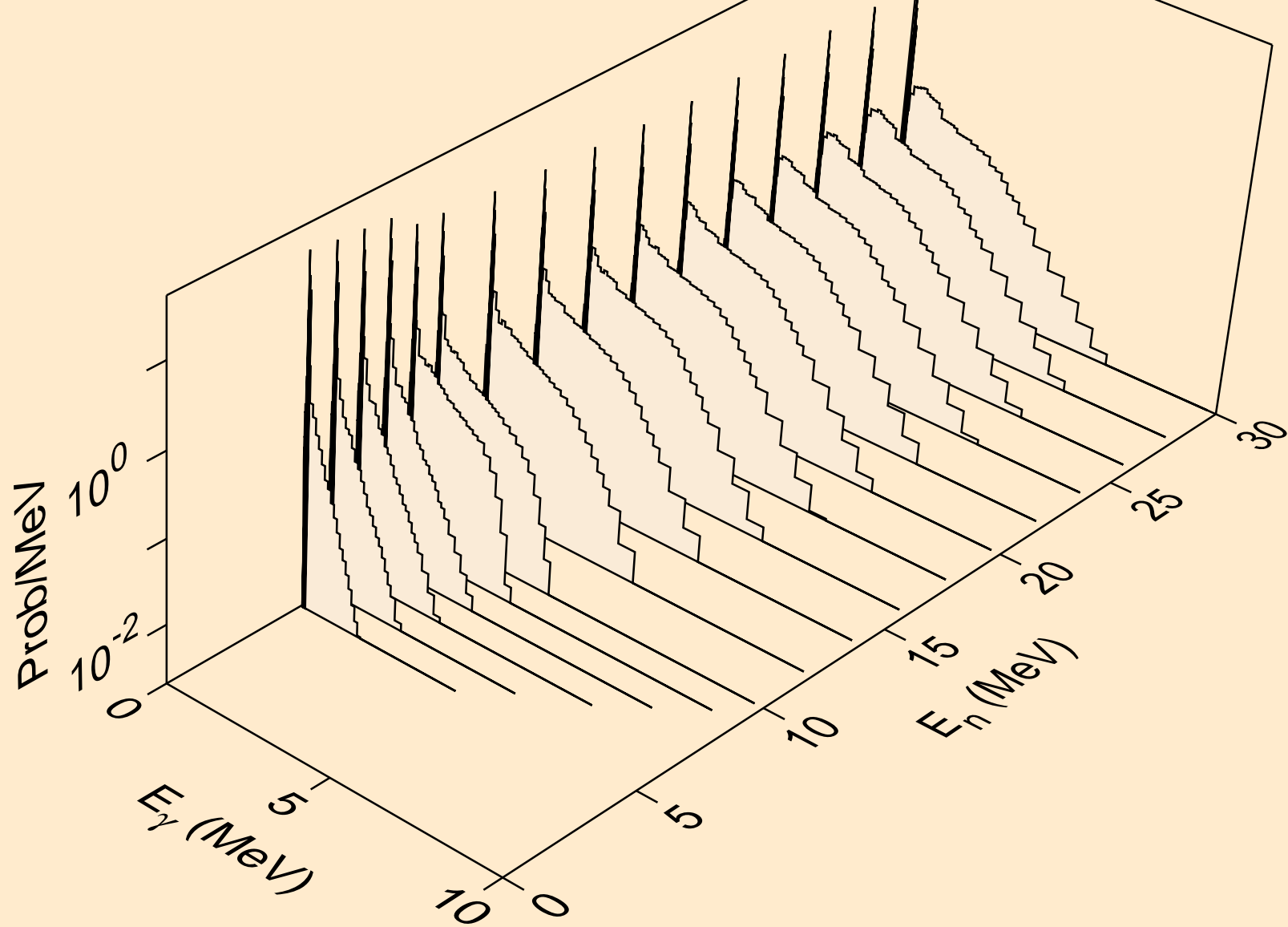

RE178 TRITON ACER TENDL-2021 LIBRARY; T=0.K  
Photon emission for (n,n\*)2a

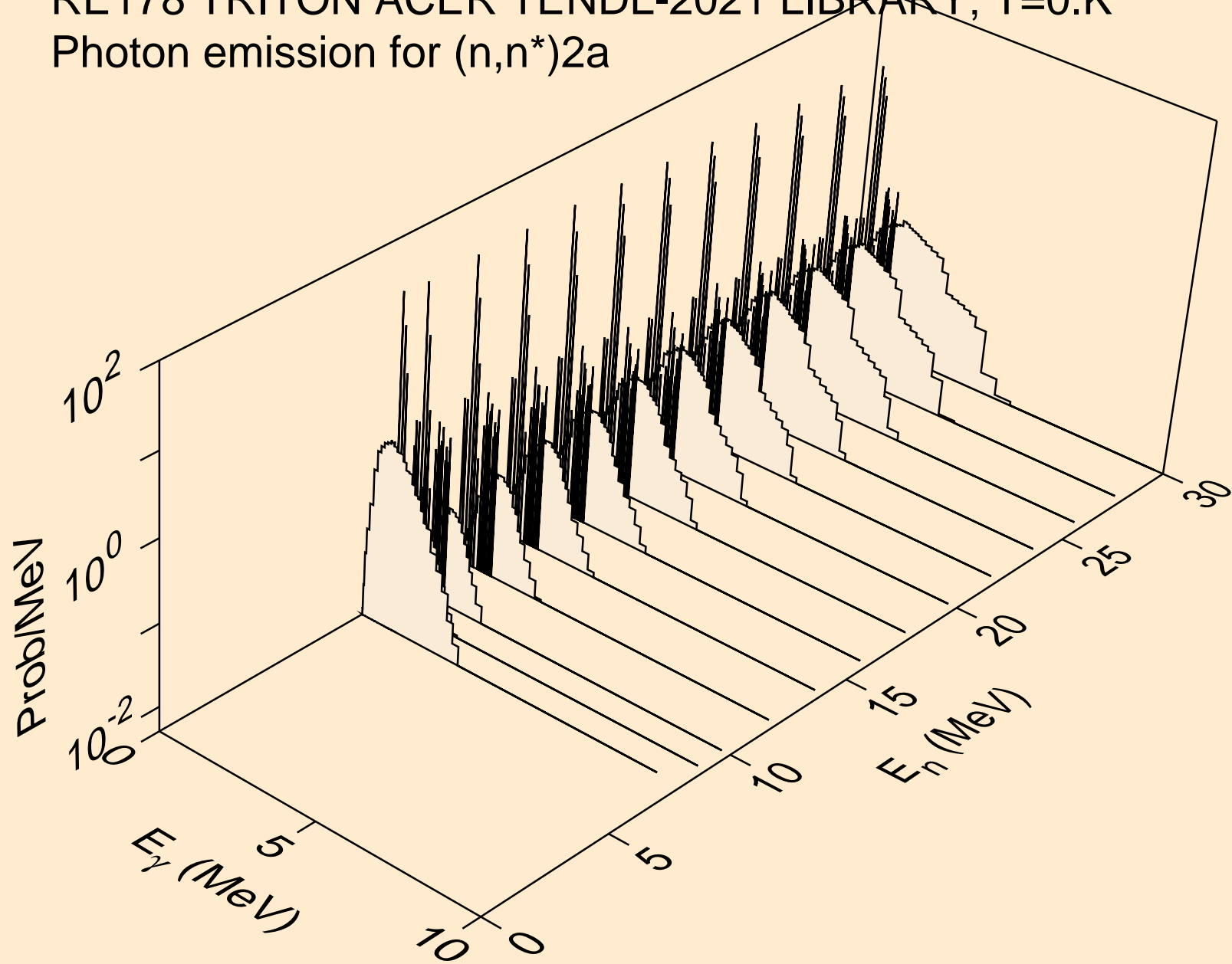

RE178 TRITON ACER TENDL-2021 LIBRARY; T=0.K  
Photon emission for (n,2n)2a

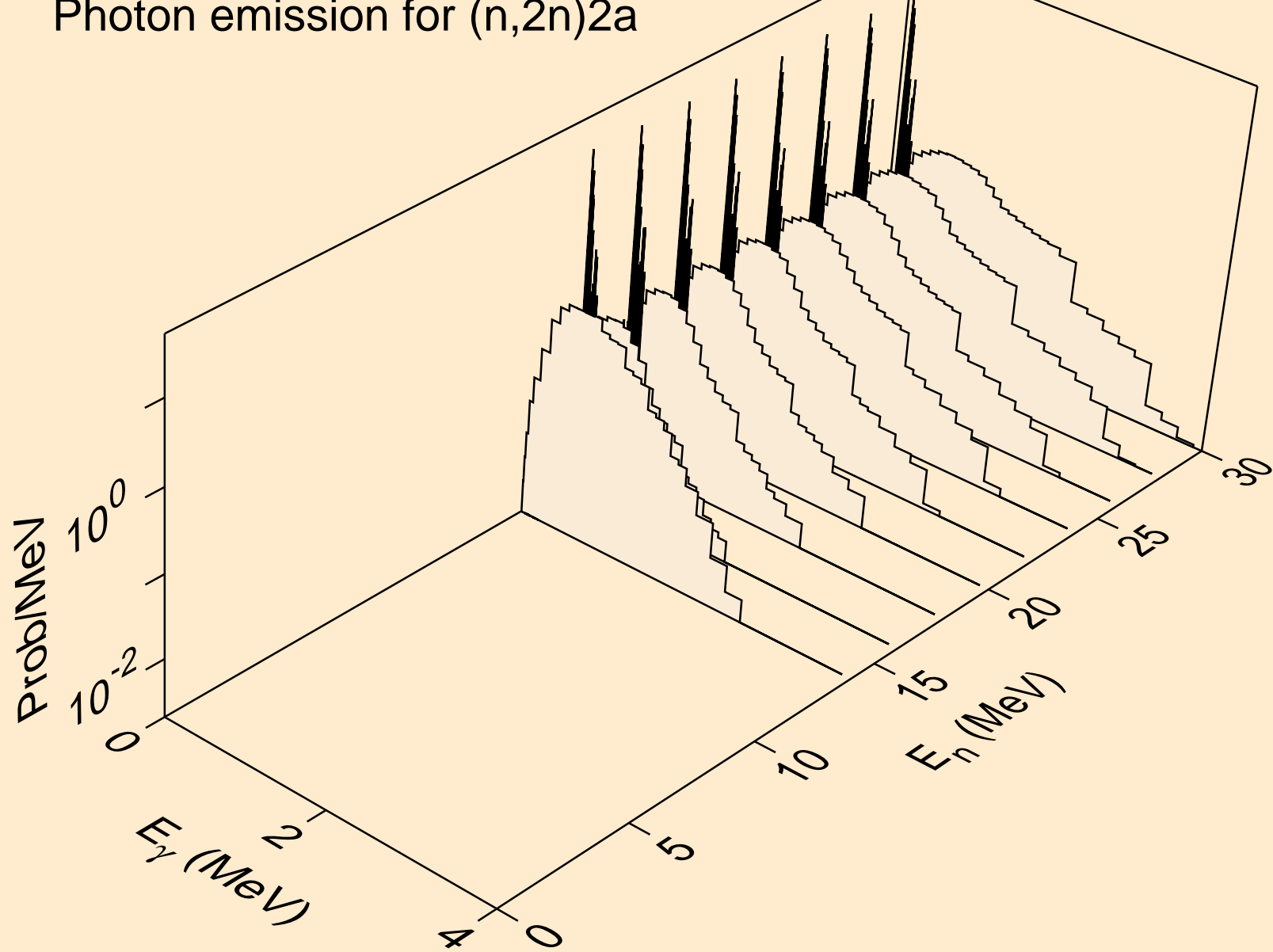



RE178 TRITON ACER TENDL-2021 LIBRARY; T=0.K  
Photon emission for (n,n\*)d

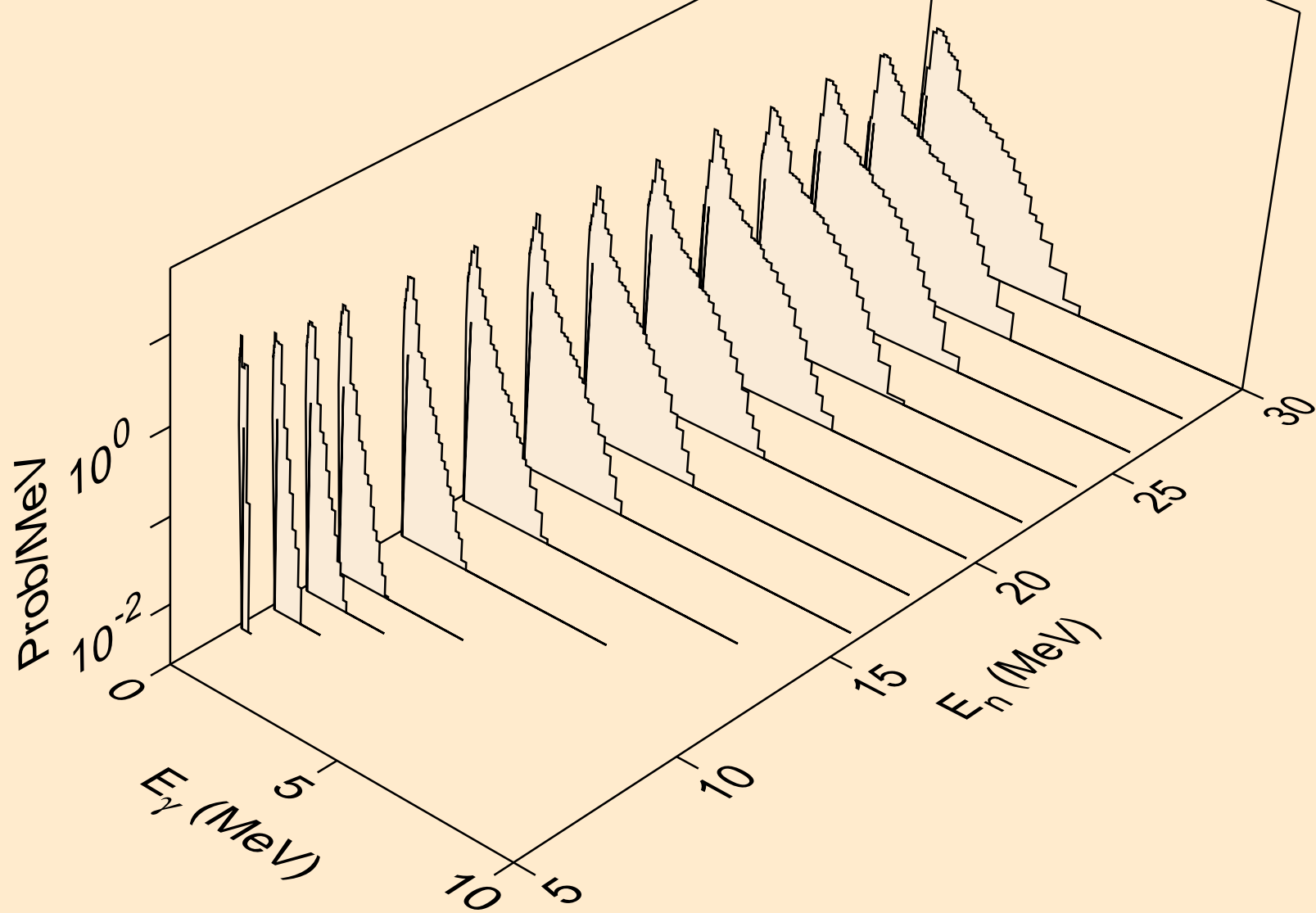

RE178 TRITON ACER TENDL-2021 LIBRARY; T=0.K  
Photon emission for (n,n\*)t

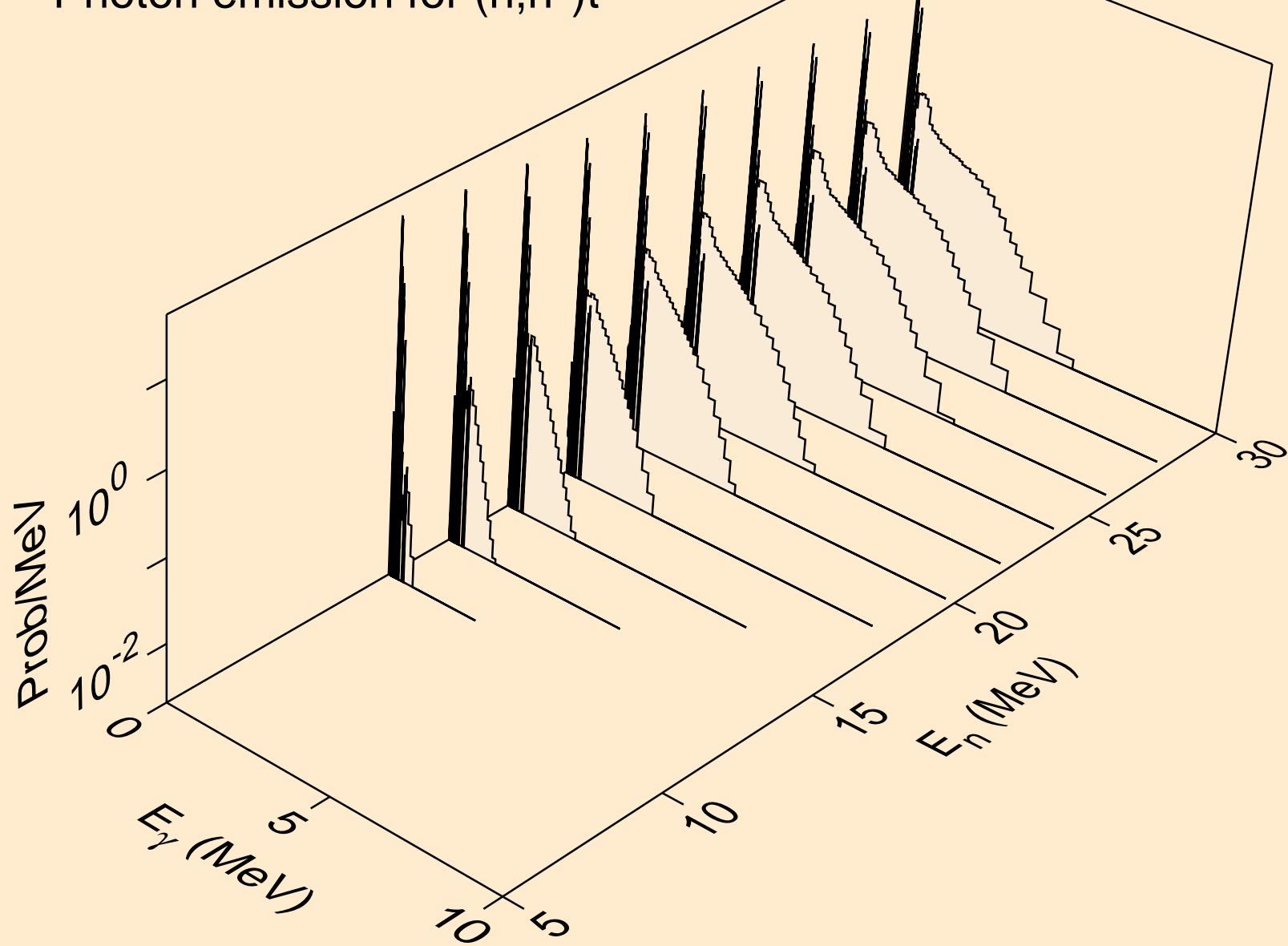

RE178 TRITON ACER TENDL-2021 LIBRARY; T=0.K  
Photon emission for (n,n\*)he3

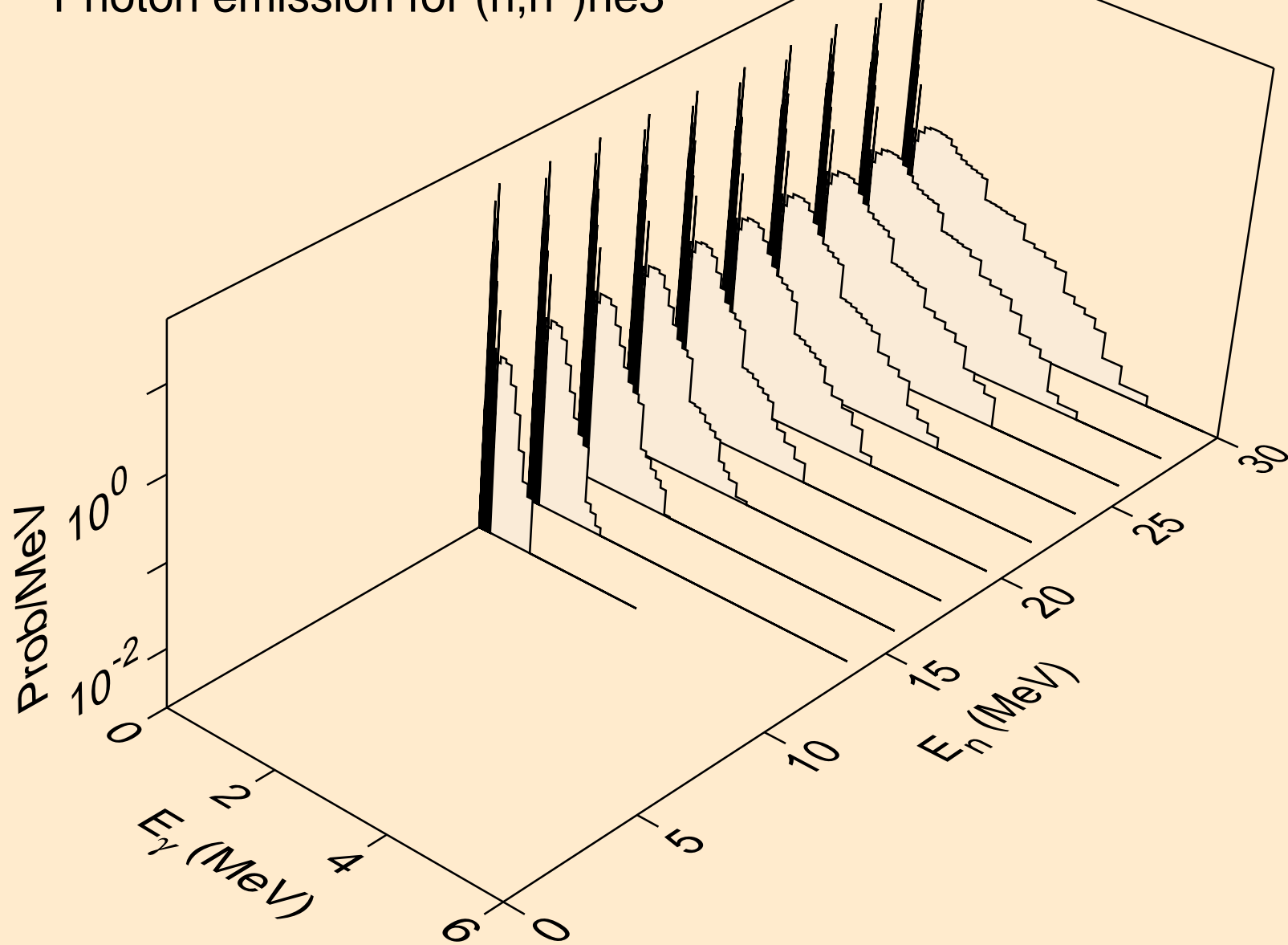

RE178 TRITON ACER TENDL-2021 LIBRARY; T=0.K  
Photon emission for (n,4n)

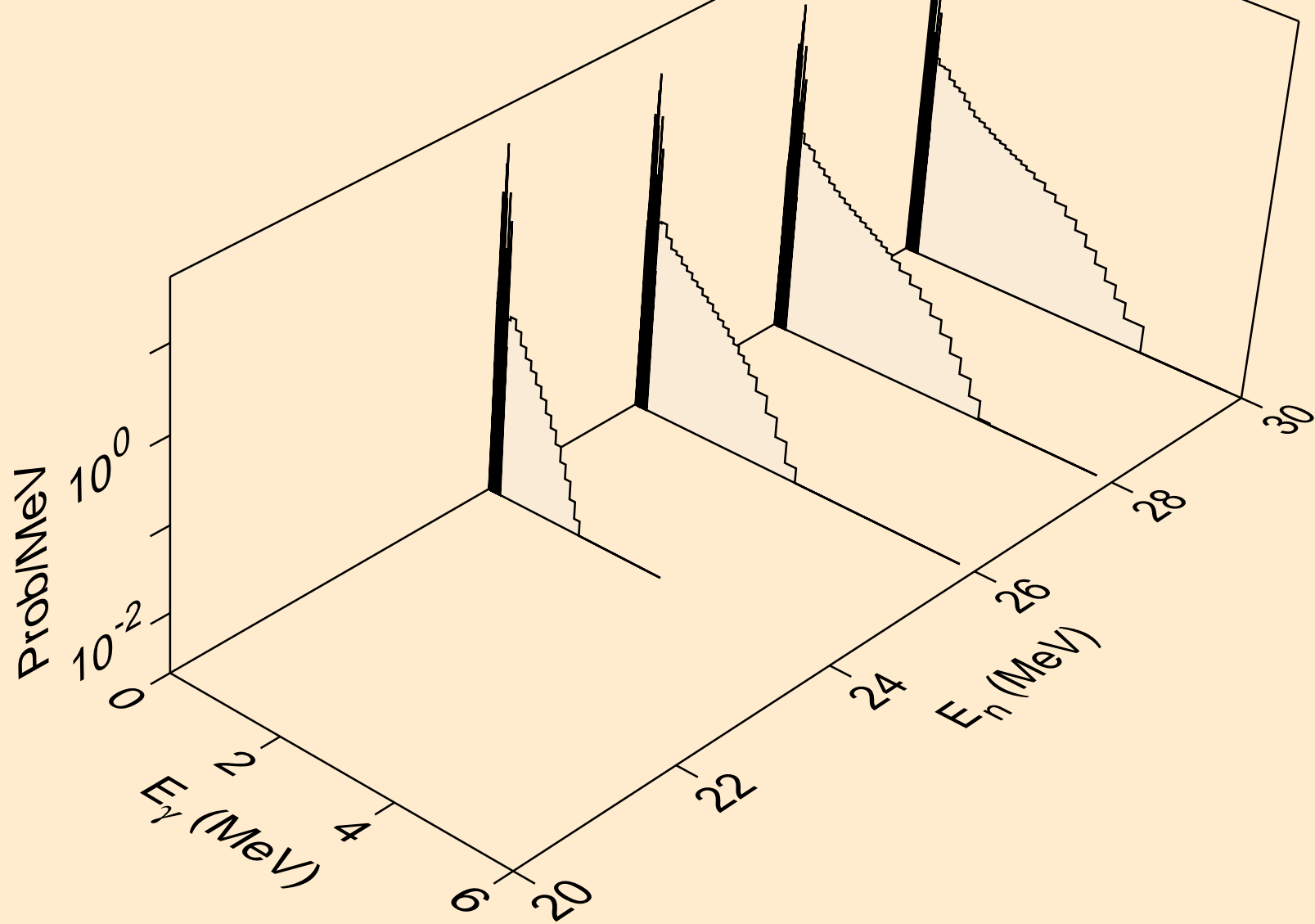

RE178 TRITON ACER TENDL-2021 LIBRARY; T=0.K  
Photon emission for (n,2np)

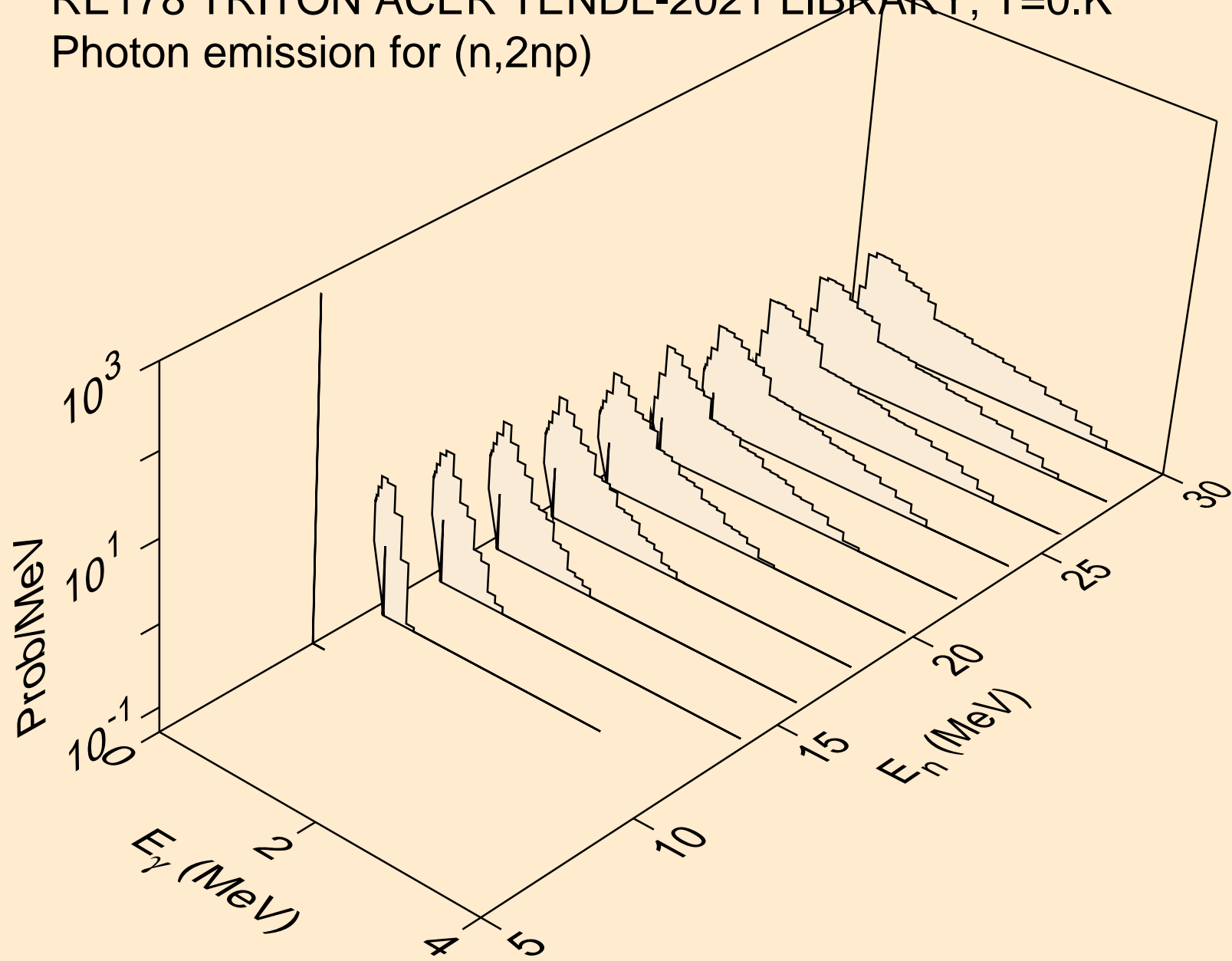

RE178 TRITON ACER TENDL-2021 LIBRARY; T=0.K  
Photon emission for (n,3np)

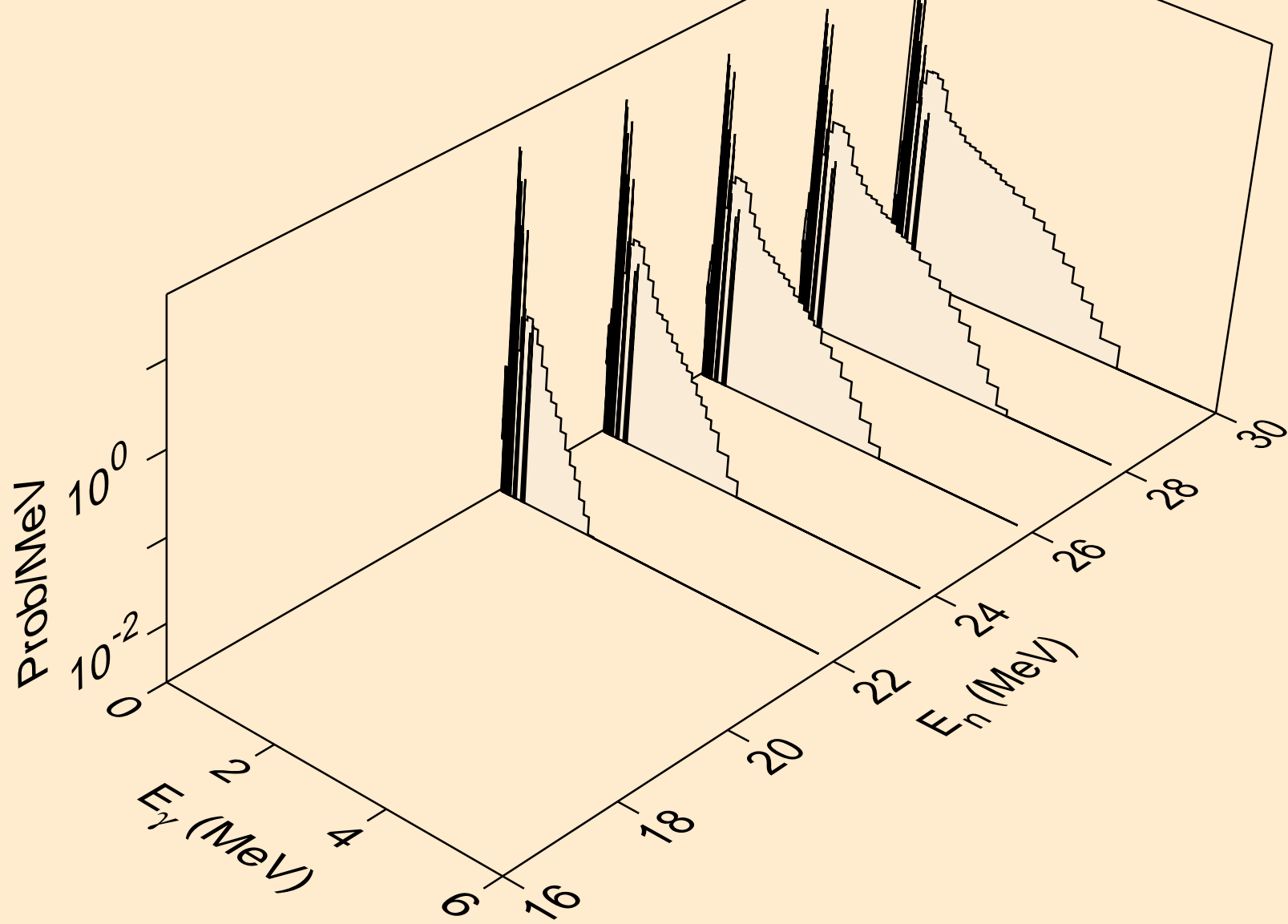

RE178 TRITON ACER TENDL-2021 LIBRARY; T=0.K  
Photon emission for (n,2np)

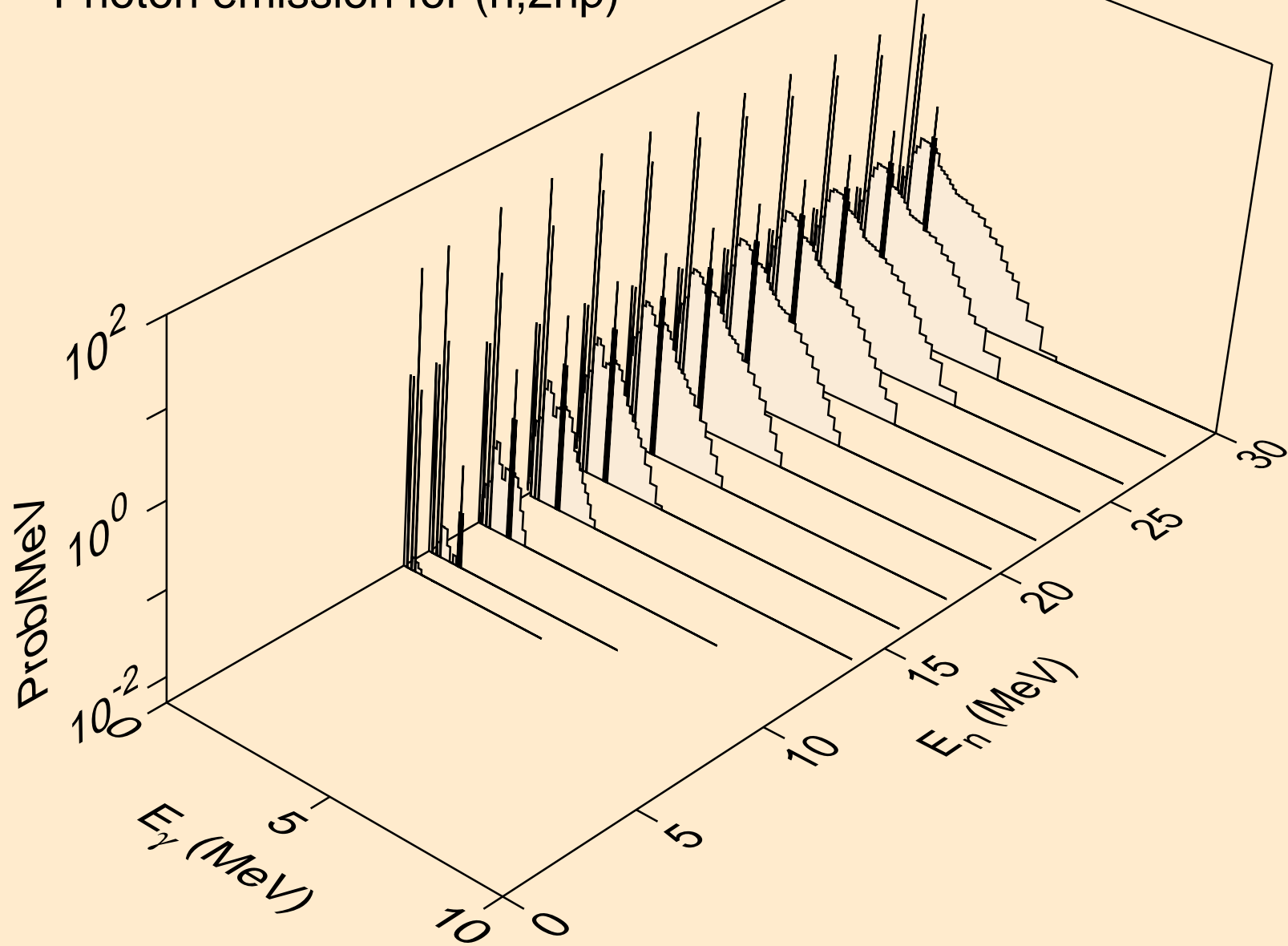

RE178 TRITON ACER TENDL-2021 LIBRARY; T=0.K  
Photon emission for (n,npa)

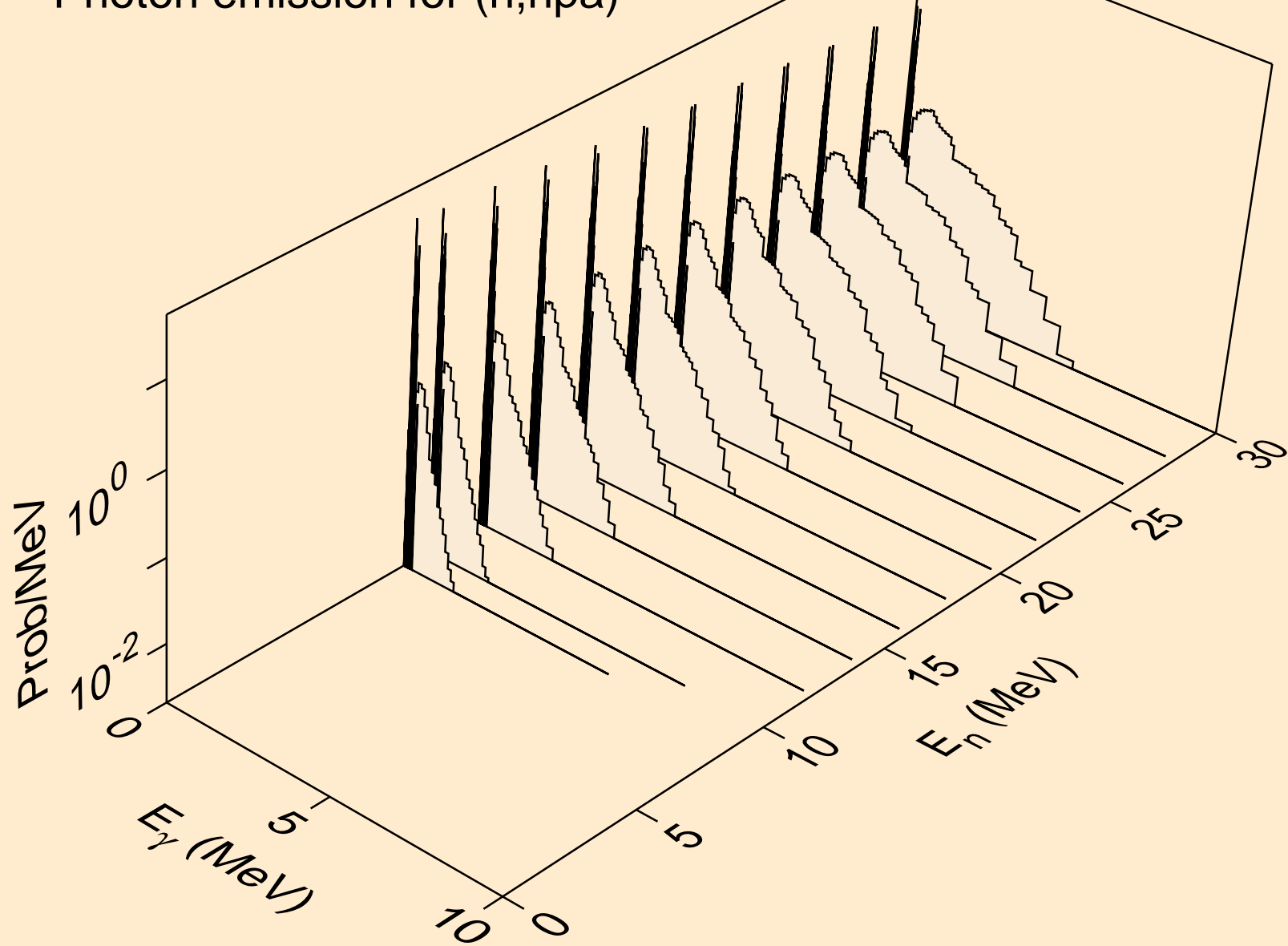



RE178 TRITON ACER TENDL-2021 LIBRARY; T=0.K  
Photon emission for (n,gma)

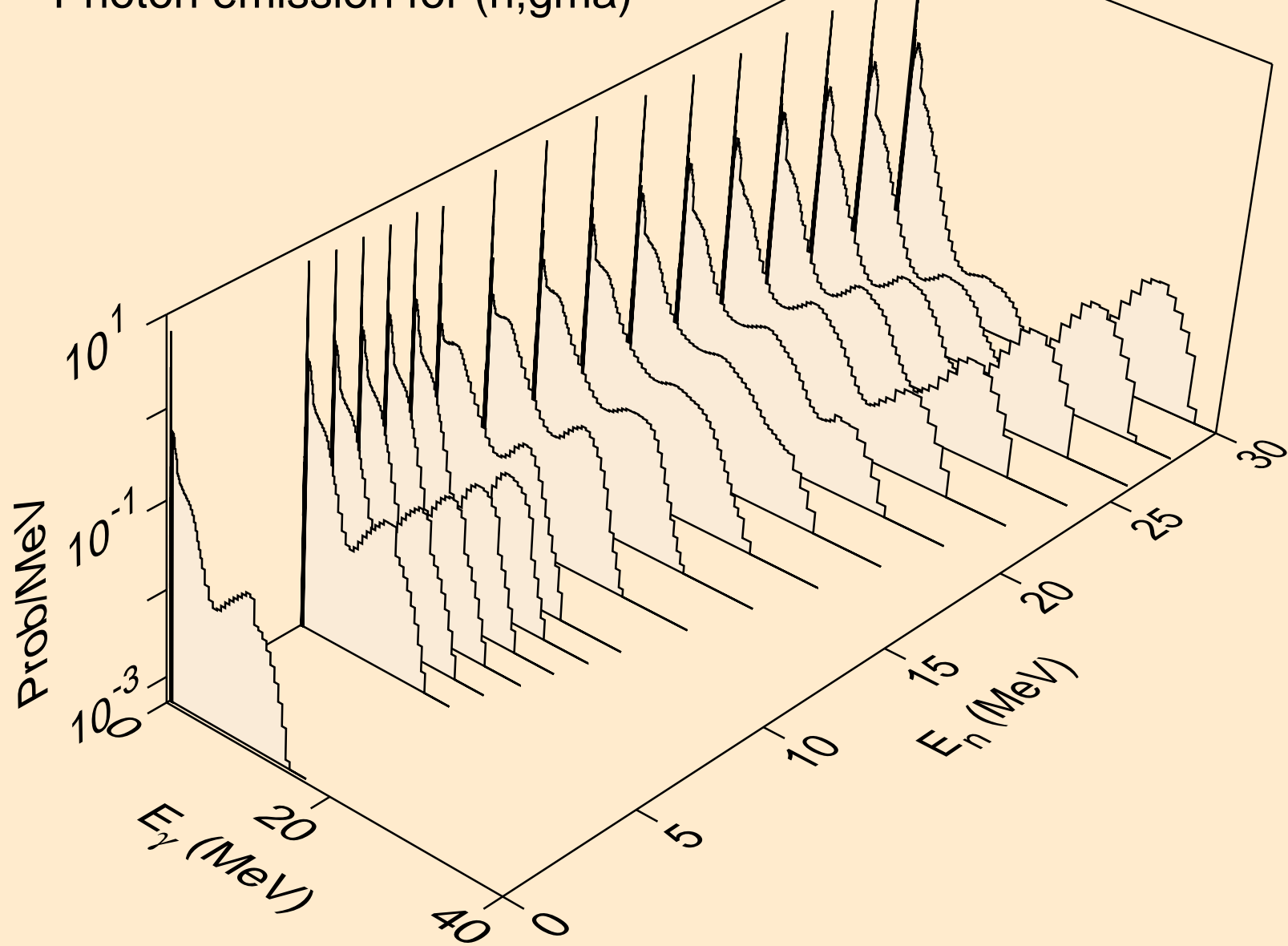

RE178 TRITON ACER TENDL-2021 LIBRARY; T=0.K  
Photon emission for (n,p)

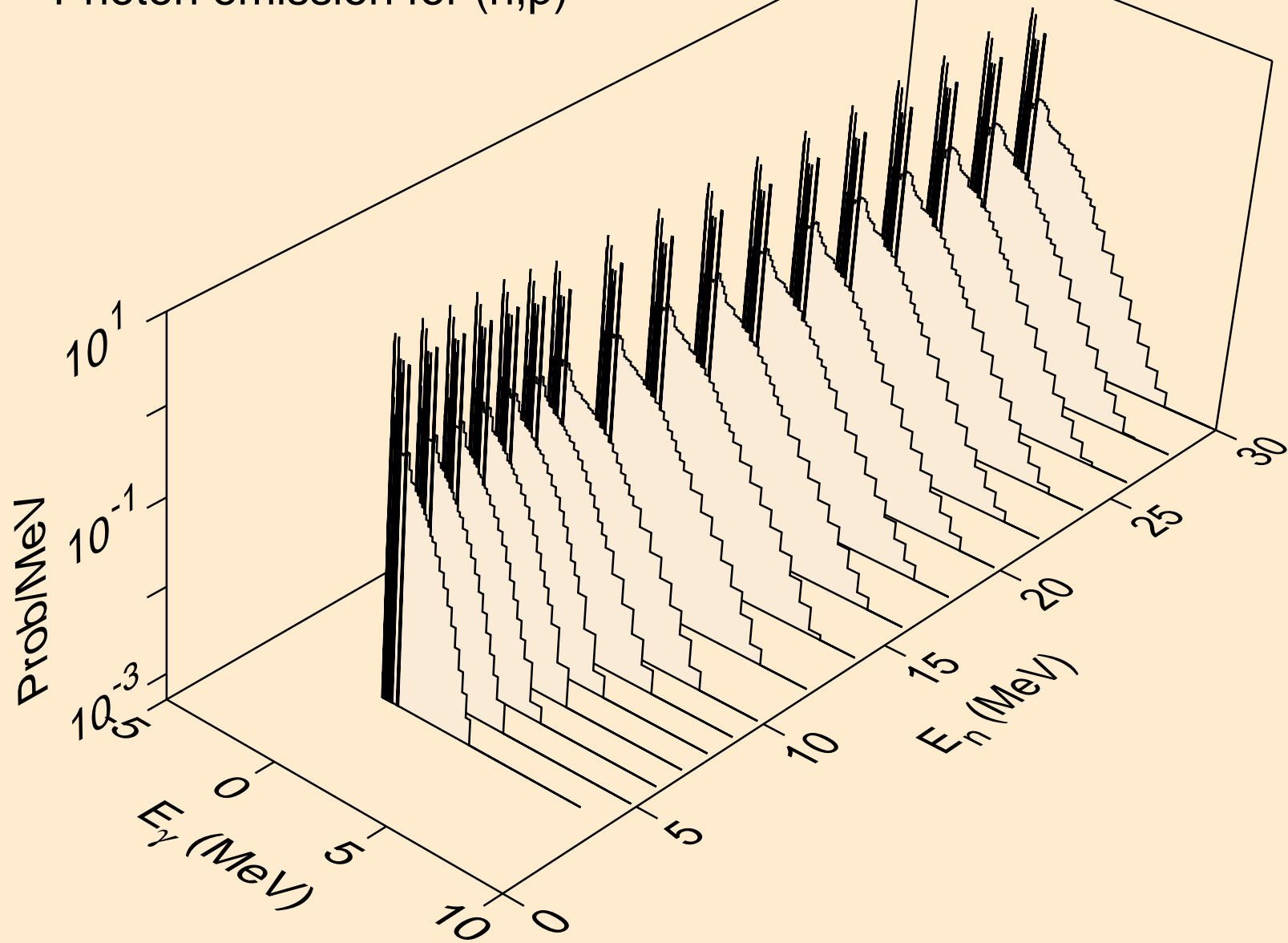

RE178 TRITON ACER TENDL-2021 LIBRARY; T=0.K  
Photon emission for (n,d)

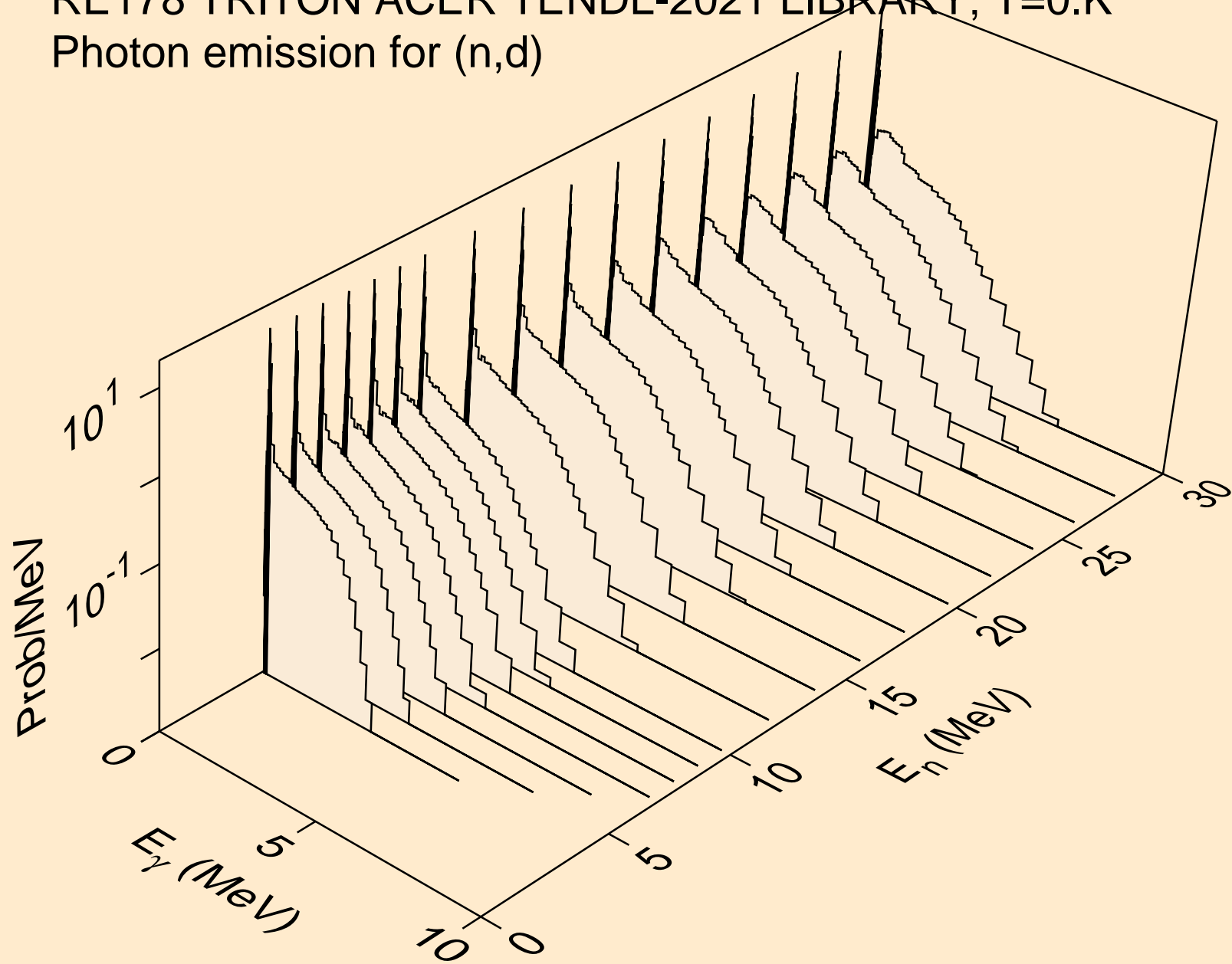

RE178 TRITON ACER TENDL-2021 LIBRARY; T=0.K  
Photon emission for inelastic

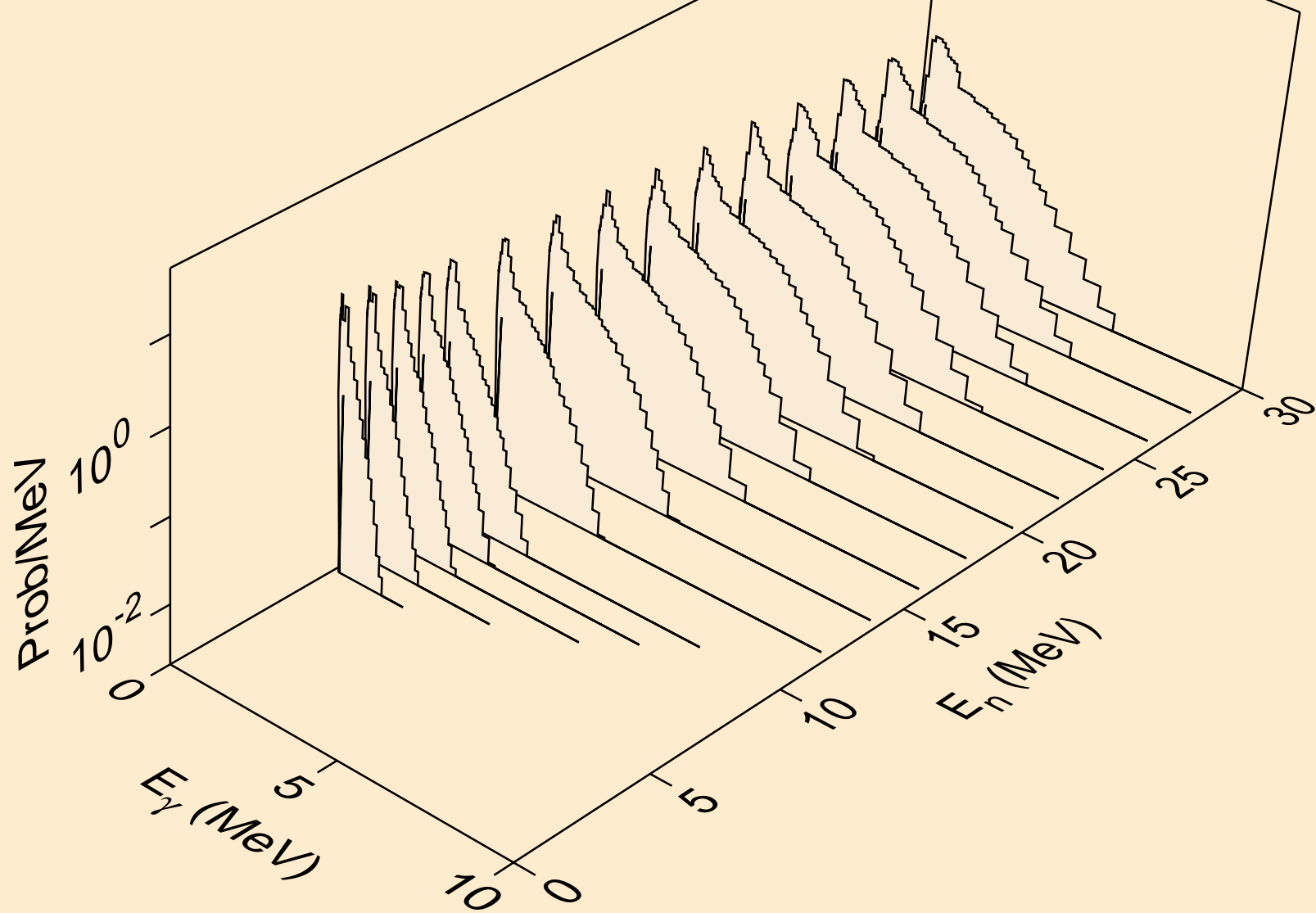

RE178 TRITON ACER TENDL-2021 LIBRARY; T=0.K  
Photon emission for (n,he3)

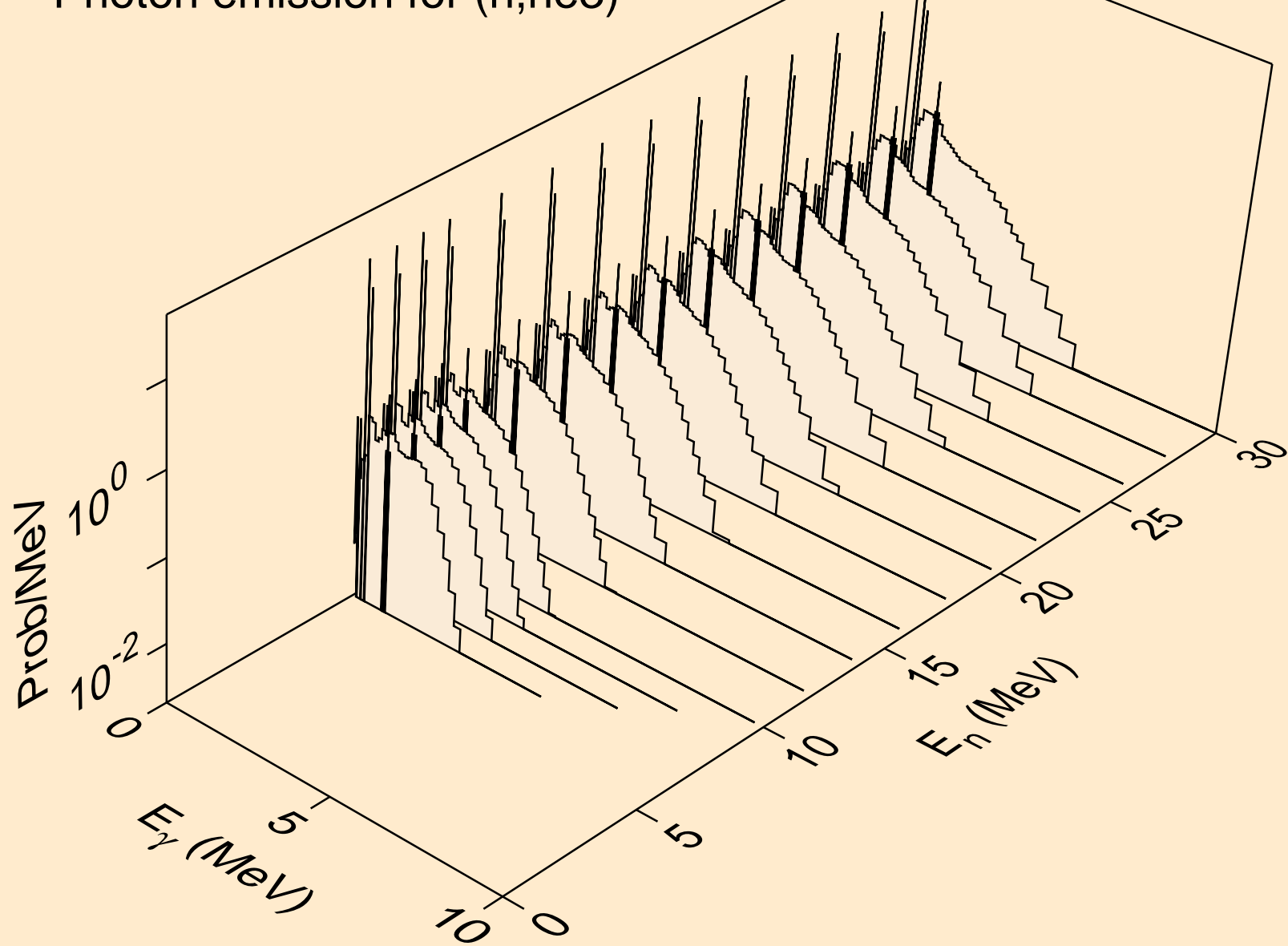

RE178 TRITON ACER TENDL-2021 LIBRARY; T=0.K  
Photon emission for (n,a)

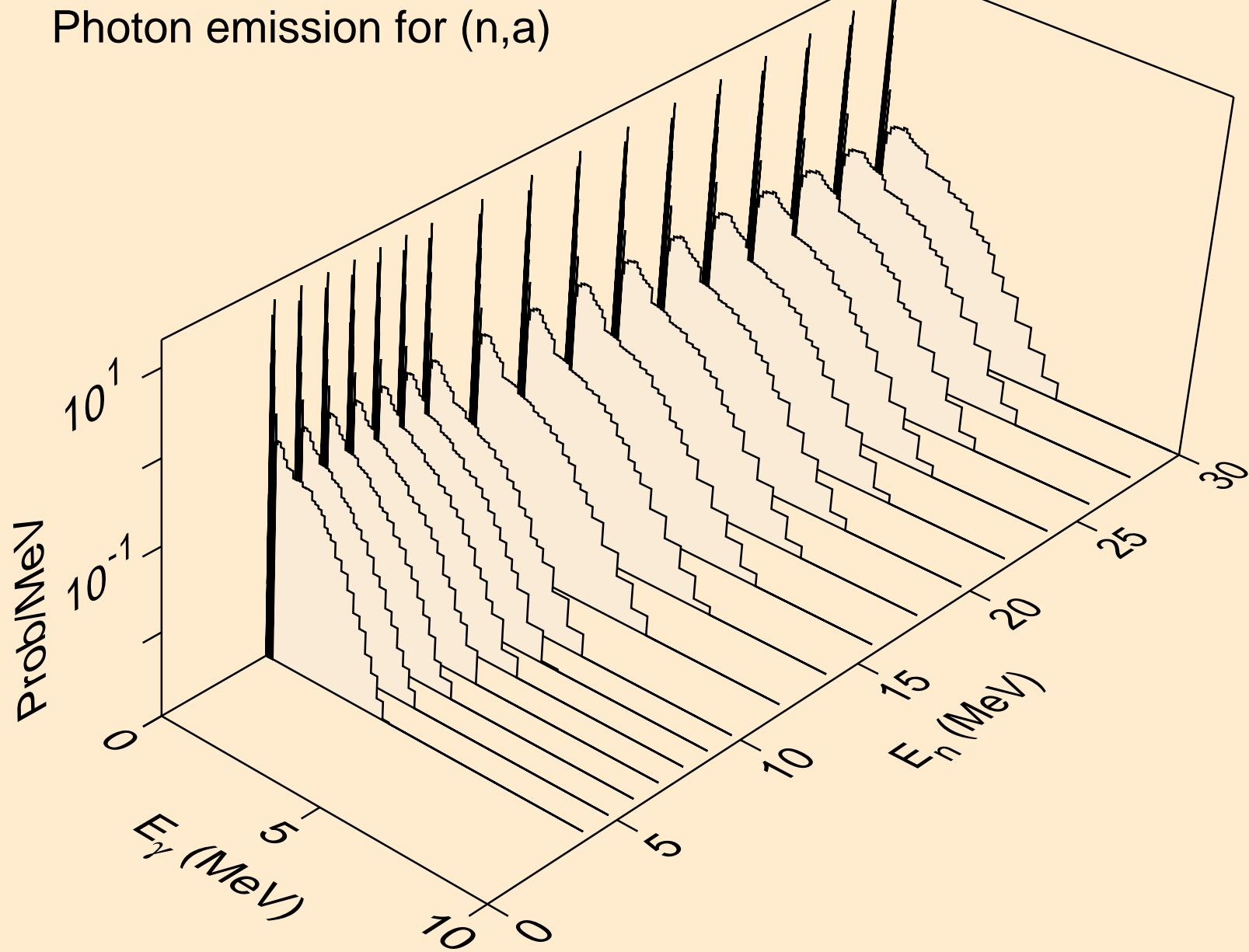

RE178 TRITON ACER TENDL-2021 LIBRARY; T=0.K  
Photon emission for (n,2a)

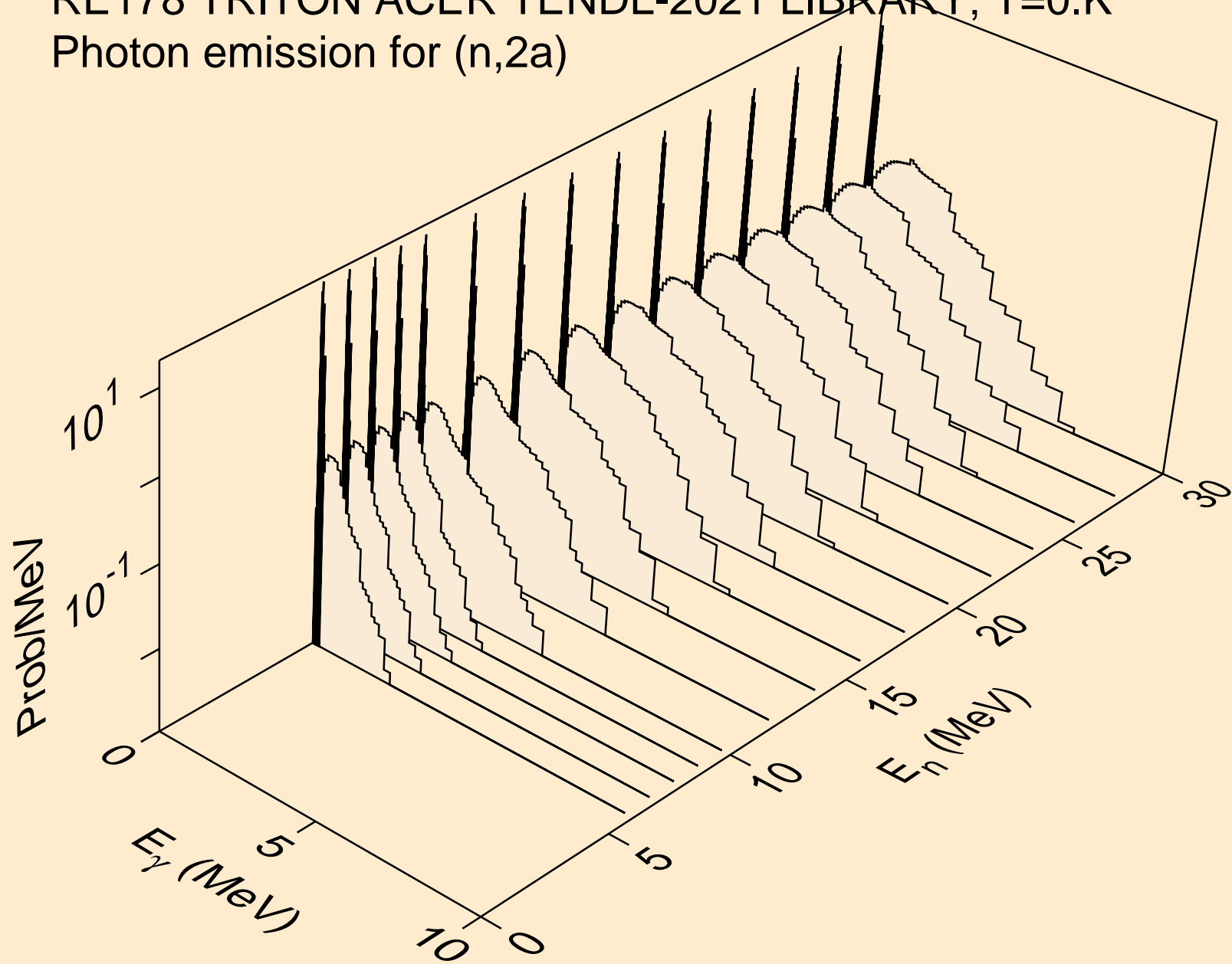

RE178 TRITON ACER TENDL-2021 LIBRARY; T=0.K  
Photon emission for (n,2p)

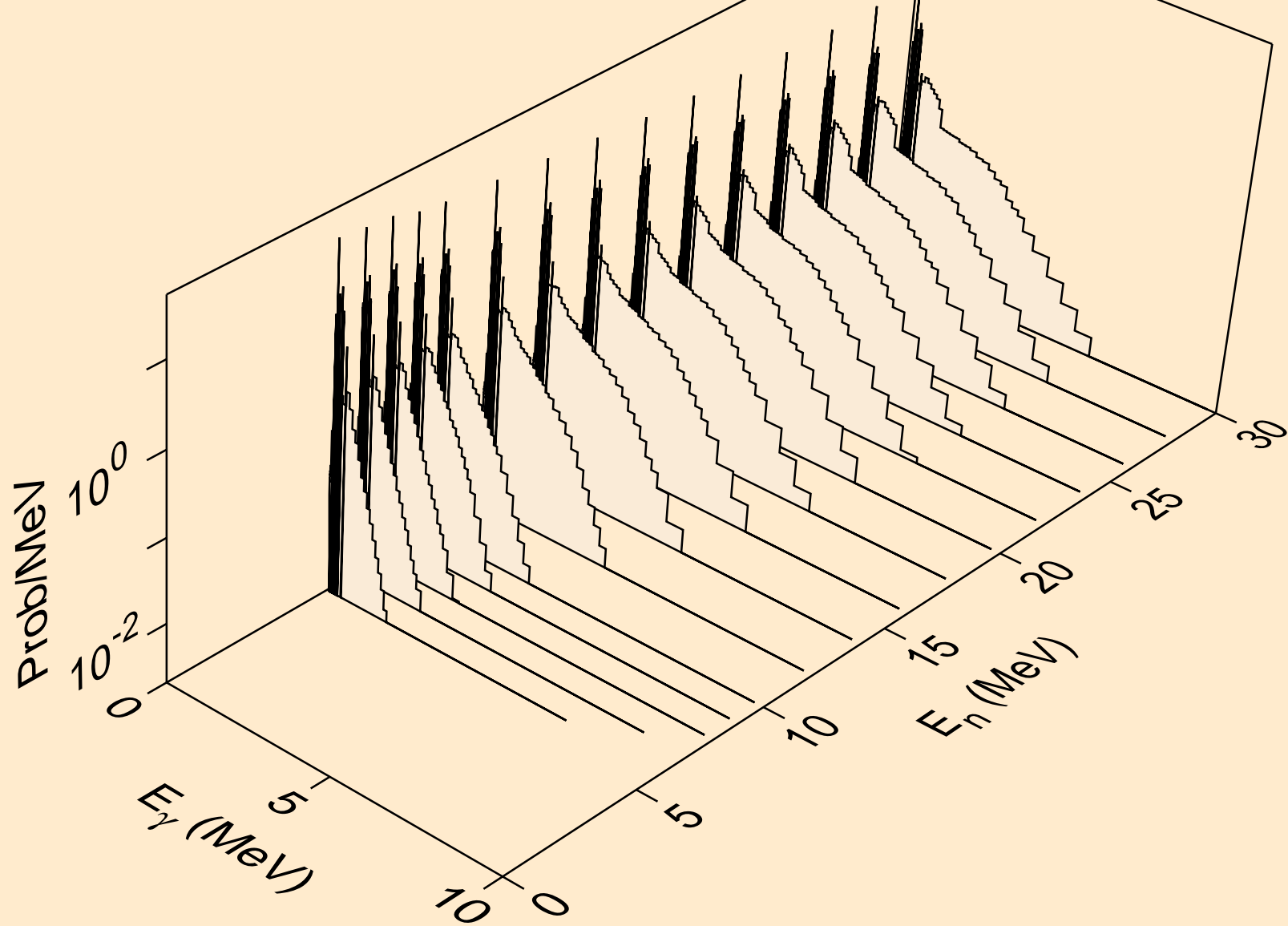



RE178 TRITON ACER TENDL-2021 LIBRARY; T=0.K  
Photon emission for (n,pa)

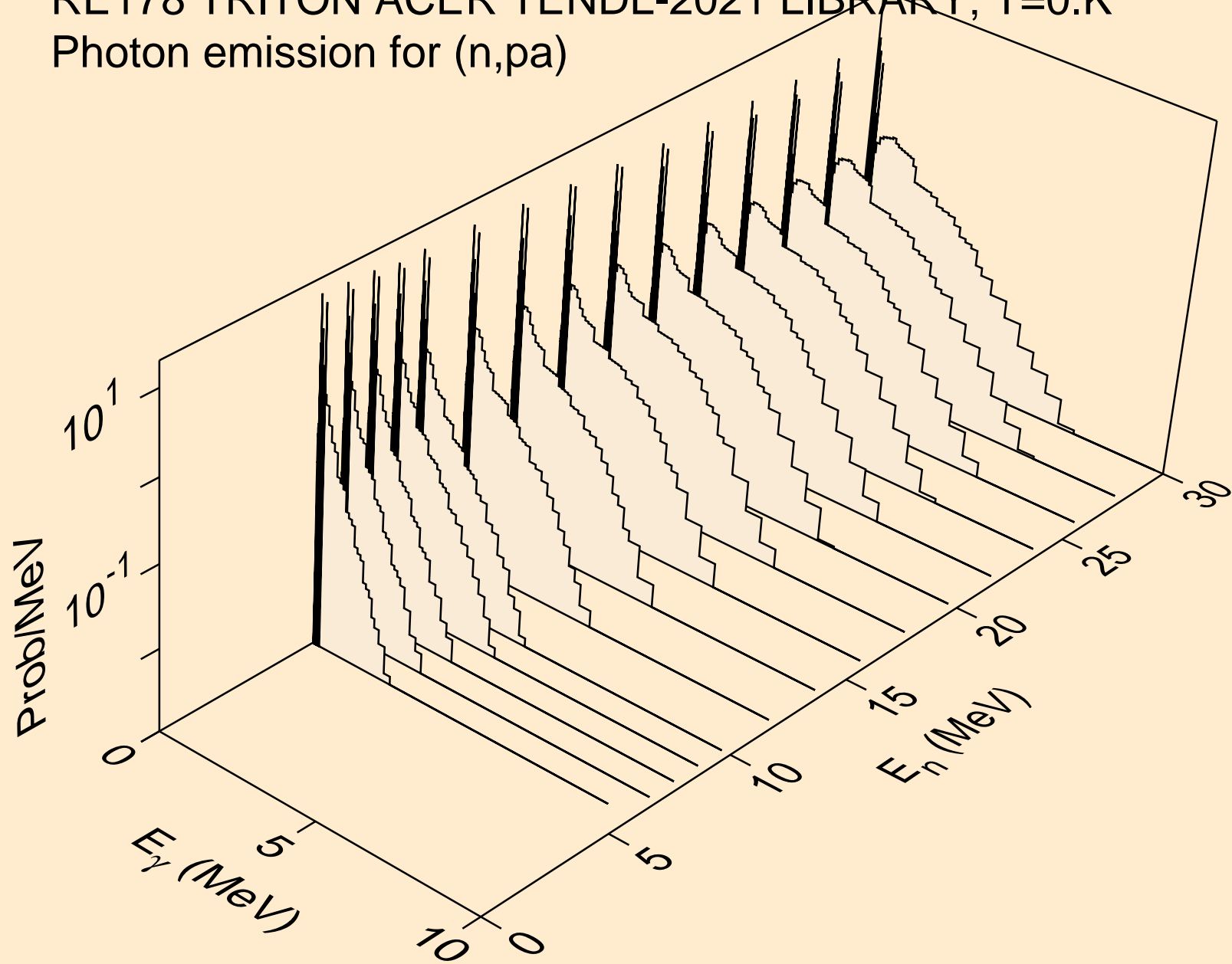

RE178 TRITON ACER TENDL-2021 LIBRARY; T=0.K  
Photon emission for (n,pd)

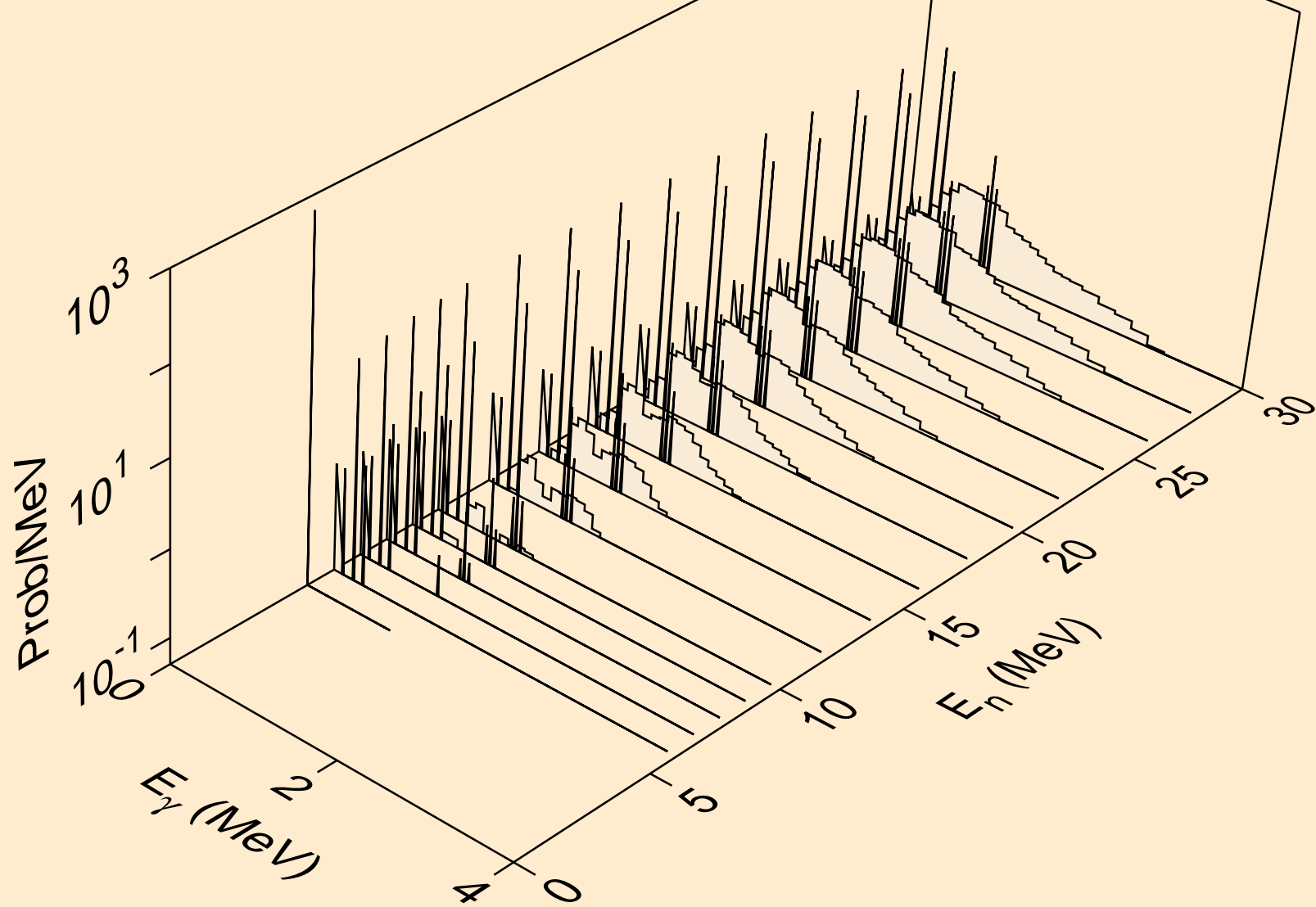

RE178 TRITON ACER TENDL-2021 LIBRARY; T=0.K  
Photon emission for (n,pt)

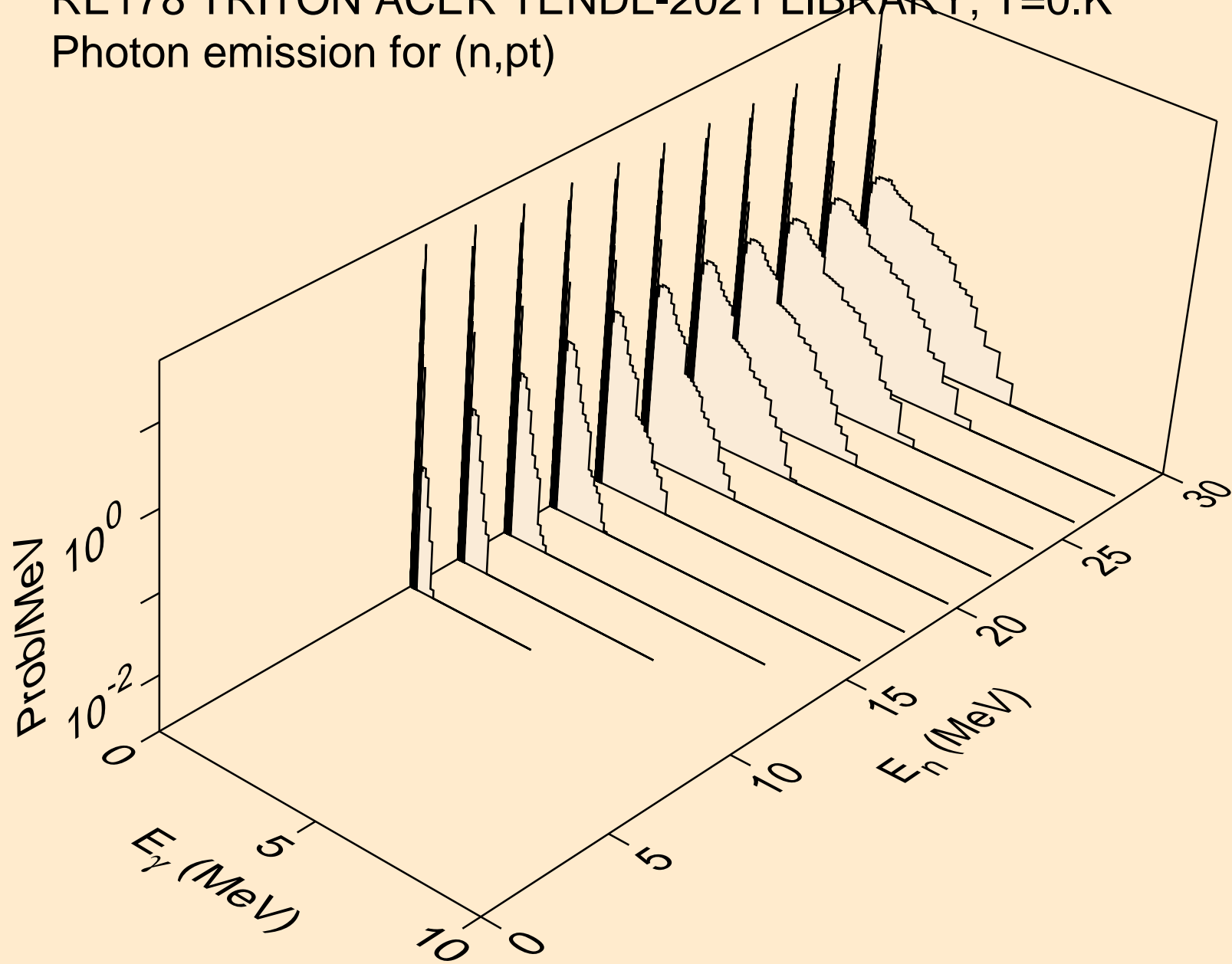

RE178 TRITON ACER TENDL-2021 LIBRARY; T=0.K  
Photon emission for (n,da)

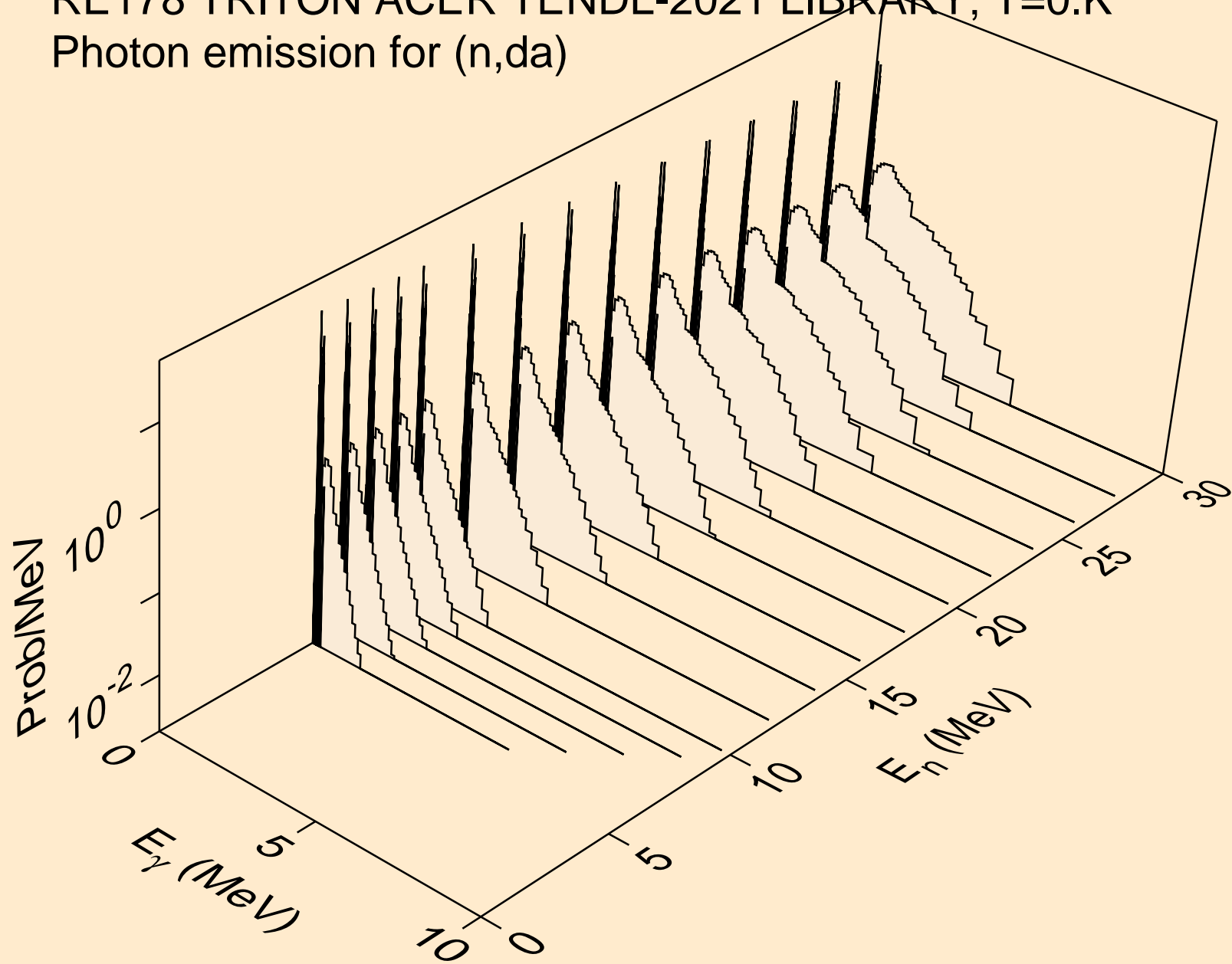

RE178 TRITON ACER TENDL-2021 LIBRARY; T=0.K  
Particle heating contributions

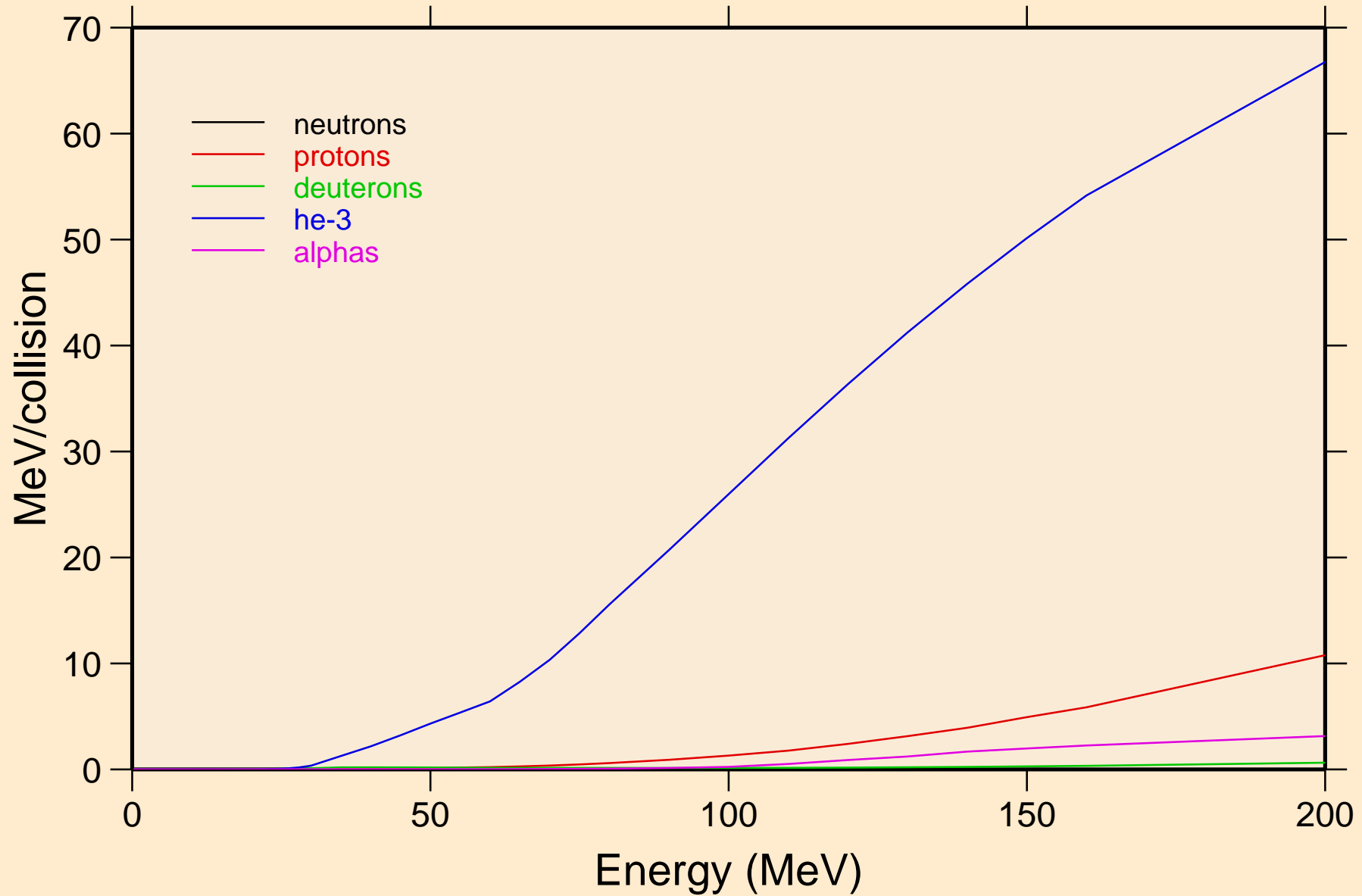

RE178 TRITON ACER TENDL-2021 LIBRARY; T=0.K  
Recoil Heating

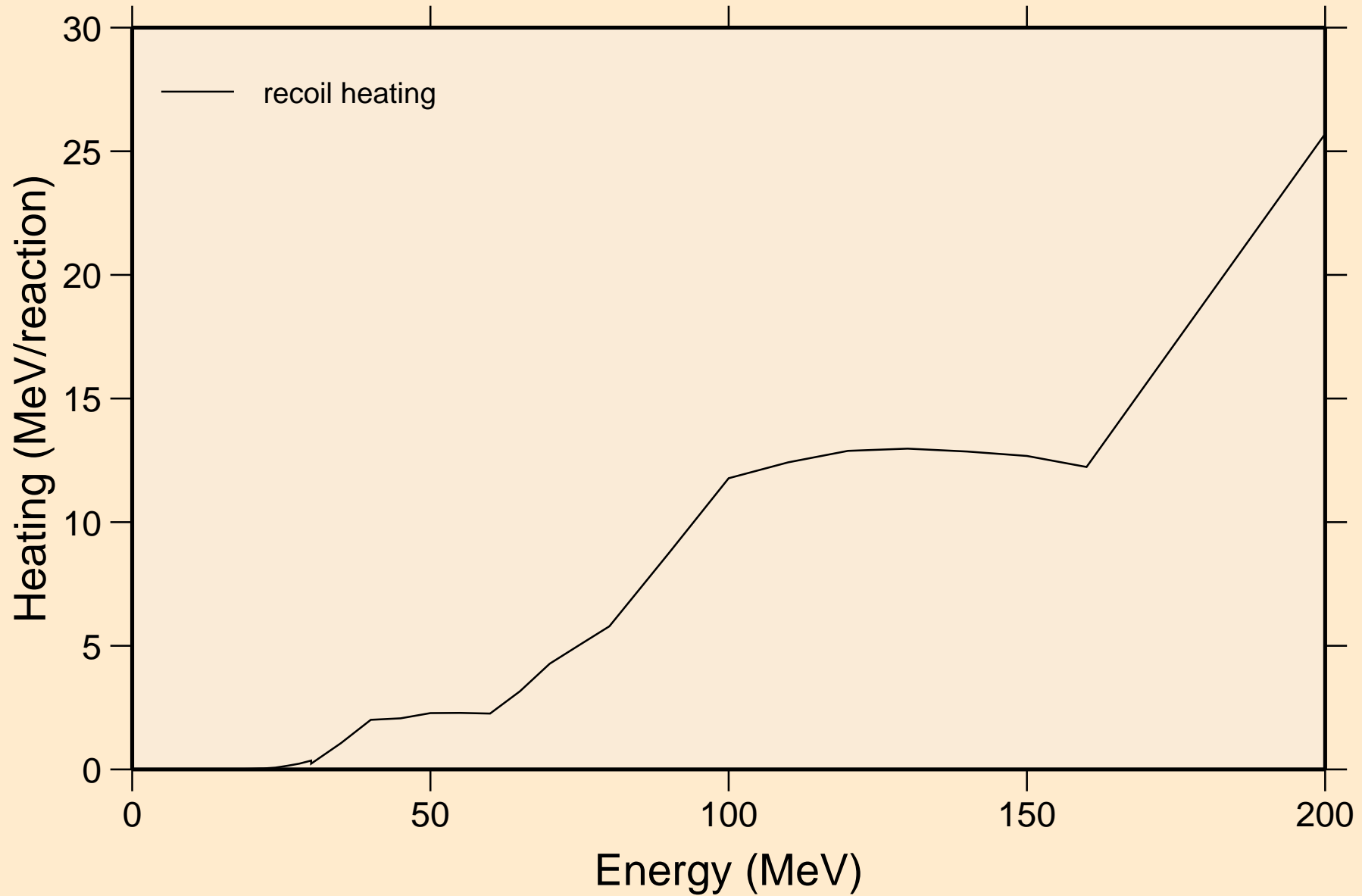

RE178 TRITON ACER TENDL-2021 LIBRARY; T=0.K  
Particle production cross sections

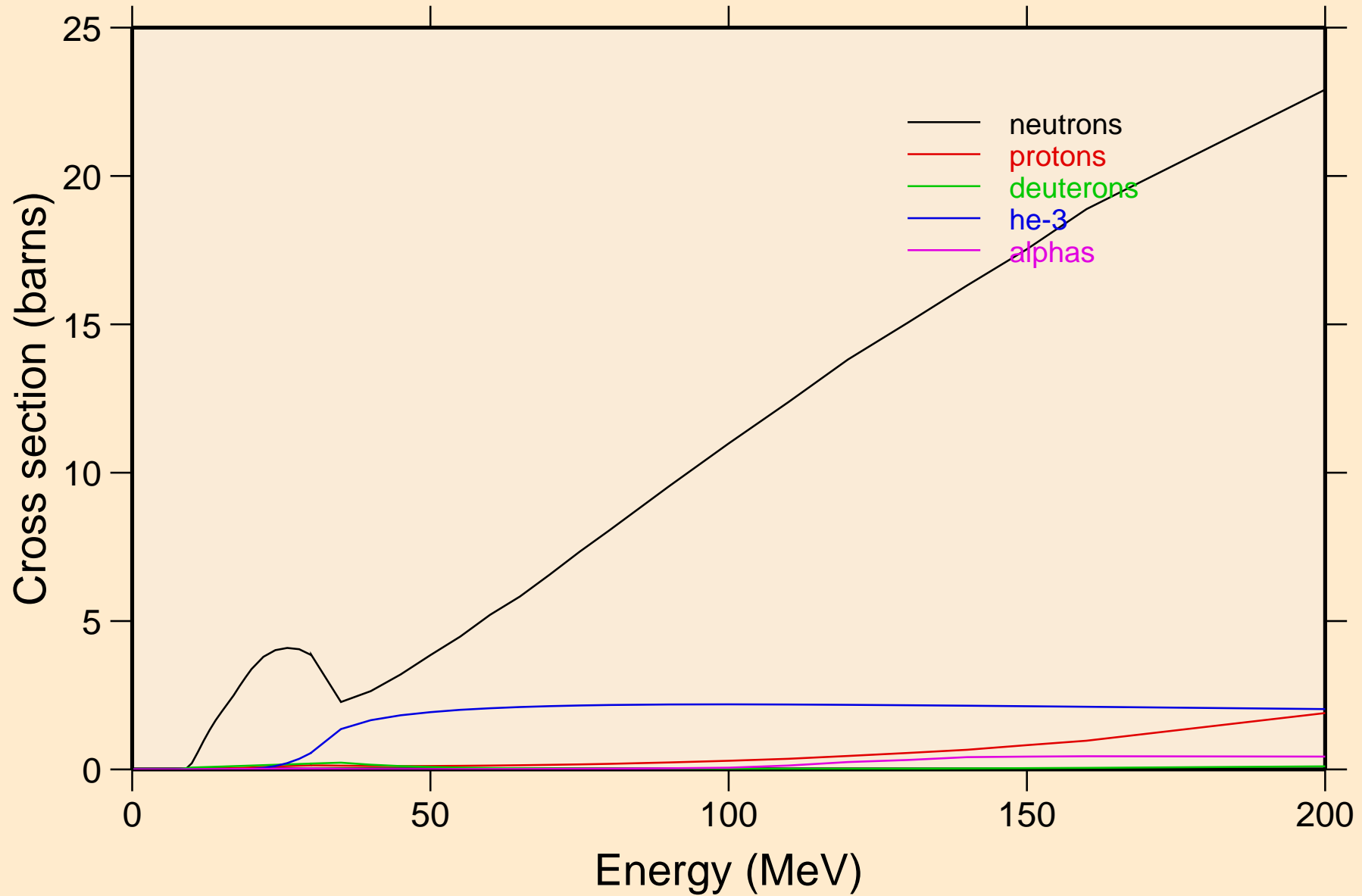

RE178 TRITON ACER TENDL-2021 LIBRARY; T=0.K  
neutrons from (t,n)

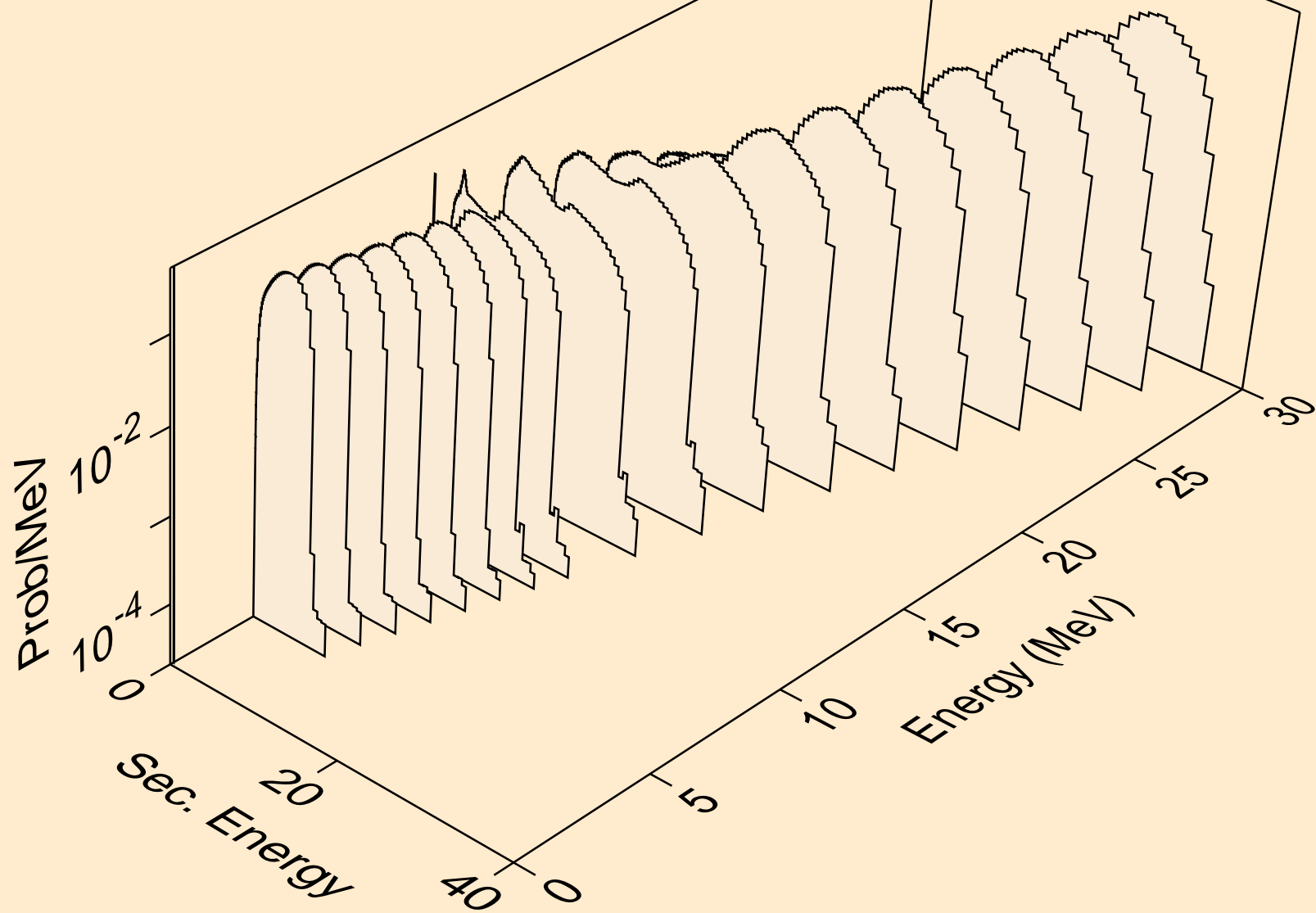



RE178 TRITON ACER TENDL-2021 LIBRARY; T=0.K  
neutrons from (t,x)

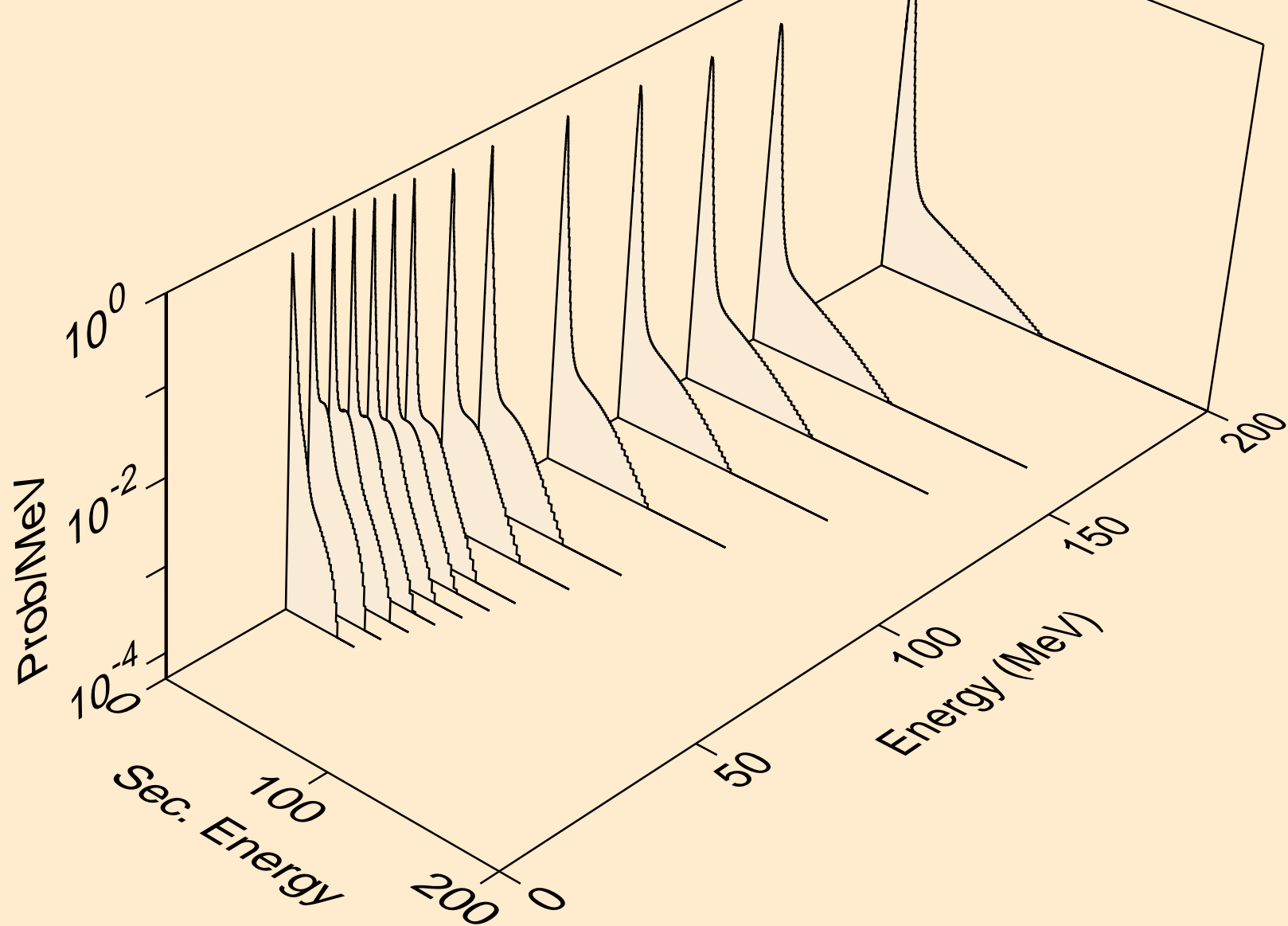

RE178 TRITON ACER TENDL-2021 LIBRARY; T=0.K  
neutrons from (t,2nd)

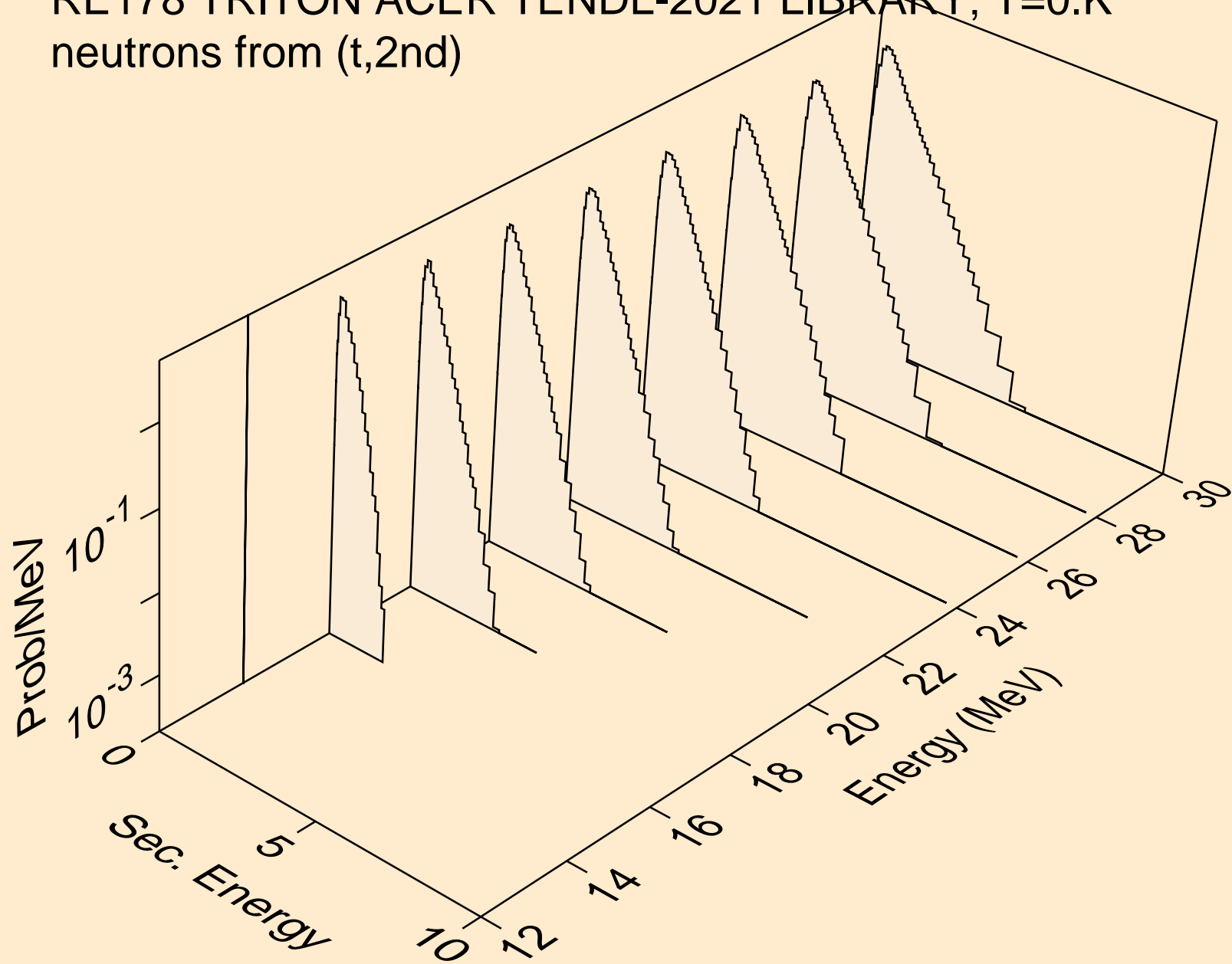

RE178 TRITON ACER TENDL-2021 LIBRARY; T=0.K  
neutrons from (t,2n)

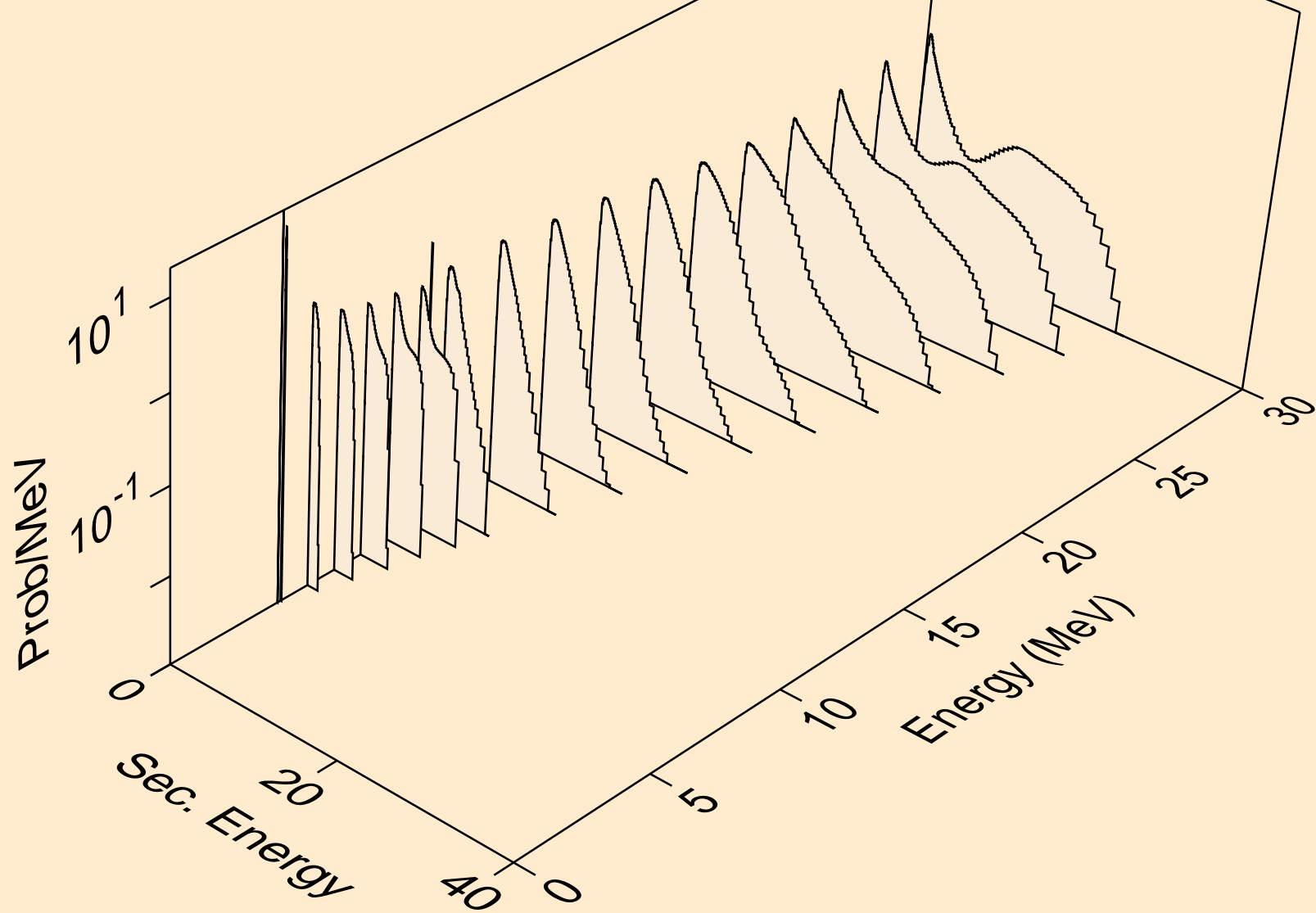

RE178 TRITON ACER TENDL-2021 LIBRARY; T=0.K  
neutrons from (t,3n)

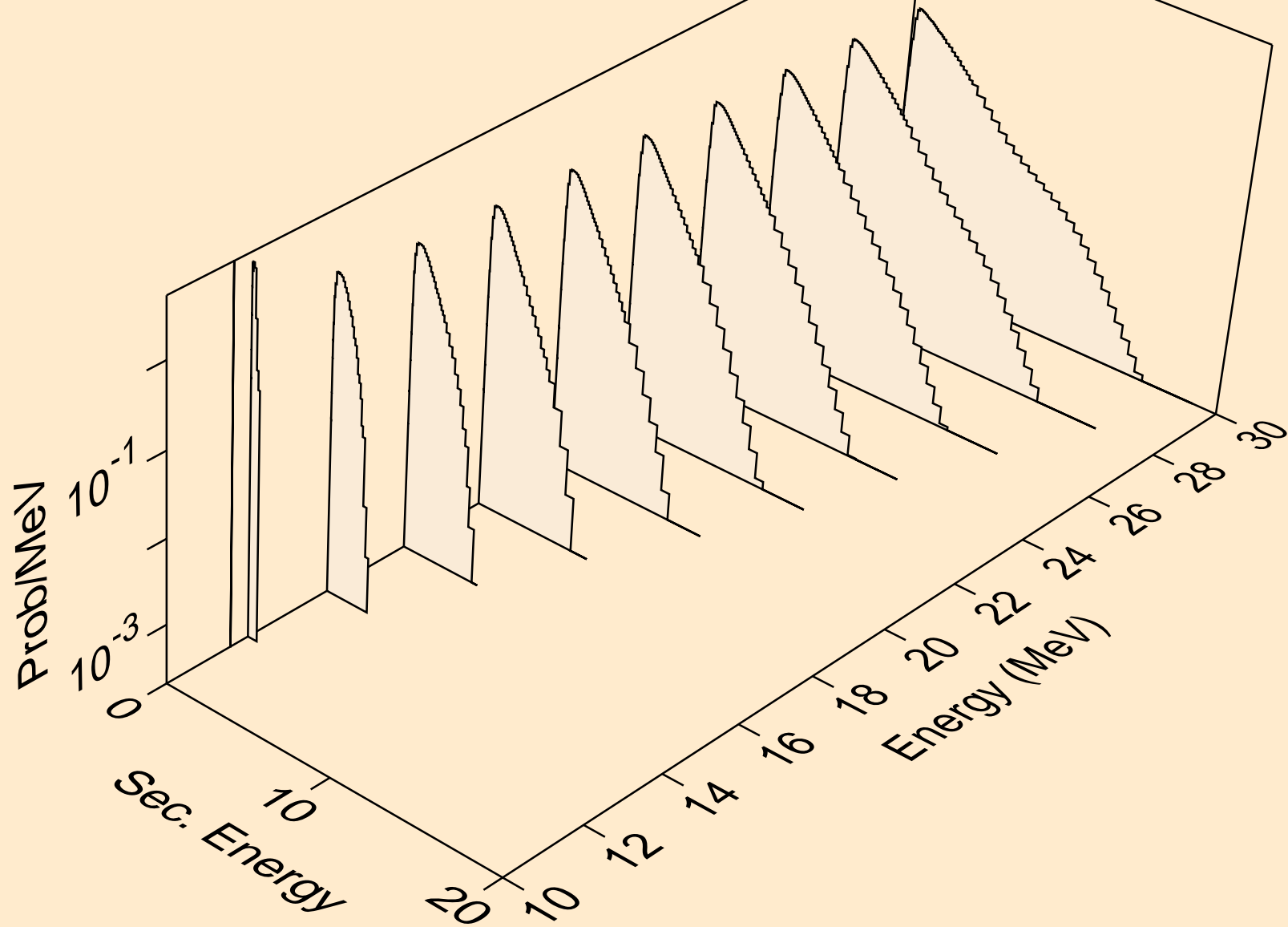

RE178 TRITON ACER TENDL-2021 LIBRARY; T=0.K  
neutrons from (t,n\*)a

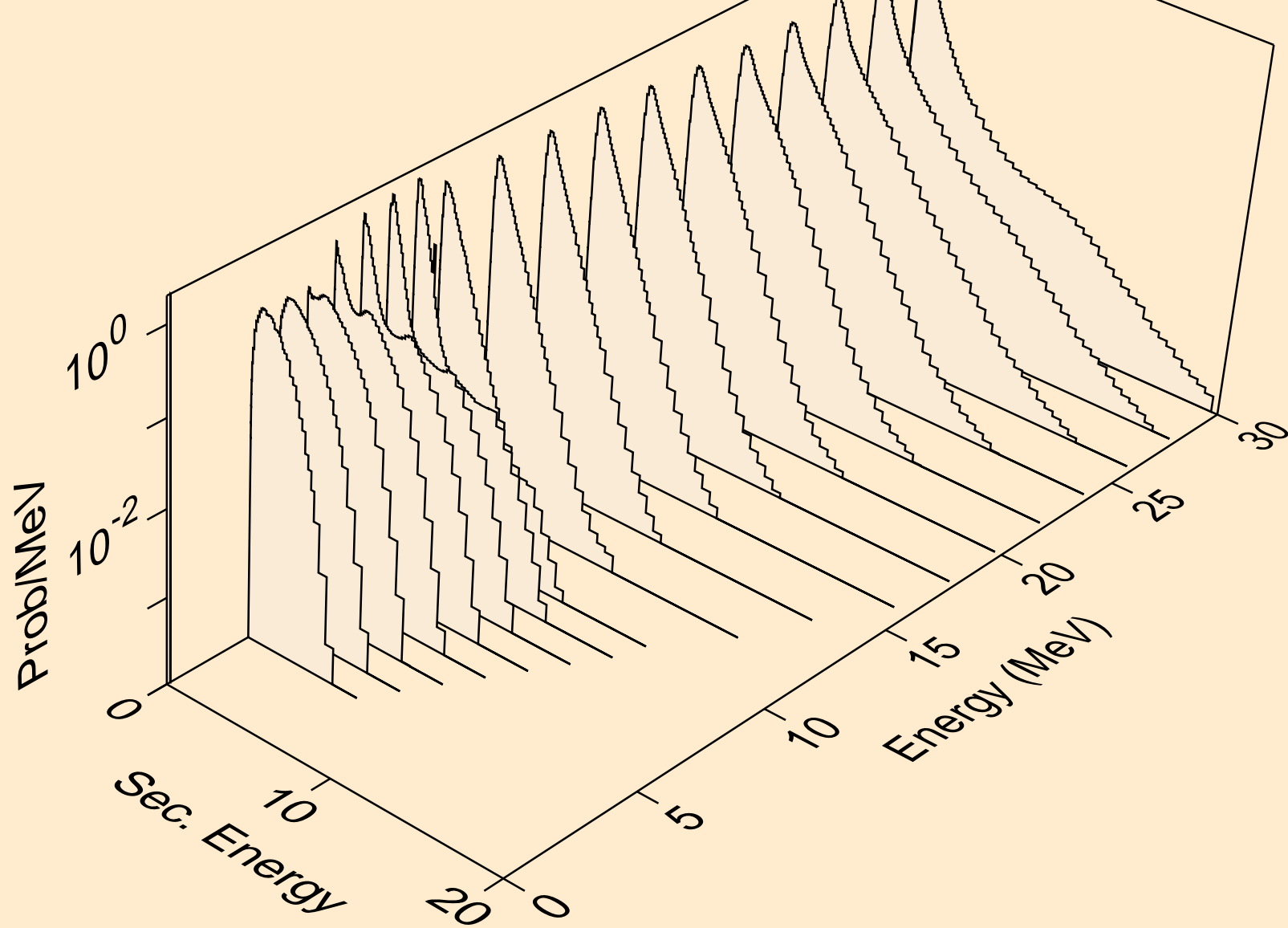

RE178 TRITON ACER TENDL-2021 LIBRARY; T=0.K  
neutrons from (t,2n)a

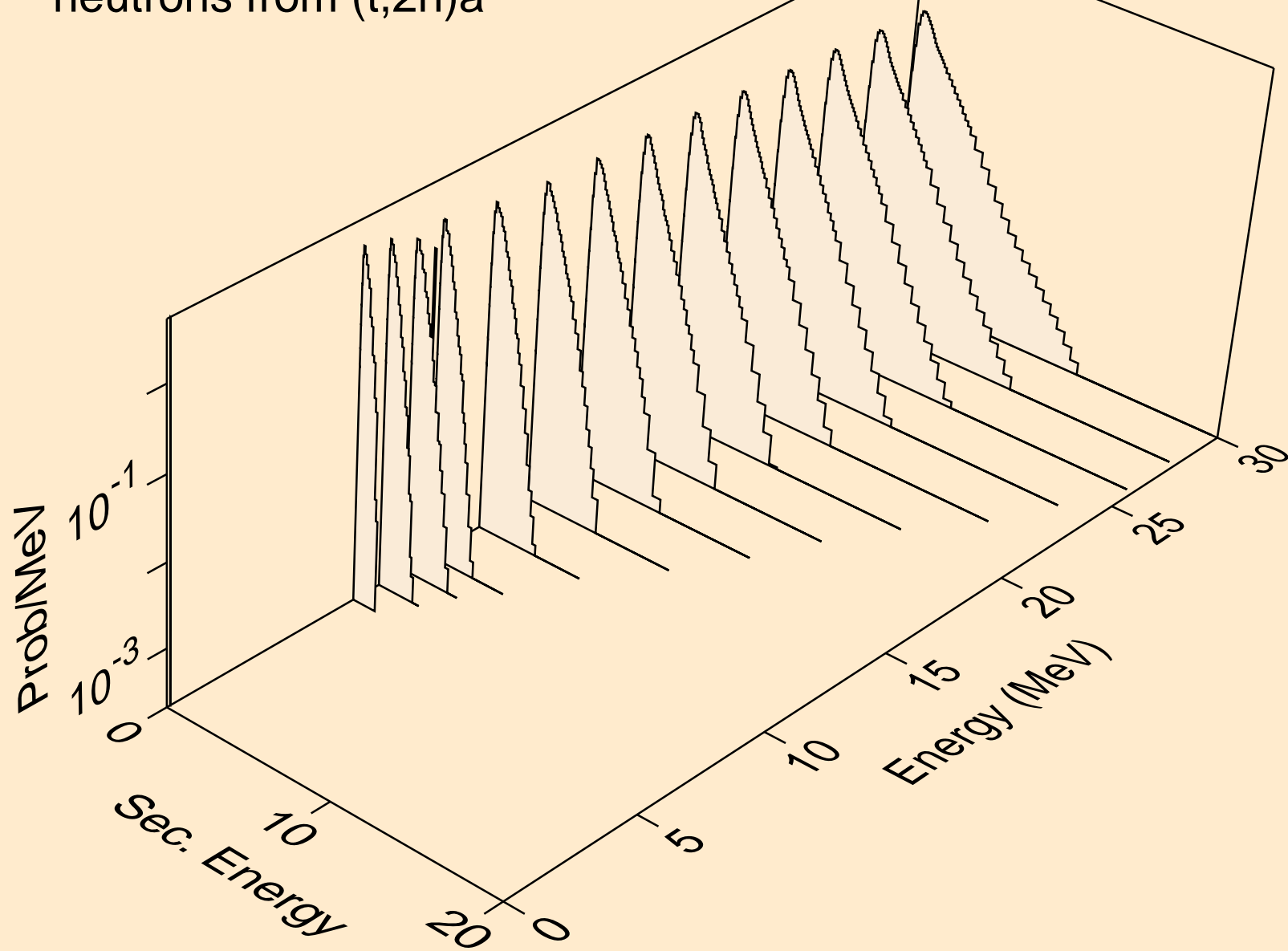

RE178 TRITON ACER TENDL-2021 LIBRARY; T=0.K  
neutrons from (t,3n)a

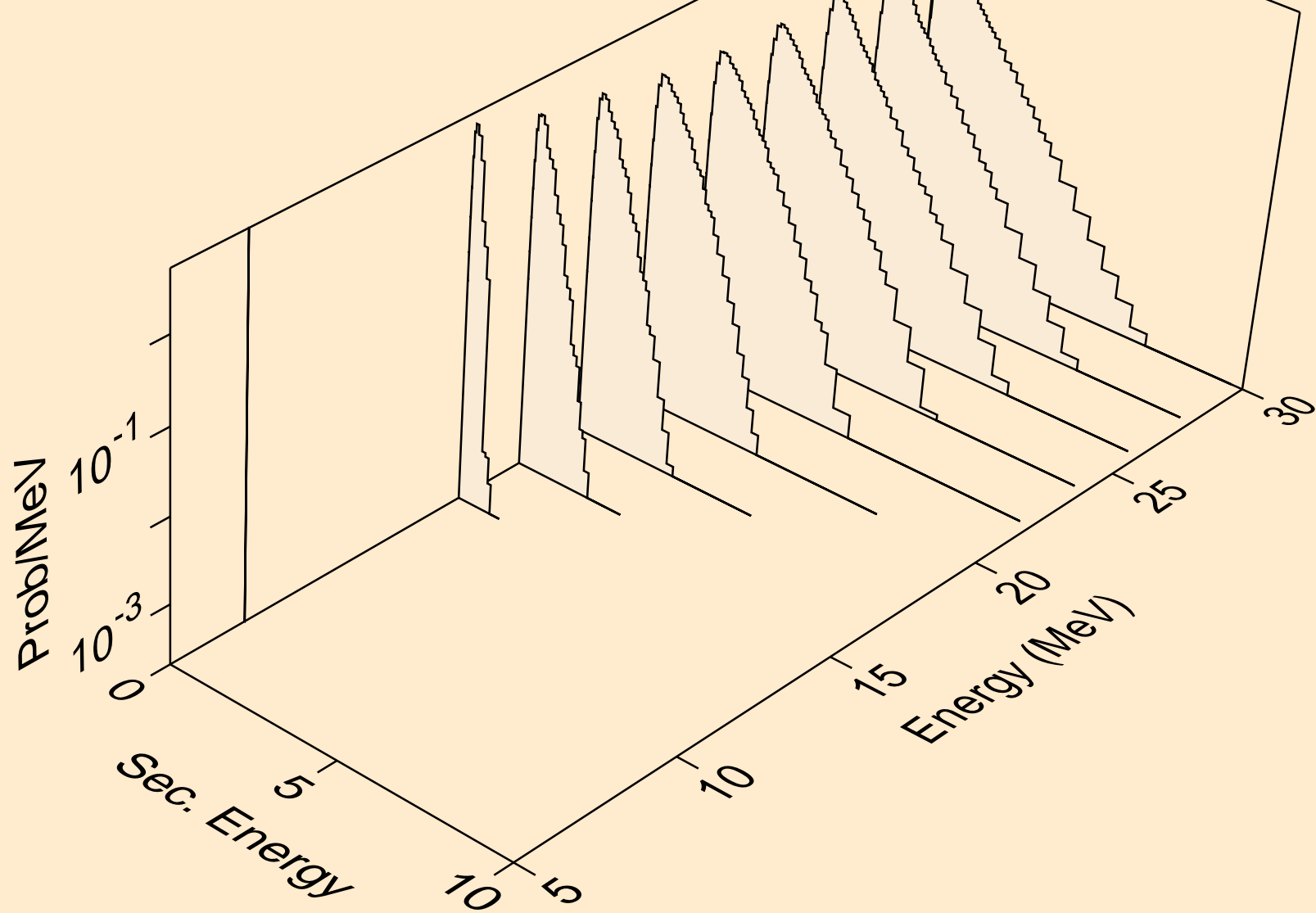

RE178 TRITON ACER TENDL-2021 LIBRARY; T=0.K  
neutrons from (t,n\*)p

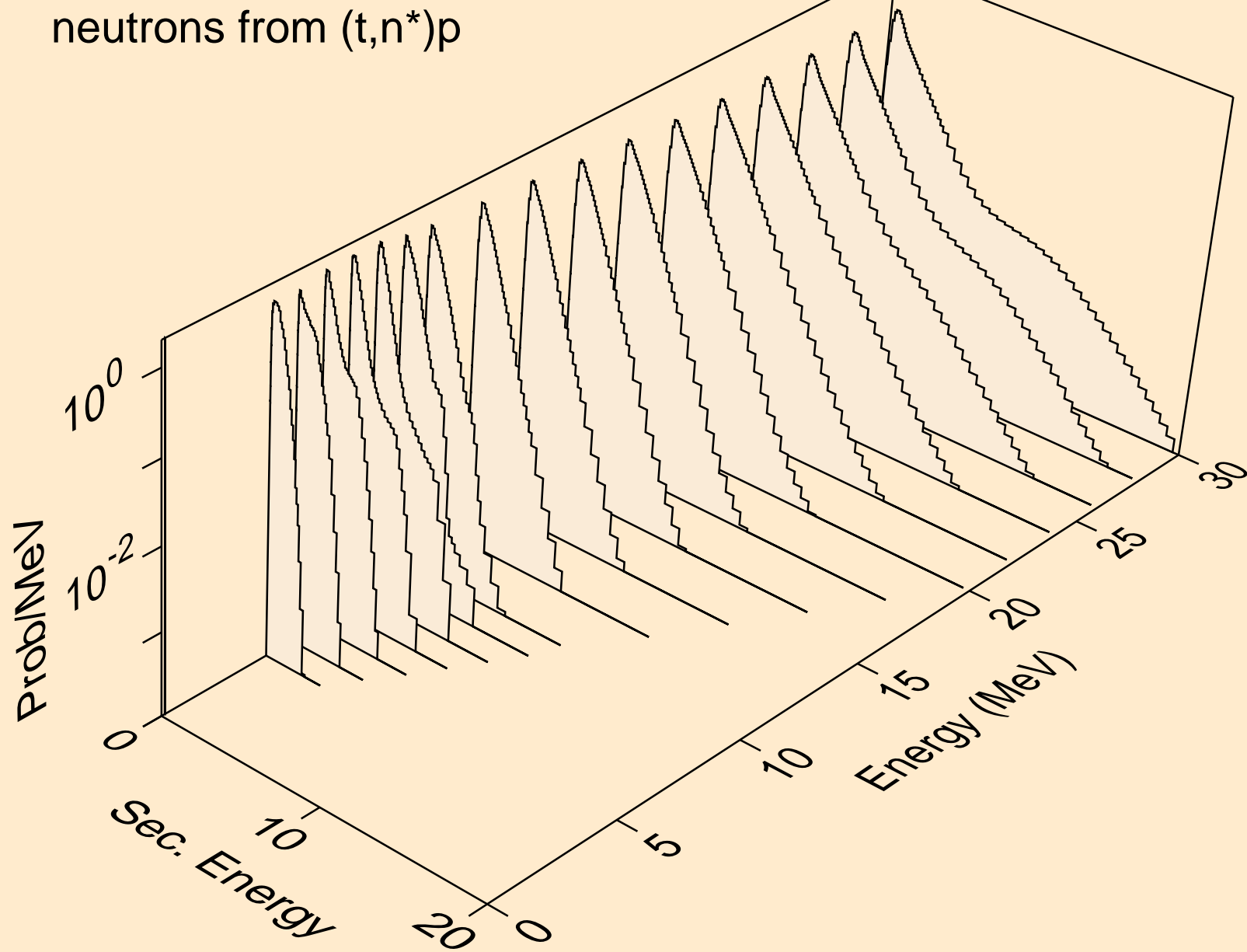



RE178 TRITON ACER TENDL-2021 LIBRARY; T=0.K  
neutrons from (t,n\*)2a

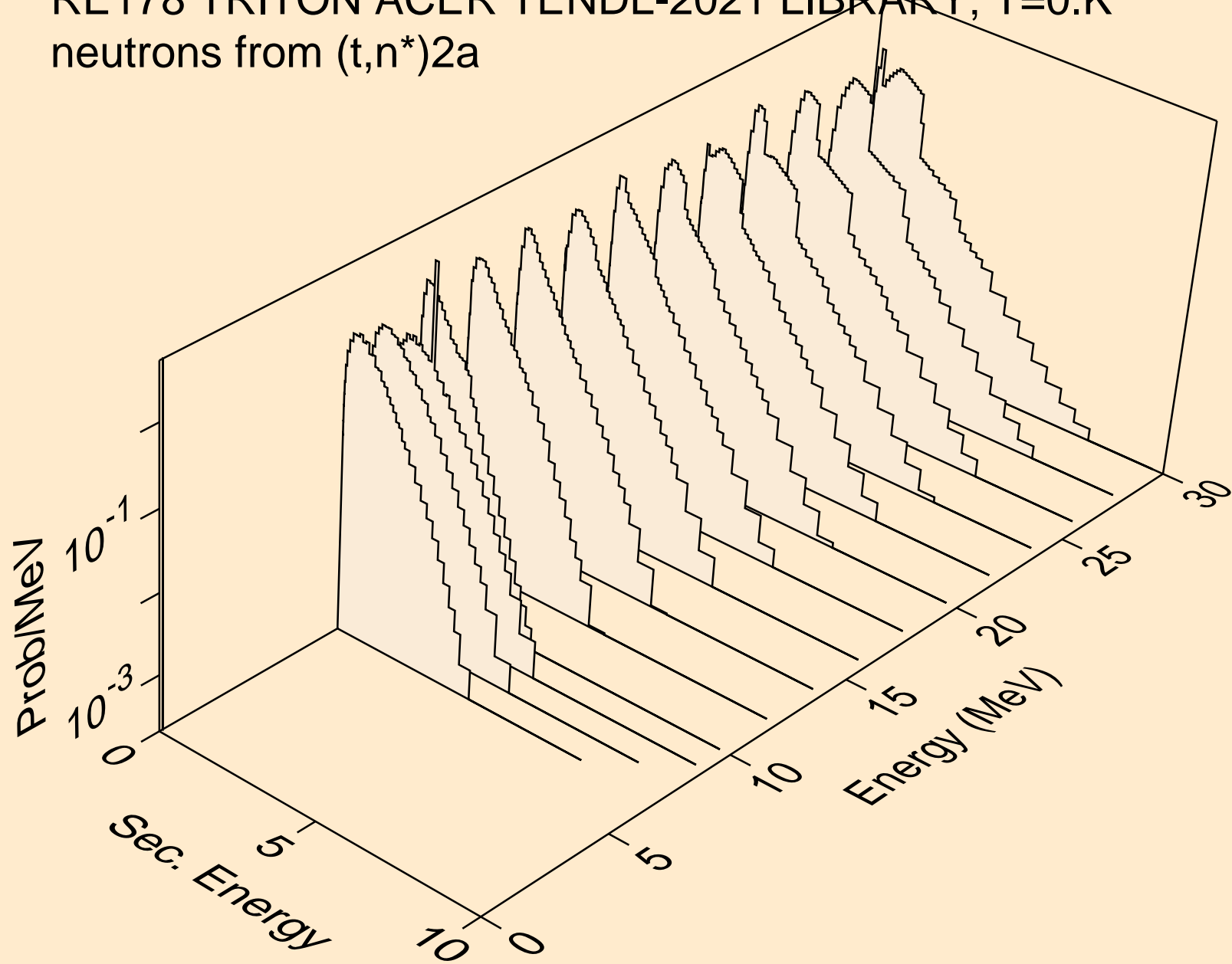

RE178 TRITON ACER TENDL-2021 LIBRARY; T=0.K  
neutrons from (t,2n)2a

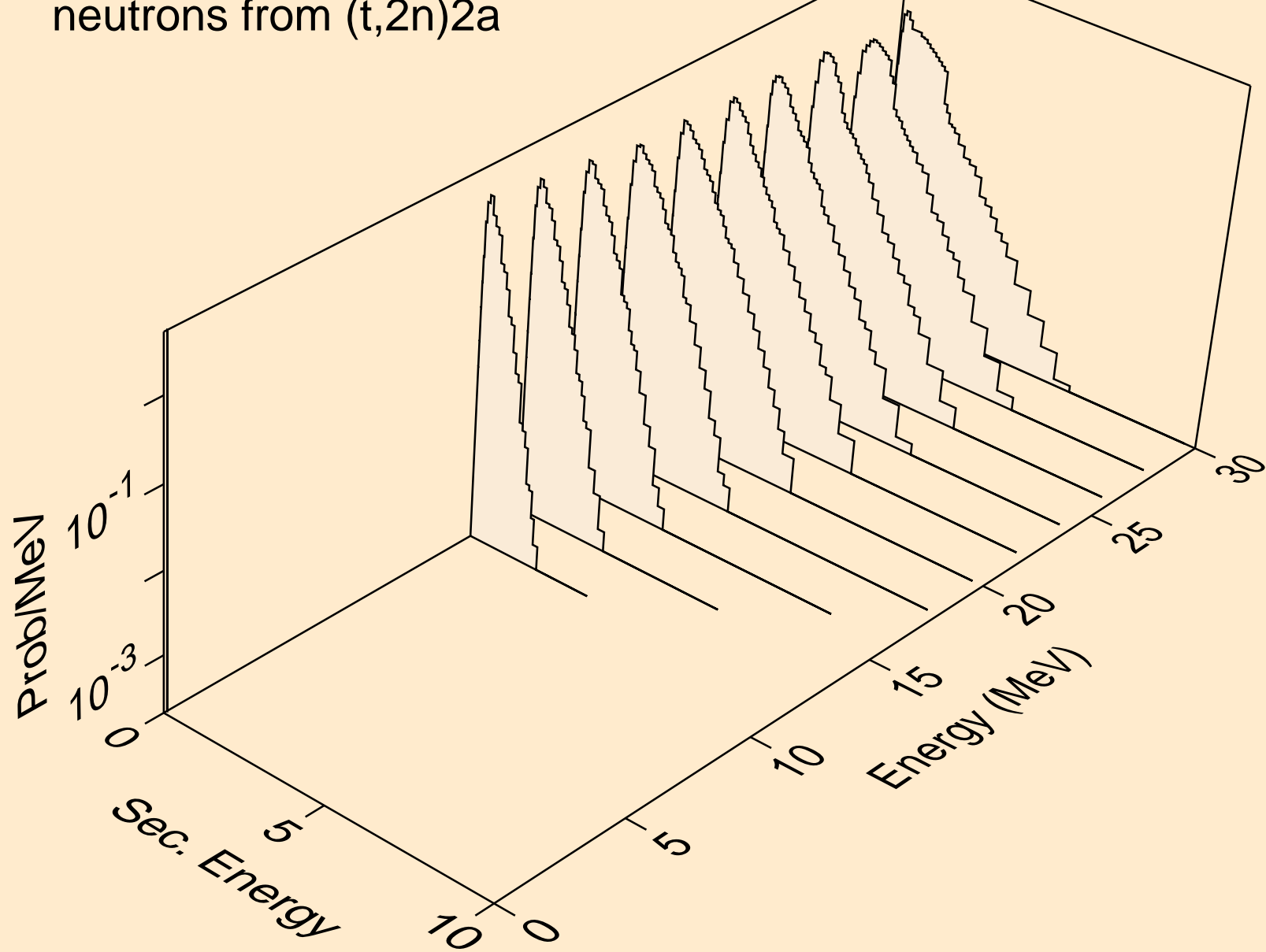

RE178 TRITON ACER TENDL-2021 LIBRARY; T=0.K  
neutrons from (t,n\*)d

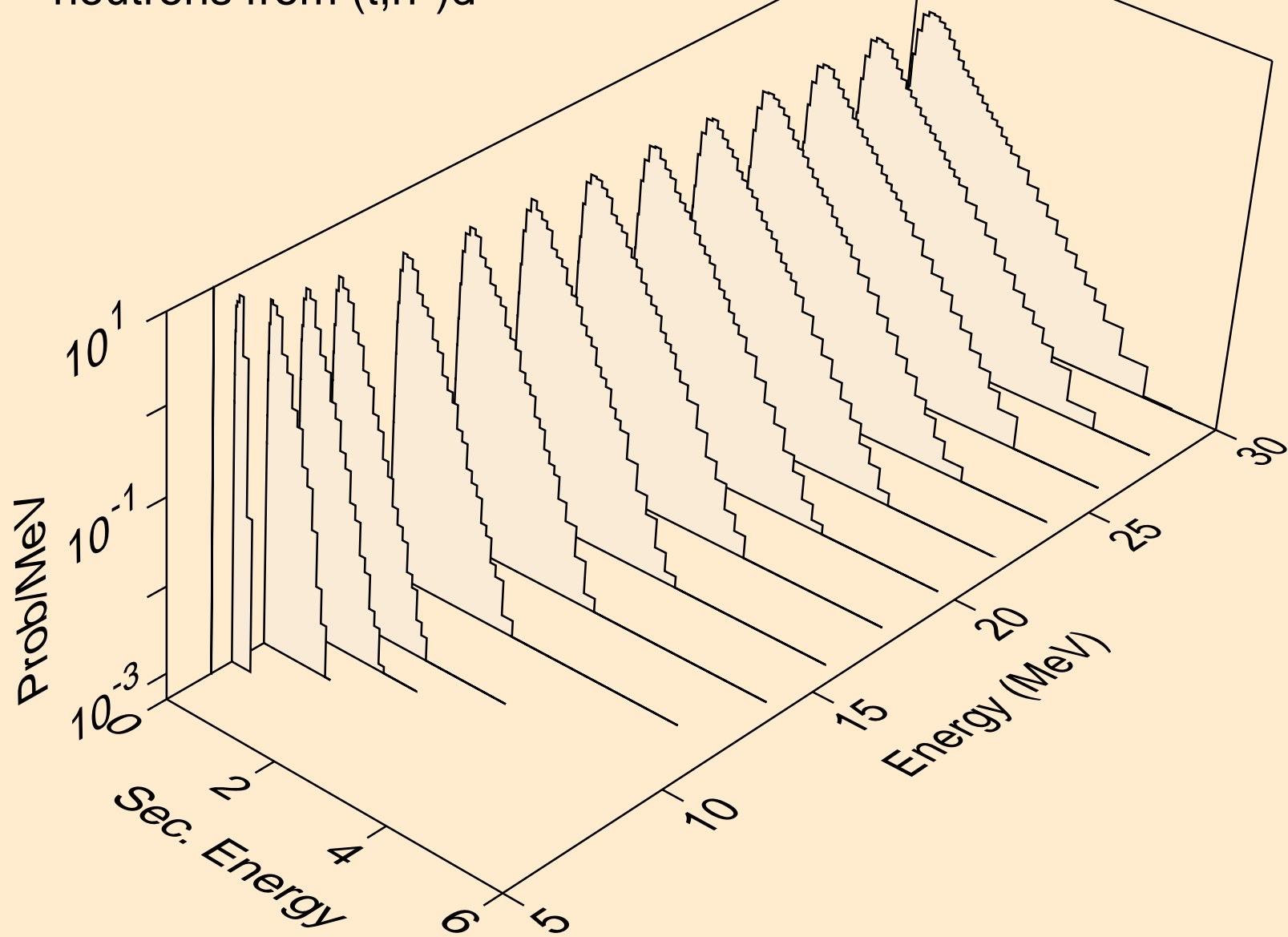

RE178 TRITON ACER TENDL-2021 LIBRARY; T=0.K  
neutrons from (t,n\*)t

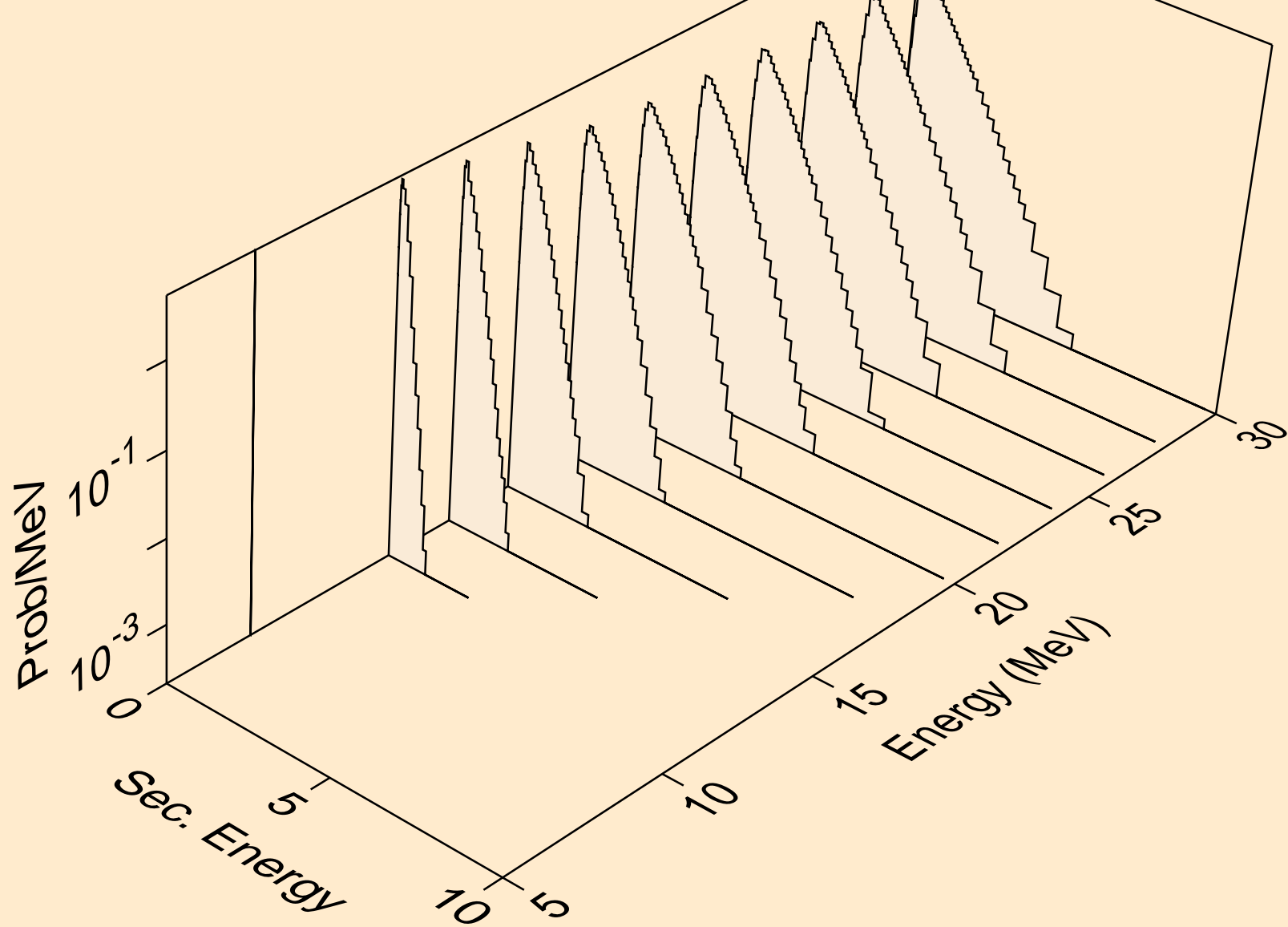

RE178 TRITON ACER TENDL-2021 LIBRARY; T=0.K  
neutrons from (t,n\*)he3

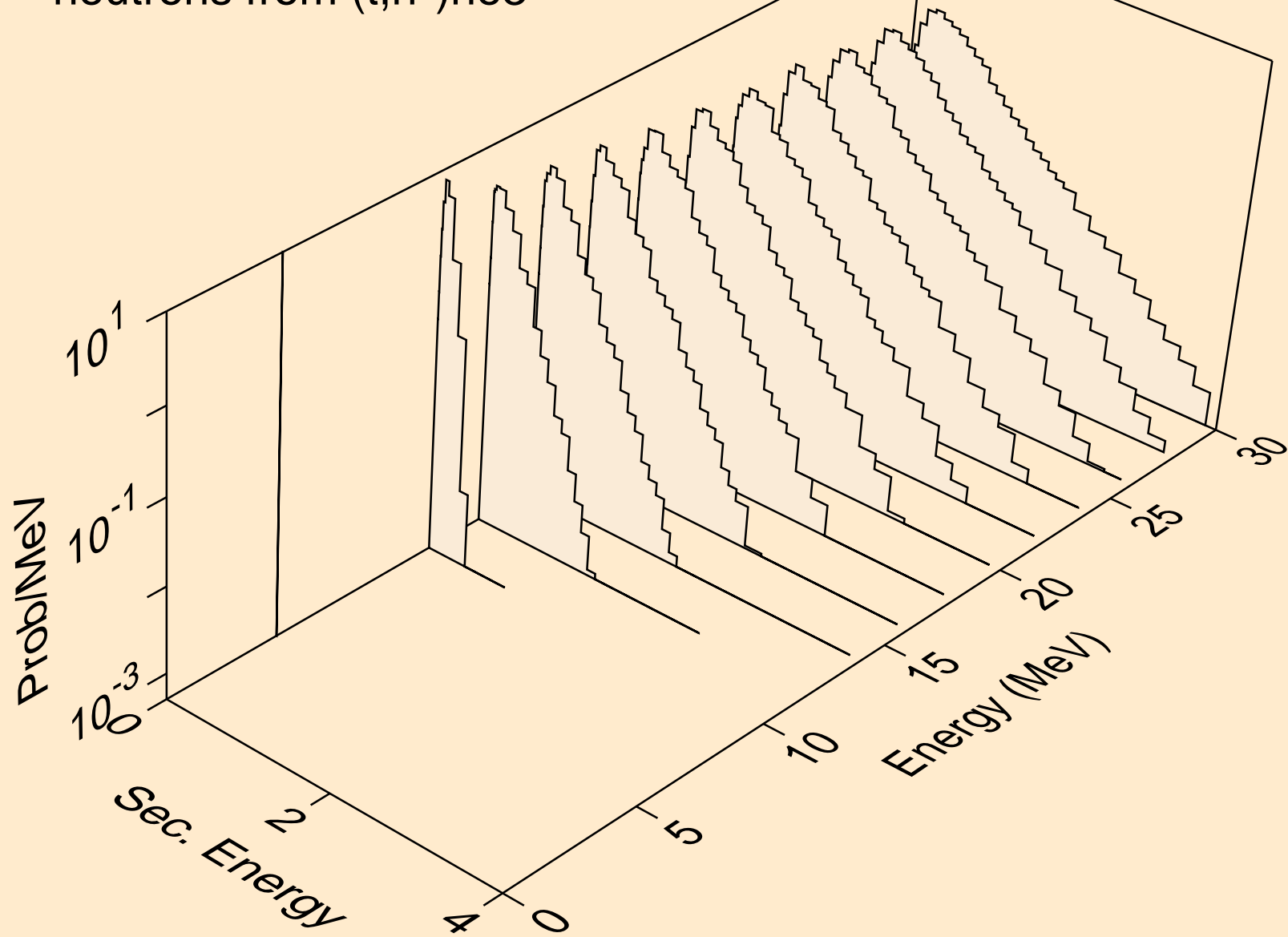

RE178 TRITON ACER TENDL-2021 LIBRARY; T=0.K  
neutrons from (t,4n)

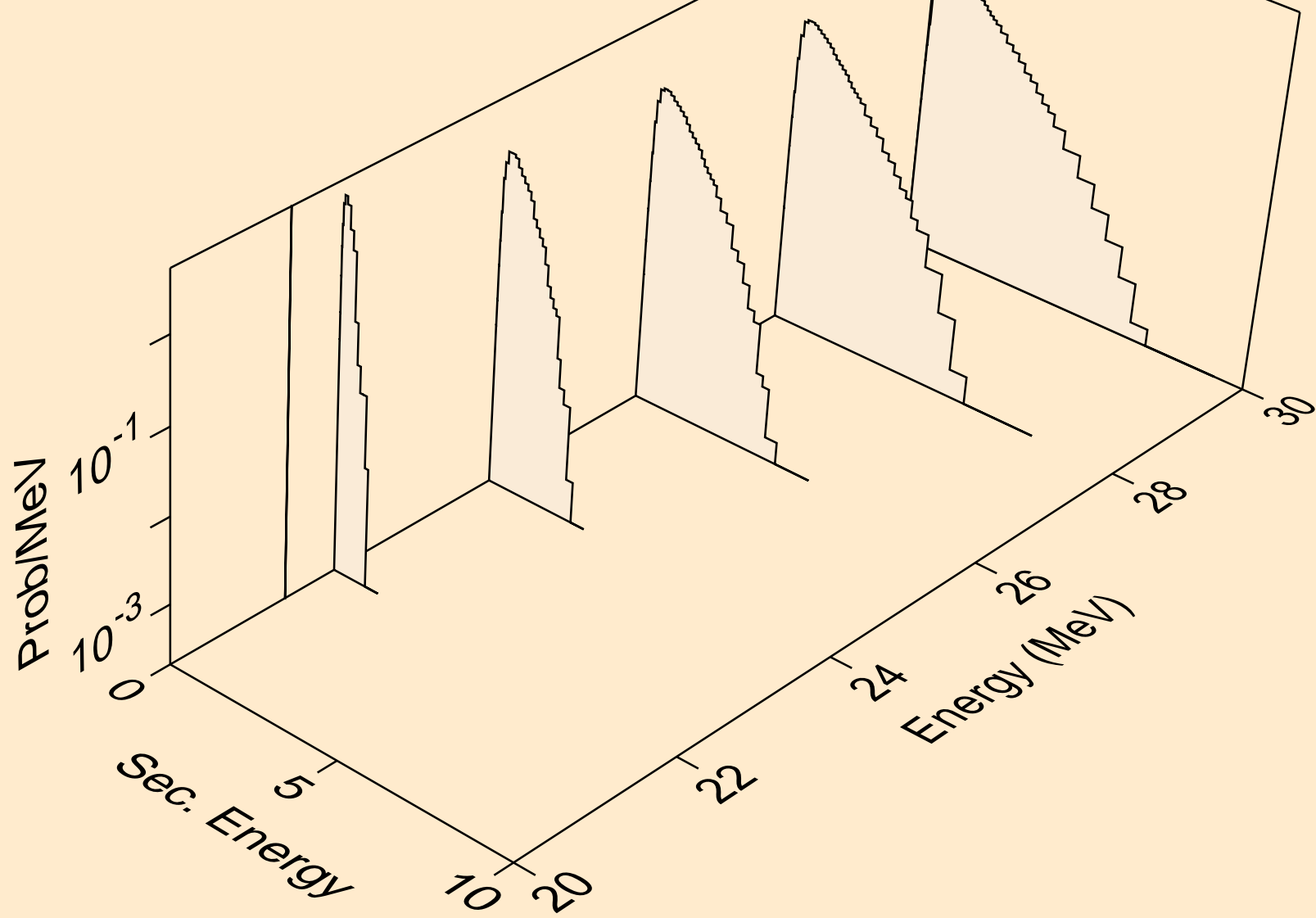

RE178 TRITON ACER TENDL-2021 LIBRARY; T=0.K  
neutrons from (t,2np)

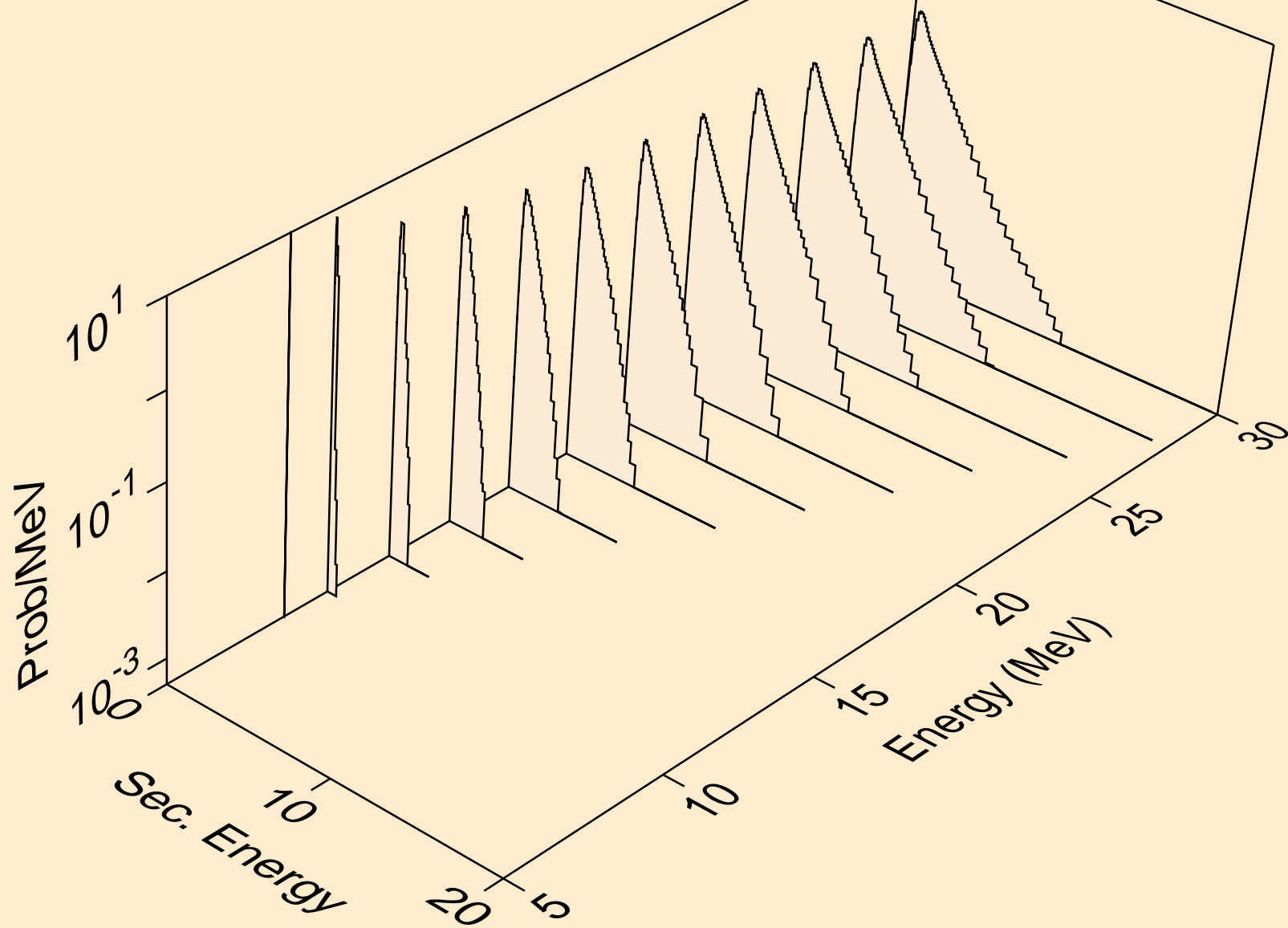

RE178 TRITON ACER TENDL-2021 LIBRARY; T=0.K  
neutrons from (t,3np)

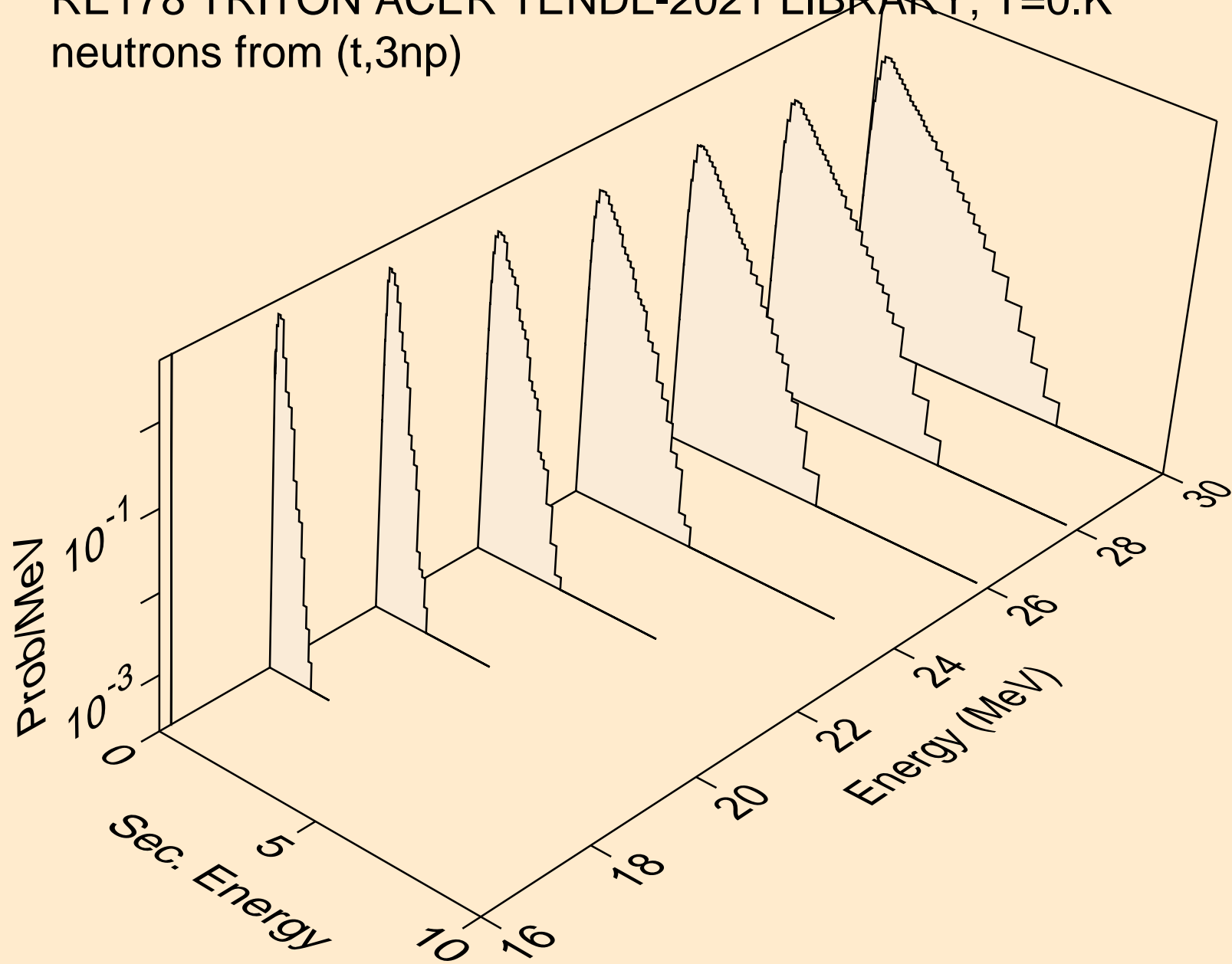



RE178 TRITON ACER TENDL-2021 LIBRARY; T=0.K  
neutrons from (t,2np)

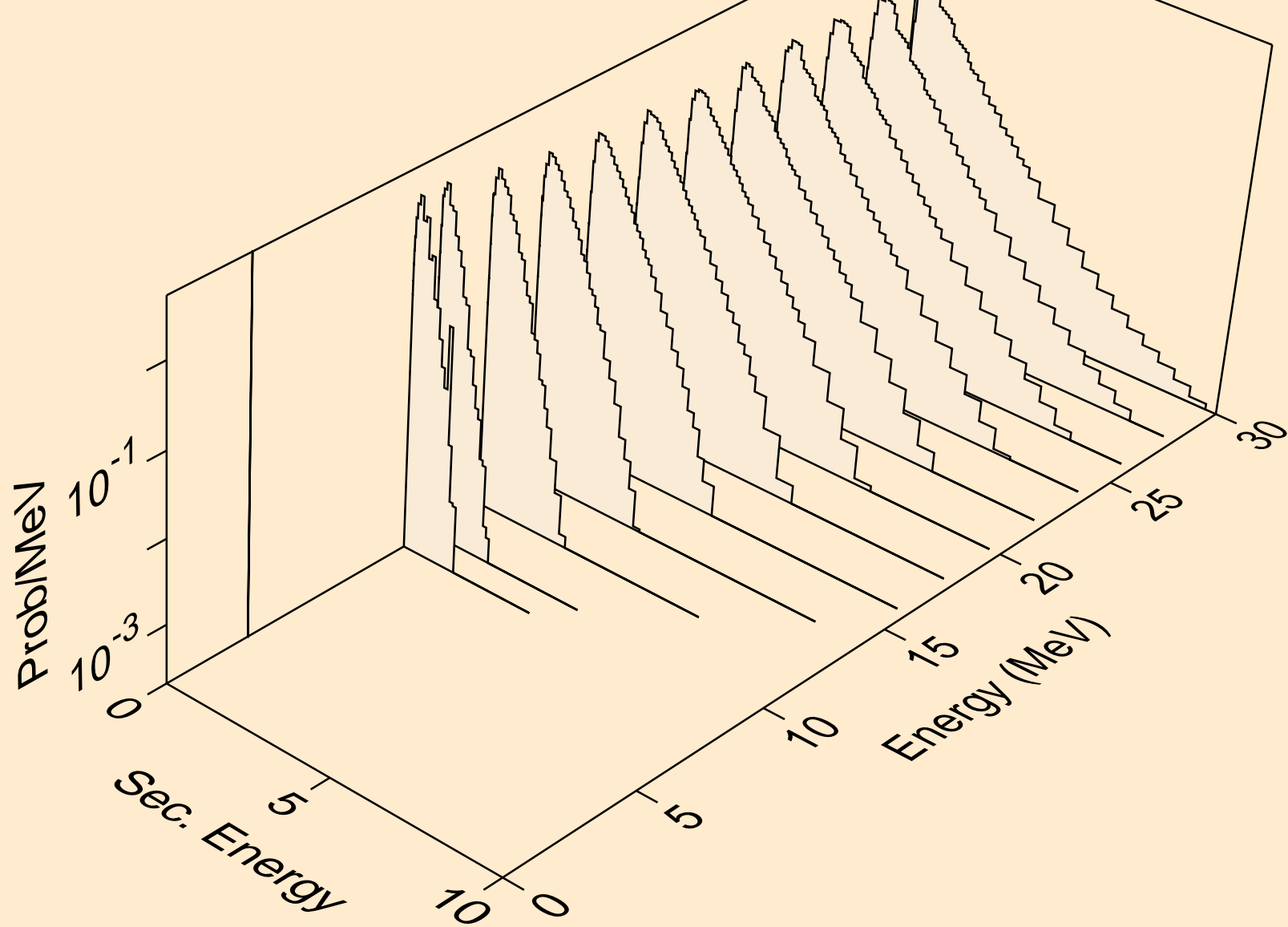

RE178 TRITON ACER TENDL-2021 LIBRARY; T=0.K  
neutrons from (t,npa)

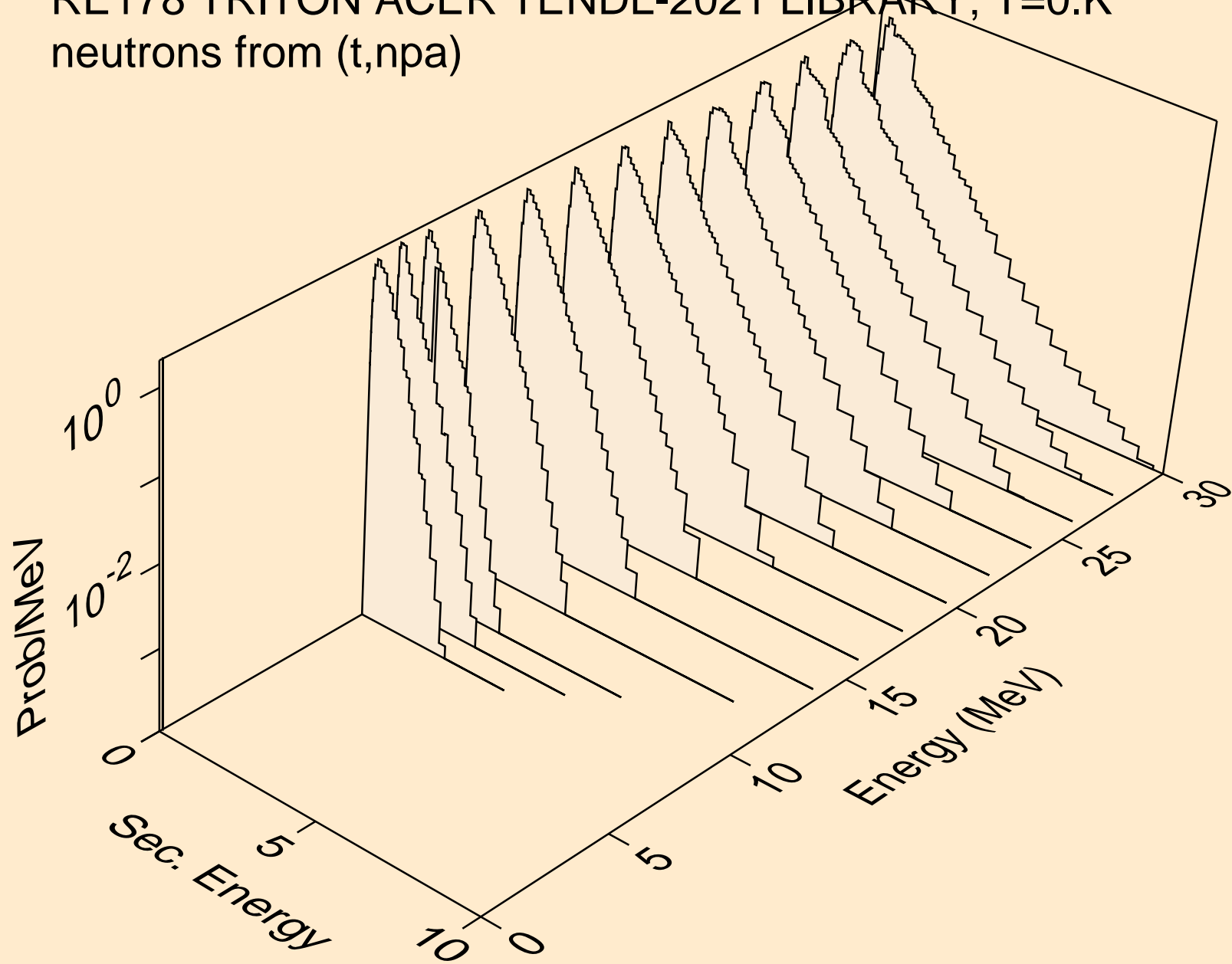

RE178 TRITON ACER TENDL-2021 LIBRARY; T=0.K  
protons from (t,x)

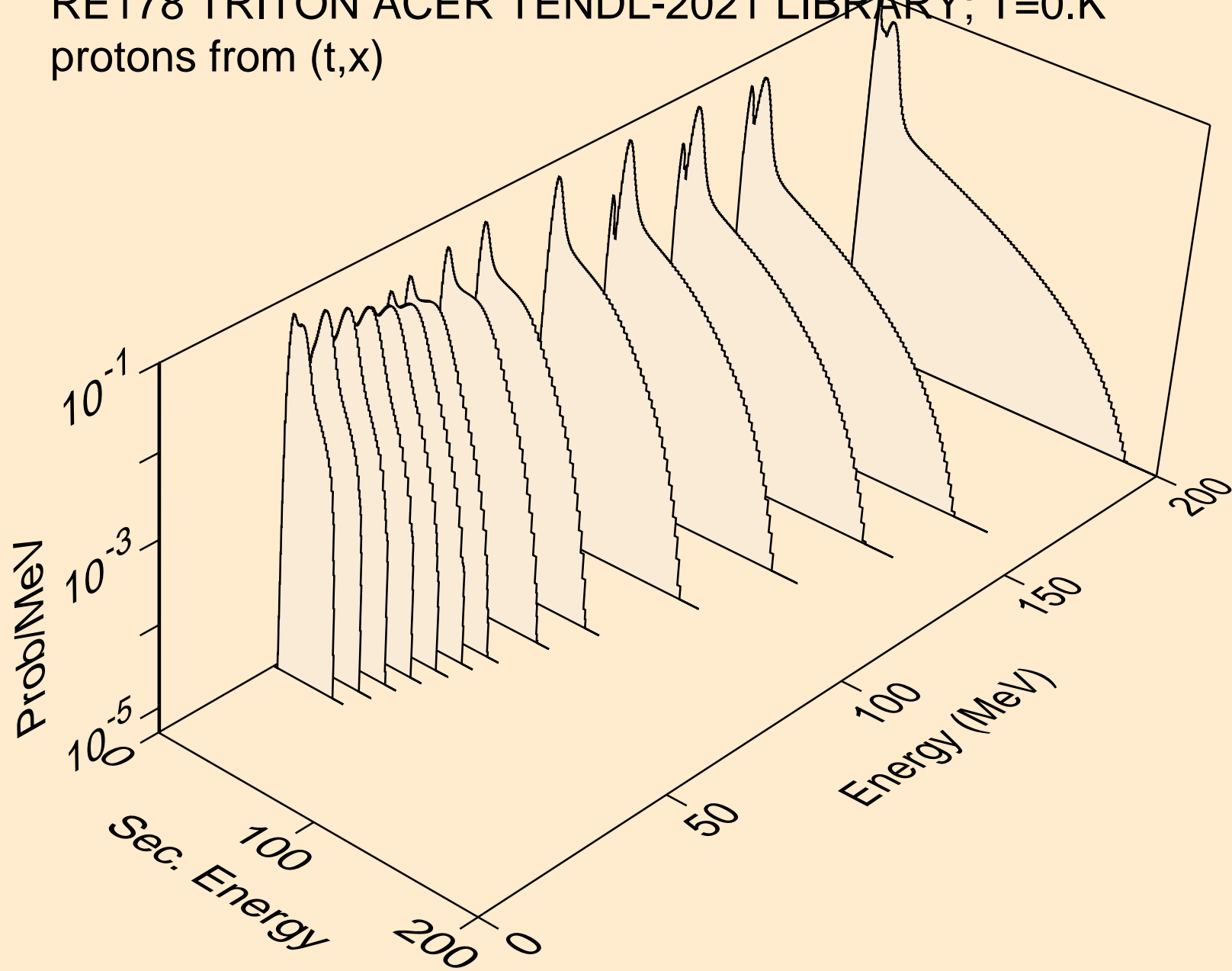

RE178 TRITON ACER TENDL-2021 LIBRARY; T=0.K  
protons from (t,n\*)p

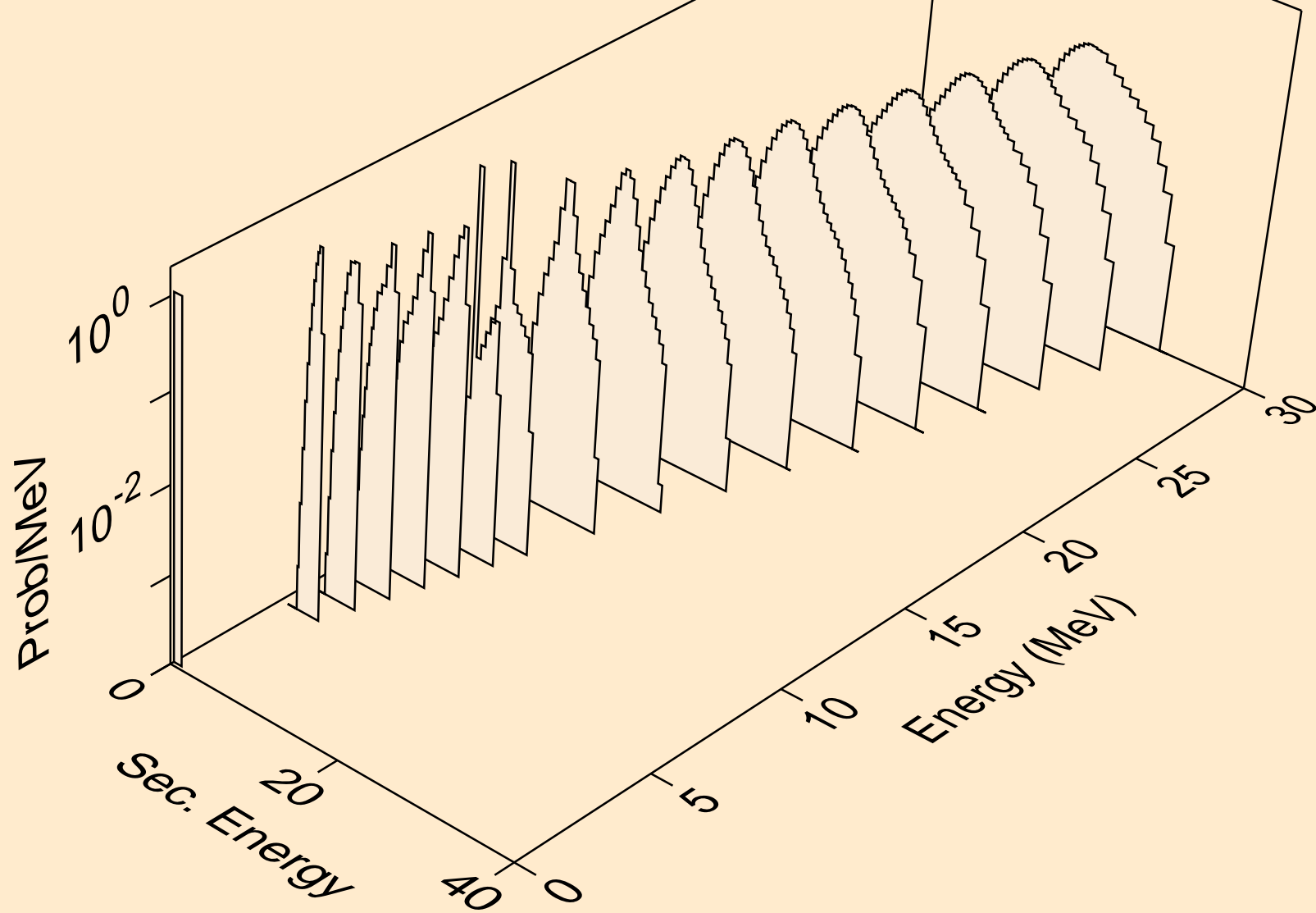

RE178 TRITON ACER TENDL-2021 LIBRARY; T=0.K  
protons from (t,2np)

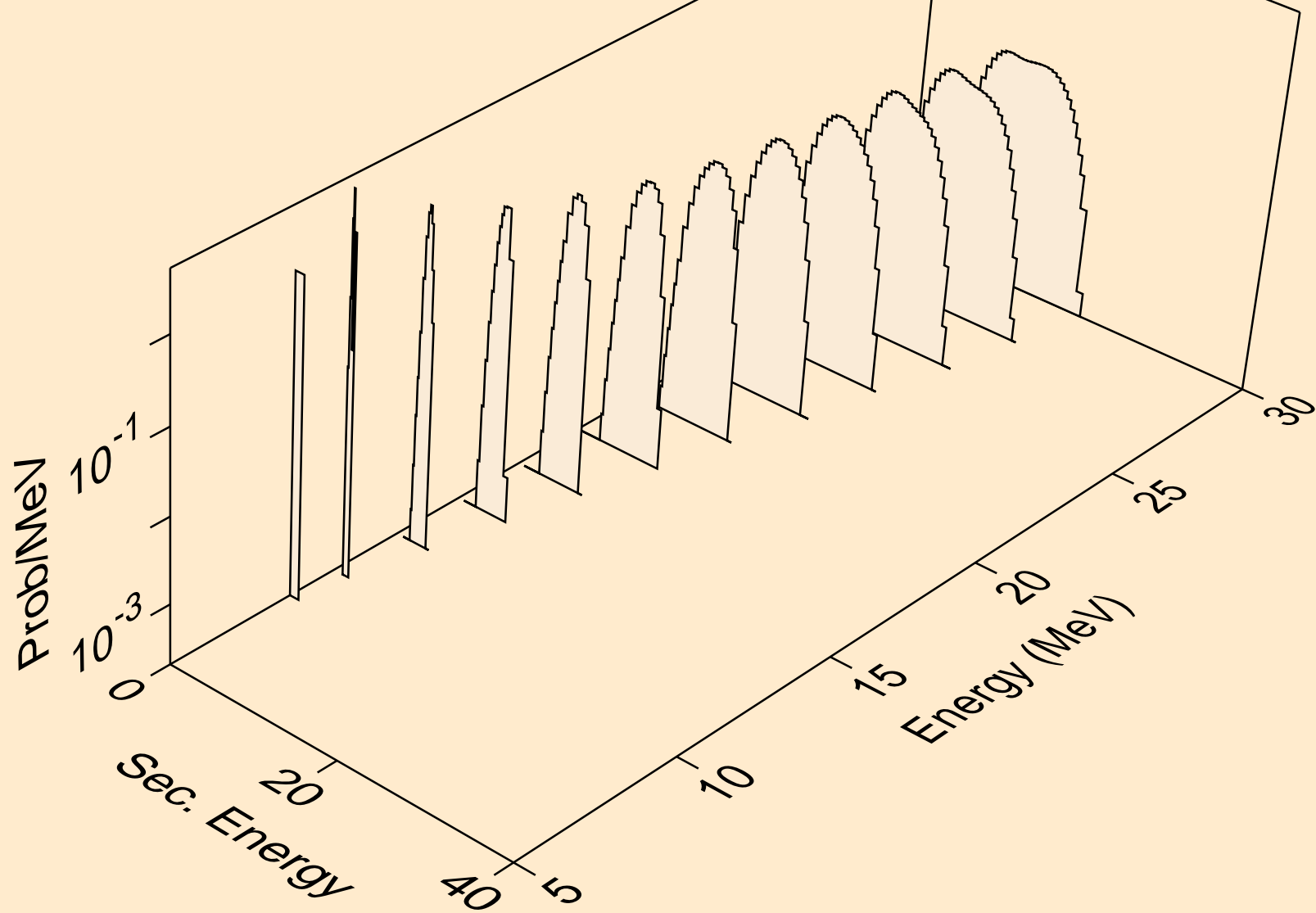

RE178 TRITON ACER TENDL-2021 LIBRARY; T=0.K  
protons from (t,3np)

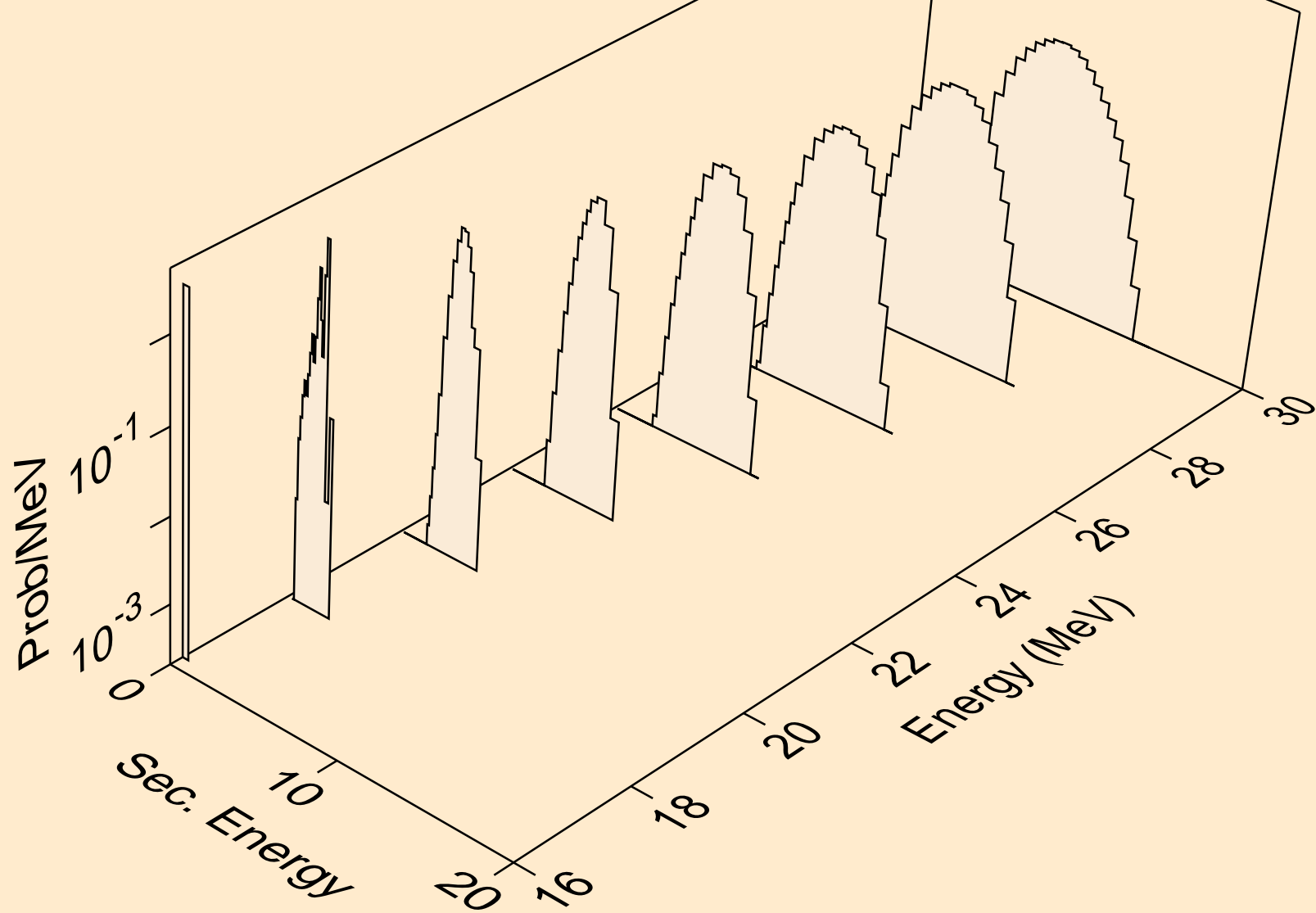

RE178 TRITON ACER TENDL-2021 LIBRARY; T=0.K  
protons from (t,2np)

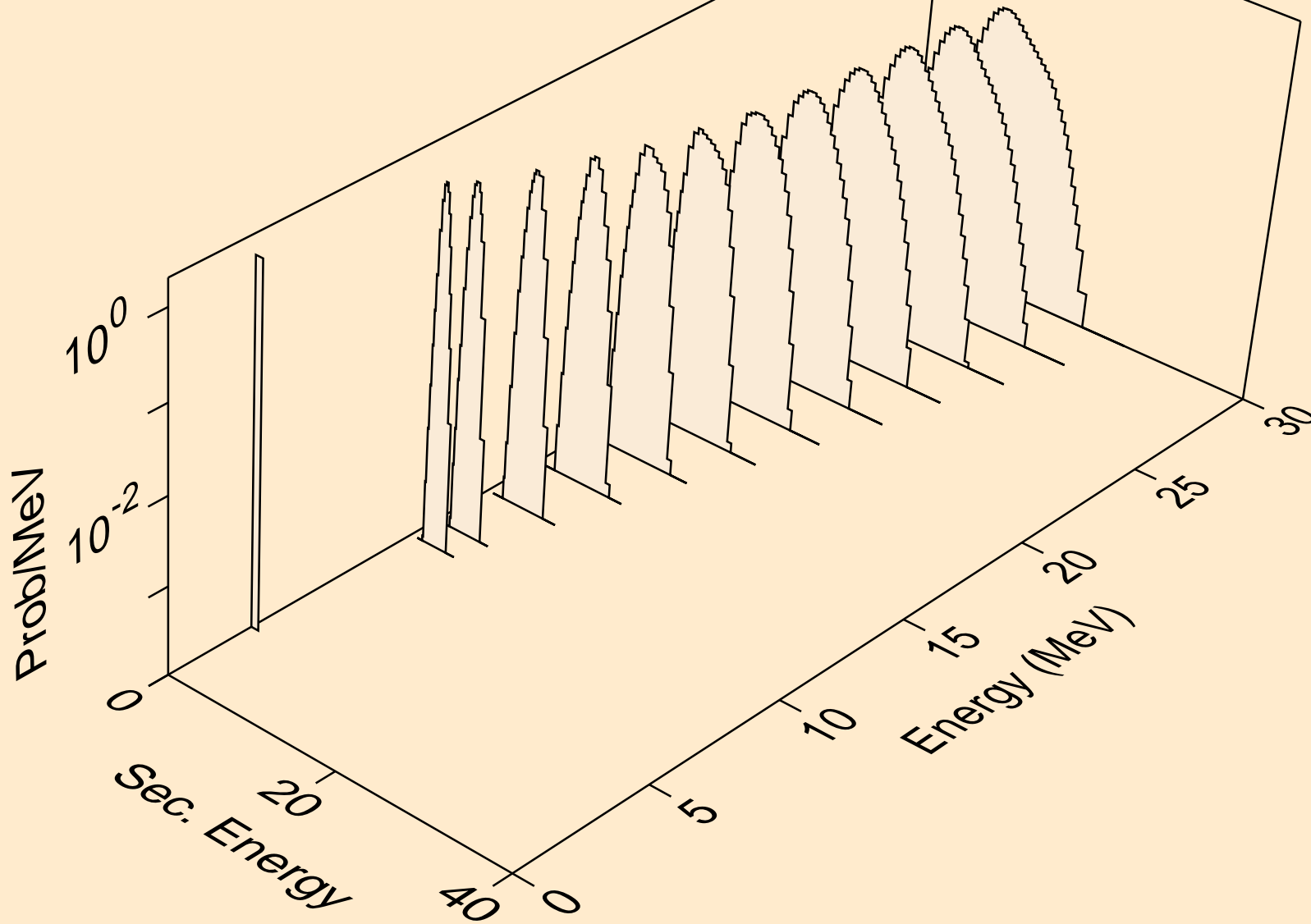

RE178 TRITON ACER TENDL-2021 LIBRARY; T=0.K  
protons from (t,npa)

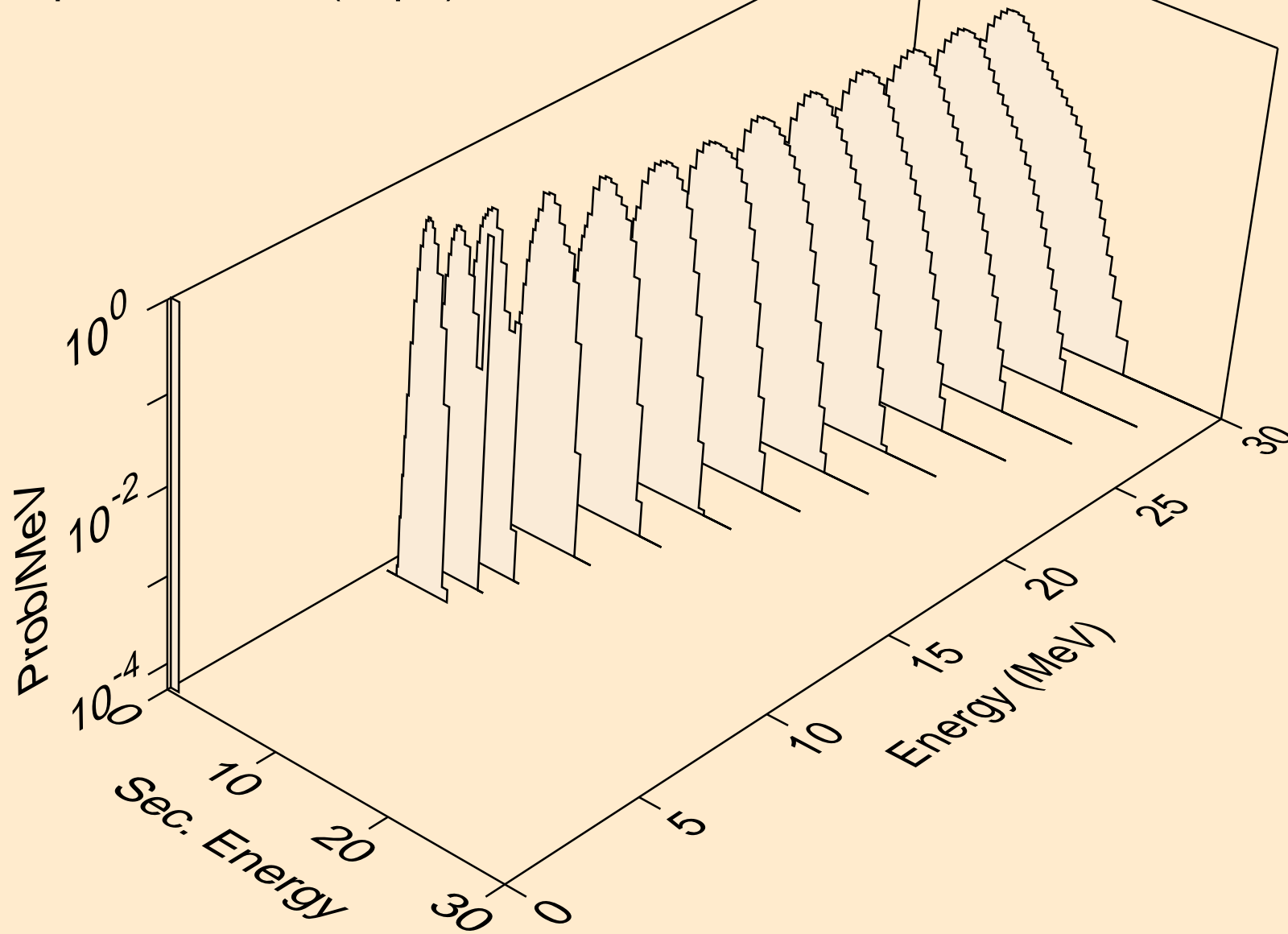



RE178 TRITON ACER TENDL-2021 LIBRARY; T=0.K  
protons from (t,p)

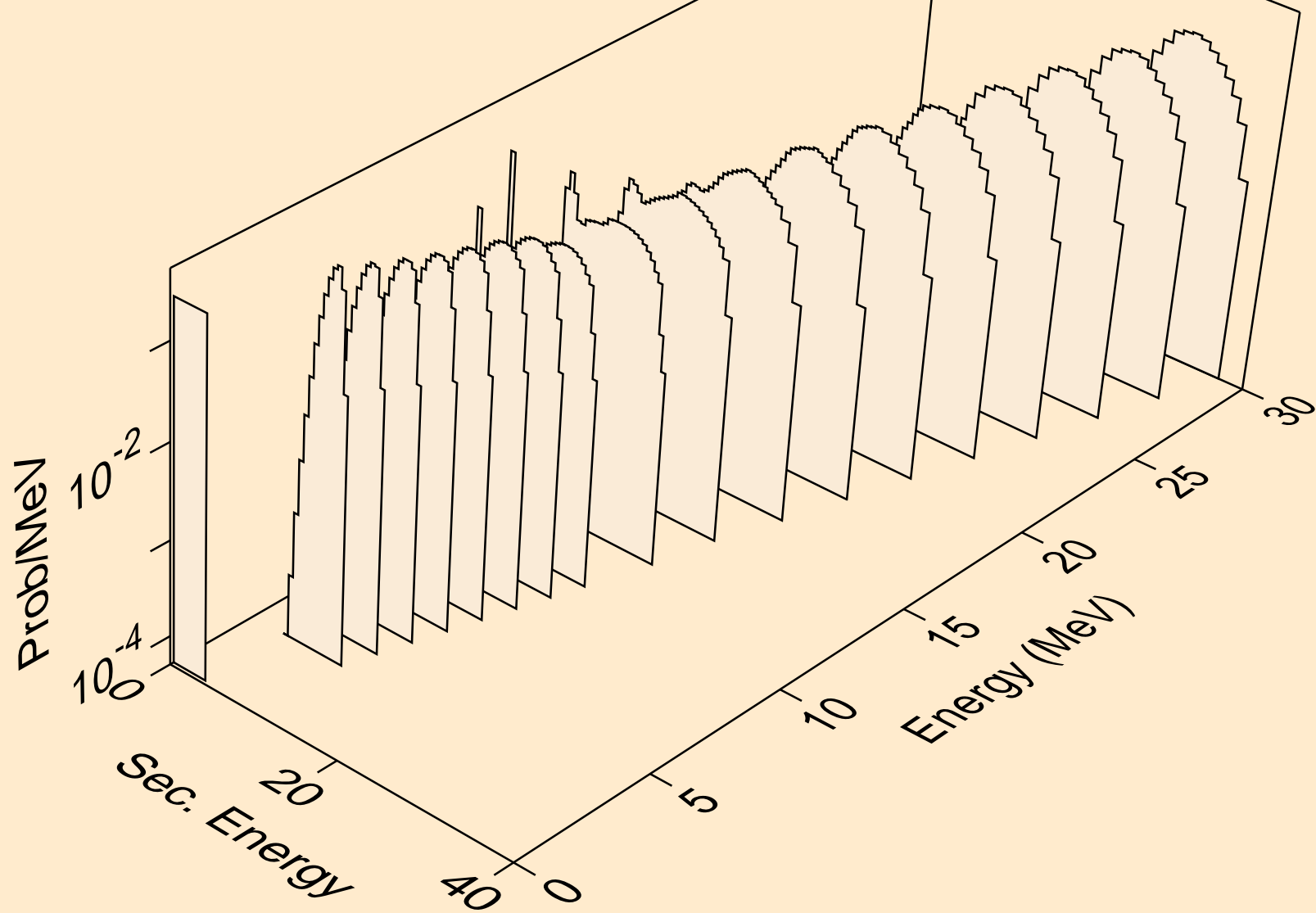

RE178 TRITON ACER TENDL-2021 LIBRARY; T=0.K  
protons from (t,2p)

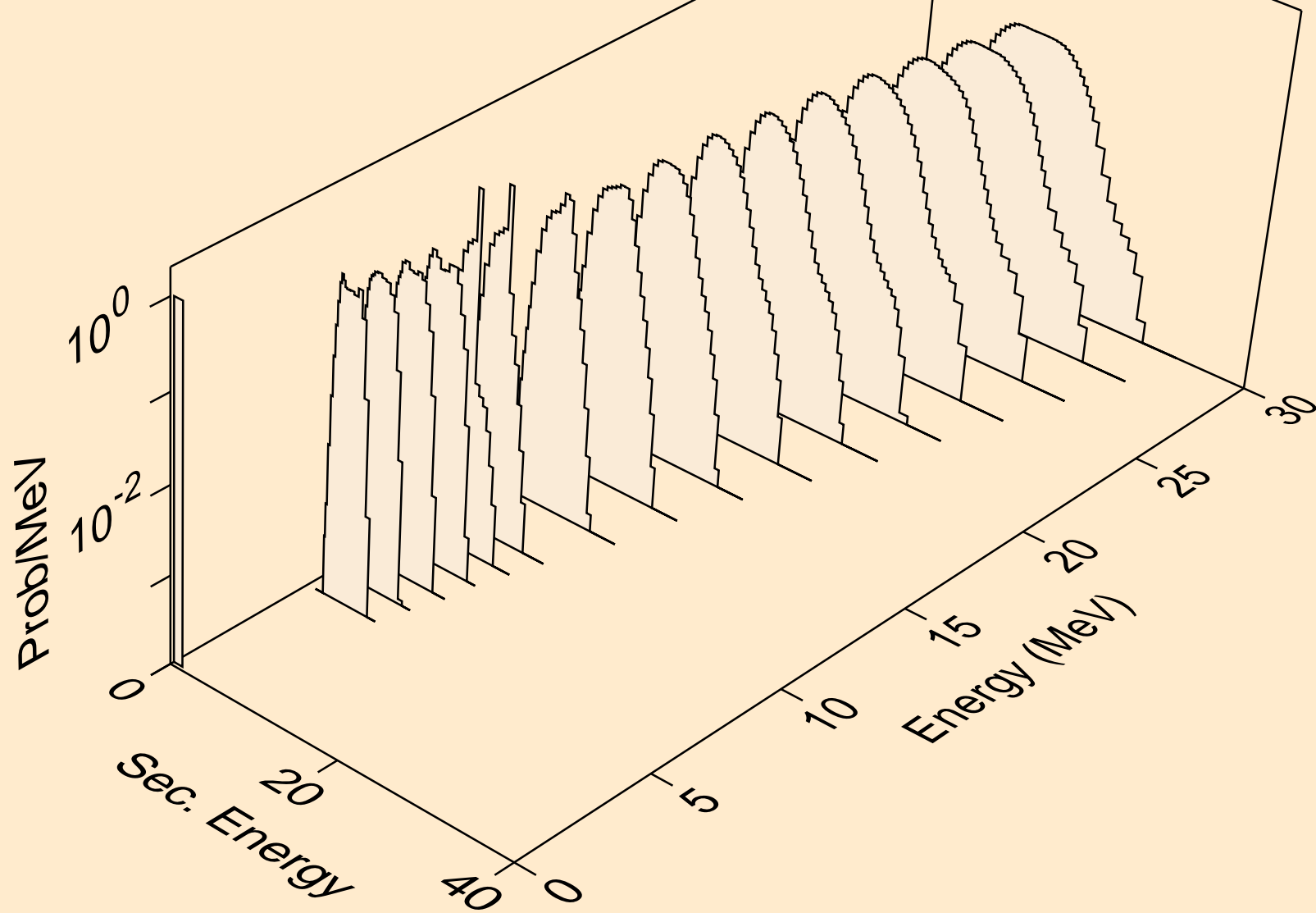

RE178 TRITON ACER TENDL-2021 LIBRARY; T=0.K  
protons from (t,pa)

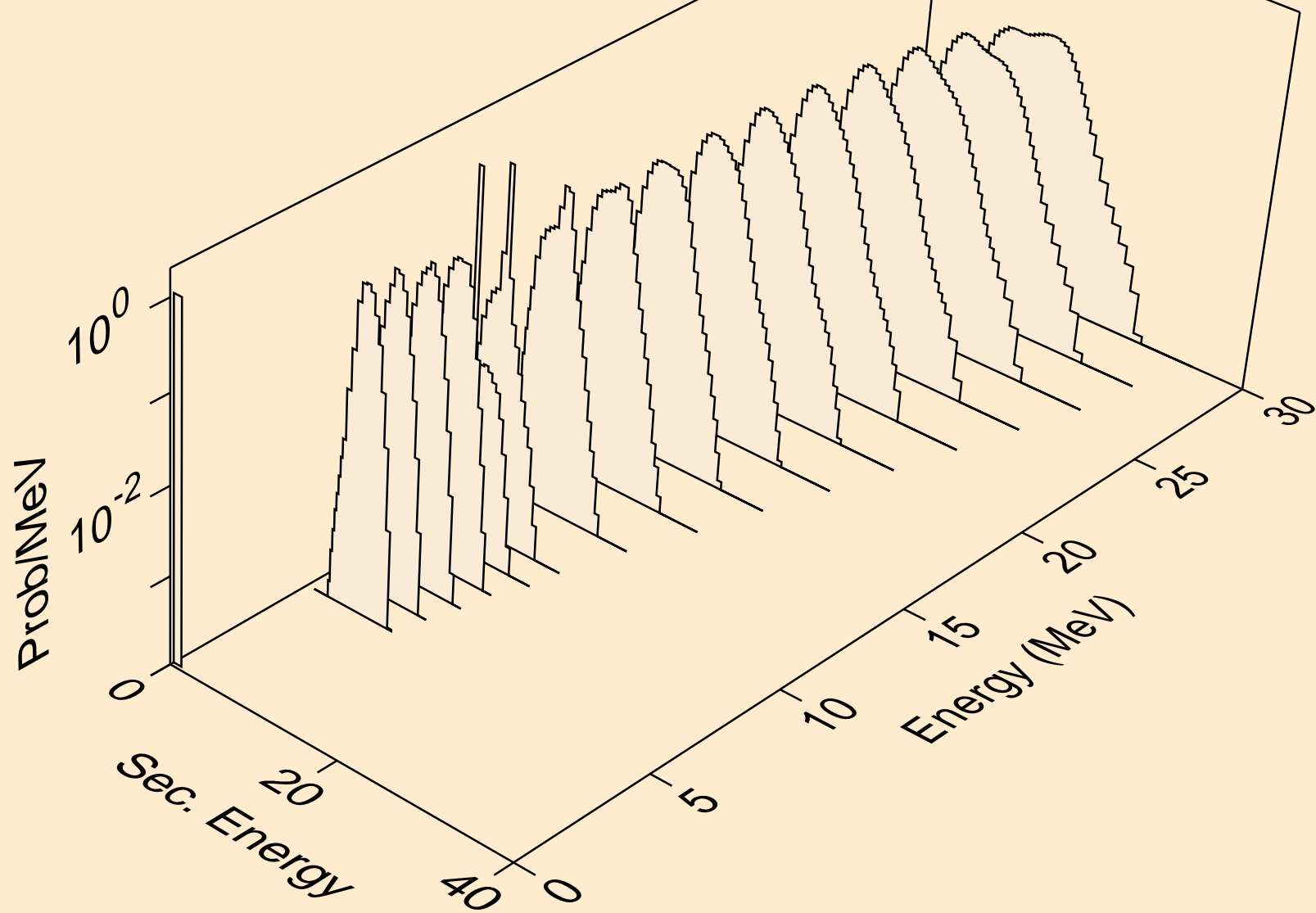

RE178 TRITON ACER TENDL-2021 LIBRARY; T=0.K  
protons from (t,pd)

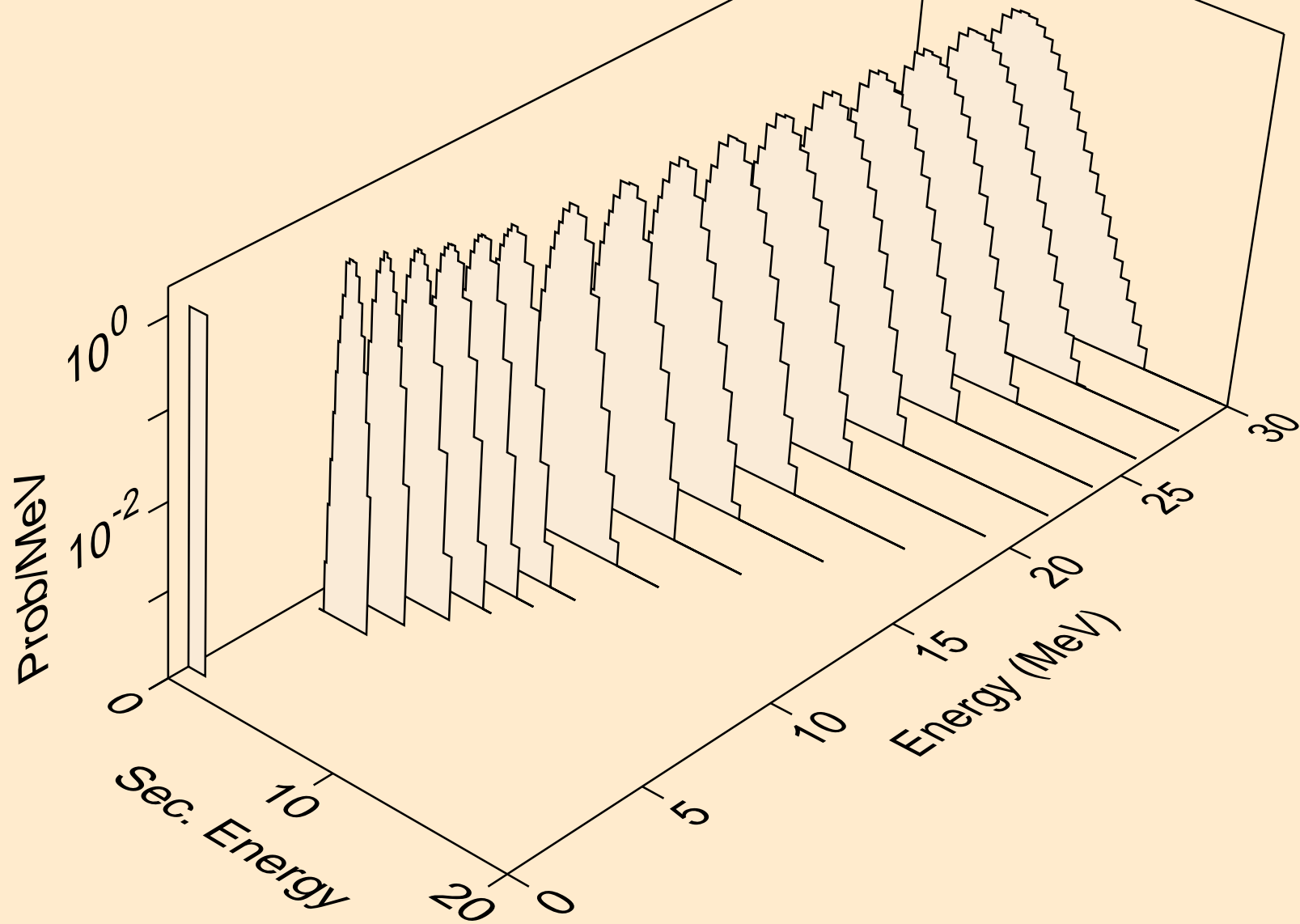

RE178 TRITON ACER TENDL-2021 LIBRARY; T=0.K  
protons from (t,pt)

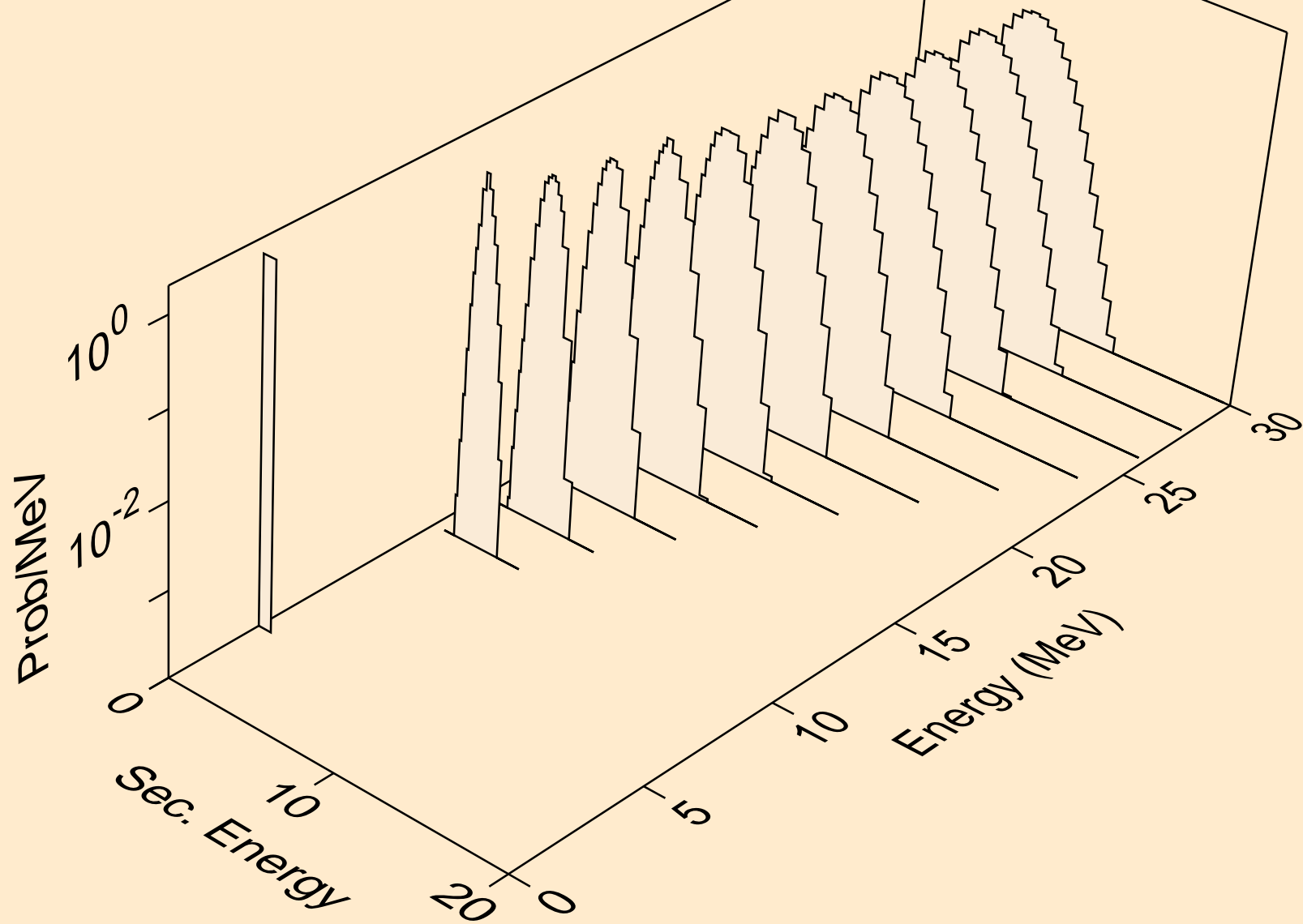

RE178 TRITON ACER TENDL-2021 LIBRARY; T=0.K  
deuterons from (t,x)

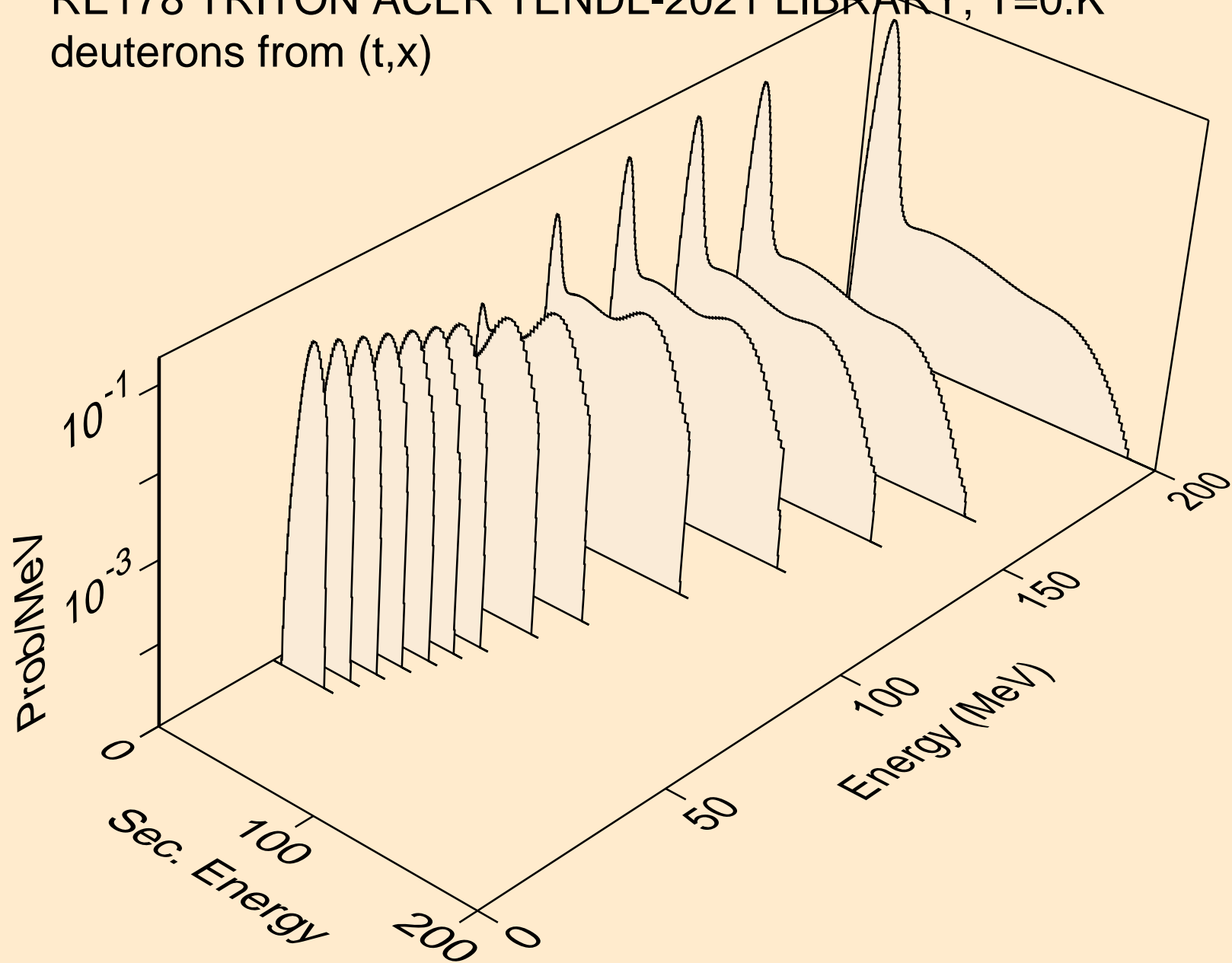

RE178 TRITON ACER TENDL-2021 LIBRARY; T=0.K  
deuterons from (t,2nd)

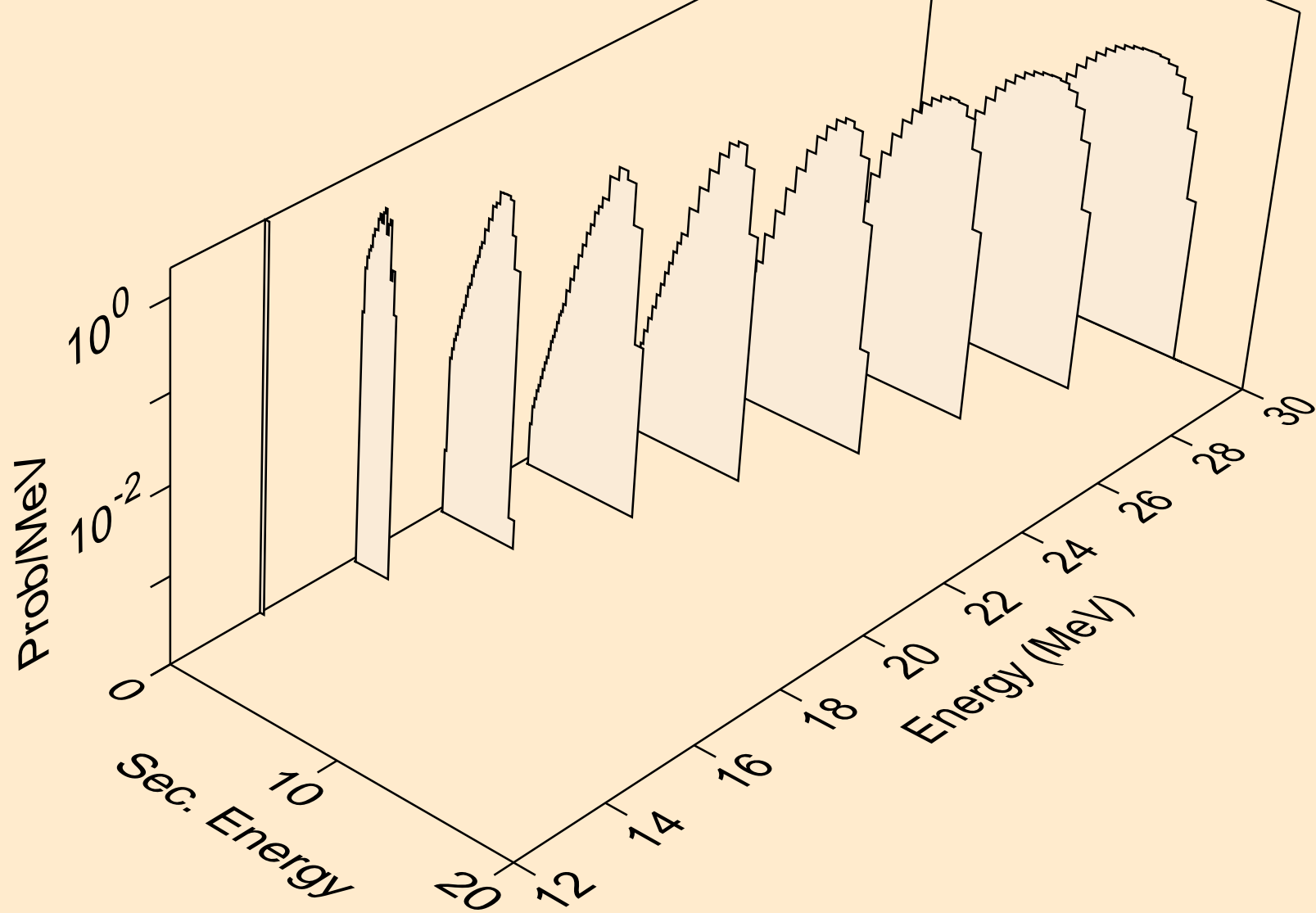

RE178 TRITON ACER TENDL-2021 LIBRARY; T=0.K  
deuterons from (t,n\*)d

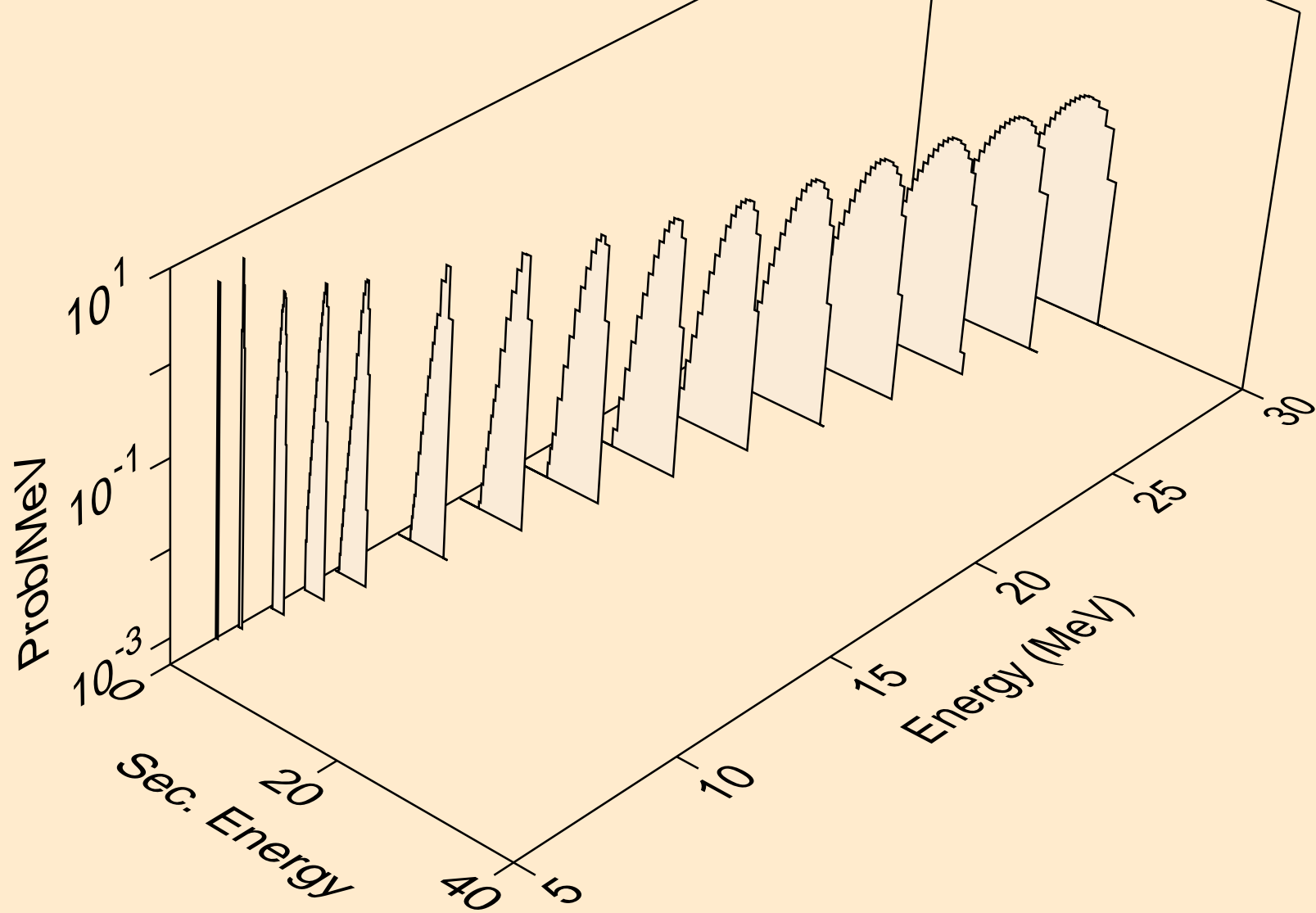



RE178 TRITON ACER TENDL-2021 LIBRARY; T=0.K  
deuterons from (t,d)

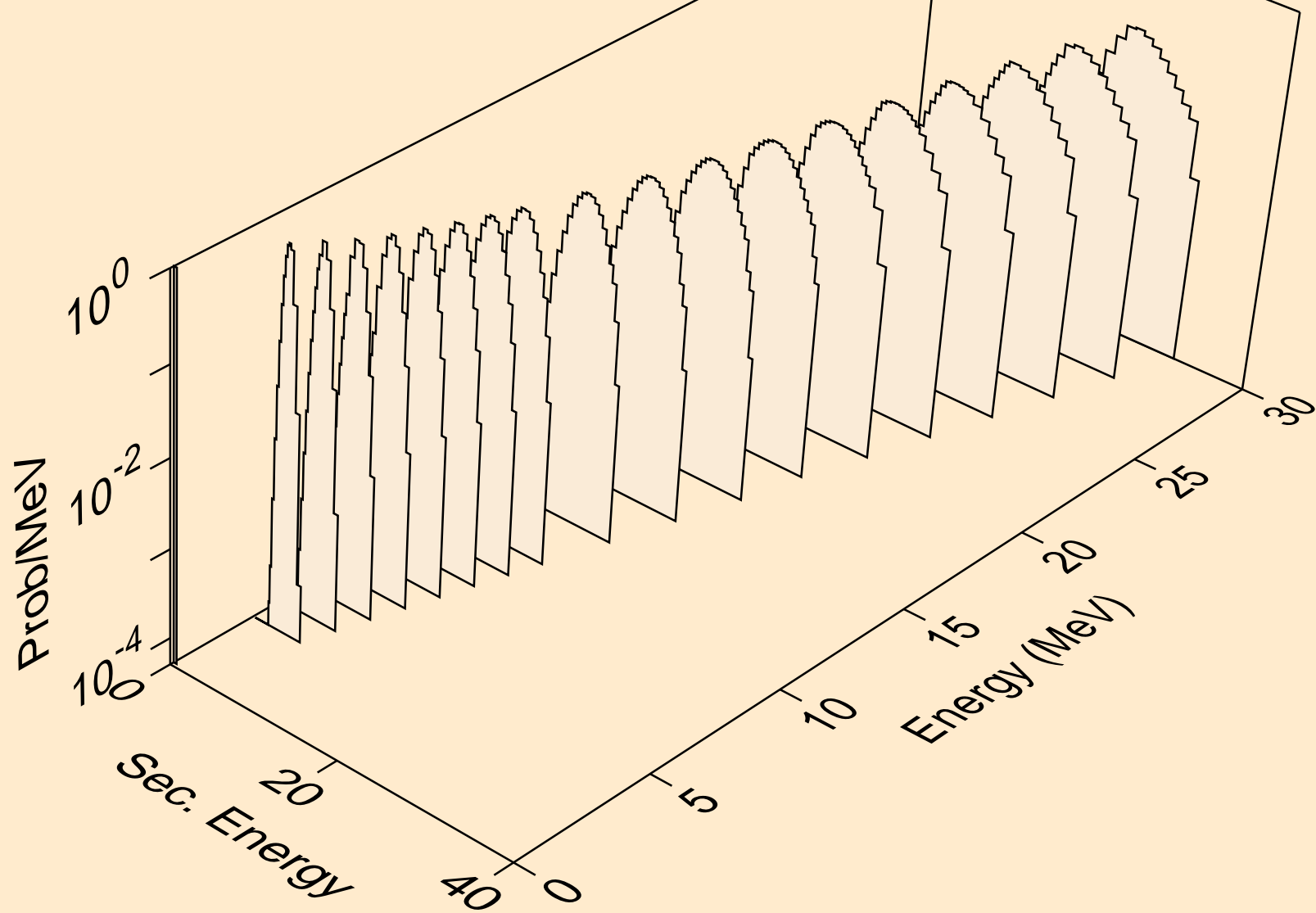

RE178 TRITON ACER TENDL-2021 LIBRARY; T=0.K  
deuterons from (t,pd)

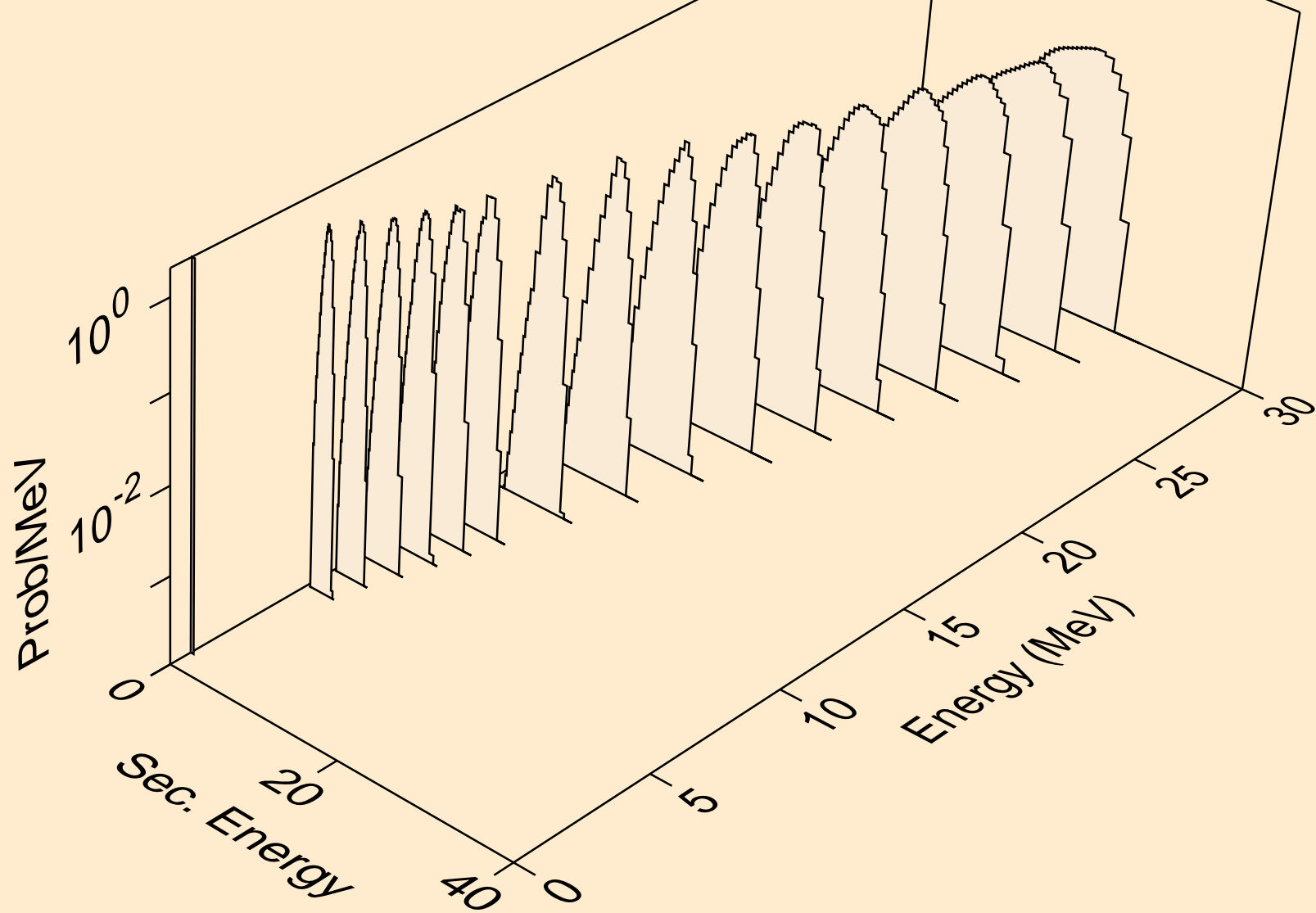

RE178 TRITON ACER TENDL-2021 LIBRARY; T=0.K  
deuterons from (t,da)

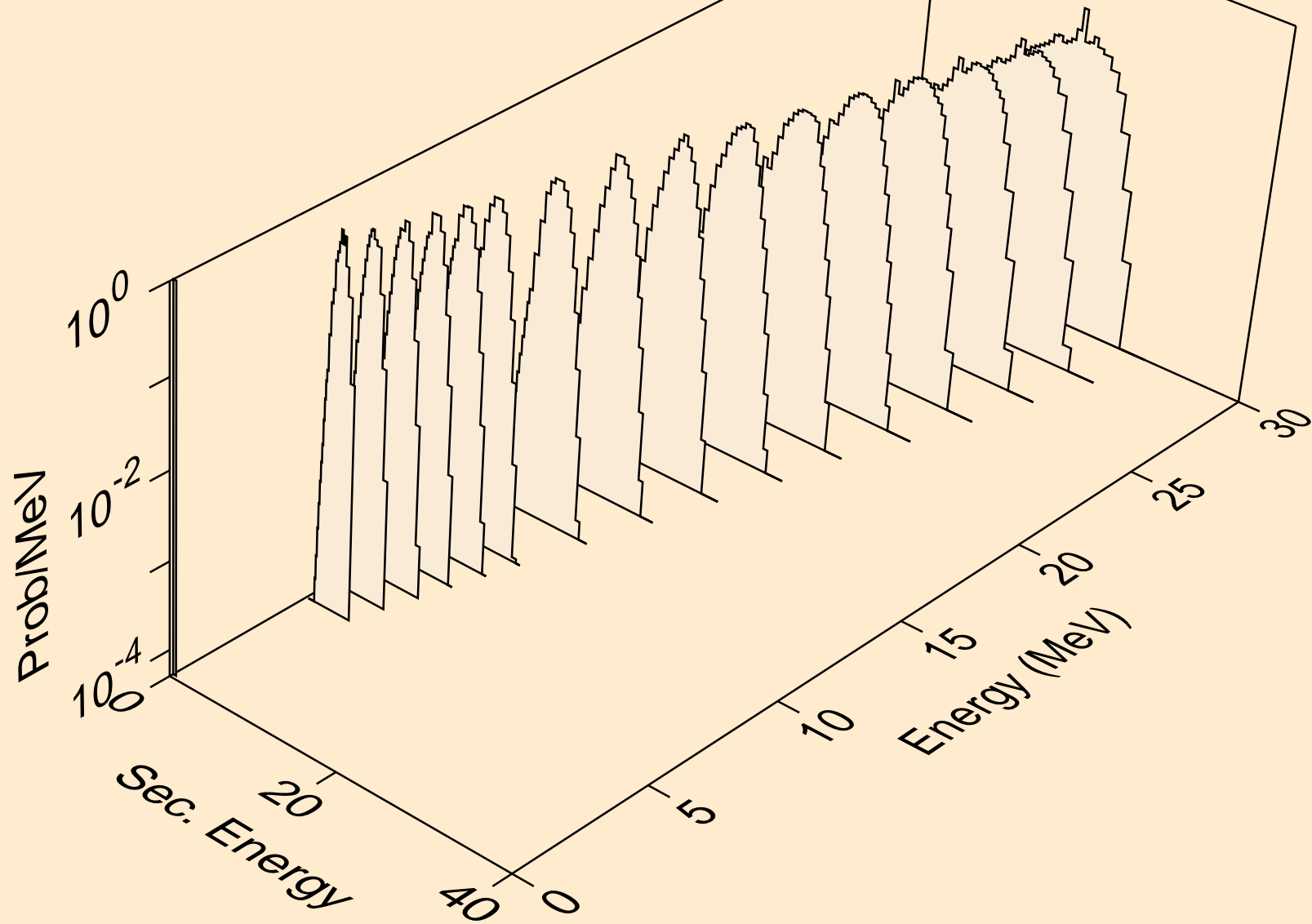

RE178 TRITON ACER TENDL-2021 LIBRARY; T=0.K  
he3s from (t,x)

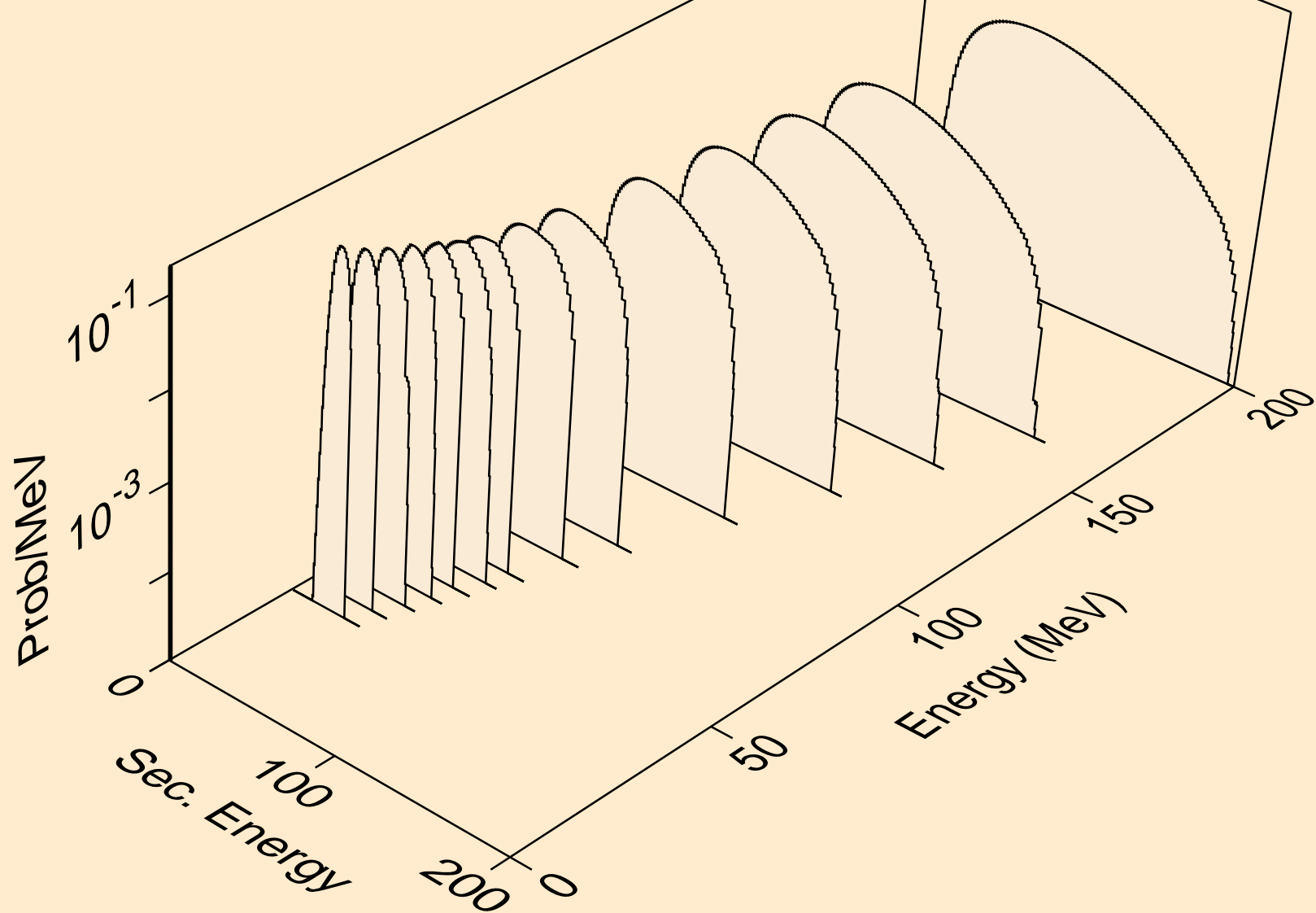

RE178 TRITON ACER TENDL-2021 LIBRARY; T=0.K  
he3s from (t,n\*)he3

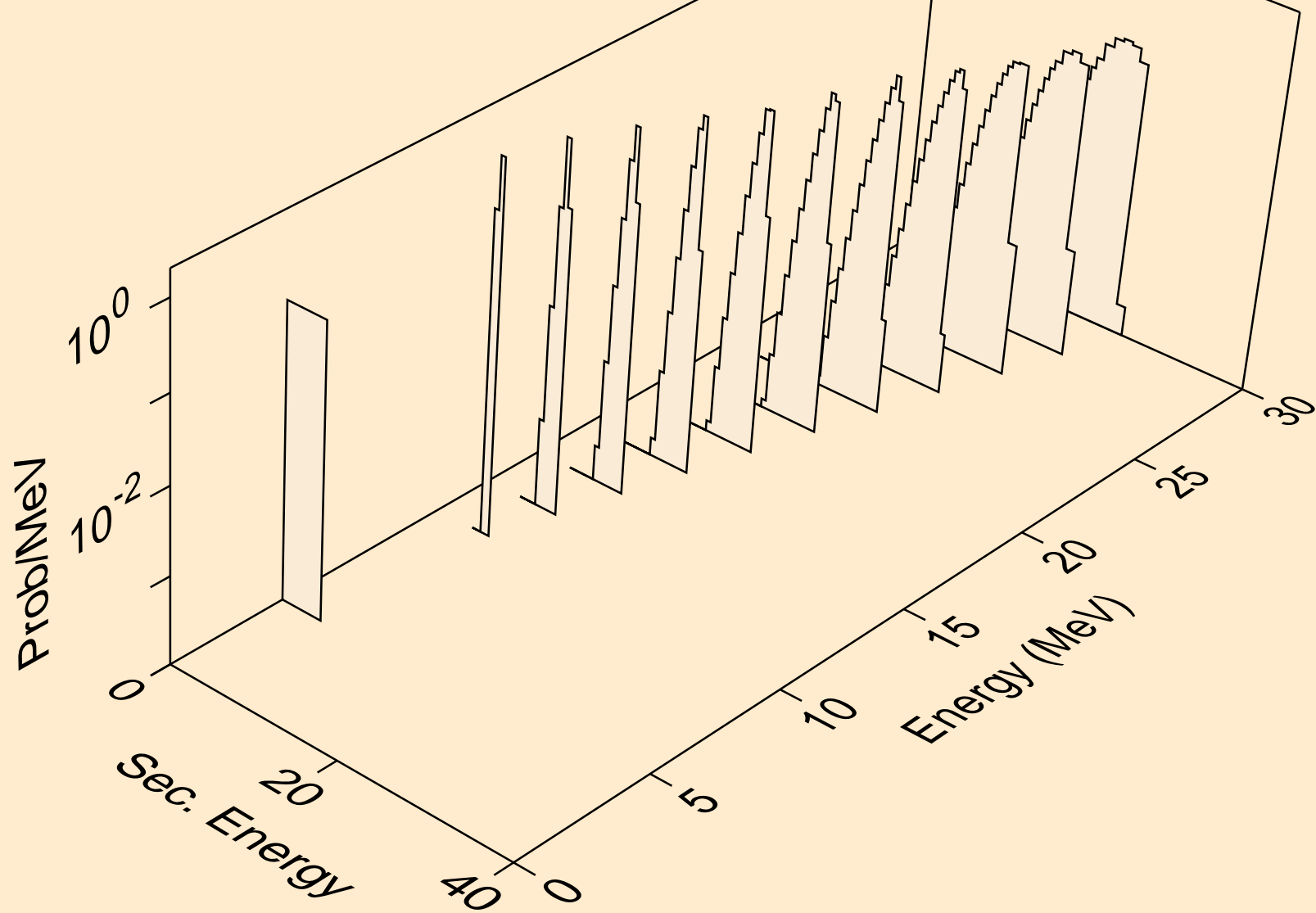

RE178 TRITON ACER TENDL-2021 LIBRARY; T=0.K  
he3s from (t,he3)

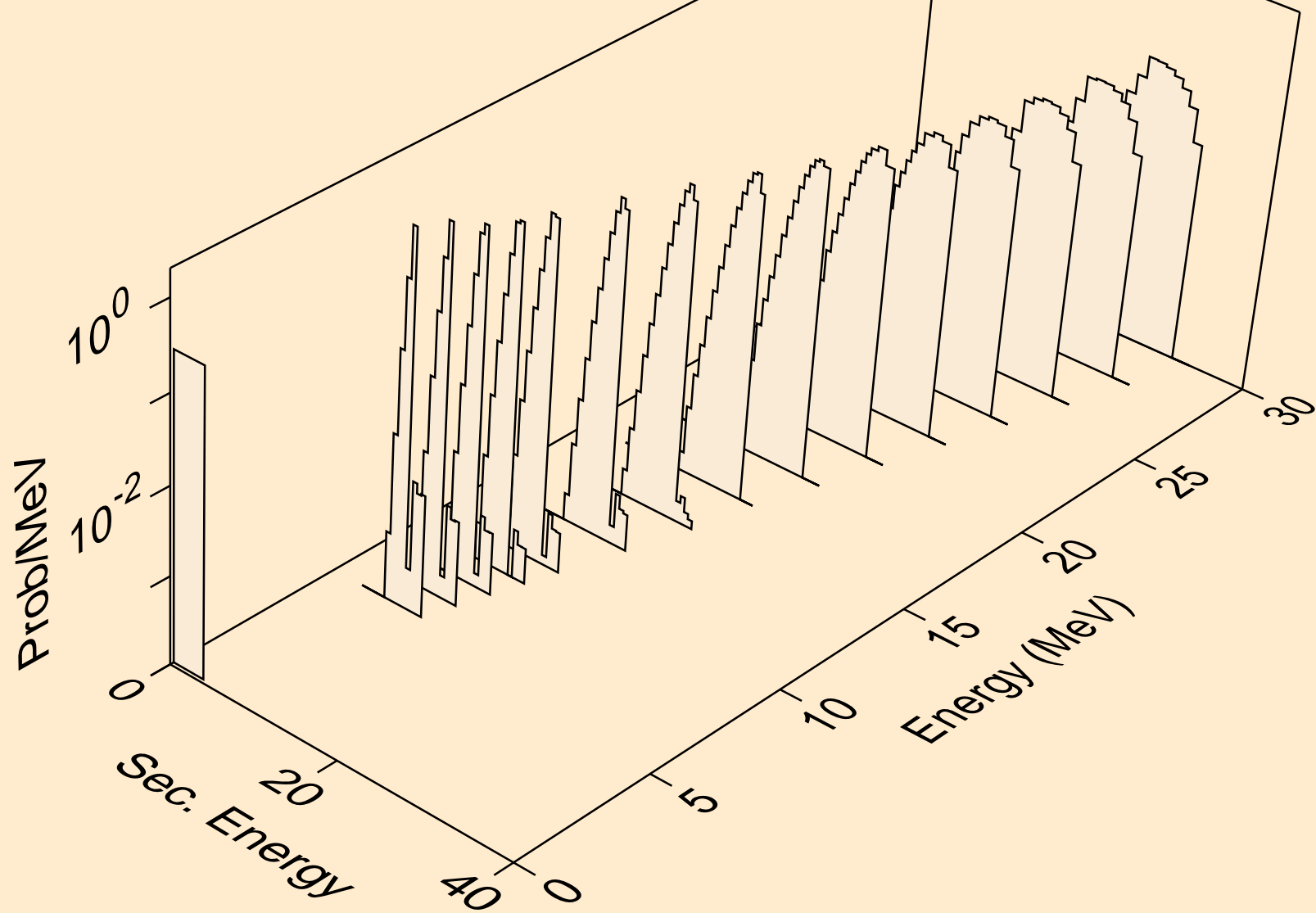

RE178 TRITON ACER TENDL-2021 LIBRARY; T=0.K  
alphas from (t,x)

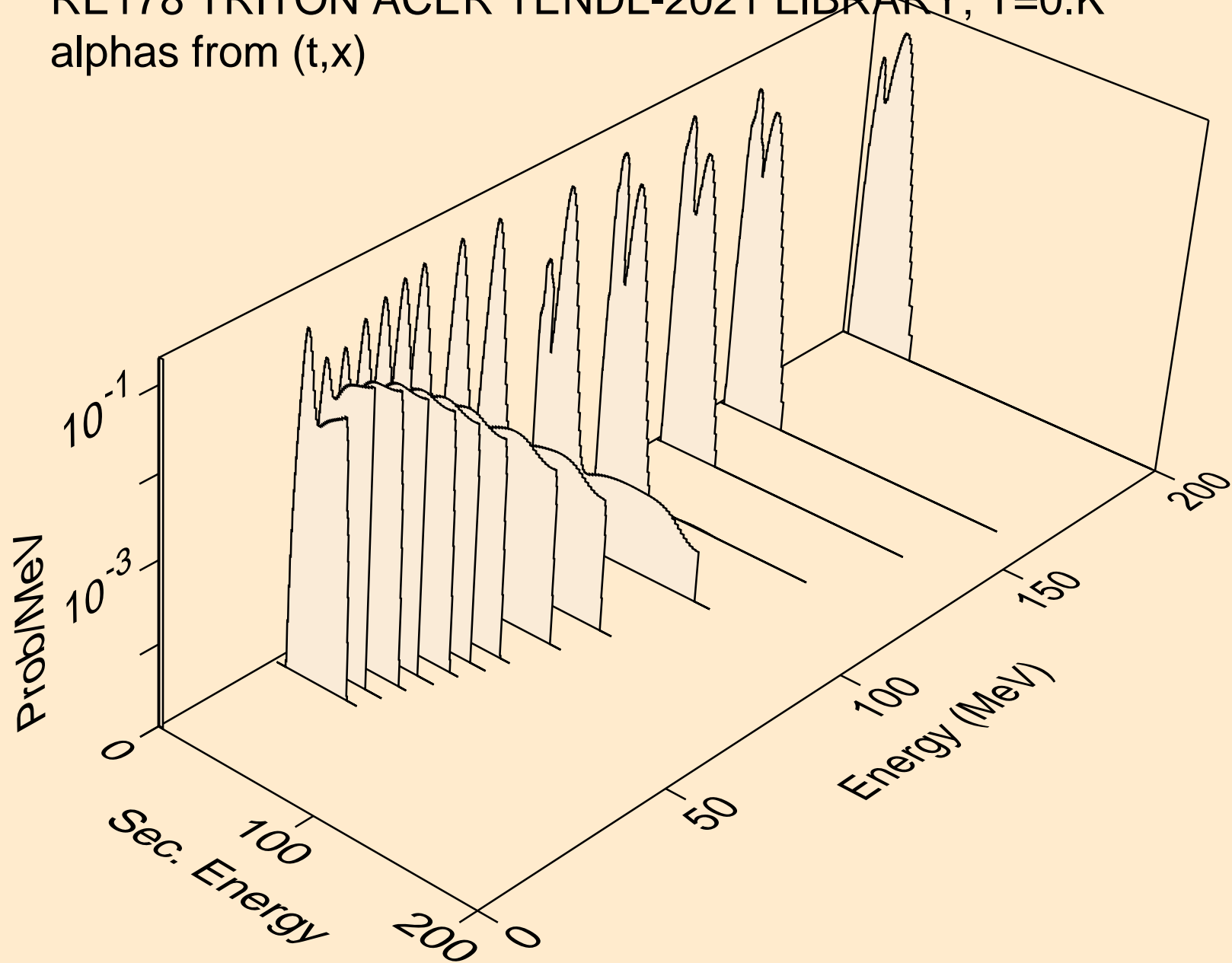

RE178 TRITON ACER TENDL-2021 LIBRARY; T=0.K  
alphas from (t,n\*)a

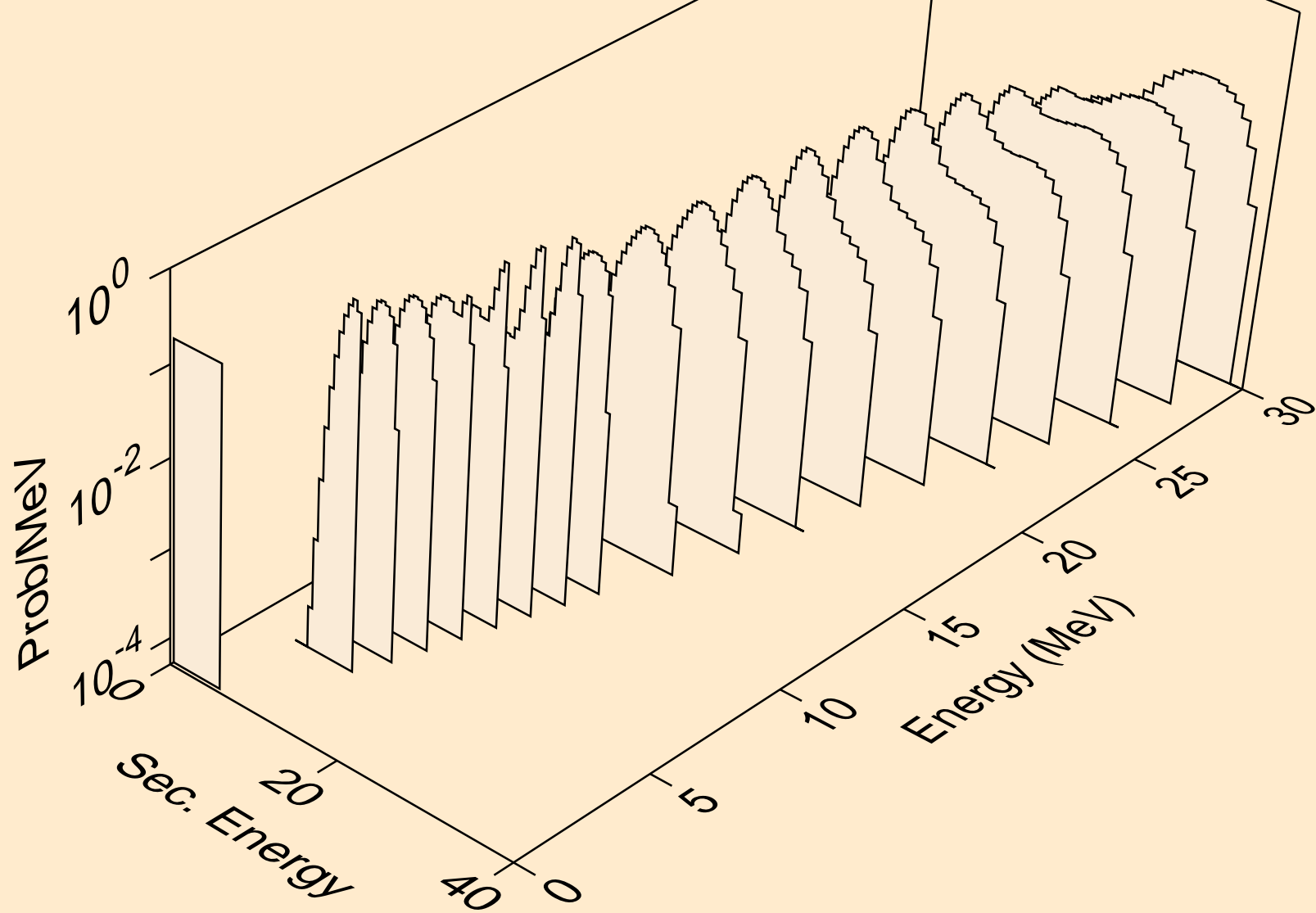



RE178 TRITON ACER TENDL-2021 LIBRARY; T=0.K  
alphas from (t,2n)a

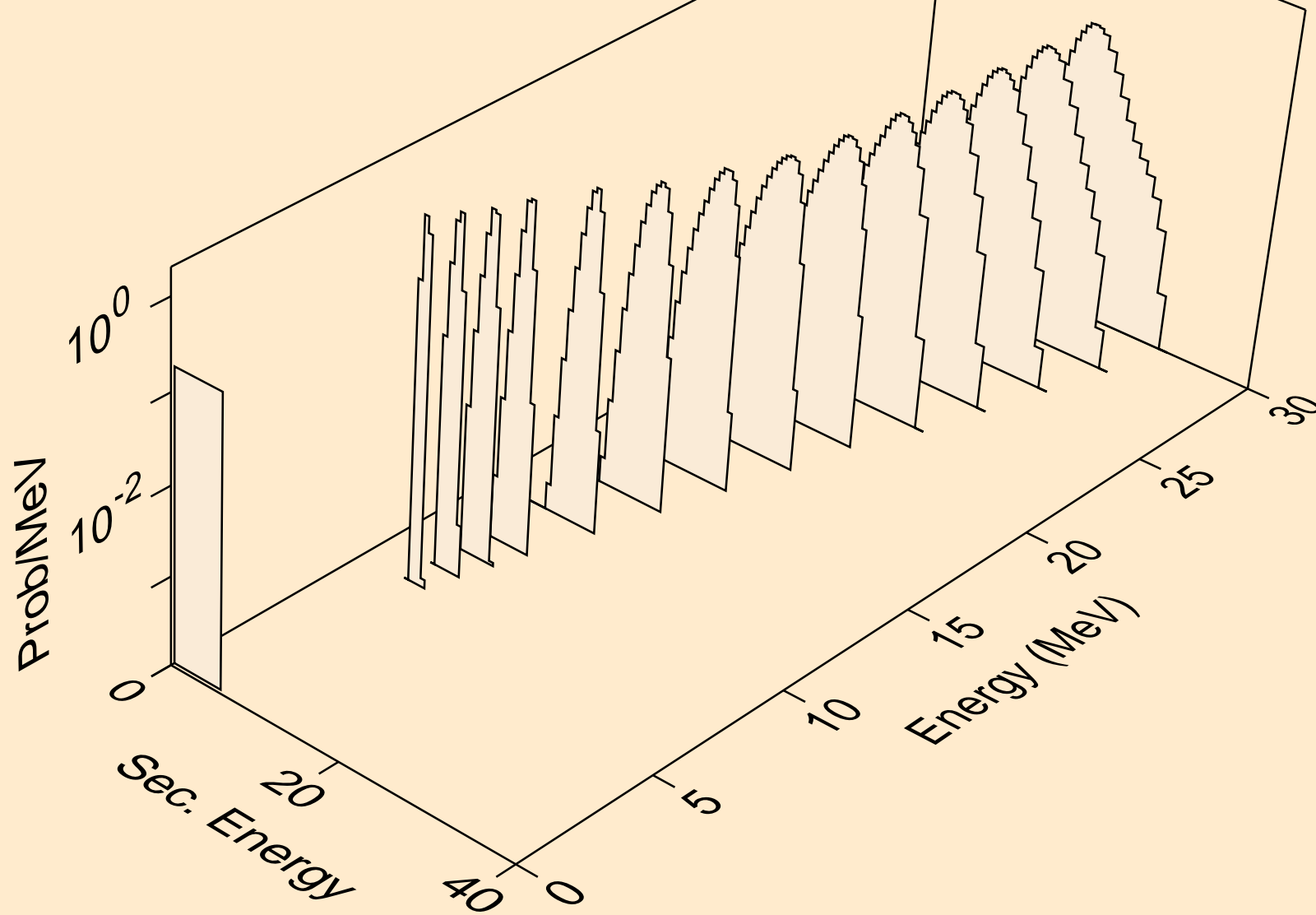

RE178 TRITON ACER TENDL-2021 LIBRARY; T=0.K  
alphas from (t,3n)a

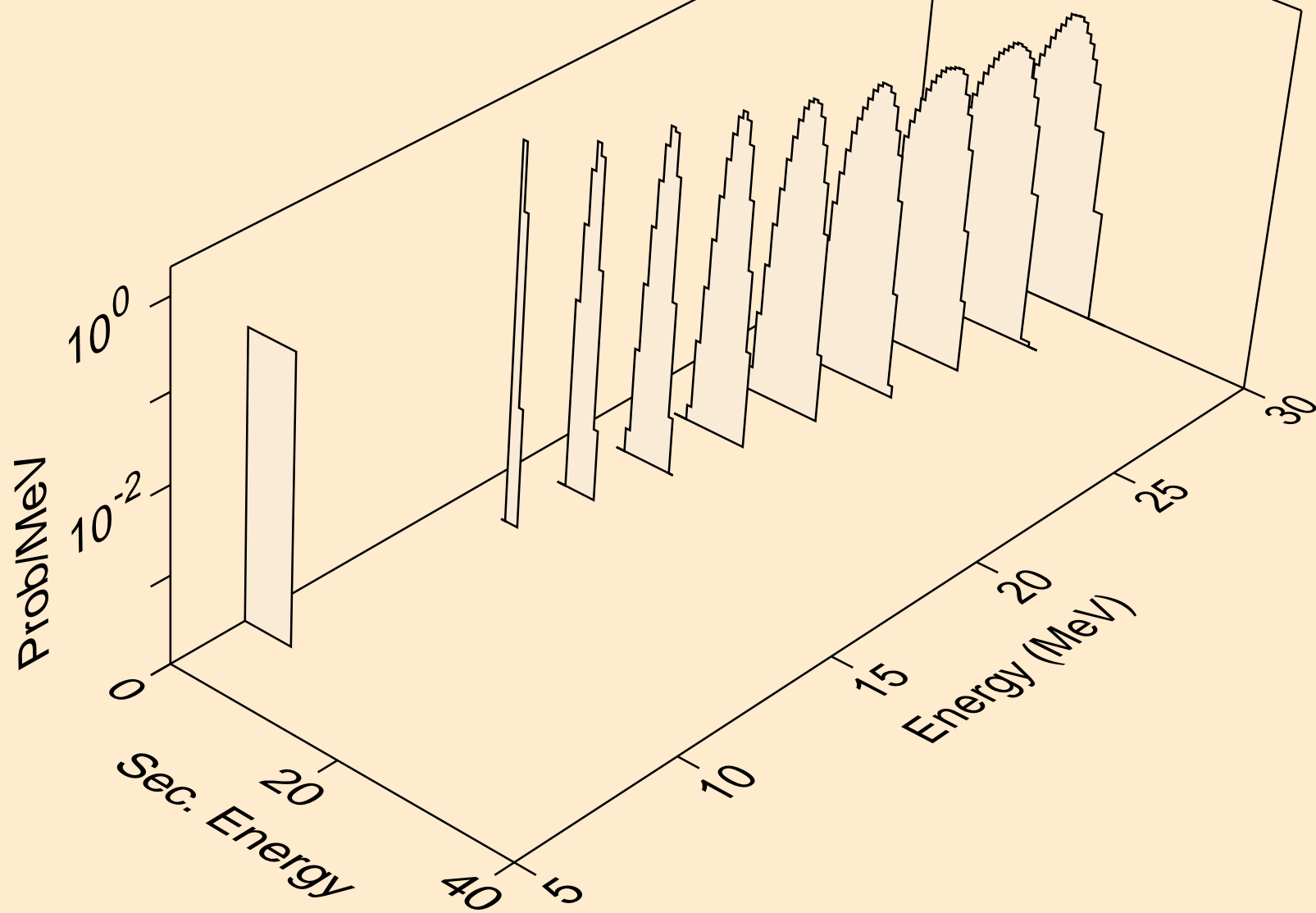

RE178 TRITON ACER TENDL-2021 LIBRARY; T=0.K  
alphas from (t,n\*)2a

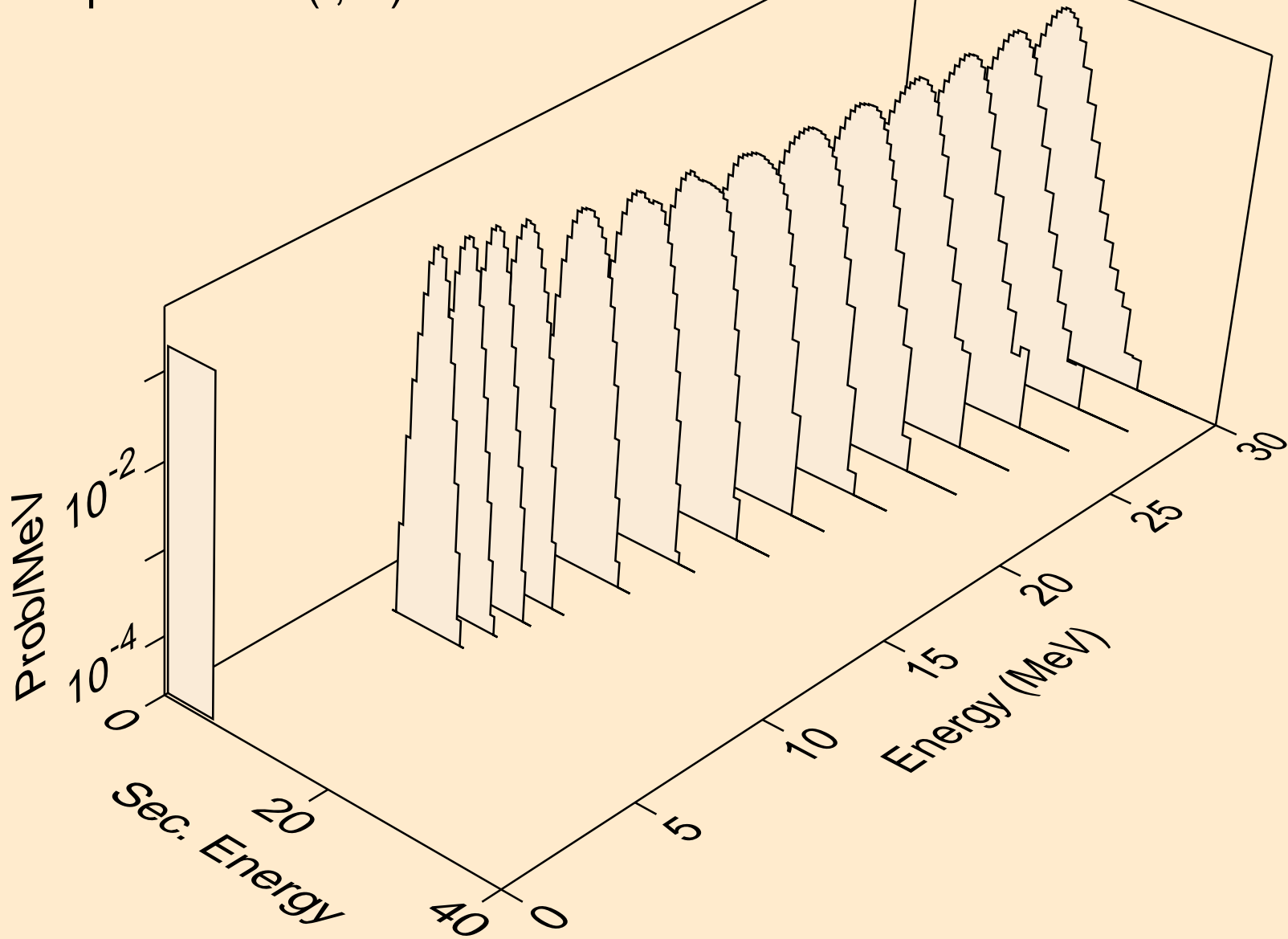

RE178 TRITON ACER TENDL-2021 LIBRARY; T=0.K  
alphas from (t,2n)2a

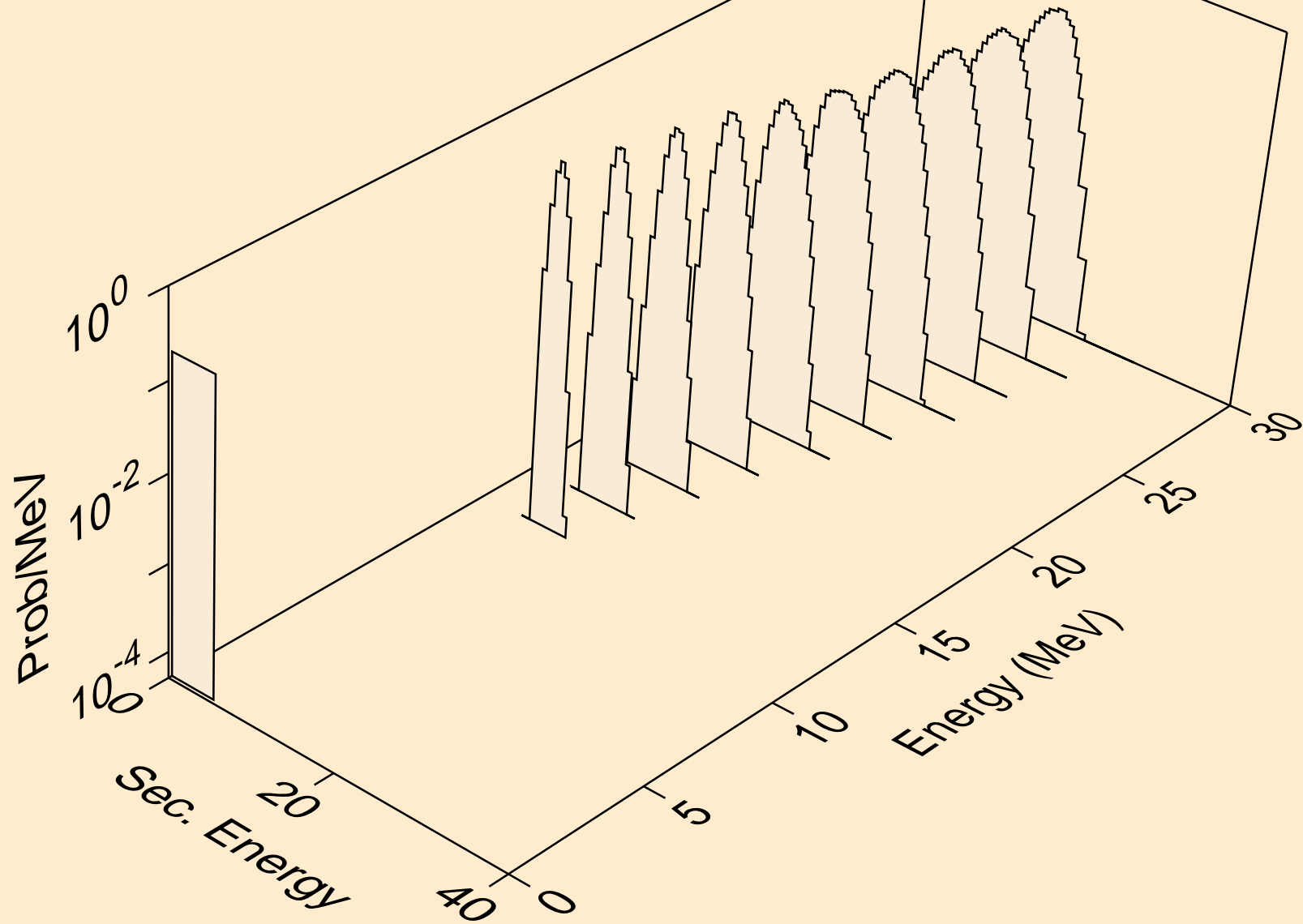

RE178 TRITON ACER TENDL-2021 LIBRARY; T=0.K  
alphas from (t,npa)

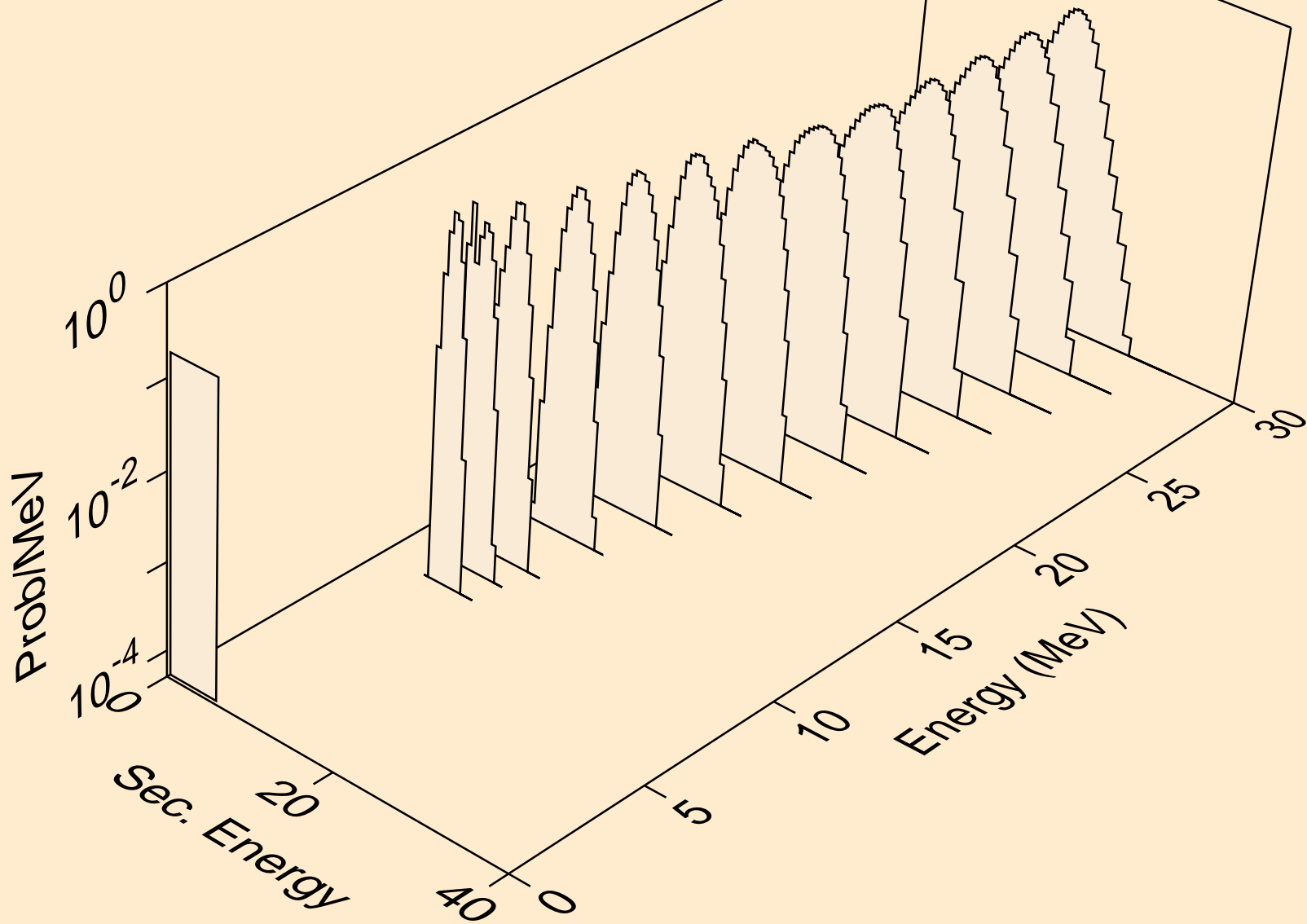

RE178 TRITON ACER TENDL-2021 LIBRARY; T=0.K  
alphas from (t,a)

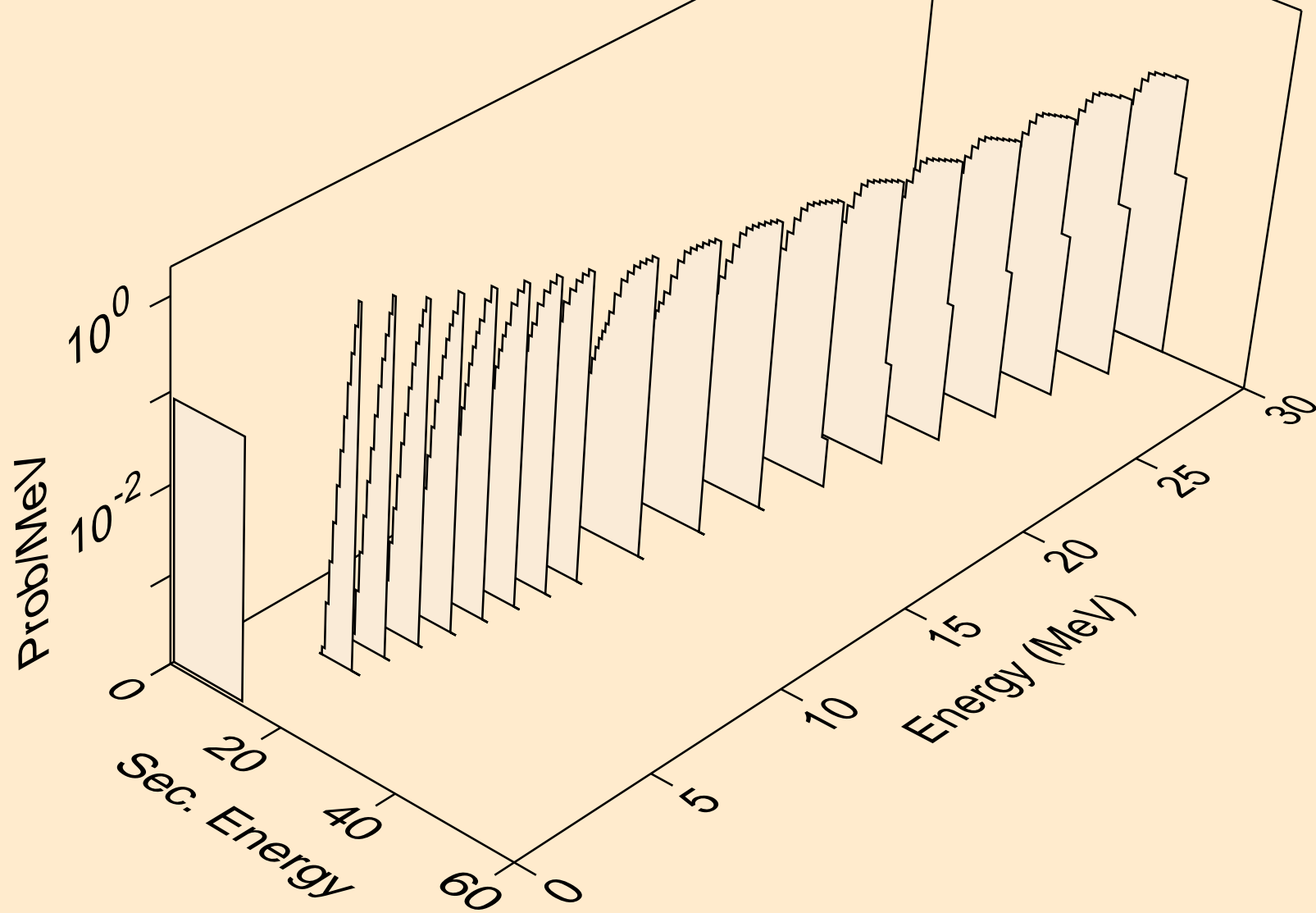

RE178 TRITON ACER TENDL-2021 LIBRARY; T=0.K  
alphas from (t,2a)

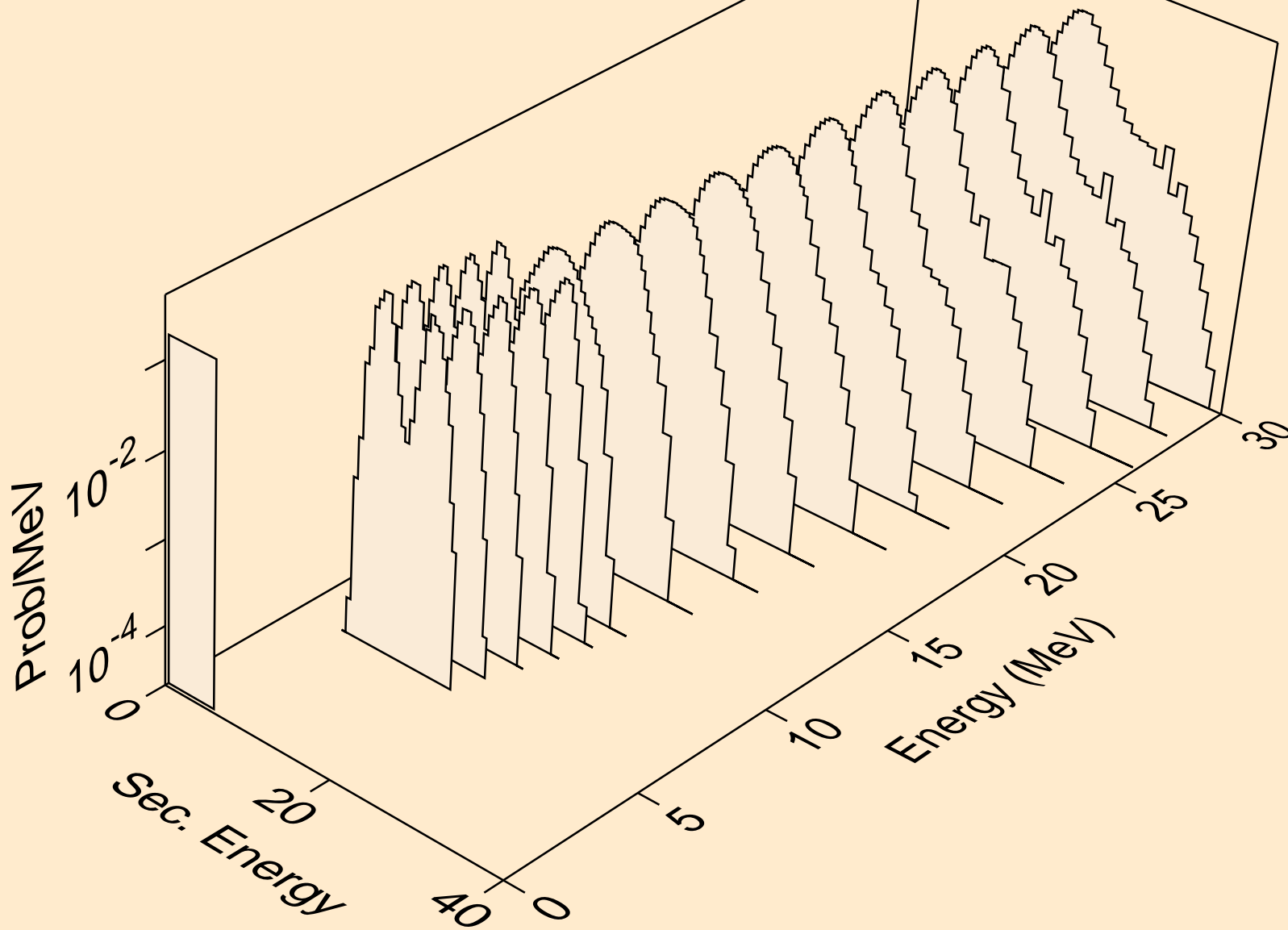

RE178 TRITON ACER TENDL-2021 LIBRARY; T=0.K  
alphas from (t,pa)

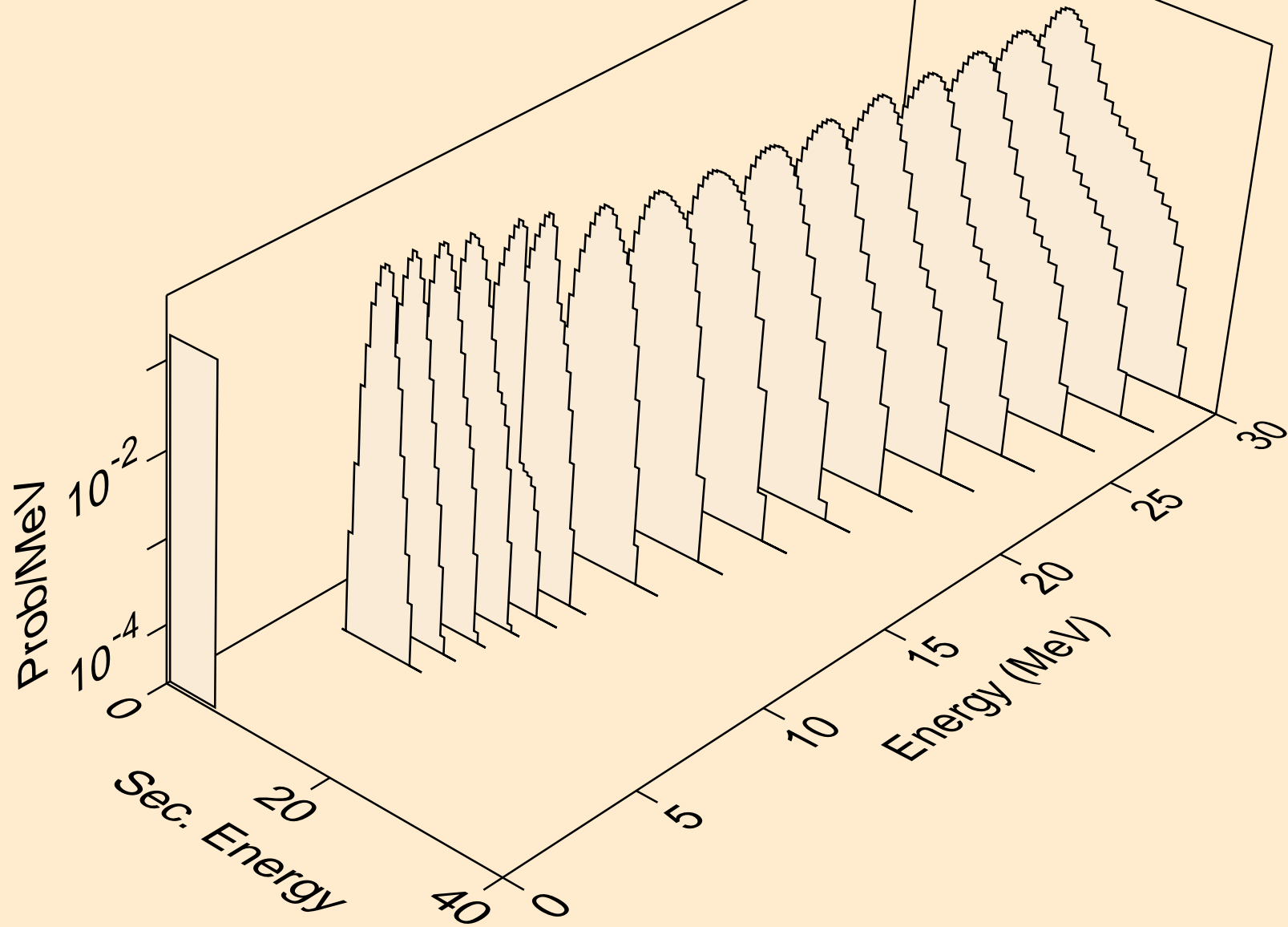



RE178 TRITON ACER TENDL-2021 LIBRARY; T=0.K  
alphas from (t,da)

