

RF263 TRITON ACER TENDL-2021 LIBRARY; T=0.K  
Principal cross sections

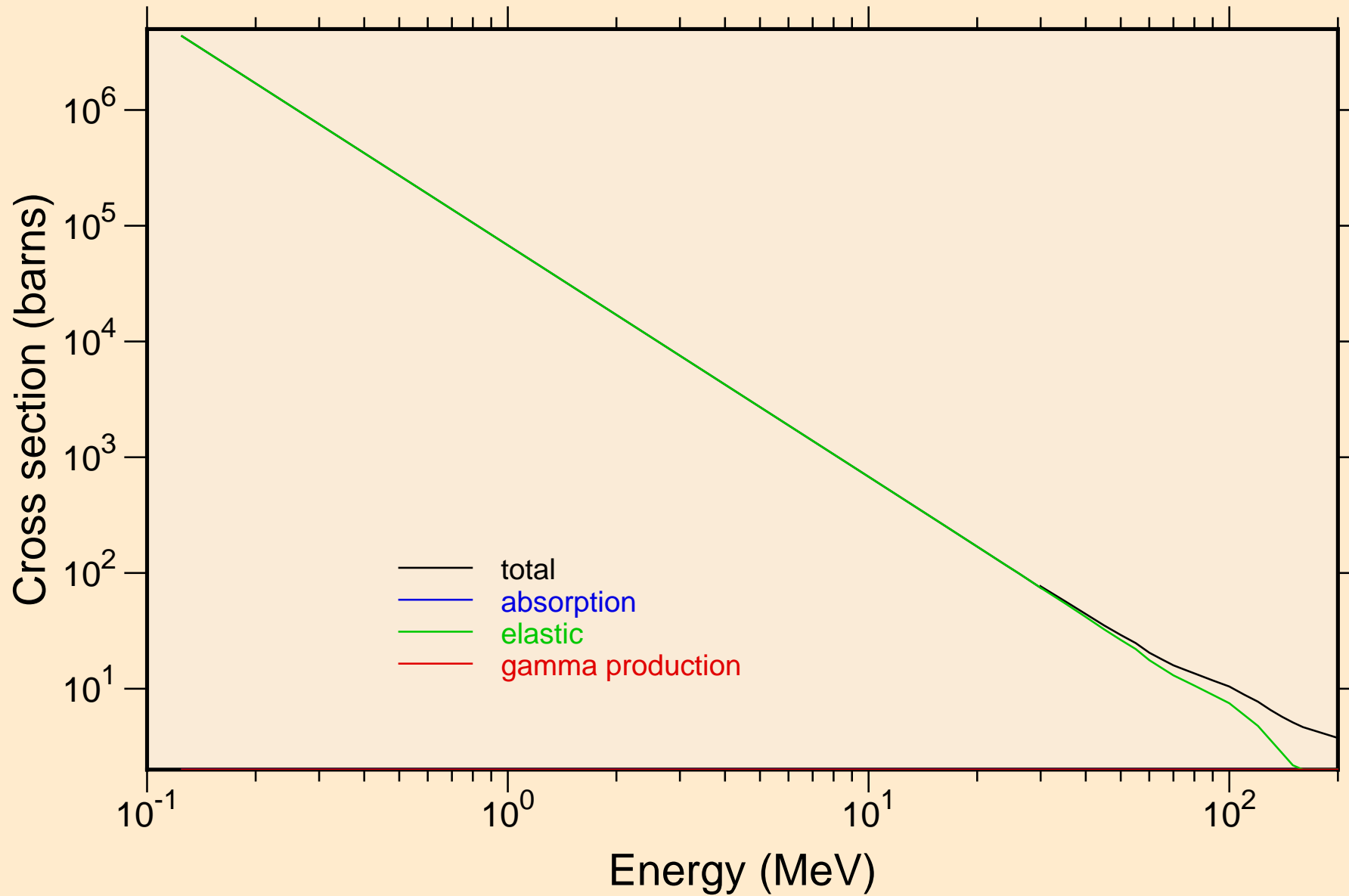

RF263 TRITON ACER TENDL-2021 LIBRARY; T=0.K

Heating

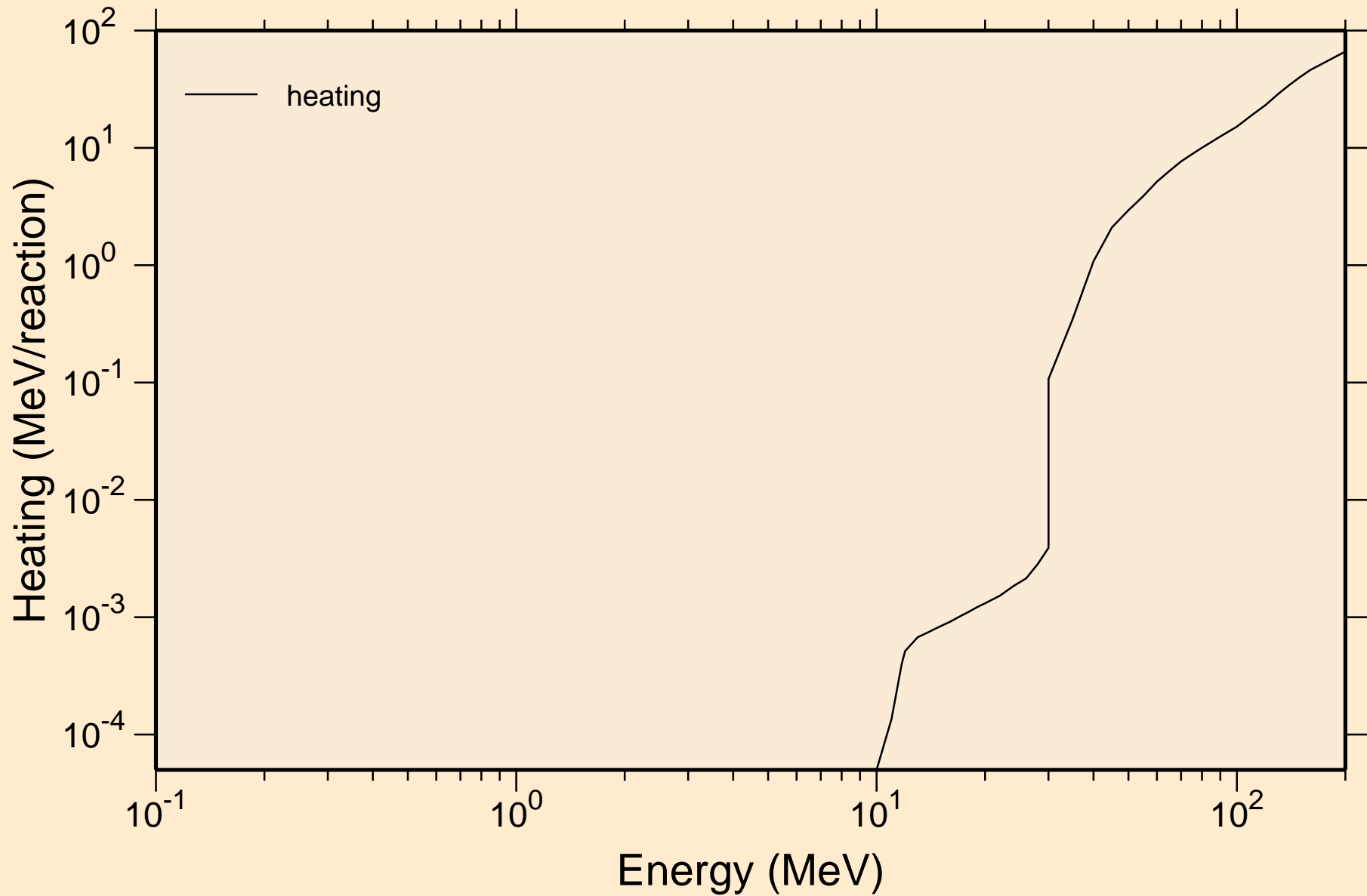

# RF263 TRITON ACER TENDL-2021 LIBRARY; T=0.K

## Principal cross sections

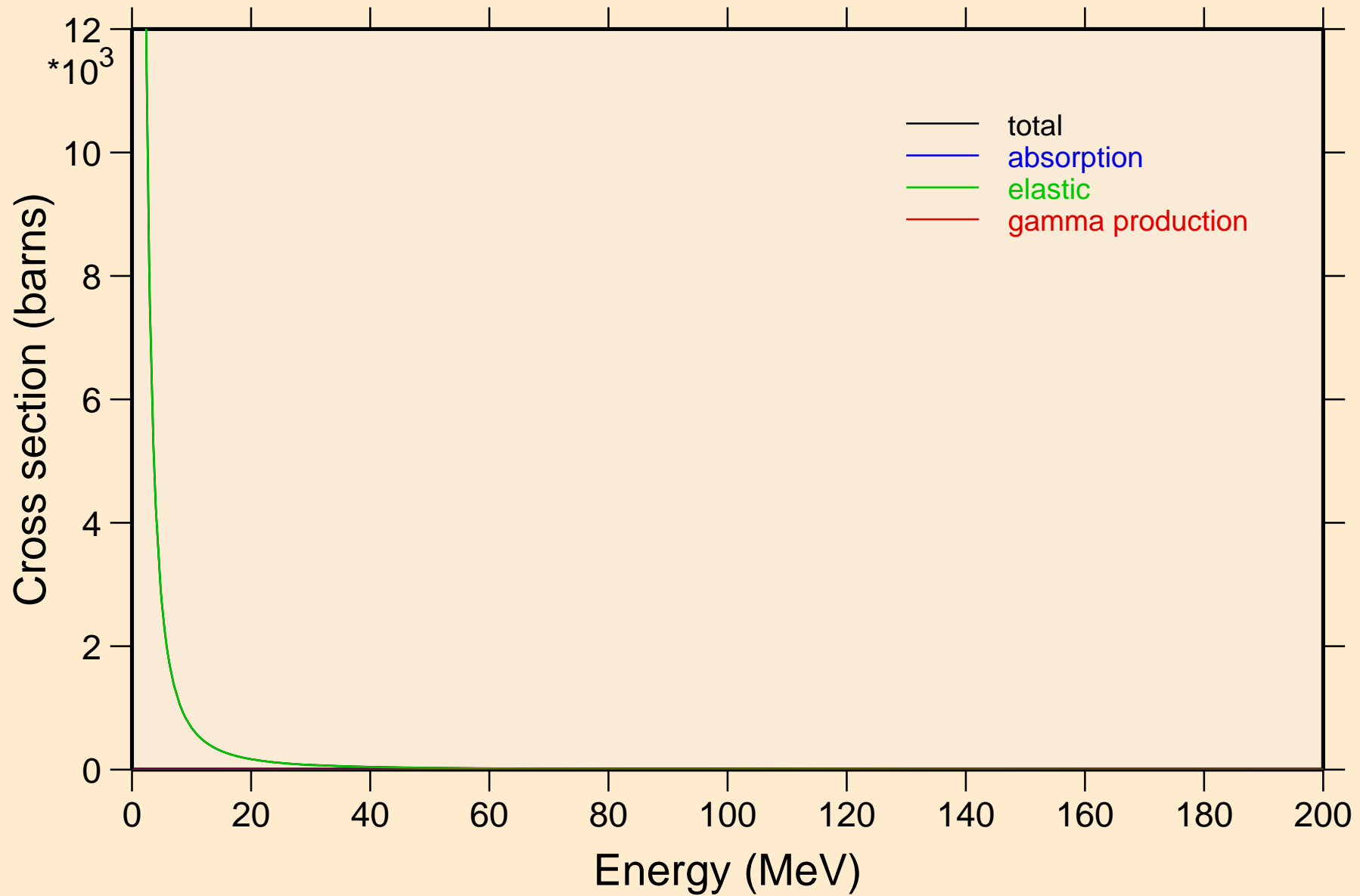

RF263 TRITON ACER TENDL-2021 LIBRARY; T=0.K

Heating

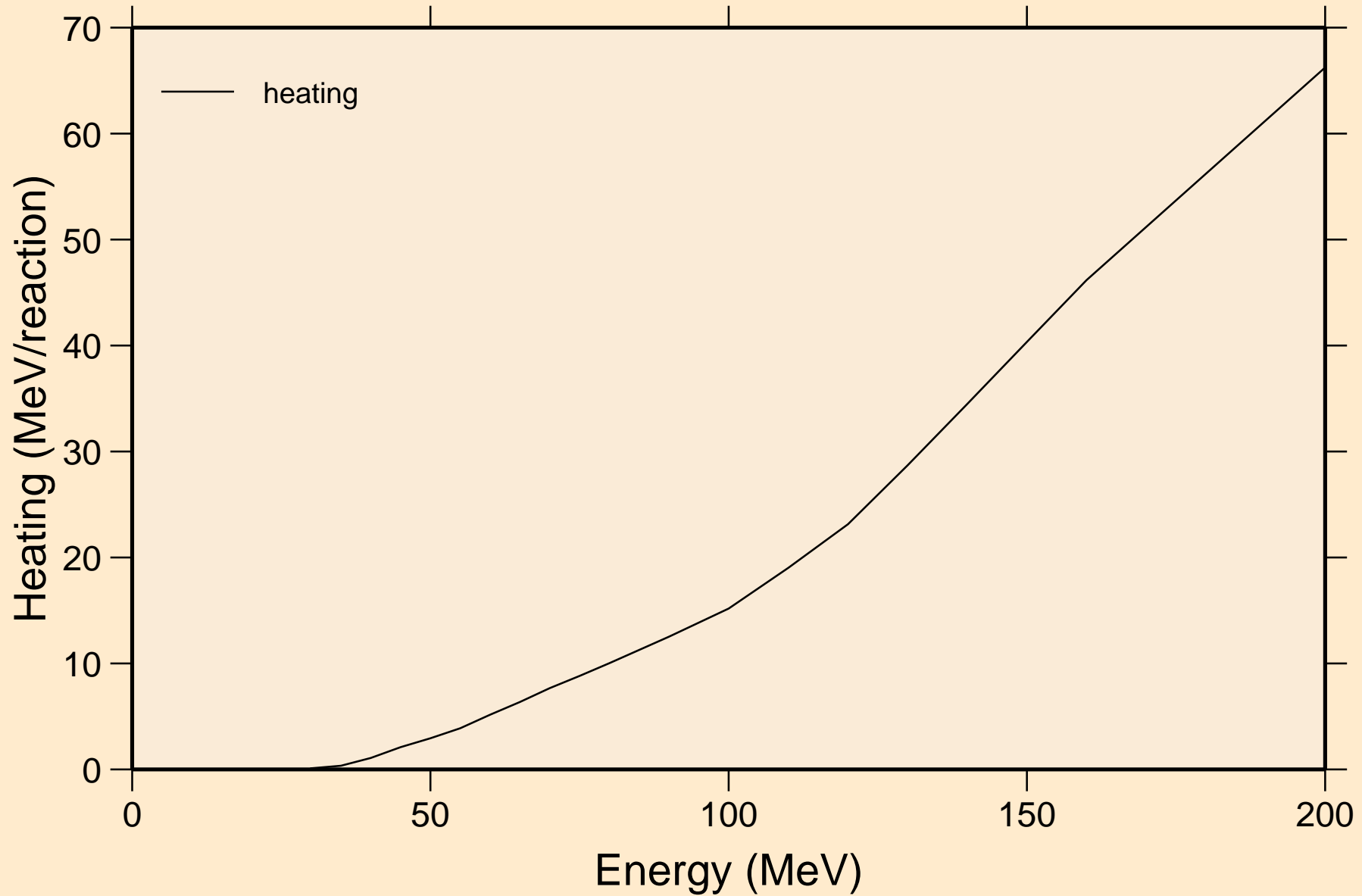

RF263 TRITON ACER TENDL-2021 LIBRARY; T=0.K  
Threshold reactions

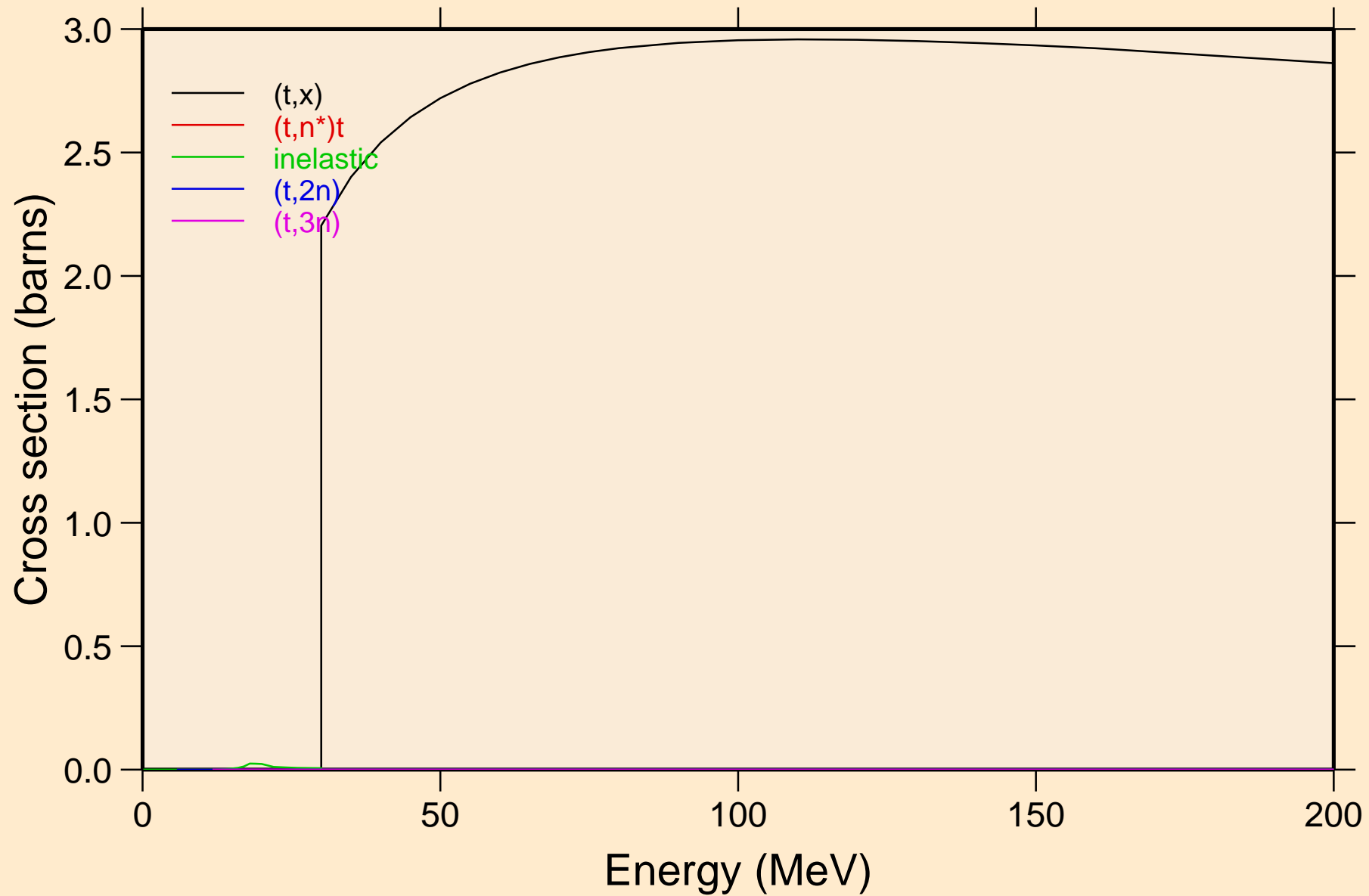

RF263 TRITON ACER TENDL-2021 LIBRARY; T=0.K  
Threshold reactions

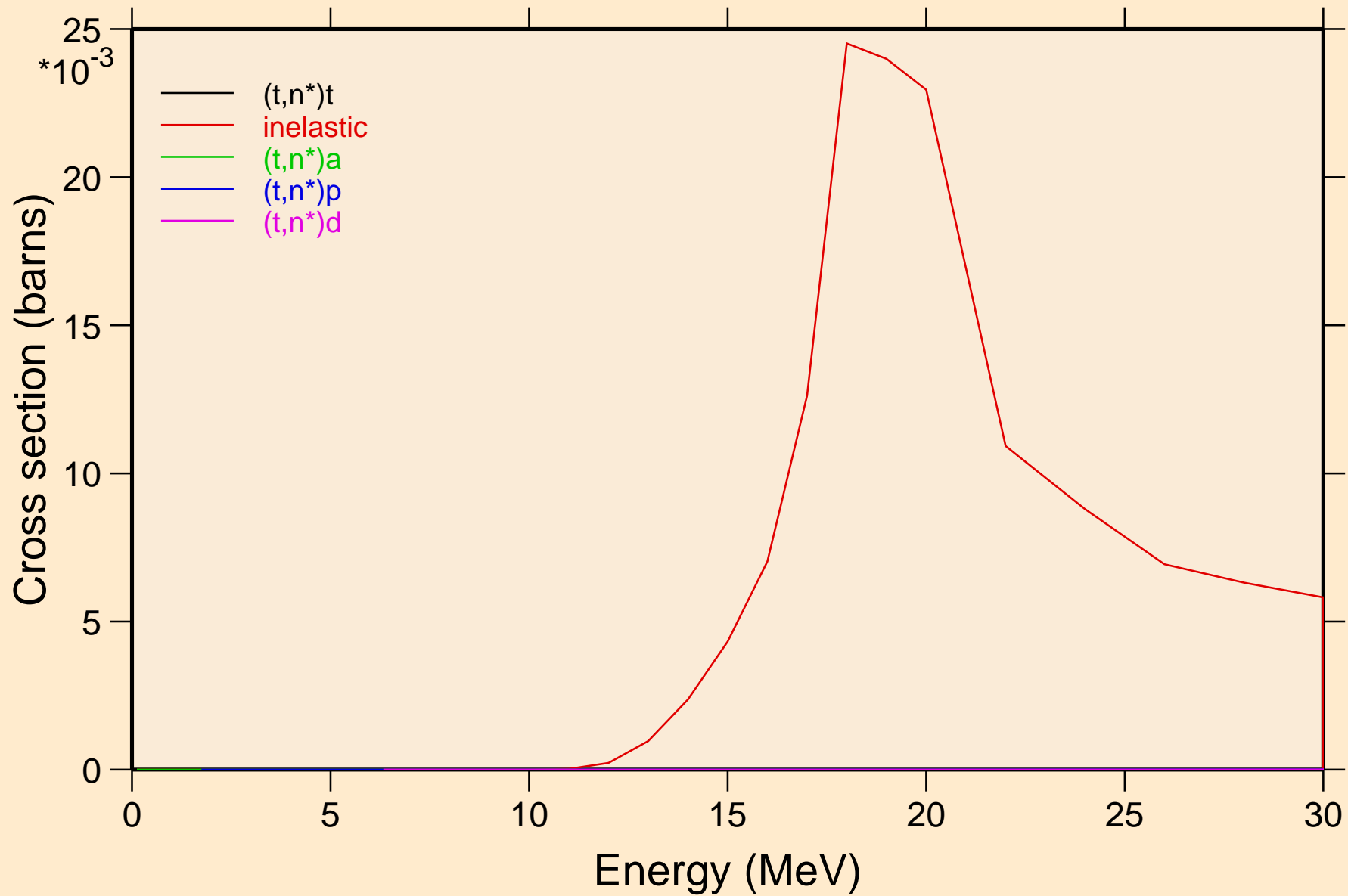

RF263 TRITON ACER TENDL-2021 LIBRARY; T=0.K  
Threshold reactions

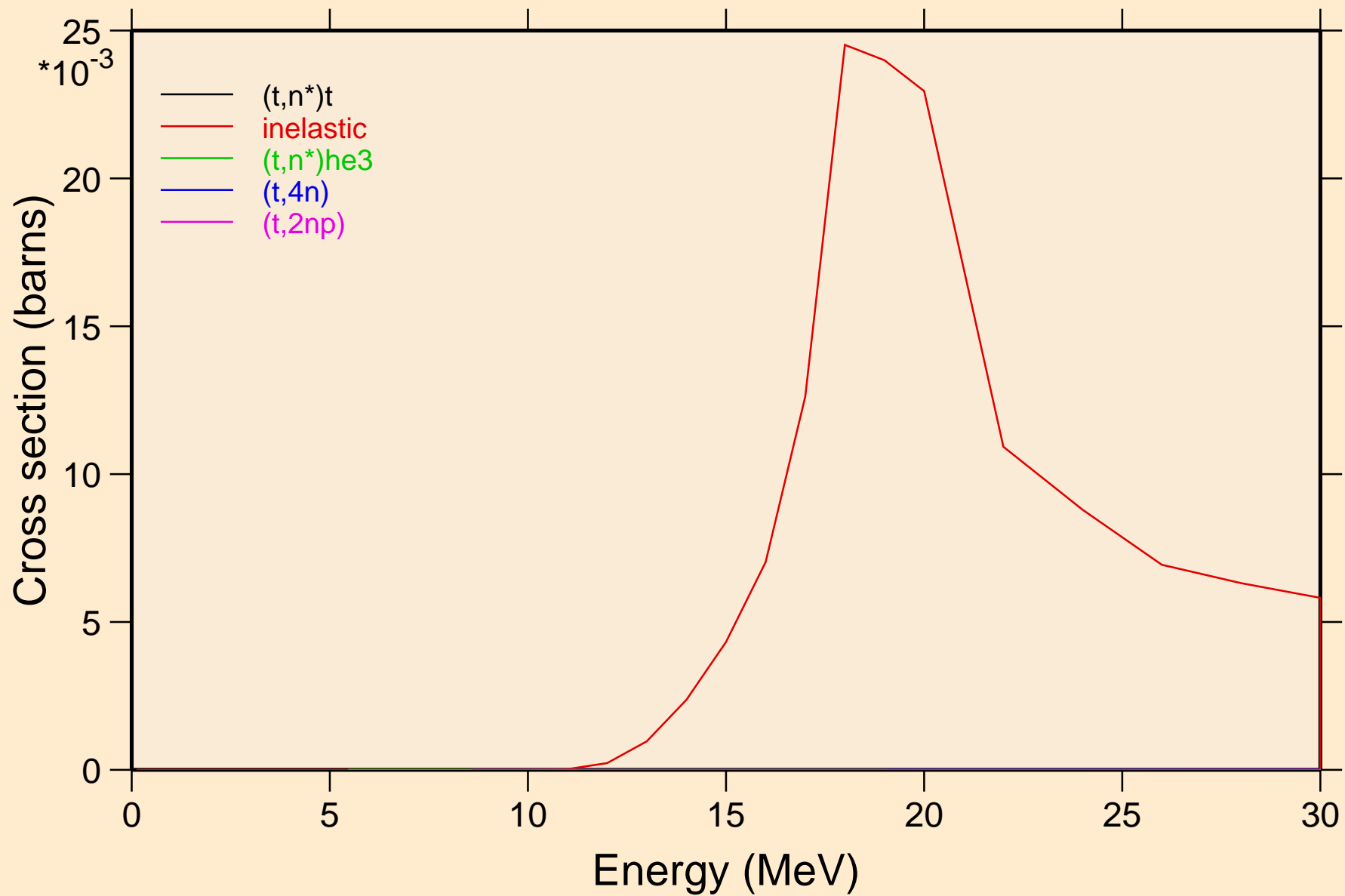

RF263 TRITON ACER TENDL-2021 LIBRARY; T=0.K  
Threshold reactions

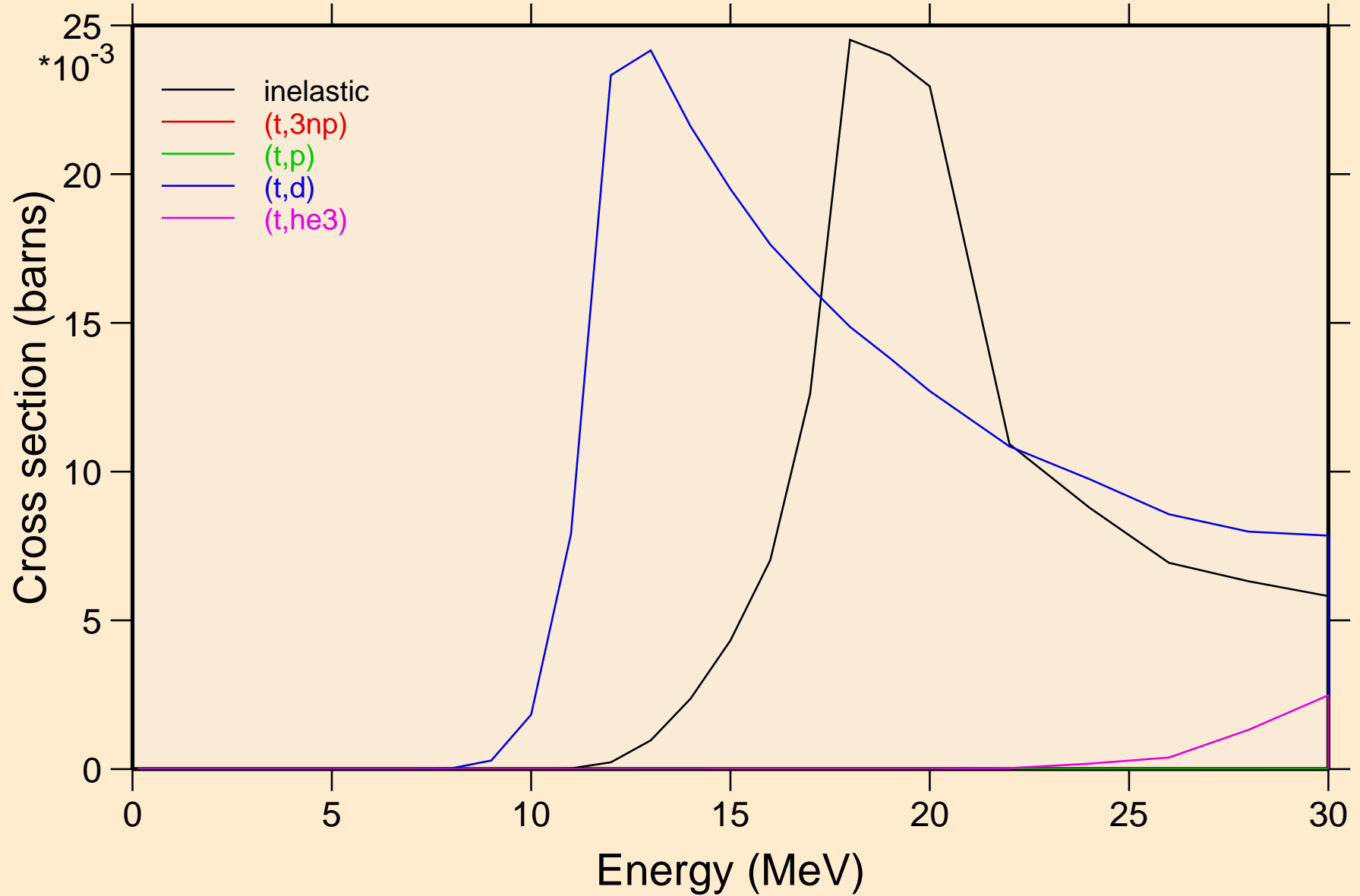



RF263 TRITON ACER TENDL-2021 LIBRARY; T=0.K  
Threshold reactions

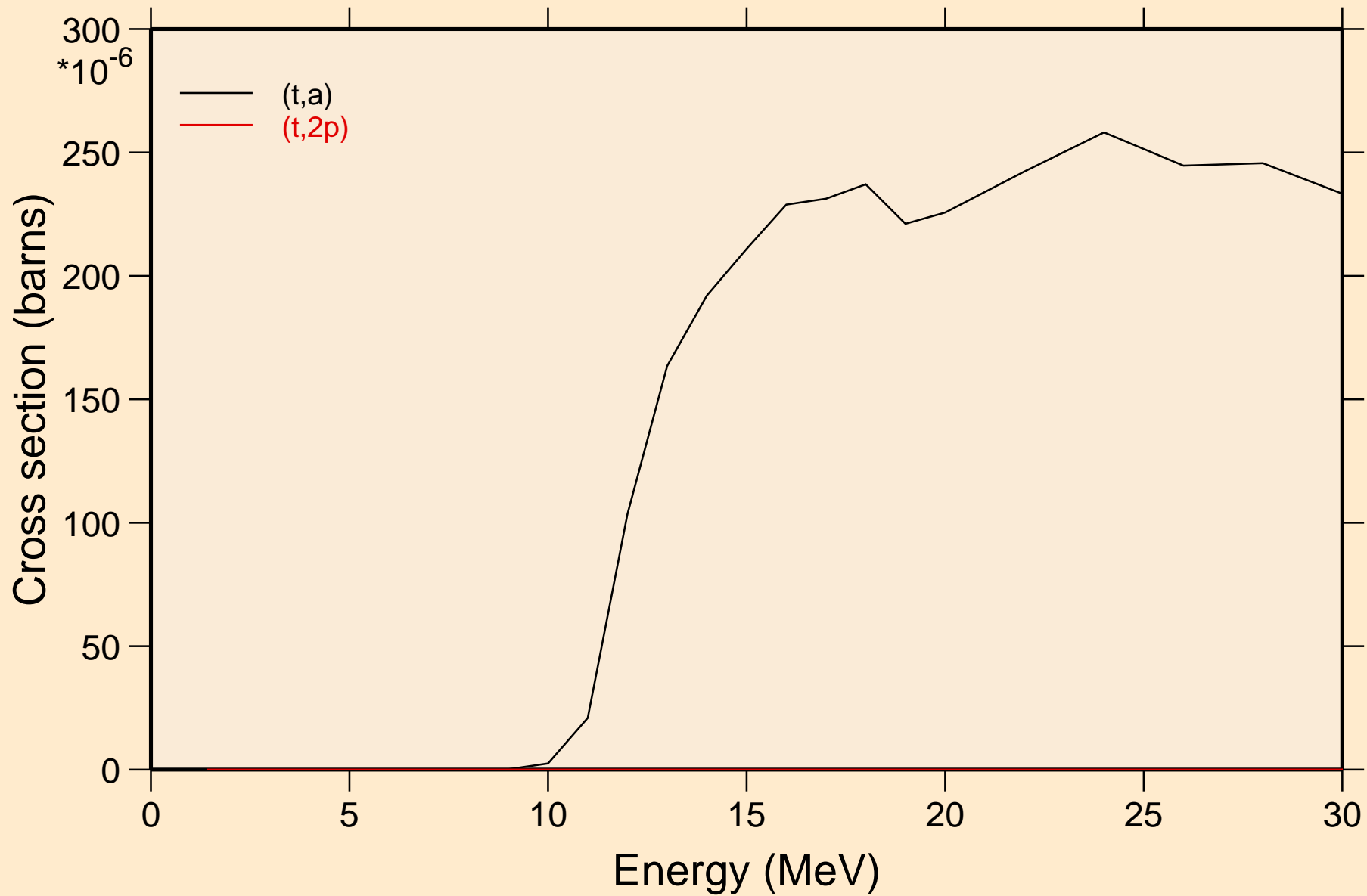

RF263 TRITON ACER TENDL-2021 LIBRARY; T=0.K  
angular distribution for elastic

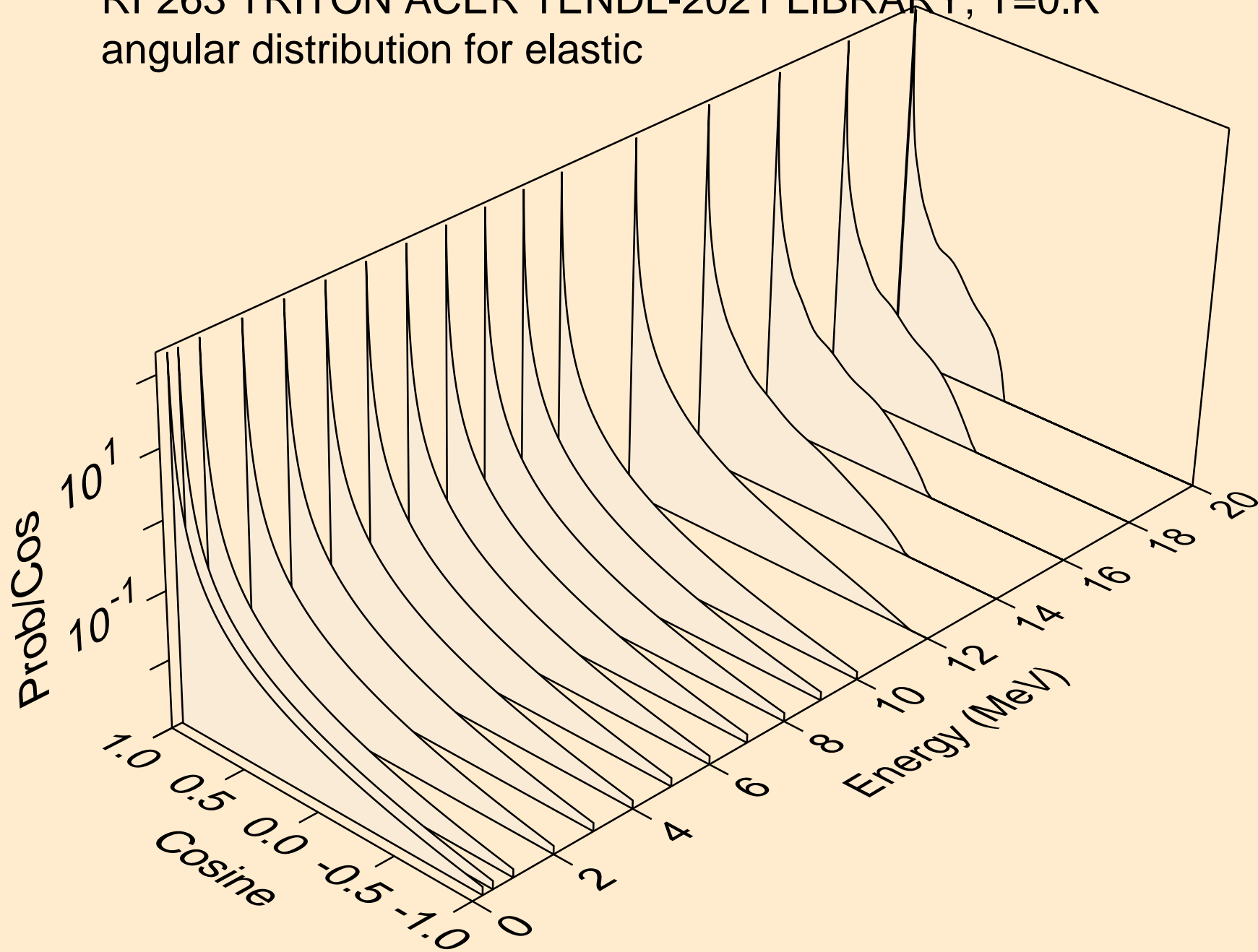

RF263 TRITON ACER TENDL-2021 LIBRARY; T=0.K  
angular distribution for elastic

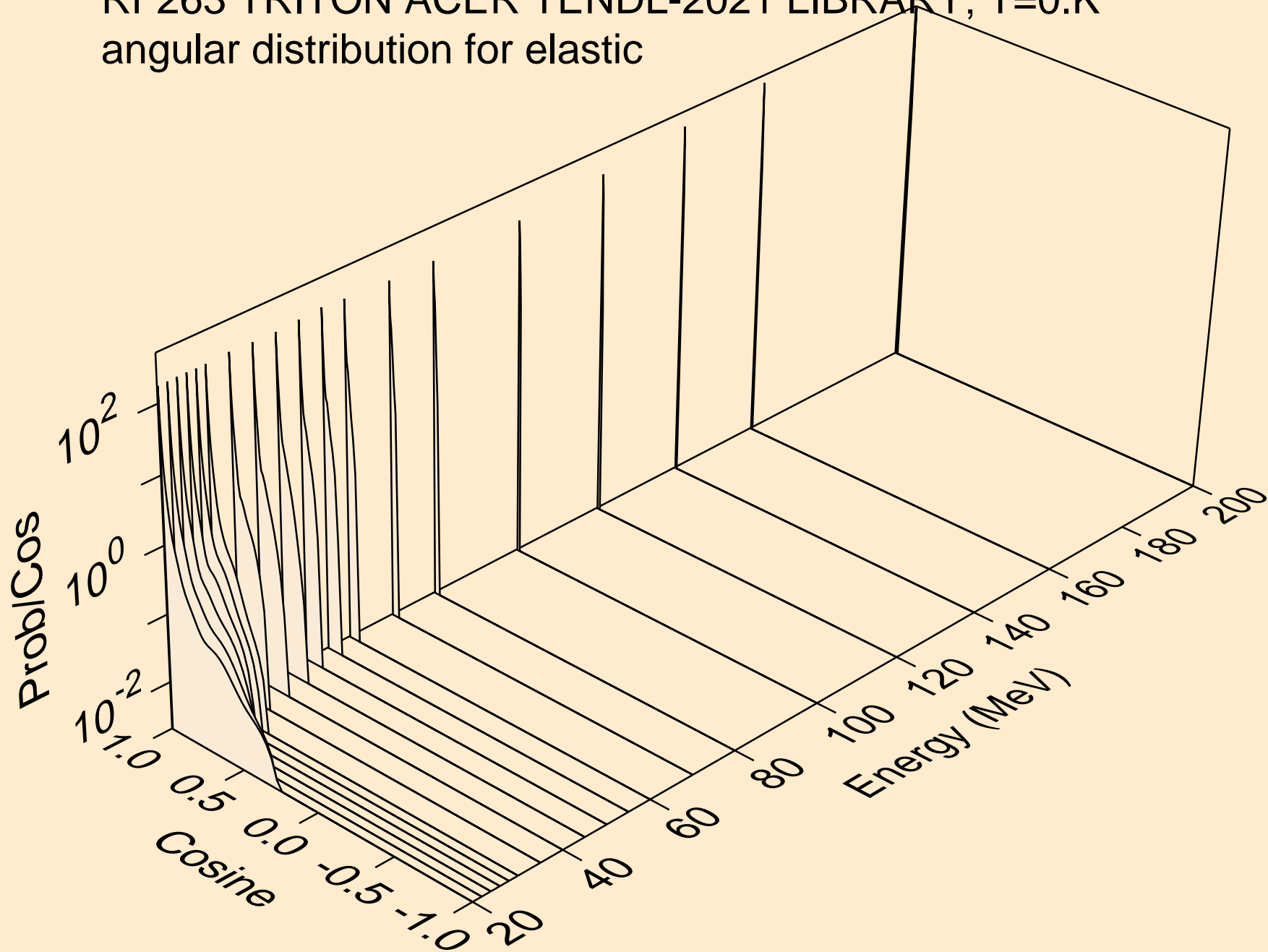

RF263 TRITON ACER TENDL-2021 LIBRARY; T=0.K  
Triton emission for (t,x)

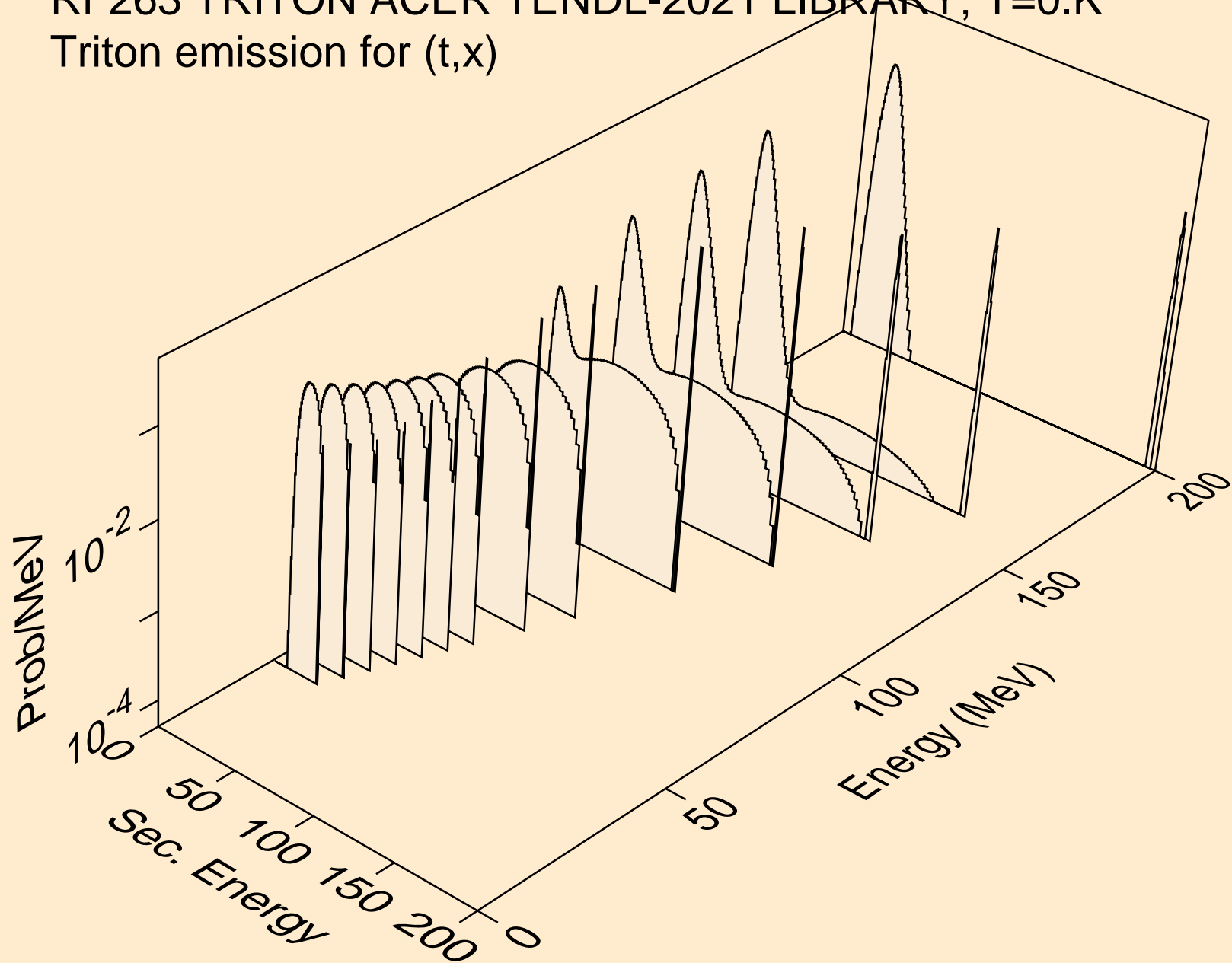

RF263 TRITON ACER TENDL-2021 LIBRARY; T=0.K  
Triton emission for (t,n\*)t

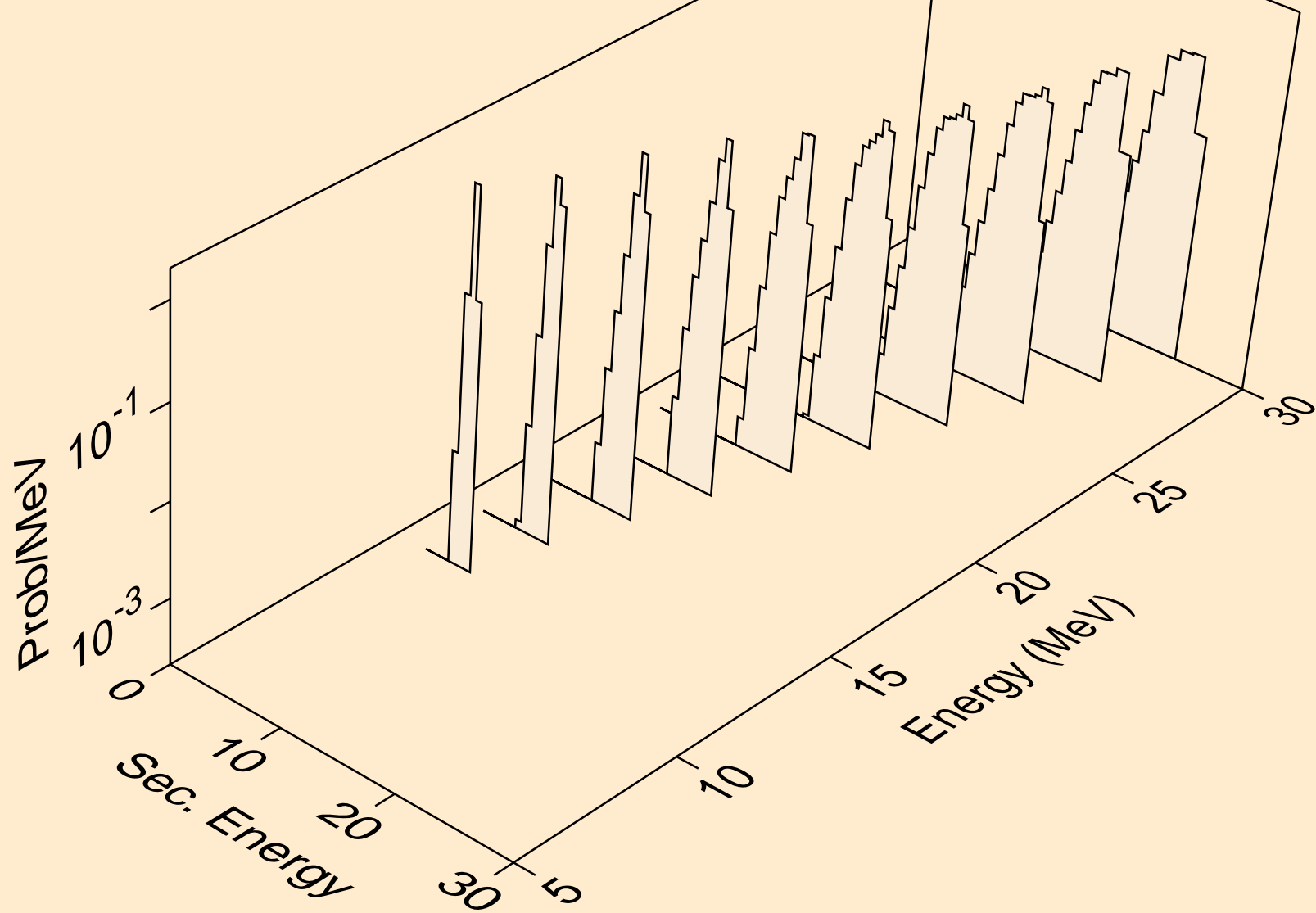

RF263 TRITON ACER TENDL-2021 LIBRARY; T=0.K  
Triton emission for inelastic

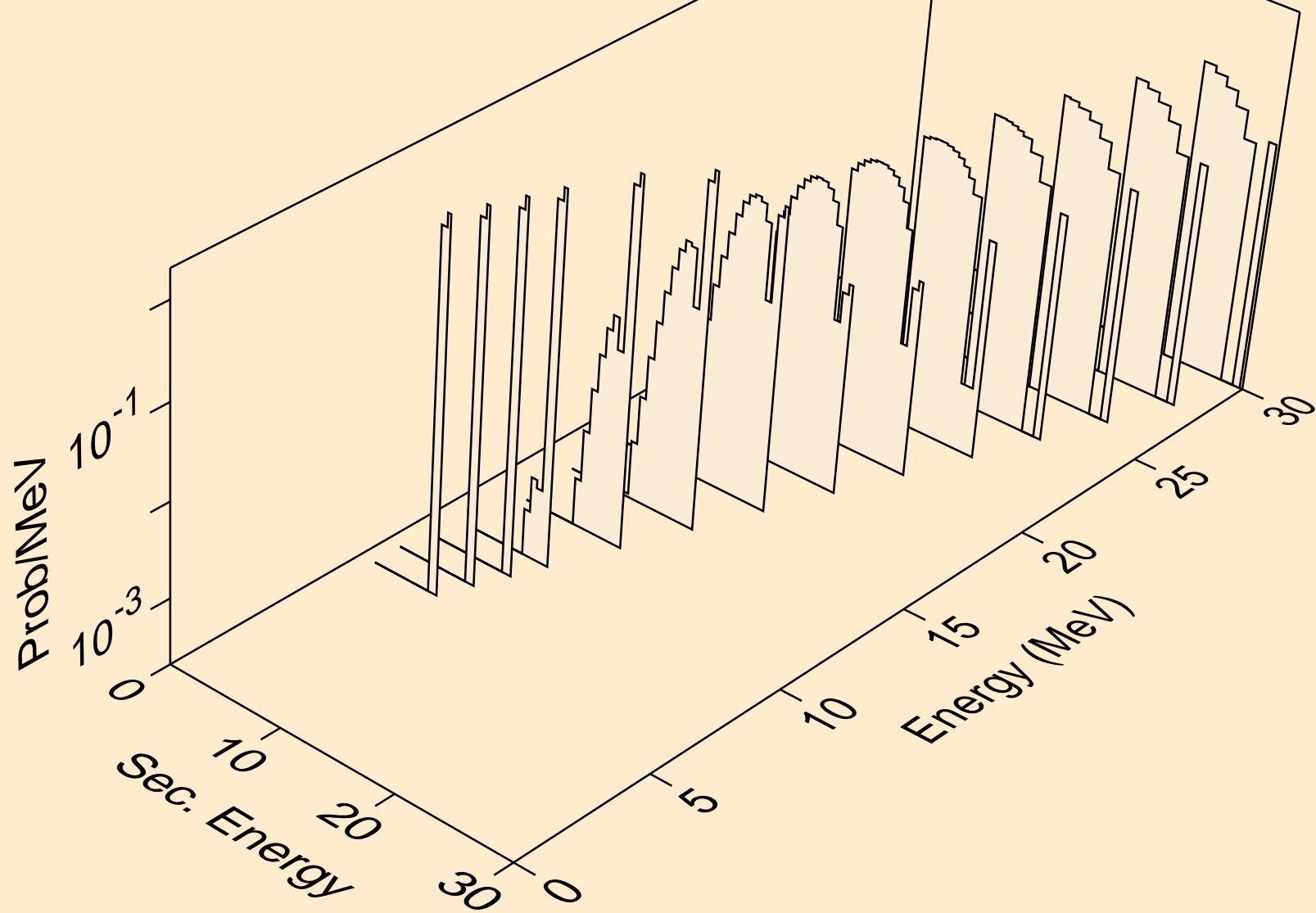

RF263 TRITON ACER TENDL-2021 LIBRARY; T=0.K  
Photon emission for (z,n)

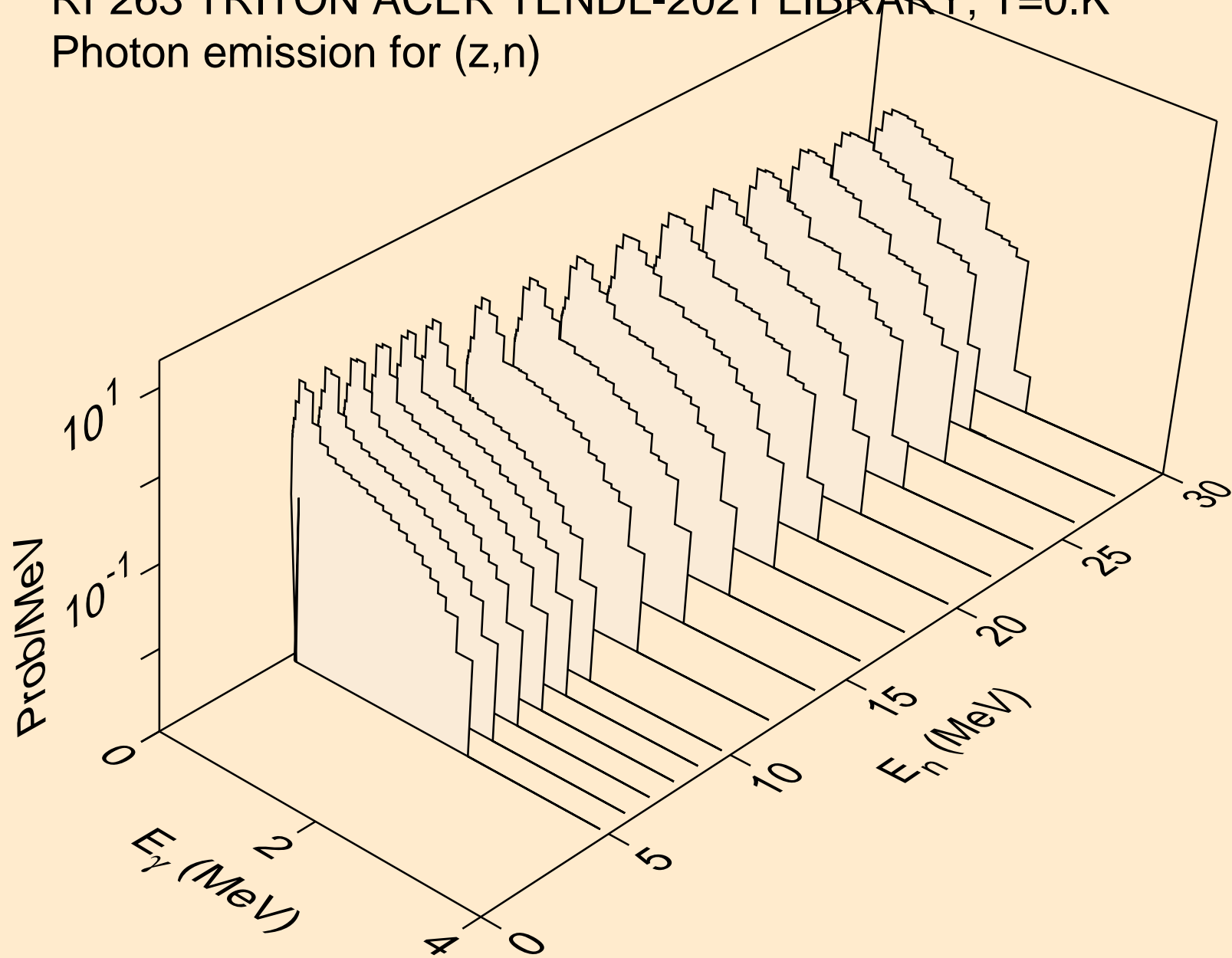

RF263 TRITON ACER TENDL-2021 LIBRARY; T=0.K  
Photon emission for (n,x)

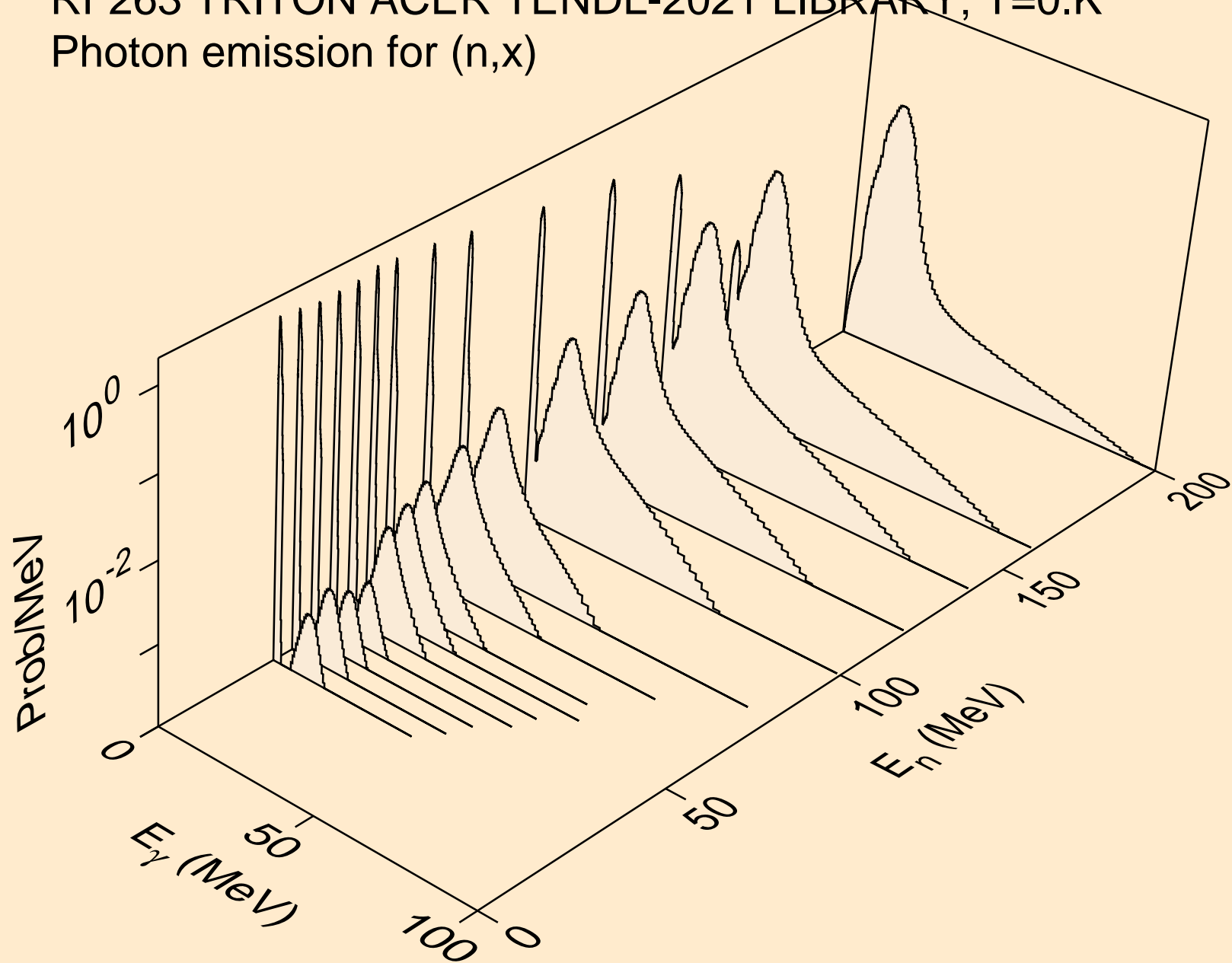



RF263 TRITON ACER TENDL-2021 LIBRARY; T=0.K  
Photon emission for (n,2n)

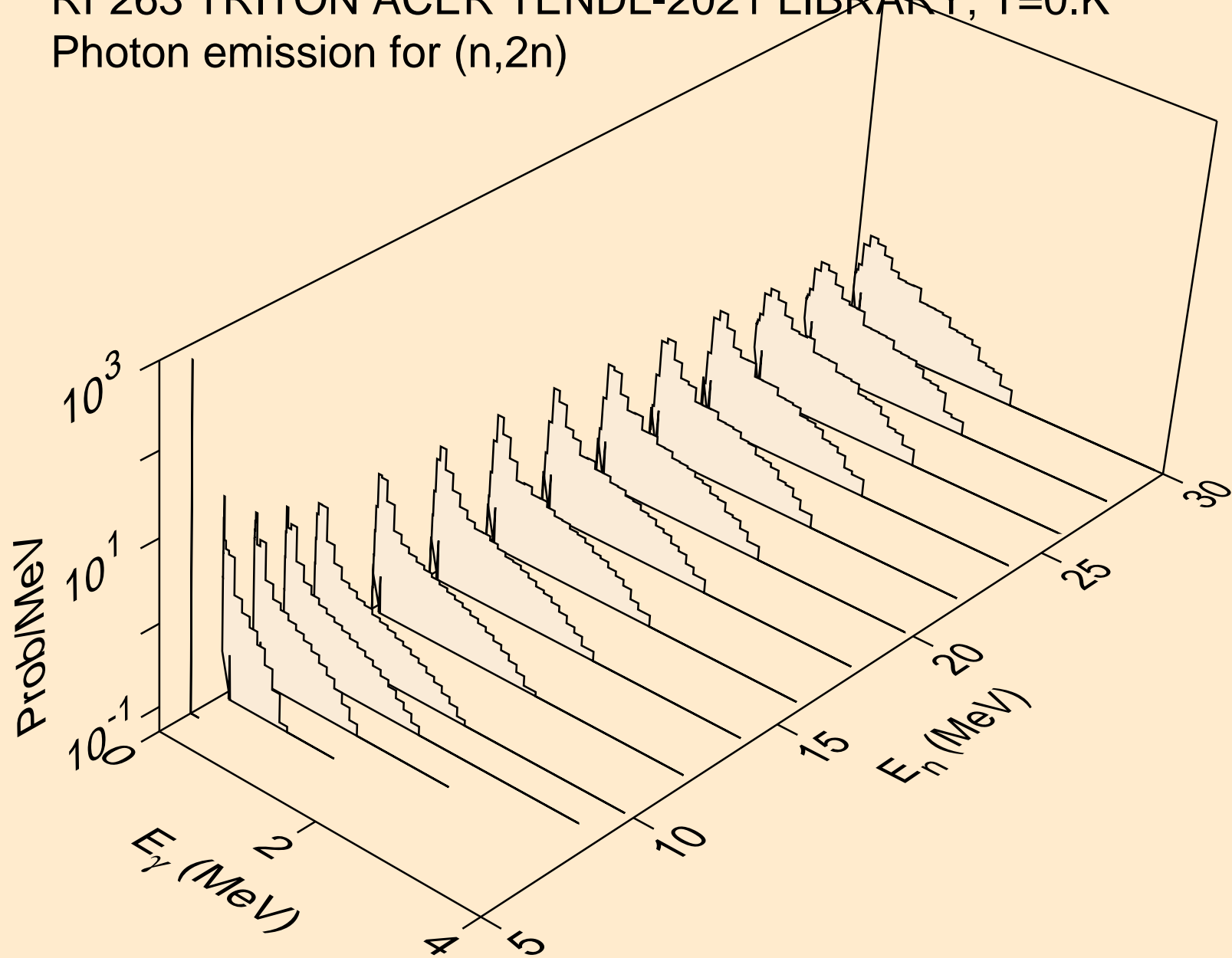

RF263 TRITON ACER TENDL-2021 LIBRARY; T=0.K  
Photon emission for (n,3n)

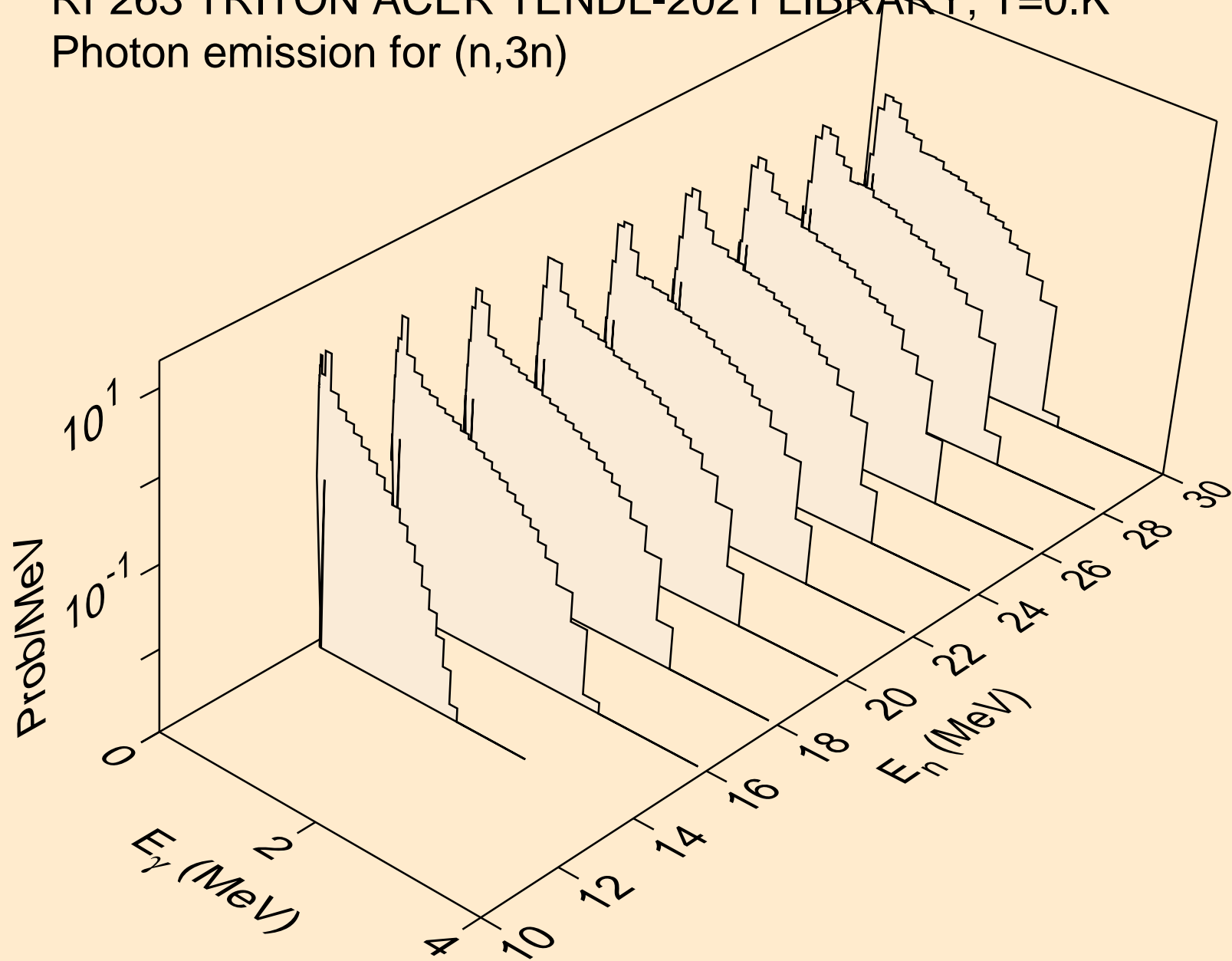

RF263 TRITON ACER TENDL-2021 LIBRARY; T=0.K  
Photon emission for (n,n\*)a

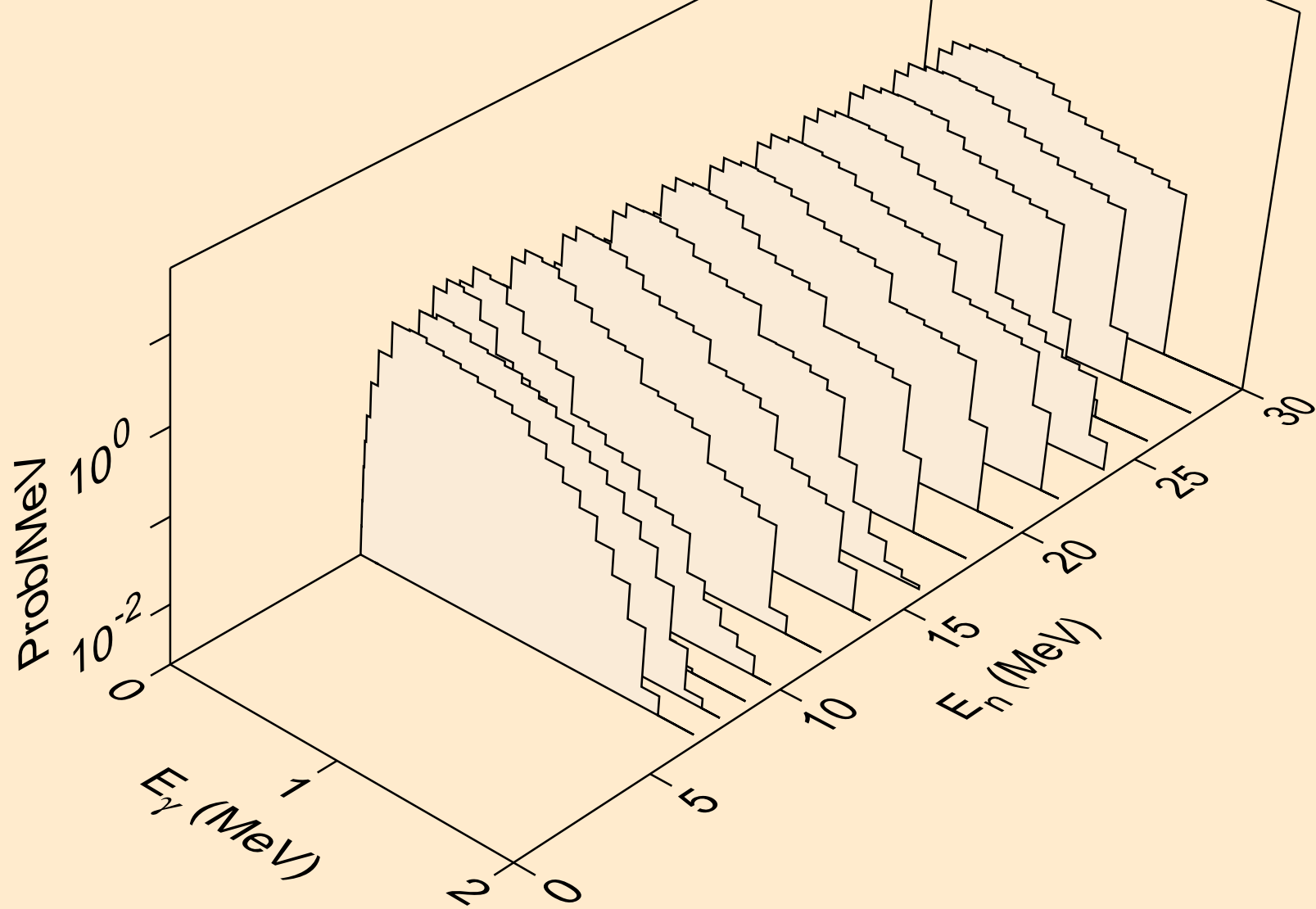

RF263 TRITON ACER TENDL-2021 LIBRARY; T=0.K  
Photon emission for (n,n\*)p

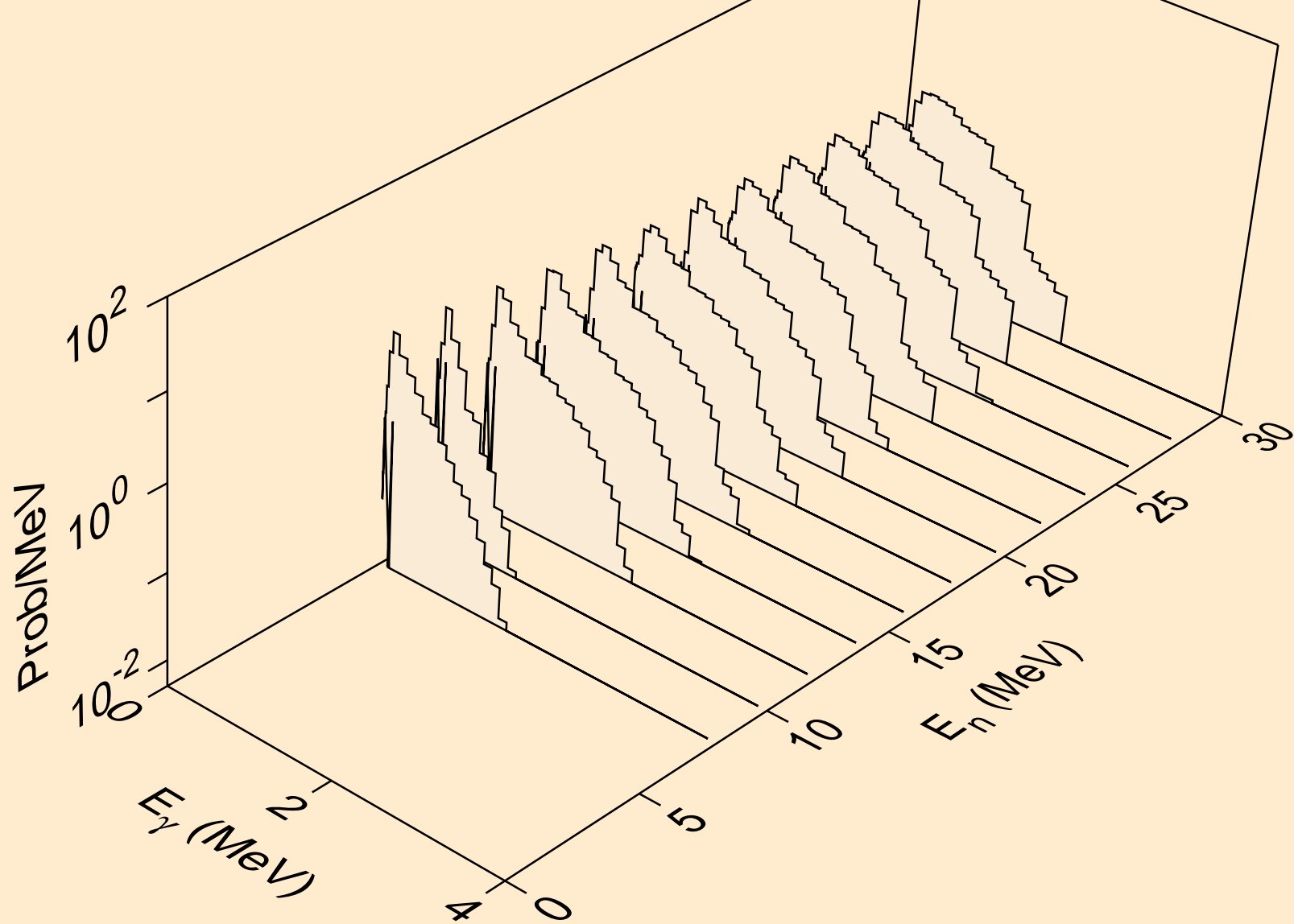

RF263 TRITON ACER TENDL-2021 LIBRARY; T=0.K  
Photon emission for (n,n\*)d

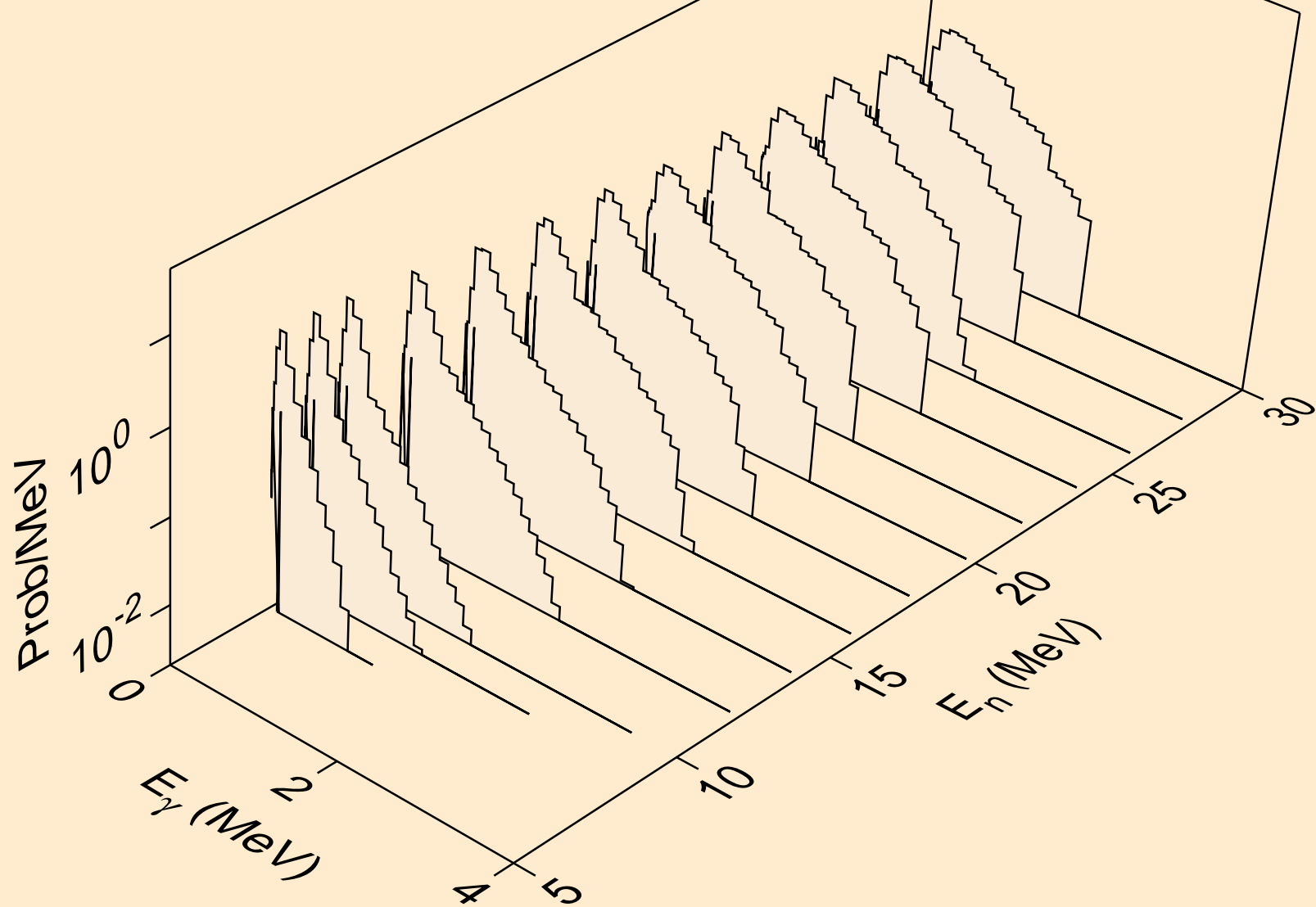

RF263 TRITON ACER TENDL-2021 LIBRARY; T=0.K  
Photon emission for (n,n\*)t

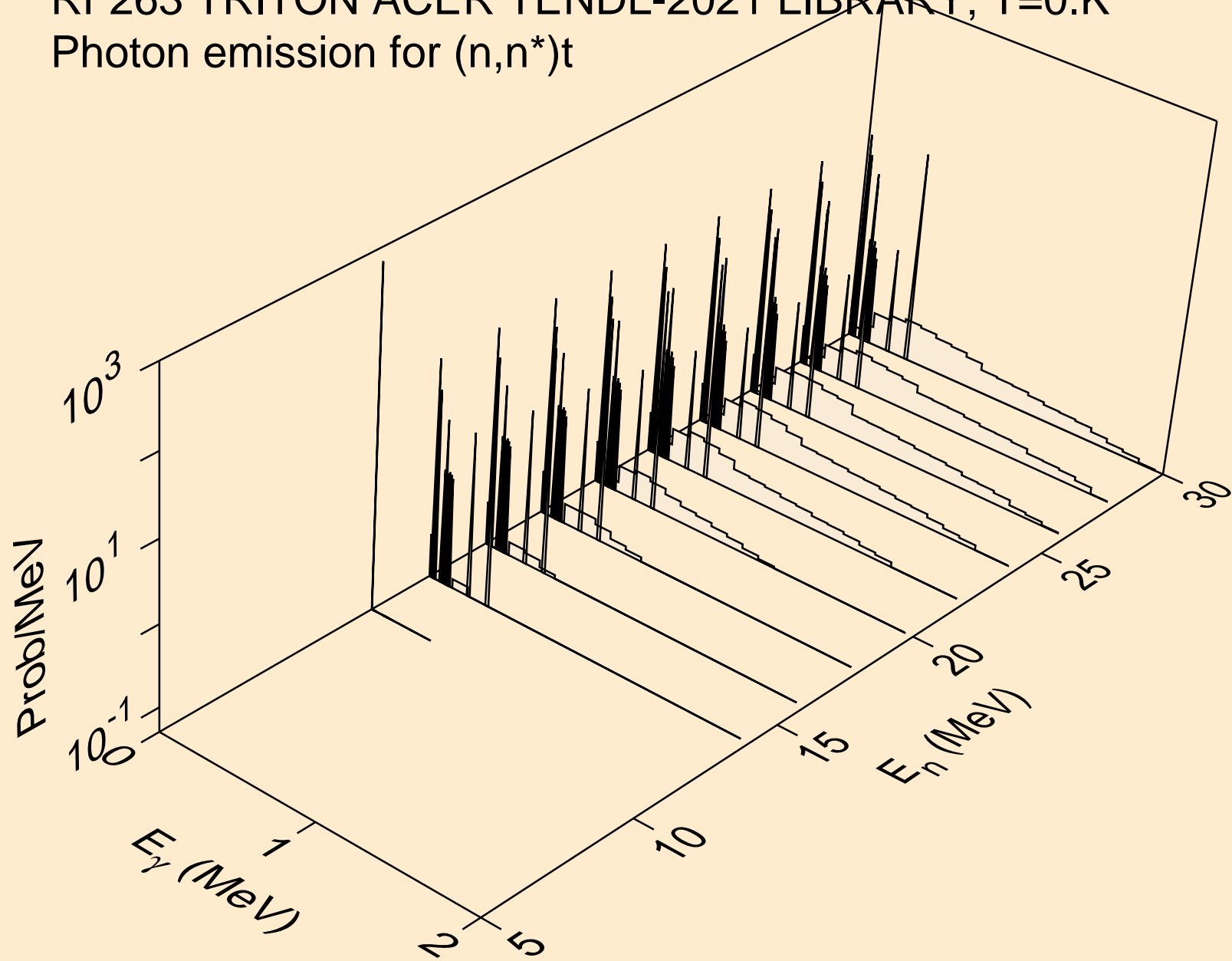

RF263 TRITON ACER TENDL-2021 LIBRARY; T=0.K  
Photon emission for (n,n\*)he3

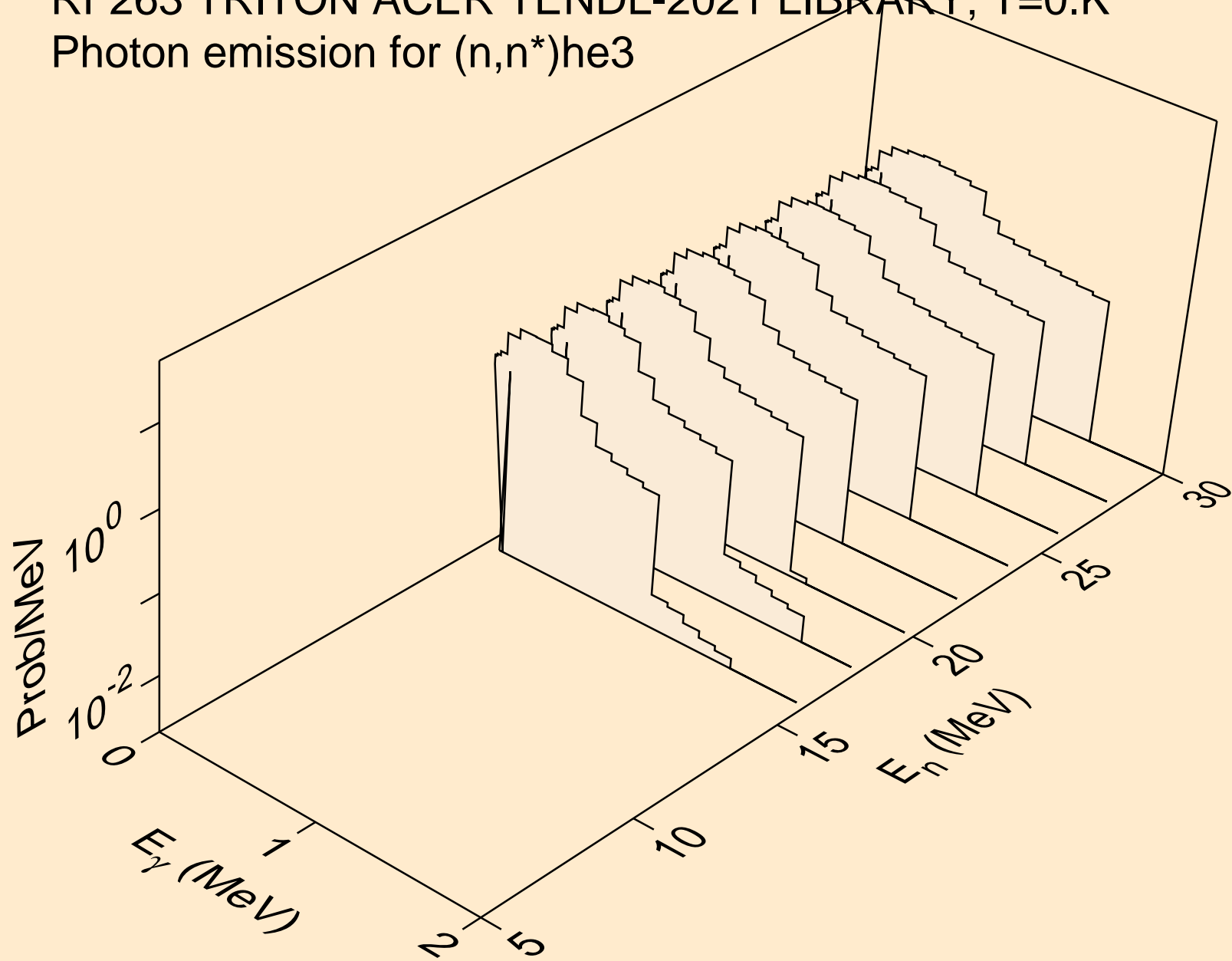

RF263 TRITON ACER TENDL-2021 LIBRARY; T=0.K  
Photon emission for (n,4n)

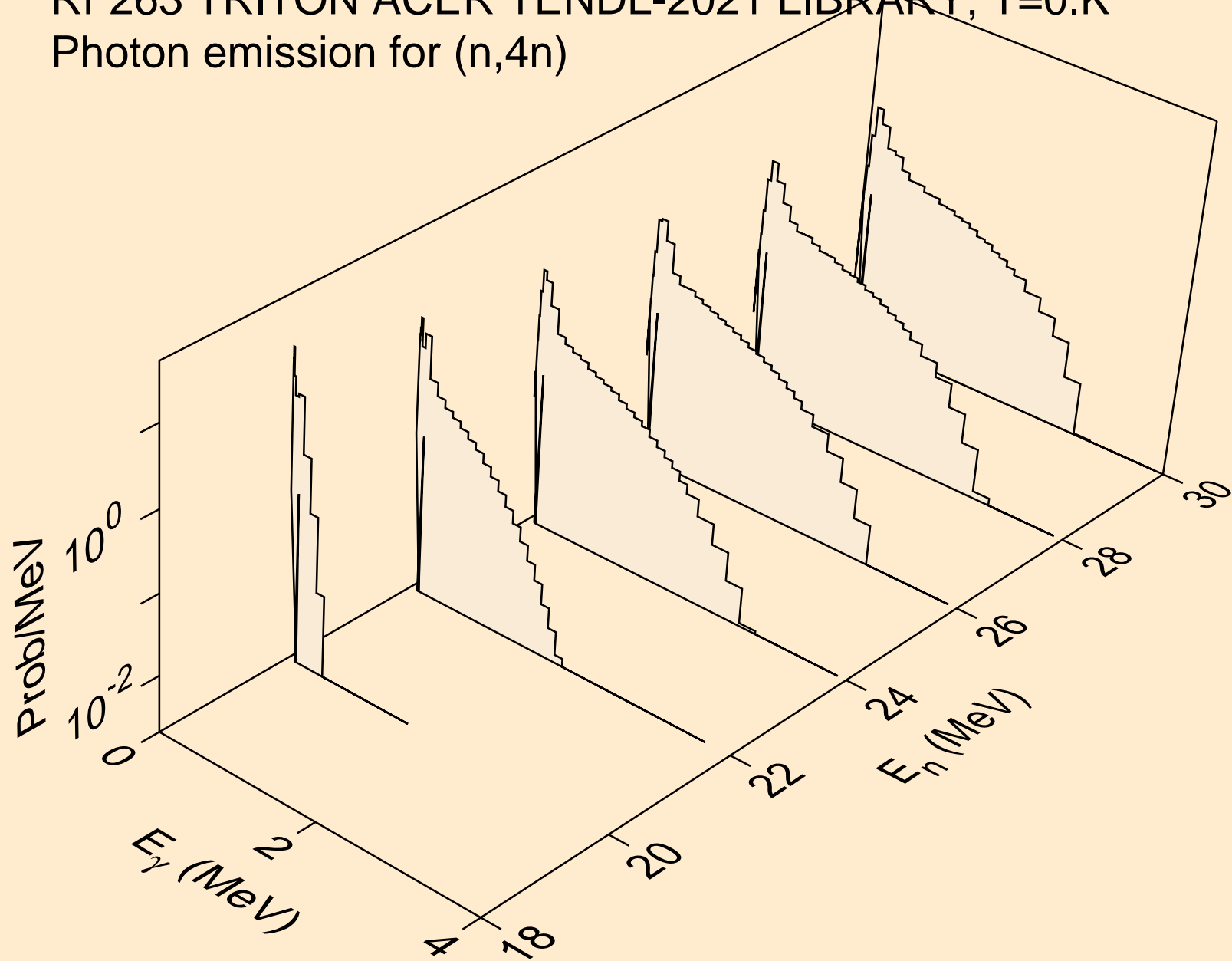



RF263 TRITON ACER TENDL-2021 LIBRARY; T=0.K  
Photon emission for (n,2np)

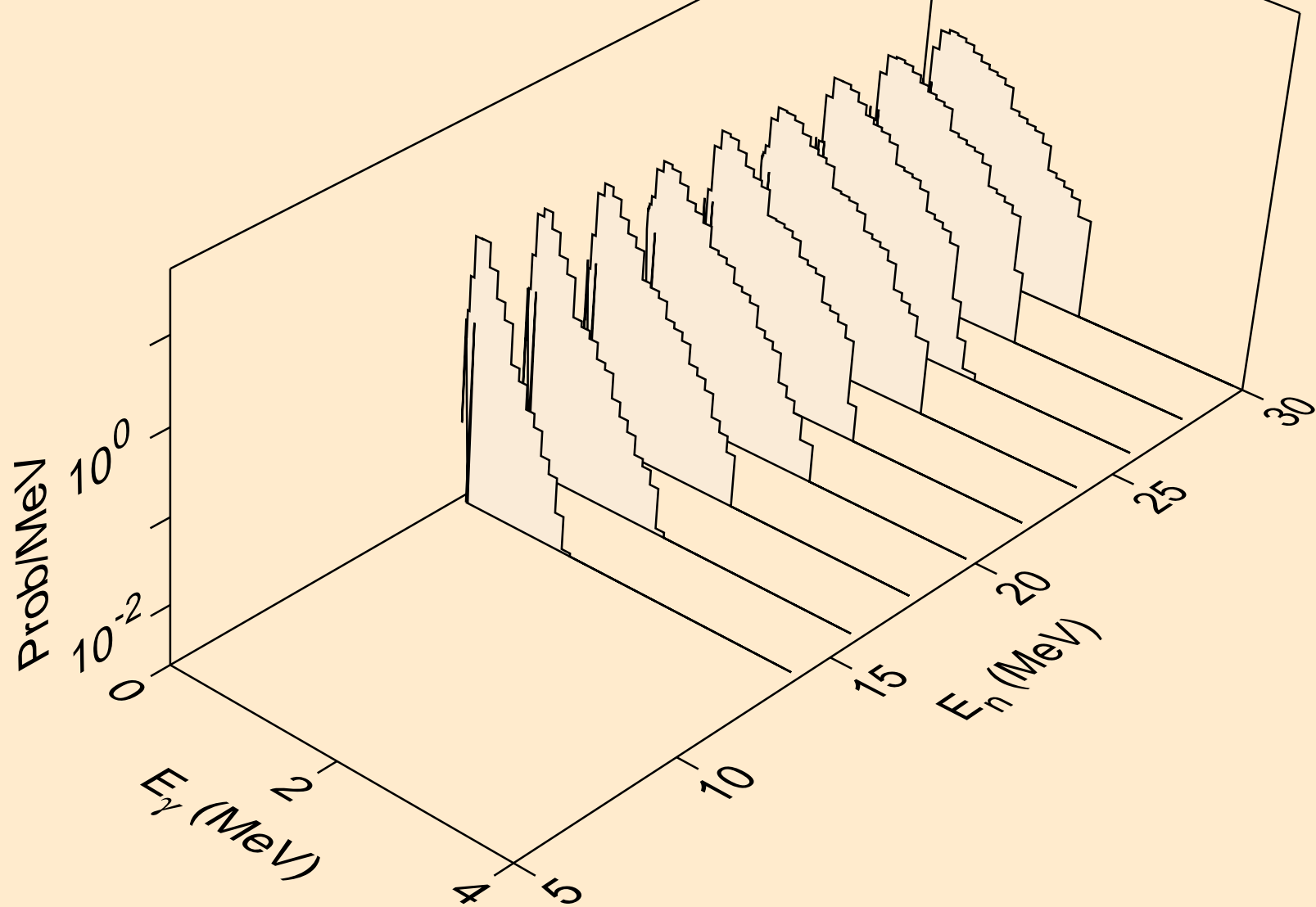

RF263 TRITON ACER TENDL-2021 LIBRARY; T=0.K  
Photon emission for (n,3np)

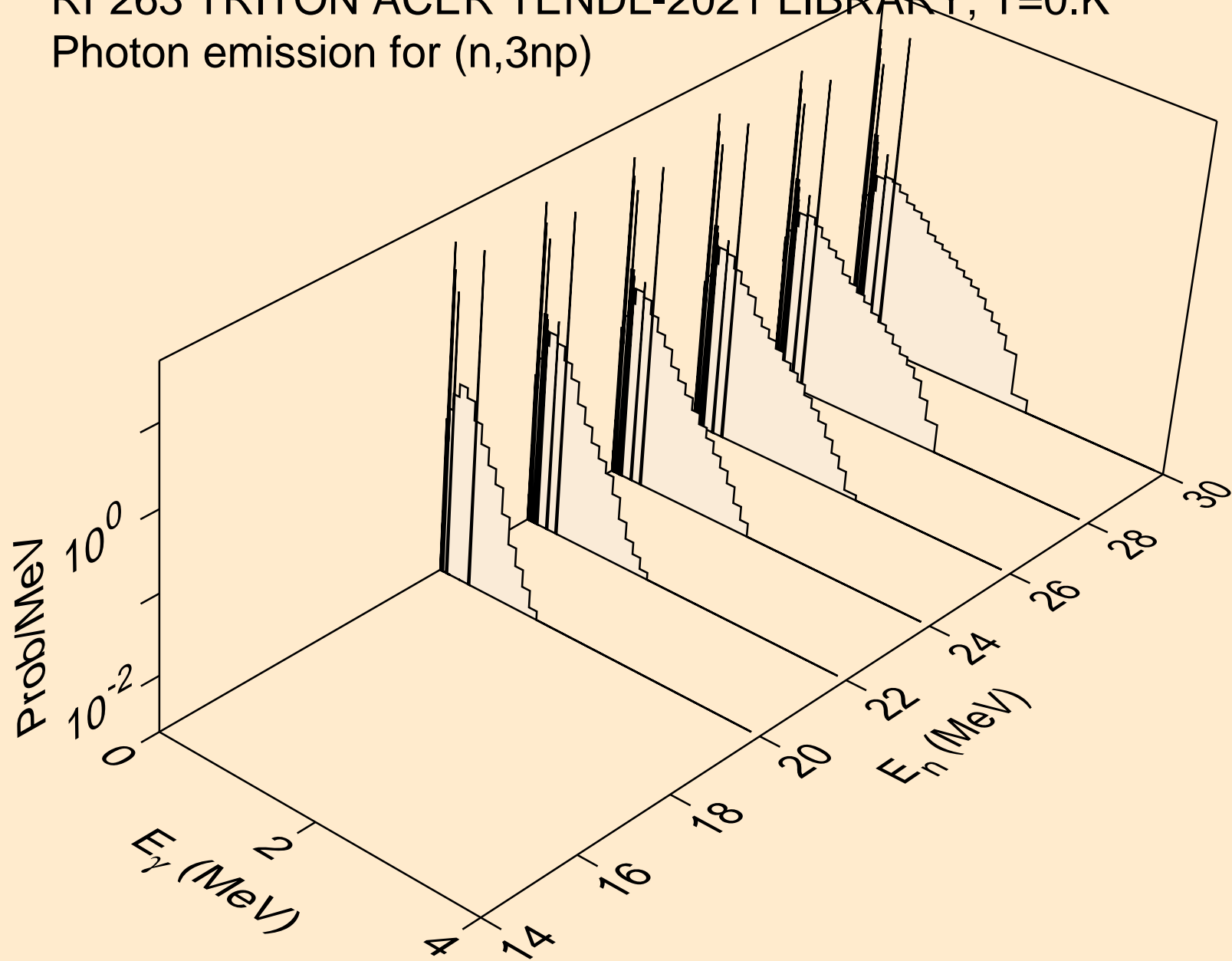

RF263 TRITON ACER TENDL-2021 LIBRARY; T=0.K  
Photon emission for (n,p)

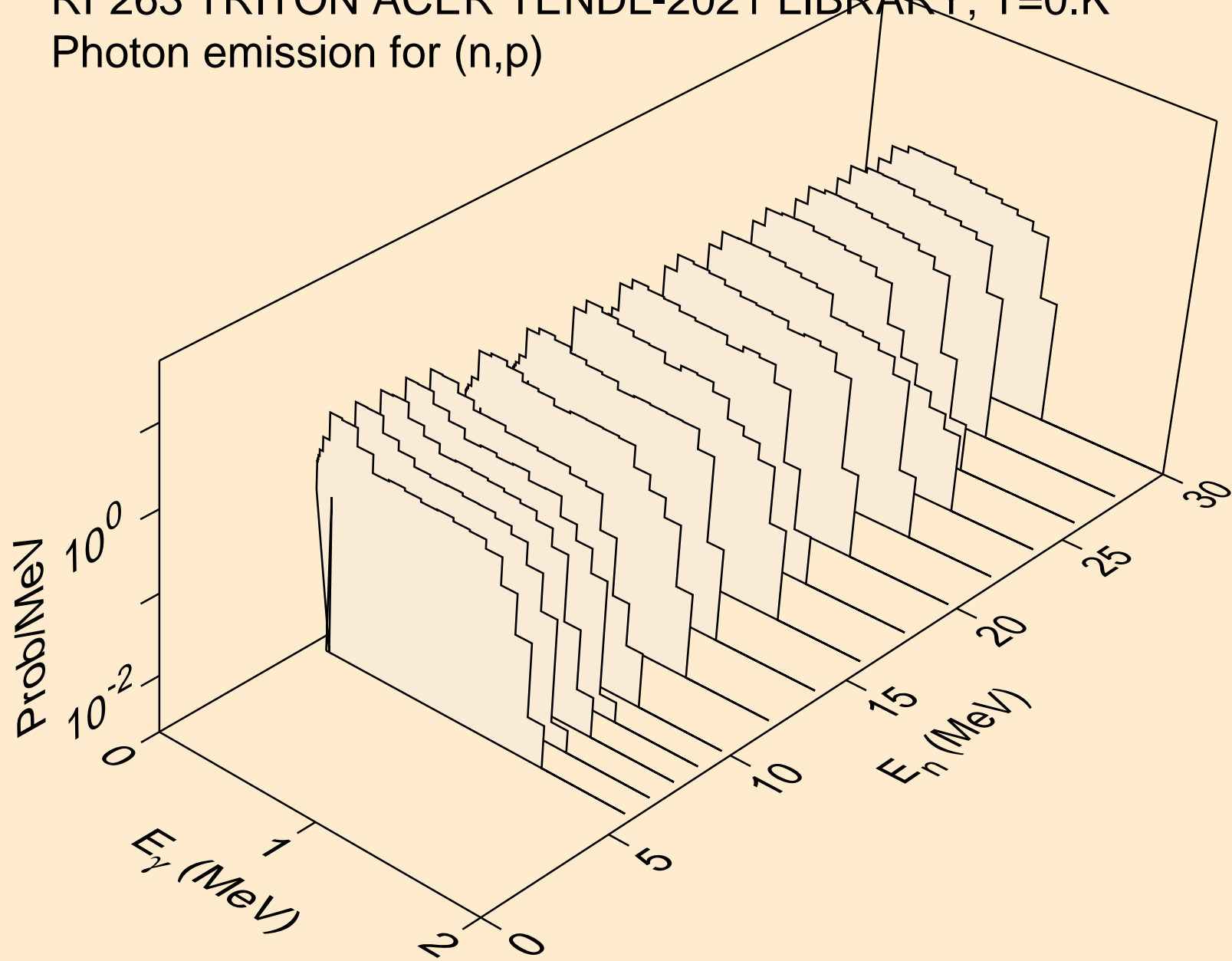

RF263 TRITON ACER TENDL-2021 LIBRARY; T=0.K  
Photon emission for (n,d)

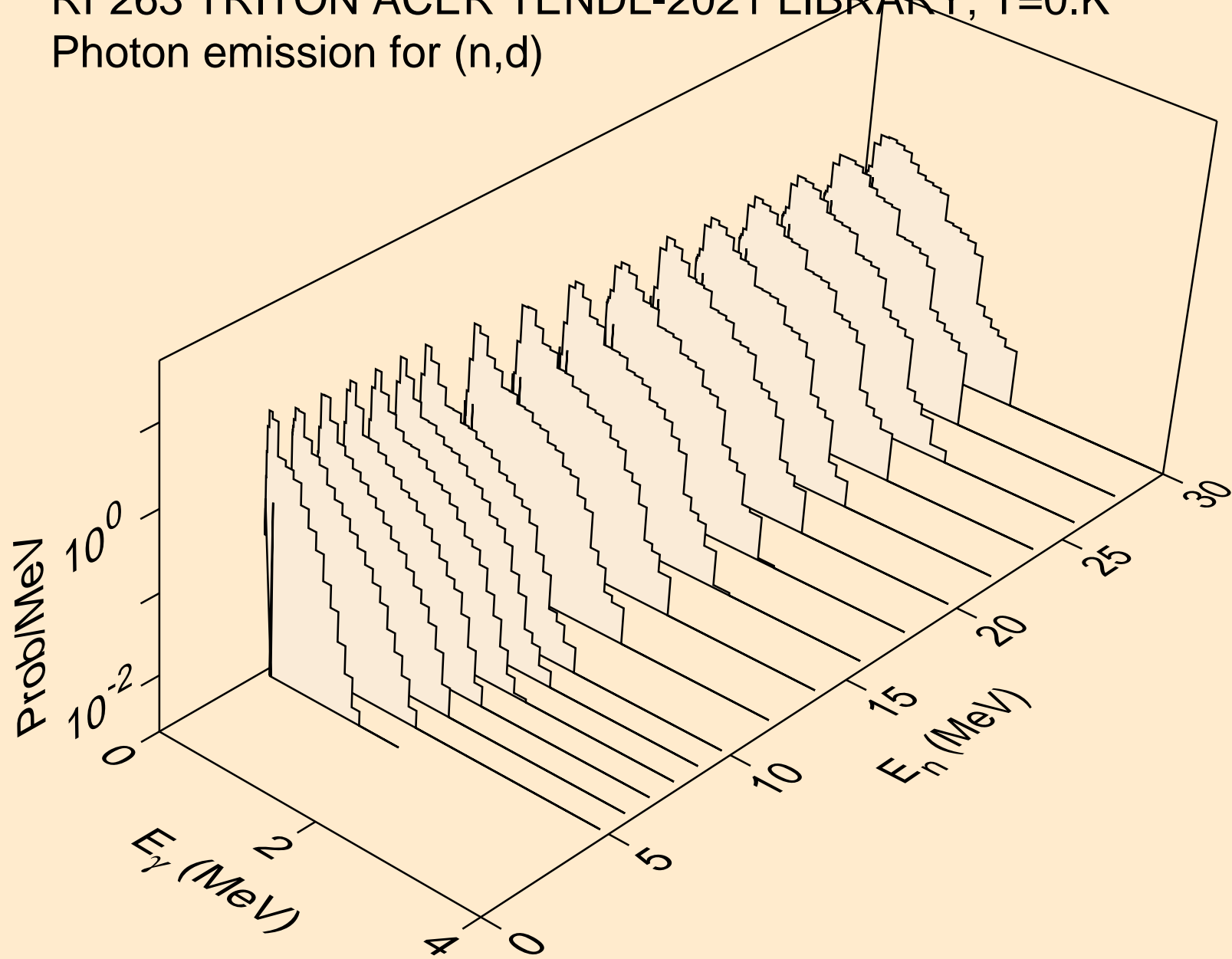

RF263 TRITON ACER TENDL-2021 LIBRARY; T=0.K  
Photon emission for inelastic

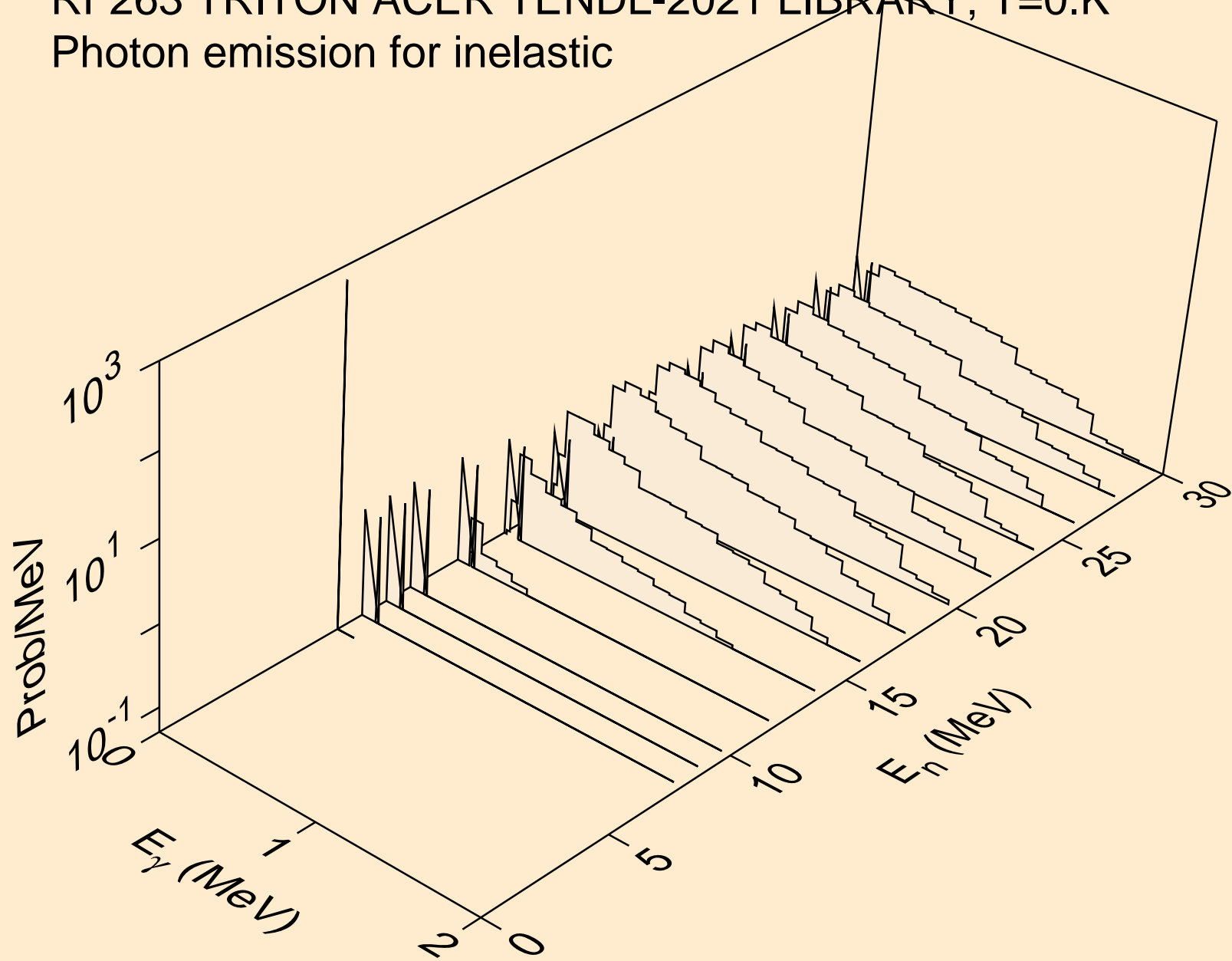

RF263 TRITON ACER TENDL-2021 LIBRARY; T=0.K  
Photon emission for (n,he3)

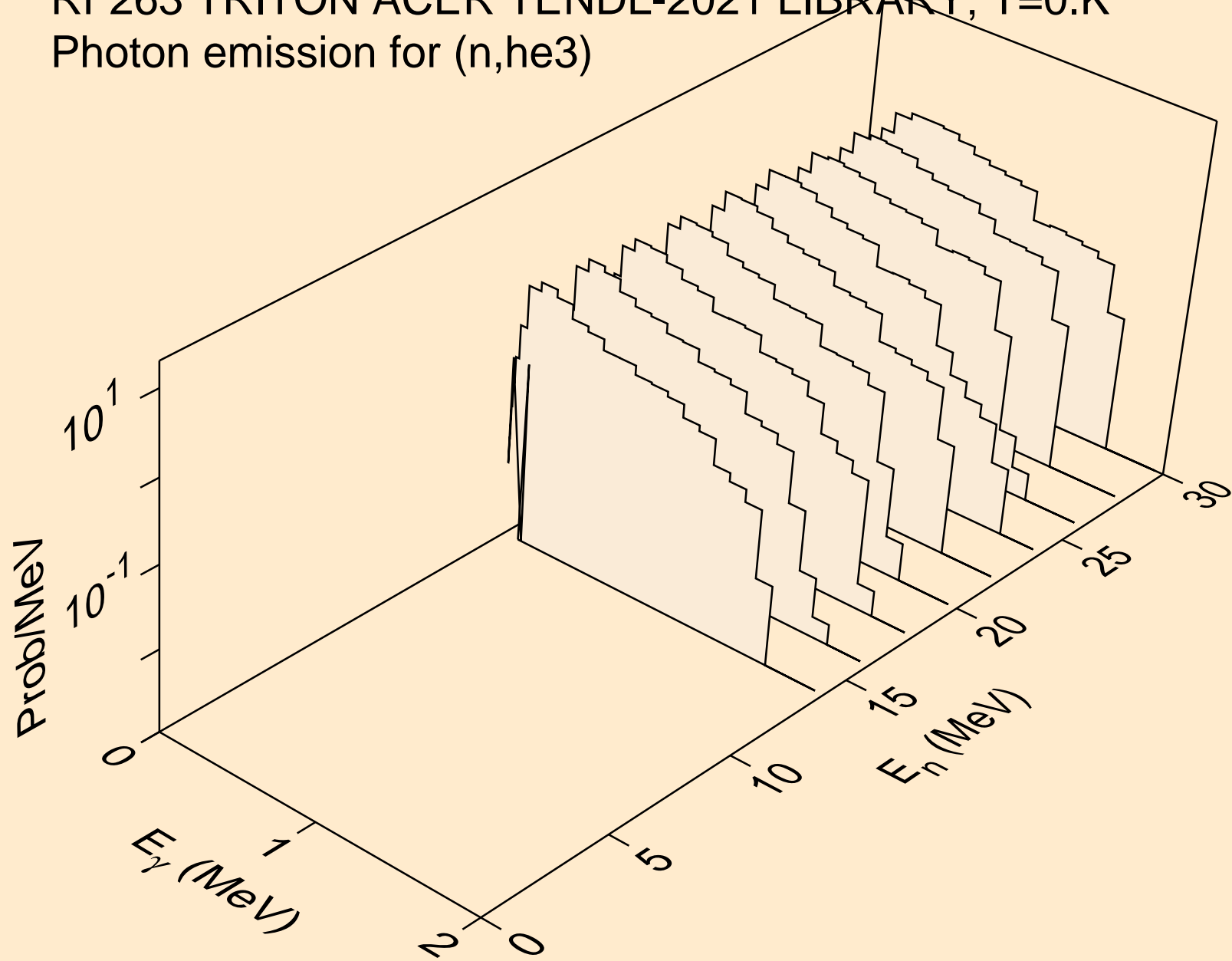

RF263 TRITON ACER TENDL-2021 LIBRARY; T=0.K  
Photon emission for (n,a)

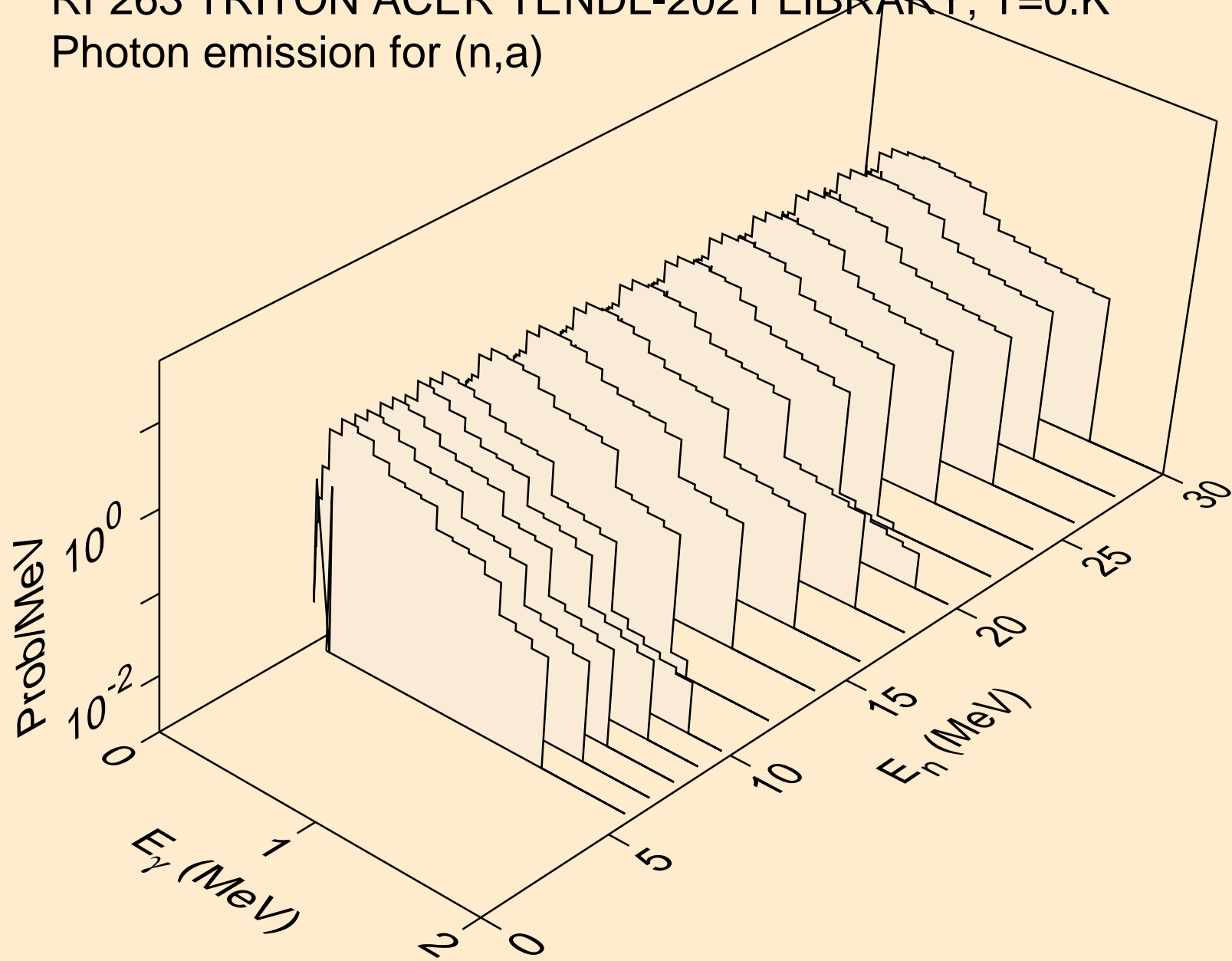

RF263 TRITON ACER TENDL-2021 LIBRARY; T=0.K  
Photon emission for (n,2p)

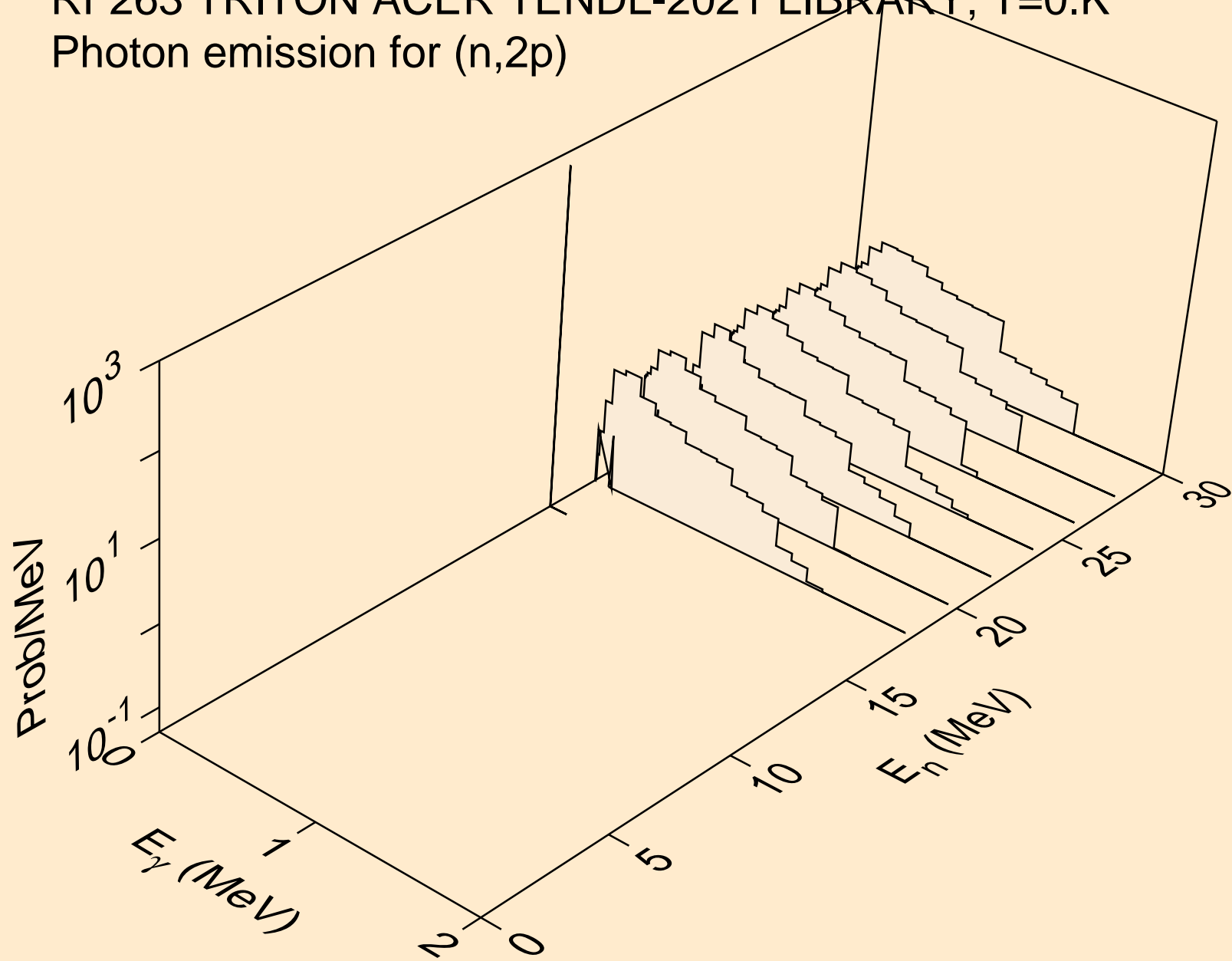



RF263 TRITON ACER TENDL-2021 LIBRARY; T=0.K  
Particle heating contributions

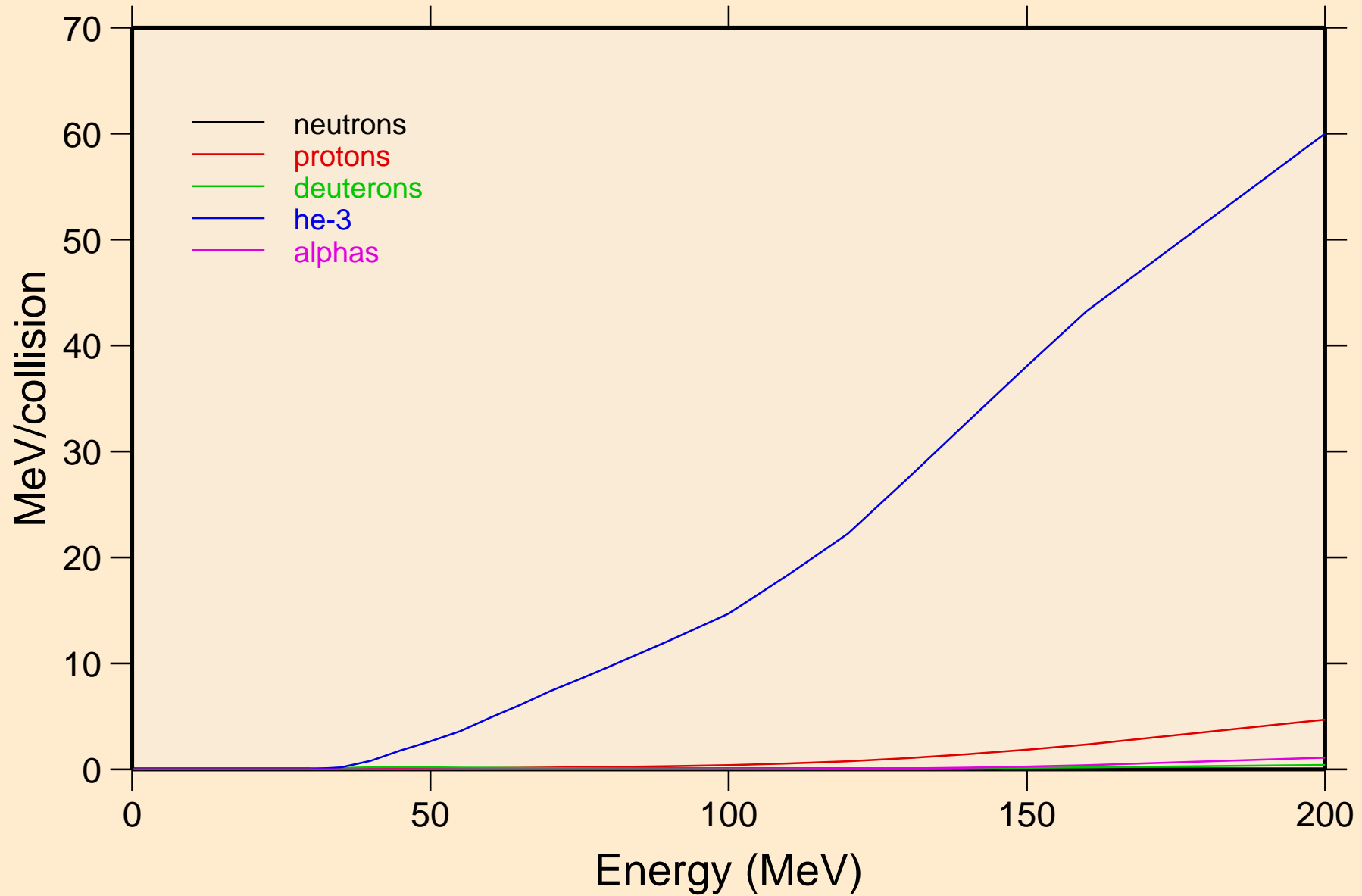

RF263 TRITON ACER TENDL-2021 LIBRARY; T=0.K  
Recoil Heating

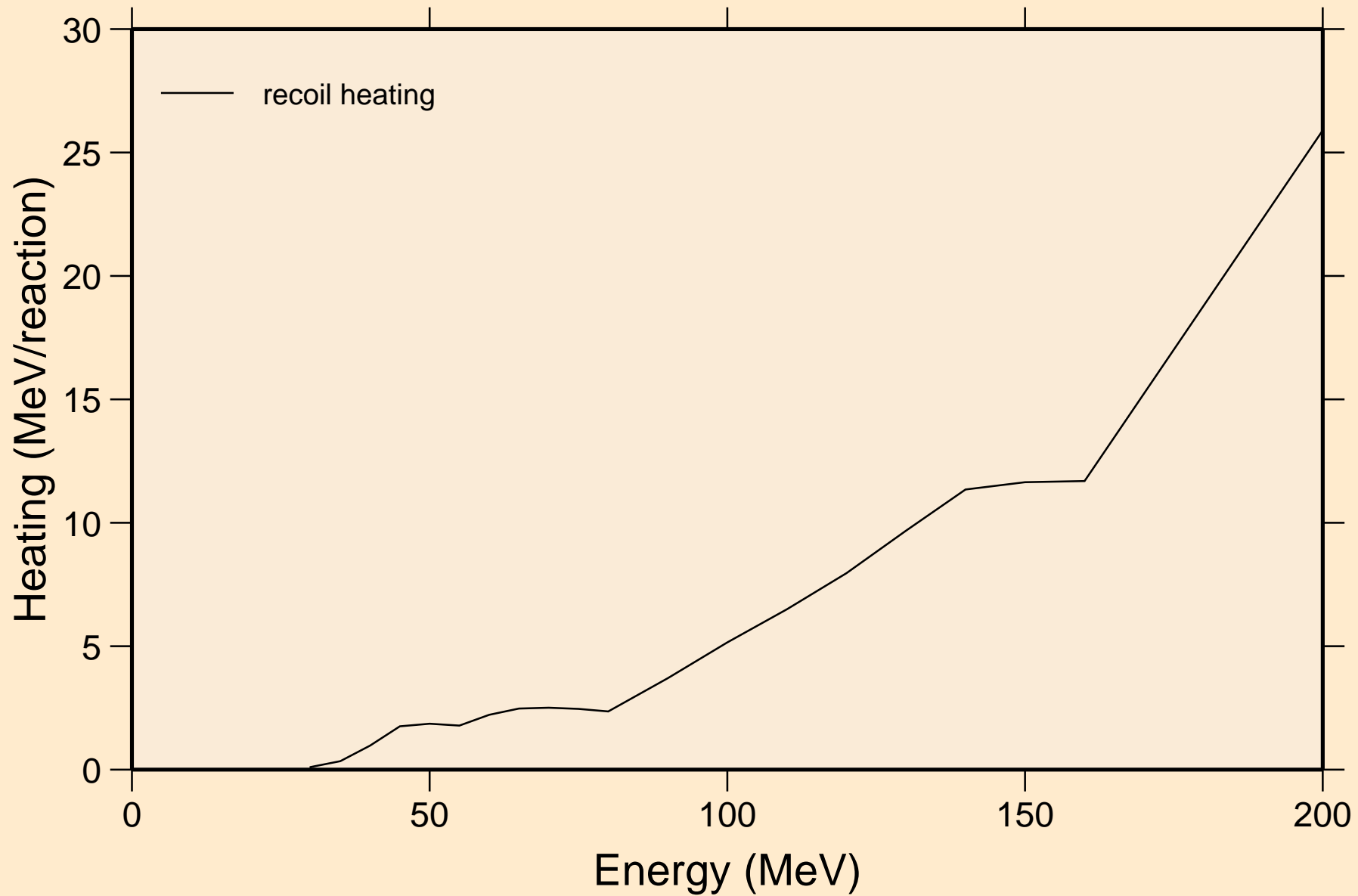

RF263 TRITON ACER TENDL-2021 LIBRARY; T=0.K  
Particle production cross sections

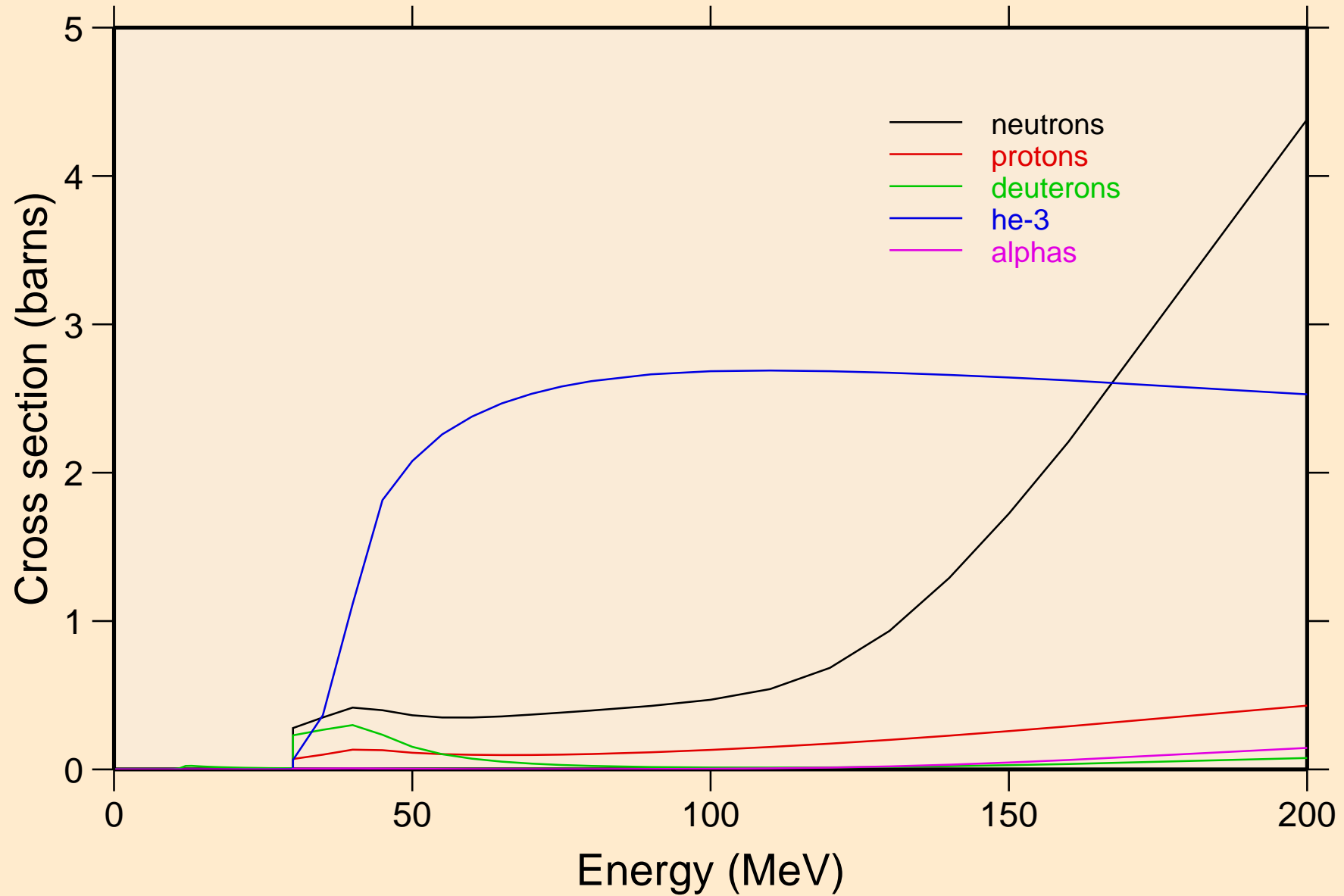

RF263 TRITON ACER TENDL-2021 LIBRARY; T=0.K  
neutrons from (t,n)

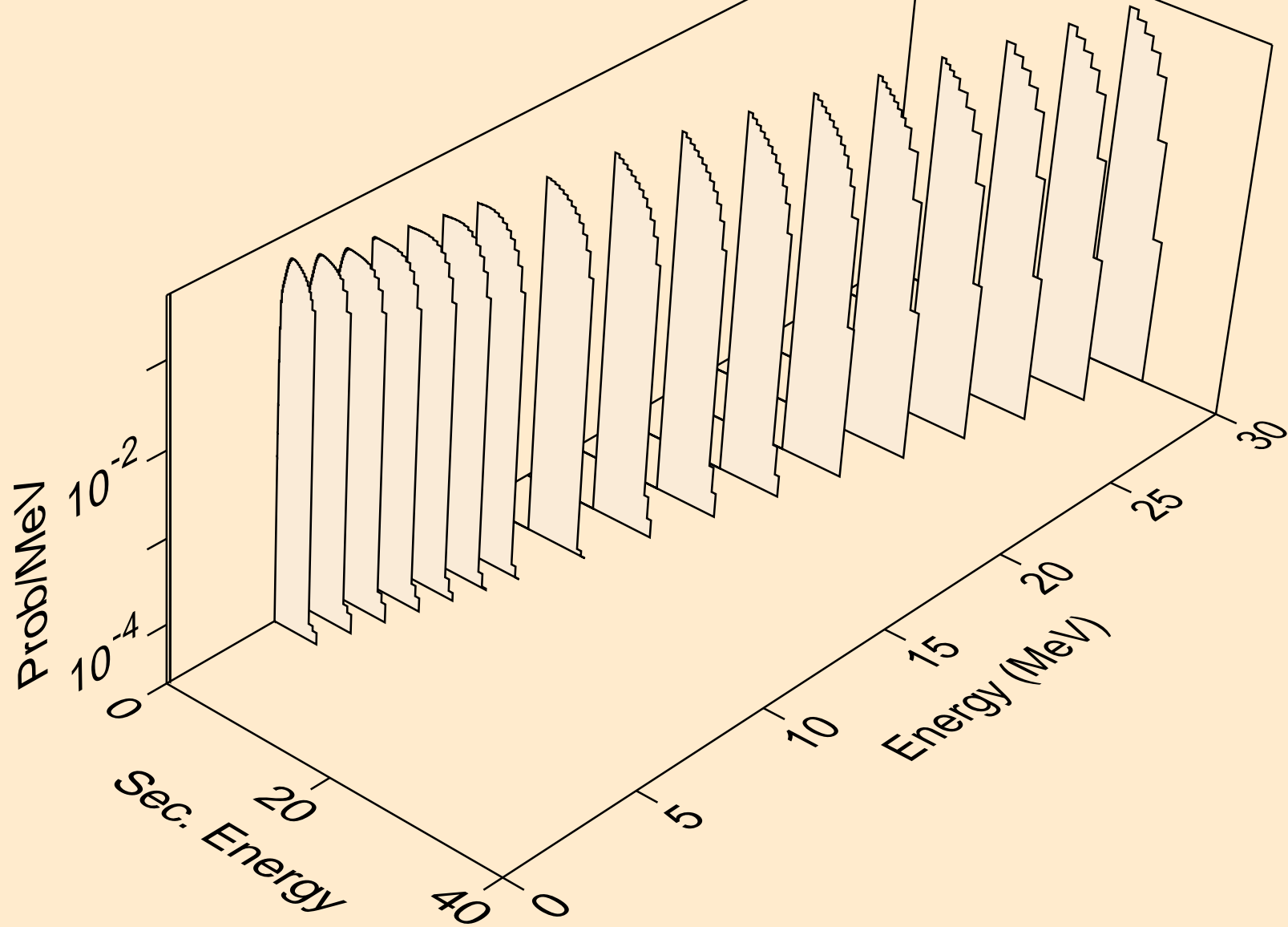

RF263 TRITON ACER TENDL-2021 LIBRARY; T=0.K  
neutrons from (t,x)

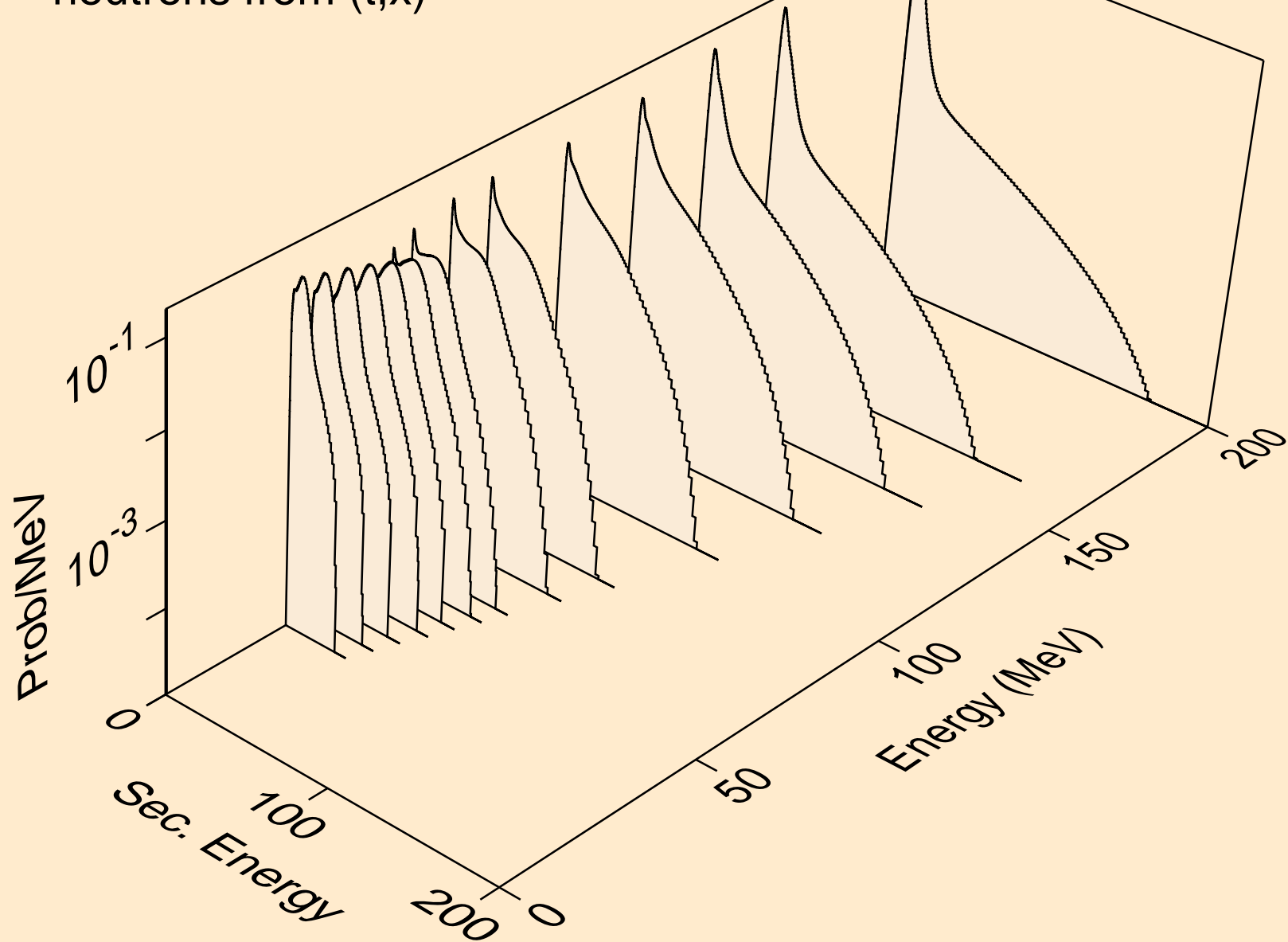

RF263 TRITON ACER TENDL-2021 LIBRARY; T=0.K  
neutrons from (t,2n)

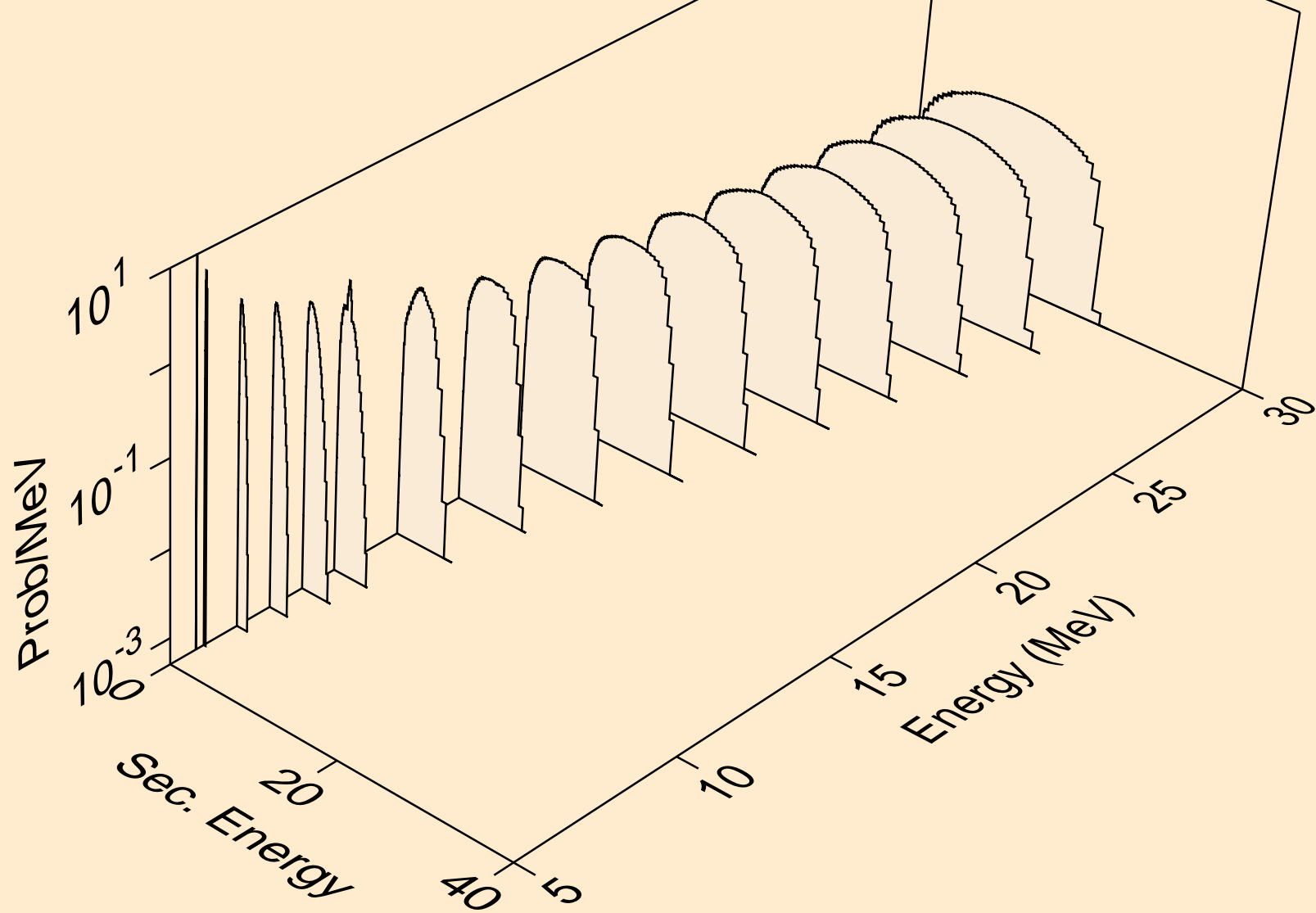

RF263 TRITON ACER TENDL-2021 LIBRARY; T=0.K  
neutrons from (t,3n)

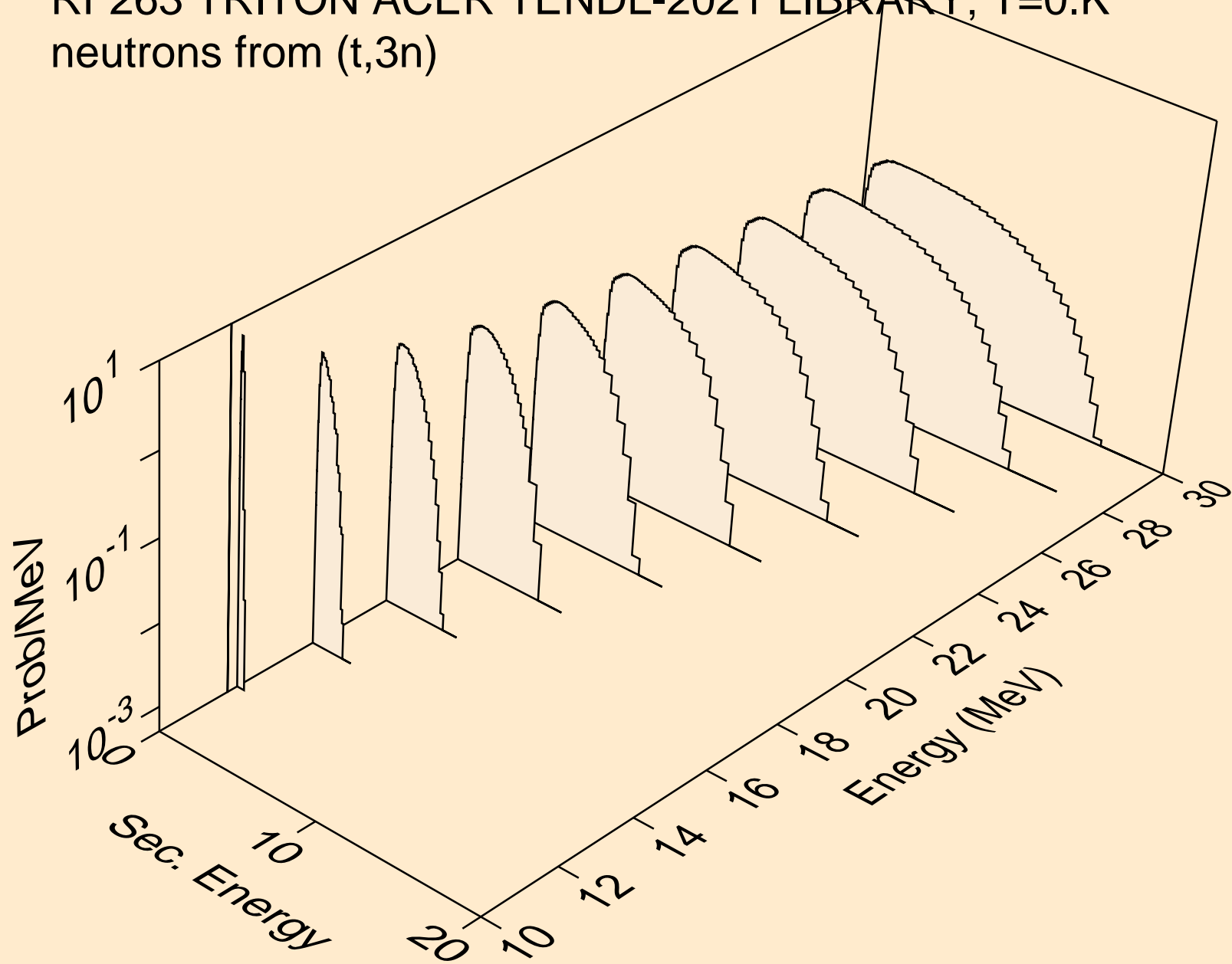

RF263 TRITON ACER TENDL-2021 LIBRARY; T=0.K  
neutrons from (t,n\*)a

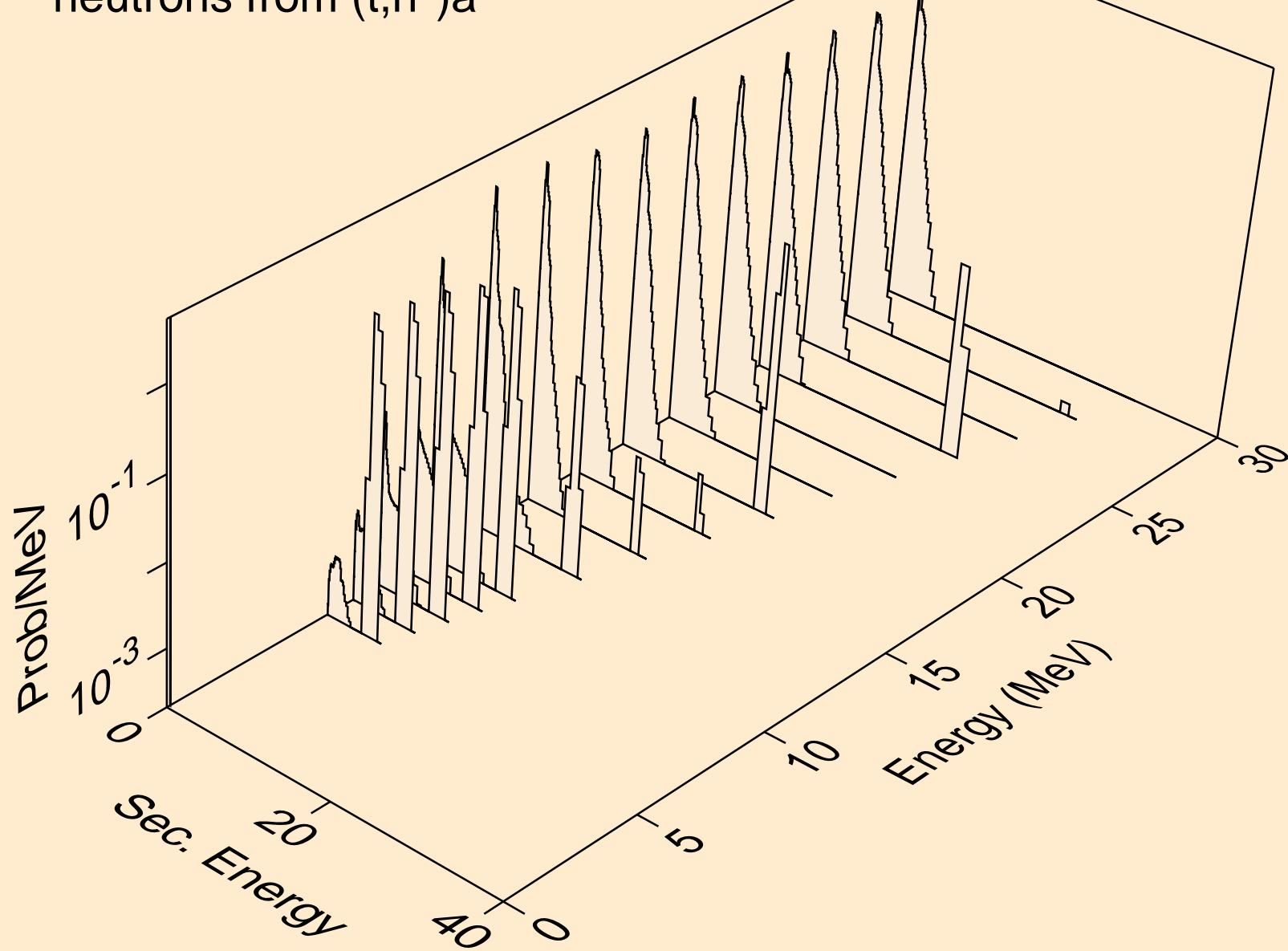



RF263 TRITON ACER TENDL-2021 LIBRARY; T=0.K  
neutrons from (t,n\*)p

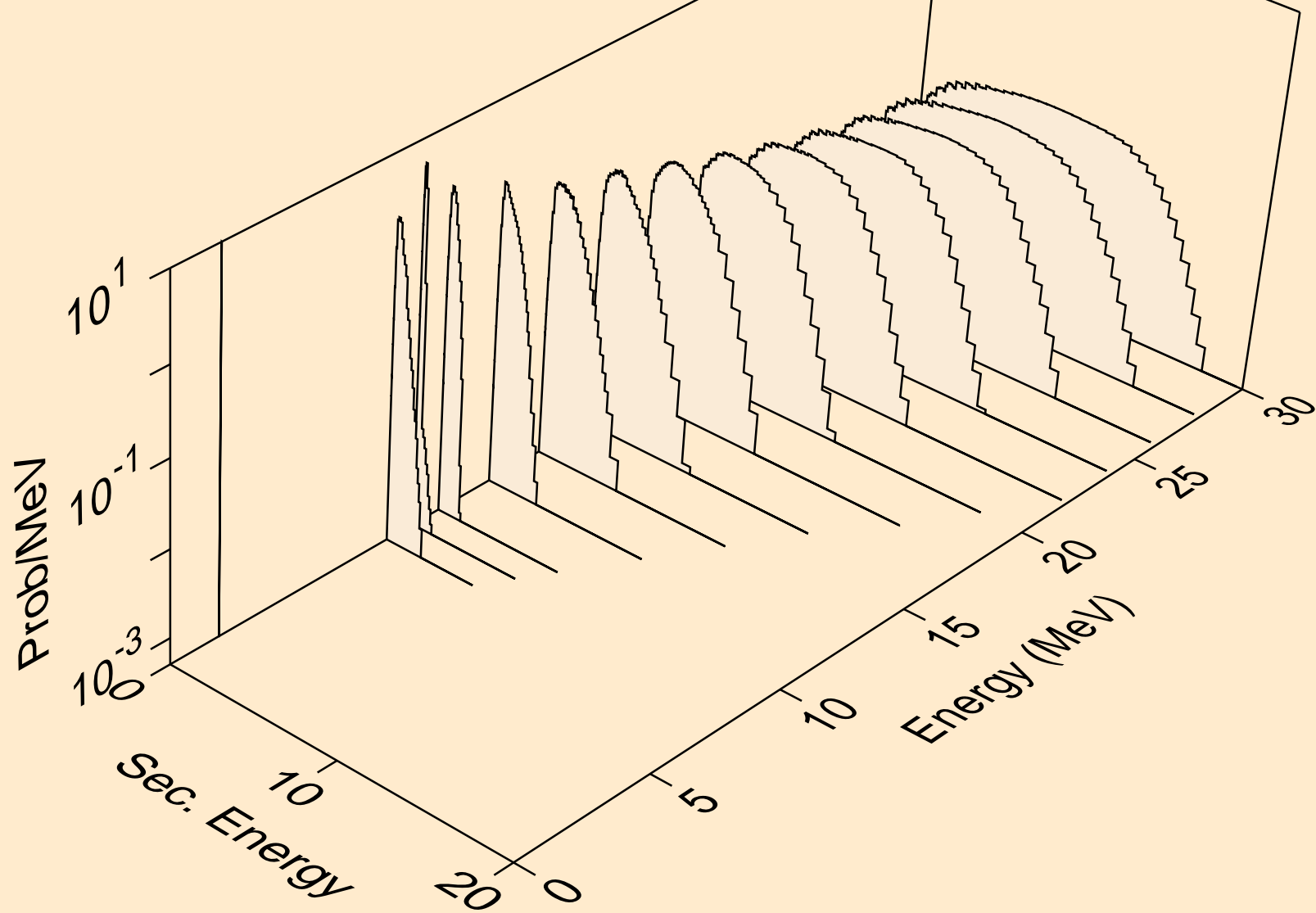

RF263 TRITON ACER TENDL-2021 LIBRARY; T=0.K  
neutrons from (t,n\*)d

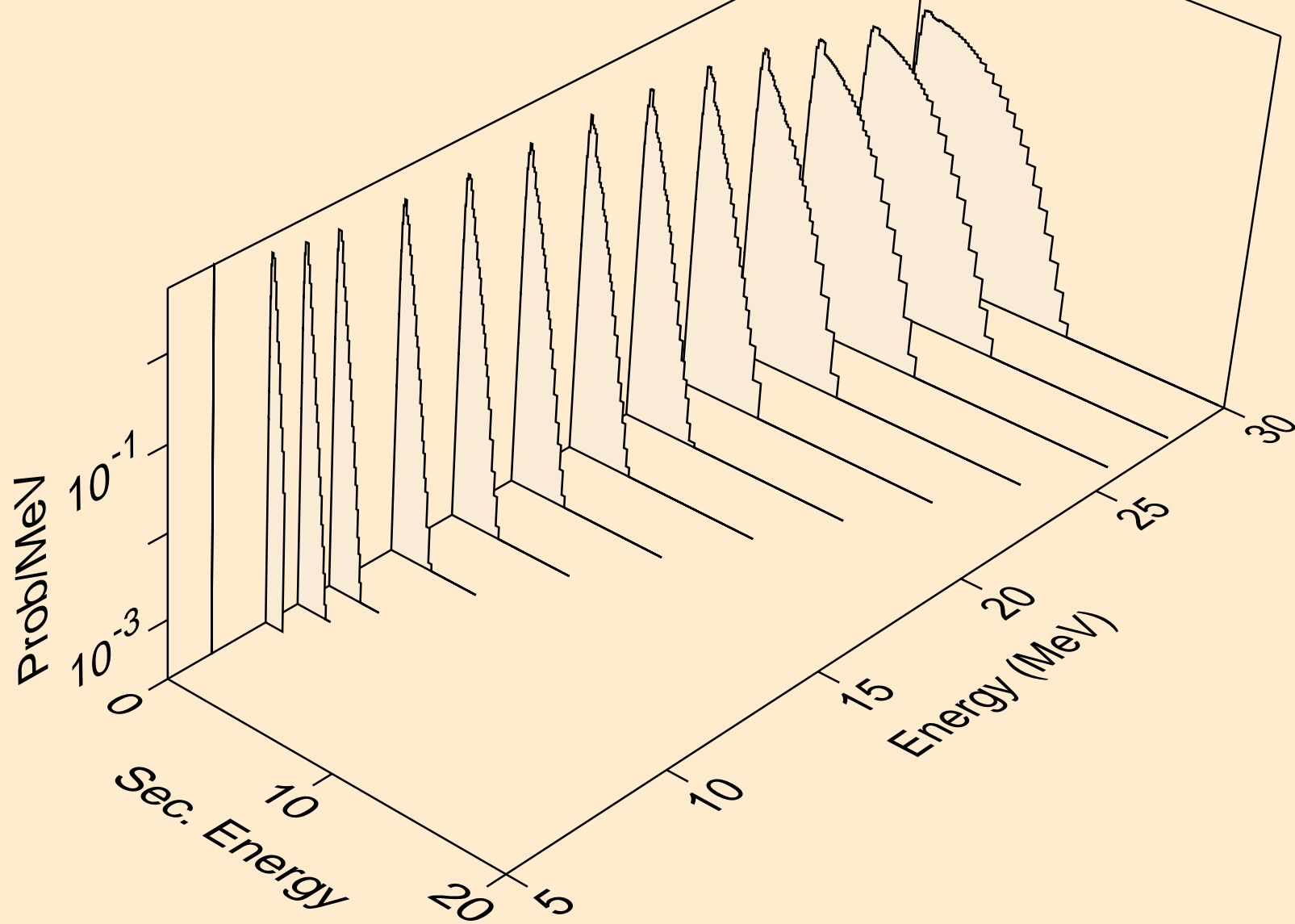

RF263 TRITON ACER TENDL-2021 LIBRARY; T=0.K  
neutrons from (t,n\*)t

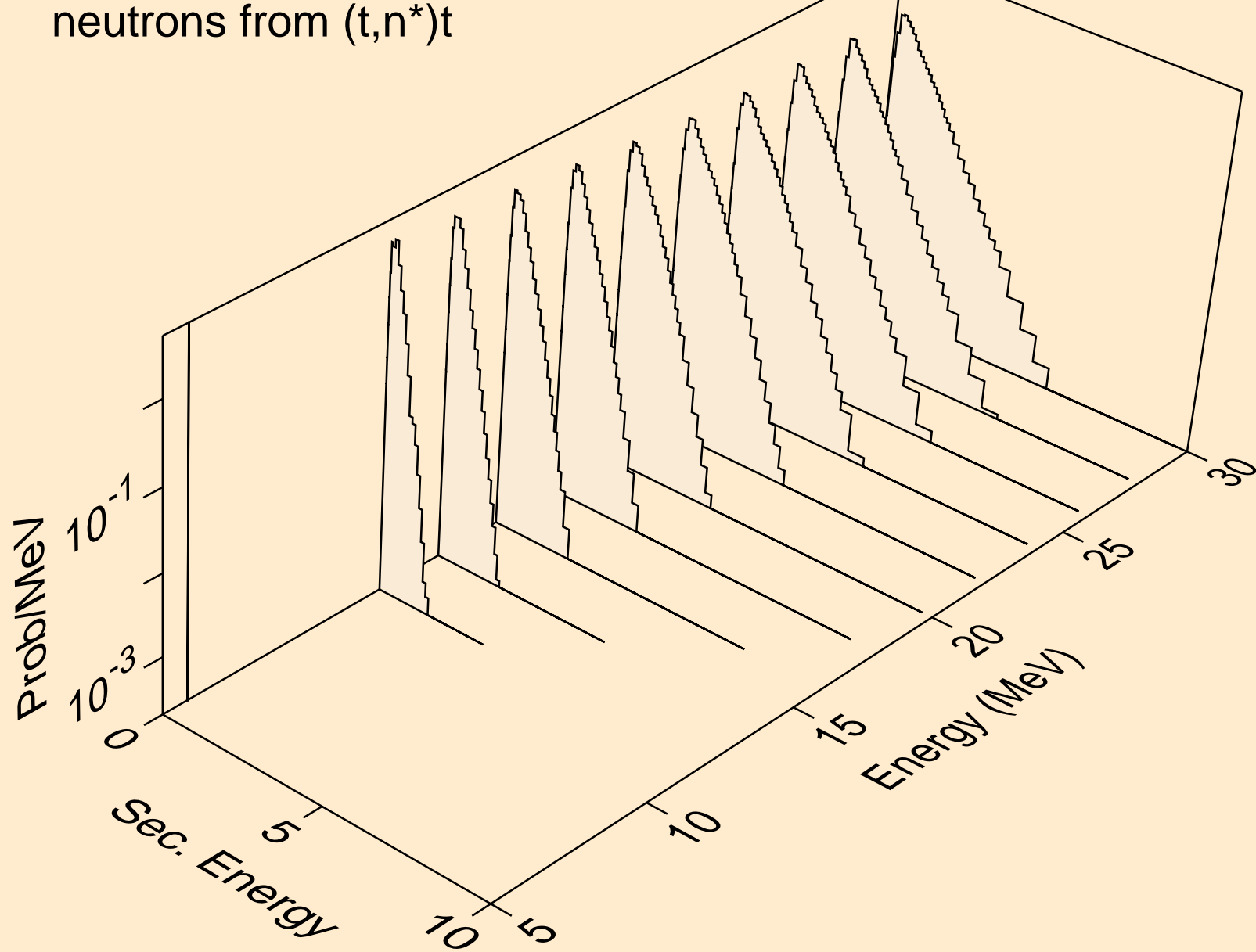

RF263 TRITON ACER TENDL-2021 LIBRARY; T=0.K  
neutrons from (t,n\*)he3

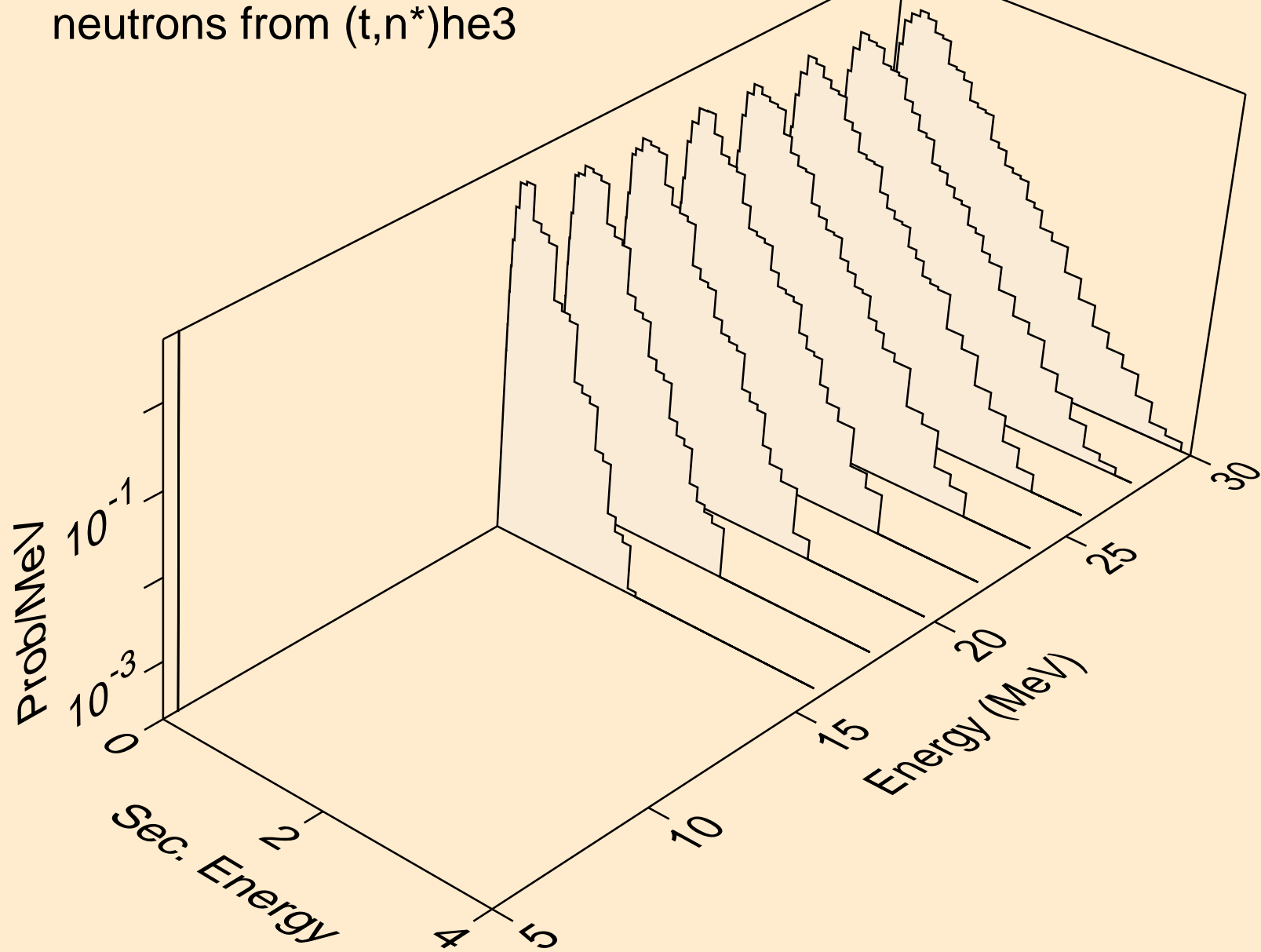

RF263 TRITON ACER TENDL-2021 LIBRARY; T=0.K  
neutrons from (t,4n)

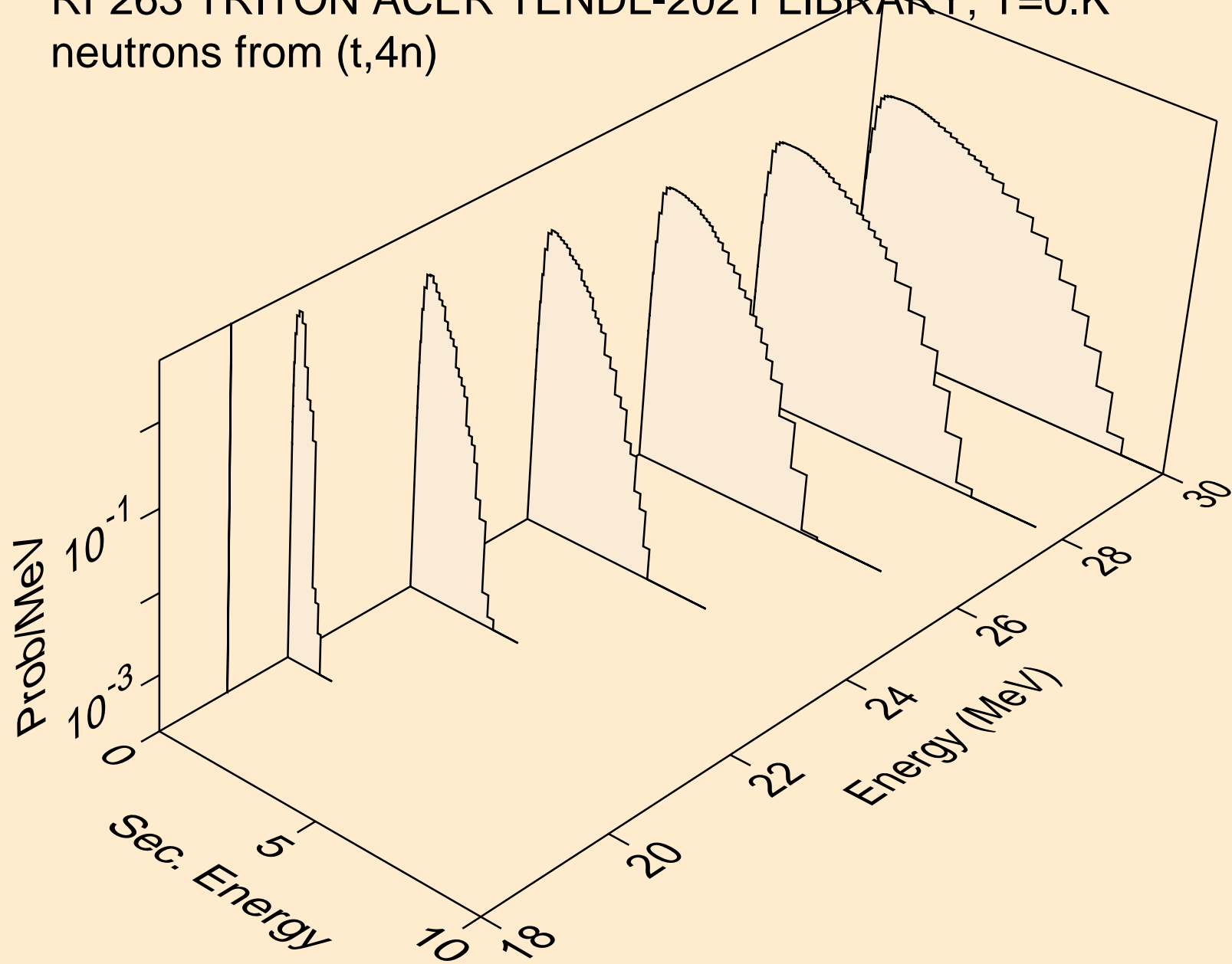

RF263 TRITON ACER TENDL-2021 LIBRARY; T=0.K  
neutrons from (t,2np)

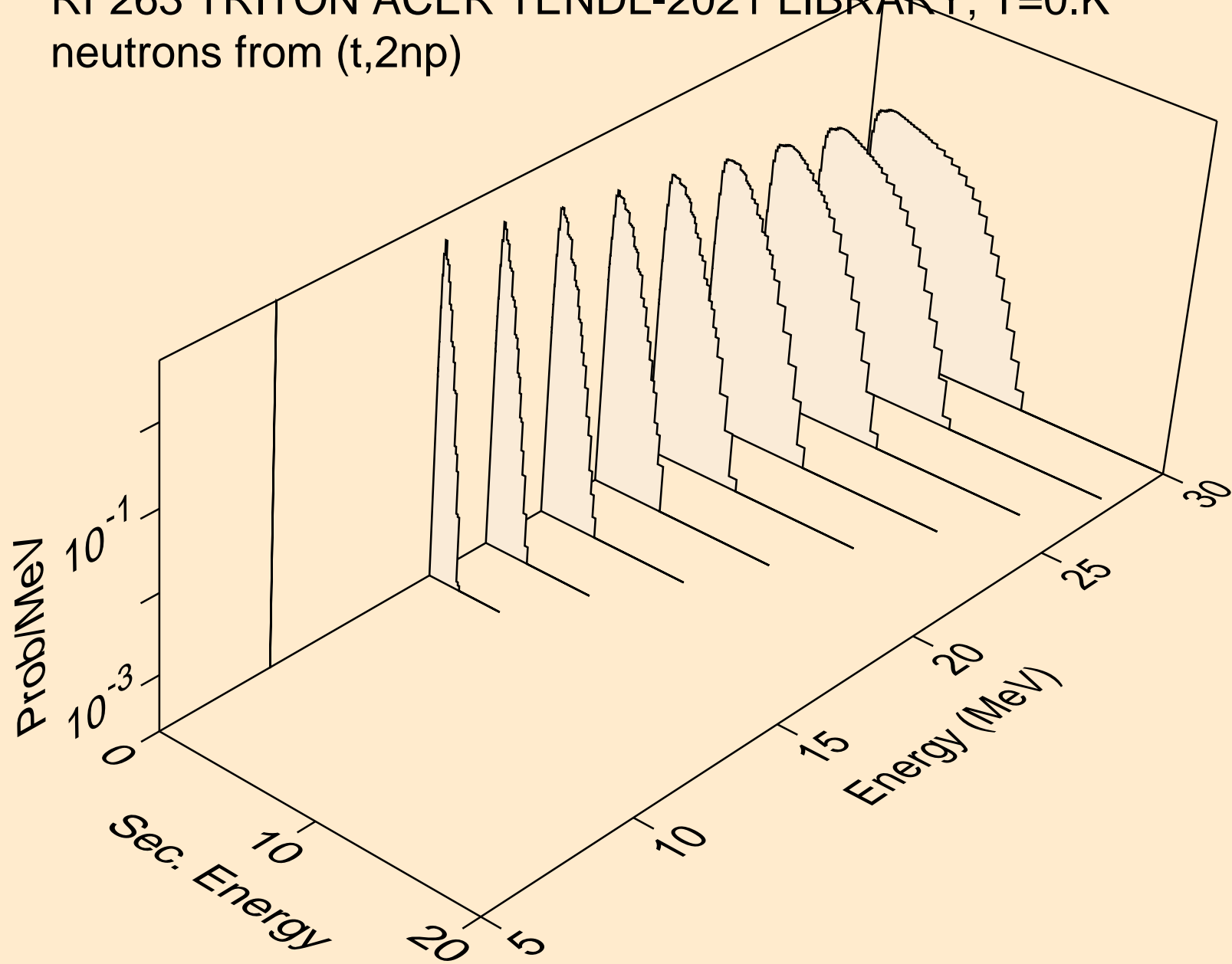

RF263 TRITON ACER TENDL-2021 LIBRARY; T=0.K  
neutrons from (t,3np)

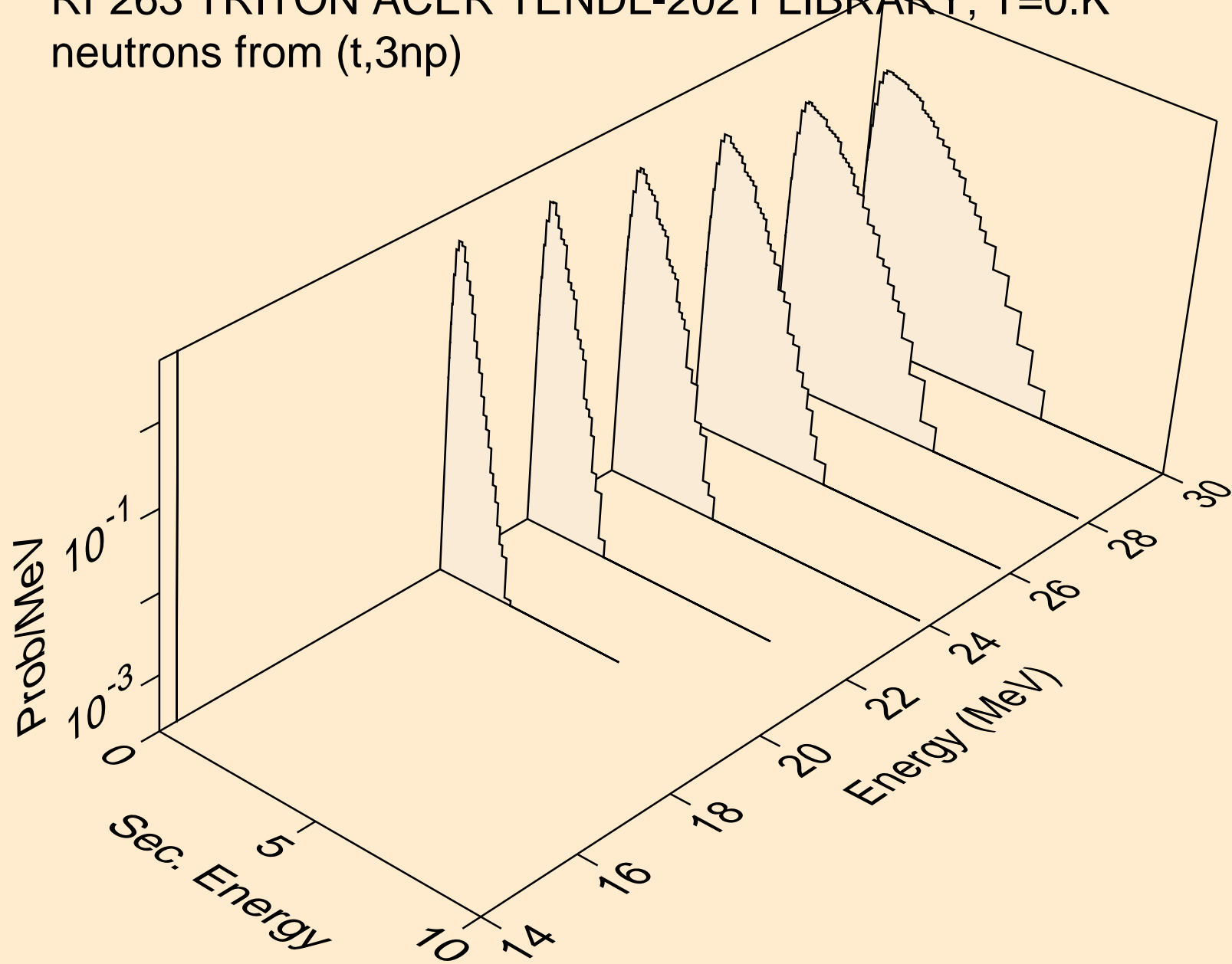

RF263 TRITON ACER TENDL-2021 LIBRARY; T=0.K  
protons from (t,x)

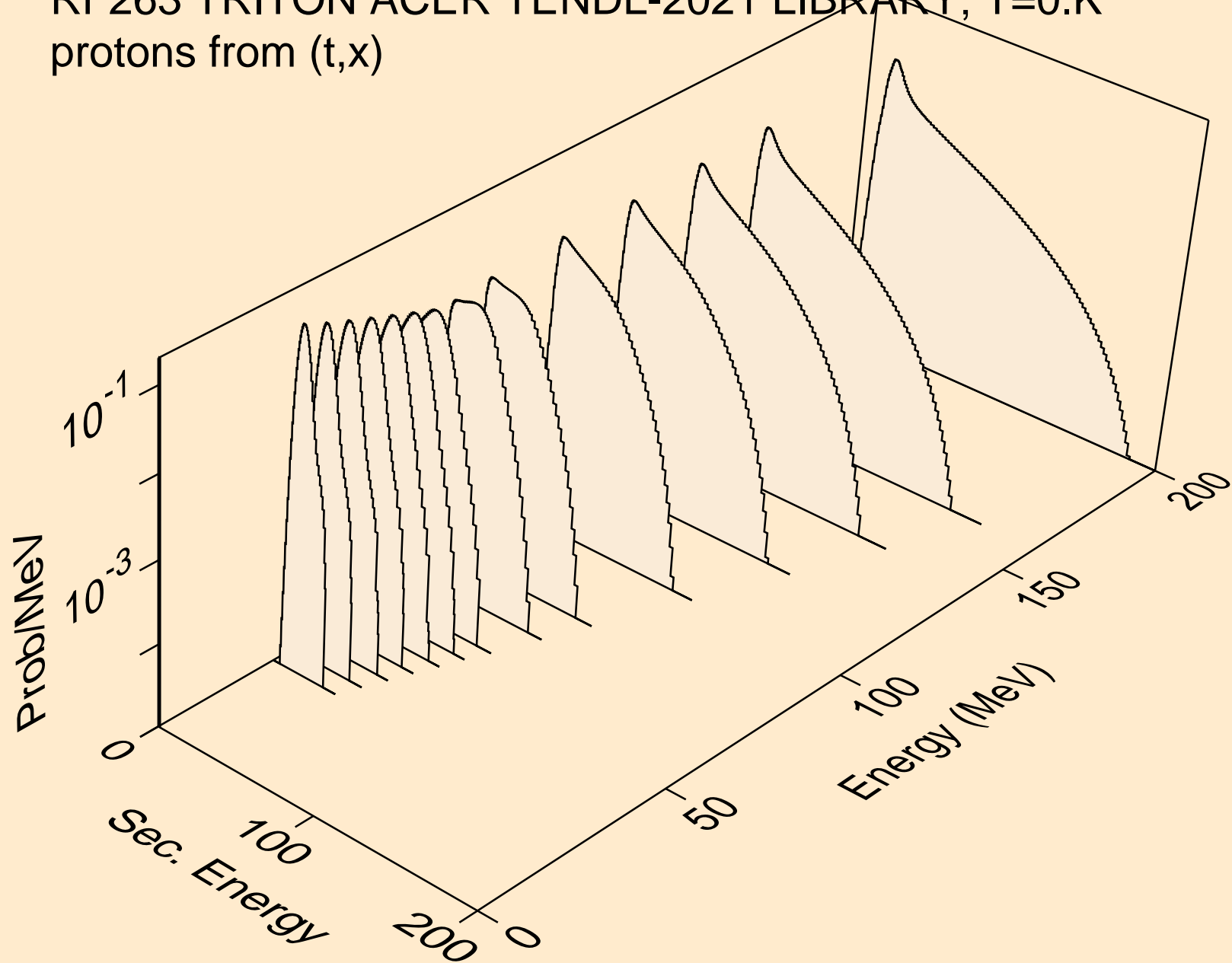



RF263 TRITON ACER TENDL-2021 LIBRARY; T=0.K  
protons from (t,n\*)p

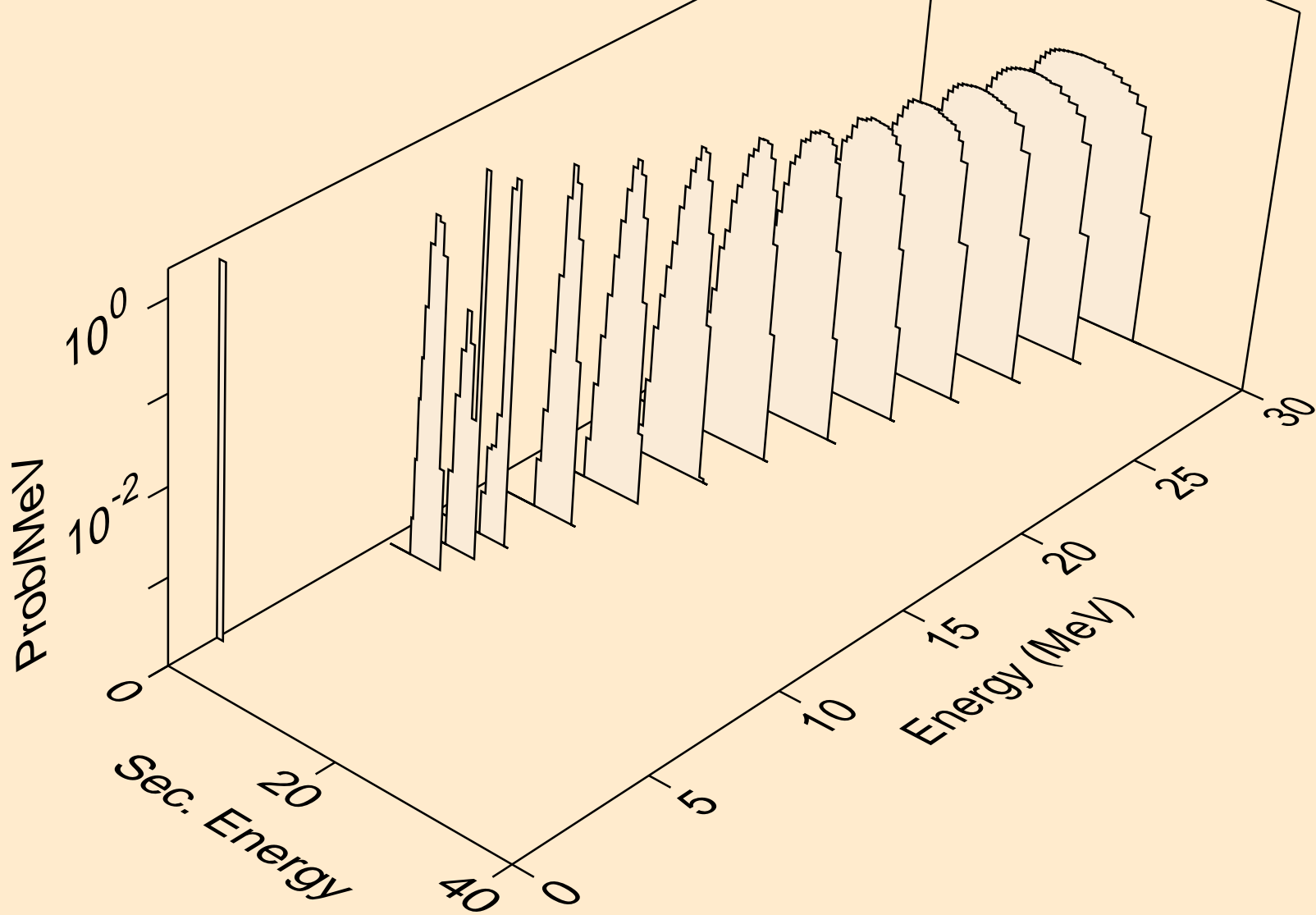

RF263 TRITON ACER TENDL-2021 LIBRARY; T=0.K  
protons from (t,2np)

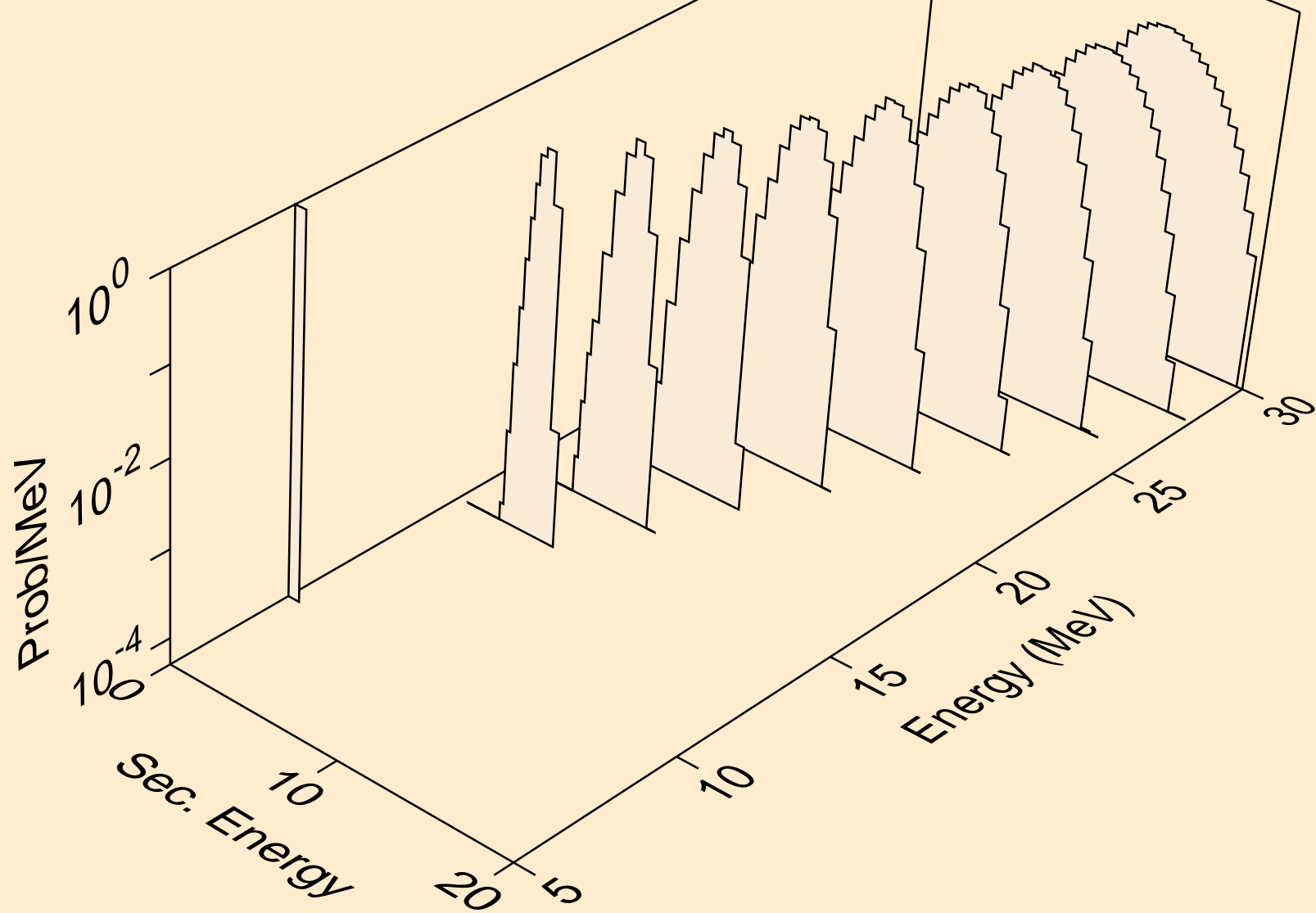

RF263 TRITON ACER TENDL-2021 LIBRARY; T=0.K  
protons from (t,3np)

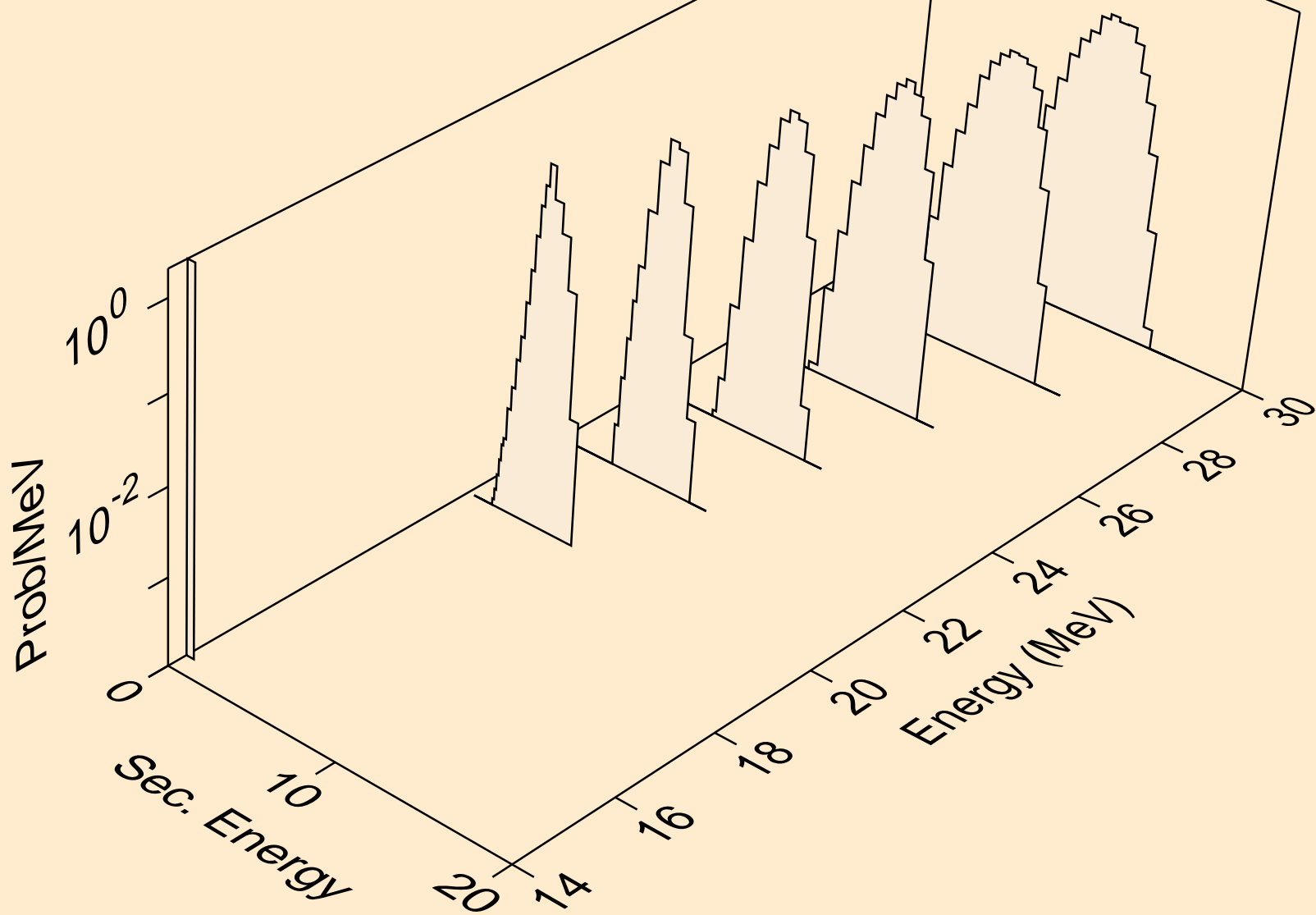

RF263 TRITON ACER TENDL-2021 LIBRARY; T=0.K  
protons from (t,p)

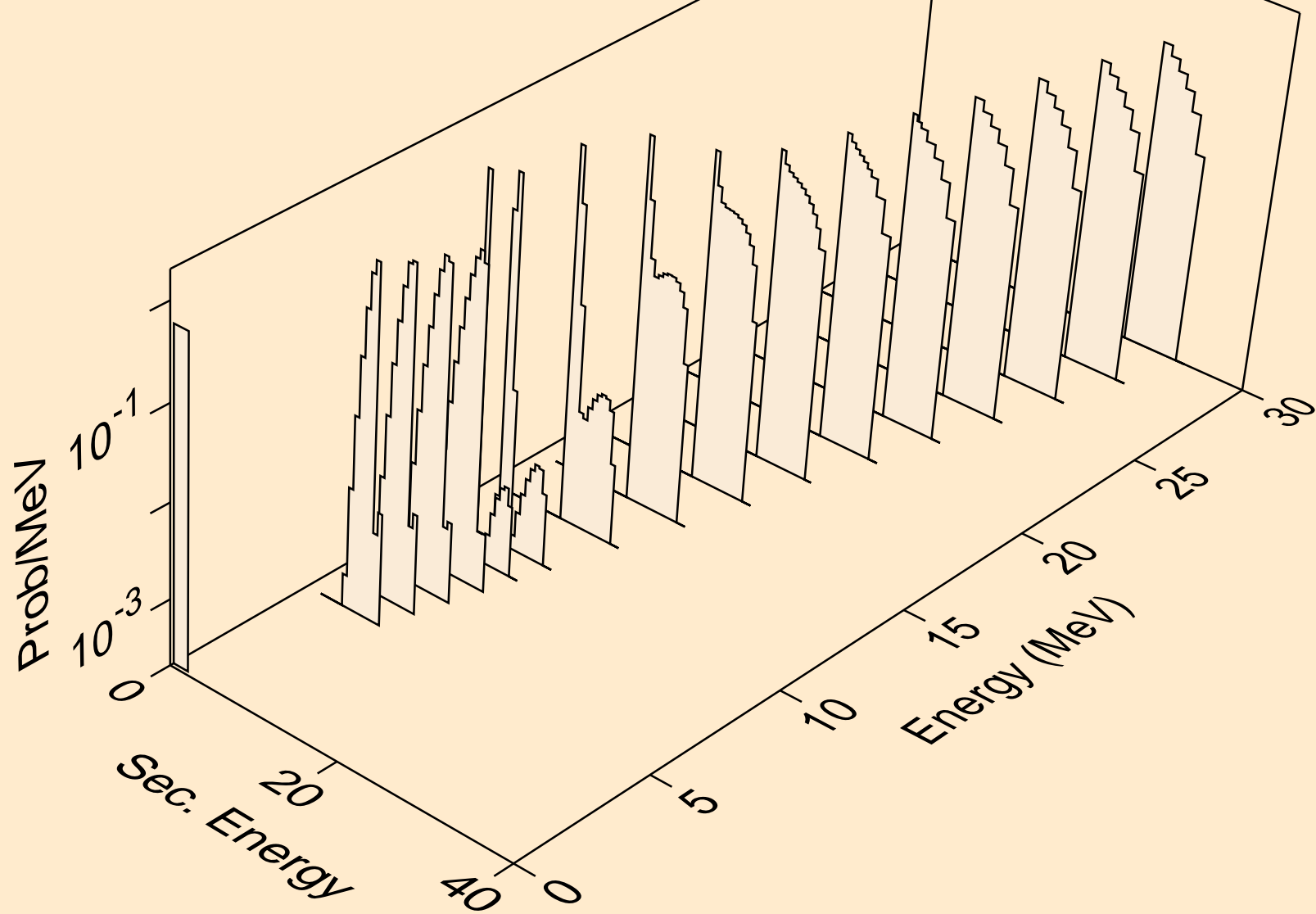

RF263 TRITON ACER TENDL-2021 LIBRARY; T=0.K  
protons from (t,2p)

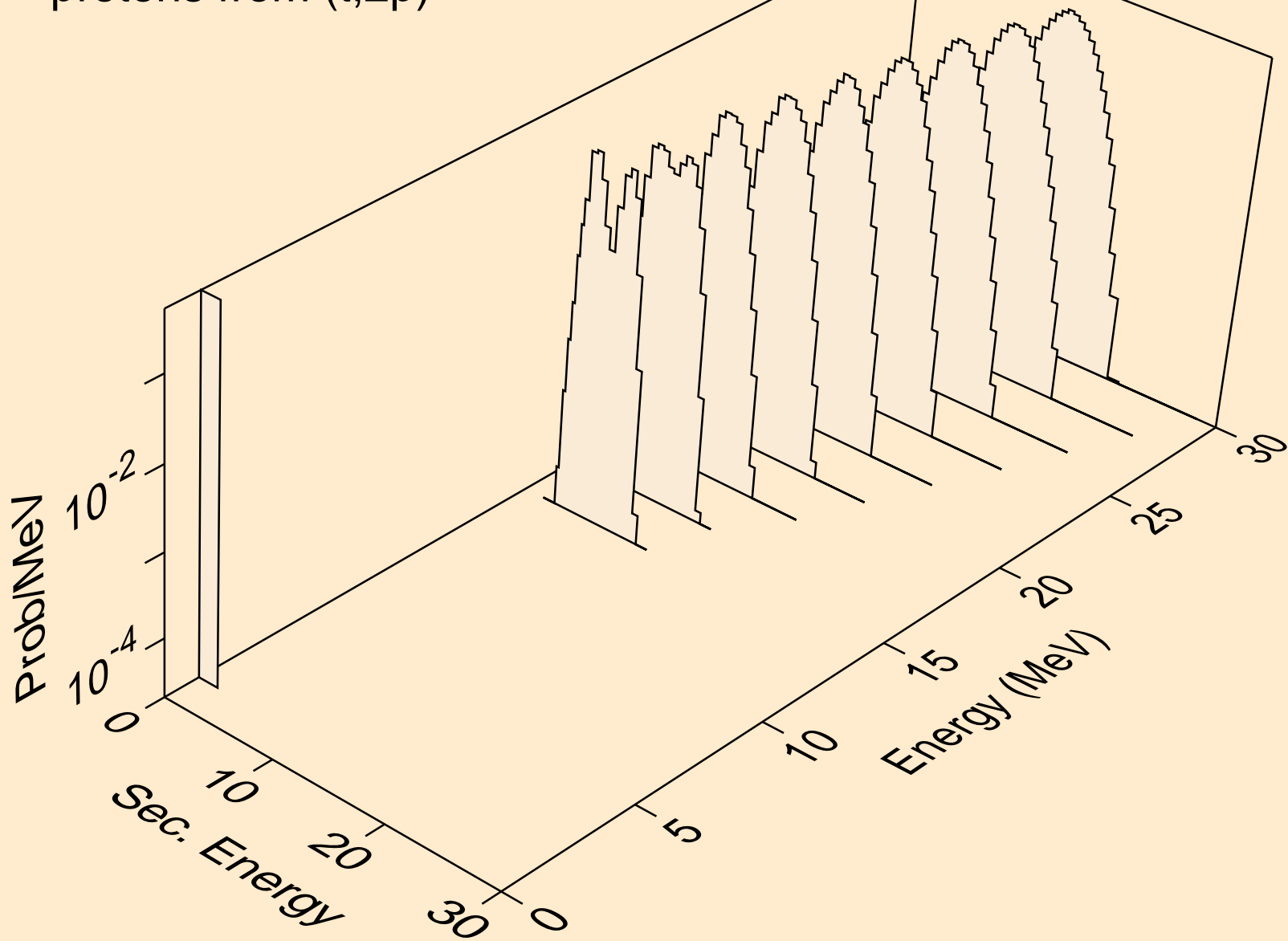

RF263 TRITON ACER TENDL-2021 LIBRARY; T=0.K  
deuterons from (t,x)

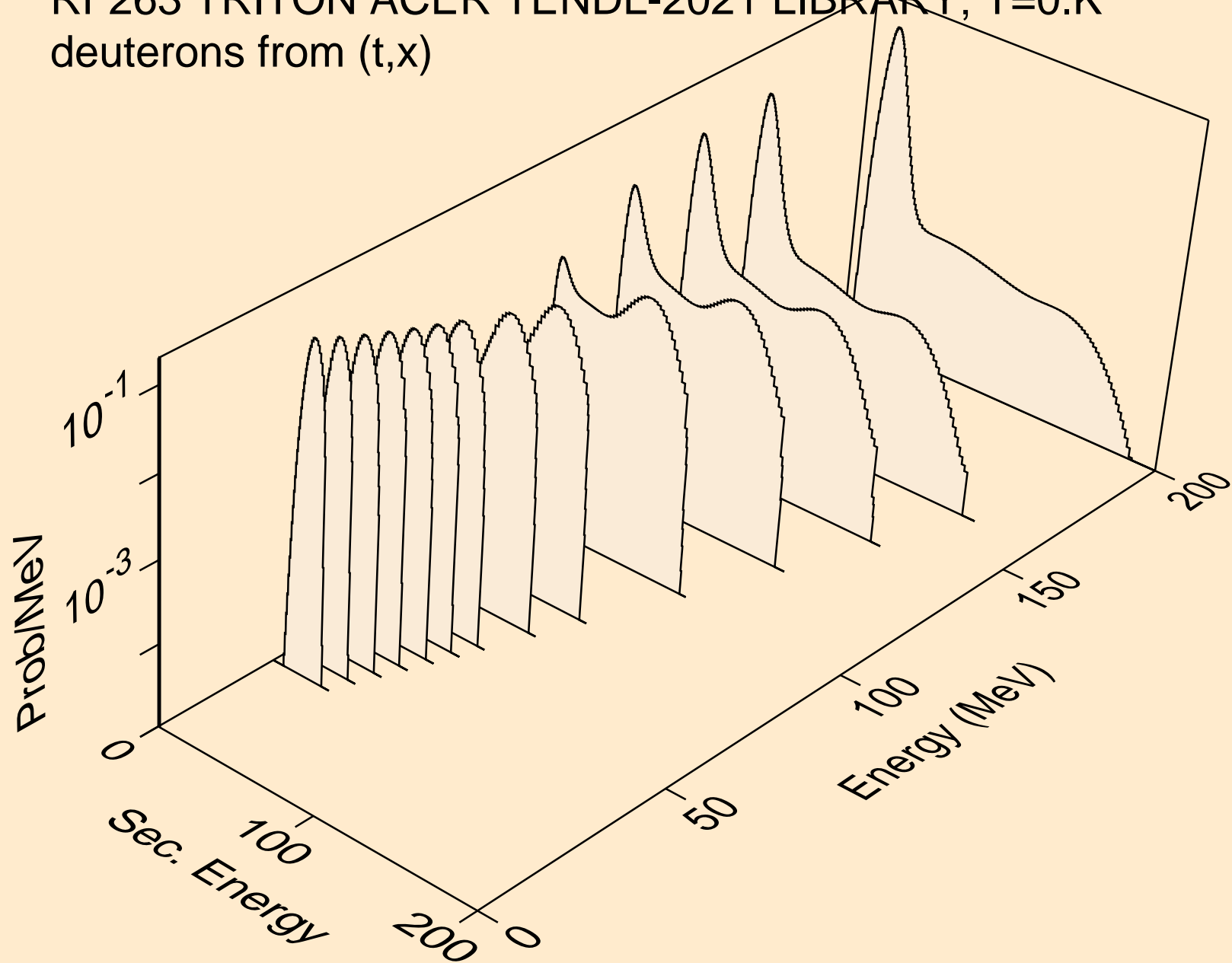

RF263 TRITON ACER TENDL-2021 LIBRARY; T=0.K  
deuterons from (t,n\*)d

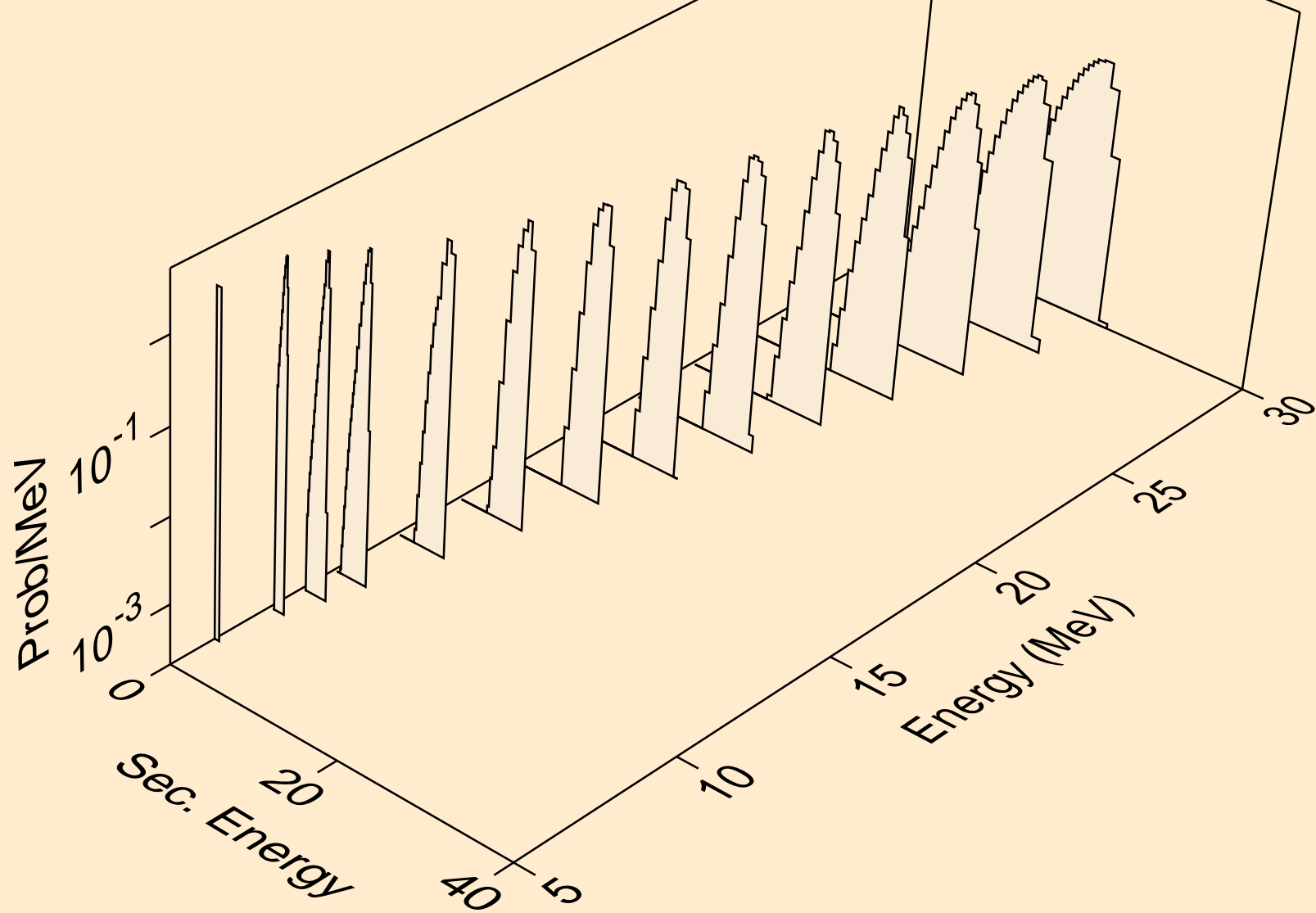

RF263 TRITON ACER TENDL-2021 LIBRARY; T=0.K  
deuterons from (t,d)

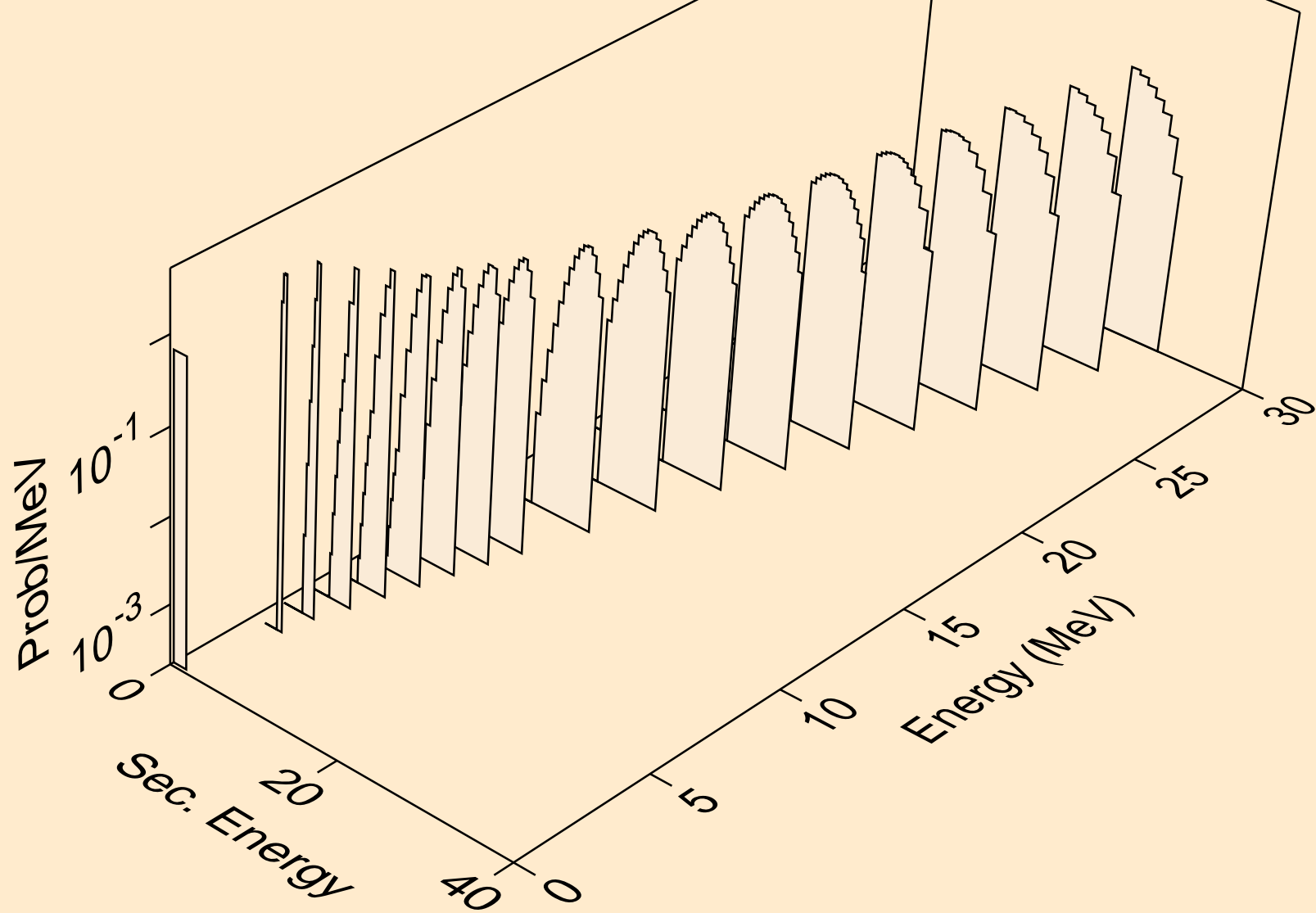



RF263 TRITON ACER TENDL-2021 LIBRARY; T=0.K  
he3s from (t,x)

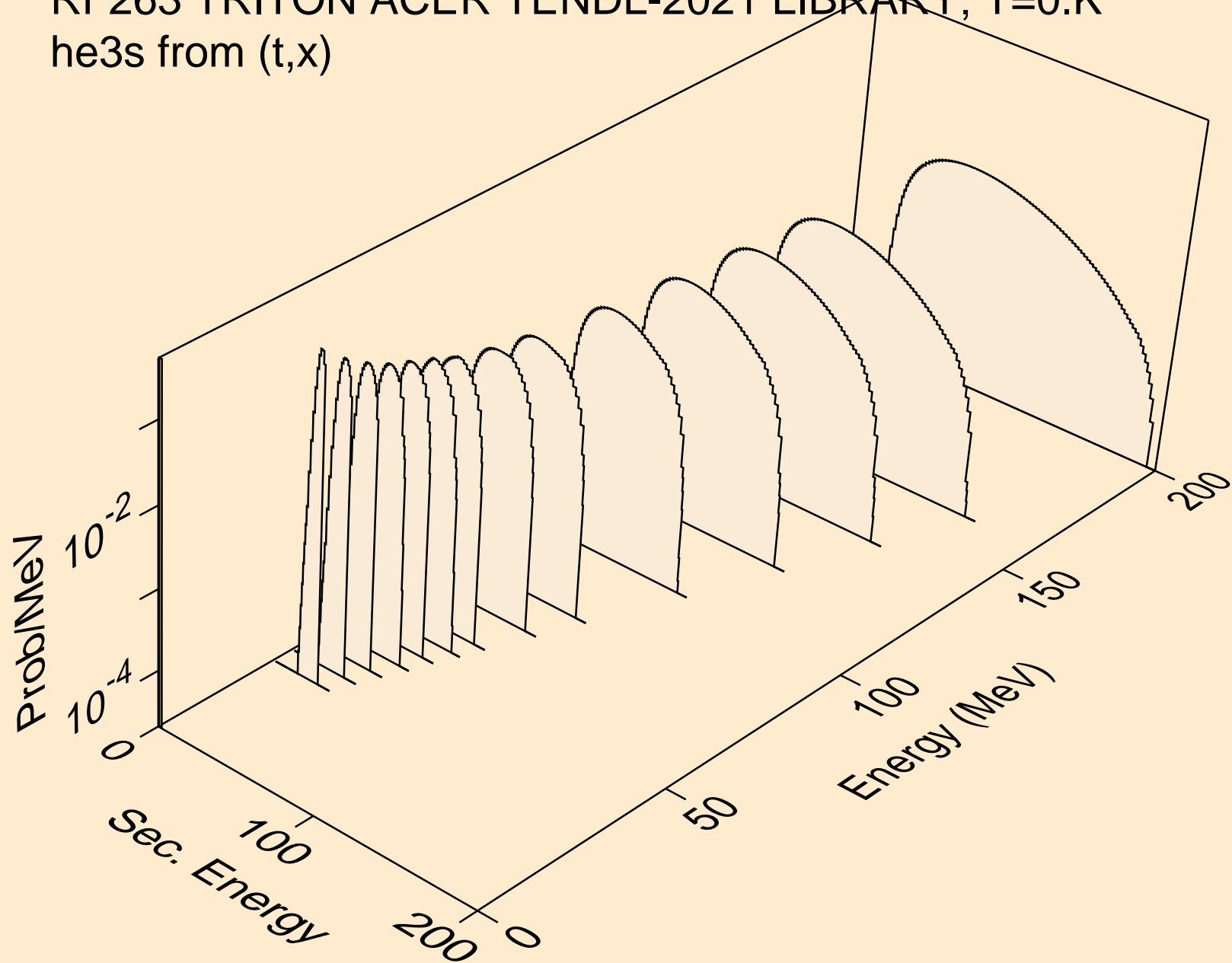

RF263 TRITON ACER TENDL-2021 LIBRARY; T=0.K  
he3s from (t,n\*)he3

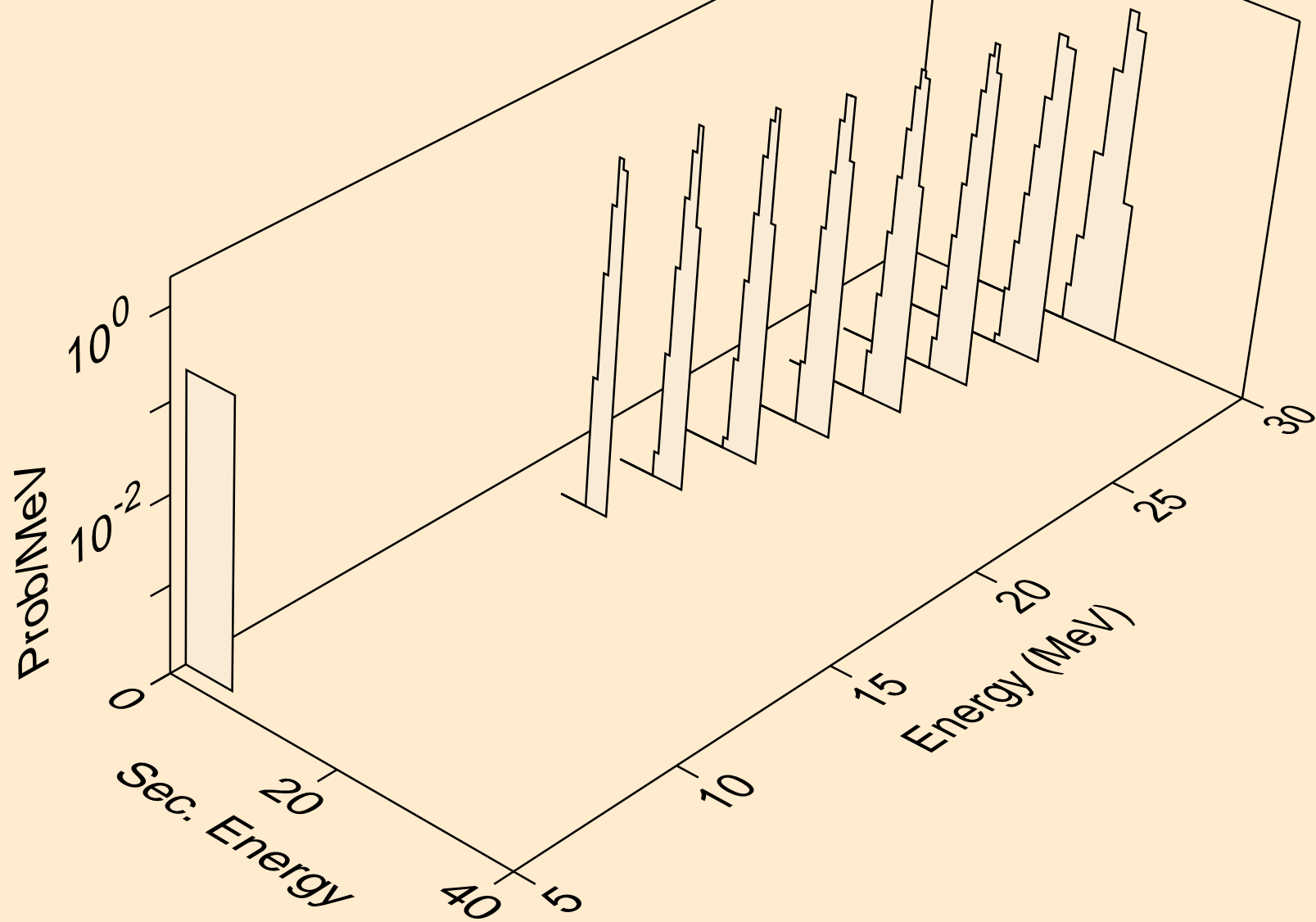

RF263 TRITON ACER TENDL-2021 LIBRARY; T=0.K  
he3s from (t,he3)

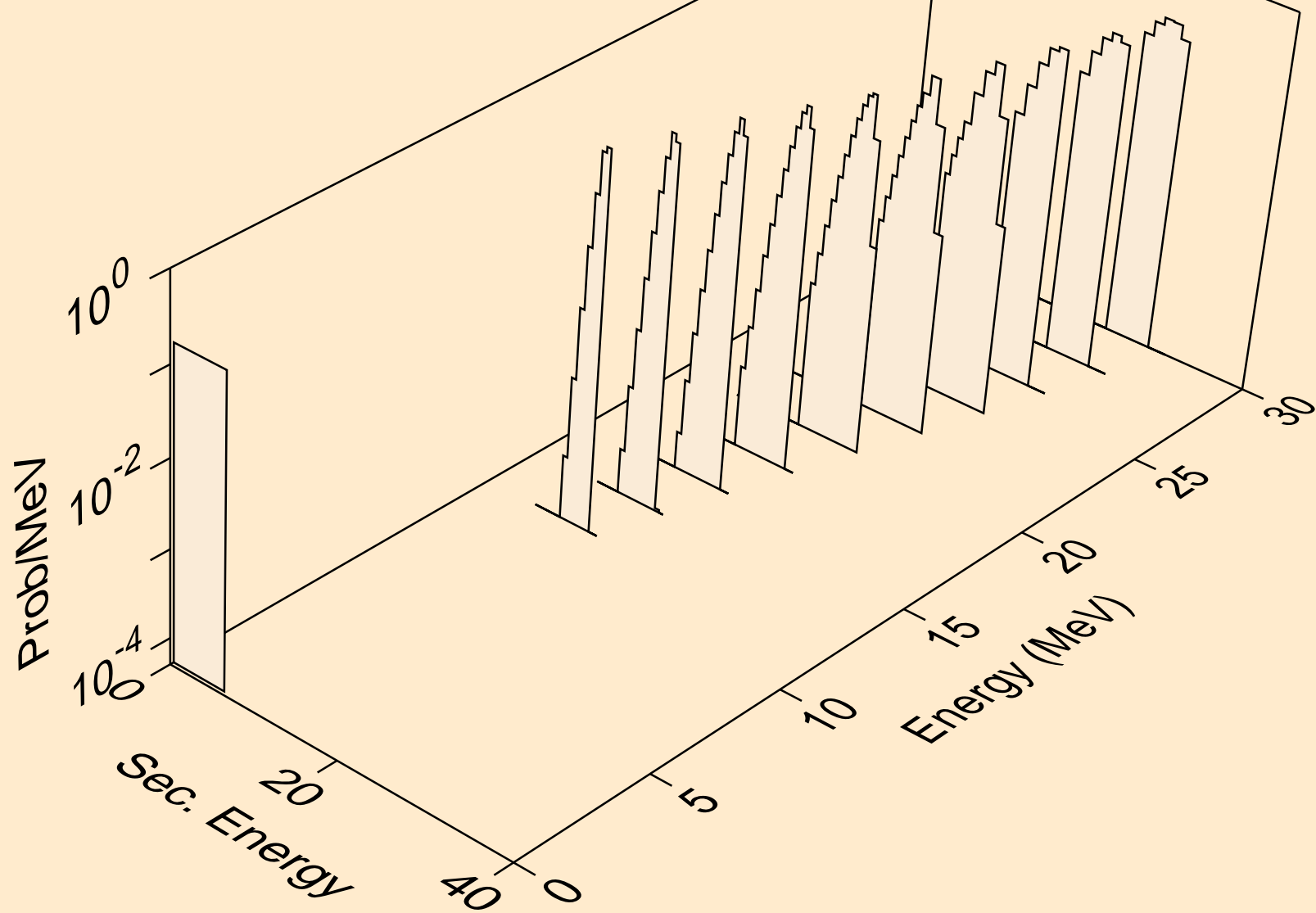

RF263 TRITON ACER TENDL-2021 LIBRARY; T=0.K  
alphas from (t,x)

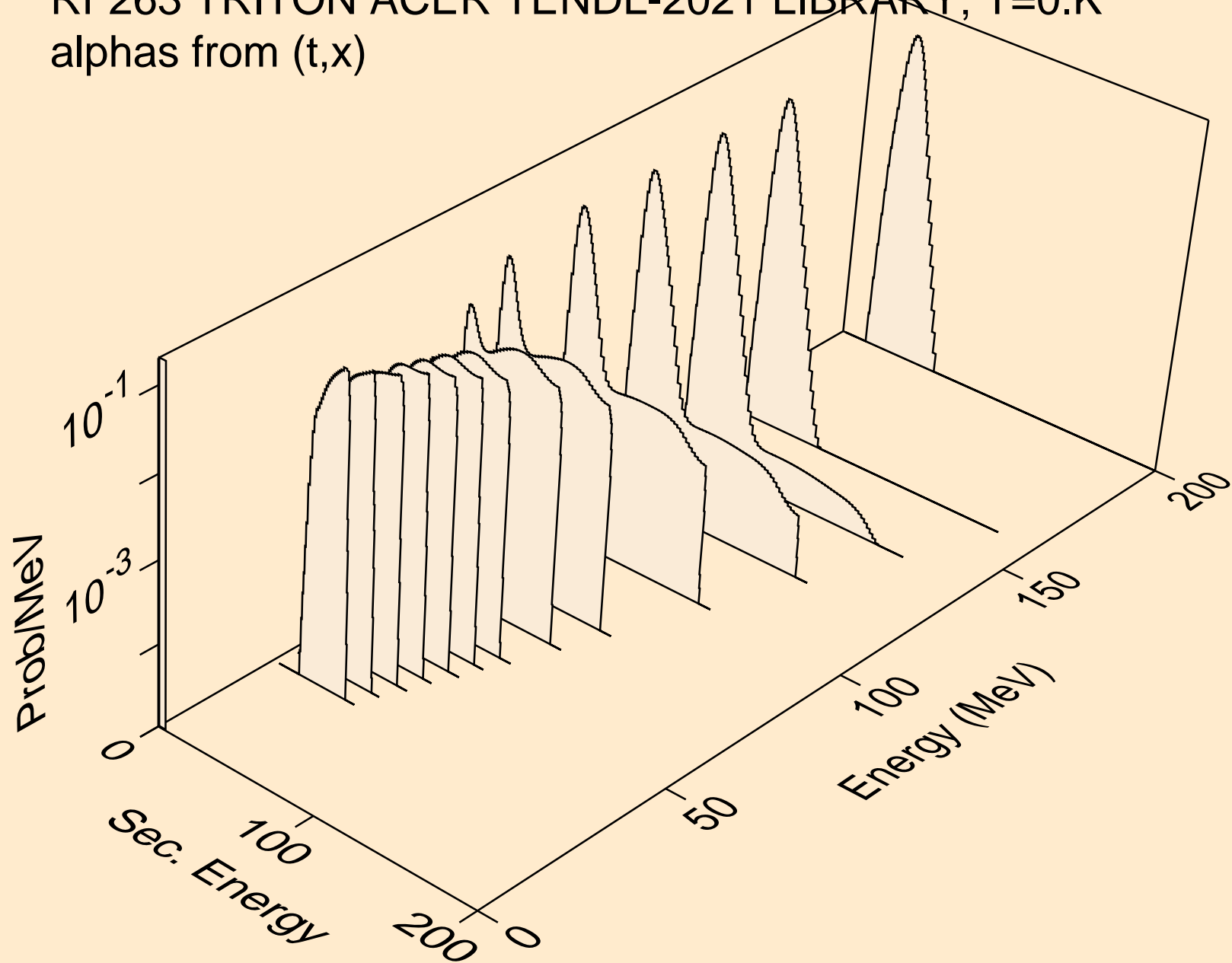

RF263 TRITON ACER TENDL-2021 LIBRARY; T=0.K  
alphas from (t,n\*)a

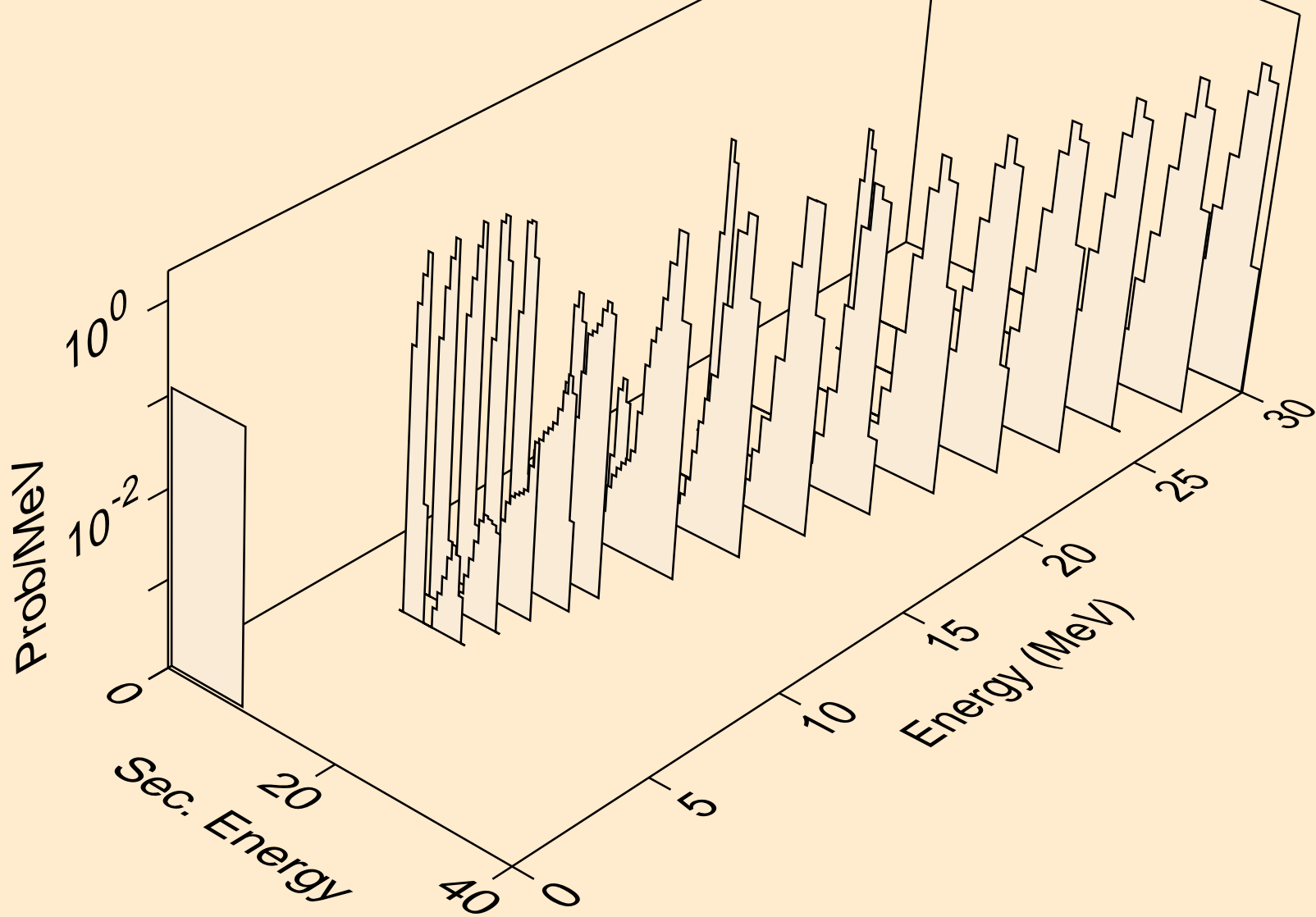

RF263 TRITON ACER TENDL-2021 LIBRARY; T=0.K  
alphas from (t,a)

