

RN230 TRITON ACER TENDL-2021 LIBRARY; T=0.K
Principal cross sections

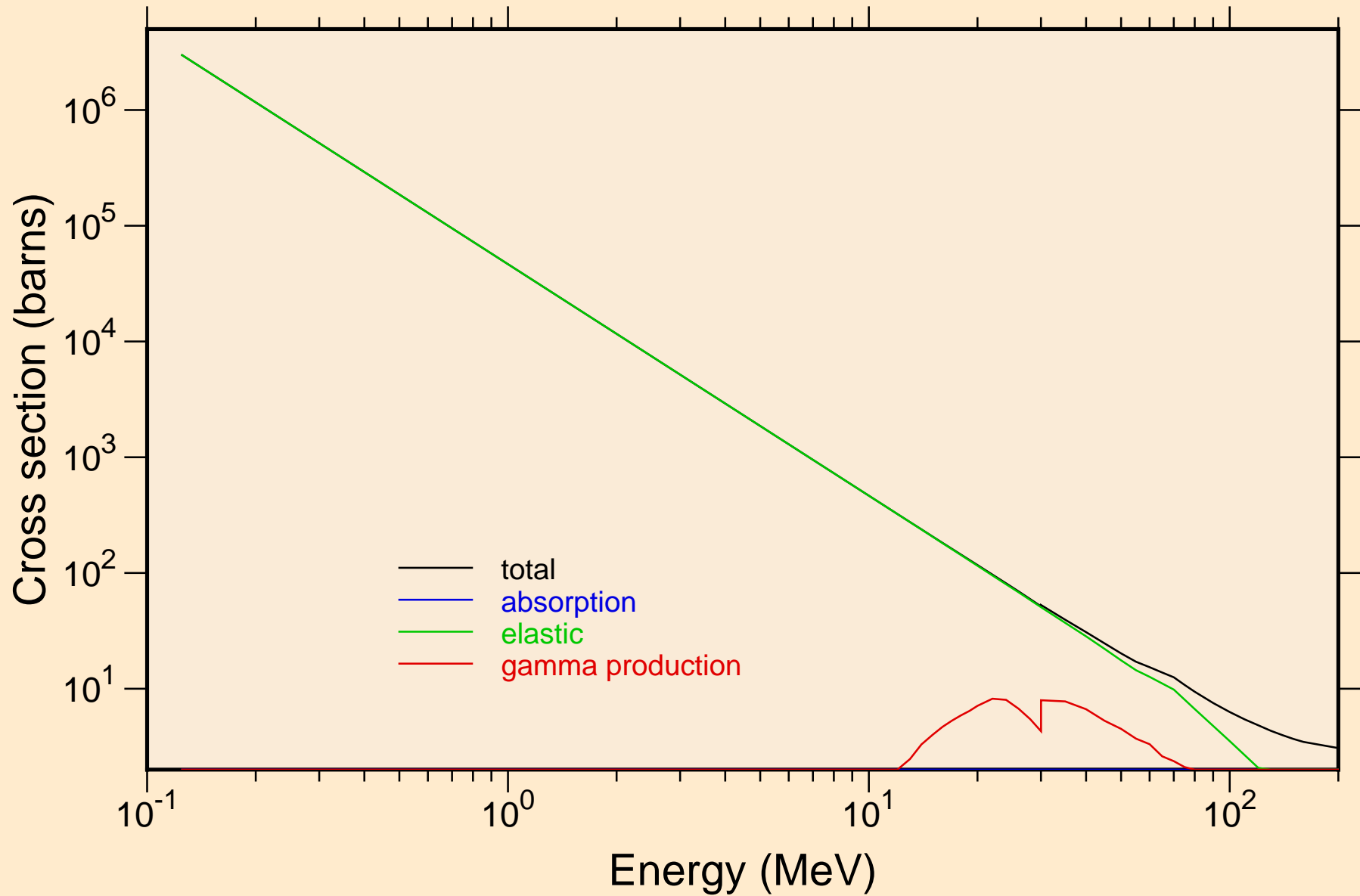

RN230 TRITON ACER TENDL-2021 LIBRARY; T=0.K

Heating

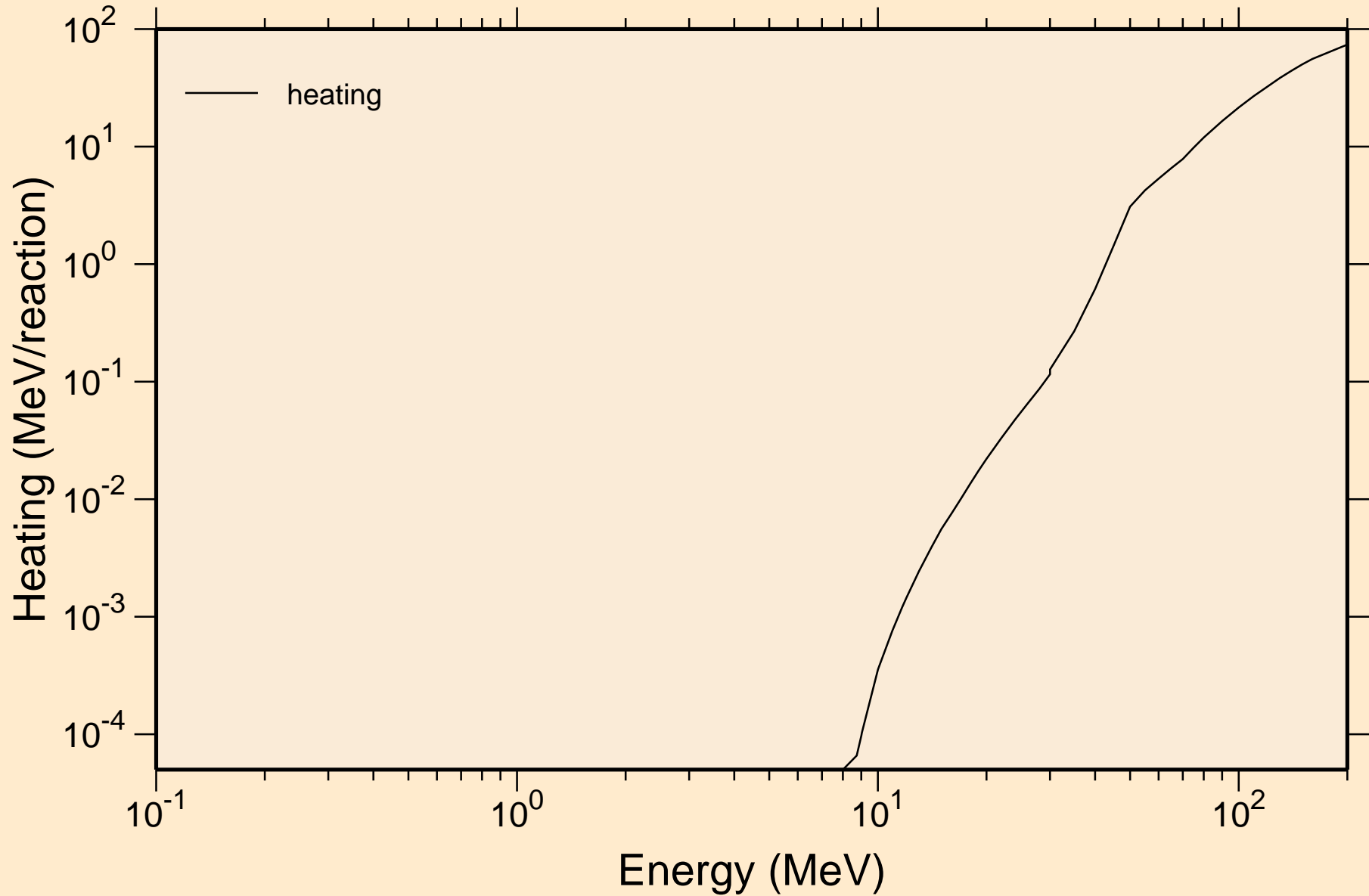

RN230 TRITON ACER TENDL-2021 LIBRARY; T=0.K

Principal cross sections

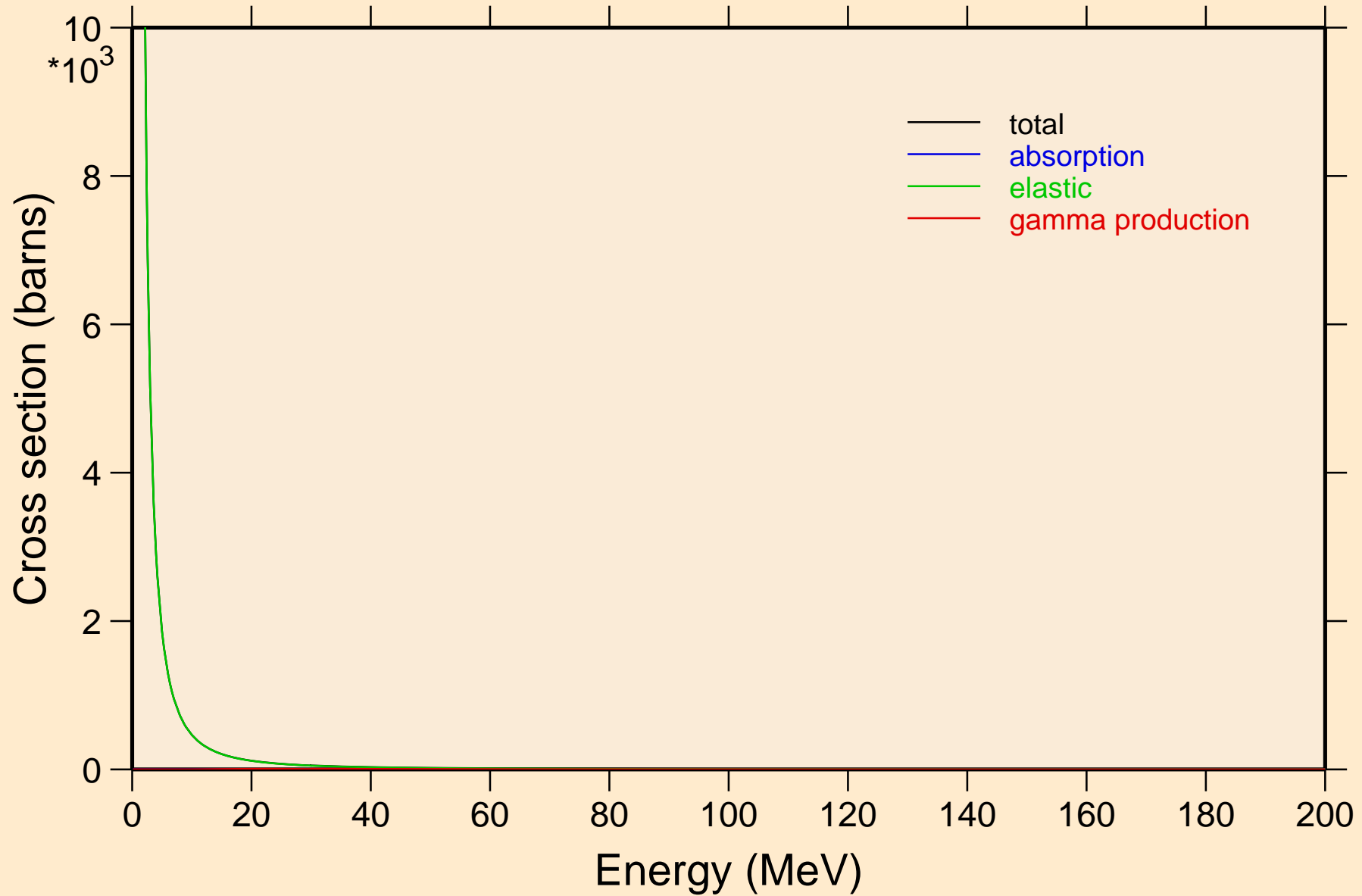

RN230 TRITON ACER TENDL-2021 LIBRARY; T=0.K

Heating

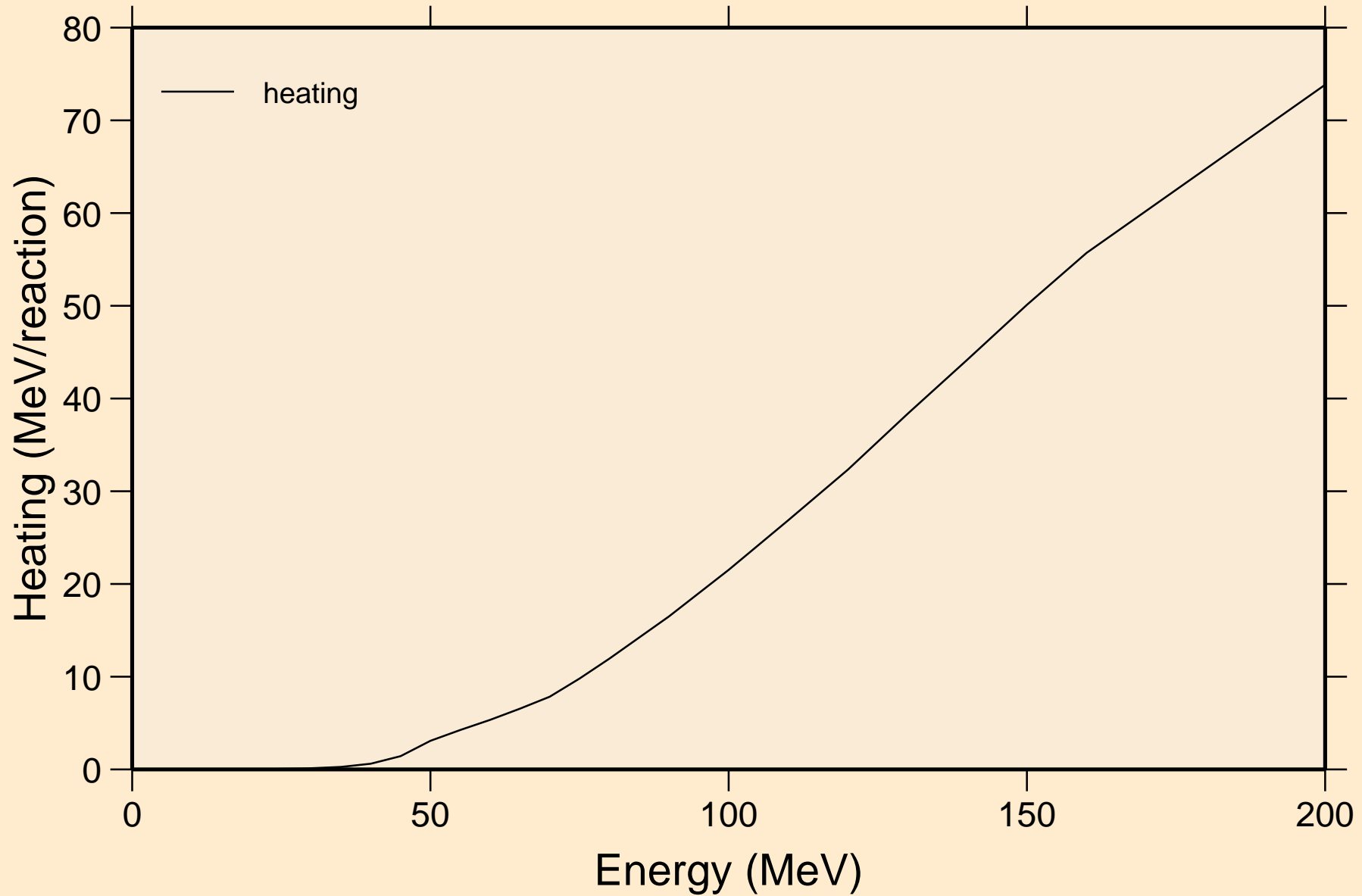

RN230 TRITON ACER TENDL-2021 LIBRARY; T=0.K
Threshold reactions

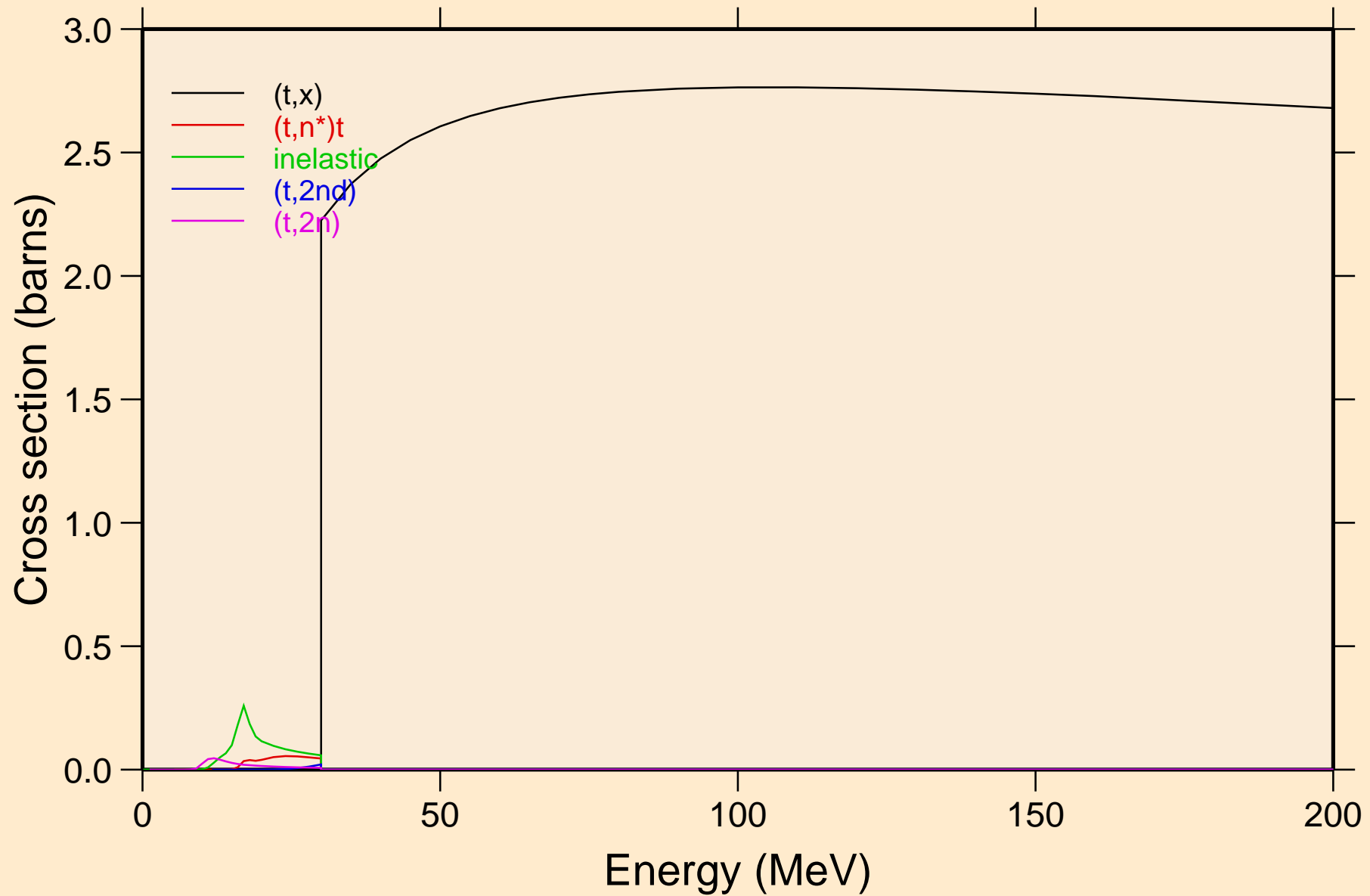

RN230 TRITON ACER TENDL-2021 LIBRARY; T=0.K
Threshold reactions

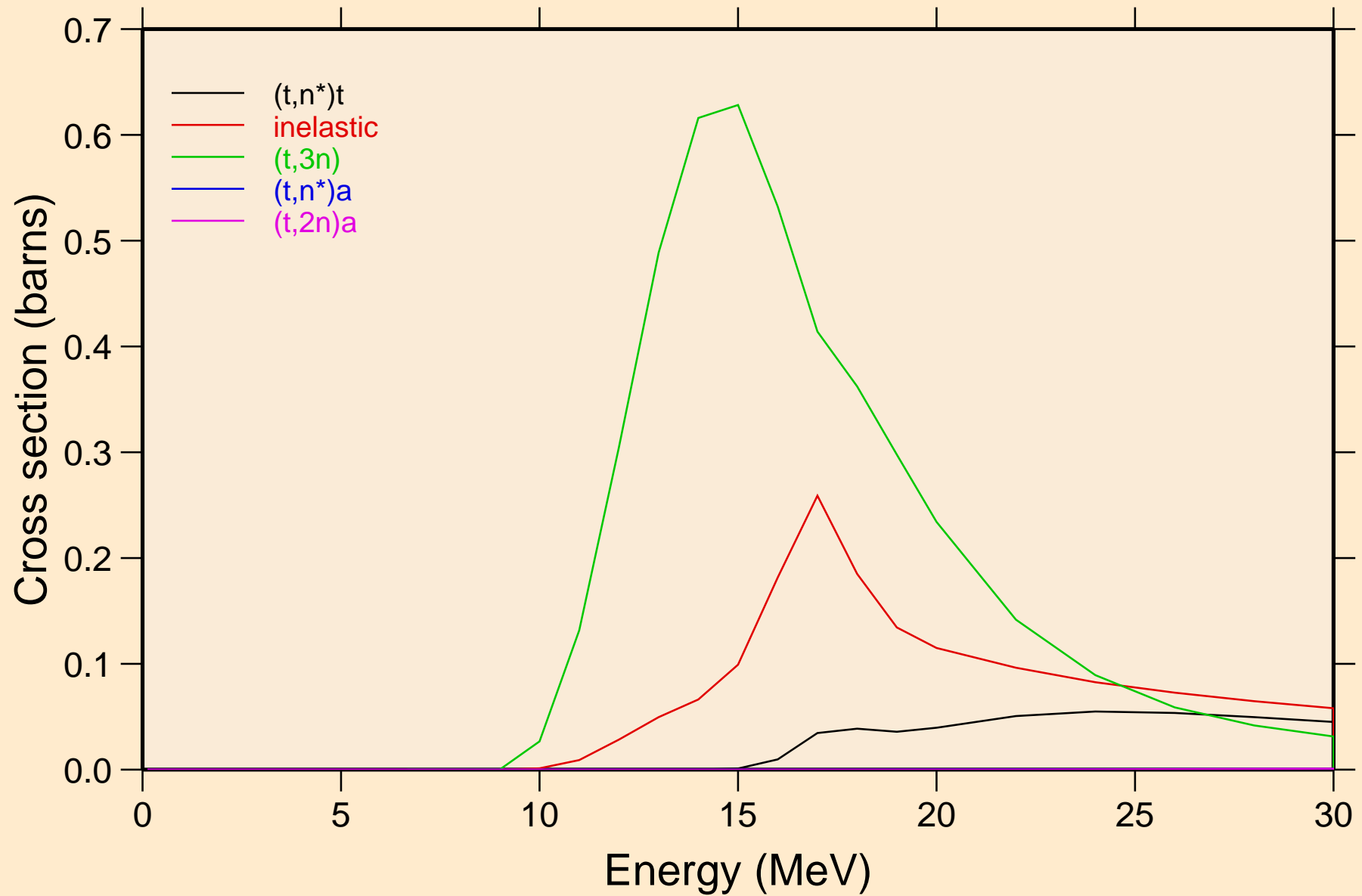

RN230 TRITON ACER TENDL-2021 LIBRARY; T=0.K
Threshold reactions

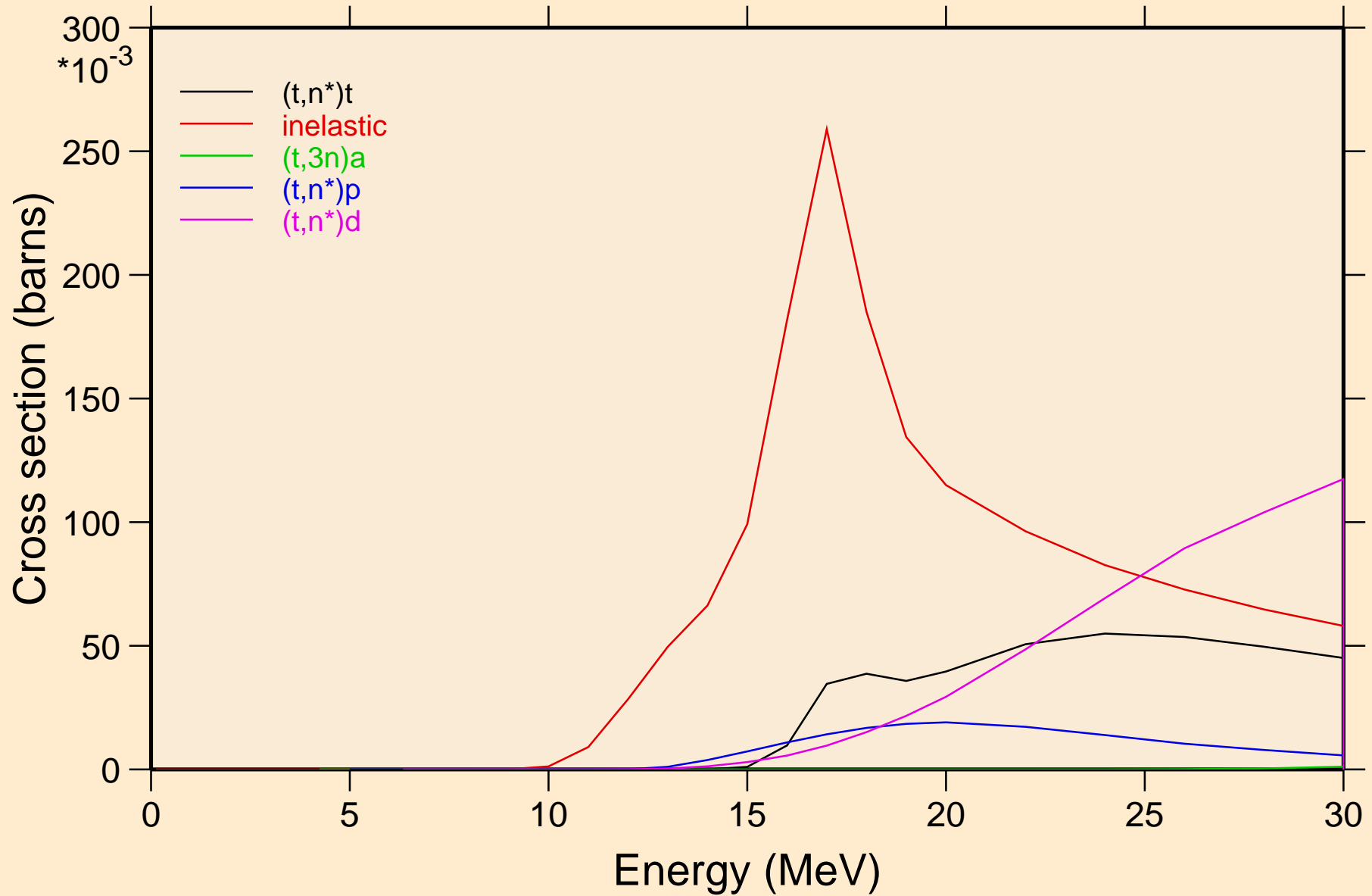

RN230 TRITON ACER TENDL-2021 LIBRARY; T=0.K
Threshold reactions

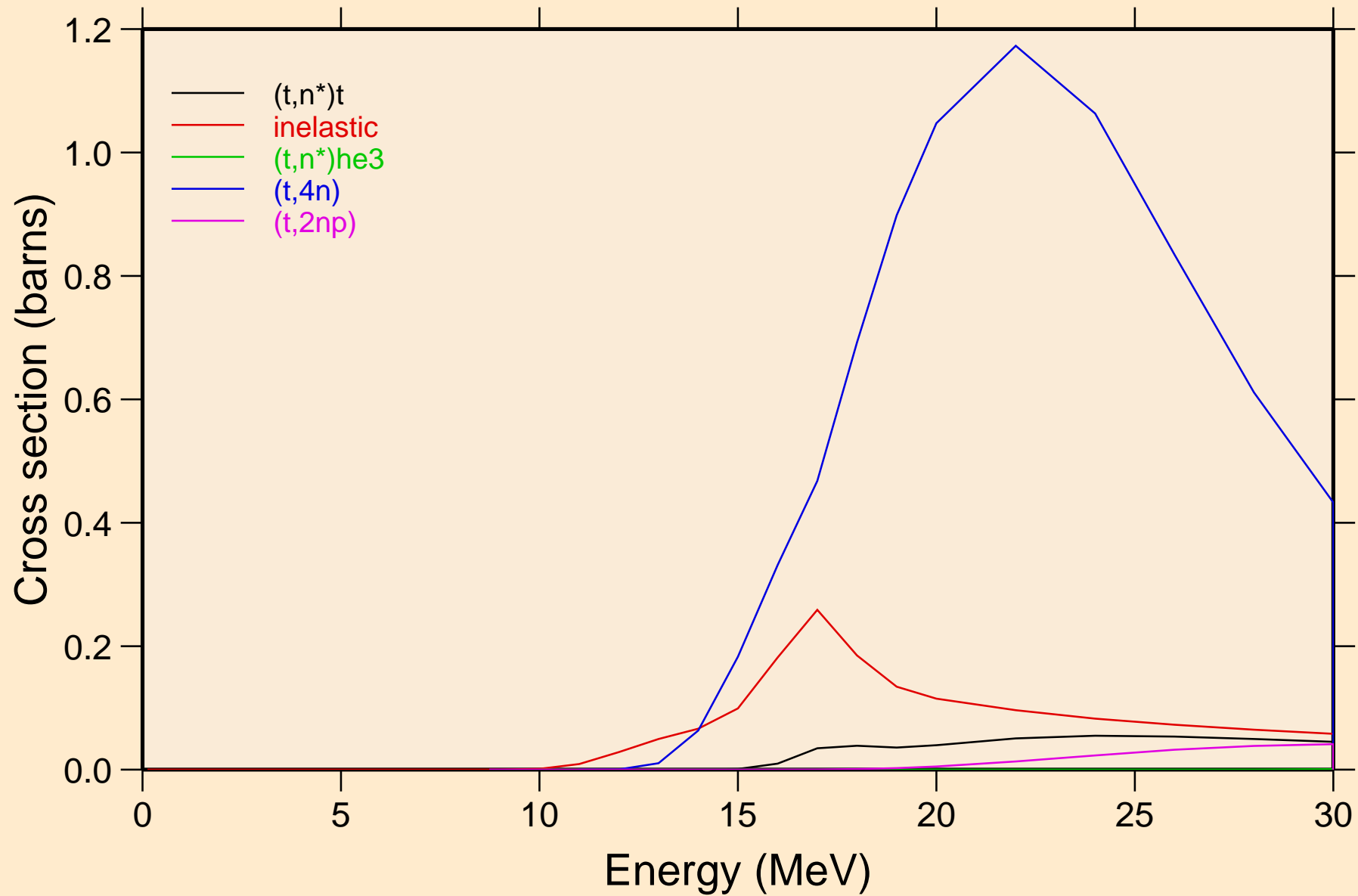

RN230 TRITON ACER TENDL-2021 LIBRARY; T=0.K
Threshold reactions

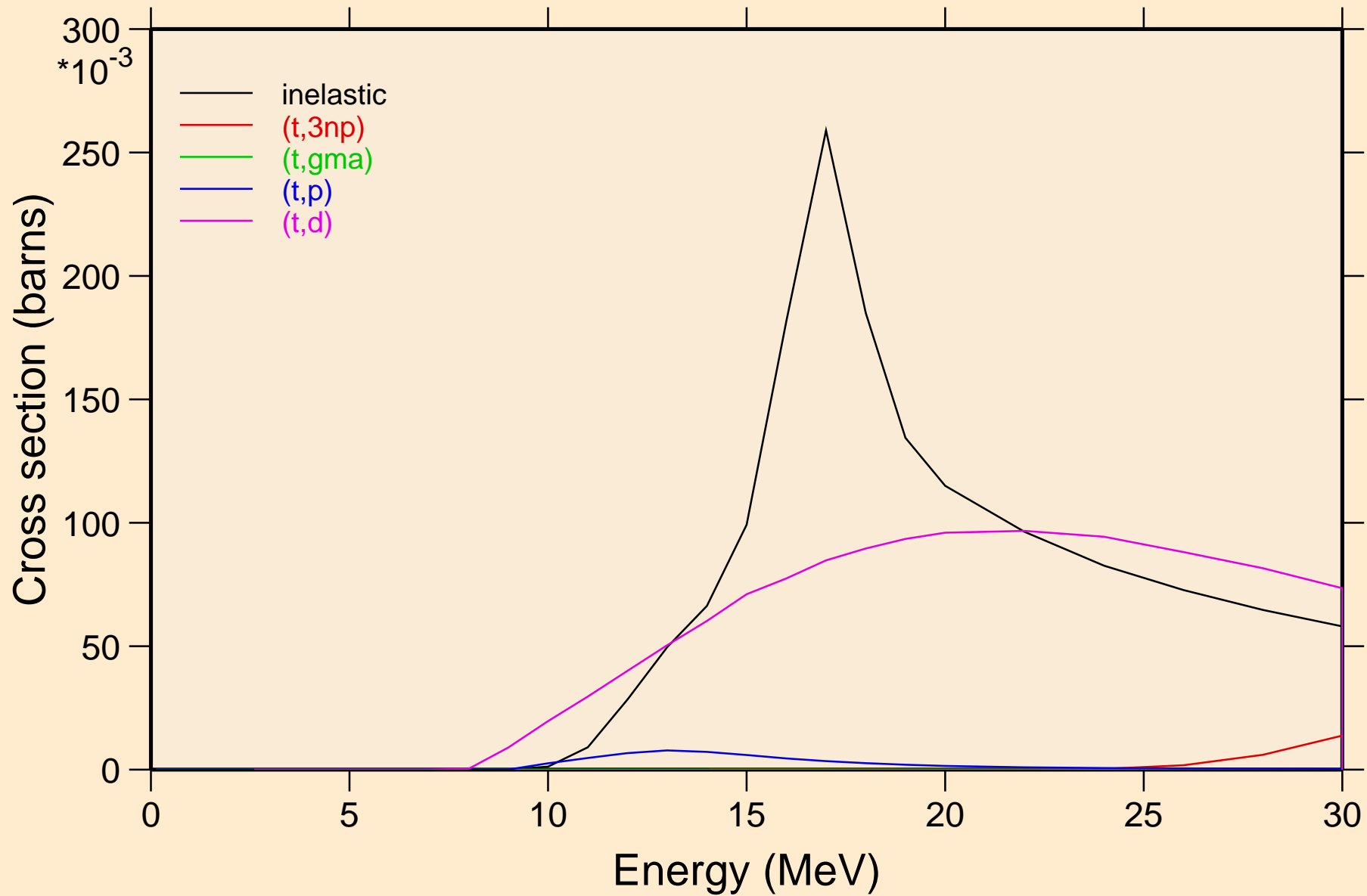

RN230 TRITON ACER TENDL-2021 LIBRARY; T=0.K
Threshold reactions

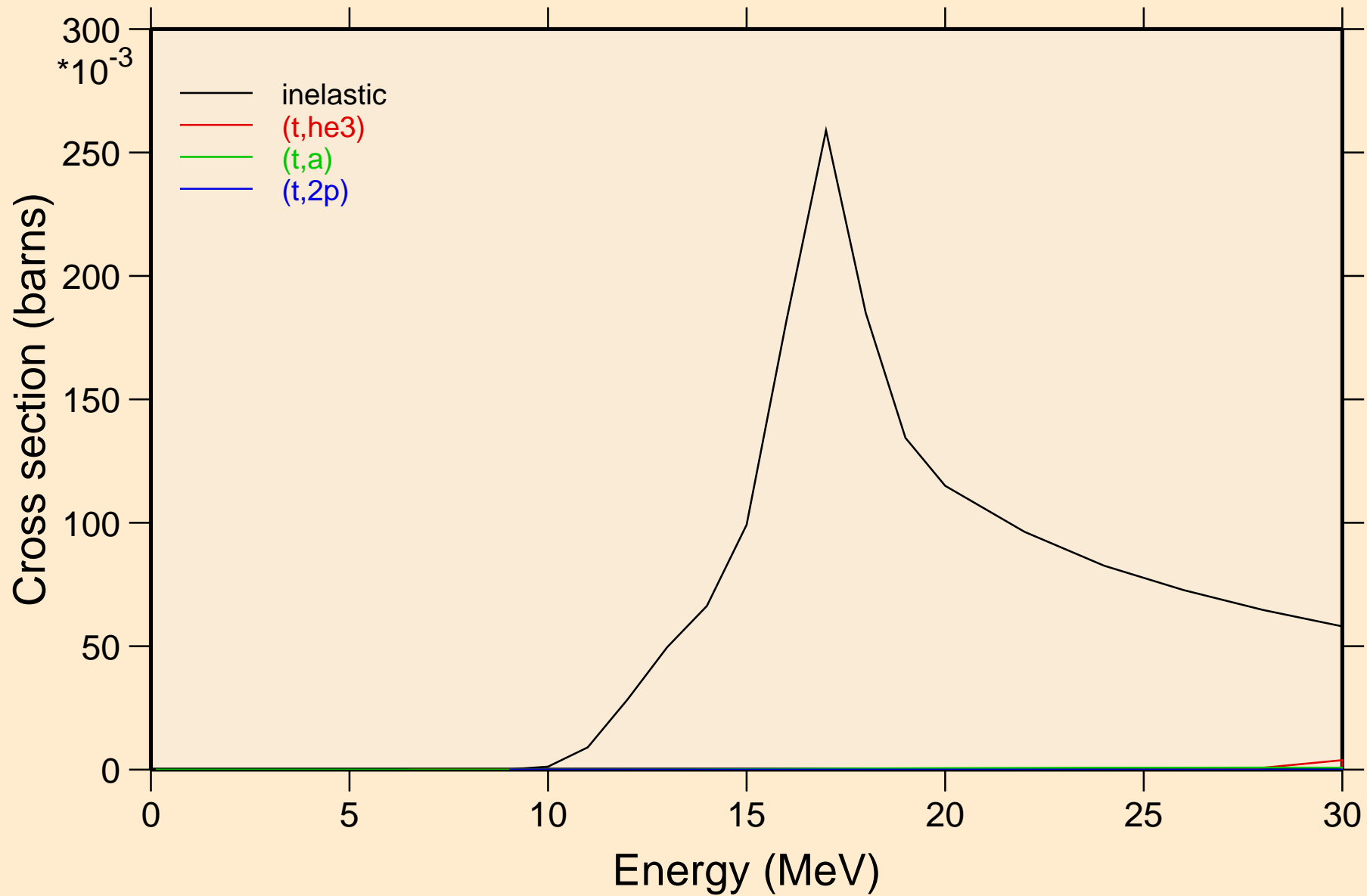

RN230 TRITON ACER TENDL-2021 LIBRARY; T=0.K
angular distribution for elastic

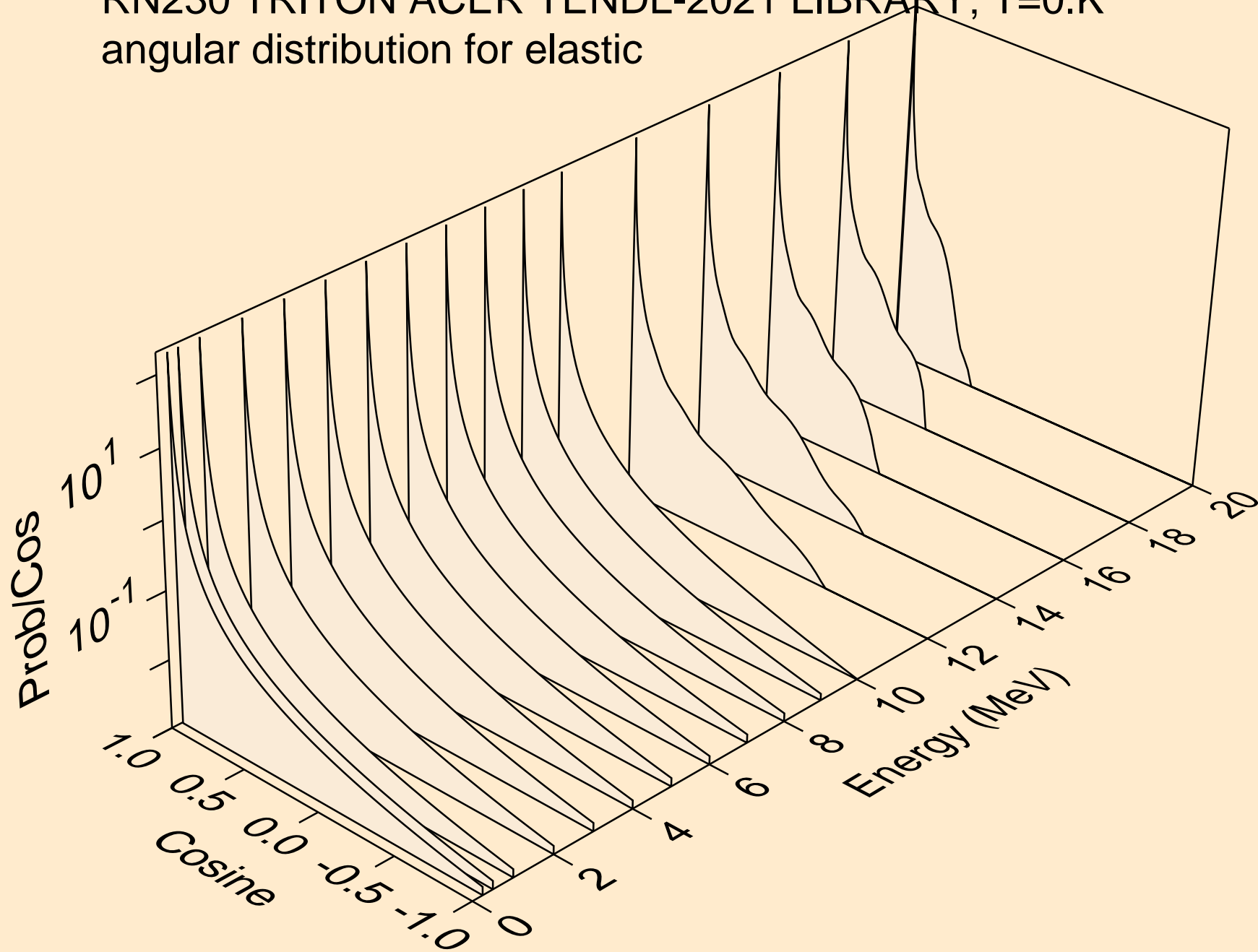

RN230 TRITON ACER TENDL-2021 LIBRARY; T=0.K
angular distribution for elastic

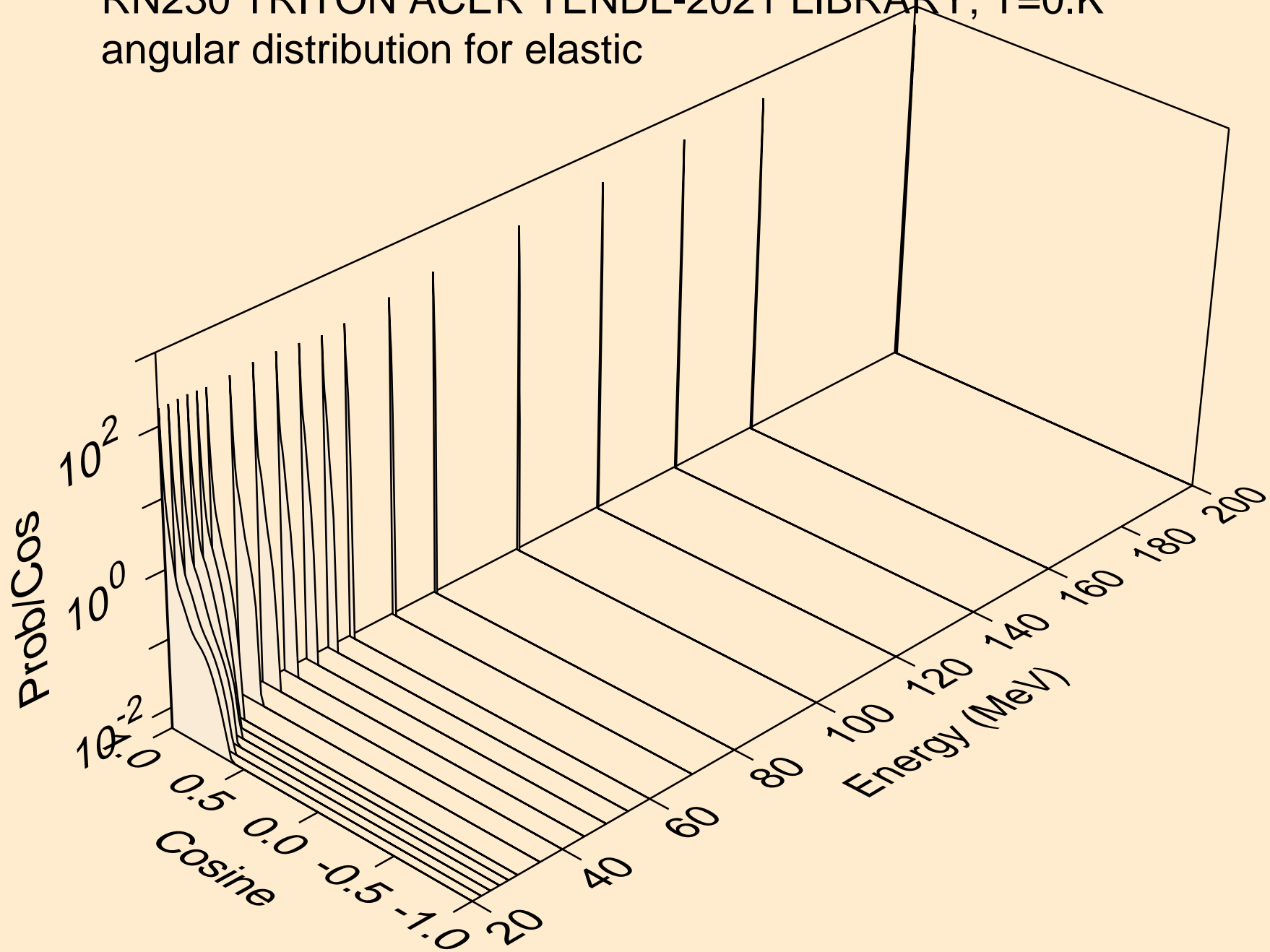

RN230 TRITON ACER TENDL-2021 LIBRARY; T=0.K
Triton emission for (t,x)

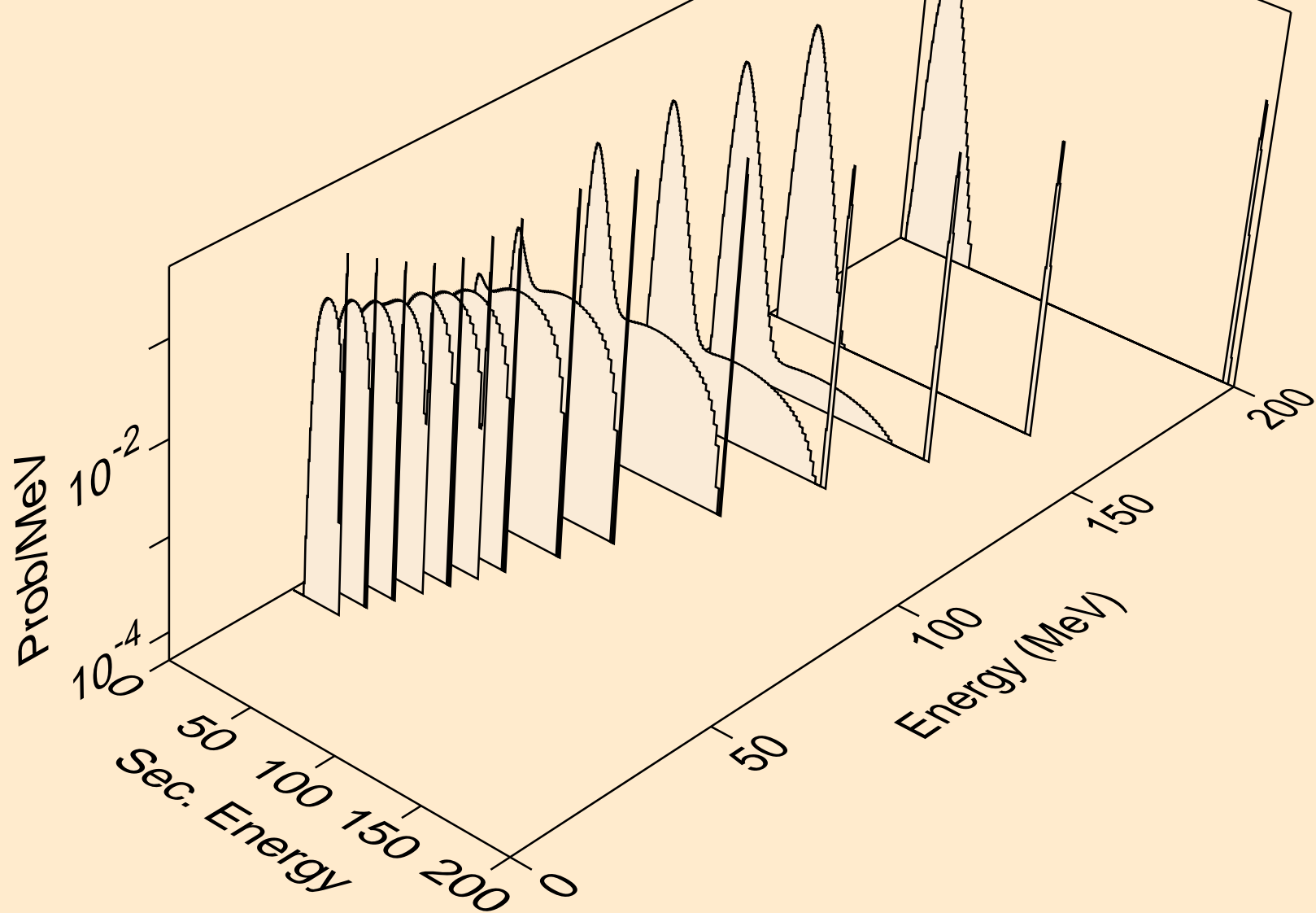

RN230 TRITON ACER TENDL-2021 LIBRARY; T=0.K
Triton emission for (t,n*)t

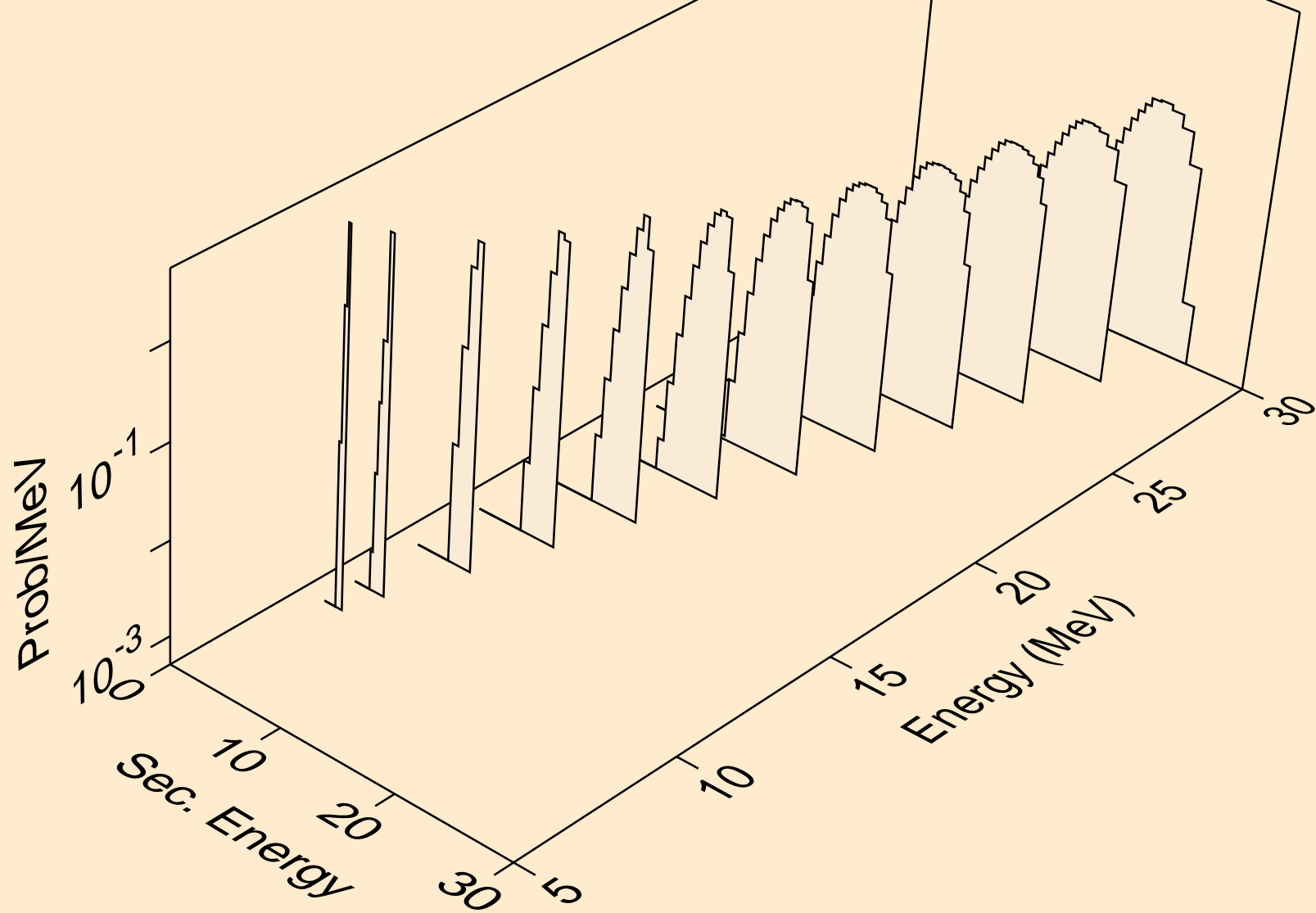

RN230 TRITON ACER TENDL-2021 LIBRARY; T=0.K
Triton emission for inelastic

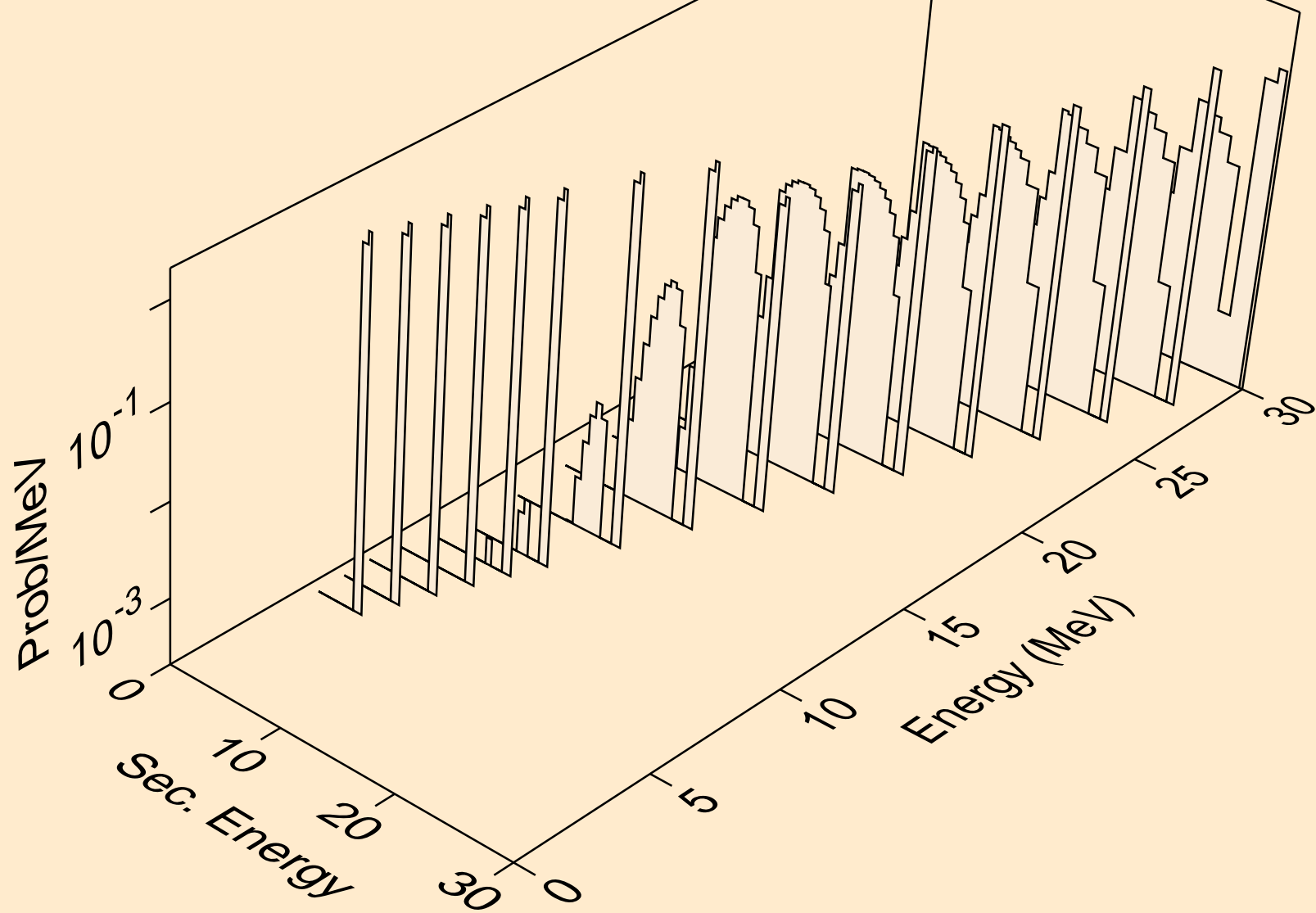

RN230 TRITON ACER TENDL-2021 LIBRARY; T=0.K
Photon emission for (z,n)

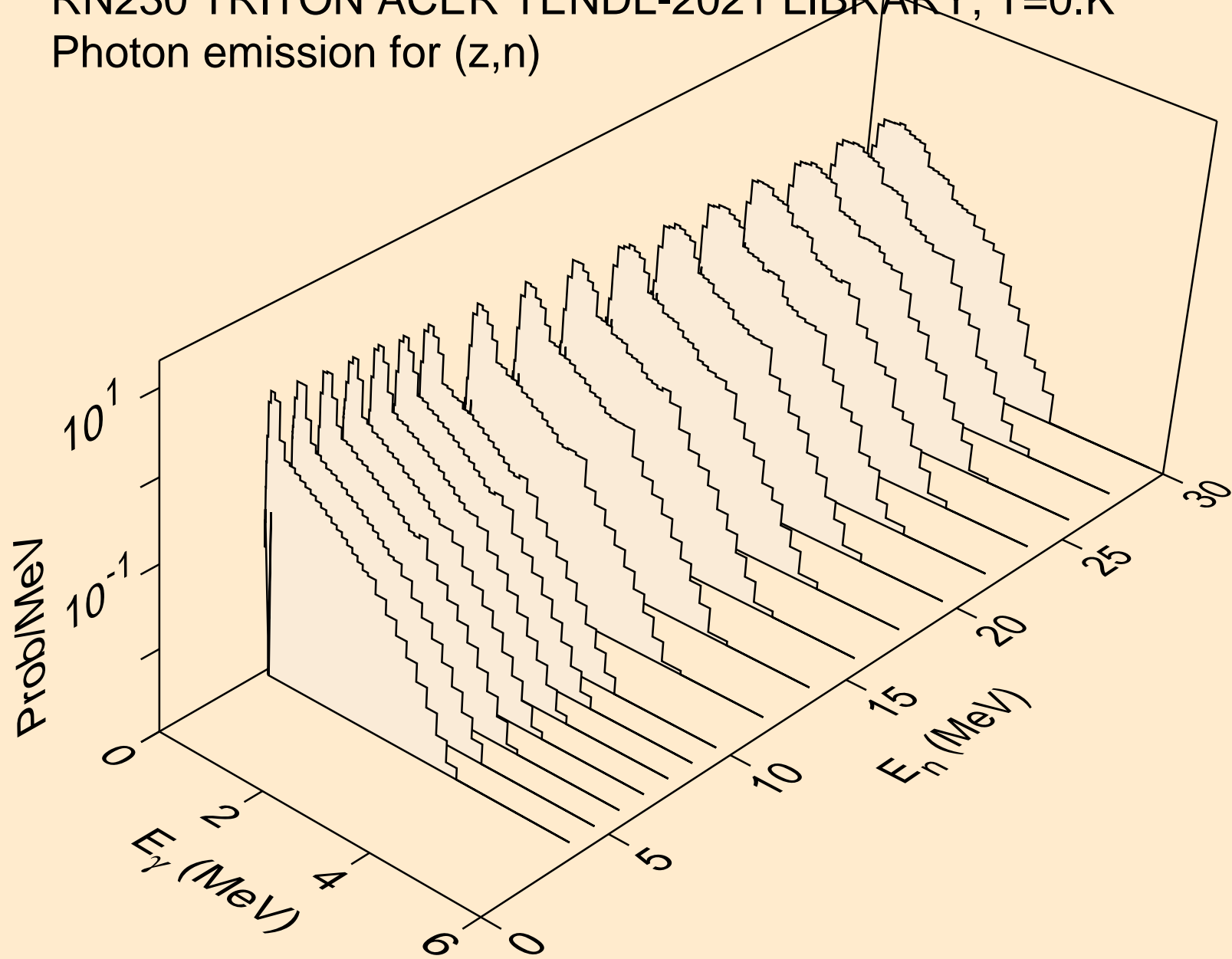

RN230 TRITON ACER TENDL-2021 LIBRARY; T=0.K
Photon emission for (n,x)

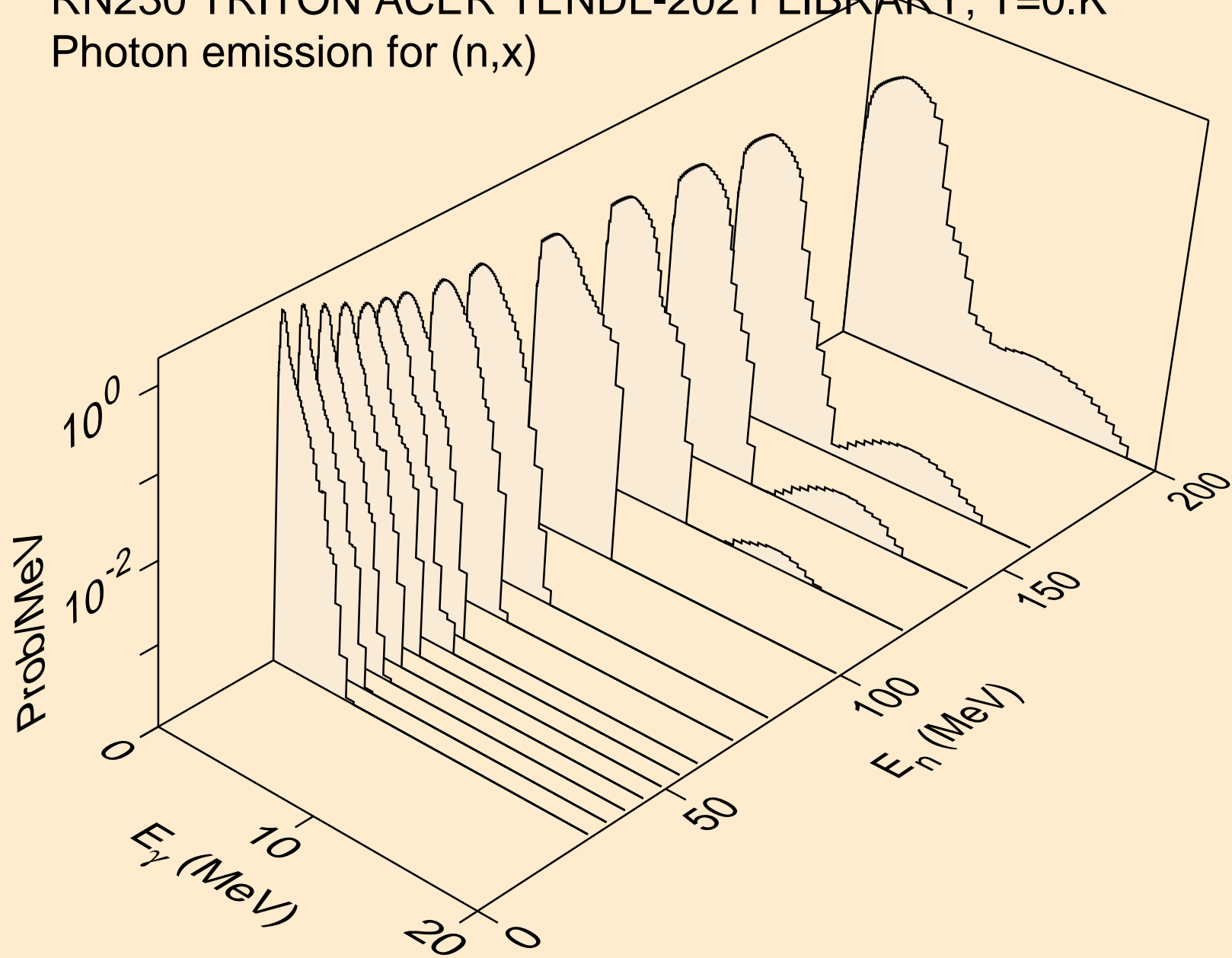

RN230 TRITON ACER TENDL-2021 LIBRARY; T=0.K
Photon emission for (n,2nd)

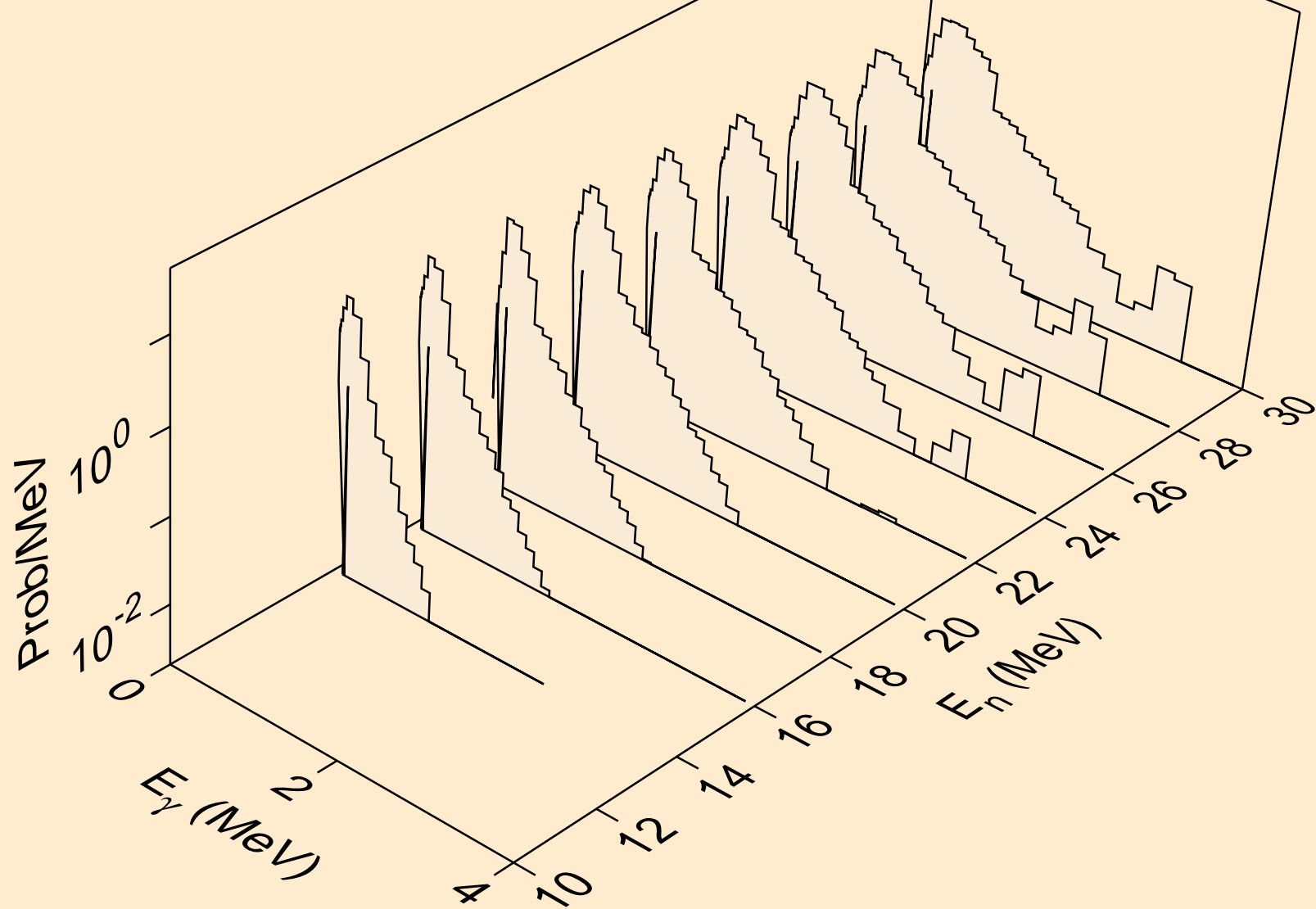

RN230 TRITON ACER TENDL-2021 LIBRARY; T=0.K
Photon emission for (n,2n)

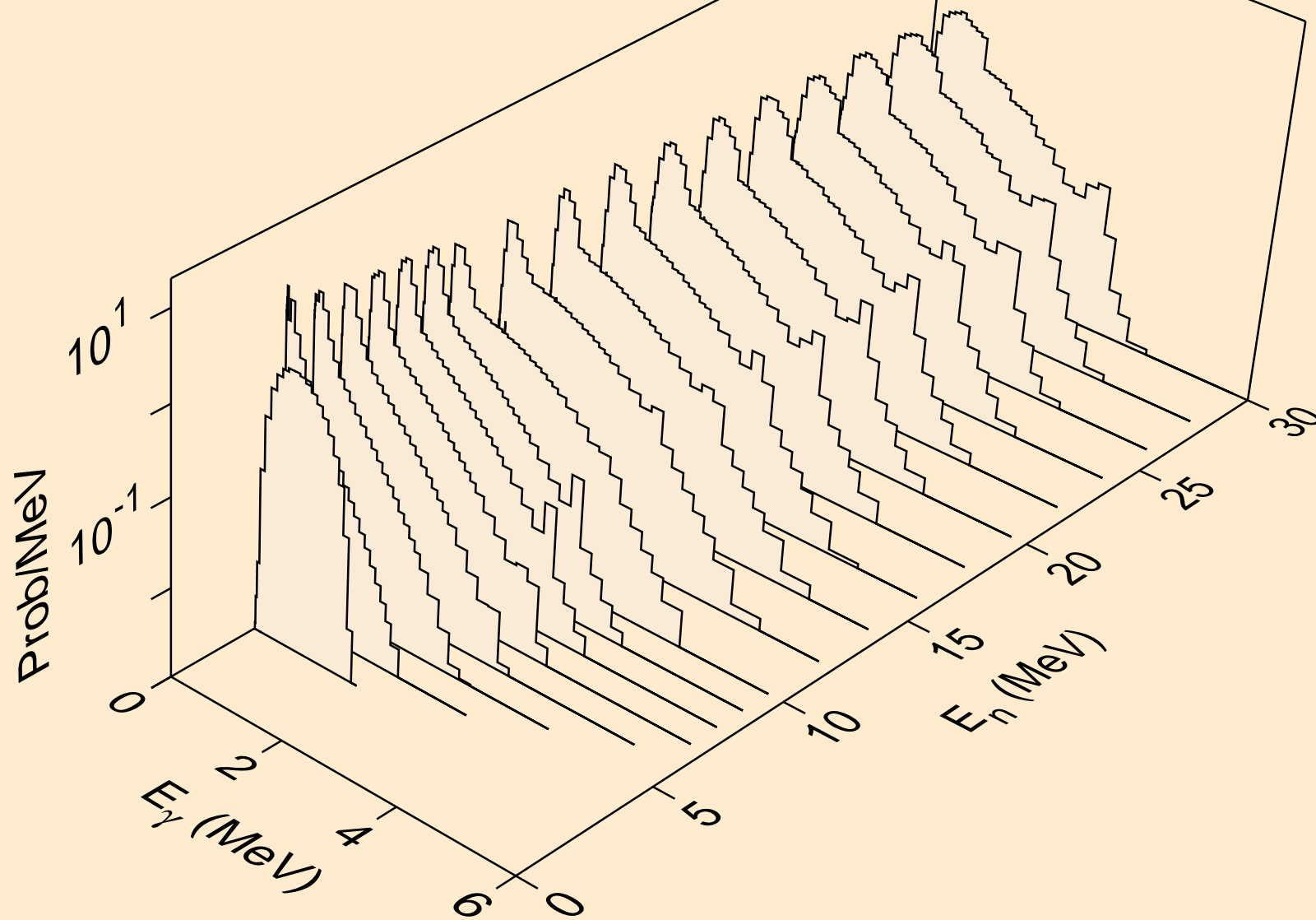

RN230 TRITON ACER TENDL-2021 LIBRARY; T=0.K
Photon emission for (n,3n)

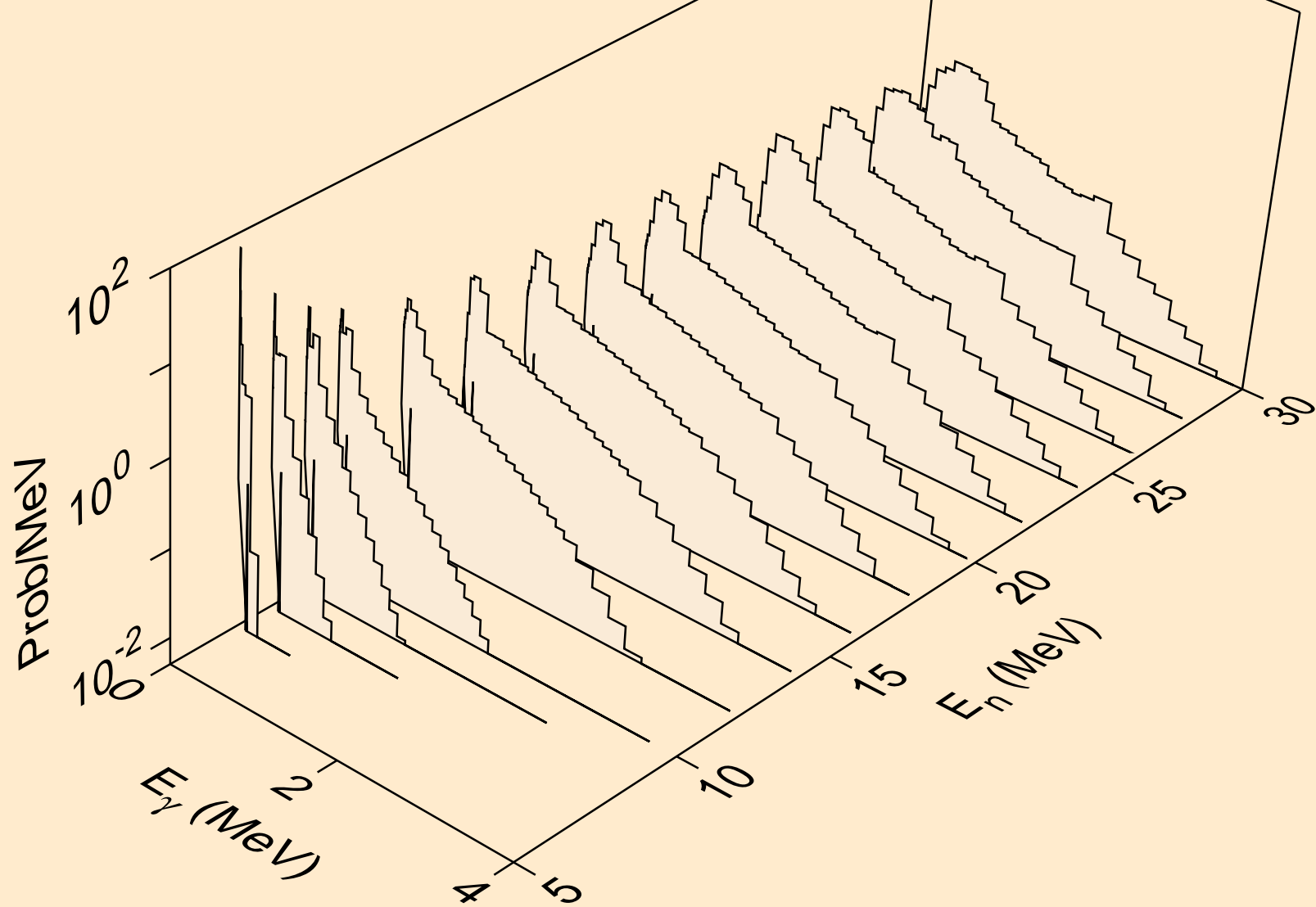

RN230 TRITON ACER TENDL-2021 LIBRARY; T=0.K
Photon emission for (n,n*)a

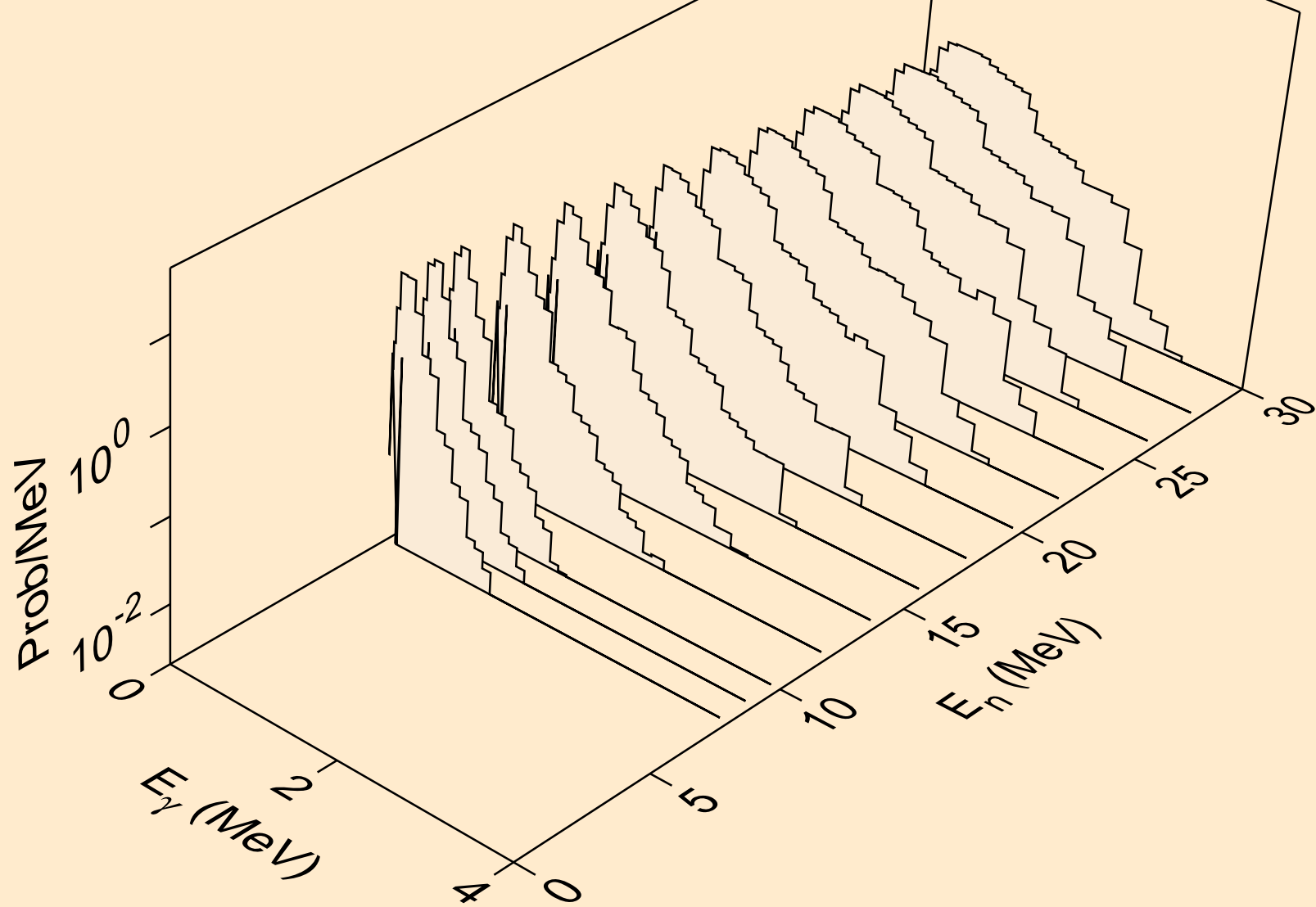

RN230 TRITON ACER TENDL-2021 LIBRARY; T=0.K
Photon emission for (n,2n)a

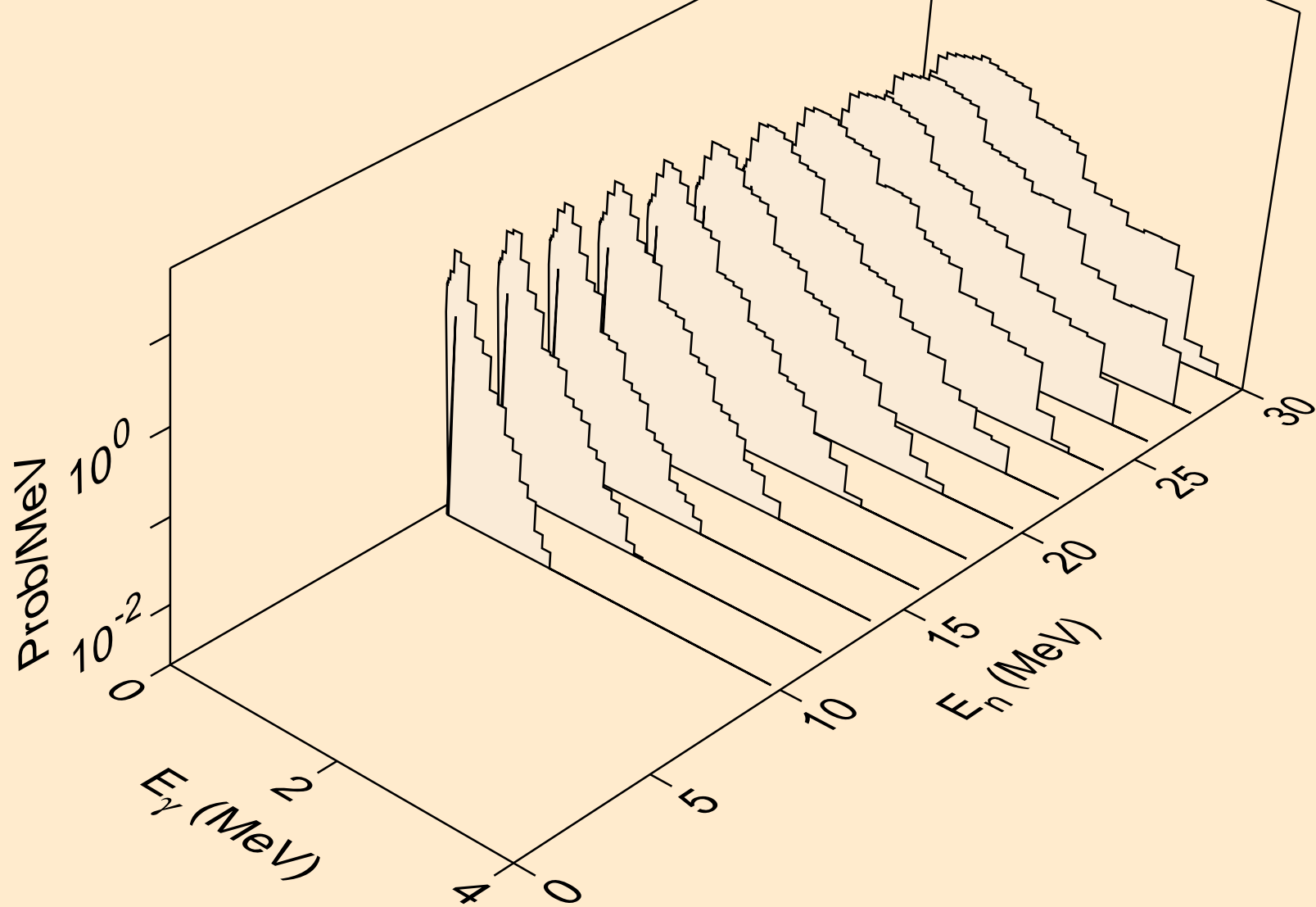

RN230 TRITON ACER TENDL-2021 LIBRARY; T=0.K
Photon emission for (n,3n)a

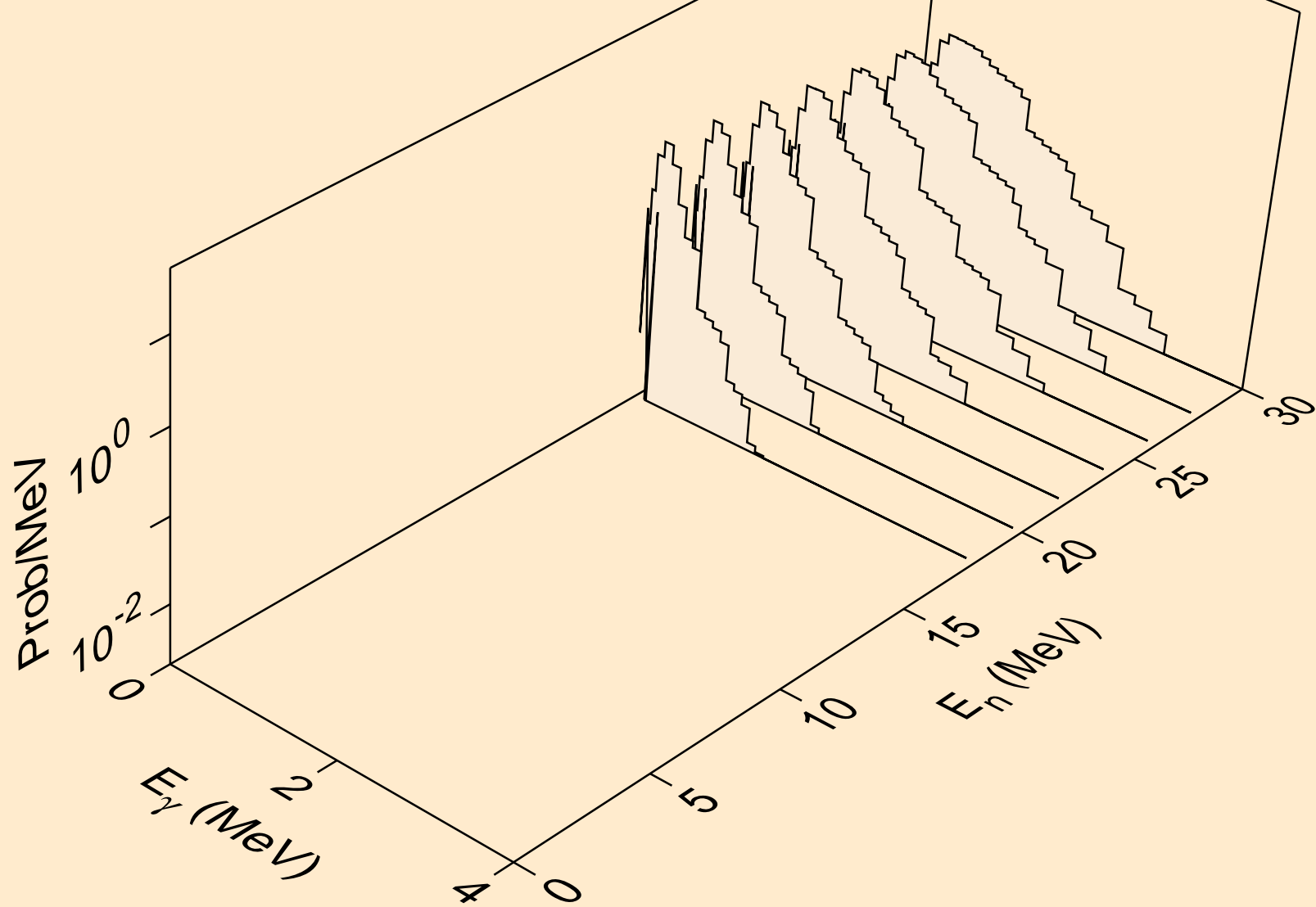

RN230 TRITON ACER TENDL-2021 LIBRARY; T=0.K
Photon emission for (n,n*)p

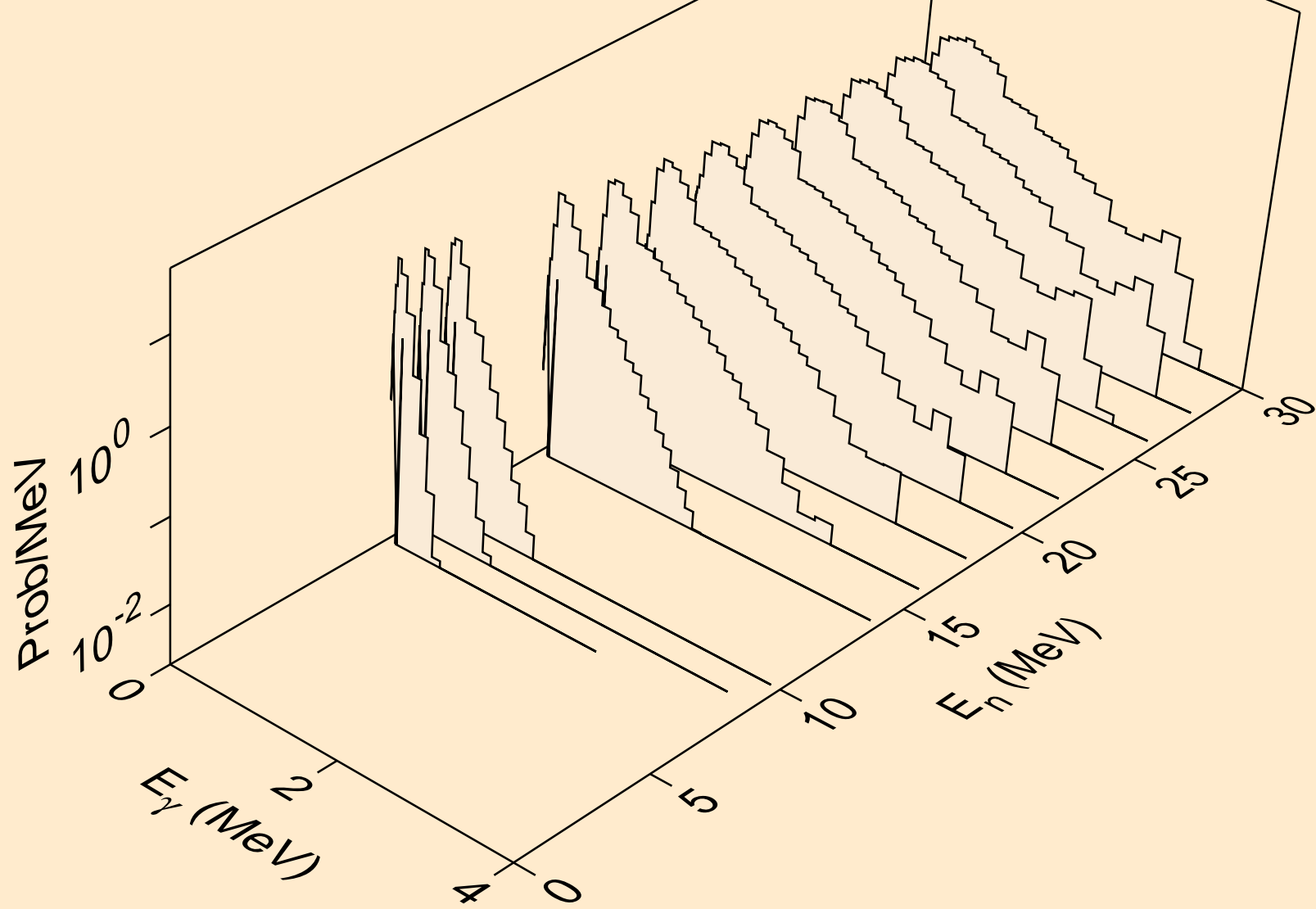

RN230 TRITON ACER TENDL-2021 LIBRARY; T=0.K
Photon emission for (n,n*)d

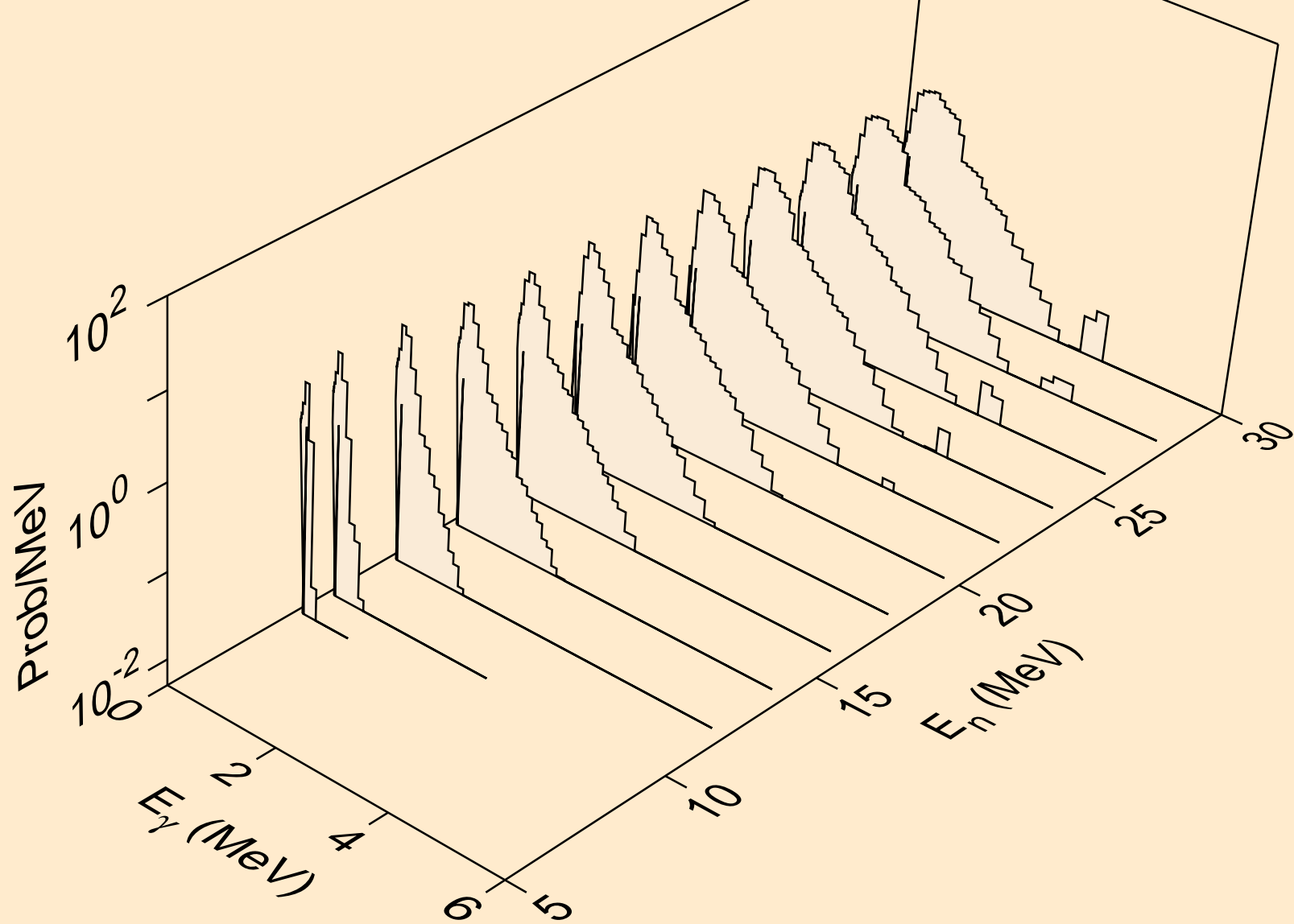

RN230 TRITON ACER TENDL-2021 LIBRARY; T=0.K
Photon emission for (n,n*)t

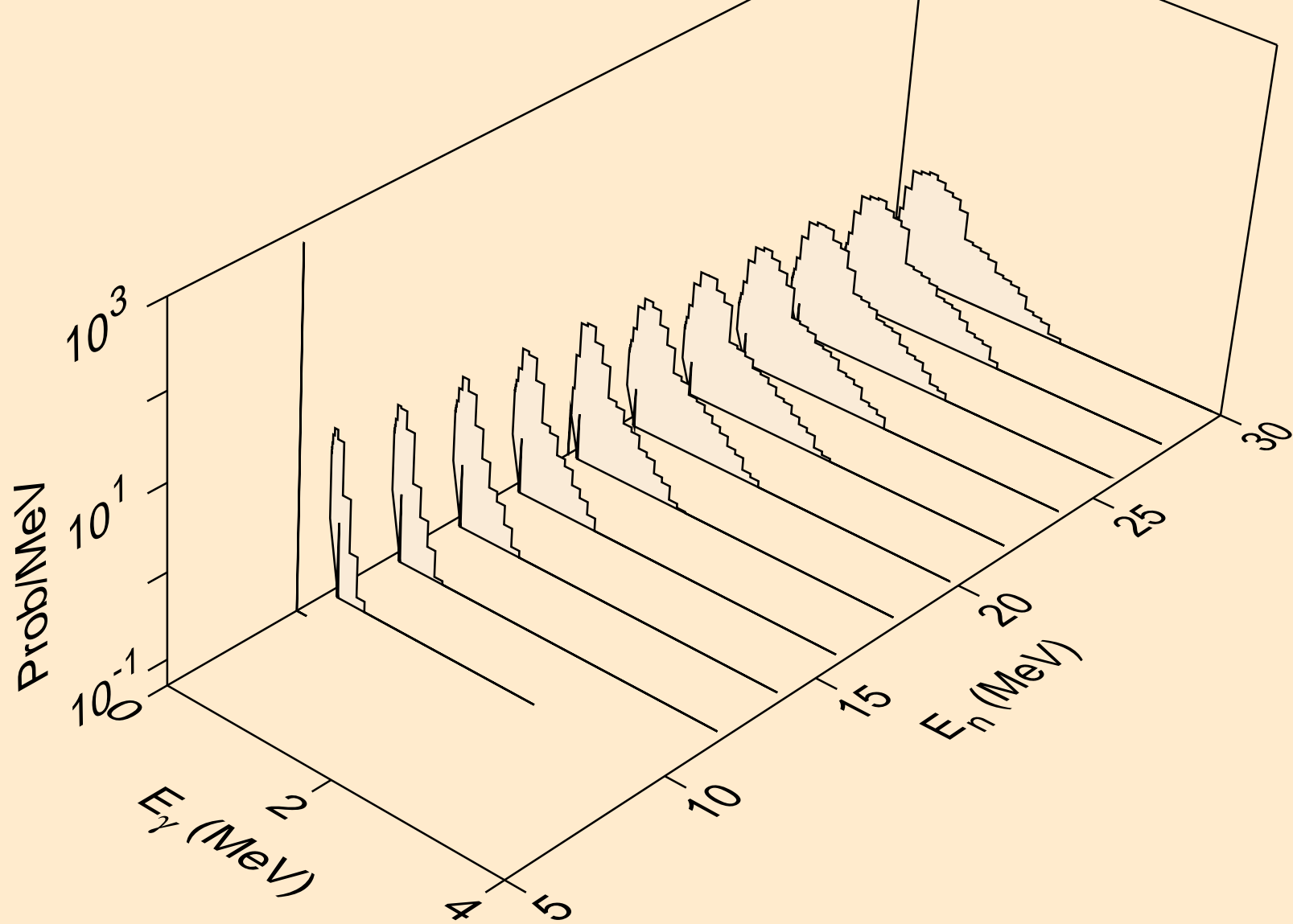

RN230 TRITON ACER TENDL-2021 LIBRARY; T=0.K
Photon emission for (n,n*)he3

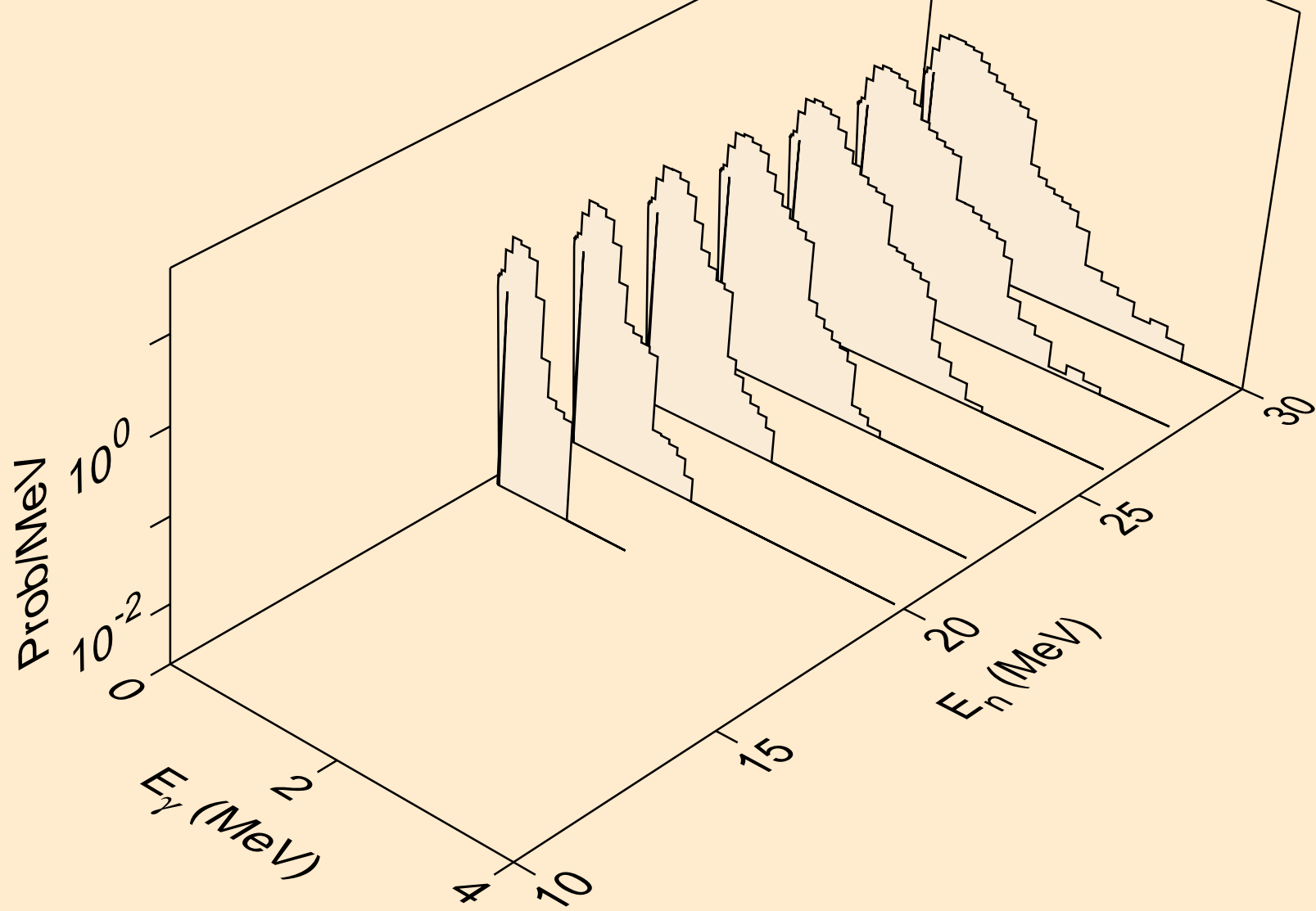

RN230 TRITON ACER TENDL-2021 LIBRARY; T=0.K
Photon emission for (n,4n)

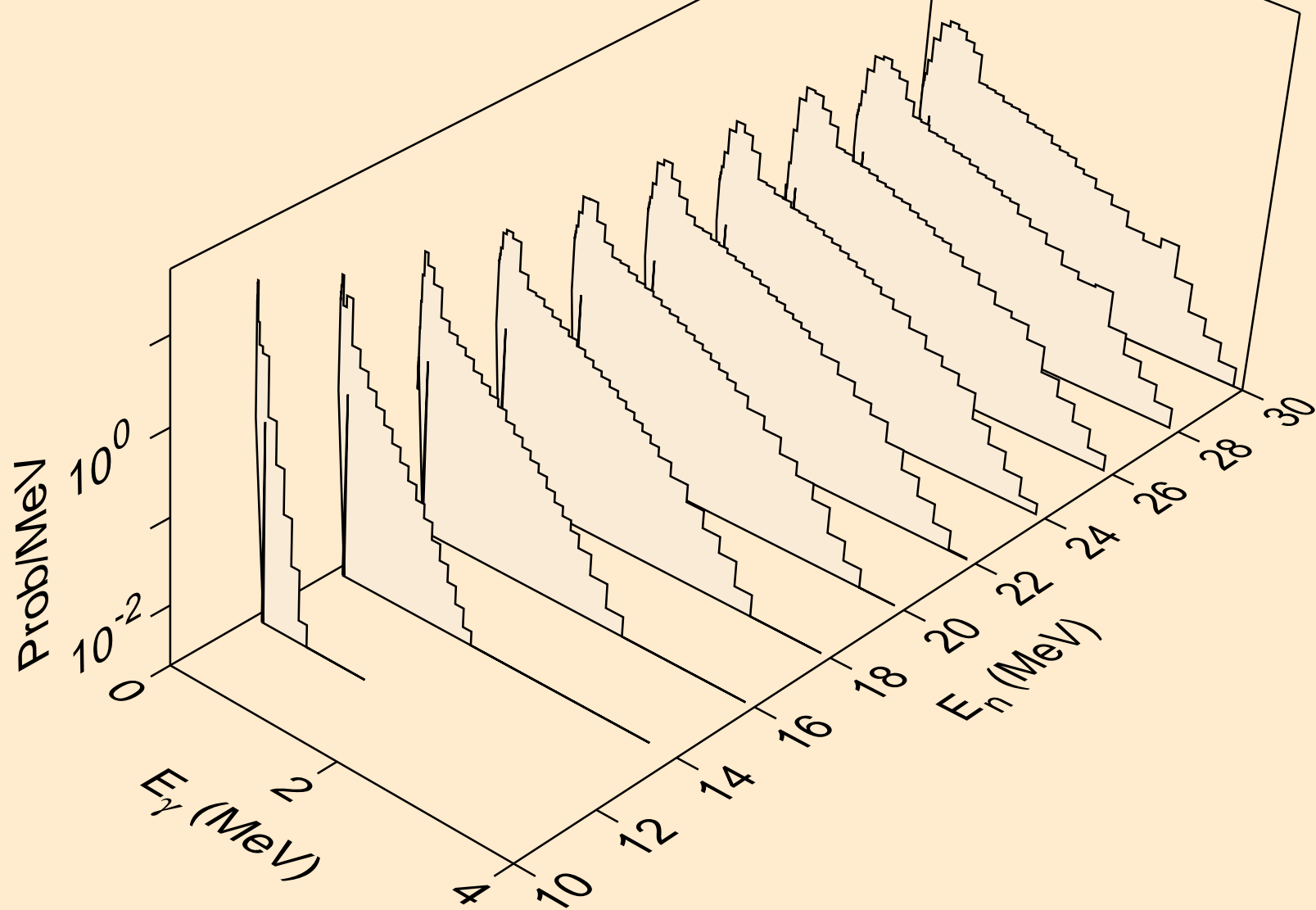

RN230 TRITON ACER TENDL-2021 LIBRARY; T=0.K
Photon emission for (n,2np)

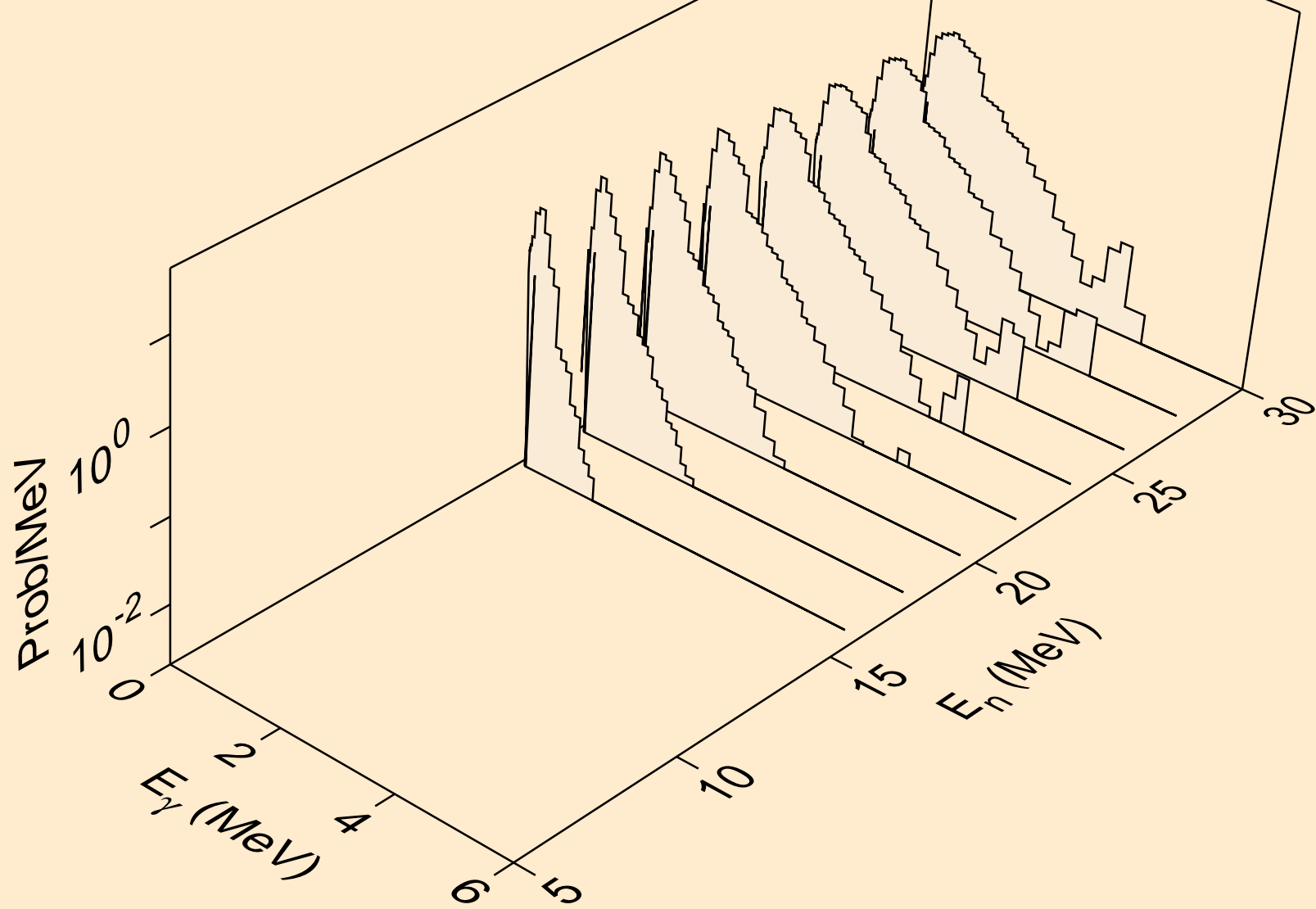

RN230 TRITON ACER TENDL-2021 LIBRARY; T=0.K
Photon emission for (n,3np)

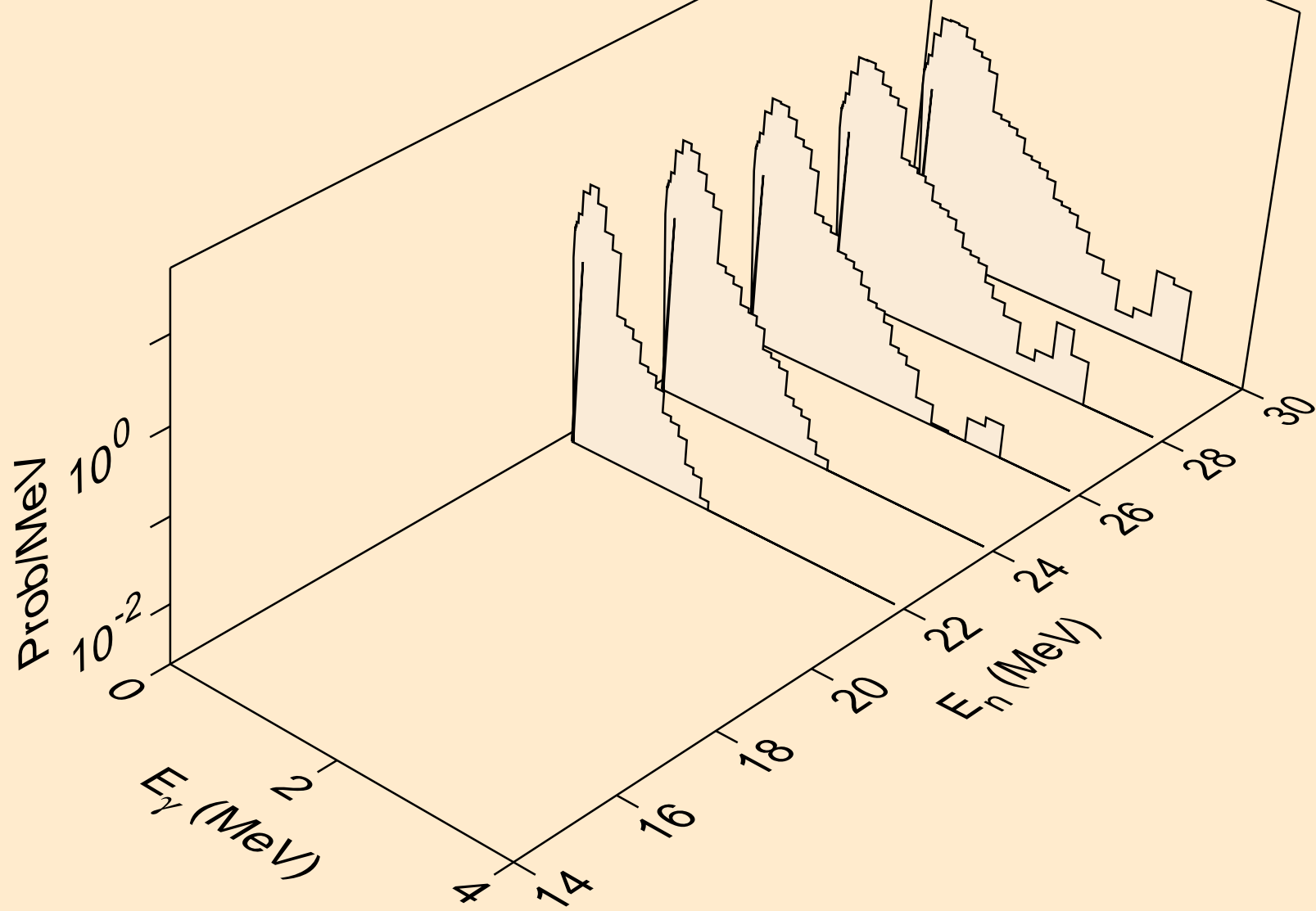

RN230 TRITON ACER TENDL-2021 LIBRARY; T=0.K
Photon emission for (n,gma)

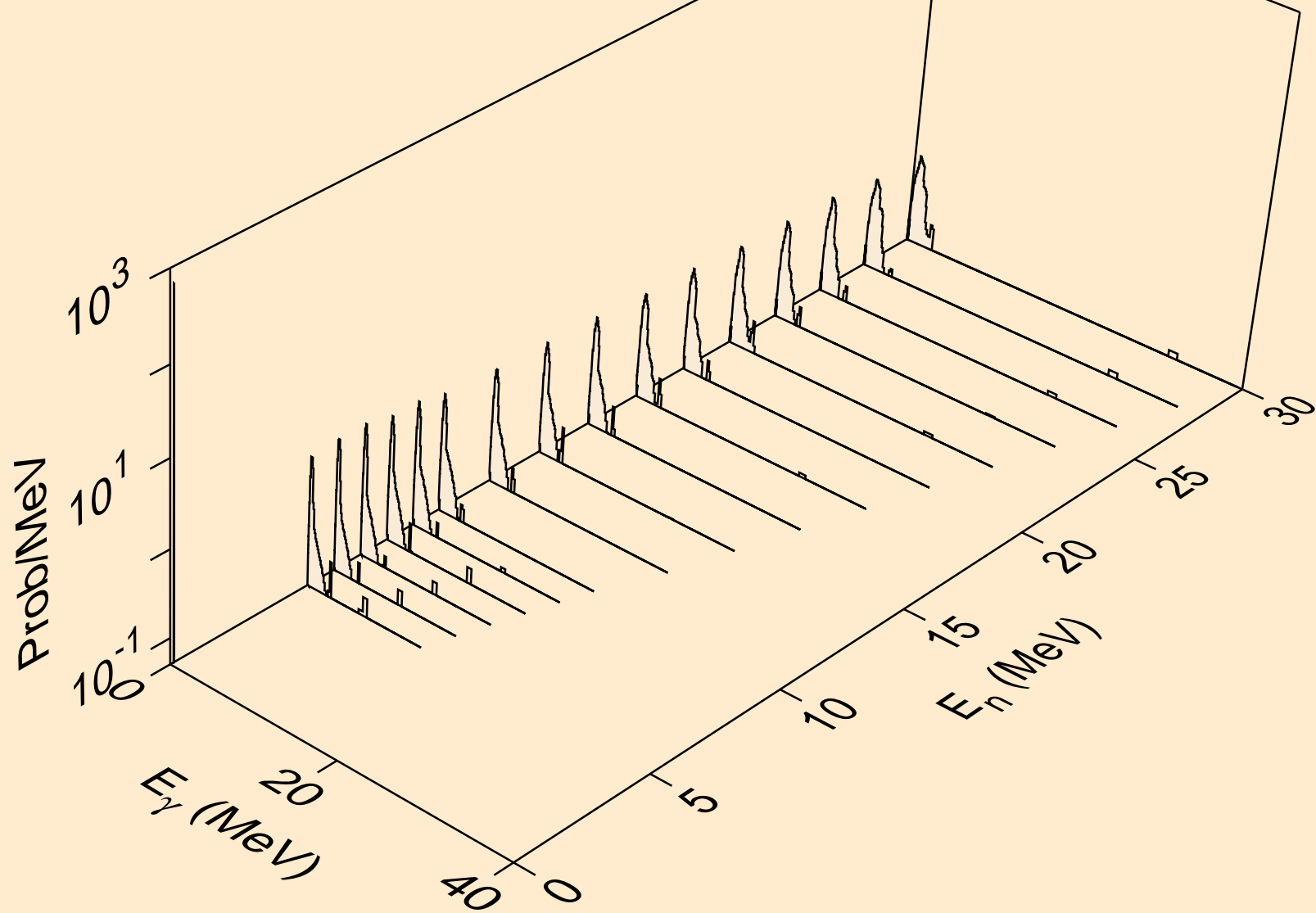

RN230 TRITON ACER TENDL-2021 LIBRARY; T=0.K
Photon emission for (n,p)

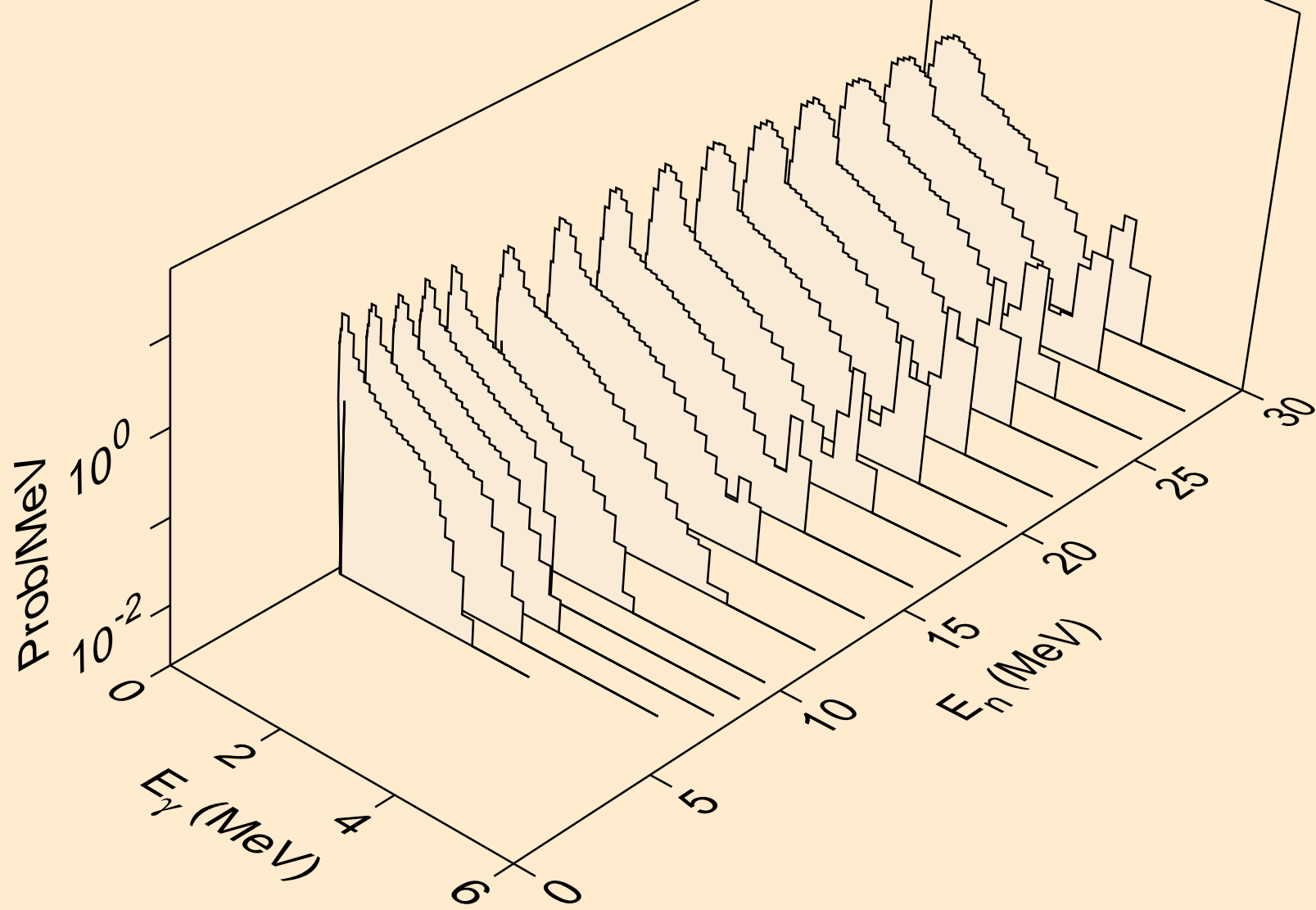

RN230 TRITON ACER TENDL-2021 LIBRARY; T=0.K
Photon emission for (n,d)

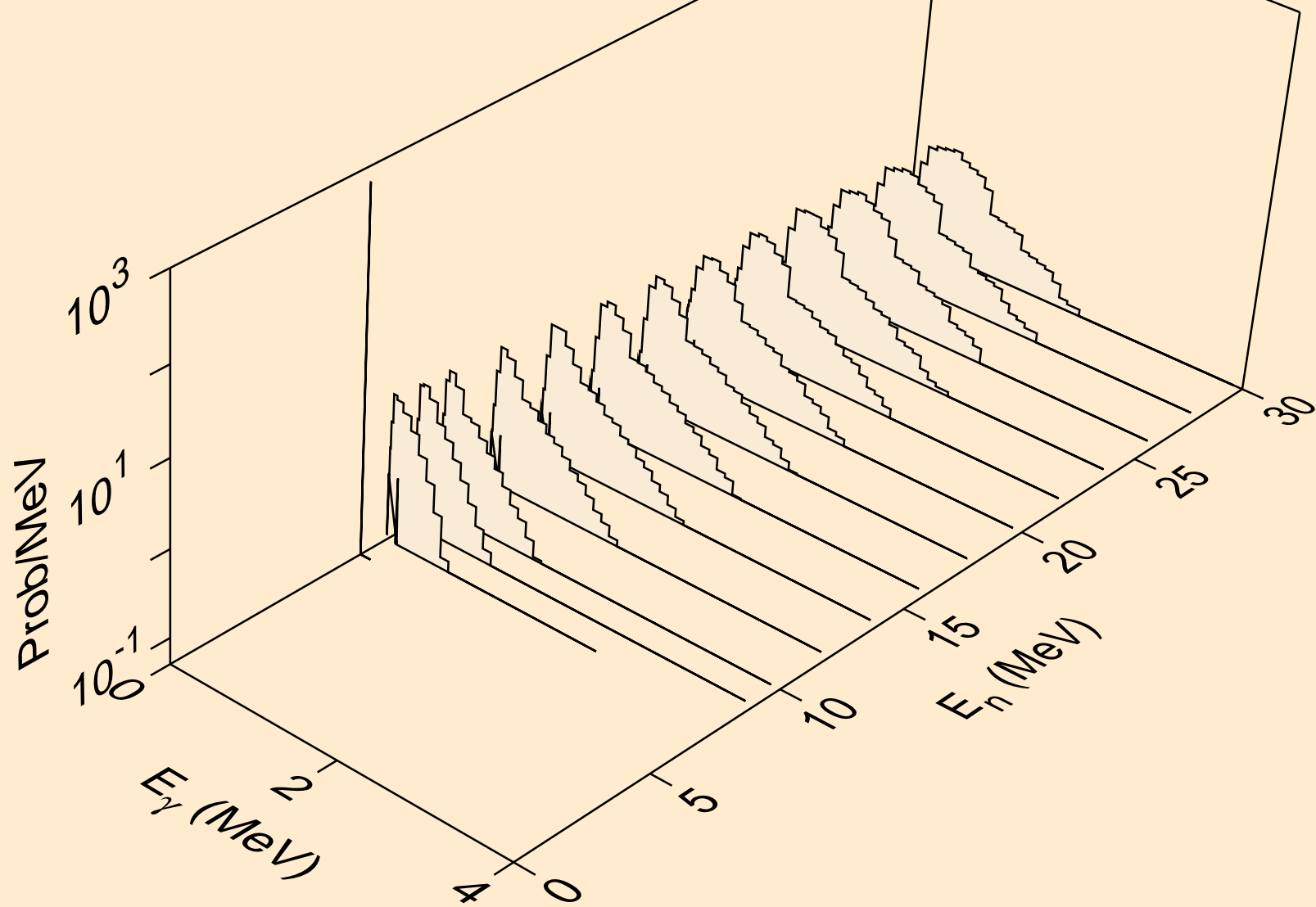

RN230 TRITON ACER TENDL-2021 LIBRARY; T=0.K
Photon emission for inelastic

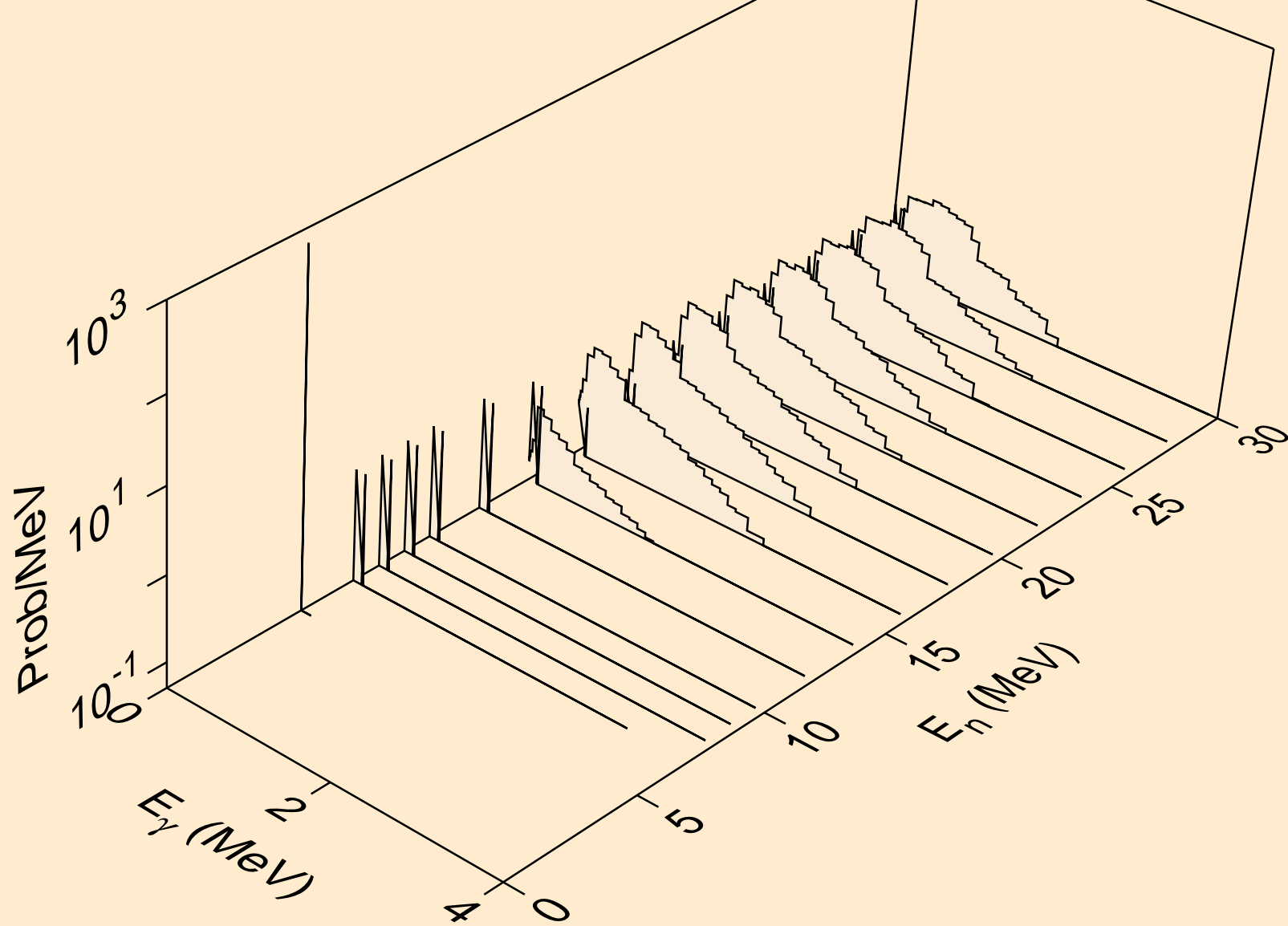

RN230 TRITON ACER TENDL-2021 LIBRARY; T=0.K
Photon emission for (n,he3)

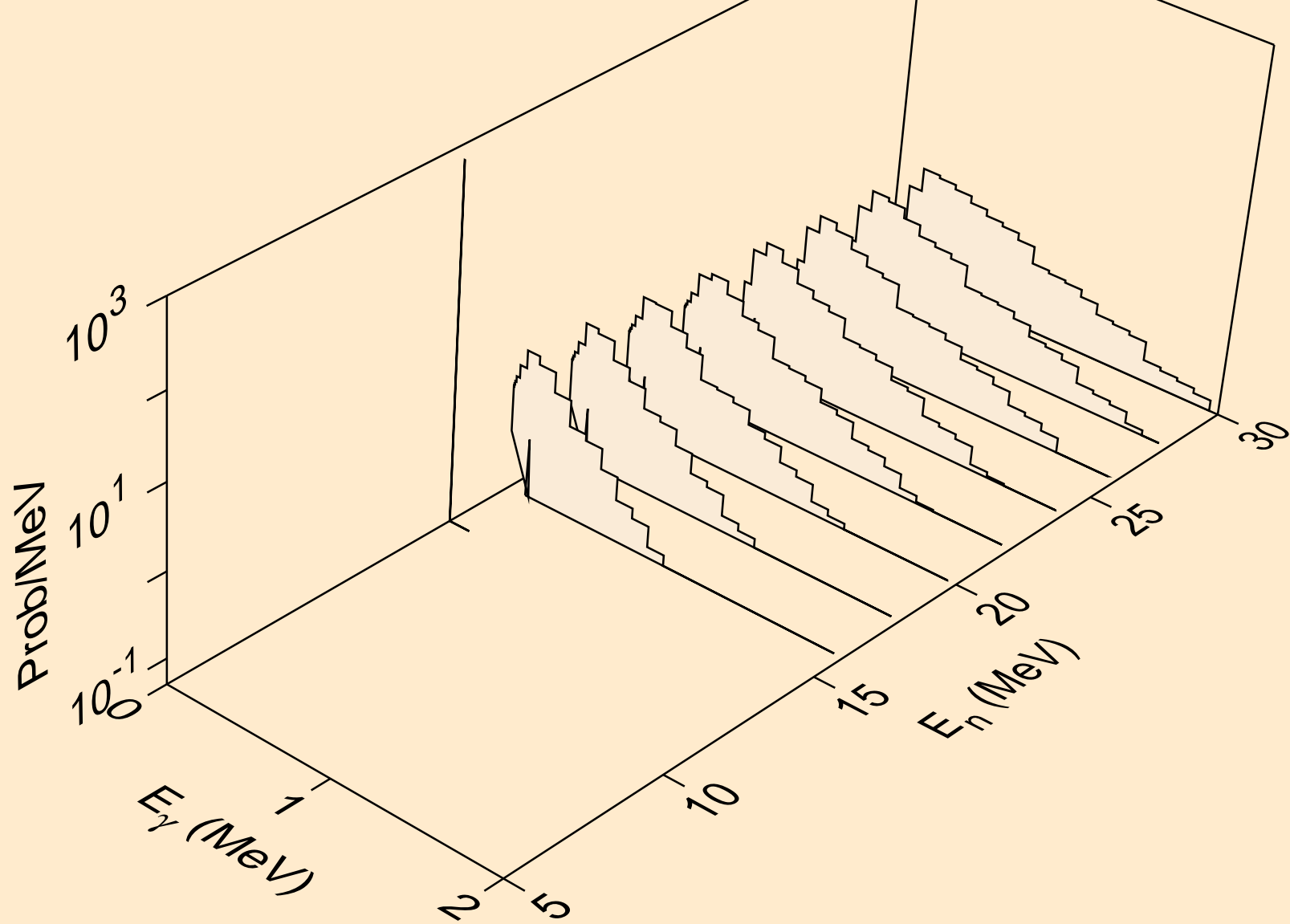

RN230 TRITON ACER TENDL-2021 LIBRARY; T=0.K
Photon emission for (n,a)

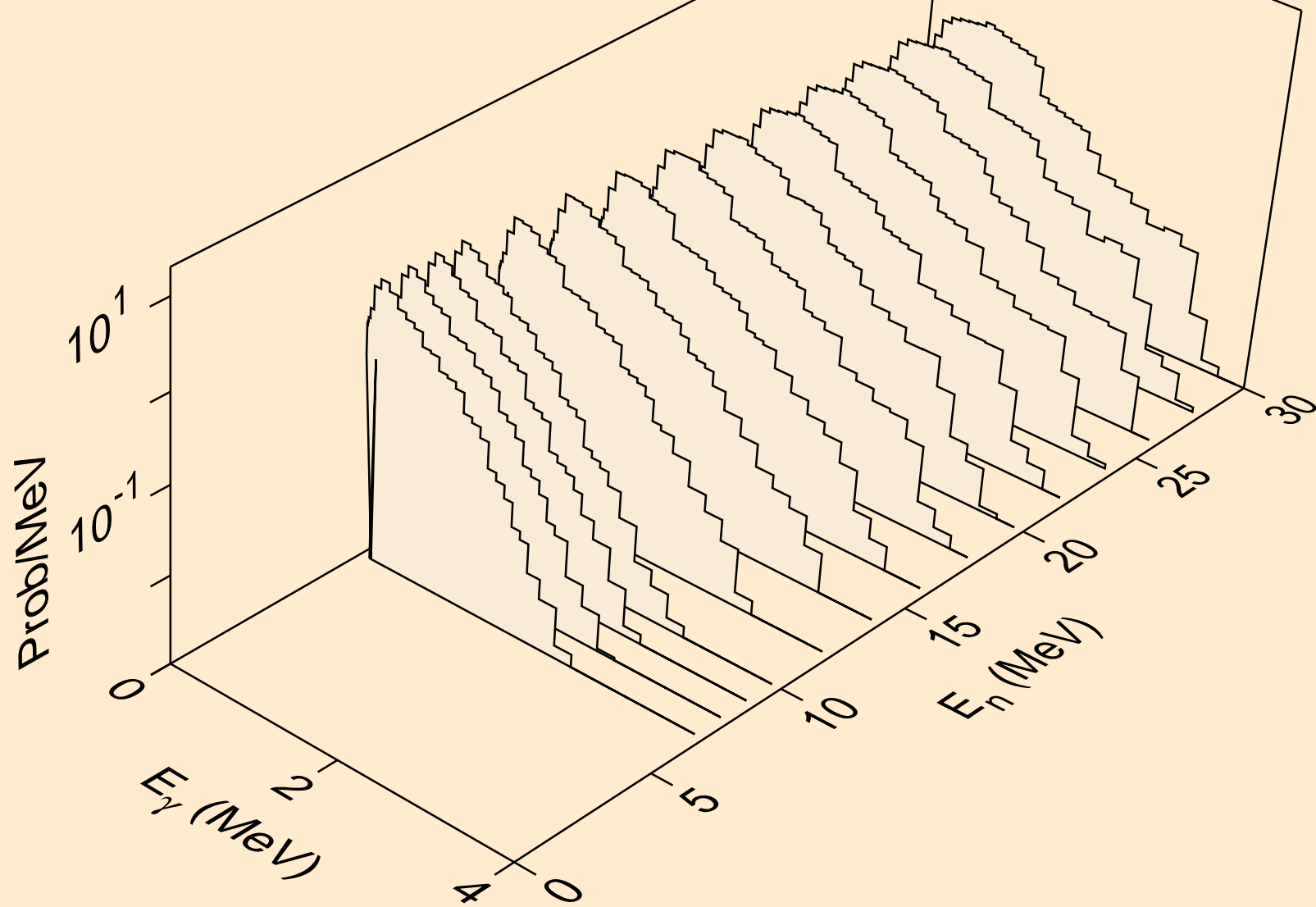

RN230 TRITON ACER TENDL-2021 LIBRARY; T=0.K
Photon emission for (n,2p)

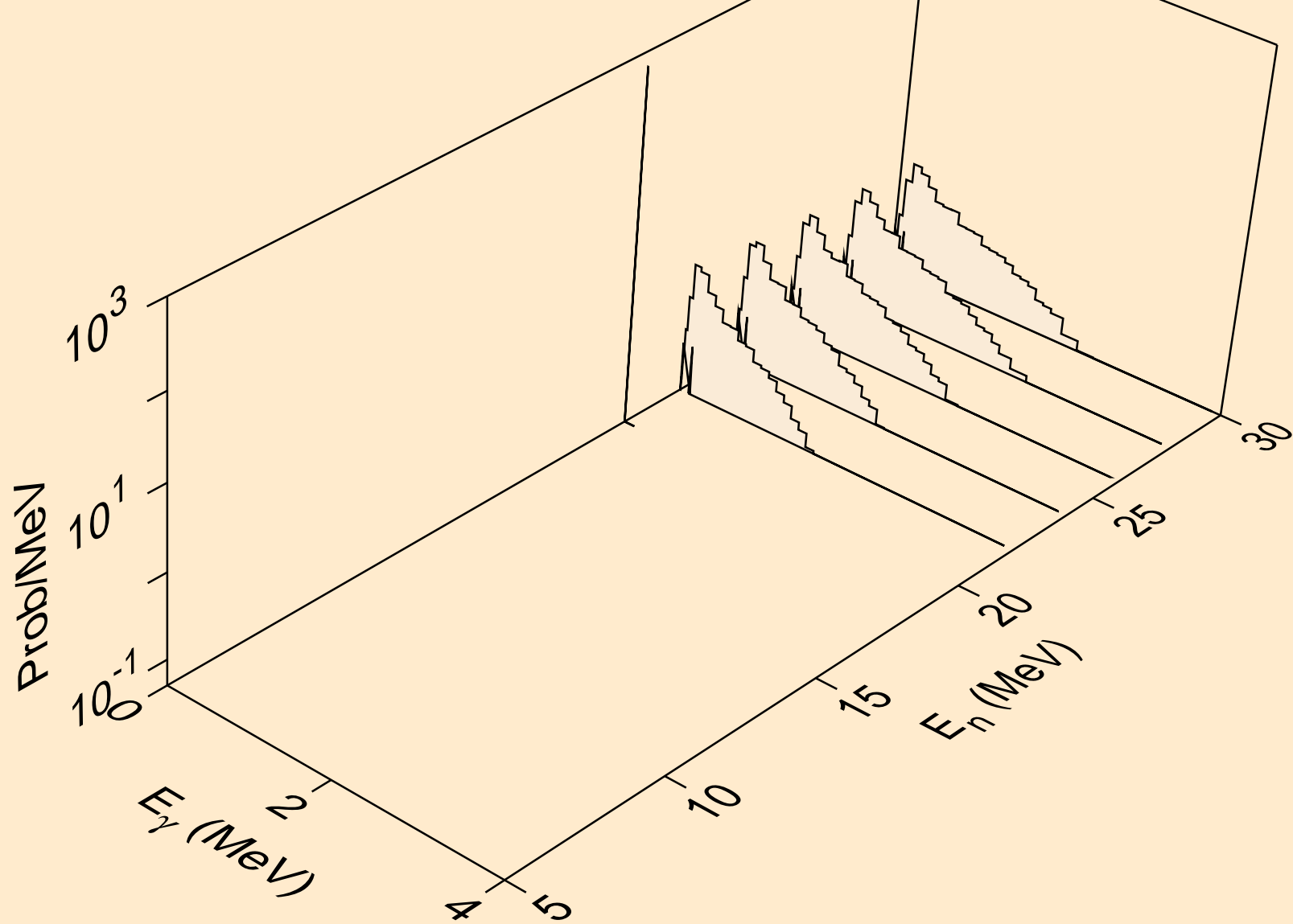

RN230 TRITON ACER TENDL-2021 LIBRARY; T=0.K
Particle heating contributions

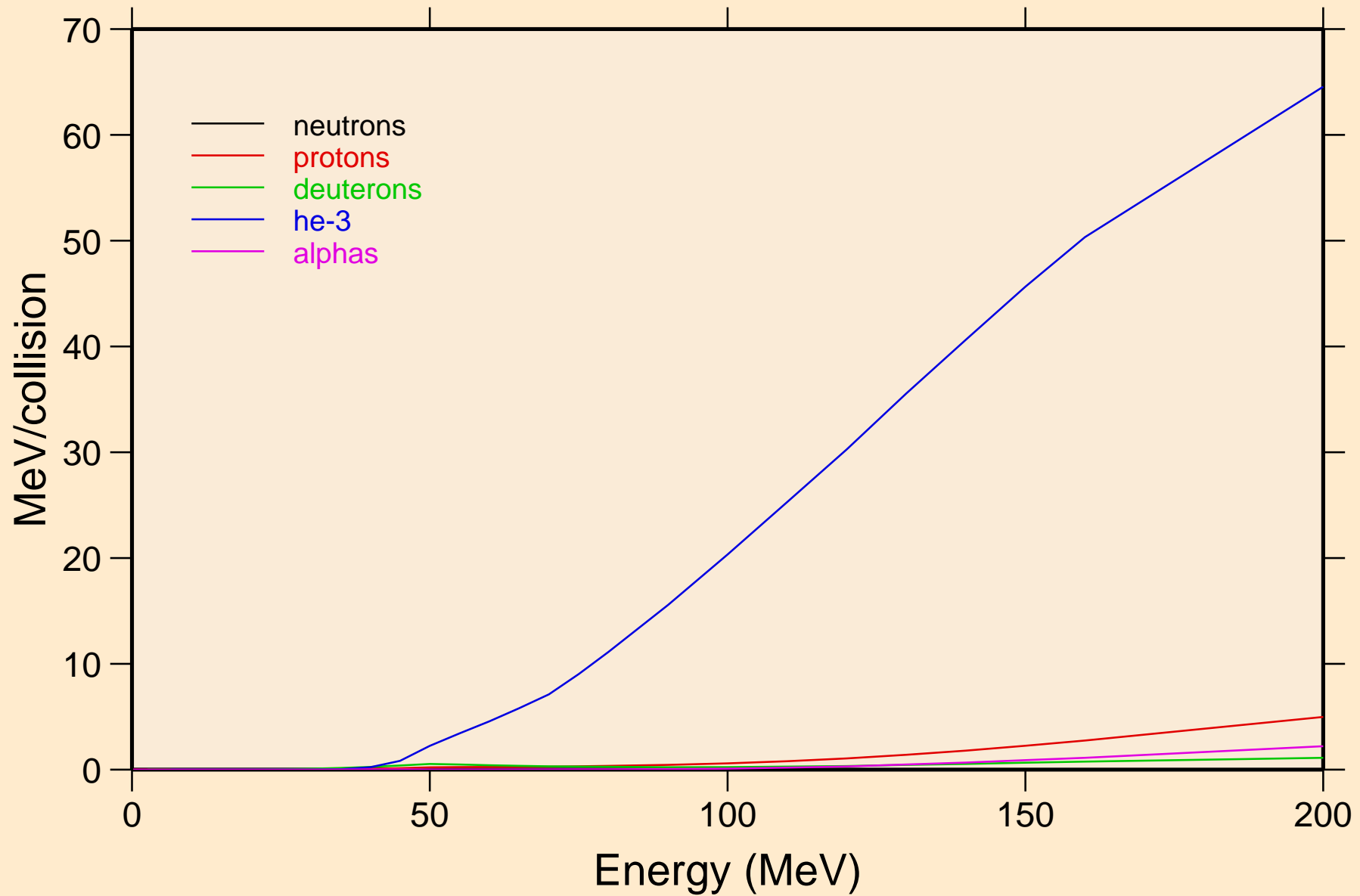

RN230 TRITON ACER TENDL-2021 LIBRARY; T=0.K
Recoil Heating

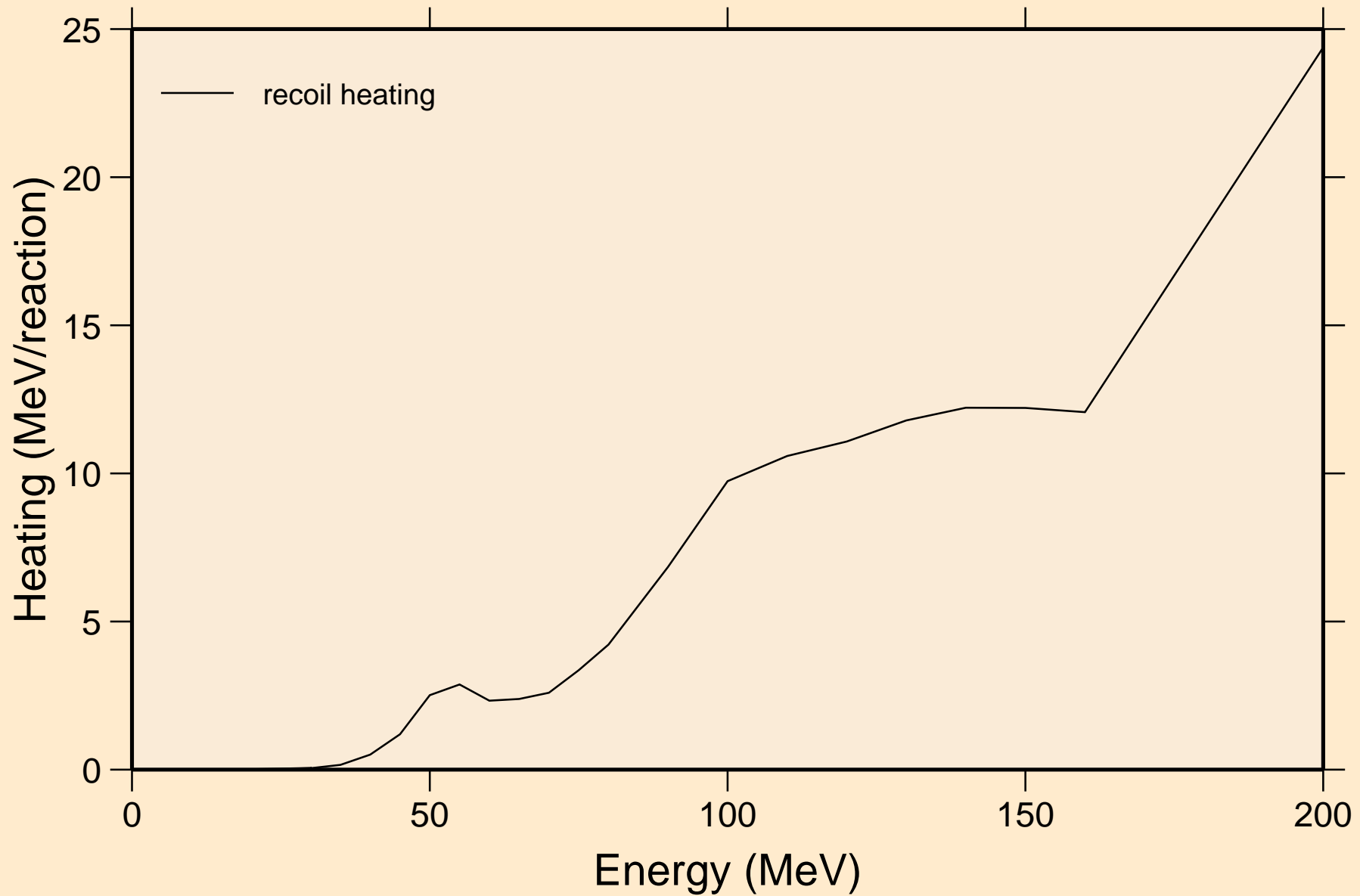

RN230 TRITON ACER TENDL-2021 LIBRARY; T=0.K
Particle production cross sections

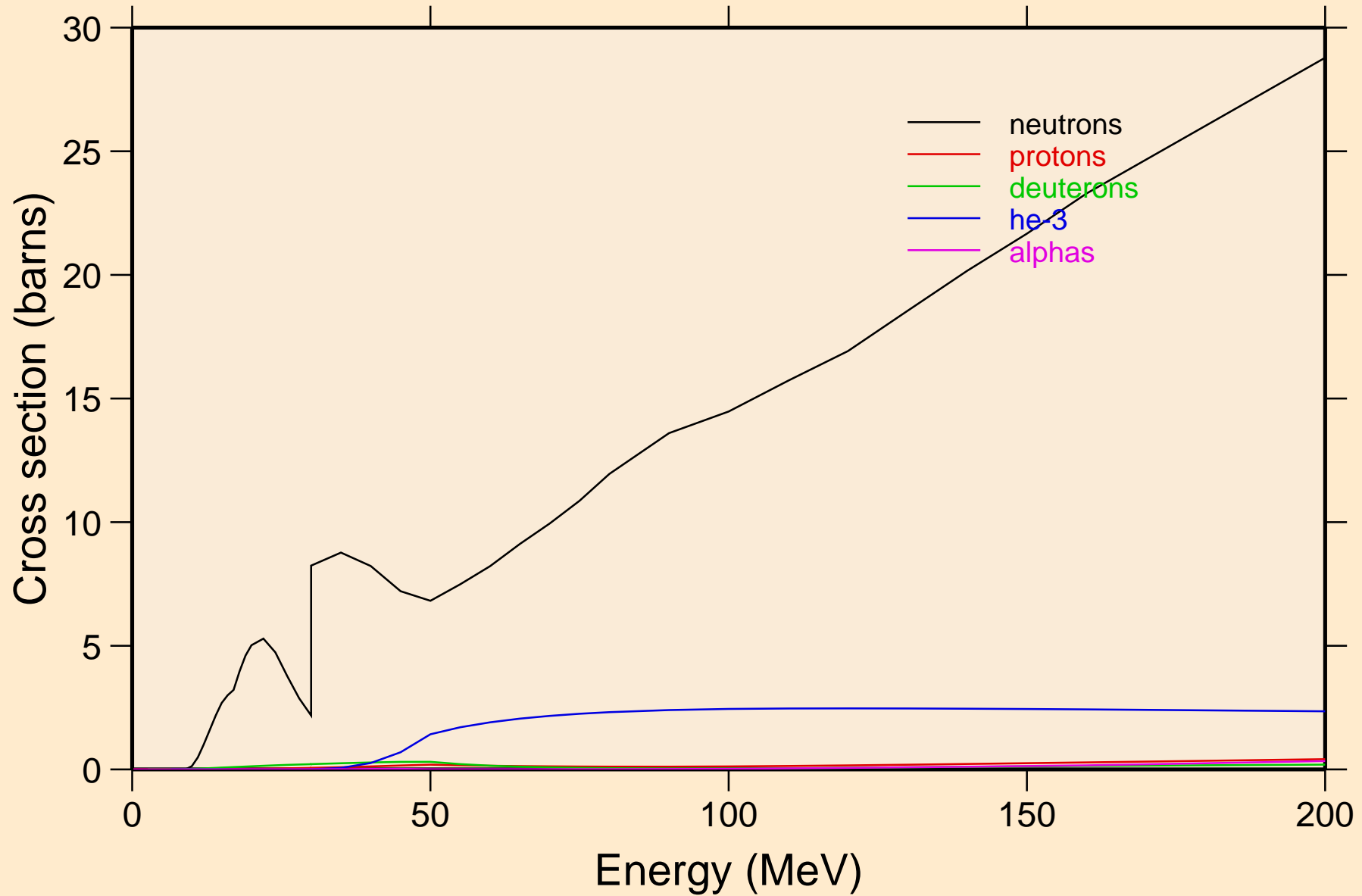

RN230 TRITON ACER TENDL-2021 LIBRARY; T=0.K
neutrons from (t,n)

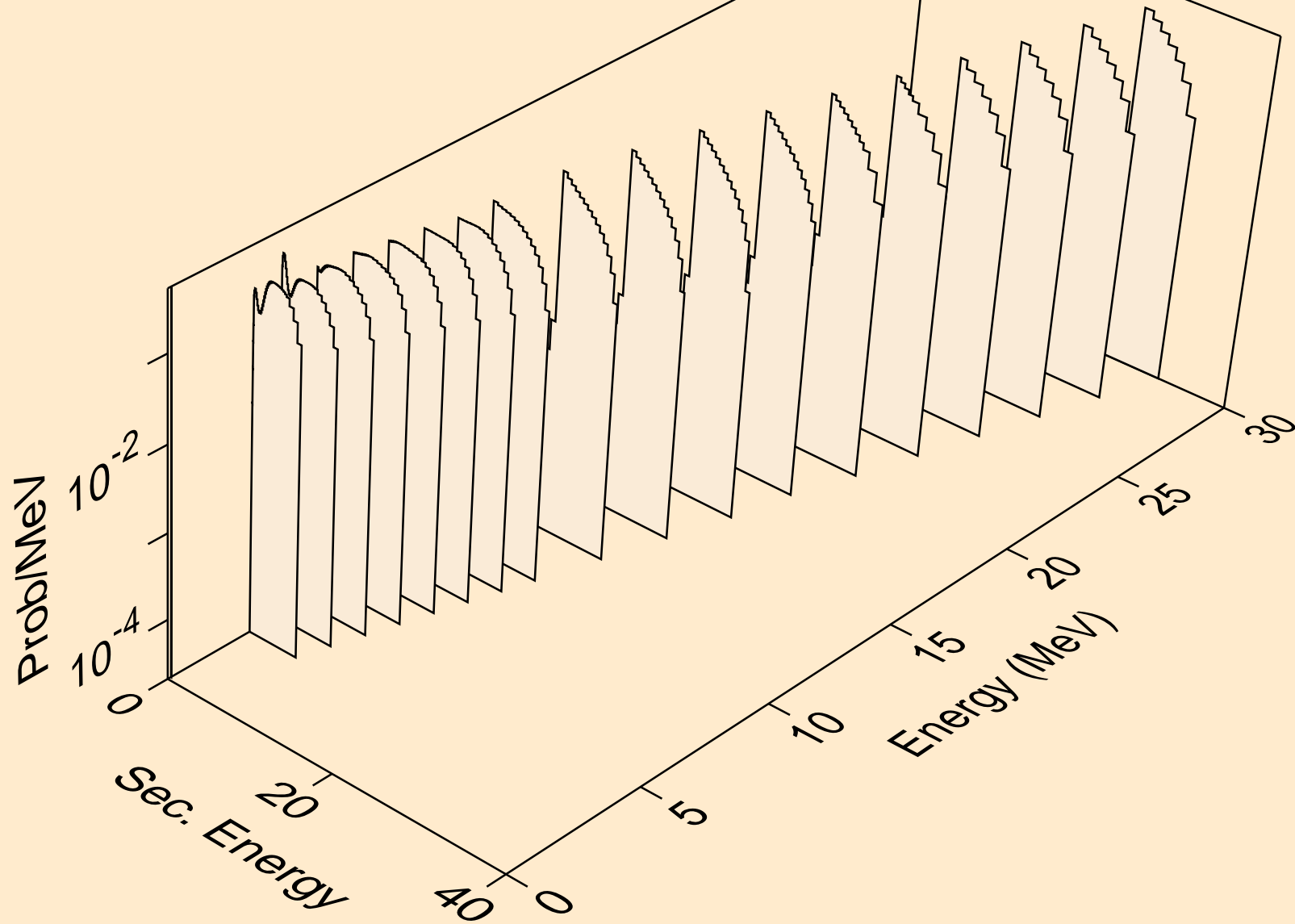

RN230 TRITON ACER TENDL-2021 LIBRARY; T=0.K
neutrons from (t,x)

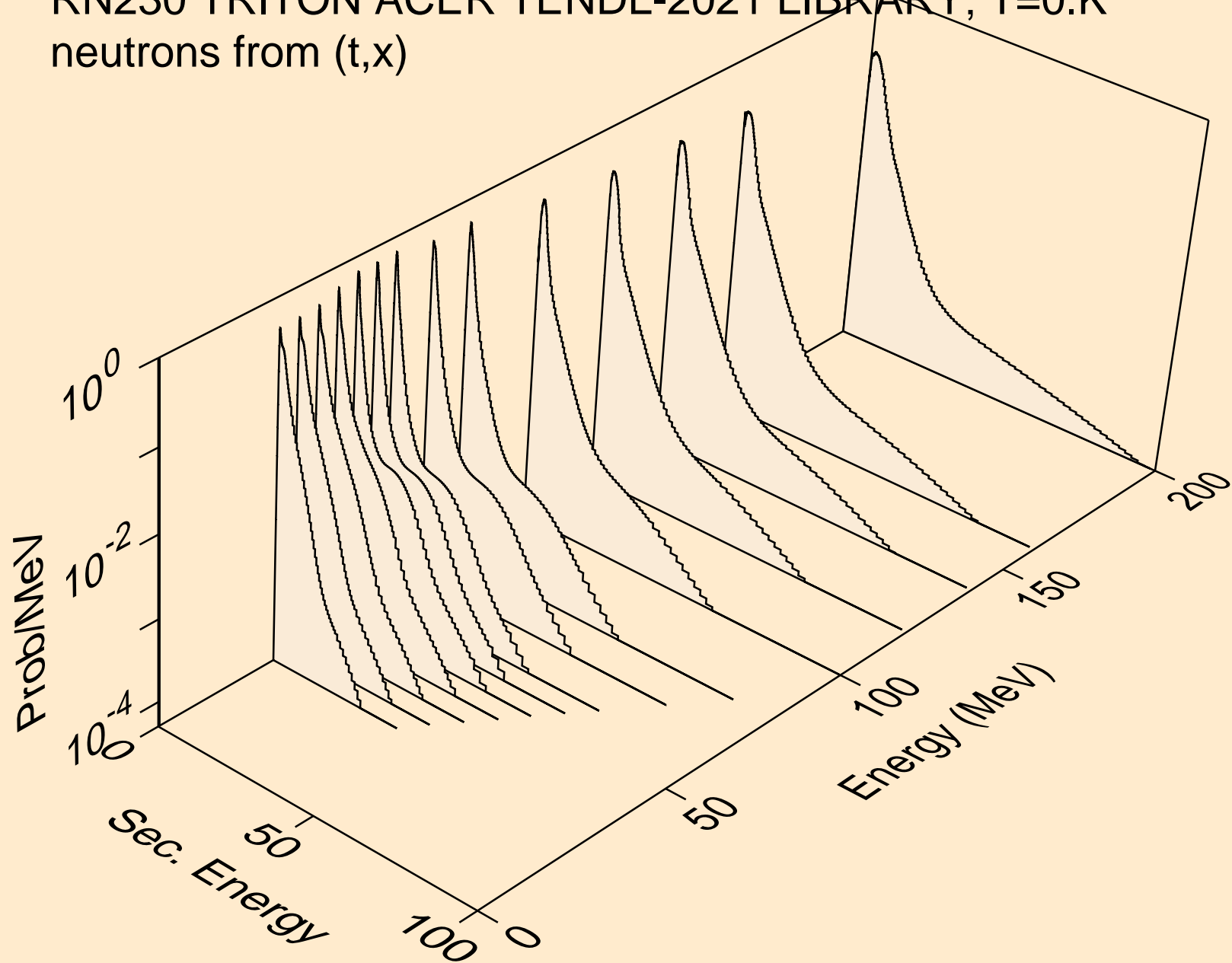

RN230 TRITON ACER TENDL-2021 LIBRARY; T=0.K
neutrons from (t,2nd)

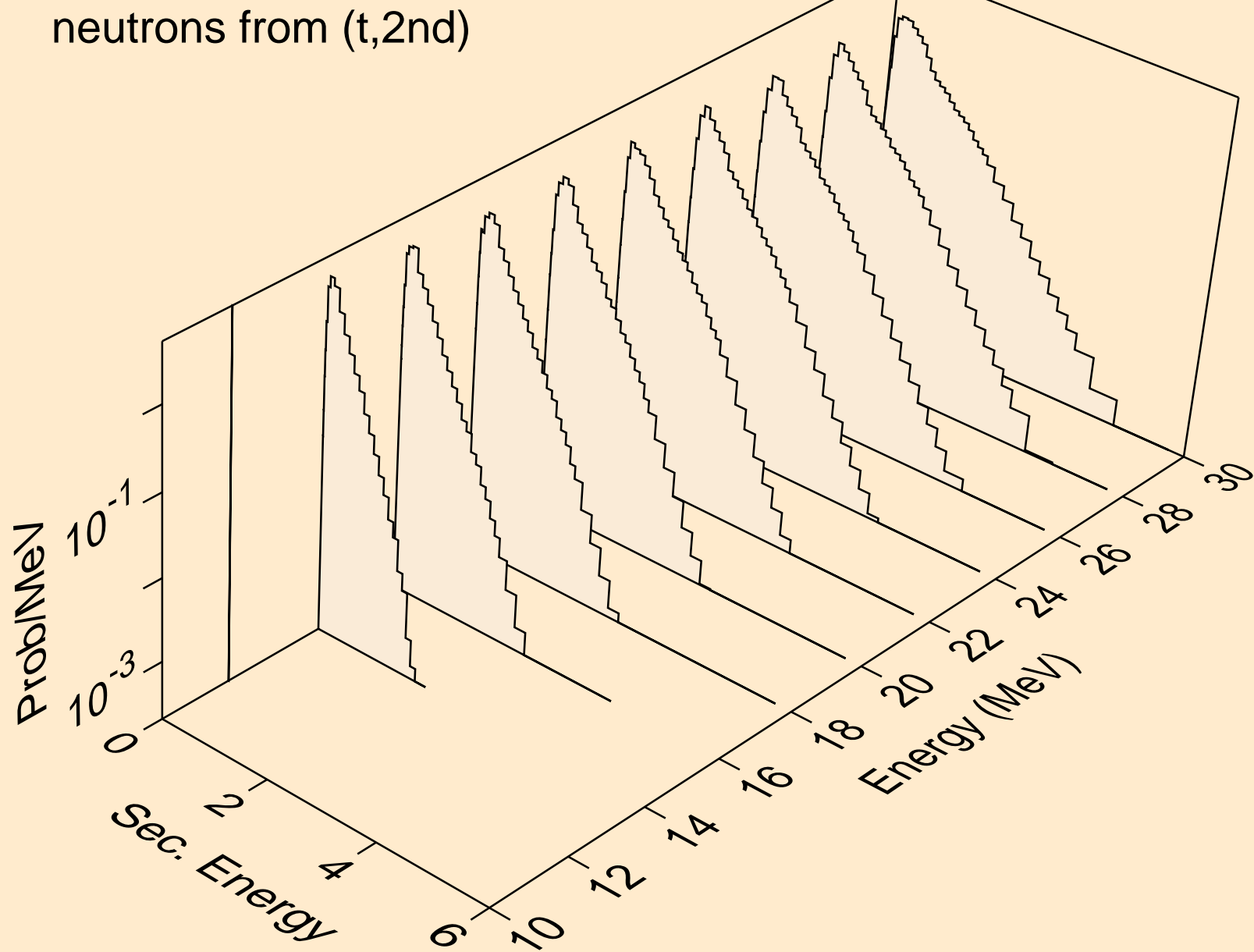

RN230 TRITON ACER TENDL-2021 LIBRARY; T=0.K
neutrons from (t,2n)

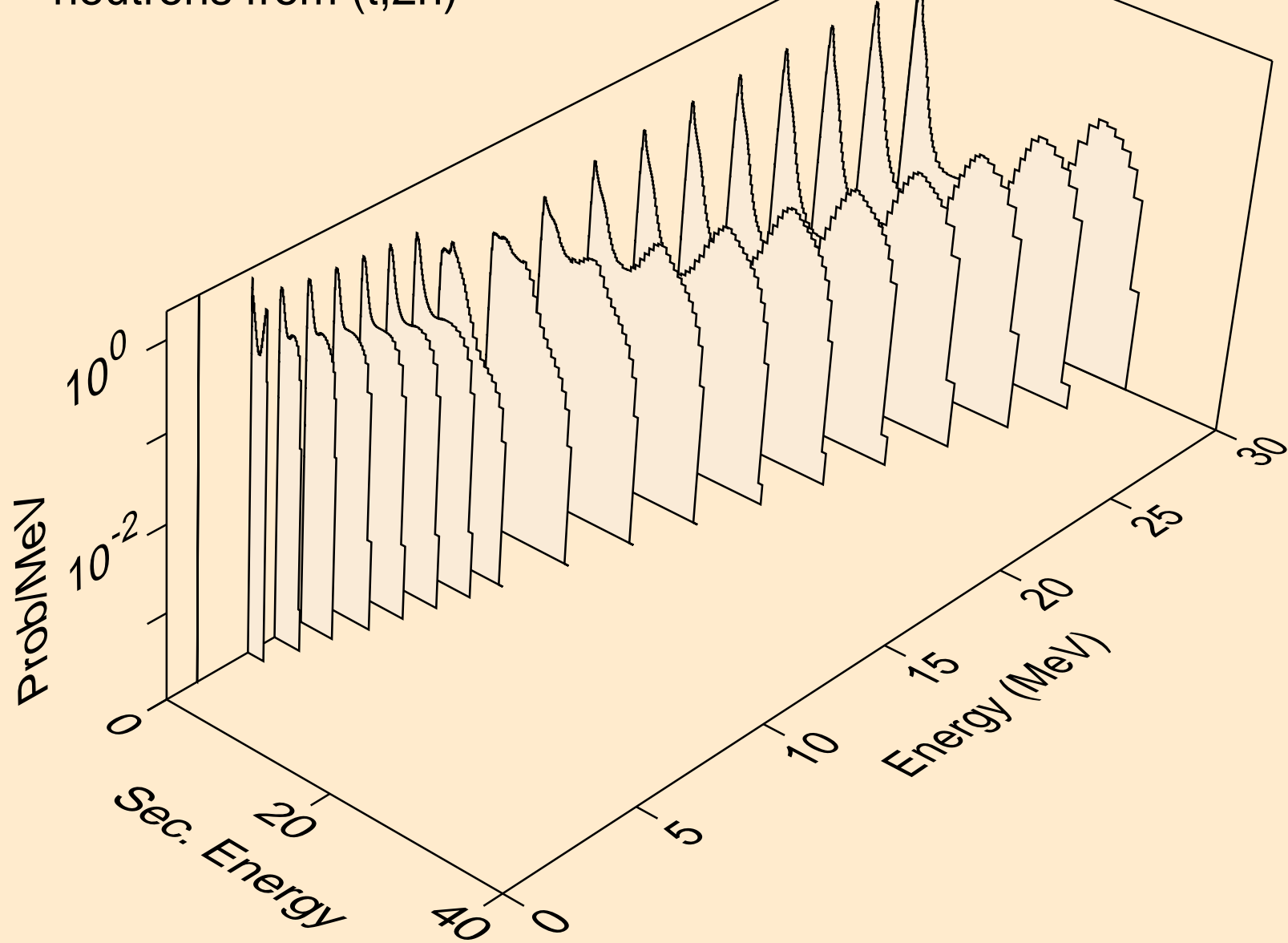

RN230 TRITON ACER TENDL-2021 LIBRARY; T=0.K
neutrons from (t,3n)

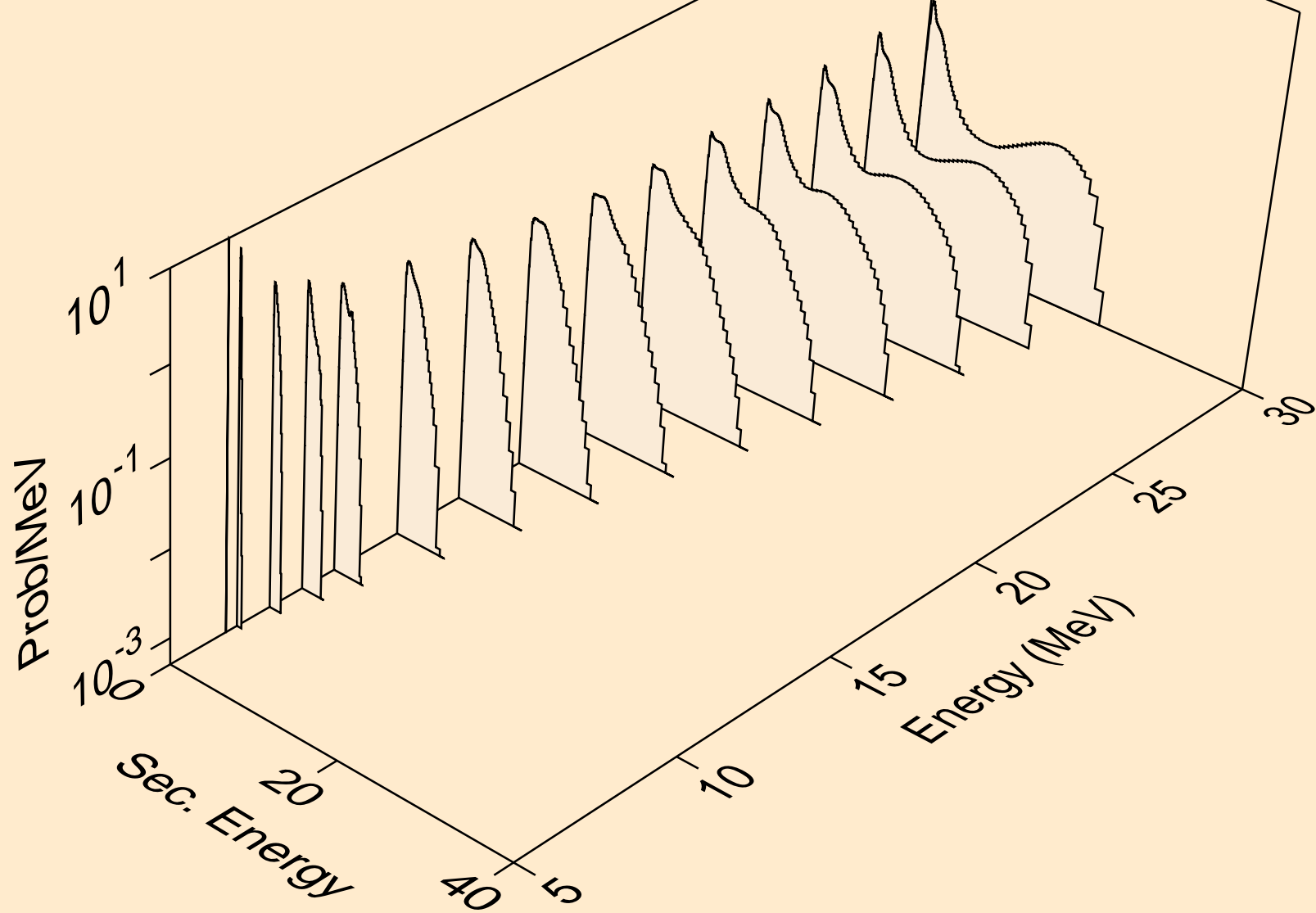

RN230 TRITON ACER TENDL-2021 LIBRARY; T=0.K
neutrons from (t,n*)a

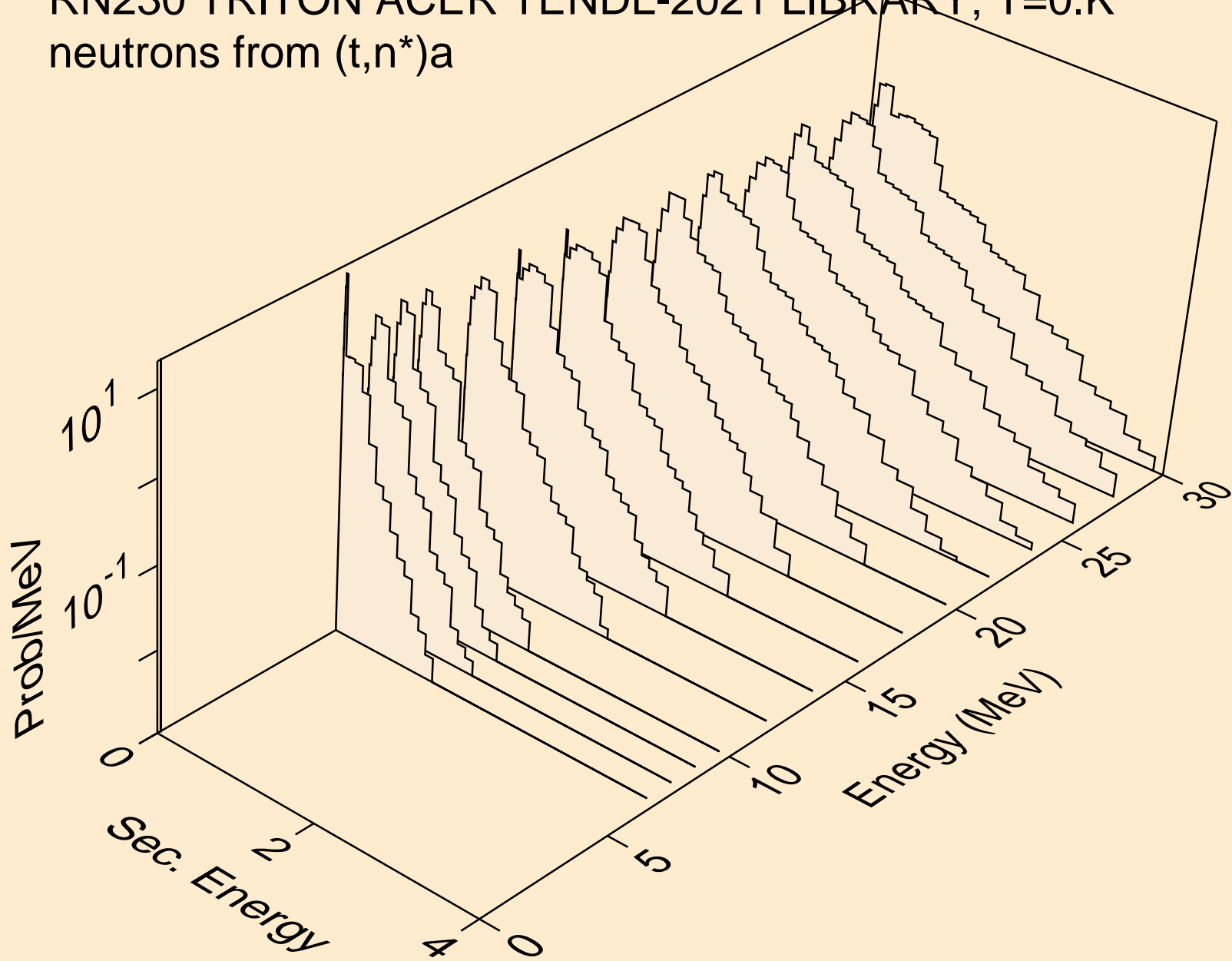

RN230 TRITON ACER TENDL-2021 LIBRARY; T=0.K
neutrons from (t,2n)a

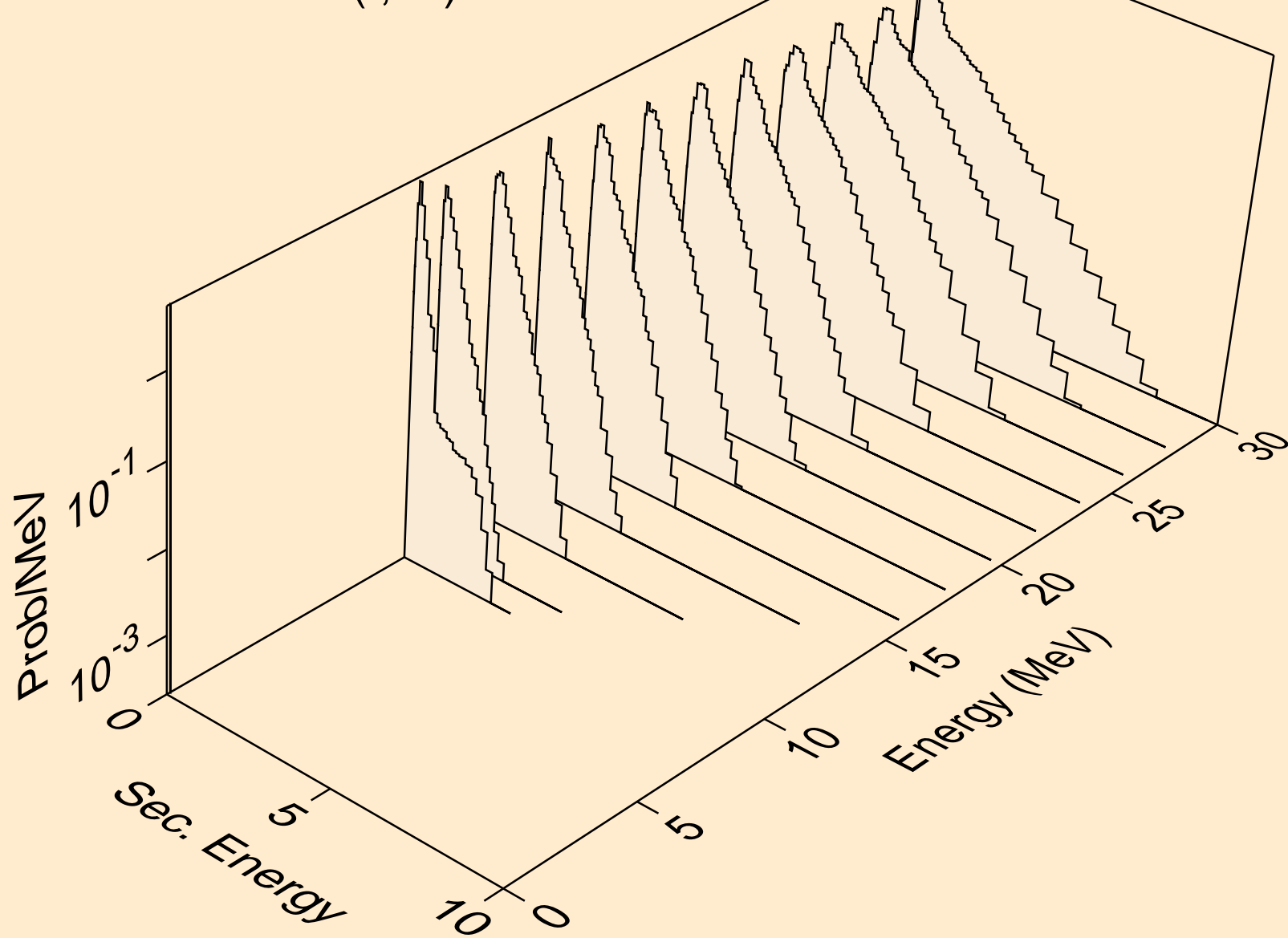

RN230 TRITON ACER TENDL-2021 LIBRARY; T=0.K
neutrons from (t,3n)a

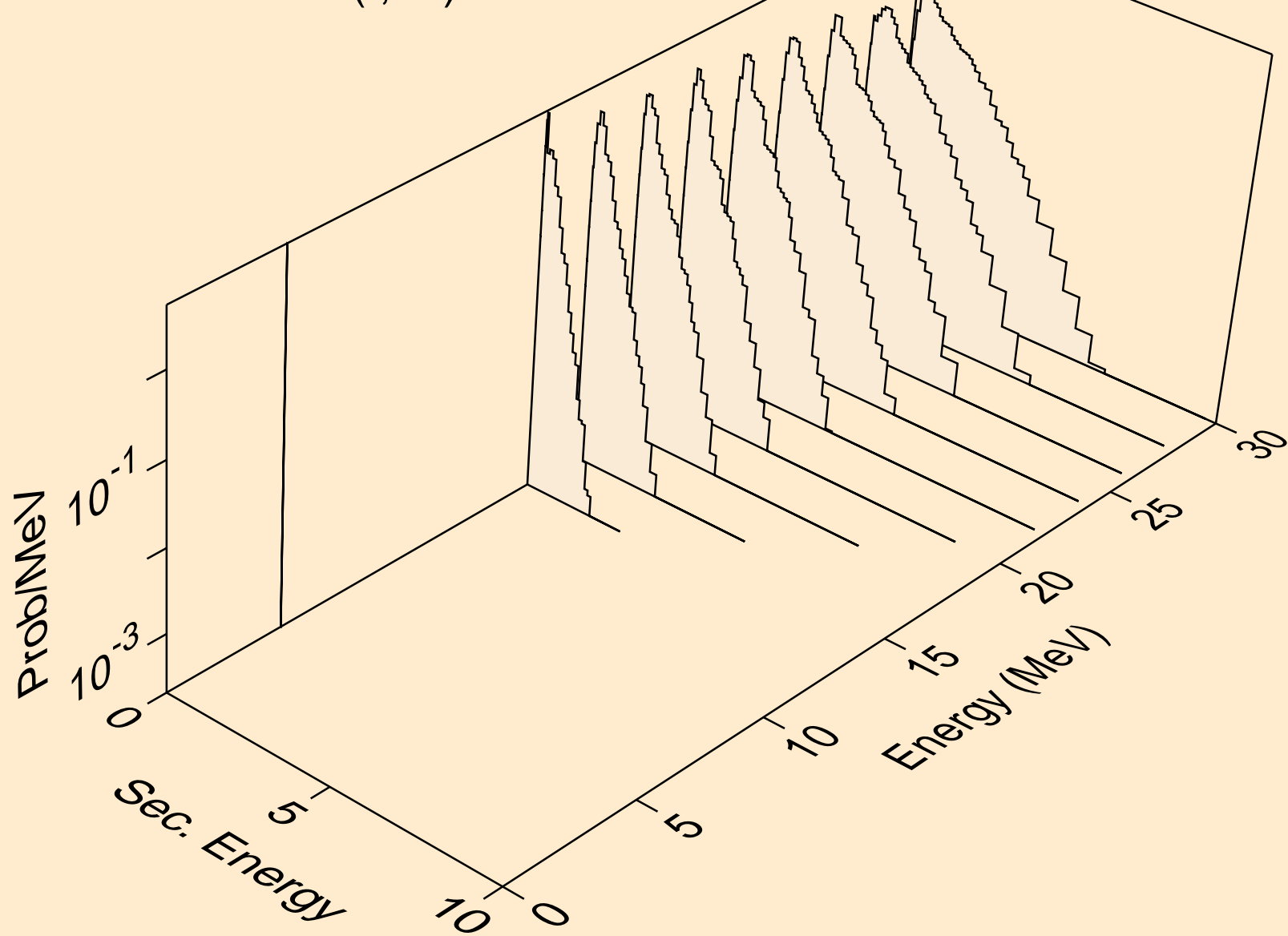

RN230 TRITON ACER TENDL-2021 LIBRARY; T=0.K
neutrons from (t,n*)p

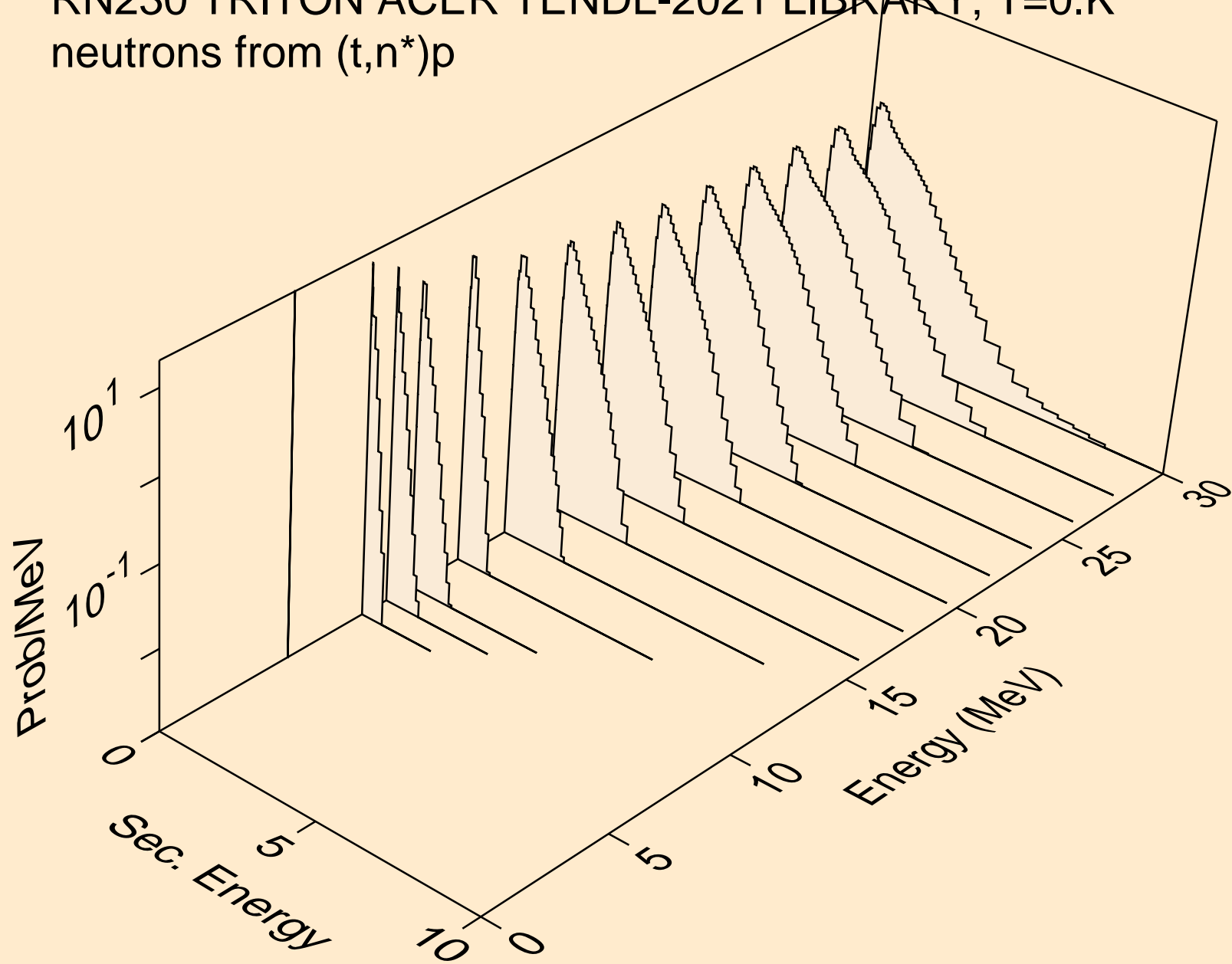

RN230 TRITON ACER TENDL-2021 LIBRARY; T=0.K
neutrons from (t,n*)d

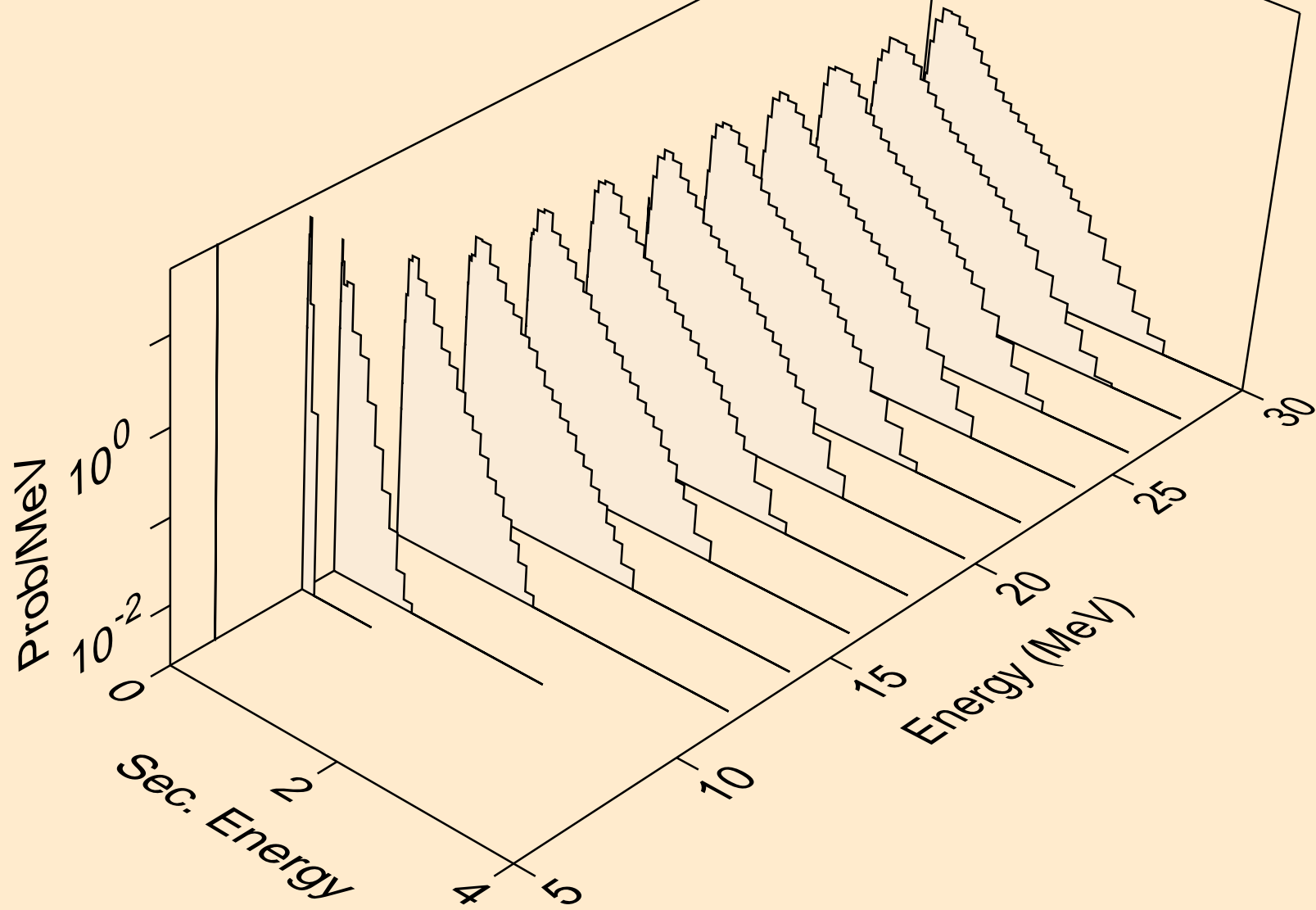

RN230 TRITON ACER TENDL-2021 LIBRARY; T=0.K
neutrons from (t,n*)t

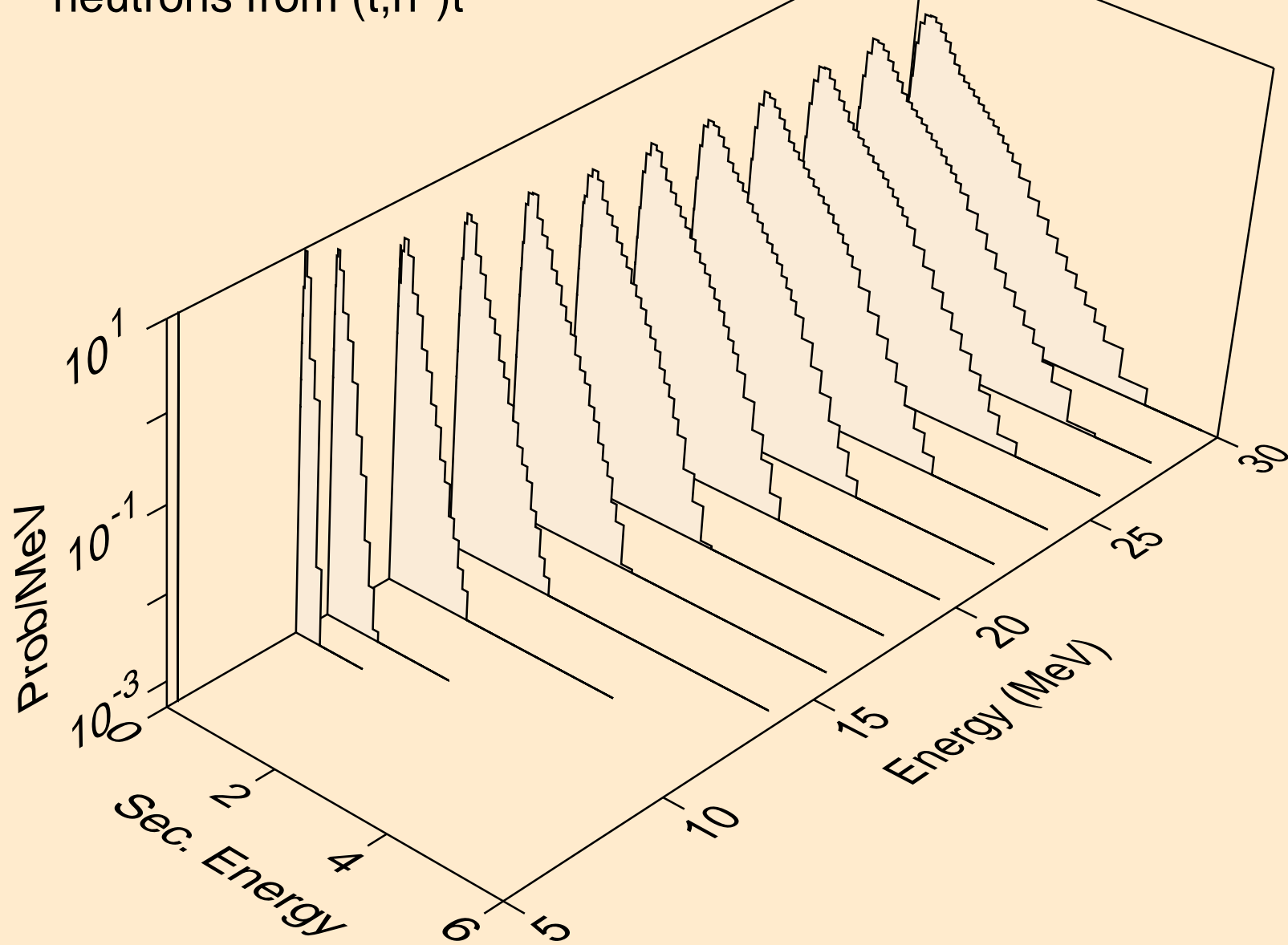

RN230 TRITON ACER TENDL-2021 LIBRARY; T=0.K
neutrons from (t,n*)he3

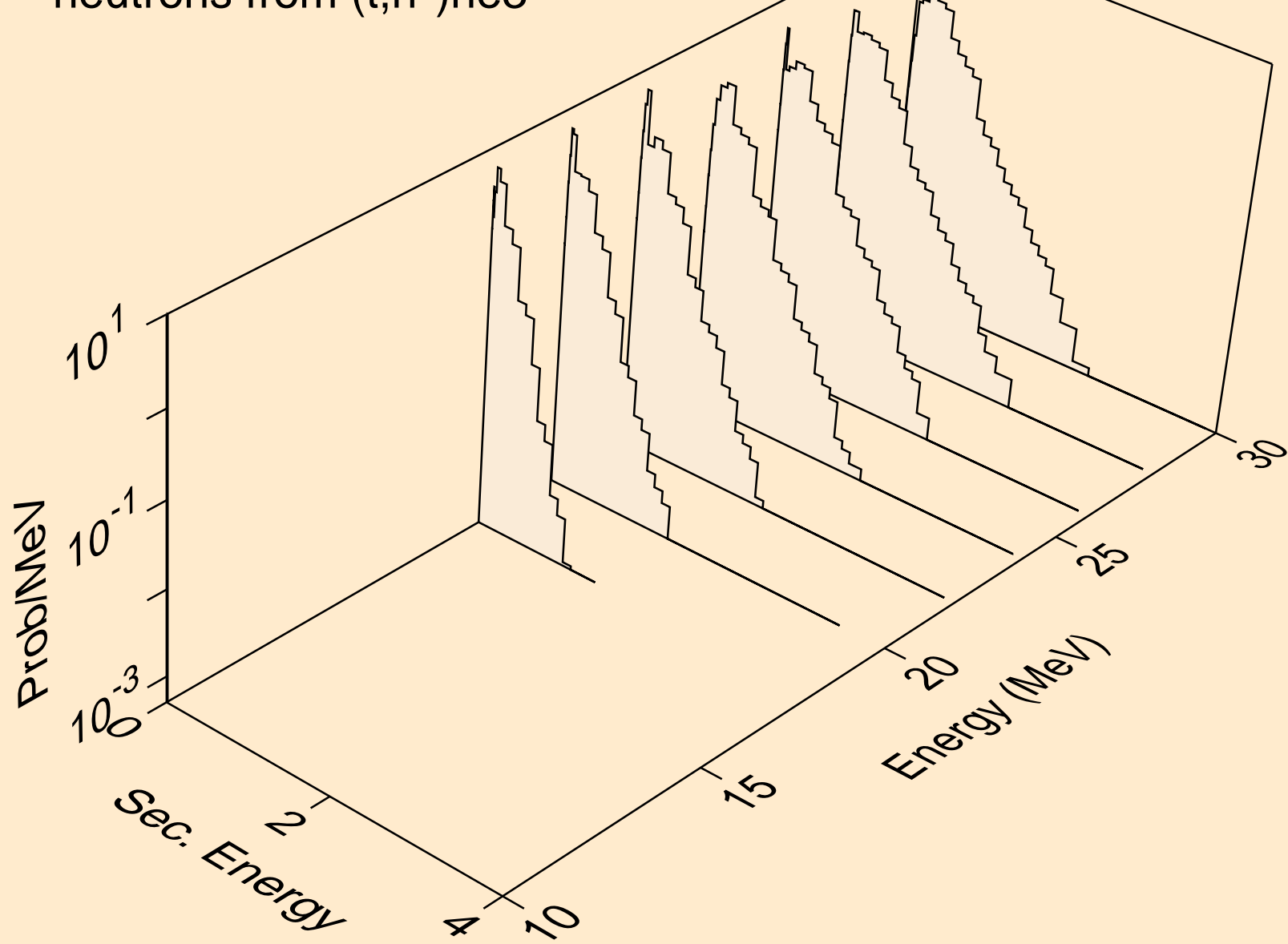

RN230 TRITON ACER TENDL-2021 LIBRARY; T=0.K
neutrons from (t,4n)

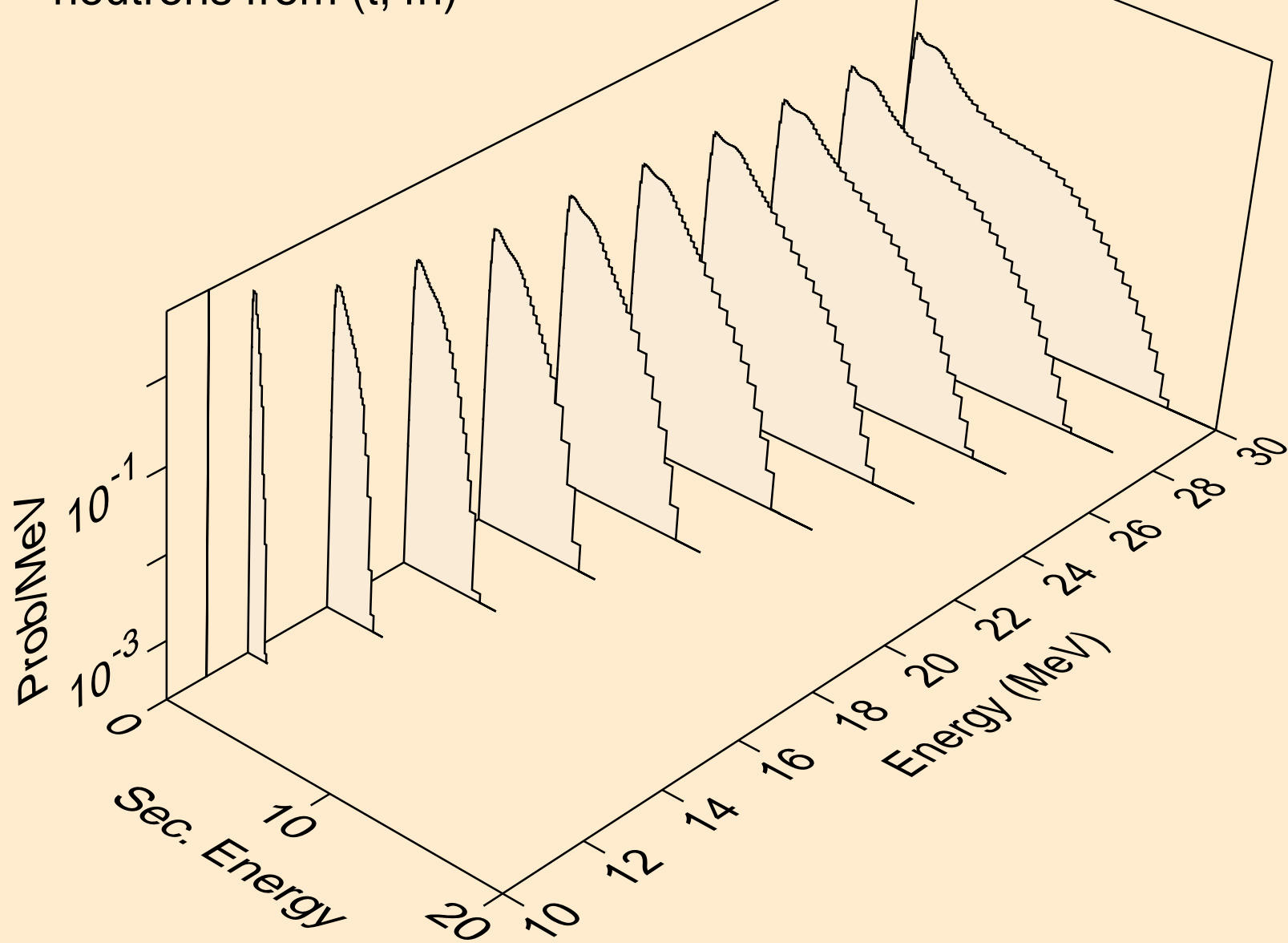

RN230 TRITON ACER TENDL-2021 LIBRARY; T=0.K
neutrons from (t,2np)

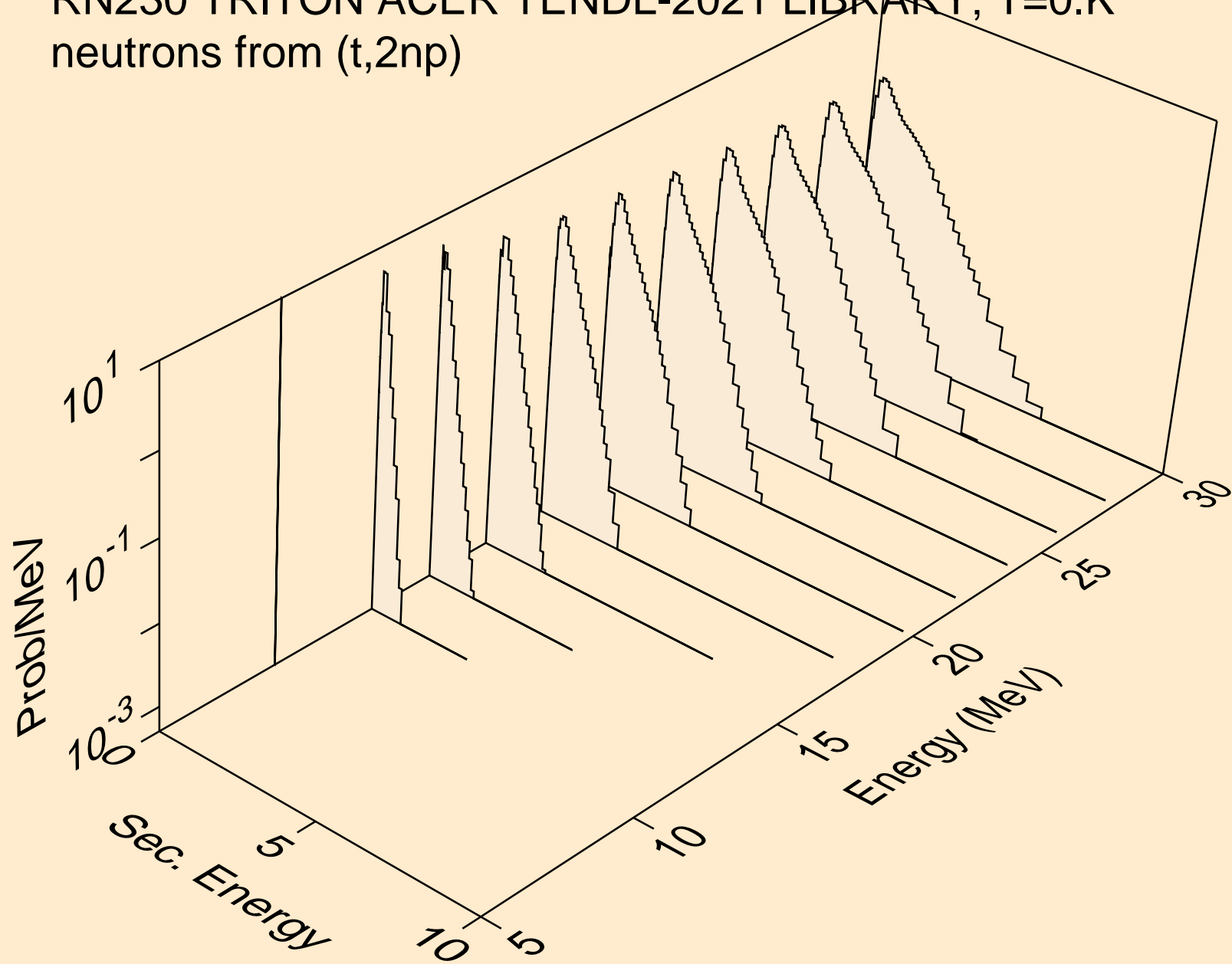

RN230 TRITON ACER TENDL-2021 LIBRARY; T=0.K
neutrons from (t,3np)

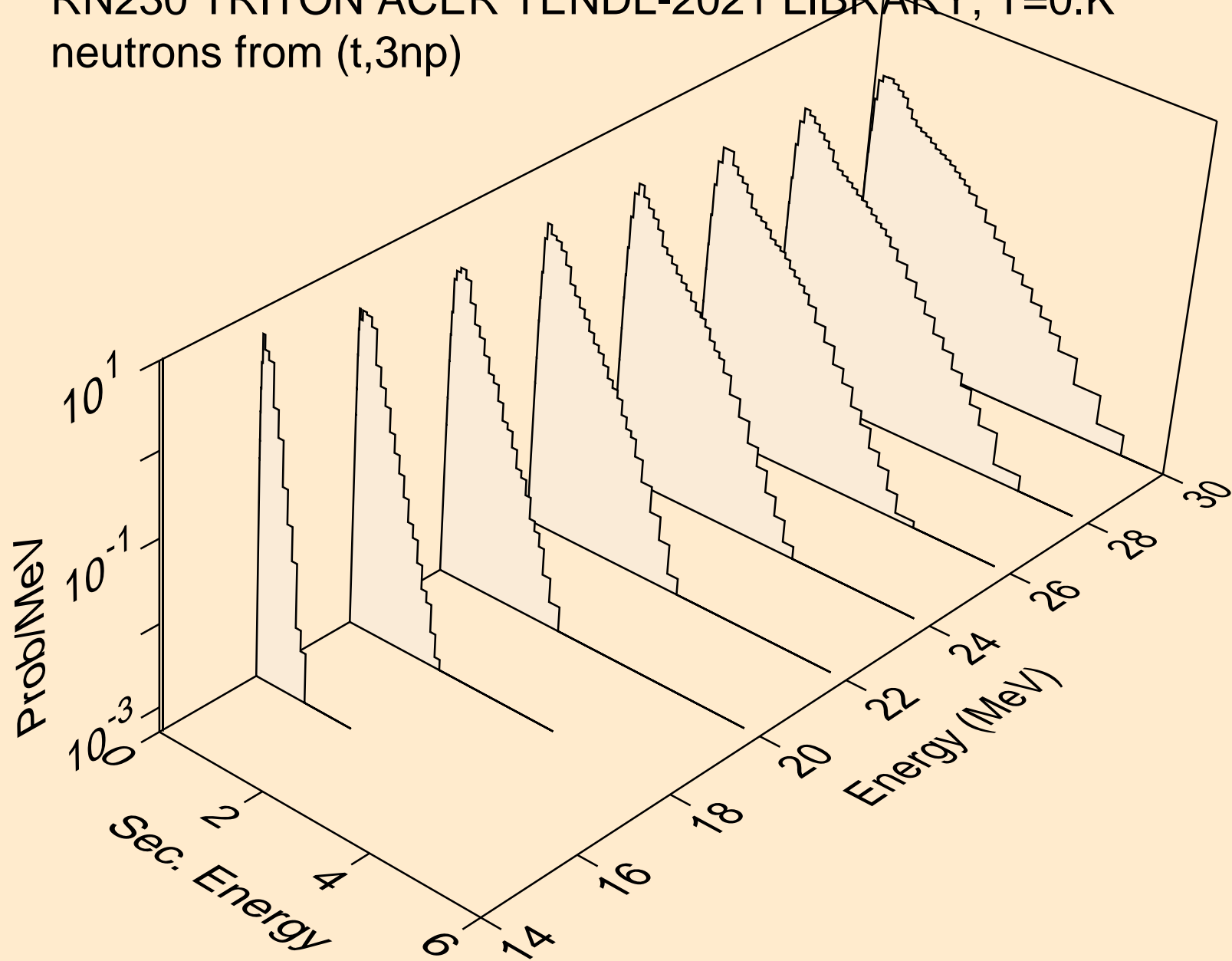

RN230 TRITON ACER TENDL-2021 LIBRARY; T=0.K
protons from (t,x)

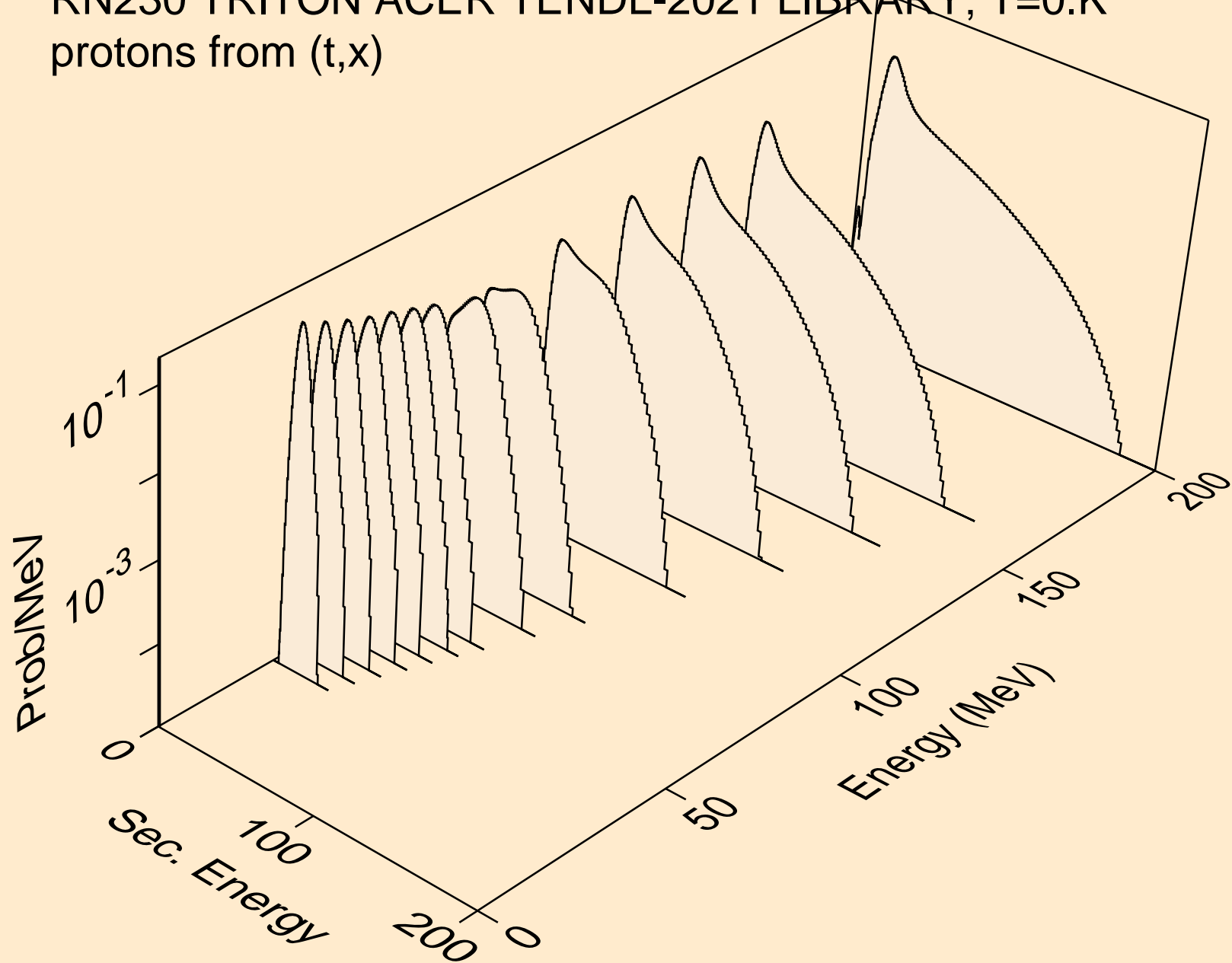

RN230 TRITON ACER TENDL-2021 LIBRARY; T=0.K
protons from (t,n*)p

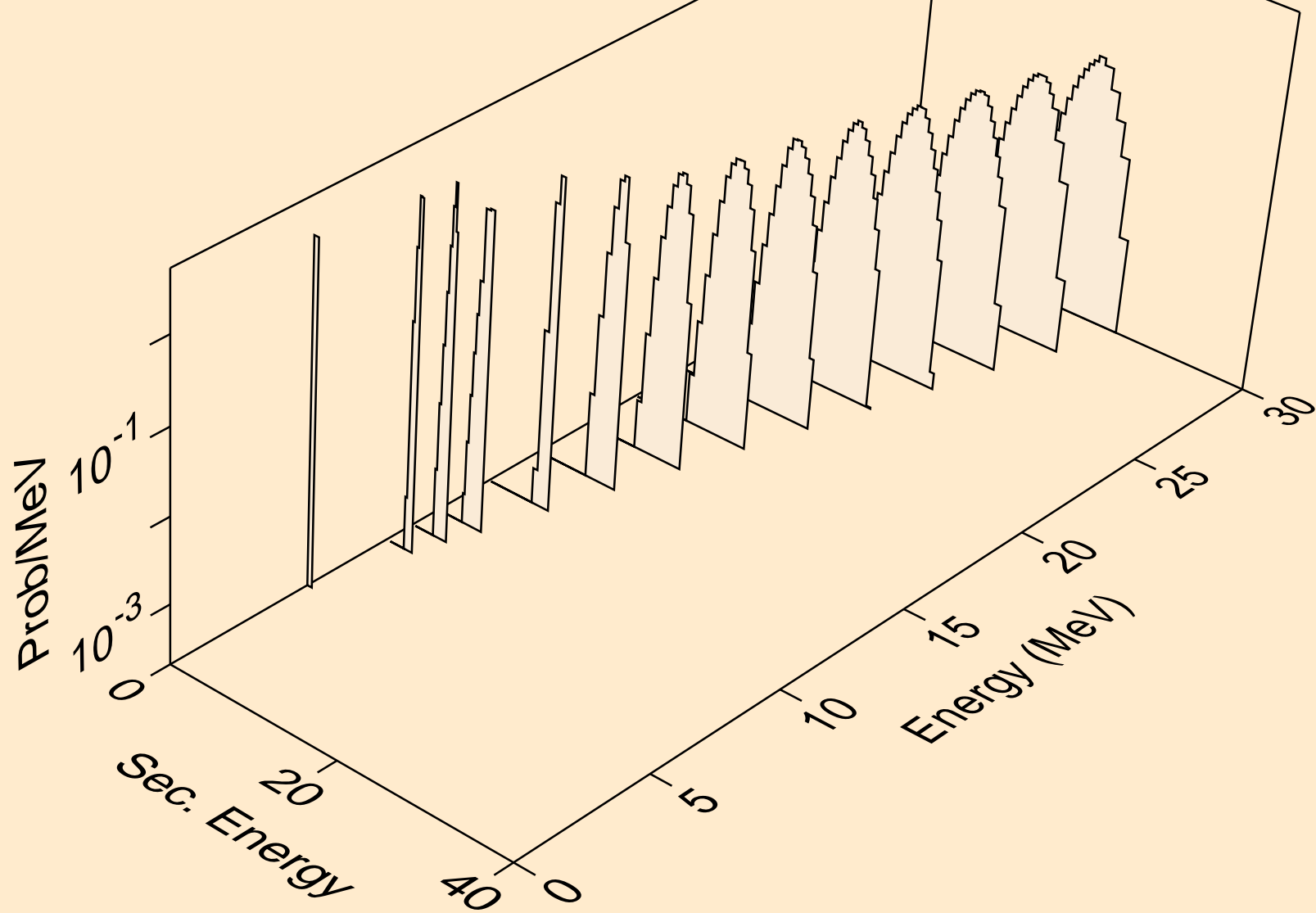

RN230 TRITON ACER TENDL-2021 LIBRARY; T=0.K
protons from (t,2np)

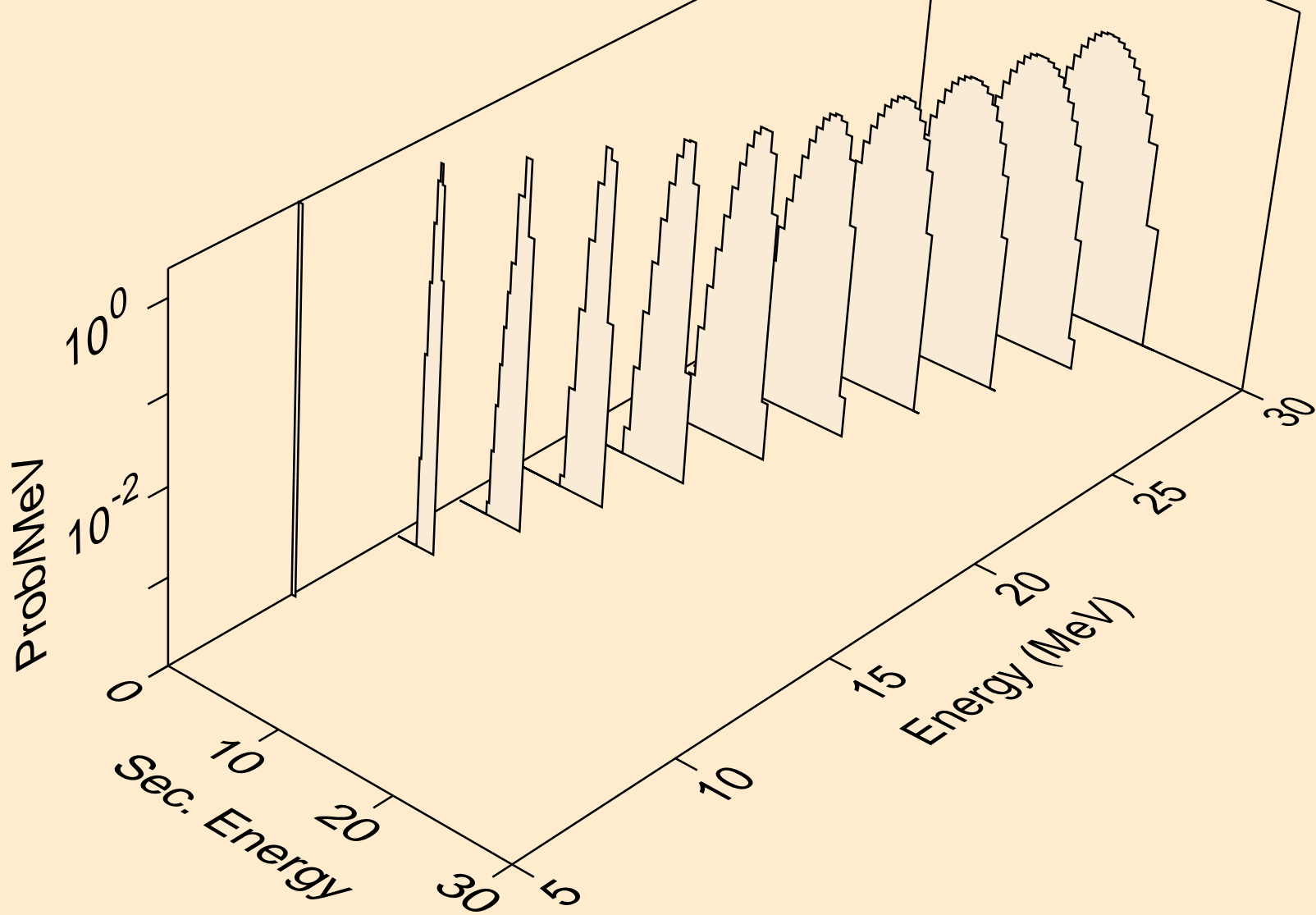

RN230 TRITON ACER TENDL-2021 LIBRARY; T=0.K
protons from (t,3np)

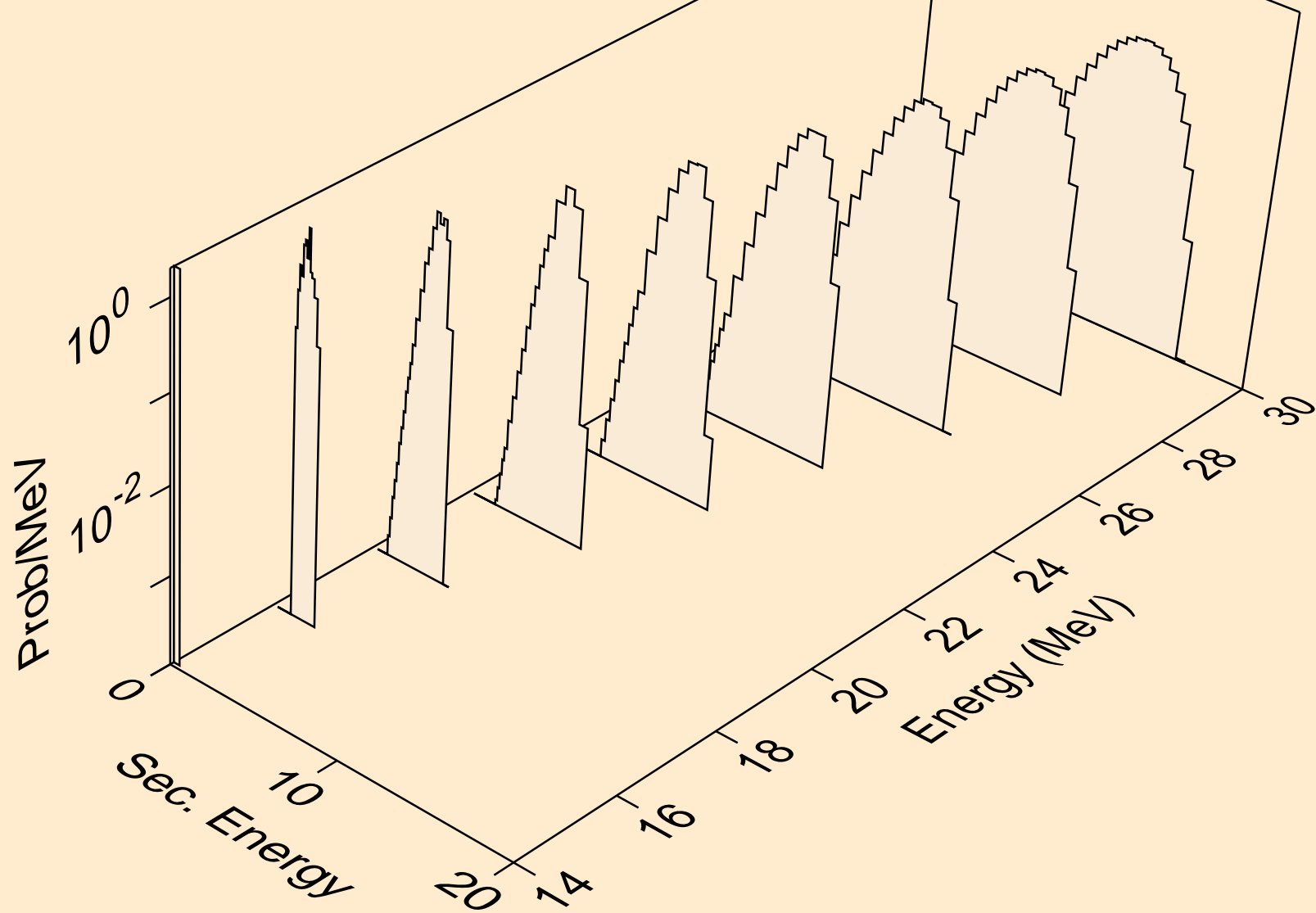

RN230 TRITON ACER TENDL-2021 LIBRARY; T=0.K
protons from (t,p)

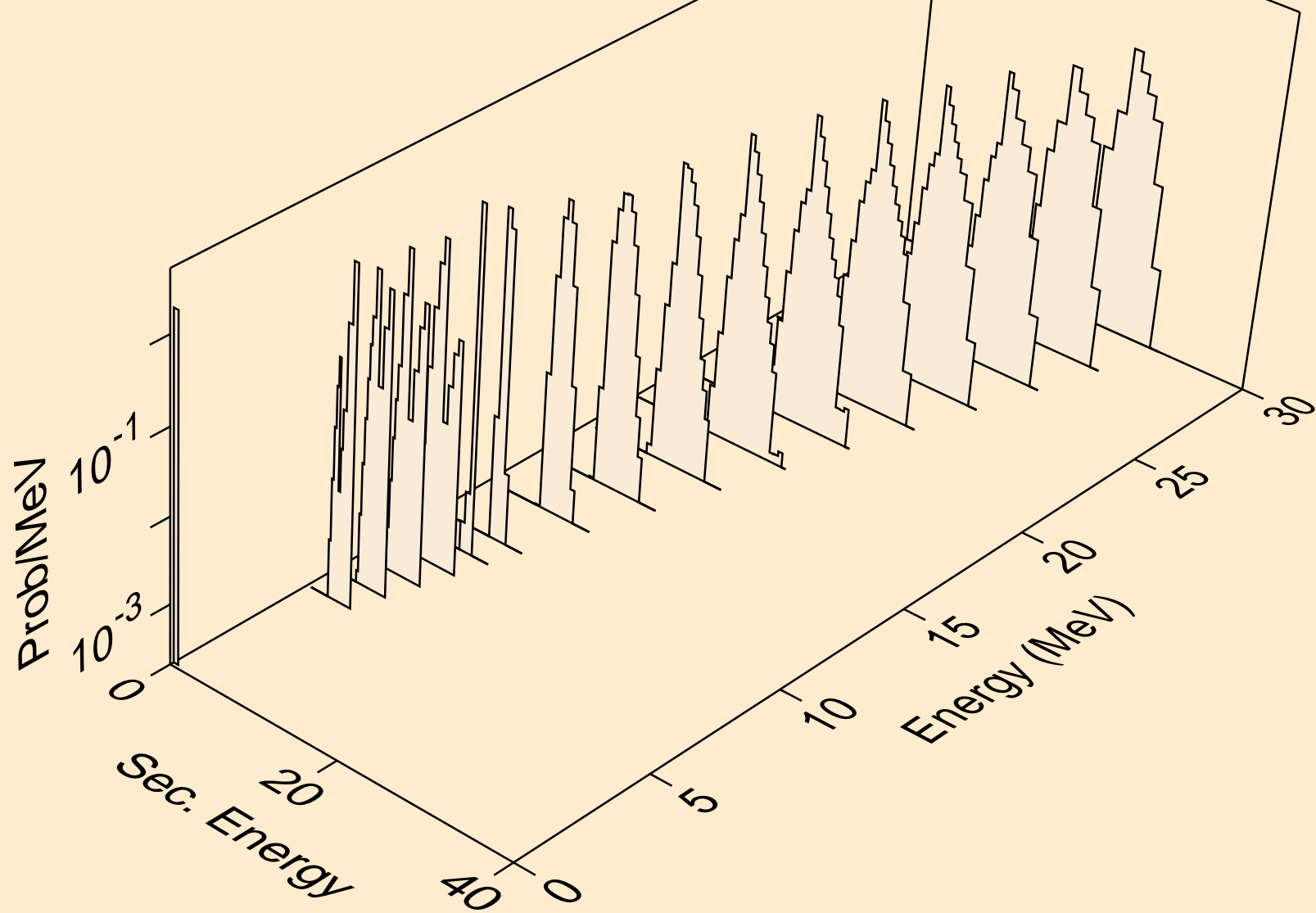

RN230 TRITON ACER TENDL-2021 LIBRARY; T=0.K
protons from (t,2p)

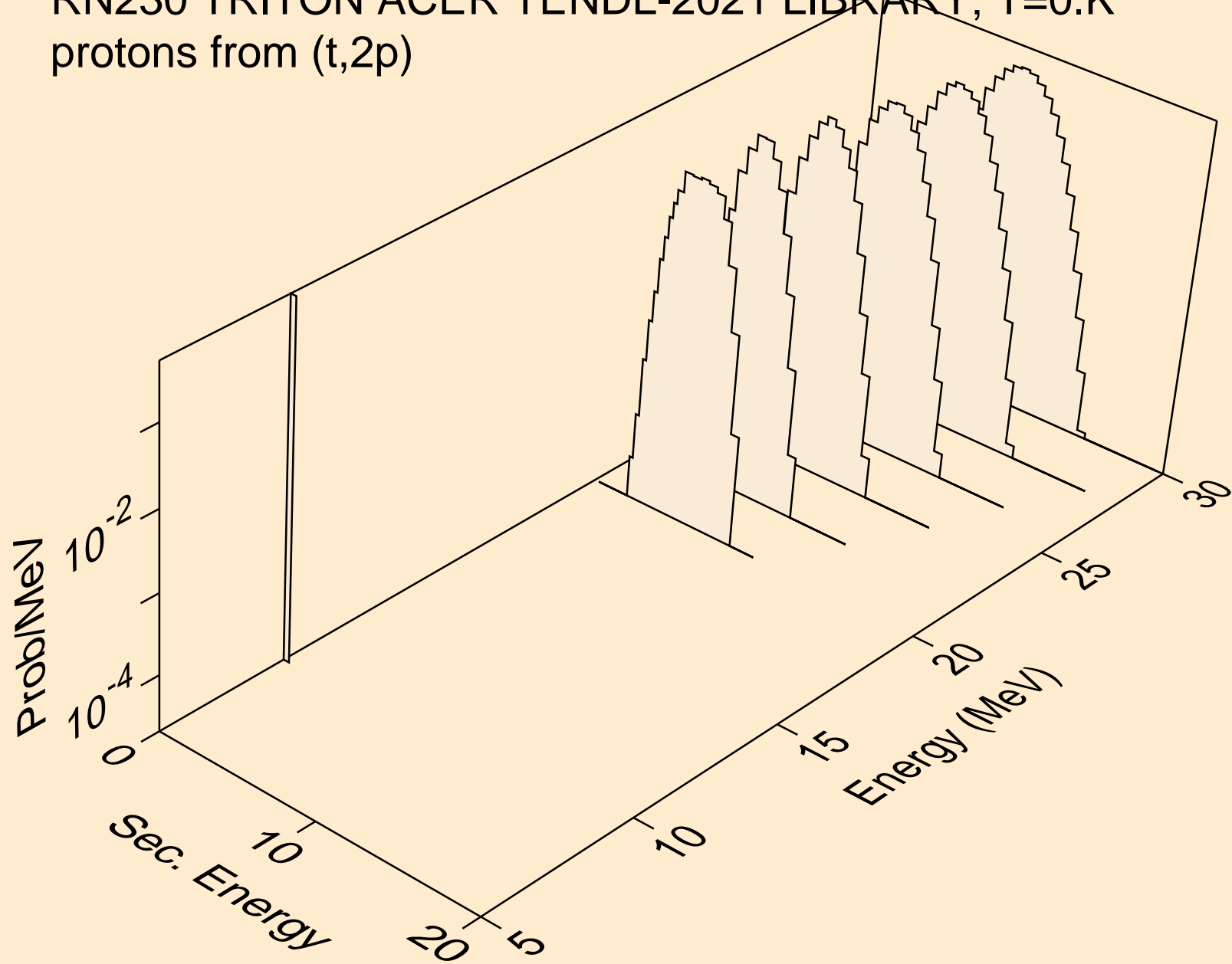

RN230 TRITON ACER TENDL-2021 LIBRARY; T=0.K
deuterons from (t,x)

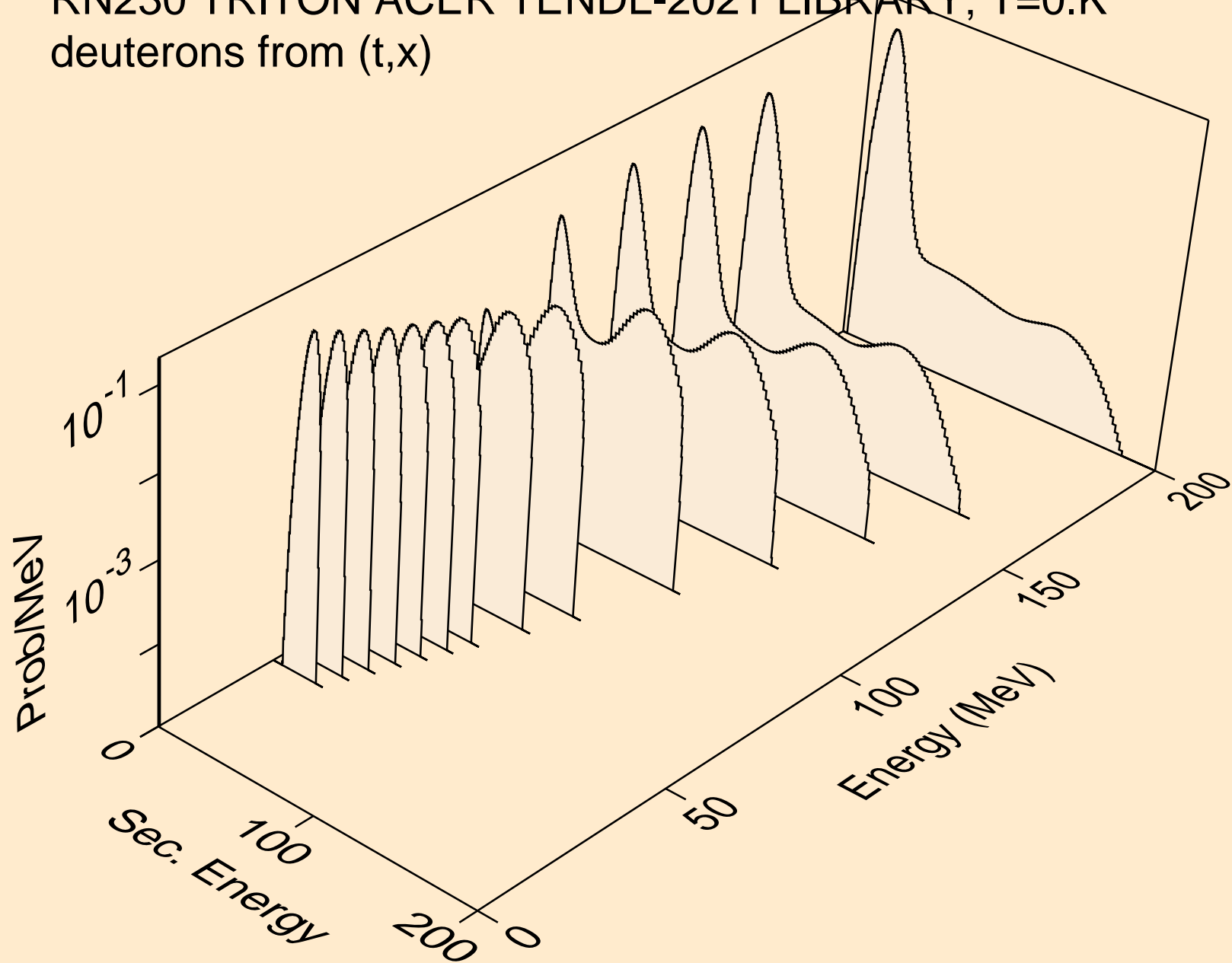

RN230 TRITON ACER TENDL-2021 LIBRARY; T=0.K
deuterons from (t,2nd)

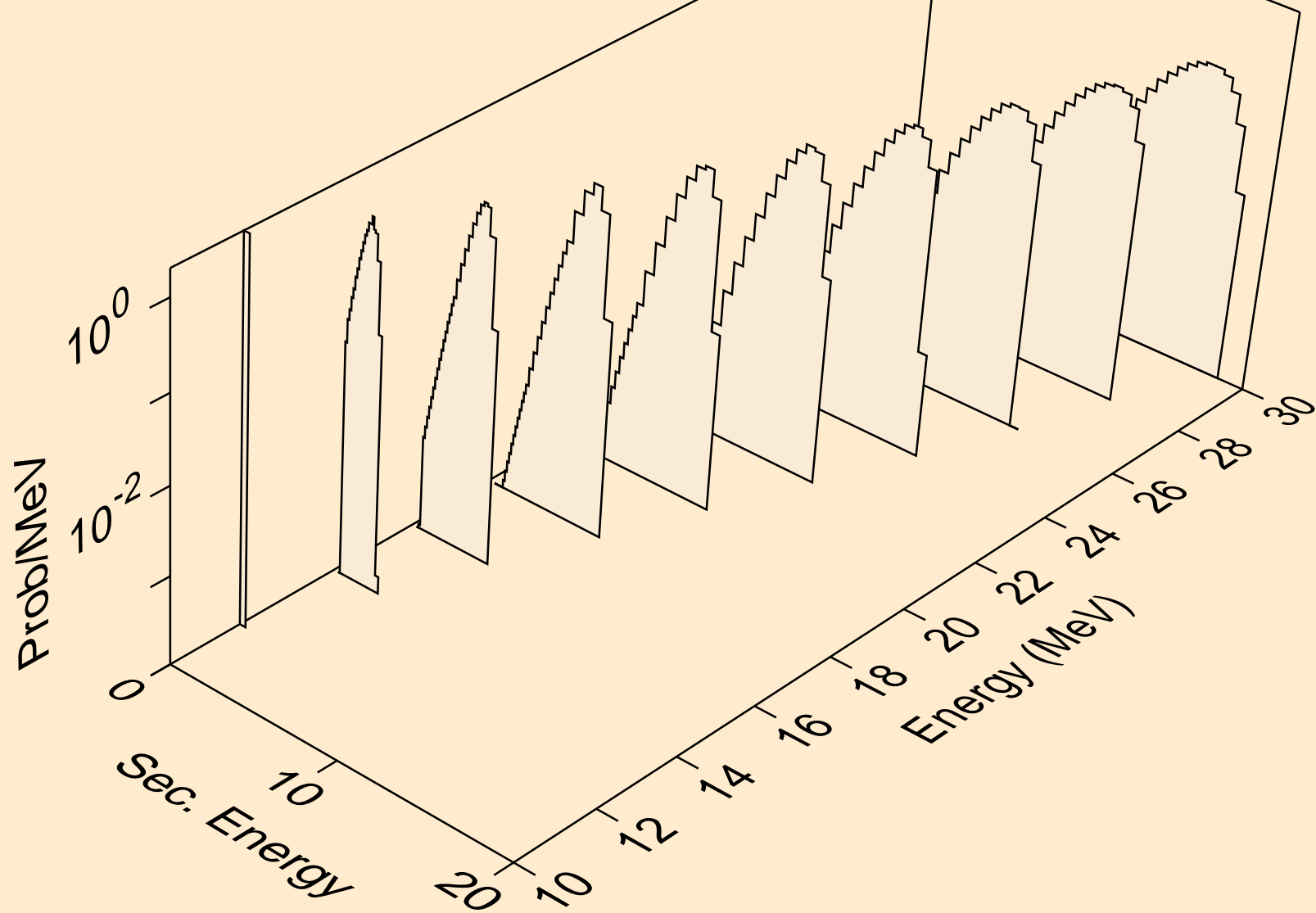

RN230 TRITON ACER TENDL-2021 LIBRARY; T=0.K
deuterons from (t,n*)d

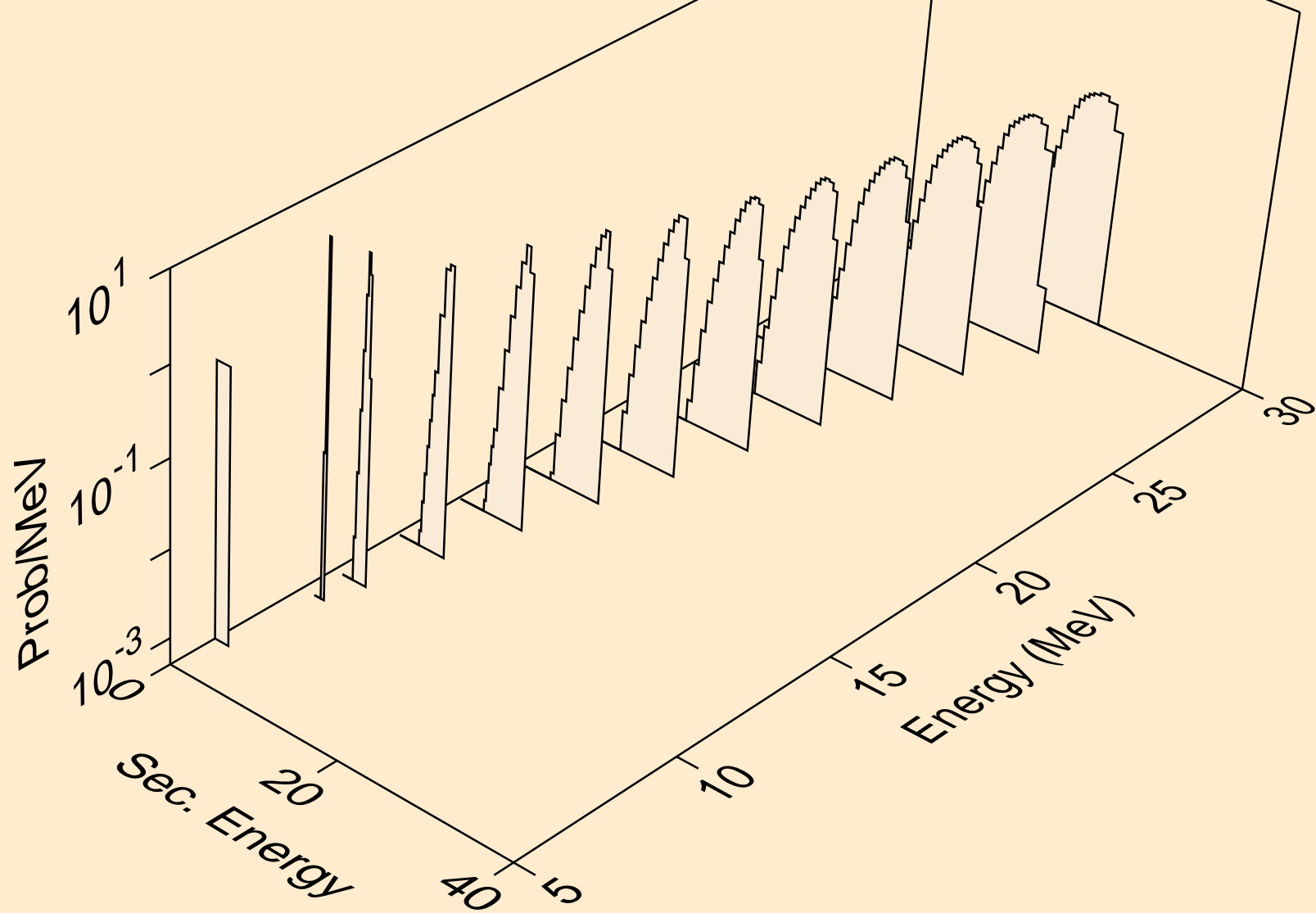

RN230 TRITON ACER TENDL-2021 LIBRARY; T=0.K
deuterons from (t,d)

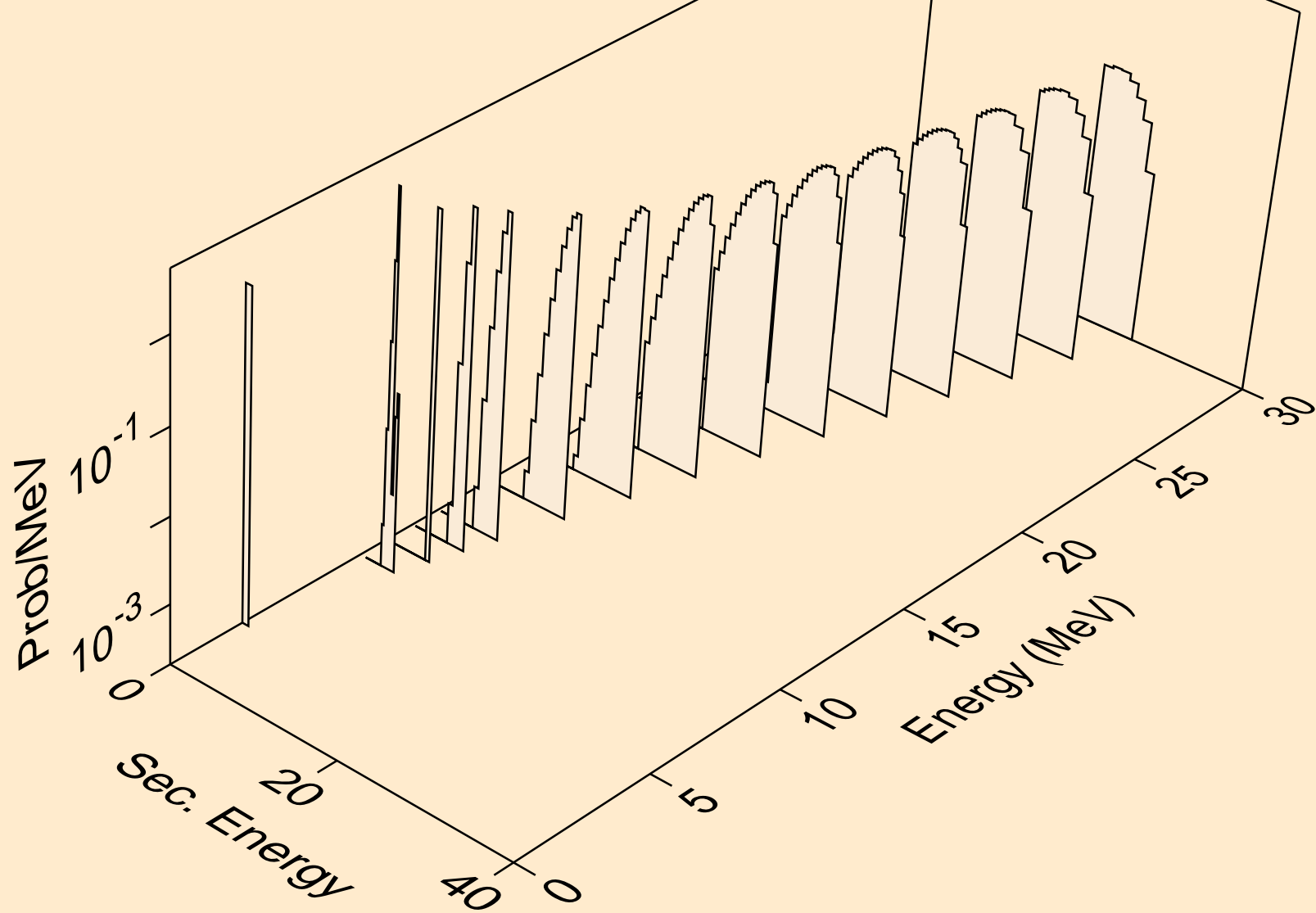

RN230 TRITON ACER TENDL-2021 LIBRARY; T=0.K
he3s from (t,x)

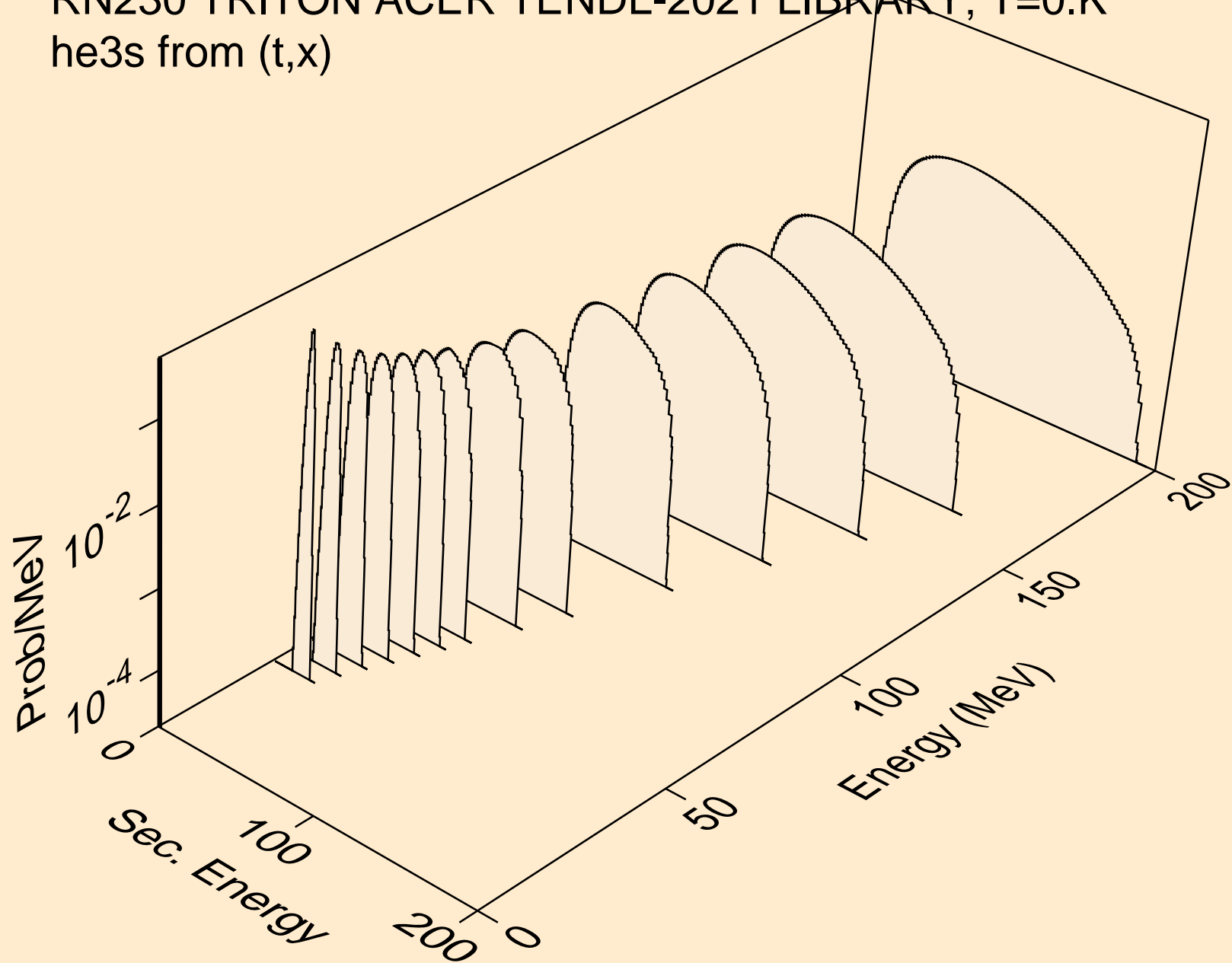

RN230 TRITON ACER TENDL-2021 LIBRARY; T=0.K
he3s from (t,n*)he3

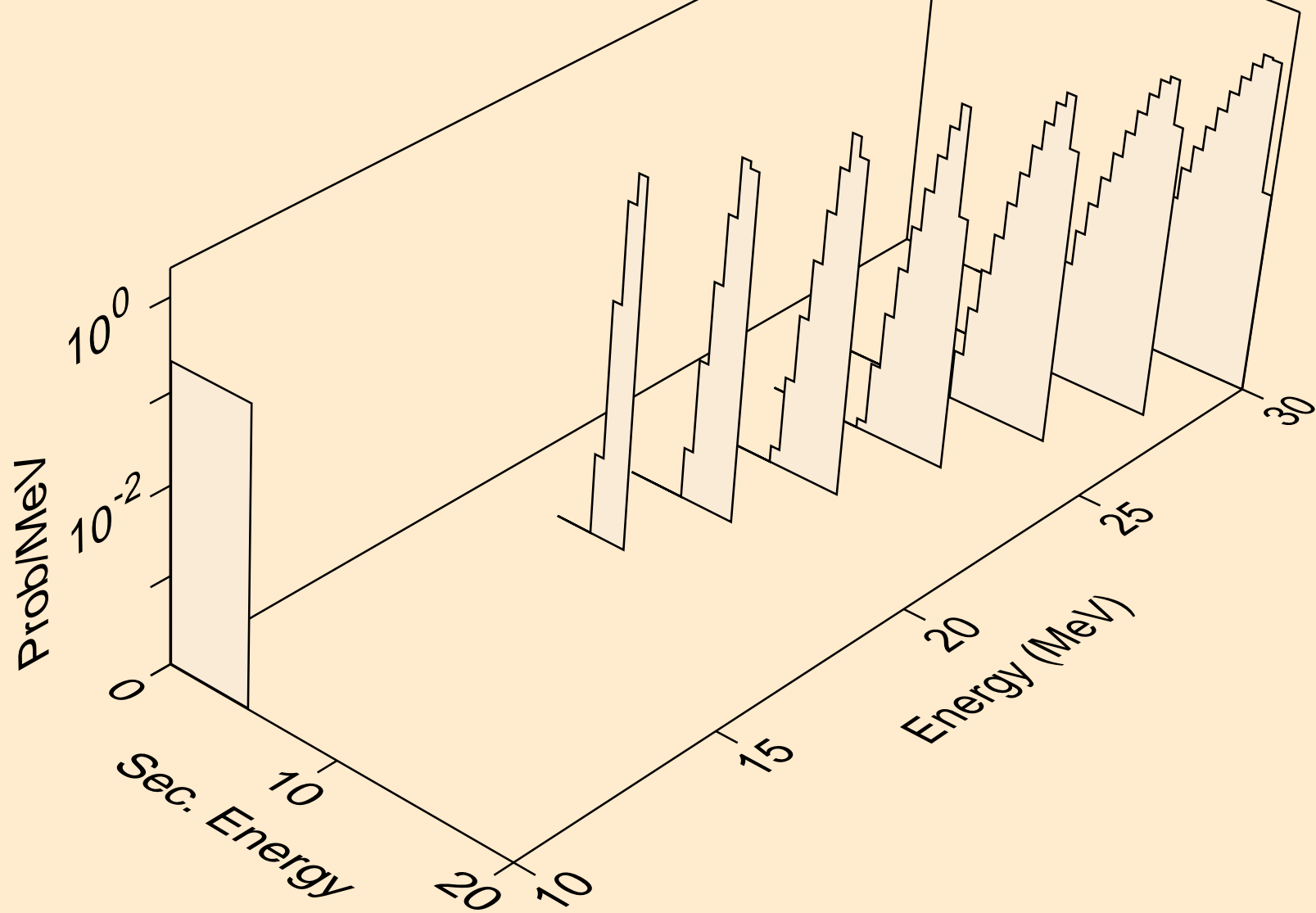

RN230 TRITON ACER TENDL-2021 LIBRARY; T=0.K
he3s from (t,he3)

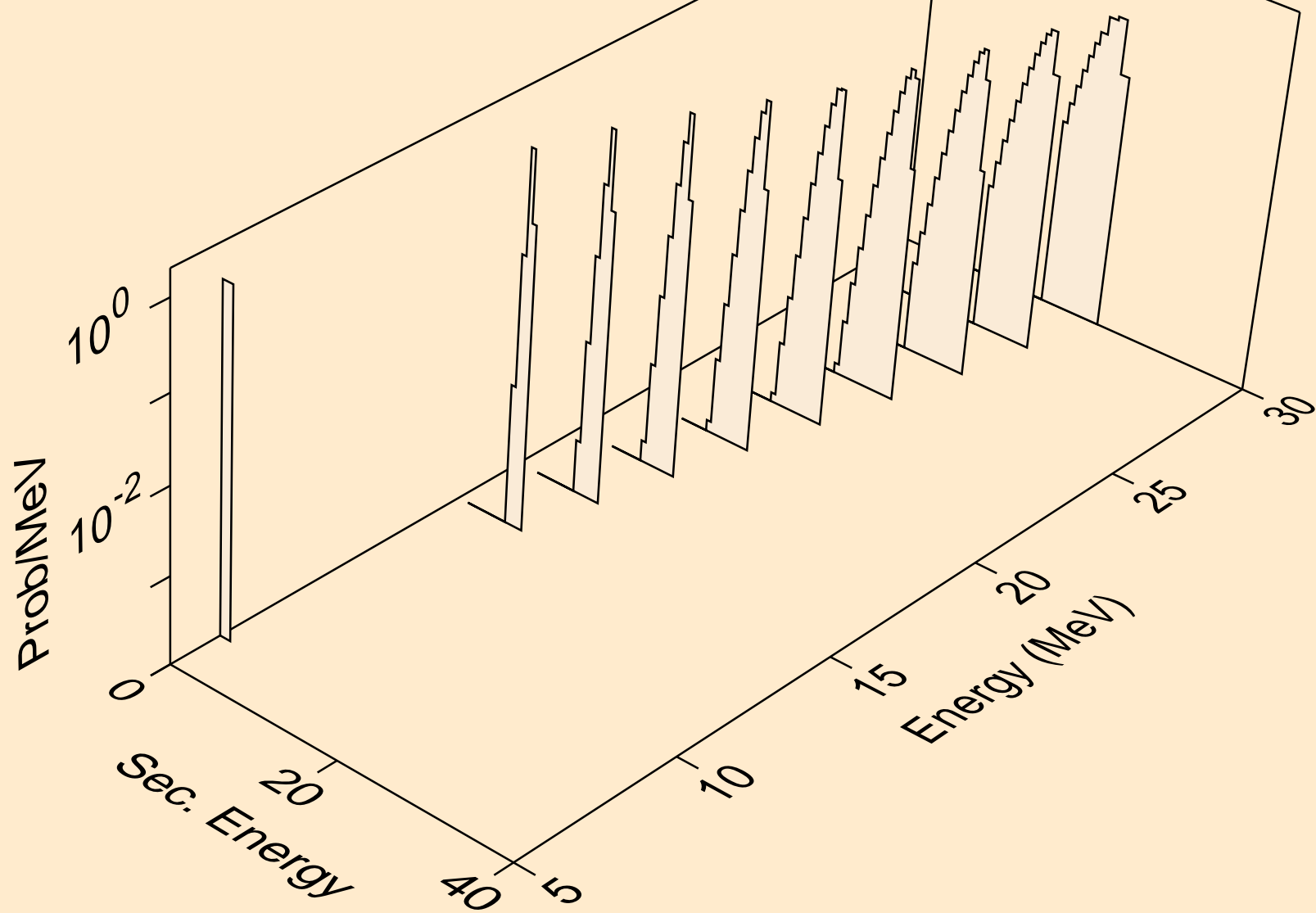

RN230 TRITON ACER TENDL-2021 LIBRARY; T=0.K
alphas from (t,x)

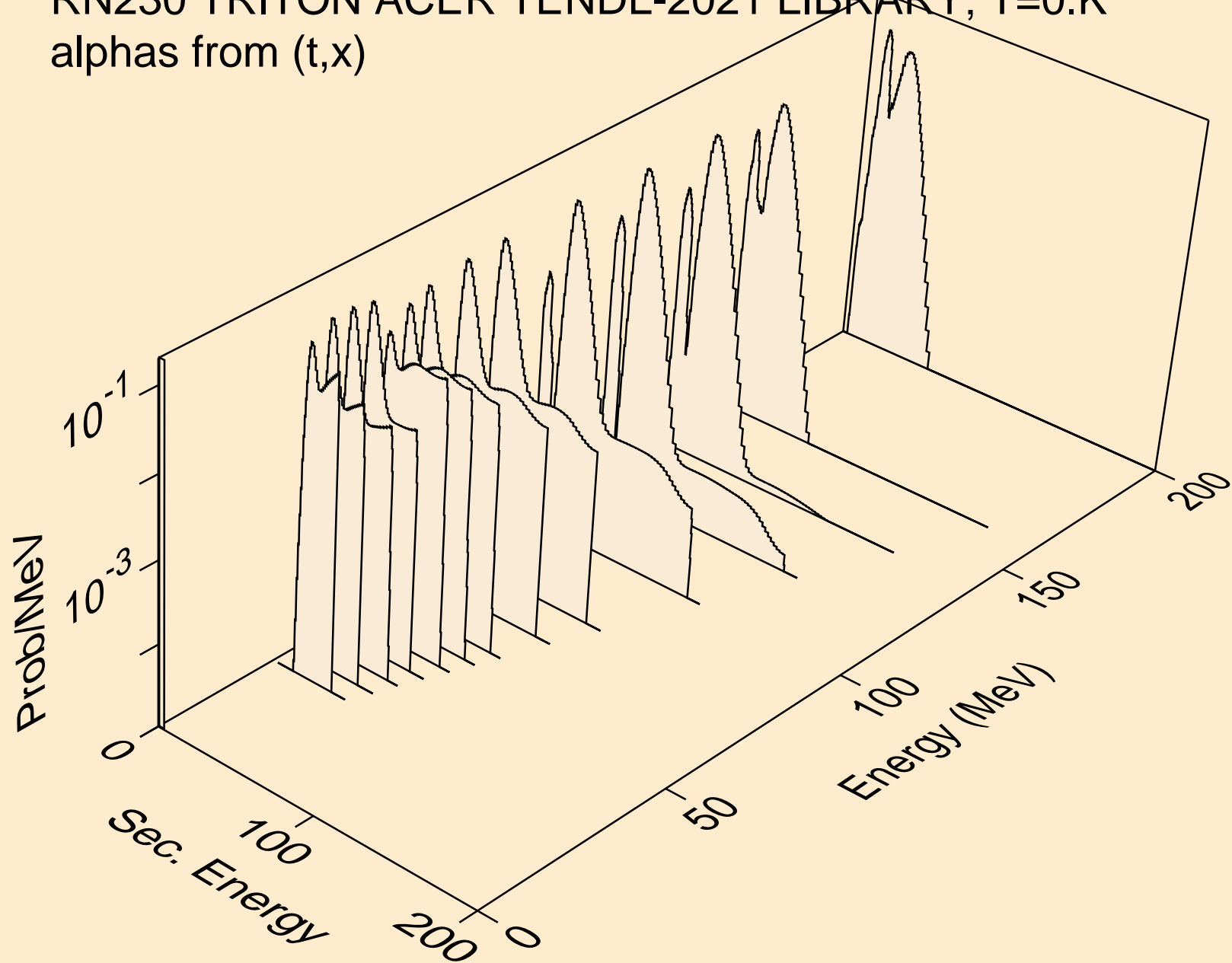

RN230 TRITON ACER TENDL-2021 LIBRARY; T=0.K
alphas from (t,n*)a

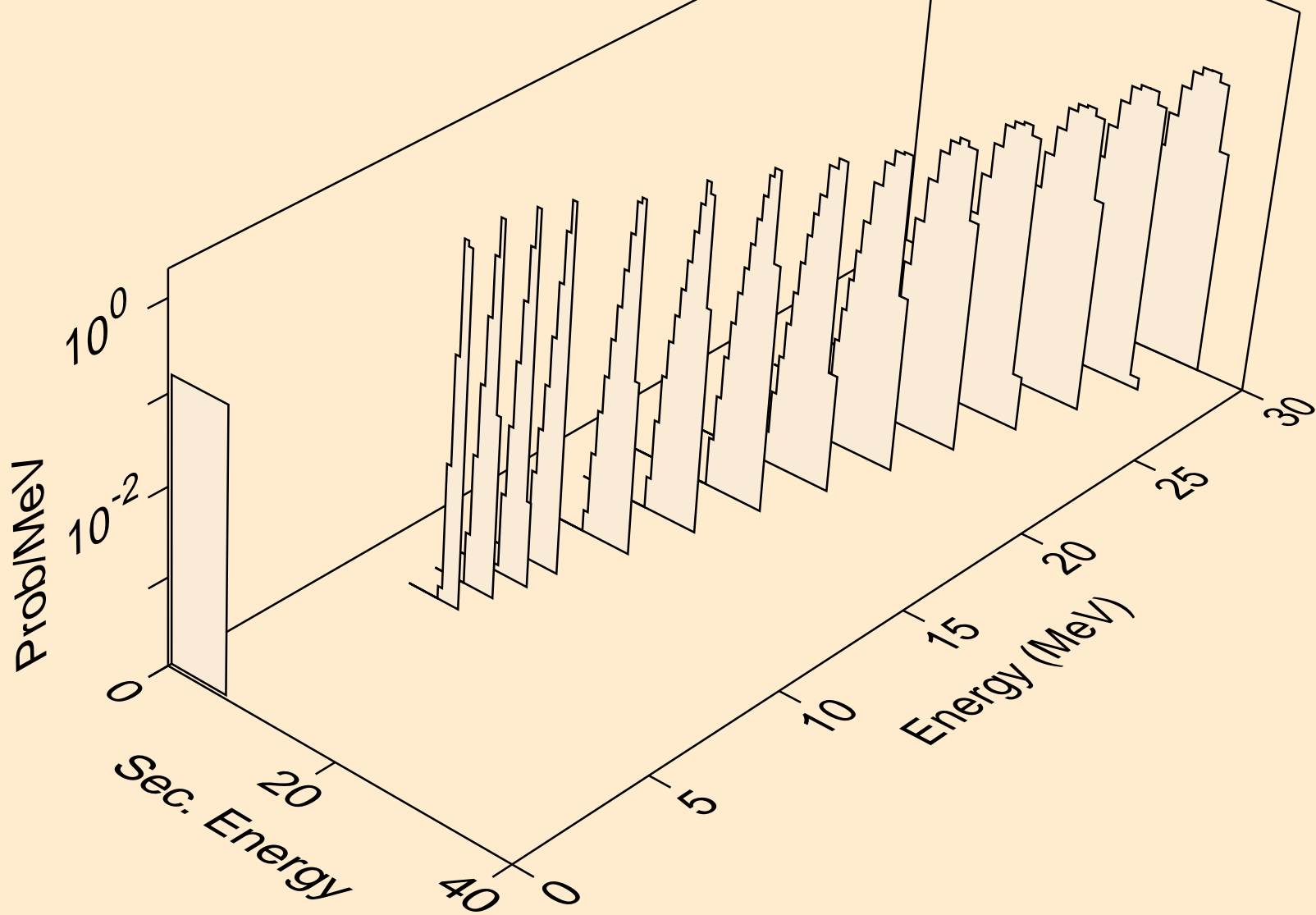

RN230 TRITON ACER TENDL-2021 LIBRARY; T=0.K
alphas from (t,2n)a

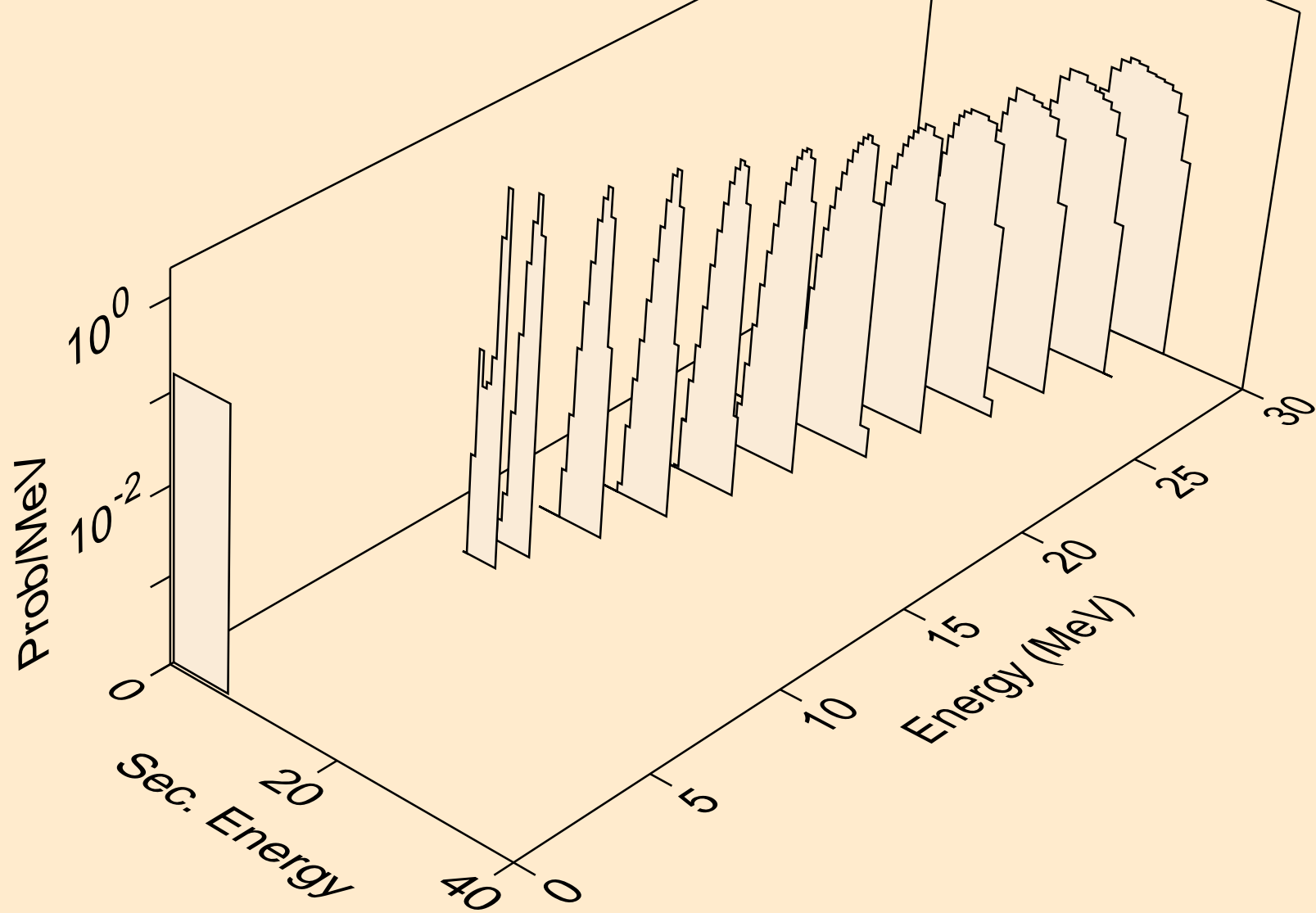

RN230 TRITON ACER TENDL-2021 LIBRARY; T=0.K
alphas from (t,3n)a

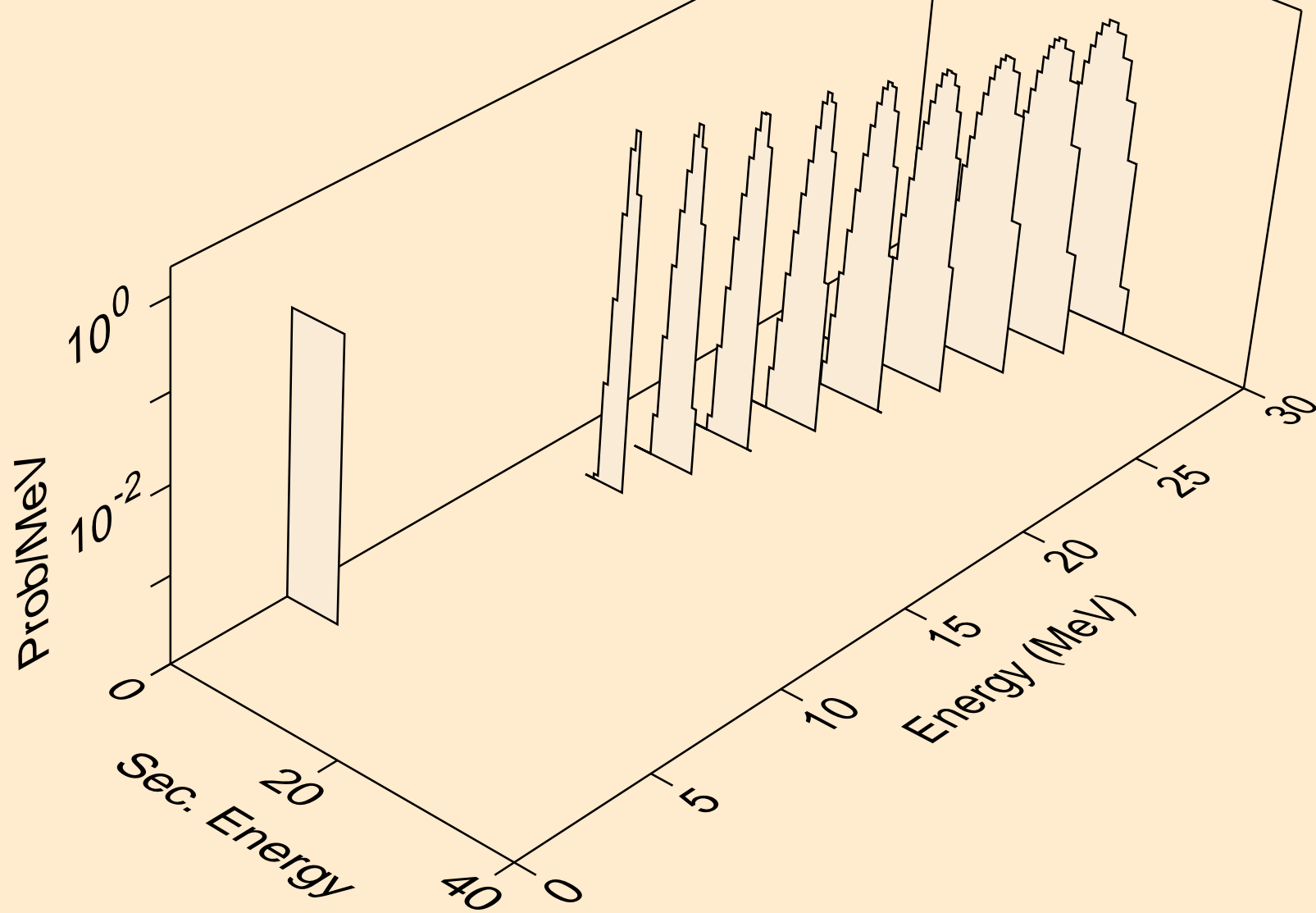

RN230 TRITON ACER TENDL-2021 LIBRARY; T=0.K
alphas from (t,a)

