

RU106 TRITON ACER TENDL-2021 LIBRARY; T=0.K  
Principal cross sections

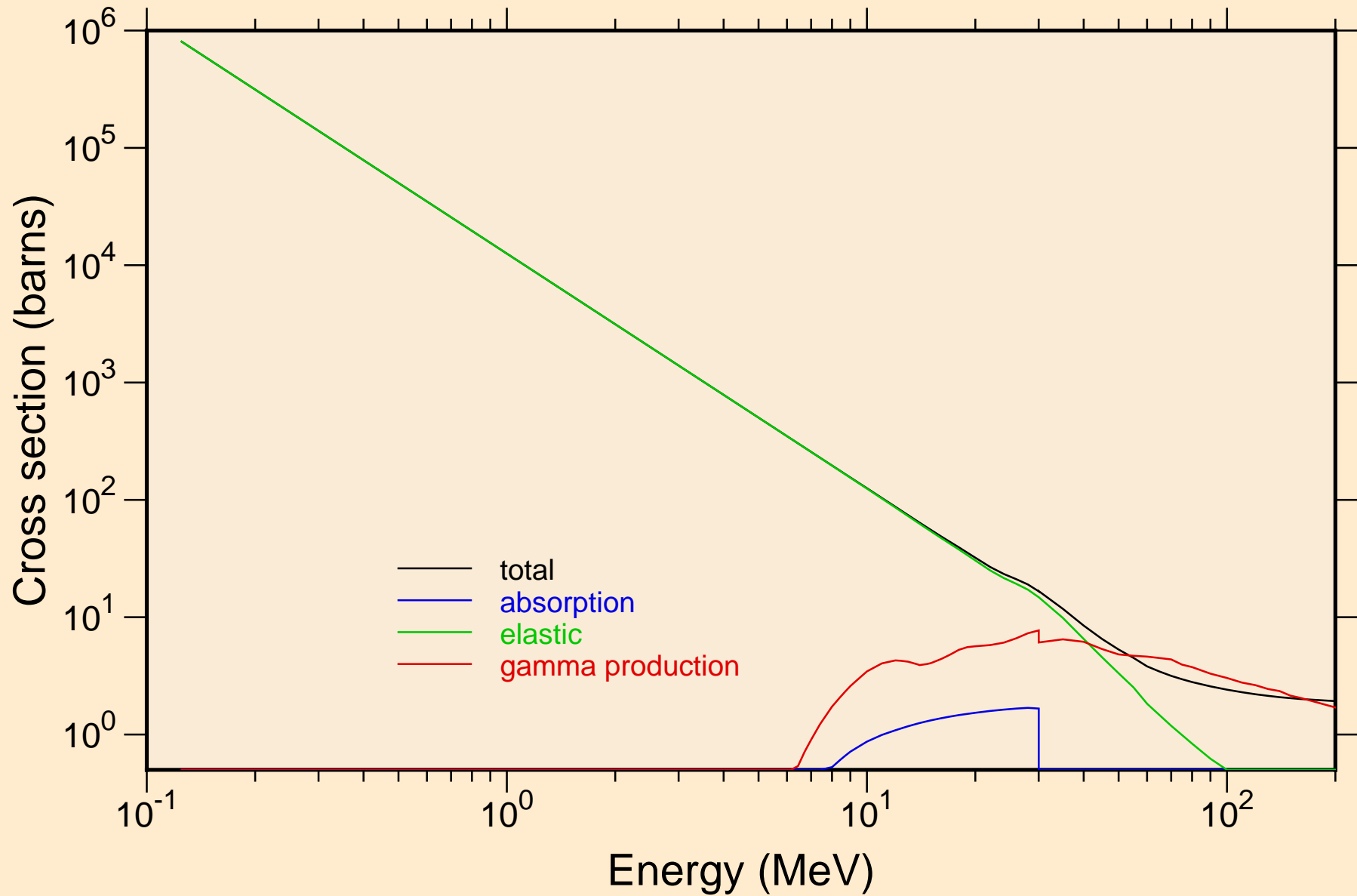

RU106 TRITON ACER TENDL-2021 LIBRARY; T=0.K

Heating

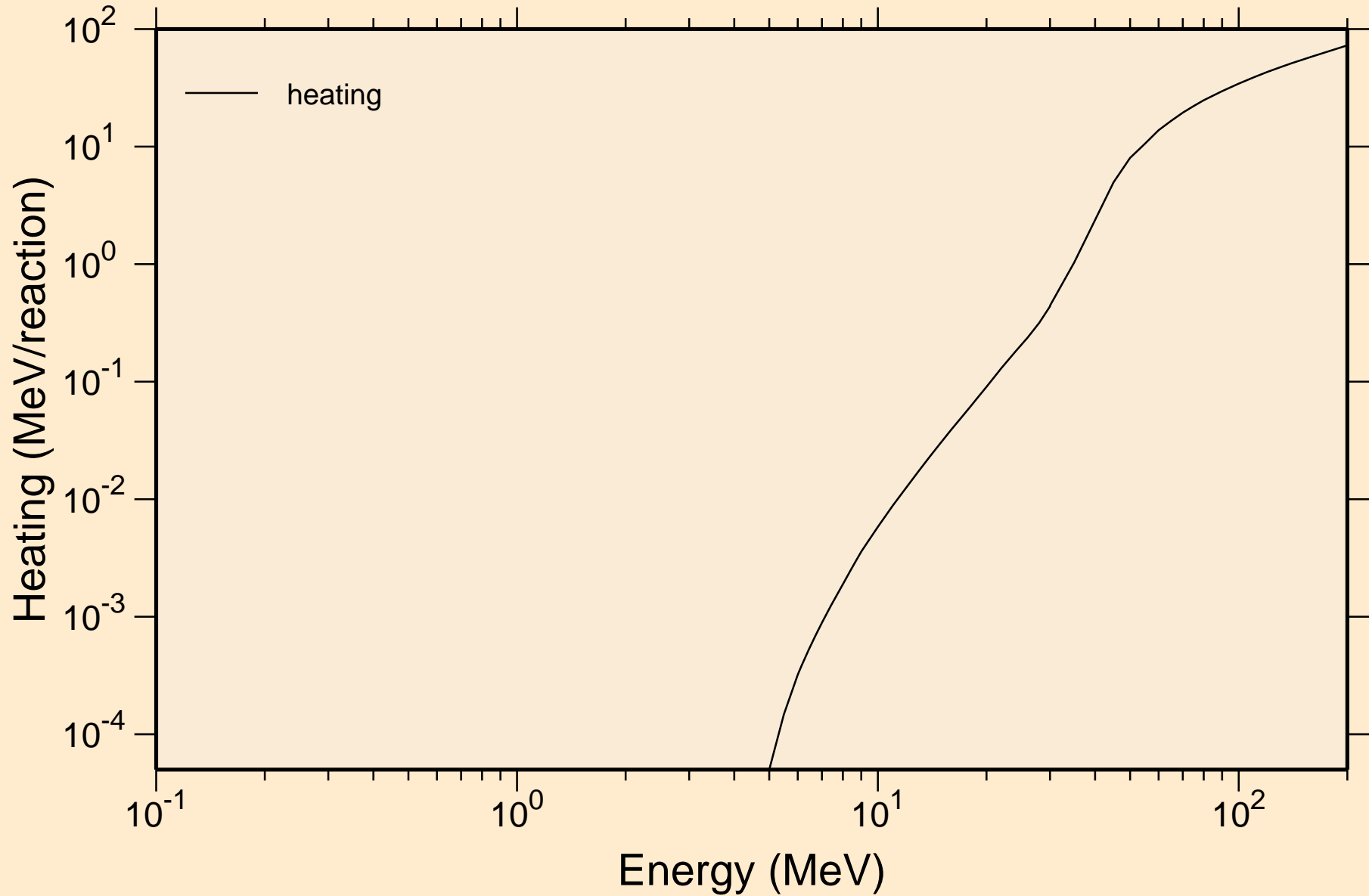

# RU106 TRITON ACER TENDL-2021 LIBRARY; T=0.K

## Principal cross sections

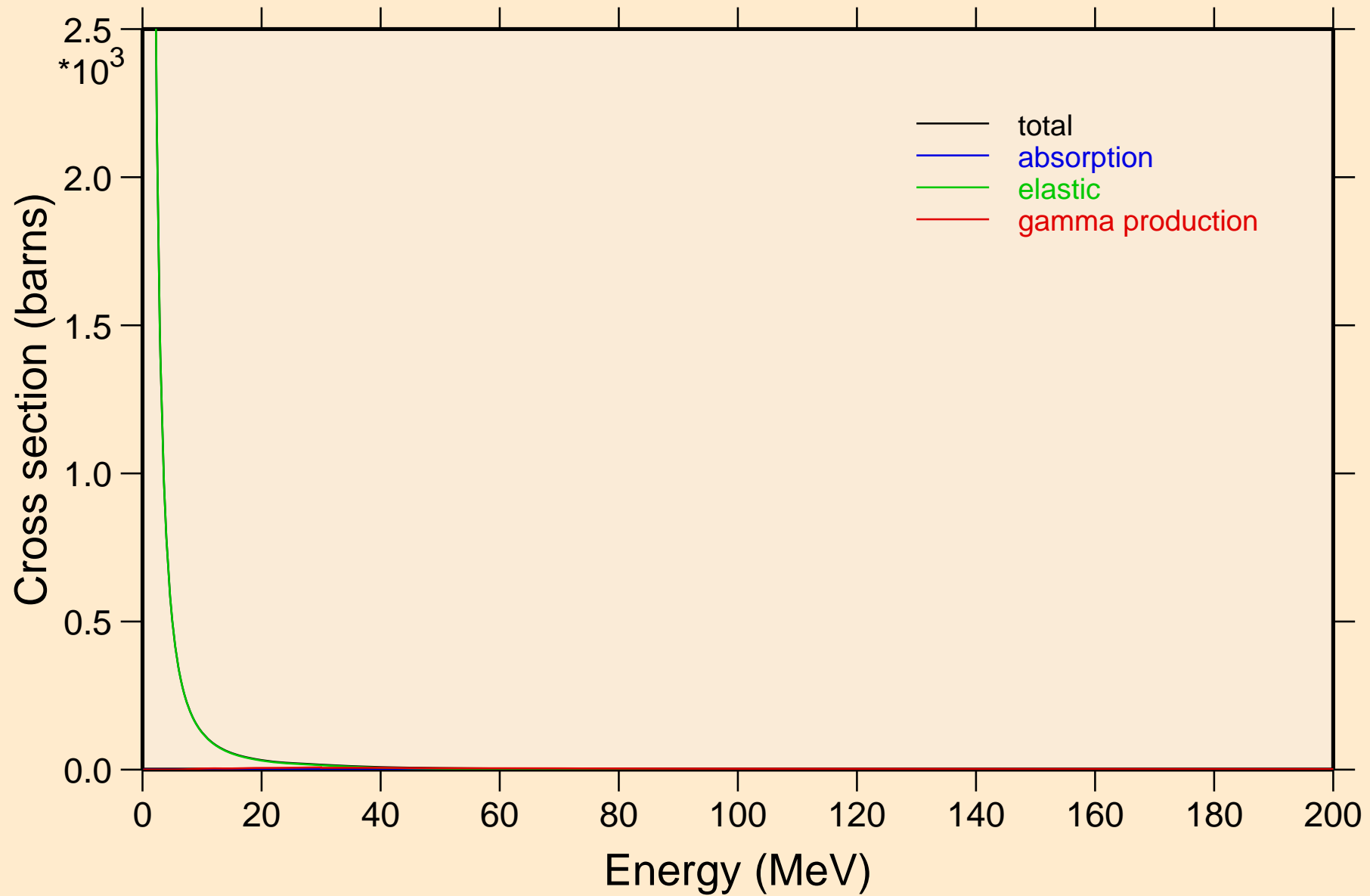

RU106 TRITON ACER TENDL-2021 LIBRARY; T=0.K

Heating

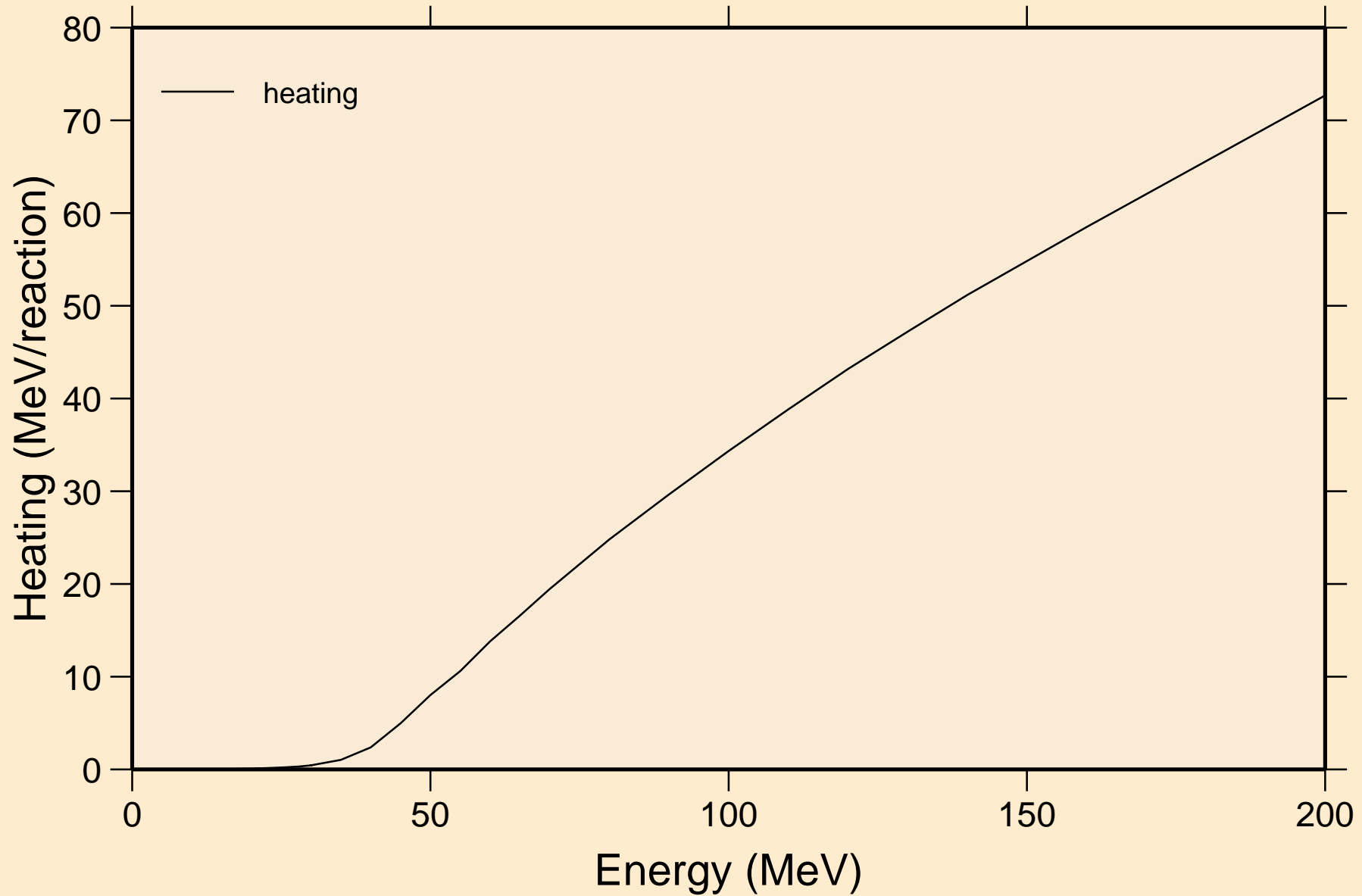

# RU106 TRITON ACER TENDL-2021 LIBRARY; T=0.K

## Threshold reactions

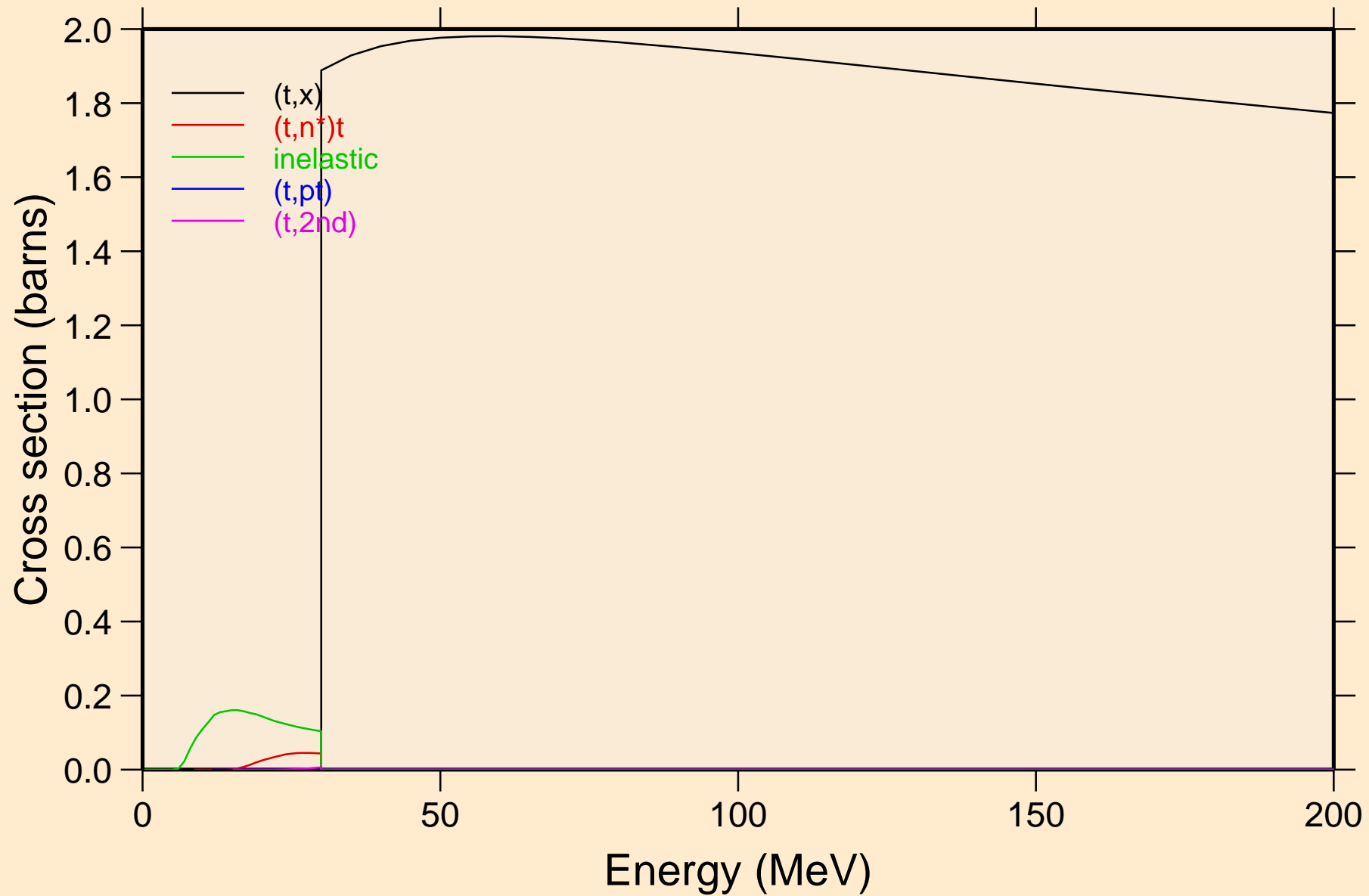

RU106 TRITON ACER TENDL-2021 LIBRARY; T=0.K  
Threshold reactions

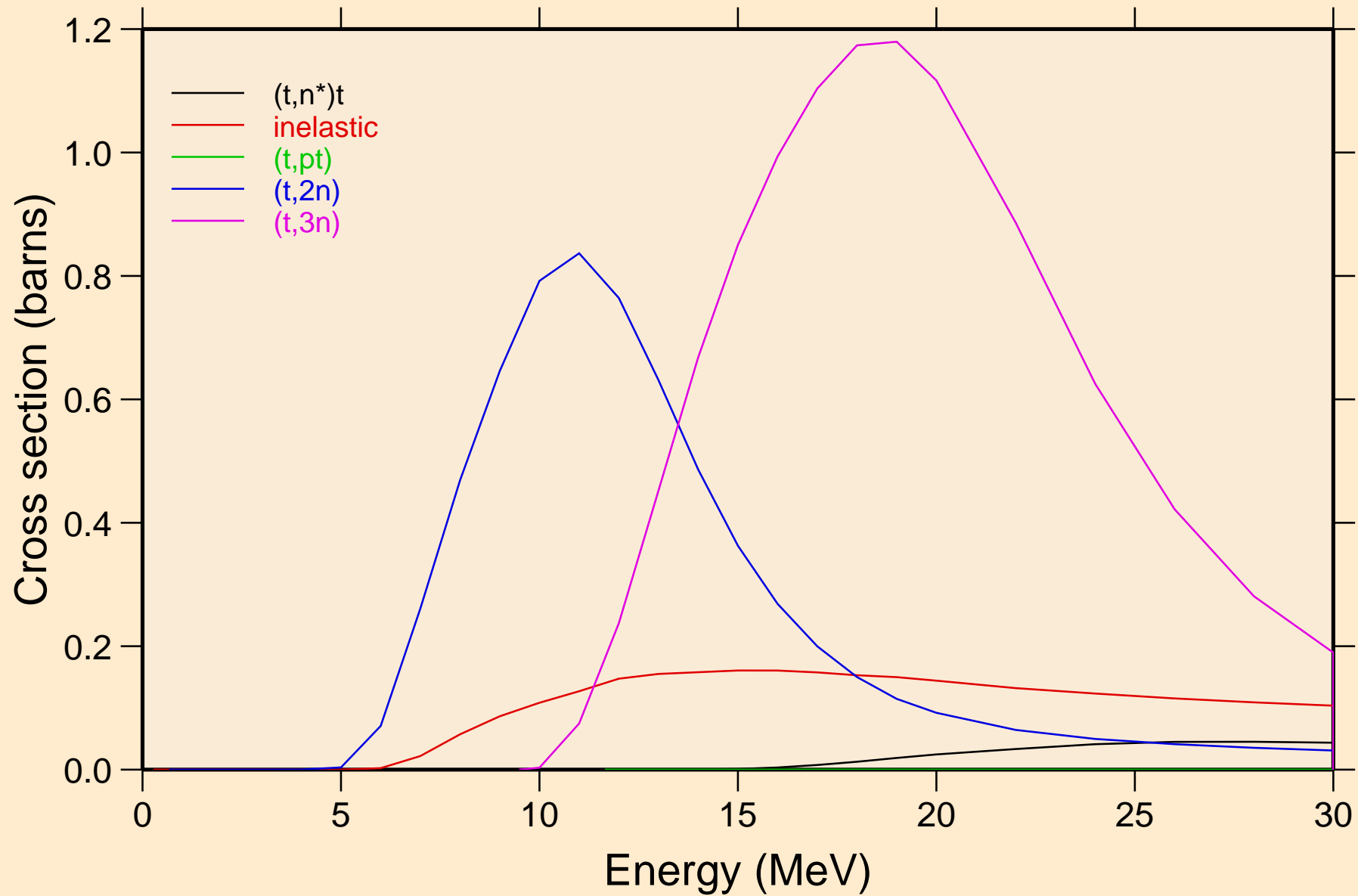

RU106 TRITON ACER TENDL-2021 LIBRARY; T=0.K  
Threshold reactions

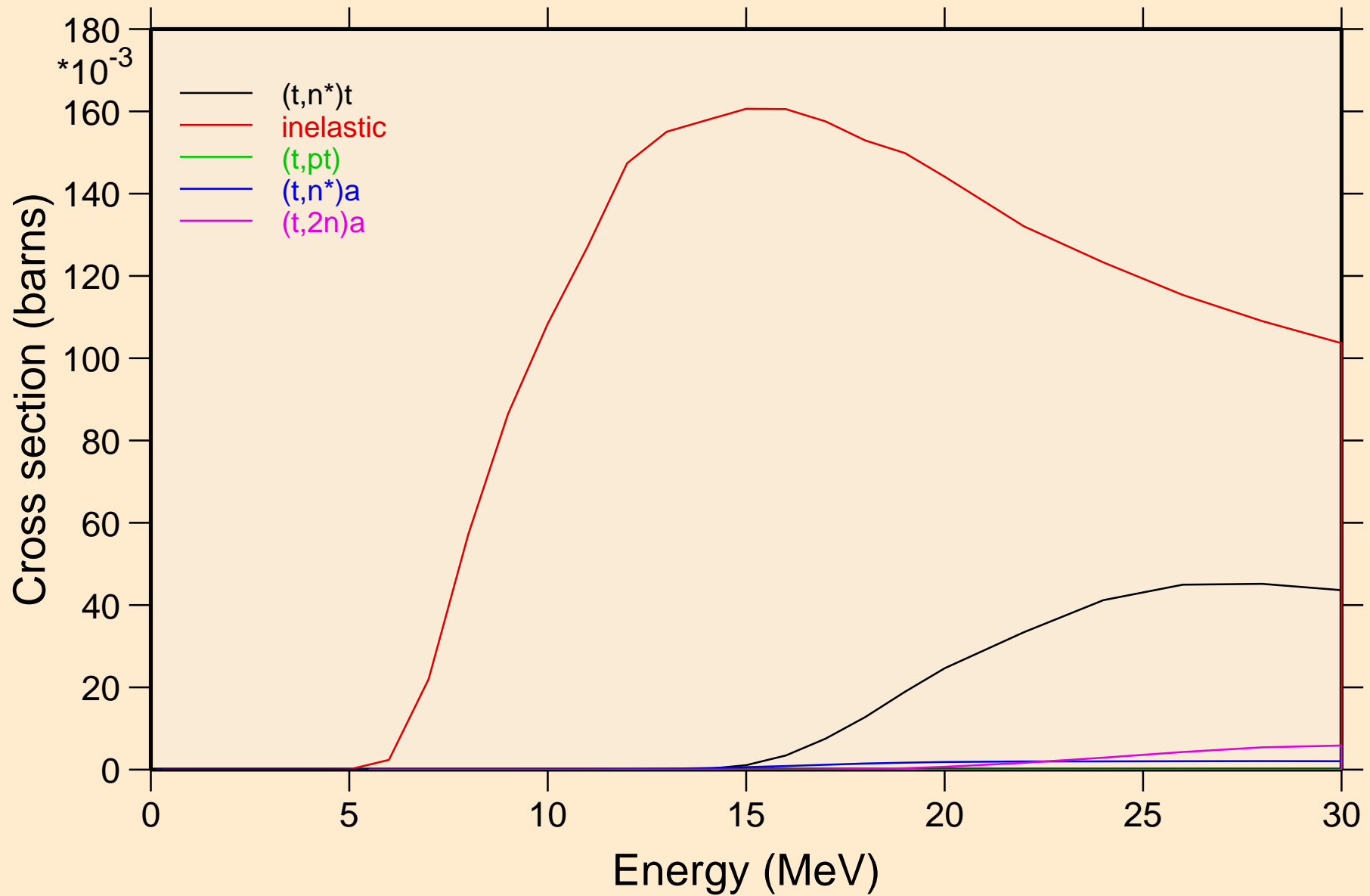

RU106 TRITON ACER TENDL-2021 LIBRARY; T=0.K  
Threshold reactions

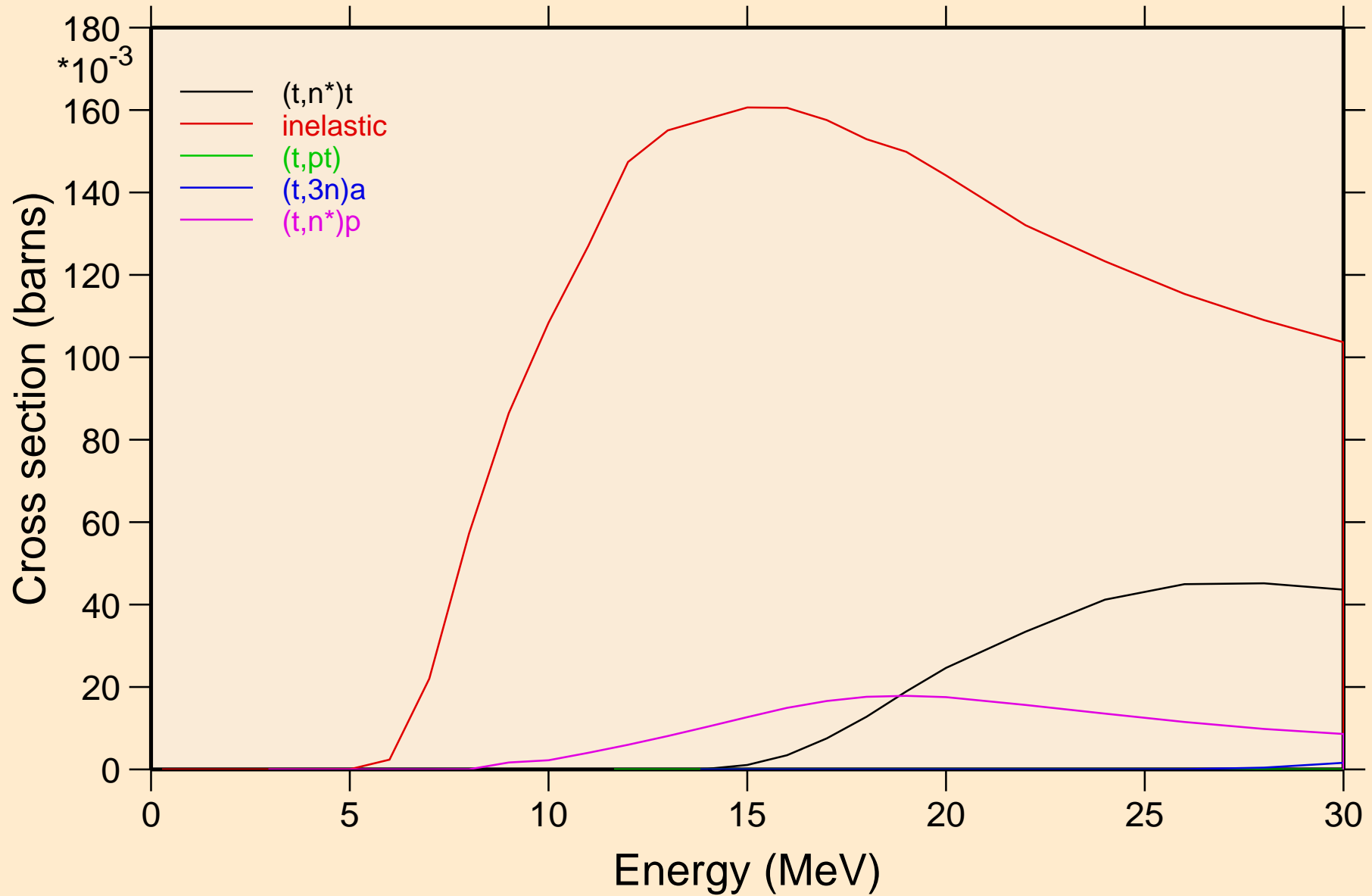



RU106 TRITON ACER TENDL-2021 LIBRARY; T=0.K  
Threshold reactions

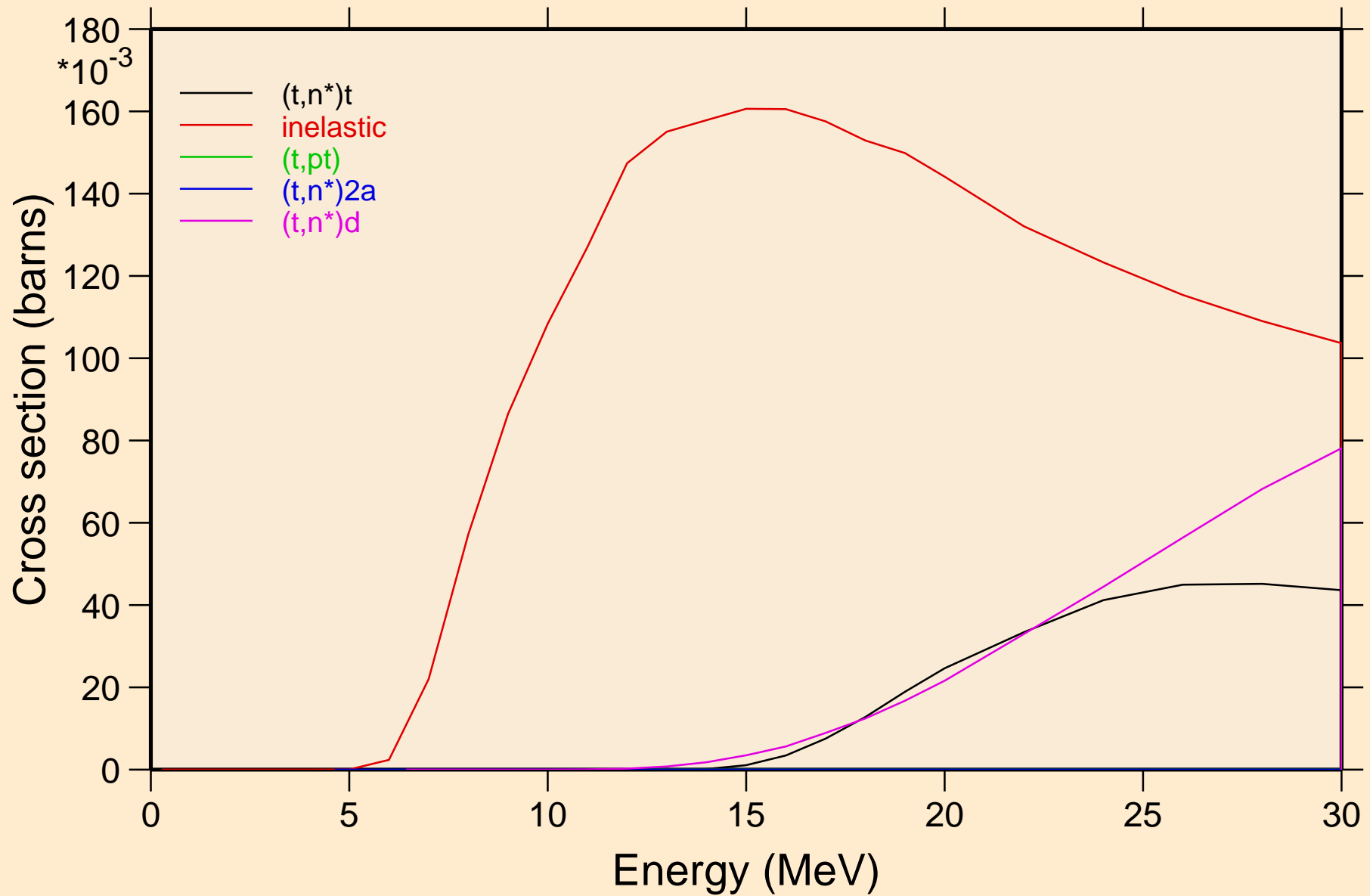

RU106 TRITON ACER TENDL-2021 LIBRARY; T=0.K  
Threshold reactions

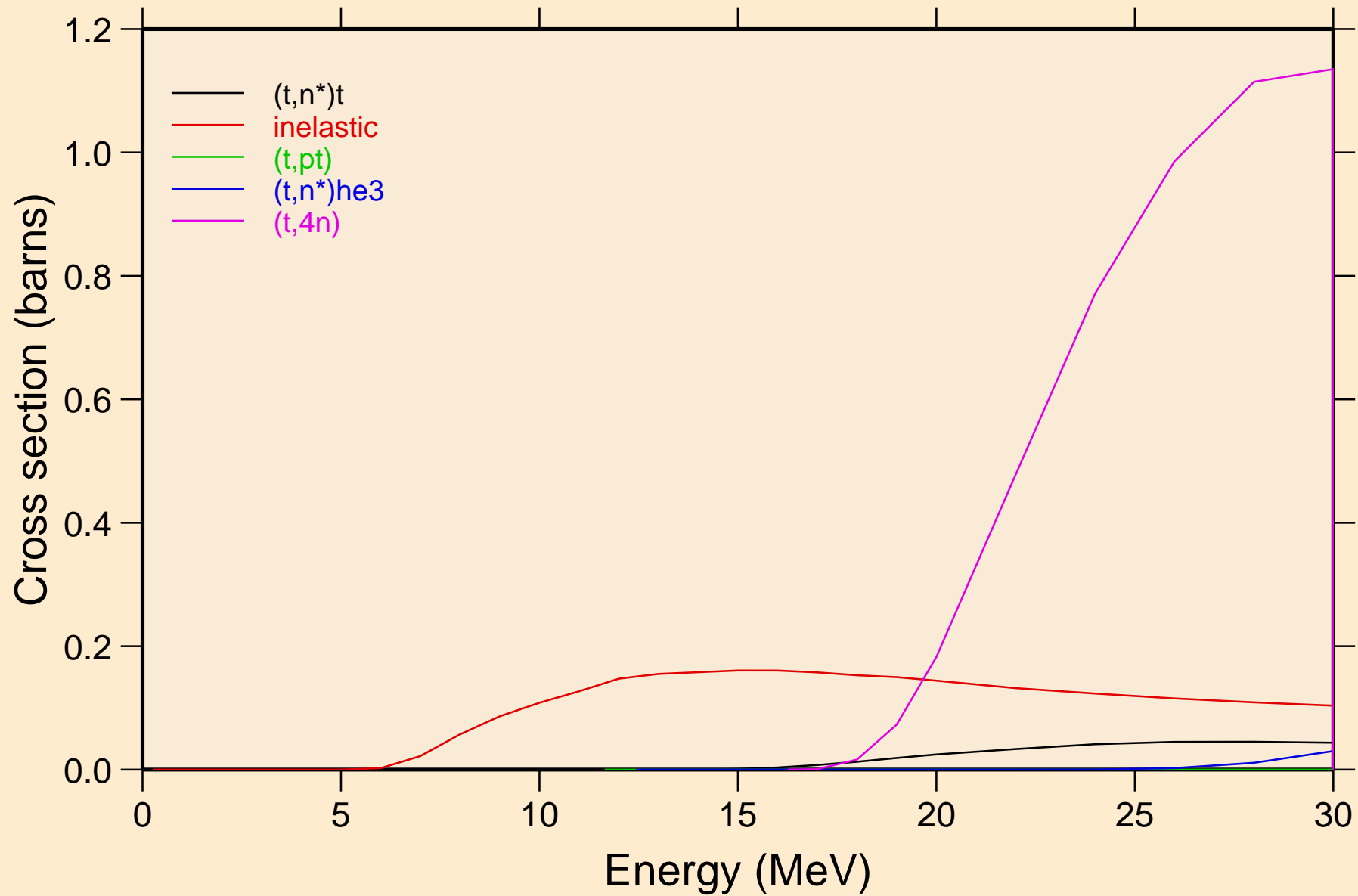

RU106 TRITON ACER TENDL-2021 LIBRARY; T=0.K  
Threshold reactions

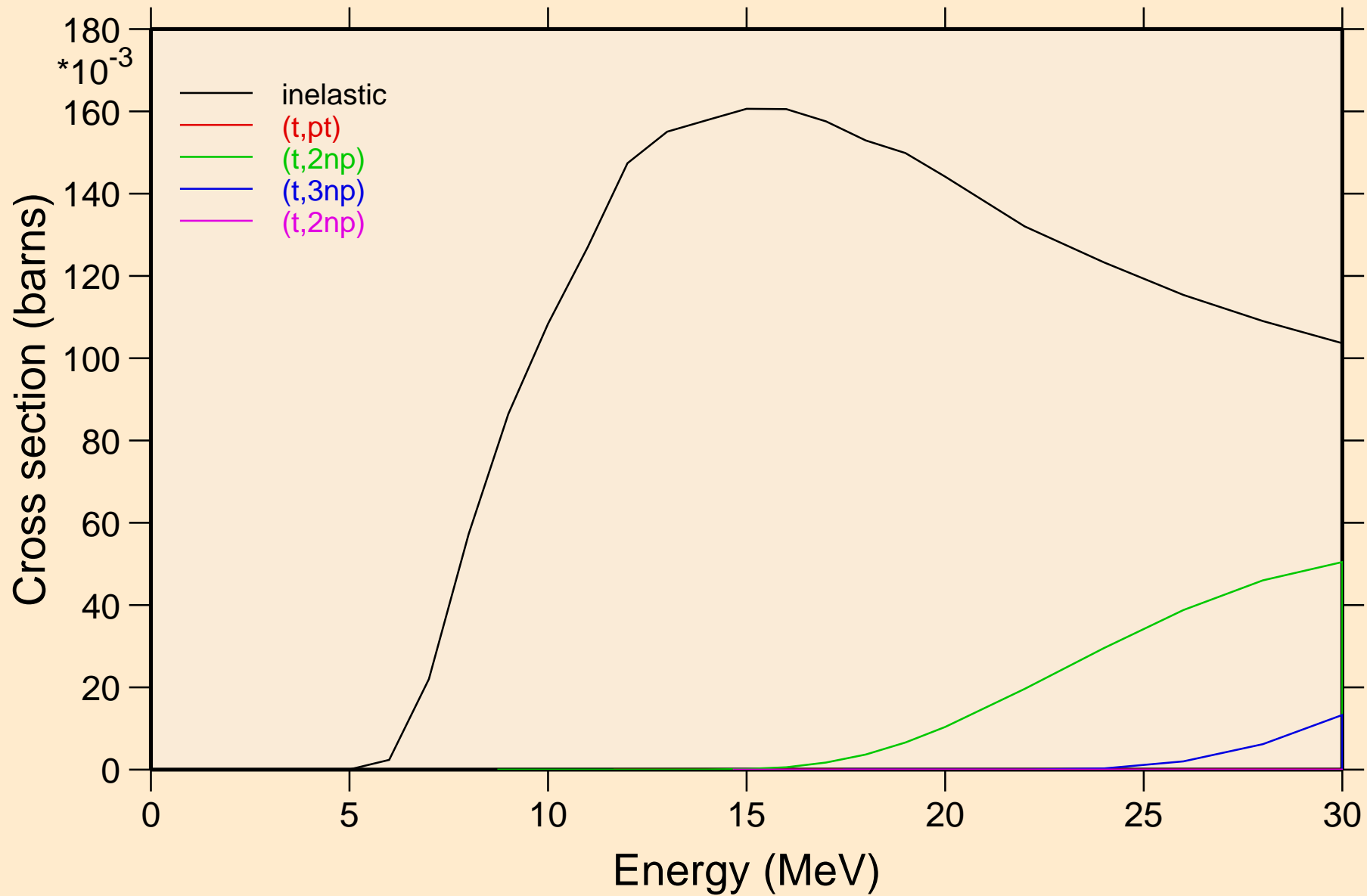

RU106 TRITON ACER TENDL-2021 LIBRARY; T=0.K  
Threshold reactions

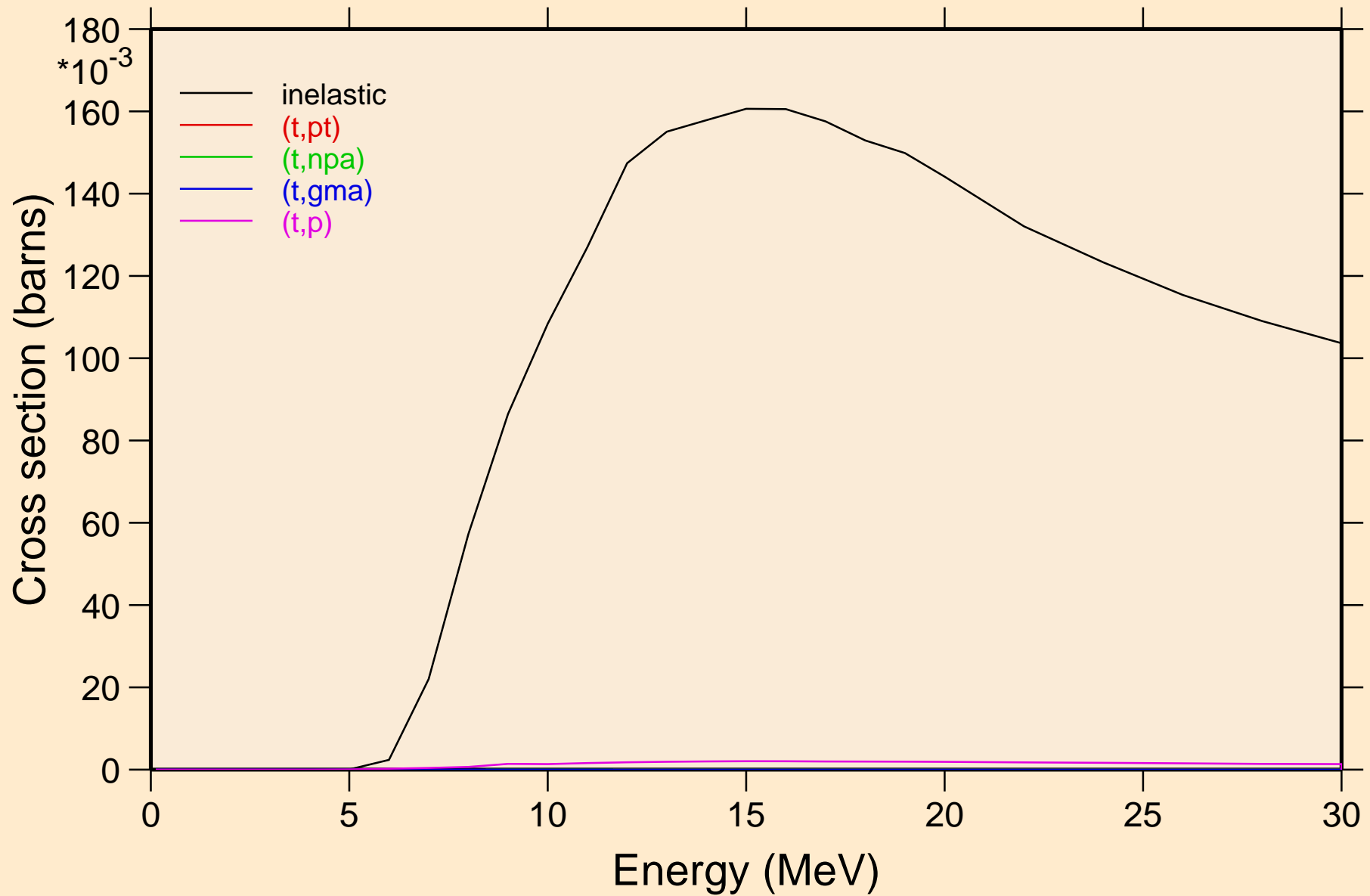

RU106 TRITON ACER TENDL-2021 LIBRARY; T=0.K  
Threshold reactions

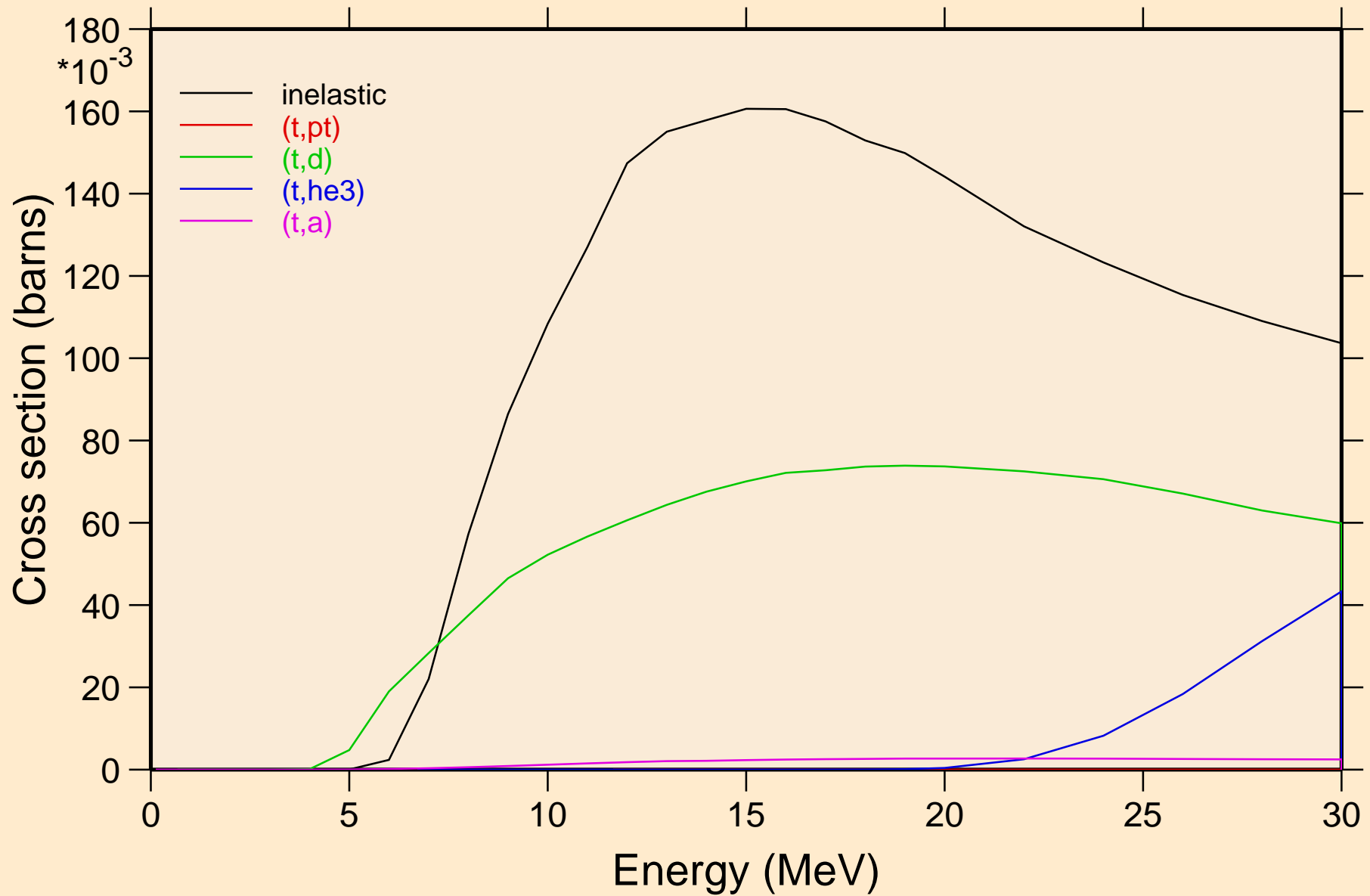

RU106 TRITON ACER TENDL-2021 LIBRARY; T=0.K  
Threshold reactions

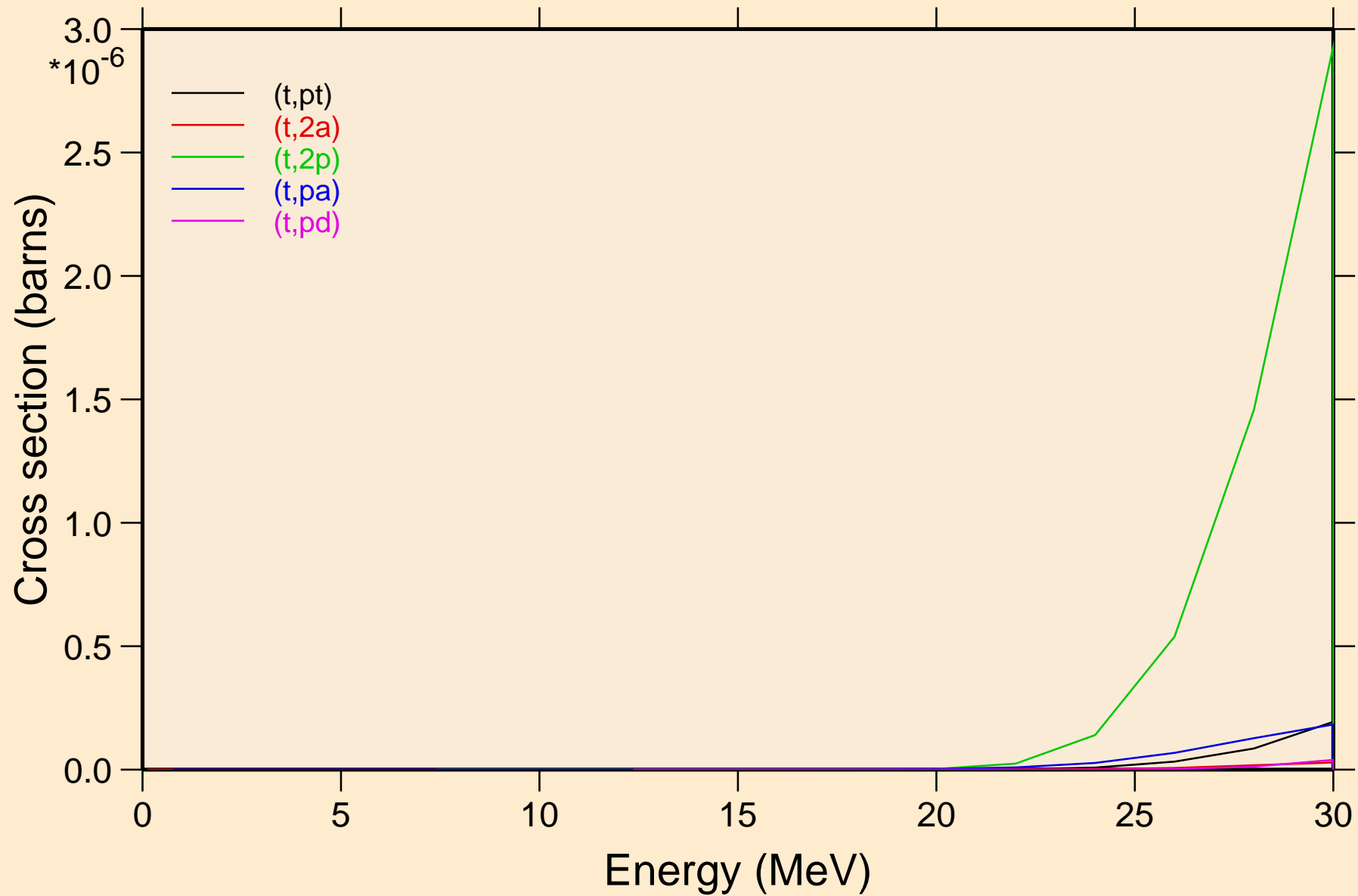

RU106 TRITON ACER TENDL-2021 LIBRARY; T=0.K  
Threshold reactions

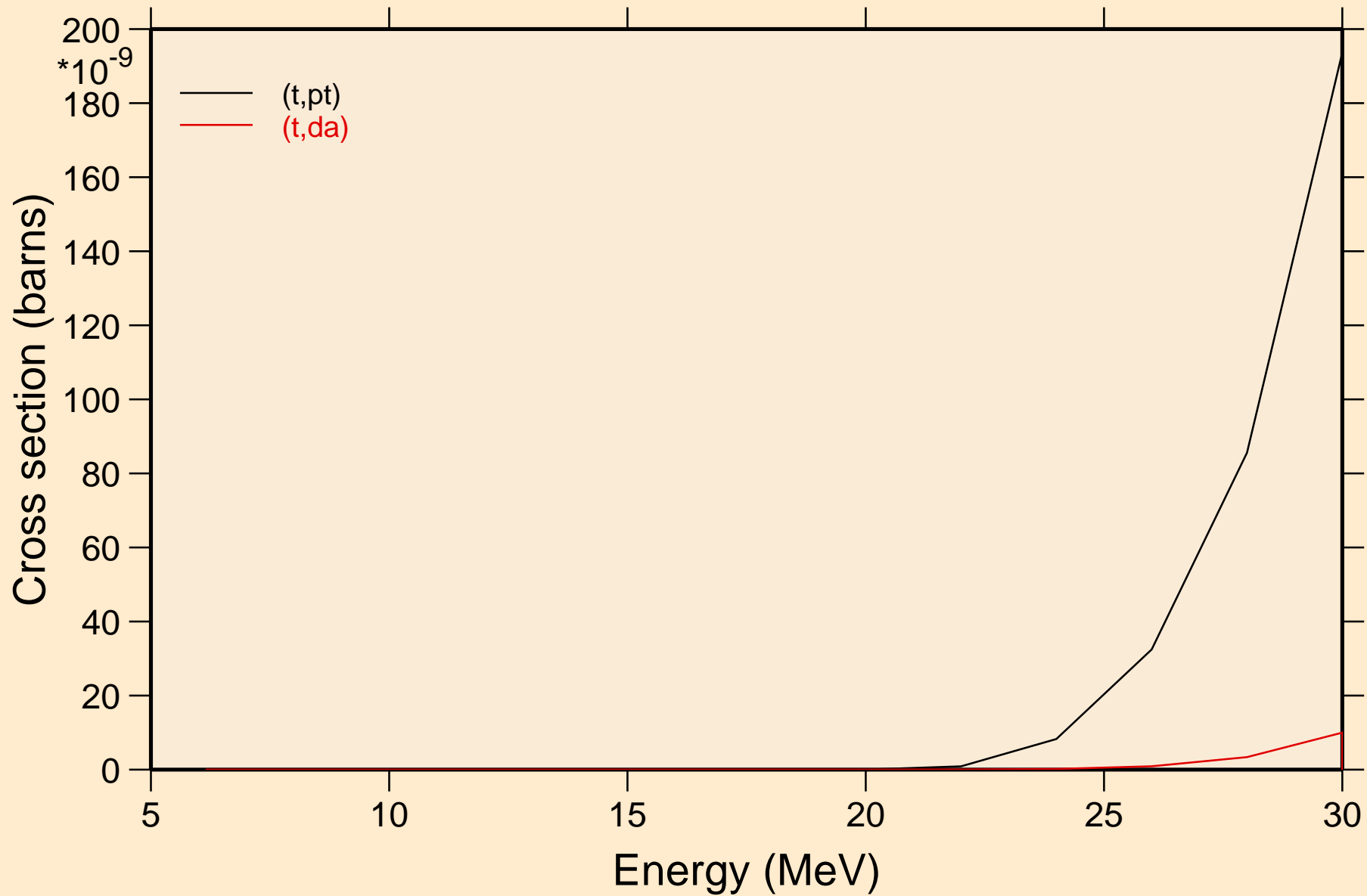

RU106 TRITON ACER TENDL-2021 LIBRARY; T=0.K  
angular distribution for elastic

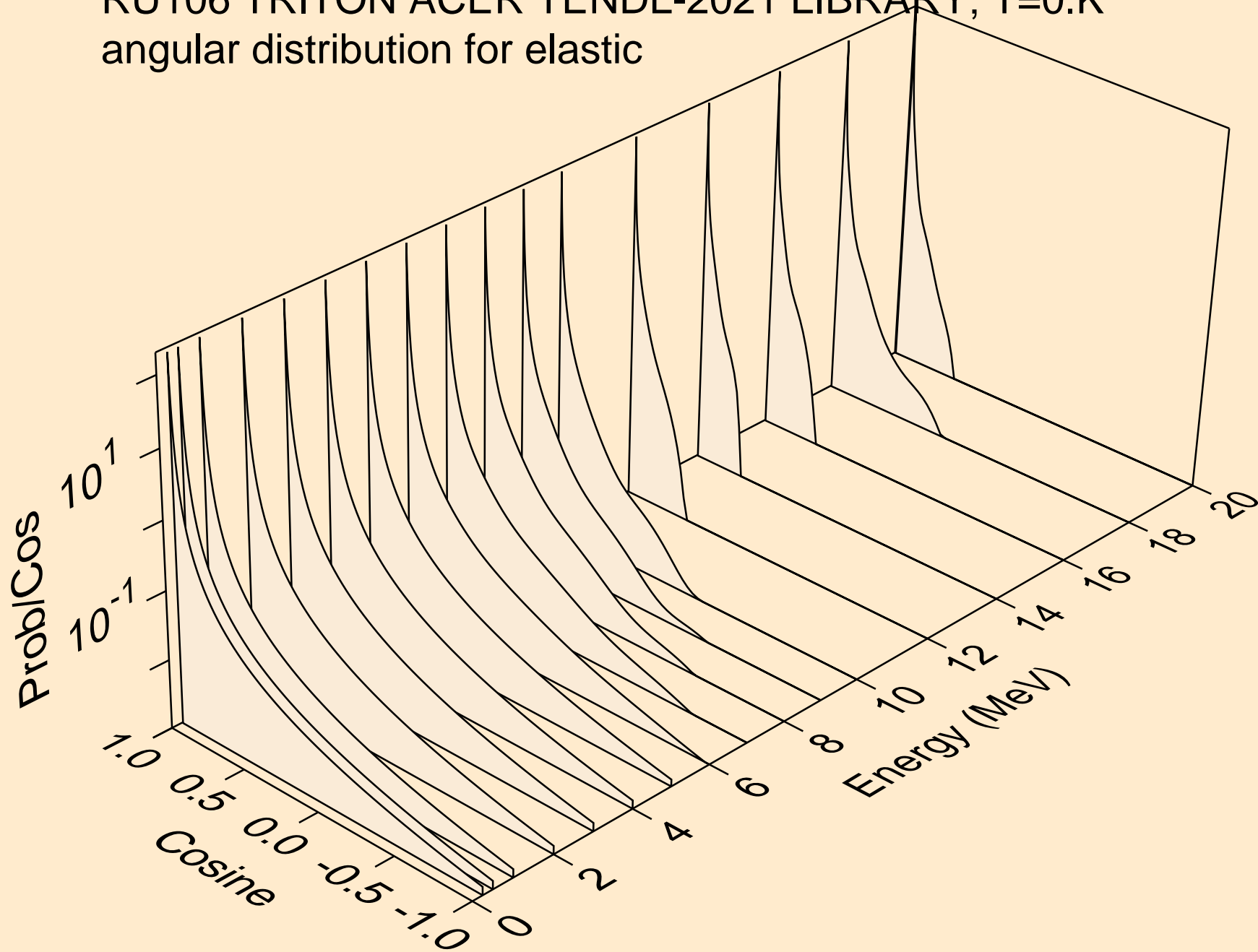



RU106 TRITON ACER TENDL-2021 LIBRARY; T=0.K  
angular distribution for elastic

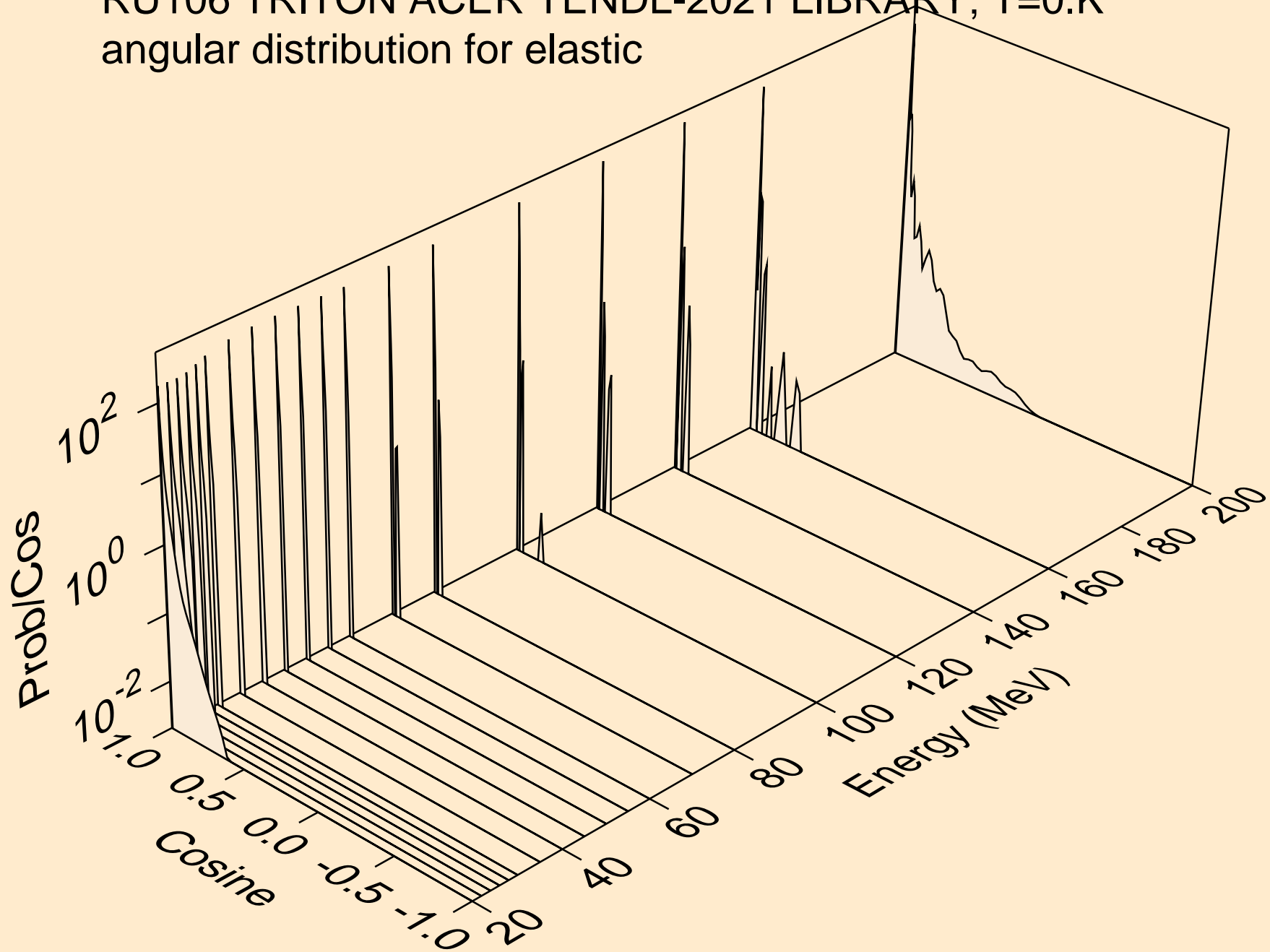

RU106 TRITON ACER TENDL-2021 LIBRARY; T=0.K  
Triton emission for (t,x)

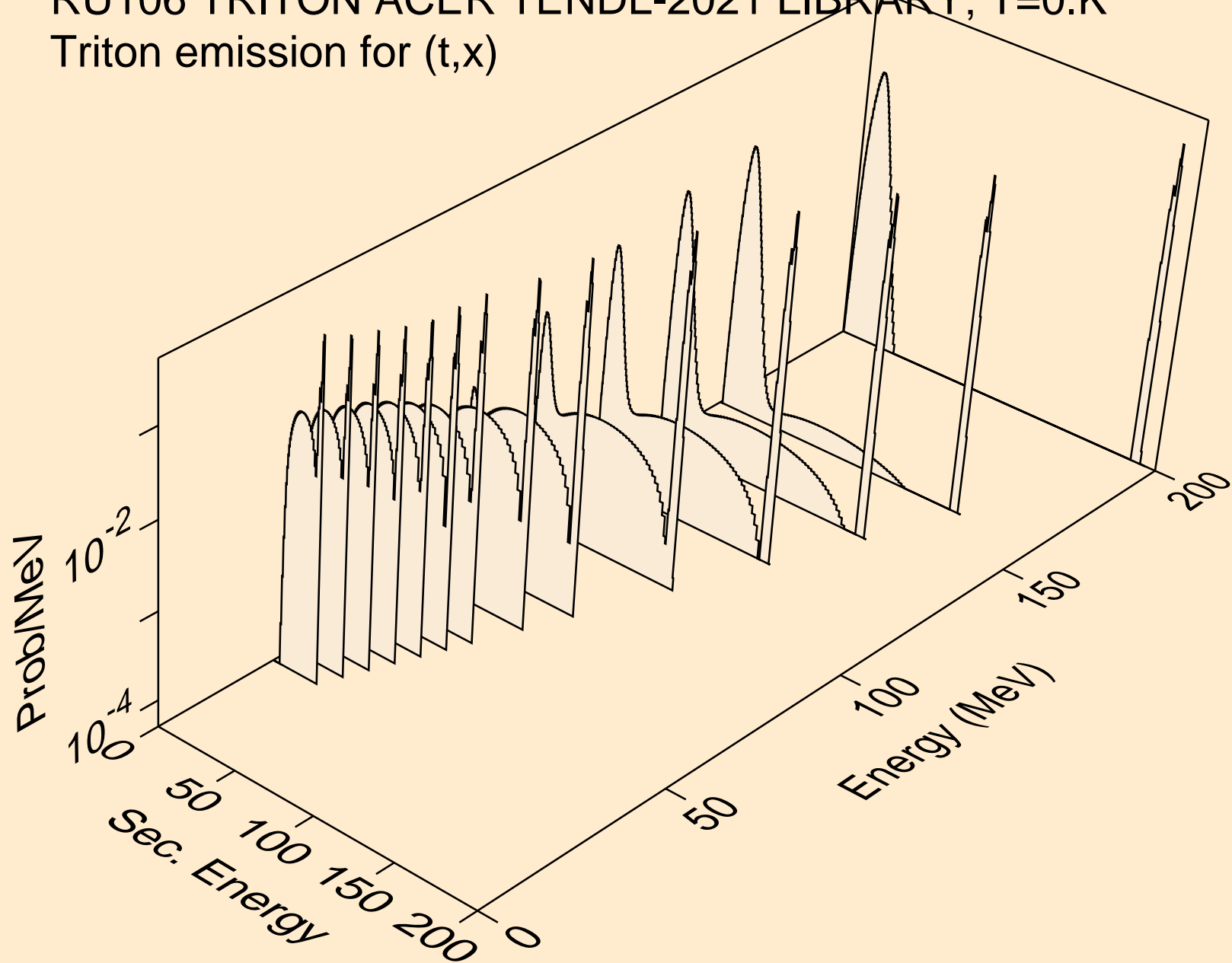

RU106 TRITON ACER TENDL-2021 LIBRARY; T=0.K  
Triton emission for (t,n\*)t

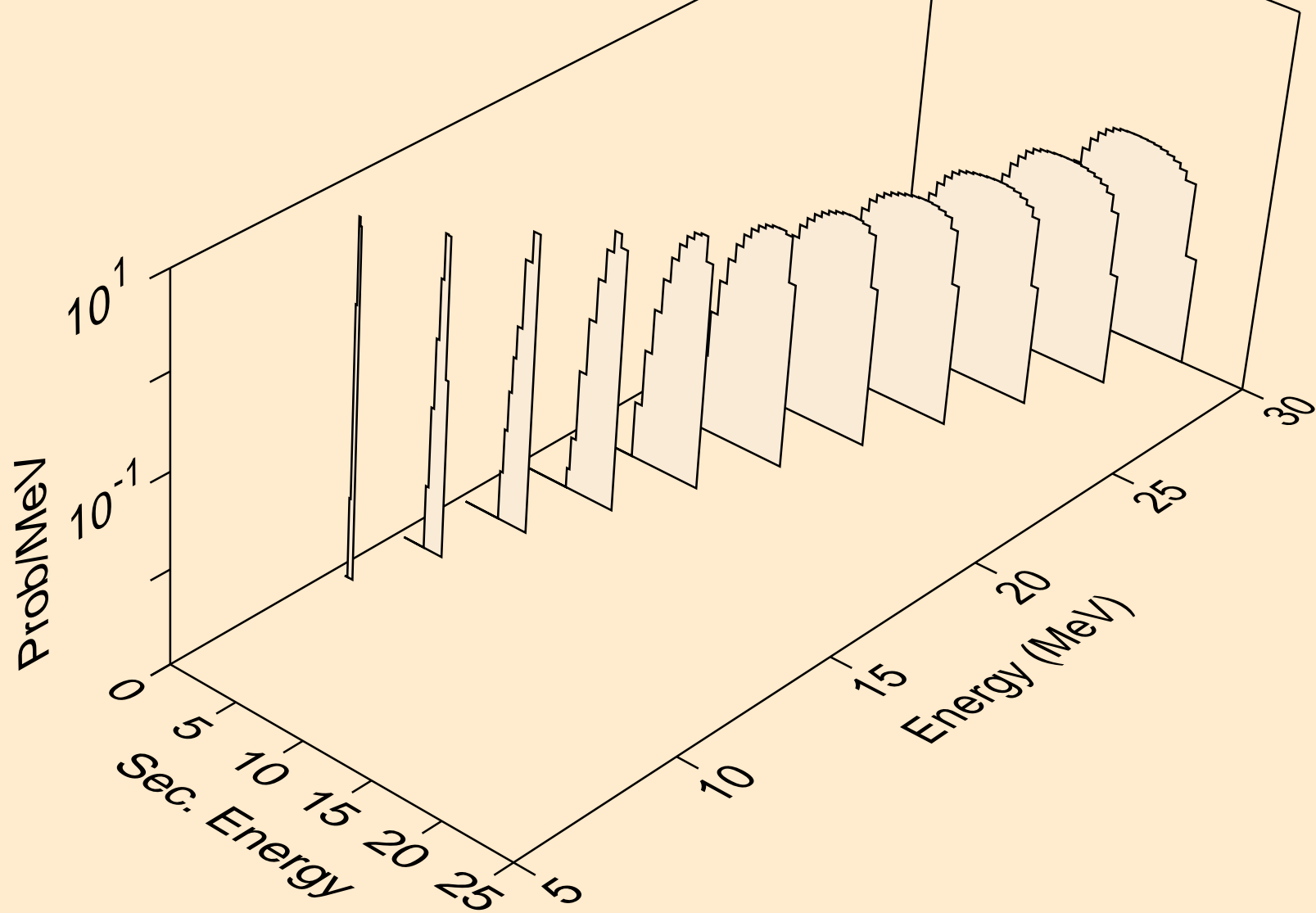

RU106 TRITON ACER TENDL-2021 LIBRARY; T=0.K  
Triton emission for inelastic

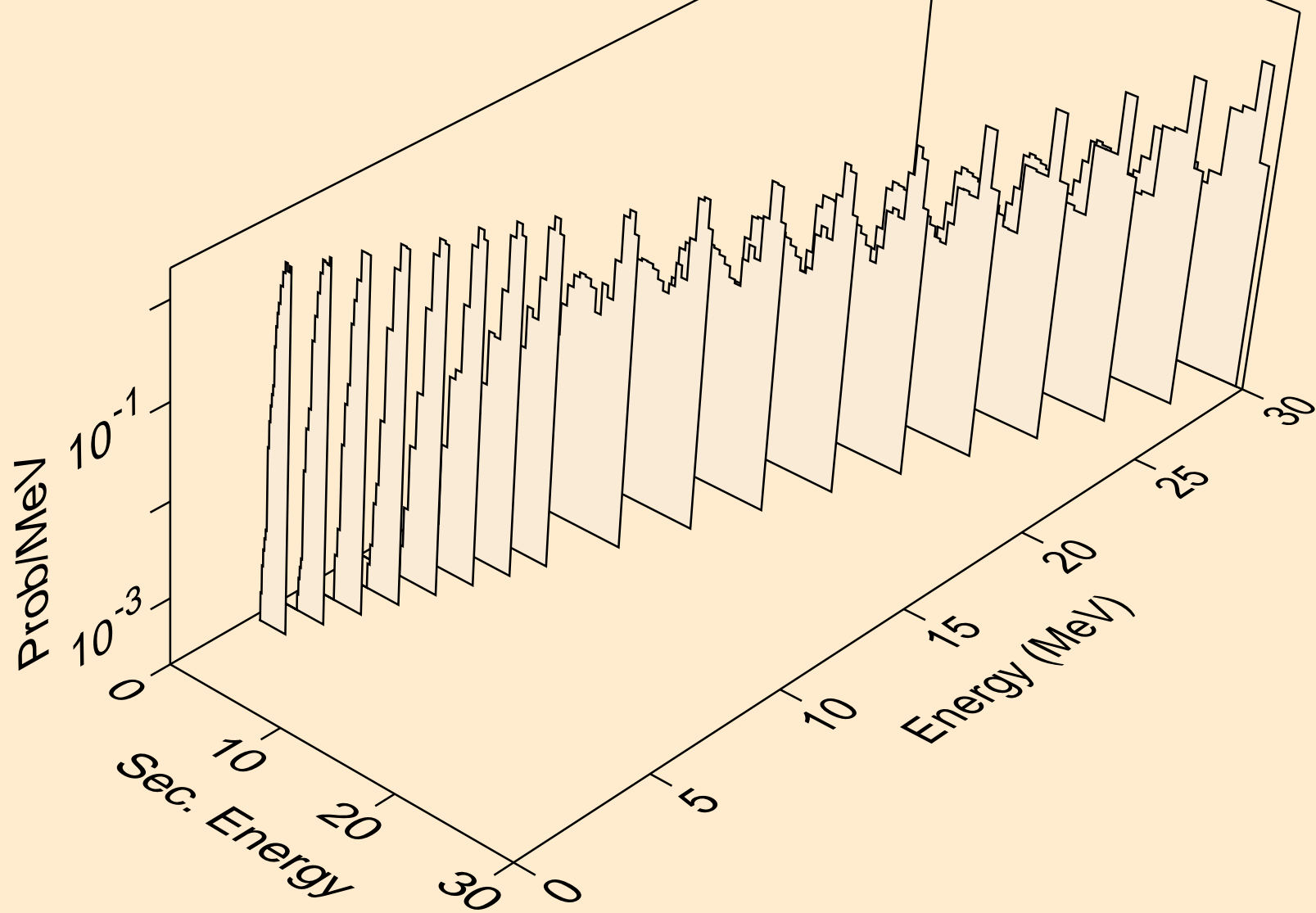

RU106 TRITON ACER TENDL-2021 LIBRARY; T=0.K  
Triton emission for (t,pt)

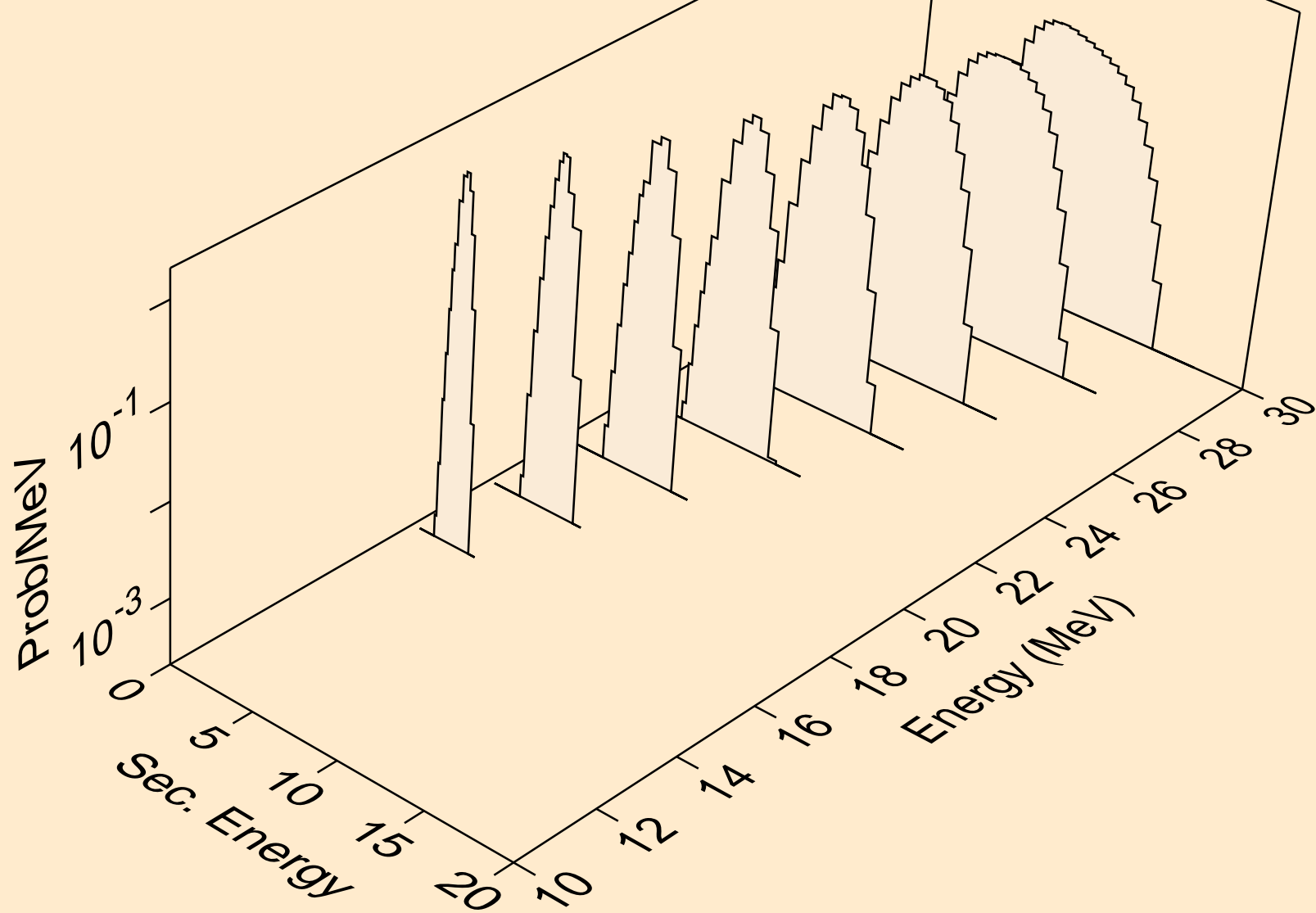

RU106 TRITON ACER TENDL-2021 LIBRARY; T=0.K  
Photon emission for (z,n)

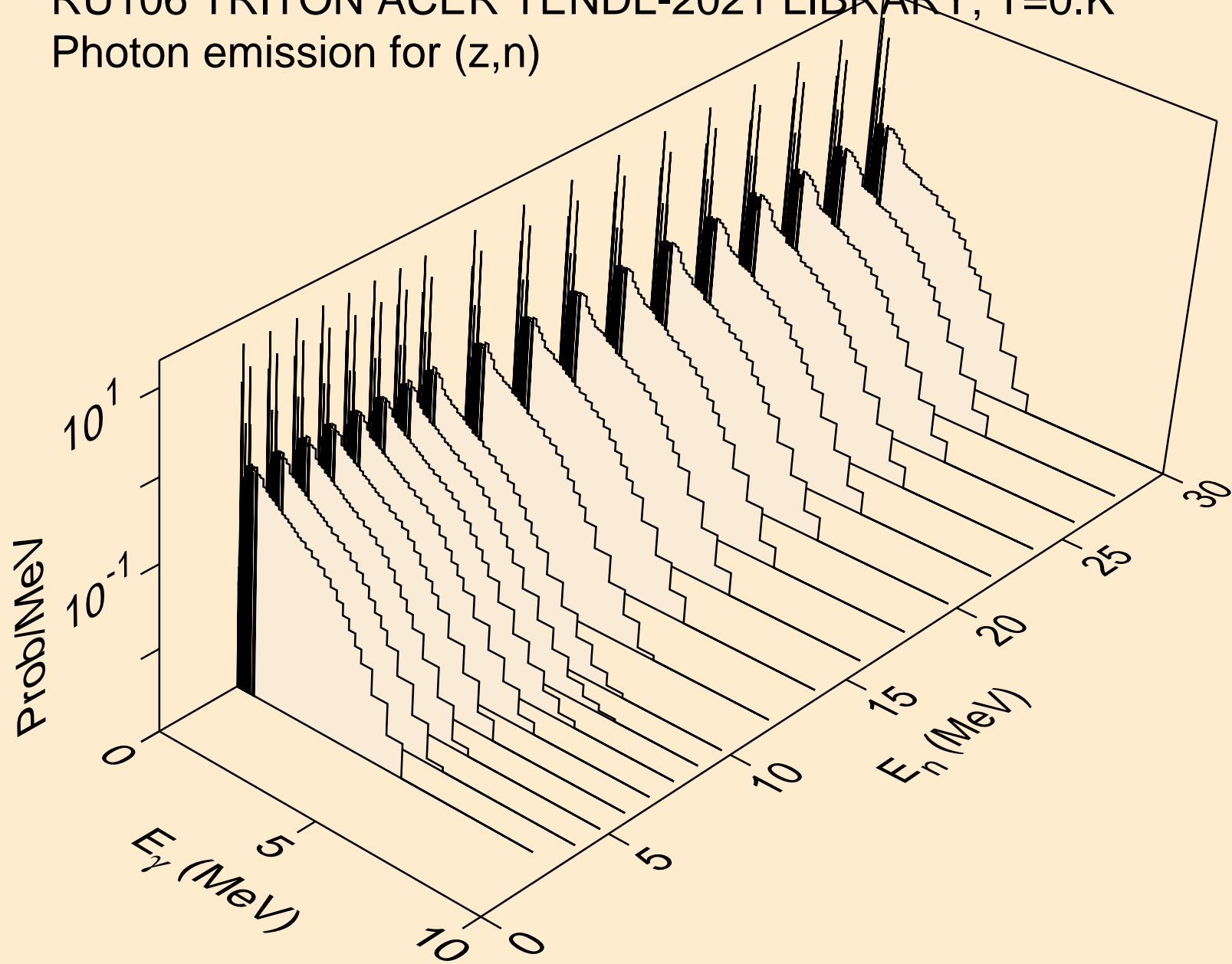

RU106 TRITON ACER TENDL-2021 LIBRARY; T=0.K  
Photon emission for (n,x)

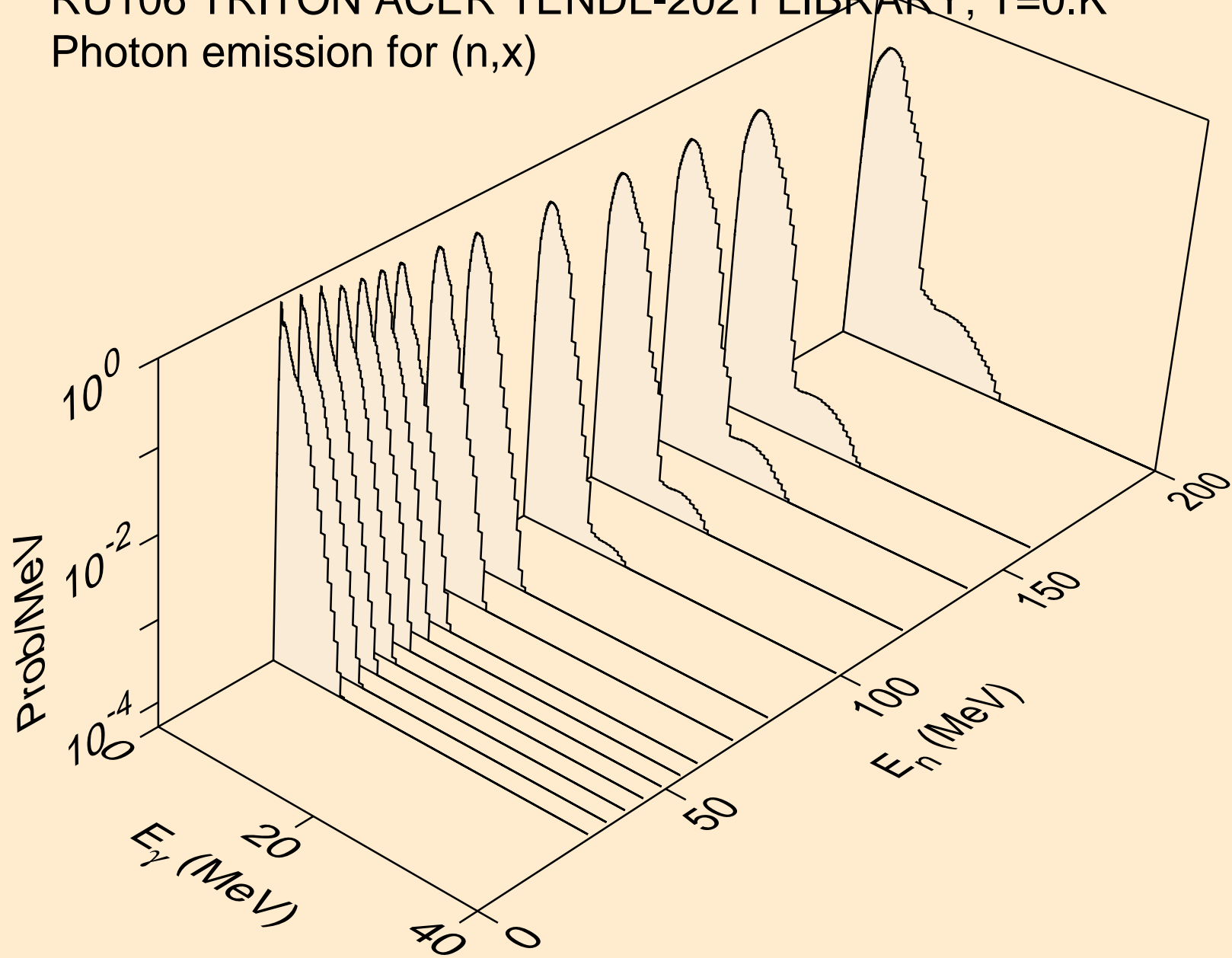

RU106 TRITON ACER TENDL-2021 LIBRARY; T=0.K  
Photon emission for (n,2nd)

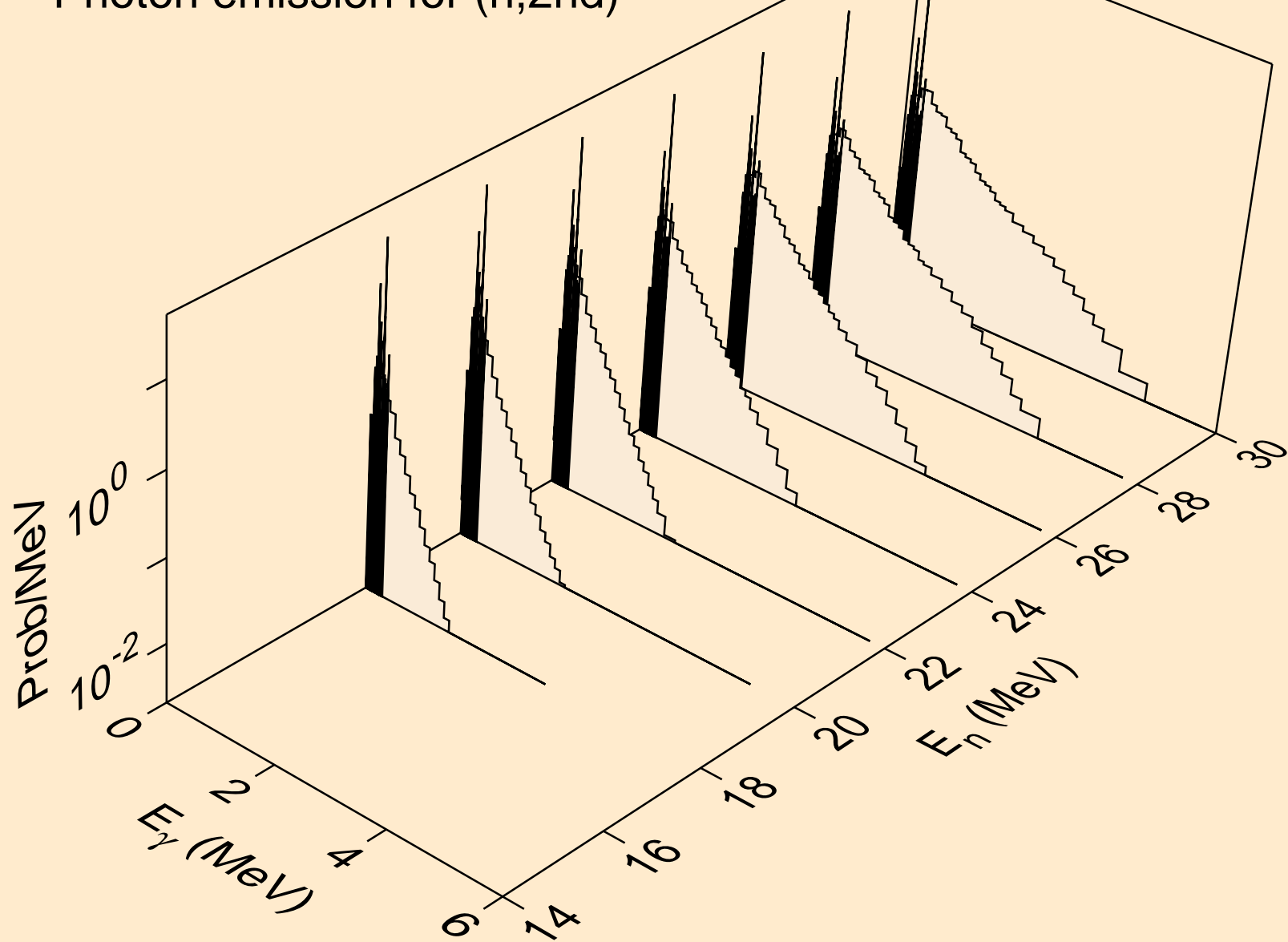



RU106 TRITON ACER TENDL-2021 LIBRARY; T=0.K  
Photon emission for (n,2n)

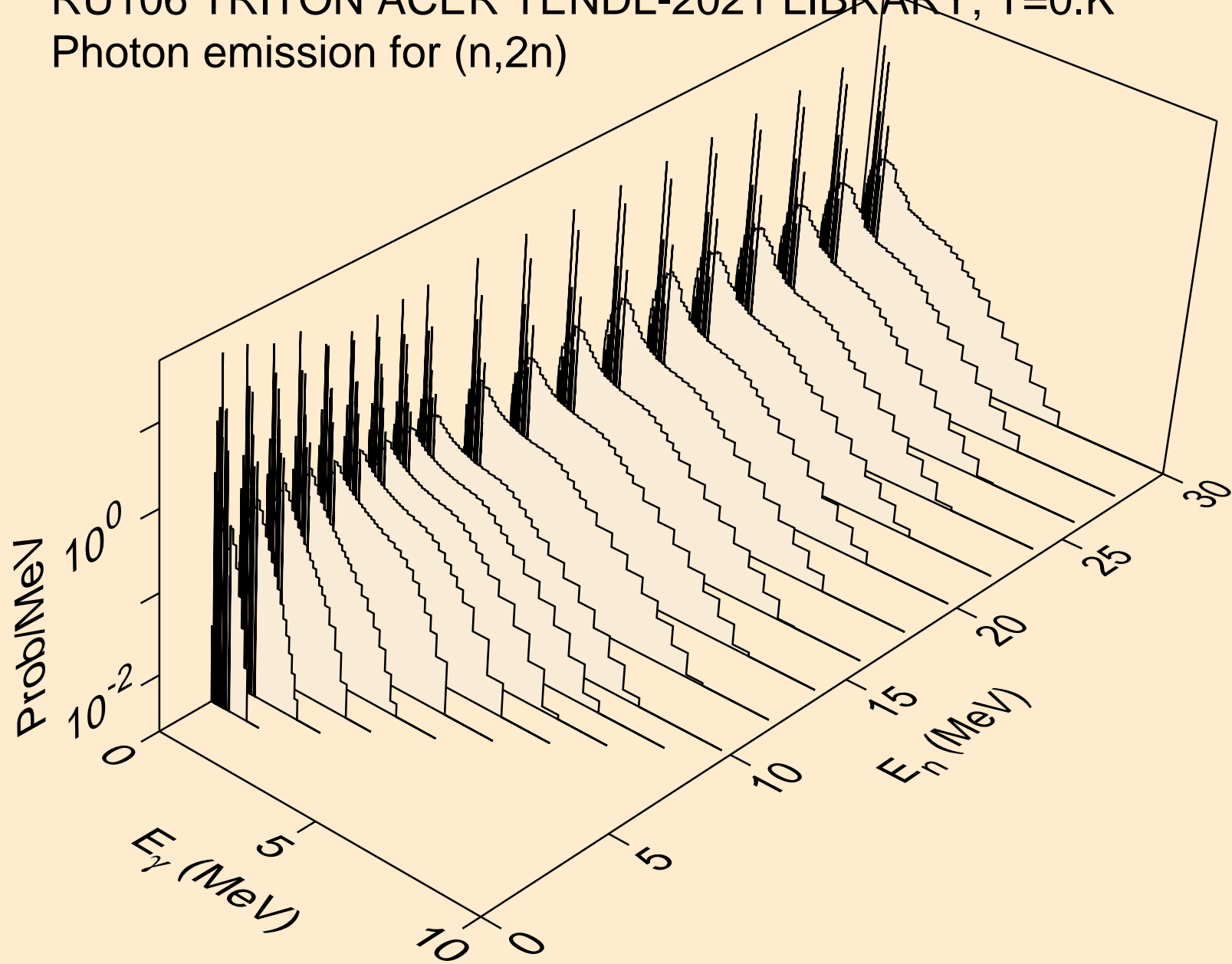

RU106 TRITON ACER TENDL-2021 LIBRARY; T=0.K  
Photon emission for (n,3n)

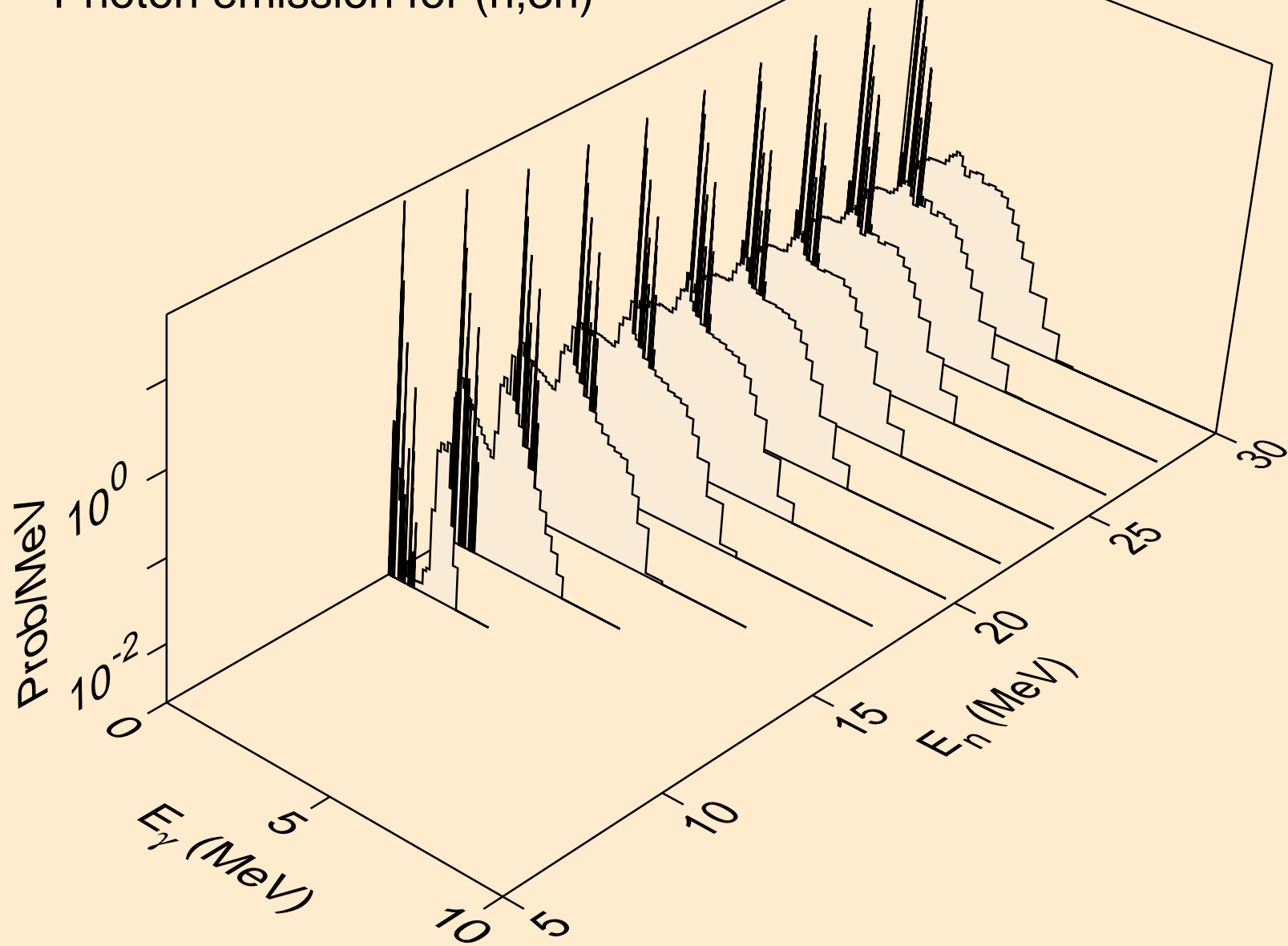

RU106 TRITON ACER TENDL-2021 LIBRARY; T=0.K  
Photon emission for (n,n\*)a

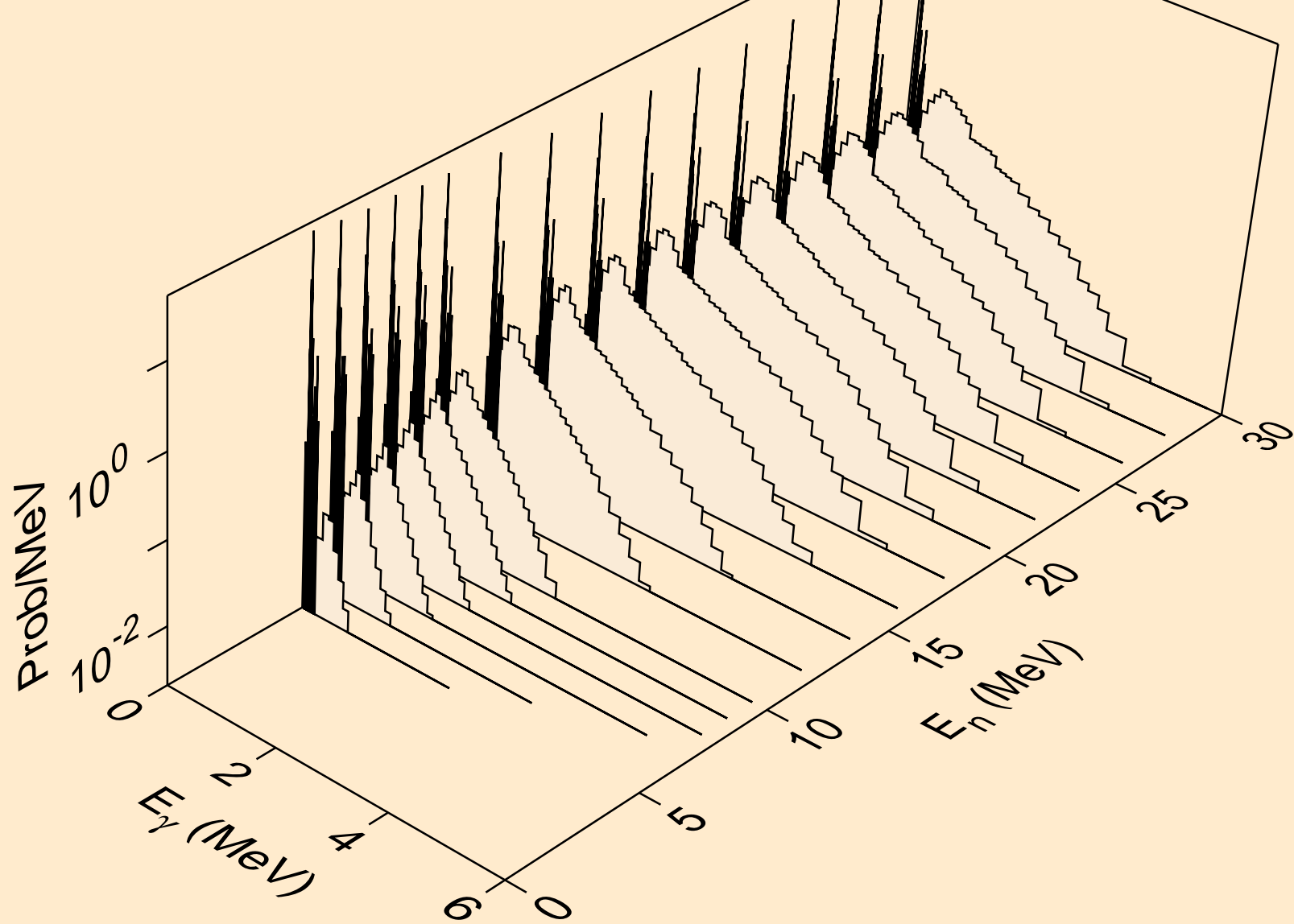

RU106 TRITON ACER TENDL-2021 LIBRARY; T=0.K  
Photon emission for (n,2n)a

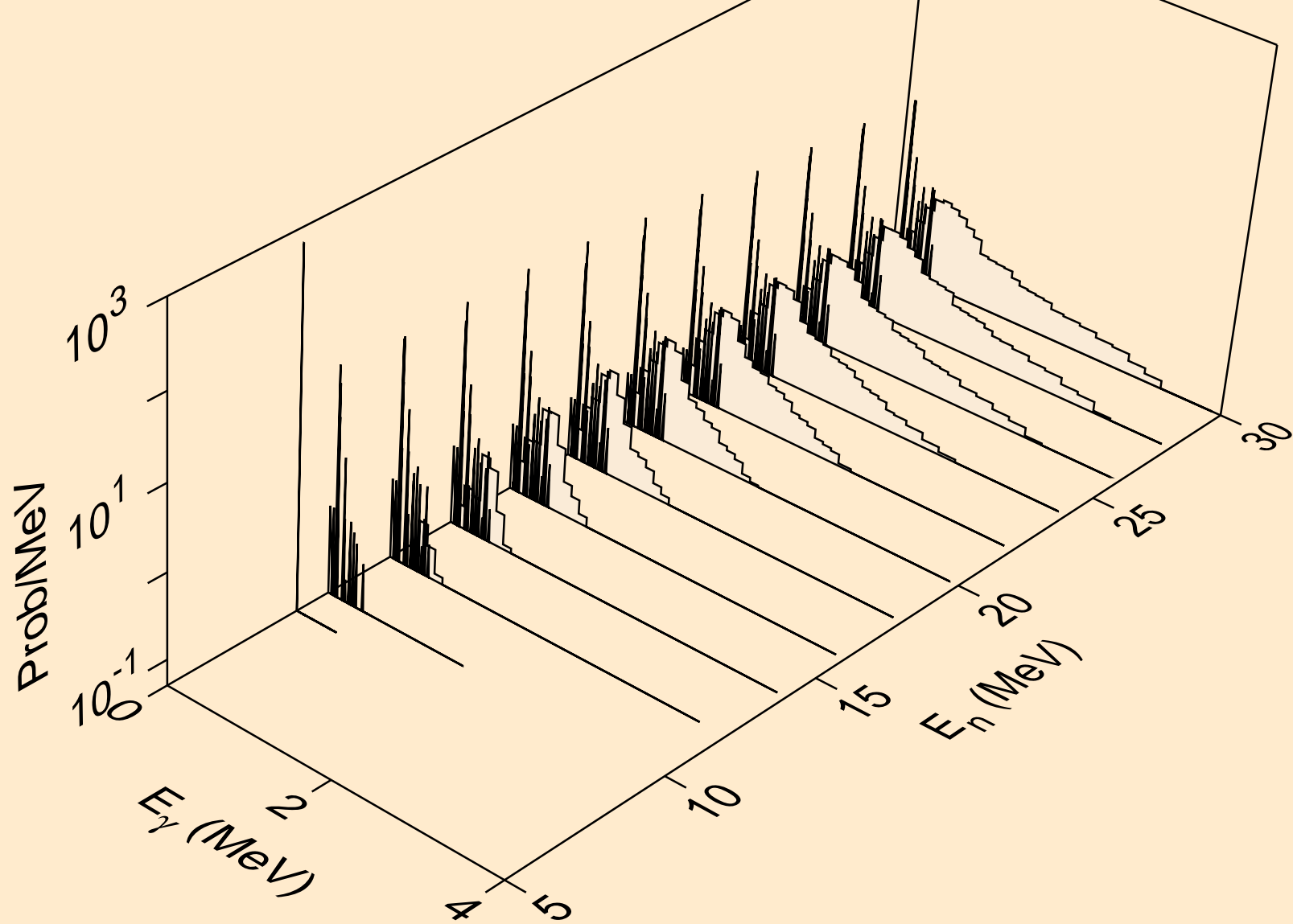

RU106 TRITON ACER TENDL-2021 LIBRARY; T=0.K  
Photon emission for (n,3n)a

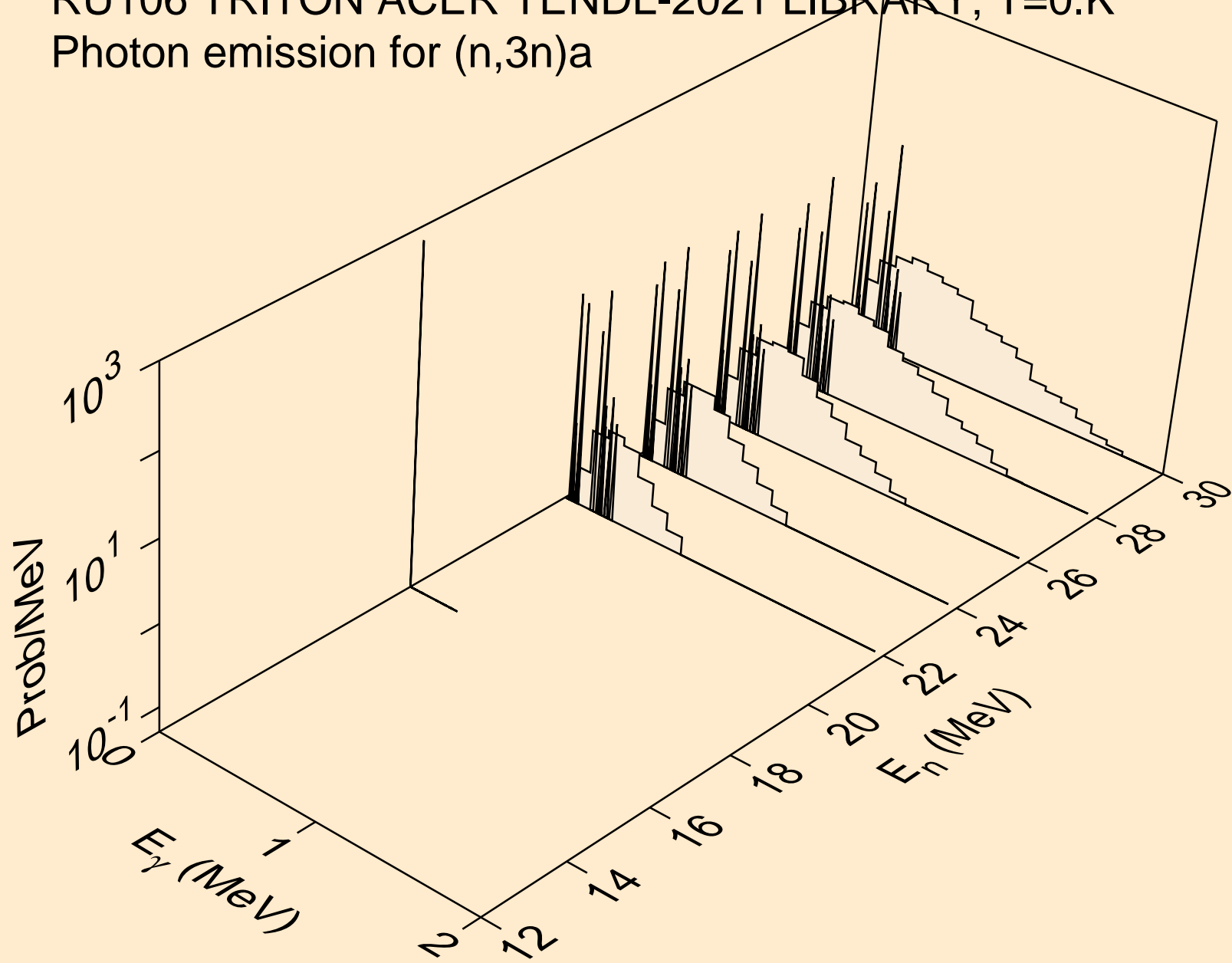

RU106 TRITON ACER TENDL-2021 LIBRARY; T=0.K  
Photon emission for (n,n\*)p

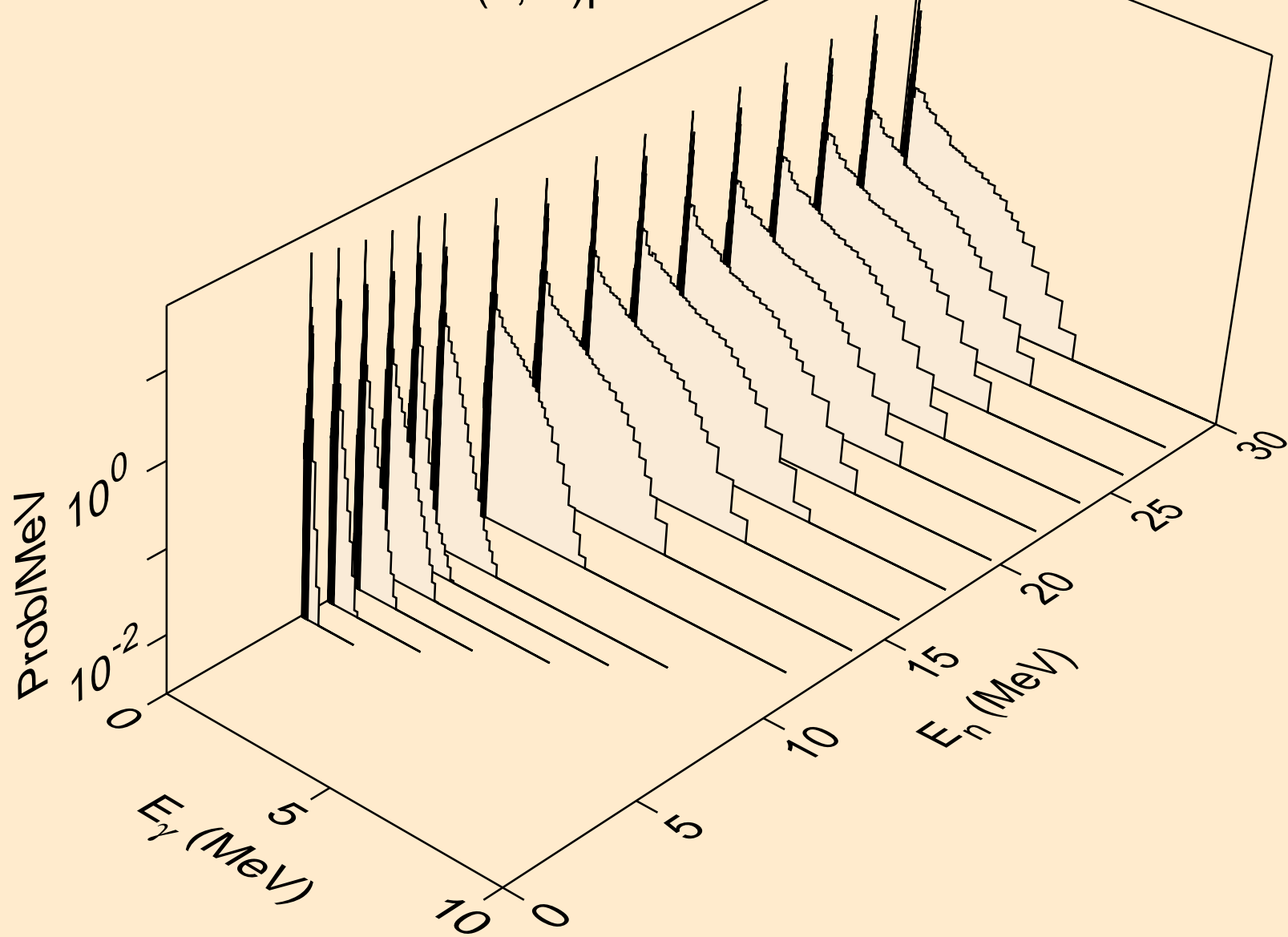

RU106 TRITON ACER TENDL-2021 LIBRARY; T=0.K  
Photon emission for (n,n\*)2a

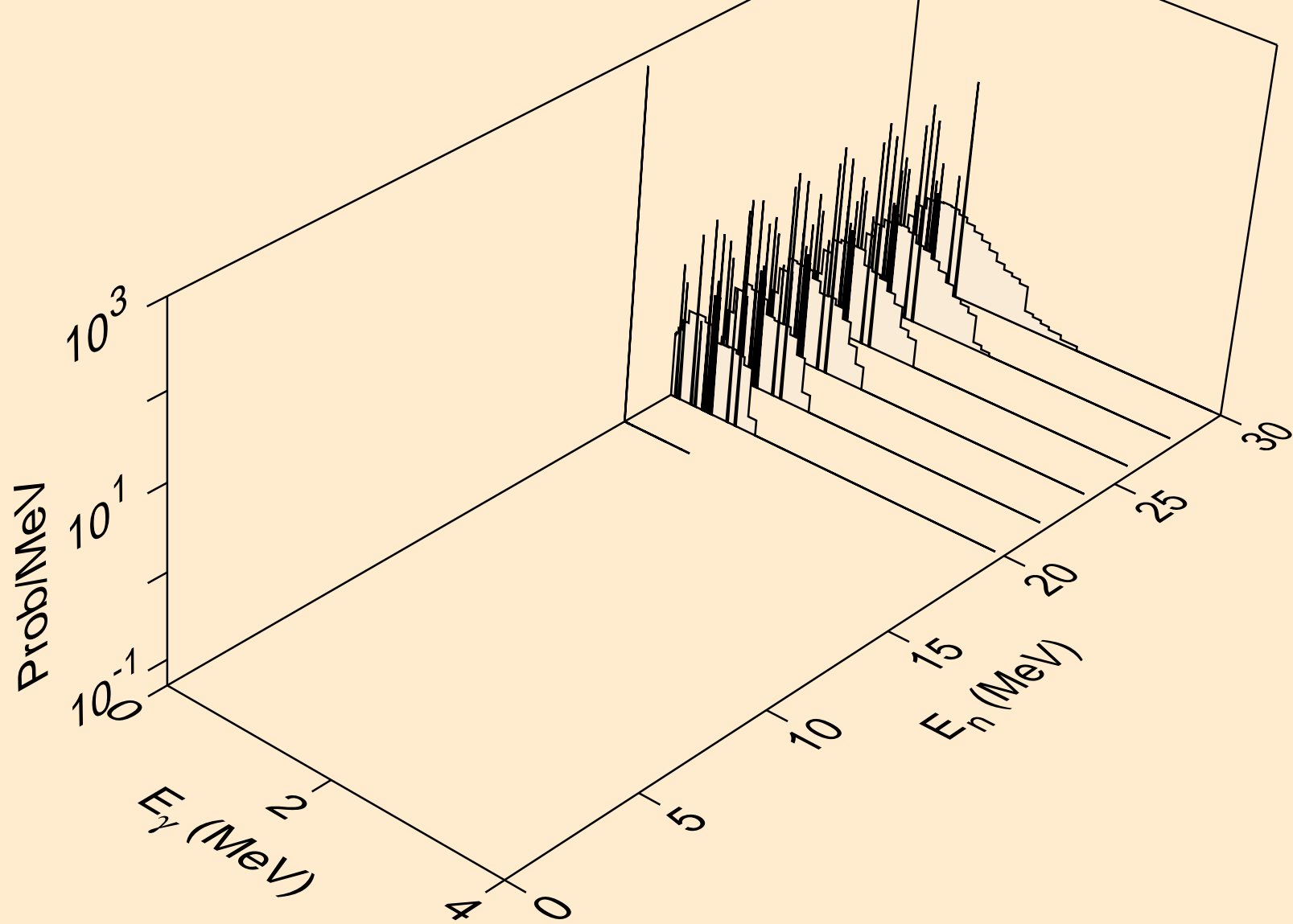

RU106 TRITON ACER TENDL-2021 LIBRARY; T=0.K  
Photon emission for (n,n\*)d

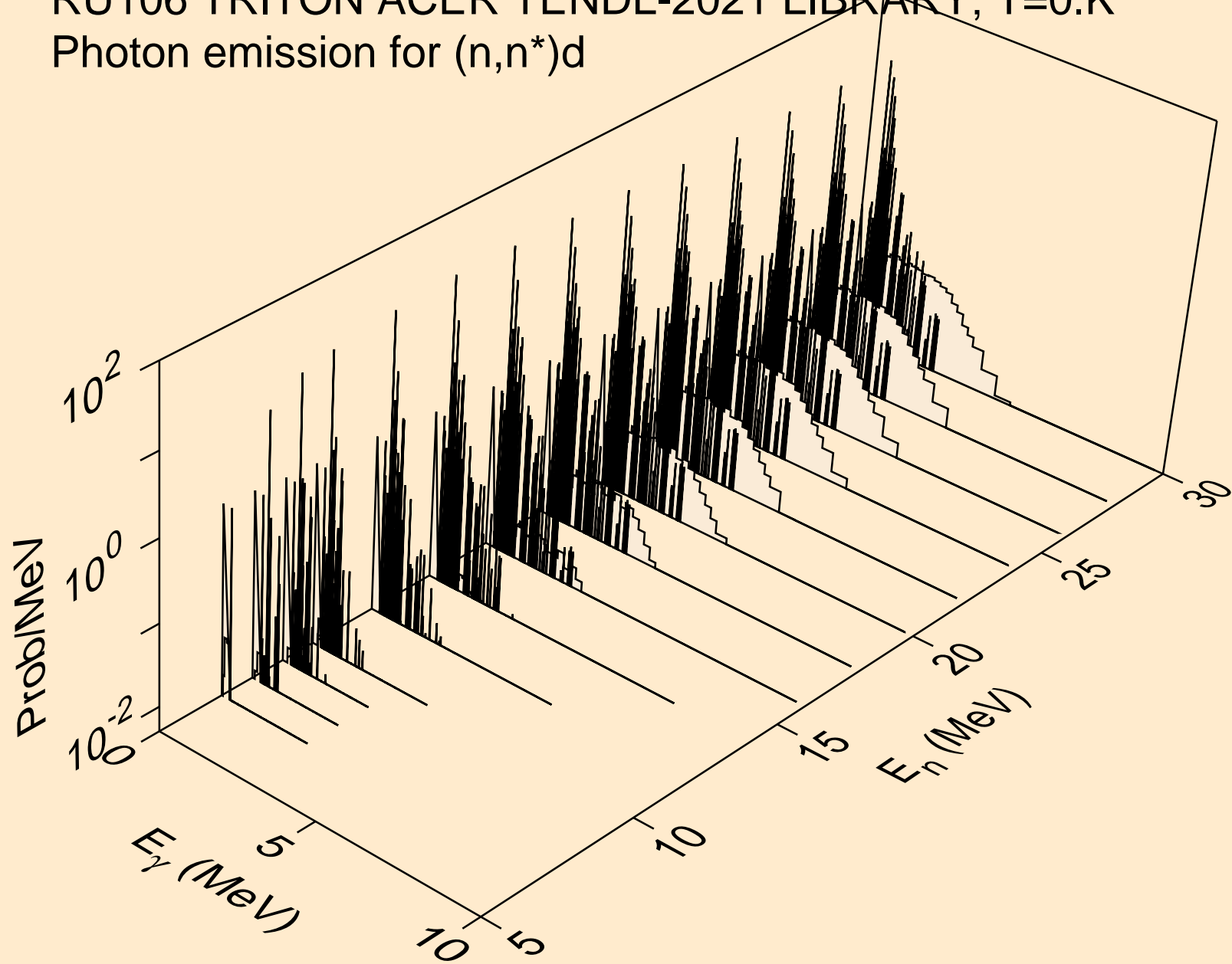



RU106 TRITON ACER TENDL-2021 LIBRARY; T=0.K  
Photon emission for (n,n\*)t

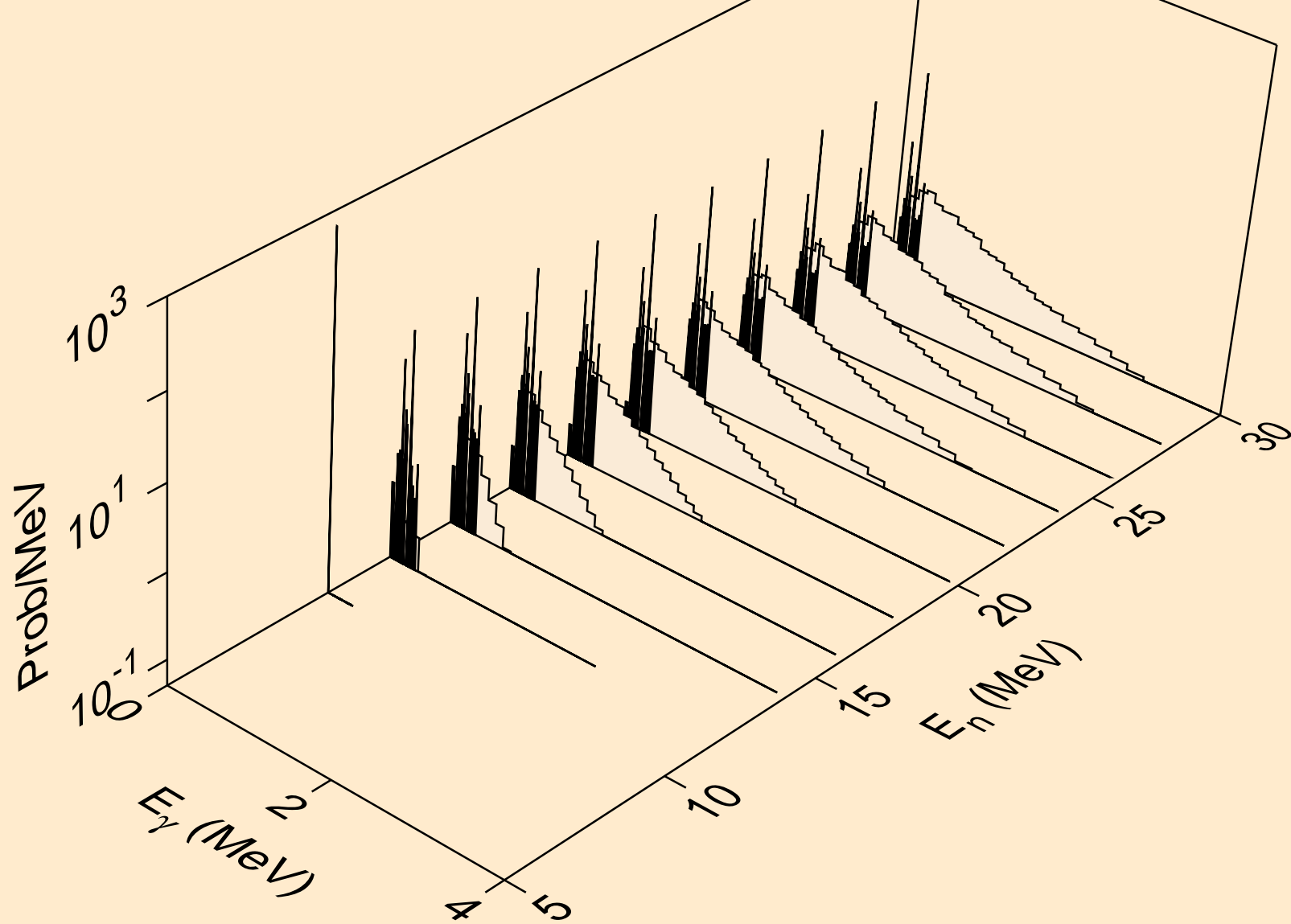

RU106 TRITON ACER TENDL-2021 LIBRARY; T=0.K  
Photon emission for (n,n\*)he3

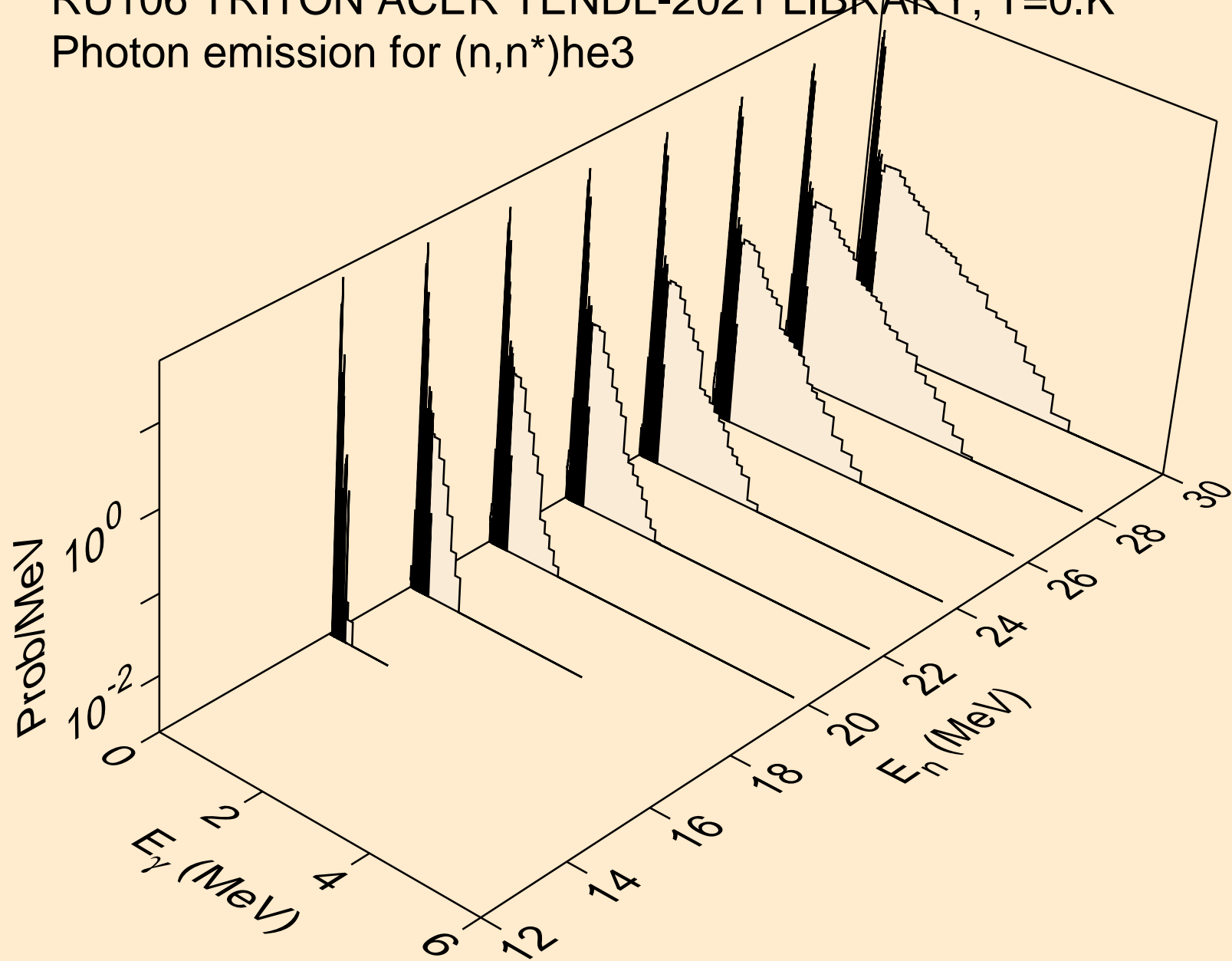

RU106 TRITON ACER TENDL-2021 LIBRARY; T=0.K  
Photon emission for (n,4n)

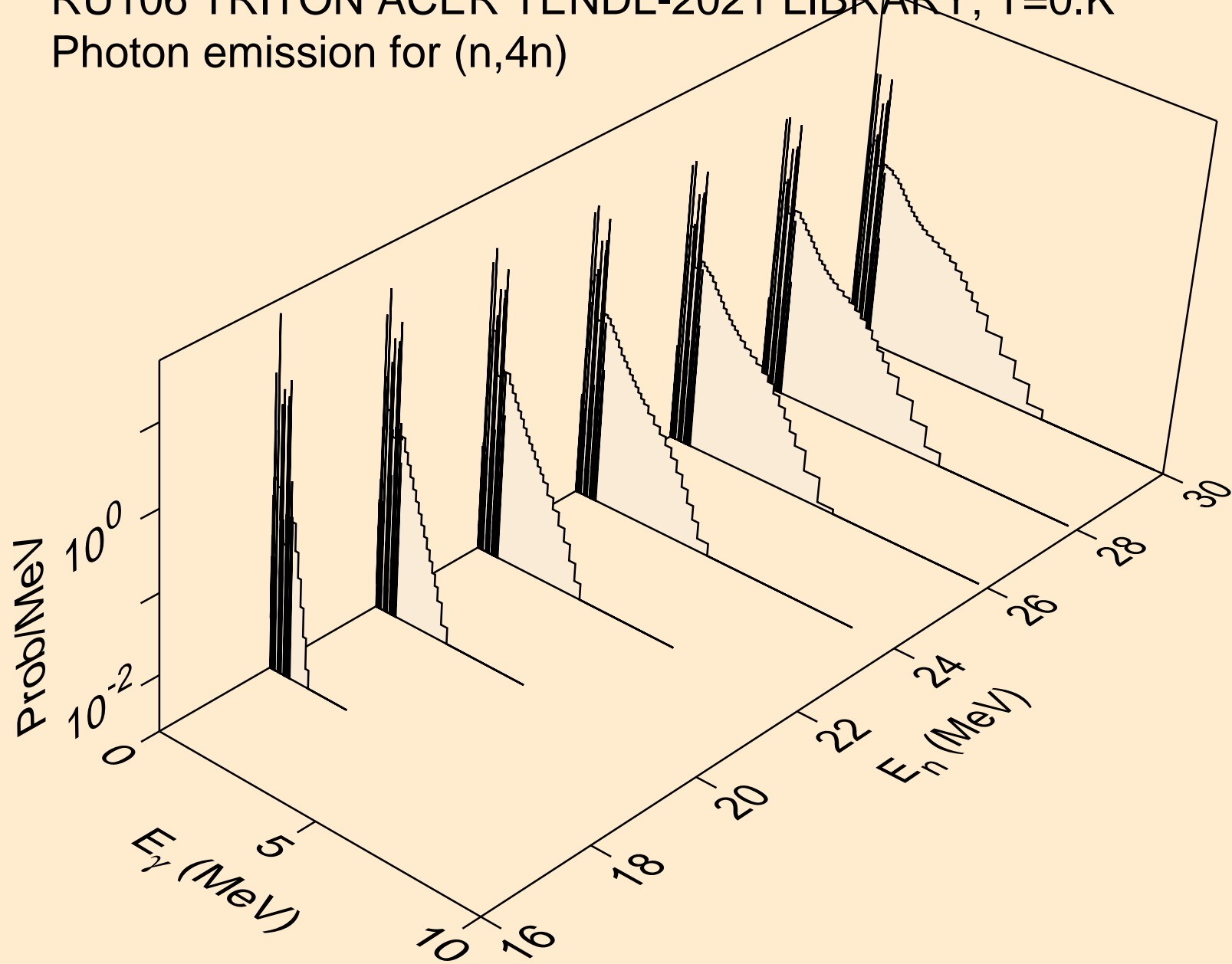

RU106 TRITON ACER TENDL-2021 LIBRARY; T=0.K  
Photon emission for (n,2np)

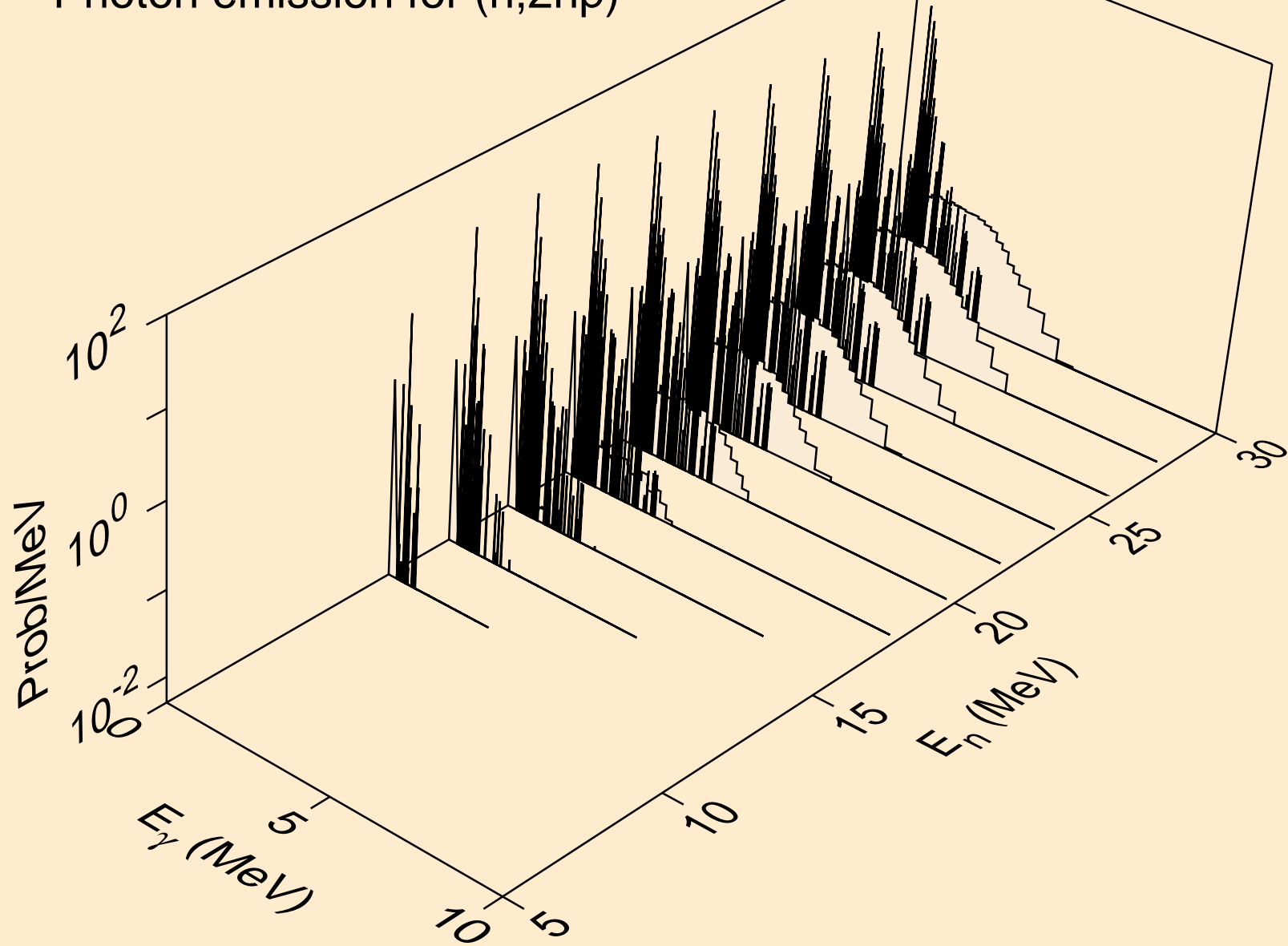

RU106 TRITON ACER TENDL-2021 LIBRARY; T=0.K  
Photon emission for (n,3np)

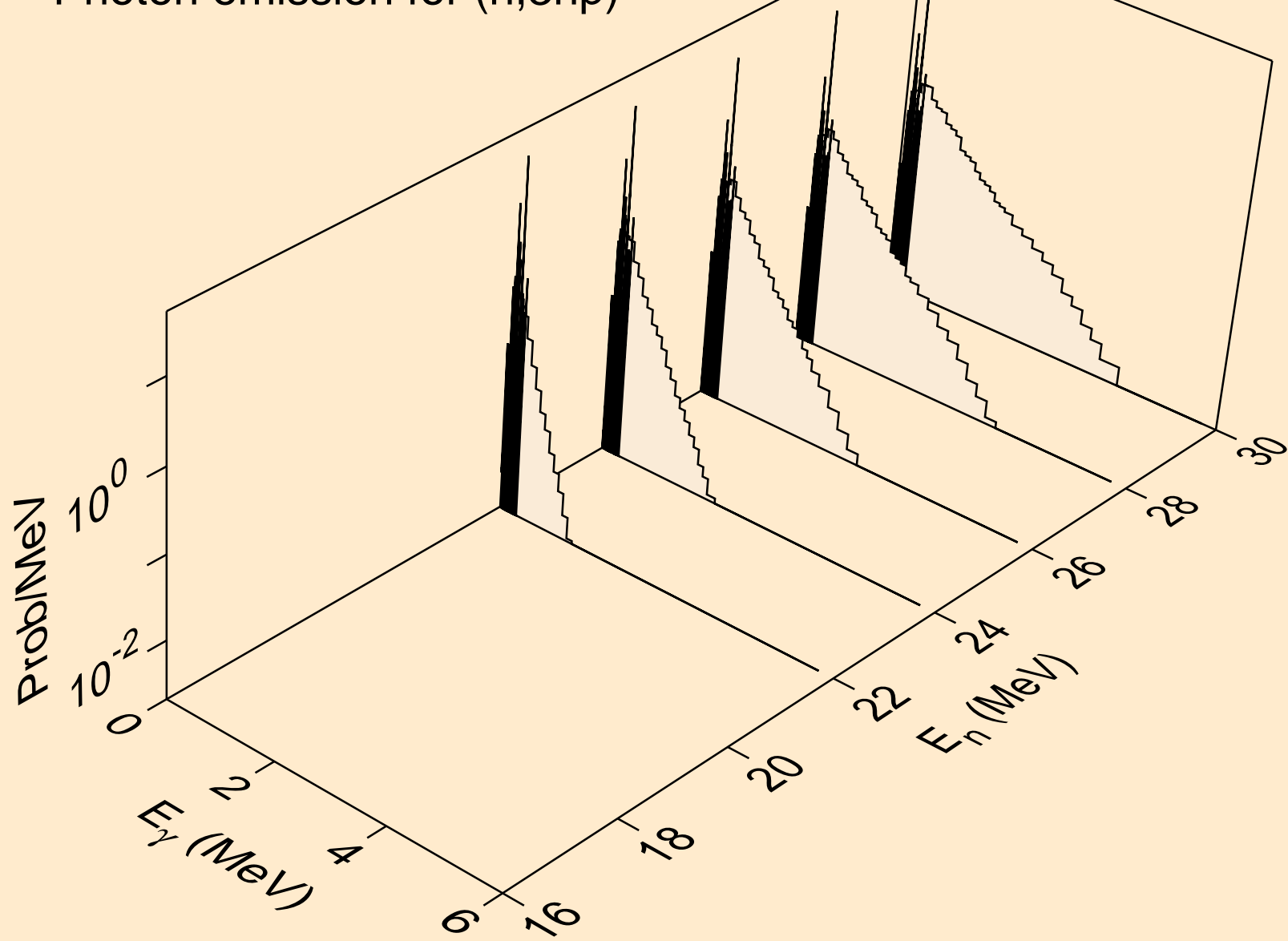

RU106 TRITON ACER TENDL-2021 LIBRARY; T=0.K  
Photon emission for (n,2np)

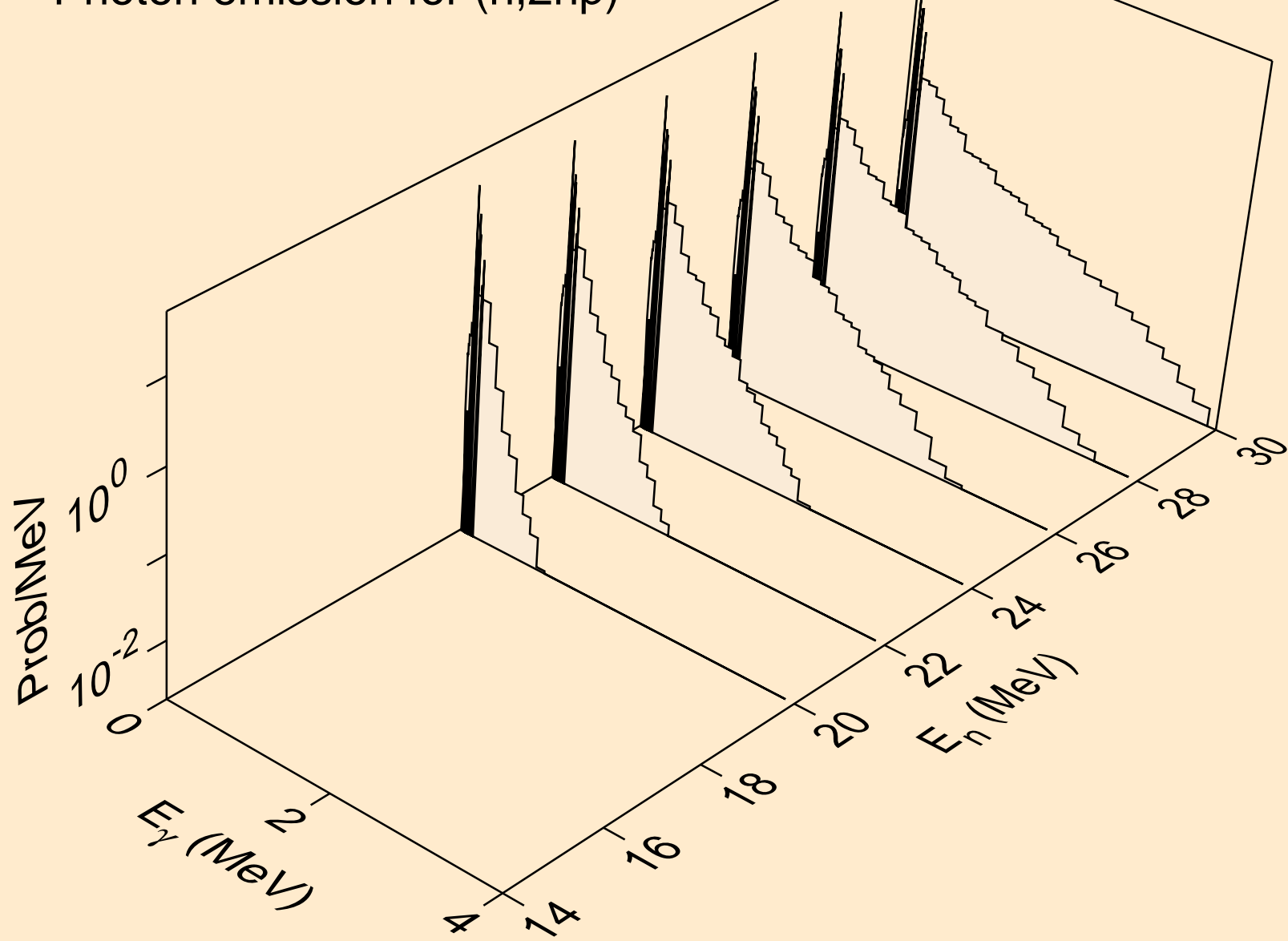

RU106 TRITON ACER TENDL-2021 LIBRARY; T=0.K  
Photon emission for (n,npa)

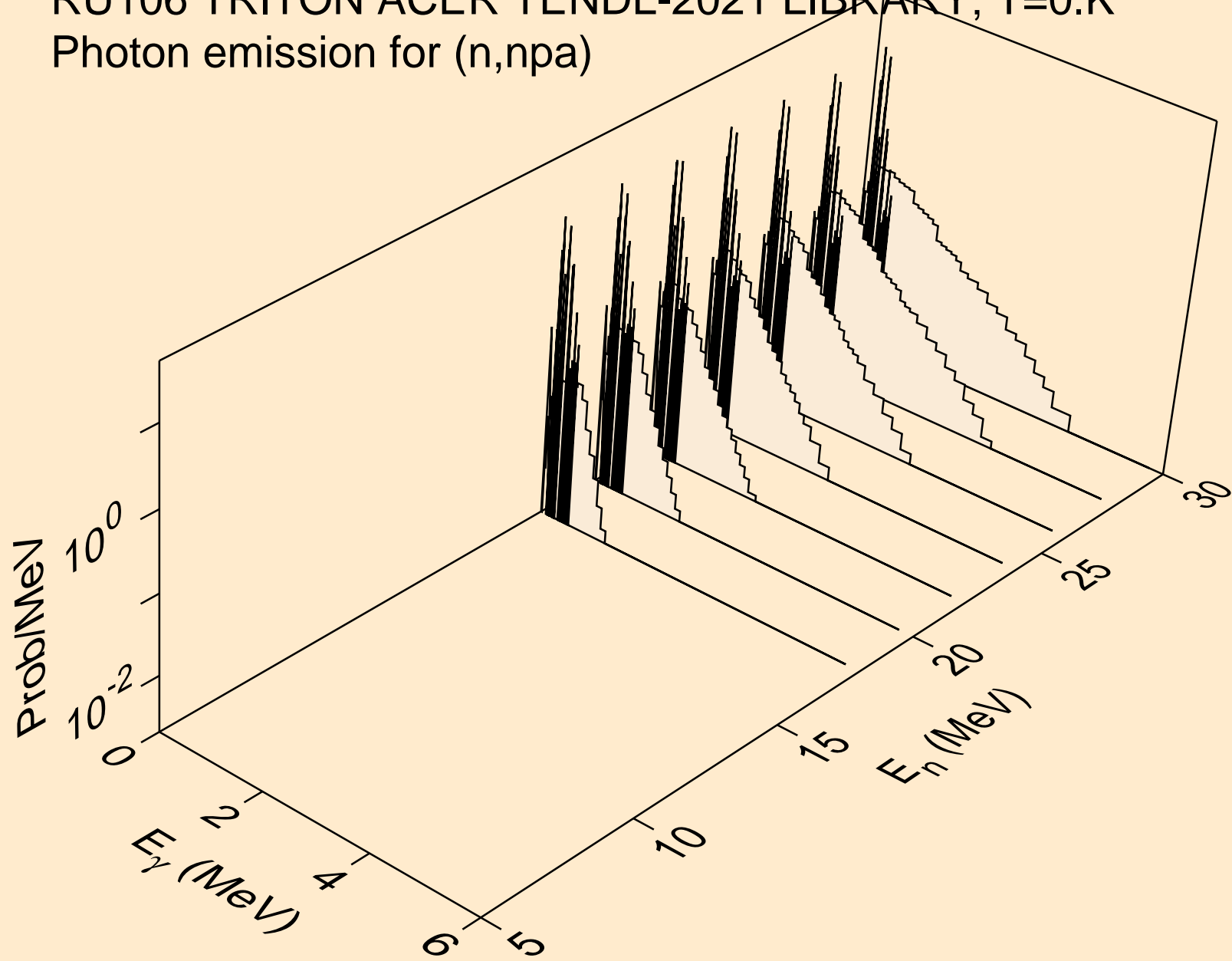

RU106 TRITON ACER TENDL-2021 LIBRARY; T=0.K  
Photon emission for (n,gma)

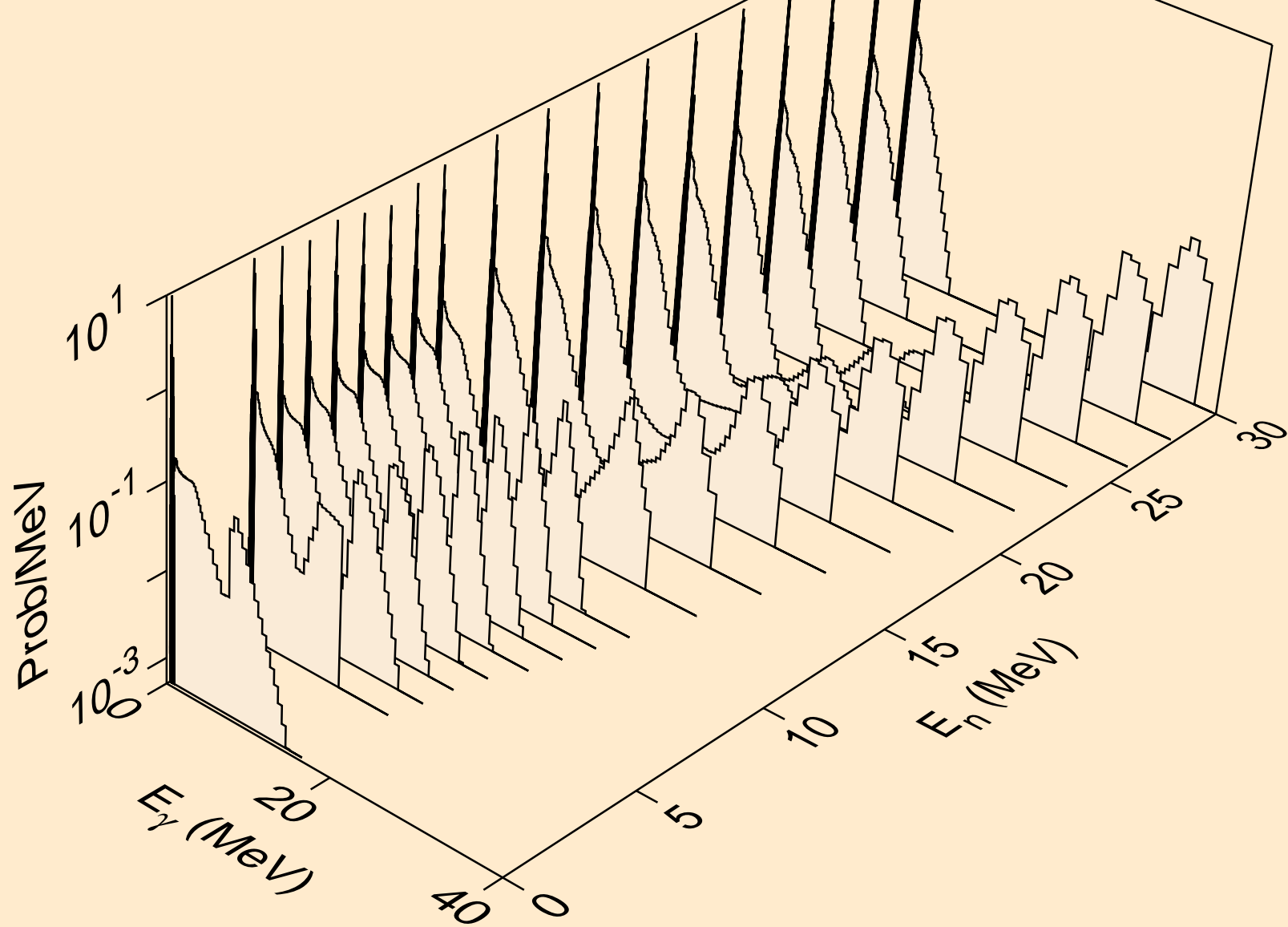



RU106 TRITON ACER TENDL-2021 LIBRARY; T=0.K  
Photon emission for (n,p)

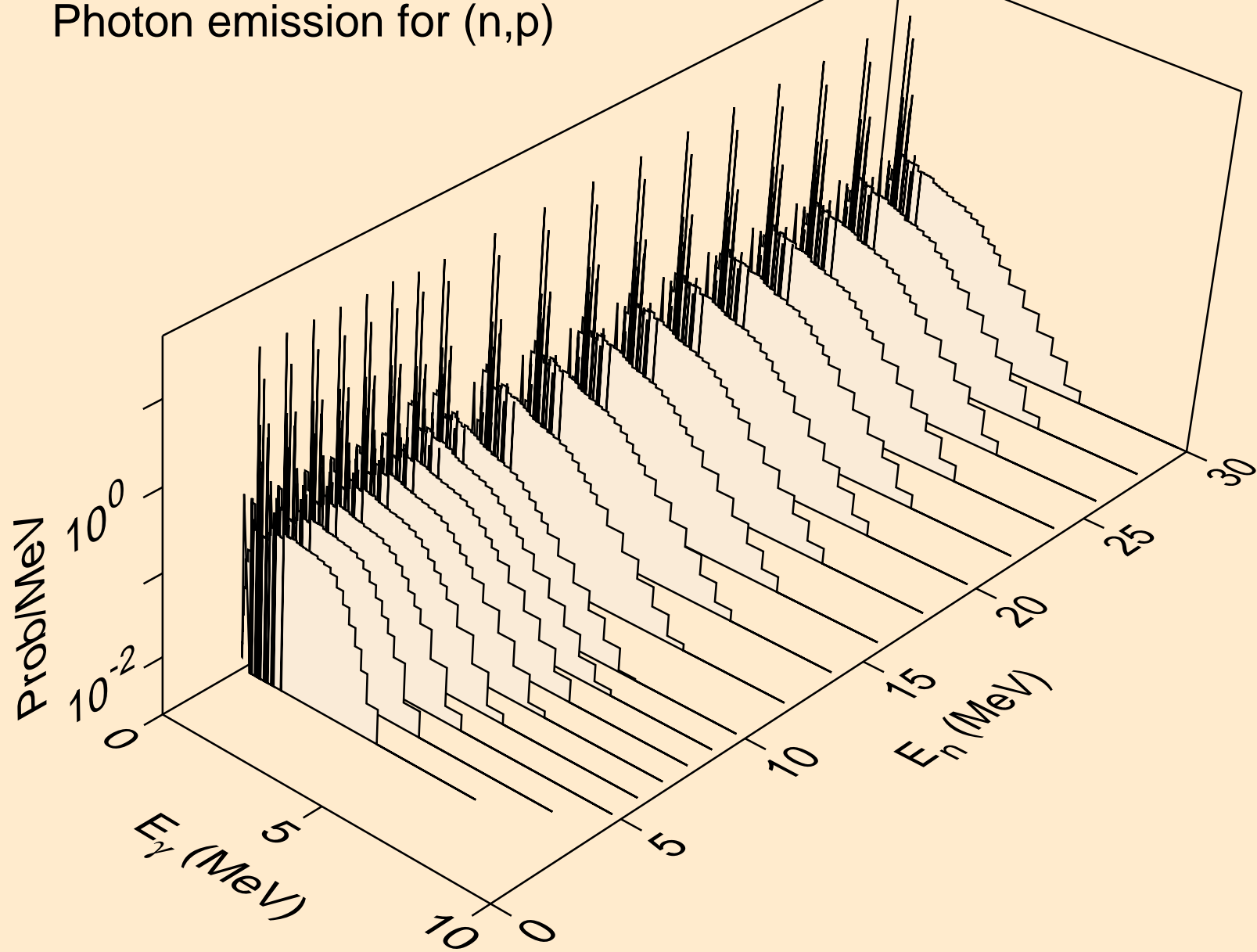

RU106 TRITON ACER TENDL-2021 LIBRARY; T=0.K  
Photon emission for (n,d)

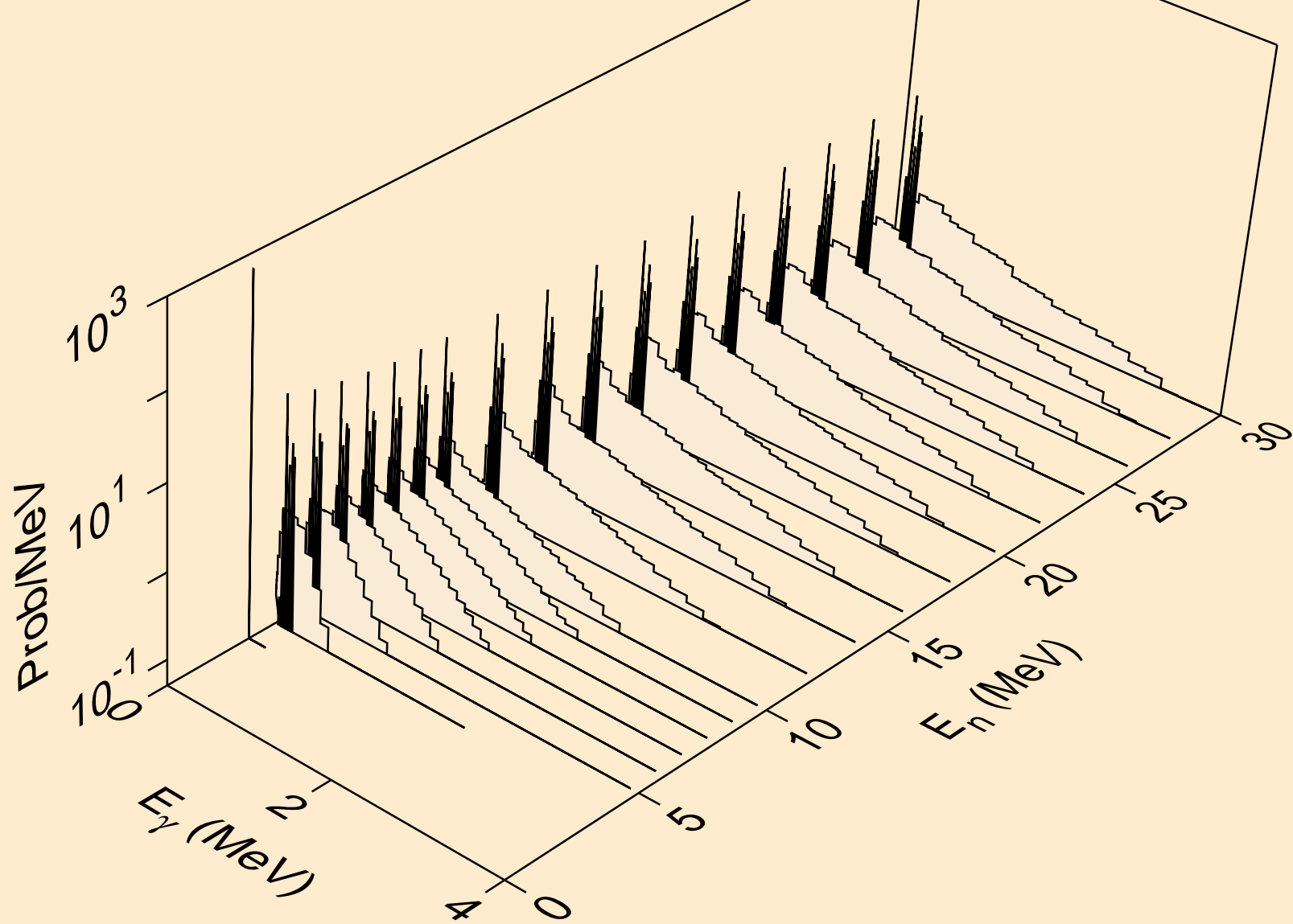

RU106 TRITON ACER TENDL-2021 LIBRARY; T=0.K  
Photon emission for inelastic

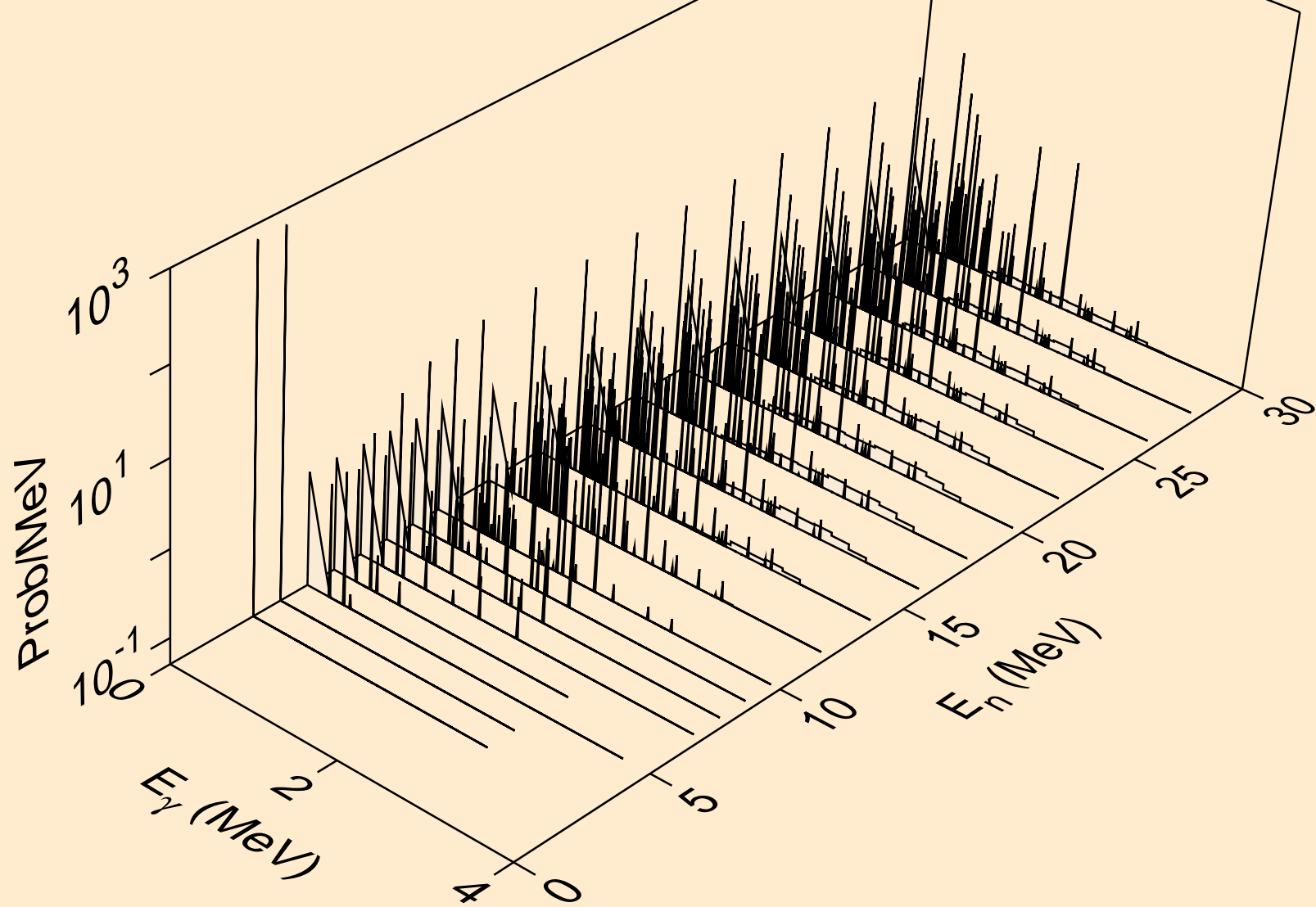

RU106 TRITON ACER TENDL-2021 LIBRARY; T=0.K  
Photon emission for (n,he3)

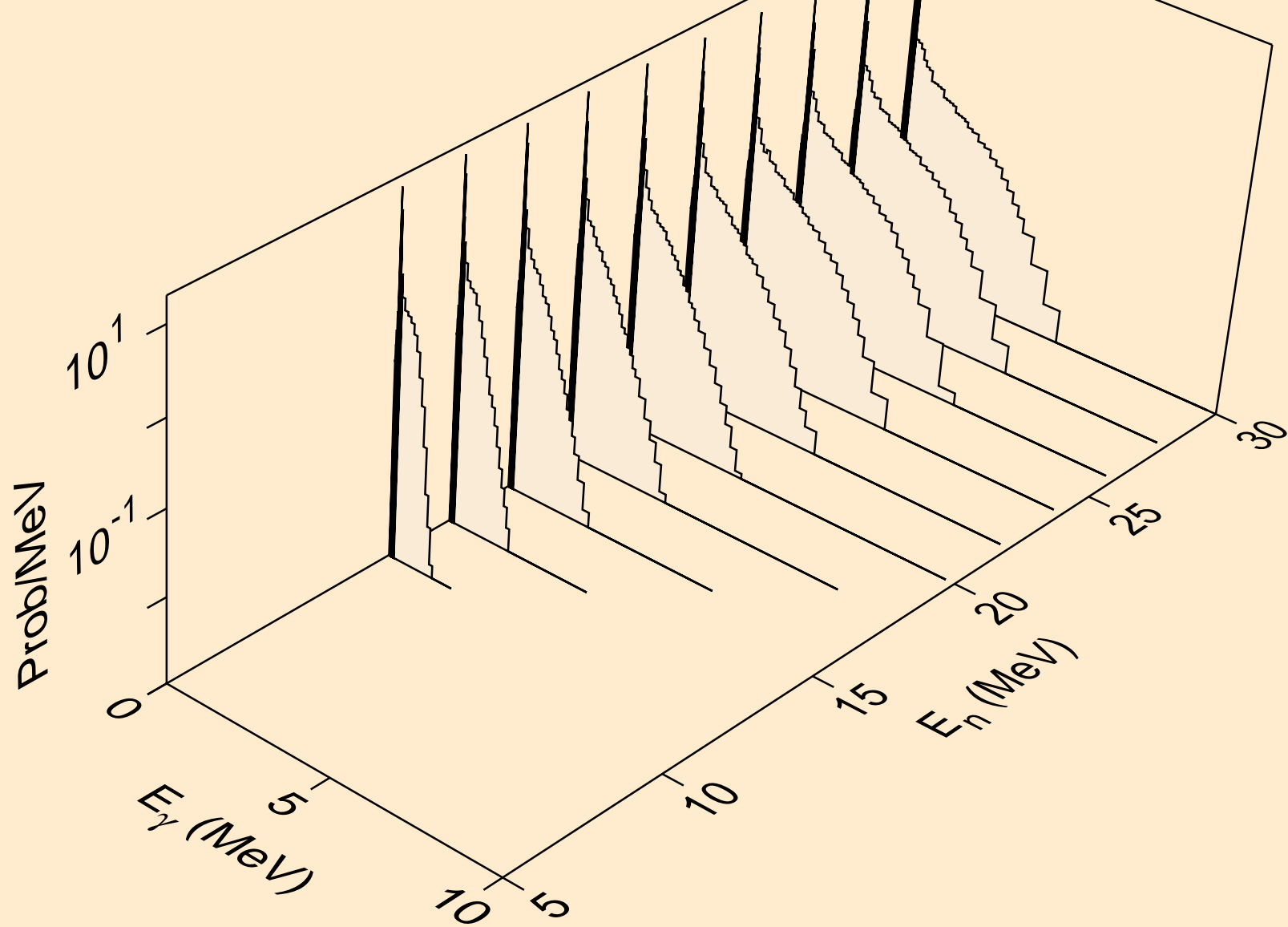

RU106 TRITON ACER TENDL-2021 LIBRARY; T=0.K  
Photon emission for (n,a)

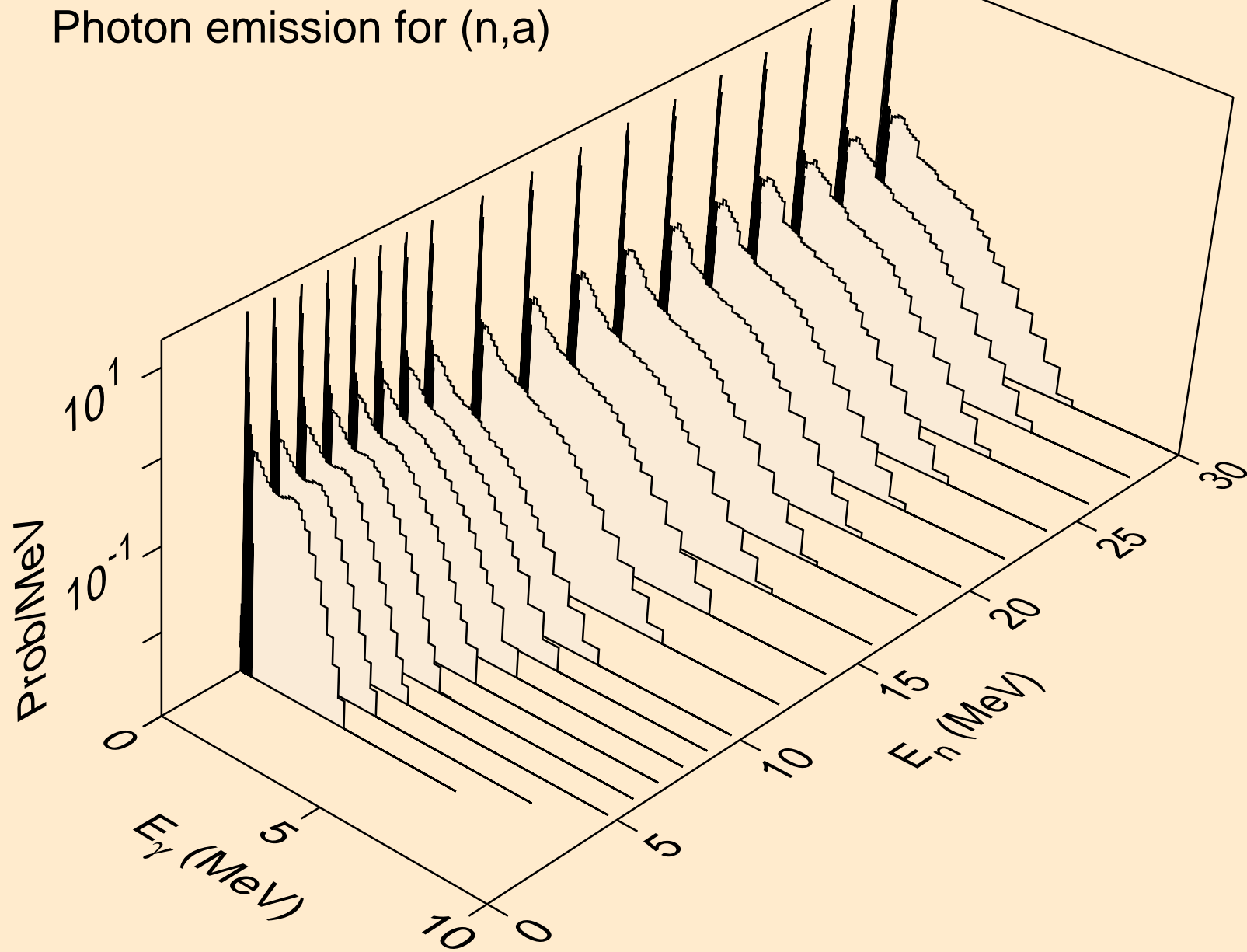

RU106 TRITON ACER TENDL-2021 LIBRARY; T=0.K  
Photon emission for (n,2a)

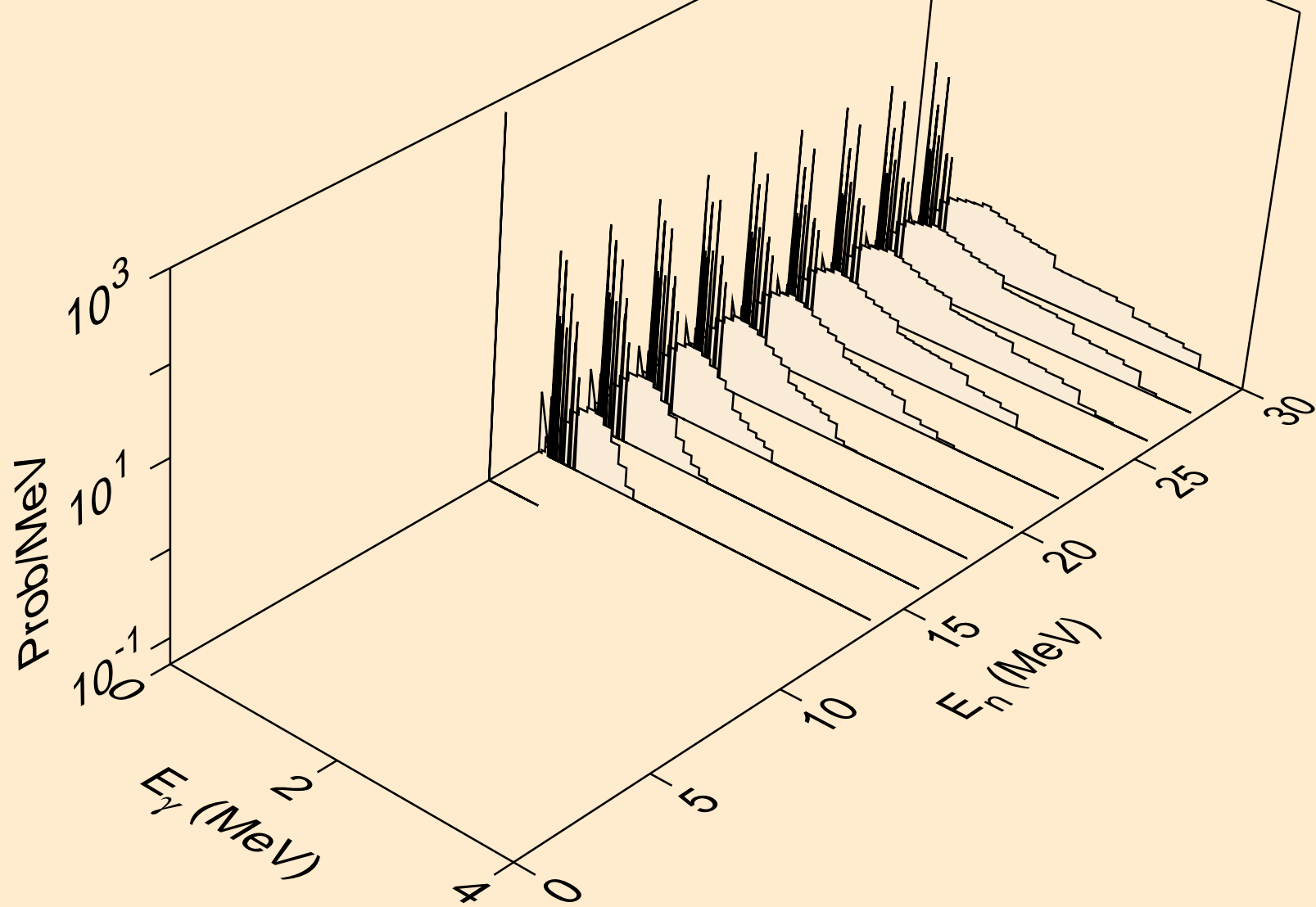

RU106 TRITON ACER TENDL-2021 LIBRARY; T=0.K  
Photon emission for (n,2p)

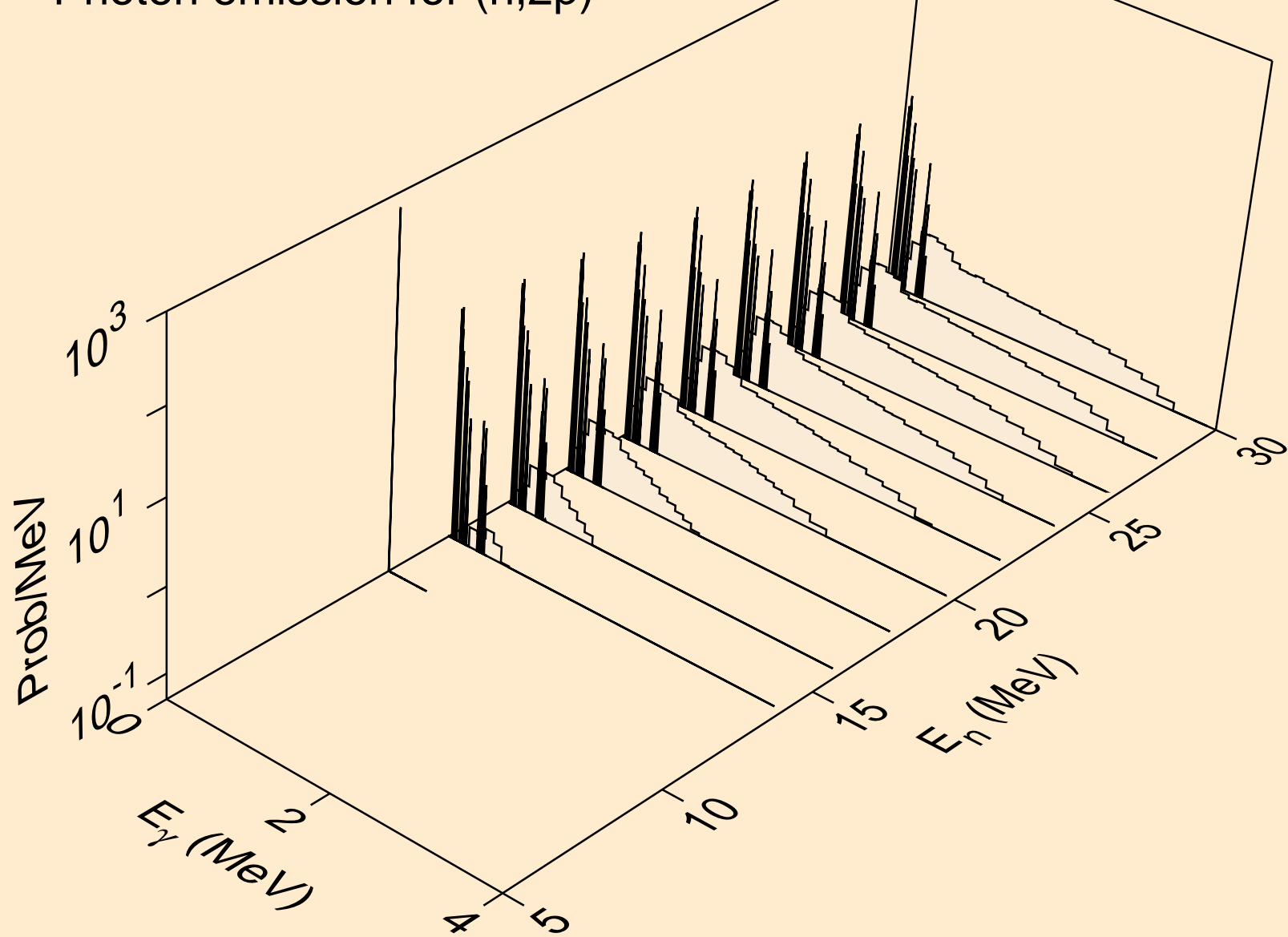

RU106 TRITON ACER TENDL-2021 LIBRARY; T=0.K  
Photon emission for (n,pa)

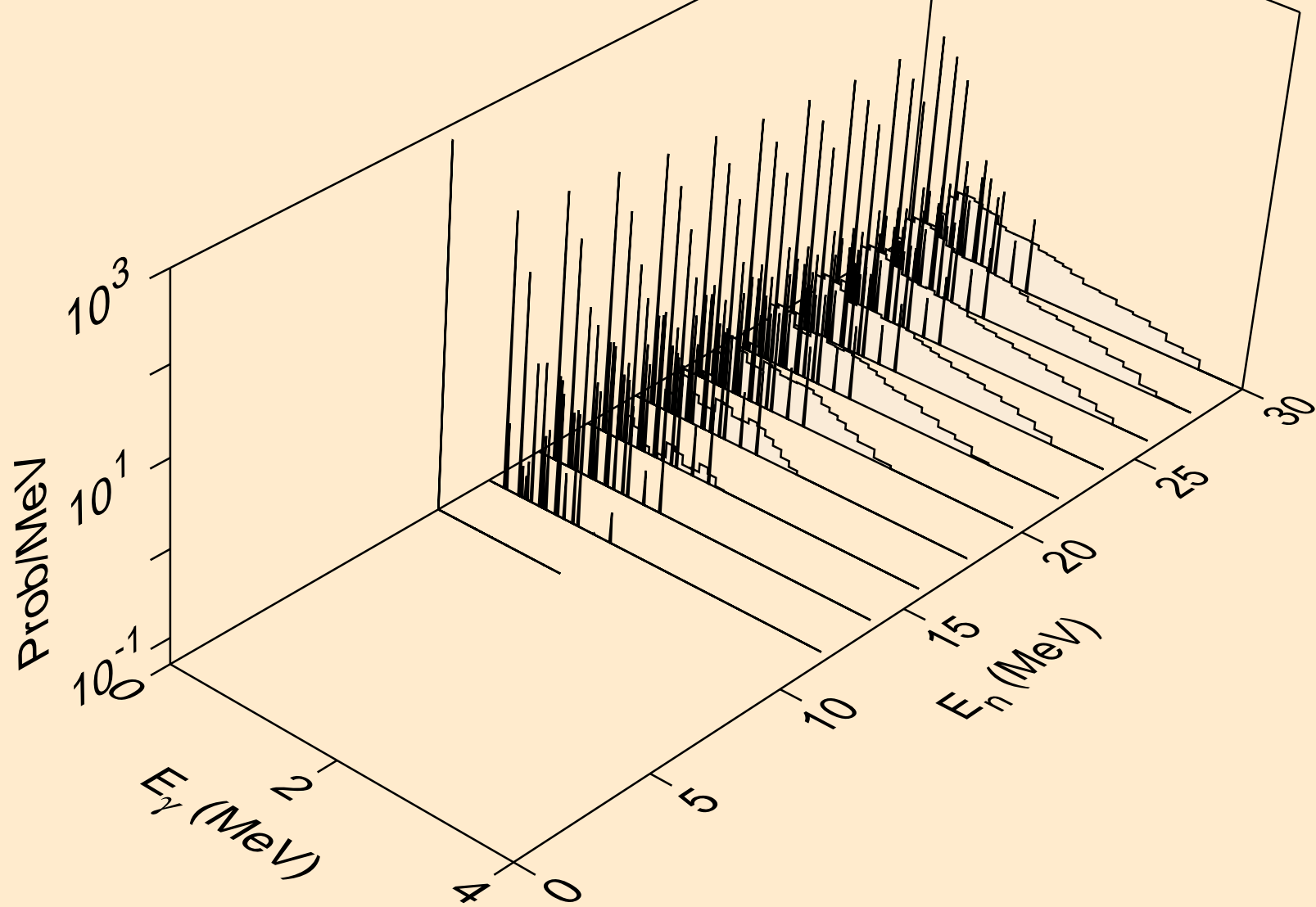



RU106 TRITON ACER TENDL-2021 LIBRARY; T=0.K  
Photon emission for (n,pd)

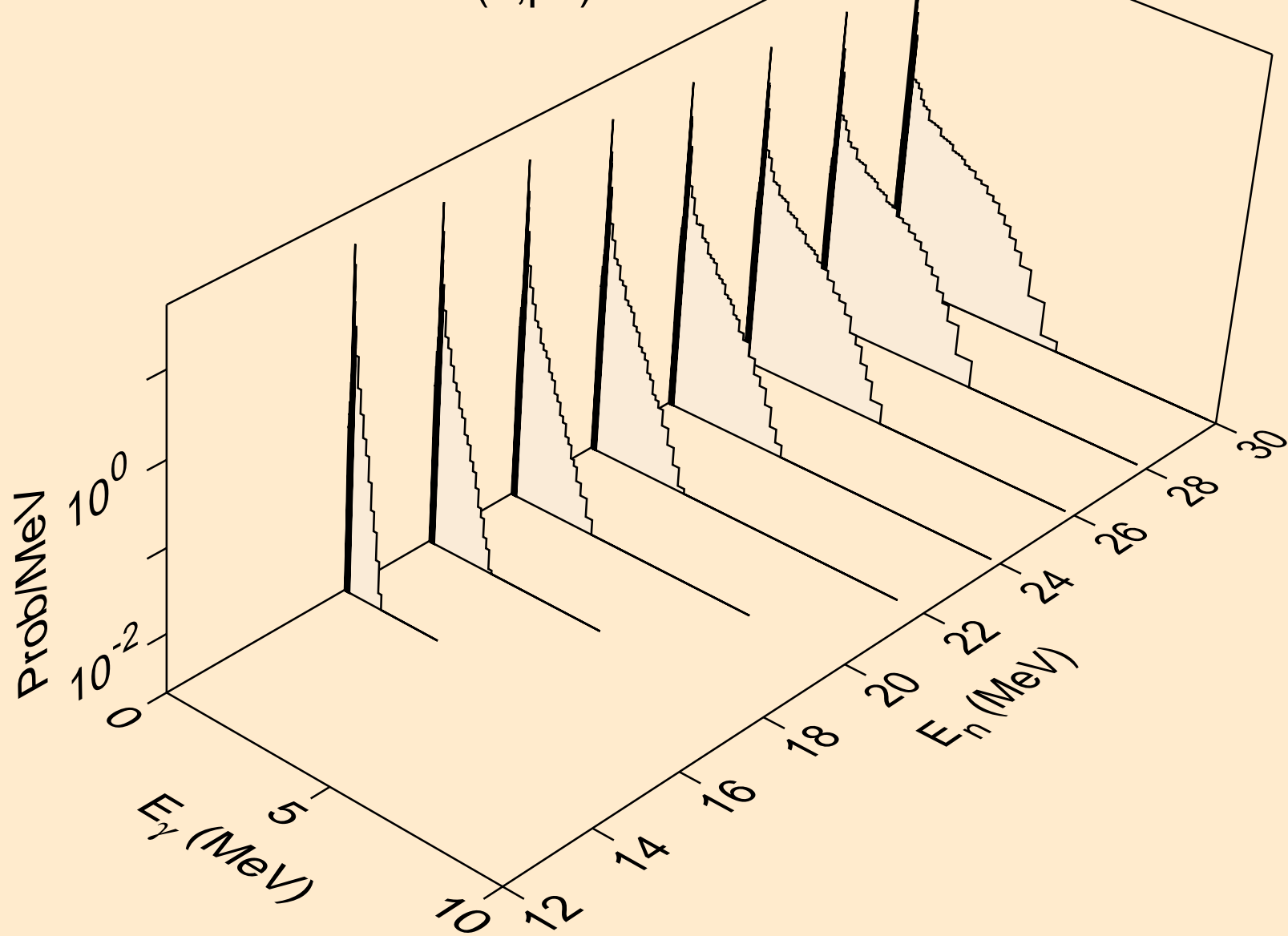

RU106 TRITON ACER TENDL-2021 LIBRARY; T=0.K  
Photon emission for (n,pt)

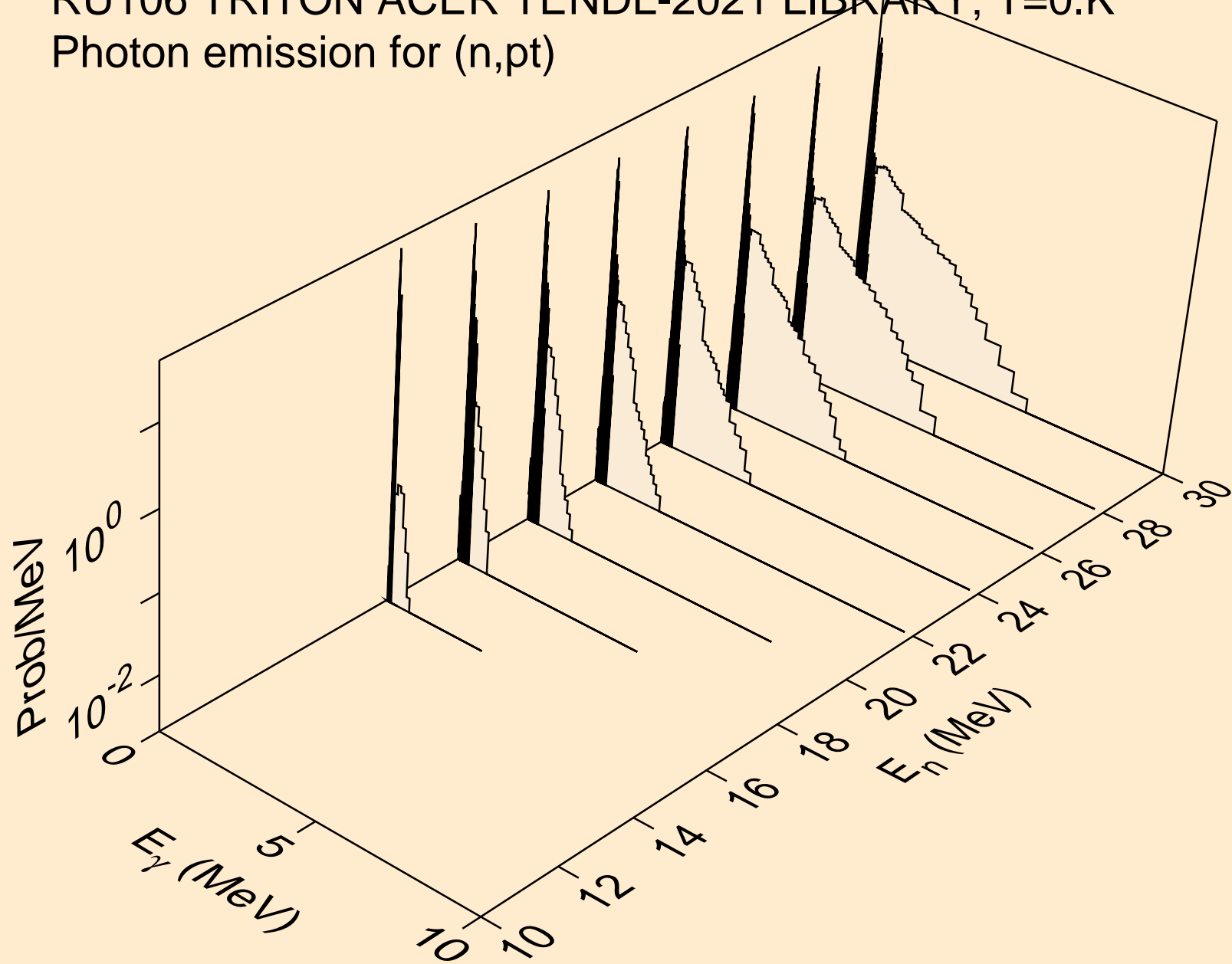

RU106 TRITON ACER TENDL-2021 LIBRARY; T=0.K  
Photon emission for (n,da)

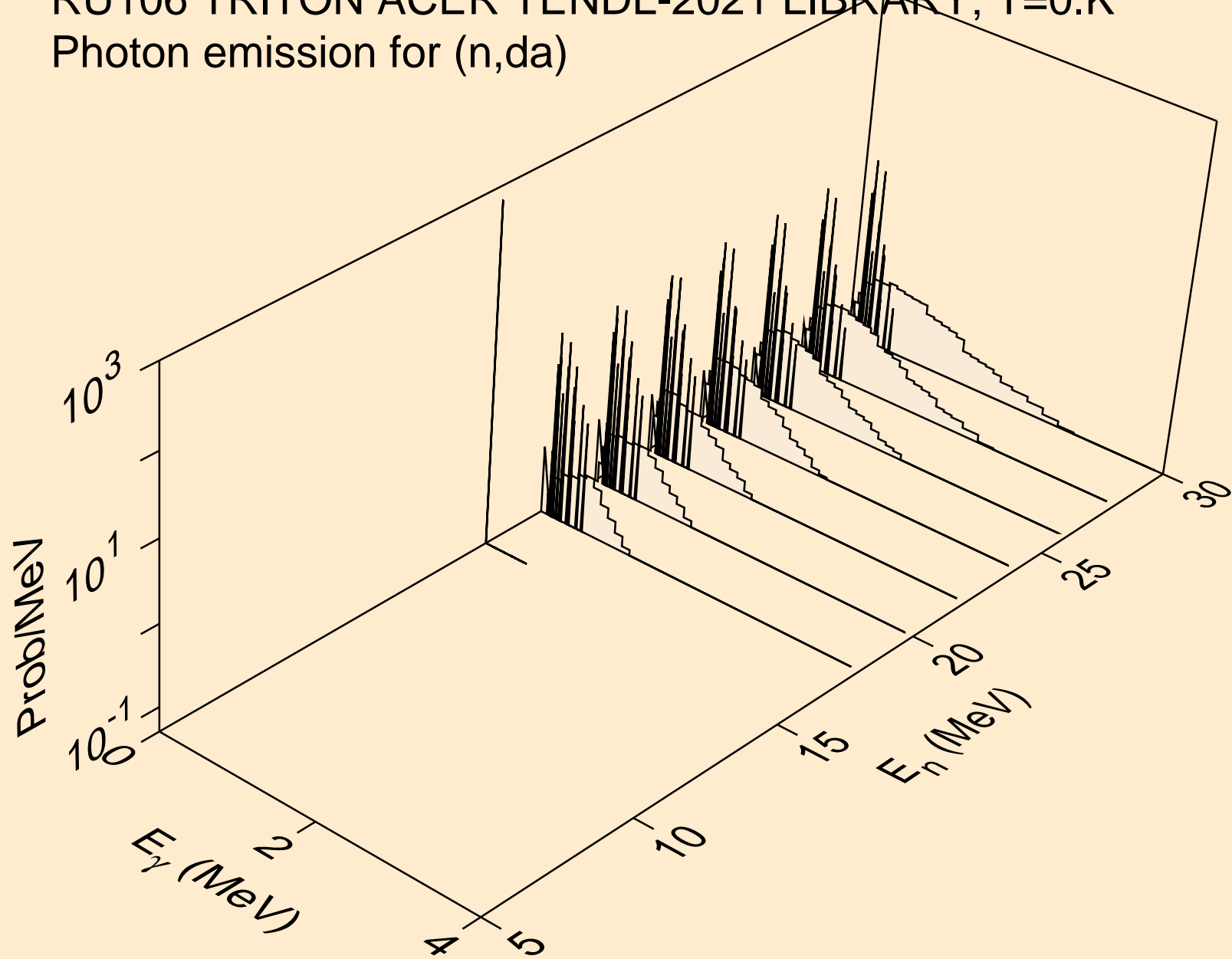

RU106 TRITON ACER TENDL-2021 LIBRARY; T=0.K  
Particle heating contributions

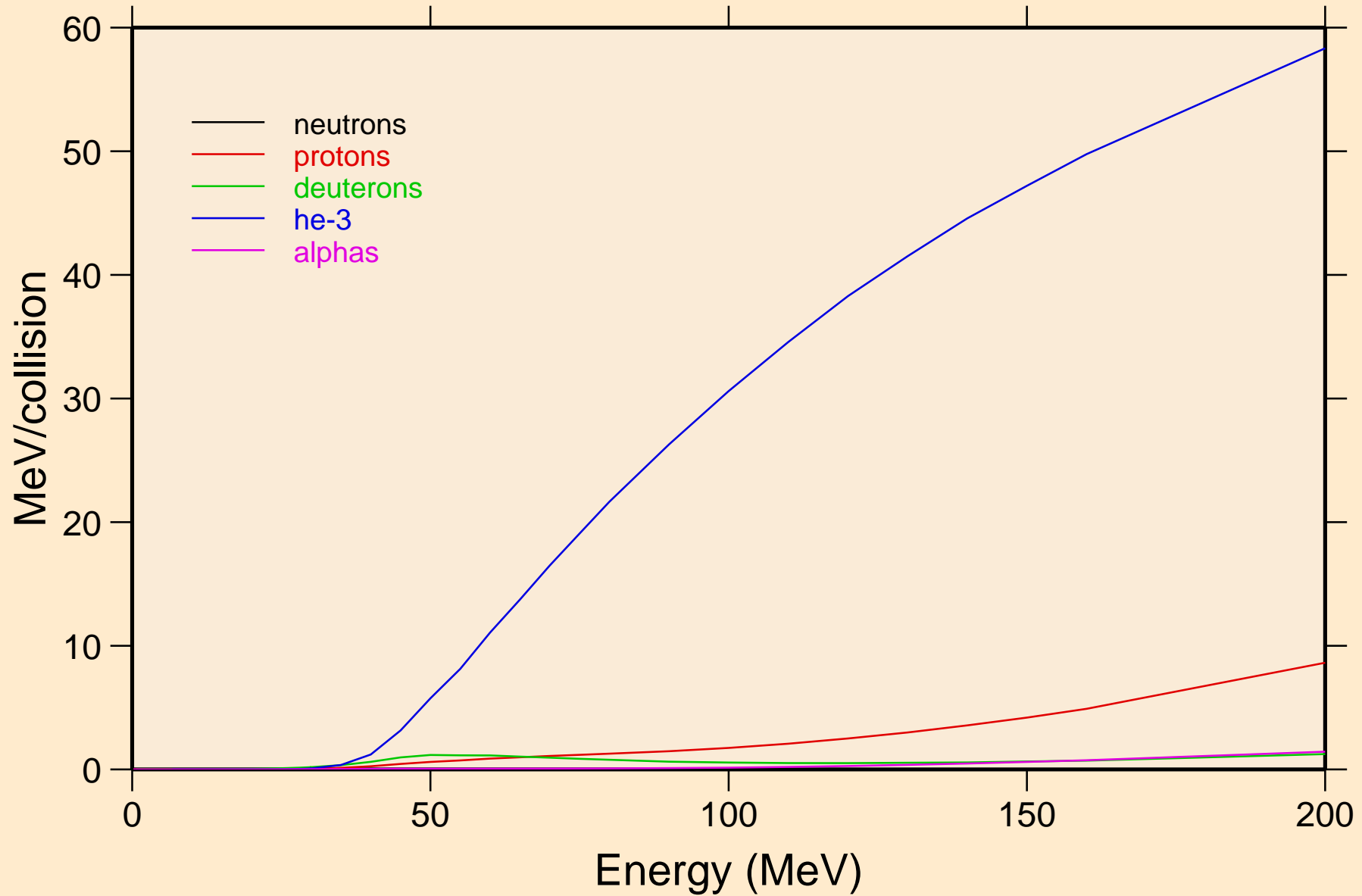

RU106 TRITON ACER TENDL-2021 LIBRARY; T=0.K  
Recoil Heating

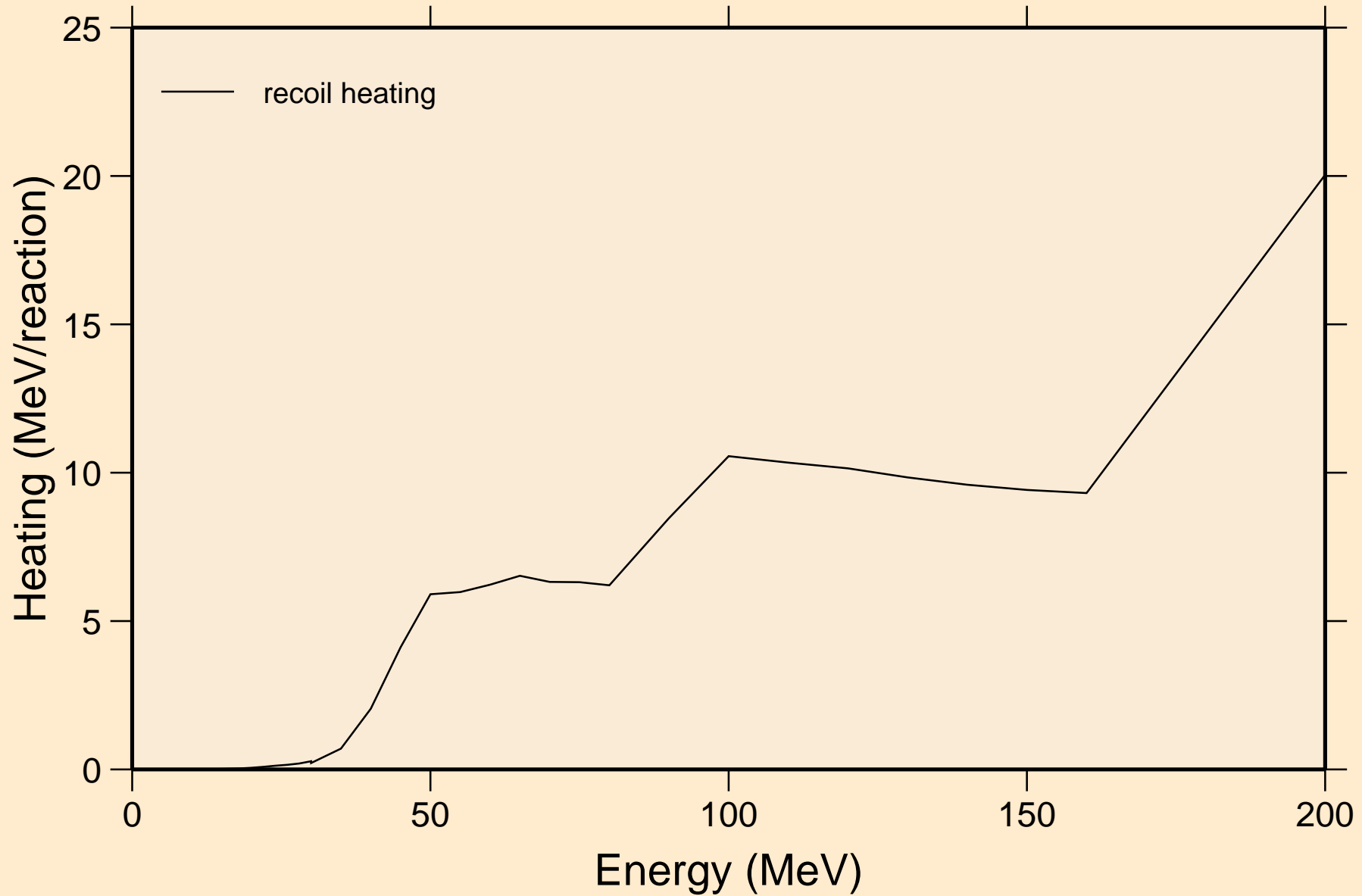

RU106 TRITON ACER TENDL-2021 LIBRARY; T=0.K  
Particle production cross sections

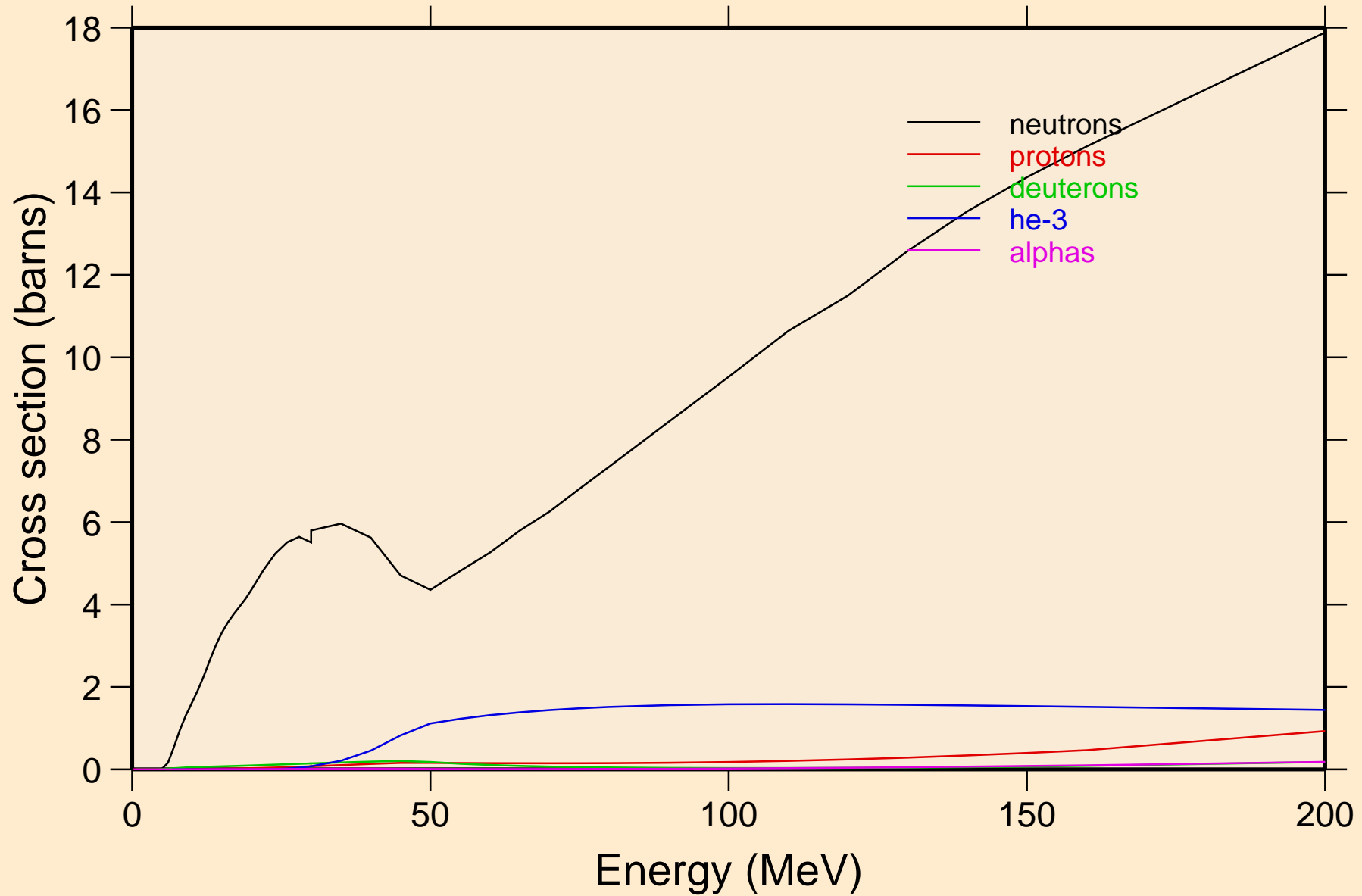

RU106 TRITON ACER TENDL-2021 LIBRARY; T=0.K  
neutrons from (t,n)

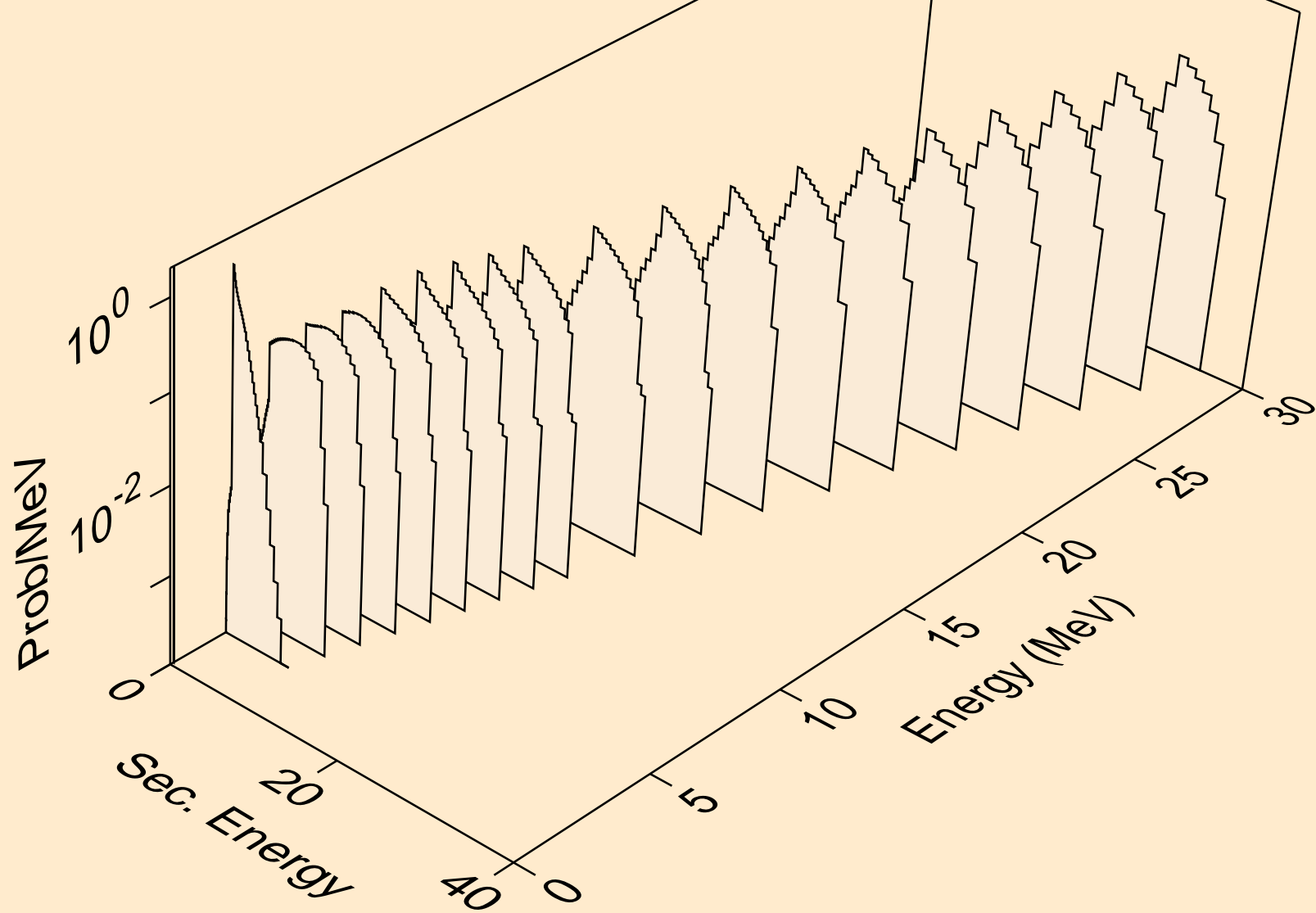

RU106 TRITON ACER TENDL-2021 LIBRARY; T=0.K  
neutrons from (t,x)

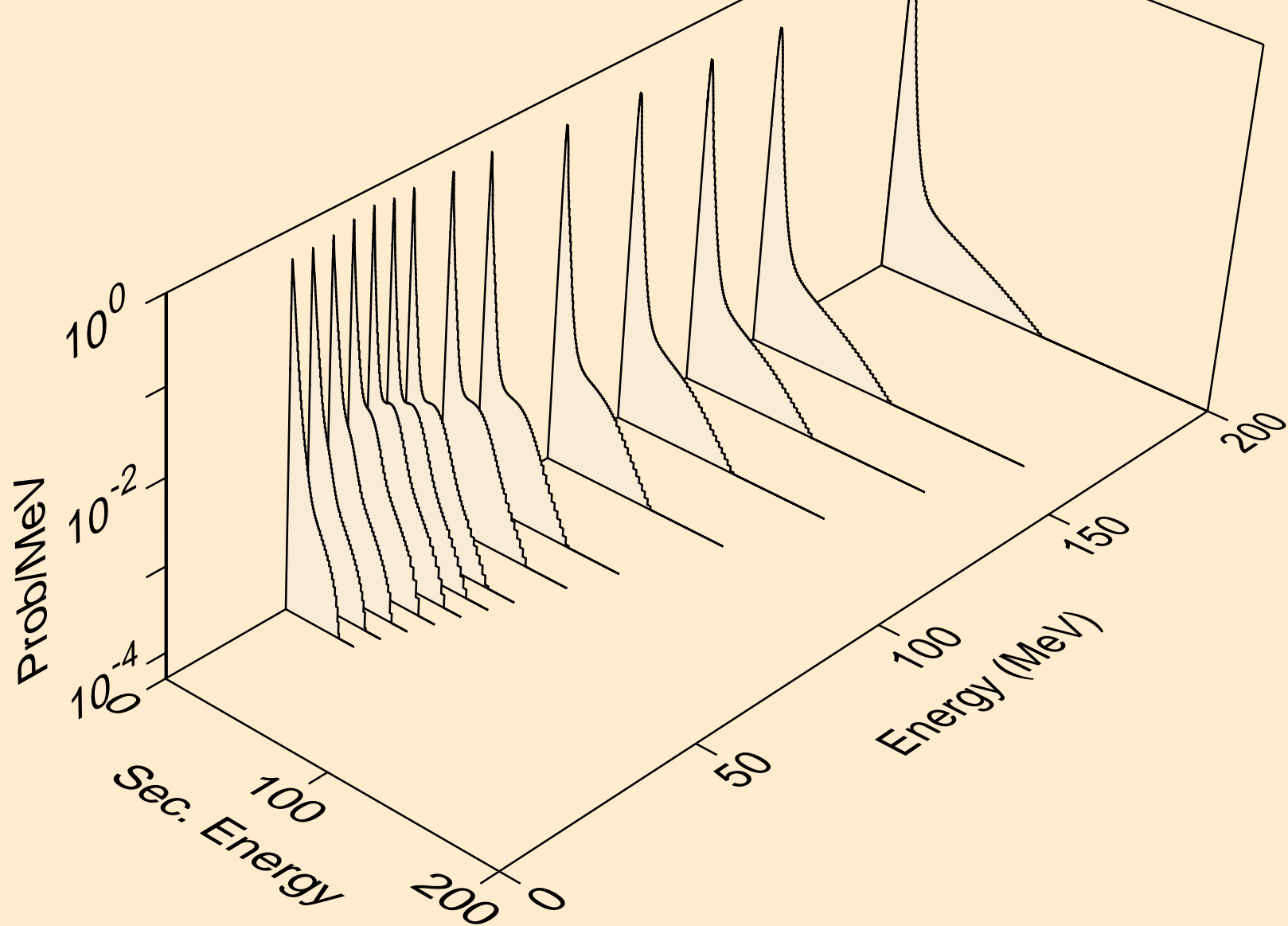



RU106 TRITON ACER TENDL-2021 LIBRARY; T=0.K  
neutrons from (t,2nd)

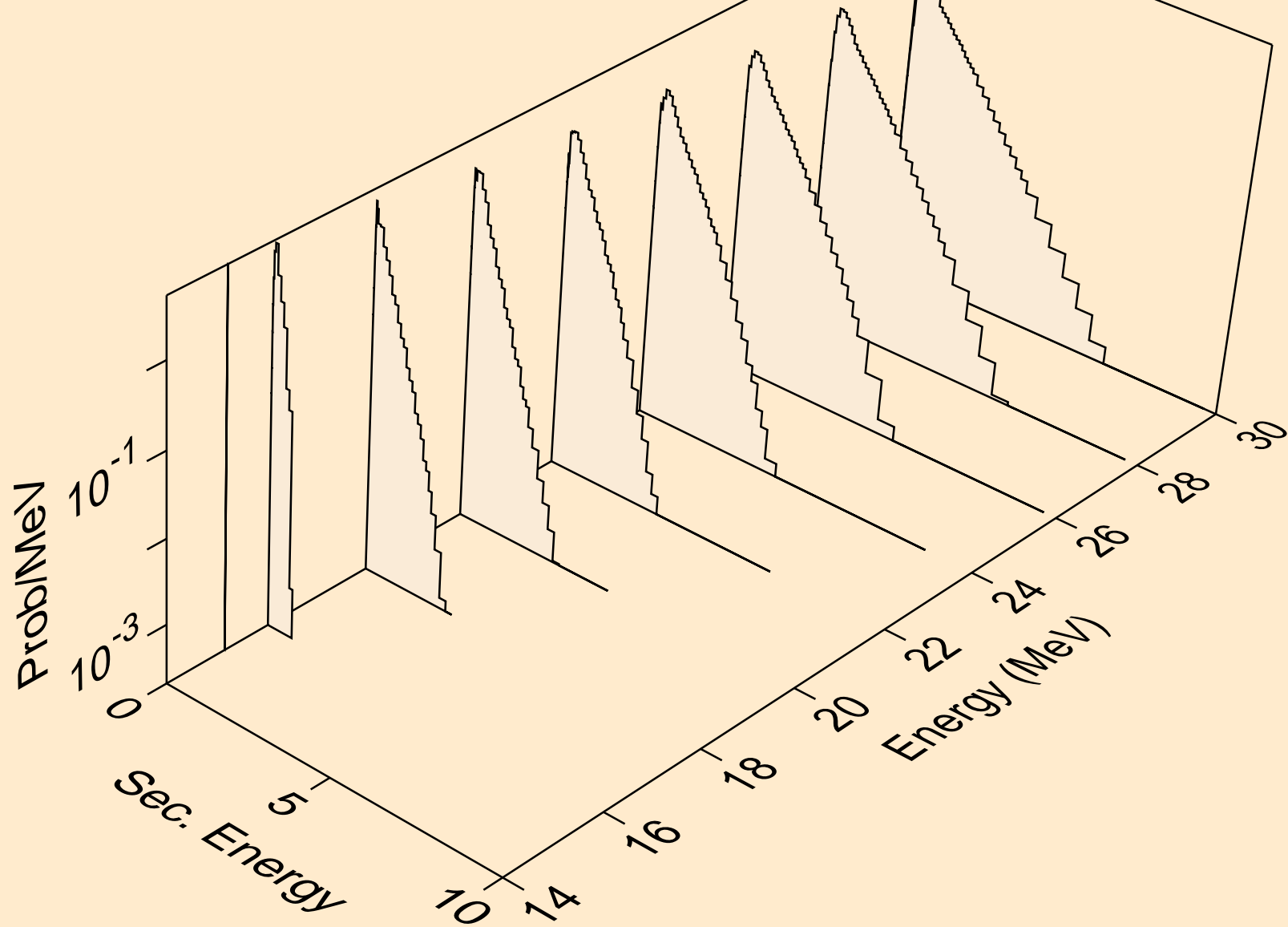

RU106 TRITON ACER TENDL-2021 LIBRARY; T=0.K  
neutrons from (t,2n)

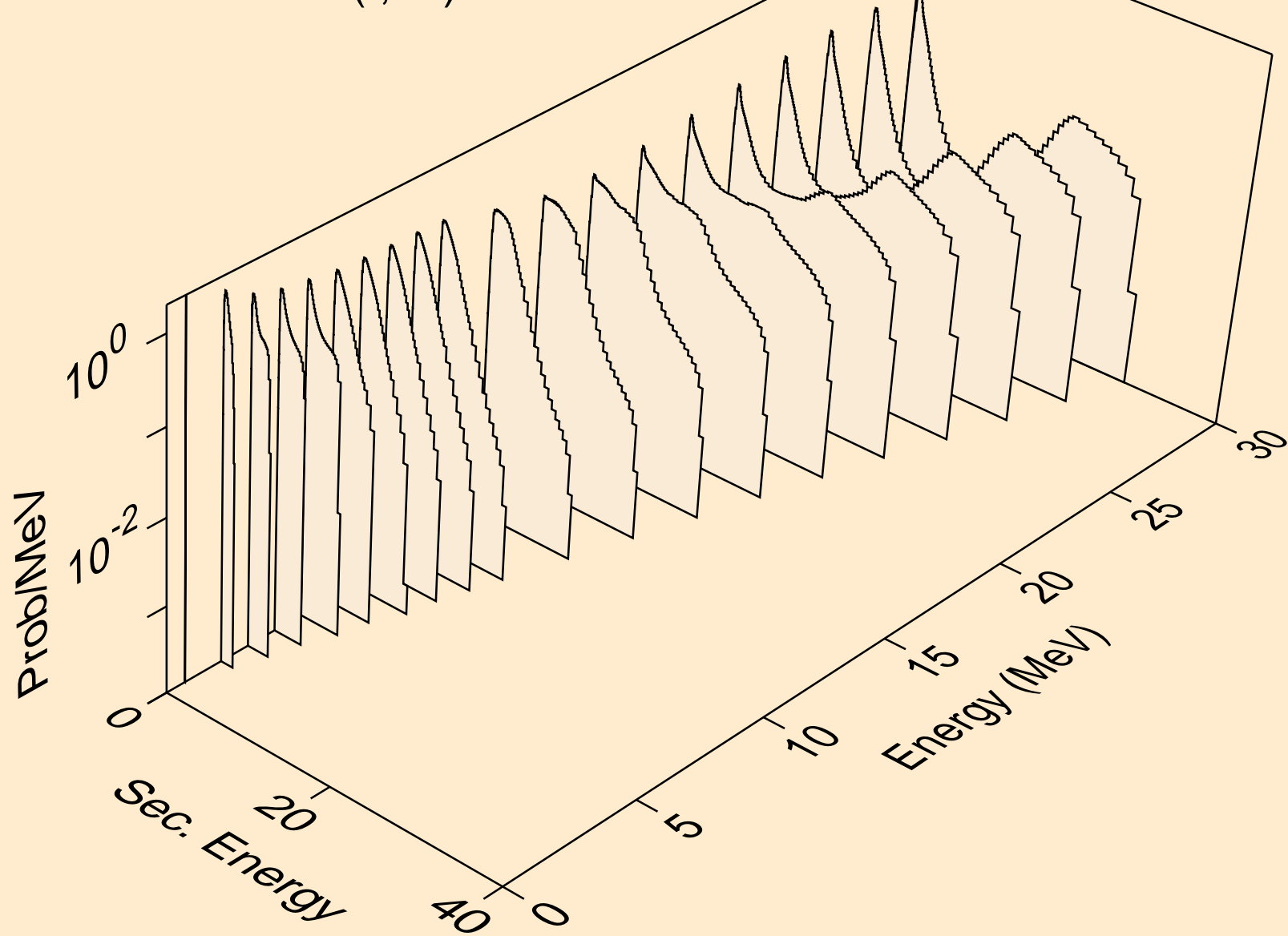

RU106 TRITON ACER TENDL-2021 LIBRARY; T=0.K  
neutrons from (t,3n)

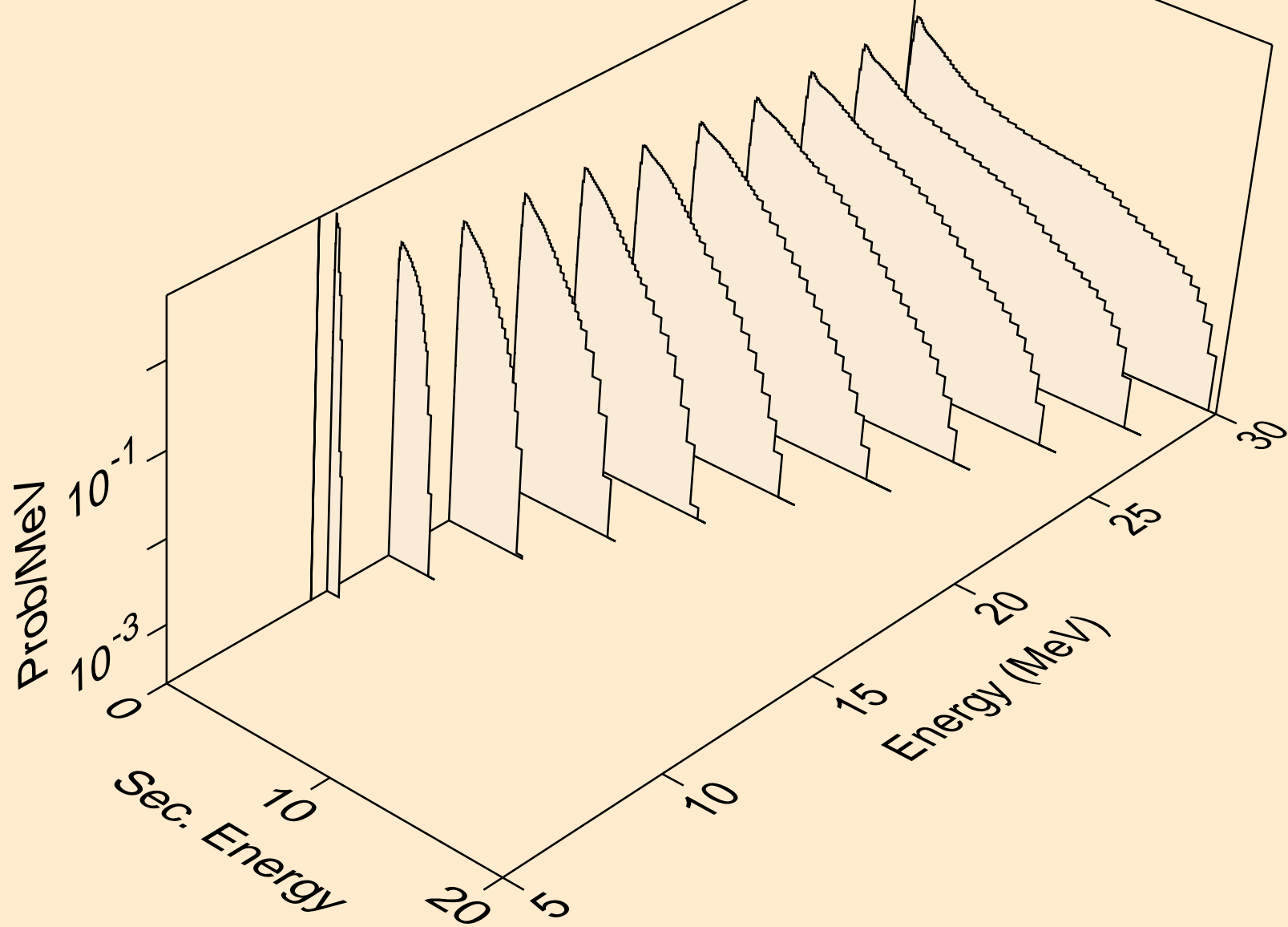

RU106 TRITON ACER TENDL-2021 LIBRARY; T=0.K  
neutrons from (t,n\*)a

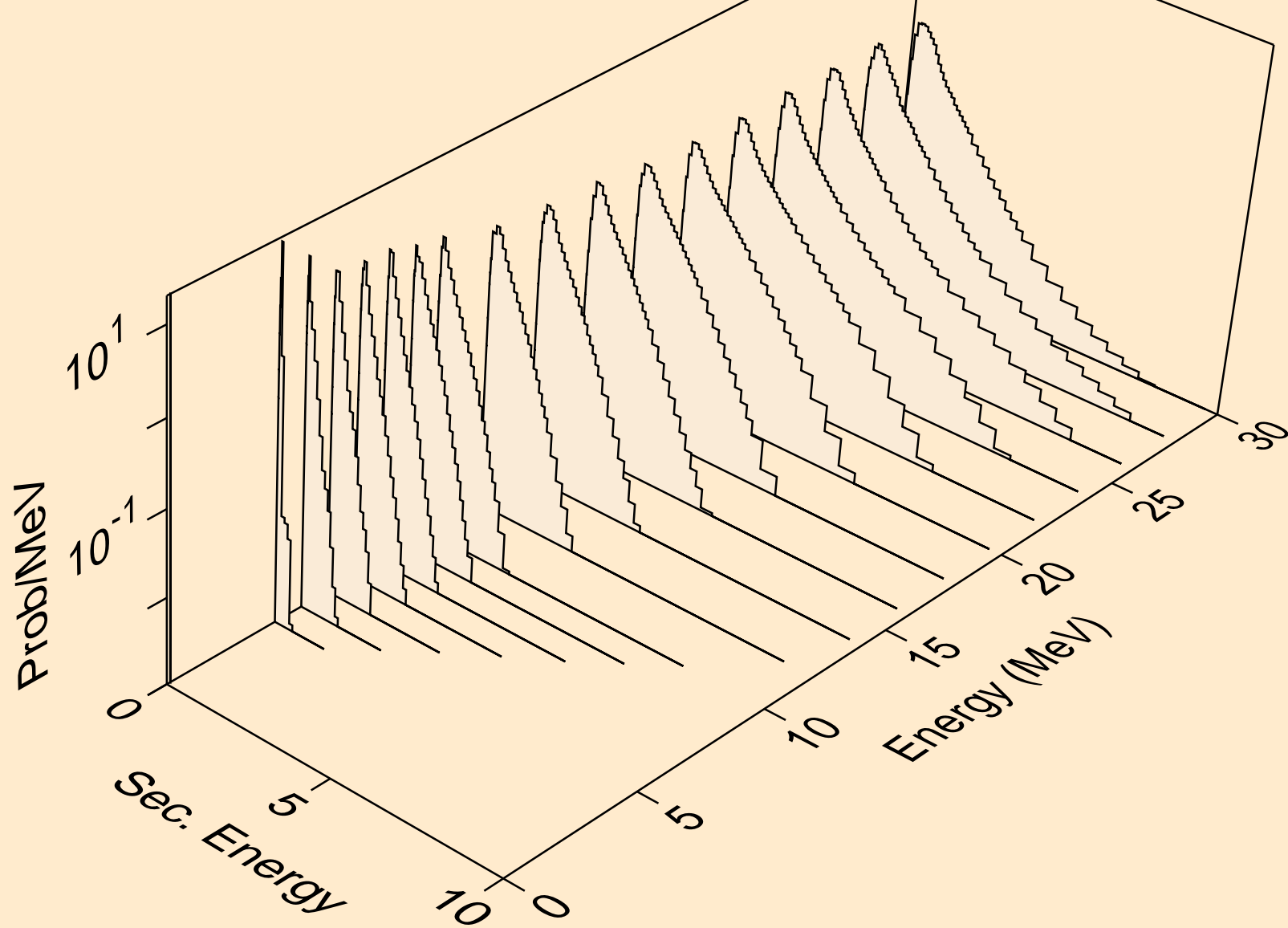

RU106 TRITON ACER TENDL-2021 LIBRARY; T=0.K  
neutrons from (t,2n)a

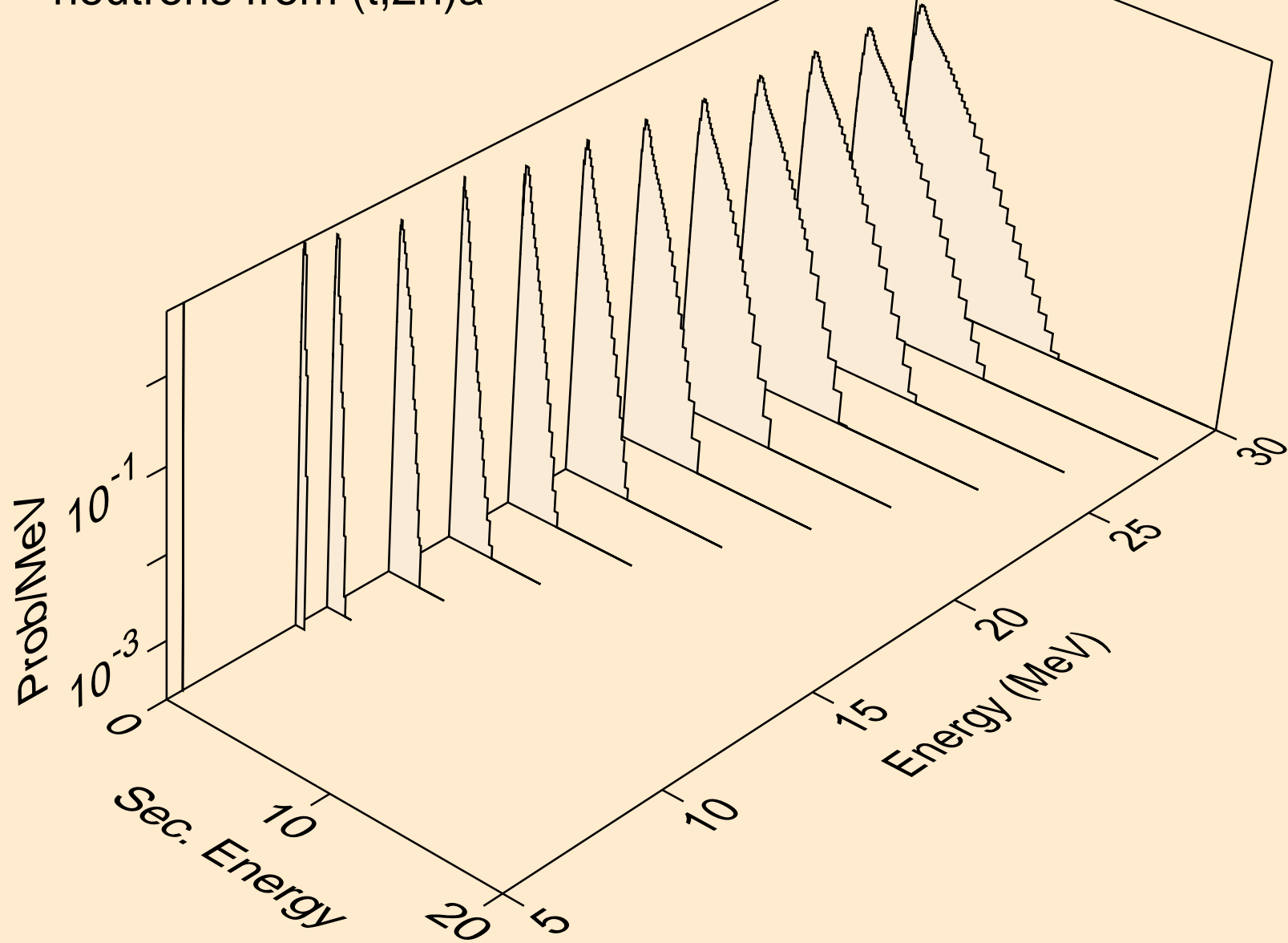

RU106 TRITON ACER TENDL-2021 LIBRARY; T=0.K  
neutrons from (t,3n)a

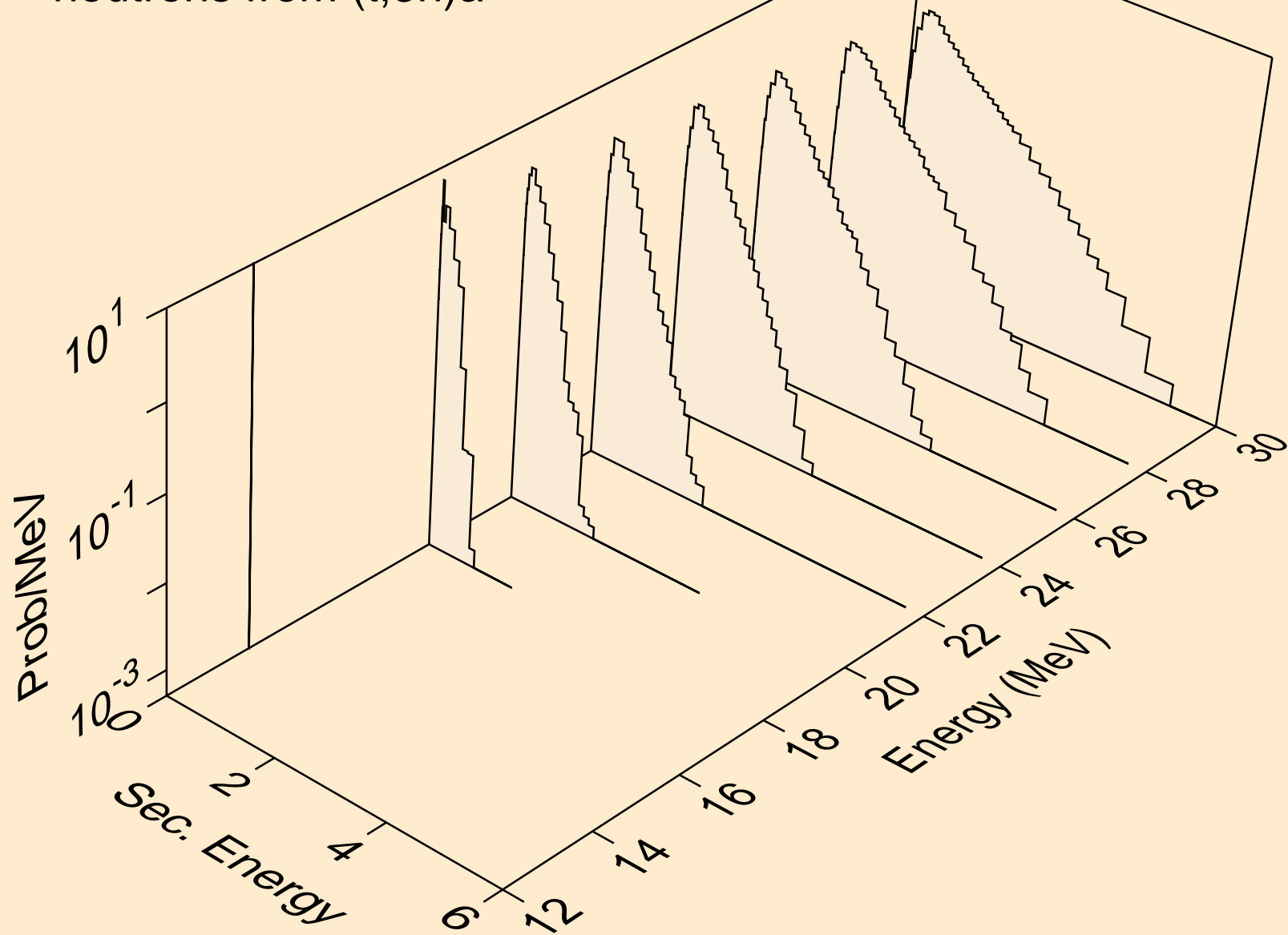

RU106 TRITON ACER TENDL-2021 LIBRARY; T=0.K  
neutrons from (t,n\*)p

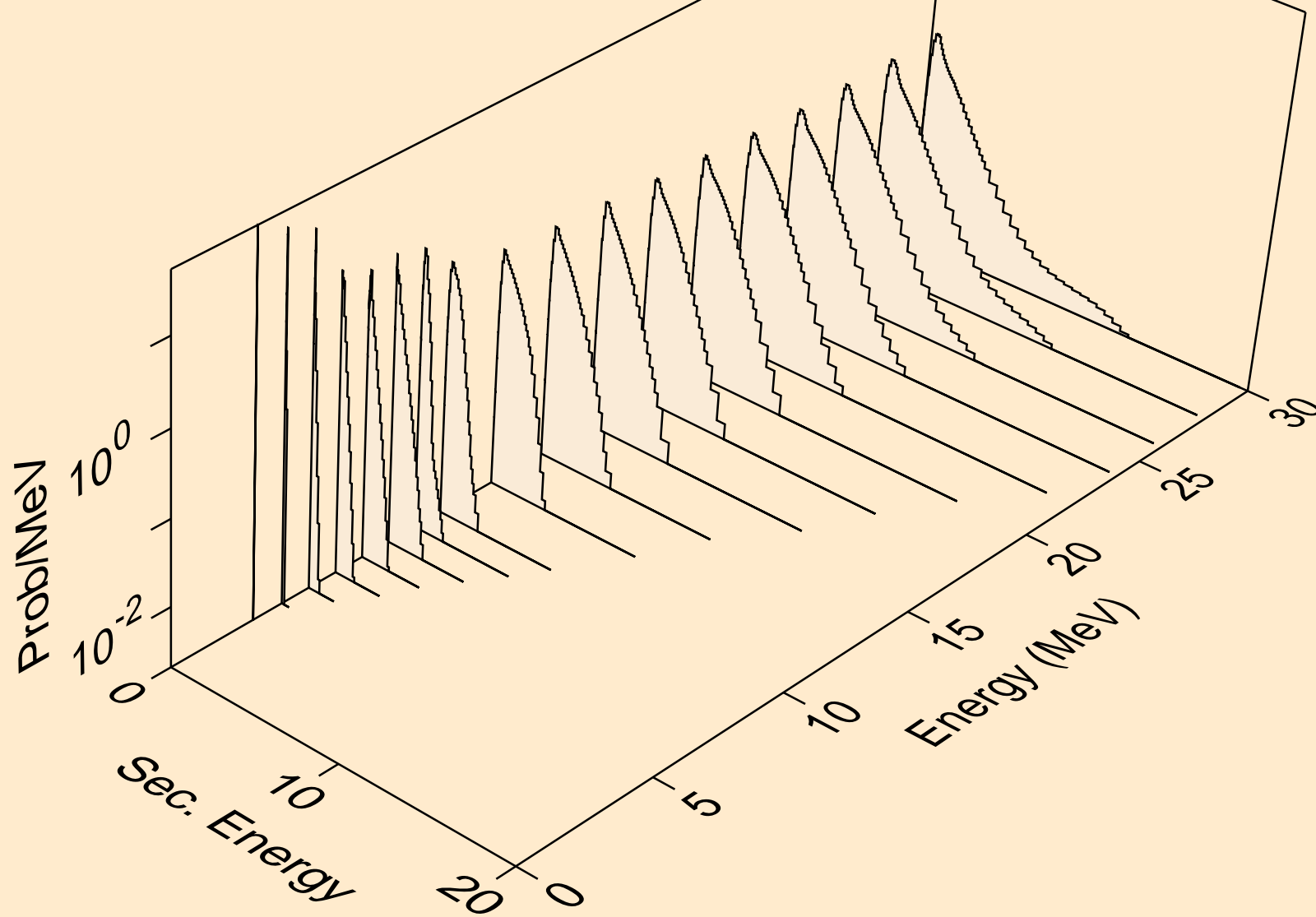

RU106 TRITON ACER TENDL-2021 LIBRARY; T=0.K  
neutrons from (t,n\*)2a

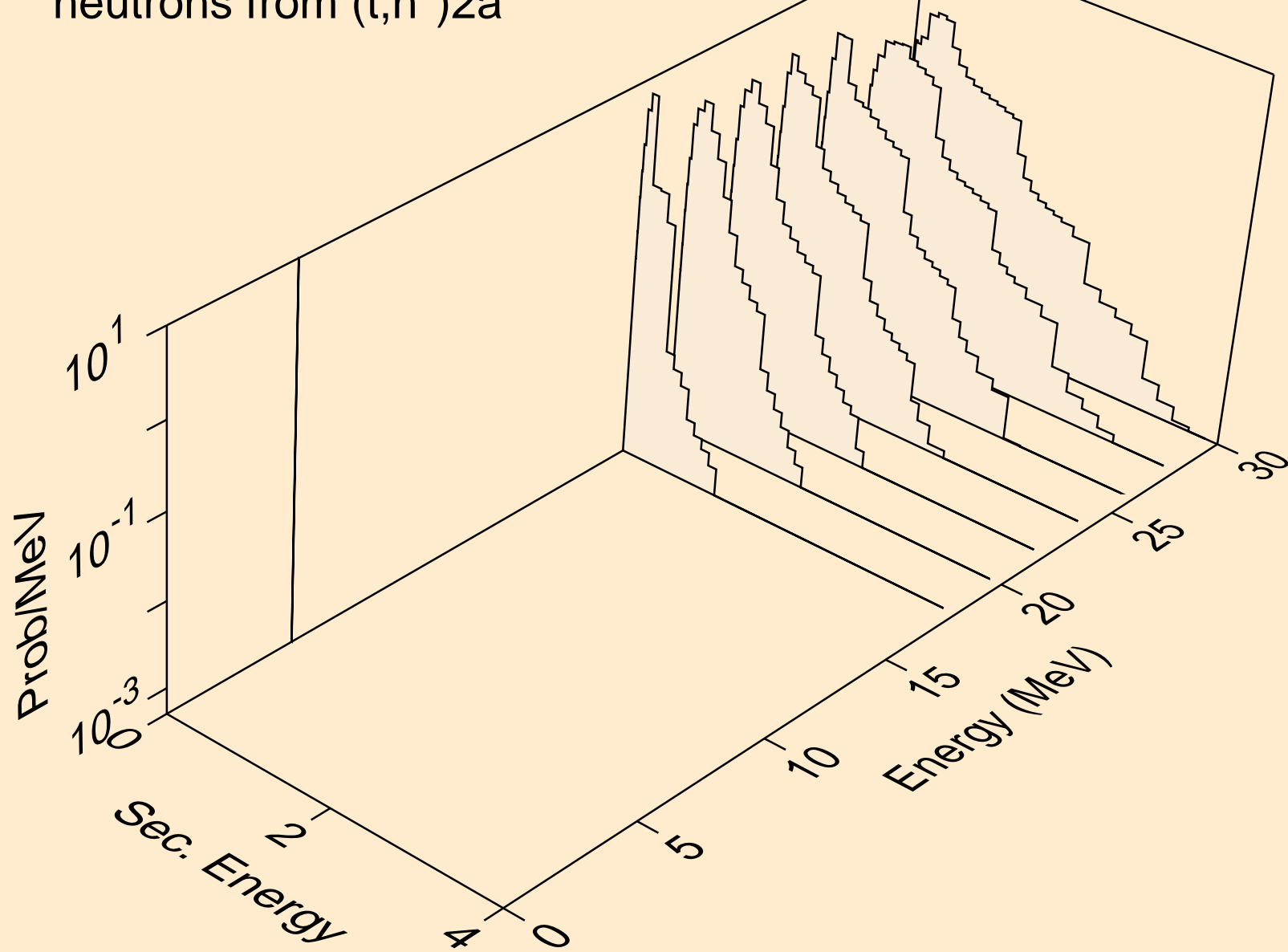



RU106 TRITON ACER TENDL-2021 LIBRARY; T=0.K  
neutrons from (t,n\*)d

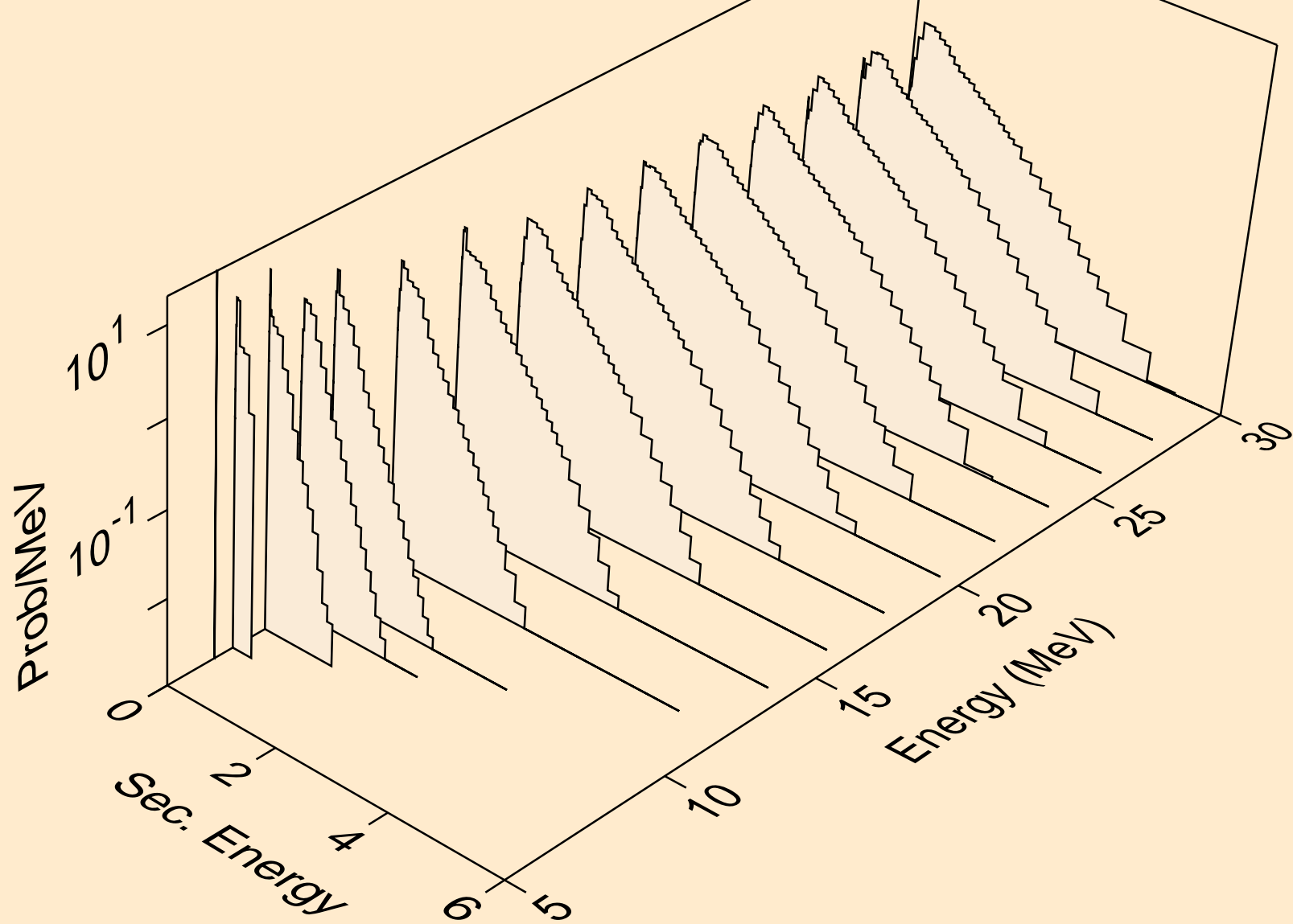

RU106 TRITON ACER TENDL-2021 LIBRARY; T=0.K  
neutrons from (t,n\*)t

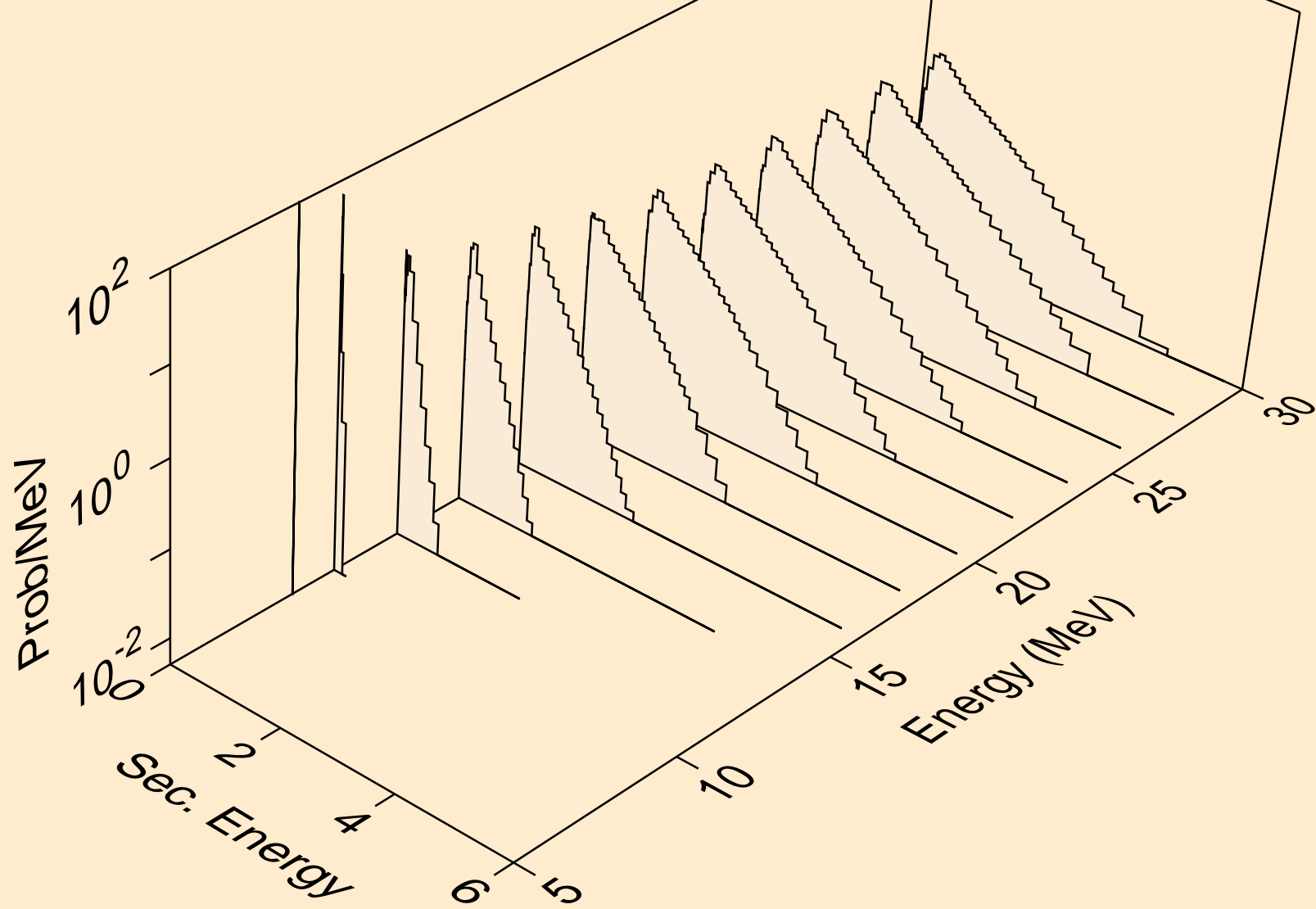

RU106 TRITON ACER TENDL-2021 LIBRARY; T=0.K  
neutrons from (t,n\*)he3

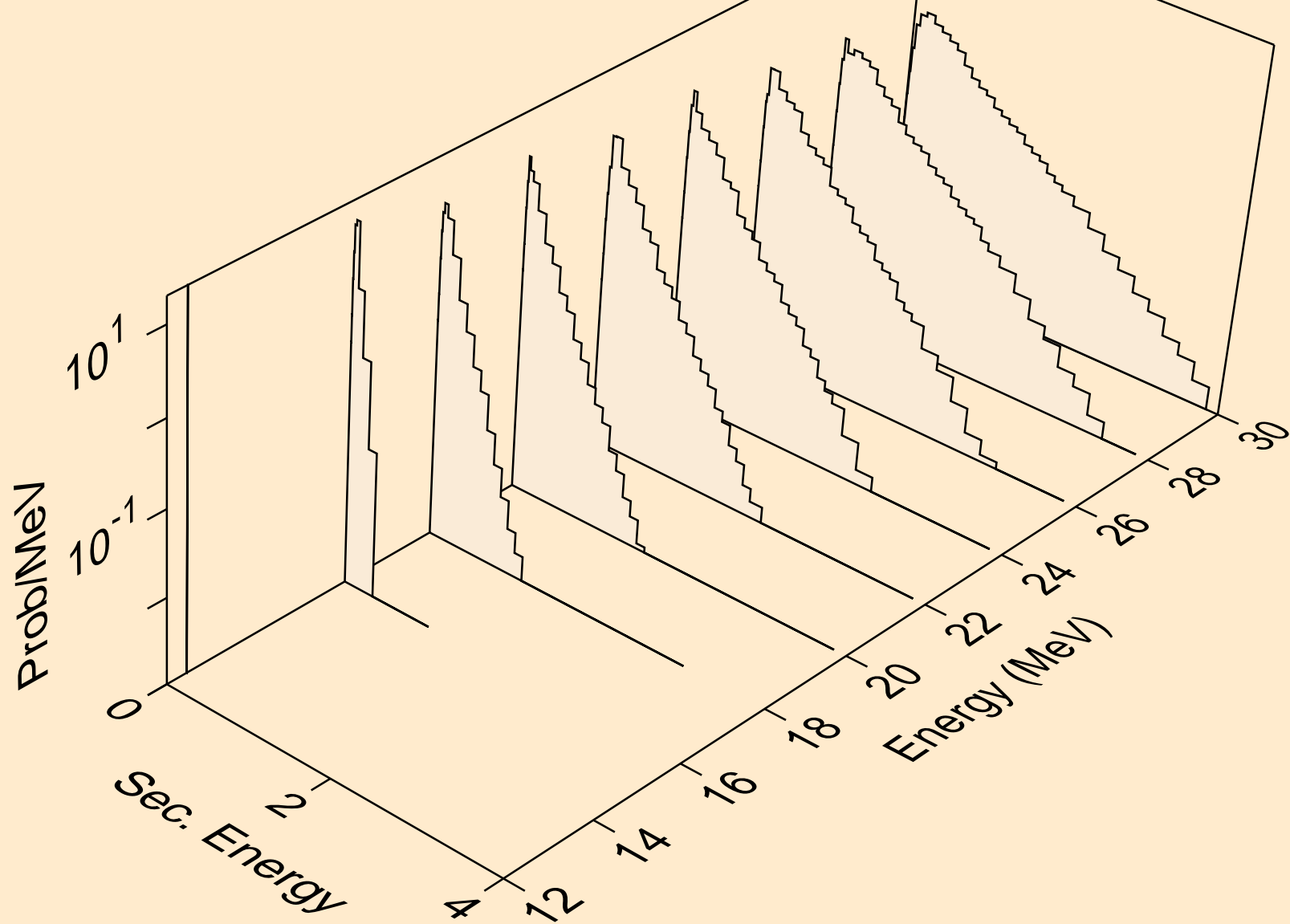

RU106 TRITON ACER TENDL-2021 LIBRARY; T=0.K  
neutrons from (t,4n)

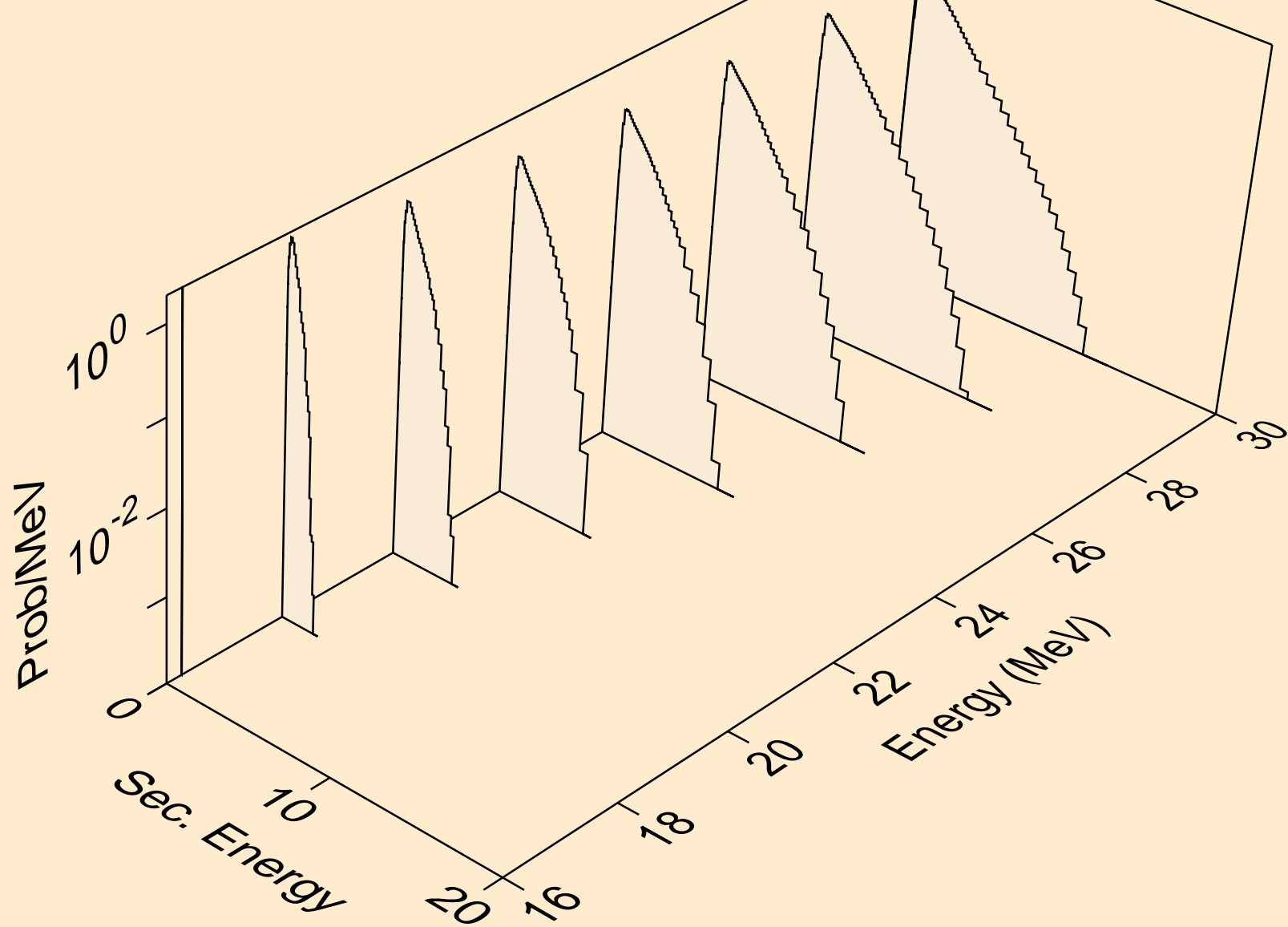

RU106 TRITON ACER TENDL-2021 LIBRARY; T=0.K  
neutrons from (t,2np)

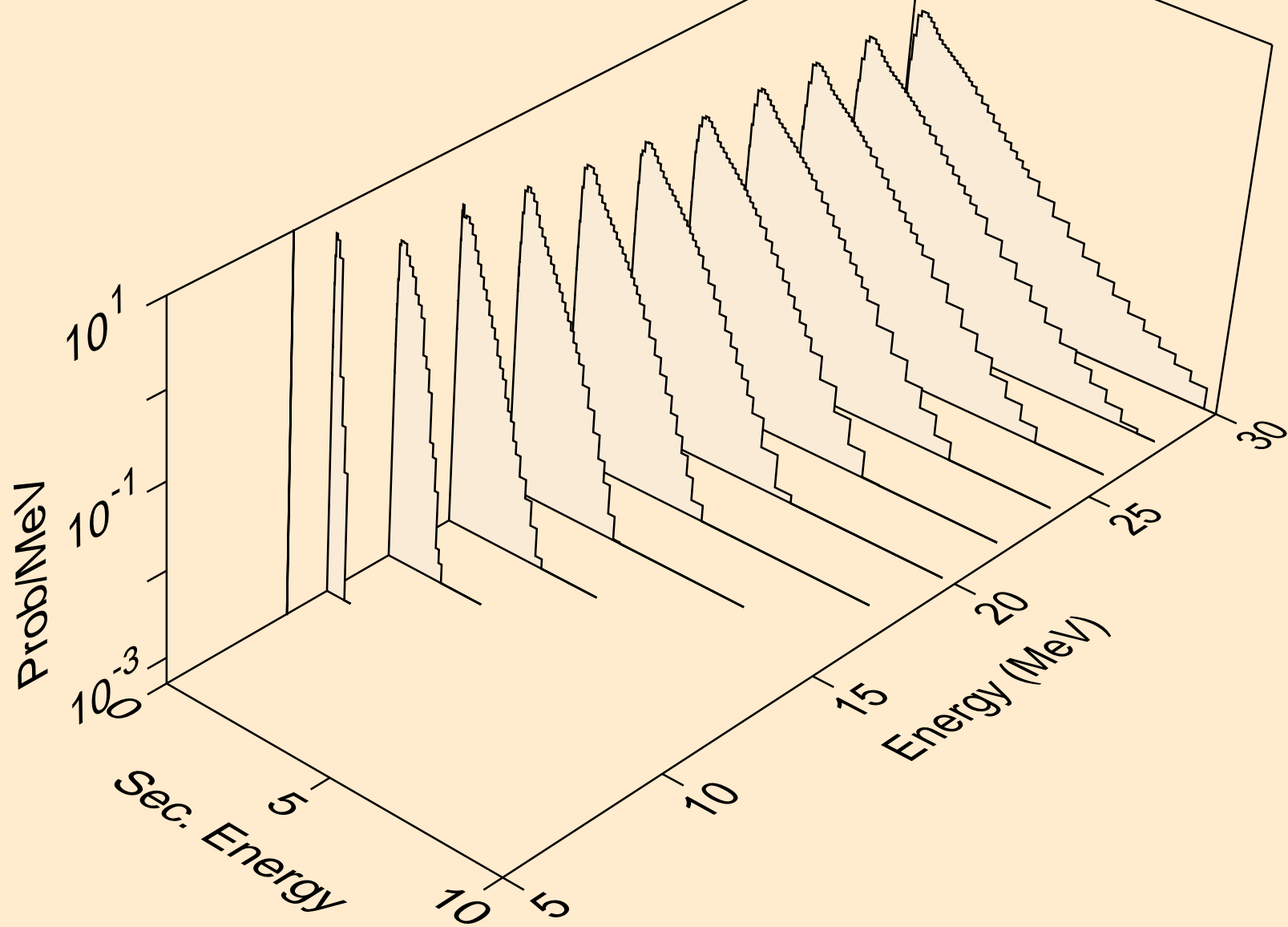

RU106 TRITON ACER TENDL-2021 LIBRARY; T=0.K  
neutrons from (t,3np)

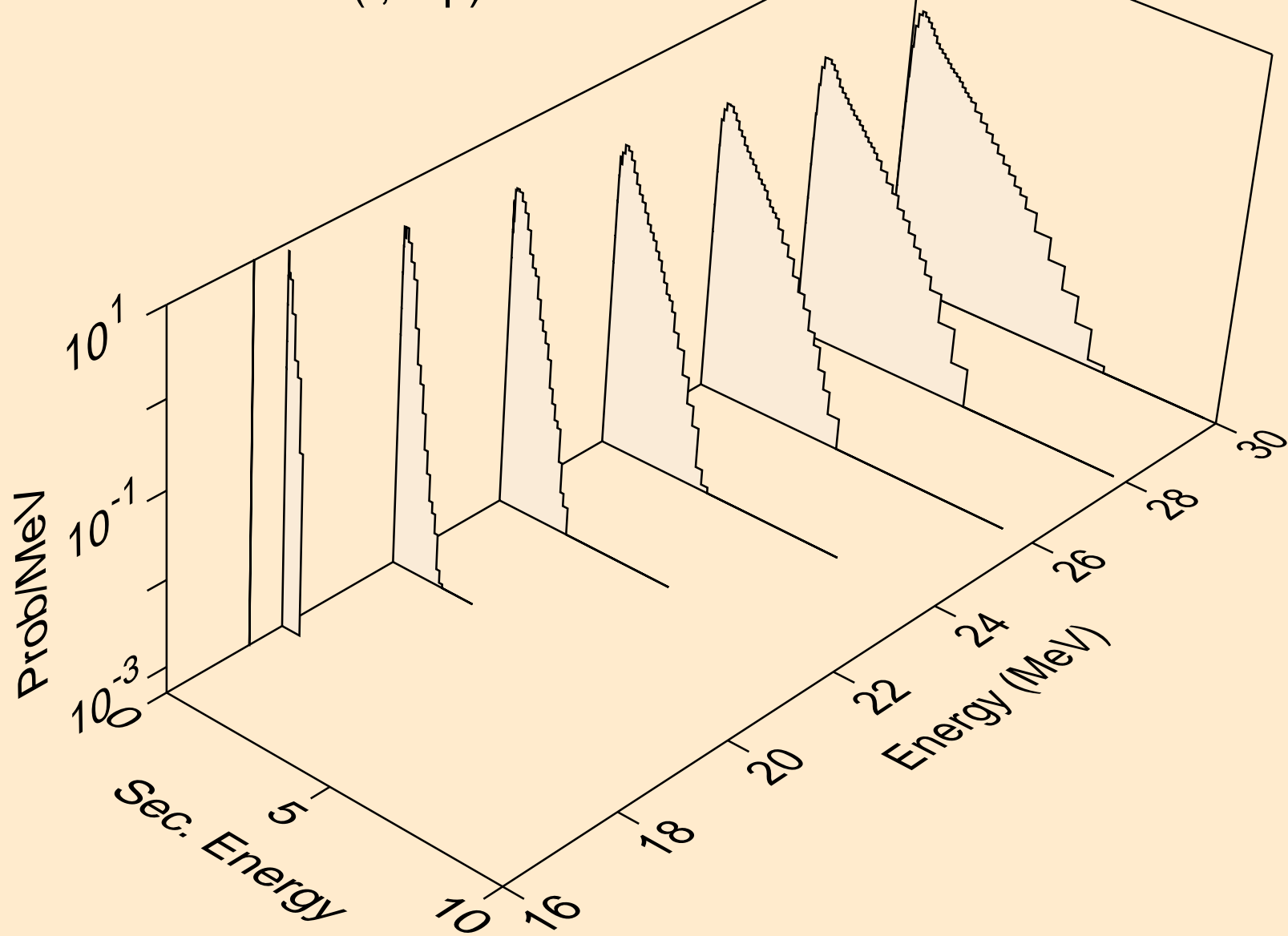

RU106 TRITON ACER TENDL-2021 LIBRARY; T=0.K  
neutrons from (t,2np)

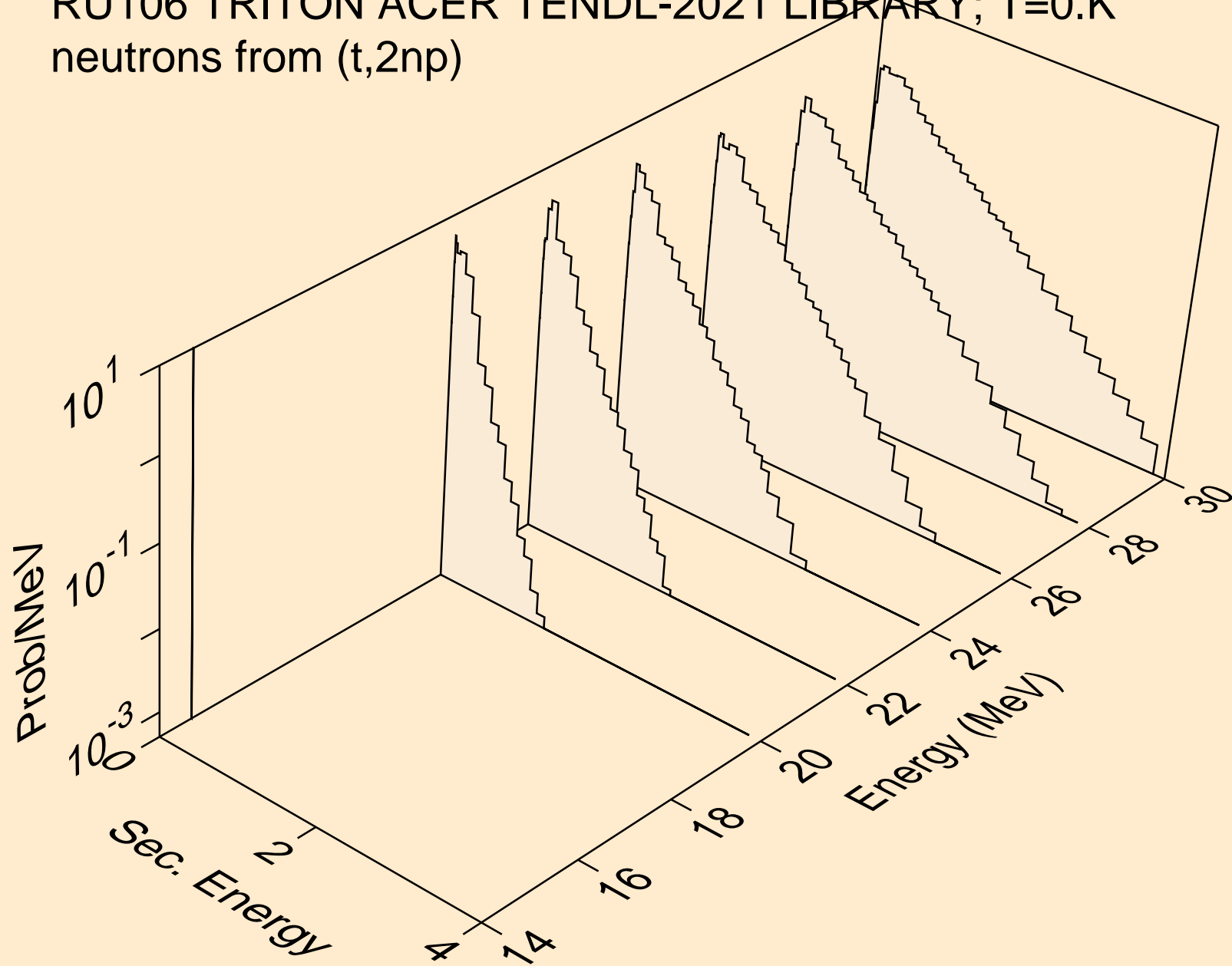

RU106 TRITON ACER TENDL-2021 LIBRARY; T=0.K  
neutrons from (t,npa)

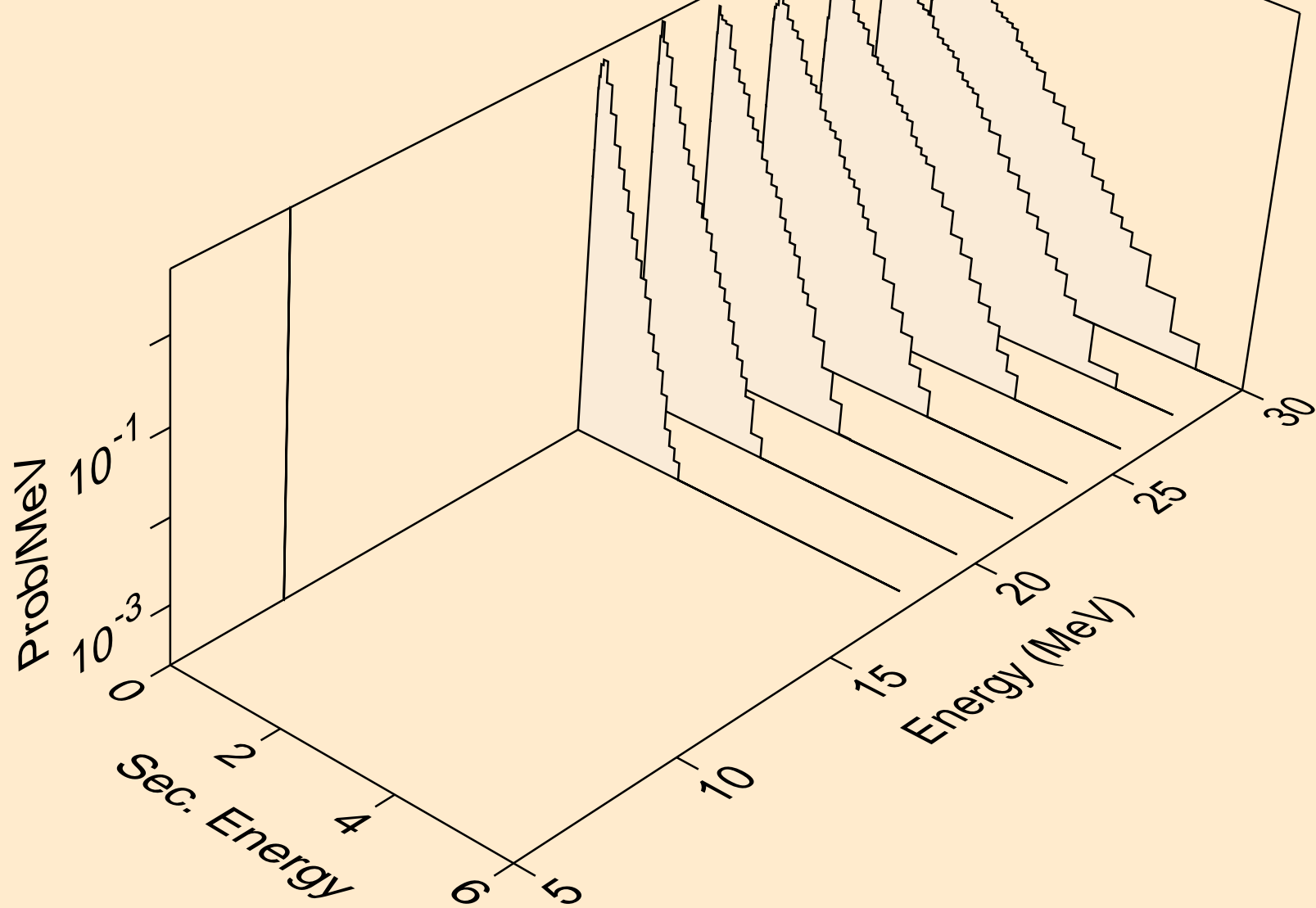



RU106 TRITON ACER TENDL-2021 LIBRARY; T=0.K  
protons from (t,x)

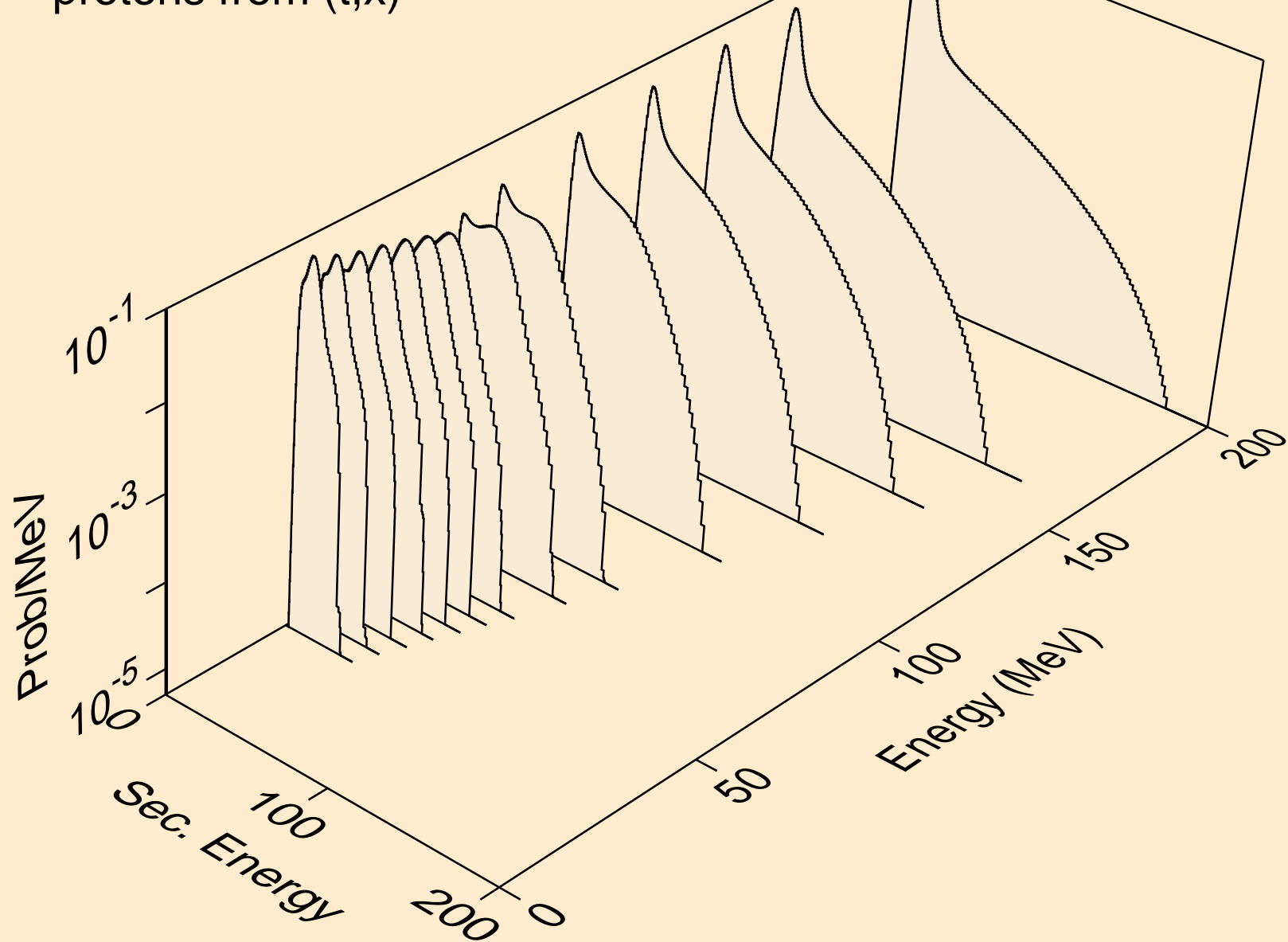

RU106 TRITON ACER TENDL-2021 LIBRARY; T=0.K  
protons from (t,n\*)p

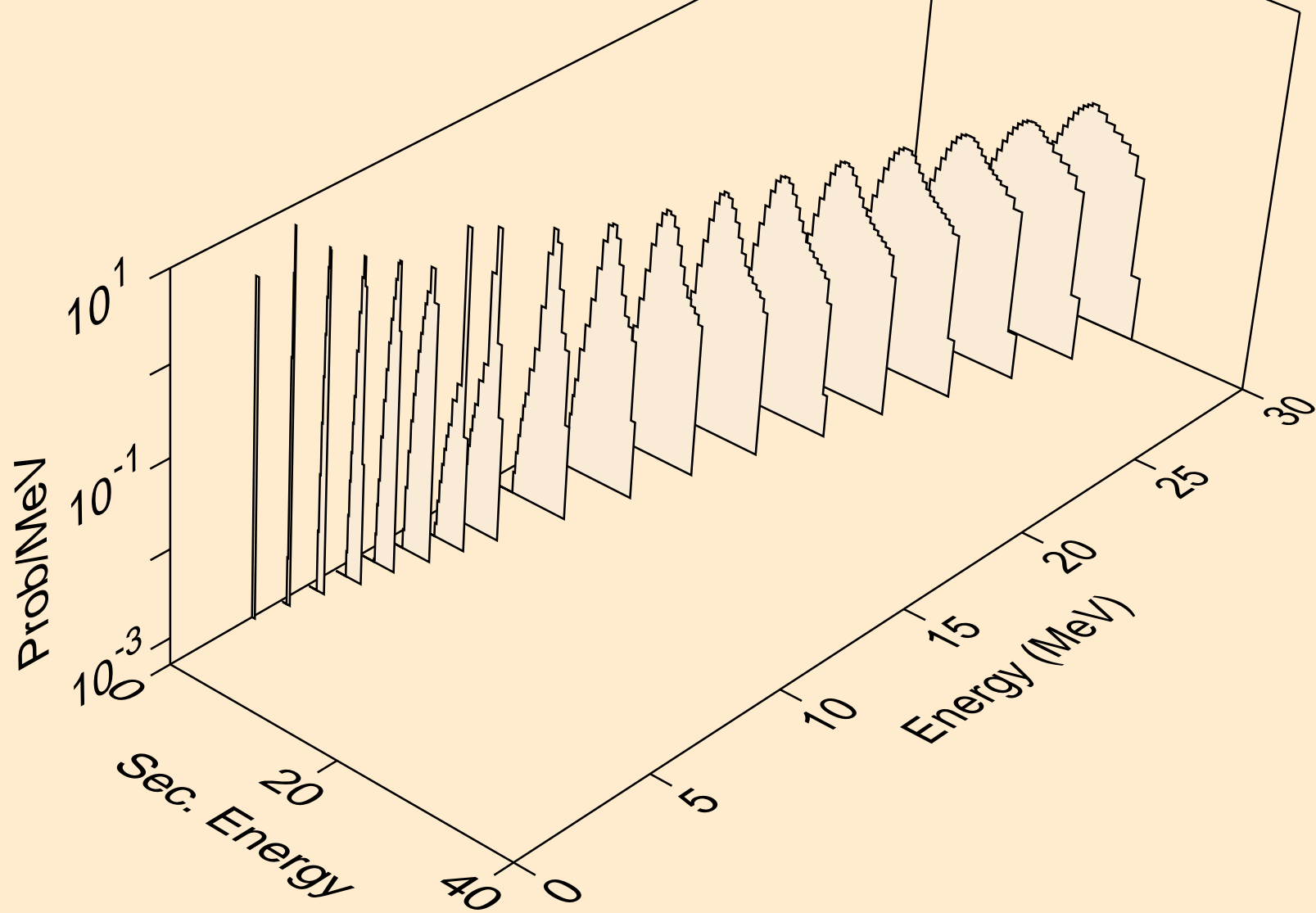

RU106 TRITON ACER TENDL-2021 LIBRARY; T=0.K  
protons from (t,2np)

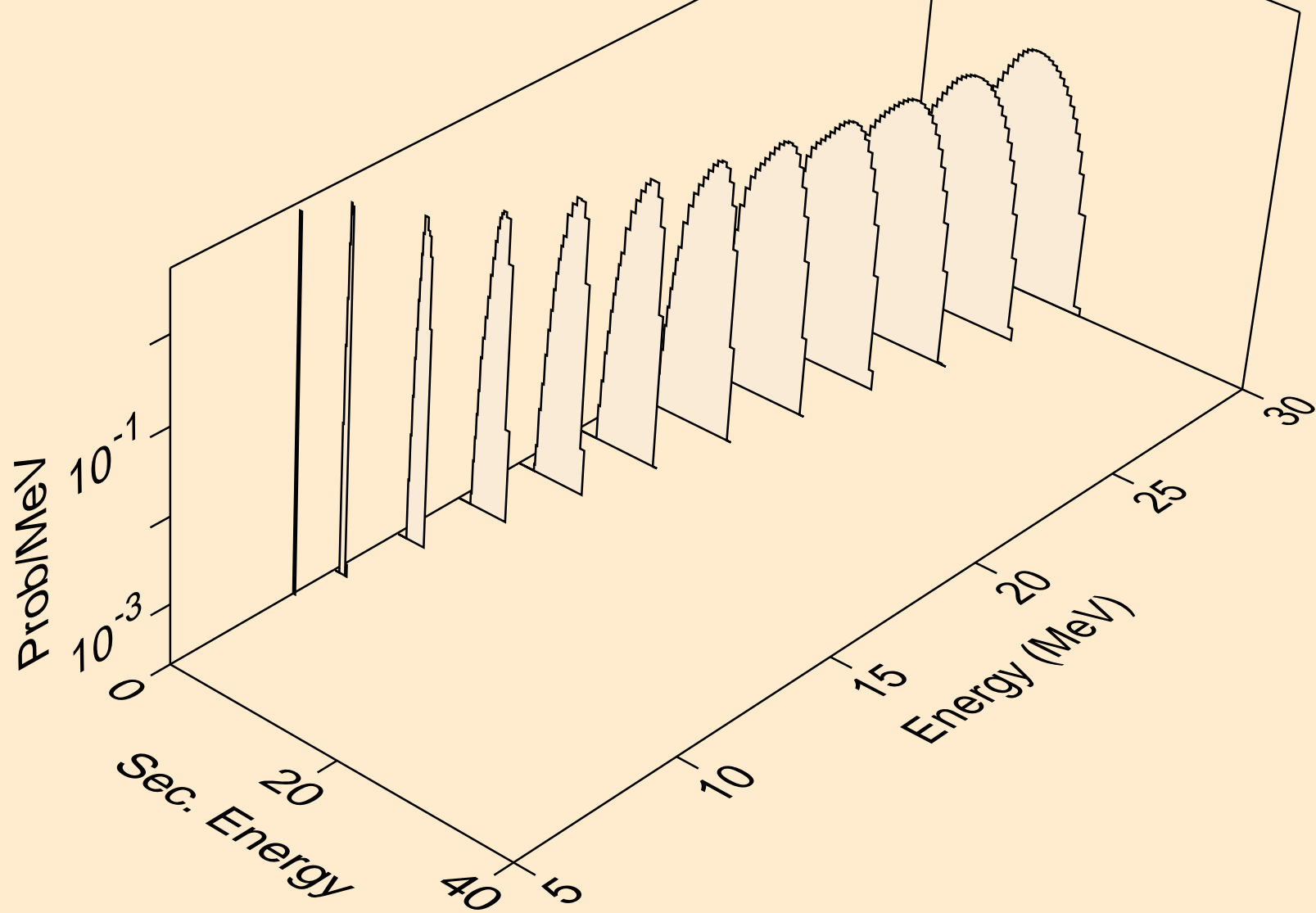

RU106 TRITON ACER TENDL-2021 LIBRARY; T=0.K  
protons from (t,3np)

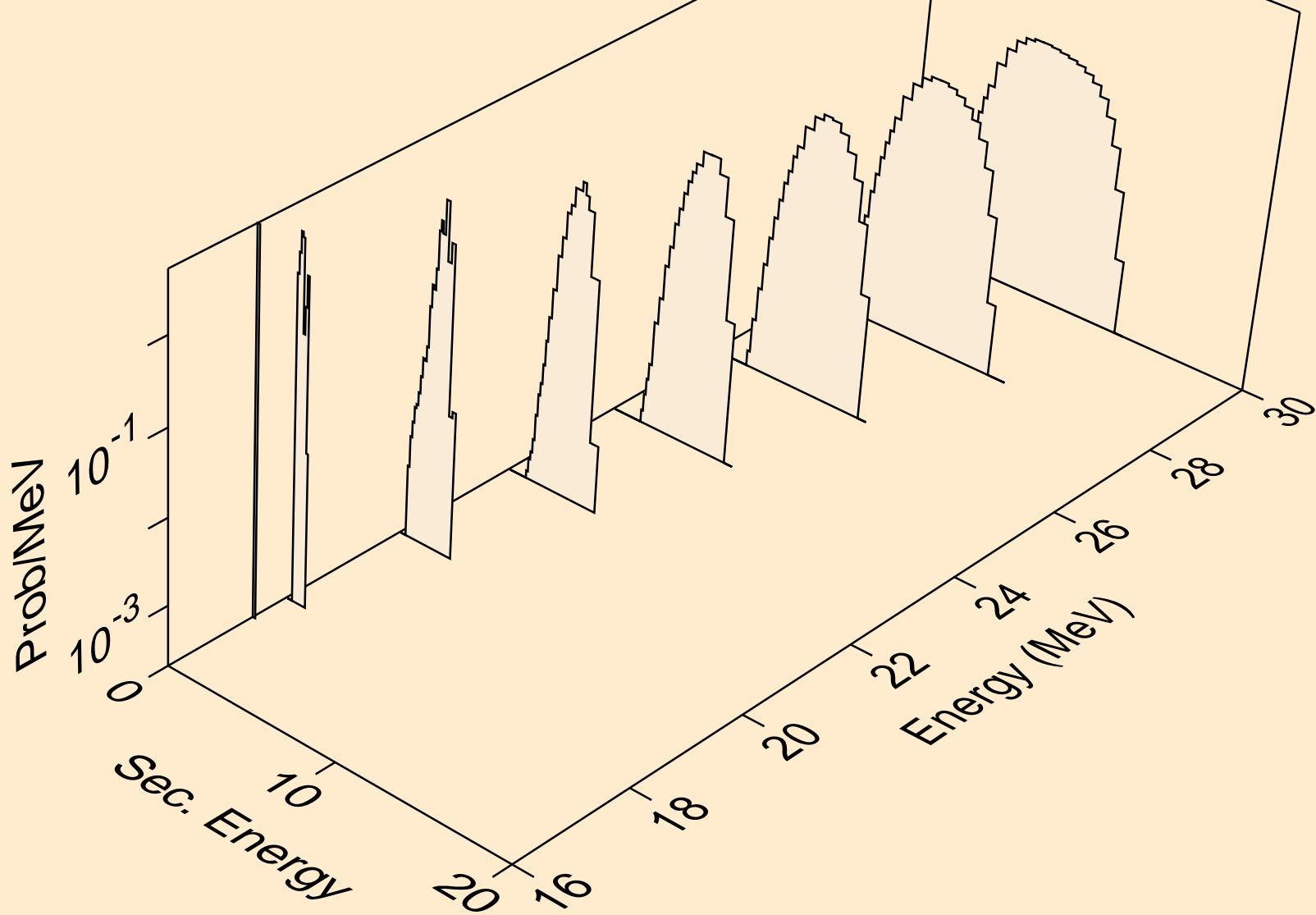

RU106 TRITON ACER TENDL-2021 LIBRARY; T=0.K  
protons from (t,2np)

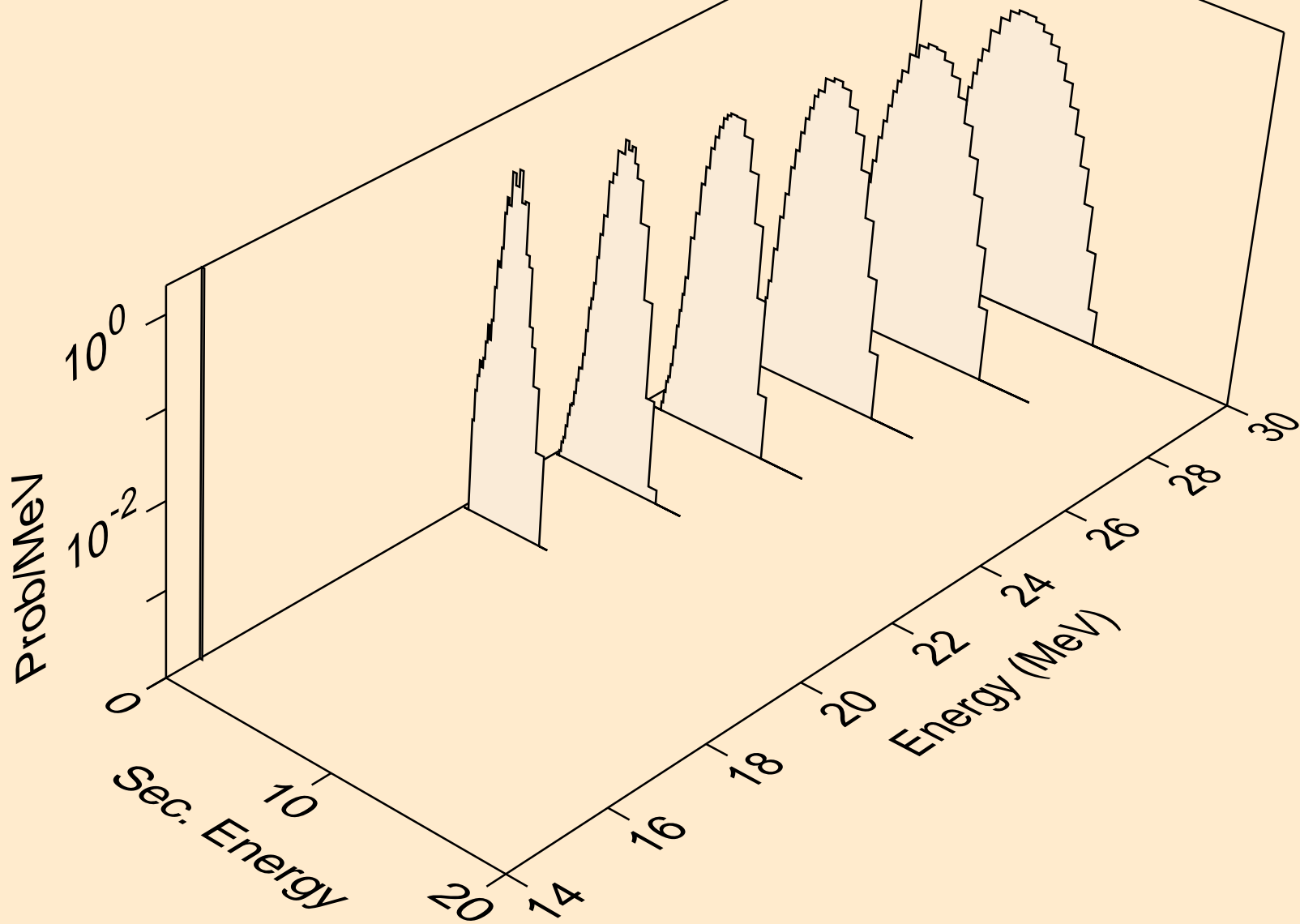

RU106 TRITON ACER TENDL-2021 LIBRARY; T=0.K  
protons from (t,npa)

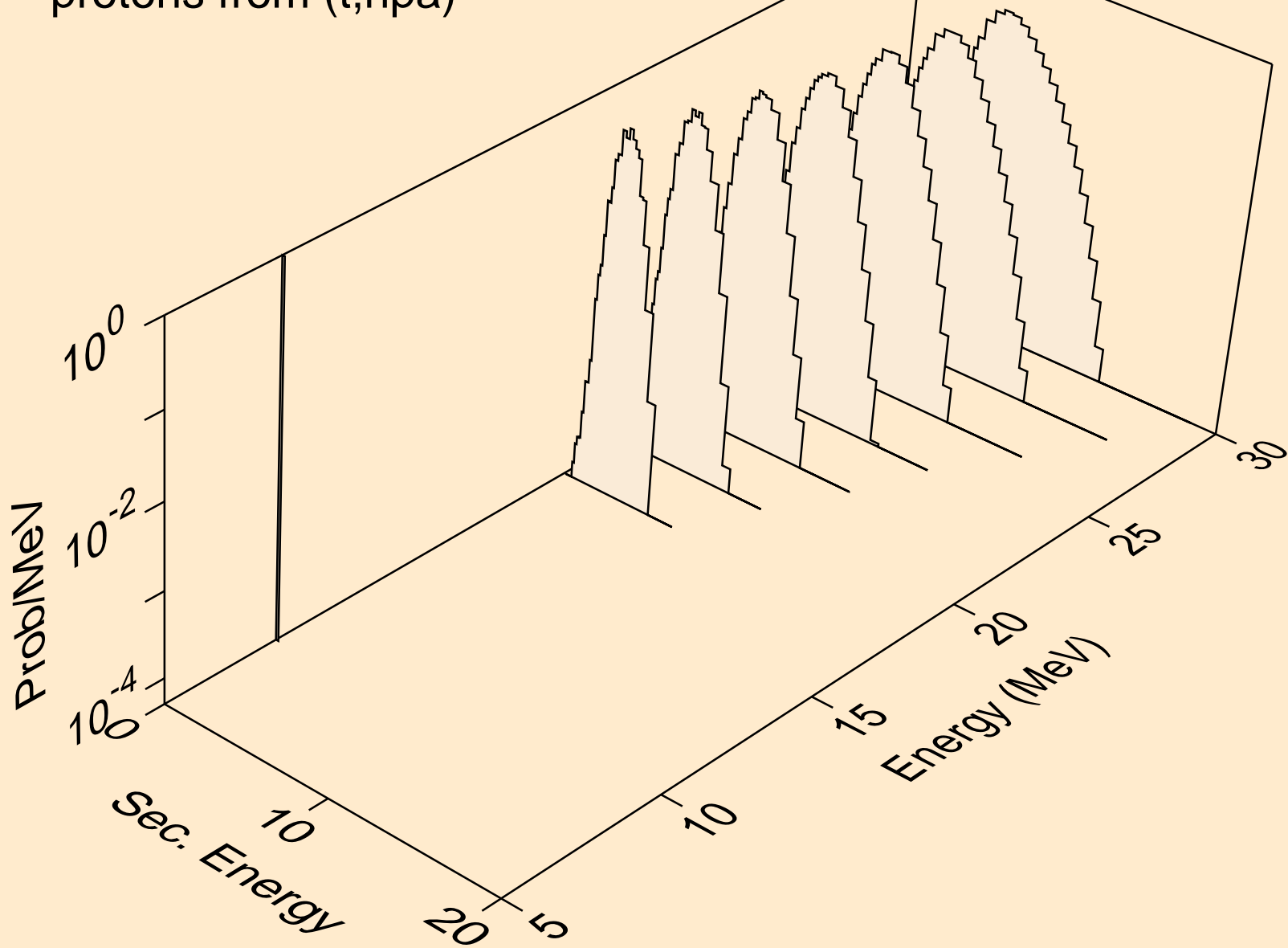

RU106 TRITON ACER TENDL-2021 LIBRARY; T=0.K  
protons from (t,p)

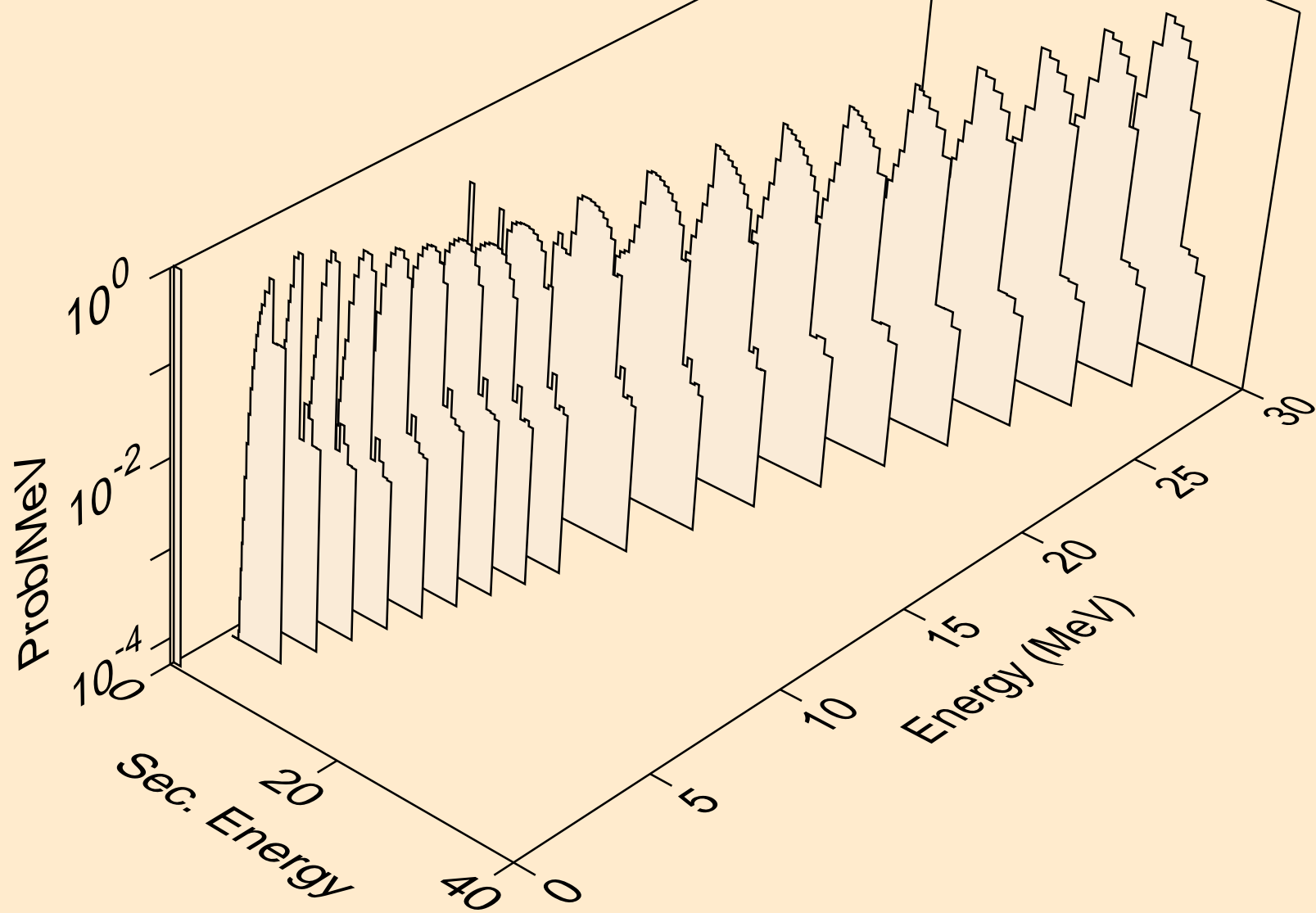

RU106 TRITON ACER TENDL-2021 LIBRARY; T=0.K  
protons from (t,2p)

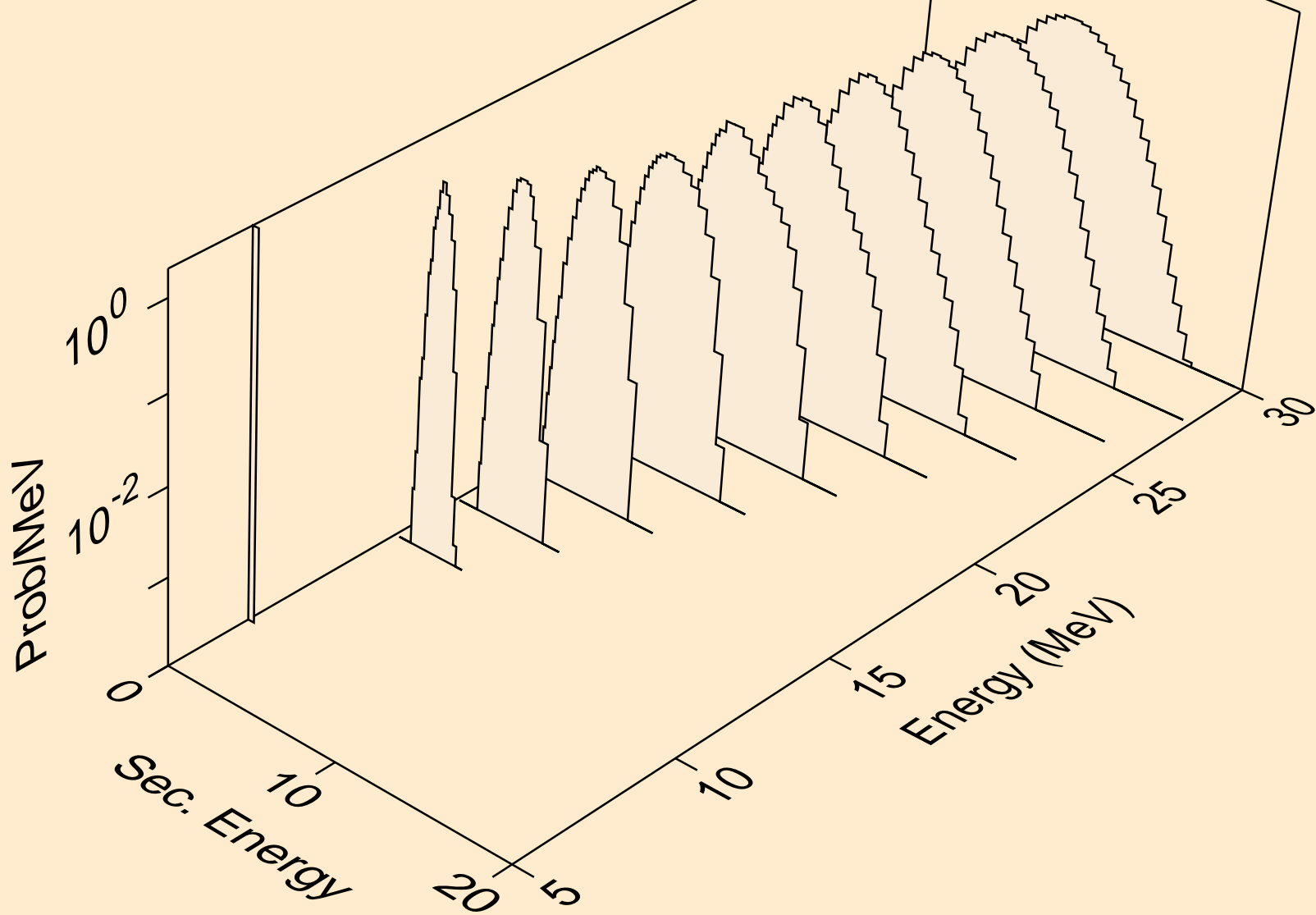



RU106 TRITON ACER TENDL-2021 LIBRARY; T=0.K  
protons from (t,pa)

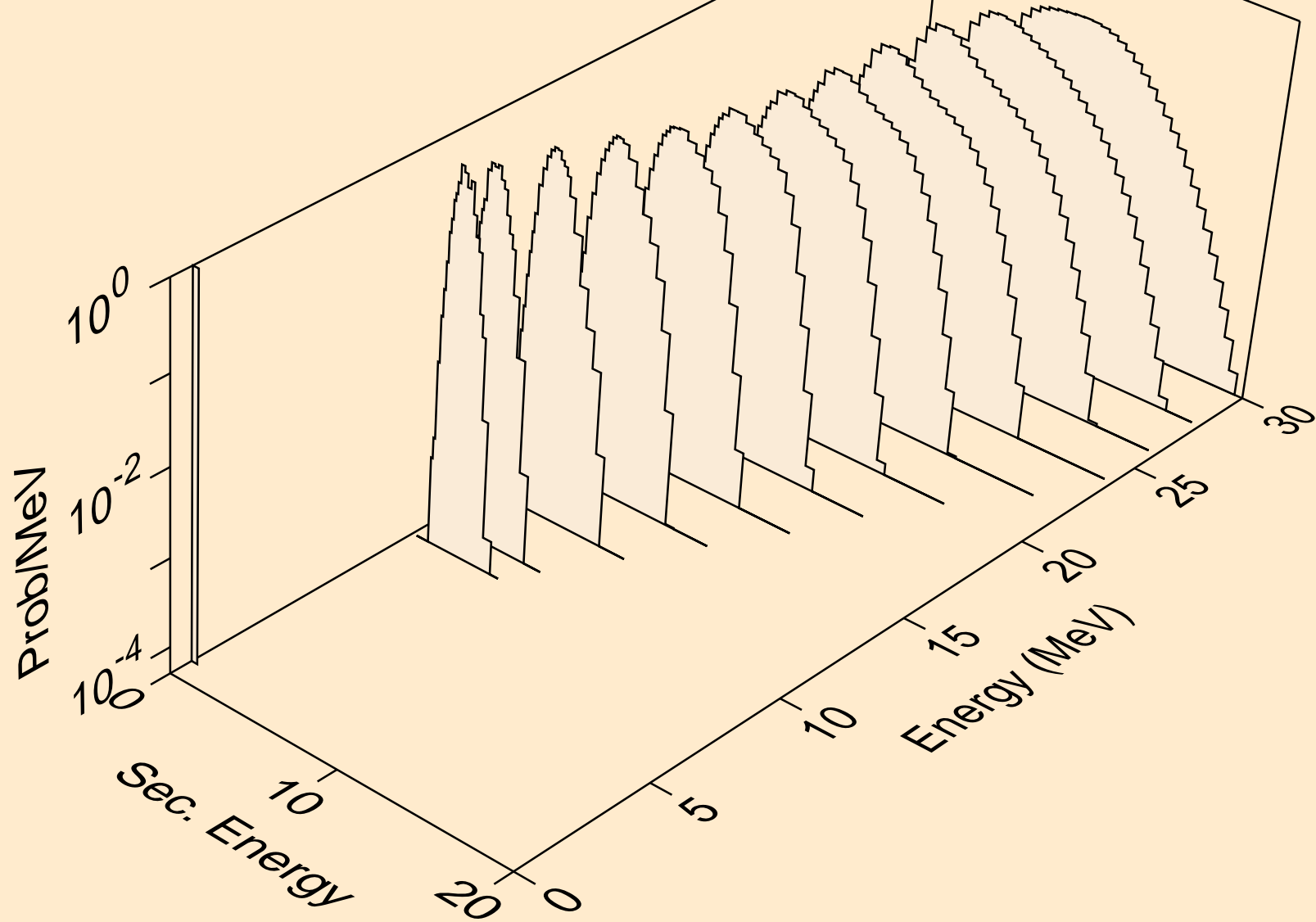

RU106 TRITON ACER TENDL-2021 LIBRARY; T=0.K  
protons from (t,pd)

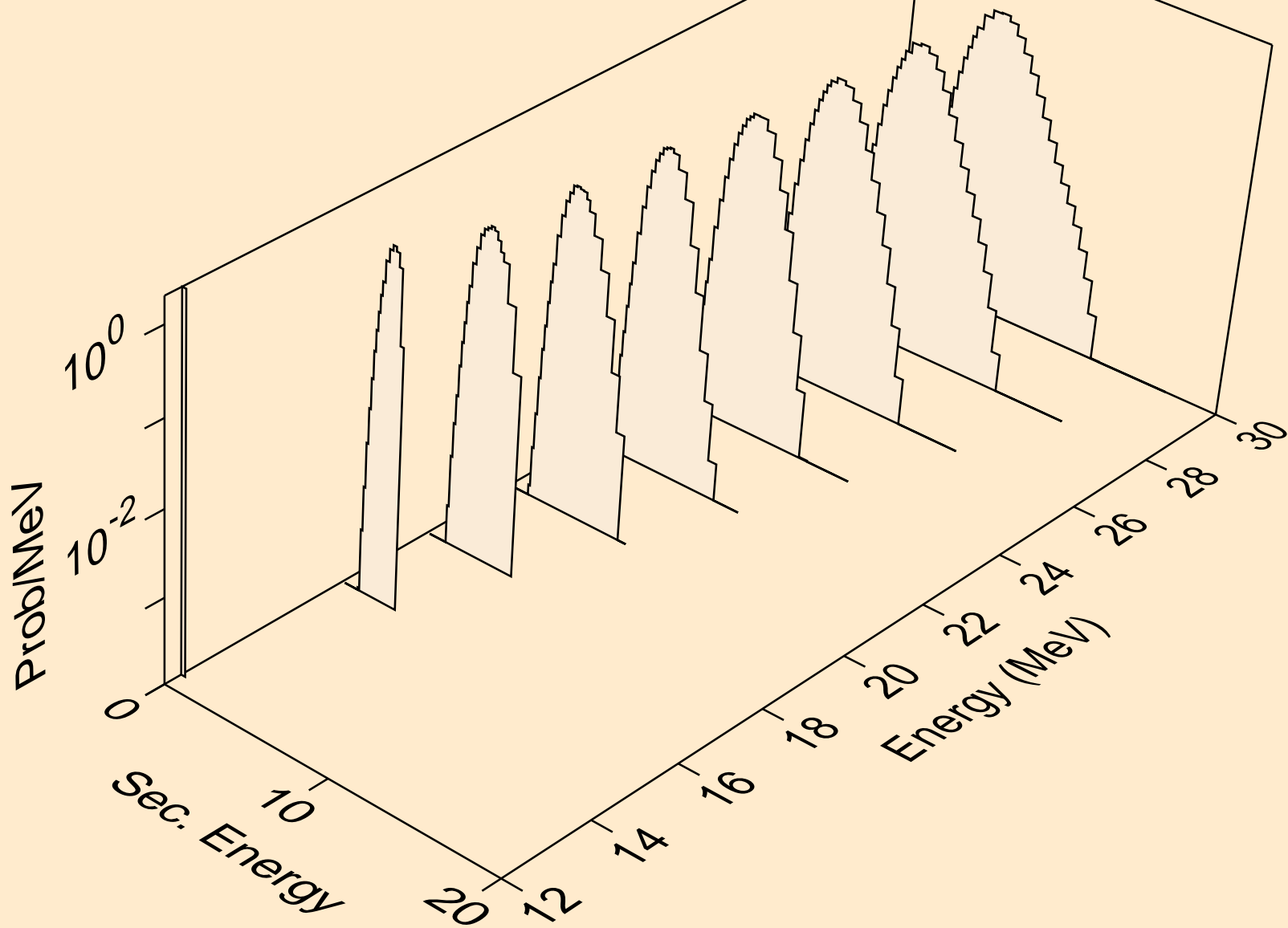

RU106 TRITON ACER TENDL-2021 LIBRARY; T=0.K  
protons from (t,pt)

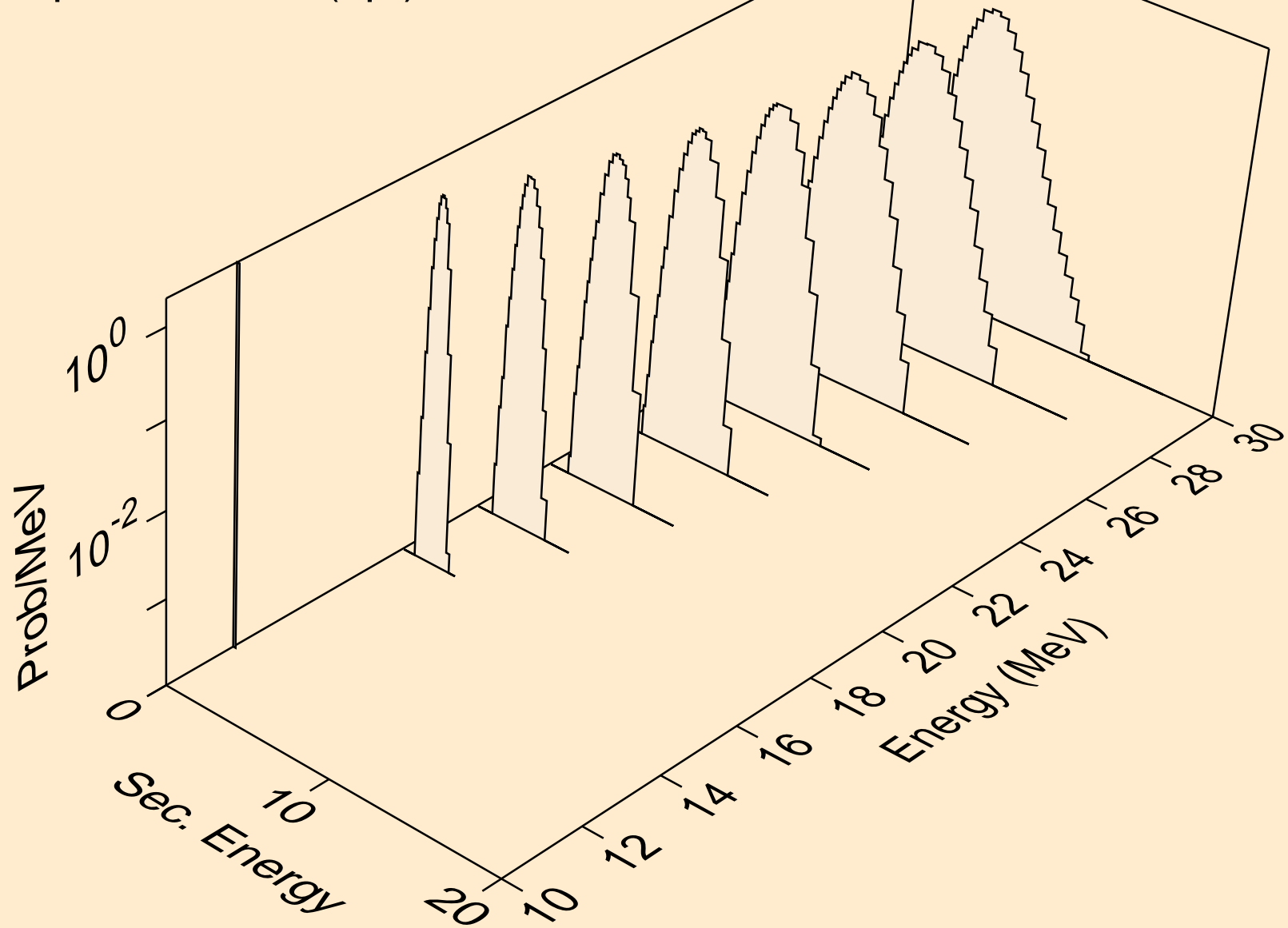

RU106 TRITON ACER TENDL-2021 LIBRARY; T=0.K  
deuterons from (t,x)

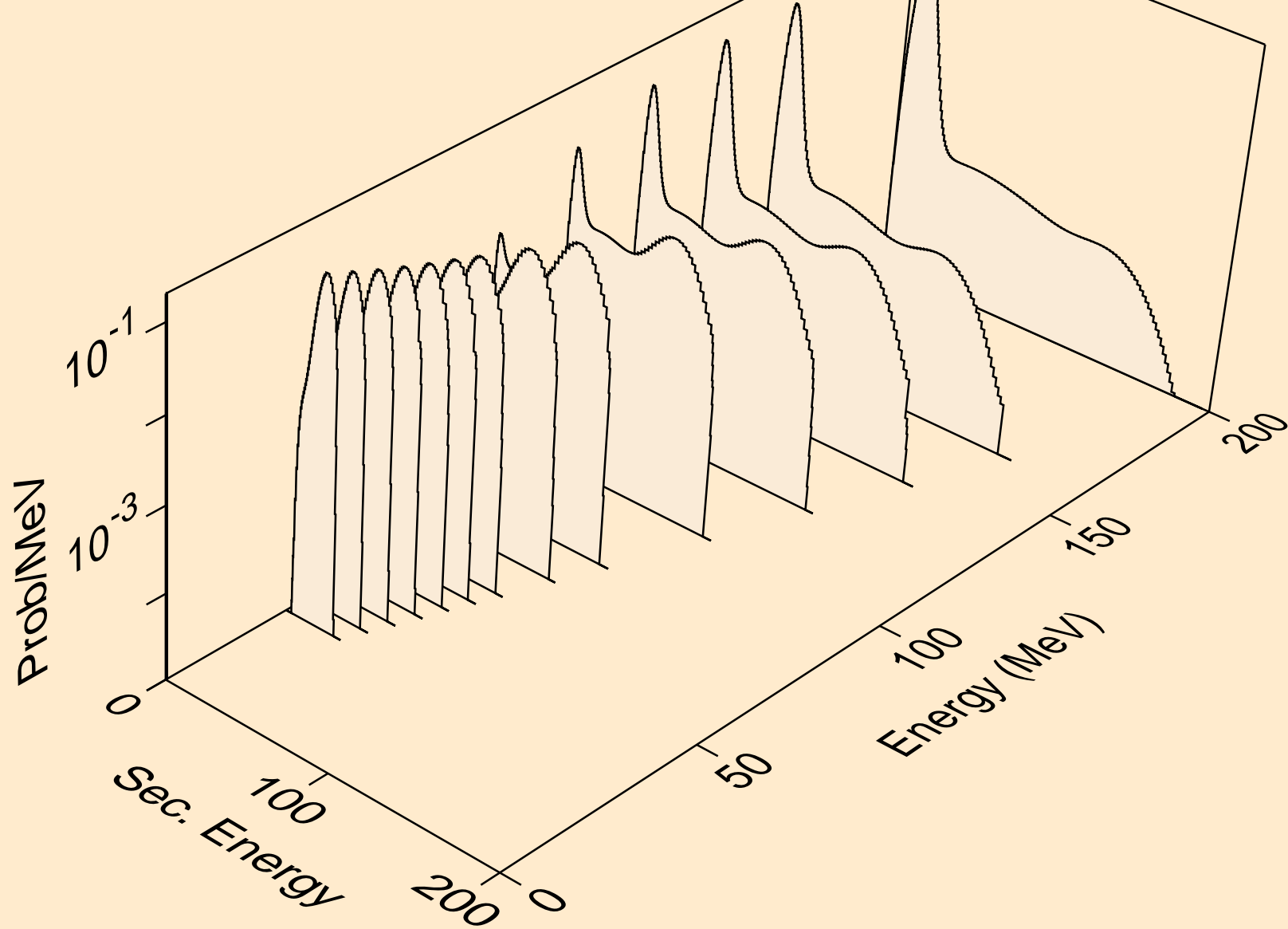

RU106 TRITON ACER TENDL-2021 LIBRARY; T=0.K  
deuterons from (t,2nd)

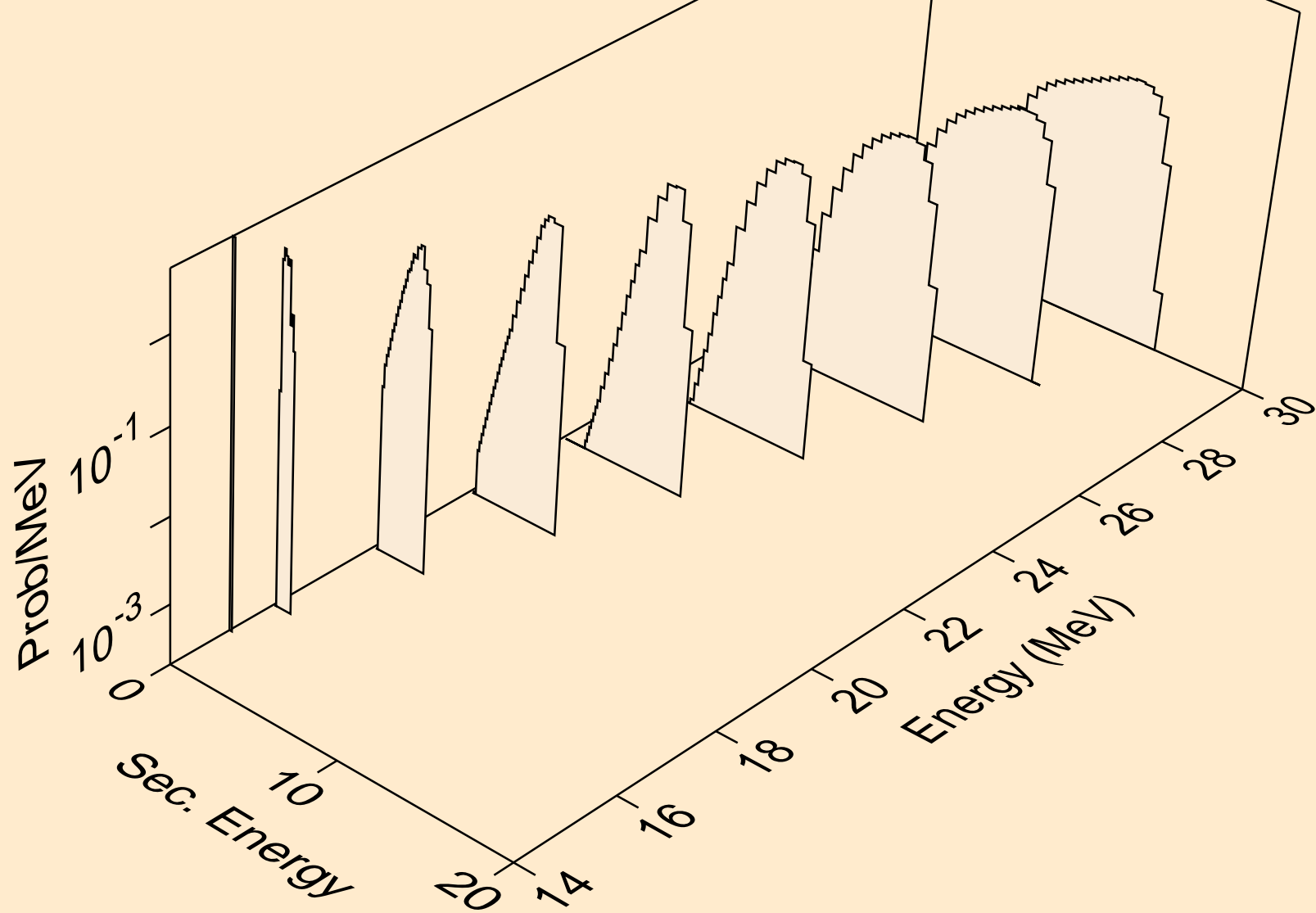

RU106 TRITON ACER TENDL-2021 LIBRARY; T=0.K  
deuterons from (t,n\*)d

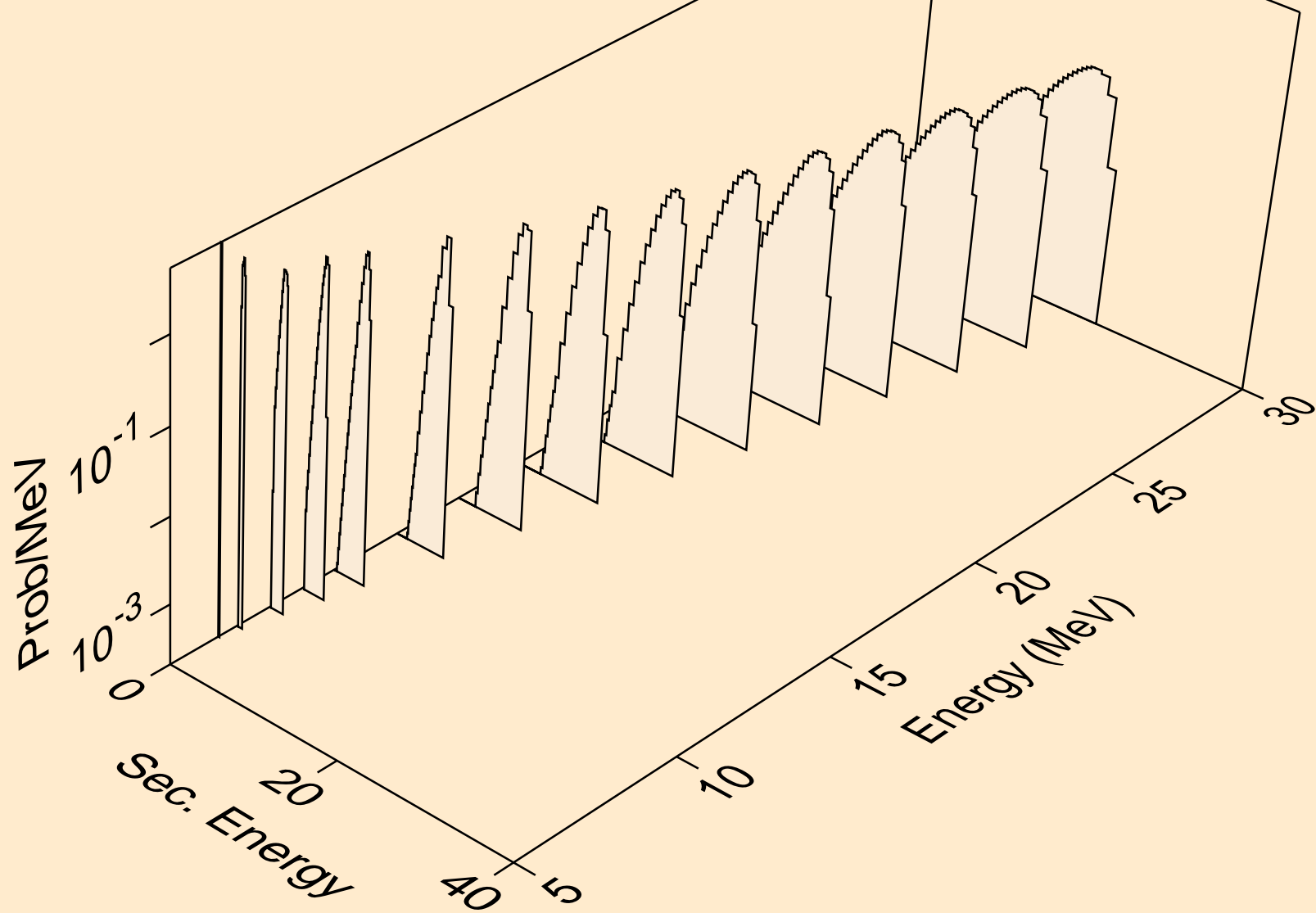

RU106 TRITON ACER TENDL-2021 LIBRARY; T=0.K  
deuterons from (t,d)

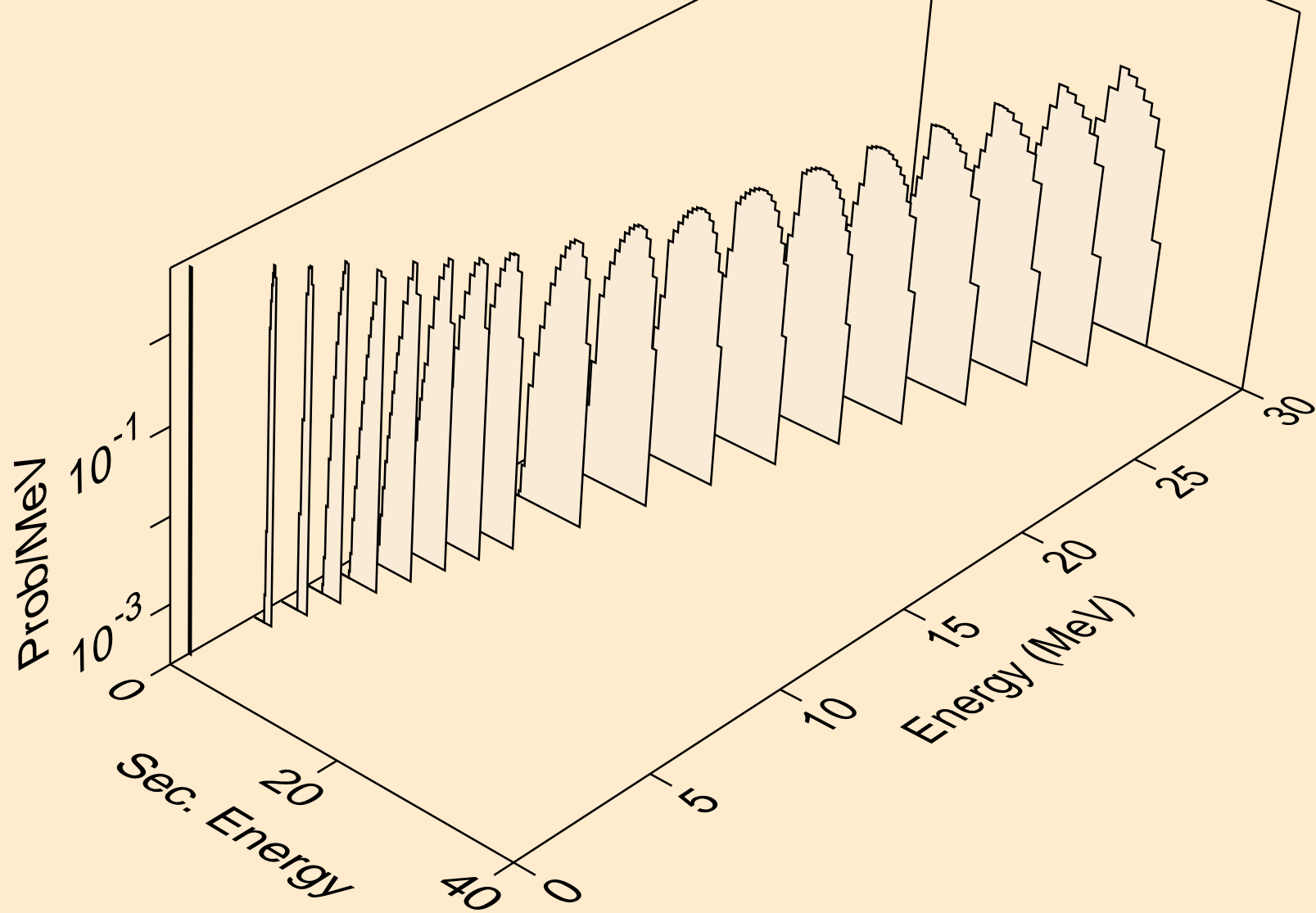

RU106 TRITON ACER TENDL-2021 LIBRARY; T=0.K  
deuterons from (t,pd)

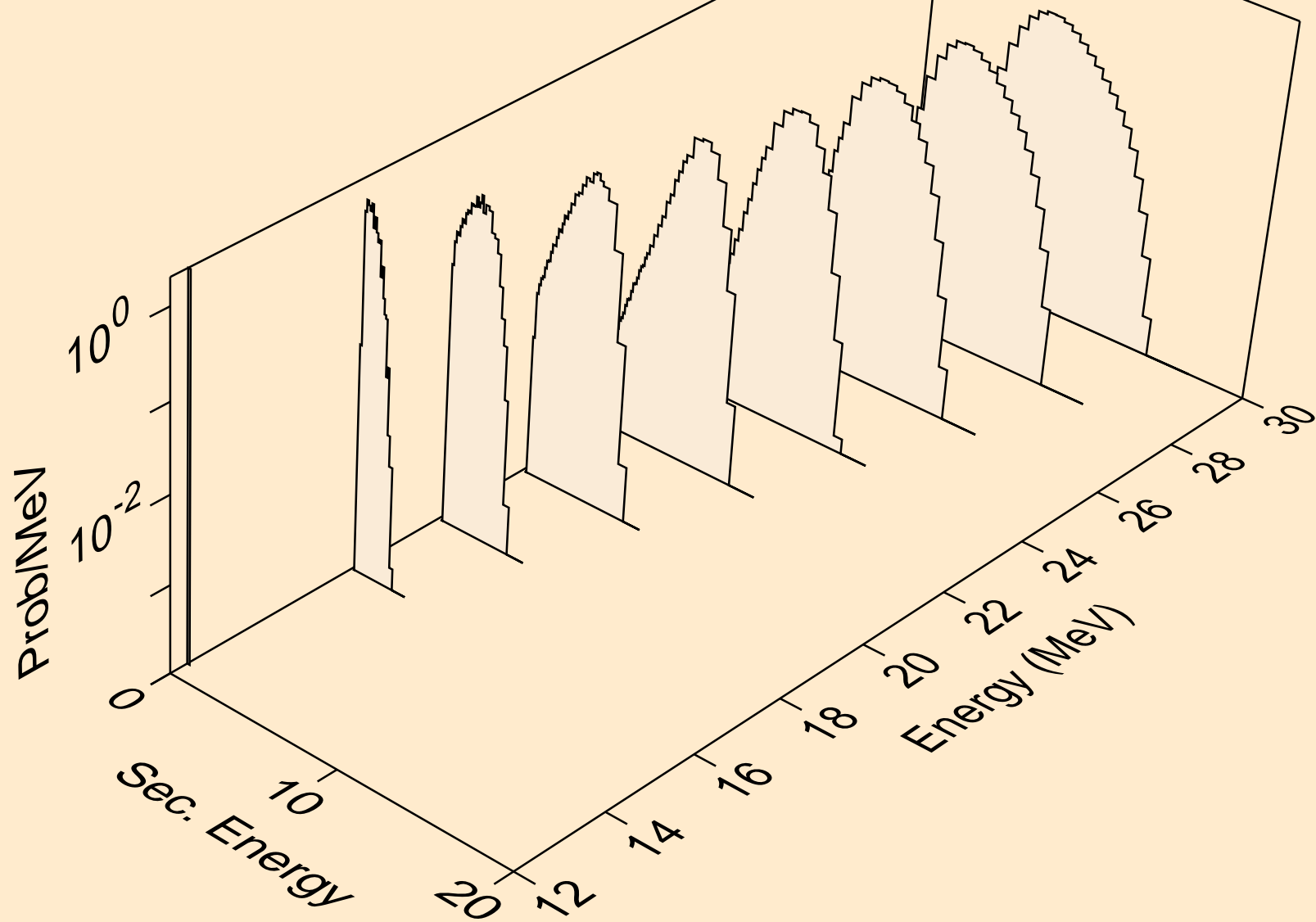



RU106 TRITON ACER TENDL-2021 LIBRARY; T=0.K  
deuterons from (t,da)

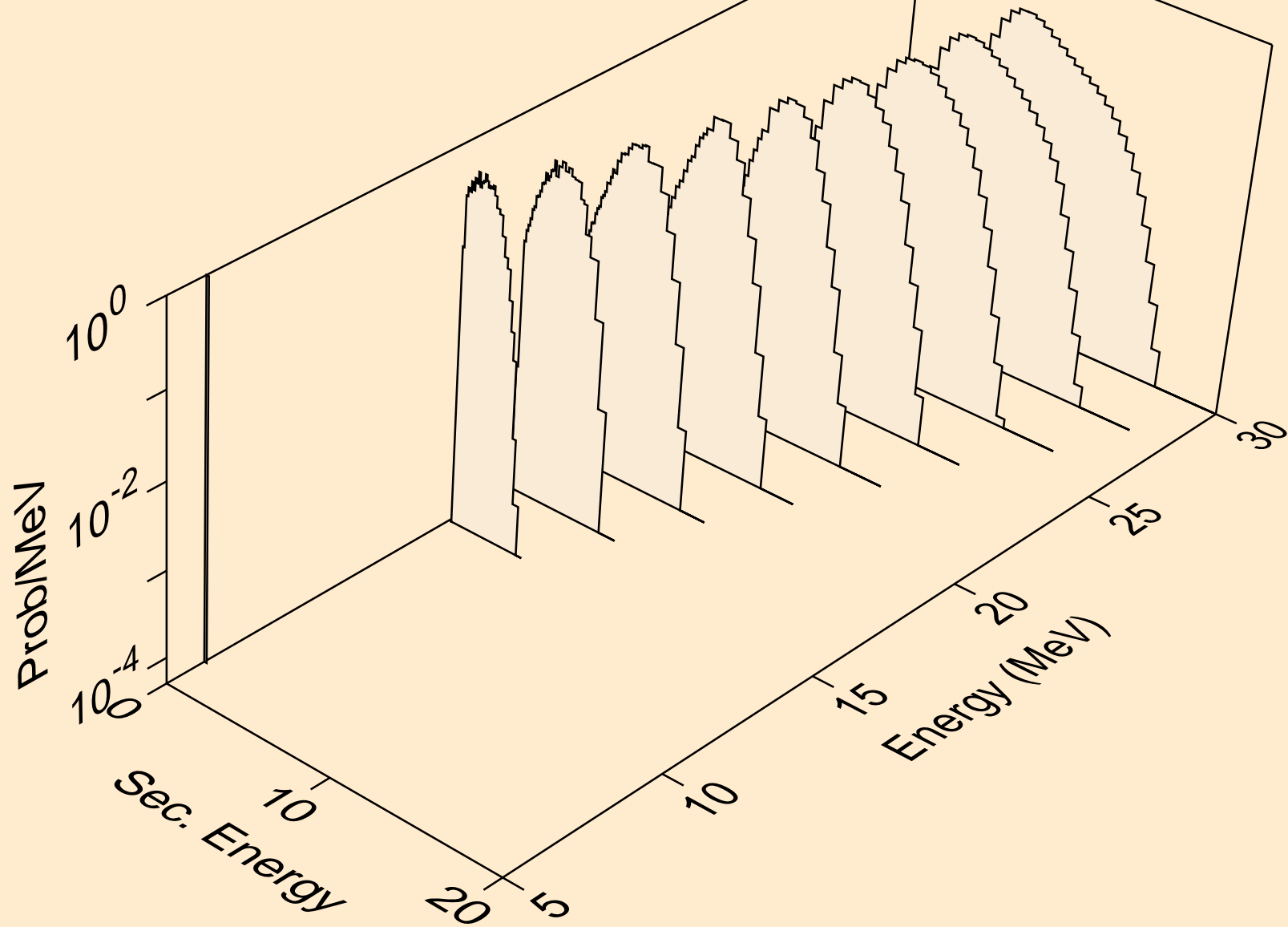

RU106 TRITON ACER TENDL-2021 LIBRARY; T=0.K  
he3s from (t,x)

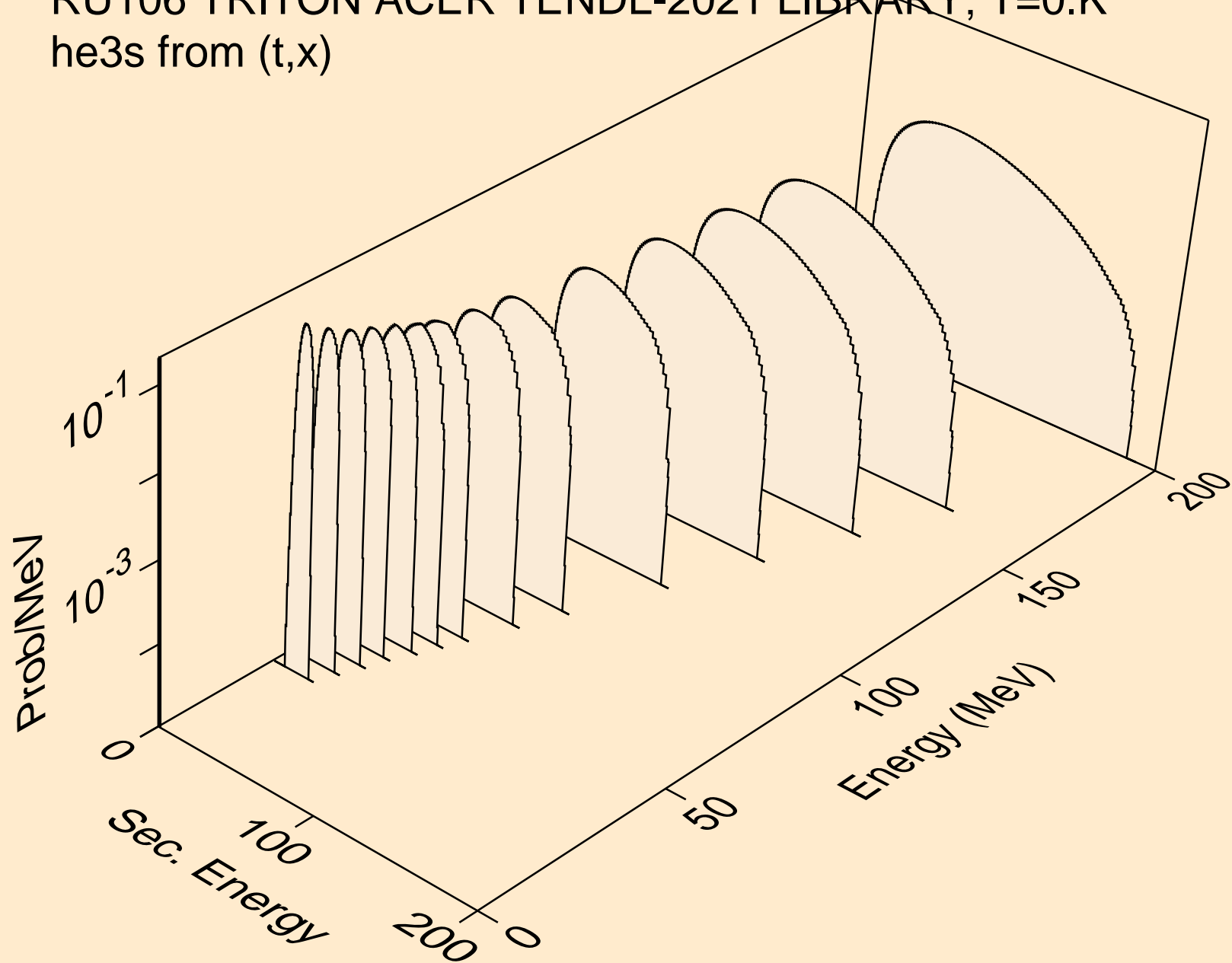

RU106 TRITON ACER TENDL-2021 LIBRARY; T=0.K  
he3s from (t,n\*)he3

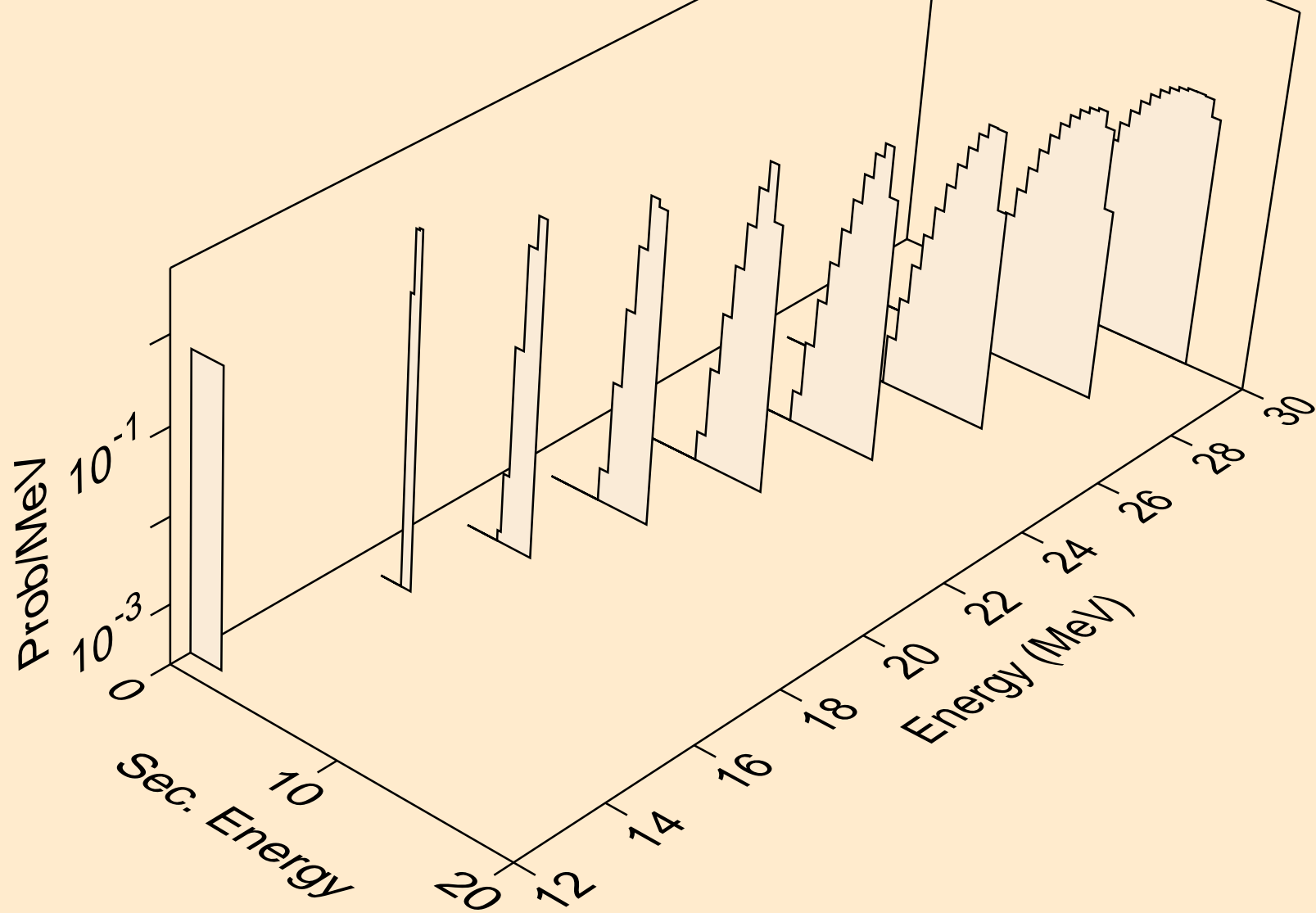

RU106 TRITON ACER TENDL-2021 LIBRARY; T=0.K  
he3s from (t,he3)

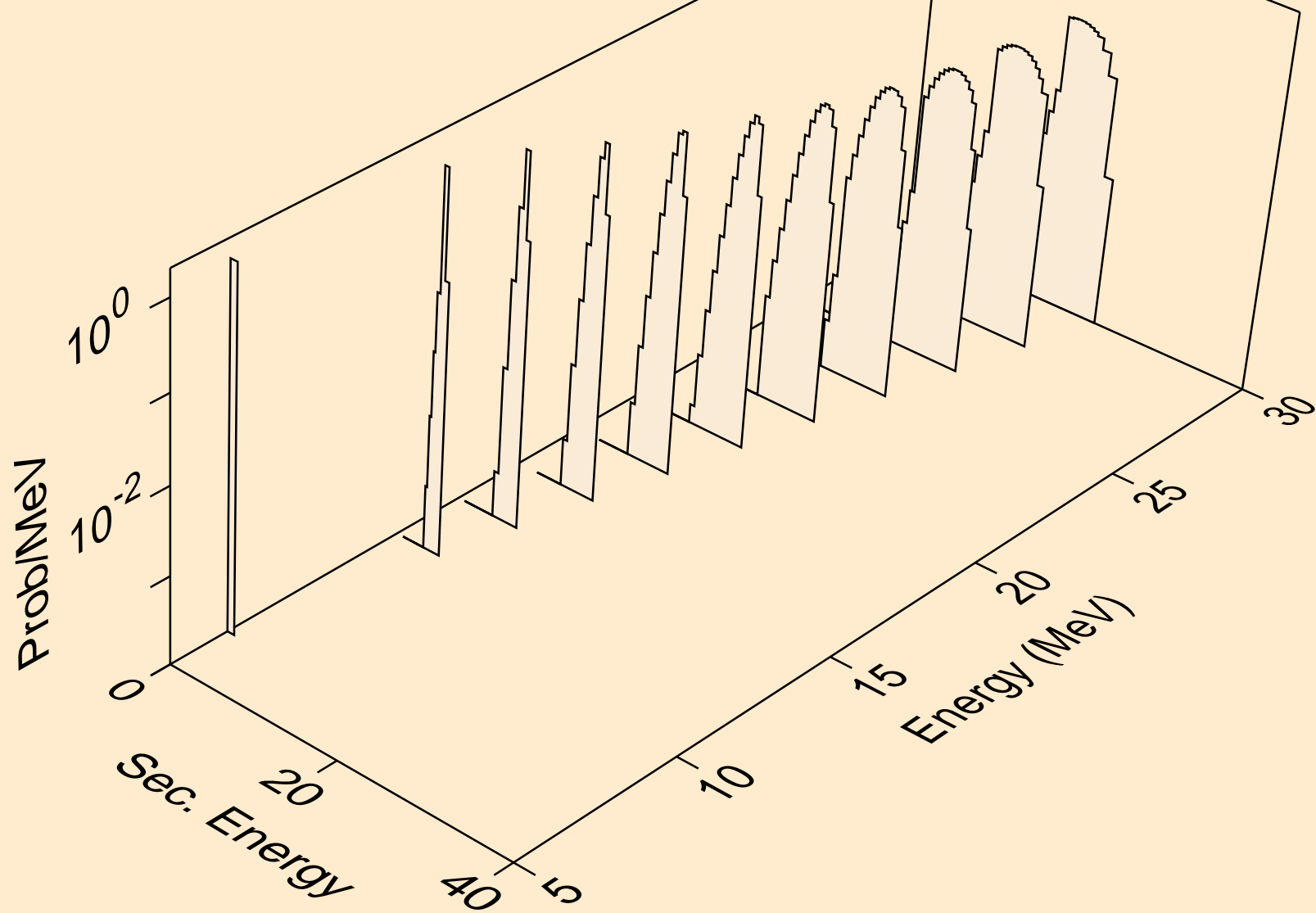

RU106 TRITON ACER TENDL-2021 LIBRARY; T=0.K  
alphas from (t,x)

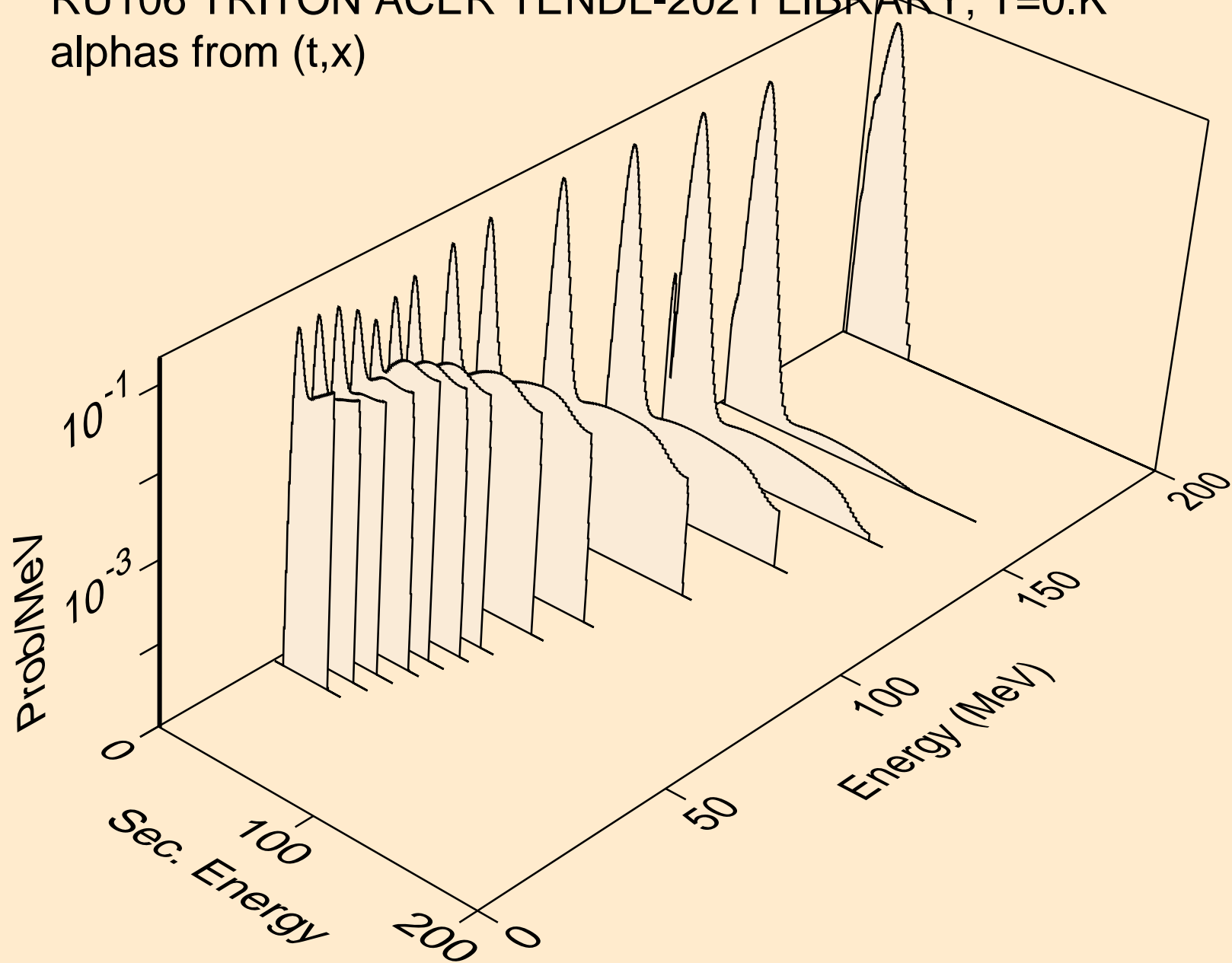

RU106 TRITON ACER TENDL-2021 LIBRARY; T=0.K  
alphas from (t,n\*)a

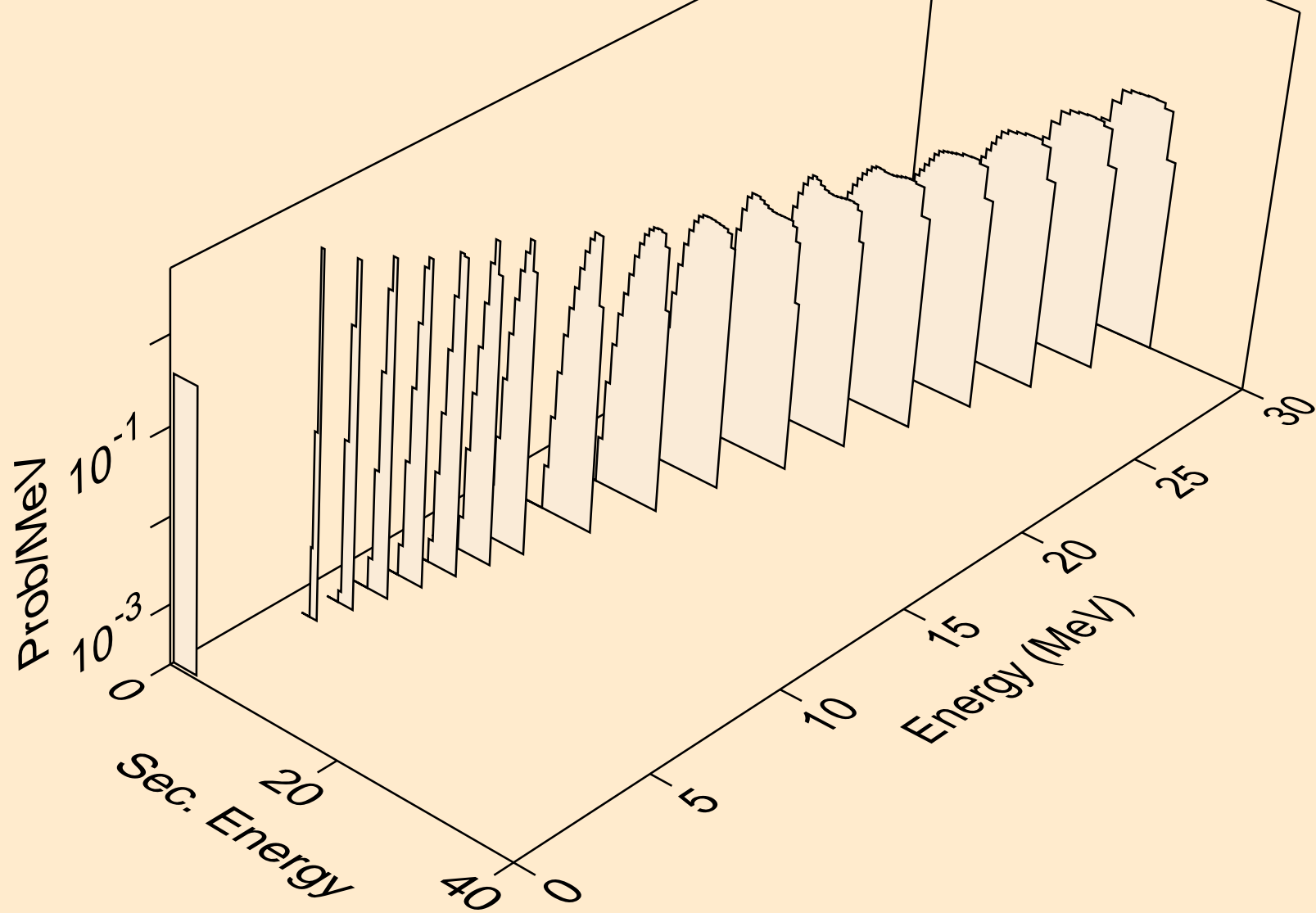

RU106 TRITON ACER TENDL-2021 LIBRARY; T=0.K  
alphas from (t,2n)a

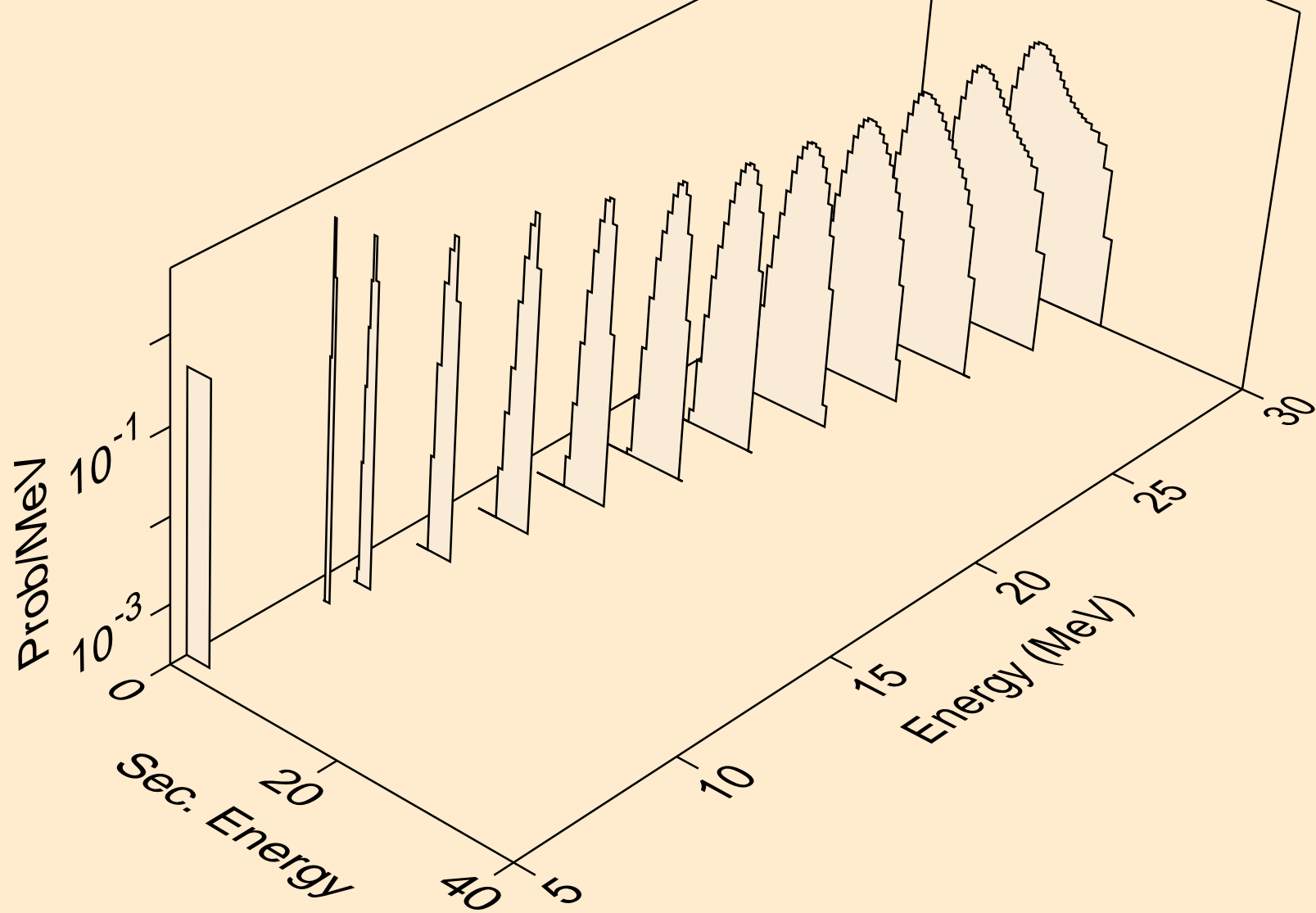

RU106 TRITON ACER TENDL-2021 LIBRARY; T=0.K  
alphas from (t,3n)a

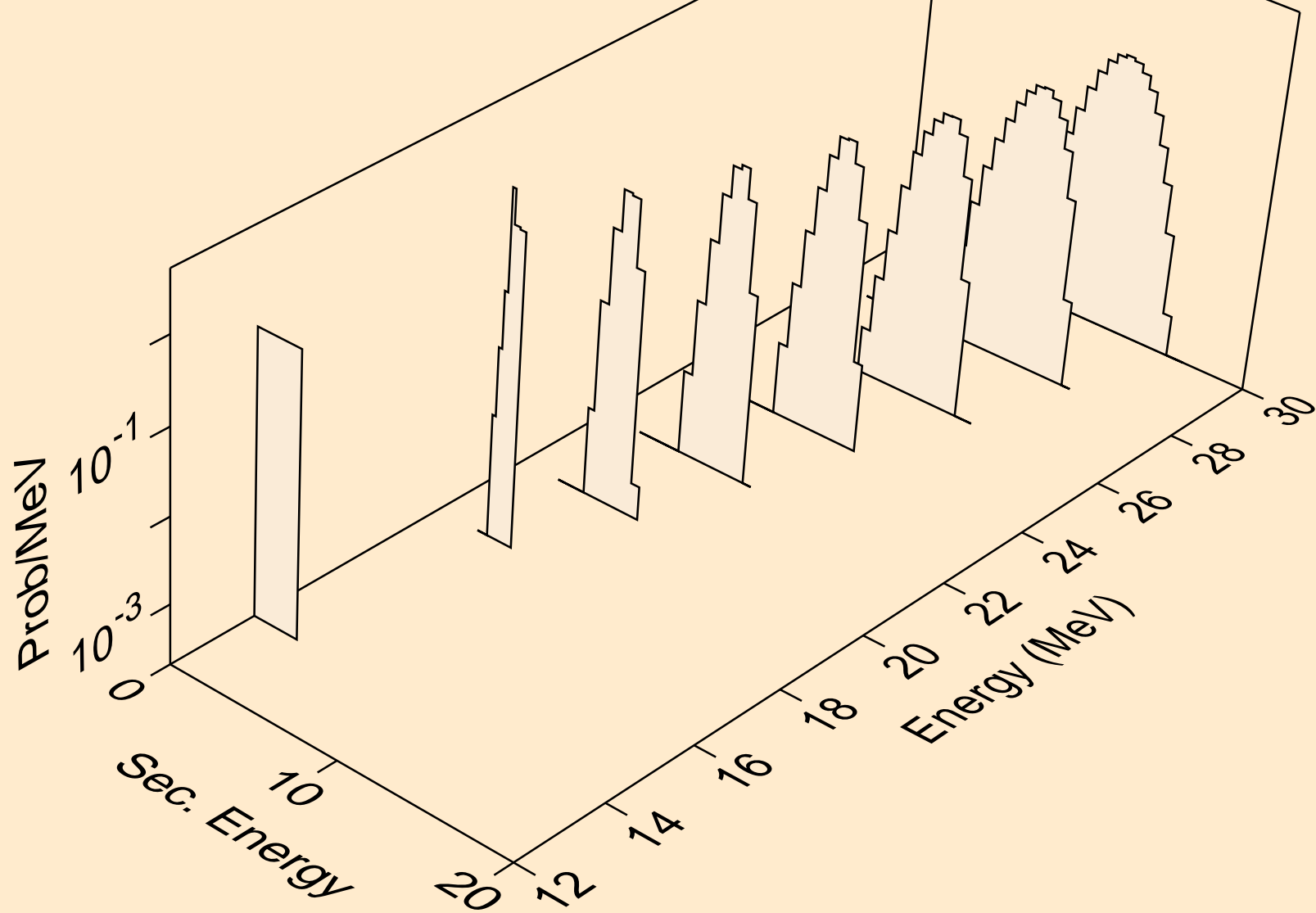



RU106 TRITON ACER TENDL-2021 LIBRARY; T=0.K  
alphas from (t,n\*)2a

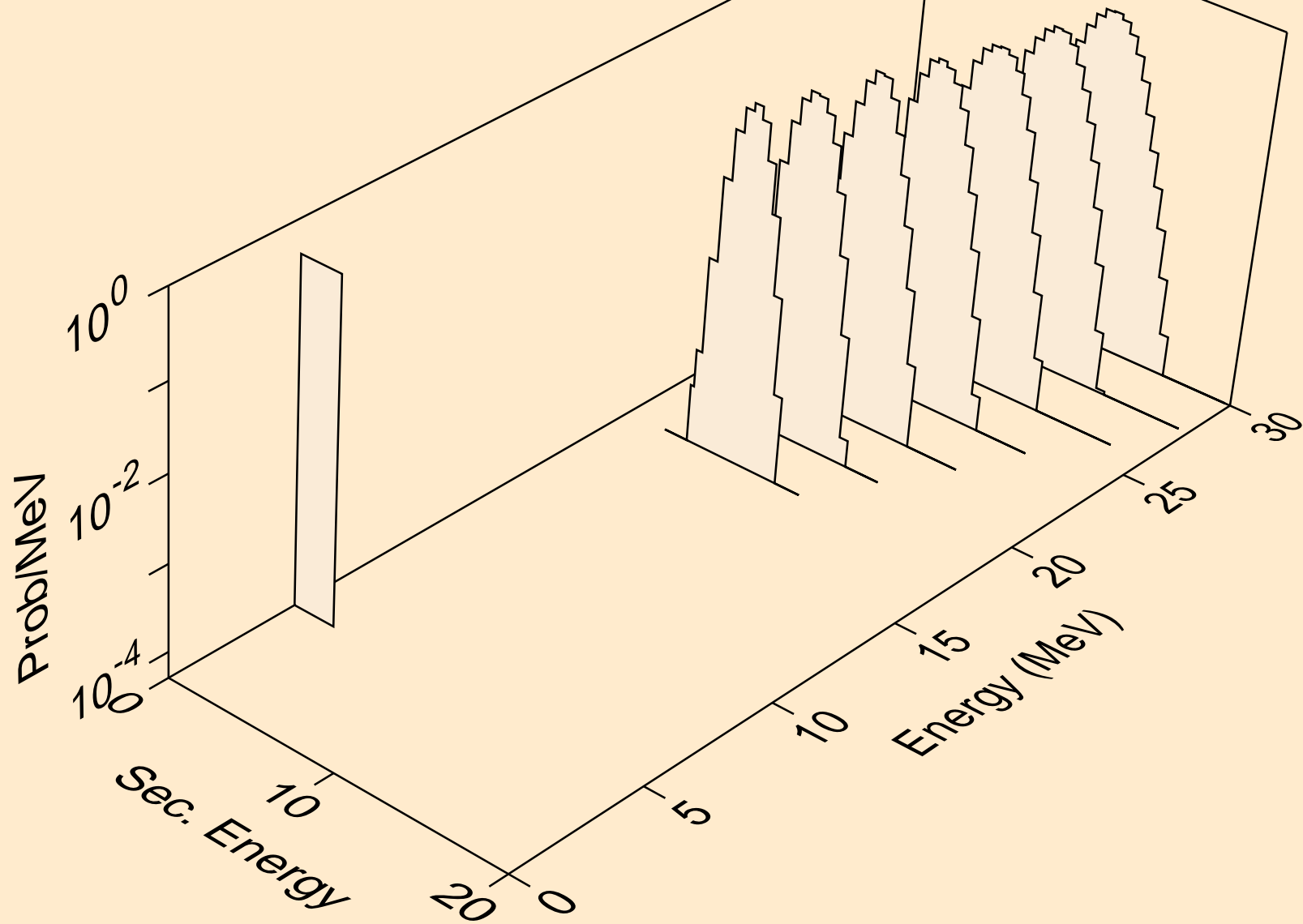

RU106 TRITON ACER TENDL-2021 LIBRARY; T=0.K  
alphas from (t,npa)

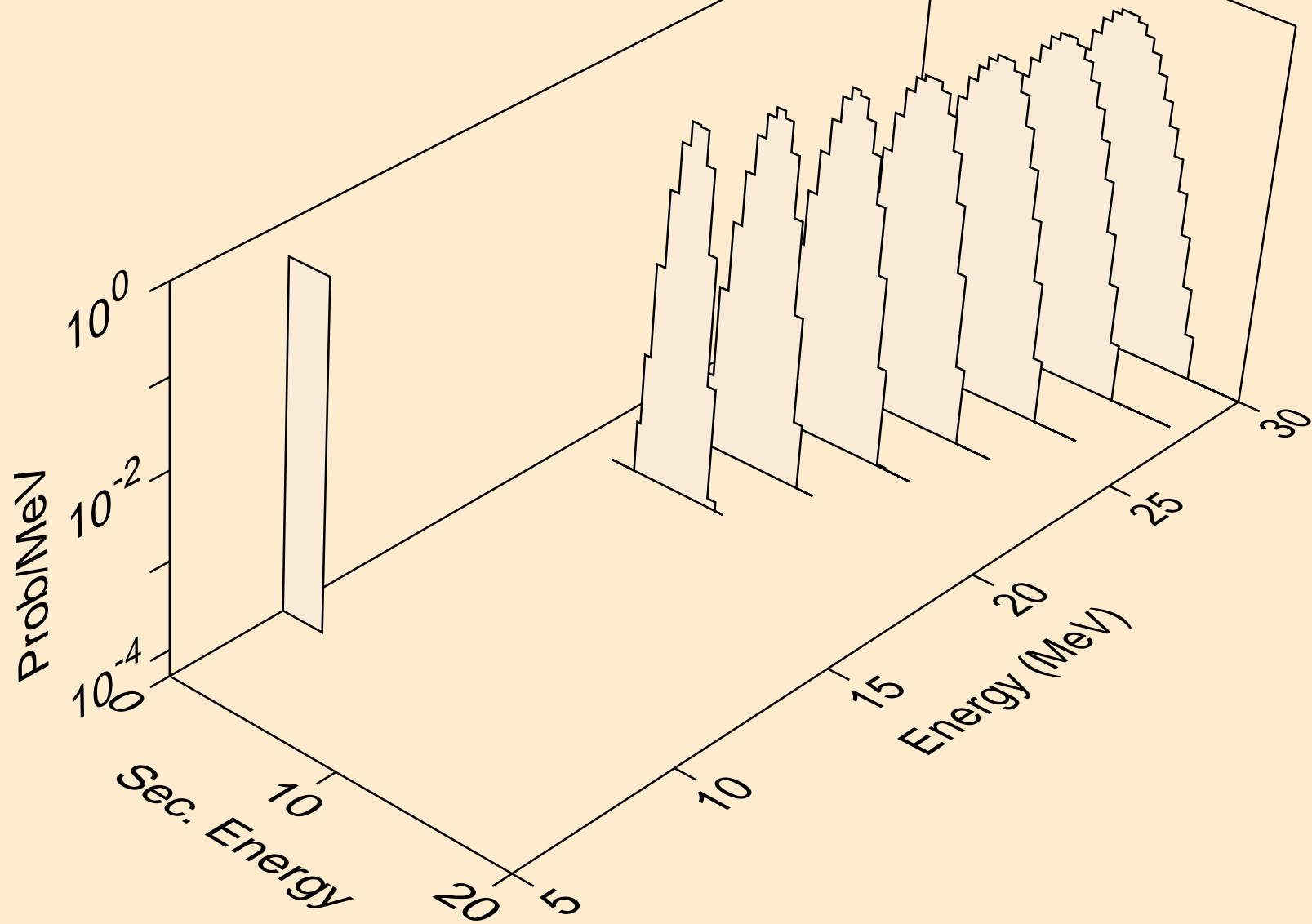

RU106 TRITON ACER TENDL-2021 LIBRARY; T=0.K  
alphas from (t,a)

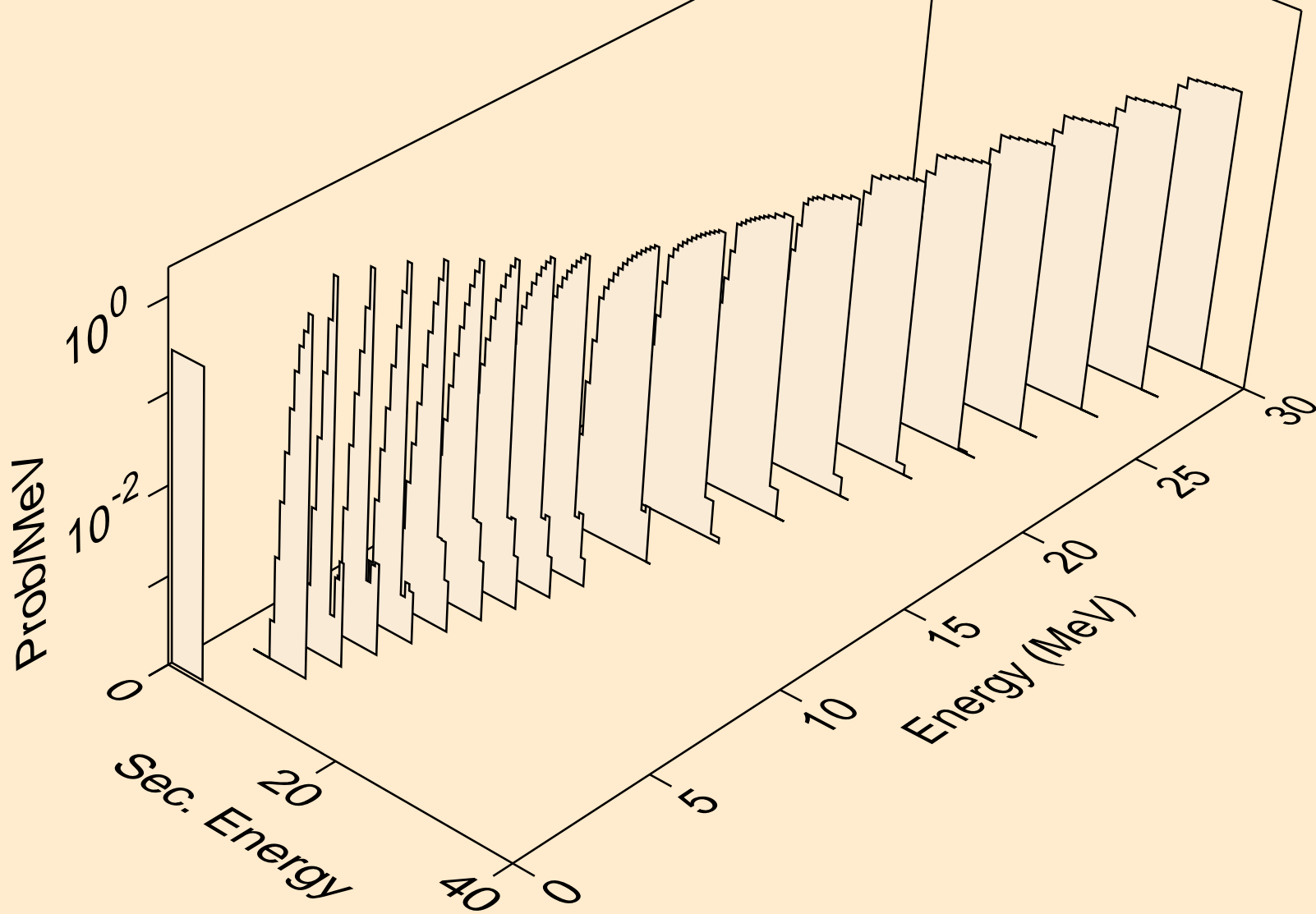

RU106 TRITON ACER TENDL-2021 LIBRARY; T=0.K  
alphas from (t,2a)

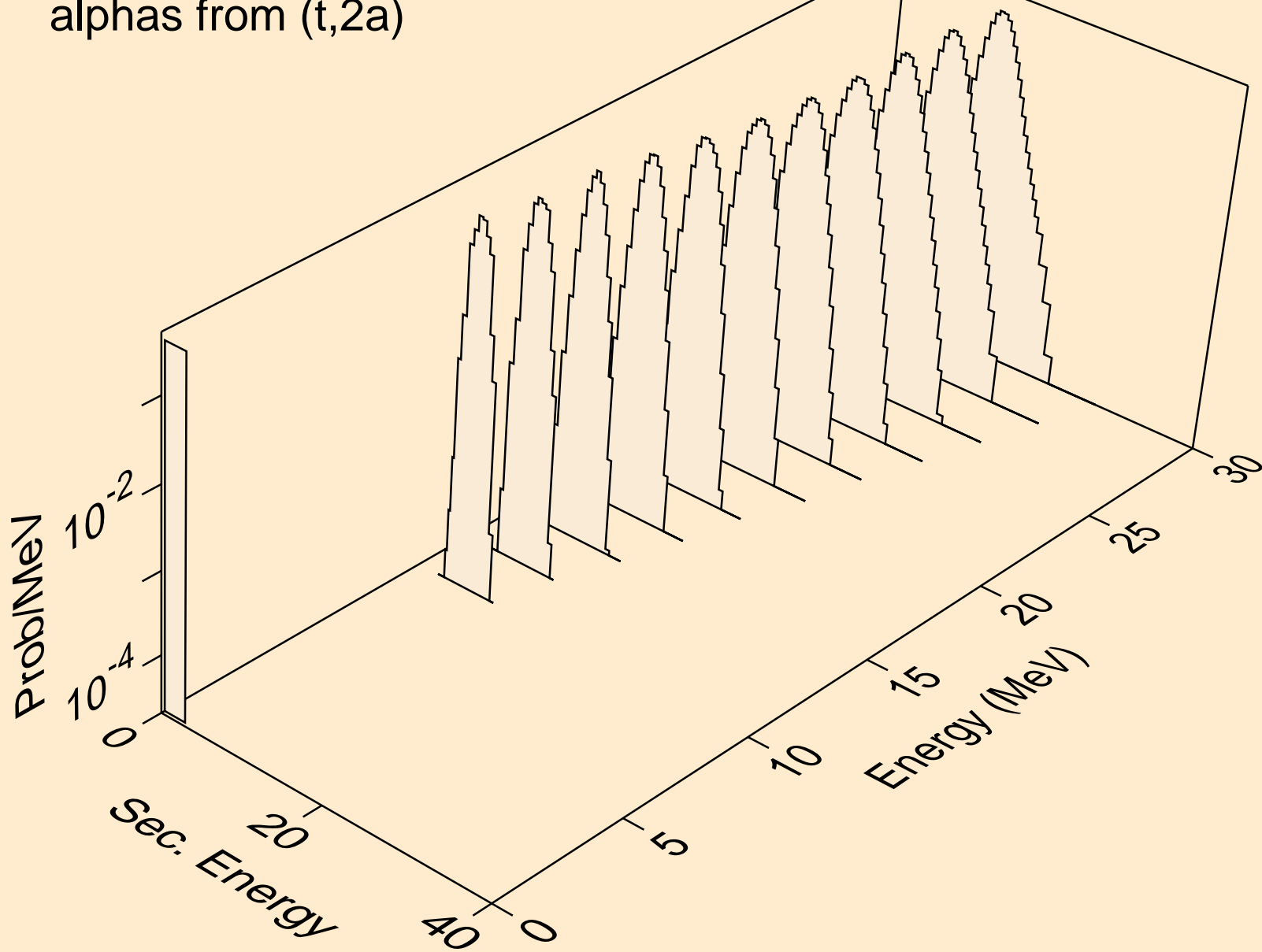

RU106 TRITON ACER TENDL-2021 LIBRARY; T=0.K  
alphas from (t,pa)

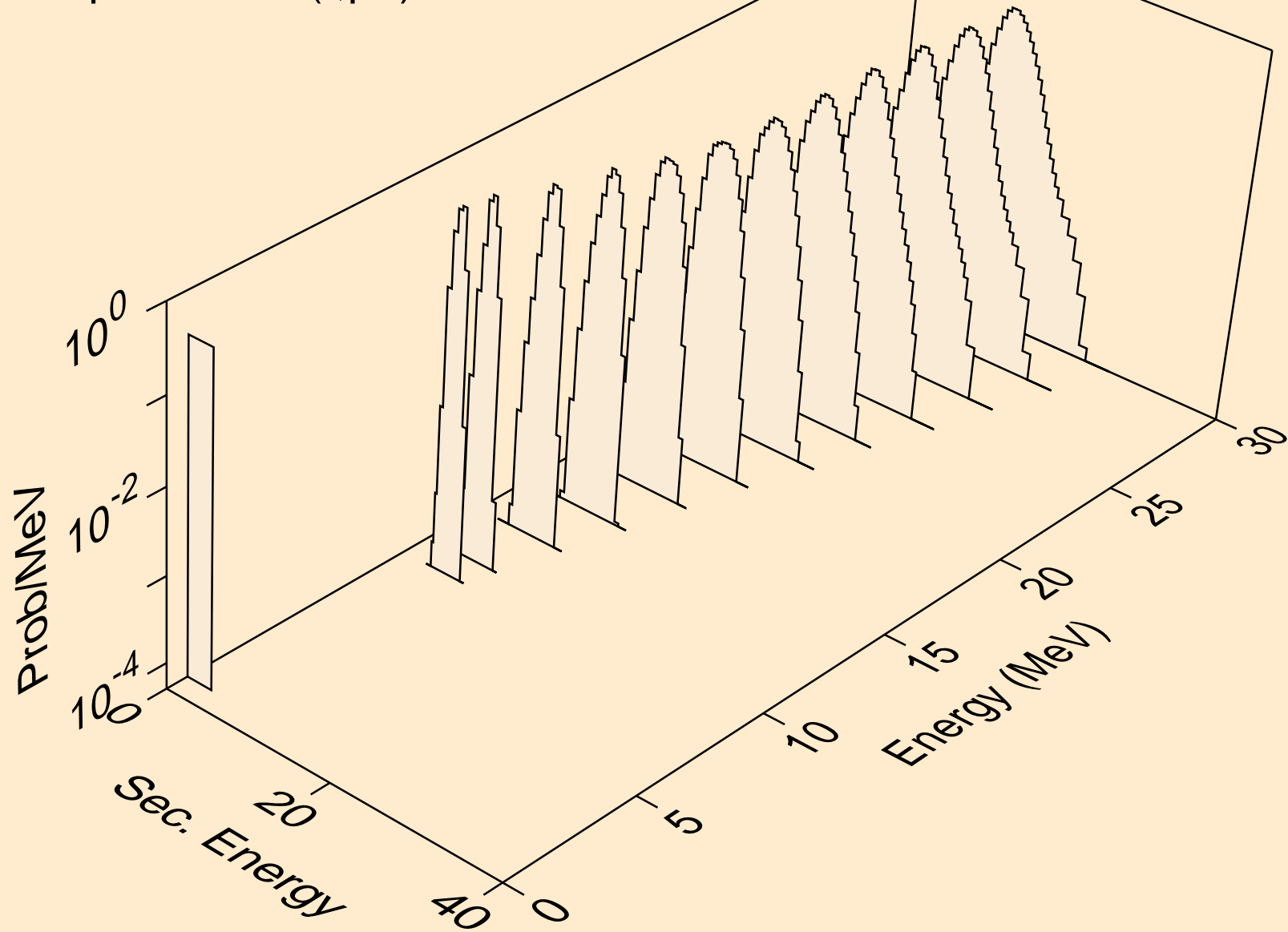

RU106 TRITON ACER TENDL-2021 LIBRARY; T=0.K  
alphas from (t,da)

