

SG270 TRITON ACER TENDL-2021 LIBRARY; T=0.K

Principal cross sections

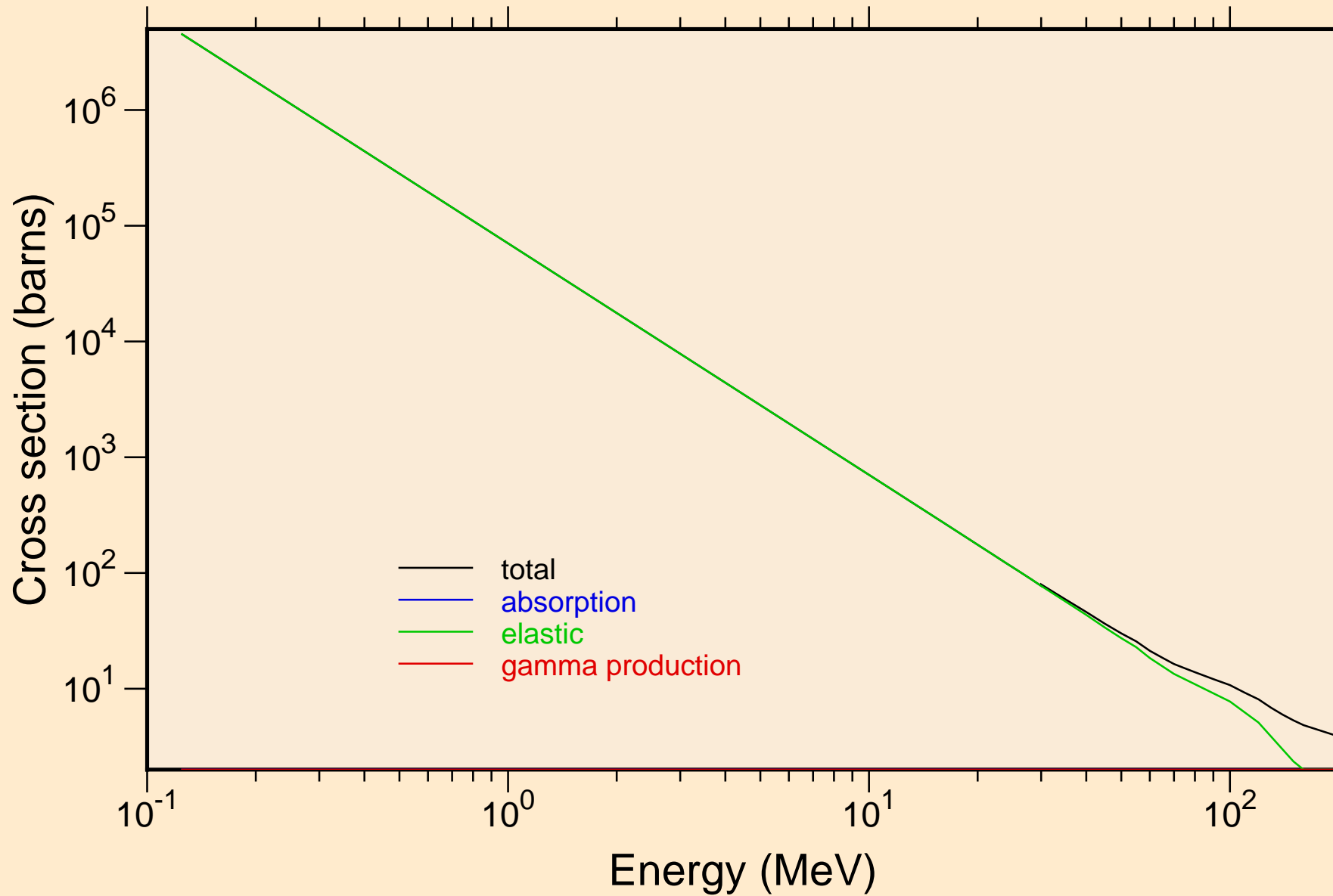

SG270 TRITON ACER TENDL-2021 LIBRARY; T=0.K

Heating

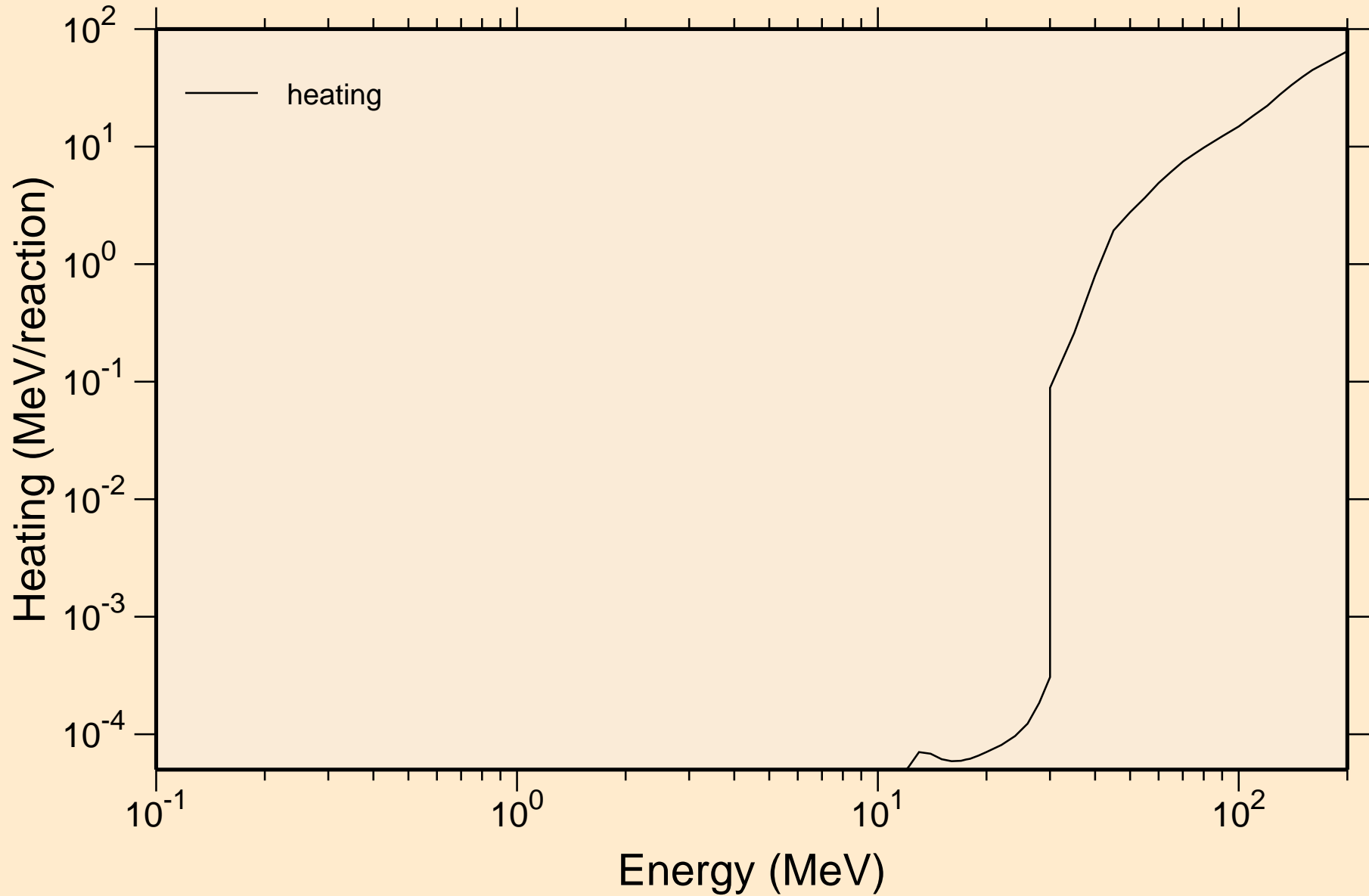

SG270 TRITON ACER TENDL-2021 LIBRARY; T=0.K

Principal cross sections

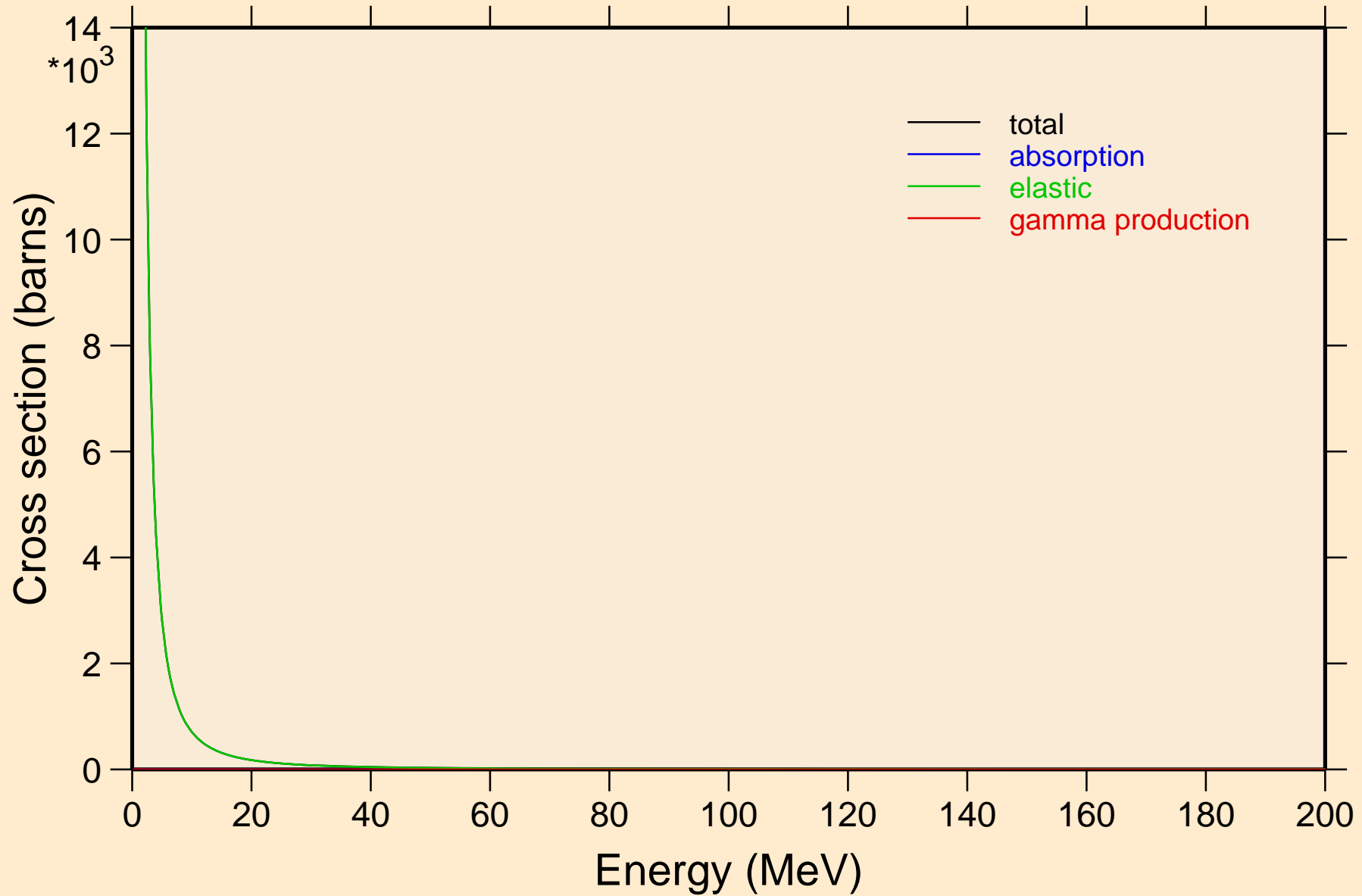

SG270 TRITON ACER TENDL-2021 LIBRARY; T=0.K

Heating

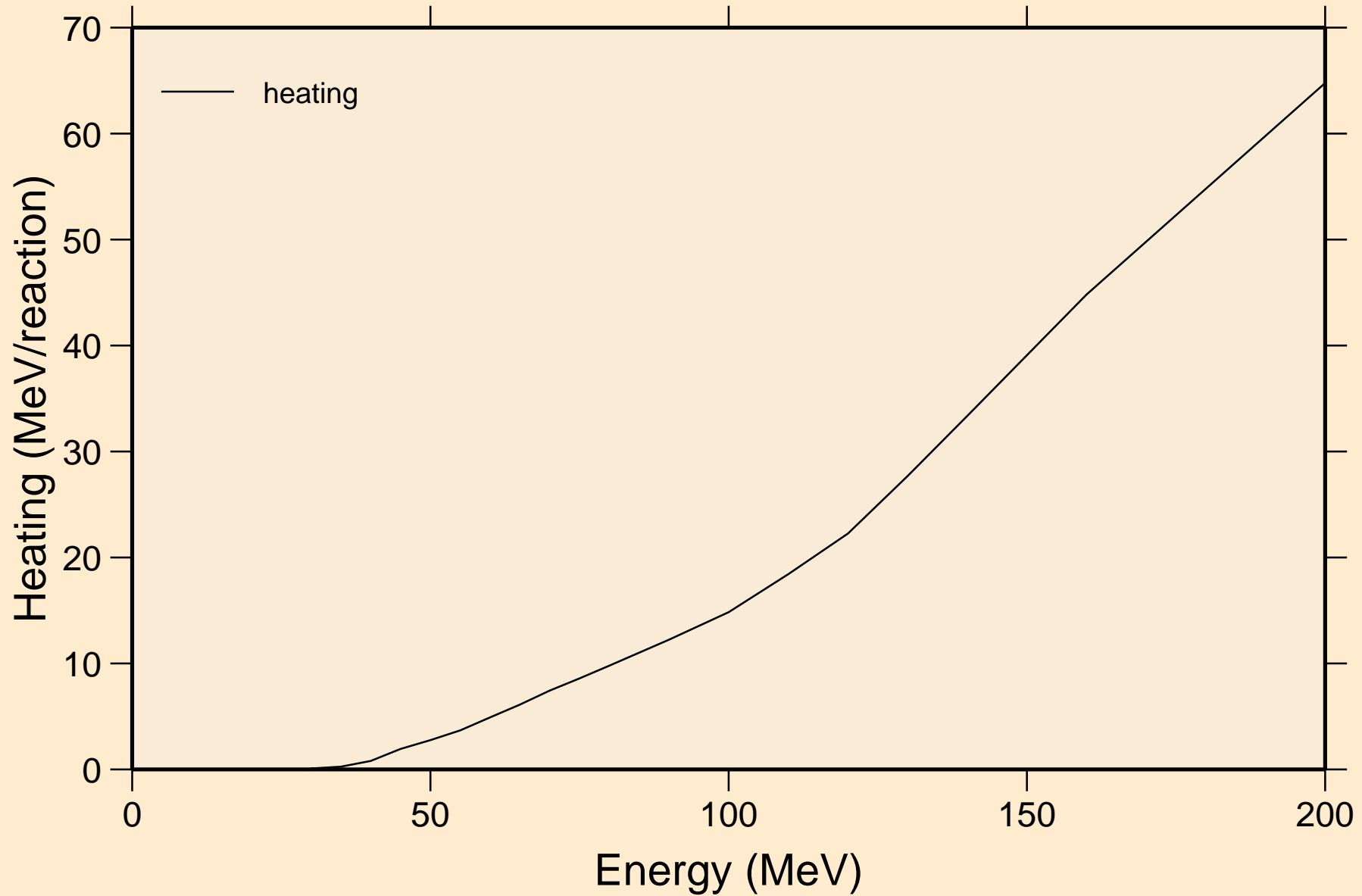

SG270 TRITON ACER TENDL-2021 LIBRARY; T=0.K
Threshold reactions

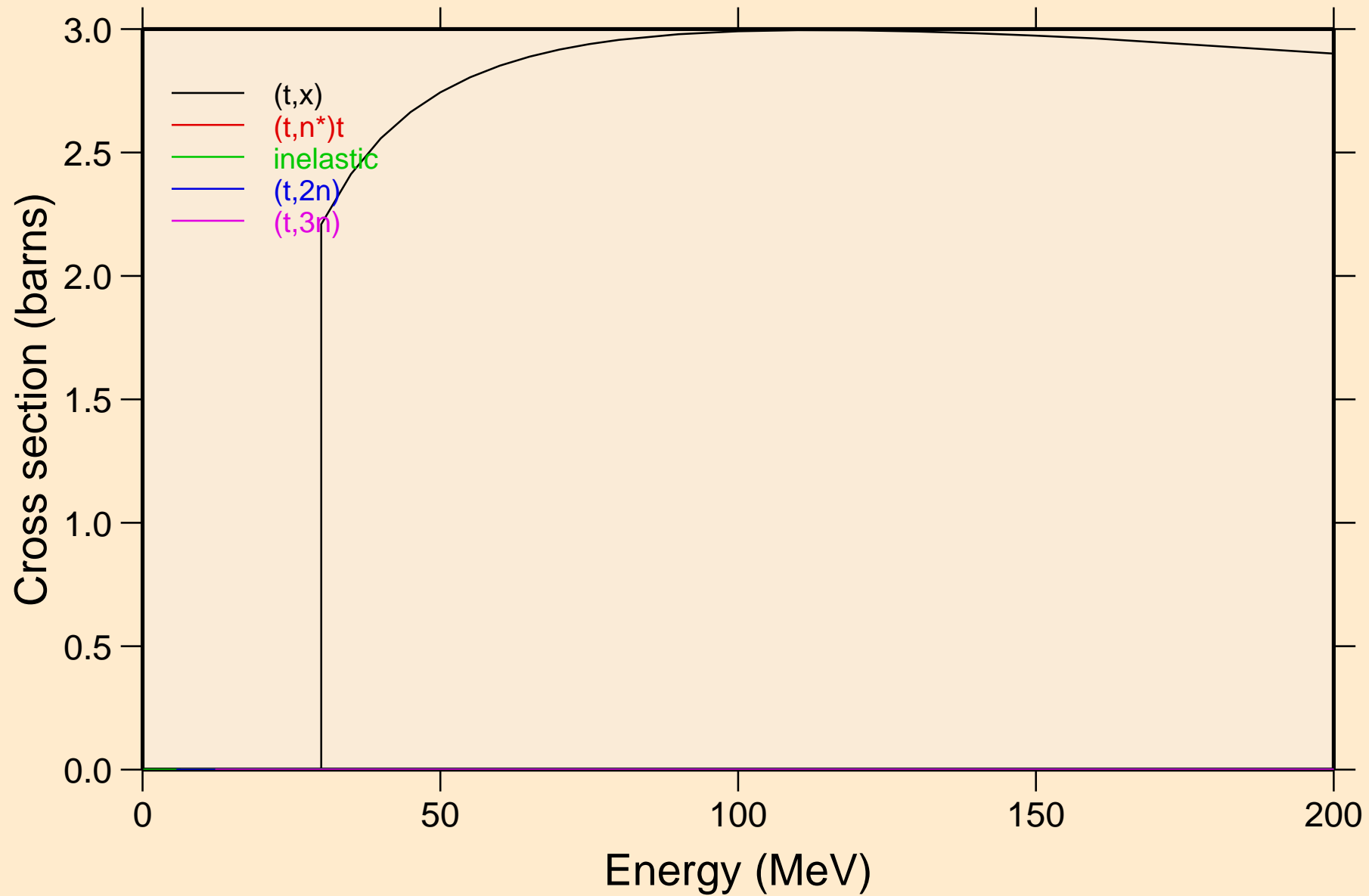

SG270 TRITON ACER TENDL-2021 LIBRARY; T=0.K
Threshold reactions

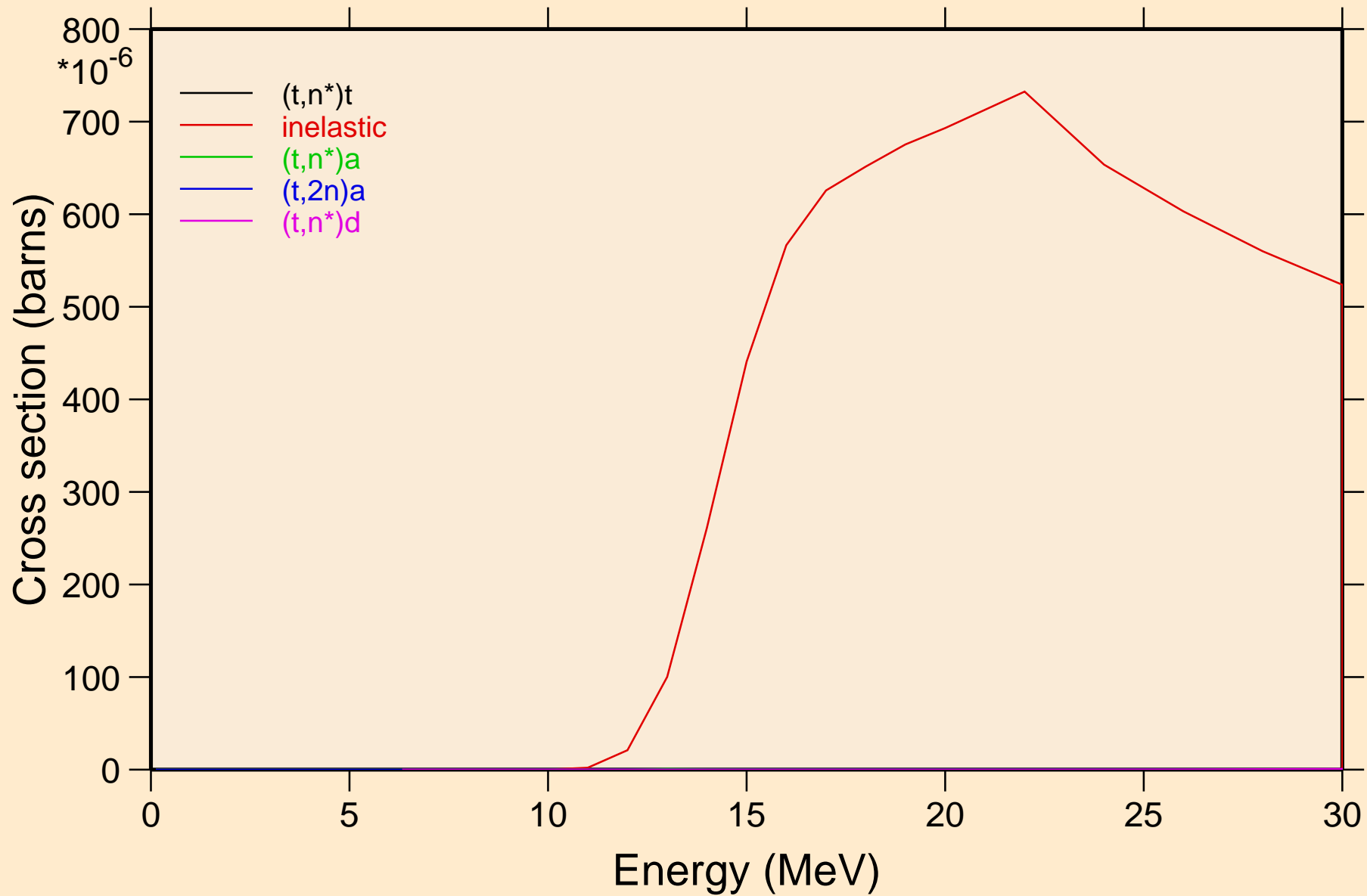

SG270 TRITON ACER TENDL-2021 LIBRARY; T=0.K
Threshold reactions

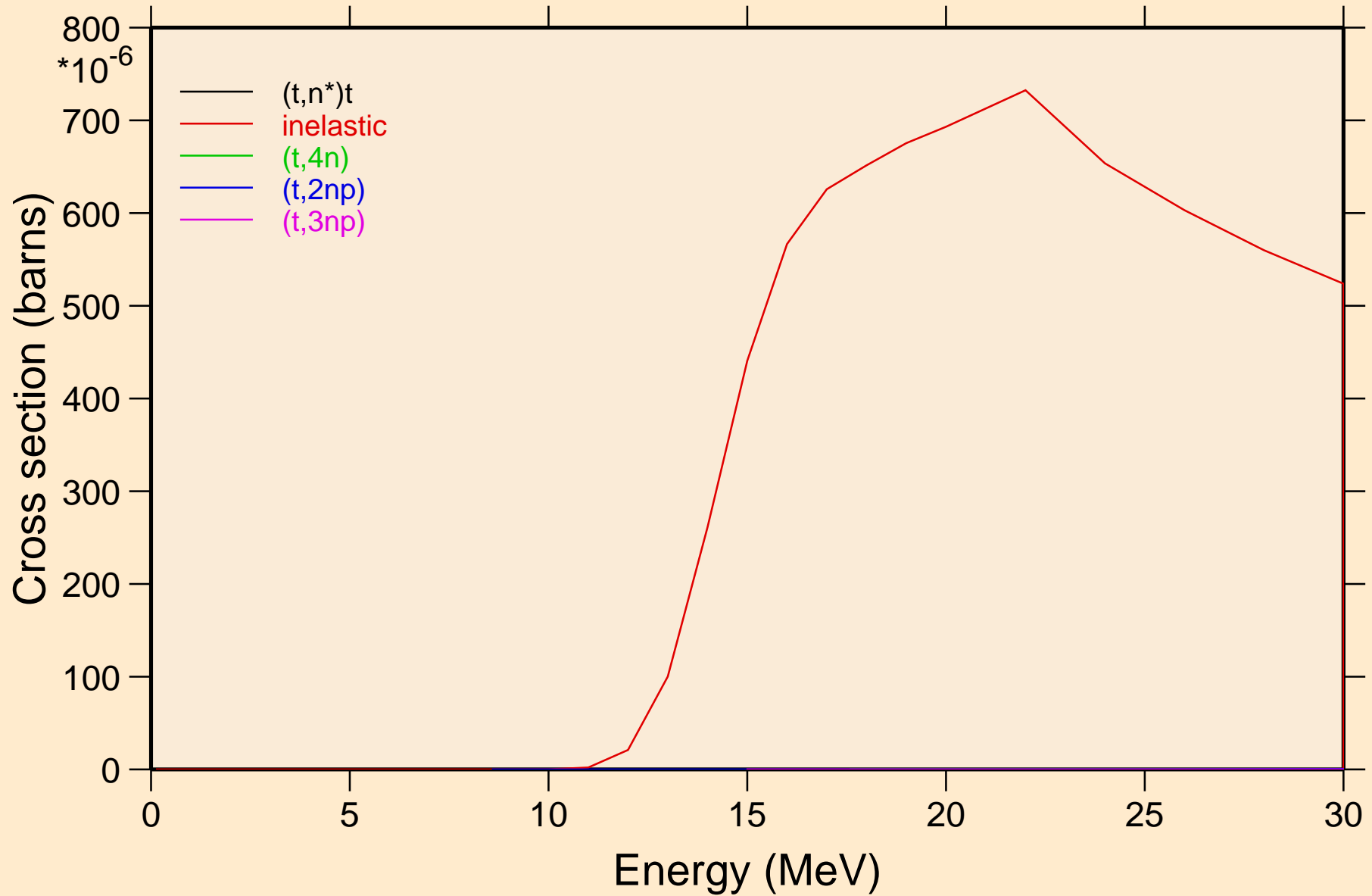

SG270 TRITON ACER TENDL-2021 LIBRARY; T=0.K

Threshold reactions

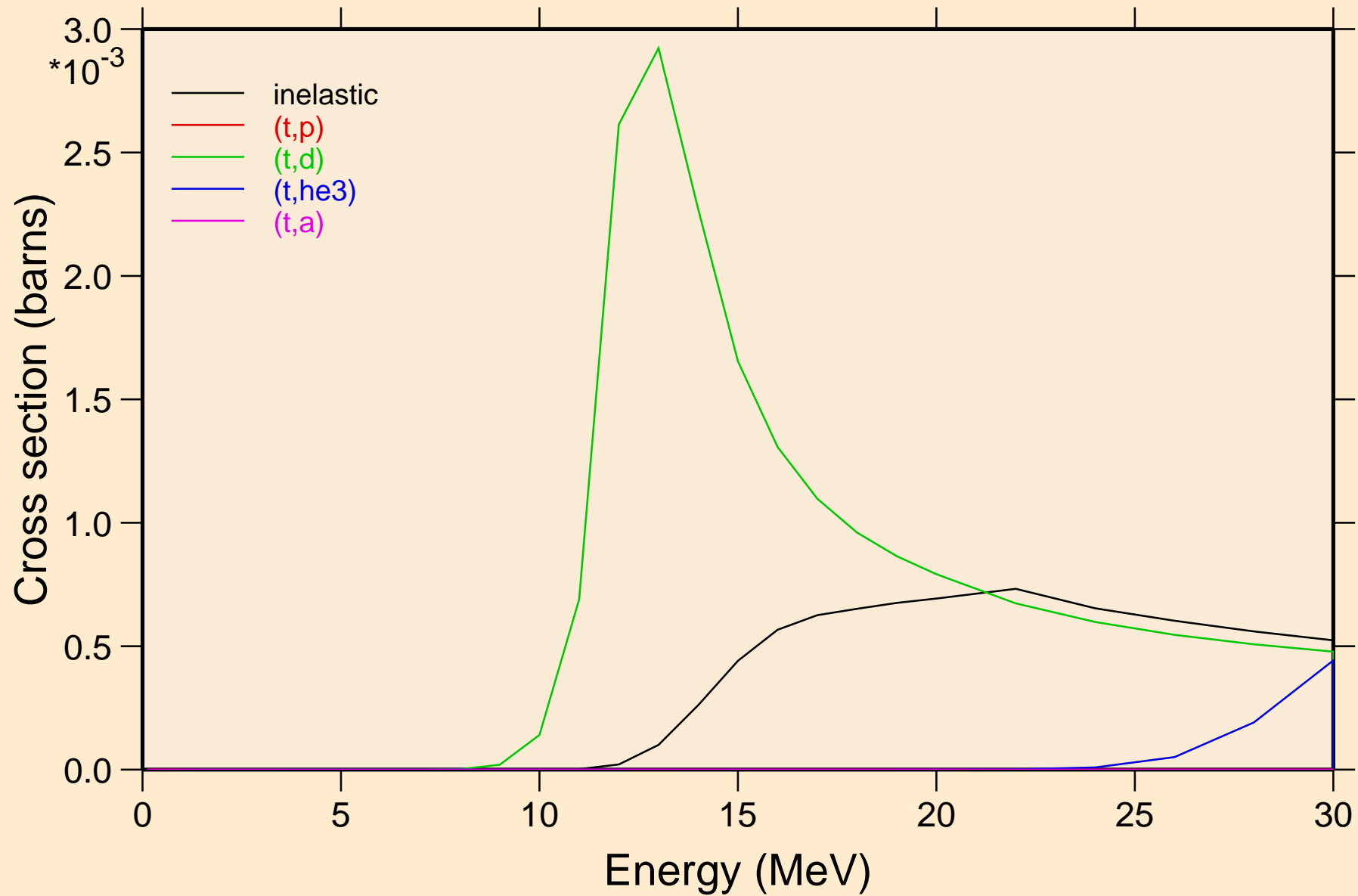

SG270 TRITON ACER TENDL-2021 LIBRARY; T=0.K
angular distribution for elastic

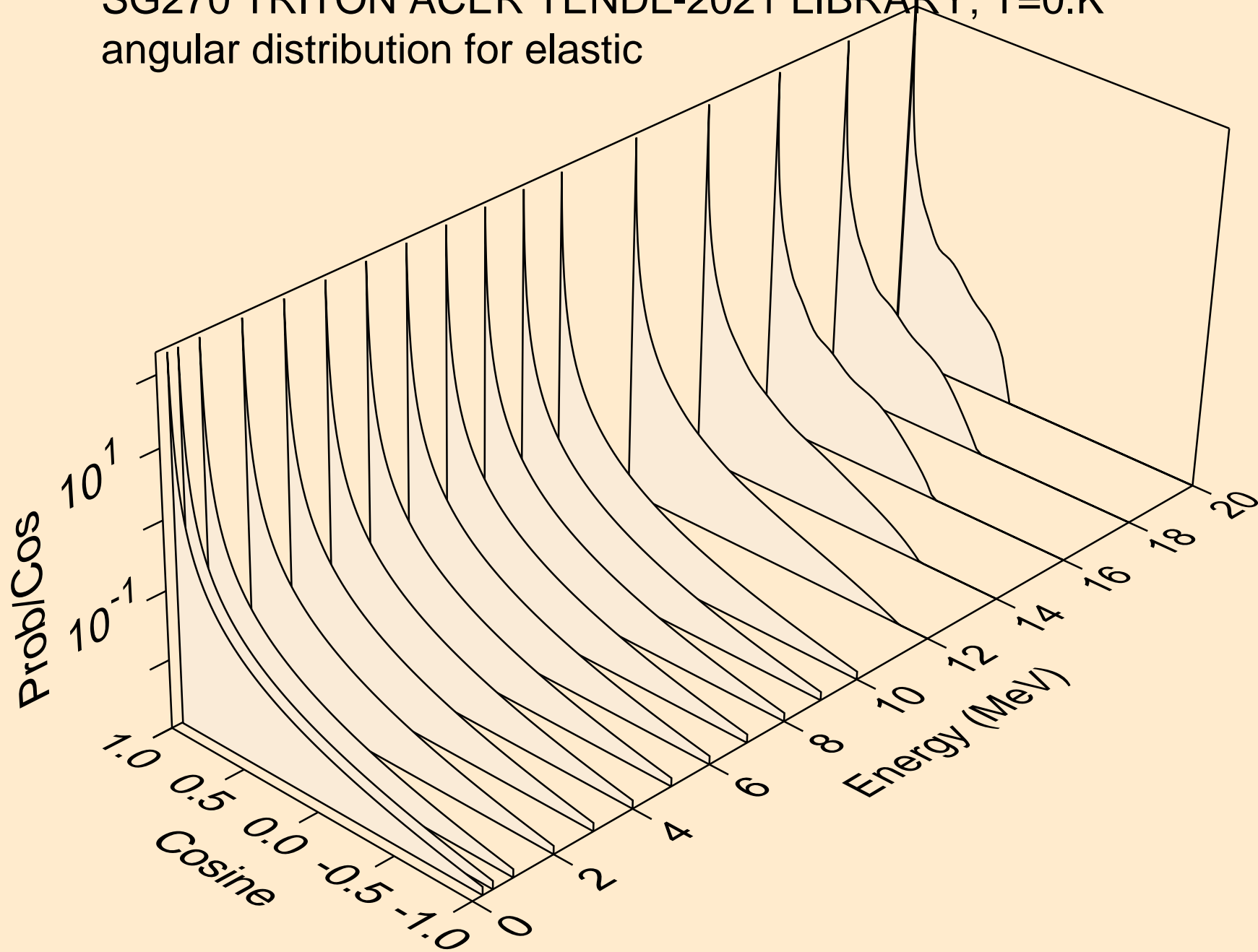

SG270 TRITON ACER TENDL-2021 LIBRARY; T=0.K
angular distribution for elastic

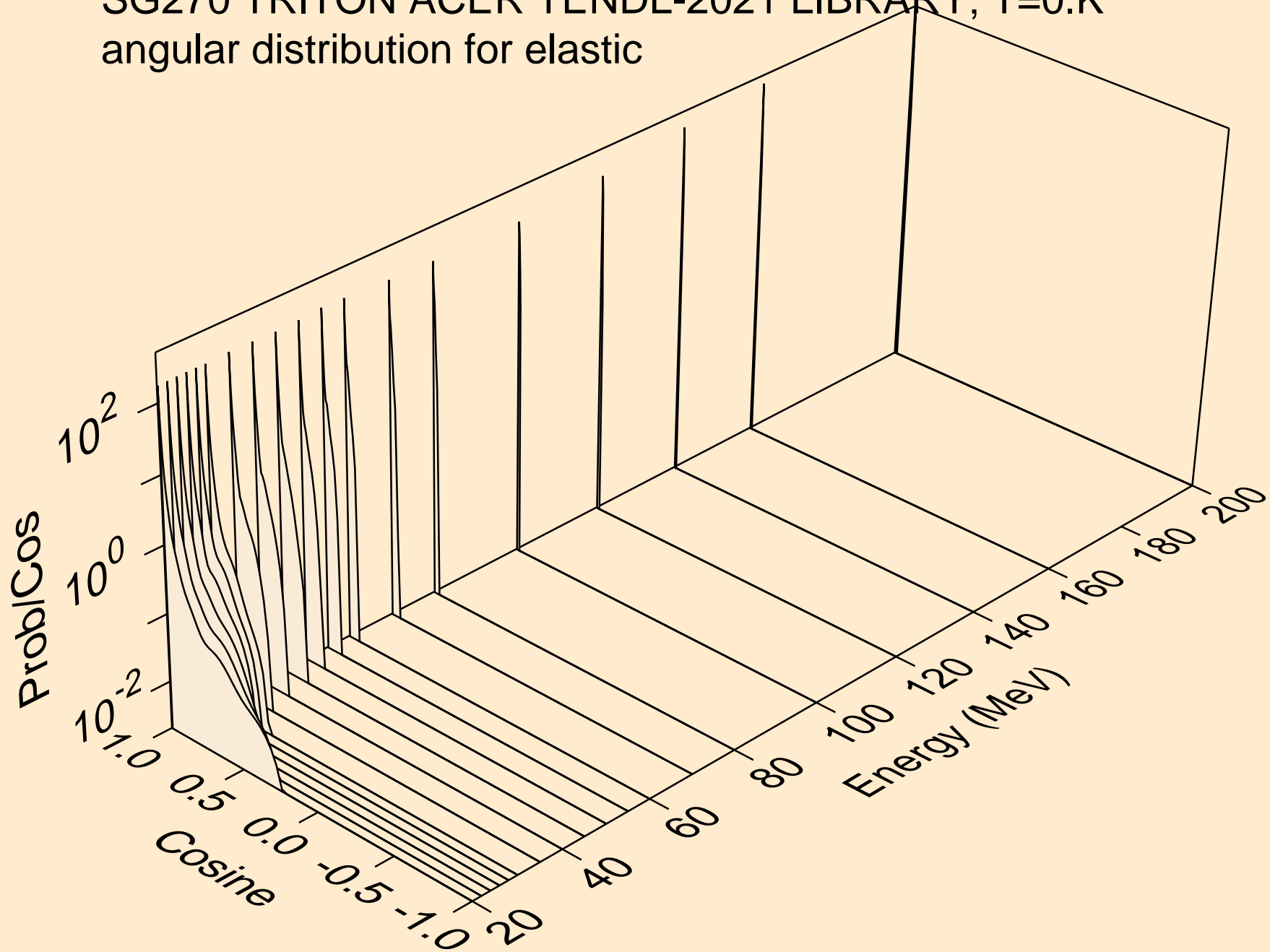

SG270 TRITON ACER TENDL-2021 LIBRARY; T=0.K
Triton emission for (t,x)

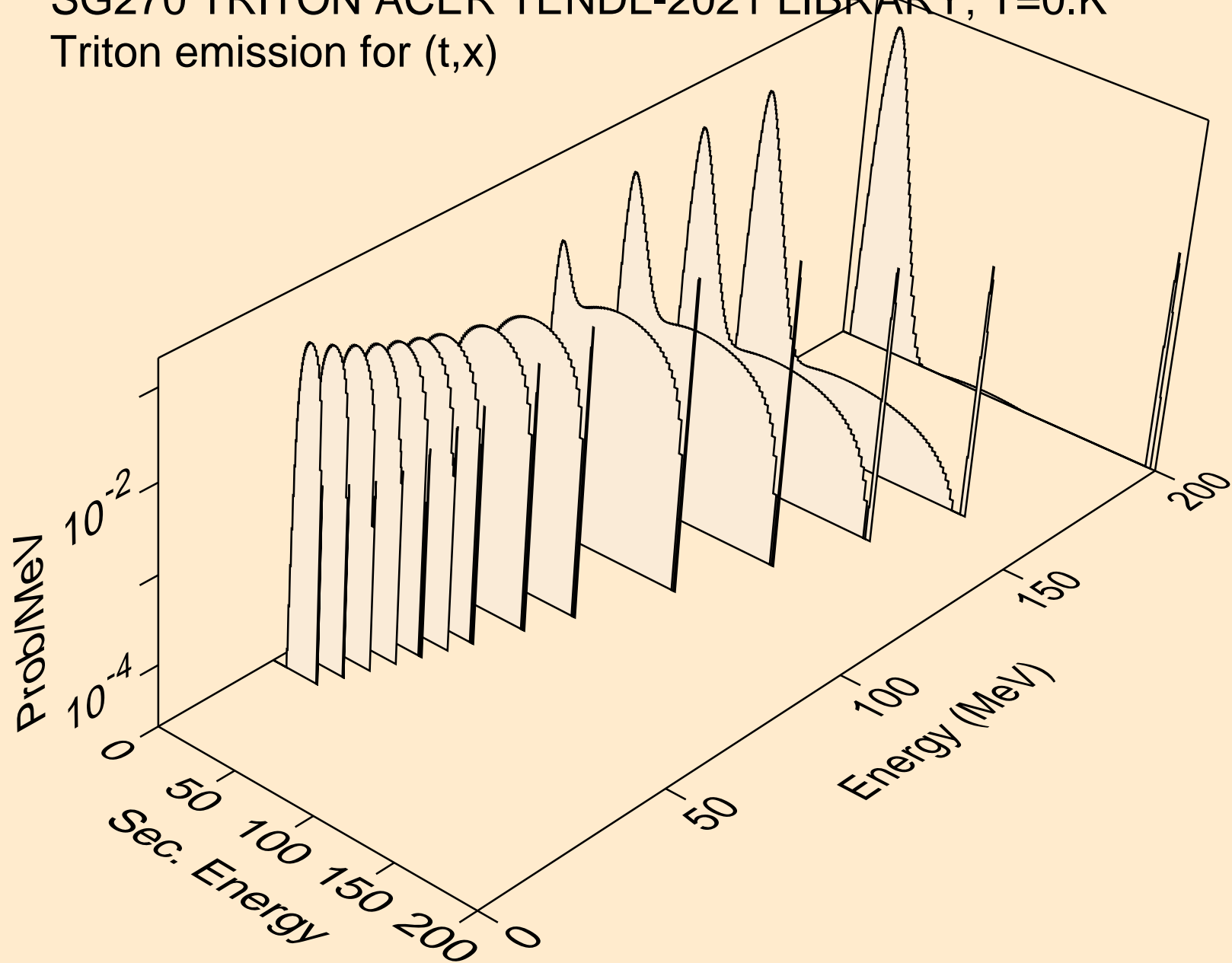

SG270 TRITON ACER TENDL-2021 LIBRARY; T=0.K
Triton emission for (t,n*)t

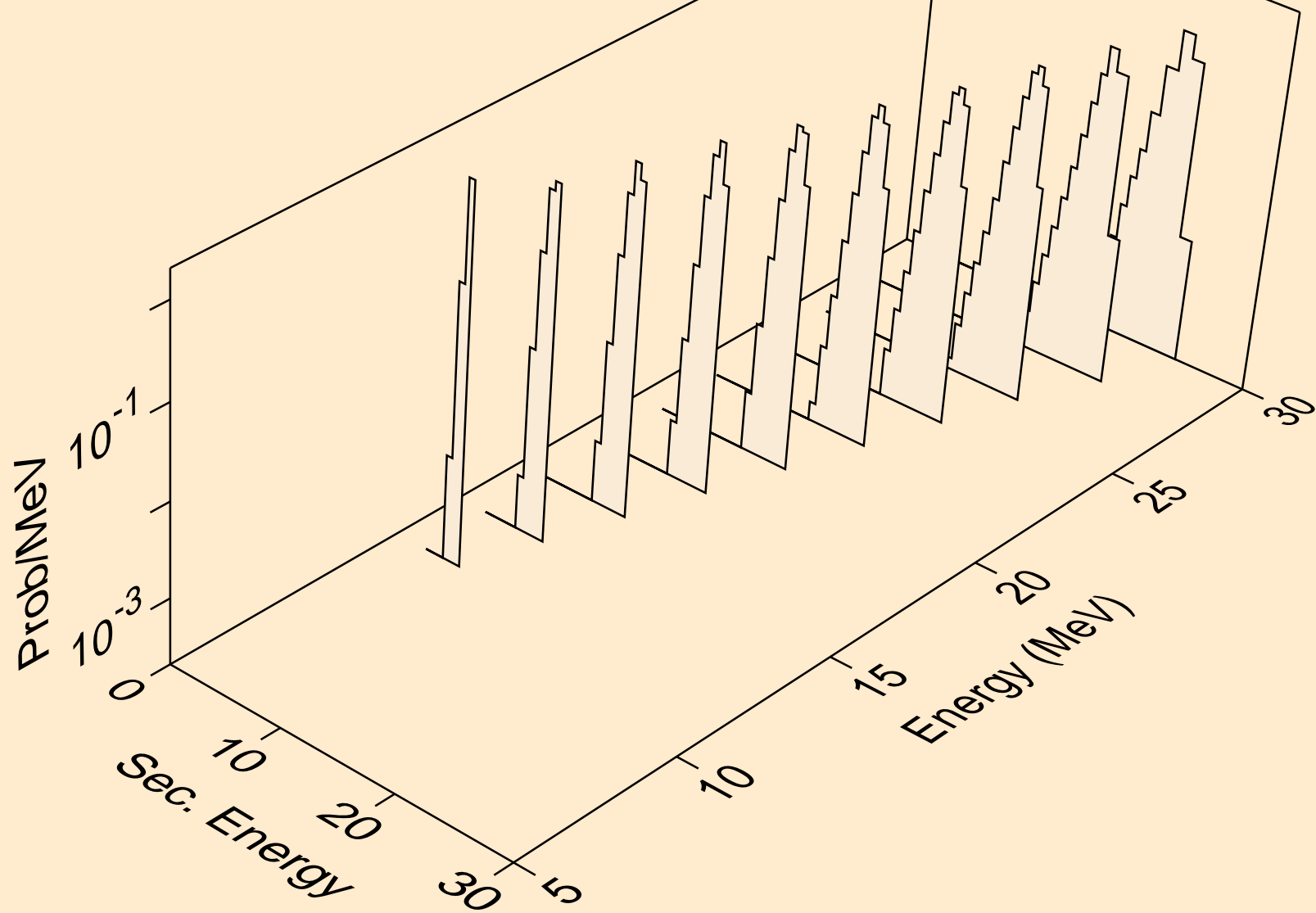

SG270 TRITON ACER TENDL-2021 LIBRARY; T=0.K
Triton emission for inelastic

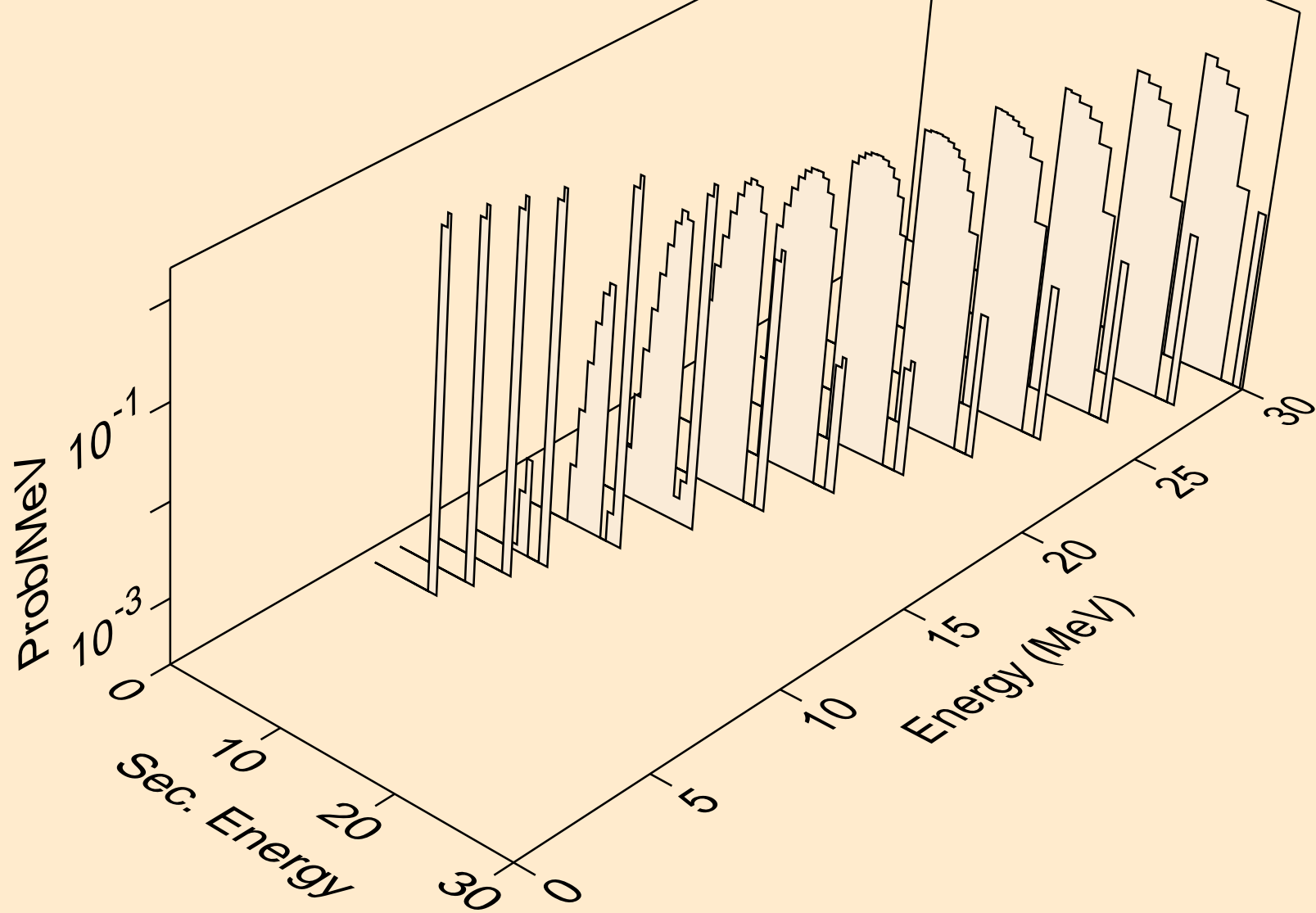

SG270 TRITON ACER TENDL-2021 LIBRARY; T=0.K
Photon emission for (z,n)

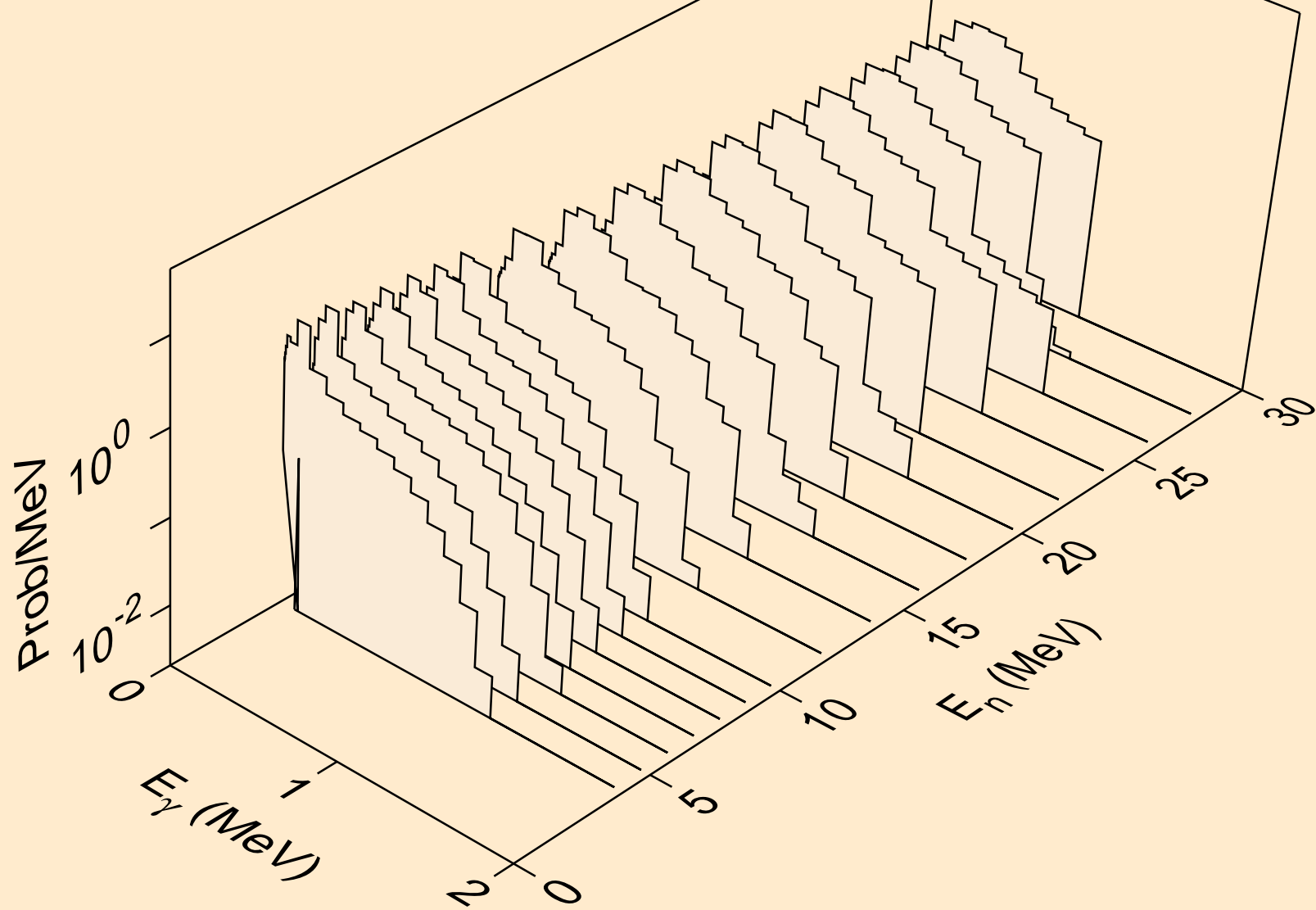

SG270 TRITON ACER TENDL-2021 LIBRARY; T=0.K
Photon emission for (n,x)

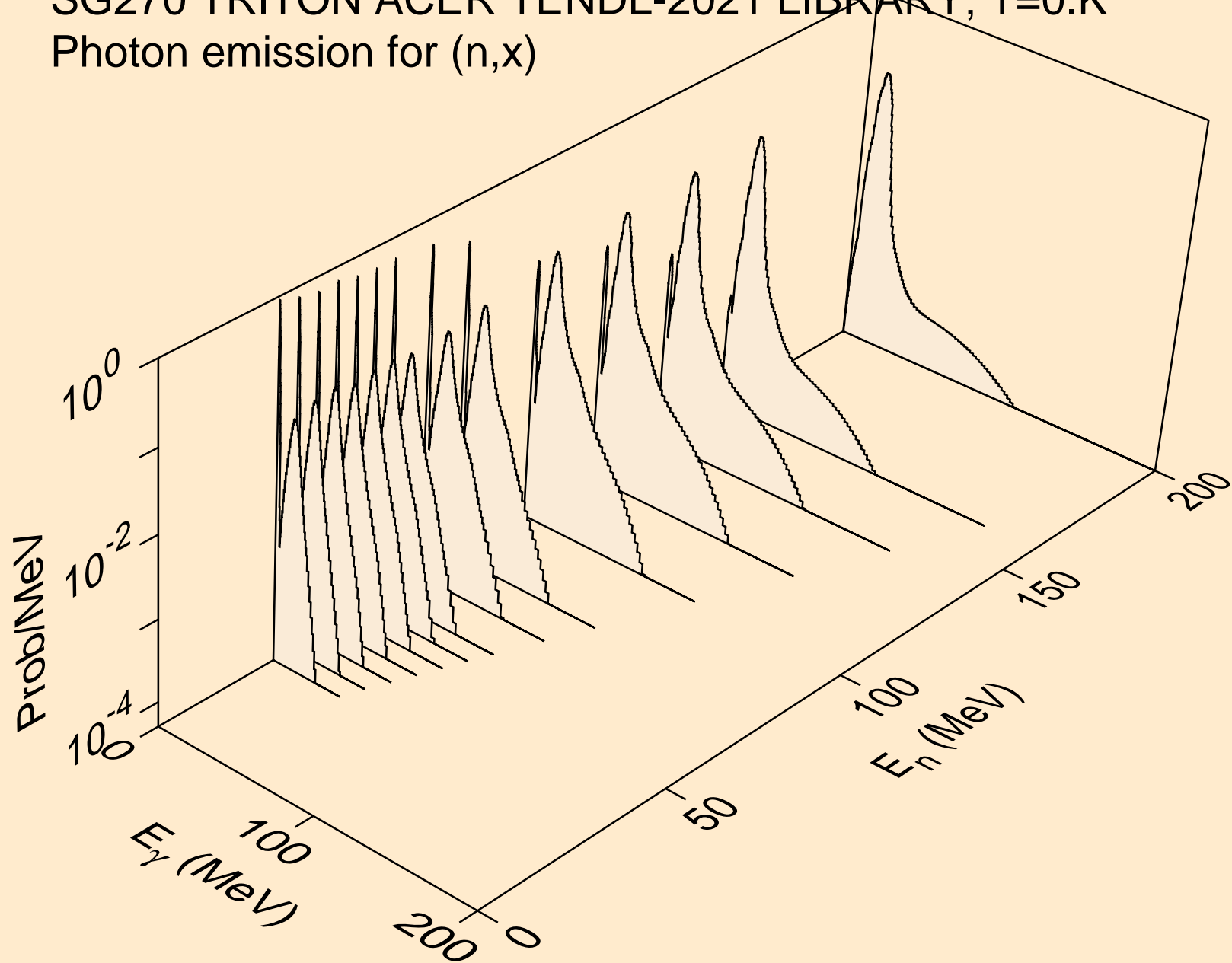

SG270 TRITON ACER TENDL-2021 LIBRARY; T=0.K
Photon emission for (n,2n)

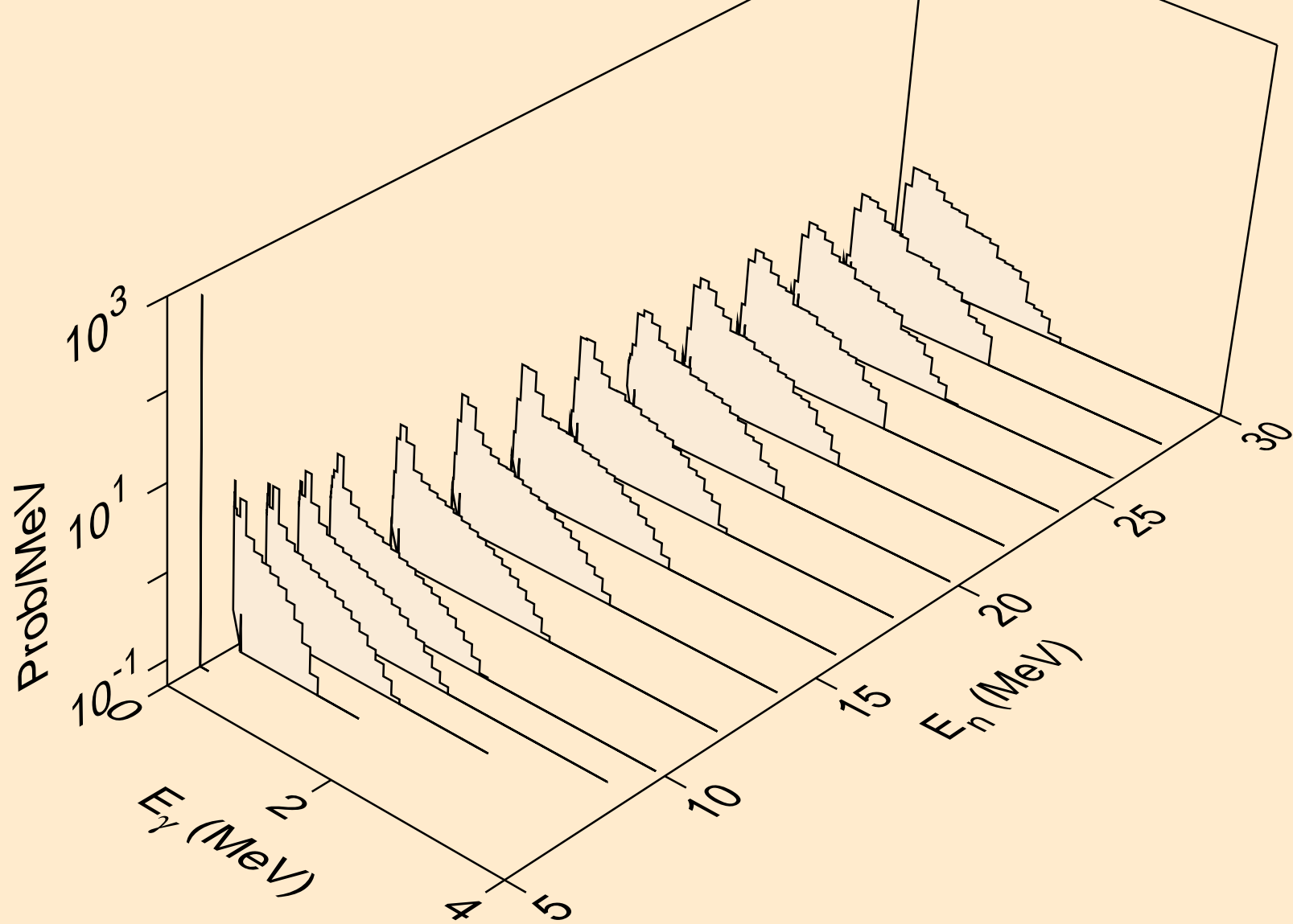

SG270 TRITON ACER TENDL-2021 LIBRARY; T=0.K
Photon emission for (n,3n)

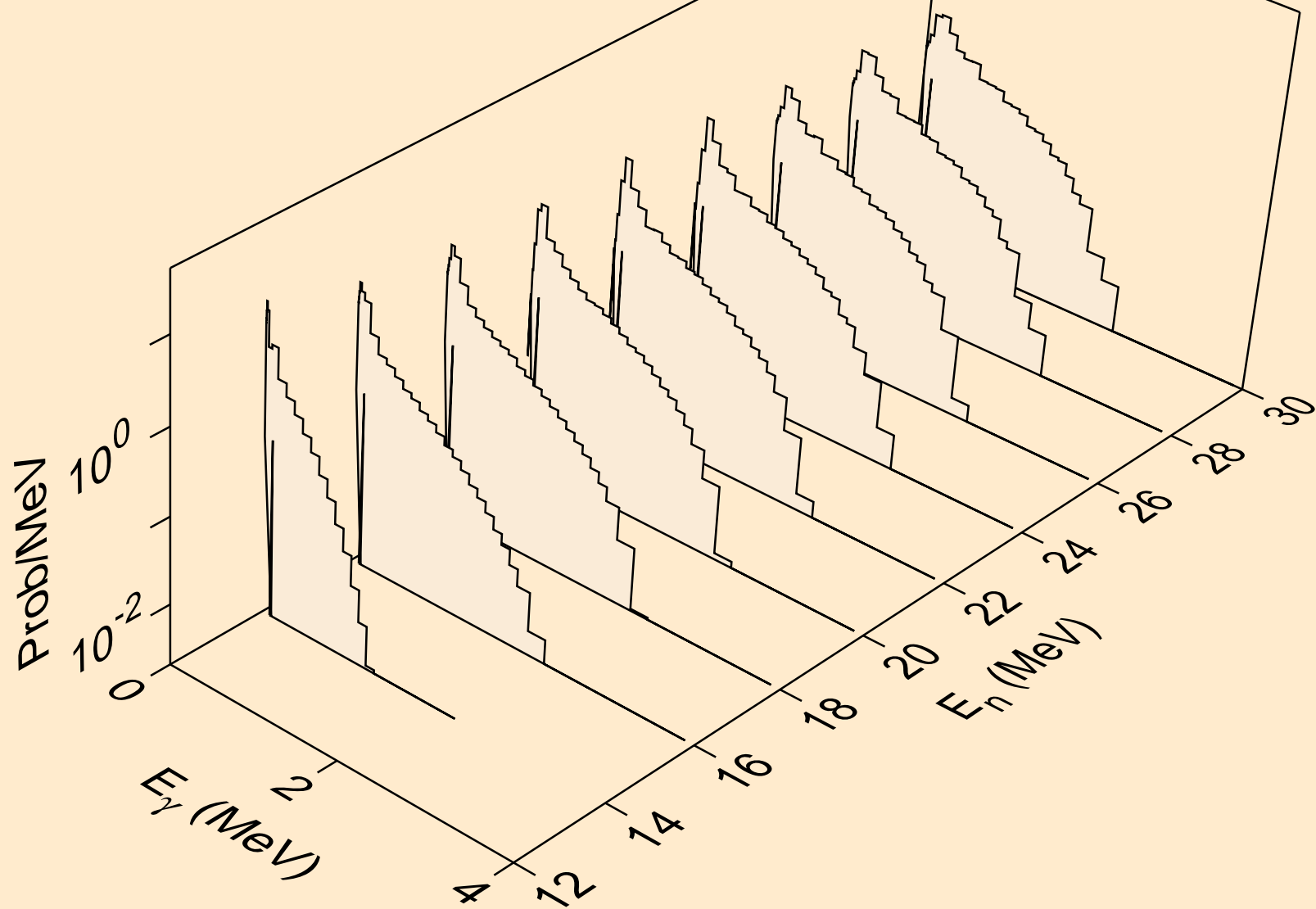

SG270 TRITON ACER TENDL-2021 LIBRARY; T=0.K
Photon emission for (n,n*)a

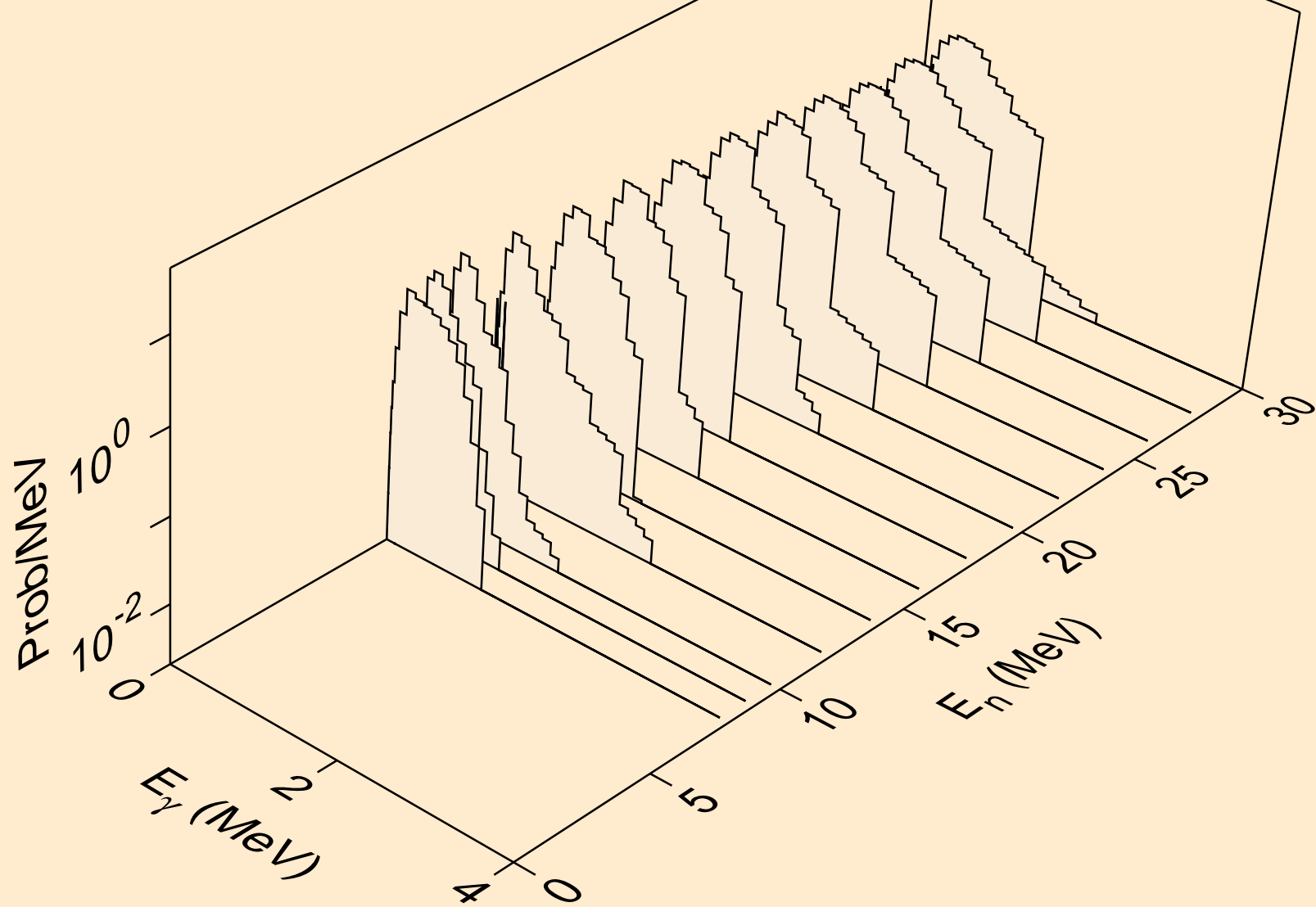

SG270 TRITON ACER TENDL-2021 LIBRARY; T=0.K
Photon emission for (n,2n)a

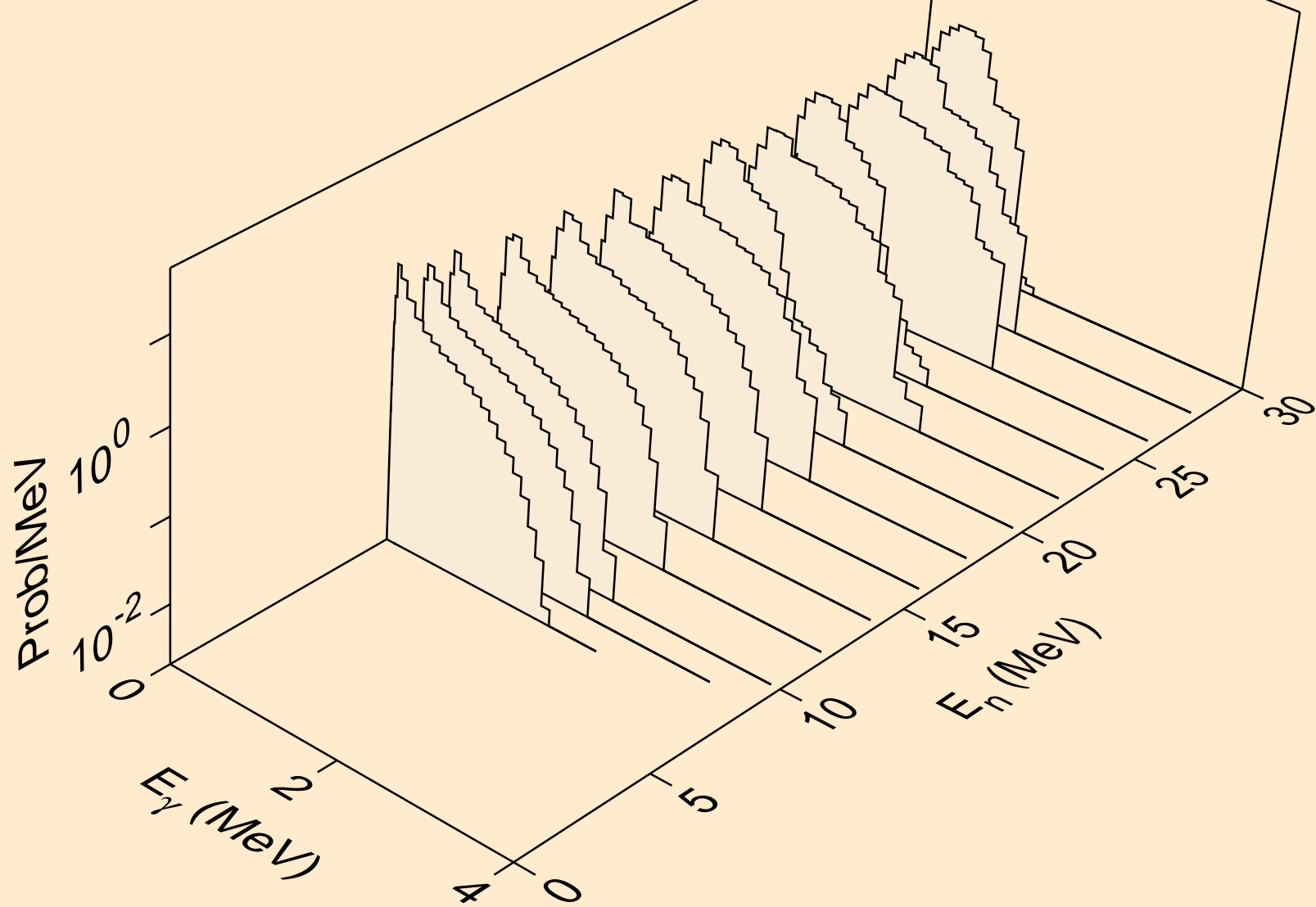

SG270 TRITON ACER TENDL-2021 LIBRARY; T=0.K
Photon emission for (n,n*)d

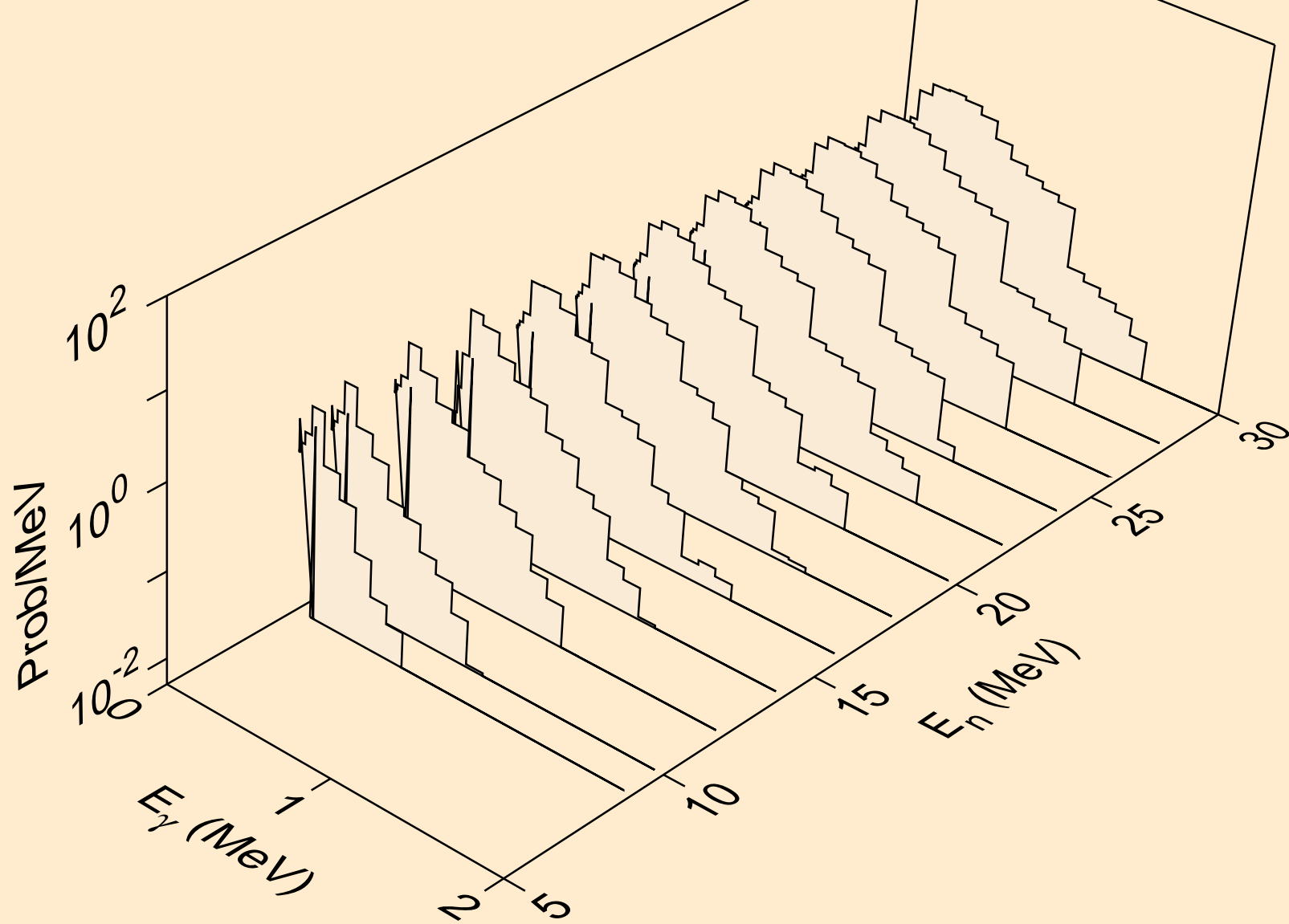

SG270 TRITON ACER TENDL-2021 LIBRARY; T=0.K
Photon emission for (n,n*)t

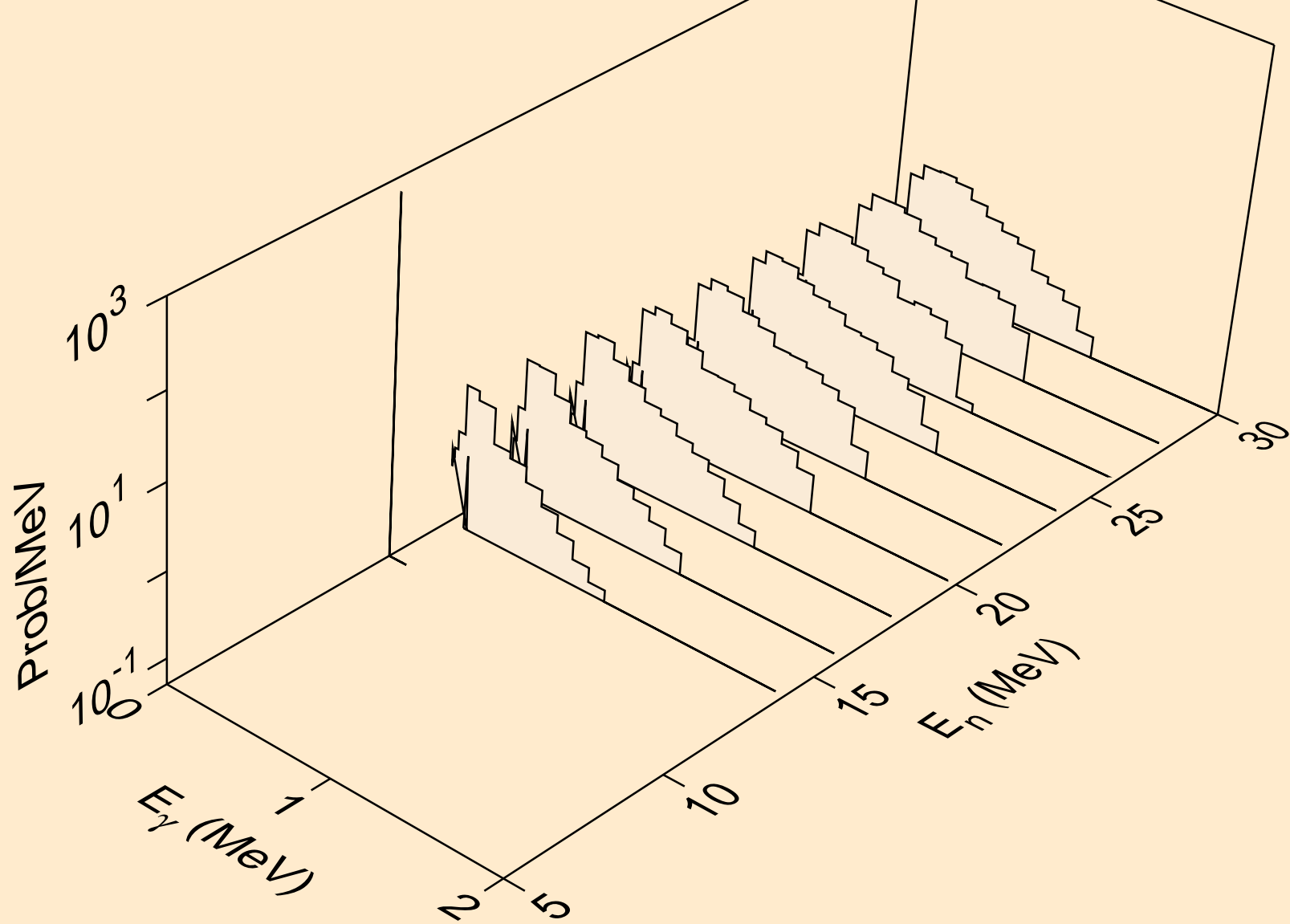

SG270 TRITON ACER TENDL-2021 LIBRARY; T=0.K
Photon emission for (n,4n)

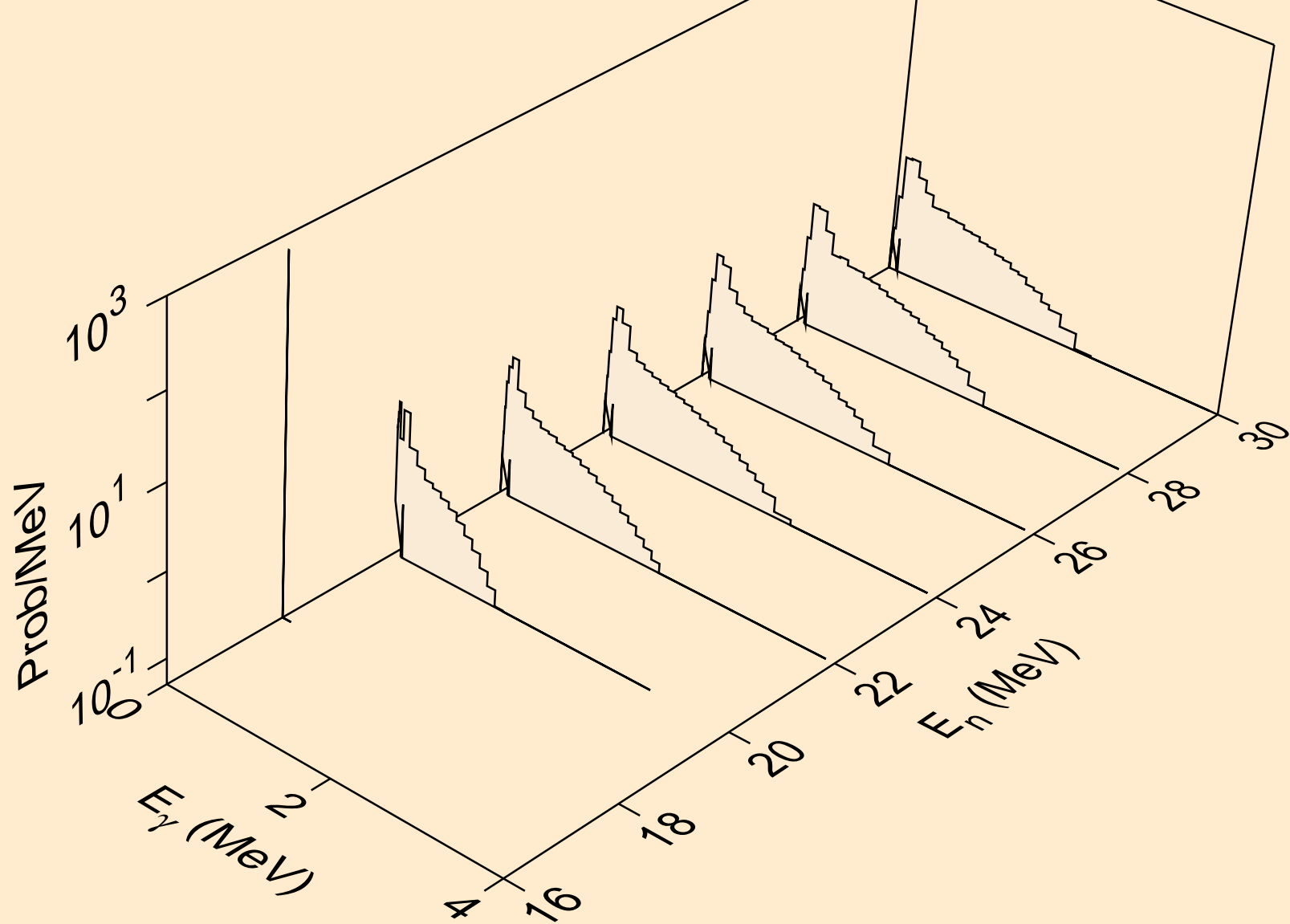

SG270 TRITON ACER TENDL-2021 LIBRARY; T=0.K
Photon emission for (n,2np)

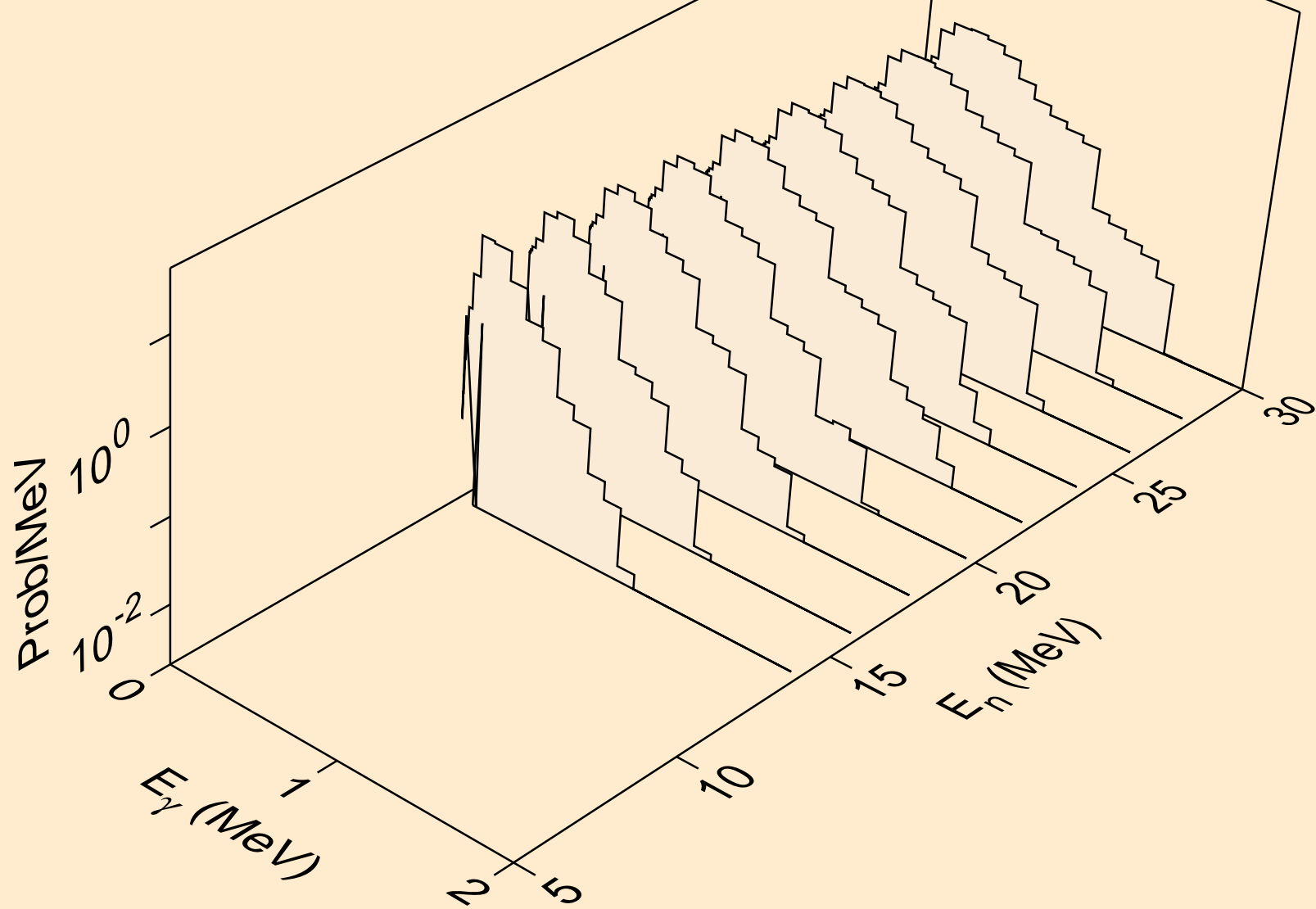

SG270 TRITON ACER TENDL-2021 LIBRARY; T=0.K
Photon emission for (n,3np)

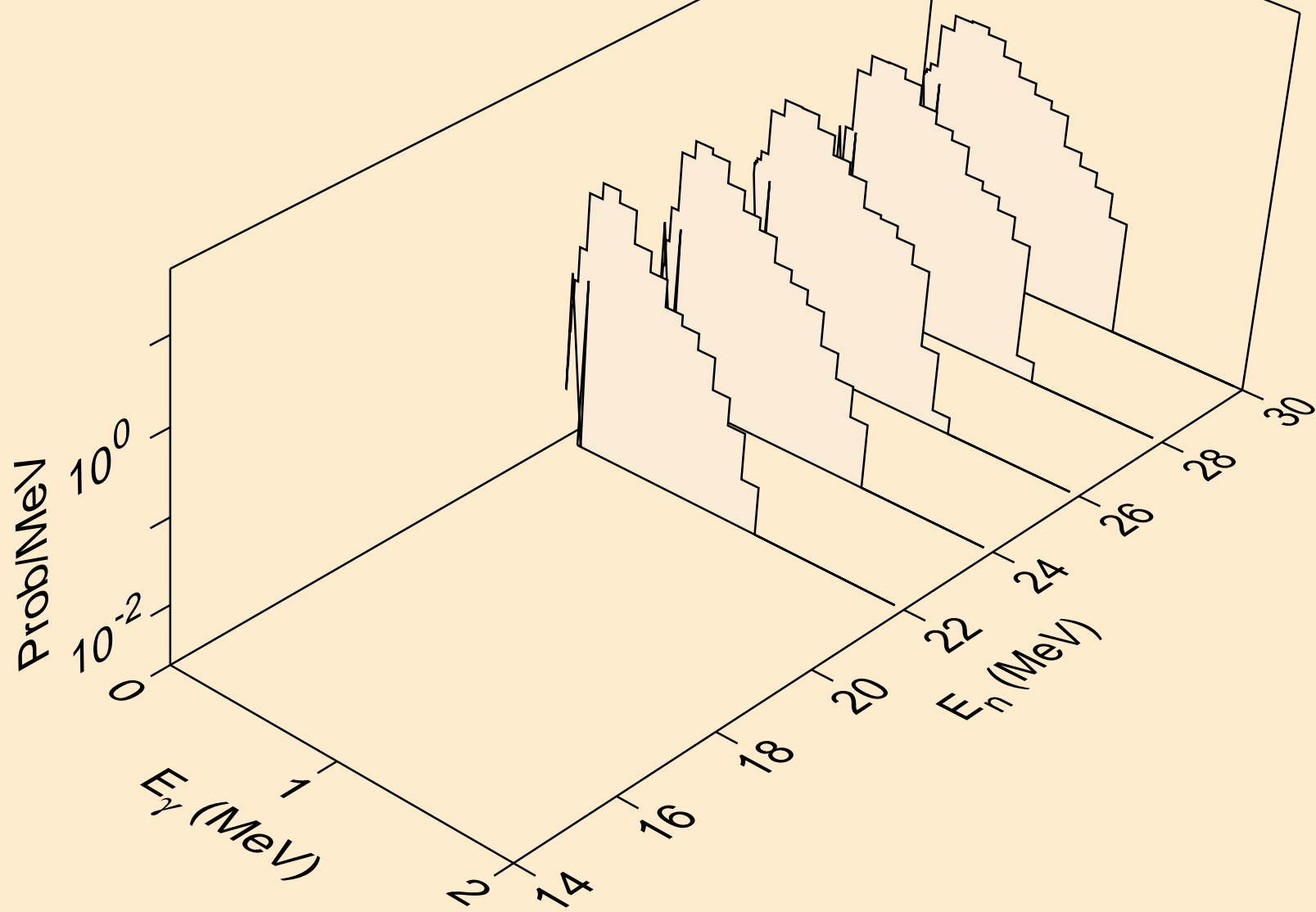

SG270 TRITON ACER TENDL-2021 LIBRARY; T=0.K
Photon emission for (n,p)

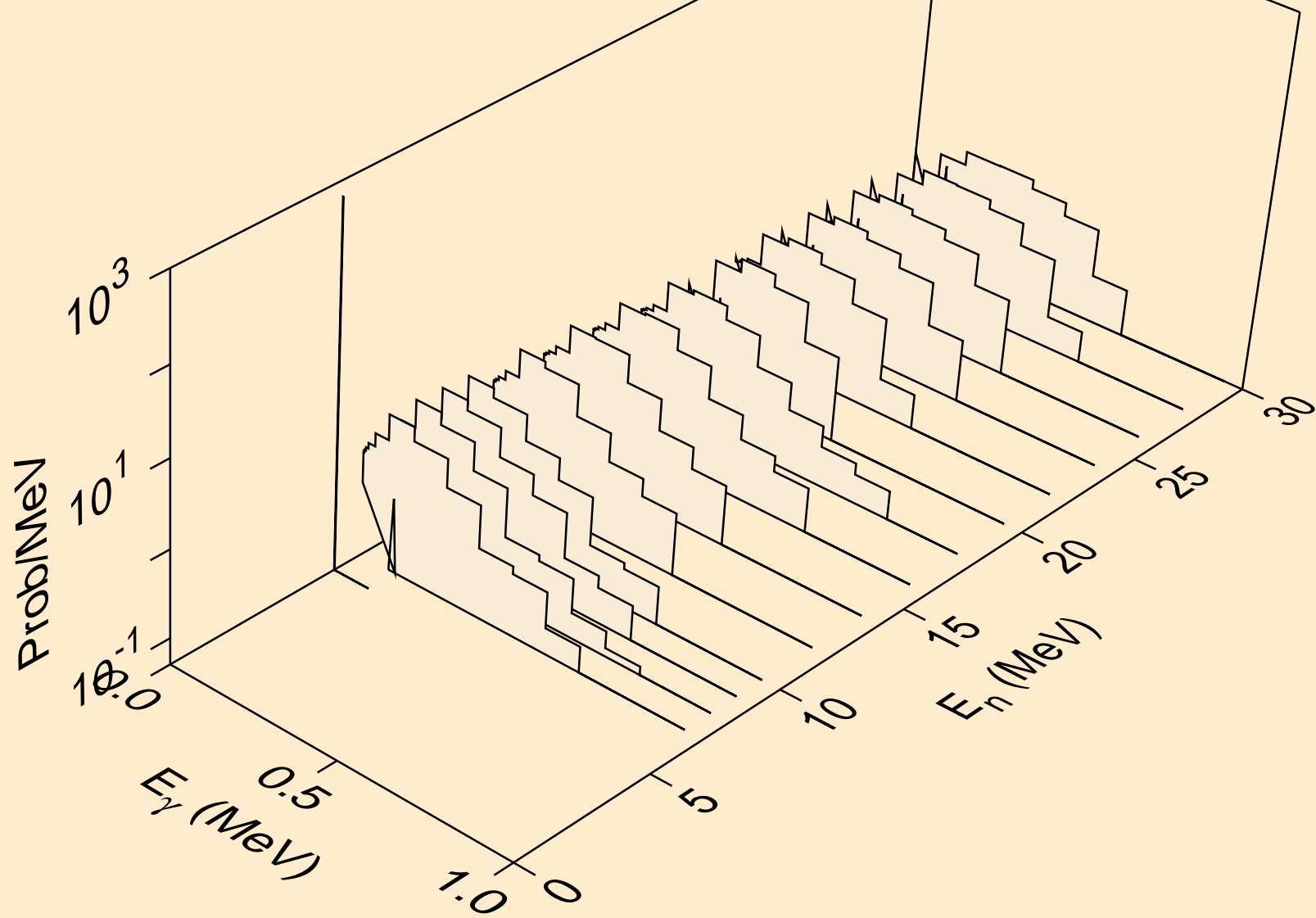

SG270 TRITON ACER TENDL-2021 LIBRARY; T=0.K
Photon emission for (n,d)

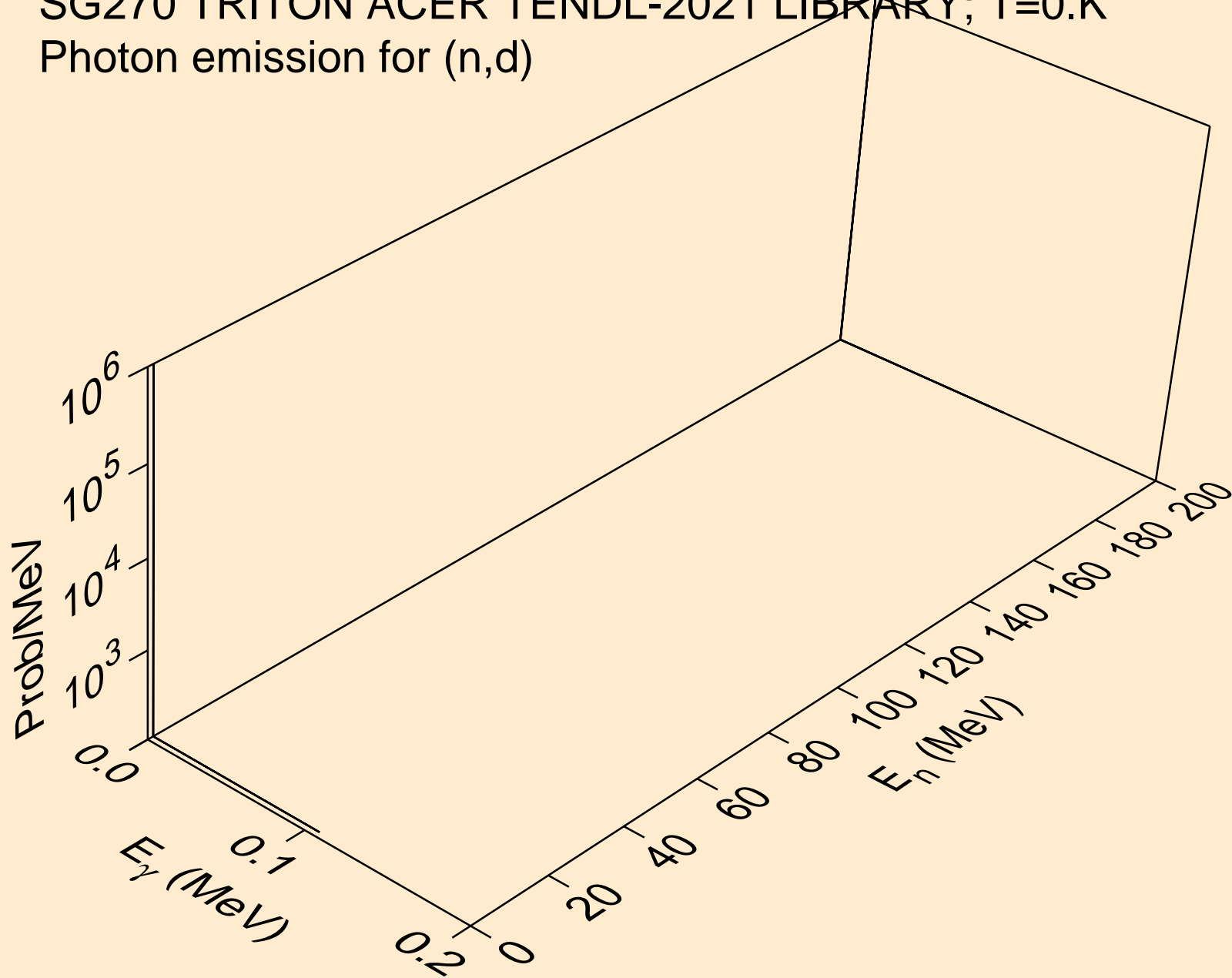

SG270 TRITON ACER TENDL-2021 LIBRARY; T=0.K
Photon emission for inelastic

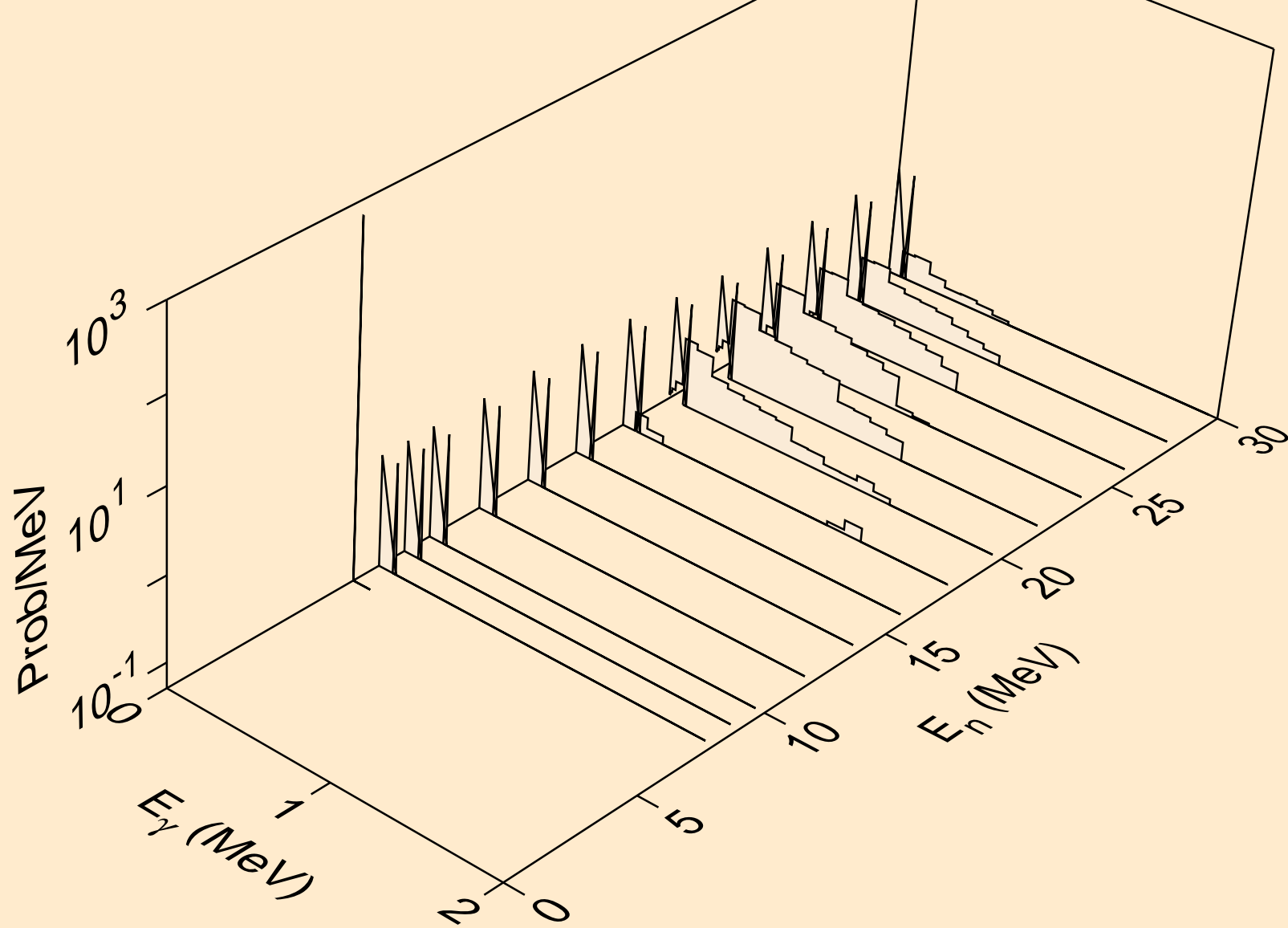

SG270 TRITON ACER TENDL-2021 LIBRARY; T=0.K
Photon emission for (n,he3)

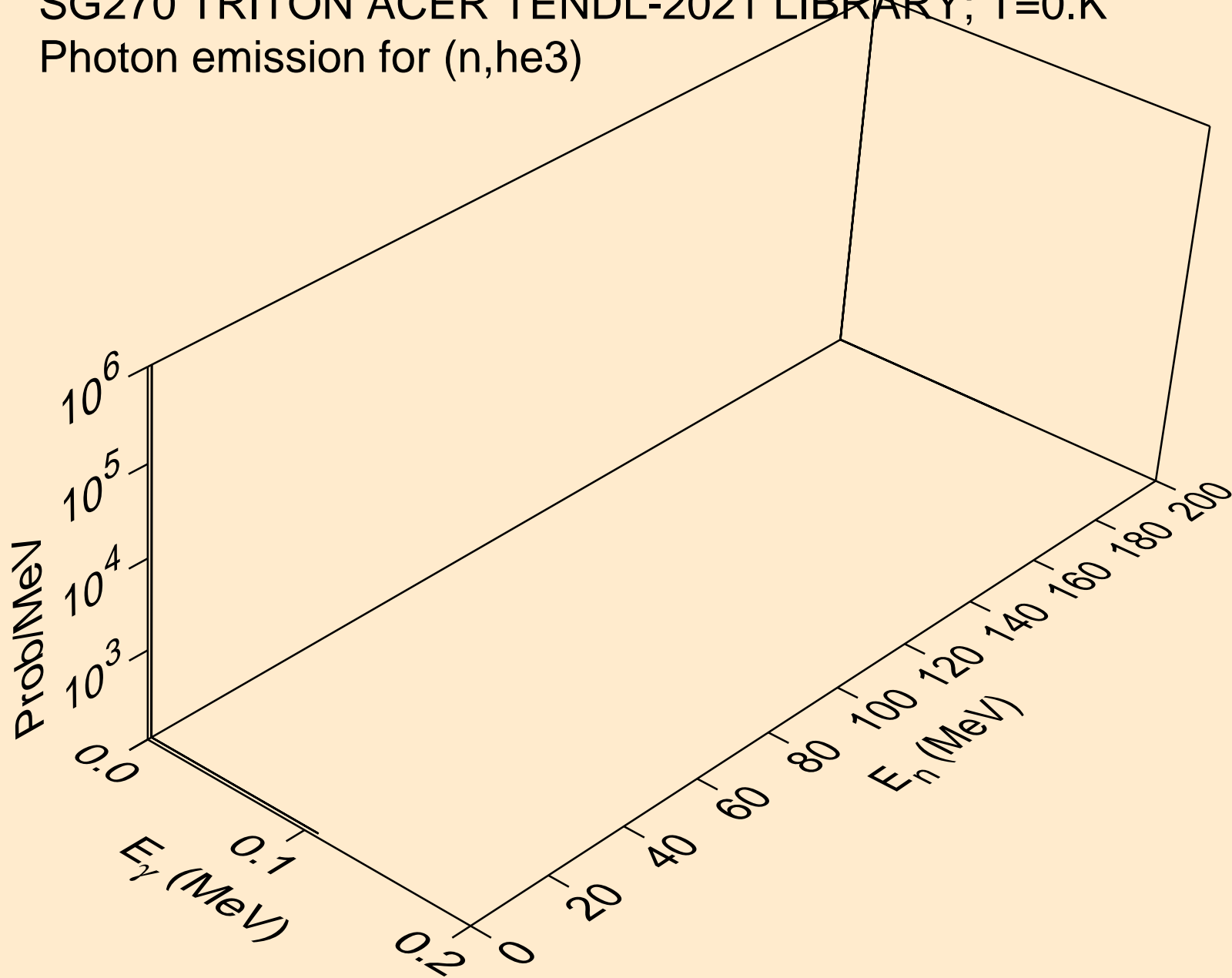

SG270 TRITON ACER TENDL-2021 LIBRARY; T=0.K
Photon emission for (n,a)

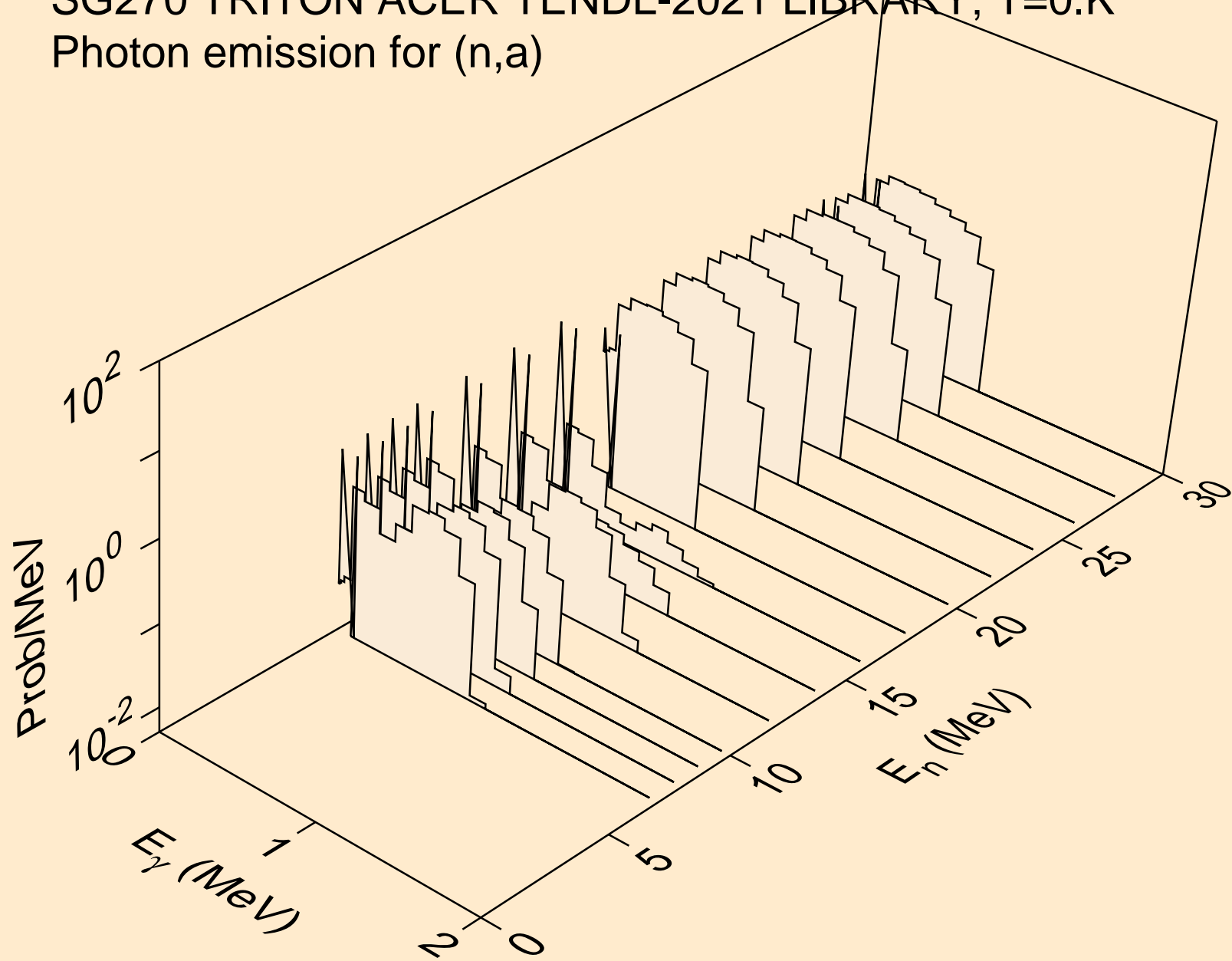

SG270 TRITON ACER TENDL-2021 LIBRARY; T=0.K

Particle heating contributions

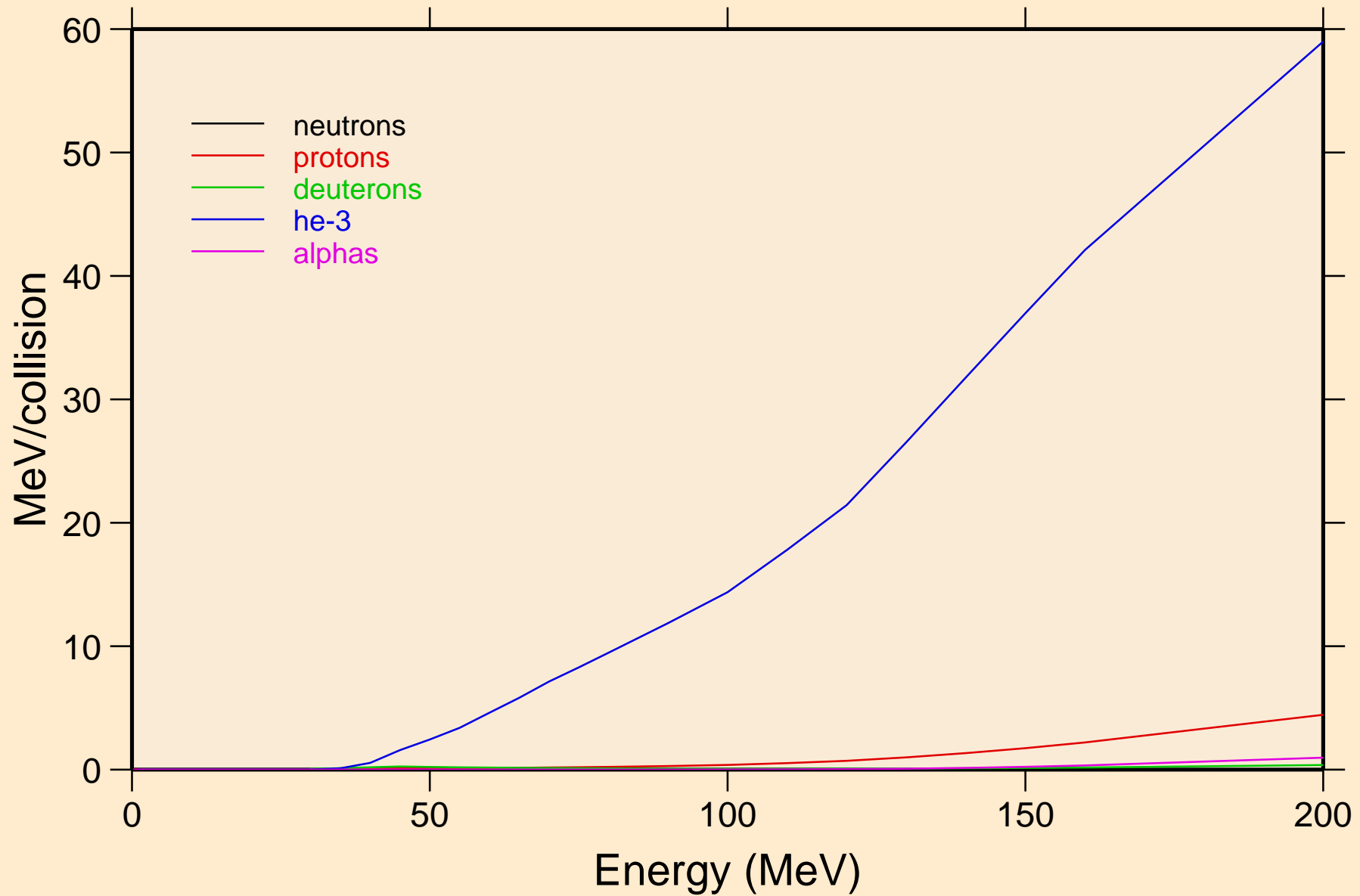

SG270 TRITON ACER TENDL-2021 LIBRARY; T=0.K

Recoil Heating

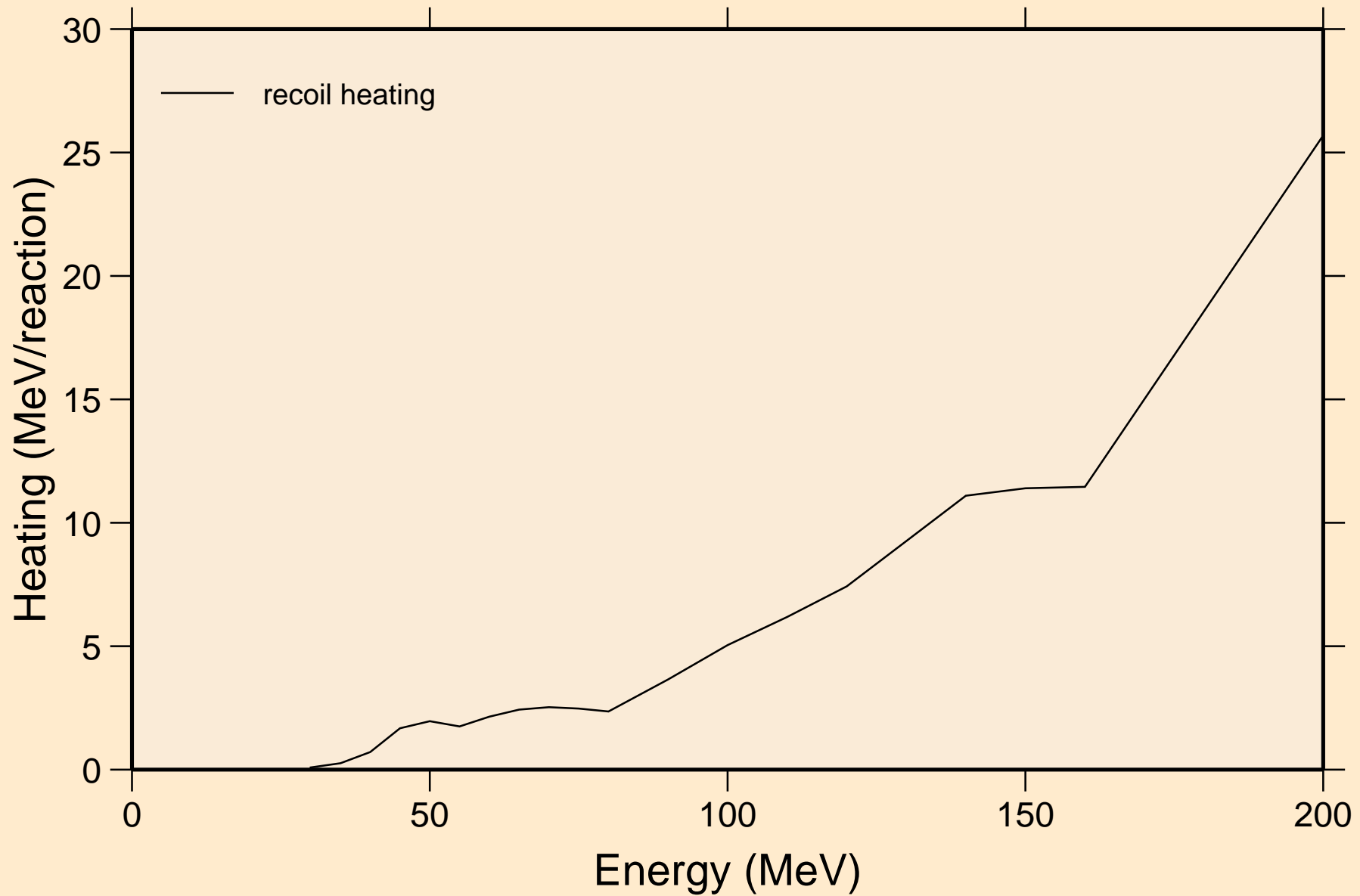

SG270 TRITON ACER TENDL-2021 LIBRARY; T=0.K
Particle production cross sections

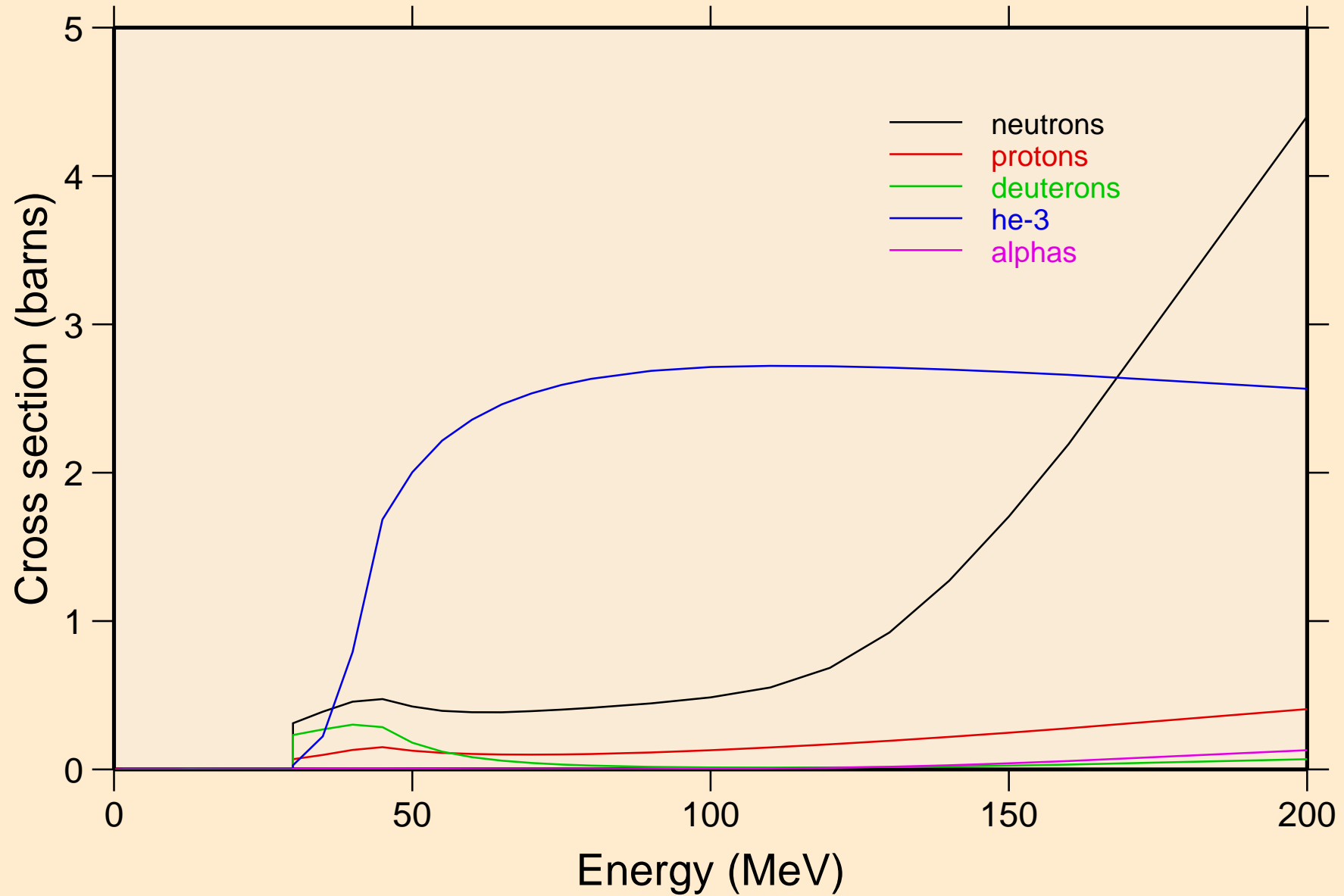

SG270 TRITON ACER TENDL-2021 LIBRARY; T=0.K
neutrons from (t,n)

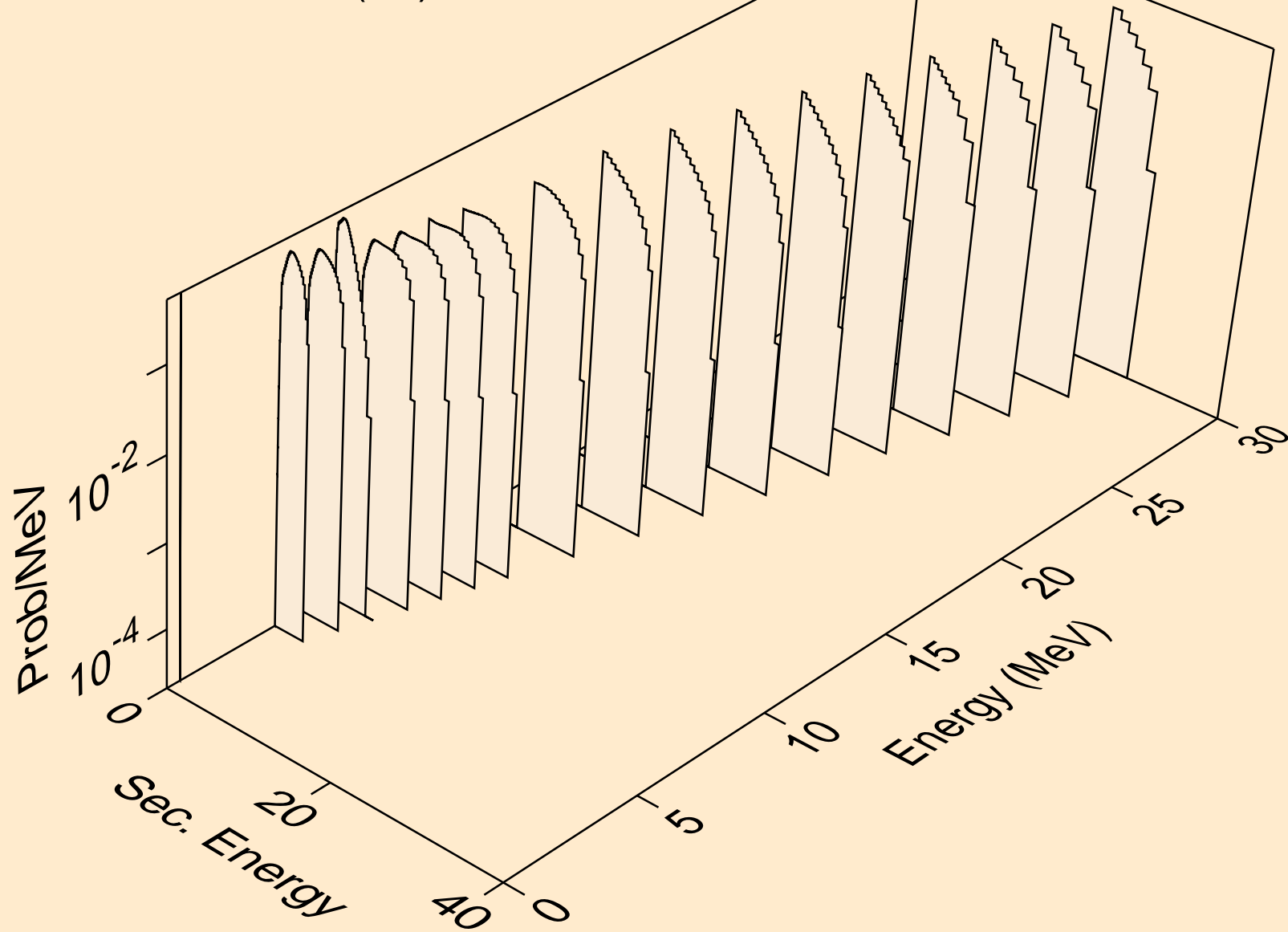

SG270 TRITON ACER TENDL-2021 LIBRARY; T=0.K
neutrons from (t,x)

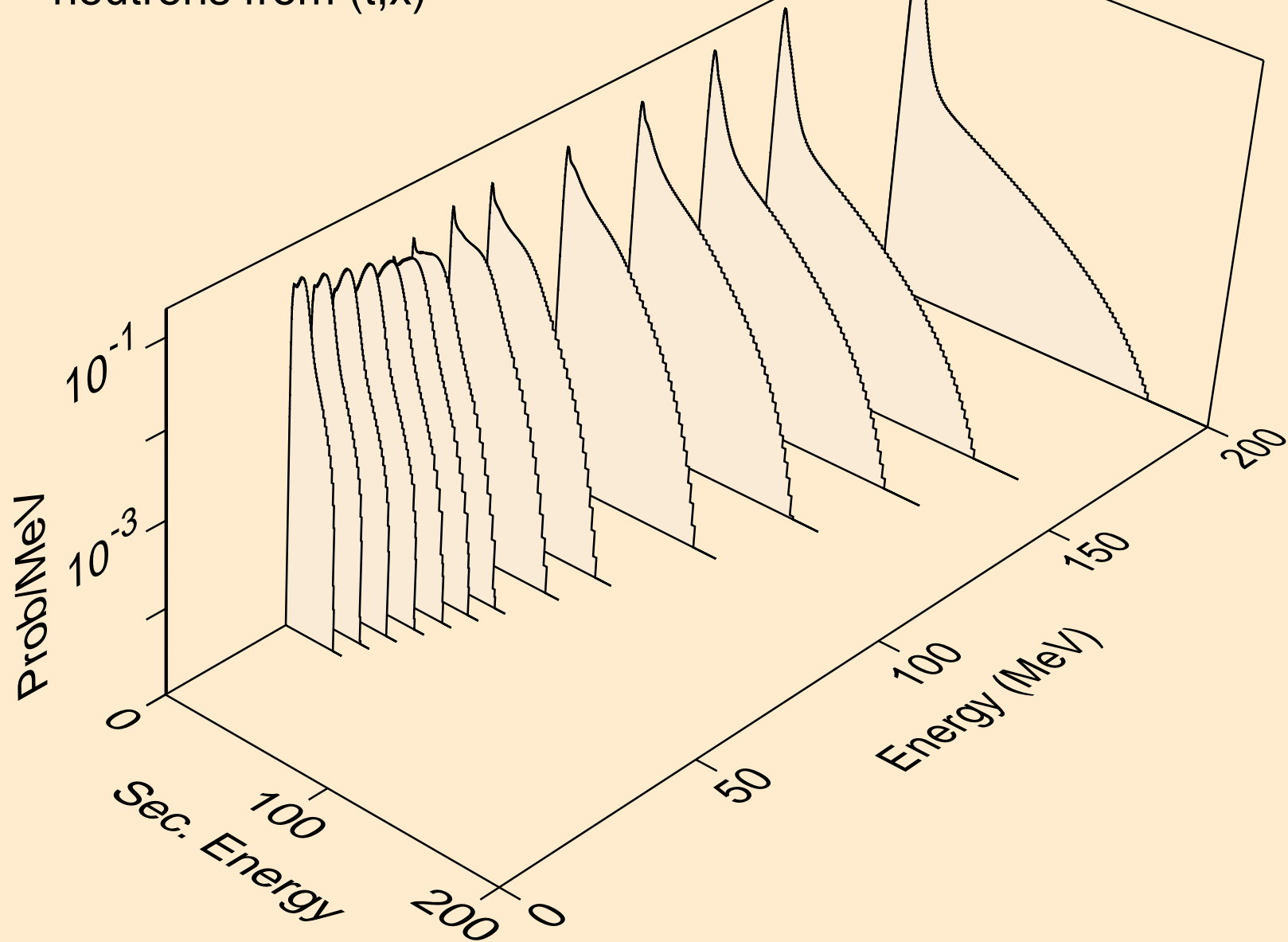

SG270 TRITON ACER TENDL-2021 LIBRARY; T=0.K
neutrons from (t,2n)

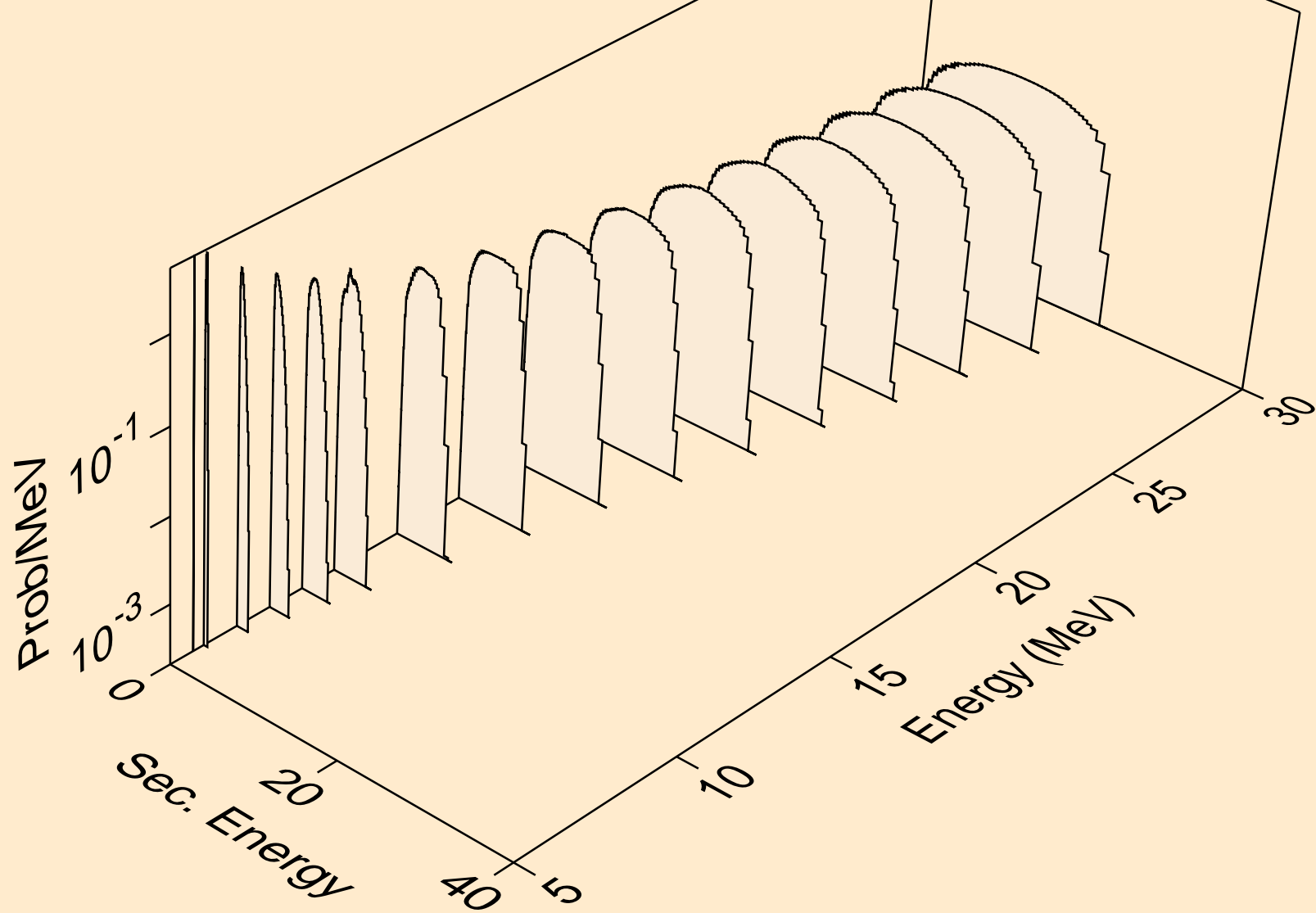

SG270 TRITON ACER TENDL-2021 LIBRARY; T=0.K
neutrons from (t,3n)

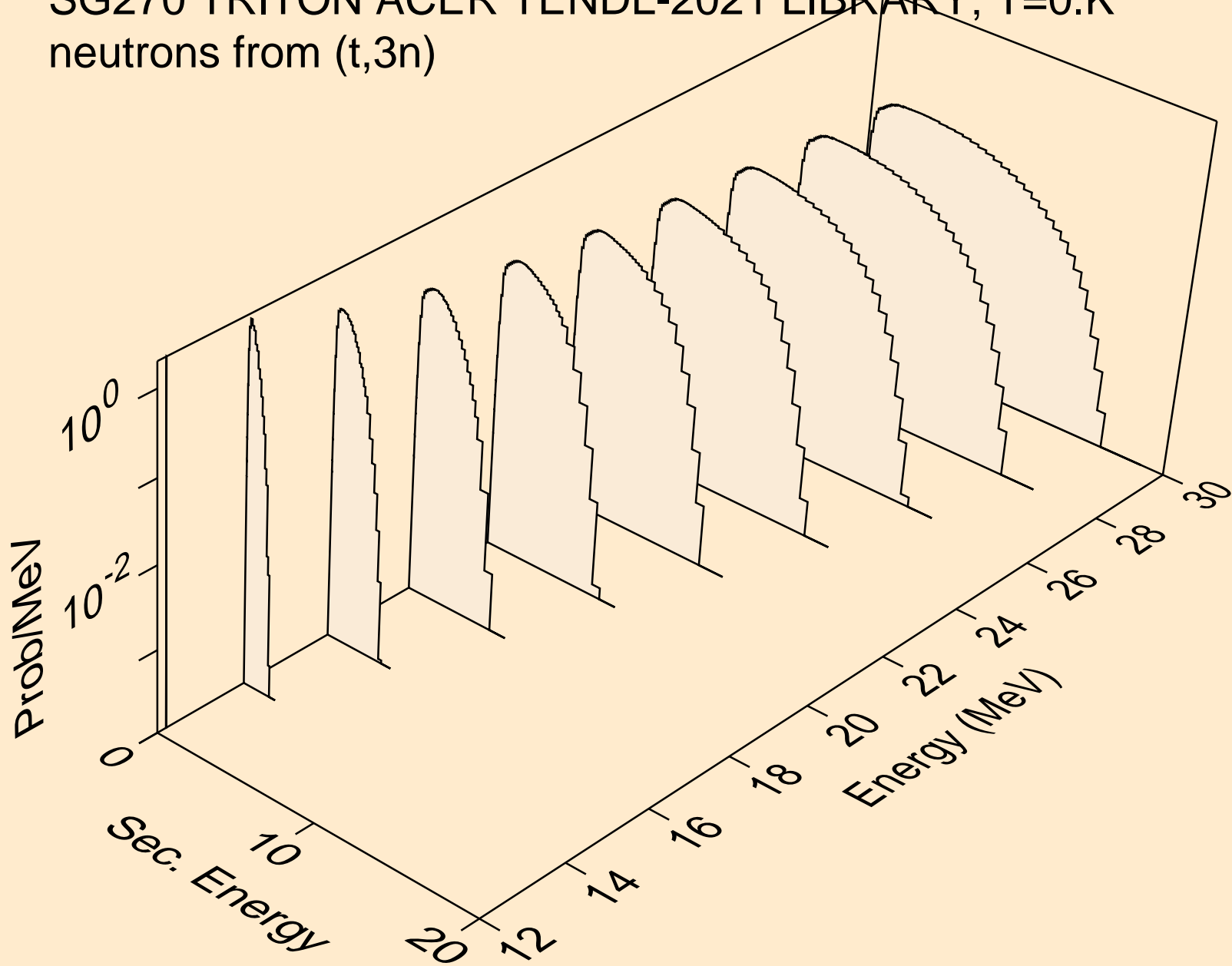

SG270 TRITON ACER TENDL-2021 LIBRARY; T=0.K
neutrons from (t,n*)a

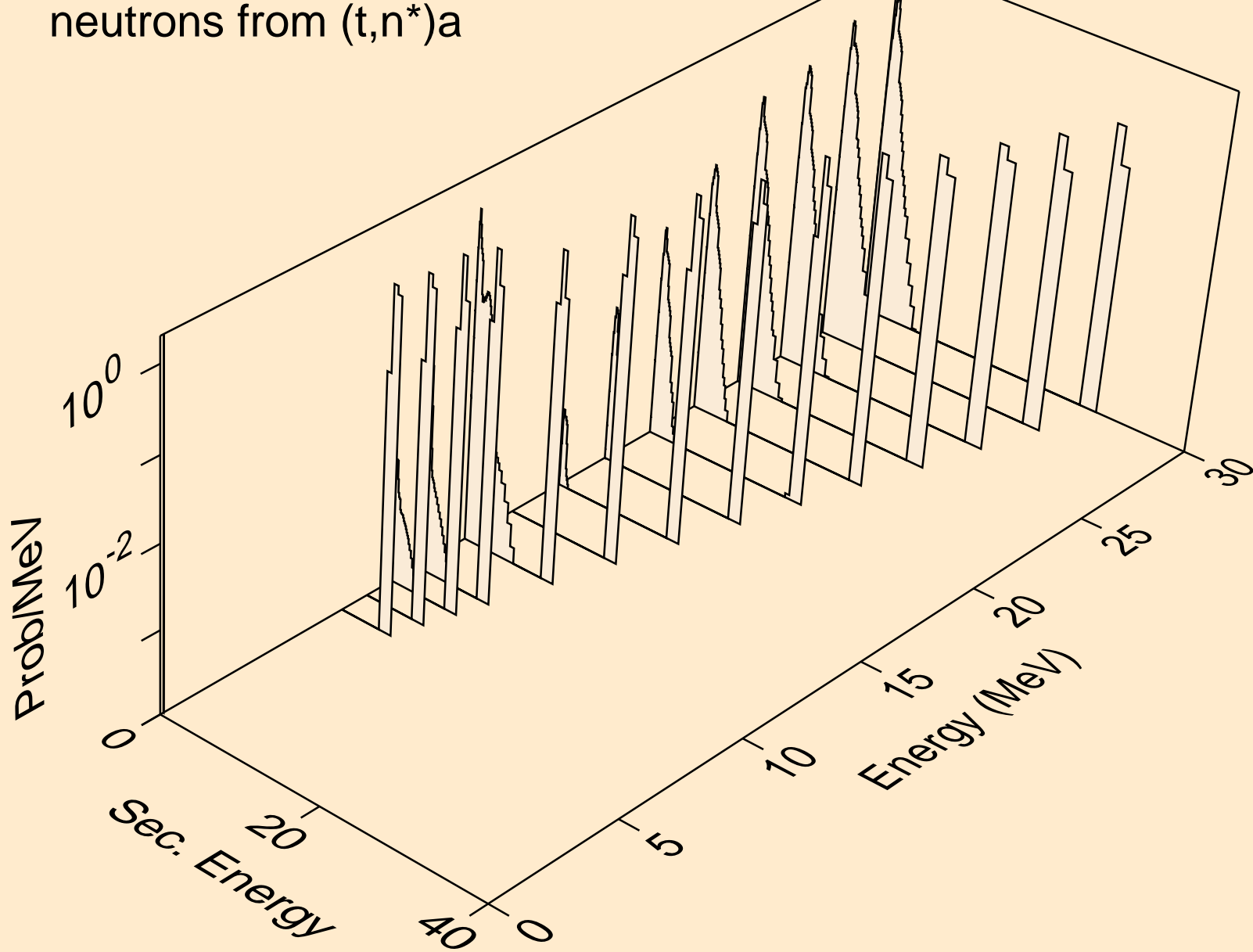

SG270 TRITON ACER TENDL-2021 LIBRARY; T=0.K
neutrons from (t,2n)a

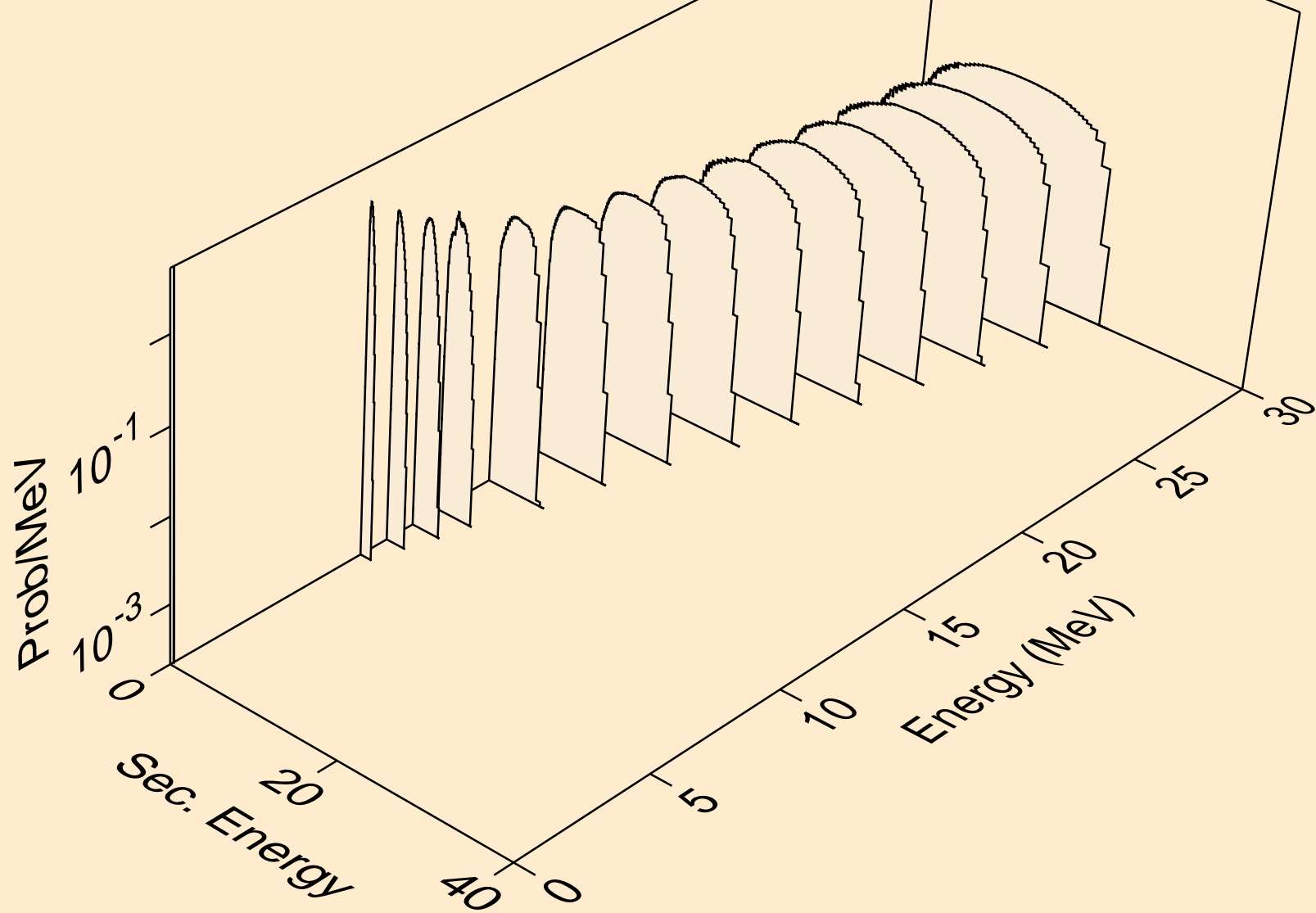

SG270 TRITON ACER TENDL-2021 LIBRARY; T=0.K
neutrons from (t,n*)d

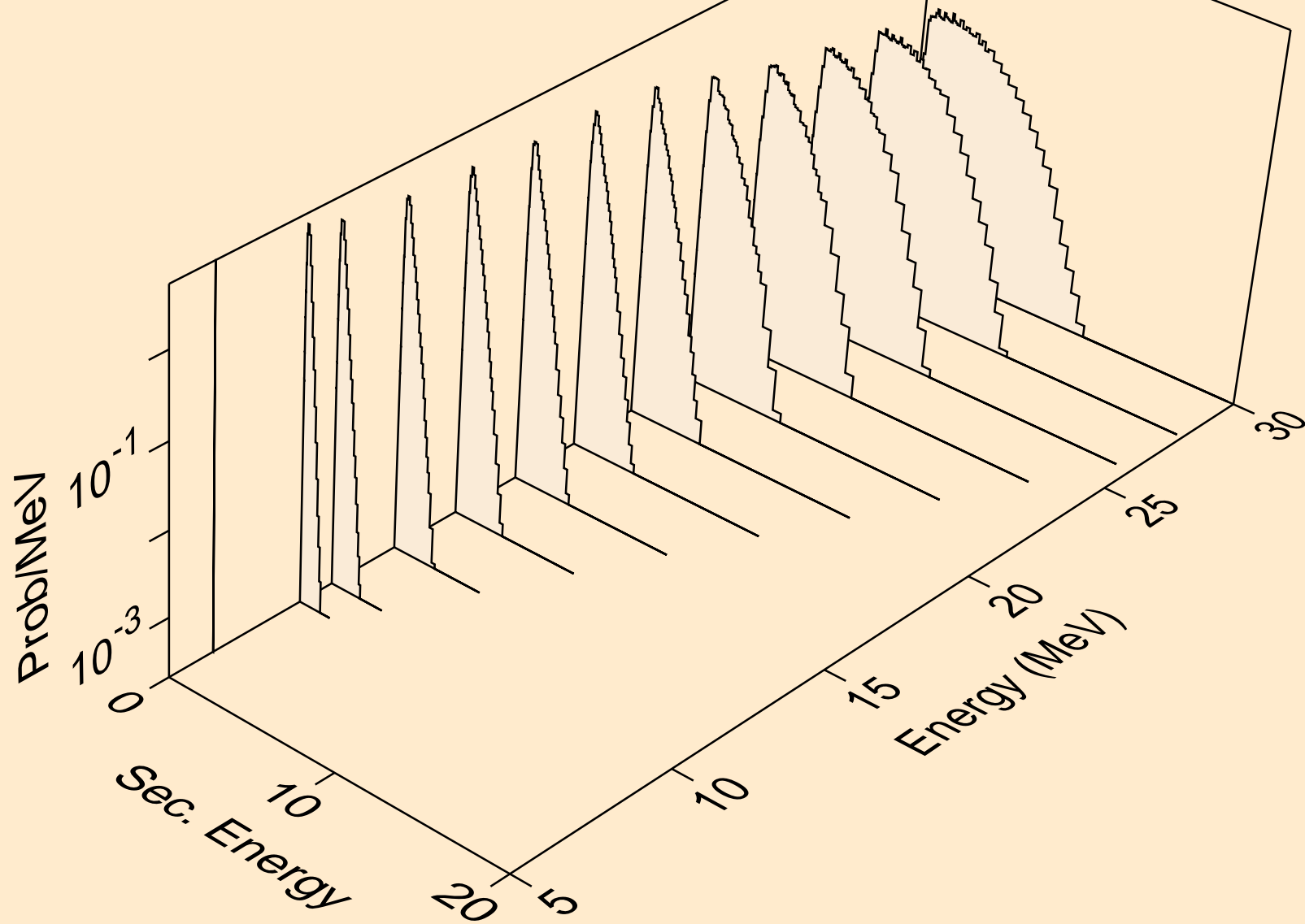

SG270 TRITON ACER TENDL-2021 LIBRARY; T=0.K
neutrons from (t,n*)t

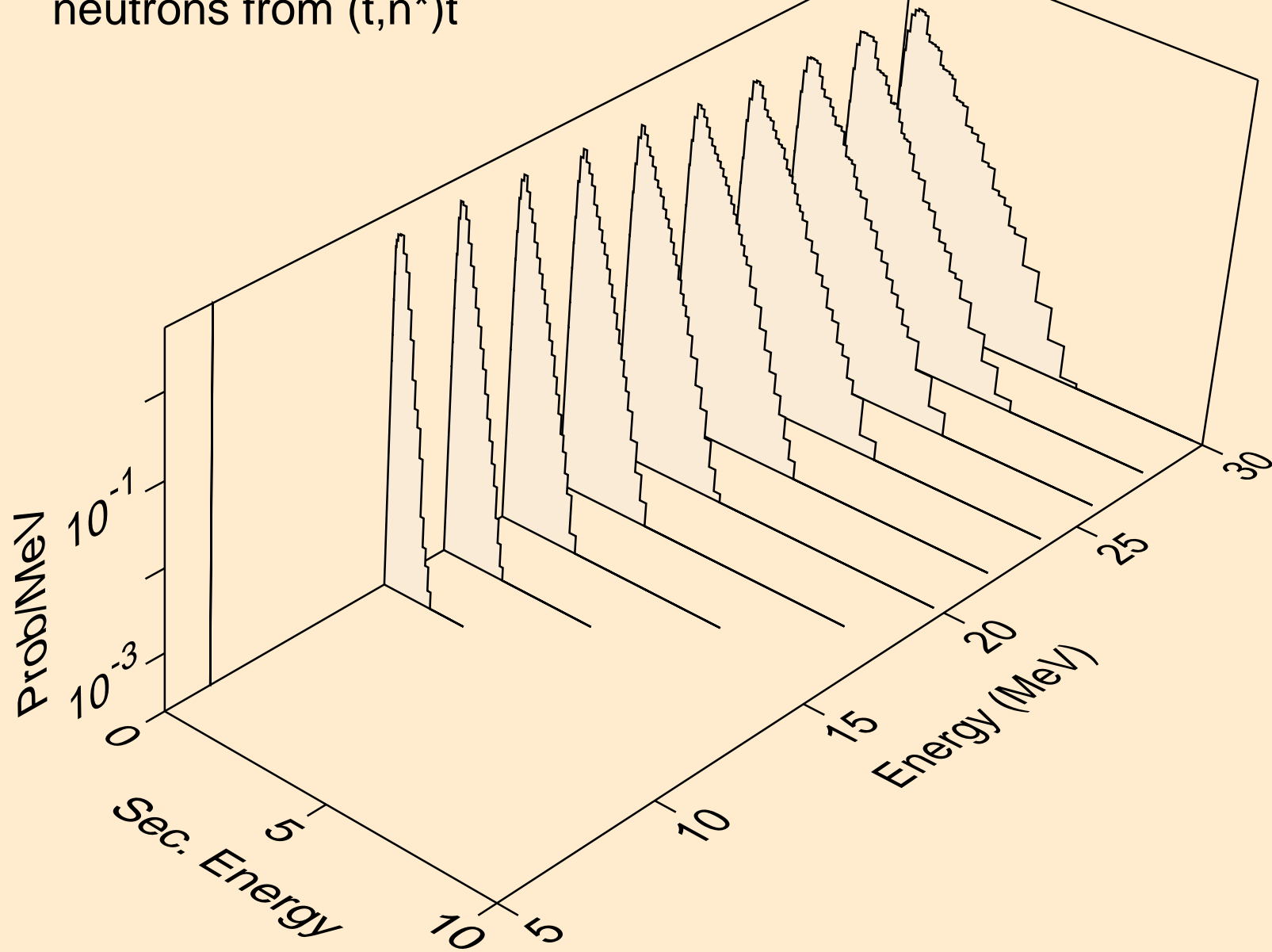

SG270 TRITON ACER TENDL-2021 LIBRARY; T=0.K
neutrons from (t,4n)

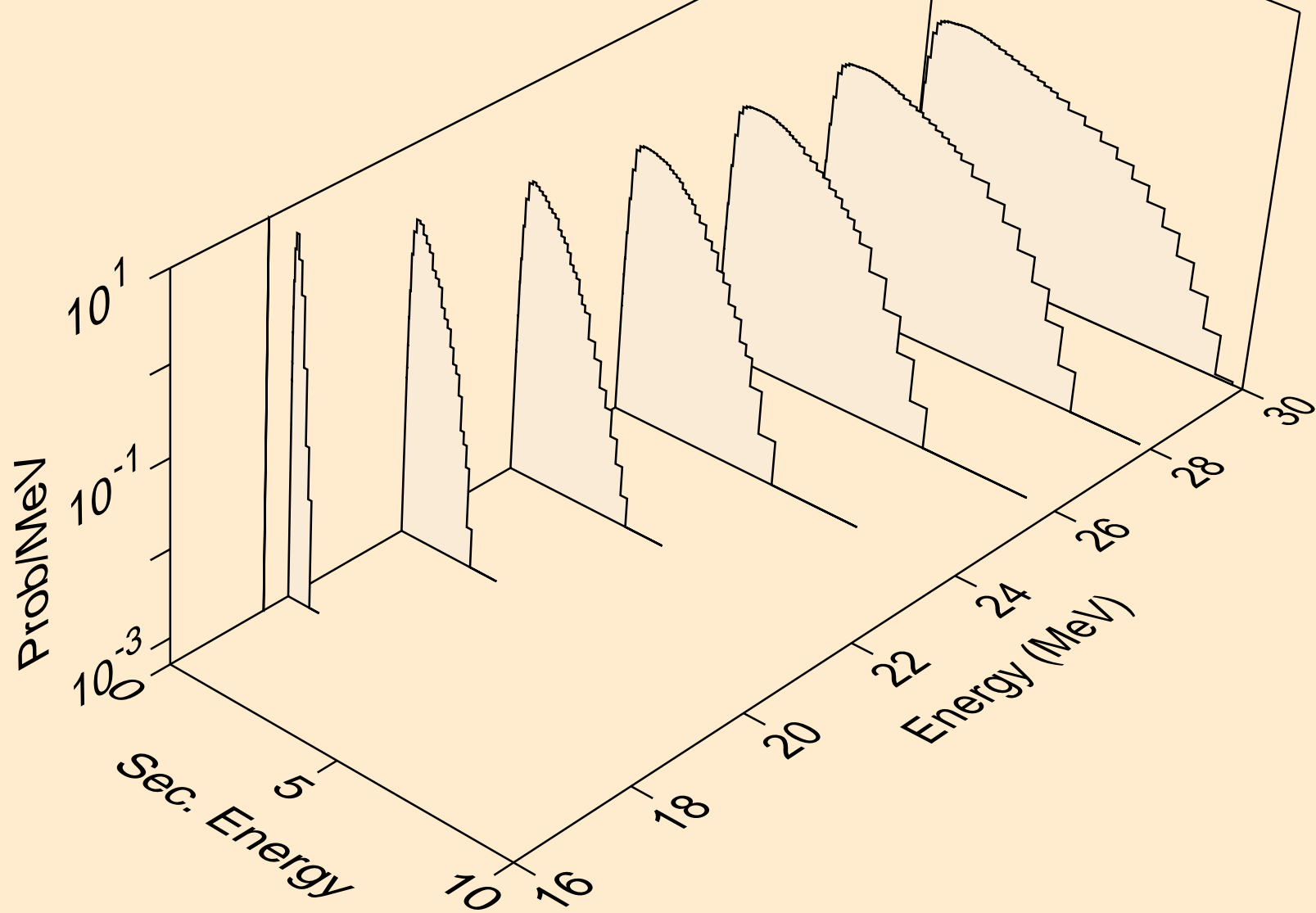

SG270 TRITON ACER TENDL-2021 LIBRARY; T=0.K
neutrons from (t,2np)

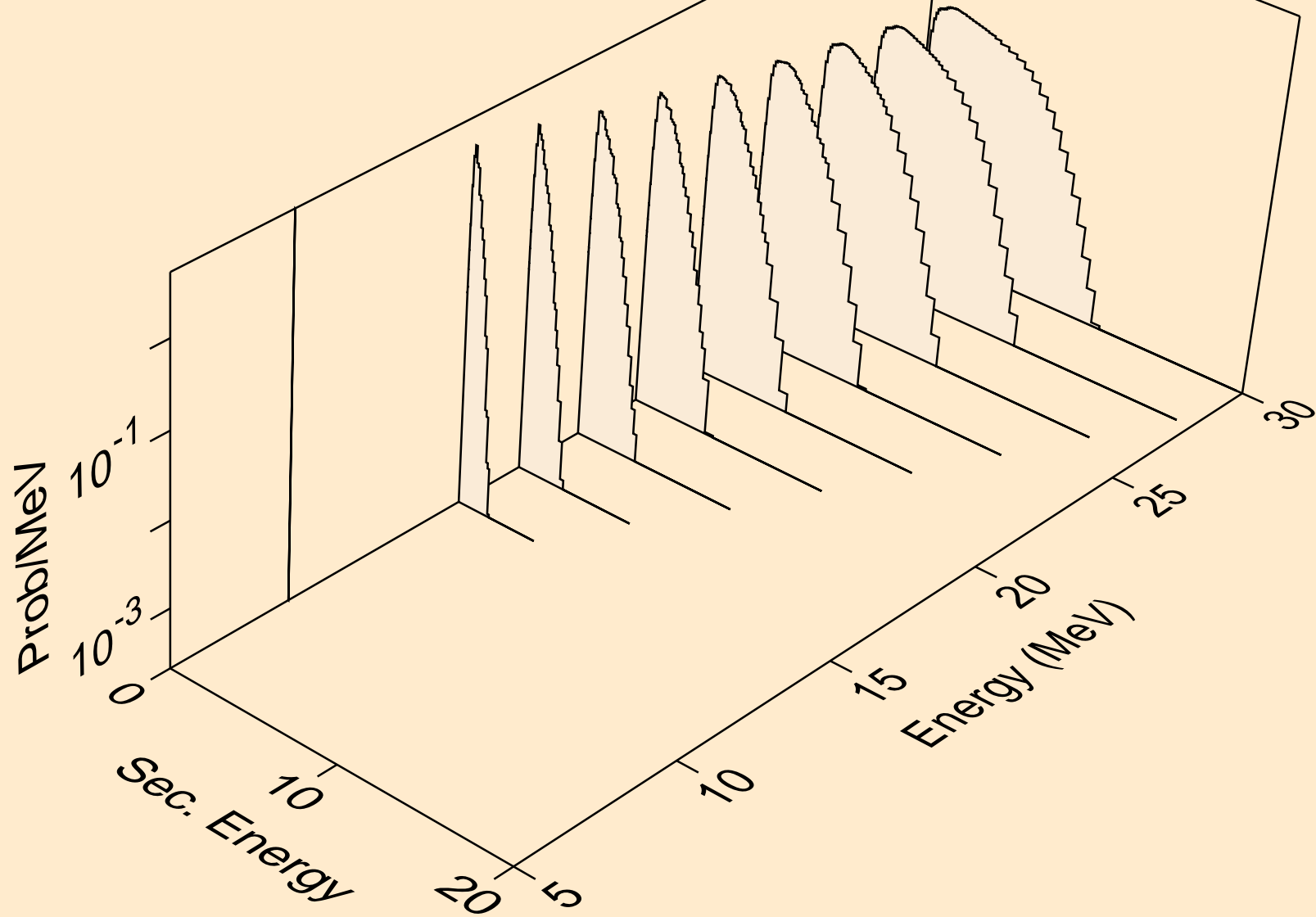

SG270 TRITON ACER TENDL-2021 LIBRARY; T=0.K
neutrons from (t,3np)

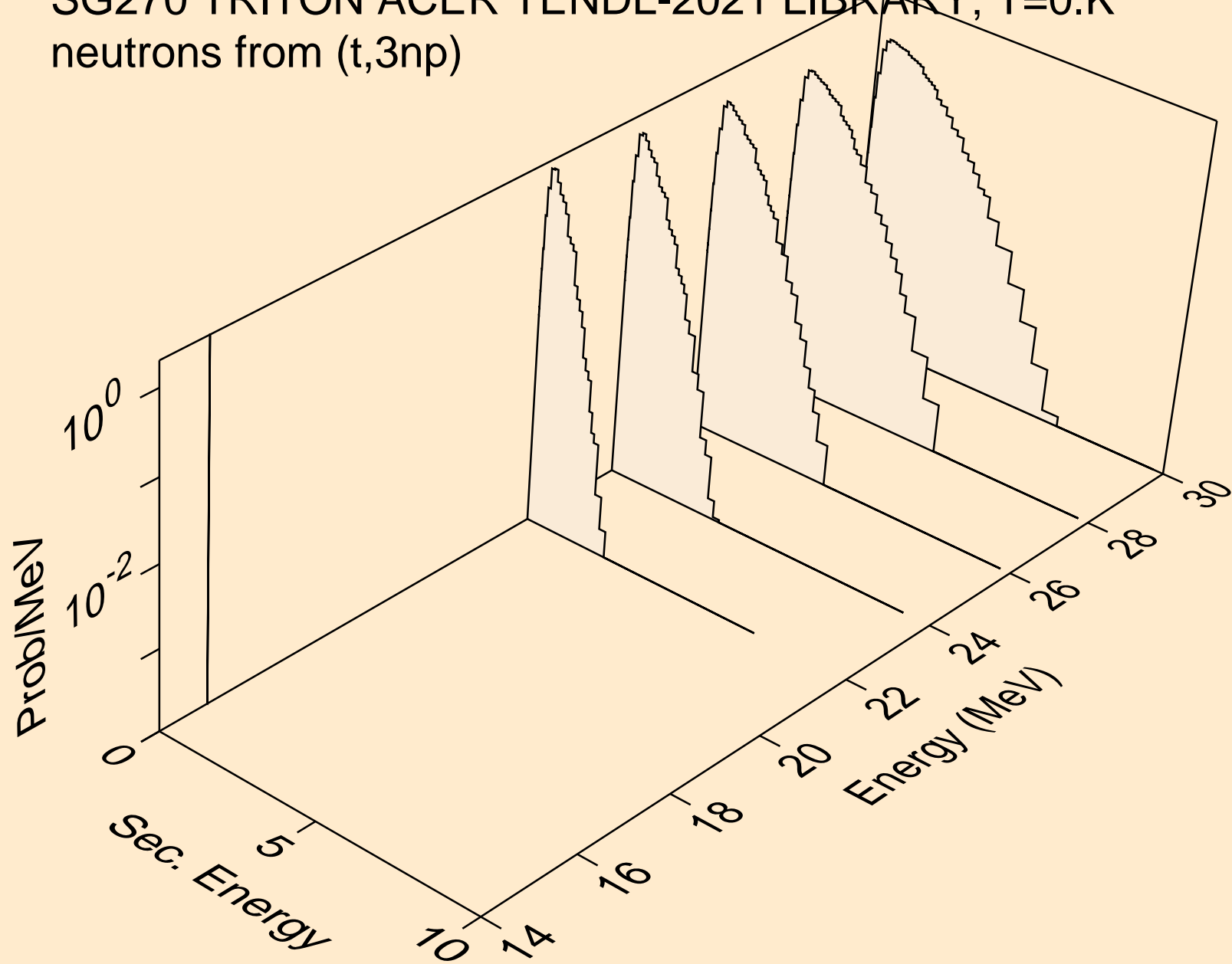

SG270 TRITON ACER TENDL-2021 LIBRARY; T=0.K
protons from (t,x)

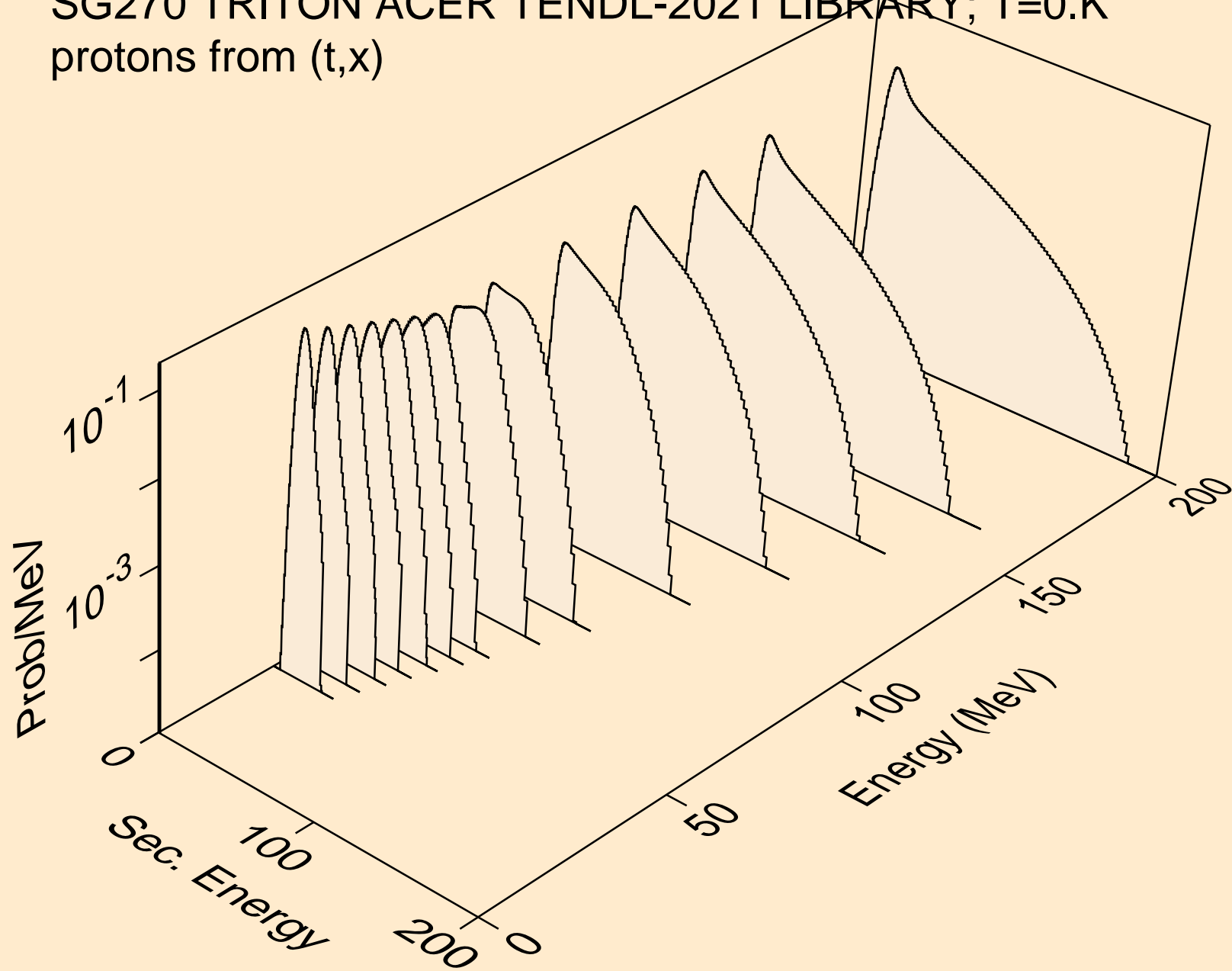

SG270 TRITON ACER TENDL-2021 LIBRARY; T=0.K
protons from (t,2np)

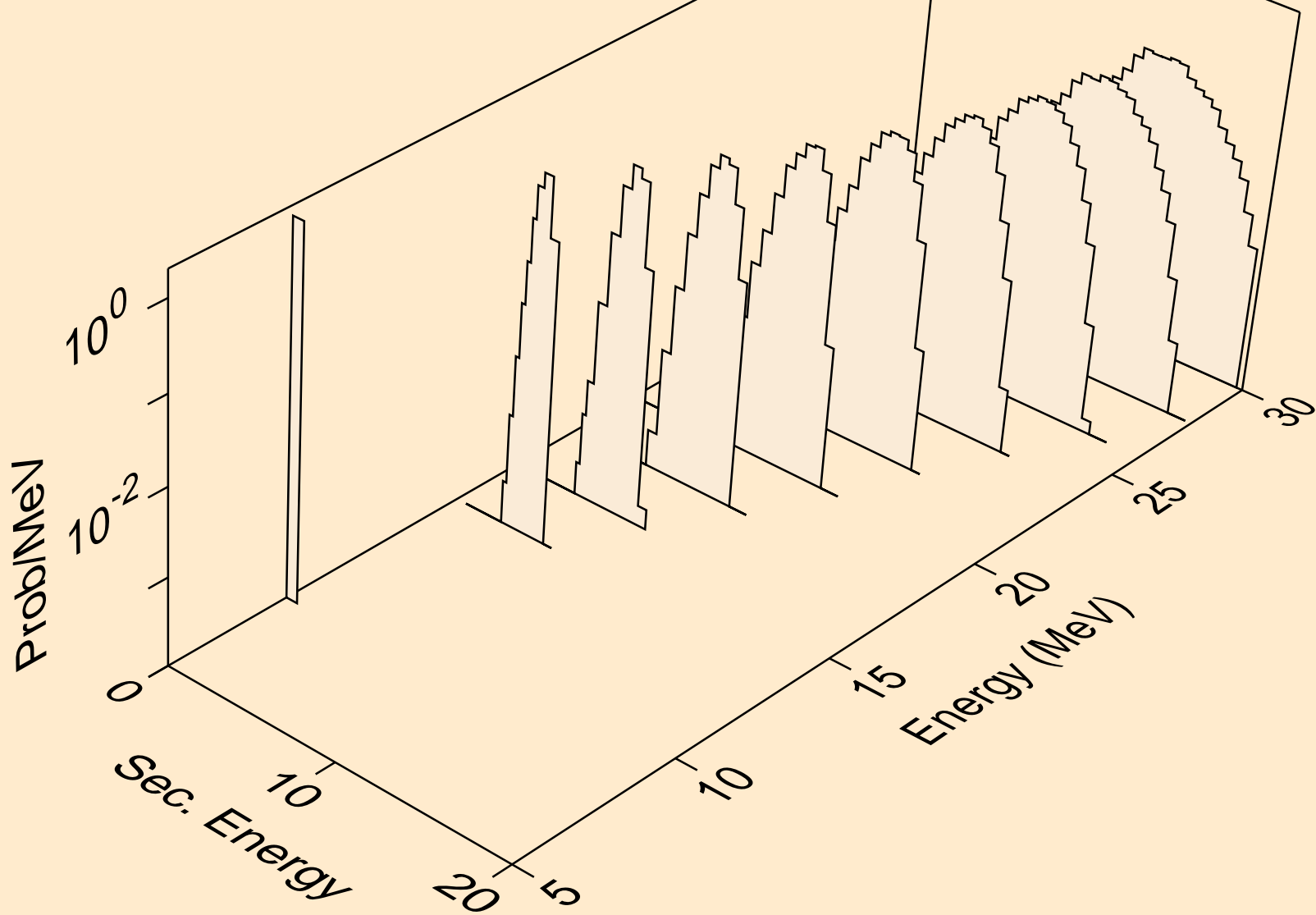

SG270 TRITON ACER TENDL-2021 LIBRARY; T=0.K
protons from (t,3np)

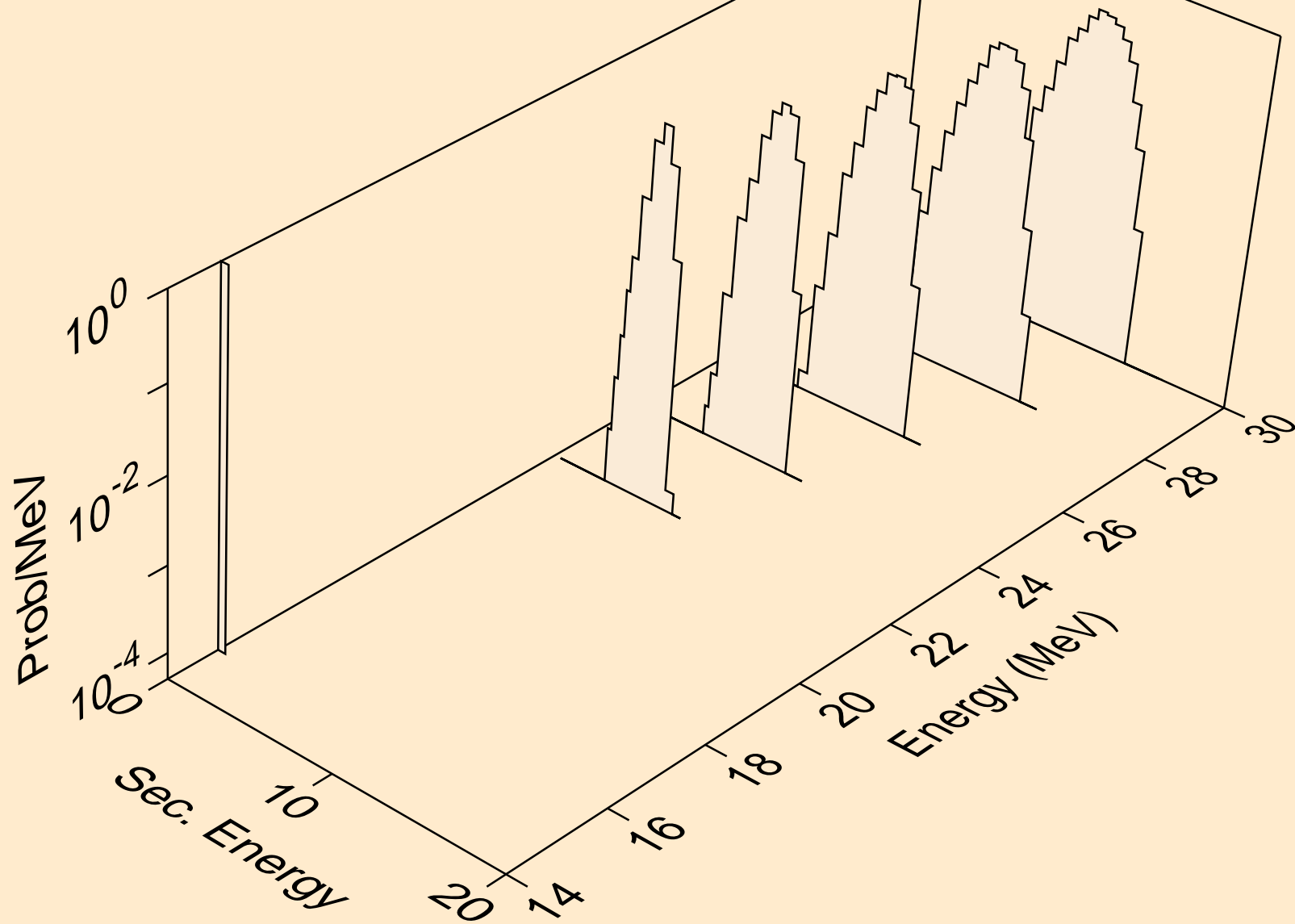

SG270 TRITON ACER TENDL-2021 LIBRARY; T=0.K
protons from (t,p)

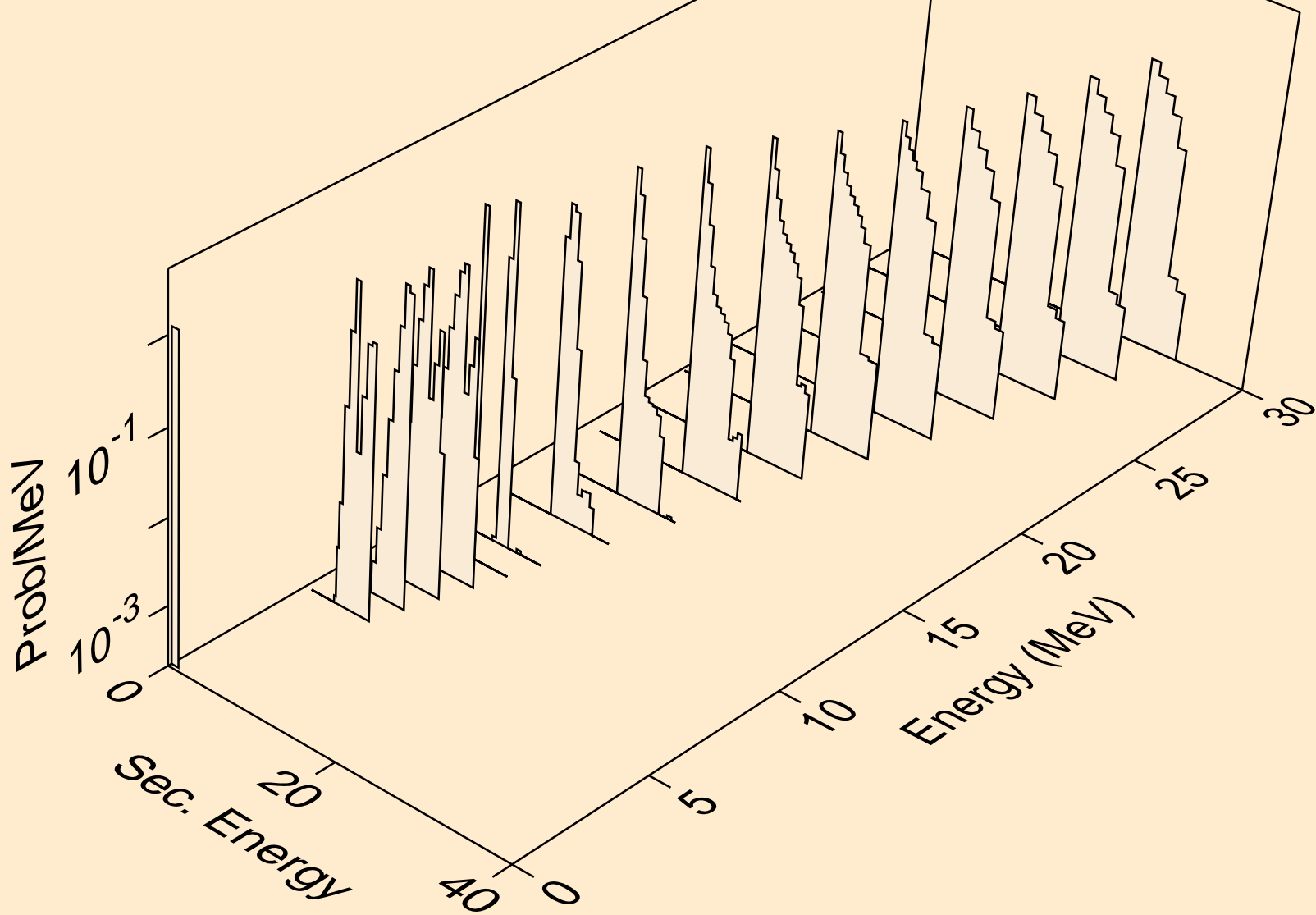

SG270 TRITON ACER TENDL-2021 LIBRARY; T=0.K
deuterons from (t,x)

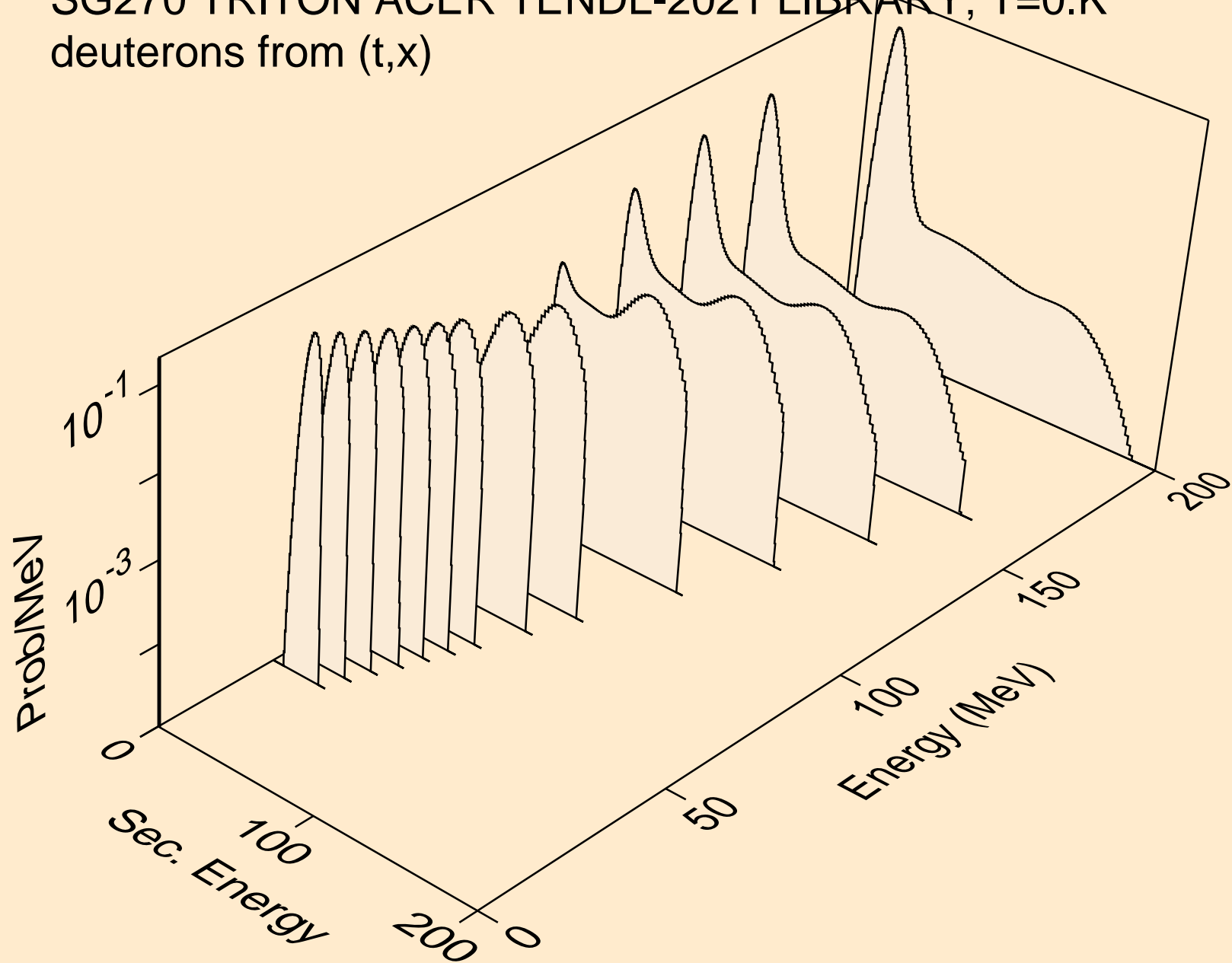

SG270 TRITON ACER TENDL-2021 LIBRARY; T=0.K
deuterons from (t,n*)d

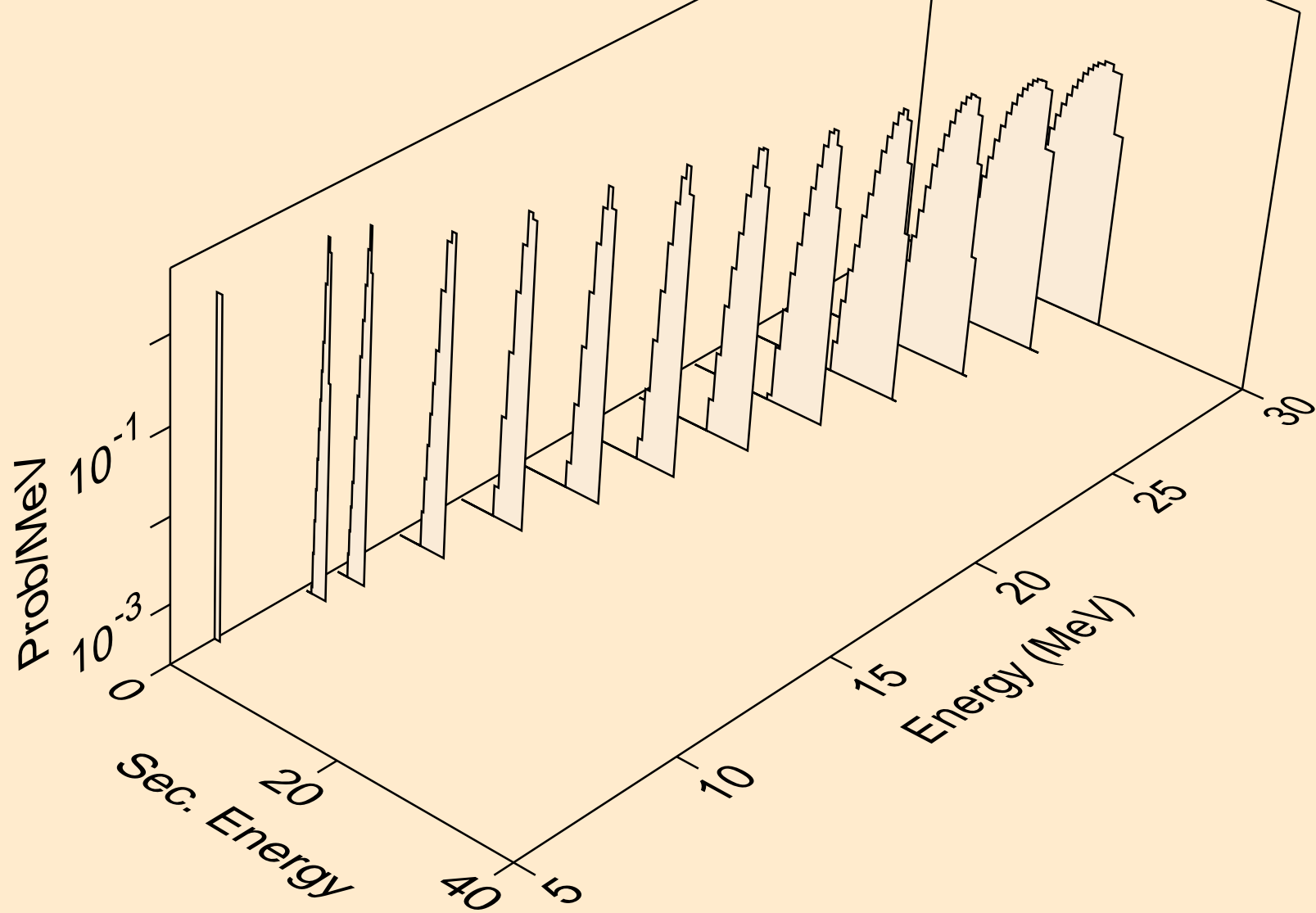

SG270 TRITON ACER TENDL-2021 LIBRARY; T=0.K
deuterons from (t,d)

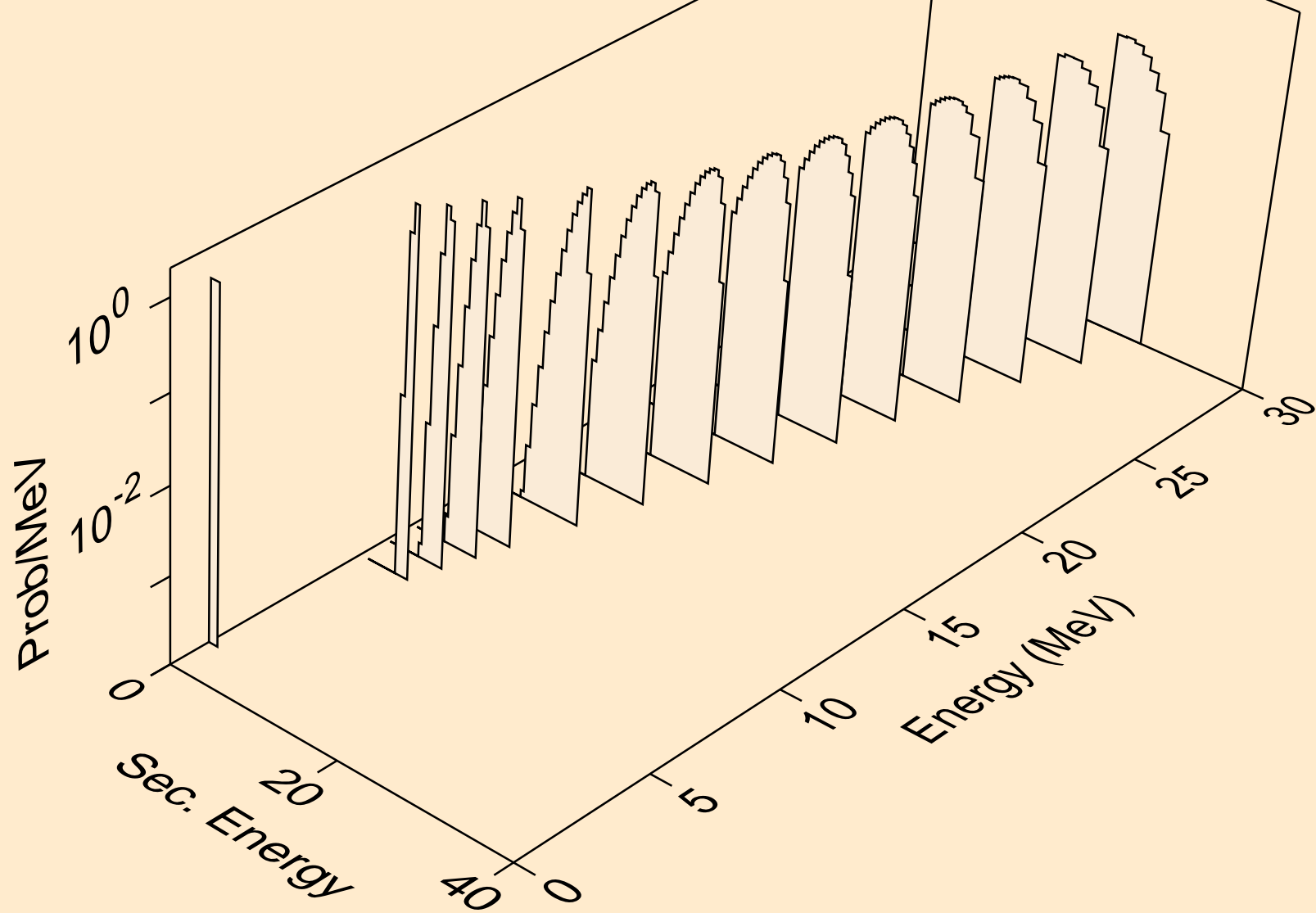

SG270 TRITON ACER TENDL-2021 LIBRARY; T=0.K
he3s from (t,x)

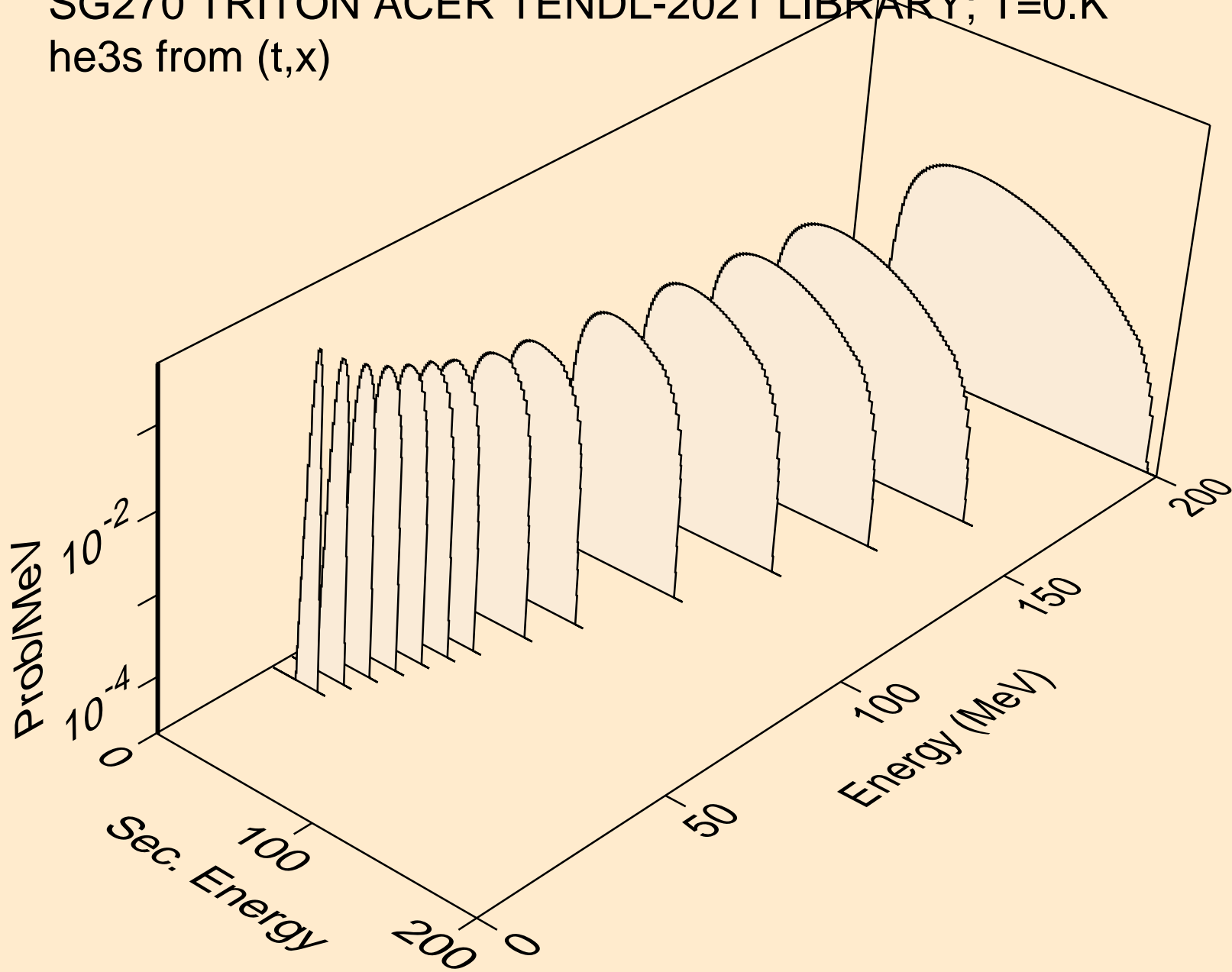

SG270 TRITON ACER TENDL-2021 LIBRARY; T=0.K
he3s from (t,he3)

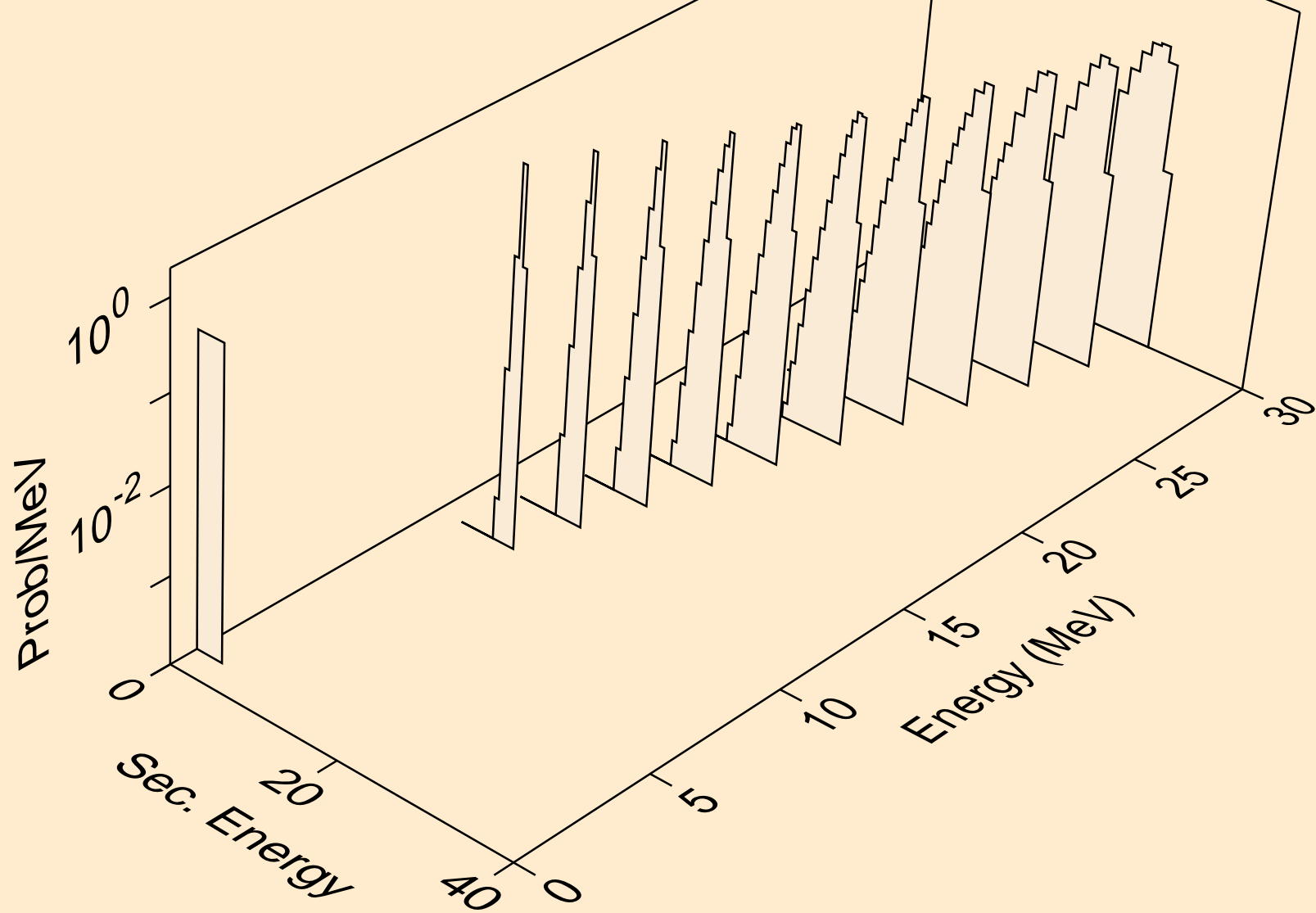

SG270 TRITON ACER TENDL-2021 LIBRARY; T=0.K
alphas from (t,x)

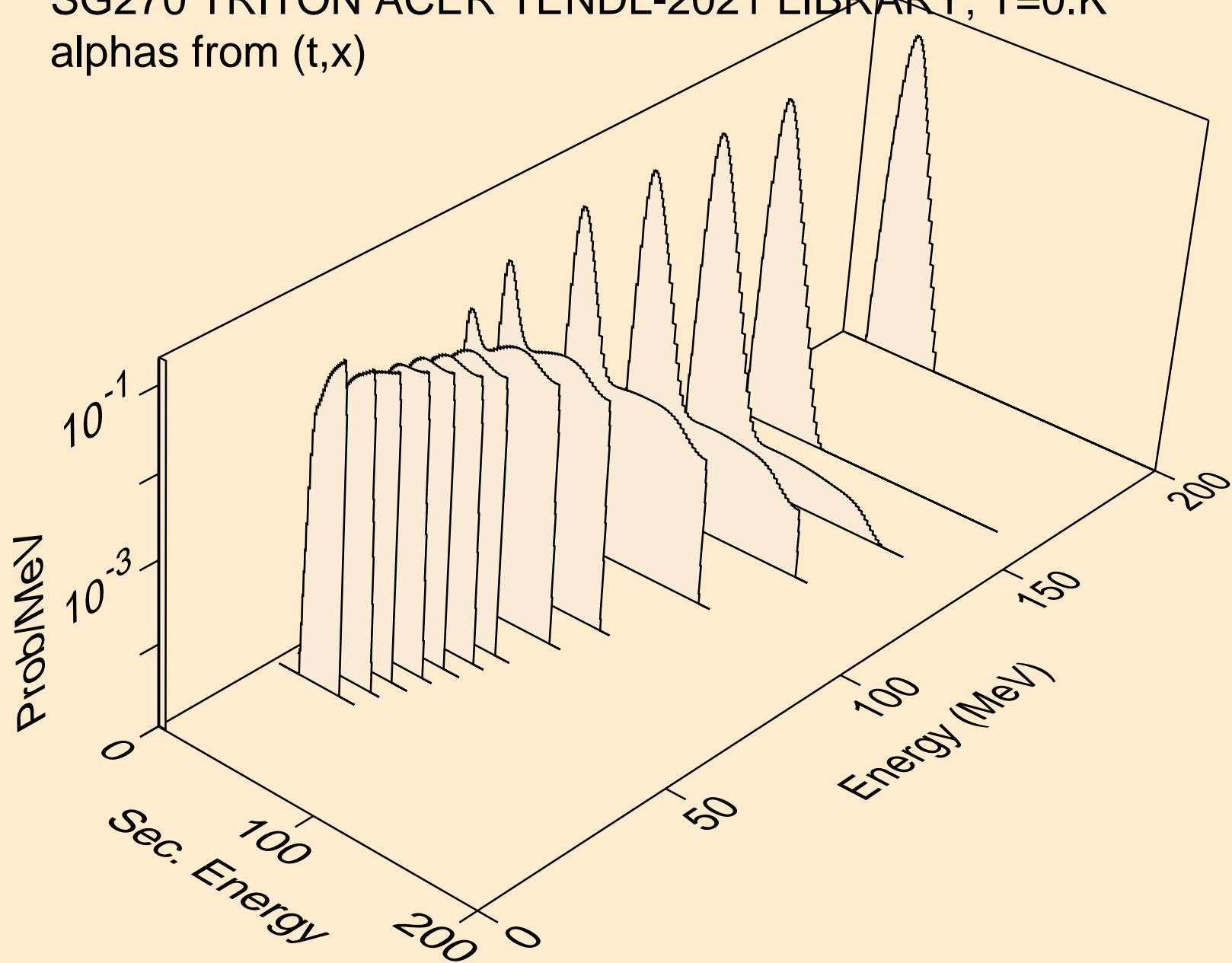

SG270 TRITON ACER TENDL-2021 LIBRARY; T=0.K
alphas from (t,n*)a

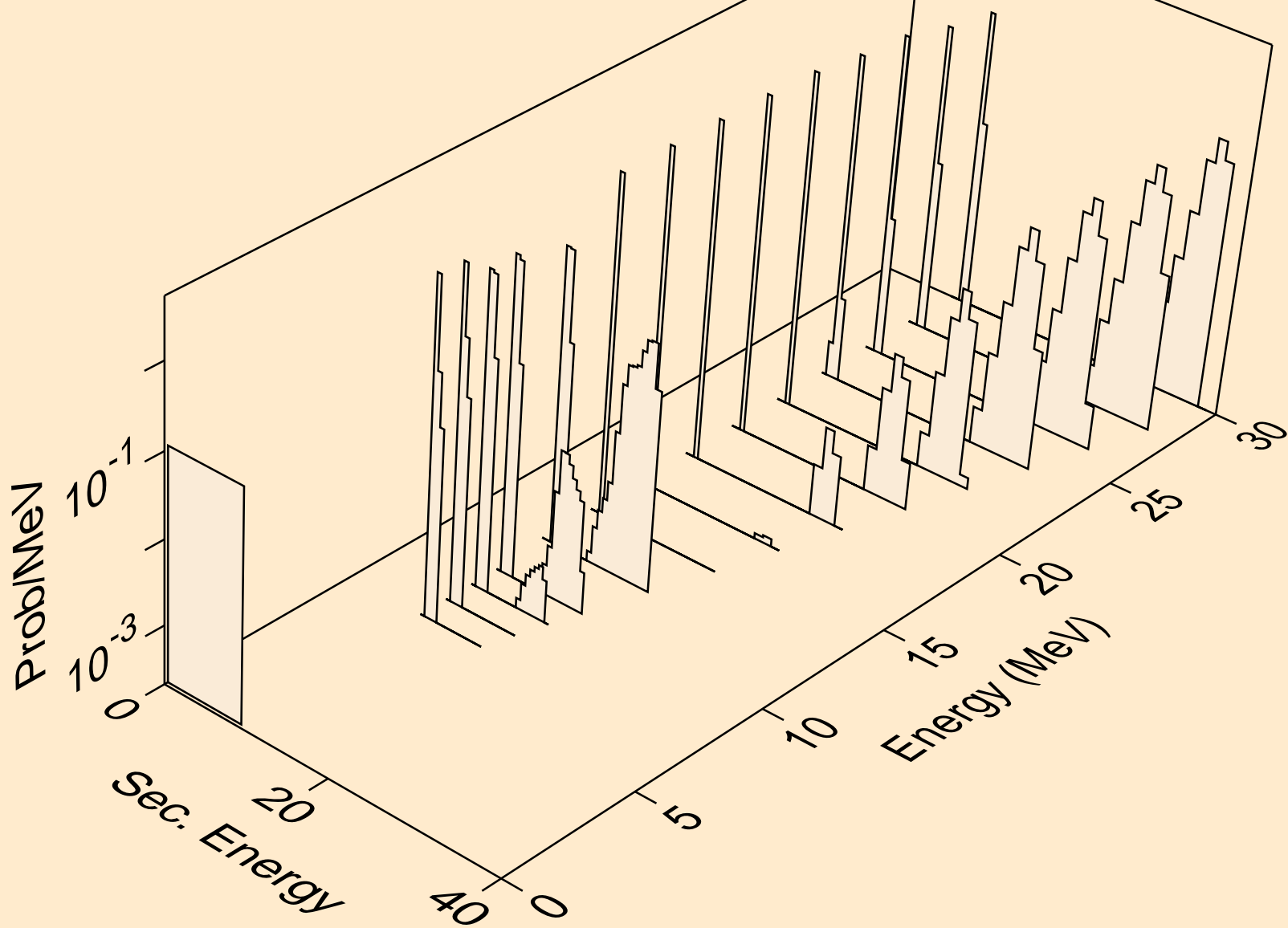

SG270 TRITON ACER TENDL-2021 LIBRARY; T=0.K
alphas from (t,2n)a

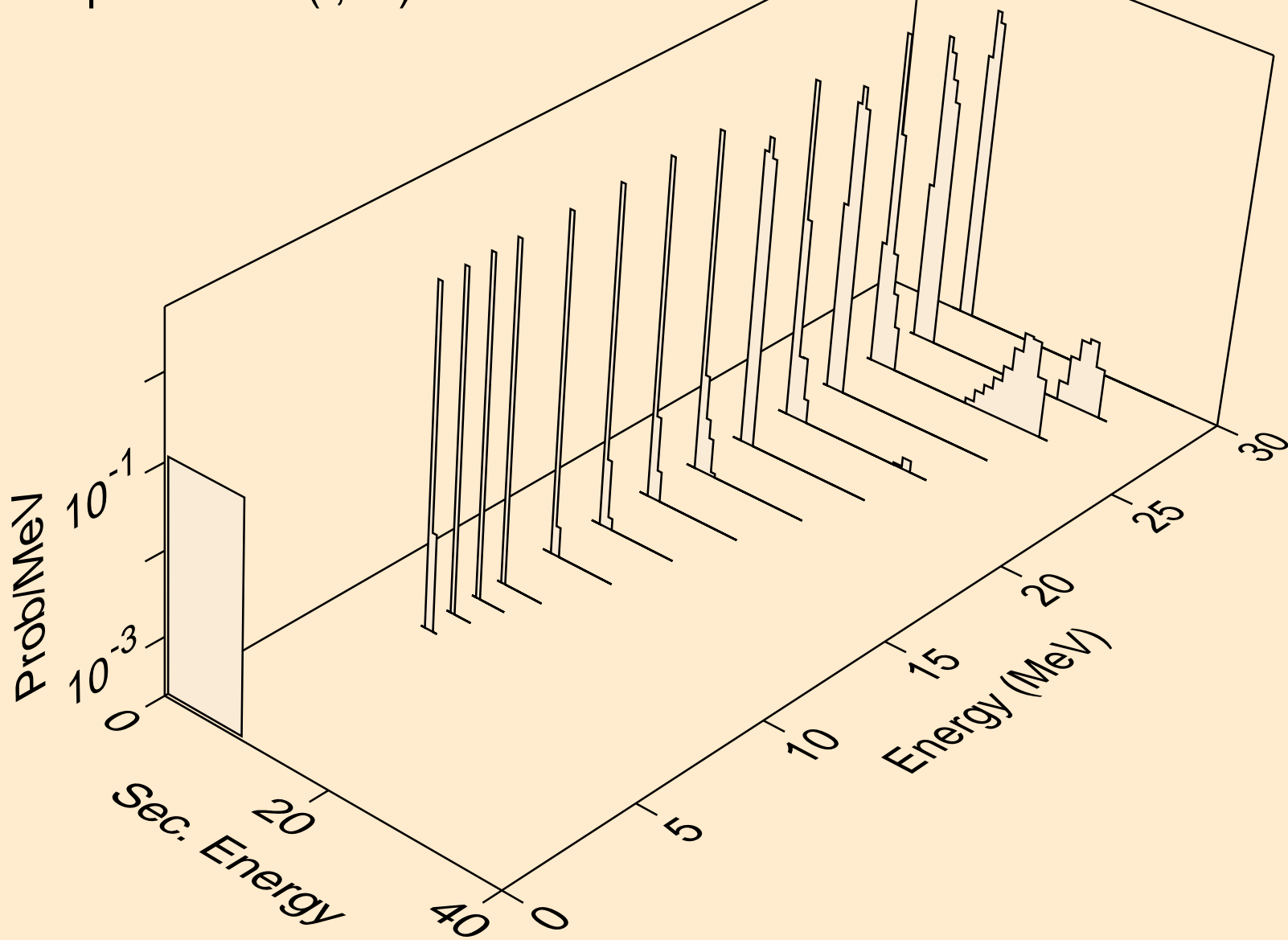

SG270 TRITON ACER TENDL-2021 LIBRARY; T=0.K
alphas from (t,a)

