

# SN112 TRITON ACER TENDL-2021 LIBRARY; T=0.K

## Principal cross sections

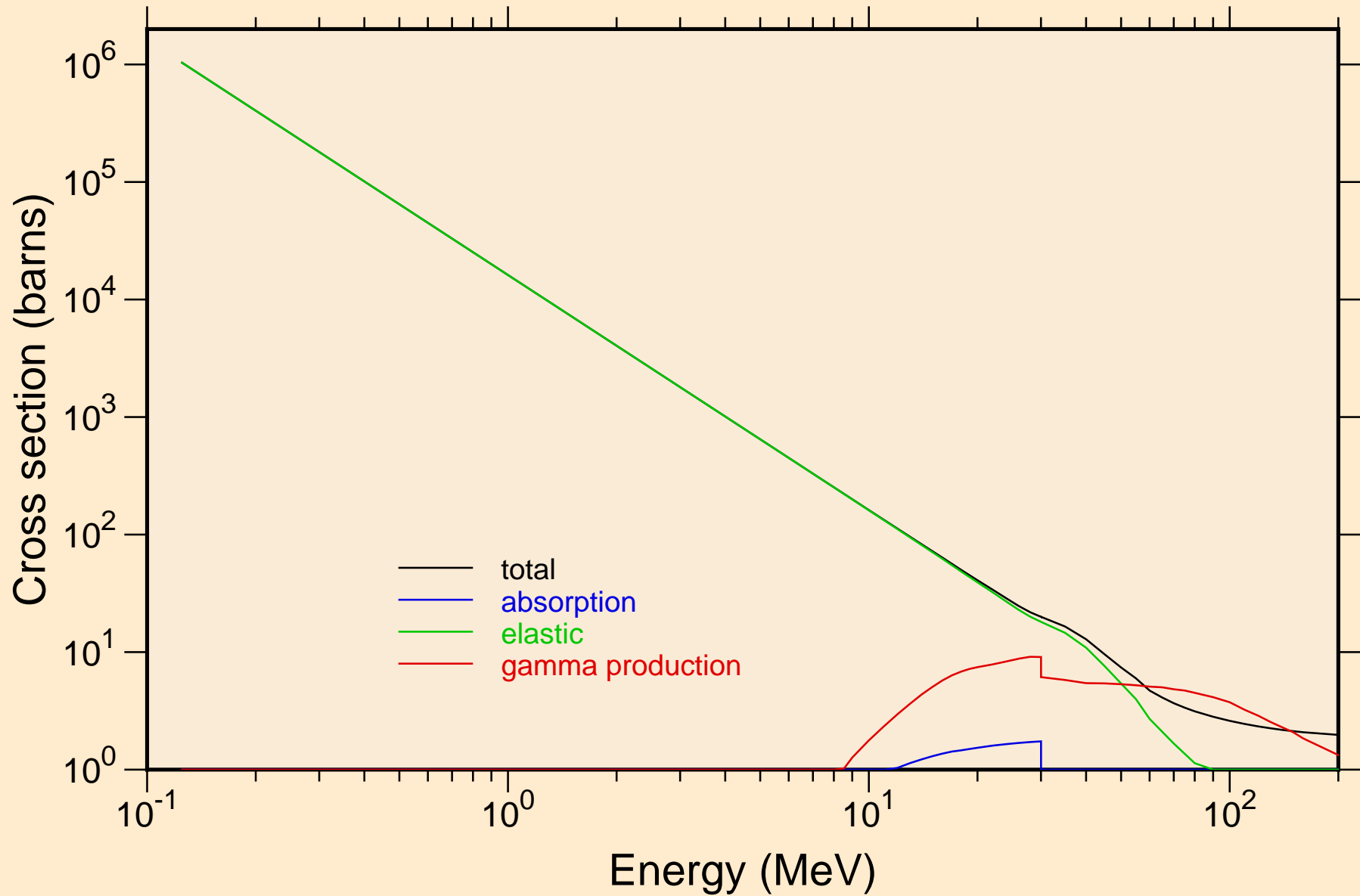

# SN112 TRITON ACER TENDL-2021 LIBRARY; T=0.K

## Heating

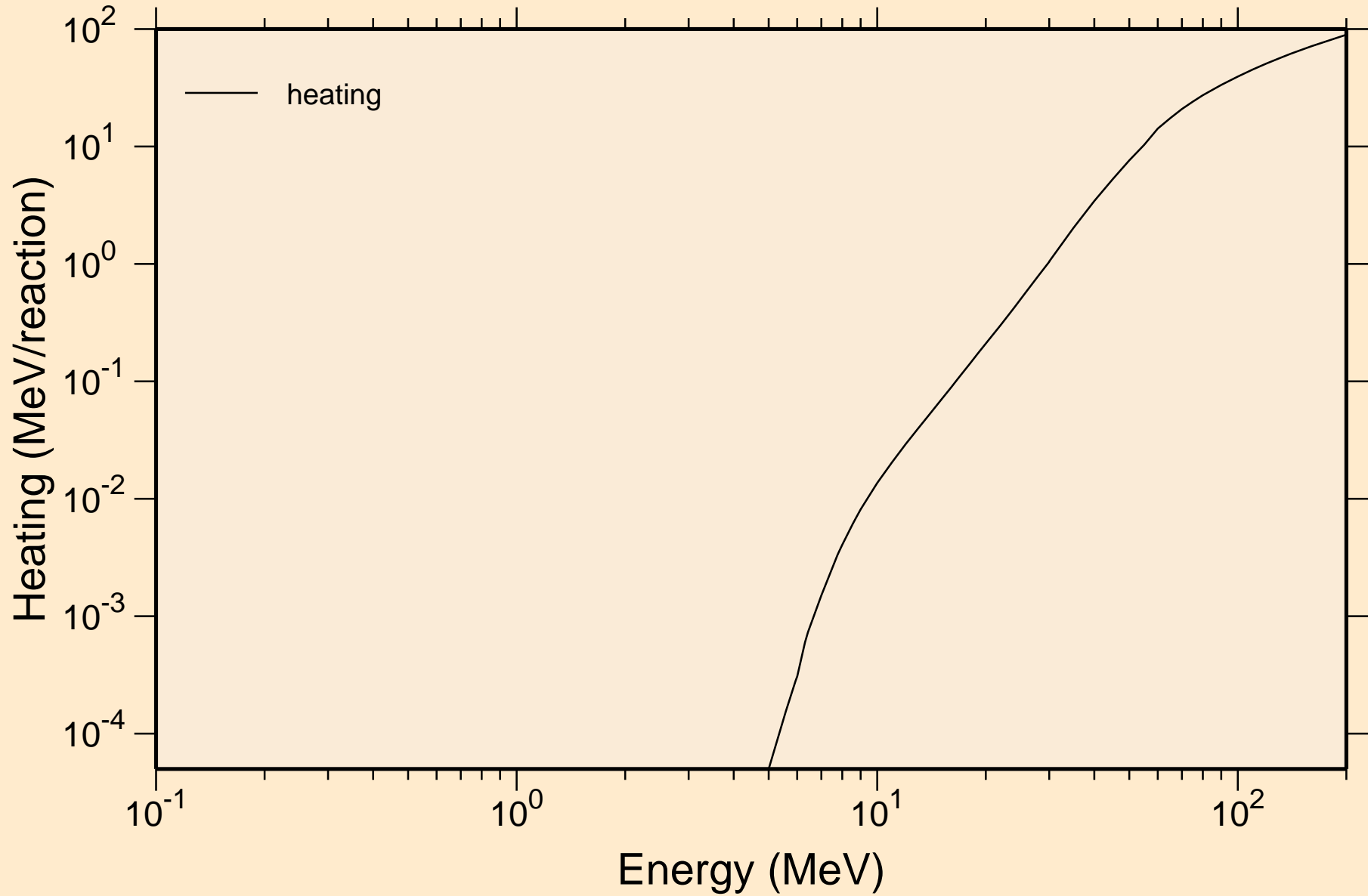

# SN112 TRITON ACER TENDL-2021 LIBRARY; T=0.K

## Principal cross sections

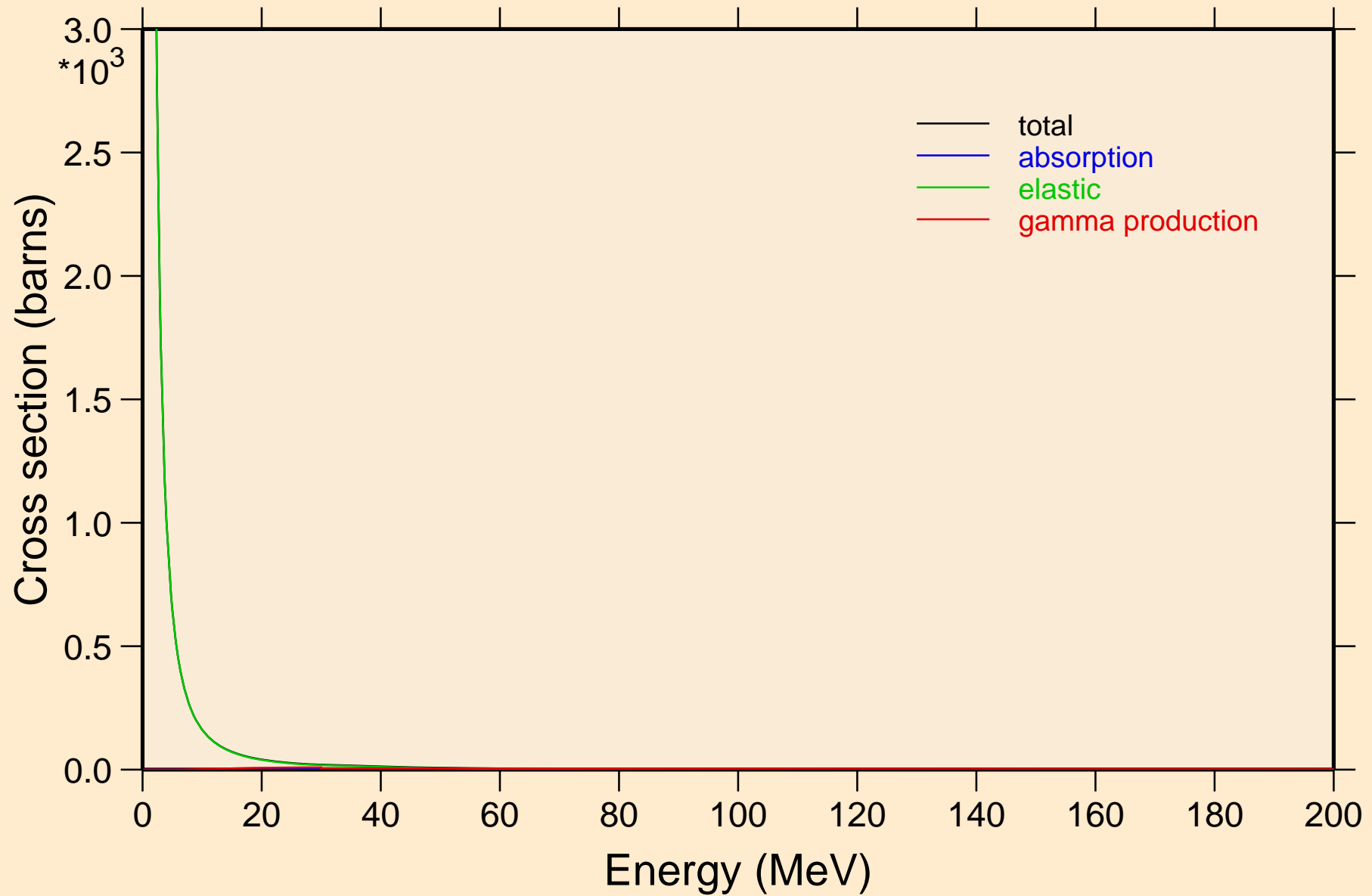

SN112 TRITON ACER TENDL-2021 LIBRARY; T=0.K

Heating

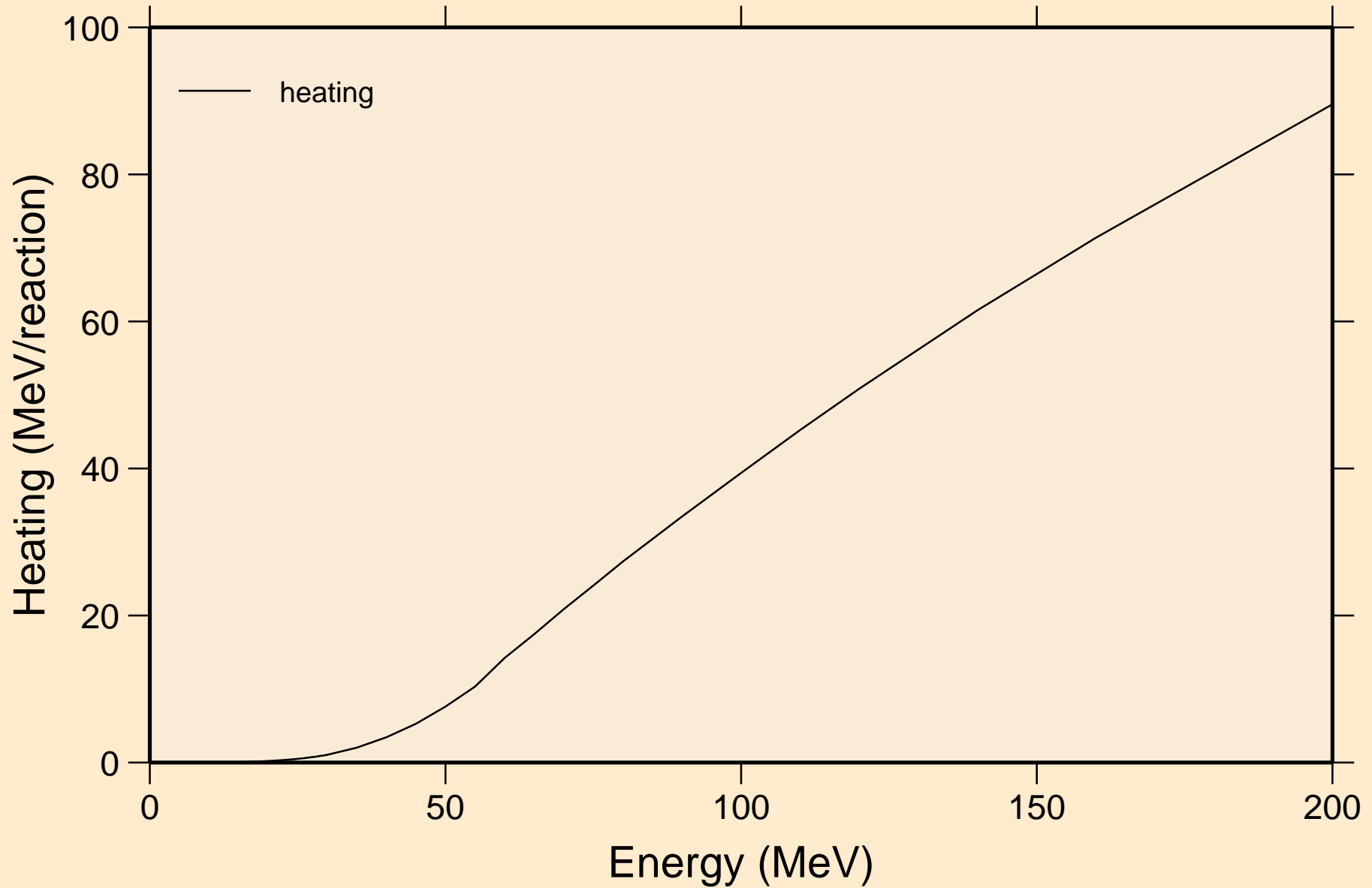

SN112 TRITON ACER TENDL-2021 LIBRARY; T=0.K  
Threshold reactions

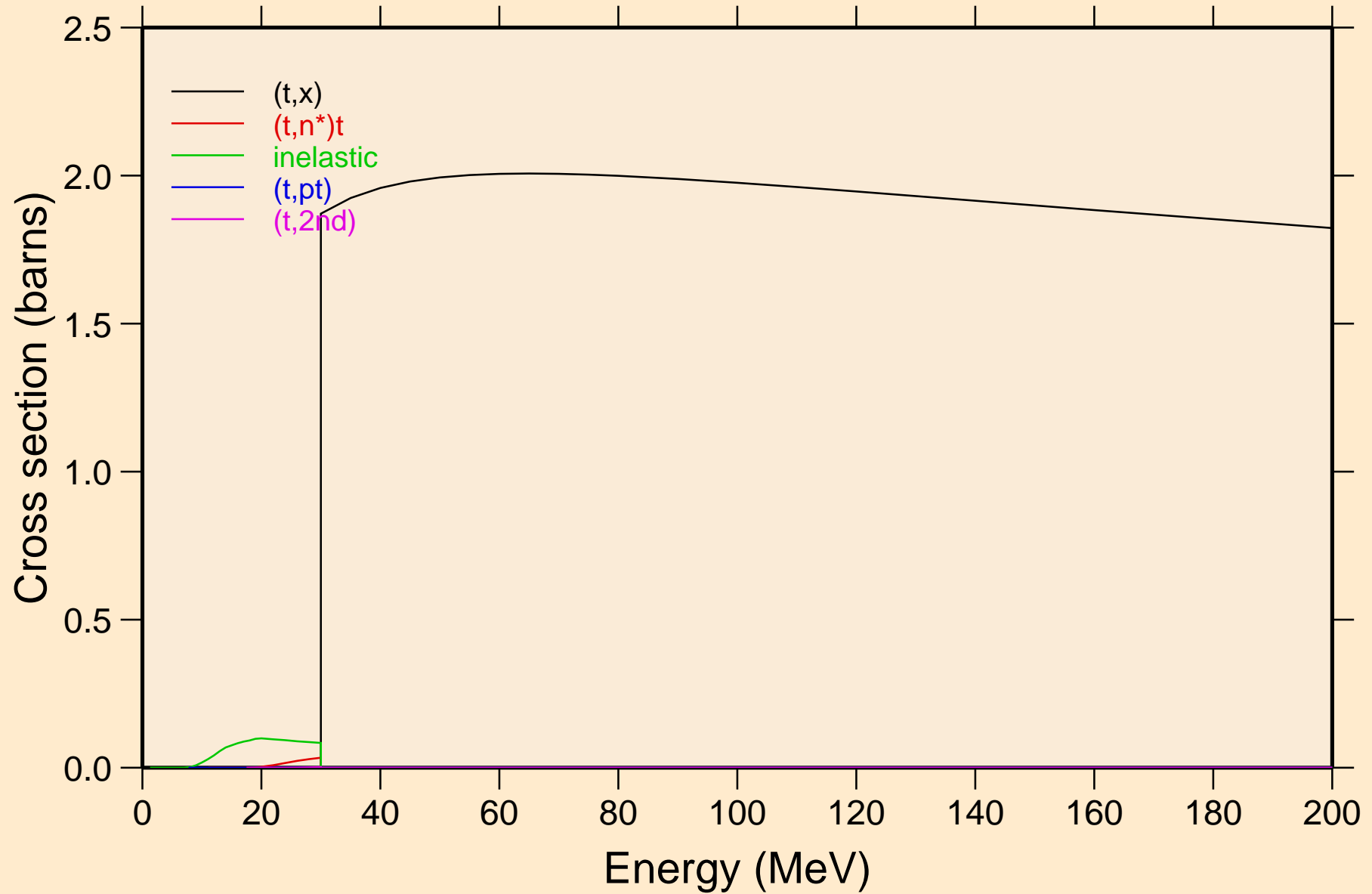

SN112 TRITON ACER TENDL-2021 LIBRARY; T=0.K  
Threshold reactions

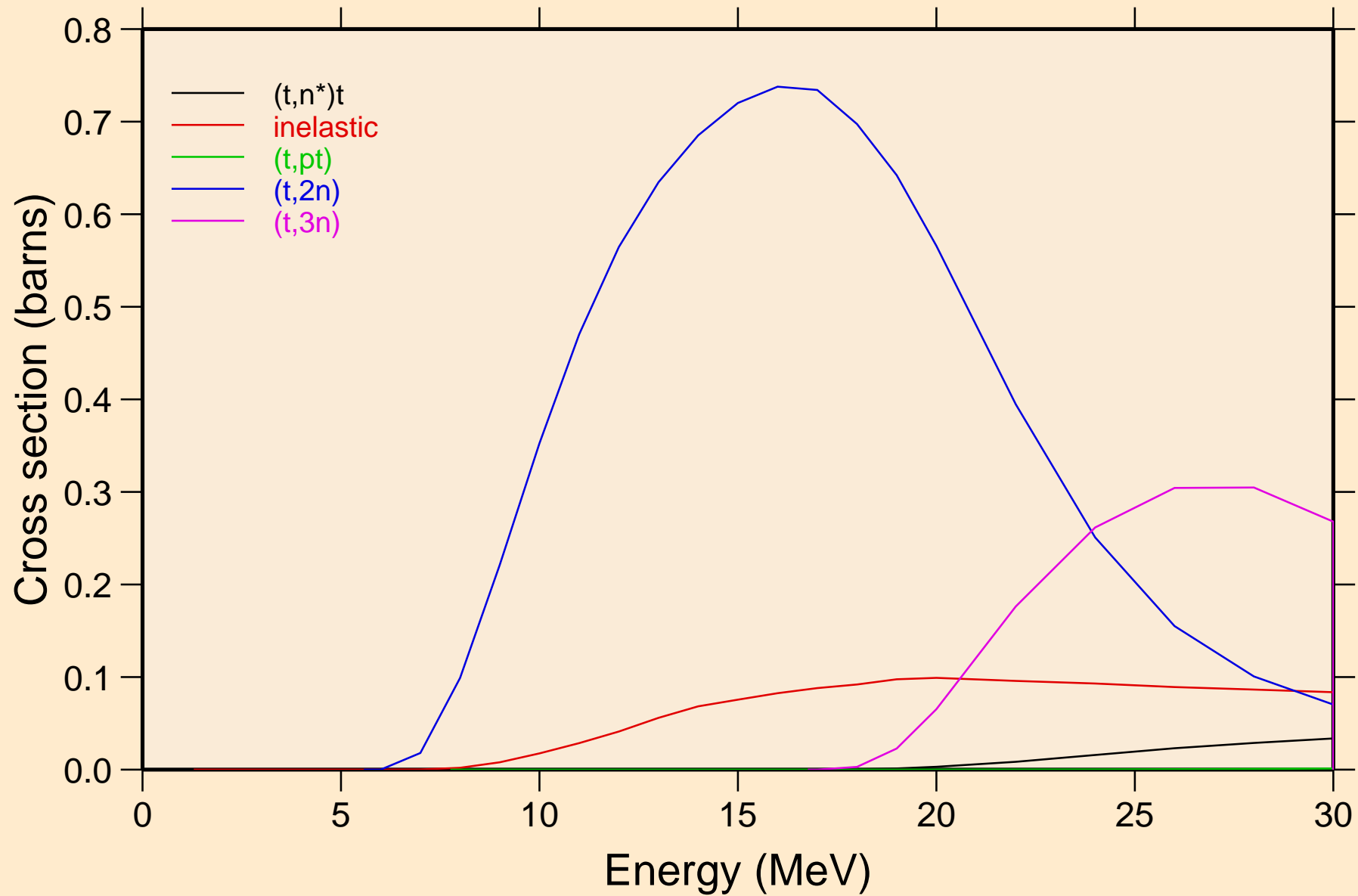

SN112 TRITON ACER TENDL-2021 LIBRARY; T=0.K  
Threshold reactions

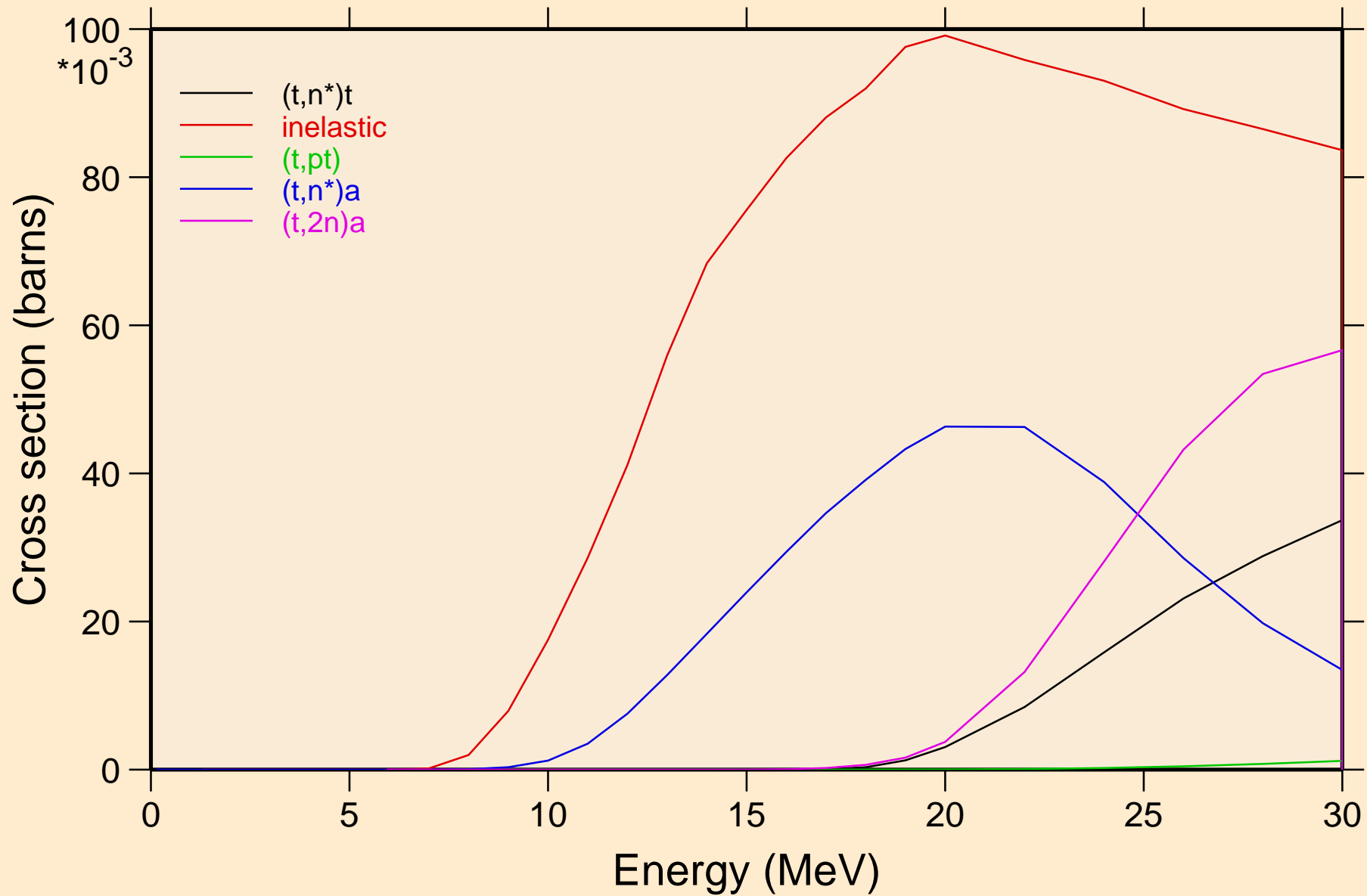

# SN112 TRITON ACER TENDL-2021 LIBRARY; T=0.K

## Threshold reactions

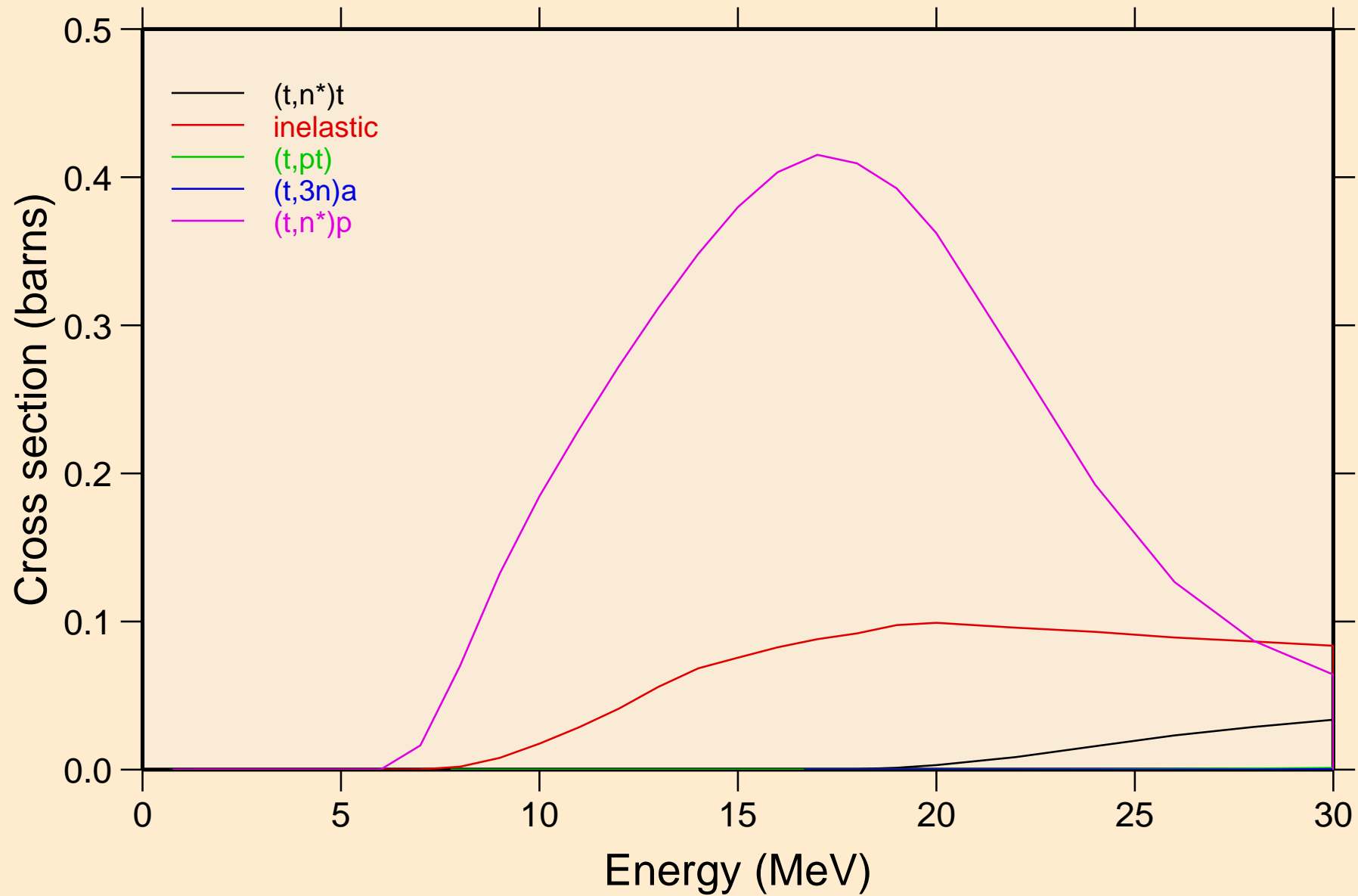



# SN112 TRITON ACER TENDL-2021 LIBRARY; T=0.K

## Threshold reactions

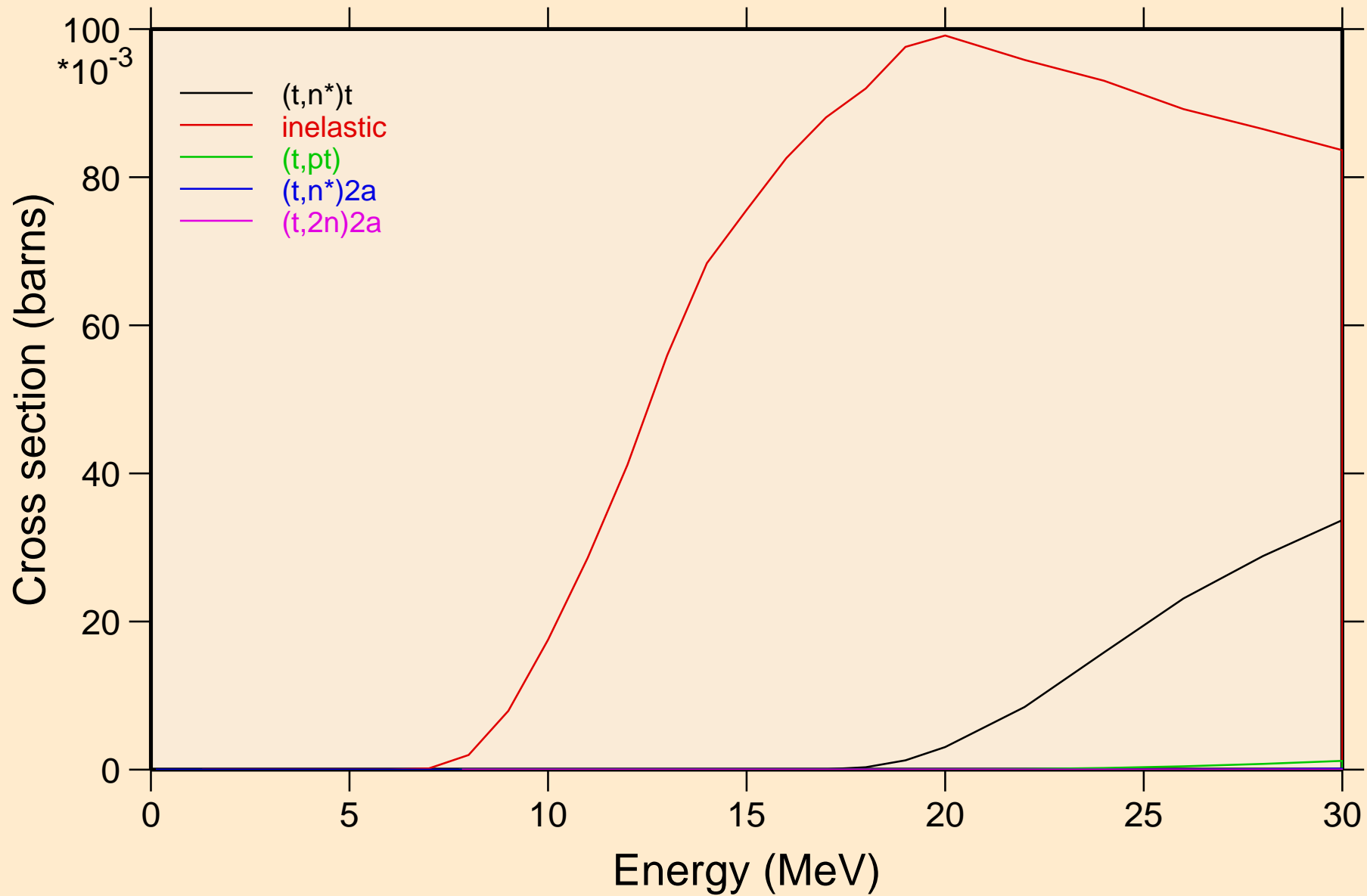

# SN112 TRITON ACER TENDL-2021 LIBRARY; T=0.K

## Threshold reactions

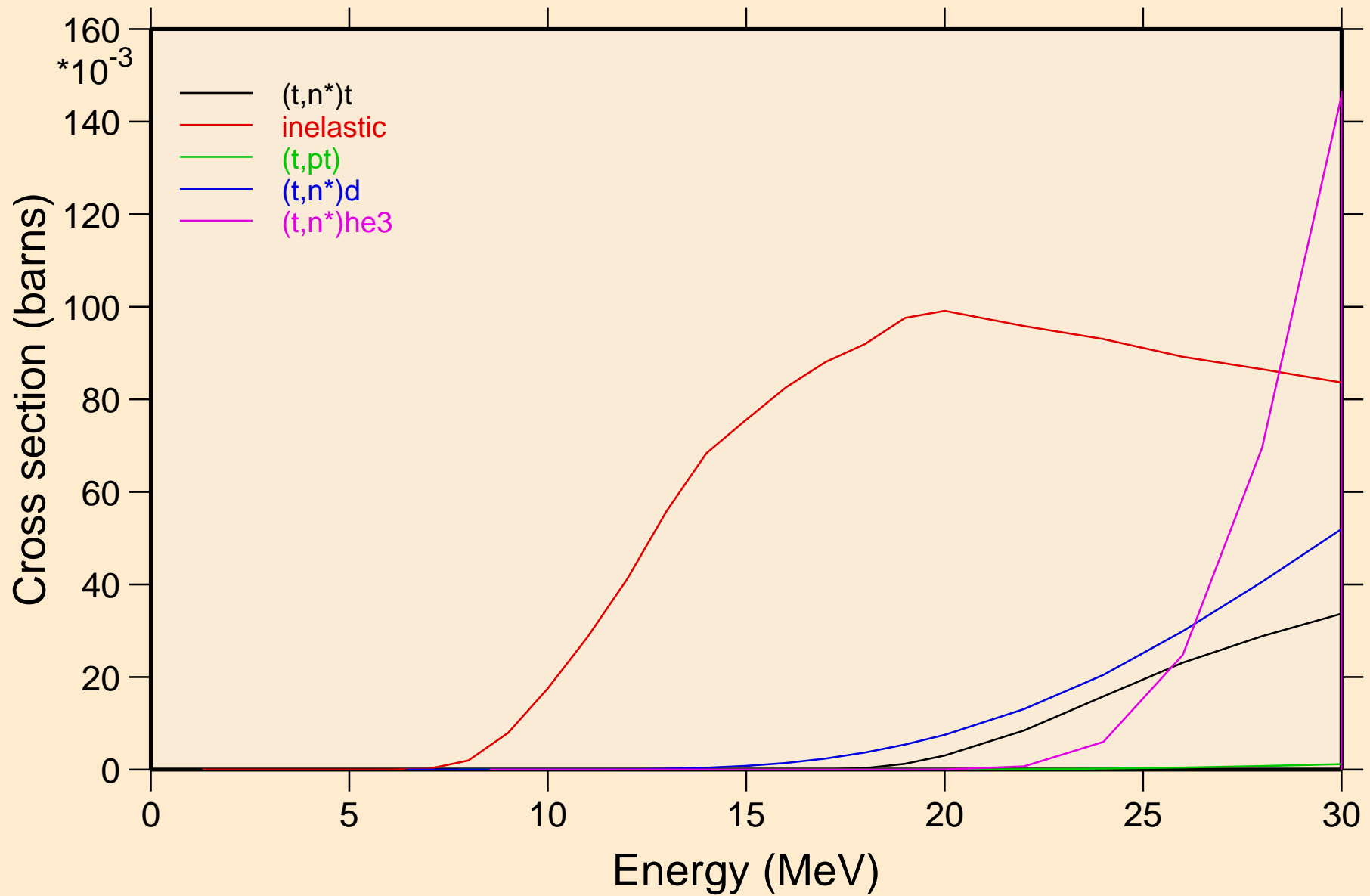

SN112 TRITON ACER TENDL-2021 LIBRARY; T=0.K  
Threshold reactions

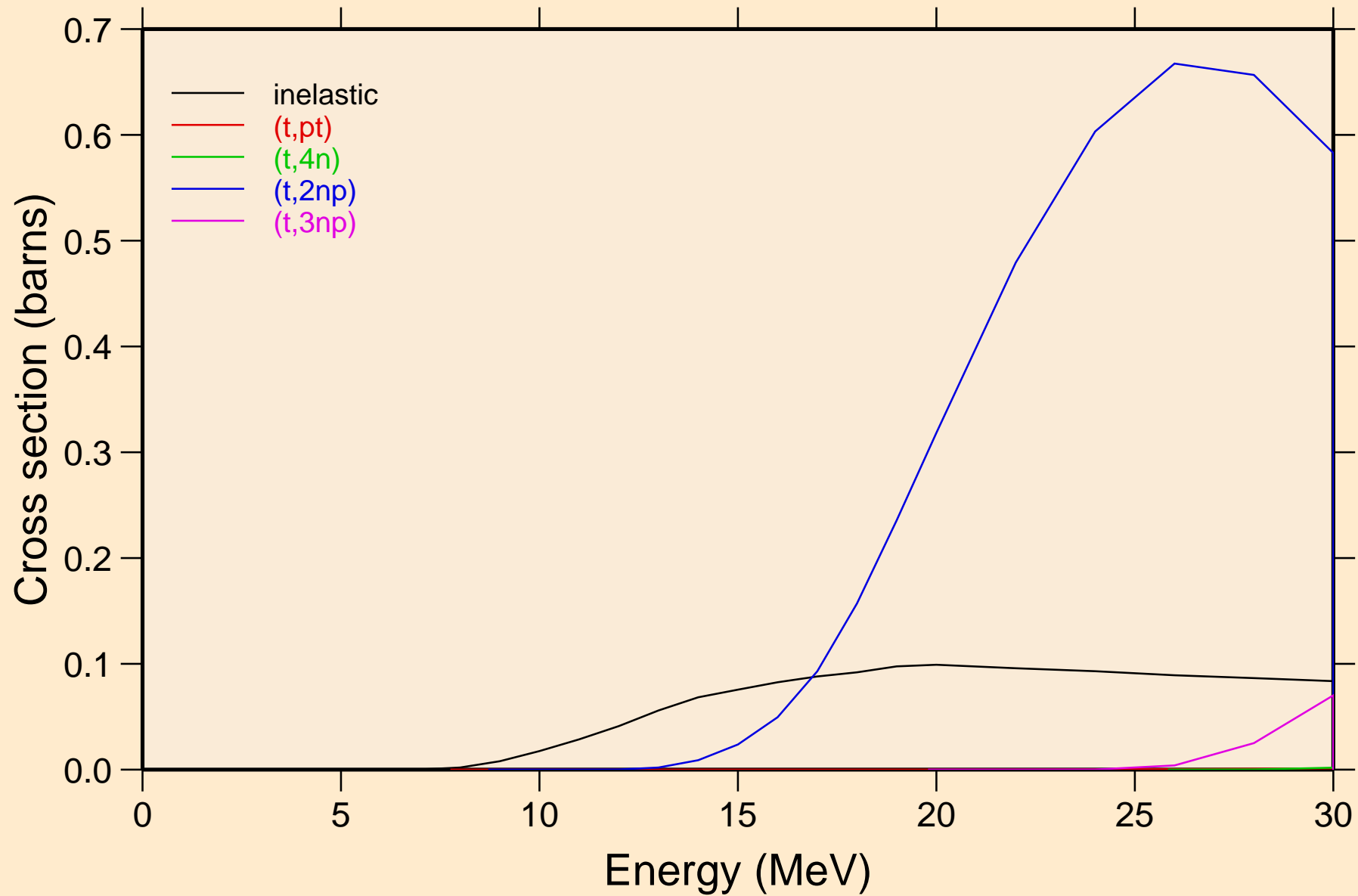

# SN112 TRITON ACER TENDL-2021 LIBRARY; T=0.K

## Threshold reactions

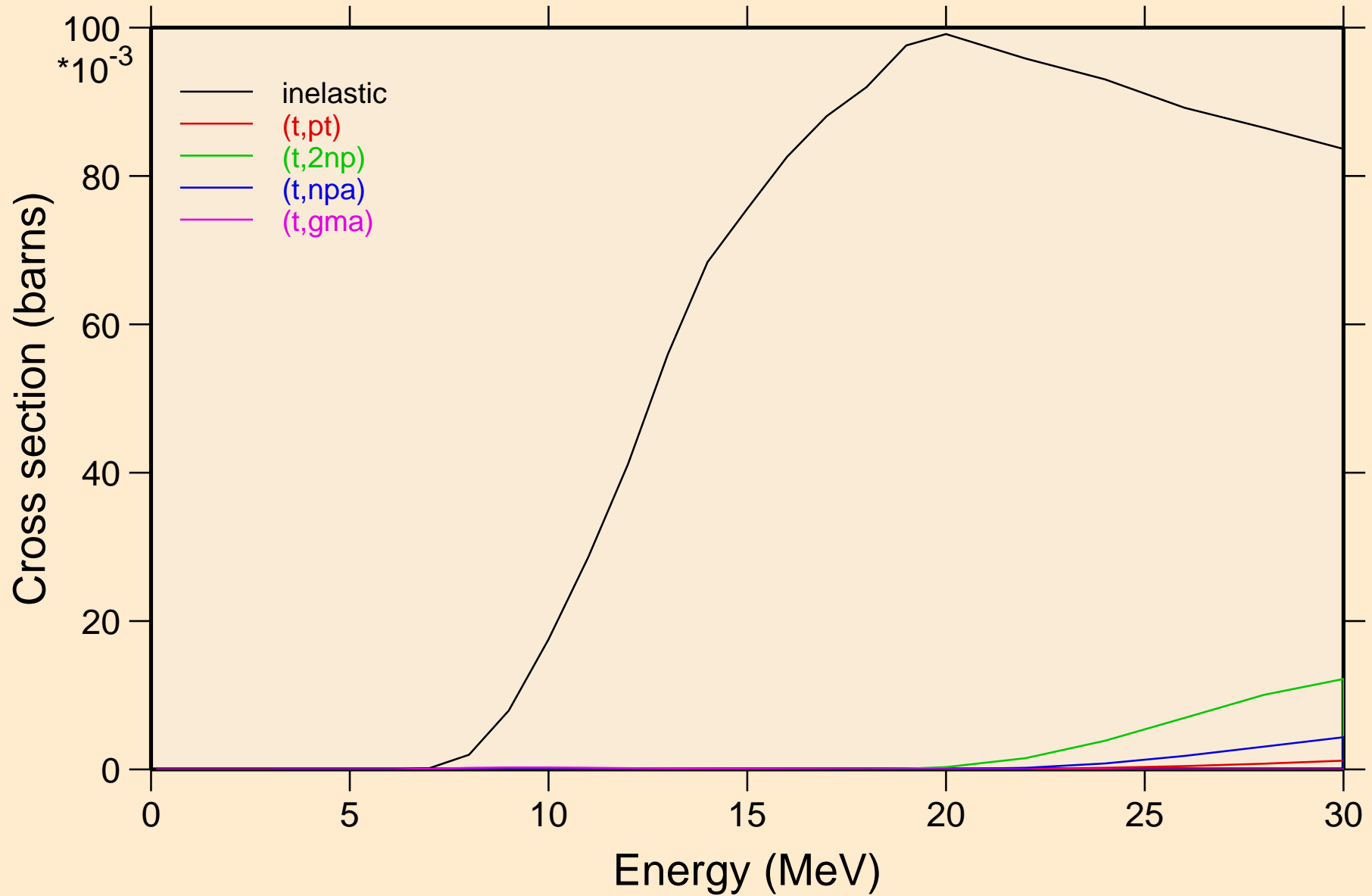

# SN112 TRITON ACER TENDL-2021 LIBRARY; T=0.K

## Threshold reactions

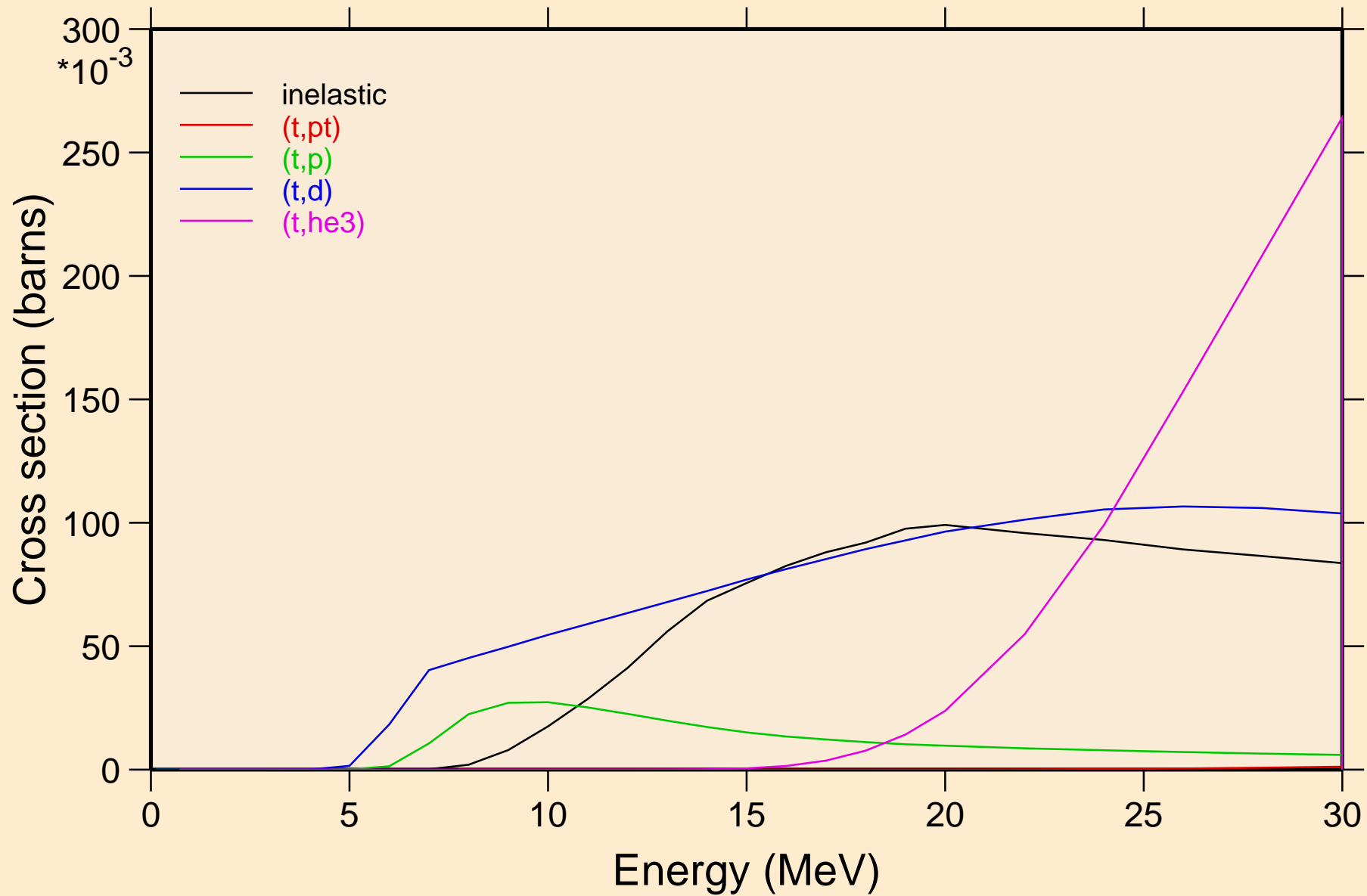

SN112 TRITON ACER TENDL-2021 LIBRARY; T=0.K  
Threshold reactions

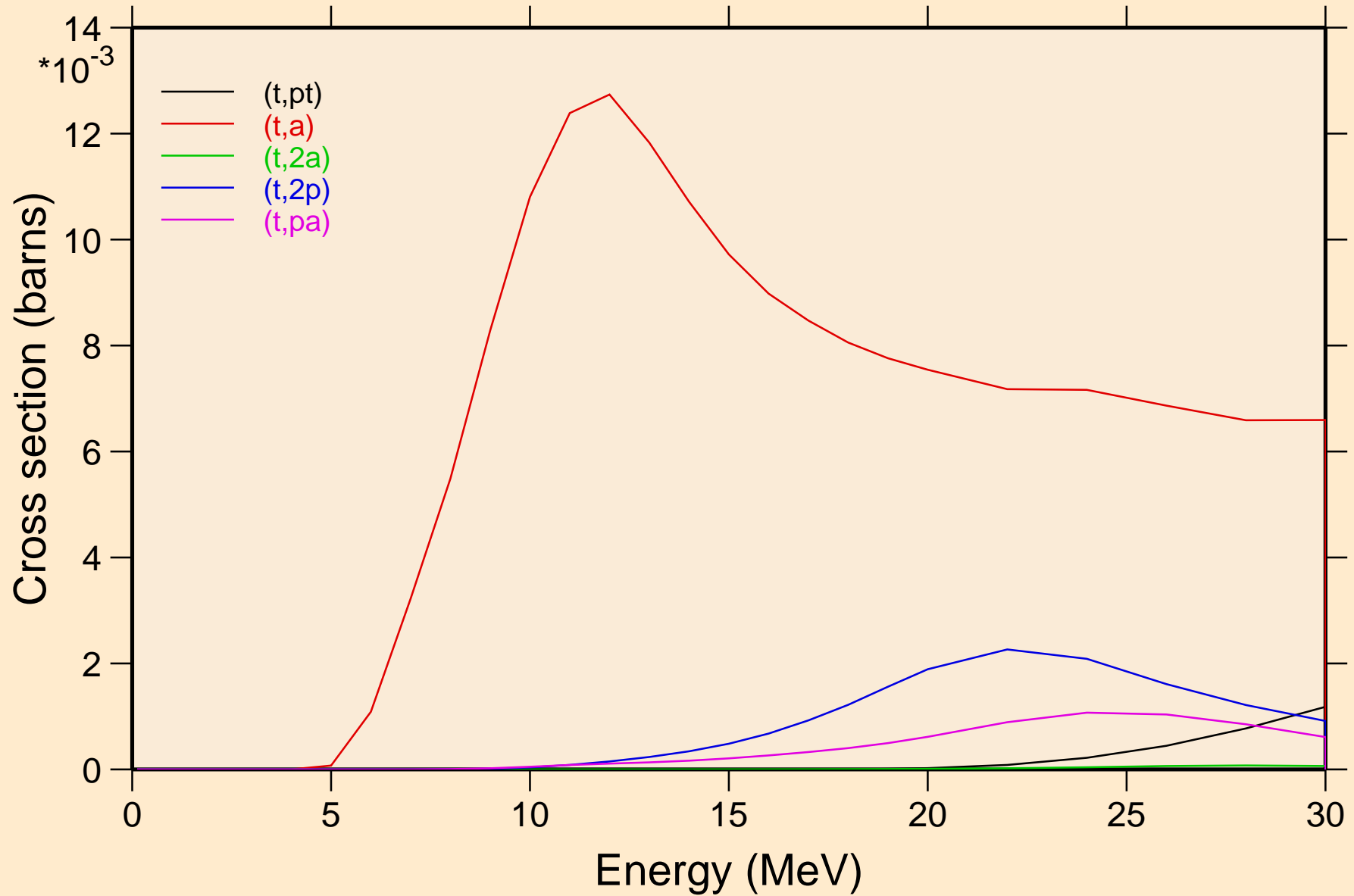

SN112 TRITON ACER TENDL-2021 LIBRARY; T=0.K  
Threshold reactions

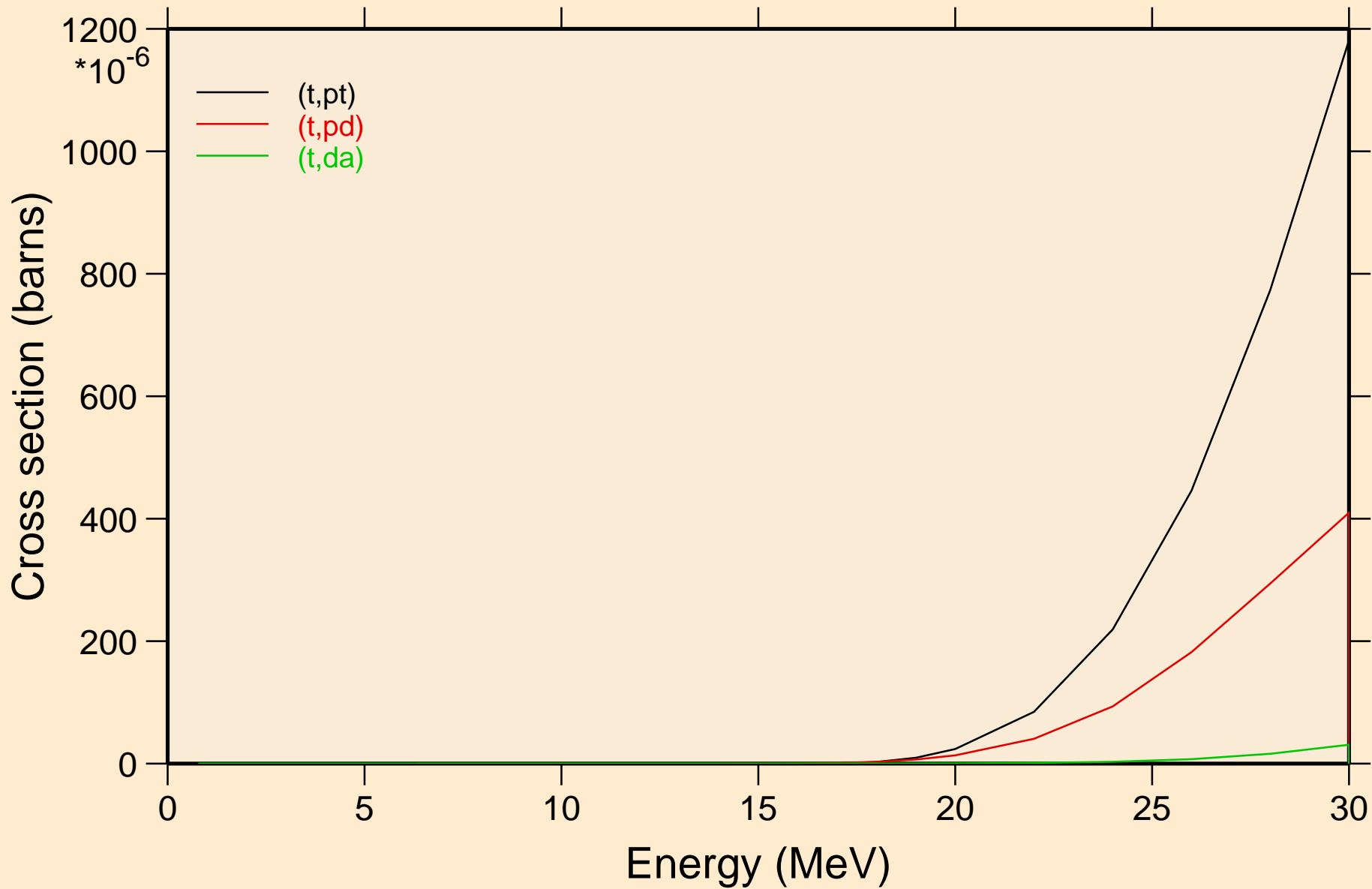

SN112 TRITON ACER TENDL-2021 LIBRARY; T=0.K  
angular distribution for elastic

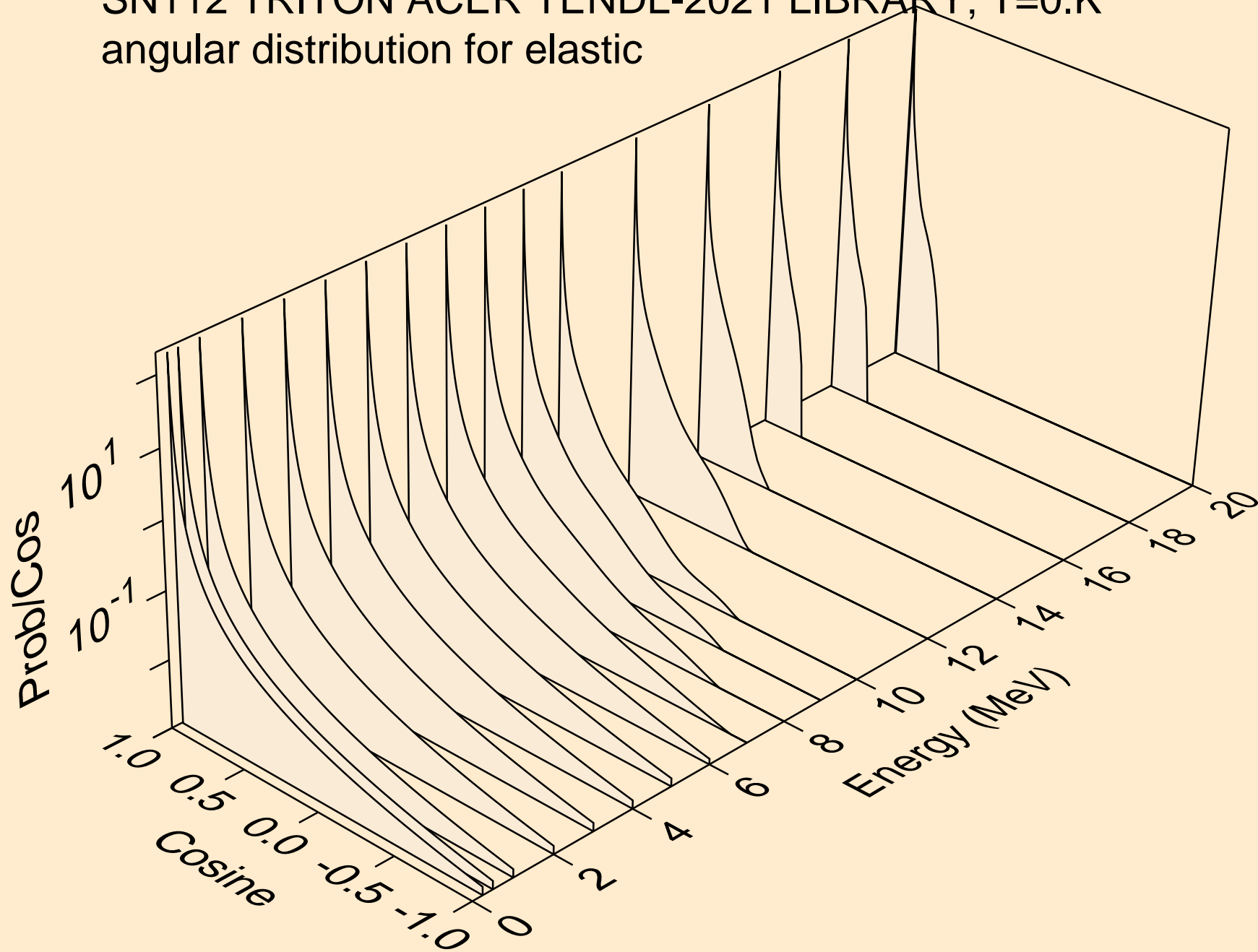



SN112 TRITON ACER TENDL-2021 LIBRARY; T=0.K  
angular distribution for elastic

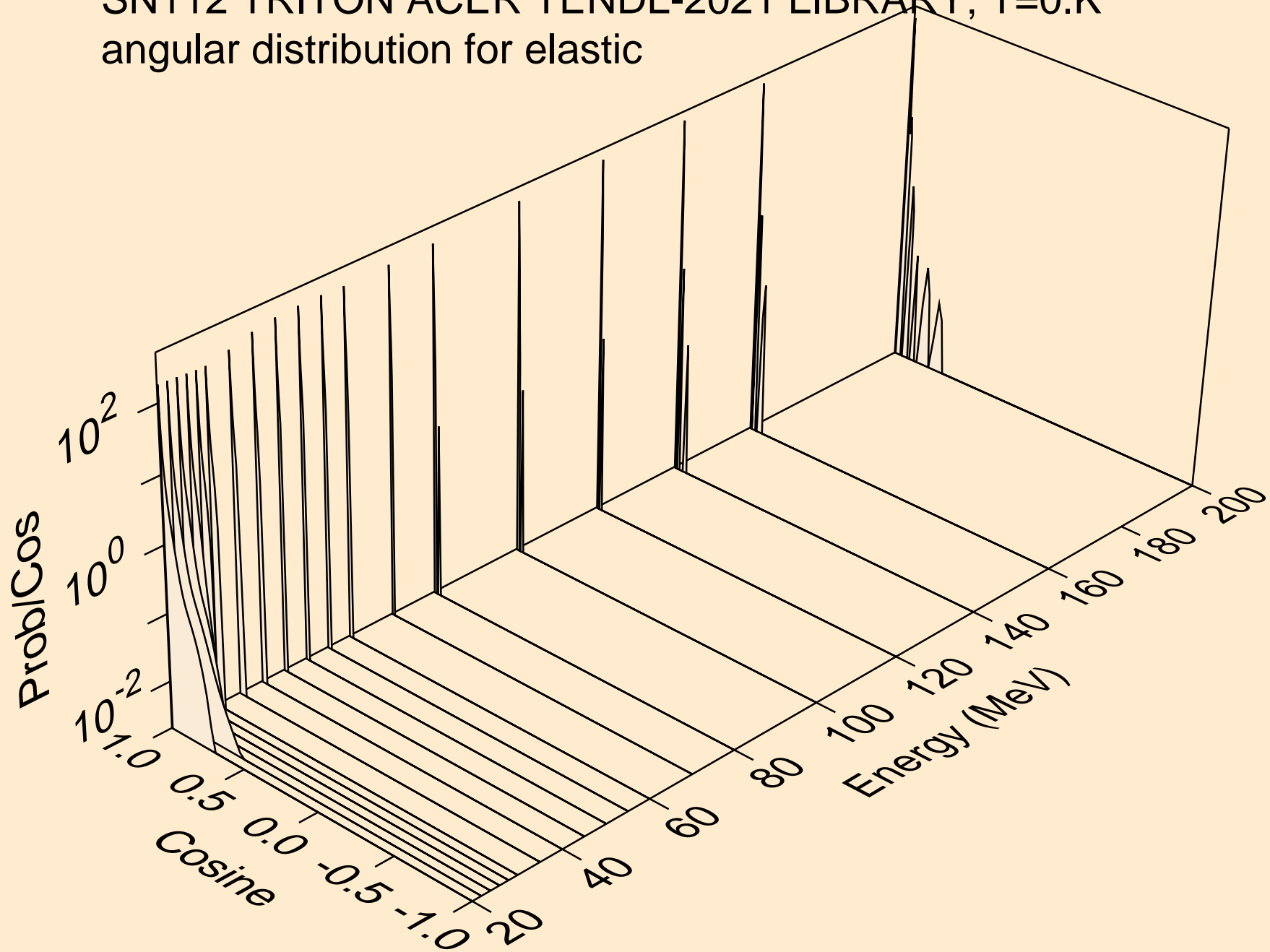

SN112 TRITON ACER TENDL-2021 LIBRARY; T=0.K  
Triton emission for (t,x)

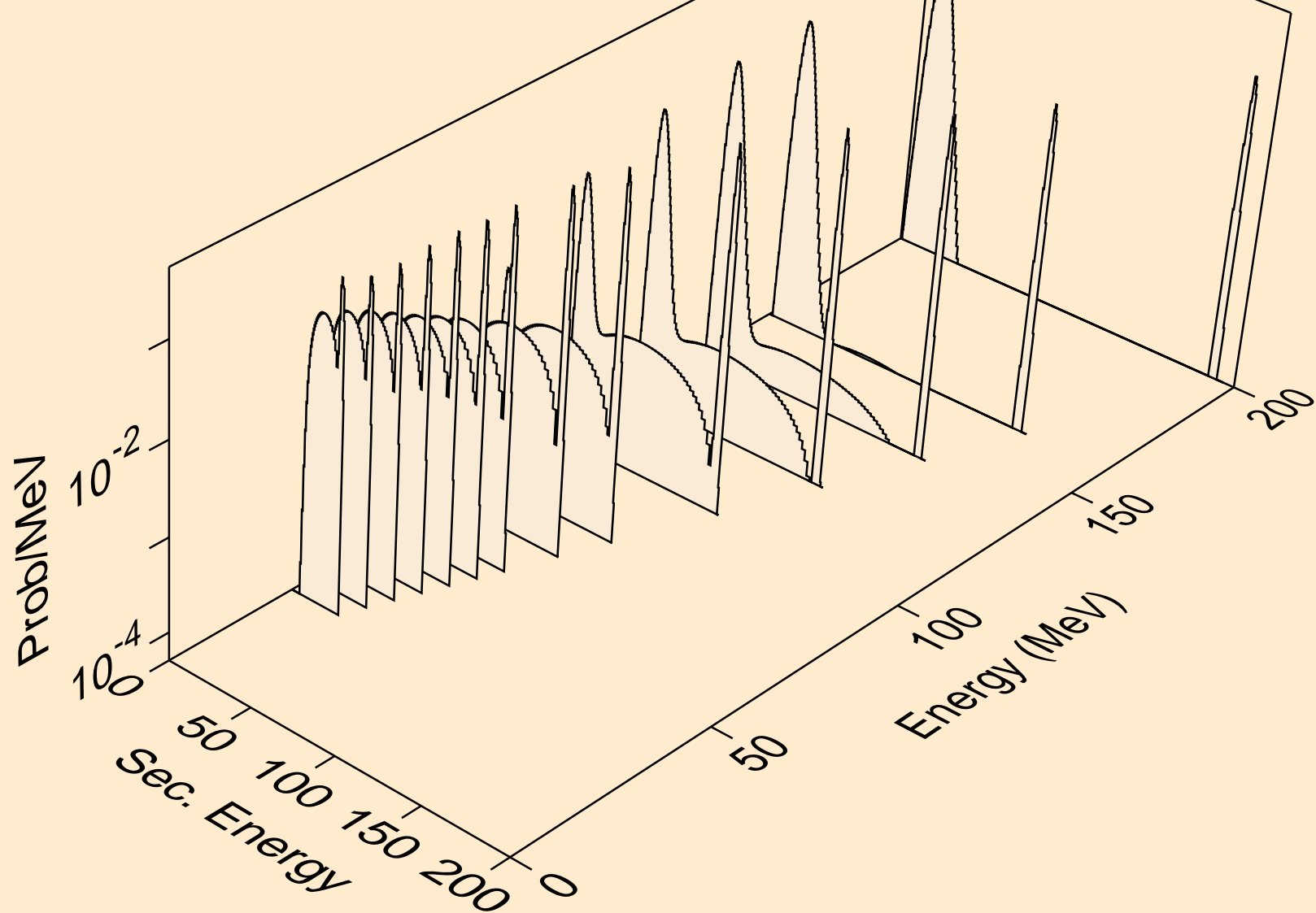

SN112 TRITON ACER TENDL-2021 LIBRARY; T=0.K  
Triton emission for (t,n\*)t

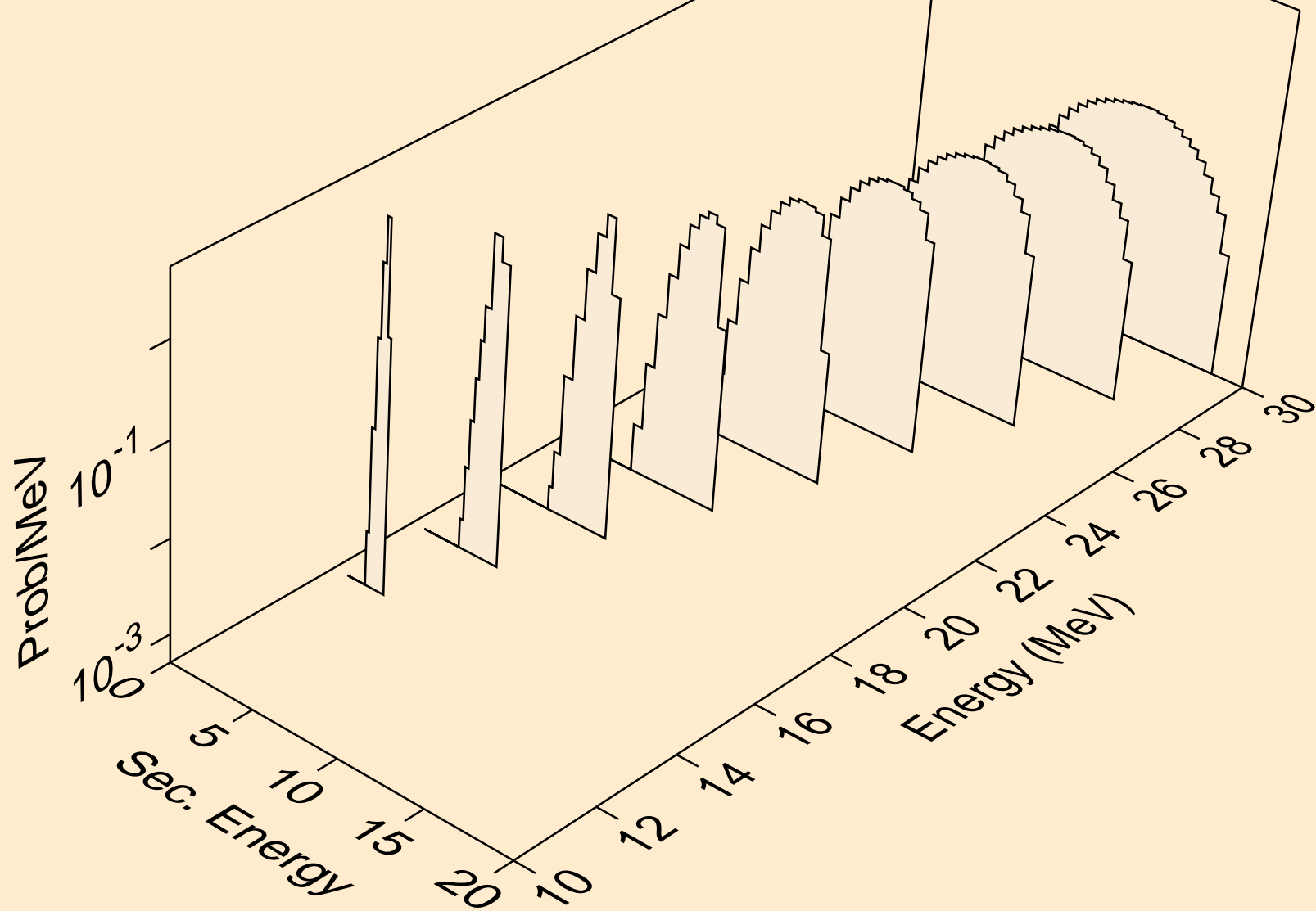

SN112 TRITON ACER TENDL-2021 LIBRARY; T=0.K  
Triton emission for inelastic

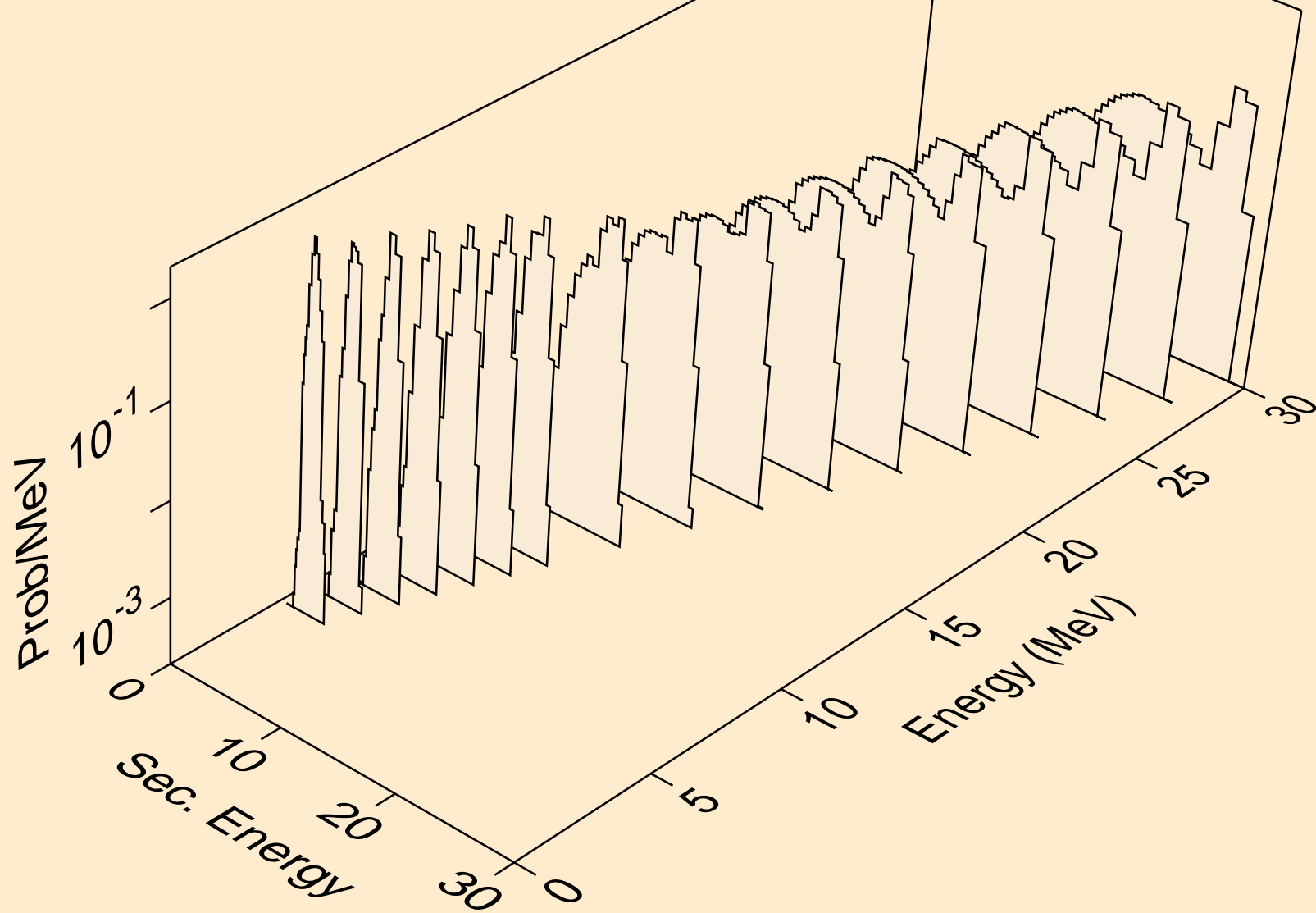

SN112 TRITON ACER TENDL-2021 LIBRARY; T=0.K  
Triton emission for (t,pt)

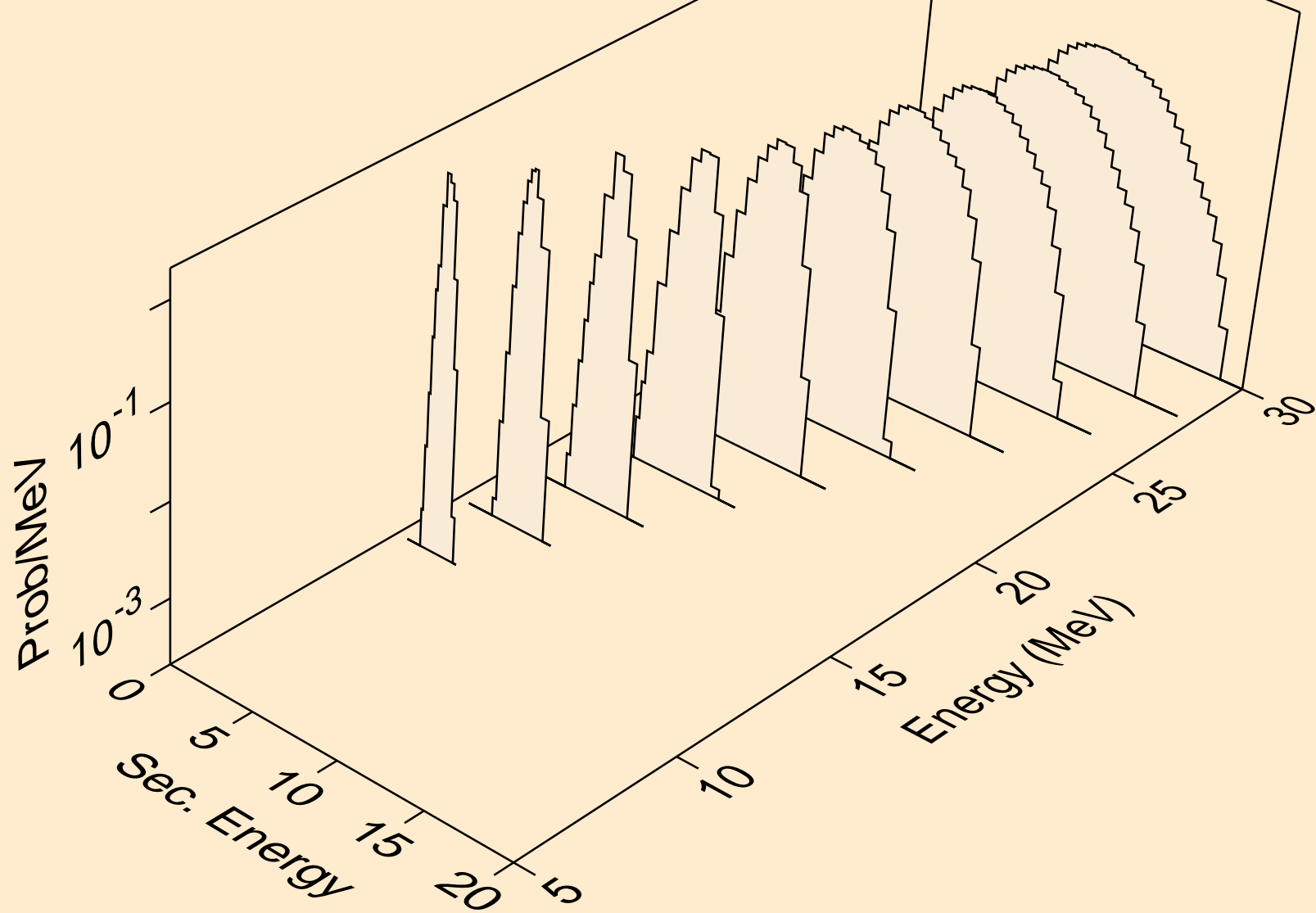

SN112 TRITON ACER TENDL-2021 LIBRARY; T=0.K  
Photon emission for (z,n)

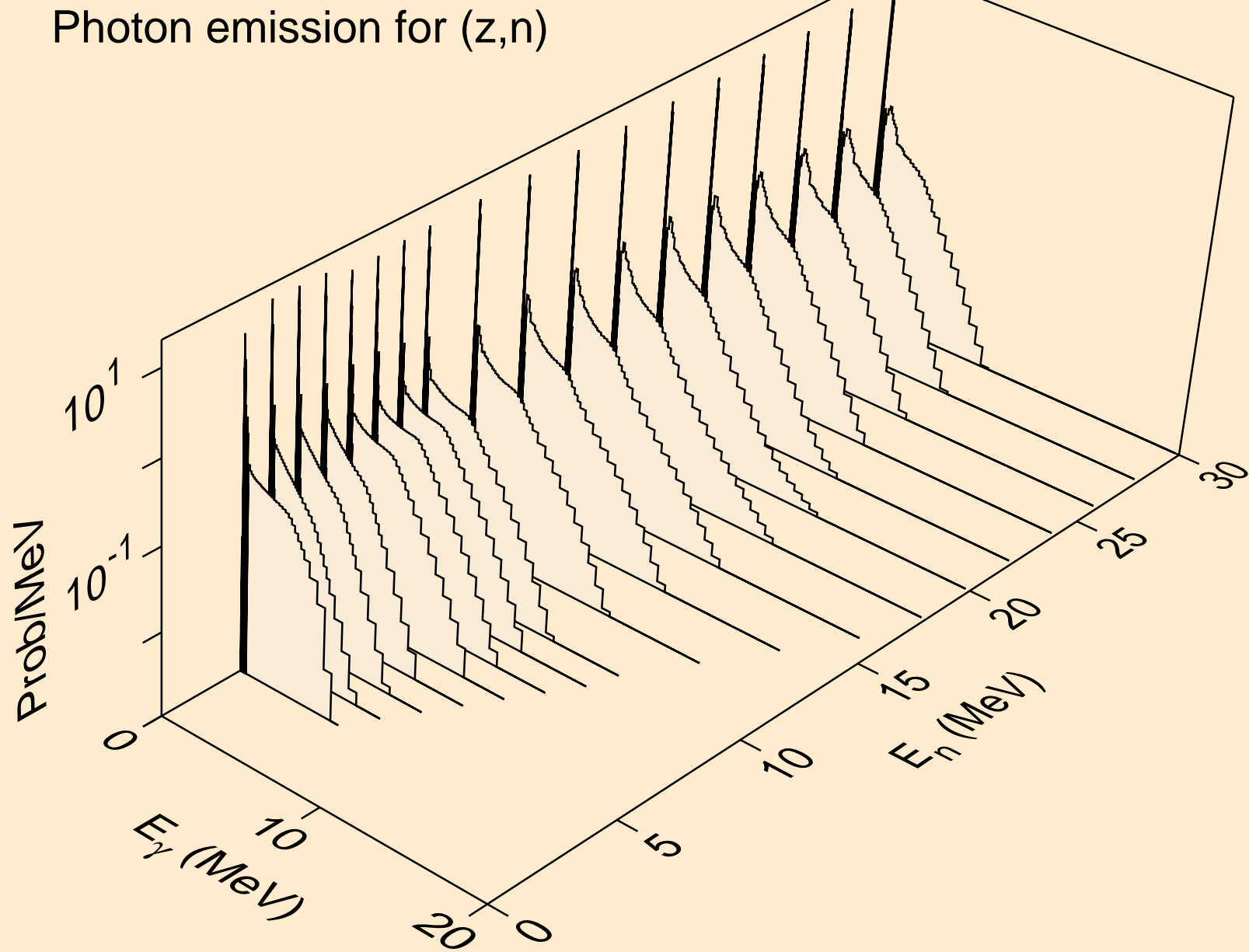

SN112 TRITON ACER TENDL-2021 LIBRARY; T=0.K  
Photon emission for (n,x)

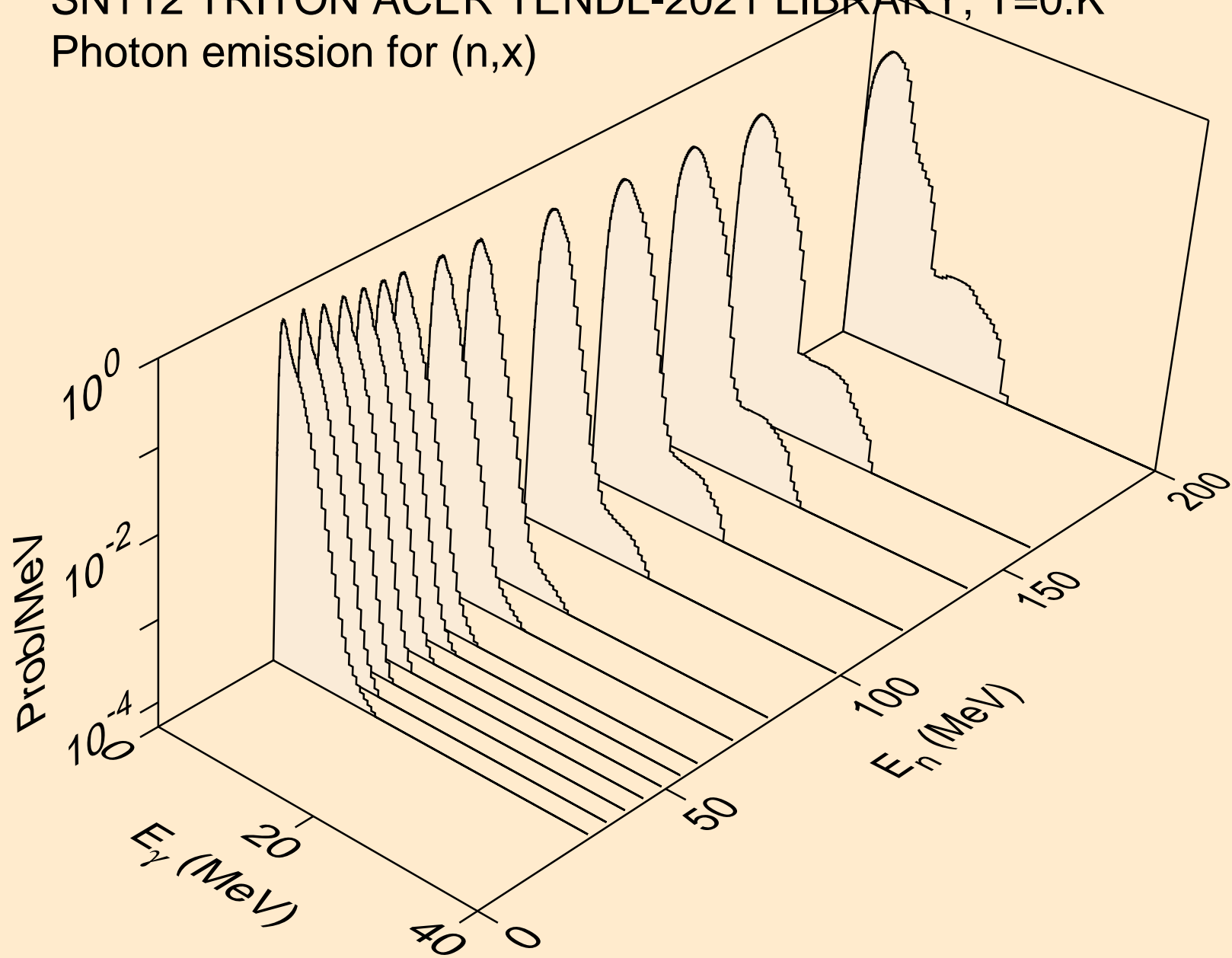

SN112 TRITON ACER TENDL-2021 LIBRARY; T=0.K  
Photon emission for (n,2nd)

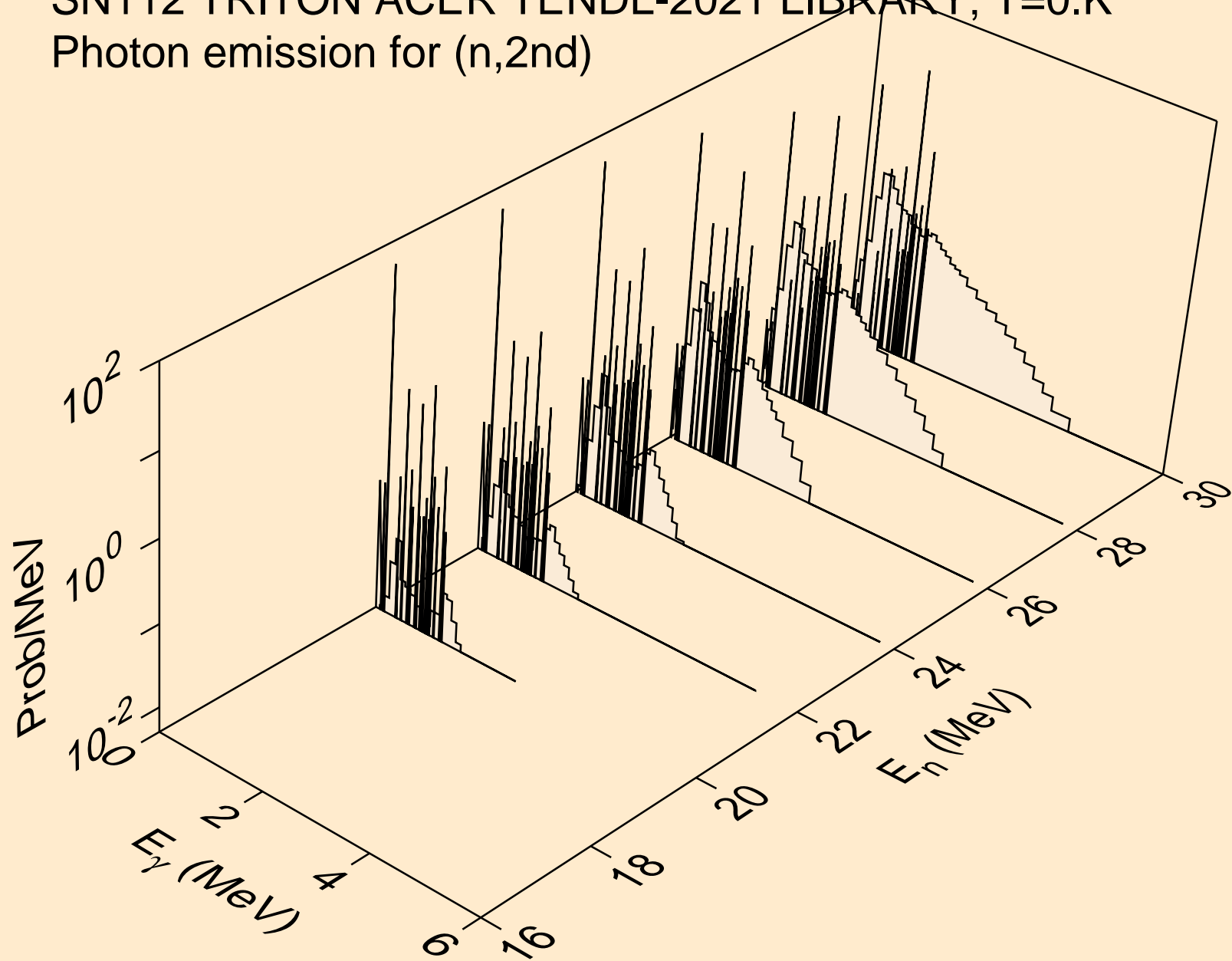



SN112 TRITON ACER TENDL-2021 LIBRARY; T=0.K  
Photon emission for (n,2n)

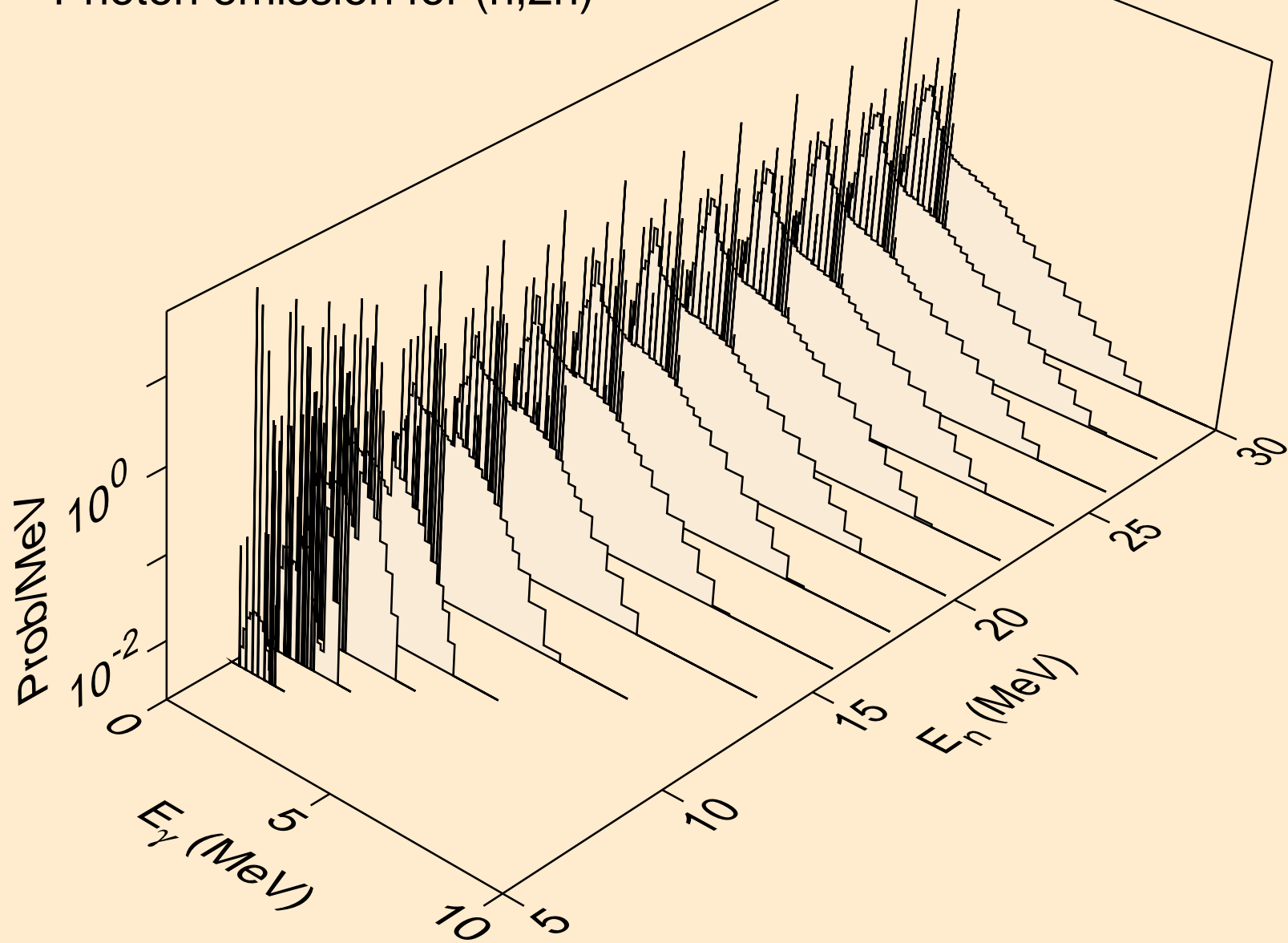

SN112 TRITON ACER TENDL-2021 LIBRARY; T=0.K  
Photon emission for (n,3n)

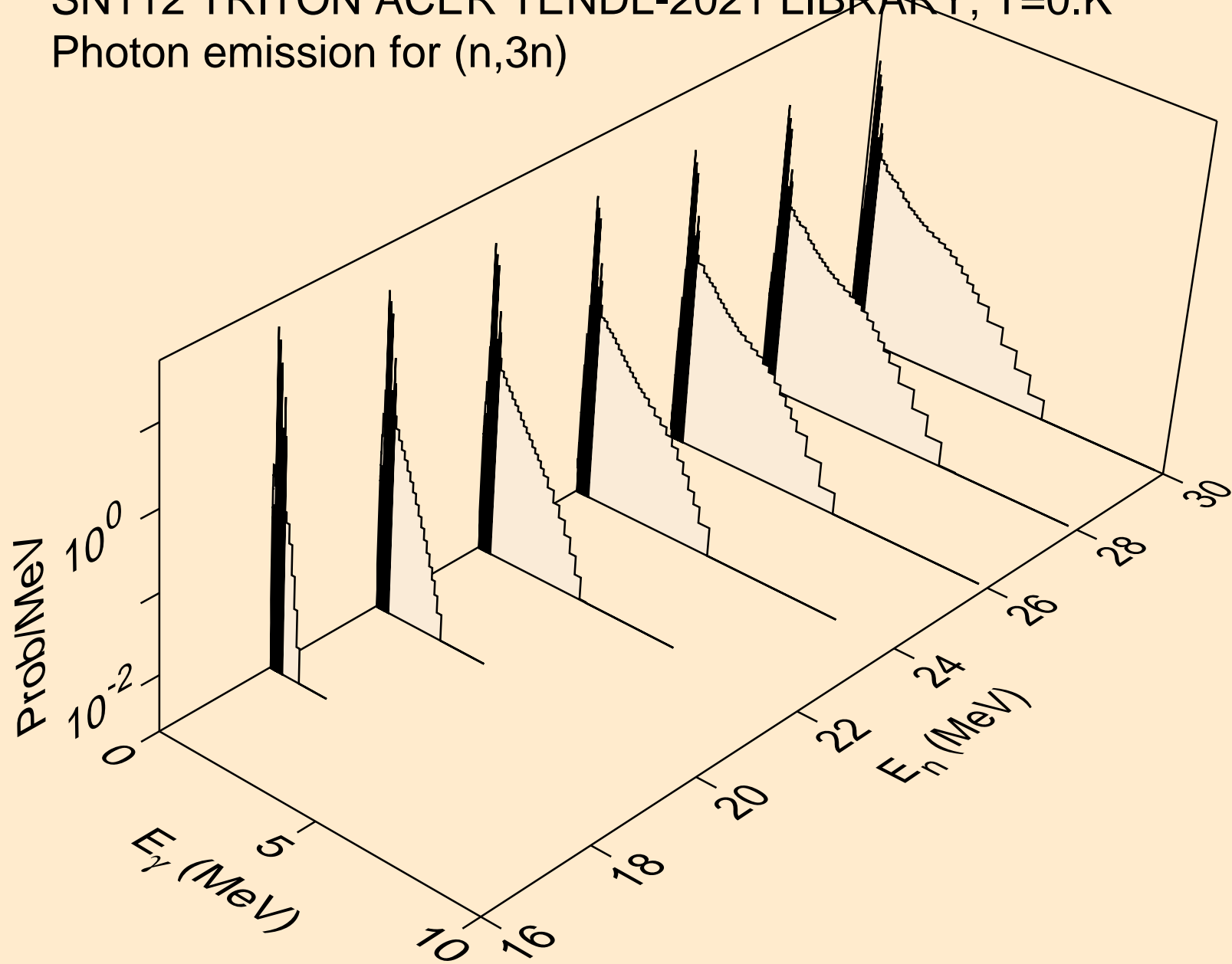

SN112 TRITON ACER TENDL-2021 LIBRARY; T=0.K  
Photon emission for (n,n\*)a

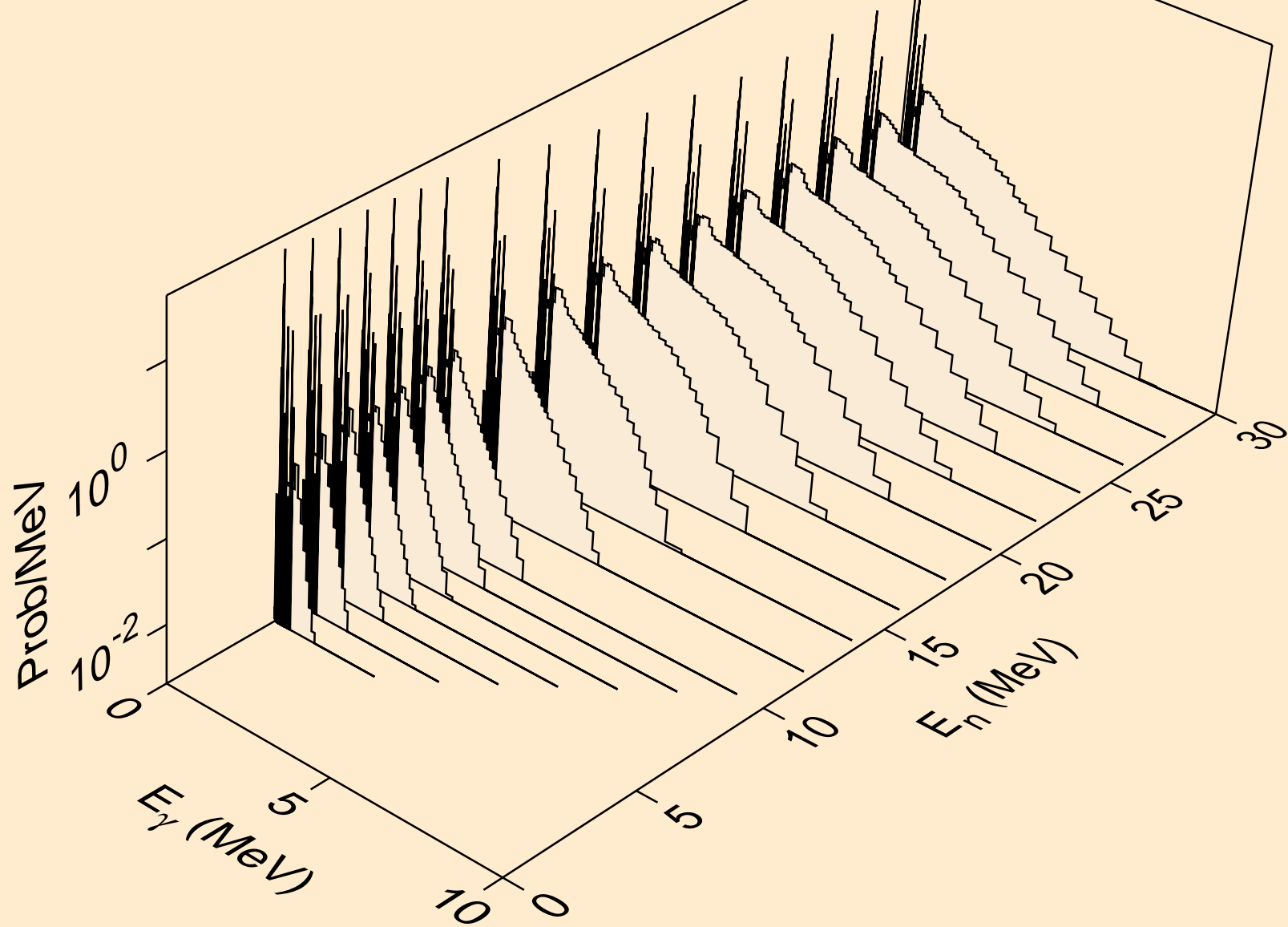

SN112 TRITON ACER TENDL-2021 LIBRARY; T=0.K  
Photon emission for (n,2n) $\alpha$

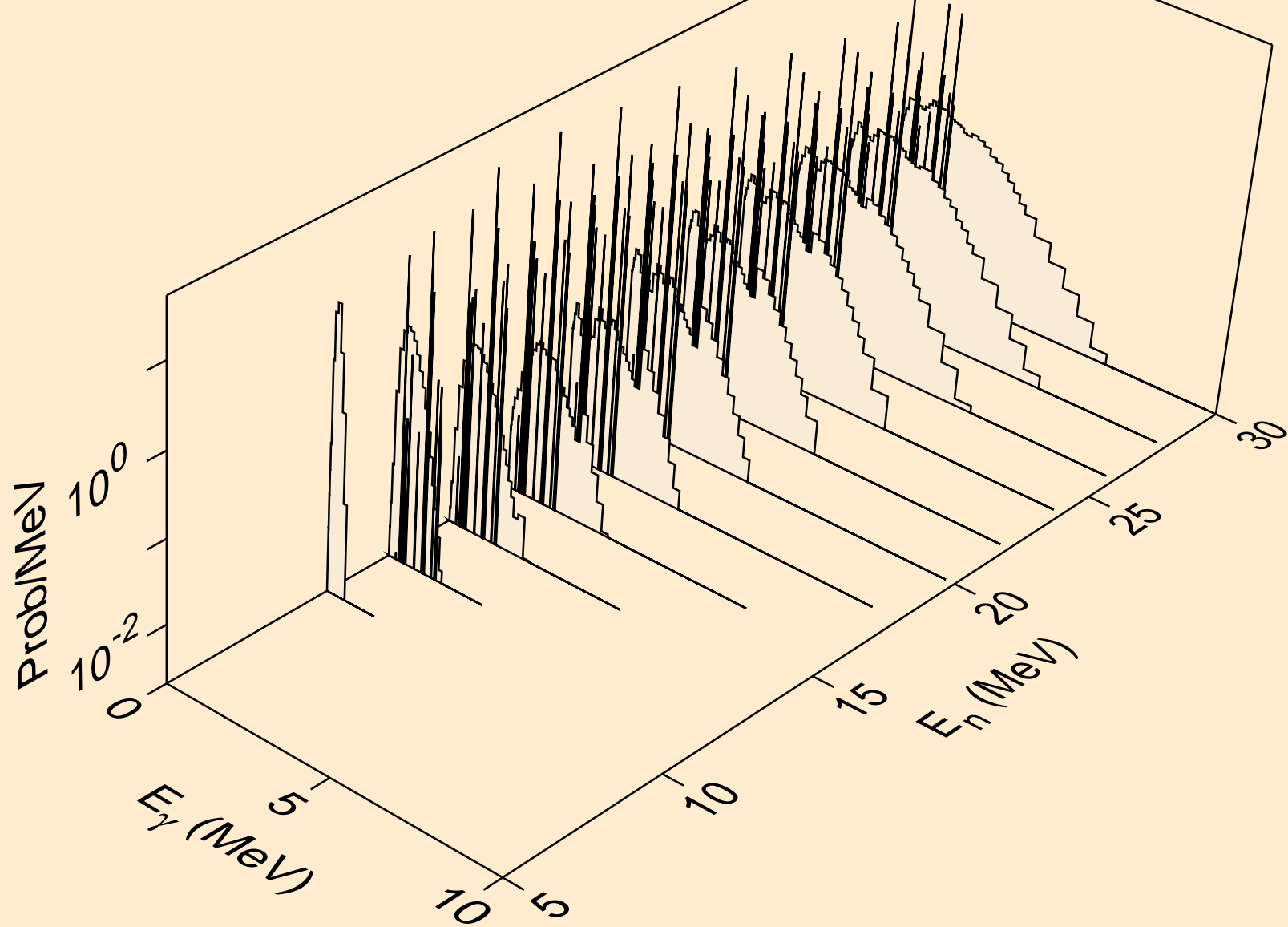

SN112 TRITON ACER TENDL-2021 LIBRARY; T=0.K  
Photon emission for (n,3n)a

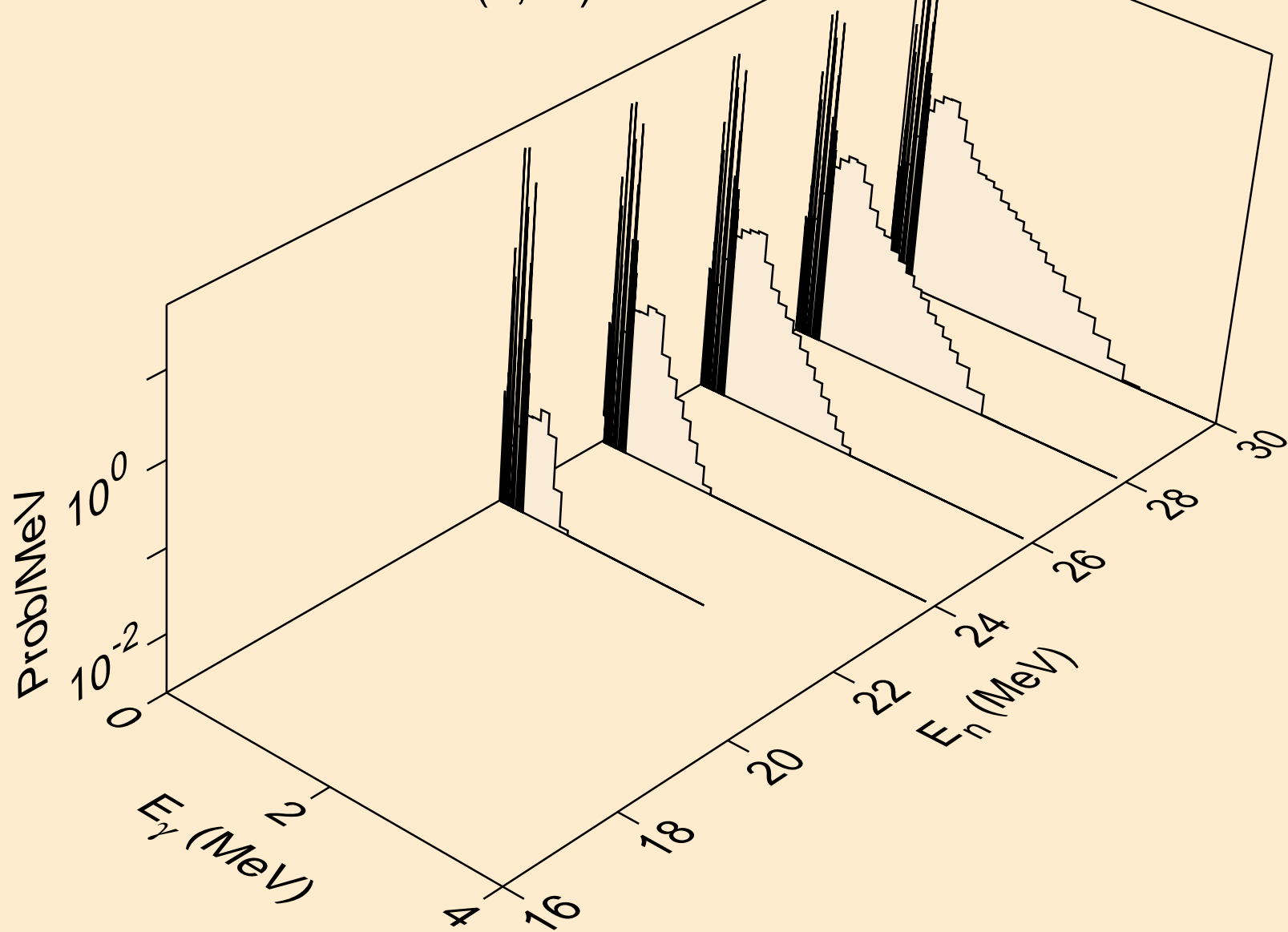

SN112 TRITON ACER TENDL-2021 LIBRARY; T=0.K  
Photon emission for (n,n\*)p

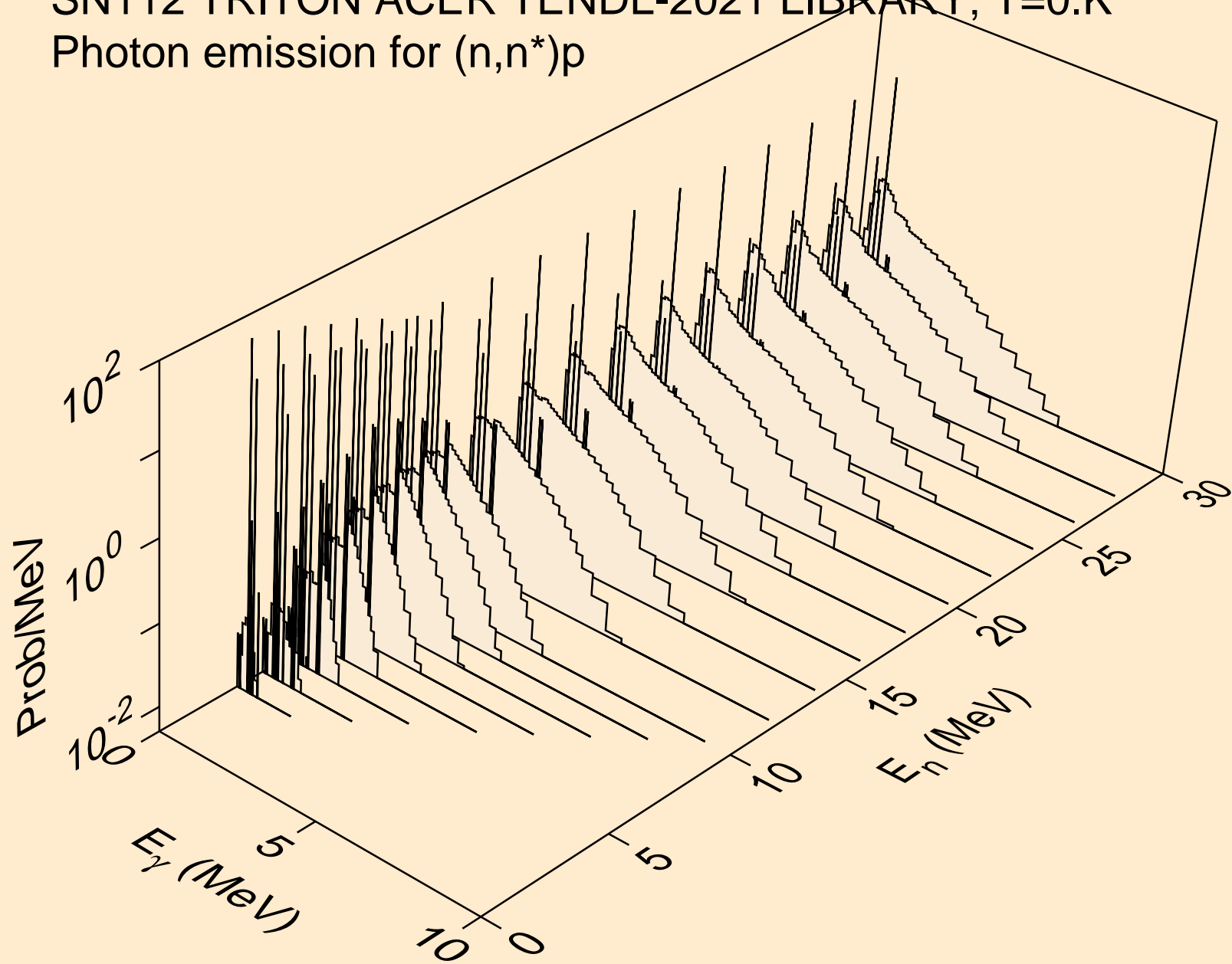

SN112 TRITON ACER TENDL-2021 LIBRARY; T=0.K  
Photon emission for (n,n\*)2a

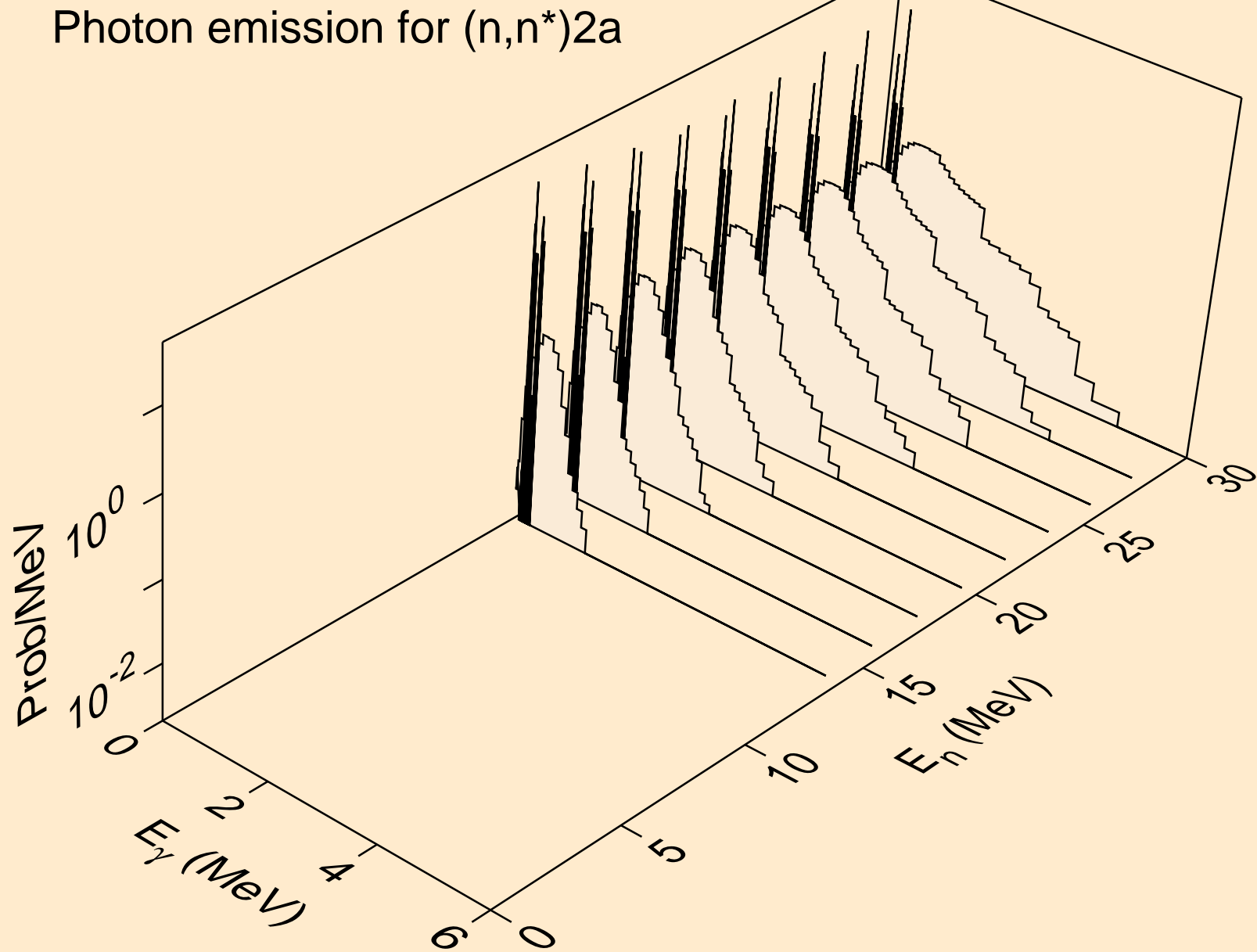

SN112 TRITON ACER TENDL-2021 LIBRARY; T=0.K  
Photon emission for (n,2n)2a

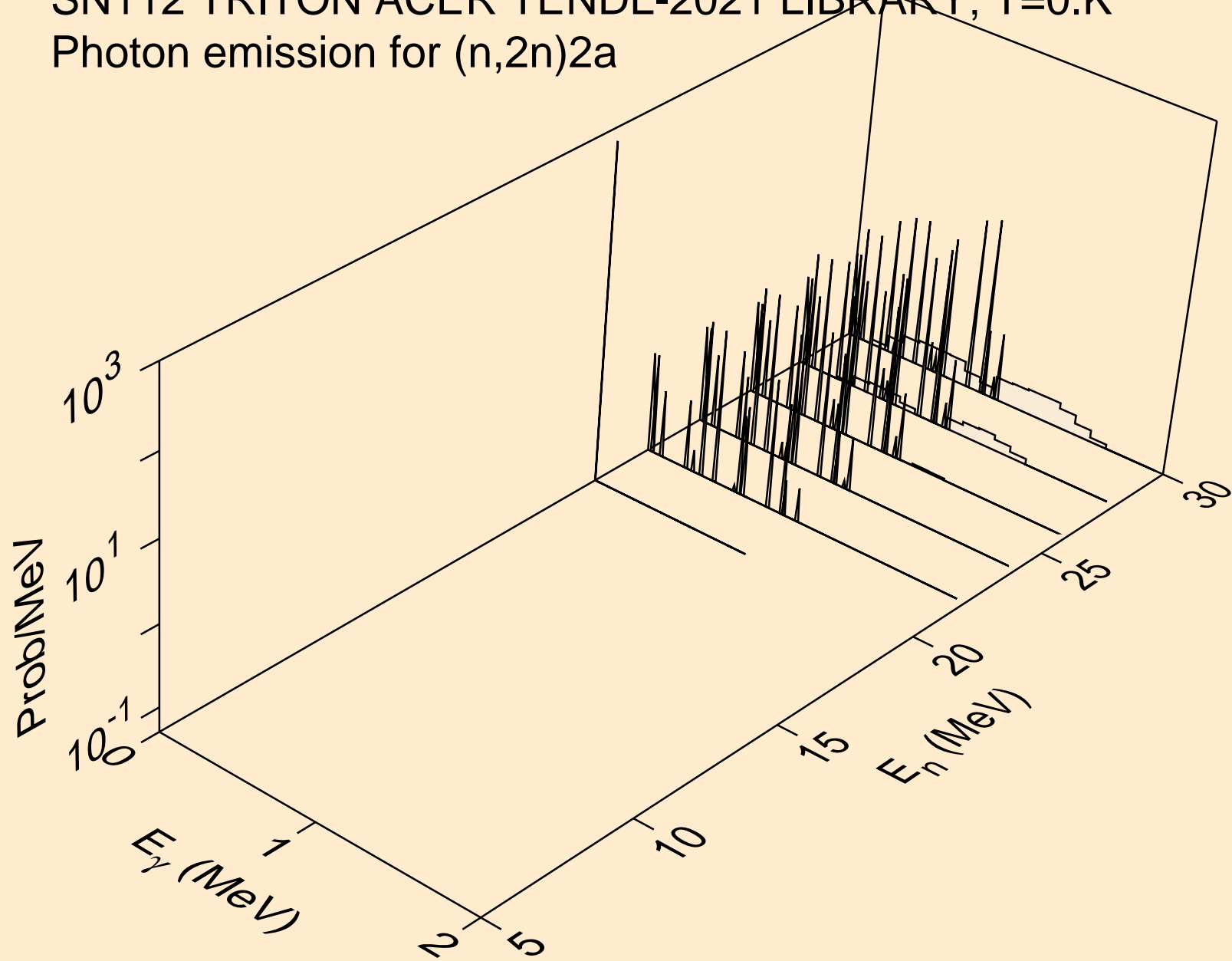



SN112 TRITON ACER TENDL-2021 LIBRARY; T=0.K  
Photon emission for (n,n\*)d

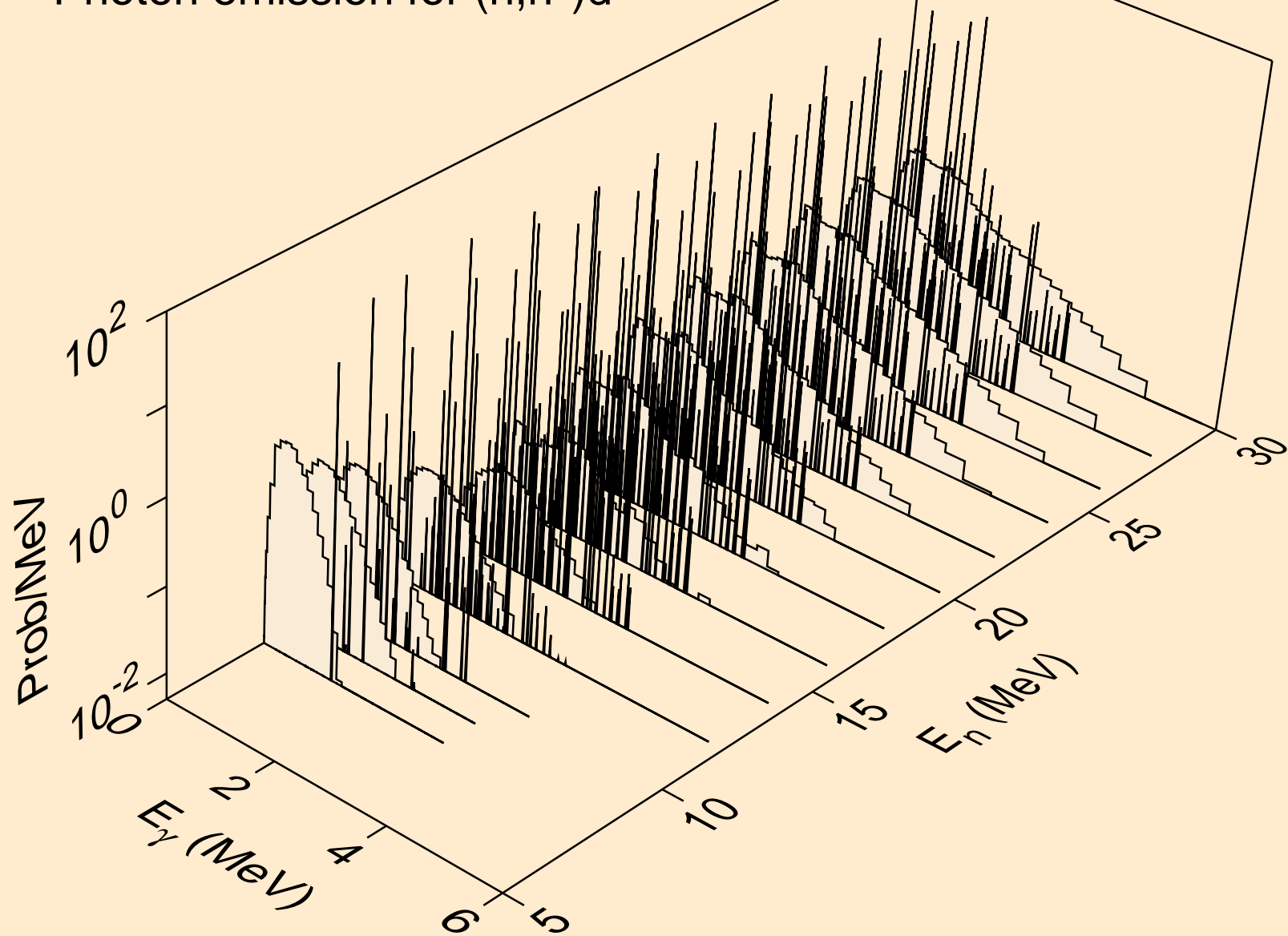

SN112 TRITON ACER TENDL-2021 LIBRARY; T=0.K  
Photon emission for (n,n\*)t

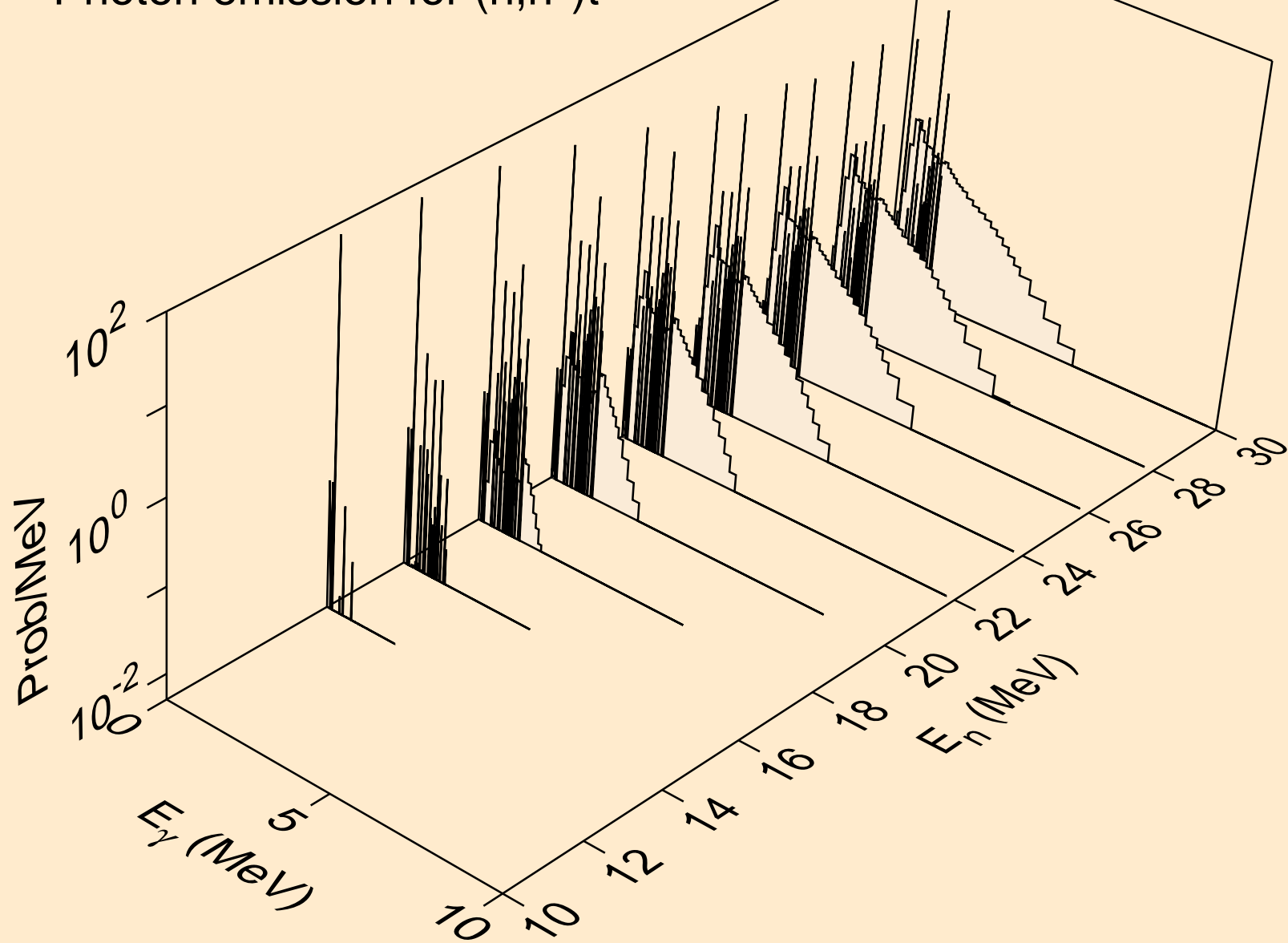

SN112 TRITON ACER TENDL-2021 LIBRARY; T=0.K  
Photon emission for (n,n\*)he3

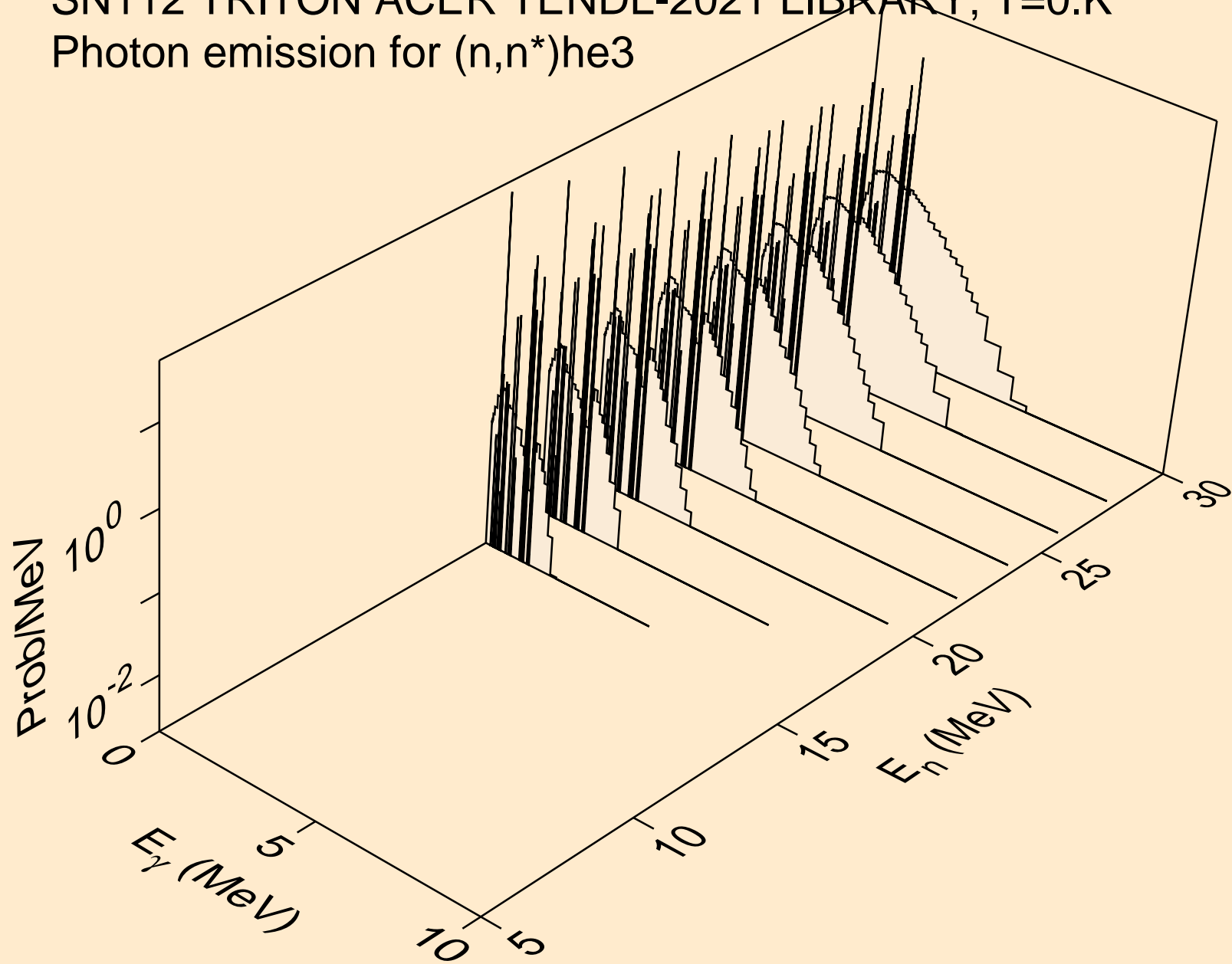

SN112 TRITON ACER TENDL-2021 LIBRARY; T=0.K  
Photon emission for (n,4n)

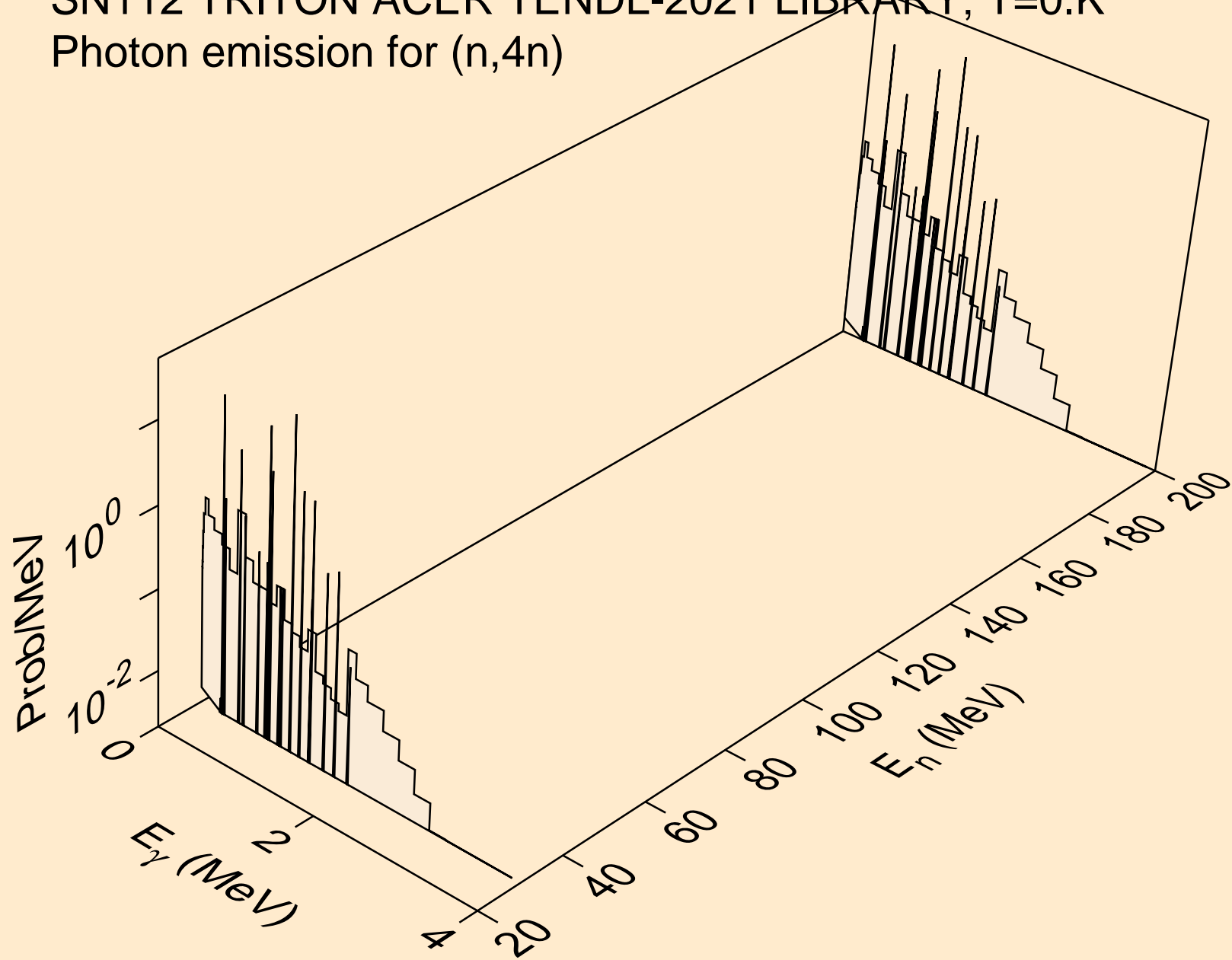

SN112 TRITON ACER TENDL-2021 LIBRARY; T=0.K  
Photon emission for (n,2np)

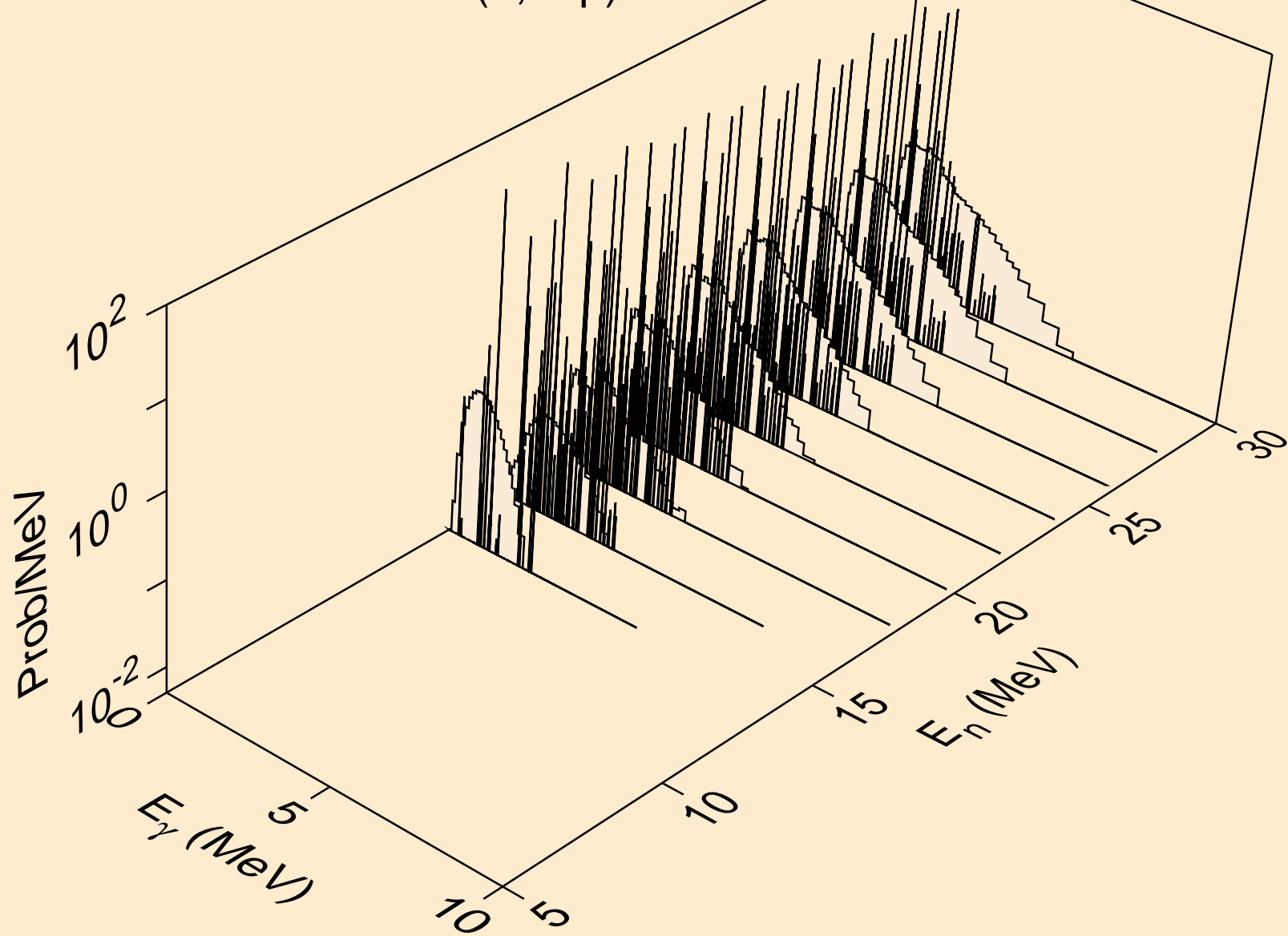

SN112 TRITON ACER TENDL-2021 LIBRARY; T=0.K  
Photon emission for (n,3np)

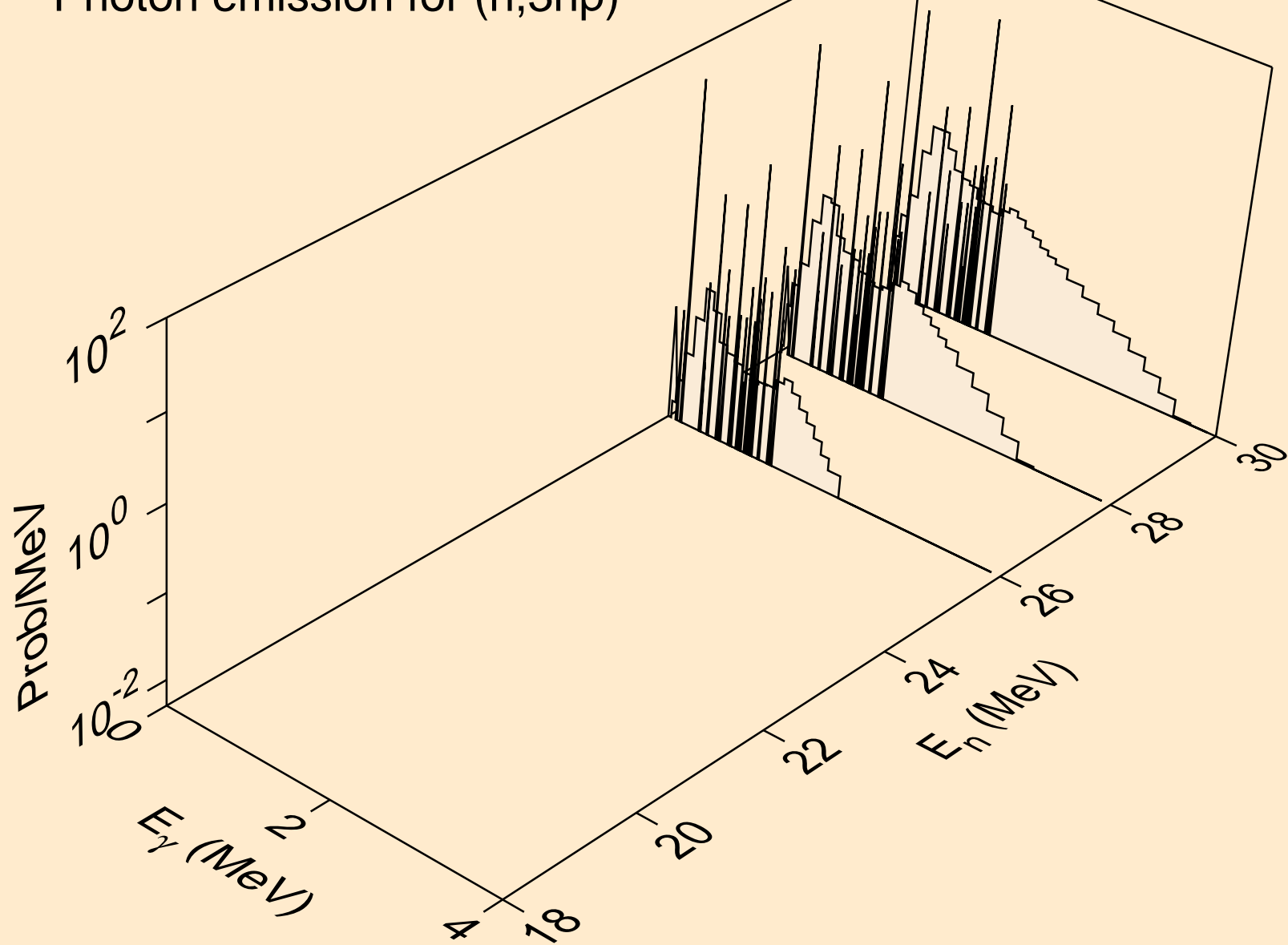

SN112 TRITON ACER TENDL-2021 LIBRARY; T=0.K  
Photon emission for (n,2np)

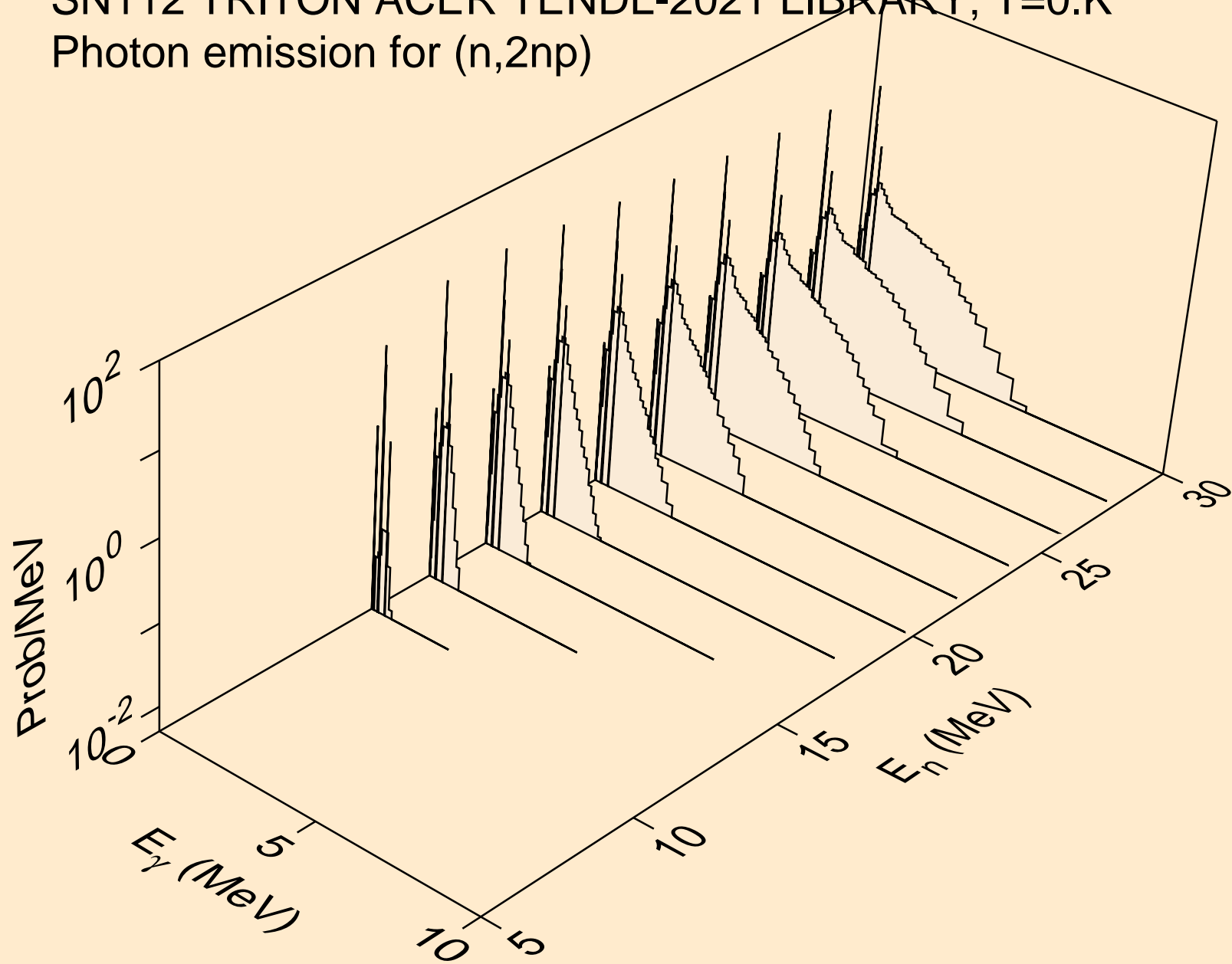

SN112 TRITON ACER TENDL-2021 LIBRARY; T=0.K  
Photon emission for (n,npa)

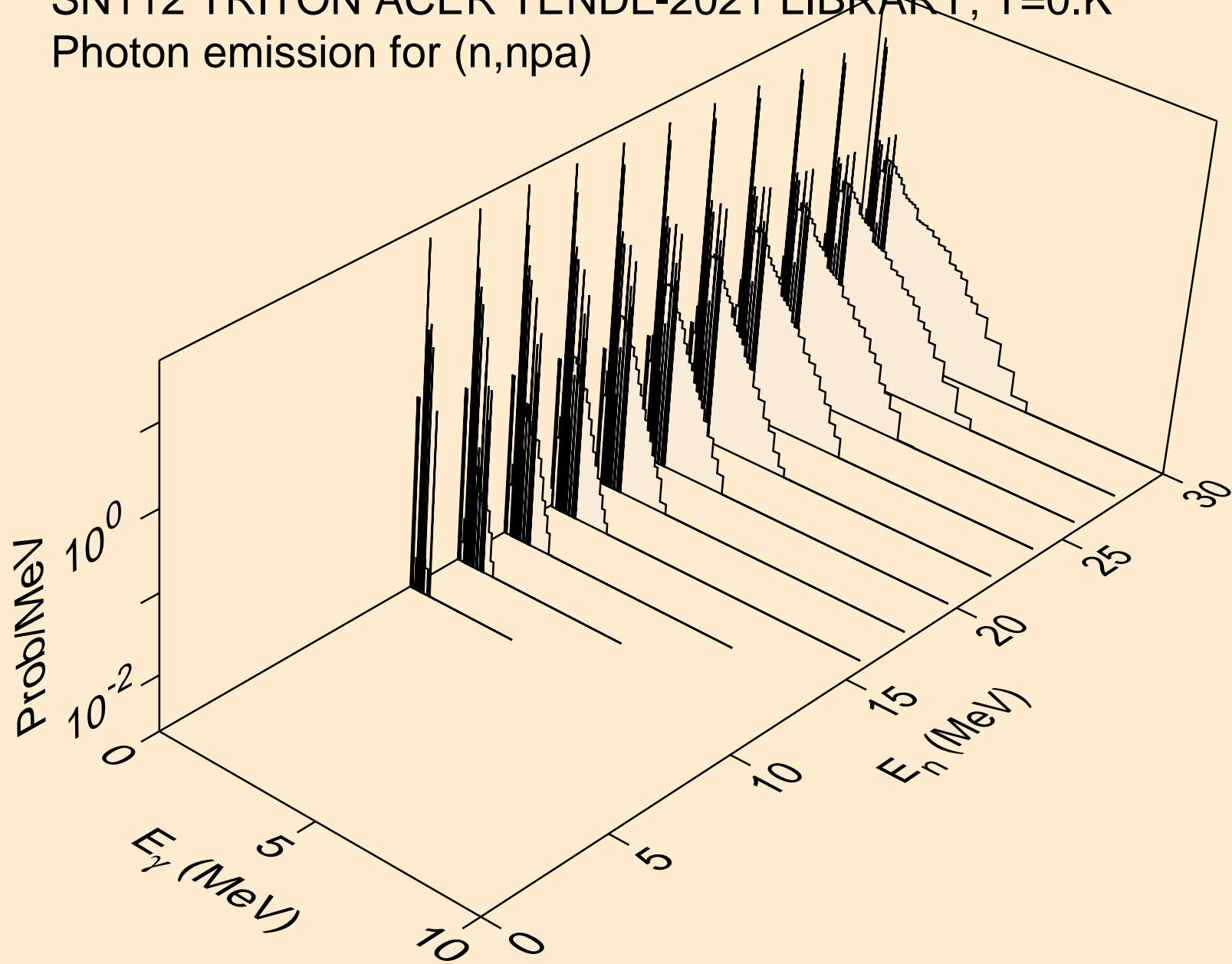



SN112 TRITON ACER TENDL-2021 LIBRARY; T=0.K  
Photon emission for (n,gma)

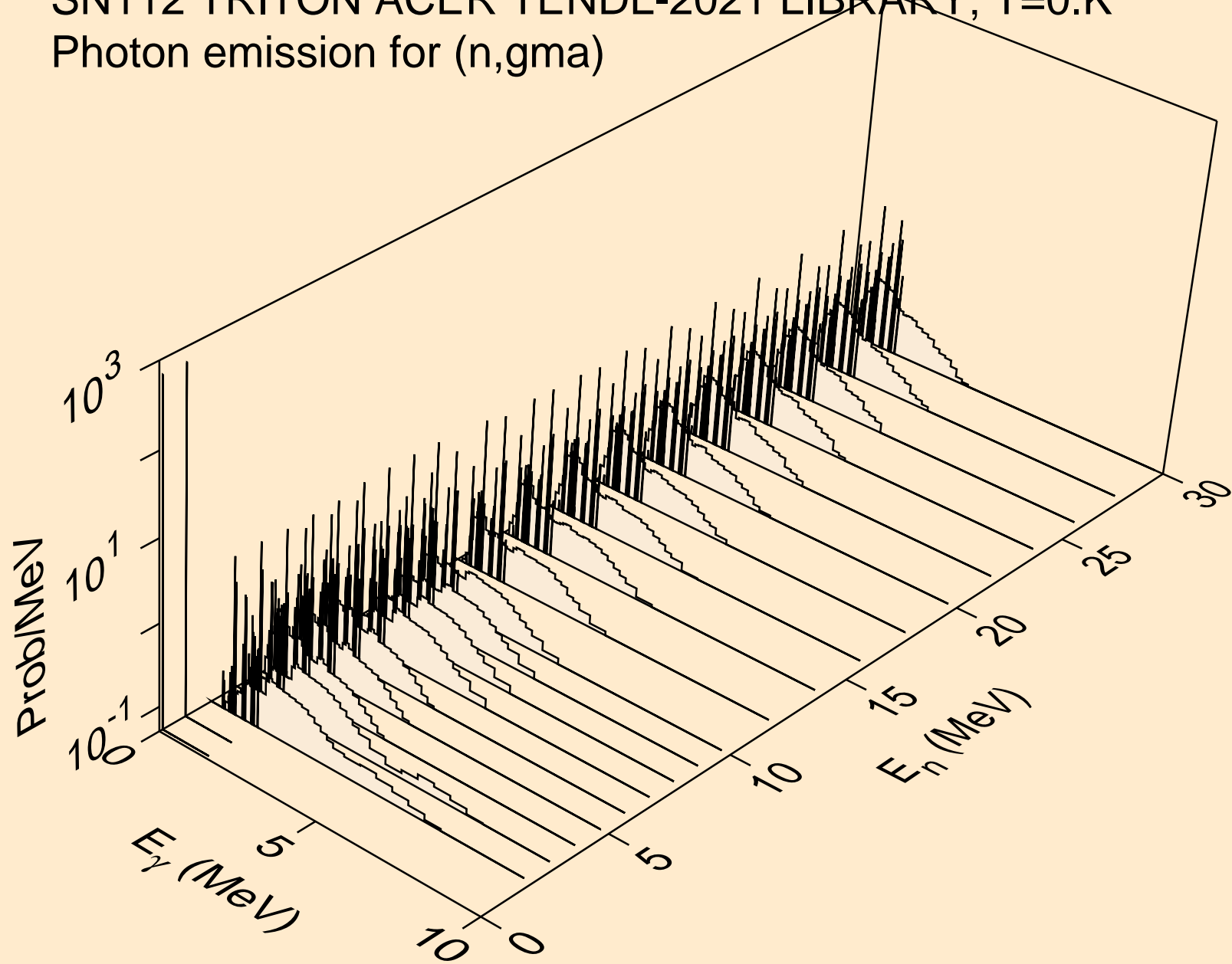

SN112 TRITON ACER TENDL-2021 LIBRARY; T=0.K  
Photon emission for (n,p)

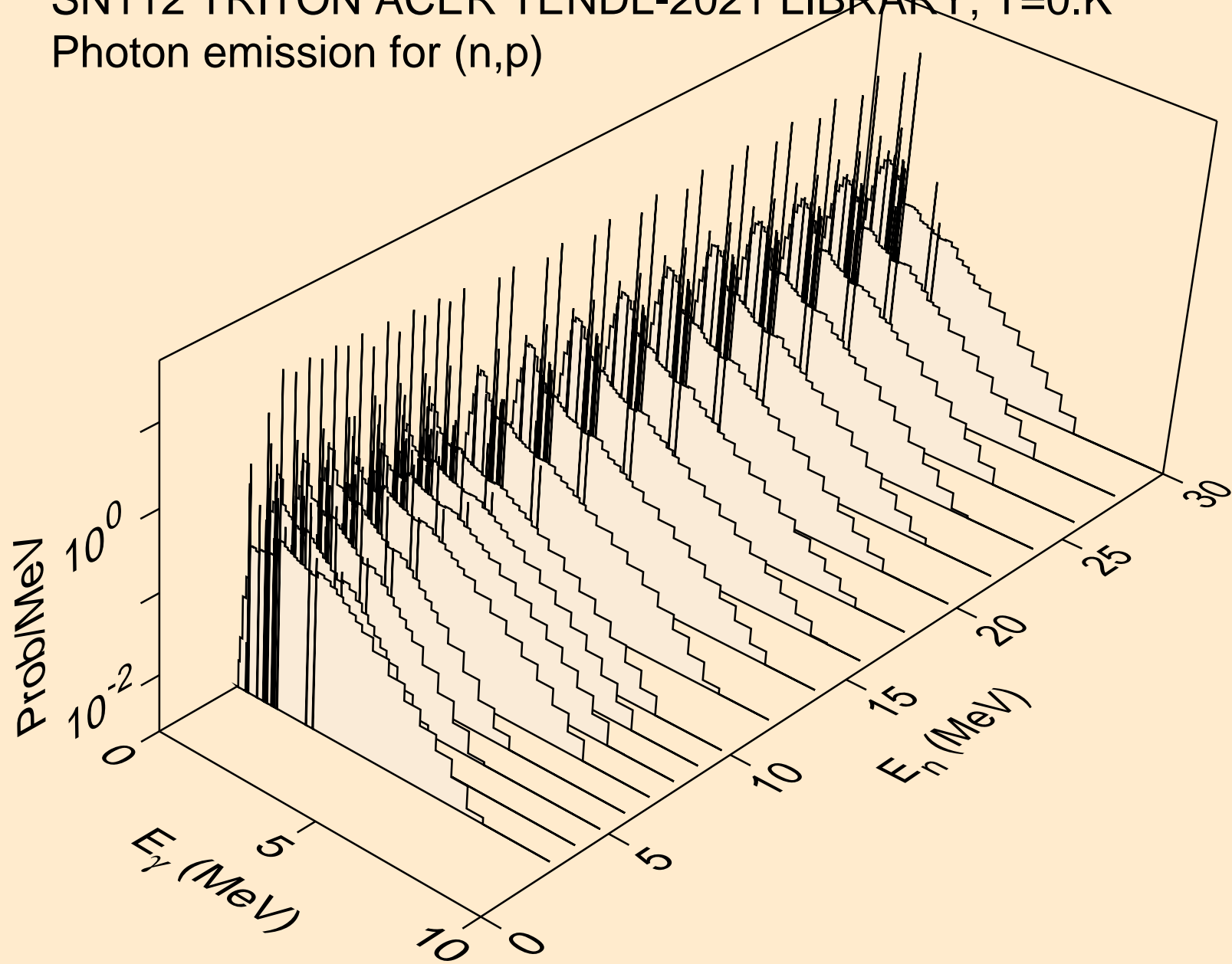

SN112 TRITON ACER TENDL-2021 LIBRARY; T=0.K  
Photon emission for (n,d)

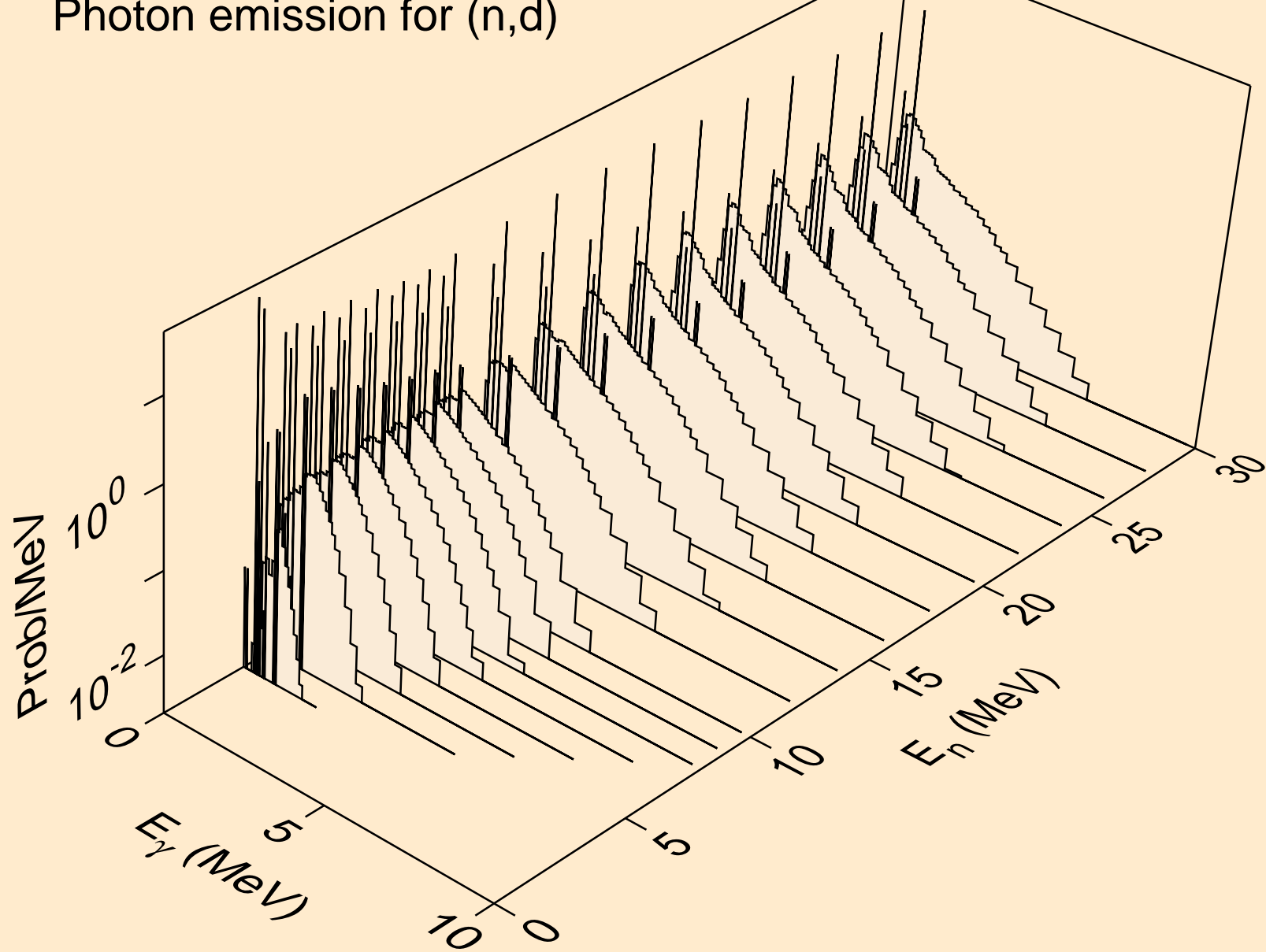

SN112 TRITON ACER TENDL-2021 LIBRARY; T=0.K  
Photon emission for inelastic

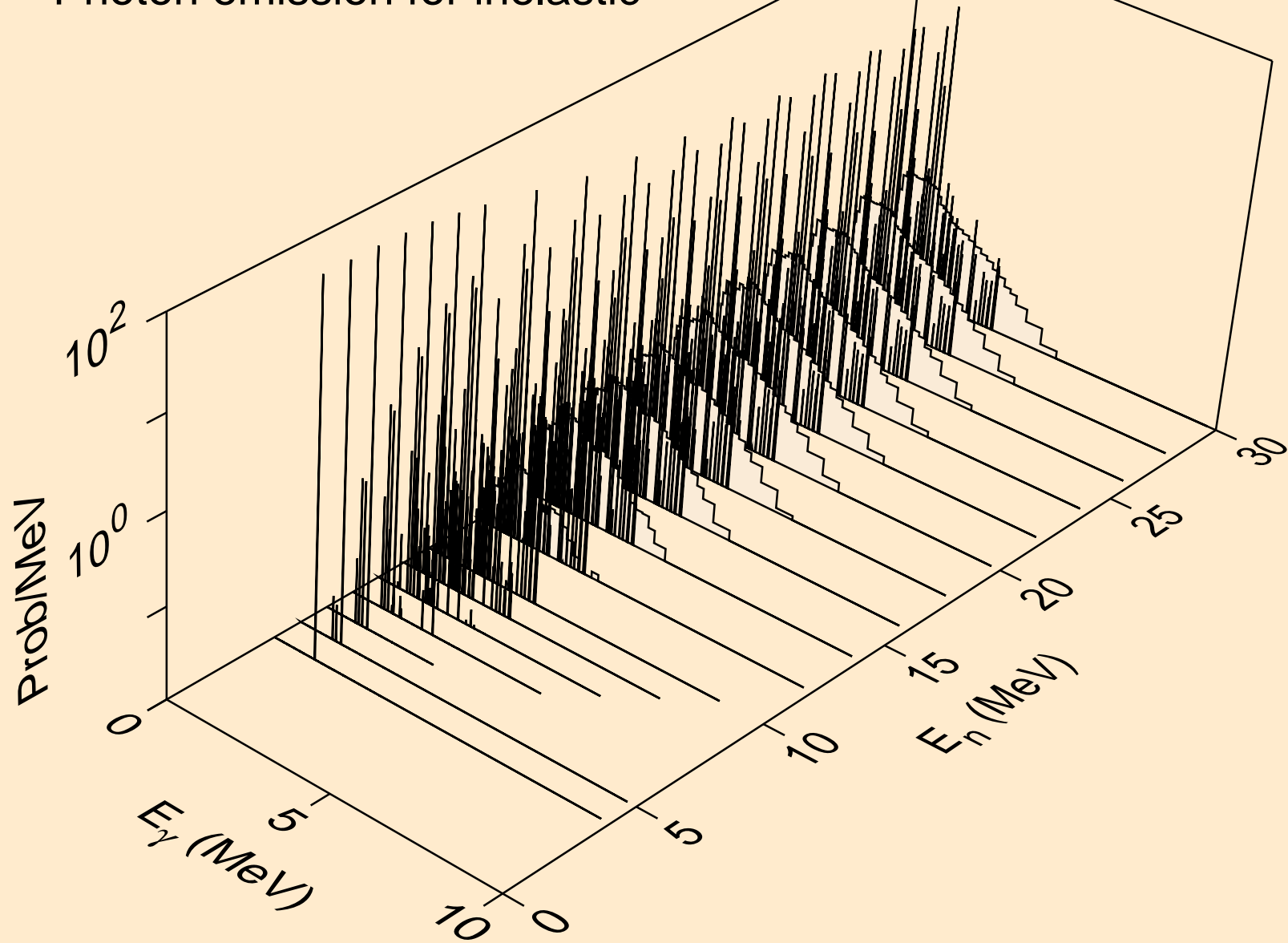

SN112 TRITON ACER TENDL-2021 LIBRARY; T=0.K  
Photon emission for (n,he3)

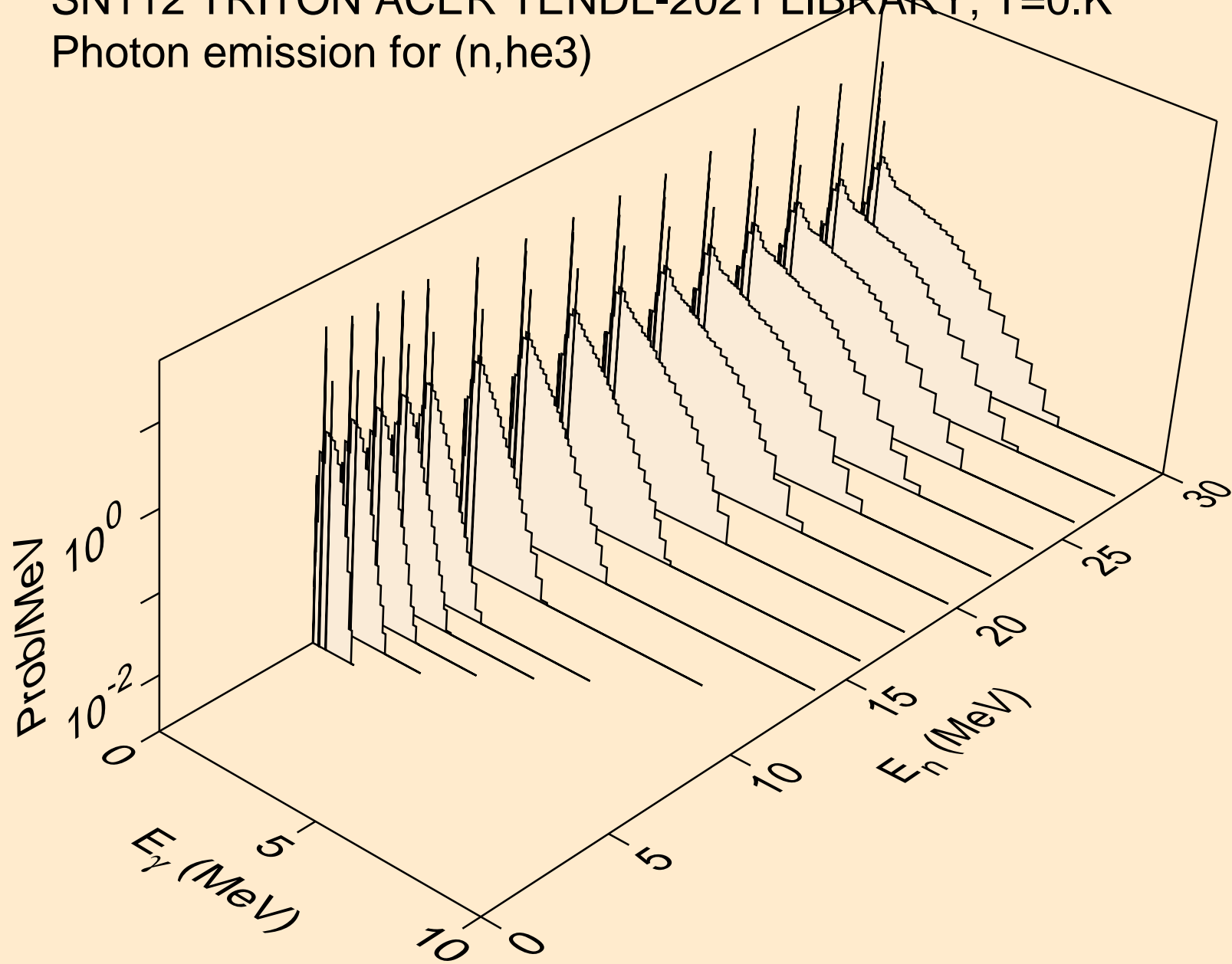

SN112 TRITON ACER TENDL-2021 LIBRARY; T=0.K  
Photon emission for (n,a)

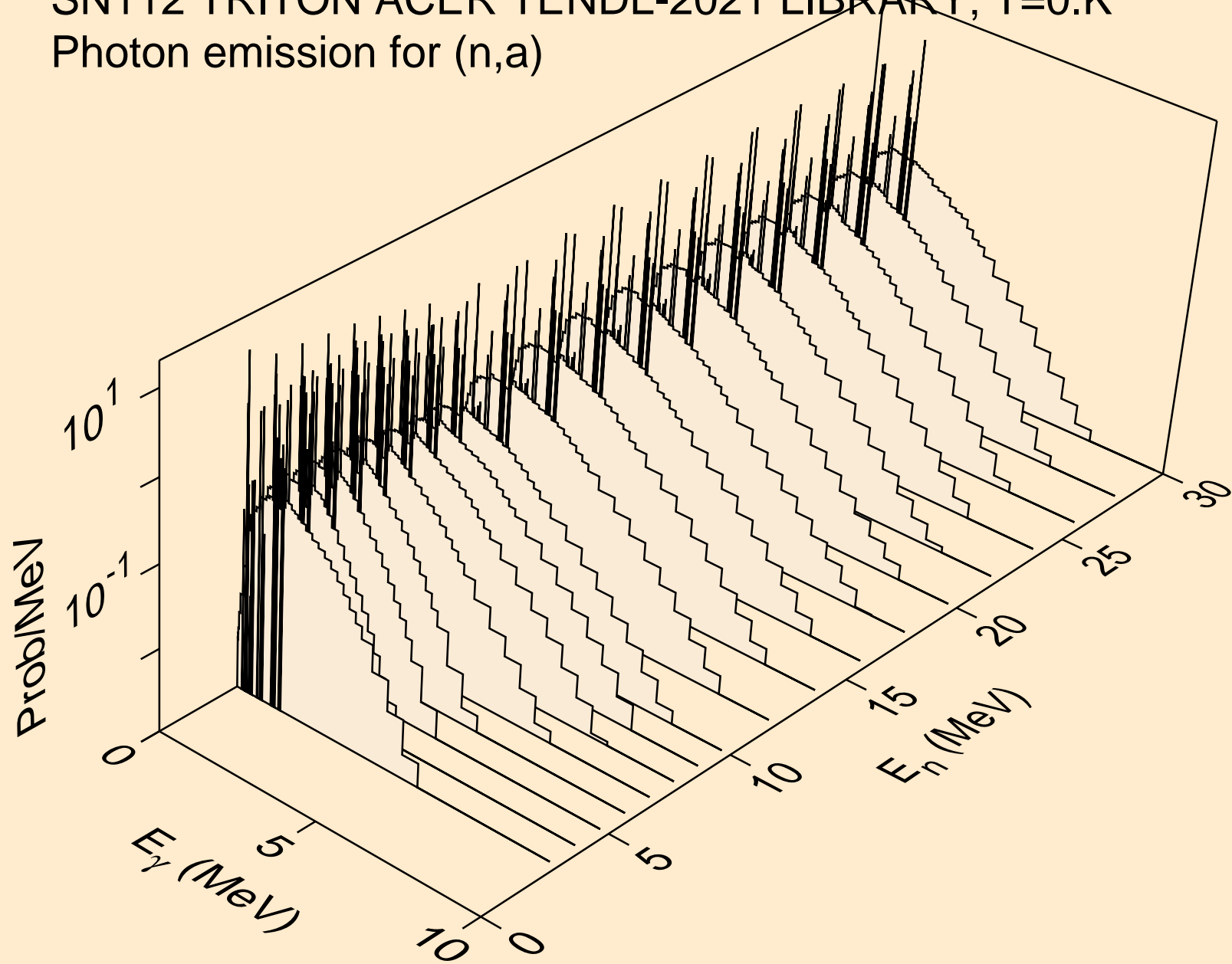

SN112 TRITON ACER TENDL-2021 LIBRARY; T=0.K  
Photon emission for (n,2a)

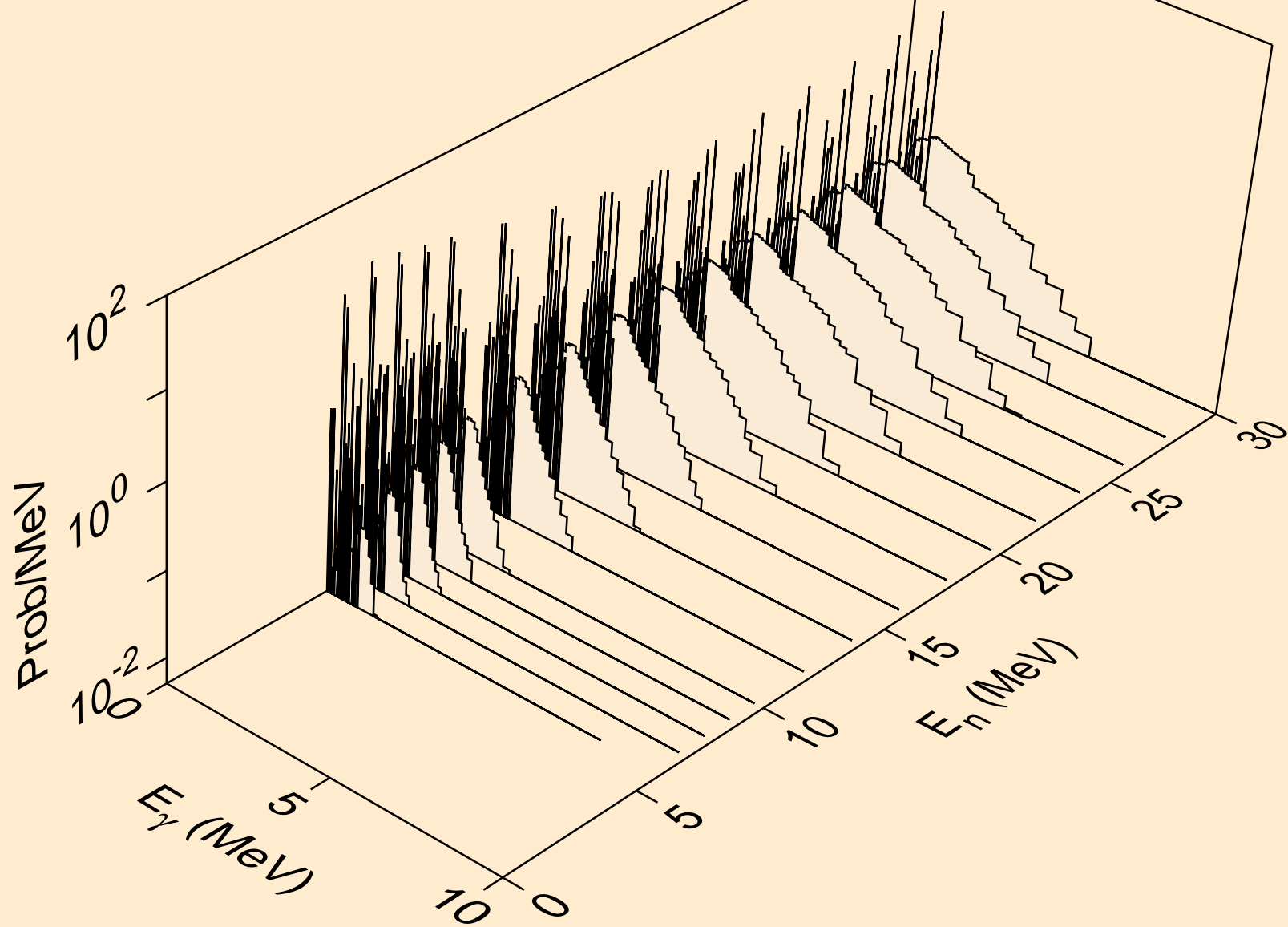

SN112 TRITON ACER TENDL-2021 LIBRARY; T=0.K  
Photon emission for (n,2p)

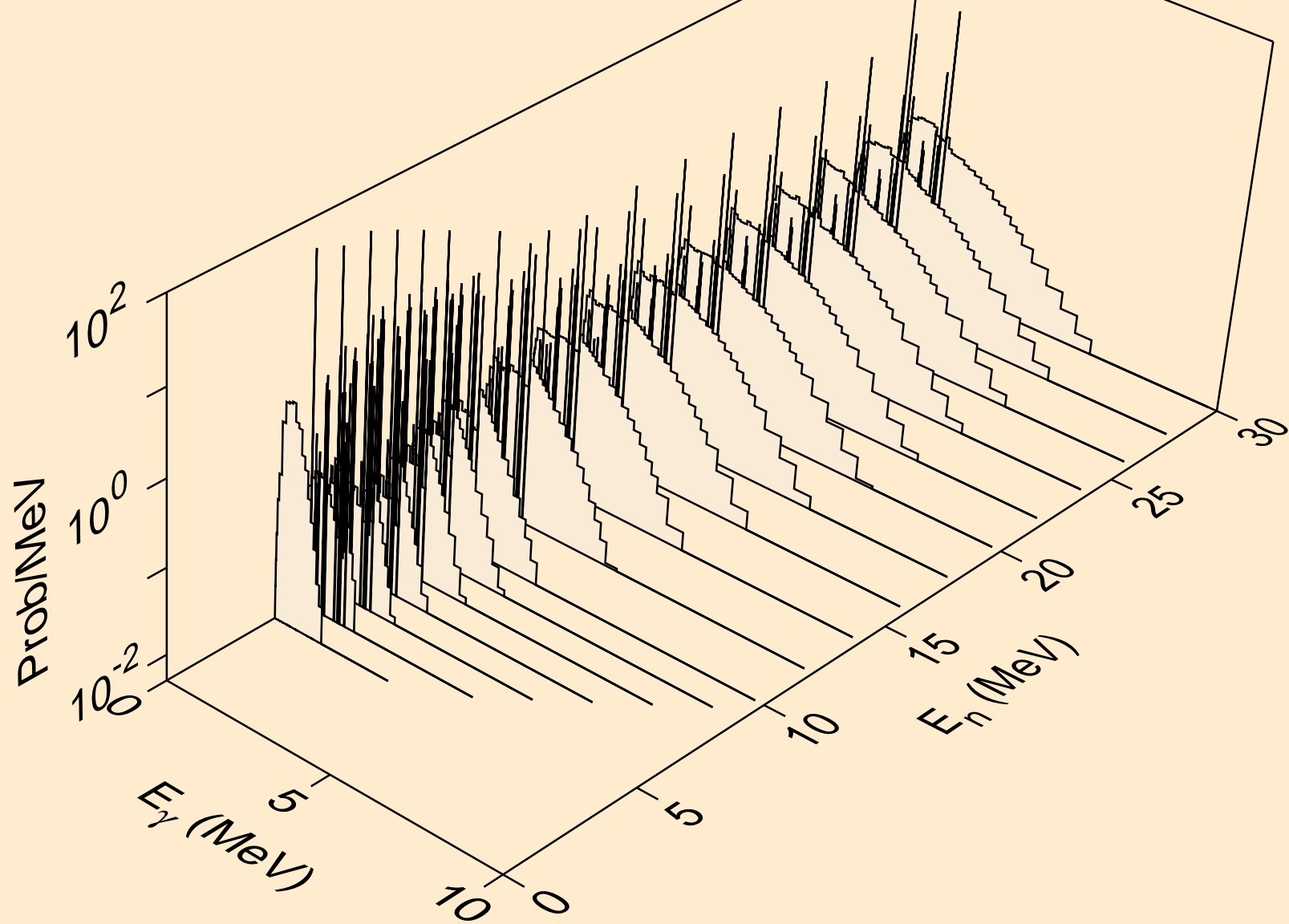



SN112 TRITON ACER TENDL-2021 LIBRARY; T=0.K  
Photon emission for (n,pa)

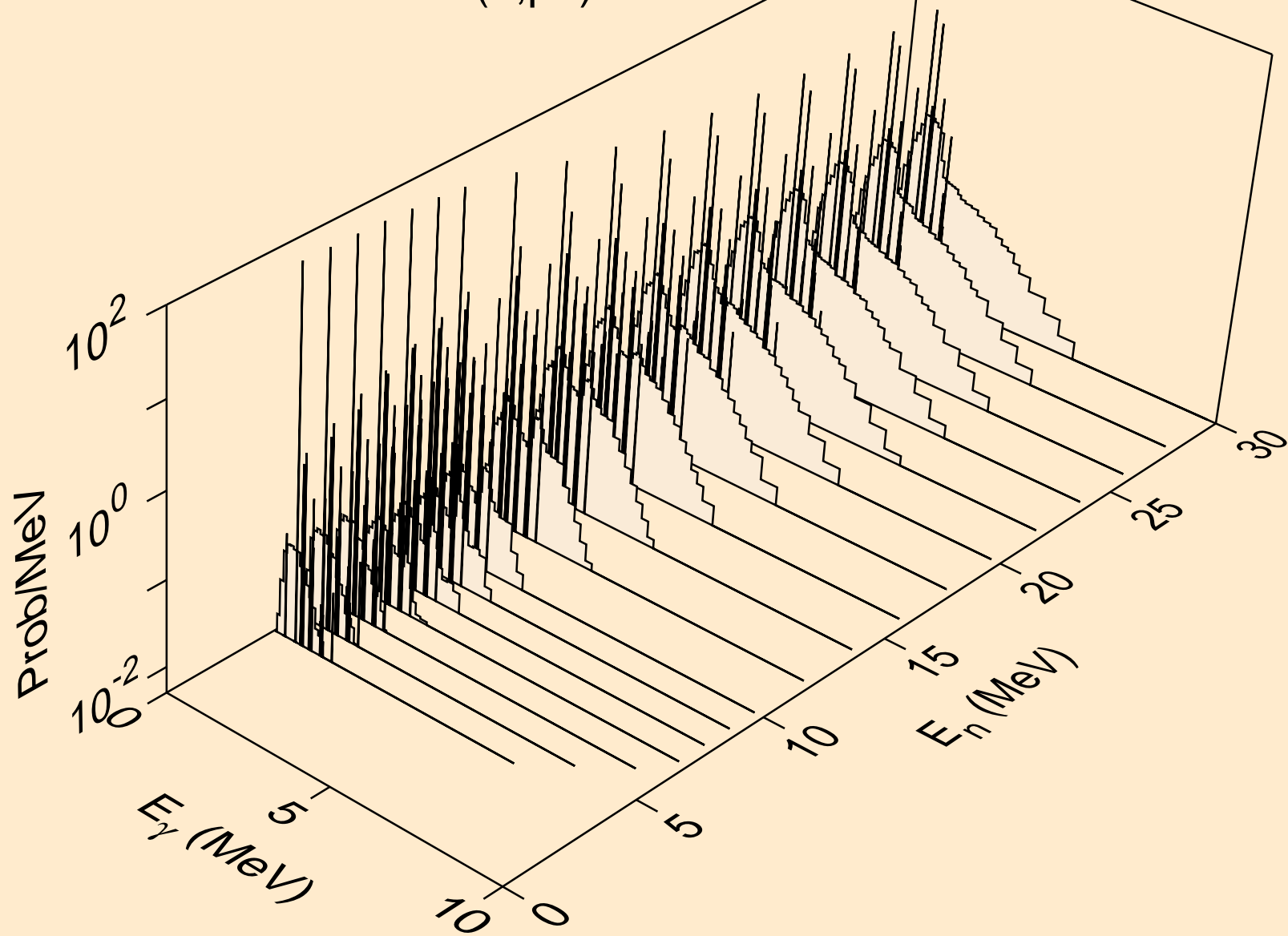

SN112 TRITON ACER TENDL-2021 LIBRARY; T=0.K  
Photon emission for (n,pd)

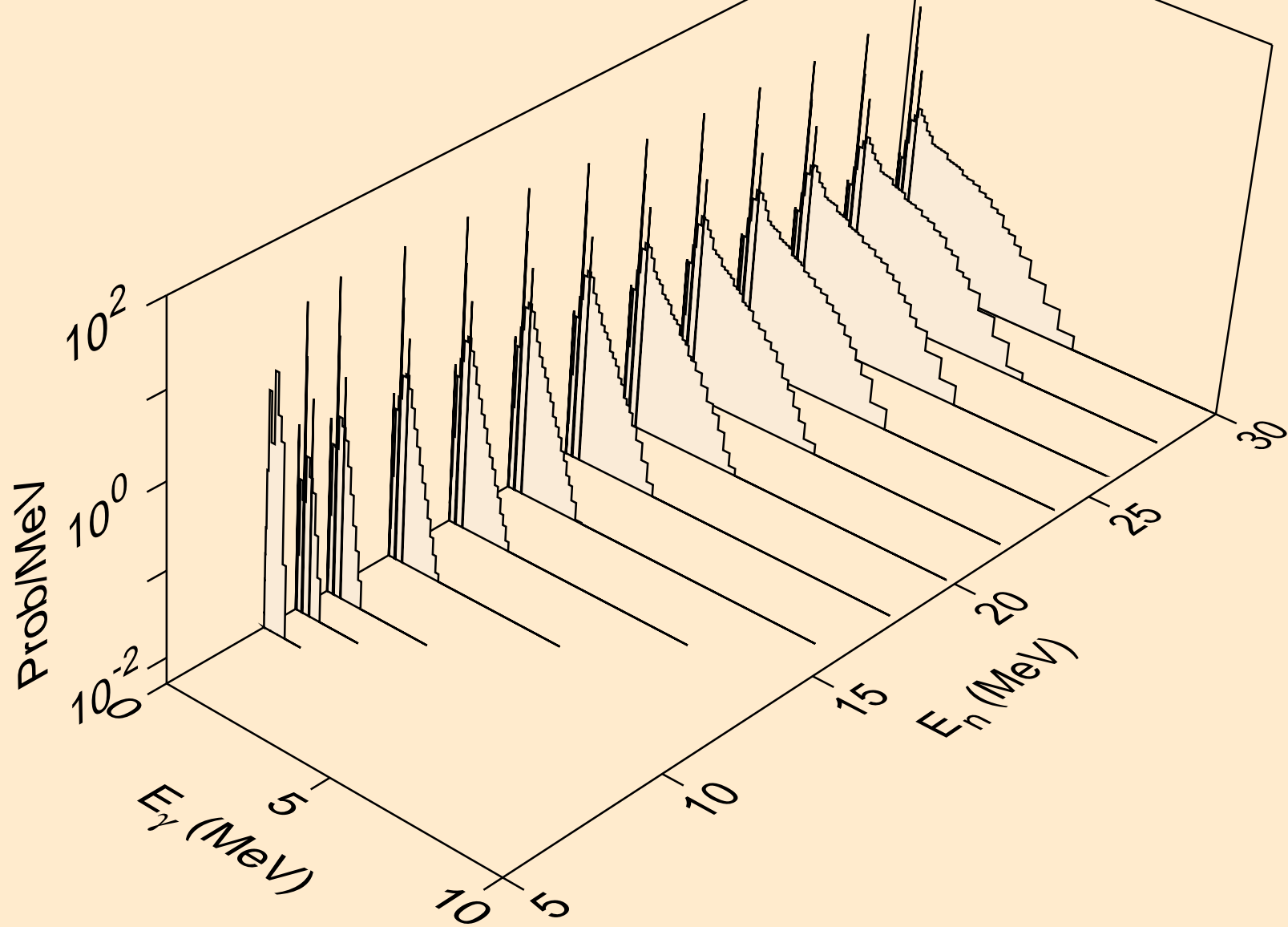

SN112 TRITON ACER TENDL-2021 LIBRARY; T=0.K  
Photon emission for (n,pt)

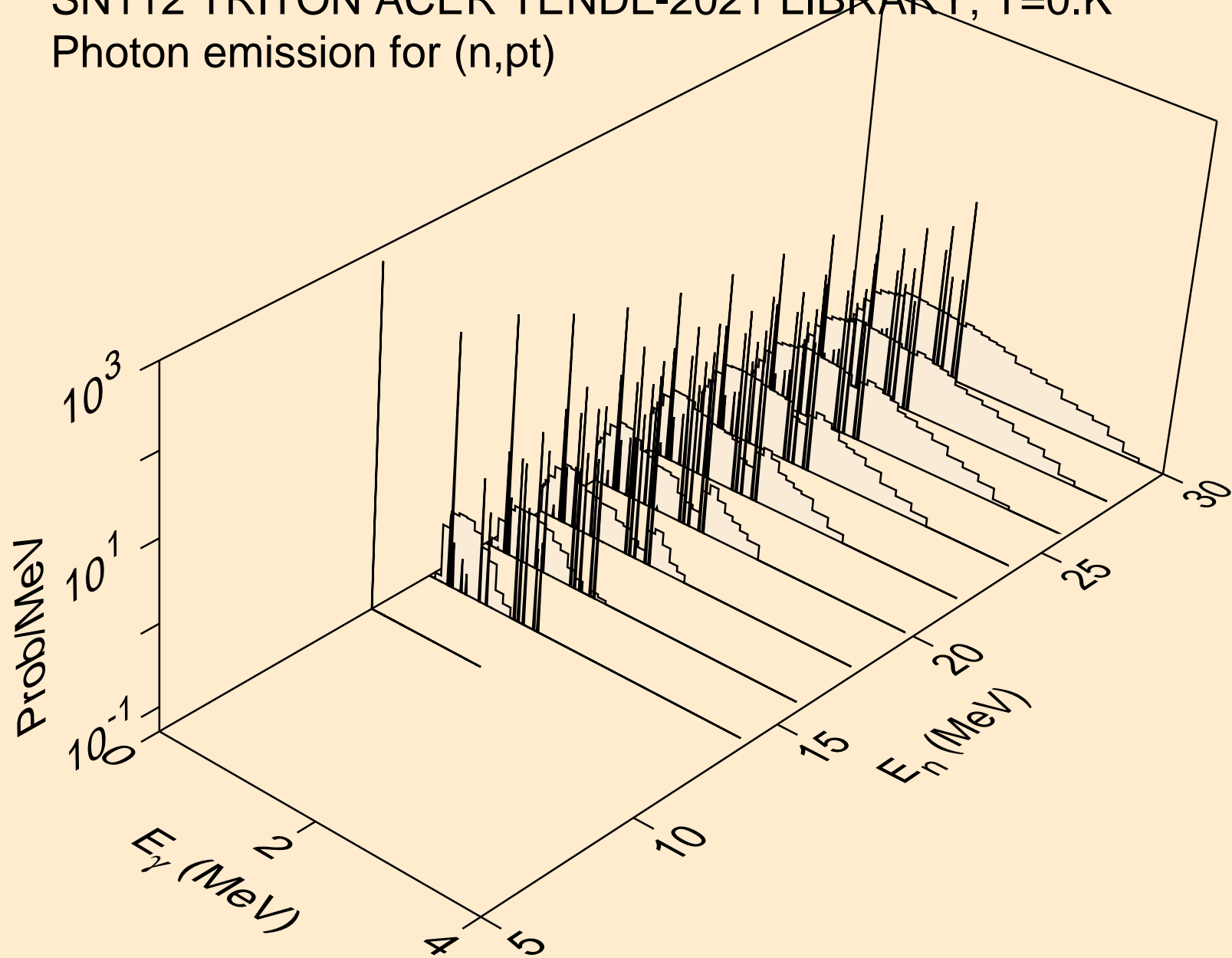

SN112 TRITON ACER TENDL-2021 LIBRARY; T=0.K  
Photon emission for (n,da)

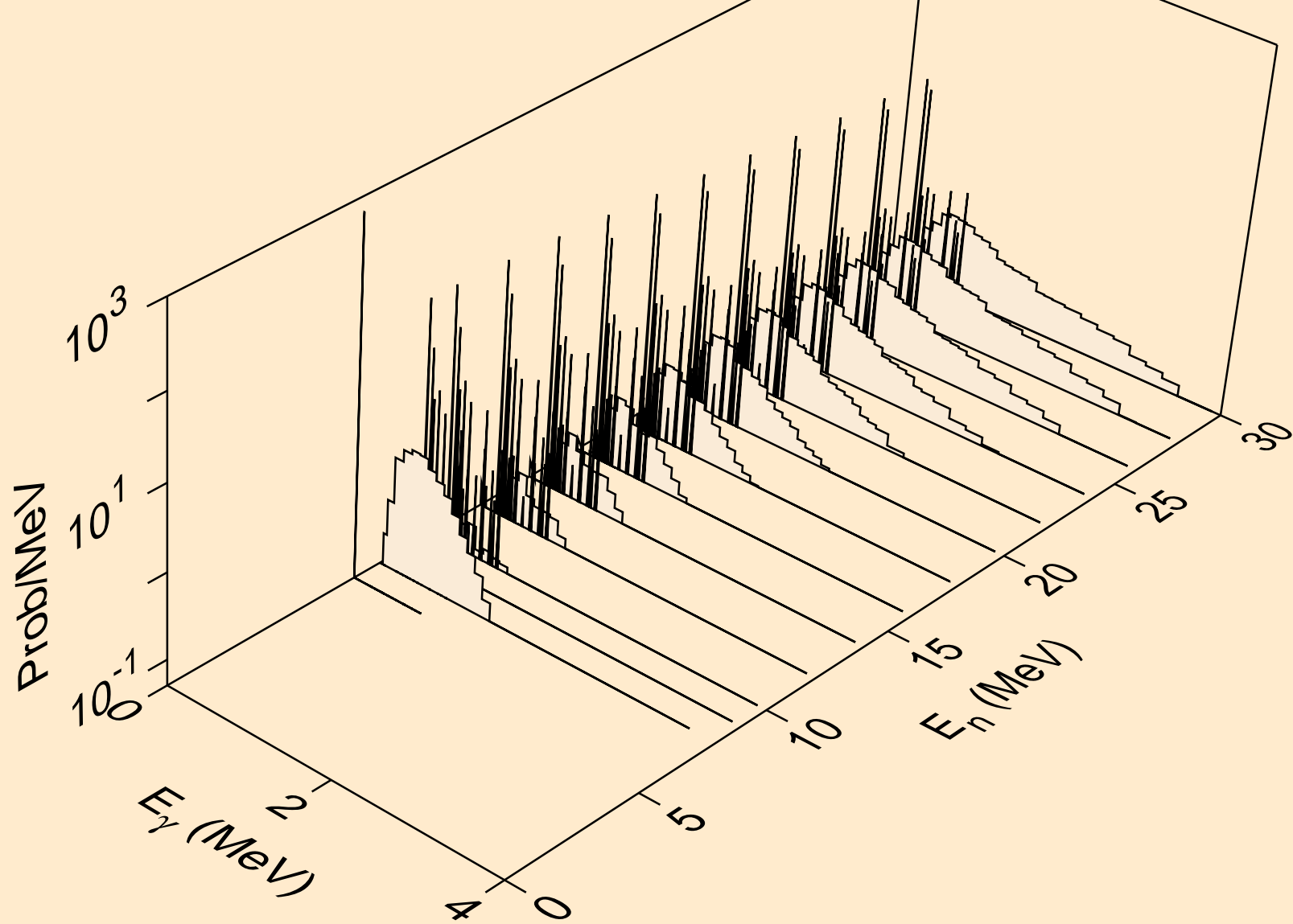

SN112 TRITON ACER TENDL-2021 LIBRARY; T=0.K  
Particle heating contributions

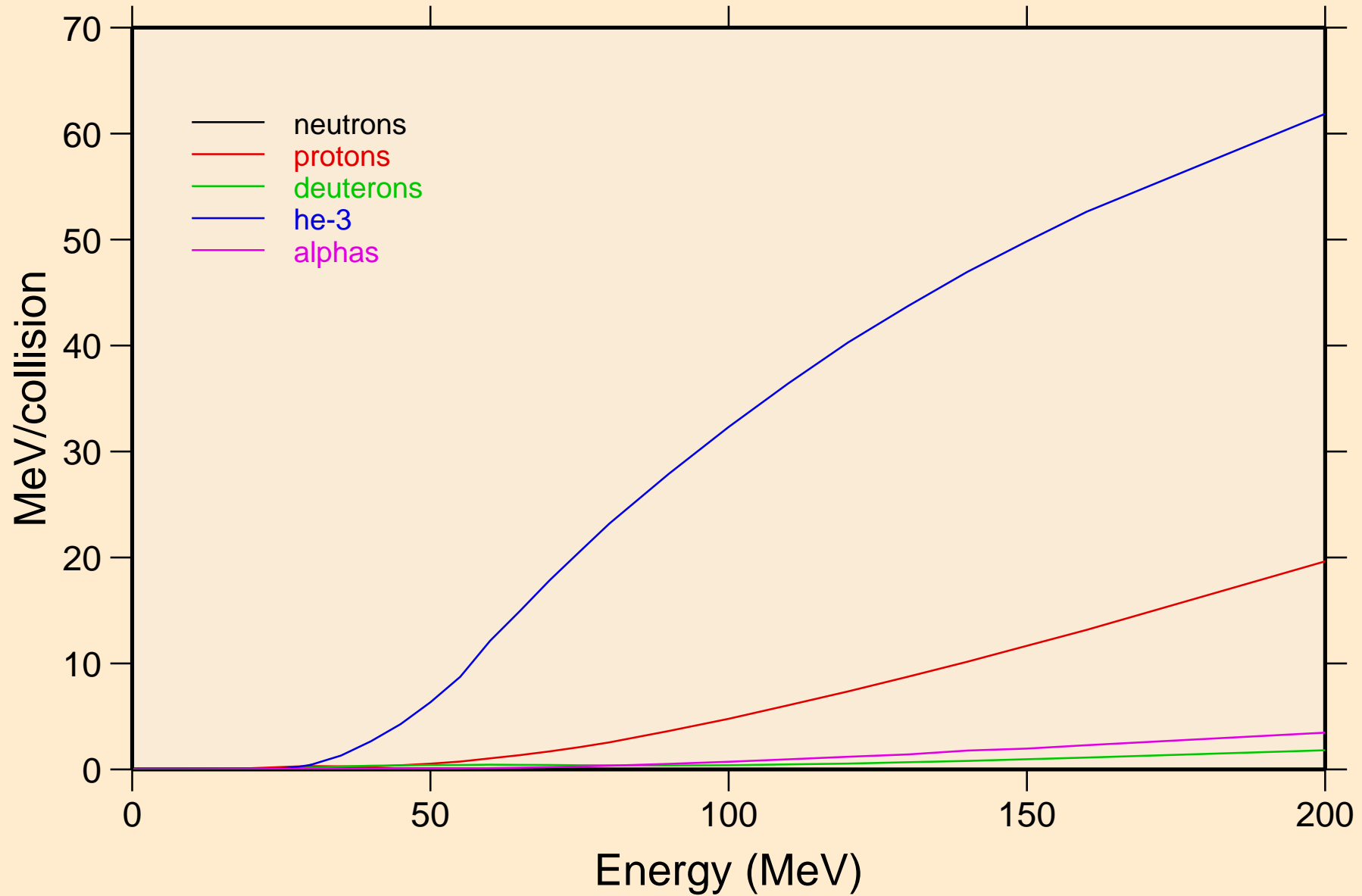

# SN112 TRITON ACER TENDL-2021 LIBRARY; T=0.K

## Recoil Heating

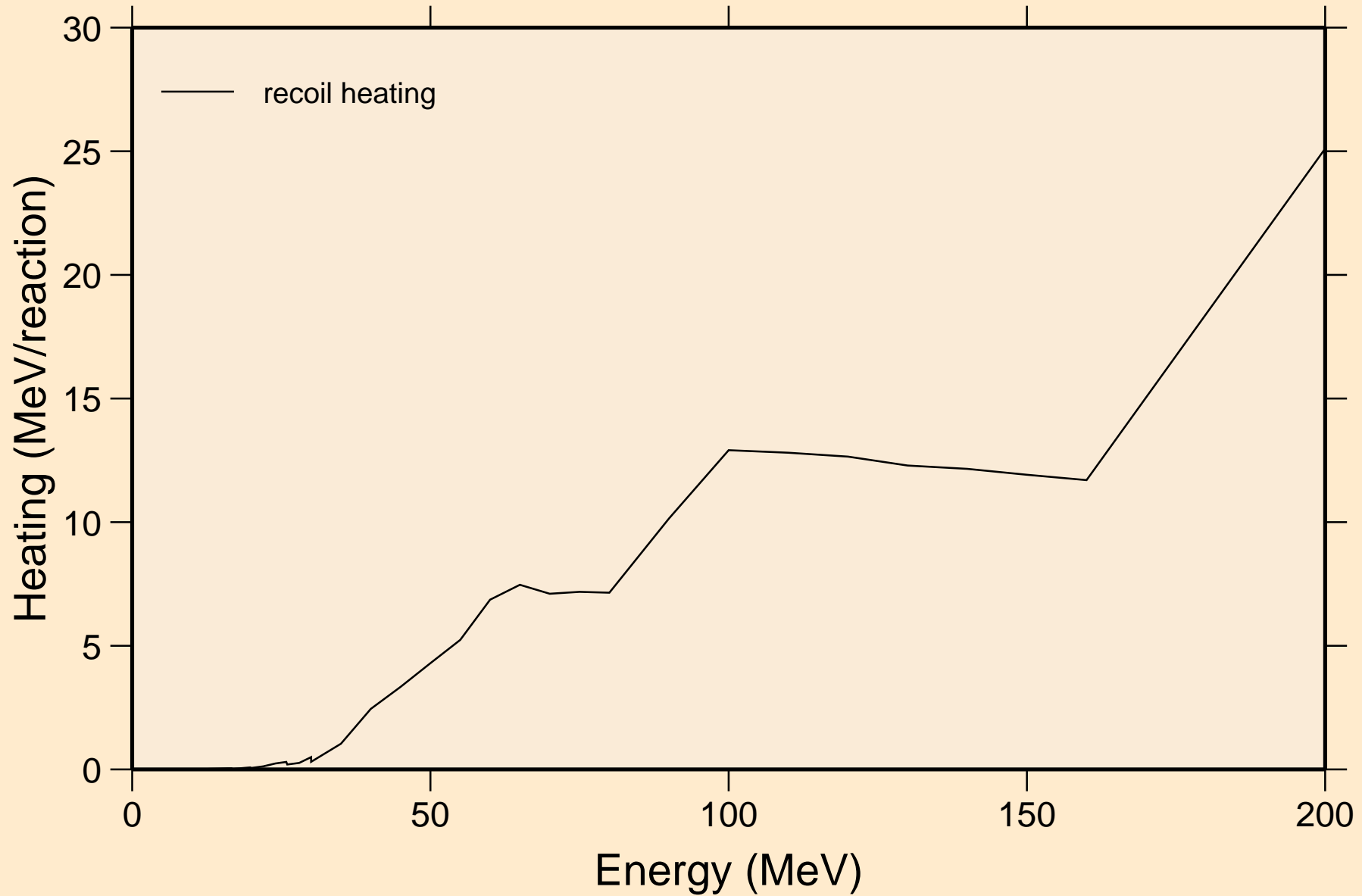

SN112 TRITON ACER TENDL-2021 LIBRARY; T=0.K  
Particle production cross sections

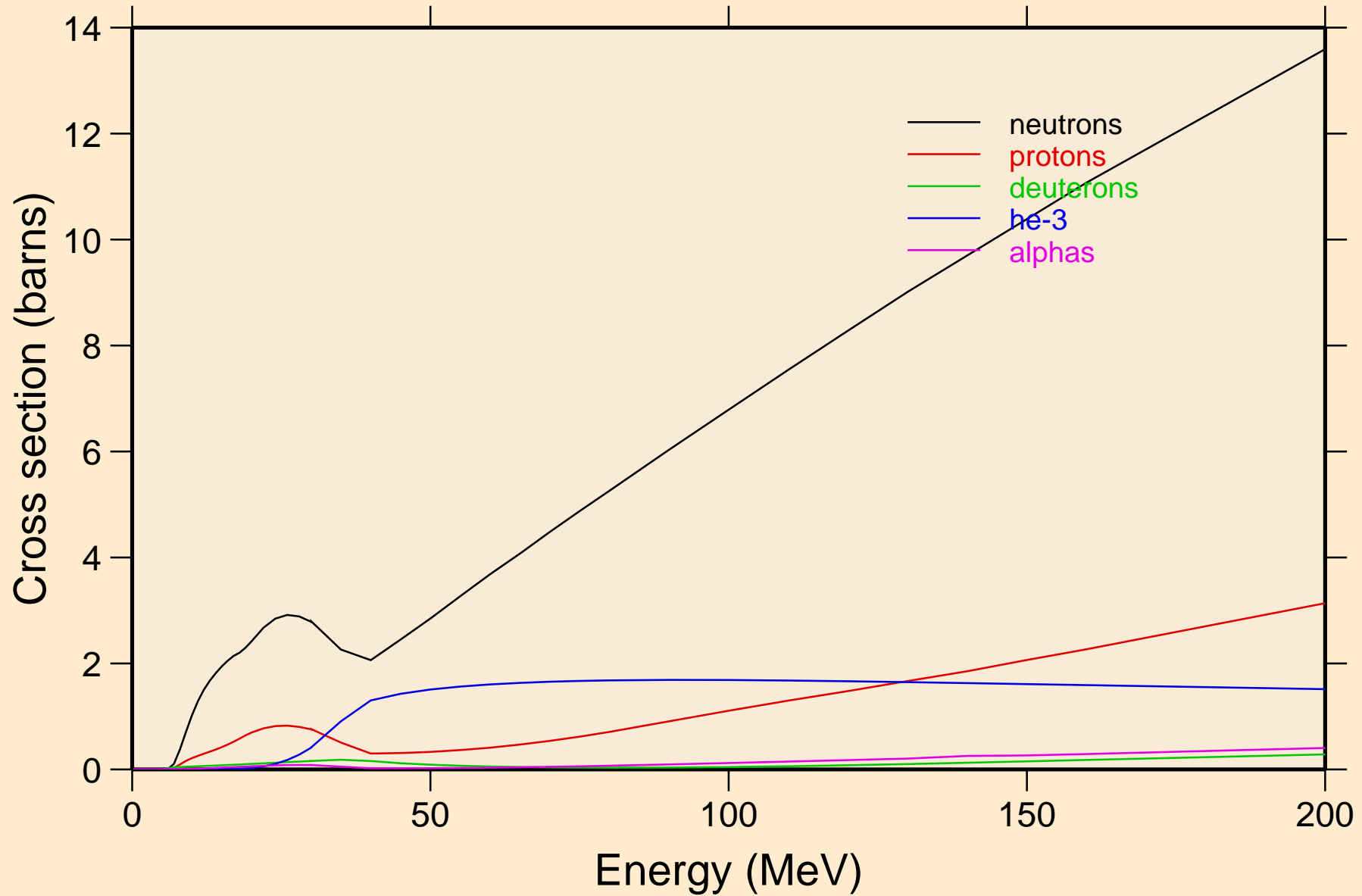

SN112 TRITON ACER TENDL-2021 LIBRARY; T=0.K  
neutrons from (t,n)

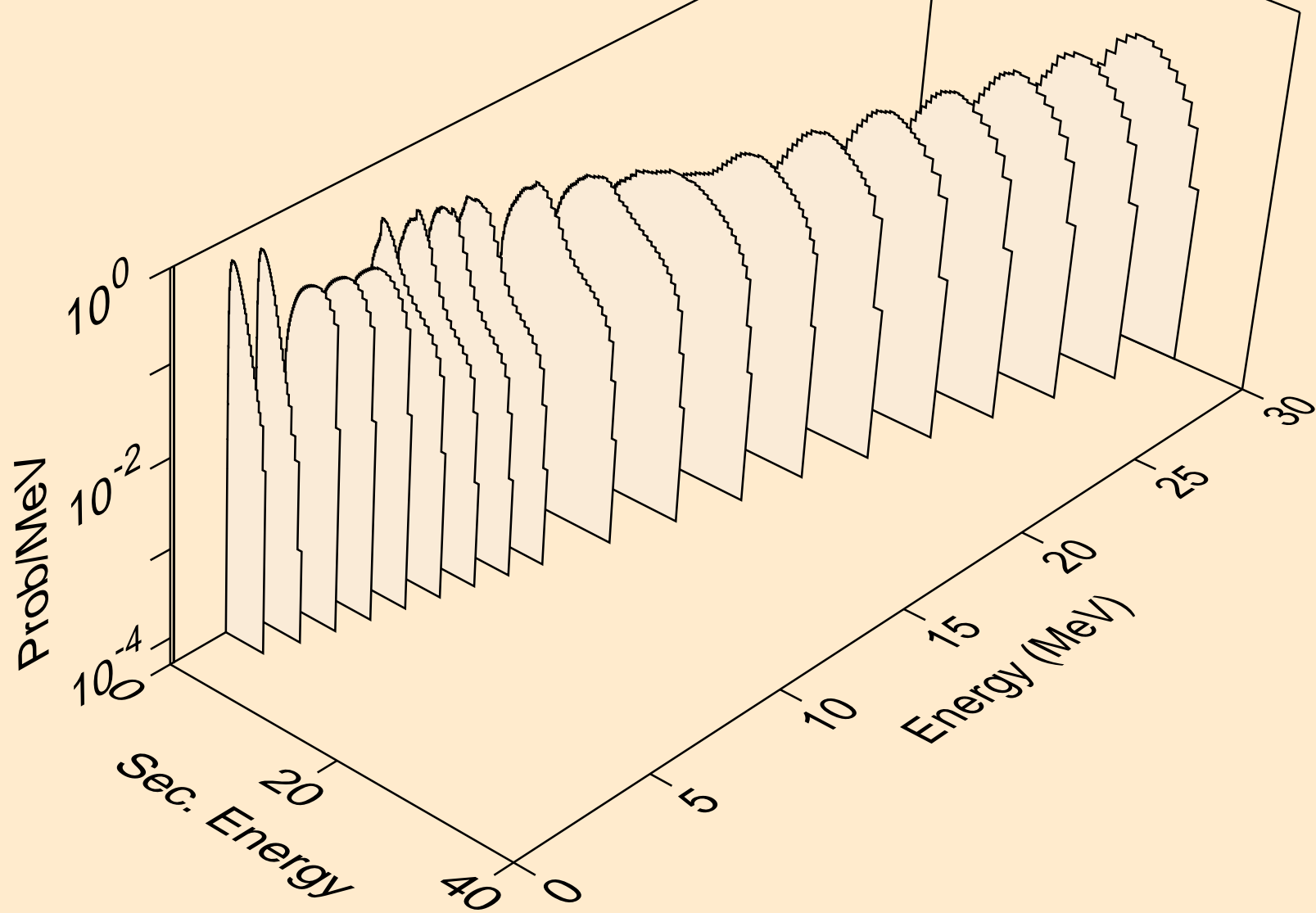



SN112 TRITON ACER TENDL-2021 LIBRARY; T=0.K  
neutrons from (t,x)

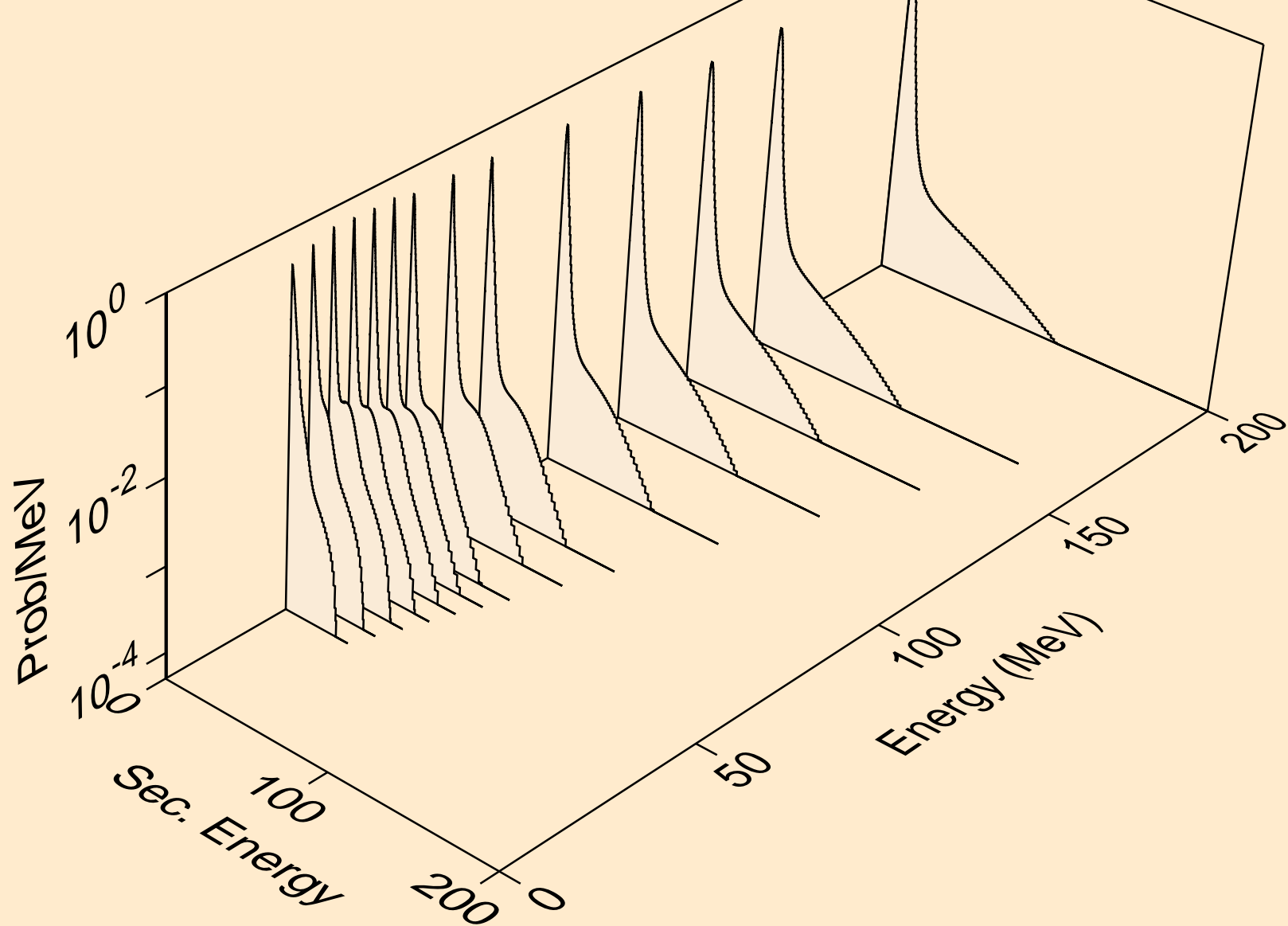

SN112 TRITON ACER TENDL-2021 LIBRARY; T=0.K  
neutrons from (t,2nd)

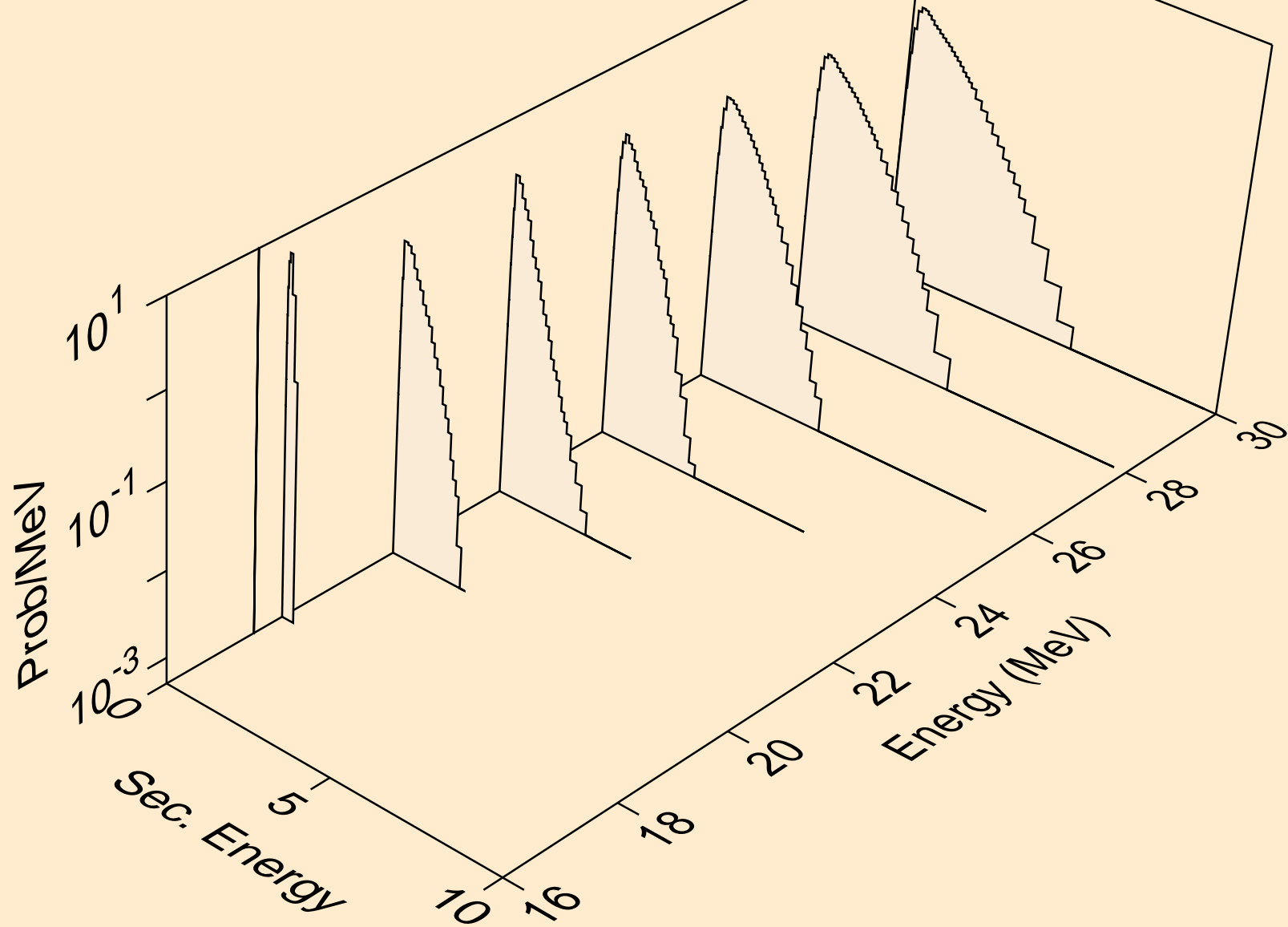

SN112 TRITON ACER TENDL-2021 LIBRARY; T=0.K  
neutrons from (t,2n)

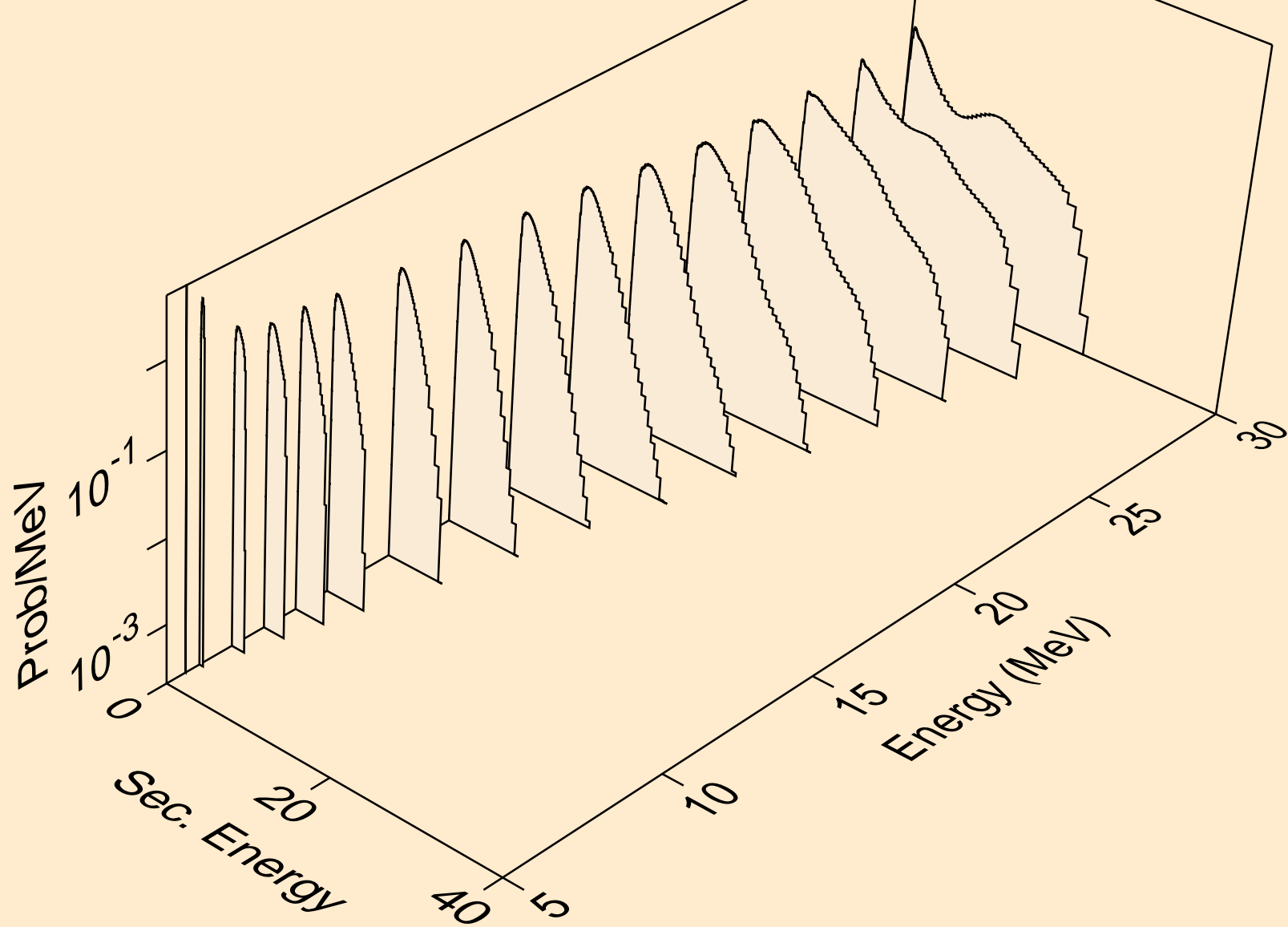

SN112 TRITON ACER TENDL-2021 LIBRARY; T=0.K  
neutrons from (t,3n)

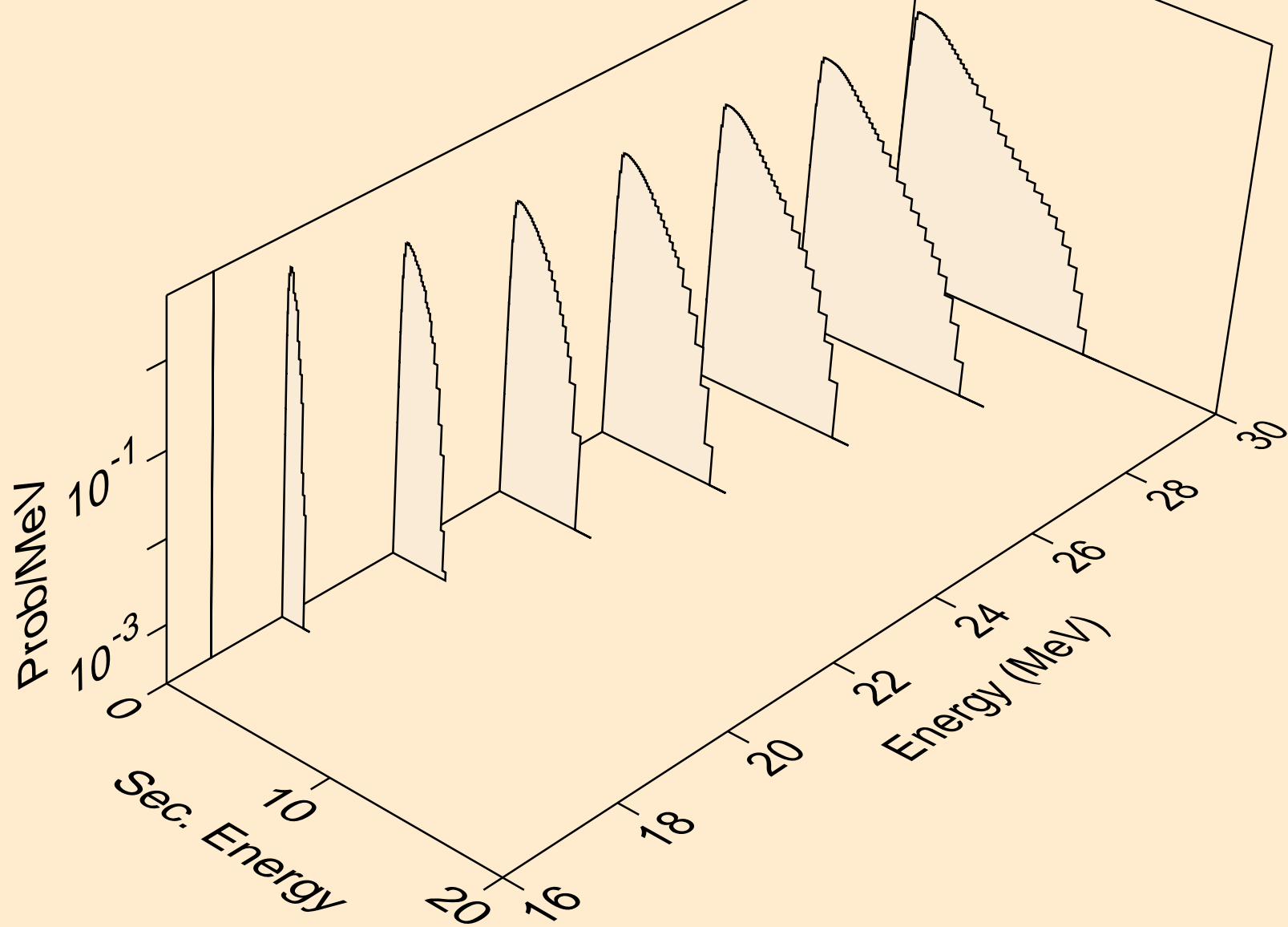

SN112 TRITON ACER TENDL-2021 LIBRARY; T=0.K  
neutrons from (t,n\*)a

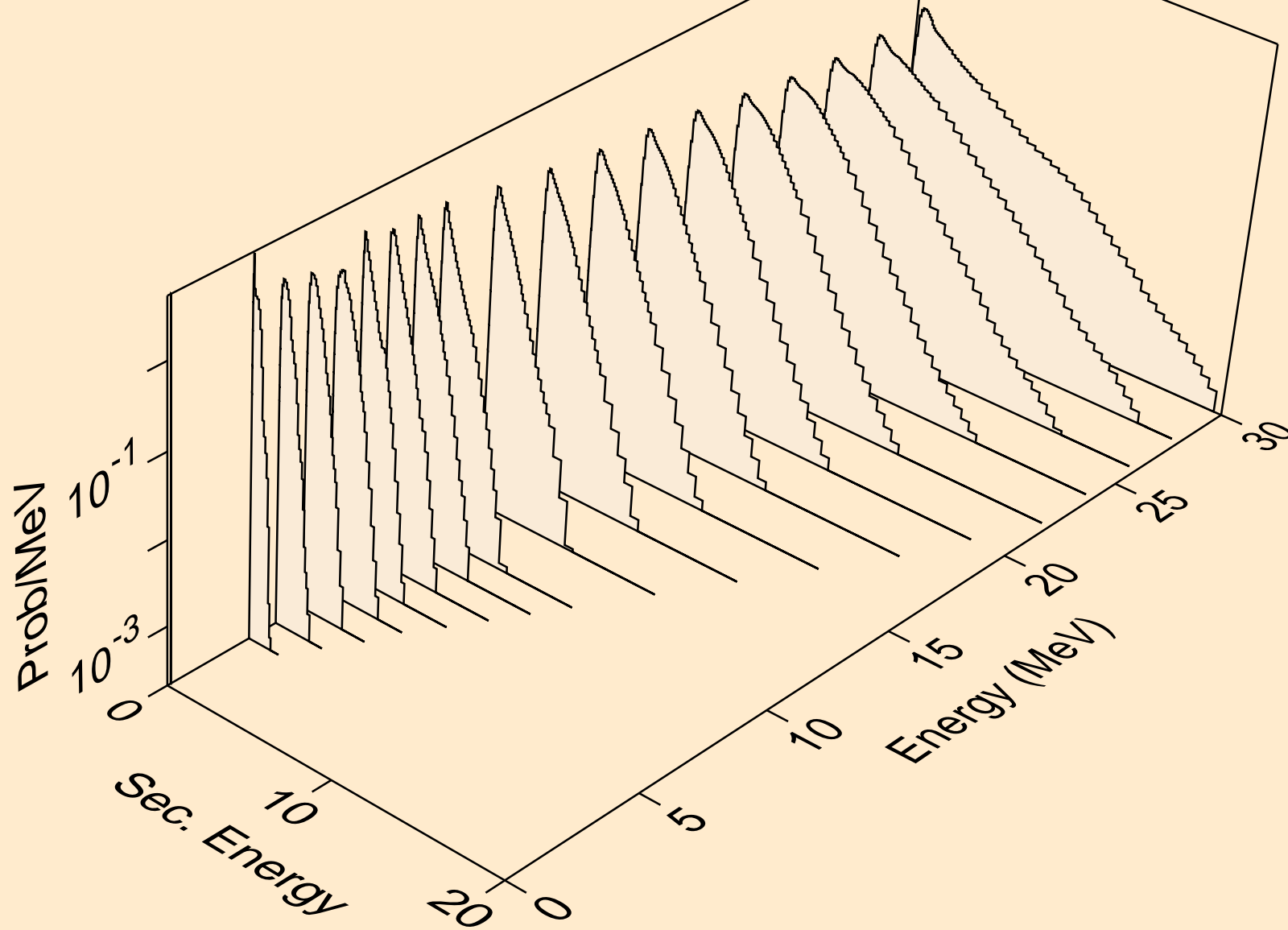

SN112 TRITON ACER TENDL-2021 LIBRARY; T=0.K  
neutrons from (t,2n)a

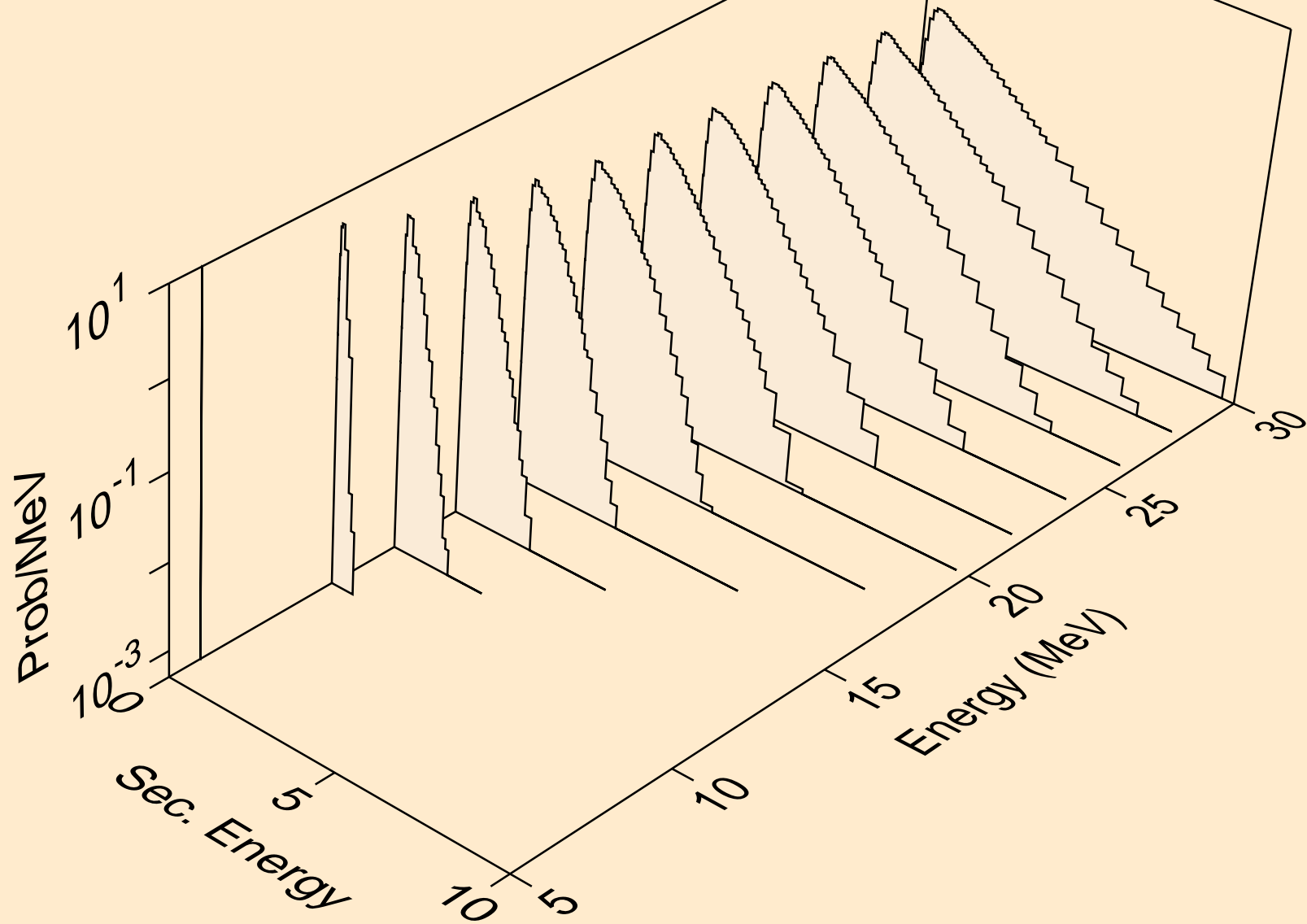

SN112 TRITON ACER TENDL-2021 LIBRARY; T=0.K  
neutrons from (t,3n)a

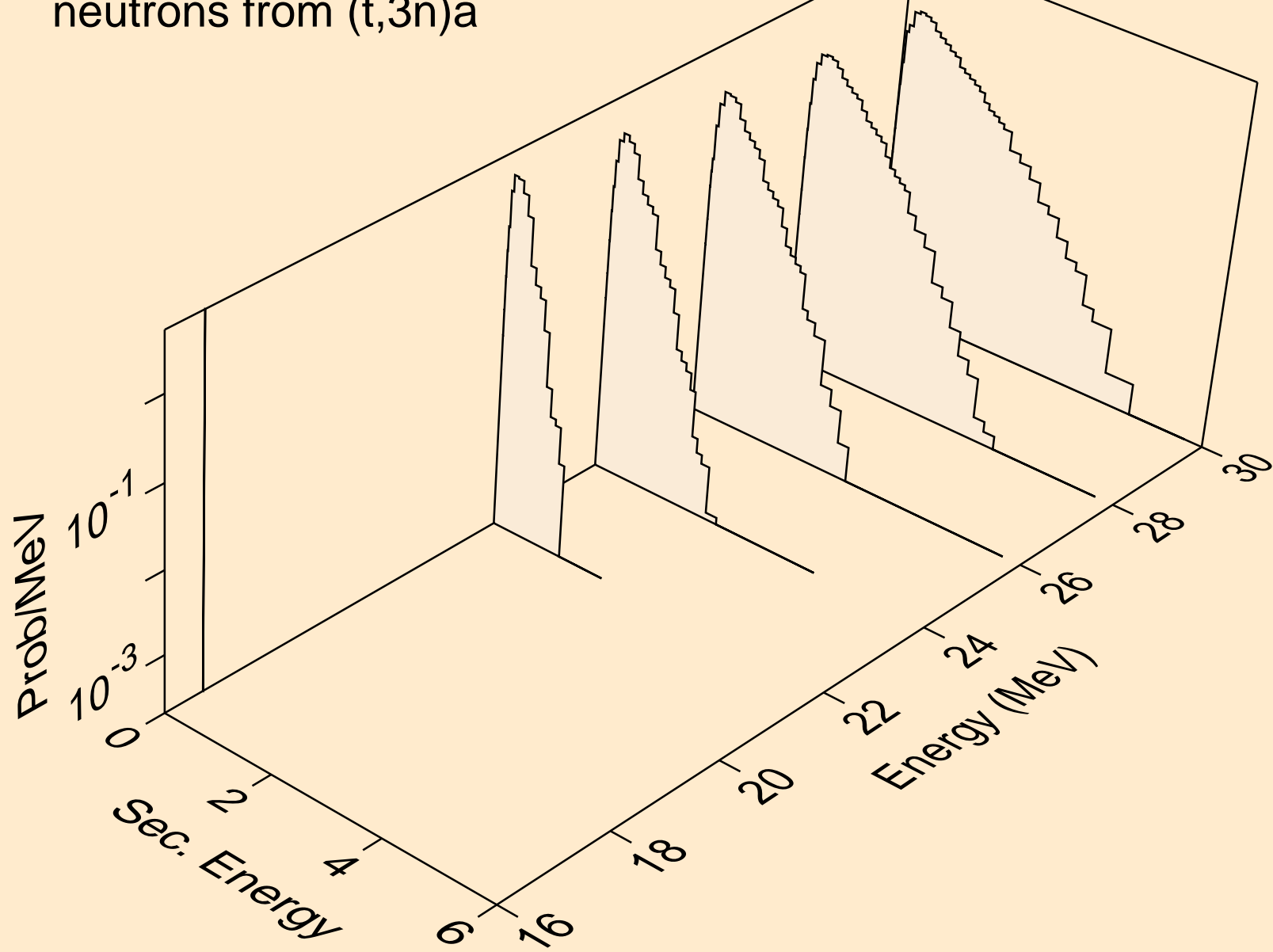

SN112 TRITON ACER TENDL-2021 LIBRARY; T=0.K  
neutrons from (t,n\*)p

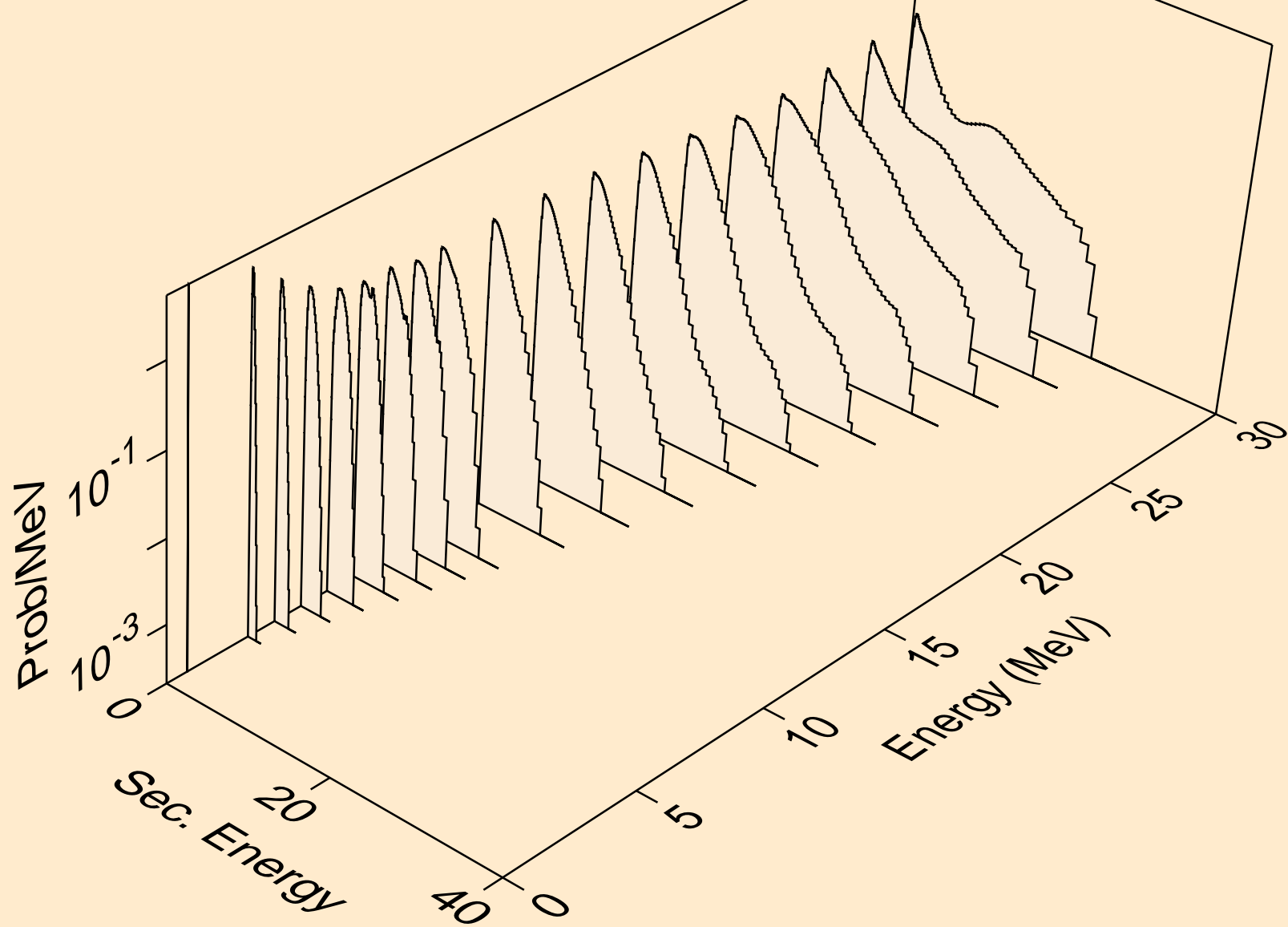



SN112 TRITON ACER TENDL-2021 LIBRARY; T=0.K  
neutrons from (t,n\*)2a

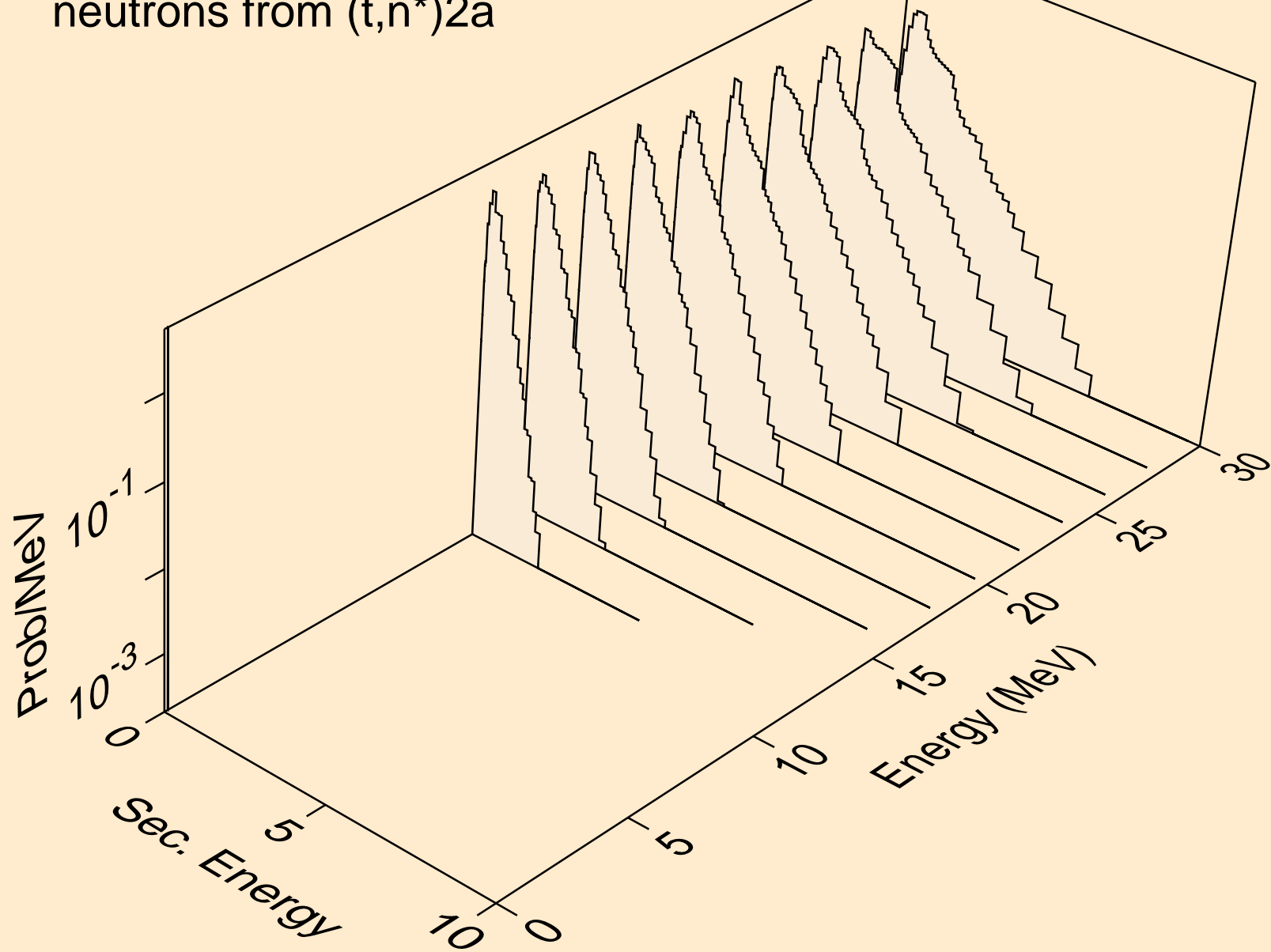

SN112 TRITON ACER TENDL-2021 LIBRARY; T=0.K  
neutrons from (t,2n)2a

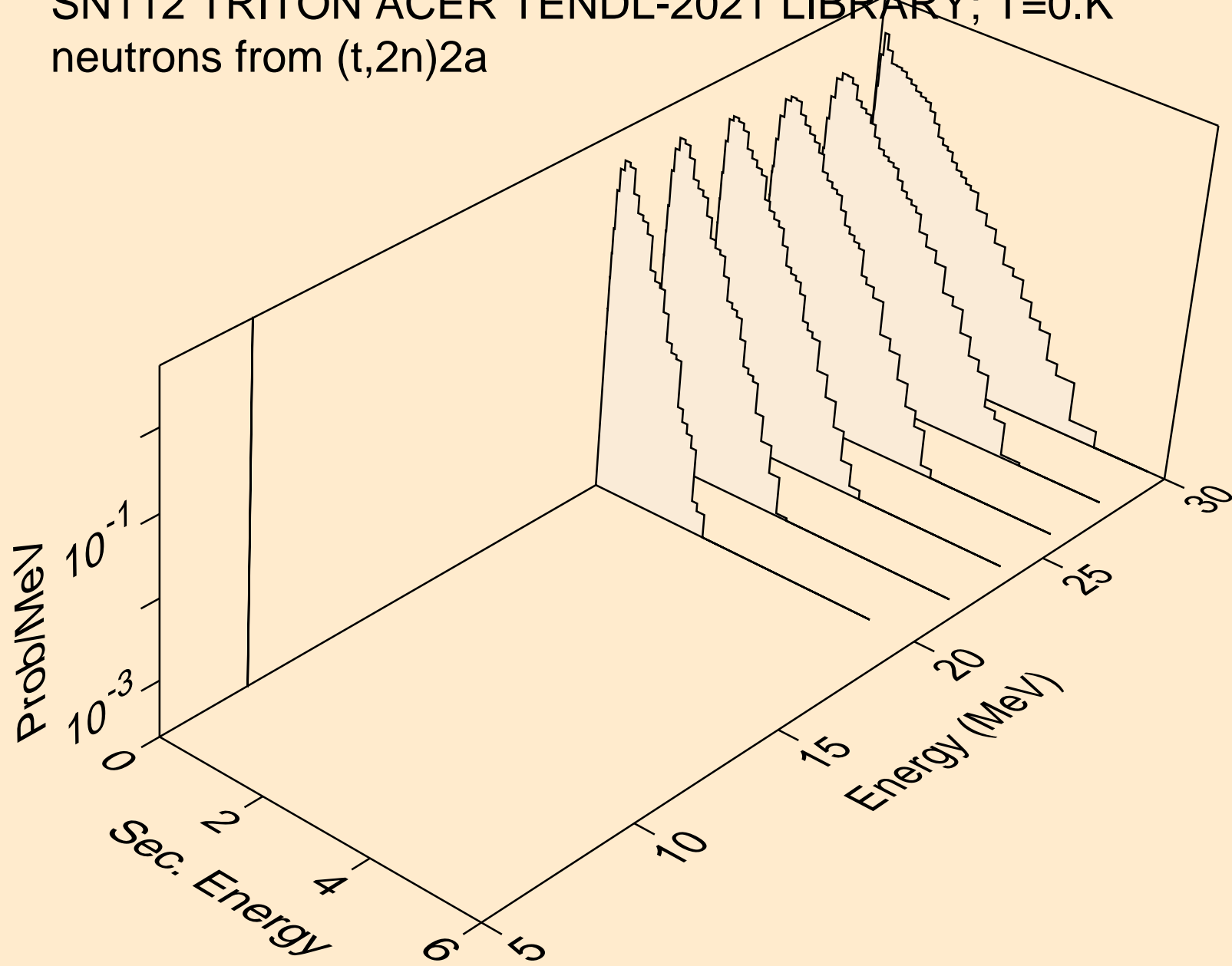

SN112 TRITON ACER TENDL-2021 LIBRARY; T=0.K  
neutrons from (t,n\*)d

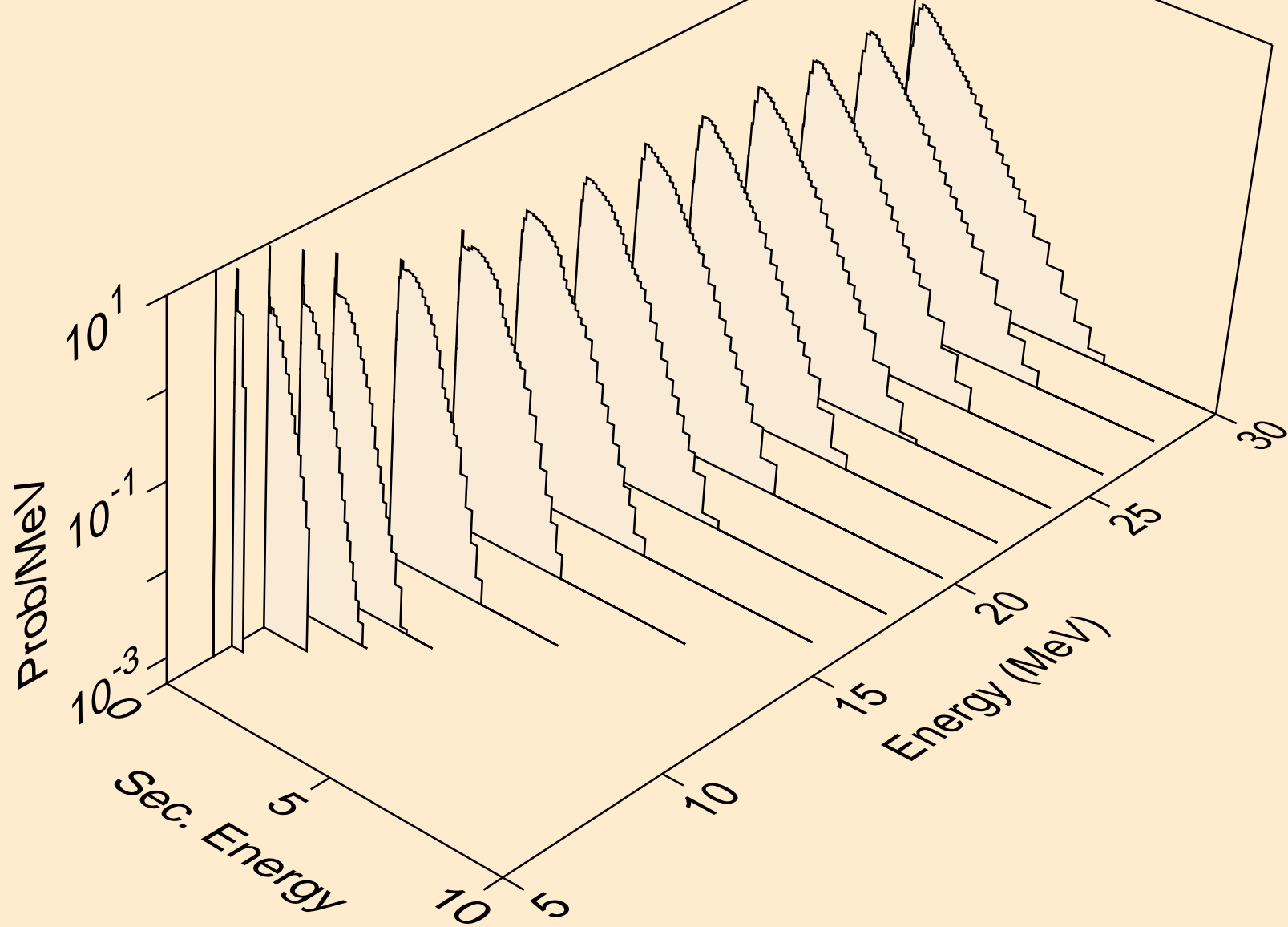

SN112 TRITON ACER TENDL-2021 LIBRARY; T=0.K  
neutrons from (t,n\*)t

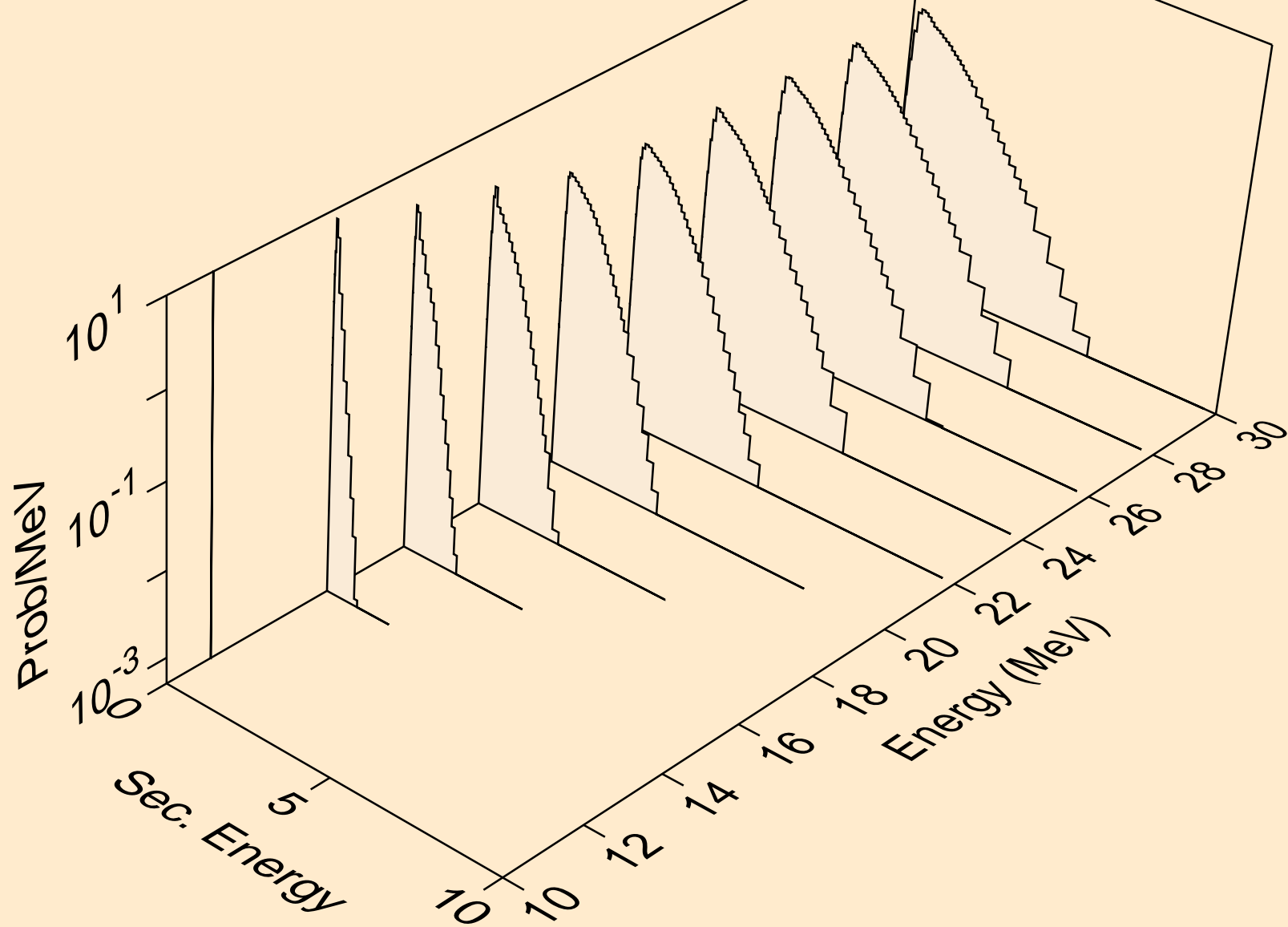

SN112 TRITON ACER TENDL-2021 LIBRARY; T=0.K  
neutrons from (t,n\*)he3

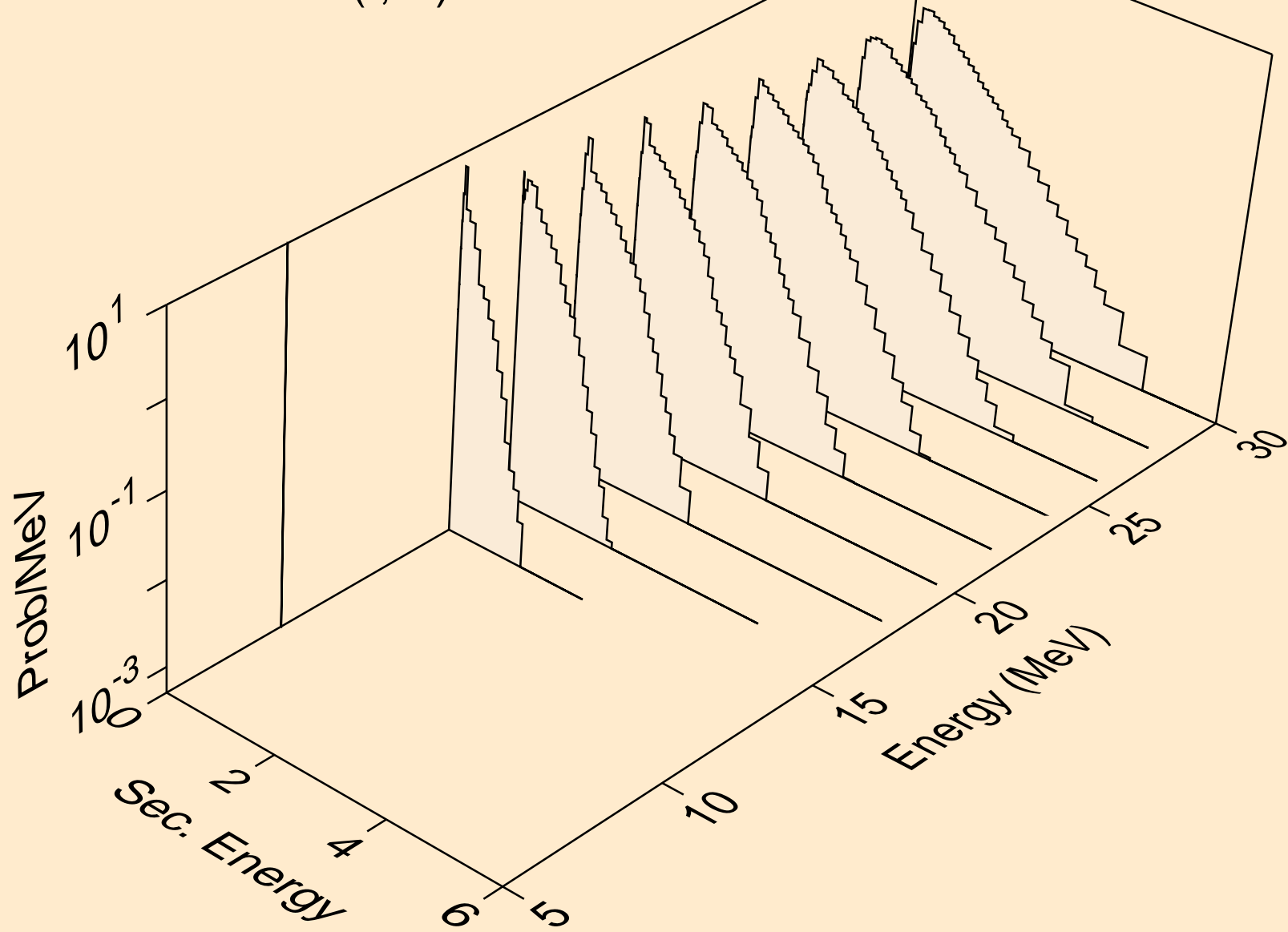

SN112 TRITON ACER TENDL-2021 LIBRARY; T=0.K  
neutrons from (t,4n)

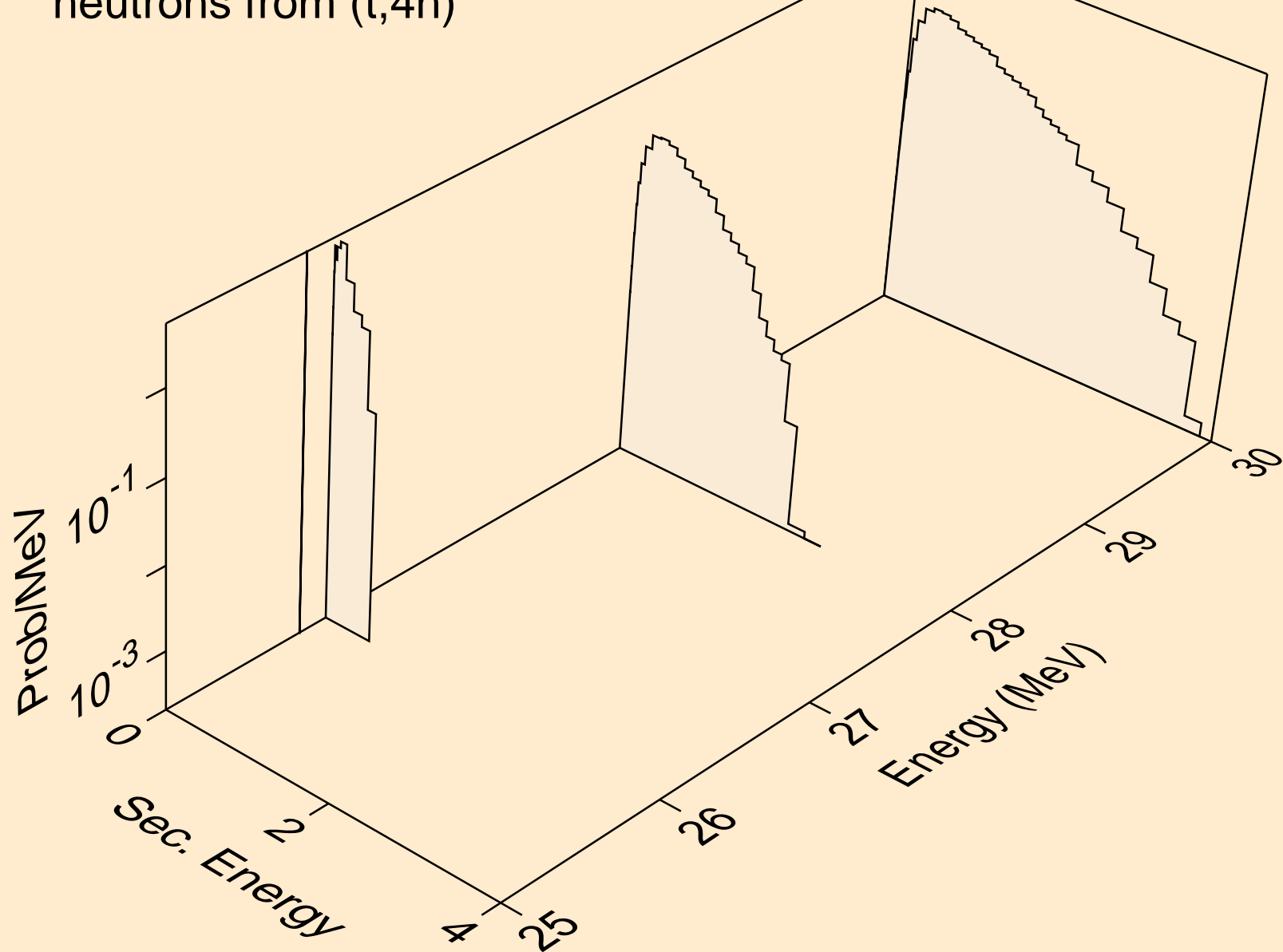

SN112 TRITON ACER TENDL-2021 LIBRARY; T=0.K  
neutrons from (t,2np)

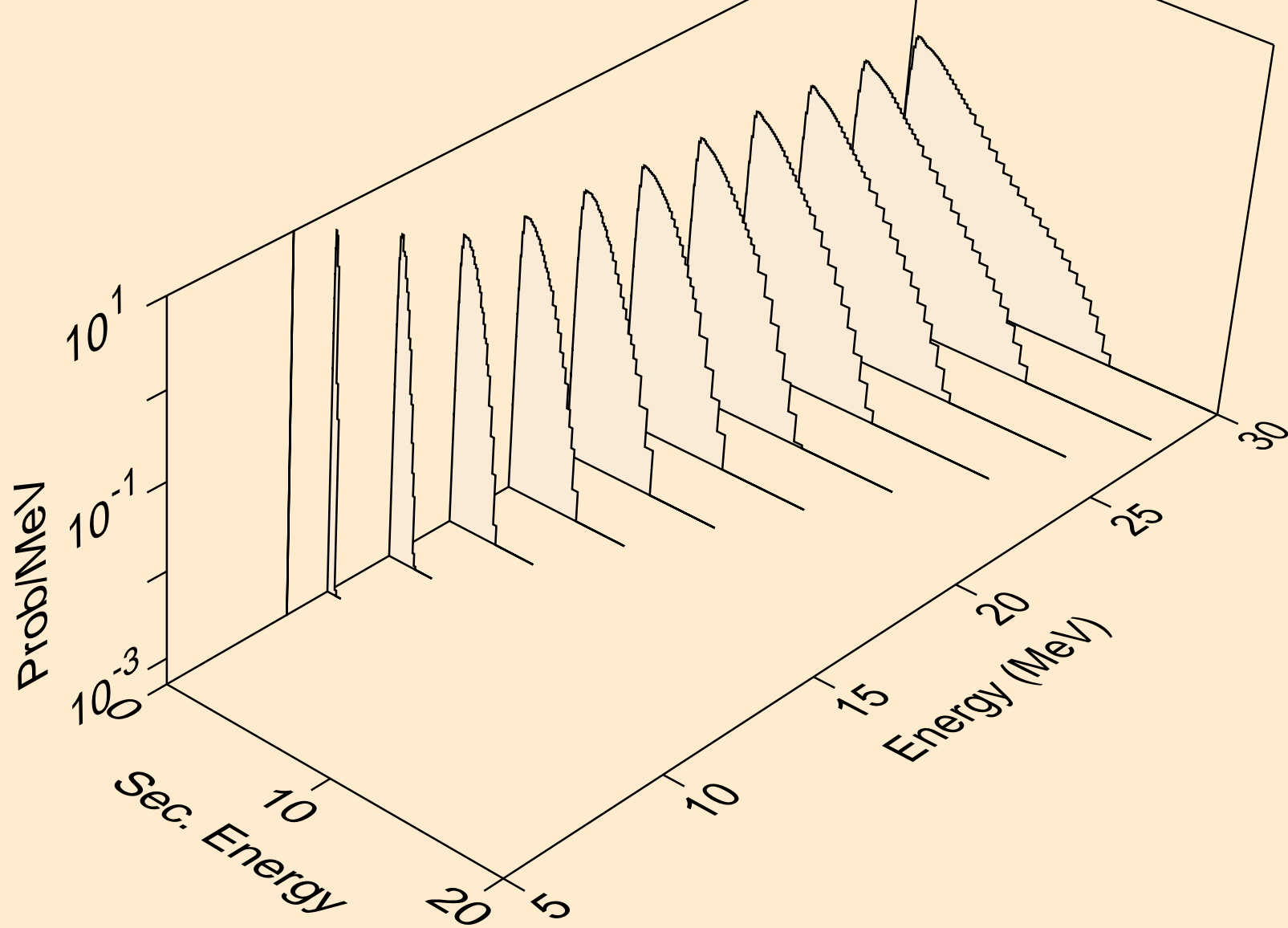

SN112 TRITON ACER TENDL-2021 LIBRARY; T=0.K  
neutrons from (t,3np)

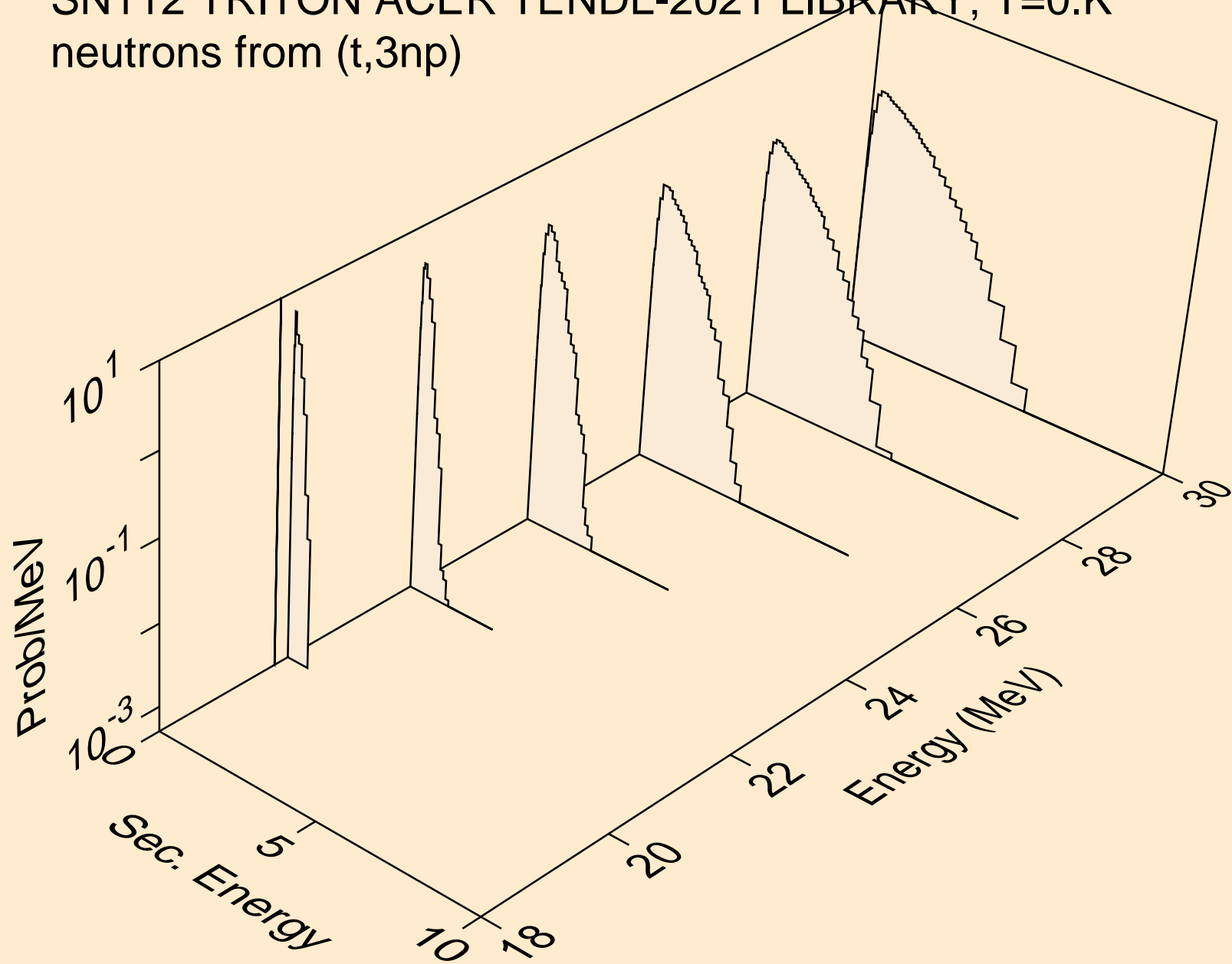



SN112 TRITON ACER TENDL-2021 LIBRARY; T=0.K  
neutrons from (t,2np)

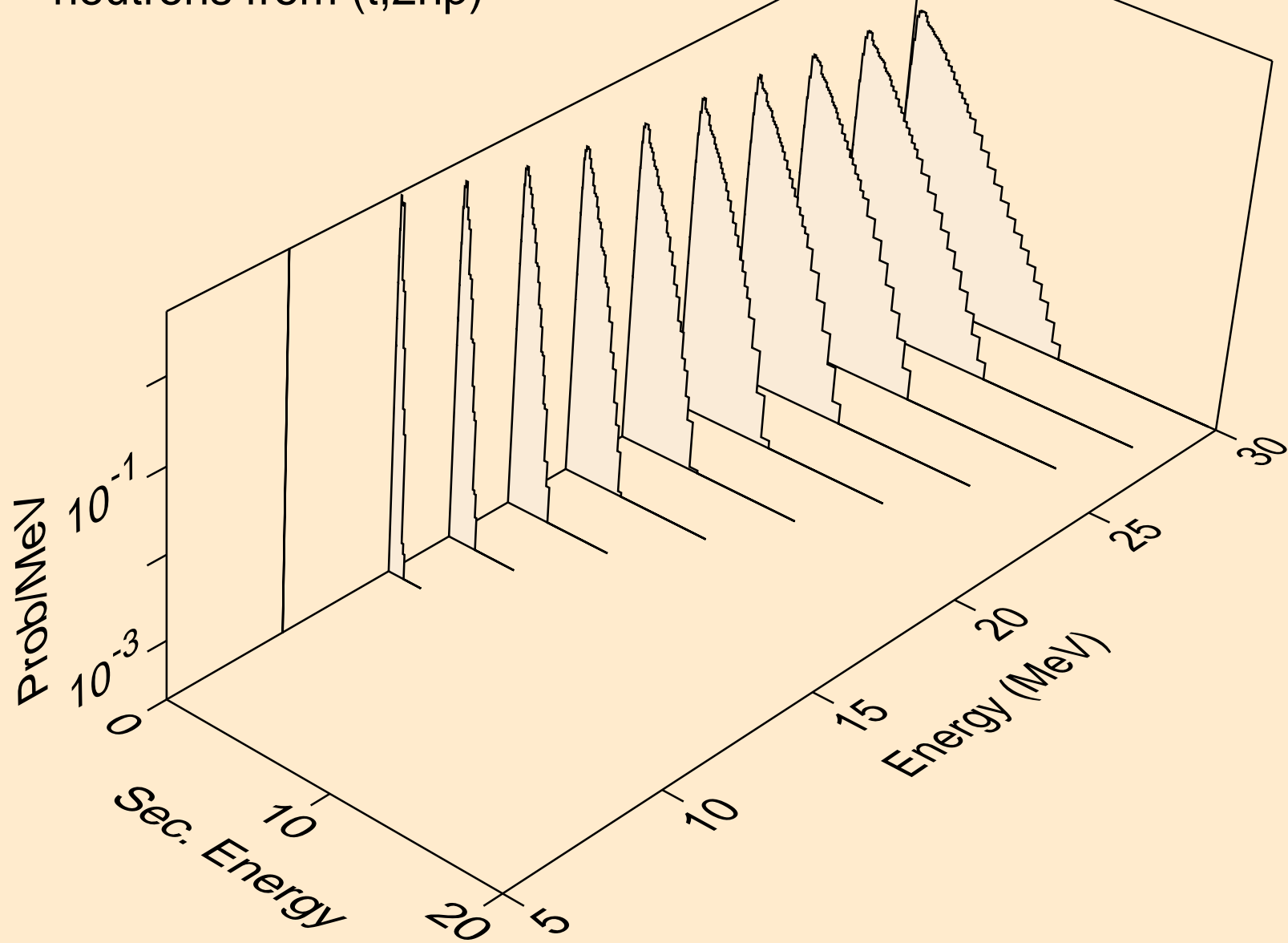

SN112 TRITON ACER TENDL-2021 LIBRARY; T=0.K  
neutrons from (t,npa)

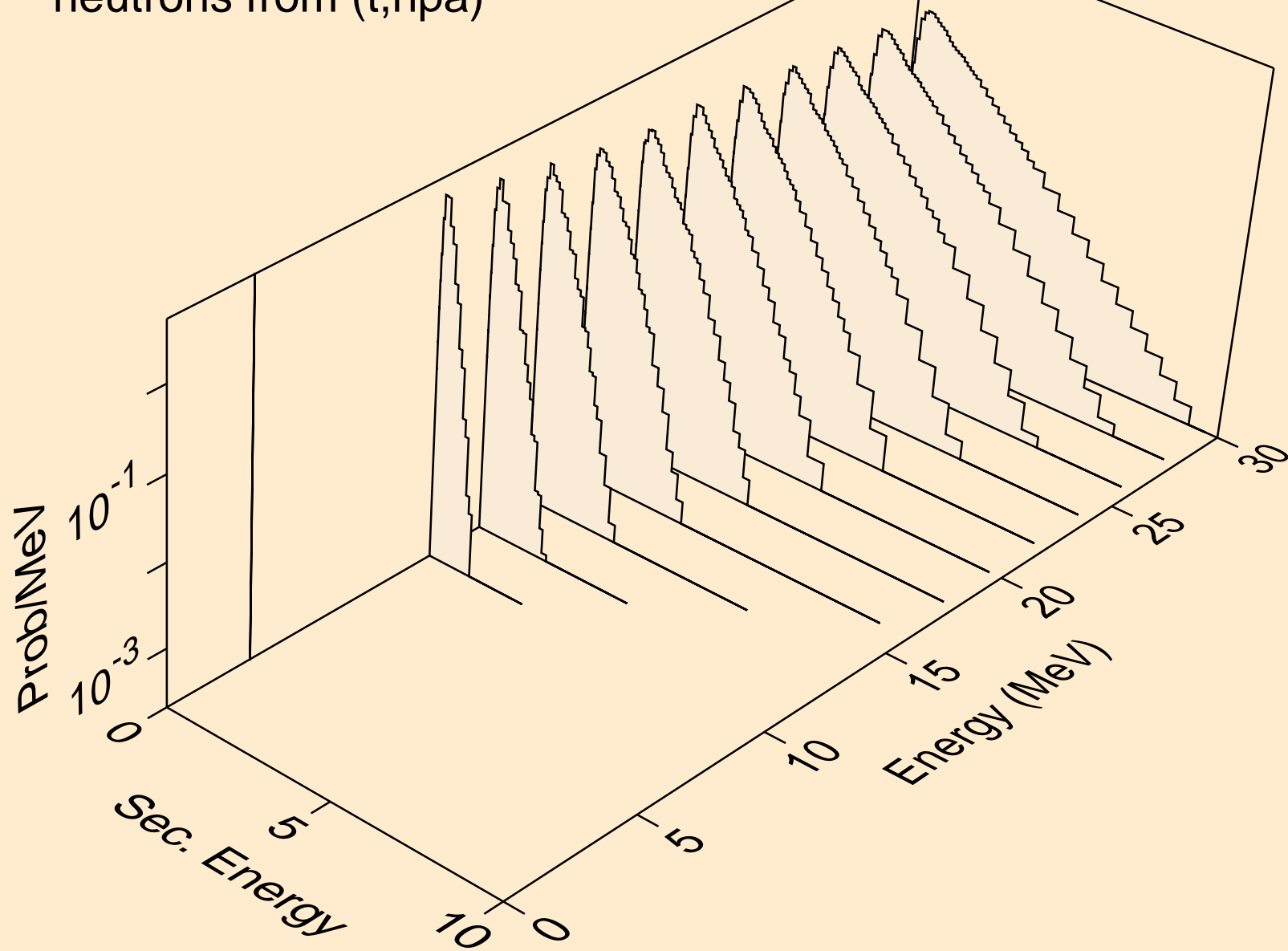

SN112 TRITON ACER TENDL-2021 LIBRARY; T=0.K  
protons from (t,x)

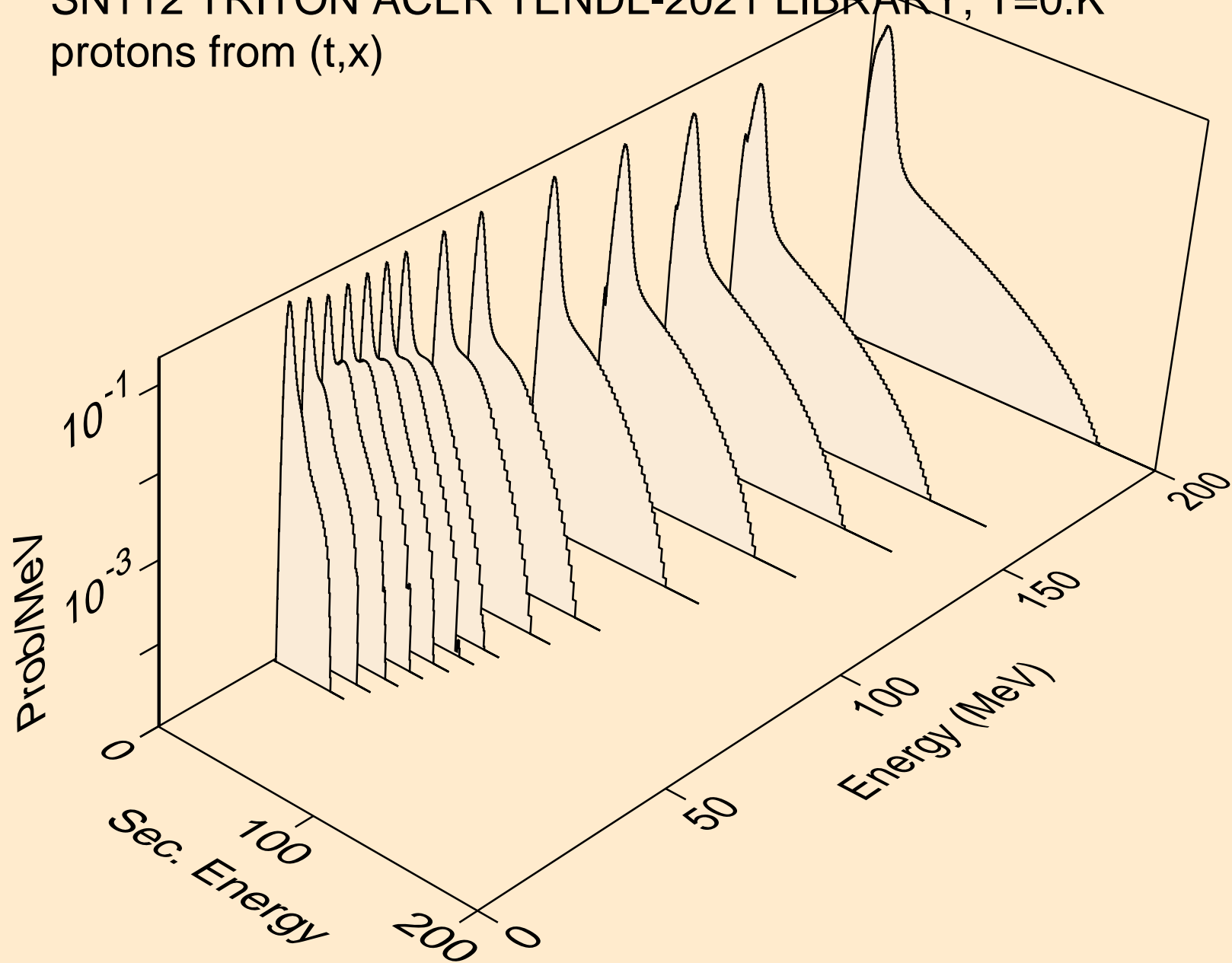

SN112 TRITON ACER TENDL-2021 LIBRARY; T=0.K  
protons from (t,n\*)p

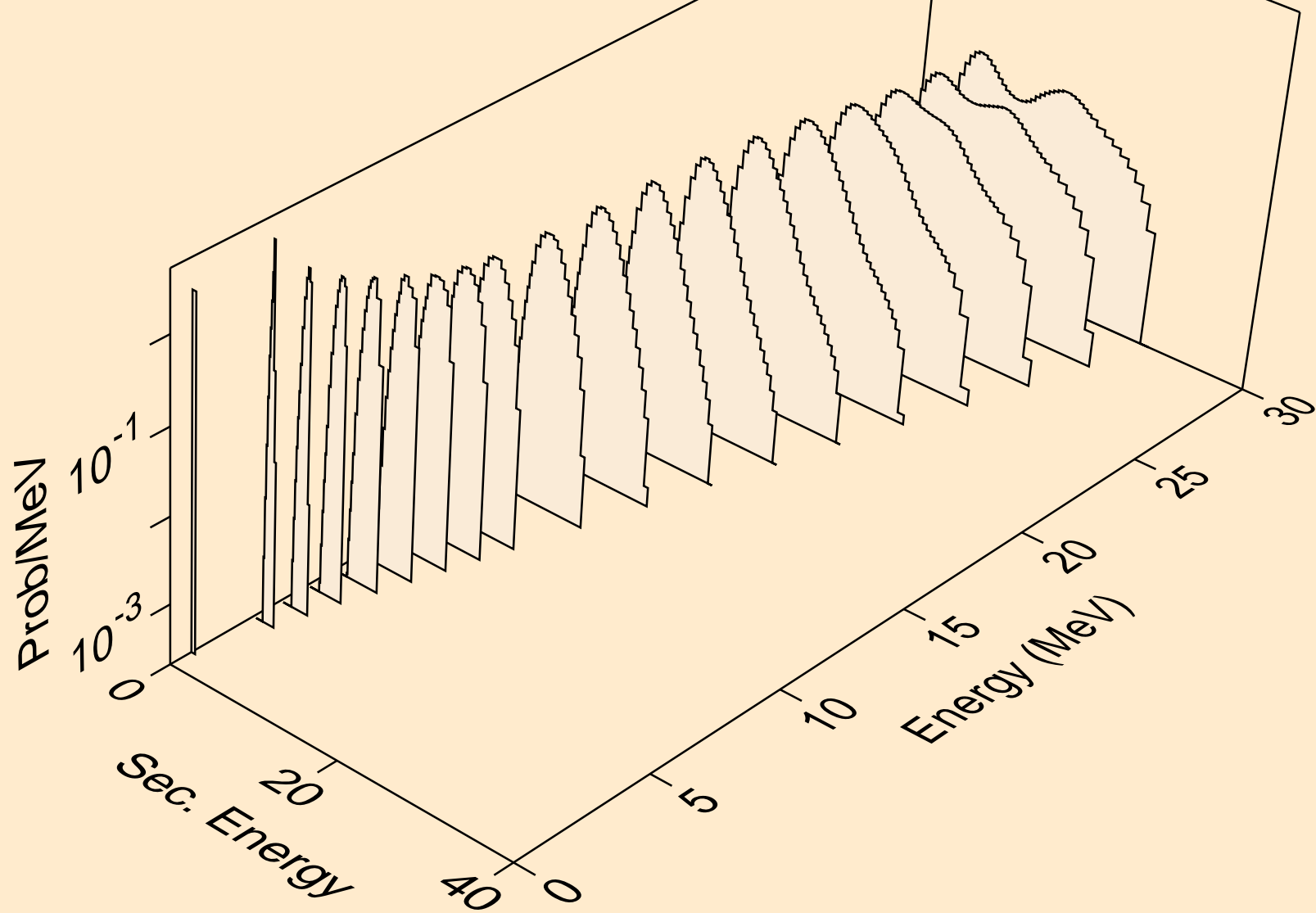

SN112 TRITON ACER TENDL-2021 LIBRARY; T=0.K  
protons from (t,2np)

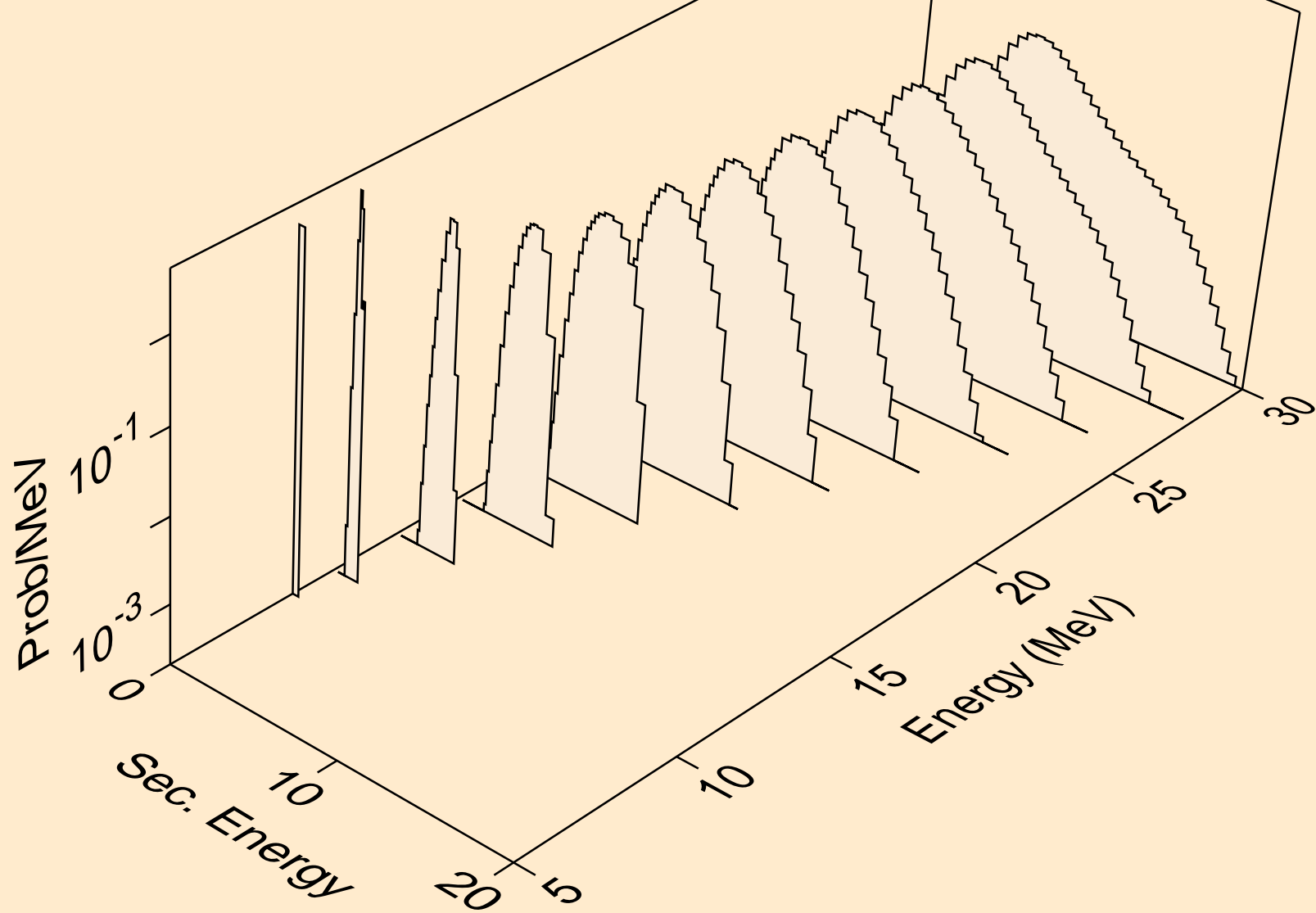

SN112 TRITON ACER TENDL-2021 LIBRARY; T=0.K  
protons from (t,3np)

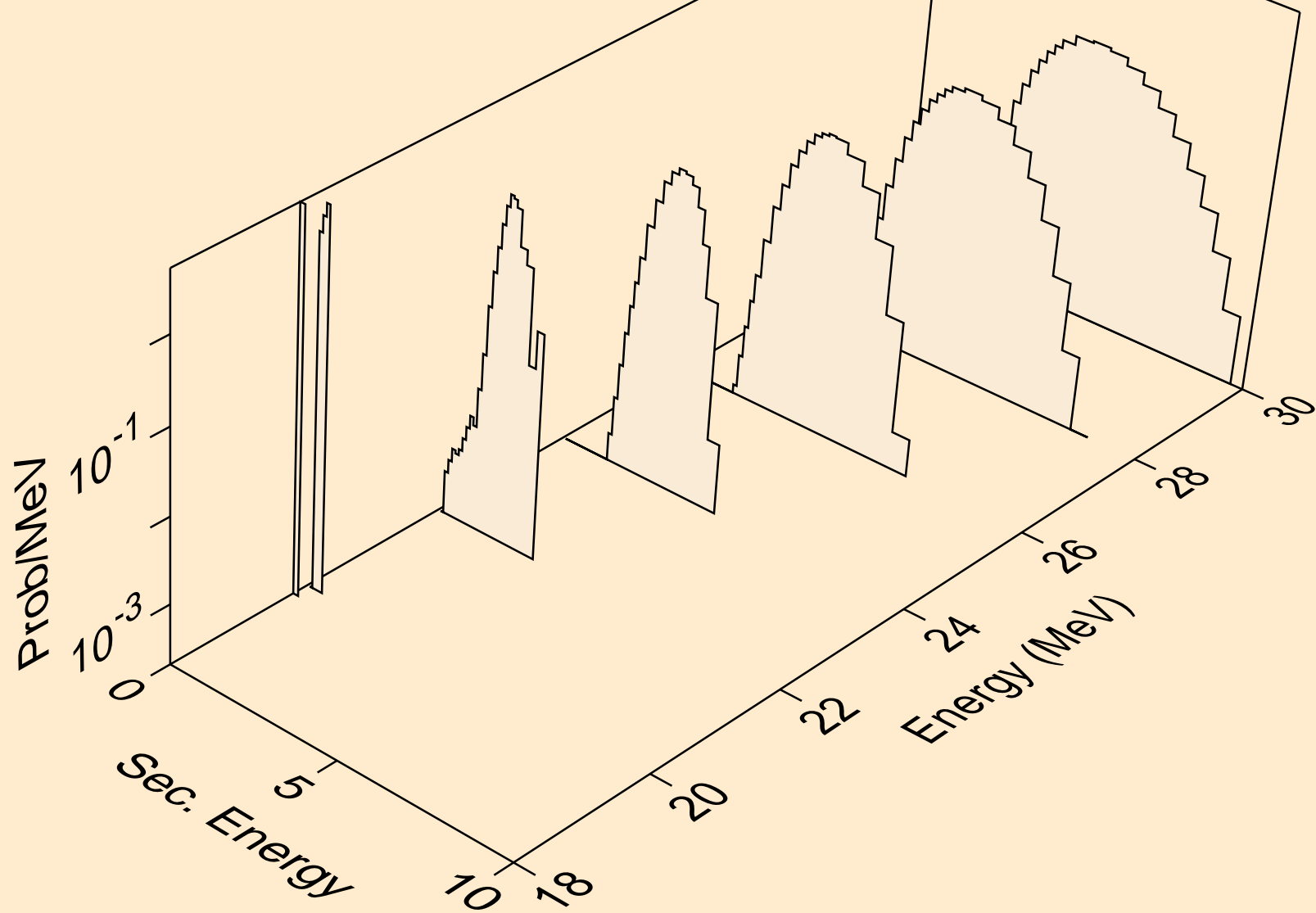

SN112 TRITON ACER TENDL-2021 LIBRARY; T=0.K  
protons from (t,2np)

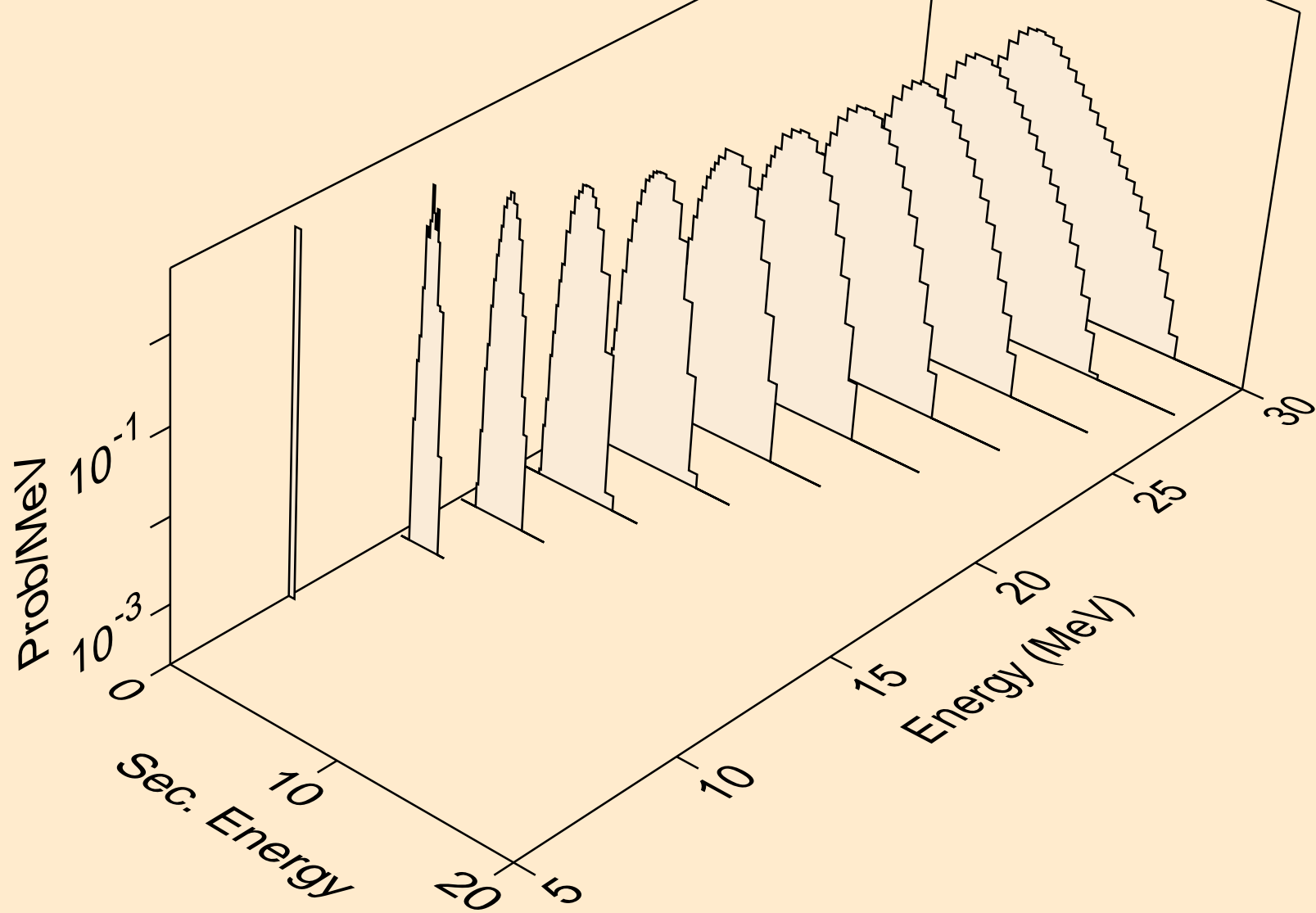

SN112 TRITON ACER TENDL-2021 LIBRARY; T=0.K  
protons from (t,npa)

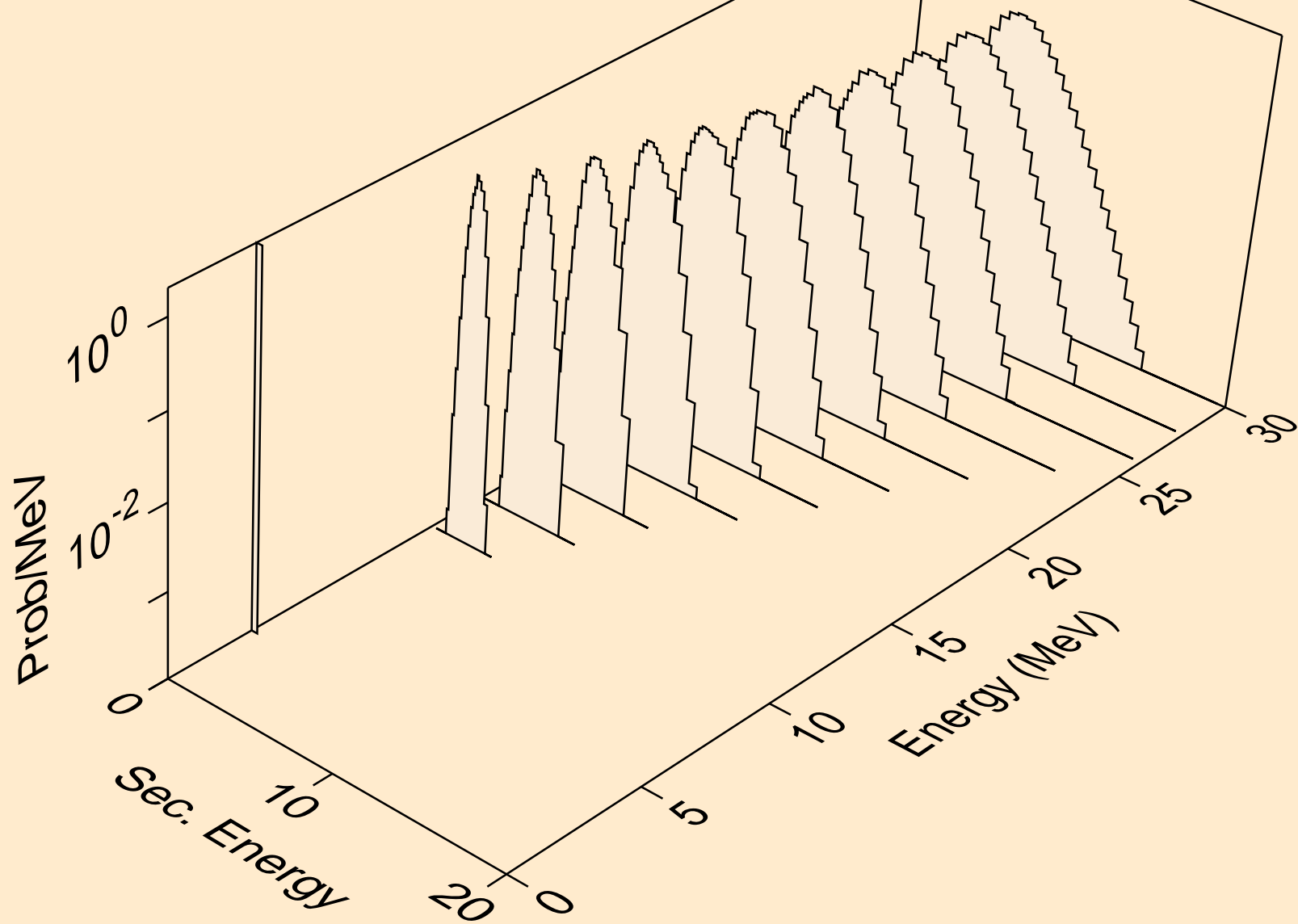



SN112 TRITON ACER TENDL-2021 LIBRARY; T=0.K  
protons from (t,p)

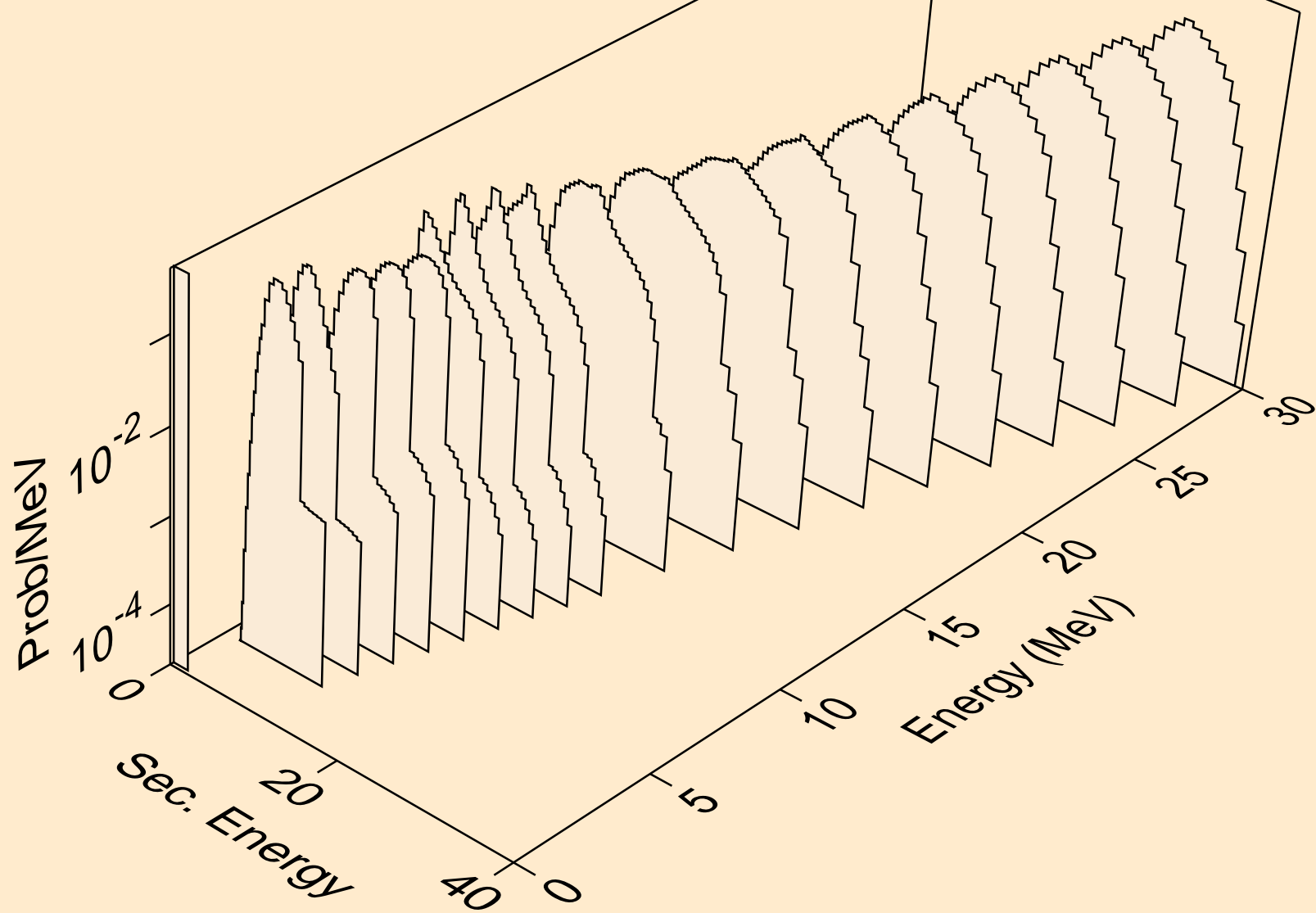

SN112 TRITON ACER TENDL-2021 LIBRARY; T=0.K  
protons from (t,2p)

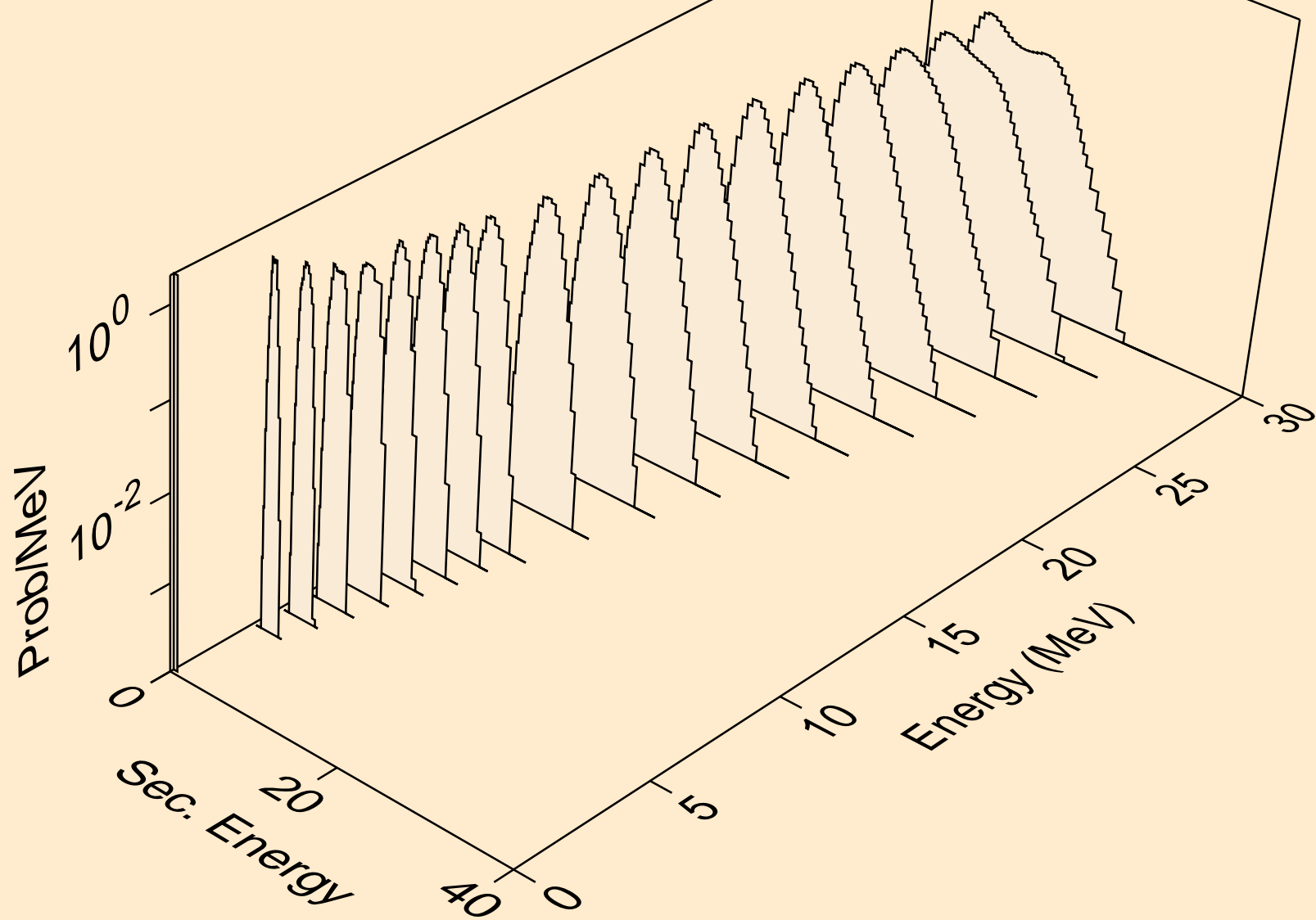

SN112 TRITON ACER TENDL-2021 LIBRARY; T=0.K  
protons from (t,pa)

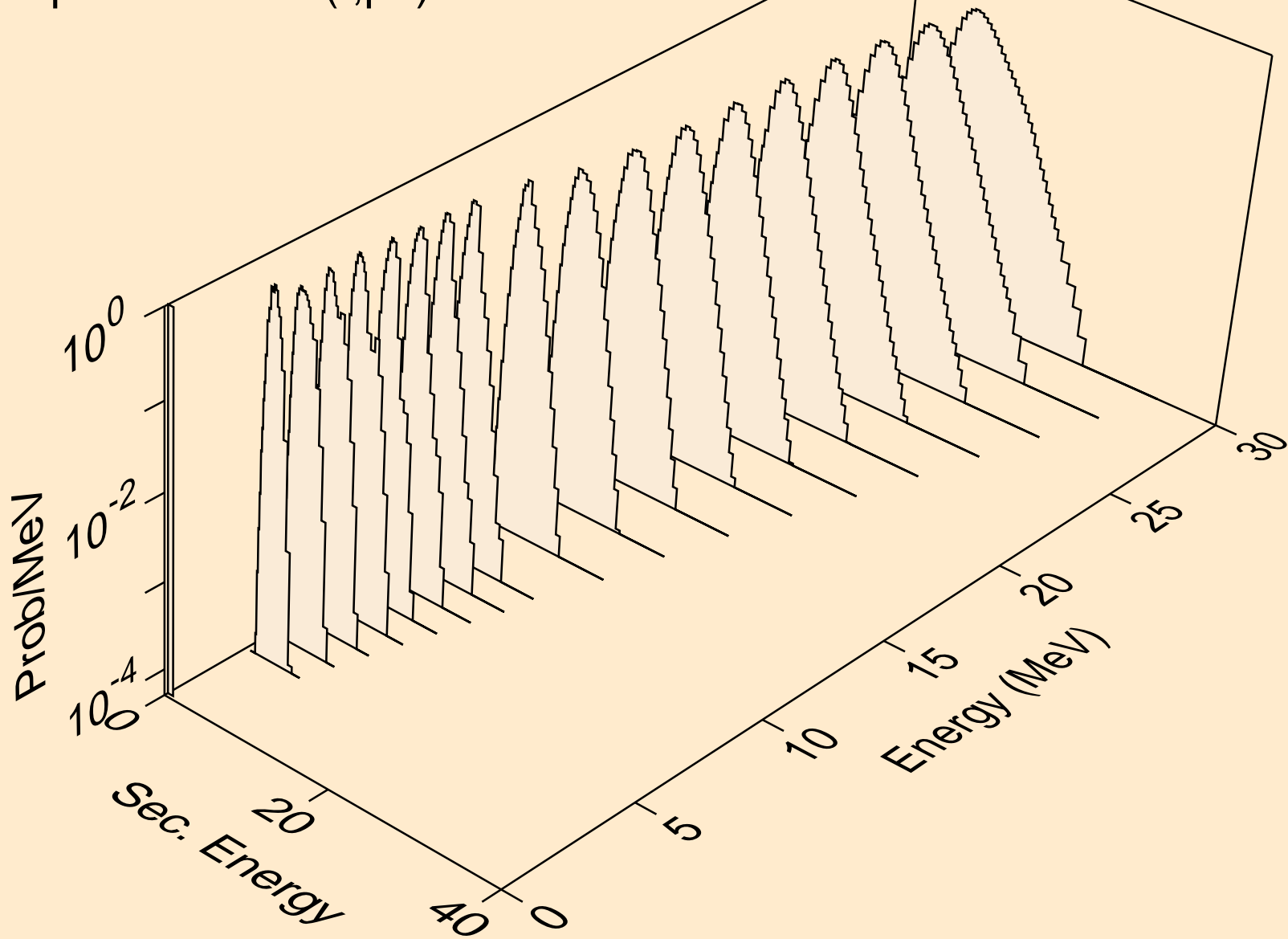

SN112 TRITON ACER TENDL-2021 LIBRARY; T=0.K  
protons from (t,pd)

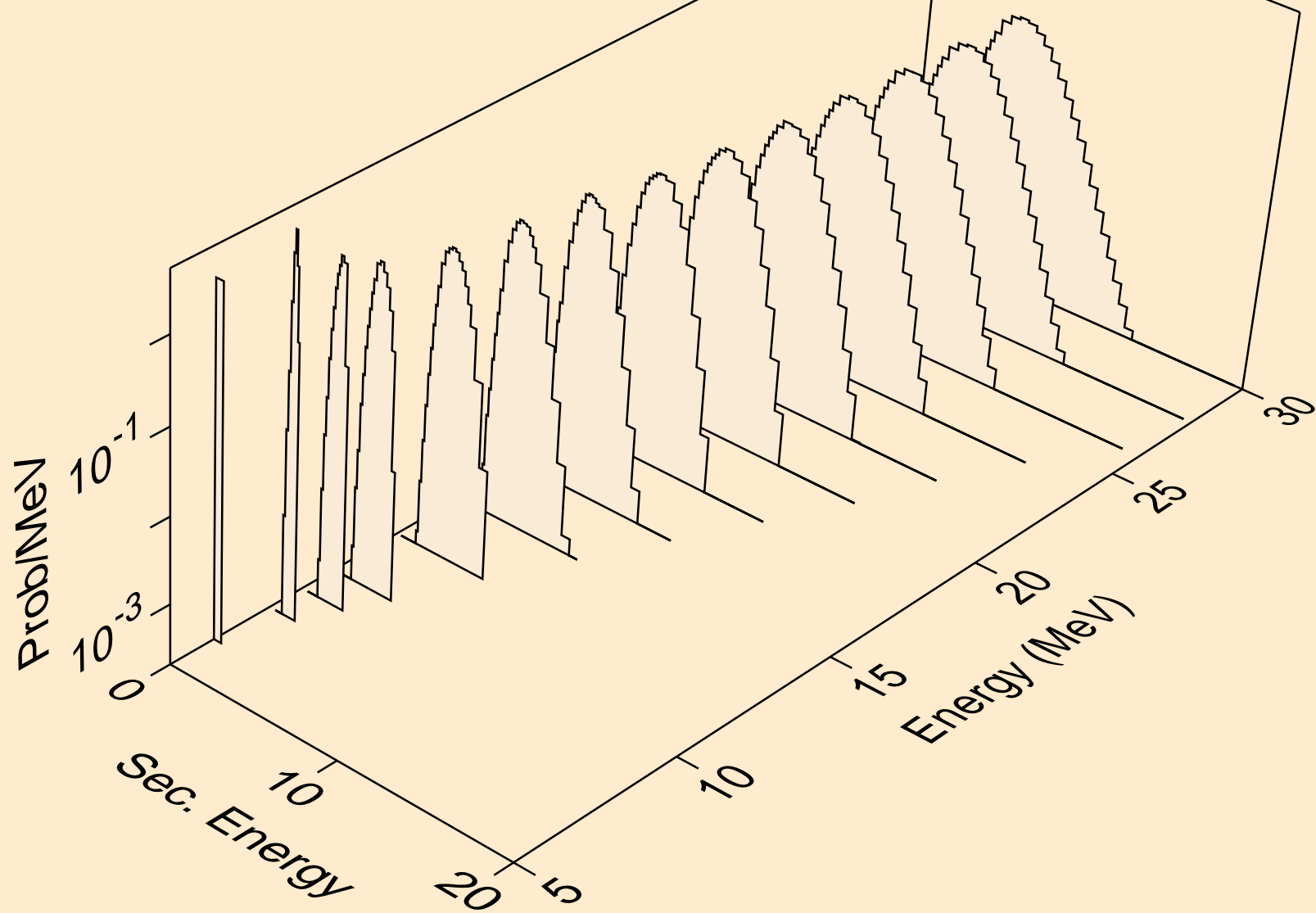

SN112 TRITON ACER TENDL-2021 LIBRARY; T=0.K  
protons from (t,pt)

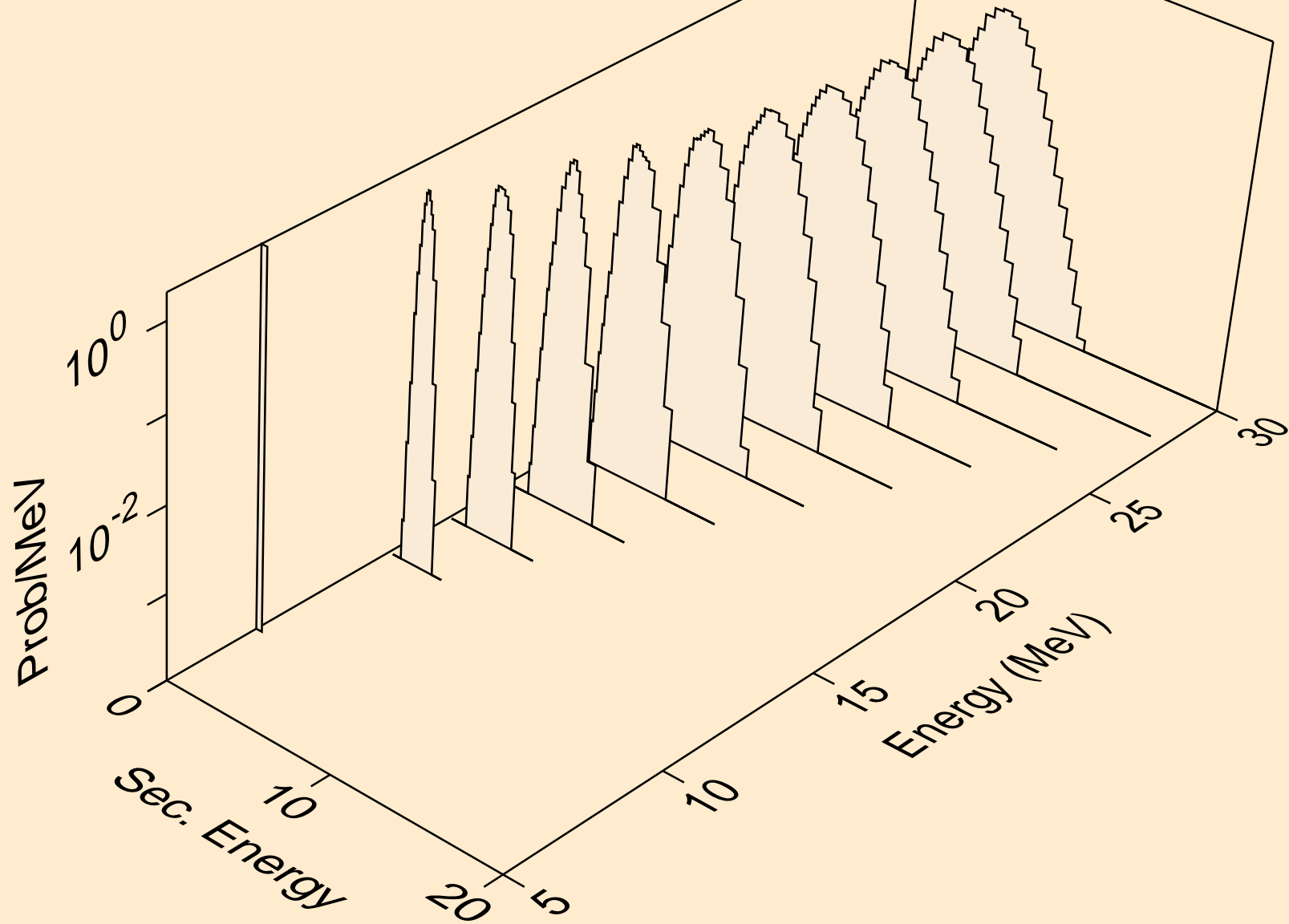

SN112 TRITON ACER TENDL-2021 LIBRARY; T=0.K  
deuterons from (t,x)

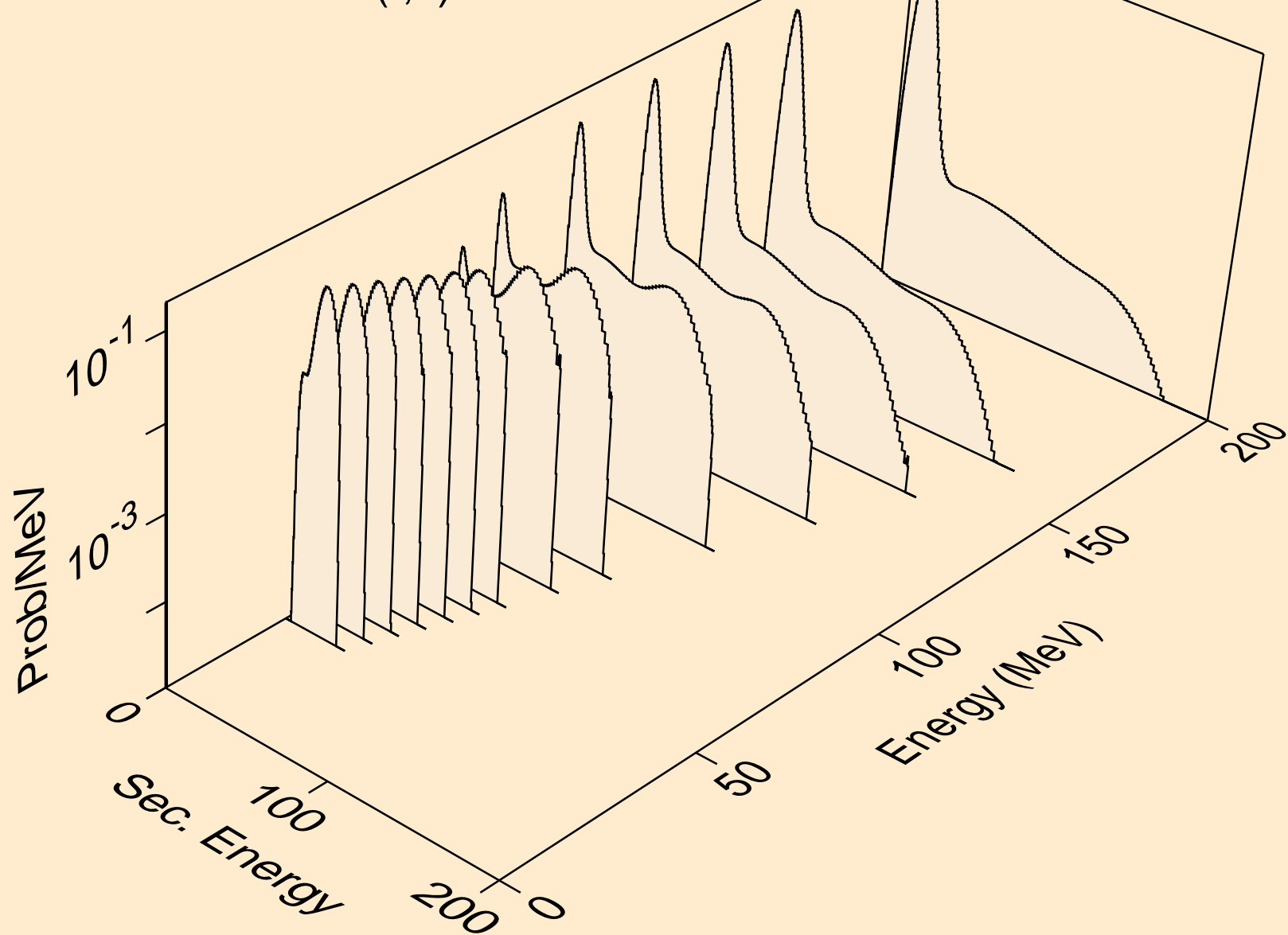

SN112 TRITON ACER TENDL-2021 LIBRARY; T=0.K  
deuterons from (t,2nd)

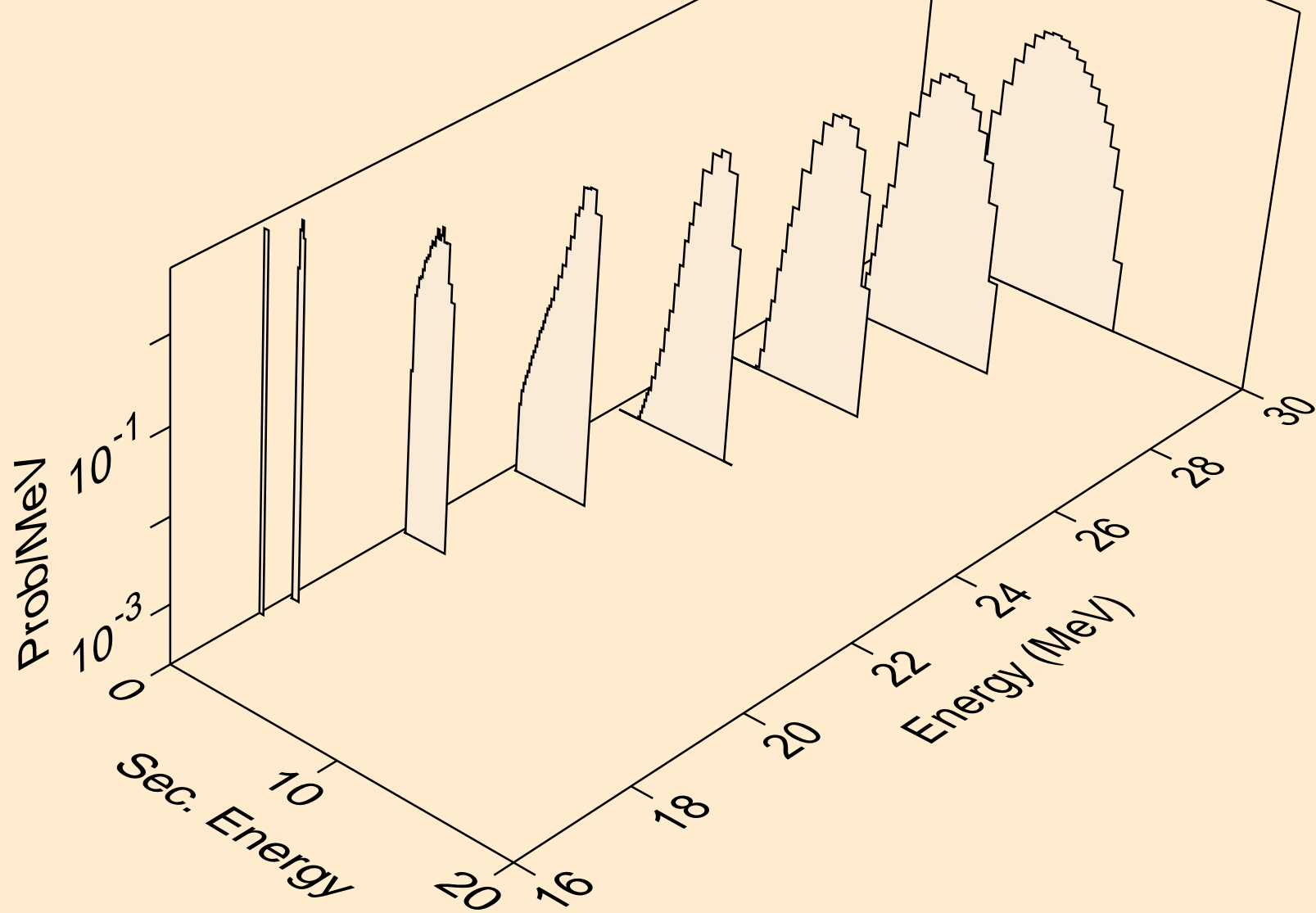

SN112 TRITON ACER TENDL-2021 LIBRARY; T=0.K  
deuterons from (t,n\*)d

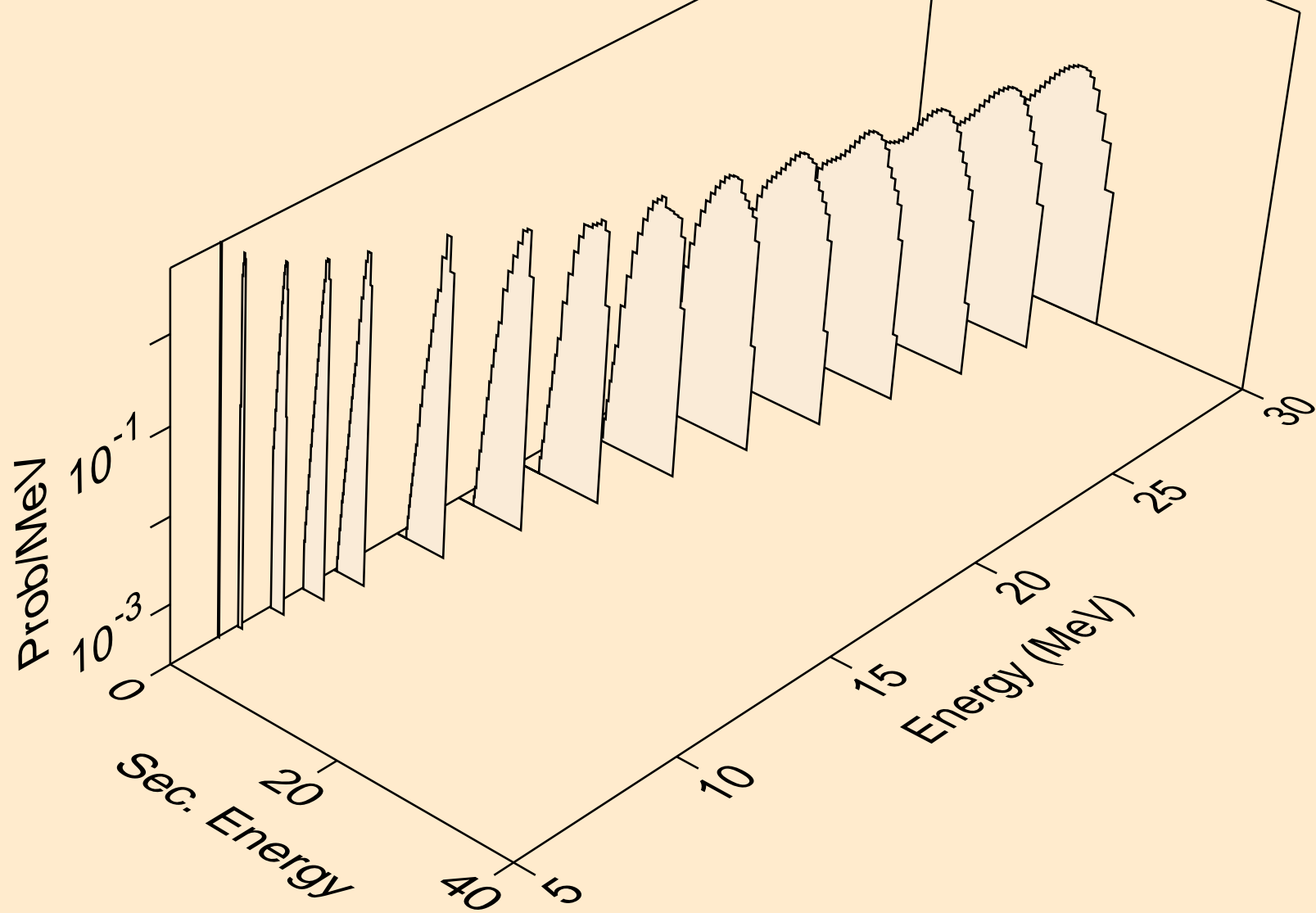



SN112 TRITON ACER TENDL-2021 LIBRARY; T=0.K  
deuterons from (t,d)

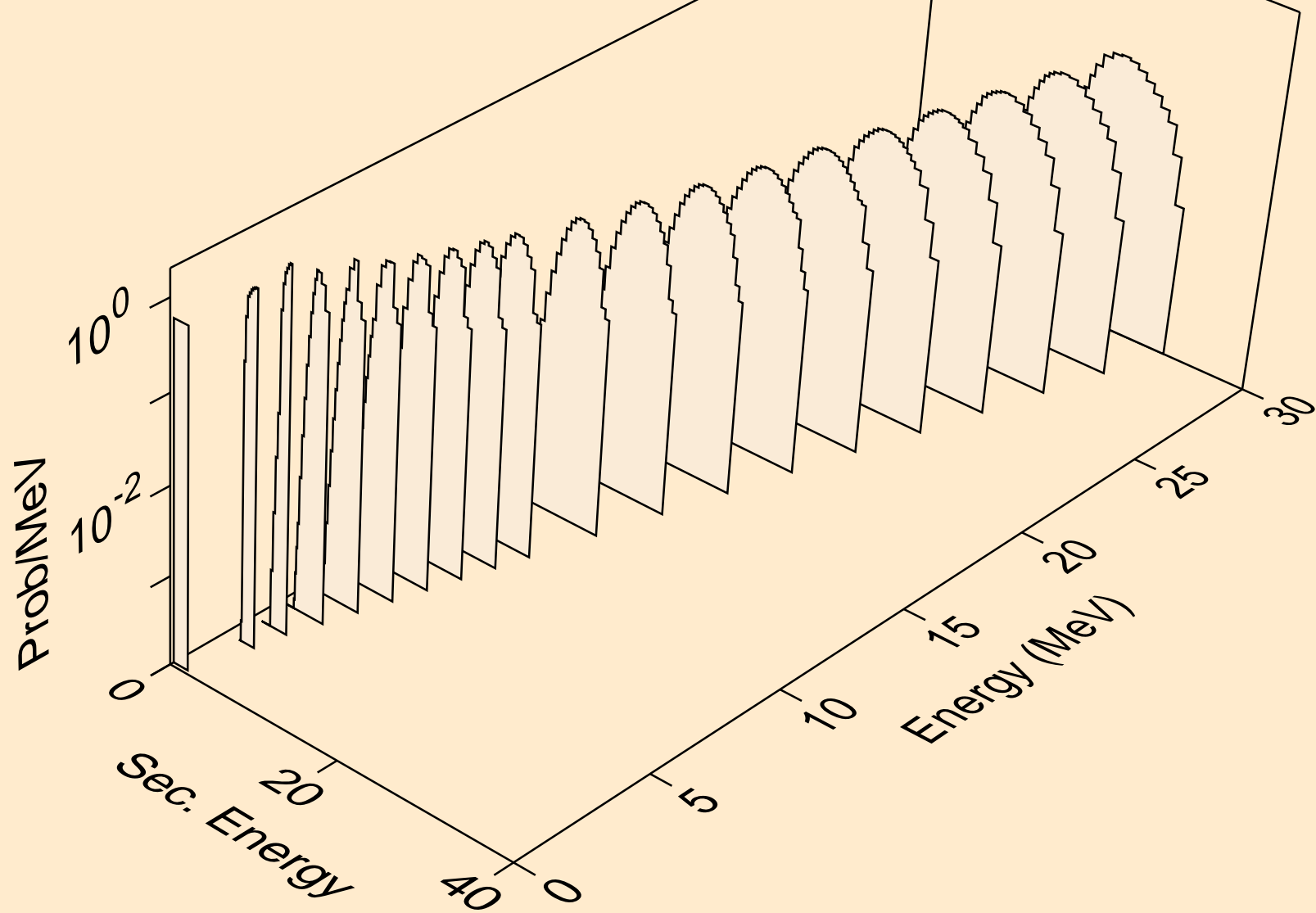

SN112 TRITON ACER TENDL-2021 LIBRARY; T=0.K  
deuterons from (t,pd)

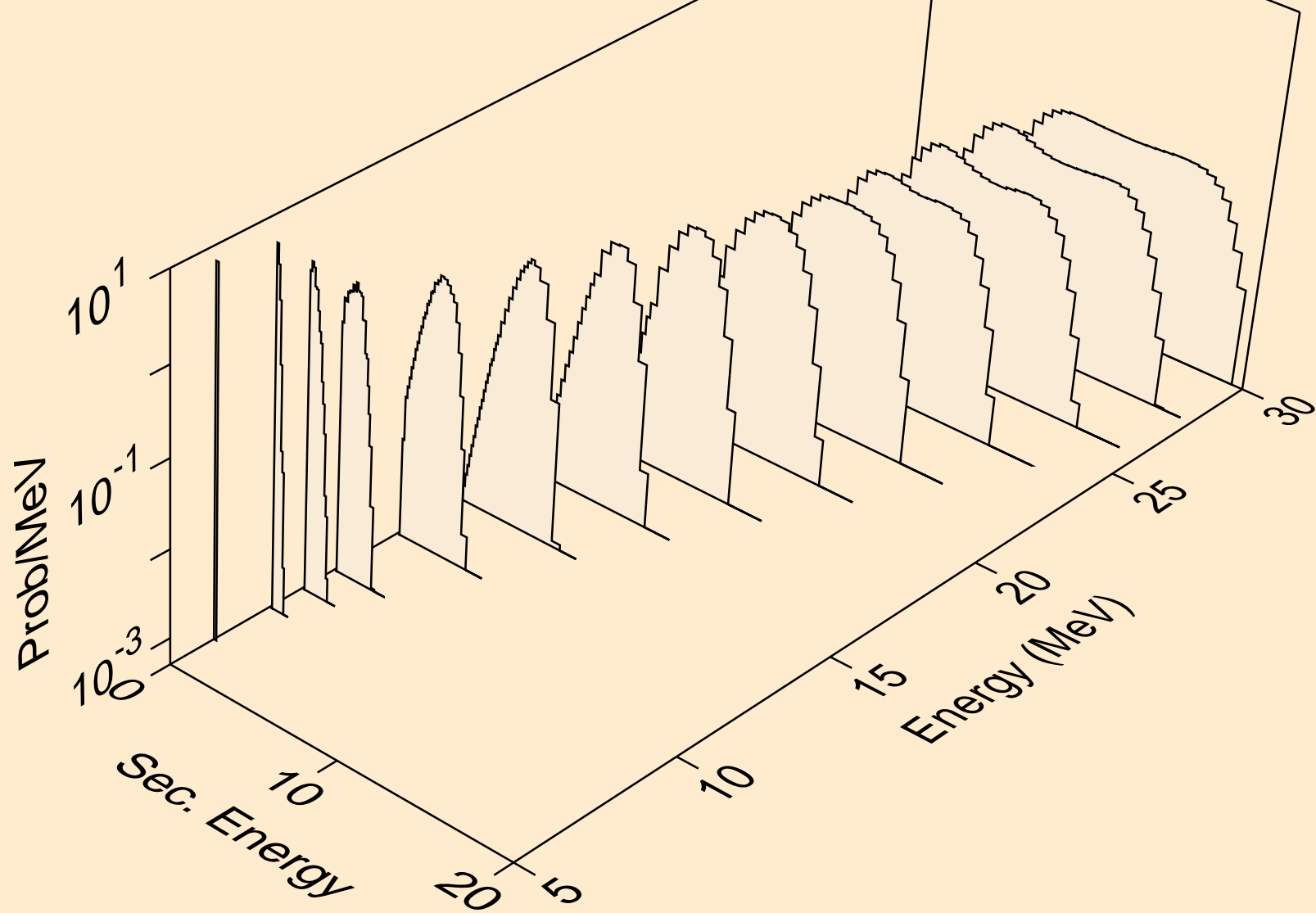

SN112 TRITON ACER TENDL-2021 LIBRARY; T=0.K  
deuterons from (t,da)

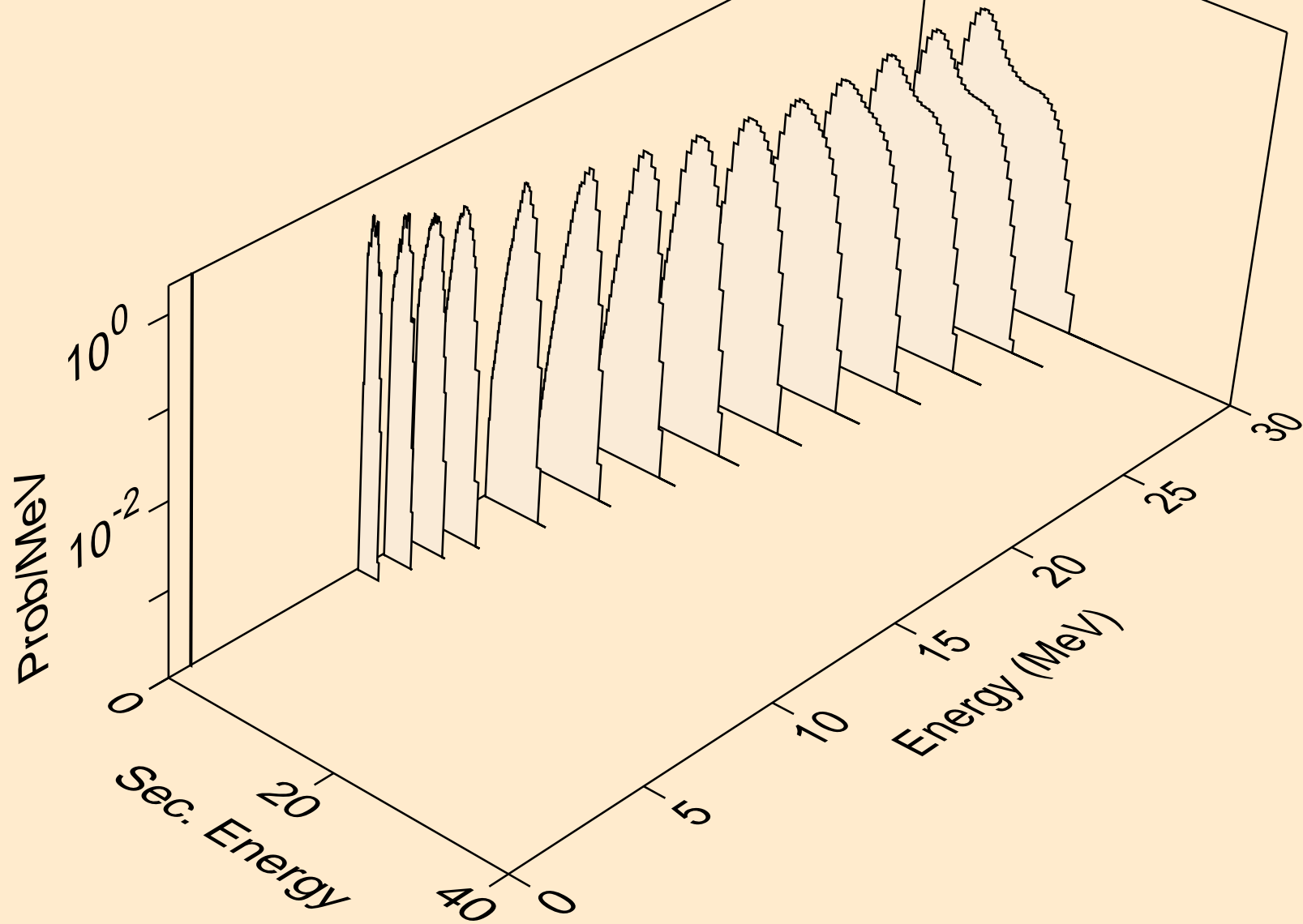

SN112 TRITON ACER TENDL-2021 LIBRARY; T=0.K  
he3s from (t,x)

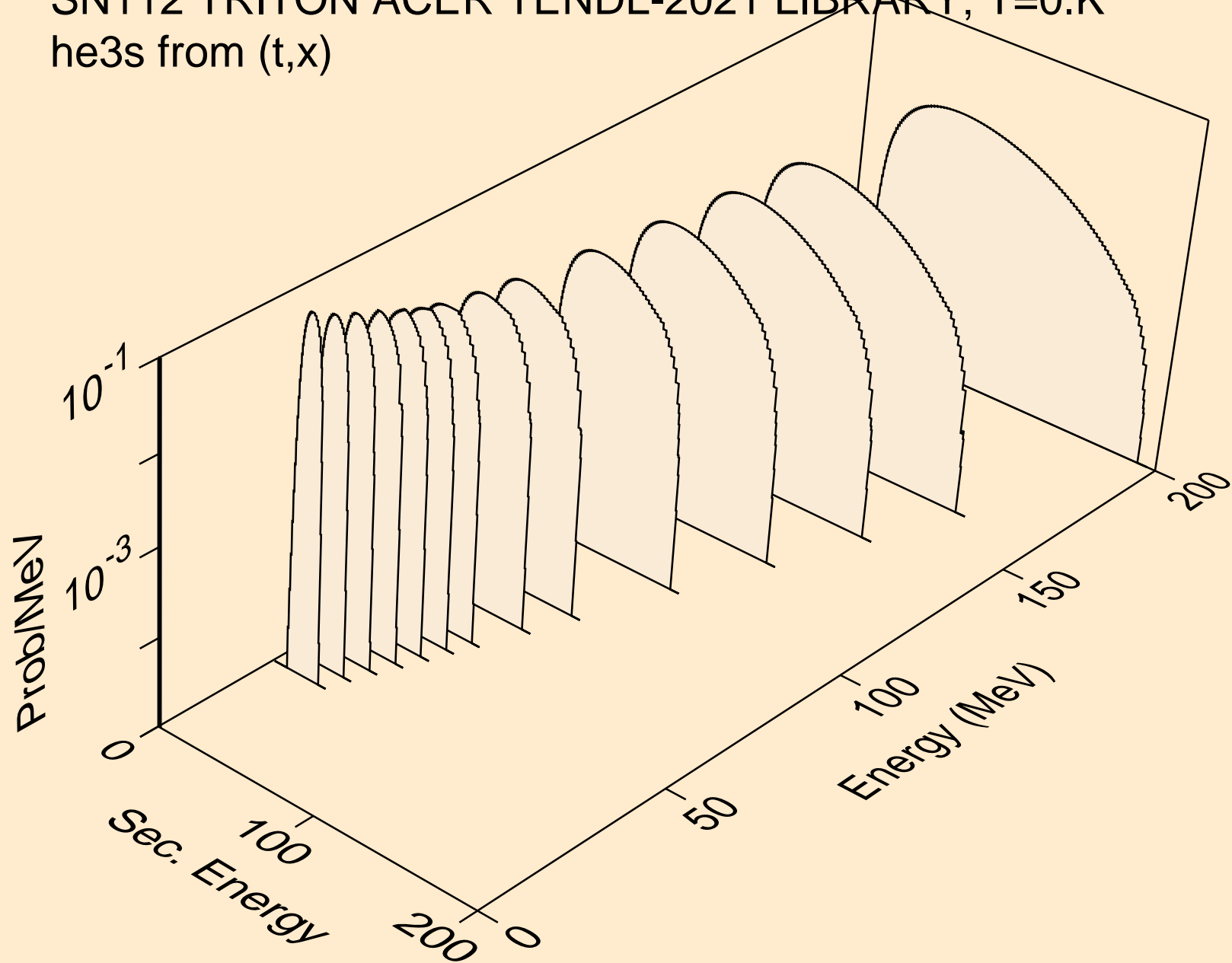

SN112 TRITON ACER TENDL-2021 LIBRARY; T=0.K  
he3s from (t,n\*)he3

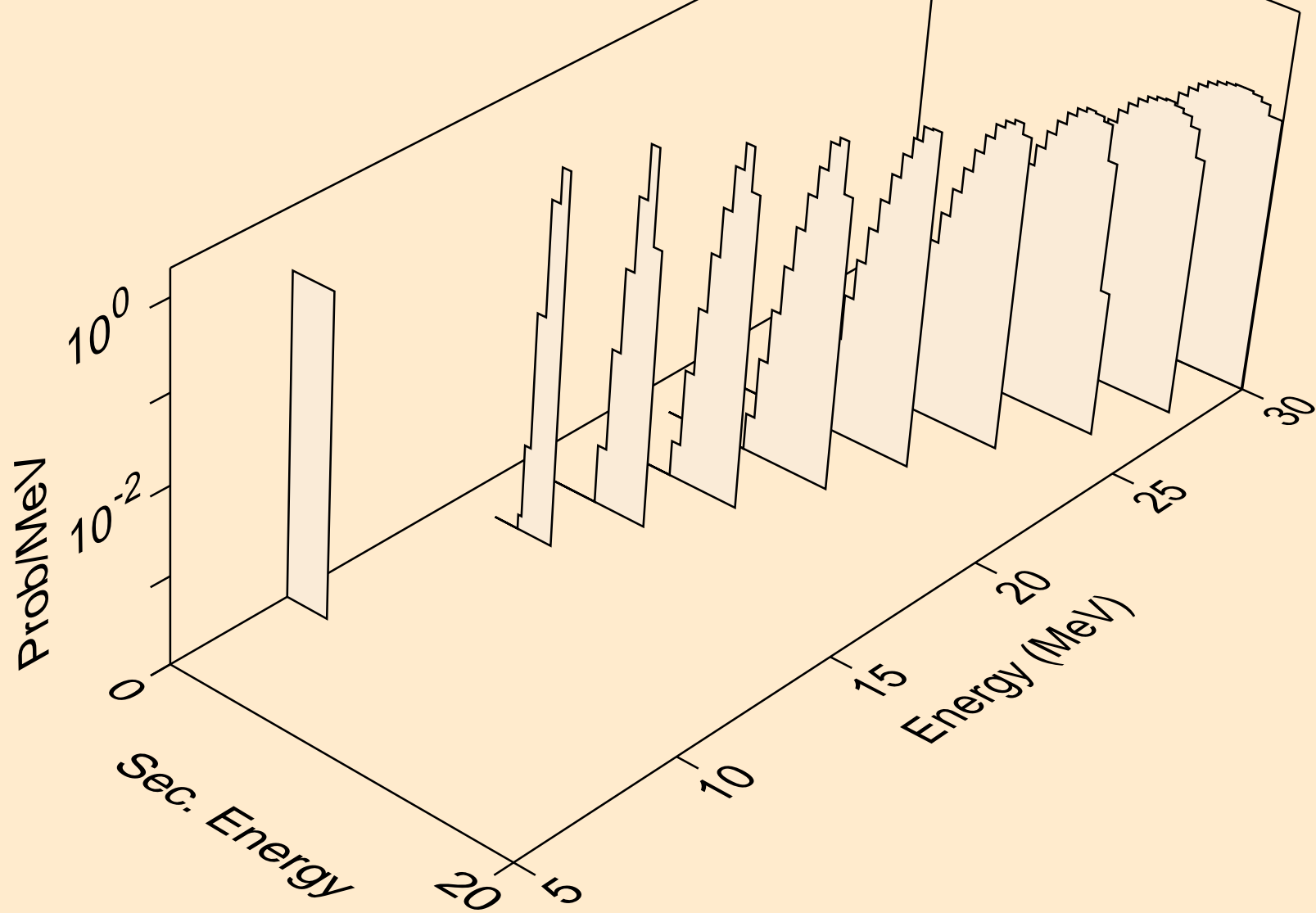

SN112 TRITON ACER TENDL-2021 LIBRARY; T=0.K  
he3s from (t,he3)

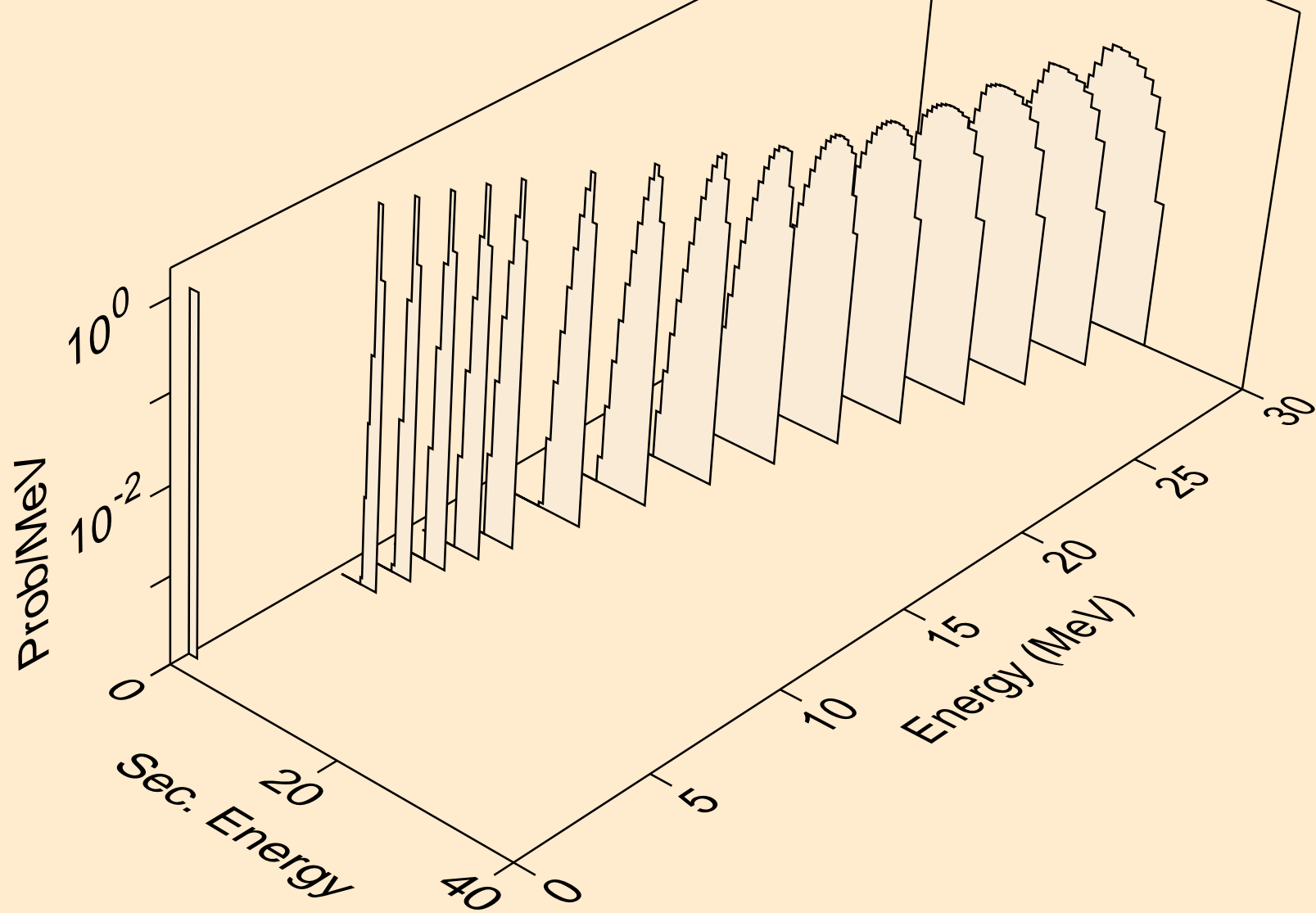

SN112 TRITON ACER TENDL-2021 LIBRARY; T=0.K  
alphas from (t,x)

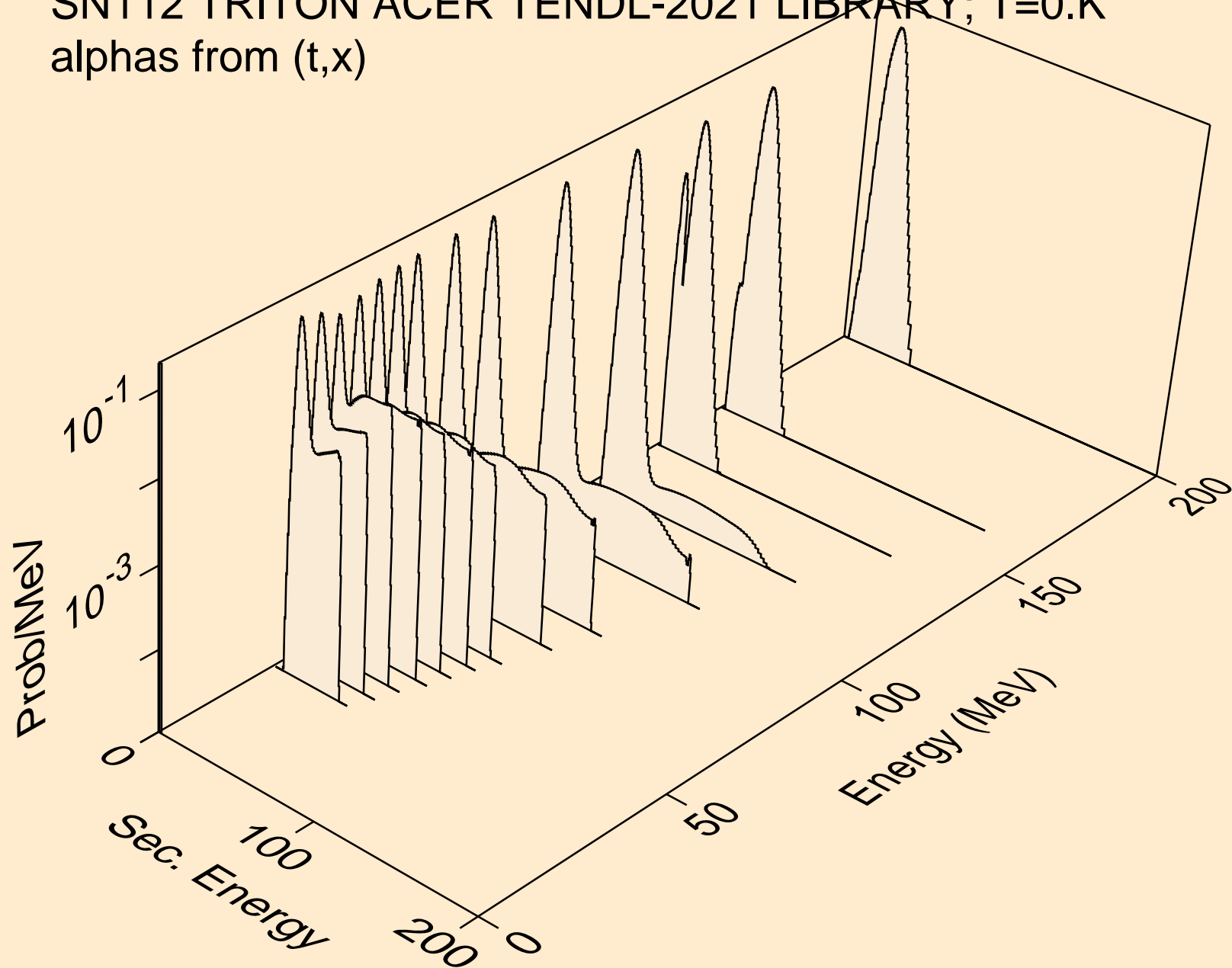

SN112 TRITON ACER TENDL-2021 LIBRARY; T=0.K  
alphas from (t,n\*)a

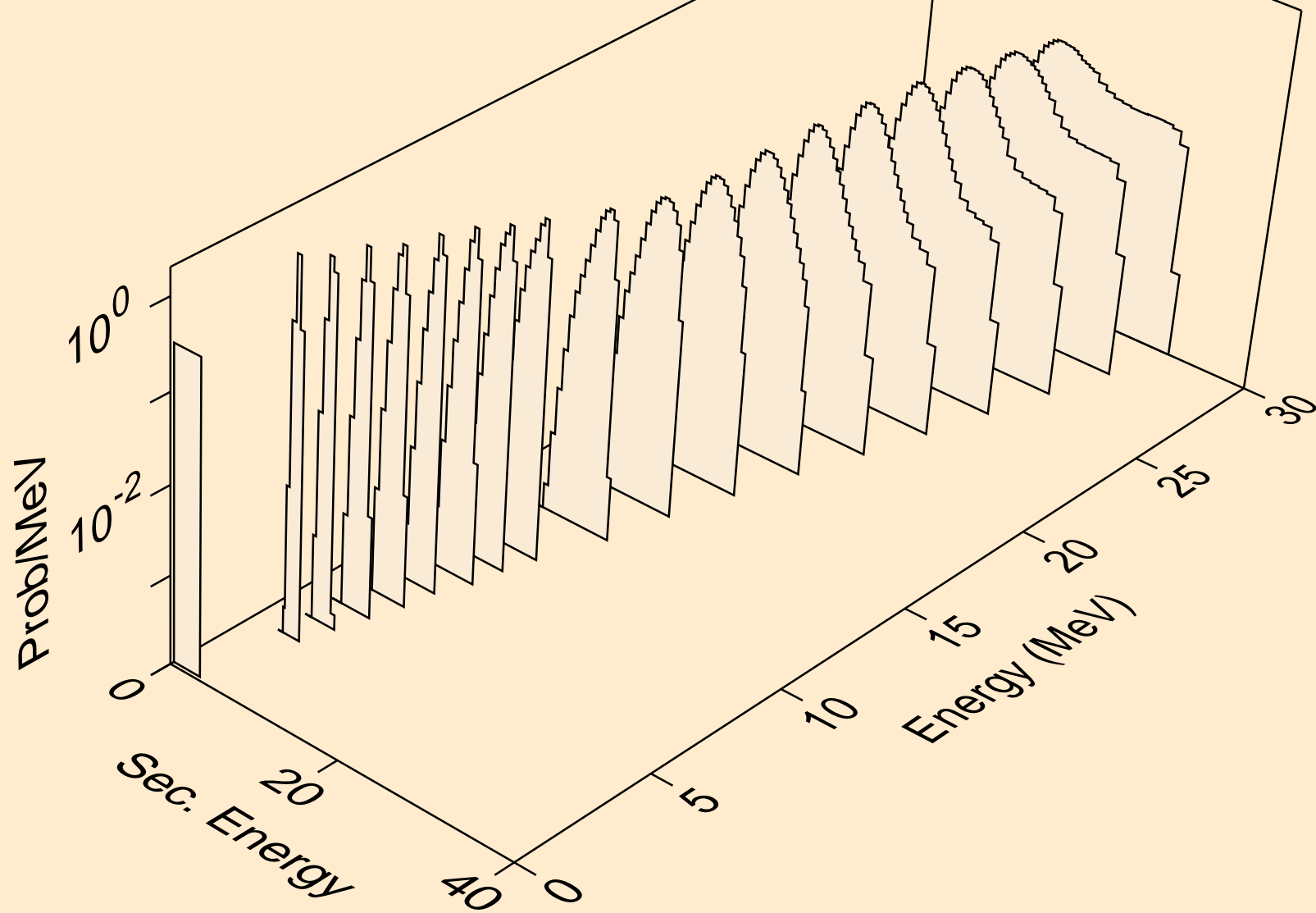



SN112 TRITON ACER TENDL-2021 LIBRARY; T=0.K  
alphas from (t,2n)a

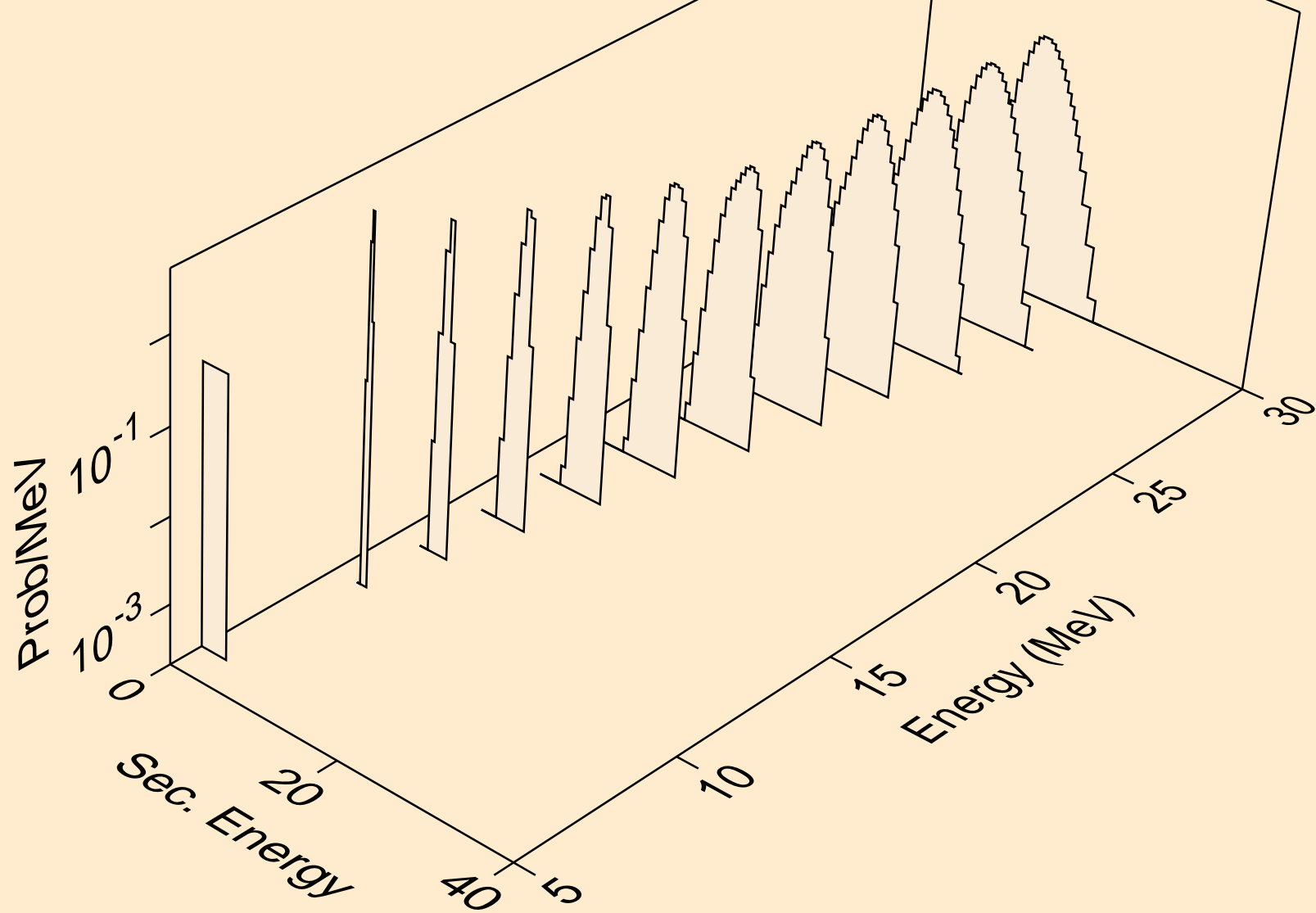

SN112 TRITON ACER TENDL-2021 LIBRARY; T=0.K  
alphas from (t,3n)a

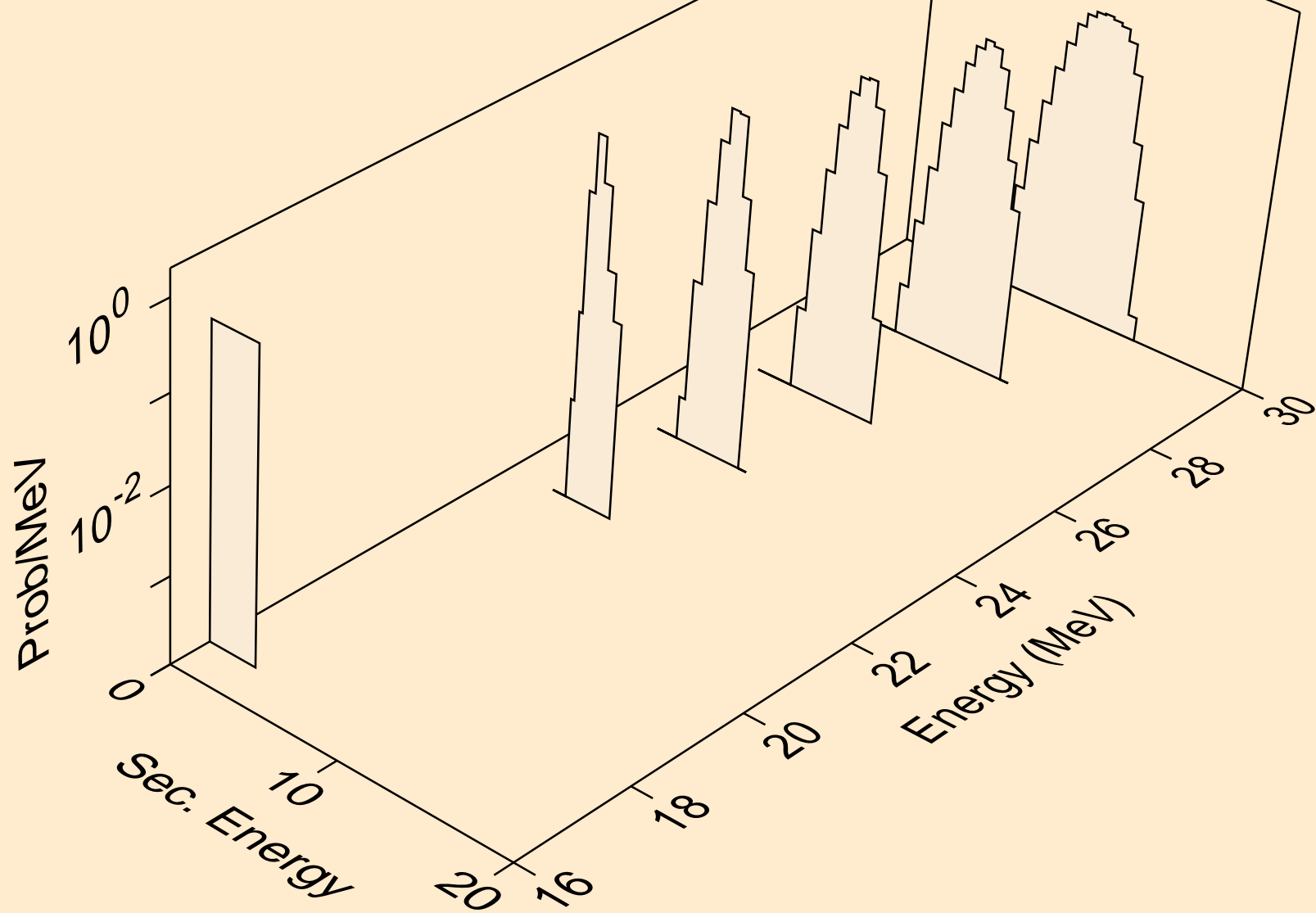

SN112 TRITON ACER TENDL-2021 LIBRARY; T=0.K  
alphas from (t,n\*)2a

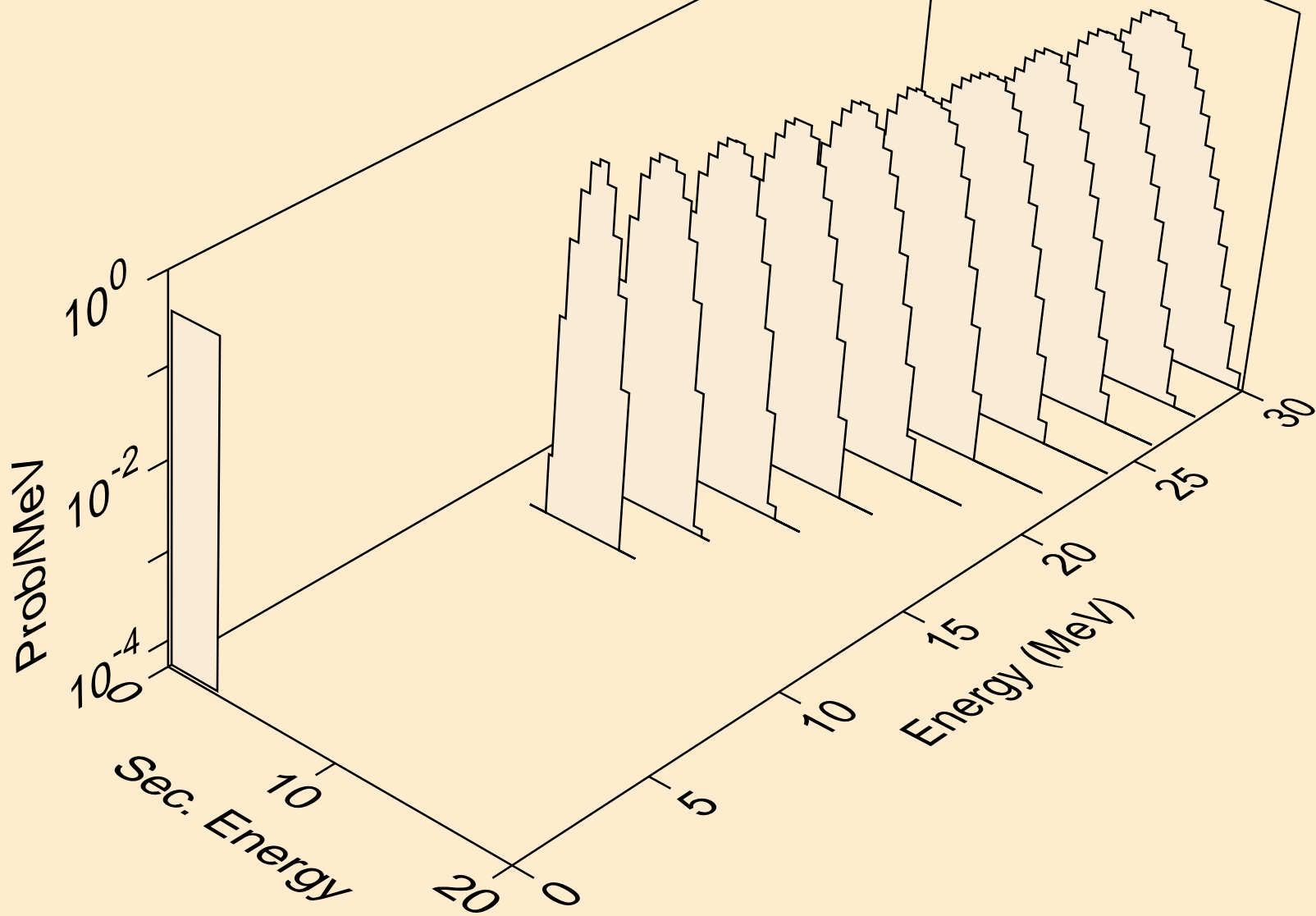

SN112 TRITON ACER TENDL-2021 LIBRARY; T=0.K  
alphas from (t,2n)2a

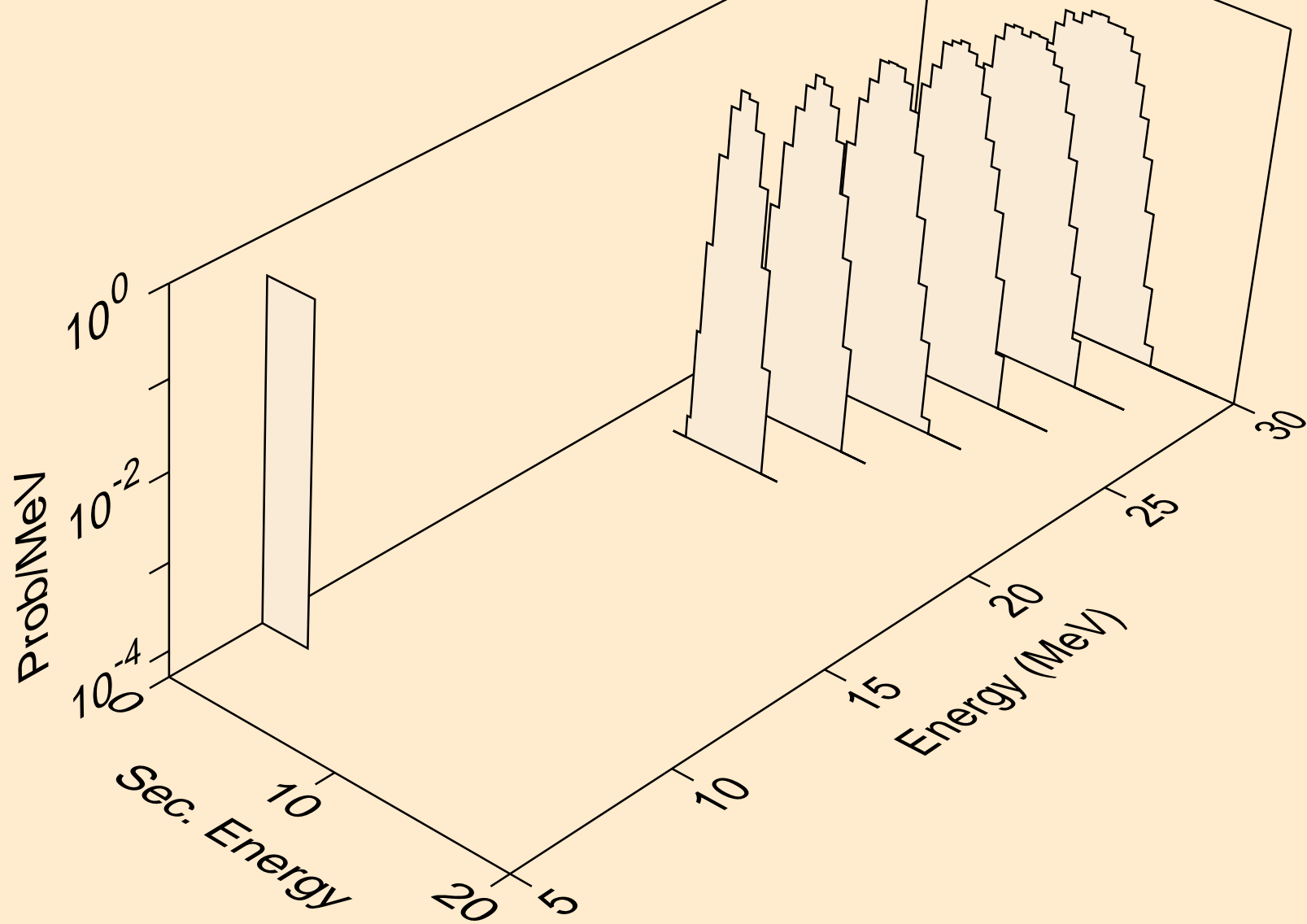

SN112 TRITON ACER TENDL-2021 LIBRARY; T=0.K  
alphas from (t,npa)

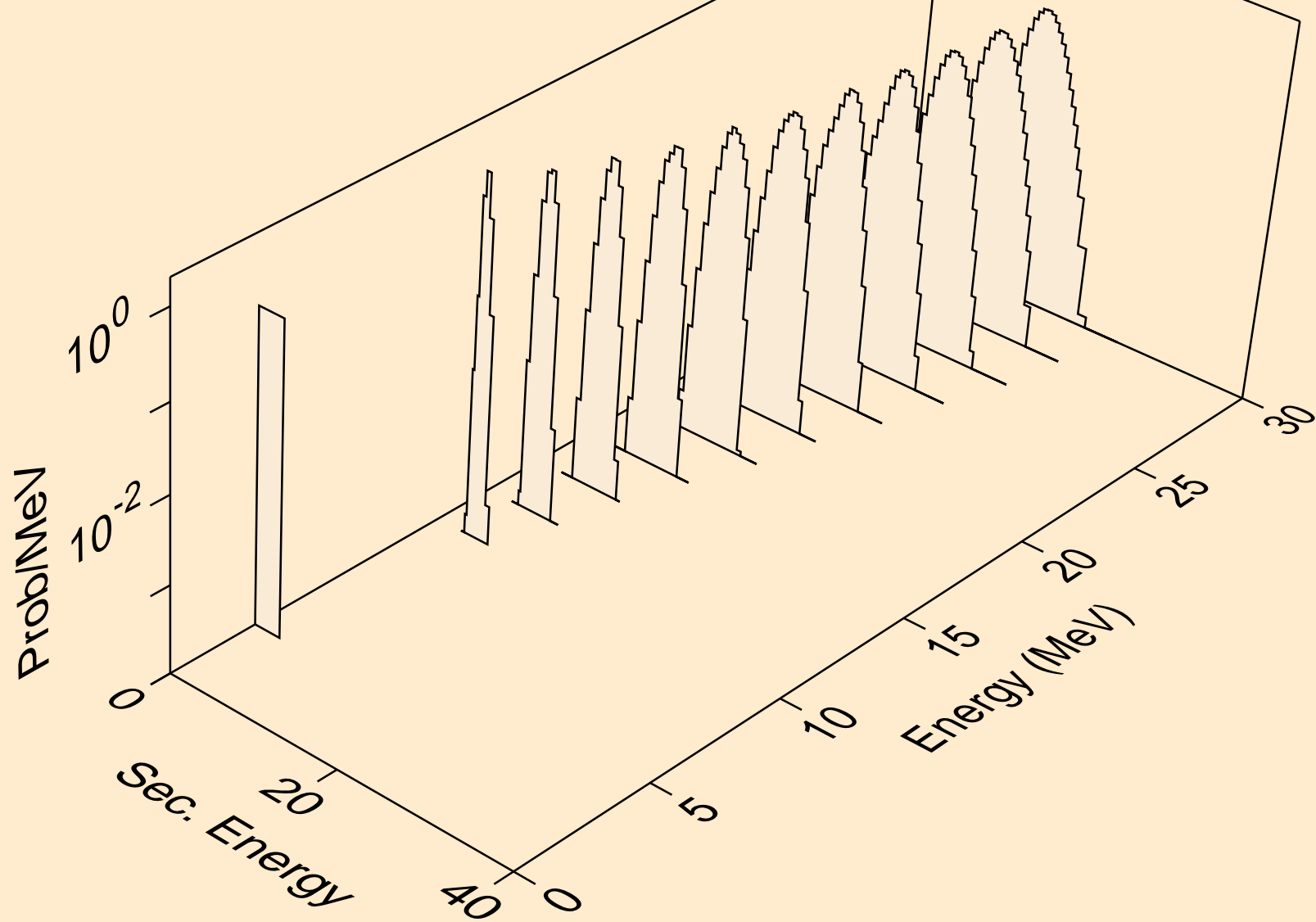

SN112 TRITON ACER TENDL-2021 LIBRARY; T=0.K  
alphas from (t,a)

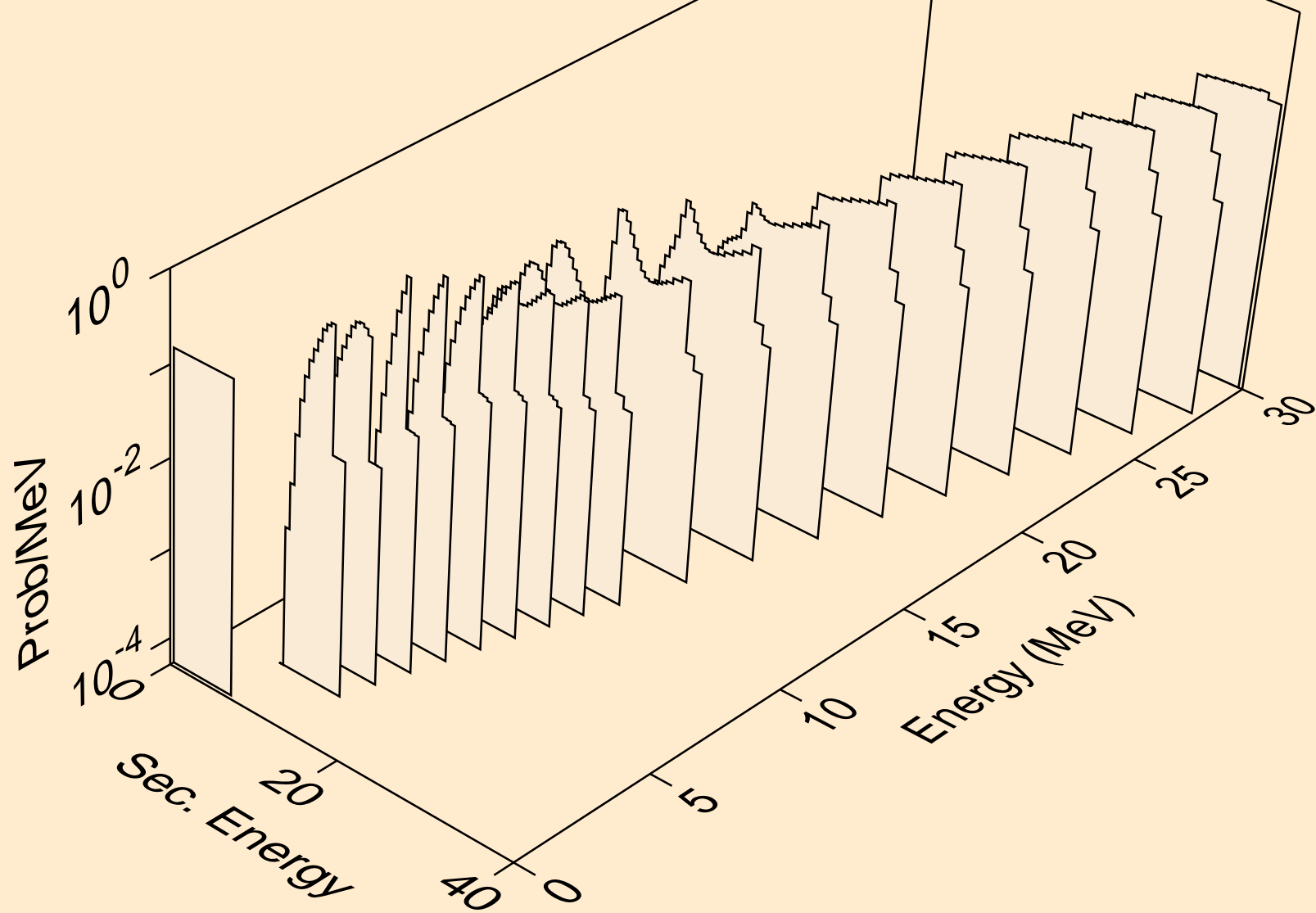

SN112 TRITON ACER TENDL-2021 LIBRARY; T=0.K  
alphas from (t,2a)

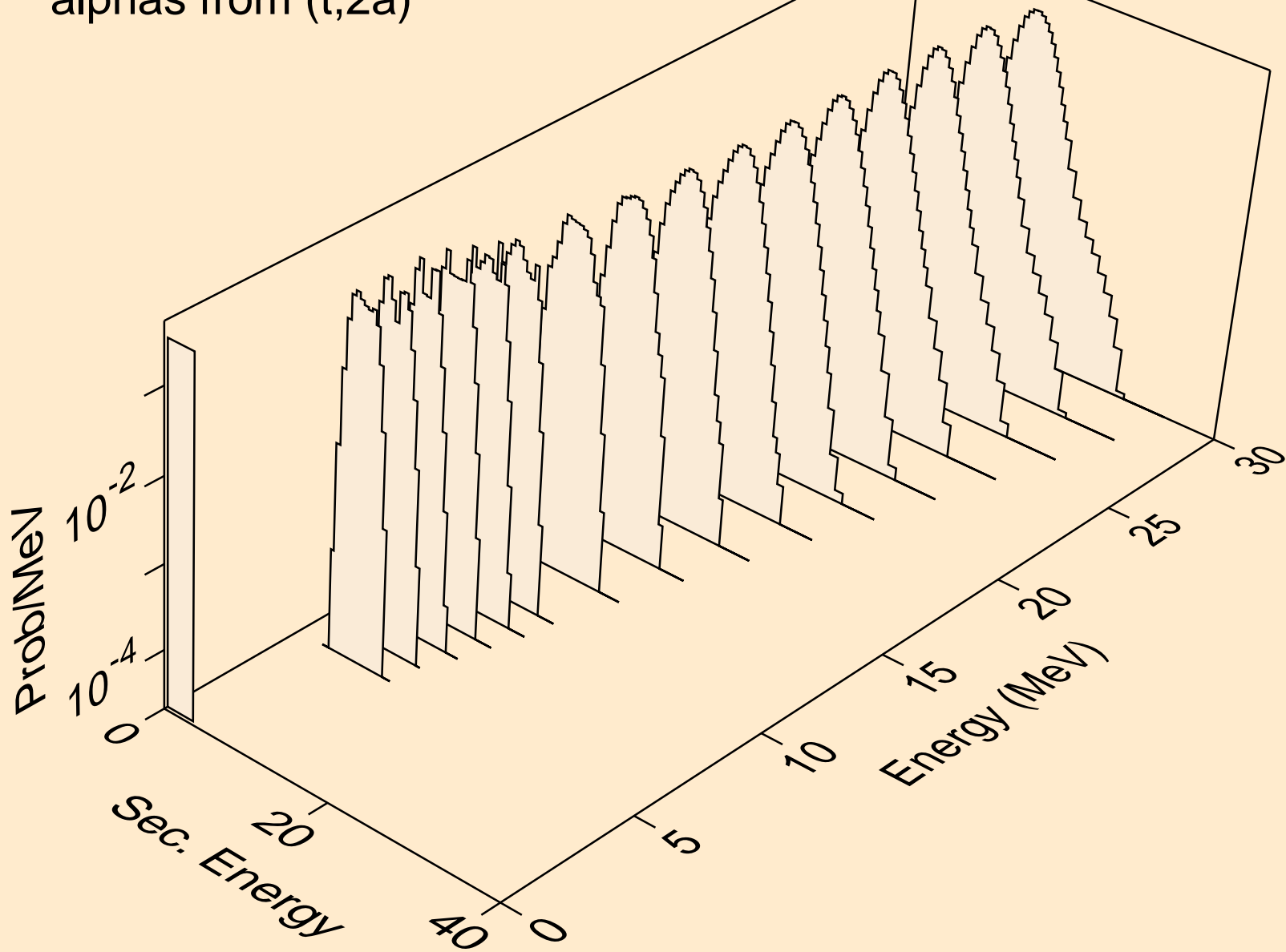

SN112 TRITON ACER TENDL-2021 LIBRARY; T=0.K  
alphas from (t,pa)

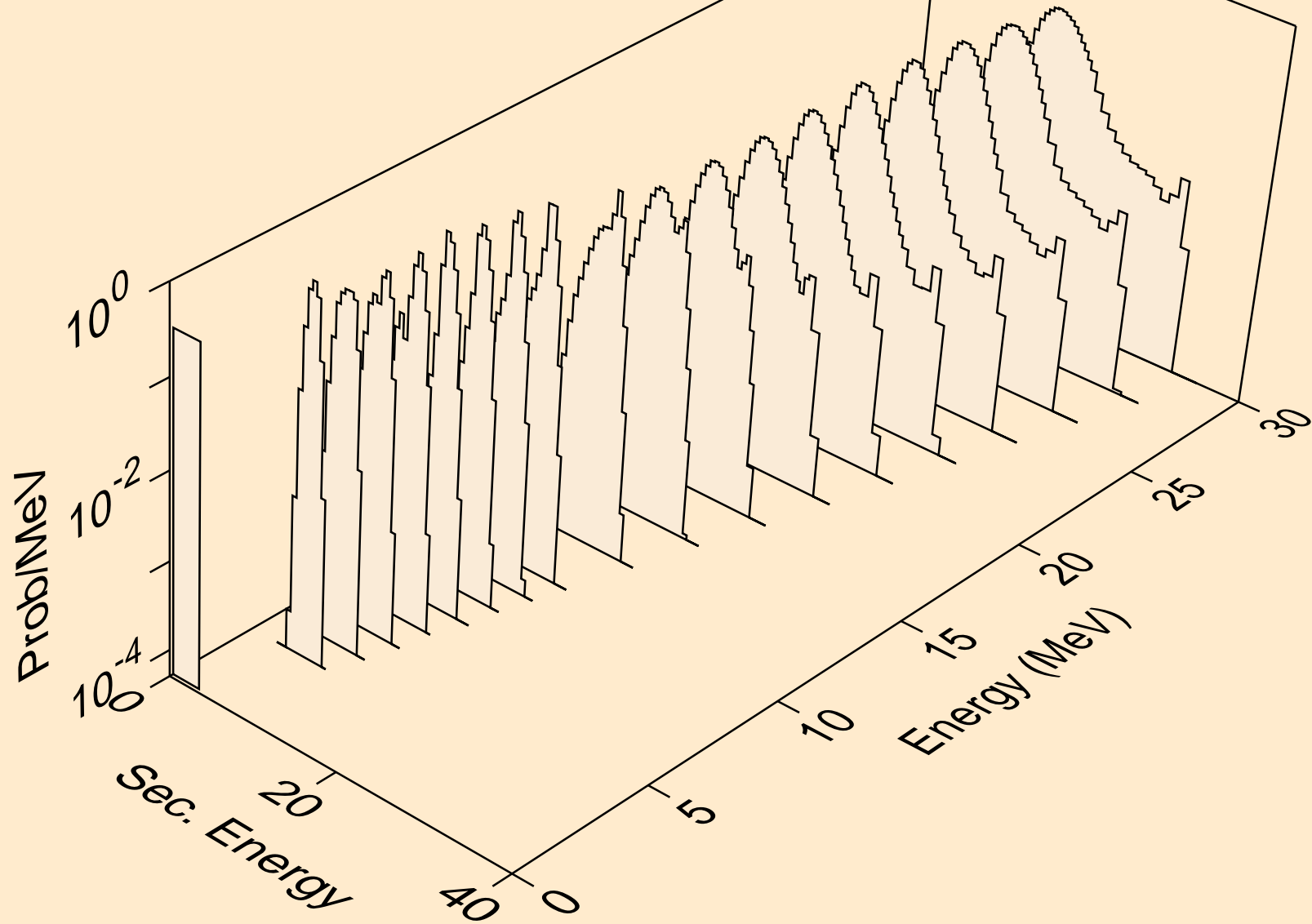



SN112 TRITON ACER TENDL-2021 LIBRARY; T=0.K  
alphas from (t,da)

