

TB151M TRITON ACER TENDL-2021 LIBRARY; T=0.K  
Principal cross sections

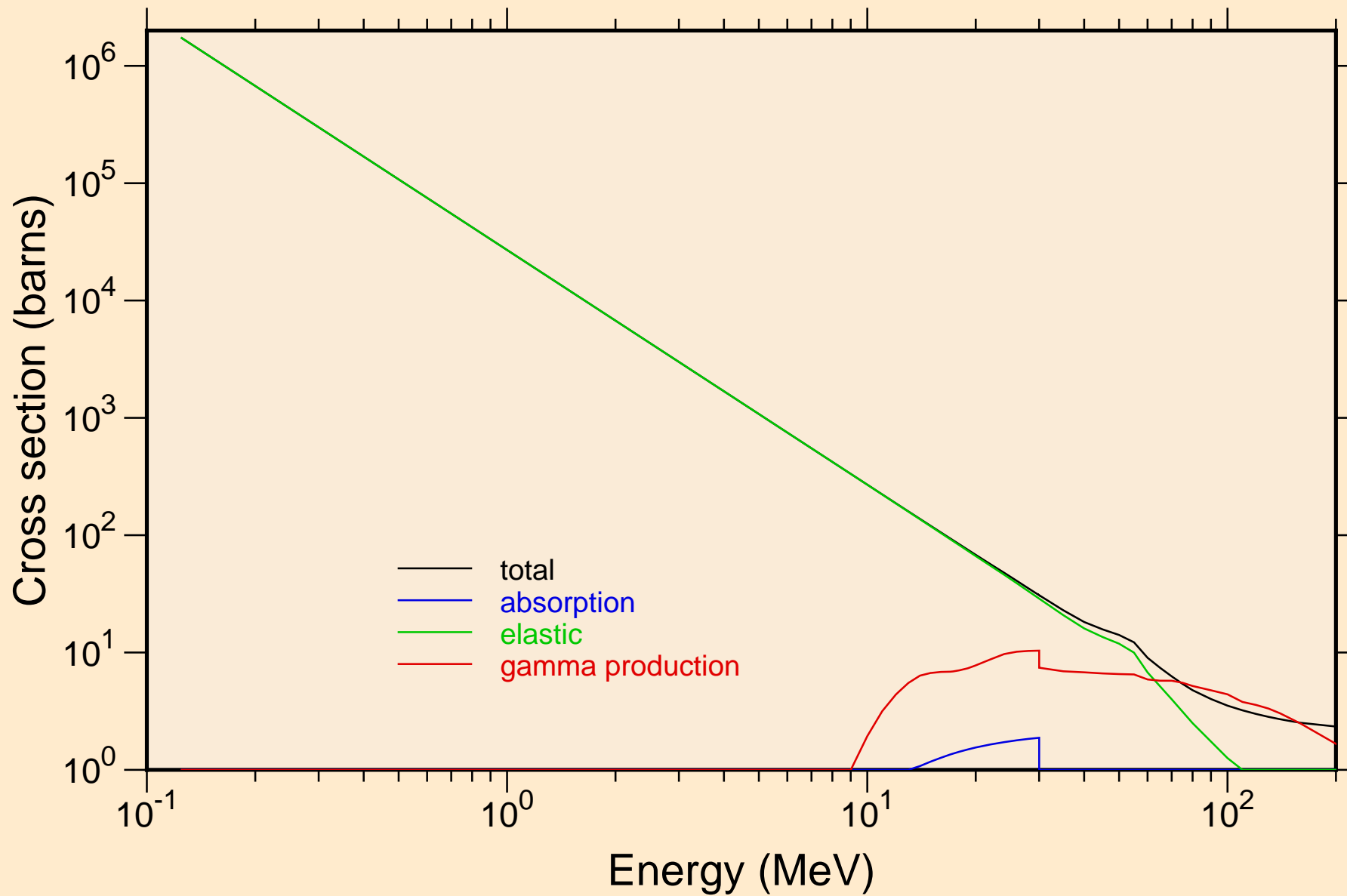

TB151M TRITON ACER TENDL-2021 LIBRARY; T=0.K

Heating

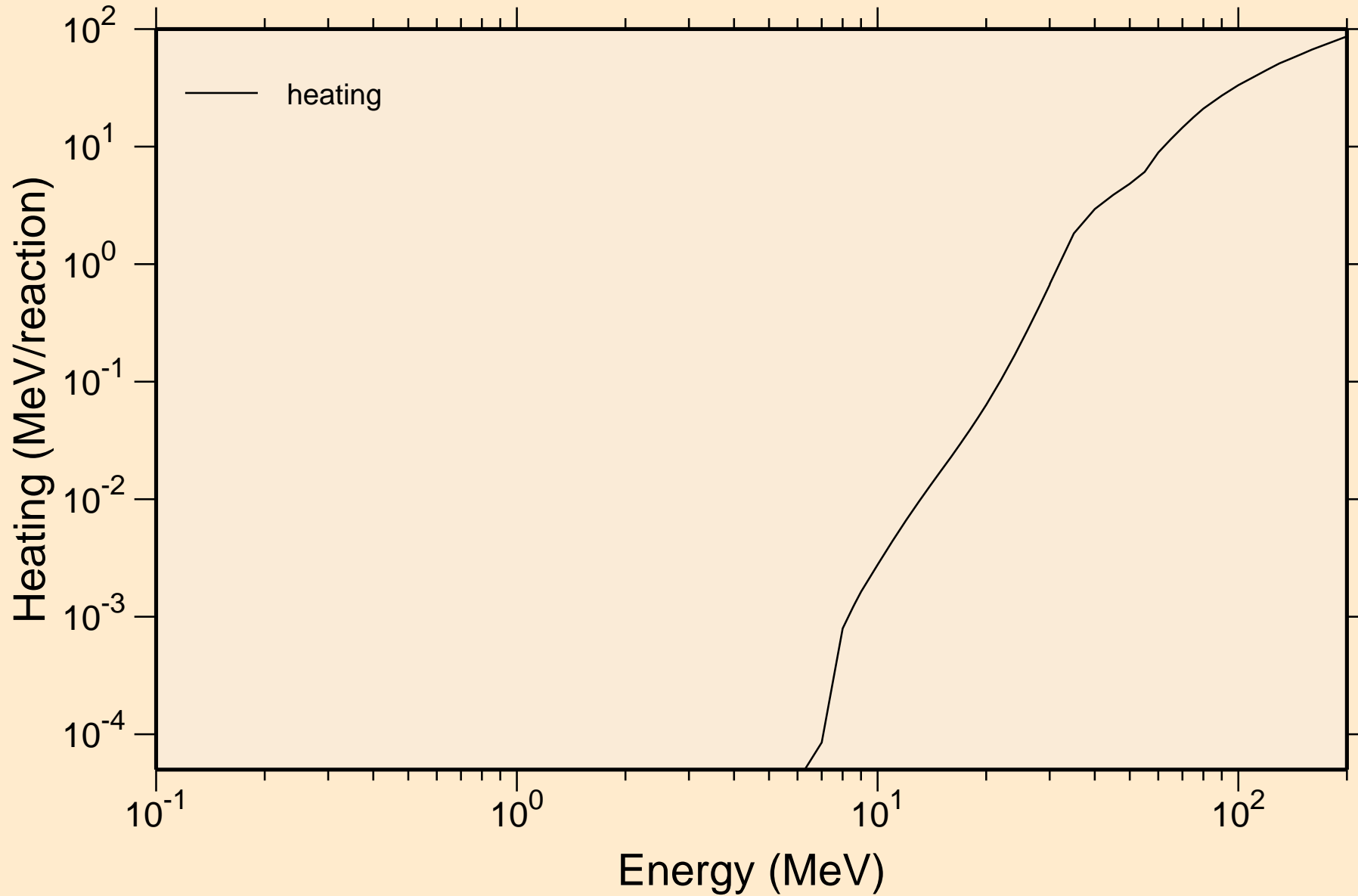

# TB151M TRITON ACER TENDL-2021 LIBRARY; T=0.K

## Principal cross sections

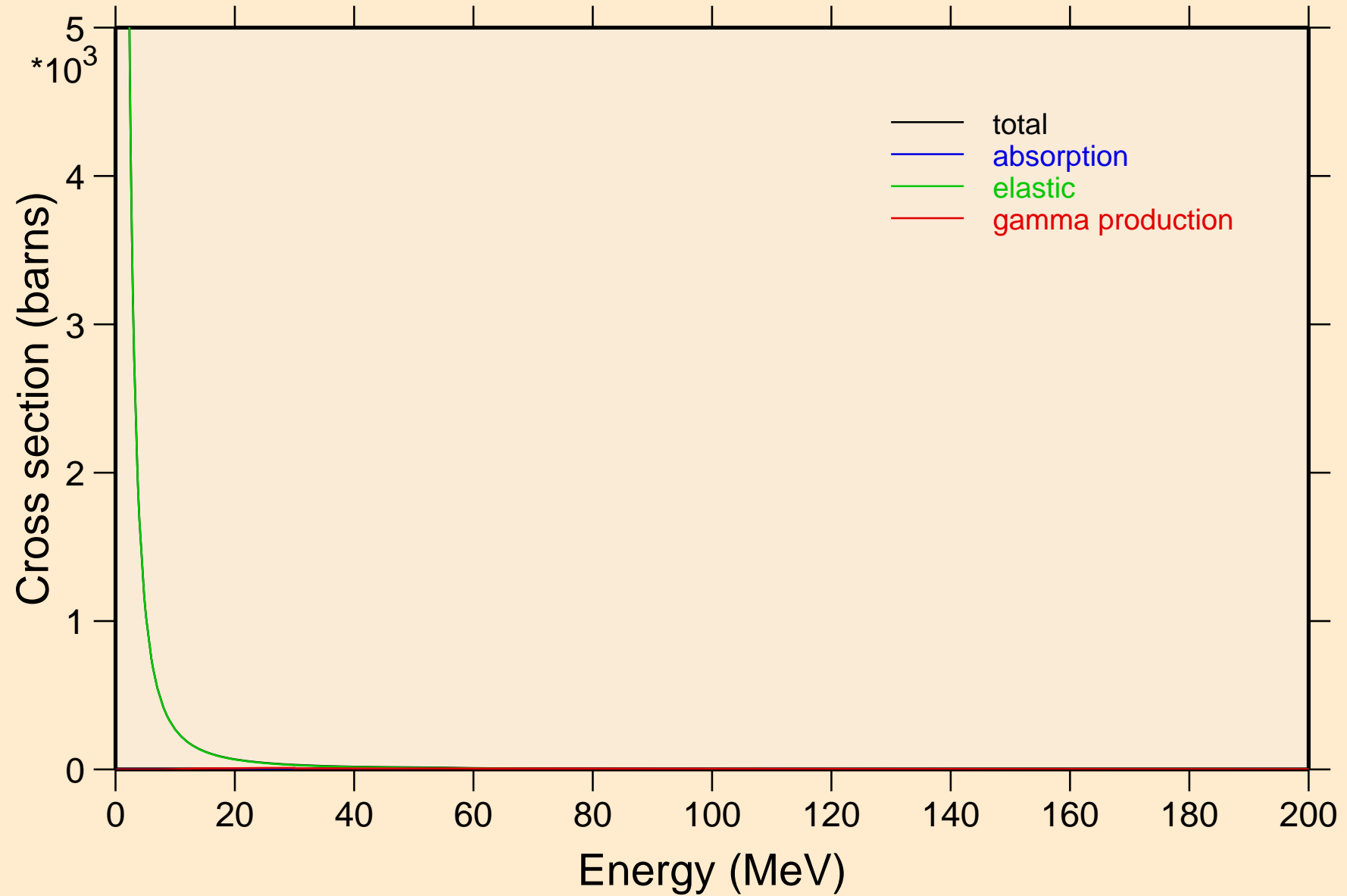

TB151M TRITON ACER TENDL-2021 LIBRARY; T=0.K

Heating

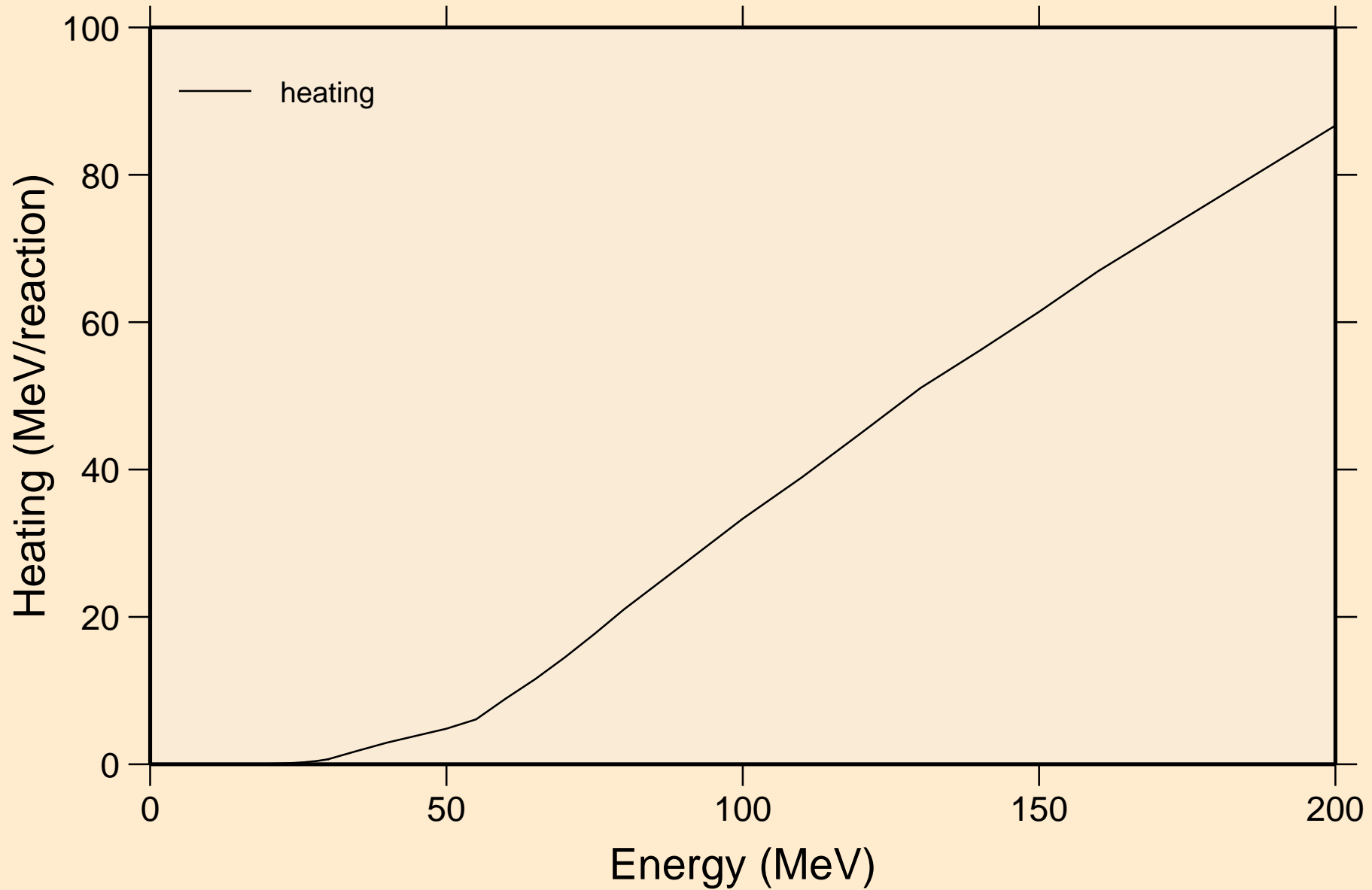

TB151M TRITON ACER TENDL-2021 LIBRARY; T=0.K  
Threshold reactions

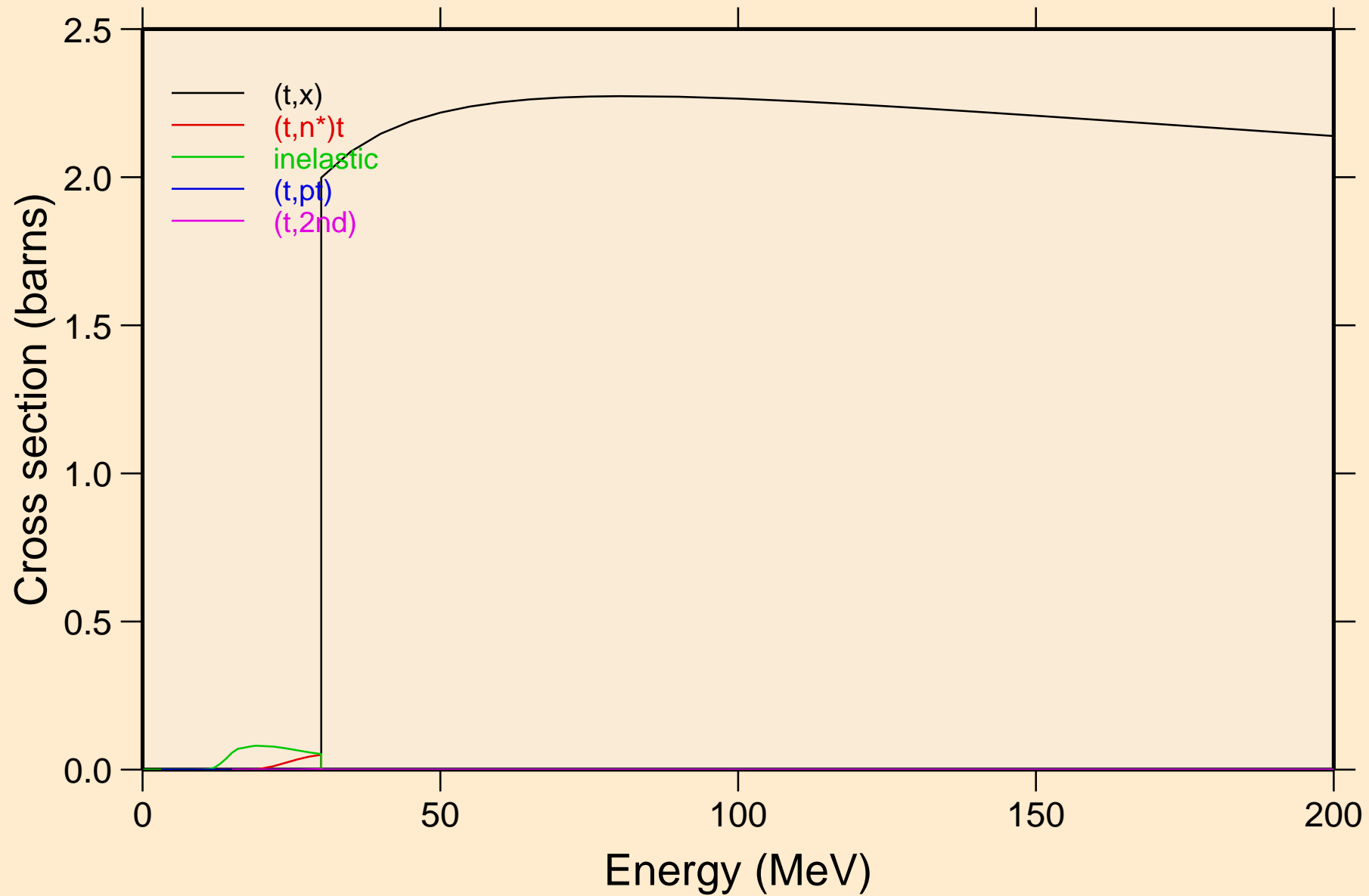

TB151M TRITON ACER TENDL-2021 LIBRARY; T=0.K  
Threshold reactions

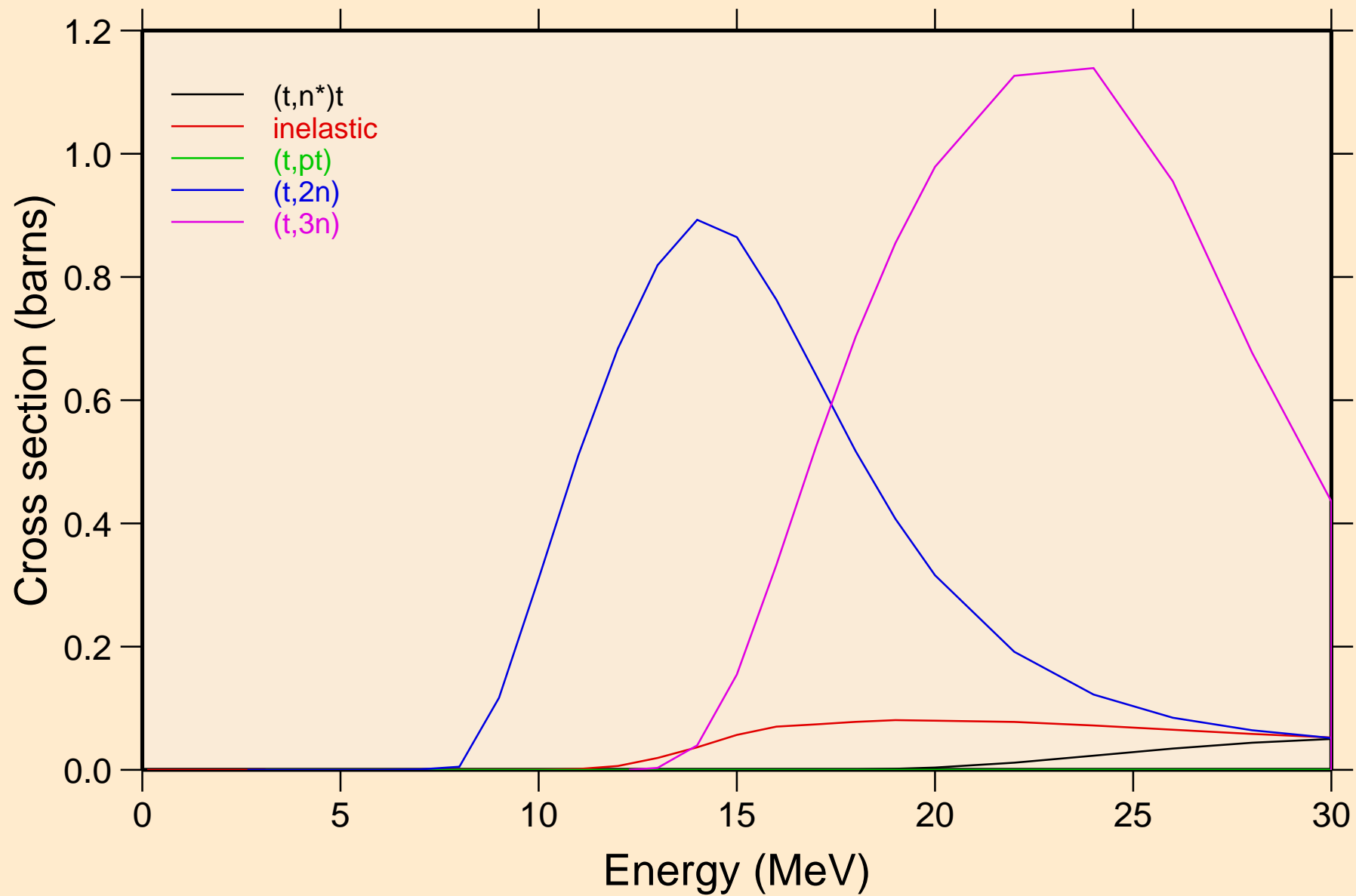

TB151M TRITON ACER TENDL-2021 LIBRARY; T=0.K  
Threshold reactions

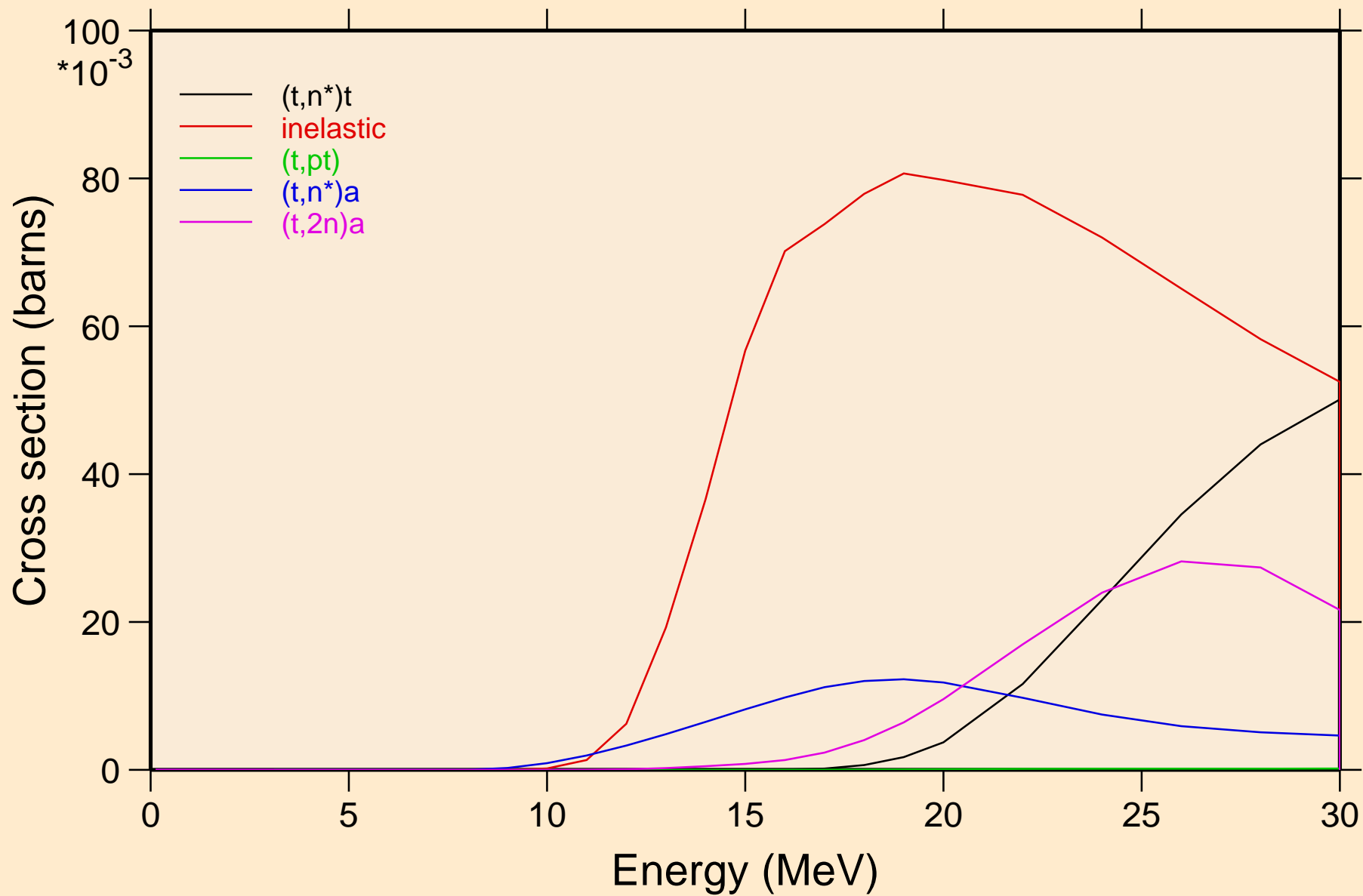

TB151M TRITON ACER TENDL-2021 LIBRARY; T=0.K  
Threshold reactions

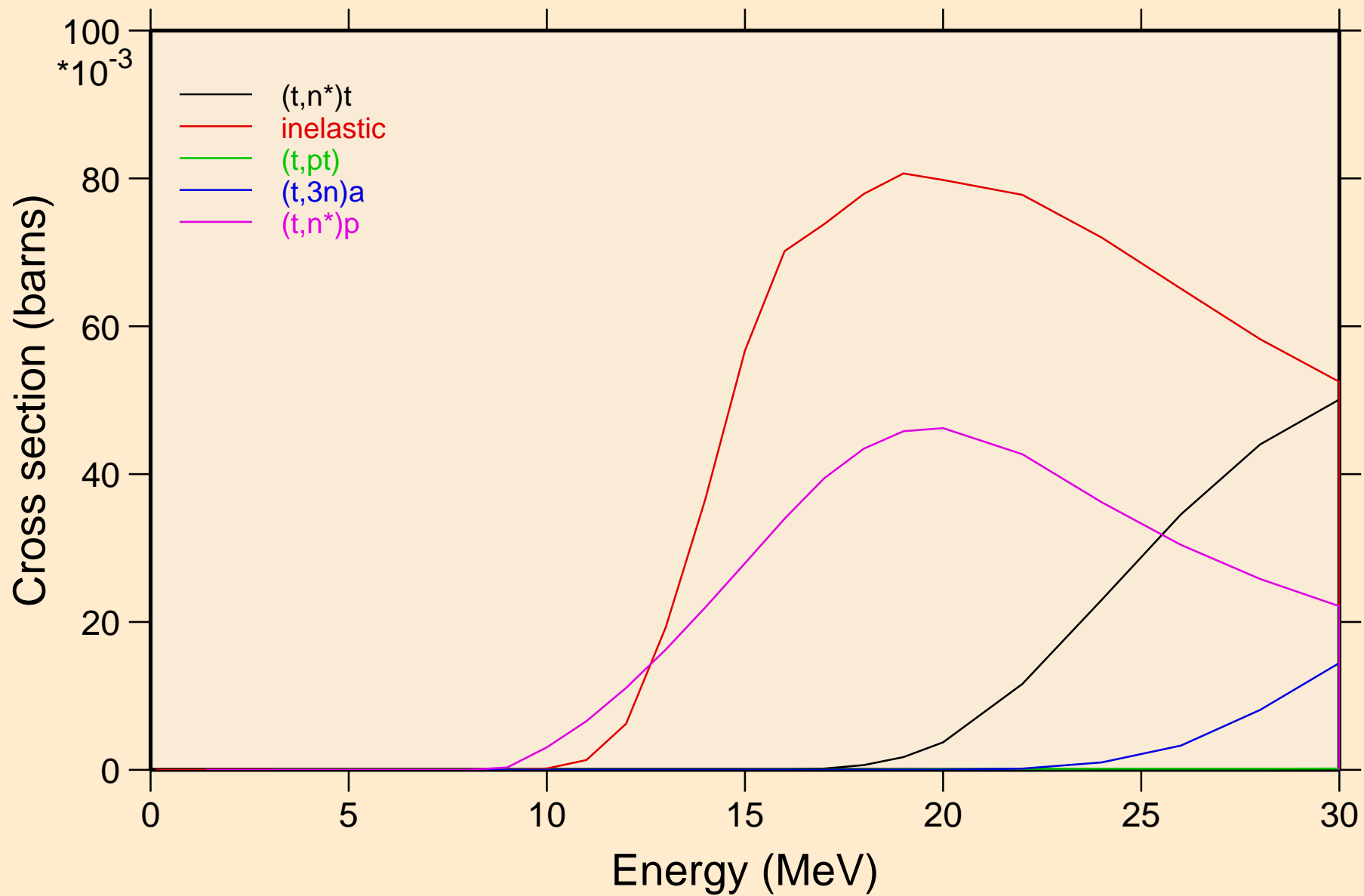



TB151M TRITON ACER TENDL-2021 LIBRARY; T=0.K  
Threshold reactions

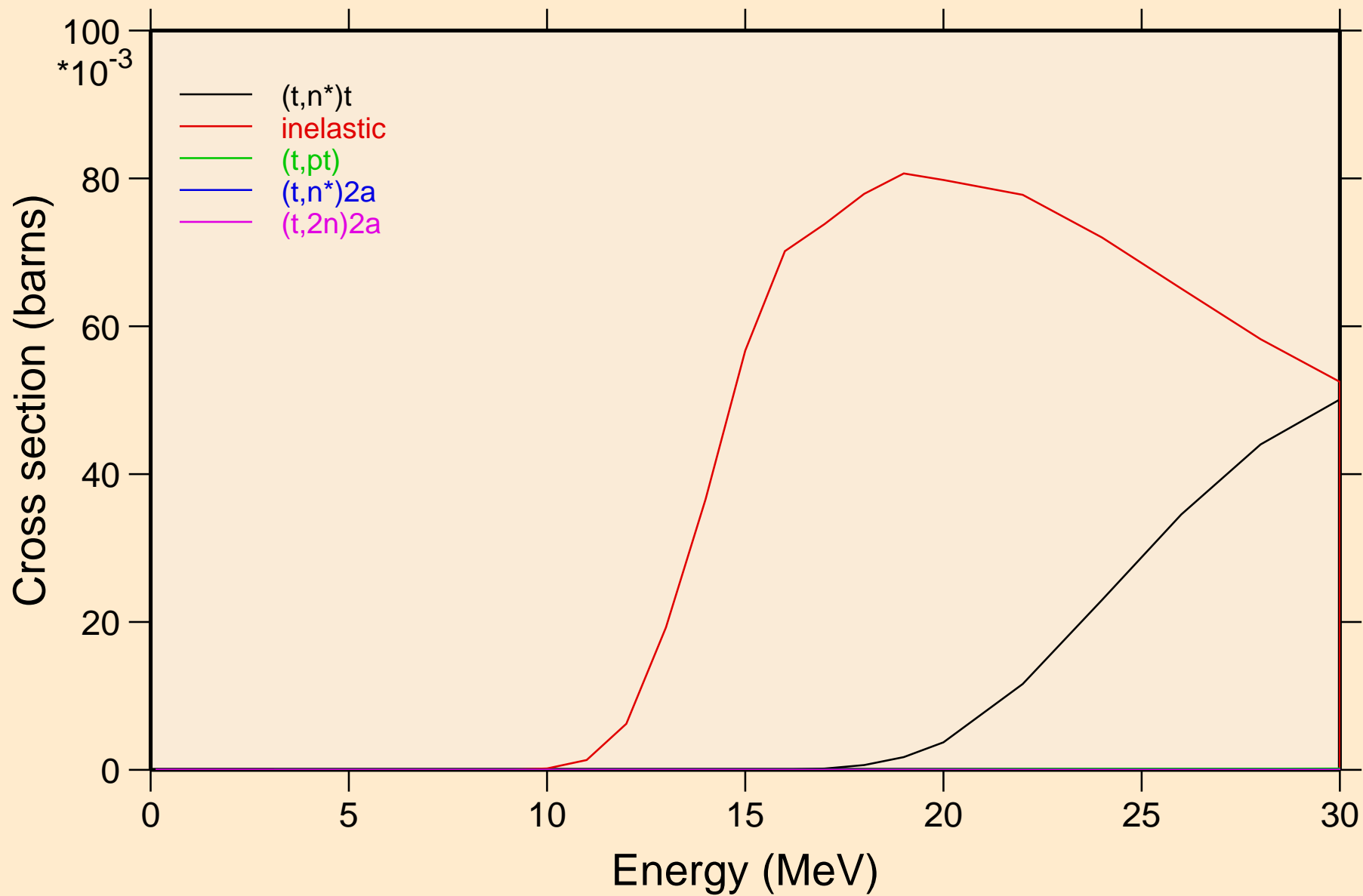

TB151M TRITON ACER TENDL-2021 LIBRARY; T=0.K  
Threshold reactions

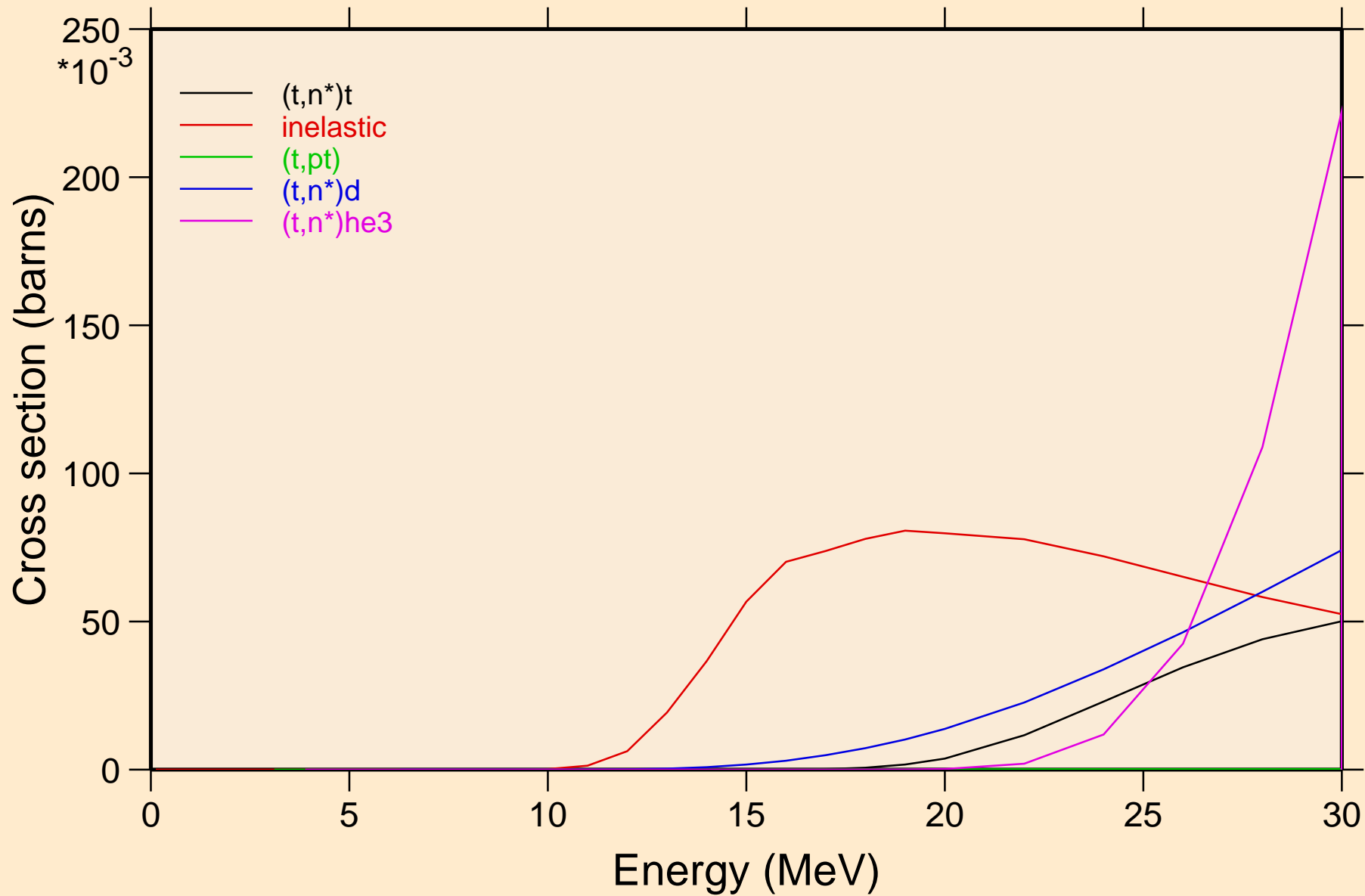

TB151M TRITON ACER TENDL-2021 LIBRARY; T=0.K  
Threshold reactions

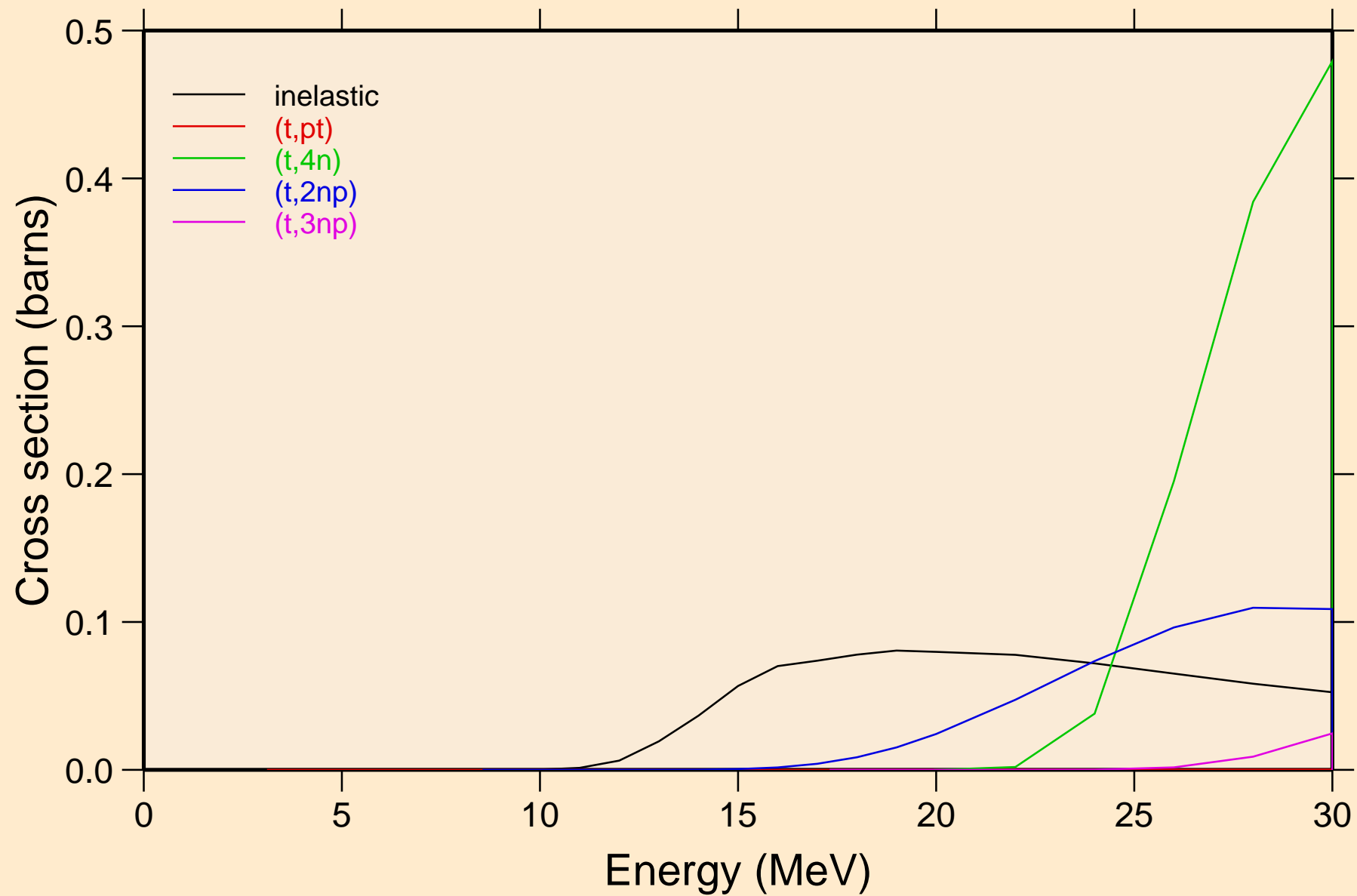

TB151M TRITON ACER TENDL-2021 LIBRARY; T=0.K  
Threshold reactions

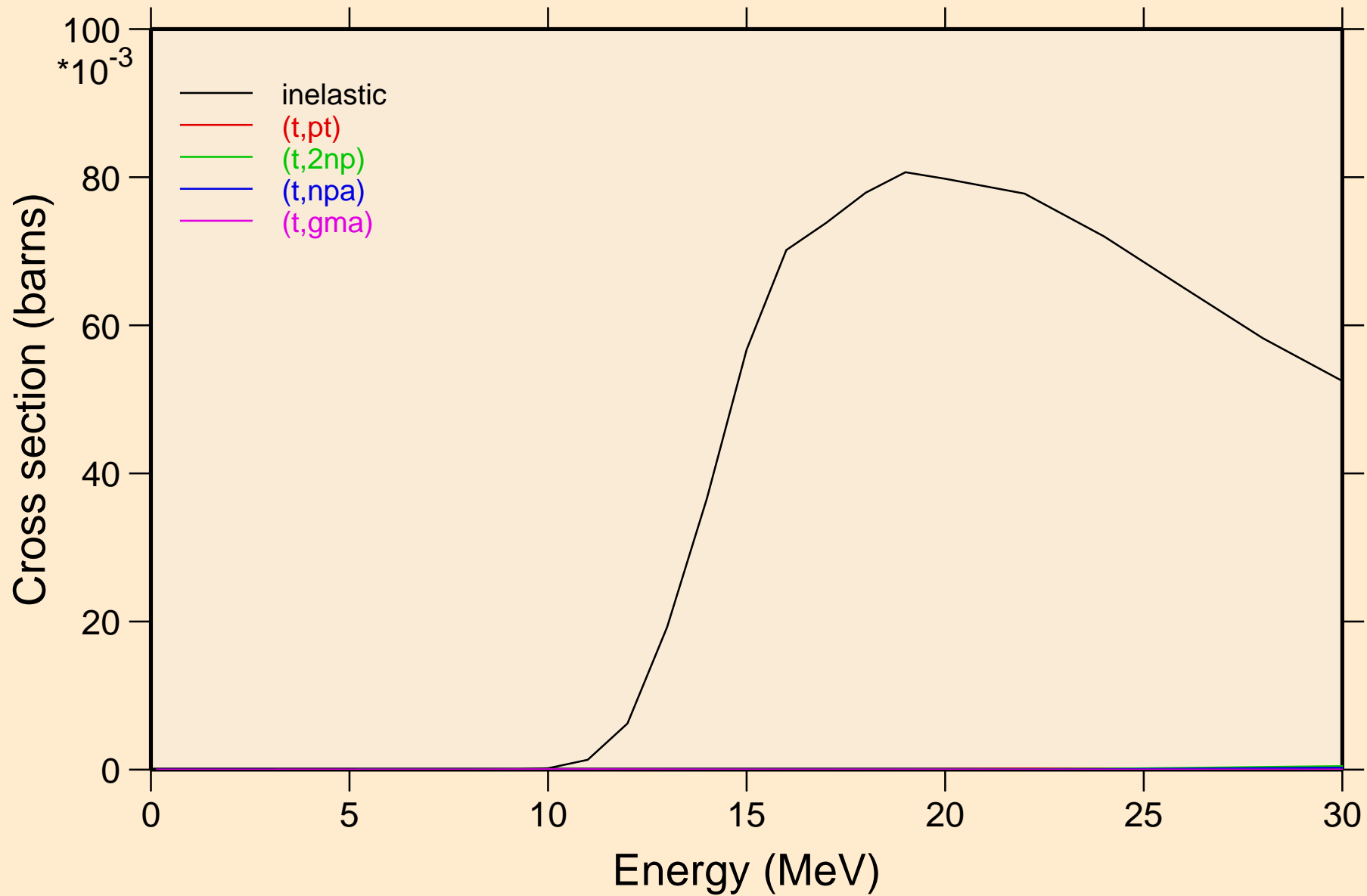

TB151M TRITON ACER TENDL-2021 LIBRARY; T=0.K  
Threshold reactions

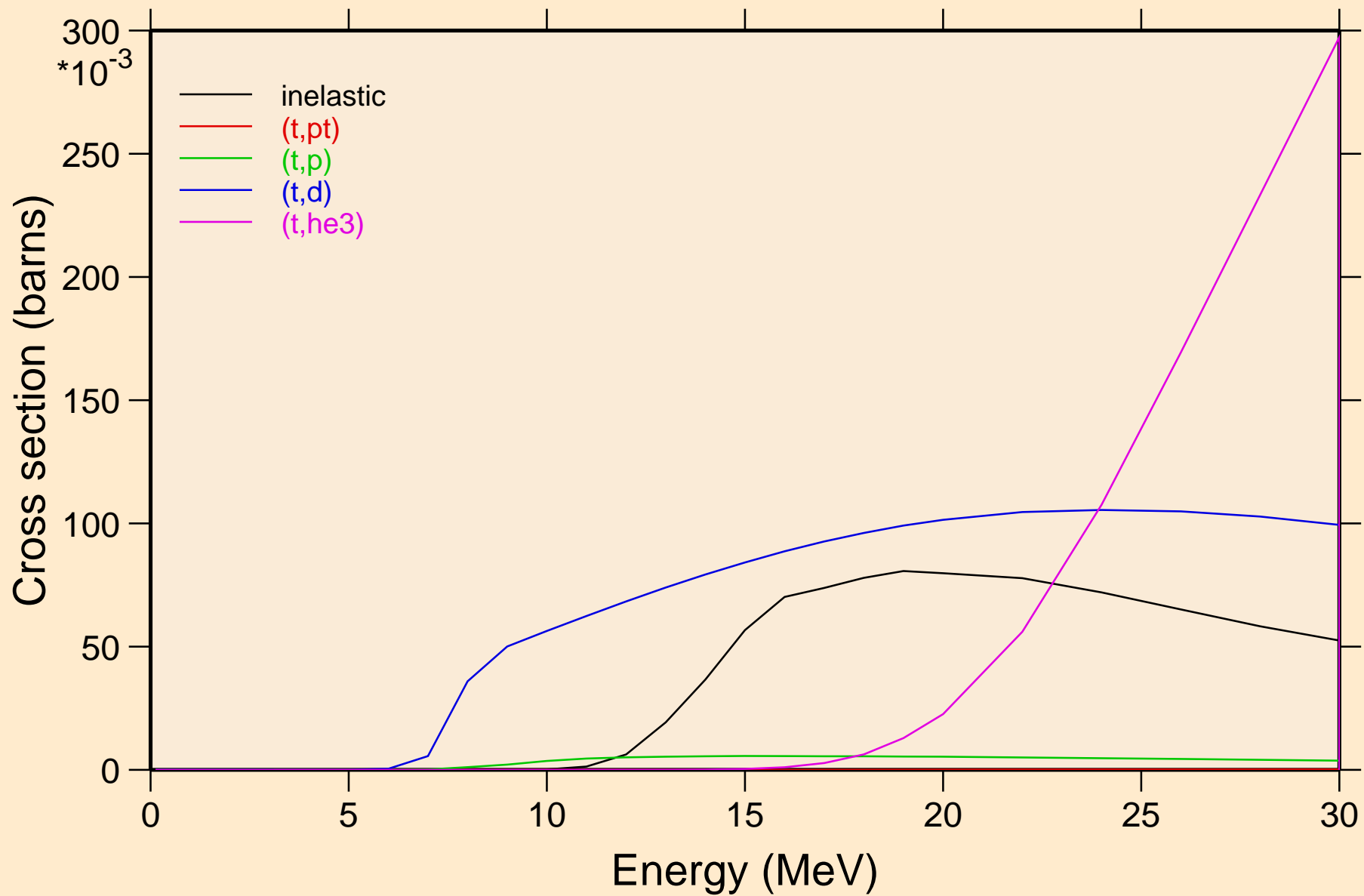

TB151M TRITON ACER TENDL-2021 LIBRARY; T=0.K  
Threshold reactions

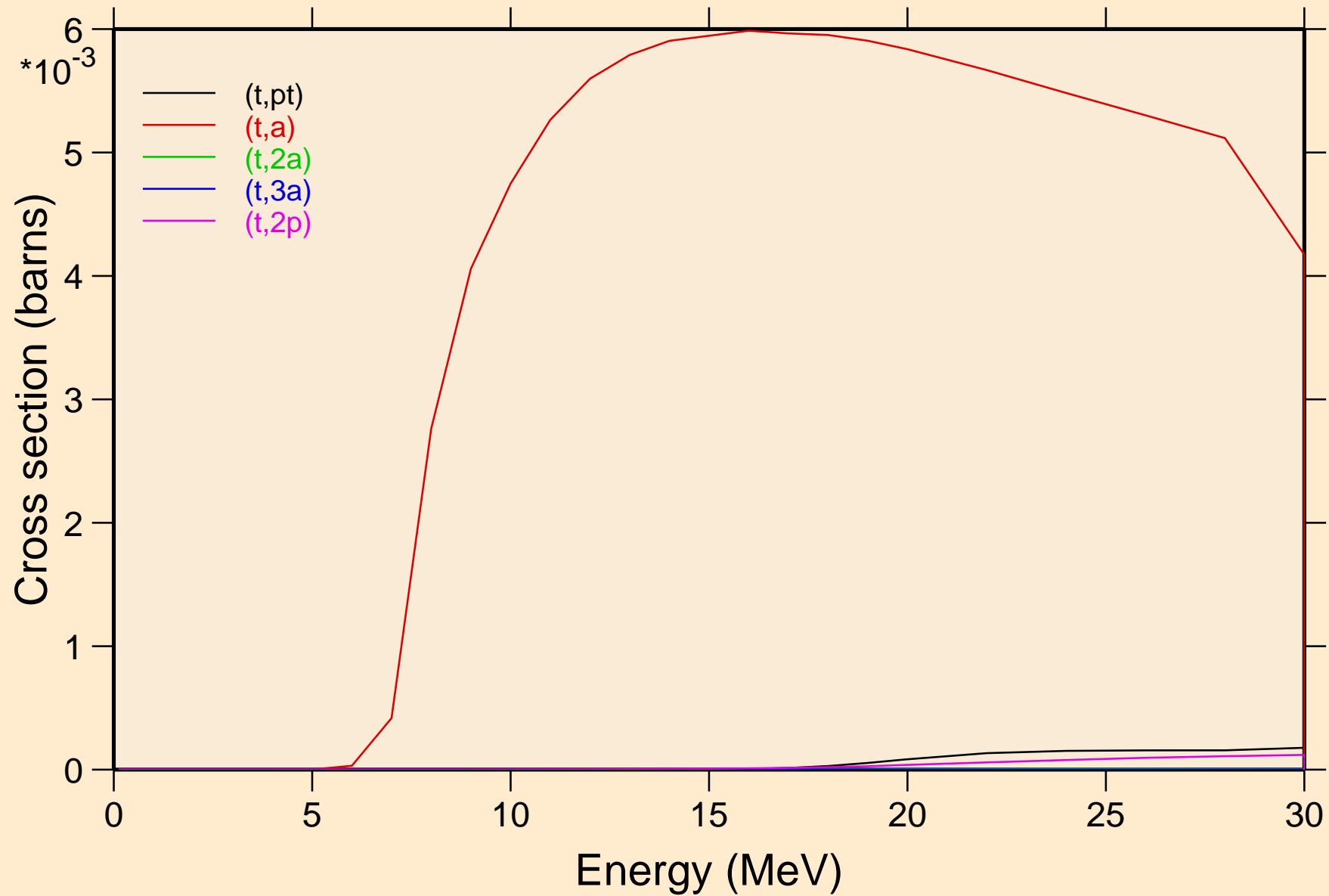

TB151M TRITON ACER TENDL-2021 LIBRARY; T=0.K  
Threshold reactions

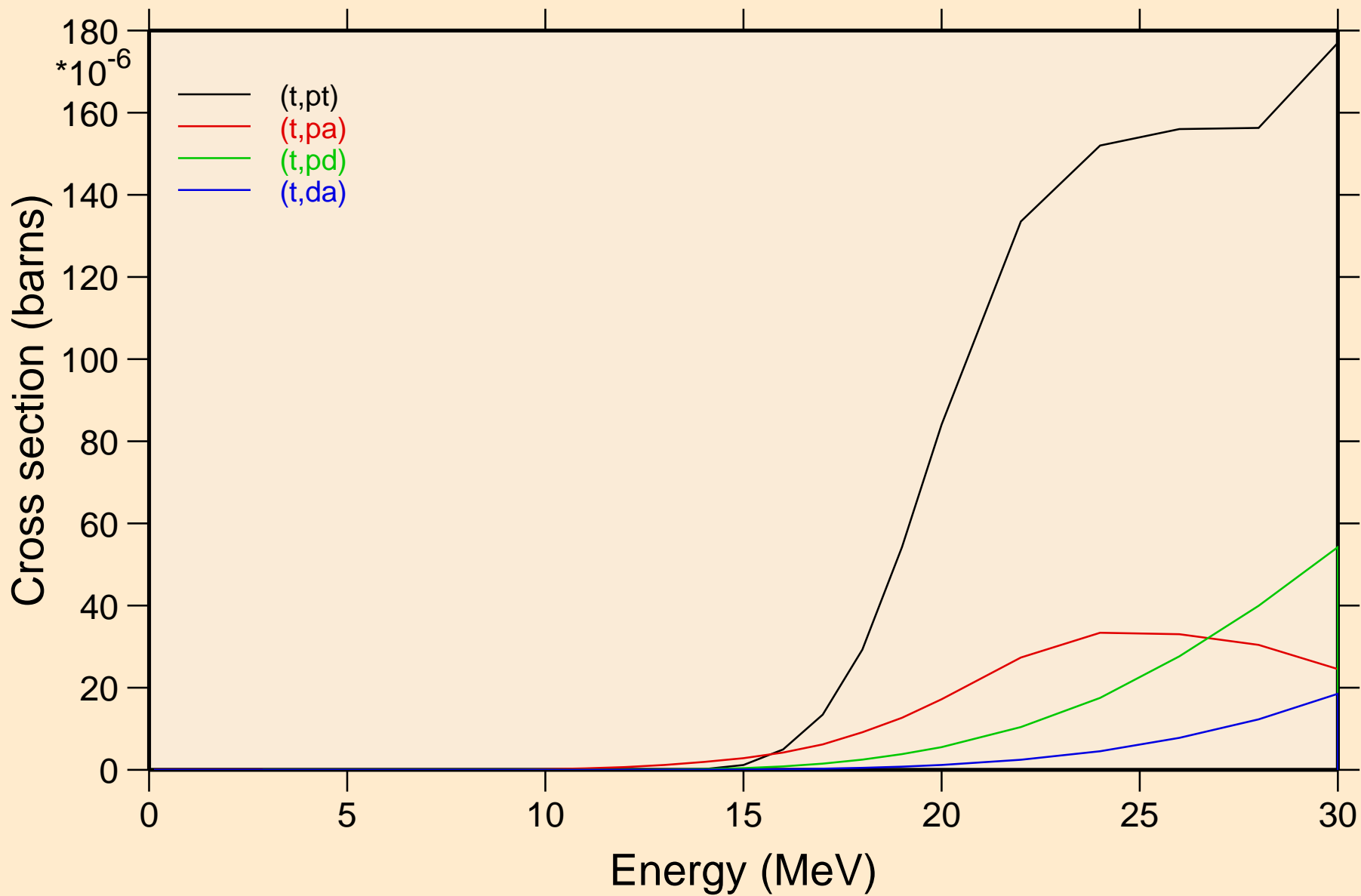

TB151M TRITON ACER TENDL-2021 LIBRARY; T=0.K  
angular distribution for elastic

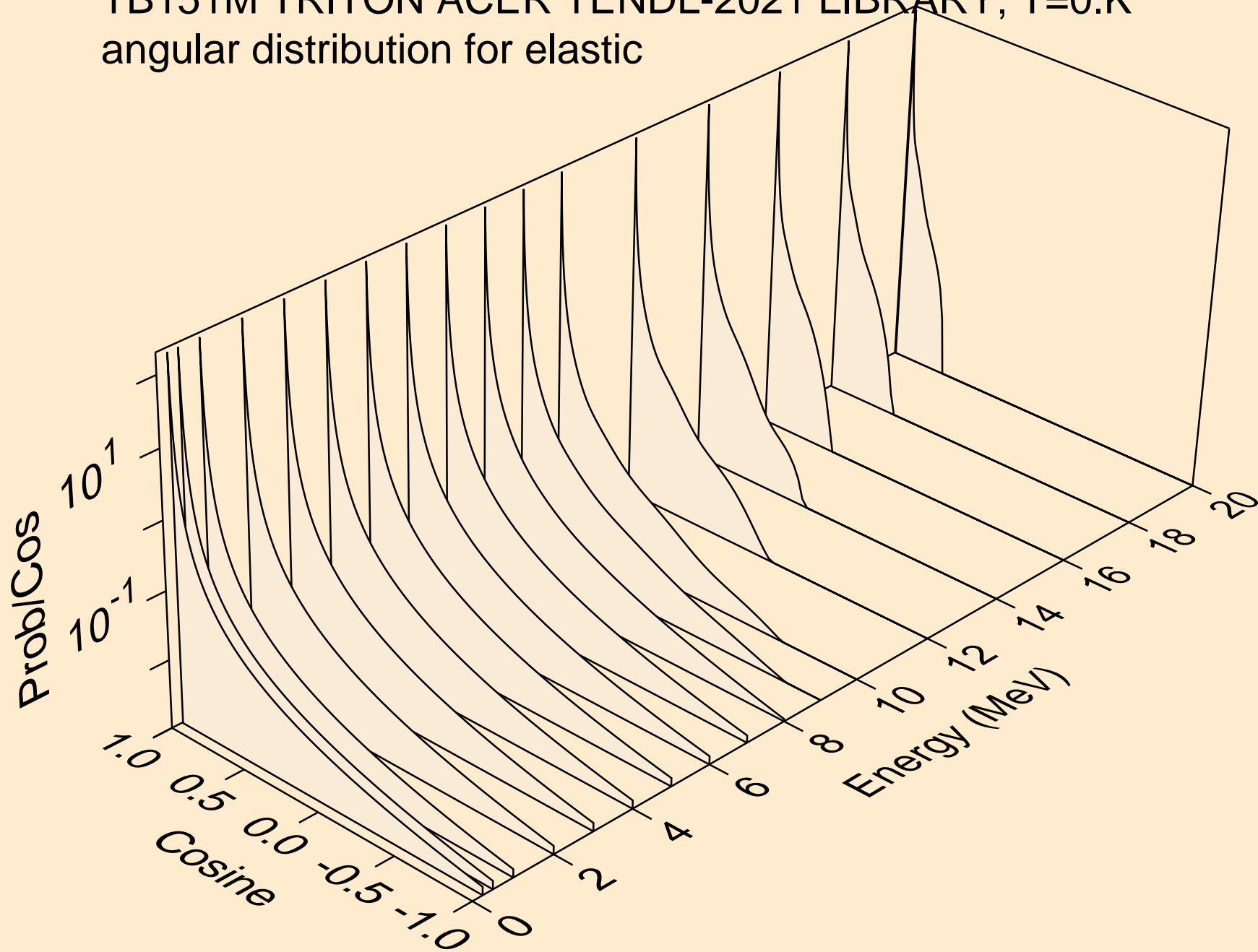



TB151M TRITON ACER TENDL-2021 LIBRARY; T=0.K  
angular distribution for elastic

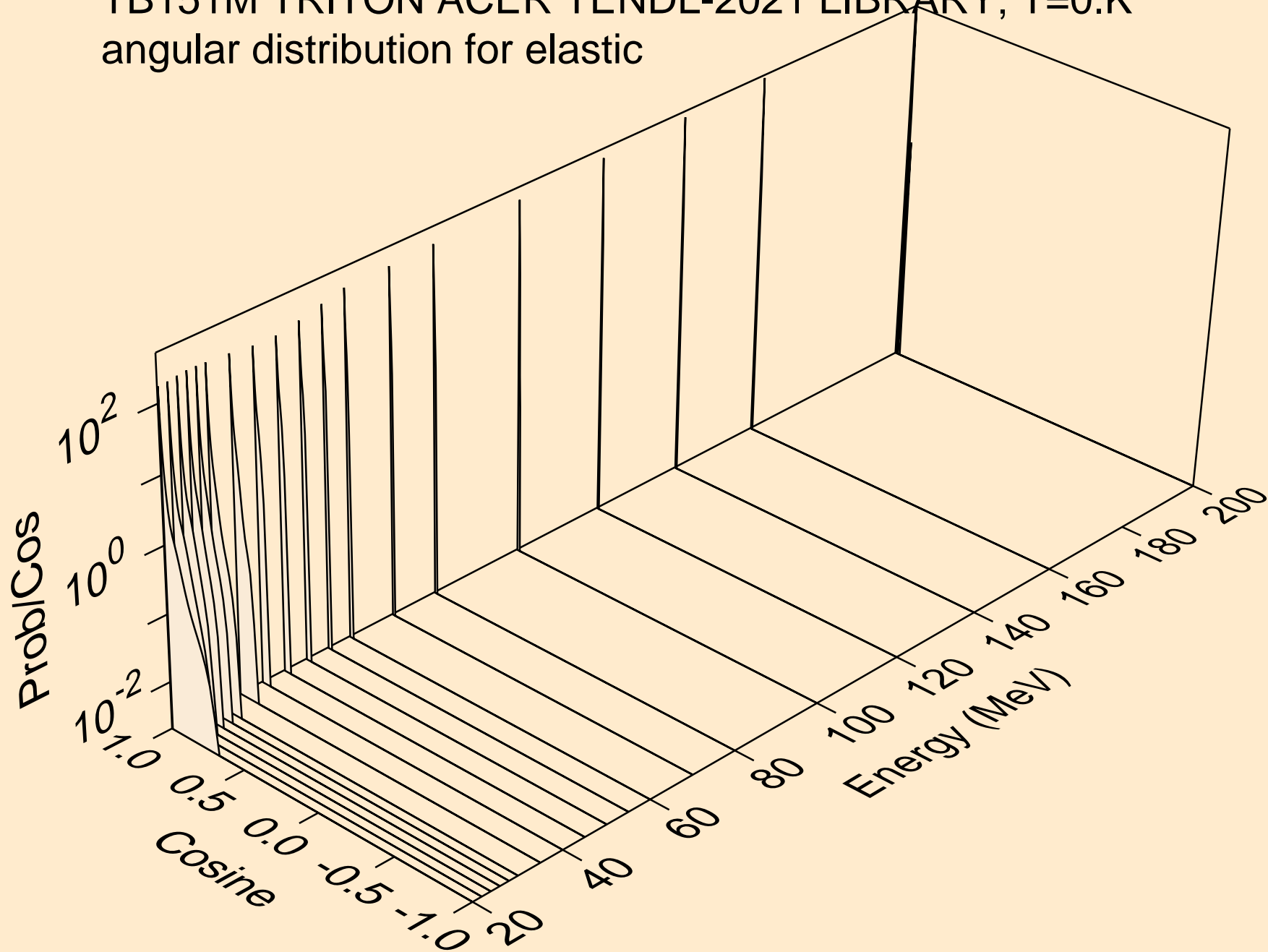

TB151M TRITON ACER TENDL-2021 LIBRARY; T=0.K  
Triton emission for (t,x)

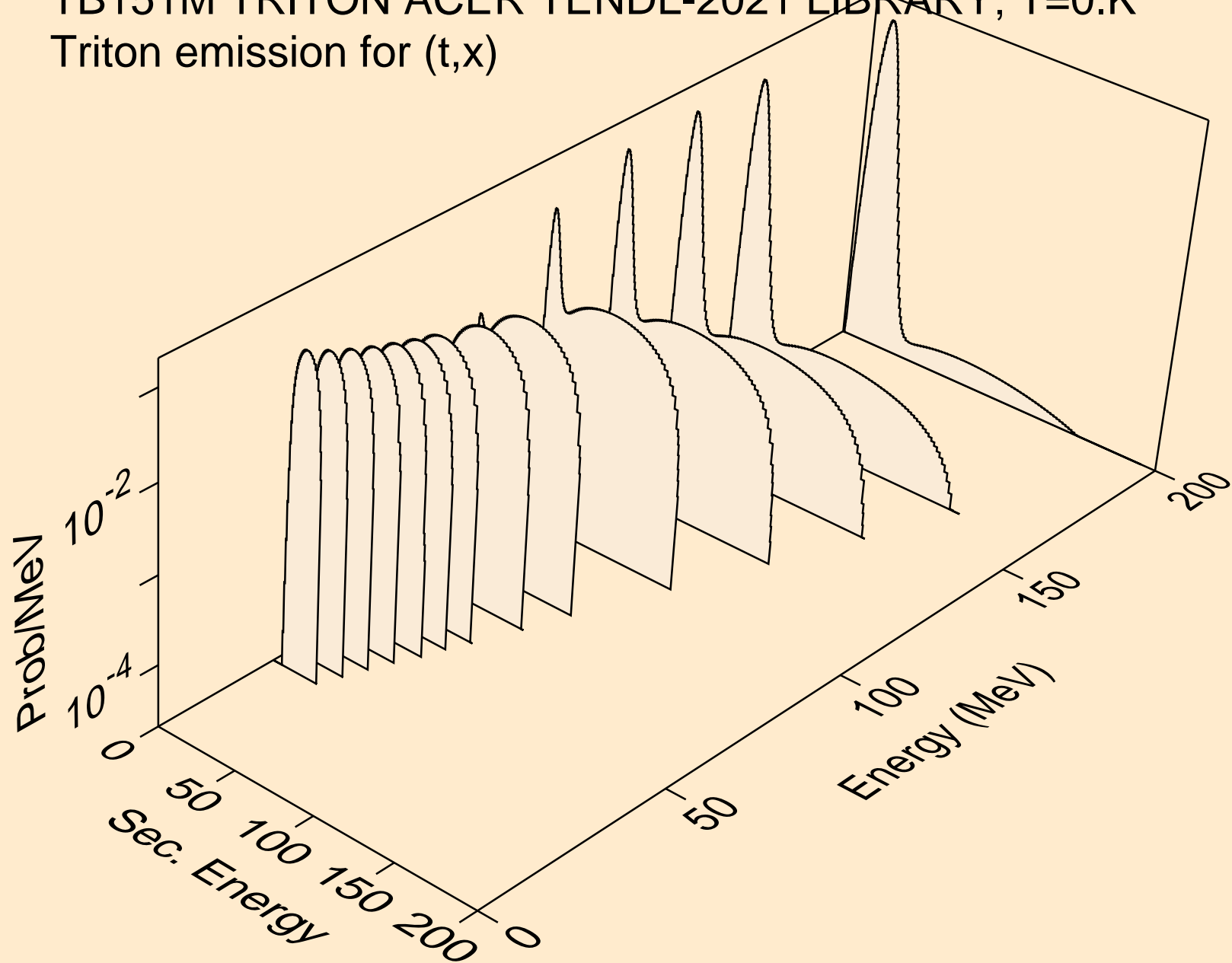

TB151M TRITON ACER TENDL-2021 LIBRARY; T=0.K  
Triton emission for (t,n\*)t

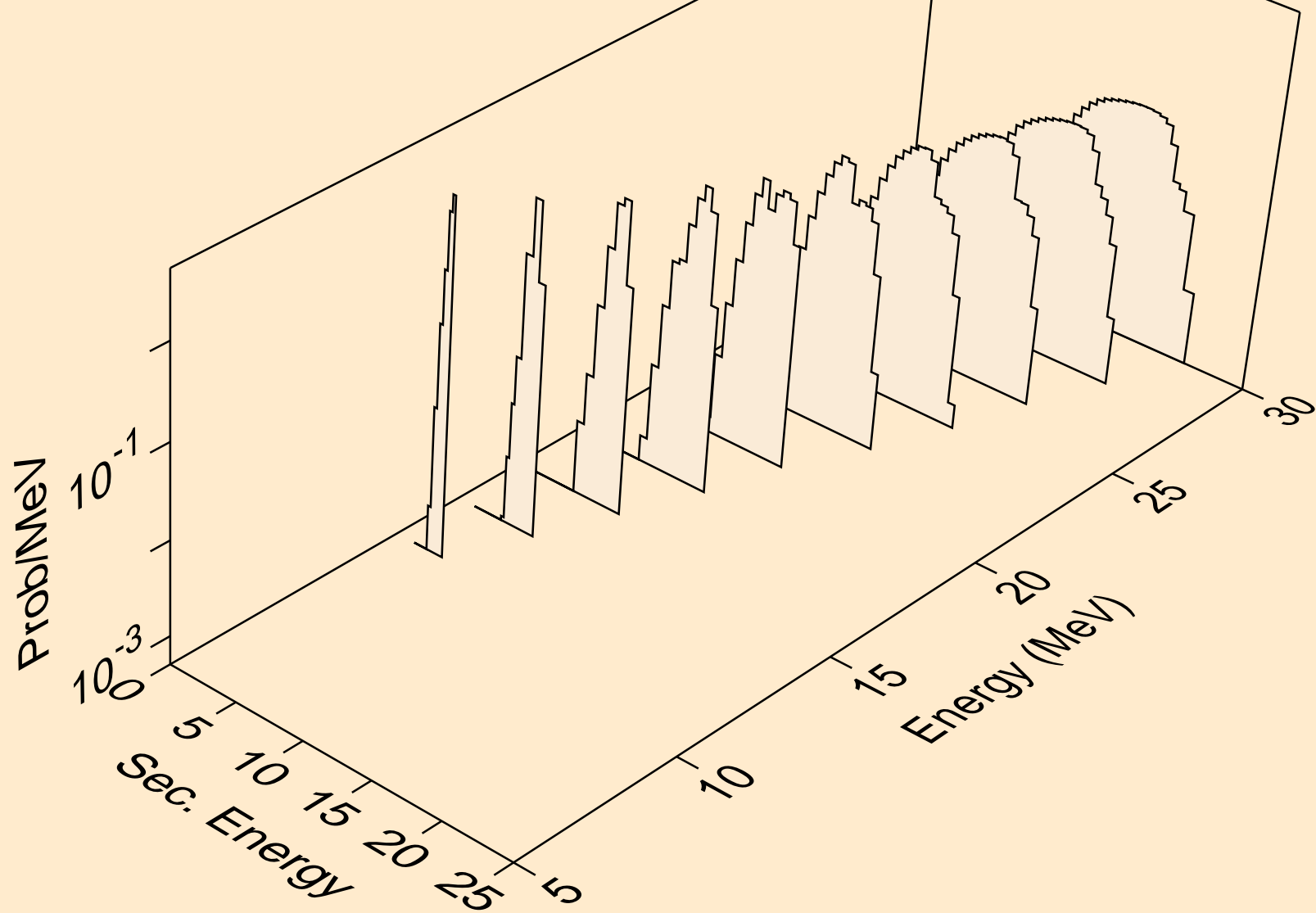

TB151M TRITON ACER TENDL-2021 LIBRARY; T=0.K  
Triton emission for inelastic

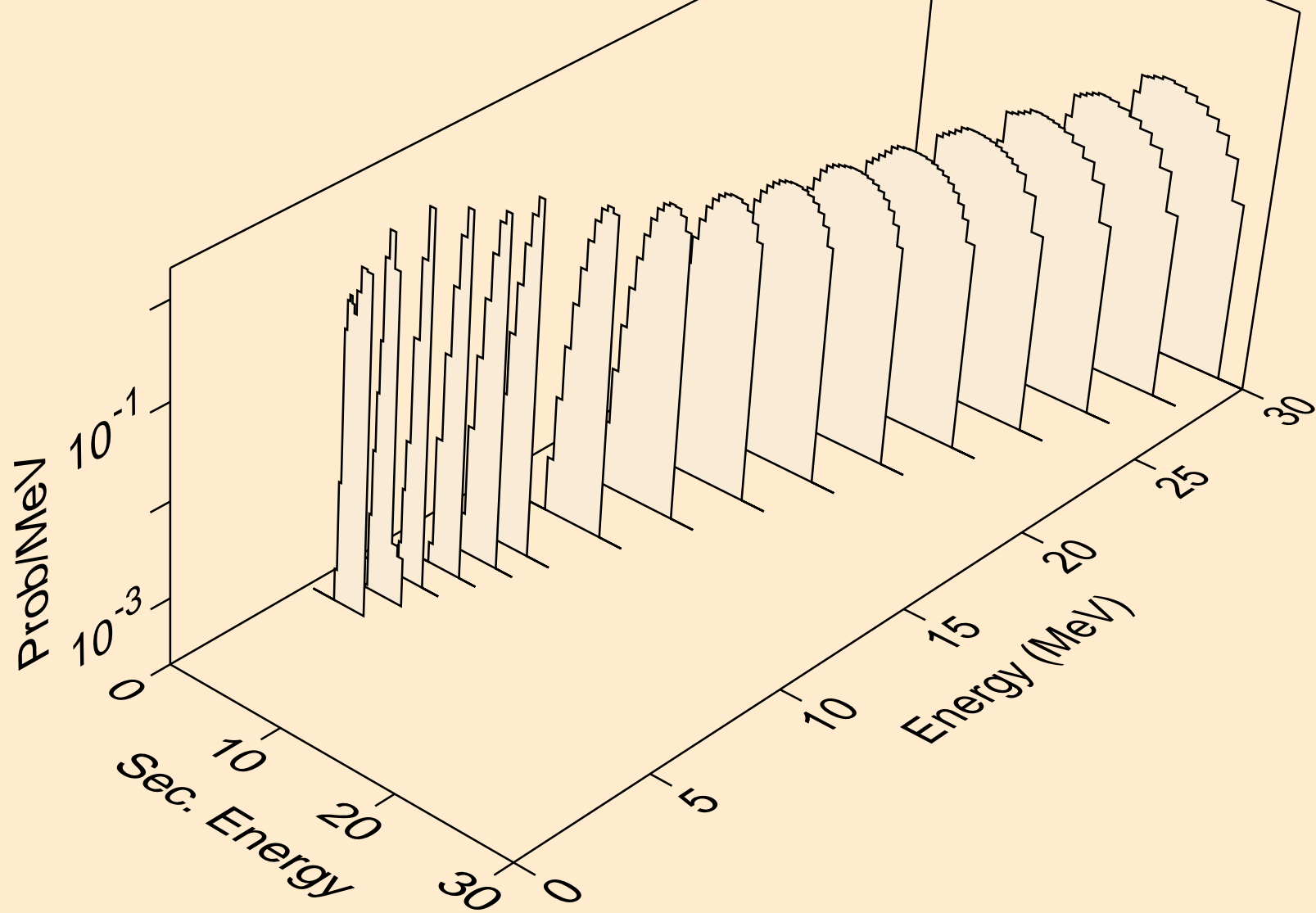

TB151M TRITON ACER TENDL-2021 LIBRARY; T=0.K  
Triton emission for (t,pt)

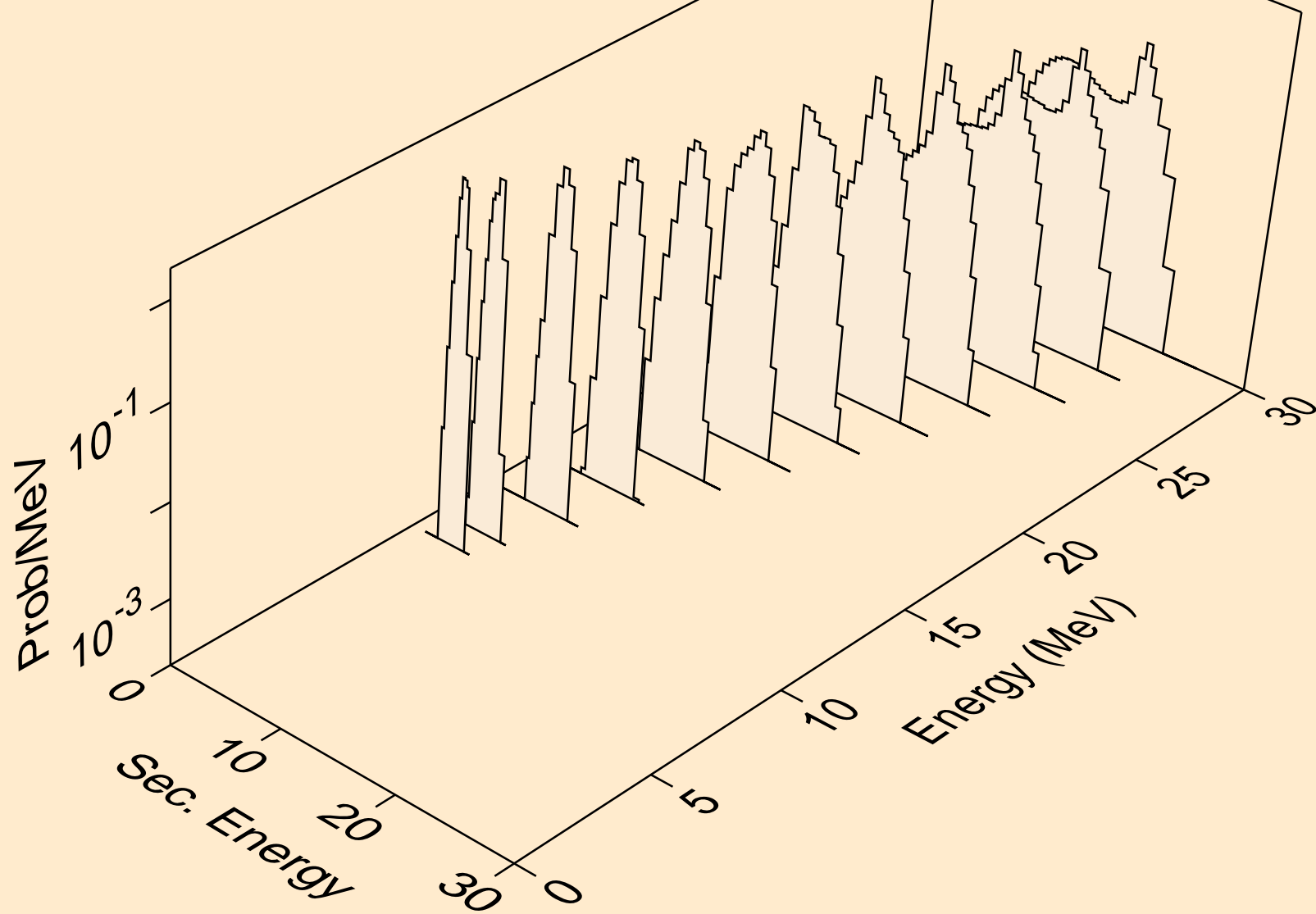

TB151M TRITON ACER TENDL-2021 LIBRARY; T=0.K  
Photon emission for (z,n)

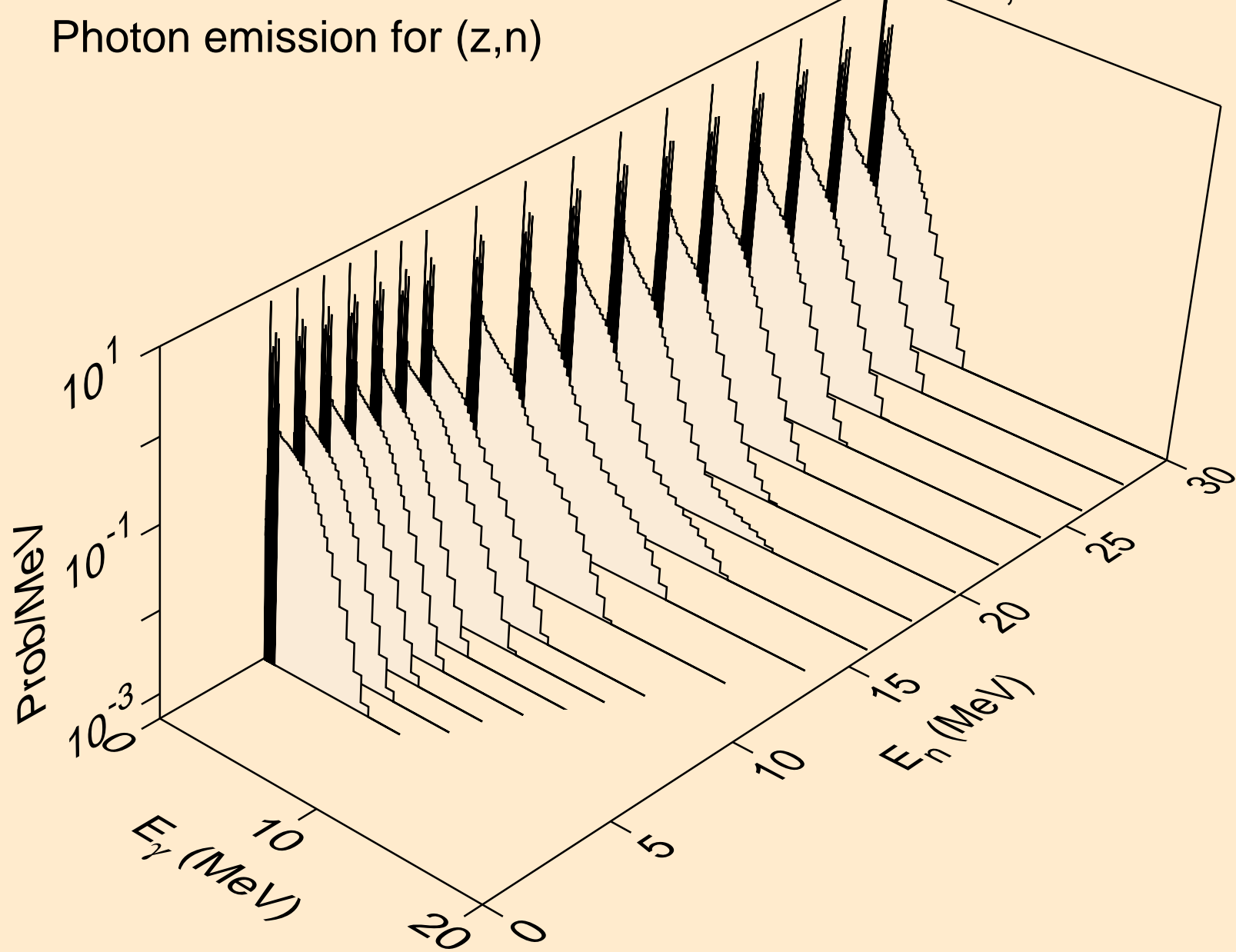

TB151M TRITON ACER TENDL-2021 LIBRARY; T=0.K  
Photon emission for (n,x)

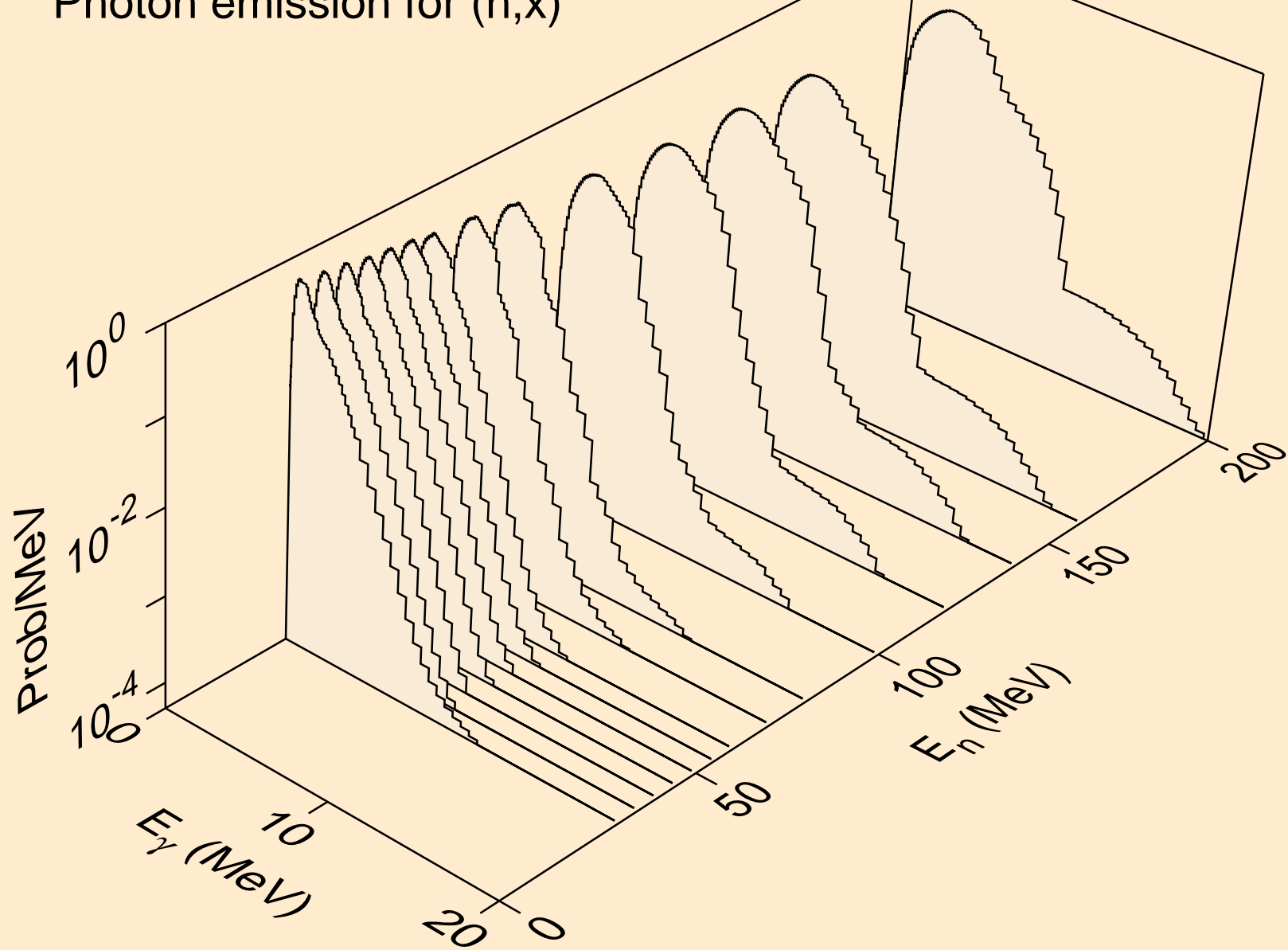

TB151M TRITON ACER TENDL-2021 LIBRARY; T=0.K  
Photon emission for (n,2nd)

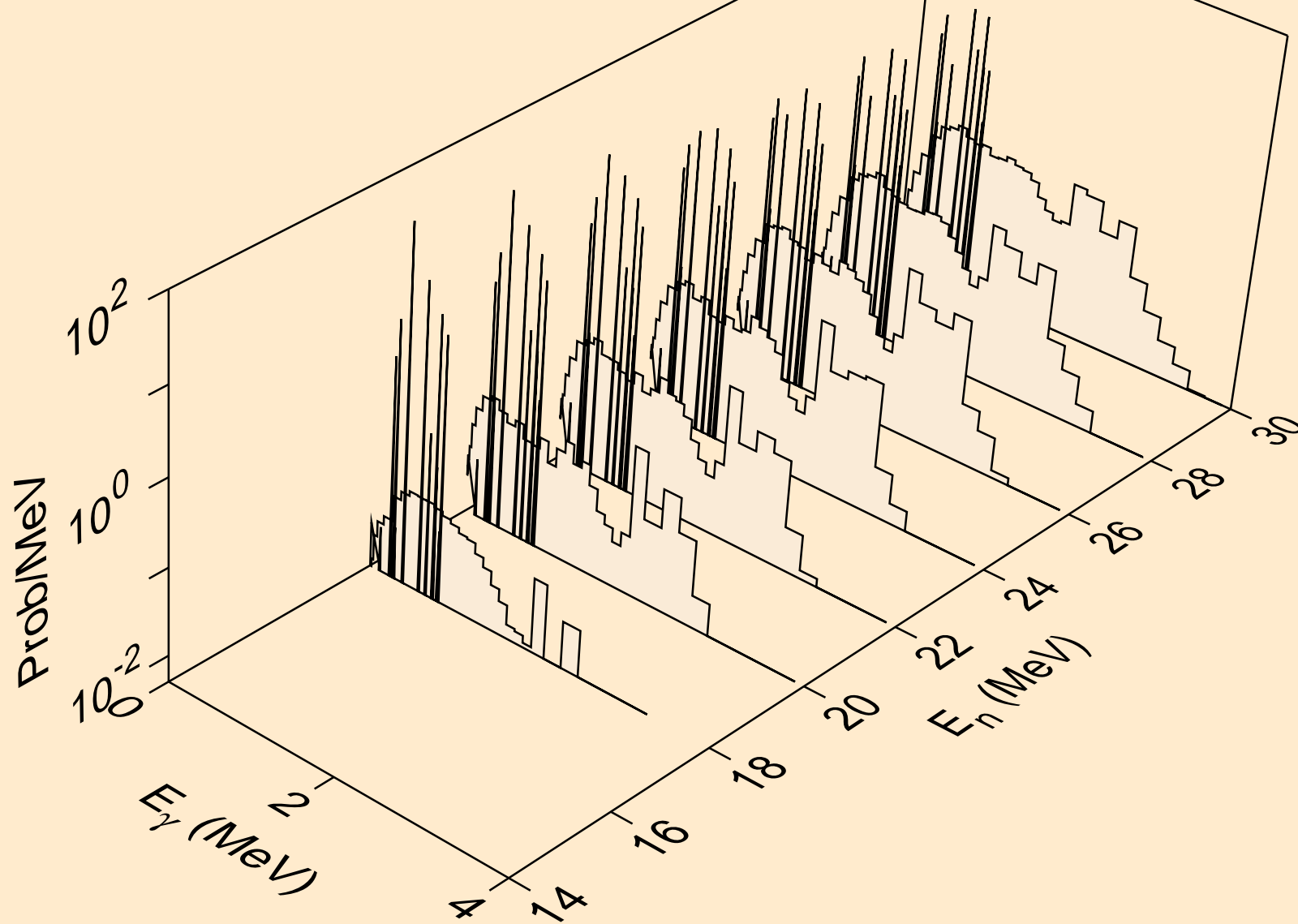



TB151M TRITON ACER TENDL-2021 LIBRARY; T=0.K  
Photon emission for (n,2n)

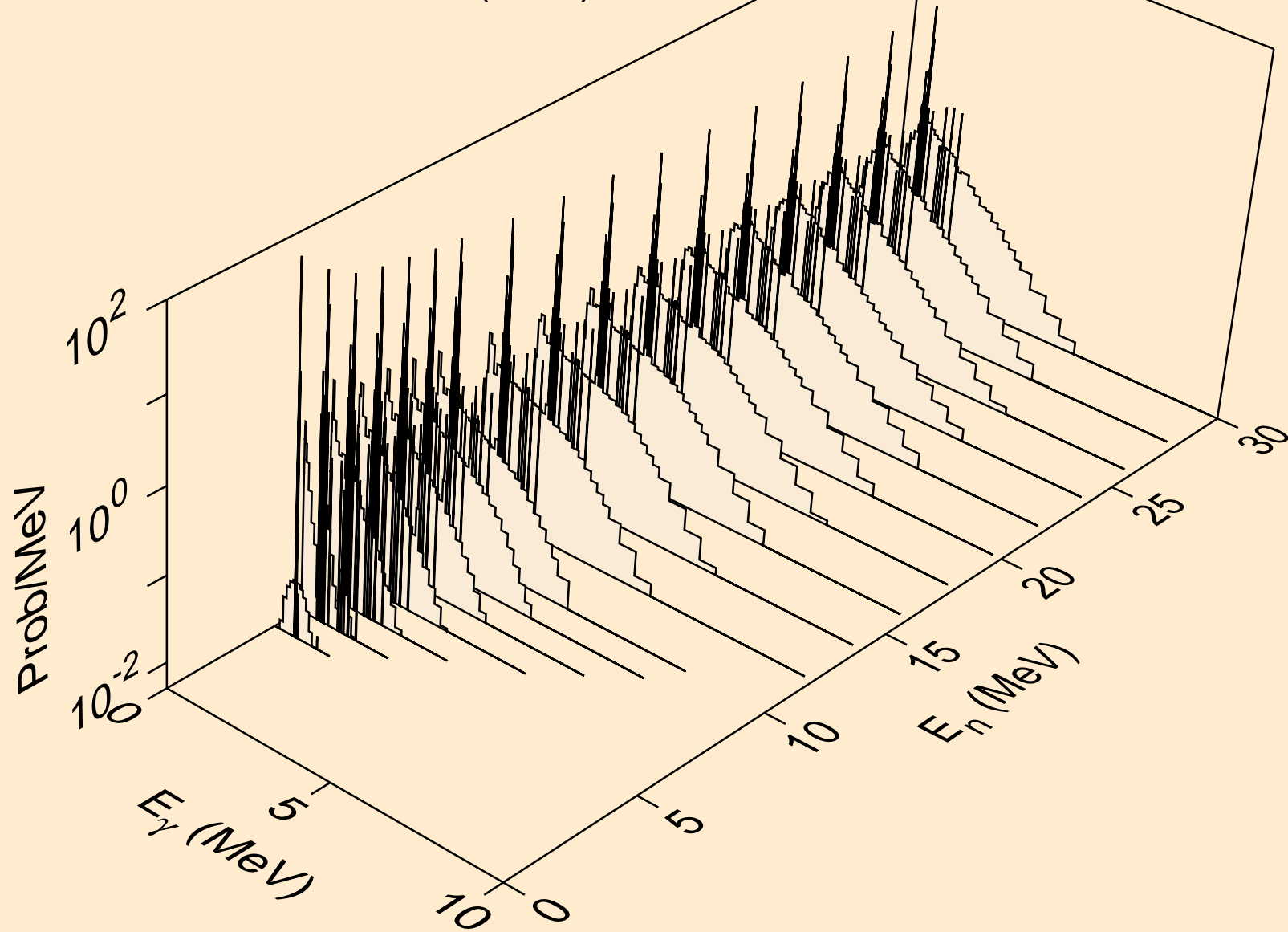

TB151M TRITON ACER TENDL-2021 LIBRARY; T=0.K  
Photon emission for (n,3n)

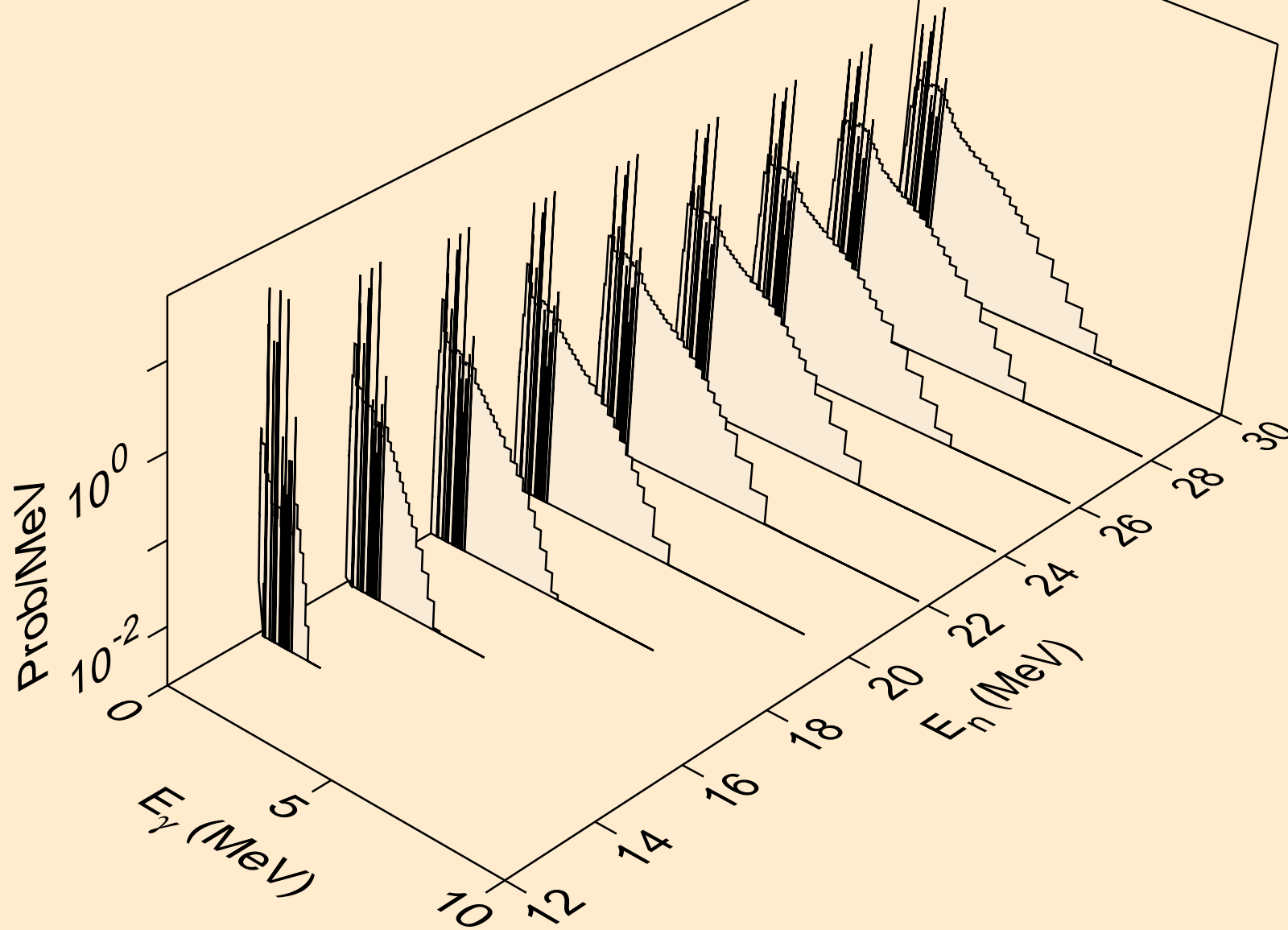

TB151M TRITON ACER TENDL-2021 LIBRARY; T=0.K  
Photon emission for (n,n\*)a

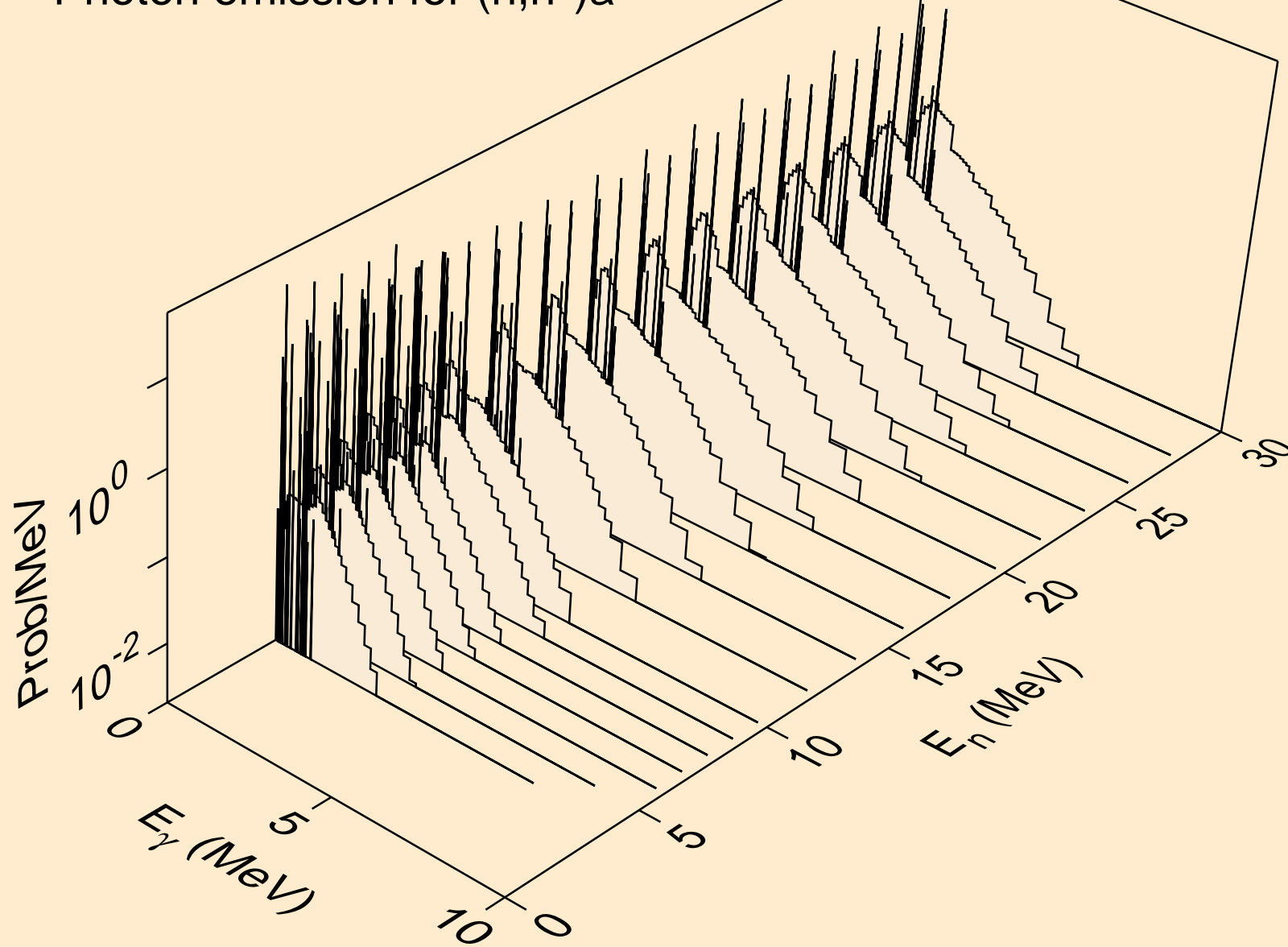

TB151M TRITON ACER TENDL-2021 LIBRARY; T=0.K  
Photon emission for (n,2n)a

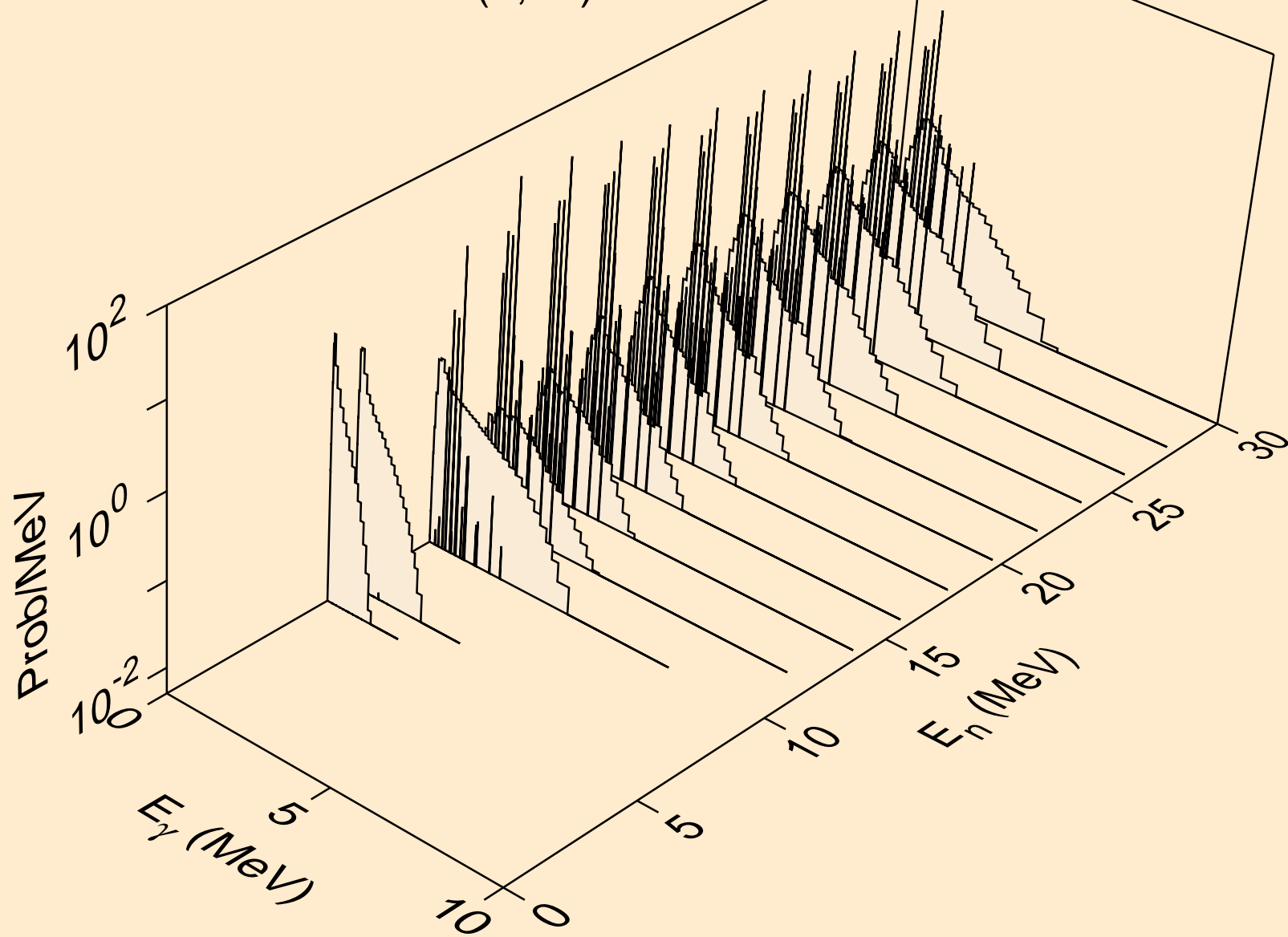

TB151M TRITON ACER TENDL-2021 LIBRARY; T=0.K  
Photon emission for (n,3n)a

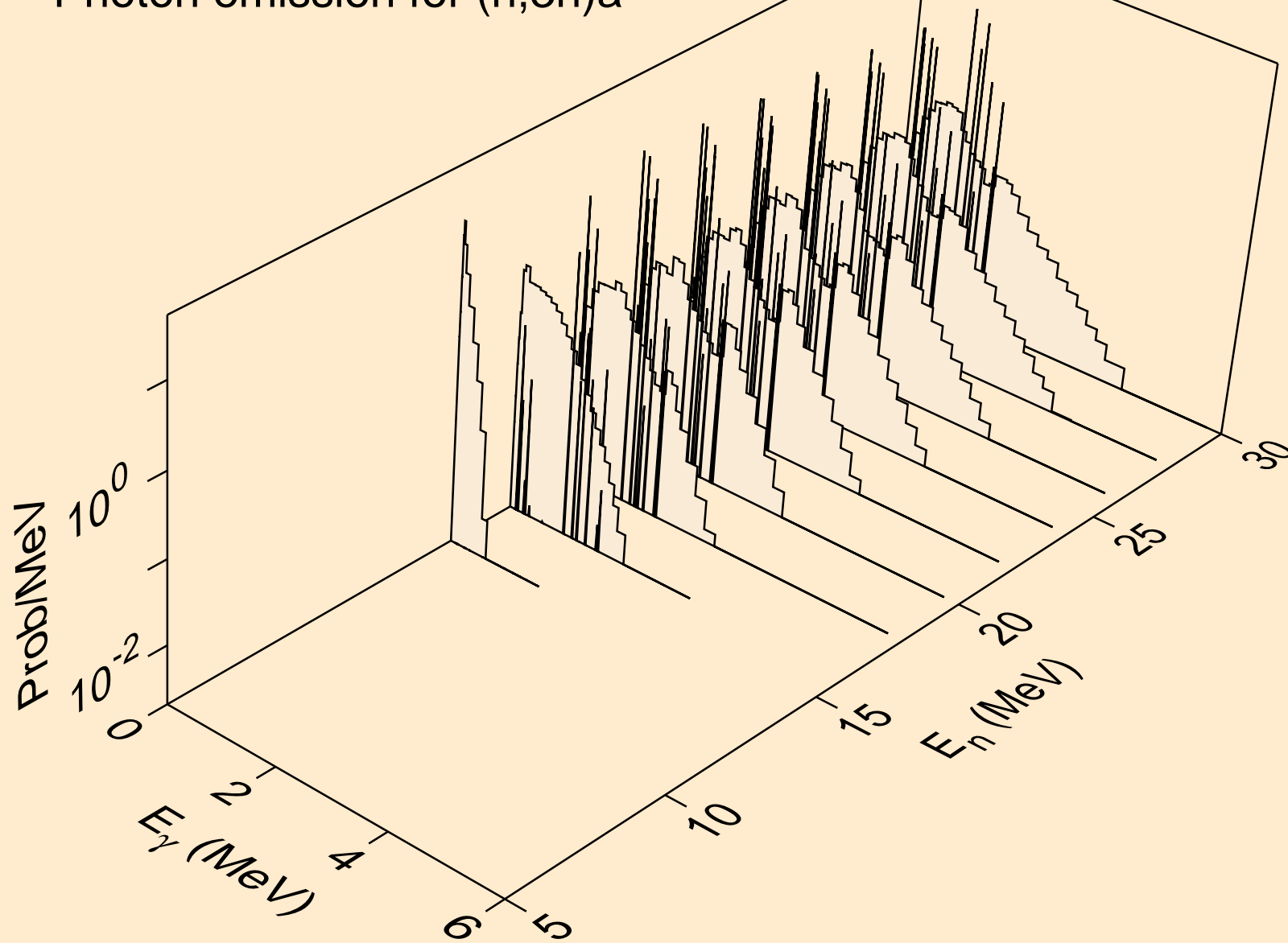

TB151M TRITON ACER TENDL-2021 LIBRARY; T=0.K  
Photon emission for (n,n\*)p

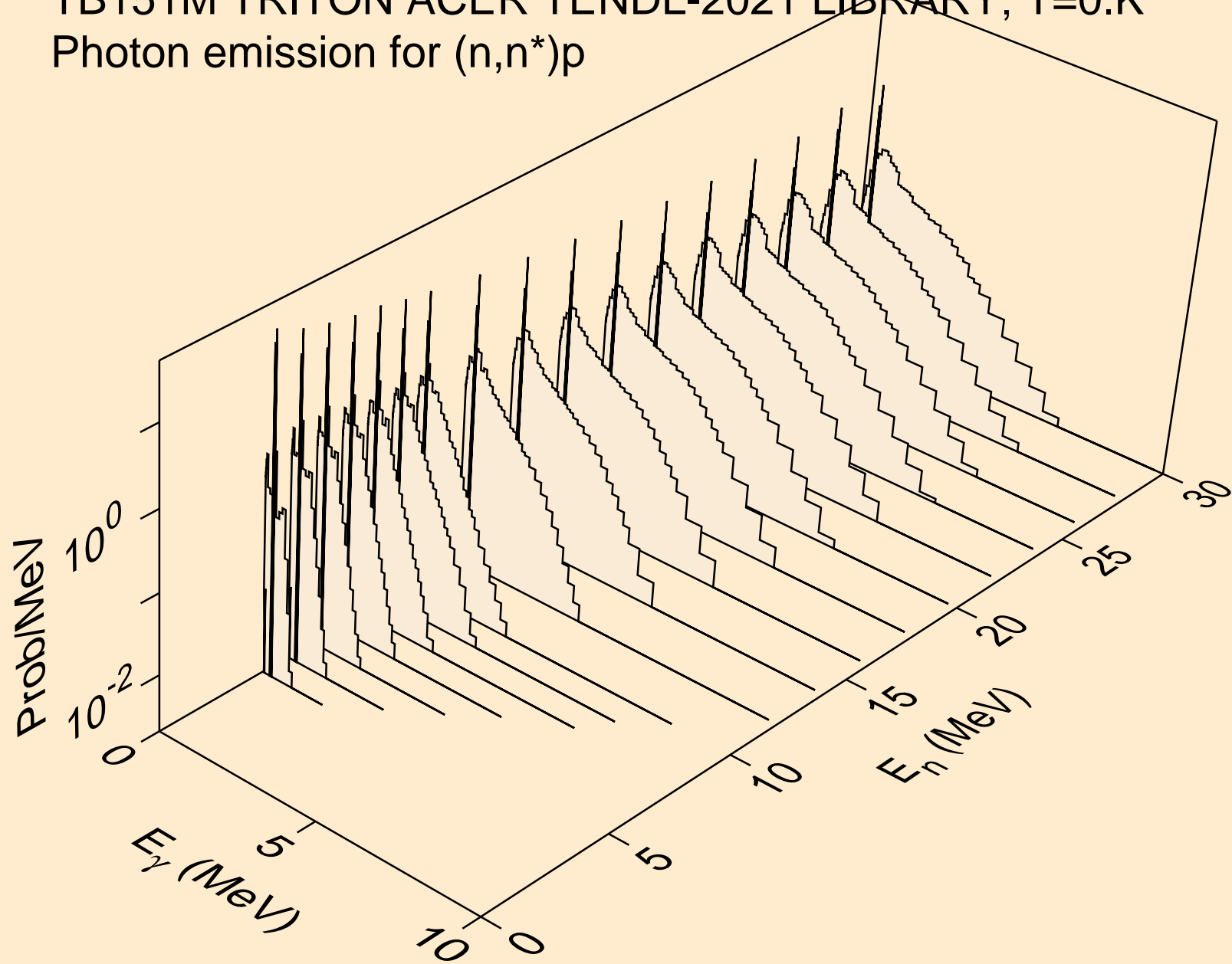

TB151M TRITON ACER TENDL-2021 LIBRARY; T=0.K  
Photon emission for (n,n\*)2a

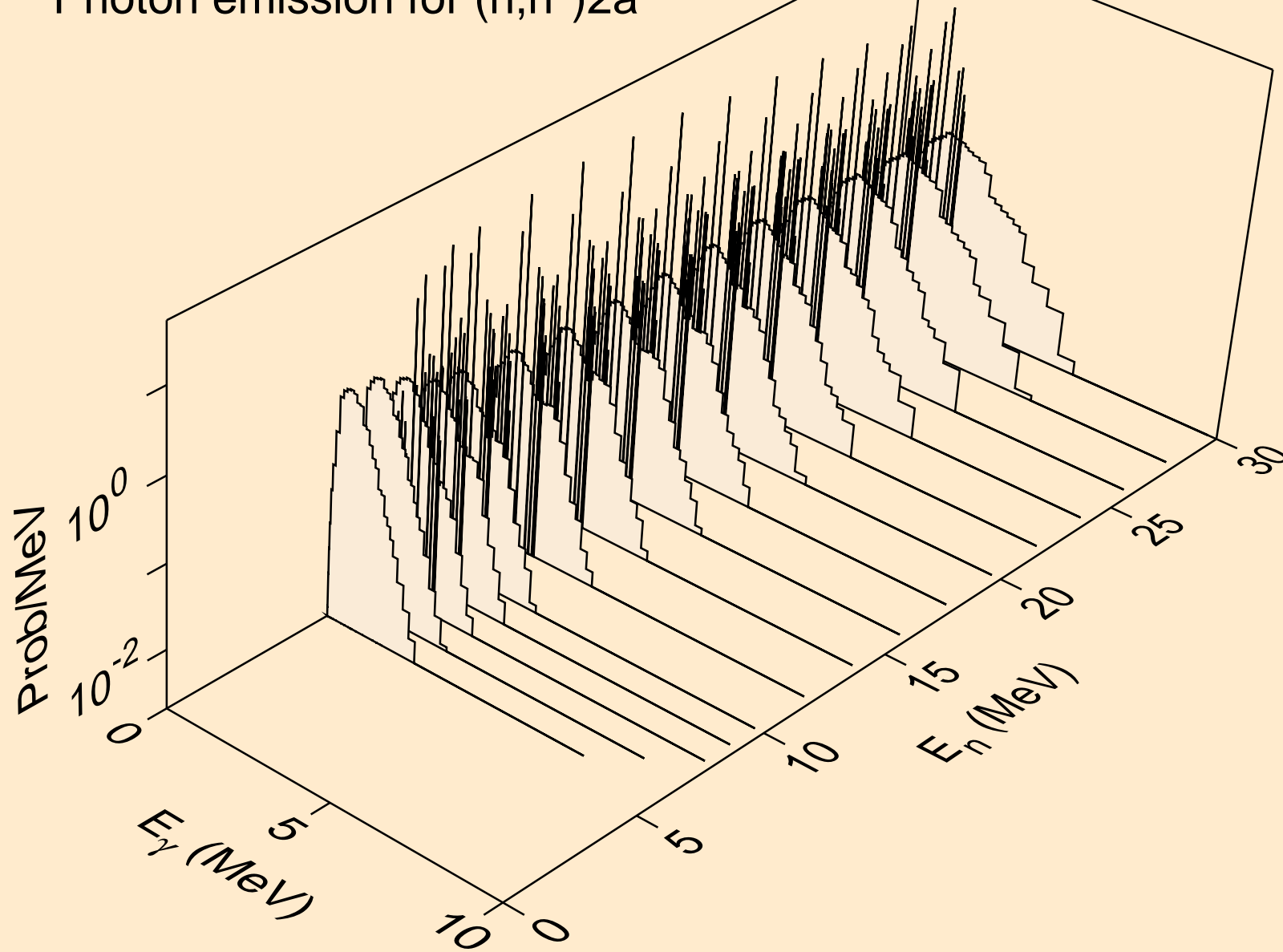

TB151M TRITON ACER TENDL-2021 LIBRARY; T=0.K  
Photon emission for (n,2n)2a

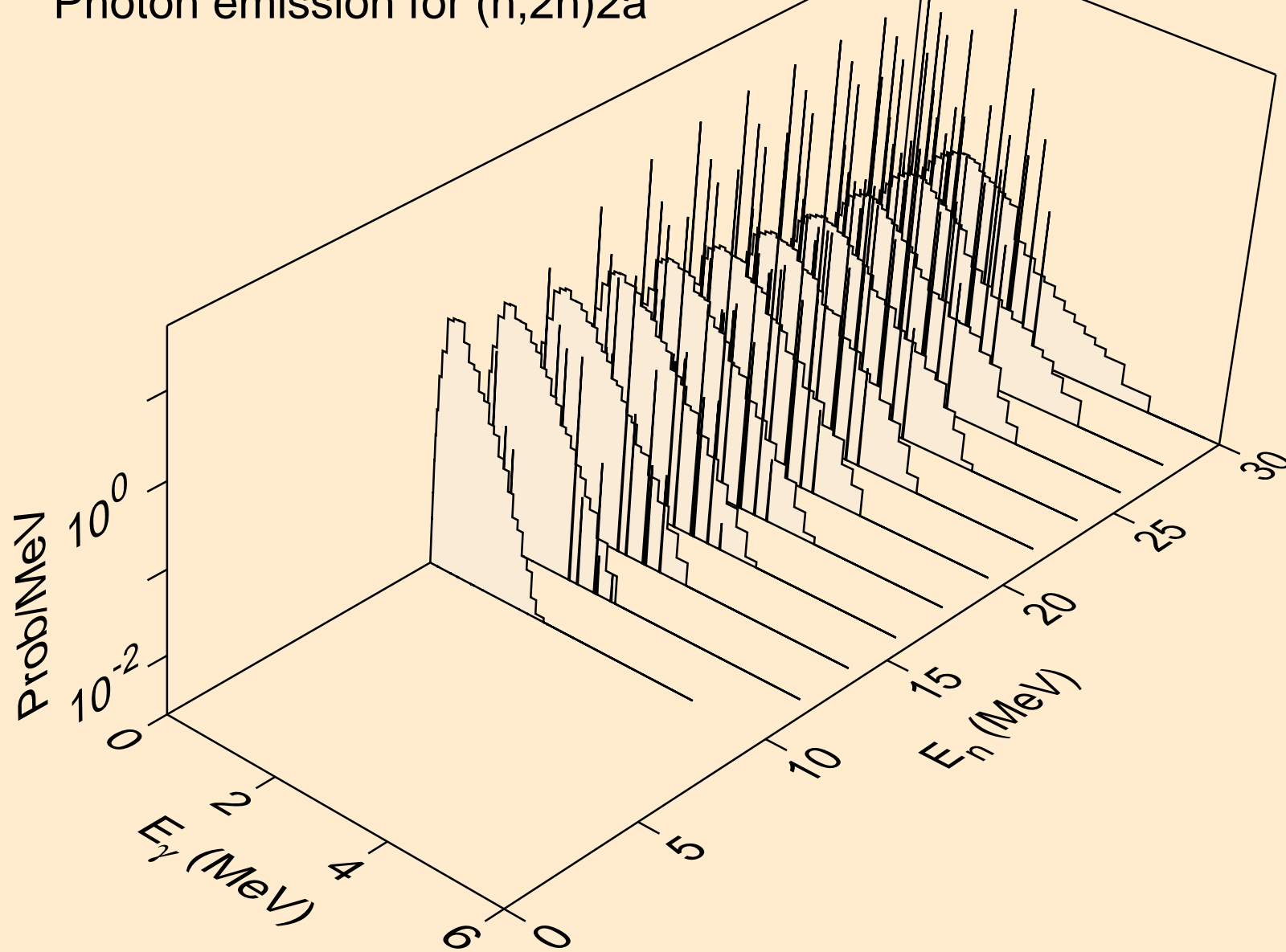



TB151M TRITON ACER TENDL-2021 LIBRARY; T=0.K  
Photon emission for (n,n\*)d

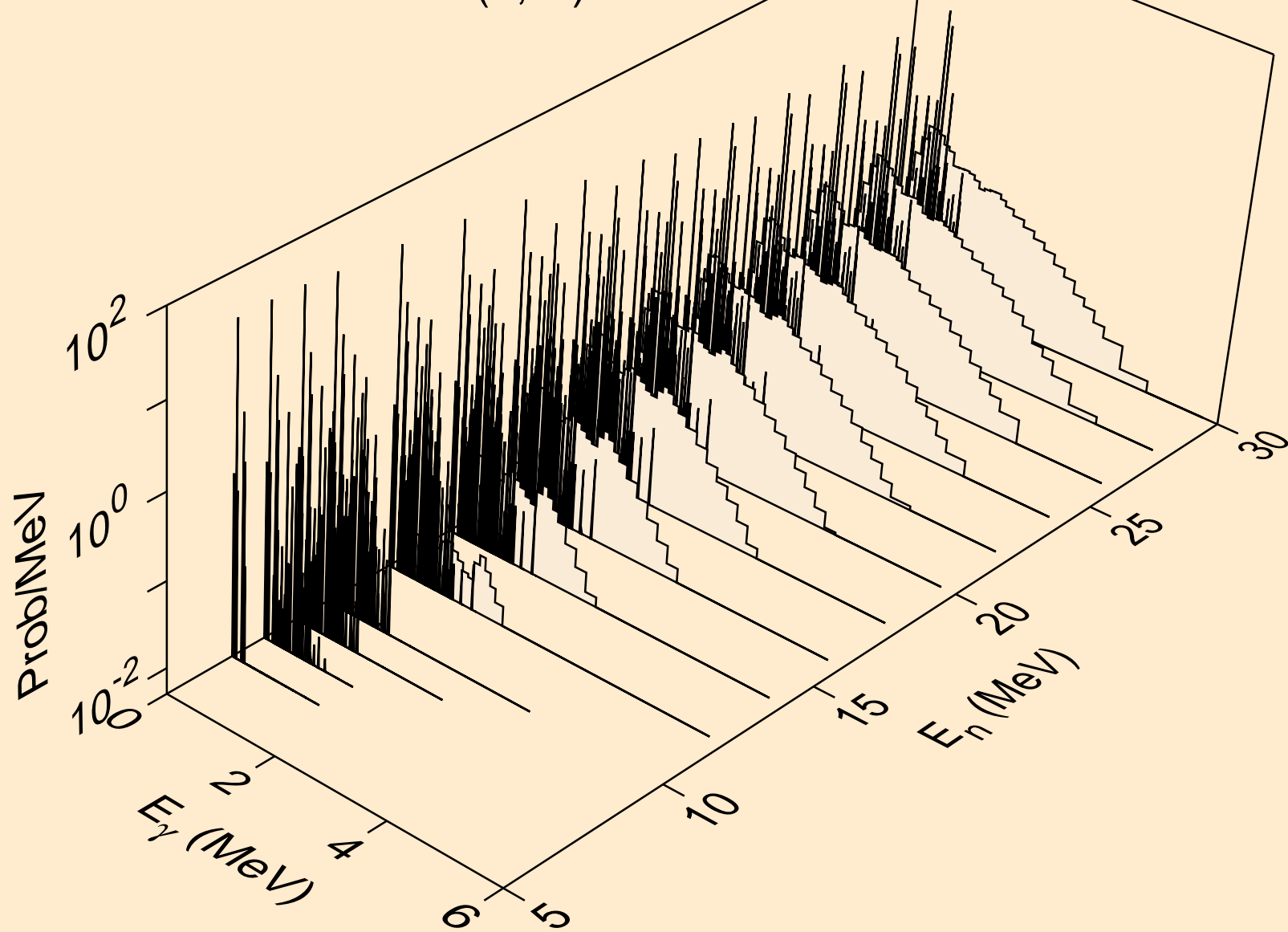

TB151M TRITON ACER TENDL-2021 LIBRARY; T=0.K  
Photon emission for (n,n\*)t

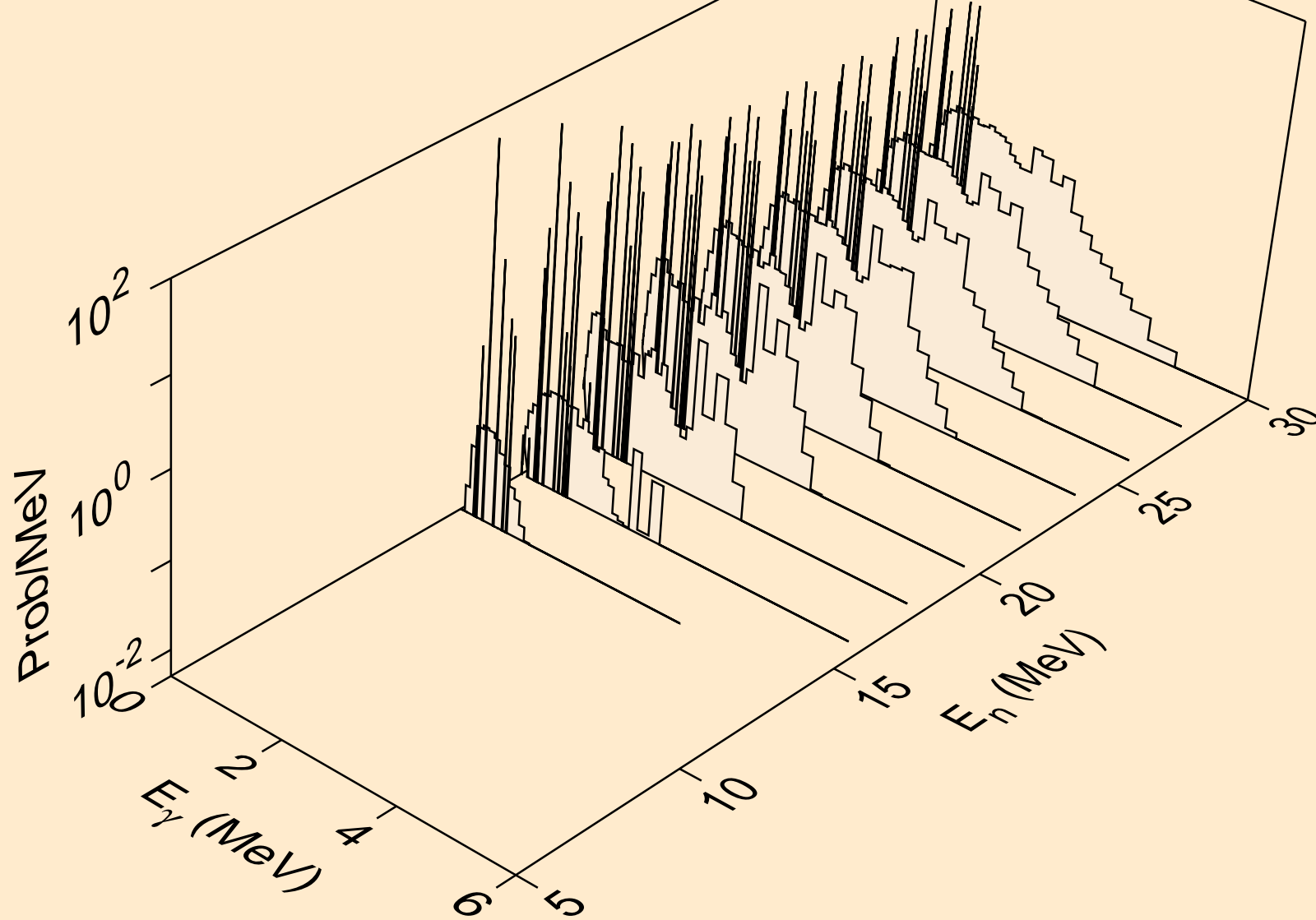

TB151M TRITON ACER TENDL-2021 LIBRARY; T=0.K  
Photon emission for (n,n\*)he3

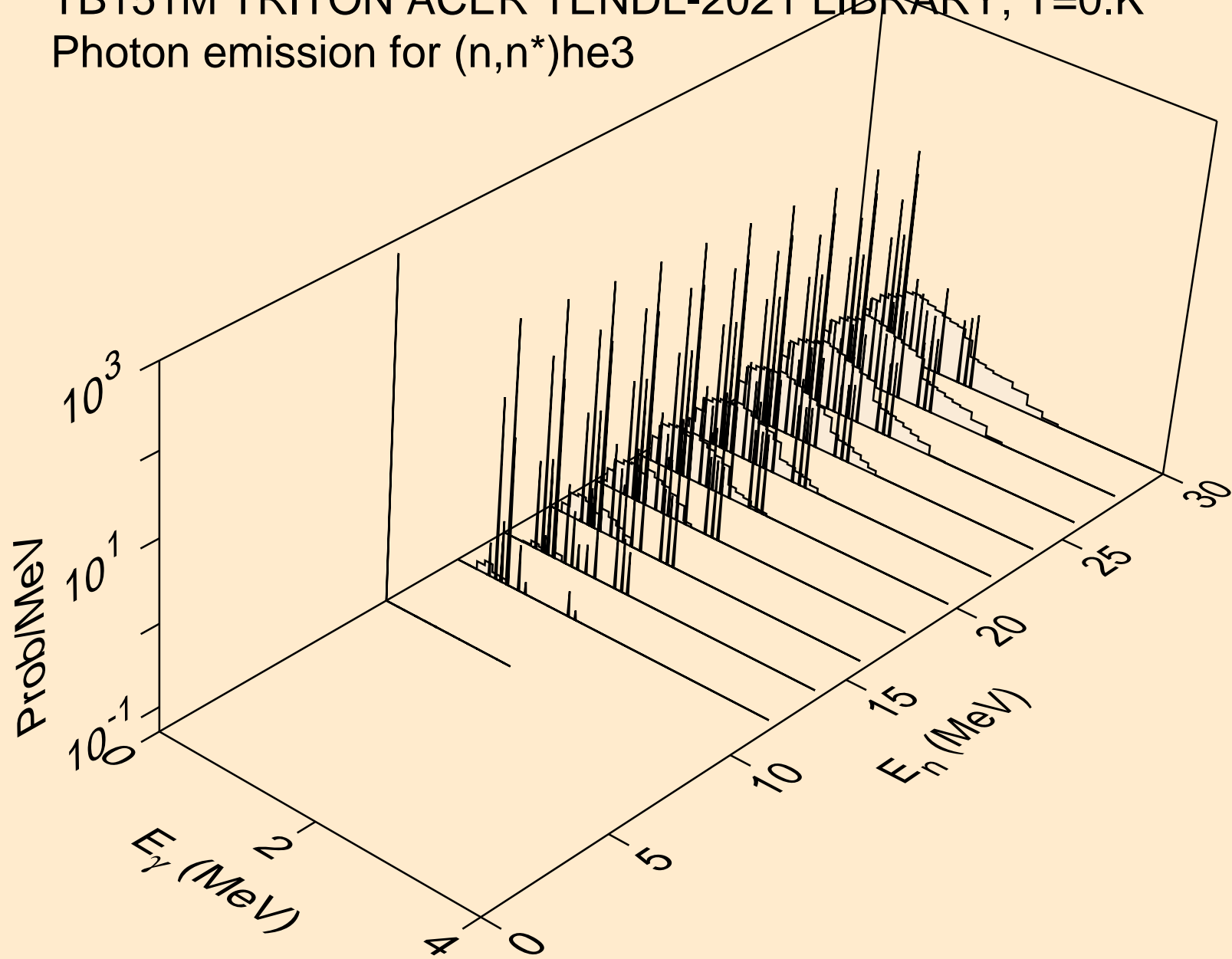

TB151M TRITON ACER TENDL-2021 LIBRARY; T=0.K  
Photon emission for (n,4n)

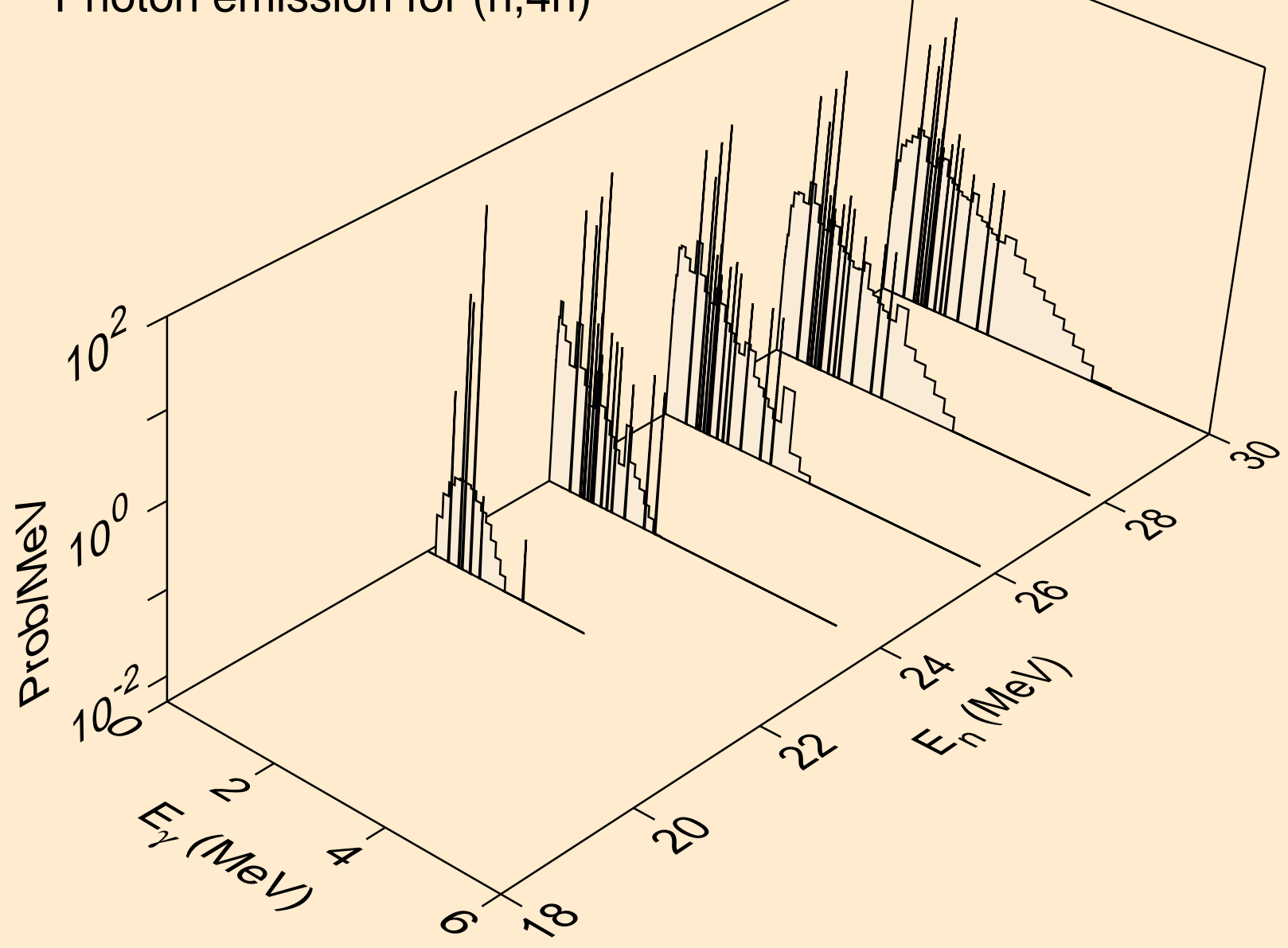

TB151M TRITON ACER TENDL-2021 LIBRARY; T=0.K  
Photon emission for (n,2np)

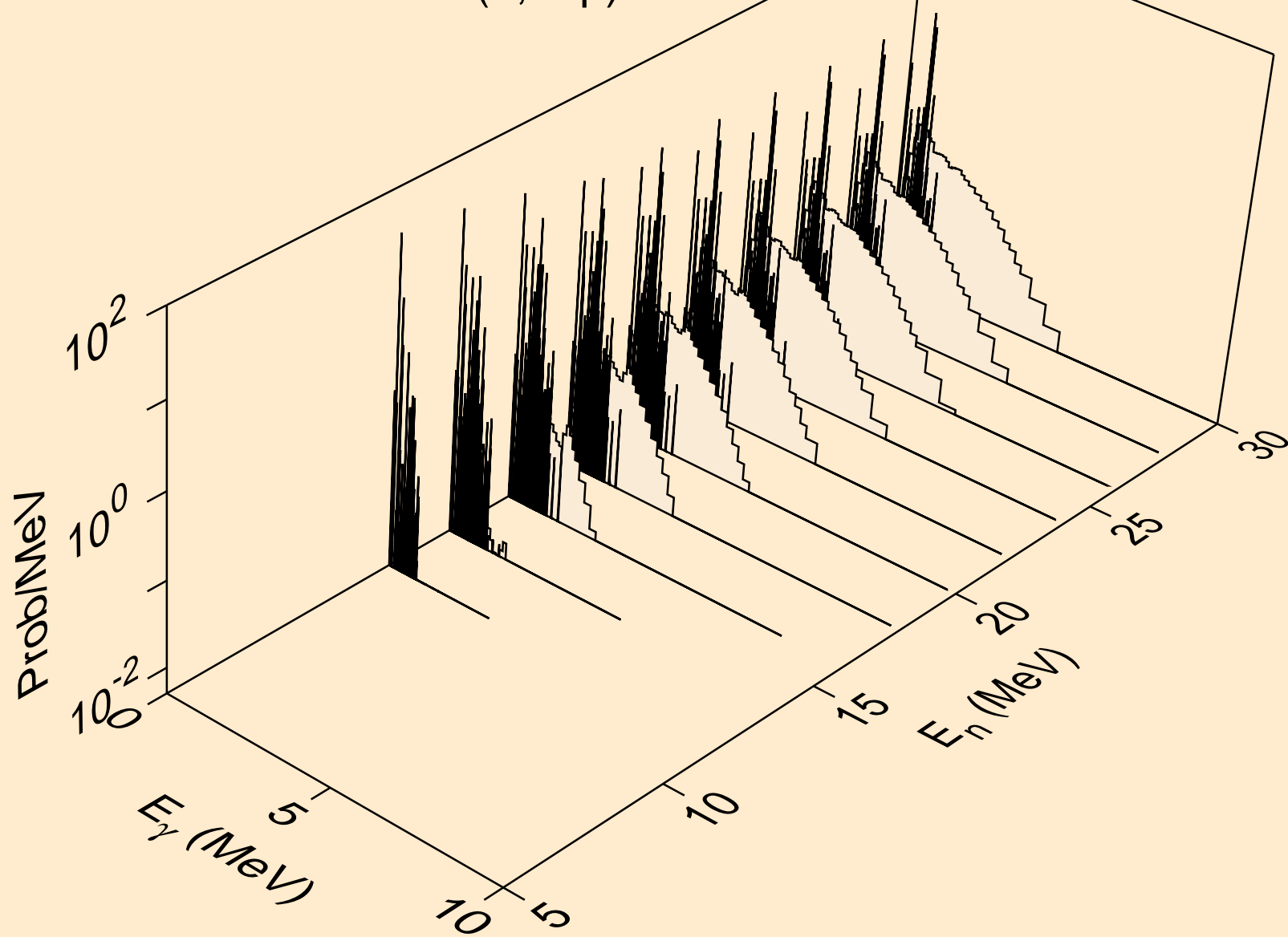

TB151M TRITON ACER TENDL-2021 LIBRARY; T=0.K  
Photon emission for (n,3np)

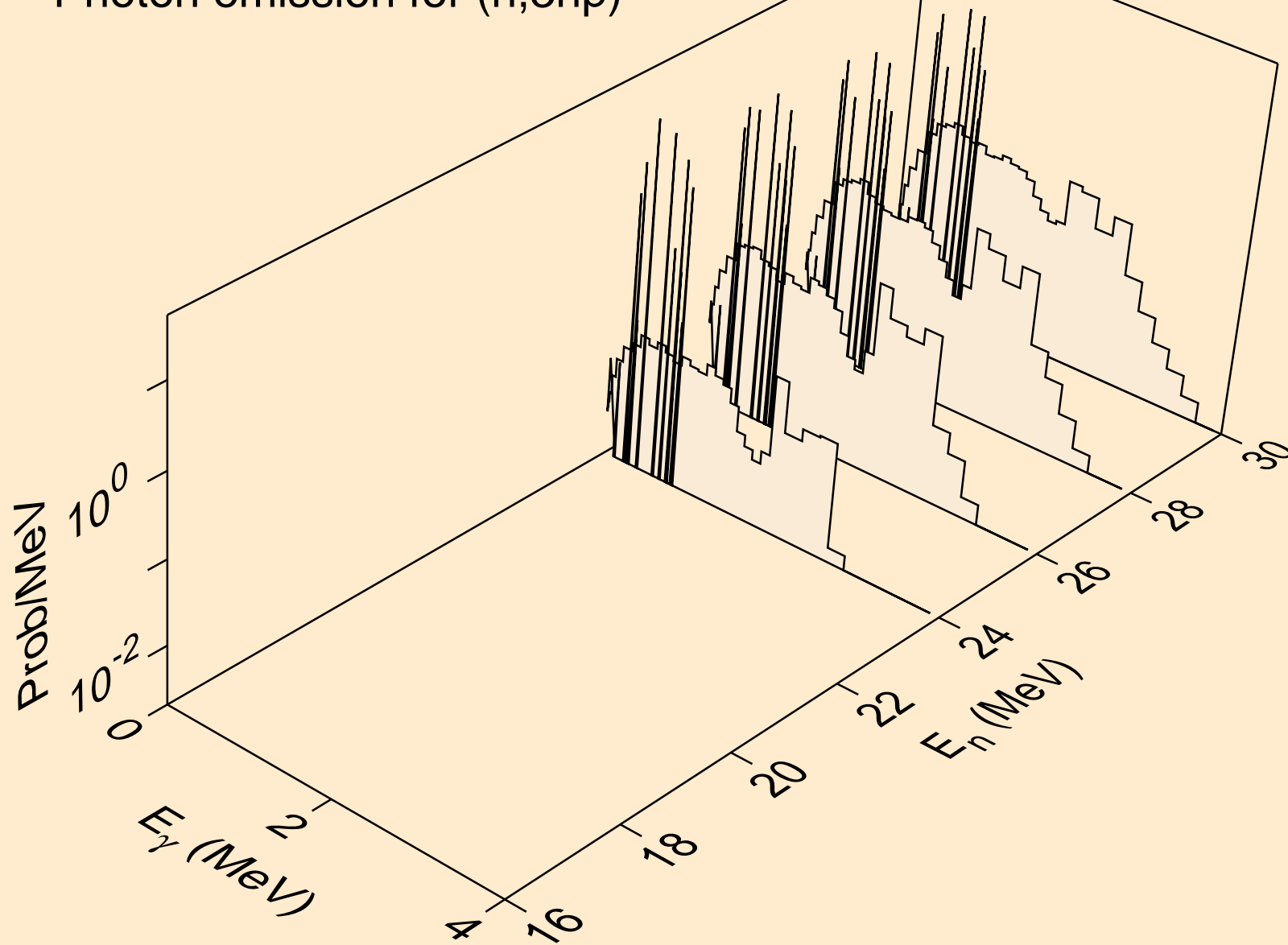

TB151M TRITON ACER TENDL-2021 LIBRARY; T=0.K  
Photon emission for (n,2np)

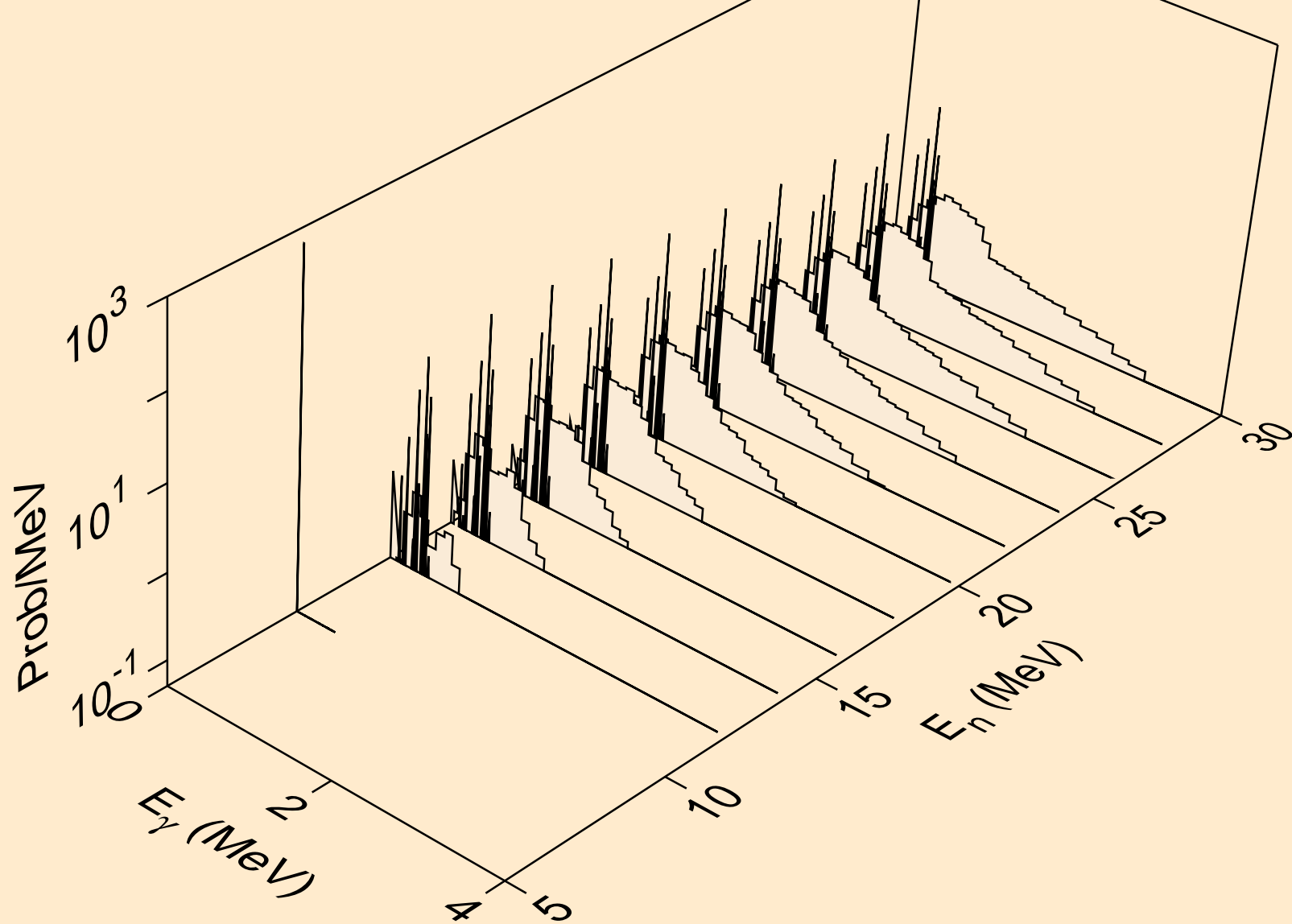

TB151M TRITON ACER TENDL-2021 LIBRARY; T=0.K  
Photon emission for (n,npa)

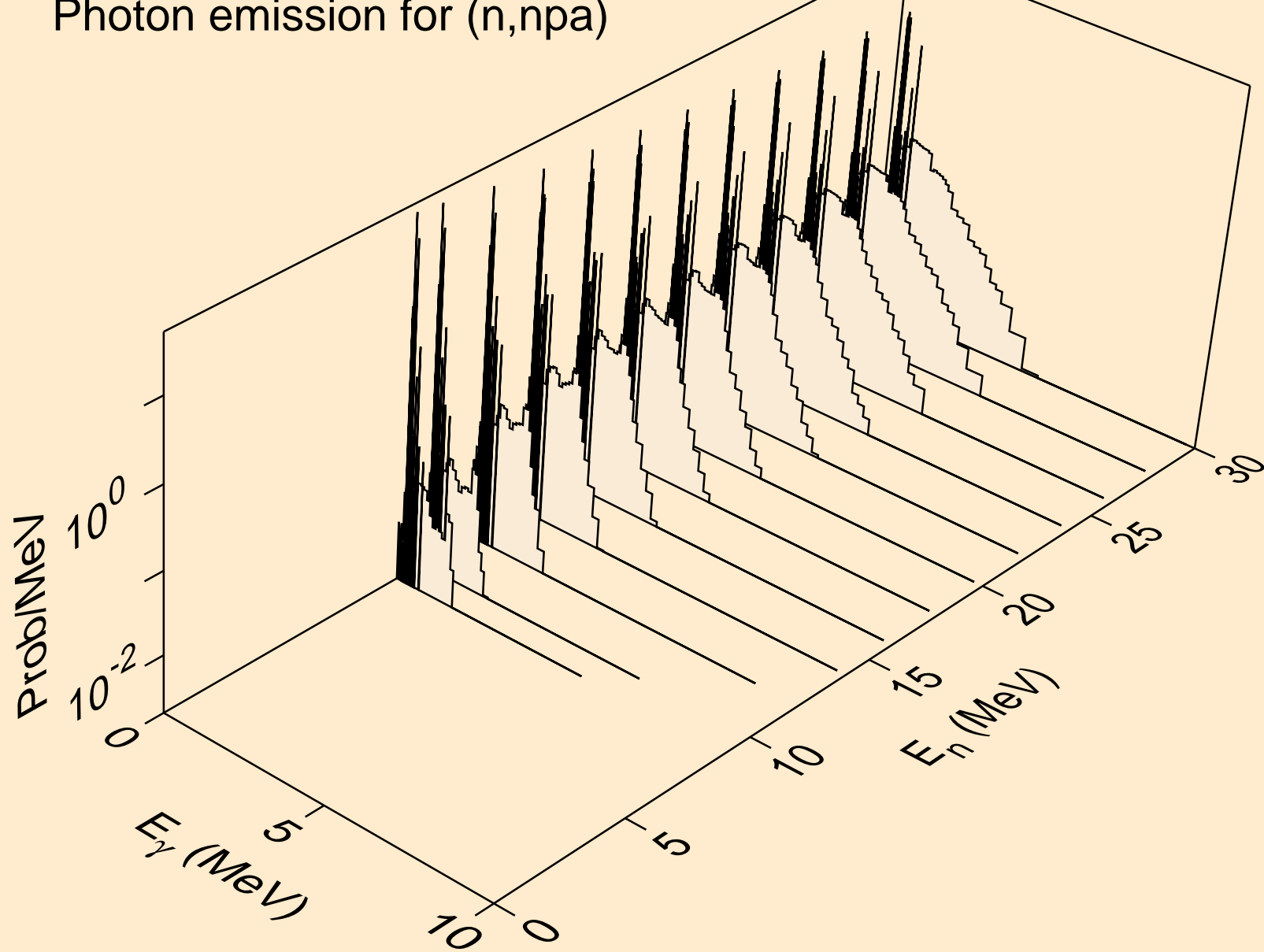



TB151M TRITON ACER TENDL-2021 LIBRARY; T=0.K  
Photon emission for (n,gma)

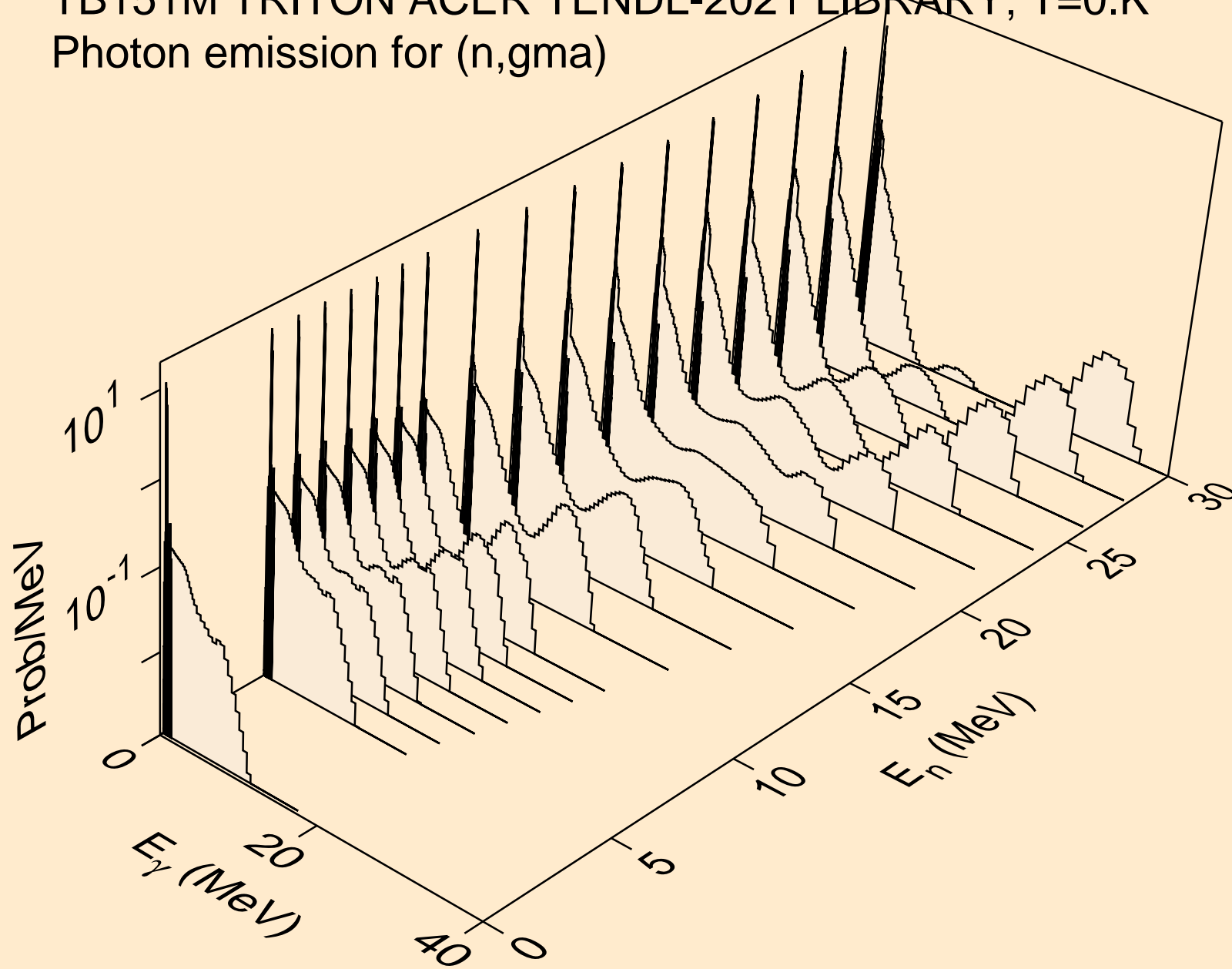

TB151M TRITON ACER TENDL-2021 LIBRARY; T=0.K  
Photon emission for (n,p)

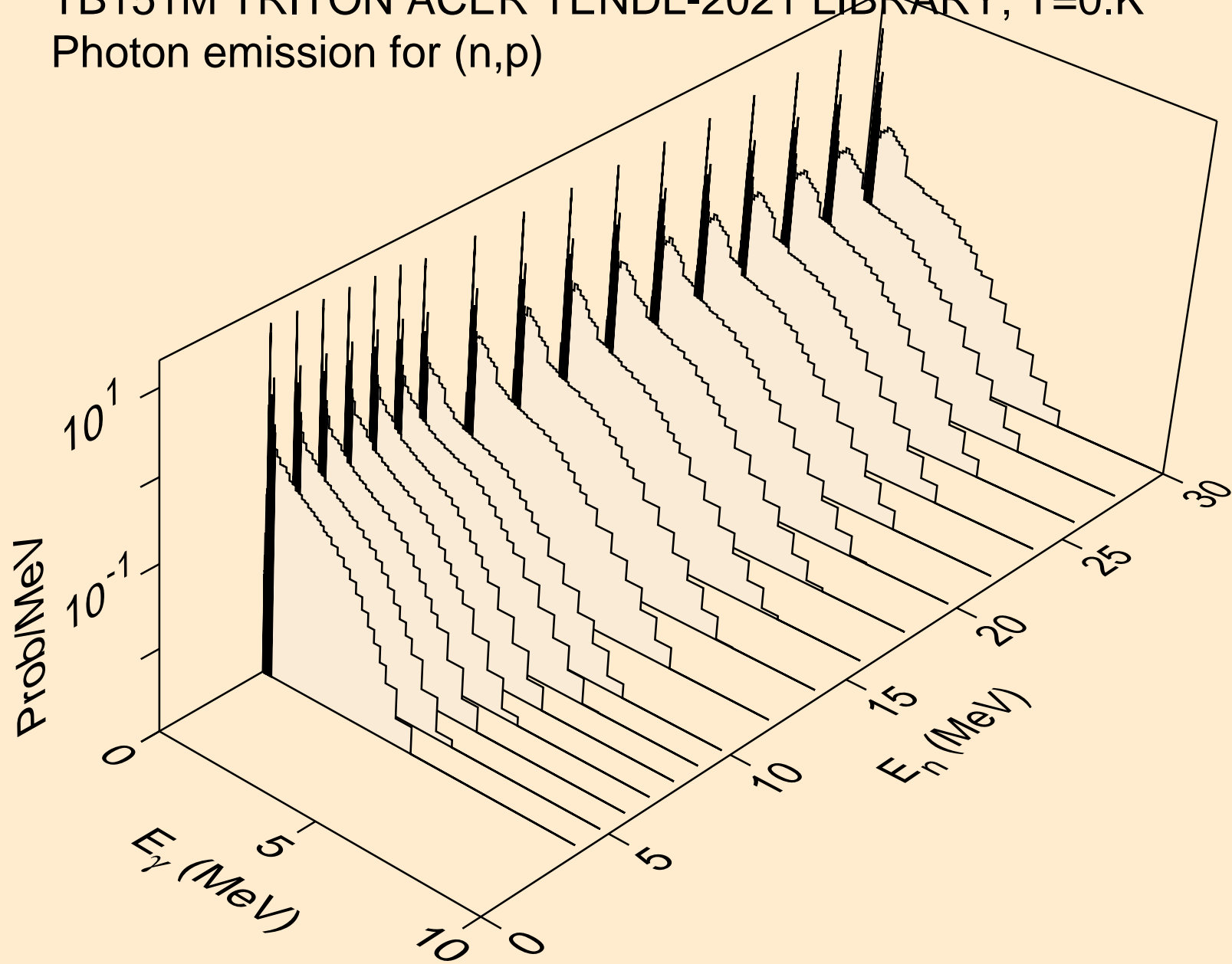

TB151M TRITON ACER TENDL-2021 LIBRARY; T=0.K  
Photon emission for (n,d)

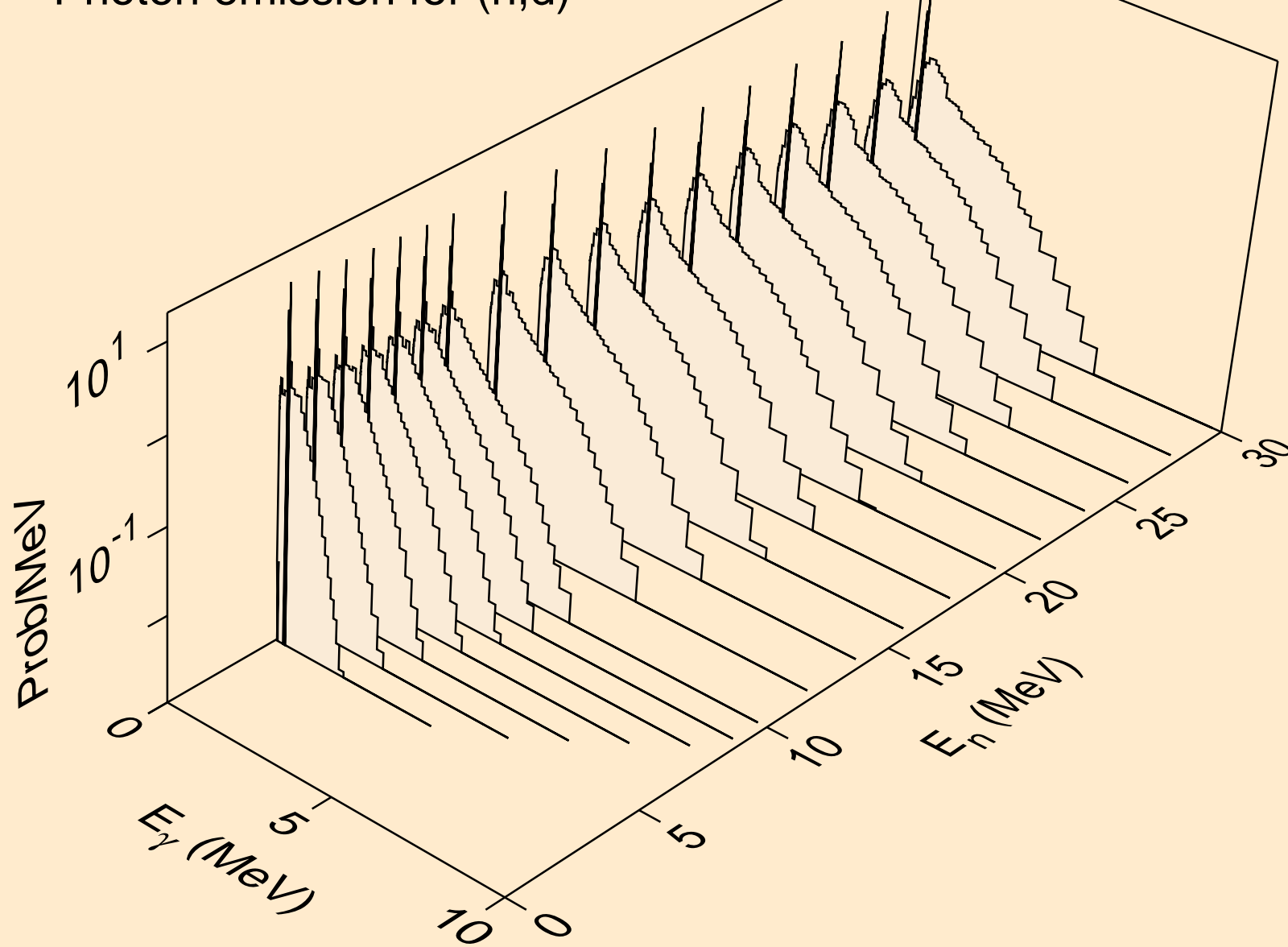

TB151M TRITON ACER TENDL-2021 LIBRARY; T=0.K  
Photon emission for inelastic

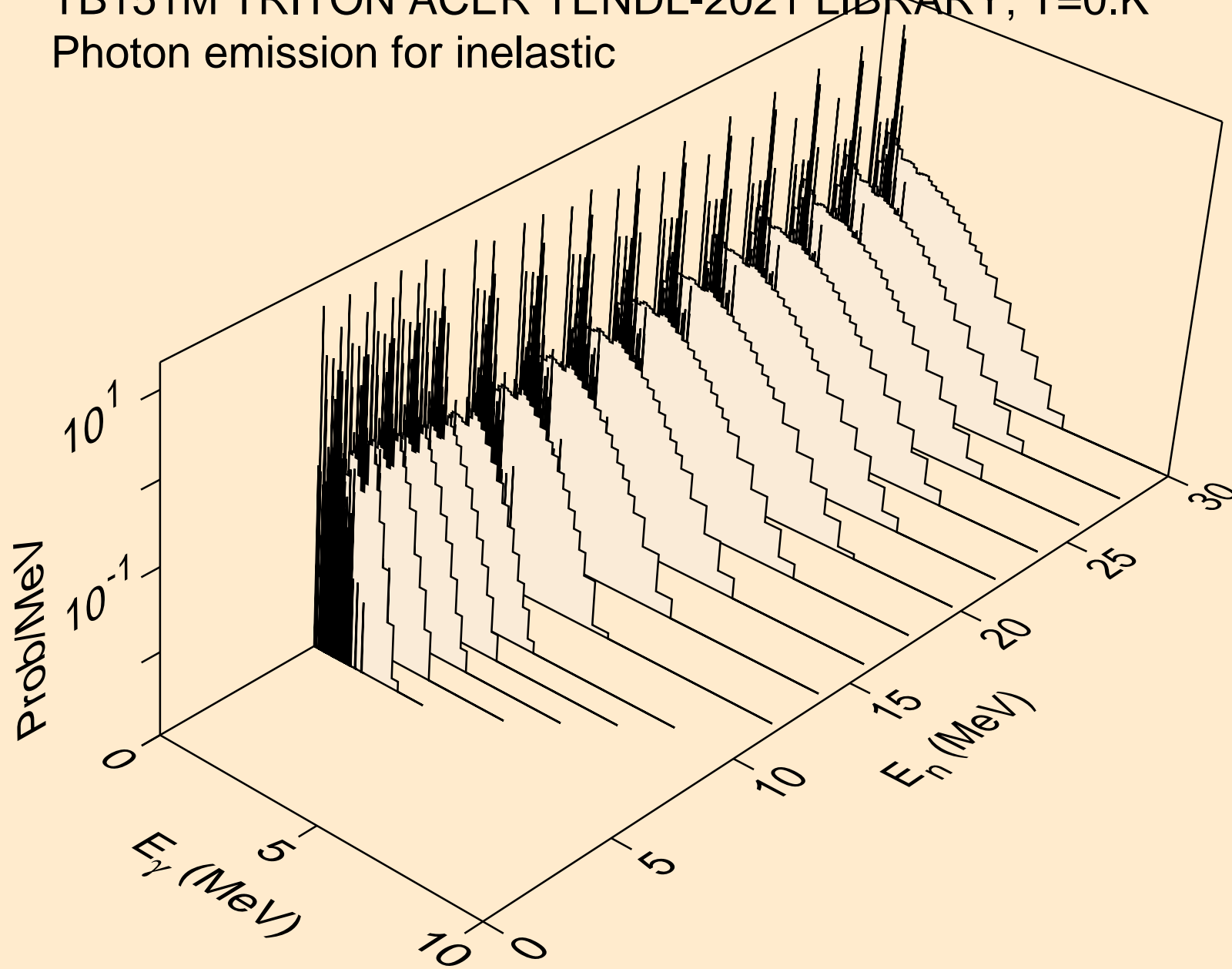

TB151M TRITON ACER TENDL-2021 LIBRARY; T=0.K  
Photon emission for (n,he3)

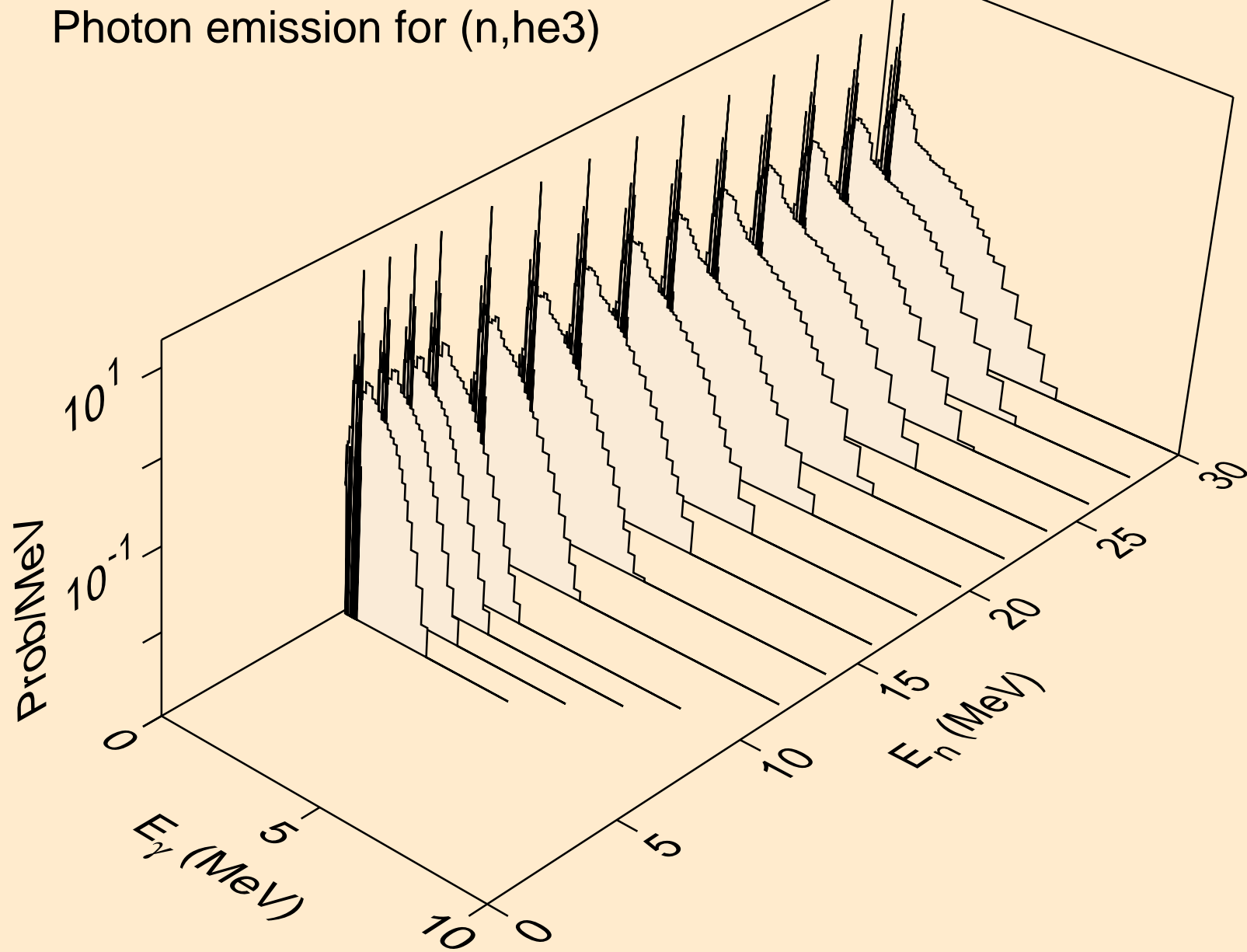

TB151M TRITON ACER TENDL-2021 LIBRARY; T=0.K  
Photon emission for (n,a)

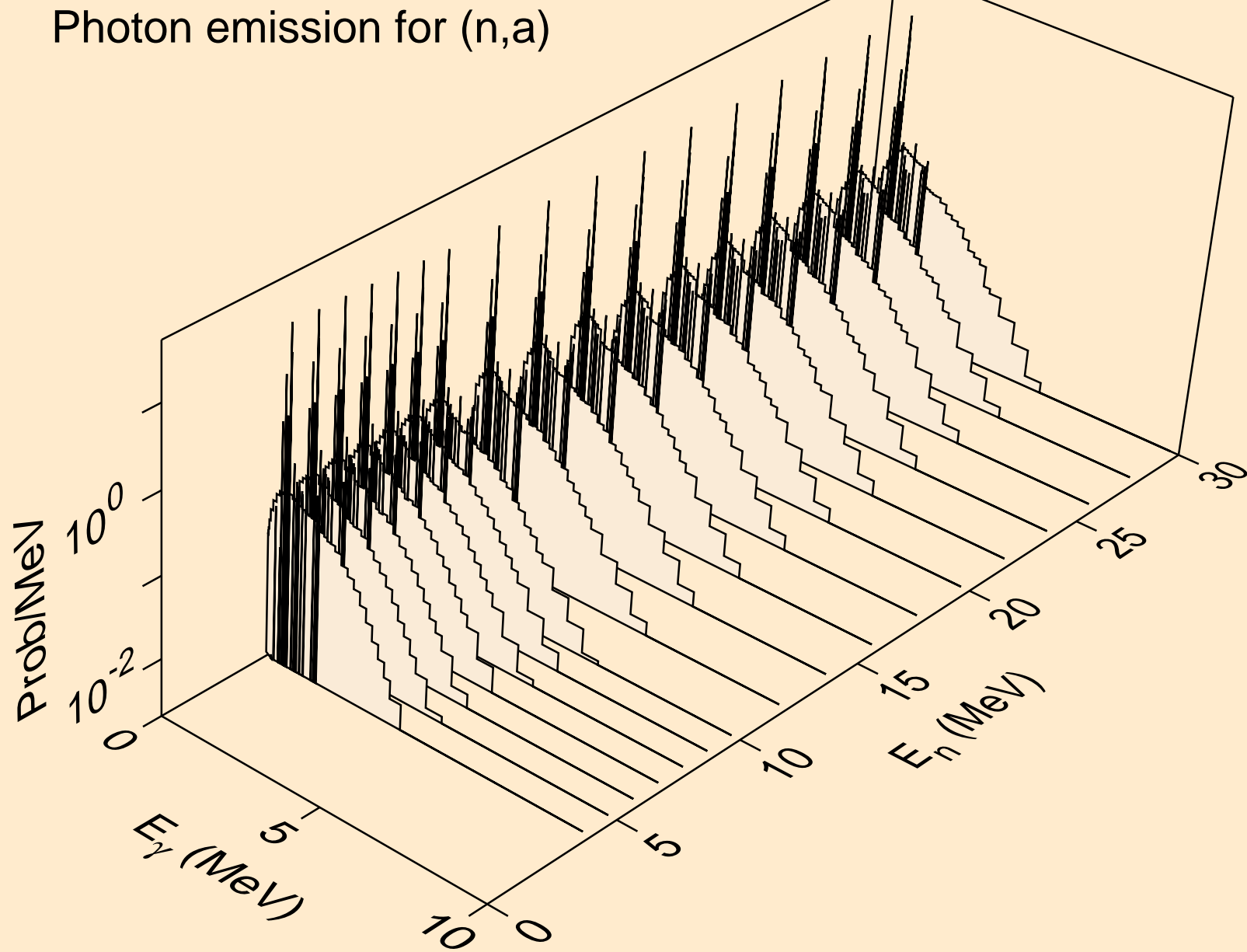

TB151M TRITON ACER TENDL-2021 LIBRARY; T=0.K  
Photon emission for (n,2a)

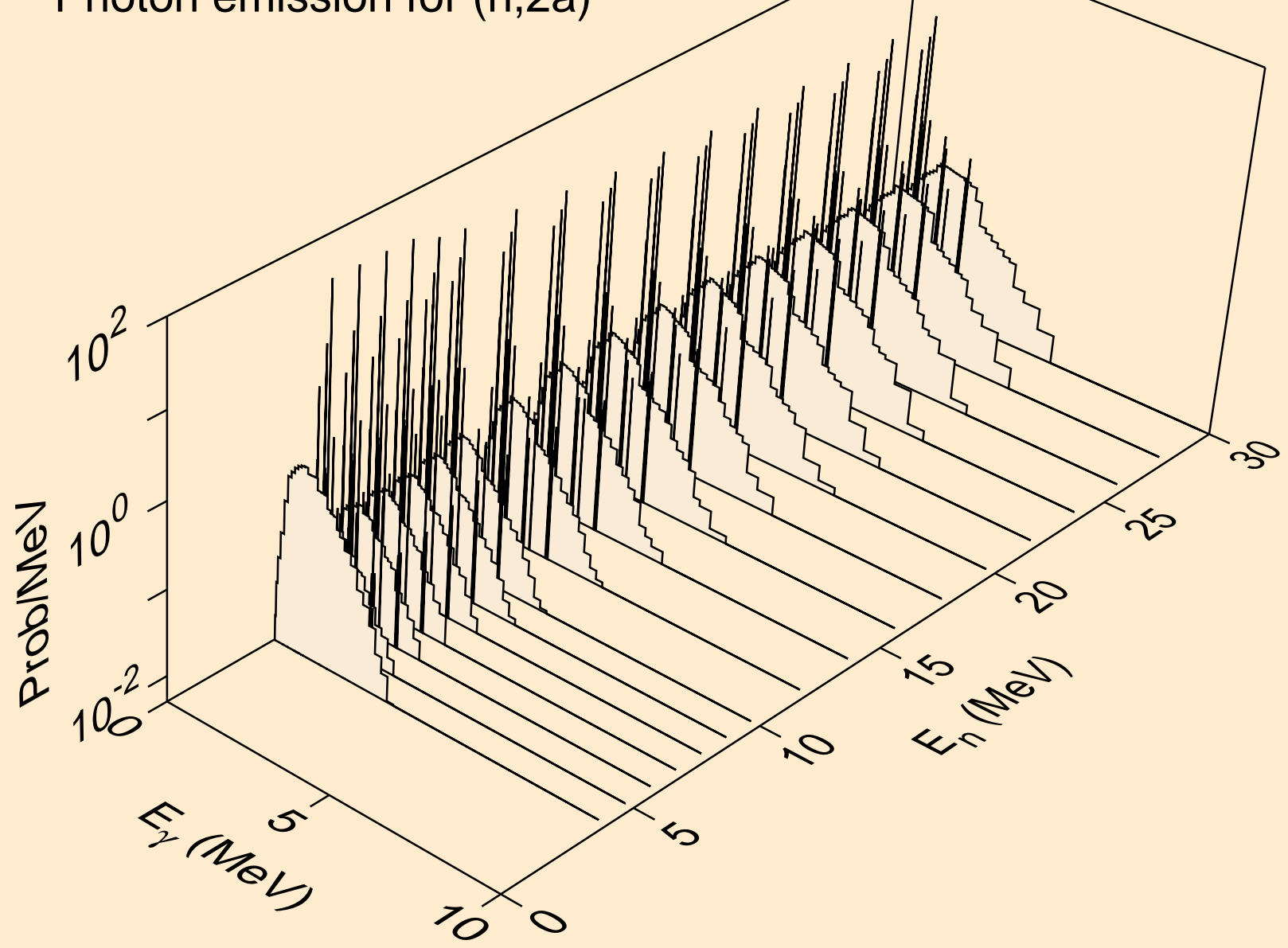

TB151M TRITON ACER TENDL-2021 LIBRARY; T=0.K  
Photon emission for (n,3a)

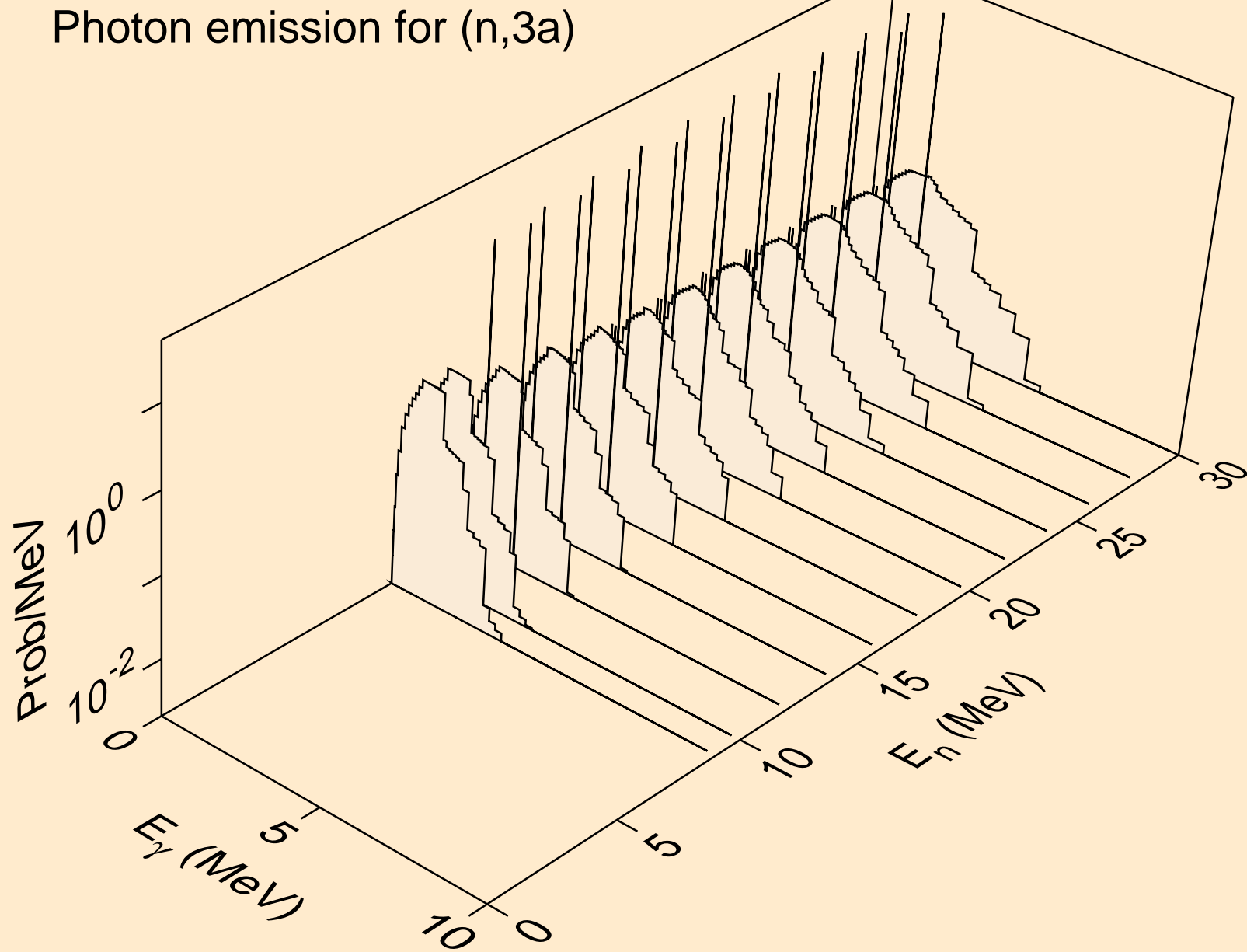



TB151M TRITON ACER TENDL-2021 LIBRARY; T=0.K  
Photon emission for (n,2p)

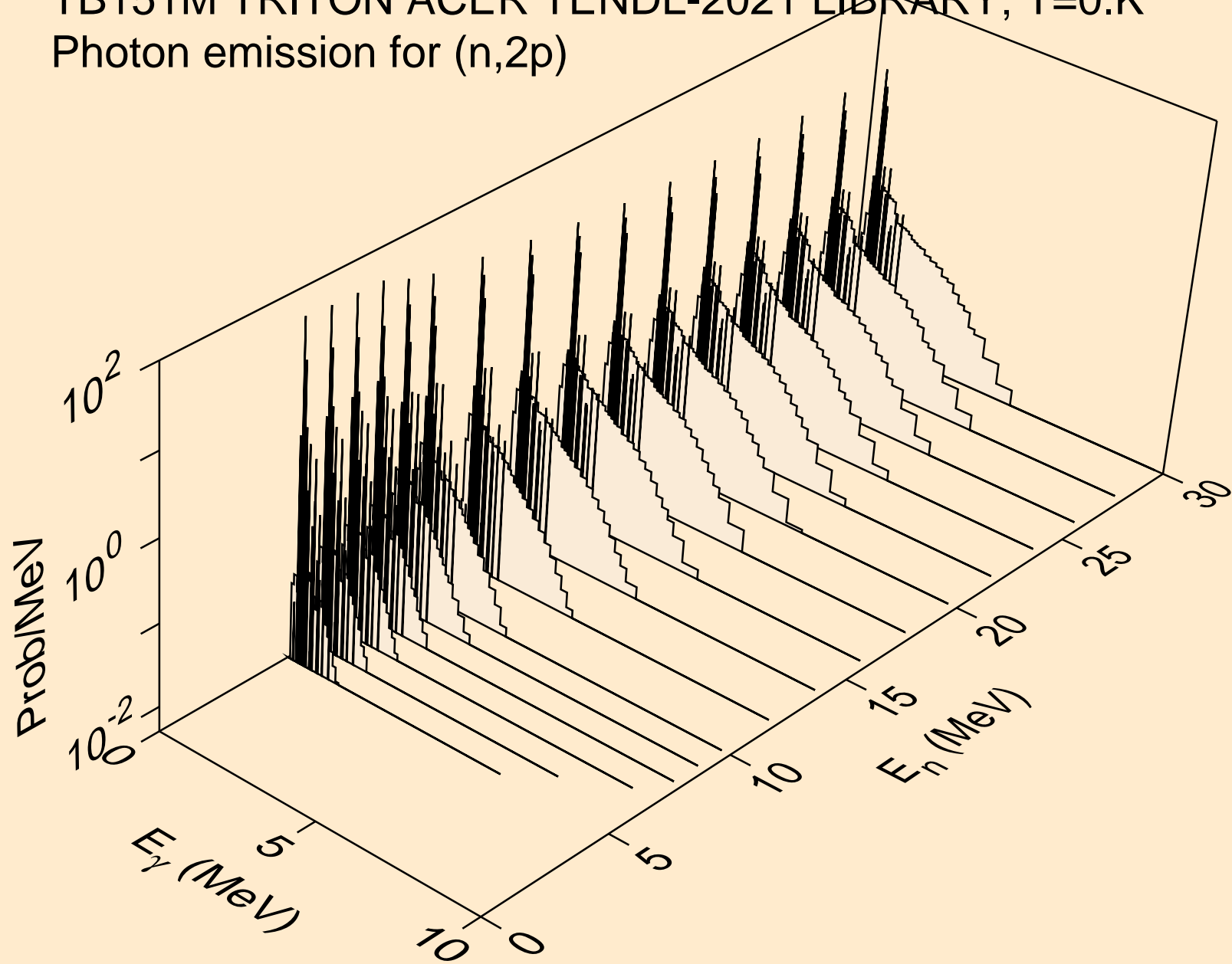

TB151M TRITON ACER TENDL-2021 LIBRARY; T=0.K  
Photon emission for (n,pa)

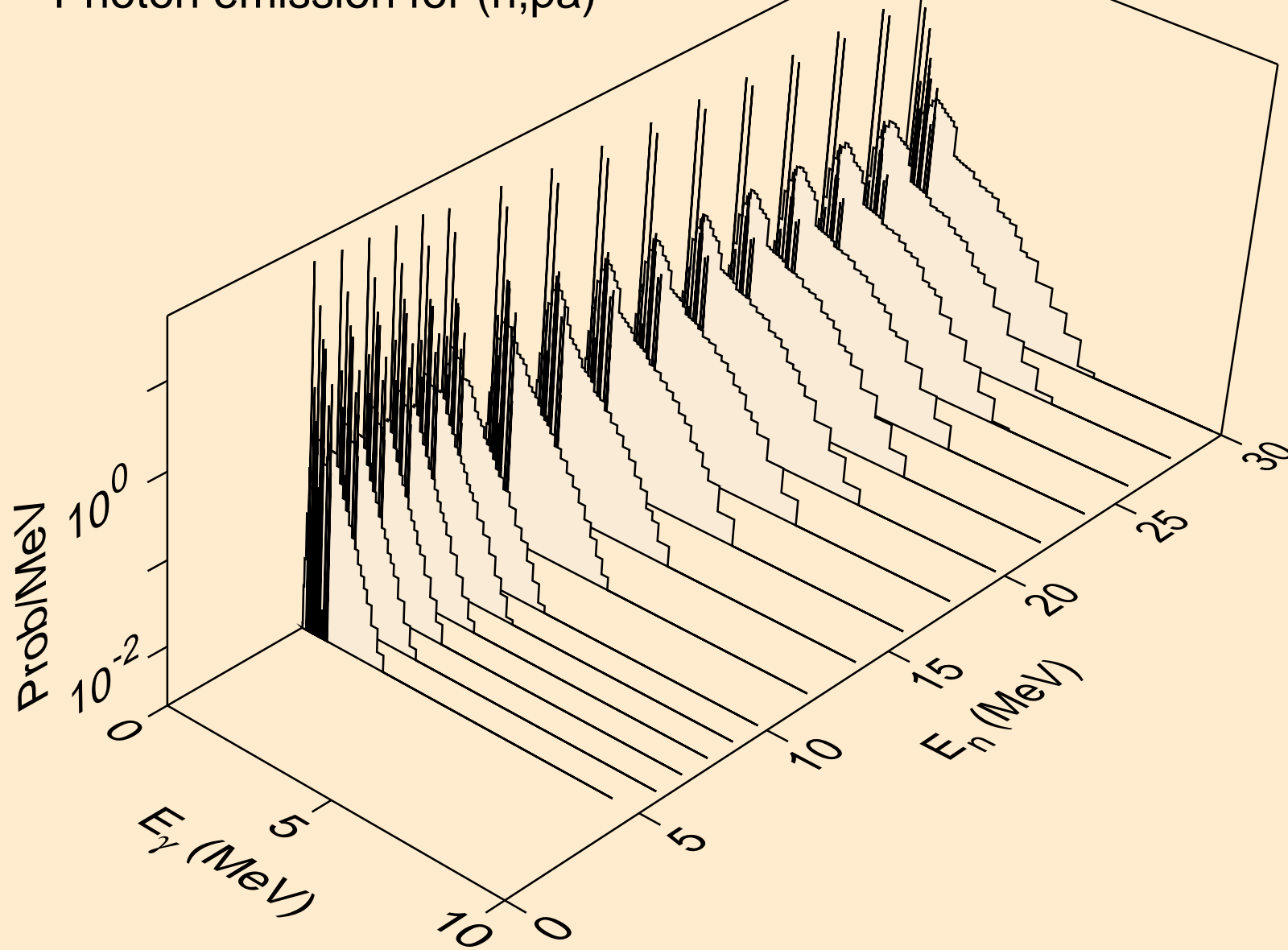

TB151M TRITON ACER TENDL-2021 LIBRARY; T=0.K  
Photon emission for (n,pd)

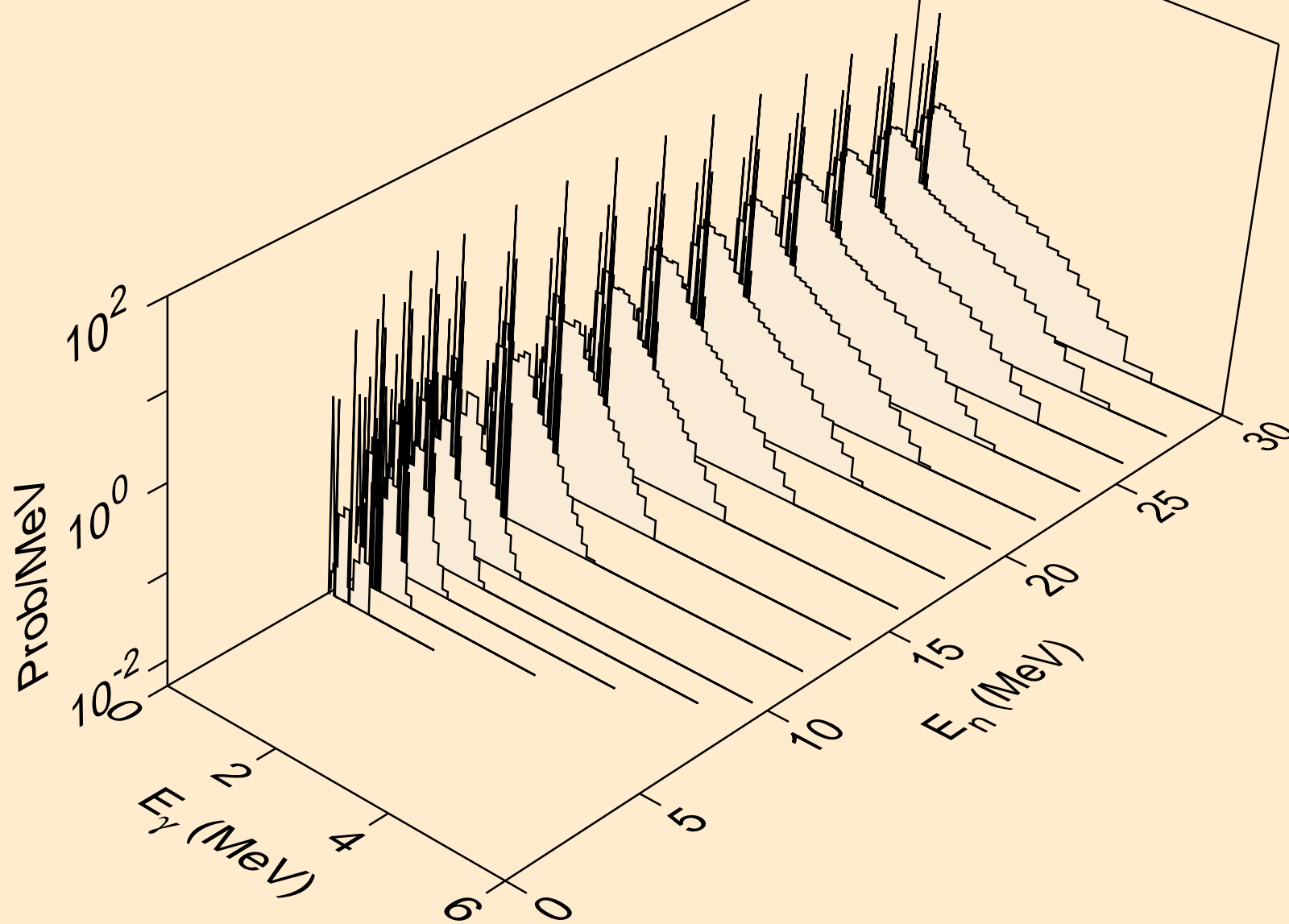

TB151M TRITON ACER TENDL-2021 LIBRARY; T=0.K  
Photon emission for (n,pt)

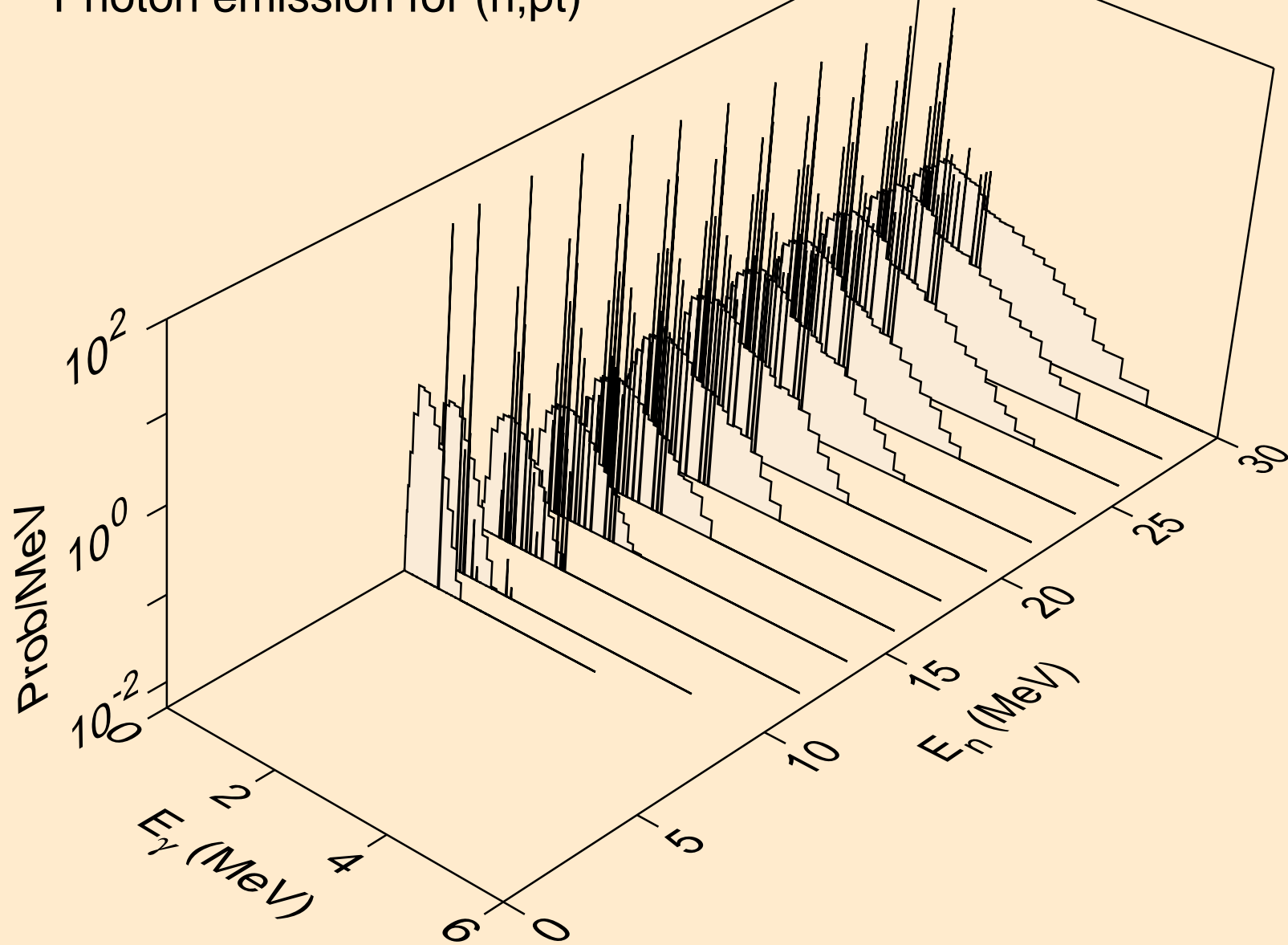

TB151M TRITON ACER TENDL-2021 LIBRARY; T=0.K  
Photon emission for (n,da)

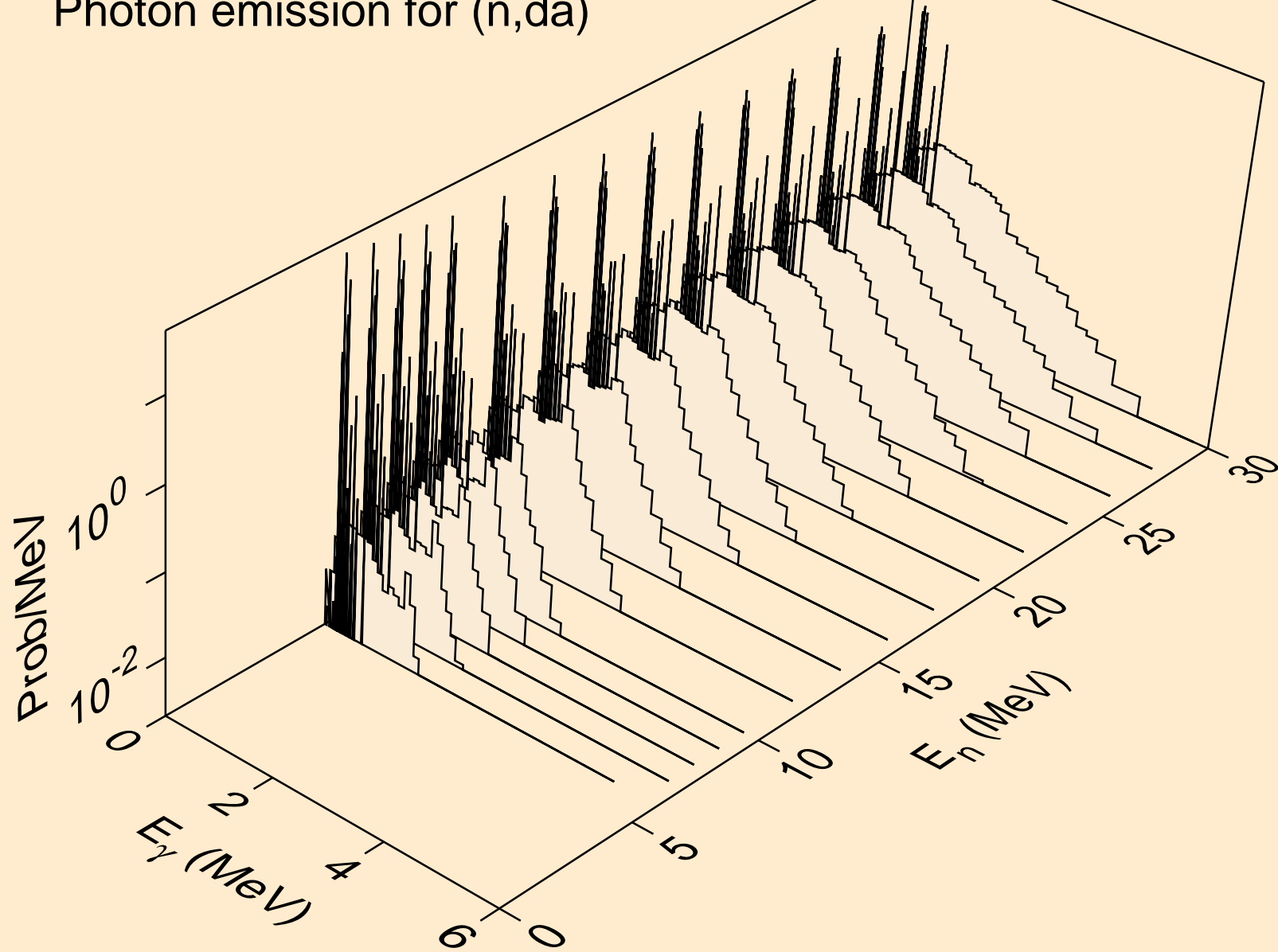

TB151M TRITON ACER TENDL-2021 LIBRARY; T=0.K  
Particle heating contributions

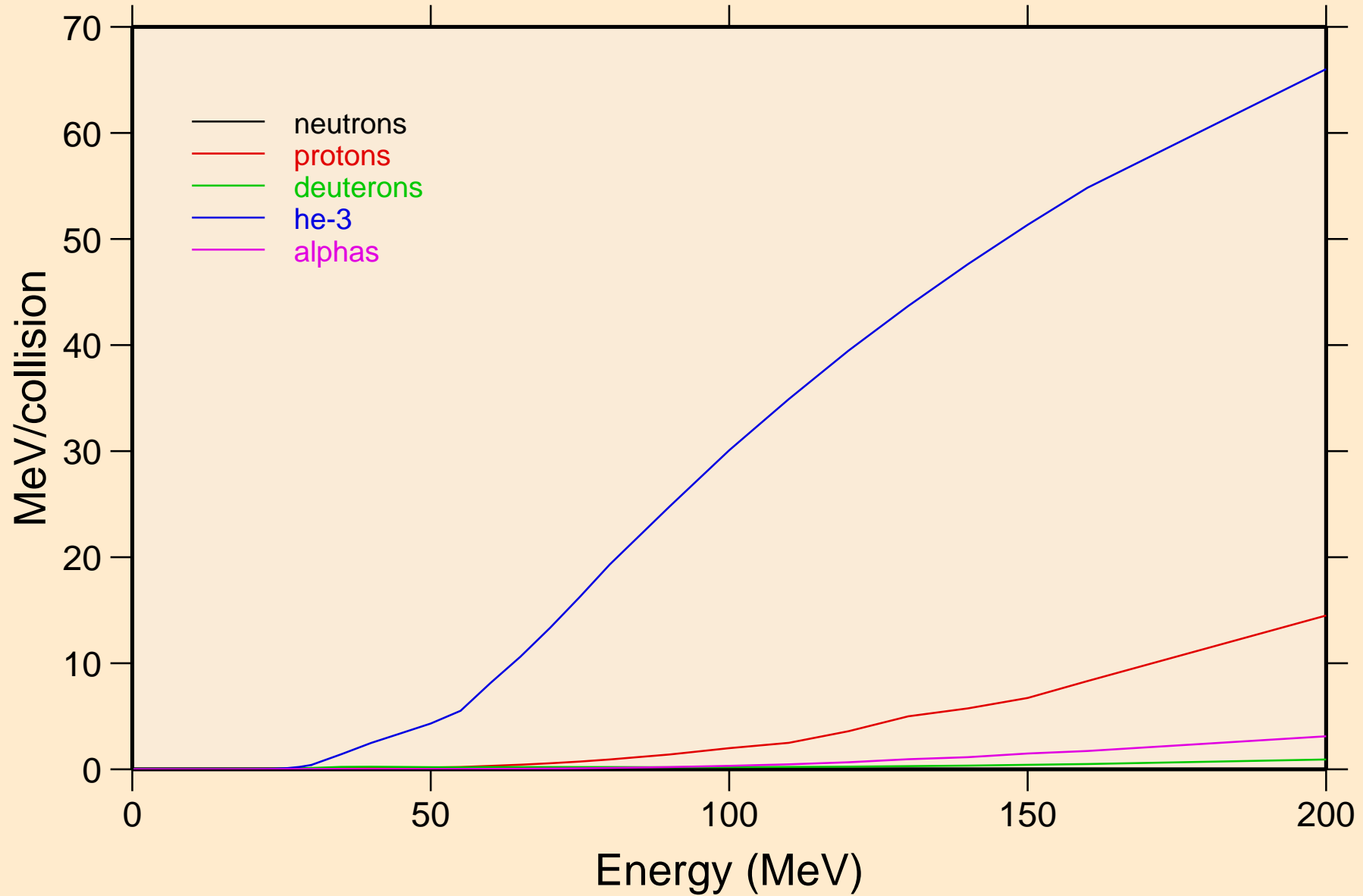

TB151M TRITON ACER TENDL-2021 LIBRARY; T=0.K  
Recoil Heating

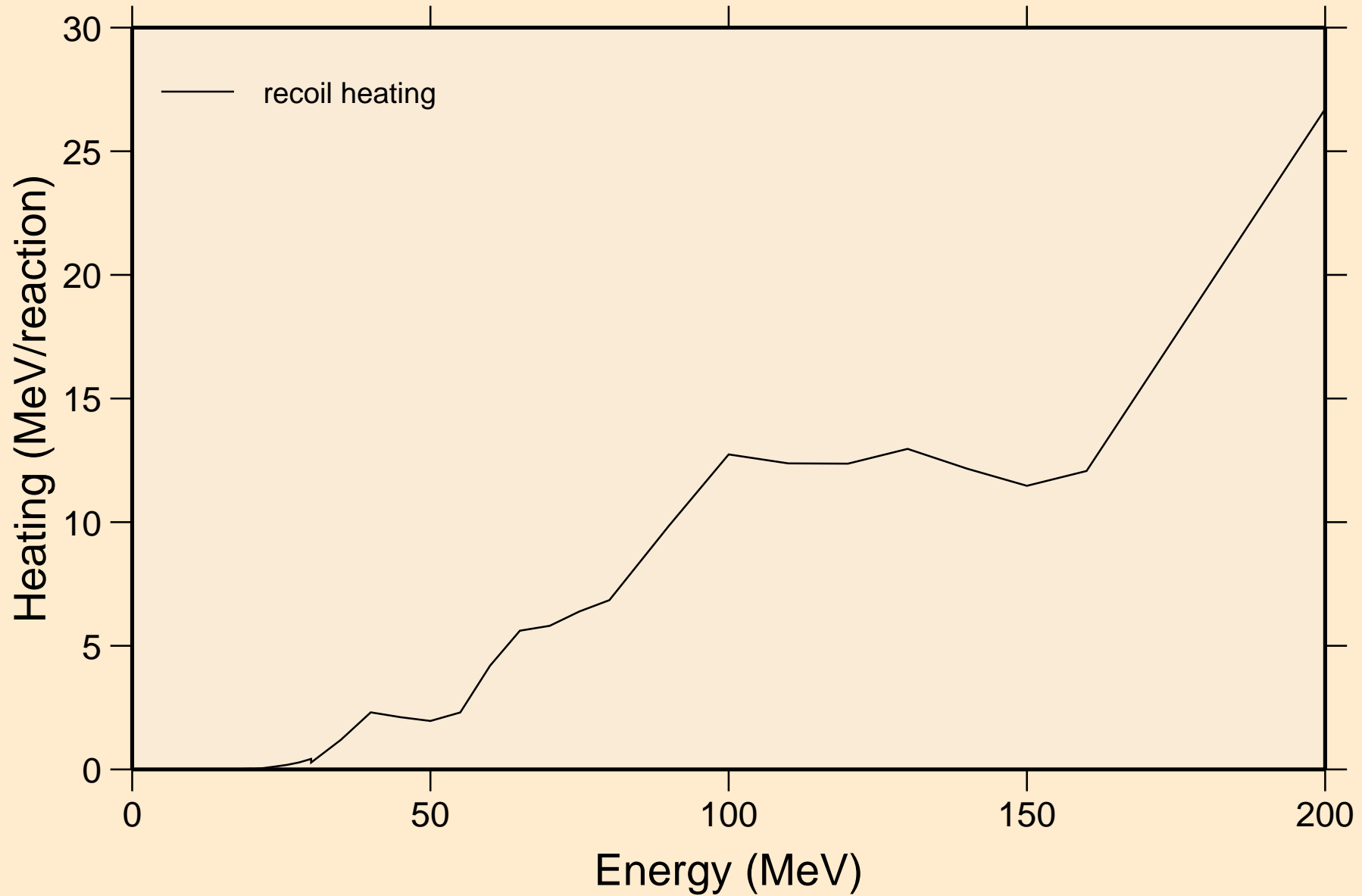

TB151M TRITON ACER TENDL-2021 LIBRARY; T=0.K  
Particle production cross sections

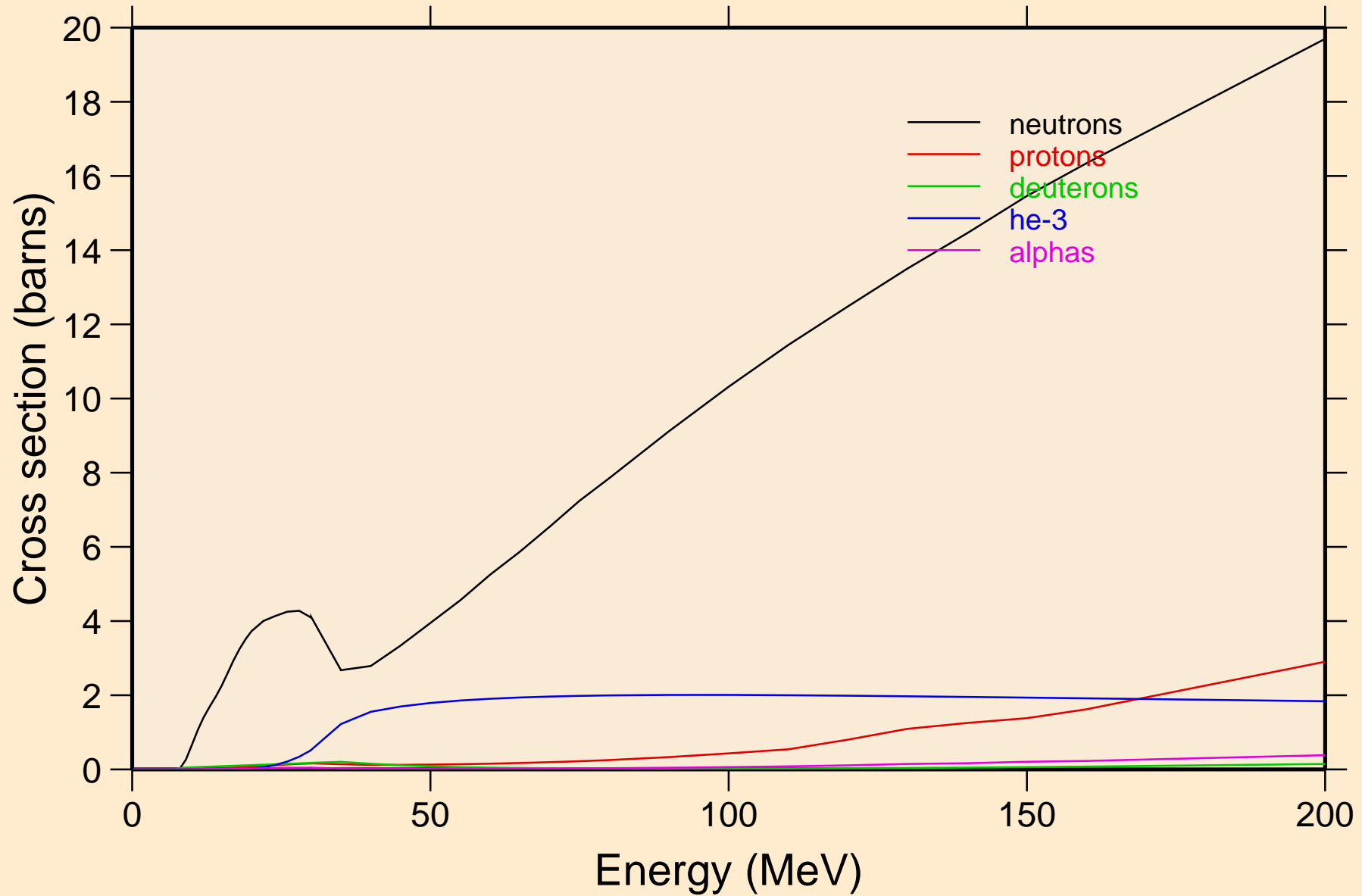



TB151M TRITON ACER TENDL-2021 LIBRARY; T=0.K  
neutrons from (t,n)

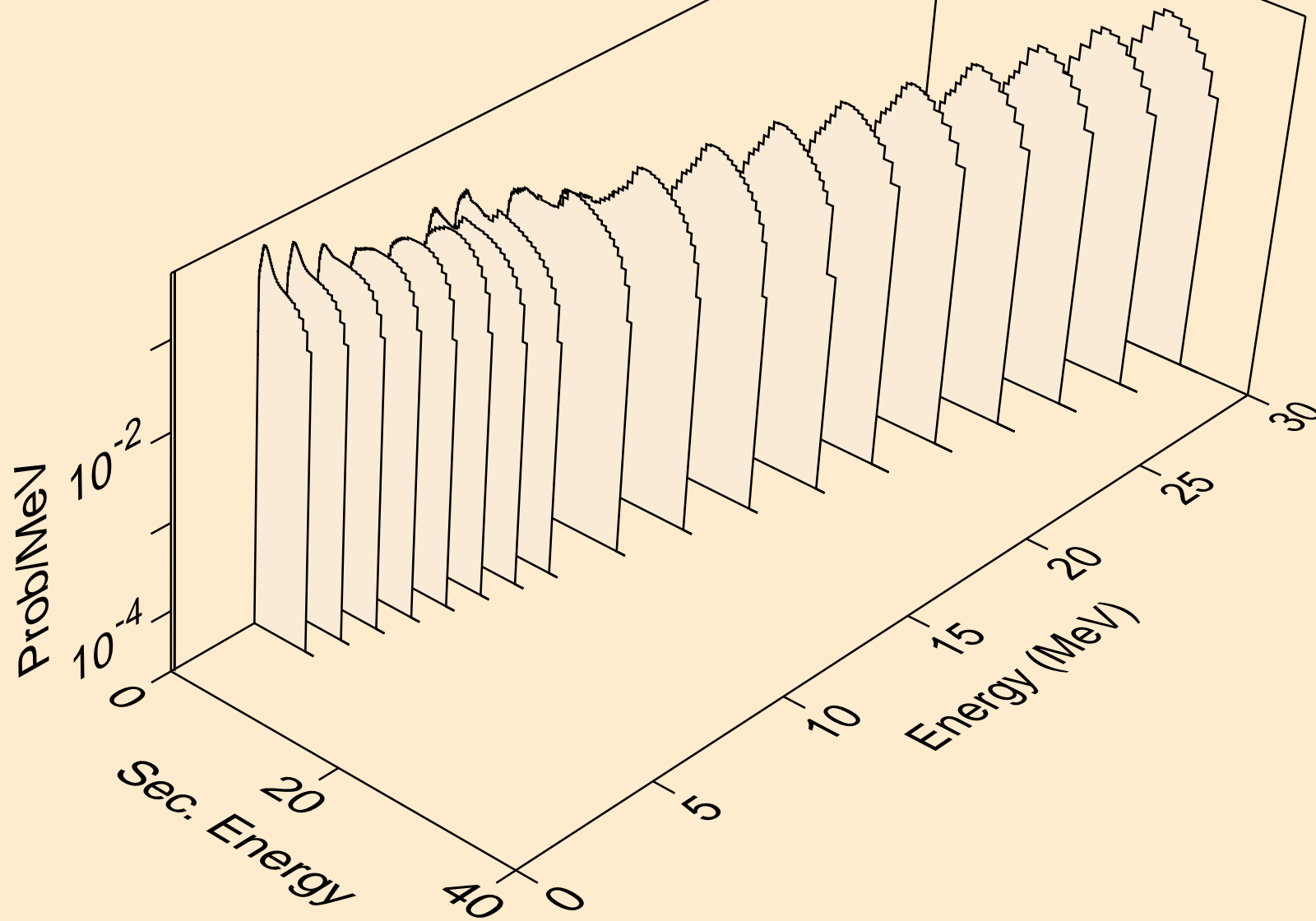

TB151M TRITON ACER TENDL-2021 LIBRARY; T=0.K  
neutrons from (t,x)

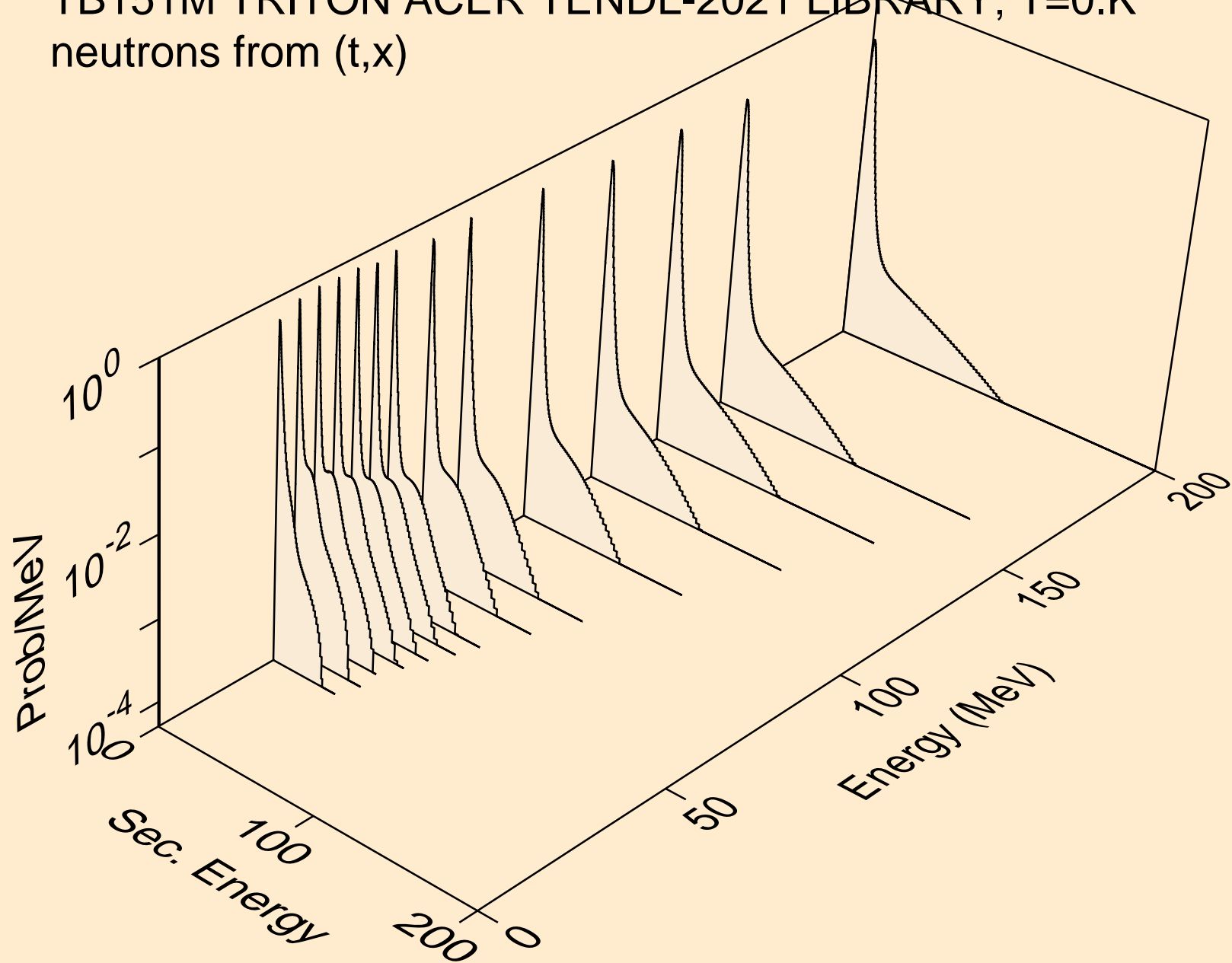

TB151M TRITON ACER TENDL-2021 LIBRARY; T=0.K  
neutrons from (t,2nd)

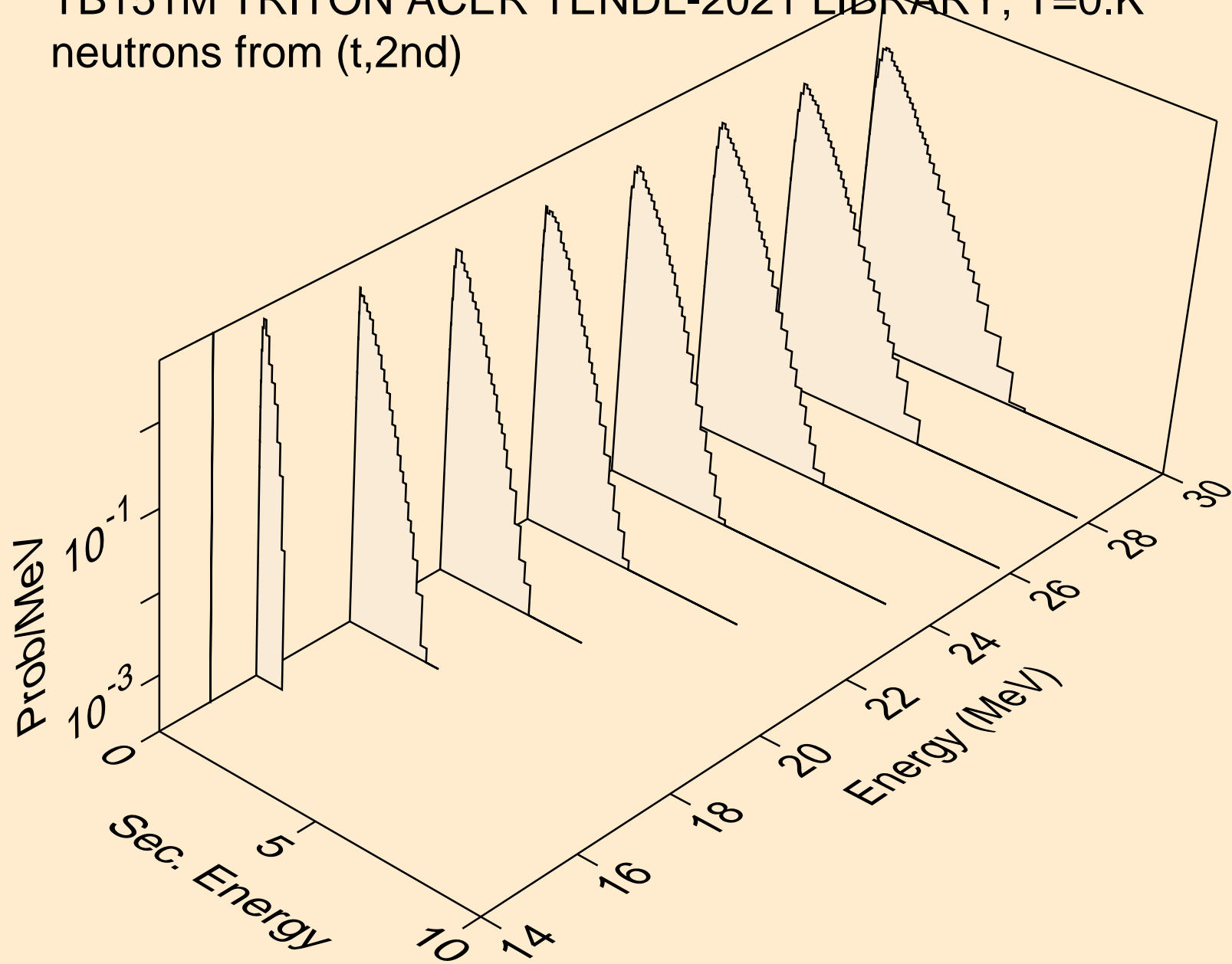

TB151M TRITON ACER TENDL-2021 LIBRARY; T=0.K  
neutrons from (t,2n)

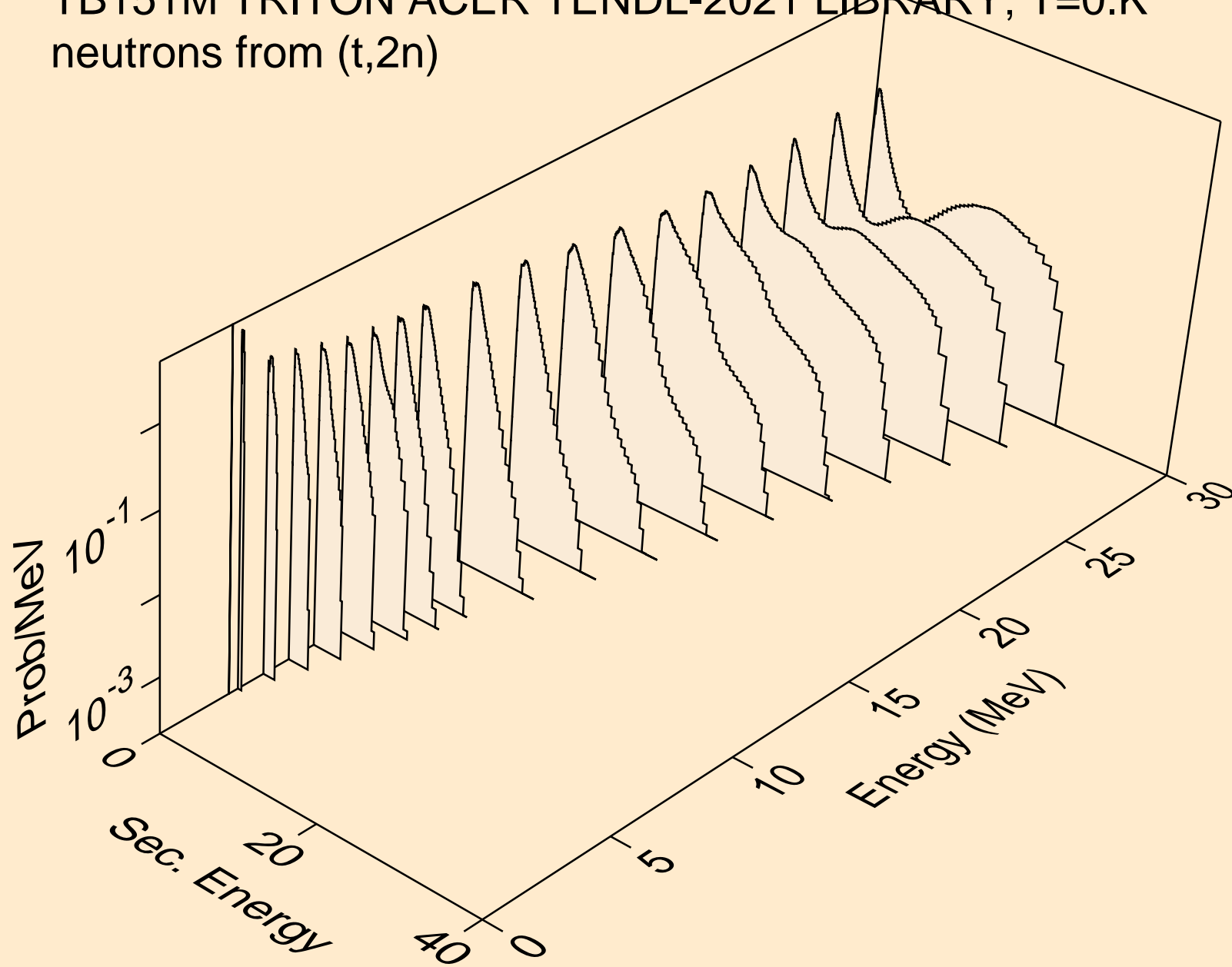

TB151M TRITON ACER TENDL-2021 LIBRARY; T=0.K  
neutrons from (t,3n)

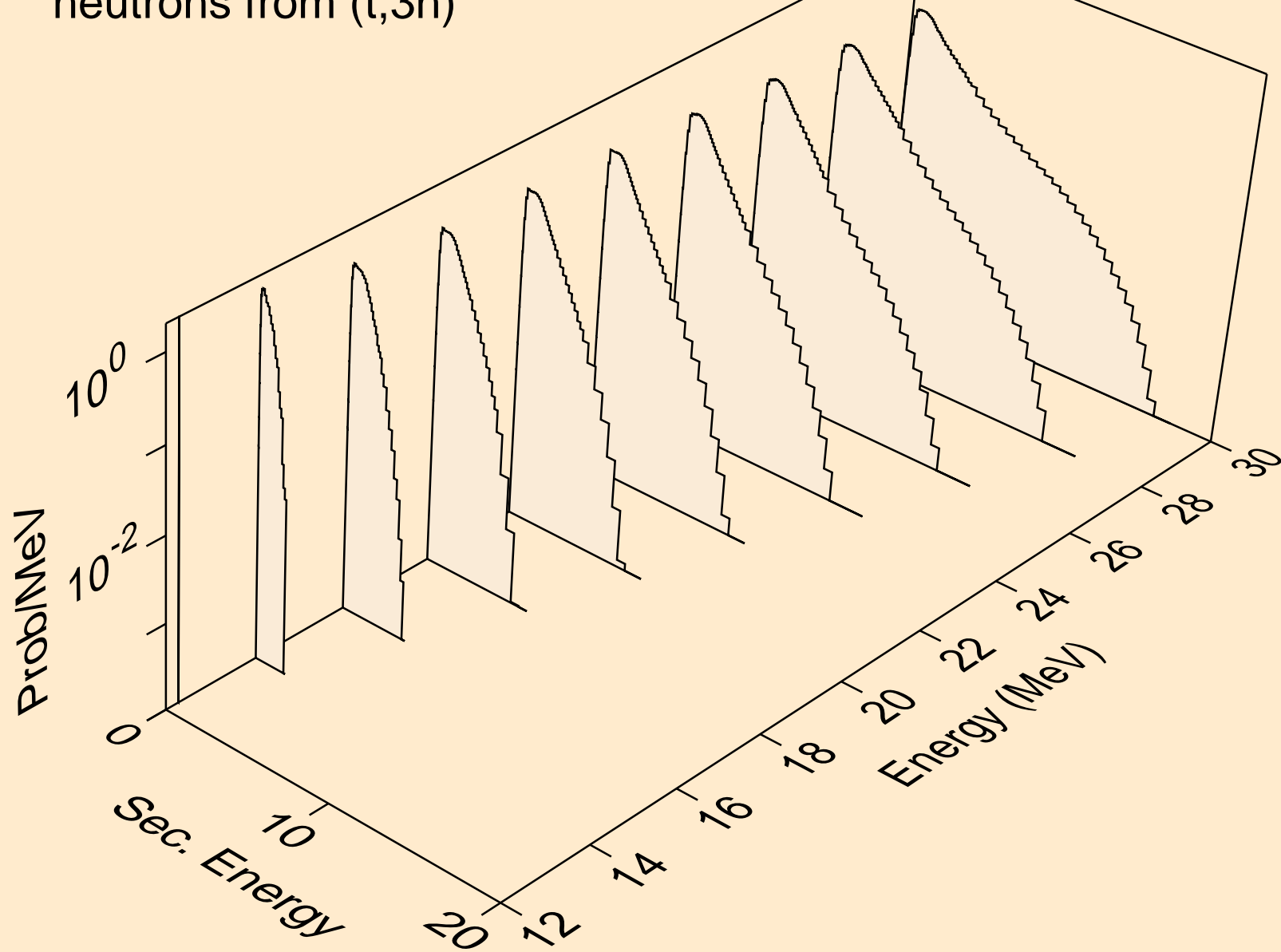

TB151M TRITON ACER TENDL-2021 LIBRARY; T=0.K  
neutrons from (t,n\*)a

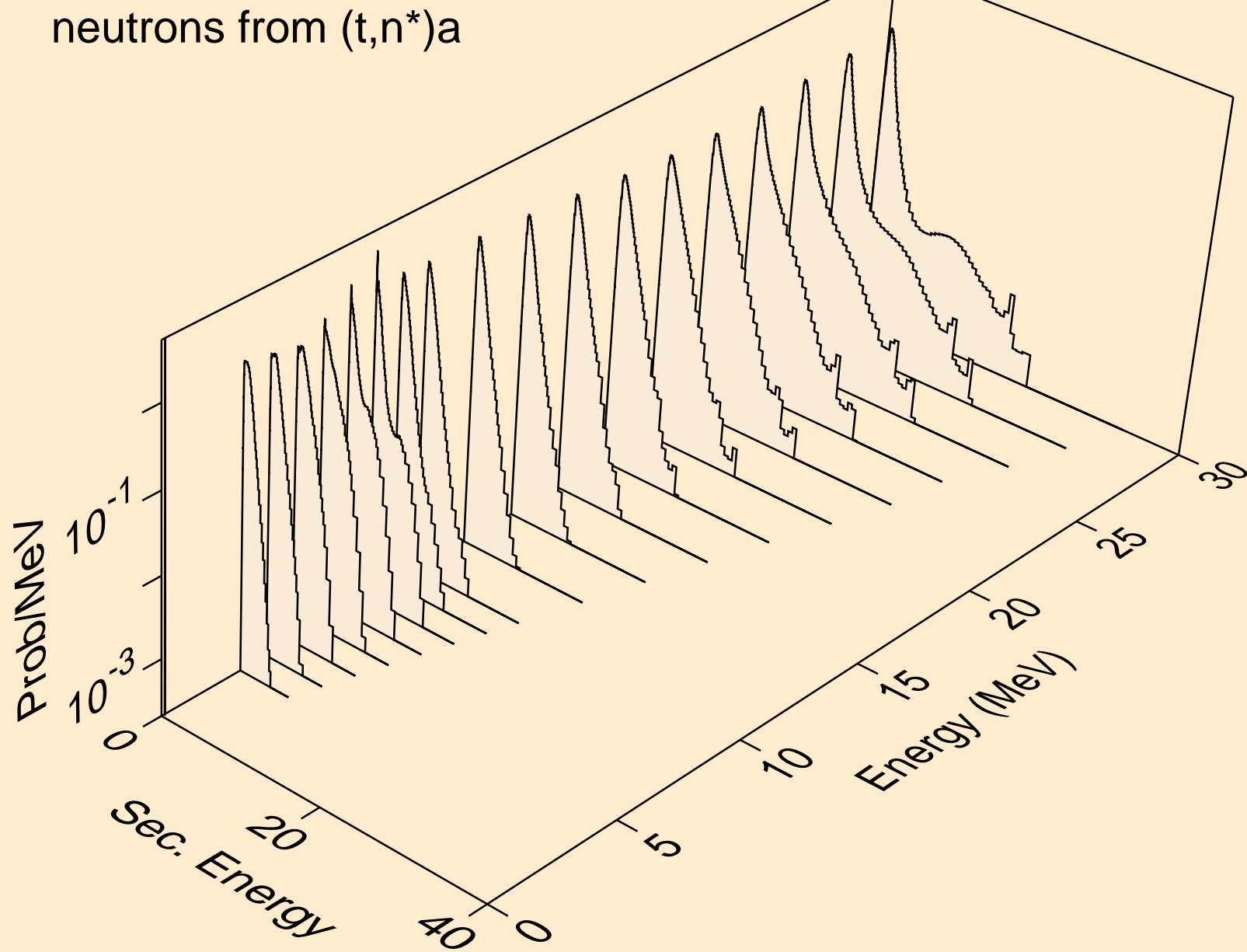

TB151M TRITON ACER TENDL-2021 LIBRARY; T=0.K  
neutrons from (t,2n)a

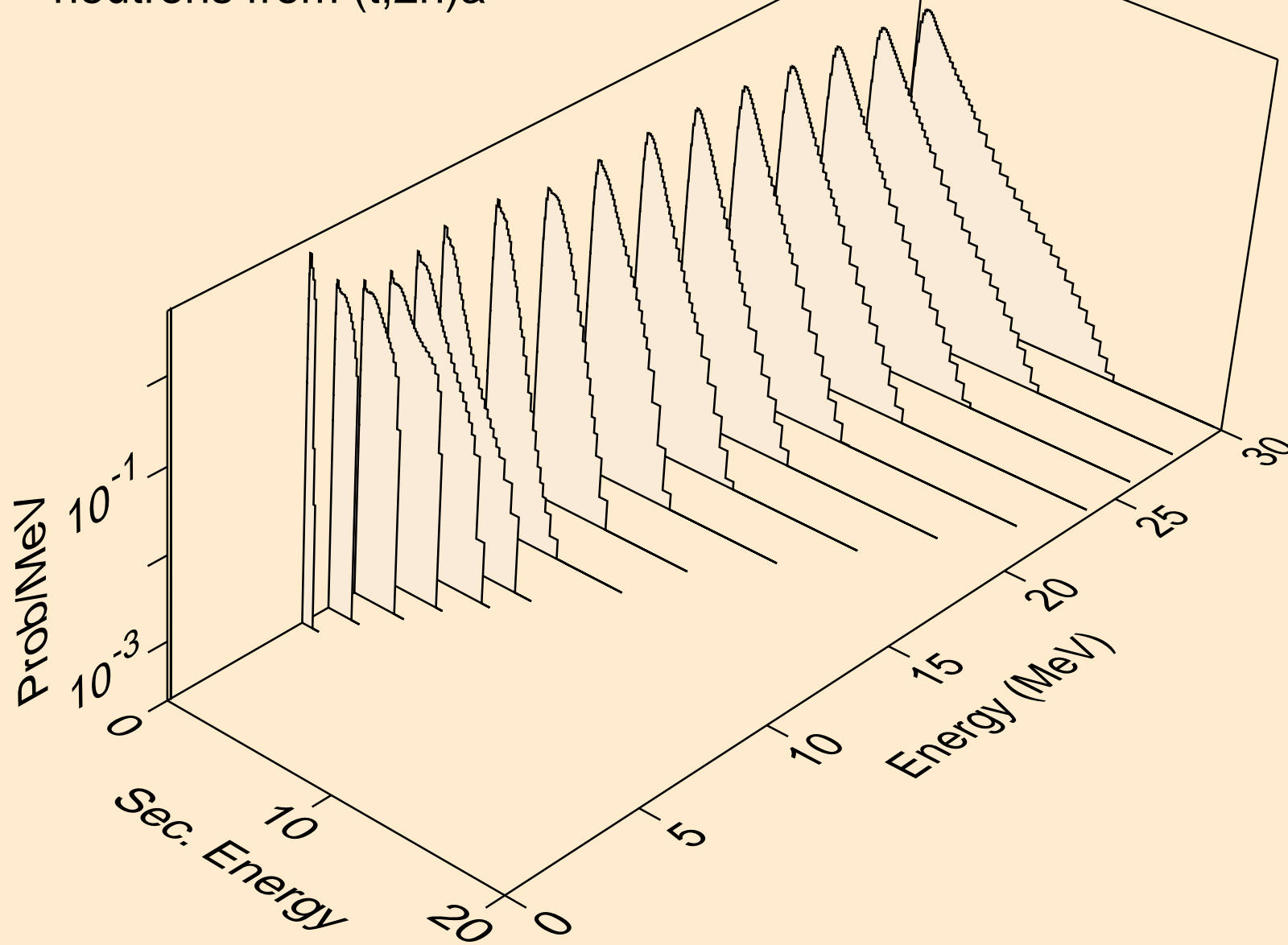

TB151M TRITON ACER TENDL-2021 LIBRARY; T=0.K  
neutrons from (t,3n)a

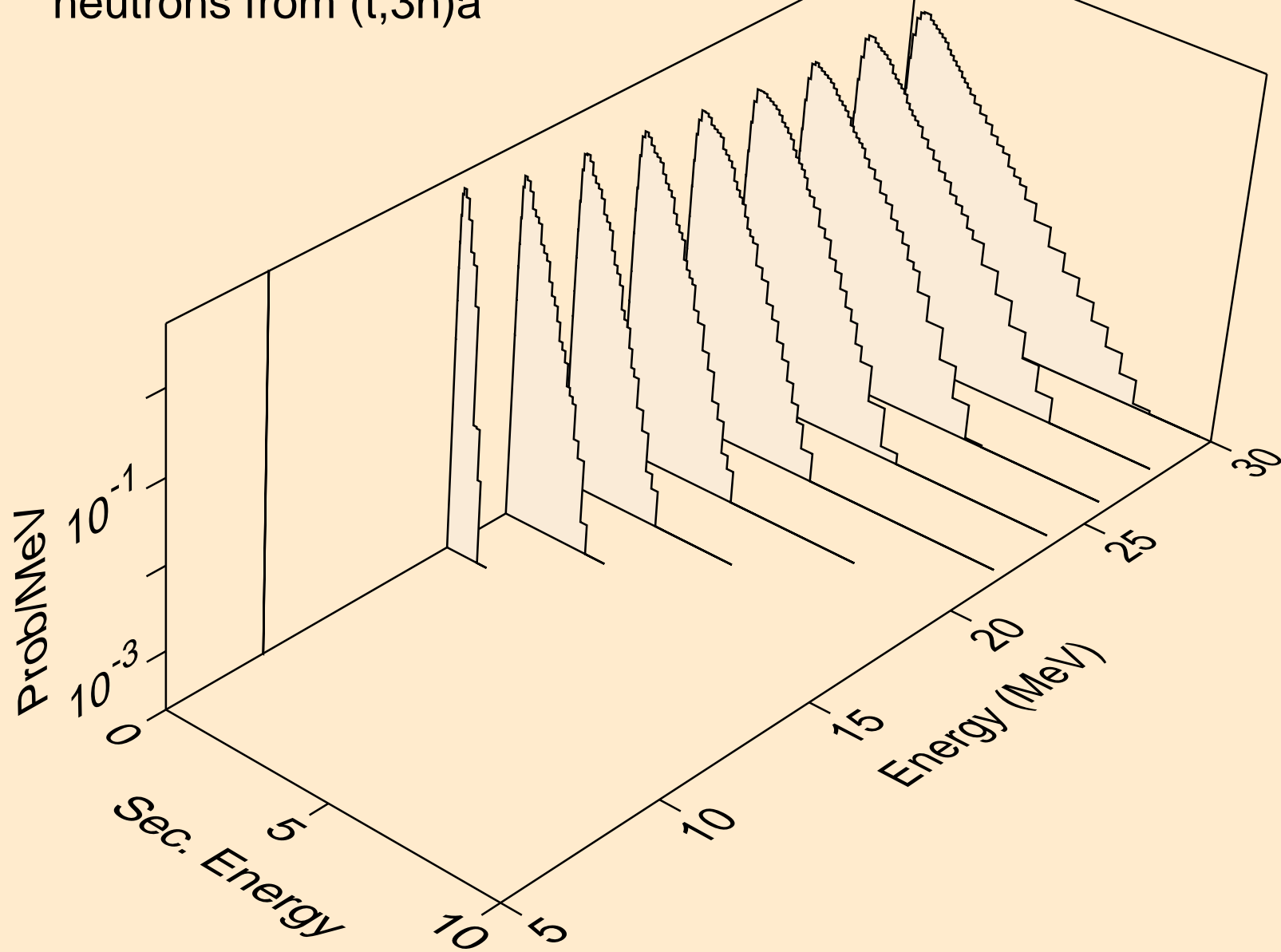



TB151M TRITON ACER TENDL-2021 LIBRARY; T=0.K  
neutrons from (t,n\*)p

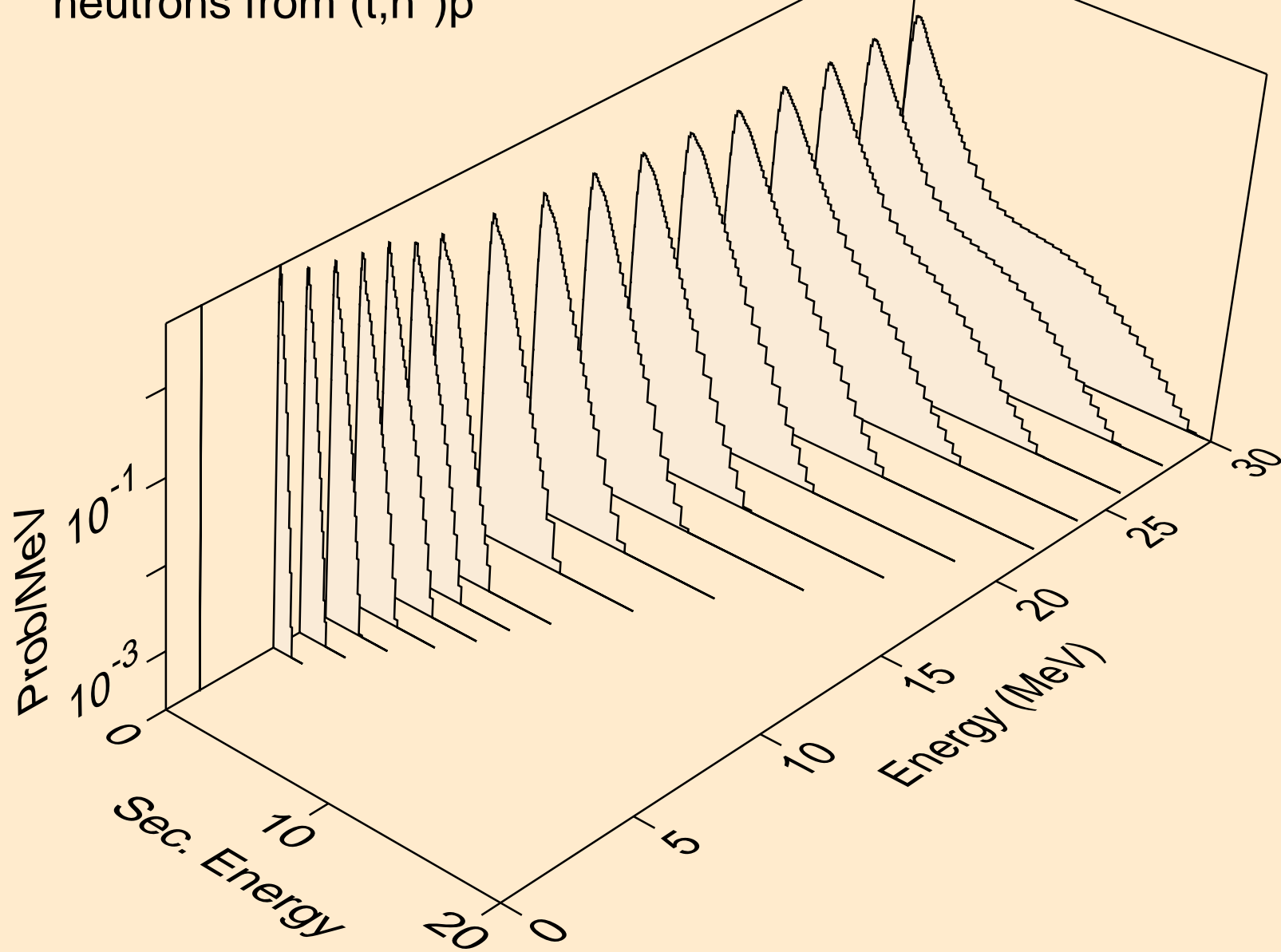

TB151M TRITON ACER TENDL-2021 LIBRARY; T=0.K  
neutrons from (t,n\*)2a

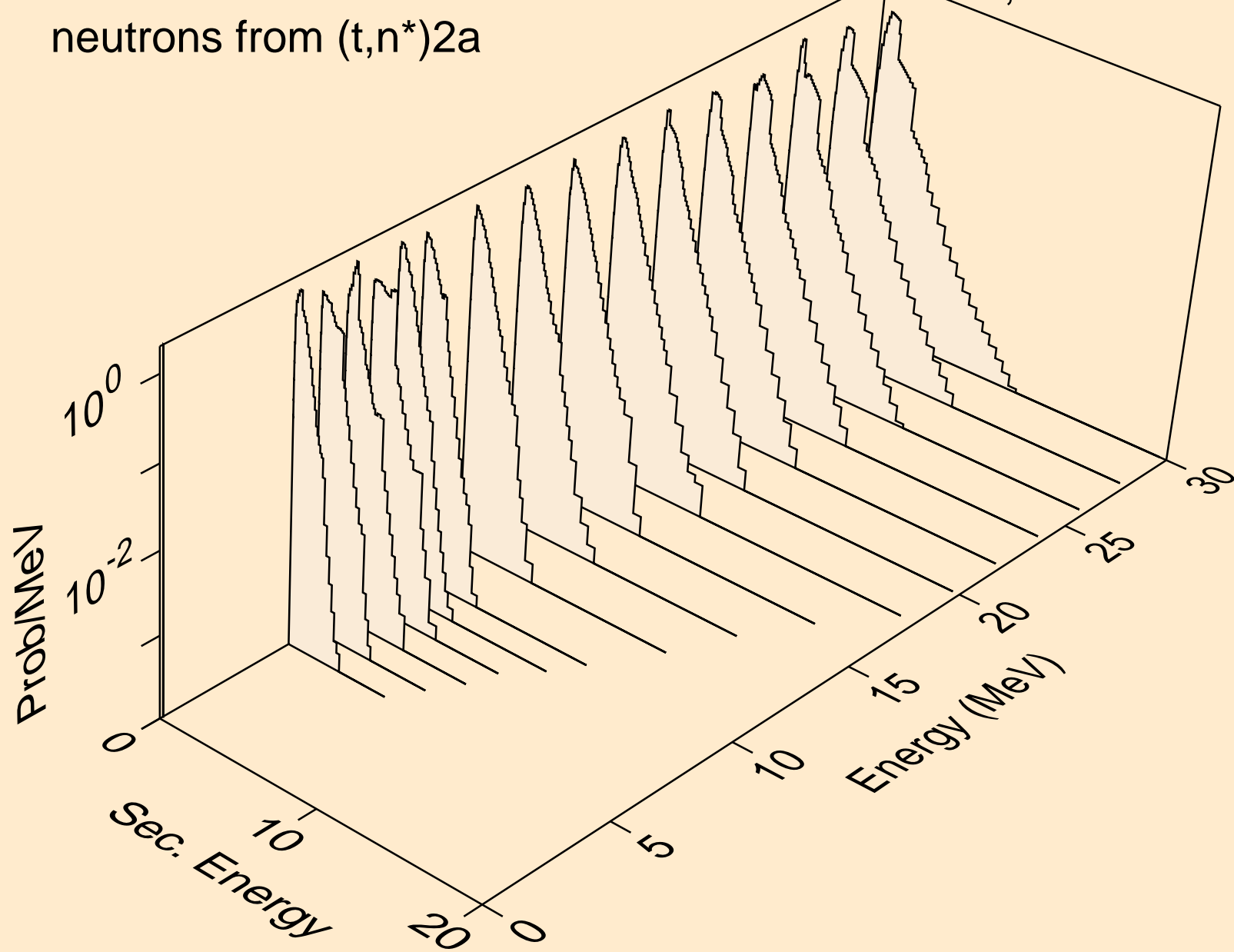

TB151M TRITON ACER TENDL-2021 LIBRARY; T=0.K  
neutrons from (t,2n)2a

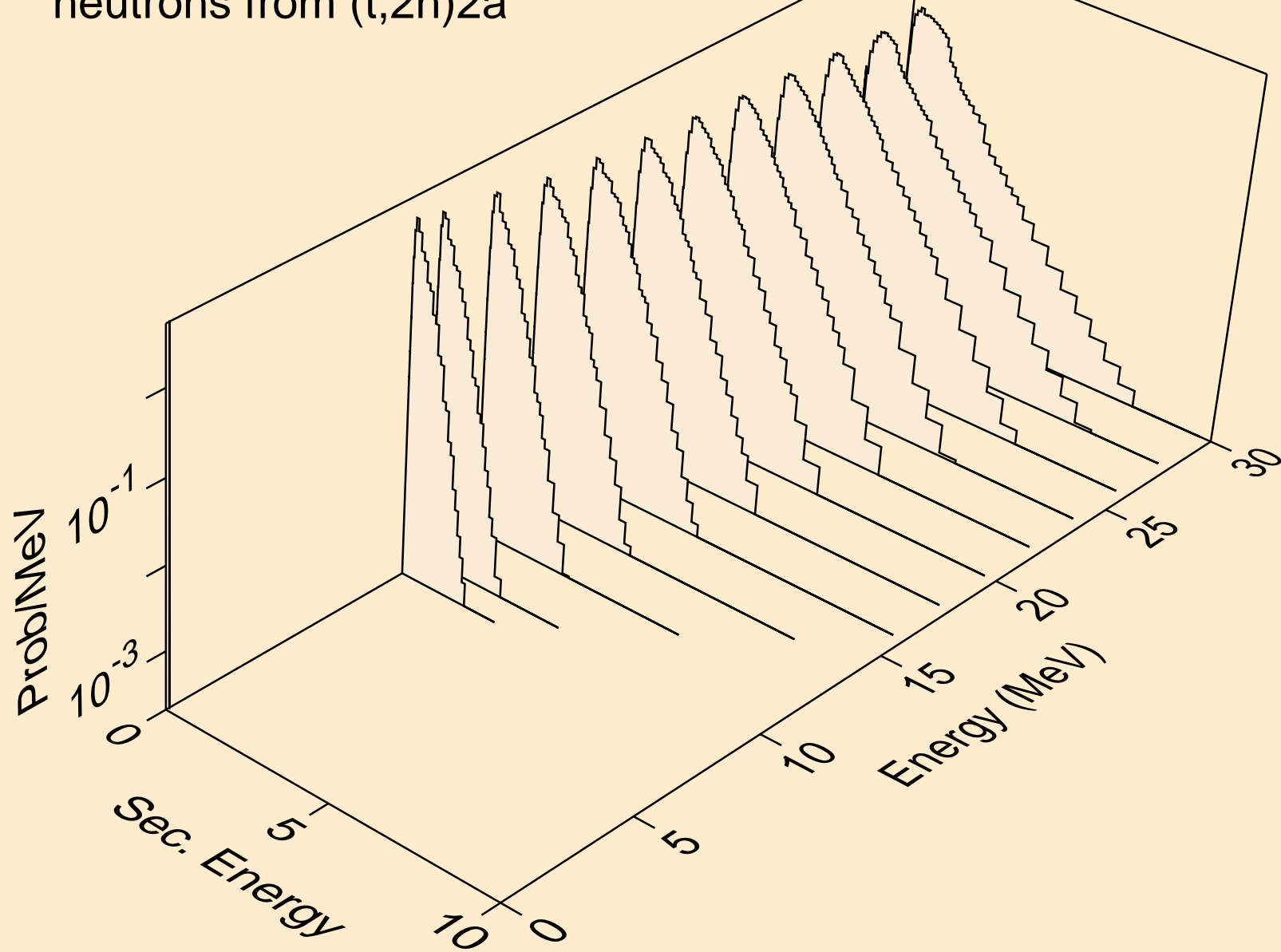

TB151M TRITON ACER TENDL-2021 LIBRARY; T=0.K  
neutrons from (t,n\*)d

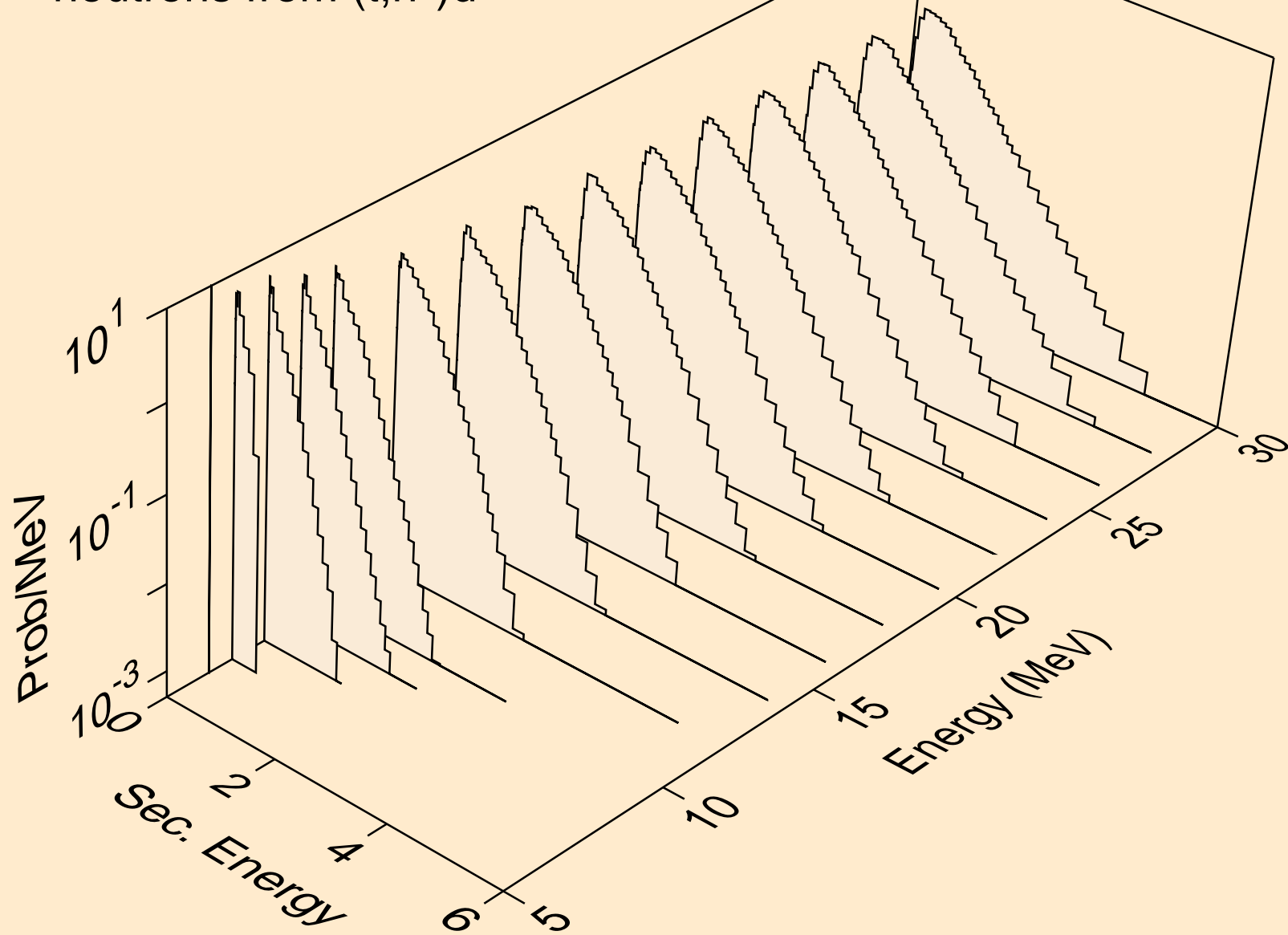

TB151M TRITON ACER TENDL-2021 LIBRARY; T=0.K  
neutrons from (t,n\*)t

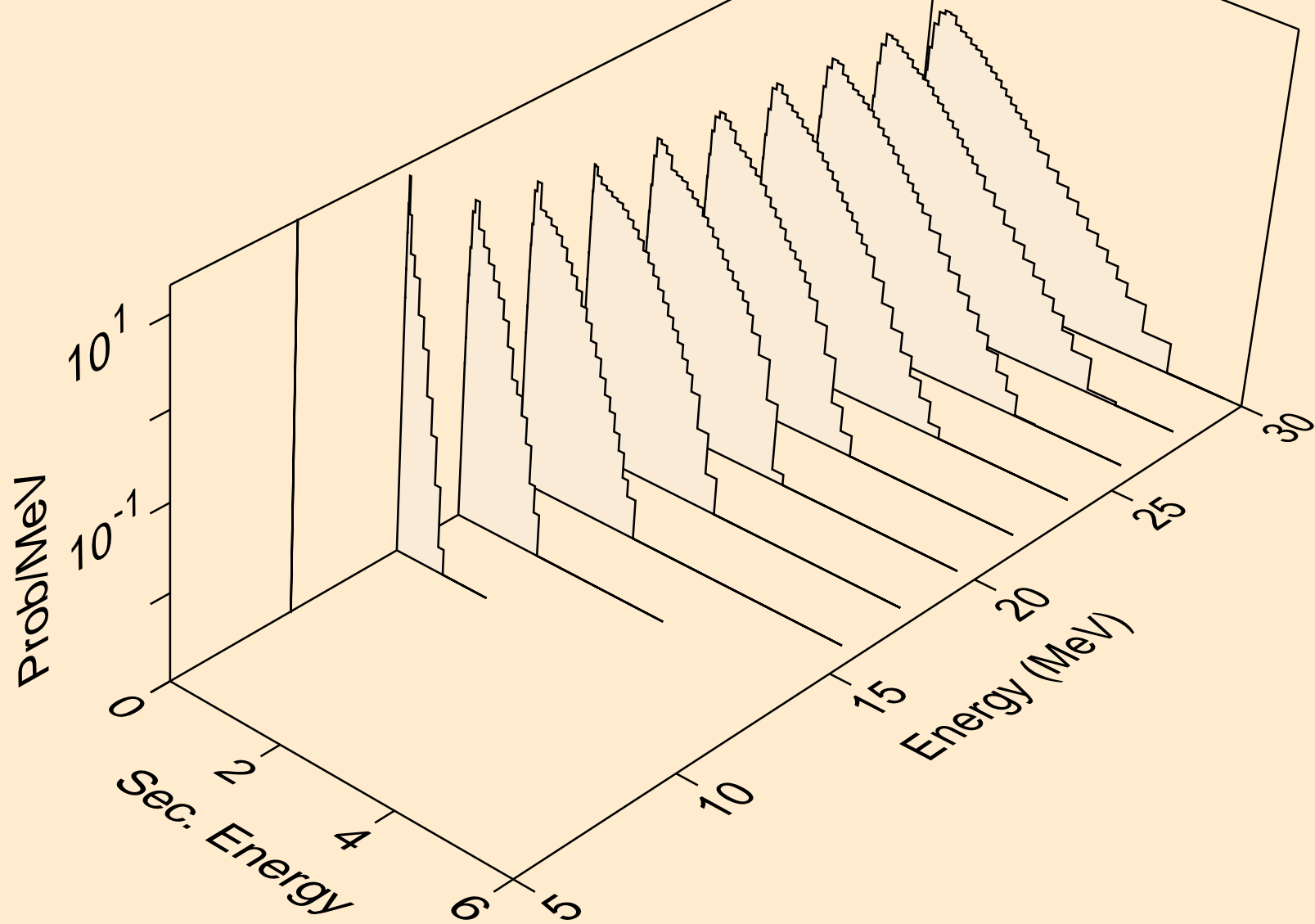

TB151M TRITON ACER TENDL-2021 LIBRARY; T=0.K  
neutrons from (t,n\*)he3

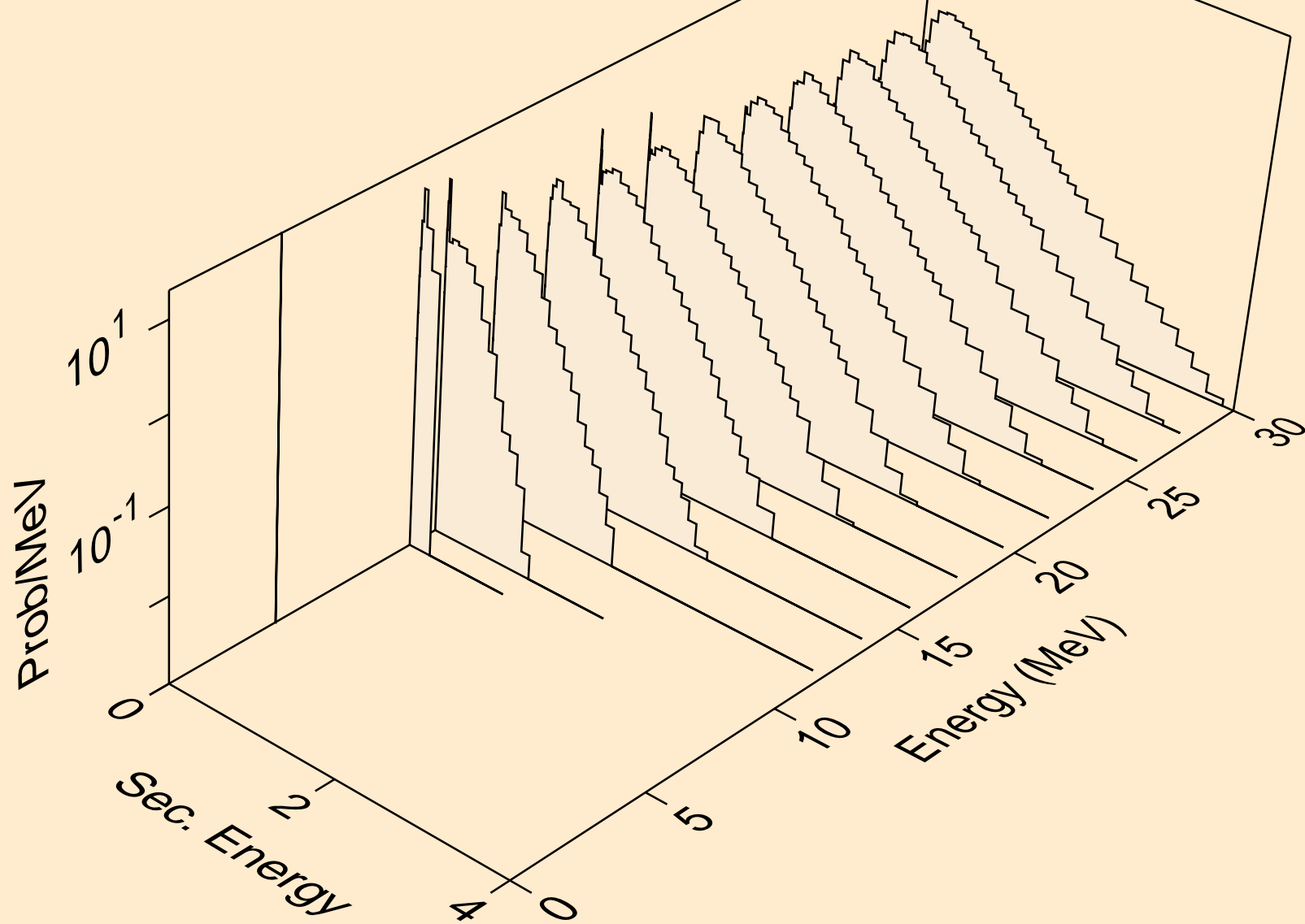

TB151M TRITON ACER TENDL-2021 LIBRARY; T=0.K  
neutrons from (t,4n)

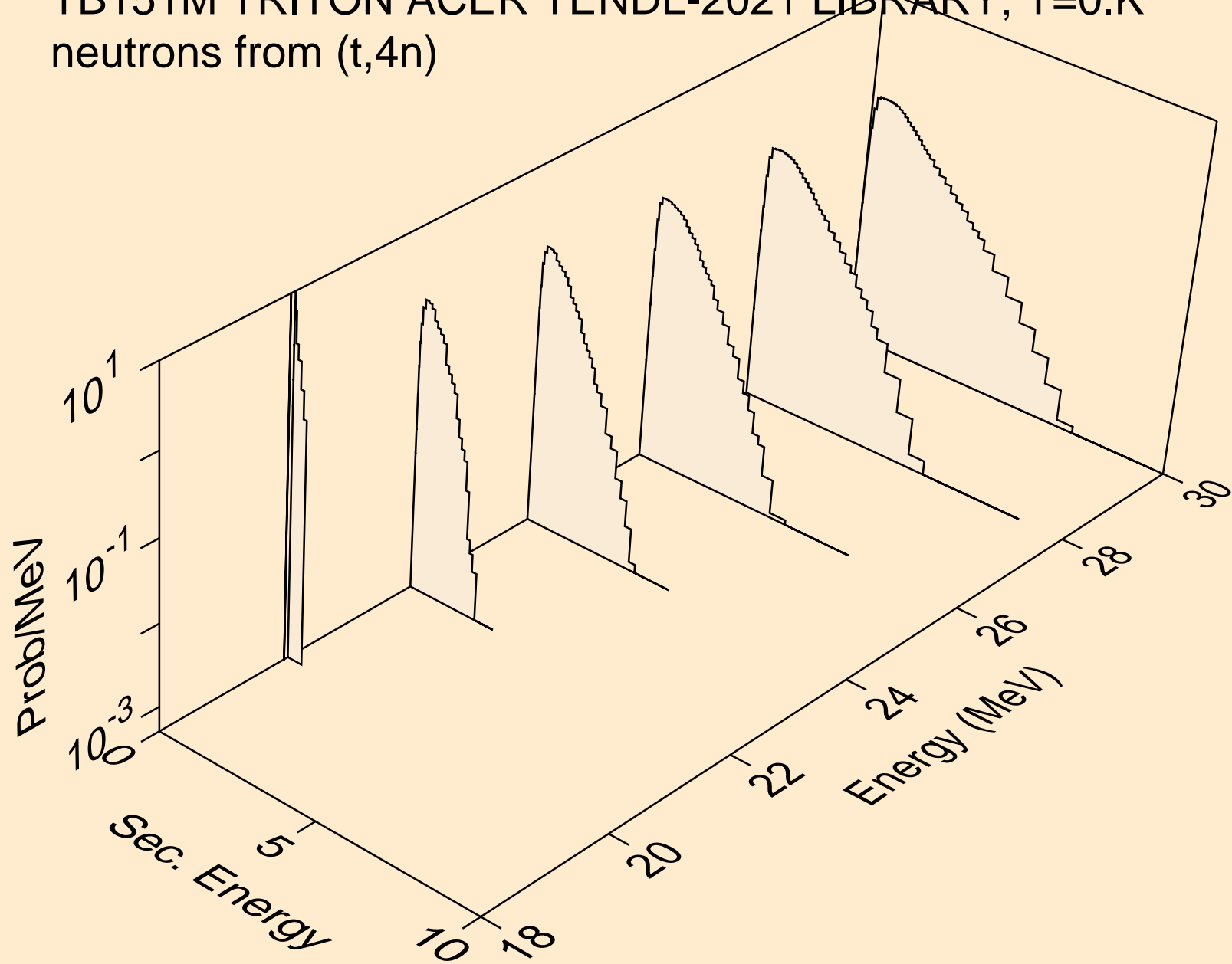

TB151M TRITON ACER TENDL-2021 LIBRARY; T=0.K  
neutrons from (t,2np)

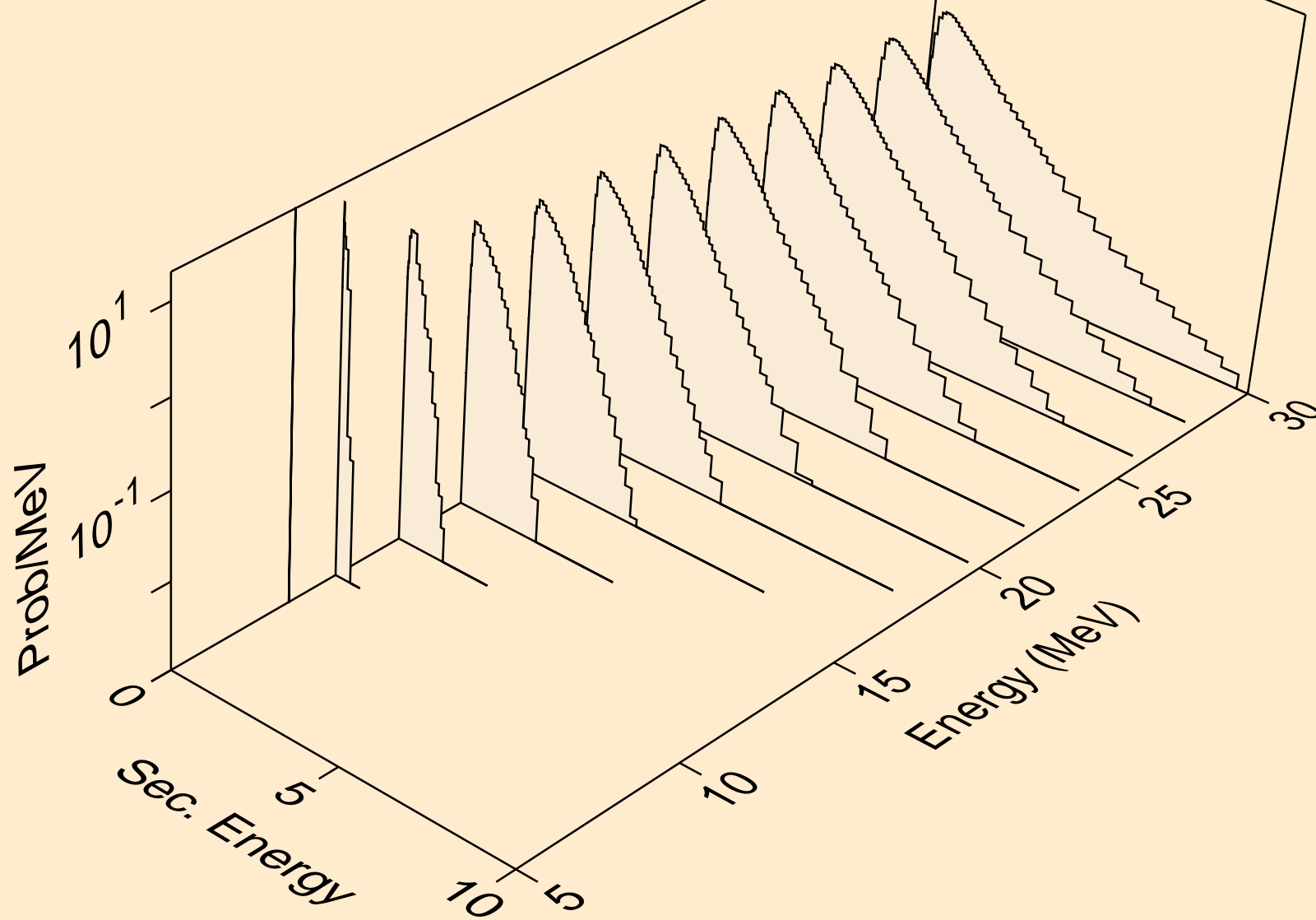



TB151M TRITON ACER TENDL-2021 LIBRARY; T=0.K  
neutrons from (t,3np)

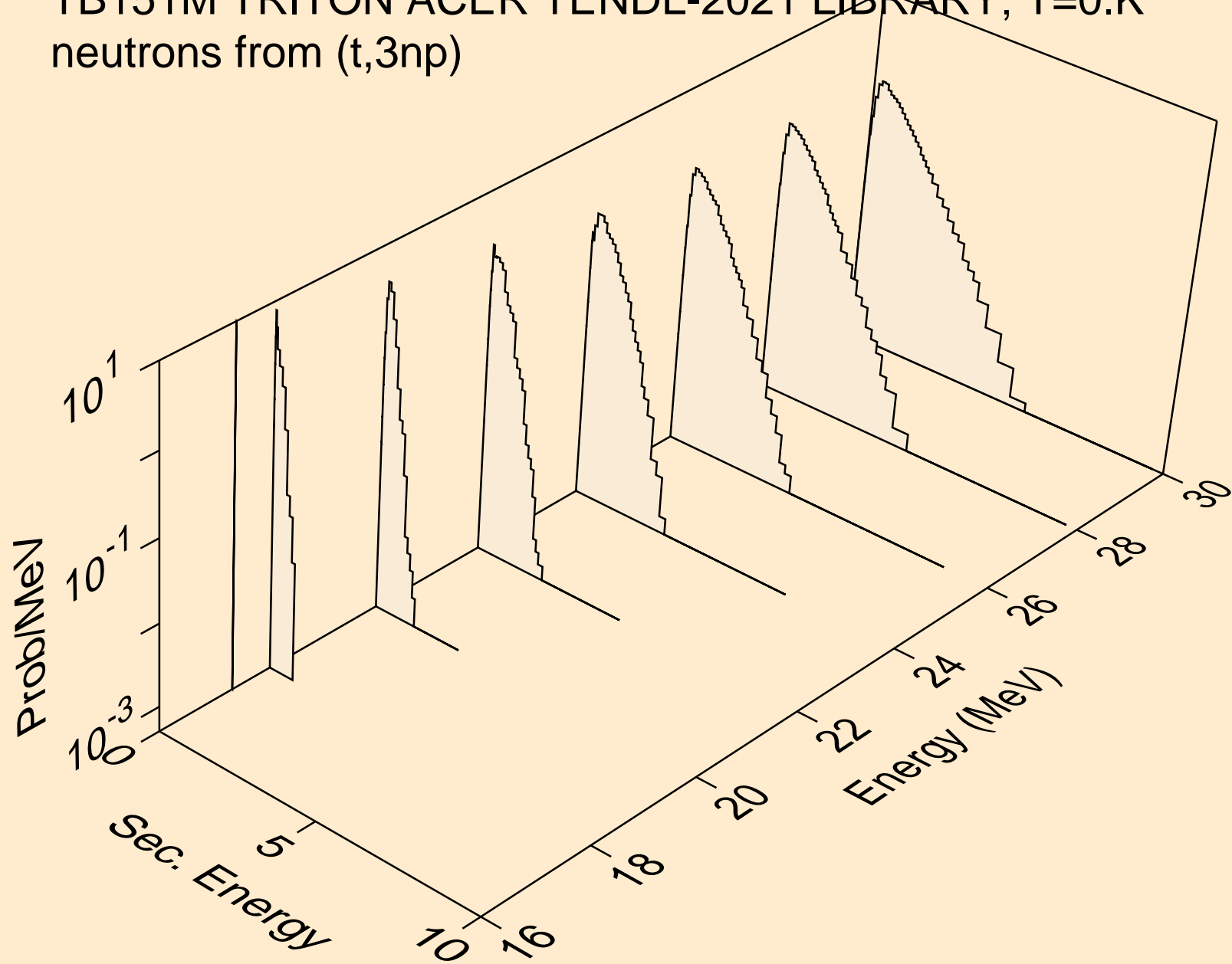

TB151M TRITON ACER TENDL-2021 LIBRARY; T=0.K  
neutrons from (t,2np)

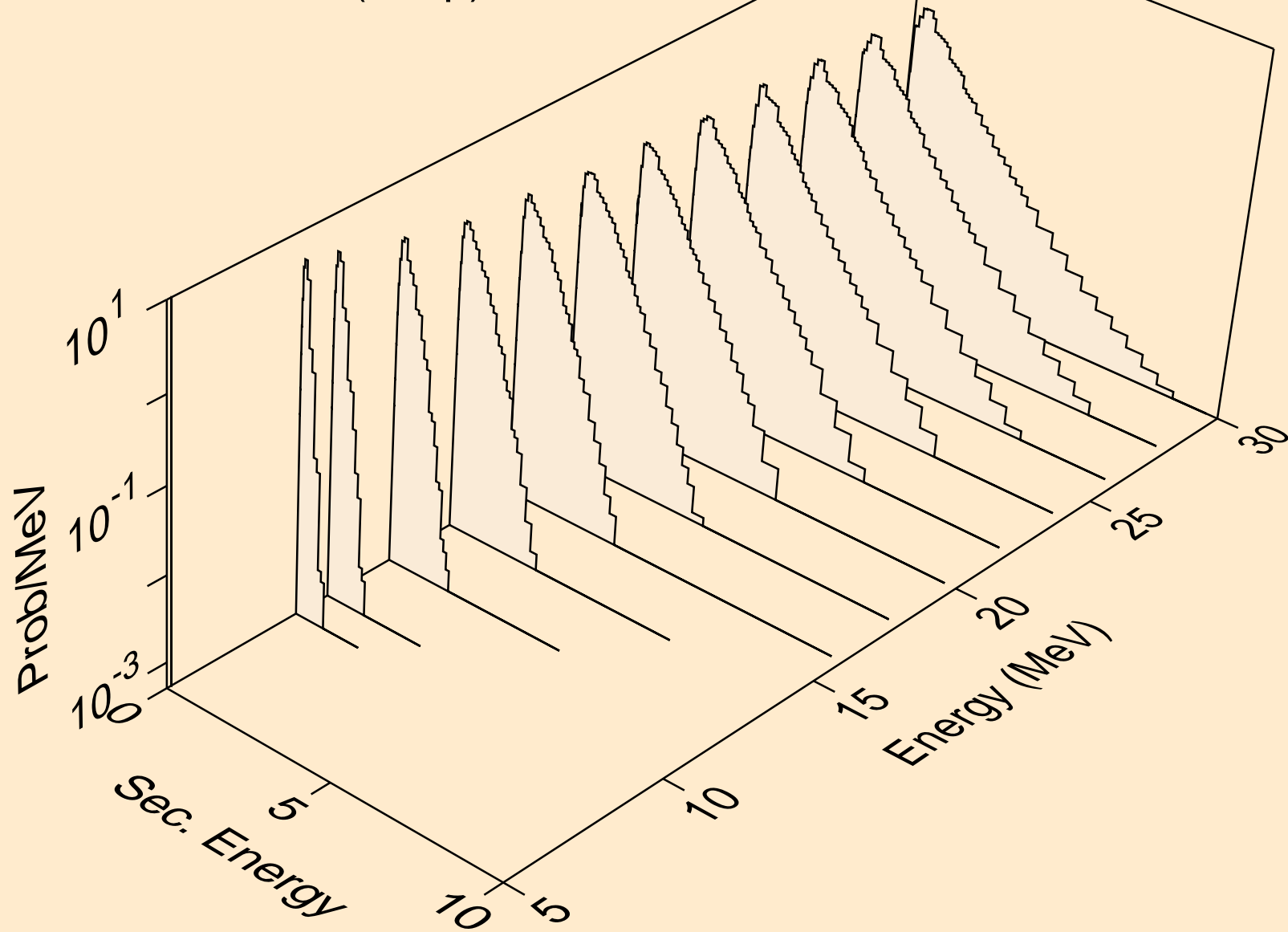

TB151M TRITON ACER TENDL-2021 LIBRARY; T=0.K  
neutrons from (t,npa)

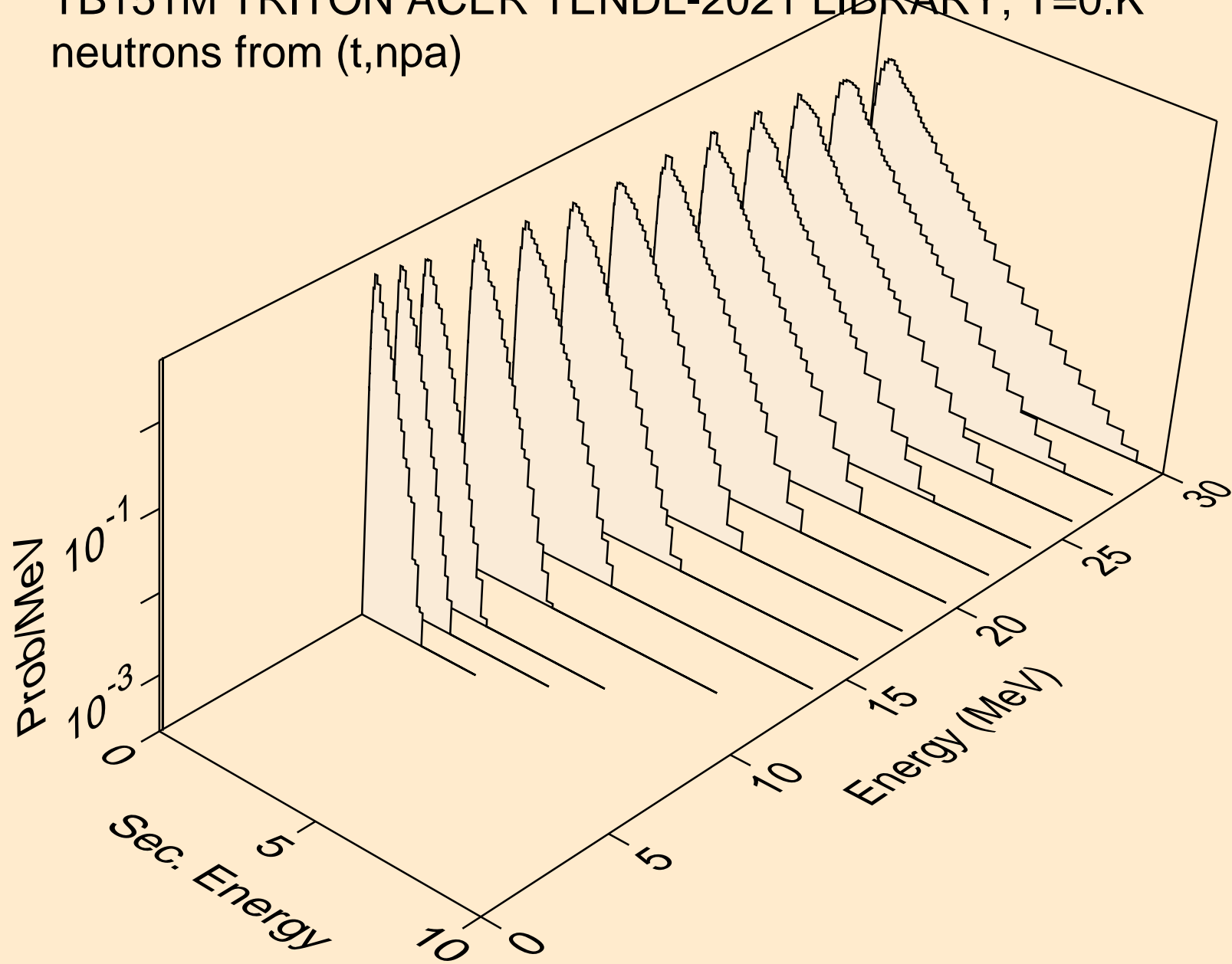

TB151M TRITON ACER TENDL-2021 LIBRARY; T=0.K  
protons from (t,x)

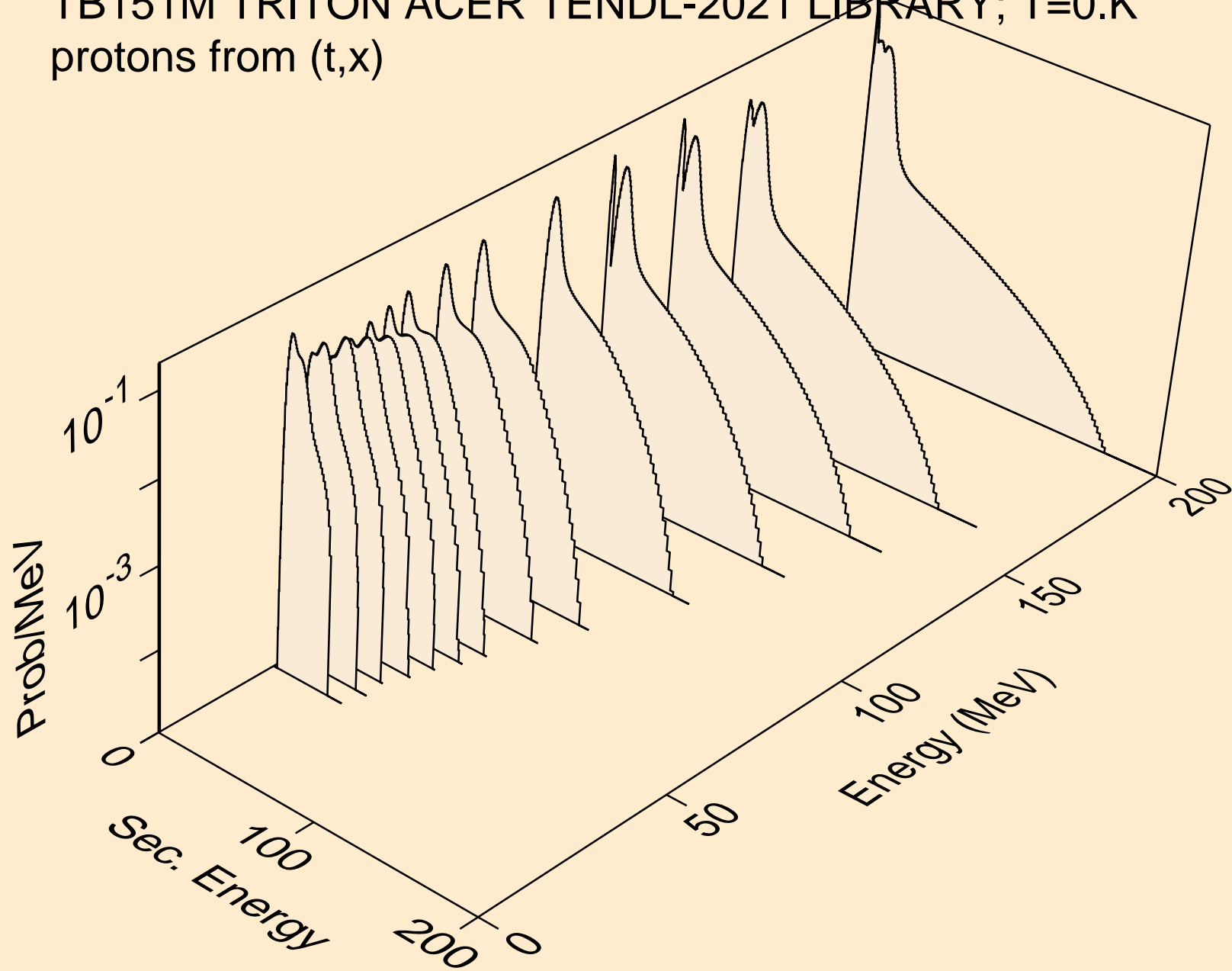

TB151M TRITON ACER TENDL-2021 LIBRARY; T=0.K  
protons from (t,n\*)p

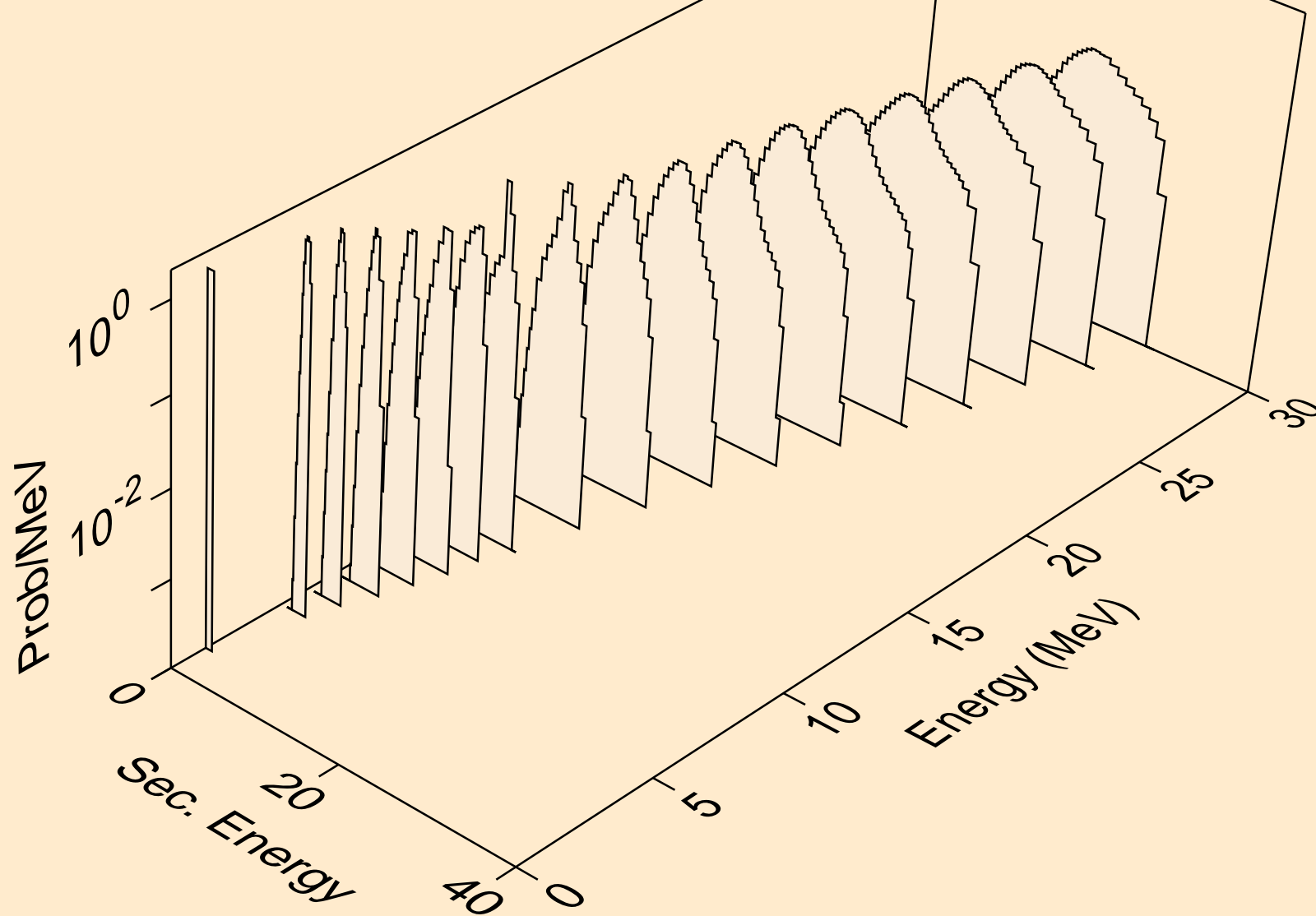

TB151M TRITON ACER TENDL-2021 LIBRARY; T=0.K  
protons from (t,2np)

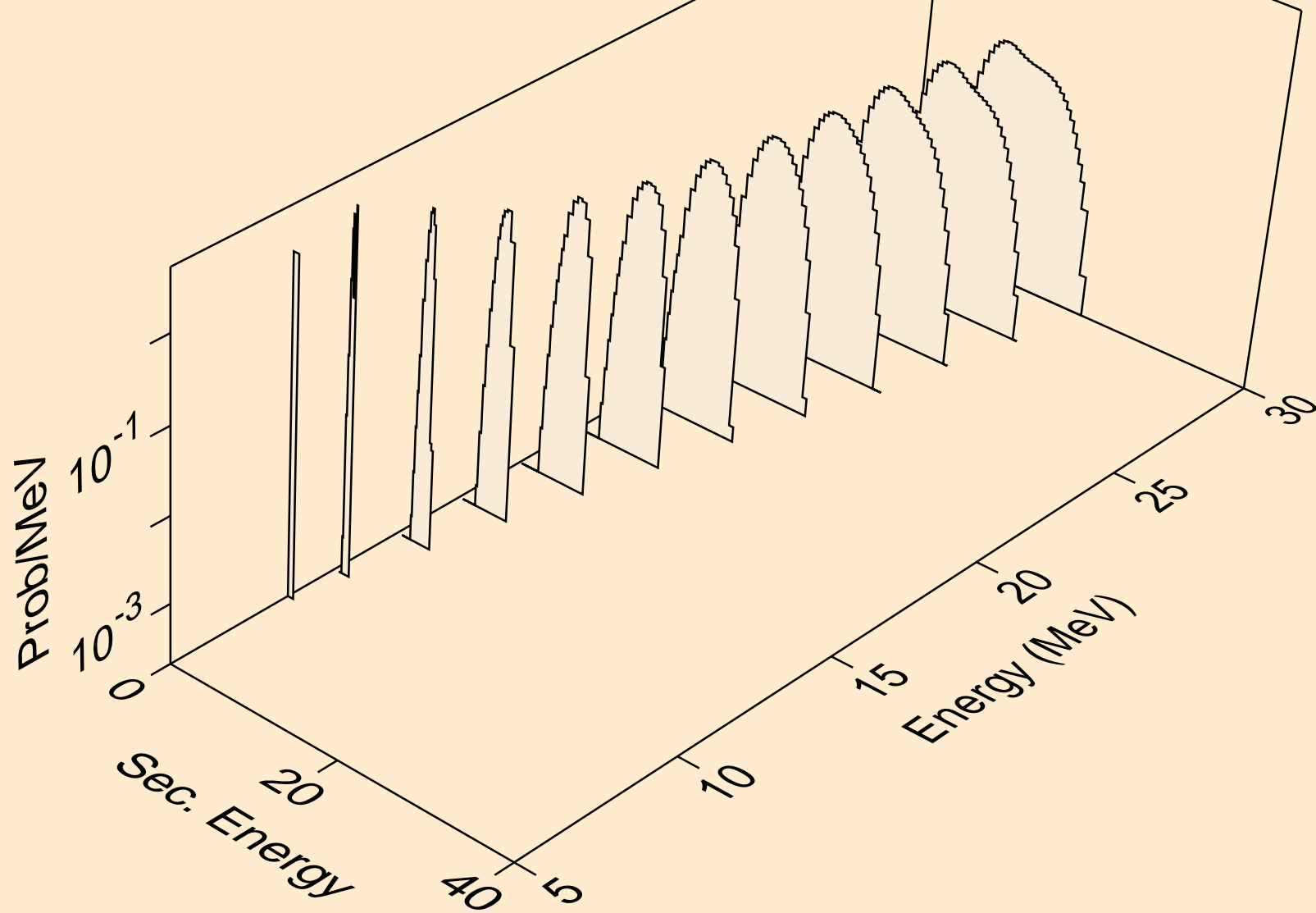

TB151M TRITON ACER TENDL-2021 LIBRARY; T=0.K  
protons from (t,3np)

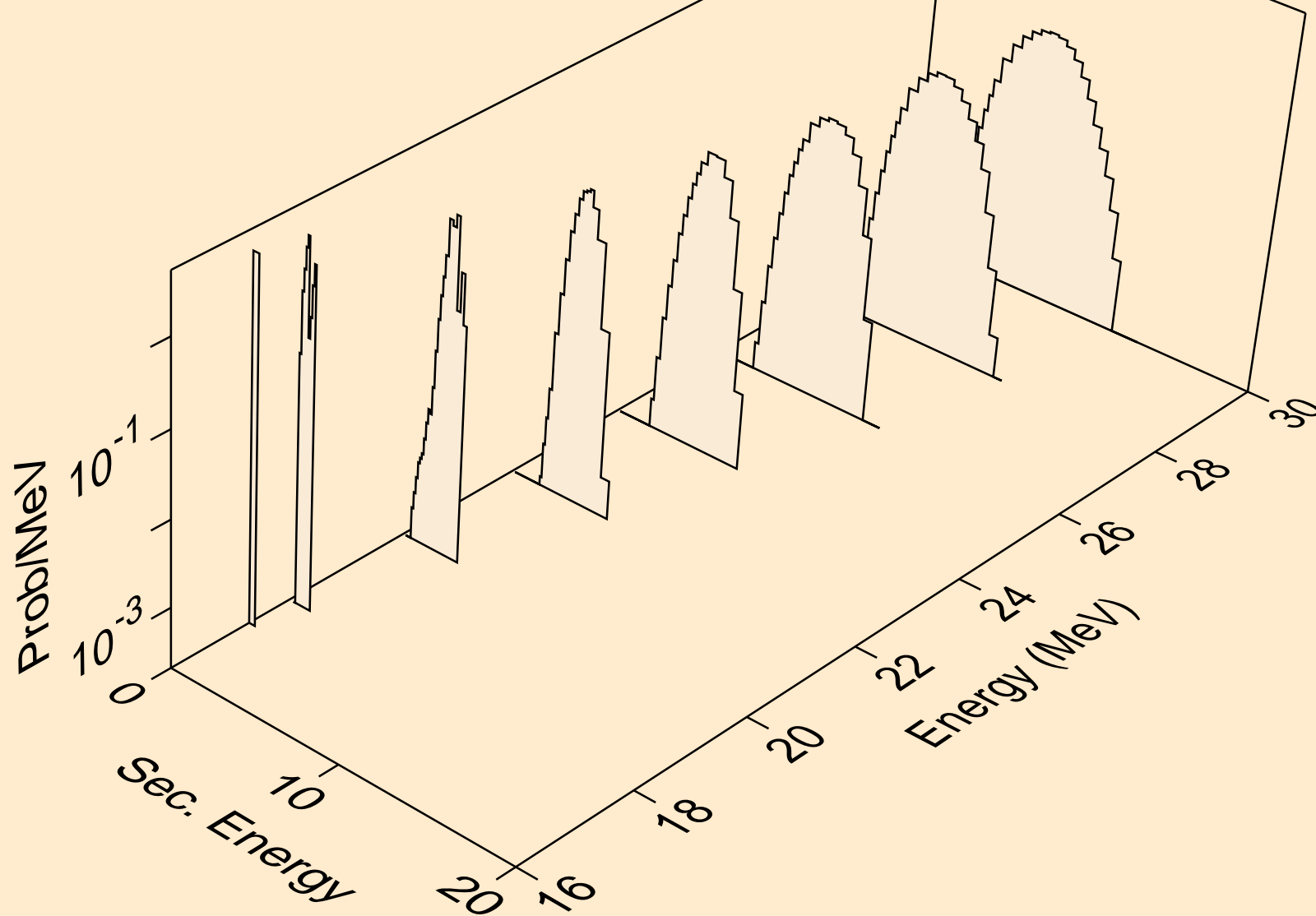

TB151M TRITON ACER TENDL-2021 LIBRARY; T=0.K  
protons from (t,2np)

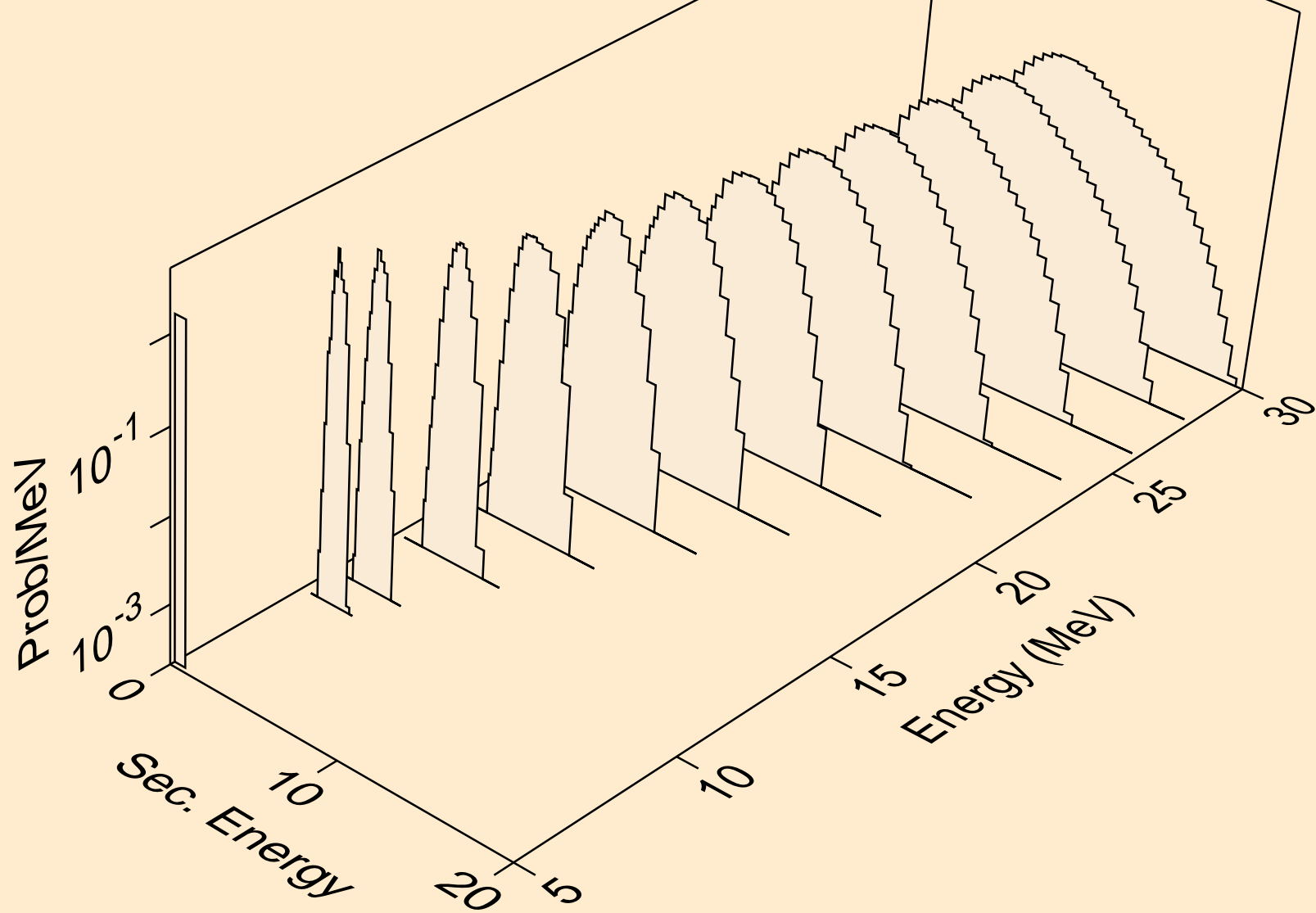



TB151M TRITON ACER TENDL-2021 LIBRARY; T=0.K  
protons from (t,npa)

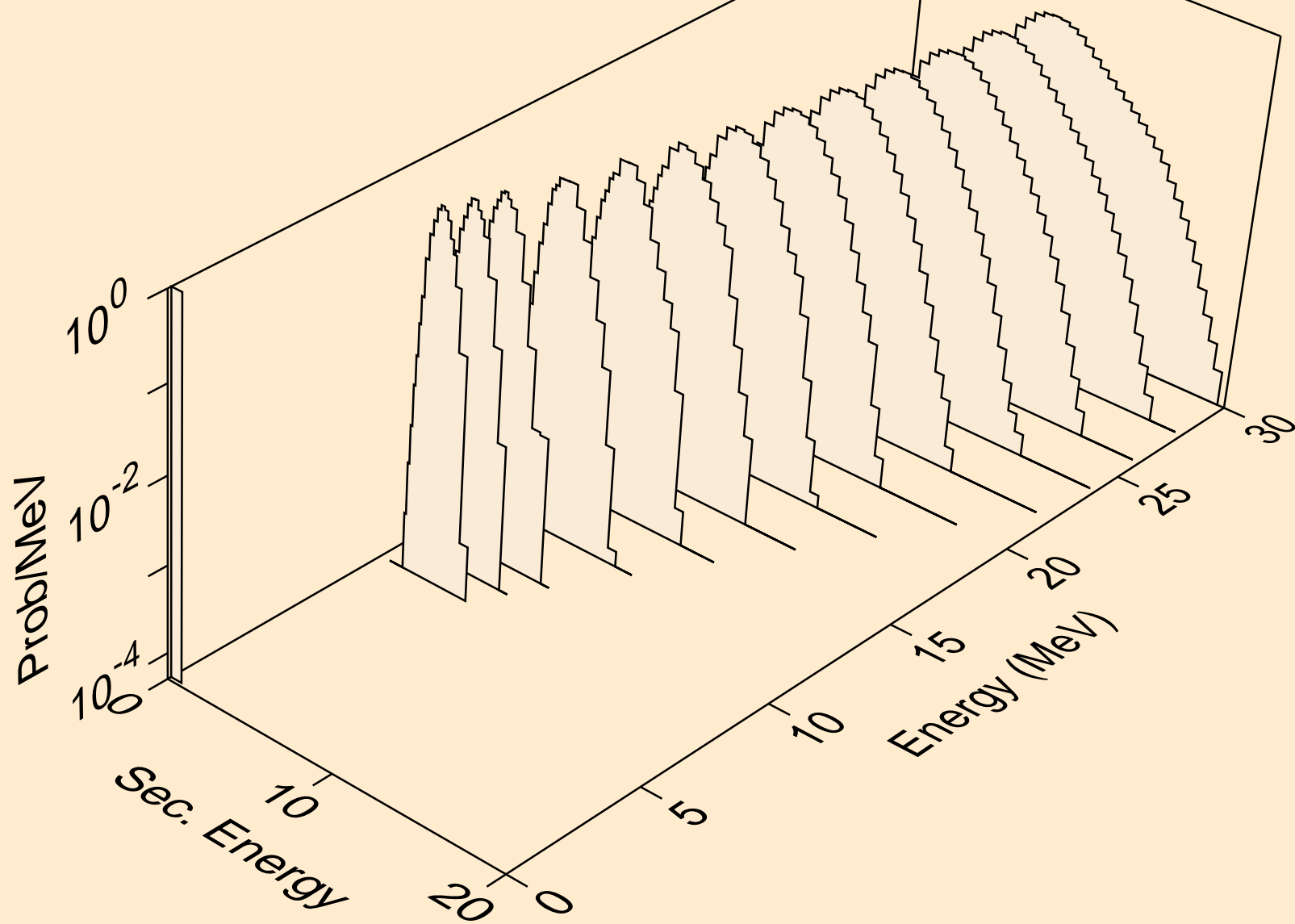

TB151M TRITON ACER TENDL-2021 LIBRARY; T=0.K  
protons from (t,p)

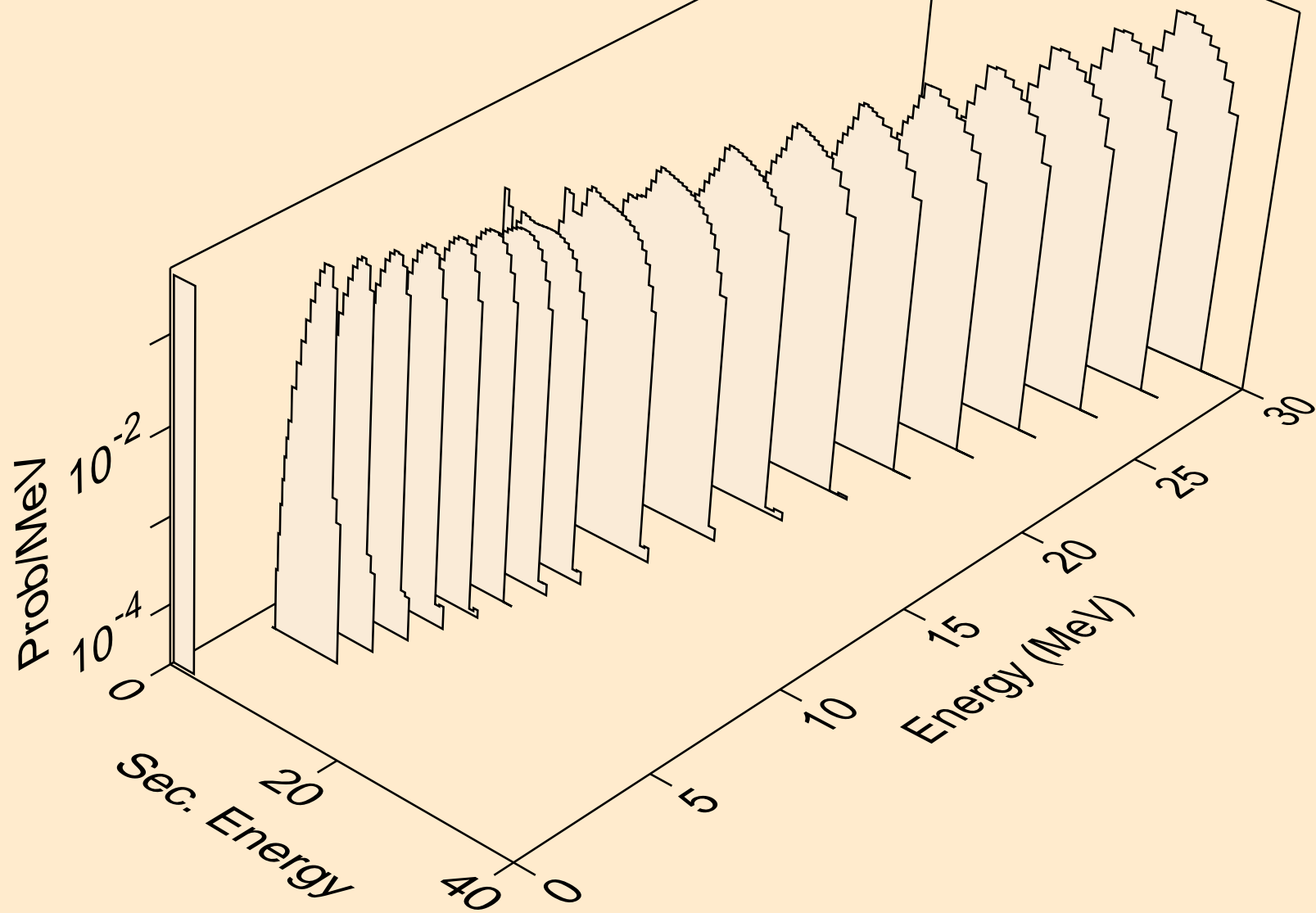

TB151M TRITON ACER TENDL-2021 LIBRARY; T=0.K  
protons from (t,2p)

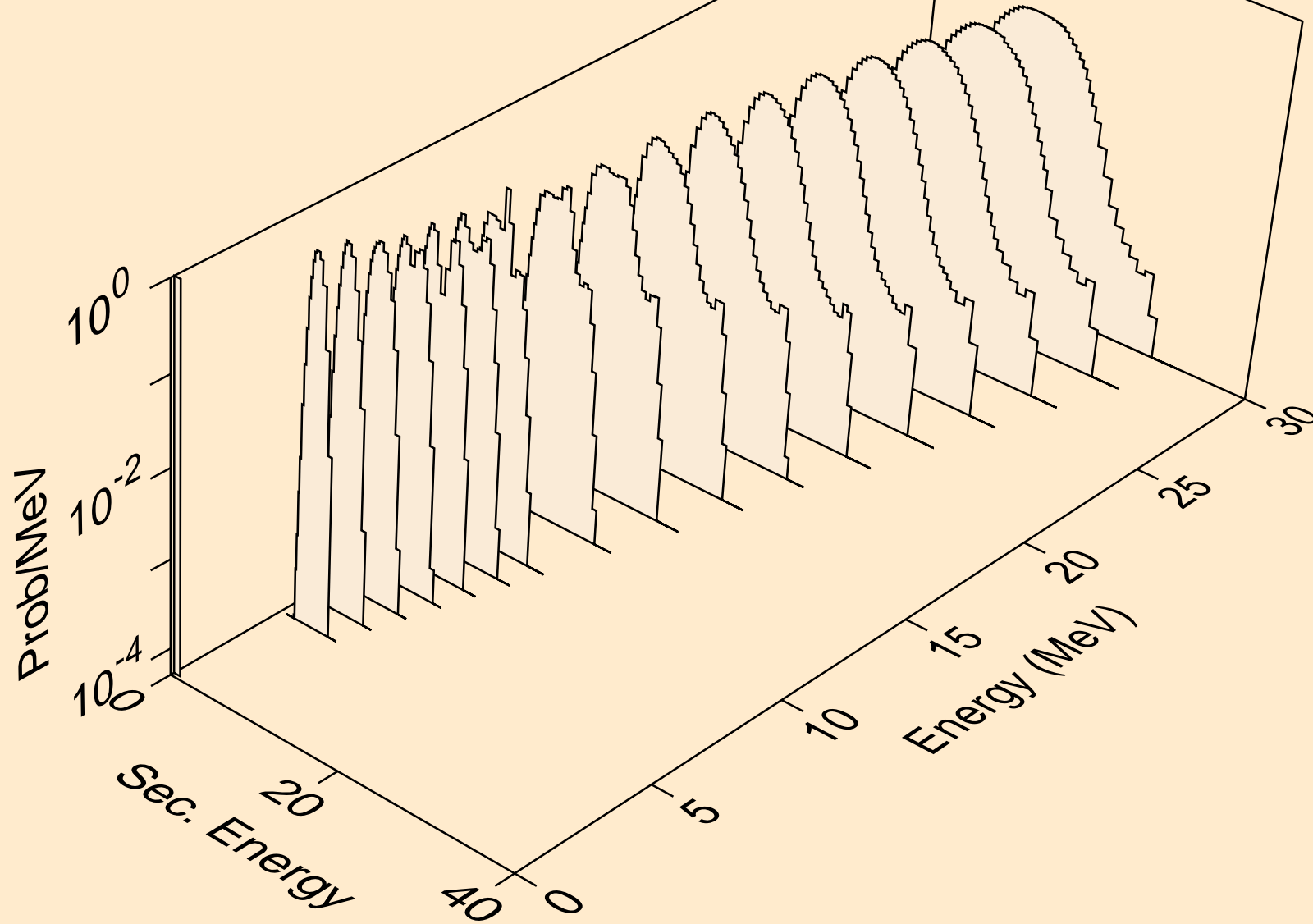

TB151M TRITON ACER TENDL-2021 LIBRARY; T=0.K  
protons from (t,pa)

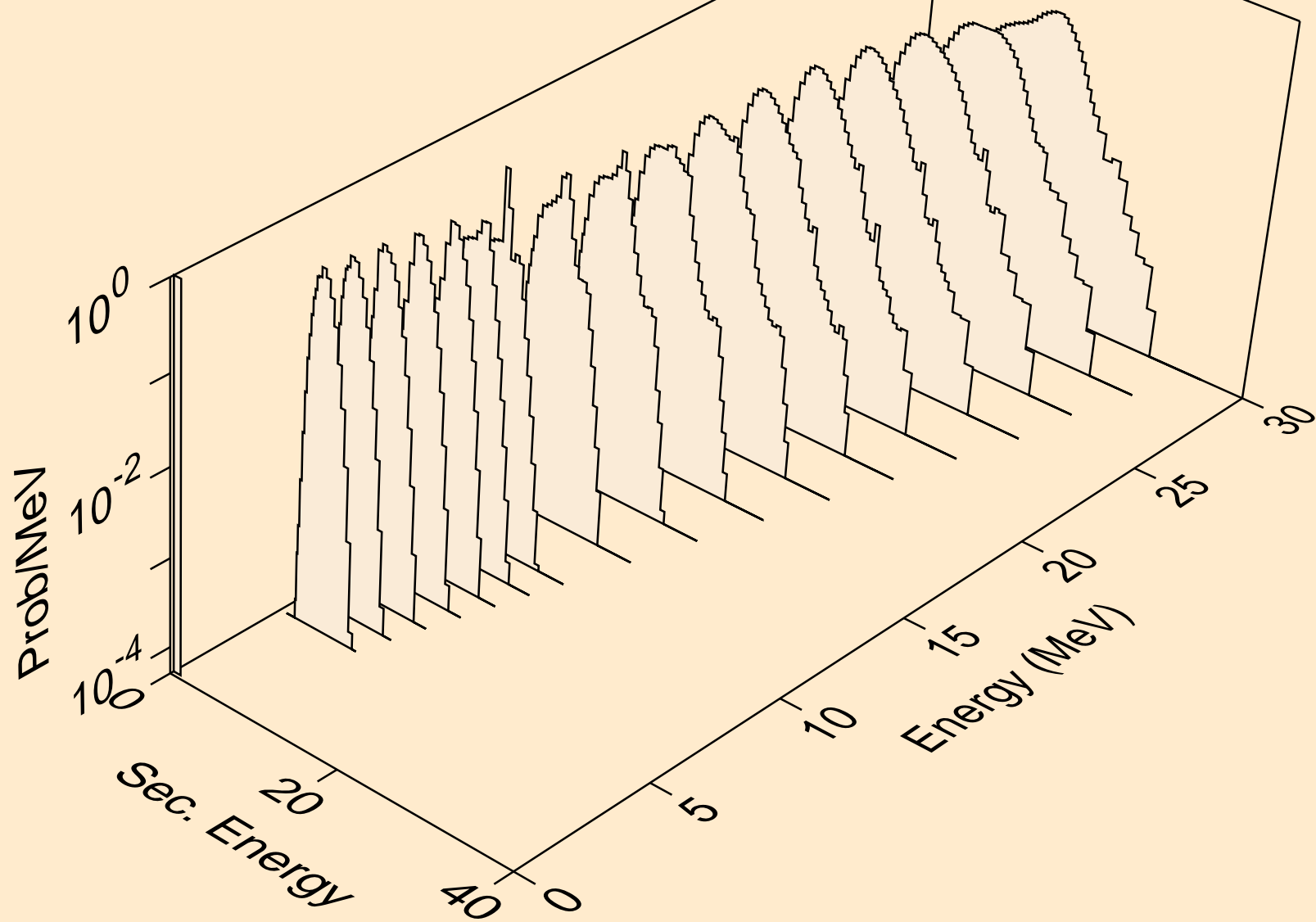

TB151M TRITON ACER TENDL-2021 LIBRARY; T=0.K  
protons from (t,pd)

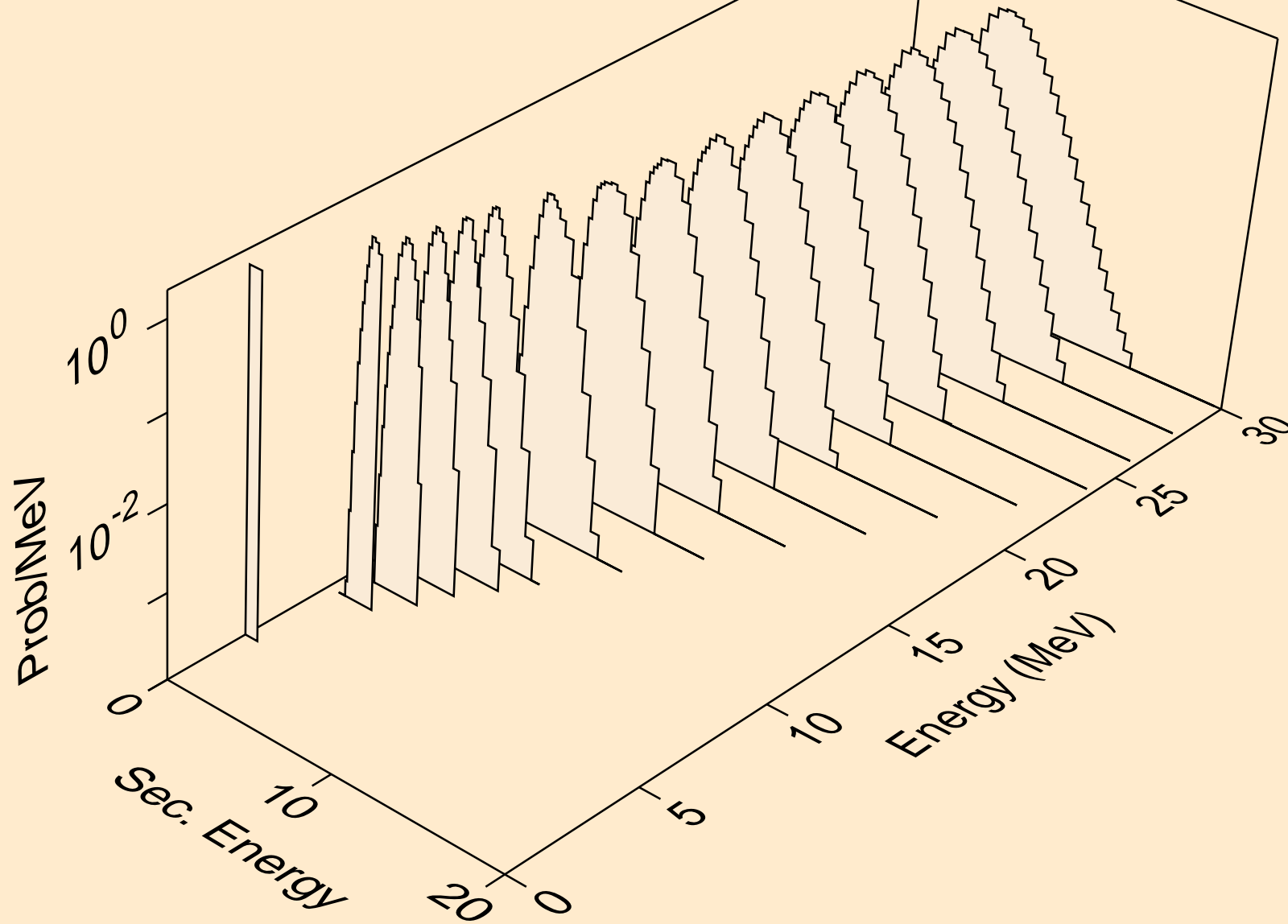

TB151M TRITON ACER TENDL-2021 LIBRARY; T=0.K  
protons from (t,pt)

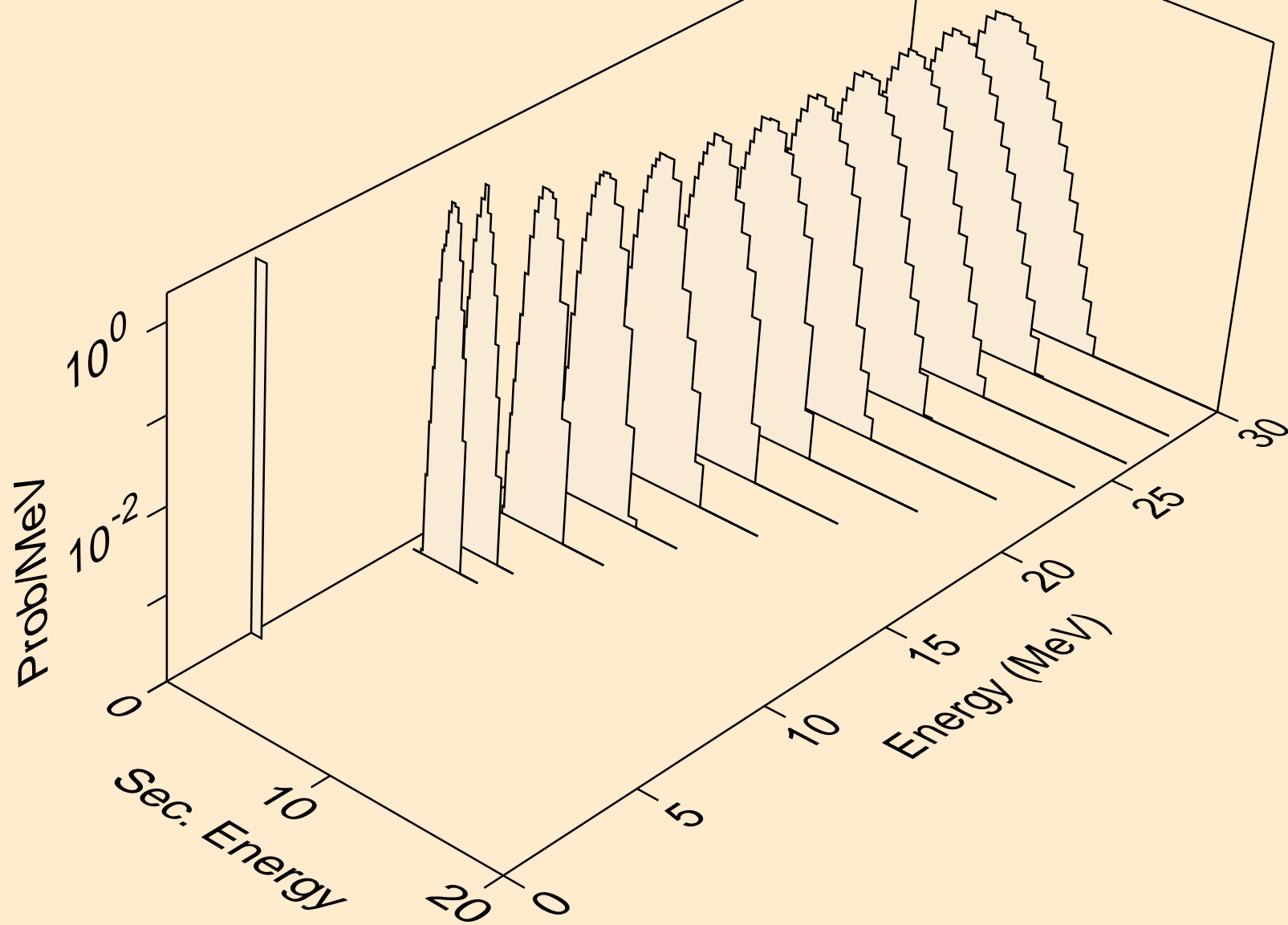

TB151M TRITON ACER TENDL-2021 LIBRARY; T=0.K  
deuterons from (t,x)

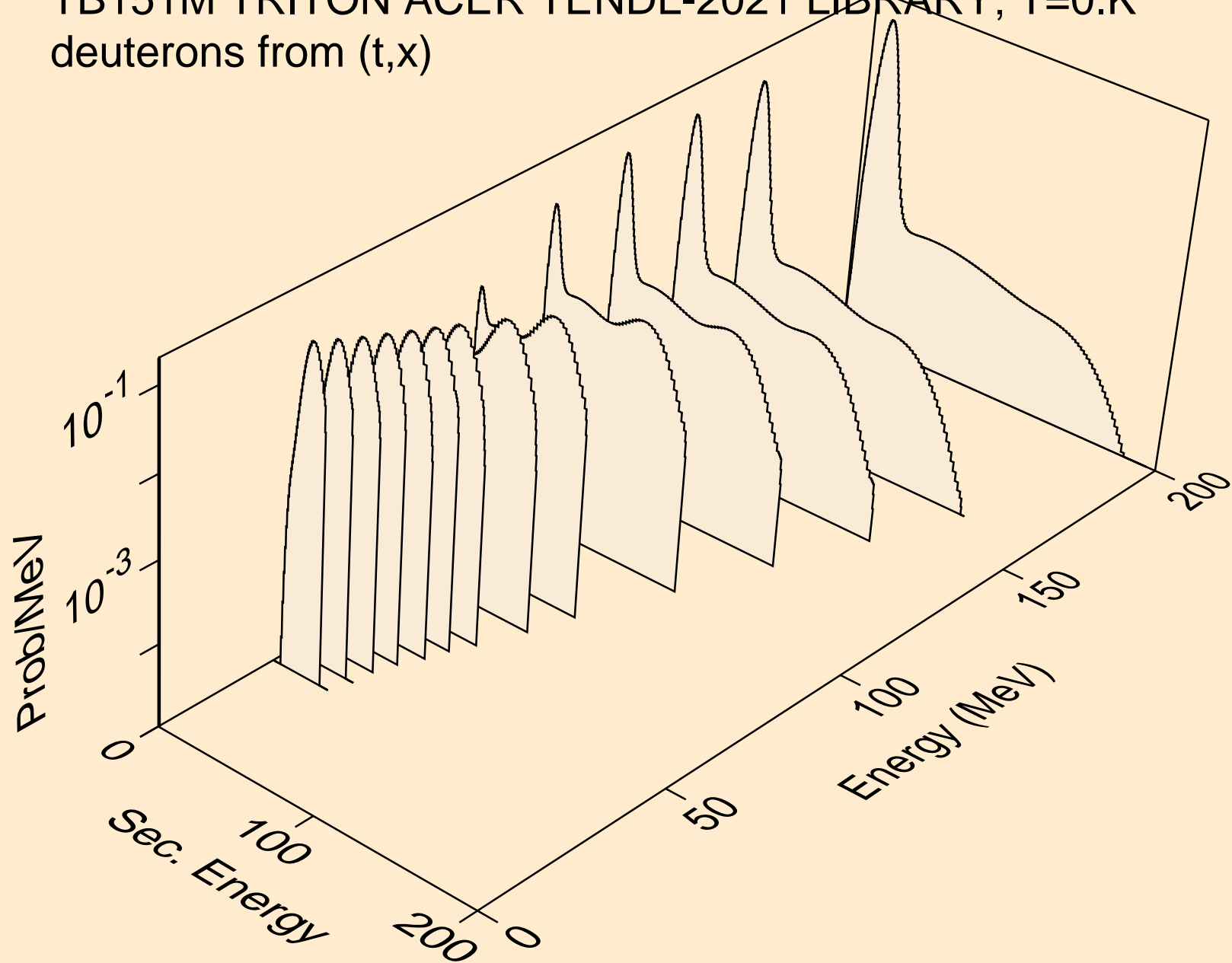

TB151M TRITON ACER TENDL-2021 LIBRARY; T=0.K  
deuterons from (t,2nd)

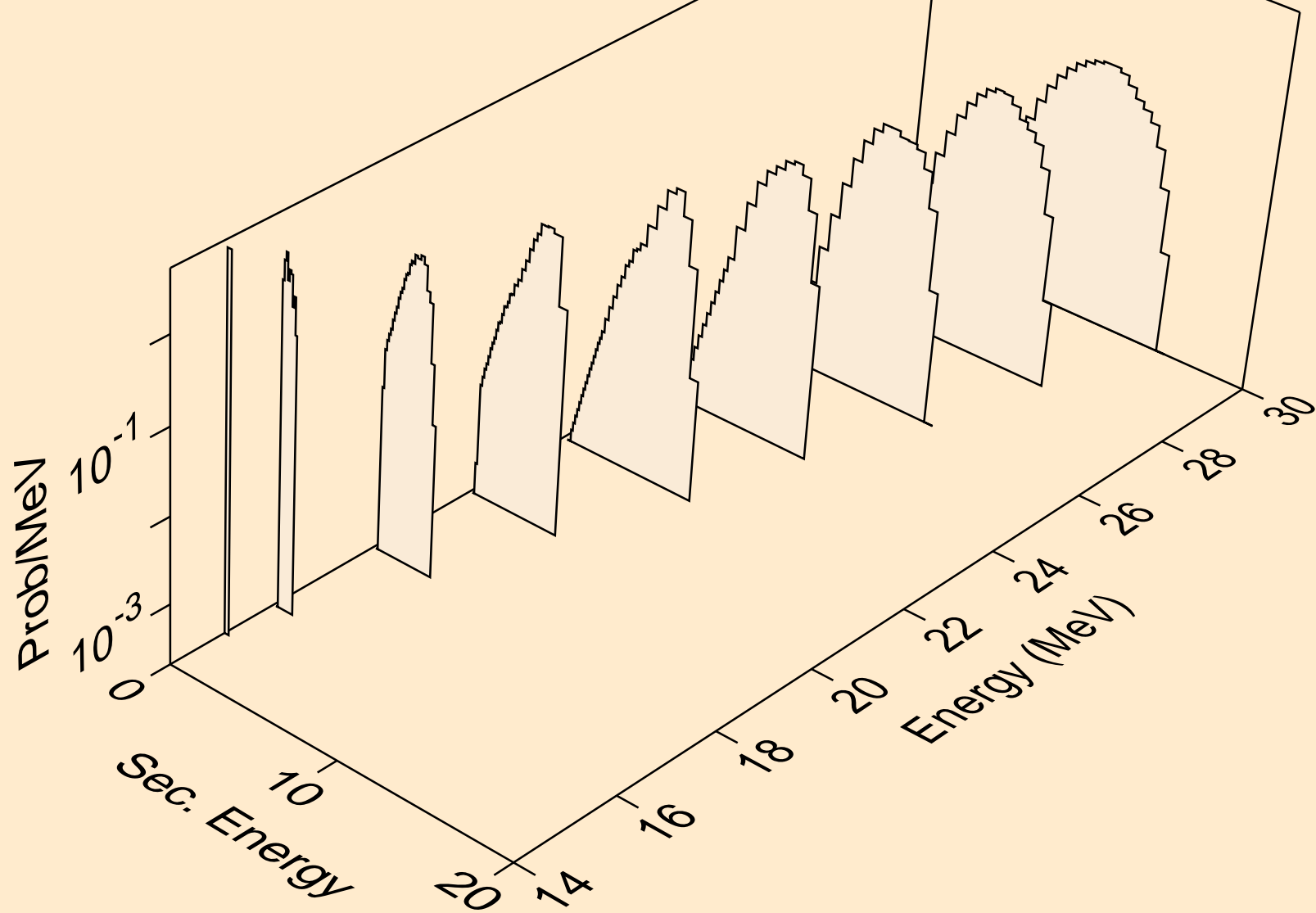



TB151M TRITON ACER TENDL-2021 LIBRARY; T=0.K  
deuterons from (t,n\*)d

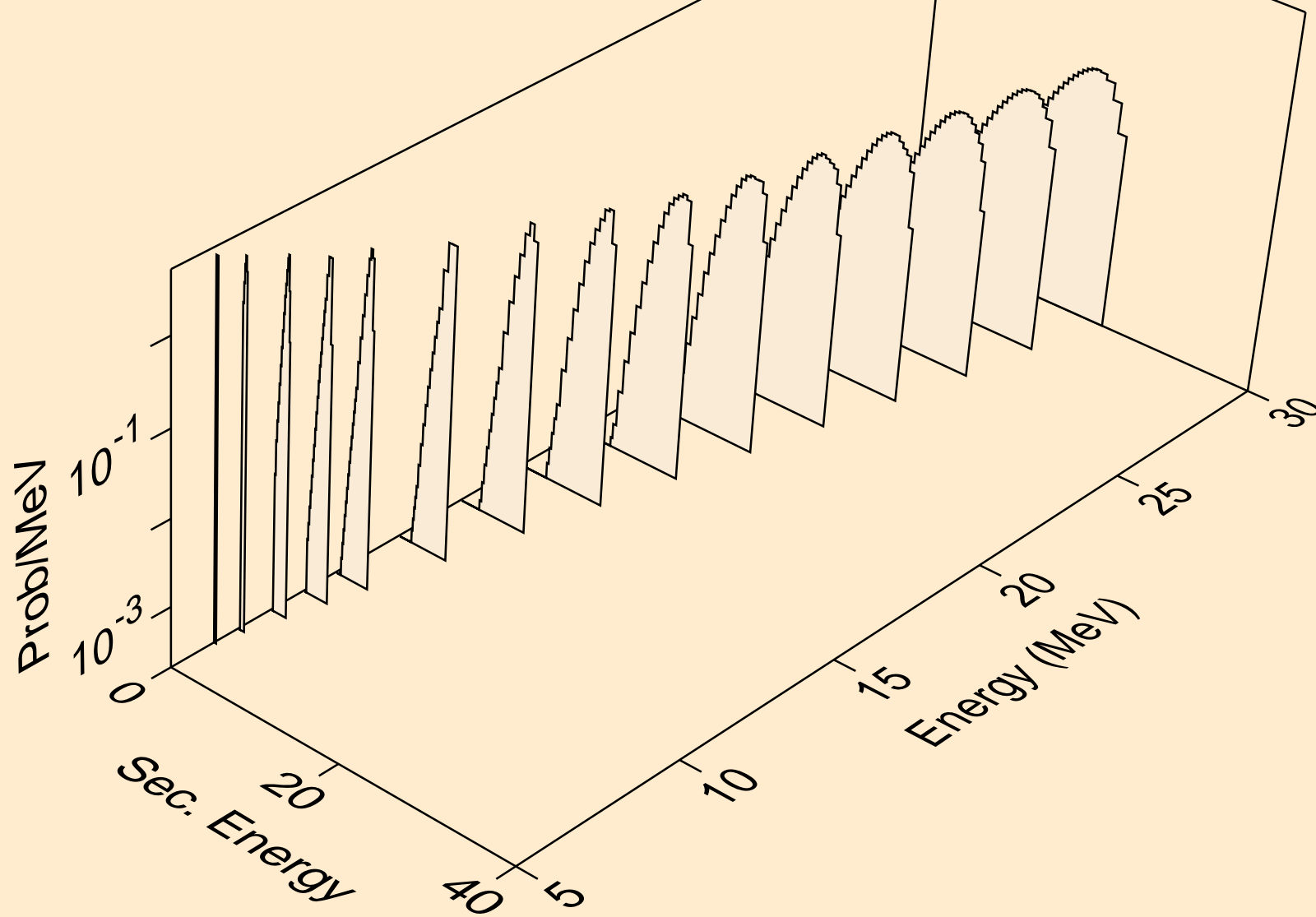

TB151M TRITON ACER TENDL-2021 LIBRARY; T=0.K  
deuterons from (t,d)

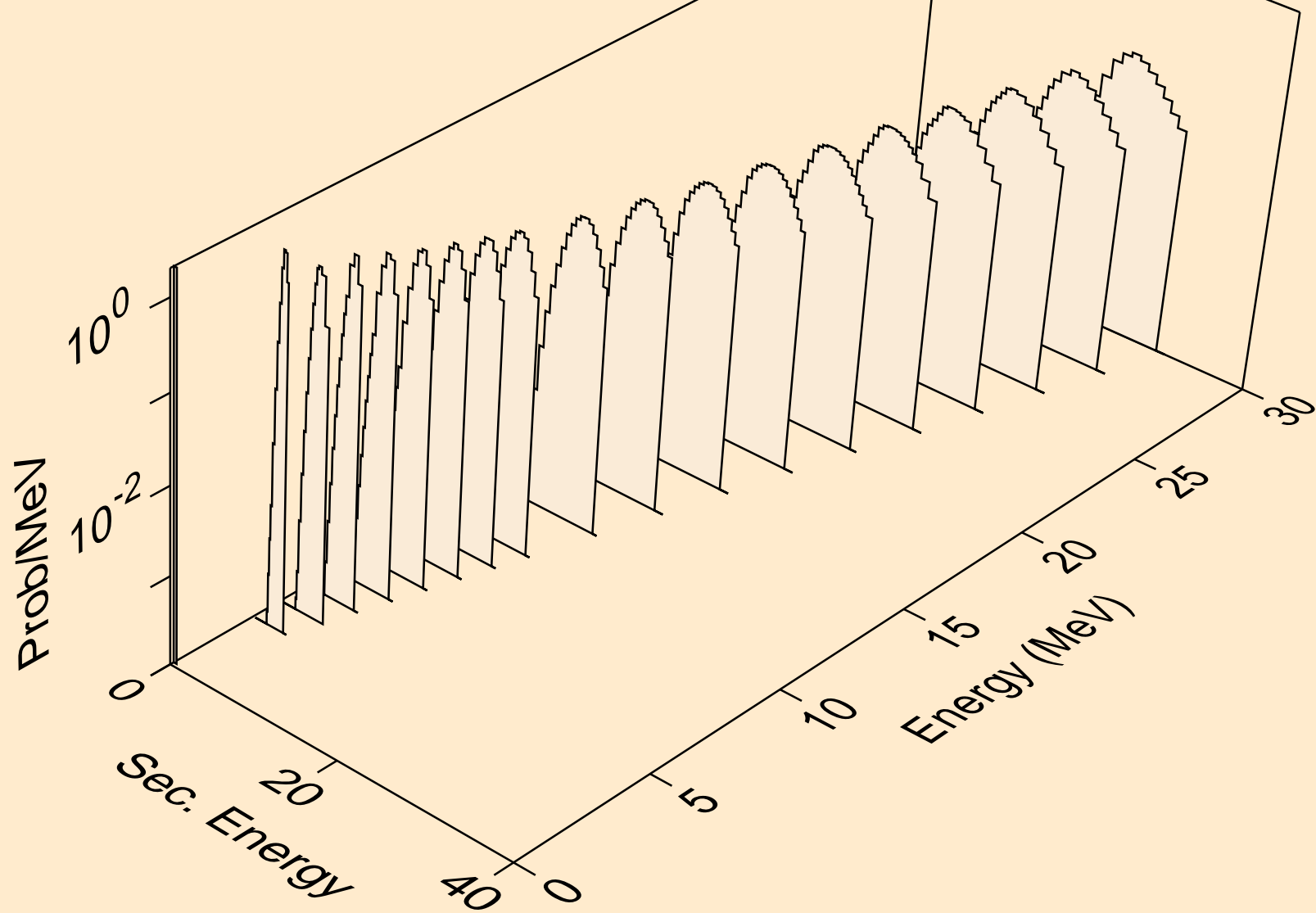

TB151M TRITON ACER TENDL-2021 LIBRARY; T=0.K  
deuterons from (t,pd)

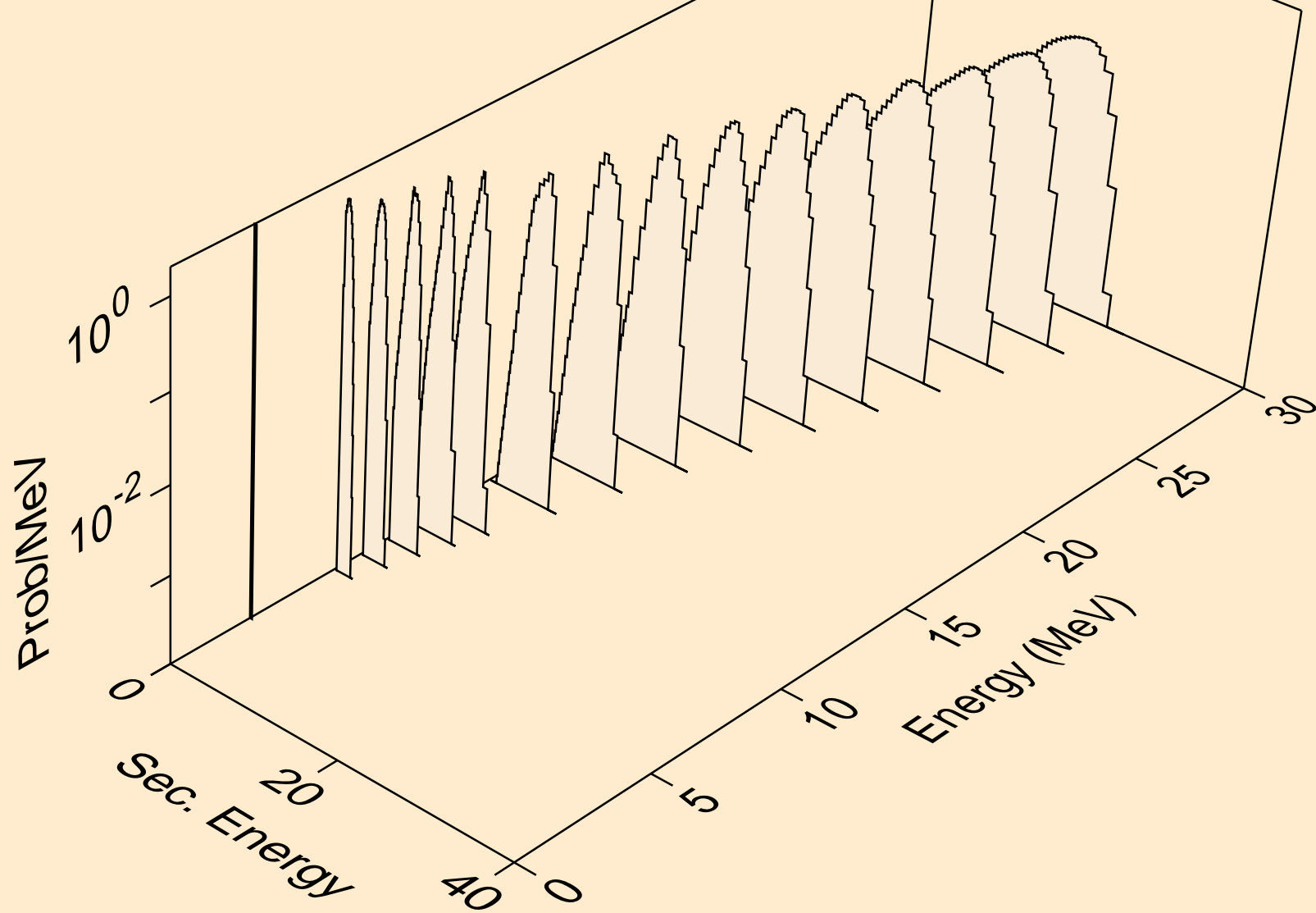

TB151M TRITON ACER TENDL-2021 LIBRARY; T=0.K  
deuterons from (t,da)

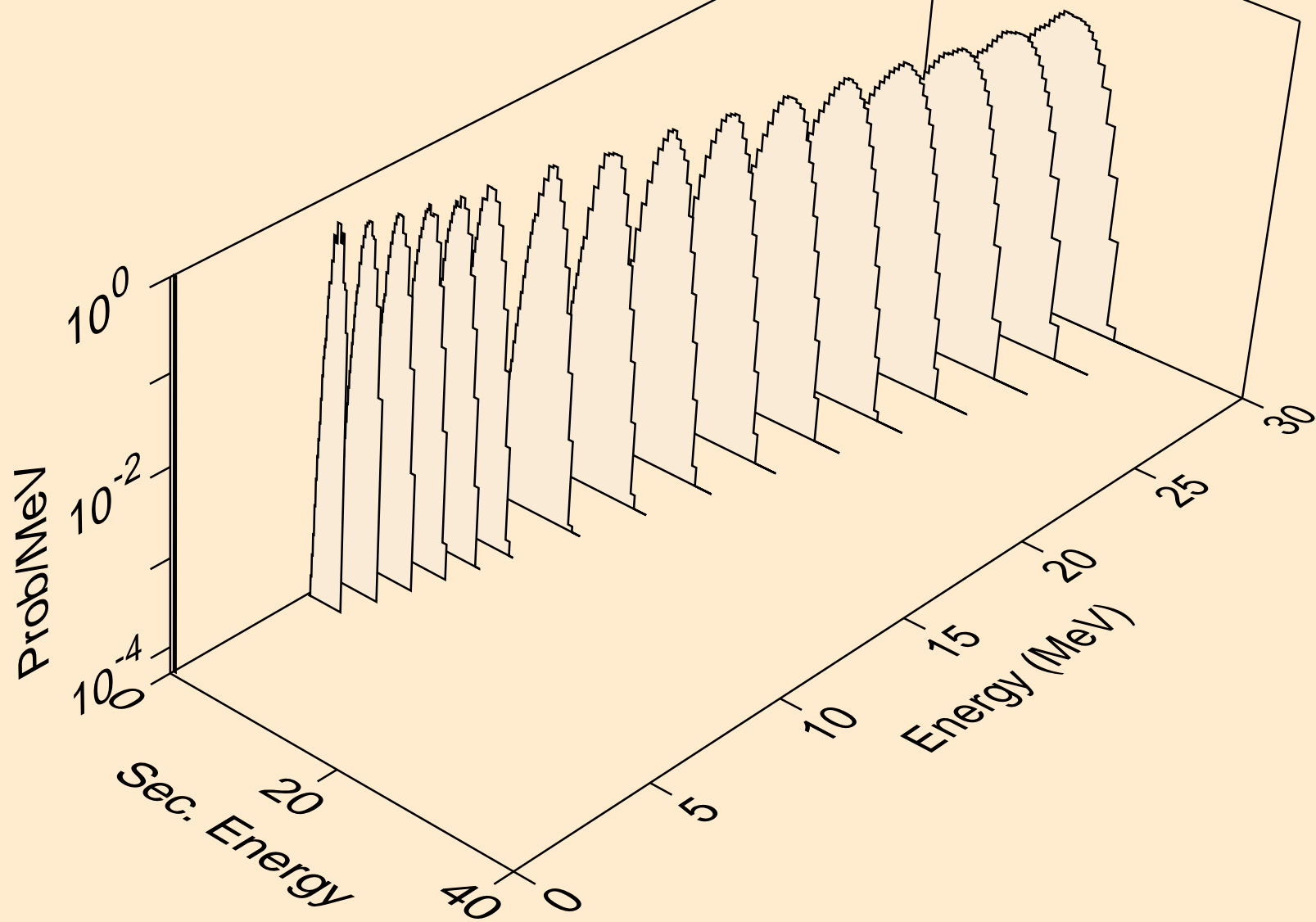

TB151M TRITON ACER TENDL-2021 LIBRARY; T=0.K  
he3s from (t,x)

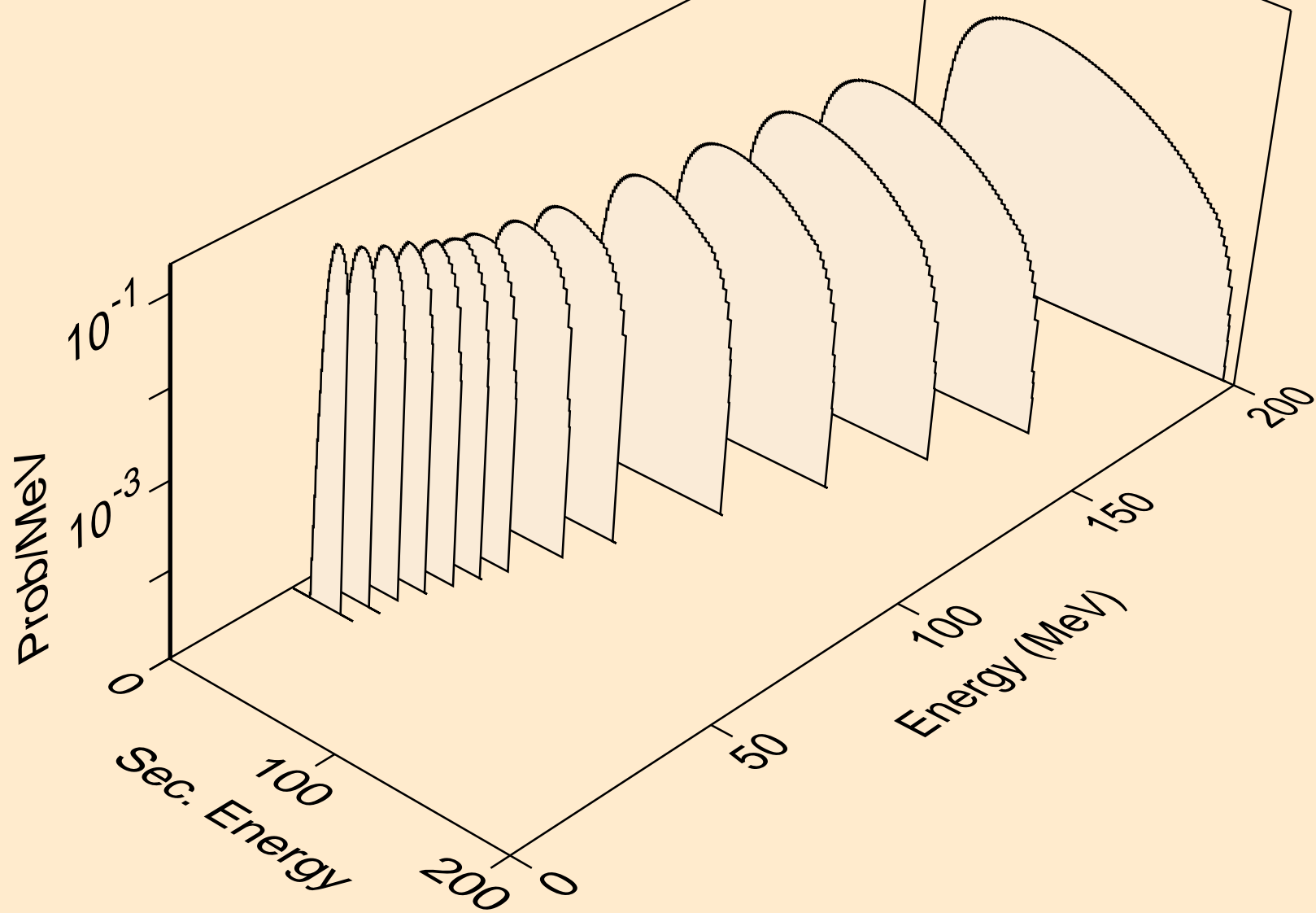

TB151M TRITON ACER TENDL-2021 LIBRARY; T=0.K  
he3s from (t,n\*)he3

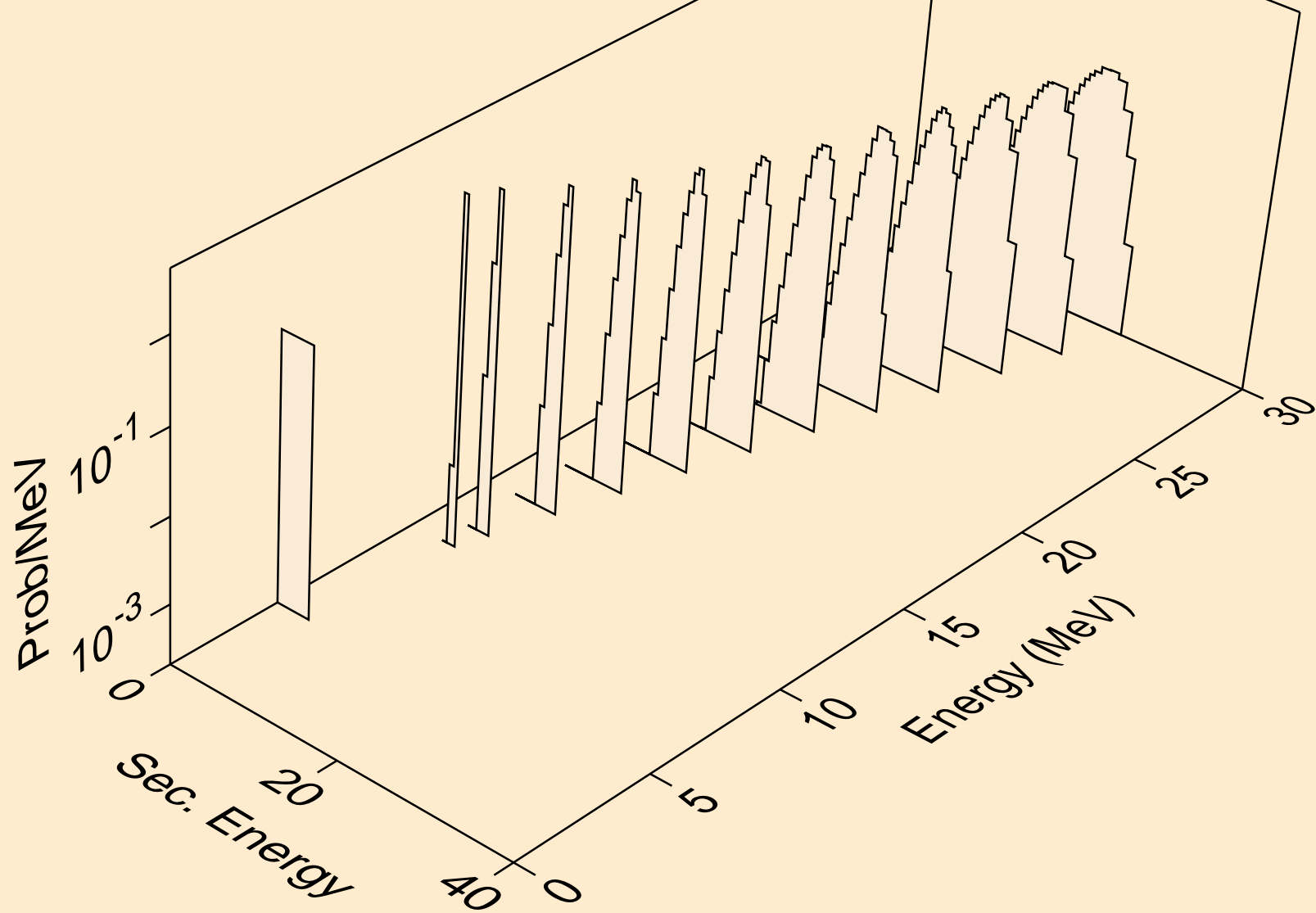

TB151M TRITON ACER TENDL-2021 LIBRARY; T=0.K  
he3s from (t,he3)

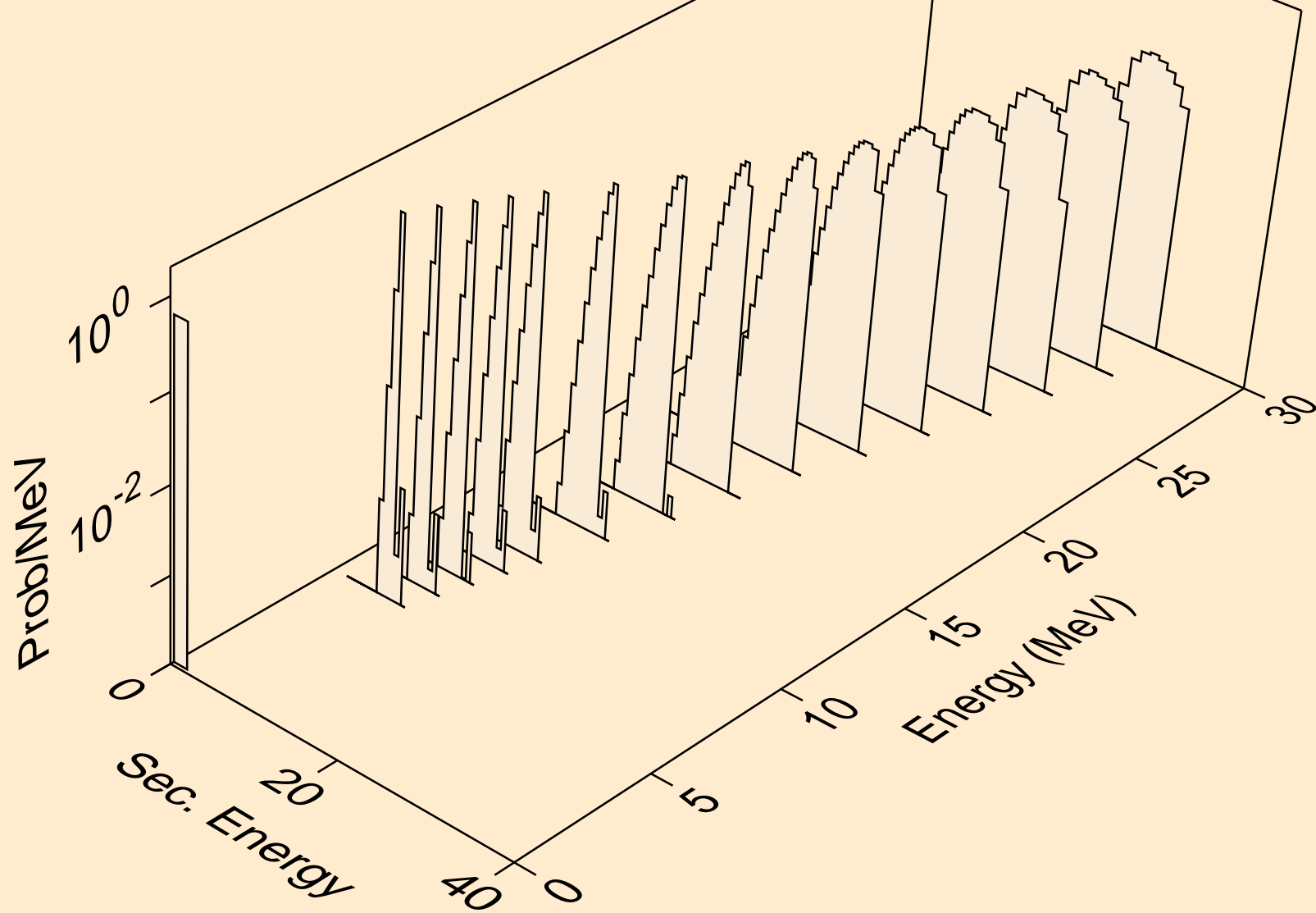

TB151M TRITON ACER TENDL-2021 LIBRARY; T=0.K  
alphas from (t,x)

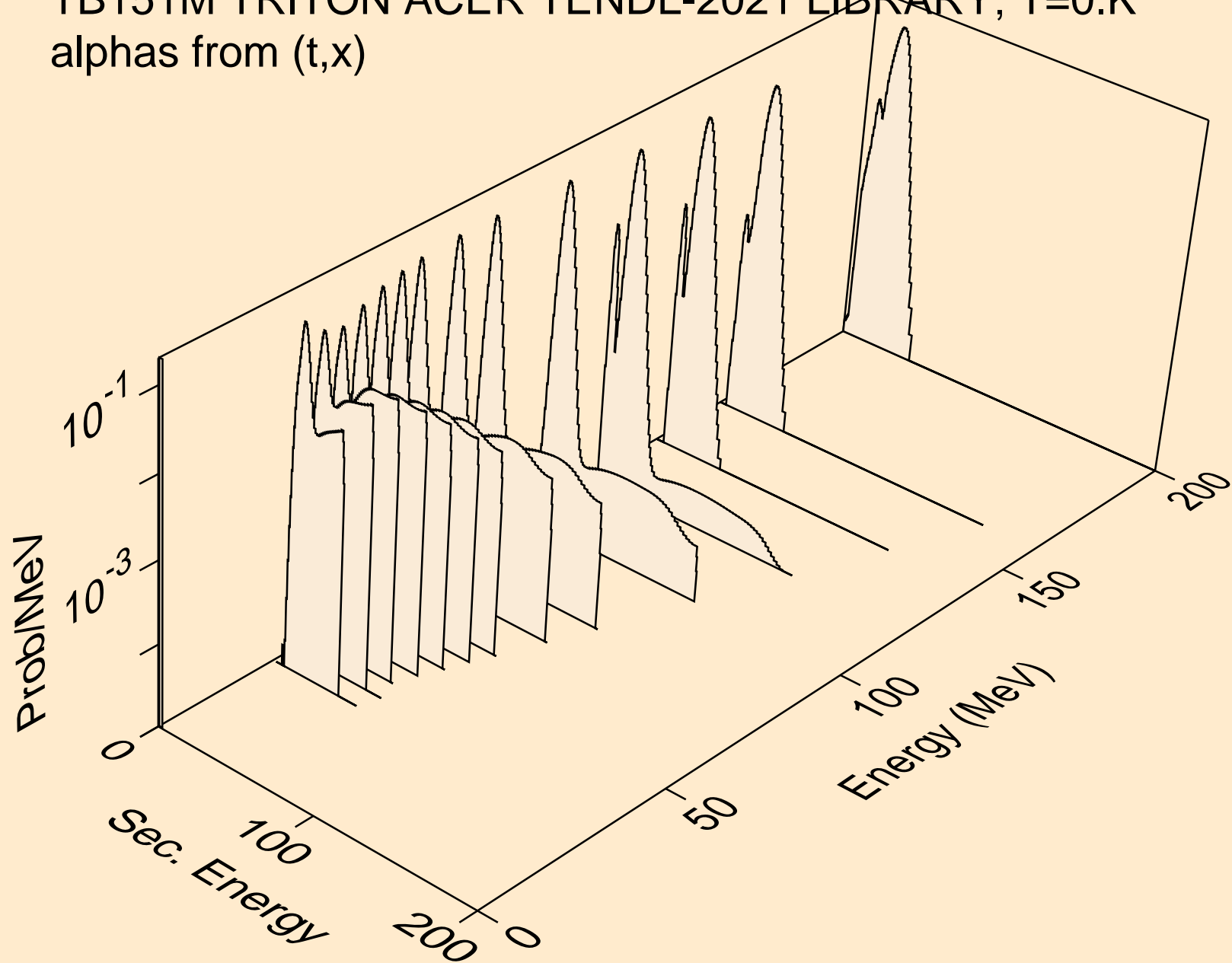



TB151M TRITON ACER TENDL-2021 LIBRARY; T=0.K  
alphas from (t,n\*)a

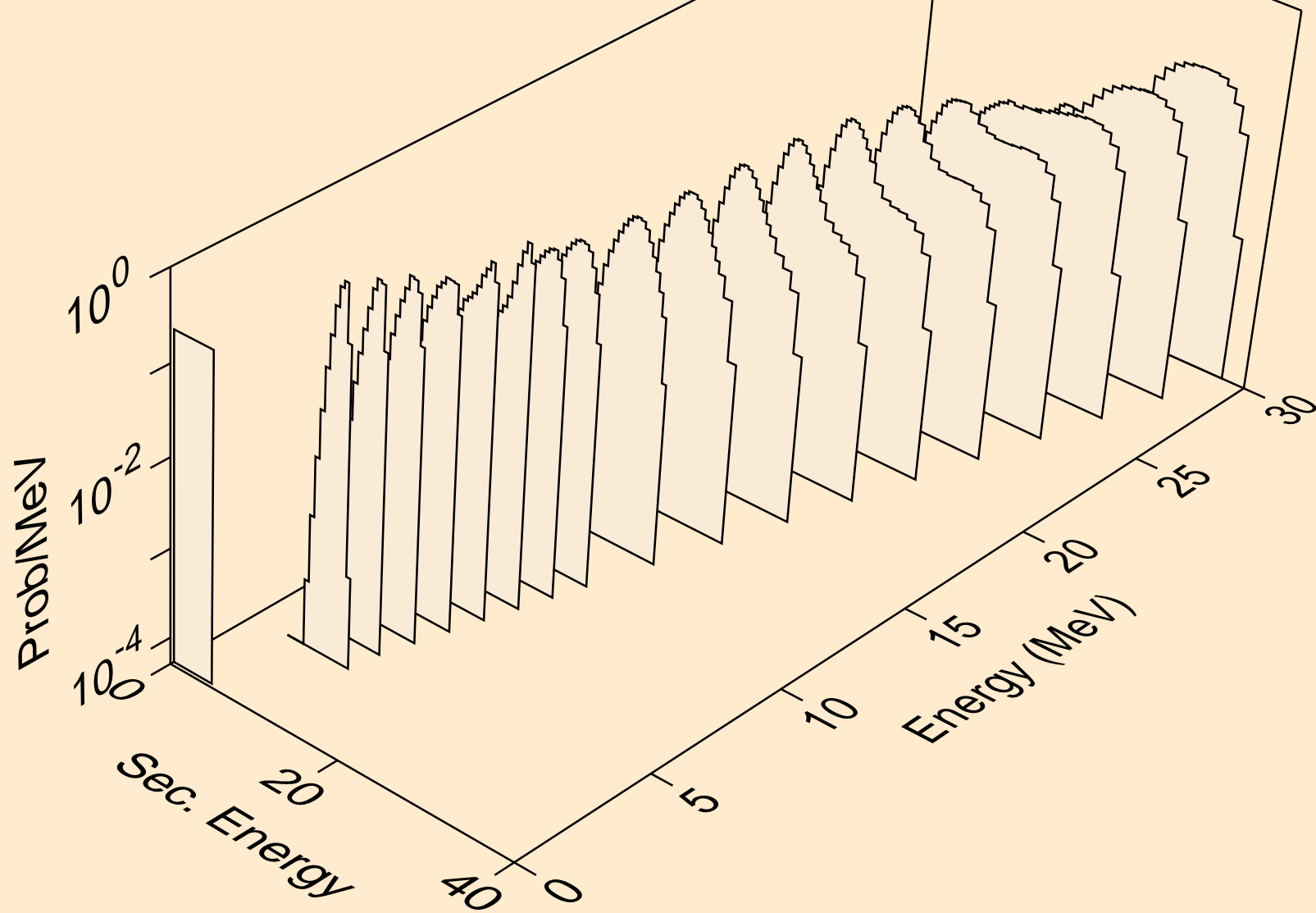

TB151M TRITON ACER TENDL-2021 LIBRARY; T=0.K  
alphas from (t,2n)a

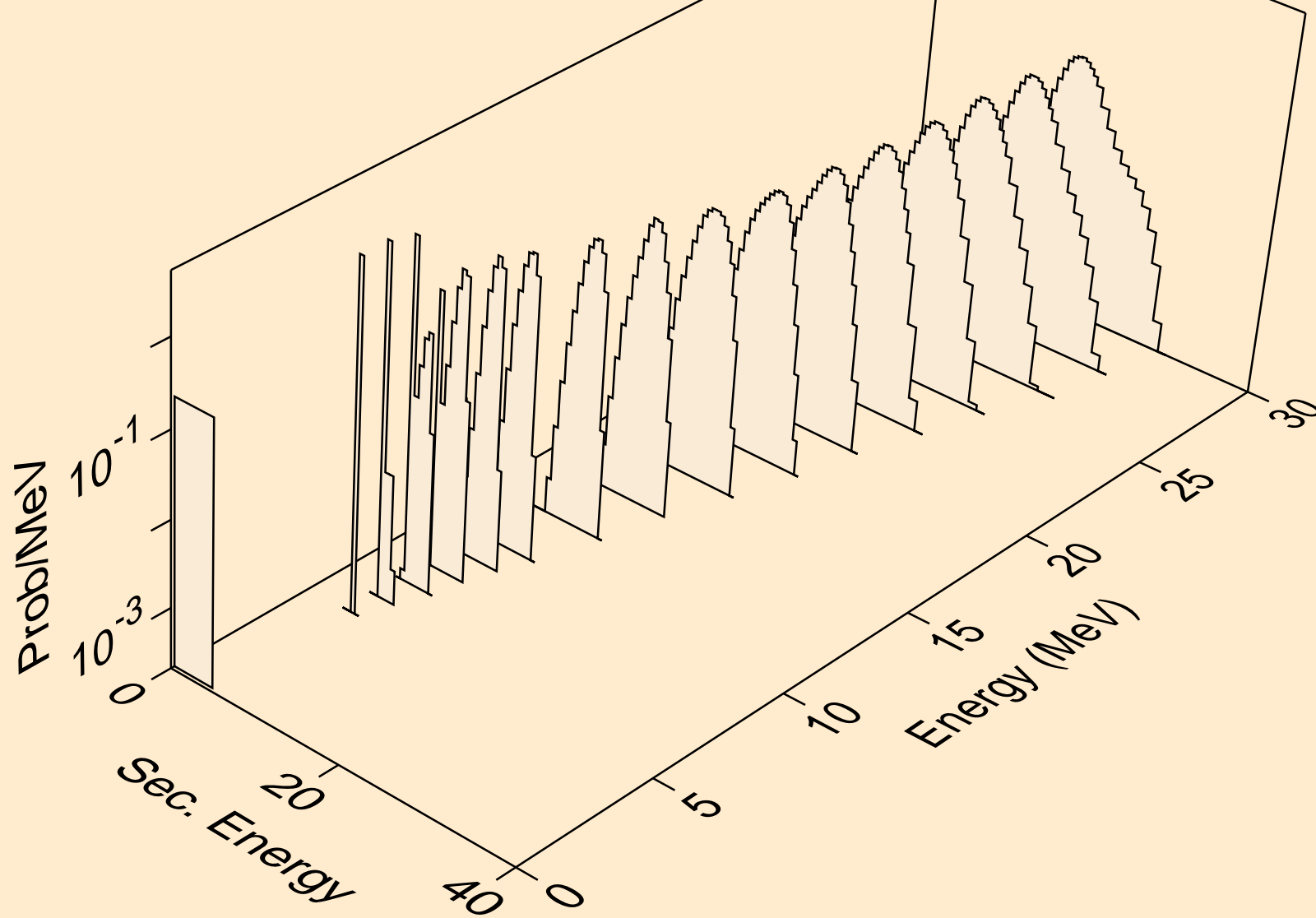

TB151M TRITON ACER TENDL-2021 LIBRARY; T=0.K  
alphas from (t,3n)a

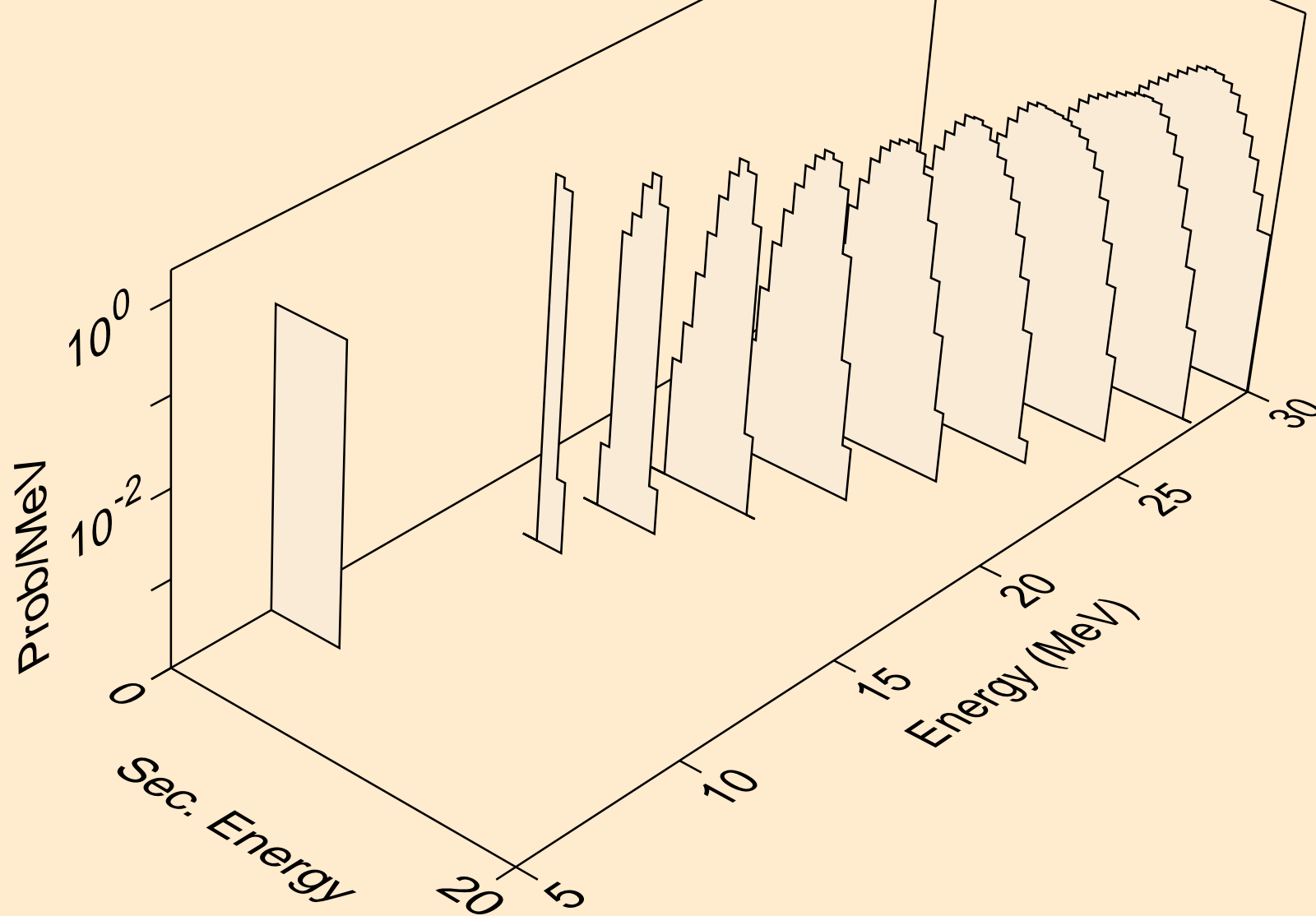

TB151M TRITON ACER TENDL-2021 LIBRARY; T=0.K  
alphas from (t,n\*)2a

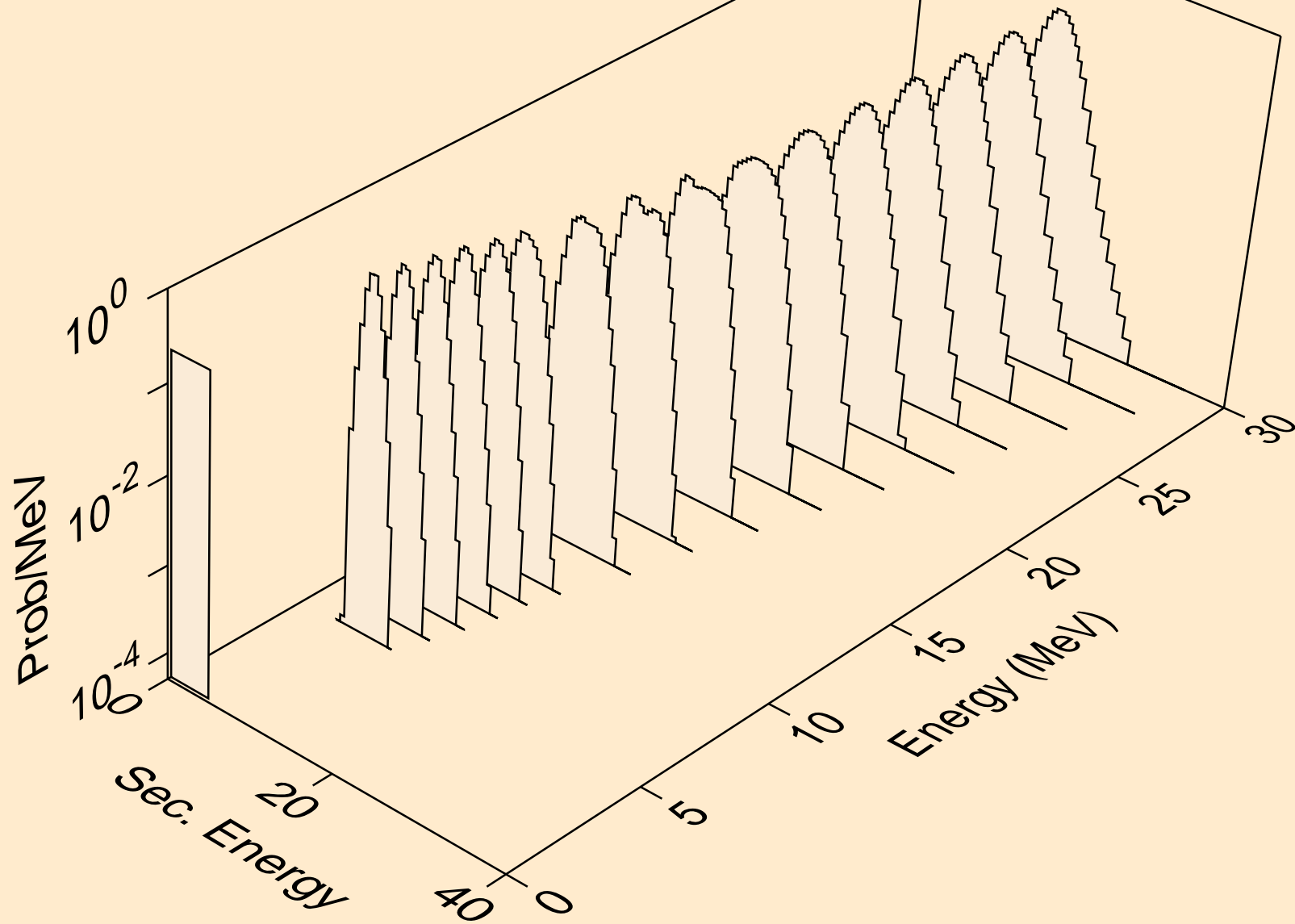

TB151M TRITON ACER TENDL-2021 LIBRARY; T=0.K  
alphas from (t,2n)2a

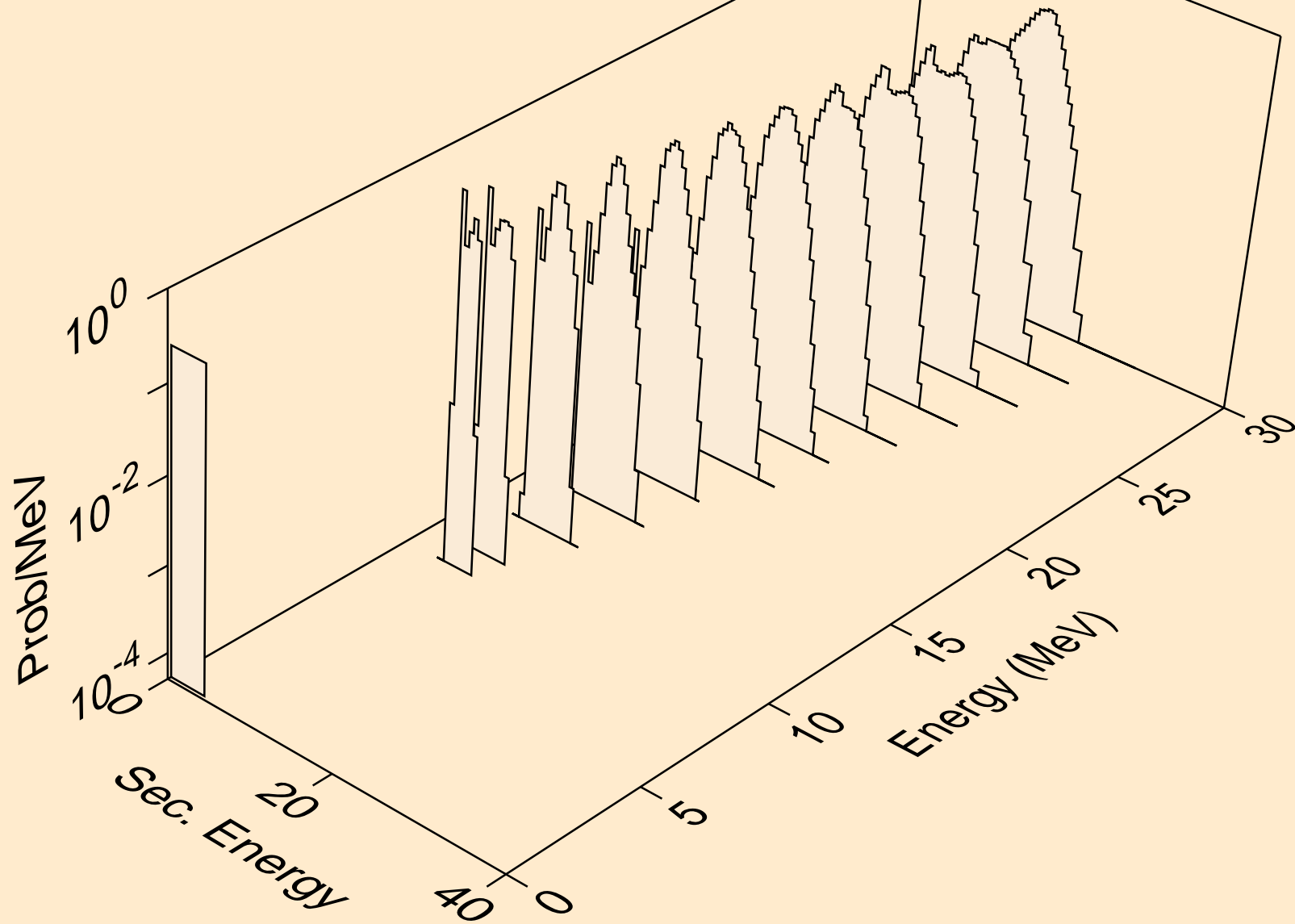

TB151M TRITON ACER TENDL-2021 LIBRARY; T=0.K  
alphas from (t,npa)

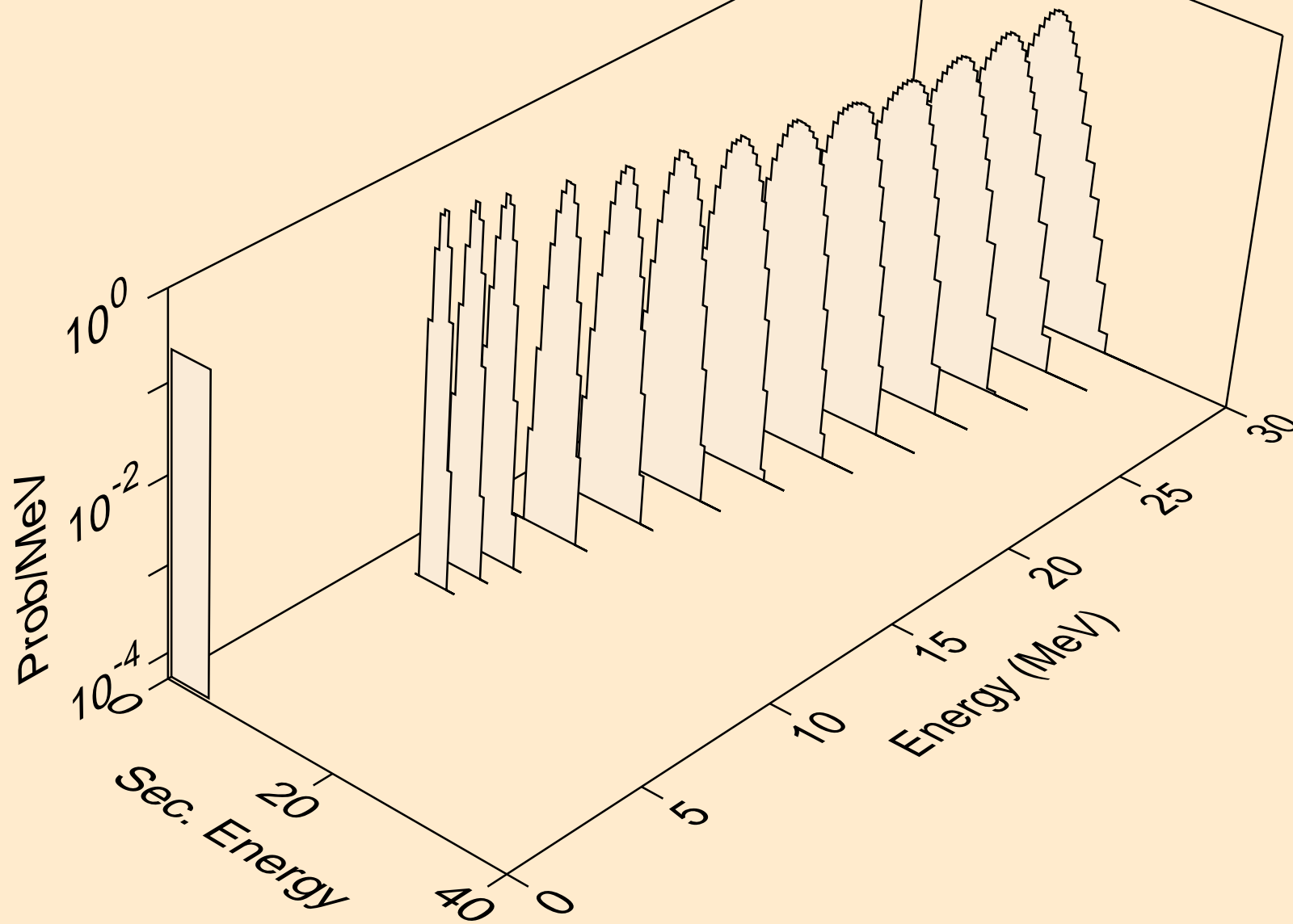

TB151M TRITON ACER TENDL-2021 LIBRARY; T=0.K  
alphas from (t,a)

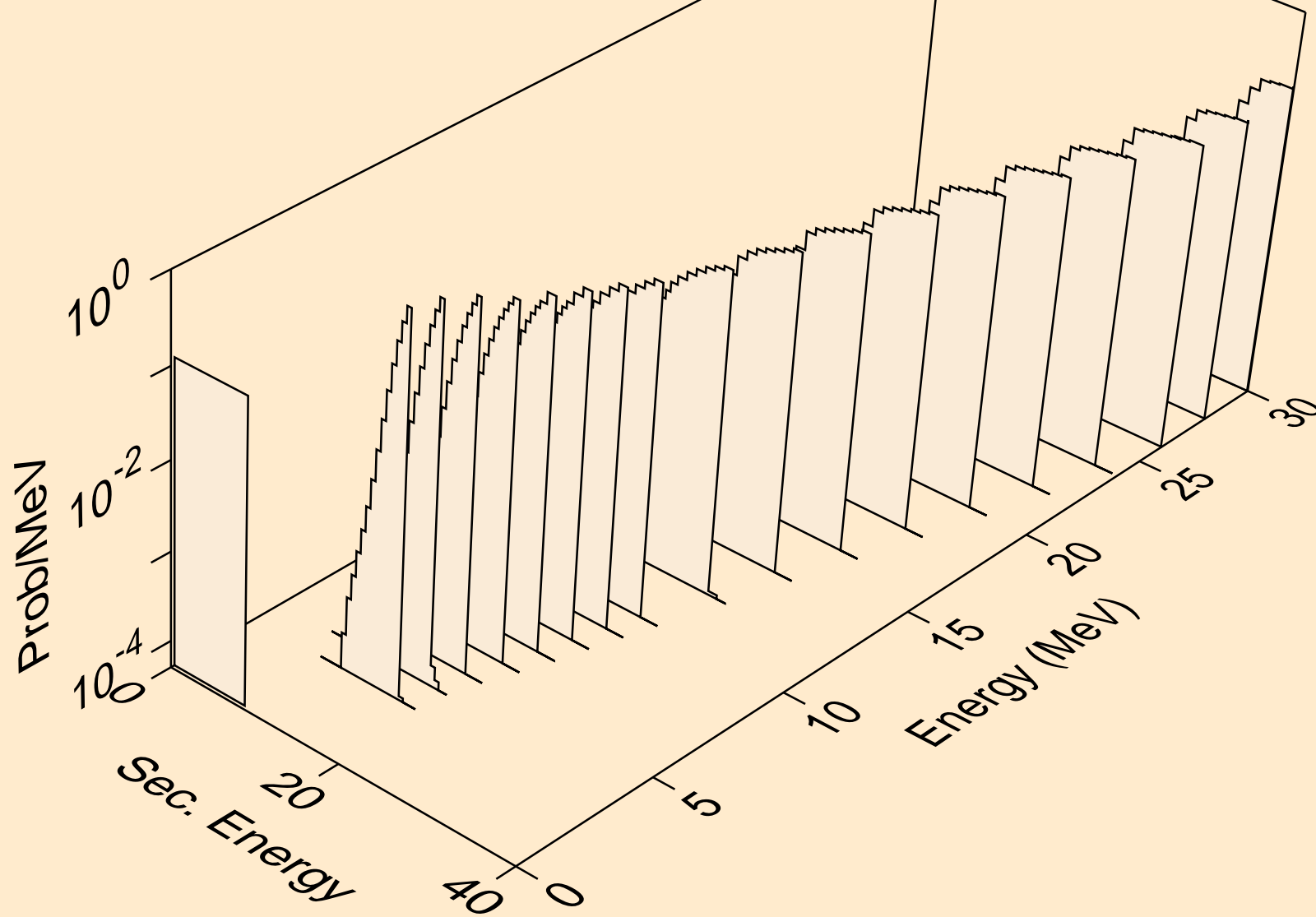

TB151M TRITON ACER TENDL-2021 LIBRARY; T=0.K  
alphas from (t,2a)

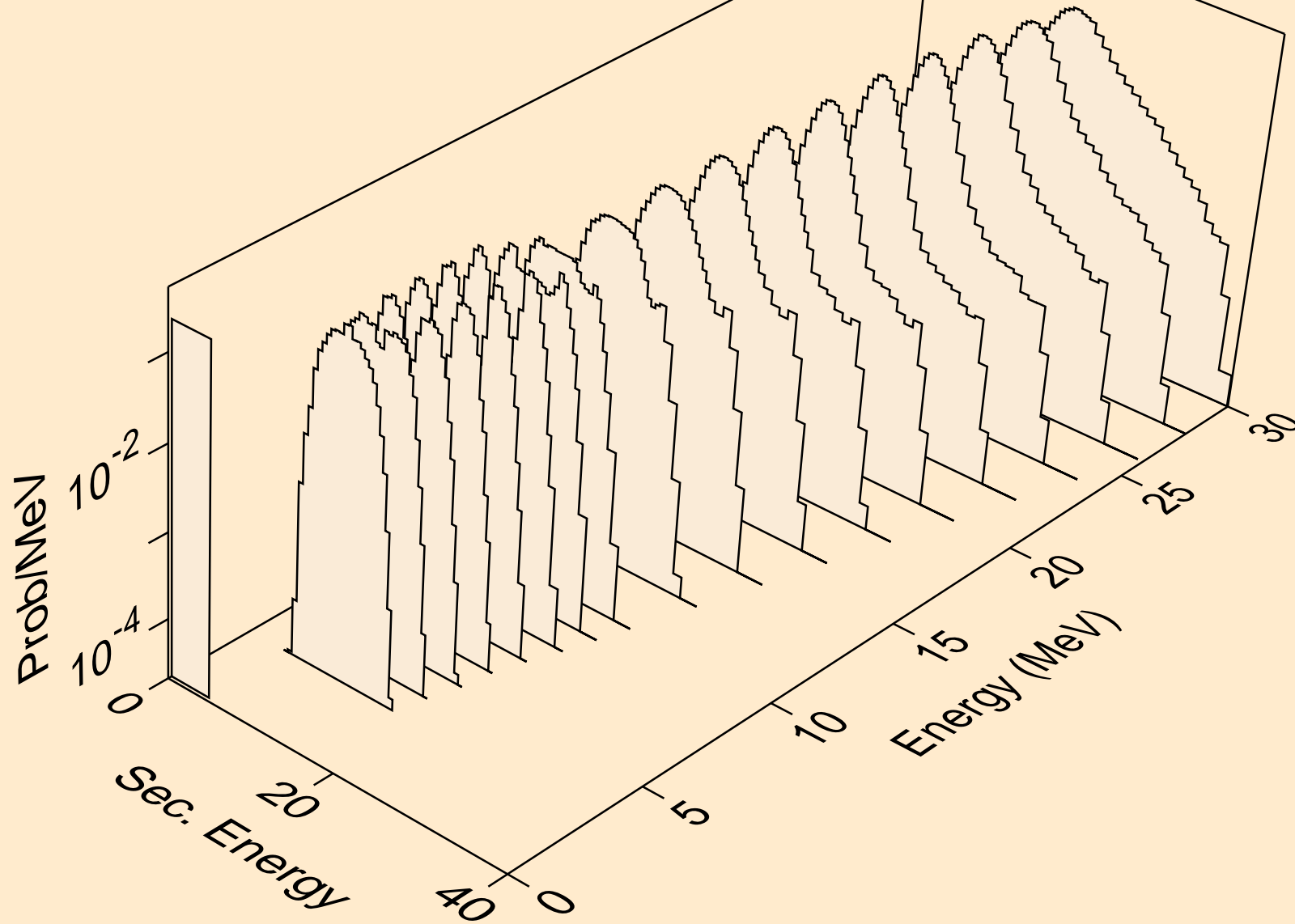



TB151M TRITON ACER TENDL-2021 LIBRARY; T=0.K  
alphas from (t,3a)

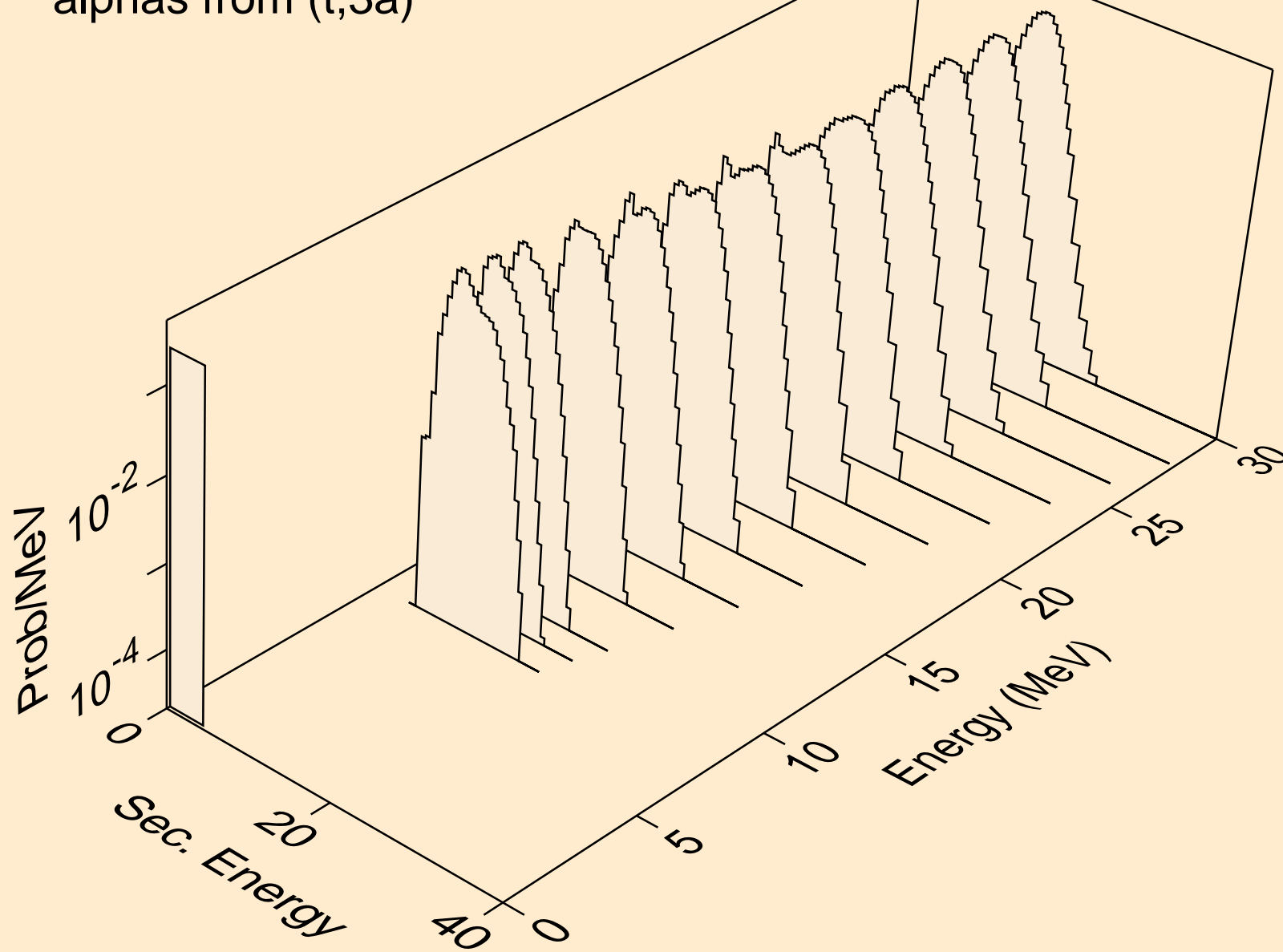

TB151M TRITON ACER TENDL-2021 LIBRARY; T=0.K  
alphas from (t,pa)

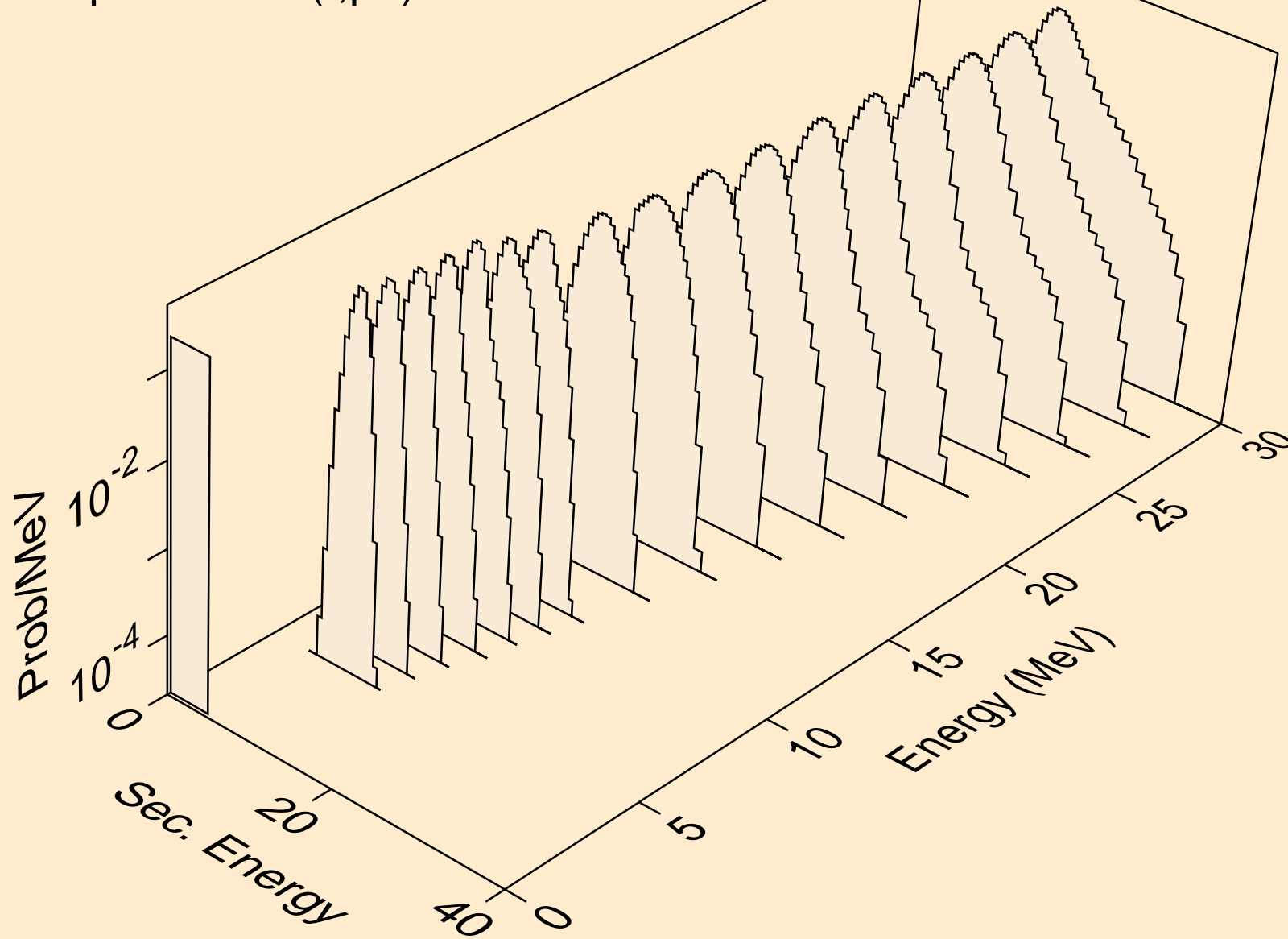

TB151M TRITON ACER TENDL-2021 LIBRARY; T=0.K  
alphas from (t,da)

