

TC102M TRITON ACER TENDL-2021 LIBRARY; T=0.K  
Principal cross sections

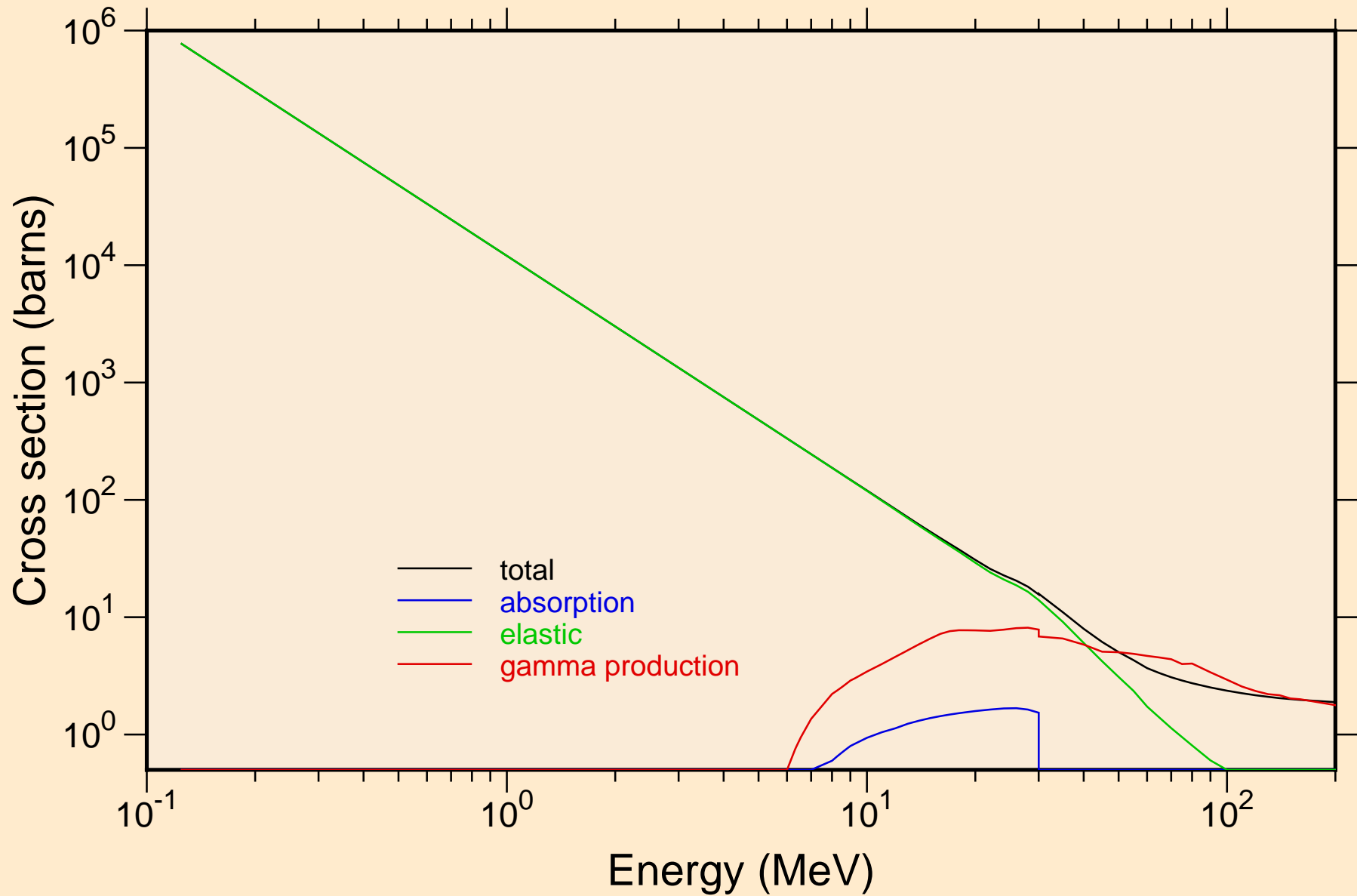

TC102M TRITON ACER TENDL-2021 LIBRARY; T=0.K

Heating

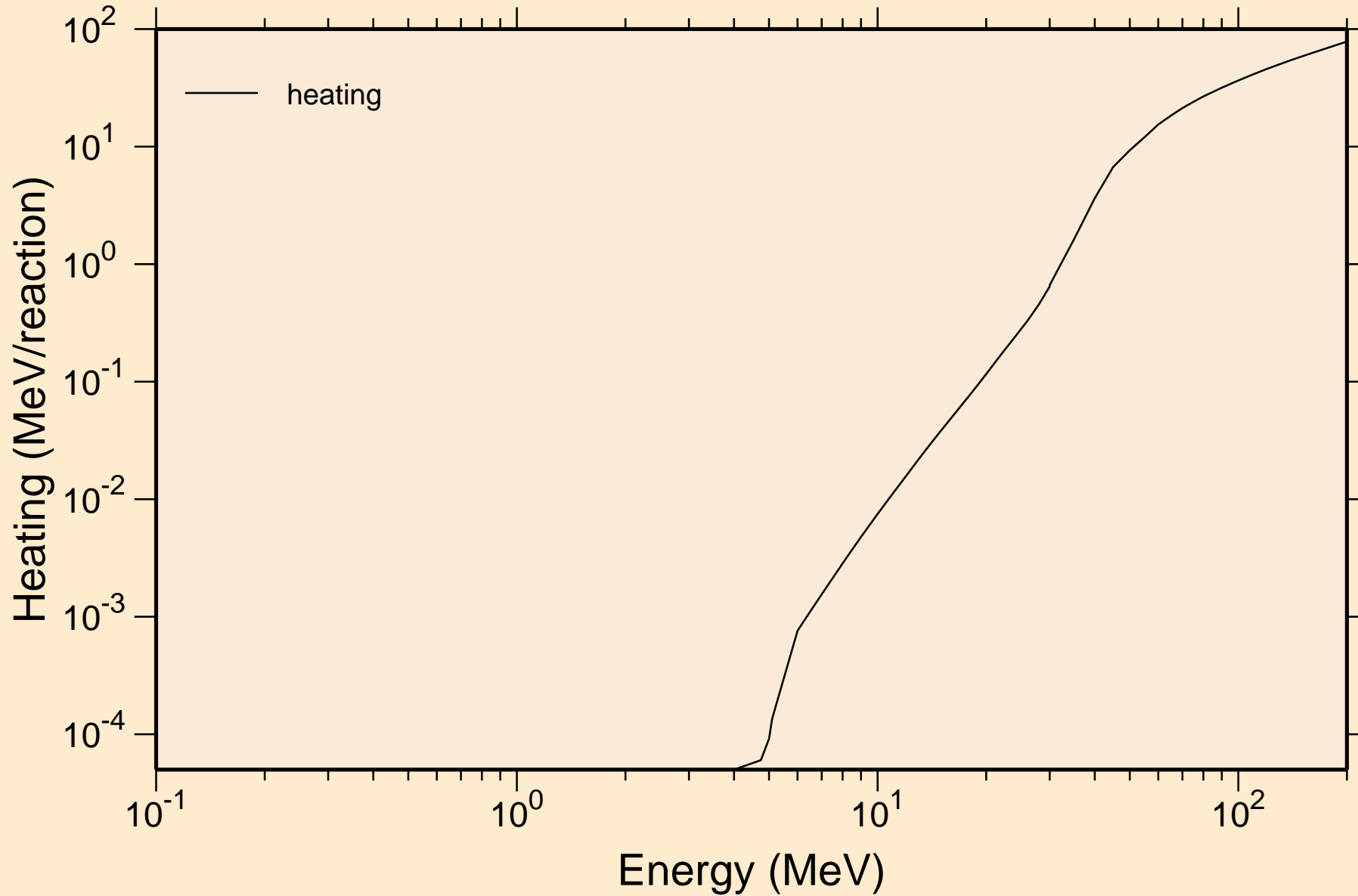

# TC102M TRITON ACER TENDL-2021 LIBRARY; T=0.K

## Principal cross sections

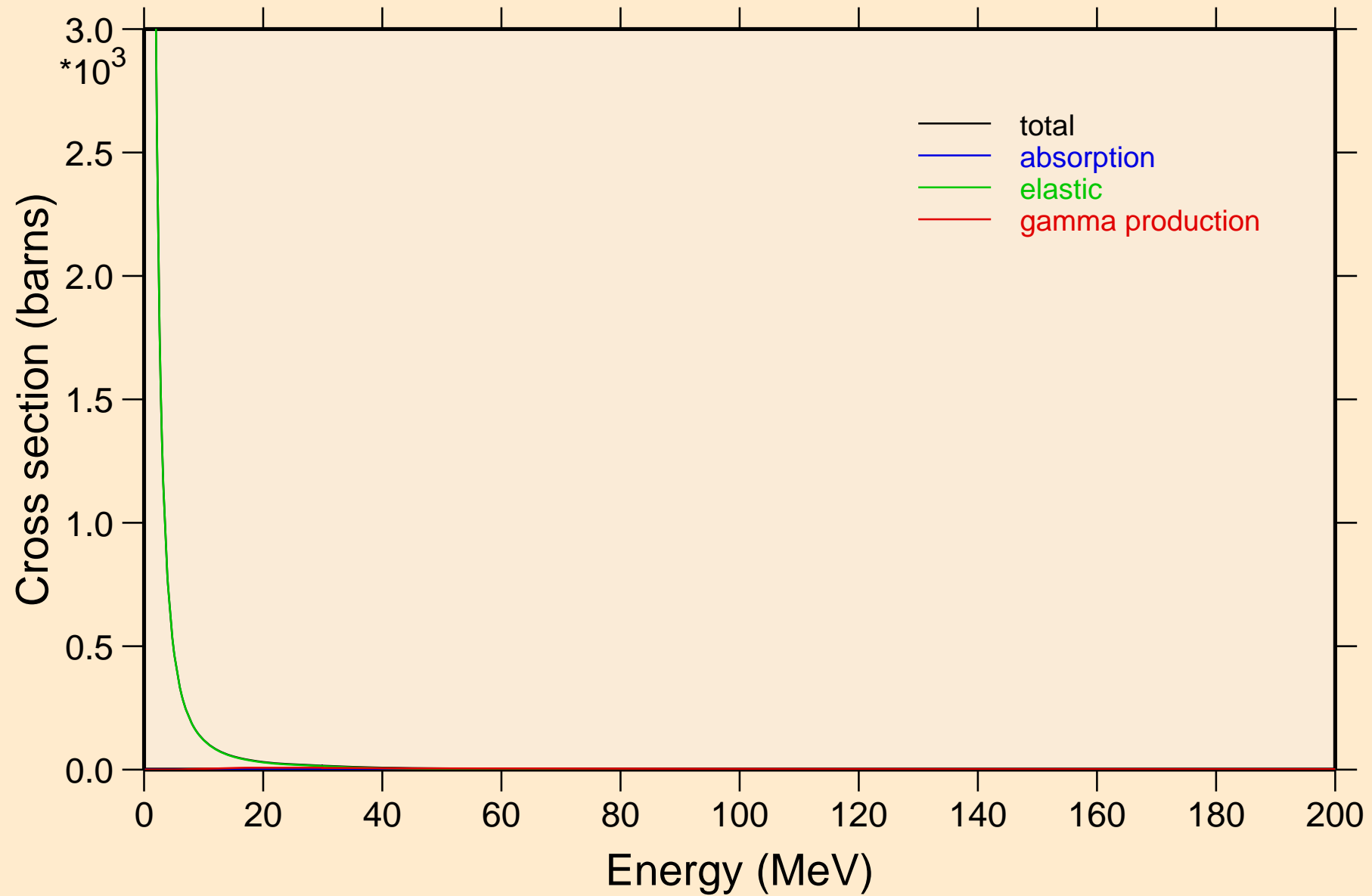

TC102M TRITON ACER TENDL-2021 LIBRARY; T=0.K

Heating

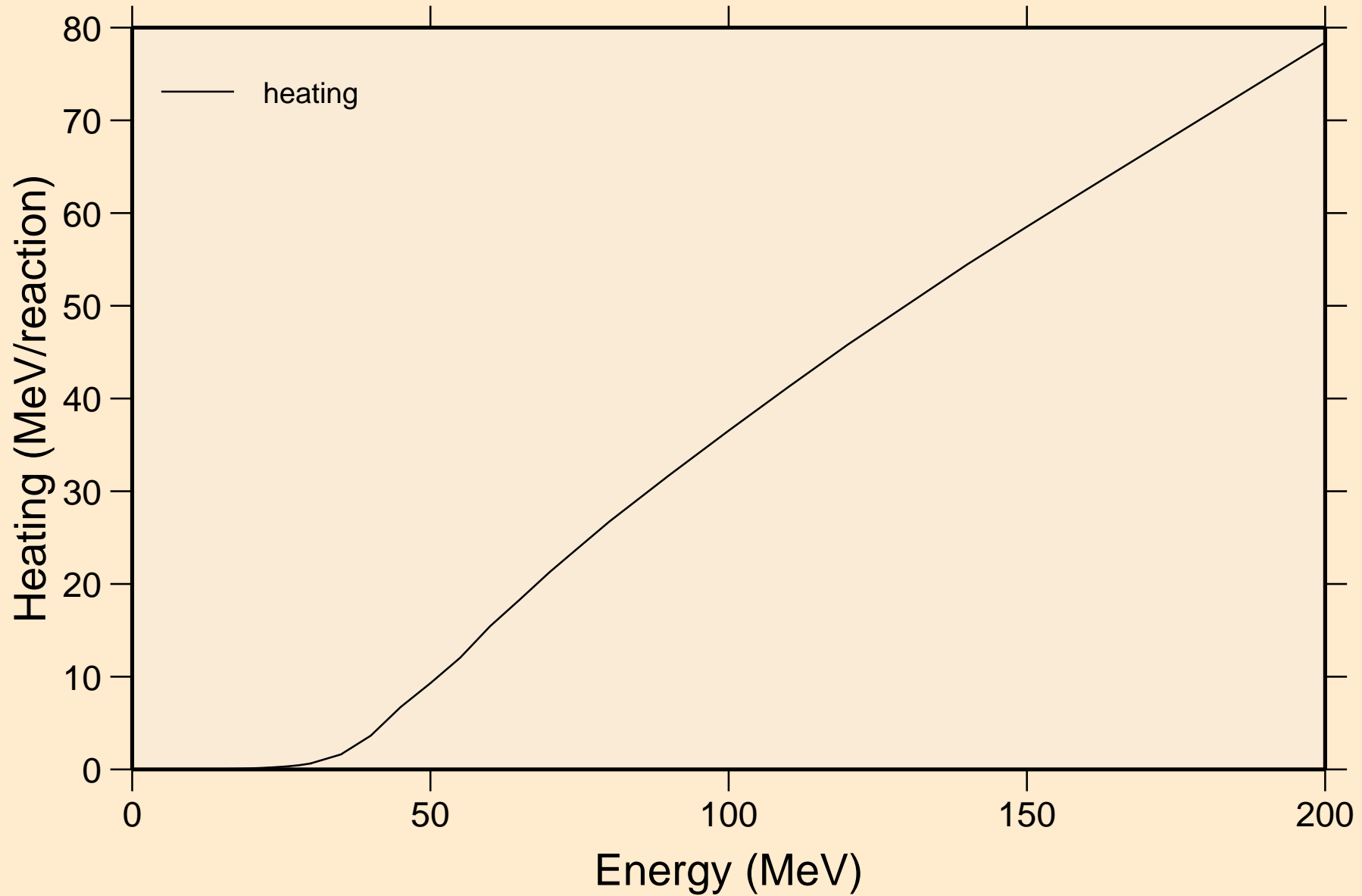

TC102M TRITON ACER TENDL-2021 LIBRARY; T=0.K  
Threshold reactions

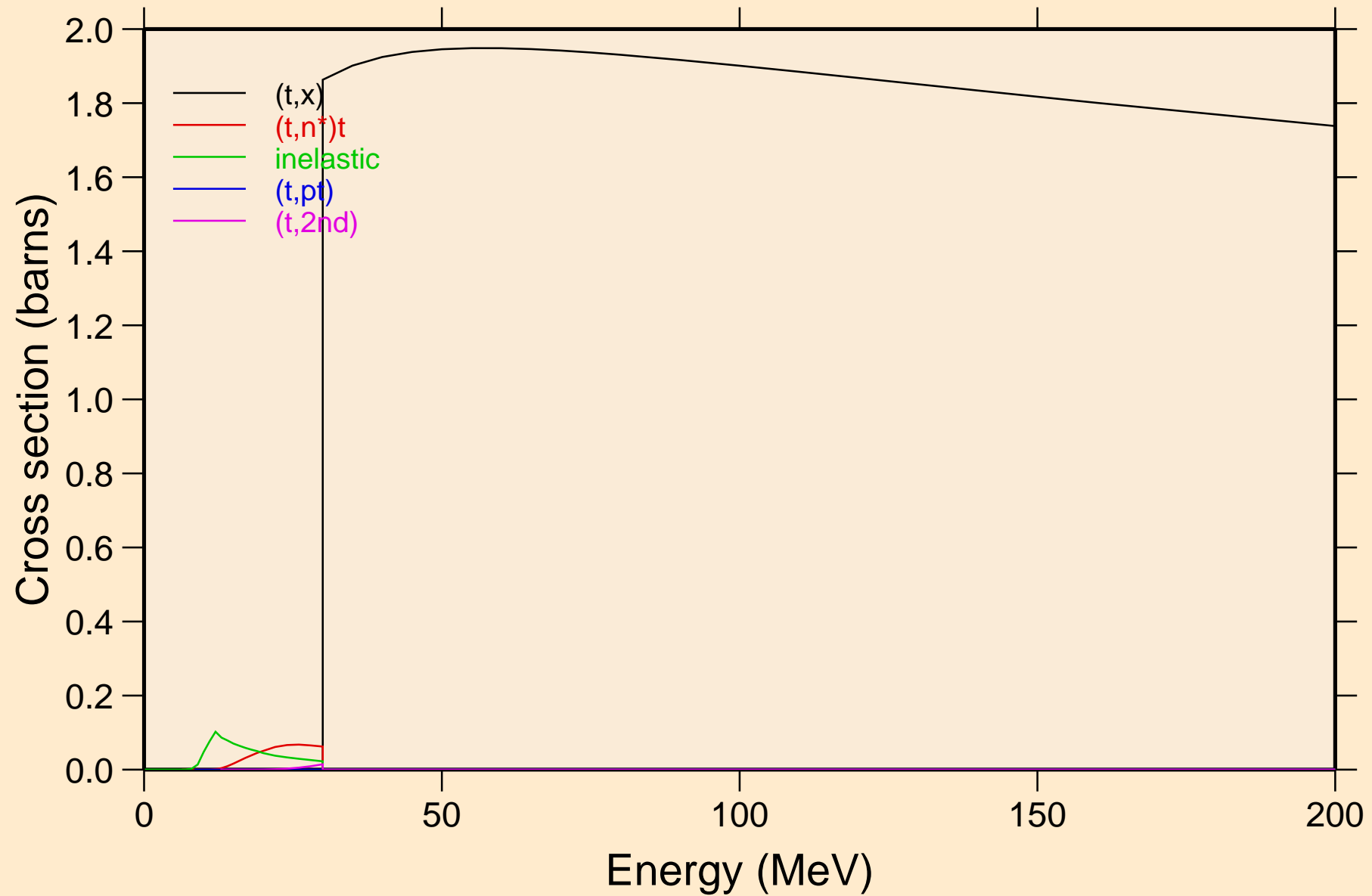

TC102M TRITON ACER TENDL-2021 LIBRARY; T=0.K  
Threshold reactions

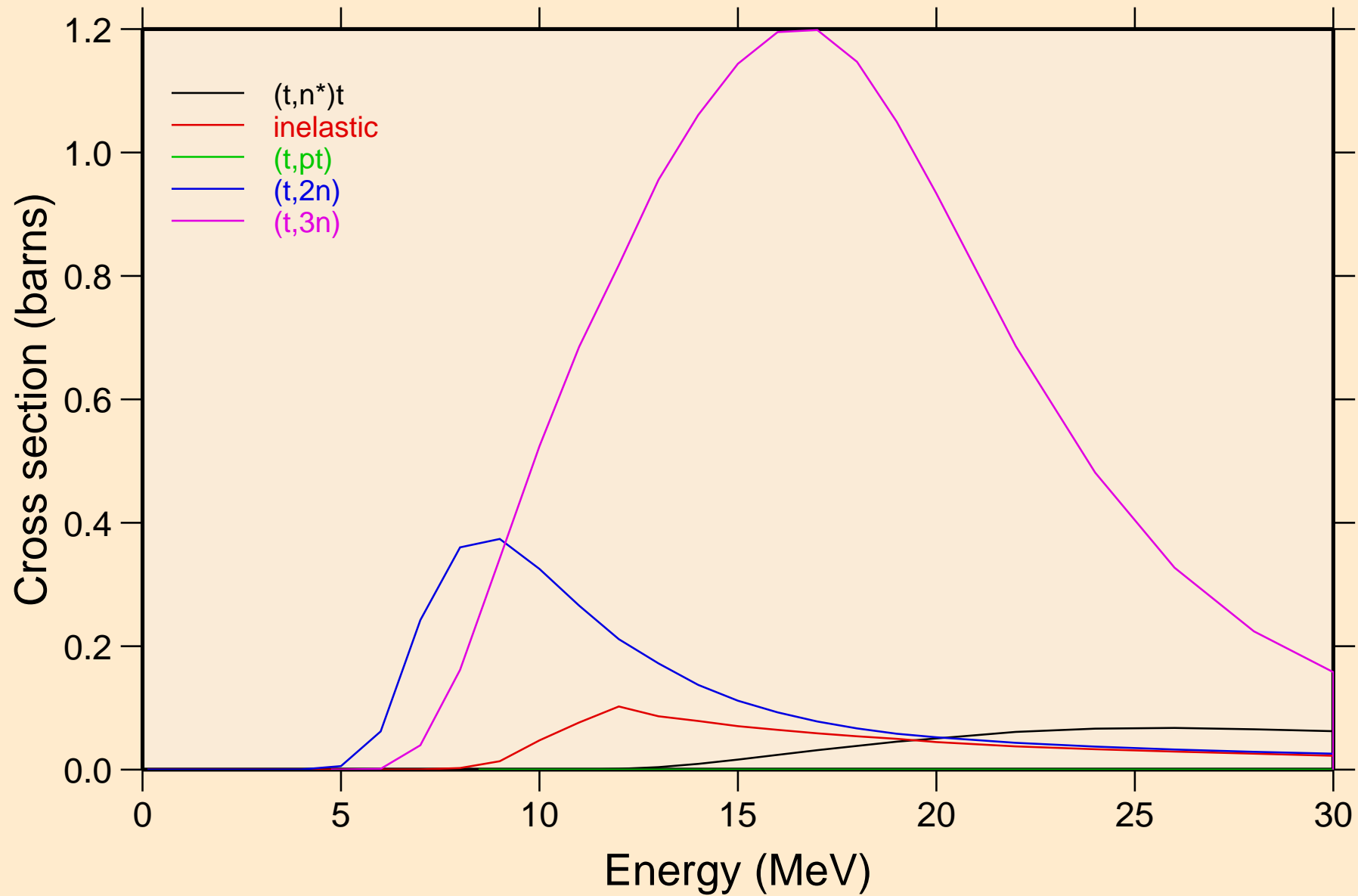

TC102M TRITON ACER TENDL-2021 LIBRARY; T=0.K  
Threshold reactions

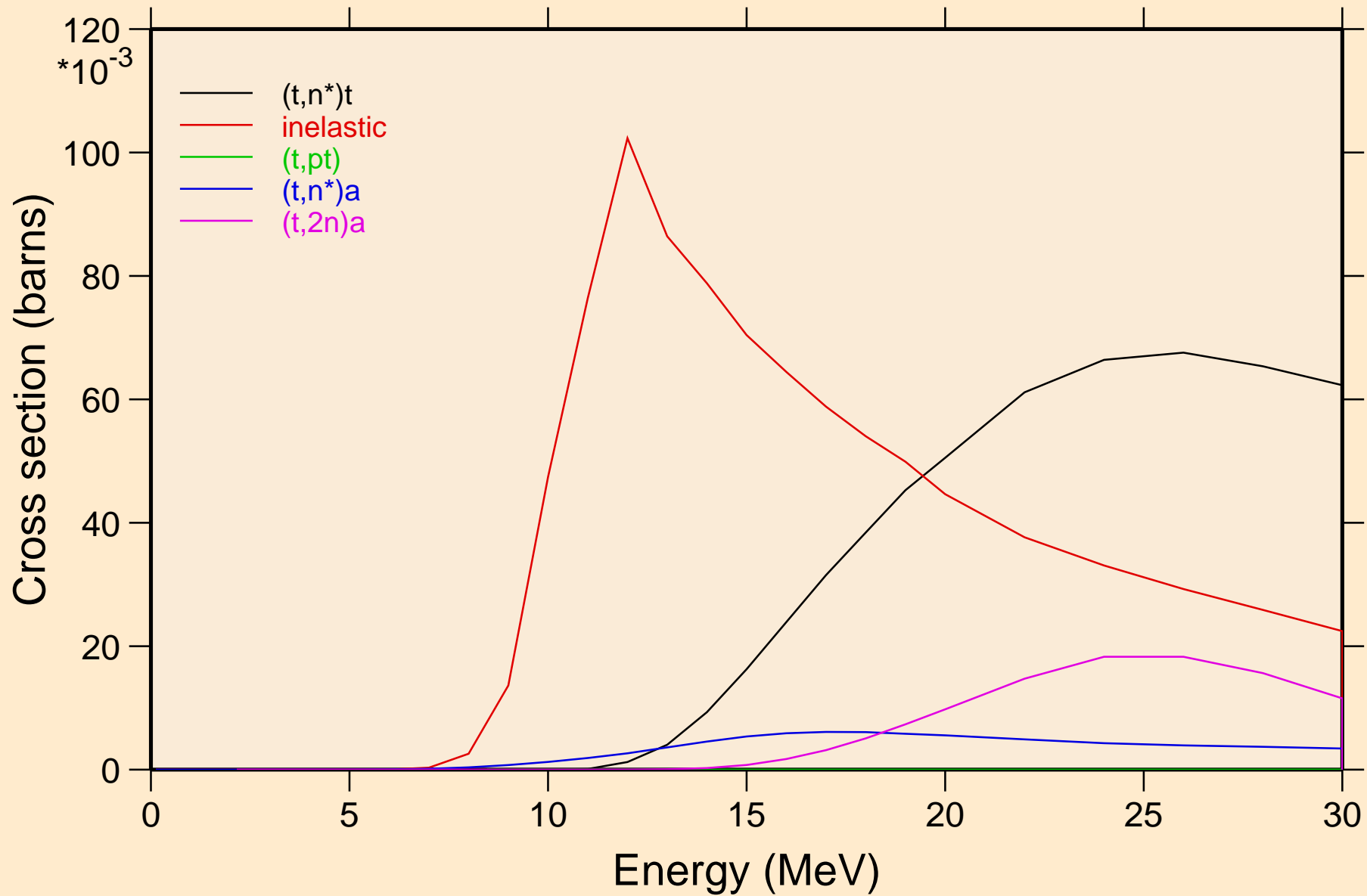

TC102M TRITON ACER TENDL-2021 LIBRARY; T=0.K  
Threshold reactions

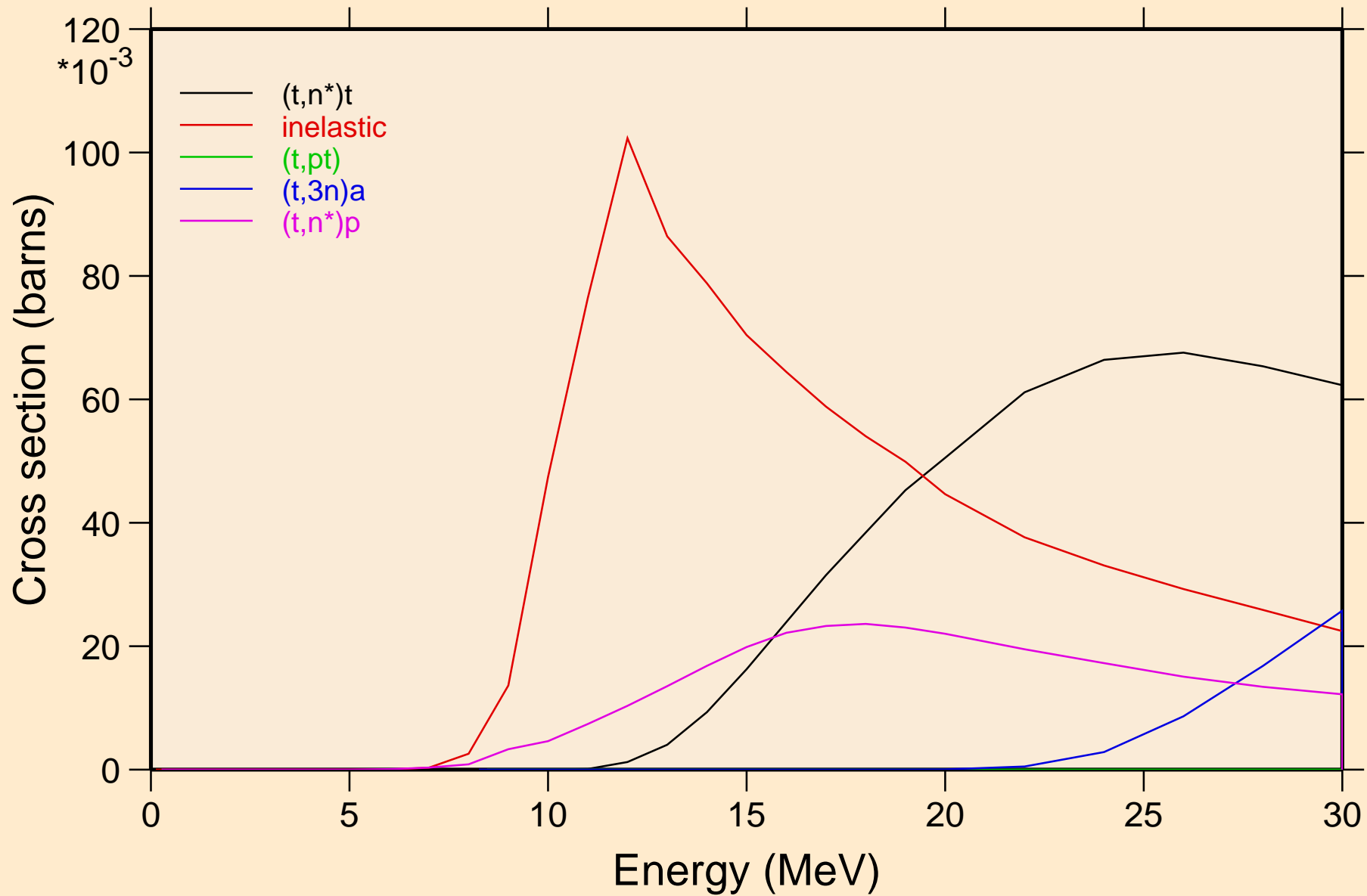



TC102M TRITON ACER TENDL-2021 LIBRARY; T=0.K  
Threshold reactions

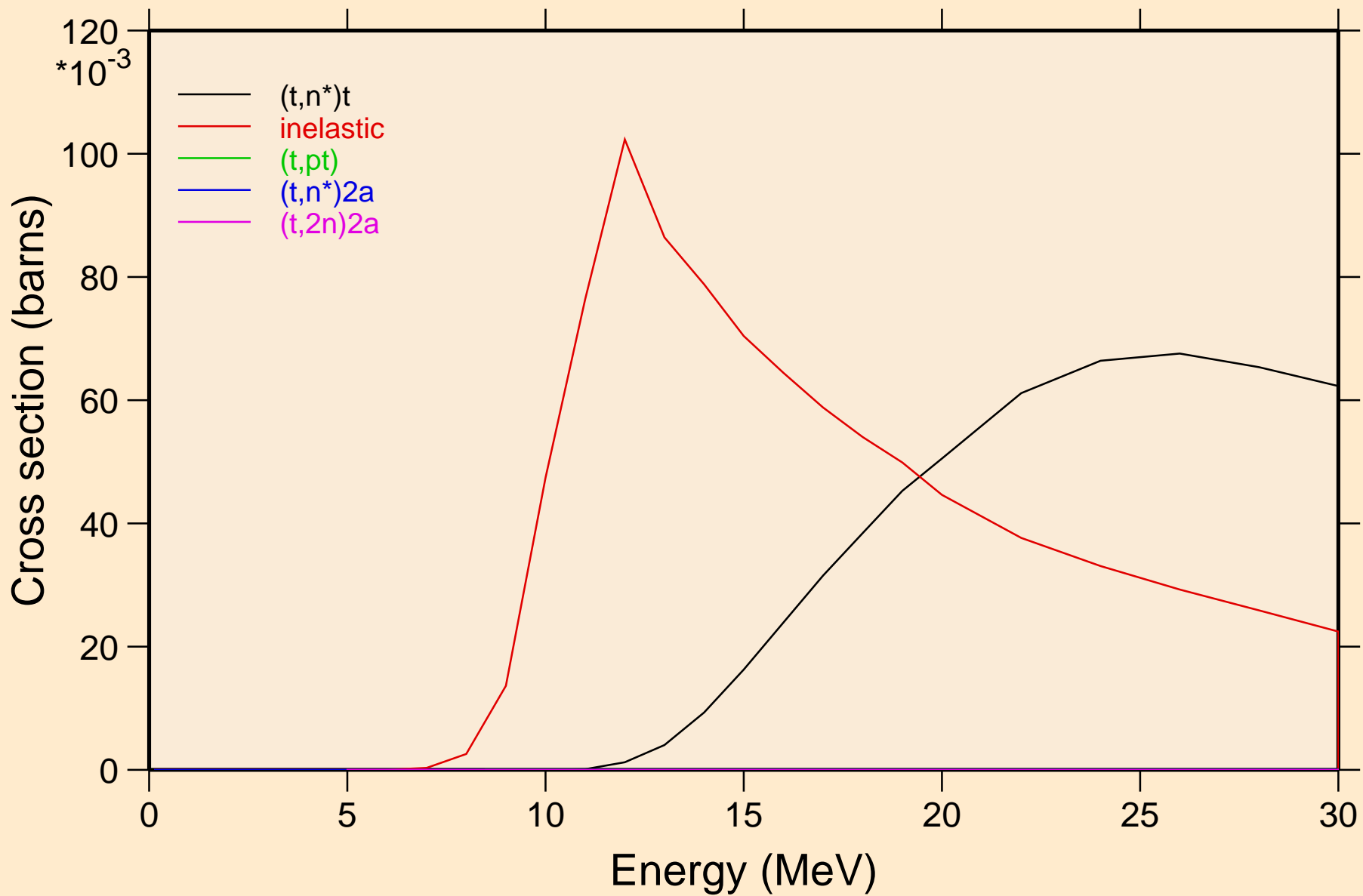

TC102M TRITON ACER TENDL-2021 LIBRARY; T=0.K  
Threshold reactions

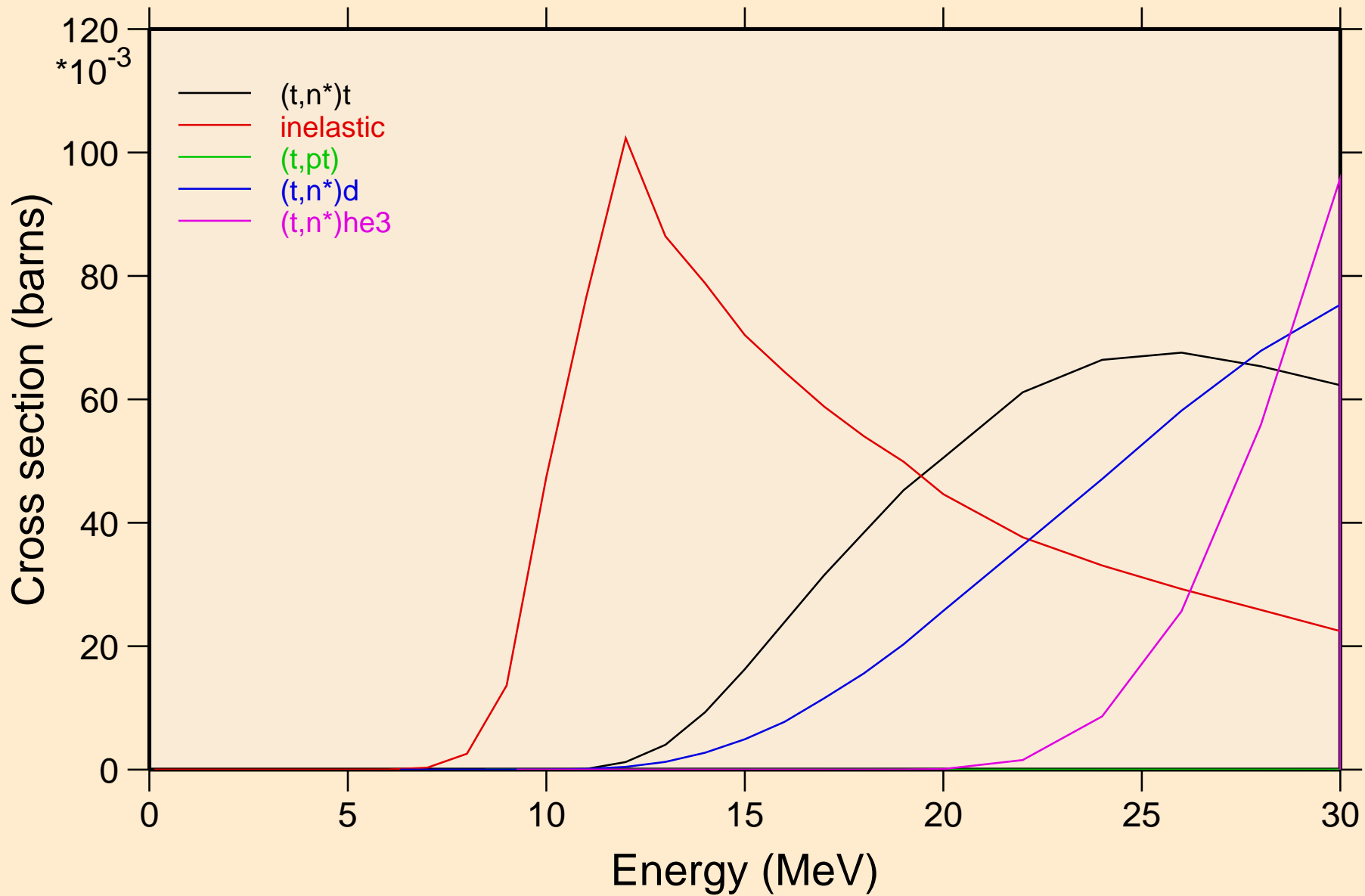

TC102M TRITON ACER TENDL-2021 LIBRARY; T=0.K  
Threshold reactions

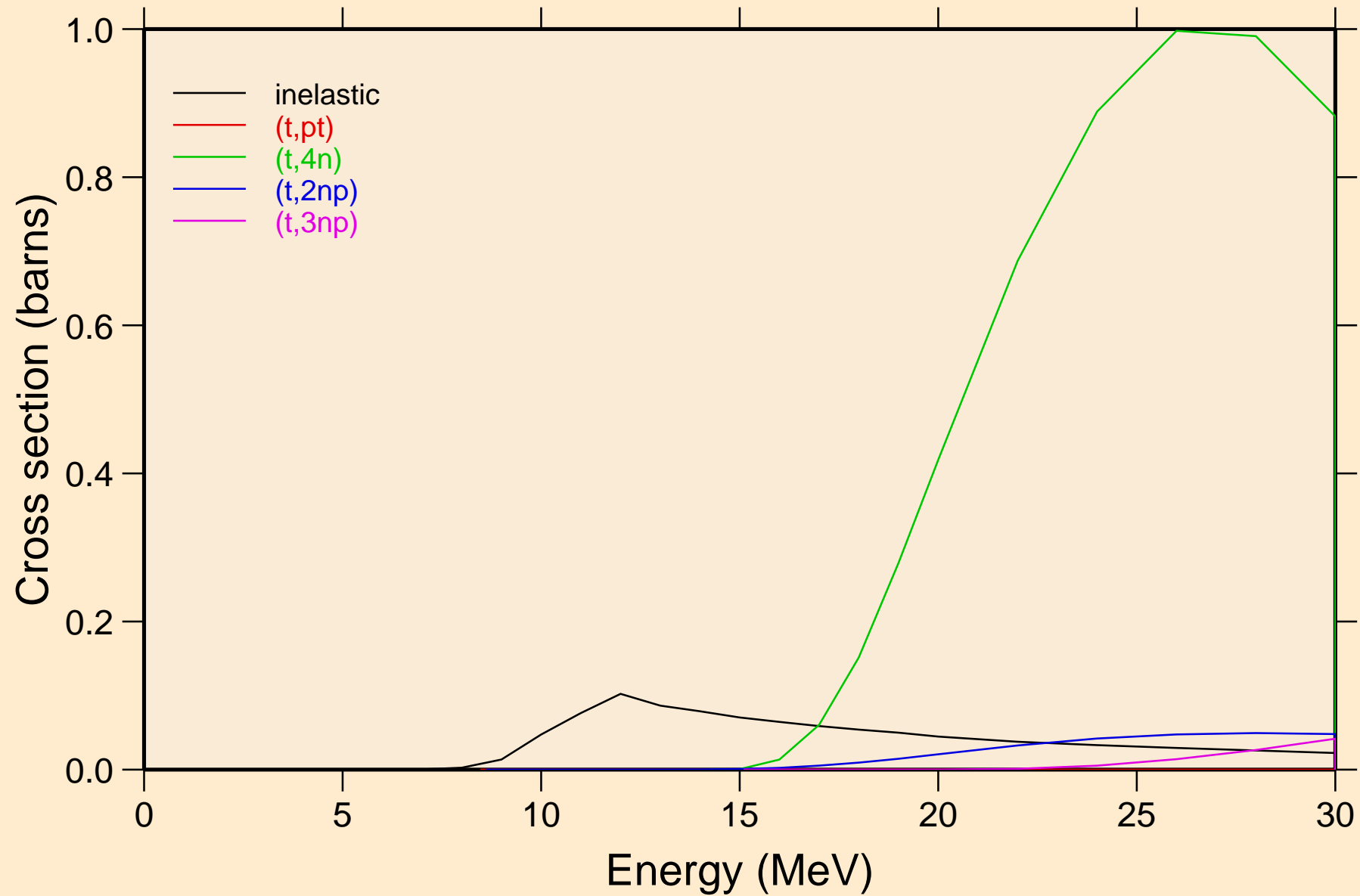

TC102M TRITON ACER TENDL-2021 LIBRARY; T=0.K  
Threshold reactions

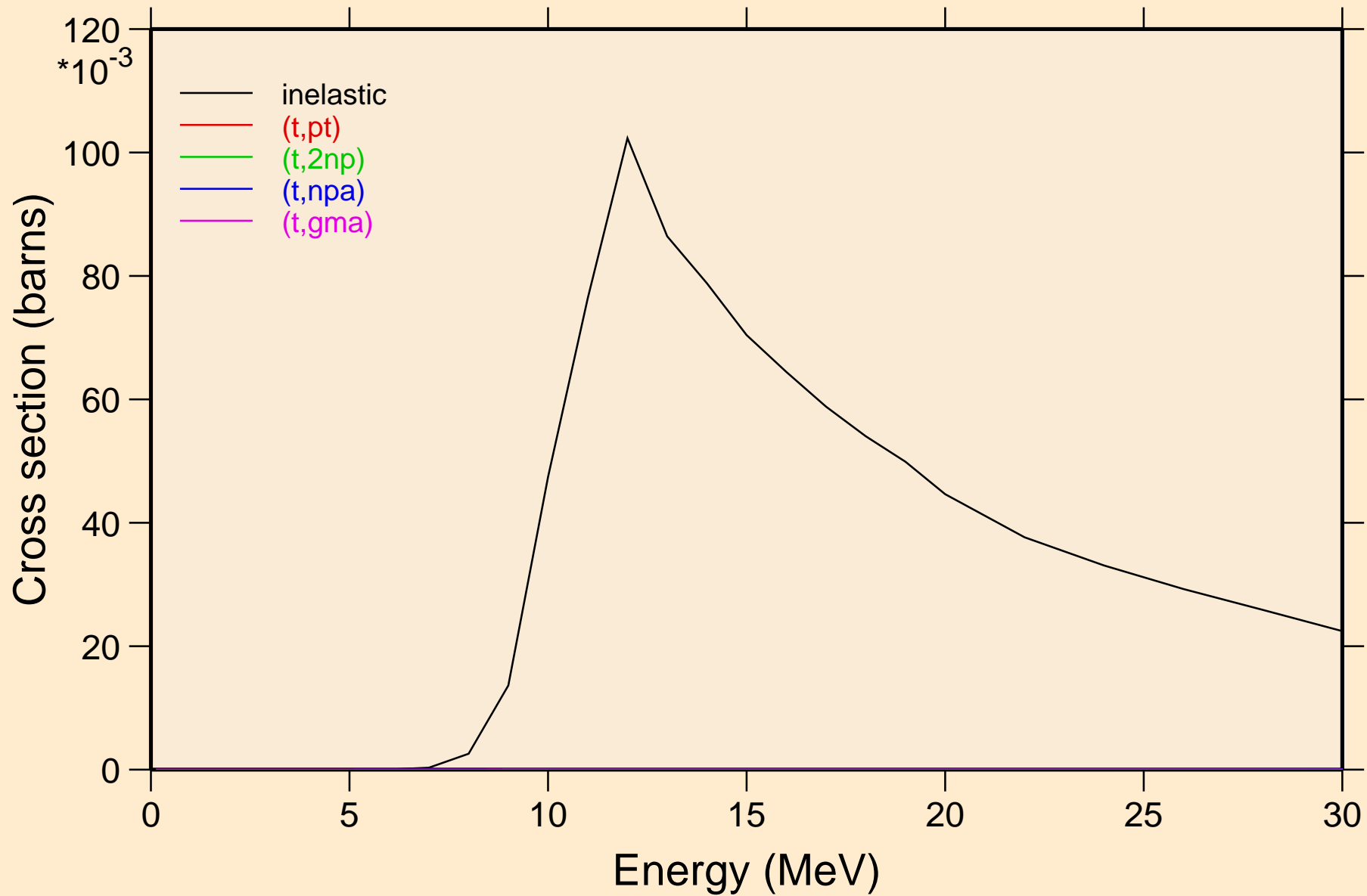

TC102M TRITON ACER TENDL-2021 LIBRARY; T=0.K  
Threshold reactions

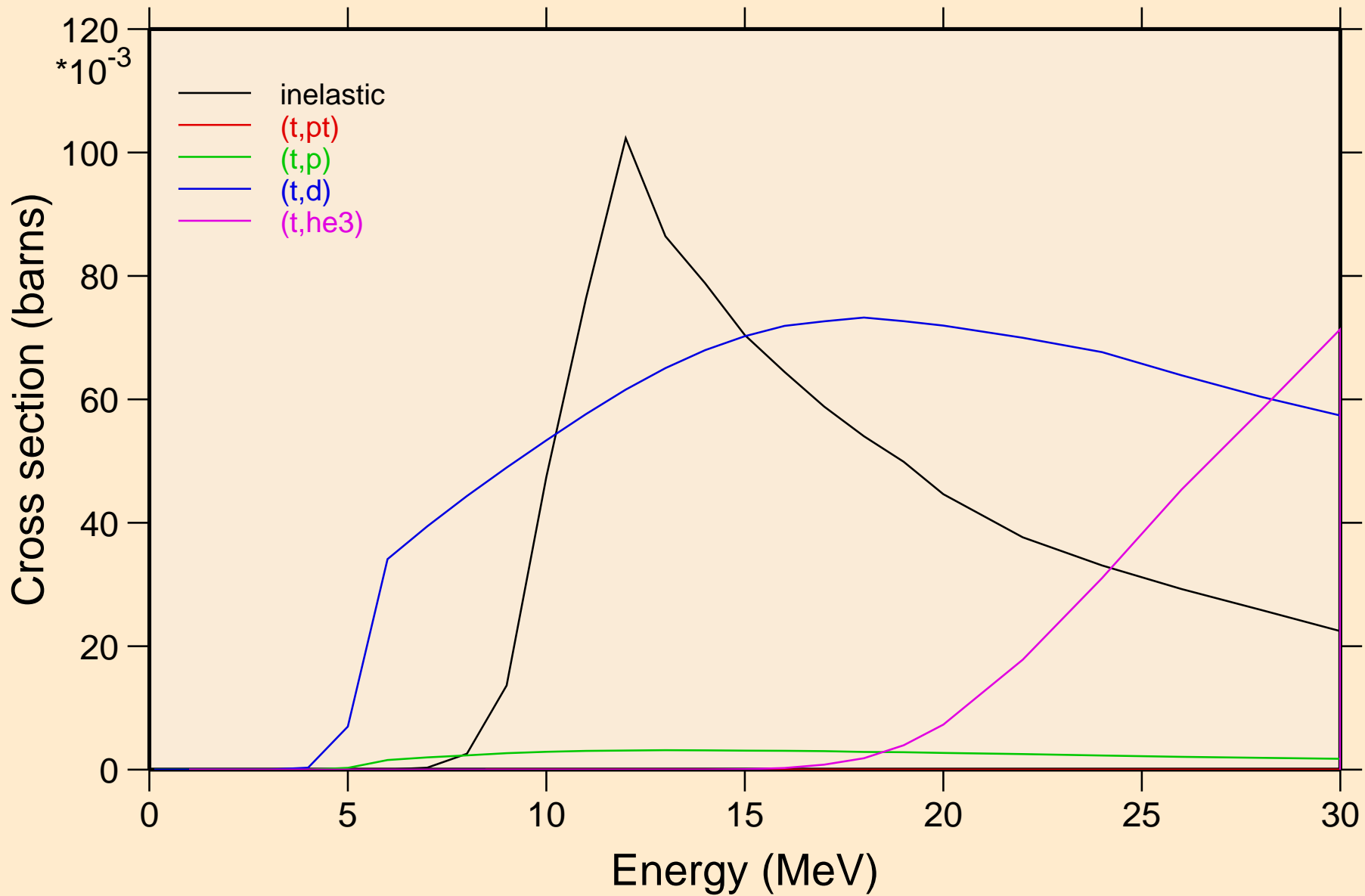

TC102M TRITON ACER TENDL-2021 LIBRARY; T=0.K  
Threshold reactions

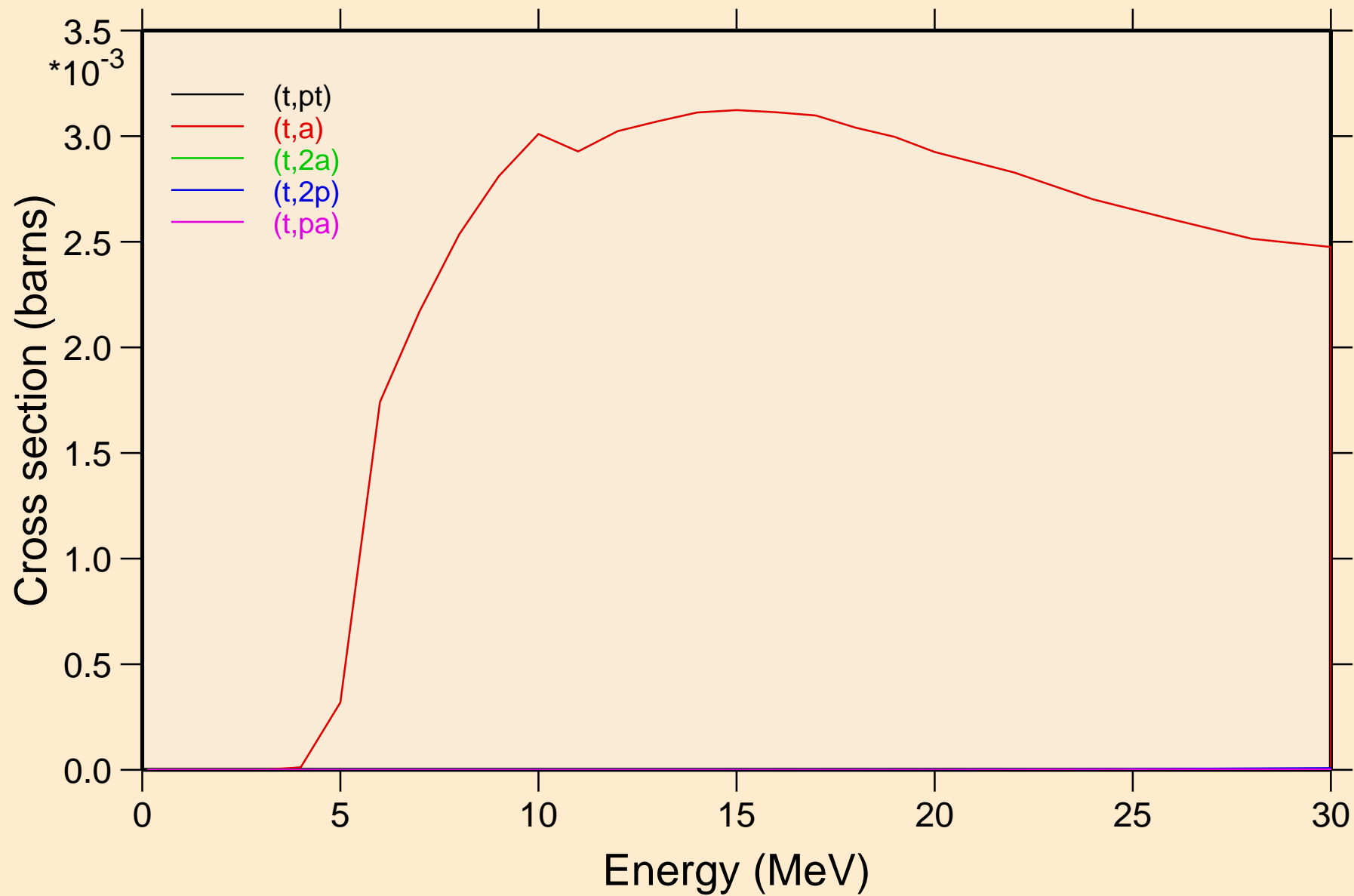

TC102M TRITON ACER TENDL-2021 LIBRARY; T=0.K  
Threshold reactions

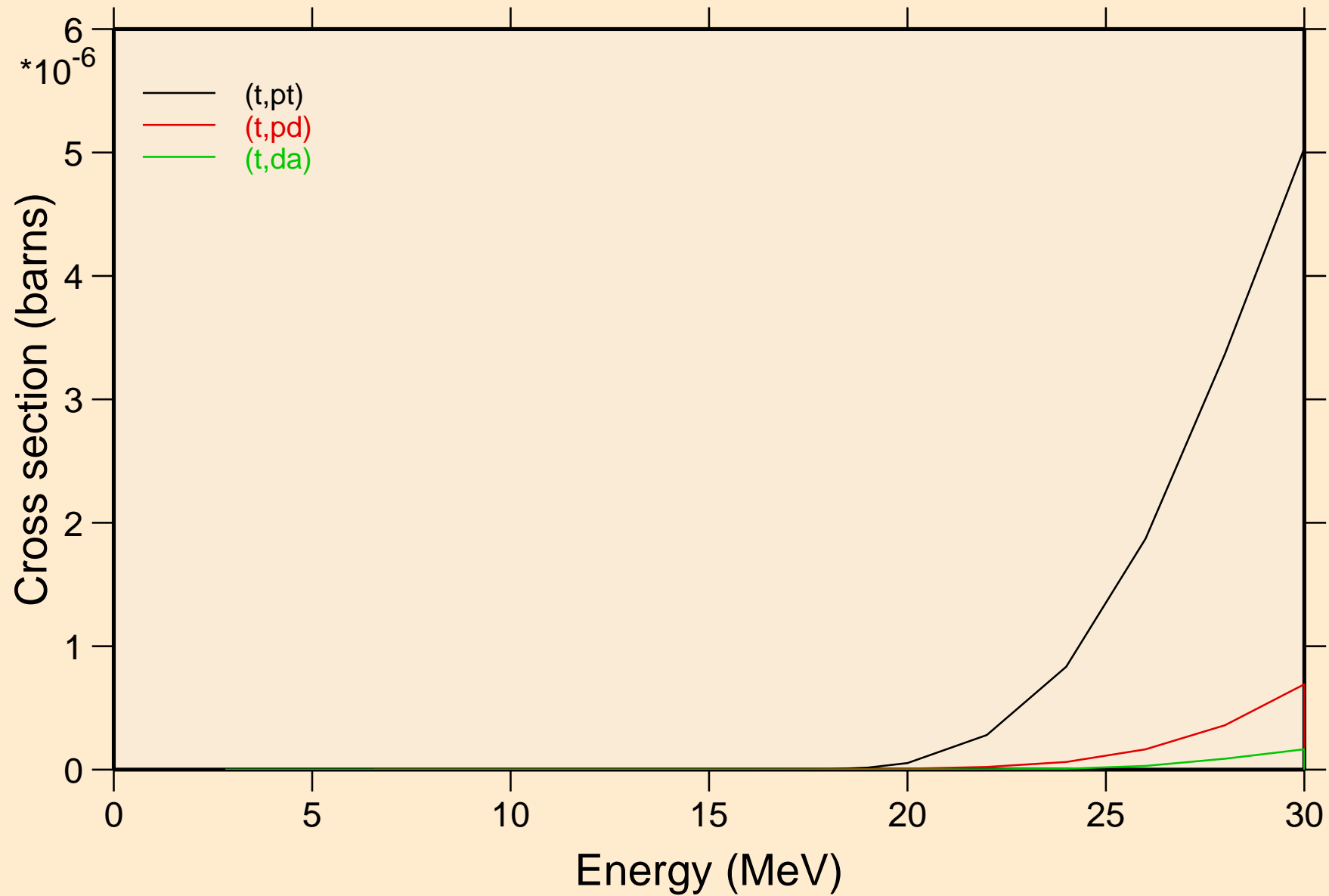

TC102M TRITON ACER TENDL-2021 LIBRARY; T=0.K  
angular distribution for elastic

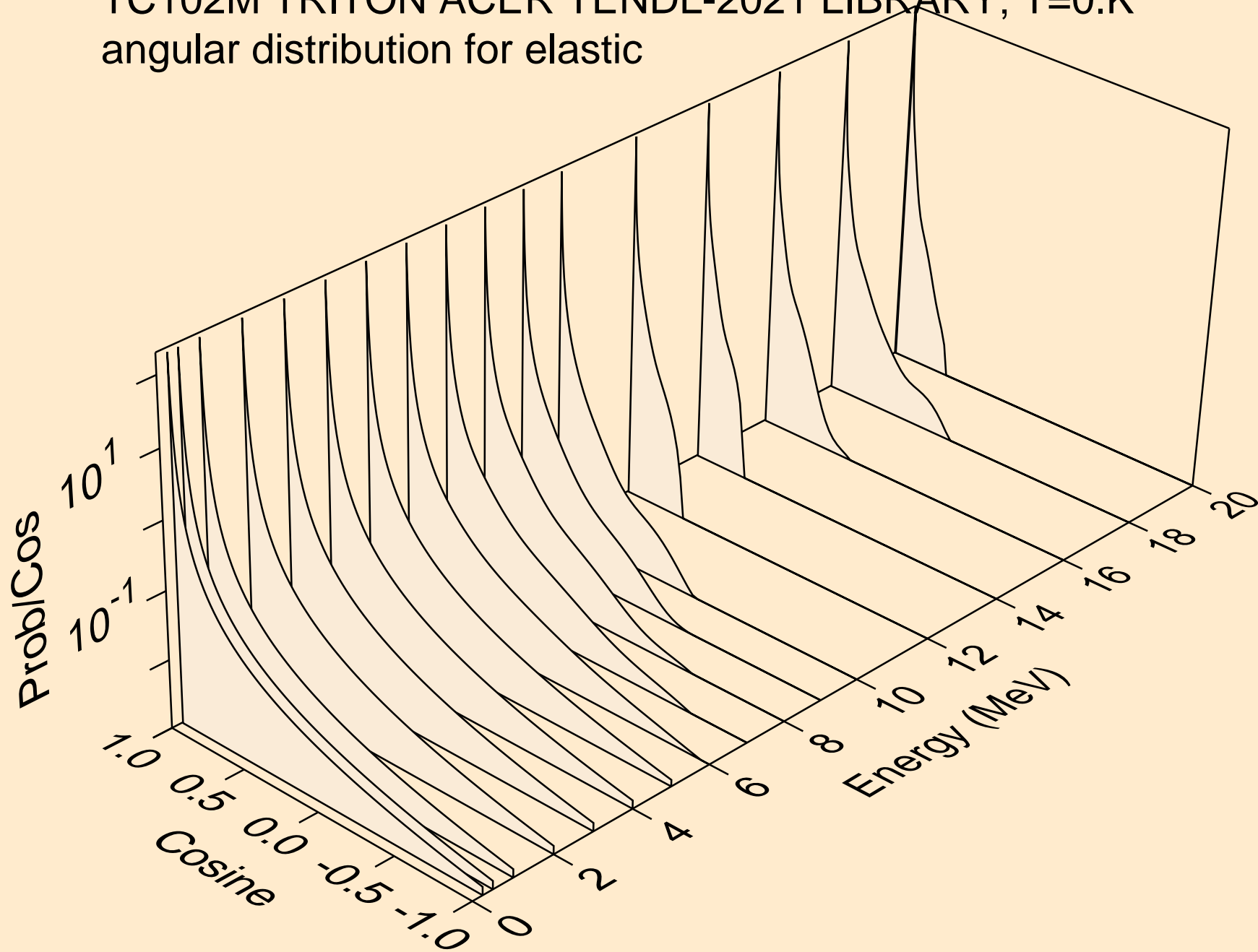



TC102M TRITON ACER TENDL-2021 LIBRARY; T=0.K  
angular distribution for elastic

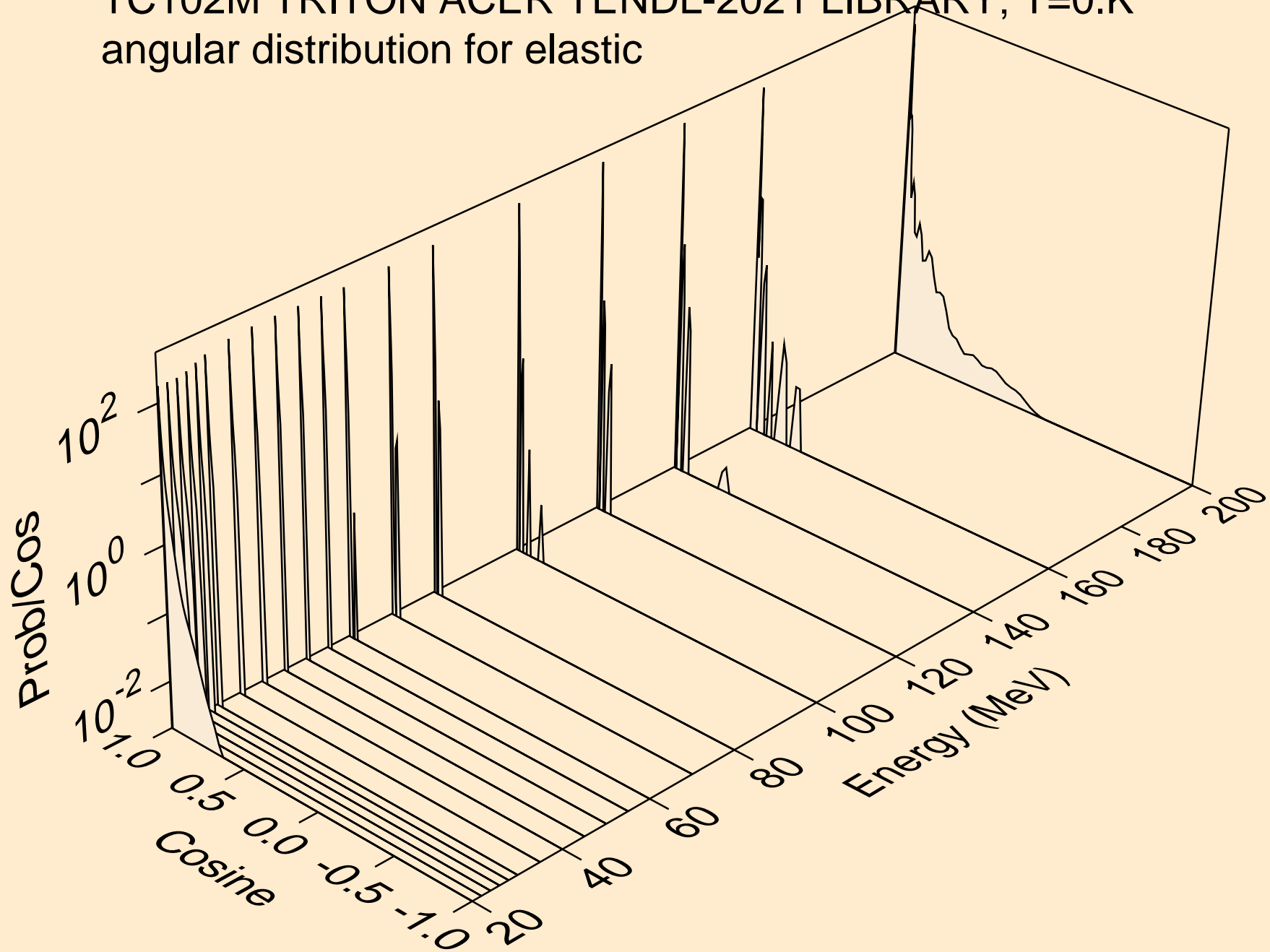

TC102M TRITON ACER TENDL-2021 LIBRARY; T=0.K  
Triton emission for (t,x)

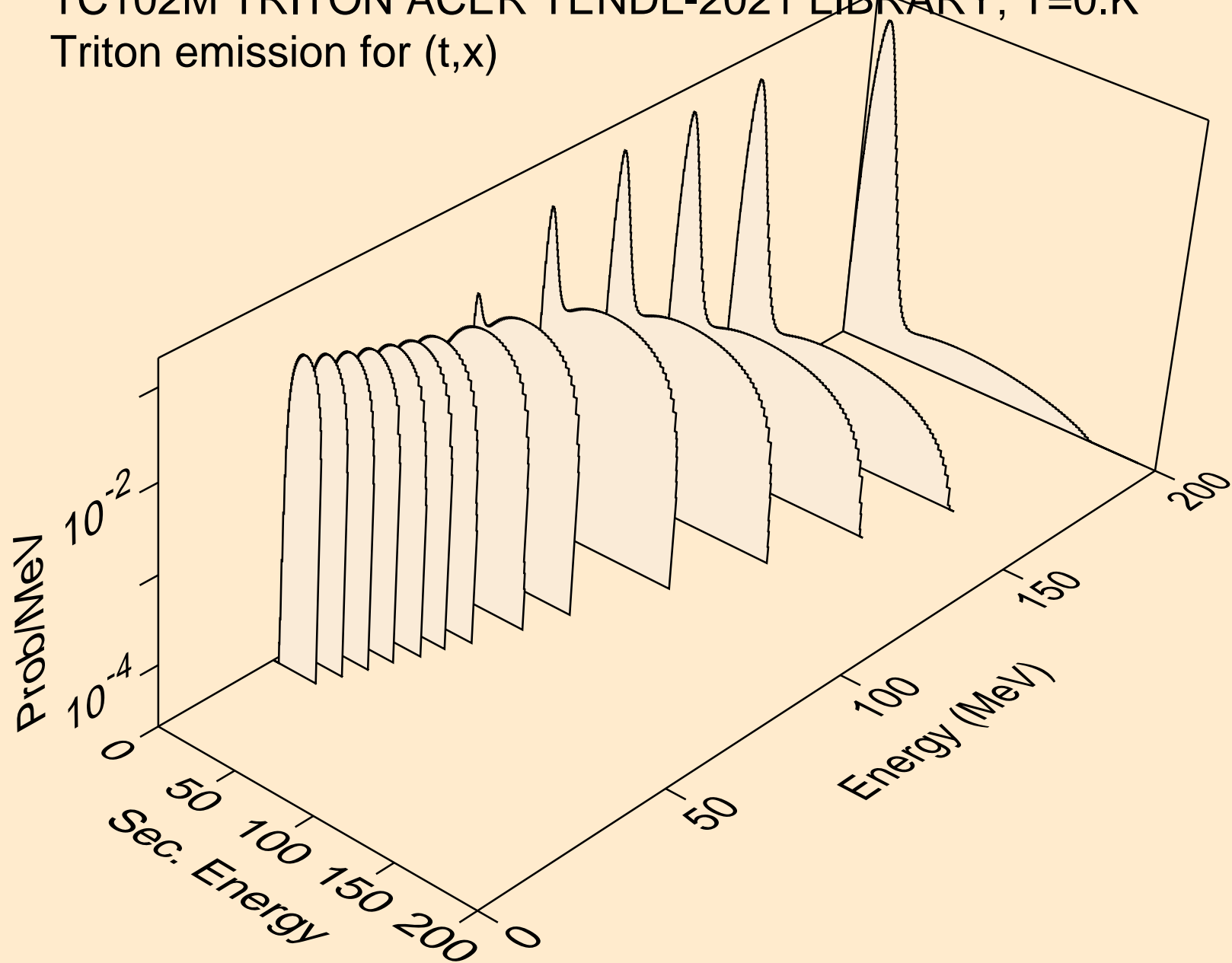

TC102M TRITON ACER TENDL-2021 LIBRARY; T=0.K  
Triton emission for (t,n\*)t

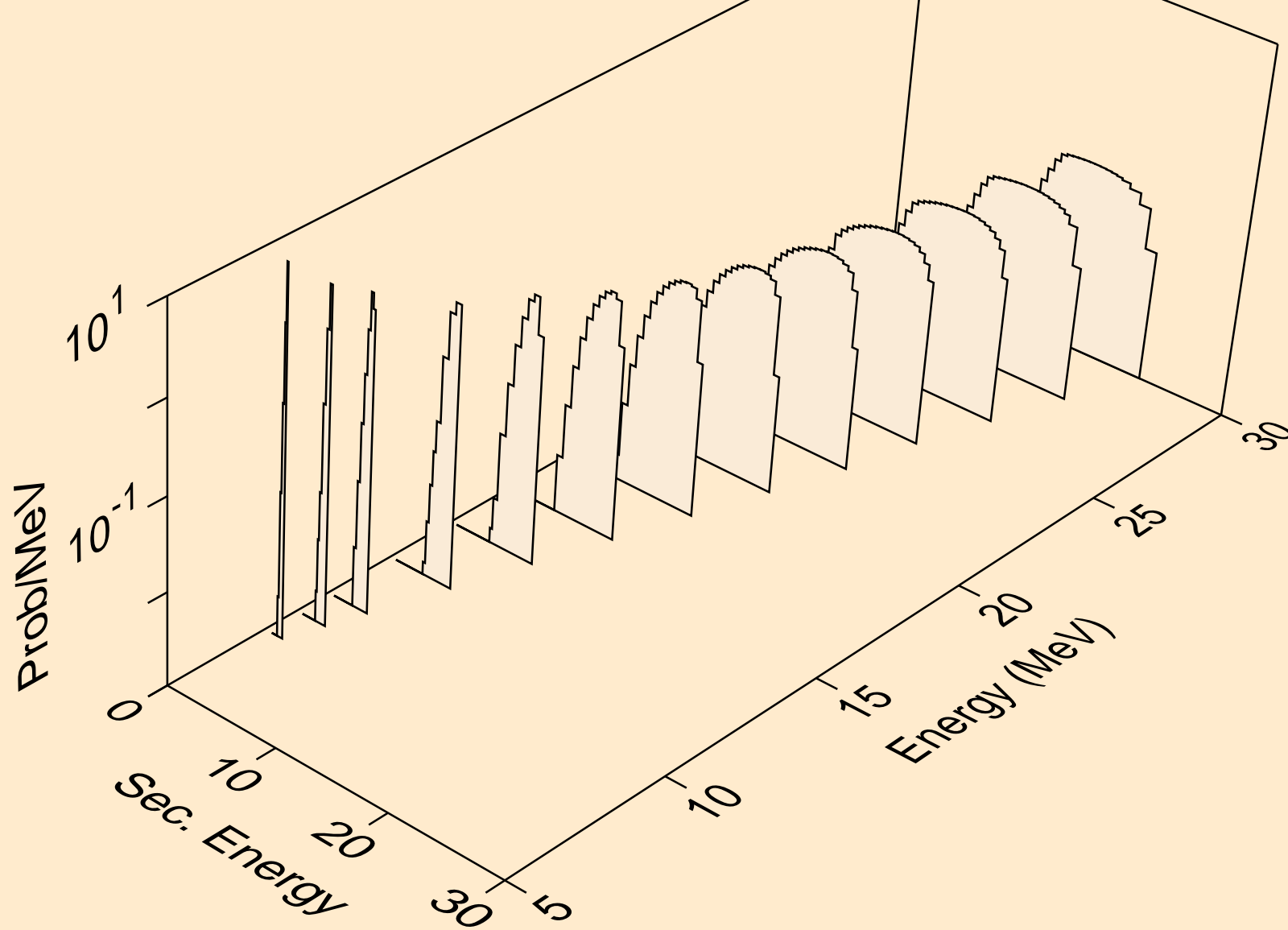

TC102M TRITON ACER TENDL-2021 LIBRARY; T=0.K  
Triton emission for inelastic

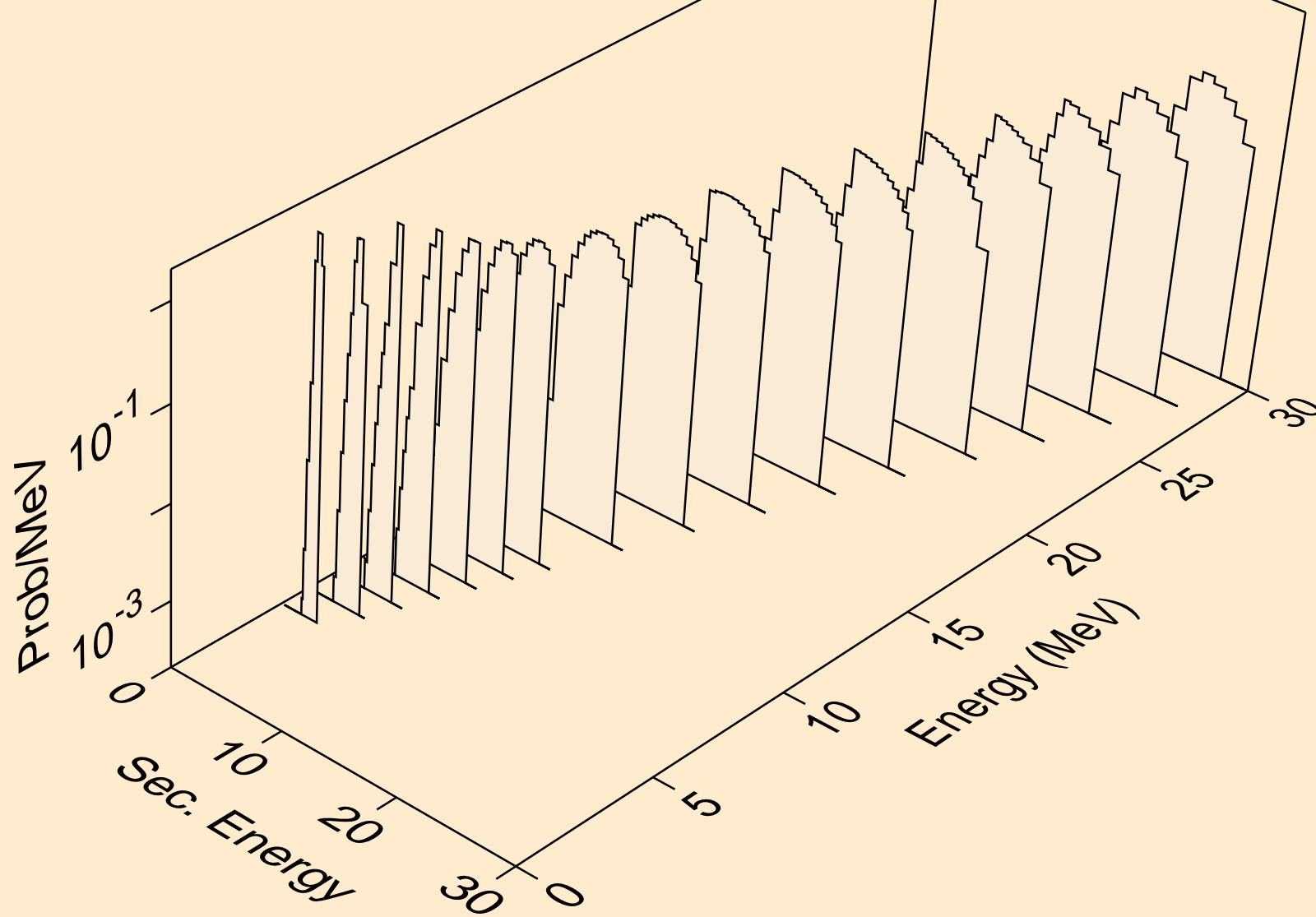

TC102M TRITON ACER TENDL-2021 LIBRARY; T=0.K  
Triton emission for (t,pt)

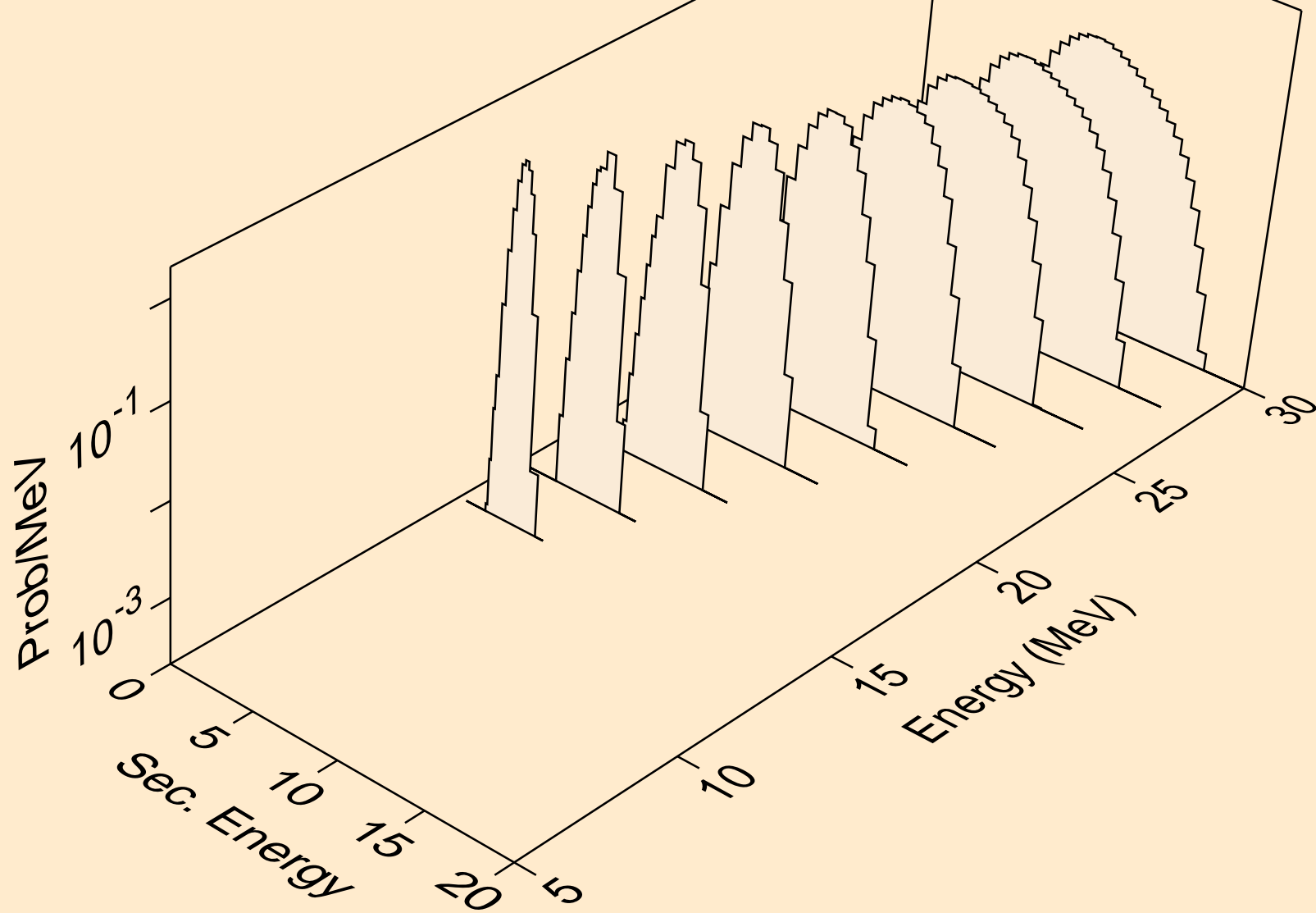

TC102M TRITON ACER TENDL-2021 LIBRARY; T=0.K  
Photon emission for (z,n)

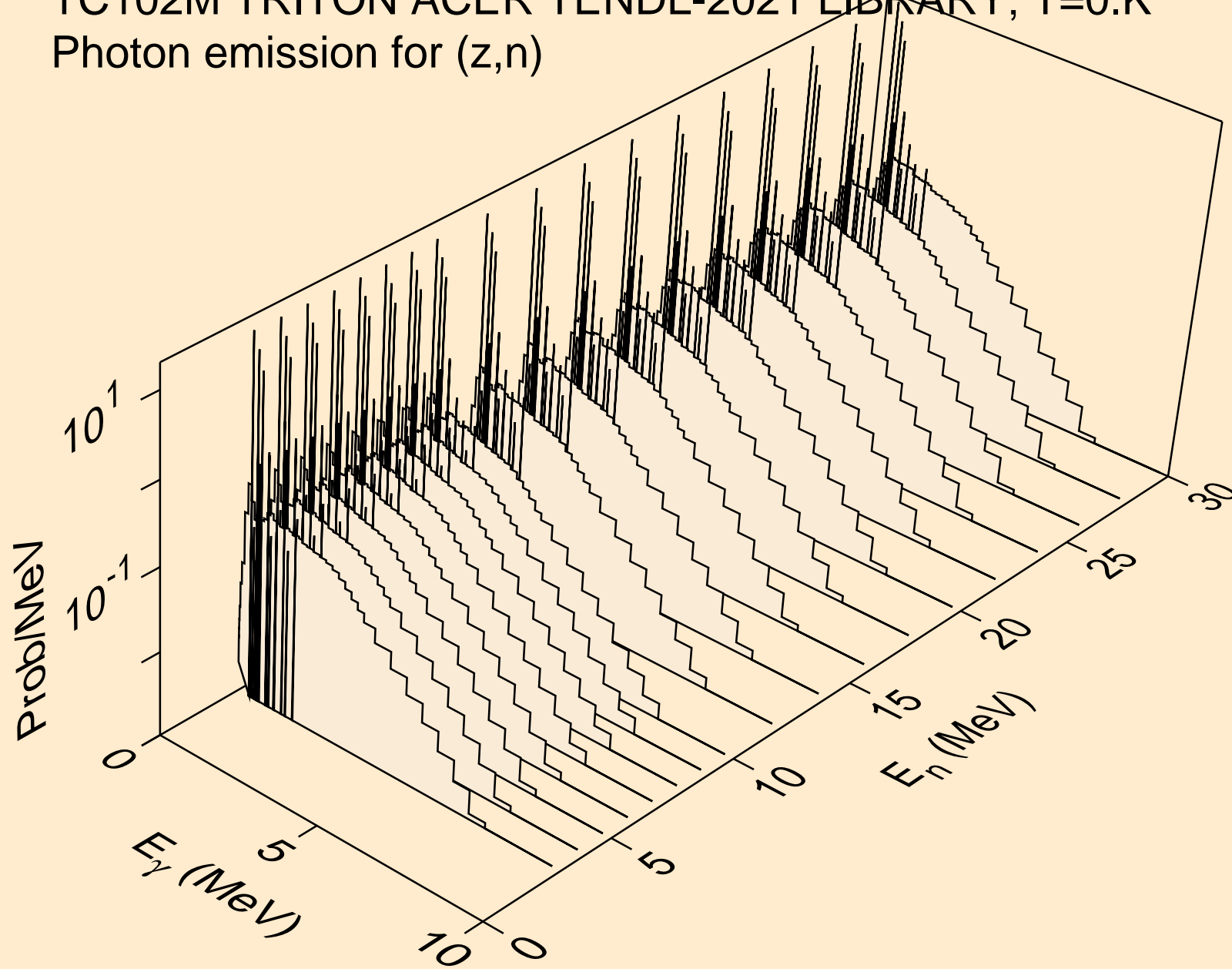

TC102M TRITON ACER TENDL-2021 LIBRARY; T=0.K  
Photon emission for (n,x)

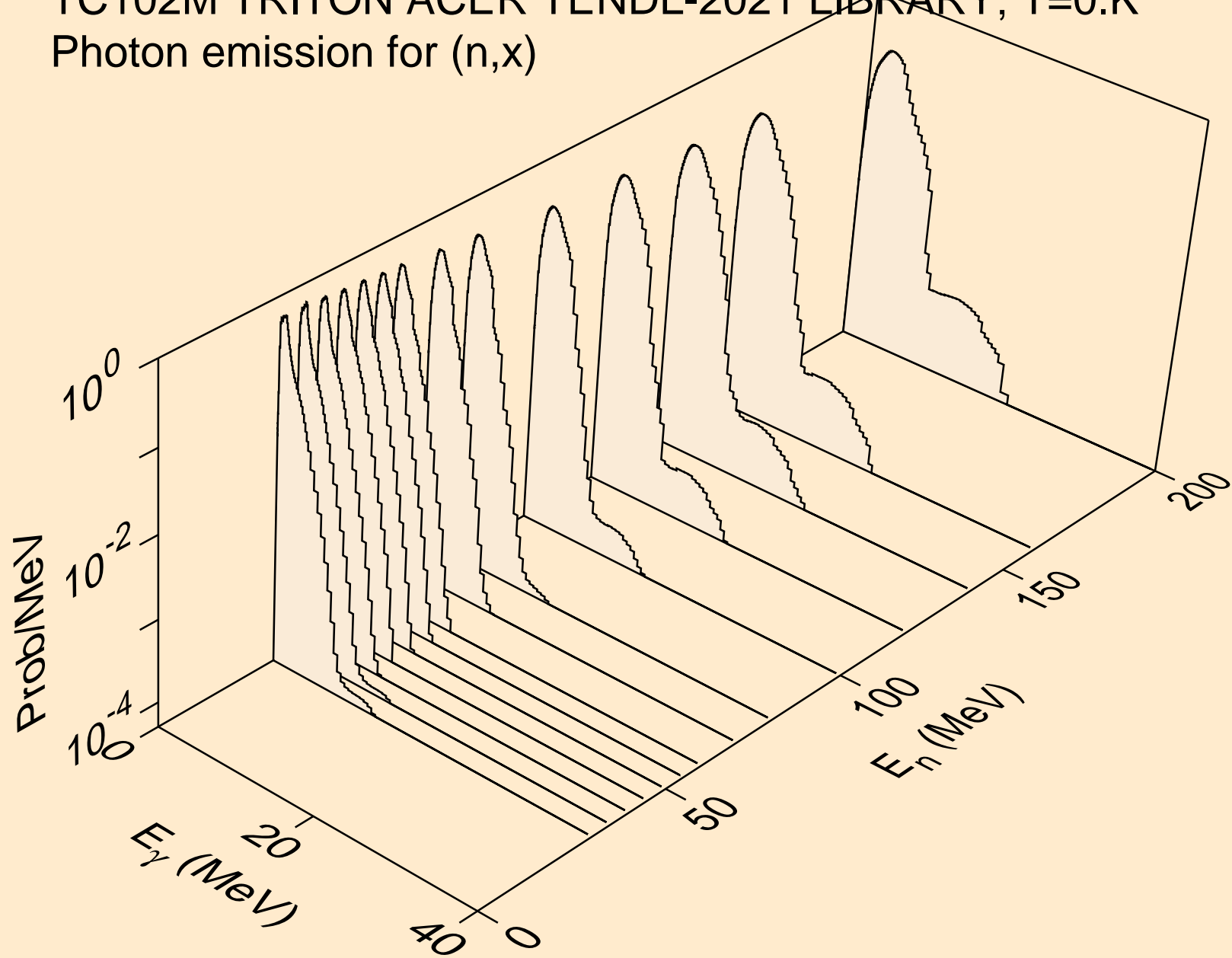

TC102M TRITON ACER TENDL-2021 LIBRARY; T=0.K  
Photon emission for (n,2nd)

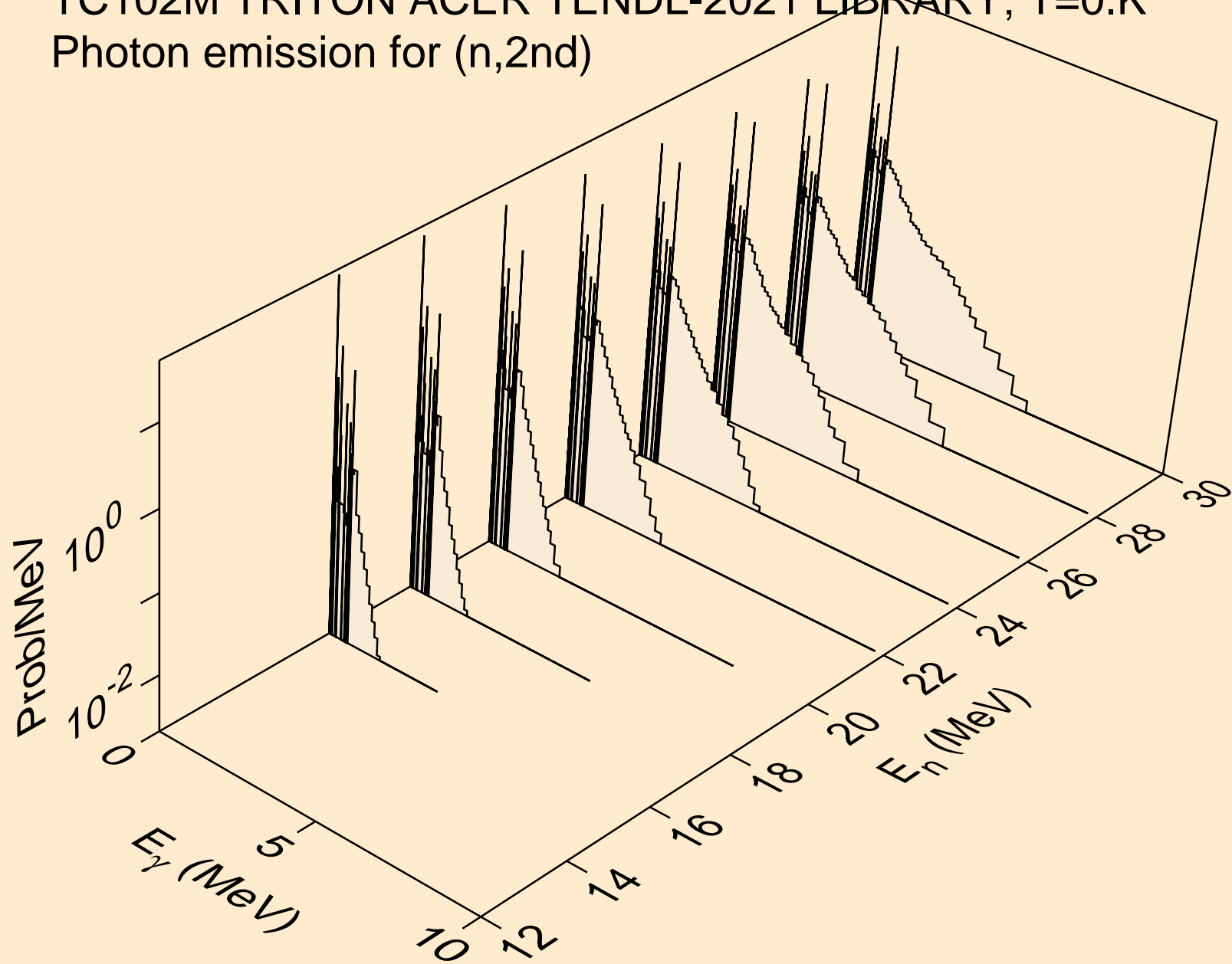



TC102M TRITON ACER TENDL-2021 LIBRARY; T=0.K  
Photon emission for (n,2n)

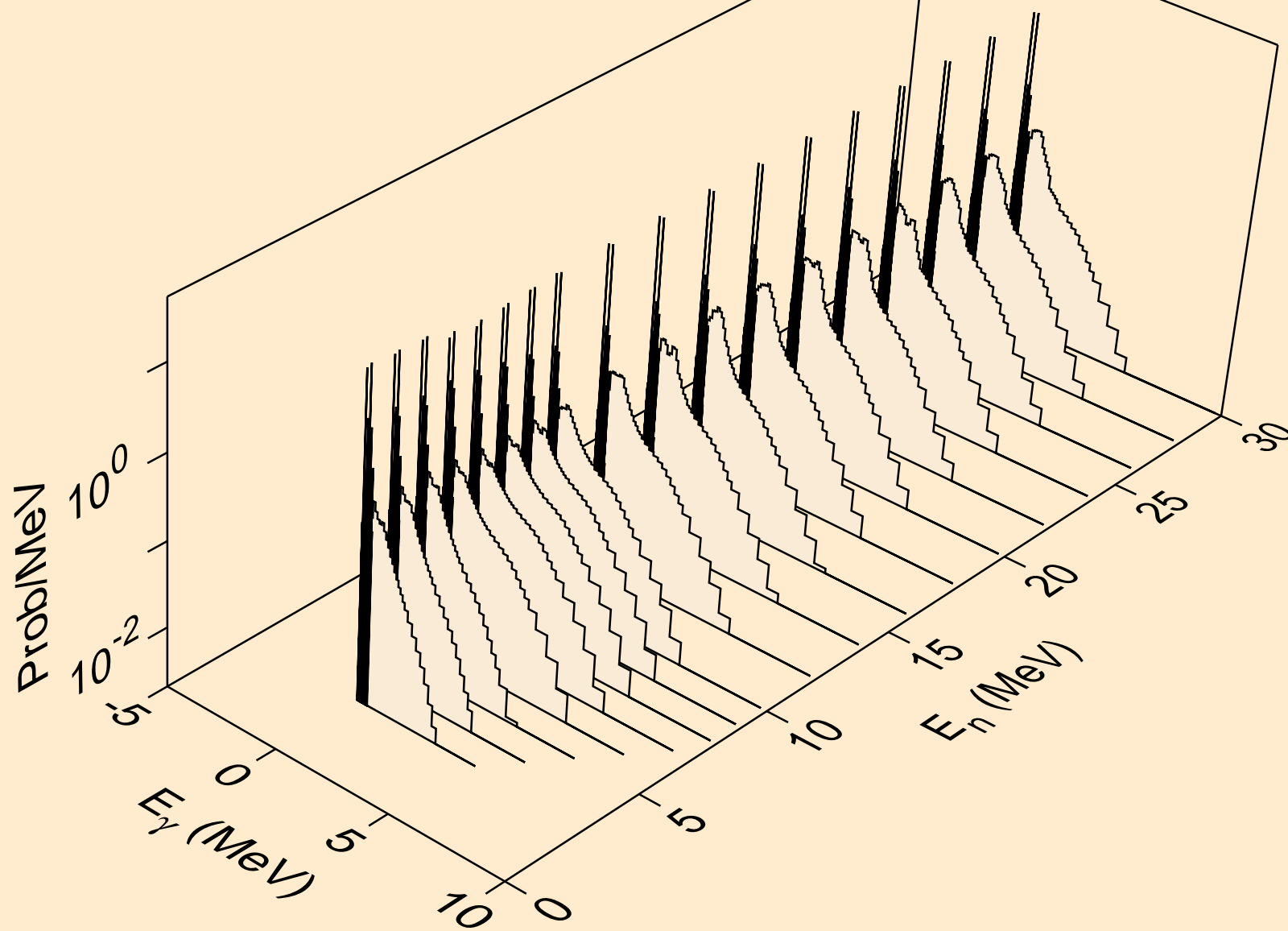

TC102M TRITON ACER TENDL-2021 LIBRARY; T=0.K  
Photon emission for (n,3n)

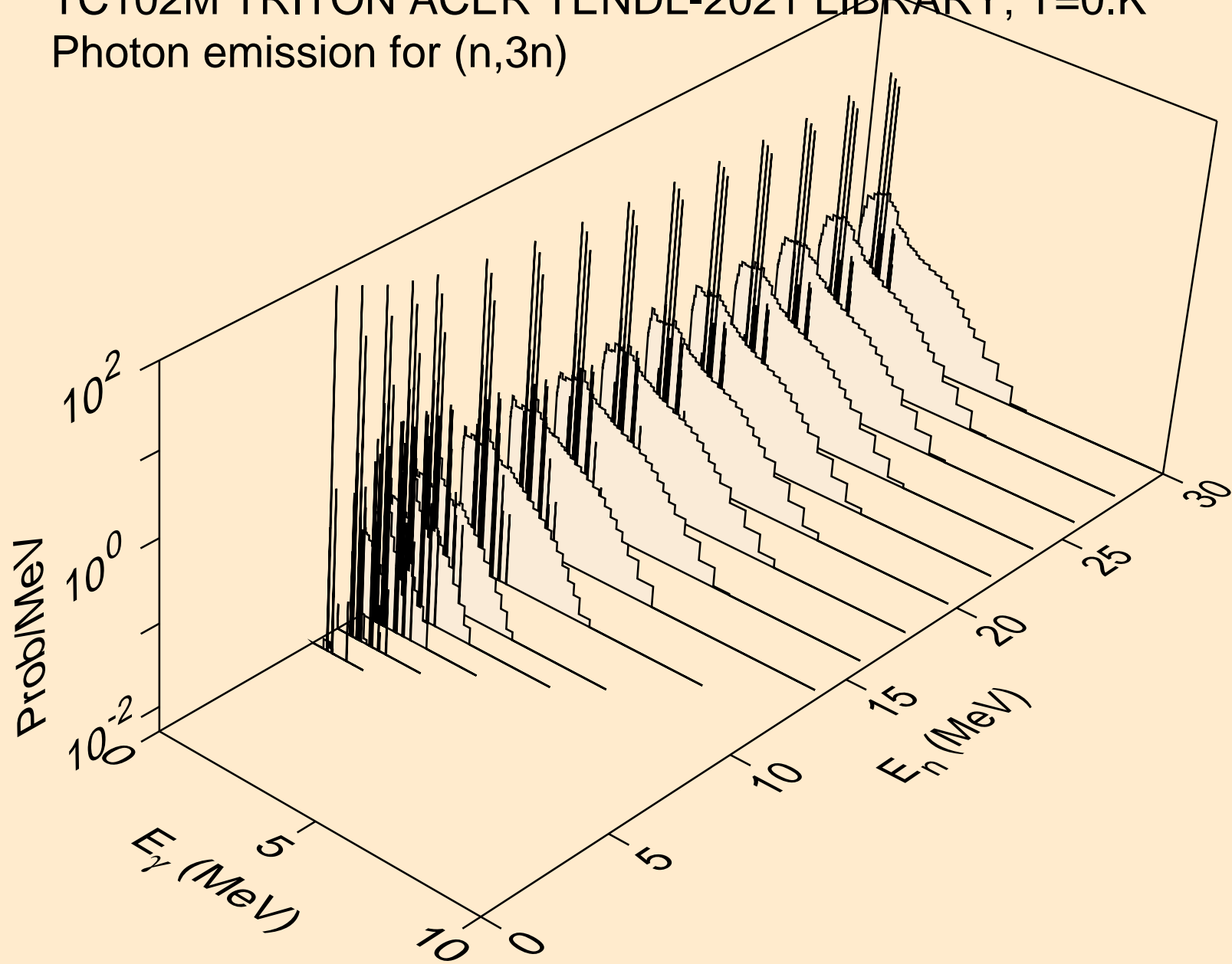

TC102M TRITON ACER TENDL-2021 LIBRARY; T=0.K  
Photon emission for (n,n\*)a

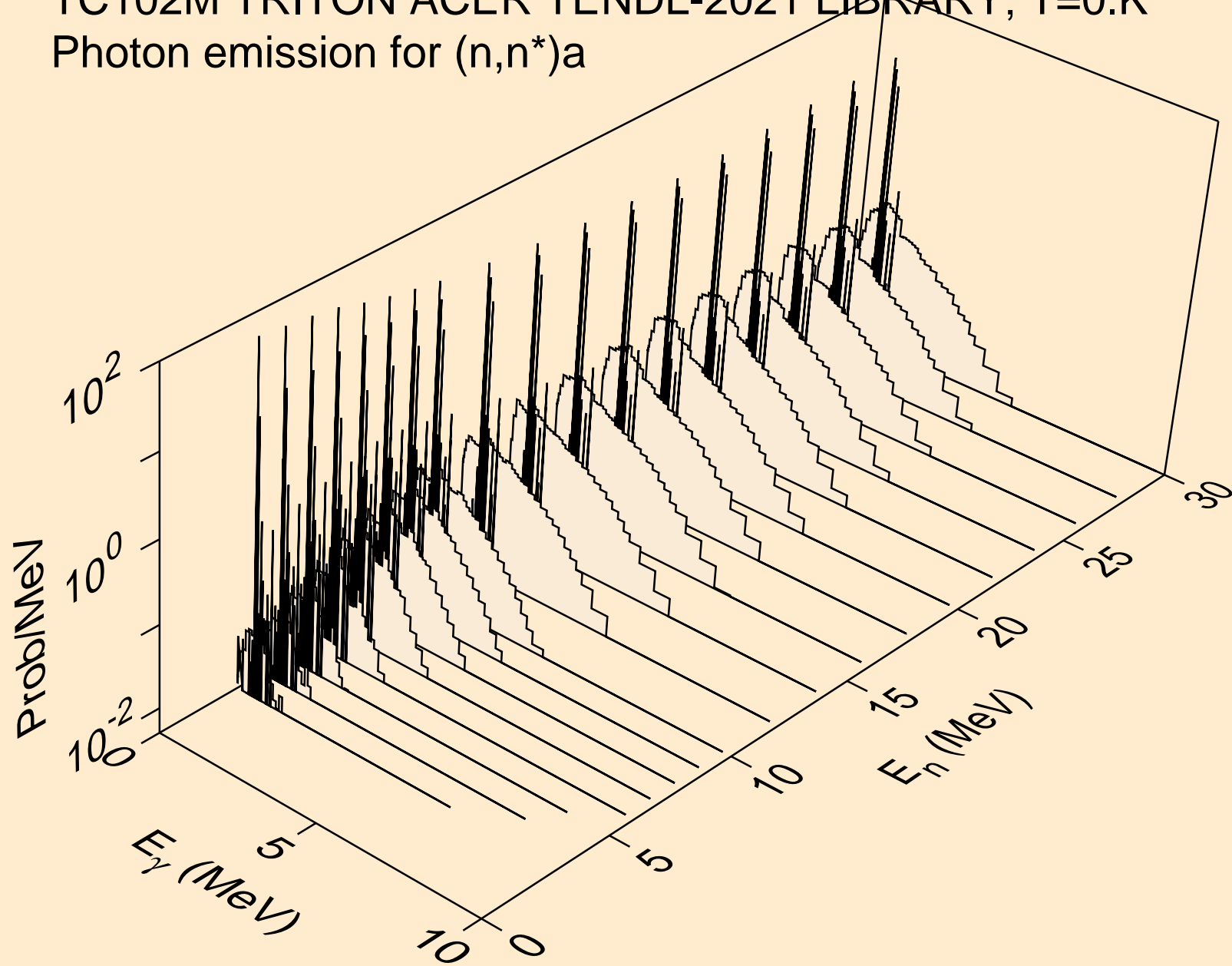

TC102M TRITON ACER TENDL-2021 LIBRARY; T=0.K  
Photon emission for (n,2n)a

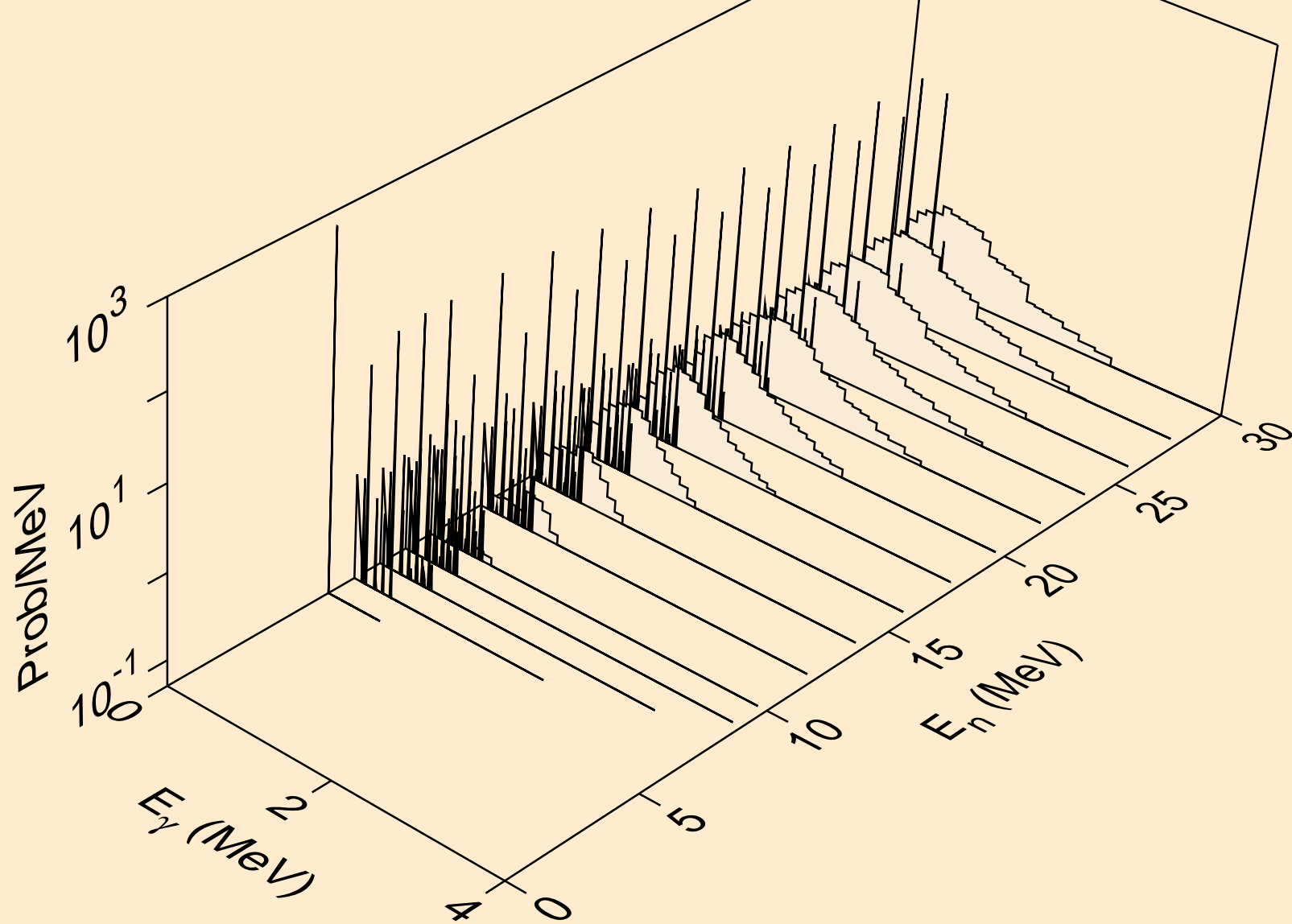

TC102M TRITON ACER TENDL-2021 LIBRARY; T=0.K  
Photon emission for (n,3n)a

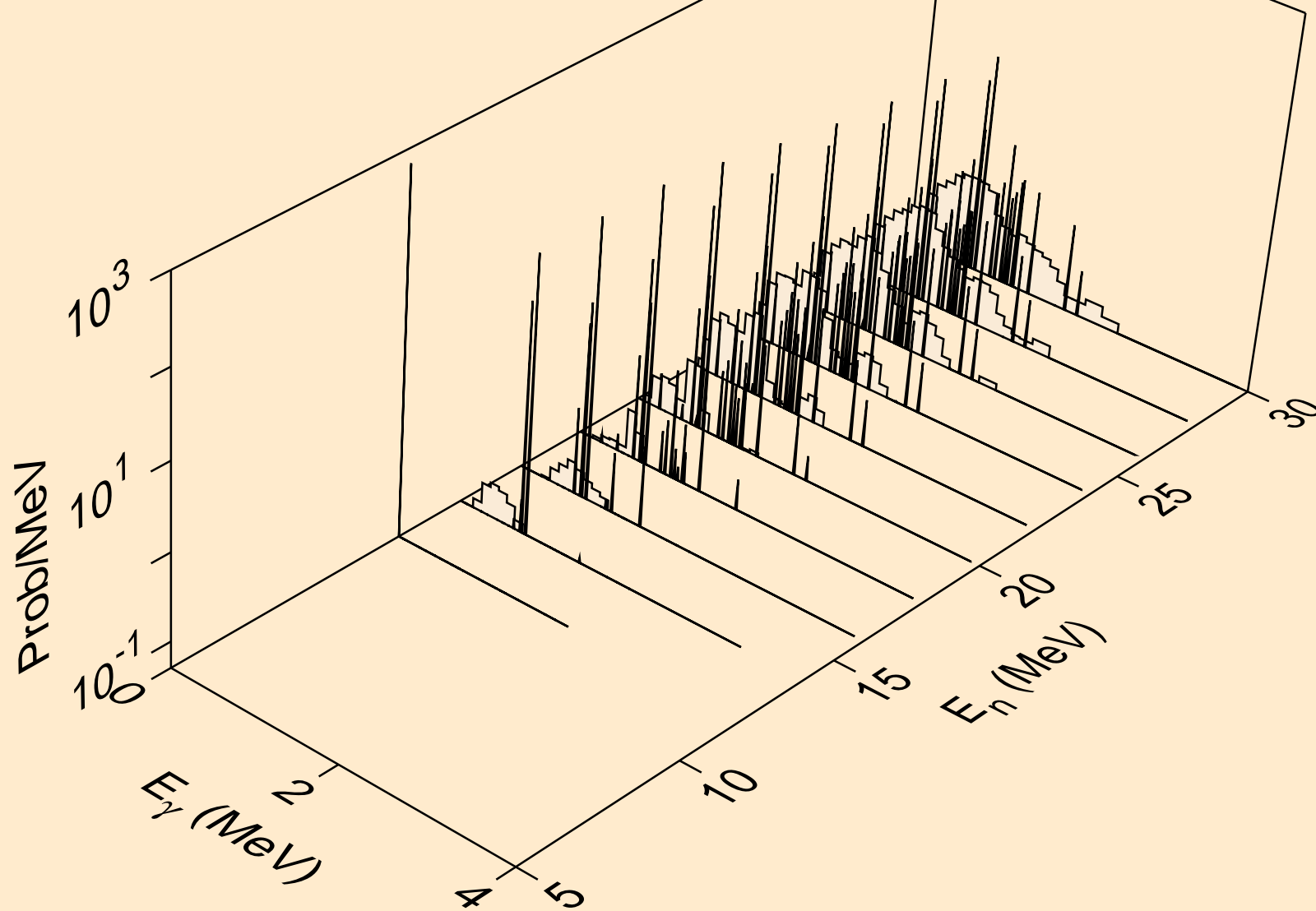

TC102M TRITON ACER TENDL-2021 LIBRARY; T=0.K  
Photon emission for (n,n\*)p

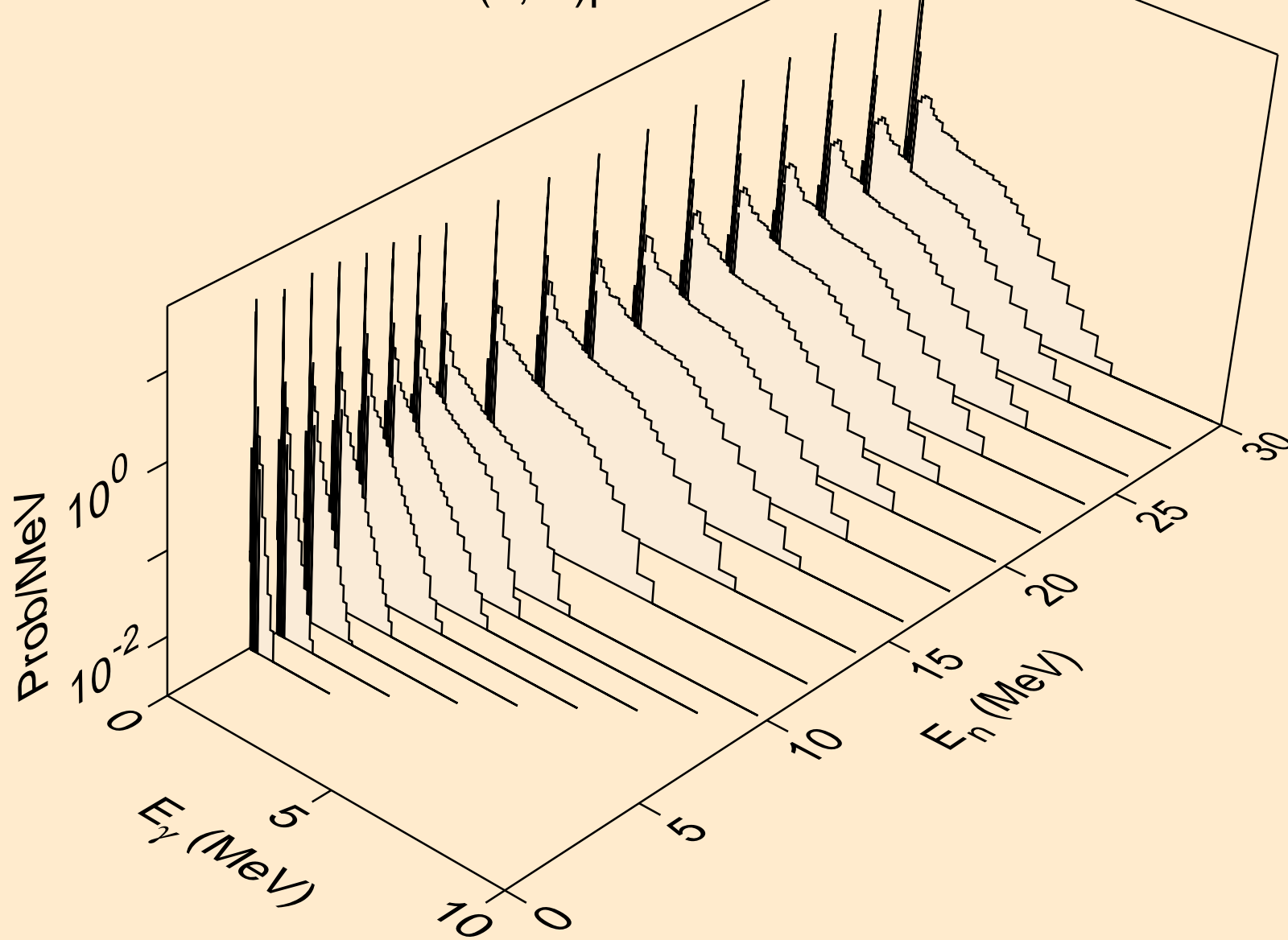

TC102M TRITON ACER TENDL-2021 LIBRARY; T=0.K  
Photon emission for (n,n\*)2a

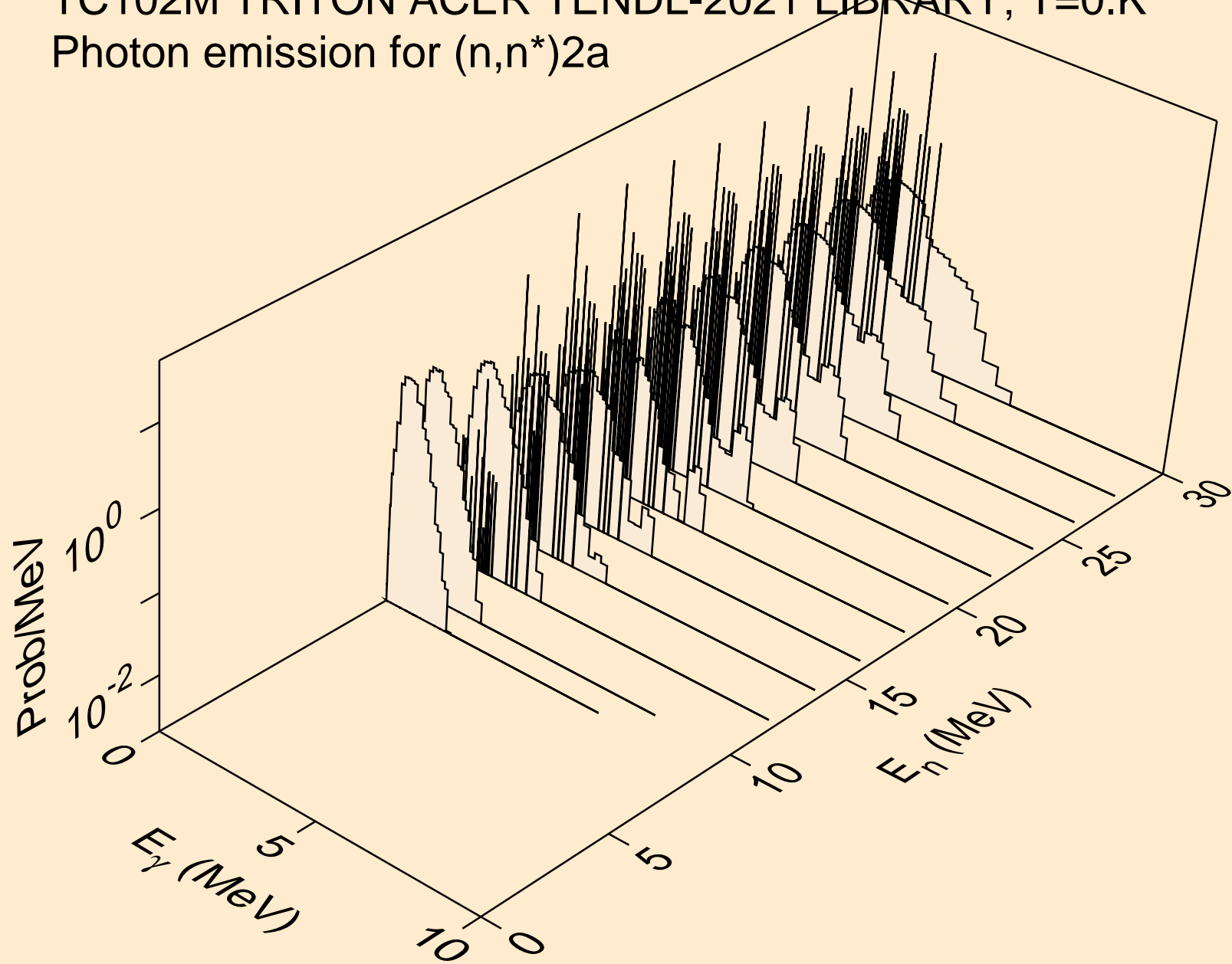

TC102M TRITON ACER TENDL-2021 LIBRARY; T=0.K  
Photon emission for (n,2n)2a

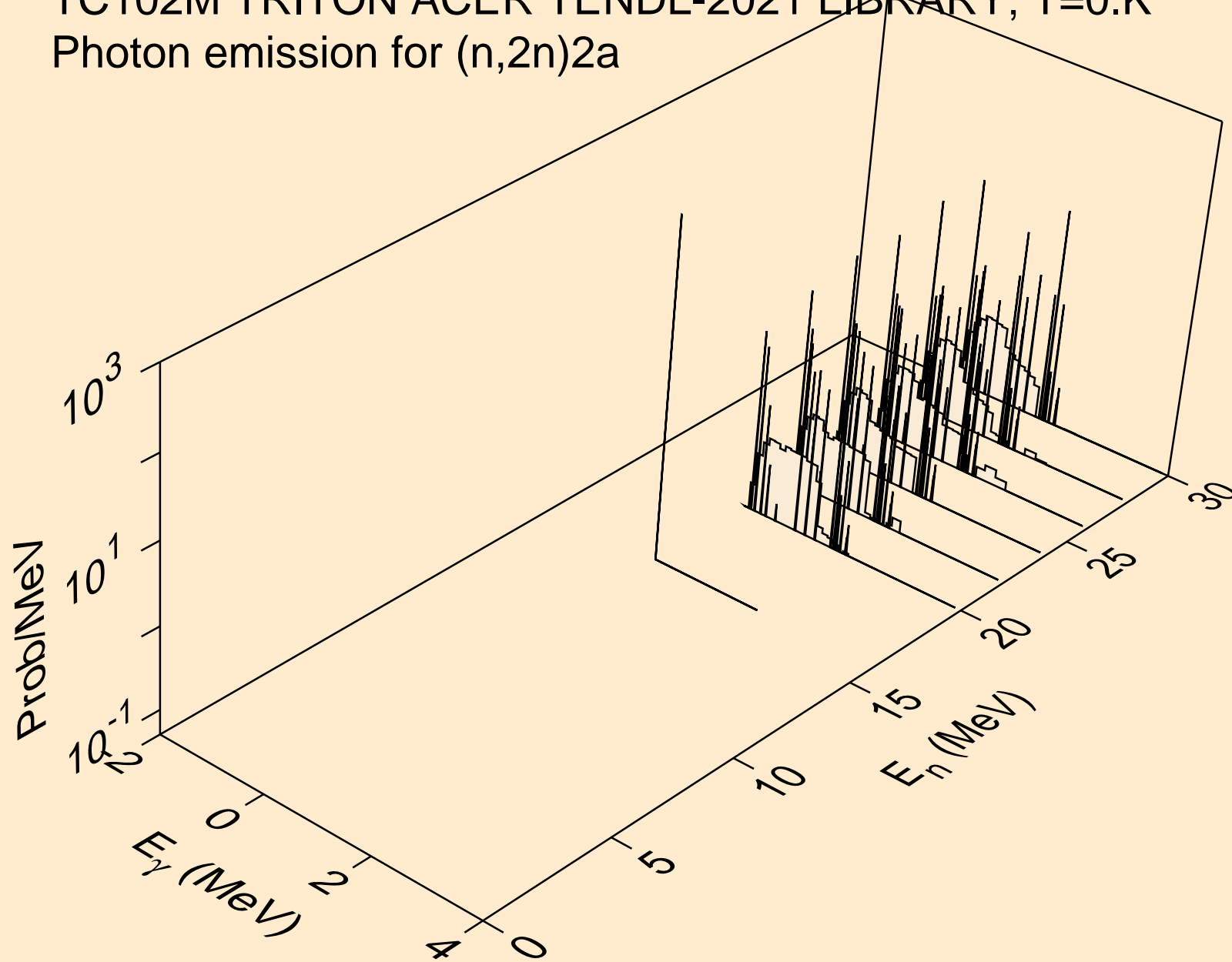



TC102M TRITON ACER TENDL-2021 LIBRARY; T=0.K  
Photon emission for (n,n\*)d

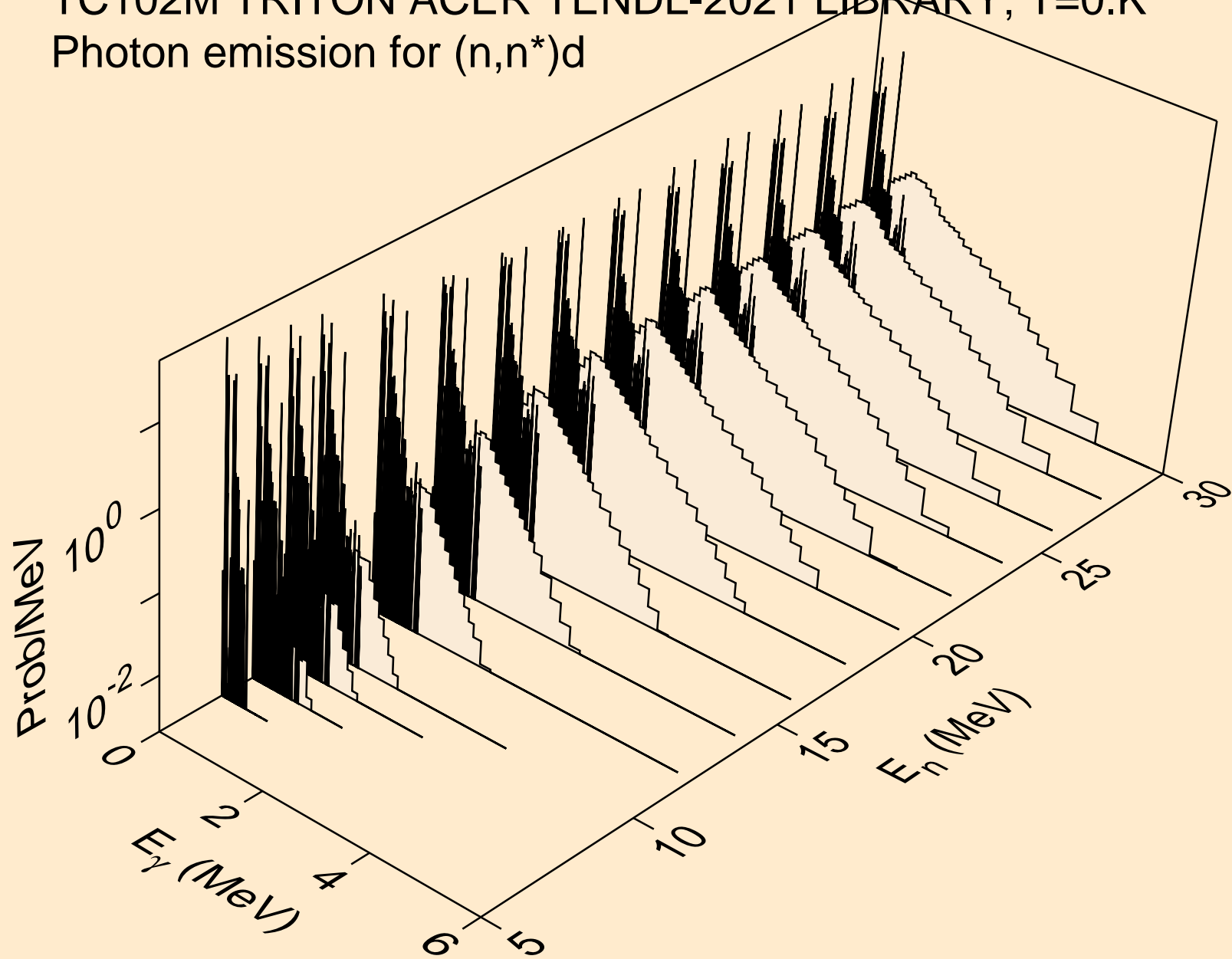

TC102M TRITON ACER TENDL-2021 LIBRARY; T=0.K  
Photon emission for (n,n\*)t

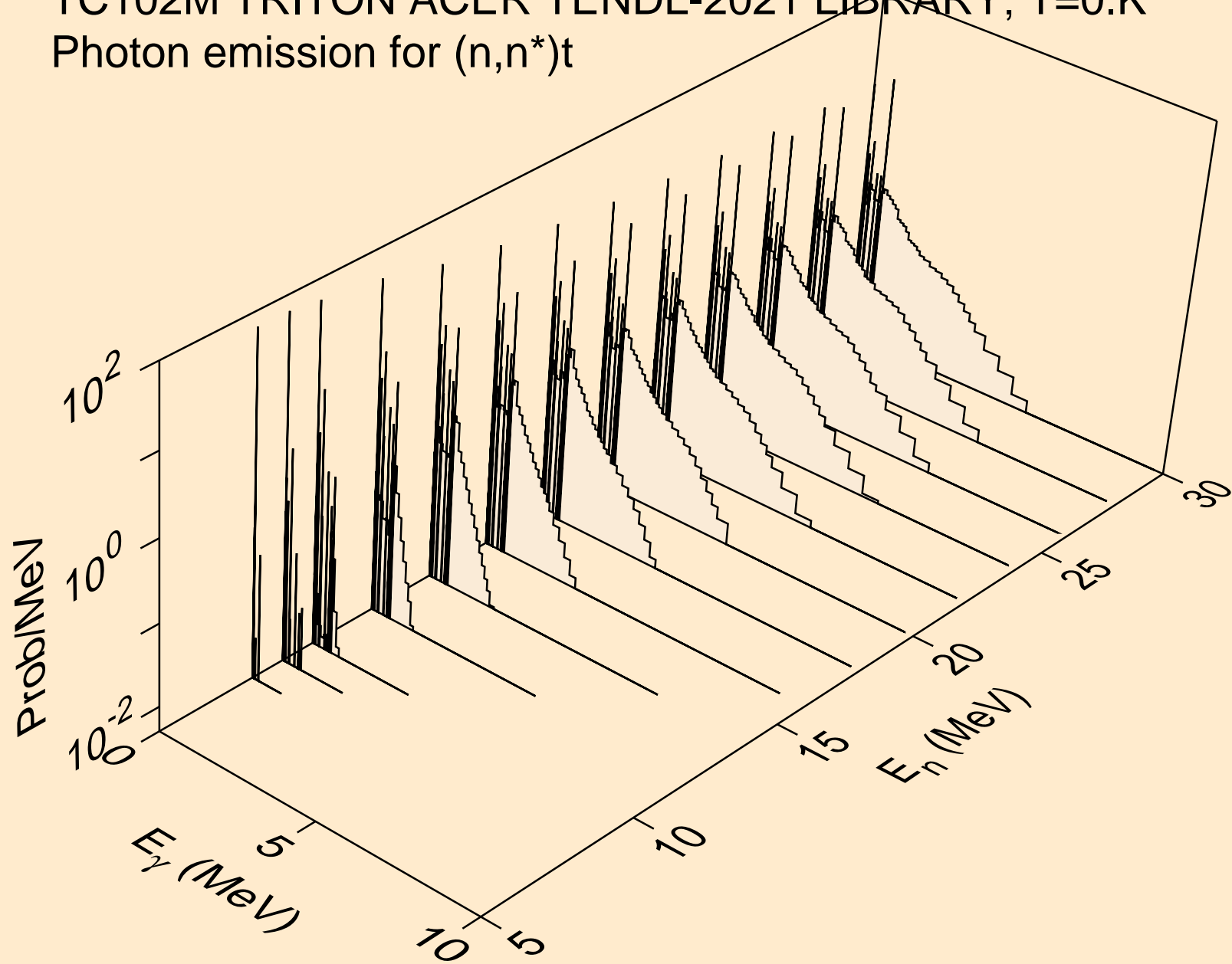

TC102M TRITON ACER TENDL-2021 LIBRARY; T=0.K  
Photon emission for (n,n\*)he3

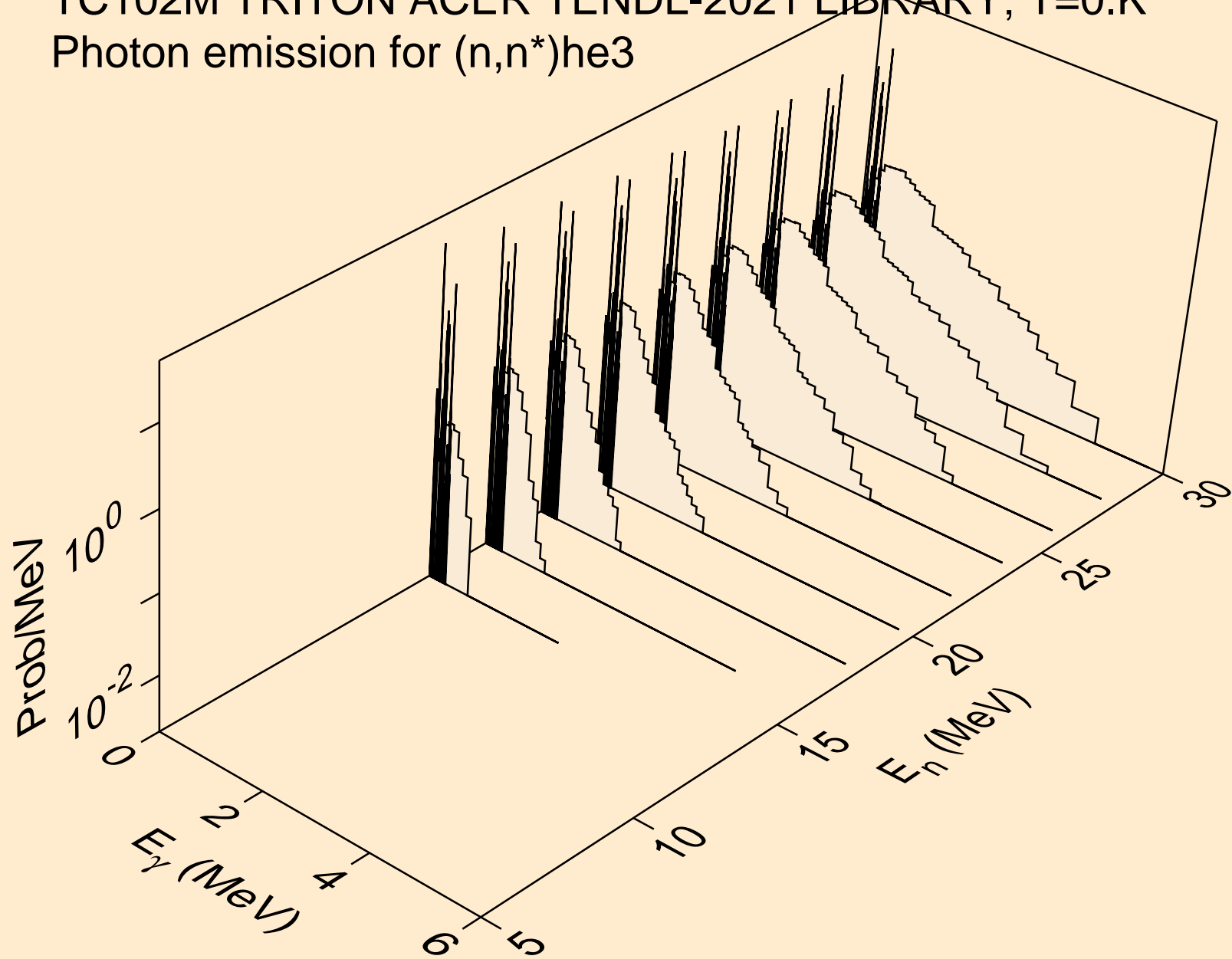

TC102M TRITON ACER TENDL-2021 LIBRARY; T=0.K  
Photon emission for (n,4n)

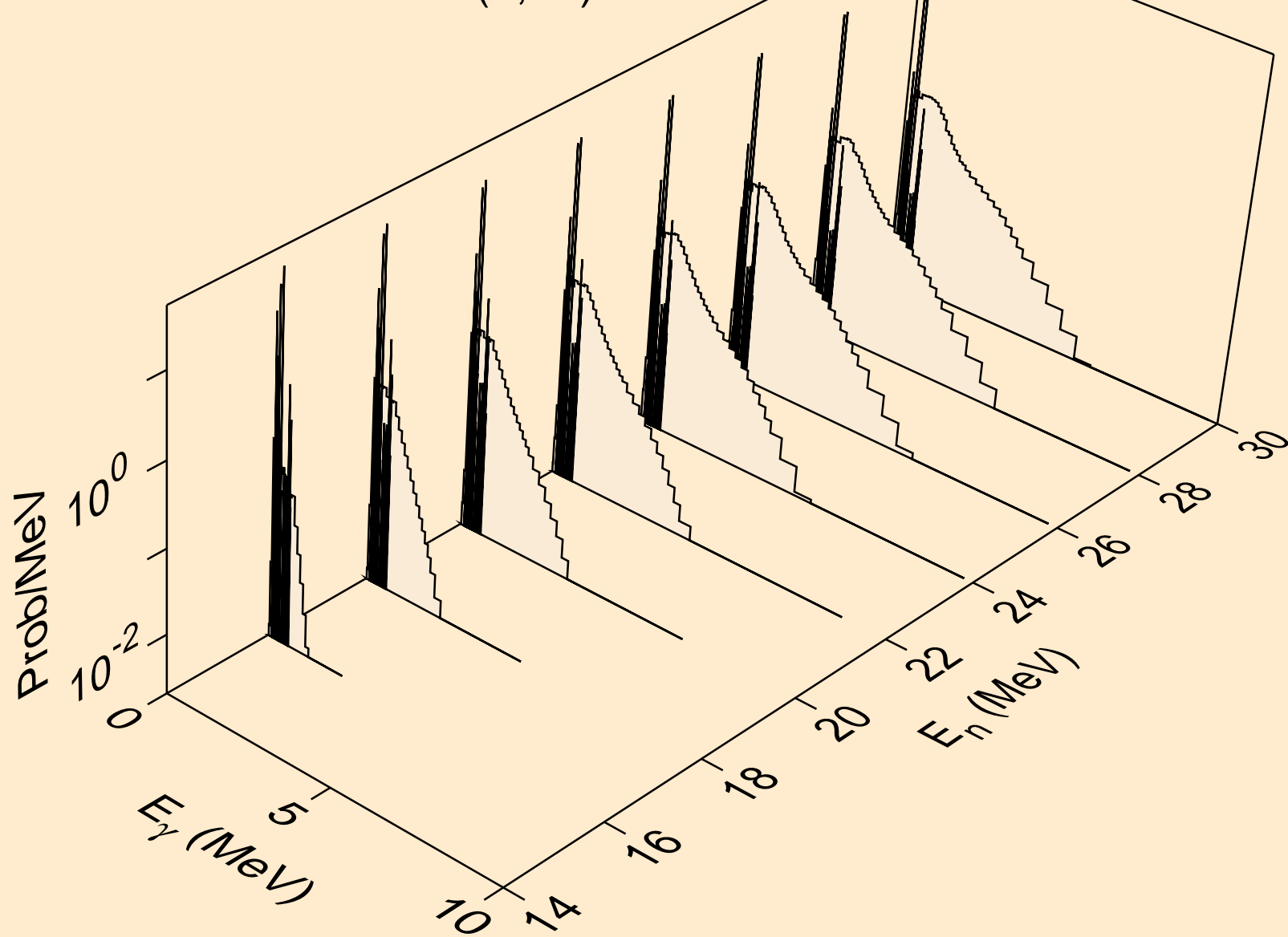

TC102M TRITON ACER TENDL-2021 LIBRARY; T=0.K  
Photon emission for (n,2np)

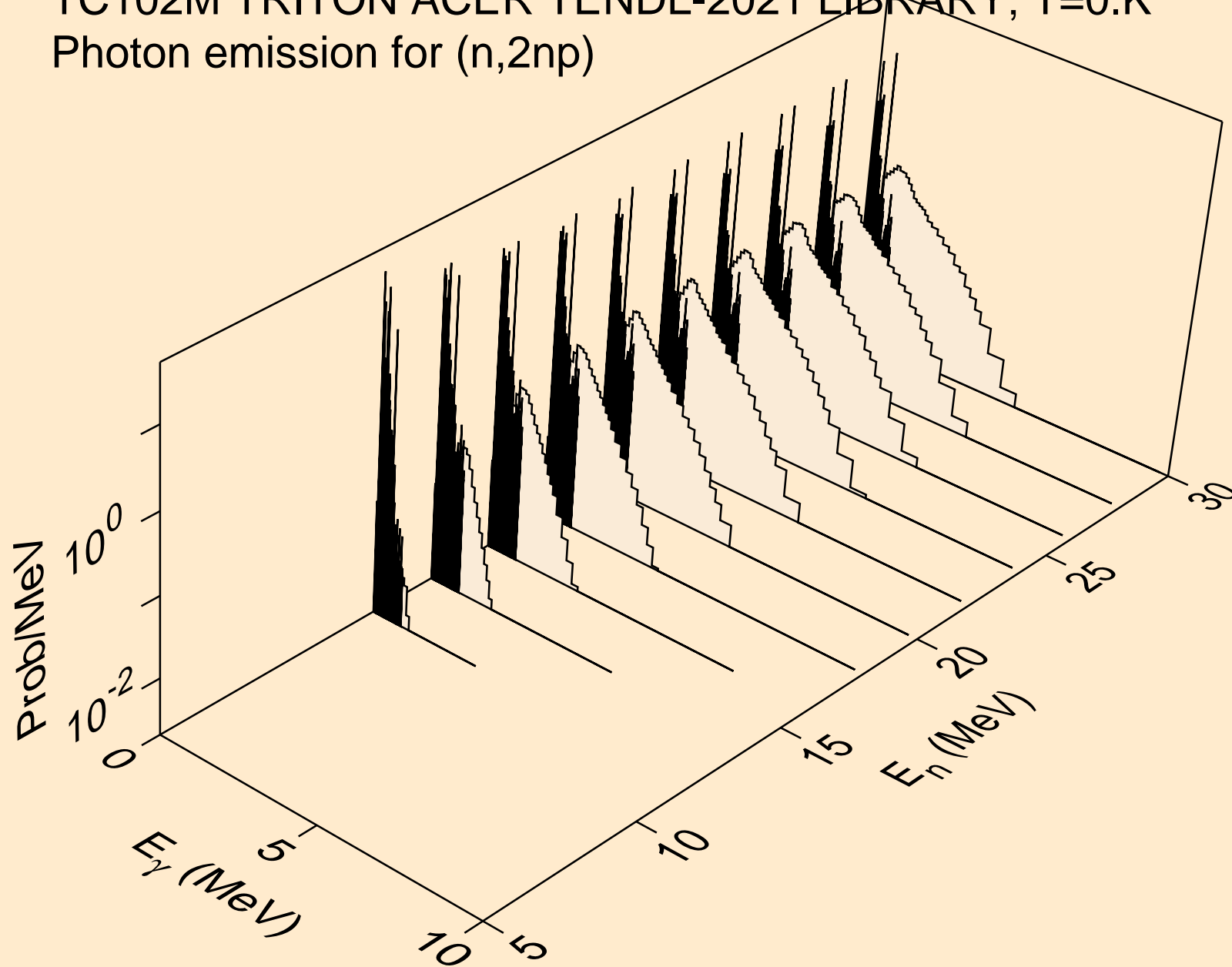

TC102M TRITON ACER TENDL-2021 LIBRARY; T=0.K  
Photon emission for (n,3np)

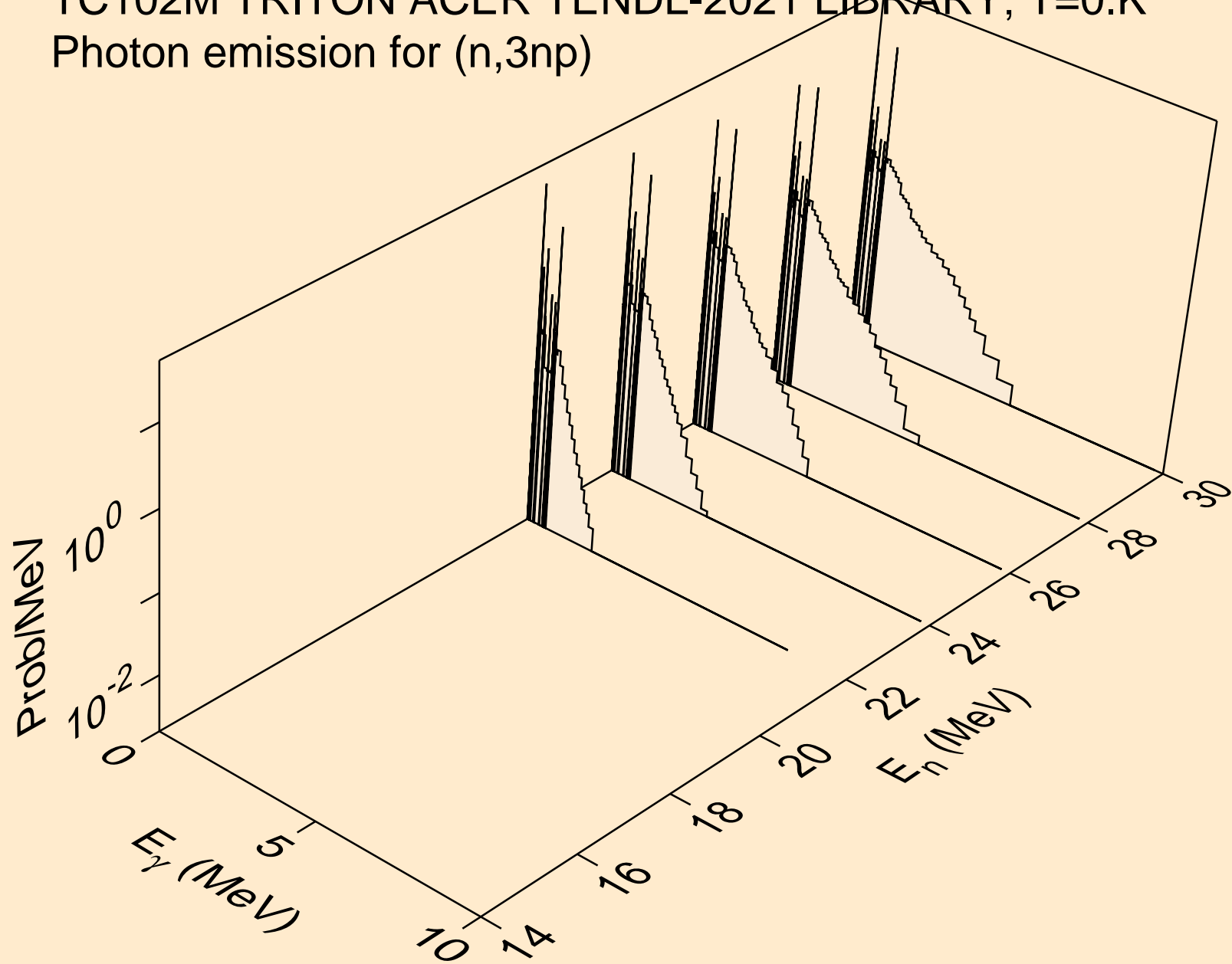

TC102M TRITON ACER TENDL-2021 LIBRARY; T=0.K  
Photon emission for (n,2np)

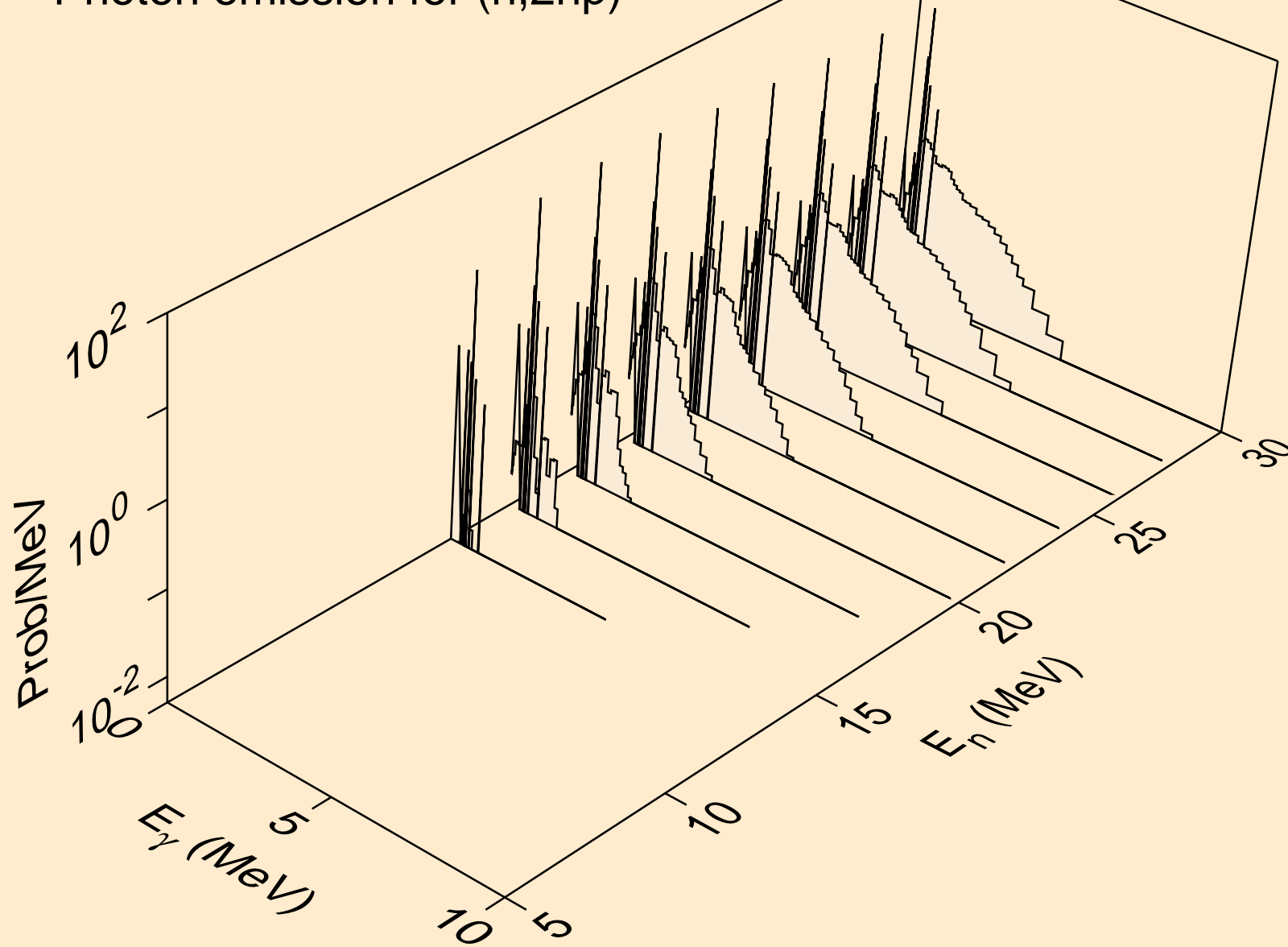

TC102M TRITON ACER TENDL-2021 LIBRARY; T=0.K  
Photon emission for (n,npa)

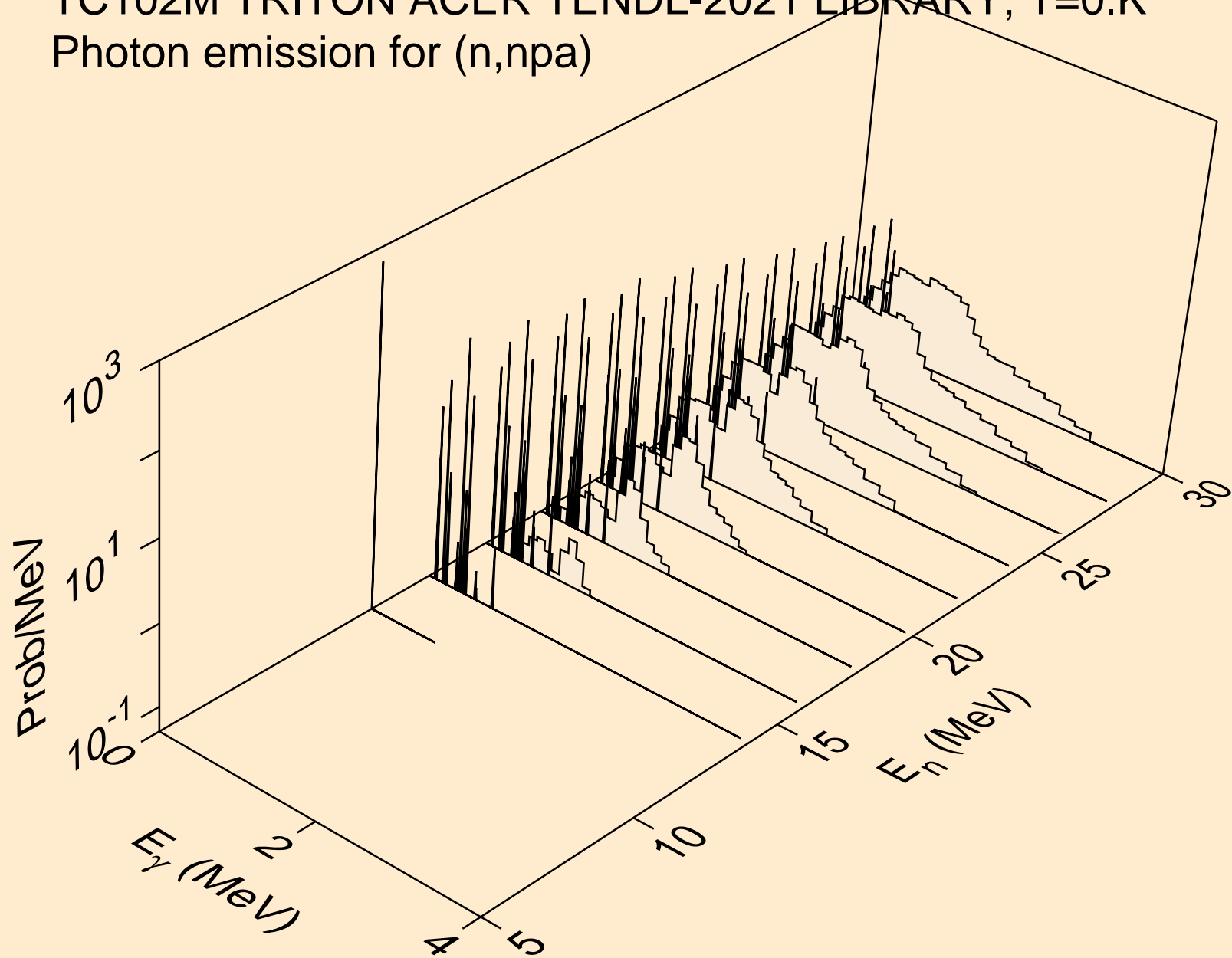



TC102M TRITON ACER TENDL-2021 LIBRARY; T=0.K  
Photon emission for (n,gma)

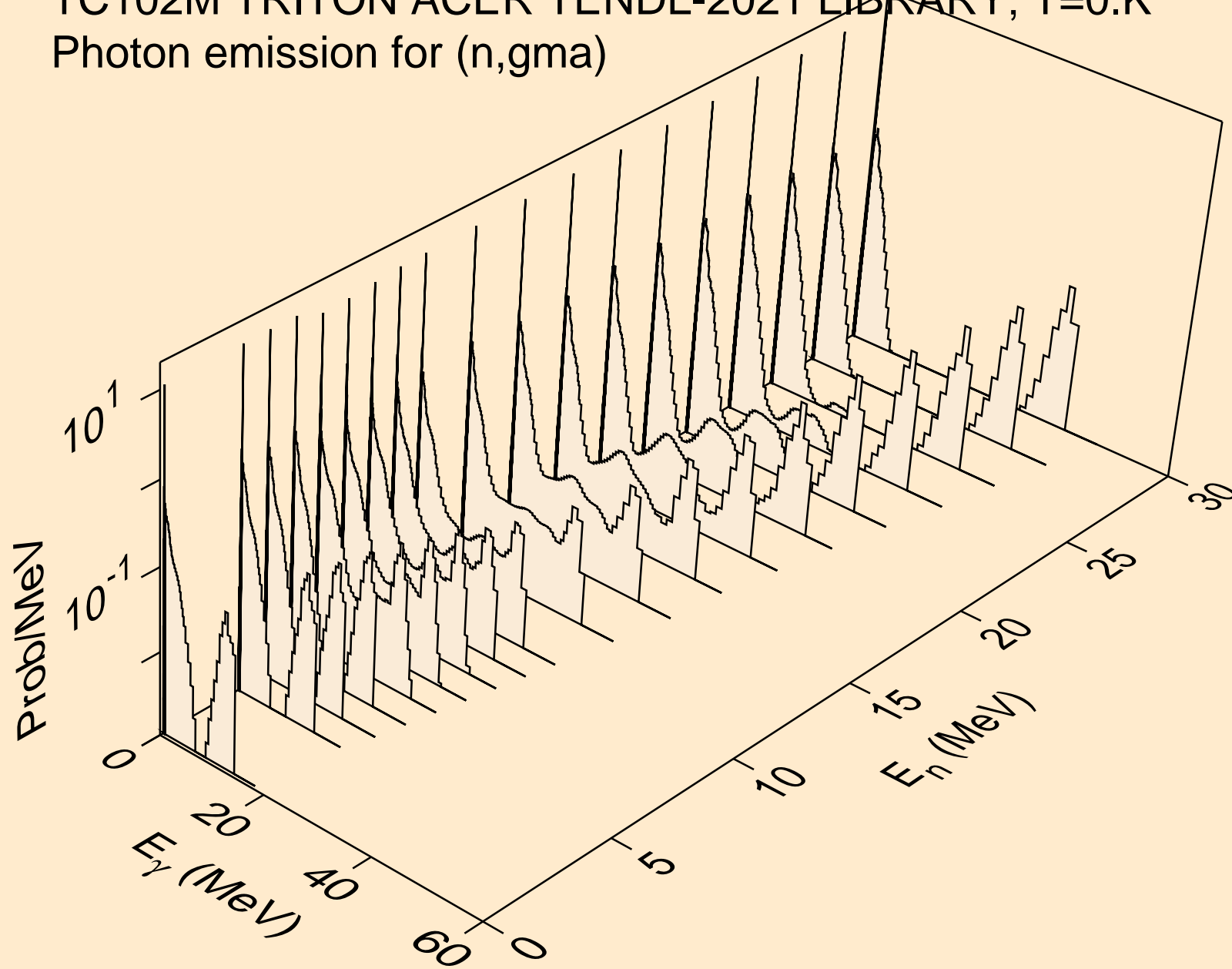

TC102M TRITON ACER TENDL-2021 LIBRARY; T=0.K  
Photon emission for (n,p)

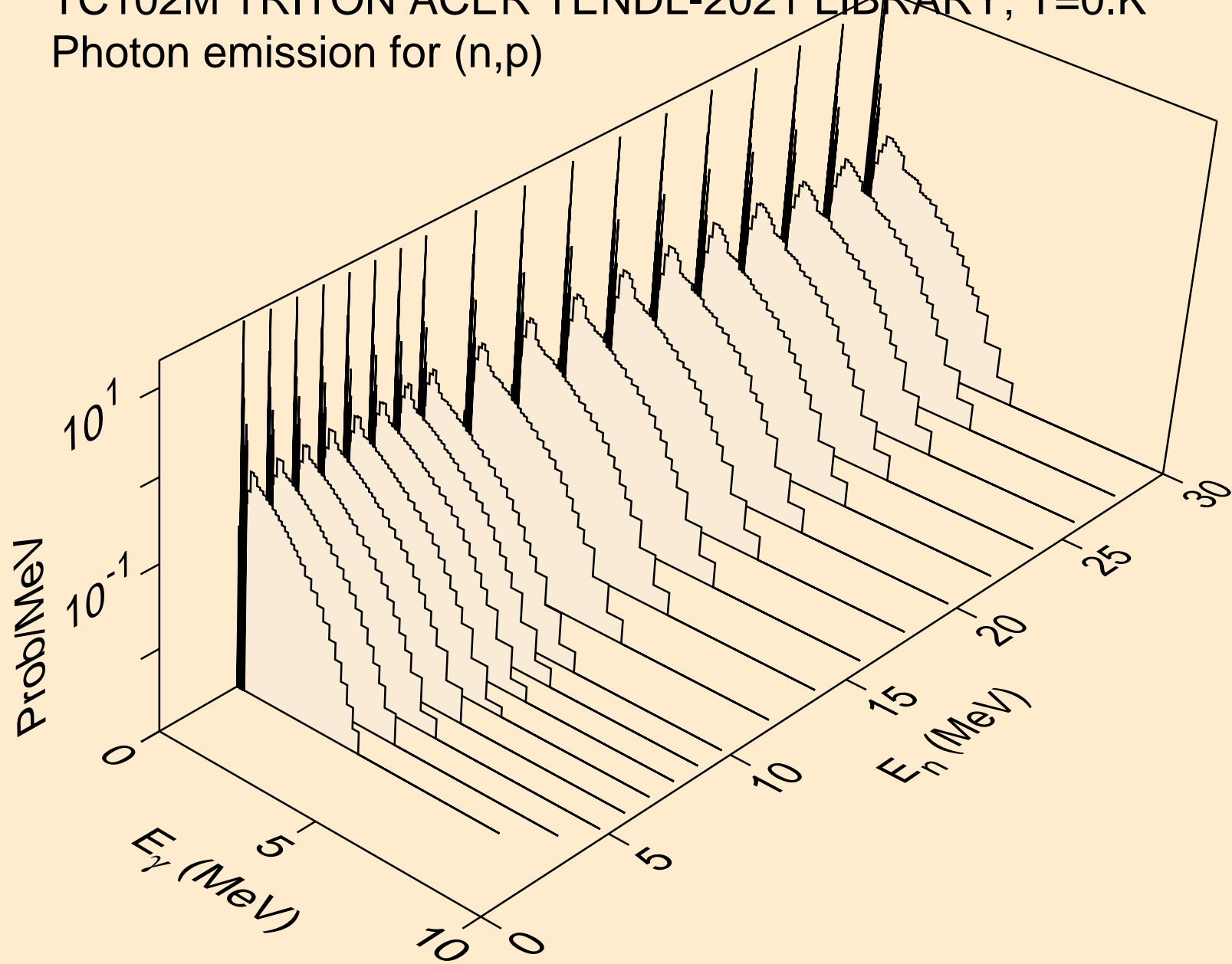

TC102M TRITON ACER TENDL-2021 LIBRARY; T=0.K  
Photon emission for (n,d)

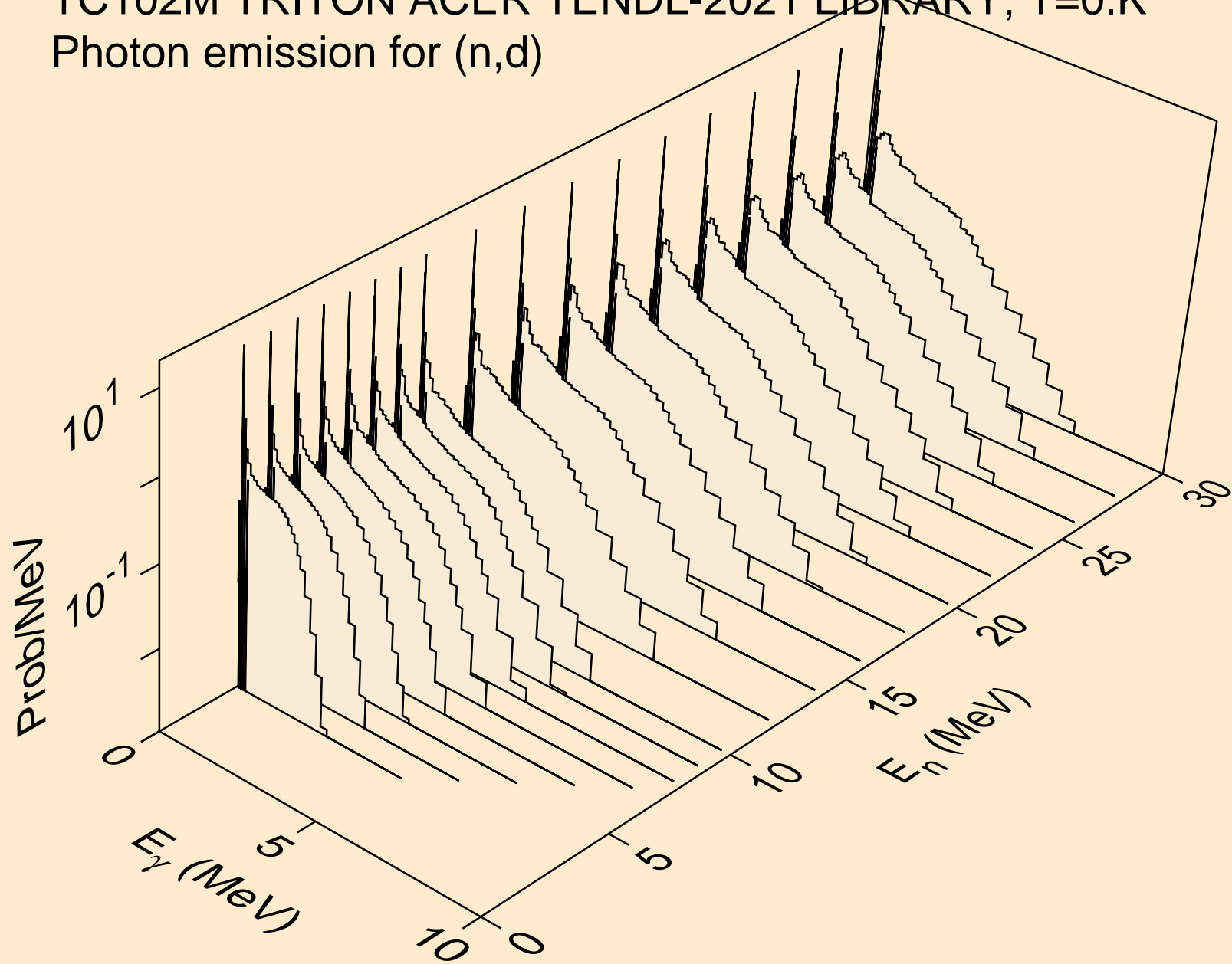

TC102M TRITON ACER TENDL-2021 LIBRARY; T=0.K  
Photon emission for inelastic

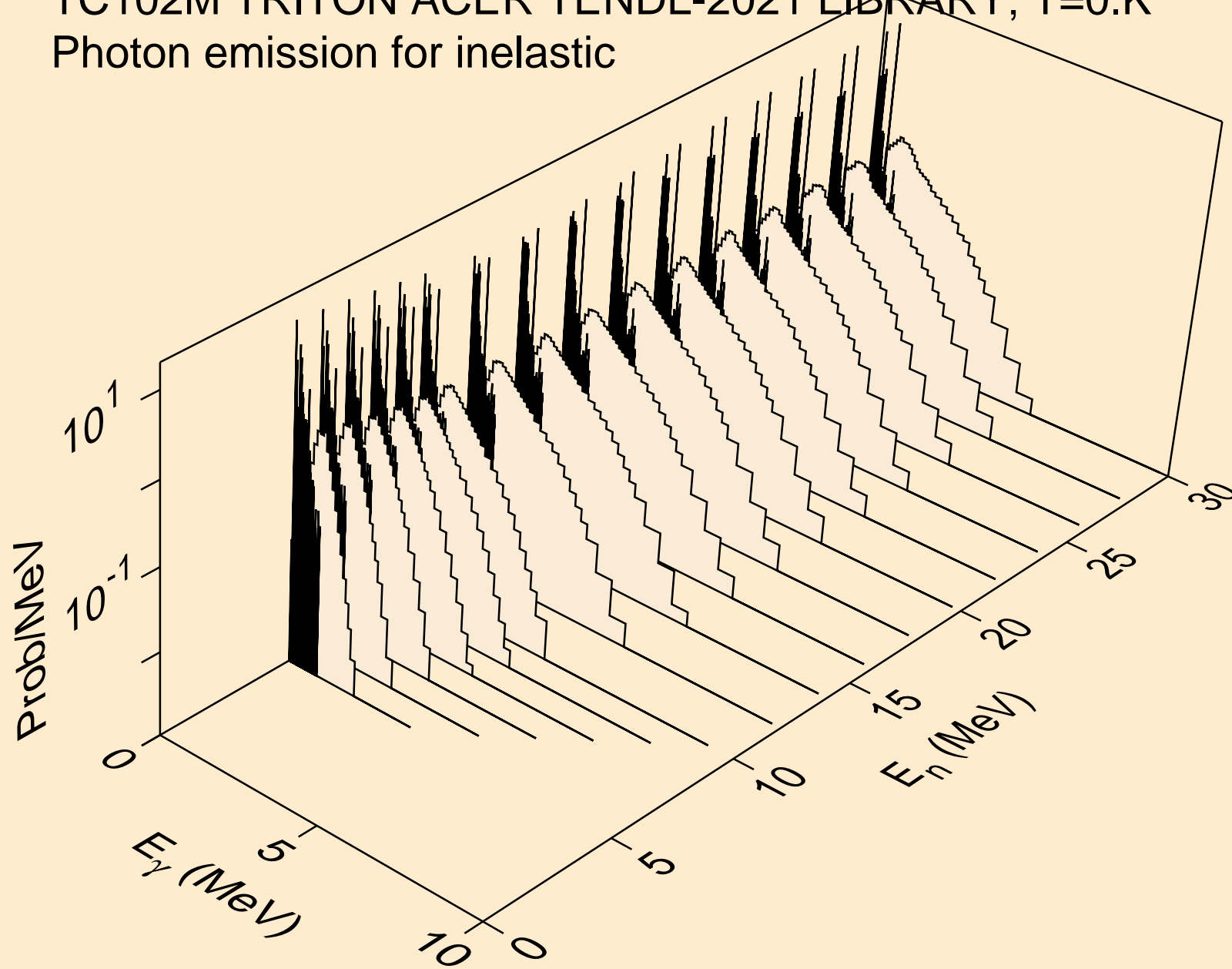

TC102M TRITON ACER TENDL-2021 LIBRARY; T=0.K  
Photon emission for (n,he3)

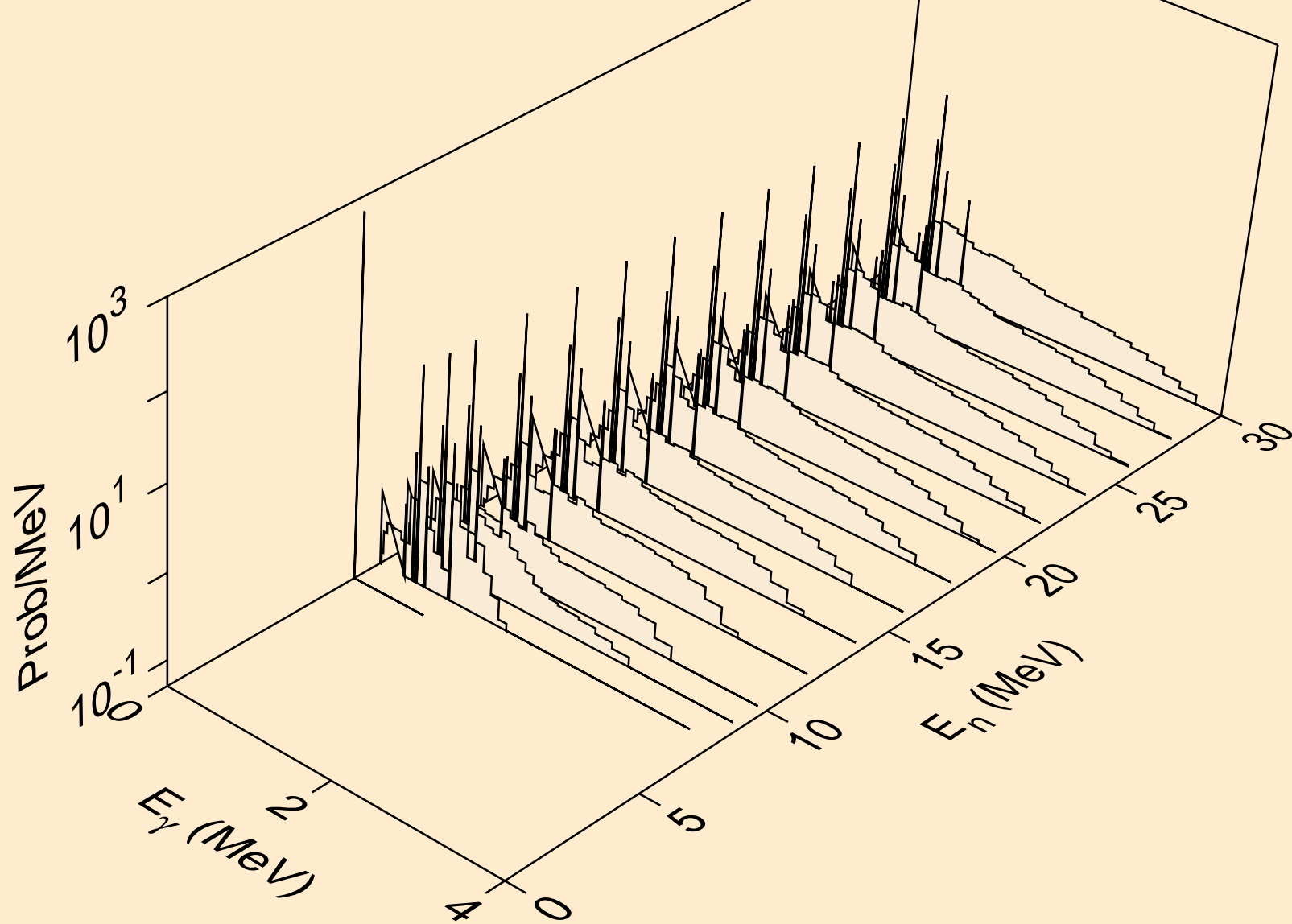

TC102M TRITON ACER TENDL-2021 LIBRARY; T=0.K  
Photon emission for (n,a)

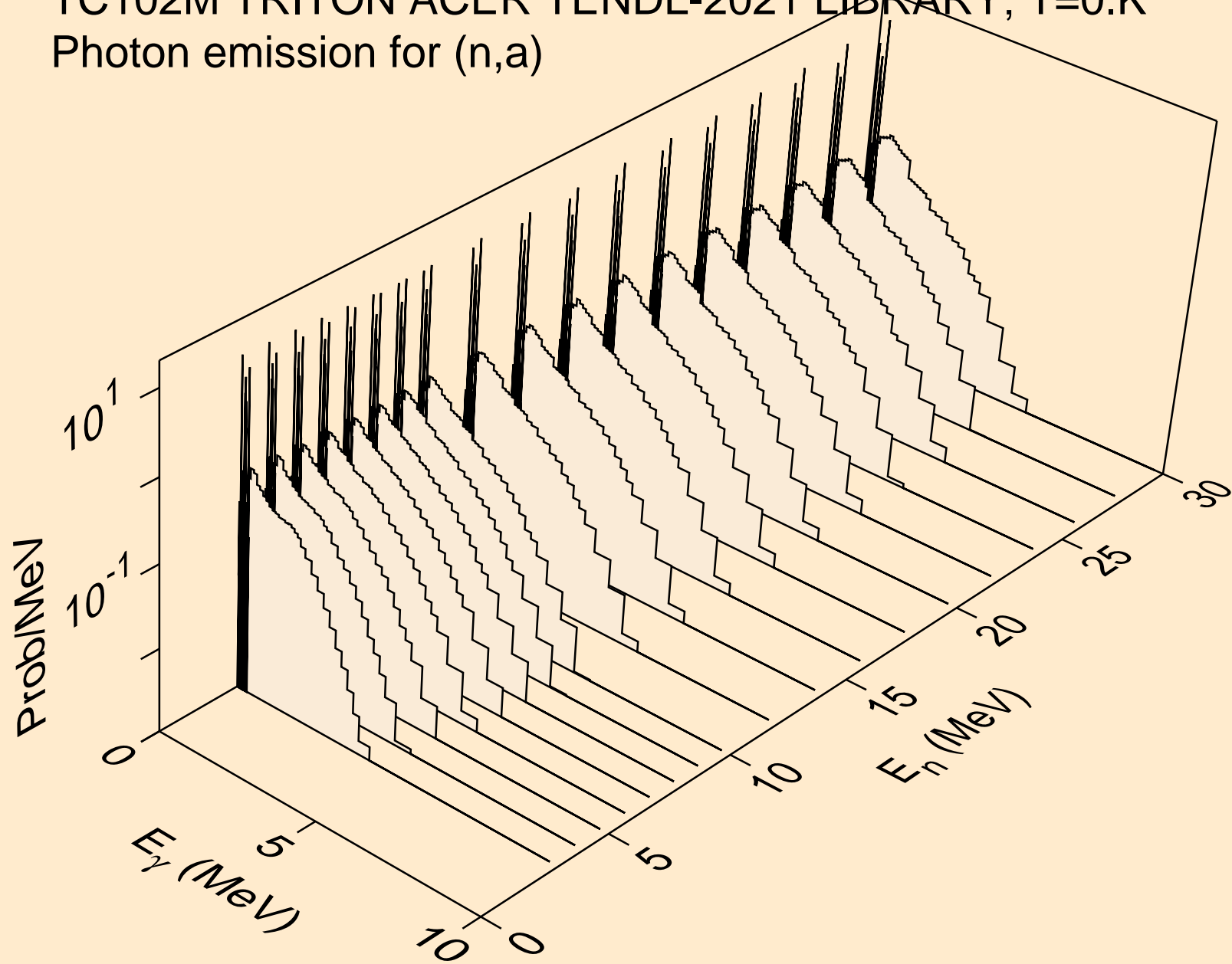

TC102M TRITON ACER TENDL-2021 LIBRARY; T=0.K  
Photon emission for (n,2a)

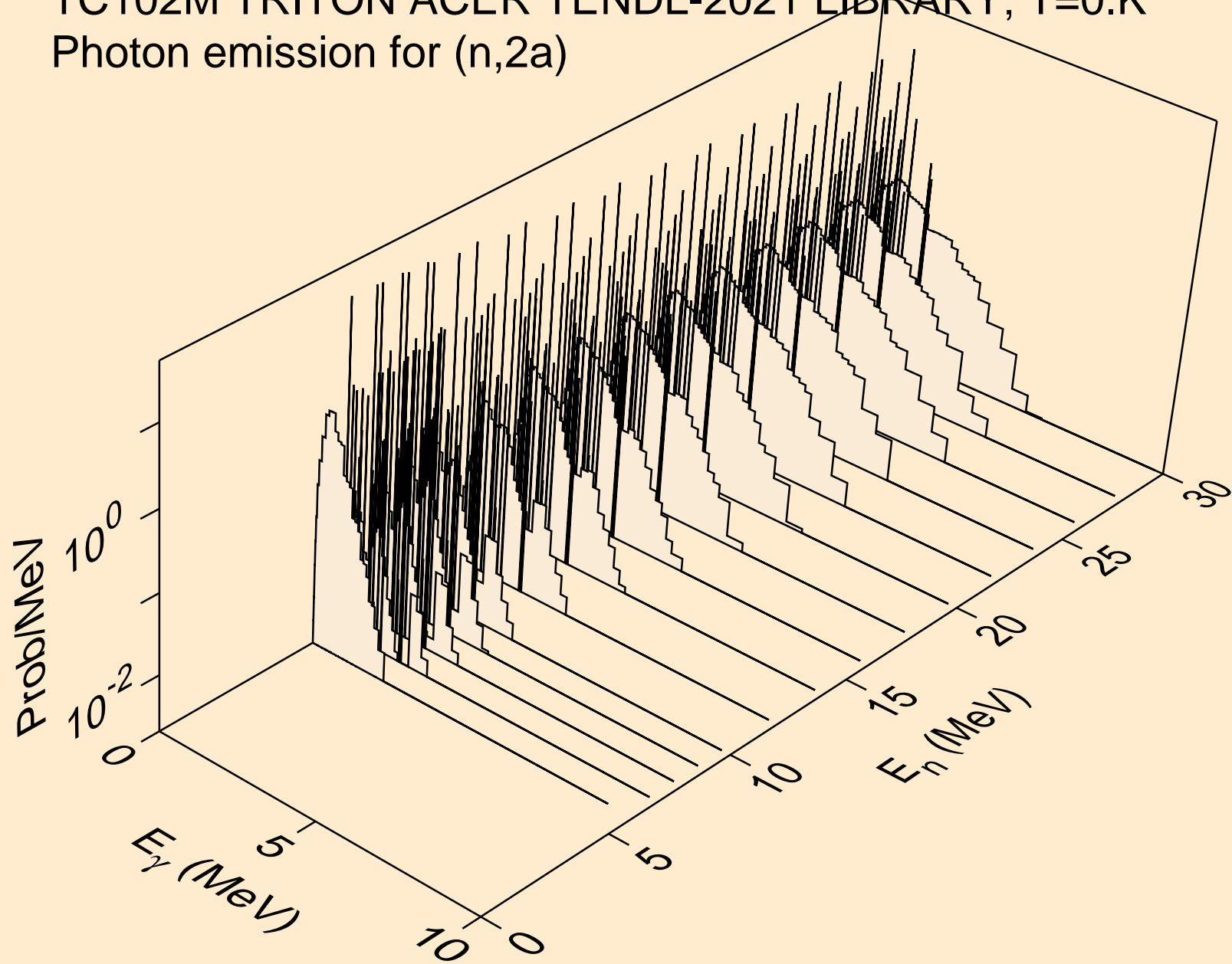

TC102M TRITON ACER TENDL-2021 LIBRARY; T=0.K  
Photon emission for (n,2p)

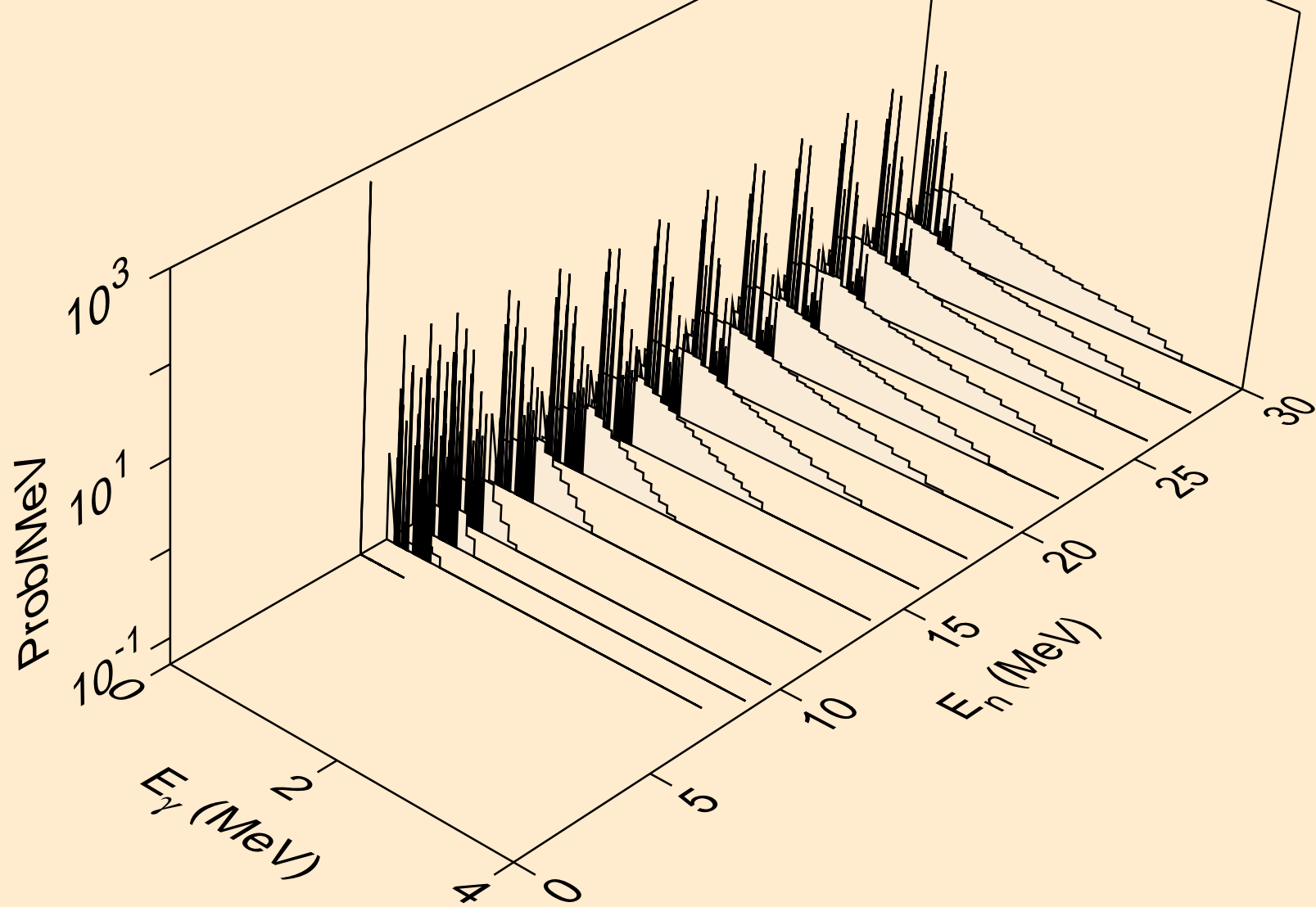



TC102M TRITON ACER TENDL-2021 LIBRARY; T=0.K  
Photon emission for (n,pa)

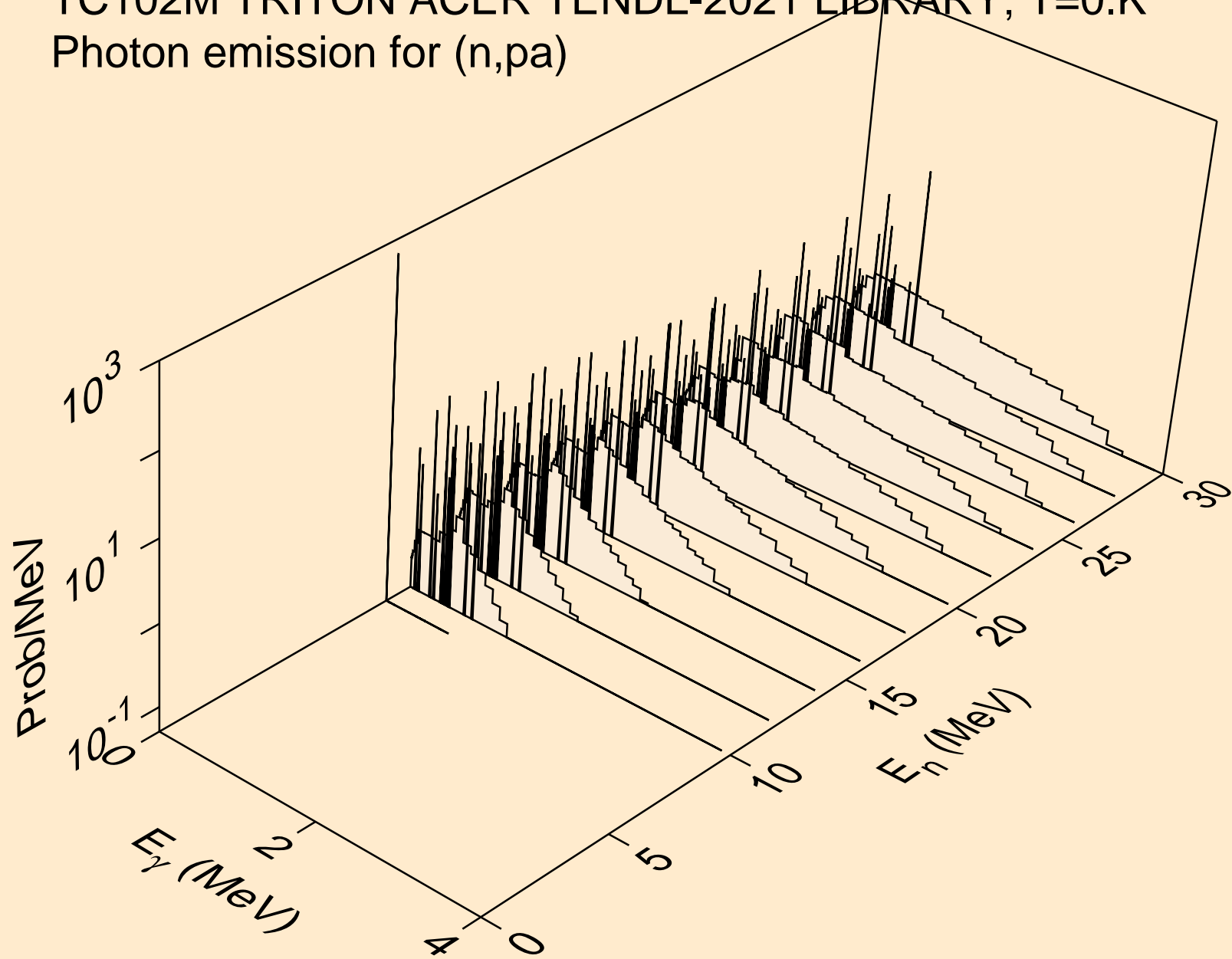

TC102M TRITON ACER TENDL-2021 LIBRARY; T=0.K  
Photon emission for (n,pd)

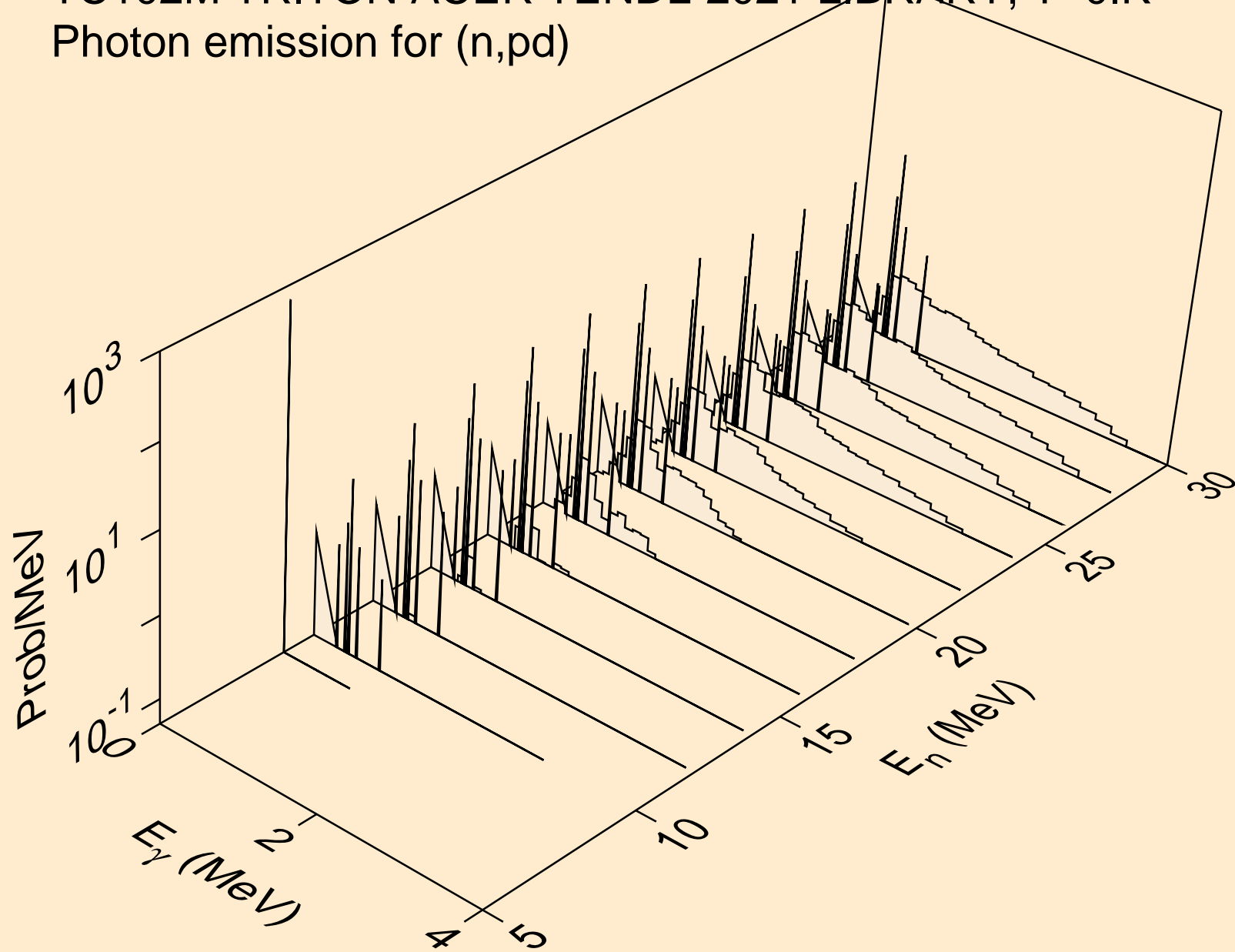

TC102M TRITON ACER TENDL-2021 LIBRARY; T=0.K  
Photon emission for (n,pt)

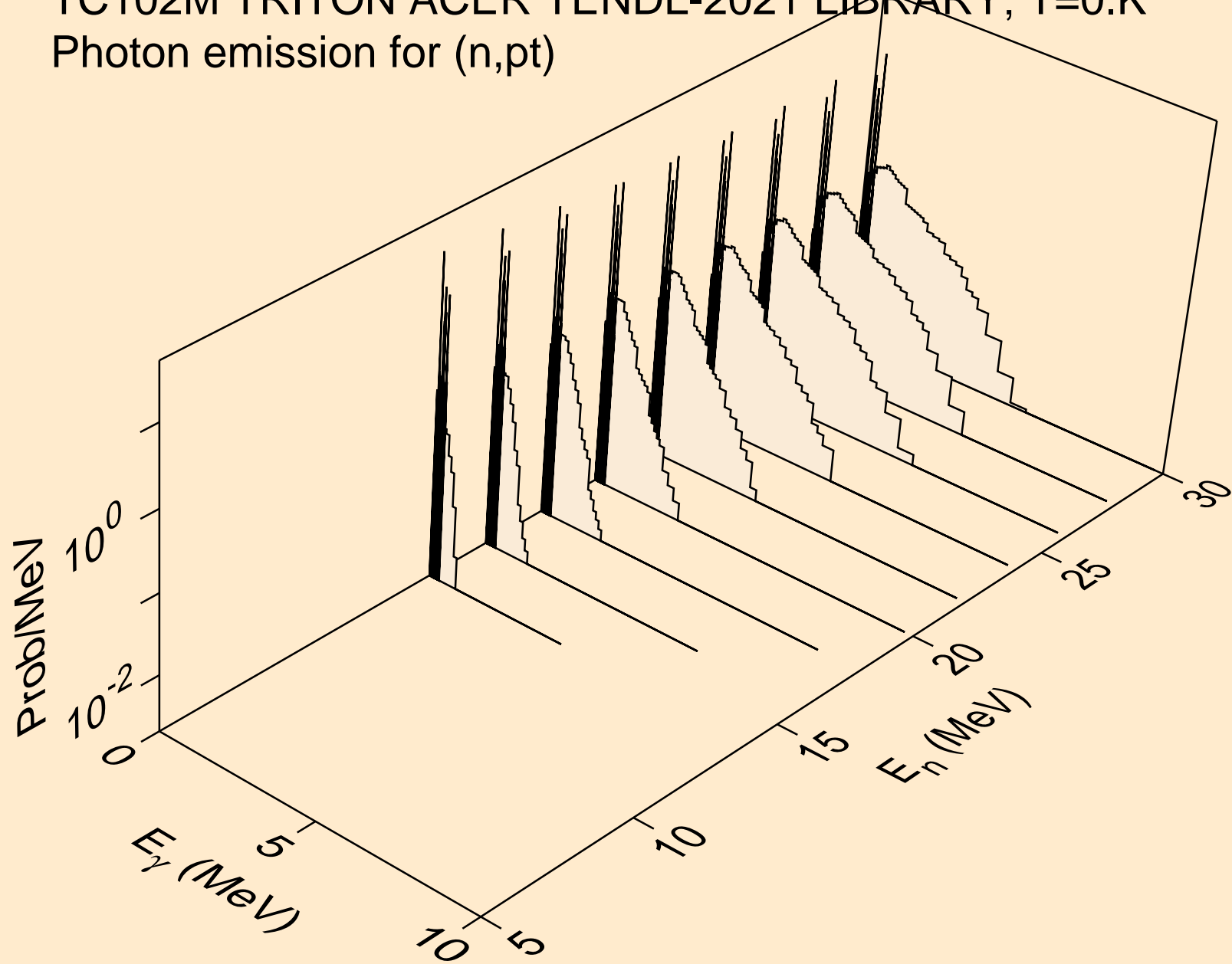

TC102M TRITON ACER TENDL-2021 LIBRARY; T=0.K  
Photon emission for (n,da)

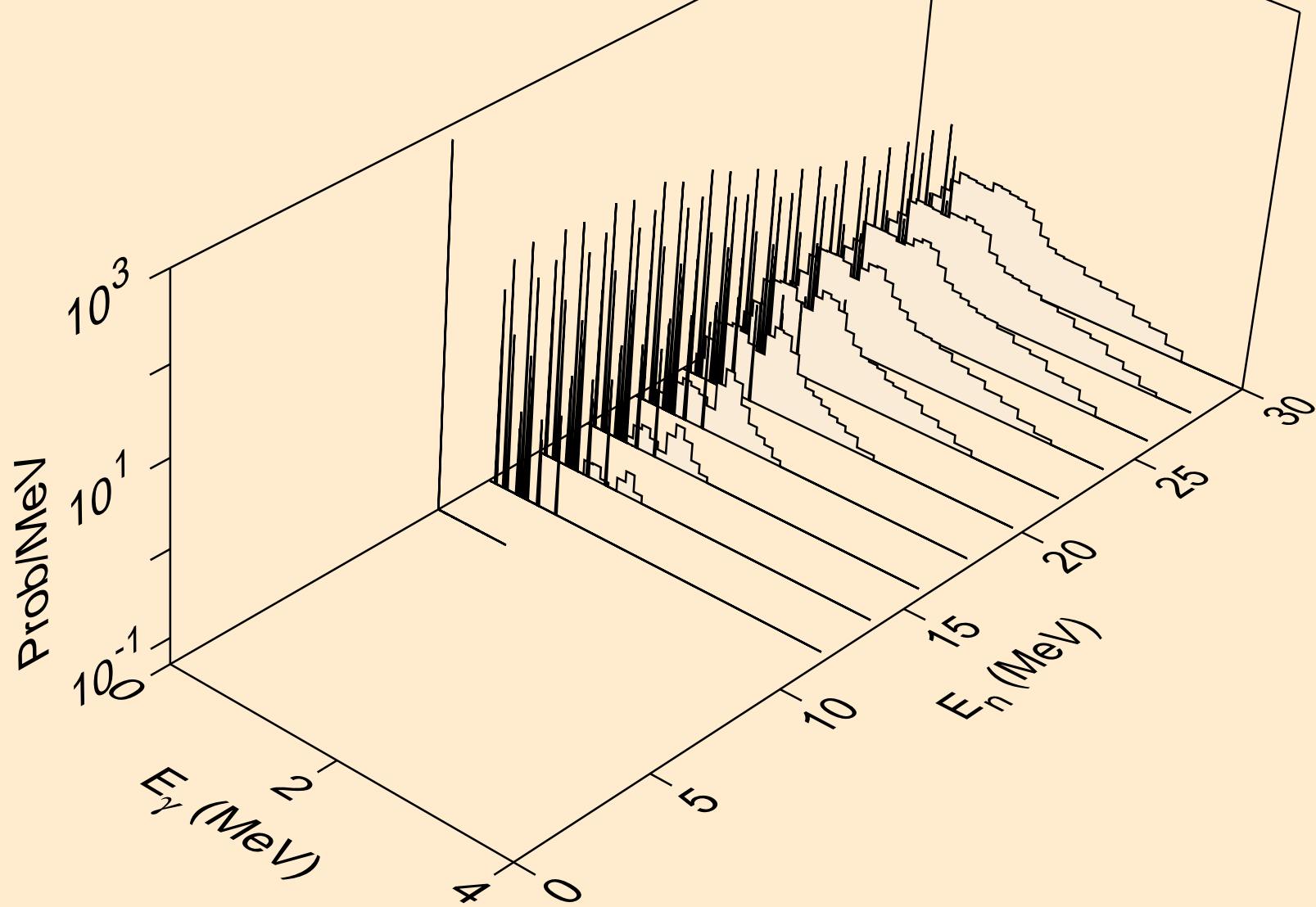

TC102M TRITON ACER TENDL-2021 LIBRARY; T=0.K  
Particle heating contributions

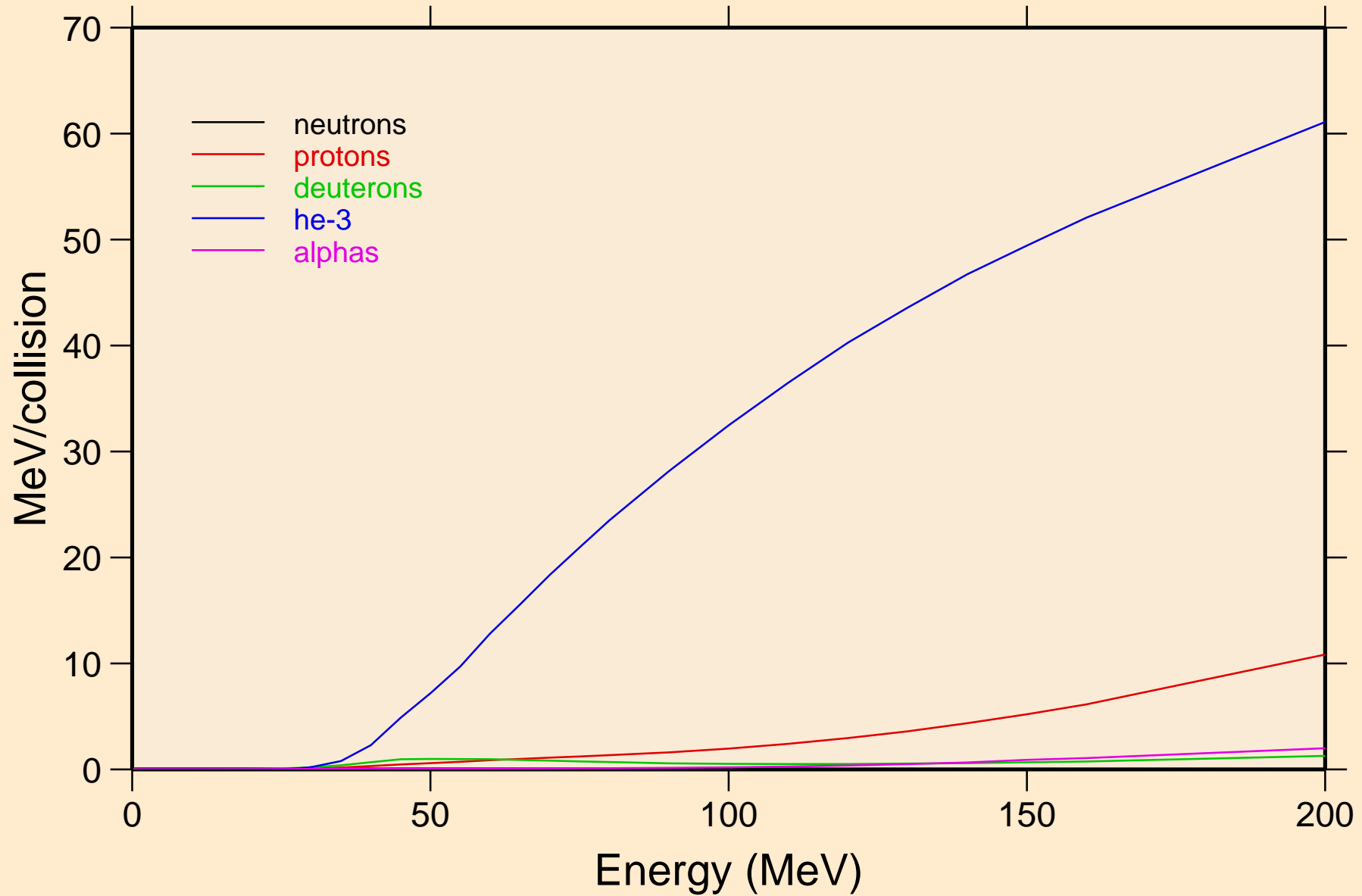

TC102M TRITON ACER TENDL-2021 LIBRARY; T=0.K  
Recoil Heating

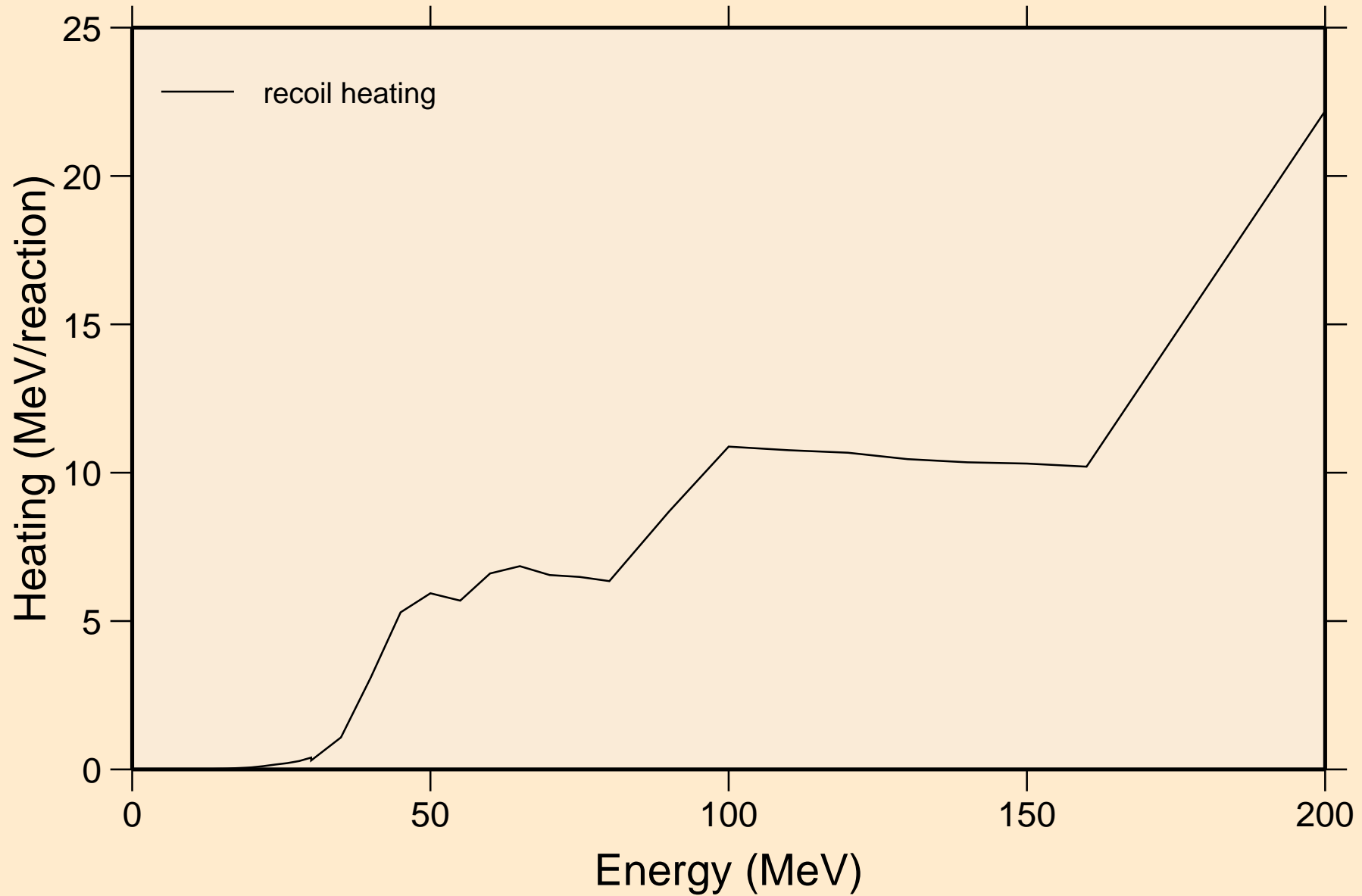

TC102M TRITON ACER TENDL-2021 LIBRARY; T=0.K  
Particle production cross sections

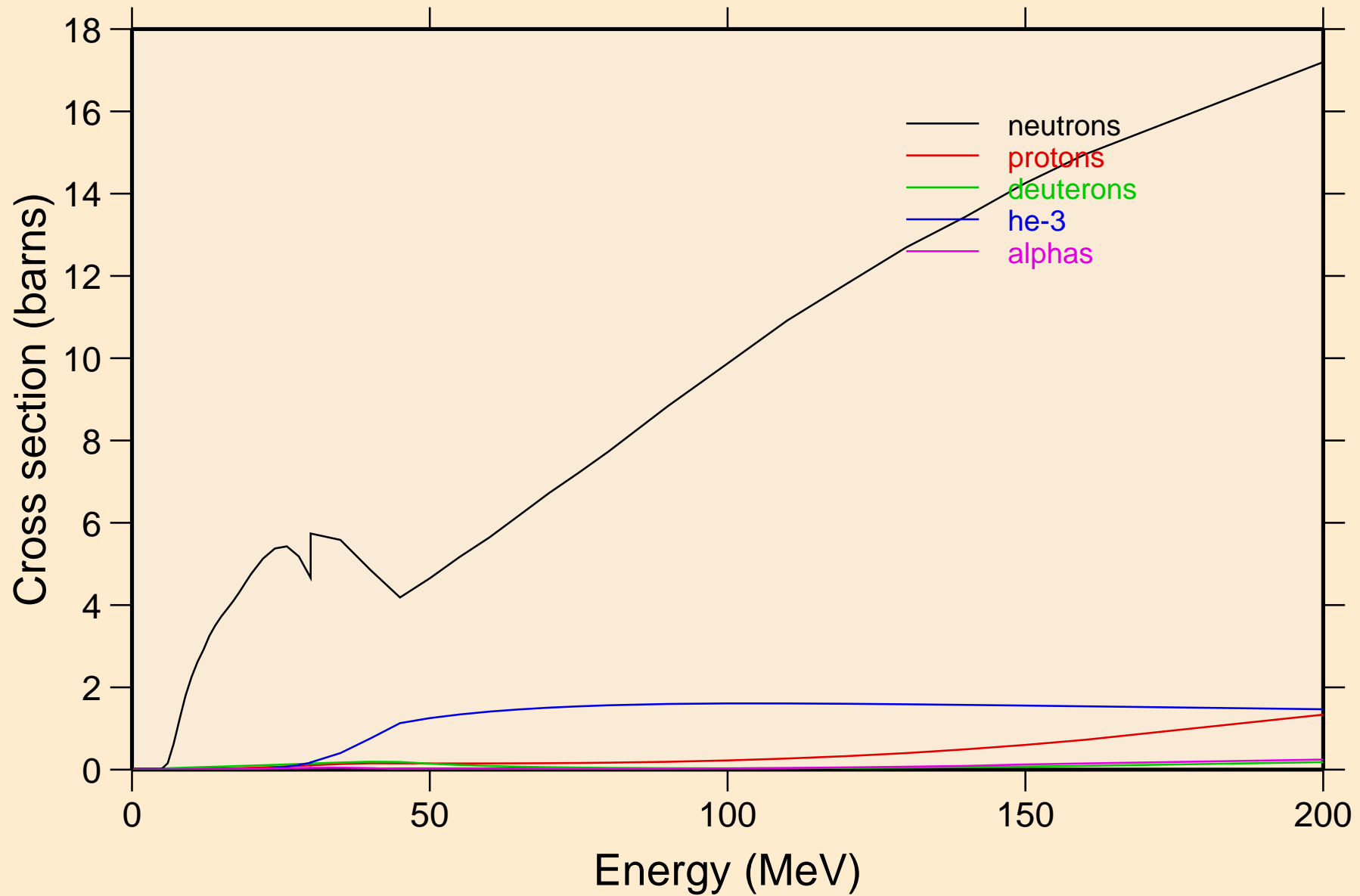

TC102M TRITON ACER TENDL-2021 LIBRARY; T=0.K  
neutrons from (t,n)

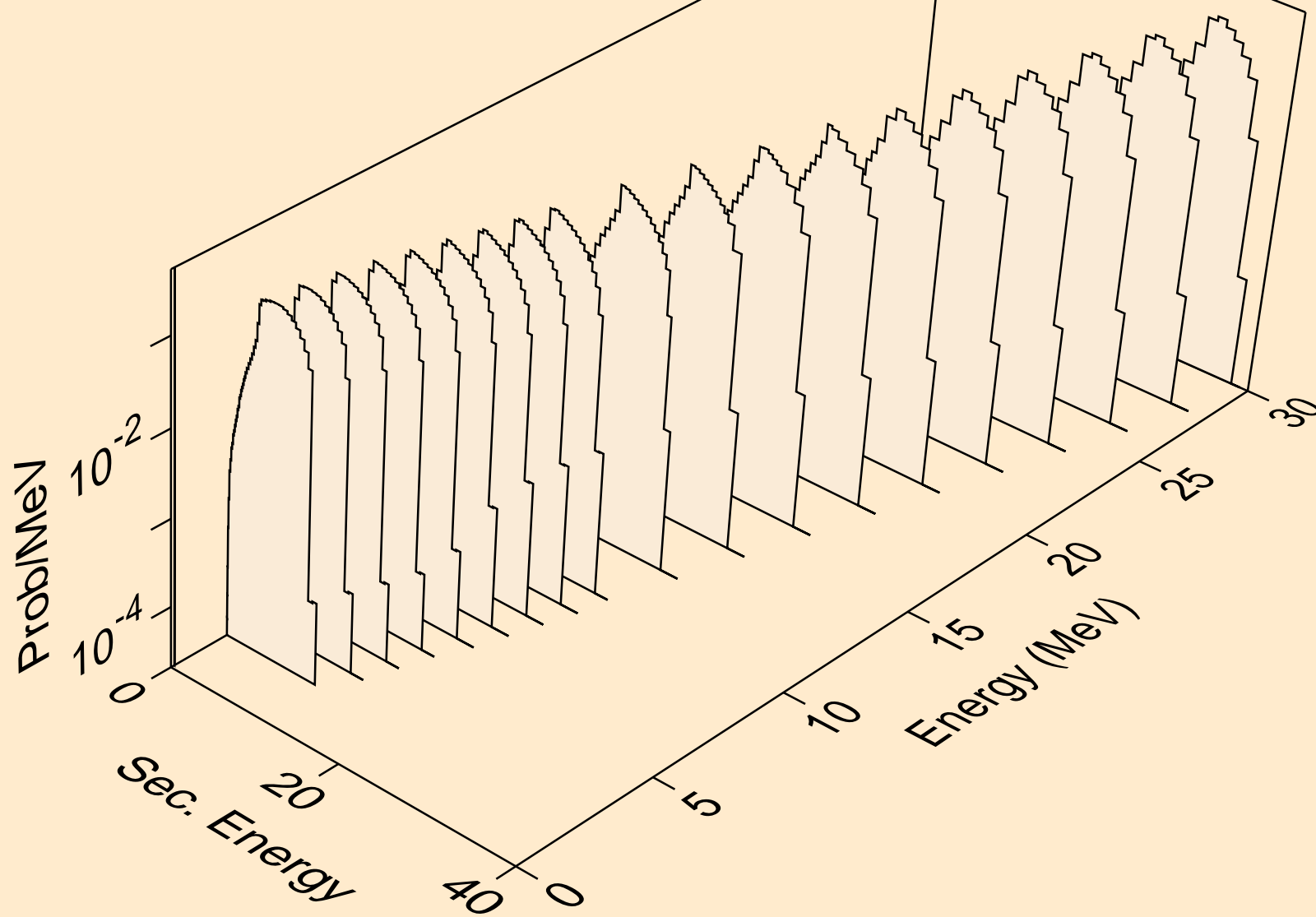



TC102M TRITON ACER TENDL-2021 LIBRARY; T=0.K  
neutrons from (t,x)

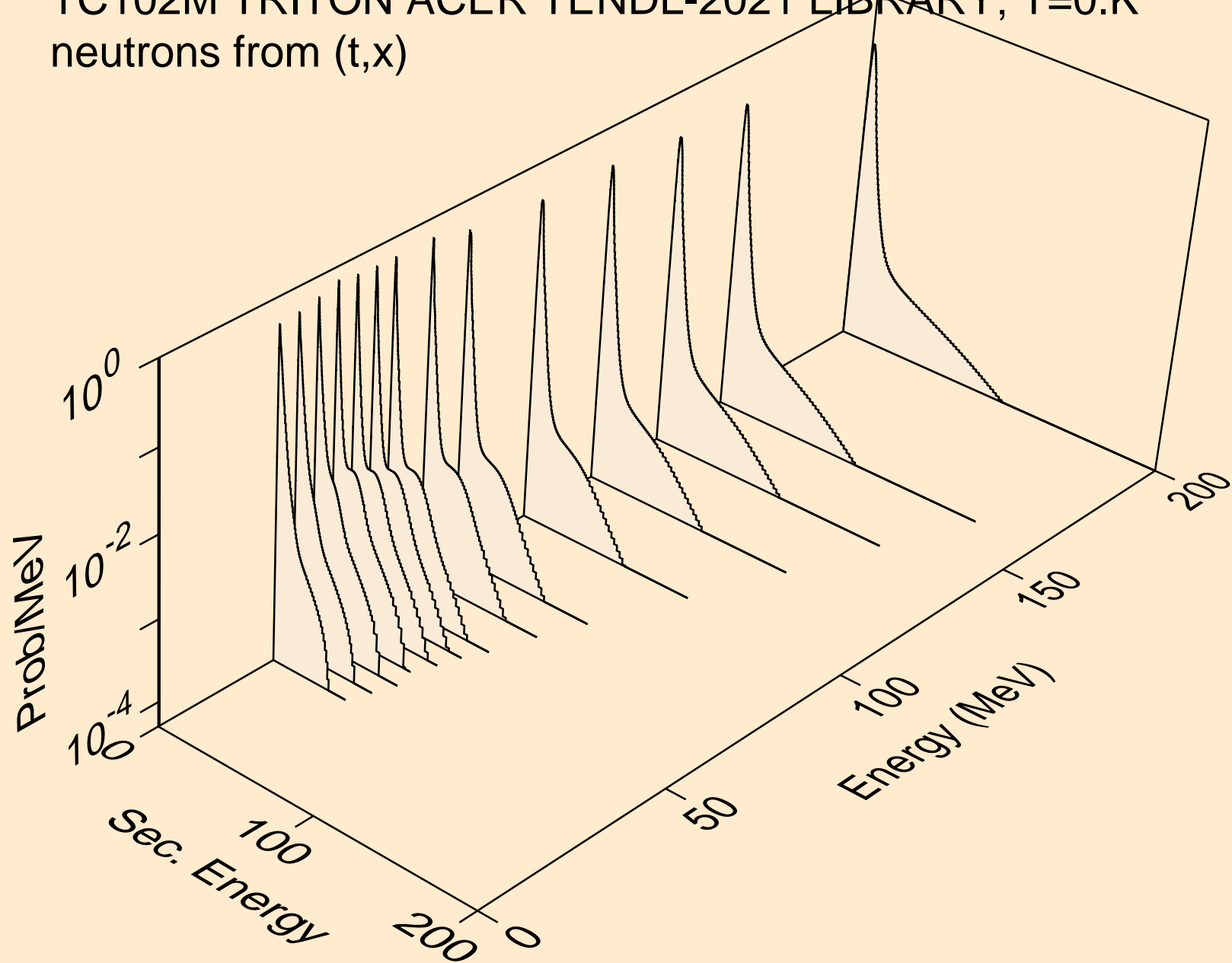

TC102M TRITON ACER TENDL-2021 LIBRARY; T=0.K  
neutrons from (t,2nd)

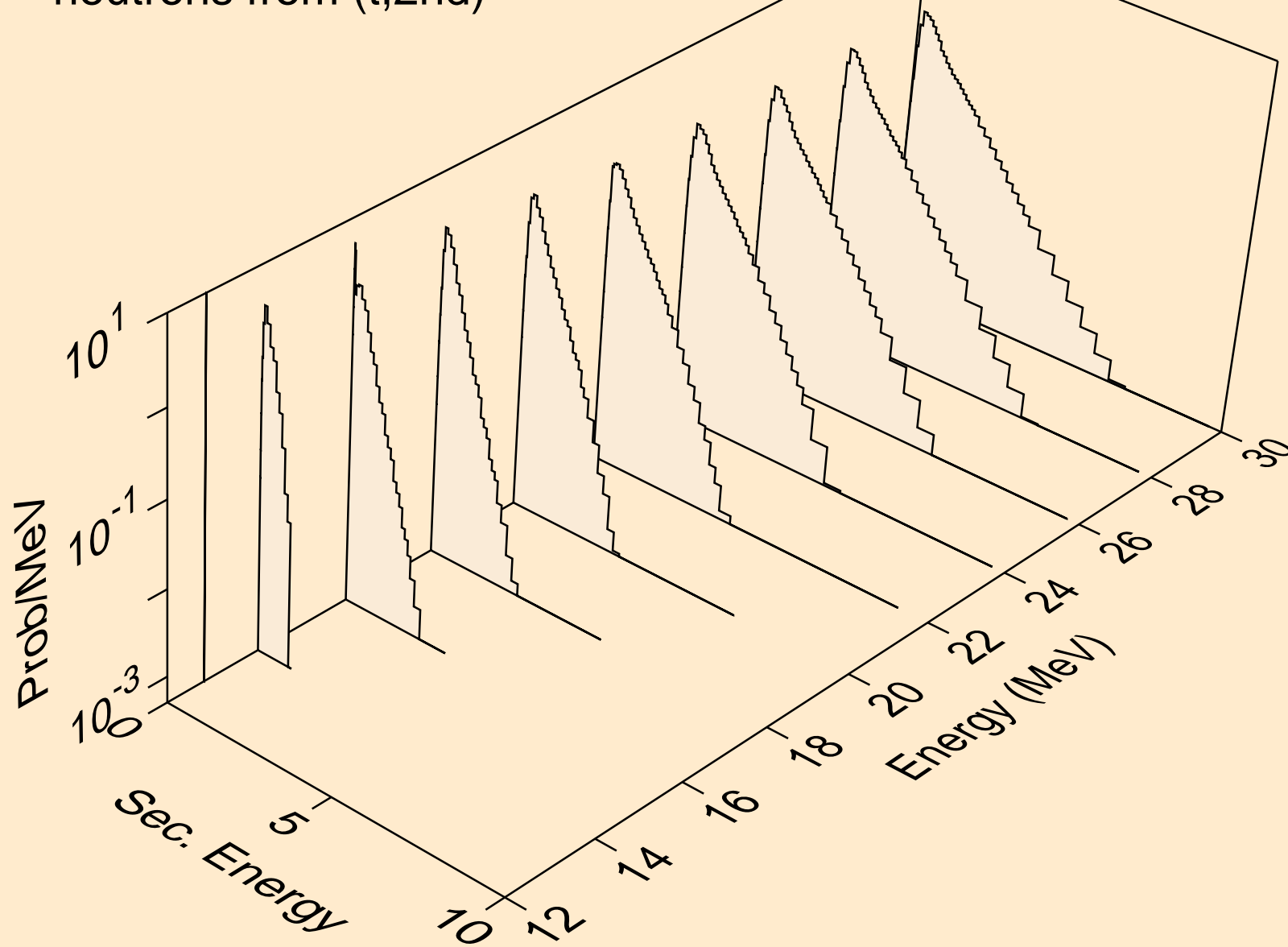

TC102M TRITON ACER TENDL-2021 LIBRARY; T=0.K  
neutrons from (t,2n)

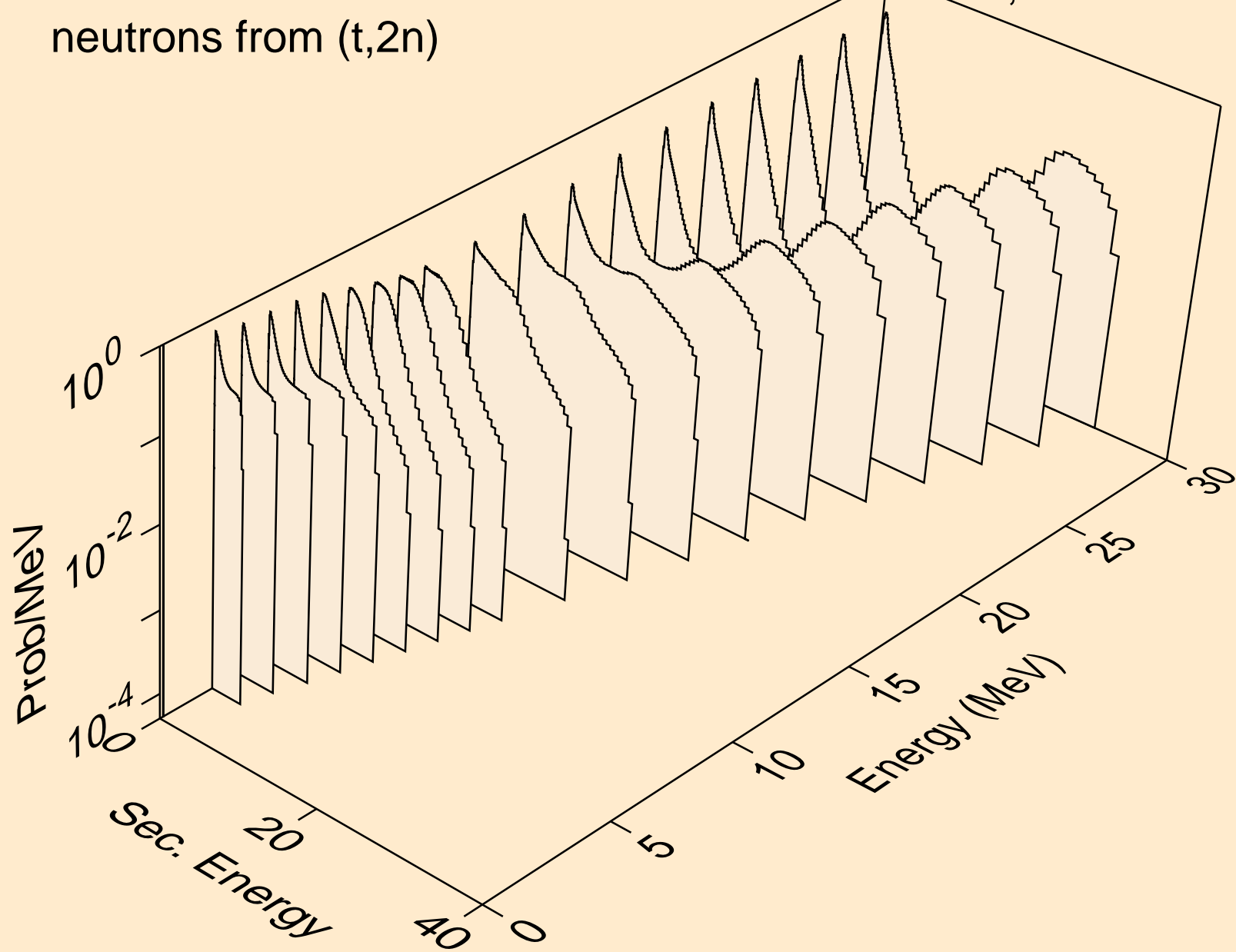

TC102M TRITON ACER TENDL-2021 LIBRARY; T=0.K  
neutrons from (t,3n)

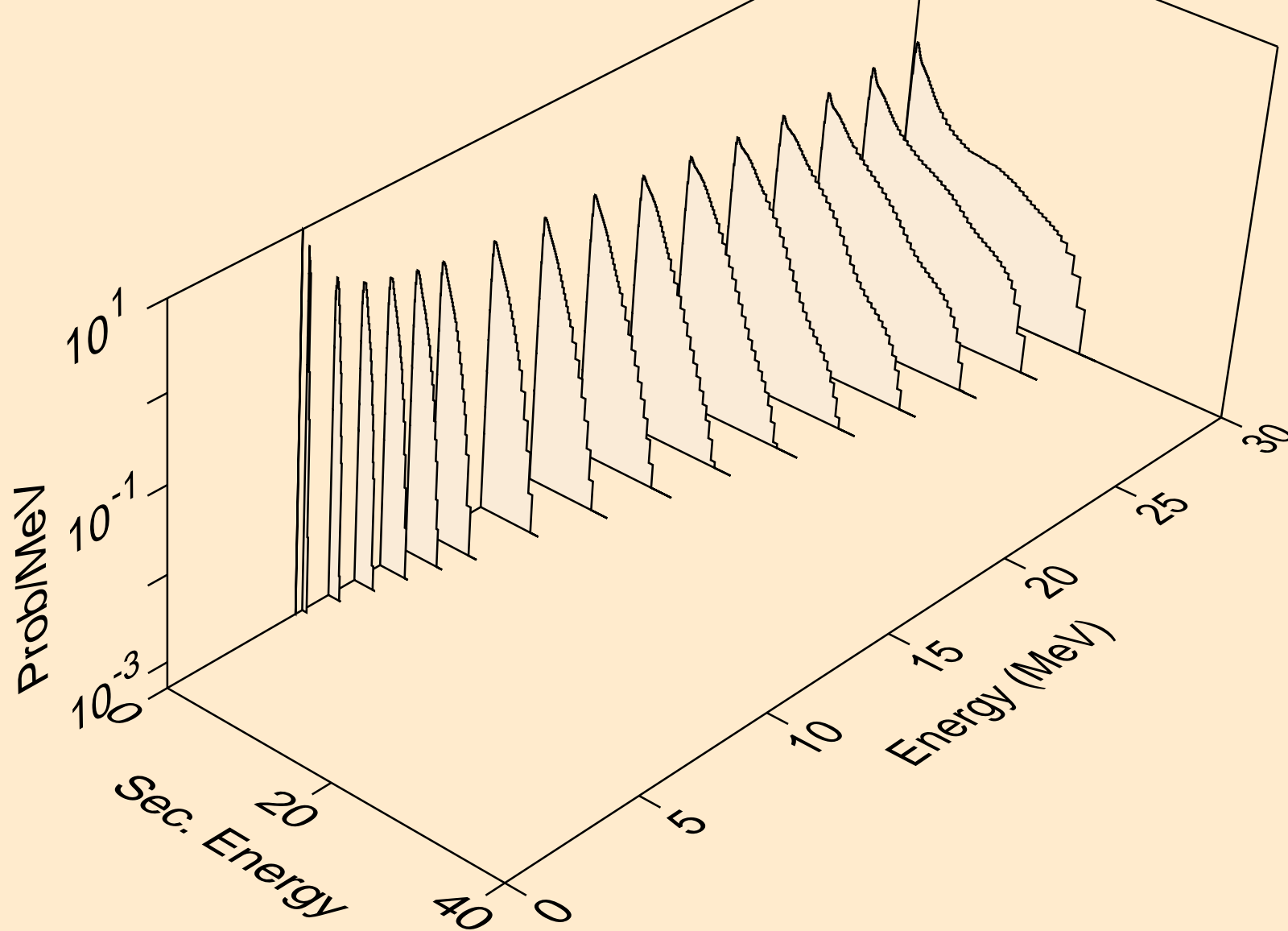

TC102M TRITON ACER TENDL-2021 LIBRARY; T=0.K  
neutrons from (t,n\*)a

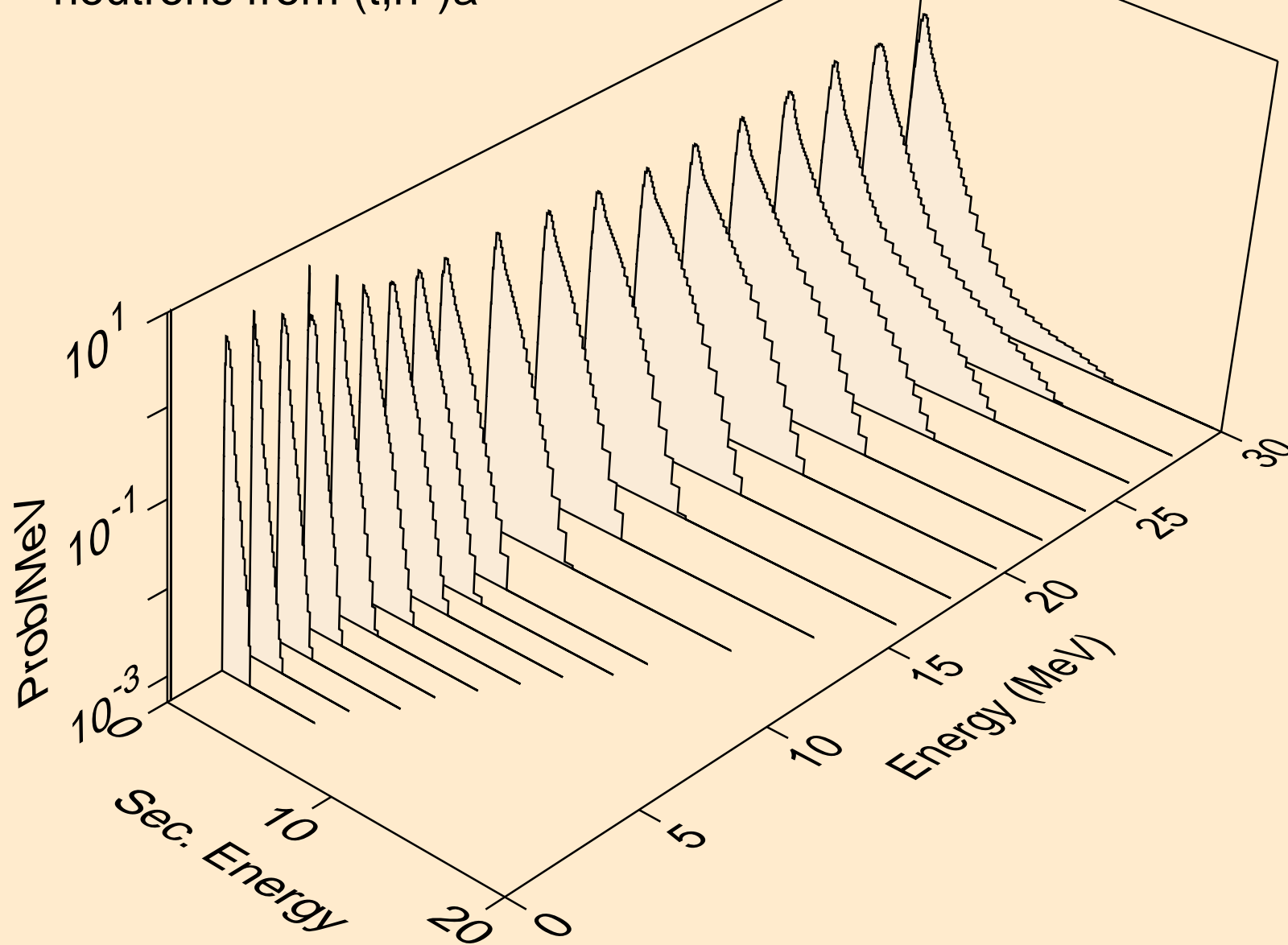

TC102M TRITON ACER TENDL-2021 LIBRARY; T=0.K  
neutrons from (t,2n)a

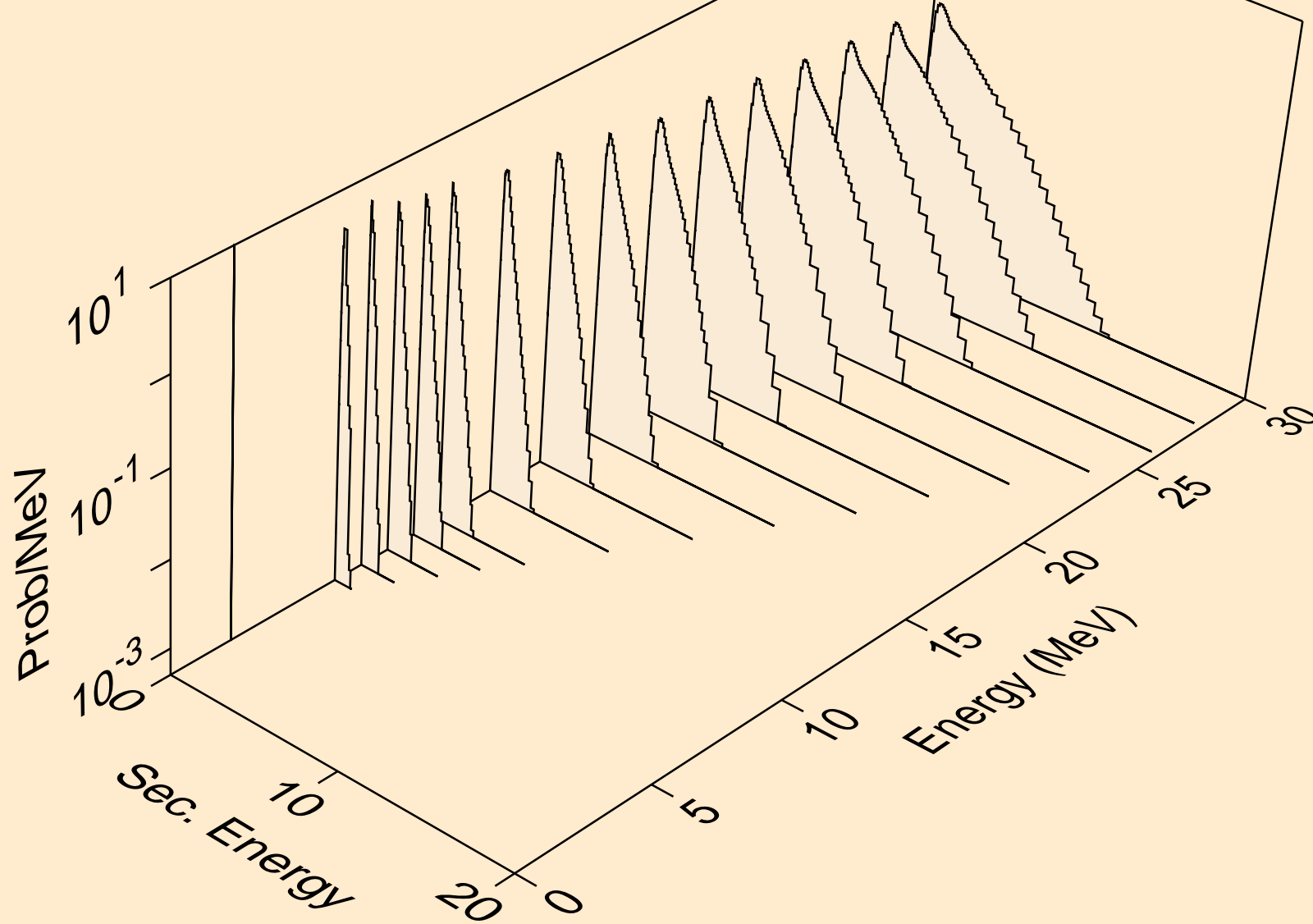

TC102M TRITON ACER TENDL-2021 LIBRARY; T=0.K  
neutrons from (t,3n)a

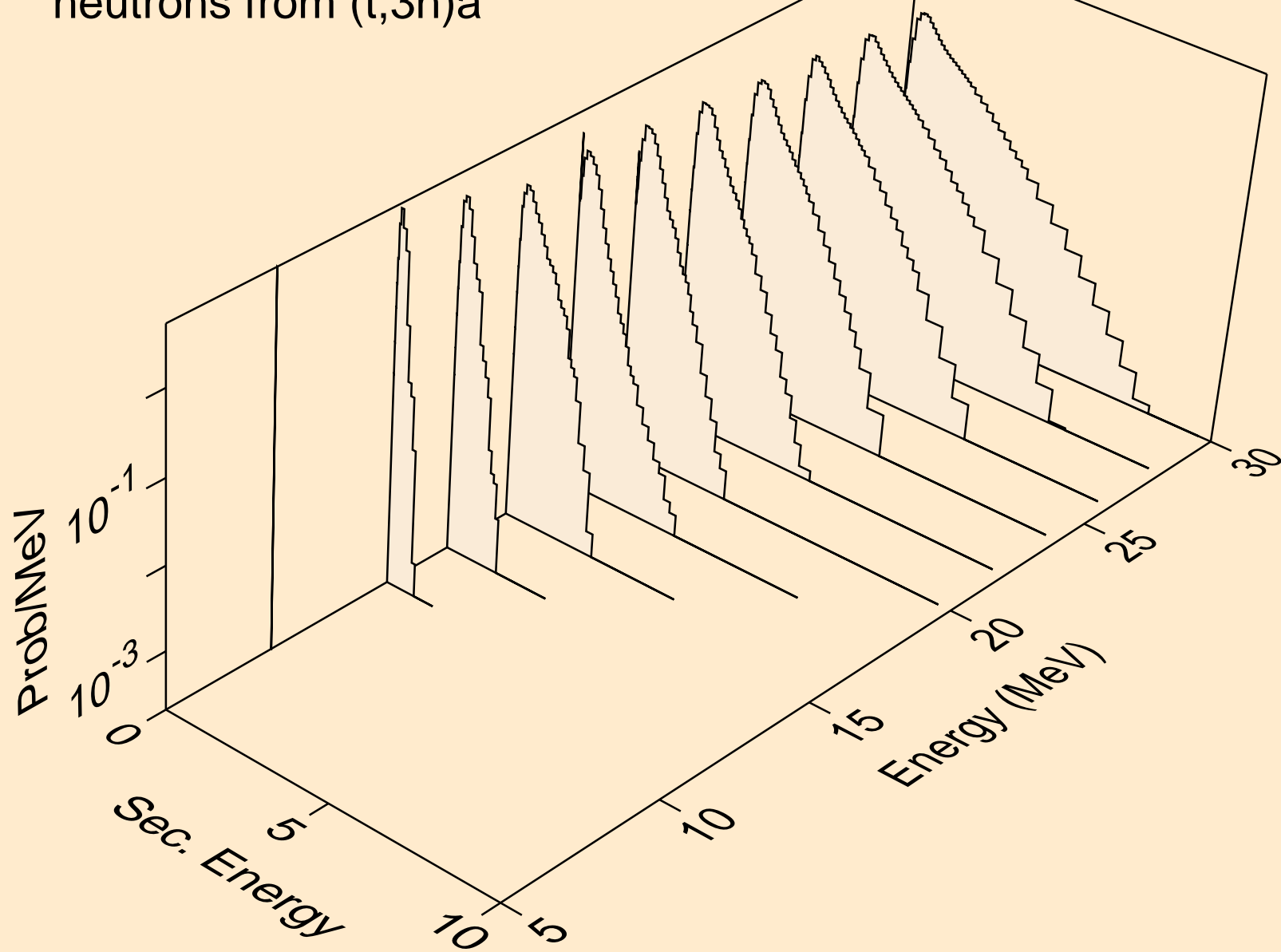

TC102M TRITON ACER TENDL-2021 LIBRARY; T=0.K  
neutrons from (t,n\*)p

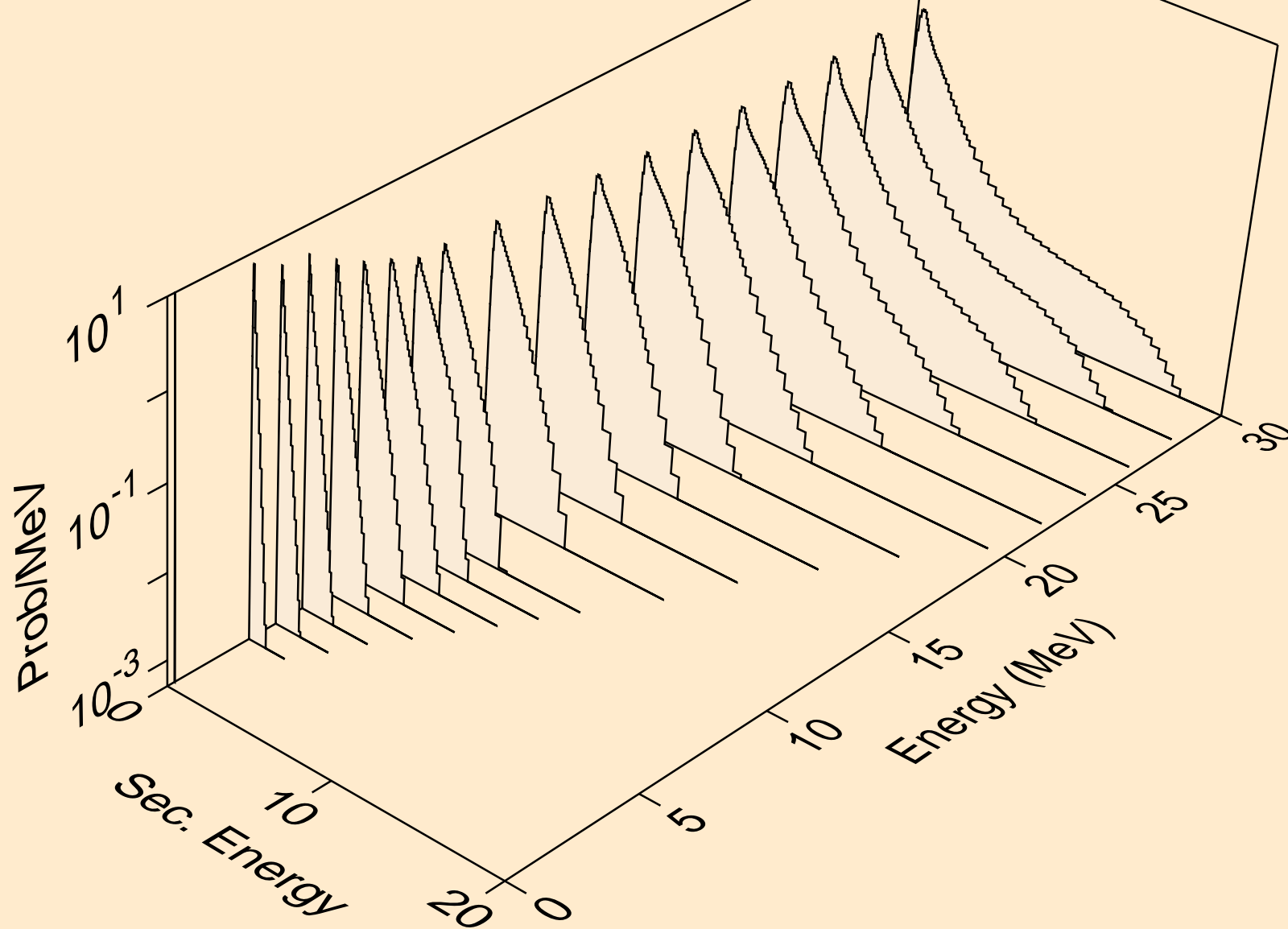



TC102M TRITON ACER TENDL-2021 LIBRARY; T=0.K  
neutrons from (t,n\*)2a

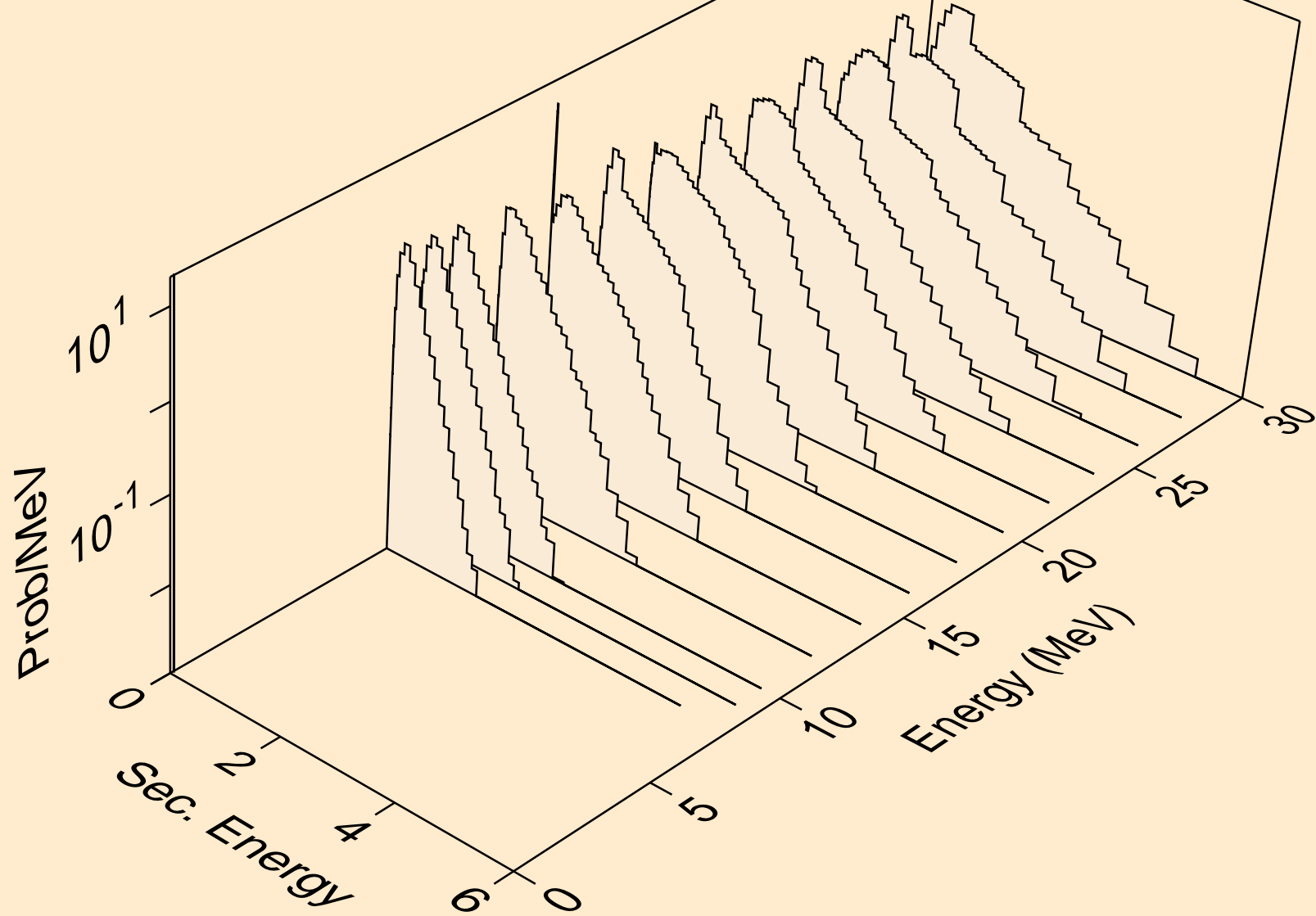

TC102M TRITON ACER TENDL-2021 LIBRARY; T=0.K  
neutrons from (t,2n)2a

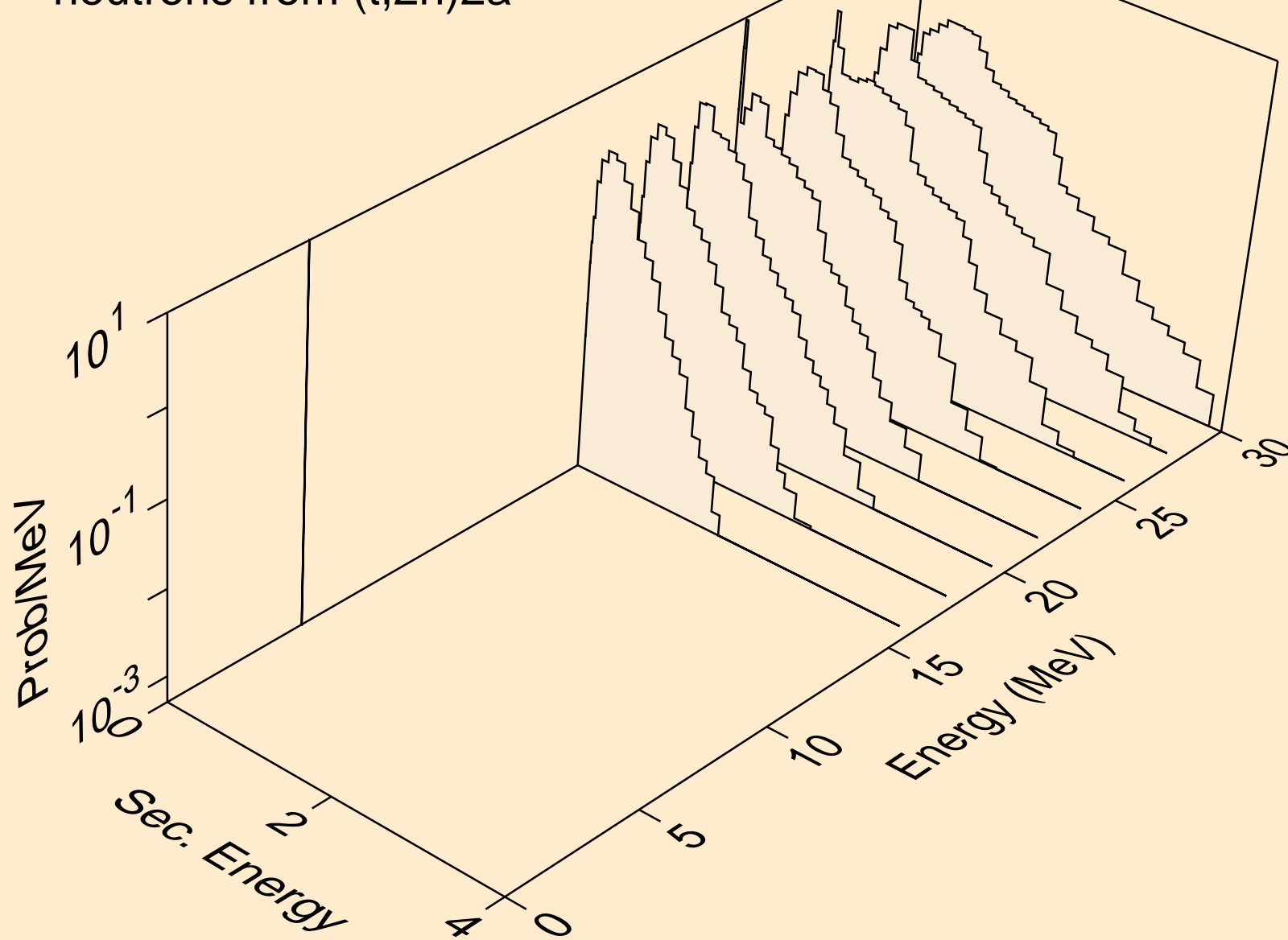

TC102M TRITON ACER TENDL-2021 LIBRARY; T=0.K  
neutrons from (t,n\*)d

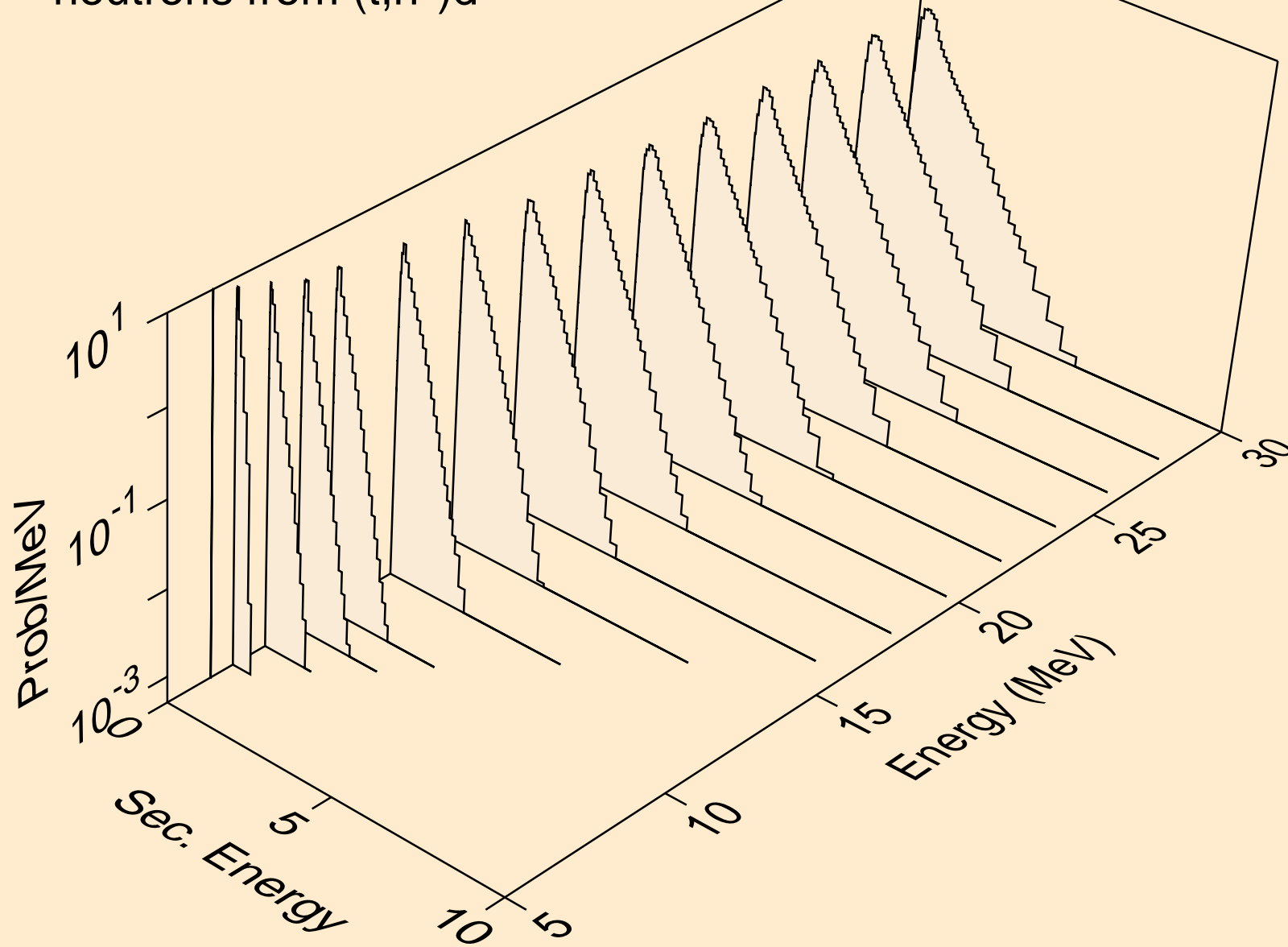

TC102M TRITON ACER TENDL-2021 LIBRARY; T=0.K  
neutrons from (t,n\*)t

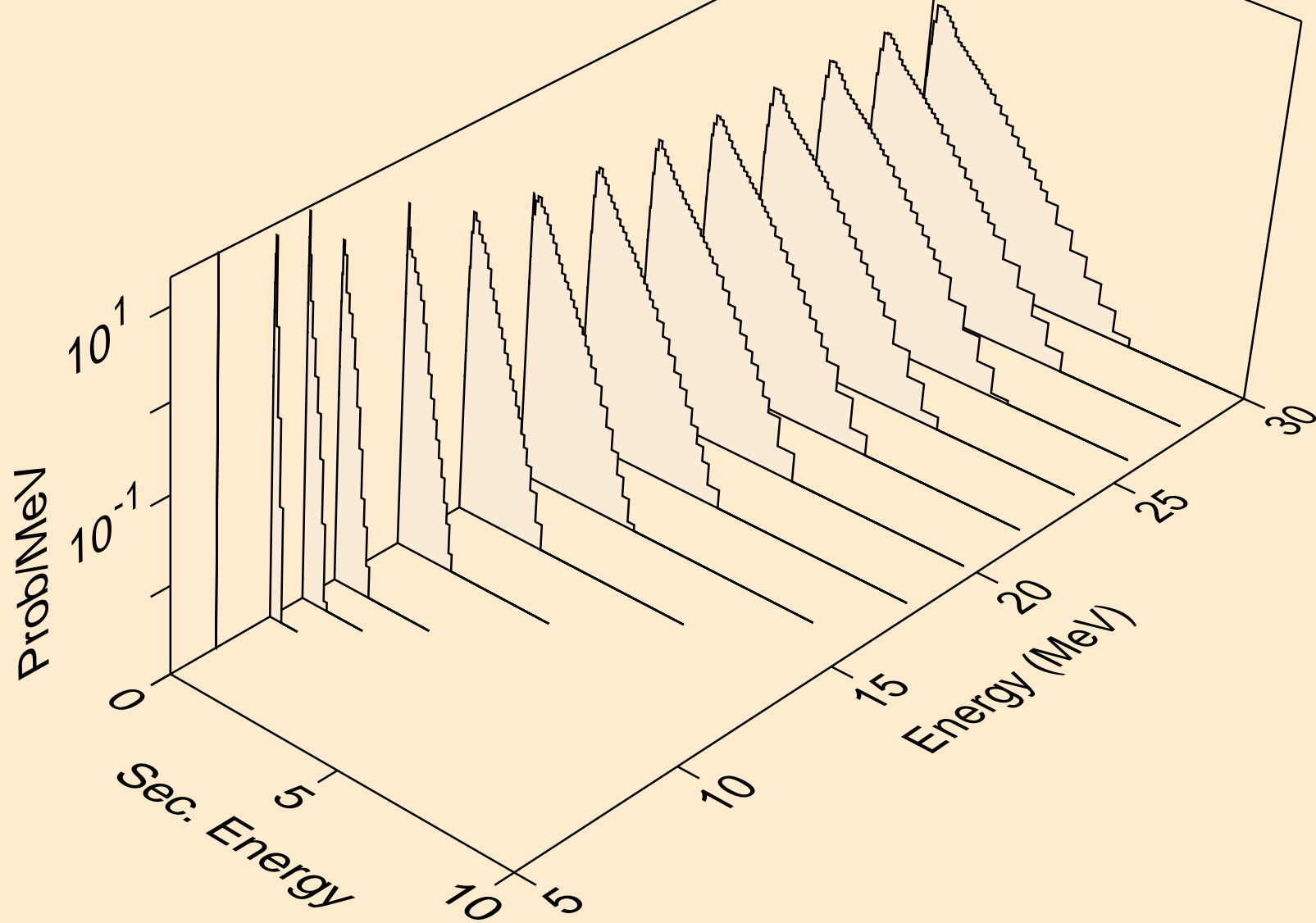

TC102M TRITON ACER TENDL-2021 LIBRARY; T=0.K  
neutrons from (t,n\*)he3

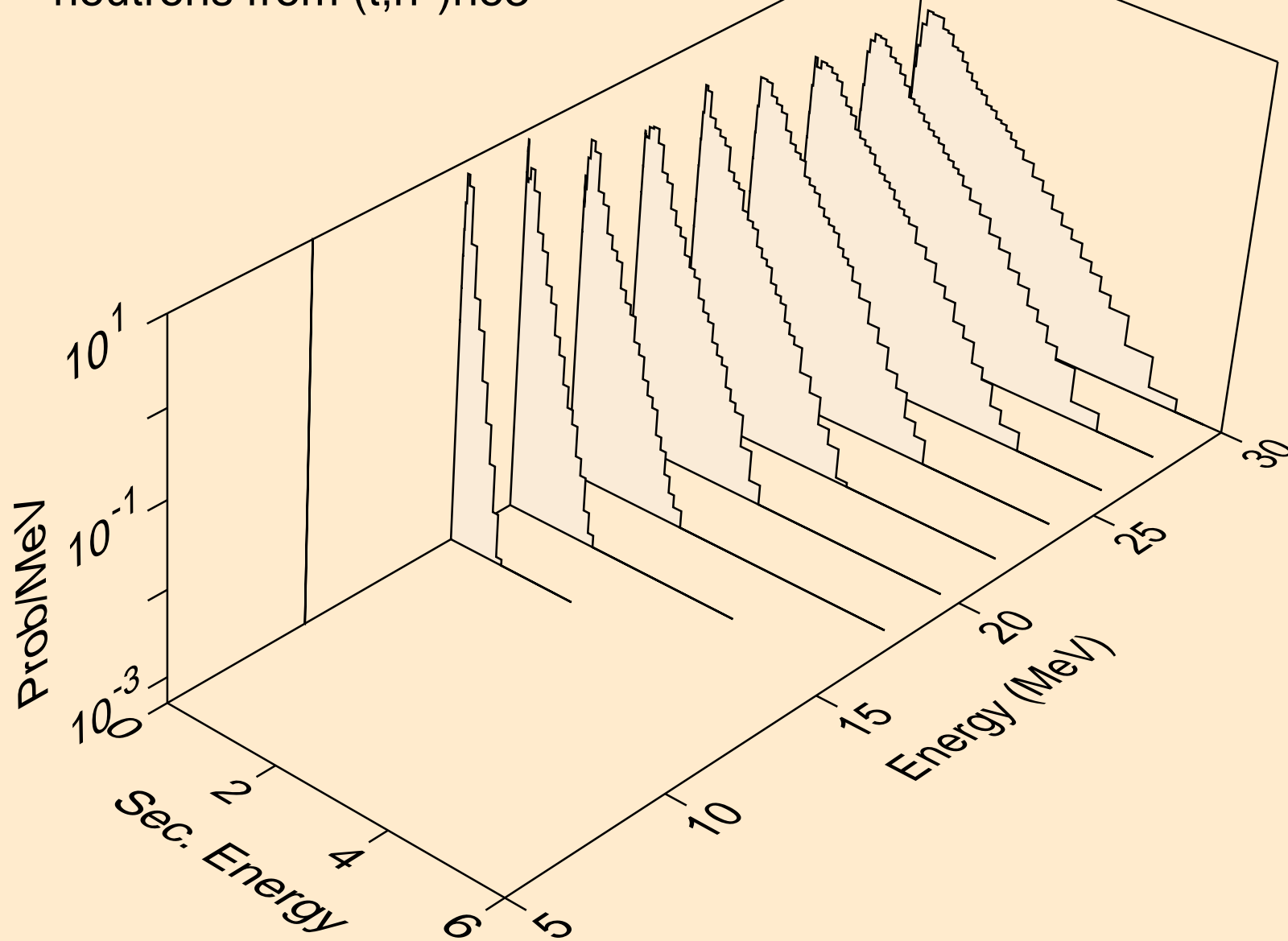

TC102M TRITON ACER TENDL-2021 LIBRARY; T=0.K  
neutrons from (t,4n)

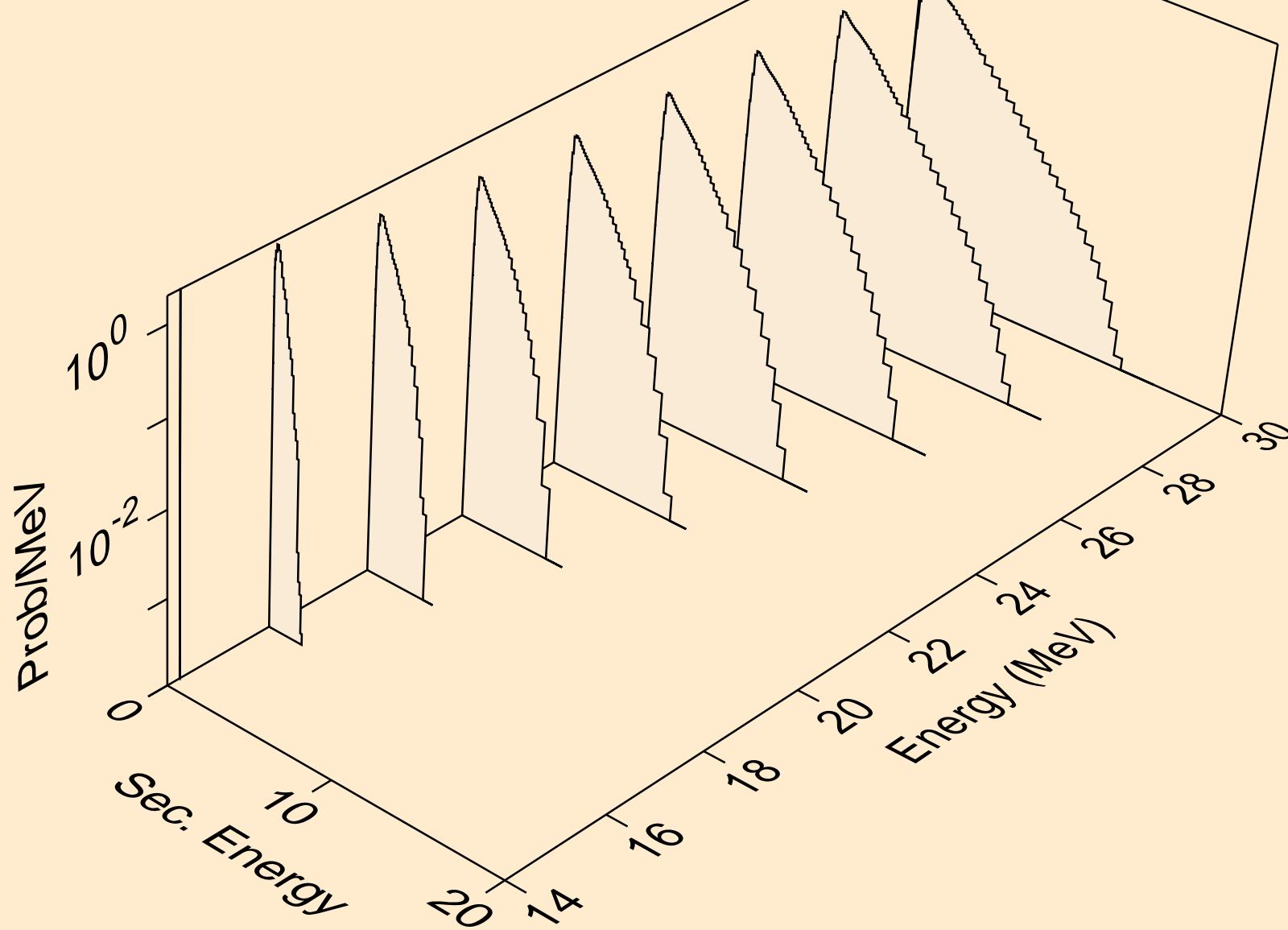

TC102M TRITON ACER TENDL-2021 LIBRARY; T=0.K  
neutrons from (t,2np)

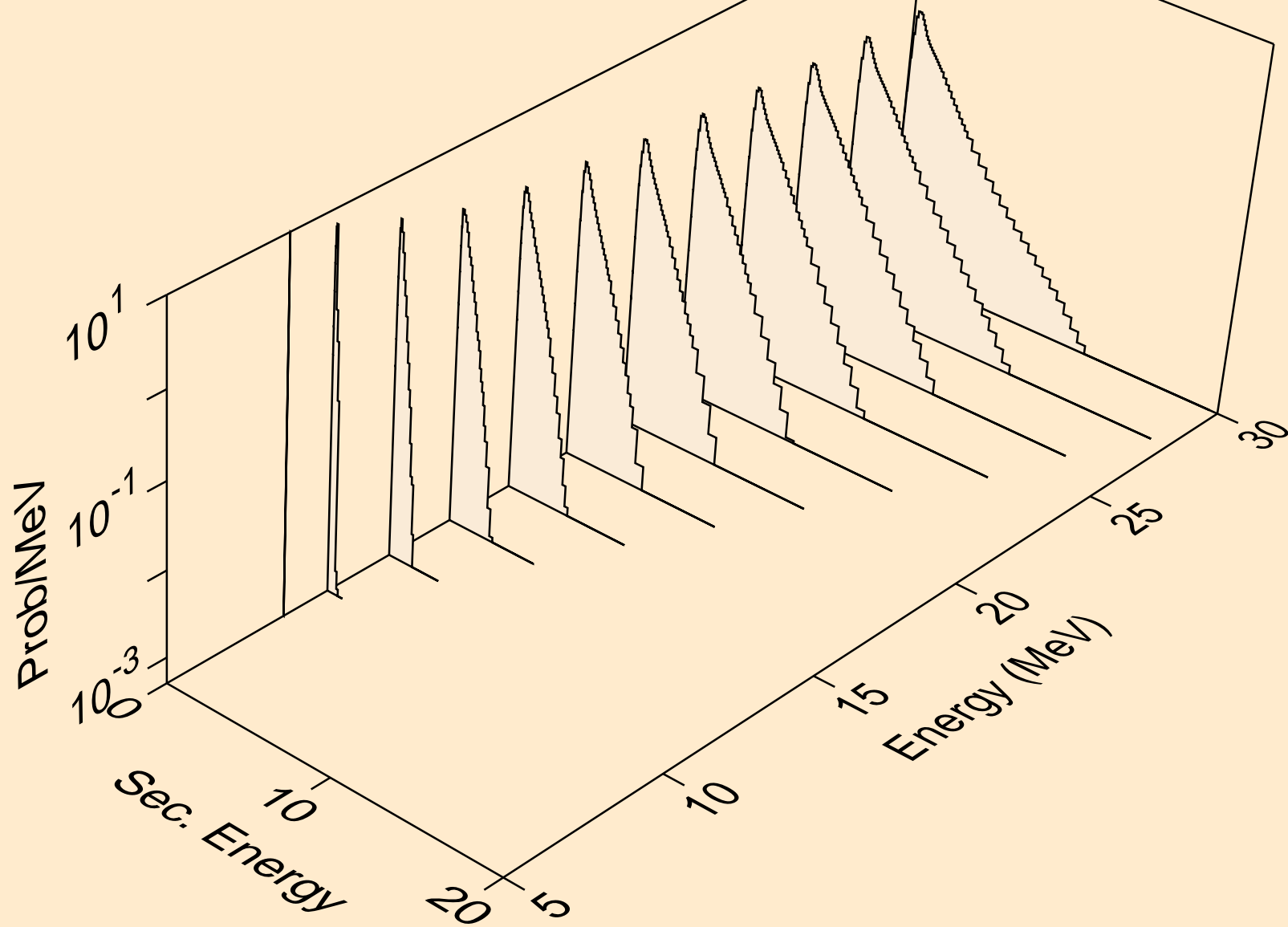

TC102M TRITON ACER TENDL-2021 LIBRARY; T=0.K  
neutrons from (t,3np)

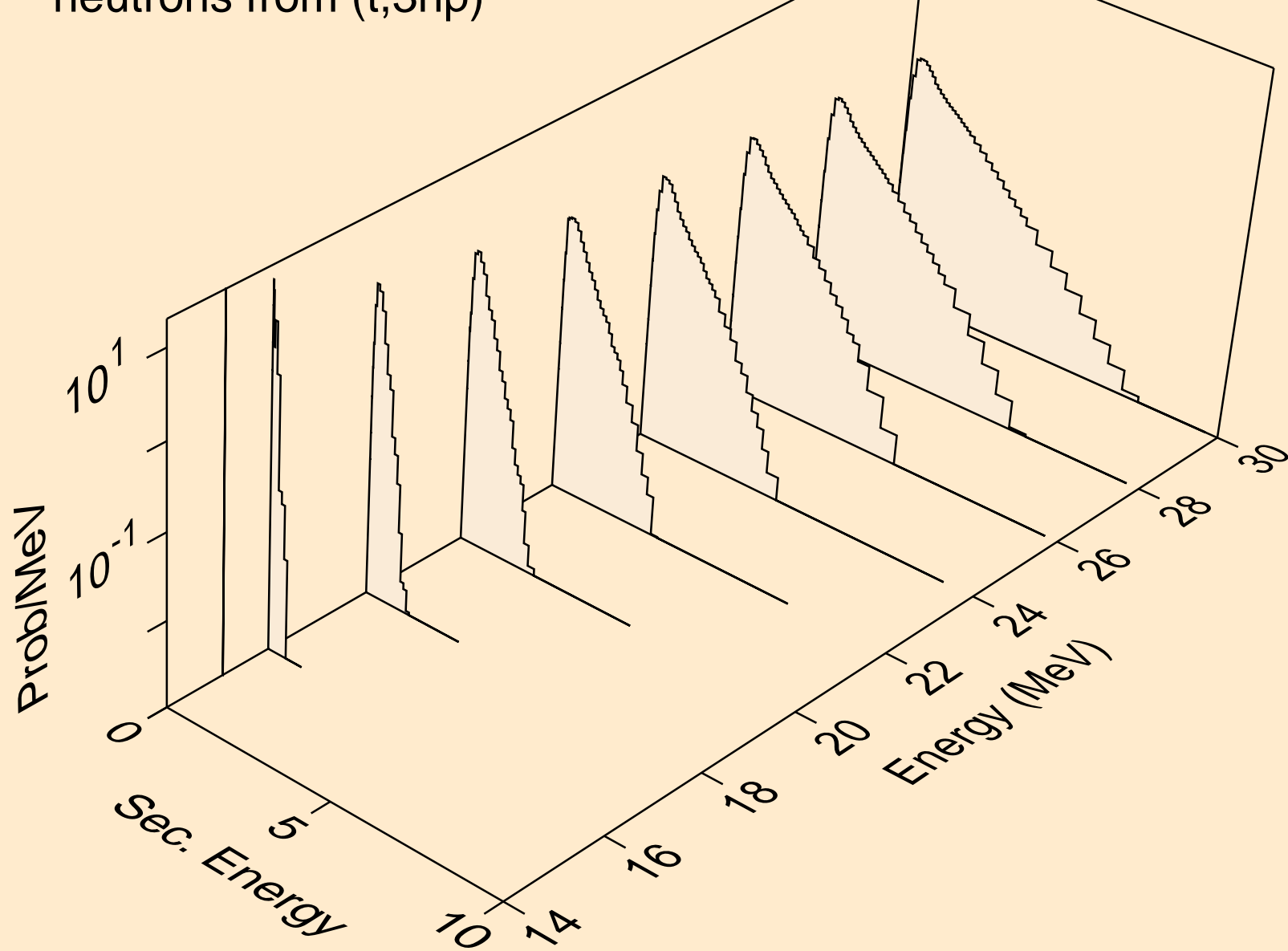



TC102M TRITON ACER TENDL-2021 LIBRARY; T=0.K  
neutrons from (t,2np)

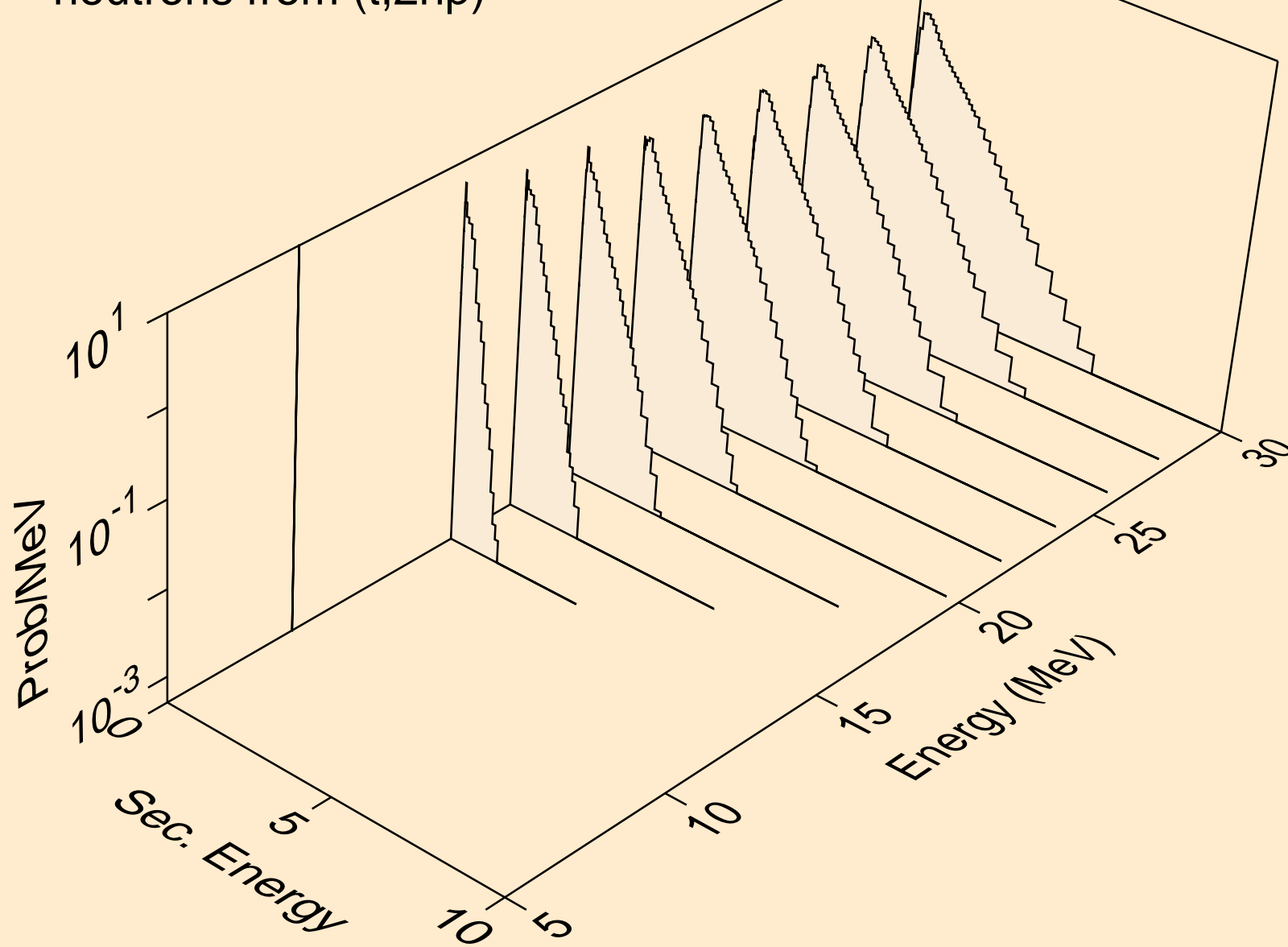

TC102M TRITON ACER TENDL-2021 LIBRARY; T=0.K  
neutrons from (t,npa)

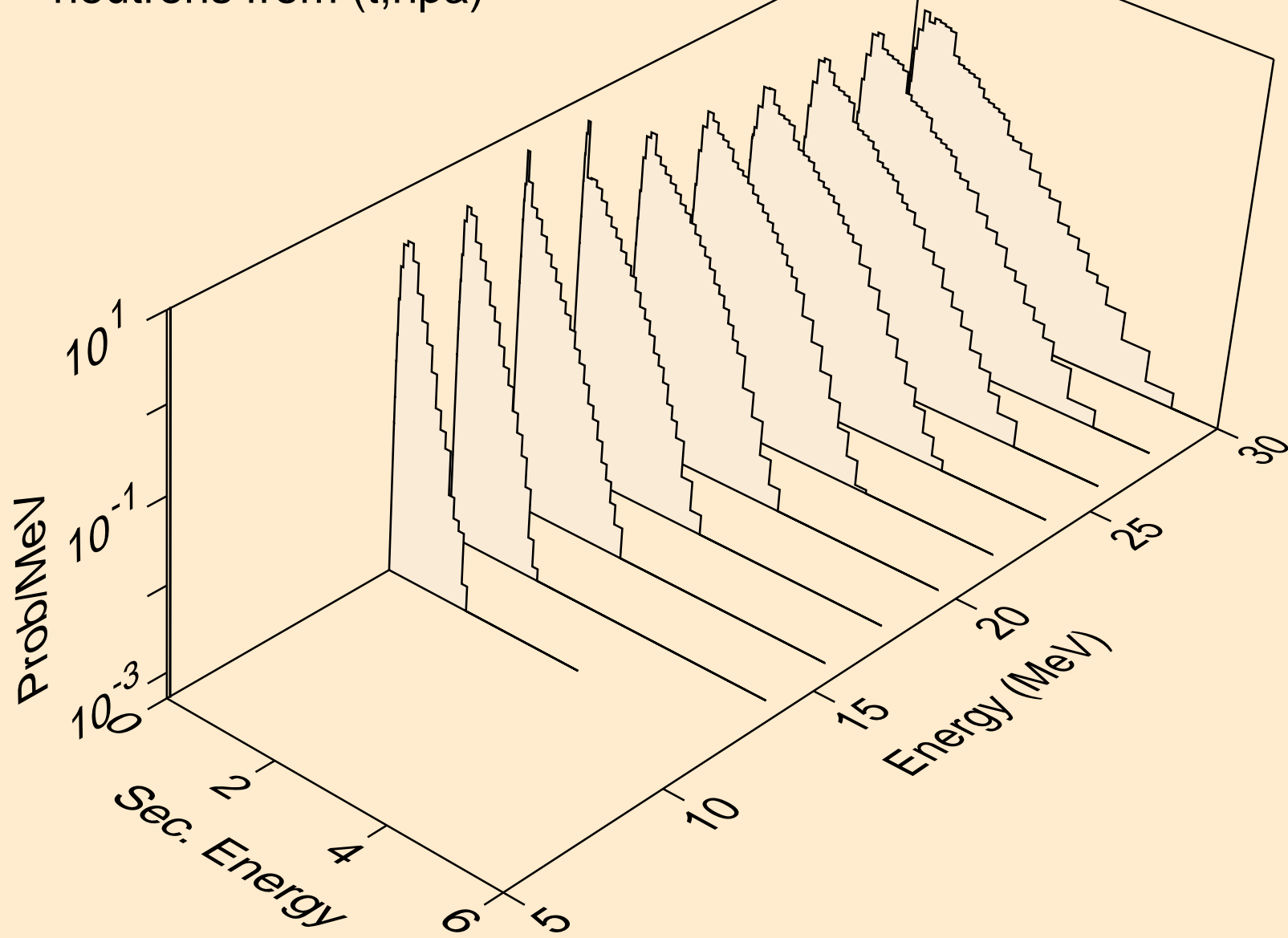

TC102M TRITON ACER TENDL-2021 LIBRARY; T=0.K  
protons from (t,x)

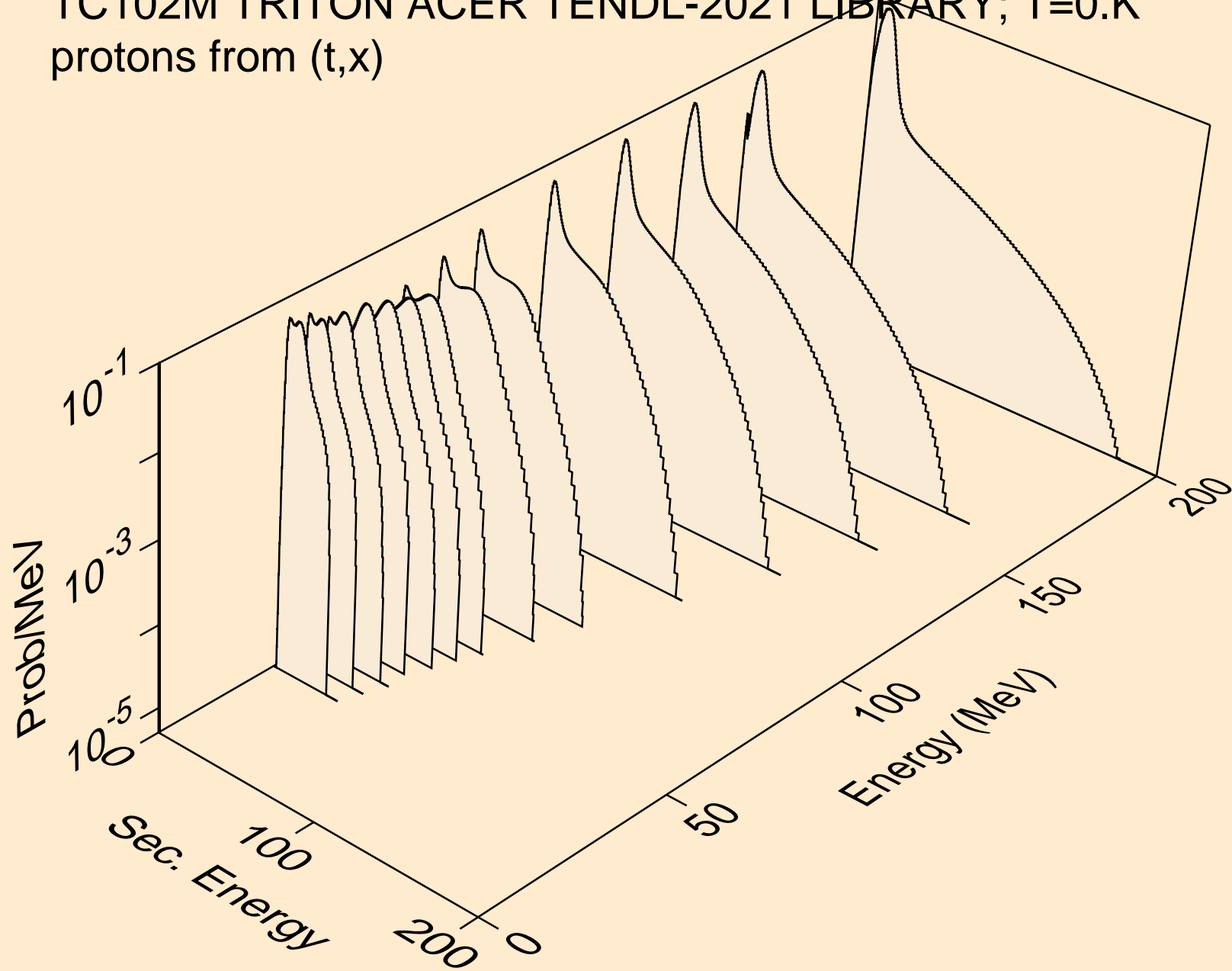

TC102M TRITON ACER TENDL-2021 LIBRARY; T=0.K  
protons from (t,n\*)p

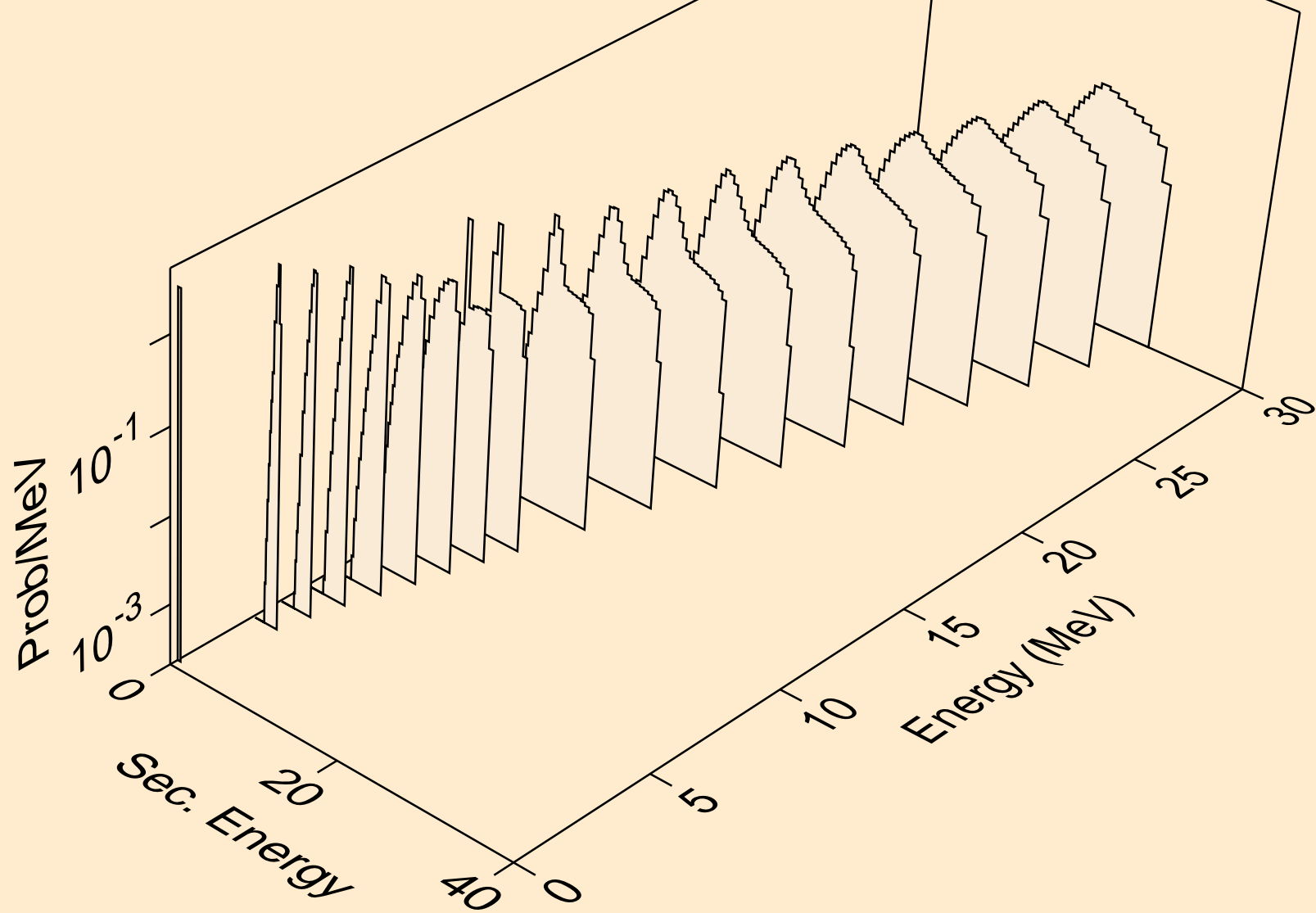

TC102M TRITON ACER TENDL-2021 LIBRARY; T=0.K  
protons from (t,2np)

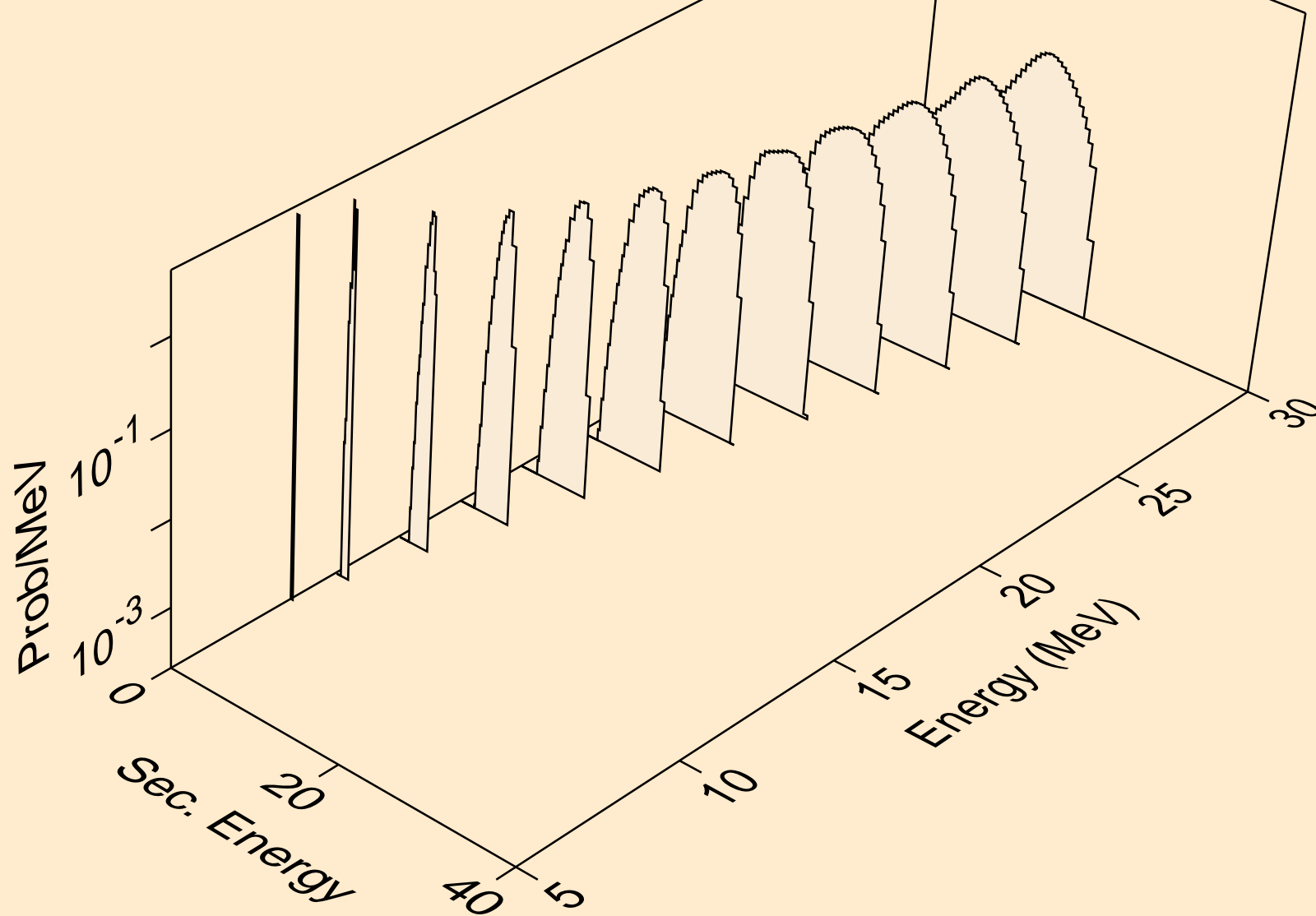

TC102M TRITON ACER TENDL-2021 LIBRARY; T=0.K  
protons from (t,3np)

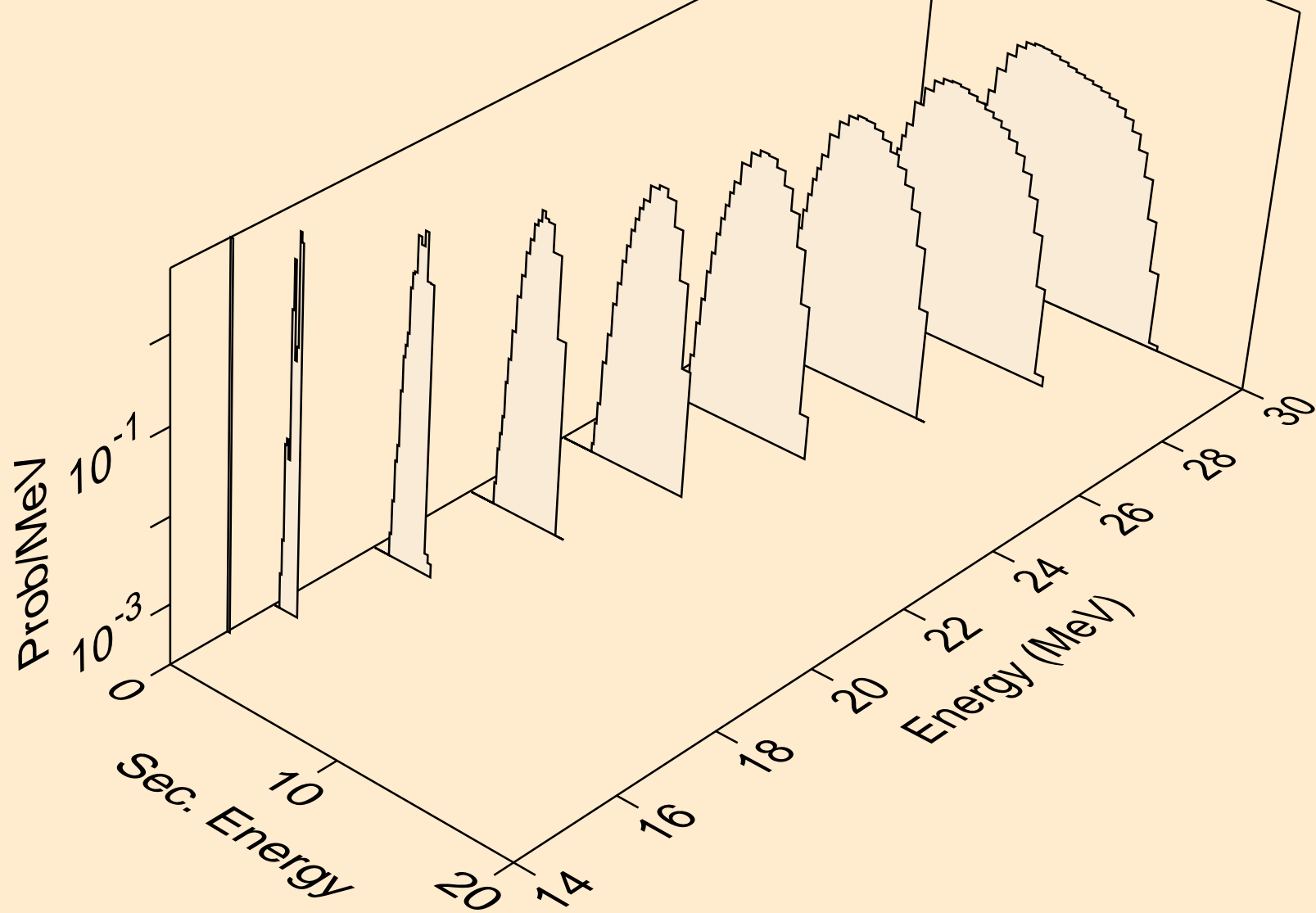

TC102M TRITON ACER TENDL-2021 LIBRARY; T=0.K  
protons from (t,2np)

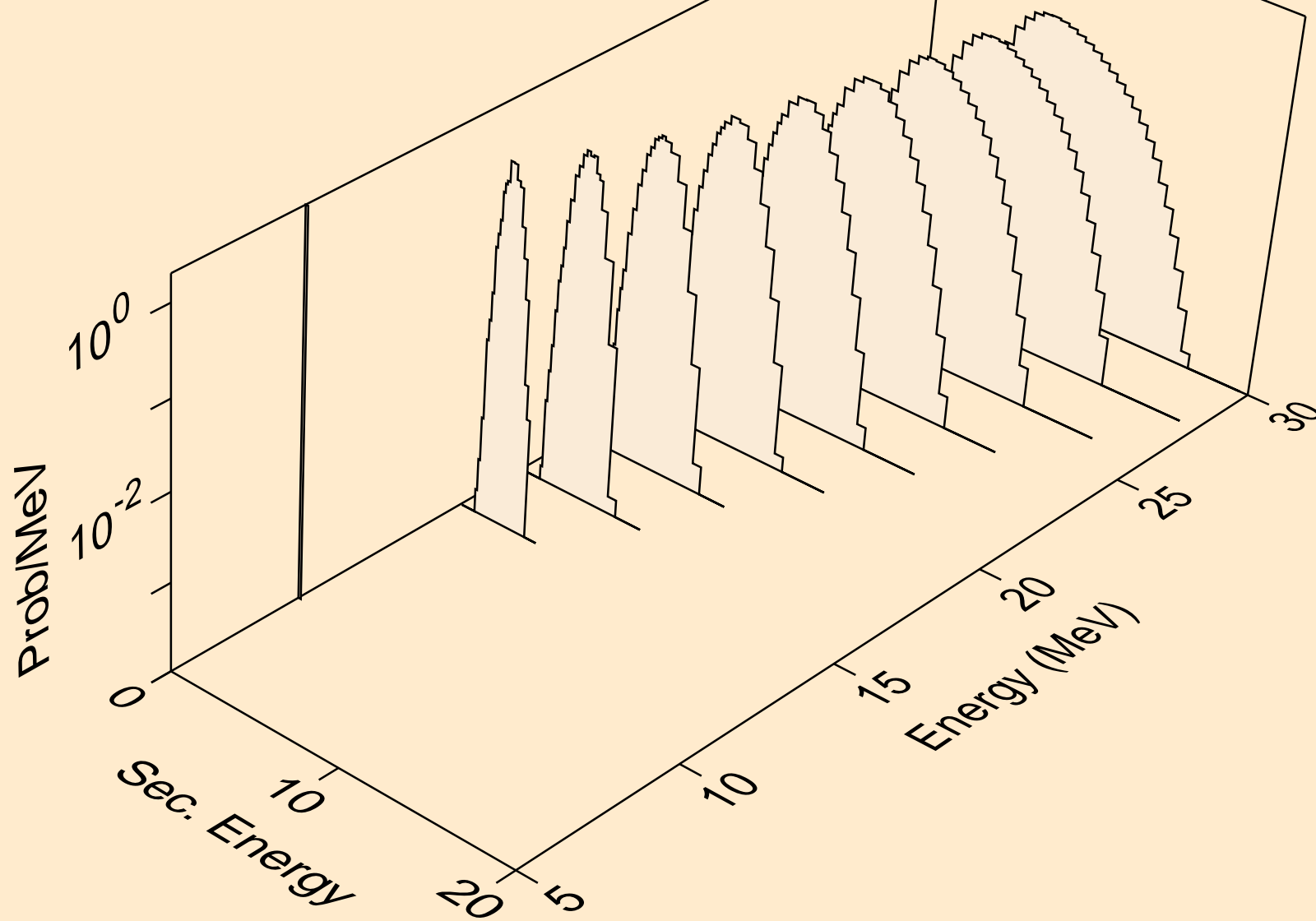

TC102M TRITON ACER TENDL-2021 LIBRARY; T=0.K  
protons from (t,npa)

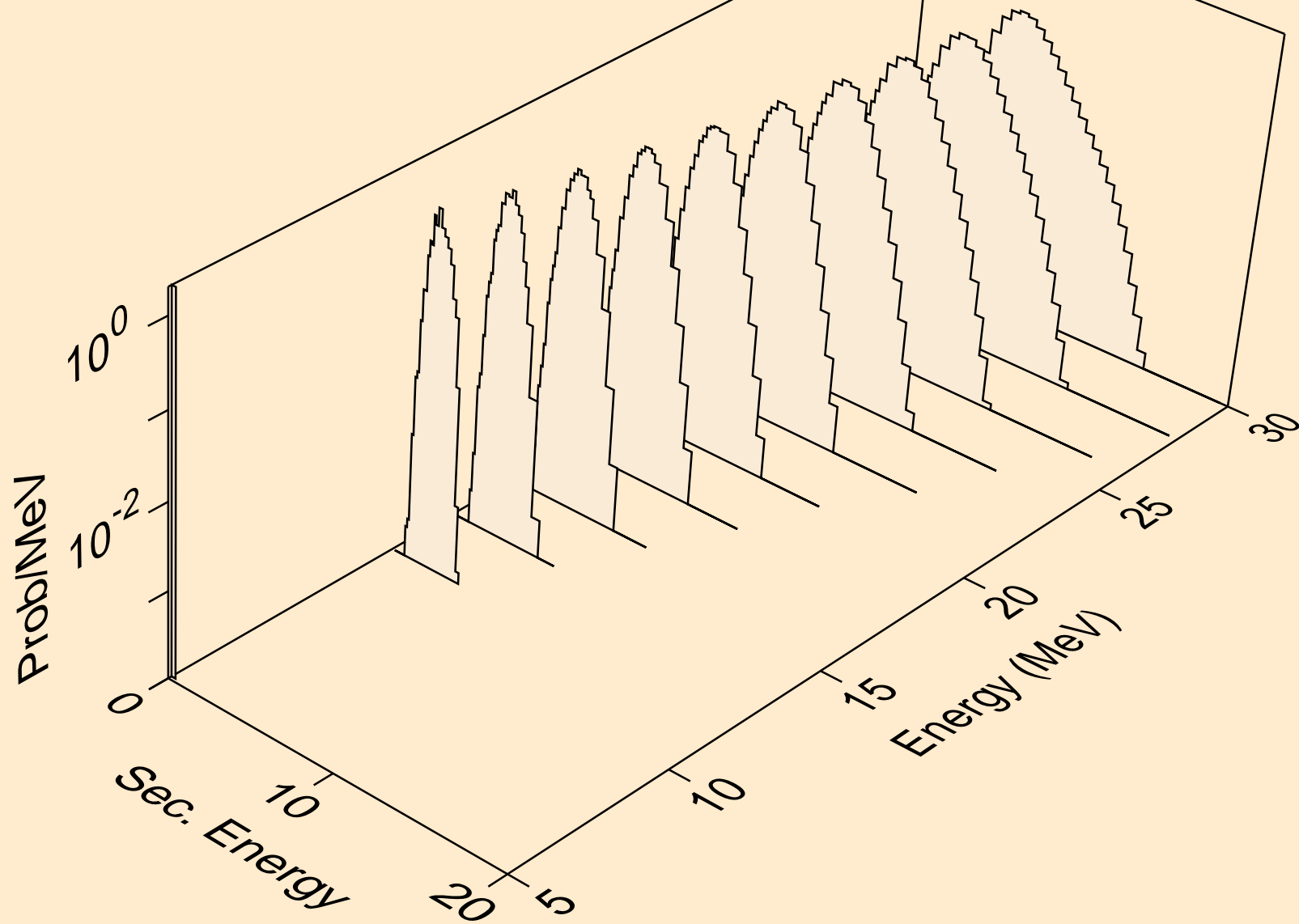



TC102M TRITON ACER TENDL-2021 LIBRARY; T=0.K  
protons from (t,p)

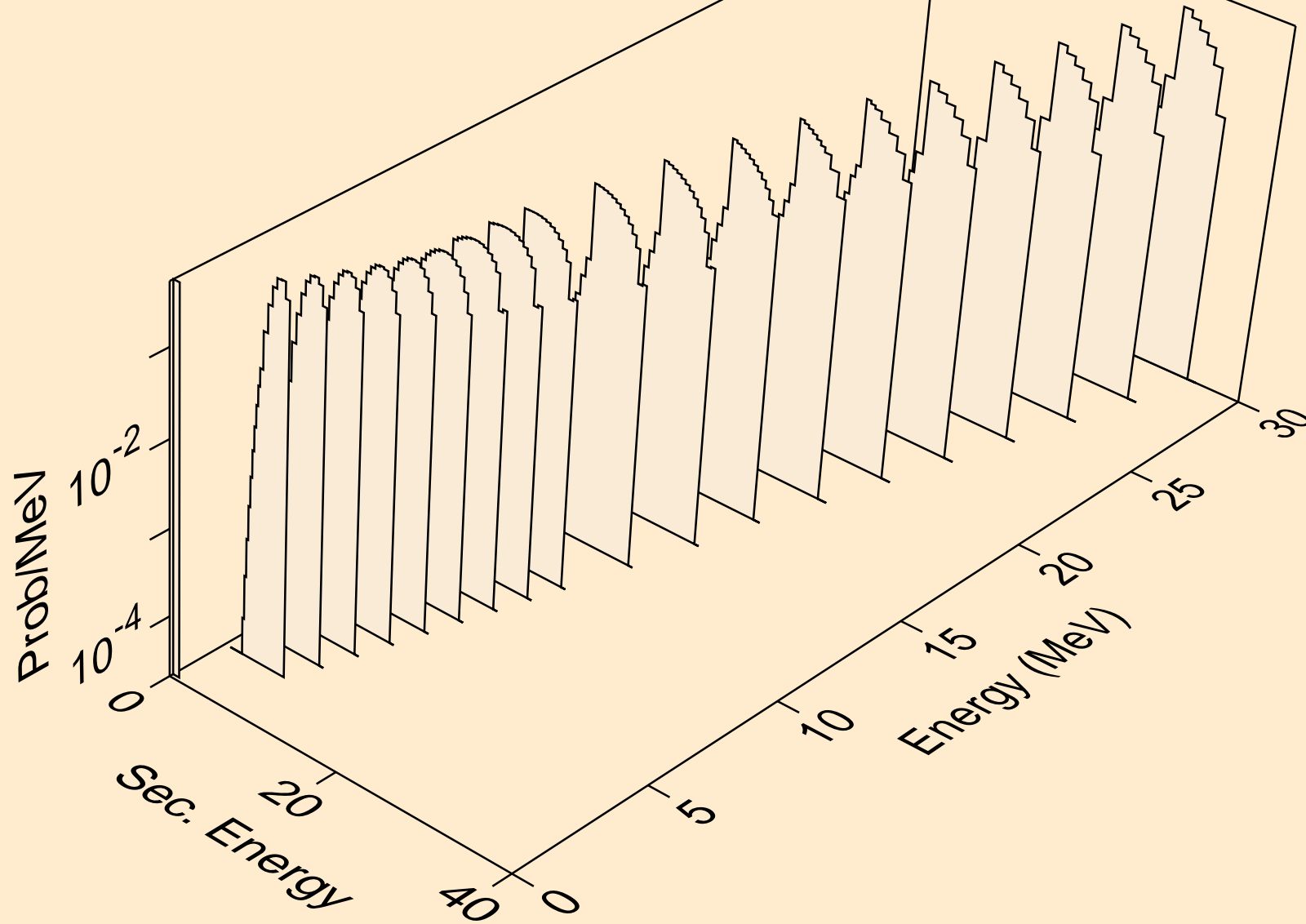

TC102M TRITON ACER TENDL-2021 LIBRARY; T=0.K  
protons from (t,2p)

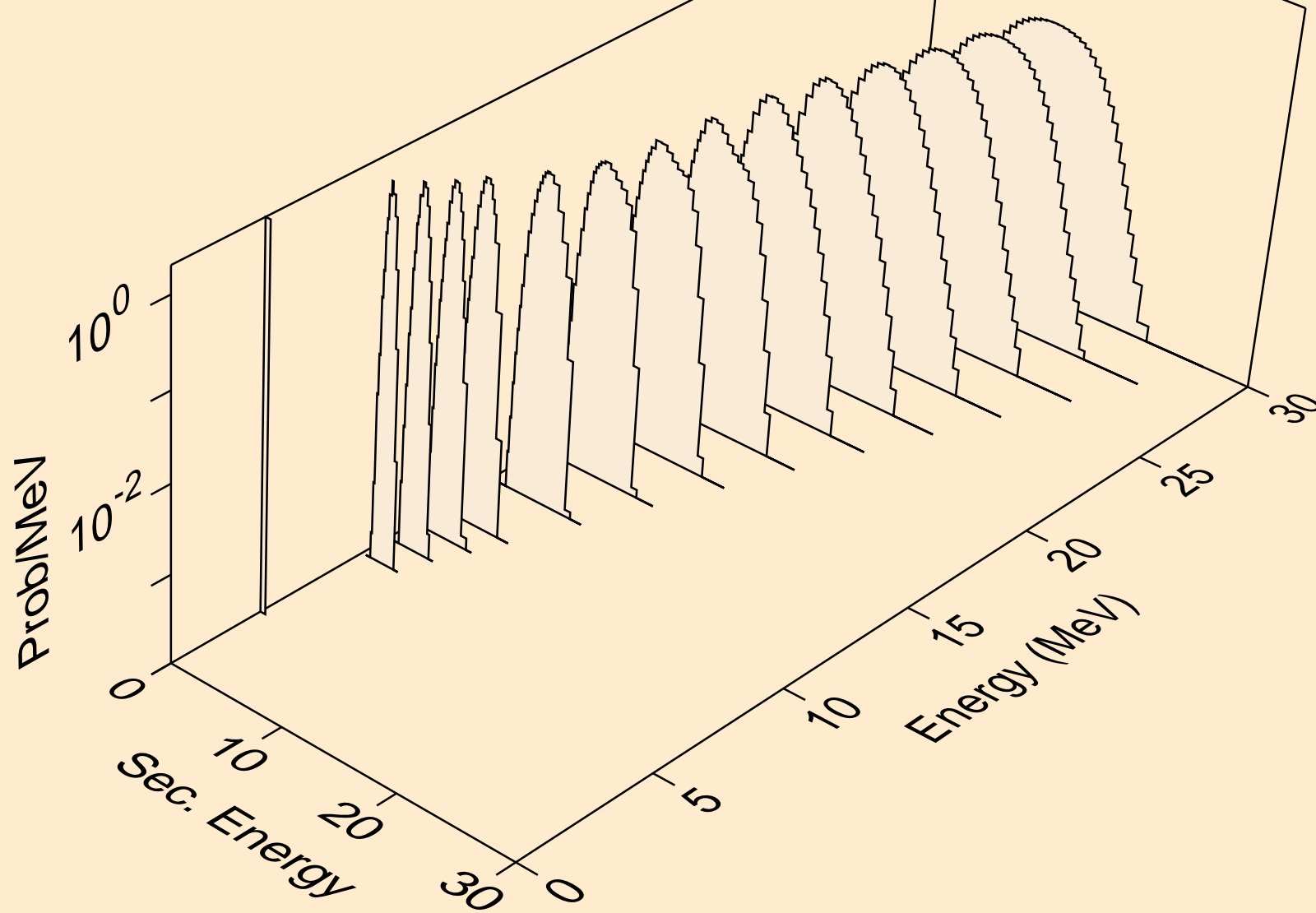

TC102M TRITON ACER TENDL-2021 LIBRARY; T=0.K  
protons from (t,pa)

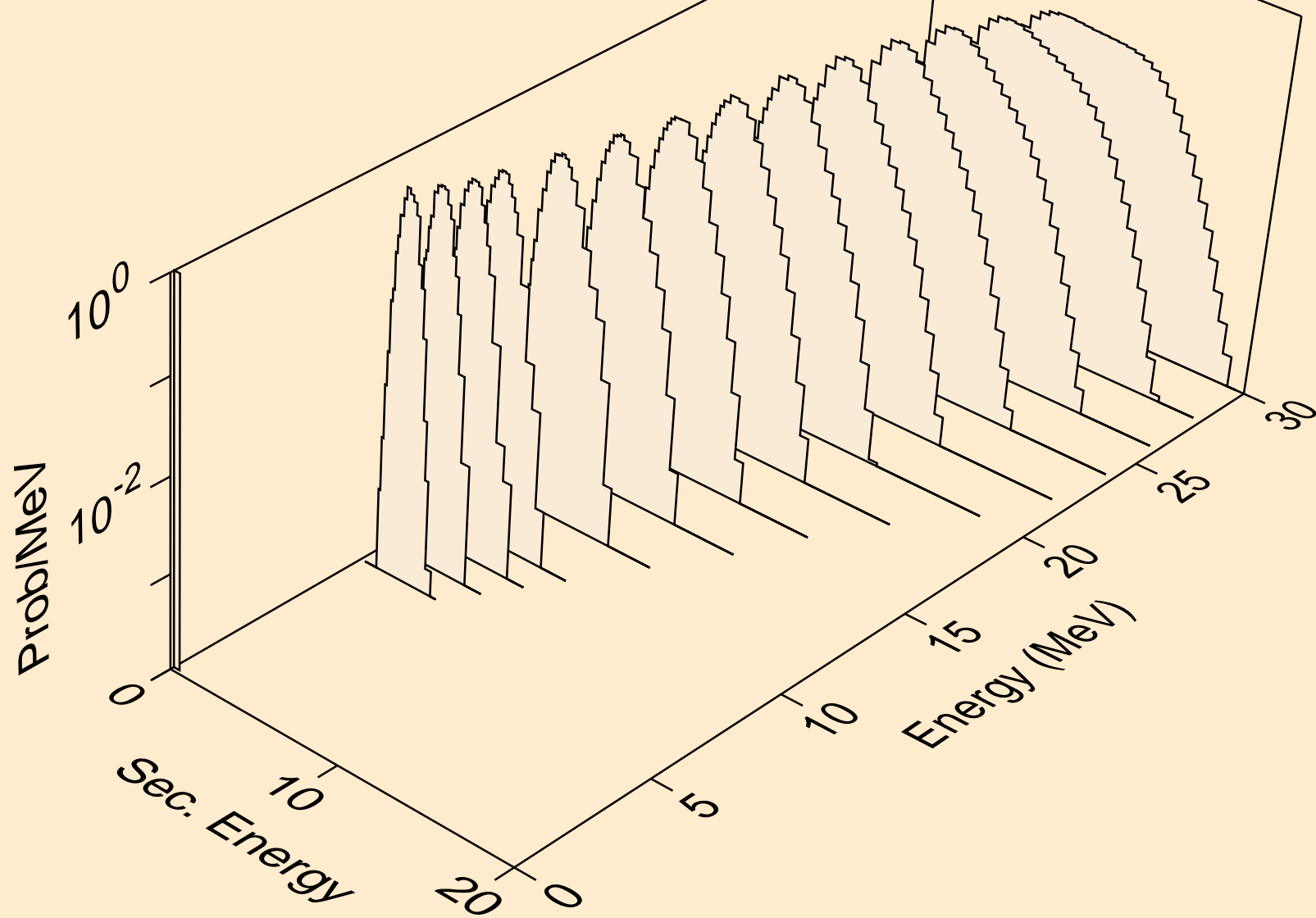

TC102M TRITON ACER TENDL-2021 LIBRARY; T=0.K  
protons from (t,pd)

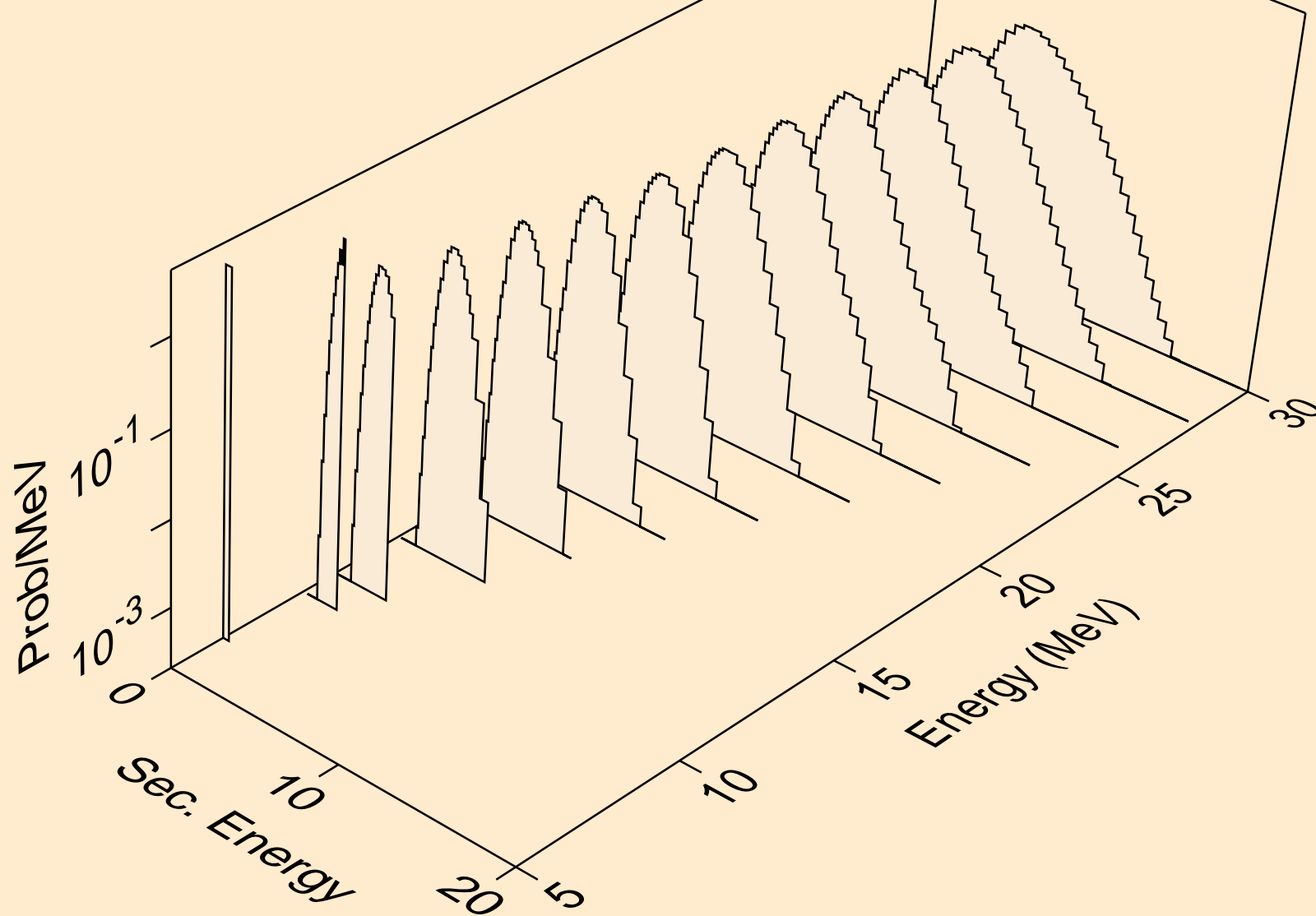

TC102M TRITON ACER TENDL-2021 LIBRARY; T=0.K  
protons from (t,pt)

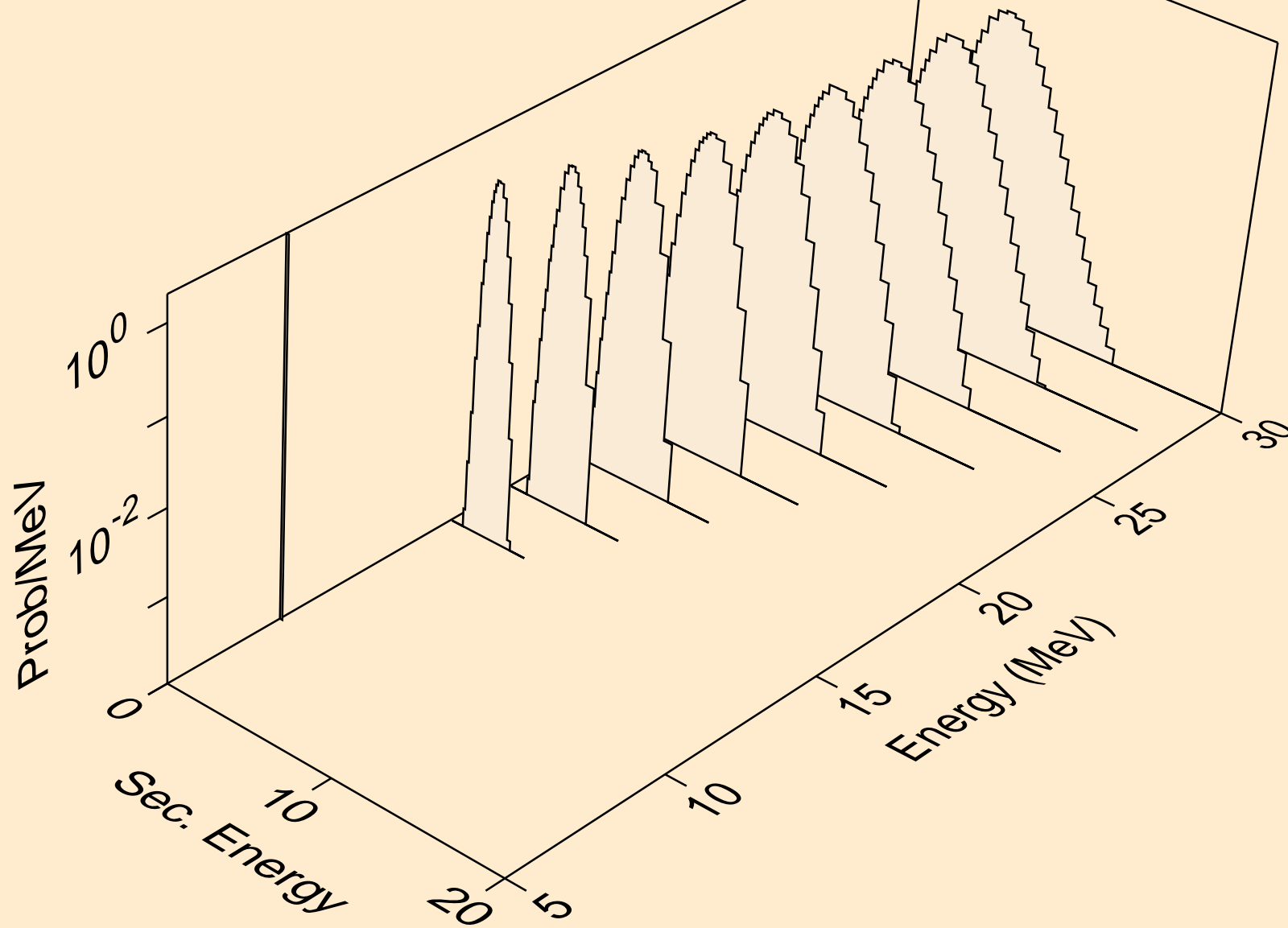

TC102M TRITON ACER TENDL-2021 LIBRARY; T=0.K  
deuterons from (t,x)

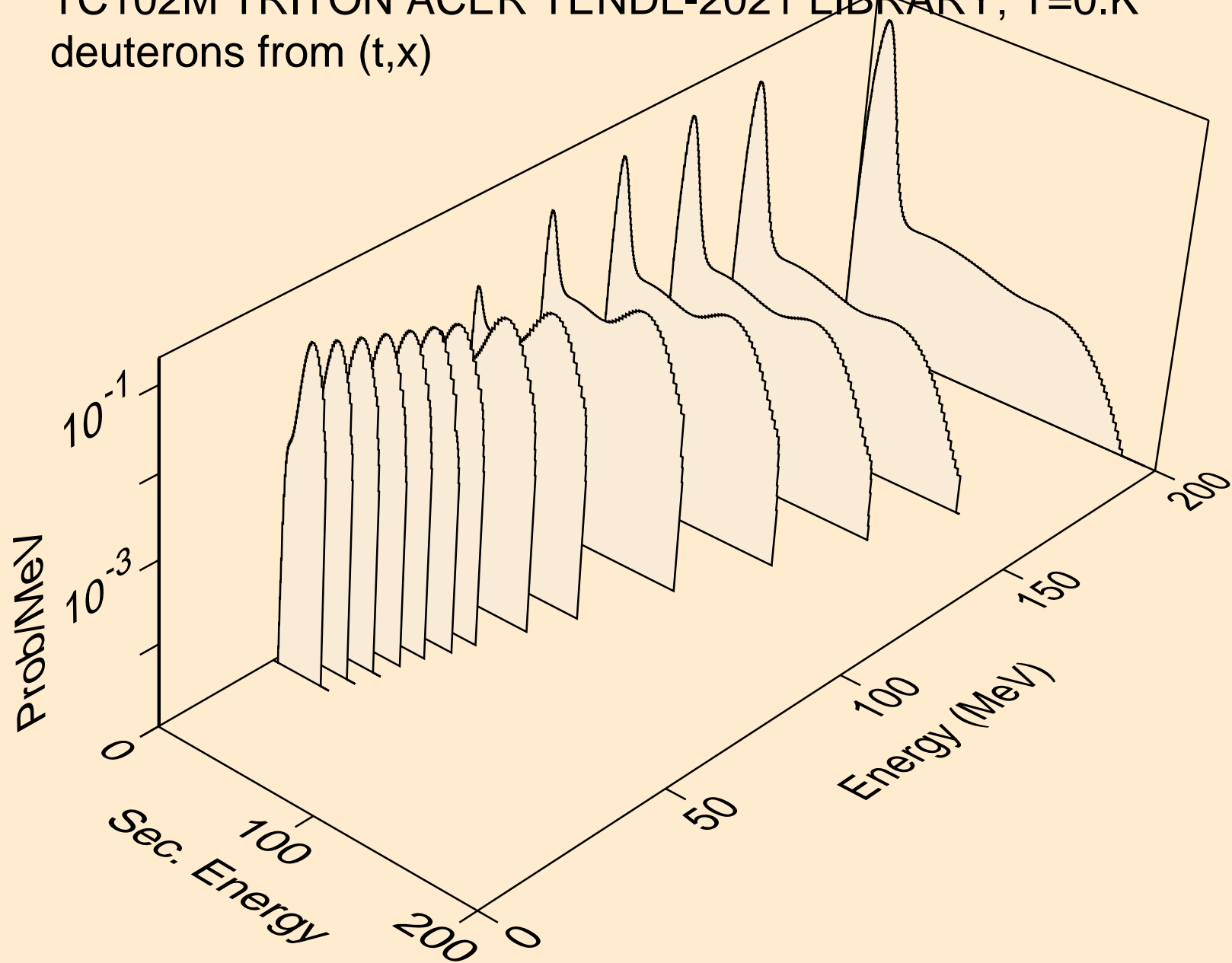

TC102M TRITON ACER TENDL-2021 LIBRARY; T=0.K  
deuterons from (t,2nd)

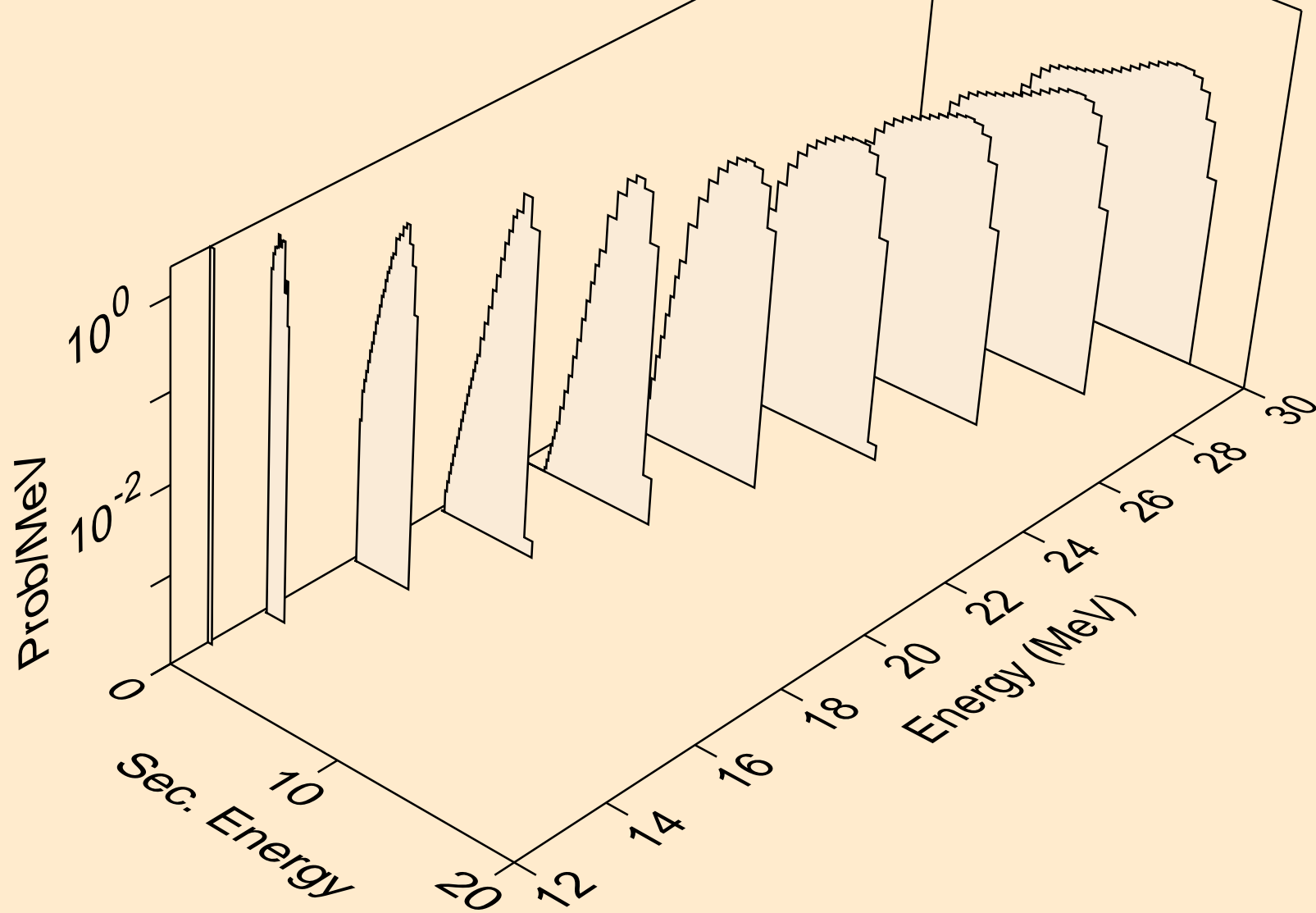

TC102M TRITON ACER TENDL-2021 LIBRARY; T=0.K  
deuterons from (t,n\*)d

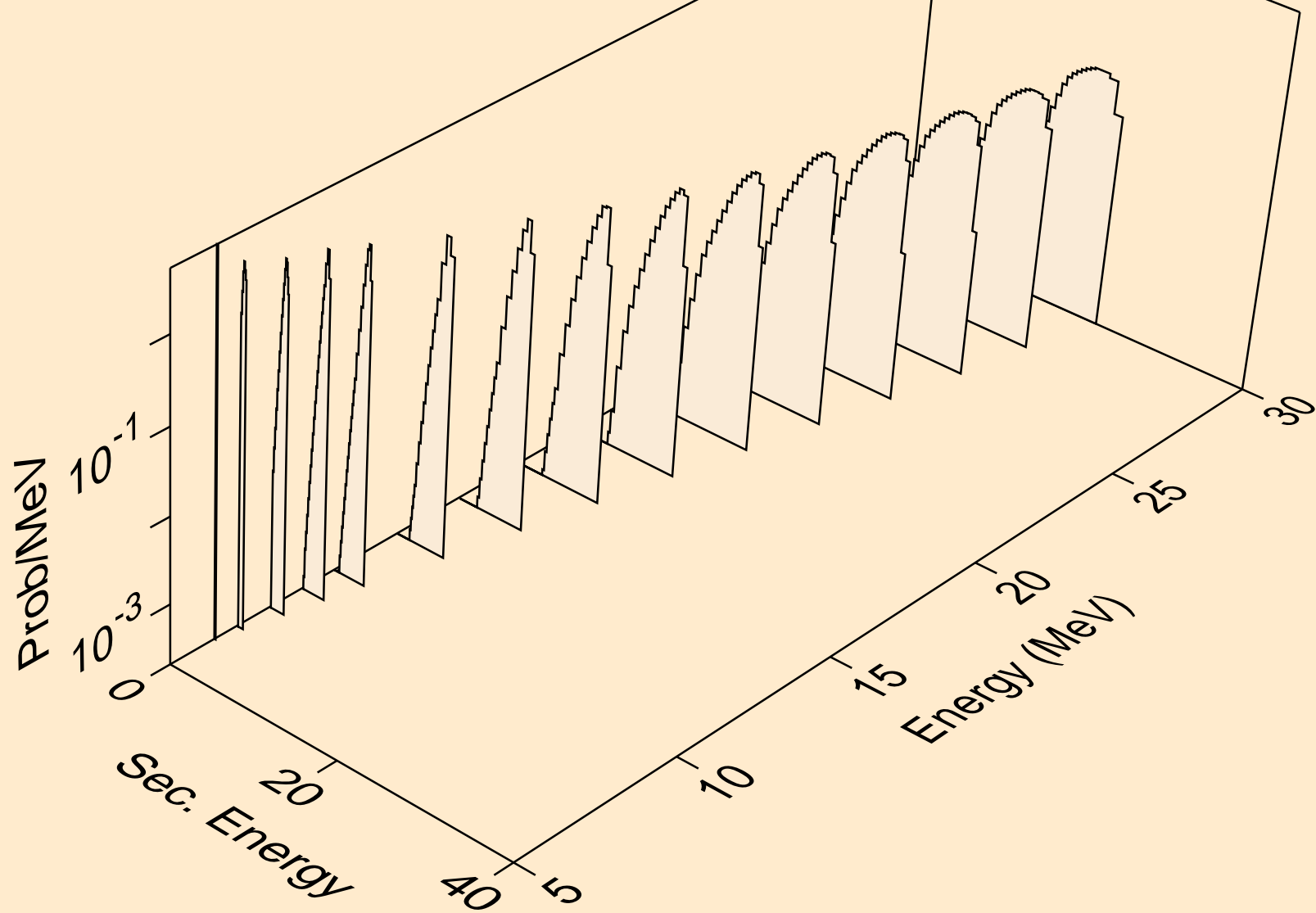



TC102M TRITON ACER TENDL-2021 LIBRARY; T=0.K  
deuterons from (t,d)

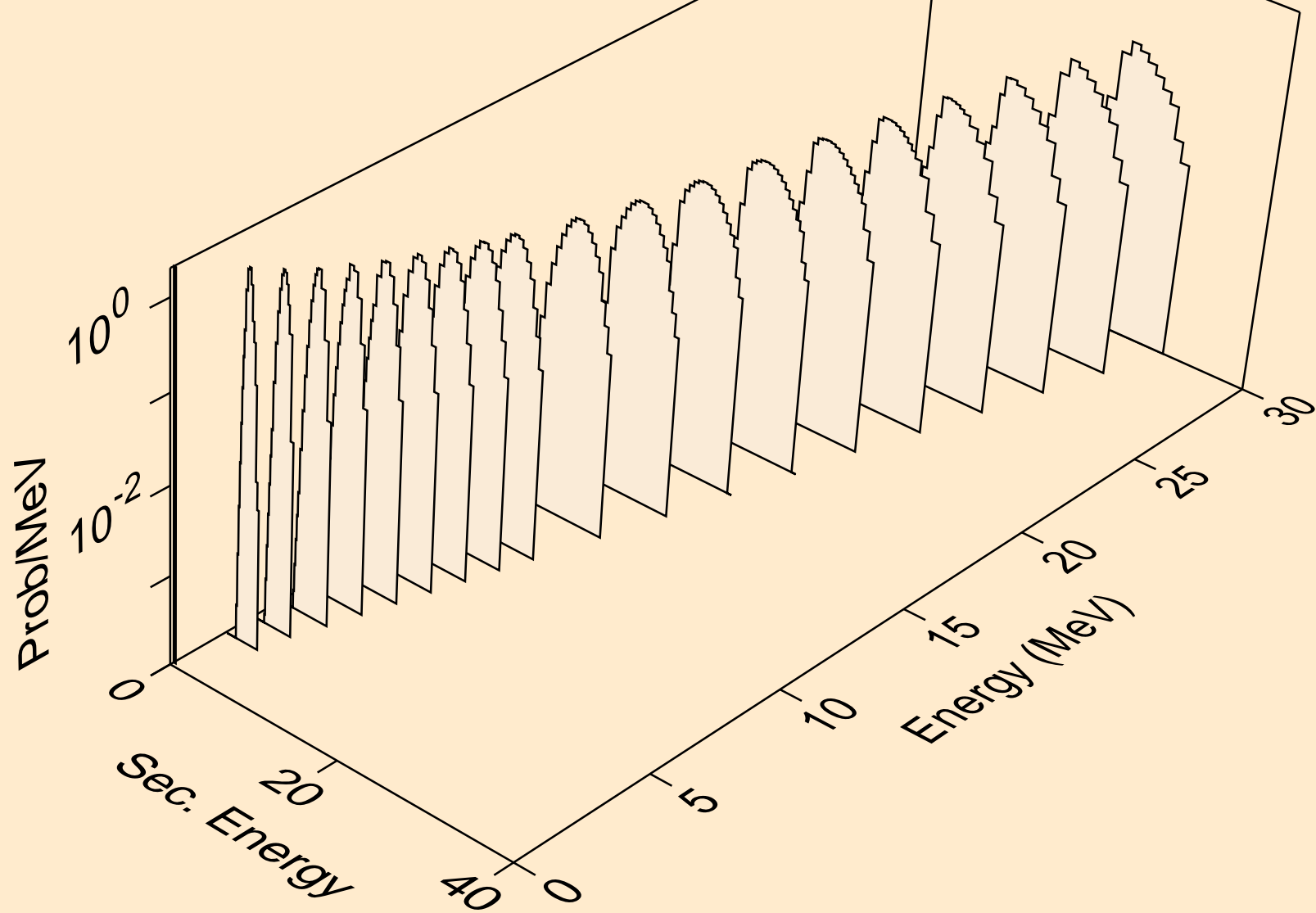

TC102M TRITON ACER TENDL-2021 LIBRARY; T=0.K  
deuterons from (t,pd)

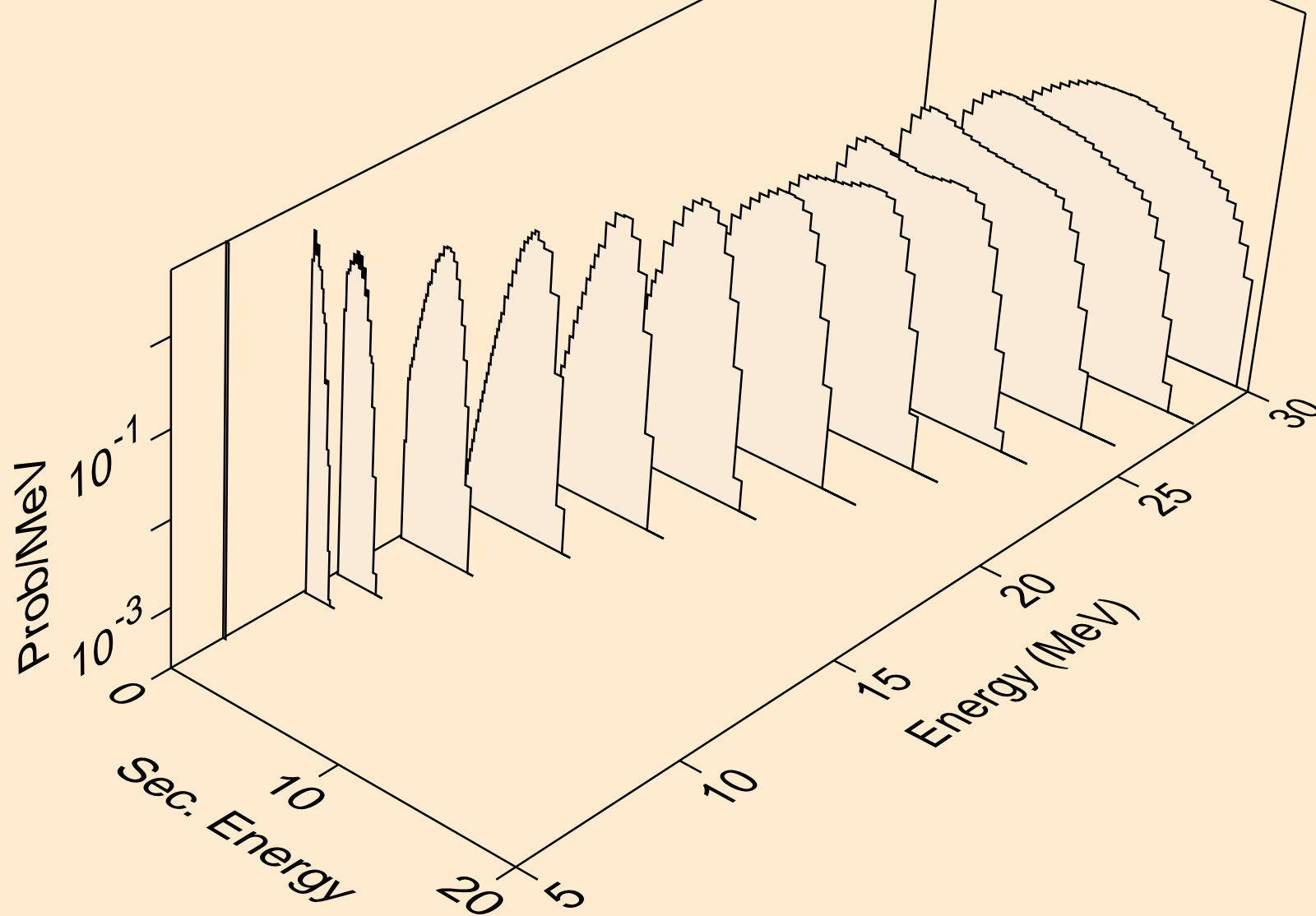

TC102M TRITON ACER TENDL-2021 LIBRARY; T=0.K  
deuterons from (t,da)

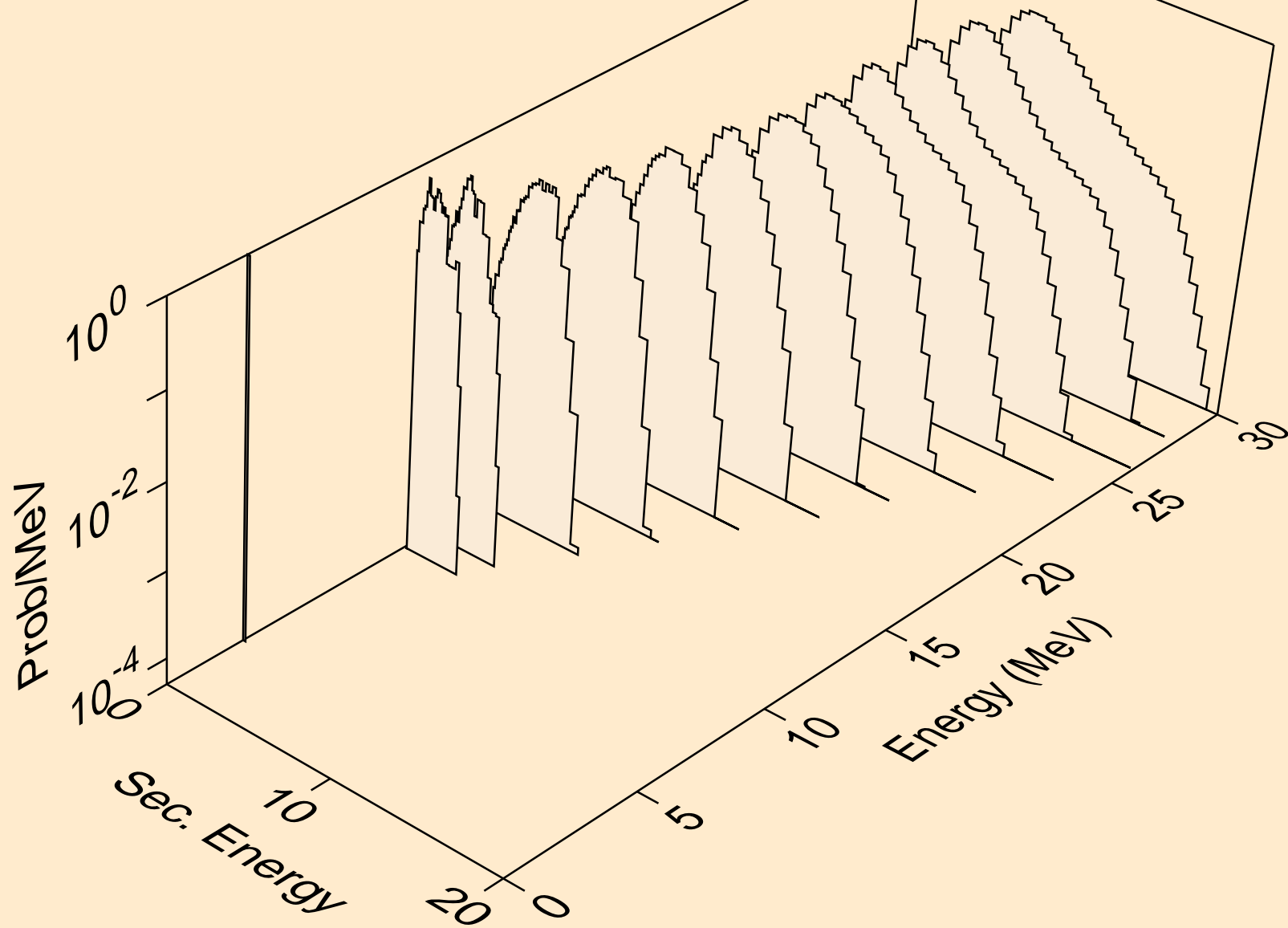

TC102M TRITON ACER TENDL-2021 LIBRARY; T=0.K  
he3s from (t,x)

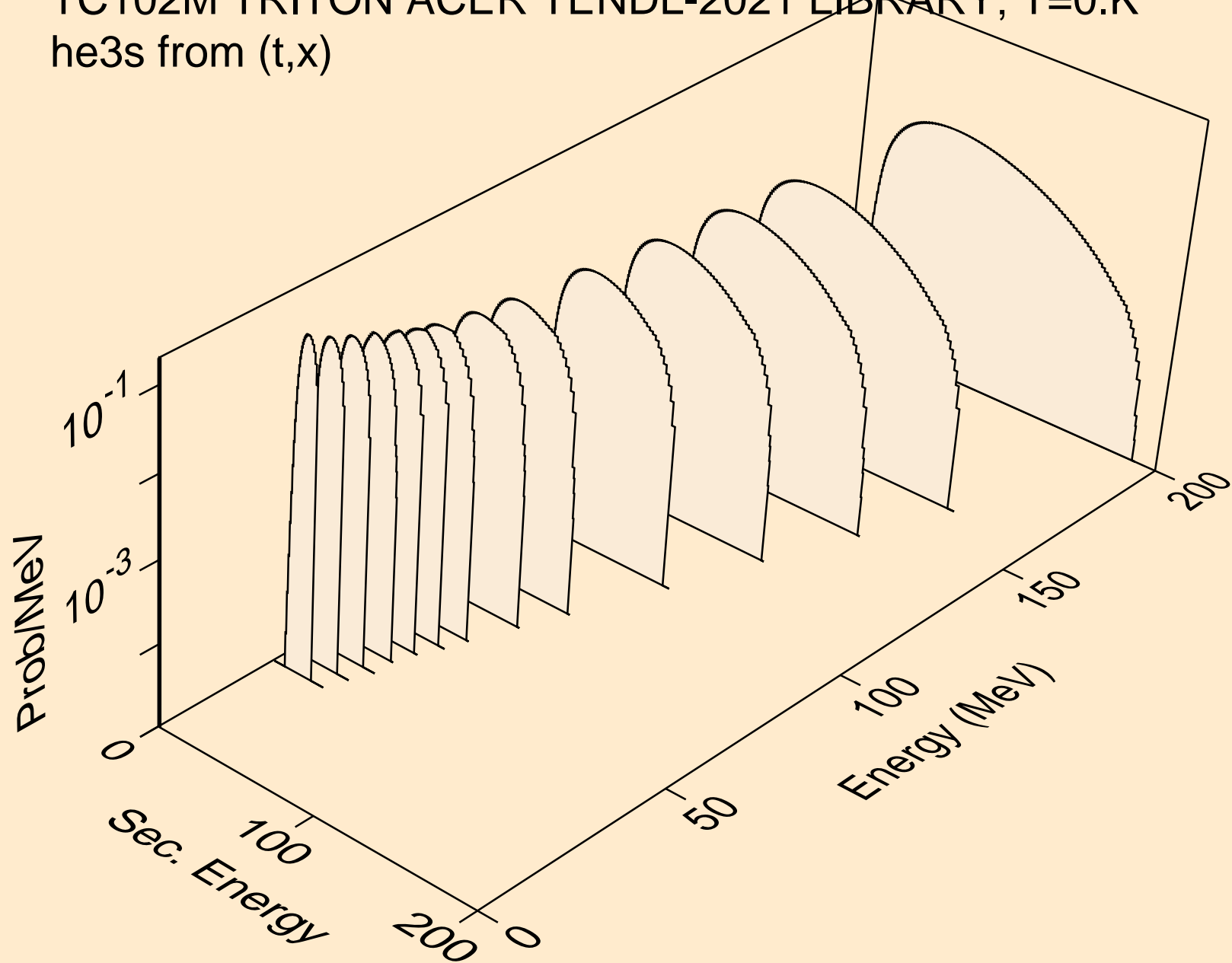

TC102M TRITON ACER TENDL-2021 LIBRARY; T=0.K  
he3s from (t,n\*)he3

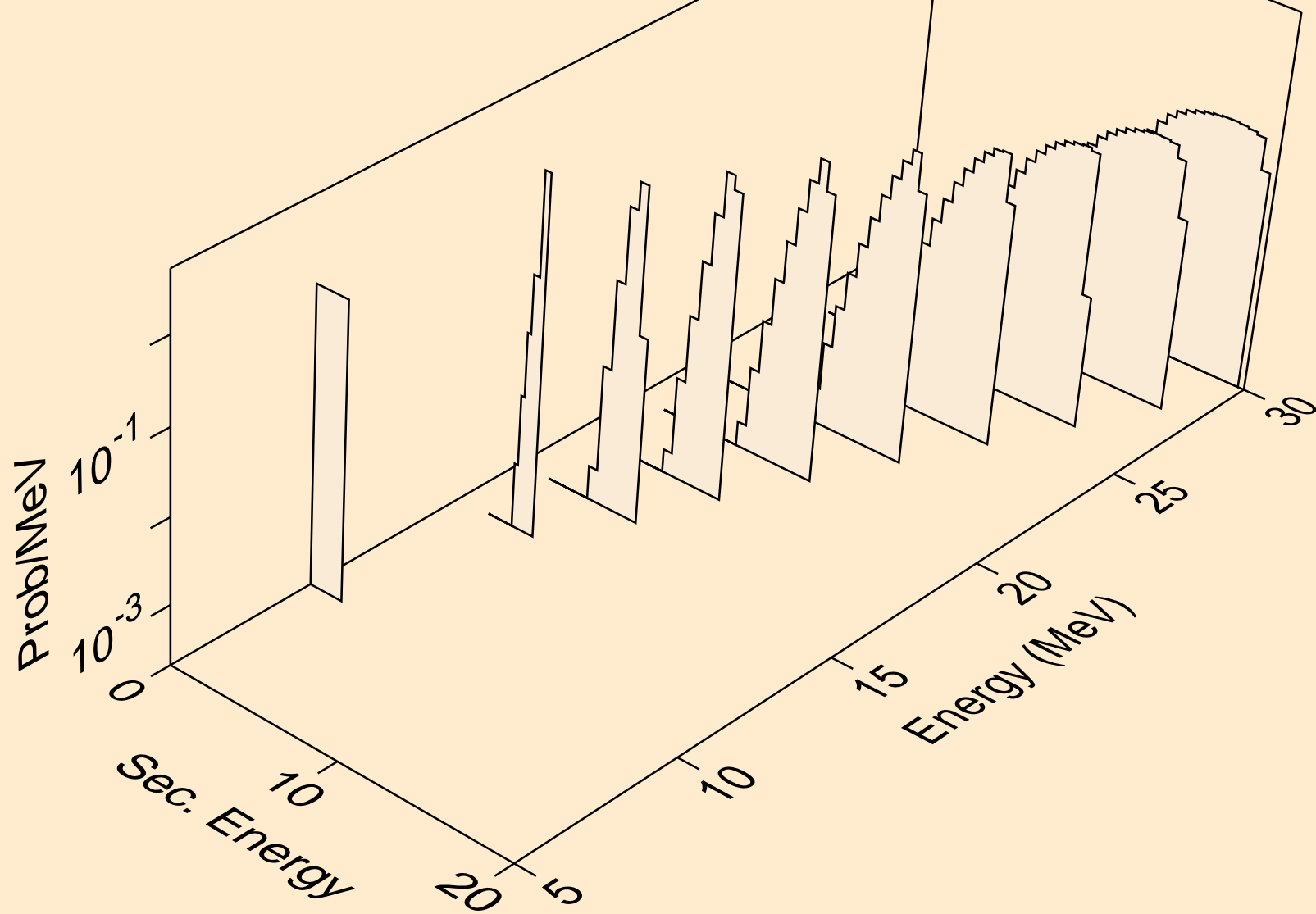

TC102M TRITON ACER TENDL-2021 LIBRARY; T=0.K  
he3s from (t,he3)

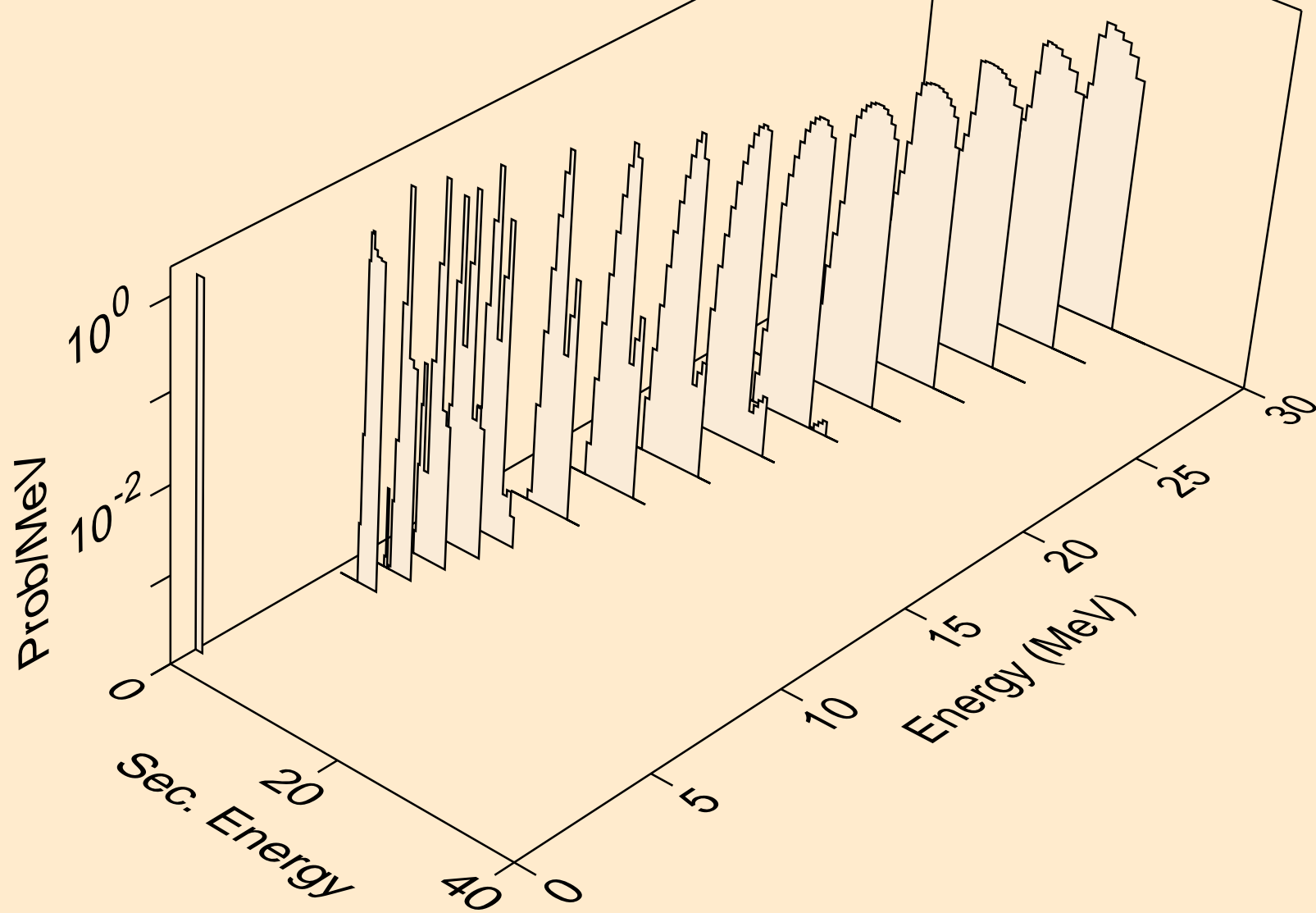

TC102M TRITON ACER TENDL-2021 LIBRARY; T=0.K  
alphas from (t,x)

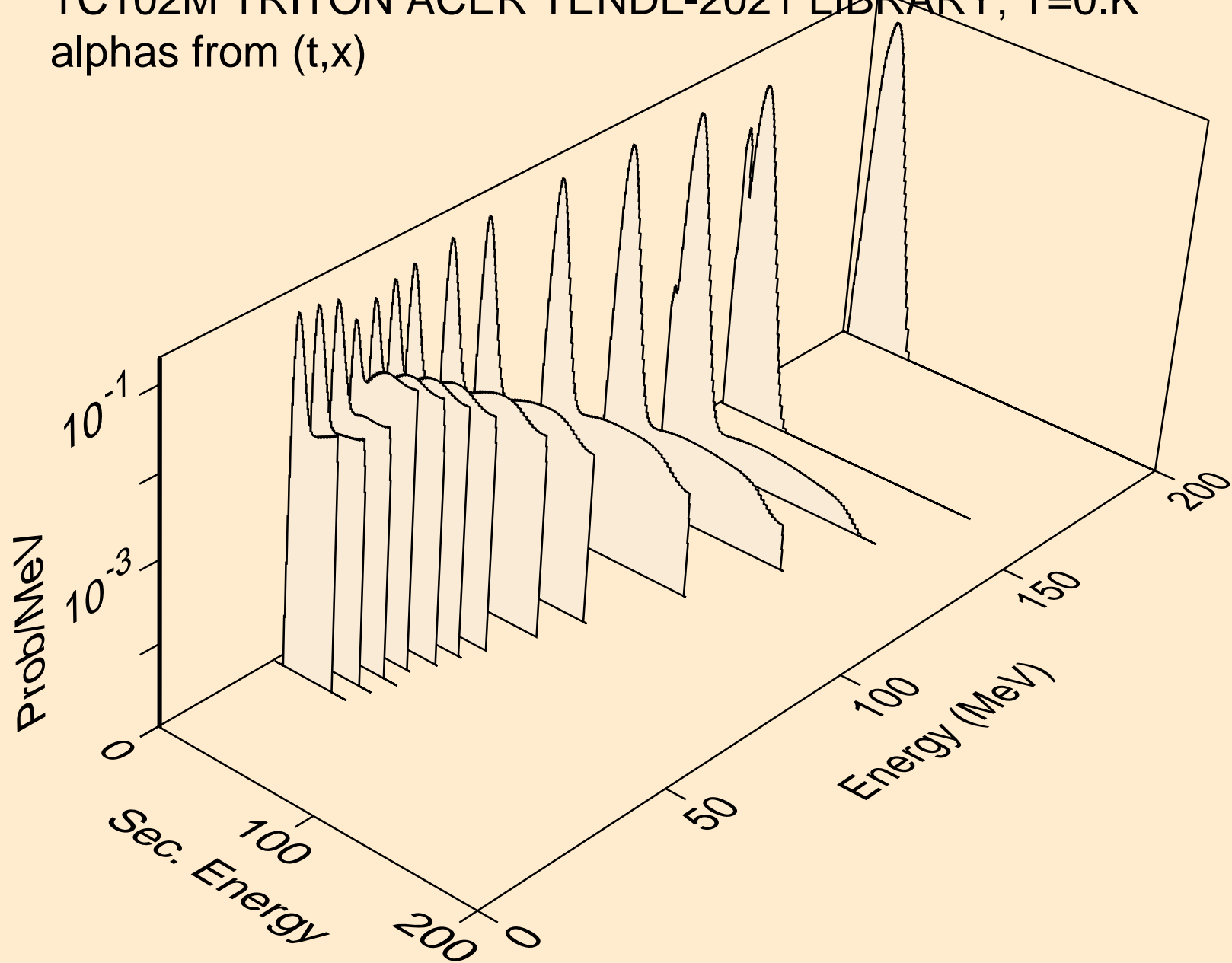

TC102M TRITON ACER TENDL-2021 LIBRARY; T=0.K  
alphas from (t,n\*)a

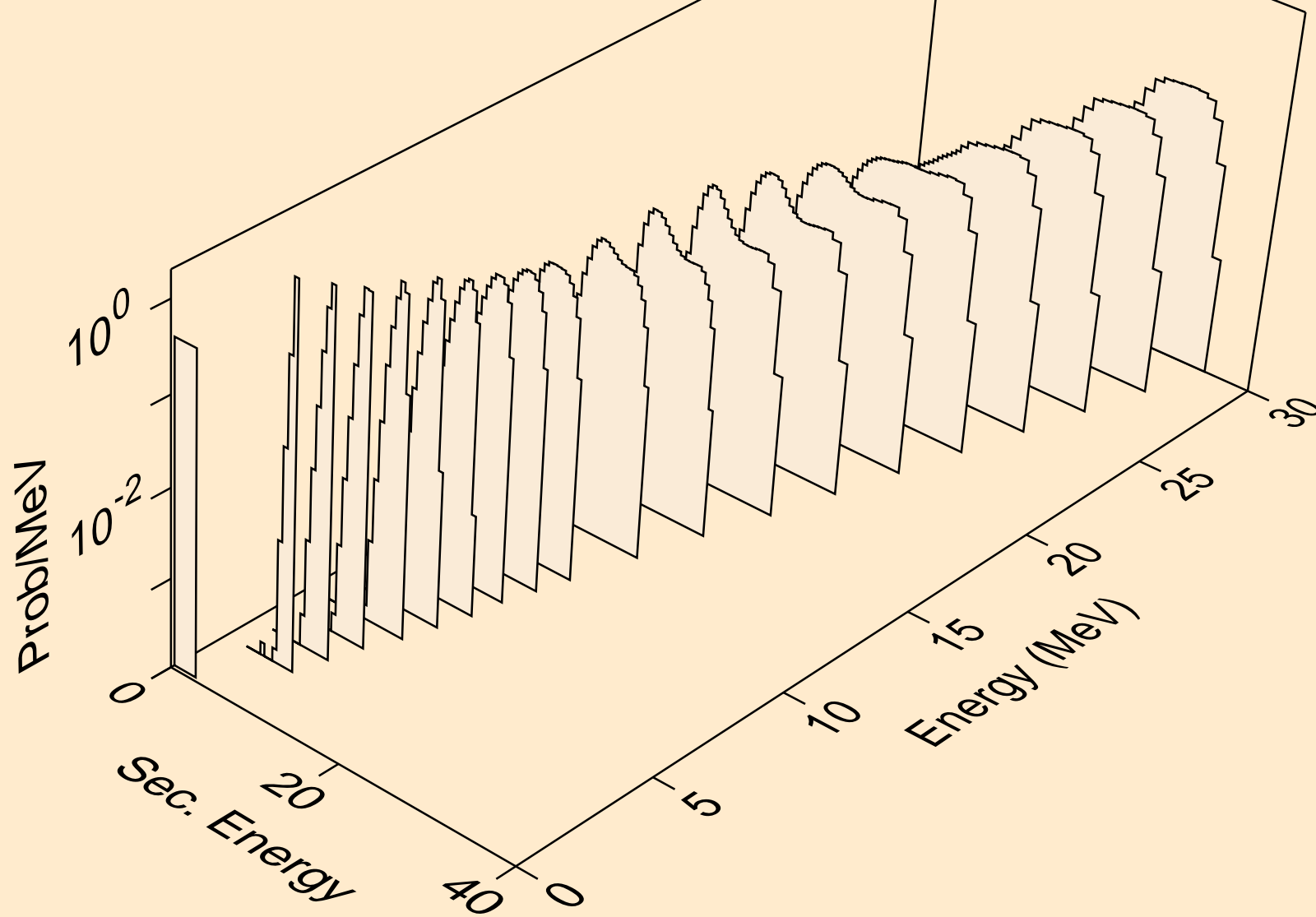



TC102M TRITON ACER TENDL-2021 LIBRARY; T=0.K  
alphas from (t,2n)a

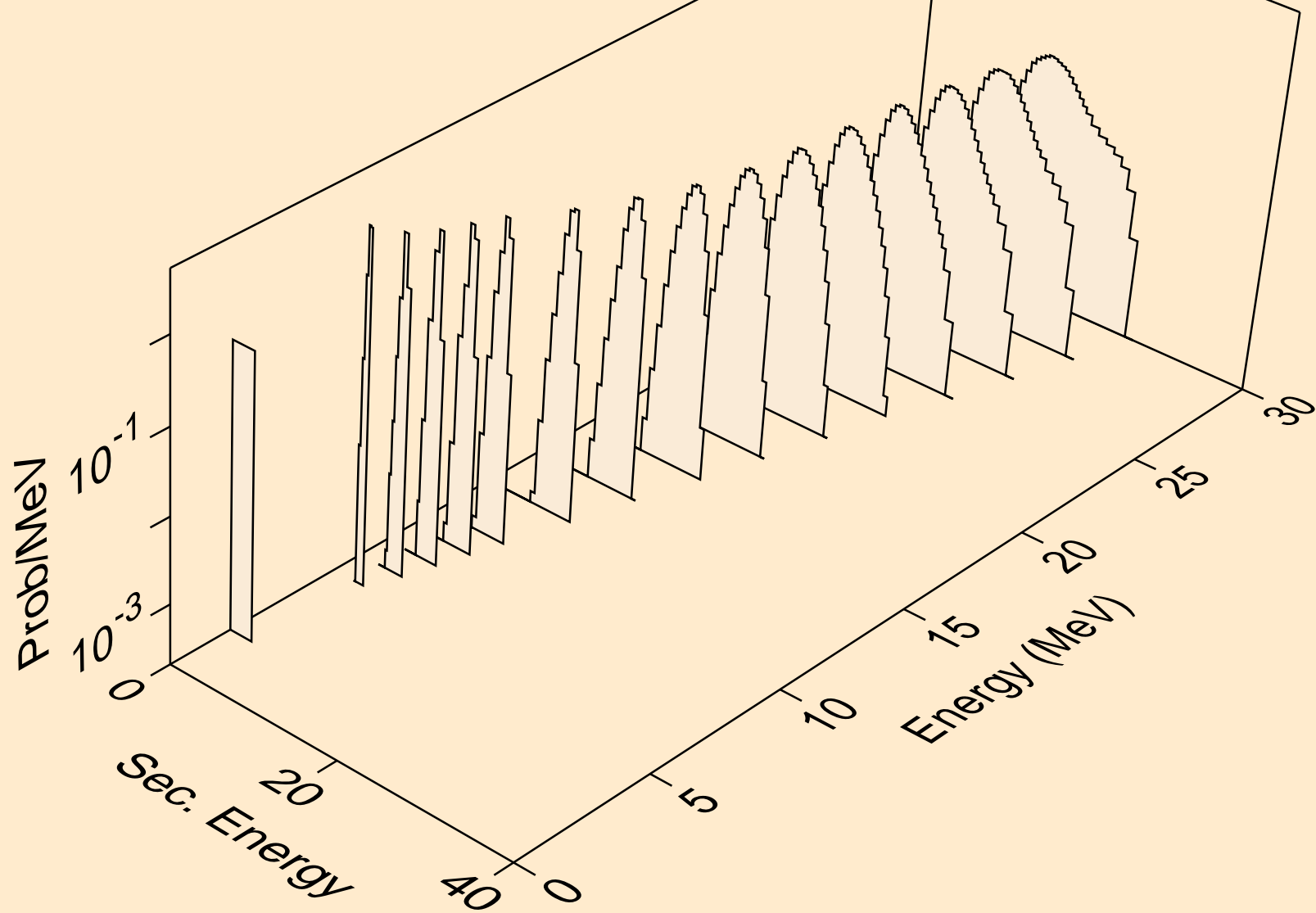

TC102M TRITON ACER TENDL-2021 LIBRARY; T=0.K  
alphas from (t,3n)a

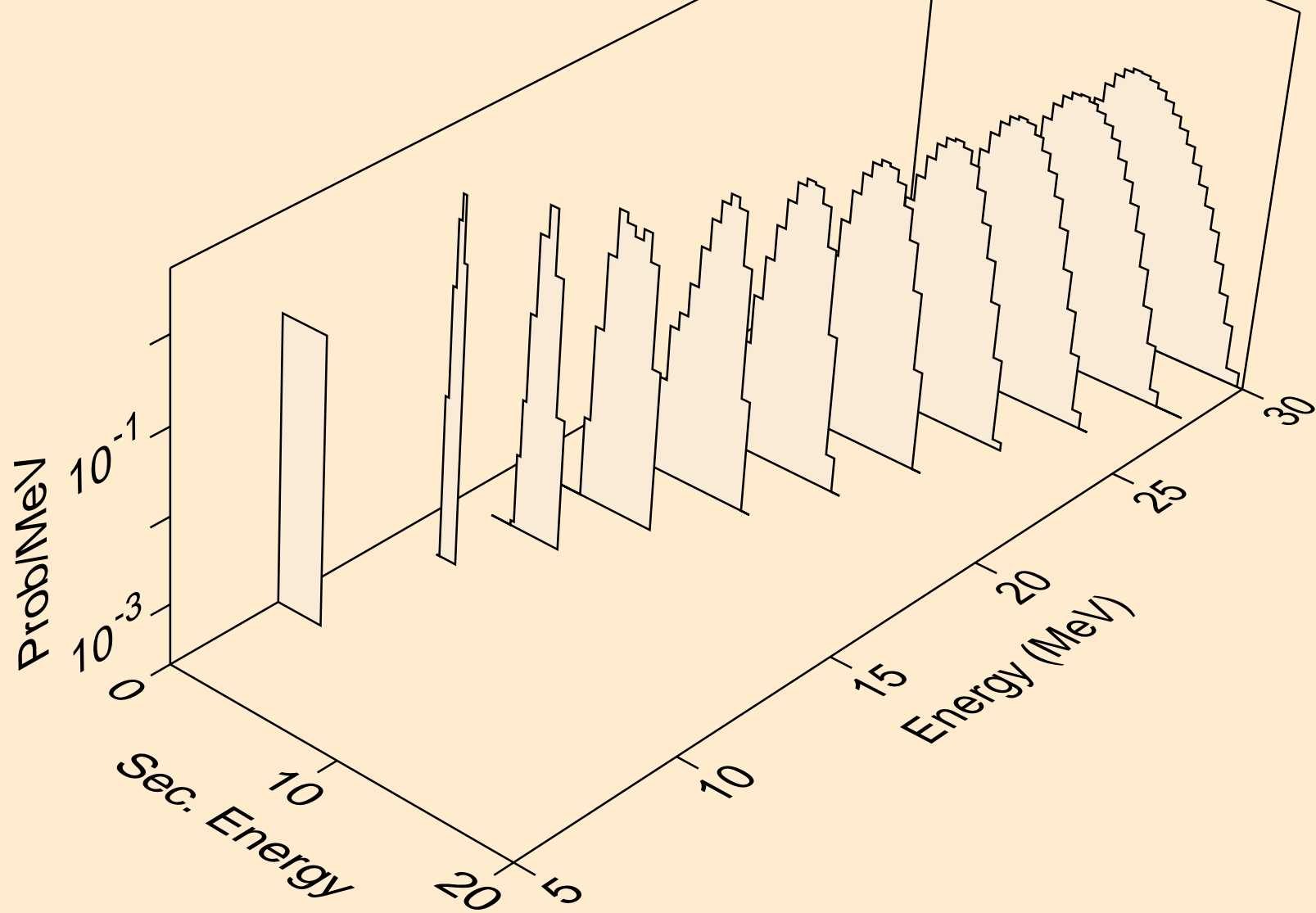

TC102M TRITON ACER TENDL-2021 LIBRARY; T=0.K  
alphas from (t,n\*)2a

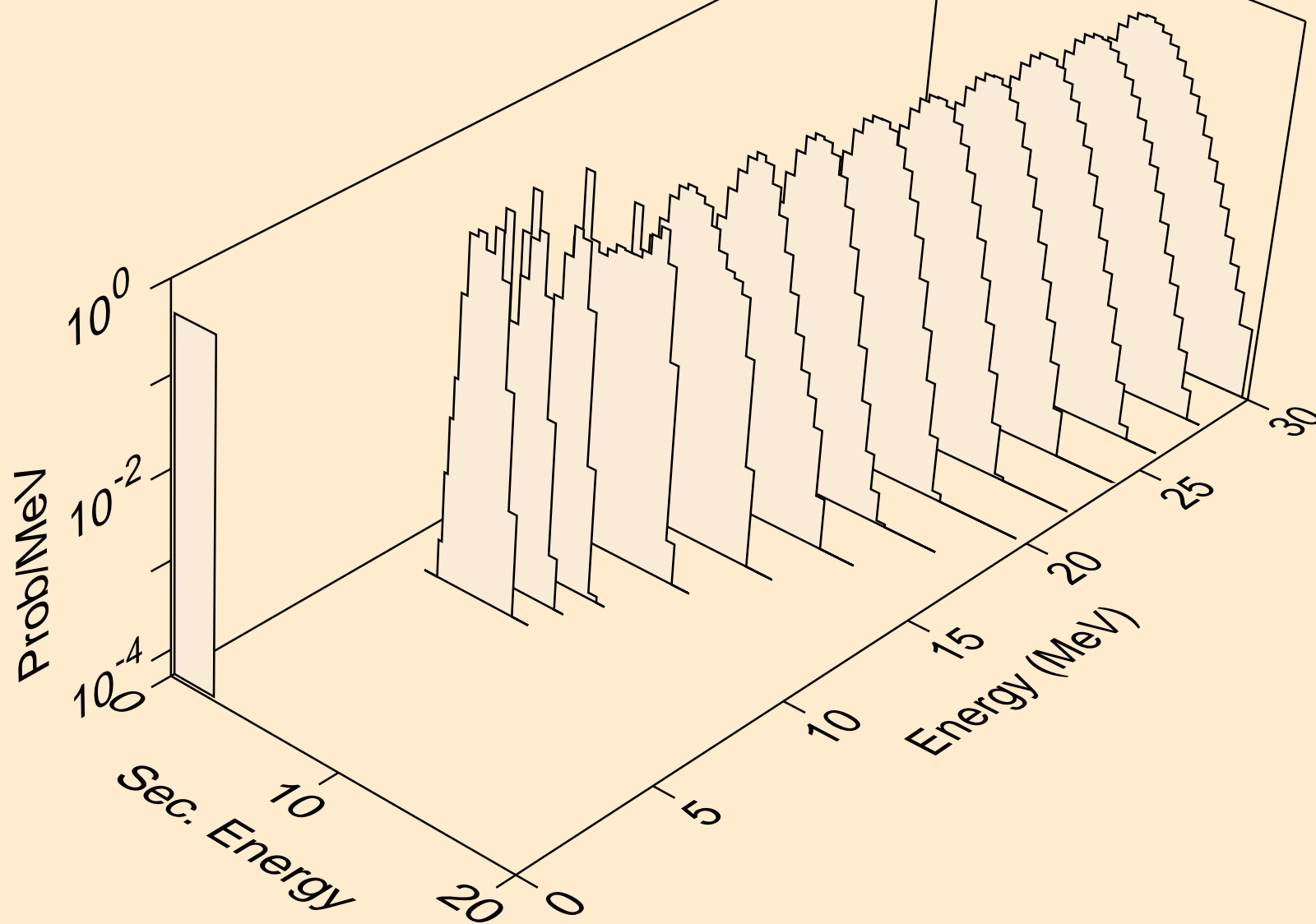

TC102M TRITON ACER TENDL-2021 LIBRARY; T=0.K  
alphas from (t,2n)2a

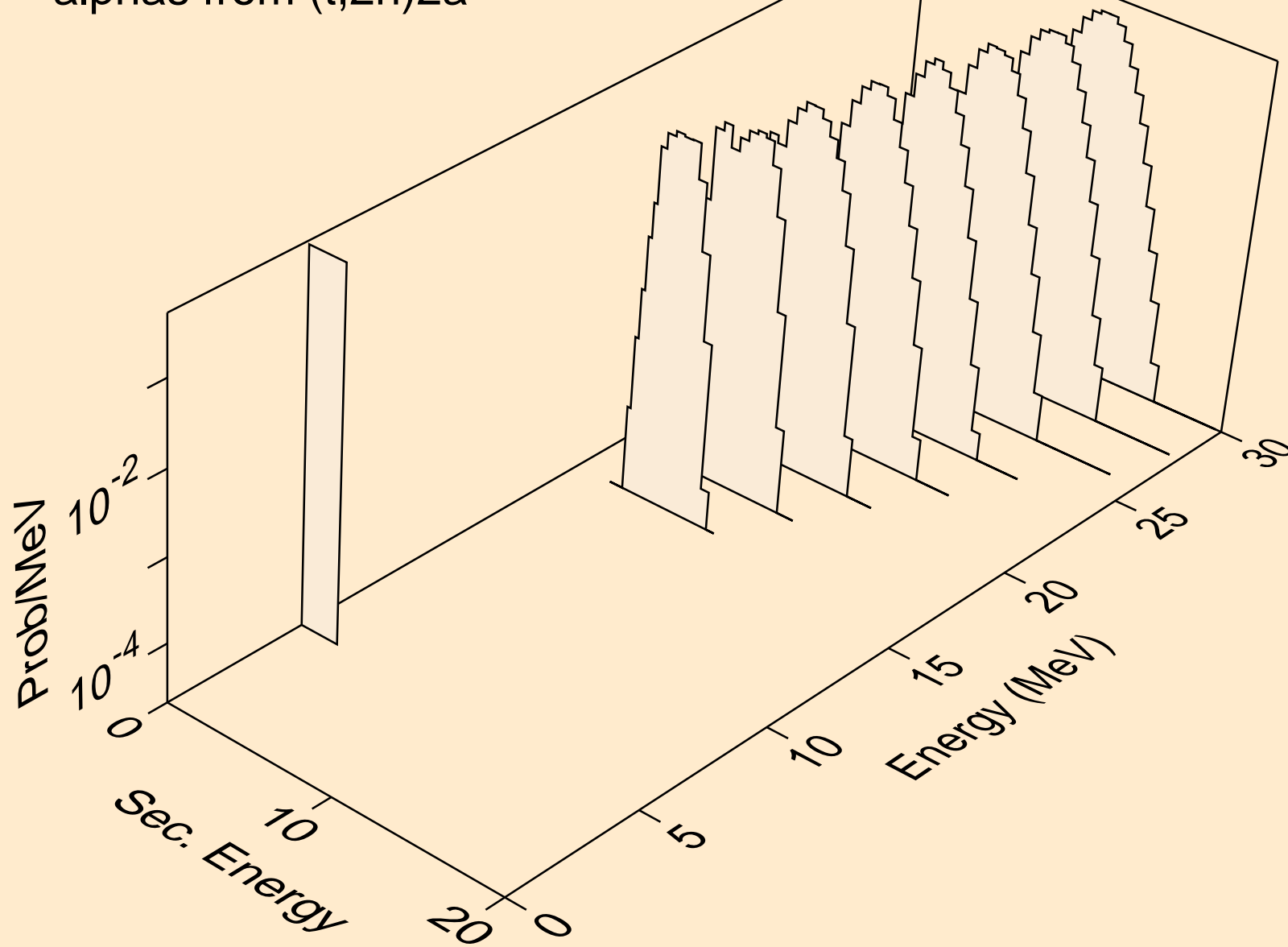

TC102M TRITON ACER TENDL-2021 LIBRARY; T=0.K  
alphas from (t,npa)

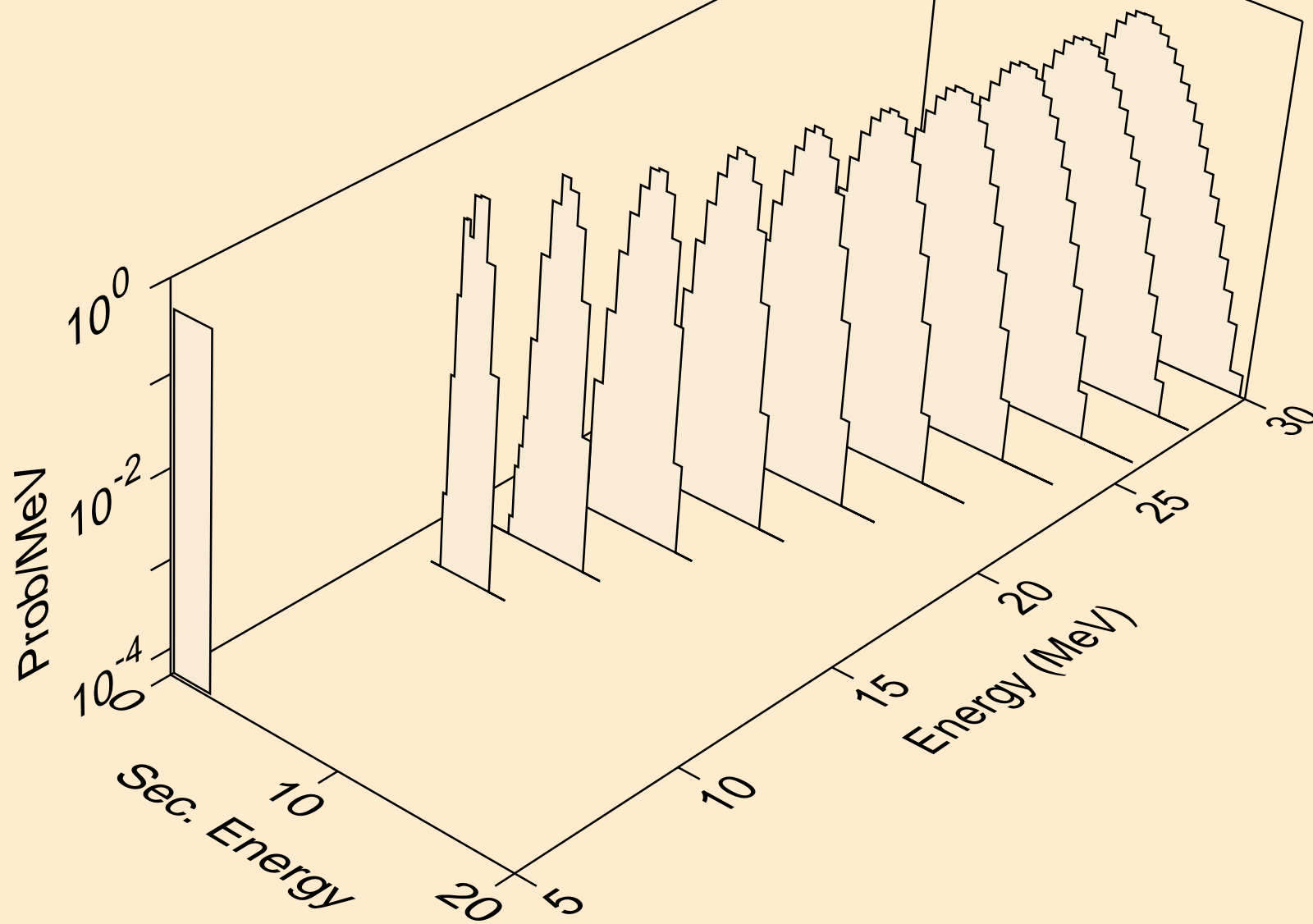

TC102M TRITON ACER TENDL-2021 LIBRARY; T=0.K  
alphas from (t,a)

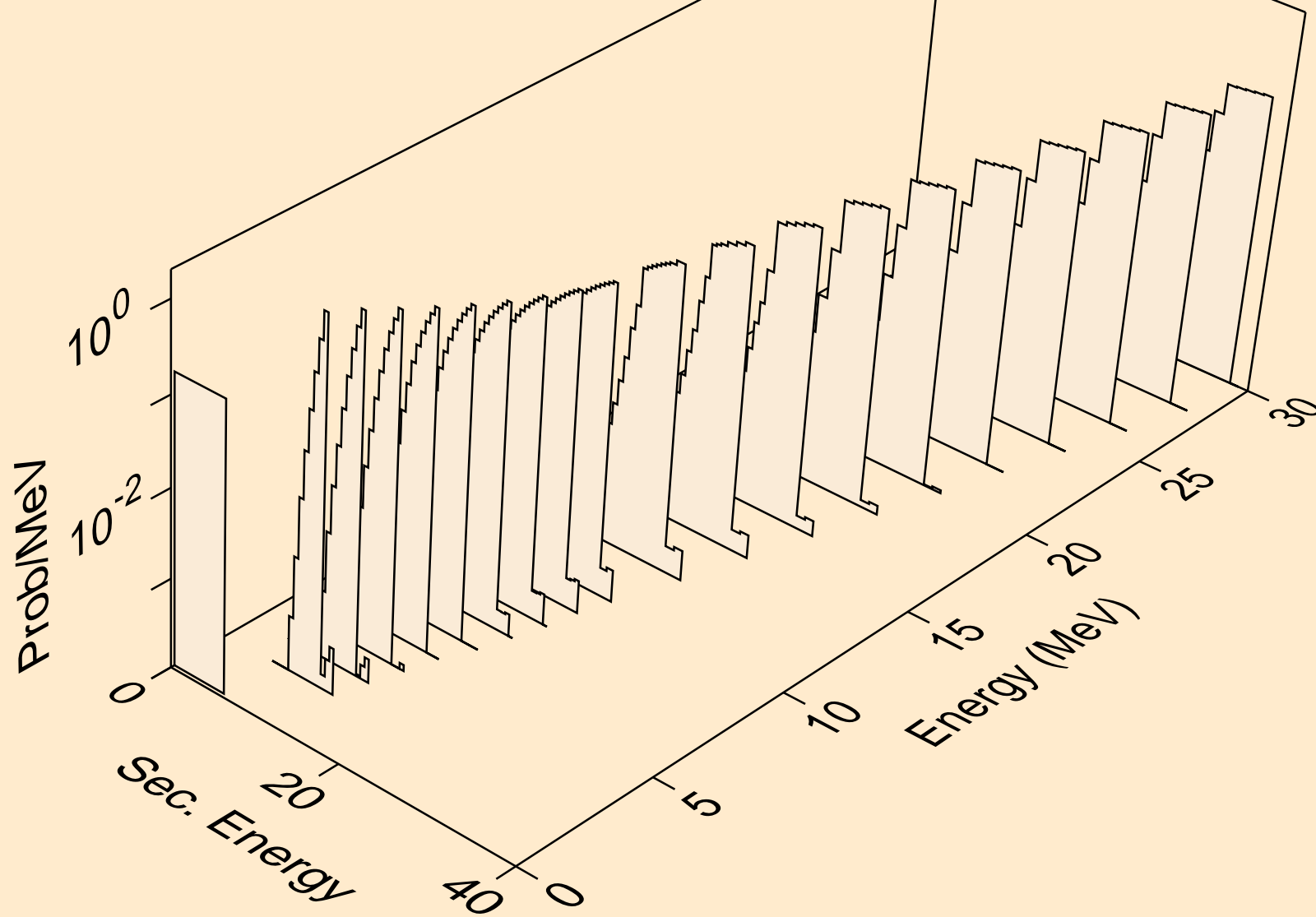

TC102M TRITON ACER TENDL-2021 LIBRARY; T=0.K  
alphas from (t,2a)

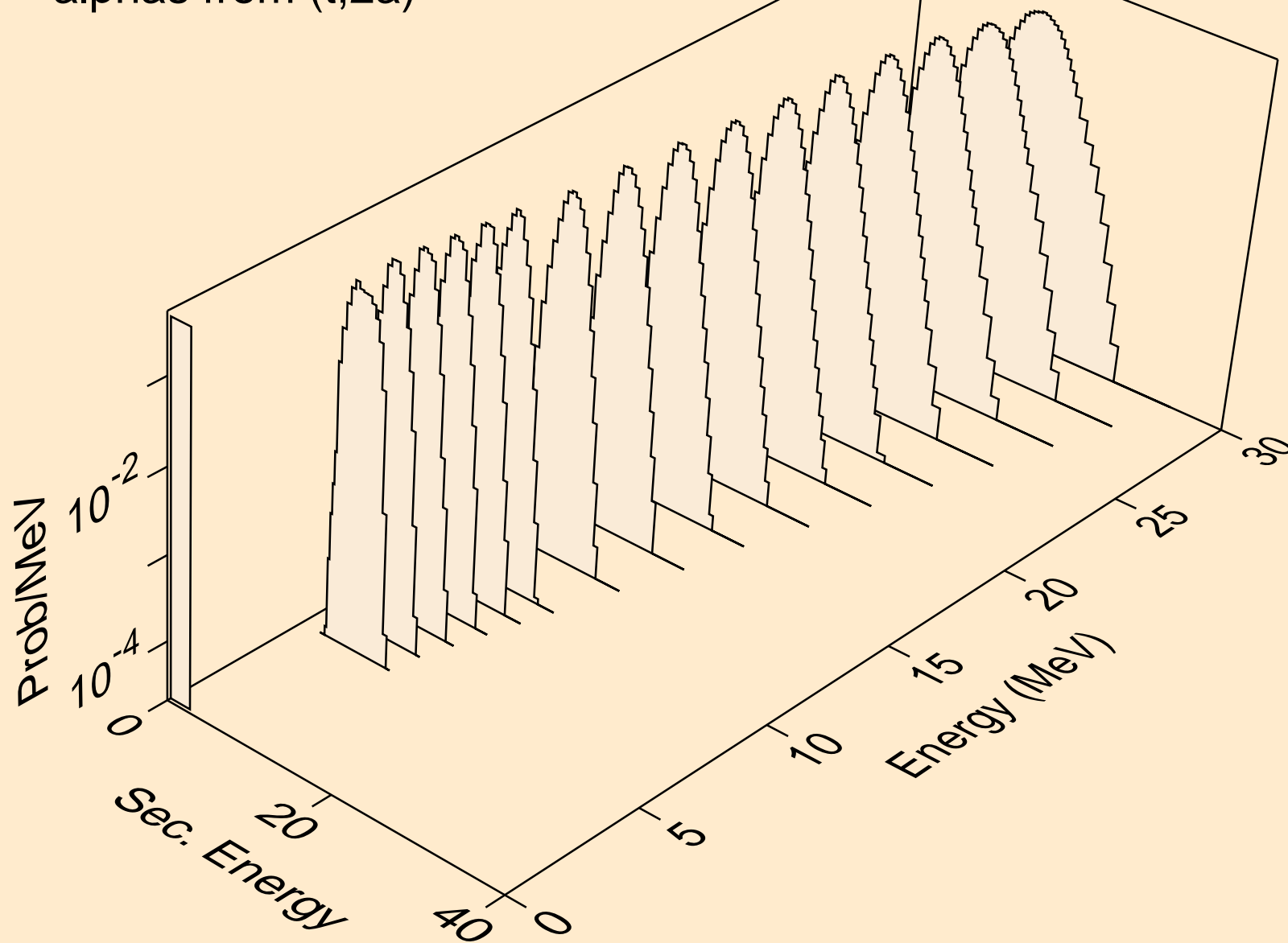

TC102M TRITON ACER TENDL-2021 LIBRARY; T=0.K  
alphas from (t,pa)

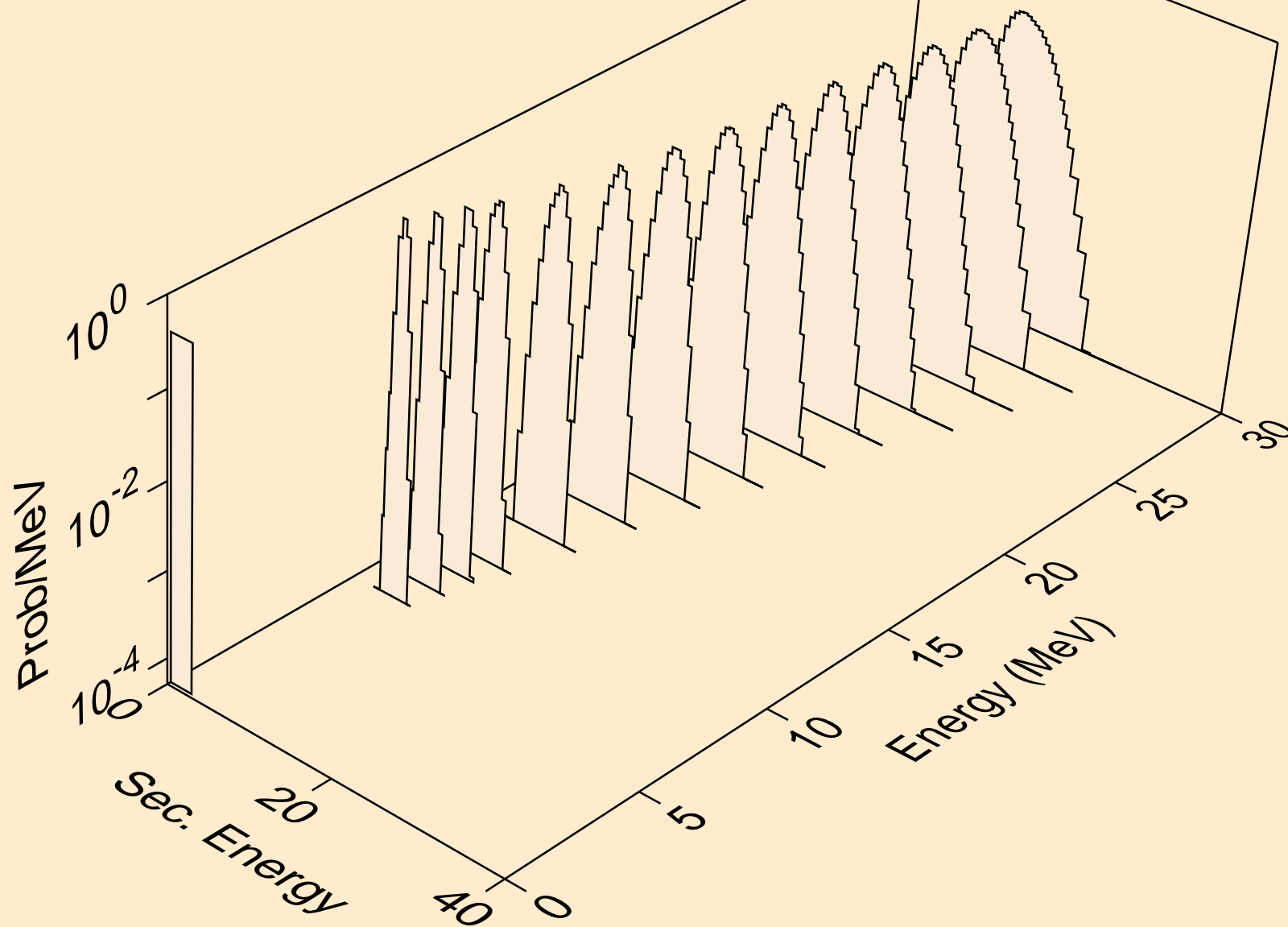



TC102M TRITON ACER TENDL-2021 LIBRARY; T=0.K  
alphas from (t,da)

