

TL202 TRITON ACER TENDL-2021 LIBRARY; T=0.K  
Principal cross sections

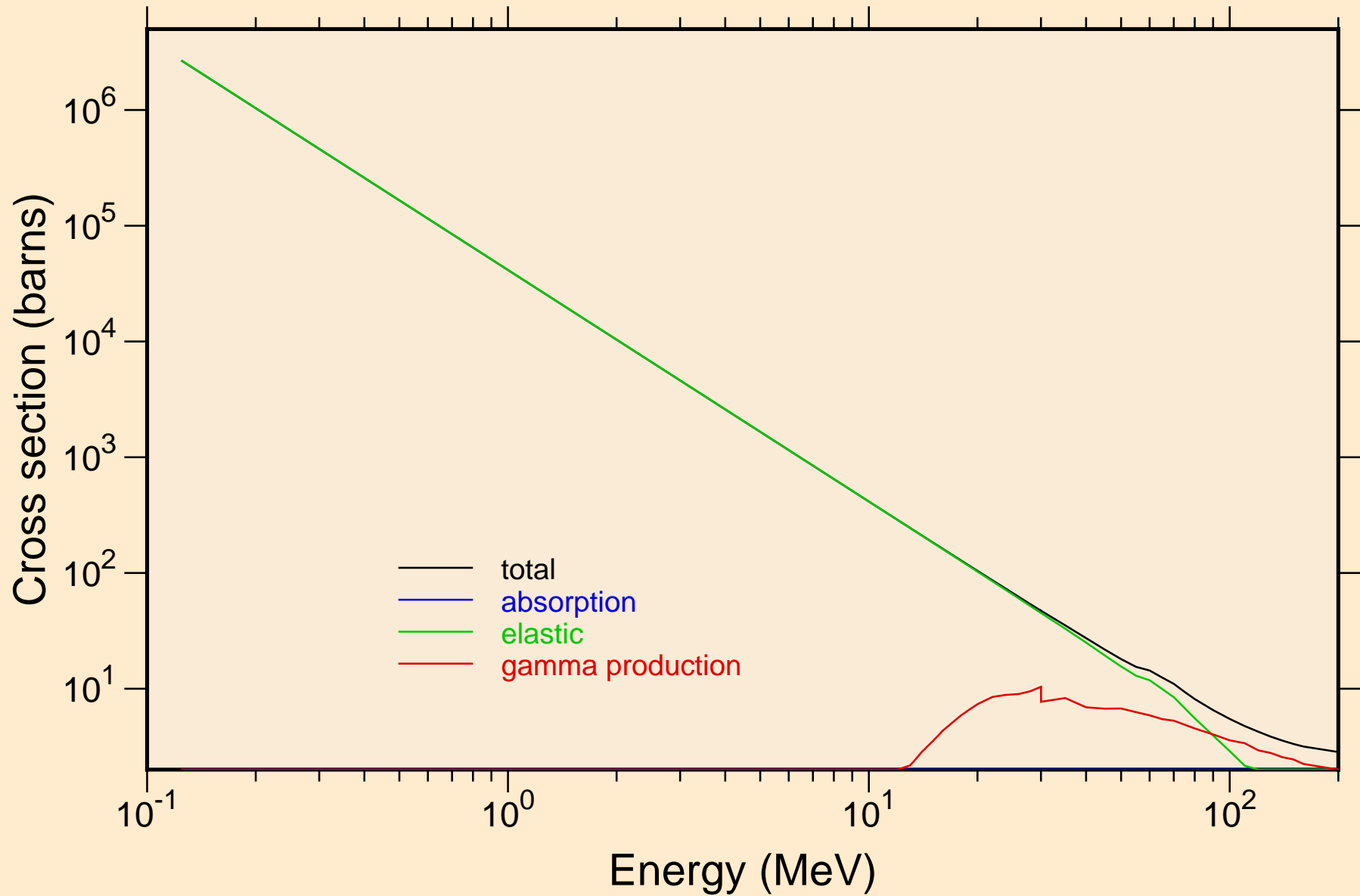

TL202 TRITON ACER TENDL-2021 LIBRARY; T=0.K

Heating

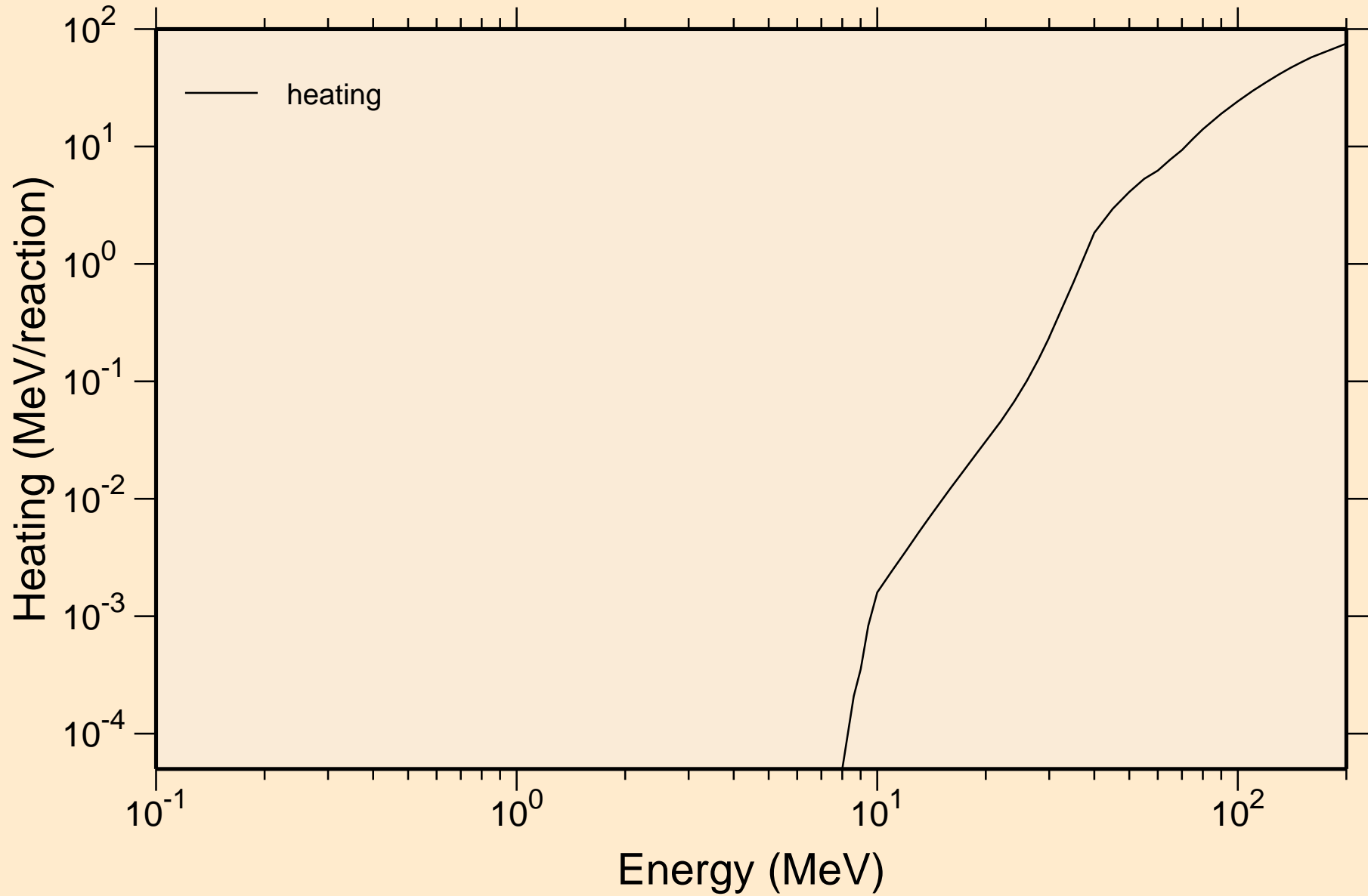

# TL202 TRITON ACER TENDL-2021 LIBRARY; T=0.K

## Principal cross sections

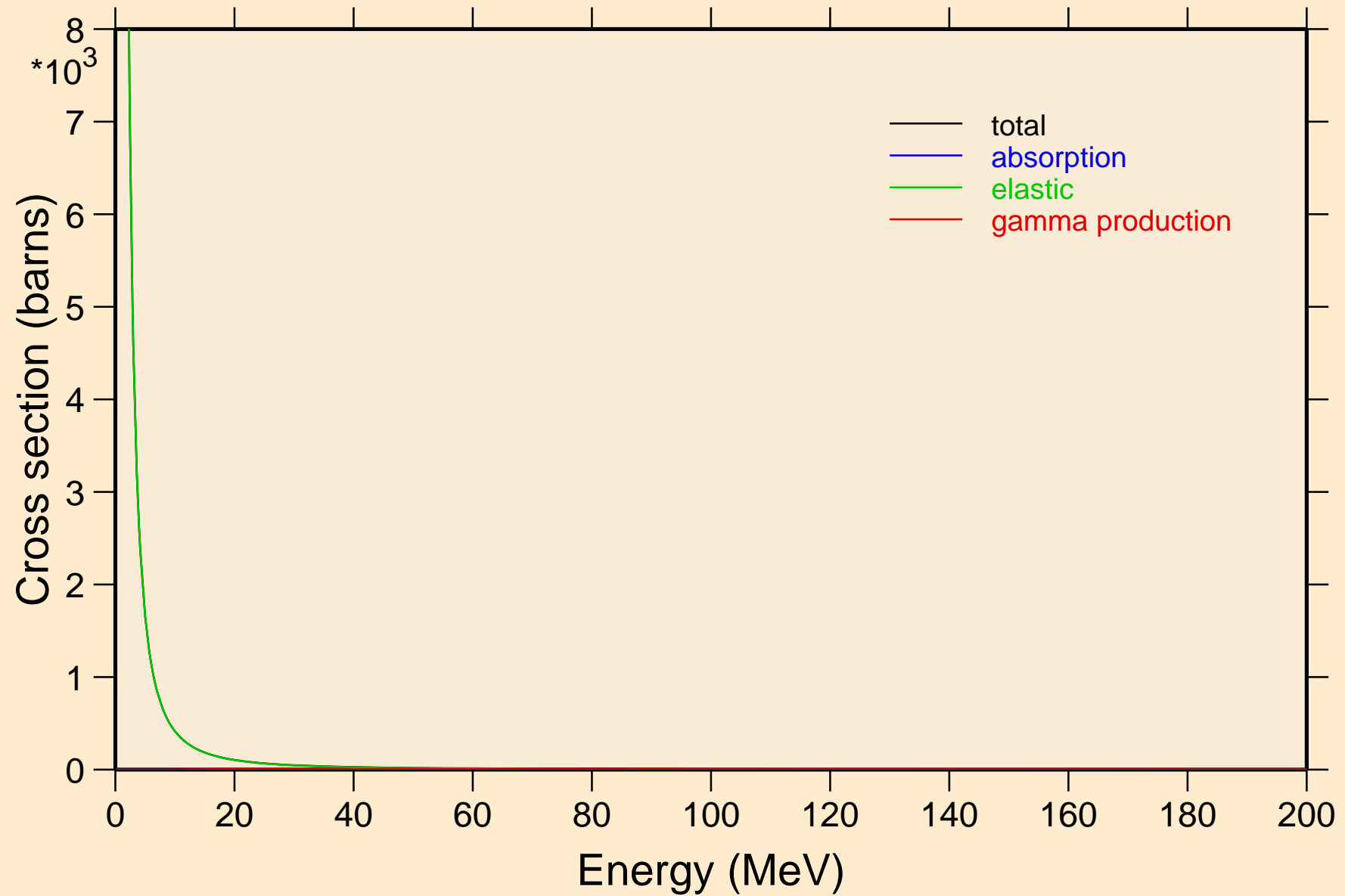

TL202 TRITON ACER TENDL-2021 LIBRARY; T=0.K

Heating

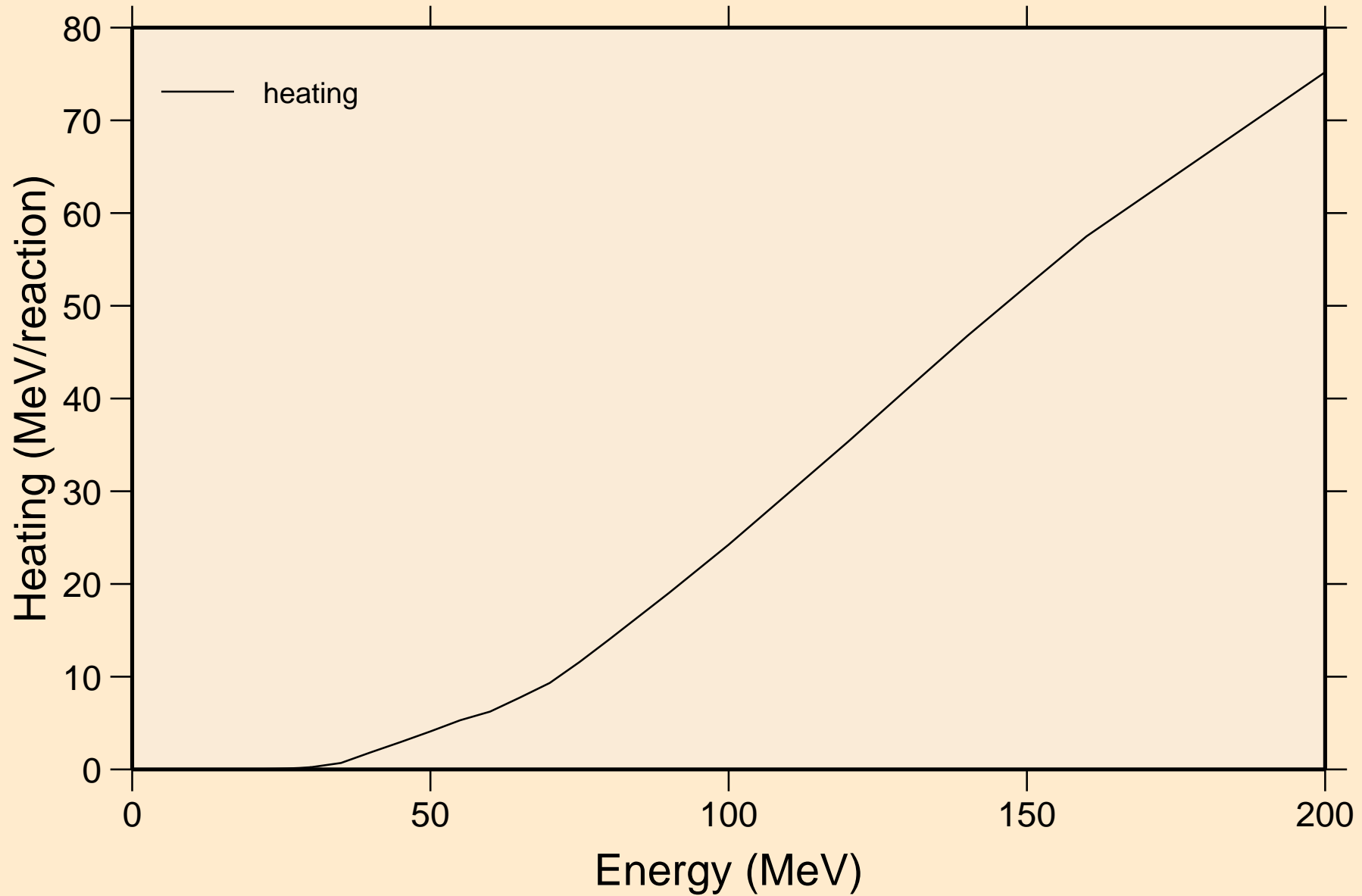

TL202 TRITON ACER TENDL-2021 LIBRARY; T=0.K  
Threshold reactions

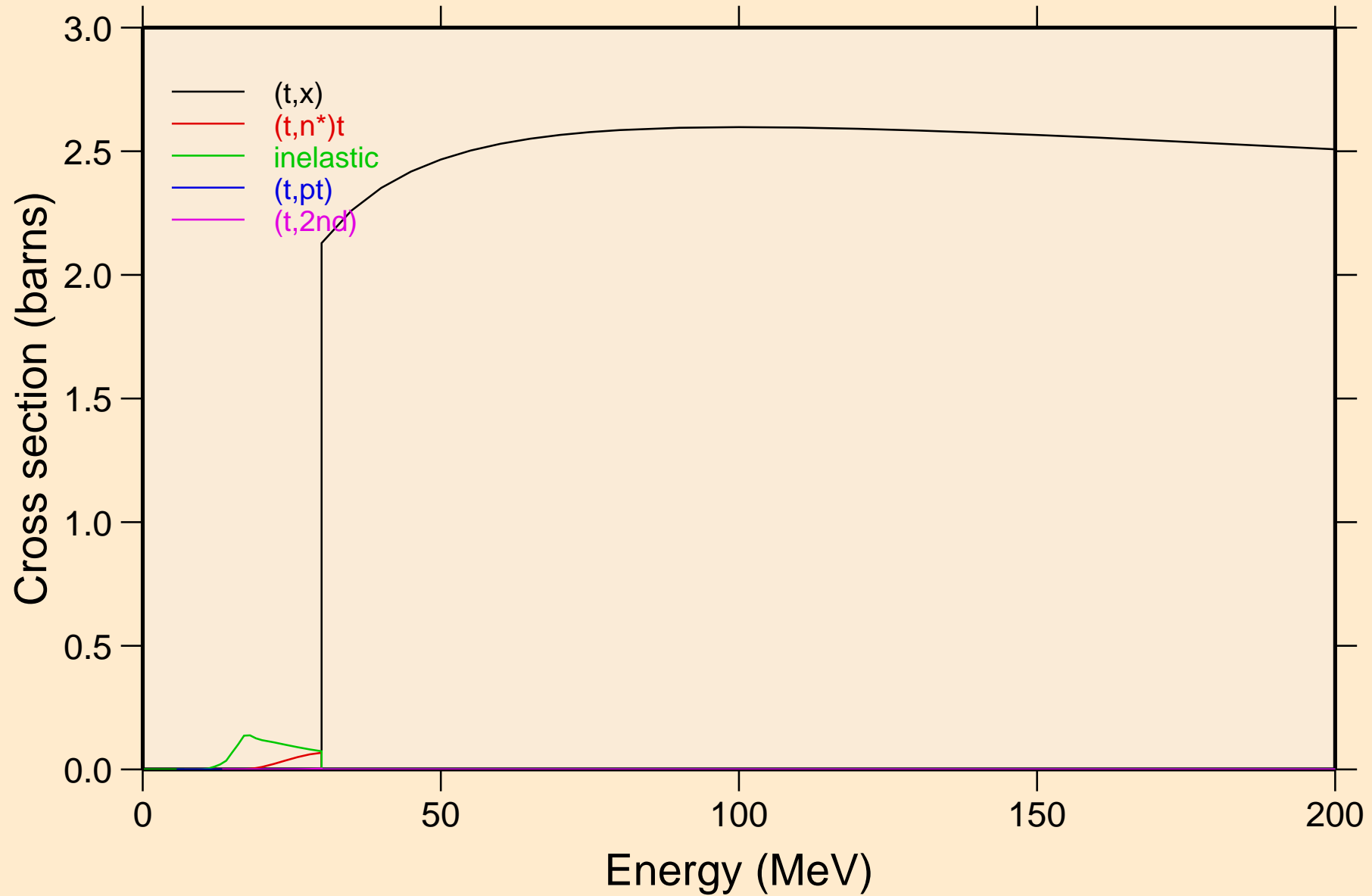

TL202 TRITON ACER TENDL-2021 LIBRARY; T=0.K  
Threshold reactions

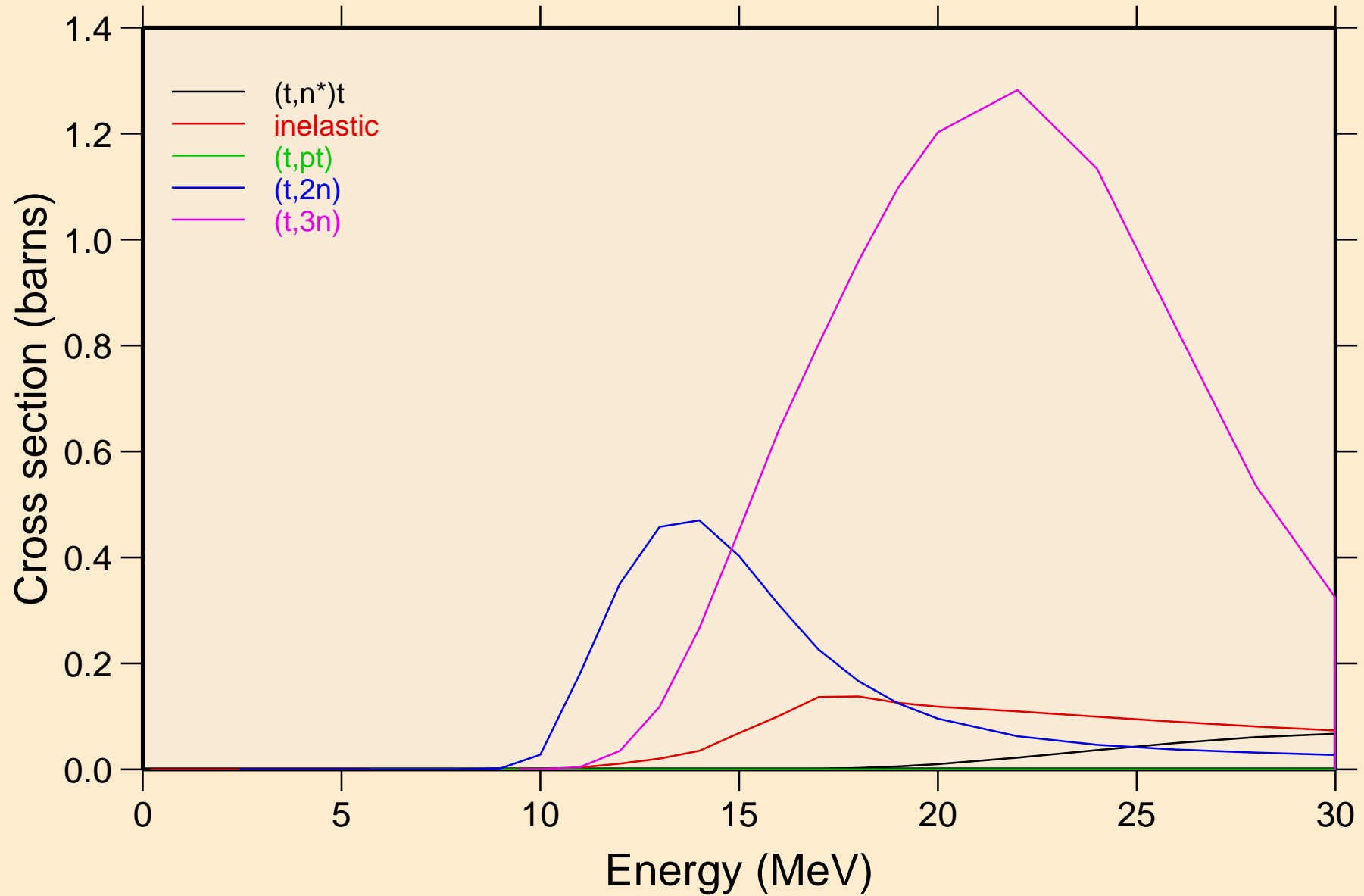

TL202 TRITON ACER TENDL-2021 LIBRARY; T=0.K  
Threshold reactions

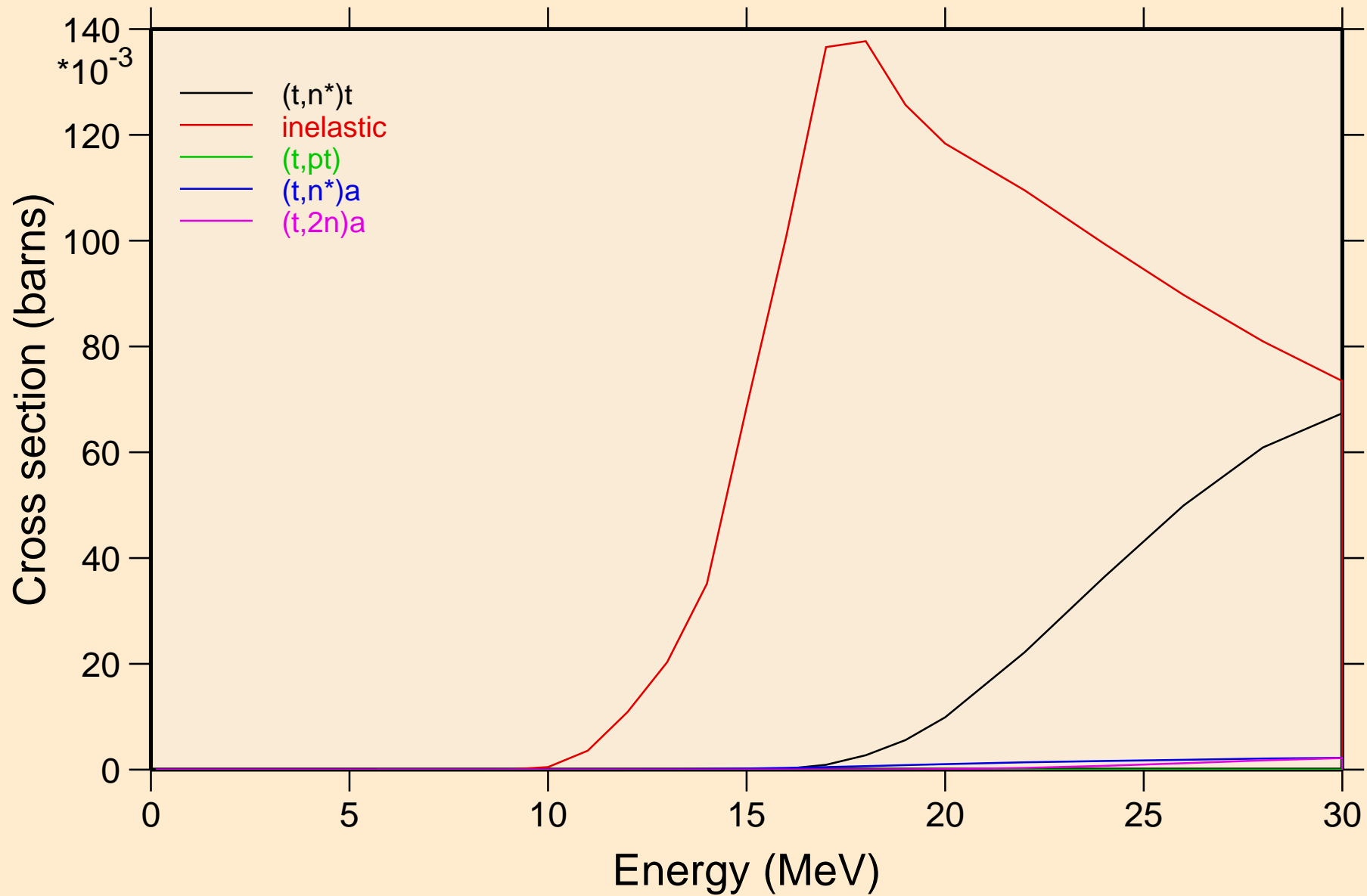

TL202 TRITON ACER TENDL-2021 LIBRARY; T=0.K  
Threshold reactions

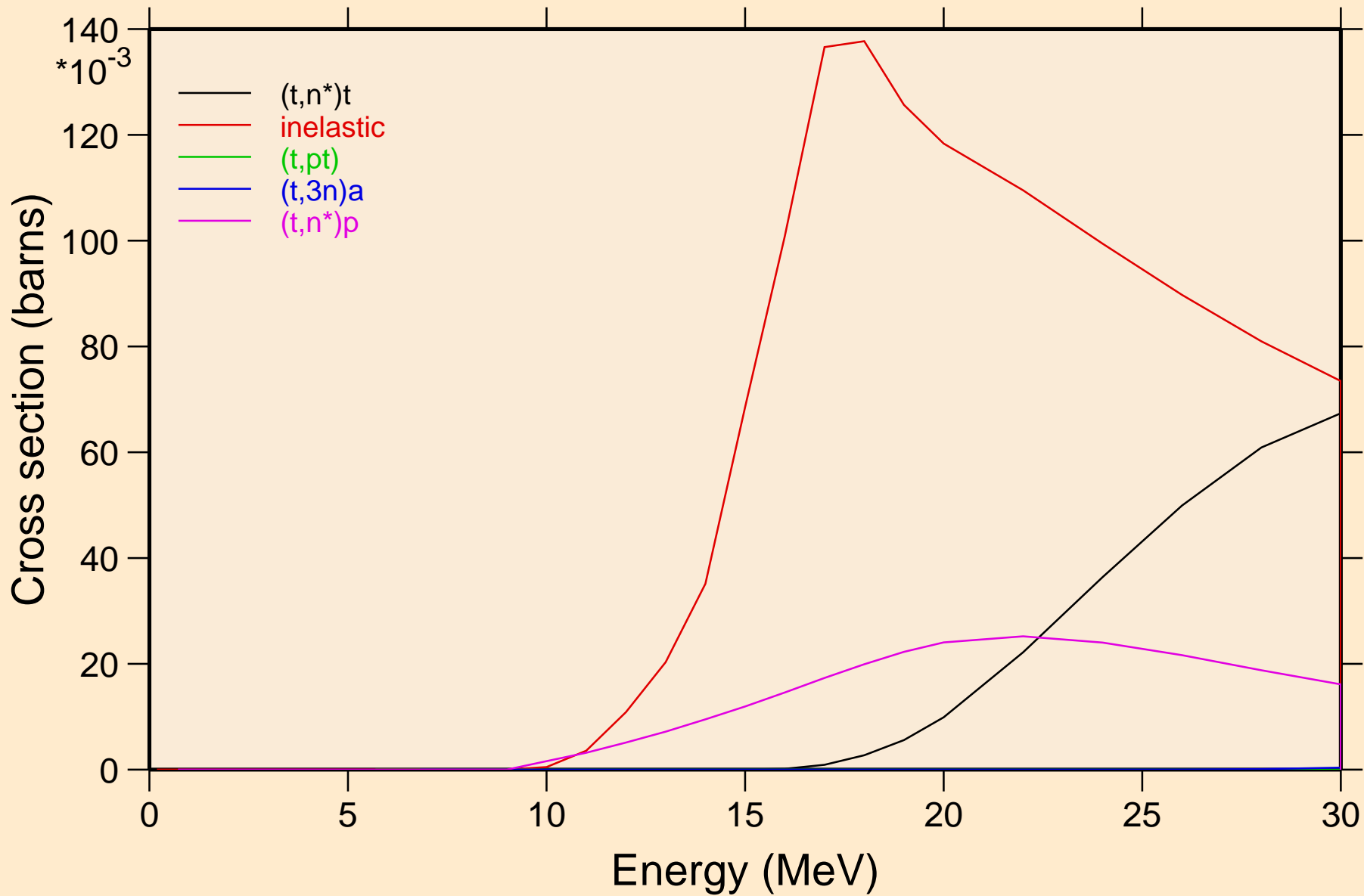



TL202 TRITON ACER TENDL-2021 LIBRARY; T=0.K  
Threshold reactions

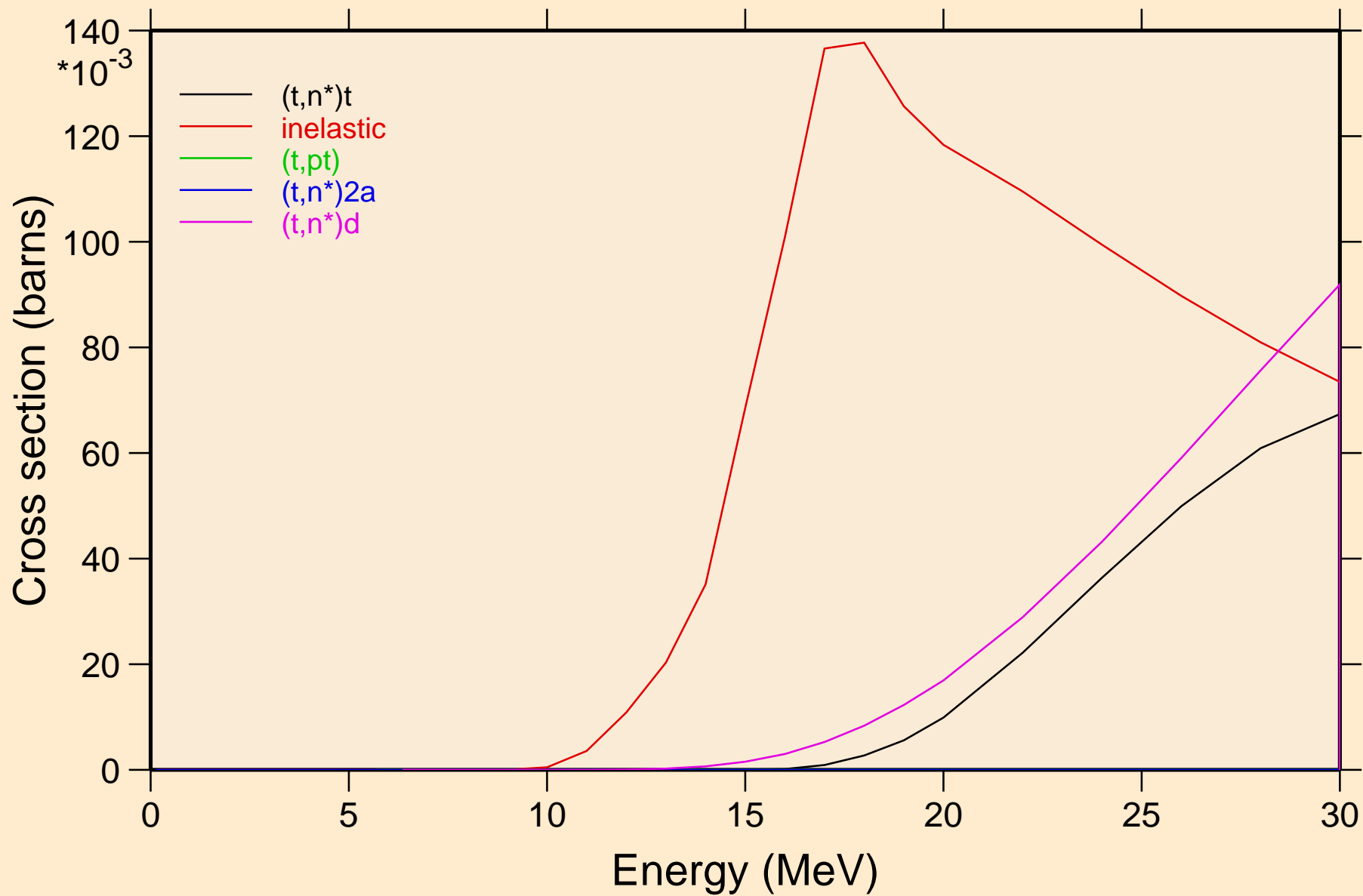

TL202 TRITON ACER TENDL-2021 LIBRARY; T=0.K  
Threshold reactions

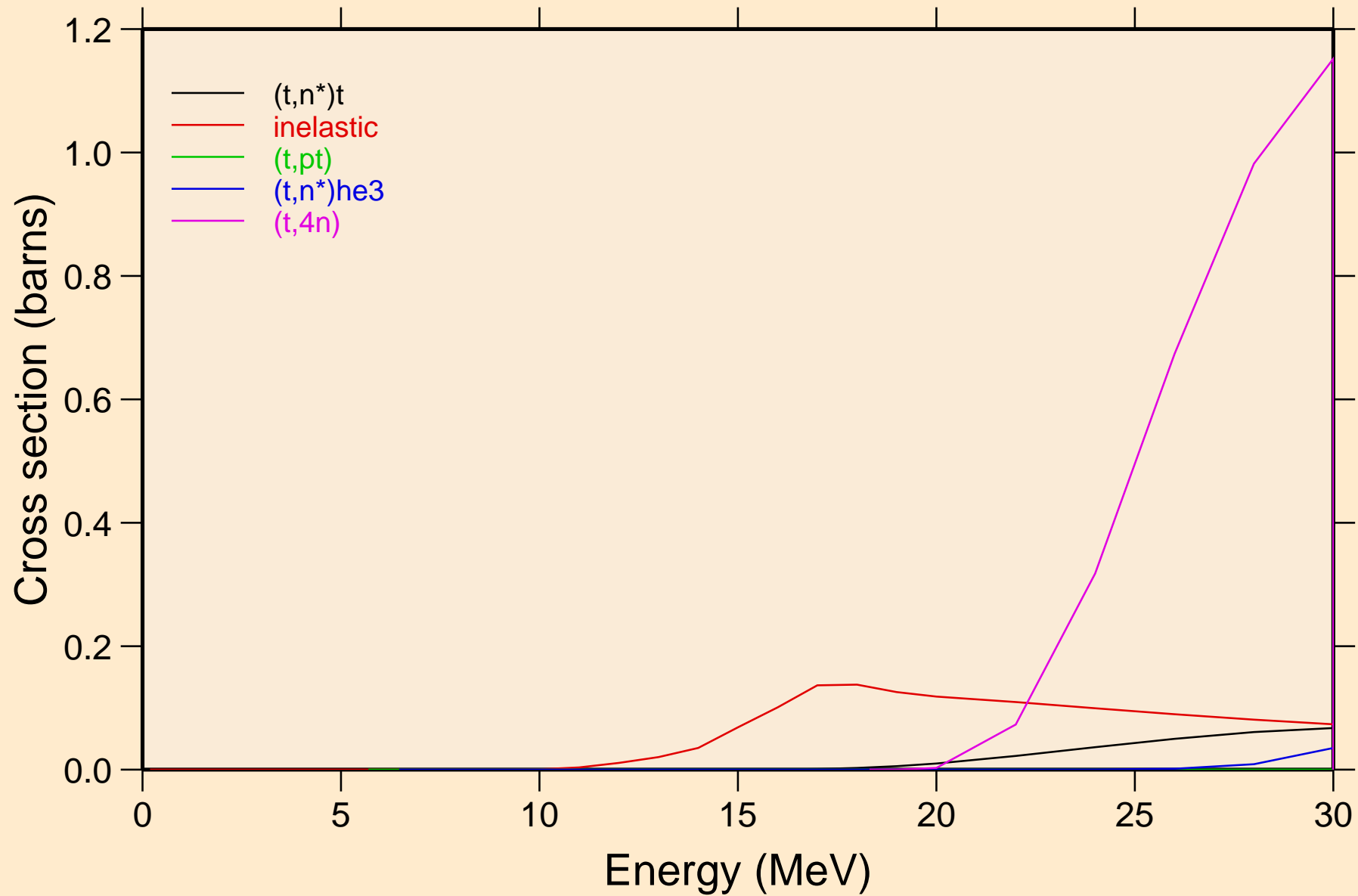

TL202 TRITON ACER TENDL-2021 LIBRARY; T=0.K  
Threshold reactions

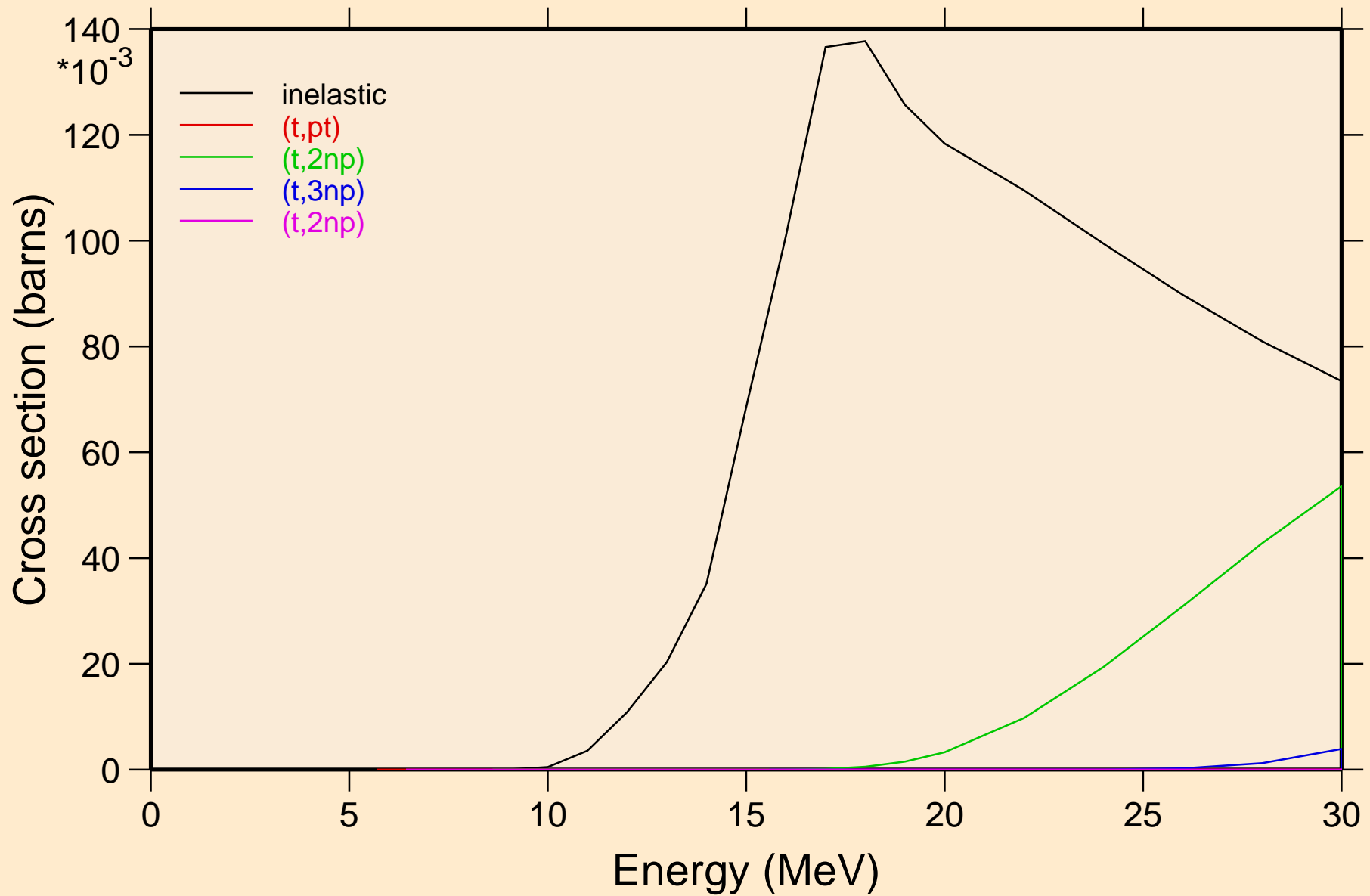

TL202 TRITON ACER TENDL-2021 LIBRARY; T=0.K  
Threshold reactions

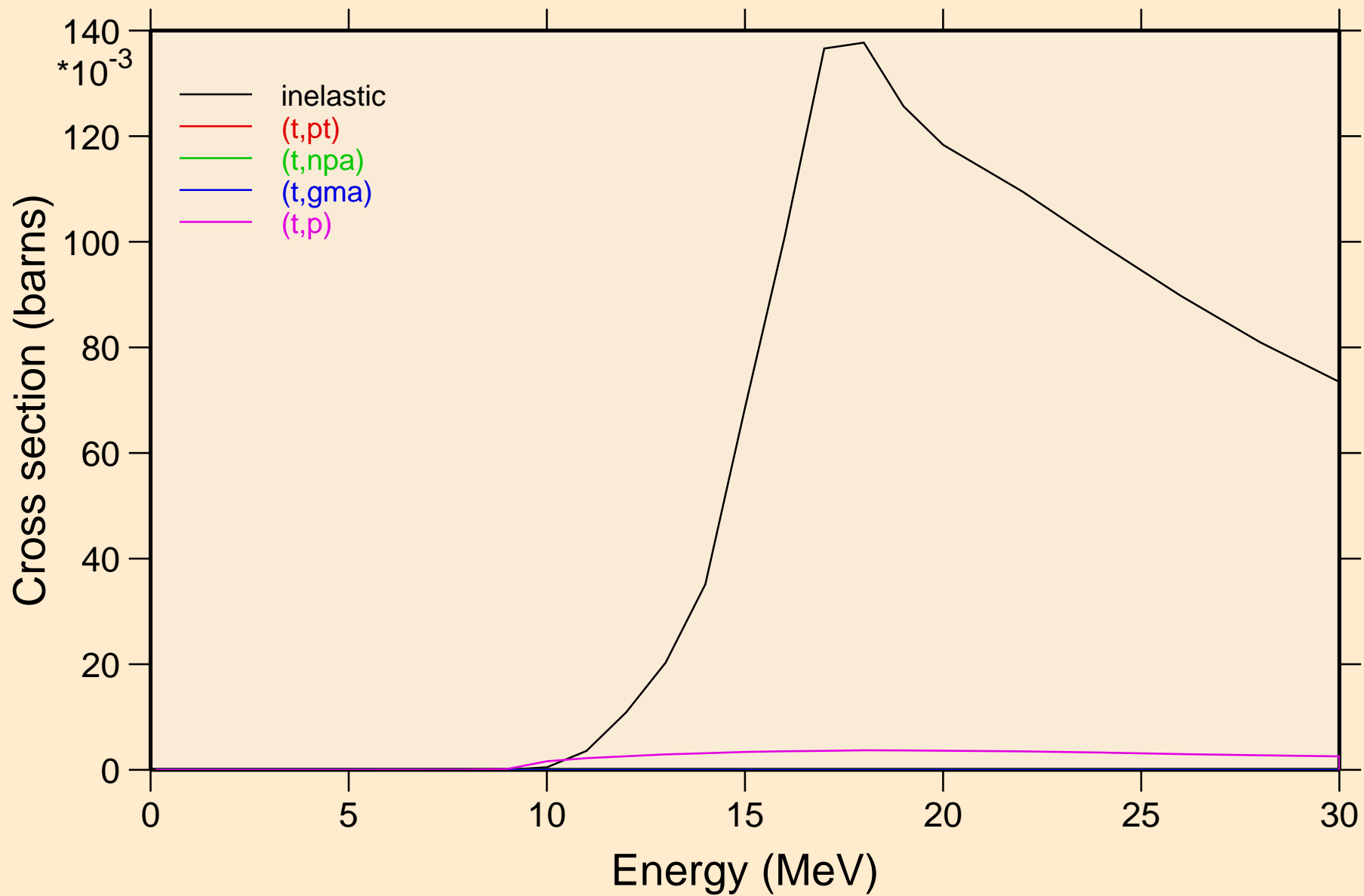

TL202 TRITON ACER TENDL-2021 LIBRARY; T=0.K  
Threshold reactions

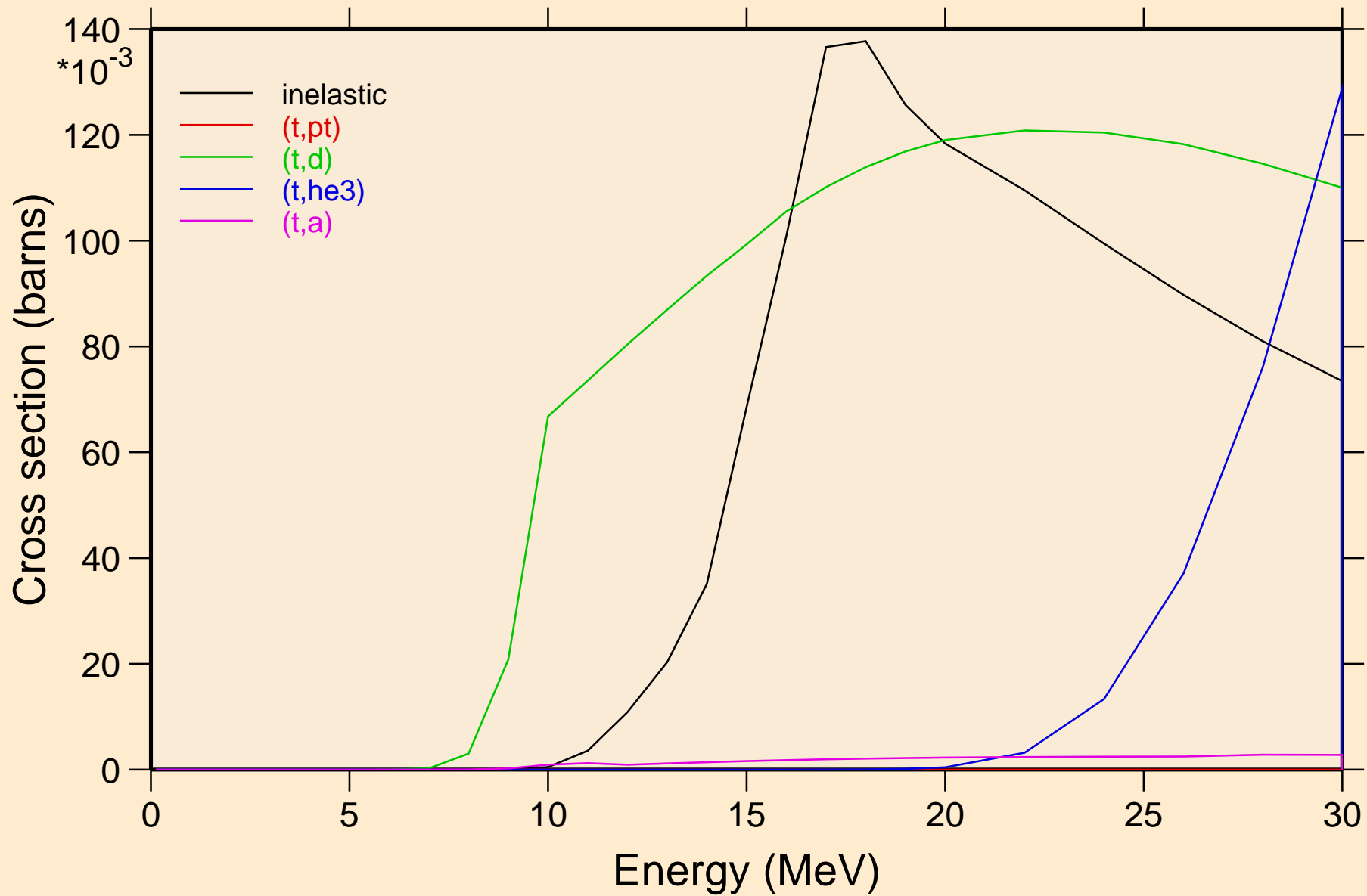

TL202 TRITON ACER TENDL-2021 LIBRARY; T=0.K  
Threshold reactions

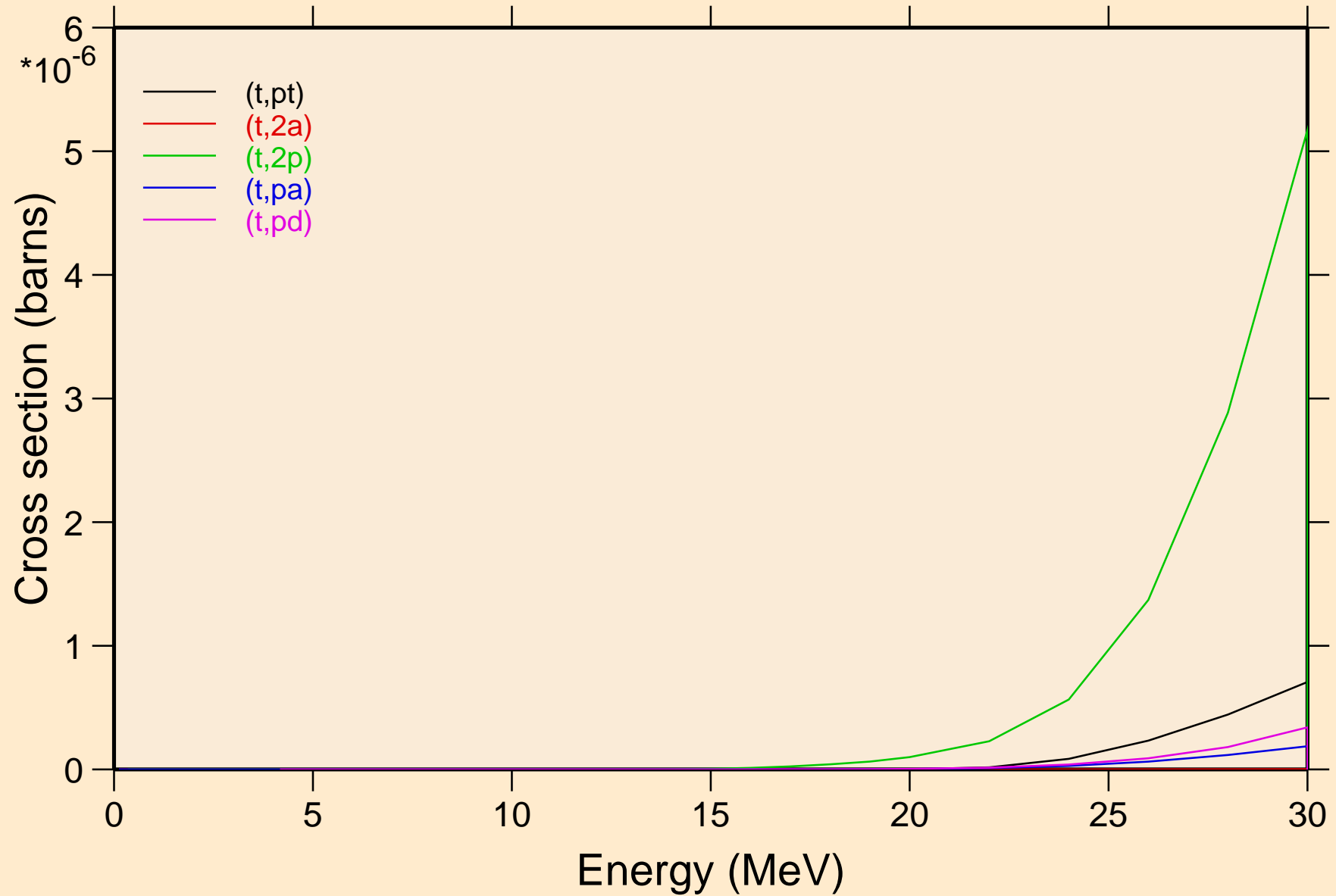

TL202 TRITON ACER TENDL-2021 LIBRARY; T=0.K  
Threshold reactions

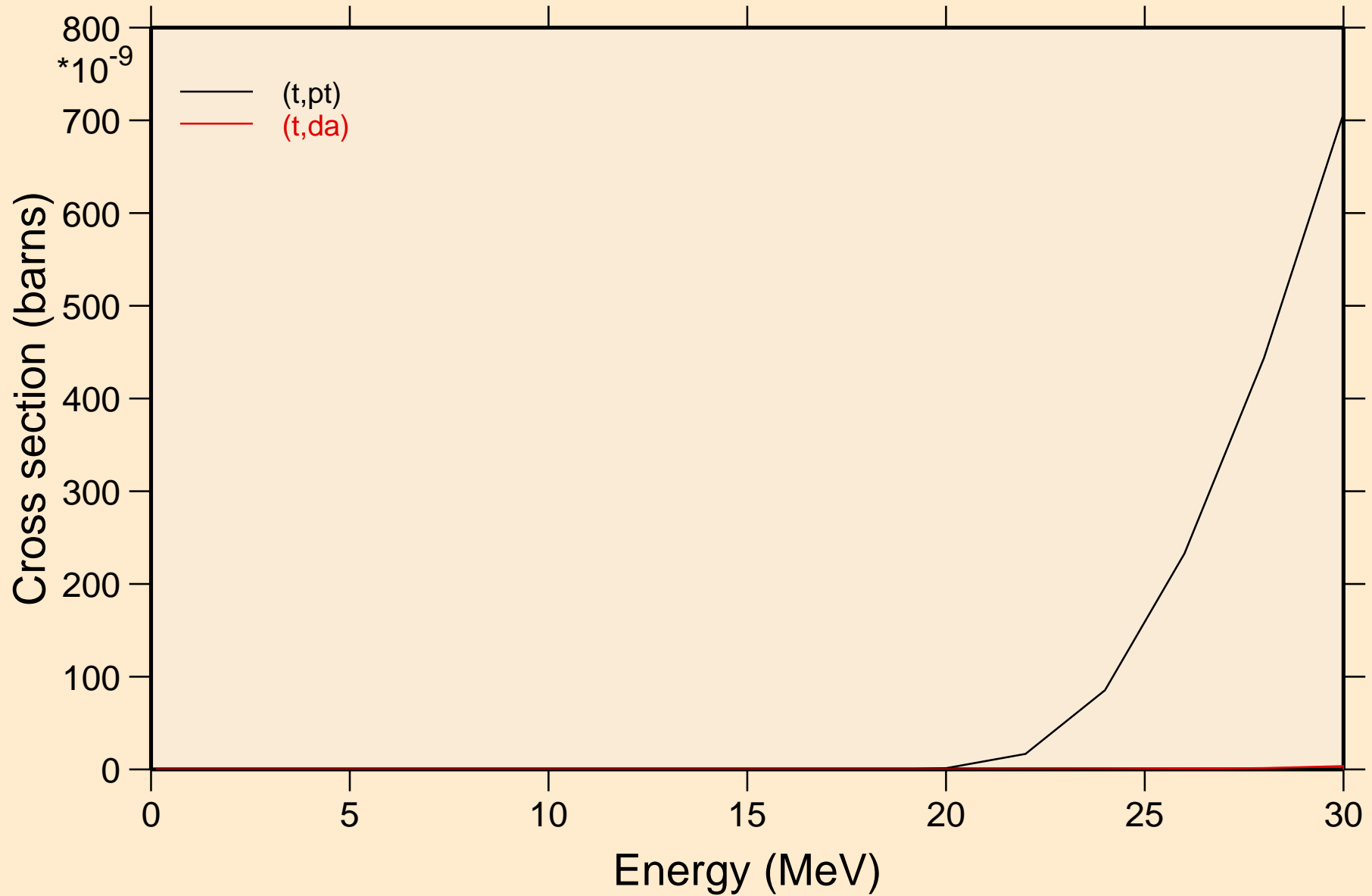

TL202 TRITON ACER TENDL-2021 LIBRARY; T=0.K  
angular distribution for elastic

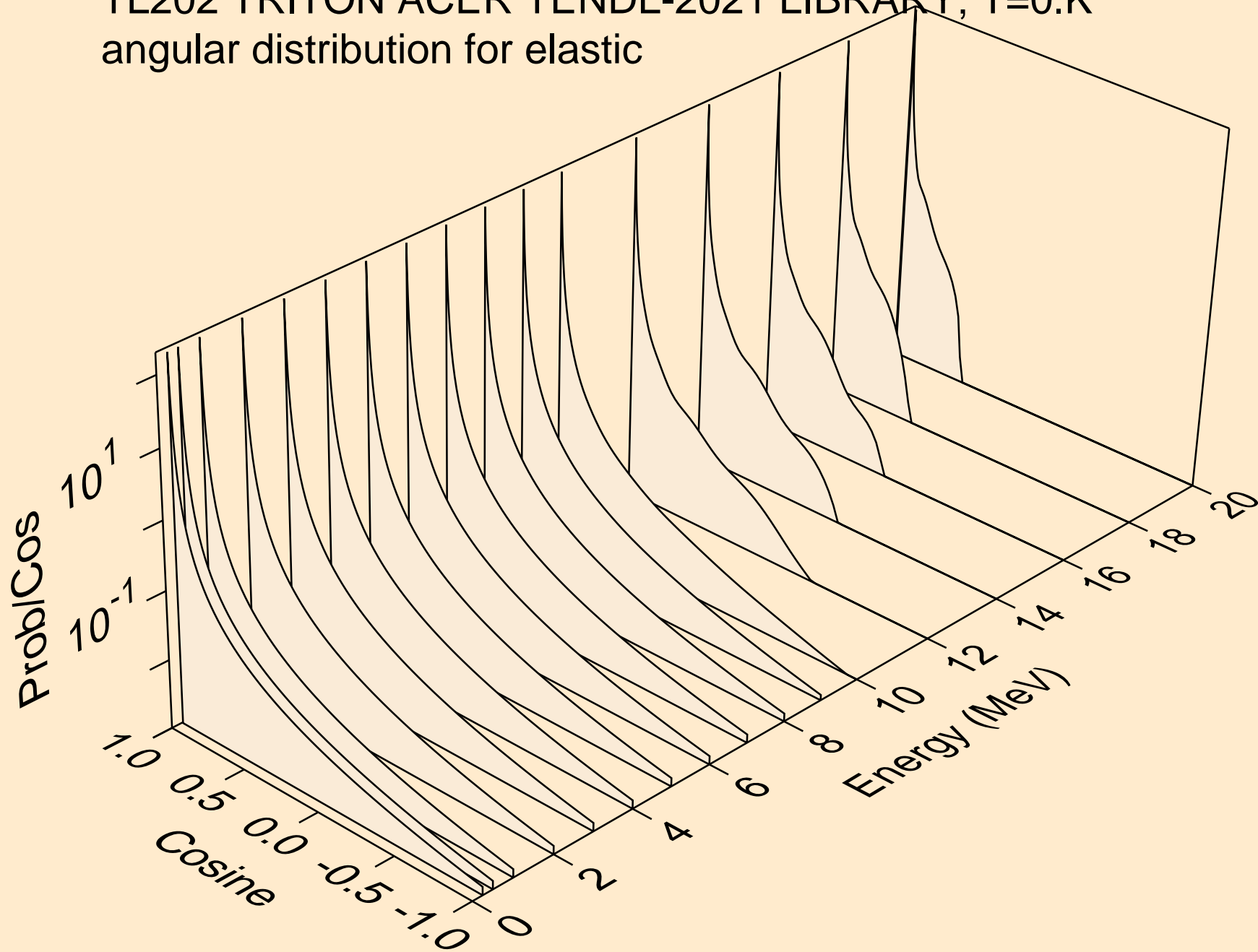



TL202 TRITON ACER TENDL-2021 LIBRARY; T=0.K  
angular distribution for elastic

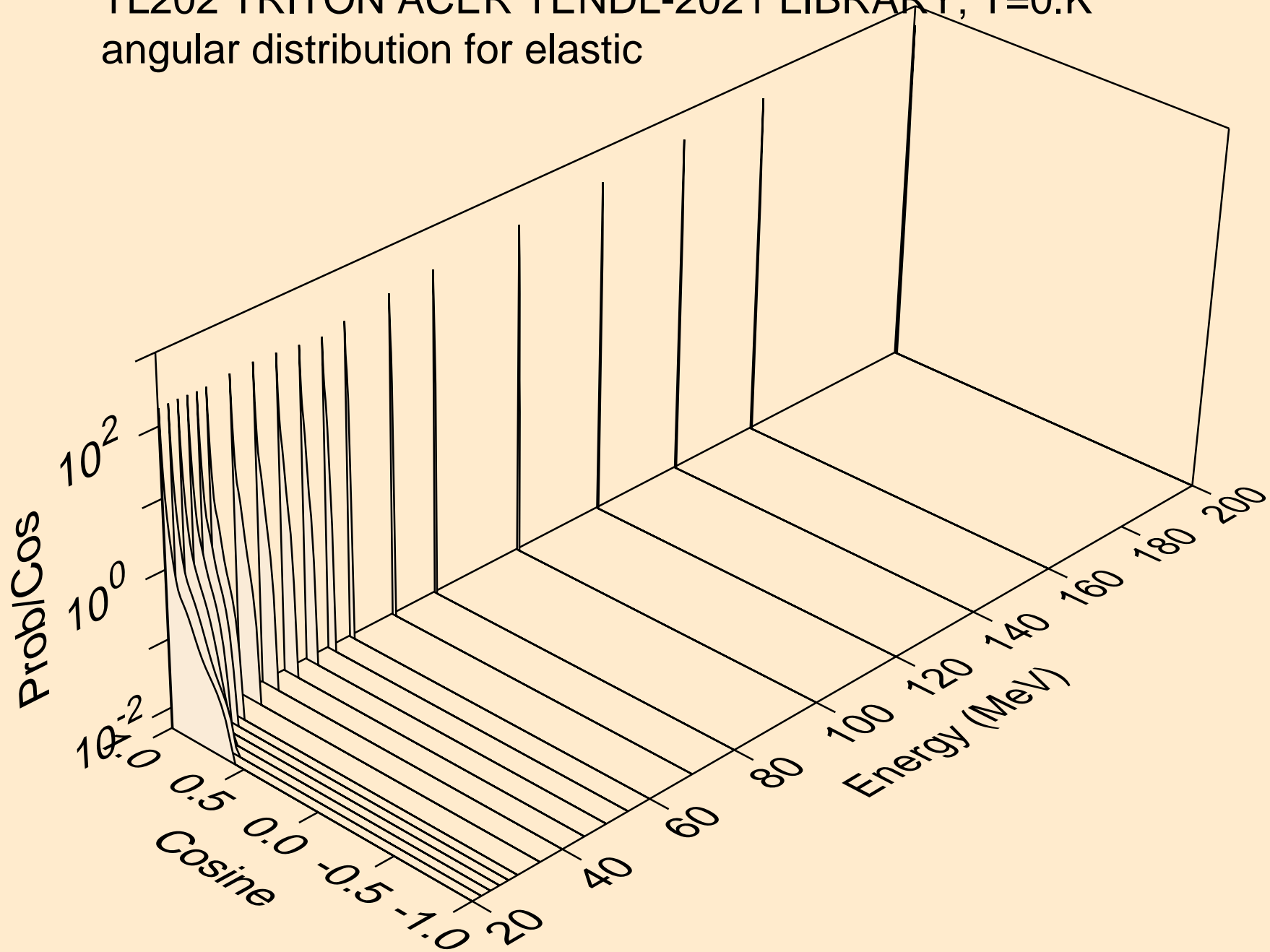

TL202 TRITON ACER TENDL-2021 LIBRARY; T=0.K  
Triton emission for (t,x)

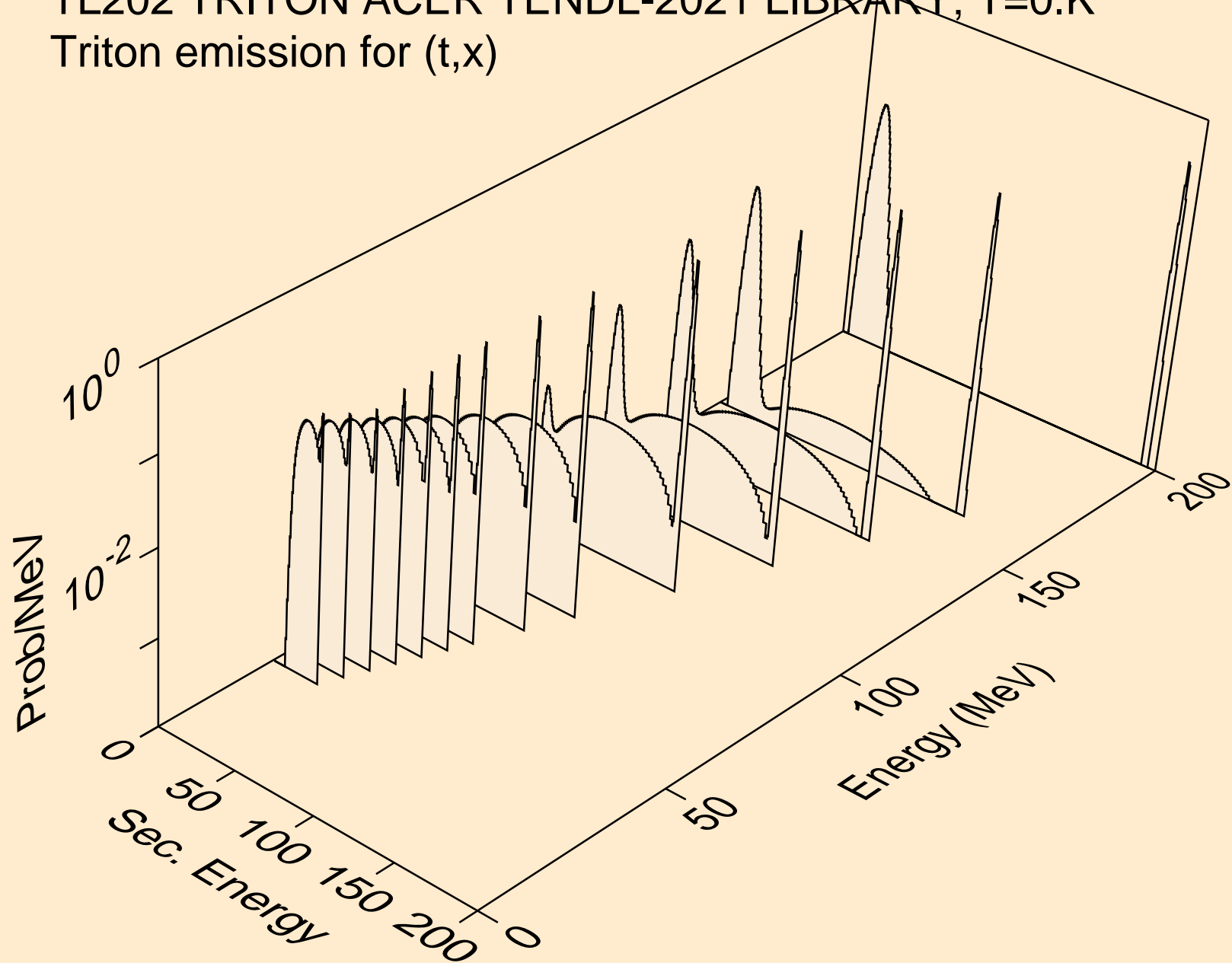

TL202 TRITON ACER TENDL-2021 LIBRARY; T=0.K  
Triton emission for (t,n\*)t

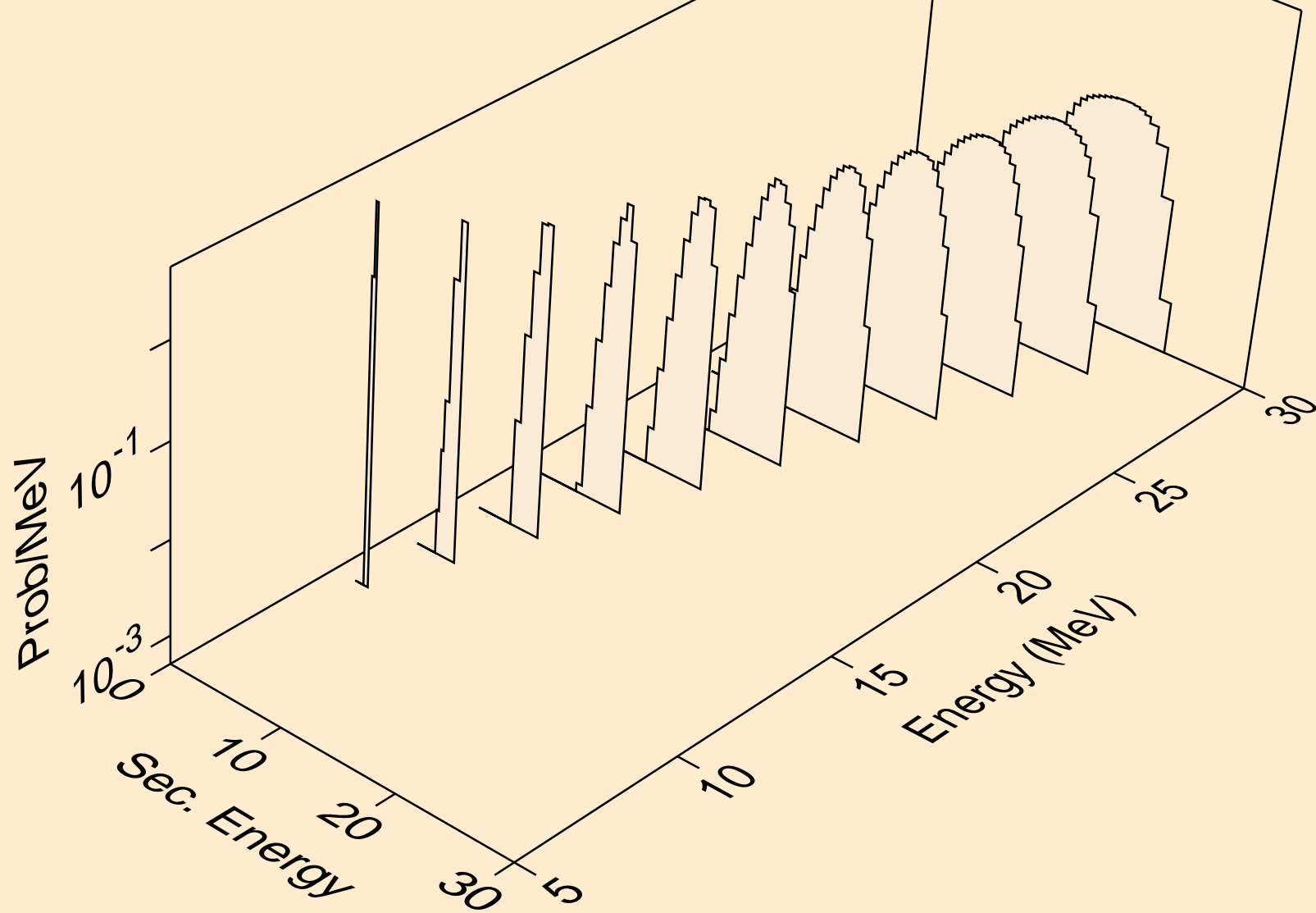

TL202 TRITON ACER TENDL-2021 LIBRARY; T=0.K  
Triton emission for inelastic

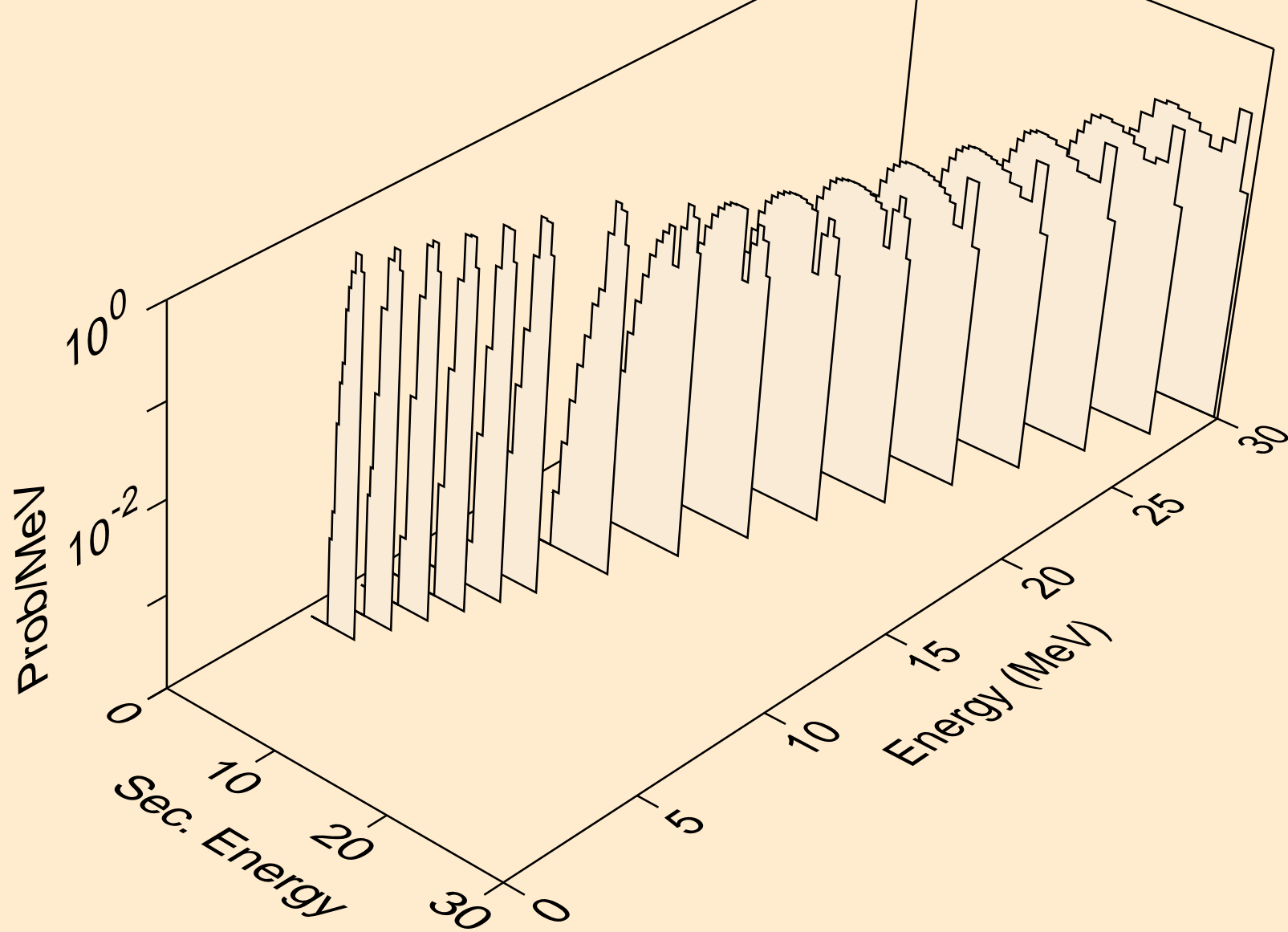

TL202 TRITON ACER TENDL-2021 LIBRARY; T=0.K  
Triton emission for (t,pt)

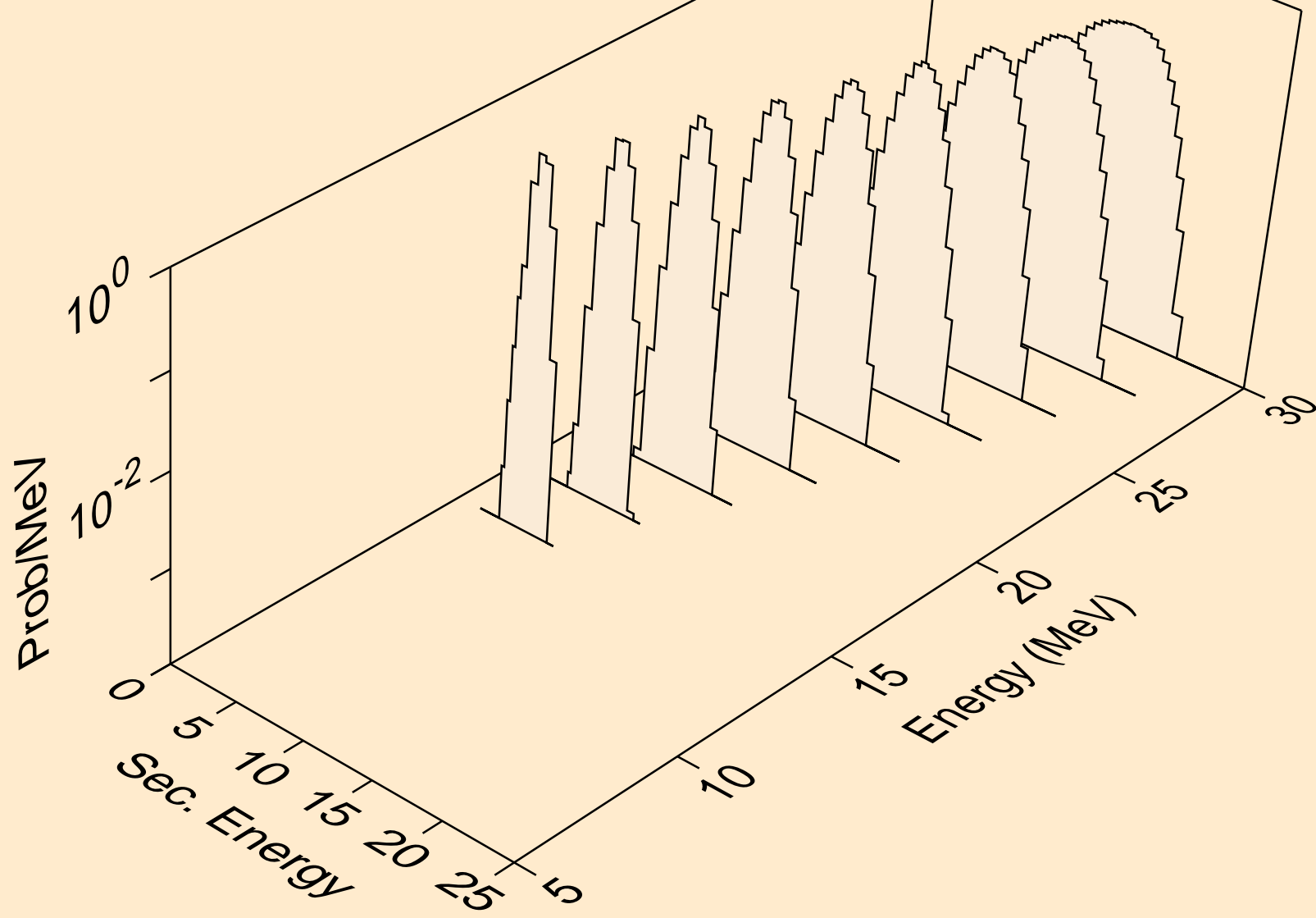

TL202 TRITON ACER TENDL-2021 LIBRARY; T=0.K  
Photon emission for (z,n)

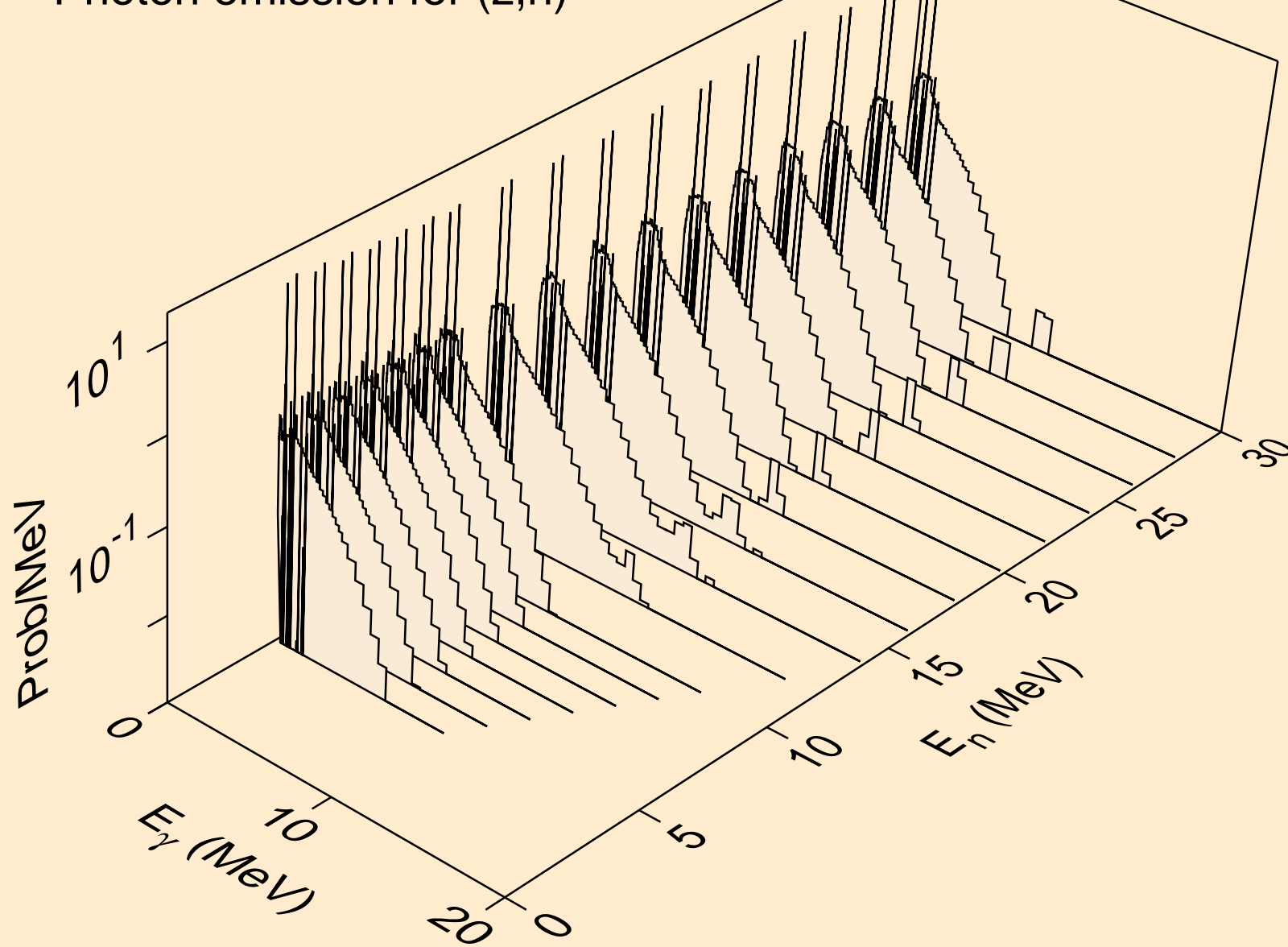

TL202 TRITON ACER TENDL-2021 LIBRARY; T=0.K  
Photon emission for (n,x)

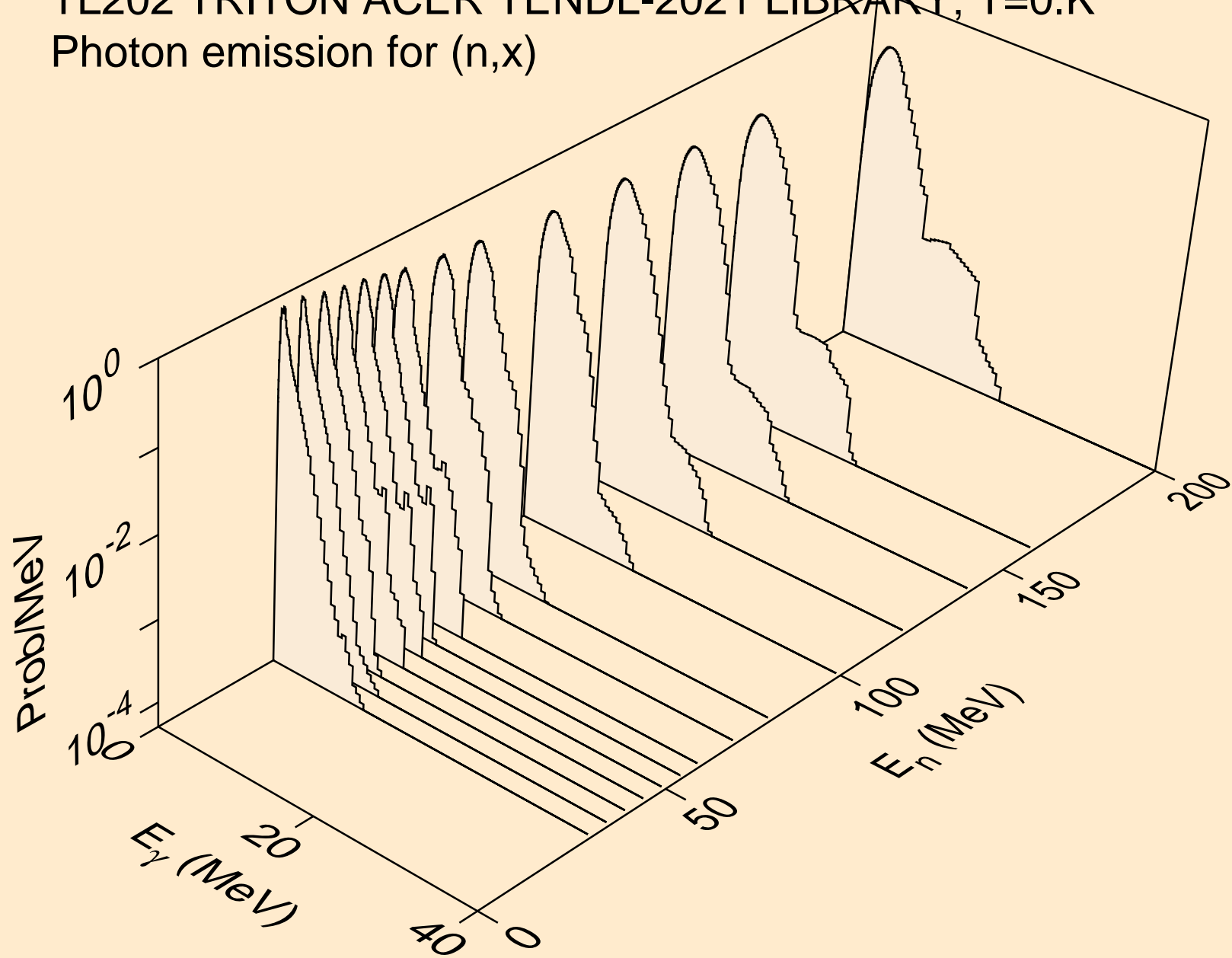

TL202 TRITON ACER TENDL-2021 LIBRARY; T=0.K  
Photon emission for (n,2nd)

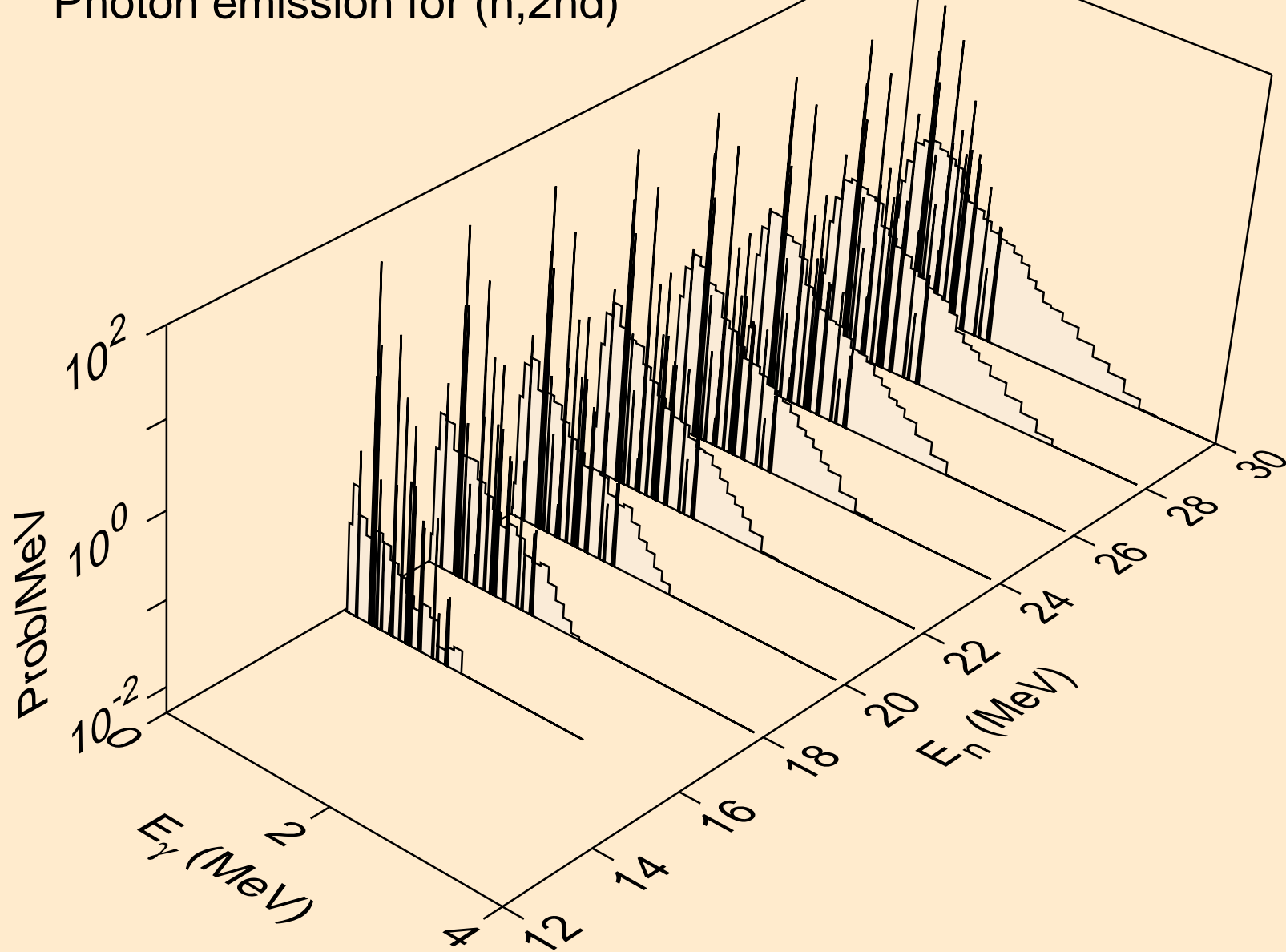



TL202 TRITON ACER TENDL-2021 LIBRARY; T=0.K  
Photon emission for (n,2n)

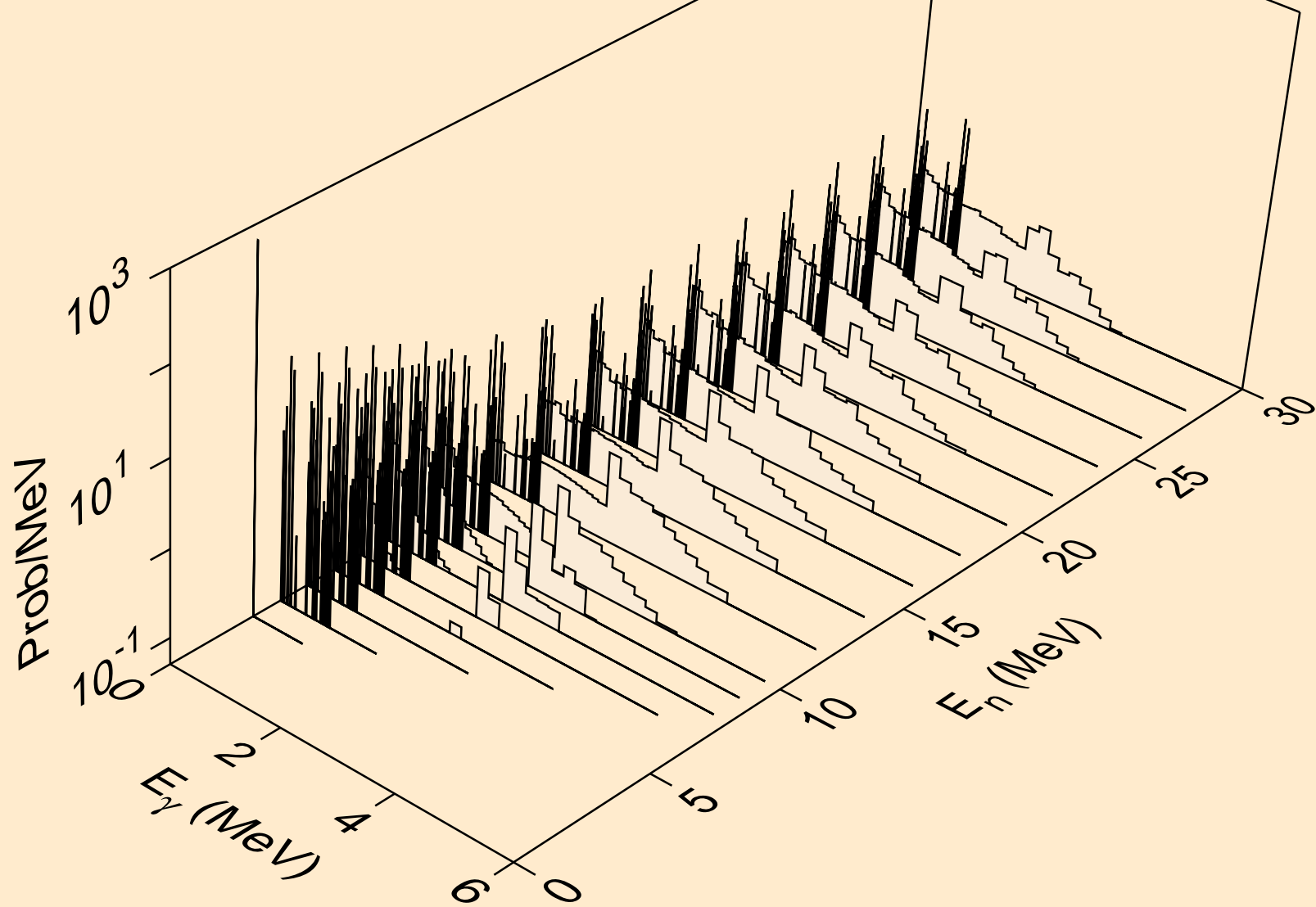

TL202 TRITON ACER TENDL-2021 LIBRARY; T=0.K  
Photon emission for (n,3n)

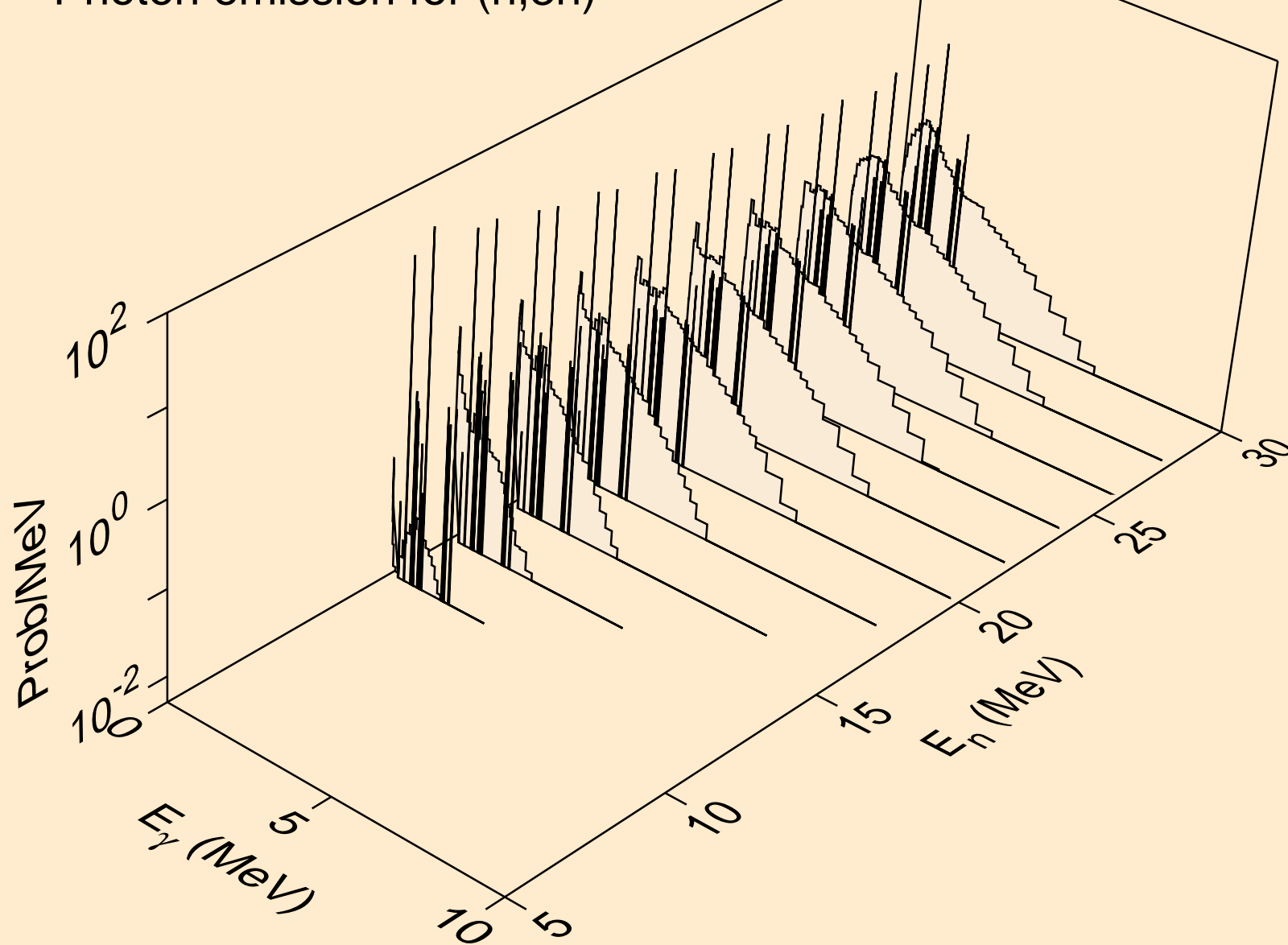

TL202 TRITON ACER TENDL-2021 LIBRARY; T=0.K  
Photon emission for (n,n\*)a

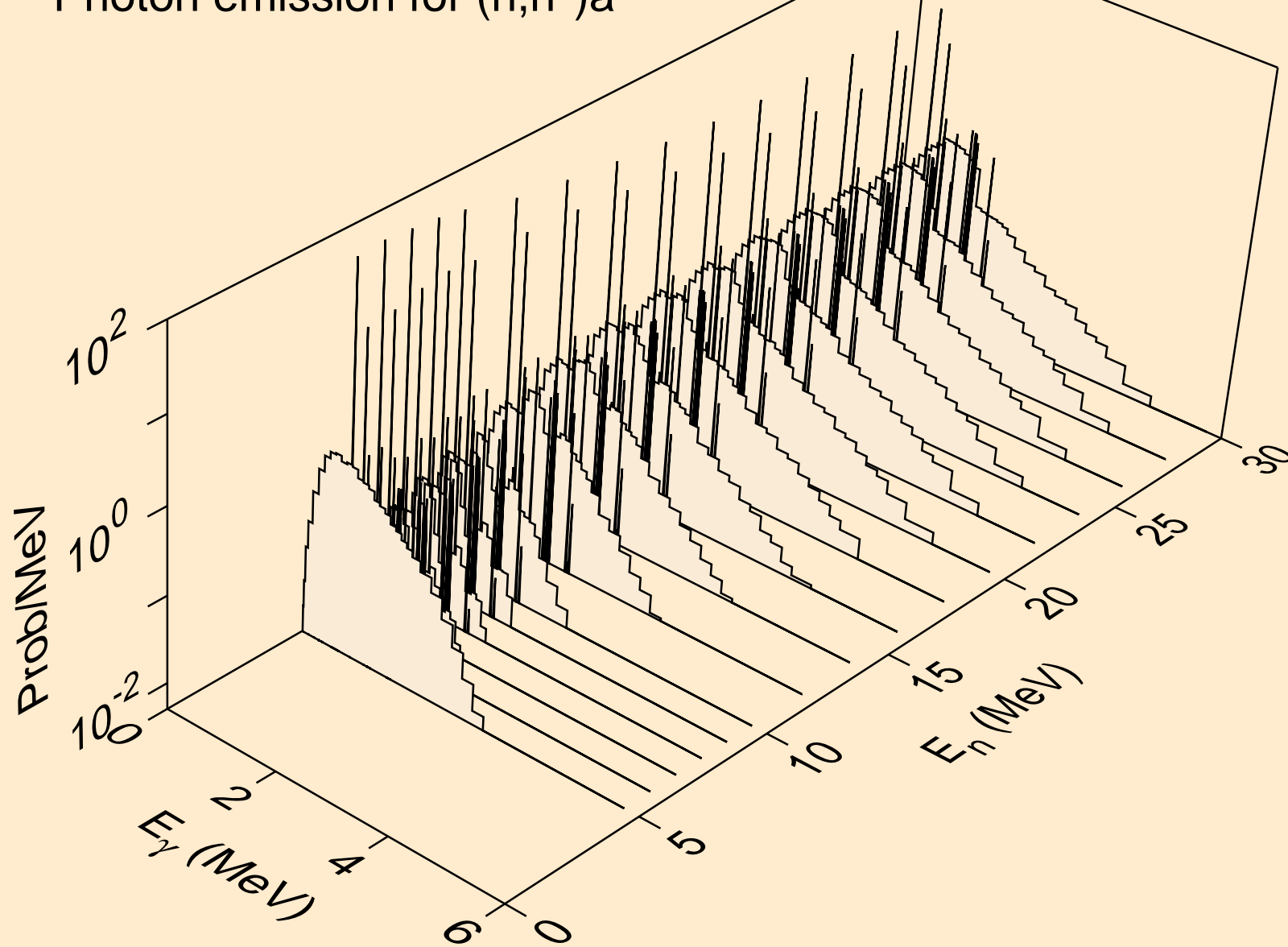

TL202 TRITON ACER TENDL-2021 LIBRARY; T=0.K  
Photon emission for (n,2n)a

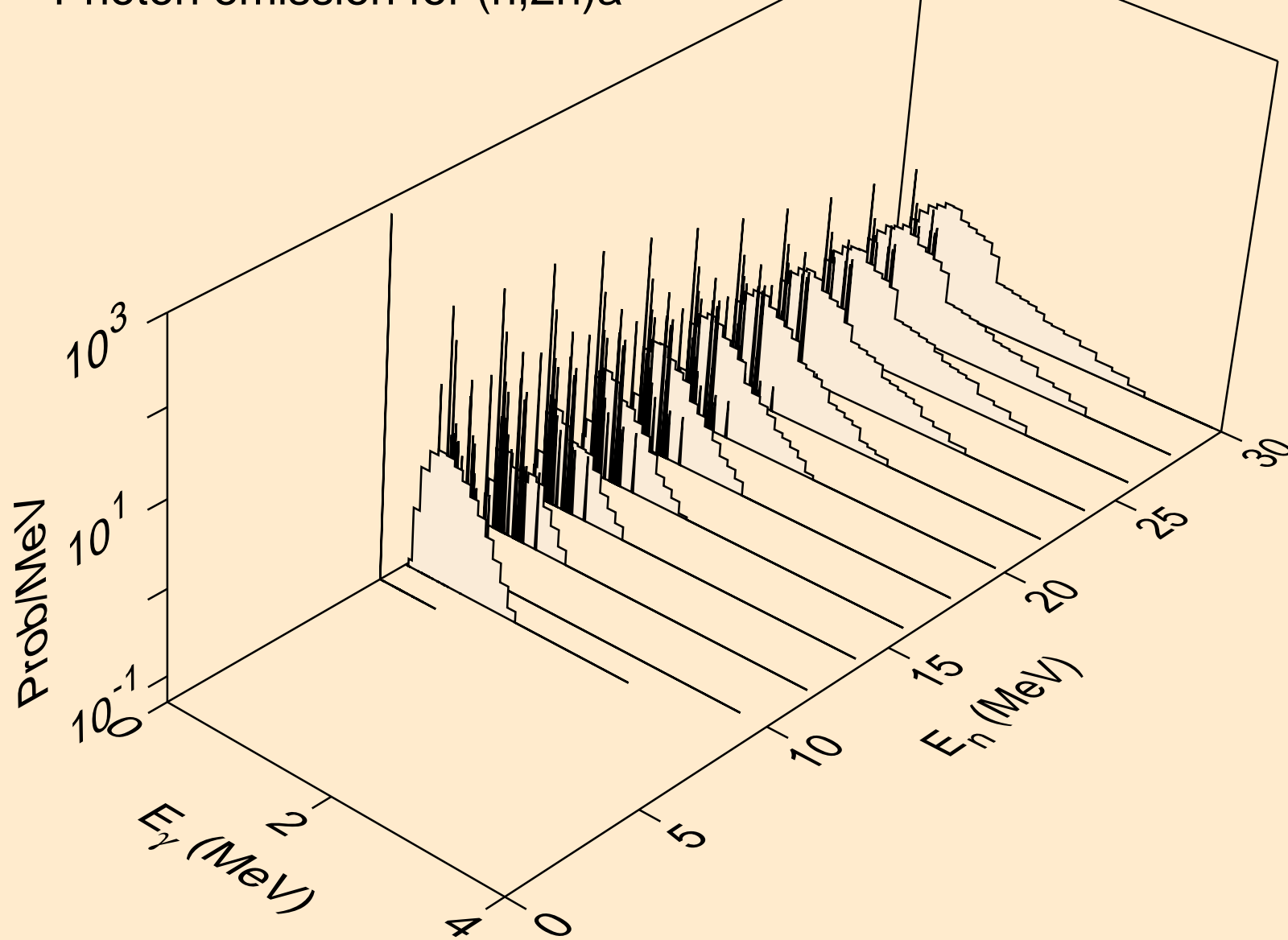

TL202 TRITON ACER TENDL-2021 LIBRARY; T=0.K  
Photon emission for (n,3n)a

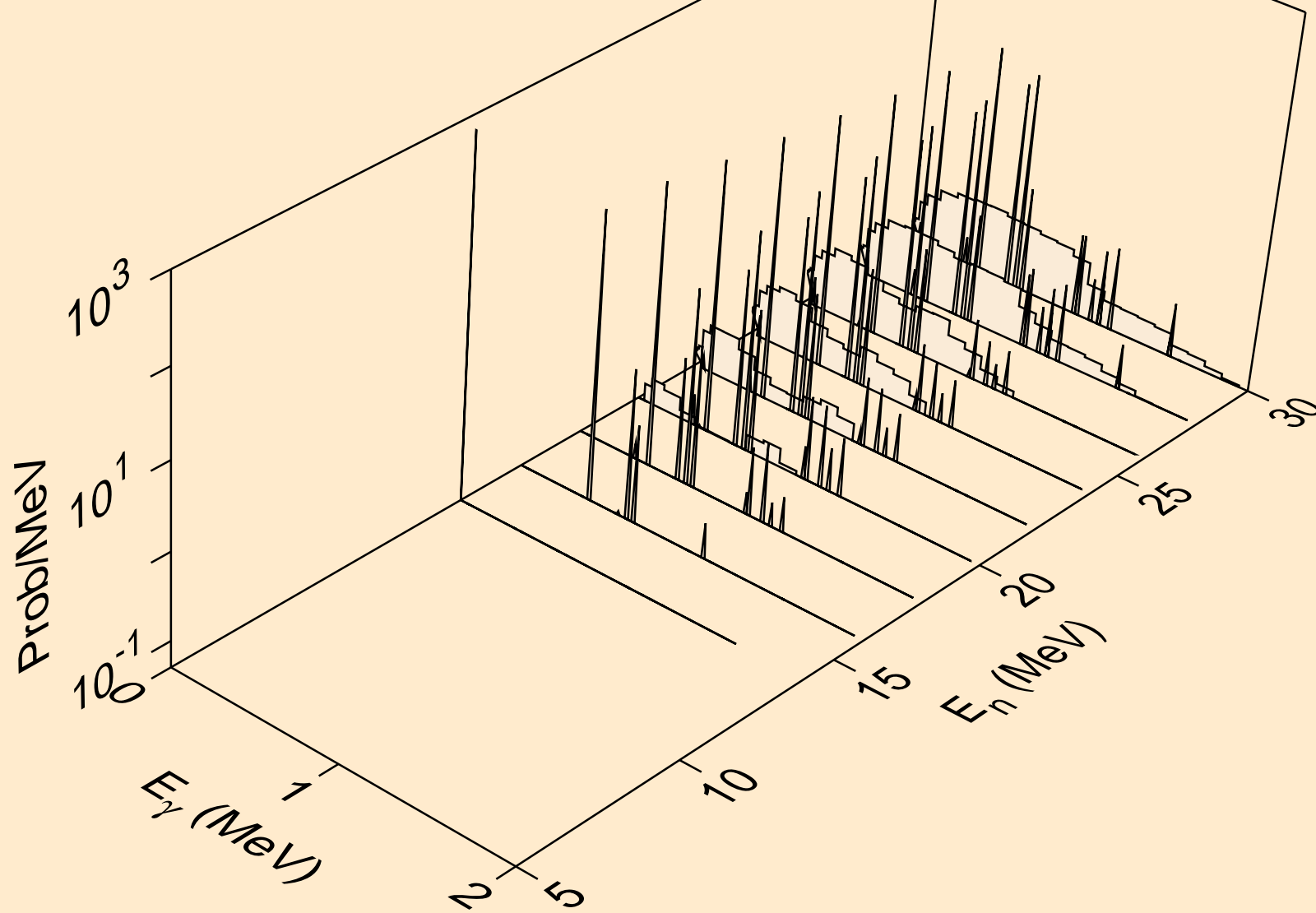

TL202 TRITON ACER TENDL-2021 LIBRARY; T=0.K  
Photon emission for (n,n\*)p

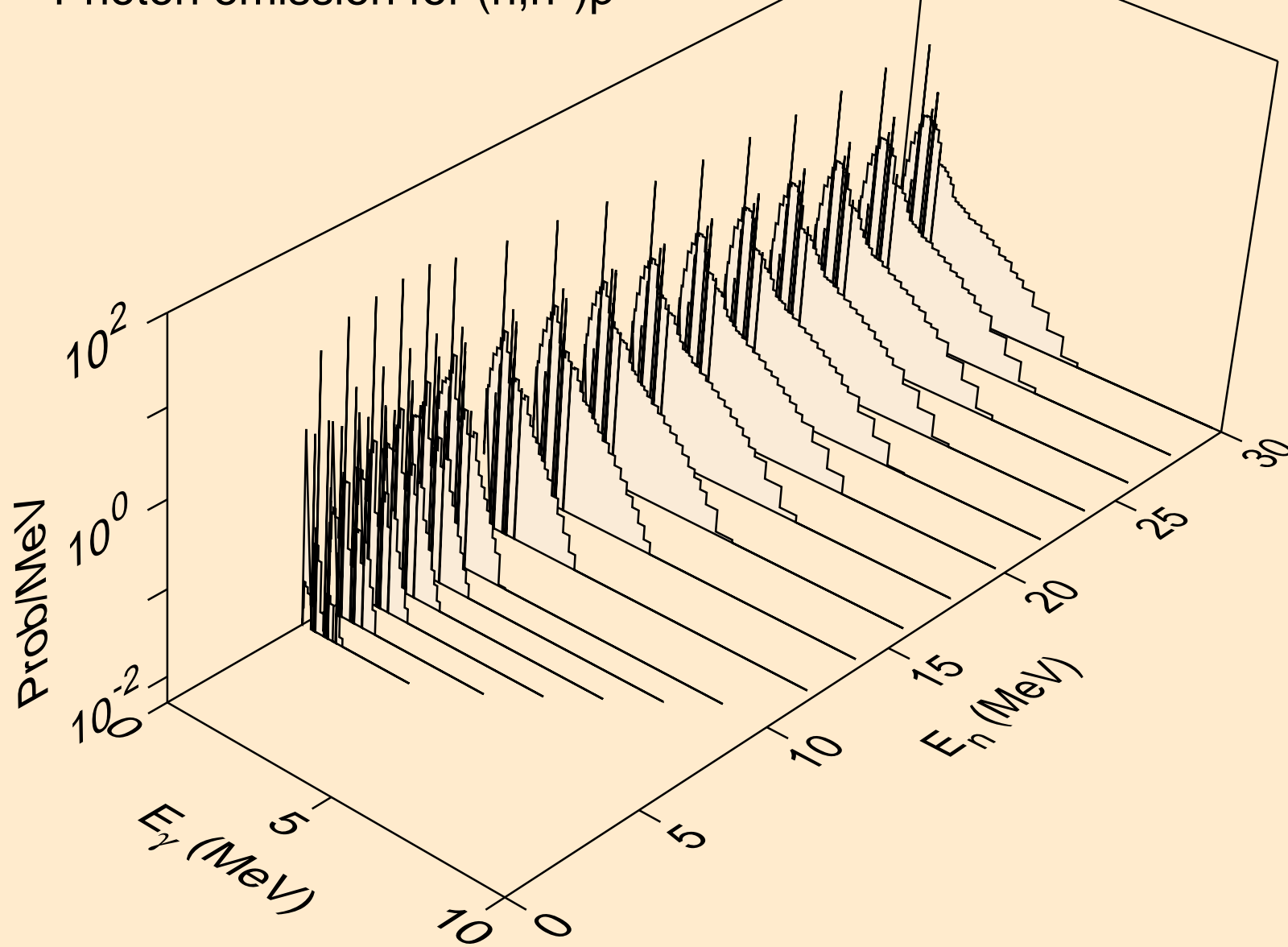

TL202 TRITON ACER TENDL-2021 LIBRARY; T=0.K  
Photon emission for (n,n\*)2a

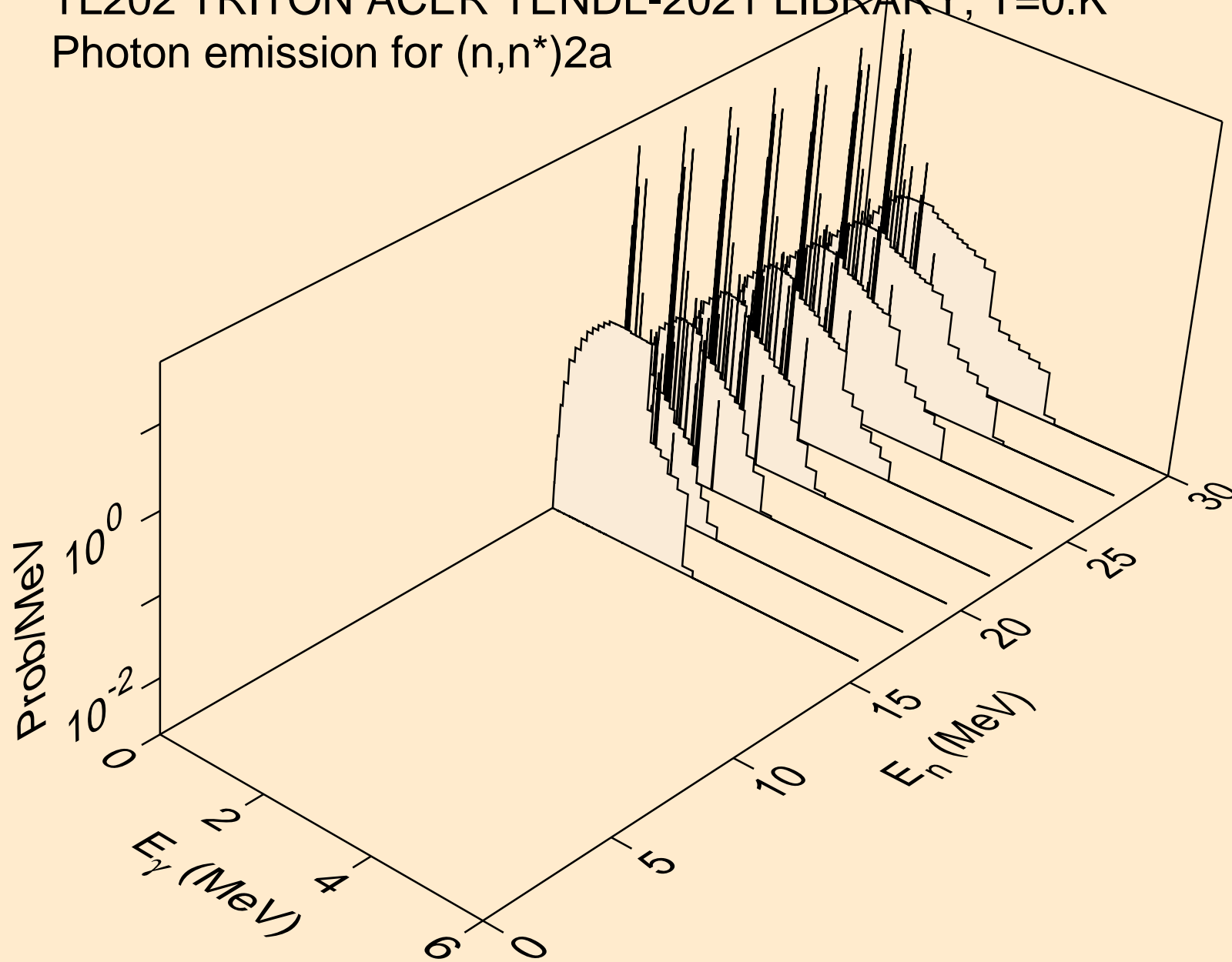

TL202 TRITON ACER TENDL-2021 LIBRARY; T=0.K  
Photon emission for (n,n\*)d

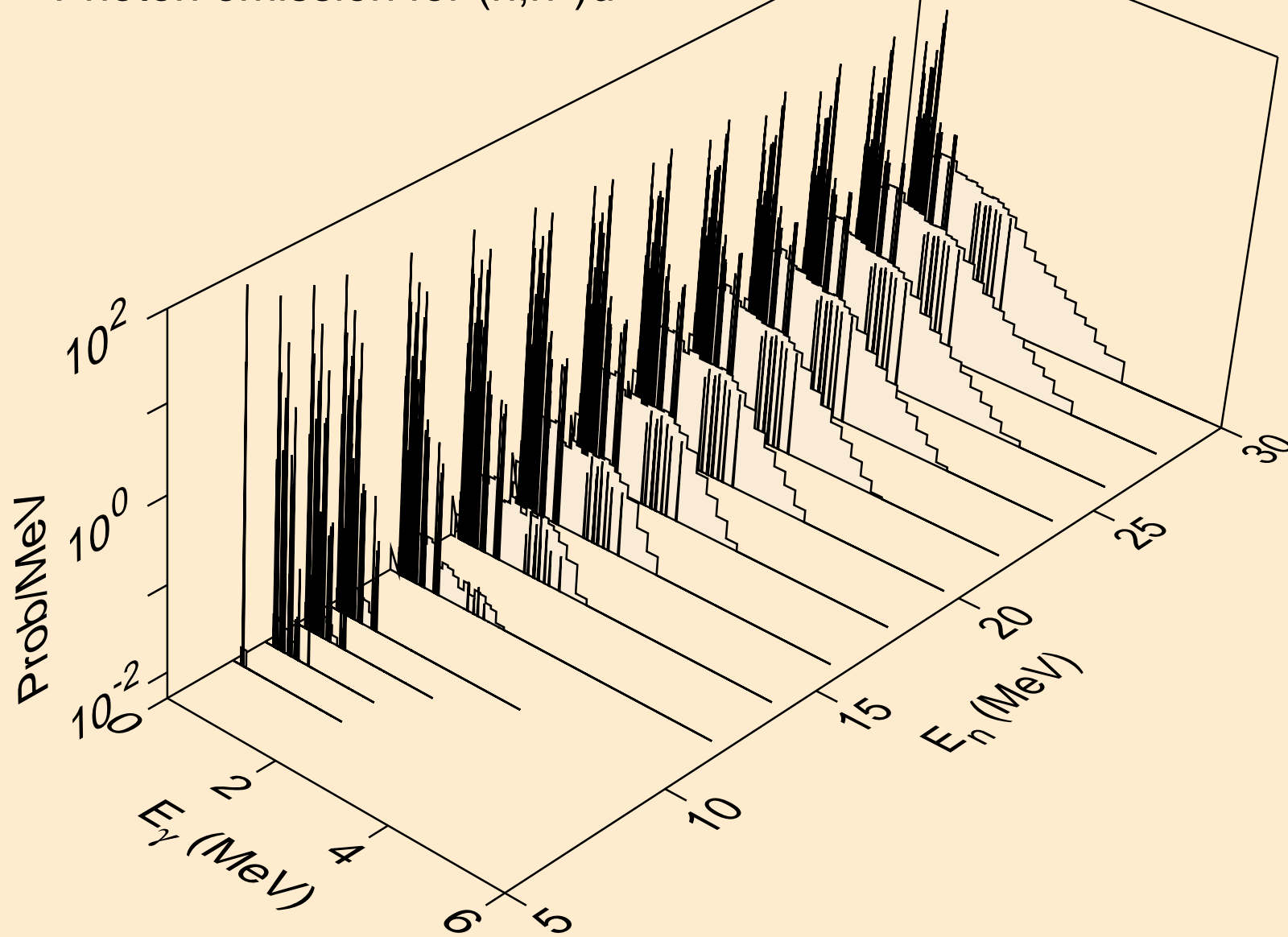



TL202 TRITON ACER TENDL-2021 LIBRARY; T=0.K  
Photon emission for (n,n\*)t

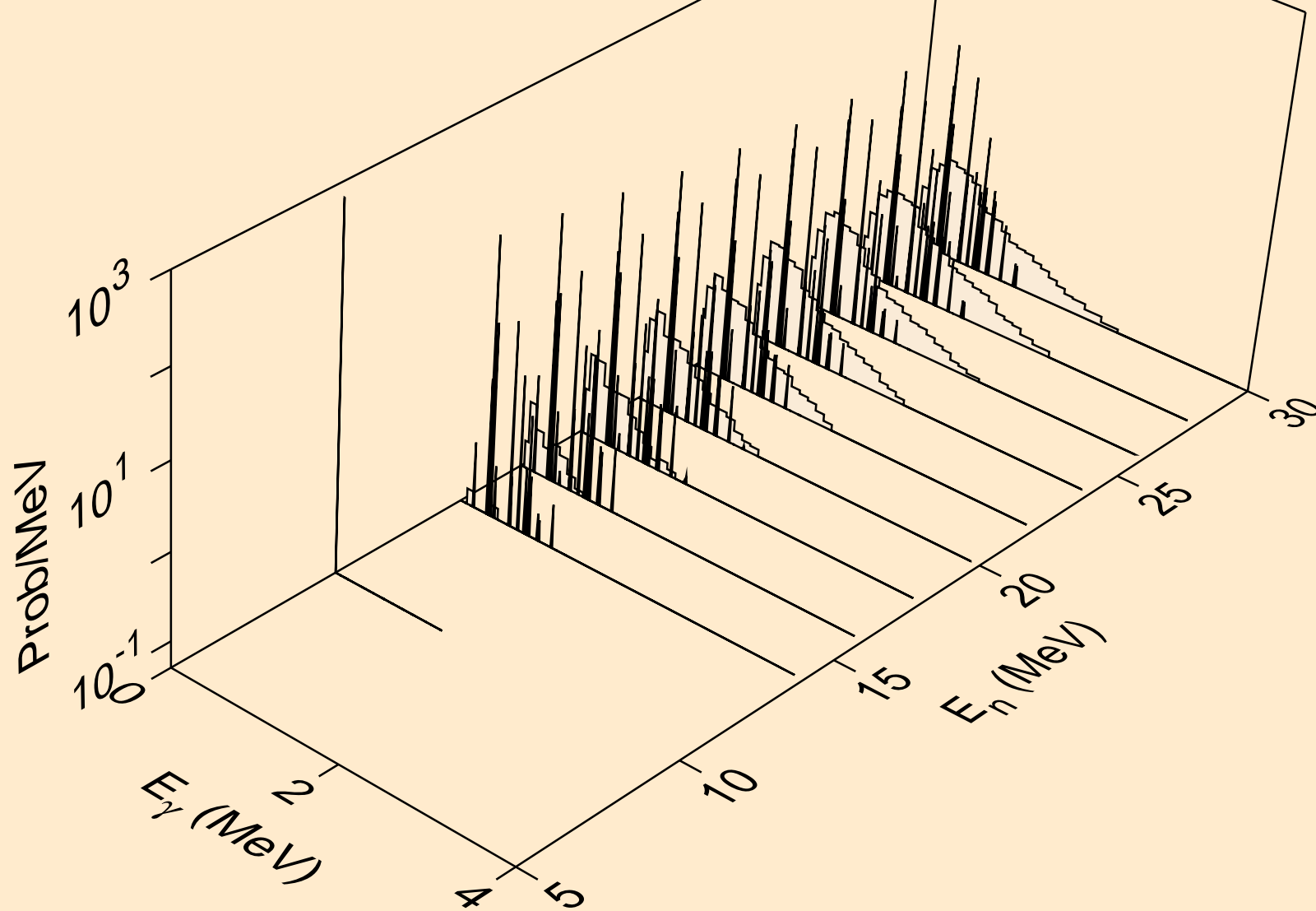

TL202 TRITON ACER TENDL-2021 LIBRARY; T=0.K  
Photon emission for (n,n\*)he3

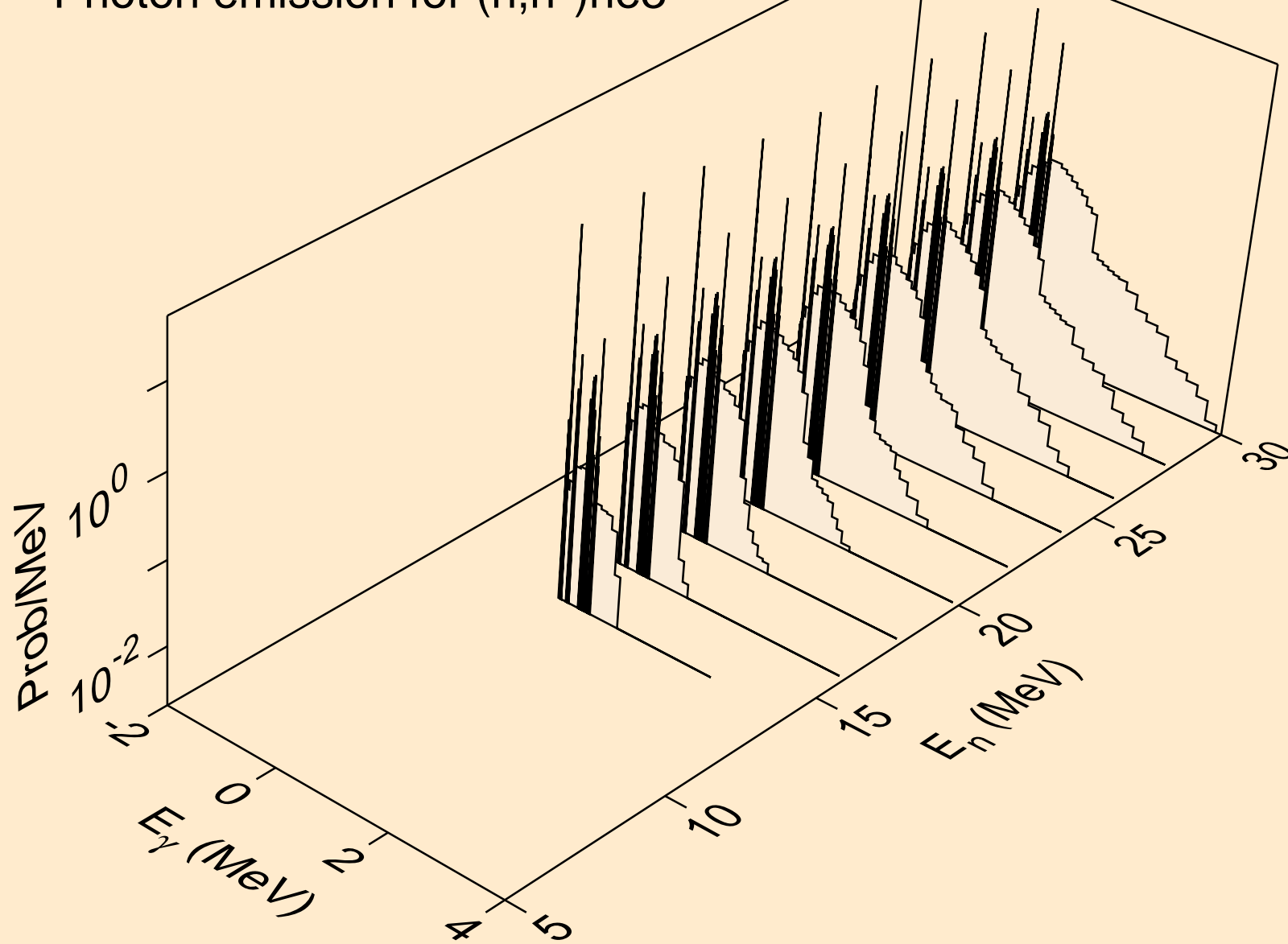

TL202 TRITON ACER TENDL-2021 LIBRARY; T=0.K  
Photon emission for (n,4n)

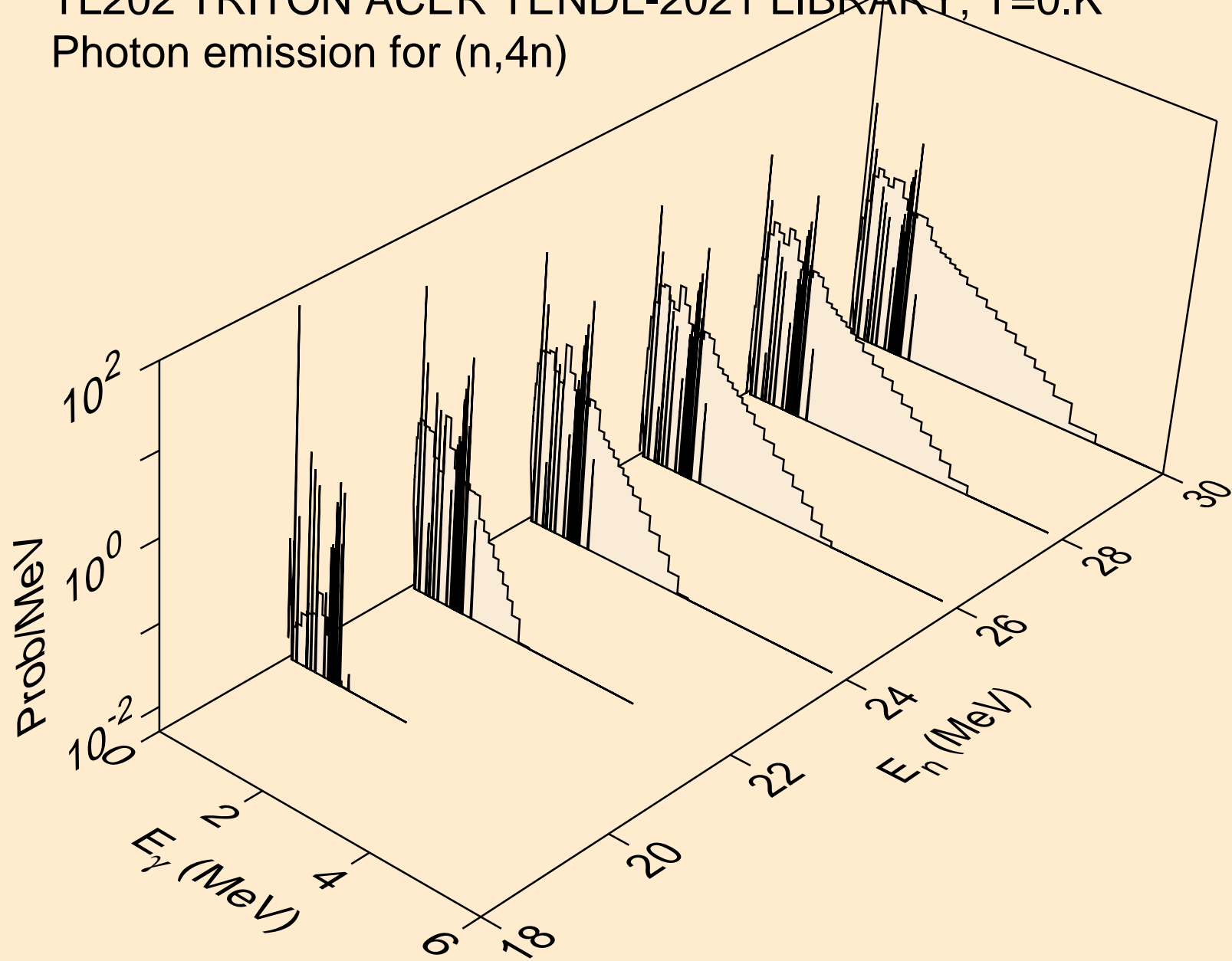

TL202 TRITON ACER TENDL-2021 LIBRARY; T=0.K  
Photon emission for (n,2np)

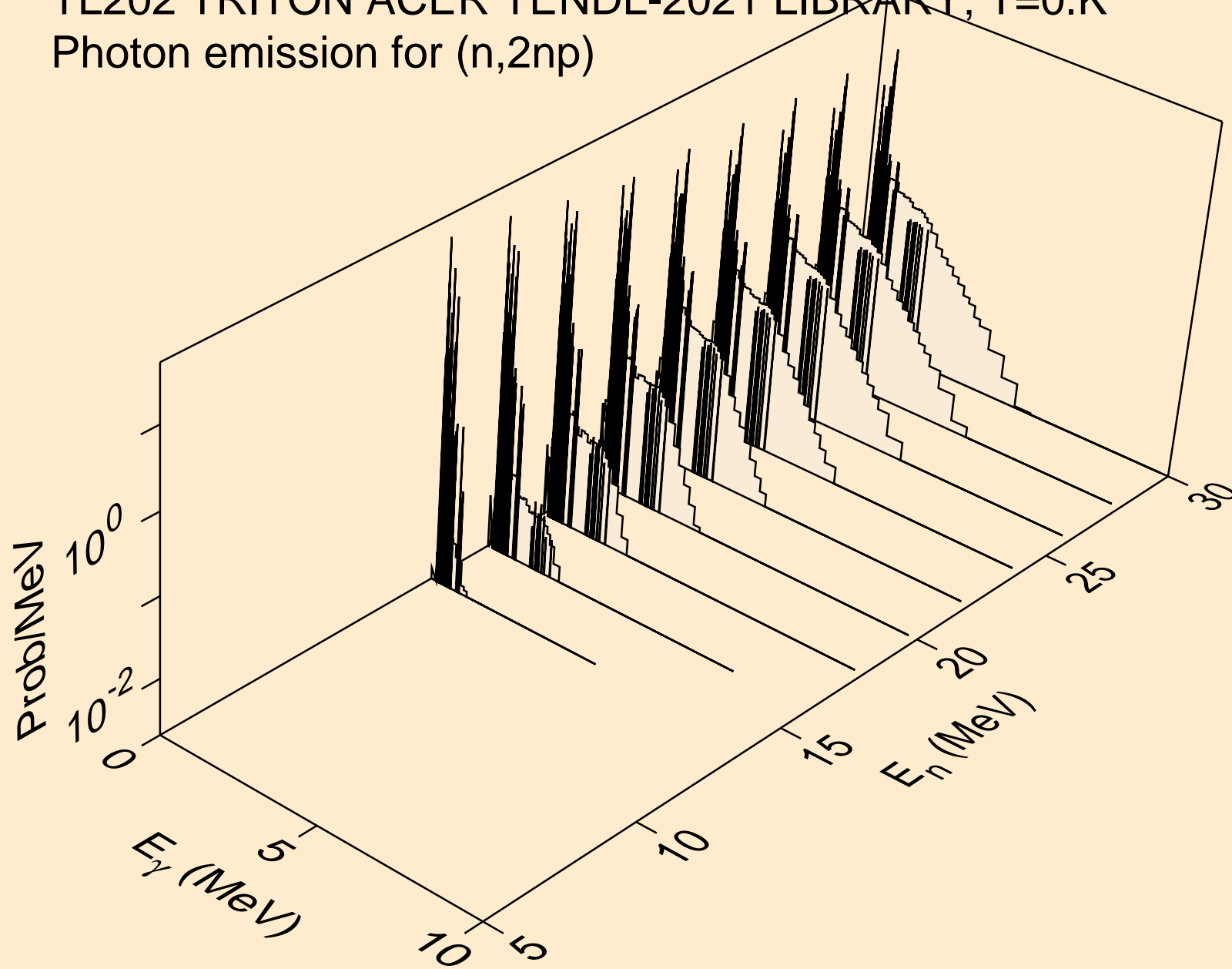

TL202 TRITON ACER TENDL-2021 LIBRARY; T=0.K  
Photon emission for (n,3np)

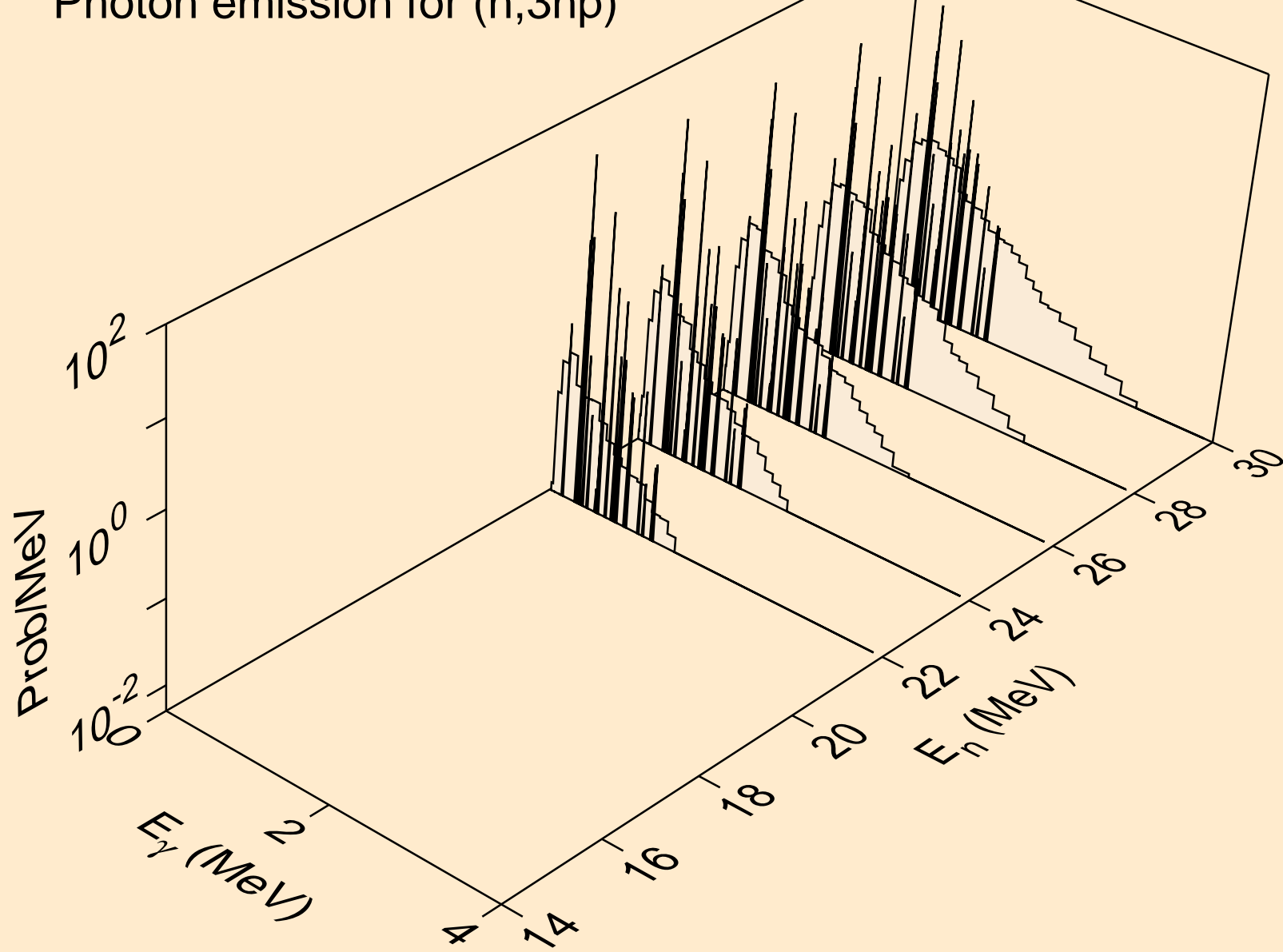

TL202 TRITON ACER TENDL-2021 LIBRARY; T=0.K  
Photon emission for (n,2np)

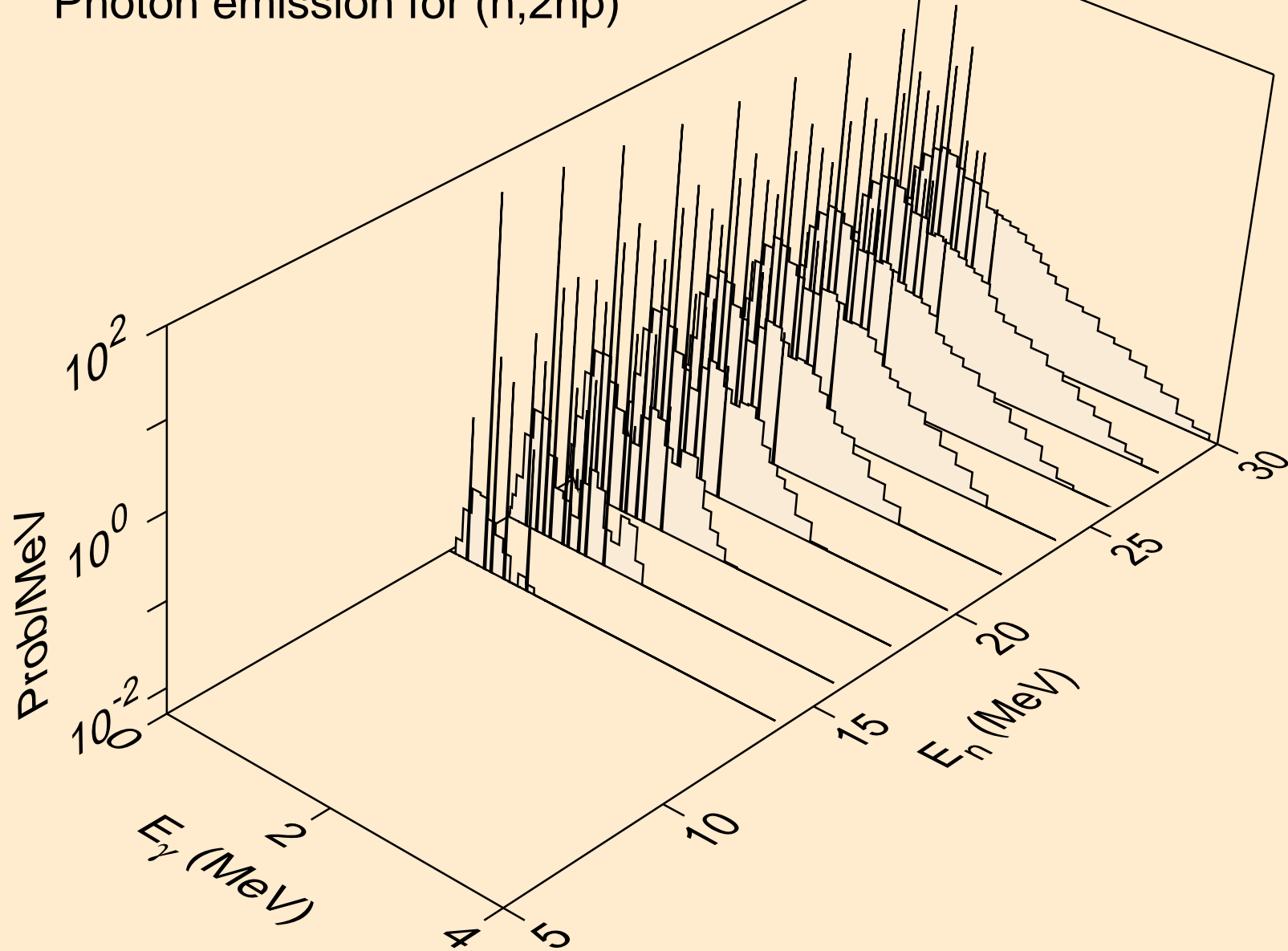

TL202 TRITON ACER TENDL-2021 LIBRARY; T=0.K  
Photon emission for (n,npa)

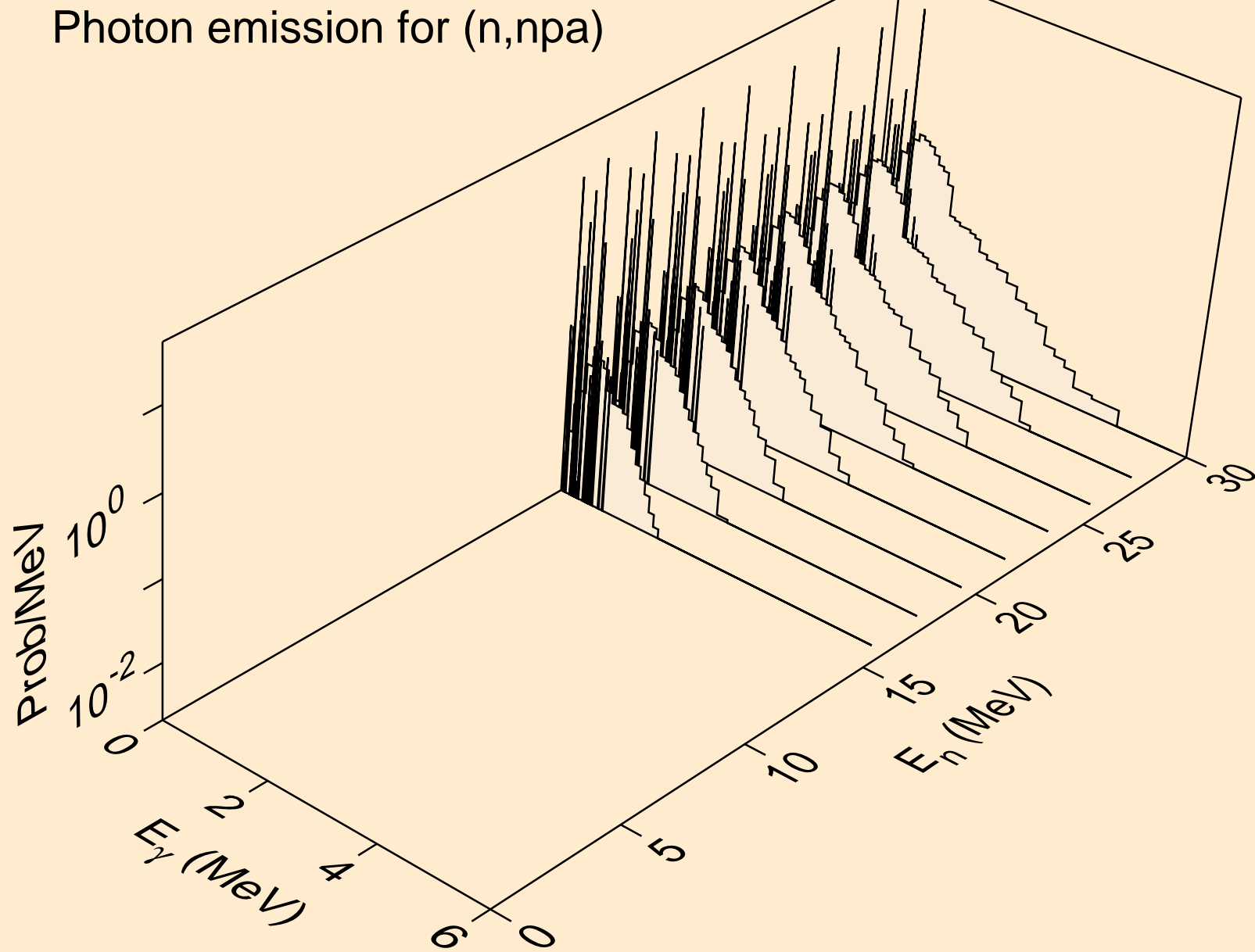

TL202 TRITON ACER TENDL-2021 LIBRARY; T=0.K  
Photon emission for (n,gma)

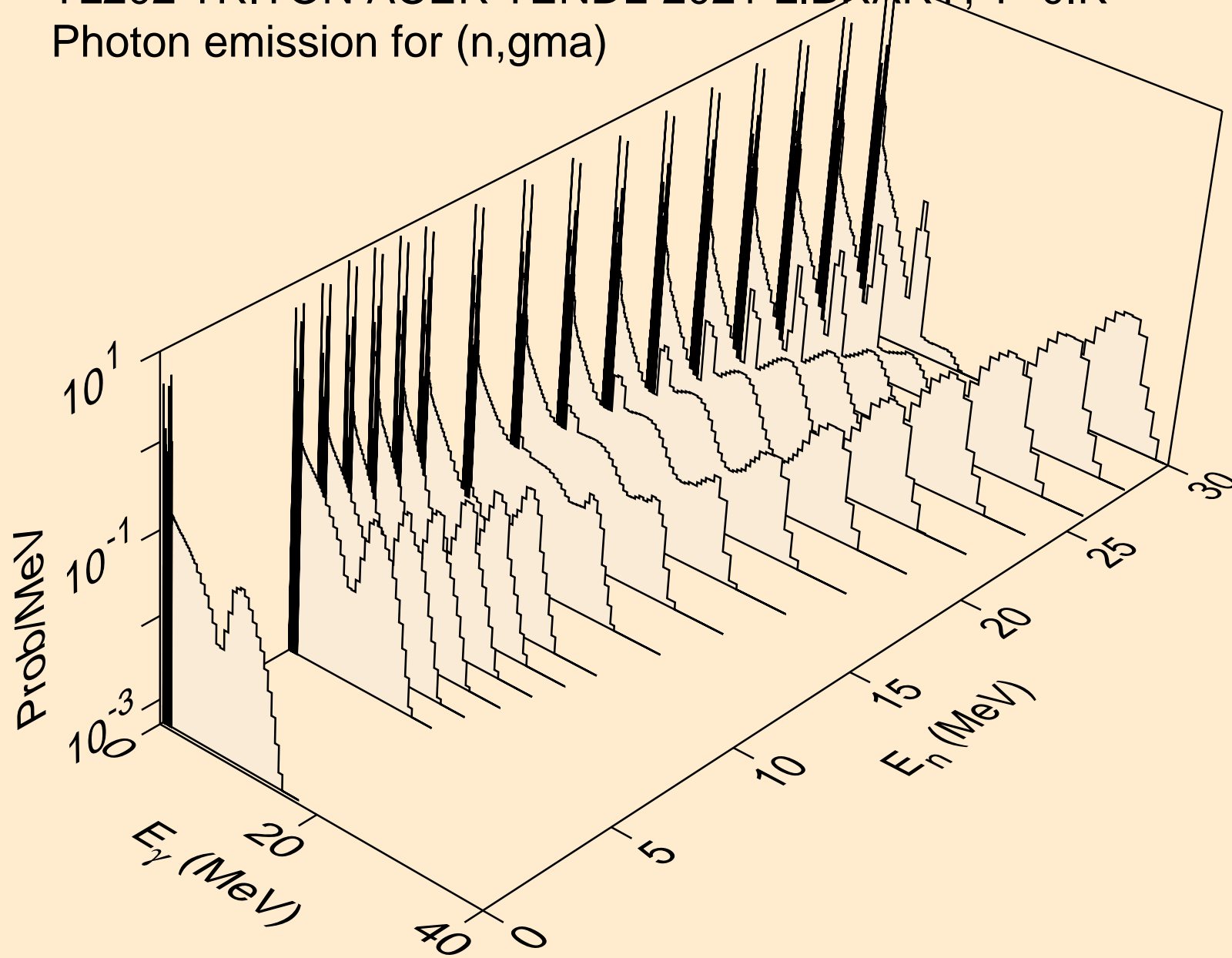



TL202 TRITON ACER TENDL-2021 LIBRARY; T=0.K  
Photon emission for (n,p)

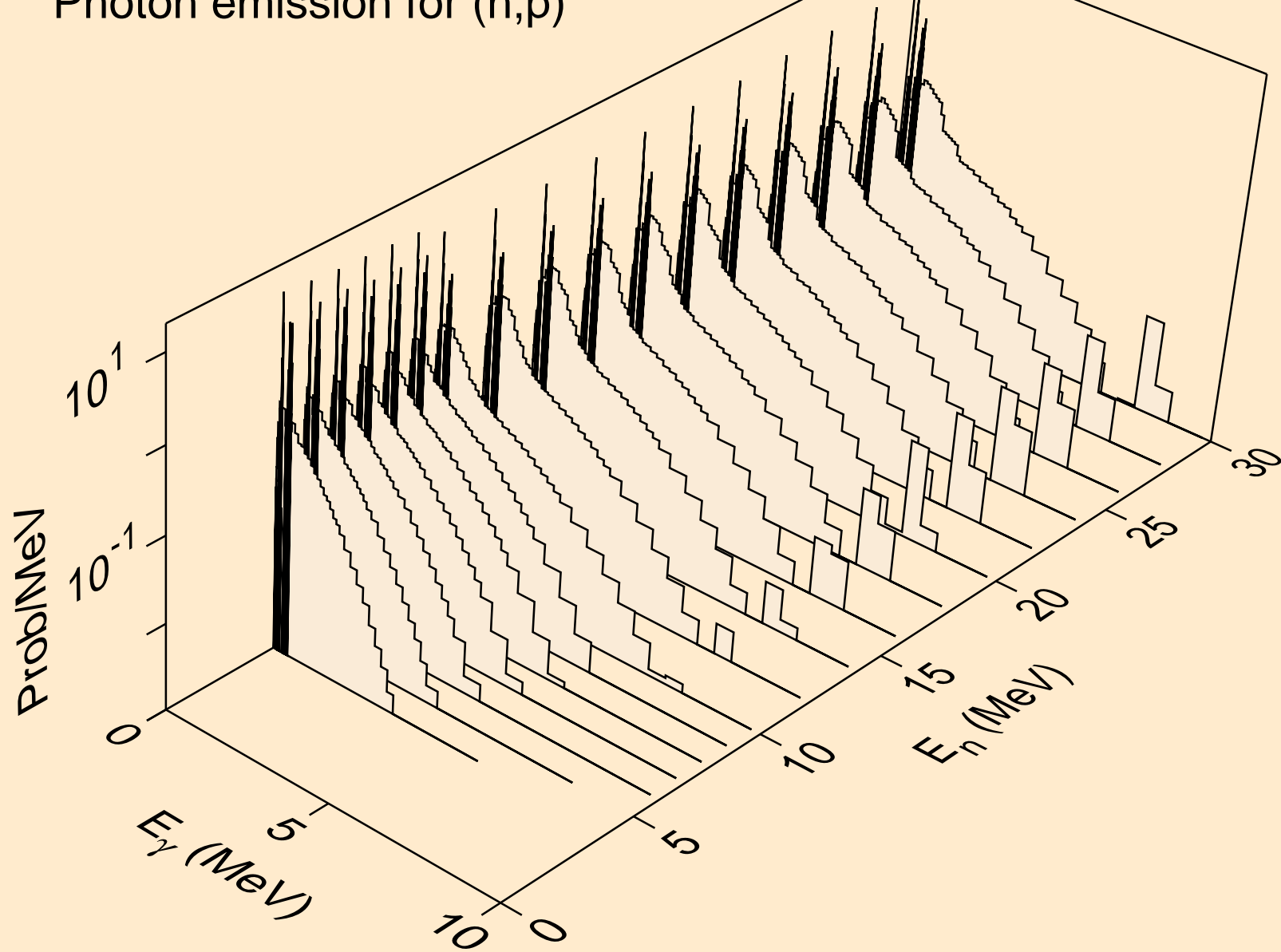

TL202 TRITON ACER TENDL-2021 LIBRARY; T=0.K  
Photon emission for (n,d)

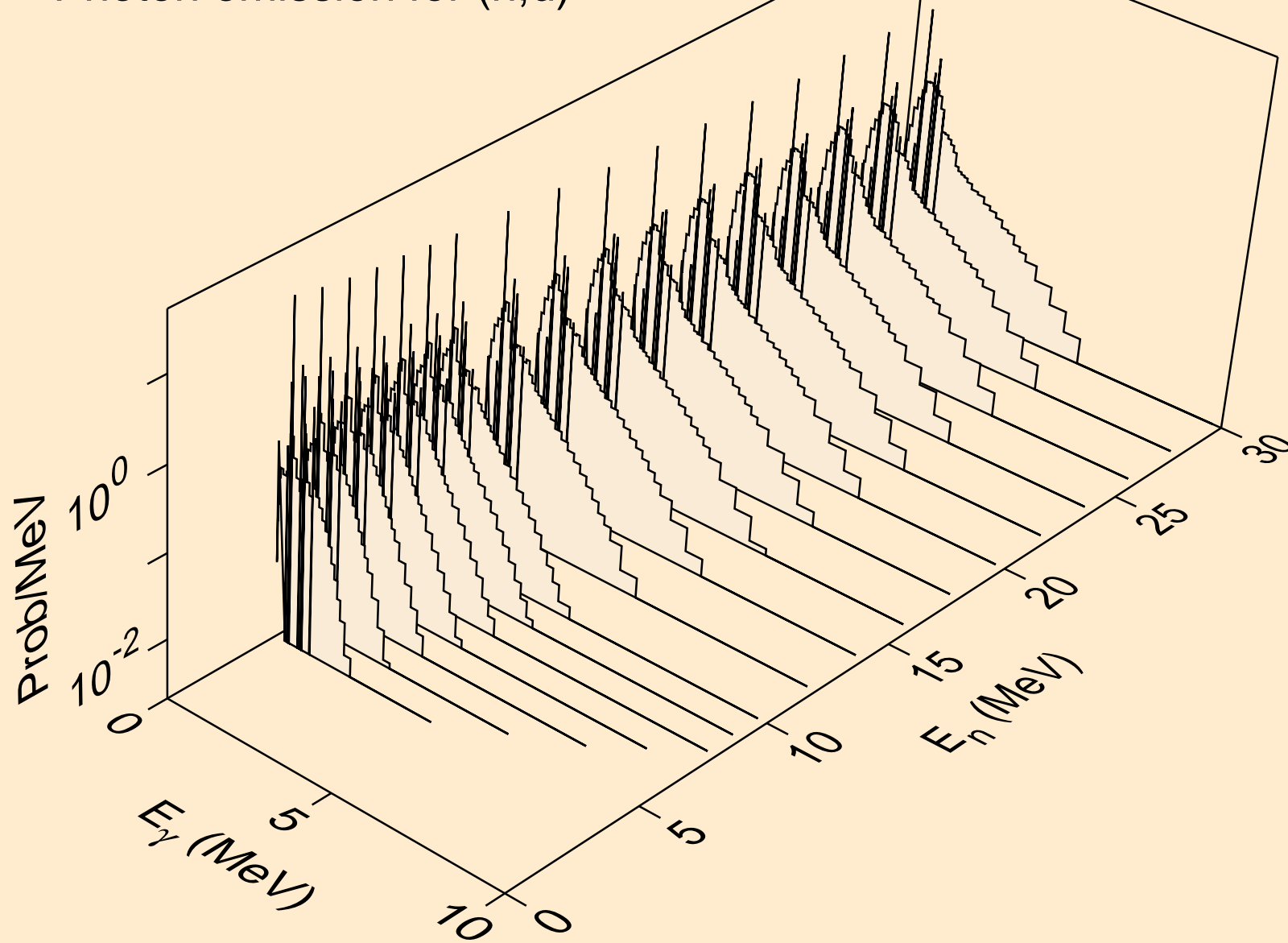

TL202 TRITON ACER TENDL-2021 LIBRARY; T=0.K  
Photon emission for inelastic

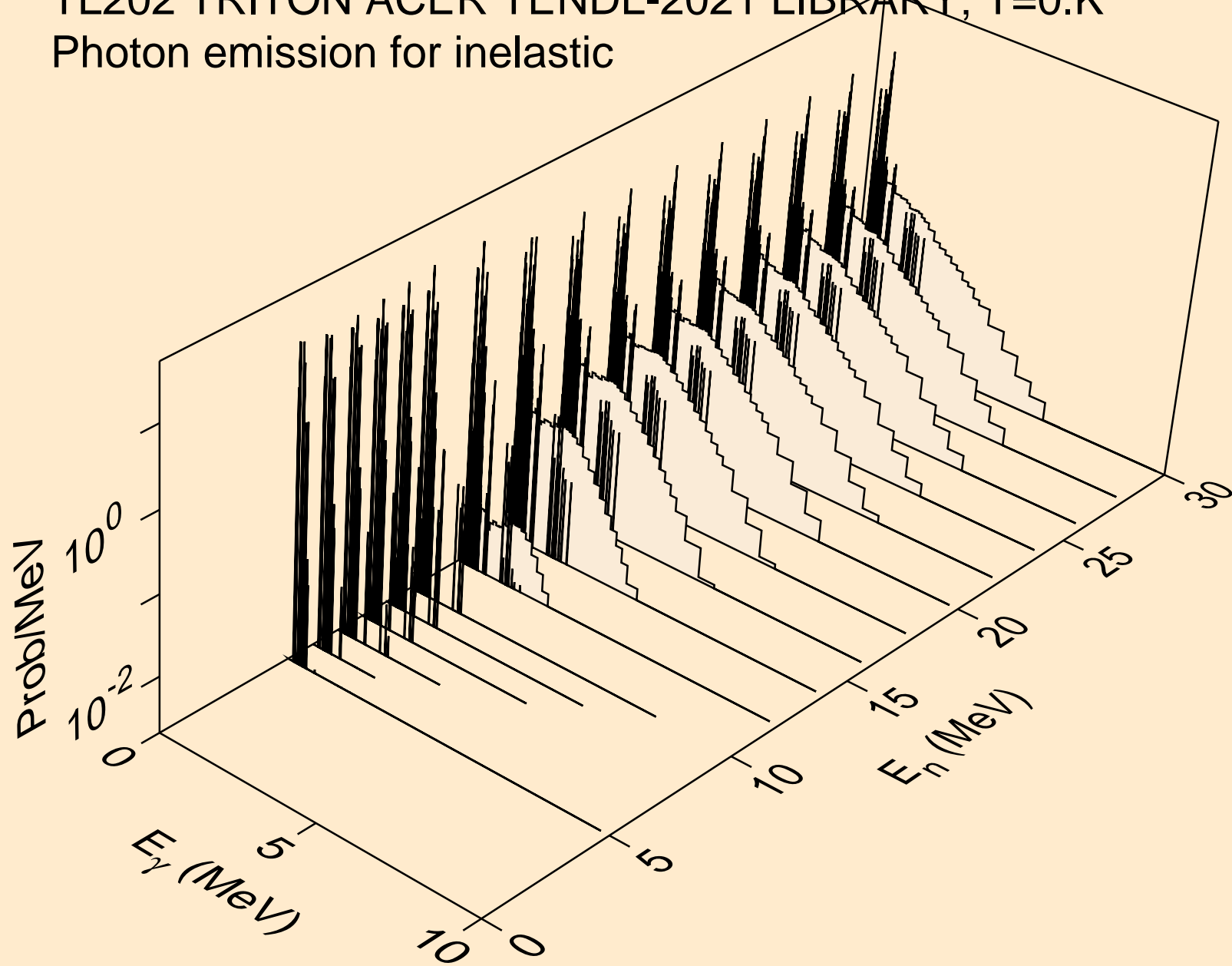

TL202 TRITON ACER TENDL-2021 LIBRARY; T=0.K  
Photon emission for (n,he3)

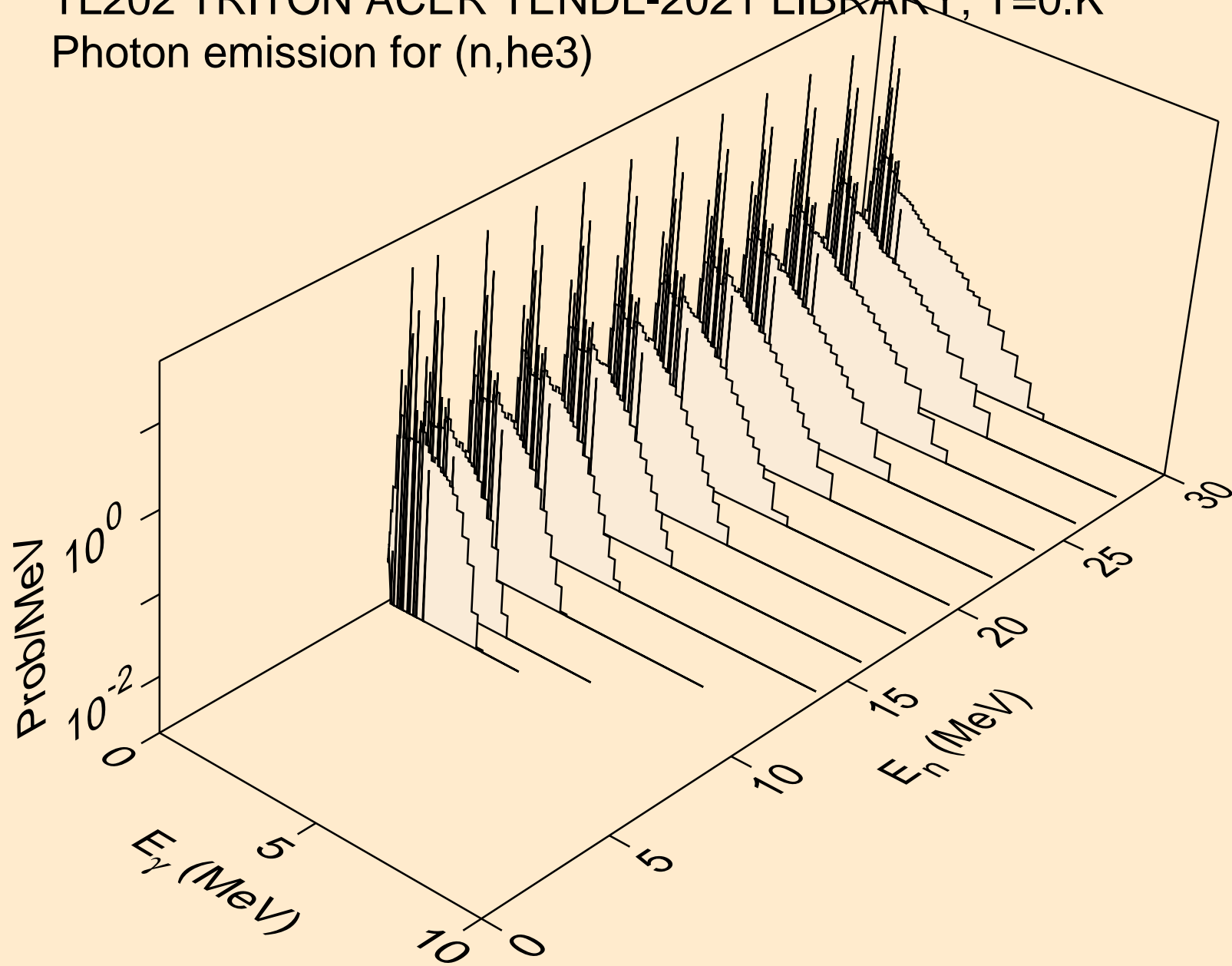

TL202 TRITON ACER TENDL-2021 LIBRARY; T=0.K  
Photon emission for (n,a)

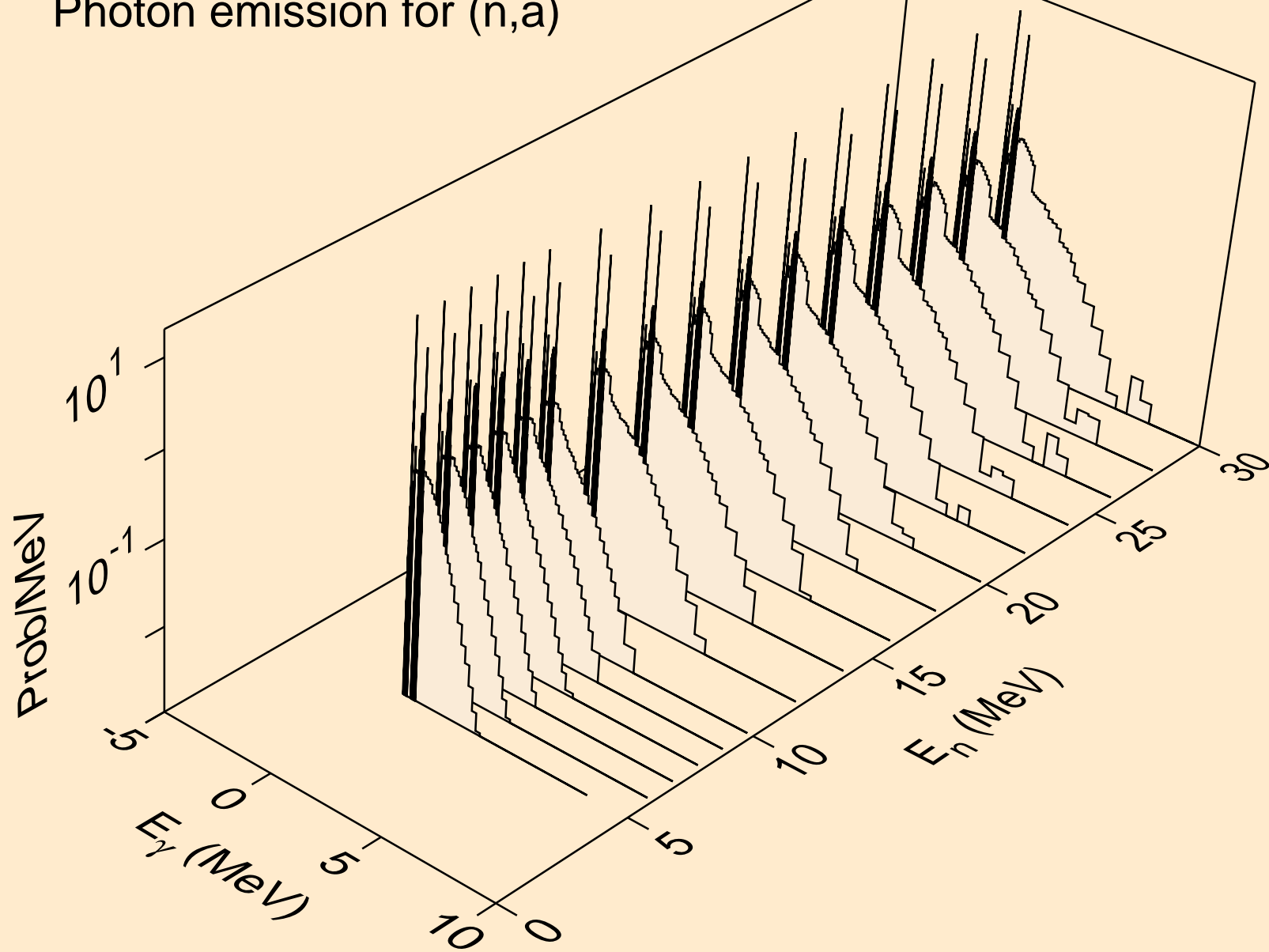

TL202 TRITON ACER TENDL-2021 LIBRARY; T=0.K  
Photon emission for (n,2a)

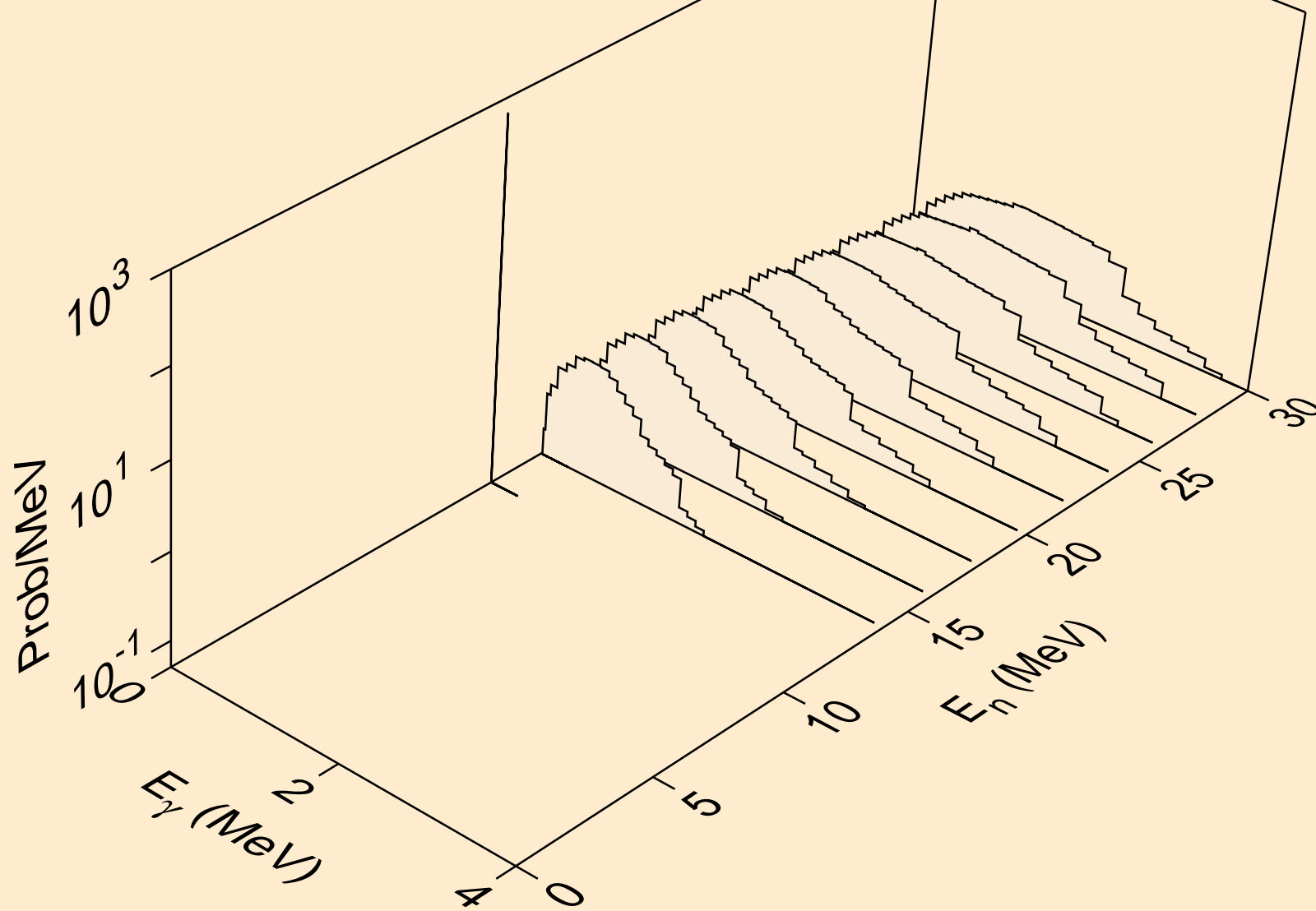

TL202 TRITON ACER TENDL-2021 LIBRARY; T=0.K  
Photon emission for (n,2p)

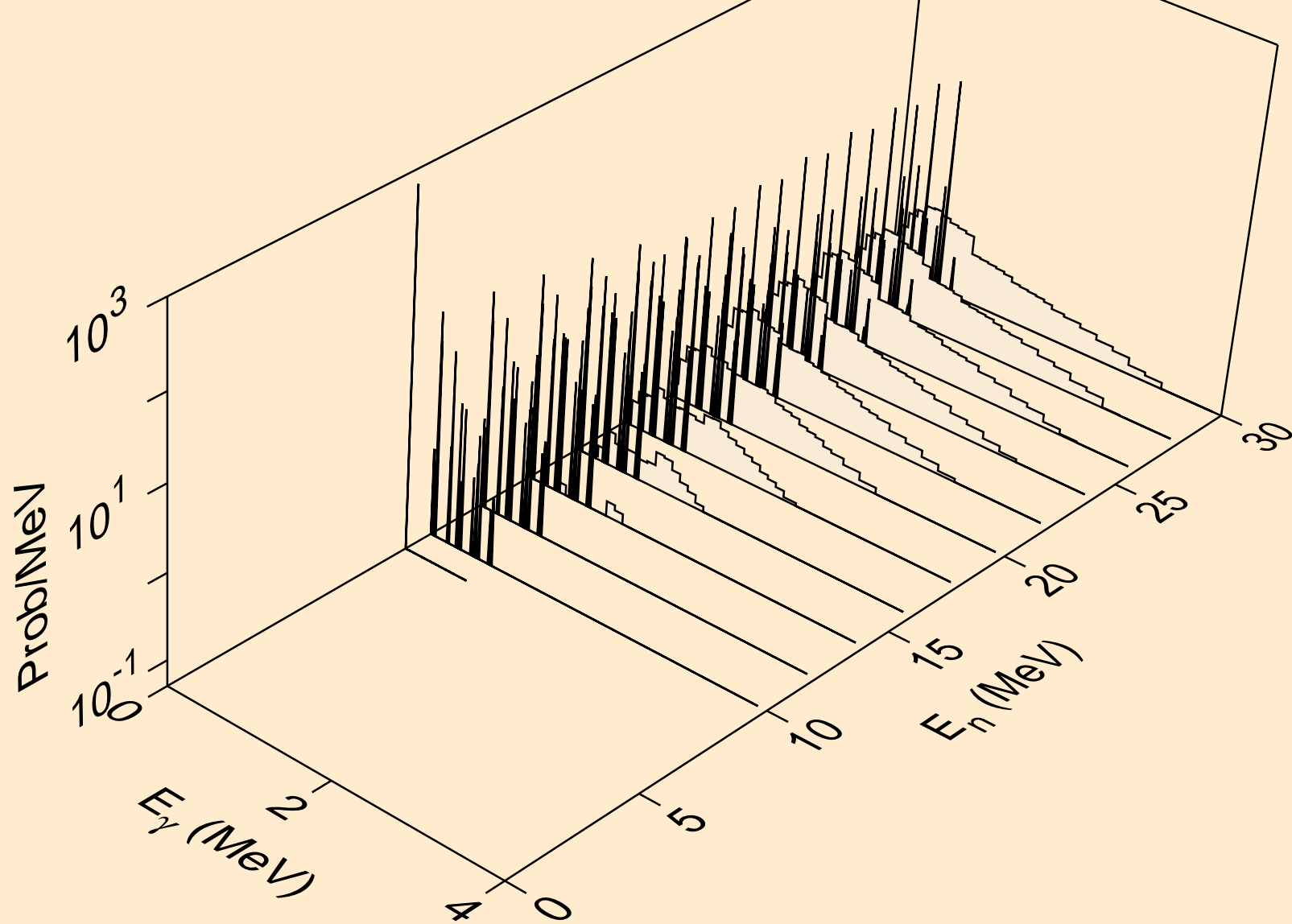

TL202 TRITON ACER TENDL-2021 LIBRARY; T=0.K  
Photon emission for (n,pa)

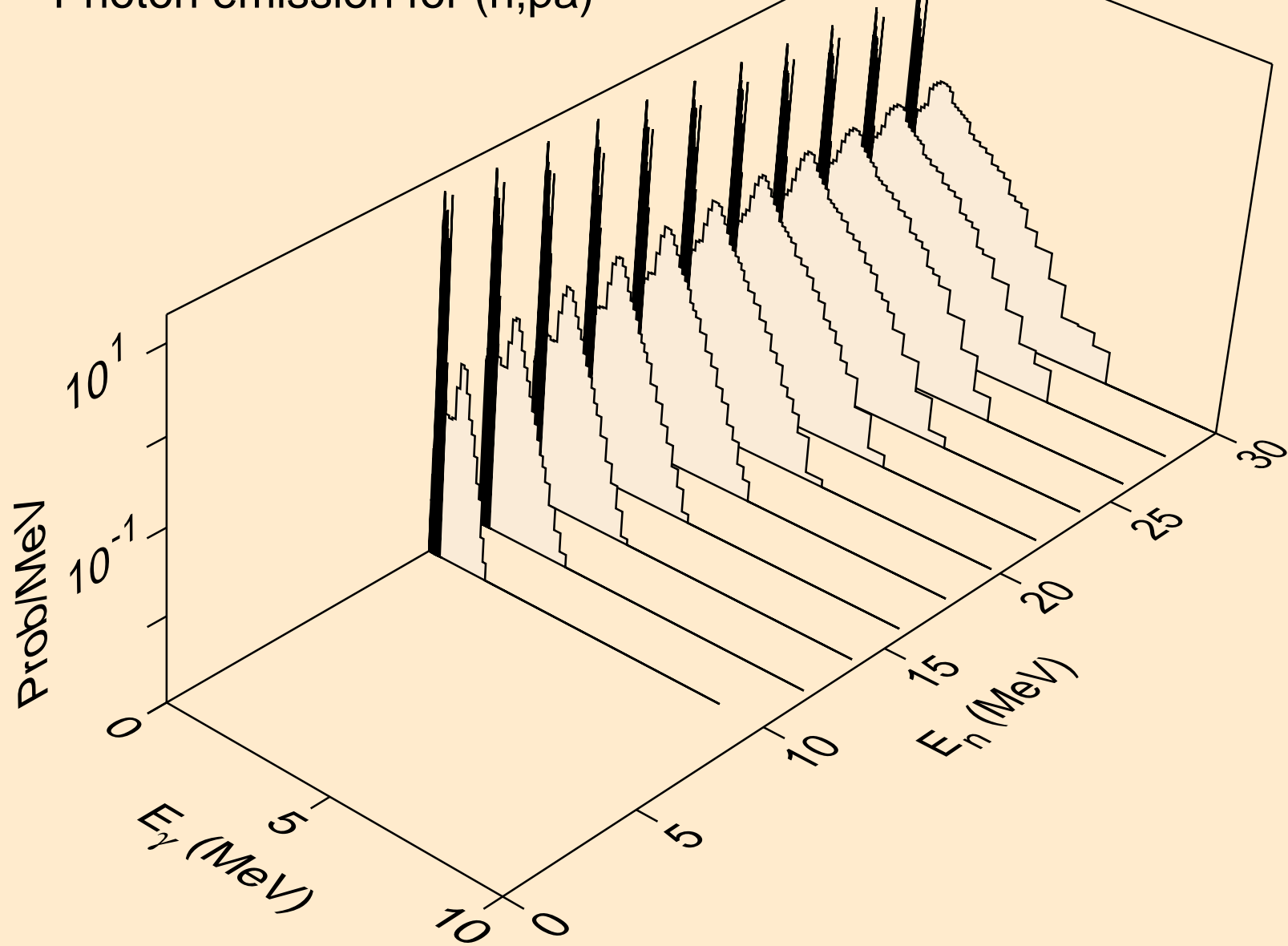



TL202 TRITON ACER TENDL-2021 LIBRARY; T=0.K  
Photon emission for (n,pd)

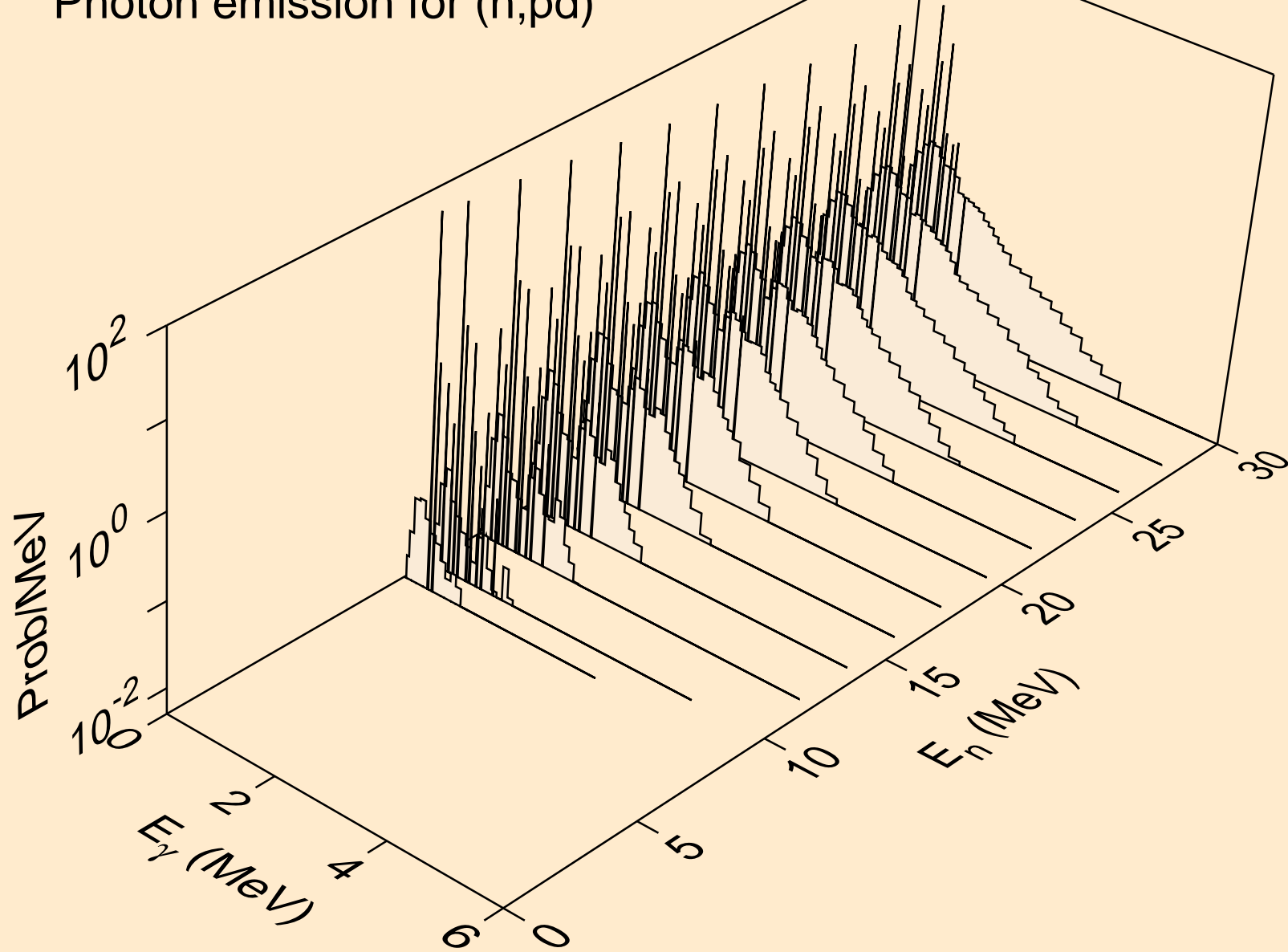

TL202 TRITON ACER TENDL-2021 LIBRARY; T=0.K  
Photon emission for (n,pt)

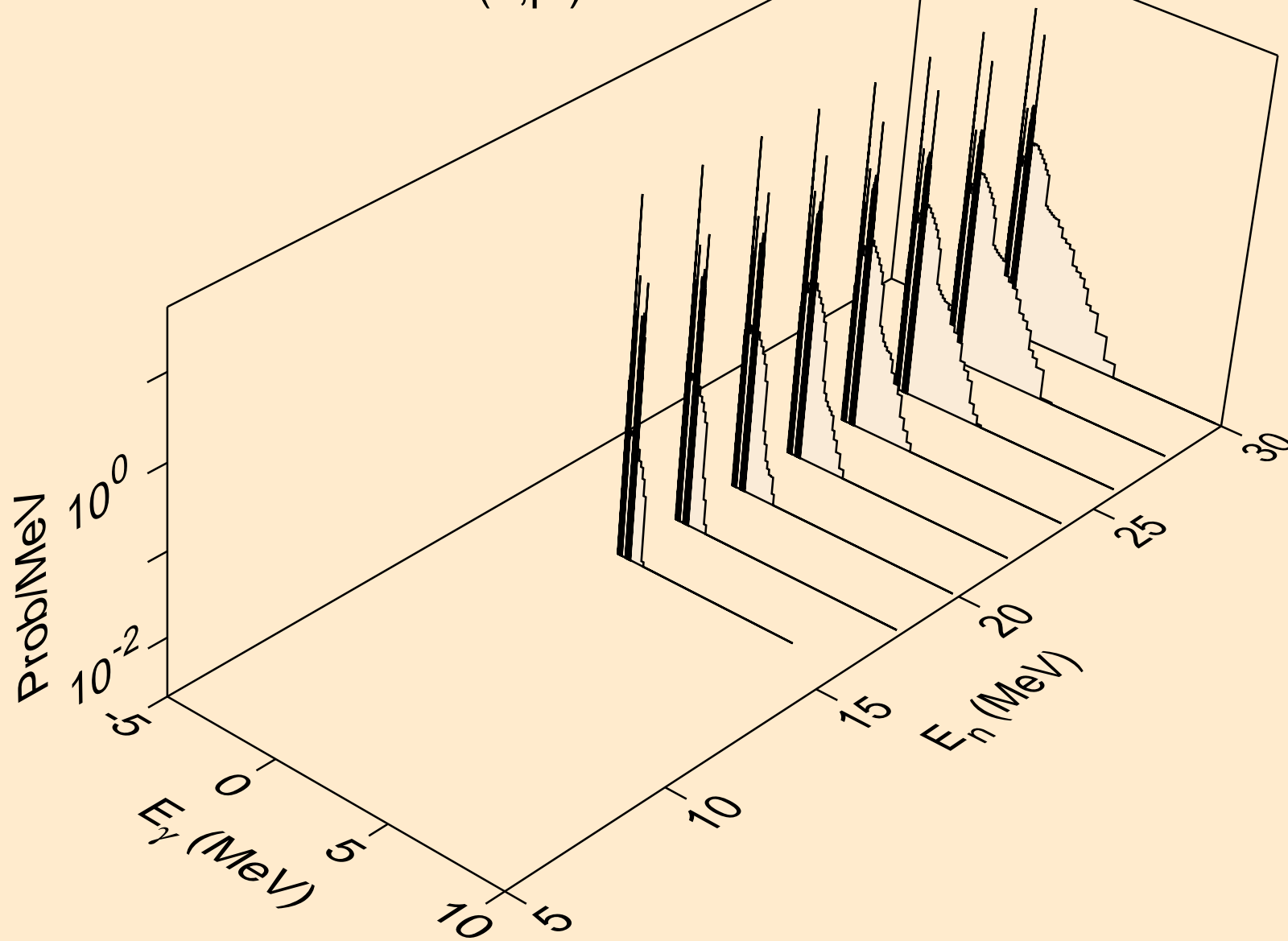

TL202 TRITON ACER TENDL-2021 LIBRARY; T=0.K  
Photon emission for (n,da)

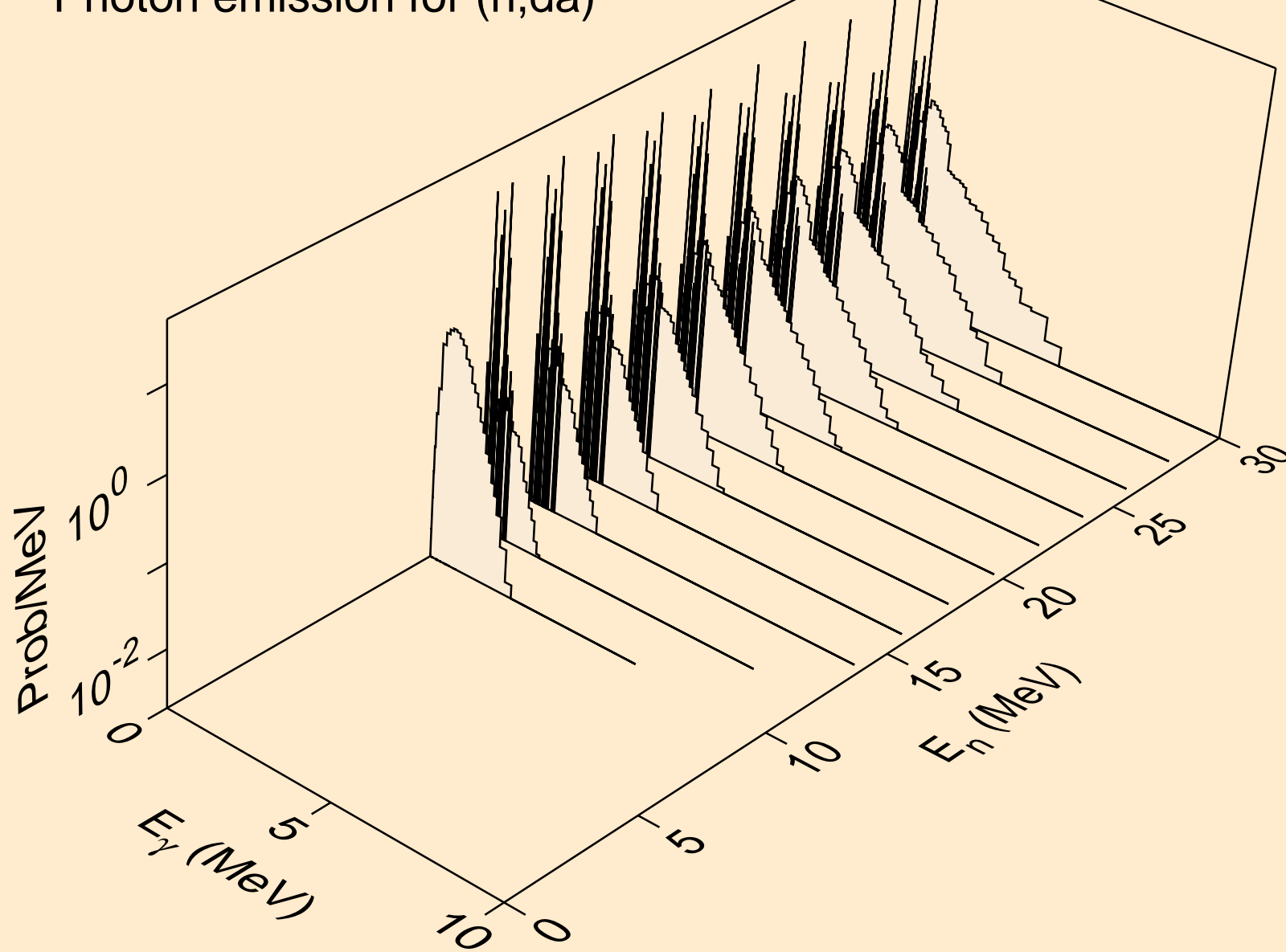

TL202 TRITON ACER TENDL-2021 LIBRARY; T=0.K  
Particle heating contributions

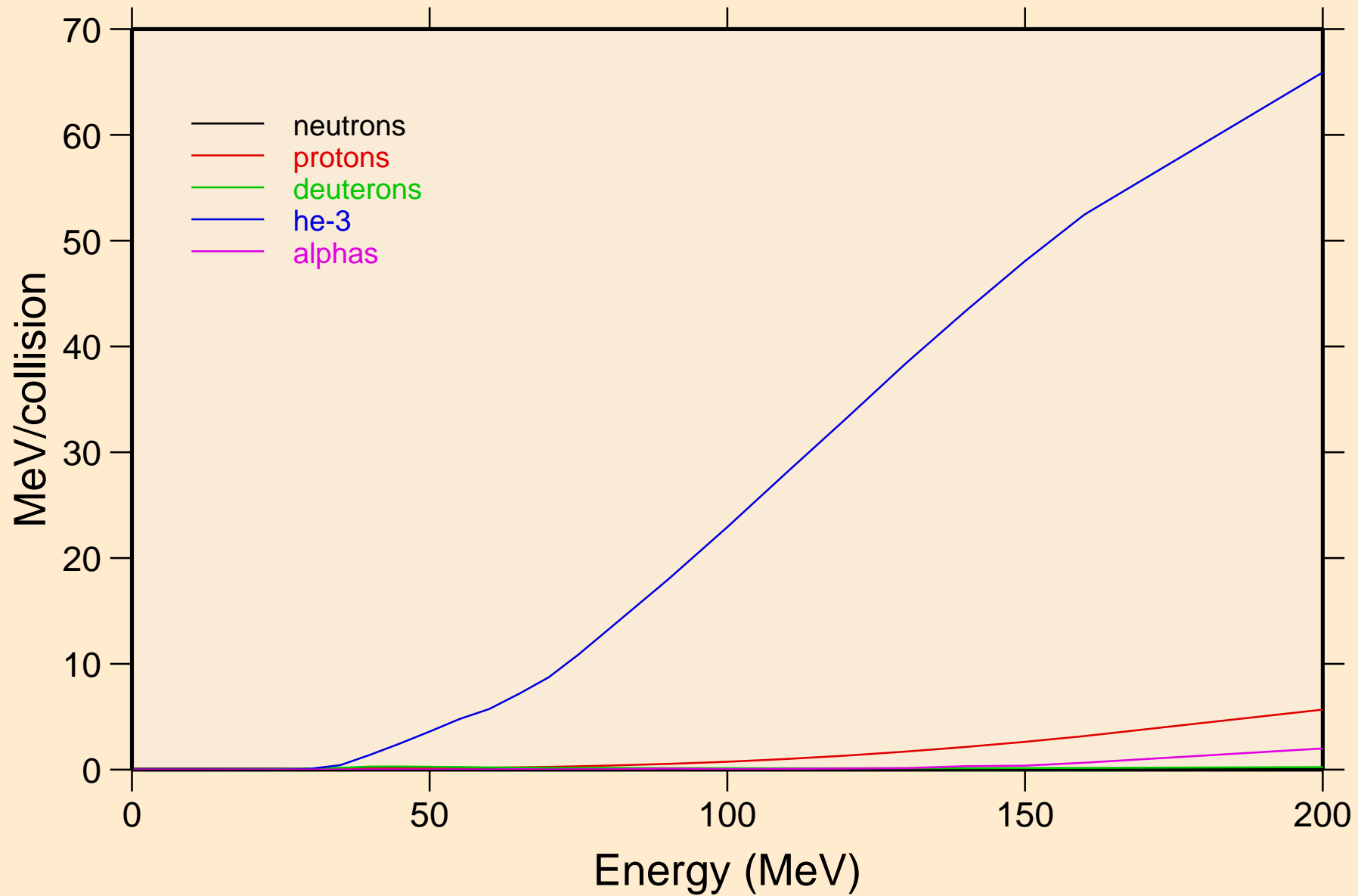

TL202 TRITON ACER TENDL-2021 LIBRARY; T=0.K  
Recoil Heating

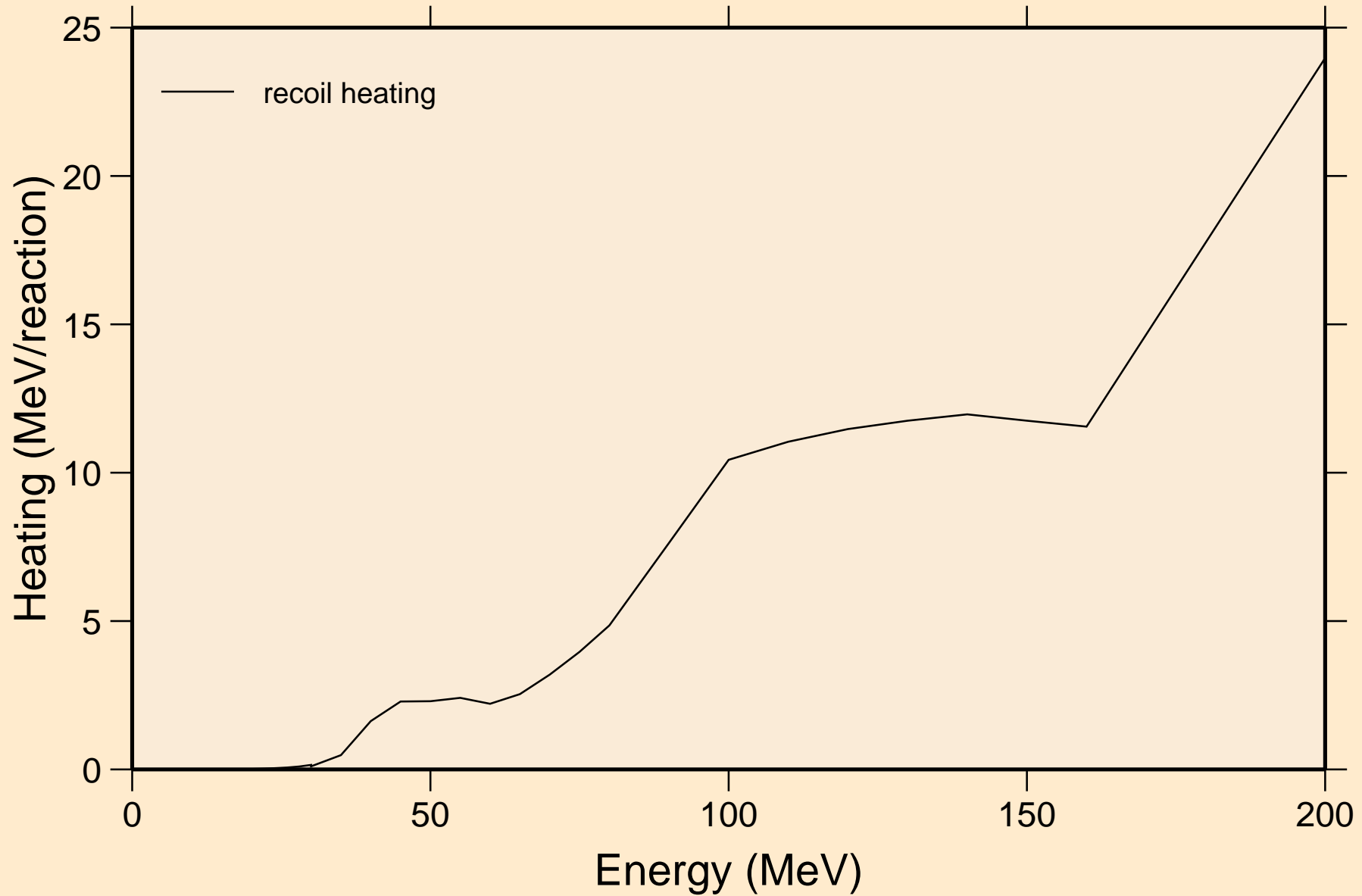

TL202 TRITON ACER TENDL-2021 LIBRARY; T=0.K  
Particle production cross sections

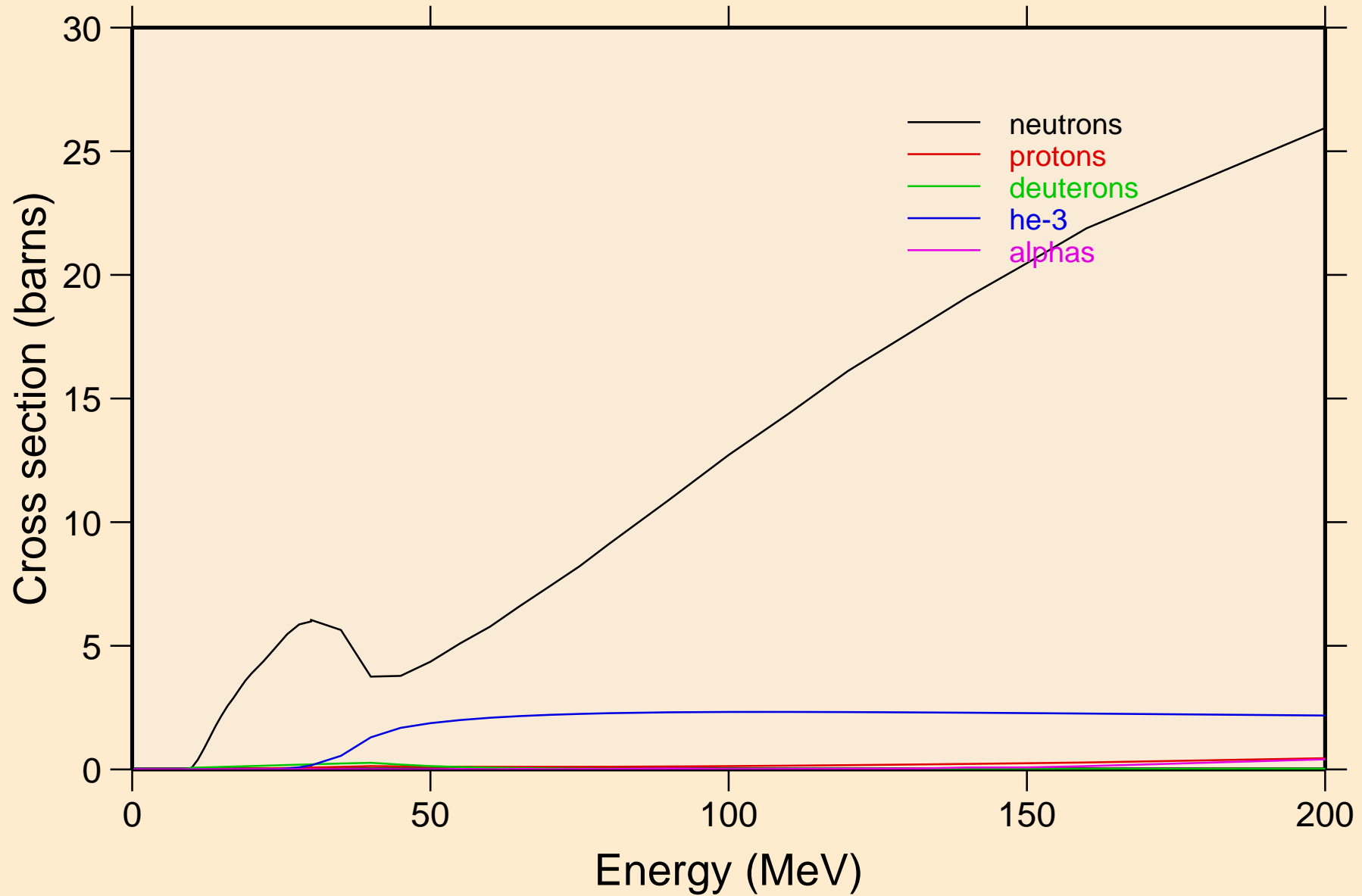

TL202 TRITON ACER TENDL-2021 LIBRARY; T=0.K  
neutrons from (t,n)

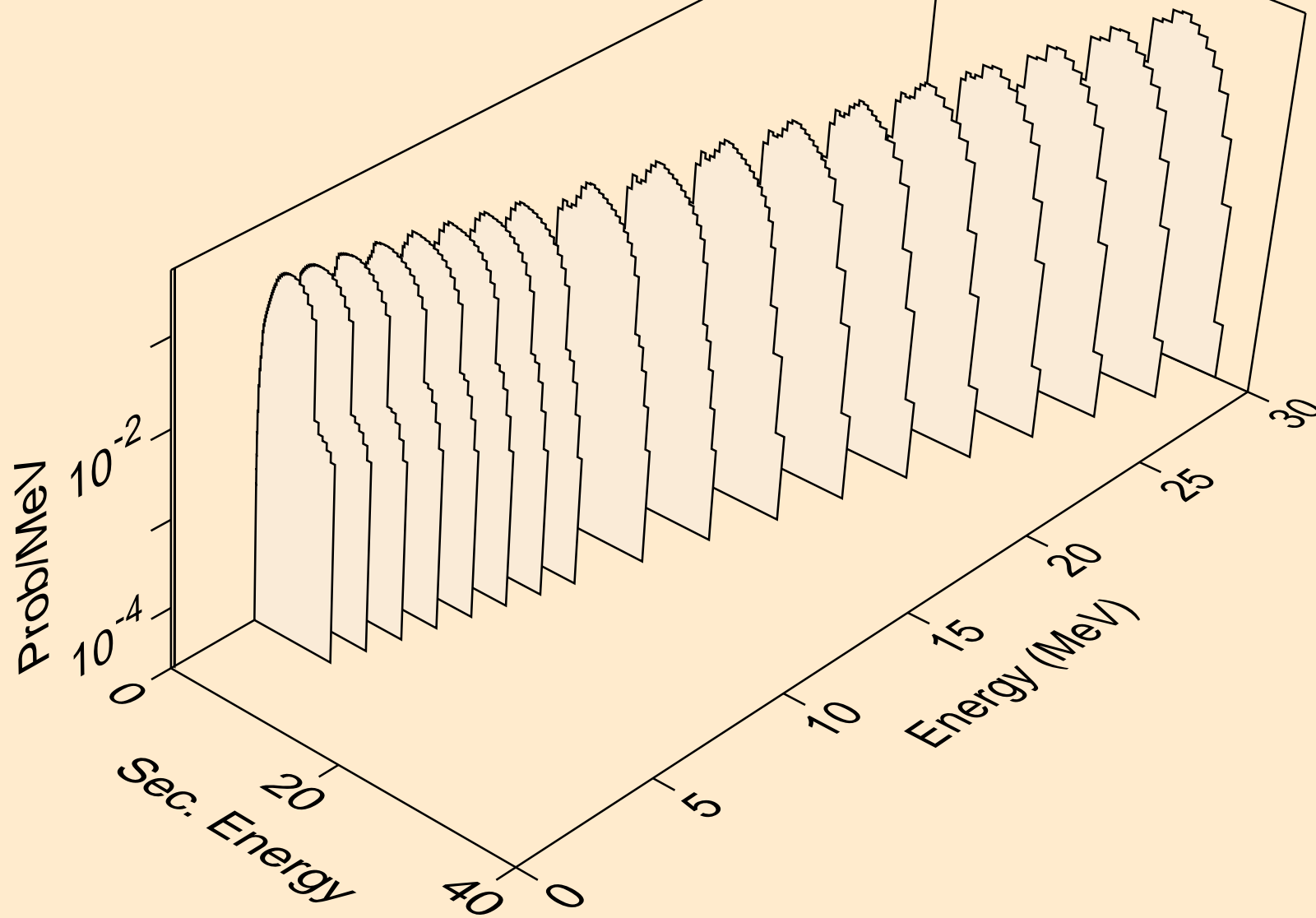

TL202 TRITON ACER TENDL-2021 LIBRARY; T=0.K  
neutrons from (t,x)

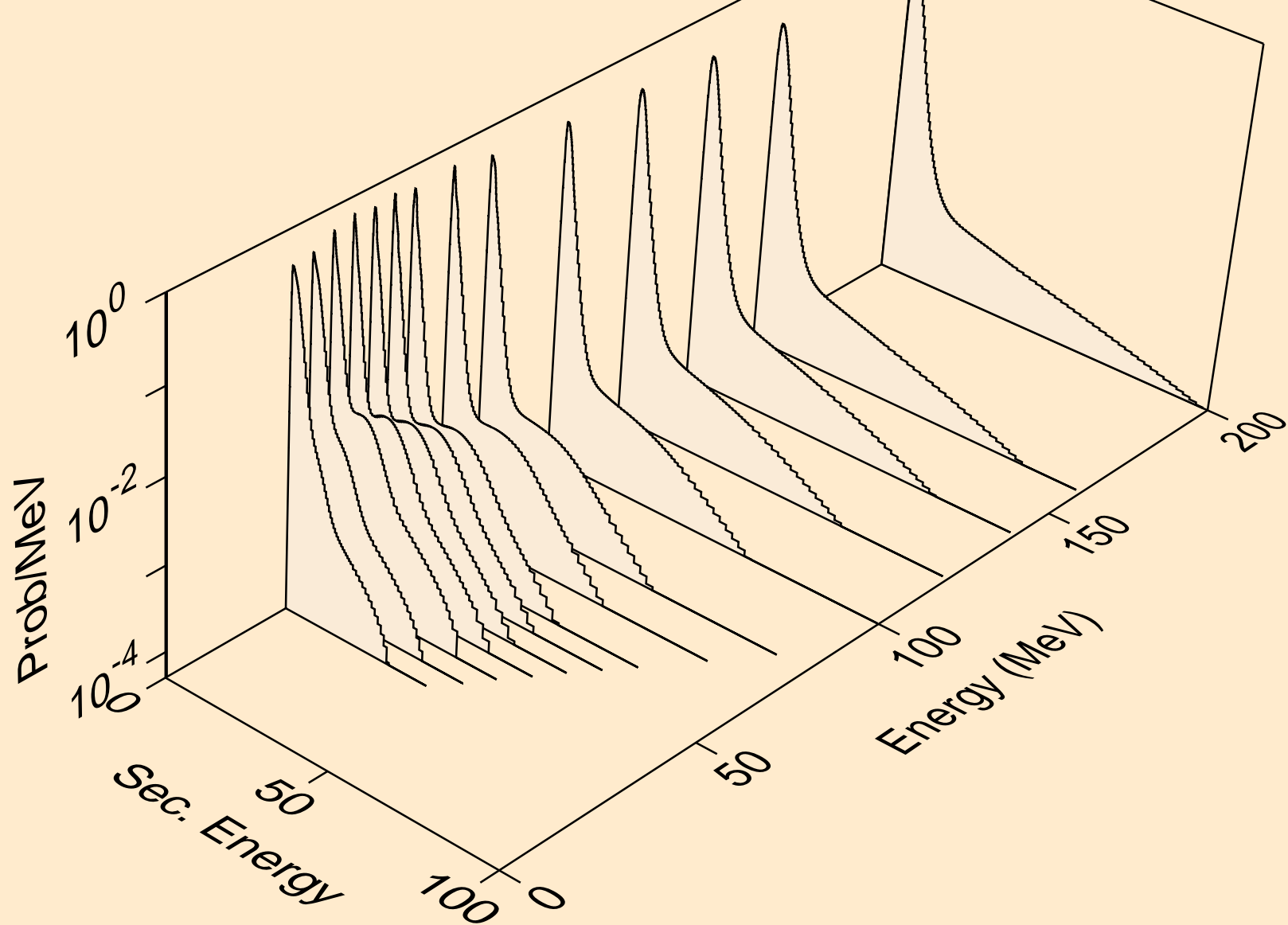



TL202 TRITON ACER TENDL-2021 LIBRARY; T=0.K  
neutrons from (t,2nd)

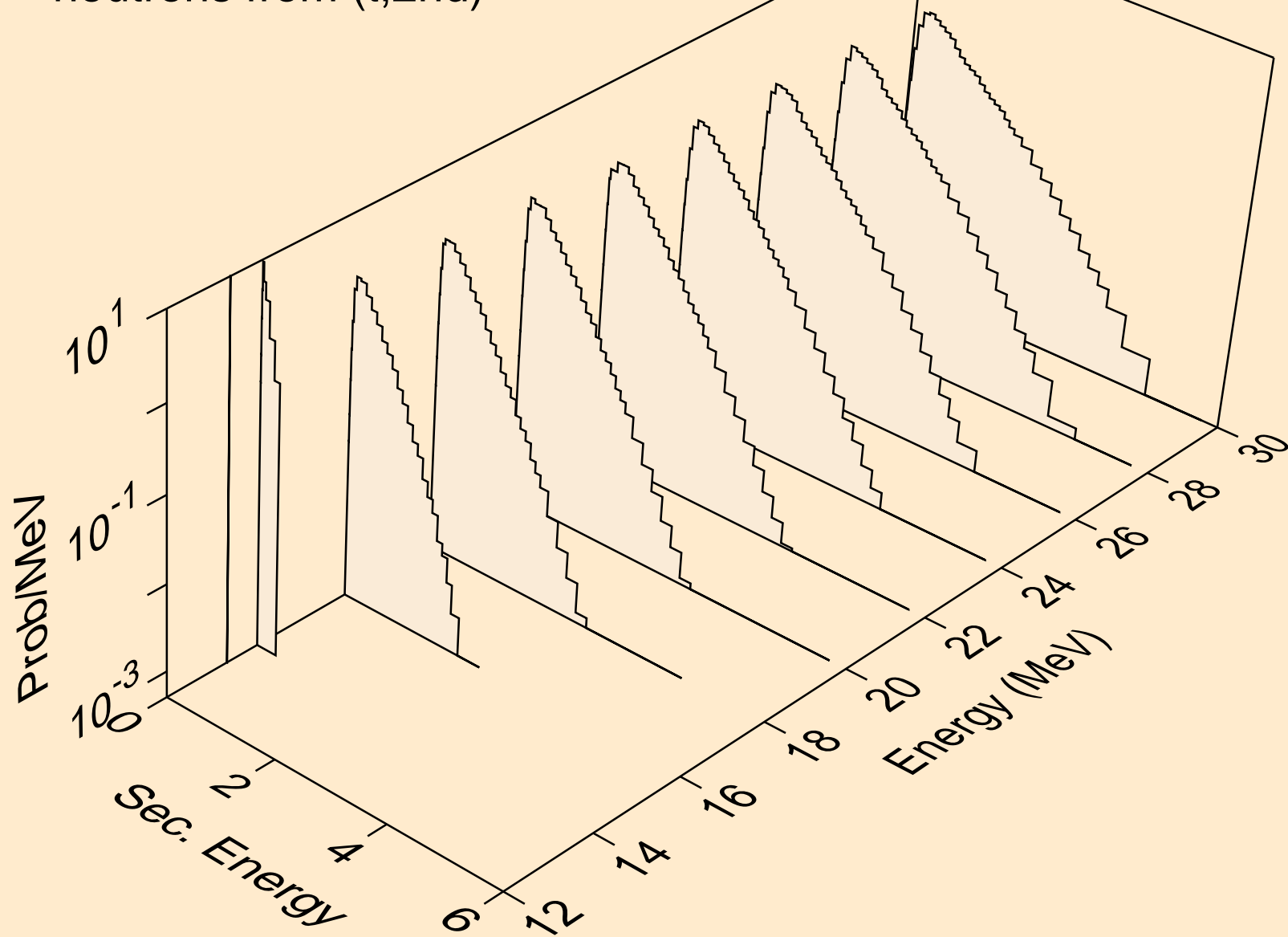

TL202 TRITON ACER TENDL-2021 LIBRARY; T=0.K  
neutrons from (t,2n)

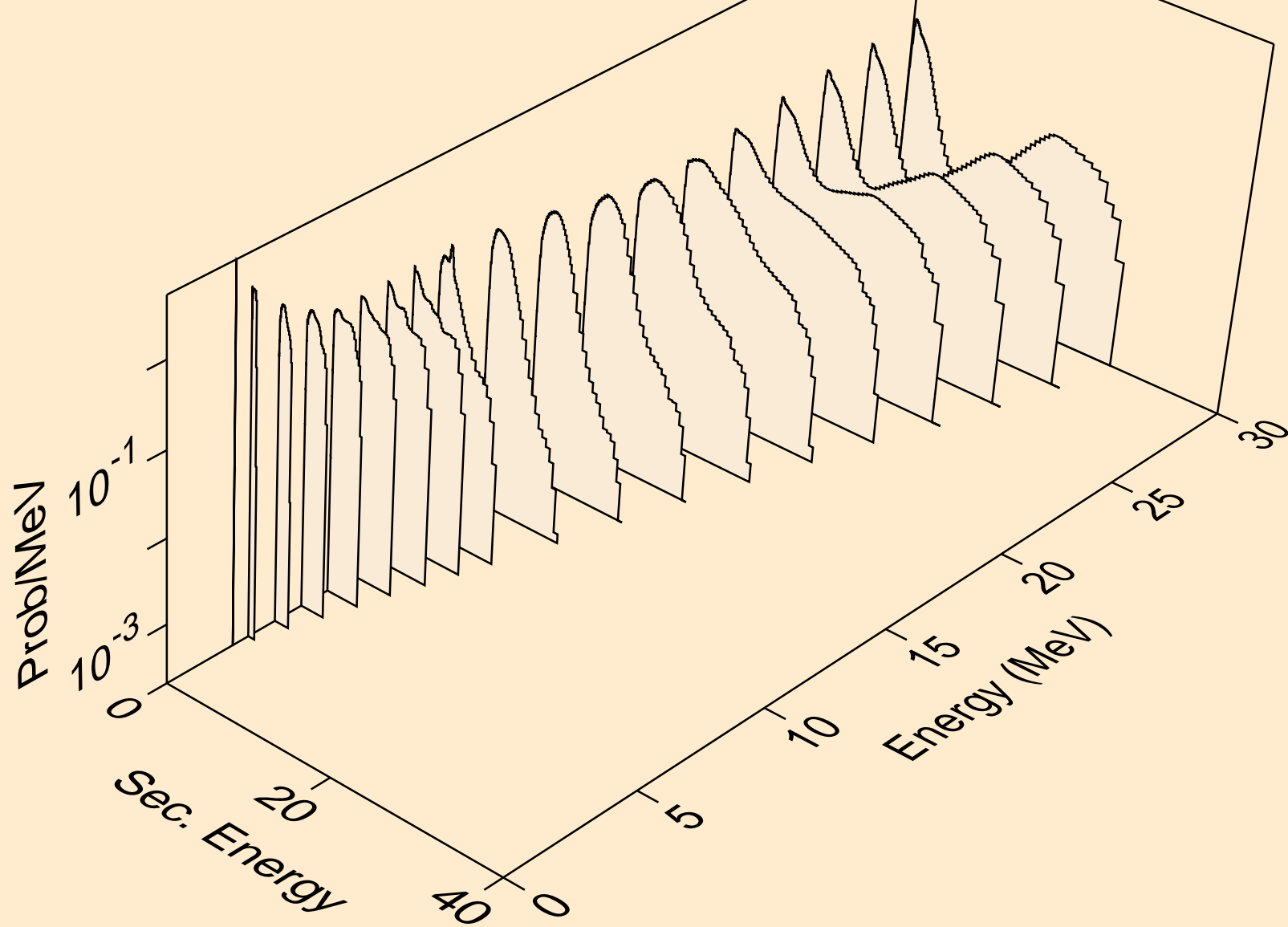

TL202 TRITON ACER TENDL-2021 LIBRARY; T=0.K  
neutrons from (t,3n)

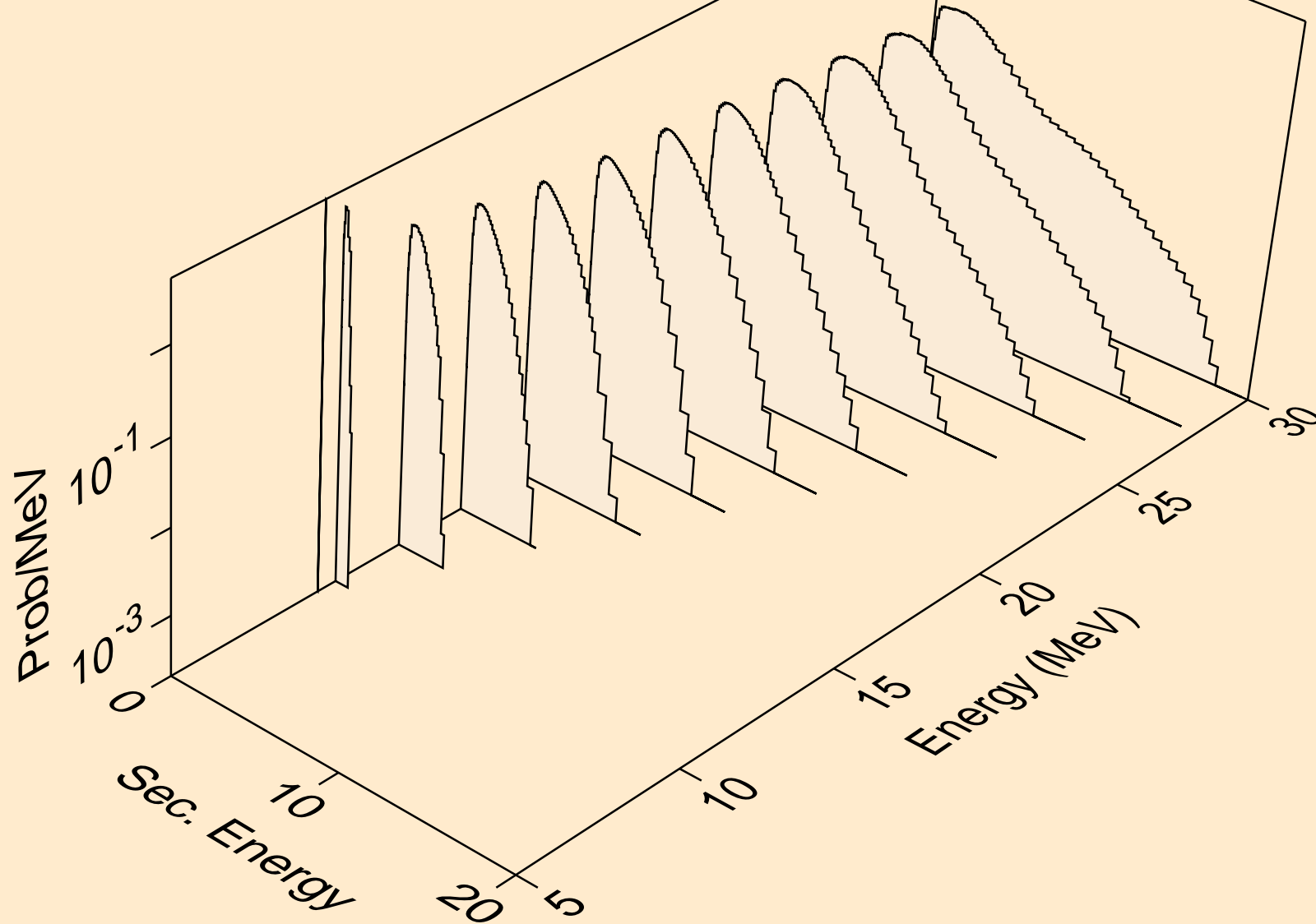

TL202 TRITON ACER TENDL-2021 LIBRARY; T=0.K  
neutrons from (t,n\*)a

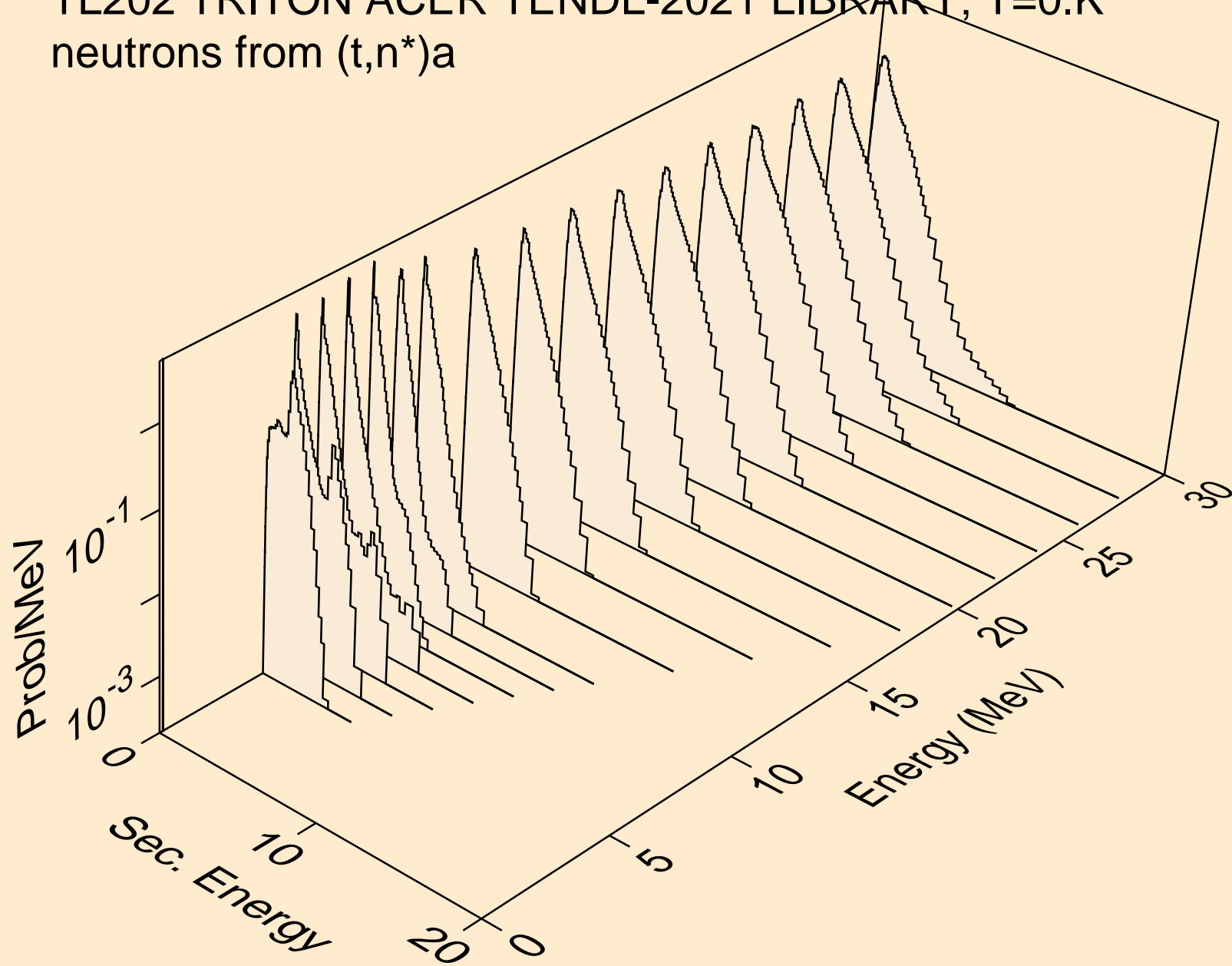

TL202 TRITON ACER TENDL-2021 LIBRARY; T=0.K  
neutrons from (t,2n)a

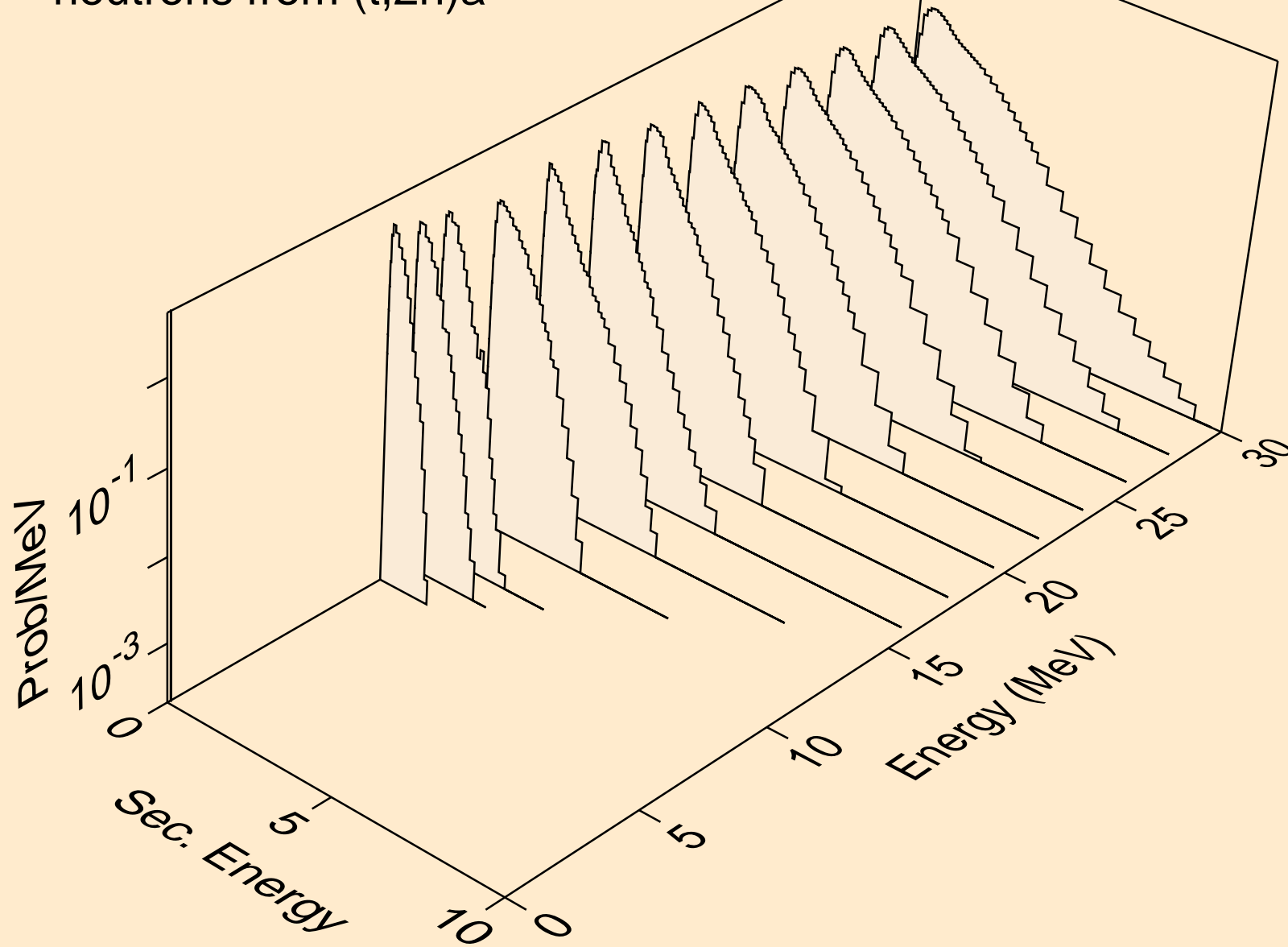

TL202 TRITON ACER TENDL-2021 LIBRARY; T=0.K  
neutrons from (t,3n)a

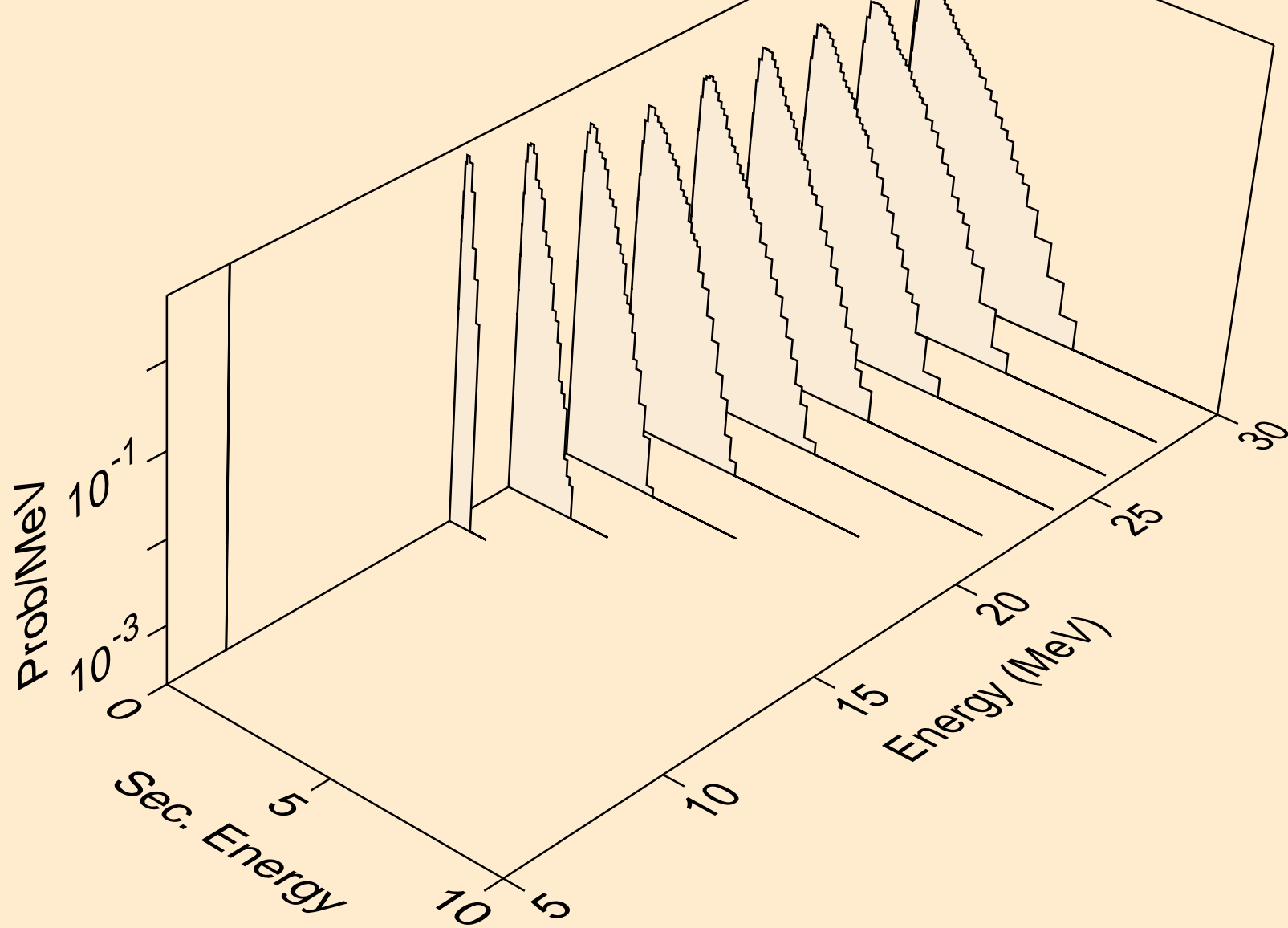

TL202 TRITON ACER TENDL-2021 LIBRARY; T=0.K  
neutrons from (t,n\*)p

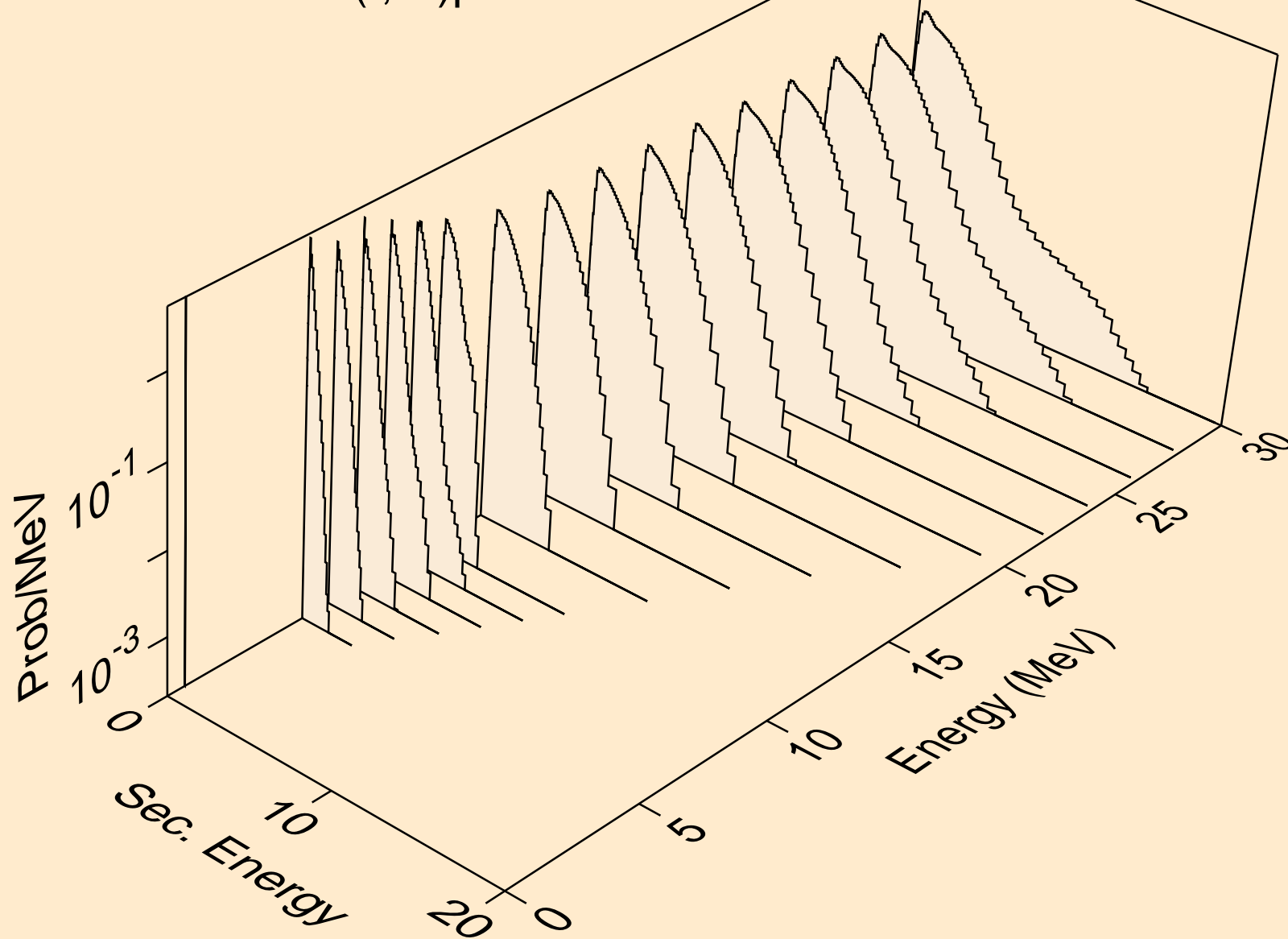

TL202 TRITON ACER TENDL-2021 LIBRARY; T=0.K  
neutrons from (t,n\*)2a

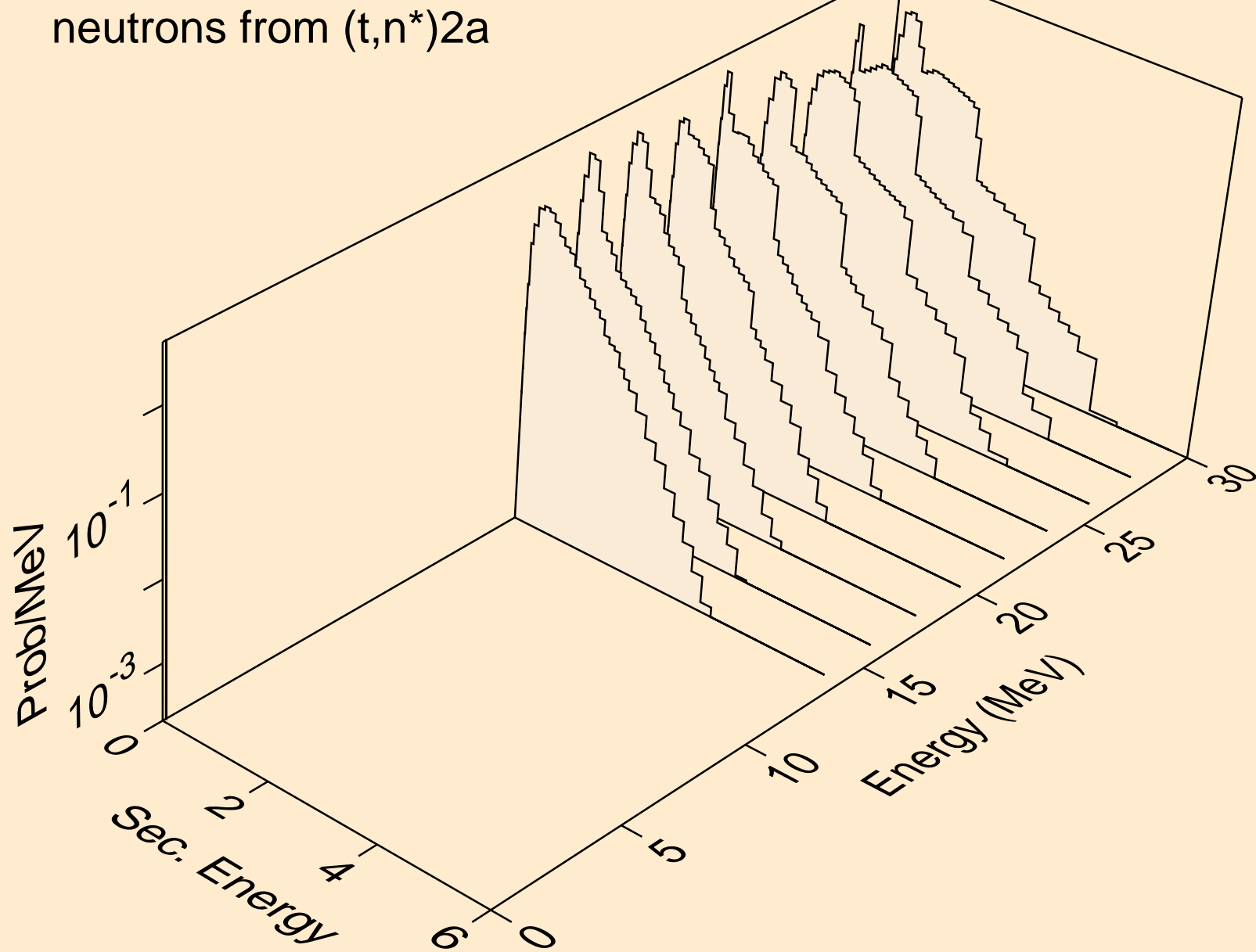



TL202 TRITON ACER TENDL-2021 LIBRARY; T=0.K  
neutrons from (t,n\*)d

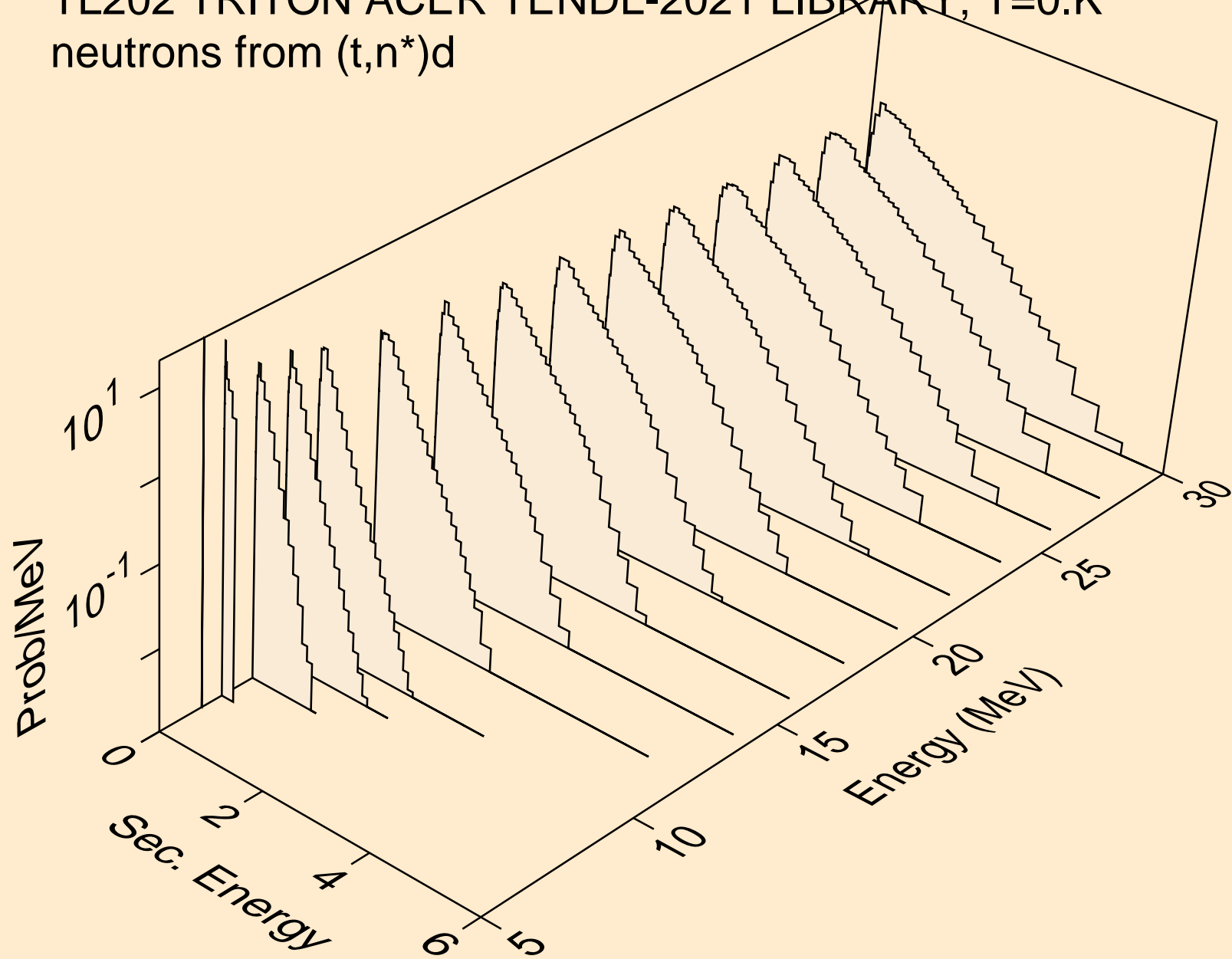

TL202 TRITON ACER TENDL-2021 LIBRARY; T=0.K  
neutrons from (t,n\*)t

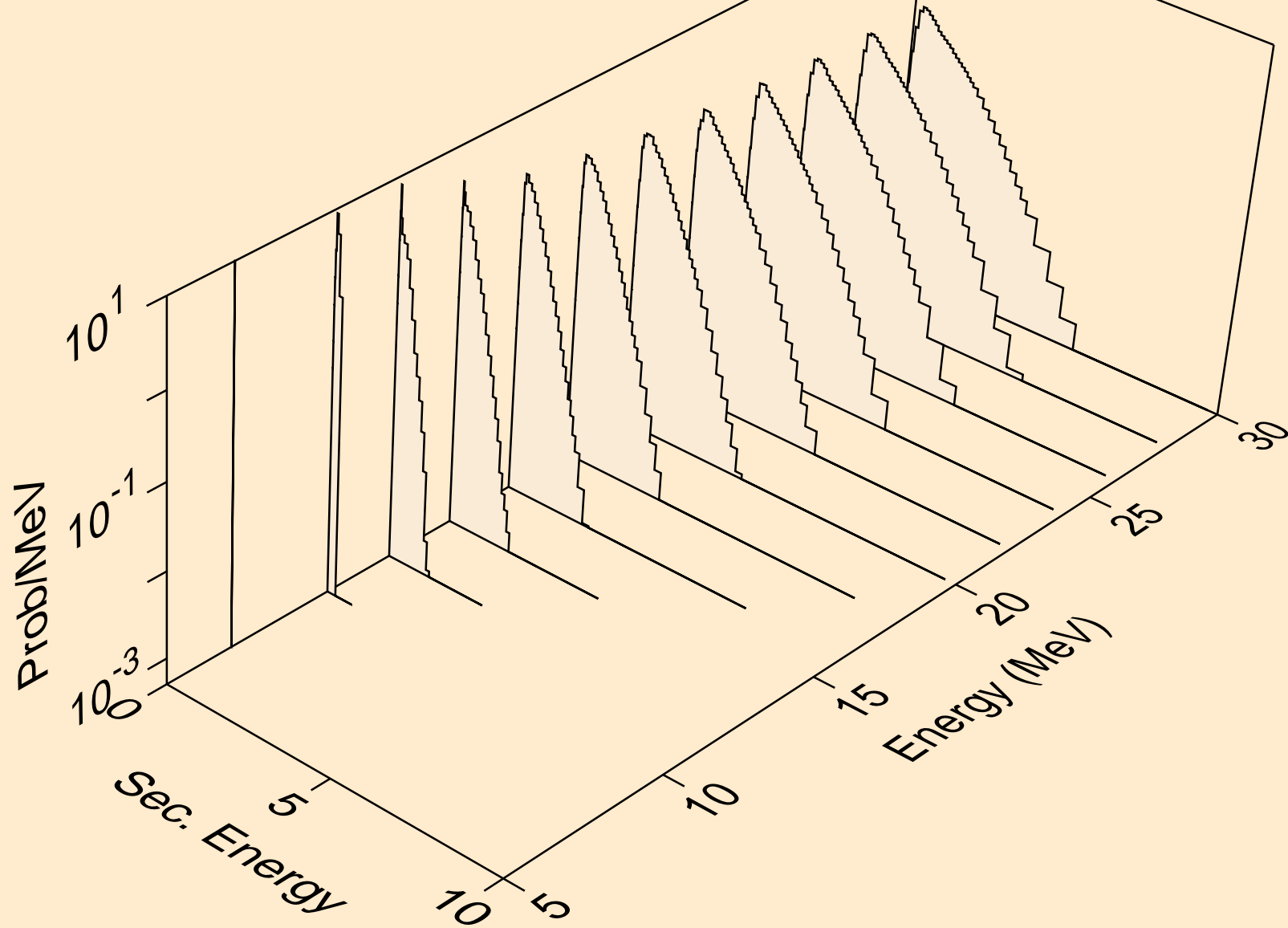

TL202 TRITON ACER TENDL-2021 LIBRARY; T=0.K  
neutrons from (t,n\*)he3

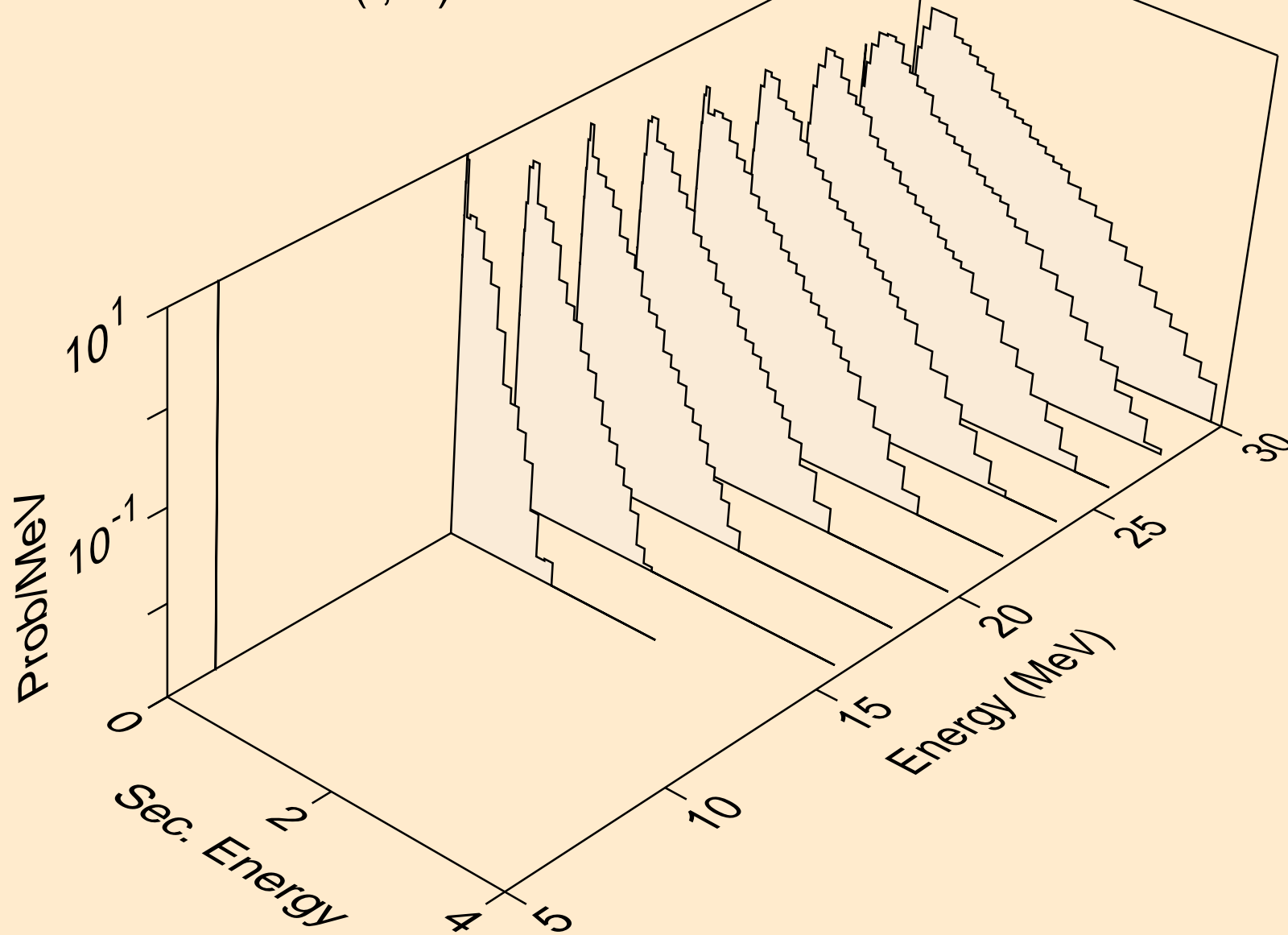

TL202 TRITON ACER TENDL-2021 LIBRARY; T=0.K  
neutrons from (t,4n)

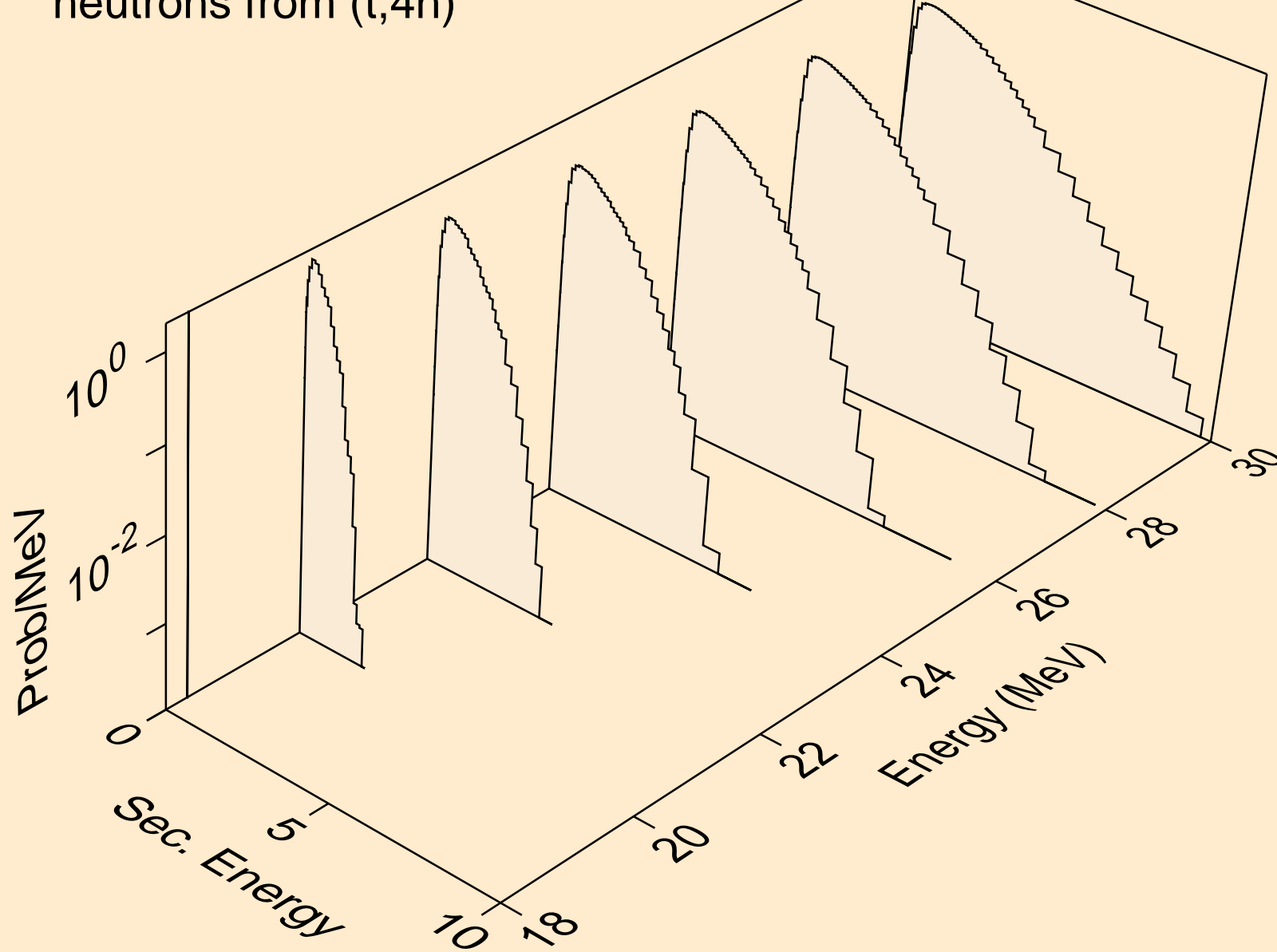

TL202 TRITON ACER TENDL-2021 LIBRARY; T=0.K  
neutrons from (t,2np)

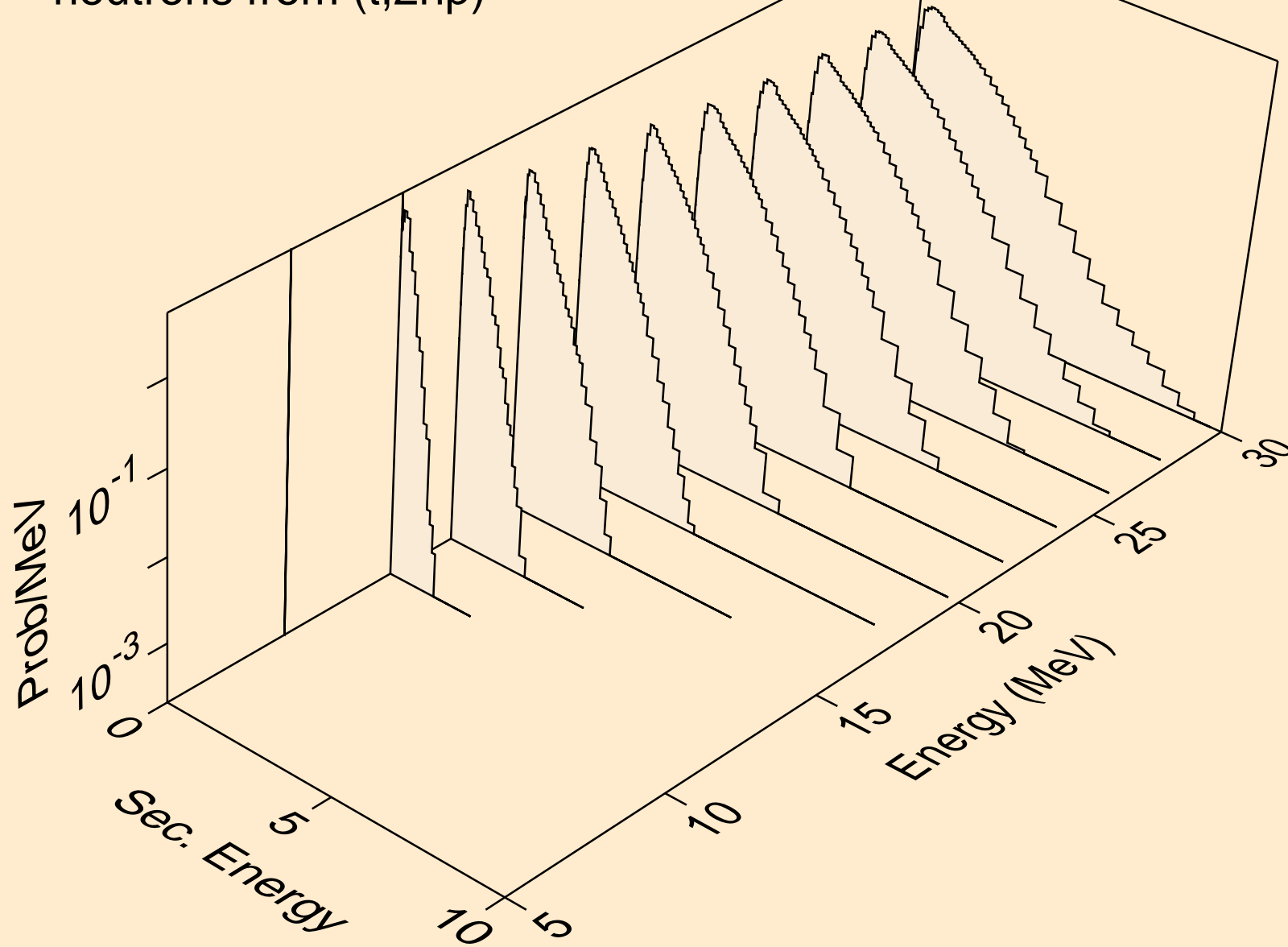

TL202 TRITON ACER TENDL-2021 LIBRARY; T=0.K  
neutrons from (t,3np)

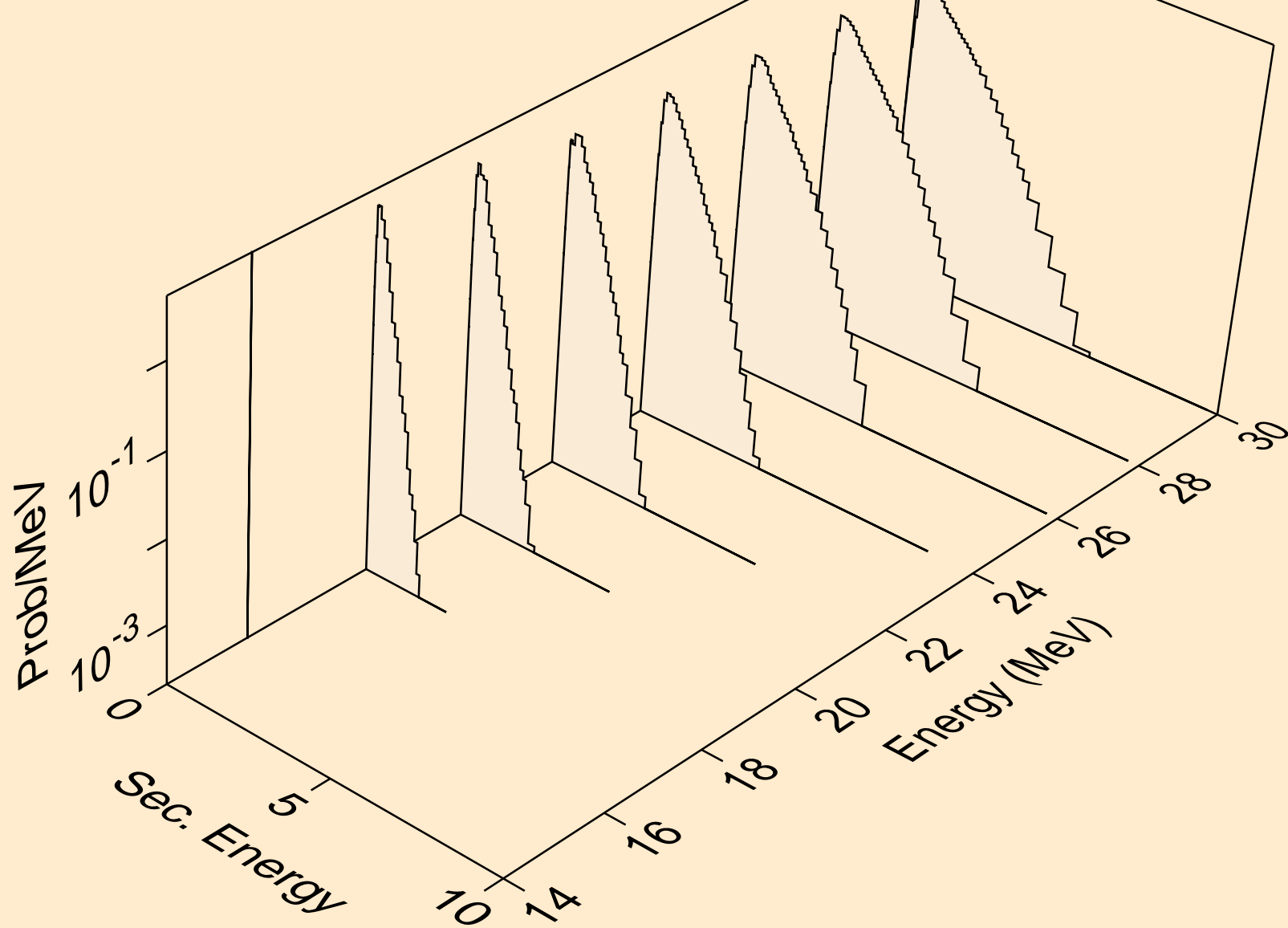

TL202 TRITON ACER TENDL-2021 LIBRARY; T=0.K  
neutrons from (t,2np)

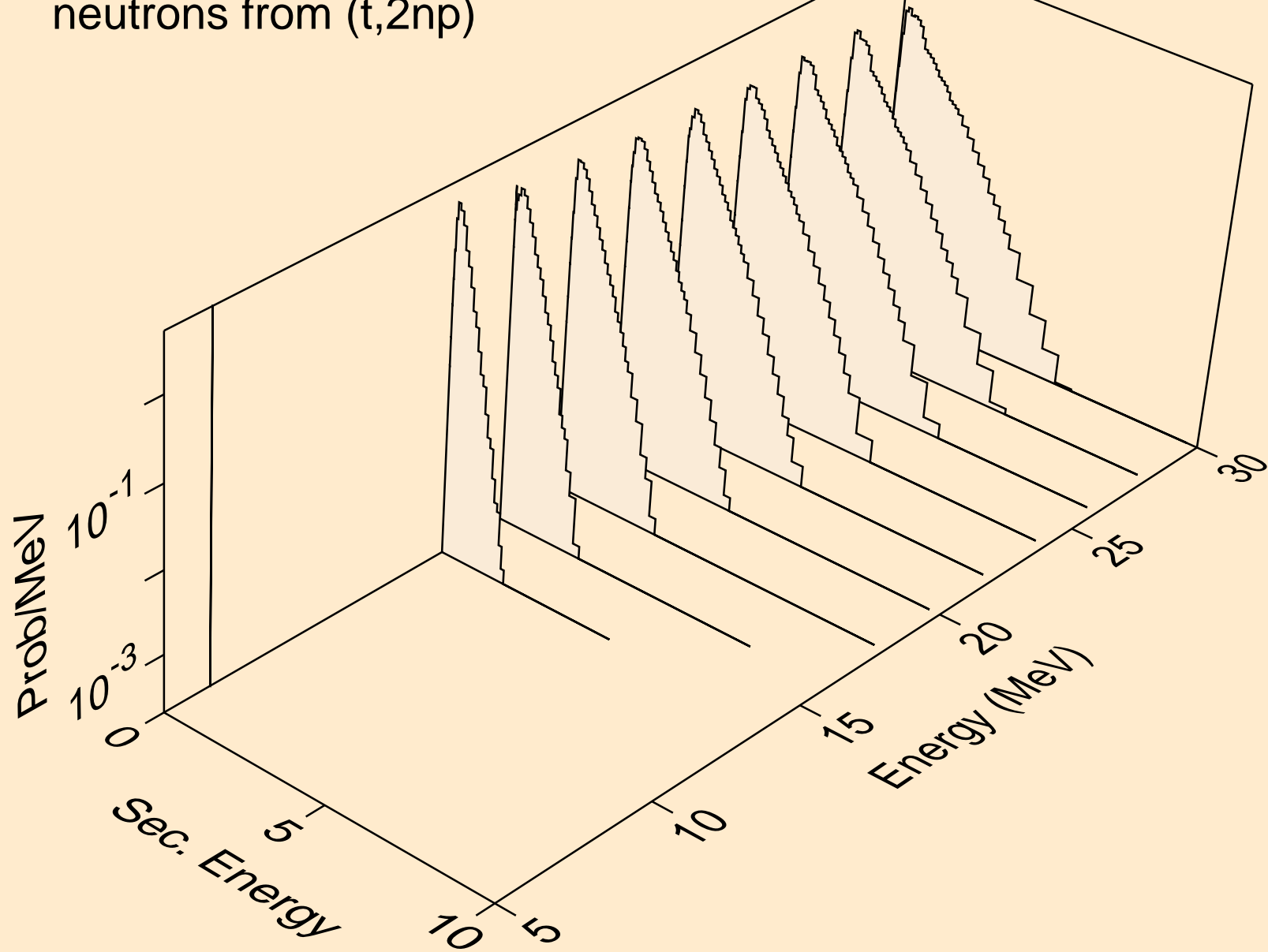

TL202 TRITON ACER TENDL-2021 LIBRARY; T=0.K  
neutrons from (t,npa)

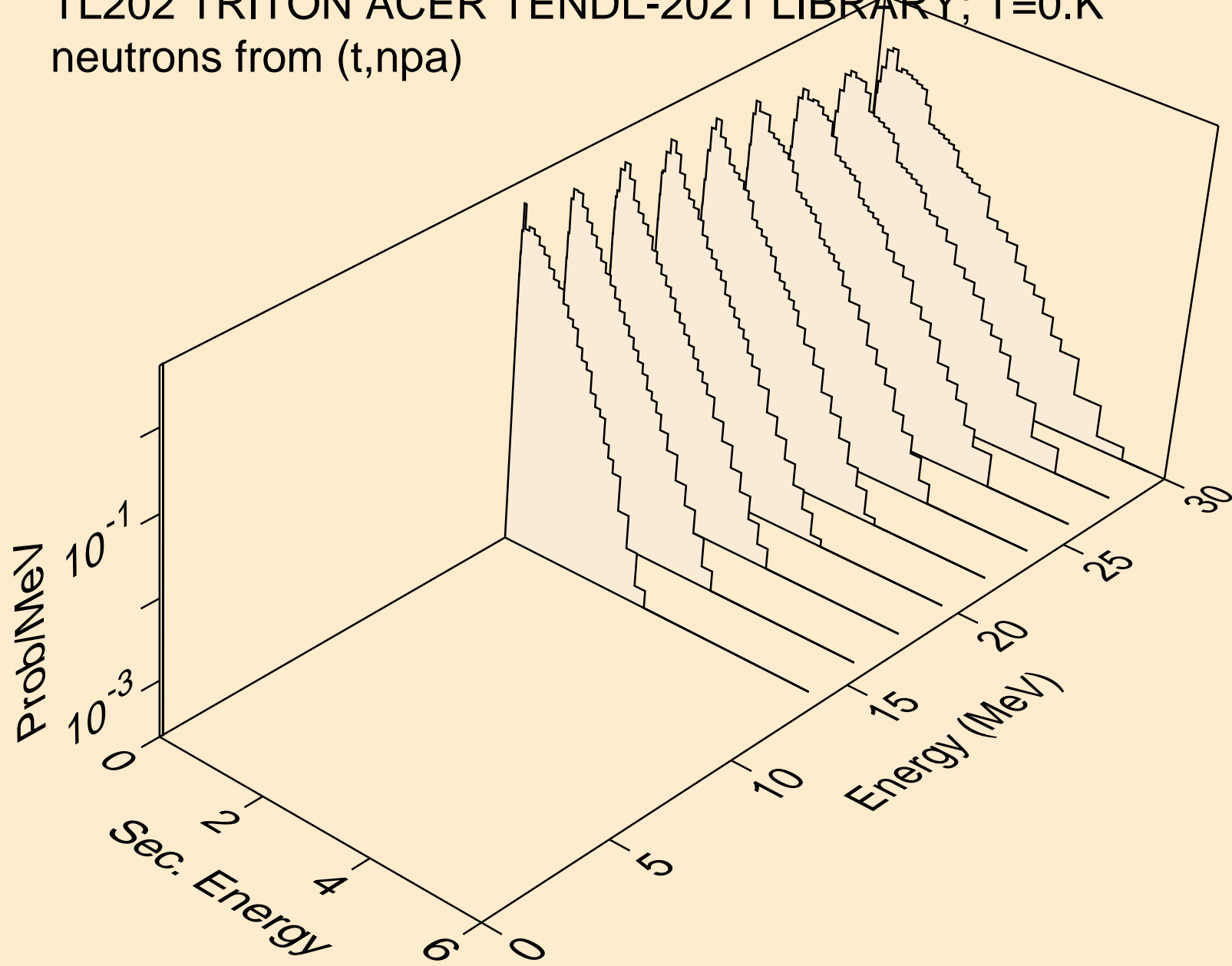



TL202 TRITON ACER TENDL-2021 LIBRARY; T=0.K  
protons from (t,x)

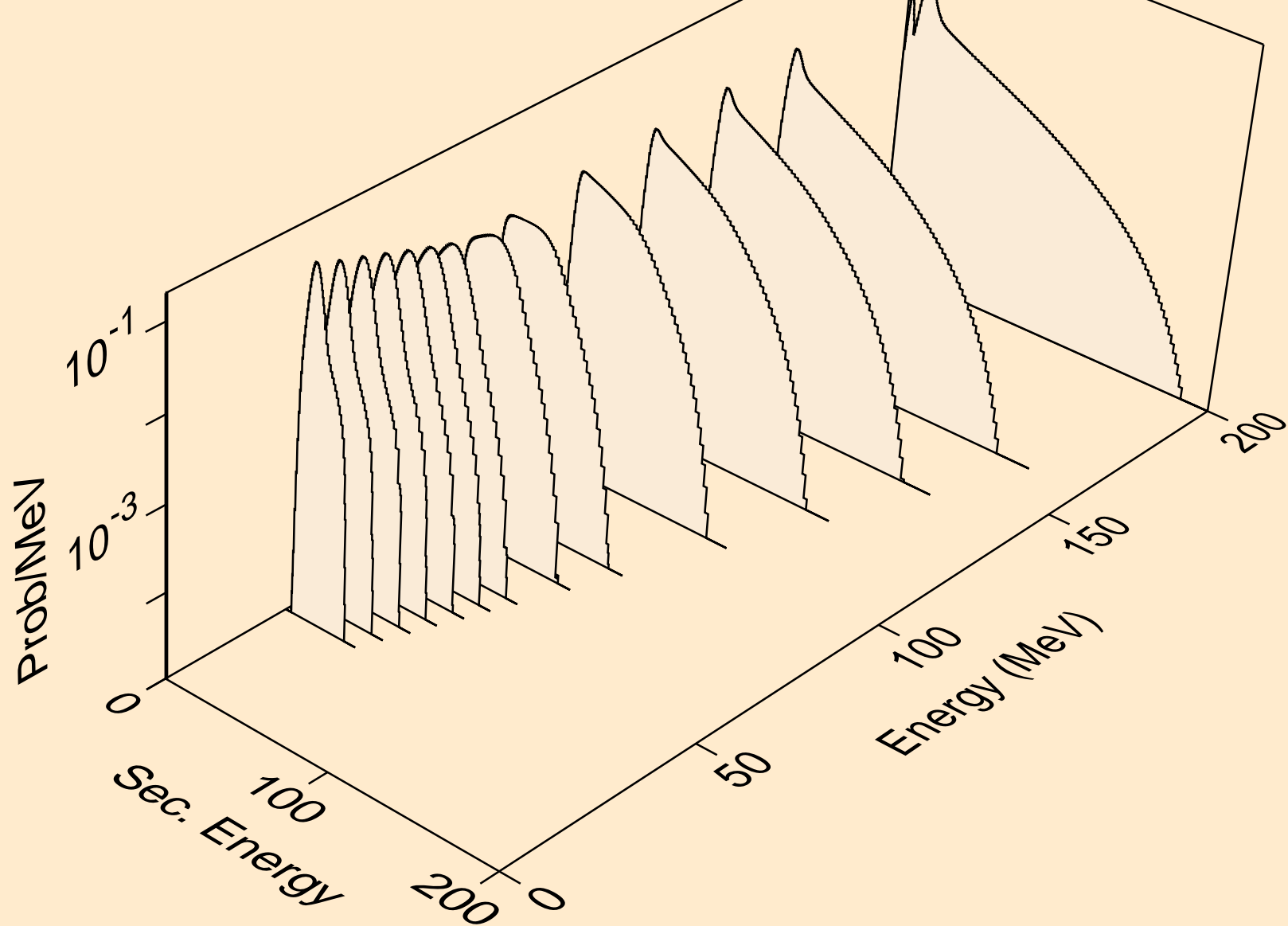

TL202 TRITON ACER TENDL-2021 LIBRARY; T=0.K  
protons from (t,n\*)p

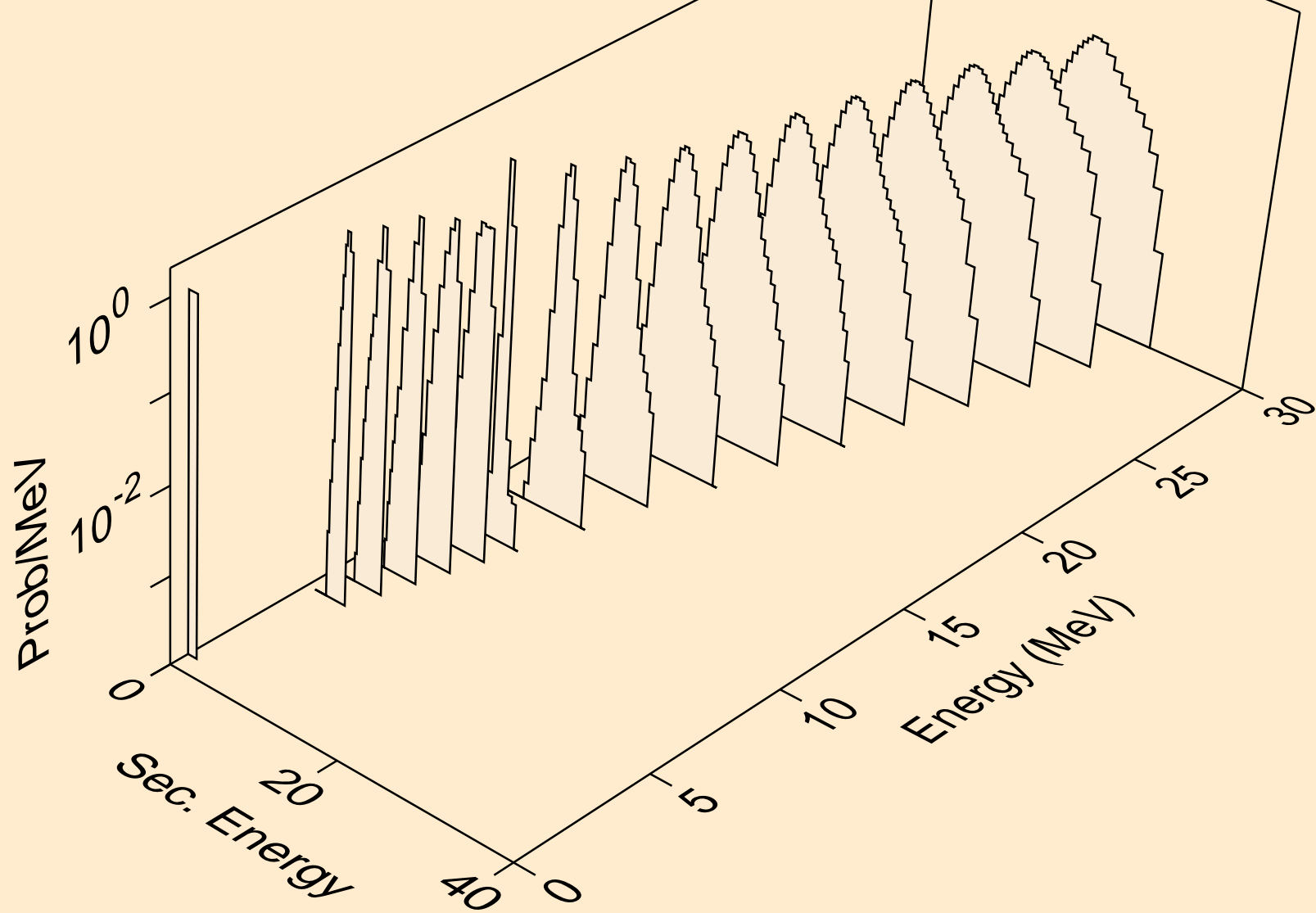

TL202 TRITON ACER TENDL-2021 LIBRARY; T=0.K  
protons from (t,2np)

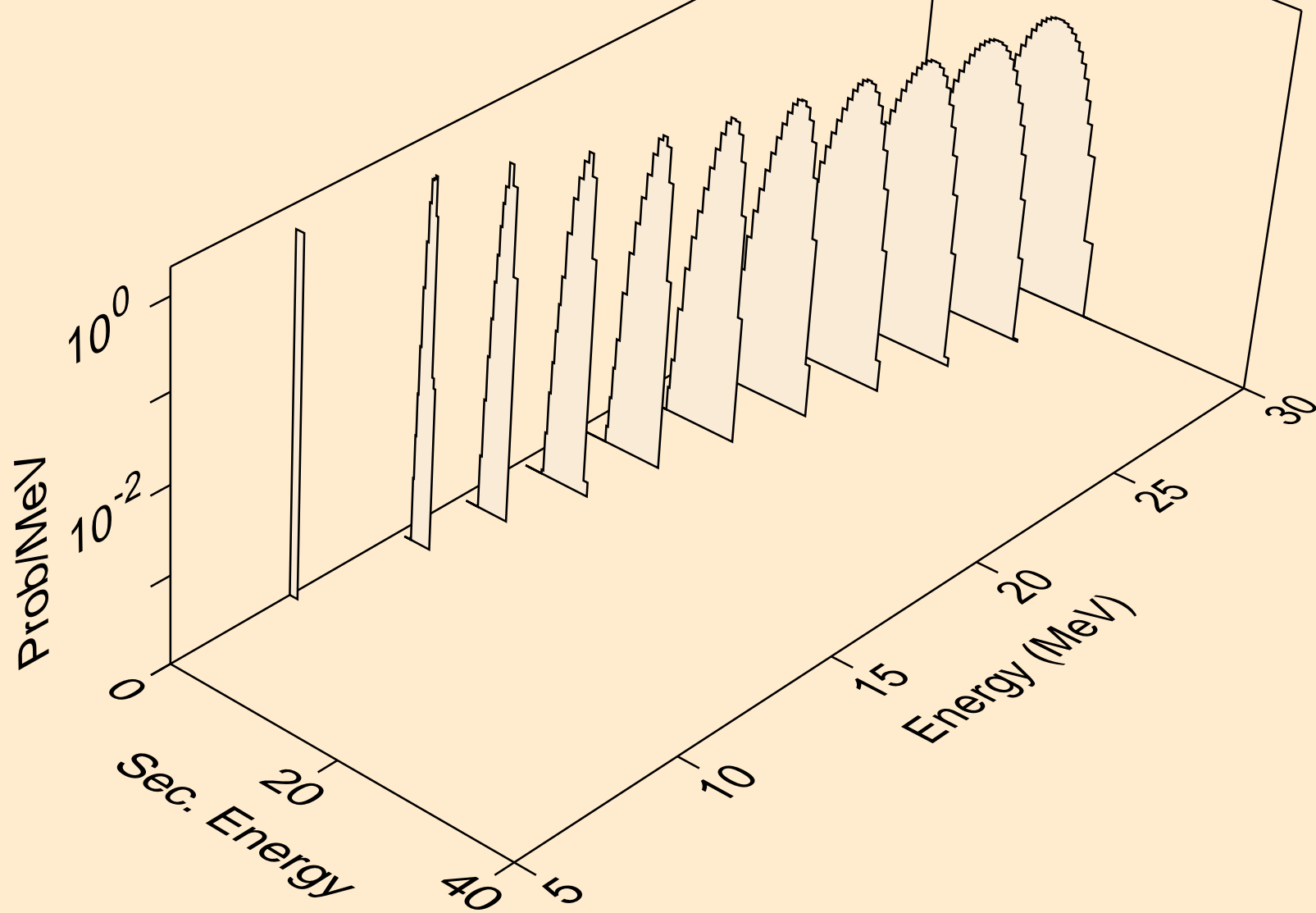

TL202 TRITON ACER TENDL-2021 LIBRARY; T=0.K  
protons from (t,3np)

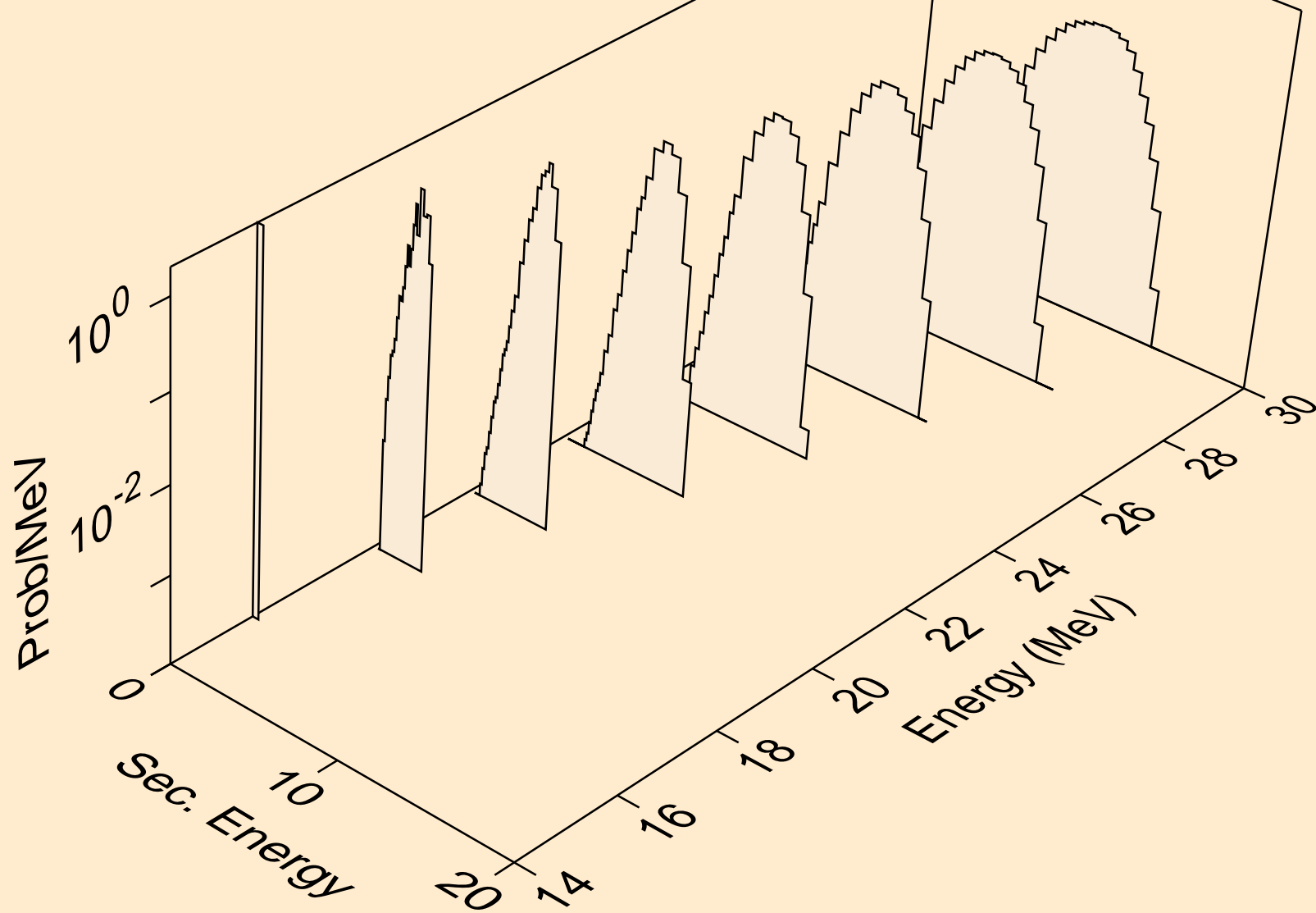

TL202 TRITON ACER TENDL-2021 LIBRARY; T=0.K  
protons from (t,2np)

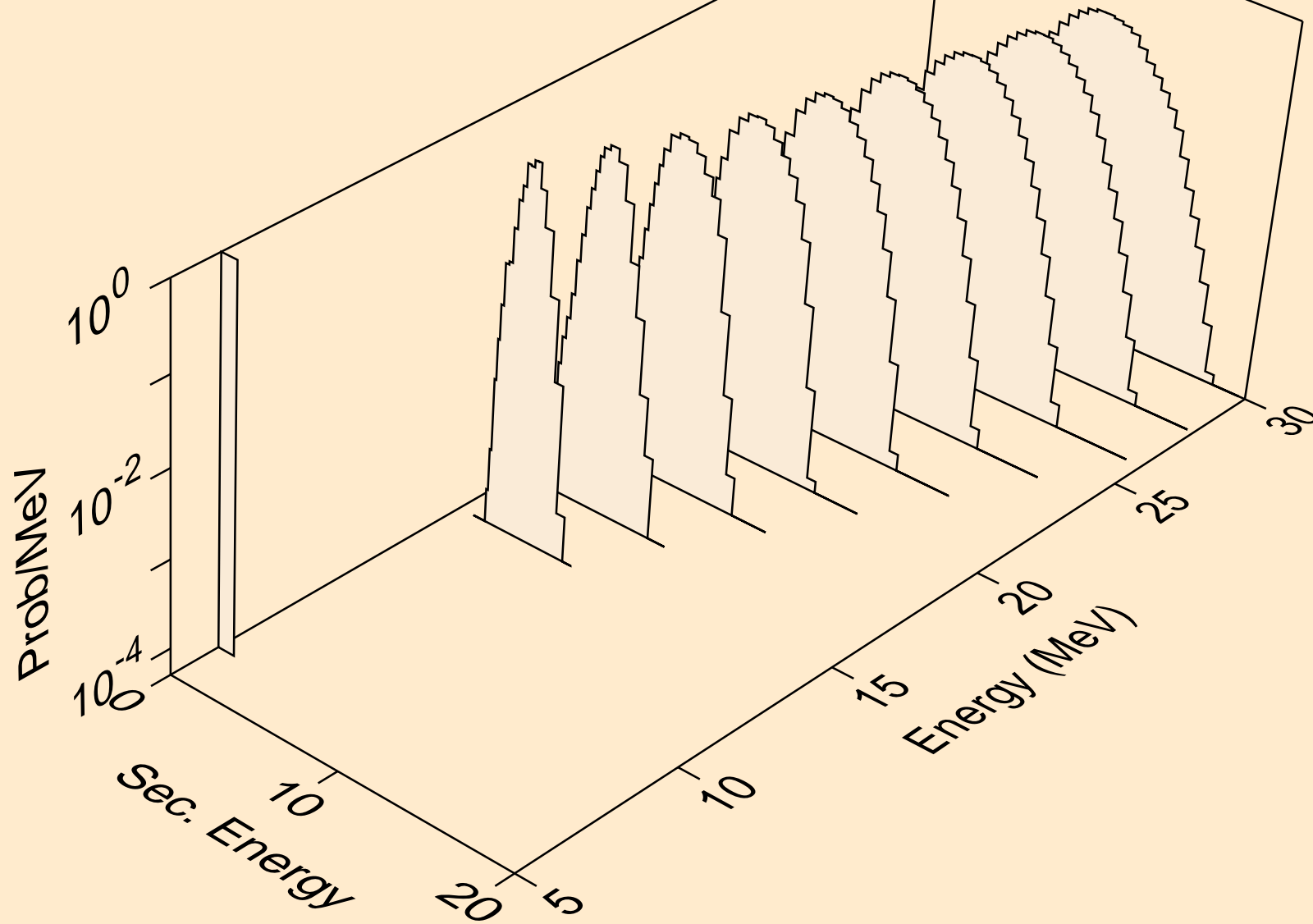

TL202 TRITON ACER TENDL-2021 LIBRARY; T=0.K  
protons from (t,npa)

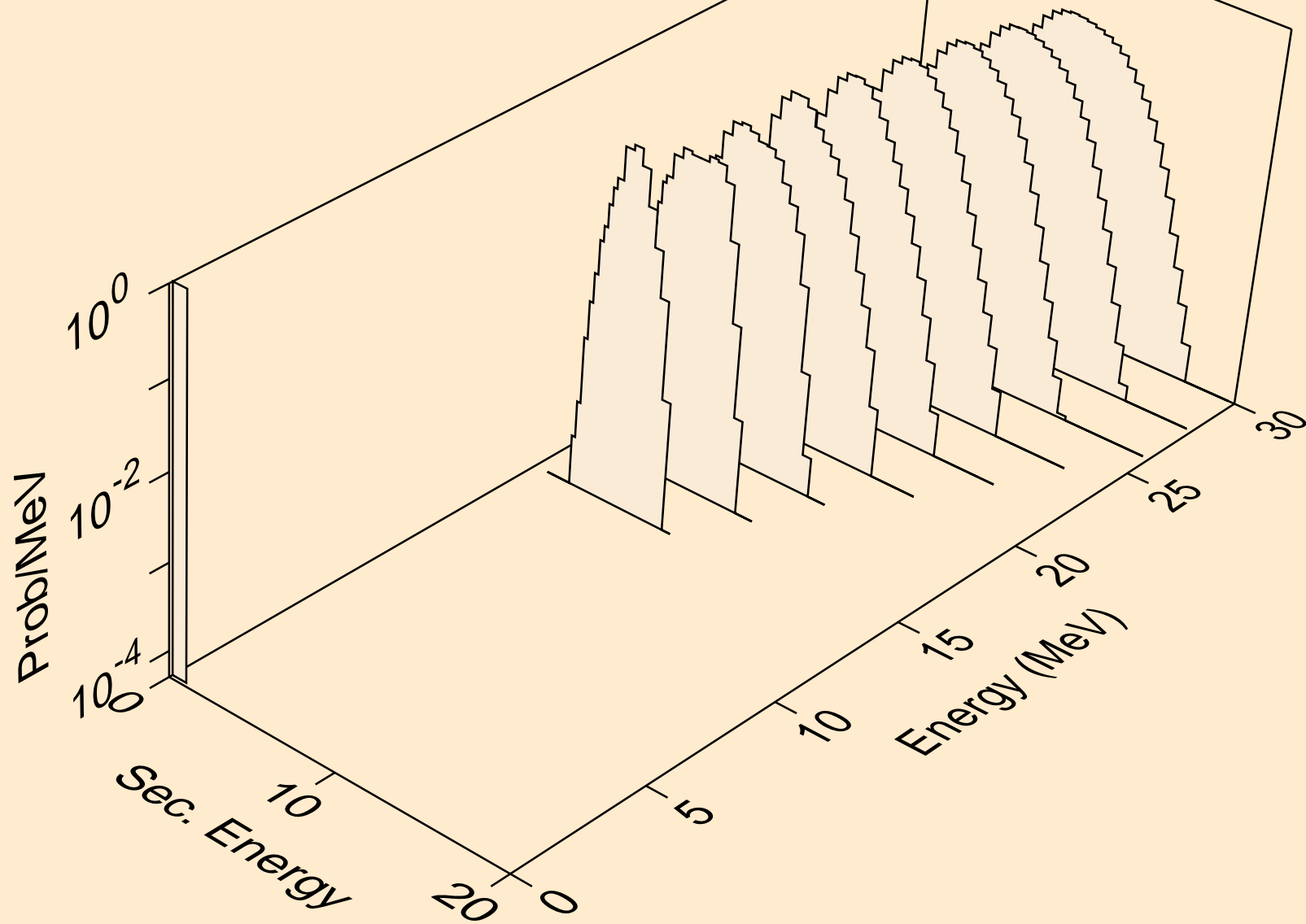

TL202 TRITON ACER TENDL-2021 LIBRARY; T=0.K  
protons from (t,p)

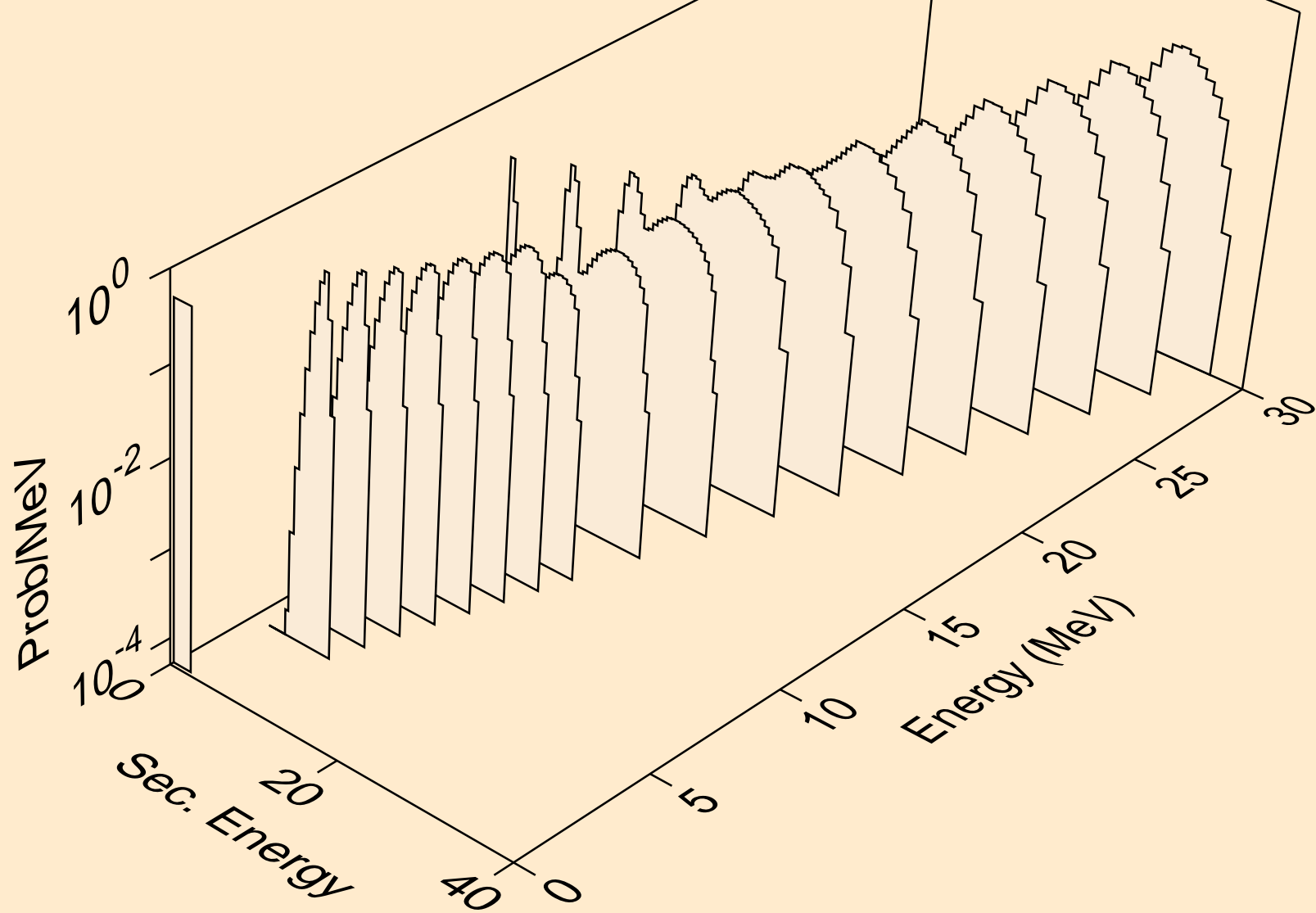

TL202 TRITON ACER TENDL-2021 LIBRARY; T=0.K  
protons from (t,2p)

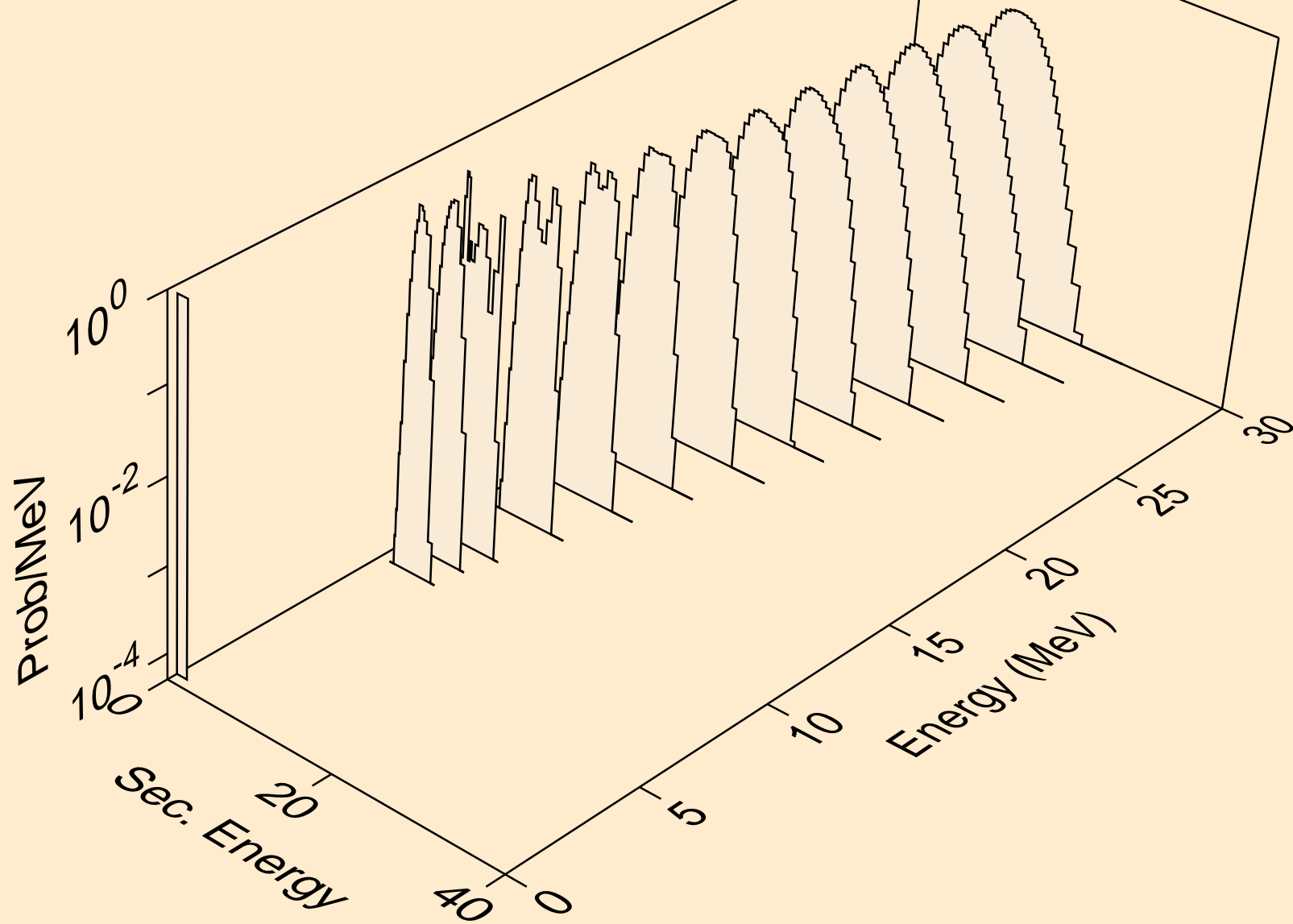



TL202 TRITON ACER TENDL-2021 LIBRARY; T=0.K  
protons from (t,pa)

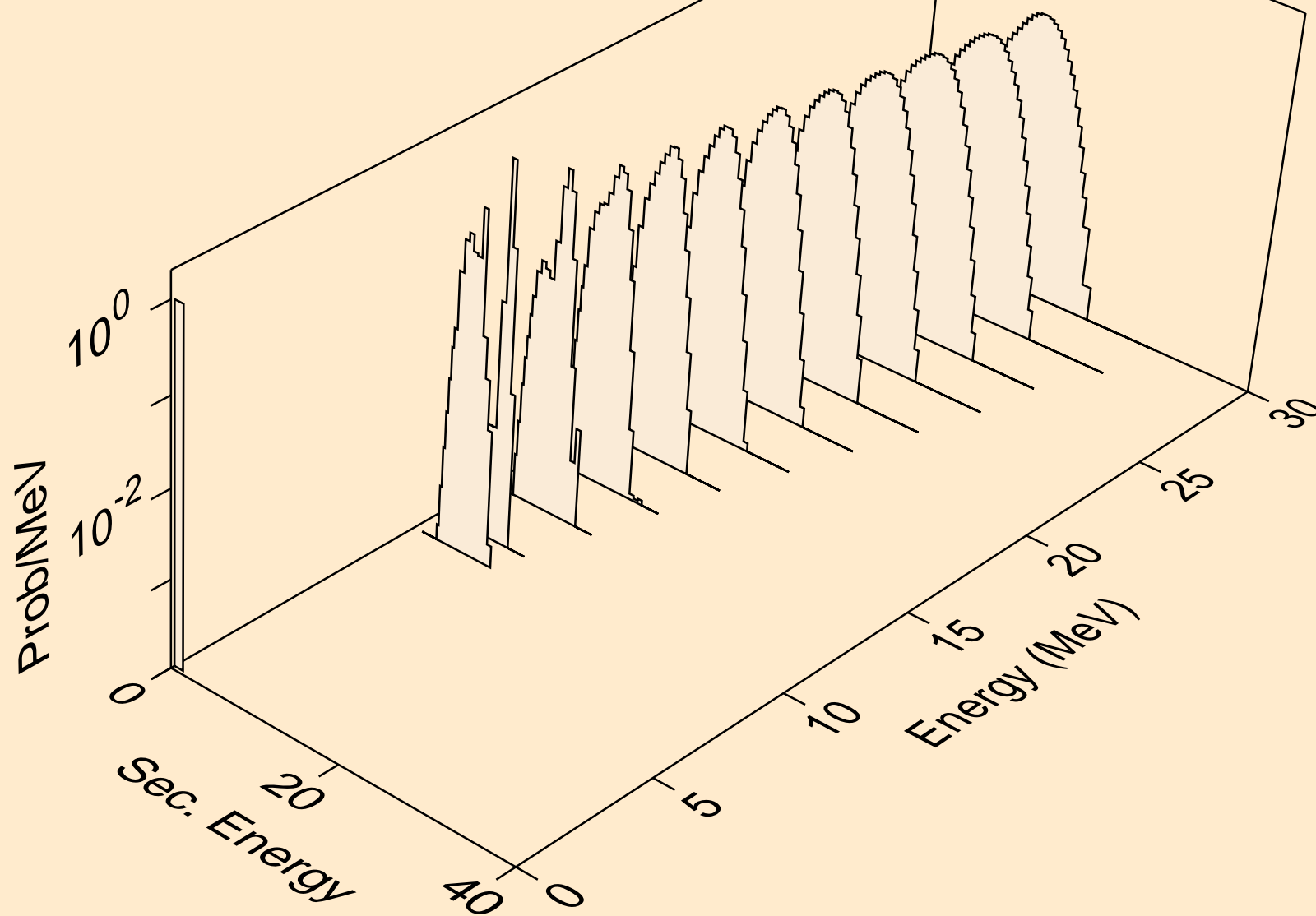

TL202 TRITON ACER TENDL-2021 LIBRARY; T=0.K  
protons from (t,pd)

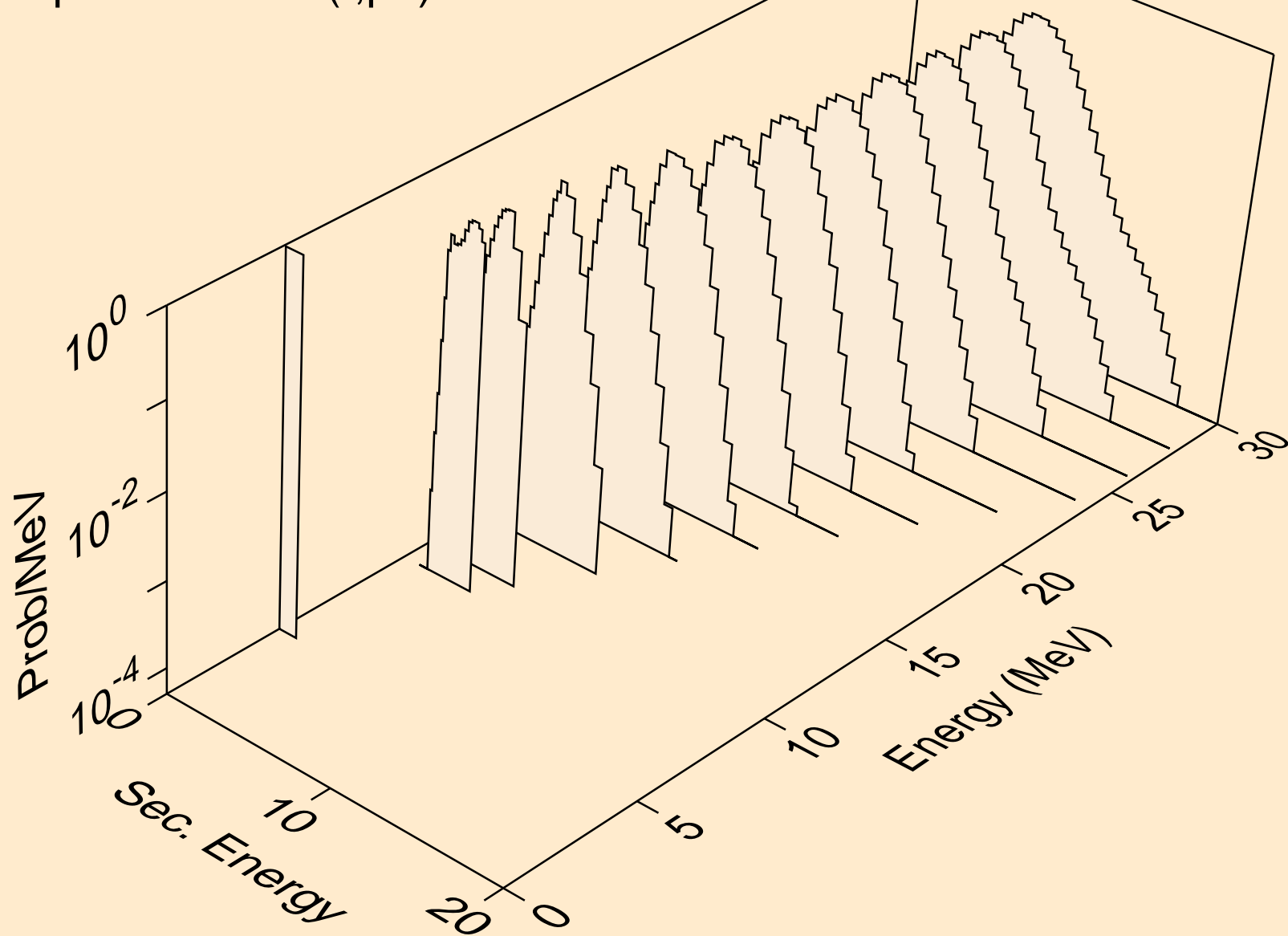

TL202 TRITON ACER TENDL-2021 LIBRARY; T=0.K  
protons from (t,pt)

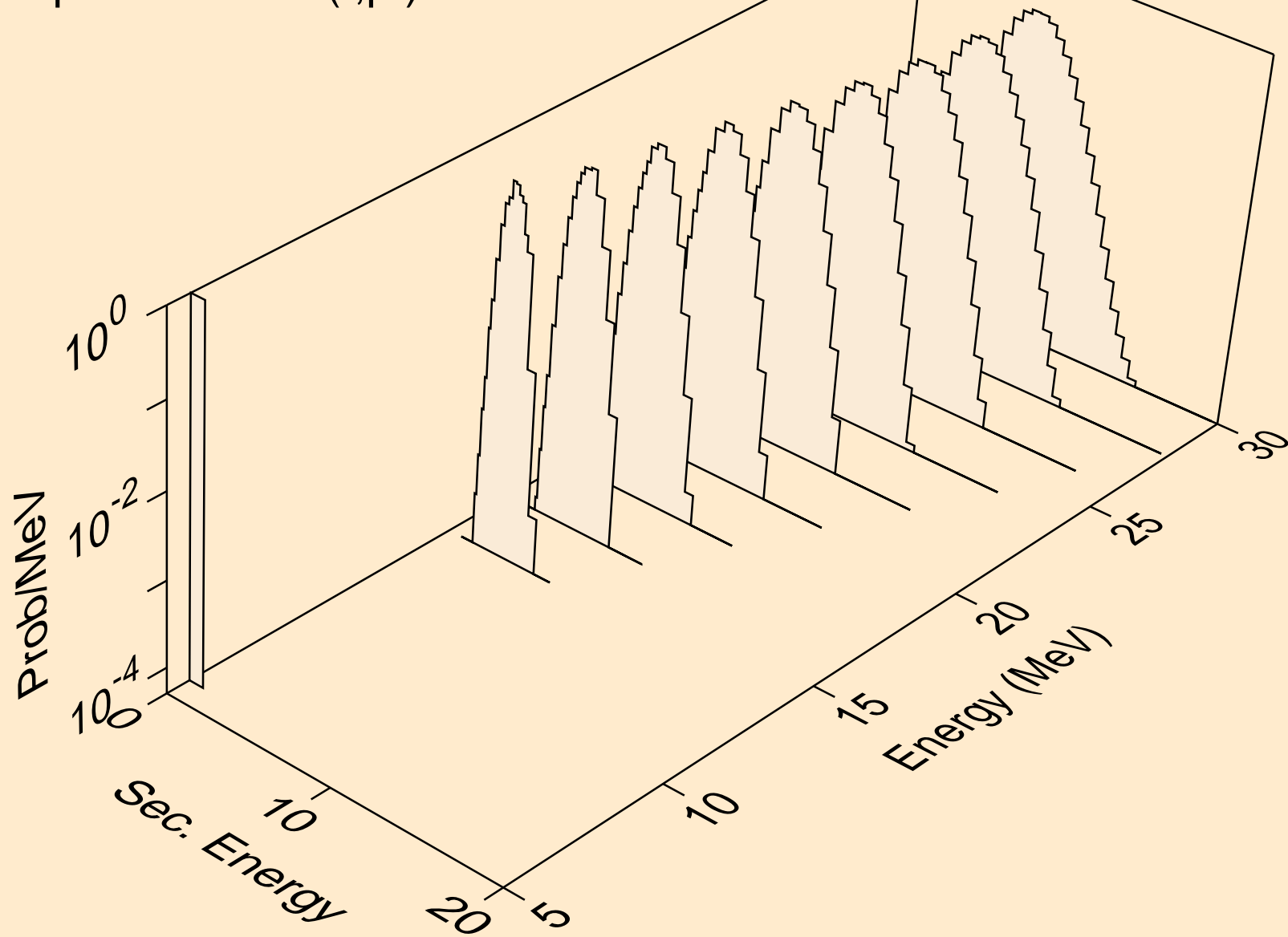

TL202 TRITON ACER TENDL-2021 LIBRARY; T=0.K  
deuterons from (t,x)

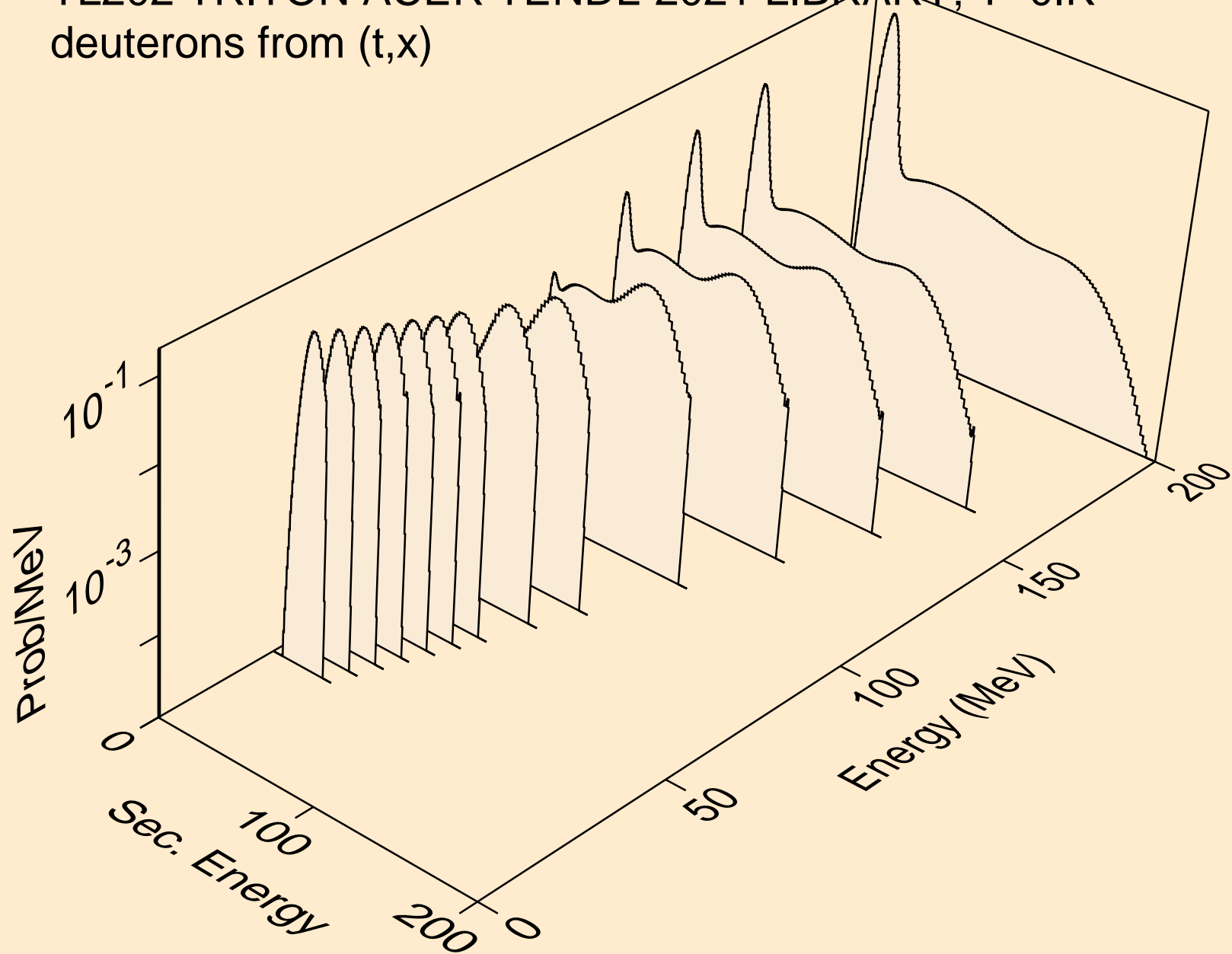

TL202 TRITON ACER TENDL-2021 LIBRARY; T=0.K  
deuterons from (t,2nd)

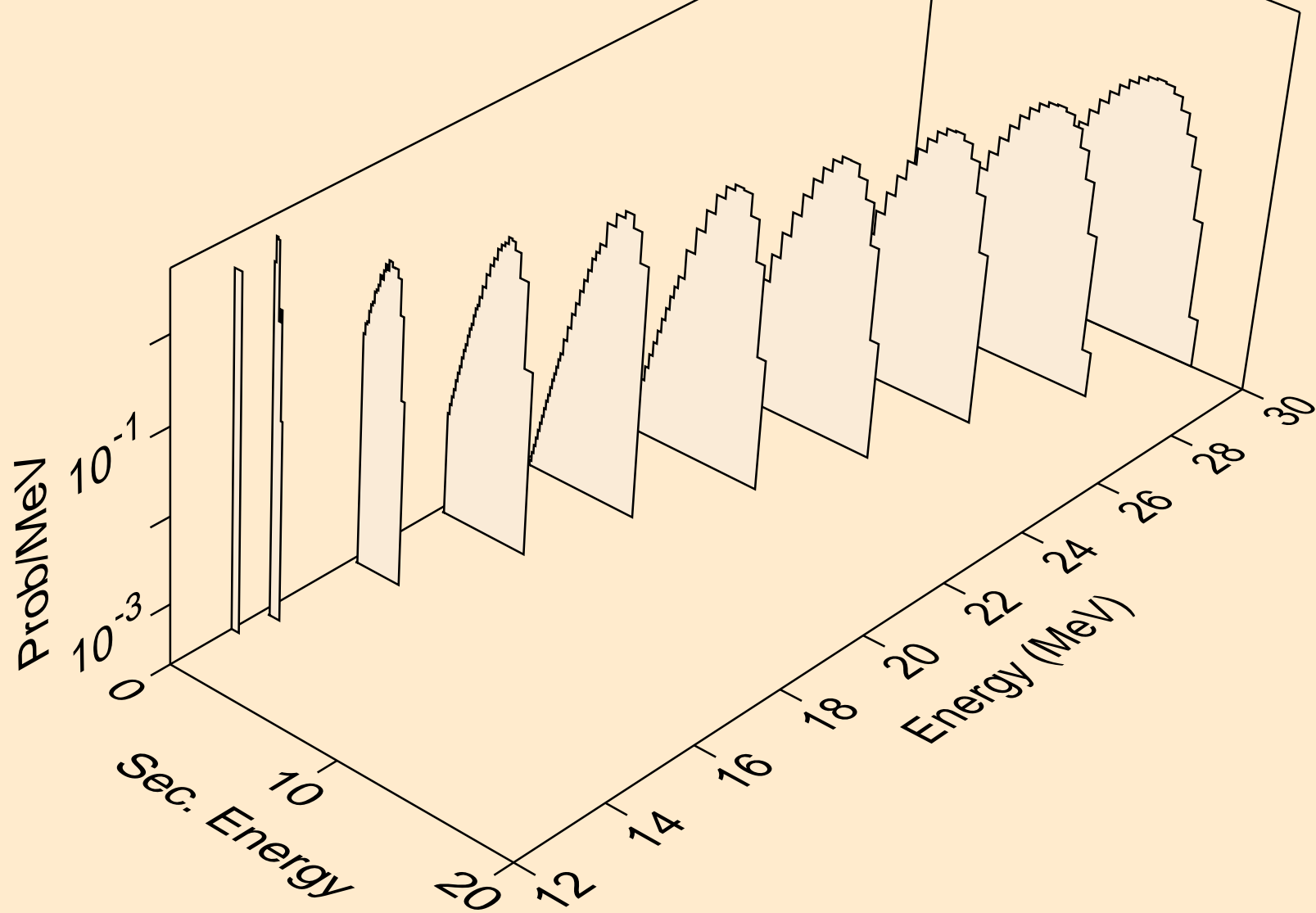

TL202 TRITON ACER TENDL-2021 LIBRARY; T=0.K  
deuterons from (t,n\*)d

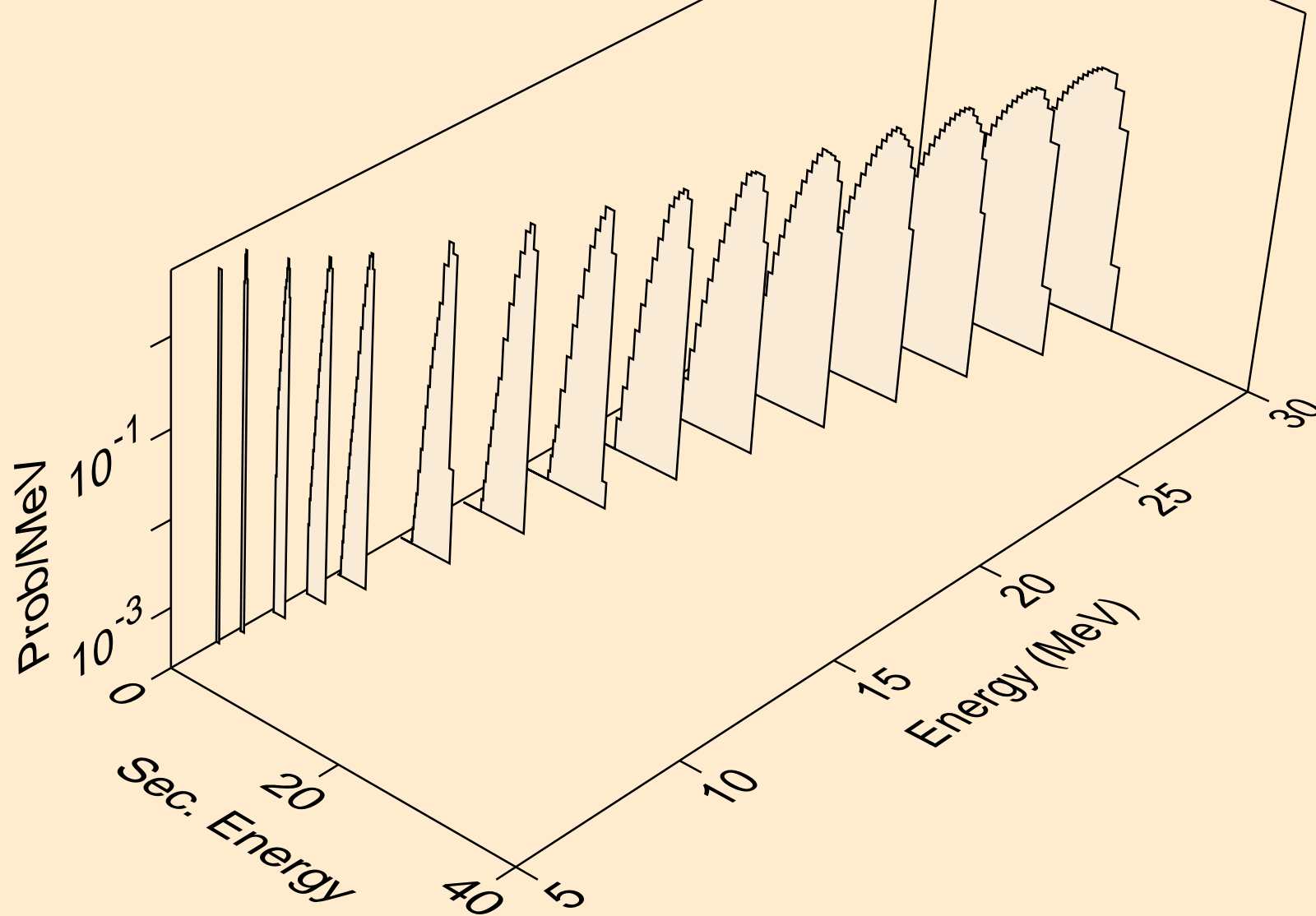

TL202 TRITON ACER TENDL-2021 LIBRARY; T=0.K  
deuterons from (t,d)

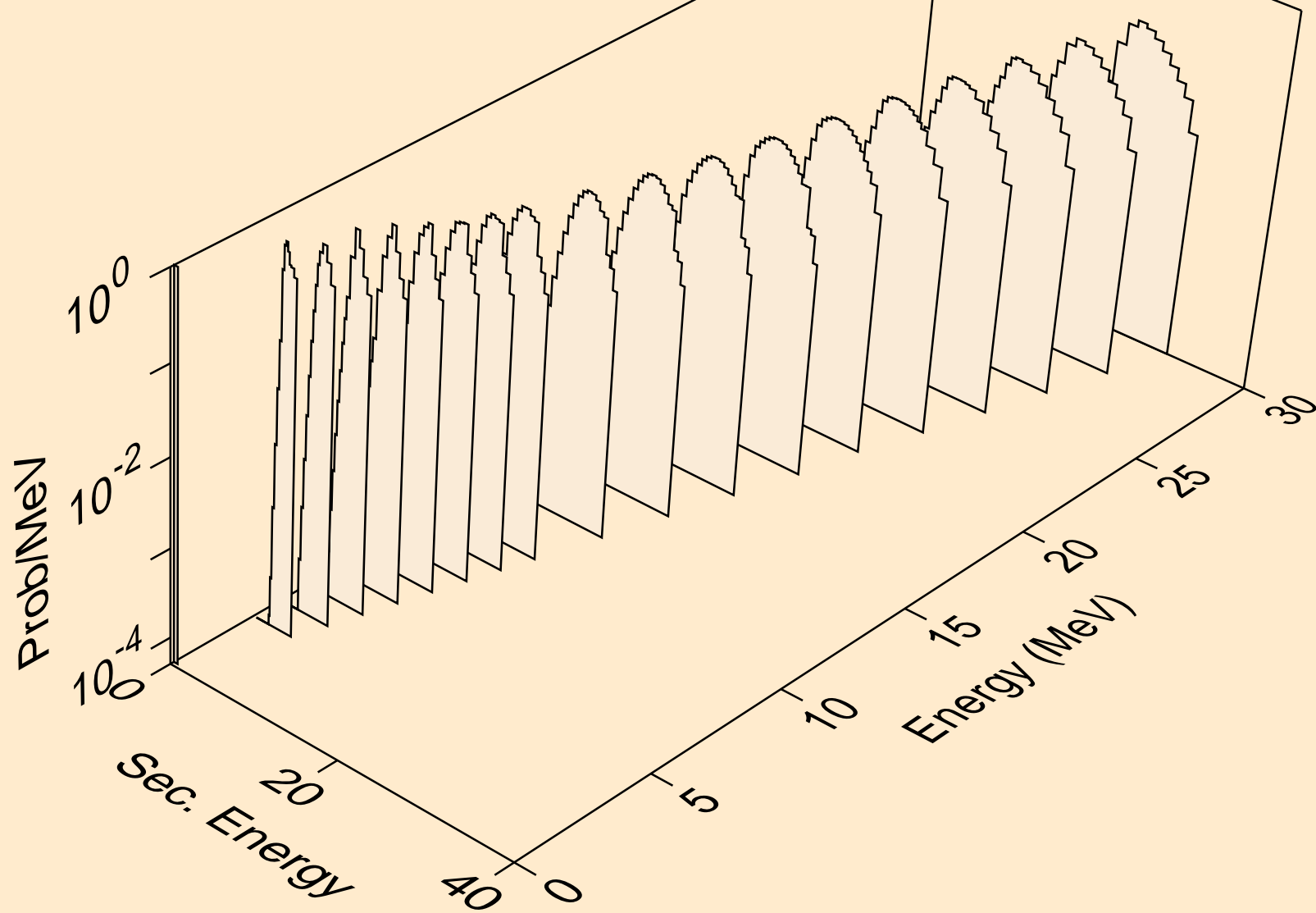

TL202 TRITON ACER TENDL-2021 LIBRARY; T=0.K  
deuterons from (t,pd)

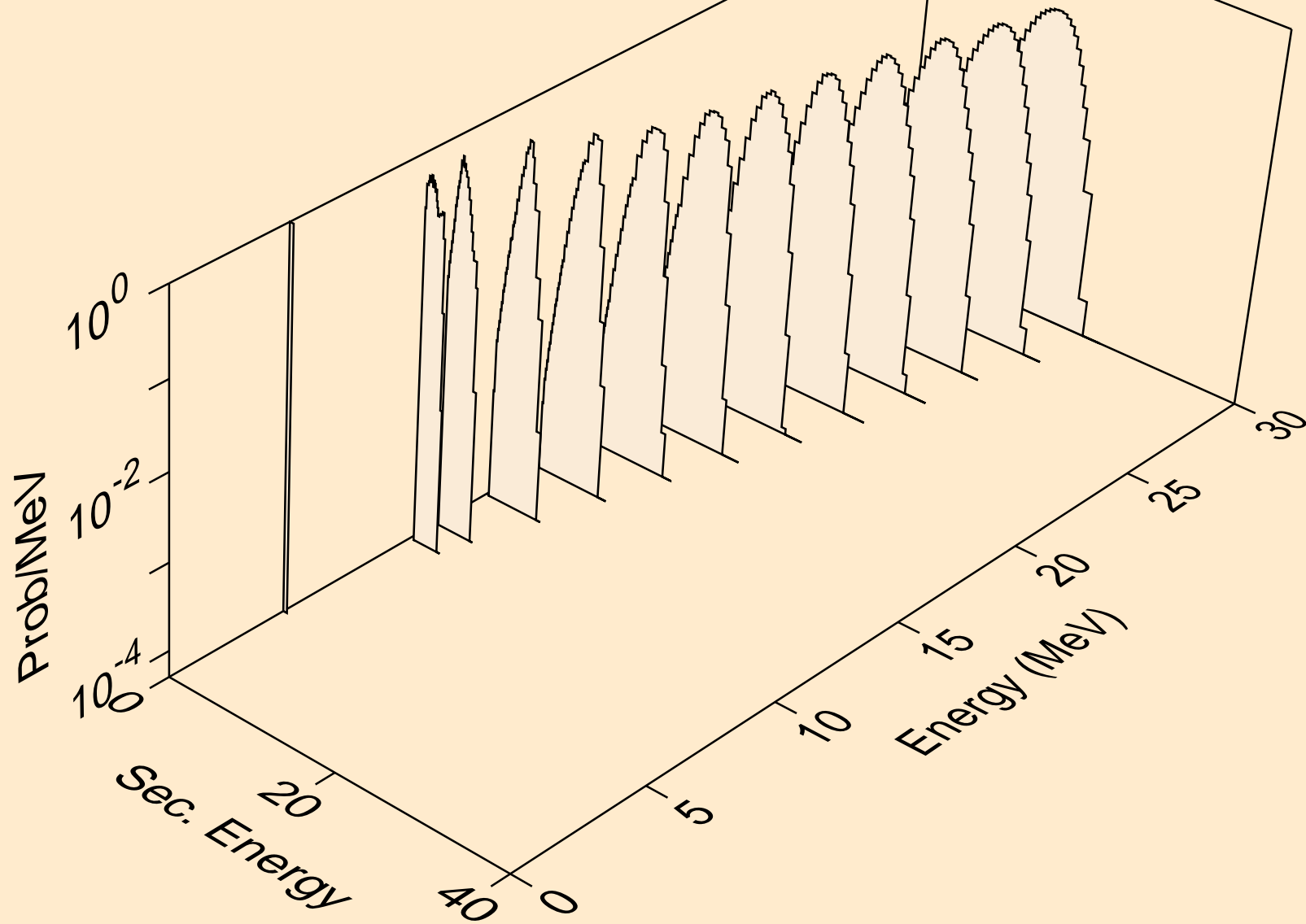



TL202 TRITON ACER TENDL-2021 LIBRARY; T=0.K  
deuterons from (t,da)

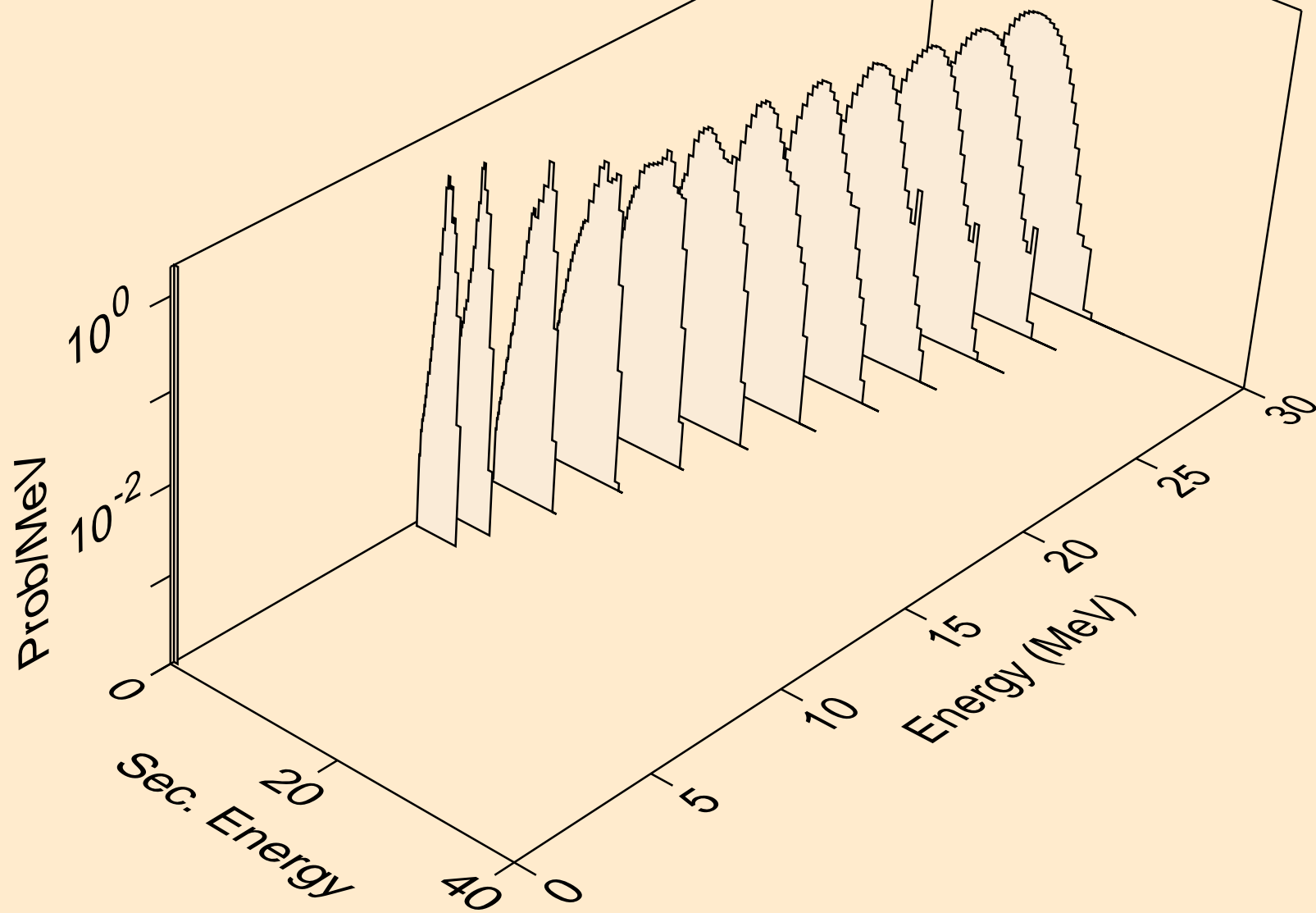

TL202 TRITON ACER TENDL-2021 LIBRARY; T=0.K  
he3s from (t,x)

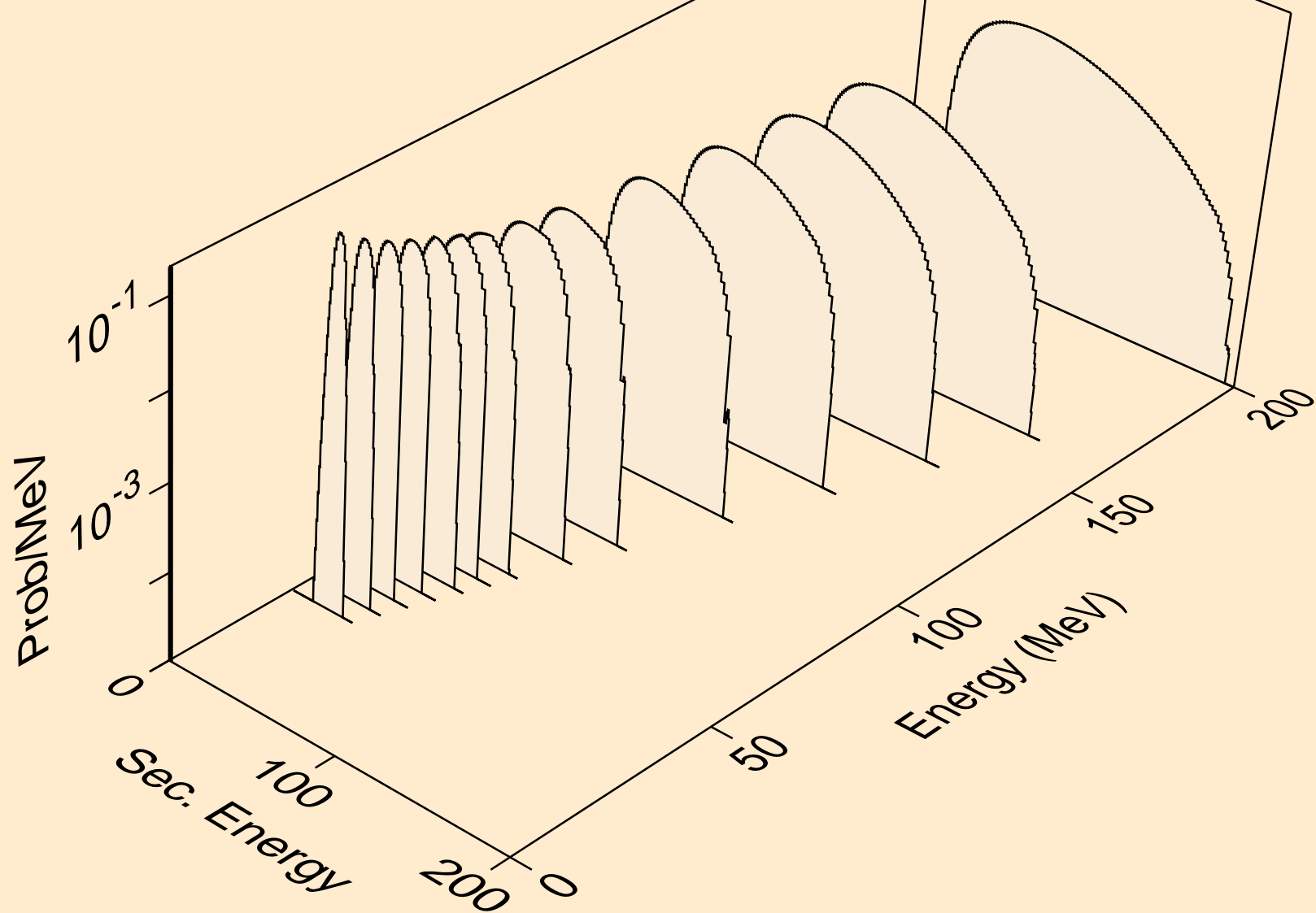

TL202 TRITON ACER TENDL-2021 LIBRARY; T=0.K  
he3s from (t,n\*)he3

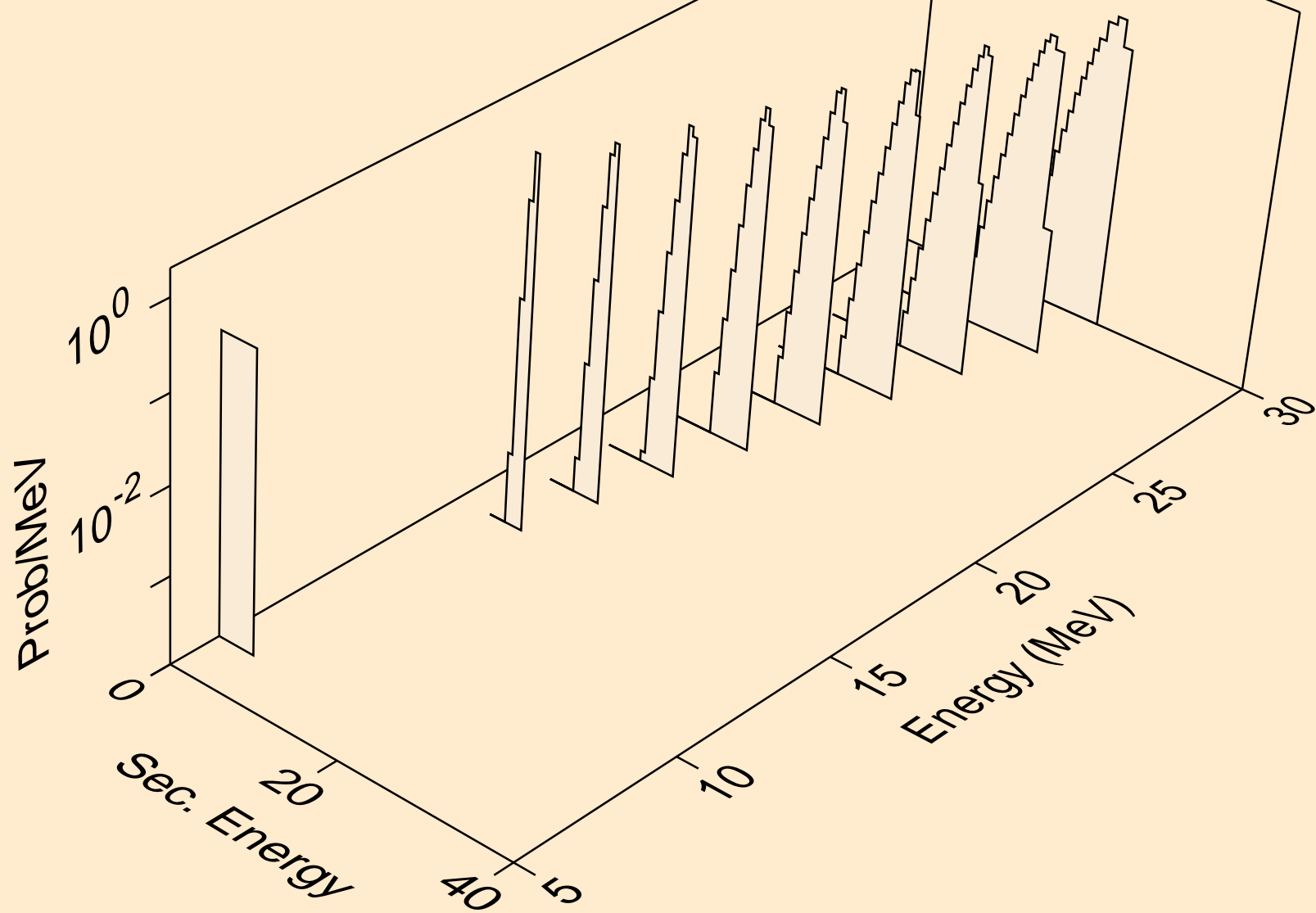

TL202 TRITON ACER TENDL-2021 LIBRARY; T=0.K  
he3s from (t,he3)

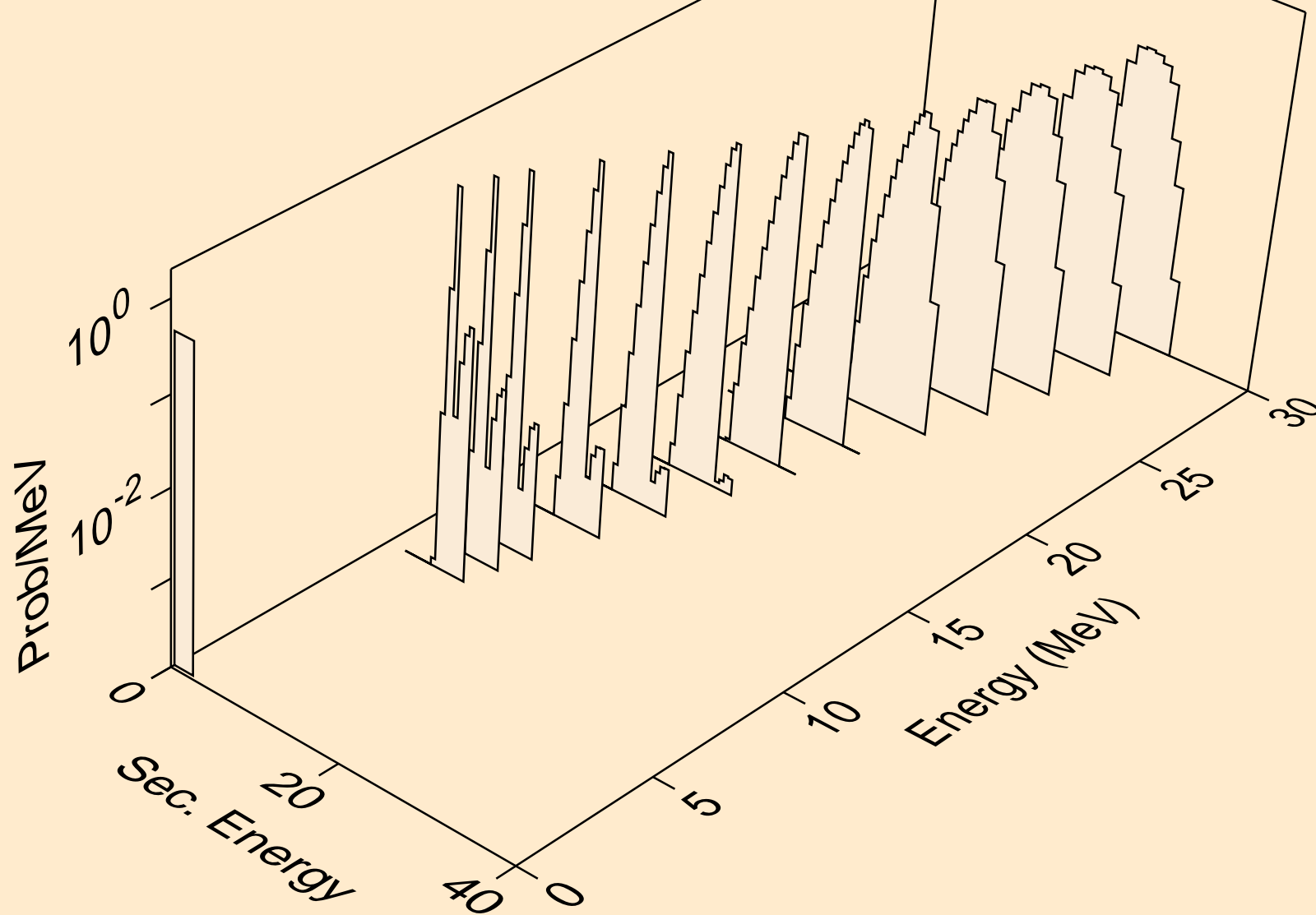

TL202 TRITON ACER TENDL-2021 LIBRARY; T=0.K  
alphas from (t,x)

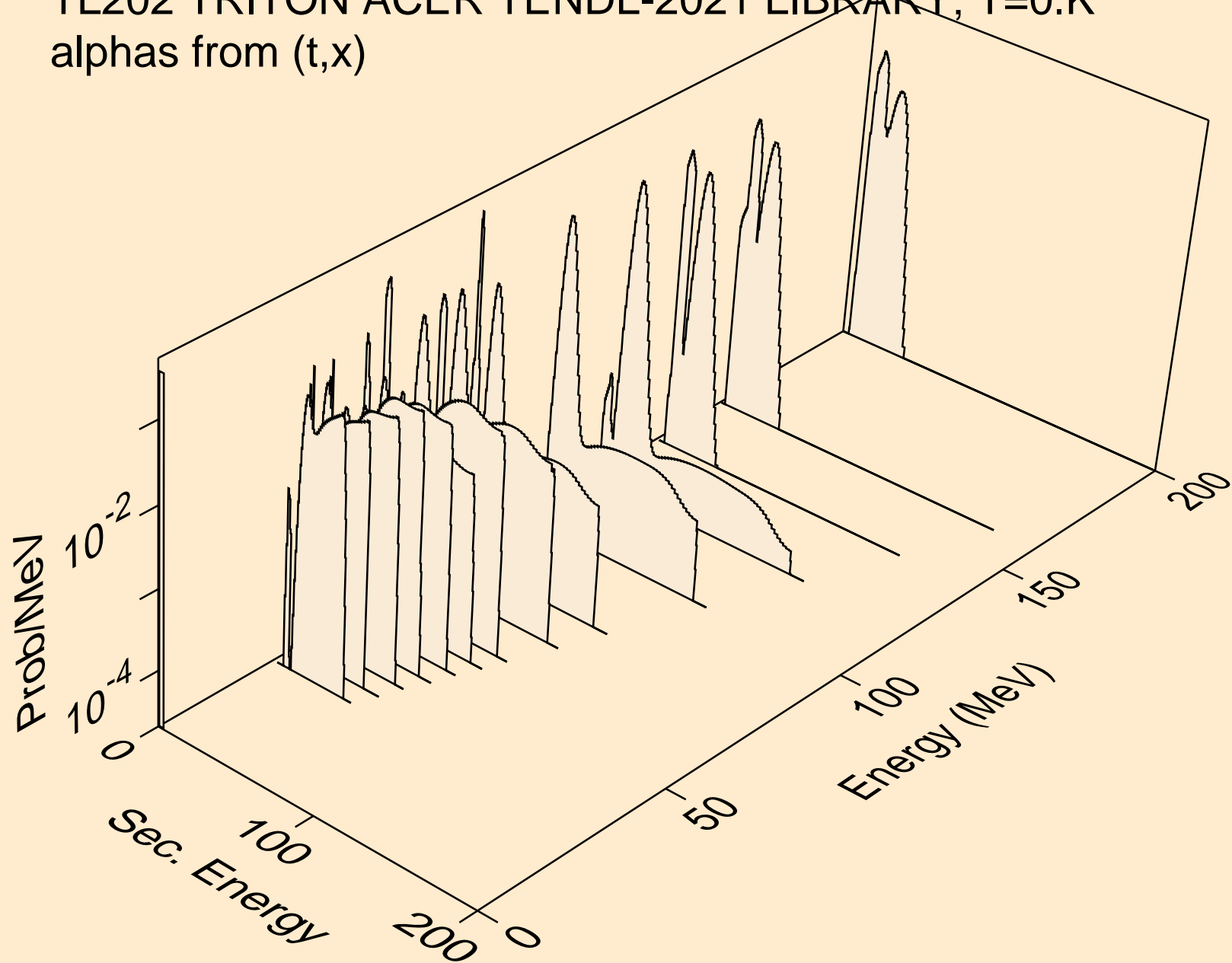

TL202 TRITON ACER TENDL-2021 LIBRARY; T=0.K  
alphas from (t,n\*)a

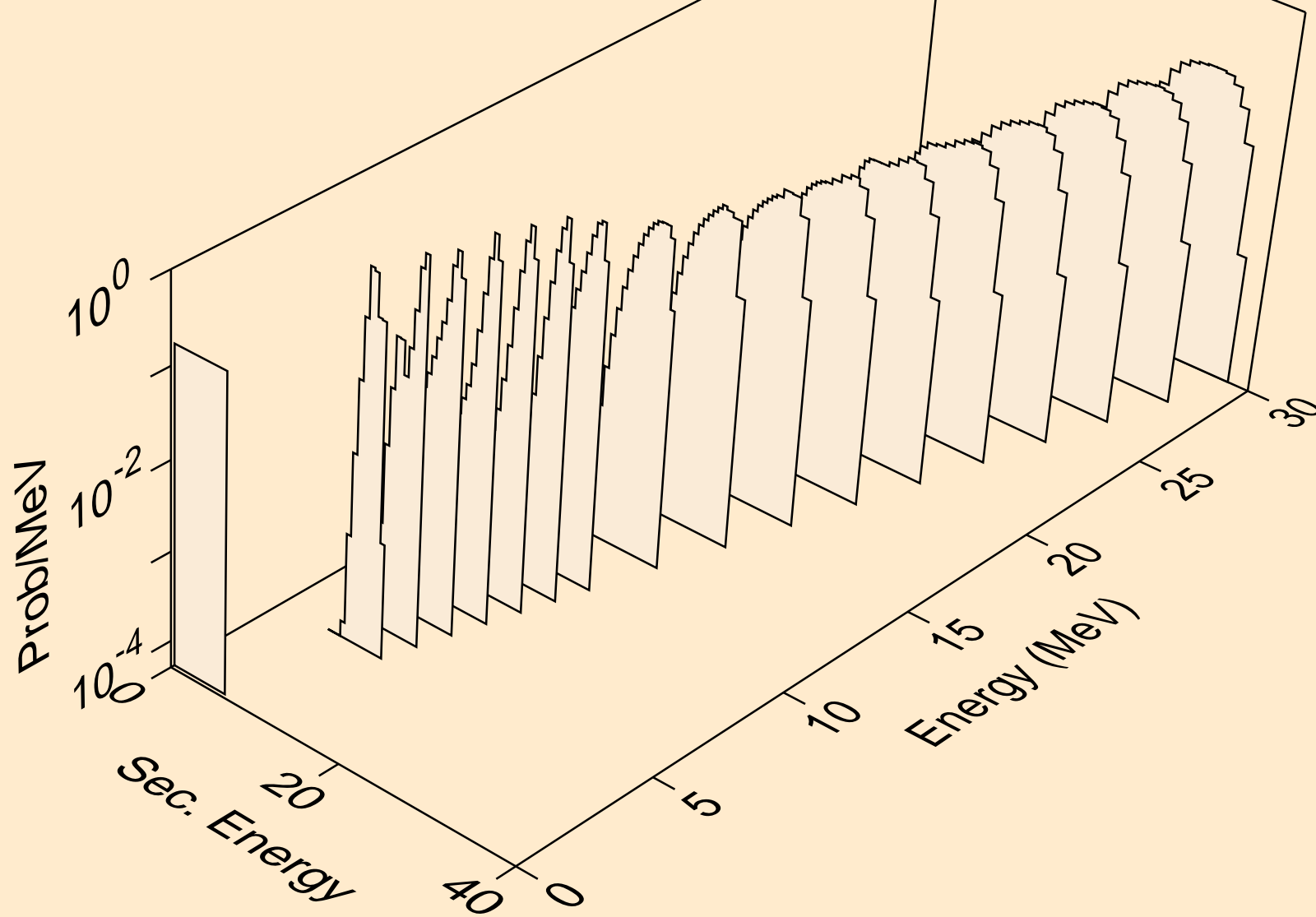

TL202 TRITON ACER TENDL-2021 LIBRARY; T=0.K  
alphas from (t,2n)a

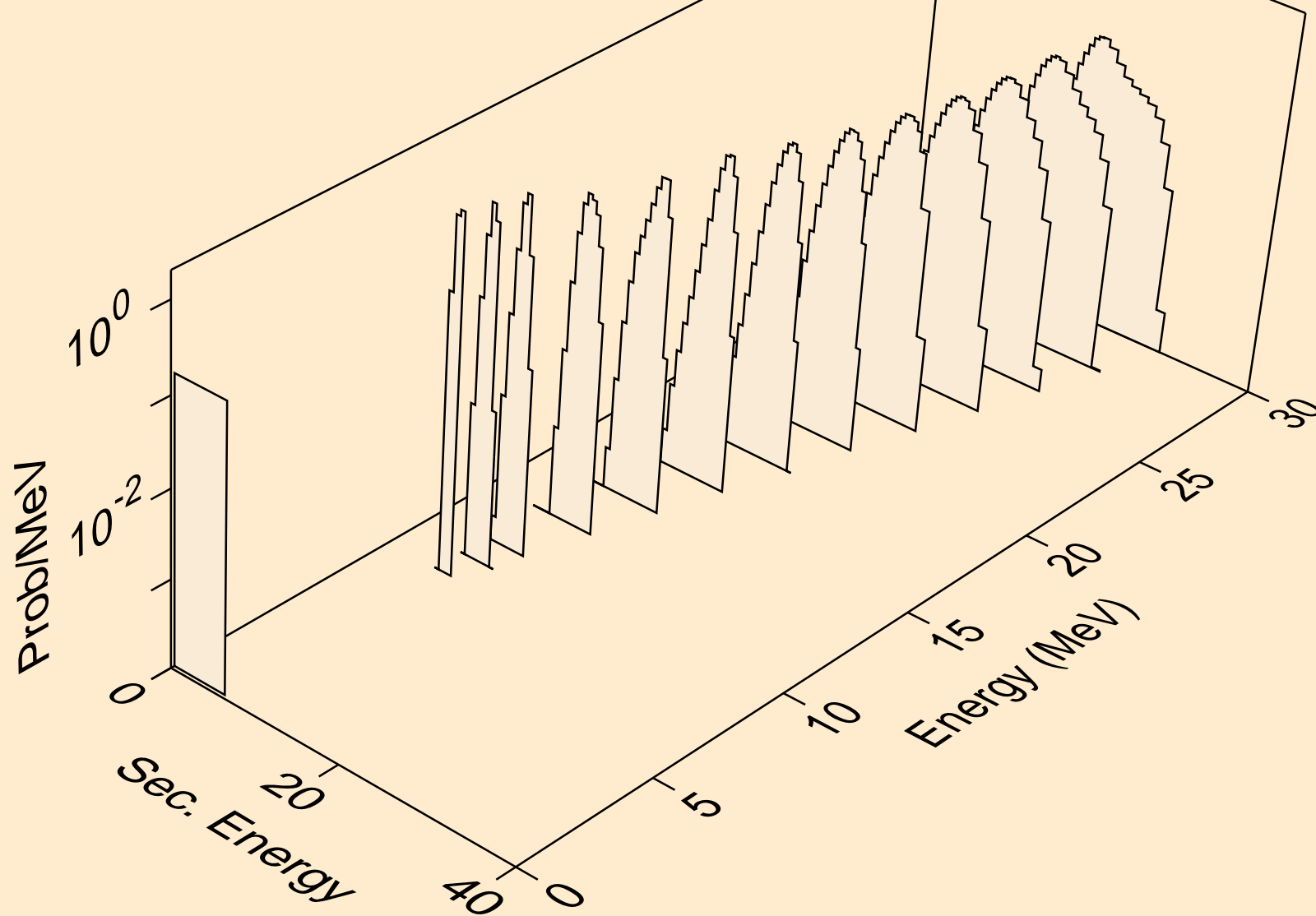

TL202 TRITON ACER TENDL-2021 LIBRARY; T=0.K  
alphas from (t,3n)a

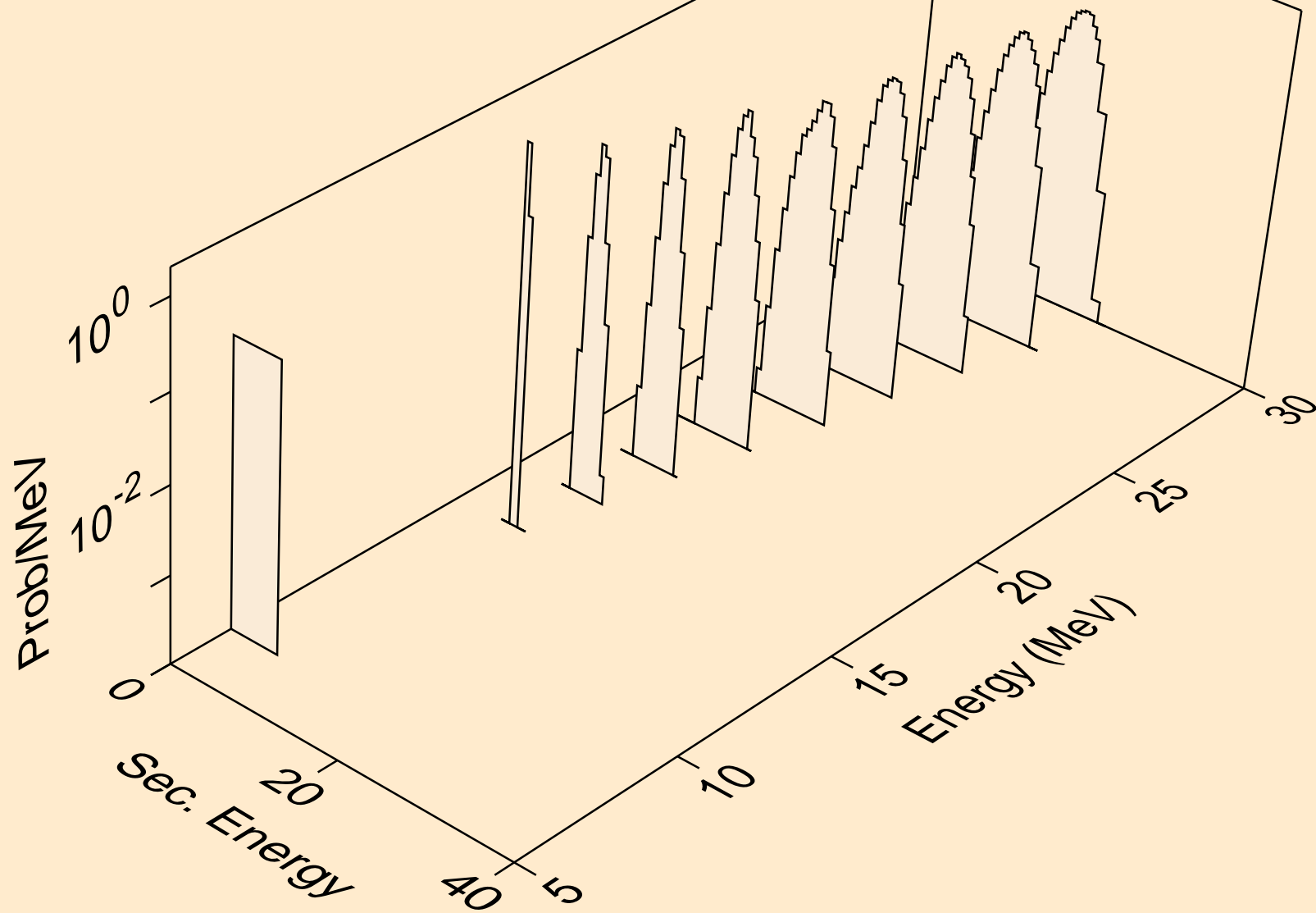



TL202 TRITON ACER TENDL-2021 LIBRARY; T=0.K  
alphas from (t,n\*)2a

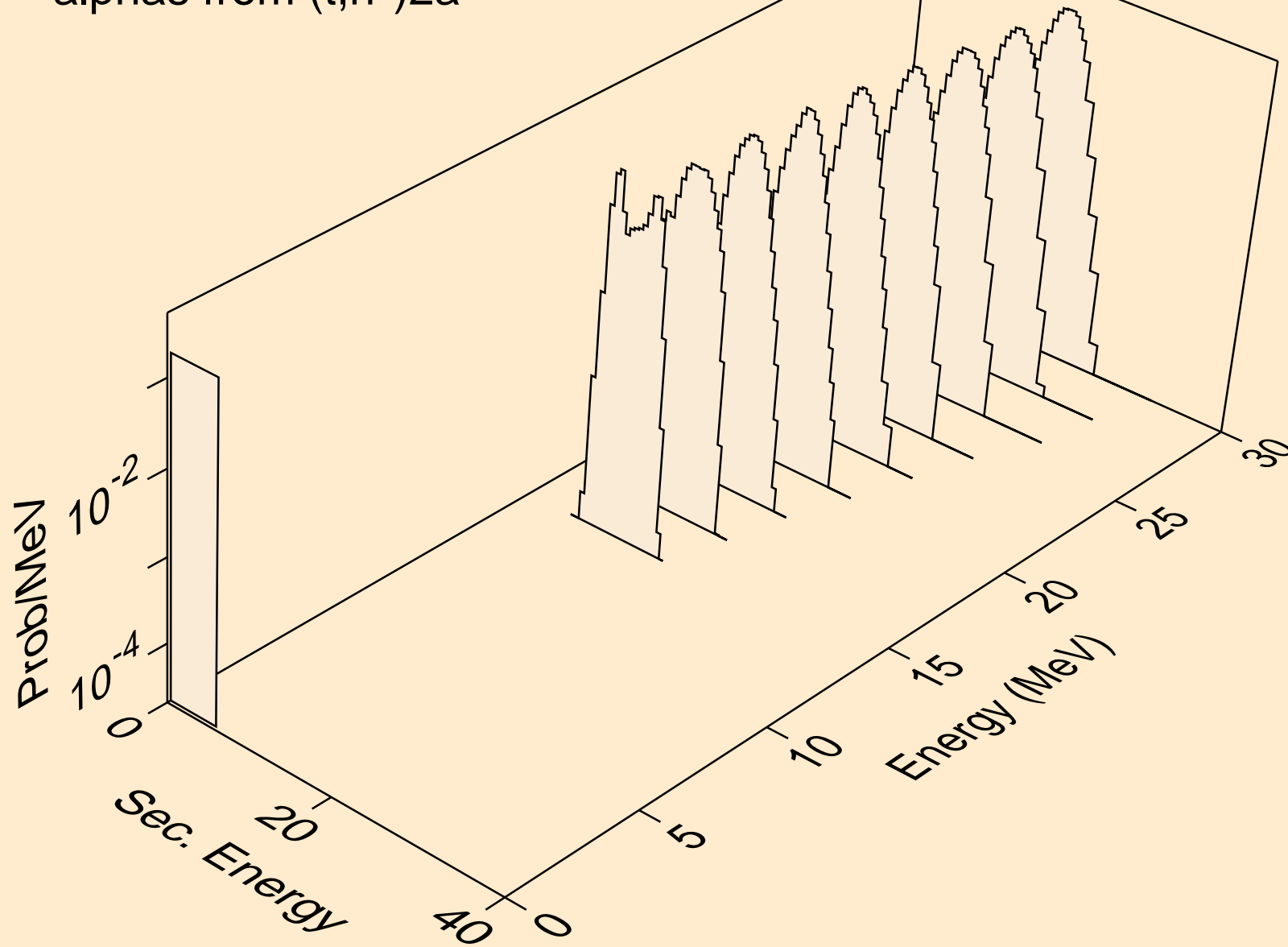

TL202 TRITON ACER TENDL-2021 LIBRARY; T=0.K  
alphas from (t,npa)

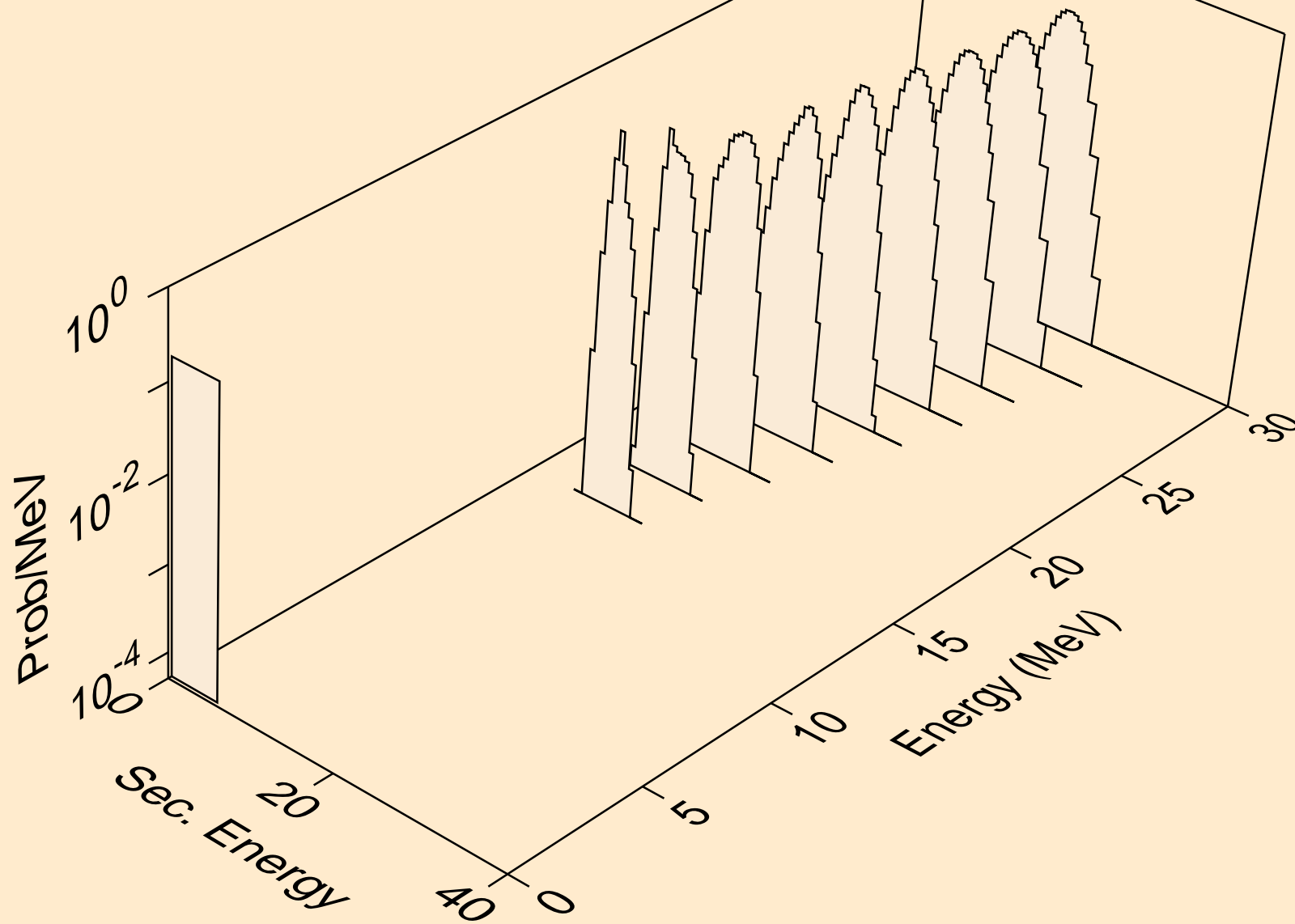

TL202 TRITON ACER TENDL-2021 LIBRARY; T=0.K  
alphas from (t,a)

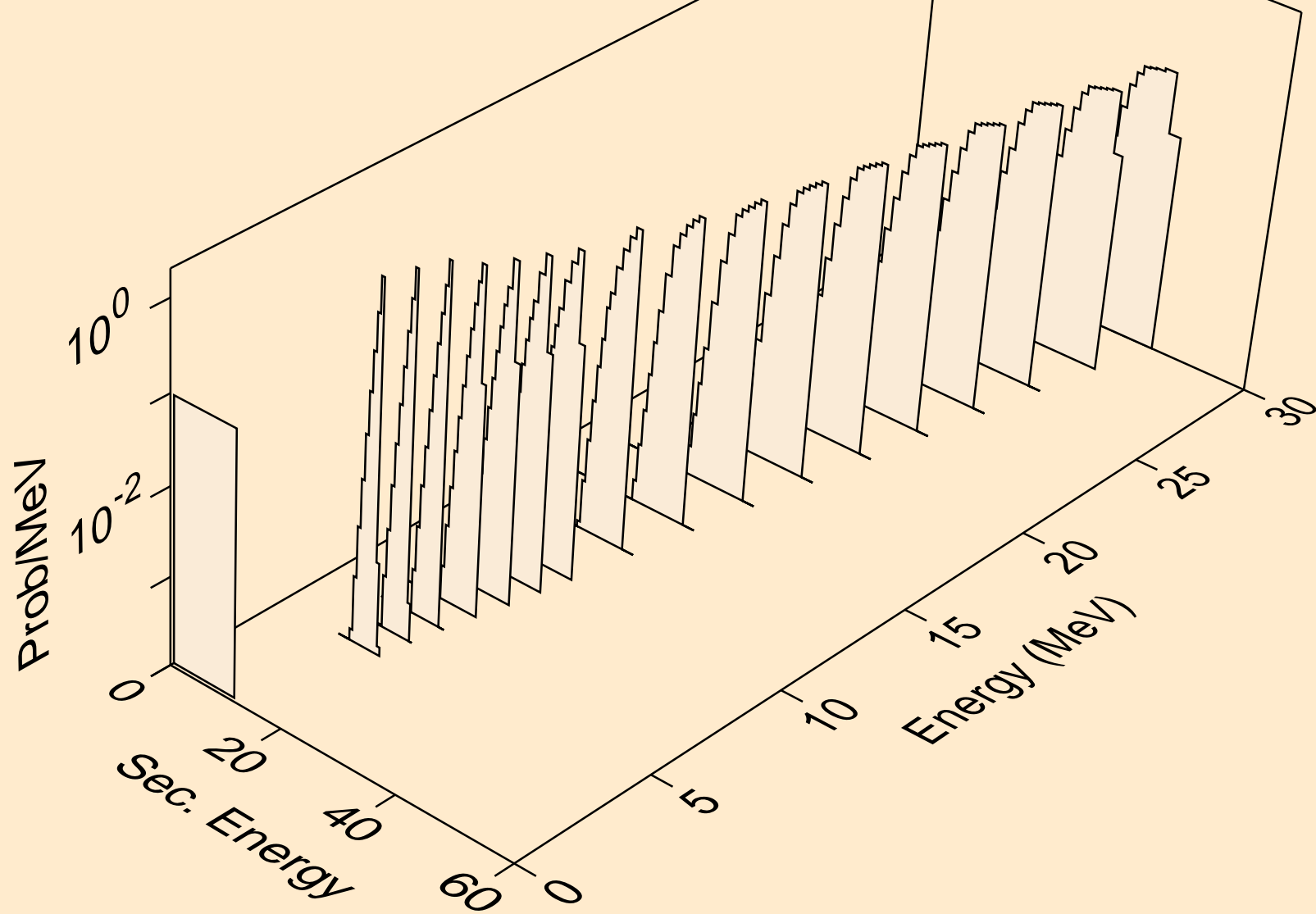

TL202 TRITON ACER TENDL-2021 LIBRARY; T=0.K  
alphas from (t,2a)

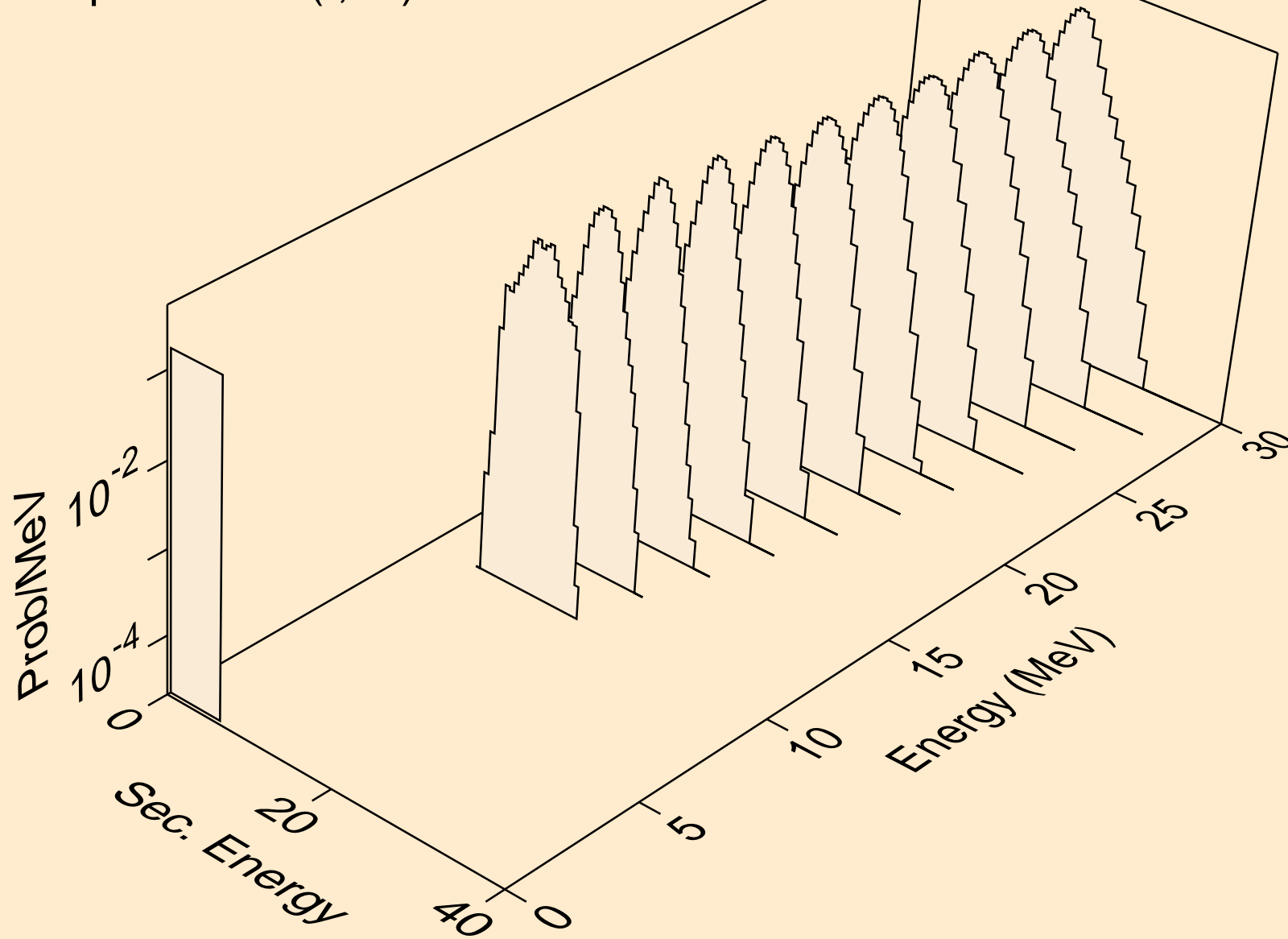

TL202 TRITON ACER TENDL-2021 LIBRARY; T=0.K  
alphas from (t,pa)

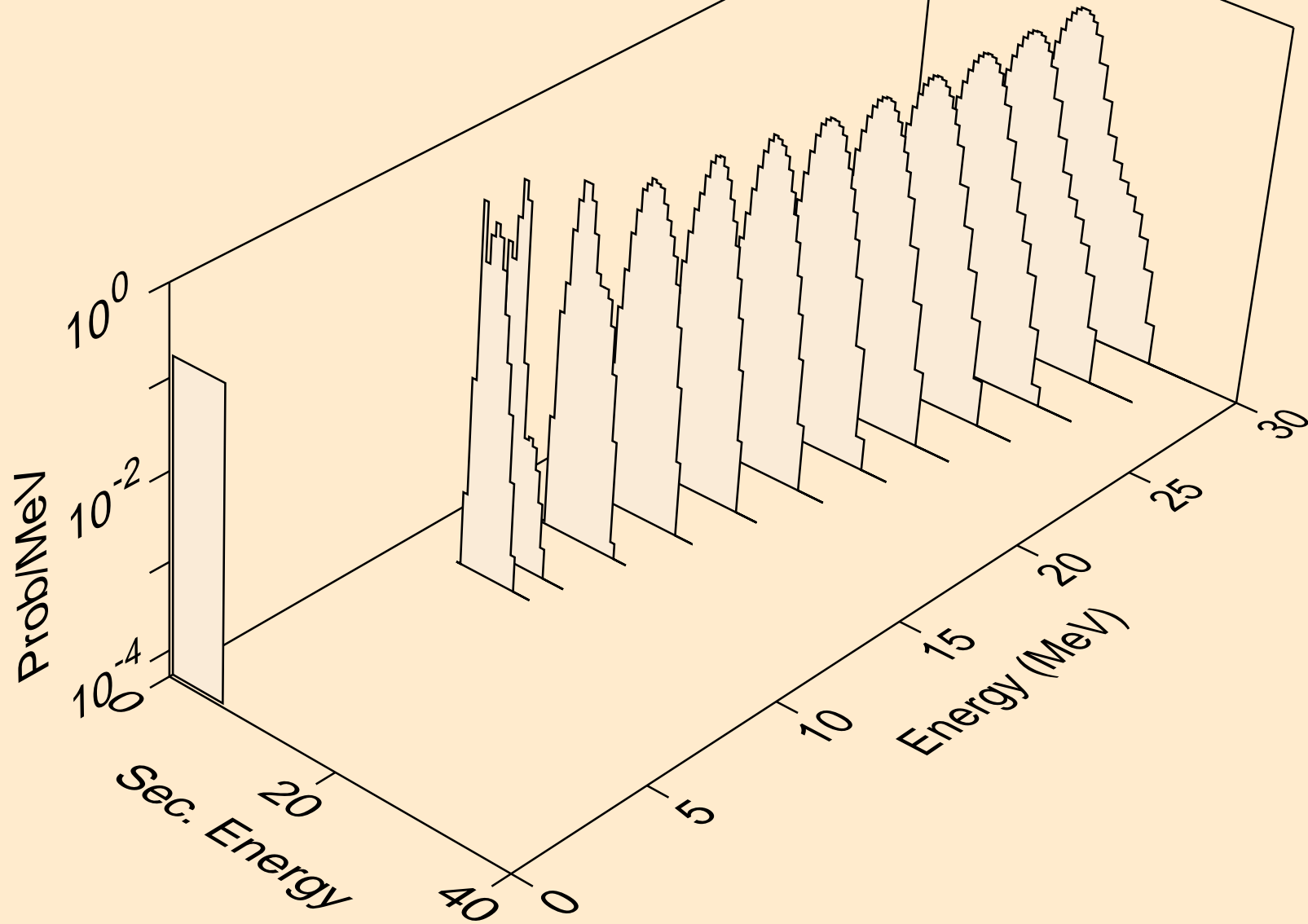

TL202 TRITON ACER TENDL-2021 LIBRARY; T=0.K  
alphas from (t,da)

