

TL204 TRITON ACER TENDL-2021 LIBRARY; T=0.K  
Principal cross sections

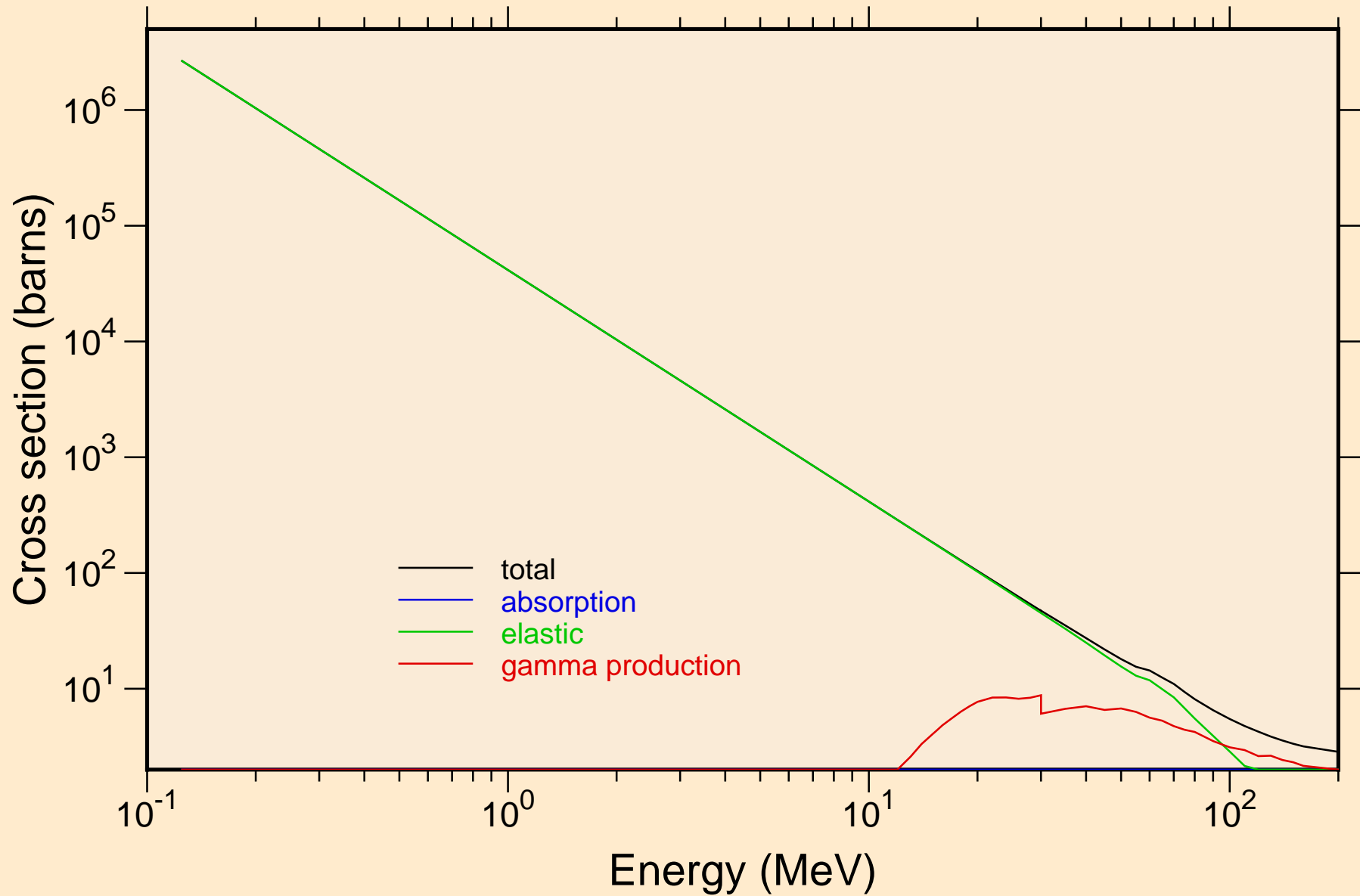

TL204 TRITON ACER TENDL-2021 LIBRARY; T=0.K

Heating

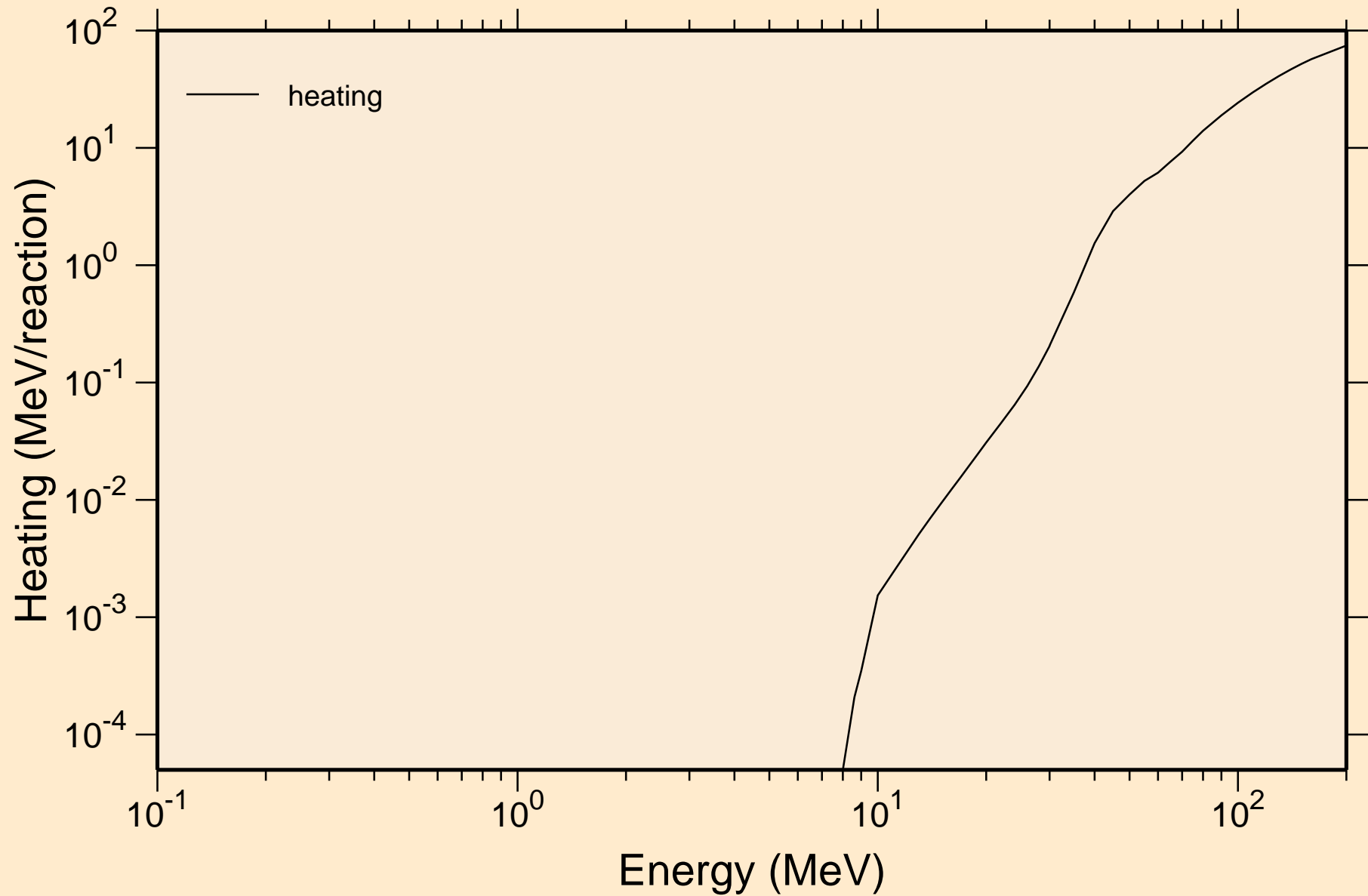

# TL204 TRITON ACER TENDL-2021 LIBRARY; T=0.K

## Principal cross sections

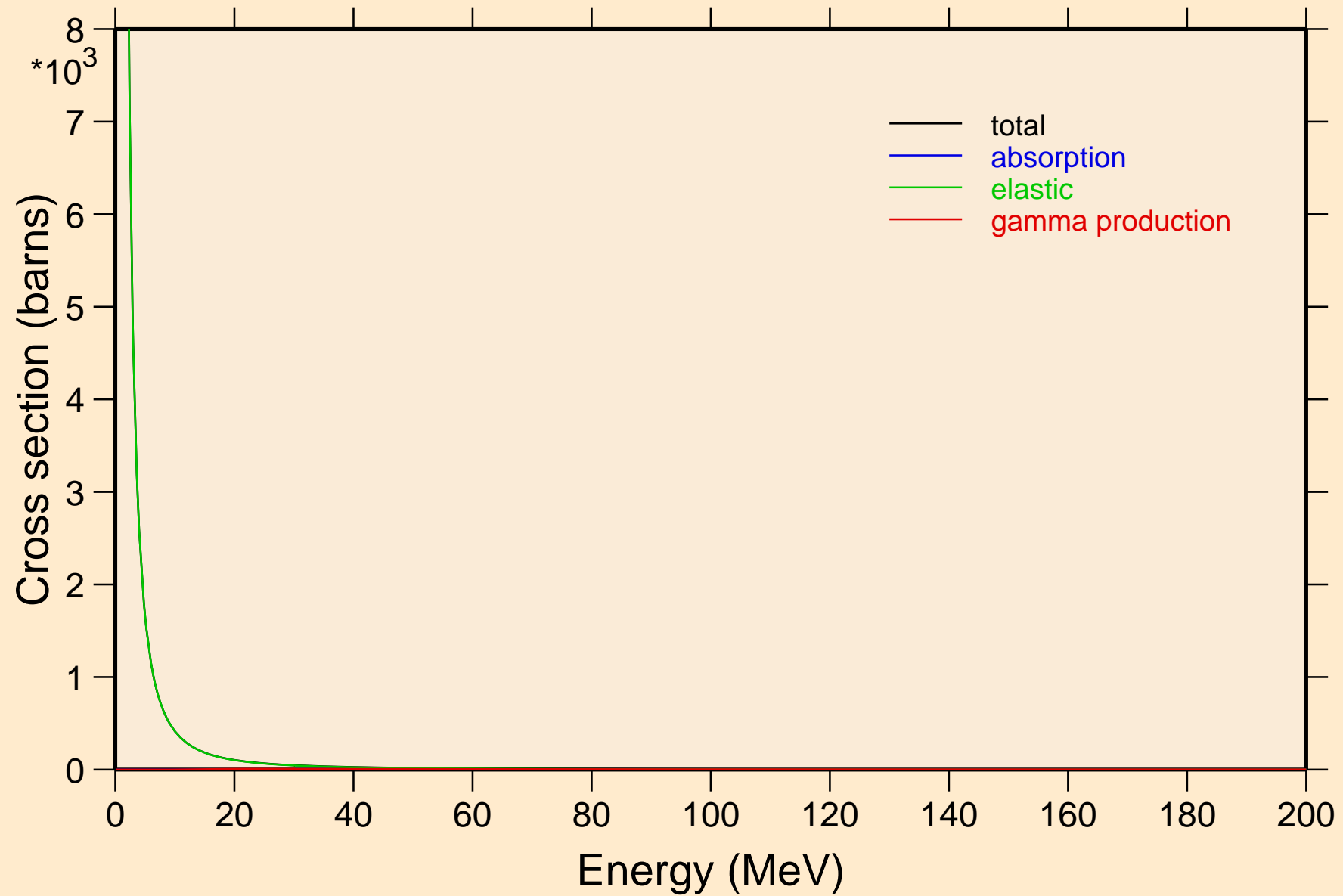

TL204 TRITON ACER TENDL-2021 LIBRARY; T=0.K

Heating

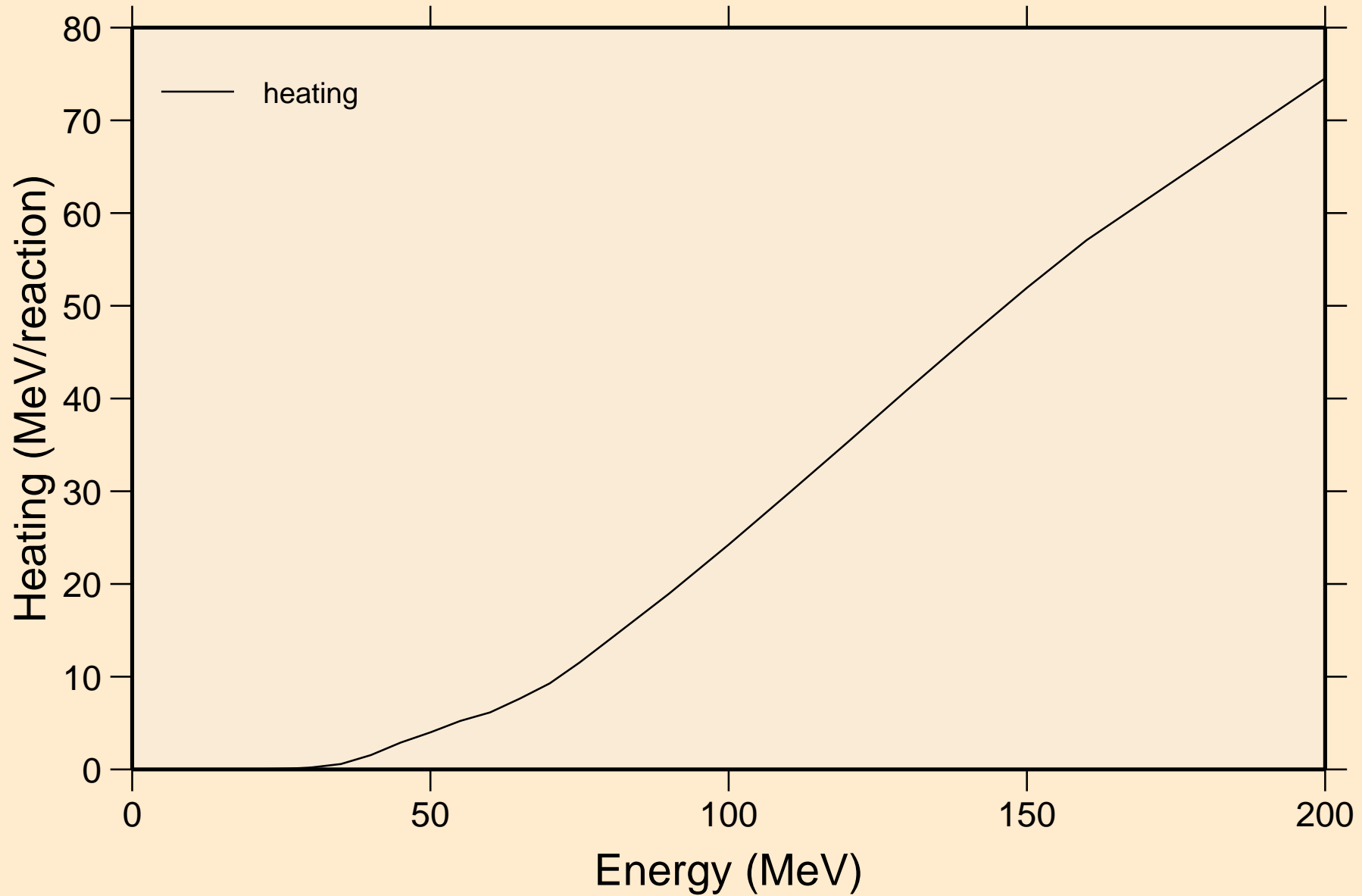

TL204 TRITON ACER TENDL-2021 LIBRARY; T=0.K  
Threshold reactions

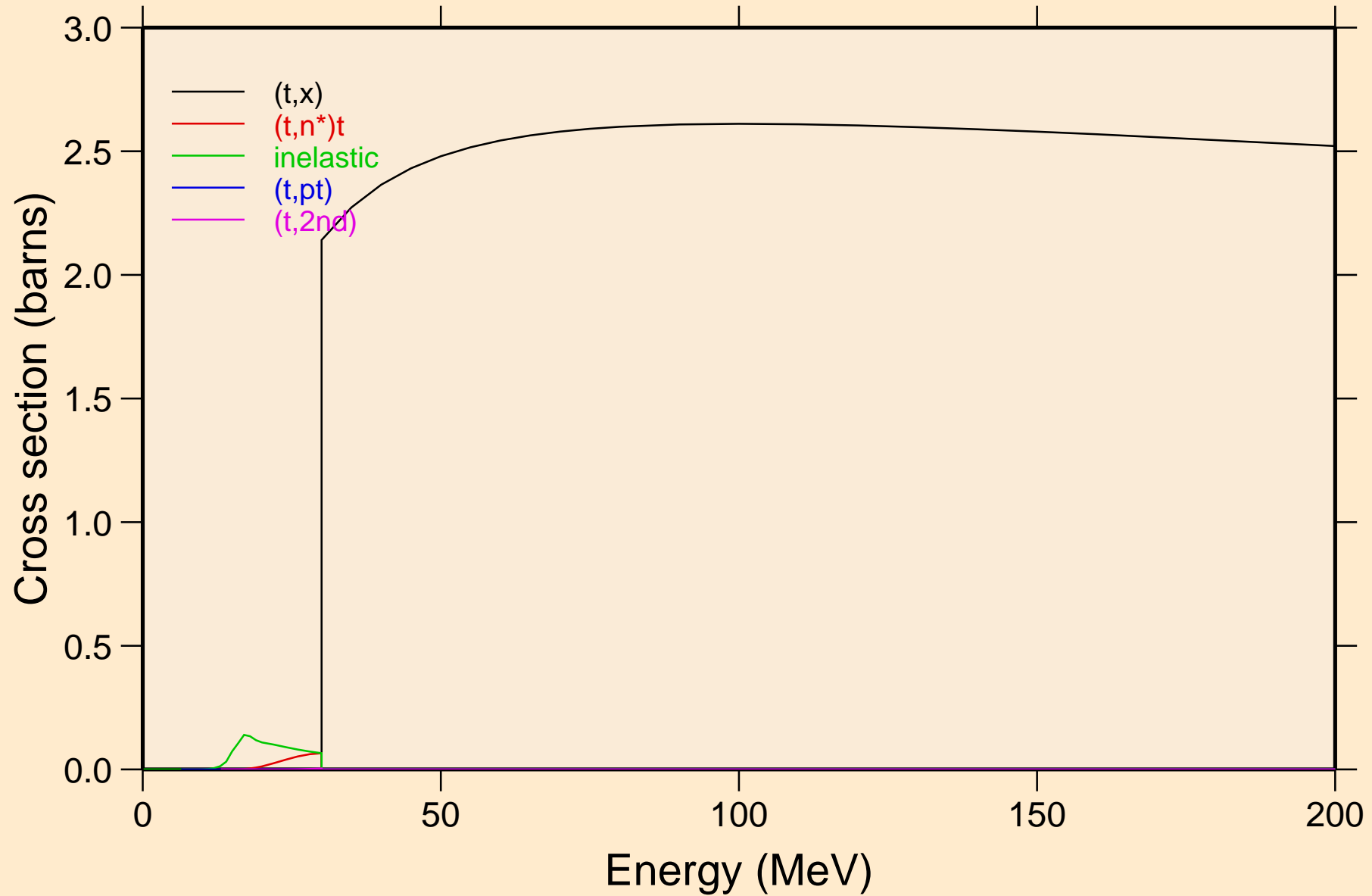

TL204 TRITON ACER TENDL-2021 LIBRARY; T=0.K  
Threshold reactions

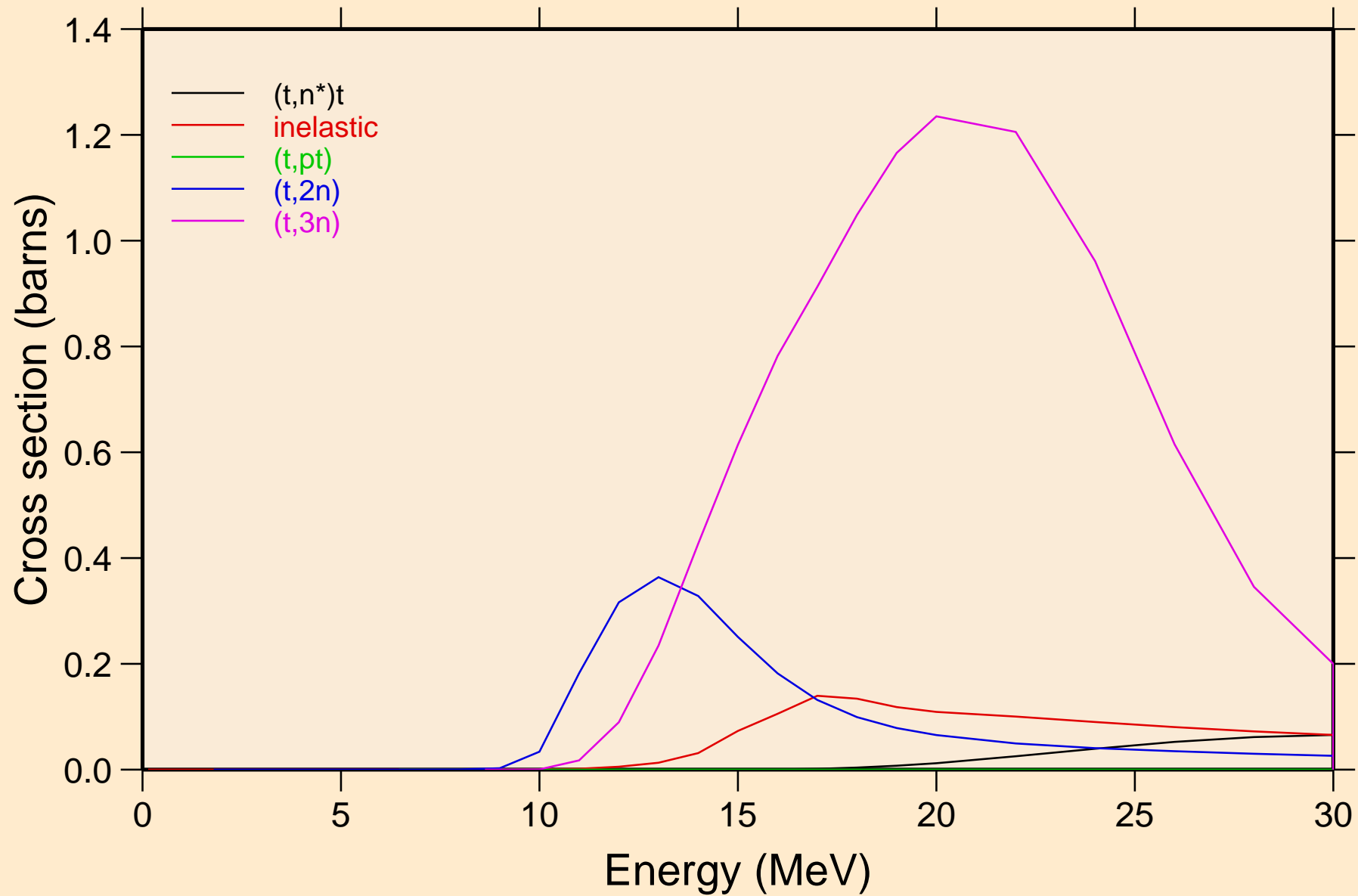

TL204 TRITON ACER TENDL-2021 LIBRARY; T=0.K  
Threshold reactions

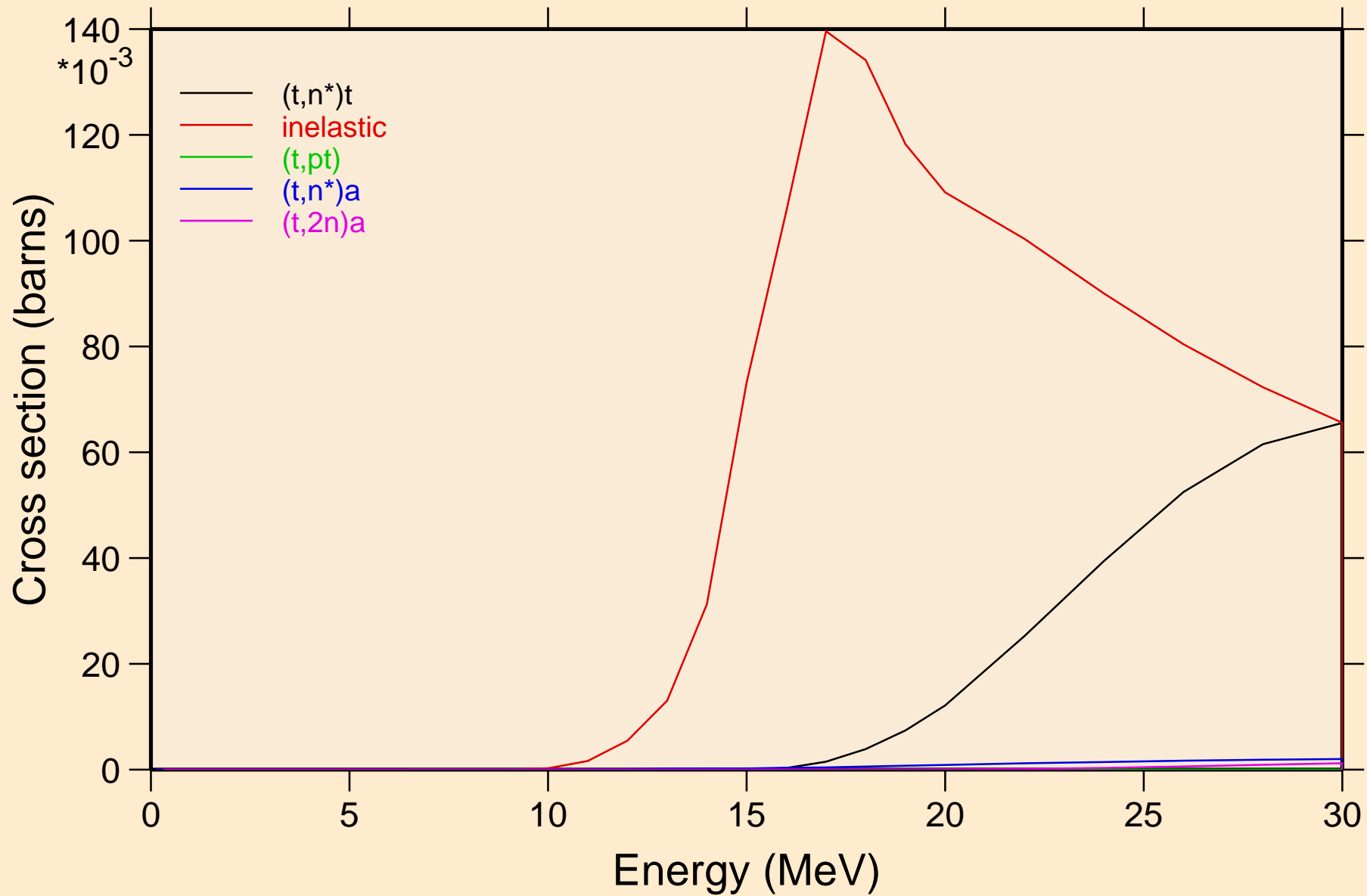

TL204 TRITON ACER TENDL-2021 LIBRARY; T=0.K  
Threshold reactions

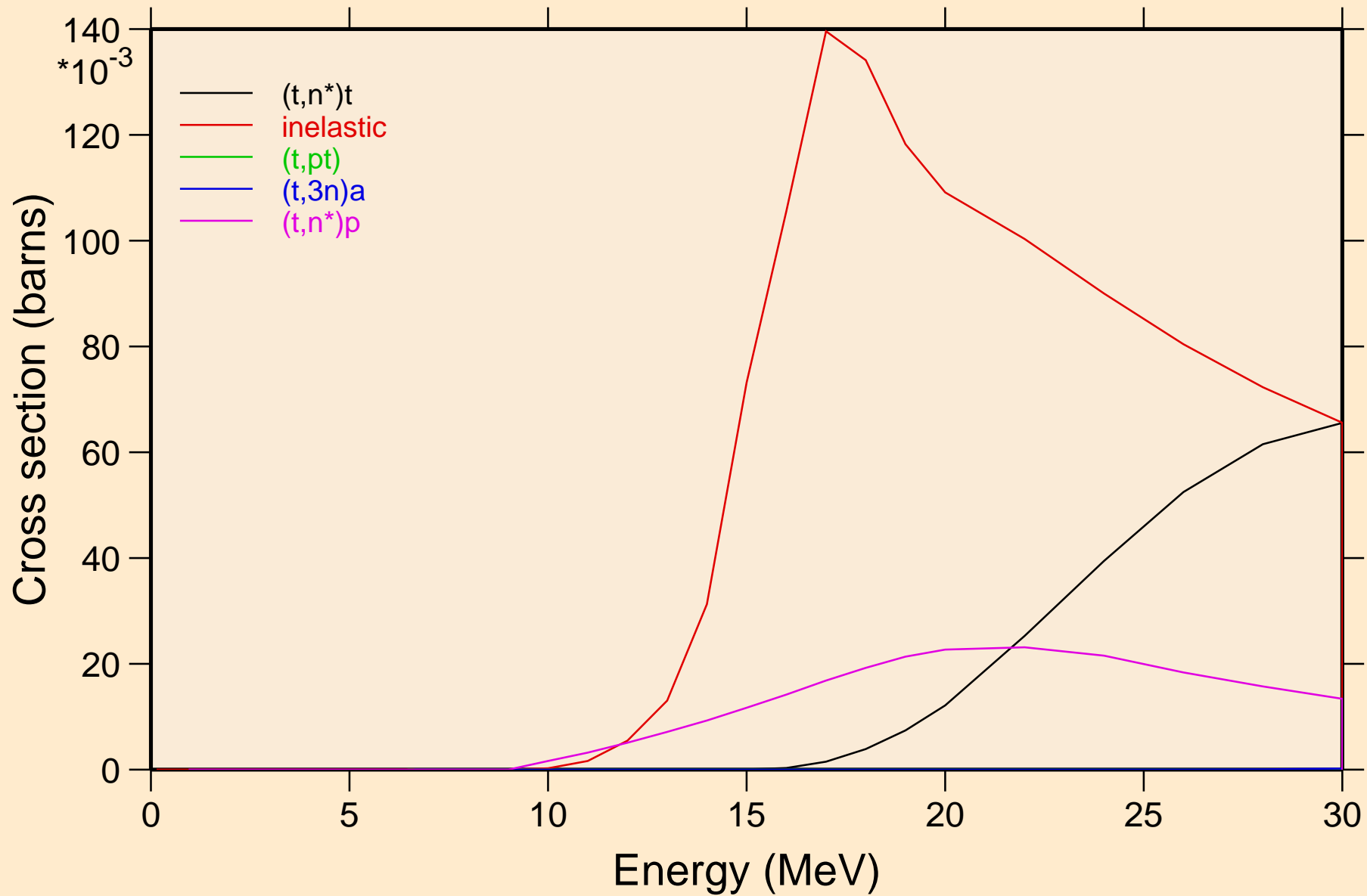



TL204 TRITON ACER TENDL-2021 LIBRARY; T=0.K  
Threshold reactions

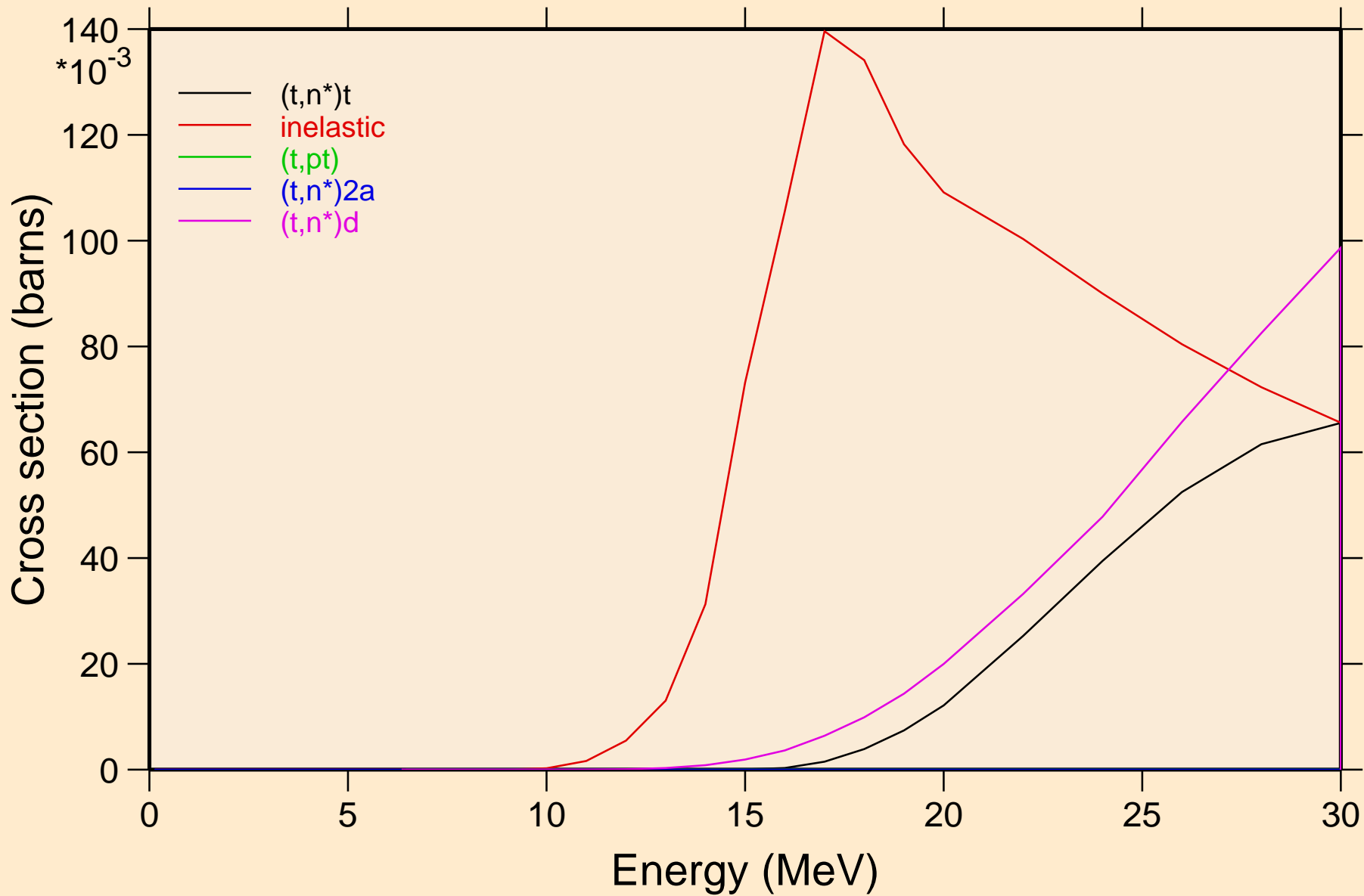

TL204 TRITON ACER TENDL-2021 LIBRARY; T=0.K  
Threshold reactions

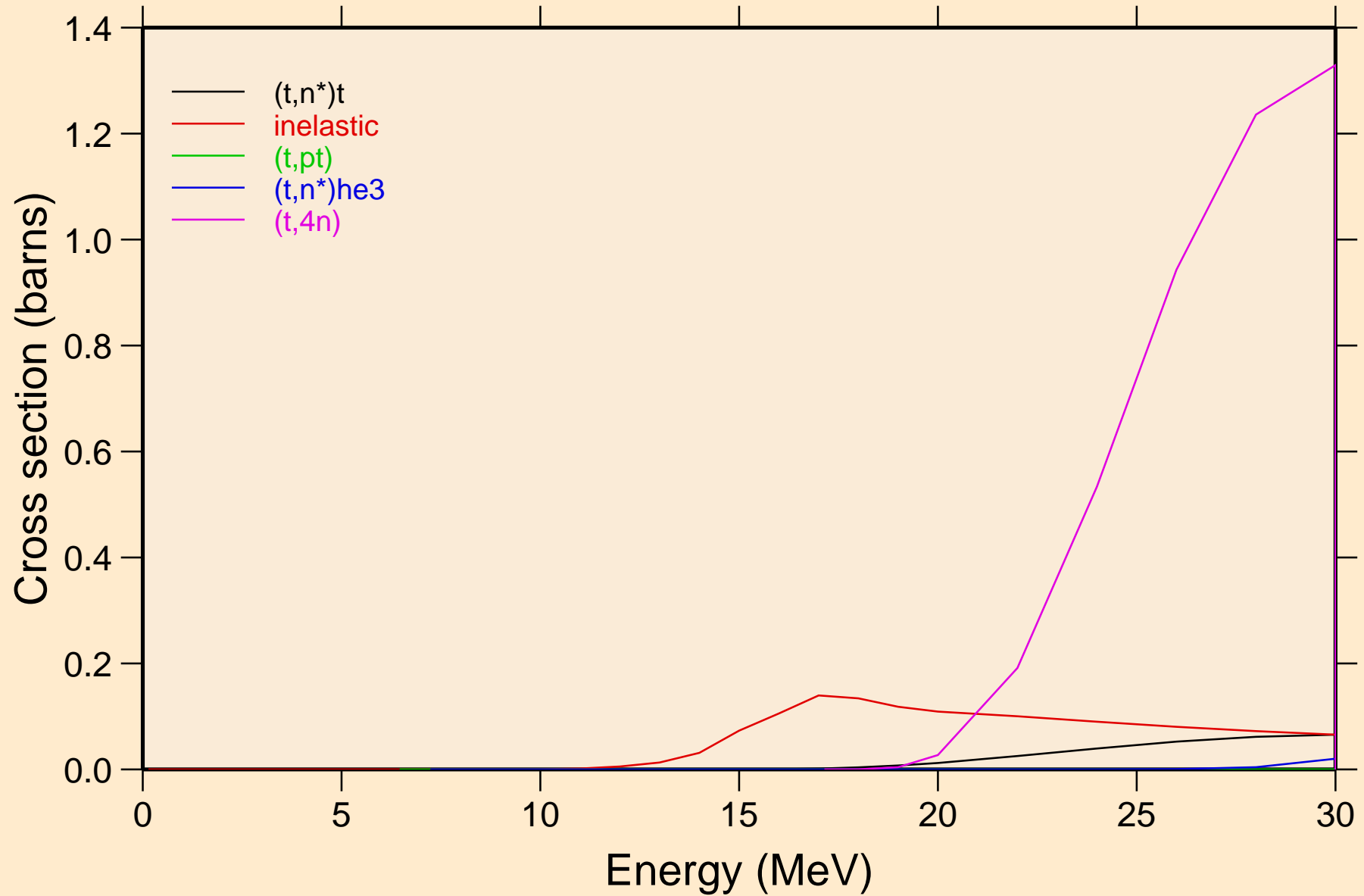

TL204 TRITON ACER TENDL-2021 LIBRARY; T=0.K  
Threshold reactions

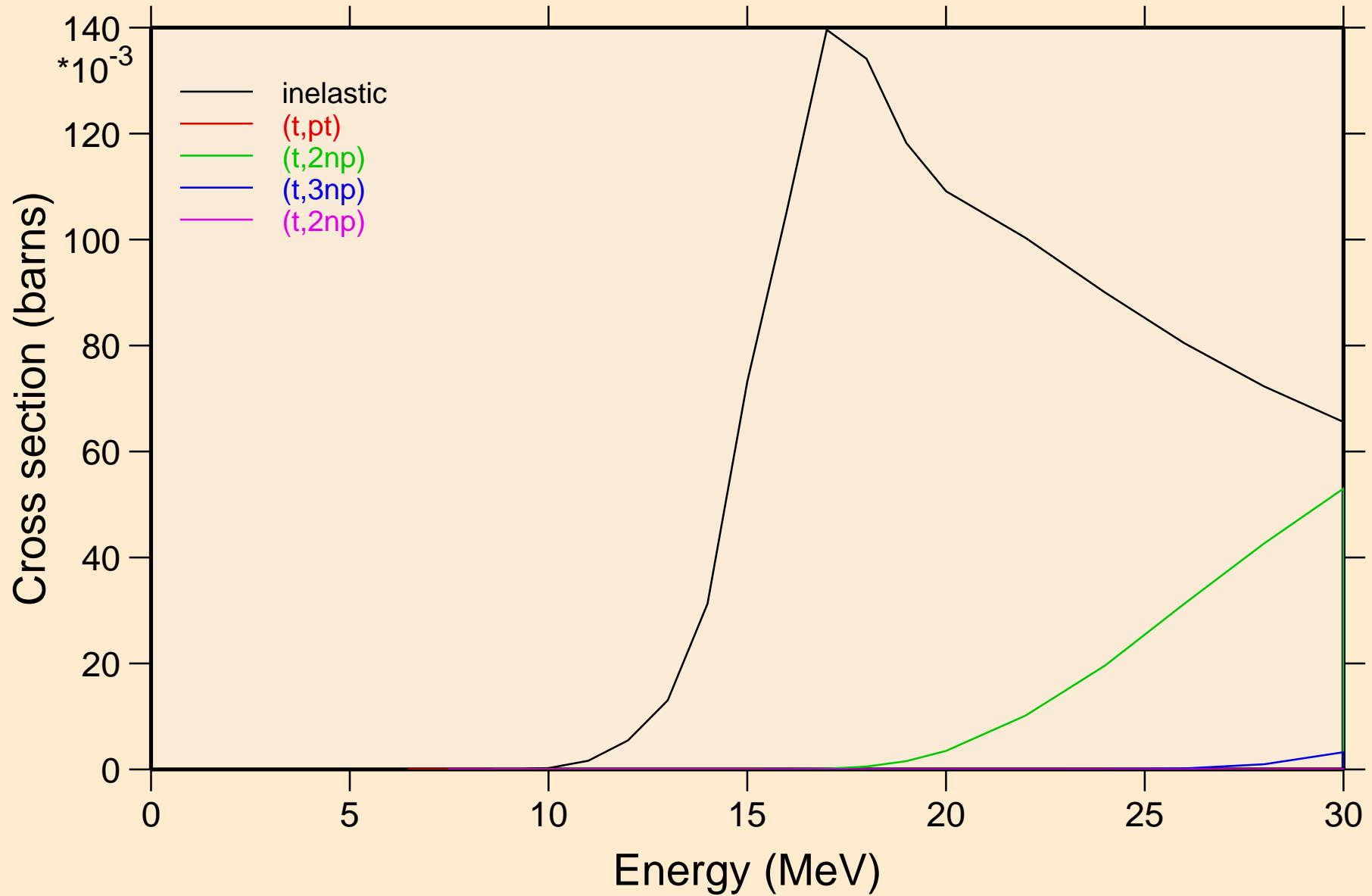

TL204 TRITON ACER TENDL-2021 LIBRARY; T=0.K  
Threshold reactions

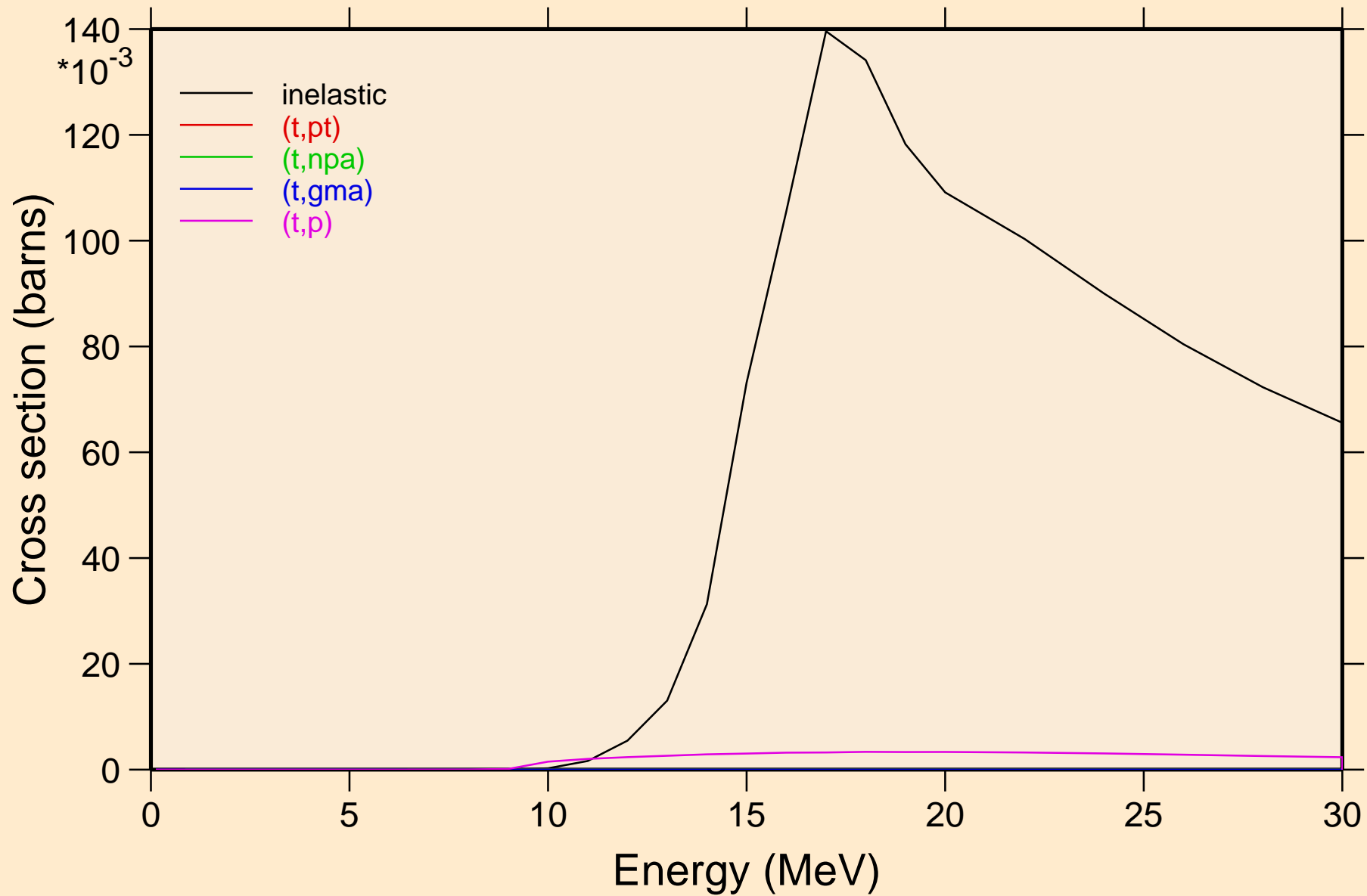

TL204 TRITON ACER TENDL-2021 LIBRARY; T=0.K  
Threshold reactions

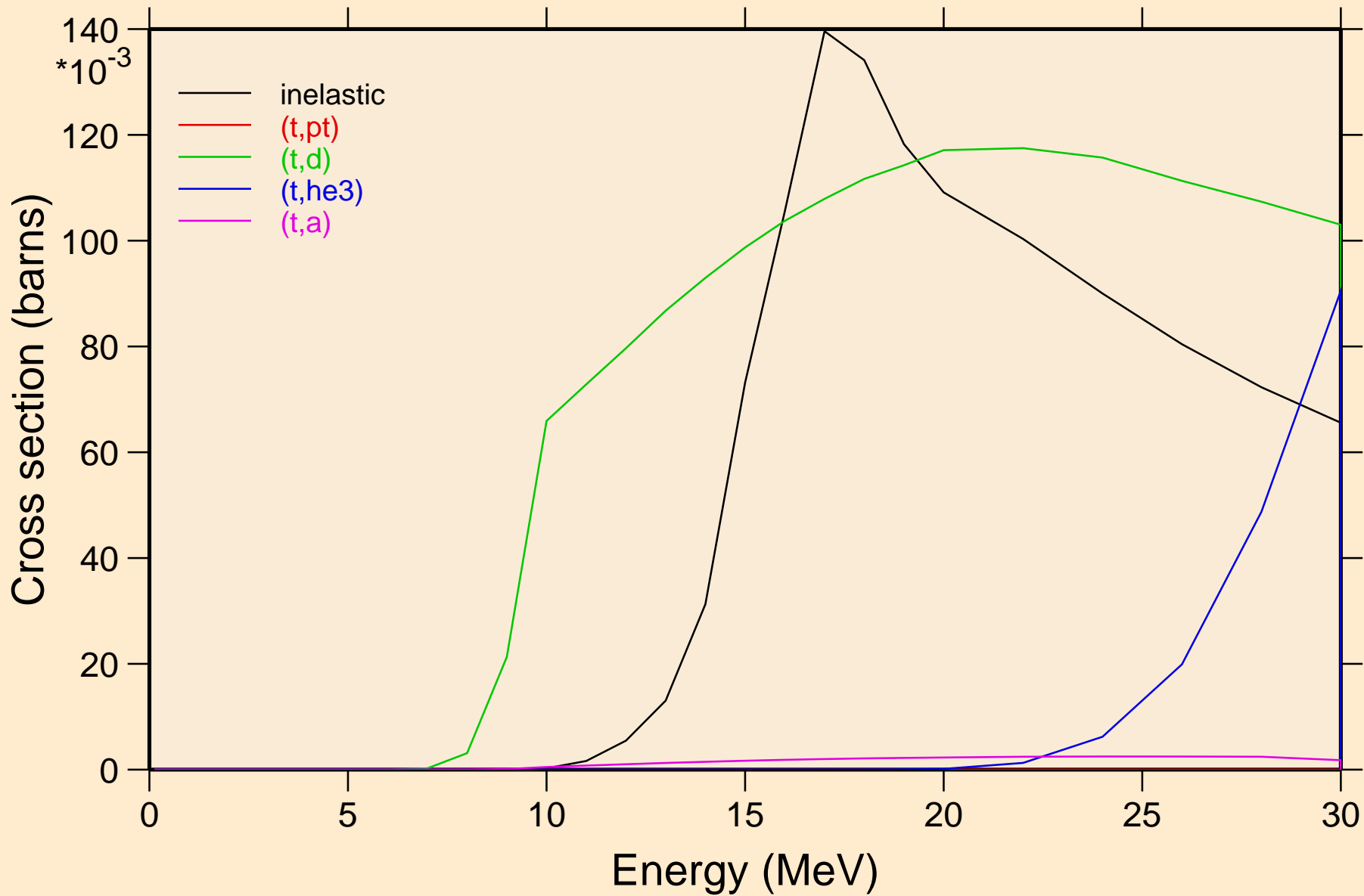

TL204 TRITON ACER TENDL-2021 LIBRARY; T=0.K  
Threshold reactions

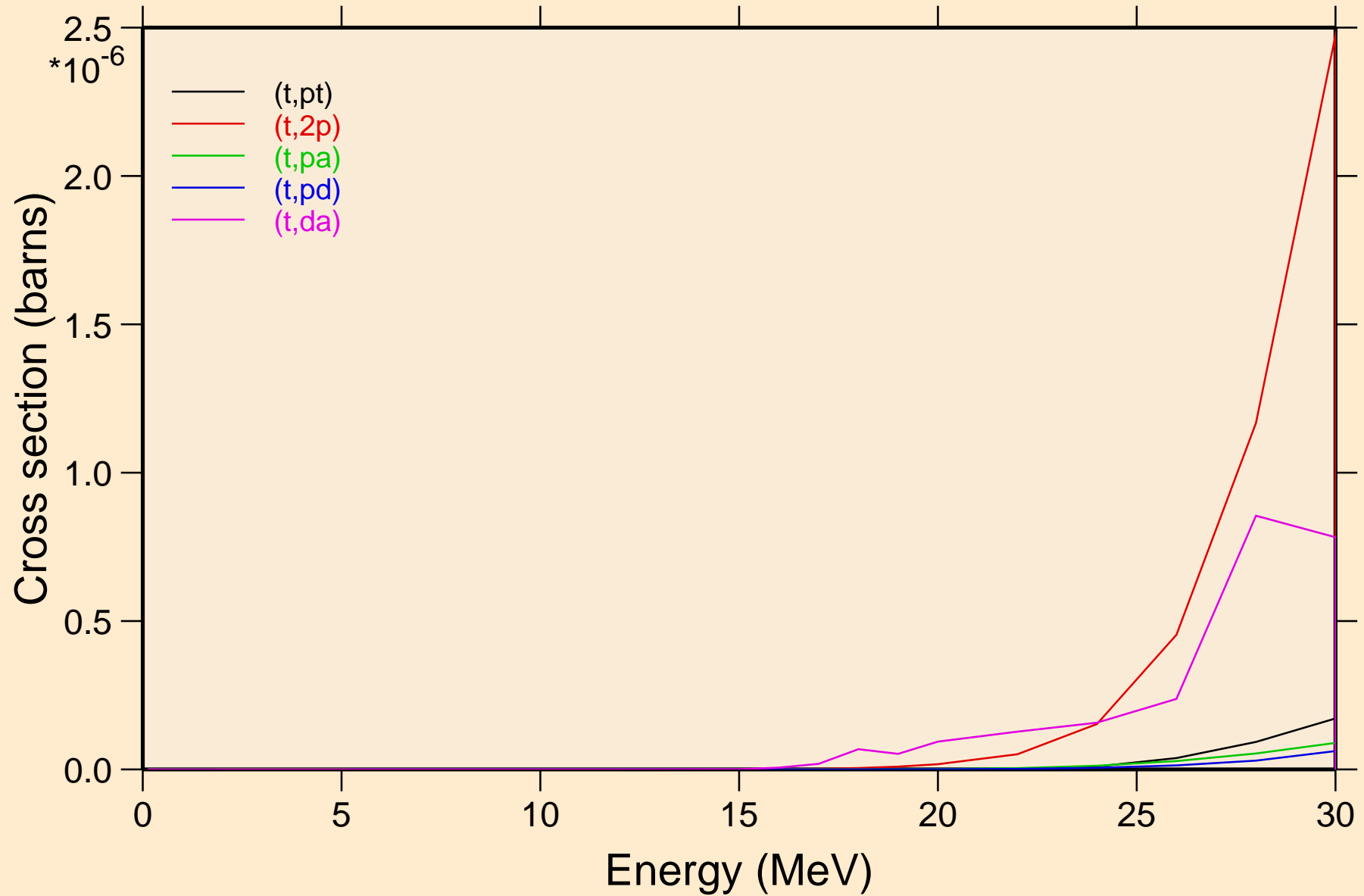

TL204 TRITON ACER TENDL-2021 LIBRARY; T=0.K  
angular distribution for elastic

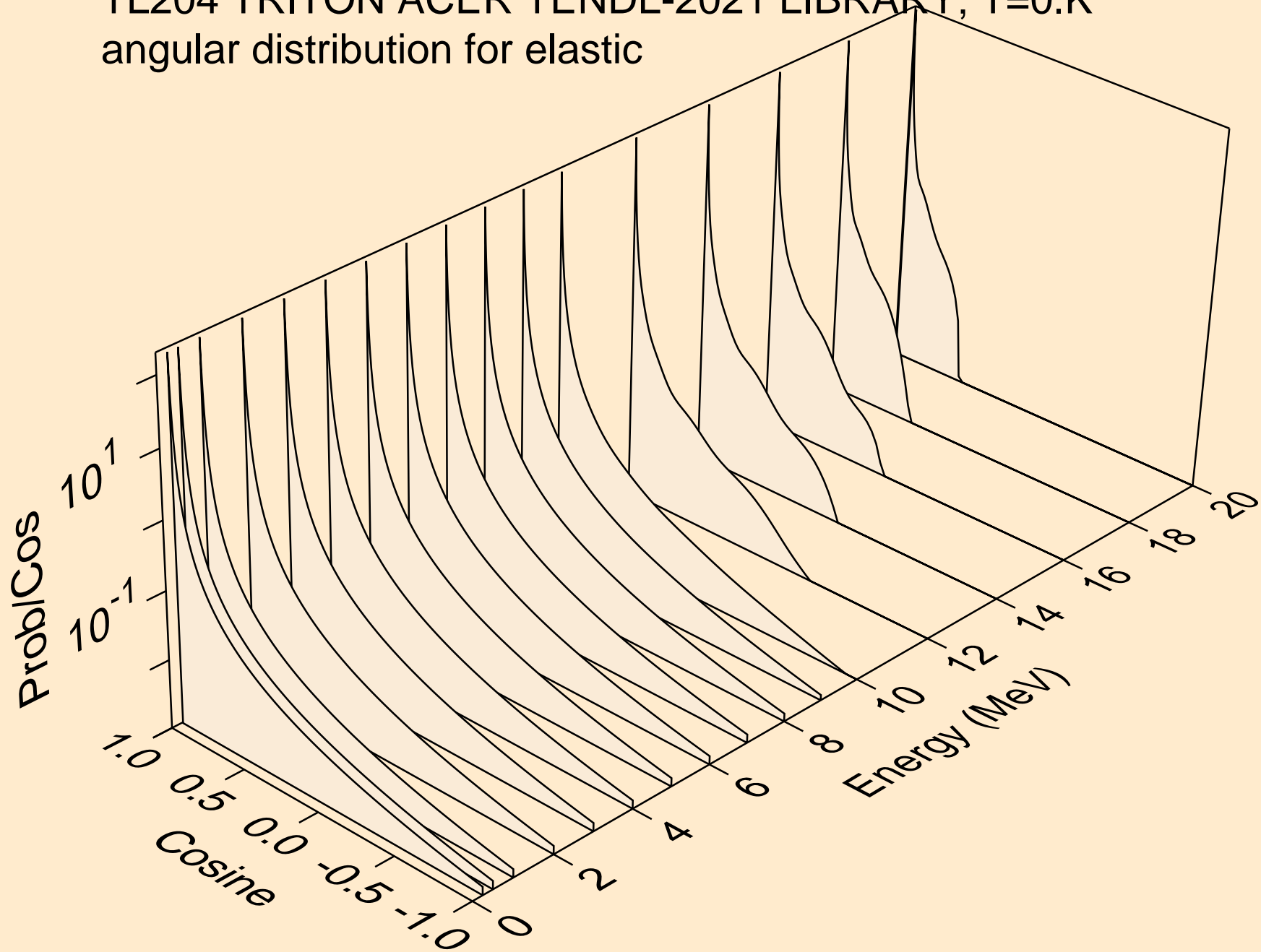

TL204 TRITON ACER TENDL-2021 LIBRARY; T=0.K  
angular distribution for elastic

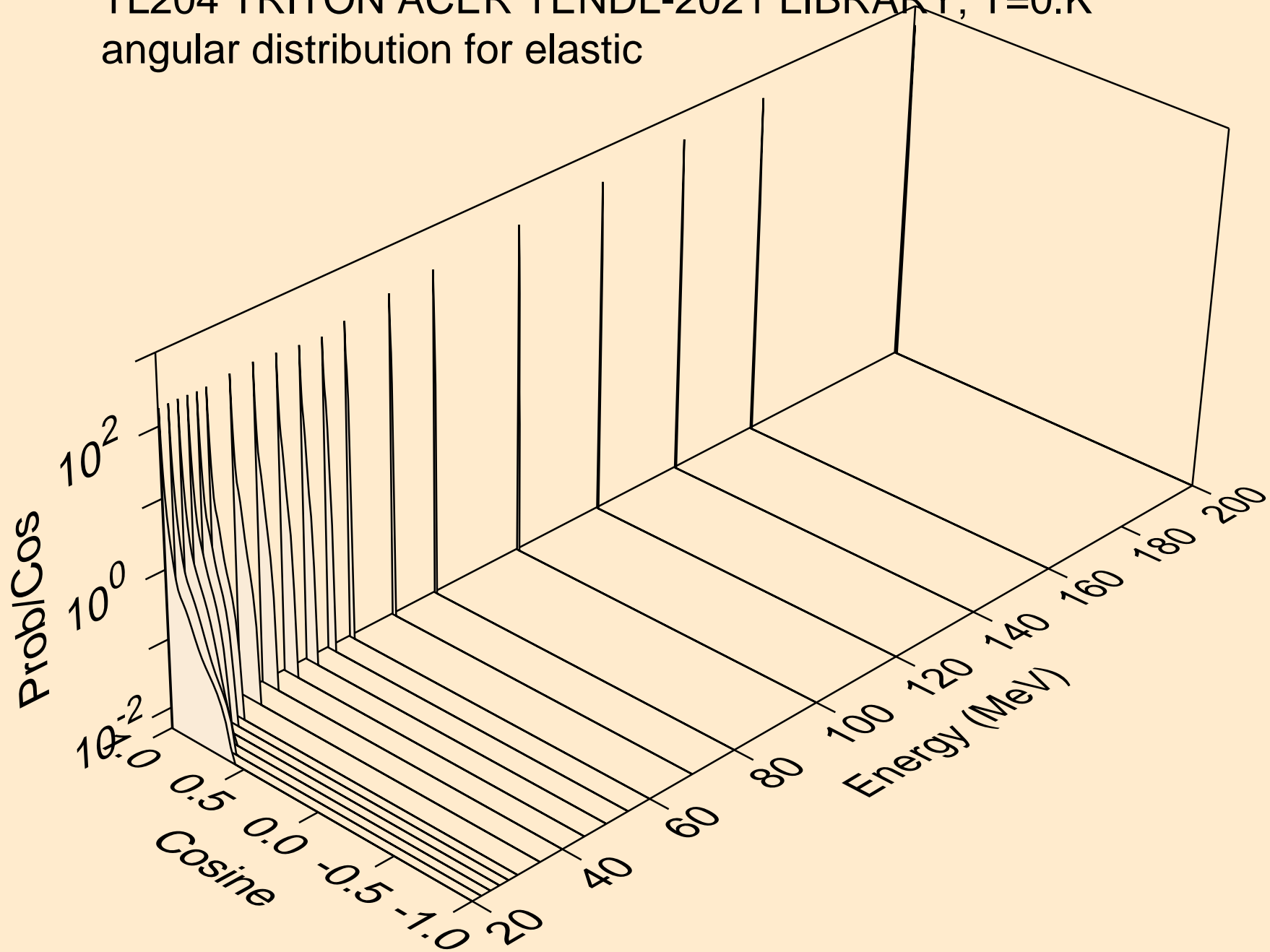



TL204 TRITON ACER TENDL-2021 LIBRARY; T=0.K  
Triton emission for (t,x)

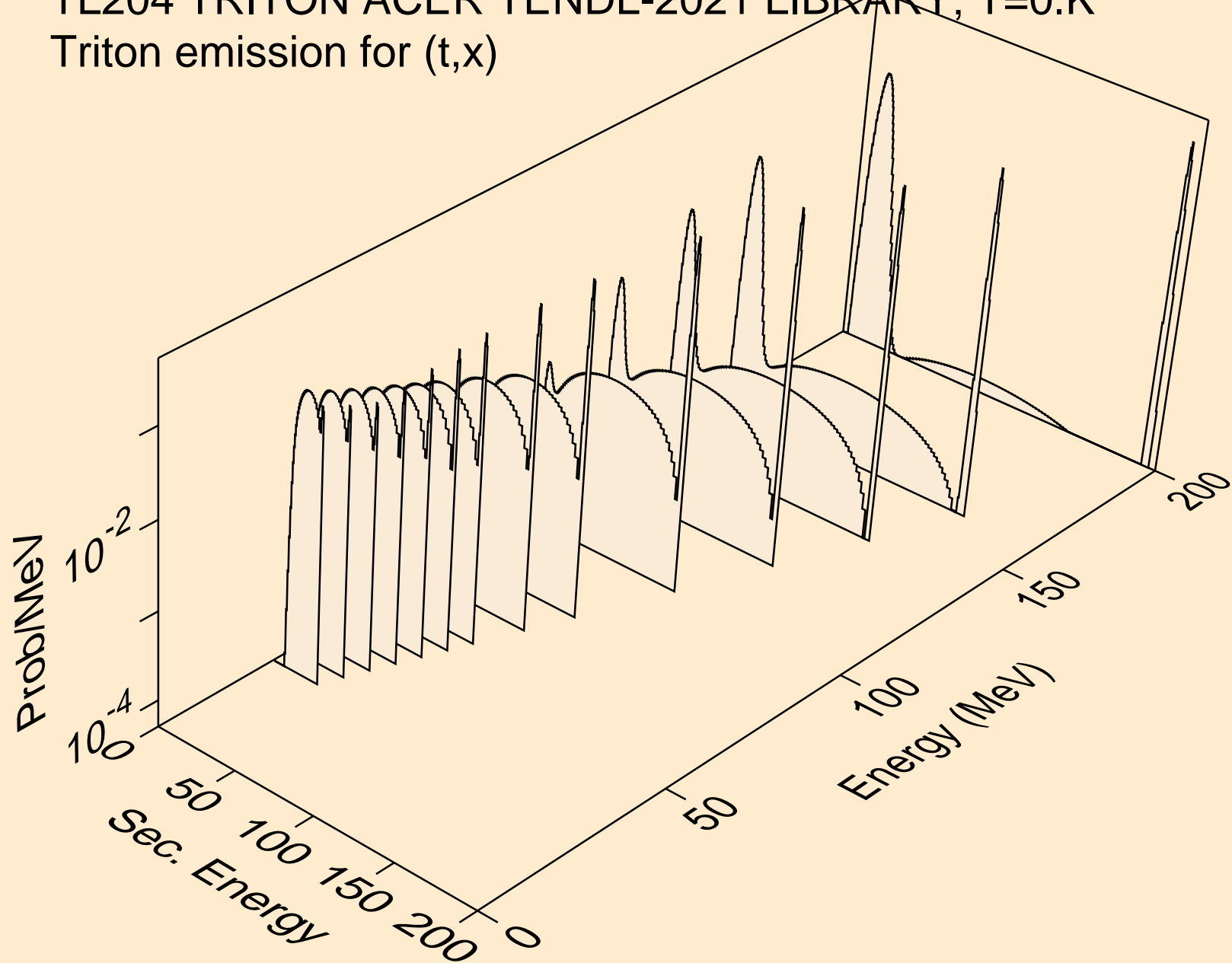

TL204 TRITON ACER TENDL-2021 LIBRARY; T=0.K  
Triton emission for (t,n\*)t

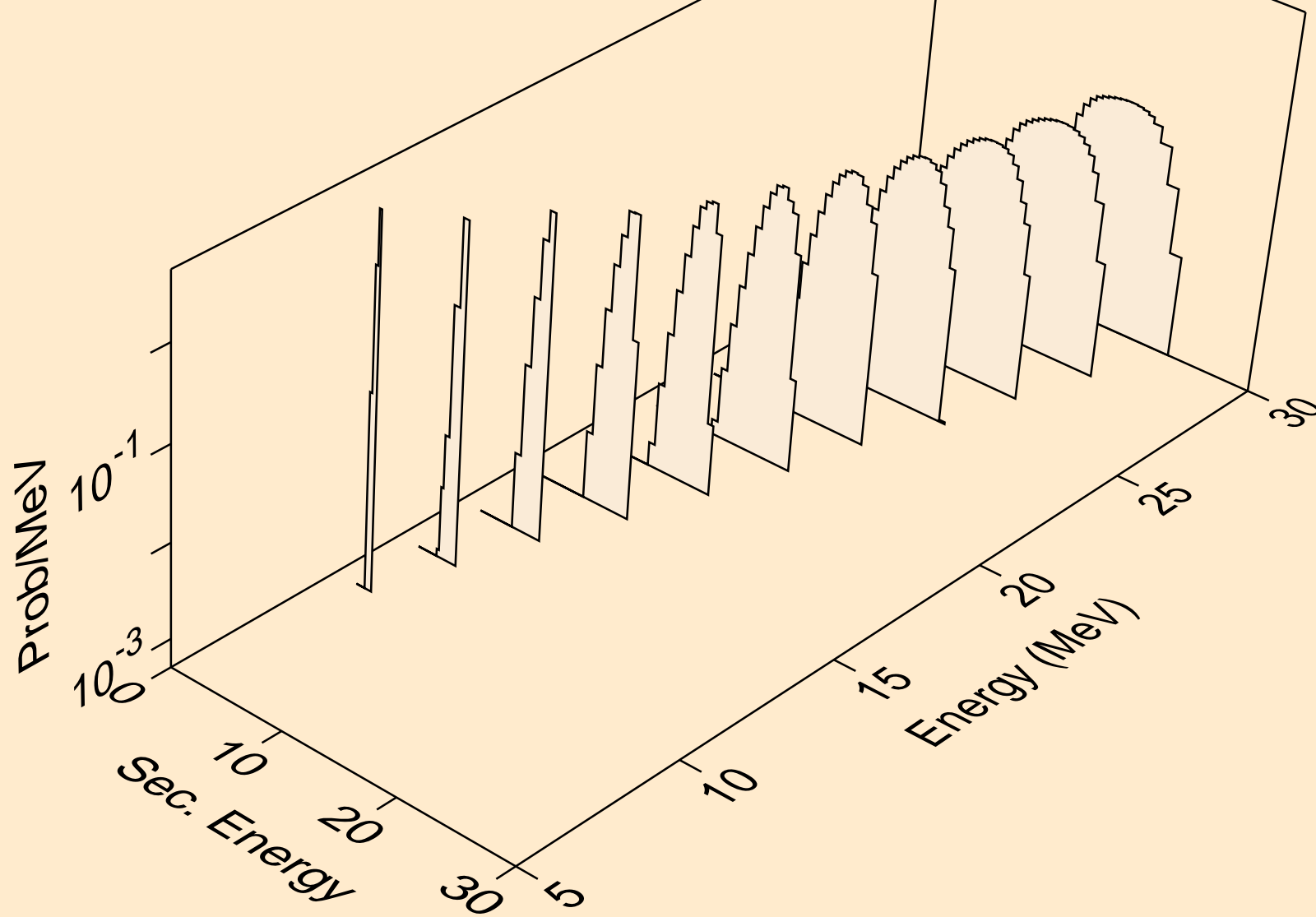

TL204 TRITON ACER TENDL-2021 LIBRARY; T=0.K  
Triton emission for inelastic

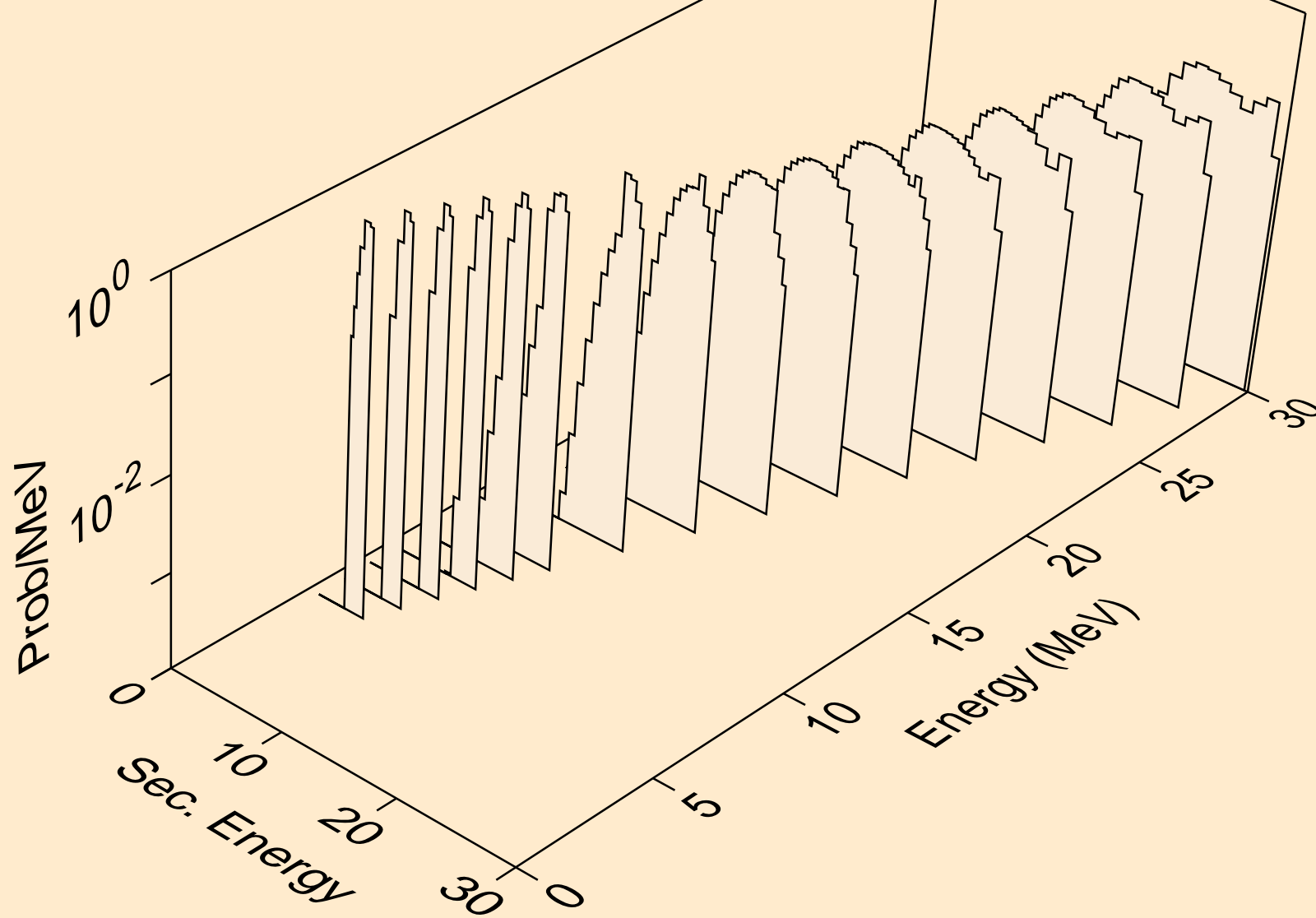

TL204 TRITON ACER TENDL-2021 LIBRARY; T=0.K  
Triton emission for (t,pt)

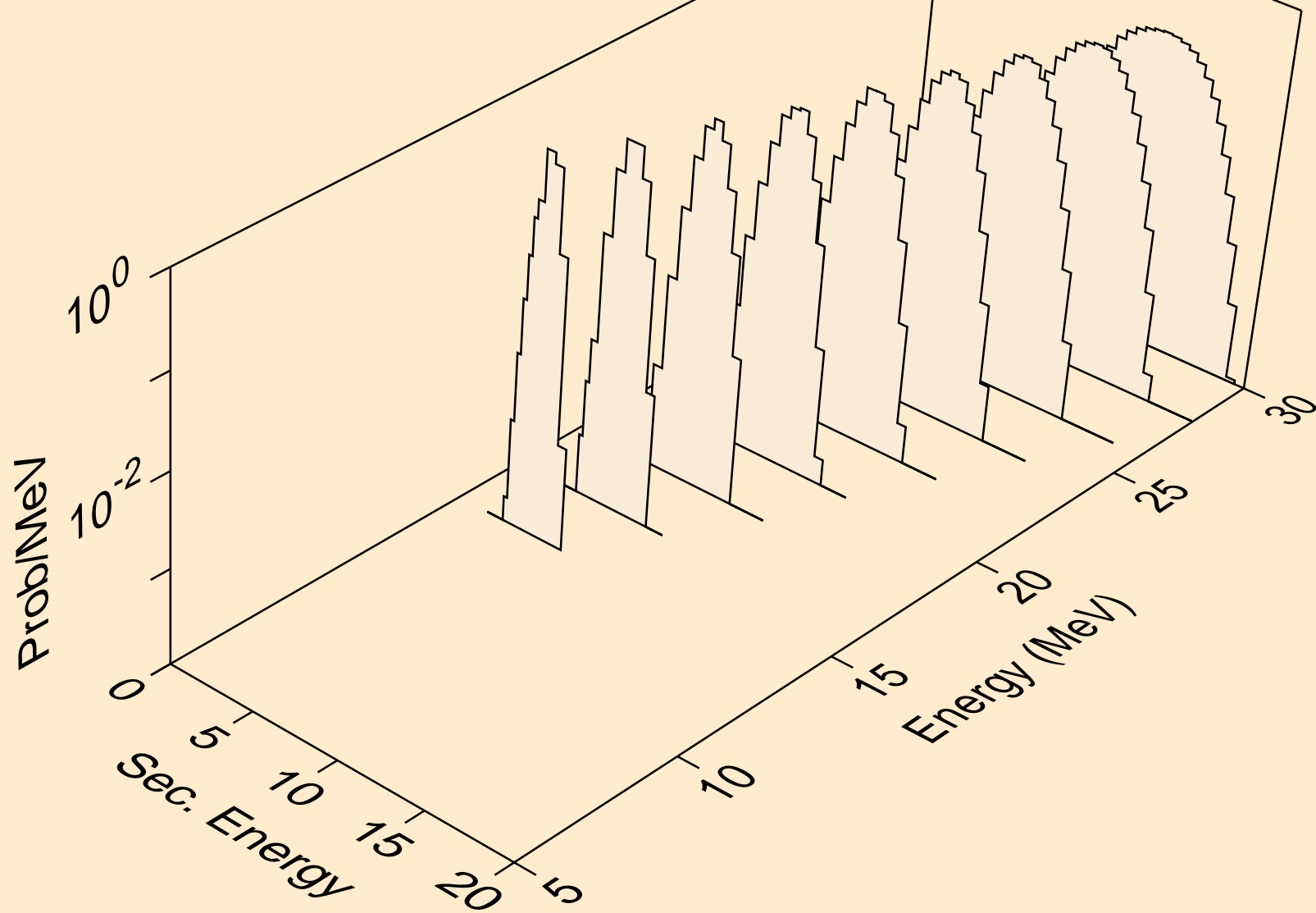

TL204 TRITON ACER TENDL-2021 LIBRARY; T=0.K  
Photon emission for (z,n)

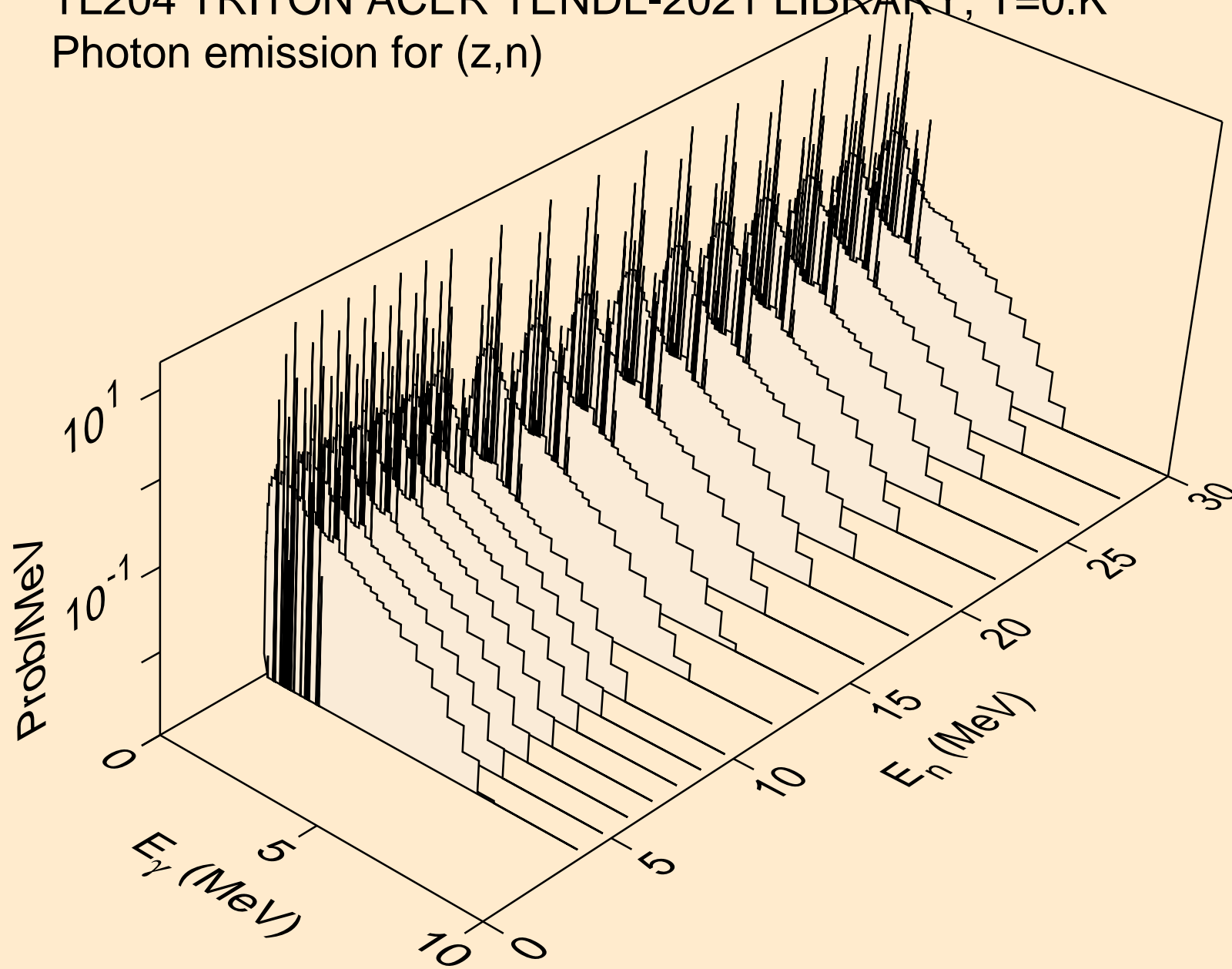

TL204 TRITON ACER TENDL-2021 LIBRARY; T=0.K  
Photon emission for (n,x)

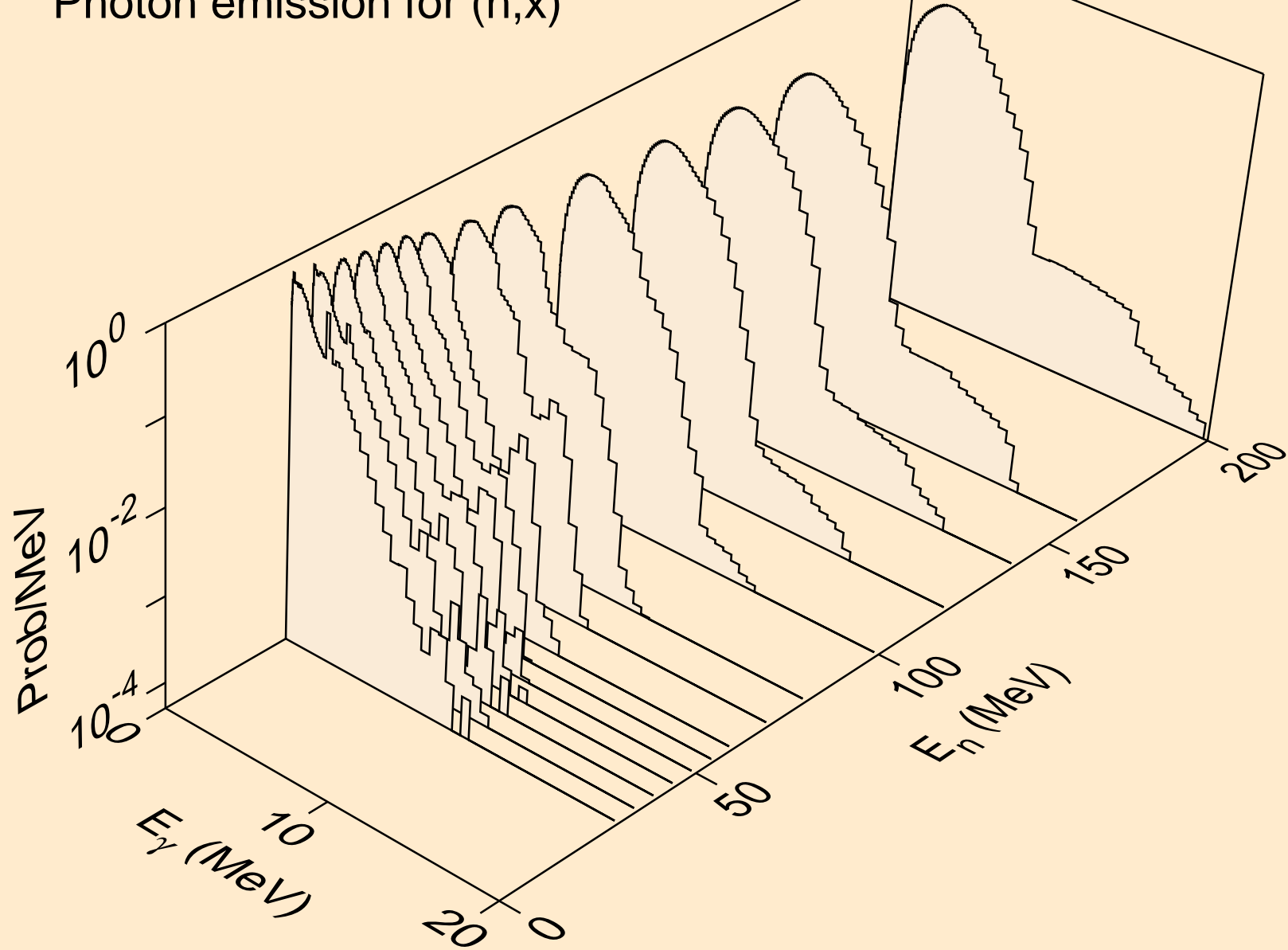

TL204 TRITON ACER TENDL-2021 LIBRARY; T=0.K  
Photon emission for (n,2nd)

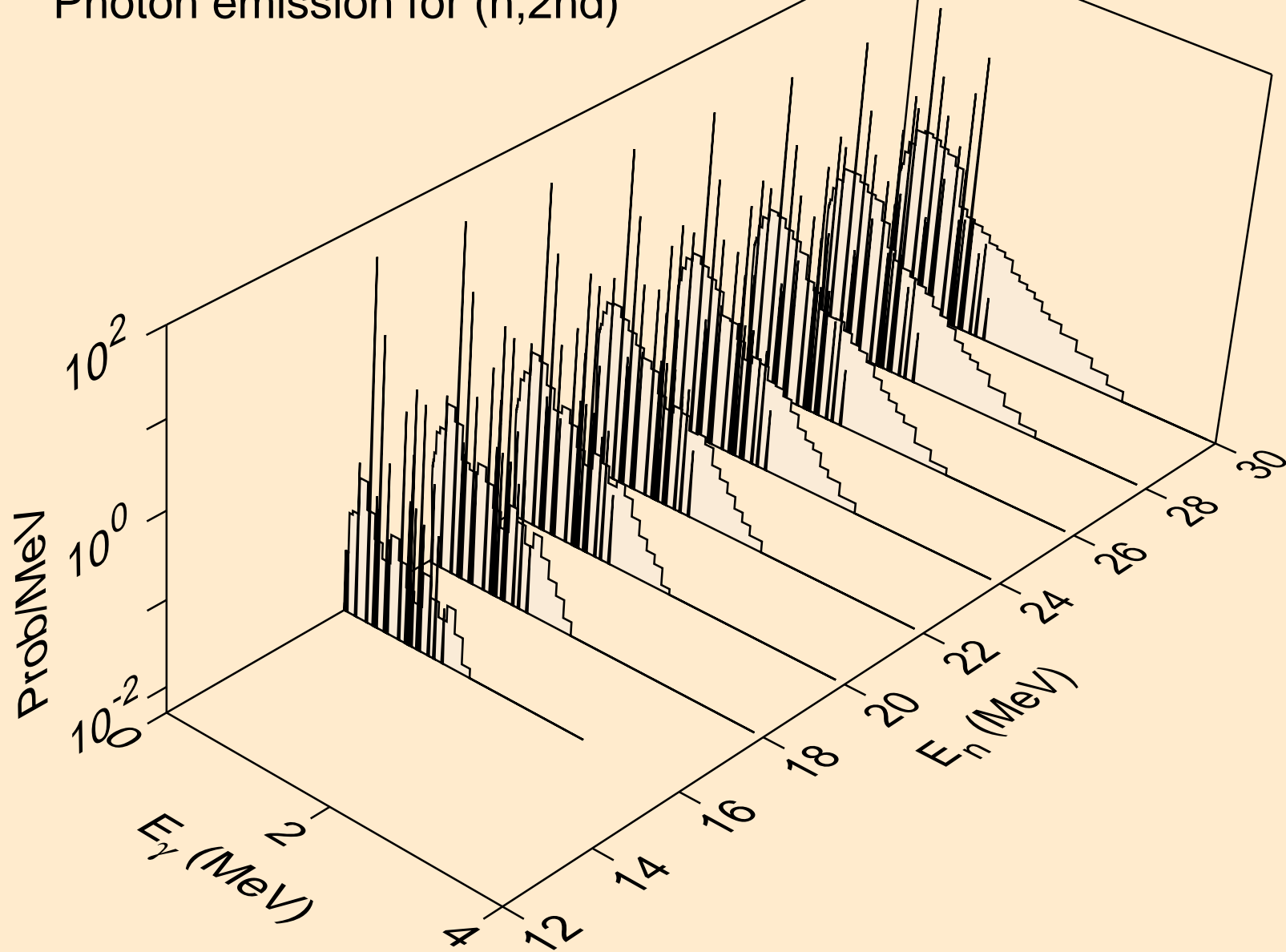

TL204 TRITON ACER TENDL-2021 LIBRARY; T=0.K  
Photon emission for (n,2n)

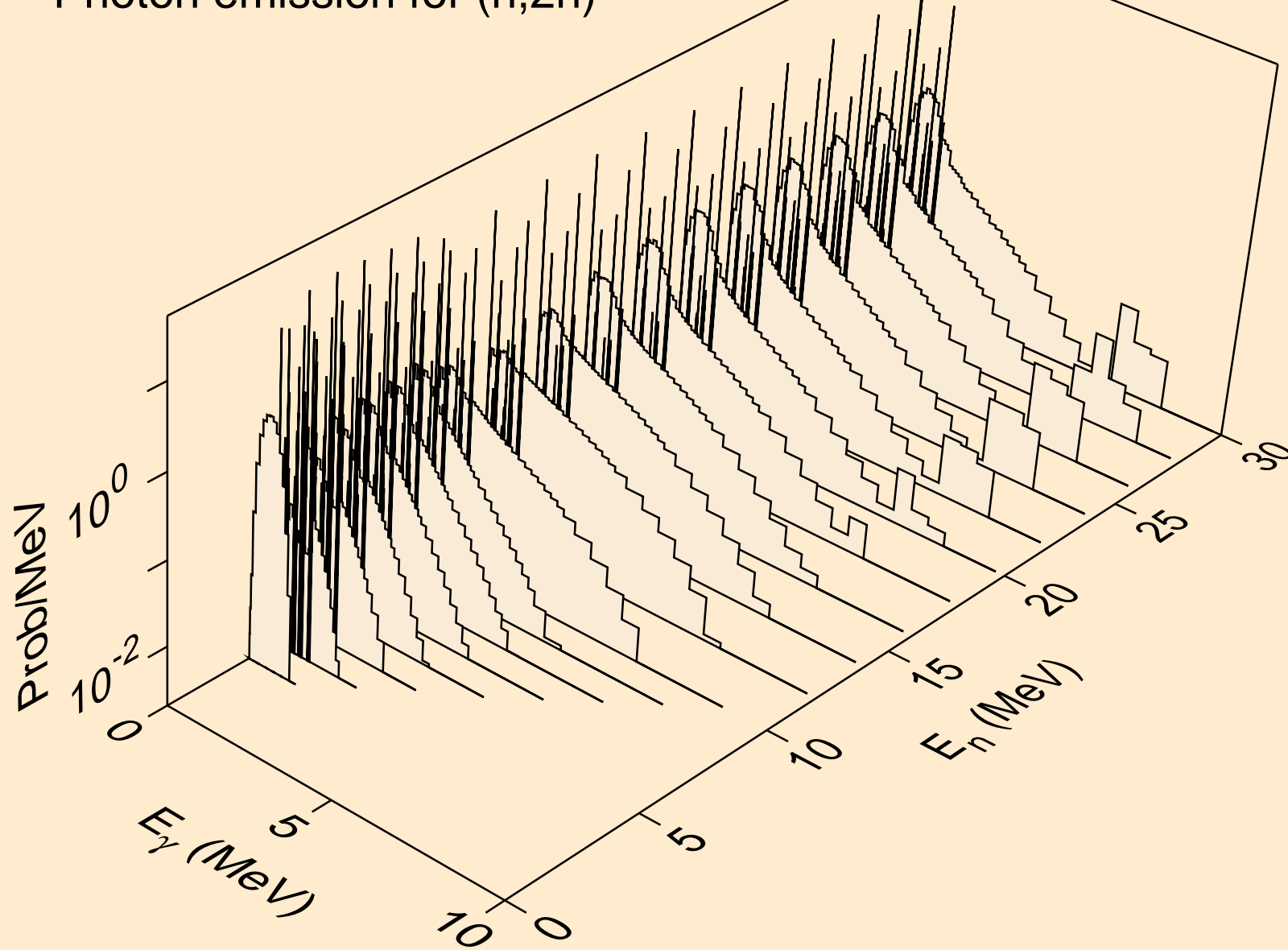



TL204 TRITON ACER TENDL-2021 LIBRARY; T=0.K  
Photon emission for (n,3n)

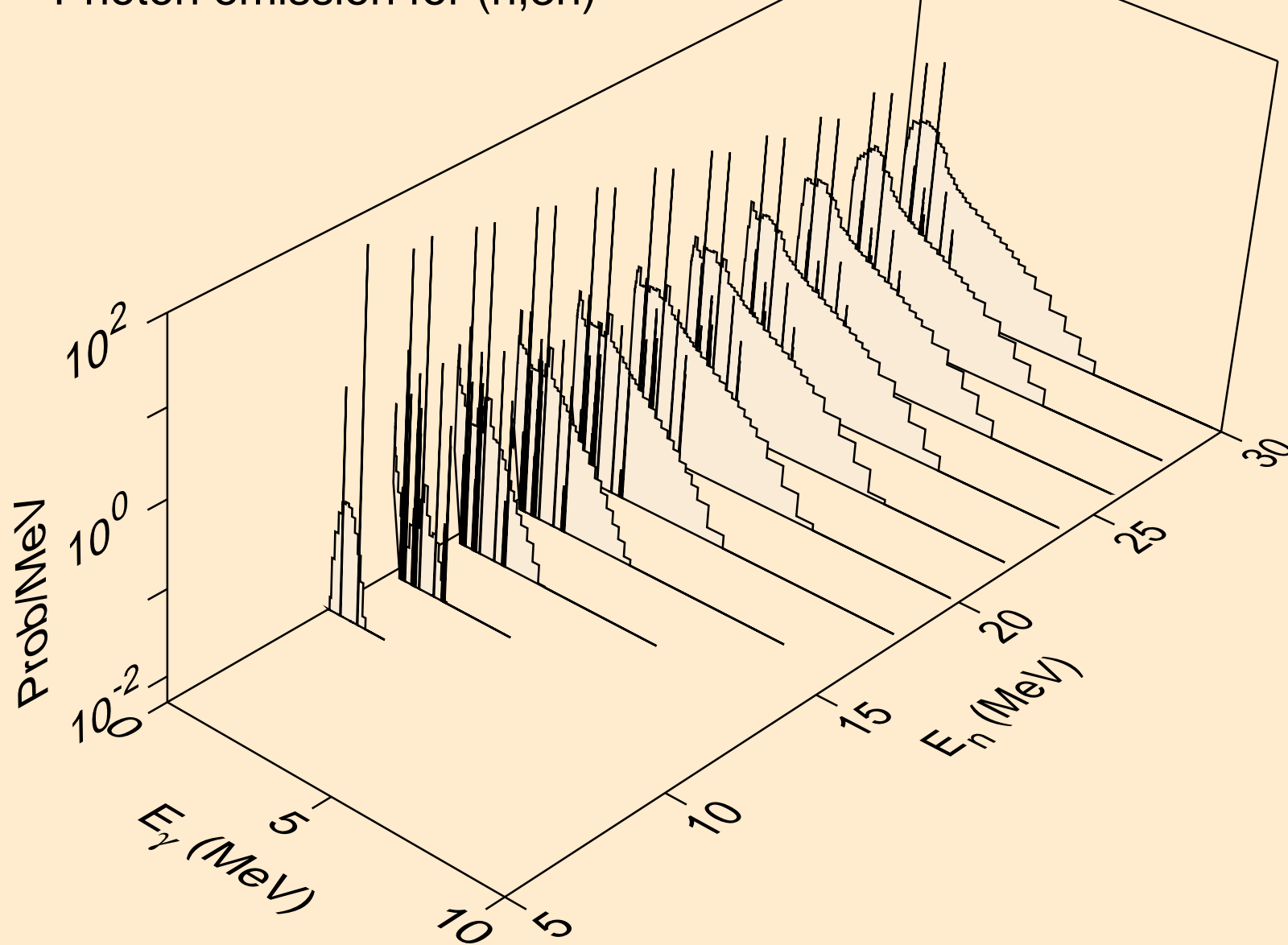

TL204 TRITON ACER TENDL-2021 LIBRARY; T=0.K  
Photon emission for (n,n\*)a

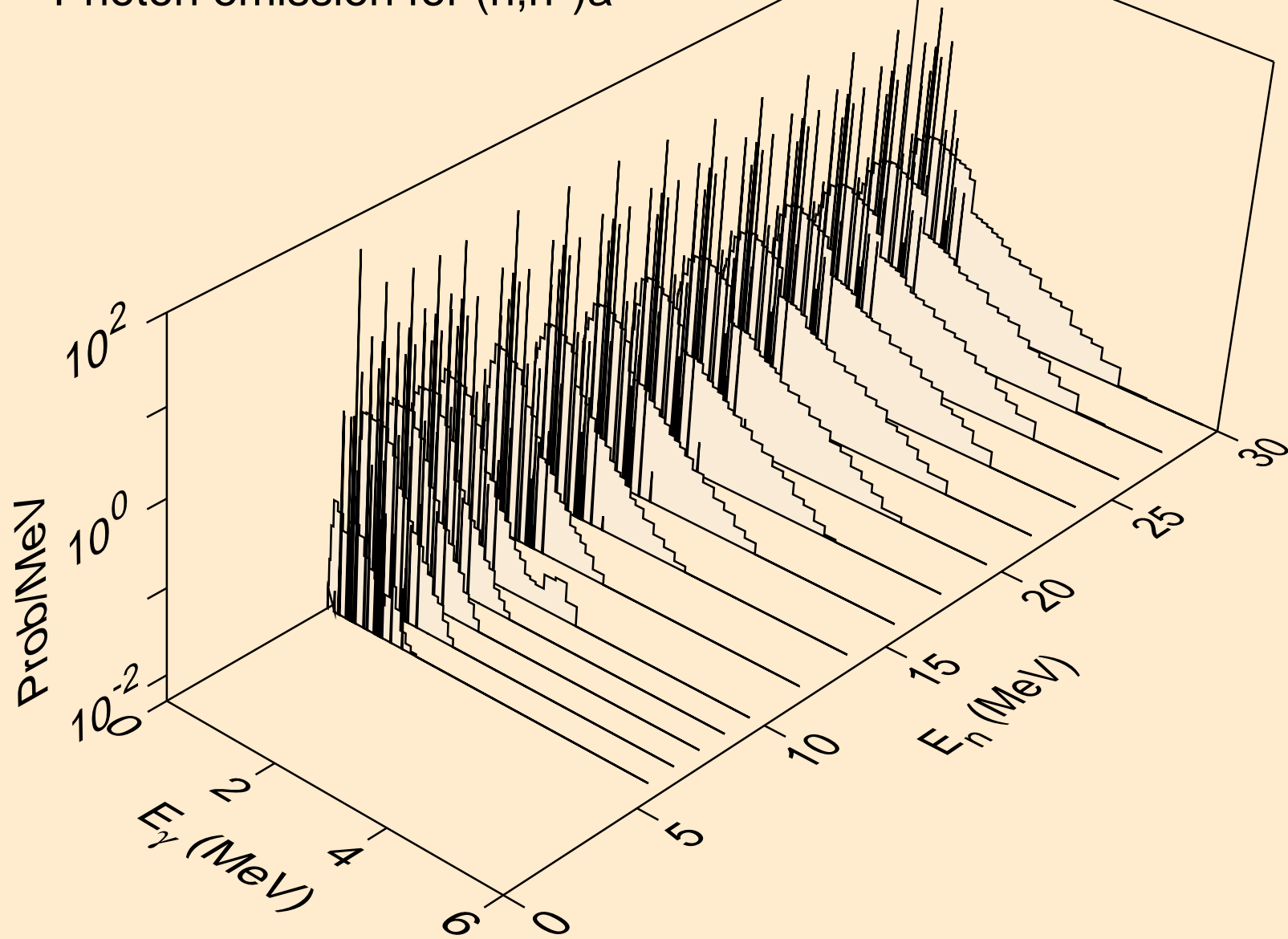

TL204 TRITON ACER TENDL-2021 LIBRARY; T=0.K  
Photon emission for (n,2n)a

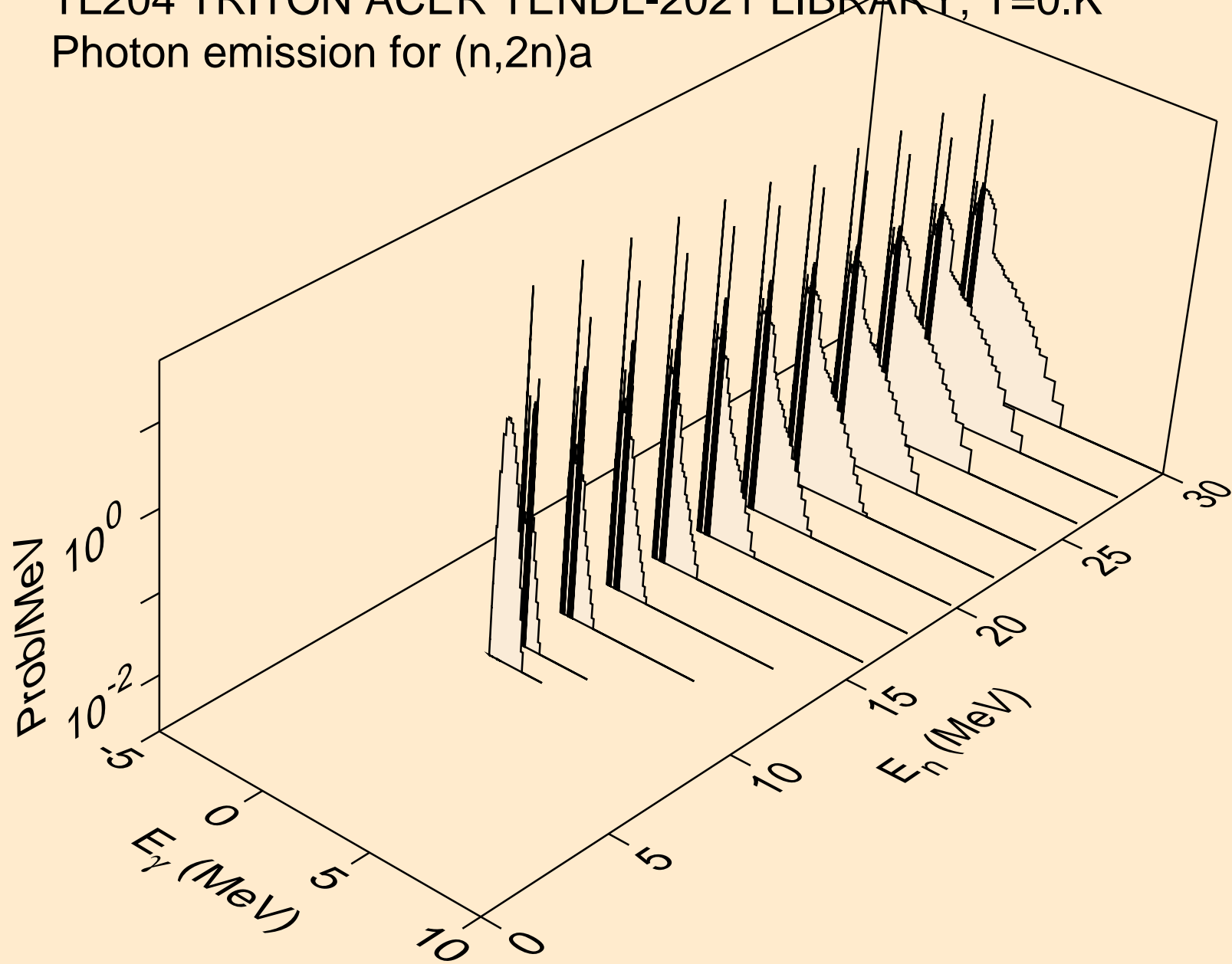

TL204 TRITON ACER TENDL-2021 LIBRARY; T=0.K  
Photon emission for (n,3n)a

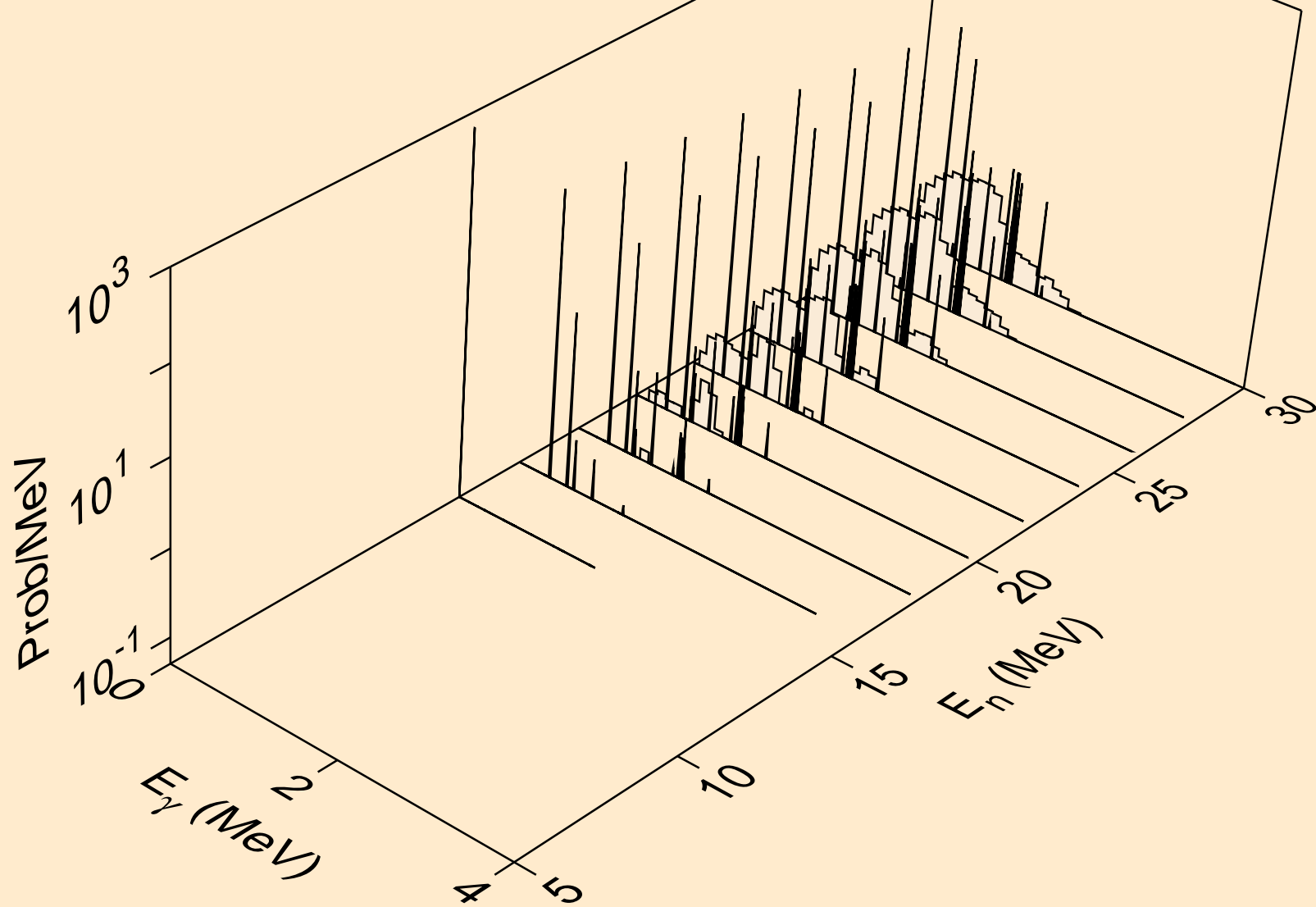

TL204 TRITON ACER TENDL-2021 LIBRARY; T=0.K  
Photon emission for (n,n\*)p

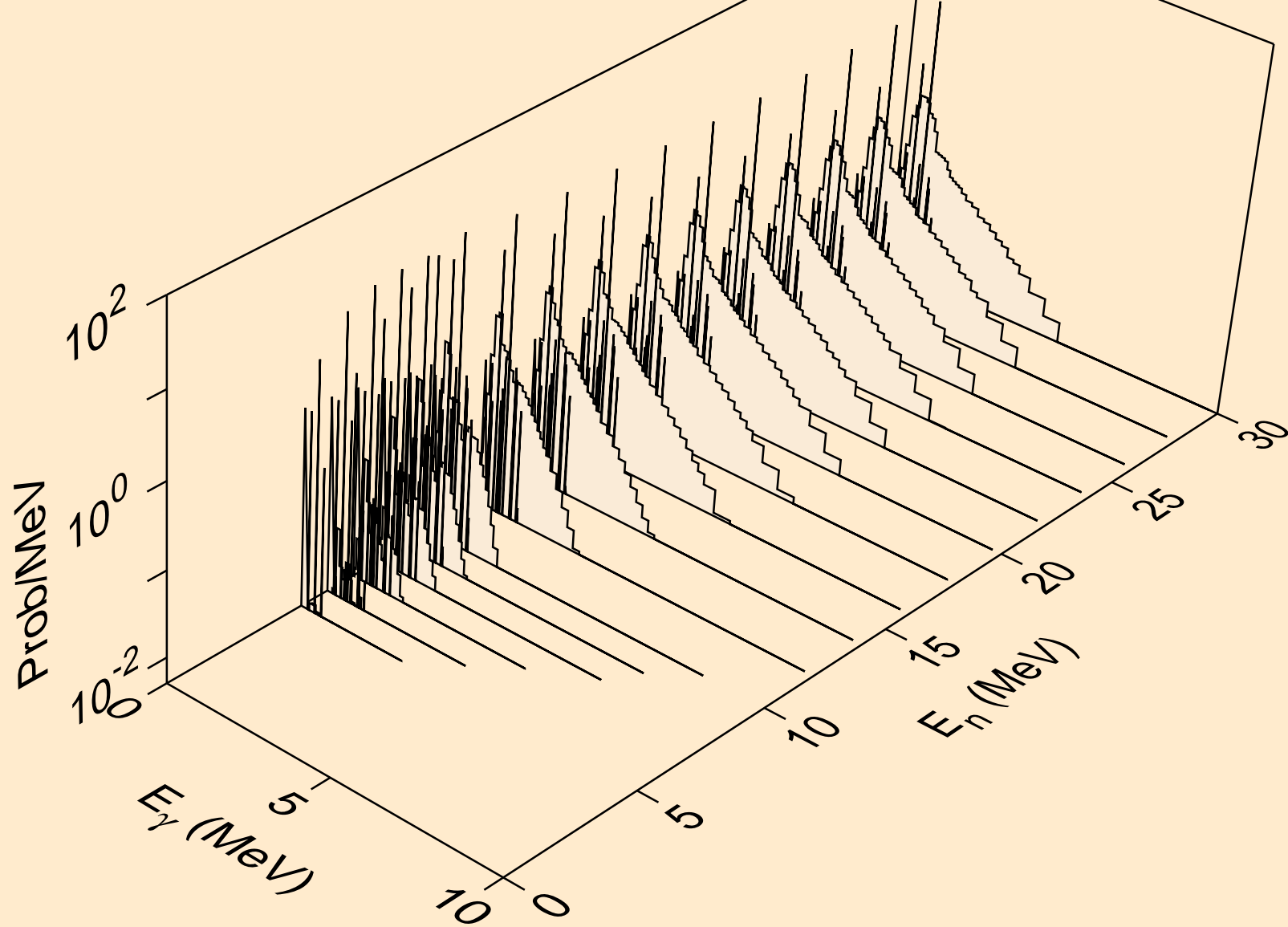

TL204 TRITON ACER TENDL-2021 LIBRARY; T=0.K  
Photon emission for (n,n\*)2a

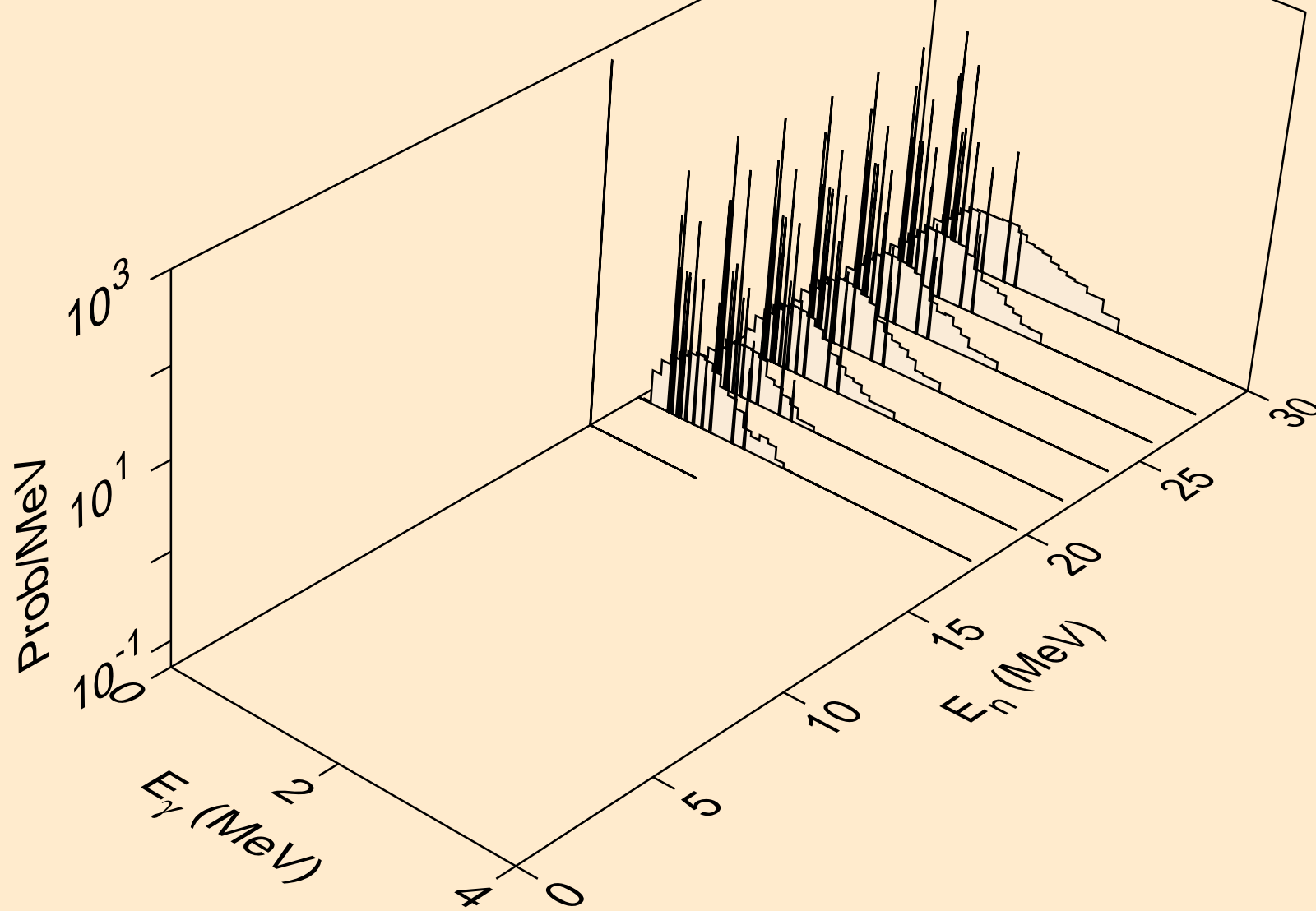

TL204 TRITON ACER TENDL-2021 LIBRARY; T=0.K  
Photon emission for (n,n\*)d

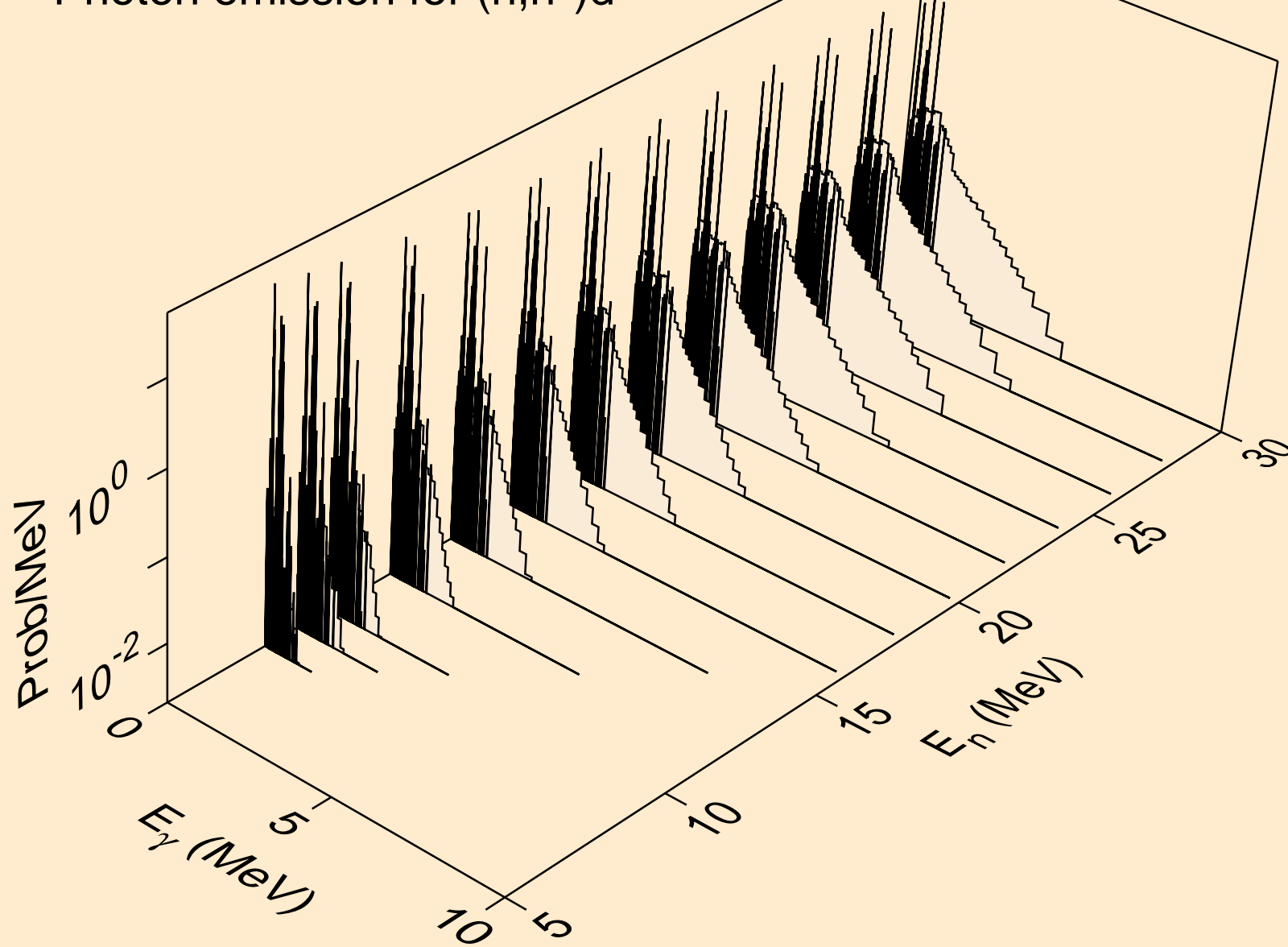

TL204 TRITON ACER TENDL-2021 LIBRARY; T=0.K  
Photon emission for (n,n\*)t

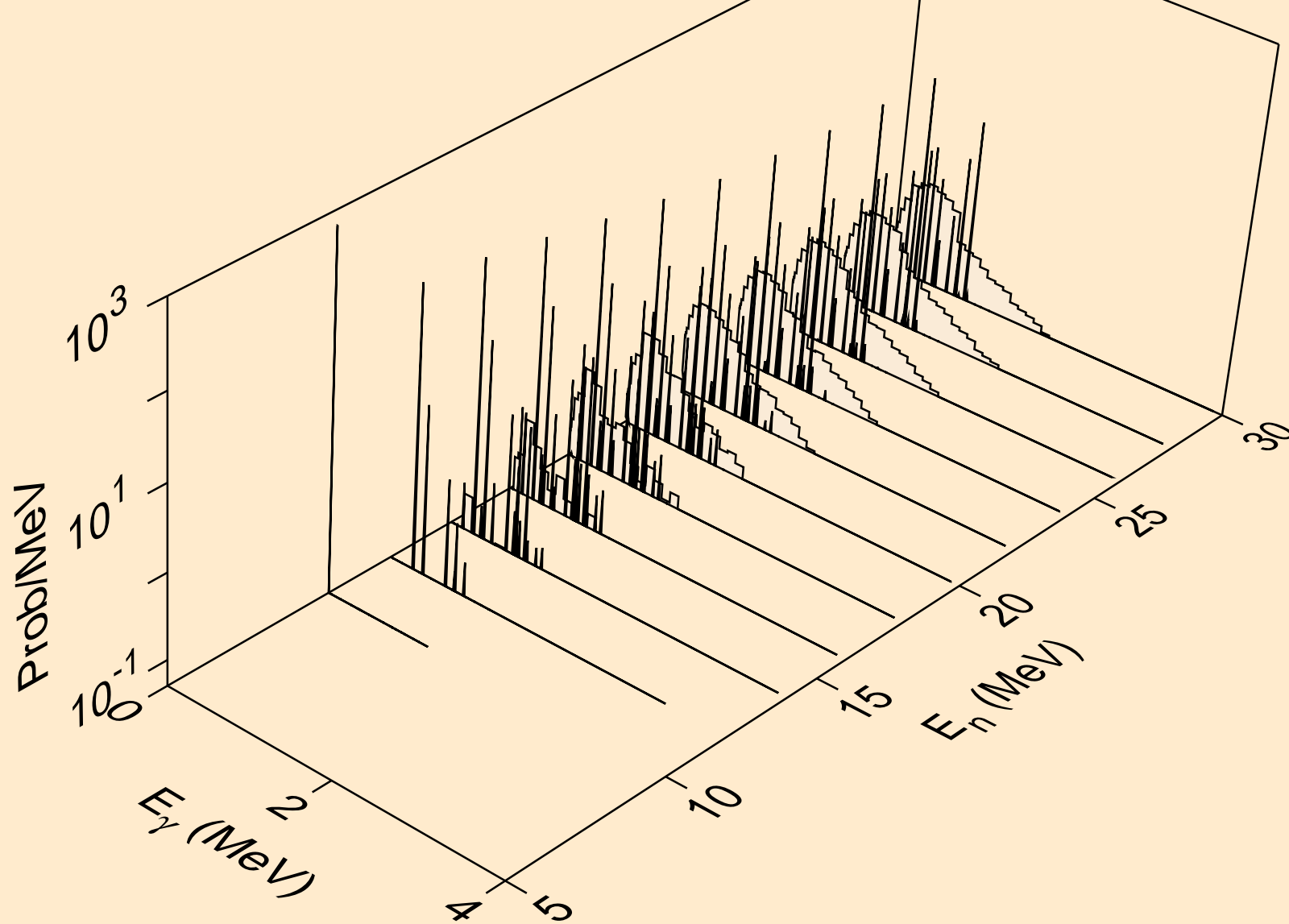



TL204 TRITON ACER TENDL-2021 LIBRARY; T=0.K  
Photon emission for (n,n\*)he3

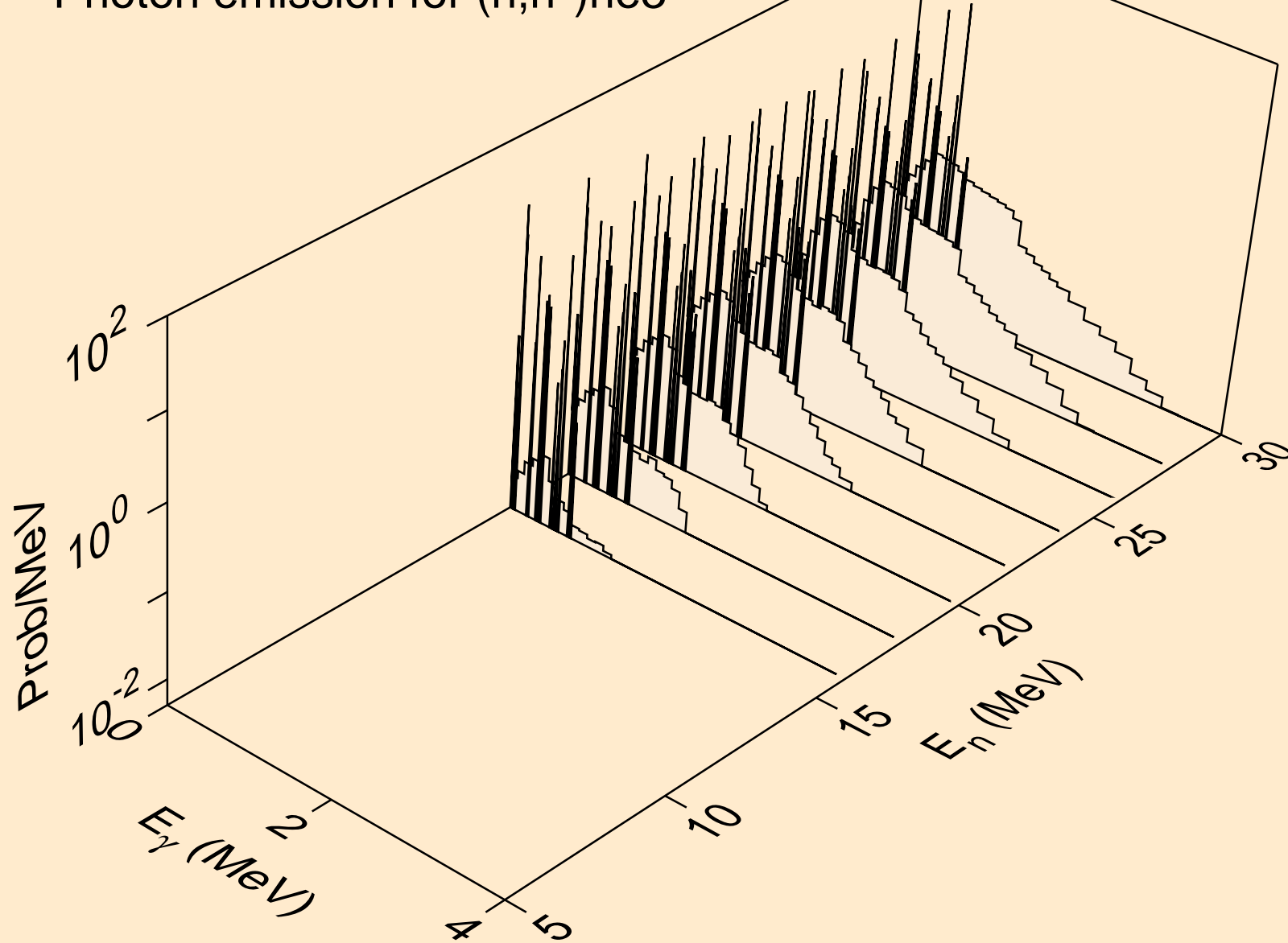

TL204 TRITON ACER TENDL-2021 LIBRARY; T=0.K  
Photon emission for (n,4n)

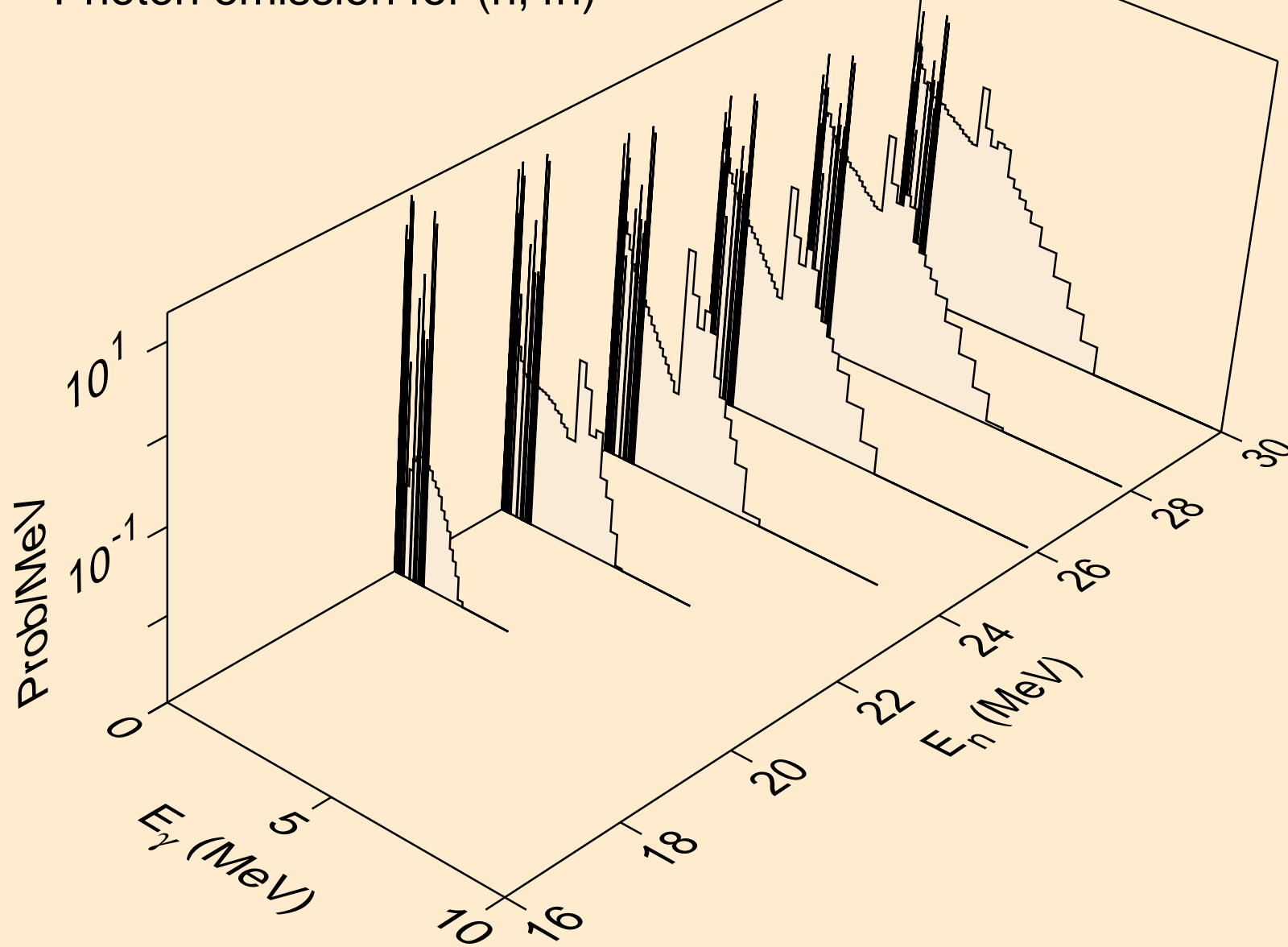

TL204 TRITON ACER TENDL-2021 LIBRARY; T=0.K  
Photon emission for (n,2np)

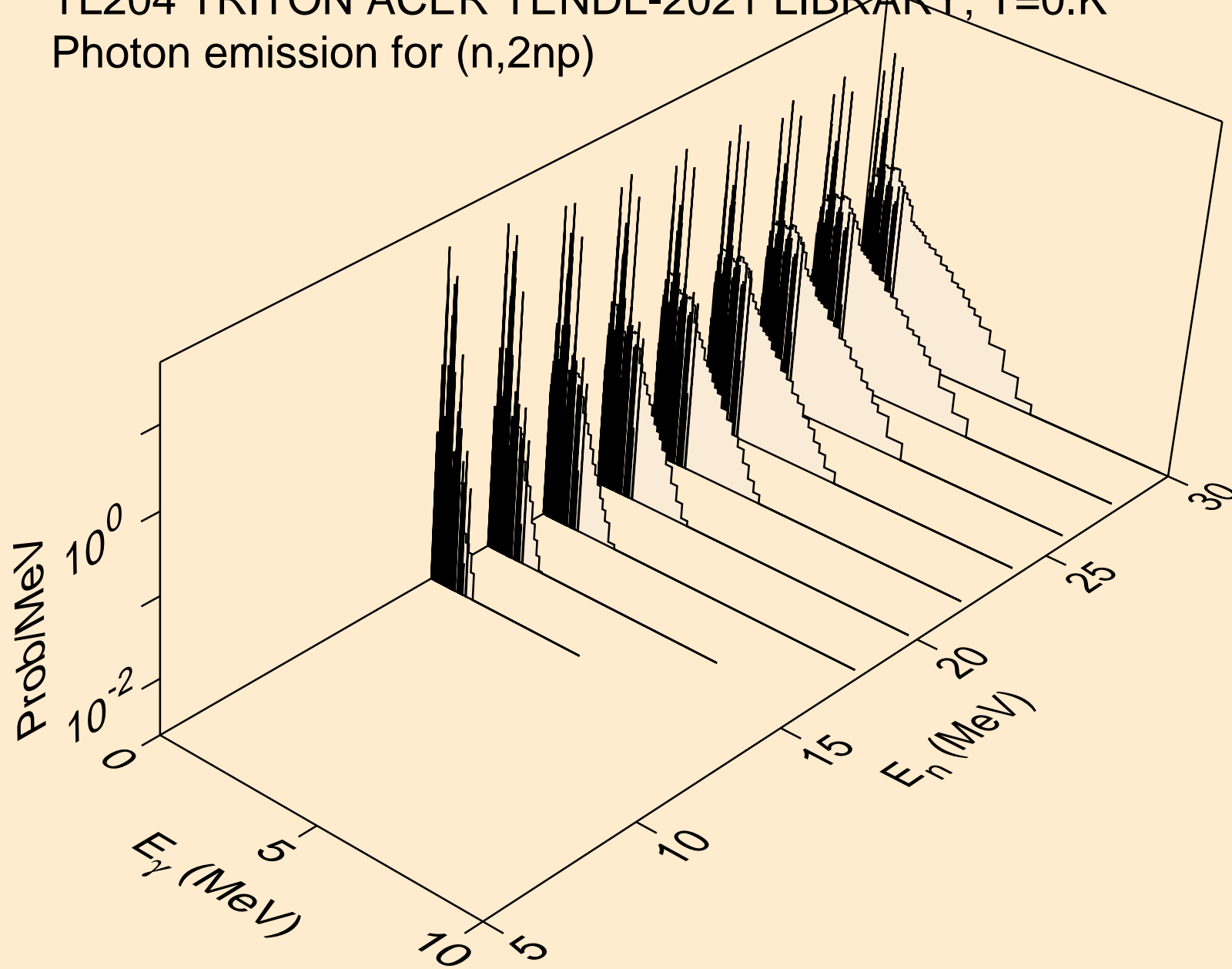

TL204 TRITON ACER TENDL-2021 LIBRARY; T=0.K  
Photon emission for (n,3np)

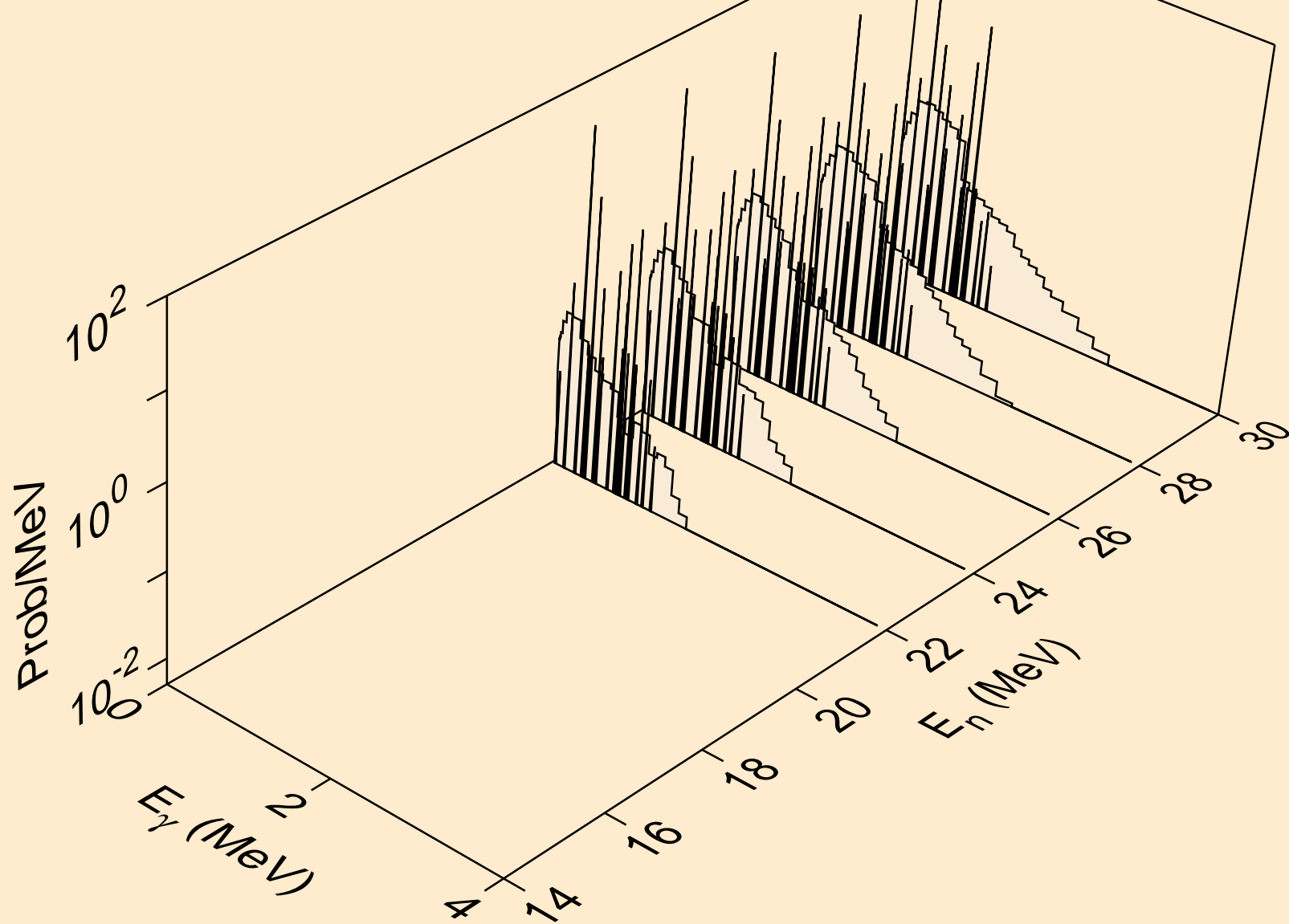

TL204 TRITON ACER TENDL-2021 LIBRARY; T=0.K  
Photon emission for (n,2np)

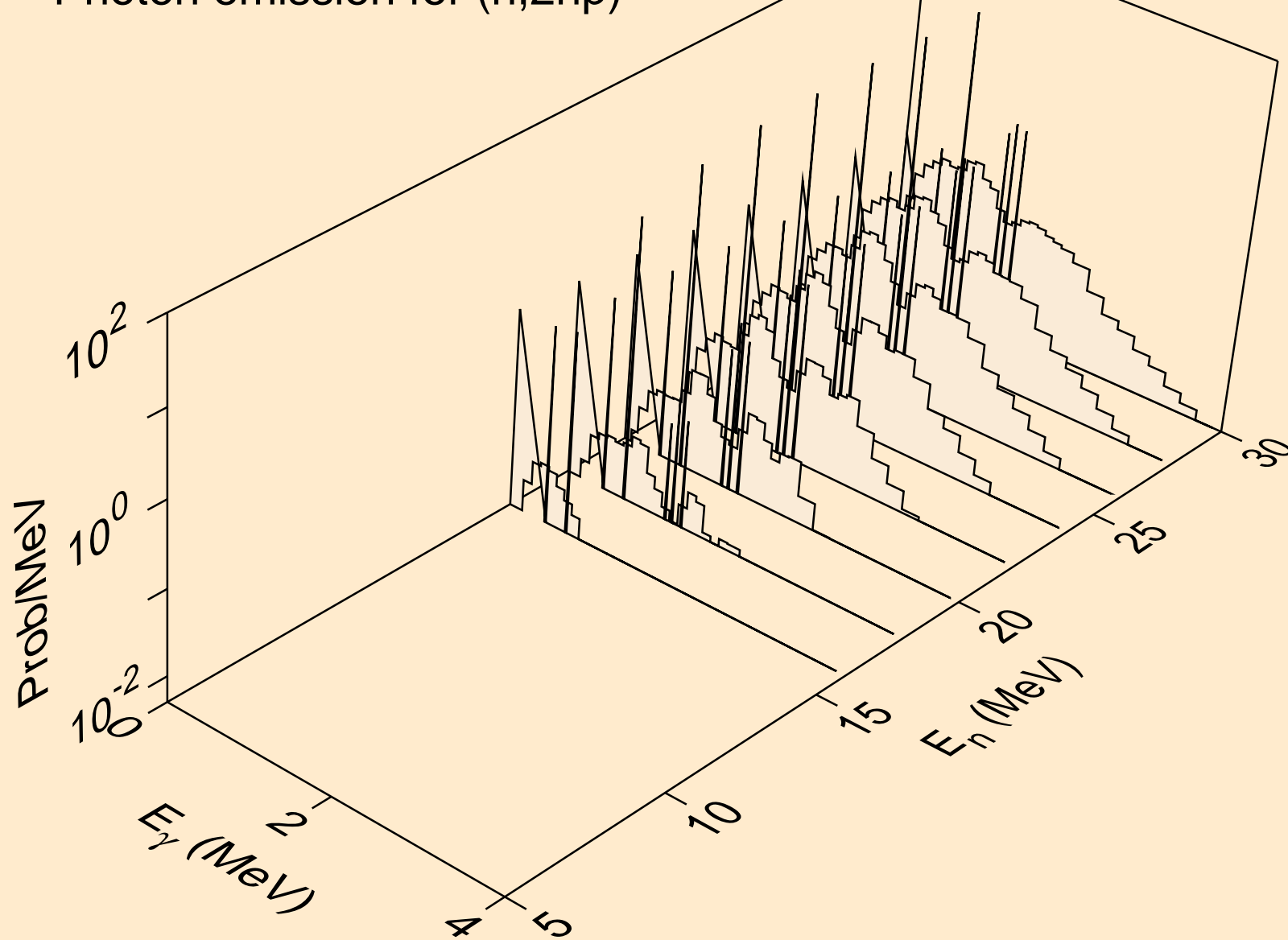

TL204 TRITON ACER TENDL-2021 LIBRARY; T=0.K  
Photon emission for (n,npa)

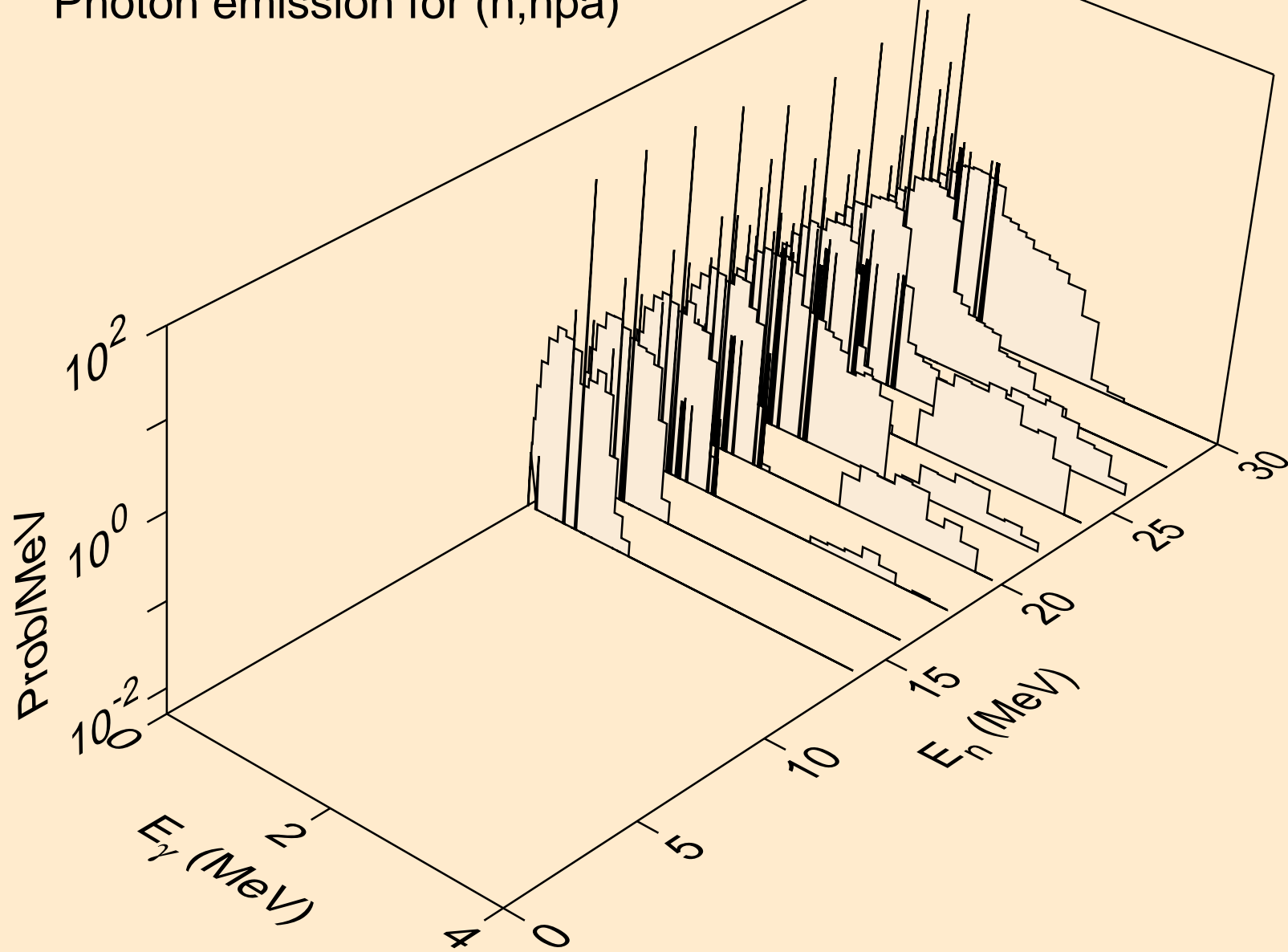

TL204 TRITON ACER TENDL-2021 LIBRARY; T=0.K  
Photon emission for (n,gma)

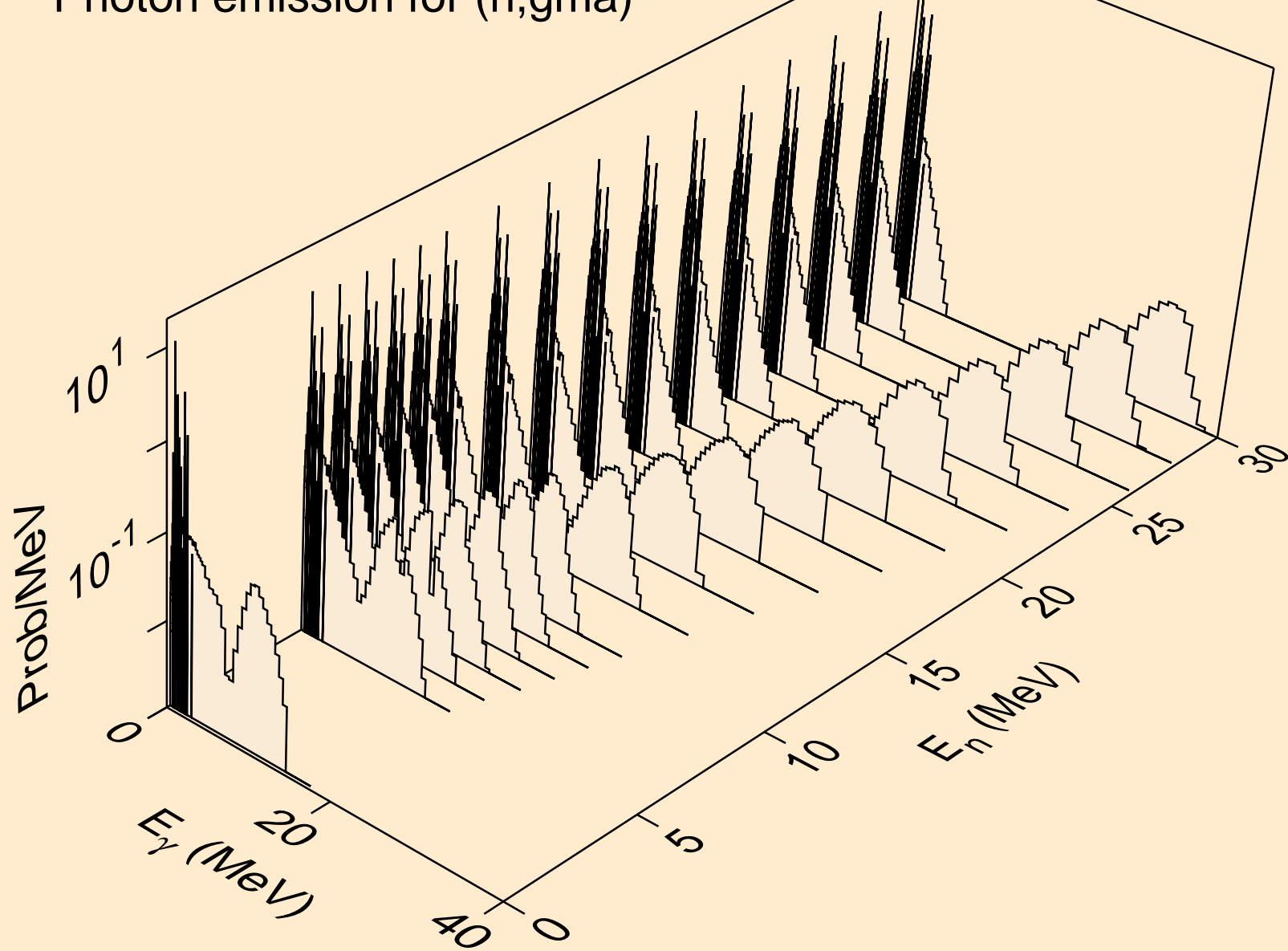

TL204 TRITON ACER TENDL-2021 LIBRARY; T=0.K  
Photon emission for (n,p)

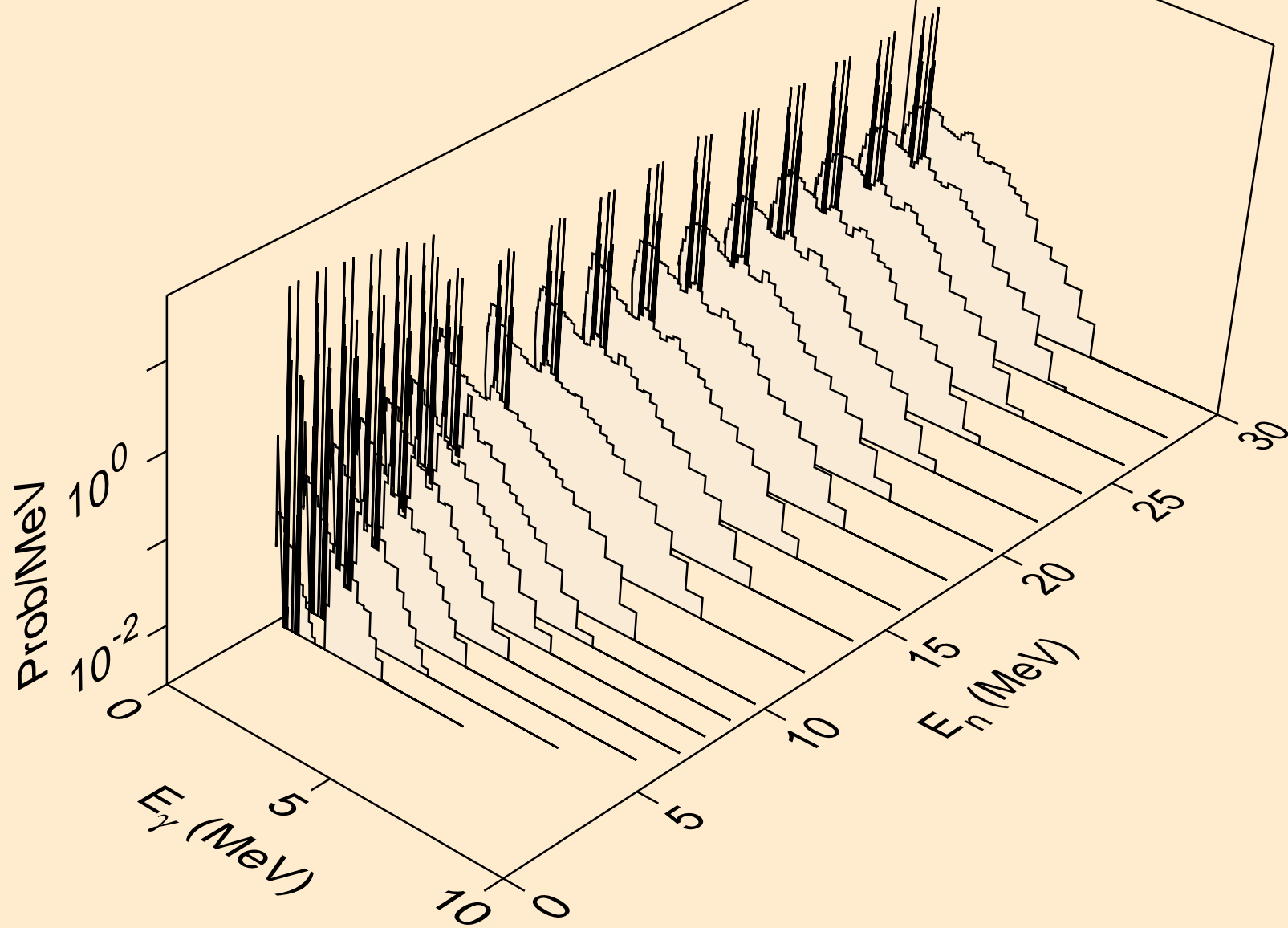



TL204 TRITON ACER TENDL-2021 LIBRARY; T=0.K  
Photon emission for (n,d)

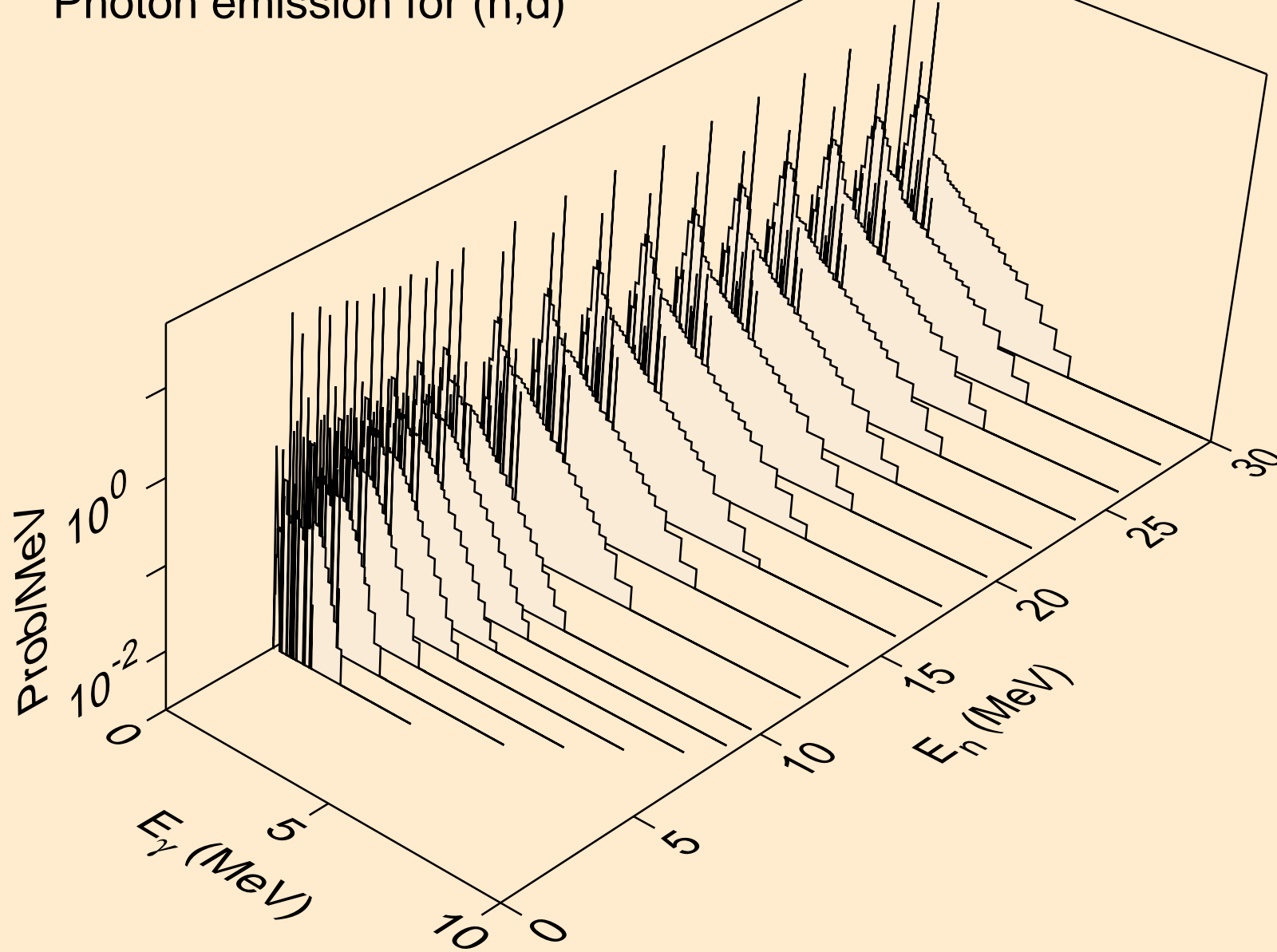

TL204 TRITON ACER TENDL-2021 LIBRARY; T=0.K  
Photon emission for inelastic

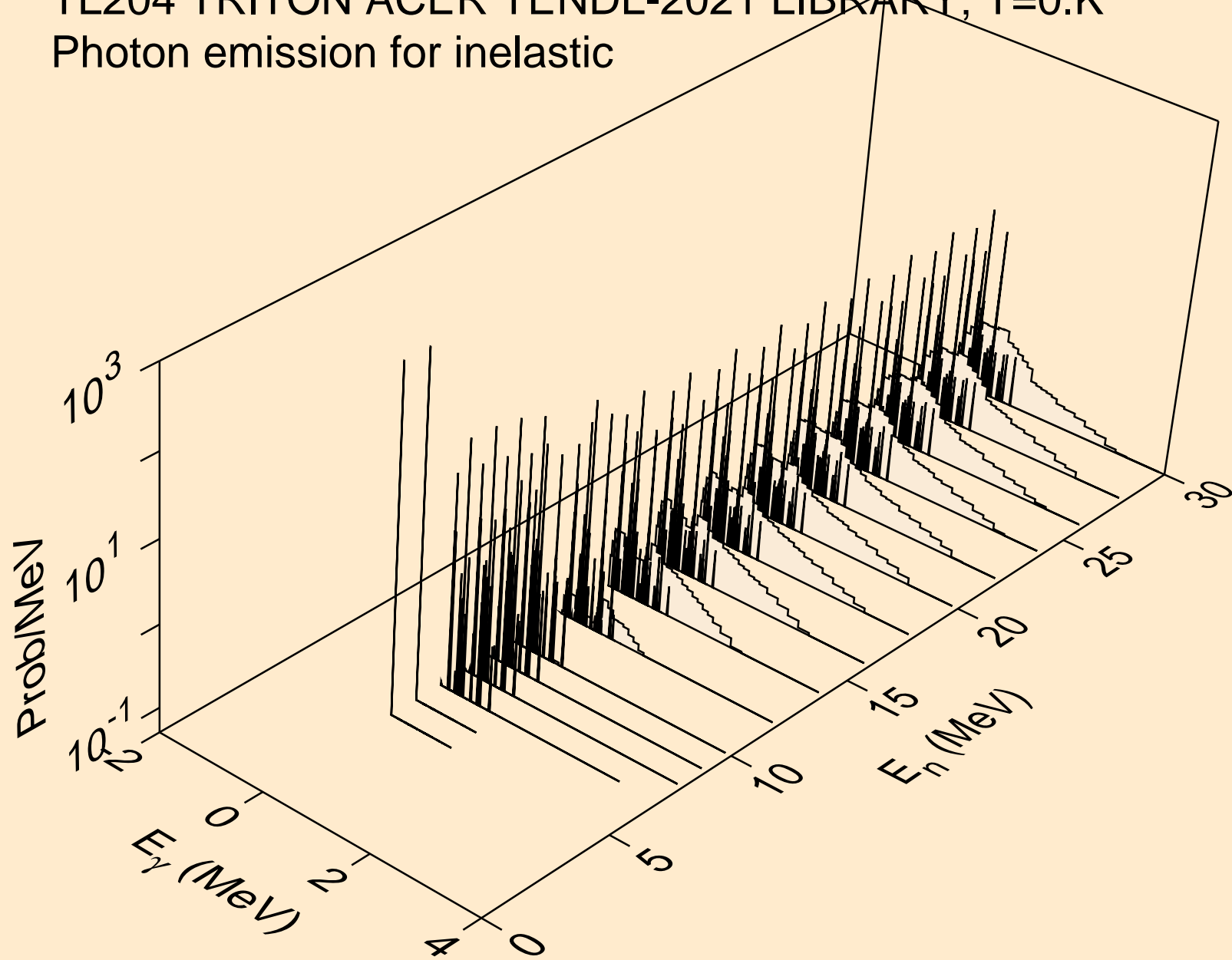

TL204 TRITON ACER TENDL-2021 LIBRARY; T=0.K  
Photon emission for (n,he3)

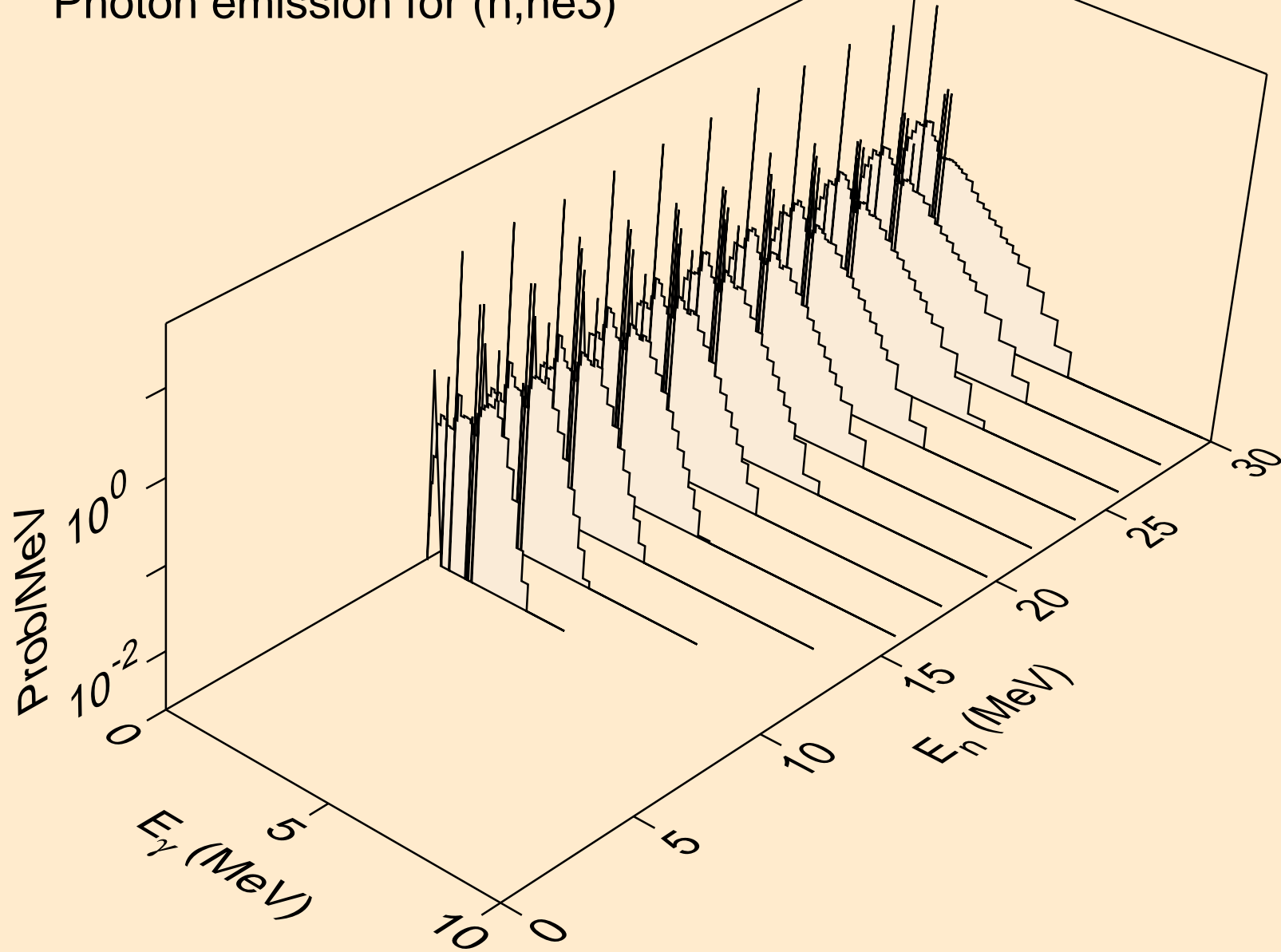

TL204 TRITON ACER TENDL-2021 LIBRARY; T=0.K  
Photon emission for (n,a)

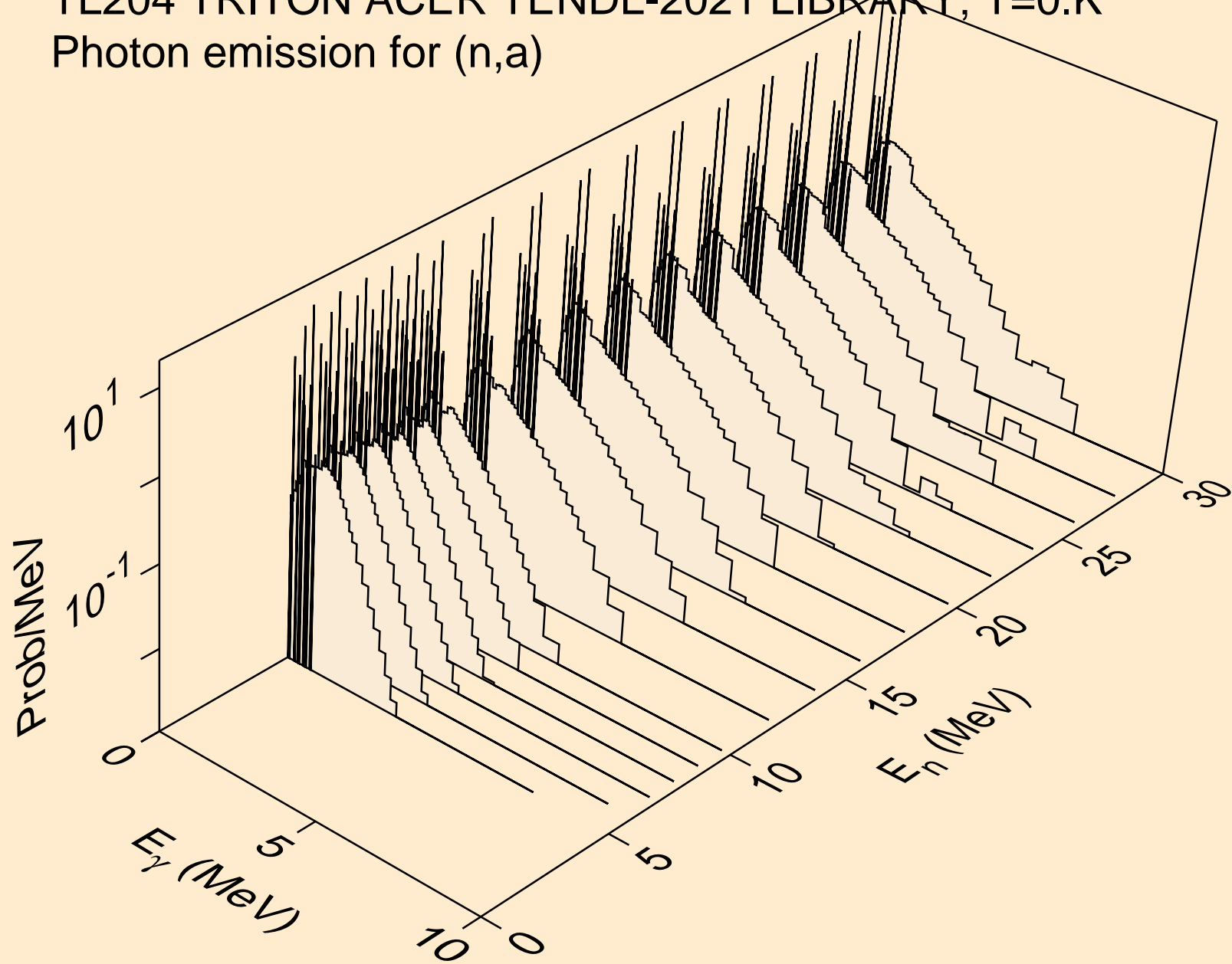

TL204 TRITON ACER TENDL-2021 LIBRARY; T=0.K  
Photon emission for (n,2p)

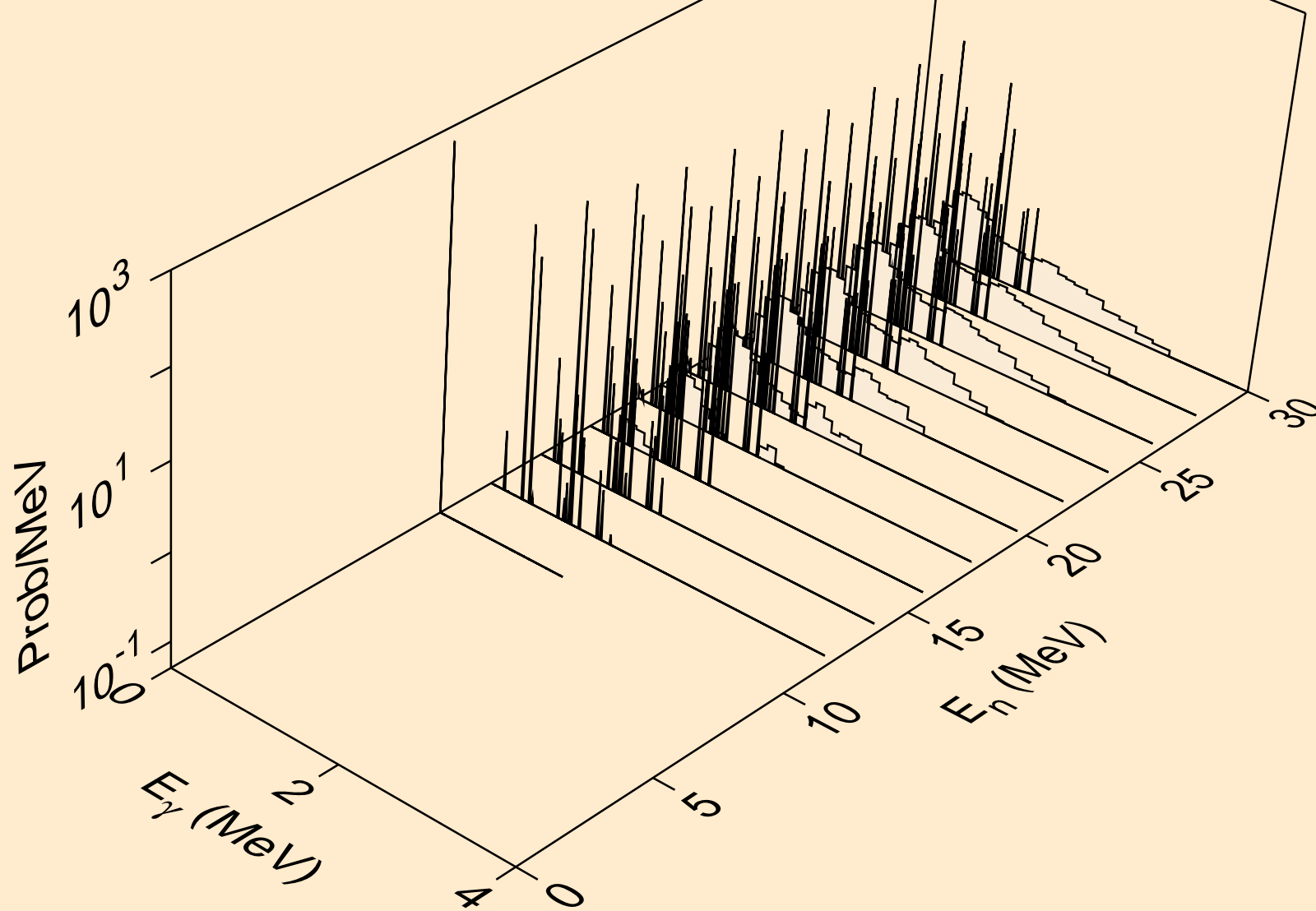

TL204 TRITON ACER TENDL-2021 LIBRARY; T=0.K  
Photon emission for (n,pa)

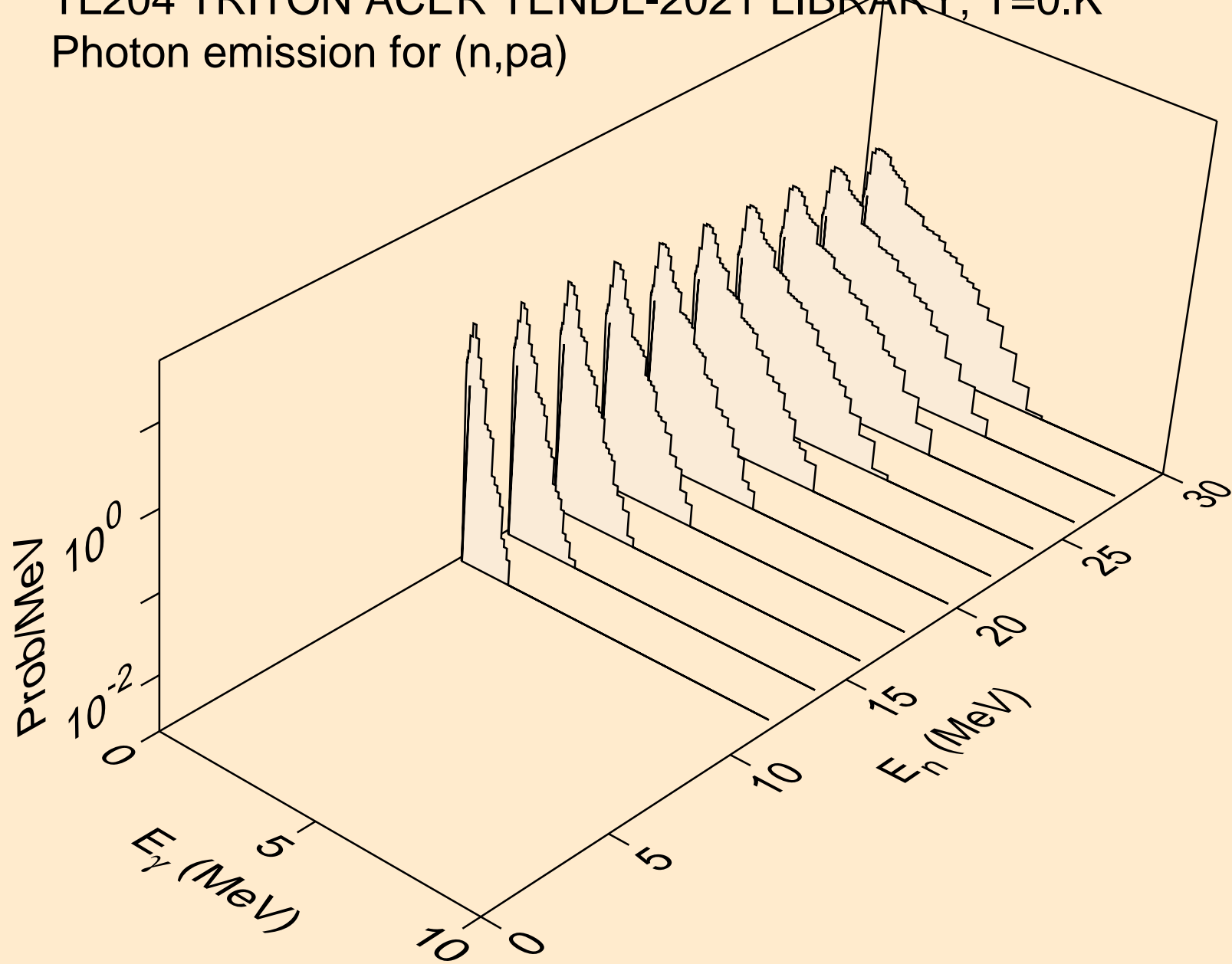

TL204 TRITON ACER TENDL-2021 LIBRARY; T=0.K  
Photon emission for (n,pd)

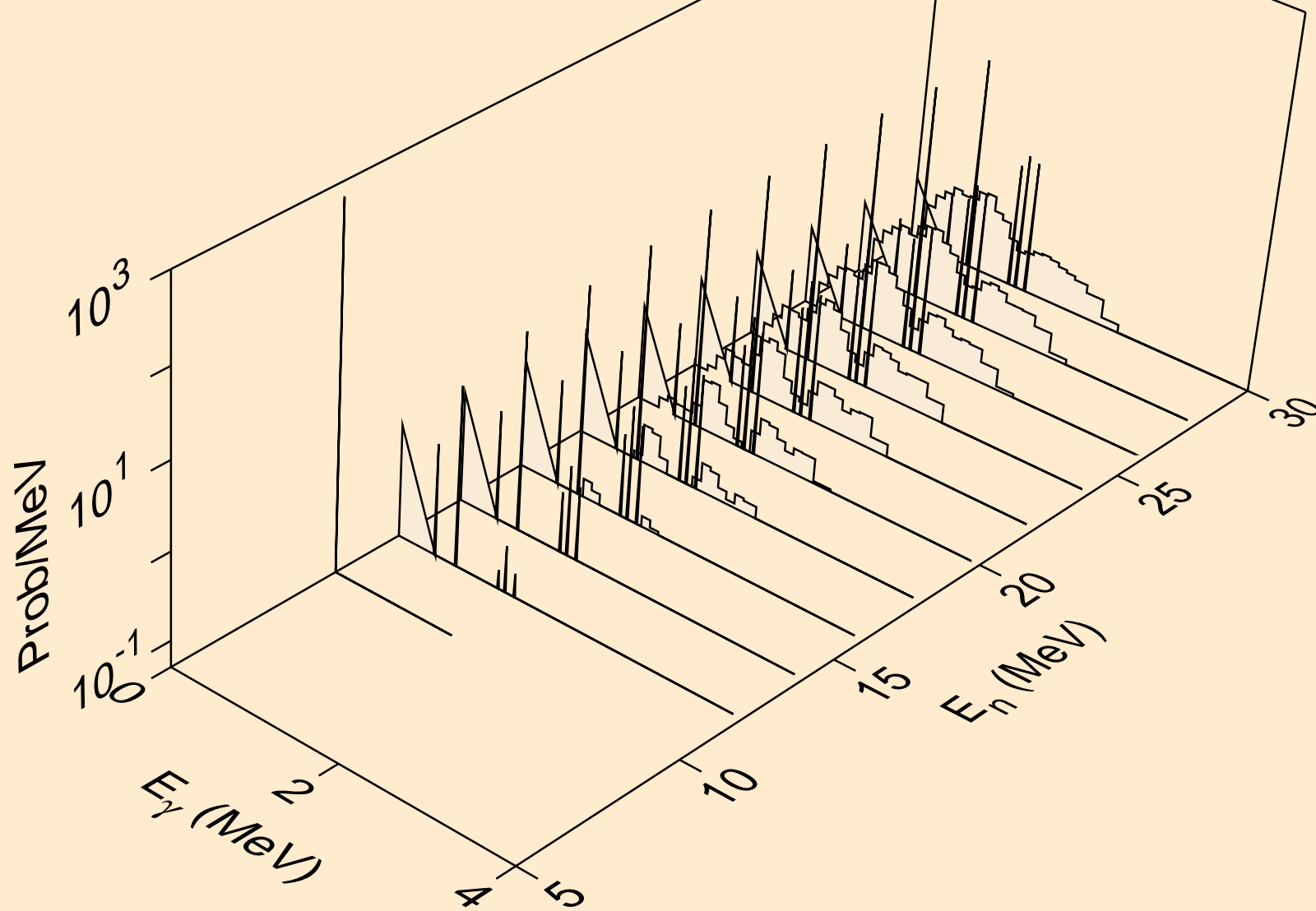

TL204 TRITON ACER TENDL-2021 LIBRARY; T=0.K  
Photon emission for (n,pt)

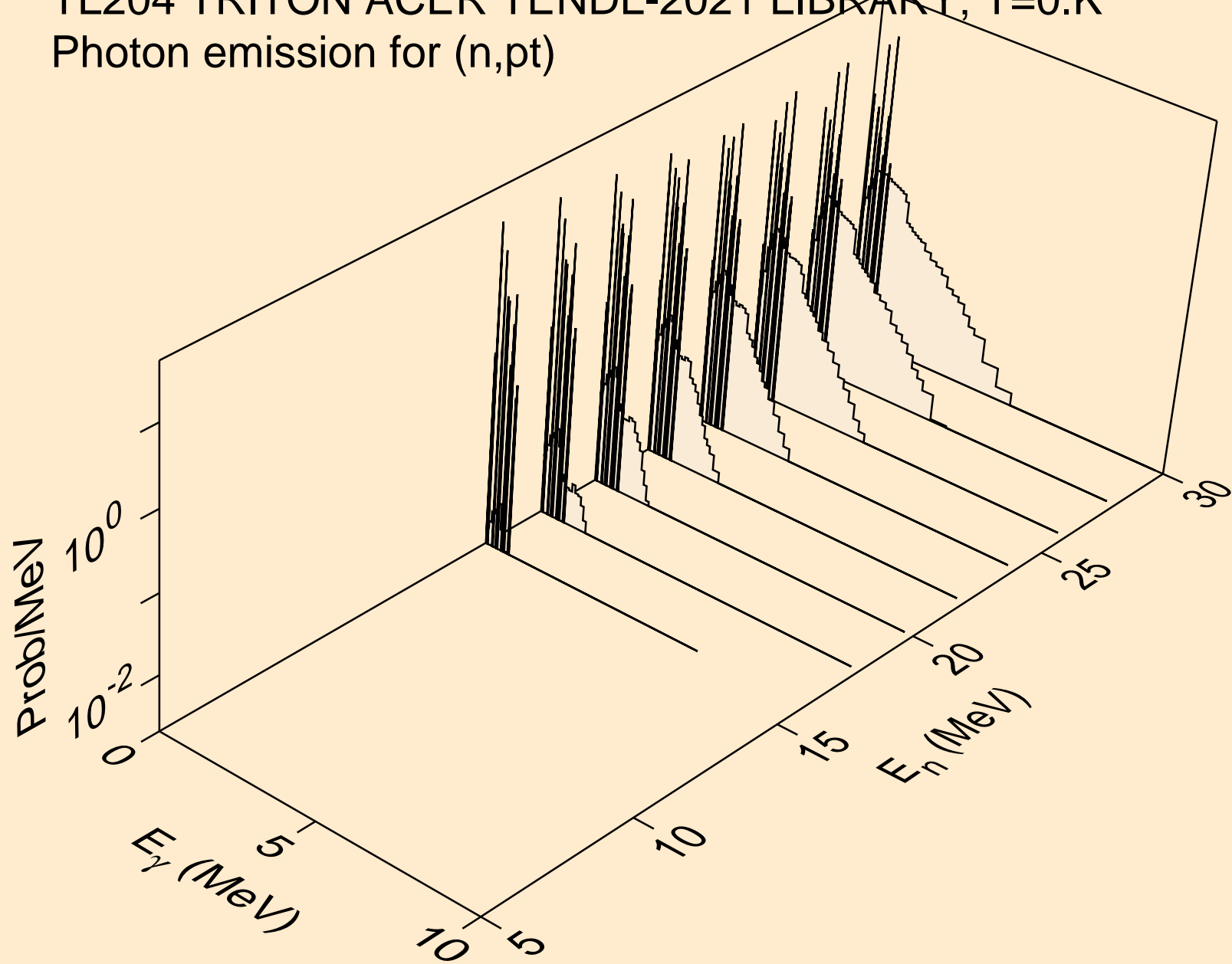



TL204 TRITON ACER TENDL-2021 LIBRARY; T=0.K  
Photon emission for (n,da)

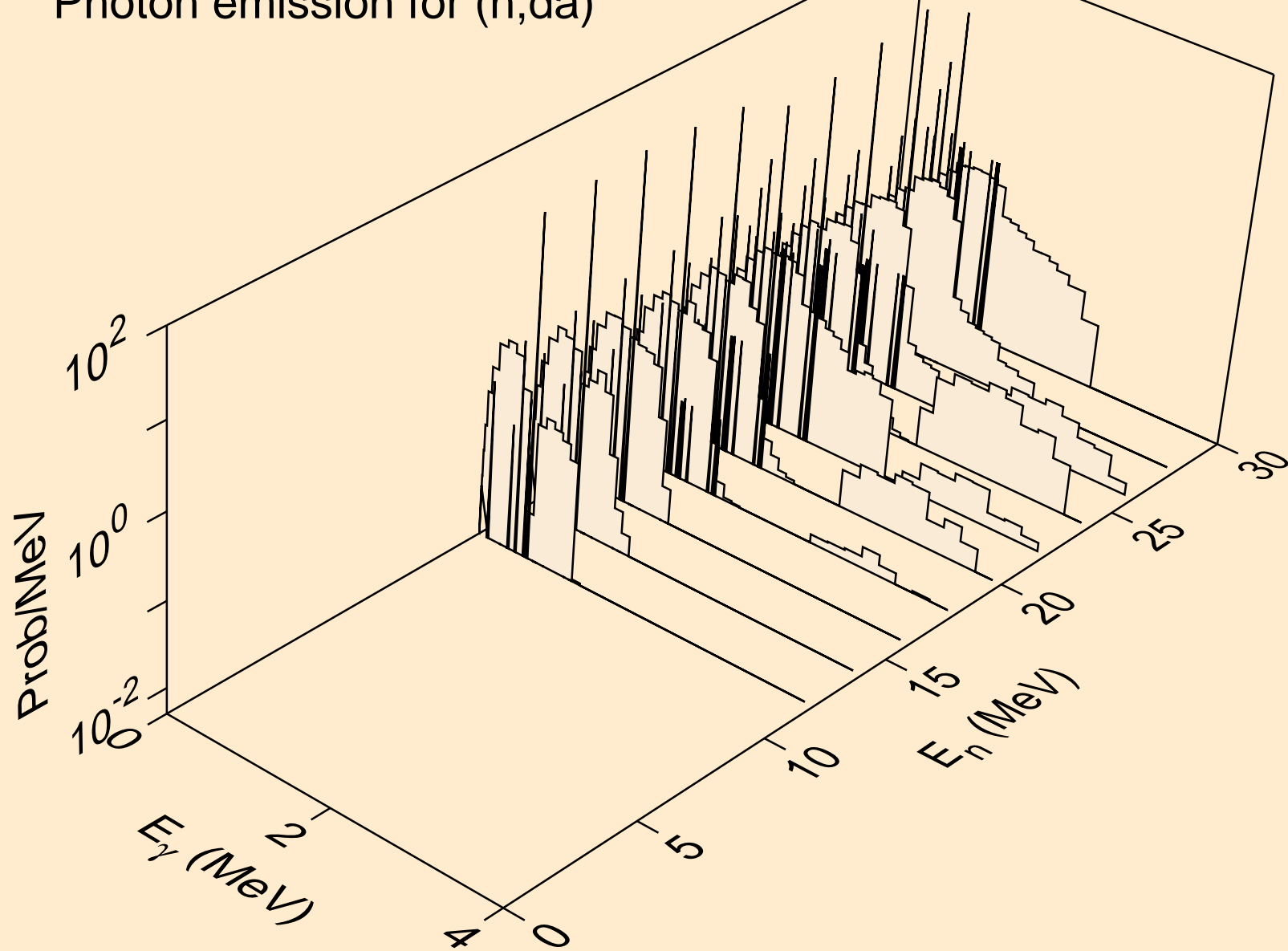

TL204 TRITON ACER TENDL-2021 LIBRARY; T=0.K  
Particle heating contributions

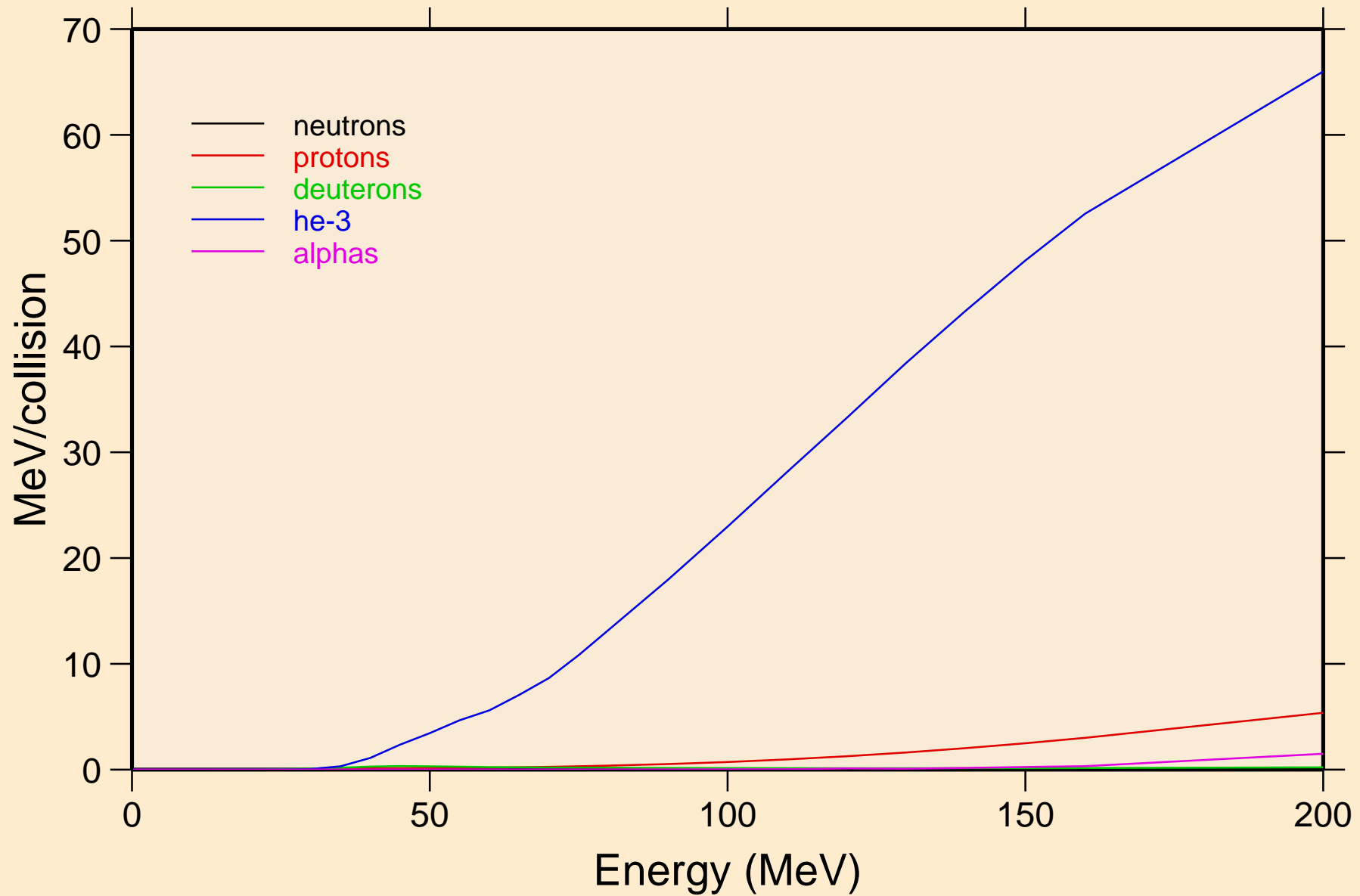

TL204 TRITON ACER TENDL-2021 LIBRARY; T=0.K  
Recoil Heating

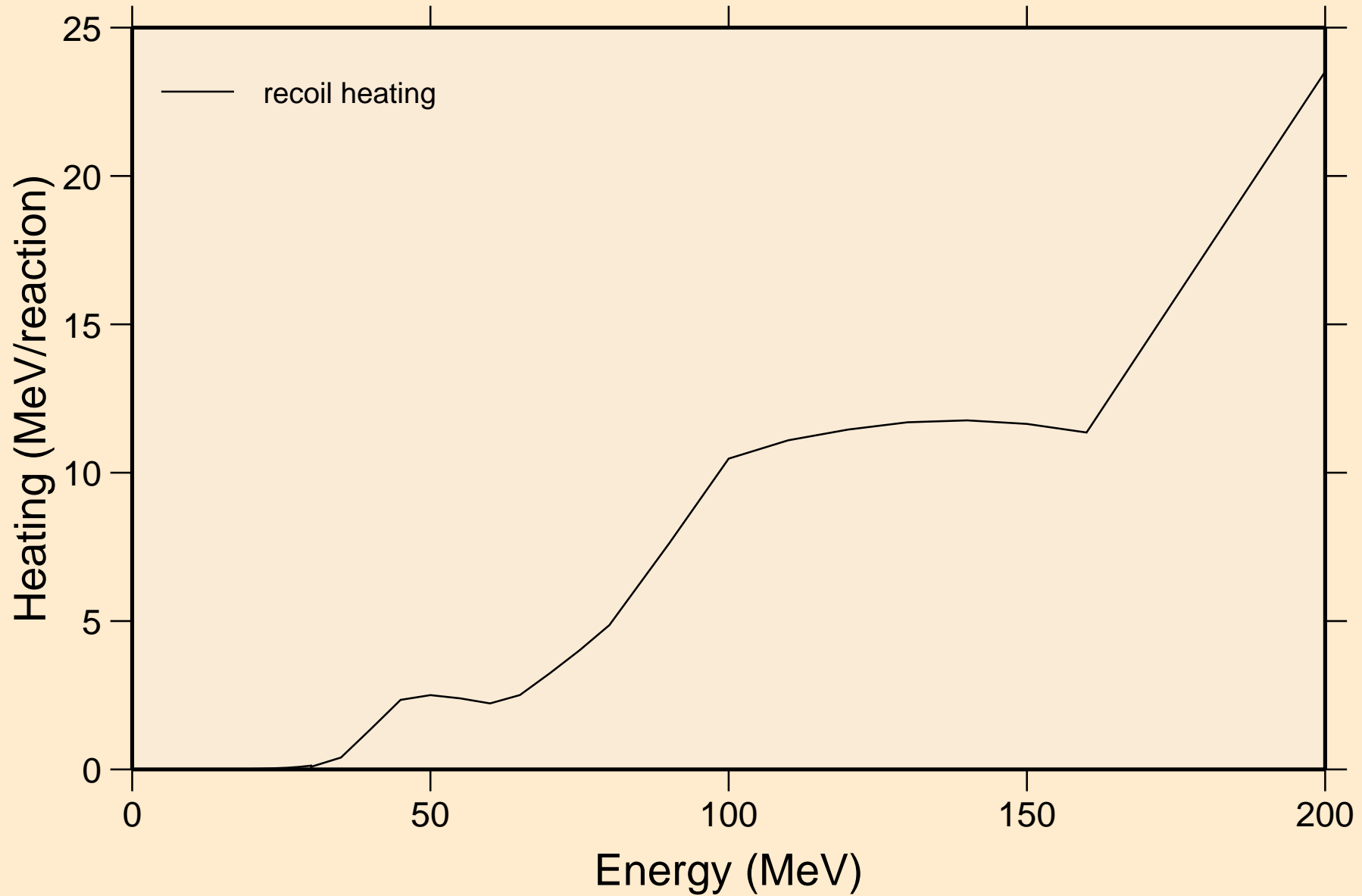

TL204 TRITON ACER TENDL-2021 LIBRARY; T=0.K  
Particle production cross sections

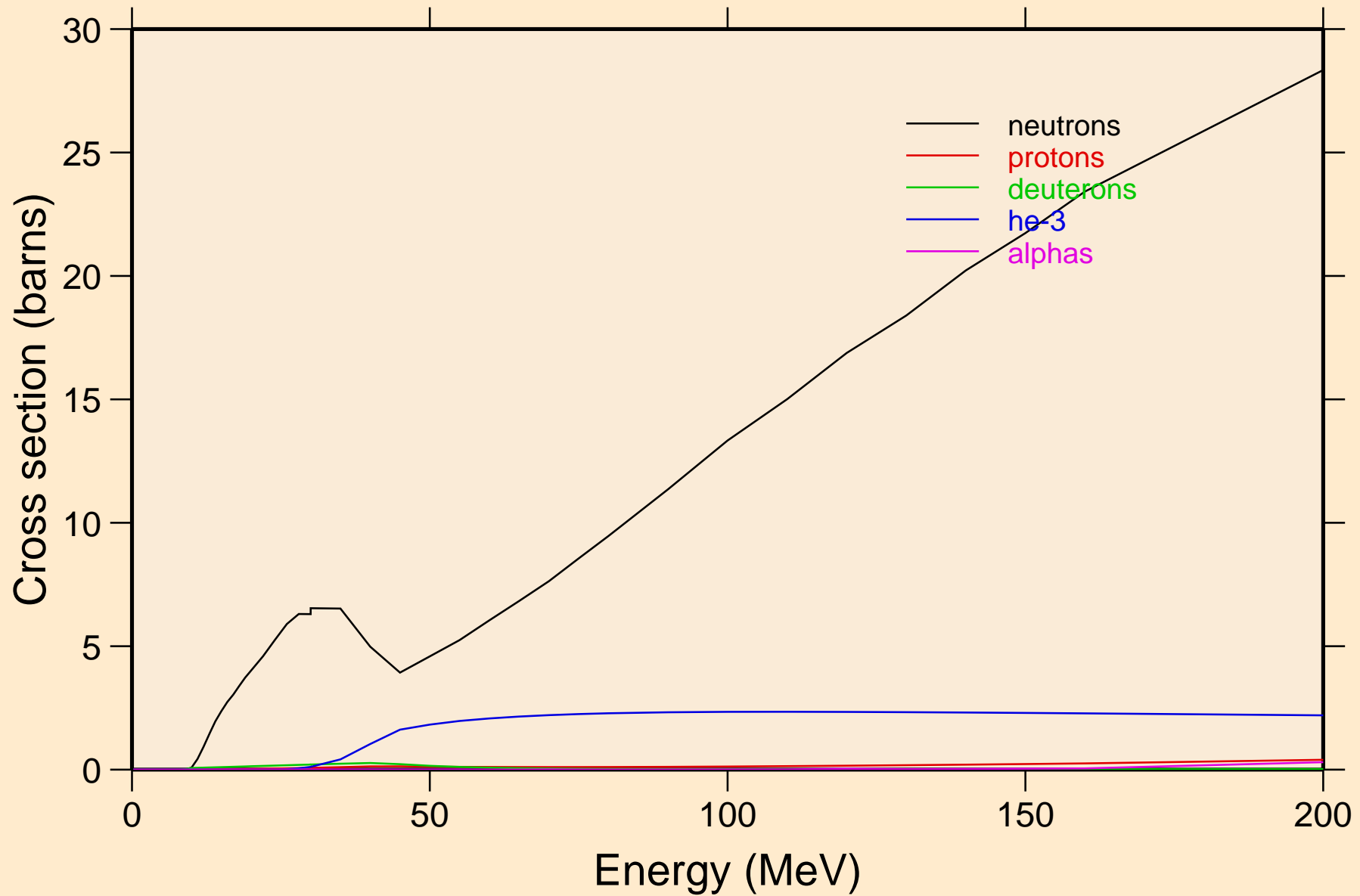

TL204 TRITON ACER TENDL-2021 LIBRARY; T=0.K  
neutrons from (t,n)

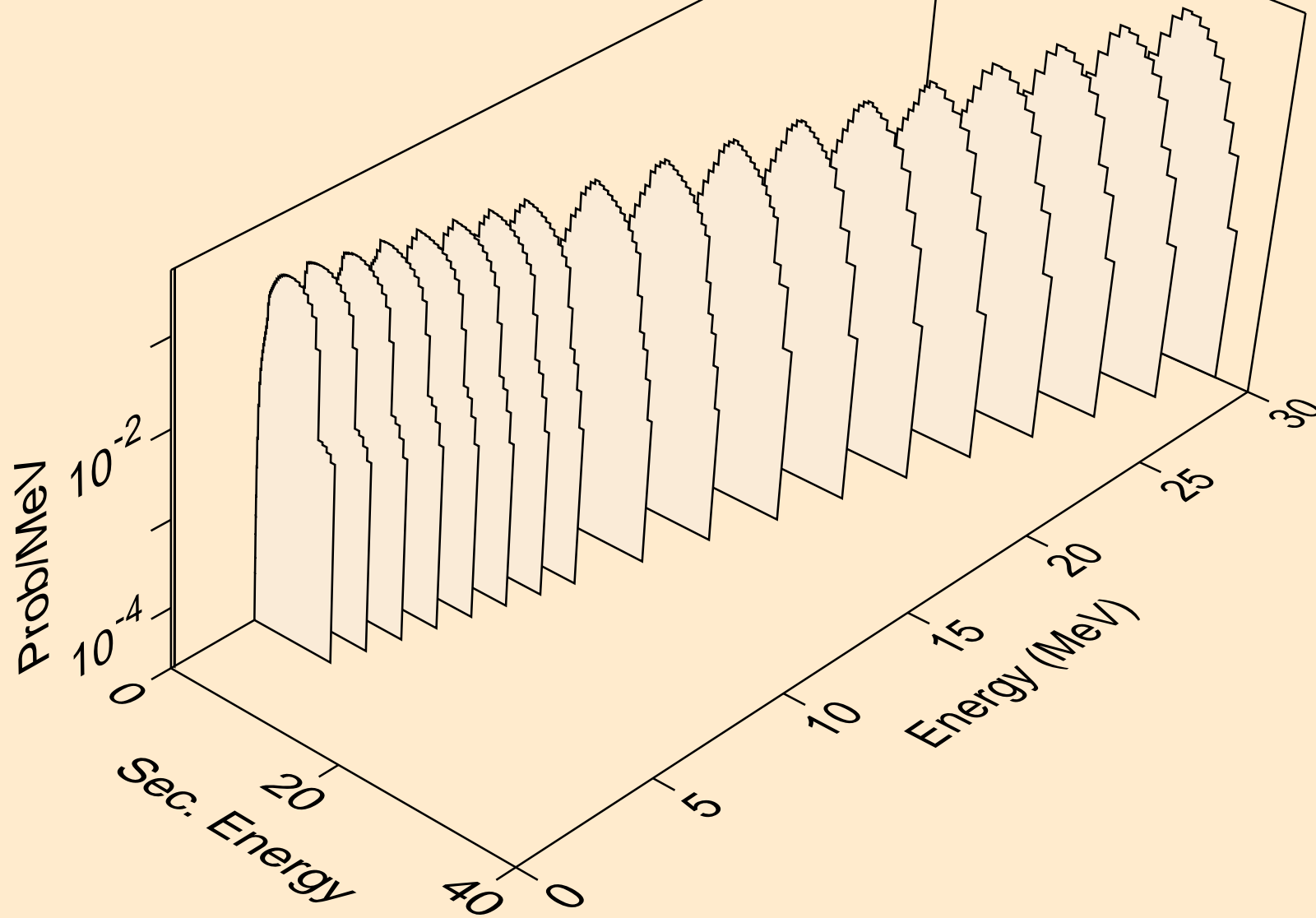

TL204 TRITON ACER TENDL-2021 LIBRARY; T=0.K  
neutrons from (t,x)

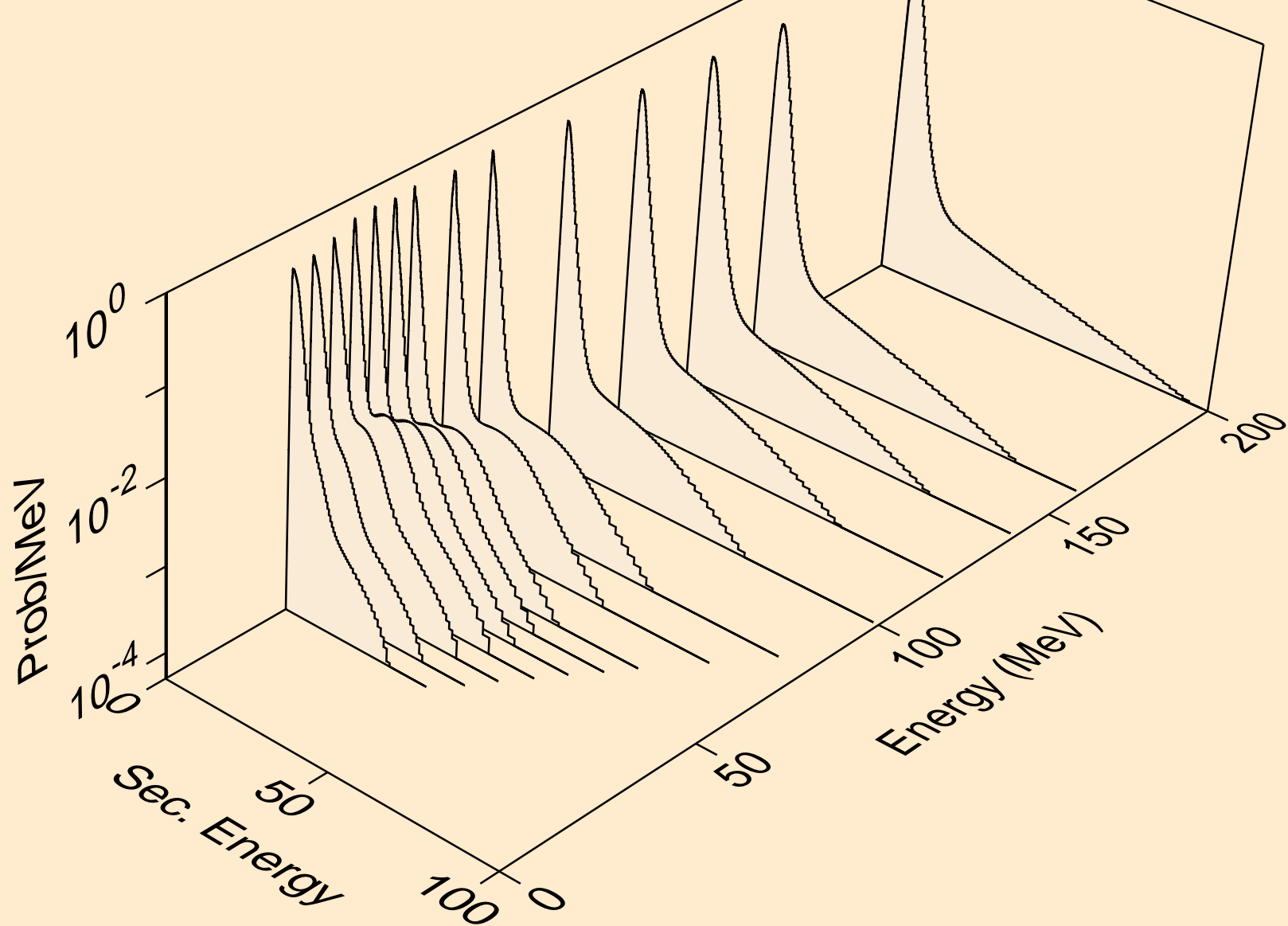

TL204 TRITON ACER TENDL-2021 LIBRARY; T=0.K  
neutrons from (t,2nd)

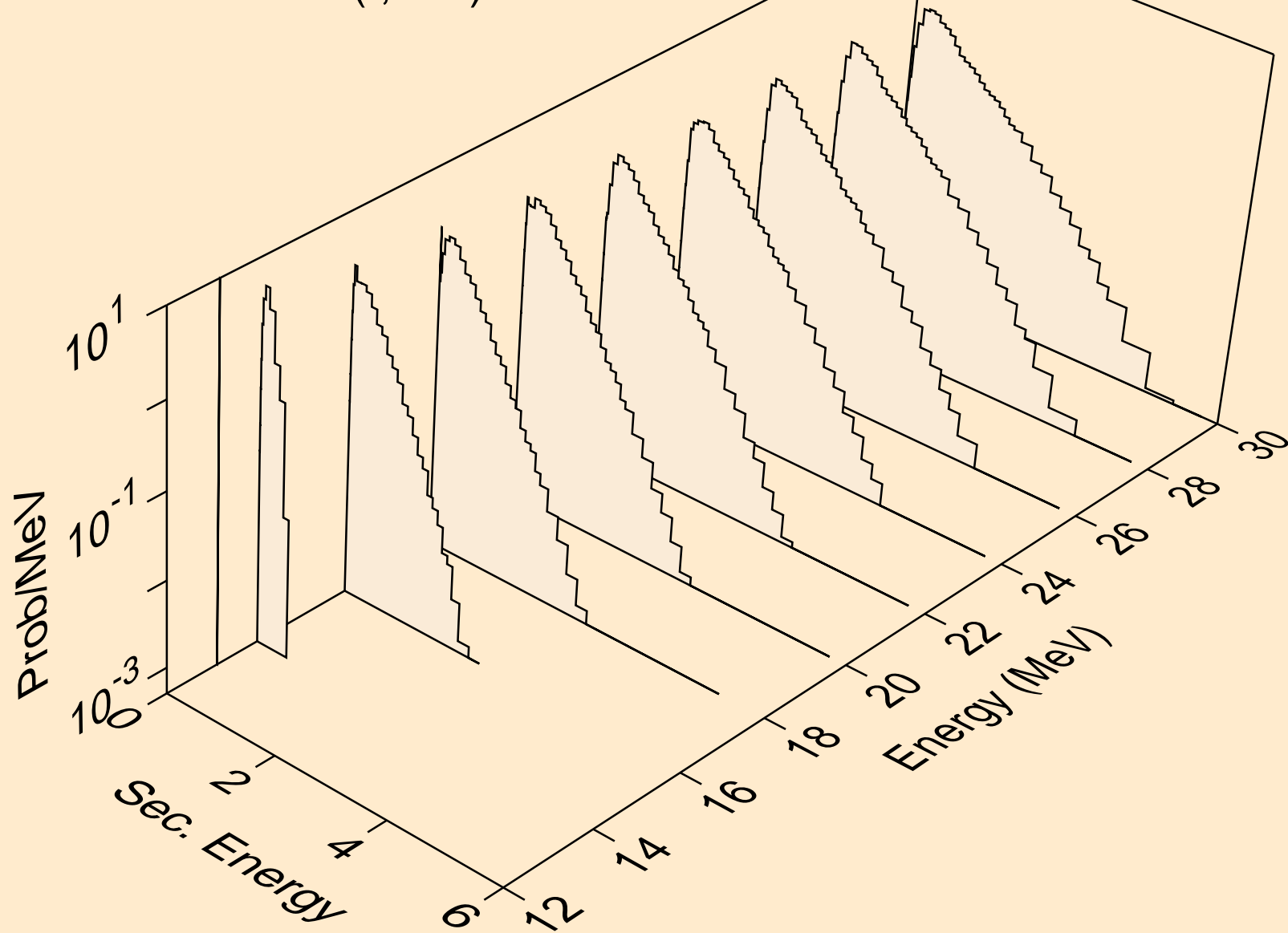

TL204 TRITON ACER TENDL-2021 LIBRARY; T=0.K  
neutrons from (t,2n)

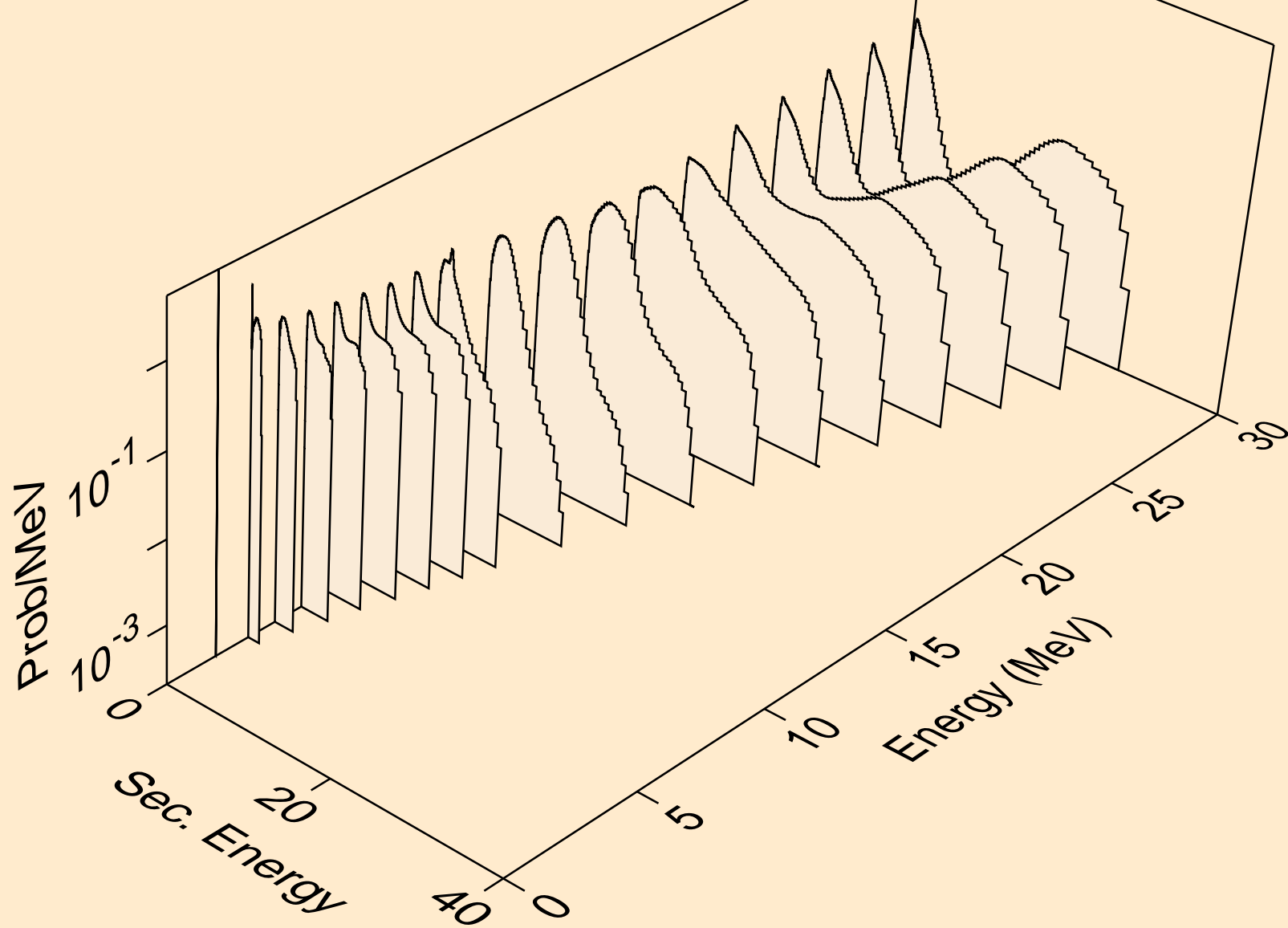



TL204 TRITON ACER TENDL-2021 LIBRARY; T=0.K  
neutrons from (t,3n)

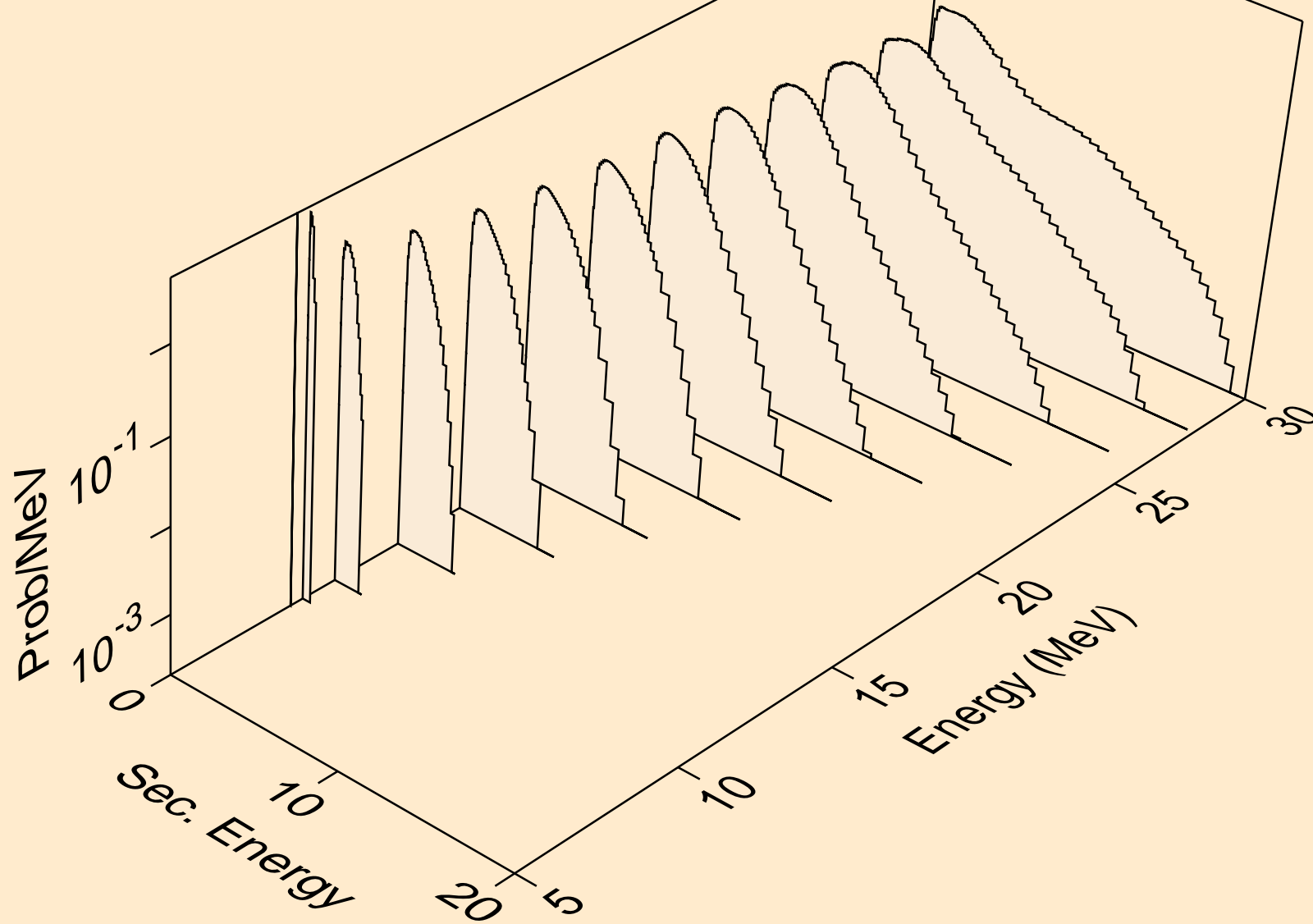

TL204 TRITON ACER TENDL-2021 LIBRARY; T=0.K  
neutrons from (t,n\*)a

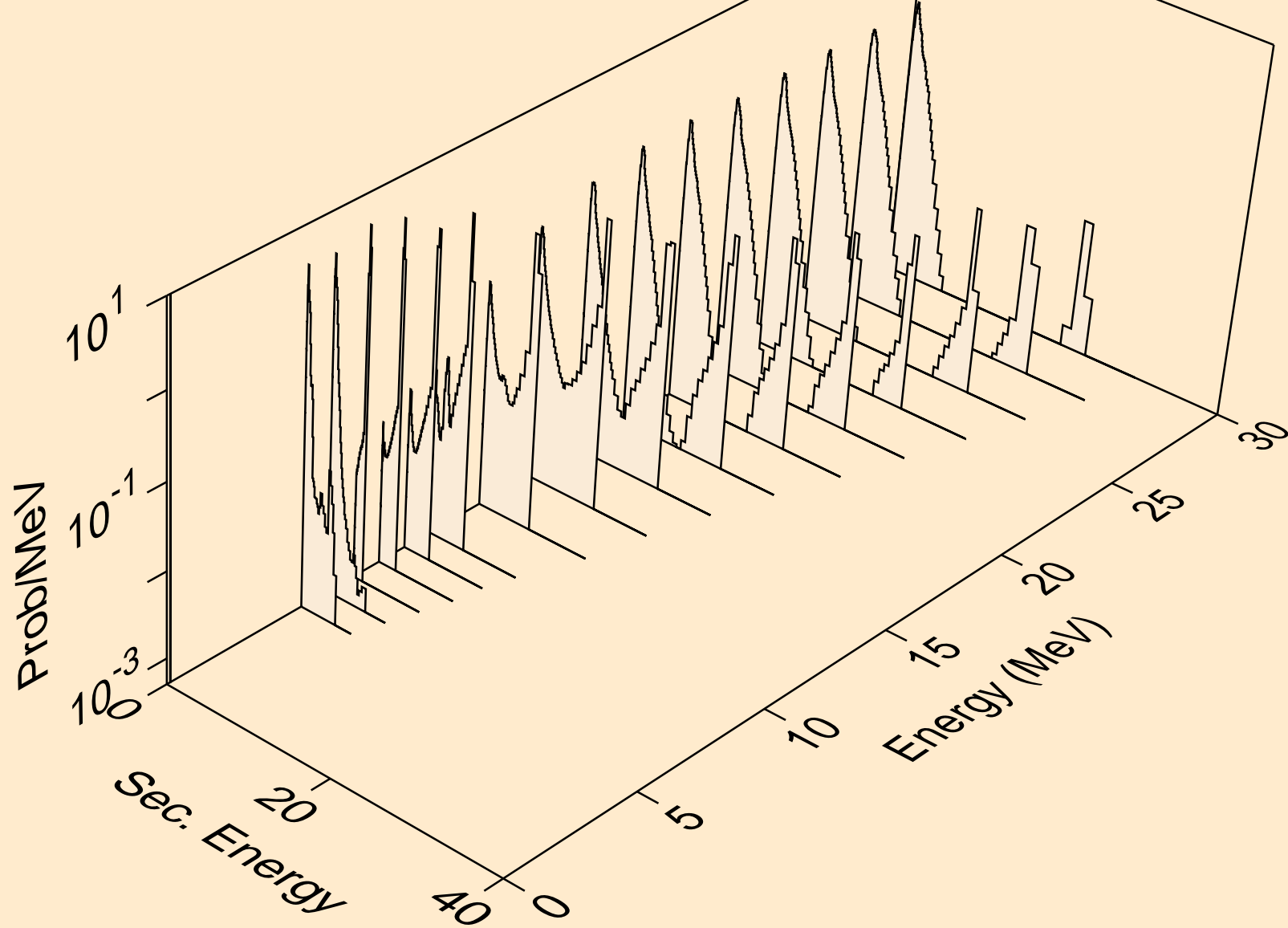

TL204 TRITON ACER TENDL-2021 LIBRARY; T=0.K  
neutrons from (t,2n)a

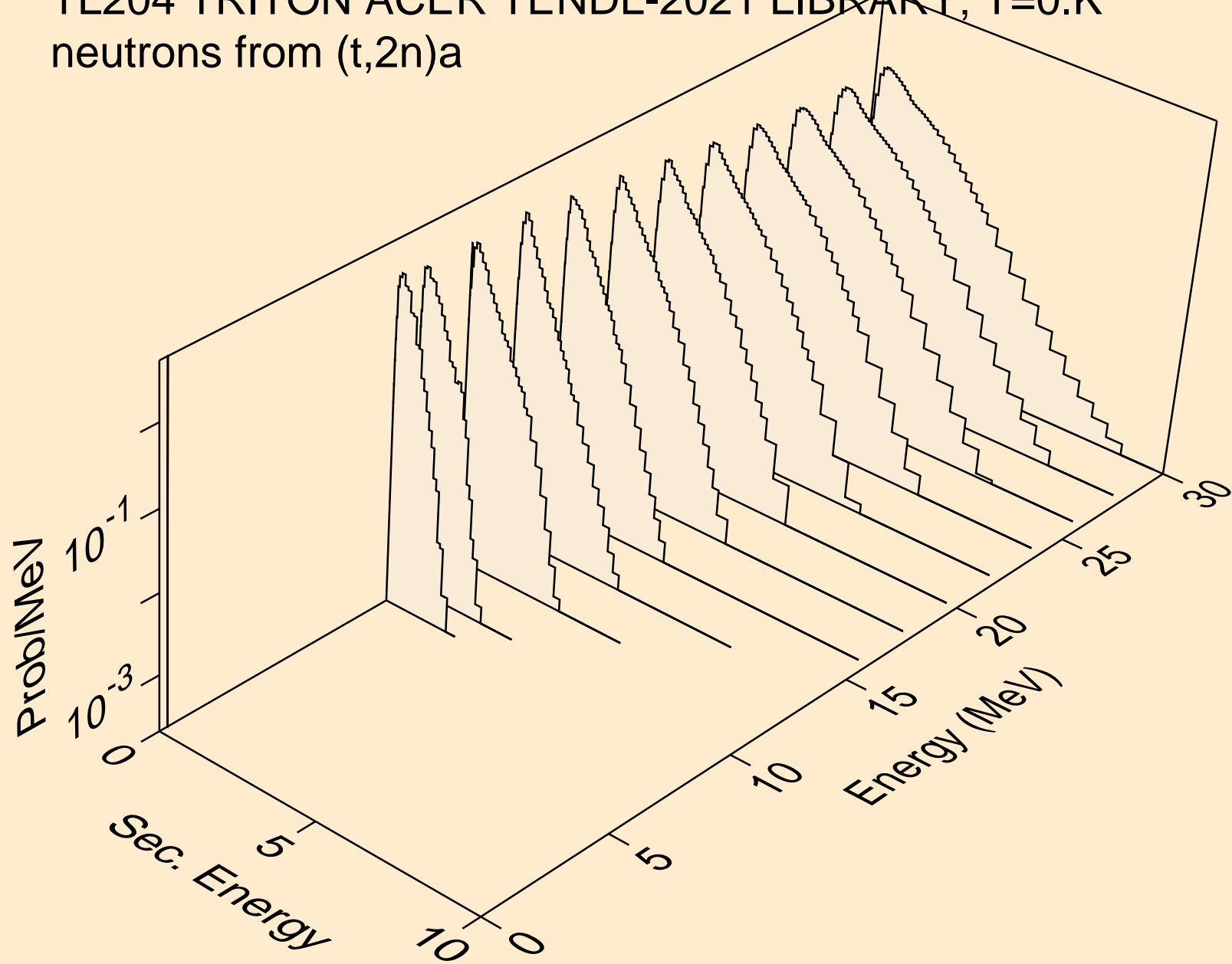

TL204 TRITON ACER TENDL-2021 LIBRARY; T=0.K  
neutrons from (t,3n)a

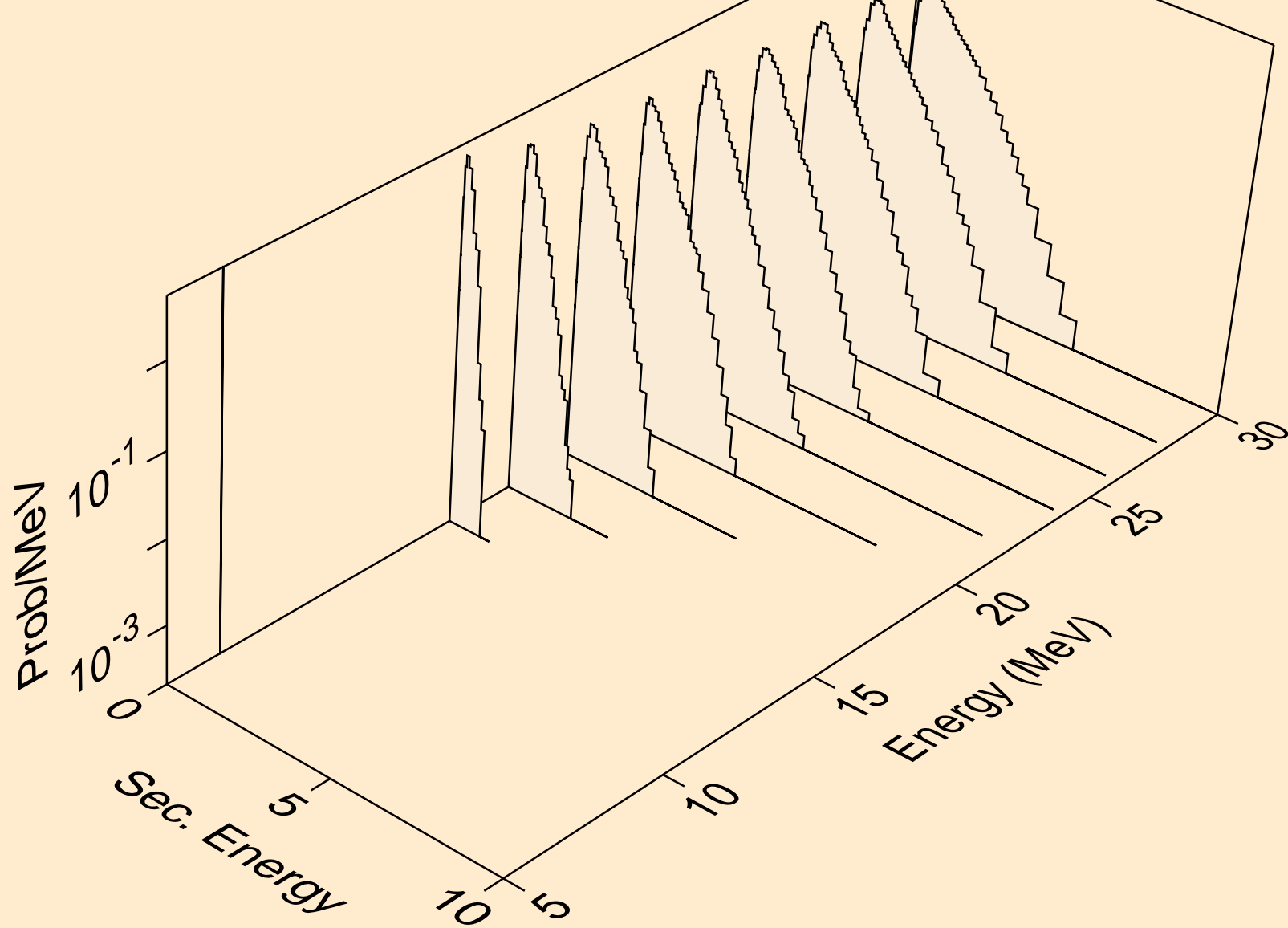

TL204 TRITON ACER TENDL-2021 LIBRARY; T=0.K  
neutrons from (t,n\*)p

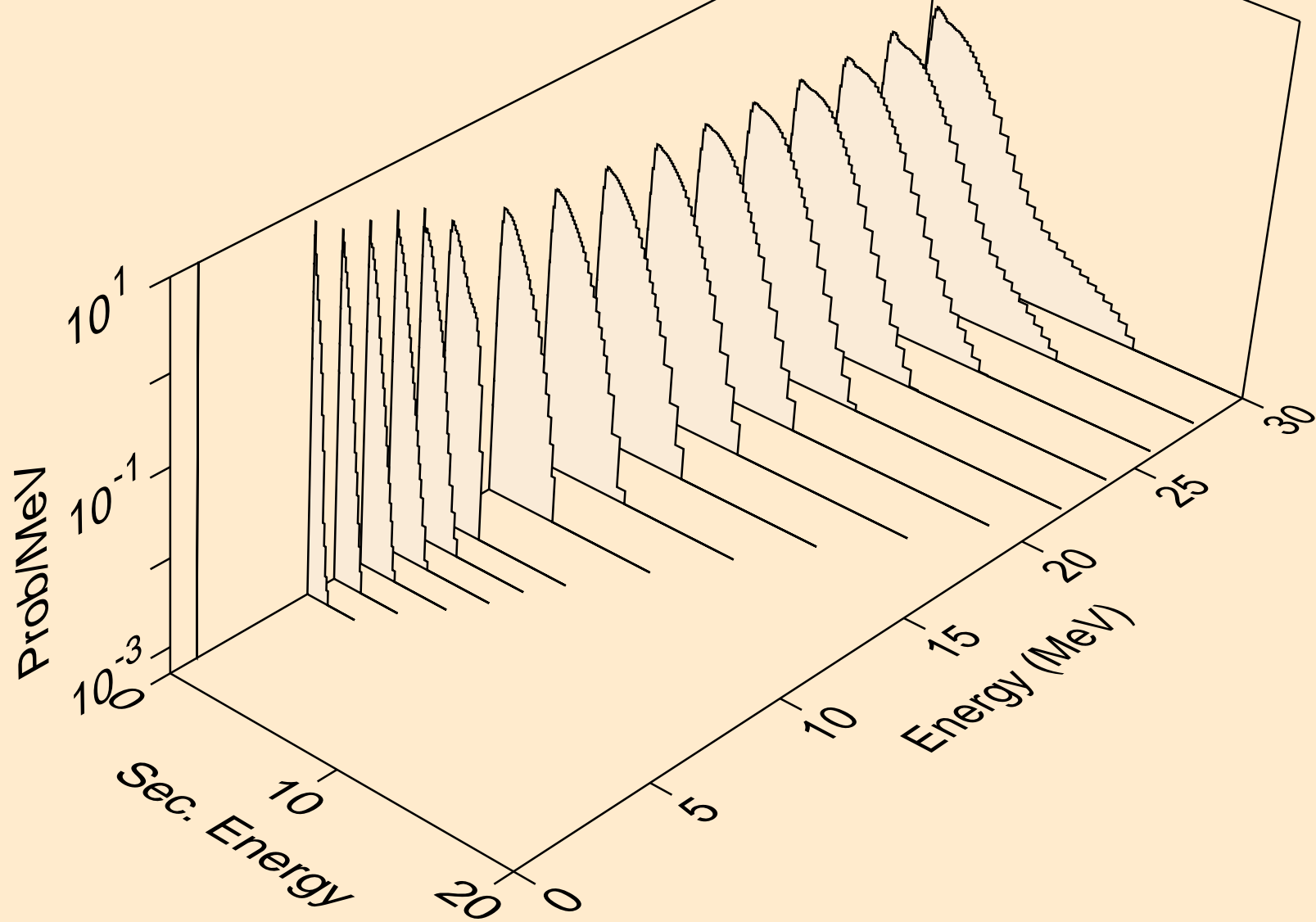

TL204 TRITON ACER TENDL-2021 LIBRARY; T=0.K  
neutrons from (t,n\*)2a

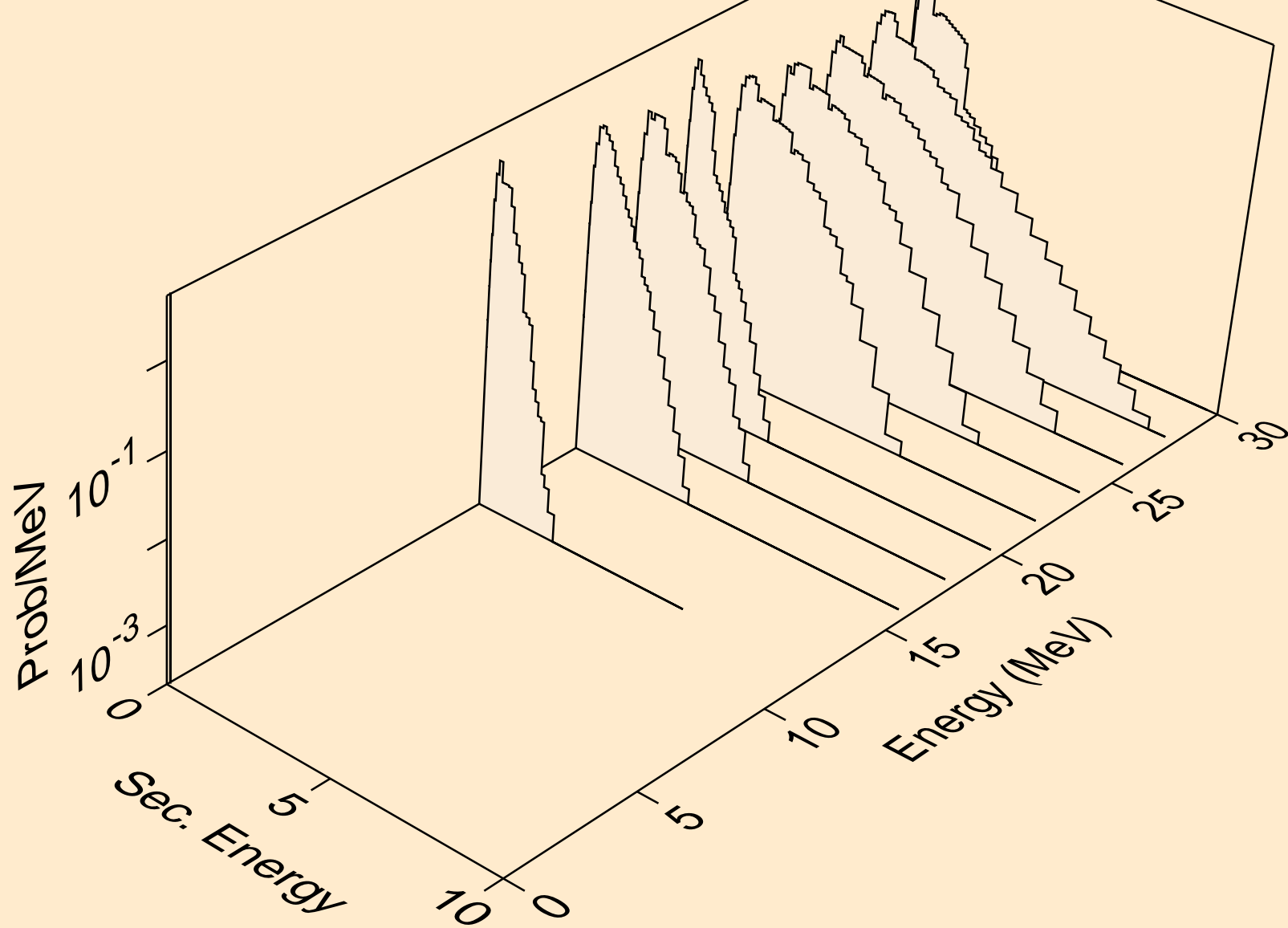

TL204 TRITON ACER TENDL-2021 LIBRARY; T=0.K  
neutrons from (t,n\*)d

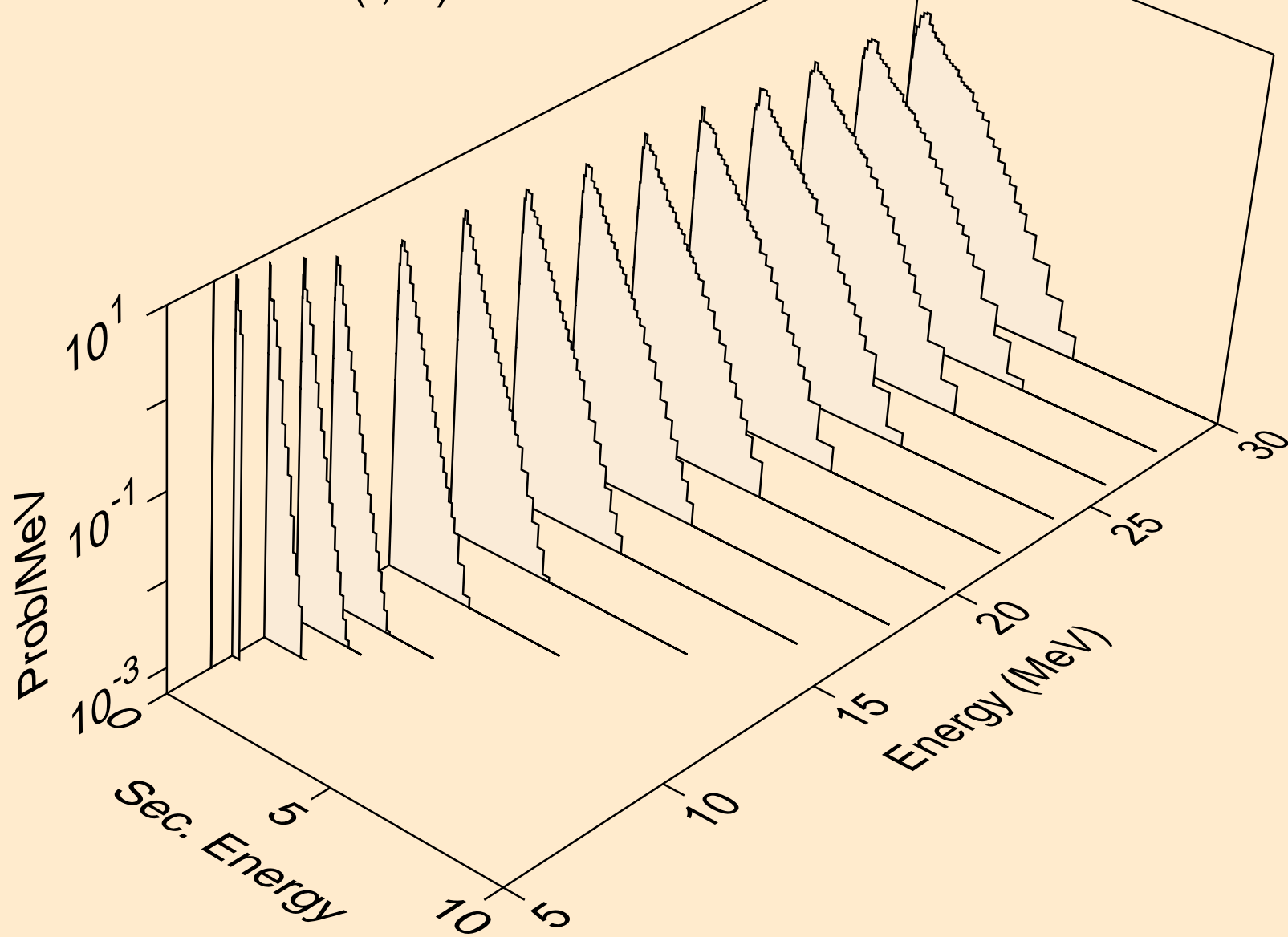

TL204 TRITON ACER TENDL-2021 LIBRARY; T=0.K  
neutrons from (t,n\*)t

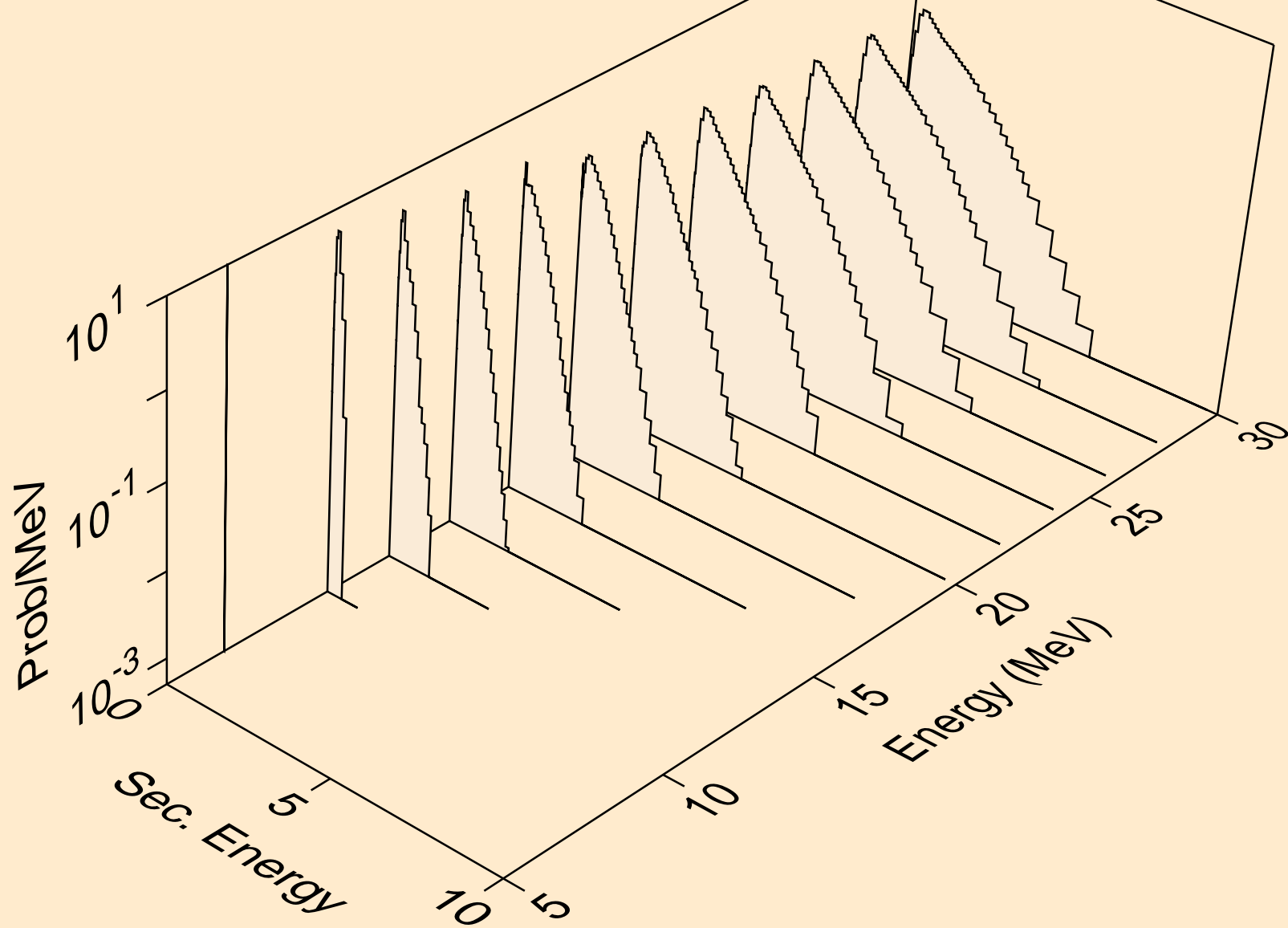



TL204 TRITON ACER TENDL-2021 LIBRARY; T=0.K  
neutrons from (t,n\*)he3

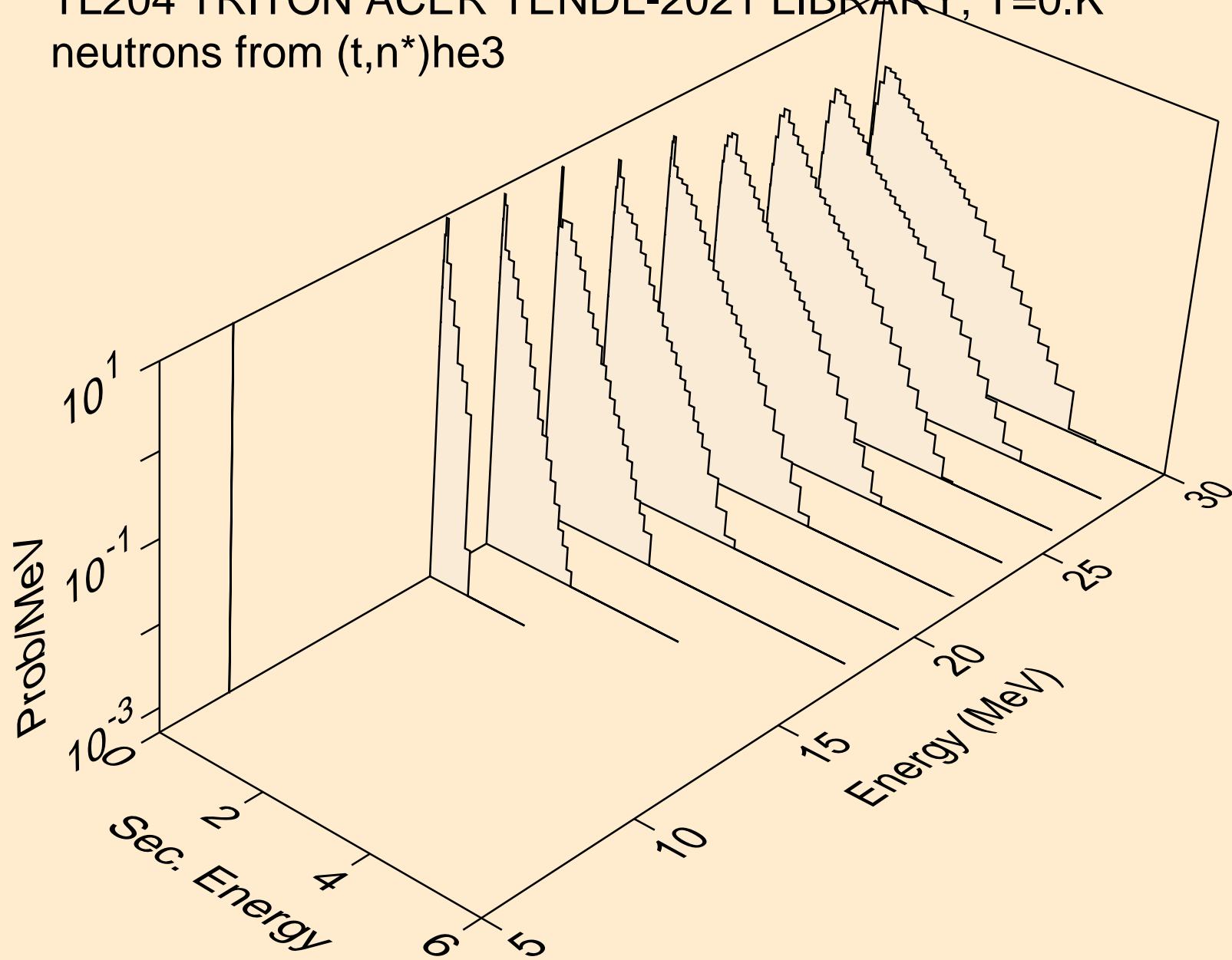

TL204 TRITON ACER TENDL-2021 LIBRARY; T=0.K  
neutrons from (t,4n)

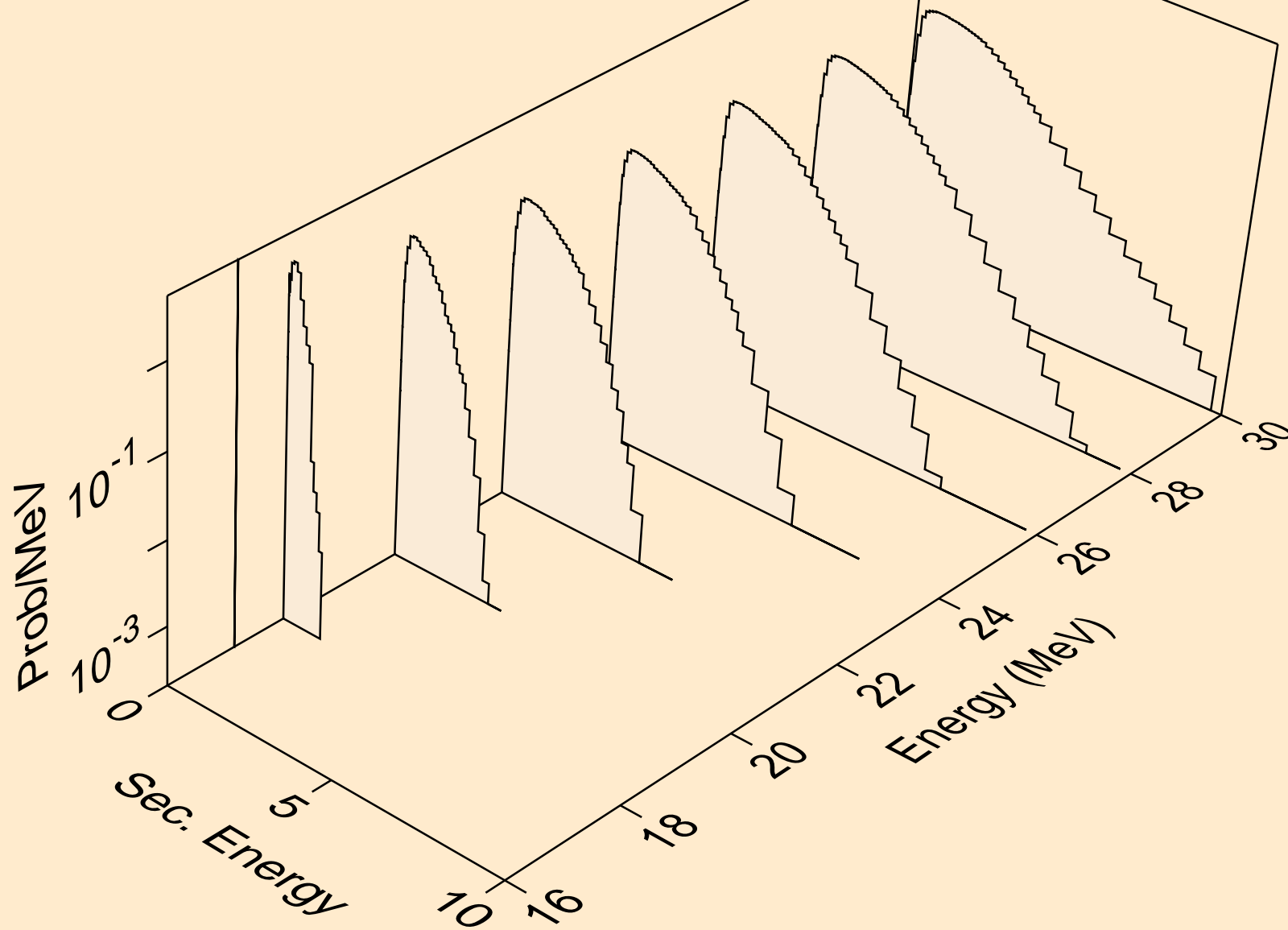

TL204 TRITON ACER TENDL-2021 LIBRARY; T=0.K  
neutrons from (t,2np)

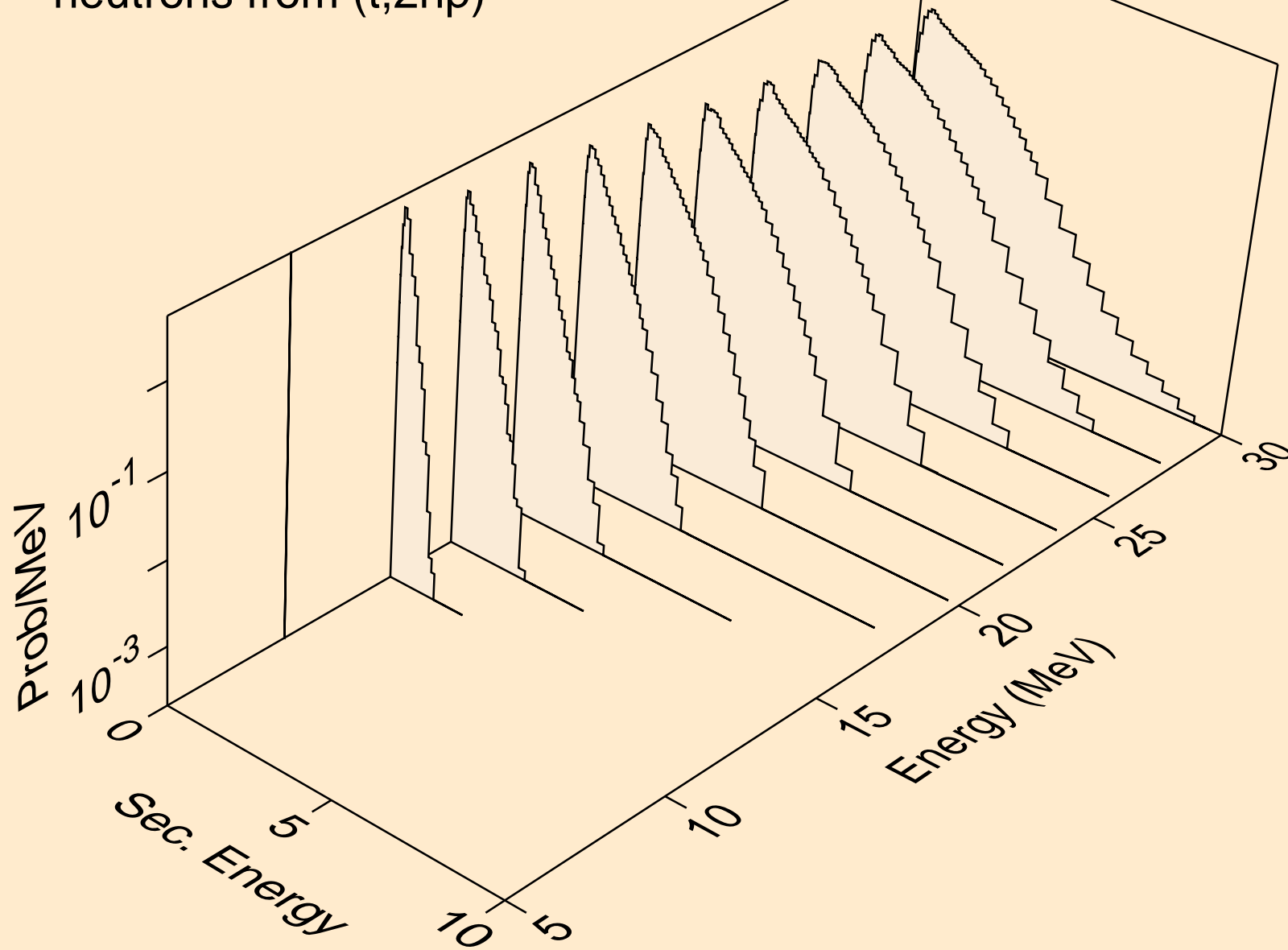

TL204 TRITON ACER TENDL-2021 LIBRARY; T=0.K  
neutrons from (t,3np)

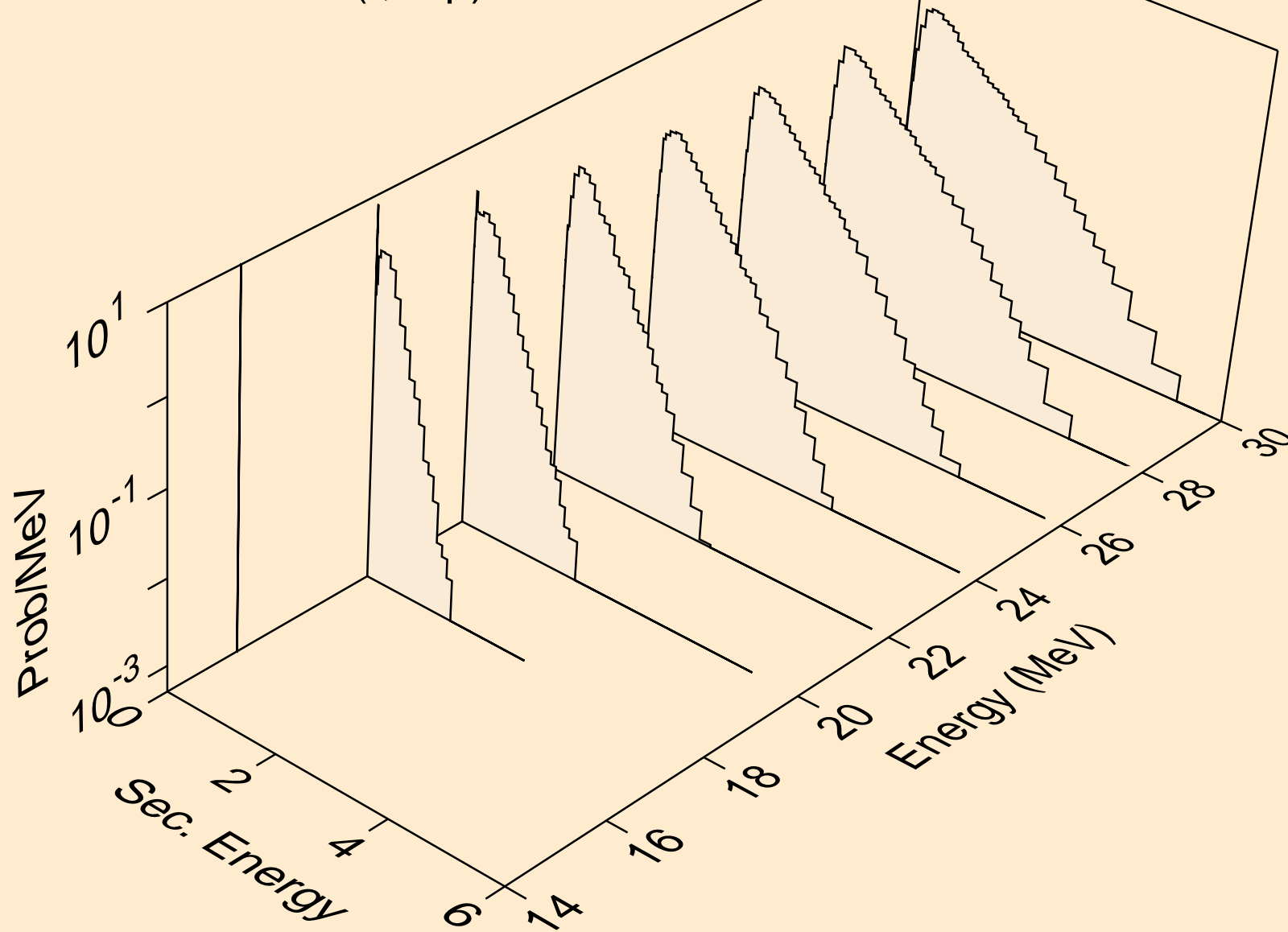

TL204 TRITON ACER TENDL-2021 LIBRARY; T=0.K  
neutrons from (t,2np)

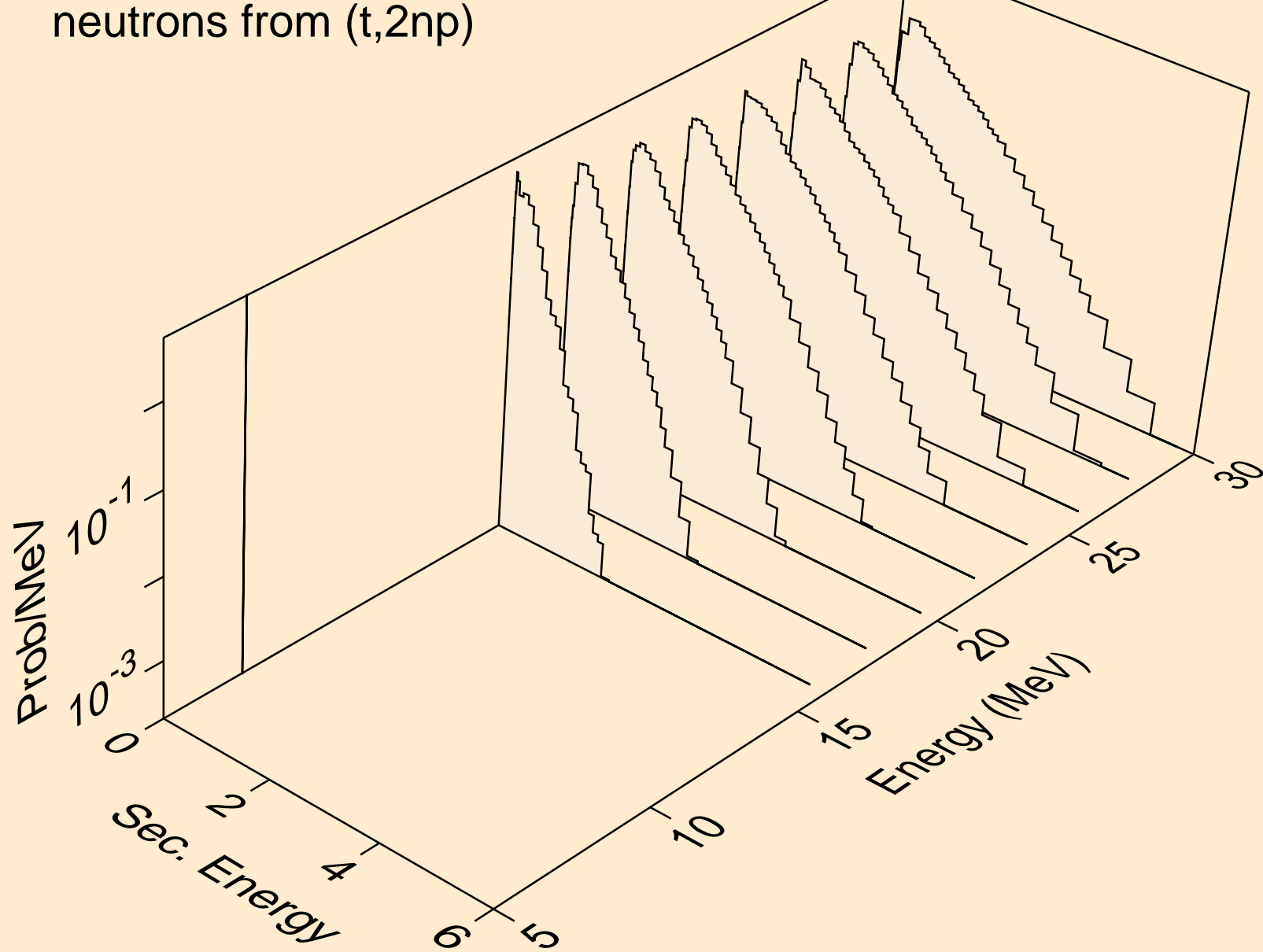

TL204 TRITON ACER TENDL-2021 LIBRARY; T=0.K  
neutrons from (t,npa)

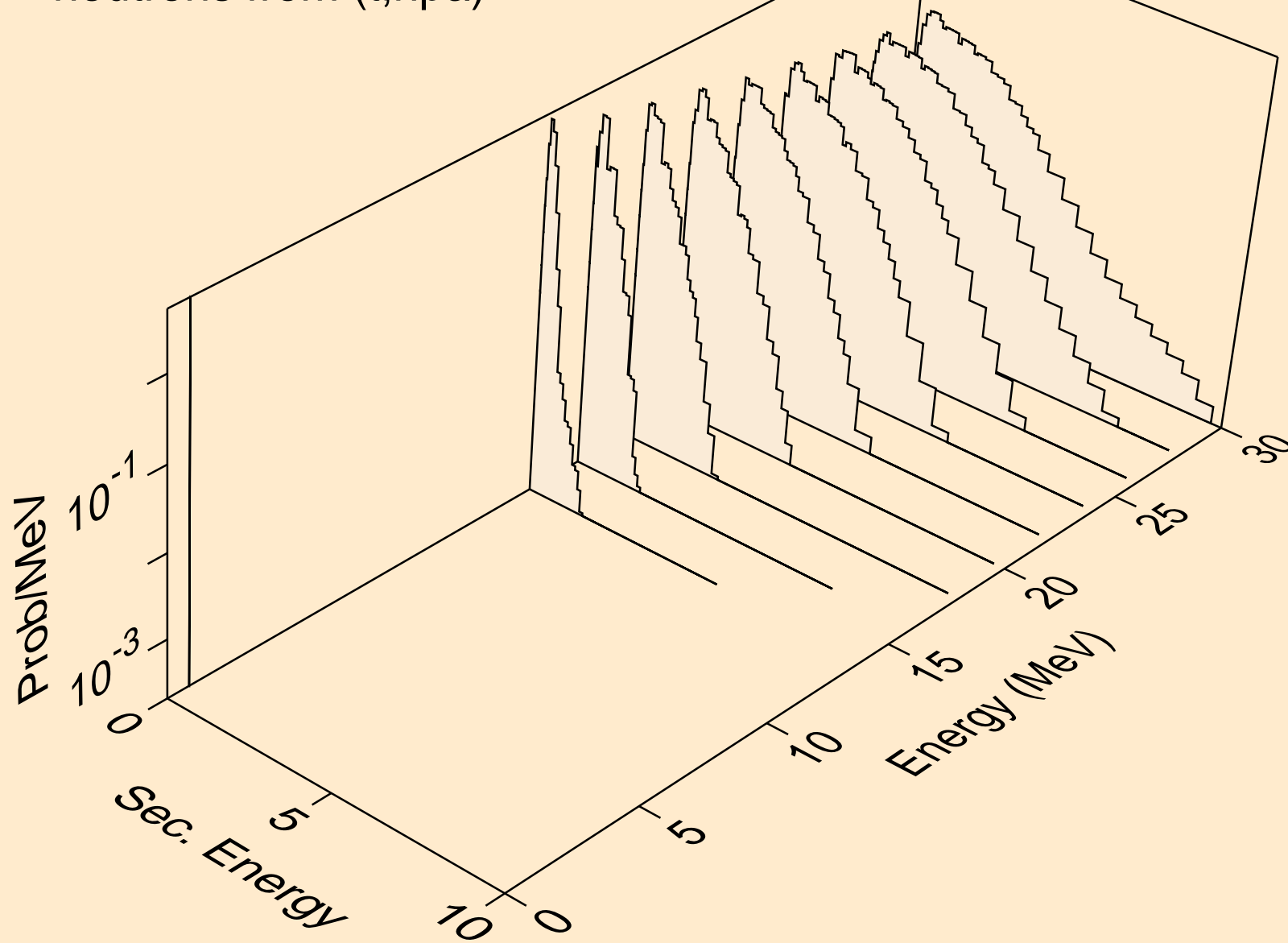

TL204 TRITON ACER TENDL-2021 LIBRARY; T=0.K  
protons from (t,x)

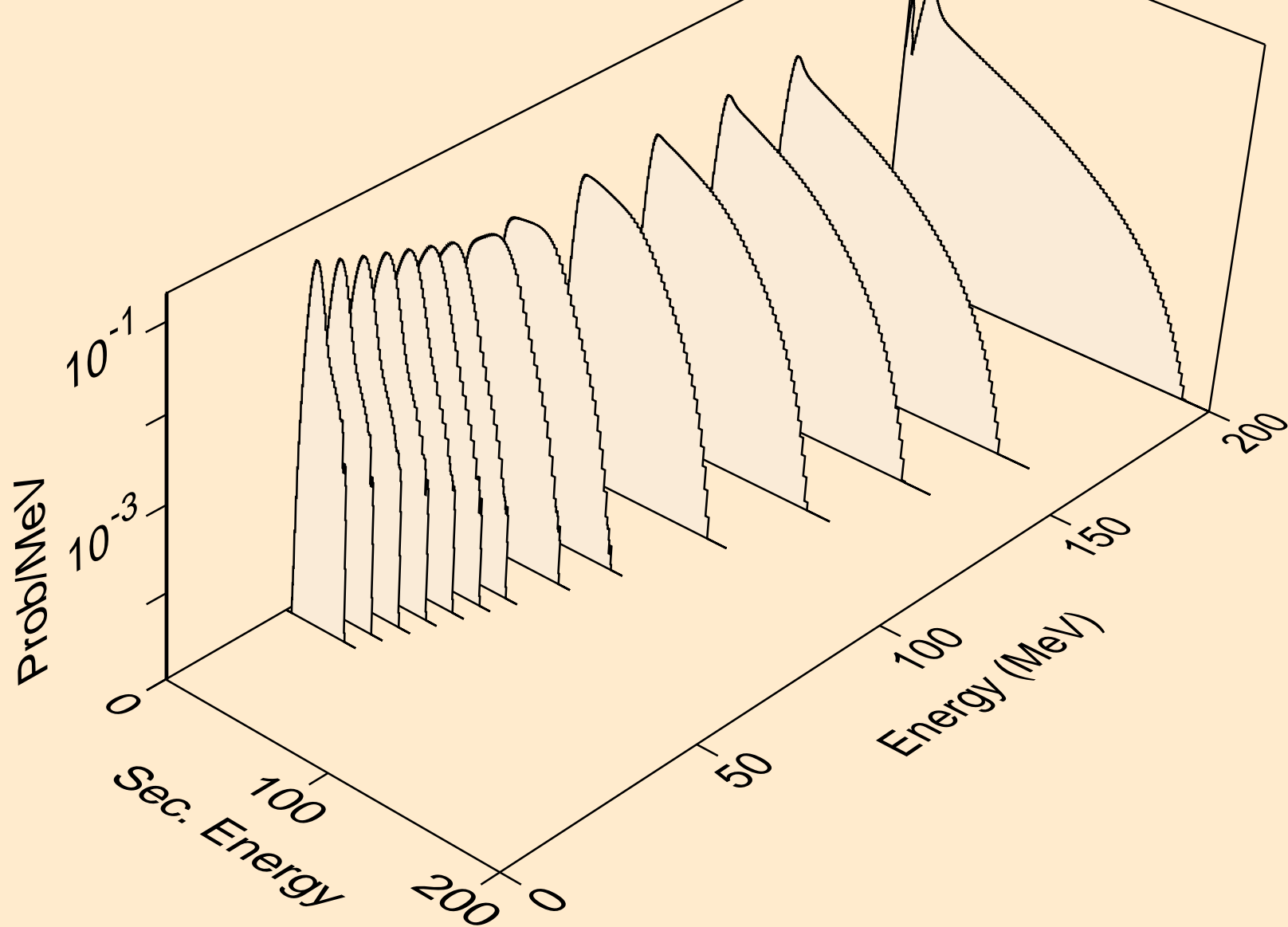

TL204 TRITON ACER TENDL-2021 LIBRARY; T=0.K  
protons from (t,n\*)p

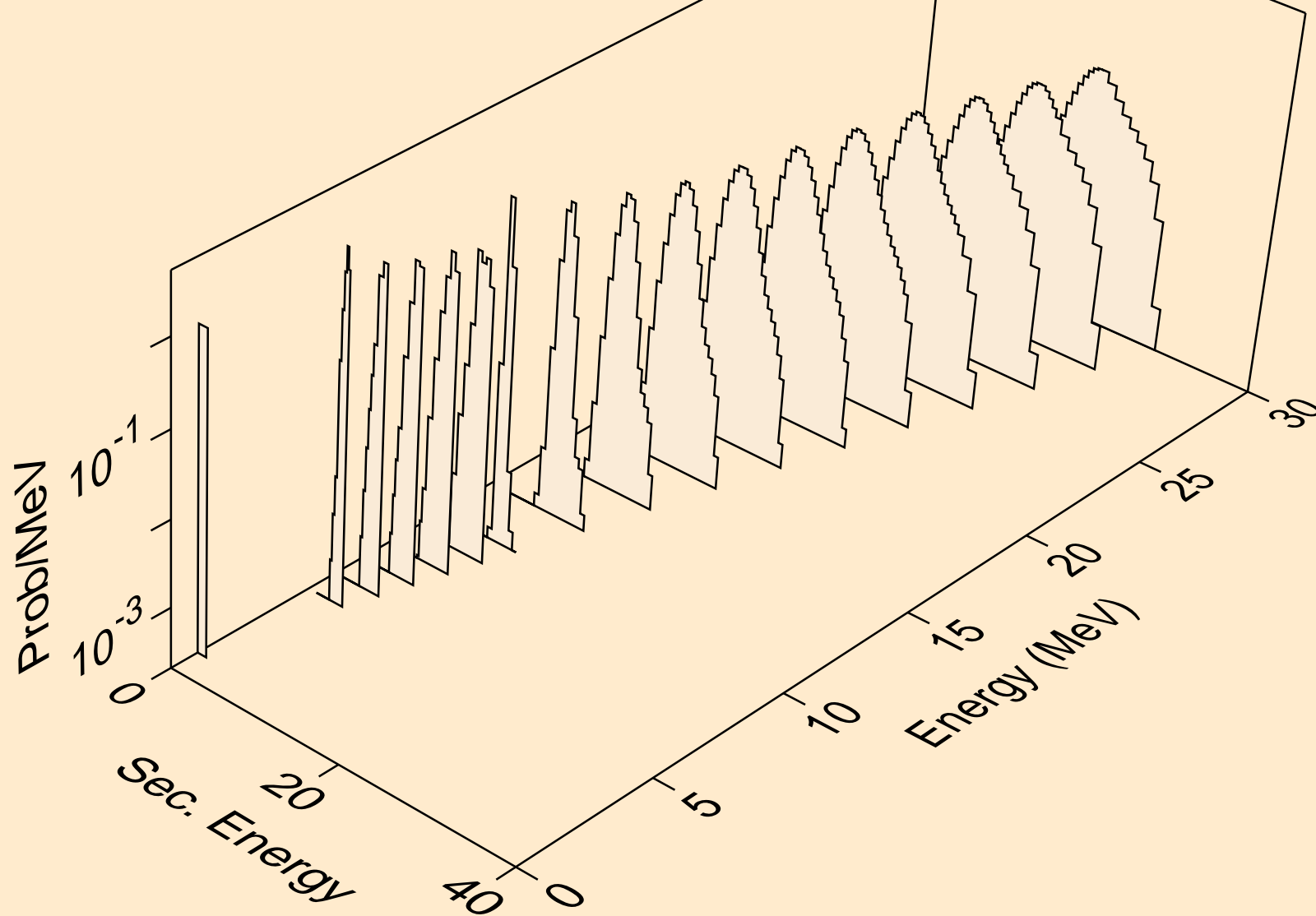



TL204 TRITON ACER TENDL-2021 LIBRARY; T=0.K  
protons from (t,2np)

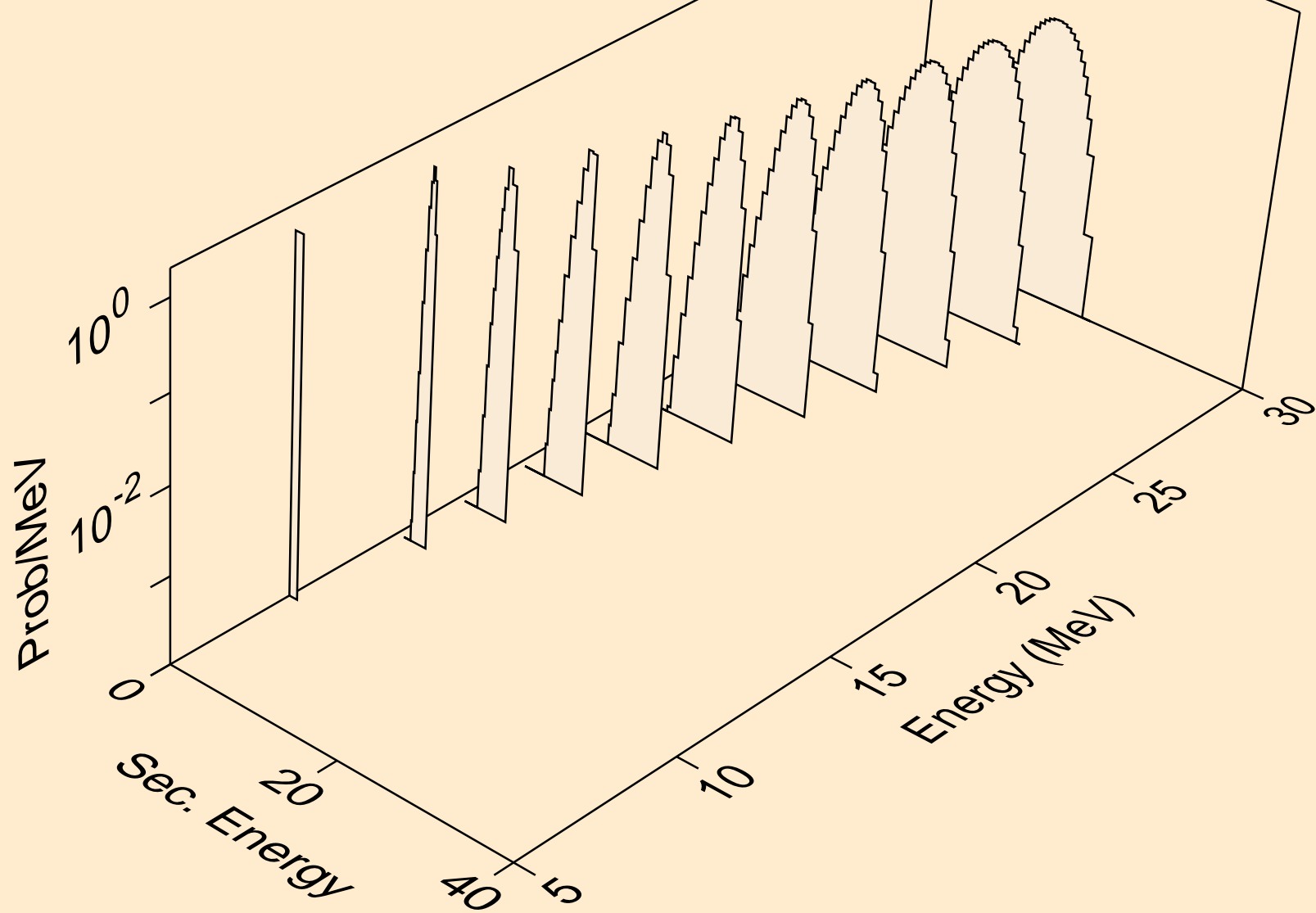

TL204 TRITON ACER TENDL-2021 LIBRARY; T=0.K  
protons from (t,3np)

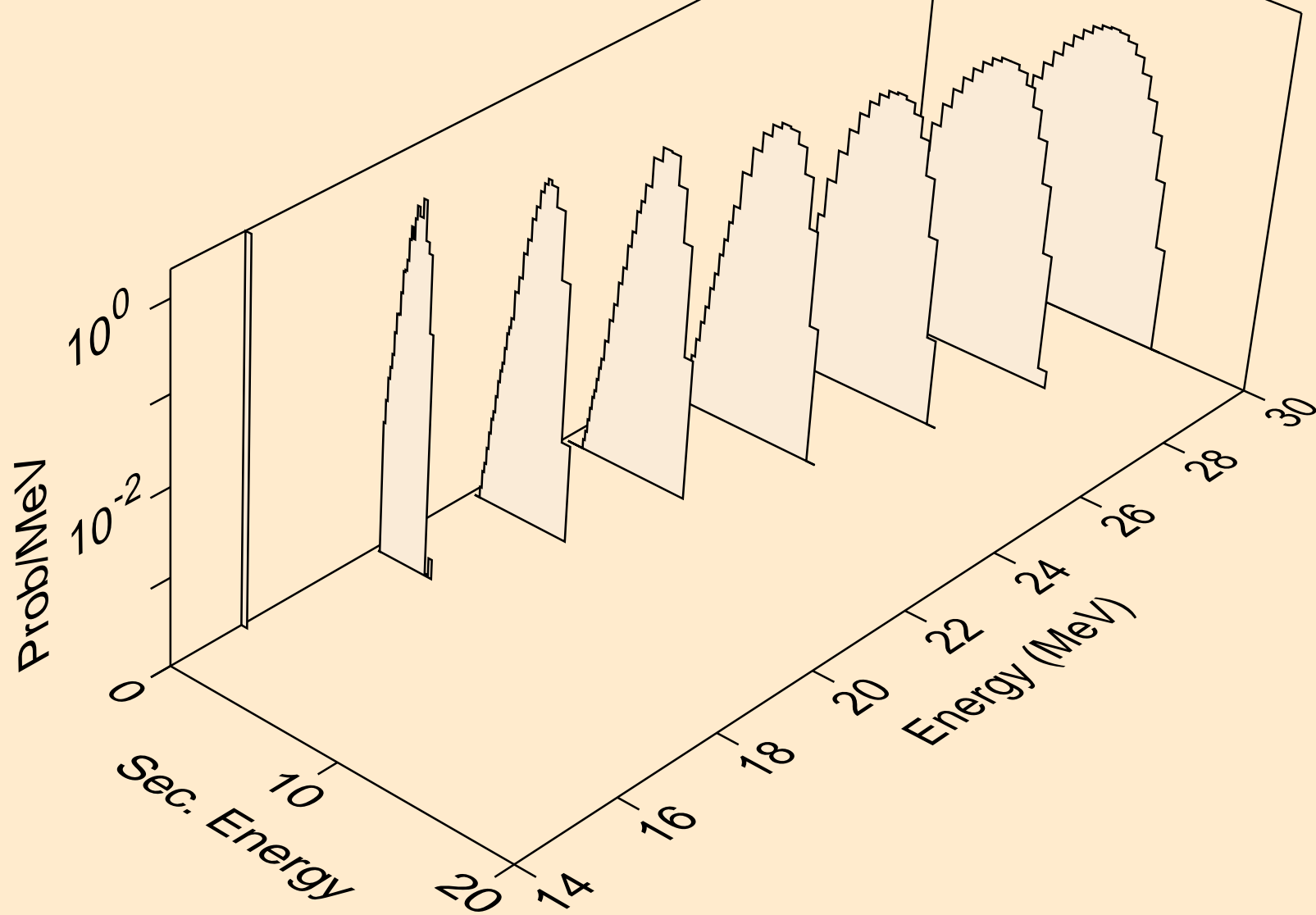

TL204 TRITON ACER TENDL-2021 LIBRARY; T=0.K  
protons from (t,2np)

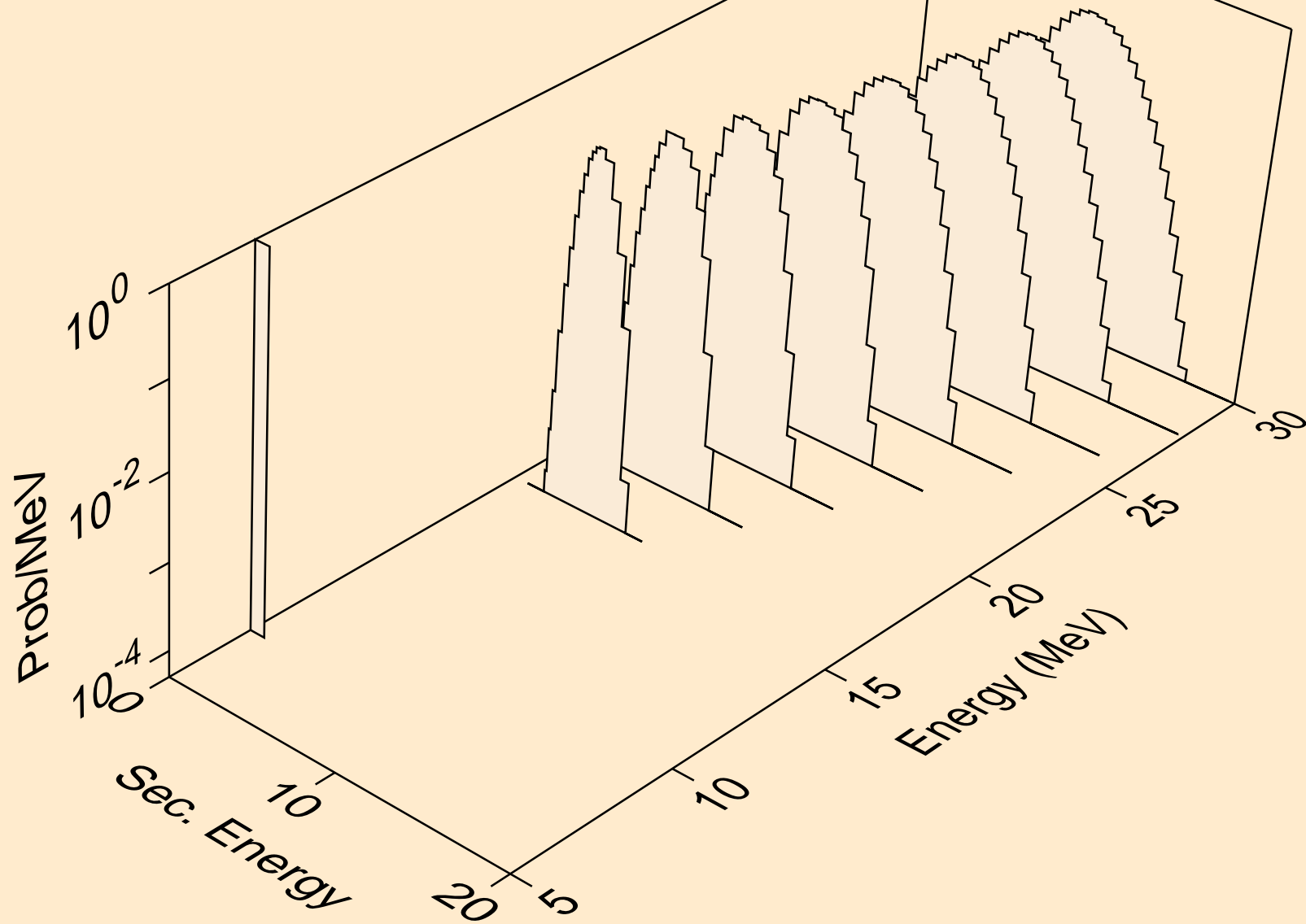

TL204 TRITON ACER TENDL-2021 LIBRARY; T=0.K  
protons from (t,npa)

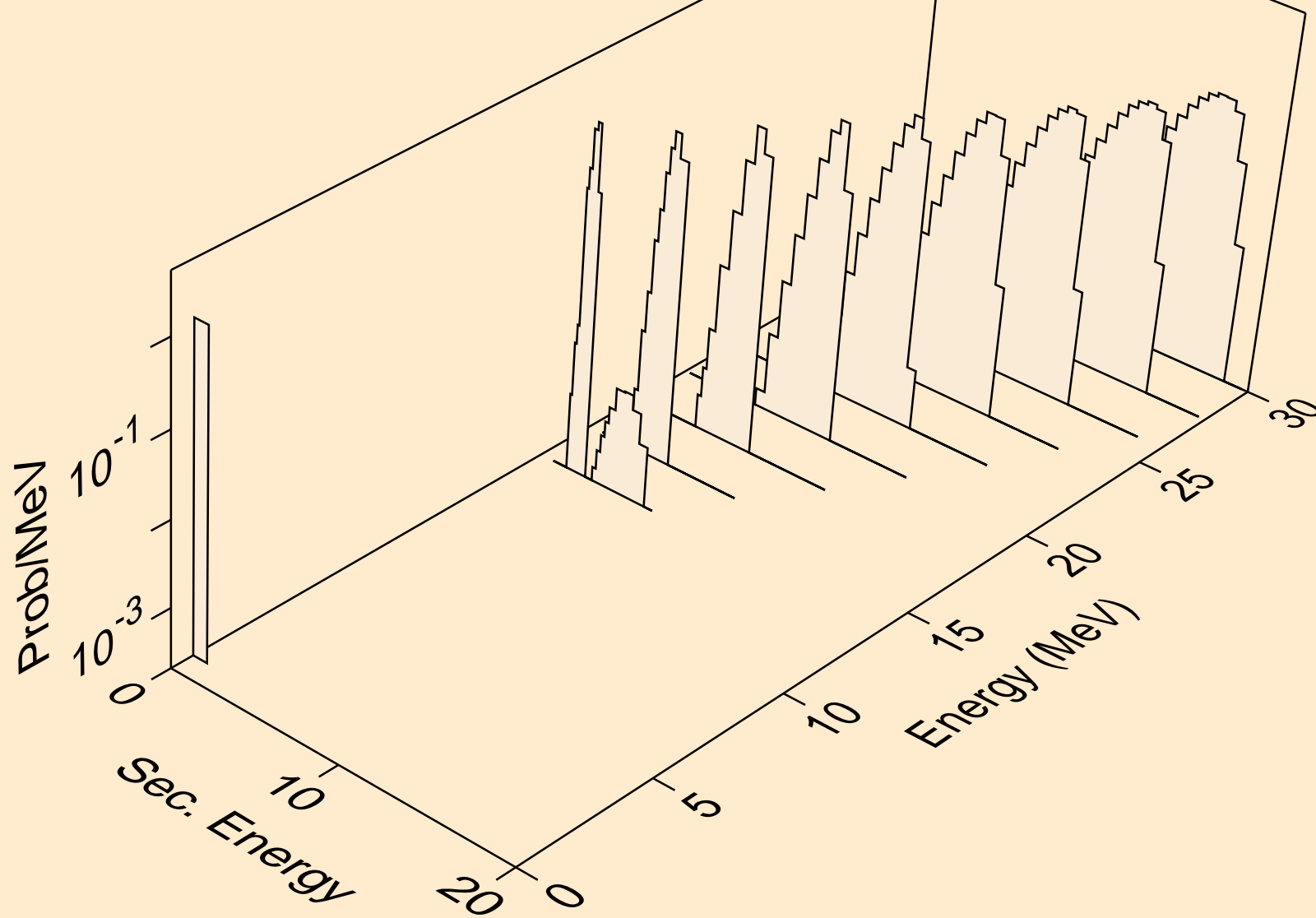

TL204 TRITON ACER TENDL-2021 LIBRARY; T=0.K  
protons from (t,p)

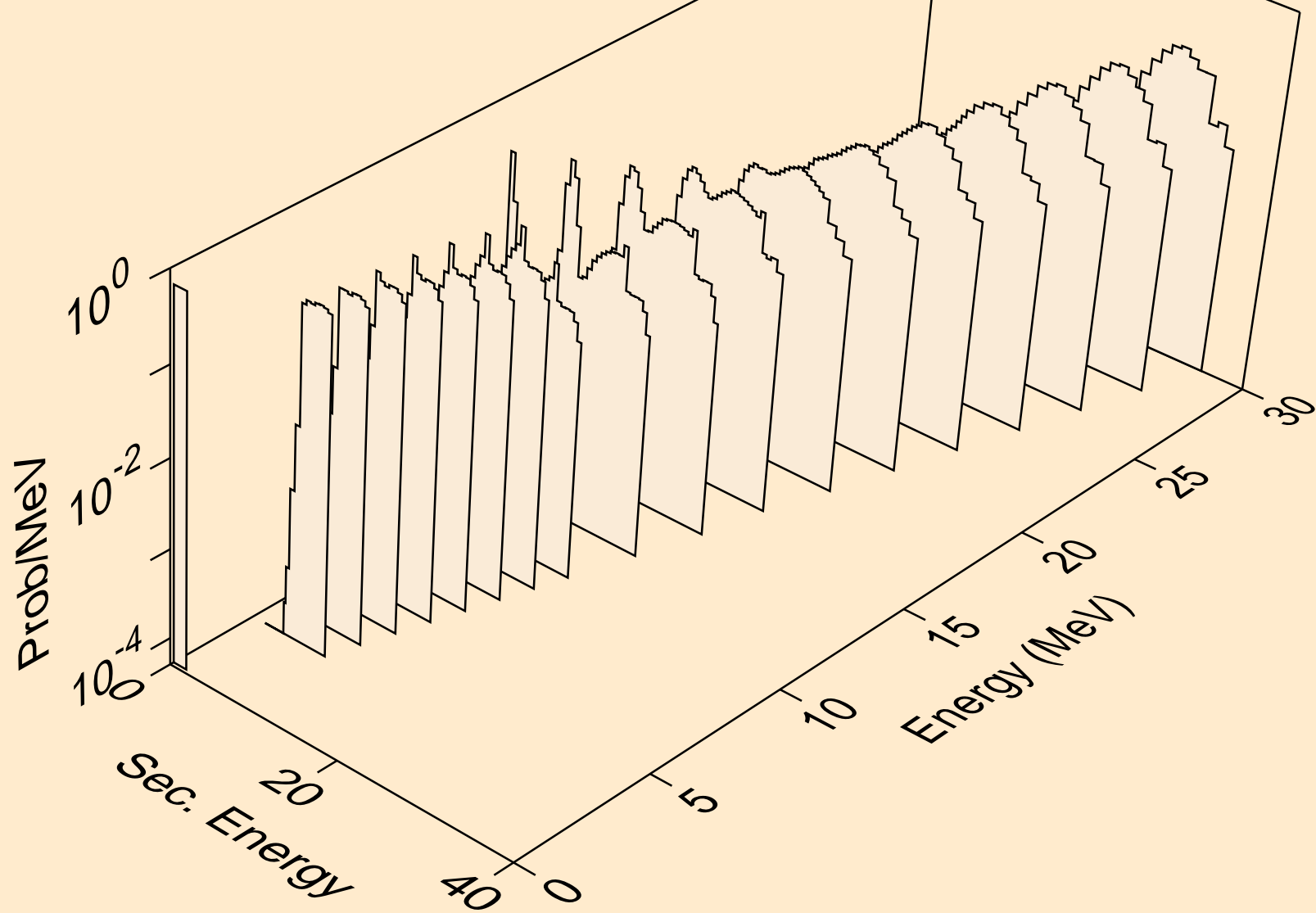

TL204 TRITON ACER TENDL-2021 LIBRARY; T=0.K  
protons from (t,2p)

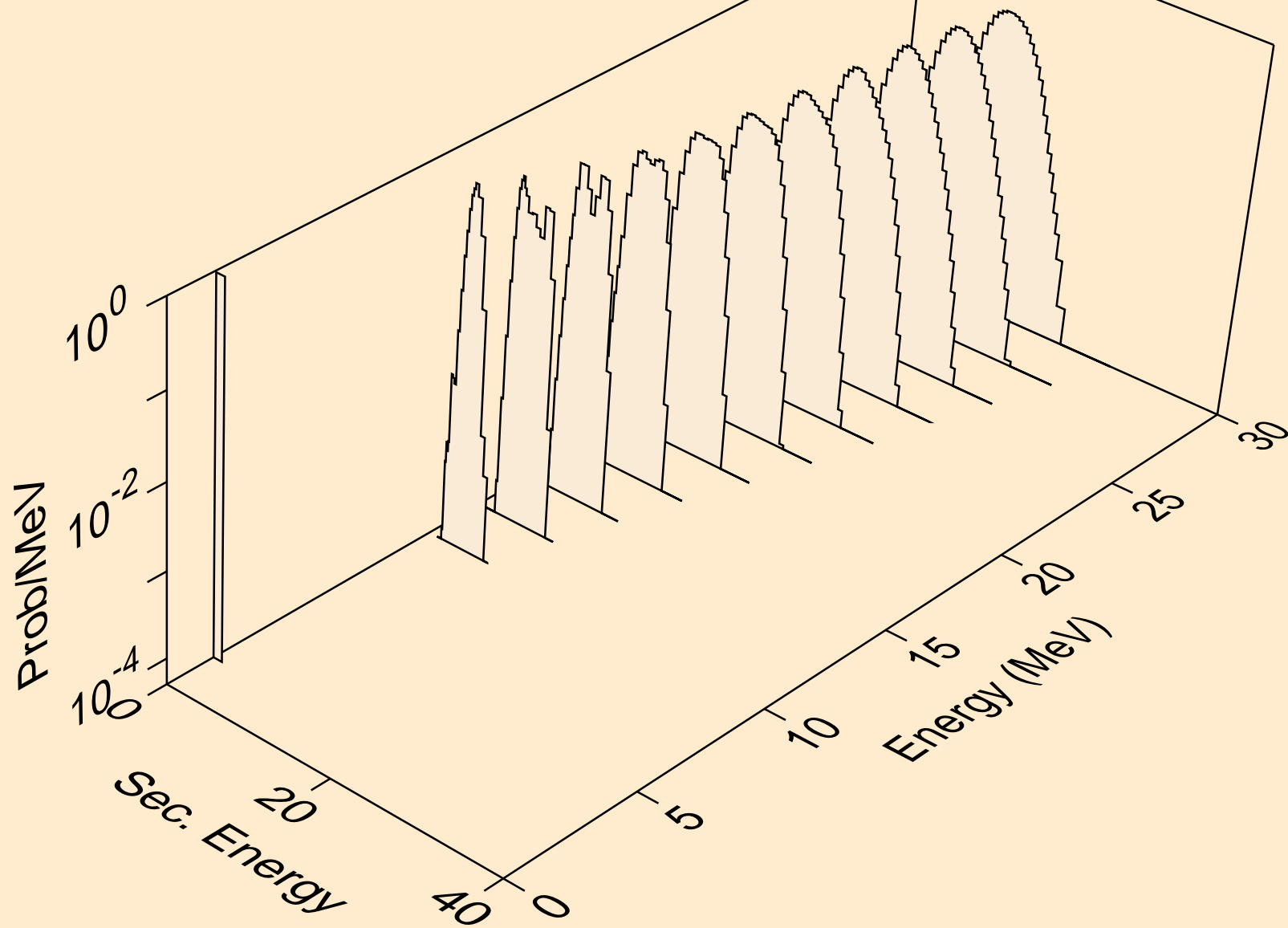

TL204 TRITON ACER TENDL-2021 LIBRARY; T=0.K  
protons from (t,pa)

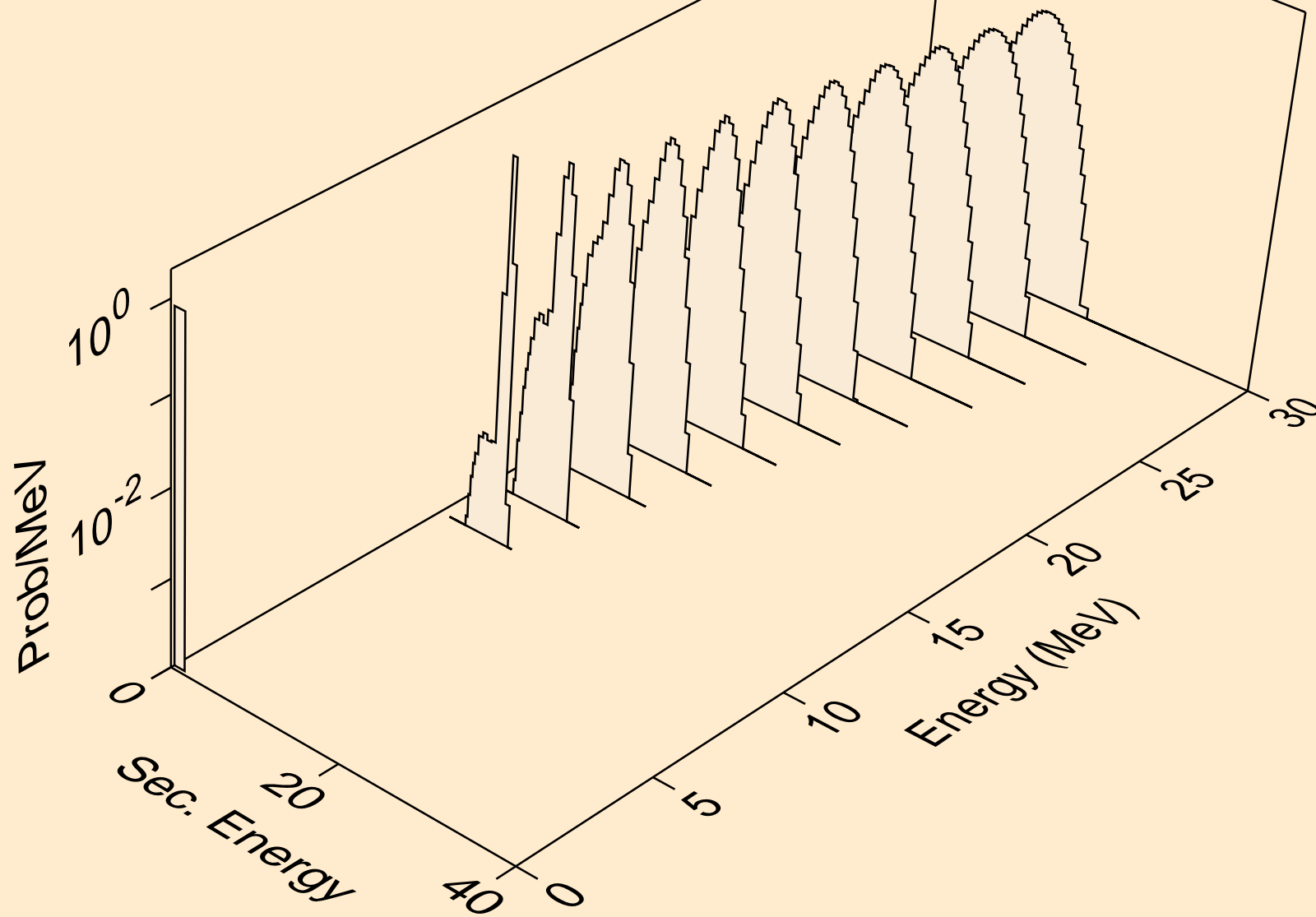

TL204 TRITON ACER TENDL-2021 LIBRARY; T=0.K  
protons from (t,pd)

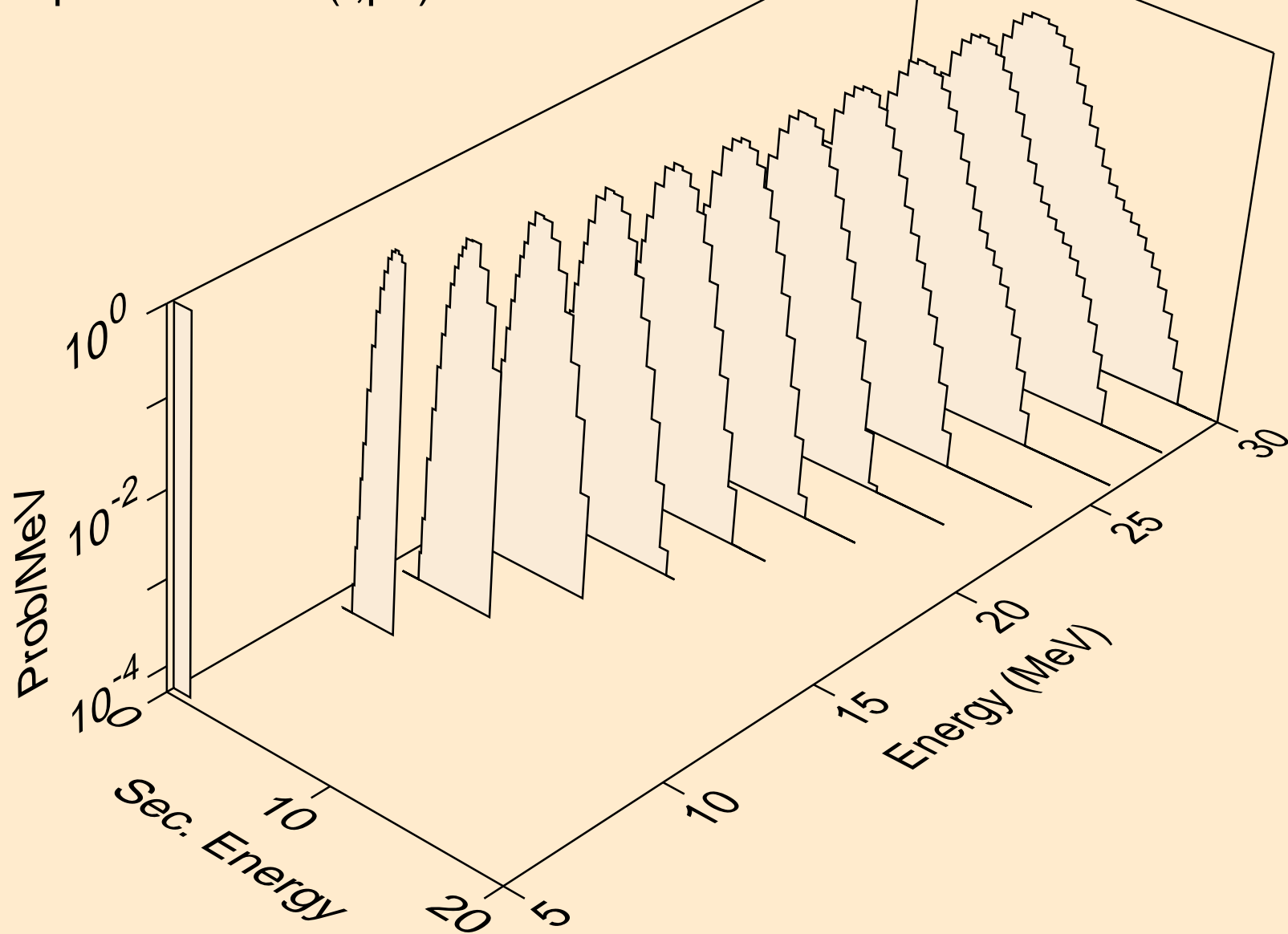



TL204 TRITON ACER TENDL-2021 LIBRARY; T=0.K  
protons from (t,pt)

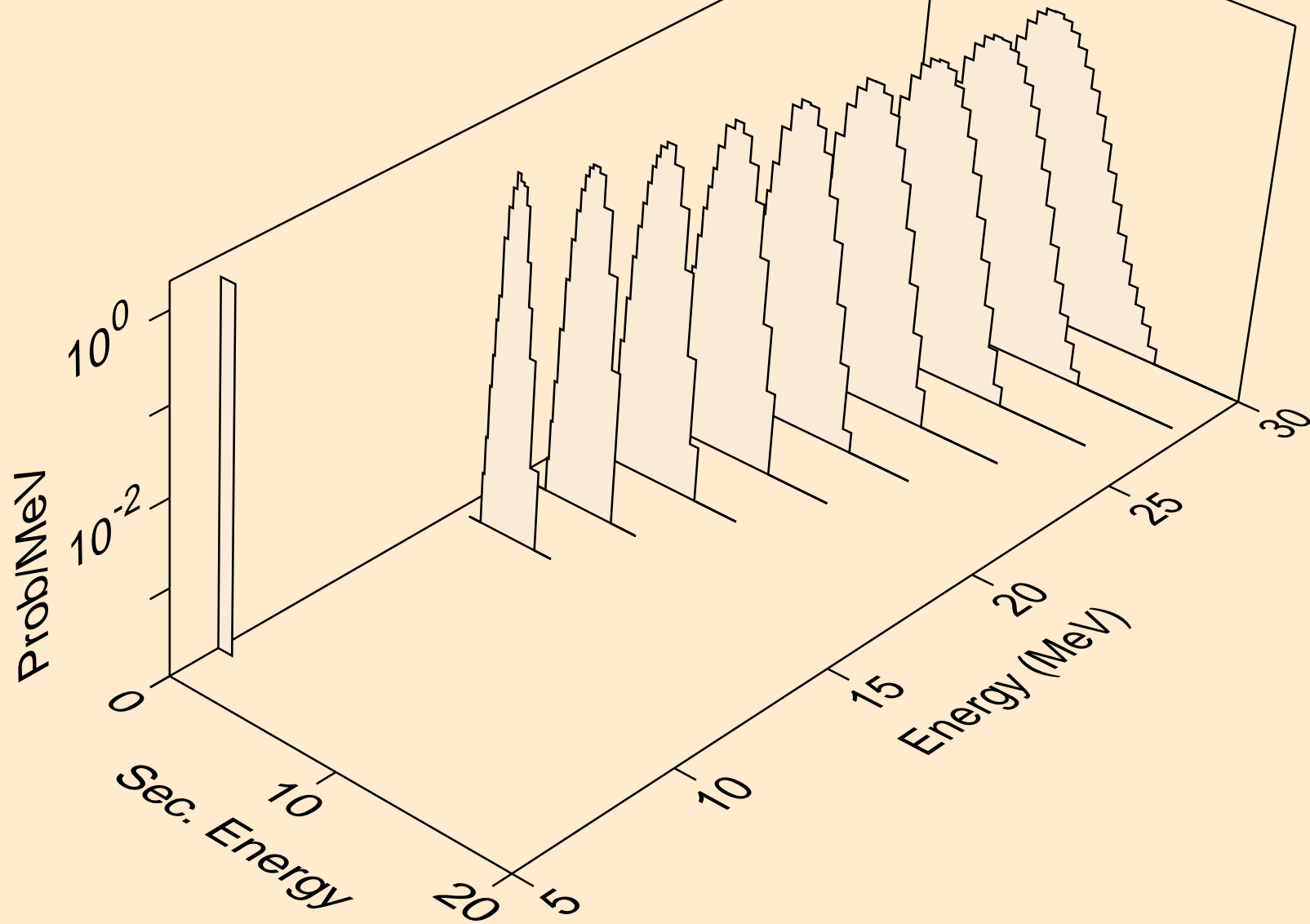

TL204 TRITON ACER TENDL-2021 LIBRARY; T=0.K  
deuterons from (t,x)

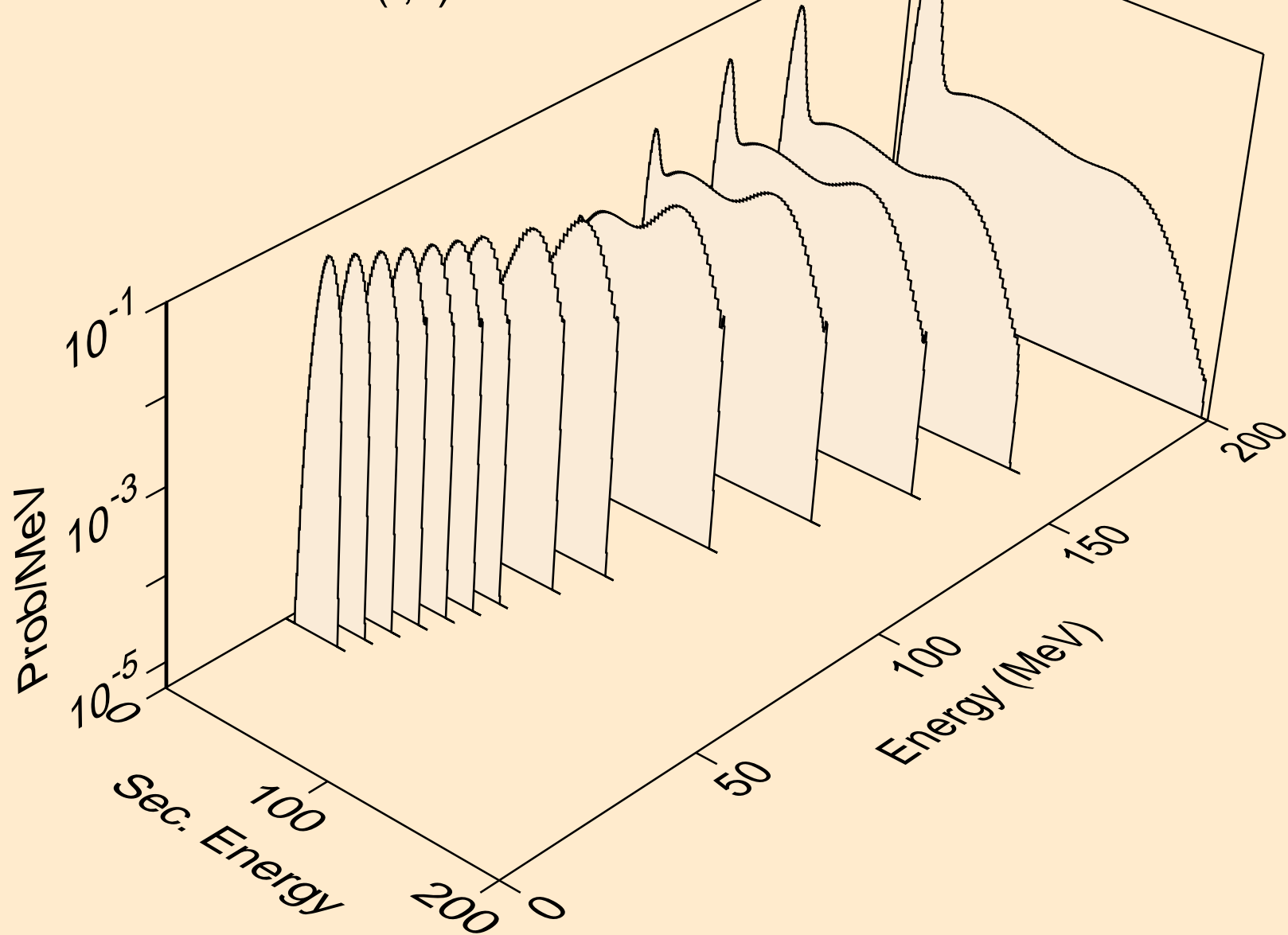

TL204 TRITON ACER TENDL-2021 LIBRARY; T=0.K  
deuterons from (t,2nd)

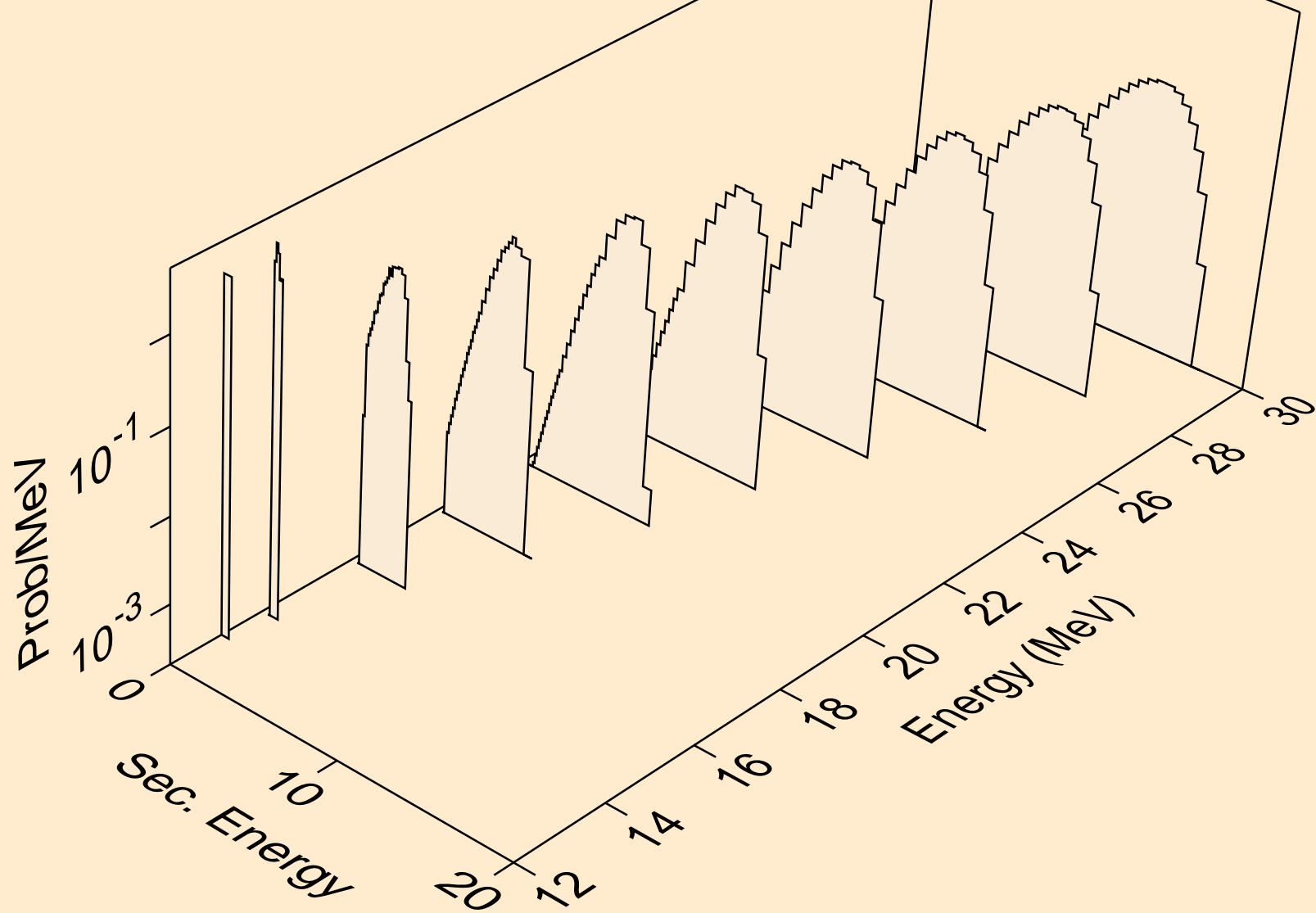

TL204 TRITON ACER TENDL-2021 LIBRARY; T=0.K  
deuterons from (t,n\*)d

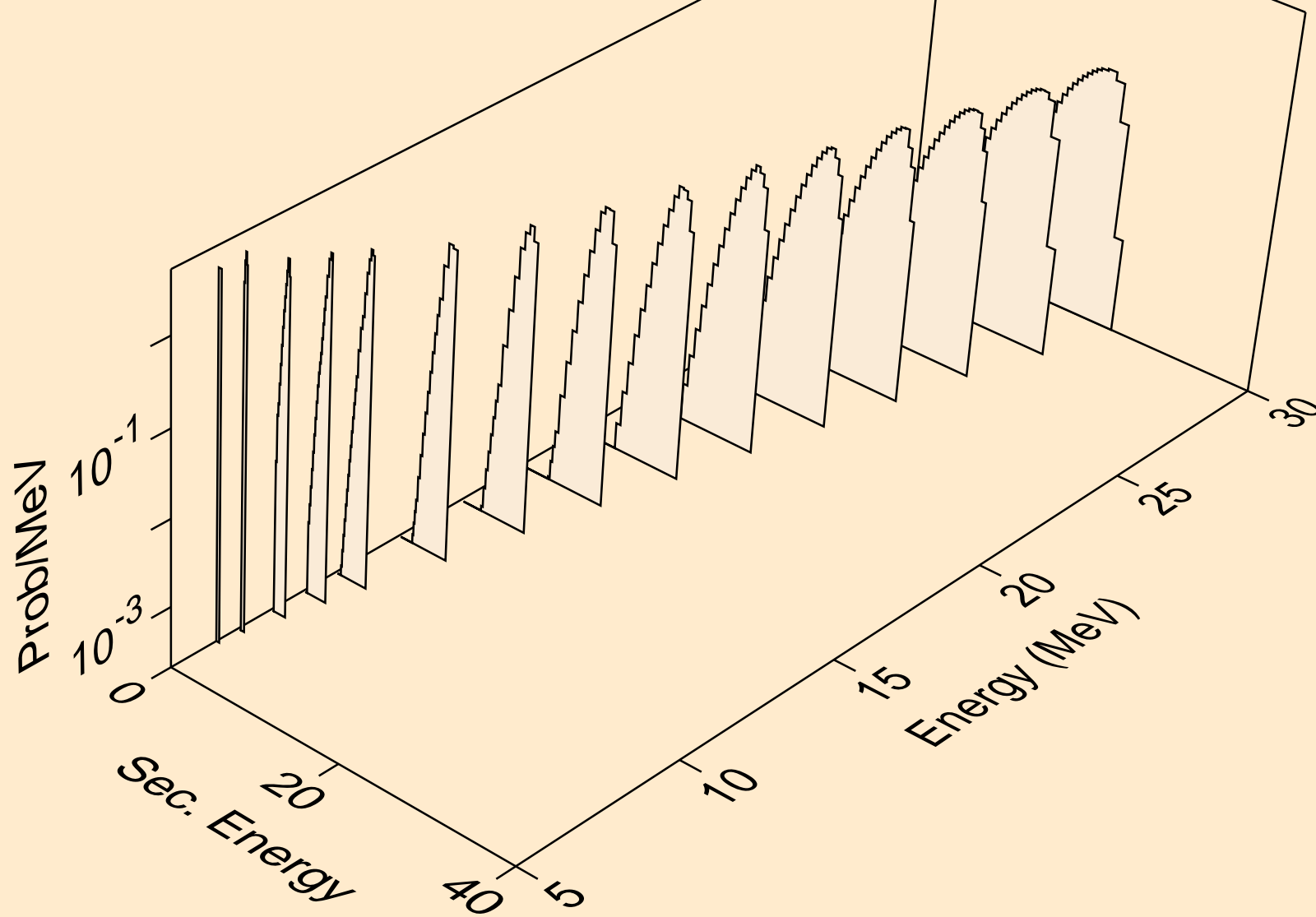

TL204 TRITON ACER TENDL-2021 LIBRARY; T=0.K  
deuterons from (t,d)

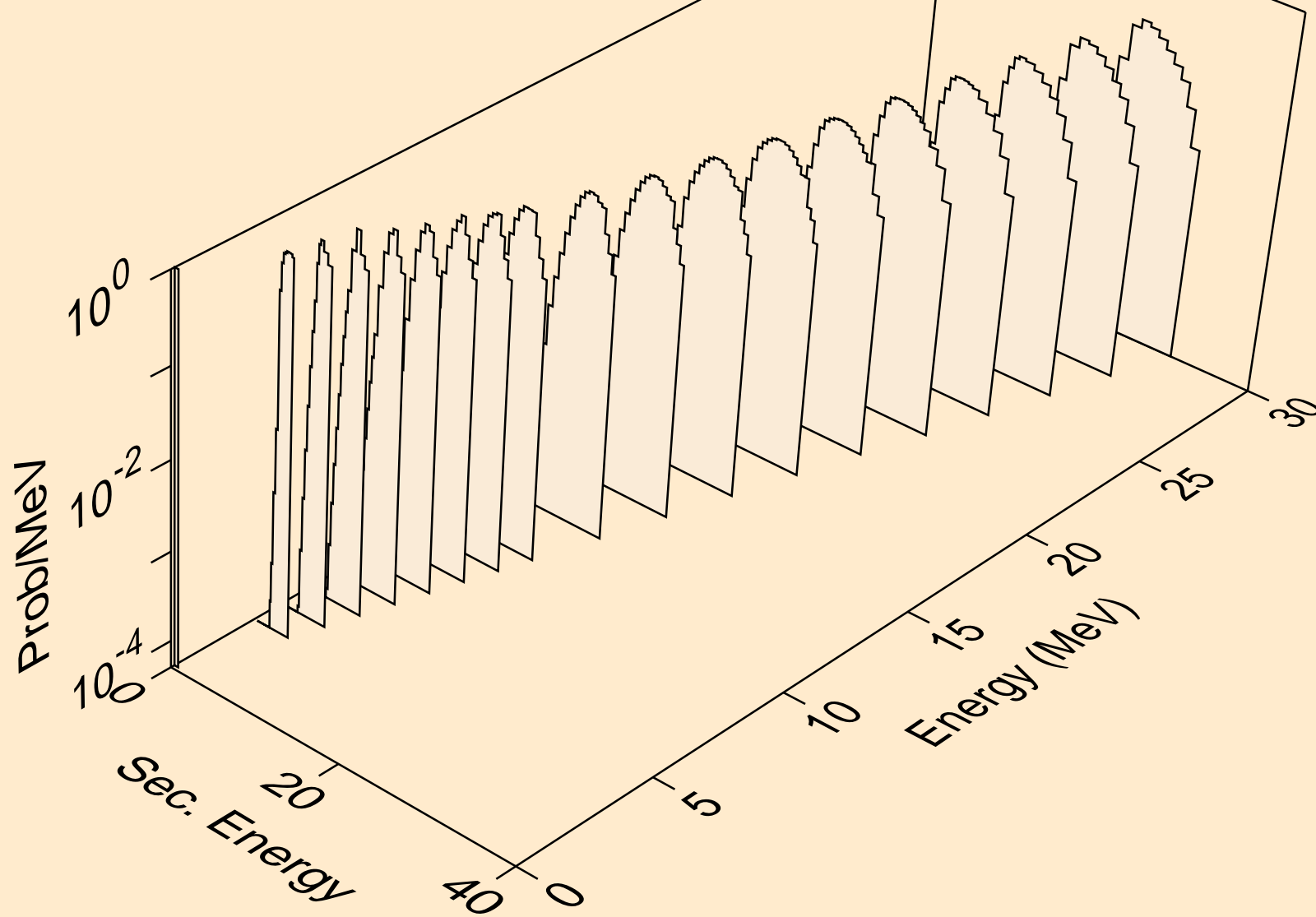

TL204 TRITON ACER TENDL-2021 LIBRARY; T=0.K  
deuterons from (t,pd)

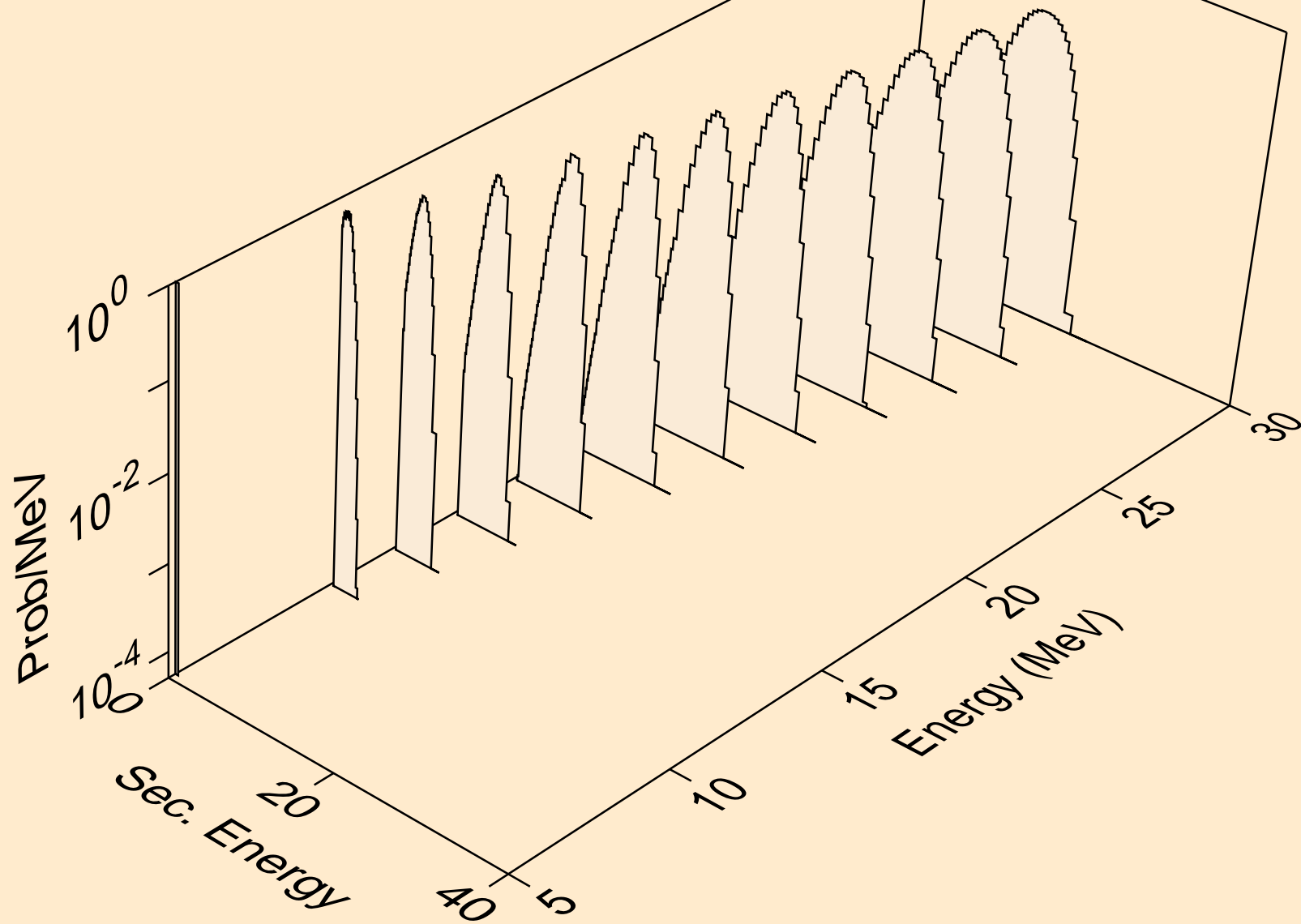

TL204 TRITON ACER TENDL-2021 LIBRARY; T=0.K  
deuterons from (t,da)

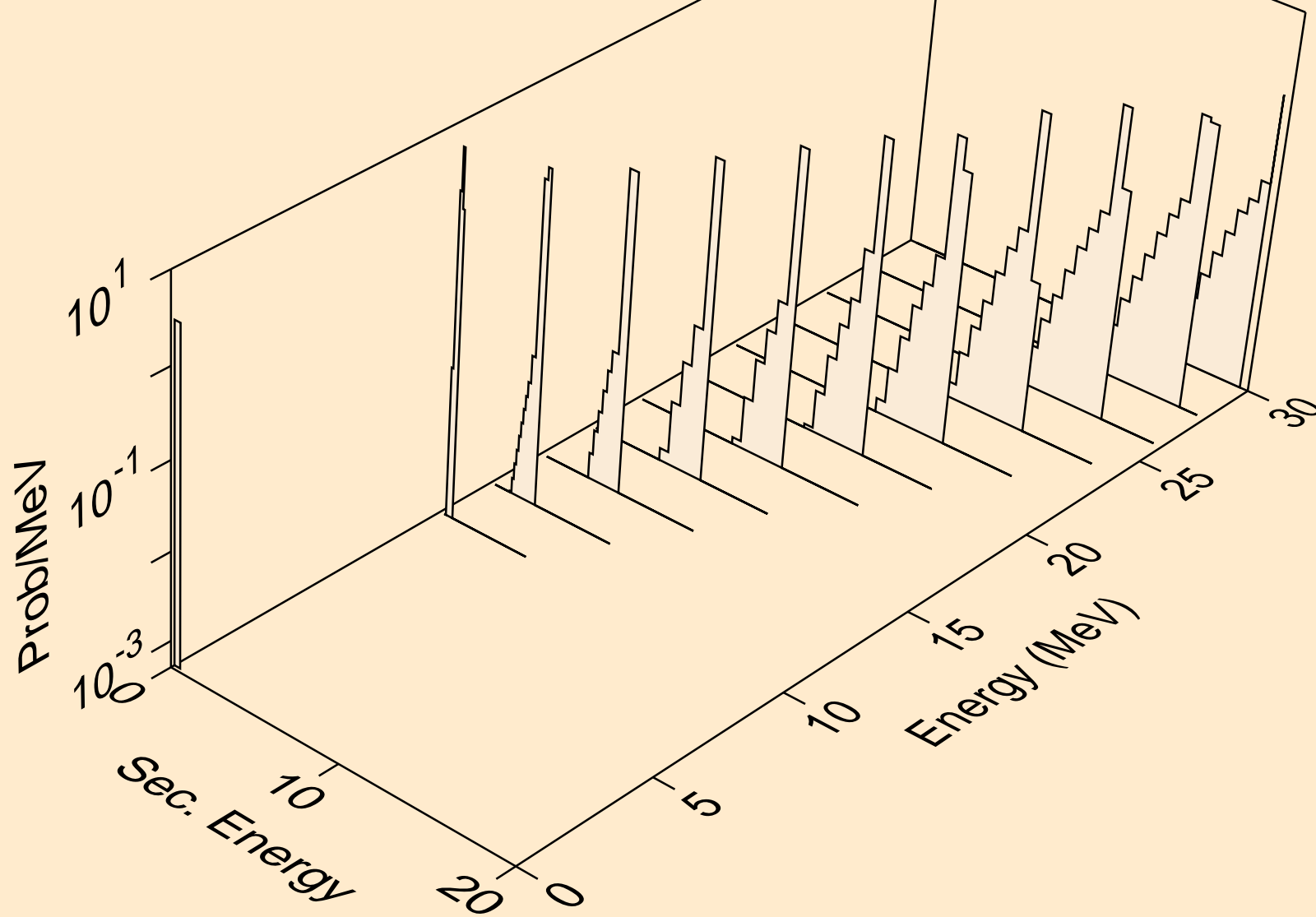

TL204 TRITON ACER TENDL-2021 LIBRARY; T=0.K  
he3s from (t,x)

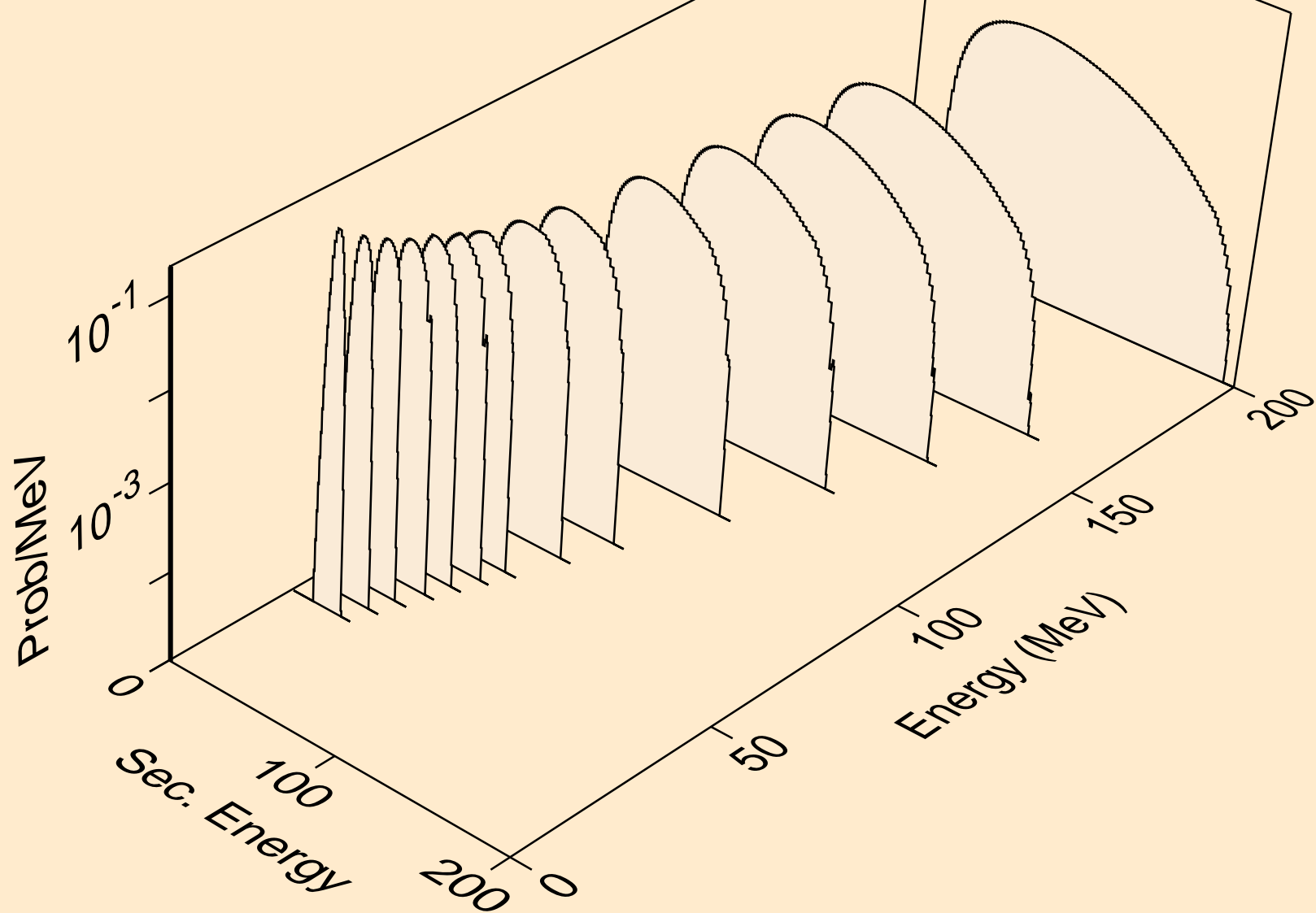



TL204 TRITON ACER TENDL-2021 LIBRARY; T=0.K  
he3s from (t,n\*)he3

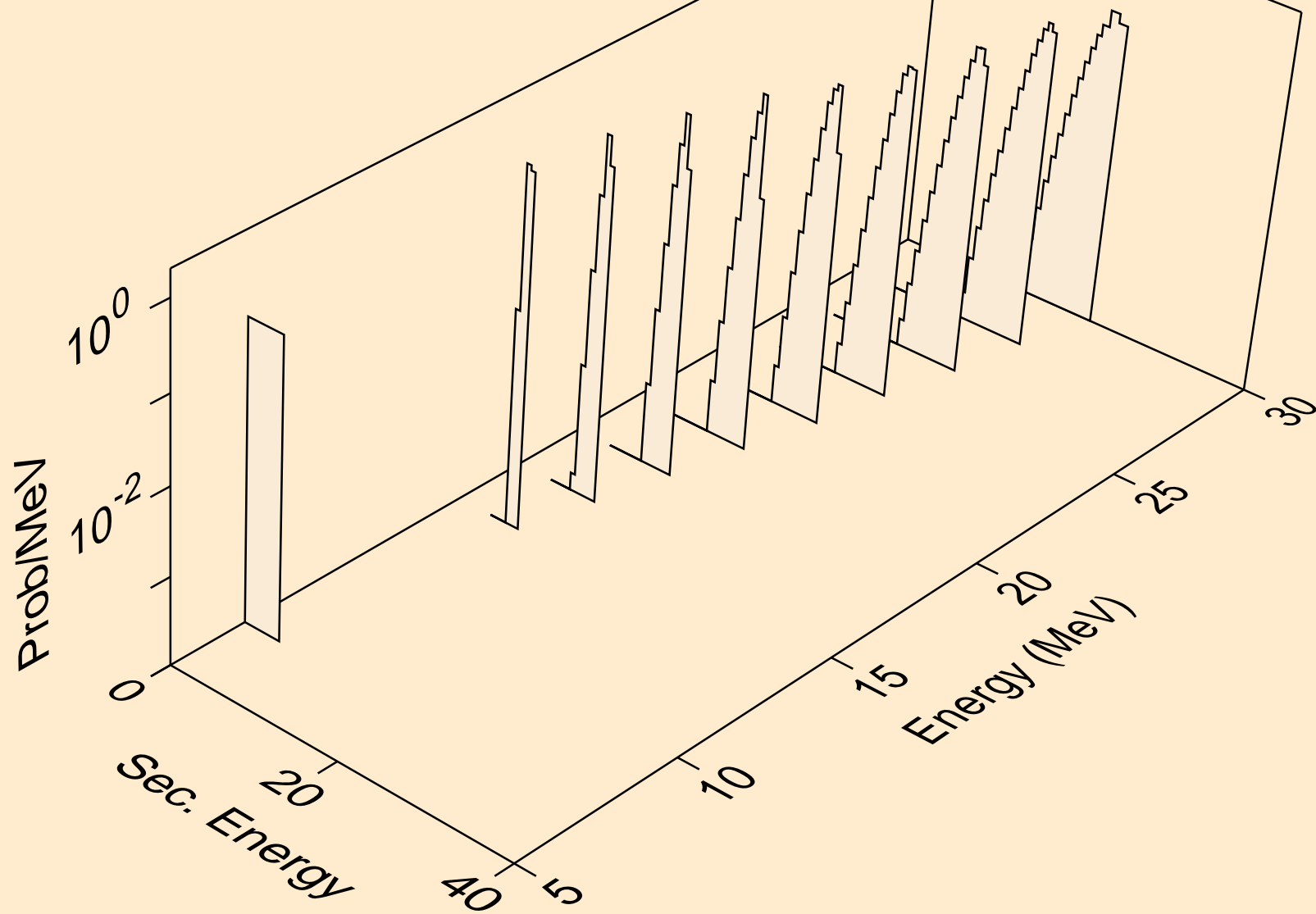

TL204 TRITON ACER TENDL-2021 LIBRARY; T=0.K  
he3s from (t,he3)

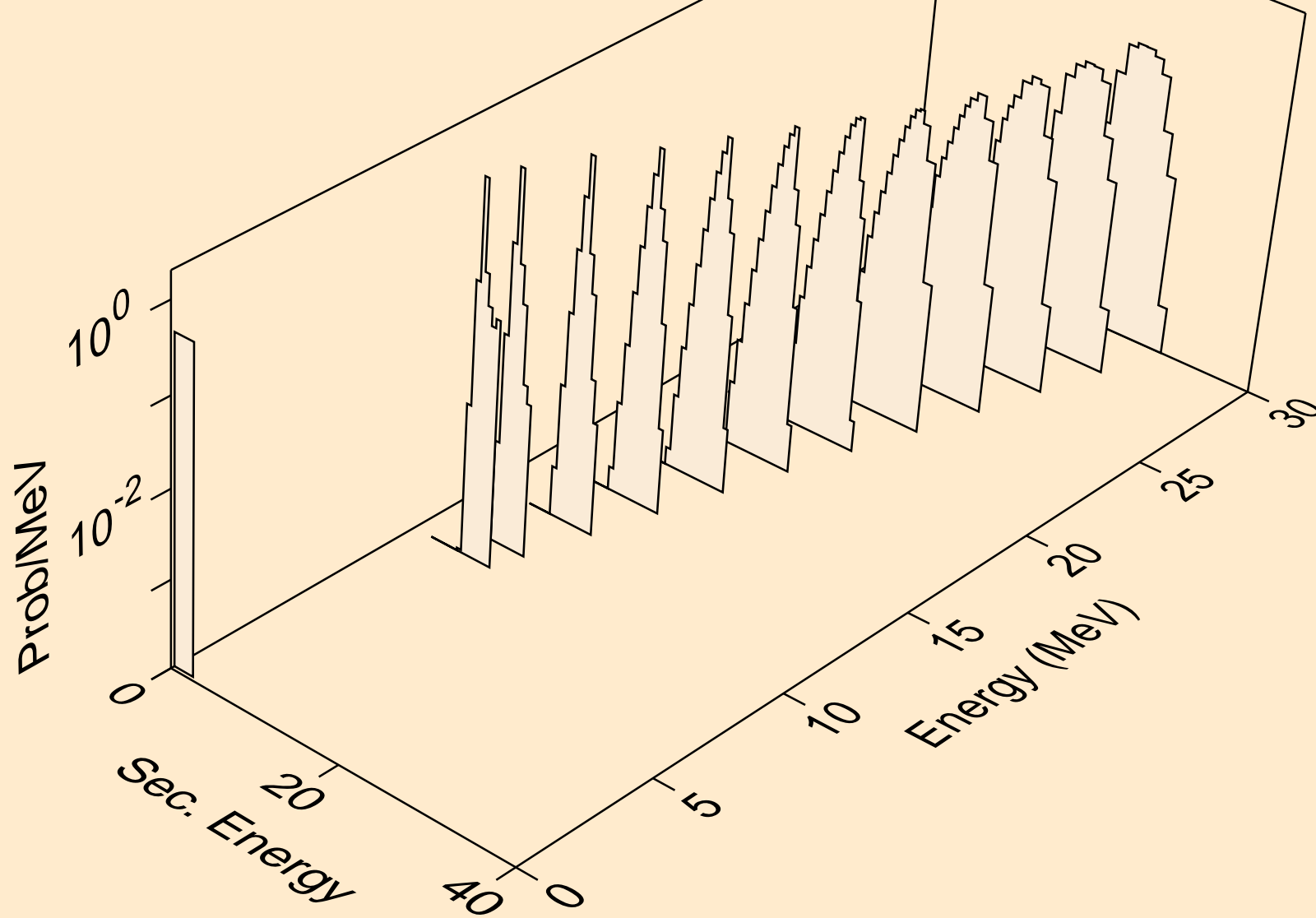

TL204 TRITON ACER TENDL-2021 LIBRARY; T=0.K  
alphas from (t,x)

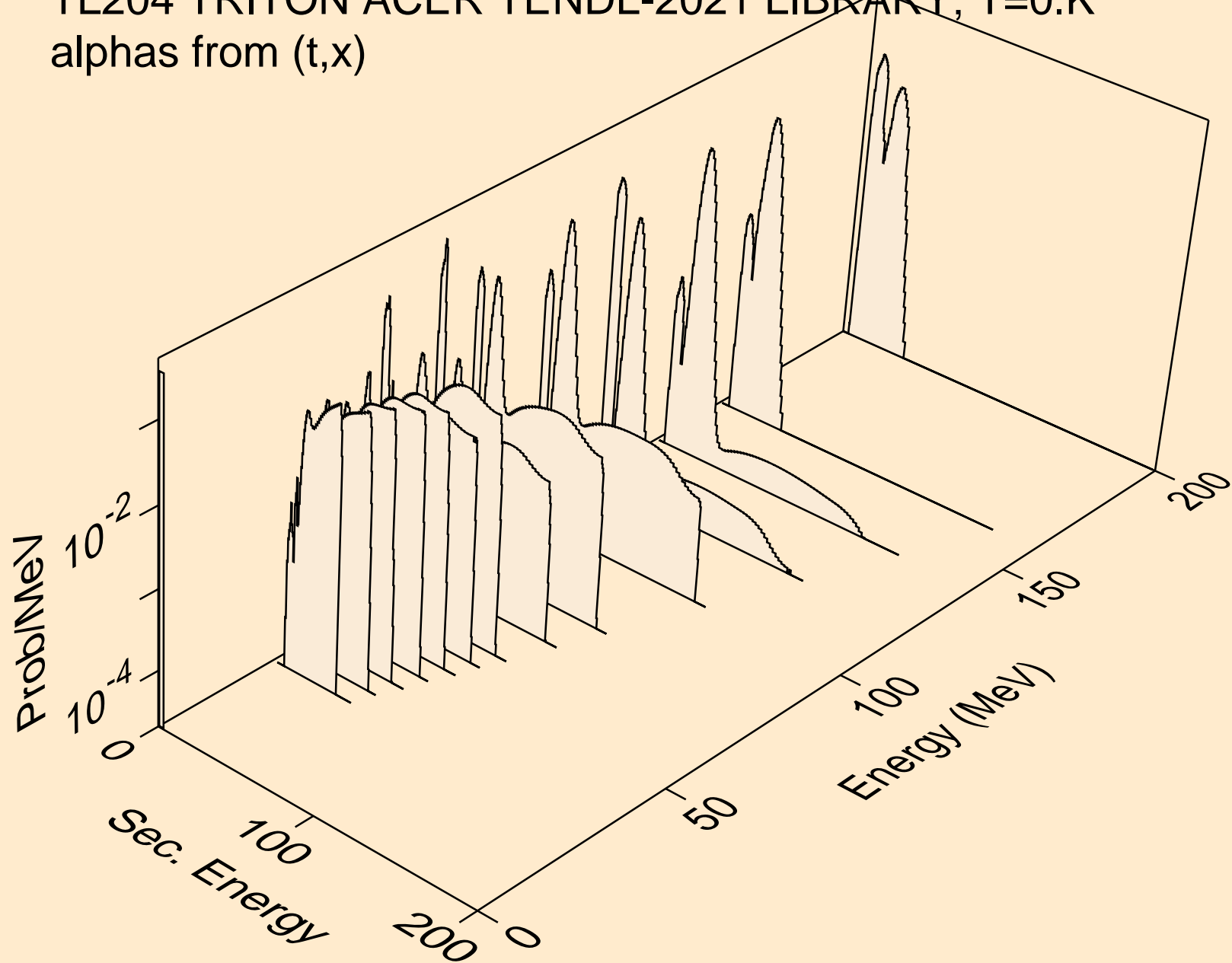

TL204 TRITON ACER TENDL-2021 LIBRARY; T=0.K  
alphas from (t,n\*)a

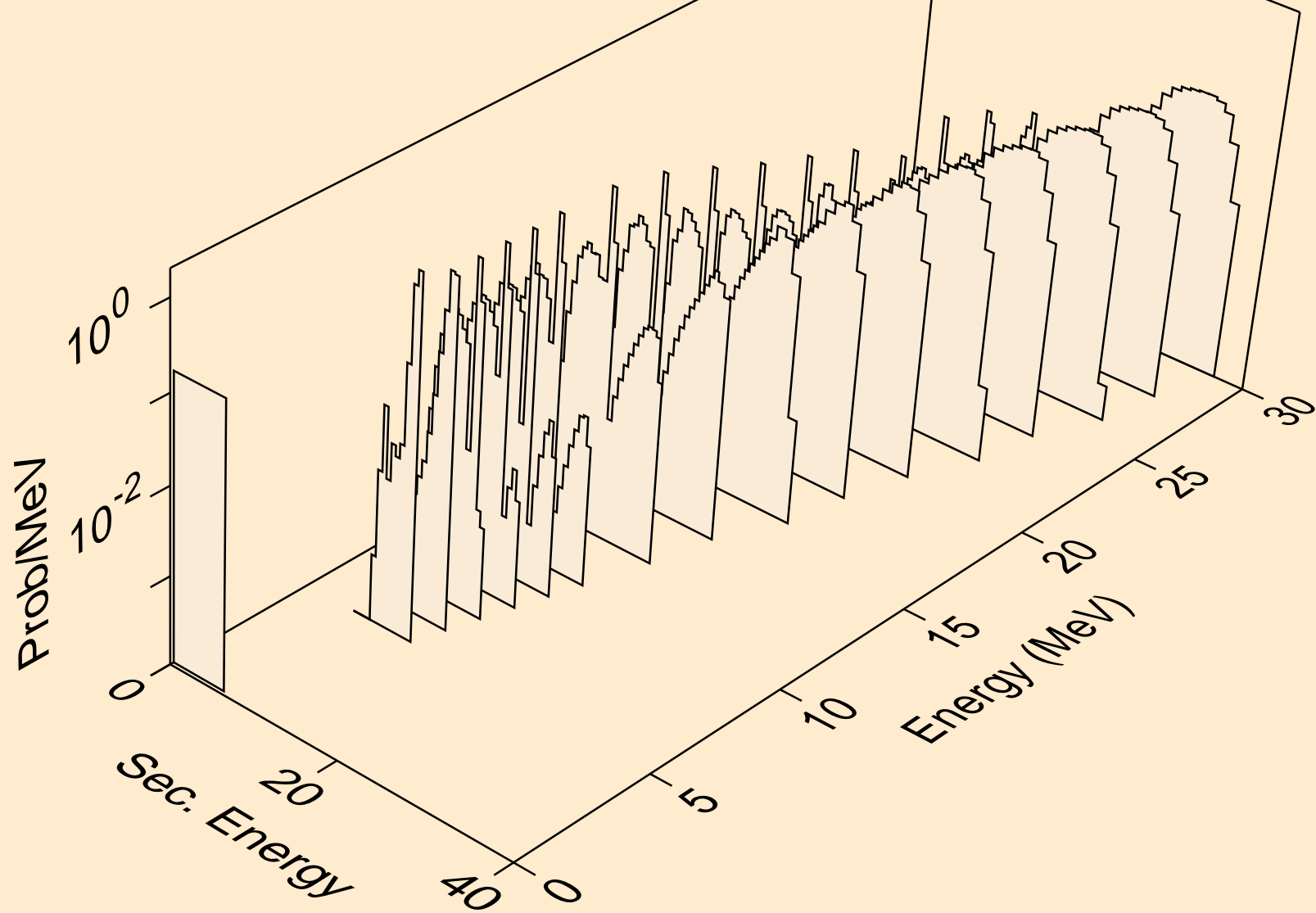

TL204 TRITON ACER TENDL-2021 LIBRARY; T=0.K  
alphas from (t,2n)a

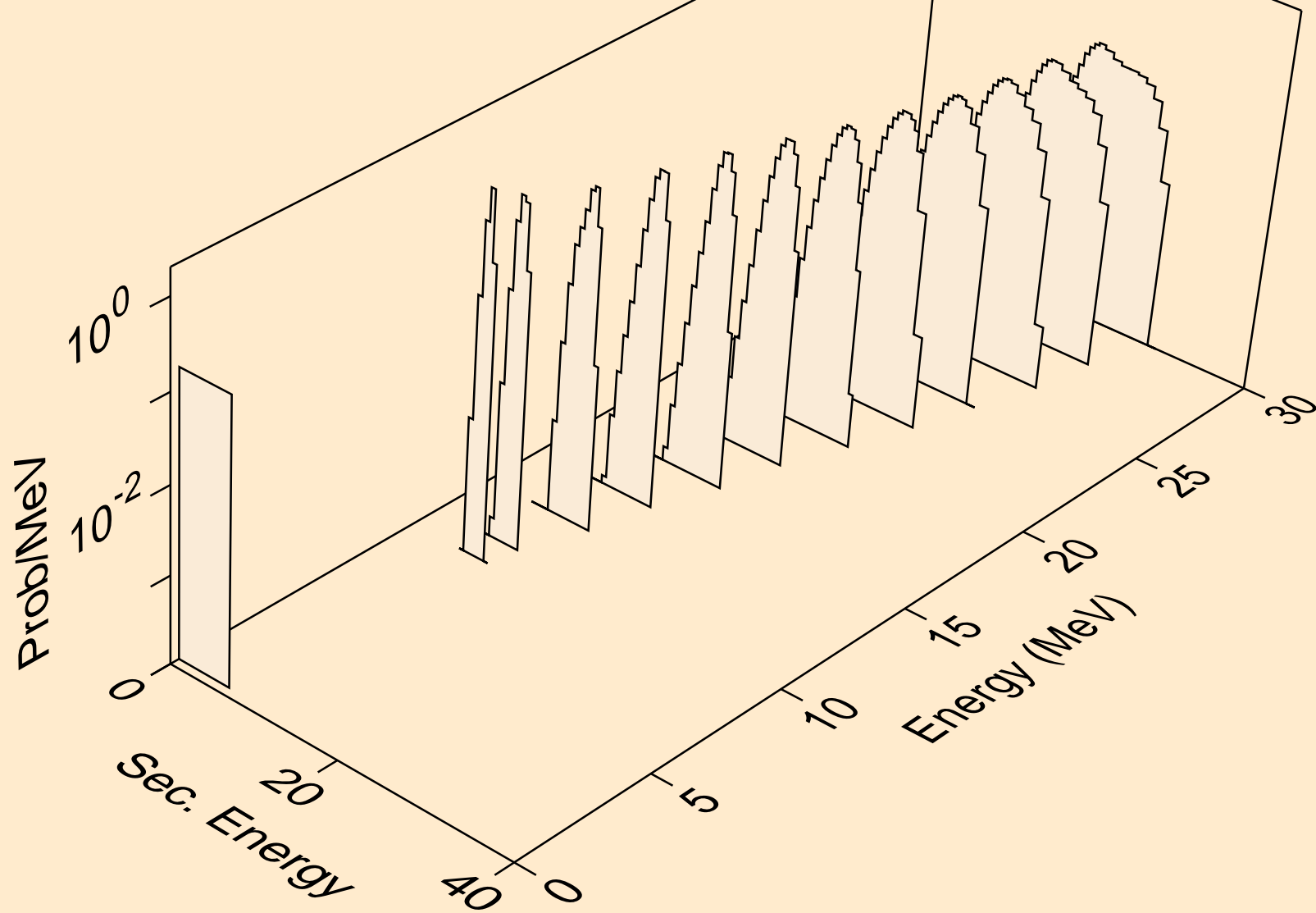

TL204 TRITON ACER TENDL-2021 LIBRARY; T=0.K  
alphas from (t,3n)a

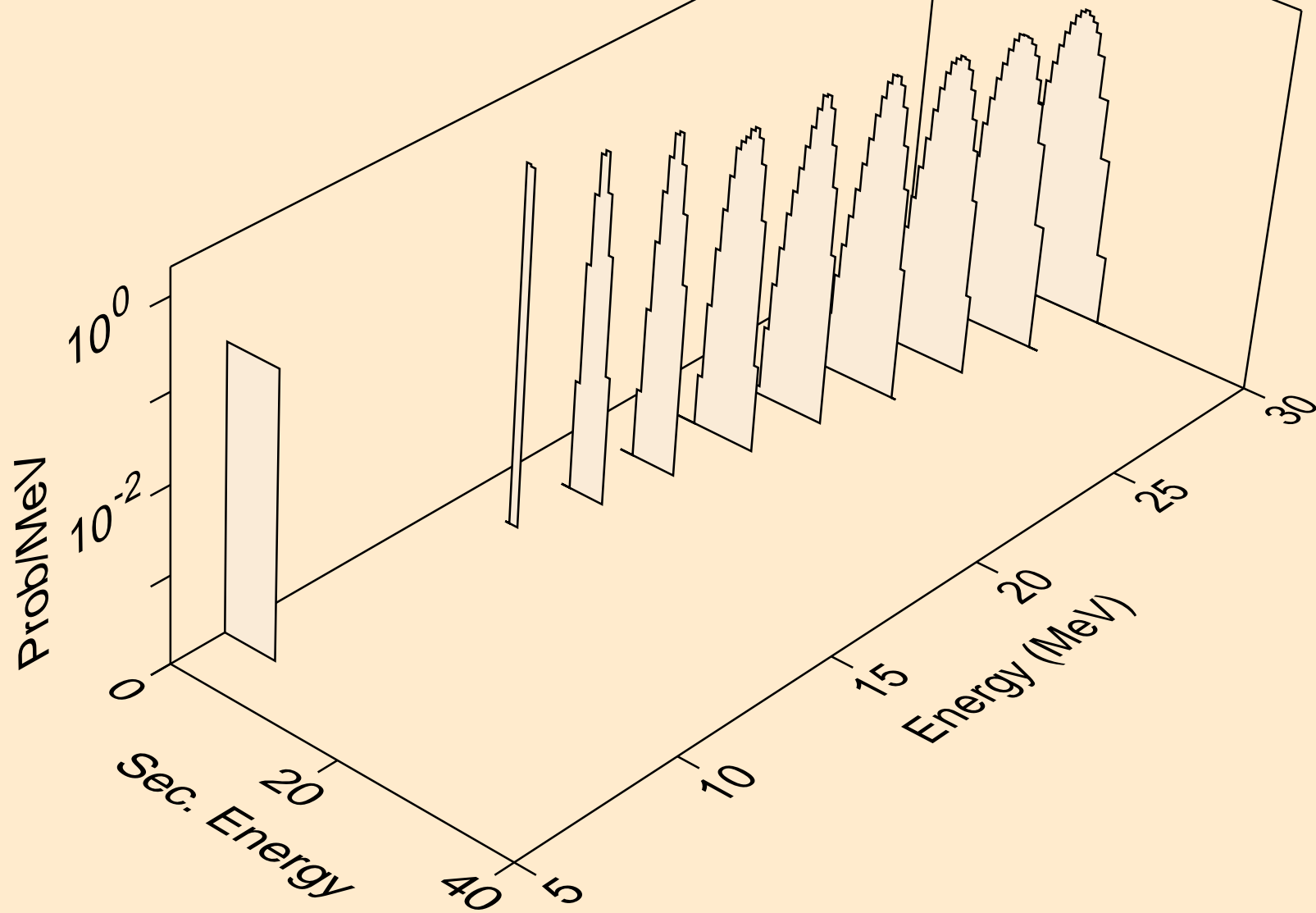

TL204 TRITON ACER TENDL-2021 LIBRARY; T=0.K  
alphas from (t,n\*)2a

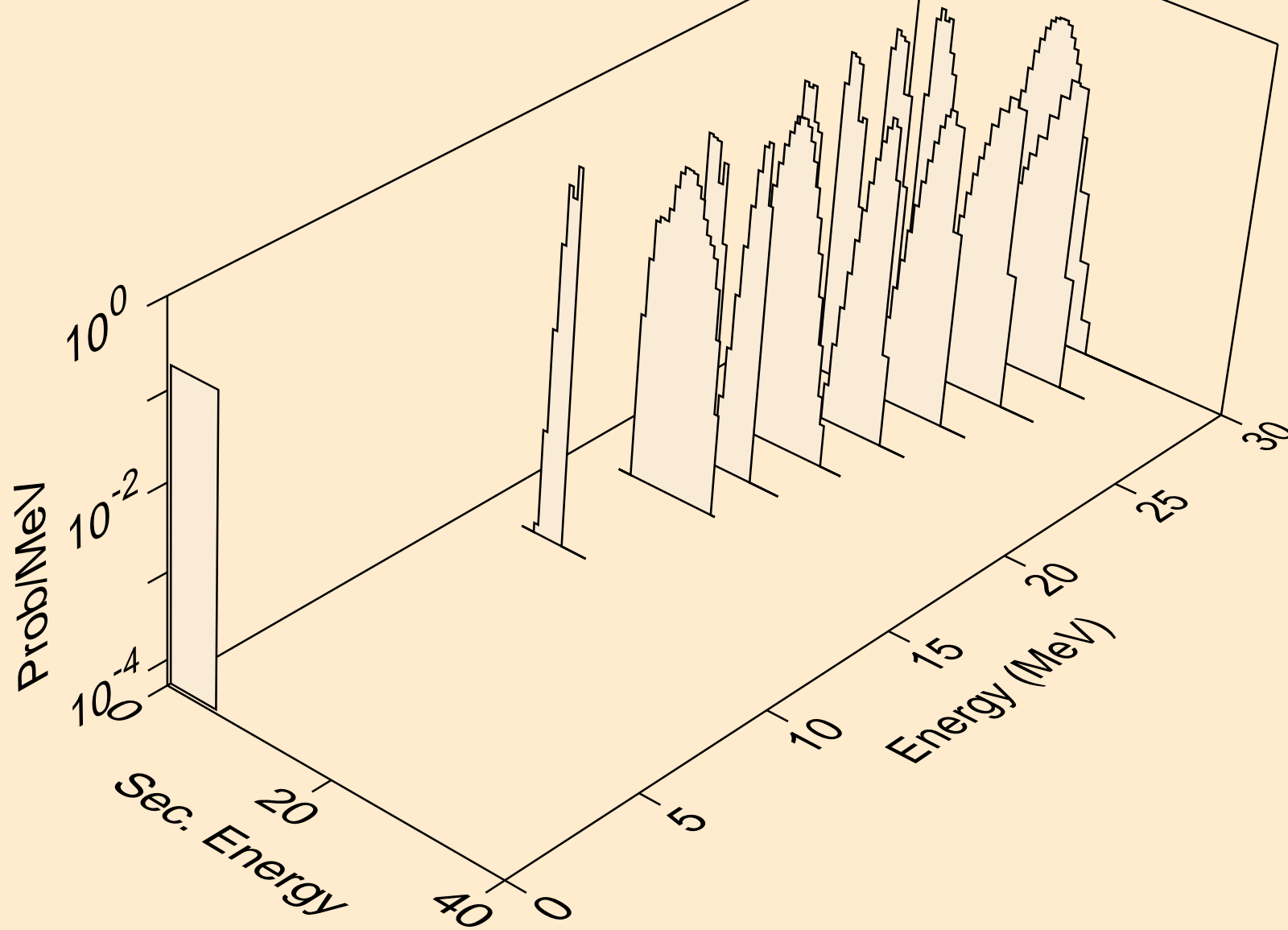

TL204 TRITON ACER TENDL-2021 LIBRARY; T=0.K  
alphas from (t,npa)

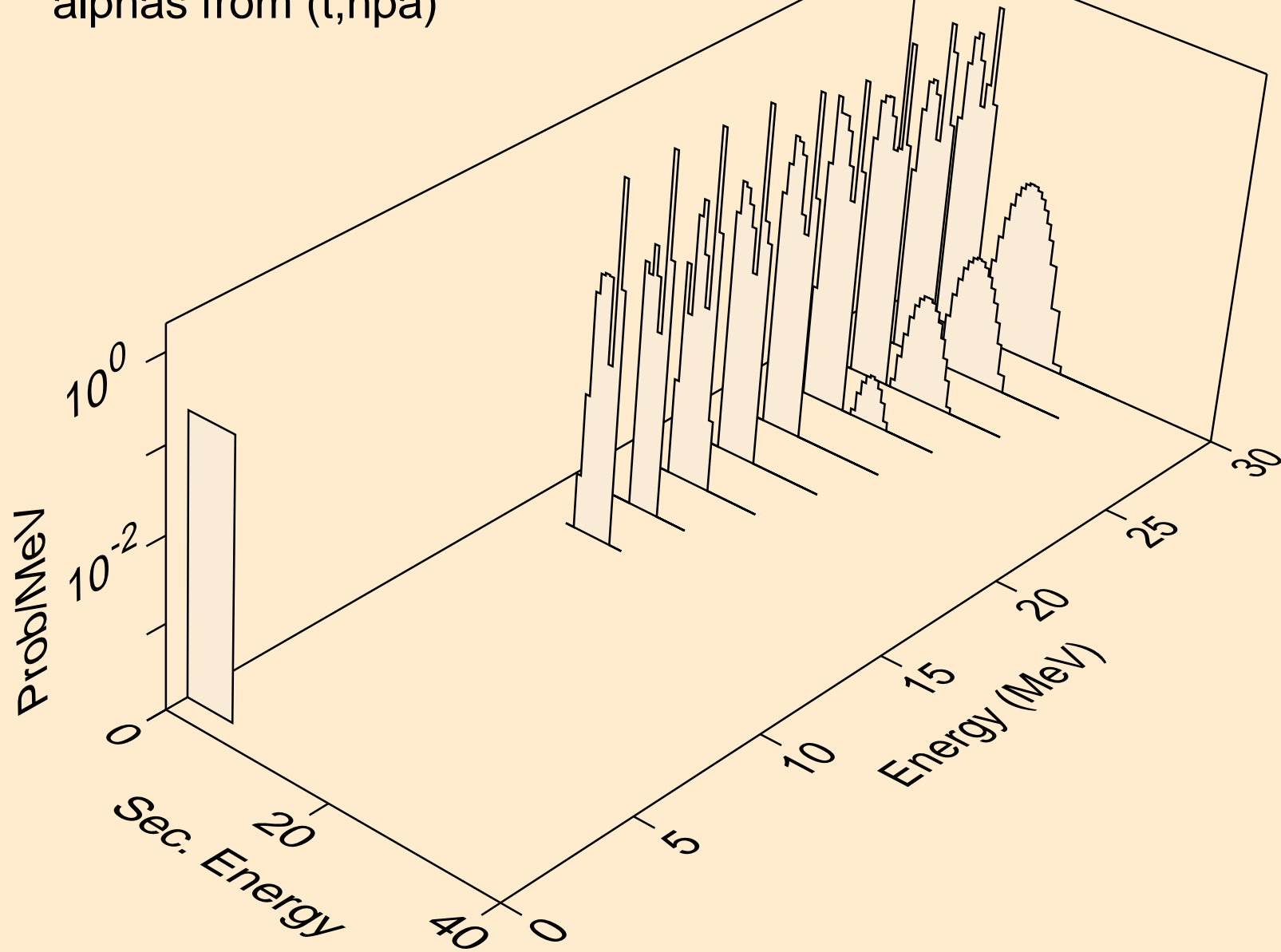



TL204 TRITON ACER TENDL-2021 LIBRARY; T=0.K  
alphas from (t,a)

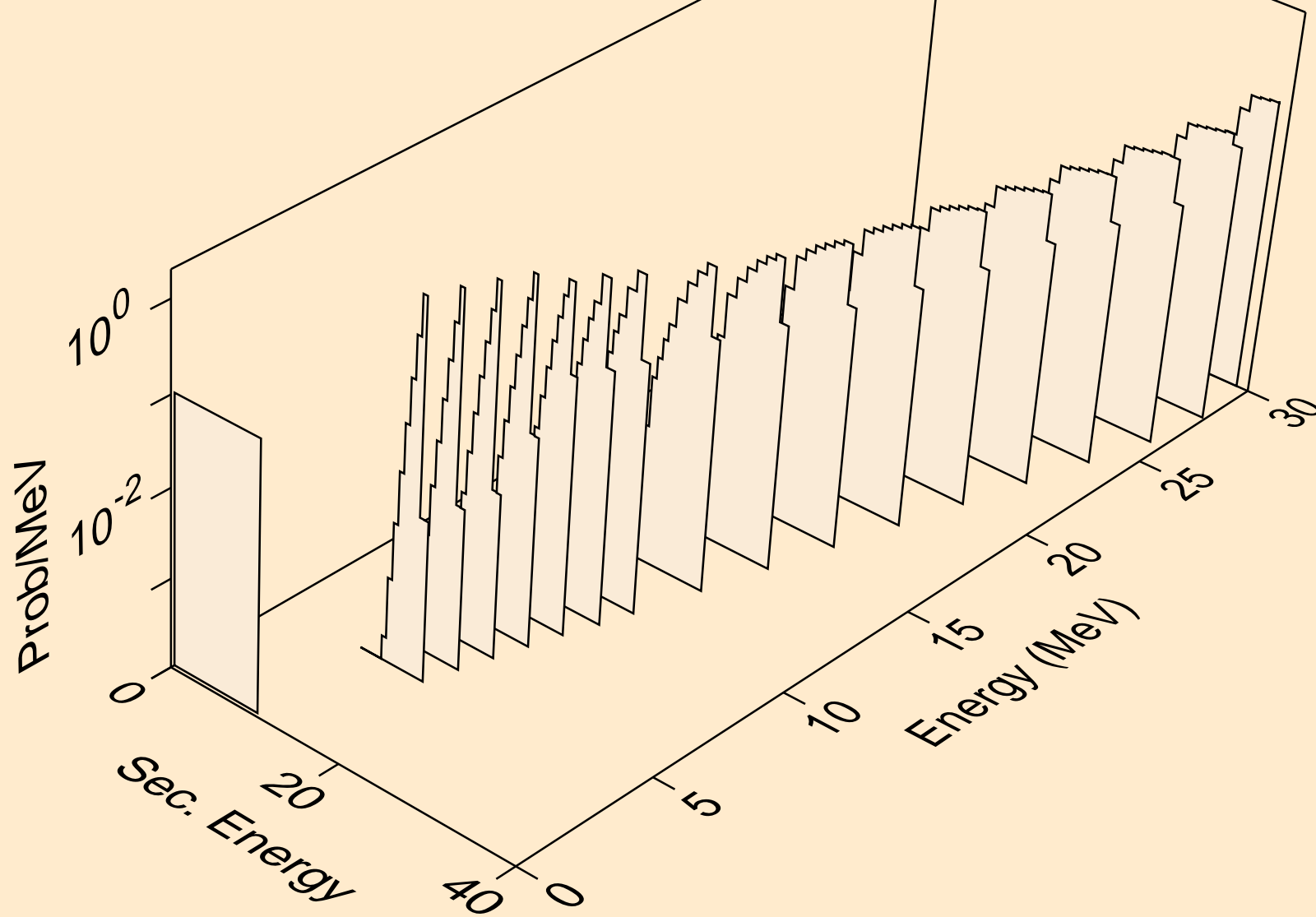

TL204 TRITON ACER TENDL-2021 LIBRARY; T=0.K  
alphas from (t,pa)

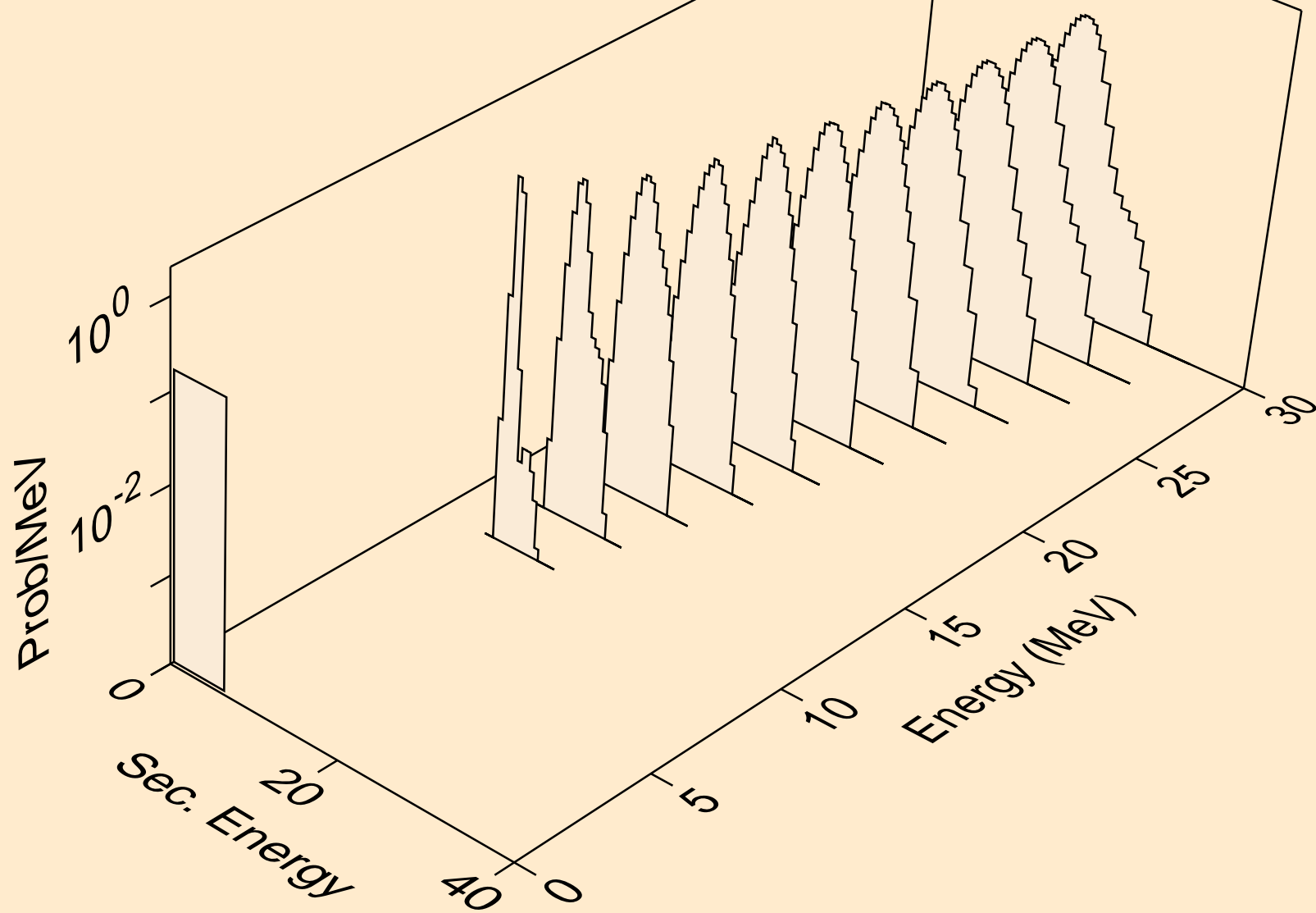

TL204 TRITON ACER TENDL-2021 LIBRARY; T=0.K  
alphas from (t,da)

